

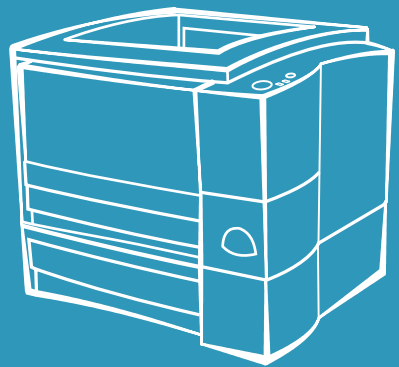

user guide



hp LaserJet 2200

hp LaserJet 2200 series printers

User Guide

Copyright and License

Copyright Hewlett-Packard Company 2001

All Rights Reserved. Except as allowed by copyright laws or herein, reproduction, adaptation, or translation without prior written permission is prohibited.

A user of the Hewlett-Packard printer associated with this user guide is granted a license to:

- print hard copies of this user guide for PERSONAL, INTERNAL or COMPANY use subject to the restriction not to sell, re-sell or otherwise distribute the hard copies; and
- place an electronic copy of this user guide on a network server, provided access to the electronic copy is limited to PERSONAL, INTERNAL users of the Hewlett-Packard printer associated with this user guide.

Part number:C7058-90956
Second Edition, October 2001

Warranty

The information contained in this document is subject to change without notice.

Hewlett-Packard makes no warranty of any kind with respect to this information. HEWLETT-PACKARD SPECIFICALLY DISCLAIMS THE IMPLIED WARRANTY OF MERCHANTABILITY AND FITNESS FOR A PARTICULAR PURPOSE.

Hewlett-Packard shall not be liable for any direct, indirect, incidental, consequential, or other damage alleged in connection with the furnishing or use of this information.

Trademark Credits

Adobe®, Acrobat®, PostScript®, and Adobe Photoshop® are trademarks of Adobe Systems Incorporated which may be registered in certain jurisdictions.

Arial®, Monotype®, and Times New Roman® are U.S. registered trademarks of the Monotype Corporation.

CompuServe™ is a U.S. trademark of CompuServe, Inc.

Helvetica™, Palatino™, Times™, and Times Roman™ are trademarks of Linotype AG and/or its subsidiaries in the U.S. and other countries.

Microsoft®, MS Windows, Windows®, Windows NT®, and MS-DOS® are U.S. registered trademarks of Microsoft Corporation.

LaserWriter® is a registered trademark of Apple Computer, Inc.

TrueType™ is a U.S. trademark of Apple Computer, Inc.

ENERGY STAR® is a U.S. registered service mark of the U.S. EPA.

Netscape is a U.S. trademark of Netscape Communications Corporation.

Unix® is a registered trademark of The Open Group.

HP Customer Care (Service and Support)

HP Customer Care (Service and Support)

<p>Online Services: for 24-hour access to information over your modem, we suggest these services:</p>	<p>World Wide Web URL - Printer drivers, updated HP printer software, plus product and support information may be obtained from the following URLs:</p> <table><tr><td>English language site</td><td>http://www.hp.com/go/support</td></tr><tr><td>in the U.S.</td><td>http://www.hp.com</td></tr><tr><td>in Europe</td><td>http://www2.hp.com</td></tr></table> <p>Printer drivers may be obtained from the following sites:</p> <table><tr><td>in Japan</td><td>ftp://www.jpn.hp.com/drivers/</td></tr><tr><td>in Korea</td><td>http://www.hp.co.kr</td></tr><tr><td>in Taiwan</td><td>http://www.hp.com.tw</td></tr></table> <p>or the local driver website http://www.dds.com.tw</p>	English language site	http://www.hp.com/go/support	in the U.S.	http://www.hp.com	in Europe	http://www2.hp.com	in Japan	ftp://www.jpn.hp.com/drivers/	in Korea	http://www.hp.co.kr	in Taiwan	http://www.hp.com.tw
English language site	http://www.hp.com/go/support												
in the U.S.	http://www.hp.com												
in Europe	http://www2.hp.com												
in Japan	ftp://www.jpn.hp.com/drivers/												
in Korea	http://www.hp.co.kr												
in Taiwan	http://www.hp.com.tw												

Contents

HP Customer Care (Service and Support)	iii
--	-----

1 Printer Basics

Getting to Know the Printer	1
Printer Configurations	2
Printer Features	3
Printer Software	5
Windows Installation	7
Software for Windows	12
Macintosh Installation	14
Software For Macintosh Computers	15
Software for Networked Computers	18
Software Installation Tips	20
Control Panel Buttons	22
Printing with the Fast Infrared Port (Wireless Printing)	23
Wireless Printing Instructions	24
Interface Ports	25
Accessories and Ordering Information	26

2 Printing Tasks

Overview	31
Purchasing Paper and Other Media	32
Media Input Options	33
Tray 2 and Optional 250-sheet Tray 3 Paper Sizes	34
Optional 500-sheet Tray 3 Paper Sizes	35
Loading Media into Tray 1	36
Loading Media into Tray 2 or Optional 250-sheet Tray 3	37
Loading Media into Optional 500-sheet Tray 3	39
Media Output Options	40
Printing Tasks	41
Printing on Labels	43
Printing on Transparencies	44
Printing on Custom-Sized Media or Cardstock	45
Printing on Both Sides of Paper (Duplexing)	46
Printing on Letterhead or Preprinted Forms	49
Canceling a Print Job	51
Software Features	52
Features in the HP LaserJet Device	
Configuration and HP LaserJet Utility	58

3 Printer Tips and Maintenance

Overview	61
Managing the UltraPrecise Toner Cartridge	62
Redistributing the Toner	63
Cleaning the Printer	65
Internal Cleaning Procedure	67

4 Problem Solving

Overview	69
Troubleshooting Checklist	70
Troubleshooting General Printing Problems	72
Printing Special Pages	77
Clearing Paper Jams	78
Solving Print Quality Problems	84
Image Defect Examples	85
Wireless Printing Problems	90
Troubleshooting Control Panel Messages	92
Control Panel Error Messages	93
Secondary Light Patterns	96
Network Printing Problems	101
Common Windows Problems	102
Common Macintosh Problems	104
Selecting an Alternate PostScript Printer Description (PPD)	108
Troubleshooting PostScript (PS) Errors	109

5 Service and Support

Availability	111
HP Express Exchange	111
Guidelines for Repacking the Printer	112
Service Information Form	113
Hewlett-Packard Limited Warranty Statement	115
Limited Warranty for Toner Cartridge Life	117

Appendix A Specifications

Printer Specifications	119
FCC Regulations	121
Environmental Product Stewardship Program	122
Regulatory Statements	125
Laser Statement for Finland	128

Appendix B Media Specifications

Overview	129
Supported Sizes of Paper	130
Guidelines for Using Paper	133
Printing and Paper Storage Environment	135
Envelopes	136
Envelopes with Double Side Seams	137
Envelope Margins	138
Labels	139
Transparencies	140

Appendix C Printer Memory and Expansion

Overview	141
Printer Memory	142
Installing Memory	143
Checking Memory Installation	145
Installing an HP JetDirect EIO Card	146

Appendix D Printer Commands

Overview	147
Understanding PCL Printer Command Syntax	149
Combining Escape Sequences	150

Index

1

Printer Basics

Getting to Know the Printer

This chapter provides information in the following areas:

- Printer Configurations
- Printer Features
- Printer Software
- Control Panel Buttons
- Printing with the Fast Infrared Port (Wireless Printing)
- Interface Ports
- Accessories and Ordering Information

Printer Configurations

Congratulations on your purchase of the HP LaserJet 2200 series printer!

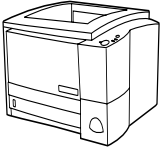

HP LaserJet 2200d

The HP LaserJet 2200d printer is a 19 pages-per-minute (ppm) laser printer (19 ppm with letter-size paper/18 ppm with A4-size paper) that comes with a built-in 250-sheet tray (Tray 2), and a built-in duplexer, for automatically printing on both sides of paper. It has parallel, Fast Infrared (FIR), and universal serial bus (USB) ports. 8 MB of Random Access Memory (RAM) are standard, and the printer is expandable, with 1 available Enhanced Input Output (EIO) slot for connecting to a network, and 2 Dual In-line Memory Module (DIMM) slots for adding fonts and memory.

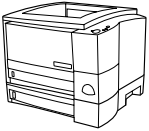

HP LaserJet 2200dt

The HP LaserJet 2200dt printer is the same as the 2200d model, with an additional 250-sheet tray (Tray 3).

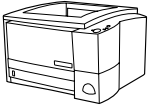

HP LaserJet 2200dn

The HP LaserJet 2200dn printer is the same as the 2200d model, except that the printer is designed for network users. It comes with a full-featured HP JetDirect EIO print server card (J4169A) for connecting to a 10/100 Base-TX network.



HP LaserJet 2200dtn

The HP LaserJet 2200dtn printer is the same as the 2200d model, with an additional 500-sheet tray (Tray 3) that supports letter and A4 sizes. The printer is designed for network users and comes with a full-featured HP JetDirect EIO print server card (J4169A) for connecting to a 10/100 Base-TX network.

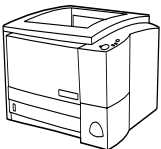

HP LaserJet 2200

The HP LaserJet 2200 is the same as the 2200d model, but with manual rather than automatic duplexing. Availability of this product will vary depending on your location.

The illustrations in this guide will be based on the HP LaserJet 2200d base printer model unless otherwise stated.

Printer Features

Fast Print Speed

- Prints letter-size paper 19 pages-per-minute (ppm) or A4-size paper 18 ppm (with Motorola RISC-based formatter).

Built-in Duplexing

- Printing on both sides of paper (two-sided printing) is a standard feature of the printer. (See [Printing on Both Sides of Paper \(Duplexing\)](#).)

Excellent Print Quality

- True 1200 x 1200 dots per inch (dpi) text and graphics.
- Resolution Enhancement technology (REt) adjusts the size and placement of each dot on the page to produce smooth angles, curves, and edges (300 and 600 dpi only).
- Adjustable settings to optimize print quality.
- The HP UltraPrecise toner cartridge has a finer toner formulation which provides sharper text and graphics.

Flexible Paper Handling

- Adjustable Tray 1 (pull-down) for letterhead, envelopes, labels, transparencies, custom-sized media, postcards, and heavy paper. See [Loading Media into Tray 1](#).
- Adjustable Tray 2 or an Optional 250-sheet Tray (Tray 3) for standard sizes of paper. See [Loading Media into Tray 2 or Optional 250-sheet Tray 3](#).
- Optional 500-sheet Tray (Tray 3) for letter and A4-size paper. See [Loading Media into Optional 500-sheet Tray 3](#).
- Two output bins: select either the top output bin or the rear output bin for the most convenient output location.
- Straight-through paper path capability from Tray 1 to the rear output bin.
- Built-in duplexing. (See [Printing on Both Sides of Paper \(Duplexing\)](#).)

Expandability

- Optional Tray 3 (250-sheet or 500-sheet), so you will not have to add paper as often.
- Enhanced Input Output (EIO) cards. See [Interface Ports](#).
- Dual In-line Memory Module (DIMM) slots for adding memory and fonts.

PCL Printer Language and Fonts

- Fast printing performance, built-in Intellifont and TrueType scaling technologies, built-in HP-GL/2 vector graphics, and advanced imaging capabilities are benefits of the PCL 6 printer language. PCL 6 also includes 45 scalable TrueType fonts and one bitmapped Line Printer Font.

PS Language and Fonts	<ul style="list-style-type: none"> ● PostScript Level 2 emulation with 35 built-in PS language fonts included.
Automatic Language Switching	<ul style="list-style-type: none"> ● When optional printer languages (such as PostScript Level 2 emulation) are installed, the printer automatically determines and switches to the appropriate language for the print job.
Wireless Printing	<ul style="list-style-type: none"> ● The printer supports wireless printing from an IrDA-compliant device, such as a notebook computer, camera, cell phone, or a Personal Digital Assistant (PDA). ● IrReady 2000
Interface Connections	<ul style="list-style-type: none"> ● Bidirectional ECP type-B parallel port (IEEE-1284 compliant) ● USB port ● EIO slot ● Wireless Fast Infrared port (IrDA compliant)
Networking	<ul style="list-style-type: none"> ● The printer provides an EIO slot for HP JetDirect EIO print servers for fast and easy connectivity.
Enhanced Memory and Memory Expansion	<ul style="list-style-type: none"> ● The HP LaserJet 2200 series printers come with 8 MB of memory and can be expanded to 72 MB with the two available memory (DIMM) slots. (The HP LaserJet 2200dtn has 16 MB and one available DIMM slot.) Most documents can be printed using the standard amount of printer memory through the aid of Memory Enhancement technology (MEt). MEt automatically compresses data, virtually doubling the printer's memory and allowing more complex printing with available memory.
Energy Savings	<ul style="list-style-type: none"> ● The printer automatically conserves electricity by substantially reducing power consumption when not printing. ● As an ENERGY STAR partner, Hewlett-Packard Company has determined that this product meets ENERGY STAR guidelines for energy efficiency.
Economical Printing	<ul style="list-style-type: none"> ● N-up printing and two-sided printing with the built-in duplexer saves paper. (See Printing on Both Sides of Paper (Duplexing) and Printing Multiple Pages on One Sheet of Paper (N-up Printing).) ● EconoMode saves toner. ● For tips on reducing the amount of paper use or extending the life of the toner cartridge, see Printing Tasks.

Printer Software

The printer comes with helpful software including printer drivers and optional software. For easy printer setup and access to the full range of printer features, it is strongly advised that you install the software provided.

This section provides information in the following areas:

- Printer Software Installation Instructions
- Overview of Printing System Components
- Printer Software Installation Tips

Once you have followed the installation instructions and loaded the software, refer to Software Features to get the most out of your printer.

Note

HP software is not available in all languages.

Check the ReadMe file provided on the HP LaserJet 2200 CD for additional software included and supported languages. The most recent drivers, additional drivers, and other software are available from the Internet and other sources. If you do not have access to the Internet, see the HP Customer Care (Service and Support) pages at the front of this user guide to obtain the most recent software.

The HP LaserJet 2200 series printer comes with printer software for the following operating systems:

- Microsoft Windows 3.1x (driver only), 95, 98, 2000, Millennium, NT 4.0, and XP. For installation instructions, see Windows Installation.
- Macintosh System 7.5.5 and above. For installation instructions, see Macintosh Installation.

For software installation on a networked computer, see Network Installation.

The following table lists the available software for your printing system.

Note

Software for DOS is not included with this printer.

	Windows 3.x	Windows 9x/Millen	Windows NT 4.0	Windows 2000	Macintosh	UNIX/ LINUX	OS/2
Windows Installer		✓	✓	✓			
PCL 6	✓*	✓	✓	✓			
PCL 5e	✓	✓	✓	✓			
PostScript Emulation	✓*	✓	✓	✓			
HP LaserJet Device Configuration		✓	✓	✓			
HP Web JetAdmin*			✓	✓		✓	
Macintosh Installer					✓		
Macintosh PPD					✓		
IBM drivers*							✓
Model scripts*						✓	

*Available only on the World Wide Web.

Windows XP

At the time of this publication, Windows XP was not released. Please go to http://www.hp.com/support/lj2200_xpinfo for Windows XP information and installation instructions.

Windows Installation

There are different Windows installation methods, depending on the type of cable you connected:

- If you connected a parallel cable, see the section below.
- If you connected a USB cable, see If You Connected a USB Cable.
- If you connected a network cable, see Network Installation.

If You Connected a Parallel Cable

Note

The following software installation instructions assume that your computer was turned OFF when the printer cable was connected. If your computer was ON, and has not been restarted, the printer software can still be installed, but the steps will be slightly different than below. Use the Windows NT 4.0 instructions for your installation.

1. Turn your computer on and quit any open programs.
2. Follow the steps for your Windows version:

Windows 3.1x (driver only)

- a. Select Main, Control Panel, Printers.
 - b. In the Printers window, click Add. In the drop-down menu, select Install Unlisted or Updated Printer, then click Install.
 - c. Place the HP LaserJet 2200 CD in the CD-ROM drive.
 - d. Click Browse. Browse to "D:\English\Drivers\Win3x" (where D is the letter of your CD-ROM drive). Select "oemsetup.inf" and click OK.
 - e. Select the HP LaserJet 2200 series driver. Click OK.
 - f. Close all windows and then restart your computer.
 - g. To verify that the installation has been completed successfully, open a software application of your choice and open or create a simple document.
 - h. Make sure the correct printer name appears, and print the document.
 - i. If the document prints correctly, installation is complete. If nothing prints or if the document does not print correctly, see the Troubleshooting Checklist.
-

Windows 95

- a. The "Update Device Driver Wizard" window should appear on the computer display.
 - b. Place the HP LaserJet 2200 CD in the CD-ROM drive.
 - c. Depending on the version of Windows 95:
 - Click Next> (if available) and then skip to step 3 below.
 - or -**
 - Click OK and then continue to step d below.
 - d. On the line provided, type `D:\9xME_LPT` (where `D` is the letter of your CD-ROM drive), and then click OK.
-

Windows 98

- a. The "Add New Hardware Wizard" window should appear on the computer display. Click Next>.
 - b. Select "Search for the best driver for your device. (Recommended)" and then click Next>.
 - c. Click the boxes as needed so that there is a check mark next to "Specify a location:" (and NO check marks next to "Floppy disk drives" and "CD-ROM drive").
 - d. Place the HP LaserJet 2200 CD in the CD-ROM drive.
 - e. Under "Specify a location:", type `D:\9xME_LPT` (where `D` is the letter of your CD-ROM drive). Click Next>.
-

Windows 2000

- a. The "Found New Hardware Wizard" window should appear on the computer display. Click Next>.
 - b. Select "Search for a suitable driver for my device (recommended)" and then click Next>.
 - c. Under "Optional search locations:", click the locations as needed so that there is a check mark next to "Specify a location:" (and NO check marks next to "Floppy disk drives" and "CD-ROM drives"). Click Next>.
 - d. Place the HP LaserJet 2200 CD in the CD-ROM drive.
 - e. Under "Copy manufacturer's files from:", type `D:\2000` (where `D` is the letter of your CD-ROM drive) and then click OK.
 - f. The Wizard should display a window indicating that it has found the driver; click Next>.
-

**Windows
Millennium**

- a. The “Add New Hardware Wizard” window should appear on the computer display.
- b. Select “Specify the location of the driver (Advanced)” and then click Next>.
- c. Select “Search for the best driver for your device. (Recommended)” and then click the boxes as needed so that there is a check mark next to “Specify a location:” (and NO check mark next to “Removable Media”).
- d. Place the HP LaserJet 2200 CD in the CD-ROM drive.
- e. Under “Specify a location:”, type `D:\9xME_LPT` (where D is the letter of your CD-ROM drive). Click Next>.

**Windows
NT 4.0**

To install the software on Windows NT 4.0, you must have administrator privileges (on start and restart).

- a. Place the HP LaserJet 2200 CD in the CD-ROM drive.
- b. When the welcome screen appears, follow the directions on the screen. If the welcome screen does not appear: click Start, click Run, type `D:\SETUP` (where D is the letter of your CD-ROM drive), and then click OK.
- c. Click the button next to Install Printer.

Windows XP

At the time of this publication, Windows XP was not released. Please go to http://www.hp.com/support/lj2200_xpinfo for Windows XP information and installation instructions.

3. Follow the instructions on the screen to install the software.

Note

Before installation is complete, make sure that there is a check mark next to “Print a test page” (when the prompt appears).

In Windows 2000, if the “Found New Hardware Wizard” window reappears before installation is complete, click Cancel.

4. Click Finish.
5. If you are prompted to restart your computer, click Yes. The test page should print after your computer restarts. If you are not prompted to restart your computer, a test page should print immediately. (If you have Windows NT 4.0 you do not need to restart your computer.)

6. If the test page printed correctly, installation is complete. (If nothing prints or if the test page does not print correctly, see the Troubleshooting Checklist.)

If You Connected a USB Cable

Note

Windows 3.1x, 95, and NT 4.0 do not support USB cable connections. The following instructions are for computers running Windows 98, 2000, or Millennium. If you want to connect a USB cable to your Macintosh, see Macintosh Installation.

1. If your computer is off, turn it on now. Quit any open programs.
2. Follow the steps for your Windows version:

Windows 98

- a. The “Add New Hardware Wizard” window should appear on the computer display. Click Next>.
- b. Select “Search for the best driver for your device. (Recommended)” and then click Next>.
- c. Click the boxes as needed so that there is a check mark next to “Specify a location:” (and NO check marks next to “Floppy disk drives” and “CD-ROM drive”).
- d. Place the HP LaserJet 2200 CD in the CD-ROM drive.
- e. Under “Specify a location:”, type `D:\98ME_USB` (where `D` is the letter of your CD-ROM drive). Click Next>.

Windows 2000

- a. The “Found New Hardware Wizard” window should appear on the computer display. Click Next>.
- b. Select “Search for a suitable driver for my device (recommended)” and then click Next>.
- c. Under “Optional search locations:”, click the locations as needed so that there is a check mark next to “Specify a location:” (and NO check marks next to “Floppy disk drives” and “CD-ROM drives”). Click Next>.
- d. Place the HP LaserJet 2200 CD in the CD-ROM drive.
- e. Under “Copy manufacturer’s files from:”, type `D:\2000` (where `D` is the letter of your CD-ROM drive) and then click OK.
- f. The Wizard should display a window indicating that it has found the driver; click Next>.

Windows Millennium

- a. The “Add New Hardware Wizard” window should appear on the computer display.
- b. Select “Specify the location of the driver (Advanced)” and then click Next>.
- c. Select “Search for the best driver for your device. (Recommended)” and then click the boxes as needed so that there is a check mark next to “Specify a location:” (and NO check mark next to “Removable Media”).
- d. Place the HP LaserJet 2200 CD in the CD-ROM drive.
- e. Under “Specify a location:”, type D:\98ME_USB (where D is the letter of your CD-ROM drive). Click Next>.

Windows XP

At the time of this publication, Windows XP was not released. Please go to http://www.hp.com/support/lj2200_xpinfo for Windows XP information and installation instructions.

3. Follow the instructions on the screen to install the software.

Note

Before installation is complete, make sure that there is a check mark next to “Print a test page” (when the prompt appears).

In Windows 2000, if the “Found New Hardware Wizard” window reappears before installation is complete, click Cancel.

-
4. Click Finish.
 5. If you are prompted to restart your computer, click Yes. The test page should print after your computer restarts. If you are not prompted to restart your computer, a test page should print immediately.
 6. If the test page printed correctly, installation is complete. Click Yes when prompted to restart your computer. (If nothing prints or if the test page does not print correctly, see the Troubleshooting Checklist.)

Software for Windows

Printer Drivers

Printer drivers access the printer's features and allow the computer to communicate with the printer. Choose a printer driver based on the way you use the printer.

- Use the PCL 6 driver to take full advantage of the printer's features. Unless complete backward compatibility with previous PCL drivers or older printers is necessary, the PCL 6 driver is recommended.
- Use the PCL 5e driver if you need print results to look consistent with those from older HP LaserJet printers. Certain features are not available in this driver. (Do not use the PCL 5e driver provided with this printer with older printers.)
- Use the PS driver for compatibility with PS needs. Certain printer features are not available in this driver.

Note

The printer automatically switches between PostScript Level 2 emulation and PCL printer languages depending on the driver you have selected.

If you need help accessing your printer driver, see [Accessing the Printer Driver](#).

Each printer driver has help screens that can be activated from the Help button, the F1 key, or a question mark symbol in the upper right corner of the printer driver (depending on the Windows operating system used). These help screens give detailed information about the specific driver. Printer driver help is separate from the software application help.

Note

For driver only or Add Printer setup, see the Readme on the HP LaserJet 2200 CD. For Windows 3.1x, this is the only installation option available. See [Windows 3.1x \(driver only\)](#).

Control Panel Simulator

The control panel simulator is a tool to help understand the control panel lights. When the lights on your control panel are lit up and you do not know what they mean, bring up the control panel simulator from the HP LaserJet 2200 program group or from the electronic user guide, click on the lights that are lit up (click once for a solid light, click twice for a blinking light), and a description of the error will be displayed in the box below the lights.

HP LaserJet Device Configuration

(Windows 9x/NT 4.0/2000/Millennium only)

Note

Printer driver settings override settings in the HP LaserJet Device Configuration, for those settings that appear in both places.

The HP LaserJet Device Configuration manages printer default settings. (Run a custom install to install the HP LaserJet Device Configuration.) It allows you to access many of the printer's features, including:

- Printing configuration reports, demo pages, PCL and PS font lists.
- Selecting page setup defaults.
- Choosing custom settings, such as jam recovery or tray locking.
- Changing the language of the self test/configuration pages.

To access the HP LaserJet Device Configuration, see *Accessing the HP LaserJet Device Configuration* or *HP LaserJet Utility*.

Note

The HP LaserJet Device Configuration performs many of the same tasks as HP Web JetAdmin. However, the HP LaserJet Device Configuration is supported only in Windows. In Windows NT 4.0 and Windows 2000 you can use either the HP LaserJet Device Configuration or HP Web JetAdmin. However, it is recommended that you use the HP LaserJet Device Configuration to manage printer default settings. (See HP Web JetAdmin for more information on HP Web JetAdmin.)

Windows XP

At the time of this publication, Windows XP was not released. Please go to http://www.hp.com/support/lj2200_xpinfo for Windows XP information and installation instructions.

Macintosh Installation

Note

The Apple LaserWriter 8 driver must be installed to use the PPD. Use the Apple LaserWriter 8 driver that came with your Macintosh.

Before beginning installation, turn off virus protection.

1. Run the install program by placing the HP LaserJet 2200 CD in the CD-ROM drive. The installation window will appear on the desktop.
2. Select the correct language and double-click the installer icon.
3. Follow the on-screen instructions.

Note

The HP LaserJet 2200 CD contains software for many languages. Once you select the installation language and double-click Install in the desired language, the installation screen will appear in that language.

4. To verify that the installation has been completed successfully, open a software application of your choice and open or create a simple document.
5. Make sure the correct printer name appears, and print the document.
6. If the document prints correctly, installation is complete. (If nothing prints or if the document does not print correctly, see the Troubleshooting Checklist.)

If You Connected a USB Cable

1. Open Apple's Desktop Printer Utility.
2. Select "Printer (USB)" and click OK.
3. Under USB Printer Selection, click Change.
4. Select the HP LaserJet 2200 printer and click OK.
5. Under "PPD" click Auto Setup.
6. Make sure you save your changes before you close the window.

Software For Macintosh Computers

PostScript Printer Description Files (PPDs)

PPDs, in combination with the LaserWriter driver, access the printer features and allow the computer to communicate with the printer. An installation program for the PPDs is provided on the HP LaserJet 2200 CD.

HP LaserJet Utility

HP LaserJet Utility allows control over features that are not available in the driver. The illustrated screens make selecting printer features from the Macintosh computer easier than ever. Use the HP LaserJet Utility to do the following:

- Name the printer, assign it to a zone on the network, download files and fonts, and change most of the printer settings. See the HP LaserJet Utility help.
- From the computer, lock out functions on the printer to prevent unauthorized access.

Network Installation

The software on the HP LaserJet 2200 CD supports network installation with Novell NetWare 3.2, 4.x, and 5.x or a Microsoft network (except Windows 3.1x). For network installation on other operating systems, go to http://www.hp.com/support/net_printing.

Note

The HP JetDirect print server included with the HP LaserJet 2200dn or 2200dtn printer has a 10/100 Base-TX network port. If you need an HP JetDirect print server with another type of network port, see Accessories and Ordering Information, or contact your local HP dealer.

Before You Install the Printer Software

- To make sure that the HP JetDirect print server is configured correctly for the network, print the self test/configuration pages (when the printer's Ready light is on, press and release the Go and Job Cancel buttons simultaneously). On the second page look for "Hardware Address" followed by a 12-digit number. You may need this hardware address number to complete network installation. (If the self test/configuration pages print in English, look for "Hardware Address" followed by a 12-digit number. The pages should print in the correct language for your printer after you complete the printer software installation. If the pages do not print in the correct language after the software is installed, see Printing Special Pages.)
- If you are installing the software on Windows NT 4.0, Windows 2000, or Novell NetWare, make sure you have administrator privileges.

Windows installation will walk you through the following:

- Connecting your printer to a Novell NetWare server. (Answer Yes when prompted from the Novell Server Detected screen.)
- Connecting your printer to a networked Windows print server. (Follow the "Client Setup" path from the Network Setup screen.)
- Connecting your printer directly to the network without going through a print server. (Follow the "Server or Peer to Peer" path from the Network Setup screen.)
- Connecting your printer to a network, when you are not sure which method is right for you. (Follow the "Help me to determine which setup is right for me" path from the Network Setup screen.)

To Install the Printer Software

Note

The following instructions are for Windows computers only. If you connected a network cable to your Macintosh, see Macintosh Installation.

1. Place the HP LaserJet 2200 CD in the CD-ROM drive.
2. When the welcome screen appears, follow the directions on the screen. If the welcome screen does not appear: click Start, click Run, type `D:\SETUP` (where `D` is the letter of your CD-ROM drive), and then click OK.
3. Click the button next to Install Printer and then follow the instructions on the screen to install the software.

Note

Before installation is complete, make sure that there is a check mark next to "Print a test page" (when the prompt appears).

In Windows 2000, if the "Found New Hardware Wizard" window reappears before installation is complete, click Cancel.

4. Click Finish.
5. If the test page printed correctly, installation is complete. (If nothing prints or if the test page does not print correctly, see the Troubleshooting Checklist.)

Networking the Printer using Windows Sharing

If the printer is directly connected to a computer using a parallel cable, you can share the printer on the network so other network users can print to it.

See your Windows documentation to enable Windows sharing. Once the printer is shared, install the printer software on all computers that need to share the printer.

Note

Network computers running Windows 3.1x can access the shared printer, but the computer directly connected to the printer must be running Windows 9x, NT 4.0, 2000, or Millennium.

Software for Networked Computers

HP Web JetAdmin

HP Web JetAdmin is intended for printer management in commercial and enterprise networks. This browser-based software can be installed on a supported server platform.

The following systems are supported:

- Microsoft Windows NT 4.0 or Windows 2000
- HP-UX
- Sun Solaris
- Red Hat Linux
- SuSE Linux

Once installed, HP Web JetAdmin allows any client PC with a supported web browser to administer the printer.

HP Web JetAdmin is not available on the HP LaserJet 2200 CD. If you have internet access, you can download HP Web JetAdmin software, obtain supporting documentation, and find the latest list of supported server platforms and web browsers at <http://www.hp.com/go/webjetadmin>.

Note

The HP Web JetAdmin web site allows access to HP Web JetAdmin in many languages.

Windows XP

At the time of this publication, Windows XP was not released. Please go to http://www.hp.com/support/lj2200_xpinfo for Windows XP information and installation instructions.

How to Access HP Web JetAdmin

Once the HP Web JetAdmin software has been installed on the supported server platform, you can access HP Web JetAdmin in a supported web browser from a client workstation by entering one of the following URLs:

- <http://server.domain:port/>
where `server.domain` is your server's hostname and `port` is the port number that you entered during the installation (the default port is 8000). This information is available in the `url.txt` file, which is stored in the directory where HP Web JetAdmin is installed.
- <http://ipaddress:port/>
where `ipaddress` is the IP address of the machine where HP Web JetAdmin is located.

Note

For non-Windows operating systems, the settings in HP Web JetAdmin may not be overridden by the printer driver settings, if the features in HP Web JetAdmin do not exist in the printer driver. Printer driver settings override settings in HP Web JetAdmin for those settings which appear in both places.

HP JetDirect Embedded Web Server

The HP JetDirect Embedded Web Server provides a solution for those who choose not to implement device management applications, such as HP Web JetAdmin.

With the HP JetDirect Embedded Web Server, you can access JetDirect print servers directly from a web browser (such as Netscape Navigator or Microsoft's Internet Explorer) without installing any software. You can use the Embedded Web Server to configure JetDirect print servers, or view status information for the JetDirect print server and the connected peripheral.

The JetDirect device is mapped to a unique URL and is accessible from a web browser using the JetDirect IP address or hostname (this can be bookmarked for easy continued access to the Embedded Web Server's home page).

Access the Embedded Web Server by going to:
<http://www.hp.com/go/jetdirect>.

Software Installation Tips

If you have internet access, you can download drivers from the World Wide Web or HP's FTP servers. The driver web page is:

http://www.hp.com/cposupport/cspt/lj2200_spt/ (click on Downloads and Drivers)

If you do not have internet access or a CD-ROM drive, install the HP LaserJet 2100 driver off of your Windows operating system, or contact HP Customer Care (Service and Support).

Note

If you install the HP LaserJet 2100 driver you will be able to print, however, many of the features of the HP LaserJet 2200 will not be available.

How do I access printer features?

Some printer features, such as custom paper sizes and page orientation, may be available through your application settings. Use application settings, if available, because they override printer driver settings.

Access advanced printer features through your printer driver. See Software Features for instructions on using specific printer driver features.

What additional drivers and software upgrades are available to me?

The latest printer drivers and printing software for HP LaserJet printers are available on the World Wide Web (<http://www.software.hp.com>). Check the "Readme" file for additional release information.

What other software is available to me?

See Printer Software for descriptions of the optional printing system software available for installation.

Note

Check the ReadMe file provided on the HP LaserJet 2200 CD for additional software included and supported languages. The most recent drivers, additional drivers, and other software are available from the Internet and other sources. If you do not have access to the Internet, see HP Customer Care (Service and Support) to obtain the most recent software.

Note

For HP networking software solutions, see HP Customer Care at http://www.hp.com/support/net_printing.

How do I remove the printing software?

Windows

In Windows (excludes 3.1x), after installation, the Uninstaller in the HP LaserJet 2200/Tools program group allows you to select and remove any or all of the Windows HP printing system components.

Starting the Uninstaller:

1. Select Start and then Programs.
2. Choose HP LaserJet 2200 and then select Tools.
3. Choose Uninstaller.
4. Click Next.
5. Select the HP printing system components you want to uninstall.
6. Click OK.
7. Follow the prompts.

Macintosh

To remove the printing software from your Macintosh, drag the HP LaserJet folder and PPDs to the trash can.

Control Panel Buttons

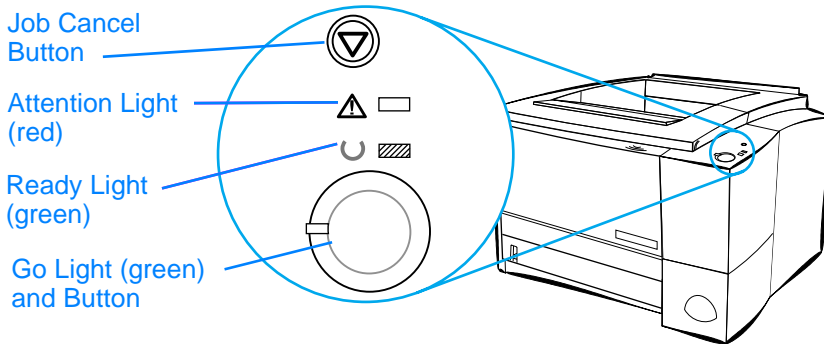

Button Usage

The printer has two buttons: **JOB CANCEL** and **GO**.

Job Cancel

Press **JOB CANCEL** to cancel a job the printer is currently printing. The control panel lights will cycle while the print job is cleared from both the printer and the computer, and then return to the ready state (Ready light on). This may take some time, depending on the size of the print job.

- If **JOB CANCEL** is accidentally pushed, the job must be reprinted. There is no undo function.
- If **JOB CANCEL** is pushed when the printer is idle, the top panel status lights will cycle, but nothing else will happen.

Go

- Press **GO** to resume printing when the printer is paused or when unprinted data is still in the printer.
- Press **GO** to clear some printer errors.
- Press **GO** to print a demo page. The printer must be in the ready state (Ready light on).

To identify and troubleshoot control panel light messages, see [Troubleshooting Control Panel Messages](#), or use the control panel simulator (see [Control Panel Simulator](#)).

Printing with the Fast Infrared Port (Wireless Printing)

The fast infrared (FIR) port is located on the lower right corner of the printer. This port is compliant with the specifications determined by the Infrared Data Association (IrDA). On the right side of the FIR port is a status light that indicates when the port is active. The FIR port transmits data at speeds of up to 4 MB per second. When the IR connection is established, the FIR status light comes on. If the connection is broken, or when the print job is complete, the FIR status light goes off.

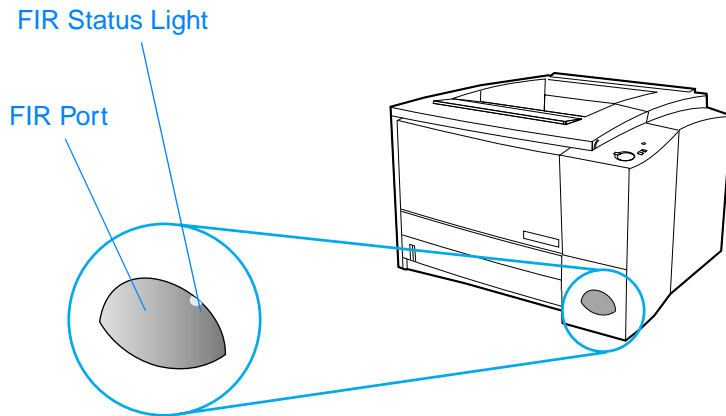

To use the FIR port, you need the following:

- A computer or Personal Digital Assistant (PDA) equipped with an IrDA-compliant IR port.
- An infrared port driver that allows printing from the computer to the printer using the FIR port and the IrDA communication protocol.
- A printer driver to generate data that the printer can print.

Note

Check with your hardware or operating system manufacturer for the correct port driver.

Wireless Printing Instructions

1. Make sure the printer is in ready state (Ready light on).
2. Align an IrDA-compliant computer within 1 meter (3 feet) of the FIR port. Ensure that the ports are facing each other with no more than a 15° angle to either the left and right or above and below. Send the print job from the computer. The FIR status light will turn on when the connection has been made.

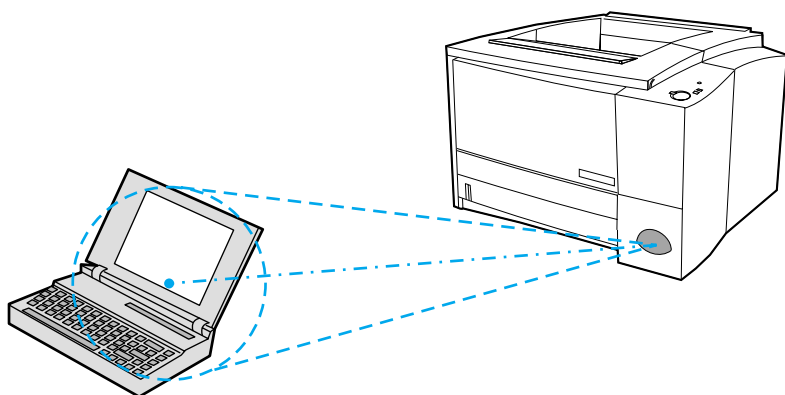

Interface Ports

The HP LaserJet 2200 printer includes two interface ports: an IEEE-1284B parallel port and a USB port.

The HP LaserJet 2200dn and 2200dtn printers also include an HP JetDirect EIO print server card (J4169A) that includes a 10/100 Base-TX port. You can purchase an HP JetDirect EIO print server card for the other HP LaserJet 2200 series printer. See Accessories and Ordering Information, or contact your local HP dealer.

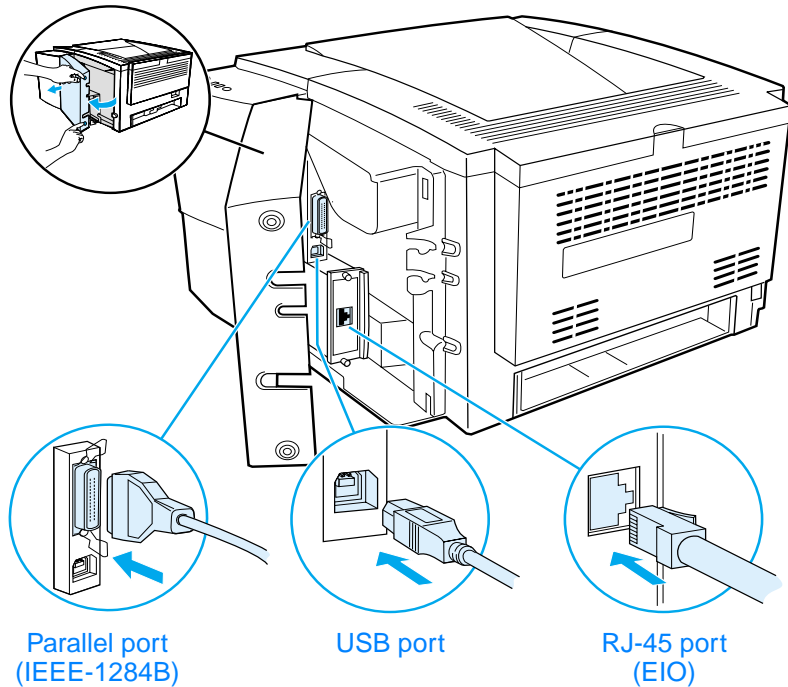

Accessories and Ordering Information

The following list of accessories was current at the time of printing. Ordering information and availability of the accessories may change during the life of the printer. For the most current ordering information, go to <http://www.hp.com/go/lj2200>.

Accessories

Option	Description or Use	Part Number
--------	--------------------	-------------

Toner Cartridge

Toner cartridge	UltraPrecise toner cartridge	C4096A
-----------------	------------------------------	--------

Memory

Memory upgrades (DIMMs)	The HP LaserJet 2200 series printer comes with 8 MB of memory and can be expanded to 72 MB with the 2 available memory (DIMM) slots. (The HP LaserJet 2200dtn printer has 16 MB and one available DIMM slot.)	8 MB C7842A 16 MB C7843A 32 MB C7845A
-------------------------	---	---

Accessories (continued)

Option	Description or Use	Part Number
--------	--------------------	-------------

Cable and Interface Accessories

Enhanced I/O cards	HP JetDirect print server multi-protocol EIO network cards:	
	● HP JetDirect 600N Ethernet (10Base-T RJ-45 only)	J3110A
	● HP JetDirect 600N Ethernet (10Base-T RJ-45, 10Base-2 BNC)	J3111A
	● HP JetDirect 610N Fast Ethernet (10/100Base-TX RJ-45 only)	J4169A
	HP JetDirect Connectivity card for:	
	● USB, Serial, and LocalTalk	J4135A
Parallel cables (IEEE-1284)	2-meter (6-foot)	C2950A
	3-meter (9-foot)	C2951A
USB cable	2-meter standard USB-compatible device connector	C6518A

Paper Handling Accessories

Note: The printer supports either a 250-sheet or 500-sheet Tray 3, but not both.

250-sheet Tray (Tray 3) and Feeder Unit	Tray (for Letter, Executive, Legal, A4, A5, B5 (ISO), B5 (JIS), and 8.5 by 13 inch paper sizes)	C4793A
500-sheet Tray (Tray 3) and Feeder Unit	Tray (for Letter and A4 paper sizes)	C7065A

Accessories (continued)

Option	Description or Use	Part Number
--------	--------------------	-------------

Media

HP Multi-purpose Paper	HP brand paper for a variety of uses (1 box of 10 reams, 500 sheets each). To order a sample, in the U.S. call 1-800-471-4701.	M1120
HP LaserJet Paper	Premium HP brand paper for use with HP LaserJet printers (1 box of 10 reams, 500 sheets each). To order a sample, in the U.S. call 1-800-471-4701.	J1124
HP LaserJet Transparency	Letter (8.5 by 11 in.) transparency film A4 (216 by 297 mm) transparency film	92296T 92296U

Note: For more information on media supplies, go to <http://www.hp.com/ljsupplies>.

Supplementary Documentation

<i>HP LaserJet Printer Family Print Media Guide</i>	A guide to using paper and other print media with HP LaserJet printers.	5963-7863
---	---	-----------

Accessories (continued)

Option	Description or Use	Part Number
<hr/> Supplementary Documentation (continued) <hr/>		
<i>hp LaserJet 2200 series printers User Guide</i>	A printed copy of this user guide.	English C7058-90956 Arabic C7058-90952 Czech C7058-90953 Danish C7058-90954 Dutch C7058-90955 Finnish C7058-90957 French C7058-90958 German C7058-90959 Greek C7058-90960 Hebrew C7058-90961 Hungarian C7058-90962 Italian C7058-90963 Korean C7058-90964 Norwegian C7058-90965 Portuguese Brazilian C7058-90966 Polish C7058-90967 Russian C7058-90968 Simplified Chinese C7058-90969 Slovak C7058-90970 Spanish Castilian C7058-90971 Swedish C7058-90972 Traditional Chinese C7058-90973 Thai C7058-90974 Turkish C7058-90975 Vietnamese C7058-90976
<i>hp LaserJet 2200 series printers Getting Started Guide</i>	An additional copy of the getting started guide.	C7058-90944 (English version)
<i>hp LaserJet 2200 series printers CD-ROM</i>	English, German, Dutch, French, Spanish Castilian, Italian, Portuguese Brazilian, Finnish, Swedish, Norwegian, Danish, Arabic, Turkish, Russian, Hungarian, Polish, Czech	C7058-60106
<i>hp LaserJet 2200 series printers CD-ROM</i>	English, Turkish, Russian, Hungarian, Polish, Czech, Hebrew, Greek, Slovak	C7058-60108
<i>hp LaserJet 2200 series printers CD-ROM</i>	English, Thai, Korean, Simplified Chinese, Traditional Chinese	C7058-60107

2

Printing Tasks

Overview

This chapter explains your printing options and gives common printing tasks:

- Purchasing Paper and Other Media
- Media Input Options
- Loading Media into Tray 1
- Loading Media into Tray 2 or Optional 250-sheet Tray 3
- Loading Media into Optional 500-sheet Tray 3
- Media Output Options
- Printing Tasks
- Canceling a Print Job
- Software Features

Purchasing Paper and Other Media

HP LaserJet printers produce excellent print quality documents. You can print on a variety of print media, such as paper (including up to 100% recycled fiber content paper), envelopes, labels, overhead transparencies, and custom-sized media. Properties such as weight, grain, and moisture content are important factors affecting printer performance and output quality.

To achieve the best possible print quality, use only high-quality, copier-grade paper. See Media Specifications for more details.

Note

Always test a sample of paper before purchasing large quantities. Your paper supplier should understand the requirements specified in the *HP LaserJet Printer Family Print Media Guide*. See Media Specifications for more information. For ordering information, see Supplementary Documentation, or go to <http://www.hp.com/ljsupplies>.

Media Input Options

The printer comes with two paper trays. By default, the printer draws first from Tray 1. If Tray 1 is empty, the printer draws from Tray 2 (or optional Tray 3 if it is installed).

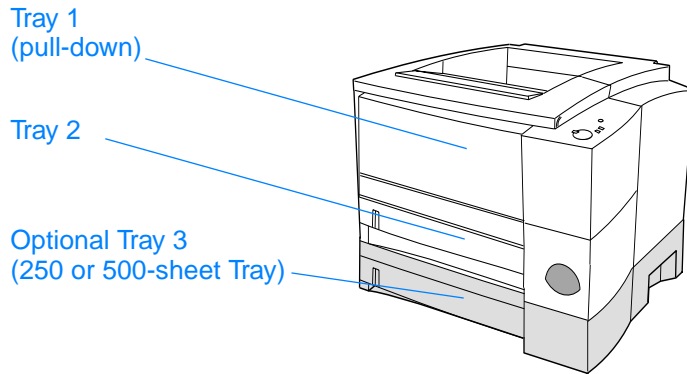

Tray 1 Media Sizes

Tray 1 adjusts for sizes from 76 by 127 mm (3 by 5 in.) to a legal-size sheet, 216 by 356 mm (8.5 by 14 in.). Tray 1 should be used when printing:

- Envelopes (see Printing on Envelopes)
- Labels (see Printing on Labels)
- Transparencies (see Printing on Transparencies)
- Custom-sized media or cardstock (see Printing on Custom-Sized Media or Cardstock)
- Postcards (see Printing on Custom-Sized Media or Cardstock)

Tray 2 and Optional 250-sheet Tray 3 Paper Sizes

Tray 2 and optional 250-sheet Tray 3 have settings for the following paper sizes:

- A4
- A5
- B5 (ISO and JIS)
- Letter
- Legal
- Executive
- 8.5 by 13 in.

See Loading Media into Tray 2 or Optional 250-sheet Tray 3 to change the paper size. See Supported Sizes of Paper for specific dimensions.

CAUTION

Load only paper in Tray 2 or optional Tray 3. Other types of printable media, such as labels or transparencies, may jam if printed from Tray 2 or optional Tray 3.

Optional 500-sheet Tray 3 Paper Sizes

The optional 500-sheet Tray 3 has settings for the following paper sizes:

- A4
- Letter

See Loading Media into Optional 500-sheet Tray 3 to change the paper size. See Supported Sizes of Paper for specific dimensions.

CAUTION

Load only paper in optional Tray 3. Other types of printable media, such as labels or transparencies, may jam if printed from optional Tray 3.

Loading Media into Tray 1

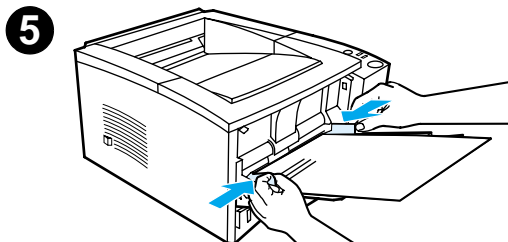
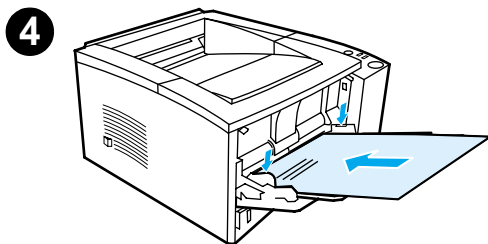
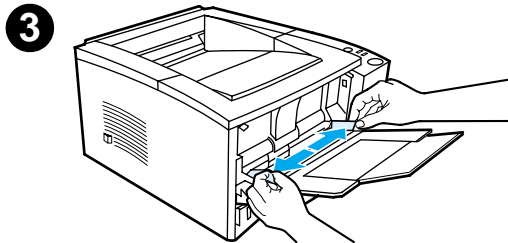
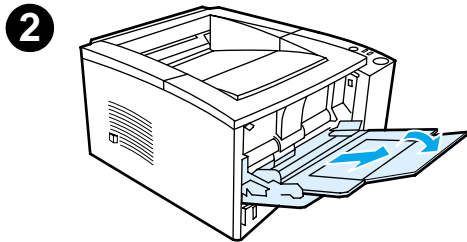
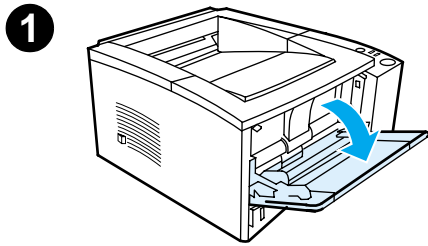

Tray 1 (multi-purpose) holds up to 100 sheets of paper or up to 10 envelopes.

- 1 Open Tray 1 by pulling the front cover down.
- 2 Slide out the plastic tray extender. If the media being loaded is longer than 229 mm (9 in.), also flip open the additional tray extender.
- 3 Slide the paper width guides slightly wider than the media.
- 4 Place media into the tray (short-edge in, print-side up). The media should be centered between the paper width guides and under the tabs on the paper width guides.
- 5 Slide the paper width guides inward until they lightly touch the media stack on both sides without bending it. Make sure the media fits under the tabs on the paper width guides.

Note

Do not add media to Tray 1 while the printer is printing. This could cause a paper jam. Do not close the front door when the printer is printing.

For preprinted material, see [Printing on Letterhead or Preprinted Forms](#).

For envelopes or labels, see [Printing on Envelopes or Printing on Labels](#).

Loading Media into Tray 2 or Optional 250-sheet Tray 3

1

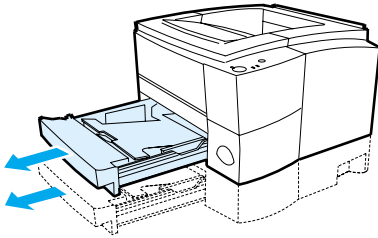

- 1 Pull the desired tray out of the printer and remove any paper.
- 2 Move the side width guides outward to match the desired paper size.
- 3 On the rear paper length guide, press on the blue tab and adjust it so the pointer matches the desired paper size.

2

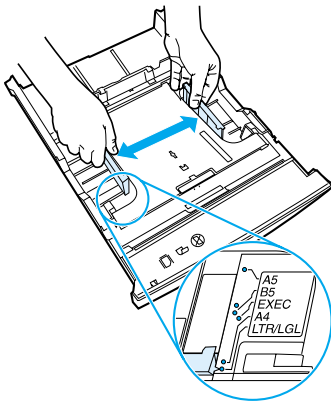

Continued on the next page.

3

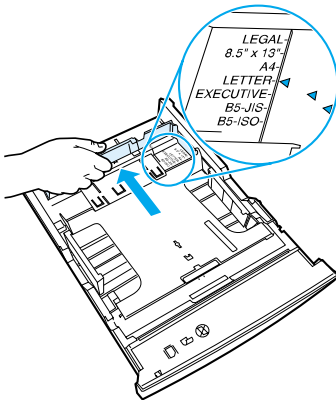

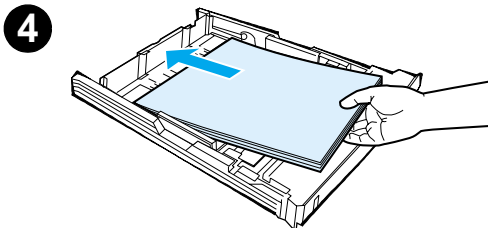

4 Add the media and make sure it is flat in the tray at all four corners. Keep the media below the height tabs on the paper length guide in the rear of the tray.

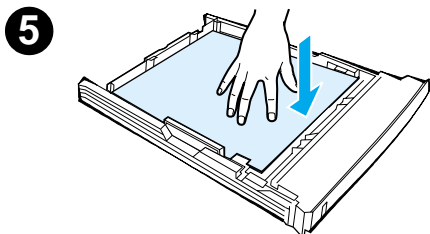

5 Push down on the metal paper lift plate to lock it in place.

6 Slide the tray back into the printer.

Note

Whenever you remove a 250-sheet tray from the printer, always push down the metal paper lift plate before you put it back. The metal paper lift plate will release and lift the paper up when you push the tray into the printer.

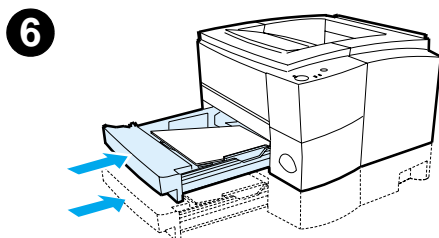

Loading Media into Optional 500-sheet Tray 3

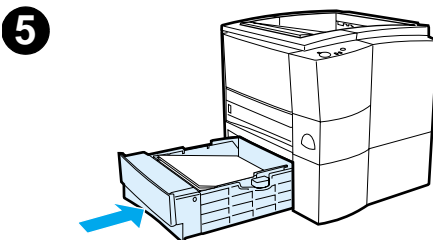
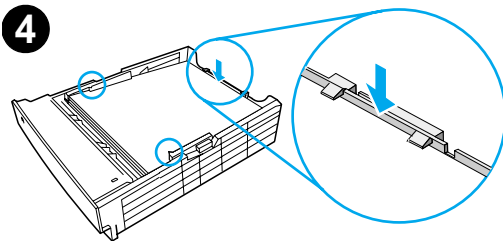
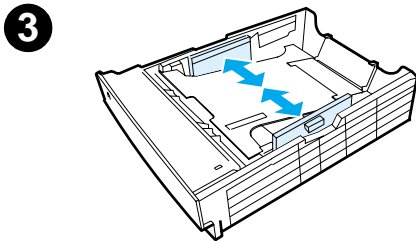
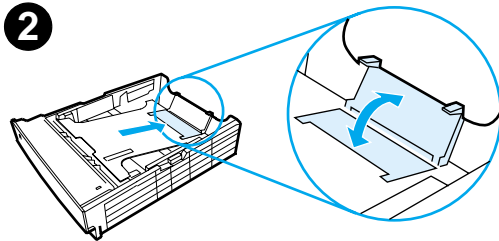
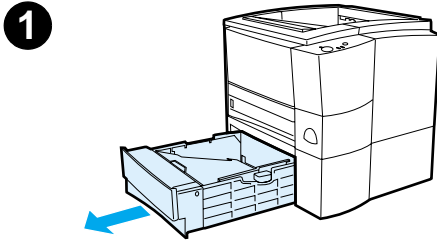

Note

The Optional 500-sheet Tray 3 supports only A4 and letter-size paper.

- 1 Pull the tray out of the printer and remove any paper.
- 2 To adjust for letter-size paper, pull up on the rear stop, or to adjust for A4-size paper, push the rear paper stop down.
- 3 For letter-size paper, move the side width guides outward as far as possible, or for A4-size paper, move the side width guides inward as far as possible.
- 4 Add the media and make sure that it is flat in the tray. Keep the media below the hooks on the side and rear of the tray.
- 5 Slide the tray back into the printer.

Media Output Options

The printer comes with two output bins. The top output bin is used when the rear output bin is closed. The rear output bin is used when the rear output bin is open.

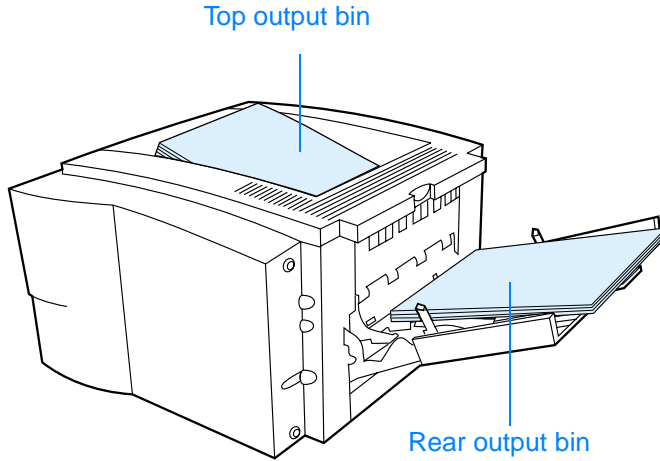

Note

When Tray 1 and the rear output bin are used together, they provide a straight-through paper path for your print job.

Printing Tasks

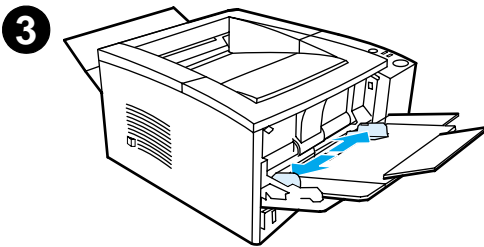
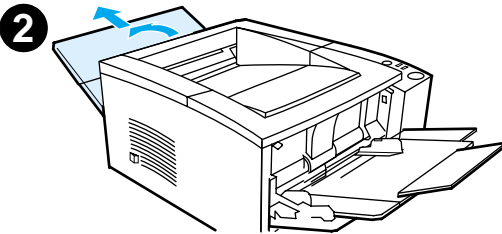
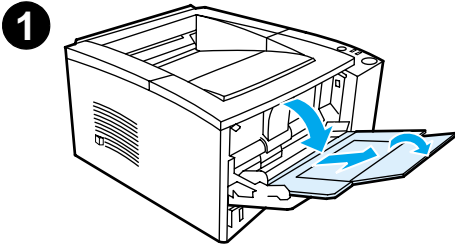

Note

Printing speeds may be automatically reduced when printing special-sized media.

Printing on Envelopes

CAUTION

Before you load envelopes in Tray 1, make sure they are undamaged and are not stuck together. Never use envelopes with clasps, snaps, windows, coated linings, self-stick adhesives, or other synthetic materials. For more information, see Media Specifications.

- 1 Open Tray 1 by pulling the front cover down.
- 2 Open the rear output bin by pulling down on the top section of the bin. Slide out the extender until it extends fully.

Note

Using the rear output bin reduces envelope curl.

- 3 Slide the width guides on Tray 1 outward slightly wider than the media.

Continued on the next page.

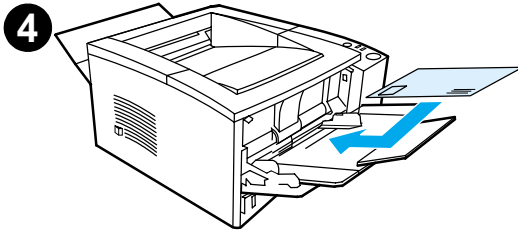

4 Place the envelopes into the tray short-edge in, print-side up. The stamp end must enter the printer first.

5 Slide the width guides inward until they lightly touch the envelope stack without bending it. The envelopes should be centered between the paper guides and under the tabs on the paper width guides.

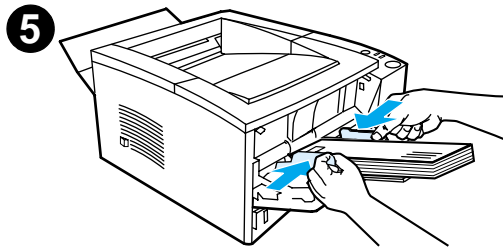

Note

If the envelope has a flap on the short edge, this edge must enter the printer first.

You may experience some paper jams when using any media with a length less than 178 mm (7 in.). This may be caused by paper that has been affected by environmental conditions. For optimum performance, make sure you are storing and handling the paper correctly (see *Printing and Paper Storage Environment*). Using media from another manufacturer may also help.

Printing on Labels

Note

Only use labels recommended for laser printers. See Media Specifications for more details.

- Print labels from Tray 1.
- Load labels print-side up.
- Use the rear output bin for labels.
- Remove label sheets from the output bin as they are printed to prevent them from sticking together.

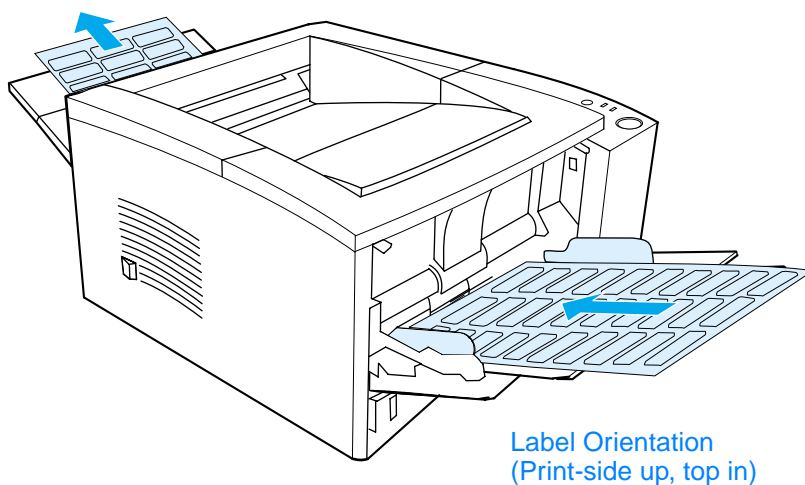

- Do not use labels that are separating from the backing sheet or are wrinkled or damaged in any way.
- Do not use label sheets with the backing sheet exposed or partially used label sheets.
- Do not feed a sheet of labels through the printer more than once. The adhesive backing is designed for one pass through the printer.

CAUTION

If a sheet of labels becomes jammed in the printer, remove the toner cartridge and then see Clearing Paper Jams to remove the jammed labels.

Printing on Transparencies

Only use transparencies recommended for use in HP LaserJet printers, such as HP transparency film. For ordering information, see HP LaserJet Transparency. For transparency specifications, see Transparencies.

- Print transparencies from Tray 1.
- Use the top output bin to reduce curling (this is for transparencies only; for other media use the rear output bin to reduce curling).
- To prevent transparencies from sticking together, remove any transparencies in the output bin as they are printed.
- Place transparencies on a flat surface after removing them from the printer.
- In the printer driver select Optimize for: and choose transparencies in the drop-down box (see Optimizing for Media Types). For non-Windows operating systems, this feature may be available through HP Web JetAdmin (see HP Web JetAdmin).
- For Macintosh, go to the HP LaserJet Utility, and choose transparencies.

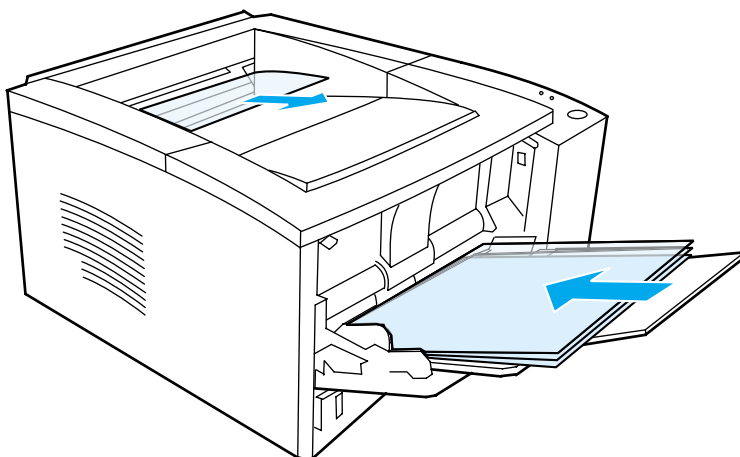

Printing on Custom-Sized Media or Cardstock

Postcards, 3 by 5 in. (index) cards, and other custom-sized media can be printed from Tray 1. The minimum media size is 76 by 127 mm (3 by 5 in.) and the maximum media size is 216 by 356 mm (8.5 by 14 in.).

Note

You may experience some paper jams when using any media with a length less than 178 mm (7 in.). This may be caused by paper that has been affected by environmental conditions. For optimum performance, make sure you are storing and handling the paper correctly (see [Printing and Paper Storage Environment](#)). Using media from another manufacturer may also help.

Custom-Sized Media and Cardstock Guidelines:

- Always insert the short-edge first into Tray 1. If you want to print in landscape mode, make this selection through your software. Inserting paper long-edge first may cause a paper jam.
- Use the rear output bin to reduce curl.
- Do not print on media smaller than 76 mm wide (3 in.) or 127 mm (5 in.) long.
- In your software application, set margins at least 6.4 mm (.25 in.) away from the edges of the media.

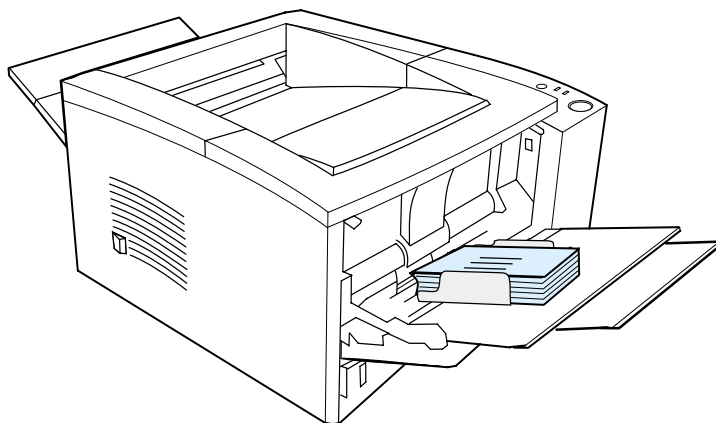

See [Media Specifications](#) for more information.

Printing on Both Sides of Paper (Duplexing)

The HP LaserJet 2200d, 2200dt, 2200dn, and 2200dtn printers can automatically print on both sides of paper. This is called duplexing or two-sided printing. (The HP LaserJet 2200 printer supports manual duplexing.)

The duplexer supports letter, A4, 8.5 x 13, and legal paper sizes.

If you want to duplex paper other than the supported sizes or weights (for example, paper heavier than 105 g/m² (28 lb) or very thin paper), you will have to go to the printer and reinsert the paper manually after the first side has printed. You will also have to reinsert the paper manually if you select Straight Paper Path in your printer driver. Follow the instructions in the driver.

CAUTION

Do not print on both sides of labels, transparencies, or vellum. Damage to the printer and paper jamming might result.

Automatic Duplexing (Printing Both Sides of Paper)

To print on both sides of paper, make the selection from your software application or printer driver (select Print on Both Sides from the Finishing tab). For non-Windows operating systems, this feature may be available through HP Web JetAdmin (see HP Web JetAdmin).

Note

When using the built-in duplexer, the paper you are printing will partially come out of the top output bin. Do not grab the paper until duplexing is complete.

Note

For automatic duplexing, the duplexer will not function if the rear output bin is open.

Manual Duplexing (Printing Both Sides of Paper)

The duplexer prints the second side of paper first. Paper needs to be oriented as shown in the illustration below.

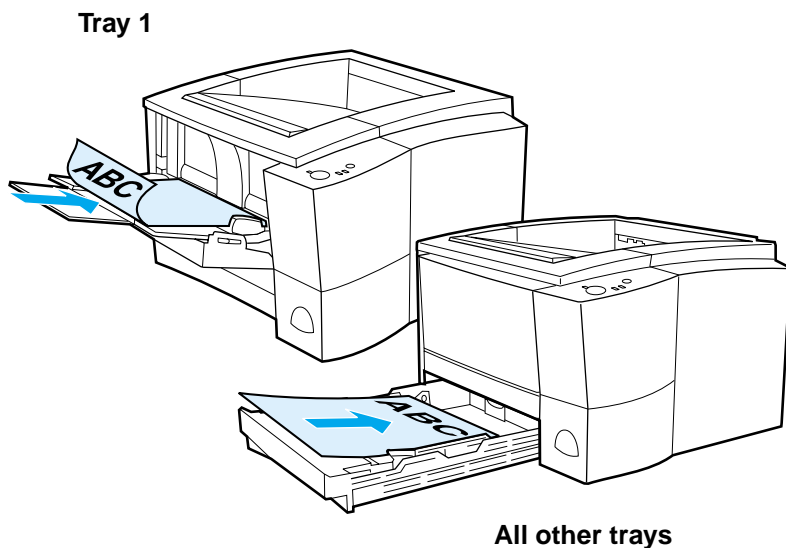

- For Tray 1, load the first side facing down with the bottom, short edge toward the printer.
- For all other trays, load the first side facing up with the top, short edge toward the printer.

To print on both sides of paper, make the following selections in your software application or printer driver:

1. In the Configure tab, select "Allow Manual Duplex."
2. In the Paper tab, select "Print on Both Sides."
3. Select a duplexing option for your print job from these options:
 - Flip Page Up
 - Straight Paper Path
 - Booklet Printing

Layout Options for Printing Both Sides of Paper

The four print orientation options are shown below. These options are available when Print on Both Sides is selected from the Finishing tab in the printer driver.

Note

For non-Windows operating systems, this feature may be available through HP Web JetAdmin (see HP Web JetAdmin).

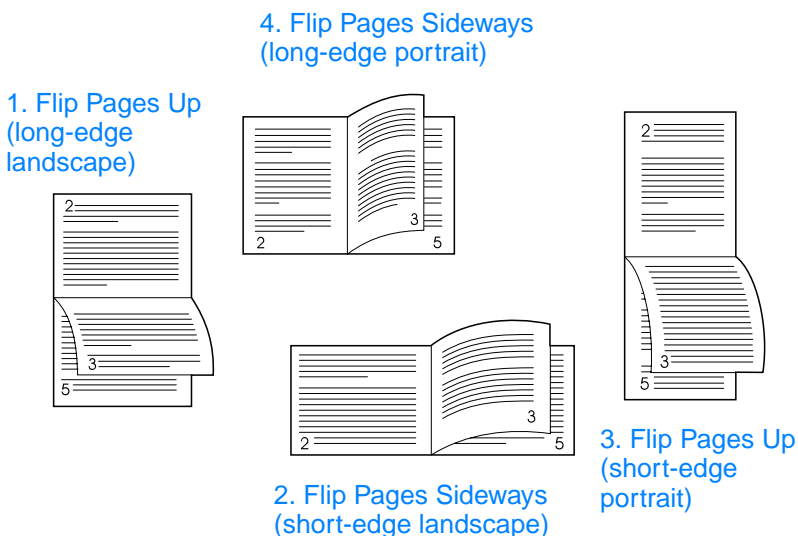

1. Flip Pages Up (long-edge landscape)

This layout is often used in accounting, data processing, and spreadsheet applications. Every other printed image is oriented upside-down. Facing pages are read continuously from top to bottom.

2. Flip Pages Sideways (short-edge landscape)

Each printed image is oriented right-side up. Facing pages are read from top to bottom on the left page, then from top to bottom on the right page.

3. Flip Pages Up (short-edge portrait)

This layout is often used with clipboards. Every other printed image is oriented upside-down. Facing pages are read continuously from top to bottom.

4. Flip Pages Sideways (long-edge portrait)

This is the default and most common layout, with every printed image oriented right-side up. Facing pages are read from top to bottom on the left page, then from top to bottom on the right page.

Printing on Letterhead or Preprinted Forms

Note

This section describes letterhead or preprinted forms orientation for single-sided printing. For duplex (two-sided printing) orientation, see paper orientation for Printing on Both Sides of Paper (Duplexing).

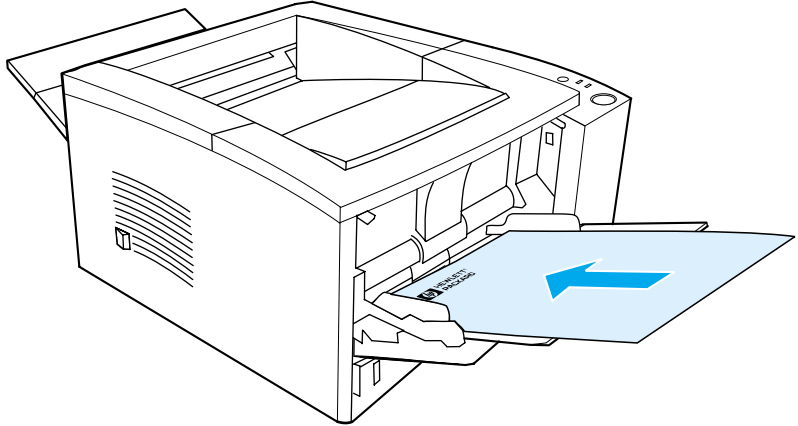

Tray 1 letterhead orientation: print-side up, top-edge toward the printer.

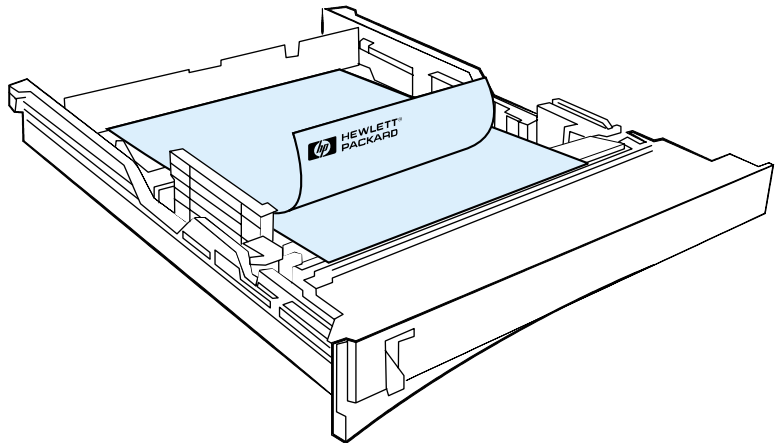

Tray 2 or optional 250- or 500-sheet Tray 3 letterhead orientation: print-side down, top-edge toward you.

Note

Do not use letterhead paper that is printed with low-temperature inks, such as those used in some types of thermography.

Do not use raised or embossed letterhead.

The printer uses heat and pressure to fuse toner to the paper. Make sure that any colored paper or preprinted forms use inks that are compatible with this fusing temperature (200° C or 392° F for 0.1 second).

Canceling a Print Job

A print job can be stopped from a software application, a print queue, or the **JOB CANCEL** button.

- If the printer has not started printing, first try to cancel the job within the software application that sent the print job.
- If the print job is waiting in a print queue or print spooler such as the Printers group in Windows 95 or Print Monitor in Mac, delete the job there.
- If the print job is already printing, press the printer **JOB CANCEL** button. The printer will finish printing any pages that are already moving through the printer and delete the rest of the print job.

If the control panel status lights continue to cycle after a job has been canceled, the computer is still sending the job to the printer. Either delete the job from the print queue or wait until the computer has finished sending data (the printer will return to the ready state, with the Ready light on).

Job Cancel Tips

Pressing **JOB CANCEL** cancels only the current job in the printer. If more than one print job is in printer memory, **JOB CANCEL** must be pressed once for each job.

Software Features

This section lists the common printing features that are controlled through the printer software.

Note

For non-Windows operating systems, some of these features are available through HP Web JetAdmin (see HP Web JetAdmin).

Features in the Printer Driver

Some printer drivers do not support all printer features. Use the PCL 6 printer driver to take full advantage of all the printer's features, including:

- Using the Printer Driver Help (Windows Only)
- Creating and Using Watermarks
- Printing Multiple Pages on One Sheet of Paper (N-up Printing)
- Setting a Custom Paper Size
- Creating and Using Quick Sets
- Using EconoMode or Draft Printing
- Choosing Print Quality Settings
- Using Reduce/Enlarge Options
- Selecting a Paper Source
- Optimizing for Media Types
- Restoring Default Printer Driver Settings
- Printing on Different Paper for the First Page
- Printing on Both Sides of Paper (Duplexing)
- Resolution Options: (to maximize print quality and speed)

Accessing the Printer Driver

After installation, you can access the printer driver through the operating system or from your software application. Although access to the printer driver may vary from one software application to another, the printer driver can usually be accessed from the File menu (choose Print or Print Setup).

Note

The method for accessing a printer driver is the same, no matter which printer driver you are using.

Accessing the Driver

Operating System	Temporarily Change Settings (from a software application)	Change Default Settings (across all applications)
Windows 9x/NT 4.0/2000	From the File menu, click Print, and then click Properties. (The actual steps can vary; this is the most common method.)	Click the Start button, point to Settings, and then click Printers. Right-click the printer icon, and choose Properties. Many of the features in NT 4.0 printer drivers are also located on the Document Defaults menu. Many of the features in Windows 2000 printer drivers are also located on the Printing Preferences menu.
Windows XP	At the time of this publication, Windows XP was not released. Please go to http://www.hp.com/support/lj2200_xpinfo for Windows XP information and installation instructions.	
Windows 3.x	From the File menu, click Print, click Printers, and then click Options. (The actual steps can vary; this is the most common method.)	From the Windows control panel, double-click Printers, highlight the printer, and click Setup.
Macintosh LaserWriter 8.3	From the File menu, select Print, and click Options.	From the File menu, select Print, and click Options. Click Save to save your changes.
Macintosh LaserWriter 8.4 and higher	From the File menu, select Print. Click the pop-up for options you wish to change.	From the File menu, select Print. Click the pop-up for options you wish to change. Click Save to save your changes.

Using the Printer Driver Help (Windows Only)

Each printer driver has help screens that can be activated from the Help button in the printer driver. These help screens give detailed information about the specific driver being used. Printer driver help is separate from the software application help.

Creating and Using Watermarks

The Watermark options allow you to specify that text be placed “underneath” (in the background) of an existing document. For example, you may want to have large gray letters reading “draft” or “confidential” placed diagonally across the first page or all pages of a document. For Windows, access the Watermark options from the Effects tab in your printer driver. For Macintosh computers, access the Watermark options from the watermark/overlay drop-down menu in your printer driver.

Note

If you are using Windows NT 4.0 or Windows 2000, you must have administrator privileges to create watermarks.

Printing Multiple Pages on One Sheet of Paper (N-up Printing)

You can select the number of pages you want to print on a single sheet of paper. If you choose to print more than one page per sheet, the pages will appear decreased in size and arranged on the sheet. You can specify up to 9 pages. Access N-up printing from the Finishing tab in your printer driver.

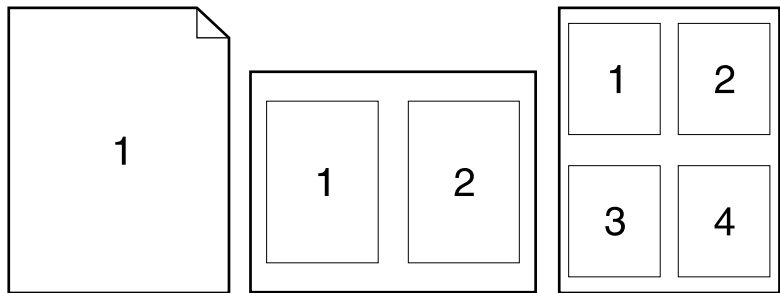

Setting a Custom Paper Size

Use the Custom Paper feature to print on paper sizes other than standard sizes. Access the Custom Paper feature from the Paper tab in your printer driver.

For Macintosh computers, go to File Menu, select Page Setup, and from the Page Attributes drop down menu, select Custom Page Size. Click New to create a named custom page size. The new custom page will automatically be added to the Page Size menu in Page Setup.

Creating and Using Quick Sets

Quick Sets allow you to save the current driver settings (for example, page orientation, n-up printing or paper source) for reuse. For convenience, Quick Sets can be selected and saved from most printer driver tabs. You can also restore printer driver default settings by selecting Defaults from the Quick Sets drop-down list. Access Quick Sets from the Finishing tab in your printer driver.

Note

If you are using Windows NT 4.0 or Windows 2000, you must have administrator privileges to save Quick Sets.

Using EconoMode or Draft Printing

EconoMode (or draft printing) allows the printer to use less toner on each page. Selecting this option may extend the life of your toner cartridge and reduce your cost per page, but will reduce print quality. Access EconoMode from the Finishing tab in your printer driver.

Note

For non-Windows operating systems, this feature is available through HP Web JetAdmin (see HP Web JetAdmin).

Choosing Print Quality Settings

If you need advanced print quality, you can choose custom settings. Access the print quality settings from the Finishing tab in your printer driver.

Resolution Options:

- **Best Quality** - ProRes 1200 for the best print quality.
- **Faster Printing** - FastRes 1200, alternate resolution for complex graphics or faster output.
- **Custom** - Allows you to specify print quality settings.

Note

Changing resolution may change the formatting of your text.

Using Reduce/Enlarge Options

Reduce/Enlarge options allow you to scale your document to a percent of its normal size. You can also choose to scale your document to fit on any size of paper supported by the printer. Access Reduce/Enlarge options from the Effects tab in your printer driver.

Selecting a Paper Source

If your application supports printing paper by source, make the selections from your application. Application settings override printer driver settings. To select a paper source from your printer driver, access Source from the Paper tab. For Macintosh computers, select a paper source from the General options in your printer driver.

Optimizing for Media Types

If you are printing on thin or heavy paper, transparencies, or labels, optimize the printer for these media types. Access the optimizing feature from the Paper tab in your printer driver. For Macintosh computers, access the optimizing feature from the General options in your printer driver.

Note

For non-Windows operating systems, this feature may be available through HP Web JetAdmin (see HP Web JetAdmin).

Restoring Default Printer Driver Settings

To restore default printer driver settings, click Defaults in the Quick Sets box of your printer driver.

Printing on Different Paper for the First Page

Printing on different paper for the first page of a print job is available only with the HP PCL 6 printer driver and the Macintosh LaserWriter driver. Access this feature from the Paper tab in your printer driver. For Macintosh computers, access this feature from the General options in your printer driver.

Some applications may also have this feature. Check with the application's help.

Note

The paper size for all pages of the print job must be the same in the driver. However, if the application supports printing on different paper for the first page, the settings in the application will override the driver.

Features in the HP LaserJet Device Configuration and HP LaserJet Utility

The HP LaserJet Device Configuration and the HP LaserJet Utility give you access to a variety of features.

Note

Settings in the printer driver and software application override printer settings made in the configuration utility. (Software application settings override printer driver settings.)

Accessing the HP LaserJet Device Configuration or HP LaserJet Utility

Windows

1. Select Start and then Programs.
2. Choose HP LaserJet 2200 and then select Tools.
3. Choose HP LaserJet Device Configuration.

Macintosh

1. Open the HP LaserJet folder.
2. Double-click on HP LaserJet Utility.
3. Select Printer.
4. Choose Settings to modify the printer defaults.

Configuration Report

Prints a list of the printer's current settings, available resources, and installed options.

Demo Page

Print this page to quickly check that the printer is set up and printing correctly.

PCL Font List

Prints a list of all available PCL and PCL-XL fonts that are currently installed in the printer including any DIMM (dual in-line memory module) or permanently downloaded fonts.

Language

Click the down arrow, then select the language (for example; English, French, German) that you want used in device generated reports, such as the configuration report and the demo page.

Tray Lock

Tray Lock is a feature that allows you to “lock” a tray so that the only time the printer will draw from that tray is when it is specifically requested, or if a tray override was requested and all unlocked trays are empty. This is useful when you want to put special paper in a tray, such as letterhead. For example, if you are using “First Available Tray,” for the paper source and you lock Tray 1, the printer will only draw from the remaining trays, either Tray 2 or optional Tray 3, if it is installed. You can still print from the locked tray, but you must specify the source. See [Selecting a Paper Source](#).

Note

The feature will not allow you to lock all the trays. One tray must be “unlocked.”

Windows

1. Run the HP LaserJet Device Configuration or HP Web JetAdmin.
2. From the Tray Setup tab, select the tray you wish to lock.

Macintosh

For Macintosh computers, this setting is available in the HP LaserJet Utility. (See [Accessing the HP LaserJet Device Configuration or HP LaserJet Utility](#)).

Printing by Size of Paper

Note

For printing by type of paper, see Tray Lock.

You can configure the printer to select paper by size (such as letter or A4), as opposed to source (a paper tray).

If you frequently use several different sizes of paper, once trays are set up correctly using the HP LaserJet Device Configuration, you do not have to check which size is loaded in each tray before you print.

To print by size of paper, do the following:

1. Be sure to adjust and load the trays correctly. (See the sections on loading paper, starting with Loading Media into Tray 1.)
2. From the Tray Setup tab in the HP LaserJet Device Configuration, select the paper size for each tray.
3. From the software or printer driver, select the desired size of paper. From a Windows application, click File and select Page Setup (software) or click File and select Print and then Properties (printer driver).

Note

The size settings may also be configured from HP Web JetAdmin. See HP Web JetAdmin.

Settings in the printer driver and software application override printer settings made in the configuration utility. (Software application settings override printer driver settings.)

Save Settings to a File

This feature allows the current device settings to be easily saved to a file and later restored if desired. Click this button to save the currently displayed settings on all of the tabs to a file.

Retrieve Settings from a File

Click this button to retrieve a set of previously stored device settings from a file. After retrieving these settings, click OK or Apply to update all of the settings on the device with the retrieved values.

3

Printer Tips and Maintenance

Overview

This chapter provides suggestions for high-quality and economical printing. It also lists special maintenance tasks for the toner cartridge and the printer.

- Managing the UltraPrecise Toner Cartridge
- Redistributing the Toner
- Cleaning the Printer

Managing the UltraPrecise Toner Cartridge

HP Policy on Non-HP Toner Cartridges

Hewlett-Packard Company cannot recommend use of non-HP toner cartridges, either new, refilled, or remanufactured. Because they are not HP products, HP cannot influence their design or control their quality.

Toner Cartridge Storage

Do not remove the toner cartridge from its package until you are ready to use it. The shelf life of a cartridge in an unopened package is approximately 2.5 years. The shelf life of a cartridge in an opened package is approximately 6 months.

CAUTION

To prevent damage to the toner cartridge, do not expose it to light for more than a few minutes.

Toner Cartridge Life Expectancy

The life of the toner cartridge depends on the amount of toner that print jobs require. When printing text at 5% coverage, an HP LaserJet 2200 series toner cartridge lasts an average of 5,000 pages. This assumes the print density is set to 3 and EconoMode is off. (These are the default settings.)

Recycling Toner Cartridges

To install a new HP toner cartridge and recycle the used cartridge, follow the instructions included in the new toner cartridge box.

See HP LaserJet Printing Supplies for more information on recycling toner cartridges.

Redistributing the Toner

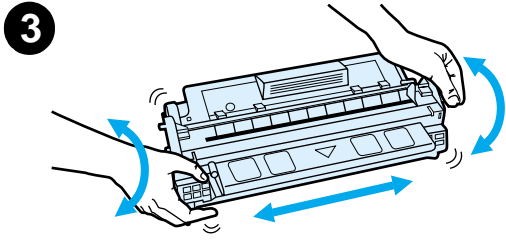
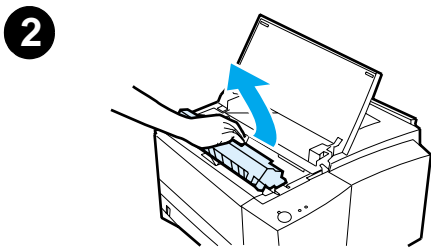
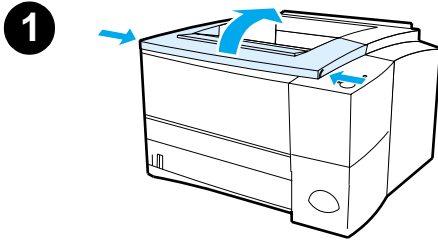

When toner is low, faded or light areas may appear on a printed page. You may be able to temporarily improve print quality by redistributing the toner. The following procedure may allow you to finish the current print job before replacing the toner cartridge.

- 1 Open the top cover.
- 2 Remove the toner cartridge from the printer.

WARNING!

Avoid reaching too far into the printer. The adjacent fusing area may be hot!

CAUTION

To prevent damage, do not expose the toner cartridge to light for more than a few minutes.

- 3 Rotate the toner cartridge and gently shake from side to side to redistribute the toner. (Do not tip the cartridge on end, or it might leak.)

CAUTION

If toner gets on your clothing or hands, wipe it off with a dry cloth and wash clothing in cold water. (Hot water sets toner into fabric.)

Continued on the next page.

4

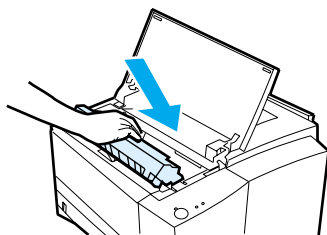

4 Reinsert the toner cartridge into the printer and close the top cover.

If the print remains light, install a new toner cartridge. (Follow the instructions provided with the new toner cartridge.)

Cleaning the Printer

To maintain print quality, follow the cleaning procedure on the following pages every time the toner cartridge is changed or whenever print quality problems occur. As much as possible, keep the printer free from dust and debris.

- Clean the outside of the printer with a lightly water-dampened cloth.
- Clean the inside with a dry, lint-free cloth.

CAUTION

Do not use ammonia-based cleaners on or around the printer. While cleaning the printer, be careful not to touch the transfer roller (located underneath the toner cartridge). Skin oils on the roller can cause print quality problems.

Using the Printer Cleaning Process

During the printing process, paper, toner and dust particles can accumulate inside the printer. Over time, this buildup can cause print quality problems such as toner specks or smearing. This printer has a cleaning mode that can correct and prevent these types of problems.

Engine Cleaning



This process uses a transparency from Tray 1 to remove dust and toner from the paper path. Use this process if toner specks or dots appear on printouts. This process will provide a blank page which should be discarded.

Note

For best results, use a transparency during this process. If a transparency is not available, use copier grade paper and not bond or rough paper.

Note

During the engine cleaning process, the printer pulls the transparency into the printer and then stops. **This is not a jam.** The transparency will be slowly stepped through the printer to complete the engine cleaning.

To Start Engine Cleaning

1. Make sure the printer is turned on and in the ready state. Load a transparency in Tray 1.
2. Press and hold the **Go** button for 10-12 seconds.
3. Release the **Go** button. The lights will cycle from front to back until the cleaning process has completed.

Note

If the **Go** button is not held long enough, the printer will print a demo page rather than perform the cleaning process.

4. Discard the blank page produced from the engine cleaning process.

Internal Cleaning Procedure

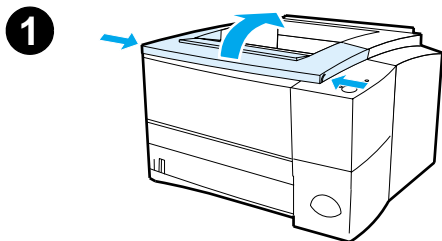

Over time, particles of toner and paper will begin to accumulate inside the printer. This may cause print quality problems during printing. Cleaning the printer will eliminate or reduce these problems.

WARNING!

Before cleaning the printer, turn the printer off and unplug the power cable.

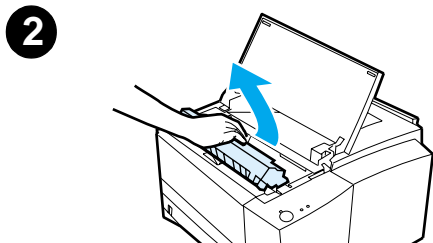

- 1 Open the top cover.
 - 2 Remove the toner cartridge.
-

CAUTION

To prevent damage, do not expose the toner cartridge to light. Place a piece of paper over the top of the toner cartridge to shield it while it is out of the printer.

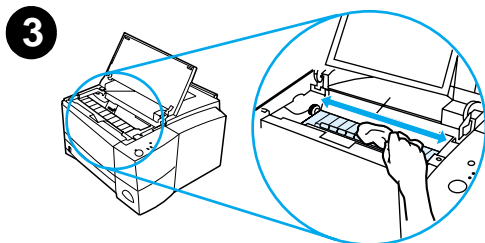

- 3 With a dry, lint-free cloth, wipe any residue from the paper path area and the toner cartridge cavity.
- 4 Replace the toner cartridge and close the top cover. Plug in the power cable, and turn the printer on.

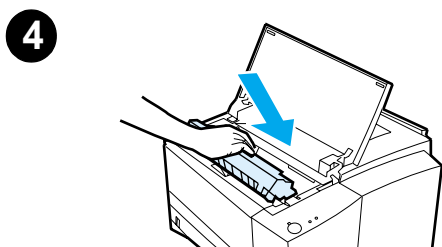

4

Problem Solving

Overview

This chapter helps you troubleshoot printer problems in the following areas:

- Troubleshooting Checklist
- Troubleshooting General Printing Problems
- Printing Special Pages
- Clearing Paper Jams
- Solving Print Quality Problems
- Wireless Printing Problems
- Troubleshooting Control Panel Messages
- Secondary Light Patterns
- Network Printing Problems
- Common Windows Problems
- Common Macintosh Problems
- Troubleshooting PostScript (PS) Errors

Troubleshooting Checklist

If the printer is not responding properly, complete the following checklist in order. If the printer does not pass a step, follow the corresponding troubleshooting suggestions.

Troubleshooting Checklist

Make sure the printer Ready light is on.

If no lights are on, check the power cord connections. Check the power switch. Check the power source by plugging into another outlet.

If other lights are on, go to Troubleshooting Control Panel Messages or use the control panel simulator.

Press **Go** to print a demo page to verify that the printer is feeding paper correctly.

If a demo page does not print, check the paper supply in Tray 2 or Tray 3.

Check for paper left in the duplexer. See Duplexer Area for instructions on clearing paper from the duplexer.

If the page jams in the printer, go to Clearing Paper Jams.

If the printer prints, but the status lights are blinking, go to Troubleshooting Control Panel Messages or use the control panel simulator.

Check the demo page to see if it printed correctly.

If there is a print quality problem, go to Solving Print Quality Problems.

Troubleshooting Checklist (continued)

Print a short document from a software application to verify the computer and printer are connected and are communicating correctly.

If the page does not print, check the cable connection between the printer and computer. Make sure you are using the proper cable.

Check the print queue or print spooler (print monitor in Mac) to see if the printer has been paused.

Verify that you have installed the HP LaserJet 2200 series printer driver.

Check the software application to make sure you are using an HP LaserJet 2200 series printer driver and port.

If the page is interrupted during printing, go to Troubleshooting General Printing Problems.

If completing the checklist did not diagnose the problem with the printer, check the following troubleshooting sections:

Troubleshooting General Printing Problems
Wireless Printing Problems
Troubleshooting Control Panel Messages
Secondary Light Patterns
Network Printing Problems
Common Windows Problems
Common Macintosh Problems
Troubleshooting PostScript (PS) Errors
Printing Special Pages

Troubleshooting General Printing Problems

Troubleshooting General Printing Problems

Symptom	Possible Cause	Solution
Printer selects media from the wrong tray.	The tray selection in the software application may be incorrect.	For many software applications, the paper tray selection is found under the Page Setup menu within the application. Remove any media in other trays to make the printer select from the desired tray. For Macintosh, use the HP LaserJet Utility to change the priority of the tray.
	The configured size does not match the size of the media loaded in the tray.	Change the configured size to match the size of the media loaded in the tray through the printer driver or the HP LaserJet Device Configuration (Windows users). For non-Windows users, configure the size through HP Web JetAdmin.
Printer does not pull paper from Tray 2 or Optional Tray 3.	The rear paper length guide is set incorrectly (Tray 2 or Optional 250-sheet Tray 3). The rear paper stop is set incorrectly (Optional 500-sheet Tray 3).	To properly set the rear guides, see Loading Media into Tray 2 or Optional 250-sheet Tray 3 or Loading Media into Optional 500-sheet Tray 3.

Troubleshooting General Printing Problems (continued)

Symptom	Possible Cause	Solution
Print job is extremely slow.	<p>The job may be very complex.</p> <p>The maximum speed of 19 pages-per-minute (letter-size paper, or 18 ppm with A4-size paper) cannot be exceeded even when more memory is added.</p> <p>Printing speeds may be automatically reduced when printing special-sized media.</p> <p>In the printer driver, Optimize for: is set to cardstock, heavy, rough or bond paper.</p>	<p>Reduce the complexity of the page or try adjusting the print quality settings. If this problem occurs frequently, add memory to the printer.</p> <p>In the printer driver, set Optimize for: to plain paper. See Optimizing for Media Types. Choose Start, Settings, Printers, right click on the icon and select Set Defaults (Windows NT) or Properties (Windows 9x). Select the Paper tab and set Optimize for: to plain paper.</p> <p>Note: If you change Optimize for: to plain, the print job will print faster. However, if you are using heavy media, for best results leave Optimize for: set to heavy even though it may print slower.</p>
Print job prints on both sides of the paper.	Duplex may be selected in the printer driver.	See Accessing the Printer Driver to find out how to access your printer driver or refer to your online help.
Pages print, but are totally blank.	<p>The sealing tape may still be in the toner cartridge.</p> <p>The file may have blank pages.</p>	<p>Remove the toner cartridge and pull out the sealing tape. Re-install the toner cartridge. Check the printer by pressing Go to print a demo page.</p> <p>Check file to make sure that it does not contain blank pages.</p>

Troubleshooting General Printing Problems (continued)

Symptom	Possible Cause	Solution
The printer prints, but the text is wrong, garbled, or incomplete.	The printer cable is loose or defective.	Disconnect the printer cable and reconnect it. Try a print job you know works. If possible, attach the cable and printer to another computer and try a print job that you know works. Finally, try a new cable.
	The printer is on a network or sharing device and is not receiving a clear signal.	Disconnect the printer from the network and attach it directly to a computer with a parallel or USB cable. Print a job that you know works.
	The wrong driver was selected in the software.	Check the software's printer selection menu to make sure that the HP LaserJet 2200 is selected.
	The software application is malfunctioning.	Try printing a job from another application.
	The operating system is malfunctioning.	If printing from Windows (any version), exit to a DOS prompt and verify functionality with the following command: At a C:\prompt, type <code>Dir LPT1</code> then press enter. (This assumes the printer is connected to LPT1). If the Go light comes on, press the Go button to print and eject the page. If the page prints correctly, then the operating system is malfunctioning.
The printer does not respond when "print" is selected in the software.	The printer may be in manual feed mode (Attention light blinking and Go light on).	Add paper to Tray 1 if empty. If paper is already added, press and release the Go button.

Troubleshooting General Printing Problems (continued)

Symptom	Possible Cause	Solution
The printer does not respond when “print” is selected in the software (continued).	The cable between the computer and the printer is not connected properly.	Disconnect and reconnect the cable.
	The printer cable is defective.	If possible, attach the cable to another computer and print a job you know works. You may also try using a different cable.
	The wrong printer was selected in the software.	Check the software printer selection menu to make sure that the HP LaserJet 2200 is selected.
	There may be a paper jam.	Clear any paper jams, paying careful attention to the duplexer area. See Clearing Paper Jams.
	The software for the printer is not configured for the printer port.	Check the software’s printer selection menu to make sure it is accessing the correct port. If the computer has more than one port, make sure the printer is attached to the correct one.
	The printer is on a network and is not receiving a signal.	Disconnect the printer from the network and attach it directly to a computer with a parallel or USB cable. Reinstall the printing software. Print a job you know works. Clear any stopped jobs from the print queue.
	The printer is not receiving power.	If no lights are on, check the power cord connections. Check the power switch. Check the power source.

Troubleshooting General Printing Problems (continued)

Symptom	Possible Cause	Solution
The printer does not respond when “print” is selected in the software (continued).	The printer is malfunctioning.	Check the lights on the printer to determine if the printer is indicating an error. See Troubleshooting Control Panel Messages or use the control panel simulator.
Paper curls when exiting the printer.	The paper curls when exiting the top output bin.	Open the rear output bin to allow the paper to exit in a straight path through the printer. Turn over the paper that you are printing on .

Printing Special Pages

There are special pages within the memory of the printer that will help you to diagnose and learn about problems with your printer.

Note

If your printer's language was not automatically or correctly set during installation, and you do not have the HP LaserJet Device Configuration, you can set the language manually. Place the HP LaserJet 2200 CD in the CD-ROM drive and from a DOS prompt type: [copy x:\DOS\French.pjl LPT1], where x is your CD-ROM drive, French is your desired language, and LPT1 is the port your printer is connected to.

Demo Page

To print the demo page, press the **Go** button when the printer is ready (Ready light is on).

Self Test/Configuration Page

The self test/configuration page lists many of the current settings and properties of the printer. To print the self test/configuration page, press and release the **Go** and **JOB CANCEL** buttons simultaneously when the printer is ready (Ready light is on). If you have an EIO print server card installed, a second page, the JetDirect Page, will print listing all of the HP JetDirect information.

Note

The demo and self test/configuration pages can also be printed from the HP LaserJet Device Configuration Reports page.

Cleaning Process

The printer has an Engine cleaning process that cleans internal areas including the paper path area. The Engine cleaning process produces a blank page that should be discarded. See Using the Printer Cleaning Process.

Font List

To print a font list, use either the HP LaserJet Device Configuration (Windows) or the HP LaserJet Utility (Macintosh).

Clearing Paper Jams

Occasionally, paper can become jammed during a print job. Some of the causes include:

- Paper trays loaded improperly or overfilled.
- Tray 2 or optional Tray 3 is removed during a print job.
- Top cover is opened during a print job.
- Media that does not meet HP specifications is used. See Media Specifications.
- Media that is outside of the supported size range is used. See Media Specifications.

Find and remove the jammed paper using the instructions on the following pages. If the location of the paper jam is not obvious, look first in the toner cartridge area.

Note

Be sure to remove all torn pieces of paper left in the printer.

Paper jams can occur at four locations:

- Toner Cartridge Area.
- Tray 2 or Optional Tray 3 Paper Feed Area.
- Output Areas.
- Duplexer Area

Note

Loose toner may remain in the printer after a paper jam. This should clear after a few sheets have printed. See Loose Toner.

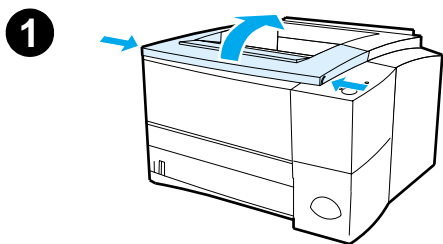

Toner Cartridge Area

- 1 Open the top cover.

CAUTION

Paper jams in this area may result in loose toner on the page. If you get any toner on your clothes or hands, wash them in cold water. (Hot water will set the toner into the fabric.)

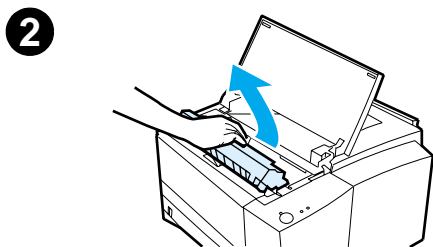

- 2 Remove the toner cartridge.

CAUTION

To prevent damage, do not expose the toner cartridge to light for more than a few minutes. Place a piece of paper over the top of the toner cartridge to shield it while it is out of the printer.

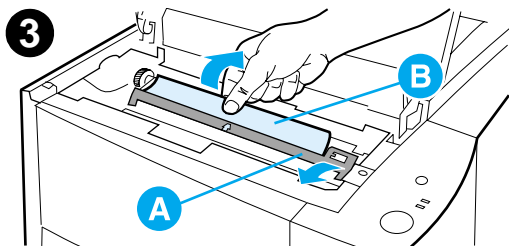

- 3 Carefully lift up the registration plate (A). If the leading edge of the paper (B) is visible, gently pull the paper toward the rear of the printer to remove it from the printer.

Continued on the next page.

4

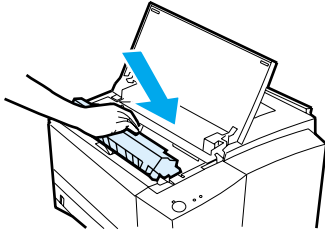

Note

If the paper is too difficult to remove or has already entered the output area, remove the jam as described in Output Areas.

- 4 When the jammed paper has been removed, gently flip down the registration plate. Replace the toner cartridge and shut the top cover.
-

Note

If the toner cartridge is difficult to re-install, make sure the registration plate has been flipped back down into position.

If the Attention light does not go out, there is still jammed paper inside the printer. Check the paper feed, rear output, and duplexer areas for paper jams.

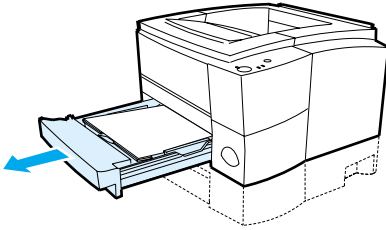
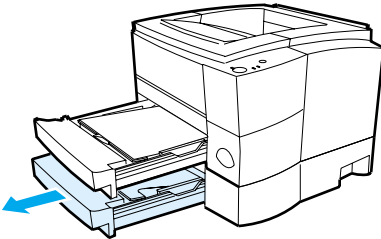
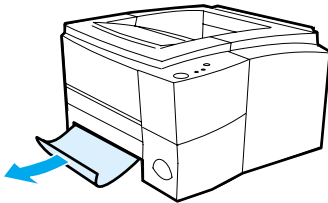
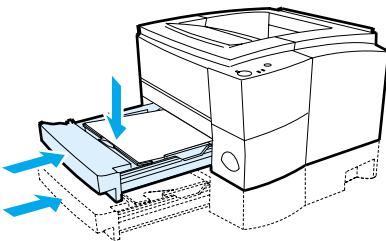
1**2****3****4**

Tray 2 or Optional Tray 3 Paper Feed Area

Note

If paper has entered the toner cartridge area, follow the instructions in Toner Cartridge Area. It is easier to remove paper from the toner cartridge area than the paper feed area.

- 1 Slide out Tray 2 to expose the jammed paper.
- 2 Remove any misfed paper by pulling it out by the visible edge. Make sure that all of the paper is aligned in the tray (see Loading Media into Tray 2 or Optional 250-sheet Tray 3). If Tray 3 is installed, remove any misfed paper and make sure that all of the paper is aligned in that tray.
- 3 If the paper is jammed in the paper feed area and cannot be accessed from the toner cartridge area, grasp the paper and carefully pull it free from the printer.
- 4 For the 250-sheet tray, push the paper down to lock the metal paper lift plate into place and slide the tray back into the printer.

Note

To reset the printer and continue printing, open the top cover all the way, then close it.

If the Attention light does not go out, there is still jammed paper inside the printer. Check the toner cartridge, rear output, and duplexer areas for paper jams.

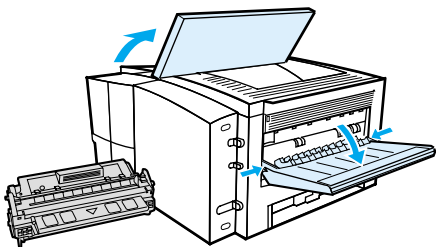
1

Output Areas

CAUTION

Paper jams in this area may result in loose toner on the page. If you get any toner on your clothes or hands, wash them in cold water. (Hot water will set the toner into the fabric.)

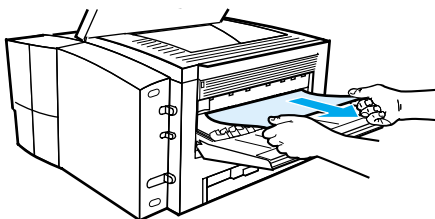
2

- 1 Open the top cover and remove the toner cartridge. Open the rear output bin.

Note

It is necessary to open the top cover in order to release the rear output gearing for easy paper removal.

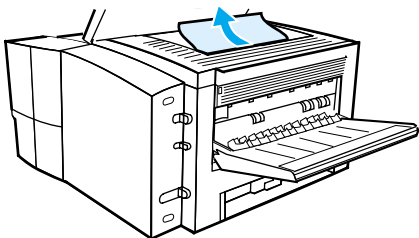
3

- 2 If the leading edge of the paper is not visible or barely visible in the cartridge area, carefully pull the leading edge out of the printer from the rear output opening using both hands. Carefully remove the rest of the jammed paper from the printer.

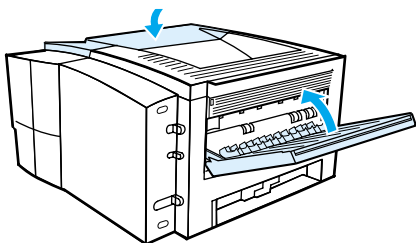
4

- 3 If the paper is almost completely visible from the top output bin, pull the remaining paper carefully out of the printer.
- 4 Re-install the toner cartridge. Close the top cover and the rear output bin.

Note

If the Attention light does not go out, there is still jammed paper inside the printer. Check the paper feed, toner cartridge, and duplexer areas for paper jams.

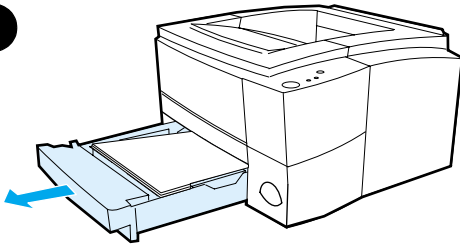
1

Duplexer Area

- 1 Slide out Tray 2 from the printer.
- 2 Pull the green lever on the left front of the printer to open the bottom of the duplexer.
- 3 Reach in and pull out the jammed paper.
- 4 Push the bottom of the duplexer back up until it clicks into place.
- 5 Slide Tray 2 back into the printer.

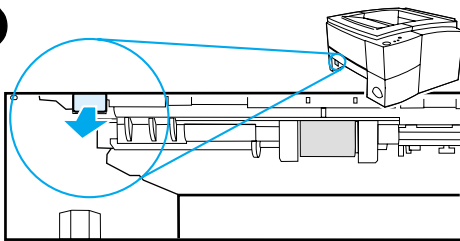
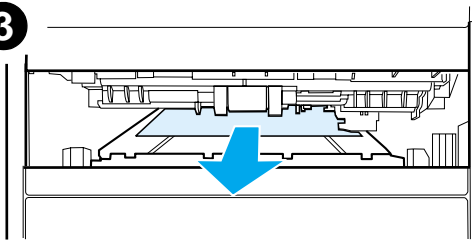
2**3**

Note

To reset the printer and continue printing, open the top cover all the way and close it.

If the Attention light does not go out, there is still jammed paper inside the printer. Check the paper feed, toner cartridge, and output areas for paper jams.

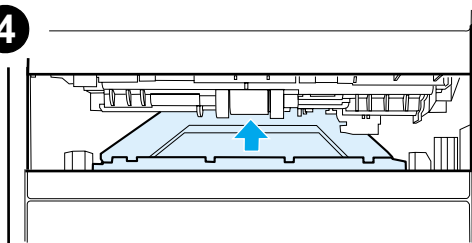
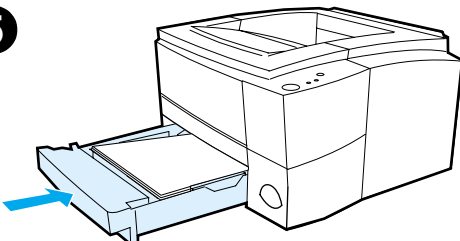
4**5**

Solving Print Quality Problems

Print Quality Checklist

General print quality problems can be solved by following the checklist below.

- Check the printer driver to make sure you are using the best available print quality option (see Choosing Print Quality Settings).
- Print using a different HP LaserJet 2200 printer driver.
- Redistribute the toner in the toner cartridge (see Redistributing the Toner).
- Clean the inside of the printer (see Cleaning the Printer).
- Check the paper type and quality (see Media Specifications).
- Check to make sure EconoMode is off in the software (see Using EconoMode or Draft Printing).
- Troubleshoot general printing problems (see Troubleshooting General Printing Problems).
- Install a new HP toner cartridge, then check print quality again. (See instructions provided with the toner cartridge.)

Note

If the page is totally blank (all white) check to make sure the sealing tape is removed from the toner cartridge and ensure that the toner cartridge is installed correctly.

Note

Newer printers have been optimized to print characters more accurately. This may result in characters looking lighter or thinner than you are used to having them print on your older printer.

Note

If the page is printing images darker than on an older printer, and you want the images to match the older printer, in your printer driver, select the Finishing tab, choose Print Quality, choose Custom, click on Details, and deselect Print Images Lighter.

Image Defect Examples

The examples below depict letter-size paper that has passed through the printer short-edge first. The following pages list the typical cause and solution for each of these examples.

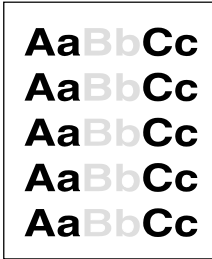

Light Print or Fade

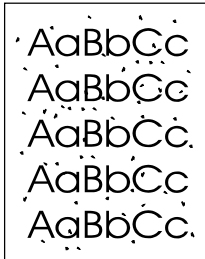

Toner Specks

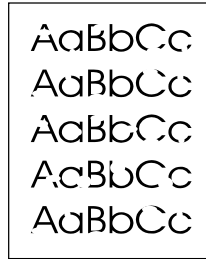

Dropouts

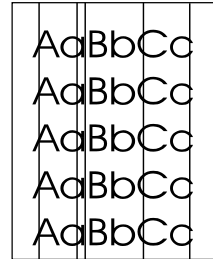

Vertical Lines



Gray Background



Toner Smear

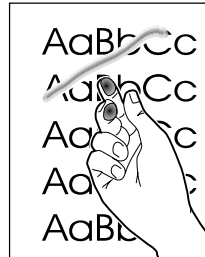

Loose Toner

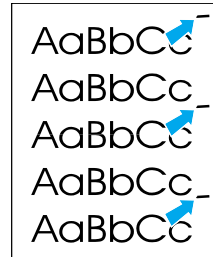

Vertical Repetitive Defects

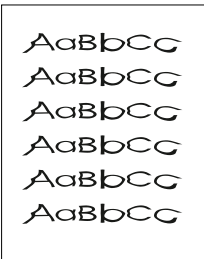

Misformed Characters

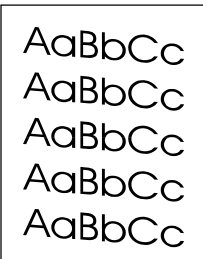

Page Skew

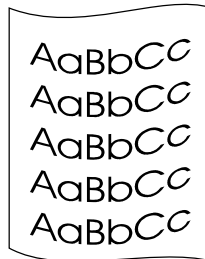

Curl or Wave

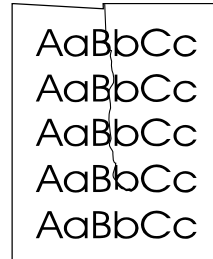

Wrinkles or Creases

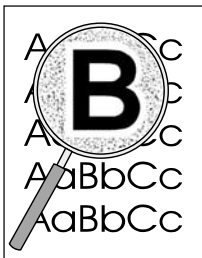

Toner Scatter Outline



Random Image Repetition (light)



Random Image Repetition (dark)

Light Print or Fade

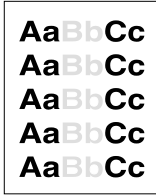

If a vertical white streak or faded area appears on the page:

- The toner supply is low. You may be able to temporarily extend the toner cartridge life. See *Redistributing the Toner*. If this does not improve the print quality, install a new HP toner cartridge.
- The paper may not meet HP's paper specifications (for example, the paper is too moist or too rough). See *Media Specifications*.
- If the whole page is light, the print density adjustment is too light or *EconoMode* may be on. Adjust the print density and *EconoMode* within the software driver. See *Using EconoMode or Draft Printing*. For non-Windows operating systems, this feature is also available in HP Web JetAdmin.

Toner Specks



- The paper may not meet HP's paper specifications (for example, the paper is too moist or too rough). See *Media Specifications*.
- The transfer roller may be dirty. See *Internal Cleaning Procedure*.
- The paper path may need cleaning. See *Engine Cleaning*.

Dropouts



If faded areas, generally rounded, occur randomly on the page:

- A single sheet of paper may be defective. Try reprinting the job.
- The moisture content of the paper is uneven or the paper has moist spots on its surface. Try paper from a different source. See *Media Specifications*.
- The paper lot is bad. The manufacturing processes can cause some areas to reject toner. Try a different kind or brand of paper. See *Media Specifications*.
- The toner cartridge may be defective. See *Vertical Repetitive Defects*.
- If these steps do not correct the problem, contact an HP-authorized dealer or service representative. See *HP Customer Care (Service and Support)*.

Vertical Lines

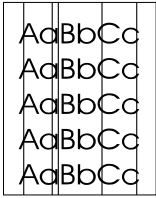

If black or white vertical streaks appear on the page:

- The photosensitive drum inside the toner cartridge has probably been scratched or is worn out. Install a new HP toner cartridge.

Gray Background



If the amount of background toner shading becomes unacceptable, the procedures described below may help to clear the condition:

- Decrease the density setting through the HP LaserJet Device Configuration (Windows) or from the HP LaserJet Utility (Macintosh). This will decrease the amount of background shading.
- Change the paper to a lighter basis weight. See Media Specifications.
- Check the printer's environment; very dry (low humidity) conditions can increase the amount of background shading.
- Install a new HP toner cartridge.

Toner Smear



- If toner smears appear on the leading edge of the paper, the paper guides are dirty. See Internal Cleaning Procedure.
- Check the paper type and quality. See Media Specifications.
- Try installing a new HP toner cartridge.

Loose Toner

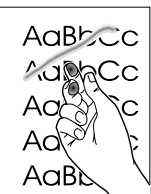

- Clean the inside of the printer. See Internal Cleaning Procedure.
- Check the paper type and quality. See Media Specifications.
- Try installing a new HP toner cartridge.
- In the printer driver, select the Paper tab and set Optimize for: to match the type of paper you are printing. Print speed may be slower if you are using heavy paper. For non-Windows operating systems, this feature is also available in HP Web JetAdmin.

Vertical Repetitive Defects



If marks repeatedly appear on the printed side of the page at even intervals:

- The toner cartridge may be damaged. The circumference of the toner cartridge drum is 94 mm (3.7 in.). If a repetitive mark occurs every 94 mm (3.7 in.) on the page, install a new HP toner cartridge.
- Internal parts may have toner on them. If the defects occur on the back of the page, the problem will likely correct itself after a few more pages.
- In the printer driver, select the Paper tab and set Optimize for: to match the type of paper you are printing. For non-Windows operating systems, this feature is also available in HP Web JetAdmin.
- The fusing assembly may be damaged. Contact an HP-approved service technician. See HP Customer Care (Service and Support).

Misformed Characters

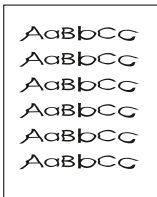

- If characters are improperly formed, producing hollow images, the paper may be too slick. Try a different paper type. See Media Specifications.
- If characters are improperly formed, producing a wavy effect, the laser scanner may need service. Verify that it also occurs on a demo page by pressing **GO** when the printer is ready. If you need service, contact an HP-authorized dealer or service representative. See Hewlett-Packard Limited Warranty Statement. See HP Customer Care (Service and Support).

Page Skew



- Check the paper type and quality. See Media Specifications.
- Make sure the paper or other media is loaded correctly and that the guides are not too tight or too loose against the paper stack. See Loading Media into Tray 1, Loading Media into Tray 2 or Optional 250-sheet Tray 3, or Loading Media into Optional 500-sheet Tray 3.

Curl or Wave



- Check the paper type and quality. Both high temperature and humidity will cause paper curl. See Media Specifications.
- Turn over the stack of paper in the tray. Also try rotating the paper 180° in the input tray.
- Open the rear door and try printing to the rear output bin.

Wrinkles or Creases



- Make sure that paper is loaded properly.
- Check the paper type and quality. See Media Specifications.
- Open the rear door and try printing to the rear output bin.
- Turn over the stack of paper in the tray or try rotating the paper 180° in the input tray.

Toner Scatter Outline

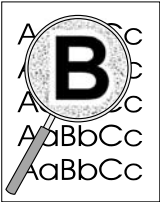

- If large amounts of toner have scattered around the characters, the paper may have high resistivity. (Small amounts of toner scatter is normal for laser printing.) Try a different paper type. See Media Specifications.
- Turn over the stack of paper in the tray.
- Use paper designed for laser printers. See Media Specifications.

Random Image Repetition



If an image that appears at the top of the page (in solid black) repeats further down the page (in gray field), the toner may not have been completely erased from the last job. (The repeated image may be lighter or darker than the field it appears in.)

- Change the tone (darkness) of the field that the repeated image appears in.
- Change the order in which the images are printed. For example, have the lighter image at the top of the page, and the darker image further down the page.
- From your software application, rotate the whole page 180° to print the lighter image first.
- If the defect occurs later in a print job, turn the printer off for ten minutes, and then turn the printer on to restart the print job.

Wireless Printing Problems

Wireless Printing Problems

Symptom	Possible Cause	Solution
The connection cannot be established or the transmission seems to be taking longer than usual.	Computer is not IrDA-compliant.	Make sure the computer you are using is IrDA-compliant; look for an IrDA symbol on the device or refer to the computer's manual.
	IR Driver is not installed on your computer or Personal Digital Assistant (PDA).	Make sure your application is using an HP LaserJet 2200 driver and that an IR port is selected within the driver. Keep in mind that complex pages take longer to print. HP does not supply the IR driver for the computer port. The IR driver is available through the hardware or operating system manufacturers. Contact your hardware or software technical support to obtain a driver.
	Computer and printer are not positioned properly.	Make sure you have positioned the device within the range of operation and that no objects, such as a finger, paper, books, or bright light are interfering with the connection (see Printer Specifications). Also make sure the two FIR ports are clean (free from dirt and grease). See Cleaning the Printer.

Wireless Printing Problems (continued)

Symptom	Possible Cause	Solution
The connection cannot be established or the transmission seems to be taking longer than usual (continued).	Bright lights are interfering with the signal.	Make sure that no bright light is shining directly into either IR port. Bright light of any kind (sunlight, incandescent light, fluorescent light, or light from an infrared remote control, such as those used for TVs and VCRs) shining directly into one of the IR ports may cause interference. Position the device closer to the IR port on the printer.
The printer prints only part of a page or document.	The connection has been interrupted during transmission.	IrDA-compliant devices are designed to recover from temporary connection interruptions. Re-establish the connection. (Depending on the device you are using, it can take anywhere from 3 to 40 seconds to re-establish the connection.)
The print job has been properly sent to the printer, but the printer will not print.	The connection may have been disrupted or broken.	If the connection is broken before the print job has started, the printer may not print any of the job. If the Ready (middle) light is on, press JOB CANCEL to clear the printer memory. Position the device within the range of operation and print the job again.
The FIR status light turns off during transmission.	The connection may have been broken.	If the Ready (middle) light is on, press JOB CANCEL to clear the printer memory. Position the device within the range of operation and print the job again.

Troubleshooting Control Panel Messages

Printer status is indicated by light patterns on the control panel. The lights can be in any one of the following states:



See the following information to interpret control panel lights, or use the control panel simulator (see Control Panel Simulator).

Basic Control Panel Messages

The following control panel messages indicate various conditions of the printer in preparation for, or during, printing. (You can also use the control panel simulator to understand printer messages.)

Startup



The Go (green), Ready (green), and Attention (red) lights cycle one after another.



The buttons have no effect until the printer is ready.

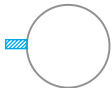

Ready



The Ready (green) light is on and the printer is ready to print.



No action is needed.



Pressing **Go** will print a demo page.

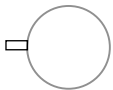



Processing

The printer is receiving or processing data when the Ready (green) light is blinking.

Pressing **JOB CANCEL** cancels the current job. One or two pages may print as the printer clears the print job. The printer will return to the ready state (Ready light on) after the job has been canceled.

Control Panel Error Messages

The following messages indicate that there is a printer error that needs attention. Some error messages will signal a secondary light message that will indicate what type of error is occurring (see Secondary Light Patterns).



Attention

The Attention (red) light is blinking. There are four possible causes that will display the Attention light pattern:

- Paper out
- Door open
- Toner cartridge missing
- Paper jam

After the cause of the problem has been addressed, pressing **Go** will cause the printer to attempt to recover from the cause of the error. If the printer is unsuccessful, it will continue to display the Attention message until the cause is remedied.

Pressing **JOB CANCEL** will cancel the print job and the printer will return to the ready state (Ready light on) unless there is a paper jam still in the printer or the toner cartridge is not in the printer. See [Clearing Paper Jams](#) if it is a paper jam.

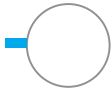

Attention with the Ability to Continue

The Attention (red) light is blinking and the Go (green) light is on. An error has occurred that has caused the printer to halt the current print job. There are three possible causes for the Attention with the Ability to Continue message:

- Manual feed with pause
Press **Go** to print from Tray 1 or from another tray if Tray 1 is empty.
- Paper out (requested tray)
Add paper to the requested tray to cause the printer to start the print job from that tray. Press **Go** to print from another tray.
- Continuable error
Press **Go** to cause the printer to attempt to recover from the error and print whatever data it can. If the attempt to recover from the error is successful, the Ready light will blink while the printer completes the job. If the printer cannot recover, it will display the Attention with the Ability to Continue message.

Press and hold **Go** and **JOB CANCEL** simultaneously to display a secondary light pattern that will indicate the error code corresponding to the current error condition. Release both buttons to display the Attention with the Ability to Continue message. See Continuable Attention Errors.

Pressing **JOB CANCEL** will cancel the print job and the printer will return to the ready state (Ready light on) if the cause of the error has been fixed.

Note

The printer can be configured to automatically recover from an error using the Input Auto Continue settings in the HP LaserJet Device Configuration.

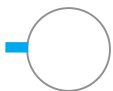

Service Error

All lights are on. An error has occurred that has caused the printer to halt the current print job. Pressing **Go** or **JOB CANCEL** with this message has no effect.

To clear the error, turn the printer off and then on again. If the problem persists, leave the printer off for 15 minutes to reset the formatter. If the problem continues, contact HP Service. See HP Customer Care (Service and Support).

Accessory Error



All of the lights are blinking in unison. An error has occurred with either the EIO port or the DIMM slots, that has caused the printer to halt the current print job. Pressing **GO** or **JOB CANCEL** has no effect.



Press and hold **GO** and **JOB CANCEL** simultaneously to display a secondary light pattern that will indicate the error code corresponding to the current error condition. See Accessory Errors. Release both buttons to display the Accessory Error message.

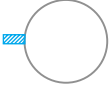

Secondary Light Patterns

Note

You can also use the control panel simulator to understand printer messages.

Continuable Attention Errors

Type of Error	Light Pattern	Recommended Action
---------------	---------------	--------------------

Memory Overflow



The printer memory is full. Press **Go** to resume printing. If you lose some data, try to free some printer memory by removing any unnecessary fonts, macros, or any data currently in printer memory. If you continue to lose data, you may need to add more printer memory. For a temporary solution, simplify the image or print at a 600-dpi resolution.

Temporary Engine Error



The printer has experienced a temporary engine error. Reset the printer by briefly turning the printer off and back on again.

Print Overrun



The print job was too complex for available printer memory. Press **Go** to resume printing. If you lose some data, you may need to add more printer memory. For a temporary solution, simplify the image or print at a 600-dpi resolution.

Continuable Attention Errors (continued)

Type of Error	Light Pattern	Recommended Action
---------------	---------------	--------------------

Bad Connection



The cable between the printer and computer has a bad connection or the cable is of poor quality. Check the cable connections to see if they are secure. Make sure you are using a high-quality cable.

Memory Configuration Error



- Reprint the job.
- Turn the printer off. Press and hold the GO button. Turn the printer on and continue to hold the GO button for approximately five seconds, but no longer than fifteen seconds. The Attention light will come on during this process. Release the Go button. If both the Attention and Ready lights came on before you released the Go button, then you must repeat the procedure.
- Replace DIMMs (memory).
- Contact your HP service representative. See HP Customer Care (Service and Support).

Personality/Job Related Error

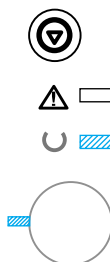

- Turn the printer off. Press and hold the GO button. Turn the printer on and continue to hold the GO button for approximately five seconds, but no longer than fifteen seconds. The Attention light will come on during this process. Release the Go button. If both the Attention and Ready lights came on before you released the Go button, then you must repeat the procedure.
- Remove or replace the language DIMM.
- Contact your HP service representative. See HP Customer Care (Service and Support).

Continuable Attention Errors (continued)

Type of Error	Light Pattern	Recommended Action
---------------	---------------	--------------------

Buffer Flow



- The cable between the printer and computer has a bad connection or the cable is of poor quality. Check the cable connections to see if they are secure. Make sure you are using a high-quality cable.
- Contact your HP service representative. See HP Customer Care (Service and Support).

General
Continuable Error



Contact your HP service representative. See HP Customer Care (Service and Support).

NVRAM Error



The nonvolatile memory (NVRAM) is temporarily full. Press **Go** to clear the message. Check the printer settings to ensure they are correct. If the problem persists, contact your dealer or HP service representative. See HP Customer Care (Service and Support).

Continuable Attention Errors (continued)

Type of Error	Light Pattern	Recommended Action
---------------	---------------	--------------------

IO Error

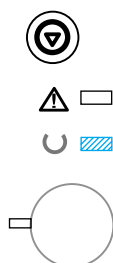



The printer has experienced a temporary EIO error. Reset the printer by turning the printer off and back on again.

Manual Feed Mode



The printer is not configured for print job requirements.
Press **Go** to print from the default paper tray.

Accessory Errors

Type of Error	Light Pattern	Recommended Action
EIO Port Error		Remove the accessory from the EIO Port or DIMM Slot indicated by the error to continue printing.
DIMM Slot 1 Error		Remove the accessory from the EIO Port or DIMM Slot indicated by the error to continue printing.
DIMM Slot 2 Error		Remove the accessory from the EIO Port or DIMM Slot indicated by the error to continue printing.

Network Printing Problems

Note

It is recommended that you use the HP LaserJet 2200 CD to install and setup the printer on a network.

- Print a self test/configuration page (see Self Test/Configuration Page). If an HP JetDirect EIO print server is installed, printing a Configuration page will also print a second page that will show the network settings and status. If these pages do not print in your language, see Printing Special Pages. Verify that all network settings are properly configured. For more information on the JetDirect self test/configuration page, see the HP JetDirect Print Server Administrator's Guide at http://www.hp.com/support/net_printing.
- Try printing the job from another computer.
- To verify if a printer works with a computer, connect it directly to a computer with a parallel or USB cable. Reinstallation of the printing software will be necessary. Print a document from an application that has printed correctly in the past. If this works, then there may be a problem with the network.
- See the HP JetDirect Print Server Administrator's Guide at http://www.hp.com/support/net_printing.
- If the printer's language was not set correctly, see Printing Special Pages.
- Contact your network administrator for assistance.

Common Windows Problems

Common Windows Problems

Symptom	Possible Cause	Solution
Error Message: "Error Writing to LPTx" in Windows 9x.		<p>Make sure that there is paper in the tray.</p> <p>Make sure the cables are connected correctly, the printer is on, and the Ready light is on.</p> <p>Click on Start, Settings, Printers. Right click on the HP LaserJet 2200 driver and select Properties. Click on Details, Port Settings. Remove check from "Check Port State before Printing" box. Click OK. Click on Spool Settings. Select "Print Directly to Printer." Click OK. Try printing again.</p>
Error Message: "General Protection Fault" "Exception OE" "Spool32" "Illegal Operation"		<p>Close all other applications, reboot Windows, and try again.</p> <p>Select a different printer driver. If the HP LaserJet 2200 series PCL 6 driver is selected, switch to a PCL 5e or PS printer driver.</p>

Common Windows Problems (continued)

Symptom	Possible Cause	Solution
Error Message: "General Protection Fault" "Exception OE" "Spool32" "Illegal Operation" (Continued)		Delete all temp files from the Temp sub-directory. You can determine the name of the directory by editing the AUTOEXEC.BAT file and looking for the statement "Set Temp =." The name after this statement is the temp directory. It is usually C:\temp by default, but can be redefined. Refer to Microsoft Windows 3.x, 9x, 2000, NT 4.0, or Millennium documentation that came with your PC for further information on Windows error messages.

Common Macintosh Problems

Macintosh Problems

Symptom	Possible Cause	Solution
Problems in the Chooser		
Printer driver icon does not appear in the Chooser.	Software not installed correctly.	<p>The LaserWriter driver should be present as a part of the Mac OS. Make sure that the LaserWriter driver is in the Extensions folder within the systems folder. If not, install the LaserWriter driver from your Mac OS CD.</p> <p>Make sure you are using a high-quality cable.</p> <p>Make sure the printer is on the correct network. Select the Network or AppleTalk Control Panel from Control Panels in the Apple menu and then choose the correct network.</p>
Printer name does not appear in the "Select a PostScript Printer" box in the Chooser.		<p>Make sure the cables are connected correctly, the printer is on, and the Ready light is on.</p> <p>Make sure the correct printer driver has been selected in the Chooser.</p> <p>If the printer resides on a network with multiple zones, make sure the correct zone is selected in the "AppleTalk Zones" box in the Chooser.</p> <p>Verify that the PS driver is installed.</p>

Macintosh Problems (continued)

Symptom

Possible Cause

Solution

Make sure the printer has been chosen in the Chooser by printing a self-test. (Simultaneously press **Go** and **JOB CANCEL**.) Check the AppleTalk name of the printer displayed on the self-test page.

Make sure AppleTalk is on. (The button next to Active is selected in the Chooser.) You may need to restart the computer to activate the change.

The printer driver does not automatically set up your selected printer even though you clicked Auto Setup in the Chooser.

Reinstall the printer software. See Macintosh Installation.

Select an alternate PPD.

Printing Errors

A print job was not sent to your desired printer.

Another printer with the same or similar name may have received your print job.

Check the AppleTalk name of the printer displayed on the self-test page.

Make sure the cables are connected correctly, the printer is on, and the Ready light is on.

You cannot use the computer while the printer is printing.

Background Printing has not been selected.

LaserWriter 8.3

Turn Background Printing on in the Chooser. Status messages will now be redirected to the Print Monitor allowing you to continue working while the computer is processing data to be sent to the printer.

LaserWriter 8.4 and higher

Turn Background Printing on by selecting File, Print Desktop, and Background Printing.

Macintosh Problems (continued)

Symptom	Possible Cause	Solution
An encapsulated PostScript (EPS) file does not print with the correct fonts.	This problem occurs with some software applications.	Try downloading the fonts contained in the EPS file to the printer before printing. Send the file in ASCII format instead of binary encoding.
Your document is not printing with New York, Geneva, or Monaco fonts.		Select Options in the Page Setup dialog box to deselect substituted fonts.

USB Problems

Unable to print from a third-party USB card.	This error occurs when the software for USB printers is not installed.	When adding a third-party USB card, you might need Apple's USB Adapter Card Support software. The most current version of this software is available from Apple's web site.
--	--	---

Macintosh Problems (continued)

Symptom	Possible Cause	Solution
The HP LaserJet USB printer does not appear in the Macintosh Chooser after the driver is selected.	This problem is caused by either a software or hardware component.	<p>Software troubleshooting</p> <ul style="list-style-type: none">• Check that your Macintosh supports USB.• Verify if your Macintosh has Mac OS 8.1 or later.• Ensure that your Macintosh has the appropriate USB software from Apple. <p>Note: The iMac and Blue G3 desktop Macintosh systems contain all the requirements to connect to a USB device.</p> <p>Hardware troubleshooting</p> <ul style="list-style-type: none">• Check that the printer is turned on.• Verify that the USB cable is properly connected.• Check that you are using the appropriate high-speed USB cable.• Ensure that there are not too many USB devices drawing power from the chain. Disconnect all devices from the chain and connect the cable directly to the USB port on the host computer.• Check to see if there are more than two non-powered USB hubs in a row on the chain. Disconnect all devices from the chain and connect the cable directly to the USB port on the host computer. <p>Note: The iMac keyboard is a non-powered USB hub.</p>

Selecting an Alternate PostScript Printer Description (PPD)

1. Open the Chooser from the Apple menu.
2. Click the LaserWriter icon.
3. If you are on a network with multiple zones, select the zone in the AppleTalk Zones box where the printer is located.
4. Click the printer name you want to use in the Select a PostScript Printer box. (Double-clicking will immediately generate the next few steps.)
5. Click Setup... (This button may read Create for first-time setup.)
6. Click Select PPD....
7. Find the desired PPD in the list and click Select. If the desired PPD is not listed, choose one of the following options:
 - Select a PPD for a printer with similar features.
 - Select a PPD from another folder.
 - Select the generic PPD by clicking Use Generic. The generic PPD allows you to print, but limits your access to printer features.
8. In the Setup dialog box, click Select, and then click OK to return to the Chooser.

Note

If you manually select a PPD, an icon might not appear next to the selected printer in the Select a PostScript Printer box. In the Chooser, click Setup, click Printer Info, and then click Update Info to bring up the icon.

-
9. Close the Chooser.

Renaming the Printer

If you are going to rename the printer, do this before selecting the printer in the Chooser. If you rename the printer after selecting it in the Chooser, you will have to go back into the Chooser and reselect it.

Use the Set Printer Name feature in the HP LaserJet Utility to rename the printer.

Troubleshooting PostScript (PS) Errors

The following situations are PS language specific and may occur when several printer languages are being used.

Note

To receive a printed or screen displayed message when PS errors occur, open the Print Options dialog box and click the desired selection next to the PS Errors section. You can also access this from the Print PS Errors check box in the HP LaserJet Device Configuration.

PS Errors

Symptom	Possible Cause	Solution
The job prints in Courier (the printer's default typeface) instead of the typeface you requested.	The requested typeface is not downloaded. A personality switch may have been performed to print a PCL job just before the PS printing job was received.	Download the desired font and send the print job again. Verify the type and location of the font. Download to printer if applicable. Check with the software documentation.
A legal page prints with clipped margins.	Print job too complex.	You may need to print your job at 600 dots per inch, reduce the complexity of the page, or install more memory.
A PS error page prints.	Print job may not be PS.	Make sure the print job is a PS job. Check to see whether the software application expected a setup or PS header file to be sent to the printer.

PS Errors (continued)

Symptom**Possible Cause****Solution**

Specific Errors

Limit Check Error

Print job too complex.

You may need to print your job at 600 dots per inch, reduce the complexity of the page, or install more memory.

VM Error

Font Error

Select unlimited downloadable fonts from printer driver.

Range Check

Font Error

Select unlimited downloadable fonts from printer driver.

5

Service and Support

Availability

HP provides a variety of service and support options around the world. Availability of these programs will vary depending upon your location.

HP Express Exchange

1. The customer contacts the local HP Customer Care Center listed in the product documentation. A technician troubleshoots the situation and determines whether the printer has actually failed. If so, the technician refers the customer to the HP Service Center.
2. A representative from the service center requests product and customer information. In some countries/regions, collateral may also be requested.
3. HP ships a refurbished replacement unit to arrive the next day. (Geographic distance might prevent next-day shipping.)
4. The customer sends the defective printer to Hewlett-Packard at HP's expense.

Customers with on-site support service provided by HP should work directly with the local HP Customer Care Center instead of following the steps outlined here.

Exchanged units carry the remainder of the original unit's warranty or 90 days, whichever is greater. The faster turnaround from HP Express Exchange minimizes downtime over traditional service programs that require you to ship the failed unit to the manufacturer, and then wait for it to be repaired and returned. Because HP pays the shipping charges, you incur no hidden costs for the service.

Guidelines for Repacking the Printer

- Remove and retain any DIMMs (dual in-line memory modules) installed in the printer.
- Remove and retain any cables and optional accessories installed in the printer.

CAUTION

Static electricity can damage DIMMs. When handling DIMMs, either wear an antistatic wrist strap or frequently touch the surface of the DIMMs' antistatic package, then touch bare metal on the printer. To remove the DIMMs see *Installing Memory*.

- Remove and retain the toner cartridge.

CAUTION

To prevent damage to the toner cartridge, store the cartridge in its original packing material, or store it so that it is not exposed to light.

- Remove and retain the HP JetDirect EIO print server card.
- Use the original shipping container and packing material, if possible. (Shipping damage as a result of inadequate packing is the customer's responsibility.) If you have already disposed of the printer's packing material, contact a local mailing service for information on repacking the printer.
- If possible, include print samples and 50-100 sheets of paper or other media that did not print correctly.
- Include a completed copy of the Service Information Form.
- HP recommends insuring the equipment for shipment.

Service Information Form

WHO IS RETURNING THE EQUIPMENT?		Date: _____
Person to contact:		Phone: () _____
Alternate contact:		Phone: () _____
Return shipping address:	Special shipping instructions:	
WHAT IS BEING SENT?		
Model name:	Model number:	Serial number:
Please attach any relevant printouts when returning equipment. DO NOT ship accessories (manuals, cleaning supplies, etc.) that are not required to complete the repair.		
WHAT NEEDS TO BE DONE? (Attach a separate sheet if necessary.)		
1. Describe the conditions of the failure. (What was the failure? What were you doing when the failure occurred? What software were you running? Is the failure repeatable?)		
2. If the failure is intermittent, how much time elapses between failures?		
3. Is the unit connected to any of the following? (Give manufacturer and model number.)		
Personal computer:	Modem:	Network:
4. Additional comments:		
HOW WILL YOU PAY FOR THE REPAIR?		
<input type="checkbox"/> Under warranty	Purchase/received date: _____ (Enclose proof of purchase or receiving document with original received date.)	
<input type="checkbox"/> Maintenance contract number:	_____	
<input type="checkbox"/> Purchase order number:	_____	
Except for contract and warranty service, a purchase order number and/or authorized signature must accompany any request for service. If standard repair prices do not apply, a minimum purchase order is required. Standard repair prices can be obtained by contacting an HP-authorized Repair Center.		
Authorized signature: _____	Phone: _____	
Billing address:	Special billing instructions:	

HP Maintenance Agreements

HP has several types of maintenance agreements that meet a wide range of support needs. Maintenance agreements are not part of the standard warranty. Support services vary by area. Check with your local HP dealer to determine the services available to you.

On-Site Service Agreements

To provide you with the level of support best suited to your needs, HP has on-site service agreements with three response times:

Priority On-Site Service

This agreement provides 4-hour service response to your site for calls made during normal HP business hours.

Next-Day On-Site Service

This agreement provides support by the next working day following a service request. Extended coverage hours and extended travel beyond HP's designated service zones are available on most on-site agreements (for additional charges).

Weekly (Volume) On-Site Service

This agreement provides scheduled weekly on-site visits for organizations with many HP products. This agreement is designated for sites using 25 or more workstation products, including printers, plotters, computers, and disk drives.

Hewlett-Packard Limited Warranty Statement

HP PRODUCT

HP LaserJet 2200d, 2200dt, 2200dn, 2200dtn,
2200

DURATION OF WARRANTY

1 year, Return to Authorized
Service Center

1. HP warrants to you, the end-user customer, that HP hardware, accessories, and supplies, will be free from defects in materials and workmanship after the date of purchase, for the period specified above. If HP receives notice of such defects during the warranty period, HP will, at its option, either repair or replace products which prove to be defective. Replacement products may be either new or like-new.
2. HP warrants to you that HP software will not fail to execute its programming instructions after the date of purchase, for the period specified above, due to defects in material and workmanship when properly installed and used. If HP receives notice of such defects during the warranty period, HP will replace software media which does not execute its programming instructions due to such defects.
3. HP does not warrant that the operation of HP products will be uninterrupted or error free. If HP is unable, within a reasonable time, to repair or replace any product to a condition as warranted, you will be entitled to a refund of the purchase price upon prompt return of the product.
4. HP products may contain remanufactured parts equivalent to a new in performance or may have been subject to incidental use.
5. Warranty does not apply to defects resulting from (a) improper or inadequate maintenance or calibration, (b) software, interfacing, parts or supplies not supplied by HP, (c) unauthorized modification or misuse, (d) operation outside of the published environmental specifications for the product, or (e) improper site preparation or maintenance.
6. HP MAKES NO OTHER EXPRESS WARRANTY OR CONDITION WHETHER WRITTEN OR ORAL. TO THE EXTENT ALLOWED BY LOCAL LAW, ANY IMPLIED WARRANTY OR CONDITION OR MERCHANTABILITY, SATISFACTORY QUALITY, OR FITNESS FOR A PARTICULAR PURPOSE IS LIMITED TO THE DURATION OF THE EXPRESS WARRANTY SET FORTH ABOVE. Some countries, states or provinces do not allow limitations on the duration of an implied warranty, so the above limitation or exclusion might not apply to you. This warranty gives you specific legal rights and you might also have other rights that vary from country to country, state to state, or province to province.

7. TO THE EXTENT ALLOWED BY LOCAL LAW, THE REMEDIES IN THIS WARRANTY STATEMENT ARE YOUR SOLE AND EXCLUSIVE REMEDIES. EXCEPT AS INDICATED ABOVE, IN NO EVENT WILL HP OR ITS SUPPLIERS BE LIABLE FOR LOSS OF DATA OR FOR DIRECT, SPECIAL, INCIDENTAL, CONSEQUENTIAL (INCLUDING LOST PROFIT OR DATA), OR OTHER DAMAGE, WHETHER BASED IN CONTRACT, TORT, OR OTHERWISE. Some countries, states or provinces do not allow the exclusion or limitation of incidental or consequential damages, so the above limitation or exclusion may not apply to you.
8. FOR CONSUMER TRANSACTIONS IN AUSTRALIA AND NEW ZEALAND; THE WARRANTY TERMS CONTAINED IN THIS STATEMENT, EXCEPT TO THE EXTENT LAWFULLY PERMITTED, DO NOT EXCLUDE, RESTRICT OR MODIFY AND ARE IN ADDITION TO THE MANDATORY STATUTORY RIGHTS APPLICABLE TO THE SALE OF THIS PRODUCT TO YOU.

Limited Warranty for Toner Cartridge Life

Note

The warranty below applies to the toner cartridge that came with this printer.

This warranty supersedes all previous warranties. (7/16/96)

This HP Toner Cartridge is warranted to be free from defects in materials and workmanship for cartridge life until the HP toner is depleted.

Your HP toner is depleted when your printer indicates a toner low message. HP will, at HP's option, either replace products which prove to be defective or refund your purchase price.

The warranty does not cover cartridges which have been refilled, are emptied, abused, misused, or tampered with in any way.

This limited warranty gives you specific legal rights. You may have other rights which vary from state to state, province to province and country to country.

To the extent allowed by applicable law, in no event shall Hewlett-Packard Company be liable for any incidental, consequential, special, indirect, punitive, or exemplary damages or lost profits from any breach of this warranty or otherwise.

A

Specifications

Printer Specifications

	HP LaserJet 2200	HP LaserJet 2200 with Optional Tray 3 (250-sheet)	HP LaserJet 2200 with Optional Tray 3 (500-sheet)
Height	255 mm (10.0 in.)	334 mm (13.2 in.)	395mm (15.6 in.)
Width	405 mm (16.0 in.)	405 mm (16.0 in.)	405 mm (16.0 in.)
Depth (body)	435 mm (17.1 in.)	435 mm (17.1 in.)	435 mm (17.1 in.)
Weight (with toner cartridge)	14.0 kg (29.0 lbs)	17.1 kg (35.9 lbs)	18.7 kg (39.4 lbs)

Electrical Specifications	110-Volt Models	220-Volt Models
Power Requirements	100-127V (+/- 10%) 50/60 Hz (+/- 3 Hz)	220-240V (+/- 10%) 50/60 Hz (+/- 3 Hz)
Minimum recommended circuit capacity for typical product	5.0 Amps	2.5 Amps
Average Power Consumption (Watts) - HP LaserJet 2200 series printers	Printing (18 PPM) = 400 W Standby = 12 W PowerSave = 12 W Off = 0 W	Printing (18 PPM) = 400 W Standby = 12 W PowerSave = 12 W Off = 0 W

PowerSave default activation time is 15 minutes.
Values are subject to change. See <http://www.hp.com/support/lj2200> for current information.

WARNING!

Power requirements are based on the country/region where the printer is sold. Do not convert operating voltages. This may damage the printer and void the product warranty.

Environmental Specifications**Operating Printing****Storage/Standby**

Temperature
(printer and toner cartridge)

15° to 32.5° C
(59° to 89° F)

-20° to 40° C
(-4° to 104° F)

Relative humidity

10% to 80%

10% to 90%

**Acoustic Emissions
(HP LaserJet 2200)****Bystander Position****Declared Per ISO 9296**

Printing (18 PPM)

$L_{pAm} = 51 \text{ dB(A)}$

PowerSave

Essentially inaudible

Sound Power**Declared Per ISO 9296**

Printing (18 PPM)

$L_{WA_d} = 6.6 \text{ bels(A)}$

PowerSave

Essentially inaudible

You may wish to place printers with sound power equal to or greater than 6.3 bels in a separate room or cubicle. Values are subject to change. See <http://www.hp.com/support/lj2200> for current information.

FCC Regulations

This equipment has been tested and found to comply with the limits for a Class B digital device, pursuant to Part 15 of the FCC rules. These limits are designed to provide reasonable protection against harmful interference in a residential installation. This equipment generates, uses, and can radiate radio frequency energy. If this equipment is not installed and used in accordance with the instructions, it may cause harmful interference to radio communications. However, there is no guarantee that interference will not occur in a particular installation; the presence of interference can be determined by turning the equipment off and on. If this equipment does cause harmful interference to radio or television communications, the user is encouraged to try to correct the interference by one or more of the following measures:

- Reorient or relocate the receiving antenna.
- Increase distance between equipment and receiver.
- Connect equipment to an outlet on a circuit different from that to which the receiver is located.
- Consult your dealer or an experienced radio/television technician.

Note

Any changes or modifications to the printer that are not expressly approved by HP could void the user's authority to operate this equipment.

Use of a shielded interface cable is required to comply with the Class B limits of Part 15 of FCC rules.

Environmental Product Stewardship Program

Protecting the Environment

Hewlett-Packard Company is committed to providing quality products in an environmentally sound manner. This product has been designed with several attributes to minimize impacts on our environment.

Ozone Production

This product generates no appreciable ozone gas (O₃).

Energy Consumption

Energy usage drops significantly while in PowerSave mode, which saves natural resources, and saves money without affecting the high performance of this product. This product qualifies for ENERGY STAR, which is a voluntary program established to encourage the development of energy-efficient office products.



ENERGY STAR is a U.S. registered service mark of the U.S. EPA. As an ENERGY STAR partner, Hewlett-Packard Company has determined that this product meets ENERGY STAR Guidelines for energy efficiency. For more information, see <http://www.epa.gov/energystar/>.

Toner Consumption

EconoMode uses significantly less toner, which might extend the life of the toner cartridge with minimal impact to print quality.

Paper Use

This product's duplex feature (two-sided printing) and N-up printing capability (multiple pages printed on one sheet of paper) can reduce paper usage and the resulting demands on natural resources.

Plastics

Plastic parts over 25 grams are marked according to international standards that enhance the ability to identify plastics for recycling purposes at the end of the product's life.

HP LaserJet Printing Supplies



In many countries/regions, this product's printing supplies (for example, toner cartridge, drum, fuser) can be returned to HP through the HP Planet Partners Printing Supplies Environmental Program. An easy-to-use and free takeback program is available in over 25 countries/regions. Multi-lingual program information and instructions are included in every new HP LaserJet Toner Cartridge and Consumables package.

HP Planet Partners Printing Supplies Environmental Program Information

Since 1990, the HP LaserJet Toner Cartridge Recycling Program has collected more than 39 million used LaserJet toner cartridges that otherwise may have been discarded in the world's landfills. The HP LaserJet toner cartridges and consumables are collected and bulk shipped to our resource and recovery partners who disassemble the cartridge. After a thorough quality inspection, selected parts are reclaimed for use in new cartridges. Remaining materials are separated and converted into raw materials for use by other industries to make a variety of useful products.

U.S. Returns

For a more environmentally responsible return of used cartridges and consumables, HP encourages the use of bulk returns. Simply bundle two or more cartridges together and use the single, pre-paid, pre-addressed UPS label that is supplied in the package. For more information in the U.S., call (1) (800) 340-2445 or visit the HP LaserJet Supplies website at <http://www.ljsupplies.com/planetpartners/>.

Non-U.S. Returns

Non-US customers should call the local HP Sales and Service Office or visit http://www.hp.com/ljsupplies/planet_recycle.html for further information regarding availability of the HP Planet Partners LaserJet Toner Cartridge and Consumables Recycling Program.

Paper

This product is capable of using recycled papers, when the paper meets the guidelines outlined in the *HP LaserJet Printer Family Print Media Guide*. See Supplementary Documentation for ordering information. This product is suitable for the use of recycled paper according to DIN 19309.

Material Safety Data Sheet

Material Safety Data Sheets (MSDS) can be obtained from the HP LaserJet Supplies web site at <http://www.hp.com/go/msds>. In the United States, if you do not have access to the internet, call the U.S. HP FIRST (fax-on-demand service) at (1) (800) 231-9300. Use Index number 7 for a listing of the material safety data sheets. Non-U.S. customers should contact HP Customer Care (Service and Support).

Regulatory Statements

Declaration of Conformity

according to ISO/IEC Guide 22 and EN 45014

Manufacturer's Name: Hewlett-Packard Company
Manufacturer's Address: 11311 Chinden Boulevard
Boise, Idaho 83714-1021, USA

declares, that the product

Product Name: HP LaserJet 2200d, 2200dt, 2200dn, 2200dtn, 2200
Model Number: C7058A, C7059A, C7063A, C7061A, C4793A", C7065A**, C7064A
Product Options: ALL

conforms to the following Product Specifications:

Safety: IEC 60950:1991+A1+A2+A3+A4 / EN 60950:1992+A1+A2+A3+A4+A11
IEC 60825-1:1993+A1 / EN 60825-1:1994+A11 (Class 1 Laser/LED Product)

EMC: CISPR 22:1997 / EN 55022:1998 Class B¹
EN 61000-3-2:1995
EN 61000-3-3:1995
EN 55024:1998
FCC Title 47 CFR, Part 15 Class B² / ICES-002, Issue 2
AS / NZS 3548:1995

Supplementary Information:

The product herewith complies with the requirements of the EMC Directive 89/336/EEC and the Low Voltage Directive 73/23/EEC, and carries the CE-marking accordingly.

- 1) The product was tested in a typical configuration with Hewlett-Packard Personal Computer Systems.
- 2) This Device complies with Part 15 of the FCC Rules. Operation is subject to the following two conditions: (1) this device may not cause harmful interference, and (2) this device must accept any interference received, including interference that may cause undesired operation.
- 3) Product exhibits Class A operation when connected to Local Area Network (LAN) cables using print server accessories.

* C4793A is the Optional 250-sheet Input Tray.

** C7065A is the Optional 500-sheet Input Tray.

**Boise, Idaho USA
April 6, 2000**

For regulatory topics only:

Australia Contact: Product Regulations Manager, Hewlett-Packard Australia Ltd., 31-41 Joseph Street, Blackburn, Victoria 3130, Australia

European Contact: Your Local Hewlett-Packard Sales and Service Office or Hewlett-Packard GmbH, Department HQ-TRE / Standards Europe, Herrenberger Straße 110-140, D-71034 Böblingen (FAX: +49-7031-14-3143)

USA Contact: Product Regulations Manager, Hewlett-Packard Company, PO Box 15, Mail Stop 160, Boise, ID 83707-0015 (Phone: 208-396-6000)

Laser Safety Statement

The Center for Devices and Radiological Health (CDRH) of the U.S. Food and Drug Administration has implemented regulations for laser products manufactured since August 1, 1976. Compliance is mandatory for products marketed in the United States. The printer is certified as a “Class 1” laser product under the U.S. Department of Health and Human Services (DHHS) Radiation Performance Standard according to the Radiation Control for Health and Safety Act of 1968.

Since radiation emitted inside the printer is completely confined within protective housings and external covers, the laser beam cannot escape during any phase of normal user operation.

WARNING!

Using controls, making adjustments, or performing procedures other than those specified in this user guide may result in exposure to hazardous radiation.

Canadian DOC Regulations

Complies with Canadian EMC Class B requirements.

«Conforme à la classe B des normes canadiennes de compatibilité électromagnétiques «CEM».»

LED Safety

The infrared port on the front panel of this printer is classified as a Class 1 LED (Light Emitting Diode) device according to International Standard IEC 60825-1 (EN 60825-1). This device is not considered harmful, but the following precautions are recommended.

- If the printer requires service, contact an authorized HP service center.
- Do not attempt to make any adjustments of the printer.
- Avoid direct eye exposure to the infrared LED beam.
- Be aware that the beam is invisible light and cannot be seen.
- Do not attempt to view the infrared LED beam with any type of optical device.

VCCI Statement (Japan)

この装置は、情報処理装置等電波障害自主規制協議会（VCCI）の基準に基づくクラスB情報技術装置です。この装置は、家庭環境で使用することを目的としていますが、この装置がラジオやテレビジョン受信機に近接して使用されると、受信障害を引き起こすことがあります。
取り扱い説明書に従って正しい取り扱いをして下さい。

Korean EMI Statement

사용자 안내문 (B 급 기기)

이 기기는 비업무용으로 전자파장해검정을 받은 기기로서, 주거지역에서는 물론 모든 지역에서 사용할 수 있습니다.

Laser Statement for Finland

LASERTURVALLISUUS

LUOKAN 1 LASERLAITE

KLASS 1 LASER APPARAT

HP LaserJet 2200 -laserkirjoitin on käyttäjän kannalta turvallinen luokan 1 laserlaite. Normaalisissa käytössä kirjoittimen suojakotelointi estää lasersäteen pääsyn laitteen ulkopuolelle.

Laitteen turvallisuusluokka on määritetty standardin EN 60825-1 (1993) mukaisesti.

VAROITUS!

Laitteen käyttäminen muulla kuin käyttöohjeessa mainitulla tavalla saattaa altistaa käyttäjän turvallisuusluokan 1 ylittävälle näkymättömälle lasersäteilylle.

VARNING!

Om apparaten används på annat sätt än i bruksanvisning specificerats, kan användaren utsättas för osynlig laserstrålning, som överskrider gränsen för laserklass 1.

HUOLTO

HP LaserJet 2200 -kirjoittimen sisällä ei ole käyttäjän huollettavissa olevia kohteita. Laitteen saa avata ja huoltaa ainoastaan sen huoltamiseen koulutettu henkilö. Tällaiseksi huoltotoimenpiteeksi ei katsota väriainekasetin vaihtamista, paperiradan puhdistusta tai muita käyttäjän käsikirjassa lueteltuja, käyttäjän tehtäväksi tarkoitettuja ylläpitotoimia, jotka voidaan suorittaa ilman erikoistyökaluja.

VARO!

Mikäli kirjoittimen suojakotelo avataan, olet alttiina näkymättömälle lasersäteilylle laitteen ollessa toiminnassa. Älä katso säteeseen.

VARNING!

Om laserprinterns skyddshölje öppnas då apparaten är i funktion, utsättas användaren för osynlig laserstrålning. Betrakta ej strålen.

Tiedot laitteessa käytettävän laserdiodin säteilyominaisuuksista:

Aallonpituus 770-795 nm

Teho 5 mW

Luokan 3B laser

B

Media Specifications

Overview

This printer accepts a variety of media, such as cut-sheet paper (including up to 100% recycled fiber content paper), envelopes, labels, transparencies, and custom-size paper. Properties such as weight, composition, grain, and moisture content are important factors affecting printer performance and output quality. Paper that does not meet the guidelines outlined in this manual can cause the following problems:

- Poor print quality.
- Increased paper jams.
- Premature wear on the printer, requiring repair.

Note

Some paper may meet all of the guidelines in this manual and still not produce satisfactory results. This might be the result of improper handling, unacceptable temperature and humidity levels, or other variables over which Hewlett-Packard has no control.

Before purchasing large quantities of paper, make sure the paper meets the requirements specified in this user guide and in the *HP LaserJet Printer Family Print Media Guide*. (For ordering information, see Supplementary Documentation). Always test paper before buying large quantities.

CAUTION

Using paper that does not meet HP specifications may cause problems for the printer, requiring repair. This repair is not covered by the Hewlett-Packard warranty or service agreements.

Supported Sizes of Paper

Tray 1	Dimensions ^a	Weight	Capacity ^b
Minimum Size (custom)	76 by 127 mm (3 by 5 in.)	60 to 163 g/m ² (16 to 43 lb)	100 sheets of 80 g/m ² (20 lb) paper
Maximum Size (custom)	216 by 356 mm (8.5 by 14 in.)		
Transparency	Same as minimum and maximum paper sizes listed above.	Thickness: .10 to .14 mm (0.0039 to 0.0055 in.)	75 typical
Labels ^c		Thickness: .10 to .14 mm (0.0039 to 0.0055 in.)	50 typical
Envelopes		Up to 90 g/m ² (16-24 lb)	up to 10

a. The printer supports a wide range of media sizes. Check the printer software for supported sizes. See Printing on Custom-Sized Media or Cardstock.

b. Capacity may vary depending on media weight and thickness, and environmental conditions.

c. Smoothness - 100 to 250 (Sheffield).

Note

You may experience some paper jams when using any media with a length less than 178 mm (7 in.). This may be caused by paper that has been affected by environmental conditions. For optimum performance, make sure you are storing and handling the paper correctly (see Printing and Paper Storage Environment).

Tray 2 or Tray 3 (250-sheet tray)	Dimensions^a	Weight	Capacity^b
Letter	216 by 279 mm (8.5 by 11 in.)	60 to 105 g/m ² (16 to 28 lb)	250 sheets of 80 g/m ² (20 lb) paper
A4	210 by 297 mm (8.3 by 11.7 in.)		
Executive	191 by 267 mm (7.3 by 10.5 in.)		
Legal	216 by 356 mm (8.5 by 14 in.)		
B5 (ISO)	176 by 250 mm (6.9 by 9.9 in.)		
B5 (JIS)	182 by 257 mm (7.2 by 10 in.)		
A5	148 by 210 mm (5.8 by 8.3 in.)		
8.5 x 13 in.	216 by 330 mm (8.5 by 13 in.)		

- a. The printer supports a wide range of media sizes. See [Printing on Custom-Sized Media or Cardstock](#).
b. Capacity may vary depending on media weight and thickness, and environmental conditions.

Tray 3 (500- sheet tray)	Dimensions^a	Weight	Capacity^b
Letter	216 by 279 mm (8.5 by 11 in.)	60 to 105 g/m ² (16 to 28 lb)	500 sheets of 80 g/m ² (20 lb) paper
A4	210 by 297 mm (8.3 by 11.7 in.)		

- a. The printer supports a wide range of media sizes. See [Printing on Custom-Sized Media or Cardstock](#).
b. Capacity may vary depending on media weight and thickness, and environmental conditions.

Automatic Duplexer	Dimensions^a	Weight
Letter	216 by 279 mm (8.5 by 11 in.)	60 to 105 g/m ² (16 to 28 lb Bond)
A4	210 by 297 mm (8.3 by 11.7 in.)	
Legal	216 by 356 mm (8.5 by 14 in.)	
8.5 x 13 in.	216 by 330 mm (8.5 by 13 in.)	

a. The printer supports a wide range of media sizes. See [Printing on Custom-Sized Media or Cardstock](#).

Guidelines for Using Paper

For best results, make sure the paper is of good quality, and free of cuts, nicks, tears, spots, loose particles, dust, wrinkles, voids, and curled or bent edges.

If you are unsure what type of paper you are loading (such as bond or recycled), check the label on the package of paper.

The following problems with paper cause print quality deviations, jamming, or even damage to the printer.

Symptom	Problem with Paper	Solution
Poor print quality or toner adhesion Problems with feeding	Too moist, too rough, too heavy, too smooth, or embossed; faulty paper lot	Try another kind of paper, between 100-250 Sheffield, 4-6% moisture content
Dropouts, jamming, curl	Stored improperly Side-to-side variability of paper	Store paper flat in its moisture-proof wrapping Turn paper over
Excessive curl problems with feeding	Too moist, wrong grain direction or short-grain construction Side-to-side variability of paper	Open the rear output bin Use long-grain paper Turn paper over
Jamming, damage to printer	Cutouts or perforations	Do not use paper with cutouts or perforations
Problems with feeding	Ragged edges Side-to-side variability of paper	Use good quality paper Turn paper over

Note

Do not use letterhead paper that is printed with low-temperature inks, such as those used in some types of thermography.

Do not use raised or embossed letterhead.

The printer uses heat and pressure to fuse toner to the paper. Make sure that any colored paper or preprinted forms use inks that are compatible with this fusing temperature (200° C or 392° F for 0.1 second).

Paper Specifications

Category	Specifications
Acid Content	5.5 pH to 8.0 pH
Caliper	.094-.18 mm (3.0-7.0 mils)
Curl in Ream	Flat within 5 mm (.02 in.)
Cut Edge Conditions	Cut with sharp blades with no visible fray.
Fusing Compatibility	Must not scorch, melt, offset, or release hazardous emissions when heated to 200° C (392° F) for .1 second.
Grain	Long Grain
Moisture Content	4% to 6% by weight
Smoothness	100-250 Sheffield

For complete paper specifications for all HP LaserJet printers, see the *HP LaserJet Printer Family Print Media Guide*. For ordering information, see Supplementary Documentation.

Printing and Paper Storage Environment

Ideally, the printing and paper storage environment should be at or near room temperature, and not too dry or too humid. Remember paper is hygroscopic; it absorbs and loses moisture rapidly.

Heat works with humidity to damage paper. Heat causes the moisture in paper to evaporate, while cold causes it to condense on the sheets. Heating systems and air conditioners remove most of the humidity from a room. As paper is opened and used, it loses moisture, causing streaks and smudging. Humid weather or water coolers can cause the humidity to increase in a room. As paper is opened and used it absorbs any excess moisture, causing light print and dropouts. Also, as paper loses and gains moisture it can distort. This can cause paper jams.

As a result, paper storage and handling are as important as the paper-making process itself. Paper storage environmental conditions directly affect the feed operation.

Care should be taken not to purchase more paper than can be easily used in a short time (about 3 months). Paper stored for long periods may experience heat and moisture extremes, which can cause damage. Planning is important to prevent damage to a large supply of paper.

Unopened paper in sealed reams can remain stable for several months before use. Opened packages of paper have more potential for environmental damage, especially if they are not wrapped with a moisture-proof barrier.

The paper storage environment should be properly maintained to ensure optimum printer performance. The required condition is 20° to 24° C (68° to 75° F), with a relative humidity of 45% to 55%. The following guidelines should be helpful when evaluating the paper's storage environment:

- Paper should be stored at or near room temperature.
- The air should not be too dry or too humid (due to the hygroscopic properties of paper).
- The best way to store an opened ream of paper is to rewrap it tightly in its moisture-proof wrapping. If the printer environment is subject to extremes, unwrap only the amount of paper to be used during the day's operation to prevent unwanted moisture changes.

Envelopes

Envelope construction is critical. Envelope fold lines can vary considerably, not only between manufacturers, but also within a box from the same manufacturer. Successful printing on envelopes depends upon the quality of the envelopes. When selecting envelopes, consider the following components:

- **Weight:** The weight of the envelope paper should not exceed 105 g/m² (24 lb) or jamming may occur.
- **Construction:** Prior to printing, envelopes should lie flat with less than 6 mm (0.25 in.) curl, and should not contain air.
- **Condition:** Envelopes should not be wrinkled, nicked, or otherwise damaged.
- **Temperature:** You should use envelopes that are compatible with the heat and pressure of the printer.
- **Size:** You should use only envelopes within the following size ranges.

	Minimum	Maximum
Tray 1	76 by 127 mm (3 by 5 in.)	216 by 356 mm (8.5 by 14 in.)

Note

Use only Tray 1 to print envelopes.

You may experience some paper jams when using any media with a length less than 178 mm (7 in.). This may be caused by paper that has been affected by environmental conditions. For optimum performance, make sure you are storing and handling the paper correctly (see [Printing and Paper Storage Environment](#)).

In the printer driver select Optimize for: and choose envelopes in the drop-down box (see [Optimizing for Media Types](#)). For non-Windows operating systems, this feature is also available in HP Web JetAdmin.

Envelopes with Double Side Seams

Double side-seam construction has vertical seams at both ends of the envelope rather than diagonal seams. This style may be more likely to wrinkle. Be sure the seam extends all the way to the corner of the envelope as illustrated below.

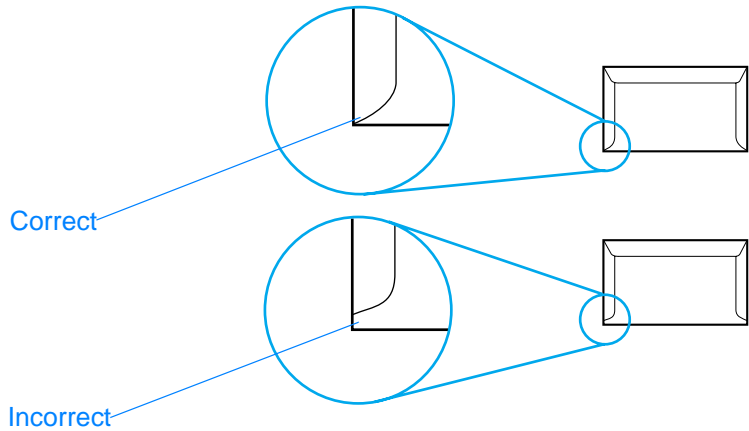

Envelopes with Adhesive Strips or Flaps

Envelopes with a peel-off adhesive strip or with more than one flap that folds over to seal must use adhesives compatible with the heat and pressure in the printer. The extra flaps and strips might cause wrinkling, creasing, or even jams and may even damage the fuser.

Envelope Margins

The following gives typical address margins for a commercial #10 or DL envelope.

Type of Address	Top Margin	Left Margin
Return address	15 mm (0.6 in.)	15 mm (0.6 in.)
Delivery address	51 mm (2 in.)	89 mm (3.5 in.)

Note

For the best print quality, position margins no closer than 15 mm (0.6 in.) from the edges of the envelope.

Avoid printing over the area where the envelope's seams meet.

Envelope Storage

Proper storage of envelopes helps contribute to print quality. Envelopes should be stored flat. If air is trapped in an envelope, creating an air bubble, then the envelope may wrinkle during printing.

For more information, see [Printing on Envelopes](#).

Labels

CAUTION

To avoid damaging the printer, use only labels recommended for laser printers

To prevent serious jams, always use Tray 1 to print labels and always use the rear output bin.

Never print on the same sheet of labels more than once or print on a partial sheet of labels.

Label Construction

When selecting labels, consider the quality of each component:

- **Adhesives:** The adhesive material should be stable at 200° C (392° F), the printer's fusing temperature.
- **Arrangement:** Only use labels with no exposed backing between them. Labels can peel off sheets with spaces between the labels, causing serious jams.
- **Curl:** Prior to printing, labels must lie flat with no more than 13 mm (.5 in.) of curl in any direction.
- **Condition:** Do not use labels with wrinkles, bubbles, or other indications of separation.

For more information, see [Printing on Labels](#).

Note

In the printer driver select Optimize for: and choose labels in the drop-down box (see [Optimizing for Media Types](#)). For non-Windows operating systems, this feature is also available in [HP Web JetAdmin](#).

Transparencies

Transparencies used in the printer must be able to withstand 200° C (392° F), the printer's fusing temperature.

CAUTION

To avoid damaging the printer, use only transparencies recommended for use in HP LaserJet printers, such as HP-brand transparencies. (For ordering information, see HP LaserJet Transparency.)

For more information, see [Printing on Transparencies](#).

Note

In the printer driver select **Optimize for:** and choose transparencies in the drop-down box (see [Optimizing for Media Types](#)). For non-Windows operating systems, this feature is also available in HP Web JetAdmin.

C

Printer Memory and Expansion

Overview

- Printer Memory
- Installing Memory
- Checking Memory Installation
- Installing an HP JetDirect EIO Card

Printer Memory

The printer has two dual in-line memory module (DIMM) slots for upgrading with:

- More printer memory. DIMMs are available in 4, 8, 16, and 32 MB for a maximum of 72 MB.
- DIMM-based accessory fonts, macros, and patterns.
- Other DIMM-based printer languages and printer options.

For ordering information, see [Accessories and Ordering Information](#).

Note

Single in-line memory modules (SIMMs) used on previous HP LaserJet printers are not compatible with the printer.

You may want to add more memory to the printer if you often print complex graphics or PS documents, or use many downloaded fonts. To find out how much memory is installed in the printer, print a self test/configuration page by pressing [Go](#) and [JOB CANCEL](#) while the printer is in the ready state (Ready light on).

Installing Memory

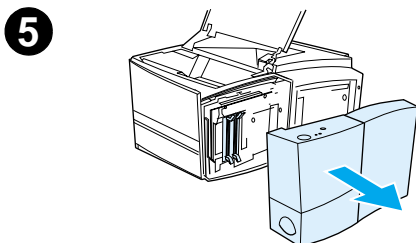
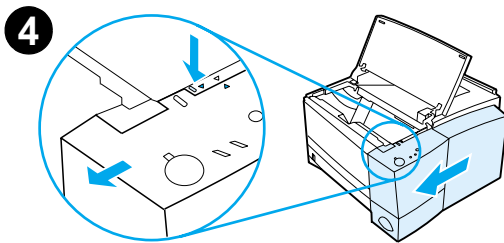
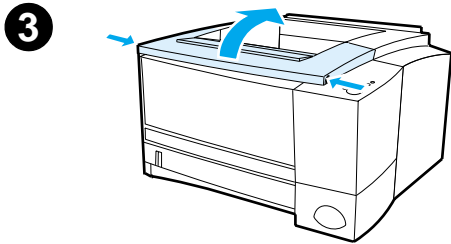
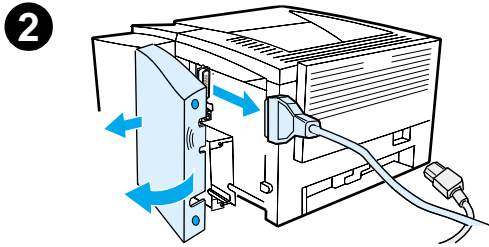
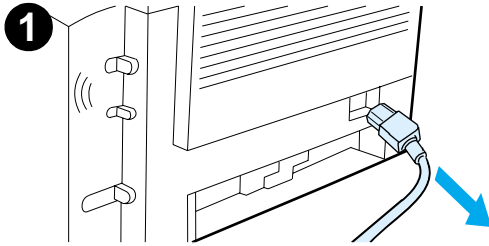

CAUTION

Static electricity can damage dual in-line memory modules (DIMMs). When handling DIMMs, either wear an antistatic wrist strap or frequently touch the surface of the DIMMs' antistatic package, then touch bare metal on the printer.

If you have not already done so, print a self test/configuration page to find out how much memory is installed in the printer before adding more memory. See Self Test/Configuration Page.

Note

If the self test/configuration page does not print in your language, see Printing Special Pages.

- 1 After the self test/configuration page is printed, turn the printer off and disconnect the power cord.
- 2 Open the interface cable door by pressing on the release tabs and swinging the door outward. Disconnect all interface cables.
- 3 Open the top cover.
- 4 Press the release button and slide the right side panel forward until the alignment arrows line up.
- 5 Pull the panel away from the printer, exposing the available DIMM slots.

Continued on the next page.

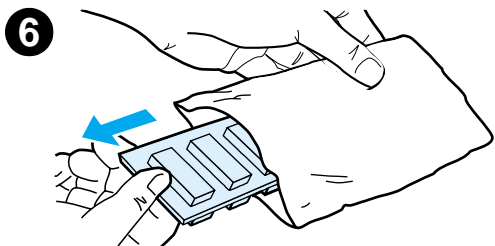

6 Remove the DIMM from the antistatic package.

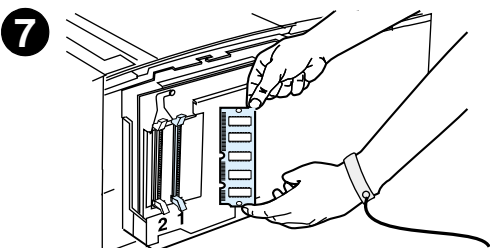

7 Holding the DIMM by the edges (as shown in the illustration), align the notches on the DIMM with the DIMM slot. (Check that the locks on each side of the DIMM slot are open.)

Note

For best results use DIMM slots in 1-2 order.

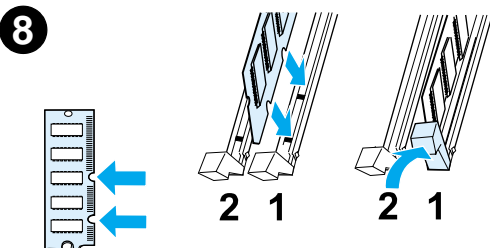

8 Press the DIMM straight into the slot (press firmly). Make sure the locks on each side of the DIMM snap inward into place. (To remove a DIMM, the locks must be released.)

Repeat steps 6, 7, and 8 for each DIMM being installed.

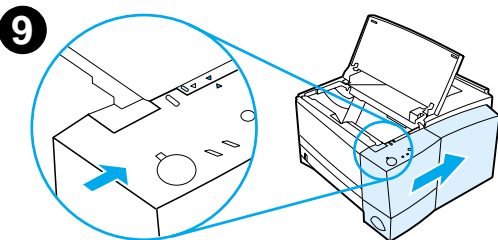

9 To replace the side panel, line up the alignment arrows and slide the panel backwards until the release button latches into place. Close the top cover.

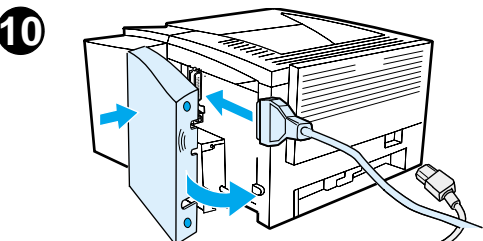

10 Reinstall the interface cable(s) and power cord. Turn the printer on.

Checking Memory Installation

To verify that DIMMs are installed correctly:

1. Turn the printer on. Check that the printer control panel displays the Ready light after the printer has gone through the startup sequence. If an error message appears, a DIMM may have been incorrectly installed. See Troubleshooting Control Panel Messages.
2. Print a self test/configuration page by pressing **Go** and **JOB CANCEL** simultaneously.
3. Check the Installed Personalities and Options section on the self test/configuration page and compare it with the self test/configuration page printed before the DIMM installation.

If the amount of recognized memory has not increased:

- The DIMM may not be installed correctly (repeat the installation procedure).
- Try another DIMM slot.
- The DIMM may be defective (try a new DIMM).

Installing an HP JetDirect EIO Card

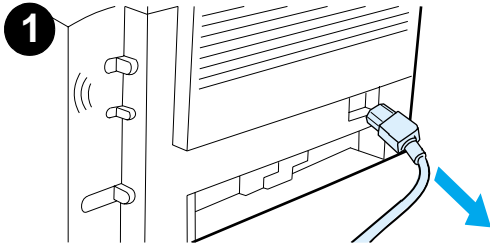

1 Turn the printer off, and disconnect the power cord.

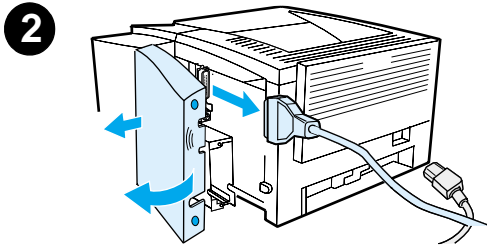

2 Open the interface cable door by pressing on the release tabs and swinging the door outward. Disconnect all interface cables.

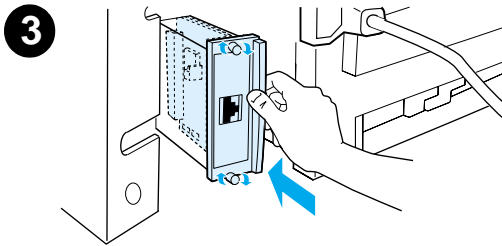

3 Locate the EIO slot. Firmly insert the HP JetDirect EIO card into the EIO slot. Twist in the retaining screws.

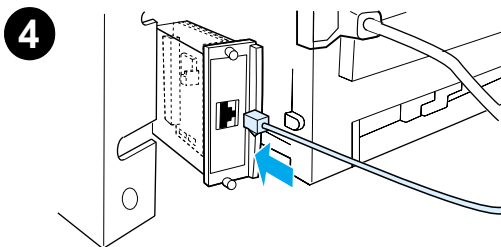

4 Attach the appropriate network cable to the EIO card.

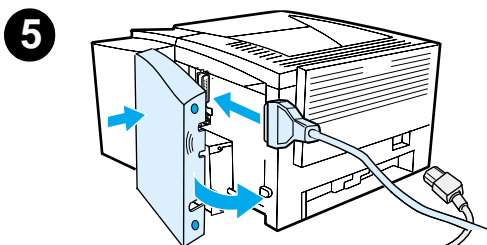

5 Reinstall the interface cable(s) and the power cord. Reinstall the interface cable door. Turn the printer on.

Note

Print a self test/configuration page to check that the HP JetDirect EIO card appears as an installed option. See [Self Test/Configuration Page](#). If this page does not print in your language, see [Printing Special Pages](#).

When you print a self test/configuration page, an HP JetDirect Configuration page that contains network configuration and status information will also print.

D Printer Commands

Overview

Most software applications do not require you to enter printer commands. See your computer and software documentation to find the method for entering printer commands, if needed.

PCL

PCL printer commands tell the printer which tasks to perform or which fonts to use. This appendix provides a quick reference for users who are already familiar with PCL command structure.

The PCL 5e printer commands are backward-compatible with previous versions of PCL.

The PCL 6 printer commands take full advantage of the printer's features.

HP-GL/2

The printer has the ability to print vector graphics using the HP-GL/2 graphics language. Printing in the HP-GL/2 language requires that the printer leave PCL language and enter HP-GL/2 mode, which can be done by sending the proper PCL codes. Some software applications switch languages through their drivers.

PJL

HP's Printer Job Language (PJL) provides control above PCL and other printer languages. The four major functions provided by PJL are:

- printer language switching
- job separation
- printer configuration
- status readback from the printer

PJL commands may be used to change printer default settings.

Note

The table at the end of this appendix contains commonly used PCL 5e commands.

Understanding PCL Printer Command Syntax

Before using printer commands, compare these characters:

Lowercase l:	<i>l</i>	Uppercase O:	O
Number one:	1	Number 0:	0

Many printer commands use the lowercase letter l (*l*) and the number one (1), or the uppercase letter O (O) and the number zero (0). These characters may not appear on your screen as shown here. You must use the exact character and case specified for PCL printer commands.

The following illustration displays the elements of a typical printer command (in this instance, a command for page orientation).

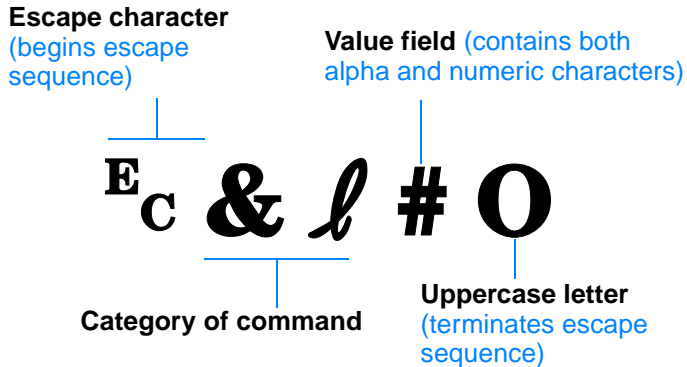

Combining Escape Sequences

Escape sequences may be combined into one escape sequence string. There are three important rules to follow when combining code:

1. For each escape sequence, the first two characters after the E_c character must be the same.
2. When combining escape sequences, change the uppercase (termination) character in each individual escape sequence to lowercase.
3. The final character of the combined escape sequence must be uppercase.

The following escape sequence string would be sent to the printer to select legal paper, landscape orientation, and 8 lines per inch:

```
 $\text{E}_c\&l3A\text{E}_c\&l1O\text{E}_c\&l8D$ 
```

The following escape sequence sends the same printer commands by combining them into a shorter sequence:

```
 $\text{E}_c\&l3a1o8D$ 
```

Entering Escape Characters

Printer commands always begin with the escape character (E_c).

The following table shows how the escape character can be entered from various DOS software applications.

DOS Software Application	Entry	What Appears
Lotus 1-2-3	Type \027	Ø27
WordPerfect for DOS	Type <27>	<27>
MS-DOS Edit	Hold down Ctrl-P, and press Esc	..
MS-DOS Edlin	Hold down Ctrl-V, release, then press [^[

Selecting PCL Fonts

PCL printer commands for selecting fonts can be found on the PCL Font List which can be printed from the HP LaserJet Device Configuration (Windows) or the HP LaserJet utility (Macintosh). A sample section is shown below. Notice the two variable boxes for symbol set and point size:

```
Univers Medium      Scale      <esc>( [ ] <esc>(s1p [ ] v0s0b4148T
```

These variables must be filled in or the printer will use defaults. For example, if you want a symbol set that contains line-draw characters, select the 10U (PC-8) or 12U (PC-850) symbol set. Other common symbol set codes are listed in the Common PCL Printer Commands table.

Note

Fonts are either “fixed” or “proportional” in spacing. The printer contains both fixed fonts (Courier, Letter Gothic, and Lineprinter) and proportional fonts (CG Times, Arial®, Times New Roman®, and others).

Fixed-spaced fonts are generally used in applications such as spreadsheets and databases, where it is important for columns to line up vertically. Proportional-spaced fonts are generally used in text and word processing applications.

Common PCL Printer Commands

Function	Command	Options (#)
----------	---------	-------------

Job Control Commands

Reset	ESC E	n/a
Number of Copies	ESC & l #X	1 to 999

Common PCL Printer Commands (continued)

Function	Command	Options (#)
----------	---------	-------------

Page Control Commands

Paper Source	$\text{E}_C\&l \#H$	0 = prints or ejects current page 1 = Tray 2 2 = manual feed, paper 3 = manual feed, envelope 4 = Tray 1 5 = Tray 3 7 = auto select
Paper Size	$\text{E}_C\&l \#A$	1 = Executive 2 = Letter 3 = Legal 4 = A5 5 = A4 6 = B5-JIS 8 = 8.5 X 13 9 = B5 (ISO) 71 = Postcard (single size) 72 = Postcard (round trip) 80 = Monarch 81 = Commercial 10 90 = DL 91 = International C5 100 = B5 101 = Custom
Orientation	$\text{E}_C\&l \#O$	0 = Portrait 1 = Landscape 2 = Reverse Portrait 3 = Reverse Landscape
Top Margin	$\text{E}_C\&l \#E$	# = number of lines
Text Length (bottom margin)	$\text{E}_C\&l \#F$	# = number of lines from top margin
Left Margin	$\text{E}_C\&a \#L$	# = column number
Right Margin	$\text{E}_C\&a \#M$	# = column number from left margin
Horizontal Motion Index	$\text{E}_C\&k\#H$	1/120-inch increments (compresses print horizontally)

Common PCL Printer Commands (continued)

Function	Command	Options (#)
Vertical Motion Index	$\text{E}_C \& \ell \#C$	1/48-inch increments (compresses print vertically)
Line Spacing	$\text{E}_C \& \ell \#D$	# = lines per inch (1, 2, 3, 4, 5, 6, 12, 16, 24, 48)
Perforation Skip	$\text{E}_C \& \ell \#L$	0 = disable 1 = enable

Cursor Positioning

Vertical Position (Rows)	$\text{E}_C \& a \#R$	# = row number
Vertical Position (Dots)	$\text{E}_C^* p \#Y$	# = dot number (300 dots = 1 inch)
Vertical Position (Decipoints)	$\text{E}_C \& a \#V$	# = decipoint number (720 decipoints = 1 inch)
Horizontal Position (Columns)	$\text{E}_C \& a \#C$	# = column number
Horizontal Position (Dots)	$\text{E}_C^* p \#X$	# = dot number (300 dots = 1 inch)
Horizontal Position (Decipoints)	$\text{E}_C \& a \#H$	# = decipoint number (720 decipoints = 1 inch)

Programming Hints

End of Line Wrap	$\text{E}_C \& s \#C$	0 = Enable 1 = Disable
Display Functions On	$\text{E}_C Y$	n/a
Display Functions Off	$\text{E}_C Z$	n/a

Common PCL Printer Commands (continued)

Function	Command	Options (#)
----------	---------	-------------

Language Selection

Enter PCL Mode	$\text{E}_C\%#A$	0 = Use previous PCL cursor position 1 = Use current HP-GL/2 pen position
Enter HP-GL/2 Mode	$\text{E}_C\%#B$	0 = Use previous HP-GL/2 pen position 1 = Use current PCL cursor position

Font Selection

Symbol Sets	$\text{E}_C(\#$	8U = HP Roman-8 Symbol Set 10U = IBM Layout (PC-8) (code page 437) Default Symbol Set 12U = IBM Layout for Europe (PC-850) (code page 850) 8M = Math-8 19U = Windows 3.1 Latin 1 9E = Windows 3.1 Latin 2 (commonly used in Eastern Europe) 5T = Windows 3.1 Latin 5 (commonly used in Turkey) 579L = Wingdings Font
Primary Spacing	$\text{E}_C(\text{s}\#P$	0 = fixed 1 = proportional
Primary Pitch	$\text{E}_C(\text{s}\#H$	# = characters/inch
Set Pitch Mode ^a	$\text{E}_C\&\text{k}\#S$	0 = 10 4 = 12 (elite) 2 = 16.5 - 16.7 (compressed)
Primary Height	$\text{E}_C(\text{s}\#V$	# = points
Primary Style	$\text{E}_C(\text{s}\#S$	0 = upright (solid) 1 = italic 4 = condensed 5 = condensed italic

Common PCL Printer Commands (continued)

Function	Command	Options (#)
Primary Stroke Wt.	$\text{E}_C(\text{s}\#B$	0 = medium (book or text) 1 = semi bold 3 = bold 4 = extra bold
Typeface ^a	$\text{E}_C(\text{s}\#T$	Print a PCL font list to view the command for each internal font.

a. The preferred method is to use the primary pitch command.

Index

Numerics

- 2-sided printing (duplexing) 46
- 3x5 cards
 - printing 45

A

- accessing the printer driver 52
- accessories 26
 - ordering 26–28
- acoustic emissions 120
- additional drivers, obtaining 5
- automatic duplexing 46

B

- background shading on page 87
- basics, printer 1–25
- built-in duplexer 46
- buttons 22
- buying paper 32

C

- canceling a print job 51
- cardstock 45
- characters improperly formed 88
- checking memory installation 145
- choosing driver 12
- cleaners
 - using on printer 65
- cleaning
 - engine 65
 - exterior 65
- cleaning process 77
- clearing paper jams 78
- commands, printer 147–155
 - escape sequences 150
 - selecting PCL fonts 151
 - syntax 149–150
- compact disc 5
- configuration page 77
- control panel 22
 - basic messages 92
 - buttons 22
 - error messages 93
 - light patterns 92
 - locking 15
 - simulator 13
 - status messages 92
 - troubleshooting 92

- custom sized paper 45
- Customer Care iii
- customer support iii

D

- demo page 77
- DIMM
 - checking installed memory 145
 - installing expansion 143
 - ordering 26
 - upgrading 142
- documentation, supplementary
 - ordering 28, 29
- double-sided printing 46
- drivers
 - OEM setup, See Readme on installation disk.
 - setup 13
- drivers, printer
 - help software 12
 - selecting 12
 - switching languages 12
- dropouts 86
- duplex 46
- duplexer 46
- duplexing
 - 2-sided printing 46
 - automatic 46
 - manual 46
 - paper jams 83

E

- EconoMode 55
- energy savings 4
- Energy Star 122
- envelopes
 - orientation 41
 - printing on 41
 - specifications 136
- environment 122
- error messages 92
- escape sequences 150

F

- font list 77
- fonts, selecting PCL 151

G

- Go button 22
- graphics, vector 147

H

- help
 - online 12
 - printer driver 12
 - software 12
- Help button, in printer driver 12
- help screens 12
- HP Customer Care iii
- HP LaserJet Device Configuration 13
 - features 58
 - how to access 58
- HP LaserJet Utility 58
 - for Macintosh 15
 - how to access 58
- HP Printer Job Language 148
- HP Web JetAdmin 18
- HP-GL/2 commands 147

I

- image defect examples 85
- image defects
 - background shading 87
 - dropouts 86
 - improperly formed characters 88
 - repetitive defects (vertical) 88
 - toner smearing on page 87
 - vertical lines on page 87
 - wavy characters 88
- index cards
 - printing on 45
- infrared port
 - printing with 24
- installing printer memory 143, 145
- interface ports 25
- internal cleaning procedure 67

J

- Job Cancel button 22

L

- label
 - orientation 43
- labels
 - specifications 139
- language switching 4
- languages
 - switching 12
- Laser Writer driver 15
- LaserJet Utility 15
- latest drivers, obtaining 5
- letterhead
 - printing on 49
- light locations 22
- locking control panel 15

M

- Macintosh
 - printer drivers 15
 - printing errors 105
 - selecting alternate PPD 108
 - software for 15
 - troubleshooting 104
- maintenance
 - printer 61
- manual duplexing 46
- media input options 33
- media sizes
 - Optional 500-Sheet Tray 3 35
 - Tray 1 33
 - Tray 2 34
- media specifications 129
- memory
 - checking installation 145
 - expanding 143, 145
 - installing 143, 145
 - ordering 26
 - upgrading printer's 142
- memory features 4
- MS Windows 3.1, 95, or NT
 - help 12
- MSDS 124

N

- network issues
 - troubleshooting 101
- N-up printing 54

O

- online help 12
- overhead transparencies
 - printing on 44
 - specifications 140

P

- paper 129
 - 3x5 cards 45
 - custom sized 45
 - guidelines 133
 - loading 36–39
 - postcards 45
 - purchasing 32
 - size specifications 130
- paper handling accessories
 - ordering 27
- paper handling features 3
- paper jam
 - areas 78
 - causes 78
 - duplexer area 83
 - output areas 82
 - paper feed areas 81
 - toner cartridge area 79
- paper selection
 - default 33
- paper sizes
 - maximum 33
 - minimum 33
- paper width guide
 - Tray 1 36
- part numbers 26
- PCL
 - commands 147–155
 - selecting fonts 151
 - syntax 149–150
- PCL 5e drivers
 - function 12
- PCL 6 drivers
 - function 12
- PCL language features 3
- PJL commands 148
- postcards
 - printing 45
- PowerSave 122
- PPDs
 - Macintosh 15
 - selecting alternate 108
- print defects
 - vertical on page 88
- print quality features 3
- print quality problems 84
- print speed 3
- printer
 - accessories 26
 - basics 1–25
 - checking installed memory 145
 - cleaning 65
 - commands 147–155
 - drivers 12
 - drivers, Macintosh 15
 - help software 12
 - installing memory 143, 145
 - maintenance 61
 - memory 143
 - redistributing toner 63
 - renaming 108
 - repacking 112
 - selecting drivers 12
 - service 111
 - software 5
 - syntax for commands 149–150
 - upgrading memory 142
- printer drivers
 - accessing 52
 - help software 12
 - windows 12
- printer features 3
- Printer Page Description Files, see PPDs
- printing
 - canceling print job 51
 - duplexing 46
 - envelopes 41
 - forms 49
 - labels 43
 - letterhead 49
 - multiple pages on one sheet 54
 - postcards 45
 - quality guidelines 133
 - stopping print job 51
 - transparencies 44
 - with low toner 63
- printing languages 12
- printing problems
 - troubleshooting 72
- problem solving checklist 70
- Product Stewardship 122–124
 - memory 143
 - memory expansion 145
- paper
 - recycled paper 129
 - specifications 134
- product return 111
- warranty
 - standard 115–116

Q

- quality, printer
 - toner cartridge 63
- quality, printing
 - guidelines for 133

R

- redistributing toner 63
- renaming the printer 108
- repacking the printer 112

S

- selecting
 - alternate PPD 108
- self-test page, see configuration page 77
- service agreements 114
- Setup
 - driver only 13
- software
 - help for drivers 12
 - HP LaserJet Utility for Macintosh 15
 - included with printer 5
 - Macintosh 15
 - Macintosh printer drivers 15
 - Web JetAdmin 18
 - Windows 12
- special pages
 - cleaning process 77
 - configuration page 77
 - demo page 77
 - font list 77
- specifications
 - envelopes 136
 - labels 139
 - media size 130
 - transparencies 140
- Status Messages
 - Accessory error 95
 - Attention 93
 - Continuable error 94
 - Paper out 93
 - processing 93
 - Ready 92
 - Service error 94
 - Startup 92
- status messages 92
- stopping a print job 51
- supplementary documentation
 - ordering 28, 29
- supplies
 - ordering 26–28
- support iii, 111
- switching printer languages 12

T

- technical support iii
- toner cartridge 62
 - ordering 26
 - recycling 62
 - warranty 117
- toner smearing on page 87
- transfer roller 65
- transparencies
 - printing on 44
 - specifications 140
- Tray 1
 - capacity 36
 - loading 36
 - media sizes and types 33, 130
 - opening 36
- Tray 2
 - media sizes 34, 35, 131
- Tray 3 (250-sheet tray)
 - media sizes 131
- Tray 3 (500-sheet tray)
 - media sizes 131
- tray locking 59
- tray, optional
 - media sizes 131
- troubleshooting
 - control panel lights 92
 - control panel simulator 13
 - error messages 92
 - general printing problems 72
 - Macintosh printing problems 104
 - PS problems 109
 - Windows problems 102
- troubleshooting checklist 70
- two-sided printing 46

V

- vector graphics 147
- vertical lines on page 87

W

- warranty
 - printer 115
 - toner cartridge 117
- wavy characters 88
- Web JetAdmin 18
- web servers, supported 18
- Windows
 - help 12
- wireless printing
 - background information 23
 - problem solving 90



i n v e n t

copyright © 2001
Hewlett-Packard Company

www.hp.com/support/lj2200

english



C7058-90956