

**hp** LaserJet 4100



i n v e n t

**user guide**





# HP LaserJet 4100, 4100N, 4100TN, and 4100DTN Printers



## User Guide



© Copyright Hewlett-Packard Company 2002

All Rights Reserved.

Except as allowed by copyright laws or herein, reproduction, adaptation, or translation without prior written permission is prohibited.

A user of the Hewlett-Packard printer associated with this user guide is granted a license to (a) print hard copies of this user guide for personal, internal, or company use subject to the restriction not to sell, re-sell or otherwise distribute the hard copies; and (b) place an electronic copy of this user guide on a network server provided access to the electronic copy is limited to personal, internal users of the Hewlett-Packard printer associated with this user guide.

The information contained in this document is subject to change without notice.

Fourth Edition, May 2003

### Trademark Credits

Adobe and PostScript are trademarks of Adobe Systems Incorporated which may be registered in certain jurisdictions.

Arial and Times New Roman are U.S. registered trademarks of the Monotype Corporation.

AutoCAD is a U.S. trademark of Autodesk, Inc.

ENERGY STAR is a U.S. registered service mark of the U.S. EPA.

HP-UX Release 10.20 and later and HP-UX Release 11.00 and later on all HP 9000 computers are Open Group UNIX products.

Microsoft and MS-DOS are registered trademarks of Microsoft Corporation.

TrueType is a U.S. trademark of Apple Computer, Inc.

UNIX is a registered trademark of the Open Group.



# Contents



## About this guide 9

How to use this online user guide . . . . .	9
Navigational features in this guide . . . . .	9
Features of Acrobat Reader . . . . .	10
Where to look for more information . . . . .	13
Setting up the printer . . . . .	13
Using the printer . . . . .	14



## 1 Printer basics

Overview . . . . .	15
Printer features and benefits . . . . .	16
Printer configurations . . . . .	18
Printer parts and locations . . . . .	19
Accessories and supplies . . . . .	21
Ordering information . . . . .	22
Items and part numbers . . . . .	22
Ordering through service or support providers . . . . .	22
Ordering directly through the embedded web server . . . . .	22
Ordering directly through the printer software . . . . .	23
Control panel layout . . . . .	29
Control panel . . . . .	29
Control panel lights . . . . .	29
Control panel keys . . . . .	30
Using the printer online help system . . . . .	31
Control panel menus . . . . .	32
Printer software . . . . .	33
Software provided . . . . .	33
Printer drivers . . . . .	35
Software for Windows-based computers . . . . .	36
Software for Macintosh computers . . . . .	40
Software for networks . . . . .	41



## 2 Printing tasks

Overview . . . . .	43
Selecting the output bin . . . . .	44
Printing to the top output bin . . . . .	44
Printing to the rear output bin . . . . .	45
Loading tray 1 . . . . .	46
Loading trays 2, 3, and 4 . . . . .	47
Printing both sides of paper (optional duplexer) . . . . .	49
Guidelines for printing both sides of paper . . . . .	50
Placement for paper requiring a specific orientation . . . . .	51
Layout options for printing both sides of paper . . . . .	52
Printing special paper . . . . .	53
Printing small or narrow paper . . . . .	53
Printing letterhead, prepunched, or preprinted paper (single-sided) . . . . .	53
Printing envelopes . . . . .	55
Printing labels . . . . .	61
Printing transparencies . . . . .	62
Printing cards, custom-size, and heavy paper . . . . .	63
Advanced printing tasks . . . . .	65
Using features in the printer driver . . . . .	65
Customizing what tray is used for printing . . . . .	68
Job retention features . . . . .	72
Quick copying a job . . . . .	72
Proofing and holding a job . . . . .	74
Printing a private job . . . . .	76
Storing a print job . . . . .	78
Printing a stored job . . . . .	78
Deleting a stored job . . . . .	79
Printing with the optional HP Fast InfraRed Receiver . . . . .	80
Setting up to print with Windows 9x . . . . .	80
Setting up to print with Macintosh computers . . . . .	80
Printing a job . . . . .	81
Interrupting and resuming printing . . . . .	82



## 3 Printer maintenance

Overview . . . . .	83
Managing the toner cartridge . . . . .	84
HP toner cartridges . . . . .	84
Non-HP toner cartridges . . . . .	84
Toner cartridge authentication . . . . .	84
Toner cartridge storage . . . . .	85
Toner cartridge life expectancy . . . . .	85
Checking the toner level . . . . .	85
Cartridge interaction (shaking) . . . . .	86
Toner low and toner out conditions . . . . .	87



Cleaning the printer . . . . .	88
General guidelines . . . . .	88
Cleaning procedure. . . . .	89
Cleaning the fuser . . . . .	91
Running the cleaning page manually . . . . .	91
Running the cleaning page automatically . . . . .	92
Performing preventative maintenance. . . . .	93
Configuring alerts . . . . .	94



## 4 Problem solving

Overview . . . . .	95
Clearing paper jams . . . . .	96
Paper jam locations . . . . .	97
Clearing jams from the top cover and toner cartridge areas. . . . .	98
Clearing jams from the optional envelope feeder . . . . .	100
Clearing jams from the input tray areas . . . . .	102
Clearing jams from the optional duplexer . . . . .	104
Clearing jams from the output areas. . . . .	106
Clearing jams from the fuser area. . . . .	107
Solving repeated paper jams . . . . .	110
Understanding printer messages . . . . .	111
Mopy disk error messages . . . . .	126
Correcting output quality problems . . . . .	128
Light print (partial page) . . . . .	130
Light print (entire page). . . . .	130
Specks . . . . .	130
Dropouts . . . . .	131
Lines . . . . .	131
Gray background . . . . .	132
Toner smear . . . . .	132
Loose toner. . . . .	133
Repeating defects. . . . .	133
Repeating image. . . . .	134
Misformed characters . . . . .	134
Page skew . . . . .	134
Curl or wave . . . . .	135
Wrinkles or creases . . . . .	135
Vertical white lines . . . . .	135
Tire tracks . . . . .	136
White spots on black. . . . .	136
Determining printer problems . . . . .	137
Troubleshooting flowchart. . . . .	137
Troubleshooting flowchart for Macintosh users . . . . .	143
Troubleshooting the optional printer hard disk accessory. . . . .	146
Troubleshooting PS. . . . .	147
Troubleshooting optional HP Fast InfraRed Receiver problems . . . . .	148



Communicating with an optional HP JetDirect print server . . . . .	150
Checking the printer configuration. . . . .	151
Menu map . . . . .	151
Configuration page . . . . .	152
Supplies status page. . . . .	154
PCL or PS font list. . . . .	156



## 5 Service and support



HP Customer Care Service and Support . . . . .	157
Online services . . . . .	157
HP fraud hotline . . . . .	161
Customer support options worldwide . . . . .	162
HP Customer Care Center and product repair assistance for the U.S. and Canada . . . . .	162
European HP Customer Care Center language and in-country options available. . . . .	163
In-country/region support numbers. . . . .	164
Warranty information. . . . .	165
Guidelines for repacking the printer . . . . .	165
Service information form . . . . .	166
Hewlett-Packard limited warranty statement . . . . .	167
Limited warranty for toner cartridge life. . . . .	169
HP software license terms. . . . .	170
Worldwide country/region sales and service offices . . . . .	172



## Appendix A Specifications

Overview . . . . .	187
Paper specifications . . . . .	188
Supported sizes and weights of paper . . . . .	189
Supported types of paper . . . . .	192
Guidelines for using paper . . . . .	192
Labels . . . . .	196
Transparencies. . . . .	196
Envelopes . . . . .	197
Card stock and heavy paper. . . . .	198
Printer specifications . . . . .	200
Physical dimensions . . . . .	200
Environmental specifications . . . . .	201
Product compatibility matrix . . . . .	203





## Appendix B Control panel menus

Overview . . . . .	205
Control panel menu map . . . . .	205
Quick Copy Jobs Menu . . . . .	206
Private/Stored Jobs Menu . . . . .	207
Information Menu . . . . .	208
Paper Handling Menu . . . . .	210
Printing Menu . . . . .	213
Print Quality Menu . . . . .	217
Configuration Menu . . . . .	219
I/O Menu . . . . .	222
Resets Menu . . . . .	223
EIO Menu . . . . .	225



## Appendix C Printer memory and expansion

Overview . . . . .	229
Installing memory . . . . .	230
Checking memory installation . . . . .	232
Saving resources (permanent resources) . . . . .	232
Installing EIO cards/mass storage . . . . .	233

## Appendix D Printer commands

Overview . . . . .	235
Understanding PCL 5e printer command syntax . . . . .	236
Combining escape sequences . . . . .	237
Entering escape characters . . . . .	237
Selecting PCL 5e fonts . . . . .	238
Common PCL 5e printer commands . . . . .	239

## Appendix E Regulatory information

FCC regulations . . . . .	243
Environmental product stewardship program . . . . .	244
Protecting the environment . . . . .	244
Material safety data sheets . . . . .	246
Safety statements . . . . .	248
Laser safety statement . . . . .	248
Canadian DOC regulations . . . . .	248
EMI statement (Korea) . . . . .	248
VCCI statement (Japan) . . . . .	248
Laser statement for Finland . . . . .	249



## Appendix F Embedded web server

Overview . . . . .	251
Accessing the embedded web server . . . . .	252
Embedded web server pages . . . . .	252
Home pages . . . . .	253
Device pages . . . . .	253
Network pages . . . . .	254



## Index



# About this guide



## How to use this online user guide

This user guide is provided in an Adobe™ Acrobat portable document format (PDF file). This section will help familiarize you with using PDF documents.

## Navigational features in this guide



Click the Table of Contents icon to go to the table of contents for the online user guide. The entries are linked to their related locations in the user guide.



Click the Introduction icon to return to this section for tips on using this online user guide.



Click the Index icon to go to the index for the online user guide. The index entries are linked to their related topics.



Click the Up Arrow icon to go to the previous page.



Click the Down Arrow icon to go to the next page.



# Features of Acrobat Reader

## Finding information in PDF documents

To find specific information in a PDF document, click **Contents** or **Index** in the upper-left corner of the Acrobat Reader window, and then click the topic you want.



## Viewing PDF documents

For complete instructions on how to view PDF documents, see the online help included with Acrobat Reader.

## Magnifying the Page View

You can use the zoom-in tool, the magnification box in the status bar, or the toolbar buttons to change the screen magnification. When you zoom in on a document, you can use the hand tool to move the page around.

Acrobat Reader also offers magnification level choices that control how the page fits on-screen:



**Fit Page** scales the page to fit within the main window.

**Fit Width** scales the page to fit the width of the main window.

**Fit Visible** fills the window with the page's content area only.



**To increase magnification:** Select the zoom-in tool and click on the document page to double the current magnification.

**To decrease magnification:** Select the zoom-in tool while holding down Ctrl (Windows and UNIX<sup>®</sup>) or Option (Macintosh), and click the center of the area you want to reduce.



## Paging through a document

The following options are available for paging through a document.

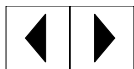

**To go to the next page:** Click the Next Page button in the toolbar, or press the Right Arrow or Down Arrow.



**To return to the previous page:** Click the Previous Page button in the toolbar, or press the Left Arrow or Up Arrow.

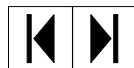

**To go to the first page:** Click the First Page button in the toolbar.



**To go to the last page:** Click the Last Page button in the toolbar.



**To jump to a specific numbered page:** Click the page number box in the status bar at the bottom of the main window, type the page number, and click **OK**.

## Browsing with thumbnails

A thumbnail is a miniature view of each document page. You can display thumbnails in the overview area. Use a thumbnail to jump quickly to a page and to adjust the view of the current page.



Click on a thumbnail to move to the page it represents.

## Finding words

Use the **Find** command to find part of a word, a complete word, or multiple words in the active document.



Click on the Find button, or choose **Find** from the **Tools** menu.

## Printing the document

**To print selected pages:** From the **File** menu, choose **Print**. Choose **Pages**. In the From and To boxes type the range of pages you wish to print. Then click **OK**.



**To print the whole document:** From the **File** menu, choose **Print**. Choose **All n pages** ( $n$  represents the total number of pages in the document), then click **OK**.

---

**Note**

---

Go to <http://www.adobe.com/> for the latest versions and additional languages of Adobe™ Acrobat Reader.



# Where to look for more information

Several references are available for use with this printer. Additional information is available at <http://www.hp.com/support/lj4100>.



## Setting up the printer

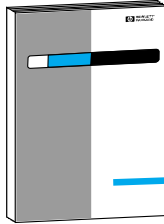

### Getting Started Guide

Information for setting up your printer (Getting Started), as well as tips and quick information for using the printer (Quick Reference). For additional copies, contact HP DIRECT at (800) 538-8787 (U.S.) or contact your HP-authorized dealer.



### HP JetDirect Print Server Administrator's Guide

Information for configuring and troubleshooting the HP JetDirect print server, available on the CD that came with the printer.



# Using the printer

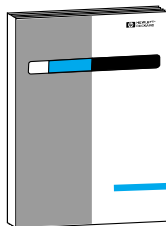

## Getting Started Guide

Information for setting up your printer (Getting Started), as well as tips and quick information for using the printer (Quick Reference). For additional copies, contact HP DIRECT at (800) 538-8787 (U.S.) or contact your HP-authorized dealer.



## Online Help

Information on printer options that are available from within printer drivers. To view a help file, access the online help through the printer driver.

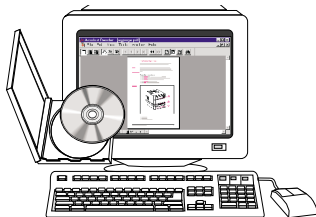

## HP Fast InfraRed Receiver User Guide

Information on using and troubleshooting the HP Fast InfraRed Receiver.

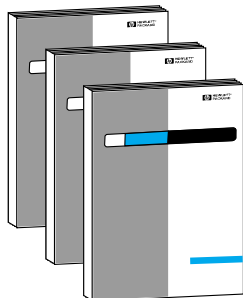

## Accessory guides

Instructions for installing and using accessories or toner cartridges, included with the accessory.





# 1 Printer basics



## Overview

Congratulations on your purchase of an HP LaserJet 4100 series printer. If you have not done so, see the getting started guide provided with the printer for setup instructions.

Now that the printer is set up and ready to use, take a few moments to get to know the printer. This chapter introduces the following:

- features and benefits of the printer
- important printer parts and locations
- accessories and supplies available for the printer
- the layout and basic operation of the printer control panel
- helpful printer software for increased printing flexibility



# Printer features and benefits

## Speed and throughput

- instant-on fuser prints the first page in 12 seconds
- prints letter-size paper at 25 pages per minute (ppm) or A4-size paper at 24 ppm
- “RIP ONCE” capability with 32 MB or hard disk options



## Resolution

- FastRes 1200—produces 1200-dpi print quality for fast, high-quality printing of business text and graphics
- ProRes 1200—produces 1200-dpi printing for best quality of graphic images
- HP UltraPrecise toner for crisp, sharp output



## Paper handling

- HP LaserJet 4100 and 4100N: hold 600 sheets of paper
- HP LaserJet 4100TN and 4100DTN: hold 1100 sheets of paper
- expandable to hold up to 1600 sheets of paper with optional accessories
- prints a wide range of sizes, types, and weights

## Language and fonts

- HP PCL 6, PCL 5e, and PostScript™ Level 2 emulation
- 80 fonts for Microsoft® Windows

## Toner cartridge

- supplies status page with toner gauge, page count, and information on paper sizes used
- no-shake cartridge design
- check for authentic HP toner cartridges



## Expandable design

- optional paper handling accessories:
  - stackable 500-sheet paper trays (up to two additional trays)
  - power envelope feeder (holds up to 75 envelopes)
  - duplex printing accessory (for two-sided printing)
- flash storage (for forms, fonts, and signatures)
- expandable memory (up to 256 MB)
- two EIO slots for connecting to networks or additional devices
- HP JetSend enabled
- hard disk (for job retention)



# Printer configurations

This printer is available in four configurations:

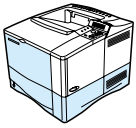

## HP LaserJet 4100

- 16 MB RAM
- 100-sheet paper tray
- 500-sheet paper tray

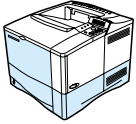

## HP LaserJet 4100N

- 32 MB RAM
- HP JetDirect 10/100Base-TX print server card for network connection
- 100-sheet paper tray
- 500-sheet paper tray

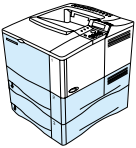

## HP LaserJet 4100TN

- 32 MB RAM
- HP JetDirect 10/100Base-TX print server card for network connection
- 100-sheet paper tray
- two 500-sheet paper trays

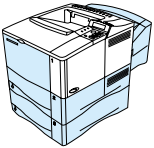

## HP LaserJet 4100DTN

- 32 MB RAM
- HP JetDirect 10/100Base-TX print server card for network connection
- 100-sheet paper tray
- two 500-sheet paper trays
- duplex printing accessory (duplexer)



# Printer parts and locations

## Printer parts (front view, HP LaserJet 4100/4100N printer)

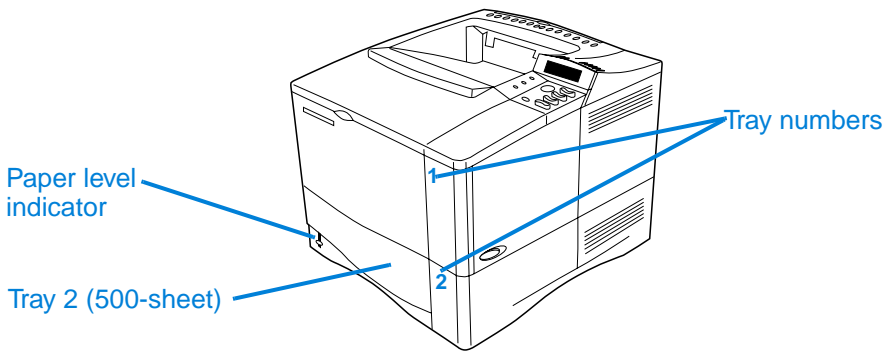
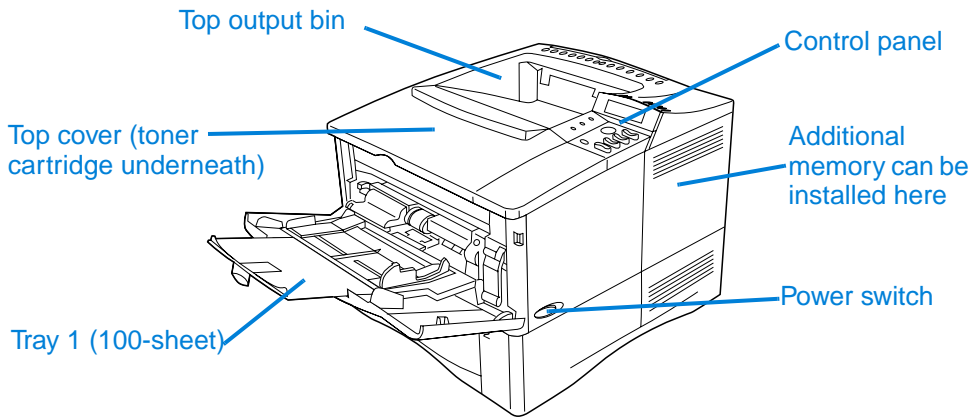

## Printer parts (back view)

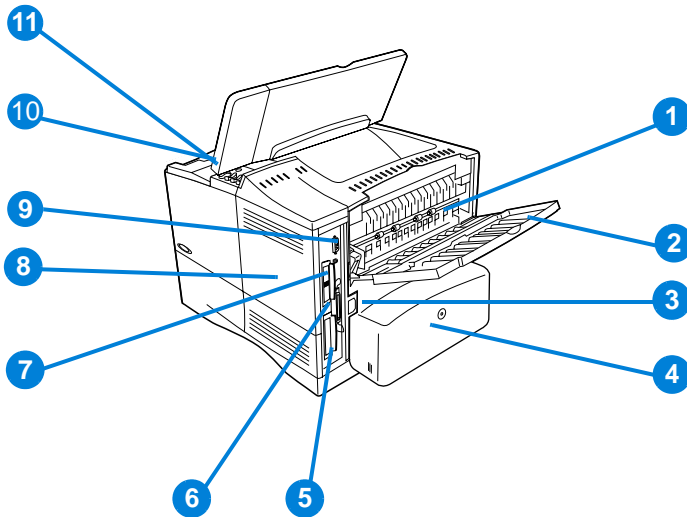

- 1 Fuser (can be removed to clear paper jams)
- 2 Rear output bin (straight-through paper path)
- 3 Power connector
- 4 Dust cover (tray 2 dust cover not installed if duplexer is installed)
- 5 Parallel interface port
- 6 Enhanced I/O (EIO) slots
- 7 Fast InfraRed (FIR) port for an optional FIR receiver
- 8 Memory access door (more than one DIMM can be installed)
- 9 Accessory interface port
- 10 Serial and model numbers (under top cover)
- 11 Toner cartridge access (under top cover)



# Accessories and supplies

You can increase the capabilities of the printer with optional accessories and supplies, as shown below. See “Ordering information” on page 22.

## Note

Use accessories and supplies specifically designed for the printer to ensure optimum performance.

The printer supports two enhanced input/output (EIO) cards. One of the card slots is already used in the HP LaserJet 4100N/4100TN/4100DTN for the HP JetDirect 10/100Base-TX print server card.

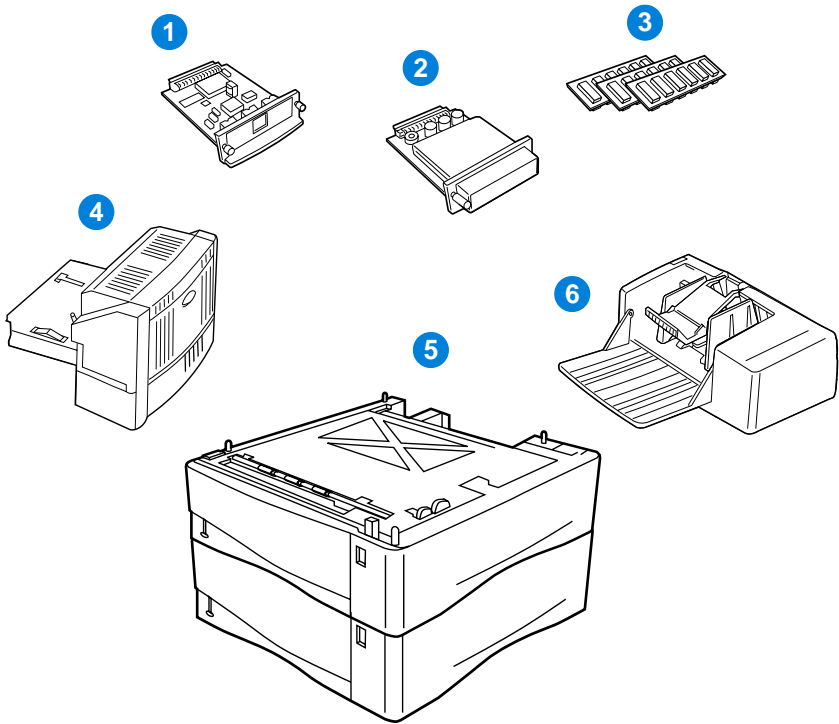

- 1 HP JetDirect print server (EIO card)
- 2 Hard disk accessory (EIO card)
- 3 Memory DIMM, flash DIMM, or font DIMM
- 4 Duplex printing accessory (duplexer), for 2-sided printing
- 5 Stackable 500-sheet paper tray (maximum of two, as shown here, for a total input capacity of 1,600 sheets)
- 6 Envelope feeder



# Ordering information

## Items and part numbers

Use only parts and accessories specifically designed for this printer. See the table ahead, which is organized according to type of accessory:

- paper handling
- memory, fonts, and mass storage
- hardware
- cables and interfaces
- documentation
- maintenance
- printing supplies

See “Product compatibility matrix” on page 203 for information on the compatibility of accessories for the HP LaserJet 4000, 4050, and 4100 Series printers.

## Ordering through service or support providers

To order a part or accessory, contact an HP-authorized service or support provider (see “HP direct ordering for accessories or supplies” on page 160, “HP direct ordering for genuine HP parts” on page 160, or “HP authorized resellers and support” on page 160).

## Ordering directly through the embedded web server

Use the following steps to order printing supplies directly through the embedded web server (see “Accessing the embedded web server” on page 252 for an explanation of this feature).

- 1 In your web browser, enter the IP address for the printer home page. This takes you to the printer status page.
- 2 Click the **Device** tab at the top of the screen.
- 3 If asked to provide a password, enter the password.





- 4 On the left side of the Device Configuration page, double-click **Order Supplies**. This provides a URL from which to purchase consumables. Supplies information with part numbers and printer information is provided.
- 5 Select the part numbers you wish to order and follow the instructions on the screen.



## Ordering directly through the printer software



The printer software gives you the ability to order parts and accessories directly from your computer. Three things are required to use this feature:



- the “Supplies Information and Ordering” software must be installed on your computer (use the custom installation option to install this software)
  - the printer must be directly connected to your computer (parallel)
  - you must have access to the World Wide Web
- 1 At the bottom right of your screen (in the system tray), click the Printer icon. This opens the status window.
  - 2 On the left side of the status window, click the Printer icon from which you wish to obtain status.
  - 3 At the top of the status window, click **Supplies** link. You can also scroll down to Supplies Status.
  - 4 Click **Order Supplies**. This opens a browser that produces a URL from which to purchase consumables.
  - 5 Select the supplies you wish to order.



## Paper handling

Item	Part number	Description or use
500-sheet feeder and paper tray	C8055A	Stackable paper feeder and 500-sheet paper tray.
Envelope feeder	C8053A	Automatically feeds up to 75 envelopes.
Duplex printing accessory (duplexer)	C8054A	Allows automatic printing on both sides of paper.
Replacement 500-sheet paper tray (without the feeder)	C8056A	Supports multiple paper sizes and custom sizes (see “Supported sizes and weights of paper - trays 2, 3, and 4” on page 190).



## Memory, fonts, and mass storage

Item	Part number	Description or use
SDRAM DIMM (Dual In-line Memory Module)		Boosts the ability of the printer to handle large print jobs (maximum 256 MB with HP-brand DIMMs).
4 MB	C4140A	
8 MB	C4141A	
16 MB	C4142A	
32 MB	C4143A	
64 MB	C3913A	
128 MB	C9121A	
Flash DIMM		Permanent storage for fonts and forms.
2 MB	C4286A	
4 MB	C4287A	
Font DIMM		8-MB Asian MROM.
Korean	D4838A	
Simplified Chinese	C4293A	
Traditional Chinese	C4292A	
EIO hard disk	C2985B	Permanent storage for fonts and forms. Also used for making multiple original prints and Job Retention features.



## Hardware

Item	Part number	Description or use
FIR receiver	C4103A	Fast InfraRed Receiver.



## Cables and interfaces

Item	Part number	Description or use
Parallel cables		
2-meter IEEE-1284 cable	C2950A	
3-meter IEEE-1284 cable	C2951A	
Macintosh computer serial cable	92215S	For connecting to a Macintosh computer.
Macintosh network cable kit	92215N	For connecting to PhoneNET or LocalTalk.
Enhanced I/O (EIO) cards		HP JetDirect EIO internal print server network cards.
Token Ring networks	J4167A	
Fast Ethernet (10/100Base-TX single RJ-45 port)	J4169A	
HP JetDirect Connectivity card (EIO) for USB, Serial, LocalTalk	J4135A	



## Documentation

Item	Part number	Description or use
<i>HP LaserJet Printer Family Paper Specification Guide</i>	5963-7863	A guide to using paper and other print media with HP LaserJet printers (English only).
HP LaserJet 4100 Software and User Documentation CD-ROM		An additional copy of the software and user documentation CD.
Americas/Western Europe	C8049-60104	
Europe	C8049-60105	
Asia Pacific	C8049-60106	
<i>Getting Started Guide</i>	C8049-90903	Printed copy of the getting started guide for the HP LaserJet 4100, 4100N, 4100TN, and 4100DTN printers (English only).



## Maintenance

Item	Part number	Description or use
Printer maintenance kit		User-replaceable parts and instructions for printer maintenance.
110 V printer kit	C8057A	
220 V printer kit	C8058A	



## Printing supplies

Item	Part number	Description or use
<b>Toner cartridges</b>		
6,000 pages	C8061A	Replacement HP UltraPrecise toner cartridge.
10,000 pages	C8061X	
<b>HP LaserJet Paper</b>		
Letter (8.5 by 11 in), 500 sheets/ream, 10-ream carton	HPJ1124	For use with HP Color LaserJet printers and HP LaserJet monochrome printers. Good for letterhead, high-value memos, legal documents, direct mail, and correspondence. Specifications: 96 bright, 24 lb.
Letter (8.5 by 11 in), 200 sheets/ream, 12-ream carton	HPJ200C	
Letter (8.5 by 11 in), 3-hole, 500 sheets/ream, 10-ream carton	HPJ113H	
Legal (8.5 by 14 in), 500 sheets/ream, 10-ream carton	HPJ1424	
A4 (216 by 279 mm), 500 sheets/ream, 5-ream carton	CHP310	
<b>HP LaserJet Soft Gloss Paper</b>		
Letter (8.5 by 11 in), 50 sheets/box	C4179A	For use with HP Color LaserJet printers and HP LaserJet monochrome printers. Coated paper, good for business documents with high impact, such as brochures, sales material, and documents with graphics and photographic images. Specifications: 32 lb.
A4 (216 by 279 mm), 50 sheets/box	C4179B	
<b>HP LaserJet Transparency</b>		
Letter (8.5 by 11 in), 50 sheets/box	92296T	For use with HP LaserJet monochrome printers. Specifications: 4.3 mil thickness.
A4 (216 by 279 mm), 50 sheets/box	92296U	
<b>HP MultiPurpose Paper</b>		
Letter (8.5 by 11 in), 500 sheets/ream, 10-ream carton	HPM1120	For use with all office equipment—laser and inkjet printers, copiers, and fax machines. Created for businesses that want one paper for all their office needs. Brighter and smoother than other office papers. Specifications: 90 bright, 20 lb.
Letter (8.5 by 11 in), 500 sheets/ream, 5-ream carton	HPM115R	
Letter (8.5 by 11 in), 250 sheets/ream, 12-ream carton	HP25011	
Letter (8.5 by 11 in), 3-hole, 500 sheets/ream, 10-ream carton	HPM113H	
Legal (8.5 by 14 in), 500 sheets/ream, 10-ream carton	HPM1420	



## Printing supplies (continued)

Item	Part number	Description or use
<b>HP Office Paper</b>		
Letter (8.5 by 11 in), 500 sheets/ream, 10-ream carton	HPC8511	For use with all office equipment—laser and inkjet printers, copiers, and fax machines. Good for high-volume printing. Specifications: 84 bright, 20 lb.
Letter (8.5 by 11 in), 3-hole, 500 sheets/ream, 10-ream carton	HPC3HP	
Legal (8.5 by 14 in), 500 sheets/ream, 10-ream carton	HPC8514	
Letter (8.5 by 11 in), Quick Pack, 2,500-sheet carton	HP2500S	
A4 (216 by 279 mm), 500 sheets/ream, 5-ream carton	CHP110	
<b>HP Office Recycled Paper</b>		
Letter (8.5 by 11 in), 500 sheets/ream, 10-ream carton	HPE1120	For use with all office equipment—laser and inkjet printers, copiers, and fax machines. Good for high-volume printing. Satisfies U.S. Executive Order 13101 for environmentally preferable products. Specifications: 84 bright, 20 lb, 30% post-consumer content.
Letter (8.5 by 11 in), 3-hole, 500 sheets/ream, 10-ream carton	HPE113H	
Legal (8.5 by 14 in), 500 sheets/ream, 10-ream carton	HPE1420	
<b>HP Premium Choice LaserJet Paper</b>		
Letter (8.5 by 11 in), 500 sheets/ream, 10-ream carton	HPU1132	For use with HP Color LaserJet printers, HP LaserJet monochrome printers, and color copiers. Good for hardcopy presentations, business reports and proposals, data sheets, price lists, and newsletters. Specifications: 98 bright, 32 lb.
A4 (216 by 279 mm), 500 sheets/ream, 4-ream carton	CHP410	
A4 (216 by 279 mm), 250 sheets/ream, 8-ream carton	CHP415	
<b>HP Printing Paper</b>		
Letter (8.5 by 11 in), 500 sheets/ream, 10-ream carton	HPP1122	For use with laser and inkjet printers. Created especially for small and home offices. Heavier and brighter than copier paper. Specifications: 92 bright, 22 lb.
A4 (216 by 279 mm), 500 sheets/ream, 5-ream carton	CHP210	



# Control panel layout

## Control panel

The printer's control panel consists of the following:

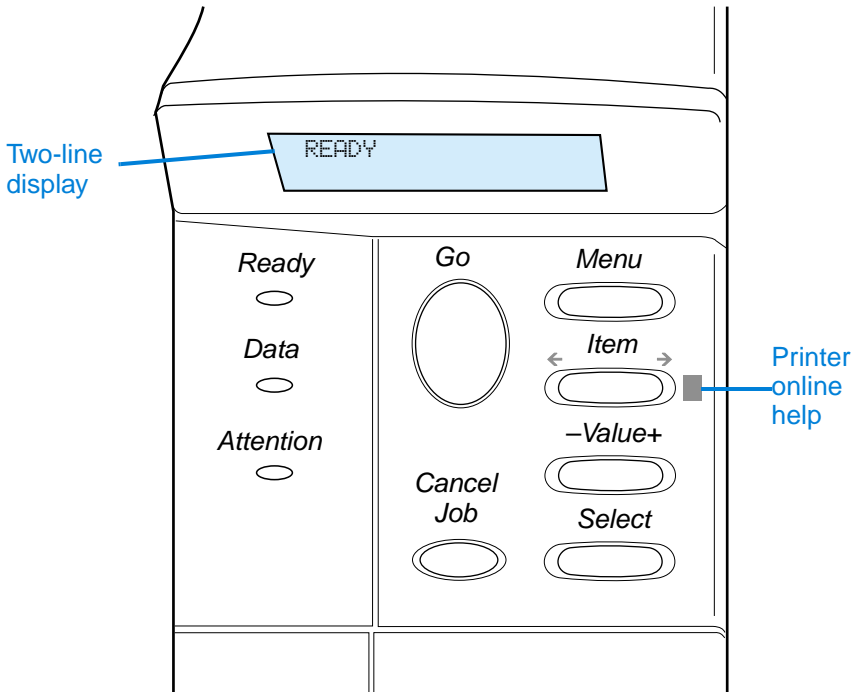

## Control panel lights

Light	Indication when lit
Ready	The printer is ready to print.
Data	The printer is processing information.
Attention	Action is required. See the control panel display for an associated message.



# Control panel keys

Key	Function
GO	<ul style="list-style-type: none"><li>• Places the printer either online or offline.</li><li>• Prints any data residing in the printer's buffer.</li><li>• Allows the printer to resume printing after being offline. Clears most printer messages and places the printer online.</li><li>• Allows the printer to continue printing with an error message such as TRAY x LOAD [TYPE] [SIZE] or UNEXPECTED PAPER SIZE.</li><li>• Confirms a manual feed request if tray 1 is loaded and TRAY 1 MODE=CASSETTE has been set from the Paper Handling Menu in the printer's control panel.</li><li>• Overrides a manual feed request from tray 1 by selecting paper from the next available tray.</li><li>• Exits the control panel menus. (To save a selected control panel setting, first press <b>SELECT</b>.)</li></ul>
CANCEL JOB	Cancels the print job that the printer is processing. (Press <b>CANCEL JOB</b> only once.) The time it takes to cancel depends on the size of the print job.
MENU	Cycles through the control panel menus. Press the right side of the key to move forward or the left side of the key to move backward.
ITEM	Cycles through the items in the selected menu. Press the right side of the key to move forward or the left side of the key to move backward.
-VALUE+	Cycles through the values in the selected menu item. Press <b>+</b> to move forward or <b>-</b> to move backward.
SELECT	<ul style="list-style-type: none"><li>• Saves the selected value for that item. An asterisk (*) appears next to the selection, indicating that it is the new default. Default settings remain when the printer is switched off or reset (unless you reset all factory defaults from the Resets Menu).</li><li>• Prints one of the printer information pages from the control panel.</li></ul>





## Using the printer online help system

This printer features an online help system on the control panel that provides instructions for resolving most printer errors. Certain control panel error messages alternate with instructions on accessing the online help system.

Whenever a ? appears in an error message or a message alternates with FOR HELP PRESS THE ? KEY, press the right side of the ITEM key to navigate through a sequence of instructions.

---

### Note

---

To exit the online help system, press GO or SELECT.



## Control panel menus

For a complete list of control panel items and possible values, see "Control panel menus" on page 205.

Press **MENU** for access to all control panel menus. When additional trays or other accessories are installed in the printer, new menus or menu items might automatically appear.



### To print a control panel menu map

To see the current settings for the menus and items available in the control panel, print a control panel menu map. You might want to store the menu map near the printer for reference.



- 1 Press **MENU** repeatedly until `INFORMATION MENU` appears.
- 2 Press **ITEM** repeatedly until `PRINT MENU MAP` appears.
- 3 Press **SELECT** to print the menu map.

---

#### Note

Certain menu options appear only when the associated accessory is installed. For example, the EIO menu appears only if you have an EIO card installed.

### To change a control panel setting

- 1 Press **MENU** repeatedly until the desired menu appears.
- 2 Press **ITEM** repeatedly until the desired item appears.
- 3 Press **-VALUE+** repeatedly until the desired setting appears.
- 4 Press **SELECT** to save the selection. An asterisk (\*) appears next to the selection in the display, indicating that it is now the default.
- 5 Press **Go** to exit the menu.

---

#### Note

Settings in the printer driver and software application override control panel settings. (Software application settings override printer driver settings.)

If you cannot access a menu or item, it is either not an option for the printer, or you have not enabled the associated higher level option. See your network administrator if this function has been locked (the control panel reads `ACCESS DENIED MENUS LOCKED`).



# Printer software

## Software provided

The printer comes with printing software and other helpful software on a CD. If your computer does not have a CD drive but you have access to one, you can copy the software onto diskettes for installation into your computer. See the getting started guide for installation instructions.

The printer drivers provided on the CD must be installed to take full advantage of printer features. The other software programs are recommended, but are not required for operation. See the ReadMe.wri file for more information.



### Note

Check the ReadMe.txt file provided on the CD for late-breaking information.

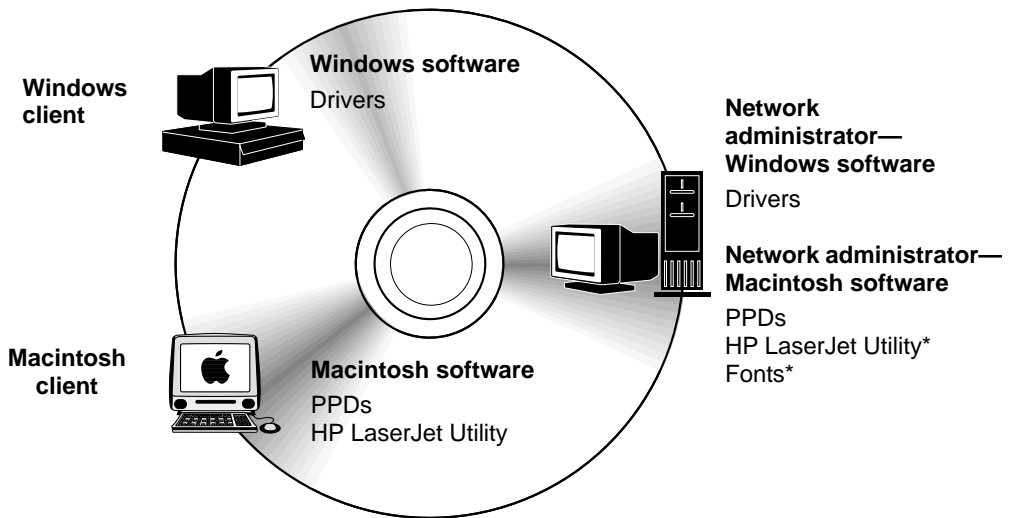

\* Not supported for the languages of Czech, Korean, Japanese, Russian, Simplified Chinese, Traditional Chinese, or Turkish.

### Note

**Network administrators:** HP Resource Manager should be installed only on the network administrator computer. Load all other applicable software on the server and all client computers.



Depending on the configuration of Windows-based computers, the installation program for the printer software automatically checks the computer for Internet access and can obtain the latest software. If you do not have access to the Internet, see "HP Customer Care Service and Support" on page 157 for information on obtaining the most recent software.



Included with the printer is a CD containing the HP LaserJet Printing System. On the CD are software components and drivers for end users and network administrators. See the ReadMe.wri file for the most current information.



The CD includes software designed for end users and network administrators operating in the following environments:



- Microsoft Windows 9x
- Microsoft Windows NT 4.0
- Microsoft Windows 2000
- Apple Mac OS, version 7.5 3 or greater
- AutoCAD™ drivers, versions 12–15

Additional drivers and documentation for Windows NT 3.51 are available on the Internet. Additional drivers, font installer, and documentation for Windows 3.1x are available on the CD that came with the printer.



## Printer drivers

Printer drivers access the printer features and allow the computer to communicate with the printer (via a printer language).

### Note

Check the ReadMe.wri file provided on the CD for additional software included and supported languages.



Certain printer features are available only from the PCL 6 drivers. See the printer software help for availability of features.



The following printer drivers are included with the printer. The most recent drivers are available at <http://www.hp.com/support/lj4100>. Depending on the configuration of Windows-based computers, the installation program for the printer software automatically checks the computer for Internet access to obtain the latest drivers.



Operating system	PCL 5e	PCL 6	PS <sup>a</sup>	PPDs
Windows 3.1x	✓	✓	✓ <sup>b</sup>	
Windows 9x	✓	✓	✓	✓
Windows NT 4.0	✓	✓	✓	✓
Windows 2000	✓	✓	✓	✓
Macintosh OS				✓

- a. PostScript 2 emulation is referred to as PS throughout this user guide.  
b. Level 1 emulation only.

You can obtain the following additional printer drivers by downloading them from the Internet, or by requesting them from an HP-authorized service or support provider. (See "HP Customer Care Service and Support" on page 157.)

- NT 3.51 PCL 5e, NT 3.51 PS (available for English only)
- UNIX and Linux Model Scripts

OS/2 drivers are available from IBM and are packaged with OS/2. They are not available for the languages of Japanese, Korean, Simplified Chinese, or Traditional Chinese.

### Note

If the desired printer driver is not on the CD or is not listed here, check the software application's installation disks or ReadMe files to see if they include support for the printer. If not, contact the software manufacturer or distributor and request a driver for the printer.



## Software for Windows-based computers

**Network administrators:** If the printer is attached to a network through an HP JetDirect EIO card, the printer must be configured for that network before you can print. For Microsoft and Novell NetWare networks, you can use the printer installation software. For other options, refer to the *HP JetDirect Print Server Administrator's Guide* (included with printers that contain an HP JetDirect print server).

Use the **Customization Utility** option to create a set of disks with the exact software you want the end users to use. This allows you to distribute drivers without distributing administration software to end users.

### Access the Windows printer driver

To configure the driver, access it in one of the following ways:



Operating system	Temporarily change settings (from a software application)	Change default settings (across all applications)
Windows 9x	From the <b>File</b> menu, click <b>Print</b> , and then click <b>Properties</b> . (The actual steps can vary; this is the most common method.)	Click the <b>Start</b> button, point to <b>Settings</b> , and then click <b>Printers</b> . Right-click the printer icon, and choose <b>Properties</b> .
Windows NT 4.0	From the <b>File</b> menu, click <b>Print</b> , and then click <b>Properties</b> . (The actual steps can vary; this is the most common method.)	Click the <b>Start</b> button, point to <b>Settings</b> , and then click <b>Printers</b> . Right-click and choose <b>Document Defaults</b> or <b>Properties</b> .
Windows 2000	From the <b>File</b> menu, click <b>Print</b> , and then click <b>Properties</b> . (The actual steps can vary; this is the most common method.)	Click the <b>Start</b> button, point to <b>Settings</b> , and then click <b>Printers</b> . Right-click and choose <b>Printing Preferences</b> or <b>Properties</b> .
Windows 3.1x and Windows NT 3.51	From the <b>File</b> menu, click <b>Print</b> , click <b>Printers</b> , and then click <b>Options</b> . (The actual steps can vary; this is the most common method.)	From the Windows control panel, double-click <b>Printers</b> , highlight the printer, and click <b>Setup</b> .

#### Note

Settings in the printer driver and software application override control panel settings. (Software application settings override printer driver settings.)



## Choose the right printer driver for your needs

Choose a printer driver based on the way you use the printer.

- Use the PCL 6 driver to take full advantage of the printer's features. Unless backward compatibility with previous PCL drivers or older printers is necessary, the PCL 6 driver is recommended.
- Use the PCL 5e driver if you want print results to look comparable to those from older printers, or for font DIMM support.
- Use the PS driver for compatibility with PostScript Level 2. Certain features are not available in this driver.
- The printer automatically switches between PS and PCL printer languages.



## Printer driver help

Each printer driver has help screens that can be activated either from the Help button, the F1 key, or a question mark symbol in the upper right corner in the printer driver (depending on the Windows operating system used). These help screens give detailed information about the specific driver. Printer driver help is separate from the software application help.

## HP Resource Manager

The HP Resource Manager should be installed only on the network administrator's computer. The HP Resource Manager allows you to control the hard disk and flash memory accessory features not found in the drivers. Bidirectional communication is required.

Use the HP Resource Manager to do the following:

- initialize disk and flash memory
- download, delete, and manage fonts and macros to disk and flash memory across networks
  - PostScript Type 1, PostScript Type 42, TrueType™ fonts converted to PostScript format, TrueType, and PCL bitmap fonts
  - To download Type 1 fonts, Adobe Type Manager must be loaded and turned on.

You can obtain a copy of HP Resource Manager over the Internet. See "Online services" on page 157 for details.



---

### Note

HP Resource Manager is not available for the Macintosh.

## HP JetSend communications technology



HP JetSend is a technology from Hewlett-Packard that allows devices to communicate with each other simply and directly. HP JetSend is built into your printer, allowing it to receive information from any HP JetSend-enabled sending device anywhere on your network, whether it is in the same office or at a remote location. When you use the HP Fast

InfraRed Receiver accessory, your printer can also receive information from any HP JetSend-enabled infrared device. Examples of HP JetSend sending devices include computers or laptops running HP JetSend software or scanners with HP JetSend built in. HP JetSend uses simple IP addressing between networked devices and cableless communication between infrared devices.

To enable HP JetSend on your computer or laptop, visit the HP JetSend website ([www.jetsend.hp.com/products](http://www.jetsend.hp.com/products)) for information on HP JetSend software. With the software, you will be able to exchange intra-company documents directly between two or more computers and send to any HP JetSend enabled printers, without the problems of incompatible software applications or versions. HP JetSend software will allow your colleagues to create documents on their computers and send copies directly to this printer without any device-specific drivers or configuration difficulties.

You can visit the HP JetSend website to learn which other devices are available to communicate easily and directly with your HP JetSend-enabled printer.

---

### Note

---

HP JetSend software is not supported for the languages of Japanese, Korean, Simplified Chinese, or Traditional Chinese.





## How the JetSend communications technology works

### *Networked devices*

To use the HP JetSend capability between networked devices, print a configuration page to find your HP JetSend IP address, and give your address to anyone who wants to send information to your printer via HP JetSend. (See “Configuration page” on page 152.)



From an HP JetSend sending device, a person only needs to enter the printer’s IP address and press “send.”



### *Infrared devices*

To use HP JetSend infrared capability, line up the infrared sensors between the sending and receiving devices, and choose the “send” option on the sending device.



The devices will automatically negotiate the best possible outcome because they have HP JetSend in them.

---

### **Note**

HP JetSend software is not available for the Macintosh computer.



# Software for Macintosh computers

## PostScript Printer Description files (PPDs)

PPDs, in combination with the Apple LaserWriter 8 Driver, access the printer features and allow the computer to communicate with the printer. An installation program for the PPDs and other software is provided on the CD. Use the Apple LaserWriter 8 Driver that comes with the computer.



## HP LaserJet Utility

HP LaserJet Utility allows control of features that are not available in the driver. The illustrated screens make selecting printer features from the Macintosh computer easier than ever. Use the HP LaserJet Utility to do the following:

- customize the printer control panel messages
- name the printer, assign it to a zone on the network, download files and fonts, and change most of the printer settings
- set a password for the printer
- from the computer, lock out functions on the printer control panel to prevent unauthorized access (see the printer software help)
- configure and set the printer for IP printing

---

### Note

---

The HP LaserJet Utility is not supported for the languages of Czech, Korean, Japanese, Russian, Simplified Chinese, Traditional Chinese, or Turkish.



## Software for networks

For a summary of available HP network installation and configuration software solutions, see the *HP JetDirect Print Server Administrator's Guide*. You can find this guide on the CD included with the printer.



### HP Web JetAdmin

HP Web JetAdmin is a browser-based management tool and should be installed only on the network administrator's computer. It can be installed and run on the following systems:



- Microsoft Windows NT and Windows 2000
- HP-UX
- Sun Solaris
- Red Hat Linux
- SuSE Linux



HP Web JetAdmin is available from the Internet at <http://www.hp.com/go/webjetadmin>.

---

#### Note

---

For the latest list of supported host systems, visit HP Customer Care Online at <http://www.hp.com/go/webjetadmin>.

When installed on a host server, HP Web JetAdmin can be accessed by any client through a supported web browser (such as Microsoft Internet Explorer 4.x or Netscape Navigator 4.x or later) by browsing to the HP Web JetAdmin host.

Use HP Web JetAdmin to do the following:

- Install and configure printers that are connected to a network with an HP JetDirect print server. When installed on a supported Microsoft host system, HP Web JetAdmin will configure Novell NetWare parameters on the HP JetDirect print server and NetWare server.
- Manage and troubleshoot network printers from any location.

### UNIX

The HP JetDirect Printer Installer for UNIX is a simple printer installation utility for HP-UX and Solaris networks. It is available for download from HP Customer Care Online at [http://www.hp.com/support/net\\_printing](http://www.hp.com/support/net_printing).





# 2 Printing tasks



## Overview

This chapter presents *basic printing tasks*, such as:

- selecting the output bin
- loading the trays
- printing on both sides of paper with the optional duplexer
- printing on special paper, such as letterhead and transparencies
- using the optional power envelope feeder

This chapter also introduces some *advanced printing tasks*:

- printing multiple originals
- creating Quick Sets to save the printer's setup information for different kinds of print jobs
- printing pages with a watermark in the background
- printing the first page of a document on a different kind of paper than the rest of the pages
- printing multiple pages on one sheet of paper
- printing booklets
- printing with ZoomSmart
- customizing what tray is used for printing



## Selecting the output bin

The printer has two output locations: the rear output bin and the top output bin. To use the top output bin, be sure the rear output bin is closed. To use the rear output bin, open it.

- If paper coming out of the top output bin has problems, such as excessive curl, try printing to the rear output bin.
- To avoid paper jams, do not open or close the rear output bin while the printer is printing.

### Printing to the top output bin

The top output bin collects paper face-down, in correct order. The top output bin should be used for most print jobs and for transparencies.

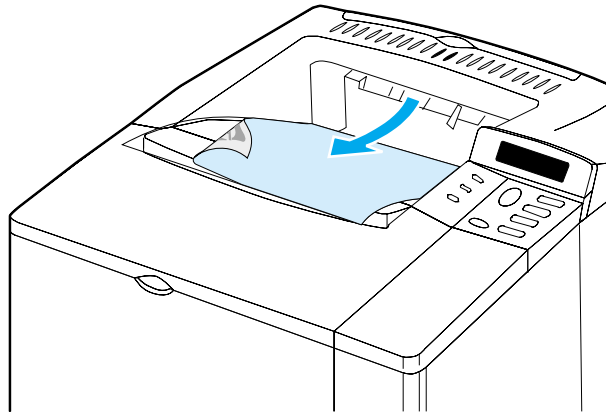

## Printing to the rear output bin

The printer always prints to the rear output bin if it is open. Paper printed to this bin will be face-up, with the last page on top.

To open the rear output bin, grasp the handle at the top of the bin. Pull the bin down, and slide out the extension.

Printing from tray 1 to the rear output bin provides the straightest paper path (which can reduce curl). Opening the rear output bin might improve performance with the following:

- envelopes
- labels
- small custom-size paper
- postcards
- paper heavier than 28 lb (105 g/m<sup>2</sup>)



---

### Note

---

Opening the rear output bin disables the optional duplexer (if installed) and the top output bin.

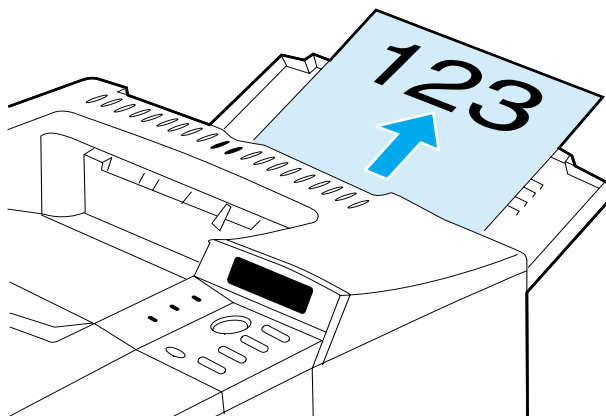

# Loading tray 1

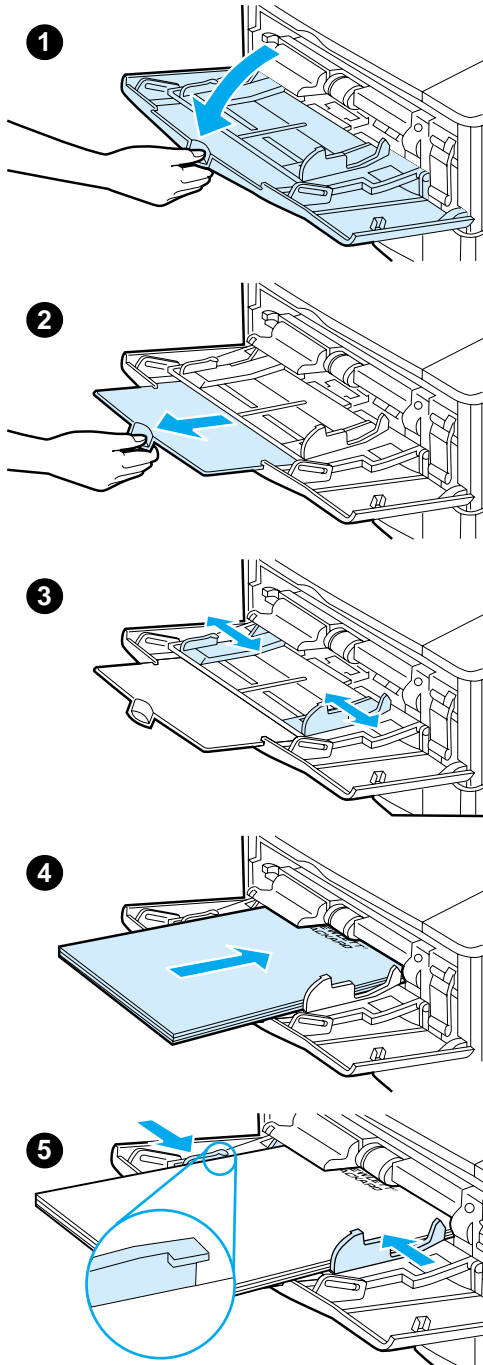

Tray 1 is a multi-purpose tray that holds up to 100 sheets of paper, 10 envelopes, or 20 index cards. The printer's default is to pull paper from tray 1 first. To change this, see "Customizing tray 1 operation" on page 69.

Tray 1 provides a convenient way to print envelopes, transparencies, custom-size paper, or other types of media without having to unload the other trays. It can also be used just as a convenient additional input tray. For supported sizes of paper, see "Supported sizes and weights of paper" on page 189.

---

## Note

To avoid paper jams, do not load trays while the printer is printing.

---

- 1 Open tray 1.
- 2 Pull out the tray extension.
- 3 Set the side guides to the desired width.
- 4 Load paper in the tray.

---

## Note

Make sure the paper fits under the tabs on the guides and not above the load level indicators.

Generally, load paper with the side to be printed up, and the top, short edge toward the printer. For information on loading special paper, see "Printing special paper" on page 53.

---

- 5 Adjust the side guides so that they lightly touch the paper stack but do not bend the paper.





# Loading trays 2, 3, and 4

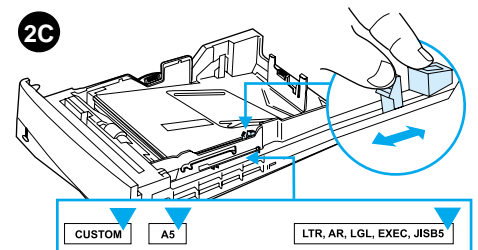
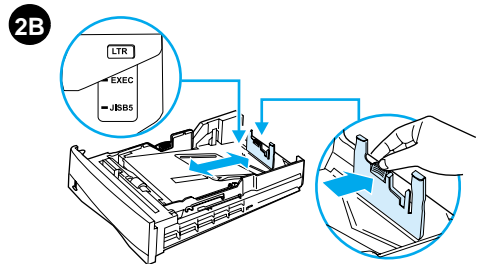
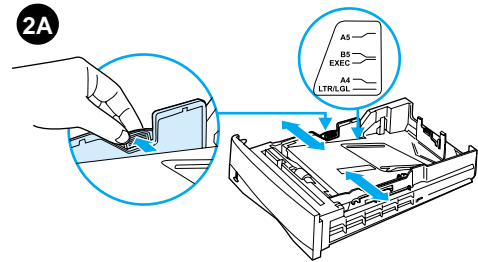
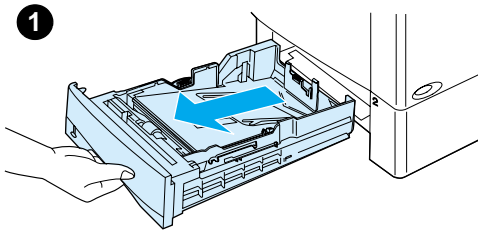

Trays 2, 3, and 4 are 500-sheet paper trays. Tray 3 is optional and comes with the 4100TN and 4100DTN models. Tray 4 is an additional 500-sheet option.

The trays adjust for six standard sizes of media, as well as for many custom sizes (for details, see “Supported sizes and weights of paper - trays 2, 3, and 4” on page 190). Three adjustments on the trays let the printer sense the paper size that is loaded.

## Note

To avoid paper jams, do not load trays while the printer is printing.

- 1 Pull the tray completely out of the printer.
- 2 If the tray is not already set to the desired paper size, you will need to make up to three adjustments:

**2A:** To adjust the width, squeeze the lever on the left guide and slide the guides into place to match the width of the paper.

**2B:** To adjust the length, squeeze the lever on the rear paper guide and slide it to the desired paper size until it clicks into place. Standard sizes are labeled. For A5-size paper, lift the metal backstop near the center of the tray.

**2C:** To make the third adjustment, squeeze the blue tab located on the right side of the tray and move it to the correct position based on the paper size required.

Continued on the next page.



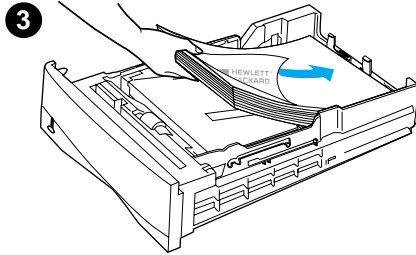

- 3 Load paper into the tray.
- 4 Make sure the paper is flat in the tray at all four corners and below the front and back tabs.
- 5 Slide the tray back into the printer.

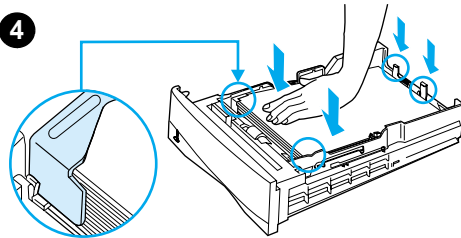

---

**Note**

If the tray is not properly adjusted, the printer might display an error message or paper might jam.

For paper orientation when you are printing on both sides, see “Printing both sides of paper (optional duplexer)” on page 49. For information on loading special paper, see “Printing special paper” on page 53.

---

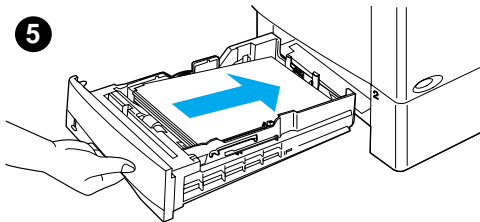

# Printing both sides of paper (optional duplexer)

The printer can automatically print on both sides of paper with an optional duplex printing accessory (duplexer). This is called duplexing.

The duplexer supports the following paper sizes: Letter, Legal, Executive, A4, and B5 (JIS). It does not support custom sizes.

---

## Note

See the documentation included with the duplexer for installation instructions. Duplexing might require additional memory (see “Printer memory and expansion” on page 229).

The tray 2 dust cover must be removed when the optional duplexer is installed.

---

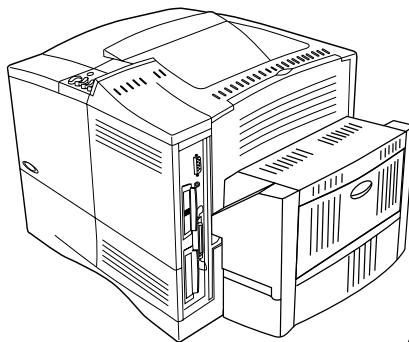

Installed

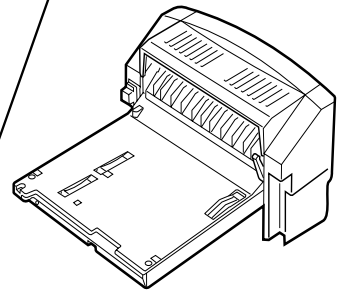

Removed



## Guidelines for printing both sides of paper

Note the following guidelines:

- Do not print on both sides of labels, transparencies, envelopes, vellum, or paper heavier than 28 lb (105 g/m<sup>2</sup>). Paper jamming might occur with these types of media, and damage to the printer might occur with labels.
- You might need to configure the printer driver to recognize the duplexer. (See the printer driver online help for details.)
- To print on both sides of paper, make the selection from the software or printer driver. (See the printer driver online help.)
- If you do not use the printer driver that came with the printer, you might need to change the Duplex setting from the Paper Handling Menu in the printer control panel to `DUPLEX=ON`. Also in the Paper Handling Menu, set Binding to long edge or short edge. (For more information, see “Layout options for printing both sides of paper” on page 52.)
- Close the rear output bin to use the duplexer (see “Selecting the output bin” on page 44). Opening the rear output bin disables the duplexer.



## Placement for paper requiring a specific orientation

Several kinds of paper require a specific orientation when you duplex—for example, letterhead, preprinted paper, and paper with watermarks and prepunched holes. The duplexer prints the second side of paper first. Orient paper in the trays as shown below.

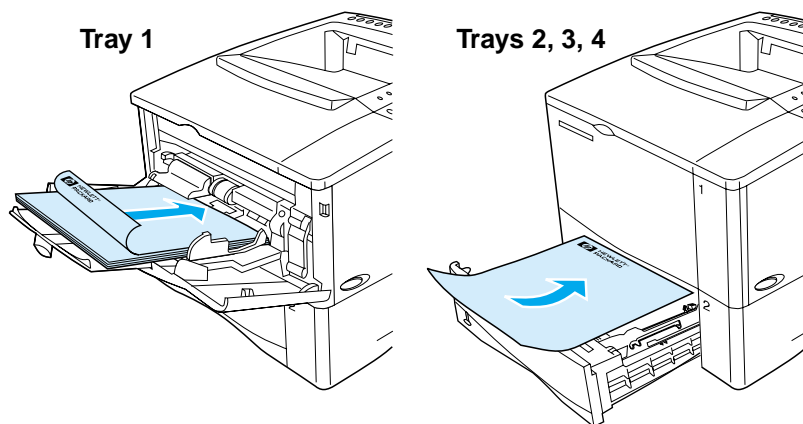

For tray 1, load the front side facing down and the top toward you. For all other trays, load the front side facing up and the top toward the printer.



## Layout options for printing both sides of paper

The four duplex orientation options are shown below. These options can be selected from the printer driver or from the printer control panel (set **BINDING** from the Paper Handling Menu and **ORIENTATION** from the Printing Menu).

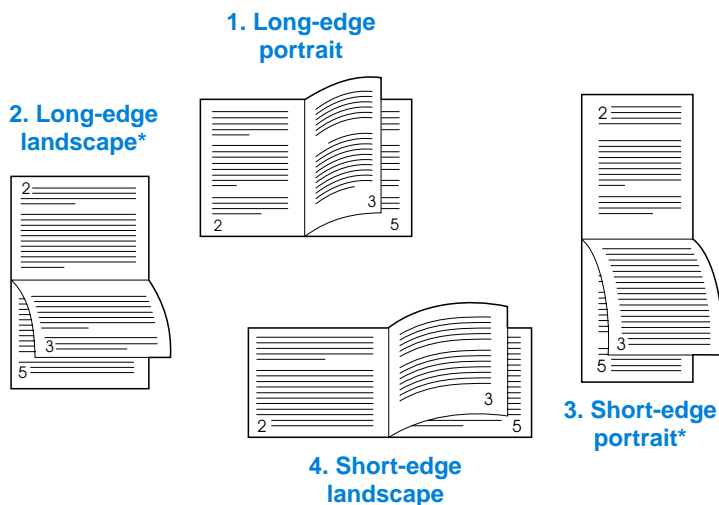

- |                         |                                                                                                                                                                                                                              |
|-------------------------|------------------------------------------------------------------------------------------------------------------------------------------------------------------------------------------------------------------------------|
| 1. Long-edge portrait   | This is the default printer setting, and the most common layout used, with every printed image oriented right side up. Facing pages are read from top to bottom on the left page, then from top to bottom on the right page. |
| 2. Long-edge landscape  | This layout is often used in accounting, data processing, and spreadsheet applications. Every other printed image is oriented upside-down. Facing pages are read continuously from top to bottom.                            |
| 3. Short-edge portrait  | This layout is often used with clipboards. Every other printed image is oriented upside-down. Facing pages are read continuously from top to bottom.                                                                         |
| 4. Short-edge landscape | Each printed image is oriented right side up. Facing pages are read from top to bottom on the left page, then from top to bottom on the right page.                                                                          |

### Note

When using Windows drivers, select “Flip Pages Up” to get the binding options designated with (\*) above.



# Printing special paper

This section discusses printing on types of paper that require special handling:

- “Printing small or narrow paper” on page 53
- “Printing letterhead, prepunched, or preprinted paper (single-sided)” on page 53
- “Printing envelopes” on page 55
- “Printing labels” on page 61
- “Printing transparencies” on page 62
- “Printing cards, custom-size, and heavy paper” on page 63



## Printing small or narrow paper

Follow the guidelines below if you will be printing primarily on small or narrow paper:

- Use the 6,000-page toner cartridge (part number C8061A). Toner might leak if large quantities of small or narrow media are printed using the 10,000-page cartridge (part number C8061X). (See “Ordering information” on page 22.)
- Print from tray 1 to the rear output bin if you experience problems such as paper jams or curl.

See “Printing cards, custom-size, and heavy paper” on page 63 for further information on printing on non-standard sizes.

## Printing letterhead, prepunched, or preprinted paper (single-sided)

When printing letterhead, prepunched, or preprinted paper, it is important to correctly orient the paper. For instructions, see the next page.

---

### Note

---

Follow the guidelines in this section for printing on one side only. For guidelines on duplexing, see “Guidelines for printing both sides of paper” on page 50.



For tray 1, load paper with the side-to-be-printed facing up, and the top, short edge toward the printer.

### Paper orientation for tray 1

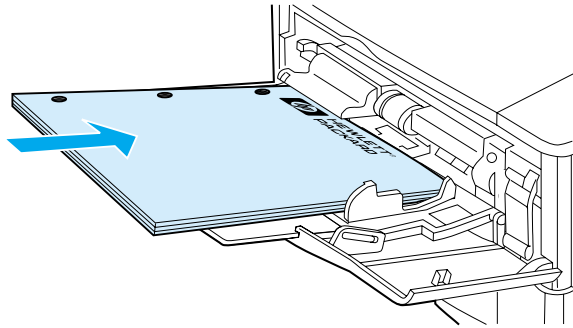

For all other trays, load paper with the side-to-be-printed facing down, and the top edge toward you.

### Paper orientation for trays 2, 3, and 4

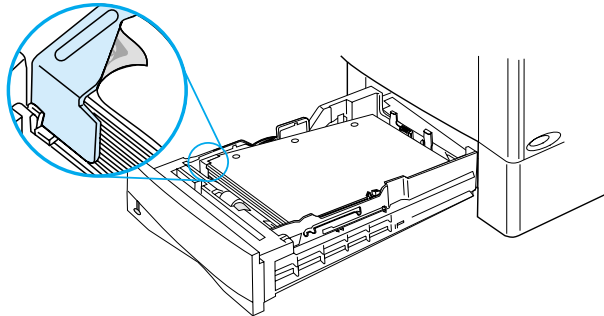



## Printing envelopes

With the optional envelope feeder, the printer will automatically feed up to 75 envelopes. To order an envelope feeder, see “Ordering information” on page 22. To print with the envelope feeder, see “Feeding envelopes automatically (optional envelope feeder)” on page 57. For envelope specifications, see “Envelopes” on page 197.

Many types of envelopes can be printed from tray 1. Up to 10 can be stacked in the tray. Printing performance depends on the construction of the envelope. Always test a few sample envelopes before purchasing a large quantity.

- In the software, set margins at least 15 mm (0.6 in) from the edge of the envelope.
- Open the rear output bin to get a straight paper path. This produces better results if envelopes are curling.

If you print large quantities of envelopes continuously or if you interleave envelopes with wide media, you might need to select `SMALL PAPER SPEED = SLOW` at the printer control panel. This setting reduces the throughput speed of narrow media to allow the heat generated from printing this media to dissipate. Although using this feature will slow your printer's throughput speed, it will help protect your printer from damage while ensuring excellent print quality.



---

### WARNING!

---

Never use envelopes with coated linings, exposed self-stick adhesives, or other synthetic materials. These items can emit noxious fumes.

---

### CAUTION

---

Envelopes with clasps, snaps, windows, coated linings, exposed self-stick adhesives, or other synthetic materials can severely damage the printer.

To avoid jamming and possible printer damage, never try to print on both sides of an envelope.

Before you load envelopes, make sure they are flat and not damaged or stuck together. Do not use envelopes with pressure-sensitive adhesive.

---



## Loading envelopes in tray 1

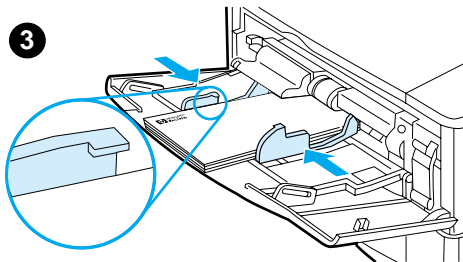
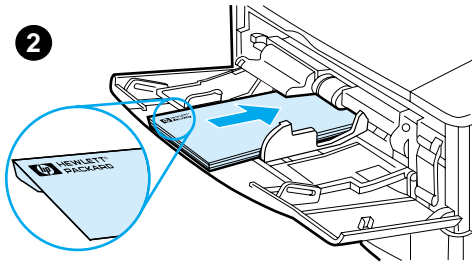
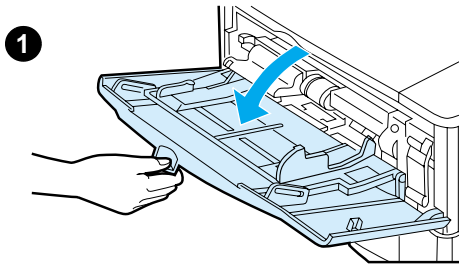

- 1 Open tray 1, but do not pull out the extension. (Most envelopes feed best without the extension. However, oversize envelopes might need the extension.)
- 2 Load up to 10 envelopes in the center of tray 1 with the side-to-be-printed facing up, and the postage-end toward the printer. Slide the envelopes into the printer as far as they will go without forcing them.
- 3 Adjust the guides to touch the envelope stack without bending the envelopes. Make sure the envelopes fit under the tabs on the guides.

---

### Note

If envelopes curl, use the rear output bin (see "Printing to the rear output bin" on page 45).

---



## Feeding envelopes automatically (optional envelope feeder)

With the optional envelope feeder, the printer will automatically feed up to 75 envelopes. To print envelopes without an envelope feeder, see "Printing envelopes" on page 55.

The envelope feeder supports only standard-size envelopes (see "Supported sizes and weights of paper - optional envelope feeder" on page 191).



---

### Note

---

See the documentation included with the envelope feeder for installation instructions.

You might need to configure the printer driver to recognize the envelope feeder. See the printer driver online help for details.

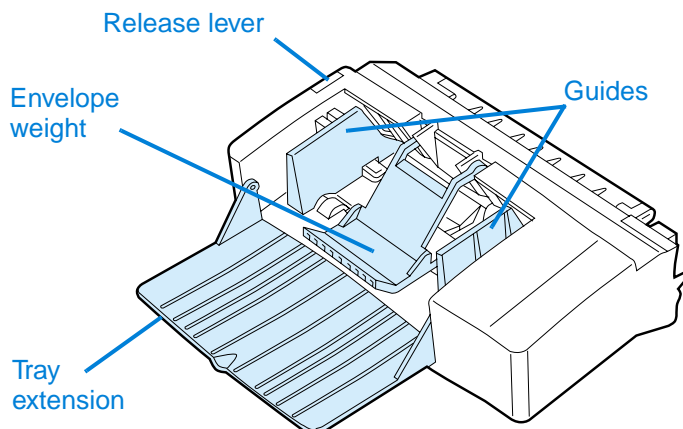

## Inserting and removing the envelope feeder

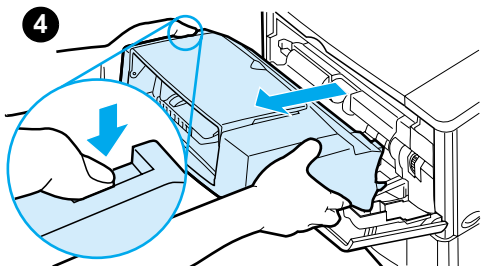
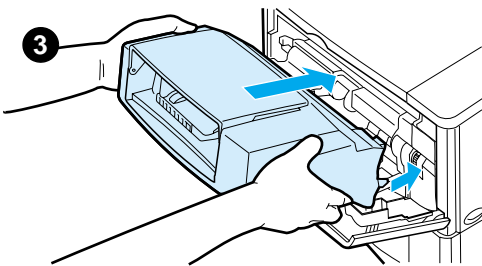
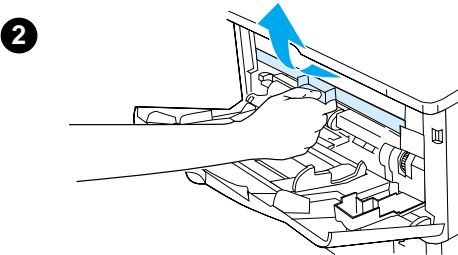
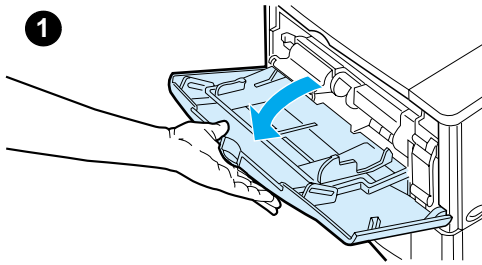

- 1 Open tray 1.
- 2 Remove the plastic cover from the printer. (Replace the cover when the envelope feeder is not attached.)
- 3 Insert the envelope feeder into the printer until it locks into place. (The connector on the top right side of the envelope feeder fits into the plug in the printer.) Pull gently on the envelope feeder to be sure that it is securely in place.
- 4 To remove the envelope feeder, press the release button on the left side and pull the envelope feeder away from the printer.



## Loading envelopes in the envelope feeder

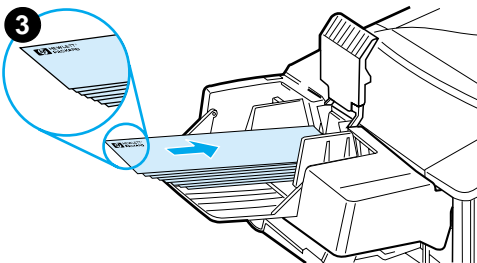
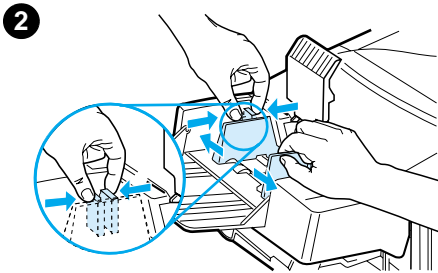
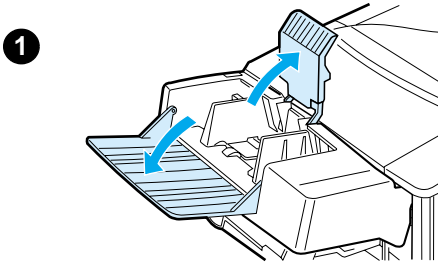

### Note

Print only on envelopes approved for use in the printer (see “Printing envelopes” on page 55 and “Envelopes” on page 197).

- 1 Fold down the tray extension. Lift the envelope weight.
- 2 Squeeze the release lever on the left envelope guide and slide the guides apart.
- 3 Load envelopes into the envelope feeder with the side-to-be-printed facing up, and the postage end toward the printer. Push the envelopes into the envelope feeder as far as they will go without forcing them. Push the bottom envelopes in slightly farther than the top envelopes. (Stack them as shown.)

**Continued on the next page.**



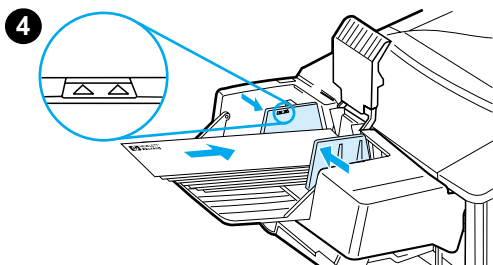

4 Adjust the guides to touch the envelopes without bending them. Make sure the envelope feeder is not overfilled.

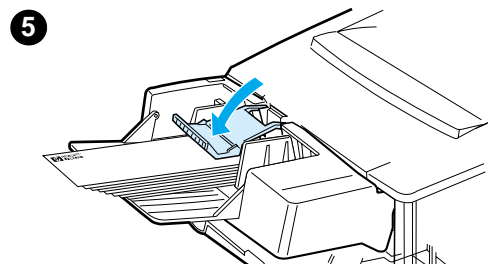

5 Lower the envelope weight onto the envelopes.

---

#### Note

Select the envelope size from the software application (if the setting is available), the printer driver, and the Paper Handling Menu in the printer control panel (see “Paper Handling Menu” on page 210). To print by type and size of paper, see “Printing by type and size of paper (locking trays)” on page 70.

---



## Printing labels

Use only labels recommended for use in laser printers. Make sure that labels meet the correct specifications (see “Labels” on page 196).

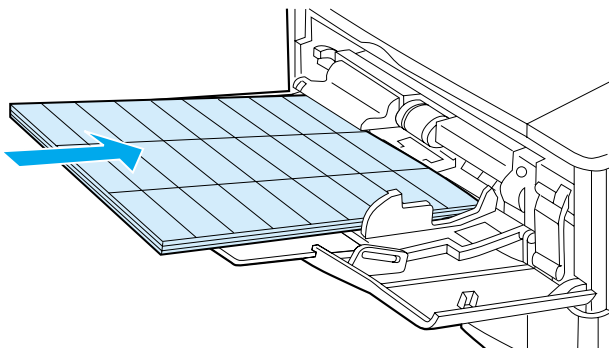

### Do:

- Print a stack of up to 50 labels from tray 1 or a stack of 50 to 100 labels from other trays.
- Load labels in tray 1 with the side-to-be-printed facing up, and the top, short edge toward the printer. For other trays, load paper with the side-to-be-printed facing down, and the top edge toward you.
- Try opening the rear output bin to reduce curl and other problems (see “Printing to the rear output bin” on page 45).

### Do not:

- Do not load the trays to capacity because labels are heavier than paper.
- Do not use labels that are separating from the backing sheet, wrinkled, or damaged in any way.
- Do not use labels that have the backing sheet exposed. (Labels must cover the entire backing sheet with no exposed spaces.)
- Do not feed a sheet of labels through the printer more than once. The adhesive backing is designed for only one pass through the printer.
- Do not print on both sides of labels.
- Do not print on sheets from which labels have been removed.



### CAUTION

Failure to follow these instructions can damage the printer.

## Printing transparencies

Use only transparencies recommended for use in laser printers. For transparency specifications, see “Transparencies” on page 196

- Load transparencies face up in tray 1 with the top toward the printer. Up to 50 transparencies can be loaded in tray 1.
- A stack of 50 to 100 transparencies can be printed from tray 2, 3, or 4 (although stacking more than 50 at a time is not recommended). Because transparencies are heavier than paper, do not load tray 2, 3, or 4 to capacity. Load them with the side-to-be-printed facing down, and the top edge toward you.
- To prevent transparencies from becoming too hot or sticking together, use the top output bin.
- Remove each transparency from the output bin before printing another.
- Do not feed transparencies through the printer more than once.
- Print only on one side of a transparency.
- Place transparencies on a flat surface to cool after removing them from the printer.
- Select the transparency paper type from the printer driver so that the printer uses the low fuser mode that is best for printing them.
- If two or more transparencies feed at the same time, try fanning the stack.

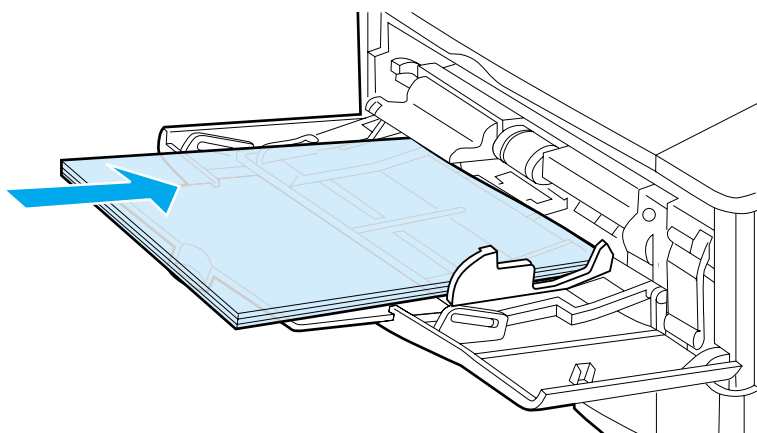



## Printing cards, custom-size, and heavy paper

Custom-size paper can be printed from any tray. For paper specifications, see “Paper specifications” on page 188.

Tray	Minimum size	Maximum size
Tray 1	76 by 127 mm (3 by 5 in)	216 by 356 mm (8.5 by 14 in)
Tray 2, 3, or 4	148 by 210 mm (5.8 by 8.2 in)	216 by 356 mm (8.5 by 14 in)

The maximum paper weight is 199 g/m<sup>2</sup> (53 lb) from tray 1 and 105 g/m<sup>2</sup> (28 lb) from trays 2, 3, and 4.



### Note

To prevent curl and other problems, heavy paper and very small custom-size paper should be printed from tray 1 to the rear output bin. Open the rear output bin to use it (see “Printing to the rear output bin” on page 45).

The printer control panel can be set for one custom size at a time. Do not load more than one size of custom paper into the printer.

### Guidelines for printing custom-size paper

- Do not attempt to print on paper smaller than 76 mm (3 in) wide or 127 mm (5 in) long.
- In the software application, set page margins at least 4.23 mm (0.17 in) away from the edges.
- Feed short-edge first.

### Setting custom paper sizes

When custom paper is loaded, size settings need to be selected from the software application (the preferred method), the printer driver, and the printer control panel.



---

**Note**

---

Settings in the printer driver and software application override control panel settings. (Software application settings generally override printer driver settings.)

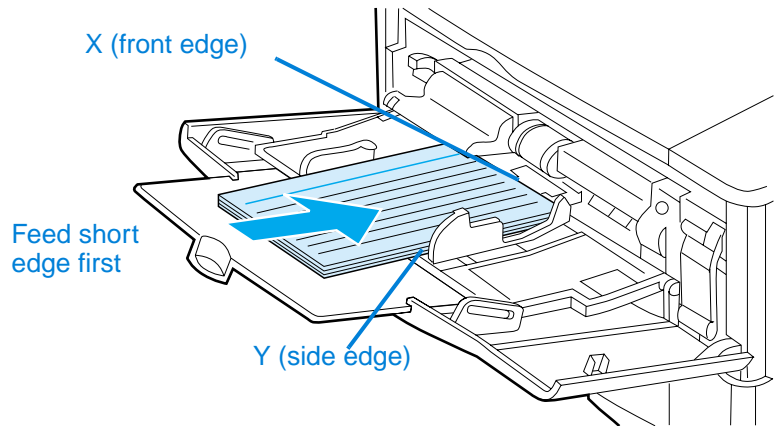

If the settings are not available from the software, set the custom paper size from the control panel:

- 1 From the Printing Menu set `CONFIGURE CUSTOM PAPER=YES`.
- 2 From the Printing Menu, select inches or millimeters as the unit of measurement.
- 3 From the Printing Menu, set the X dimension (the front edge of the paper) as shown in the figure above. The X dimension can be 76 to 216 mm (3 to 8.5 in).
- 4 Set the Y dimension (the side edge of the paper) as shown in the figure above. The Y dimension can be 127 to 356 mm (5 to 14 in).

For example, if the custom paper is 203 by 254 mm (8 by 10 in), set X=203 mm and Y=254.

- 5 If custom paper is loaded into tray 1, set `TRAY 1 MODE=CASSETTE` and then set `TRAY 1 SIZE=CUSTOM` from the Paper Handling Menu in the printer control panel. See “Customizing tray 1 operation” on page 69.

If custom paper is loaded in tray 2, 3, or 4, be sure the paper size slider is set to Custom (see “Loading trays 2, 3, and 4” on page 47).



# Advanced printing tasks

This section will help you take full advantage of the printer's features.

## Using features in the printer driver

When you print from a software application, many of the printer's features are available from the printer driver. To access Windows printer drivers, see "Access the Windows printer driver" on page 36.

---

### Note

Certain printer features might not be available with all drivers. Check the drivers for available options.

Settings in the printer driver and software application generally override control panel settings. (Software application settings generally override printer driver settings.)

---

## Printer collation

The Printer Collation feature, only available with a minimum of 32 MB of RAM or a hard disk accessory, allows multiple original prints (mopying) that provides you the following advantages:

- reduces network traffic
- faster return to application
- all documents are original

---

### Note

See the application or printer driver online help for specific steps.

## RIP ONCE

RIP ONCE allows the print job to be processed one time at the printer. The RIP ONCE capability creates an image of the page then saves a compressed image of the page into memory. RIP ONCE is enabled when a minimum of 32 MB of RAM or a hard disk accessory is installed in the printer. Pages are printed by decompressing page images without pausing to process the print job again. The print job will print exactly the same every time because the compressed image is not dependent on any other printer data.



## **Saving printer setup information (Quick Sets)**

Printer drivers allow you to save the printer settings you use most often as the default settings. For example, the driver might be set to print on letter size paper, portrait orientation, with automatic tray selection (from the first available tray).

Windows PCL 6 and PCL 5e printer drivers will allow you to save printer settings for multiple kinds of print jobs. For example, you might want to create a Quick Set for envelopes, or for printing the first page of a document on letterhead.

See the printer driver online help for more information on the Quick Sets feature.



## **Scaling page image (ZoomSmart)**

Windows PCL 6 and PCL 5e printer drivers include a feature called ZoomSmart that lets you scale the page image from any page size to any page size. You can do this either by a numeric percentage or by specifying a different paper size scale.

See the printer driver online help for more information on the ZoomSmart feature.

## **Printing booklets**

Windows PCL 6 and PCL 5e printer drivers let you control the printing of booklets when duplexing. You have the choice of binding on the left or right side on Letter, Legal, or A4 paper size.

See the printer driver online help for more information on this feature.

## **Printing with a watermark**

A watermark is a notice, such as “Top Secret,” printed in the background of each page in a document. Check the driver for available options, or see the printer driver online help for more information.



## Different first page

Follow these instructions for printing a first page that is different from other pages in the print job.

- 1 For Windows, select “Use different paper for first page” in your printer driver. Choose one tray (or Manual Feed) for the first page and one of the other trays for the remaining pages. Place the paper for the first page in tray 1 (or whichever tray you selected). (For manual feed, place paper in tray 1 after the job is sent to the printer and the printer requests paper.) For loading tray 1, place the paper with the side-to-be-printed up, the top of the page facing the rear of the printer.

For Macintosh computers, select “First from” and “Remaining from” in the print dialog box.



---

### Note

---

Where and how you make selections depends on your software application or associated printer driver. (Some options may only be available through the printer driver.)

- 2 Load the paper for the remaining pages of the document into another tray. You may select the first and remaining pages by type of paper. For more information, see “Manually feeding paper from tray 1” on page 71.

## Printing multiple pages on one sheet of paper (n-up)

You can print more than one page on a single sheet of paper. This feature is available in some printer drivers, and provides a cost-effective way to print draft pages.

To print more than one page on a sheet of paper, look for a Layout or Pages Per Sheet option in the printer driver. (This is sometimes called 2-up, 4-up, or n-up printing.)

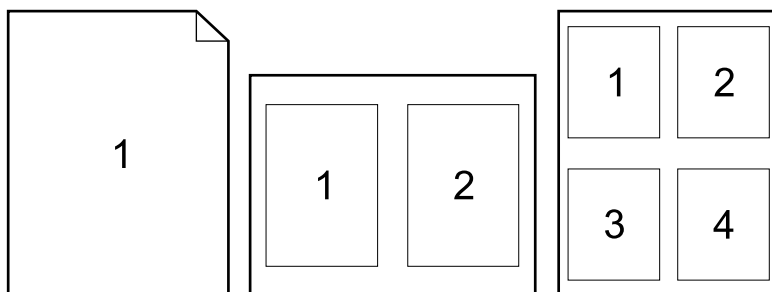

# Customizing what tray is used for printing

## Understanding tray order

When the printer receives a print job, it selects the paper tray by trying to match the requested paper type and size with what has been loaded in the trays. Using an “autoselect” process, it searches all available input paper trays for the paper that satisfies the request, starting with the bottom tray and ending with the top tray (tray 1). The printer begins printing the job as soon as it finds the proper type/size.

If any paper is loaded in tray 1 and tray 1 is set to `FIRST` mode in the Paper Handling Menu, the printer will always pull paper from tray 1 first. (See the explanation of `FIRST` mode in “Customizing tray 1 operation” on page 69.)

If the search fails, the printer displays a message on the control panel requesting you to load the correct paper type/size. You can load that paper type/size, or you can override the request by entering a different type/size at the control panel.

If a tray runs out of paper during a print job, the printer automatically switches to any paper tray that contains the same paper type/size.

The autoselect process changes somewhat if you customize tray 1 operation (as explained in “Customizing tray 1 operation” on page 69) or set tray 1 for manual feed (as explained in “Manually feeding paper from tray 1” on page 71).



## Customizing tray 1 operation

The printer can be set to print from tray 1 as long as it is loaded, or to print only from tray 1 if the type of paper loaded is specifically requested. Set `TRAY 1 MODE=FIRST` or `TRAY 1 MODE=CASSETTE` in the Paper Handling Menu at the printer control panel (see “Paper Handling Menu” on page 210).



Setting	Explanation
<code>TRAY 1 MODE=FIRST</code>	Means that the printer usually pulls paper from tray 1 first unless it is empty or closed. If you do not keep paper in tray 1 all the time, or you use tray 1 only for manually feeding paper, keep the default setting of <code>TRAY 1 MODE=FIRST</code> in the Paper Handling Menu.
<code>TRAY 1 MODE=CASSETTE</code>	<p>Means that the printer treats tray 1 like trays 2, 3, and 4. Instead of looking for paper in tray 1 first, the printer pulls paper from the tray that matches type and size settings selected from the software.</p> <p>When <code>TRAY 1 MODE=CASSETTE</code> is set, an option appears in the Paper Handling Menu to configure <i>size</i> as well as <i>type</i> settings for tray 1.</p> <p>Through the printer driver, you can select paper from any tray (including tray 1) by type, size, or source. To print by type and size of paper, see “Printing by type and size of paper (locking trays)” on page 70.</p>



## Printing by type and size of paper (locking trays)

You can configure the printer to select paper by *type* (such as plain or letterhead) and *size* (such as letter or A4), as opposed to *source* (a paper tray).

See “Supported sizes and weights of paper” on page 189 and “Supported types of paper” on page 192.



### Benefits of printing by type and size of paper

If you frequently use several different kinds of paper, once trays are set up correctly, you do not have to check which paper is loaded in each tray before you print. This is especially helpful when the printer is shared, and more than one person loads or removes paper.



Printing by type and size of paper is a way to be sure that print jobs always print on the desired paper. (Some older model printers have a feature which “locks out” trays to prevent printing on the wrong paper. Printing by type and size of paper eliminates the need to lock out trays.)

### To print by type and size of paper

- 1 Be sure to load the trays correctly and make all three adjustments. (See the sections on loading paper, starting with “Loading tray 1” on page 46).
- 2 From the Paper Handling Menu in the printer control panel, select the paper *type* for each tray. If you are unsure what type you are loading (such as bond or recycled), check the label on the package of paper.
- 3 Select the paper *size* settings from the control panel.
  - **Tray 1:** If the printer has been set to TRAY 1 MODE=CASSETTE from the Paper Handling Menu, also set the paper size from the Paper Handling Menu. If custom paper is loaded, set the size of custom paper from the Printing Menu to match the paper loaded in tray 1. To print custom-size paper, see “Guidelines for printing custom-size paper” on page 63.
  - **Trays 2, 3, and 4:** Paper size is automatically detected when paper is properly loaded into the tray and the paper size adjustments have been made to match the paper size (see “Loading trays 2, 3, and 4” on page 47 for information on tray adjustments). If custom paper is loaded, set the size of custom paper from the Printing Menu to match the paper loaded in the tray. Set the paper size slider in the tray to Custom. To print custom-size paper, see “Guidelines for printing custom-size paper” on page 63.





- **Optional envelope feeder:** Set the paper size from the Paper Handling Menu.
- 4 From the software or printer driver, select the desired type and size of paper.

---

## Note

The type and size settings can also be configured from HP Web JetAdmin software for networked printers. See the printer driver online help.

To print by type and size, it might be necessary to unload or close tray 1, or set `TRAY 1 MODE=CASSETTE` from the Paper Handling Menu in the printer control panel. For more information, see “Customizing tray 1 operation” on page 69.

Settings in the printer driver and software application override control panel settings. (Software application settings generally override printer driver settings.)

---

## Manually feeding paper from tray 1

The manual feed feature is another way of printing on special paper from tray 1. Setting manual feed to on either from the printer control panel or from the printer driver will stop the printer after each job is sent, allowing you time to load special media in tray 1. Press **Go** to continue printing.

If there is already paper in tray 1 when you send the print job and the printer control panel has `TRAY 1= FIRST` as the default configuration for tray 1 operation, the printer will *not* stop and wait for paper to be loaded. To use this feature, set `TRAY 1=CASSETTE` in the Paper Handling Menu (see the description of “`TRAY 1 MODE= FIRST`” on page 210).

If you have selected `MANUAL FEED=ON` in the printer control panel, this setting will override the printer driver, and all print jobs sent to the printer will request manually fed paper in tray 1 unless a specific tray has been selected from the printer driver. If this feature is to be used only occasionally, it is best to set `MANUAL FEED=OFF` in the printer control panel and to select the manual feed option from within the printer driver on a job-by-job basis.



# Job retention features

To use the job retention features listed below, you must install a hard disk accessory in the printer and properly configure the drivers.

To support job retention features for complex jobs, HP recommends that you install additional memory (see “Ordering information” on page 22).

## CAUTION

Make sure to identify your jobs in the printer driver before printing. Using default names may override previous jobs with the same default name or cause the job to be deleted.



## Quick copying a job

The quick copy feature prints the requested number of copies of a job and stores a copy on the printer's hard disk accessory. Additional copies of the job can be printed later. This feature can be turned off from the driver.

For more information about specifying the number of quick copy jobs that can be stored, see the QUICK COPY JOBS control panel item described in “Quick Copy Jobs Menu” on page 206.

## Printing additional copies of a quick copy job

To print additional copies of a job stored on the printer's hard disk accessory from the control panel:

- 1 Press **MENU** repeatedly until **QUICK COPY JOBS MENU** appears.
- 2 Press **ITEM** until the desired user or job name appears.
- 3 For Macintosh computers only: The user name appears on the first line of the display and the job name appears on the second line of the display. After you have selected the desired user name using **ITEM**, press **-VALUE+** until the desired job name appears.
- 4 Press **SELECT** to select the job. **COPIES=1** appears.
- 5 Press **-VALUE+** until the desired number of copies appears.
- 6 Press **SELECT** to print the job.



## Deleting a quick copy job

When a user sends a quick copy job, the printer overwrites any previous jobs with the same user and job name. If there is not a quick copy job already stored under the same user and job name and the printer needs additional space, the printer may delete other quick copy jobs starting with the oldest job. The default number of quick copy jobs that can be stored is 32. The number of quick copy jobs that can be stored is set from the control panel (see the description of "QUICK COPY JOBS=32" on page 221).



---

### Note

---

If you turn the printer off, all quick copy, proof and hold, and private jobs are deleted. A quick copy job can also be deleted from the control panel or from HP Web JetAdmin.

- 1 Press **MENU** repeatedly until `QUICK COPY JOBS MENU` appears.
- 2 Press **ITEM** until the desired user name appears.
- 3 For Macintosh computers only: The user name appears on the first line of the display and the job name appears on the second line of the display. After you have selected the desired user name using **ITEM**, press **-VALUE+** until the desired job name appears.
- 4 Press **SELECT** to select the job. `COPIES=1` appears.
- 5 Press **-VALUE+** until `DELETE` appears.
- 6 Press **SELECT** to delete the job.



## Proofing and holding a job

The proof and hold feature provides a quick and easy way to print and proof one copy of a job and then print the additional copies.

To permanently store the job and prevent the printer from deleting it when space is needed for something else, select the Stored Job option in the driver.



## Printing the remaining copies of a held job

The user can print the remaining copies of a job held on the printer's hard disk accessory from the control panel.



- 1 Press **MENU** repeatedly until `QUICK COPY JOBS MENU` appears.
- 2 Press **ITEM** until the desired user name appears.
- 3 For Macintosh computers only: The user name appears on the first line of the display and the job name appears on the second line of the display. After you have selected the desired user name using **ITEM**, press **-VALUE+** until the desired job name appears.
- 4 Press **SELECT** to select the job. `COPIES=1` appears.
- 5 Press **-VALUE+** until the desired number of copies appears.
- 6 Press **SELECT** to print the job.



## Deleting a held job

When a user sends a proof and hold job, the printer automatically deletes that user's previous proof and hold job. If there is not a proof and hold job already for that job name and the printer needs additional space, the printer may delete other proof and hold jobs starting with the oldest one.



---

### Note

---

If you turn the printer off, all quick copy, proof and hold, and private jobs are deleted. A job can also be deleted from the control panel.



- 1 Press **MENU** repeatedly until `QUICK COPY JOBS MENU` appears.
- 2 Press **ITEM** until the desired user name appears.
- 3 For Macintosh computers only: The user name appears on the first line of the display and the job name appears on the second line of the display. After you have selected the desired user name using **ITEM**, press **-VALUE+** until the desired job name appears.
- 4 Press **SELECT** to select the job. `COPIES=1` appears.
- 5 Press **-VALUE+** until `DELETE` appears.
- 6 Press **SELECT** to delete the job.



## Printing a private job

The private printing feature lets a user specify that a job is not printed until that user releases it using a 4-digit personal identification number (PIN) through the printer control panel. The user specifies the PIN in the driver and it is sent to the printer as part of the print job.



## Specifying a private job

To specify that a job is private from the driver, select the Private Job option and type a 4-digit PIN.



## Releasing a private job

The user can print a private job from the control panel.



- 1 Press **MENU** repeatedly until PRIVATE/STORED JOBS MENU appears.
- 2 Press **ITEM** until the desired user name appears.
- 3 For Macintosh computers only: The user name appears on the first line of the display and the job name appears on the second line of the display. After you have selected the desired user name using **ITEM**, press **-VALUE+** until the desired job name appears.
- 4 Press **SELECT** PIN:0000 appears.
- 5 Press **-VALUE+** to change the first number of the PIN, and then press **SELECT**. An \* appears in place of the number. Repeat these steps to change the remaining three numbers of the PIN. COPIES=1 appears.
- 6 Press **-VALUE +** until the desired number of copies appears.
- 7 Press **SELECT** to print the job.



## Deleting a private job

A private job is automatically deleted from the printer's hard disk accessory after the user releases it for printing, unless the user selects the Stored Job option in the driver.

### Note

If you turn the printer off, all quick copy, proof and hold, and private jobs are deleted. A private job can also be deleted from the printer control panel before it is ever printed.

- 1 Press **MENU** repeatedly until PRIVATE/STORED JOBS MENU appears.
- 2 Press **ITEM** until the desired user name appears.
- 3 For Macintosh computers only: The user name appears on the first line of the display and the job name appears on the second line of the display. After you have selected the desired user name using **ITEM**, press **-VALUE+** until the desired job name appears.
- 4 Press **SELECT** to select the job. PIN:0000 appears.
- 5 Press **-VALUE+** to change the first number of the PIN, and then press **SELECT**. An \* appears in place of the number. Repeat these steps to change the remaining three numbers of the PIN. COPIES=1 appears.
- 6 Press **-VALUE+** until DELETE appears.
- 7 Press **SELECT** to delete the job.



# Storing a print job

The user can download a print job to the printer's hard disk accessory without printing it. The user can then print the job at any time through the printer control panel. For example, a user may want to download a personnel form, calendar, time sheet, or accounting form that other users can access and print.

To store a print job permanently on the hard disk accessory, select the Stored Job option in the driver when printing the job.



## Printing a stored job

The user can print a job stored on the printer's hard disk accessory from the control panel.

- 1 Press **MENU** repeatedly until `PRIVATE/STORED JOBS MENU` appears.
- 2 Press **ITEM** until the desired user name appears.
- 3 For Macintosh computers only: The user name appears on the first line of the display and the job name appears on the second line of the display. After you have selected the desired user name using **ITEM**, press **-VALUE+** until the desired job name appears.
- 4 Press **SELECT** to select the job name. `COPIES=1` appears.
- 5 Press **-VALUE+** until the desired number of copies appears.
- 6 Press **SELECT** to print the job.





## Deleting a stored job

Jobs stored on the printer's hard disk accessory can be deleted from the control panel.

- 1 Press **MENU** repeatedly until PRIVATE/STORED JOBS MENU appears.
- 2 Press **ITEM** until the desired user name appears.
- 3 For Macintosh computers only: The user name appears on the first line of the display and the job name appears on the second line of the display. After you have selected the desired user name using **ITEM**, press **-VALUE+** until the desired job name appears.
- 4 Press **SELECT** to select the job. COPIES=1 appears.
- 5 Press **-VALUE+** until DELETE appears.
- 6 Press **SELECT** to delete the job.



# Printing with the optional HP Fast InfraRed Receiver

The optional HP Fast InfraRed Receiver enables wireless printing from any IRDA-compliant portable device (such as a laptop computer) to the HP LaserJet Series printers.

The printing connection is maintained by positioning the sending infrared (FIR) port within operating range. Note that the connection can be blocked by objects such as a hand, paper, direct sunlight, or any bright light shining into either FIR port.

---

## Note

For more information, see the user guide that came with the HP Fast InfraRed Receiver.

If your operating system does not have infrared software installed, contact your computer manufacturer for drivers and installation instructions.

---



## Setting up to print with Windows 9x

Before launching the InfraRed Driver, complete the following steps:

- 1 Click **Start**, click **Settings**, and then click **Printers**.
- 2 Select the HP LaserJet 4100, 4100N, 4100TN, or 4100DTN as your default printer.
- 3 While in the same **Printers** folder, choose **Properties/Details**, and make sure that Virtual Infrared LPT Port is selected.
- 4 Select the file to print.

## Setting up to print with Macintosh computers

The first step for setting up an infrared printer is creating a Desktop Printer icon using the Desktop Printer Utility. By default, the Desktop Printer Utility is located in the **Apple Extras/Apple LaserWriter** folder on the hard drive.

Printer IR will not be an option if the Infrared Control Panel and extensions are not active. In addition, the infrared print capability is possible only with the HP LaserWriter version 8.6 driver or later.

- 1 Launch the Desktop Utility.
- 2 Select **Printer IR (Infrared)** and click **OK**.



- 3 Change **PostScript Printer Description (PPD) File** to match the printer.
- 4 On the **File** menu, select **Save**.
- 5 Enter a name and location for the desktop printer icon and click **OK**.



---

**Note**

---

Once the icon is on the desktop (or saved elsewhere), printer options need to be manually configured. This step is essentially the same as selecting **Configure** after setting up a printer in the Chooser. To set the options, highlight the Desktop Printer icon and select **Change Setup** from the **Printing** menu.

## Printing a job

- 1 Align your laptop computer (or other portable device equipped with an IRDA-compliant FIR window) within 1 meter (3 feet) maximum of the HP Fast InfraRed Receiver. The FIR window must be at an angle of within +/- 15 degrees relative to the printer to ensure an effective connection for printing.
- 2 Print the job. The status indicator on the HP Fast InfraRed Receiver lights up, and, after a short delay, the printer status panel displays `PROCESSING JOB`.

If the status indicator does not light up, realign the HP Fast InfraRed Receiver with the FIR port on the sending device, resend the print job, and maintain the alignment of all devices. If you have to move the equipment (for example, to add paper), make sure that all devices remain within the range of operation to maintain the connection.

If the connection is interrupted before your print job is complete, the HP Fast InfraRed Receiver status indicator turns off. You have up to 40 seconds to correct the interruption and continue the job. If the connection is resumed within this time, the status indicator lights up again.

---

**Note**

---

The connection is permanently broken if the sending port is moved out of operating range or if anything passing between the ports blocks transmission for more than 40 seconds. (This block could be a hand, paper, or even direct sunlight.) Depending on the size of the job, printing with the HP Fast InfraRed Receiver may be slower than printing with a cable connected directly to the parallel port.



## Interrupting and resuming printing

The job interrupt and resume feature lets you temporarily stop the job that is currently printing in order to print another job through an FIR connection. When the FIR job is finished printing, the interrupted job resumes printing.

To interrupt the job at the printer, connect to the FIR port on the printer and send a job to the printer. The printer stops printing the current job when it reaches the end of the copy it is printing. The printer then prints the job sent over the FIR connection. When the printer is done printing that job, it resumes printing the original job with multiple copies where it left off.



# 3 Printer maintenance



## Overview

This chapter explains basic printer maintenance:

- managing the toner cartridge
- cleaning the printer
- cleaning the fuser (manual and automatic)
- performing preventative maintenance
- configuring alerts



# Managing the toner cartridge

## HP toner cartridges

When you use a genuine new HP toner cartridge (part number C8061A or C8061X), you can obtain the following types of supplies information:

- amount of toner remaining
- estimated number of pages remaining
- number of pages printed
- other supplies information



## Non-HP toner cartridges

Hewlett-Packard Company cannot recommend use of non-HP toner cartridges, either new or remanufactured. Because they are not HP products, HP cannot influence their design or control their quality. Service or repair required as a result of using a non-HP toner cartridge will *not* be covered under the printer warranty.

When you use a non-HP toner cartridge, the printer is unable to report on the number of pages that can still be printed with the amount of toner left in the cartridge. The toner level estimate will only be an approximate percentage.

If the non-HP toner cartridge was sold to you as a genuine HP product, please call HP's fraud hotline (see "HP fraud hotline" on page 161).

## Toner cartridge authentication

The printer will let you know that a cartridge is not a genuine HP toner cartridge when you insert it in the printer. If you insert a used HP cartridge from another HP printer, the printer can take up to 20 printed pages to receive the message authenticating that the cartridge is a genuine HP part.

If the printer control panel message states that this is not a genuine HP toner cartridge and you believe you purchased an HP cartridge, call the HP fraud hotline at 1-887-219-3183 (toll-free in North America).



## Toner cartridge storage

Do not remove the toner cartridge from its package until you are ready to use it. The shelf life of a cartridge in an unopened package is approximately 2.5 years.



### CAUTION

To prevent damage to the toner cartridge, do not expose it to light for more than a few minutes.



## Toner cartridge life expectancy

The life of the toner cartridge depends on the amount of toner that print jobs require. When printing text at 5% coverage, an HP toner cartridge lasts an average of 10,000 or 6,000 pages, depending on which toner cartridge is installed. (A typical business letter is about 5% coverage.) This assumes that print density is set to 3 and EconoMode is off. (These are the default settings. For details on other settings, see the description of `ECONOMODE` and `TONER DENSITY` in “Print Quality Menu” on page 217.)



At any time, you can verify life expectancy by checking the toner level, as described below.

## Checking the toner level

You can check the toner level using the printer control panel, the embedded web server, printer software, or HP Web JetAdmin.

### Using the printer control panel

- 1 Press **MENU** until `INFORMATION MENU` appears.
- 2 Press **ITEM** until `PRINT SUPPLIES STATUS PAGE` appears.
- 3 Press **SELECT** to print the supplies status page. See “Supplies status page” on page 154 for information on the supplies status page.

### Using the embedded web server

- 1 In your web browser, enter the IP address for the printer home page. This takes you to the printer status page. (See “Accessing the embedded web server” on page 252.)
- 2 On the left side of the screen, click **Supplies Status**. This takes you to the supplies status page, which provides toner level information. See “Supplies status page” on page 154 for information on the supplies status page.



## Using printer software

Three things are required to use this feature:

- the “Supplies Information and Ordering” software must be installed on your computer (use the custom installation option to install this software)
  - the printer must be directly connected to your computer (parallel)
  - you must have access to the World Wide Web
- 1 At the bottom right of your screen (in the system tray), double-click the Printer icon. This opens the status window.
  - 2 On the left side of the status window, click the Printer icon from which you wish to obtain status.
  - 3 At the top of the status window, click the **Supplies** link. You can also scroll down to Supplies Status.



---

### Note

---

If you want to order supplies, click **Order Supplies**. This opens a browser that produces a URL from which to purchase consumables. Select the supplies you wish to order and finish the ordering process.

## Using HP Web JetAdmin

In HP Web JetAdmin, select the printer device. The device status page shows toner level information.

## Cartridge interaction (shaking)

When you install a toner cartridge for the first time, gently shake it from side to side to distribute the toner evenly inside the cartridge. Due to new cartridge design, this is the only time you will need to shake the cartridge.





# Toner low and toner out conditions

## When toner is low

When toner is low, the printer control panel displays a `TONER LOW` message and the printer continues to print. The message first appears when about 15% of the toner remains in the cartridge (about 1,500 pages remaining for the 10,000-page cartridge and about 900 pages remaining for the 6,000-page cartridge at 5% page coverage).

You might prefer to have the printer stop instead of continuing when the `TONER LOW` message first appears—for example, if you want print quality to remain consistently high during print jobs or if you do not want toner to run out during a long print job. To configure the printer to stop, change the `TONER LOW` menu item on the Print Quality Menu from `CONTINUE` to `STOP` (see “`TONER LOW= CONTINUE`” on page 219). Then when `TONER LOW` appears, the printer will stop printing. You can resume printing by pressing [Go](#).



## When toner is out

When the toner cartridge runs out of toner, the printer control panel displays a `TONER OUT` message and the printer stops printing. You can continue printing the current job by pressing [Go](#). The message continues to appear for every job until you take one of the following actions:

- replace the toner cartridge
- press [Go](#) (the printer will print the current job)

If you want the printer to continue printing when `TONER OUT` appears, change the `TONER OUT` menu item on the Print Quality Menu from `STOP` to `CONTINUE` (see “`TONER OUT= STOP`” on page 219). Subsequent jobs will continue to print indefinitely while `TONER OUT` is displayed.



# Cleaning the printer

## General guidelines

Follow the cleaning procedure on the following page every time you change the toner cartridge or whenever print quality problems occur. As much as possible, keep the printer free from dust and debris.

- Clean the outside of the printer with a slightly water-dampened cloth.
- Clean the inside with a dry, lint-free cloth.

### CAUTION

Do not use ammonia-based cleaners on or around the printer.

While cleaning the printer, be careful not to touch the transfer roller (the black, rubber roller located underneath the toner cartridge). Skin oils on the roller can cause print quality problems.

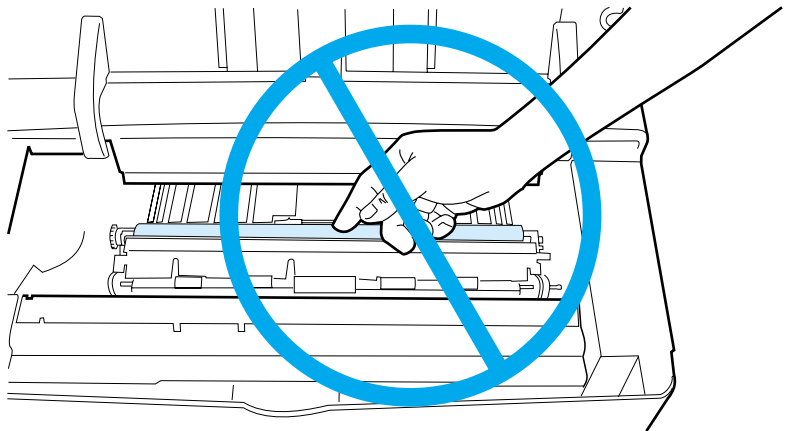

## Cleaning procedure

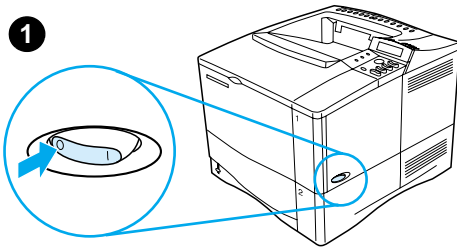

- 1 Turn the printer off and unplug the power cord.
- 2 Open the top cover and remove the toner cartridge.



### WARNING!

Avoid reaching too far into the printer. The adjacent fusing area might be hot!

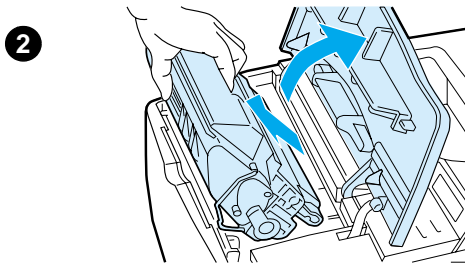

### CAUTION

To prevent damage to the toner cartridge, do not expose it to light for more than a few minutes.

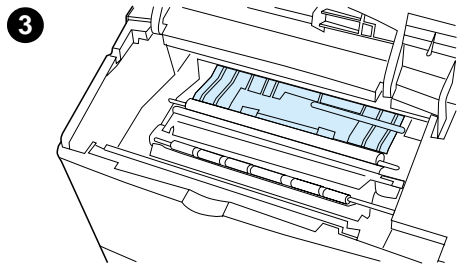

- 3 Wipe any dust or dirt off the paper feed guides (shaded areas) with a dry, lint-free cloth.

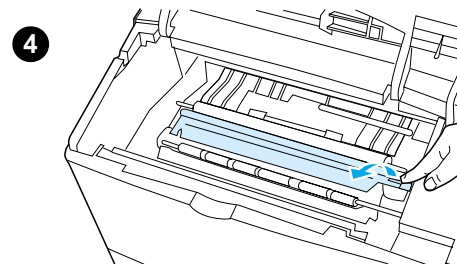

### Note

If toner gets on your clothing, wipe it off with a dry cloth and wash clothing in cold water. (Hot water sets toner into fabric.)

- 4 Using the green handle, lift the paper access plate and wipe off any residue with a dry, lint-free cloth.

**Continued on the next page.**



5

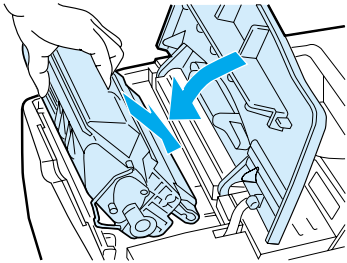

5 Reinstall the toner cartridge, close the top cover, plug the power cord in, and turn the printer on.



# Cleaning the fuser

Run the printer cleaning page to keep the fuser free of toner and paper particles that can sometimes accumulate. Accumulation of toner and particles can cause specks to appear on the front or back side of your print jobs (see “Specks” on page 130).



To ensure optimum print quality, HP recommends that you use the cleaning page every time you replace the toner cartridge or on an automatic schedule that you can set up.



You can run a cleaning page in two ways:

- manually as needed from the printer control panel
- automatically according to an interval that you set



The cleaning procedure takes about 2.5 minutes to complete. A message on the control appears while the cleaning is taking place (either `PROCESSING CLEANING PAGE` or `PROCESSING AUTO CLEANING PAGE`).

## Running the cleaning page manually

In order for the cleaning page to work properly, print the page on copier grade paper (not bond, heavy, or rough paper).

To run the cleaning page manually:

- 1 At the printer control panel, press **MENU** until `PRINT QUALITY MENU` appears.
- 2 Press **ITEM** until `CREATE CLEANING PAGE` appears.
- 3 Press **SELECT** to create the cleaning page. A page with a black stripe prints.
- 4 Follow the instructions on the cleaning page to complete the cleaning process.



## Running the cleaning page automatically

Using the procedure below, you can set the printer to print cleaning pages automatically at an interval that you choose.

In order for the cleaning page to run without intervention, you must keep the selected size and Plain paper type available in the printer.

The printer will not interrupt a printing job in process.

You can discard the output page created by the automatic cleaning process.

To set the cleaning page to run automatically:

- 1 At the printer control panel, press **MENU** until PRINT QUALITY MENU appears.
- 2 Press **ITEM** until AUTO CLEANING PAGE=OFF appears.
- 3 Press **-VALUE+** to change OFF to ON and then press **SELECT**.
- 4 Press **ITEM** until AUTO CLEANING FREQUENCY=2000 appears.

The default frequency is every 2,000 pages. To change this value, press **-VALUE+** up or down. The options are 1,000, 2,000, 5,000, 10,000, and 20,000 pages.

- 5 Once you have selected the page frequency, press **SELECT** to save the choice.
- 6 Press **ITEM** once again until CLEANING PAGE SIZE=LETTER appears.

You can choose to run the cleaning page on either Letter size or A4 size.

- 7 Press **-VALUE+** to select either A4 or Letter and then press **SELECT** to save your selection.



# Performing preventative maintenance

You should replace certain parts when the `PERFORM PRINTER MAINTENANCE` message appears on the printer control panel. This will help ensure that your printer maintains optimum performance.

The maintenance message will appear every 200,000 pages. To check the number of pages the printer has printed, print either a configuration page or a supplies status page (see “Configuration page” on page 152 or “Supplies status page” on page 154 for details).

To order the printer maintenance kit, see “Ordering information” on page 22. The kit includes:

- fuser
- rollers (transfer, pickup, and feed)
- instructions

---

## Note

---

The printer maintenance kit is a consumable item and is not covered under warranty.



# Configuring alerts

You can use HP Web JetAdmin or the printer's embedded web server to configure the system to alert you of problems with the printer. The alerts take the form of e-mail messages to the e-mail account or accounts that you specify.



You can configure the following:

- the device you want to monitor (in this case, the printer)
- what alerts are to be received (for example, alerts for paper jams, paper out, toner low, toner out, and cover open)
- the e-mail account to which the alerts should be forwarded



For	See the following
HP Web JetAdmin	<ul style="list-style-type: none"><li>● "HP Web JetAdmin" on page 41 for general information about HP Web JetAdmin</li><li>● HP Web JetAdmin online help for details on alerts and how to set them up</li></ul>
Embedded web server	<ul style="list-style-type: none"><li>● "Embedded web server" on page 251 for general information about the embedded web server</li><li>● Embedded web server online help for details on alerts and how to set them up</li></ul>





# 4 Problem solving



## Overview

This chapter will help you to troubleshoot and solve printer problems.

- Clear paper jams** Occasionally, paper can jam during printing. This section will help you to locate paper jams, properly clear them from the printer, and solve repeated paper jams.
- Understand printer messages** Many different messages can appear on the printer control panel display. Some messages tell the printer's current status, such as `INITIALIZING`. Other messages require an action, such as `CLOSE TOP COVER`. Many of these messages are self-explanatory. However, some messages indicate a problem with the printer, or request further action or description. This section lists these types of messages, and tells what to do if a message persists.
- Correct output quality problems** The printer should produce print jobs of the highest quality. If print jobs do not look sharp and clear, defects such as lines, specks, or smears appear on the page, or paper is wrinkled or curled, use this section to troubleshoot and solve the output quality problem.
- Determine printer problems** Before you can fix a printer problem, you must understand where the problem lies. Use the flowchart in this chapter to determine the printer problem, and then follow the corresponding troubleshooting suggestions.
- Check printer configuration** From the printer, you can print information pages, which give details about the printer and its configuration.



# Clearing paper jams

If the printer control panel displays a paper jam message, look for paper in the locations indicated in the figure on the next page, then see the procedure for clearing the paper jam. You might need to look for paper in other locations than indicated in the paper jam message. If the location of the paper jam is not obvious, look first in the top cover area underneath the toner cartridge.

When clearing paper jams, be very careful not to tear the paper. If a small piece of paper is left in the printer, it could cause additional jams. If paper jams are a recurring problem, see “Solving repeated paper jams” on page 110.

---

## Note

---

The top cover of the printer must be opened and then closed to clear a paper jam message.



## Paper jam locations

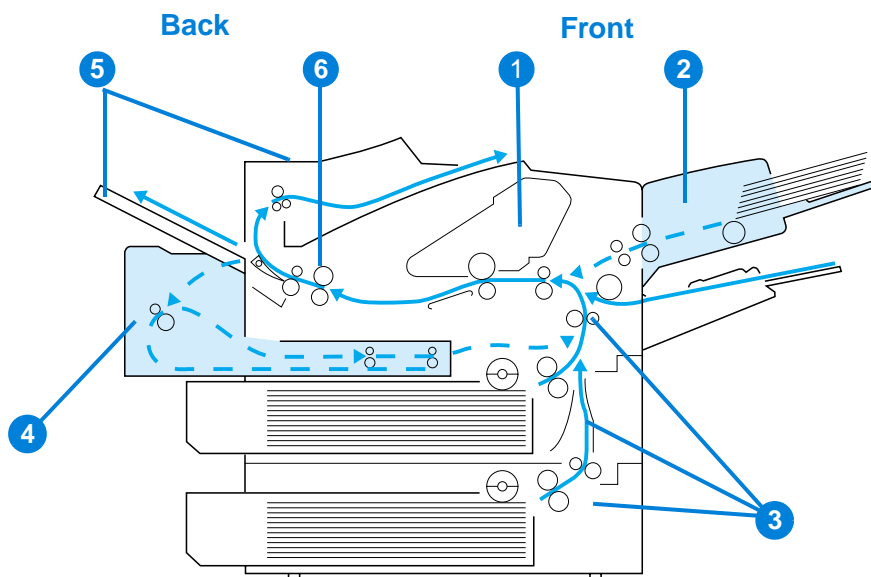

- 1 Top cover and toner cartridge area
- 2 Optional envelope feeder
- 3 Input tray areas
- 4 Optional duplexer
- 5 Output areas (top and rear)
- 6 Fuser area

---

### Note

---

Loose toner might remain in the printer after a paper jam and cause output quality problems. These should clear up within a few pages.



## Clearing jams from the top cover and toner cartridge areas

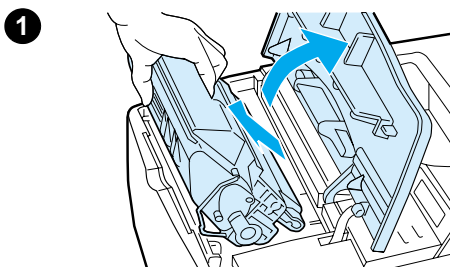

- 1 Open the top cover and remove the toner cartridge.



---

### CAUTION

To prevent damage to the toner cartridge, do not expose it to light for more than a few minutes.

---

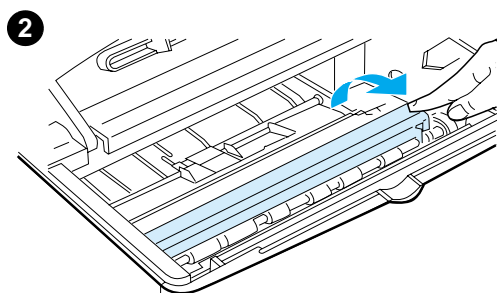

- 2 Use the green handle to lift the paper access plate.

- 3 Slowly pull the paper out of the printer. Do not tear the paper.
- 

### Note

If paper is difficult to remove, try clearing it from the input tray area (see “Clearing jams from the input tray areas” on page 102).

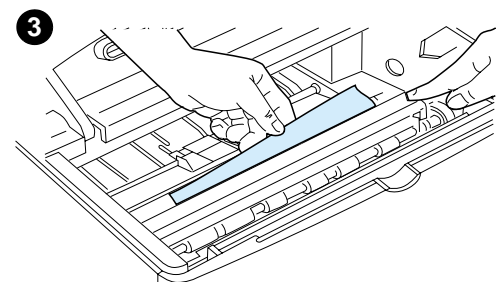

Avoid spilling loose toner. Using a dry, lint-free cloth, clean any loose toner that might have fallen into the printer.

If loose toner falls into the printer, it might cause temporary problems with print quality. Loose toner should clear from the paper path after a few pages are printed.

If toner gets on your clothing, wipe it off with a dry cloth and wash clothing in cold water. (Hot water sets toner into fabric.)

---

Continued on the next page.



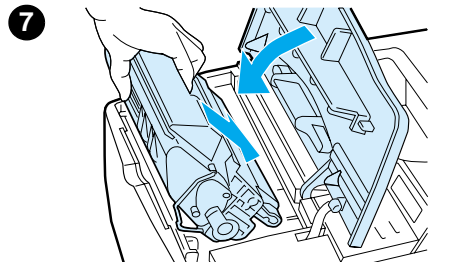
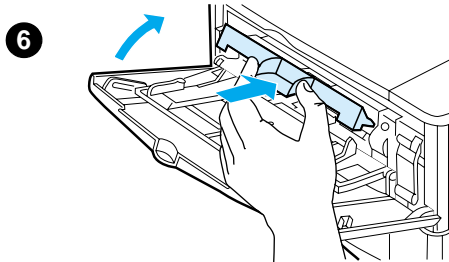
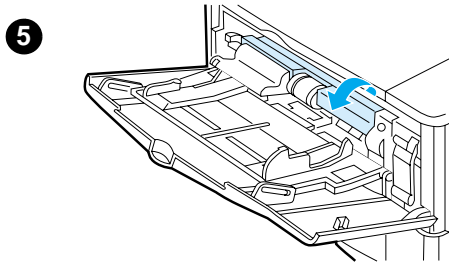
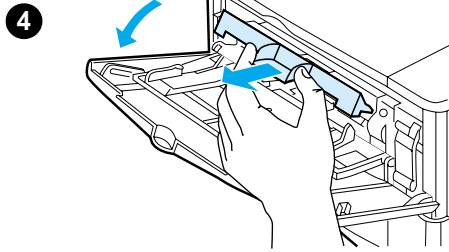

- 4 Open tray 1 and remove the entrance cover to check for additional jammed paper. If paper is present, remove it.
- 5 Rotate the paper guide to check for additional jammed paper. If paper is present, remove it.
- 6 Replace the entrance cover and close tray 1.
- 7 Reinstall the toner cartridge and close the top cover.
- 8 If a paper jam message persists, there is still paper in the printer. Look for paper in another location (see "Paper jam locations" on page 97).

If you are using a non-HP toner cartridge, the message **NON HP TONER DETECTED** might appear on the control panel. Press **Go** to continue.



## Clearing jams from the optional envelope feeder

1

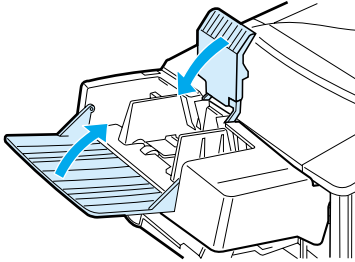

2

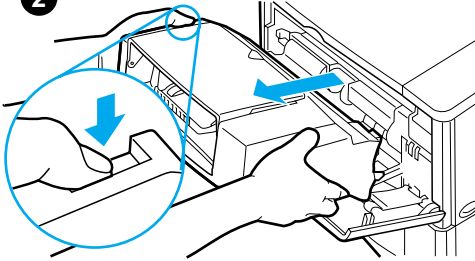

3

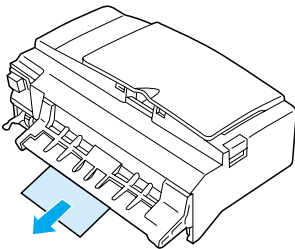

4

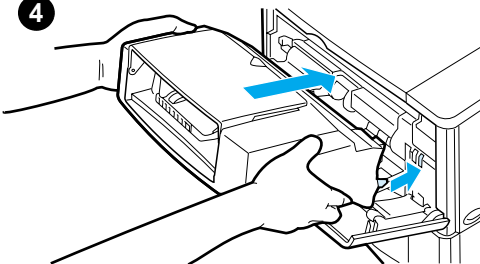

- 1 Remove any envelopes loaded in the envelope feeder. Lower the envelope weight and lift the tray extension up to the closed position.
- 2 Press and hold the release button on the left side of the envelope feeder. Grasp both sides of the envelope feeder and carefully pull it out of the printer.
- 3 Slowly remove any envelopes out of the envelope feeder and the printer.
- 4 Insert the envelope feeder into the printer until it locks into place. (The connector on the top right side of the envelope feeder fits into the plug in the printer.) Pull gently on the envelope feeder to be sure that it is securely in place.

**Continued on the next page.**



5

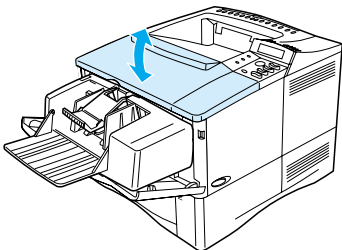

- 5 Open and close the top cover to clear the paper jam message.
- 6 If a paper jam message persists, there is still paper in the printer. Look for paper in another location (see “Paper jam locations” on page 97).
- 7 Reload envelopes, making sure that you push the bottom envelopes in slightly further than the top envelopes (see “Loading envelopes in the envelope feeder” on page 59).



# Clearing jams from the input tray areas

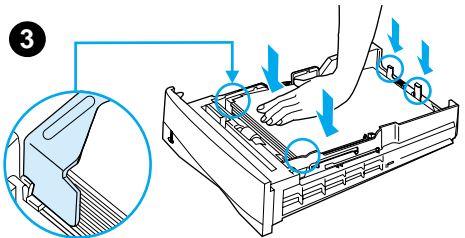
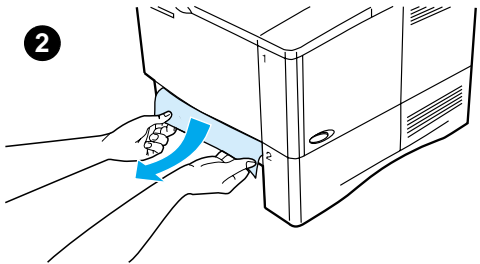
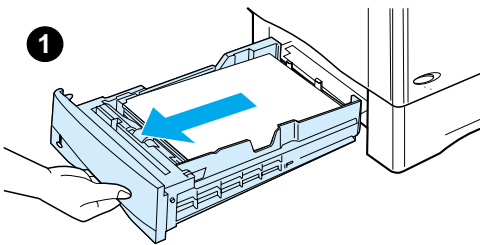

## Tray 1

Slowly pull the paper out of the printer. If part of the paper has already been pulled into the printer, follow the steps under “Clearing jams from the top cover and toner cartridge areas” on page 98.

## Trays 2, 3, and 4

For all other trays, follow the steps below (see “Clearing jams from the optional envelope feeder” on page 100 for clearing envelope feeder jams).

- 1 Slide the tray out of the printer, and remove any damaged paper from the tray.
- 2 If the edge of the paper is visible in the feed area, slowly pull the paper down and out of the printer. (Do not pull the paper straight out or it will tear.) If the paper is not visible, look in the top cover area (see “Clearing jams from the top cover and toner cartridge areas” on page 98).

### Note

Do not force the paper if it will not move easily. If the paper is stuck in a tray, try removing it through the tray above (if applicable) or through the top cover area.

- 3 Make sure the paper is flat in the tray at all four corners and below the front and back tabs.

**Continued on the next page.**





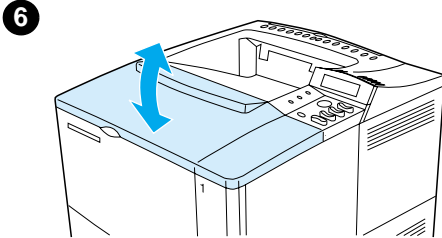
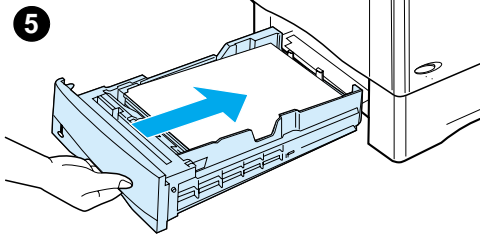

- 4 Make sure that all three paper size adjustments are correct (see “Loading trays 2, 3, and 4” on page 47).
- 5 Slide the tray back into the printer.
- 6 Open and close the top cover to clear the paper jam message.
- 7 If a paper jam message persists, there is still paper in the printer. Look for paper in another location (see “Paper jam locations” on page 97).



## Clearing jams from the optional duplexer

1

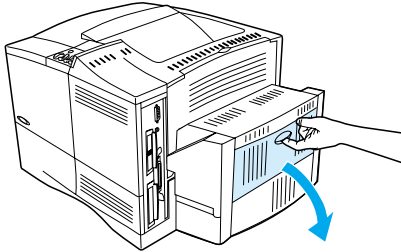

2

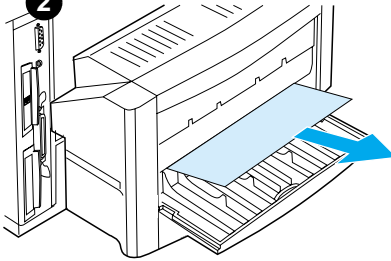

3

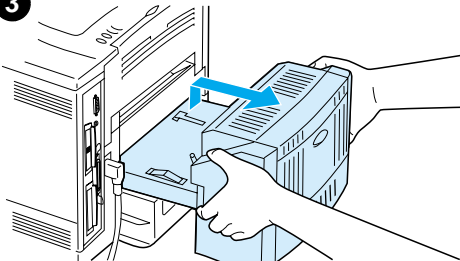

4

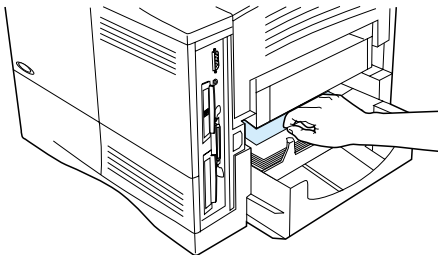

1 Open the duplexer's rear door.

2 Slowly pull any paper out of the duplexer.

3 Remove the duplexer by lifting it slightly and pulling it out of the printer.

4 From the rear of the printer, remove any paper on top of tray 2. (You might need to reach inside the printer.)

**Continued on the next page.**



5

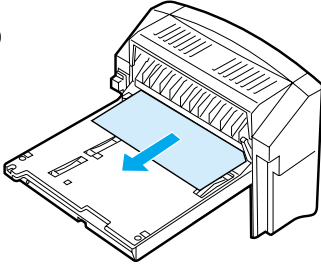

6

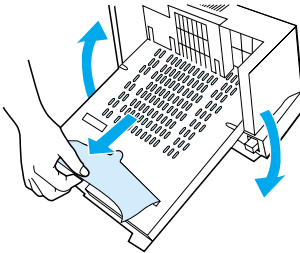

7

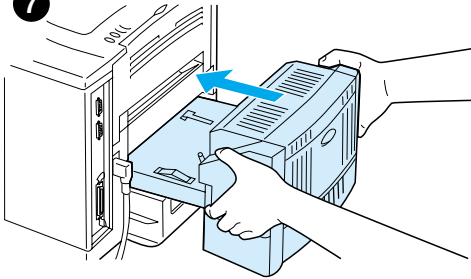

8

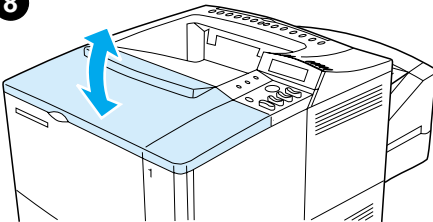

- 5 Slowly pull any paper out of the duplexer.
- 6 Turn the duplexer over and remove any paper.
- 7 Insert the duplexer into the printer.
- 8 Open and close the top cover to clear the paper jam message.
- 9 If a paper jam message persists, there is still paper in the printer. Look for paper in another location (see "Paper jam locations" on page 97).



## Clearing jams from the output areas

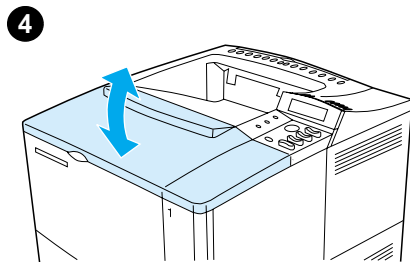
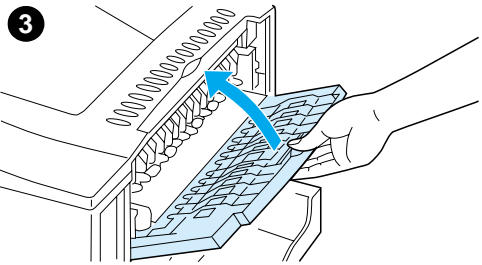
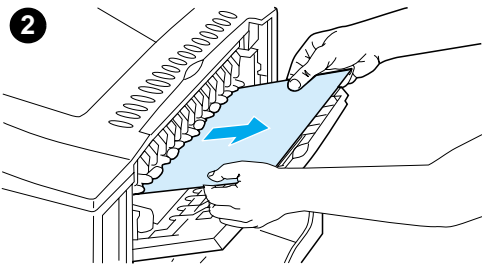
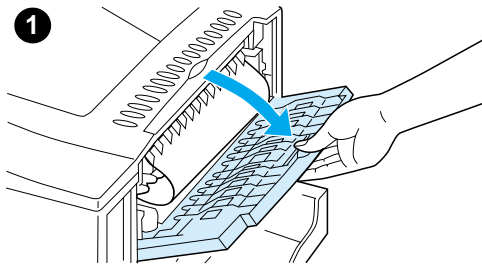

### Note

If most of the paper is still inside the printer, it is best to remove it through the top cover area. See “Clearing jams from the top cover and toner cartridge areas” on page 98.

- 1 Open the rear output bin.
- 2 Grasp both sides of the paper, and slowly pull the paper out of the printer. (There might be loose toner on the paper. Be careful not to spill it on yourself or into the printer.)

### Note

If paper is difficult to remove, try opening the top cover all the way to release pressure on the paper.

If the paper has torn or you still cannot remove the paper, see “Clearing jams from the fuser area” on page 107.

- 3 Close the rear output bin.
- 4 Open and close the top cover to clear the paper jam message.
- 5 If a paper jam message persists, there is still paper in the printer. Look for paper in another location (see “Paper jam locations” on page 97).



## Clearing jams from the fuser area

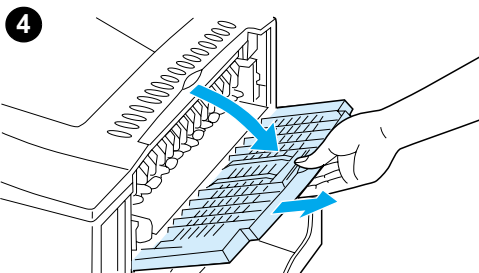
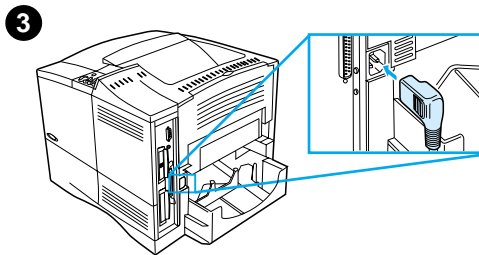
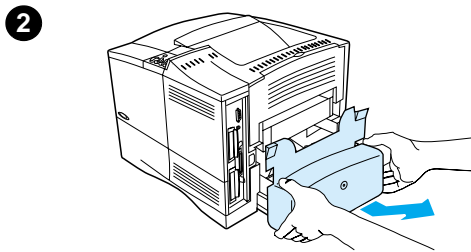
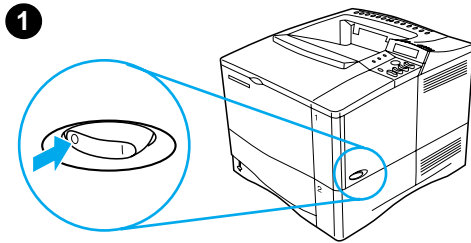

Use this procedure:

- when paper has jammed inside the fuser and cannot otherwise be removed
- when a page has torn while you were trying to clear a jam from the fuser

1 Turn the printer off.

---

### WARNING!

To avoid minor burns, wait 30 minutes for the fuser to cool before continuing with this procedure.

---

- 2 Turn the printer so its rear cover faces you and remove the tray 2 dust cover or optional duplexer.
- 3 Unplug the power cord from the printer.
- 4 Open the rear output bin and pull the extension out.

**Continued on the next page.**



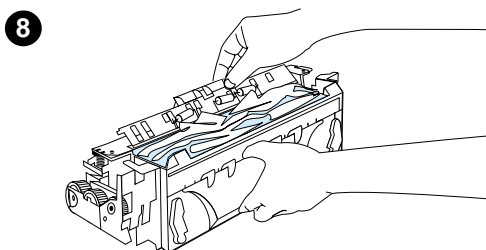
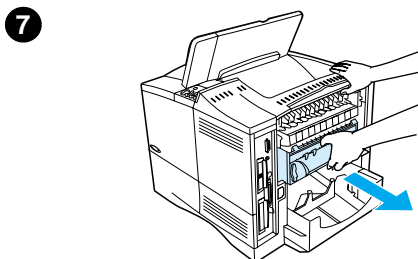
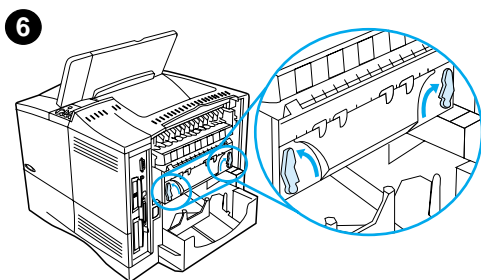
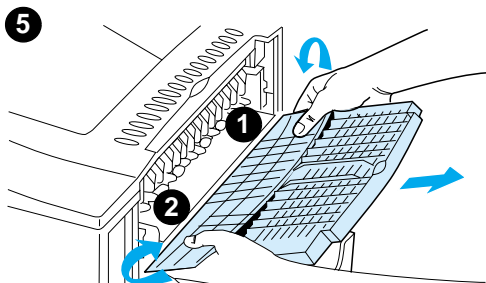

- 5 Remove the rear output bin and extension. To do this, bend the middle down slightly, release tab 1 and then release tab 2.
- 6 Unlock the fuser by rotating the blue fuser levers so that they point up.
- 7 Pull the fuser out of the printer. To release the fuser from the printer, hold the back of the printer while pulling on the fuser. Do not pull on the black plastic flapper.
- 8 Remove the paper that has jammed.

---

### CAUTION

Do not use a sharp object to clear paper from the fuser area. You might damage the fuser.

---

**Continued on the next page.**



9

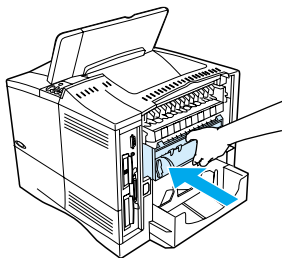

10

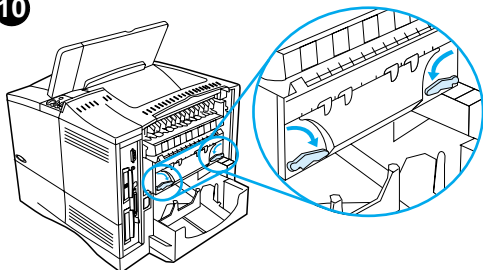

11

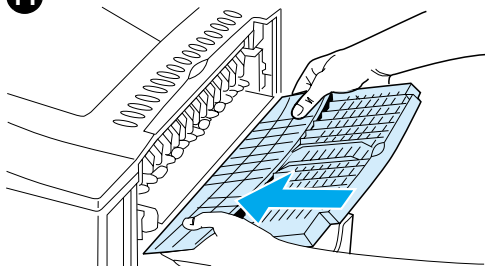

- 9 Replace the fuser, left side first. Be sure to push the fuser firmly into the printer.
- 10 Lock the fuser in place by rotating the levers to the horizontal position.
- 11 Replace the rear output bin, left side first.
- 12 Plug the power cord into the printer.
- 13 Replace the tray 2 dust cover or the optional duplexer.
- 14 Turn the printer back on.
- 15 If a paper jam message persists, there is still paper in the printer. Look for paper in another location (see "Paper jam locations" on page 97).

---

#### Note

Since the printer has been turned off, you will need to send the print job again.

---



# Solving repeated paper jams

## If paper jams occur frequently, try the following:

- Check all the paper jam locations (see “Clearing paper jams” on page 96). A piece of paper might be stuck somewhere in the printer. Even a small torn piece of paper in the printer path can cause repeated jams.
- If using a duplexer, check all areas (including under the duplexer).
- Check that paper is correctly loaded in the trays, that all three adjustments have been made, and that the trays are not overfilled. Make sure paper is under the front and back tabs. (See the sections on loading paper, starting with “Loading tray 1” on page 46.)
- Check that all trays and paper handling accessories are completely inserted into the printer. (If a tray is opened during a print job, this might cause a paper jam.)
- Check that all covers and doors are closed. (If a cover or door is opened during a print job, this might cause a paper jam.)
- Try printing to a different output bin (see “Selecting the output bin” on page 44).
- The sheets might be sticking together. Try bending the stack to separate each sheet. Do not fan the stack.
- If you are printing from tray 1, try reducing the size of the stack.
- If printing from the envelope feeder, make sure it is loaded correctly, pushing the bottom envelopes in slightly farther than the top envelopes (see “Loading envelopes in the envelope feeder” on page 59).
- If you are printing small sizes, feed paper short edge first (see “Guidelines for printing custom-size paper” on page 63).
- Turn over the stack of paper in the tray. Also try rotating the paper 180°.
- Check the characteristics of the media you are using. Use only paper that meets HP specifications (see “Paper specifications” on page 188). Try using different paper to see if the problem goes away. Do not use curled, deformed, damaged, or irregular paper.
- Check that the environmental conditions for the printer are met (see “Environmental specifications” on page 201).
- Avoid using paper that has already been used in a printer or copier.
- Do not print on both sides of envelopes or transparencies (see “Printing envelopes” on page 55 or “Printing transparencies” on page 62).
- Print only on full sheets of labels and do not print on both sides of label sheets (see “Printing labels” on page 61).
- Check that the power supplied to the printer is steady and meets printer specifications (see “Electrical specifications” on page 201).
- Clean the printer (see “Cleaning the printer” on page 88).
- Perform preventative printer maintenance if maintenance is due (see “Performing preventative maintenance” on page 93).





# Understanding printer messages

The table in this section explains messages that might appear on the printer control panel. Printer messages and their meanings are listed in alphabetical order, with numbered messages following.



## If a message persists:

- If a message persists requesting that you load a tray, or if a message indicates that a previous print job is still in the printer's memory, press **GO** to print or press **CANCEL JOB** to clear the job from the printer's memory.
- If a message persists after performing all of the recommended actions, contact an HP-authorized service or support provider (see "HP Customer Care Service and Support" on page 157).



---

### Note

Not all messages are described in this user guide (many are self-explanatory).

Some printer messages are affected by the Auto Continue and Clearable Warning settings from the Configuration Menu in the printer control panel (see the description of "CLEARABLE WARNINGS=JOB" on page 220).

---

## Using the printer online help system

This printer features an online help system on the control panel that provides instructions for resolving most printer errors. Certain control panel messages alternate with instructions on accessing the online help system.

Whenever a **?** appears in an error message or the message alternates with **FOR HELP PRESS THE ? KEY**, press the right side of the **ITEM** key to navigate through a sequence of instructions.

---

### Note

To exit the online help system, press either **GO** or **SELECT**.



## Printer messages

Message	Explanation or recommended action
ACCESS DENIED MENUS LOCKED	The printer control panel function you are trying to access has been locked to prevent unauthorized access. See your network administrator.
BAD DUPLEXER CONNECTION	The duplexer is not properly connected to the printer. Ensure that the right-angle power cord that shipped with the printer is being used. Try removing and reinstalling the duplexer. Then turn the printer off and back on.
BAD ENV FEEDER CONNECTION	The envelope feeder is not connected properly to the printer. Try removing and reinstalling the envelope feeder. Then turn the printer off and back on.
BAD OPT TRAY CONNECTION	There is a problem with an optional 500-sheet paper tray connection with the printer: <ul style="list-style-type: none"> <li>the tray is not connected properly</li> <li>more than two optional 500-sheet paper trays have been installed (the printer cannot support more than four trays total)</li> <li>the electronics in the paper tray are faulty</li> </ul> Try removing and reinstalling the paper tray. Then turn the printer off and back on.
CANNOT DUPLEX CLOSE REAR BIN	The printer cannot duplex because the rear output bin is open. Close the rear output bin.
CHECK INPUT DEVICE alternates with PAPER PATH OPEN PLEASE CLOSE IT	The optional input tray cannot feed paper to the printer because a door or paper guide is open. Check the doors and paper guides and close any that are open.
CHECK OUTPUT DEVICE alternates with CLOSE OUTPUT DELIVERY PATH	The optional output device is not properly connected to the printer. A proper connection must be made for printing to continue.
CHECKING PAPER PATH	The engine is checking for possible paper jams or paper that was not cleared from the printer.
CLOSE TOP COVER	The top cover is open and must be closed for printing to continue.
DISK DEVICE FAILURE	The EIO disk had a critical failure and can no longer be used. Remove the EIO disk and replace it with a new one.



## Printer messages (continued)

Message	Explanation or recommended action
DISK FILE OPERATION FAILED	The requested operation could not be performed. You might have attempted an illegal operation, such as trying to download a file to a non-existent directory.
DISK FILE SYSTEM IS FULL	Delete files from the EIO disk and then try again. Use HP Resource Manager to download or delete files and fonts. (See the software help for more information.)
DISK IS WRITE PROTECTED	The EIO disk is protected, and no new files can be written to it. Disable the write protection through HP Resource Manager.
EIO [n] DISK INITIALIZING	The disk accessory in EIO slot [n] is initializing.
EIO [n] DISK NOT FUNCTIONAL	The EIO disk is not working correctly. Remove the EIO disk from the slot indicated by [n]. Replace it with a new EIO disk.
EIO [n] INITIALIZING alternates with DO NOT POWER OFF	Wait for the message to disappear (up to 5 minutes). If the printer EIO card is operating correctly and communicating with the network, this message disappears after approximately 1 minute and no action is required.  If the EIO card is unable to communicate with the network, this message remains for 5 minutes and then disappears. In this case the printer is not communicating with the network (even though the message is no longer present). The problem may be a bad EIO card, a bad cable or connection on the network, or a network problem. Contact your network administrator.
EIO [n] DISK SPINNING UP	The disk accessory in EIO slot [n] is initializing.
ENV FEEDER LOAD [TYPE] [SIZE]	A job has been sent to the envelope feeder and it is empty. Load the correct size and type in the feeder. Pressing <b>GO</b> will prompt a question asking if you would rather print on another available size of envelope in the printer. Press <b>-VALUE+</b> to scroll through the available types and sizes; press <b>SELECT</b> to accept an alternate type or size.  Make sure the envelope size and type are set correctly from the Paper Handling Menu in the printer control panel (see "Paper Handling Menu" on page 210).



## Printer messages (continued)

Message	Explanation or recommended action
ENVELOPE FEEDER SIZE = [xxxxxx]	<p>The printer is asking what size of envelopes has been loaded in the envelope feeder. In response, you can take either of the following actions:</p> <ul style="list-style-type: none"><li>press <b>SELECT</b> to accept the current envelope size</li><li>press <b>-VALUE+</b> to change the size and then press <b>SELECT</b> to accept the new size</li></ul> <p>If you do not press any buttons, the message disappears in about 1 minute.</p> <p><b>Note</b> Changing the size here changes the default for envelope size in the envelope feeder in the Paper Handling Menu (see the description of "ENVELOPE FEEDER SIZE=COM10" on page 210).</p>
ENVELOPE FEEDER TYPE = [xxxxxx]	<p>The printer has received a job under the following conditions:</p> <ul style="list-style-type: none"><li>the envelope type requested by the job is not available in the printer</li><li>envelopes have just been placed in the envelope feeder (thus triggering the paper sensor)</li></ul> <p>You can take either of the following actions:</p> <ul style="list-style-type: none"><li>press <b>SELECT</b> to accept the paper type and then press <b>GO</b></li><li>press <b>+VALUE-</b> to change the type, press <b>SELECT</b> to accept the new type, and then press <b>Go</b> to continue</li></ul>
EXTERNAL DEVICE INITIALIZING	<p>When an external paper handling device is connected to the printer, it must initialize after the computer boots or after coming out of PowerSave mode.</p>
FLASH DEVICE FAILURE	<p>The flash DIMM had a critical failure and no longer can be used. Remove the flash DIMM and replace it with a new one.</p>
FLASH FILE OPERATION FAILED	<p>The requested operation could not be performed. You might have attempted an illegal operation, such as trying to download a file to a non-existent directory.</p>
FLASH FILE SYSTEM IS FULL	<p>Delete files from the flash DIMM. Use HP Resource Manager to download or delete files and fonts. (See the software help for more information.)</p>
FLASH IS WRITE PROTECTED	<p>The flash DIMM is protected and no new files can be written to it. Disable the write protection through HP Resource Manager.</p>



## Printer messages (continued)

Message	Explanation or recommended action
INPUT DEVICE CONDITION [xx.yy]	<p>An input paper handling device has a condition that needs attention before printing can resume.</p> <p>Turn the printer off.</p> <p>Disconnect the cable to the input paper handling devices and then reconnect it.</p> <p>Turn the printer on.</p> <p>See the documentation that came with the paper handling device for assistance.</p>
INSTALL TONER CARTRIDGE	<p>The toner cartridge has been removed and must be reinstalled for printing to continue.</p>
INSTALL TRAY [x]	<p>The specified tray is not installed and must be inserted and closed for printing to continue.</p>
LOADING PROGRAM <number> alternates with DO NOT POWER OFF	<p>Programs and fonts can be stored on the printer's file system. At bootup time, these entities are loaded into RAM. (These entities can take a long time to load into RAM depending on the size and number of entities being loaded.) The &lt;number&gt; specifies a sequence number indicating the current program being loaded.</p>
MANUALLY FEED [TYPE] [SIZE]	<p>Load the requested paper into tray 1.</p> <p>Press <b>Go</b> if the desired paper is already loaded in tray 1.</p>
MEMORY FULL STORED DATA LOST	<p>There is no available memory in the printer. The current job might not print correctly and some resources (such as downloaded fonts or macros) might have been deleted.</p> <p>Consider adding more memory to the printer (see "Printer memory and expansion" on page 229).</p>
MEMORY SETTINGS CHANGED	<p>The printer changed its memory settings because it did not have enough memory to use the previous settings for I/O Buffering and Resource Saving. This usually occurs after removing memory from the printer, adding a duplexer, or adding a printer language.</p> <p>Consider adding more memory to the printer (see "Printer memory and expansion" on page 229).</p>
MEMORY SHORTAGE JOB CLEARED	<p>The printer did not have enough free memory to print the entire job. The remainder of the job will not print and will be cleared from memory.</p> <p>Press <b>Go</b> to continue.</p> <p>Consider adding more memory to the printer (see "Printer memory and expansion" on page 229).</p>



## Printer messages (continued)

Message	Explanation or recommended action
MEMORY SHORTAGE PAGE SIMPLIFIED	<p>The printer had to compress the job in order to fit it in available memory. Some data loss might have occurred.</p> <p>Press <b>Go</b> to continue.</p> <p>The print quality of these pages may not be acceptable. Reduce the complexity of these pages and reprint them.</p> <p>Consider adding more memory to the printer (see “Printer memory and expansion” on page 229).</p>
NON HP TONER DETECTED alternates with PRESS GO TO CONTINUE	<p>The printer has detected that the toner cartridge is not a genuine HP toner cartridge. If you believe you purchased an HP toner cartridge, call the HP fraud hotline (see “HP fraud hotline” on page 161). Any printer repair required as a result of using non-HP toner is not covered under the printer warranty.</p>
OFFLINE	<p>Press <b>Go</b> to place the printer online.</p>
OUTPUT BIN FULL alternates with CLEAR PAPER FROM [BINNAME ]	<p>The output bin is full and needs to be emptied.</p>
PAPER WRAPPED AROUND FUSER	<p>Turn the printer off to keep the paper from wrapping more firmly around the fuser. Open the top cover and remove the toner cartridge. Remove all visible paper. If you cannot locate the paper, leave printer turned off and remove the fuser to remove paper (see “Clearing jams from the fuser area” on page 107).</p>
PERFORM PRINTER MAINTENANCE	<p>To ensure optimum print quality, the printer prompts you to perform routine maintenance every 200,000 pages. (To order a printer maintenance kit, see “Ordering information” on page 22. For information on maintenance, see “Performing preventative maintenance” page 93.)</p>
PRINTER LANGUAGE NOT AVAILABLE	<p>A print job requested a printer language that does not exist in the printer. The job will not print and will be cleared from memory.</p> <p>Print the job using a driver for a different printer language, or add the requested language to the printer (if available).</p> <p>Press <b>Go</b> to continue.</p>
PROCESSING AUTO CLEANING PAGE	<p>The printer is conducting the auto cleaning page process. This can take up to 2.5 minutes.</p>
PROCESSING CLEANING PAGE	<p>The printer is conducting the manual cleaning page process. This can take up to 2.5 minutes.</p>
RAM DISK DEVICE FAILURE	<p>The RAM disk had a critical failure and can no longer be used.</p>



## Printer messages (continued)

Message	Explanation or recommended action
RAM DISK FILE OPERATION FAILED	The requested operation could not be performed. You might have attempted an illegal operation, such as trying to download a file to a non-existent directory.
RAM DISK FILE SYSTEM IS FULL	Delete files and then try again, or turn the printer off, and then turn the printer on to delete all files on the device. (Delete files using HP Resource Manager or another software utility. See the software online help for more information.)  If the message persists, increase the size of the RAM disk. Change the RAM disk size from the Configuration Menu in the printer control panel (see the description of the RAM disk menu items in "Configuration Menu" on page 219). HP Resource Manager can also be used to increase/decrease the RAM disk size.
TONER LOW	The message first appears when about 15% of the toner is remaining in the toner cartridge (about 1,500 pages remaining for the 10,000-page cartridge and about 900 pages remaining for the 6,000-page cartridge at 5% coverage). Depending on how the printer has been configured, it will either continue to print or stop.  If the printer has stopped, you can resume printing by pressing <b>Go</b> for each job.  You might want to ensure that you have a replacement toner cartridge on hand.  See "Toner low and toner out conditions" on page 87 for information on how to configure the printer's response to toner messages.
TONER OUT	The toner cartridge has run out of toner. Depending on how the printer has been configured, it will either continue to print or stop.  If the printer has stopped, you can resume printing by pressing <b>Go</b> for each job.  Replace the toner cartridge.  See "Toner low and toner out conditions" on page 87 for details on how to configure the printer's response to toner messages.
TRAY [x] EMPTY [TYPE] [SIZE]	Load paper in the empty tray (x) to clear the message.  If you do not load the specified tray, the printer will continue printing from the next tray with the same paper size and type, and the message will continue to appear.



## Printer messages (continued)

Message	Explanation or recommended action
TRAY 1 LOAD [TYPE] [SIZE]	<p>This message occurs for the following reasons:</p> <ul style="list-style-type: none"><li>• tray 1 was requested from the application, but the tray is empty</li><li>• the printer cannot find the requested size of paper in the printer</li></ul> <p>If the correct paper size is loaded, the adjustments to the tray have not been set correctly, either in the control panel or on the tray itself. To set the type at the control panel, see the descriptions of TRAY 1 TYPE in “Paper Handling Menu” on page 210. To set adjustments on the tray, see “Loading tray 1” on page 46.</p> <p>Load the requested paper into tray 1, or press <b>SELECT</b> to override the message and print on a loaded paper size.</p> <p>If printing does not continue, press <b>Go</b>.</p> <p>If you are trying to print A4- or letter-size paper and this message appears, make sure the default paper size is set correctly from the Printing Menu in the printer control panel and also in the software program (see the description of PAPER SIZE in “Printing Menu” on page 213).</p> <p>Press <b>Go</b> to print from the next available tray.</p> <p>Press <b>-VALUE+</b> to scroll through the available types and sizes.</p> <p>Press <b>SELECT</b> to accept the alternate type or size.</p> <p><b>Note</b></p> <p>If custom size is being used, another line appears in the message giving the x and y dimensions of the paper.</p>

TRAY [x] LOAD [TYPE] [SIZE] where x is tray 2, 3, or 4	<p>This message occurs for the following reasons:</p> <ul style="list-style-type: none"><li>• tray 2, 3, or 4 was requested, but the tray is empty</li><li>• tray 2, 3, or 4 was requested, but the adjustments are not set for the requested type or size</li></ul> <p>Make sure that all three paper size adjustments have been made (see the explanation of adjustments in “Loading trays 2, 3, and 4” on page 47). Also make sure that the type has been set at the control panel (see the descriptions of TRAY 2 TYPE, TRAY 3 TYPE, and TRAY 4 TYPE in the “Paper Handling Menu” on page 210).</p> <p>Load the requested paper into the indicated tray, or press <b>SELECT</b> to override the message and print on a loaded paper size.</p> <p>If printing does not continue, press <b>Go</b>.</p> <p>If you are trying to print A4- or letter-size paper and this message appears, make sure the default paper size is set correctly in the Printing Menu at the printer control panel and also in the software program (see the description of PAPER SIZE in “Printing Menu” on page 213).</p> <p>Press <b>Go</b> to print from the next available tray.</p> <p>Press <b>-VALUE+</b> to scroll through the available types and sizes.</p> <p>Press <b>SELECT</b> to accept the alternate type or size.</p>
-----------------------------------------------------------------	--------------------------------------------------------------------------------------------------------------------------------------------------------------------------------------------------------------------------------------------------------------------------------------------------------------------------------------------------------------------------------------------------------------------------------------------------------------------------------------------------------------------------------------------------------------------------------------------------------------------------------------------------------------------------------------------------------------------------------------------------------------------------------------------------------------------------------------------------------------------------------------------------------------------------------------------------------------------------------------------------------------------------------------------------------------------------------------------------------------------------------------------------------------------------------------------------------------------------------------------------------------------------------------------------------------------





## Printer messages (continued)

Message	Explanation or recommended action
TRAY 1 SIZE = [xxxx]	<p>The printer is asking what size of paper has been loaded in tray 1. In response, you can take either of the following actions:</p> <ul style="list-style-type: none"><li>• press <b>SELECT</b> to accept the current paper size</li><li>• press <b>-VALUE+</b> to change the size and then press <b>SELECT</b> to accept the new size</li></ul> <p>The printer will first display the TRAY 1 TYPE=xxxx message (see the description of that message). If you do not press any buttons in the timeout period (about 1 minute), it displays this TRAY 1 SIZE=xxxx message).</p> <p><b>Note</b> Changing the size here changes the default for tray 1 paper size in the Paper Handling Menu (see the description of “TRAY 1 SIZE=LETTER” on page 210).</p>
TRAY 1 TYPE = [xxxx]	<p>The printer has received a job under the three following conditions:</p> <ul style="list-style-type: none"><li>• the paper type requested by the job is not available in the printer</li><li>• tray 1 has been set for CASSETTE</li><li>• paper has been placed in tray 1 (thus triggering tray 1’s paper sensor)</li></ul> <p>If you do press any buttons, the message disappears in about 1 minute. You can take either of the following actions:</p> <ul style="list-style-type: none"><li>• press <b>SELECT</b> to accept the paper type</li><li>• press <b>-VALUE+</b> to change the type and then press <b>SELECT</b> to accept the new type</li></ul> <p><b>Note</b> Changing the type here changes the default for tray 1 paper type in the Paper Handling Menu (see the description of “TRAY 1 TYPE=PLAIN” on page 211).</p> <p>If you do not do anything during the timeout period (about 1 minute), the printer will print on the paper in tray 1. It will also change the default for tray 1 paper type in the Paper Handling Menu to the type requested by the application that sent the job.</p>
UNABLE TO COPY JOB	<p>Memory or file system failures would not allow a mopy job to occur. Only one copy will be produced.</p>
UNSUPPORTED SIZE IN TRAY [yy]	<p>An external paper handling device detected an unsupported paper size. The printer will go offline until the condition is corrected.</p>
USE [TYPE] [SIZE] INSTEAD?	<p>If the requested paper size or type is not available, the printer asks if it should use another paper size or type instead.</p> <p>Press <b>-VALUE+</b> to scroll through the available types and sizes. Press <b>SELECT</b> to accept the alternate type or size.</p>



## Printer messages (continued)

Message	Explanation or recommended action
WAIT FOR PRINTER TO REINITIALIZE	The RAM disk setting has been changed from the printer control panel. This change will not take effect until the printer reinitializes. If you change the mode of the external device, turn the printer off, turn the printer on and wait for the printer to reinitialize.
xx.yy PRINTER ERROR PRESS GO TO CONTINUE	A printer error has occurred that can be cleared by pressing <b>Go</b> in the printer control panel.
13.x PAPER JAM [LOCATION]	<p>Paper has either jammed in the printer or has been caught in a paper tray.</p> <ol style="list-style-type: none"> <li>1. Open the top cover or tray indicated by the message.</li> <li>2. Clear all paper from the area. If necessary, remove the toner cartridge, duplexer, or paper trays.</li> <li>3. If the message persists, check for paper in all other areas.</li> </ol> <p><b>Caution</b> Ensure that all jammed paper is removed before closing the cover or tray. Open and close the top cover to clear the message. See “Clearing paper jams” on page 96 for more detailed information.</p>
20 INSUFFICIENT MEMORY alternates with PRESS GO TO CONTINUE	<p>The printer received more data than can fit in its available memory. You might have tried to transfer too many macros, soft fonts, or complex graphics.</p> <p>Press <b>Go</b> to print the transferred data (some data might be lost), then simplify the print job or install additional memory (see “Printer memory and expansion” on page 229).</p>
21 PAGE TOO COMPLEX alternates with PRESS GO TO CONTINUE	<p>The data (dense text, rules, raster or vector graphics) sent to the printer was too complex.</p> <p>Press <b>Go</b> to print the transferred data. (Some data might be lost.)</p>
22 EIO x BUFFER OVERFLOW alternates with PRESS GO TO CONTINUE	<p>Too much data was sent to the EIO card in the specified slot (x). An improper communications protocol may be in use.</p> <p>Press <b>Go</b> to clear the message. (Data will be lost.) Check the host configuration.</p>



## Printer messages (continued)

Message	Explanation or recommended action
22 PARALLEL I/O BUFFER OVERFLOW alternates with PRESS GO TO CONTINUE	<p>Too much data was sent to the parallel port.</p> <p>Check for a loose cable connection and be sure to use a high-quality cable (see “Ordering information” on page 22). (Some non-HP parallel cables might be missing pin connections or might otherwise not conform to the IEEE-1284 specification.)</p> <p>This error can occur if the driver you are using is not IEEE-1284 compliant. For best results, use an HP driver that came with the printer (see “Printer drivers” on page 35).</p> <p>Press <b>Go</b> to clear the error message. (Data will be lost.)</p>
40 EIO [x] BAD TRANSMISSION alternates with PRESS GO TO CONTINUE	<p>The connection has been broken between the printer and the EIO card in the specified slot. (Data loss might occur in this situation.)</p> <p>Press <b>Go</b> to clear the error message and continue printing.</p>
41.3 UNEXPECTED PAPER SIZE alternates with EXPECTED [TYPE] [SIZE]	<p>The printer detected a paper size different than what it was expecting. This is typically caused if two or more sheets stick together in the printer or if the paper tray is not properly adjusted.</p> <p>Reload the tray with the correct paper size.</p> <p>Ensure that paper in the tray is loaded under the front and back tabs.</p> <p>If you are printing from tray 1, verify that the correct paper size is selected in the control panel (see “Paper Handling Menu” on page 210).</p> <p>If you are printing from tray 2, 3, or 4, verify that the three paper size adjustments on the paper tray have been made correctly (see the description of adjustments in “Loading trays 2, 3, and 4” on page 47).</p> <p>After performing the actions above, press <b>Go</b>. The page containing the error will automatically be reprinted if jam recovery is enabled. (Or, you might want to press <b>CANCEL JOB</b> to clear the job from the printer’s memory.)</p>
41.x PRINTER ERROR alternates with CYCLE POWER TO CONTINUE	<p>A temporary printing error occurred.</p> <p>Press <b>Go</b>. The page containing the error will automatically be reprinted if jam recovery is enabled.</p> <p>If the error does not clear, turn the printer off, then turn the printer on.</p>
49.xx PRINTER ERROR alternates with CYCLE POWER TO CONTINUE	<p>A temporary printing error occurred.</p> <p>Press <b>Go</b>. The page containing the error will automatically be reprinted if jam recovery is enabled.</p> <p>If the error does not clear, turn the printer off, then turn the printer on.</p>



## Printer messages (continued)

Message	Explanation or recommended action
50.x FUSER ERROR	A fusing error has occurred. Turn the printer off and then on.
50.4 PRINTER ERROR  alternates with CYCLE POWER TO CONTINUE	<p>There is a problem with the power supply.</p> <p>Remove the printer from any UPS supplies, additional power supplies, or power strips. Plug the printer into a wall outlet and see if this resolves the problem.</p> <p>If the printer is already plugged into a wall outlet, try another power source in the building that is independent of the one currently being used.</p> <p>The line voltage and current source at the printer location might need to be inspected to ensure that it meets the printer's electrical specifications (see "Electrical specifications" on page 201).</p>
51.x or 52.x PRINTER ERROR  alternates with CYCLE POWER TO CONTINUE	<p>A temporary printing error occurred.</p> <p>Turn the printer off, then turn the printer on.</p>
53.xy.zz PRINTER ERROR	<p>There is a problem with the printer's memory. The DIMM that caused the error will not be used. Values of x, y, and zz are as follows:</p> <p>x = DIMM type            0 = ROM            1 = RAM</p> <p>y = Device location            0 = Internal memory (ROM or RAM)            1 to 3 = DIMM slots 1, 2, or 3</p> <p>zz = Error number</p> <p>You might need to replace the specified DIMM.</p> <p>Turn the printer off, and then replace the DIMM that caused the error.</p>
54.1 REMOVE SEALING TAPE  alternates with FROM TONER CARTRIDGE	<p>The toner cartridge has been installed without removing the sealing tape.</p> <p>Open the top cover and remove the toner cartridge. Pull the sealing tape tab to remove the strip. Reinstall the toner cartridge and close the top cover.</p>



## Printer messages (continued)

Message	Explanation or recommended action
55.x PRINTER ERROR alternates with CYCLE POWER TO CONTINUE	A temporary printing error occurred. Press <b>Go</b> . The page containing the error will automatically be reprinted if jam recovery is enabled. If the error does not clear, turn the printer off, then turn the printer on.
56.x PRINTER ERROR alternates with CYCLE POWER TO CONTINUE	A temporary printing error occurred. Turn the printer off, then turn the printer on.
57.x PRINTER ERROR alternates with CYCLE POWER TO CONTINUE	A temporary printing error occurred. Turn the printer off, then turn the printer on.
58.x PRINTER ERROR alternates with CYCLE POWER TO CONTINUE	A temporary printing error occurred. Turn the printer off, then turn the printer on.
59.x PRINTER ERROR alternates with CYCLE POWER TO CONTINUE	A temporary printing error occurred. Turn the printer off, then turn the printer on.
62.x PRINTER ERROR	There is a problem with the printer's memory. The x value refers to the location of the problem: 0 = Internal memory 1 to 3 = DIMM slots 1, 2, or 3 You might need to replace the specified DIMM.
64 PRINTER ERROR alternates with CYCLE POWER	A temporary printing error occurred. Turn the printer off, and then turn the printer on.



## Printer messages (continued)

Message	Explanation or recommended action
66.xx.xx SERVICE ERROR alternates with CHECK CABLES AND CYCLE POWER	<p>An error occurred in an external paper handling device.</p> <p>Turn the printer off.</p> <p>Disconnect the cables to all external paper handling devices, and then reconnect them.</p> <p>Turn the printer on.</p>
68.x PERMANENT STORAGE ERROR alternates with CHECK SETTINGS	<p>An error occurred in the printer's permanent storage and one or more printer settings has been reset to its factory default.</p> <p>Print a configuration page and check the printer settings to determine which values have changed (see "Configuration page" on page 152).</p>
68.x PERMANENT STORAGE FULL	<p>The printer's permanent storage is full. Some settings might have been reset to the factory defaults.</p> <p>Print a configuration page and check the printer settings to determine which values have changed (see "Configuration page" on page 152).</p> <p>Hold down <b>CANCEL JOB</b> while turning the printer on. This will clean up the permanent storage by removing old areas that are not being used.</p>
79 SERVICE [xxxx]	<p>The printer detected an error.</p> <p>Press <b>CANCEL JOB</b> to clear the print job from the printer memory. Turn the printer off, and then turn the printer on.</p> <p>Try printing a job from a different software application. If the job prints, go back to the first application and try printing a different file. (If the message only appears with a certain software application or print job, contact the software vendor for assistance.)</p> <p>If the message persists with different software applications and print jobs, disconnect all cables to the printer that connect it to the network or printer. Turn the printer off. Remove all memory DIMMs or third-party DIMMs from the printer (see "Installing memory" on page 230). Remove all EIO devices from the printer (see "Installing EIO cards/mass storage" on page 233). Turn the printer on. If the error no longer exists, install each DIMM and EIO device one at a time, making sure to turn the printer off and back on as you install each device. Replace a DIMM or EIO device if you determine that it causes the error. Remember to reconnect all cables that connect the printer to the network or computer.</p>



## Printer messages (continued)

Message	Explanation or recommended action
8x.yyyy EIO [z] ERROR	<p>The EIO accessory in slot [z] has encountered a critical error. [z] description:</p> <ul style="list-style-type: none"><li>1 = EIO slot 1 - The printer detected an error with the EIO accessory.</li><li>2 = EIO slot 2 - The printer detected an error with the EIO accessory.</li><li>6 = EIO slot 1 - The EIO accessory detected an error. The EIO accessory may be defective.</li><li>7 = EIO slot 2 - The EIO accessory detected an error. The EIO accessory may be defective.</li></ul> <p>Turn the printer off, and then turn the printer on.</p> <p>Turn the printer off, reseal the EIO accessory in slot [z], and then turn the printer on.</p> <p>Turn the printer off, remove the EIO accessory from slot [z], install it in a different EIO slot, and then turn the printer on.</p> <p>Replace the EIO accessory in slot [z].</p>



# Mopy disk error messages

The following table lists the disk mopy (multiple original copy) error numbers reported on either the Printer Collation or Job Storage Disk Error page, which is printed when an error exists. Use the HP Resource Manager for management of the disk (see “HP Resource Manager” on page 37).



## Mopy disk error messages

Disk error number	Error description	Solution
1	Disk volume not present – it may be uninitialized.	<ul style="list-style-type: none"><li>• Hard disk: Initialize the hard disk accessory. If problem persists, replace the hard drive.</li><li>• RAM disk: Turn the printer off and then on again.</li></ul>
3	A file or directory asked for could not be found.	<ul style="list-style-type: none"><li>• Possible data corruption. Delete the job that prompted the error.</li></ul>
5	Invalid # of bytes given in a read/write request.	<ul style="list-style-type: none"><li>• Possible data corruption. Delete the job that prompted the error.</li></ul>
6	Attempt to create a file or directory that already exists.	<ul style="list-style-type: none"><li>• The user has sent a username that is the same as an existing directory. Change the username in the driver and resend the job.</li></ul>
15	Bad Disk	<ul style="list-style-type: none"><li>• Hard disk: Initialize the hard disk accessory. If problem persists, replace the hard drive.</li></ul>
16	No volume label	<ul style="list-style-type: none"><li>• Hard disk: Initialize the hard disk accessory. If problem persists, replace the hard drive.</li></ul>
23	Bad seek request – the resulting offset would be negative.	<ul style="list-style-type: none"><li>• Possible data corruption. Delete the job that prompted the error.</li></ul>
24	Unexpected internal error	<ul style="list-style-type: none"><li>• Possible data corruption, delete the job the error occurred with.</li><li>• Disk media problem – initialize the hard disk accessory or reboot to reinit the RAM disk.</li><li>• If the problem persists on a hard drive, replace the hard drive.</li></ul>





## Mopy disk error messages (continued)

Disk error number	Error description	Solution
55	Bad file system	<ul style="list-style-type: none"><li>• Possible data corruption. Delete the job that prompted the error.</li><li>• Disk media problem – initialize the hard disk accessory or reboot to reinit the RAM disk.</li><li>• If the problem persists on a hard drive, replace the hard drive.</li></ul>
56	Hardware failure	<ul style="list-style-type: none"><li>• Replace the hard drive.</li></ul>
59	The maximum number of directories has been reached	<p>There is a maximum number of directories that can be put on a disk. Stored jobs are stored in directories created for each user. To solve this problem:</p> <ul style="list-style-type: none"><li>• Delete all jobs stored for a user. The firmware will automatically delete the directory for a user with no stored jobs.</li><li>• Delete other directories on the disk.</li></ul>
70	Disk Error	<ul style="list-style-type: none"><li>• Contact your HP Service and Support Representative.</li></ul>



# Correcting output quality problems

This section of the manual helps you define print quality problems and what to do to correct them. Often output quality problems can be handled quite easily by making sure that your printer is properly maintained, using media that meets HP specifications, or running a cleaning page.



Use the examples in the image defect table starting on this page to determine which output quality problem you are experiencing, then see the corresponding reference pages to troubleshoot. These examples consist of the most common methods to remedy print quality problems. If you still have problems after trying the suggested remedies, contact HP Customer Care Service and Support (see “Service and support” on page 157).



## Note

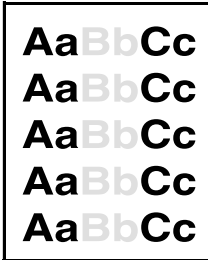

The examples below depict letter-size paper that has passed through the printer short-edge first.

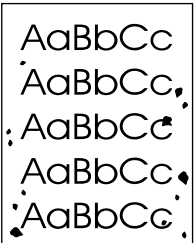
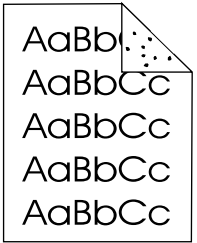
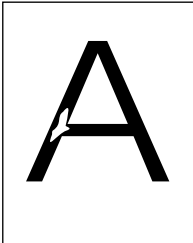
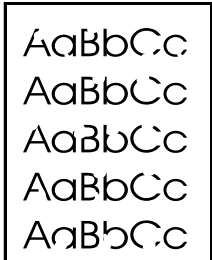
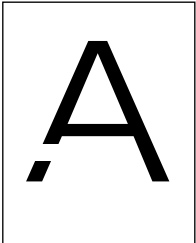
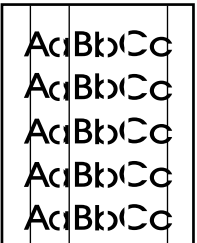
### Image defect table

 <p>See “Light print (partial page)” on page 130</p>	 <p>See “Light print (entire page)” on page 130</p>	 <p>See “Specks” on page 130</p>	 <p>See “Specks” on page 130</p>
 <p>See “Dropouts” on page 131</p>	 <p>See “Dropouts” on page 131</p>	 <p>See “Dropouts” on page 131</p>	 <p>See “Lines” on page 131</p>

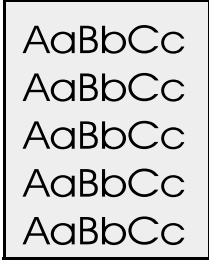

**Image defect table (continued)**

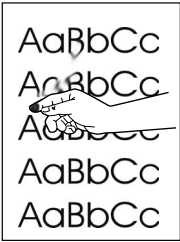
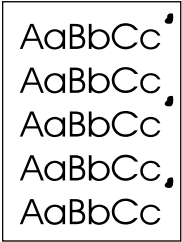
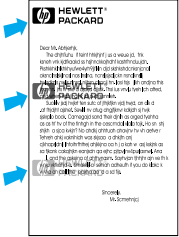
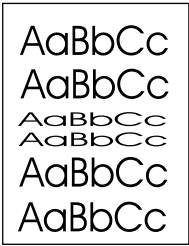
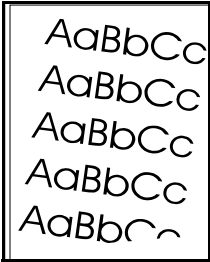
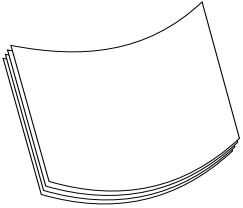
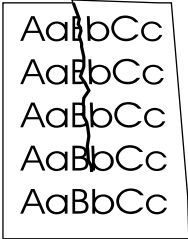
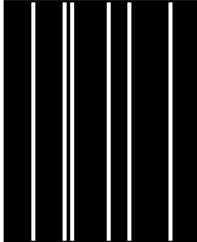
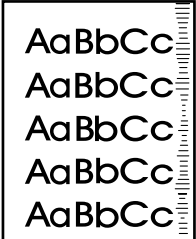
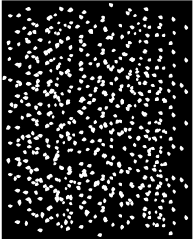
 <p>See “Gray background” on page 132</p>	 <p>See “Toner smear” on page 132</p>	 <p>See “Loose toner” on page 132</p>	 <p>See “Repeating defects” on page 133</p>
 <p>See “Repeating image” on page 134</p>	 <p>See “Misformed characters” on page 134</p>	 <p>See “Page skew” on page 134</p>	 <p>See “Curl or wave” on page 135</p>
 <p>See “Wrinkles or creases” on page 135</p>	 <p>See “Vertical white lines” on page 135</p>	 <p>See “Tire tracks” on page 136</p>	 <p>See “White spots on black” on page 136</p>



AaBbCc  
AaBbCc  
AaBbCc  
AaBbCc  
AaBbCc

## Light print (partial page)

- 1 The toner cartridge might be low. Replace the toner cartridge.
- 2 Maintenance might be due. Check this by printing a copy of the supplies status page (see “Supplies status page” on page 154). If maintenance is due, order and install the printer maintenance kit (see “Performing preventative maintenance” on page 93).
- 3 The toner cartridge might be almost empty. Replace the toner cartridge.



AaBbCc  
AaBbCc  
AaBbCc  
AaBbCc  
AaBbCc

## Light print (entire page)

- 1 Make sure that EconoMode is turned off (see `ECONOMODE` in “Print Quality Menu” on page 217).
- 2 At the printer control panel, use the Print Quality Menu to increase the toner density setting (see `TONER DENSITY` in “Print Quality Menu” on page 217)).
- 3 Try using a different type of paper.
- 4 The toner cartridge might be almost empty. Replace the toner cartridge.

AaBbCc  
AaBbCc  
AaBbCc  
AaBbCc  
AaBbCc

## Specks

Specks might appear on a page after a jam has been cleared.

- 1 Print a few more pages to see if the problem corrects itself.
- 2 If specks occur frequently, set your printer up to automatically run a cleaning page (see “Running the cleaning page automatically” on page 92).
- 3 Clean the inside of the printer (see “Cleaning the printer” on page 88) and run a manual cleaning page to clean the fuser (see “Running the cleaning page manually” on page 91).
- 4 Try using a different type of paper.
- 5 Check for toner cartridge leaks. If the toner cartridge is leaking, replace it.

AaBbCc  
AaBbCc  
AaBbCc  
AaBbCc  
AaBbCc



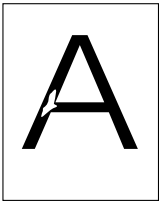

## Dropouts

- 1 Make sure that the environmental specifications for the printer are being met (see “General specifications” on page 202).
- 2 If the paper is rough and the toner easily rubs off, either try changing the fuser mode to High 1 or High 2 (see “Paper Handling Menu” on page 210), or try using a smoother paper.
- 3 Try changing to a different paper type.

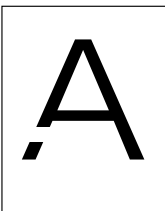

## Lines

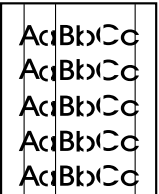

- 1 Print a few more pages to see if the problem corrects itself.
- 2 Clean the inside of the printer (see “Cleaning the printer” on page 88) and run a manual cleaning page to clean the fuser (see “Running the cleaning page manually” on page 91).
- 3 Replace the toner cartridge.
- 4 Maintenance might be due. Check this by printing a copy of the supplies status page (see “Supplies status page” on page 154). If maintenance is due, order and install the printer maintenance kit (see “Performing preventative maintenance” on page 93).



AaBbCc  
AaBbCc  
AaBbCc  
AaBbCc  
AaBbCc

## Gray background

- 1 Do not use paper that has already been run through the printer.
- 2 Print a few more pages to see if the problem corrects itself.
- 3 Turn over the stack of paper in the tray. Also, try rotating the paper 180°.
- 4 At the printer control panel, use the Print Quality Menu to decrease the toner density setting (see the description of **TONER DENSITY** in “Print Quality Menu” on page 217).
- 5 Make sure that the environmental specifications for the printer are being met (see “General specifications” on page 202).
- 6 Replace the toner cartridge.



AaBbCc  
AaBbCc  
AaBbCc  
AaBbCc  
AaBbCc

## Toner smear

Also see “Loose toner” on page 133.

- 1 Print a few more pages to see if the problem corrects itself.
- 2 Try using a different type of paper.
- 3 Make sure that the environmental specifications for the printer are being met (see “General specifications” on page 202).
- 4 Clean the inside of the printer (see “Cleaning the printer” on page 88) and run a manual cleaning page to clean the fuser (see “Running the cleaning page manually” on page 91).
- 5 Maintenance might be due. Check this by printing a copy of the supplies status page (see “Supplies status page” on page 154). If maintenance is due, order and install the printer maintenance kit (see “Performing preventative maintenance” on page 93).
- 6 Replace the toner cartridge.



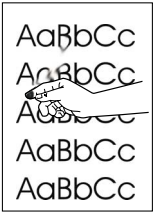

## Loose toner

Loose toner, in this context, is defined as toner that can be rubbed off the page.

- 1 If paper is heavy or rough, try using a high fuser mode so that toner fuses more completely onto the paper. At the printer control panel, use `CONFIGURE FUSER MODE MENU` in the Paper Handling Menu. To do this (see “Paper Handling Menu” on page 210).
- 2 If you have observed a rougher texture on one side of your paper, try printing on the non-rough side.
- 3 Make sure that the environmental specifications for the printer are being met (see “Printer specifications” on page 200).
- 4 Make sure that paper type and quality meet HP specifications (see “Paper specifications” on page 188).
- 5 Maintenance might be due. Check this by printing a copy of the supplies status page (see “Supplies status page” on page 154). If maintenance is due, order and install the printer maintenance kit (see “Performing preventative maintenance” on page 93).

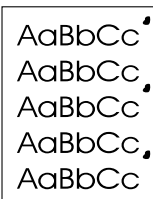

## Repeating defects

See also “Repeating image” on page 134.

- 1 Print a few more pages to see if the problem corrects itself.
- 2 If the distance between defects is 38 mm (1.5 in) or 94 mm (3.76 in), the toner cartridge might need to be replaced.
- 3 Clean the inside of the printer (see “Cleaning the printer” on page 88) and run a manual cleaning page to clean the fuser (see “Running the cleaning page manually” on page 91).
- 4 Maintenance might be due. Check this by printing a copy of the supplies status page (see “Supplies status page” on page 154). If maintenance is due, order and install the printer maintenance kit (see “Performing preventative maintenance” on page 93).





## Repeating image

This type of defect might occur when using preprinted forms or a large quantity of narrow media.

- 1 Print a few more pages to see if the problem corrects itself.
- 2 Make sure that paper type and quality meet HP specifications (see “Paper specifications” on page 188).
- 3 If you observe that this type of defect occurs on wide paper (such as letter- or A4-size paper) just after printing on narrow media (such as envelopes), you can set **SMALL PAPER SPEED** on the Paper Handling Menu to **SLOW** (see “Paper Handling Menu” on page 210). Note that this will slow down printing.
- 4 Maintenance might be due. Check this by printing a copy of the supplies status page (see “Supplies status page” on page 154). If maintenance is due, order and install the printer maintenance kit (see “Performing preventative maintenance” on page 93).

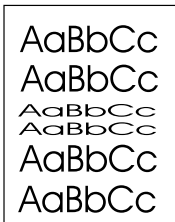

## Misformed characters

- 1 Print a few more pages to see if the problem corrects itself.
- 2 Make sure that the environmental specifications for the printer are being met (see “General specifications” on page 202).
- 3 Maintenance might be due. Check this by printing a copy of the supplies status page (see “Supplies status page” on page 154). If maintenance is due, order and install the printer maintenance kit (see “Performing preventative maintenance” on page 93).

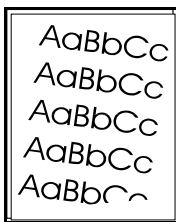

## Page skew

- 1 Print a few more pages to see if the problem corrects itself.
- 2 Verify that there are no torn pieces of paper inside the printer.
- 3 Make sure that paper is loaded correctly, all adjustments have been made, and the paper is under the corner tabs (see “Loading tray 1” on page 46 and “Loading trays 2, 3, and 4” on page 47).
- 4 Turn over the stack of paper in the tray. Also, try rotating the paper 180°.
- 5 Make sure that paper type and quality meet HP specifications (see “Paper specifications” on page 188).
- 6 Make sure that the environmental specifications for the printer are being met (see “General specifications” on page 202).





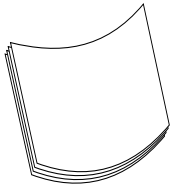

## Curl or wave

- 1 Turn over the stack of paper in the tray. Also, try rotating the paper 180°.
- 2 Make sure that paper type and quality meet HP specifications (see “Paper specifications” on page 188).
- 3 Make sure that the environmental specifications for the printer are being met (see “Printer specifications” on page 200).
- 4 Try printing to a different output bin.
- 5 If media is lightweight and smooth, try using a low fuser mode to reduce the heat in the fusing process. At the printer control panel, use **CONFIGURE FUSER MODE MENU** on the Paper Handling Menu to do this (see “Paper Handling Menu” on page 210).

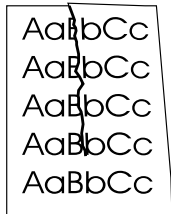

## Wrinkles or creases

- 1 Print a few more pages to see if the problem corrects itself.
- 2 Make sure that the environmental specifications for the printer are being met (see “General specifications” on page 202).
- 3 Turn over the stack of paper in the tray. Also, try rotating the paper 180°.
- 4 Make sure that paper is loaded correctly, all adjustments have been made, and the paper is under the corner tabs (see “Loading tray 1” on page 46 and “Loading trays 2, 3, and 4” on page 47).
- 5 Make sure that paper type and quality meet HP specifications (see “Paper specifications” on page 188).
- 6 If envelopes are creasing, try storing envelopes so that they lie flat.

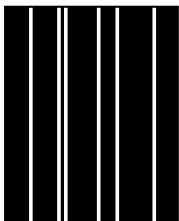

## Vertical white lines

- 1 Print a few more pages to see if the problem corrects itself.
- 2 Make sure that paper type and quality meet HP specifications (see “Paper specifications” on page 188).
- 3 Replace the toner cartridge.



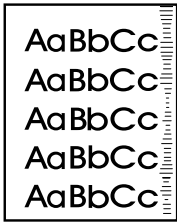

## Tire tracks

This defect typically occurs when the toner cartridge has far exceeded its rated usage of 10,000 pages (for example, printing a very large quantity of pages with very little toner coverage).

- 1 Replace the toner cartridge.
- 2 Reduce the number of pages that you print with very low toner coverage.
- 3 Use the 6,000-page cartridge if you cannot reduce the number of pages with very little toner coverage (part number C8061A).

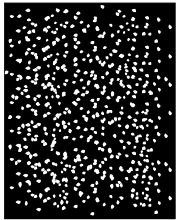

## White spots on black

- 1 Print a few more pages to see if the problem corrects itself.
- 2 Make sure that paper type and quality meet HP specifications (see “Paper specifications” on page 188).
- 3 Make sure that the environmental specifications for the printer are being met (see “General specifications” on page 202).
- 4 Replace the toner cartridge.



# Determining printer problems

## Troubleshooting flowchart

If the printer is not responding properly, use the flowchart to determine the problem. If the printer does not pass a step, follow the corresponding troubleshooting suggestions.

If you cannot resolve the problem after following the suggestions in this guide, contact an HP-authorized service or support provider (see “HP Customer Care Service and Support” on page 157).



### Note

Macintosh users: For more troubleshooting information, see “Troubleshooting flowchart for Macintosh users” on page 143.

**1 Does the control panel display READY?**

YES →

Go to step 2.

NO ↓

The display is blank and the printer's fan is off.	The display is blank but the printer's fan is on.	The display is in the wrong language.	The display shows garbled or unfamiliar characters.	A message other than READY is displayed.
<ul style="list-style-type: none"> <li>Check the power cord connections and the power switch.</li> <li>Plug the printer into a different outlet.</li> <li>Check that the power supplied to the printer is steady, and meets printer specifications (see “Electrical specifications” on page 201).</li> </ul>	<ul style="list-style-type: none"> <li>Press any control panel key to see if the printer responds.</li> <li>Turn the printer off, and then turn the printer on.</li> </ul>	<ul style="list-style-type: none"> <li>Turn the printer off. Hold down <b>SELECT</b> while turning the printer on. Press <b>-VALUE+</b> to scroll through the available languages. Press <b>SELECT</b> to save the desired language as the new default. Press <b>Go</b> to return to <b>READY</b>.</li> </ul>	<ul style="list-style-type: none"> <li>Make sure the desired language is selected from the control panel.</li> <li>Turn the printer off, and then turn the printer on.</li> </ul>	<ul style="list-style-type: none"> <li>Go to “Understanding printer messages” on page 111.</li> </ul>



**2 Can you print a configuration page (see “Configuration page” on page 152)?**

**YES →**

**Go to step 3.**

**NO ↓**

A configuration page does not print.	A blank page prints.	A message other than <b>READY</b> or <b>PRINTING CONFIGURATION</b> is displayed.
<ul style="list-style-type: none"> <li>• Check that all trays are properly loaded, adjusted, and installed in the printer.</li> <li>• From the computer, check the print queue or print spooler to see if the printer has been paused. If there are problems with the current print job, or if the printer is paused, a configuration page will not print. (Press <b>CANCEL JOB</b> and try step 2 again.)</li> </ul>	<ul style="list-style-type: none"> <li>• Check that the sealing tape is not still in the toner cartridge. (See the getting started guide or the instructions that came with the toner cartridge.)</li> <li>• The toner cartridge might be empty. Install a new toner cartridge.</li> </ul>	<ul style="list-style-type: none"> <li>• Go to “Understanding printer messages” on page 111.</li> </ul>



### 3 Can you print from a software application?

YES →

Go to step 4.

NO ↓

The job will not print.	A PS error page or list of commands prints
<ul style="list-style-type: none"><li>• If the job will not print, and a message is displayed on the control panel, see “Understanding printer messages” on page 111.</li><li>• From the computer, check to see if the printer has been paused.</li><li>• If the printer is on a network, check that you are printing to the correct printer. To verify that it is not a network problem, connect the computer directly to the printer with a parallel cable, change the port to LPT1, and try to print.</li><li>• Check the interface cable connections. Disconnect and reconnect the cable at the computer and the printer.</li><li>• Test the cable by trying it on another computer.</li><li>• If you are using a parallel connection, make sure the cable is IEEE-1284 compliant.</li><li>• If the printer is on a network, print a configuration page (see “Configuration page” on page 152) and verify in the Protocol Information that server and node name match the names in the printer driver.</li><li>• To verify that it is not a computer problem, print from another computer (if possible).</li><li>• Make sure the print job is being sent to the correct port (LPT1, or network printer port, for example).</li><li>• Check that you are using the proper printer driver (see “Choose the right printer driver for your needs” on page 37).</li><li>• Reinstall the printer driver (see the getting started guide).</li><li>• Check that the port is configured and working properly. (Try connecting another printer to that port and printing.)</li><li>• If printing with the PS driver, from the Configuration Menu in the printer control panel, set PRINT PS ERRORS=ON, then print the job again (see “PRINT PS ERRORS= OFF” on page 221. If an error page prints, see the instructions in the next column).</li><li>• From the Configuration Menu in the printer control panel, make sure that PERSONALITY=AUTO (see “PERSONALITY= AUTO” on page 221).</li><li>• You might be missing a printer message that could help you solve the problem. From the Configuration Menu in the printer control panel, temporarily turn the Clearable Warnings and Auto Continue settings off (see “CLEARABLE WARNINGS=JOB” on page 220 and “AUTO CONTINUE= ON” on page 220) and then print the job again.</li></ul>	<ul style="list-style-type: none"><li>• The printer might have received a nonstandard PS code. From the Configuration Menu in the printer control panel, set PERSONALITY to PS for this print job only. After the job has printed, return the setting to AUTO (see “PERSONALITY= AUTO” on page 221).</li><li>• Make sure the print job is a PS job, and that you are using the PS driver.</li><li>• The printer might have received PS code when it is set to PCL. From the Configuration Menu, set PERSONALITY to AUTO (see “PERSONALITY= AUTO” on page 221).</li></ul>



## 4 Does the job print as expected? (Continued on the following page.)

NO ↓

Print is garbled or only a portion of the page prints	Printing stops in the middle of the job.	Print speed is slower than expected.	A control panel setting is not taking effect.
<ul style="list-style-type: none"> <li>• Check that you are using the proper printer driver (see “Choose the right printer driver for your needs” on page 37).</li> <li>• The data file sent to the printer might be corrupt. To test, try printing it on another printer (if possible), or try a different file.</li> <li>• Check the interface cable connections. Test the cable by trying it on another computer (if possible).</li> <li>• Replace the interface cable with a high-quality cable (see “Ordering information” on page 22).</li> <li>• Reduce the job’s complexity, print at a lower resolution (see the description of “RESOLUTION=FASTRES 1200” on page 217), or install more printer memory (see “Printer memory and expansion” on page 229).</li> <li>• You might be missing a printer message that could help you solve the problem. From the Configuration Menu in the printer control panel, temporarily turn the Clearable Warnings and Auto Continue settings off (see “CLEARABLE WARNINGS=JOB” on page 220 and “AUTO CONTINUE=ON” on page 220) and then print the job again.</li> </ul>	<ul style="list-style-type: none"> <li>• <b>CANCEL JOB</b> might have been pressed.</li> <li>• Check that the power supplied to the printer is steady, and meets printer specifications (see “Electrical specifications” on page 201).</li> </ul>	<ul style="list-style-type: none"> <li>• Simplify the print job.</li> <li>• Add more memory to the printer (see “Printer memory and expansion” on page 229).</li> <li>• Turn banner pages off. (See your network administrator.)</li> <li>• Note that slower speeds should be expected if you are printing narrow paper, printing from tray 1, using HIGH 2 fuser mode, or have small paper speed set to slow.</li> </ul>	<ul style="list-style-type: none"> <li>• Check settings in the printer driver or software application. (Printer driver and software commands override control panel settings.)</li> </ul>



Does the job print as expected? (continued)

YES →

Go to step 5.

NO ↓

<b>The print job is not formatted correctly.</b>	<b>Pages are not fed correctly or are damaged.</b>	<b>There are print quality problems.</b>
<ul style="list-style-type: none"><li>• Check that you are using the proper printer driver (see “Choose the right printer driver for your needs” on page 37).</li><li>• Check the software settings. (See the software help.)</li><li>• Try a different font.</li><li>• Downloaded resources might have been lost. You might need to download them again.</li></ul>	<ul style="list-style-type: none"><li>• Make sure paper is loaded correctly and that the guides are not too tight or too loose against the paper stack.</li><li>• If you are having problems printing custom-size paper, see “Guidelines for printing custom-size paper” on page 63.</li><li>• If pages are wrinkled or curled, or if the image is skewed on the page, see “Correcting output quality problems” on page 128.</li></ul>	<ul style="list-style-type: none"><li>• Adjust the print resolution (see “RESOLUTION=FASTRES 1200” on page 217).</li><li>• Check that REt is on (see “RET=MEDIUM” on page 217).</li><li>• Go to “Correcting output quality problems” on page 128.</li></ul>



**5 Does the printer select the proper trays, output locations, and paper handling accessories?**

YES →

For other problems, check the Contents, the Index, or the printer software help.



NO ↓



The printer pulls paper from the wrong tray.	An optional accessory is not working properly.	A message other than <b>READY</b> is displayed.
<ul style="list-style-type: none"> <li>• See “Customizing what tray is used for printing” on page 68.</li> <li>• Make sure paper trays are correctly configured for paper size and type (see “Loading trays 2, 3, and 4” on page 47). Print a configuration page to see current tray settings (see “Configuration page” on page 152).</li> <li>• Make sure the tray selection (or paper type) in the printer driver or software application is set correctly. (The printer driver and software application settings override the printer control panel settings.)</li> <li>• If you do not want to print from tray 1, remove any paper loaded in the tray or change the <b>TRAY 1 MODE</b> setting to <b>CASSETTE</b> (see “Customizing tray 1 operation” on page 69). By default, paper loaded in tray 1 will be printed first.</li> <li>• If you want to print from tray 1, but cannot select the tray from a software application, see “Customizing tray 1 operation” on page 69.</li> </ul>	<ul style="list-style-type: none"> <li>• Print a configuration page to verify that the accessory is installed properly and is functional (see “Configuration page” on page 152).</li> <li>• Configure the printer driver for the installed accessories (see the software help).</li> <li>• Turn the printer off, and then turn the printer on.</li> <li>• Verify that you are using the correct optional accessory for the printer.</li> <li>• If the optional duplexer will not duplex, check that the rear output bin is closed.</li> <li>• If the optional duplexer will not duplex, you might need to install more memory (see “Printer memory and expansion” on page 229).</li> </ul>	<ul style="list-style-type: none"> <li>• Go to “Understanding printer messages” on page 111.</li> </ul>





# Troubleshooting flowchart for Macintosh users

**1 Can you print from a software application?**

**YES →**

**Go to step 2.**

**NO ↓**

<b>The Macintosh computer is not communicating with the printer.</b>	<b>Auto Setup did not automatically set up the printer.</b>	<b>The printer driver icon does not appear in the Chooser.</b>
<ul style="list-style-type: none"> <li>• Make sure the printer control panel displays <b>READY</b> (see the first page of “Troubleshooting flowchart” on page 137).</li> <li>• Make sure the correct printer driver is selected in the left half of the Chooser. Then make sure that the desired printer name is selected (highlighted) on the right half of the Chooser. There will be an icon next to the printer name after the driver has been set up and configured with the PPD.</li> <li>• If the printer resides on a network with multiple zones, make sure the correct zone is selected in the AppleTalk Zones box in the Chooser.</li> <li>• Make sure the correct printer has been chosen in the Chooser by printing a configuration (see “Configuration page” on page 152). Make sure the name of the printer displayed on the configuration page matches the printer in the Chooser.</li> <li>• Make sure AppleTalk is active. (Select this in the Chooser or in the AppleTalk control panel, whichever is applicable for your OS version.)</li> <li>• Make sure the computer and printer are on the same network. From Control Panels in the Apple menu, select the Network (or the AppleTalk) control panel and then choose the correct network (for example, LocalTalk or EtherNet).</li> </ul>	<ul style="list-style-type: none"> <li>• Set up the printer manually by selecting Configure.</li> <li>• Reinstall the printer software. (See the getting started guide.)</li> <li>• Select an alternate PPD (see “Selecting an alternate PPD” on page 145).</li> <li>• The PPD might have been renamed. If so, select the renamed PPD (see “Selecting an alternate PPD” on page 145).</li> <li>• A network queue might be present.</li> </ul>	<ul style="list-style-type: none"> <li>• Make sure the Apple LaserWriter 8 Chooser extension resides in the Extensions folder.</li> <li>• If it is not present anywhere on your system, contact Apple Computer, Inc.</li> </ul>



## 2 Does the job print as expected?

YES →

For other problems, check the Contents, the Index, or the printer online help.

NO ↓



The print job is not sent to the desired printer.	The print job has incorrect fonts.	The computer cannot be used while the printer is printing.
<ul style="list-style-type: none"><li>• Another printer with the same or similar name might have received the print job. Verify that the printer name matches the name selected in the Chooser (see “Selecting an alternate PPD” on page 145).</li></ul>	<ul style="list-style-type: none"><li>• If you are printing an .eps file, try downloading the fonts contained in the .eps file to the printer before printing. Use the HP LaserJet Utility (see “HP LaserJet Utility” on page 40).</li><li>• If the document is not printing with New York, Geneva, or Monaco fonts, go into the Page Setup dialog box, and select Options to deselect substituted fonts.</li></ul>	<ul style="list-style-type: none"><li>• Select <b>Print in Background</b> from the Background Printing menu in the Print Dialog box. Status messages will be redirected to the Desktop Print Monitor, allowing the computer to continue working while the printer is printing.</li></ul>



## Selecting an alternate PPD

- 1 Open the **Chooser** from the **Apple** menu.
- 2 Click the **LaserWriter 8** icon.
- 3 If you are on a network with multiple zones, select the zone in the **AppleTalk Zones** box where the printer is located.
- 4 Click the printer name you want to use in the **Select a PostScript Printer** box. (Double-clicking will immediately generate the next few steps.)
- 5 Click **Setup**. (This button might read **Create** for first-time setup.)
- 6 Click **Select PPD**.
- 7 Find the desired PPD in the list and click **Select**. If the desired PPD is not listed, choose one of the following options:
  - Select a PPD for a printer with similar features.
  - Select a PPD from another folder.
  - Select the generic PPD by clicking **Use Generic**. The generic PPD allows you to print, but limits your access to printer features.
- 8 In the **Setup** dialog box, click **Select**, and then click **OK** to return to the **Chooser**.



---

### Note

---

If you manually select a PPD, an icon might not appear next to the selected printer in the **Select a PostScript Printer** box. In the **Chooser**, click **Setup**, click **Printer Info**, and then click **Update Info** to bring up the icon.

- 9 Close the **Chooser**.

## Renaming the printer

If you are going to rename the printer, do this before selecting the printer in the **Chooser**. If you rename the printer after selecting it in the **Chooser**, you will have to go back into the **Chooser** and reselect it.

Use the **Set Printer Name** feature in the **HP LaserJet Utility** to rename the printer.



# Troubleshooting the optional printer hard disk accessory



## Troubleshooting the optional printer hard disk accessory

Item	Explanation
Printer does not recognize the hard disk accessory.	Turn the printer off and verify that the hard disk accessory is inserted correctly and is securely fastened. Print a configuration page to confirm that the hard disk accessory has been recognized (see "Configuration page" on page 152).
Disk is not initialized. DISK x NOT INITIALIZED	Use the Windows-based HP Resource Manager or the Macintosh-based HP LaserJet Utility to initialize the disk.
Disk failure. EIO x DISK NOT FUNCTIONAL	Turn the printer off and make sure that the EIO disk is inserted correctly and securely fastened. If the control panel message continues to be displayed, the disk drive needs to be replaced.
Disk is write protected. DISK IS WRITE PROTECTED	Fonts and forms cannot be stored on the disk when the disk is write protected. Use the Windows-based HP LaserJet Resource Manager or the Macintosh-based HP LaserJet Utility to remove the write protection from the disk.
Attempted to use a disk-resident font, but the printer substituted a different font.	If you are using PCL, print the PCL Font Page, and verify that the font is on the disk. If you are using PS, print the PS Font Page and make sure that the font is on the disk. If the font is not on the disk, use the HP Resource Manager or the Macintosh-based HP LaserJet Utility to download the font. (See "PCL or PS font list" on page 156).



# Troubleshooting PS



## PS troubleshooting

Item	Explanation
A text listing of PS commands prints instead of your PS printing job.	The control panel PERSONALITY=AUTO setting may have been confused by a nonstandard PS code. Check the PERSONALITY setting to see if it is set to PS or PCL (see "Configuration Menu" on page 219). If it is set to PCL, set it to PERSONALITY=AUTO. If it is set to AUTO, set it to PS for this print job only. When the job has printed, return the setting to AUTO.
The job prints in Courier (the printer's default font) instead of the font you requested.	<p>The requested typeface is not available in the printer or is not present on the disk. Use a font download utility to download the desired font.</p> <p>Fonts downloaded to memory are lost when the printer is turned off. They are also lost if Resource Saving is not used and a personality switch is performed to print a PCL job. Disk fonts are not affected by PCL jobs or by turning the printer off.</p> <p>Print a PS Font Page to verify that the font is available (see "PCL or PS font list" on page 156). If a disk font appears to be missing, it may be because a software utility was used to delete the font, because the disk was re-initialized, or because the disk drive is not installed correctly. Print a configuration page to verify that the disk drive is installed and functioning correctly (see "Configuration page" on page 152).</p> <p>Print a file directory to help identify available fonts (see "Information Menu" on page 208).</p>
A page prints with clipped margins.	If the page margins are clipped, you may have to print the page at 300-dpi resolution or install more memory.
A page fails to print.	Set PRINT PS ERRORS=ON (see "Configuration Menu" on page 219, and then send the job again to print a PS error page.
A PS error page prints.	<p>Make sure the print job is a PS job.</p> <p>Check to see whether your software expected you to send a setup or PS header file to the printer.</p> <p>Check the printer setup in your software application to make sure that the printer is selected.</p> <p>Check cable connections to ensure that they are secure.</p> <p>Reduce the complexity of the graphic.</p>
Printer pulls paper from the wrong tray.	Use the information in "Customizing what tray is used for printing" on page 68 to change the tray being used.



# Troubleshooting optional HP Fast InfraRed Receiver problems



## Troubleshooting HP Fast InfraRed Receiver problems

Item	Explanation
FIR port status indicator does not light up.	<p>Make sure that the printer is in <b>READY</b> mode and that the FIR port you are printing from is IRDA-compliant and within the range of operation described in the user guide for the HP Fast InfraRed Receiver.</p> <p>Make sure that the HP Fast InfraRed Receiver is properly connected to the printer.</p> <p>Print a configuration page (see “Configuration page” on page 152). Make sure that “FIR POD (IRDA Compliant)” is printed under Installed Personalities and Options.</p>
Connection cannot be established or seems to take longer than usual.	<p>Use a device that is IRDA-compliant; look for an IRDA symbol on the device or see the computer’s user guide for IRDA specifications. Connection often cannot take place because the computer does not have the software that is required for FIR. Make sure that the operating system on your computer includes an FIR driver and your application uses an HP LaserJet 4100, 4100N, 4100TN, 4100DTN, or compatible driver.</p> <p>Note that complex pages take longer to print.</p> <p>Position the HP Fast InfraRed Receiver within the range of operation described in the user guide for the HP Fast InfraRed Receiver. Make sure that no object is blocking the connection. (This object could be a hand, paper, books, or even bright light.)</p> <p>Make sure that the two IR ports are clean (free from dirt and grease). Bright light of any kind (sunlight, incandescent light, fluorescent light, or light from an infrared remote control, such as those used for TVs and VCRs) shining directly into one of the IR ports might cause interference. Make sure that no bright light is shining directly into either IR port.</p> <p>Position the portable device closer to the FIR port on the printer.</p>
The printer prints only part of a page or document.	<p>The connection has been broken during transmission. If you move the portable device during transmission, the connection can be broken. IRDA-compliant devices are designed to recover from temporary connection interruptions. You have up to 40 seconds to re-establish the connection (depending on the portable device being used).</p>



## Troubleshooting HP Fast InfraRed Receiver problems (continued)

Item	Explanation
The print job has been properly sent, but the printer will not print.	If the connection is broken before the entire print job has been transmitted to the printer (printing has not yet started), the printer may not print any of the job. Press <b>CANCEL JOB</b> to clear the printer's memory. Then, reposition the portable device within the range of operation described in the user guide for the HP Fast InfraRed Receiver, and print the job again.
The FIR status indicator turns off during transmission.	The connection might have been broken. Press <b>CANCEL JOB</b> to clear the printer's memory. Then, reposition the portable device within the range of operation described in the user guide for the HP Fast InfraRed Receiver, and print the job again.



# Communicating with an optional HP JetDirect print server

If the printer contains an optional HP JetDirect print server, and you cannot communicate with the printer over the network, verify the operation of the print server.

- Check the HP JetDirect configuration page (to print, see “Configuration page” on page 152).
- If the message, “I/O CARD READY” does not appear on the HP JetDirect configuration page, see the troubleshooting section of the *HP JetDirect Print Server Administrator’s Guide*.

If the printer contains an HP JetDirect 10/100TX print server, check to see that the print server was able to link to the network:

- Check the link-speed indicators (10 or 100) on the print server. If both are off, the print server failed to link to the network.
- Check the HP JetDirect configuration page. The message “LOSS OF CARRIER ERROR” indicates that the print server failed to link to the network.

If the print server failed to link, verify that all cables are correctly connected. If all cables are correctly connected and the print server still fails to link, follow the steps below to reconfigure the print server:

- 1 Use the EIO Menu to manually set the link speed (10 or 100 Mbps) and duplex mode (full- or half-duplex) so that they match the network (see “EIO Menu” on page 225). For example, if the port on the network switch is set for 100TX full-duplex operation, you must set the print server for 100TX full-duplex operation.
- 2 Turn the printer off and back on and check the print server operation. If the print server fails to link, try a different network cable.





# Checking the printer configuration

From the printer control panel, you can print pages that give details about the printer and its current configuration. The following information pages are described here:

- Menu map
- Configuration page
- Supplies status page (includes information on toner cartridge use)
- PCL or PS font list

For a complete list of the printer's information pages, see the Information Menu in the printer control panel ("Information Menu" on page 208).

Keep these pages handy for troubleshooting. They are also useful if you contact HP Customer Care.

## Menu map

To see the current settings for the menus and items available in the control panel, print a control panel menu map:

- 1 At the printer control panel, press **MENU** until INFORMATION MENU appears.
- 2 Press **ITEM** until PRINT MENU MAP appears.
- 3 Press **SELECT** to print the menu map.

You might want to store the menu map near the printer for reference. The content of the menu map varies, depending on the options currently installed in the printer. (Many of these values can be overridden from the printer driver or software application.)

For a complete list of control panel items and possible values, see Appendix B. To change a control panel setting, see "Control panel menus" on page 32.



## Configuration page

Use the configuration page to view current printer settings, to help troubleshoot printer problems, or to verify installation of optional accessories, such as memory (DIMMs), paper trays, and printer languages.



---

### Note

---

If an HP JetDirect print server card is installed (HP LaserJet 4100N, 4100TN, and 4100DTN printers), an HP JetDirect configuration page will print out as well.

To print a configuration page at the control panel:

- 1 Press **MENU** until INFORMATION MENU appears.
- 2 Press **ITEM** until PRINT CONFIGURATION appears.
- 3 Press **SELECT** to print the page. Note the pages since last maintenance.

The next page contains an example of the configuration page. The content of the configuration page varies, depending on the options currently installed in the printer.

---

### Note

---

You can also obtain configuration information from the embedded web server. For details, see “Embedded web server” on page 251.



## Configuration page

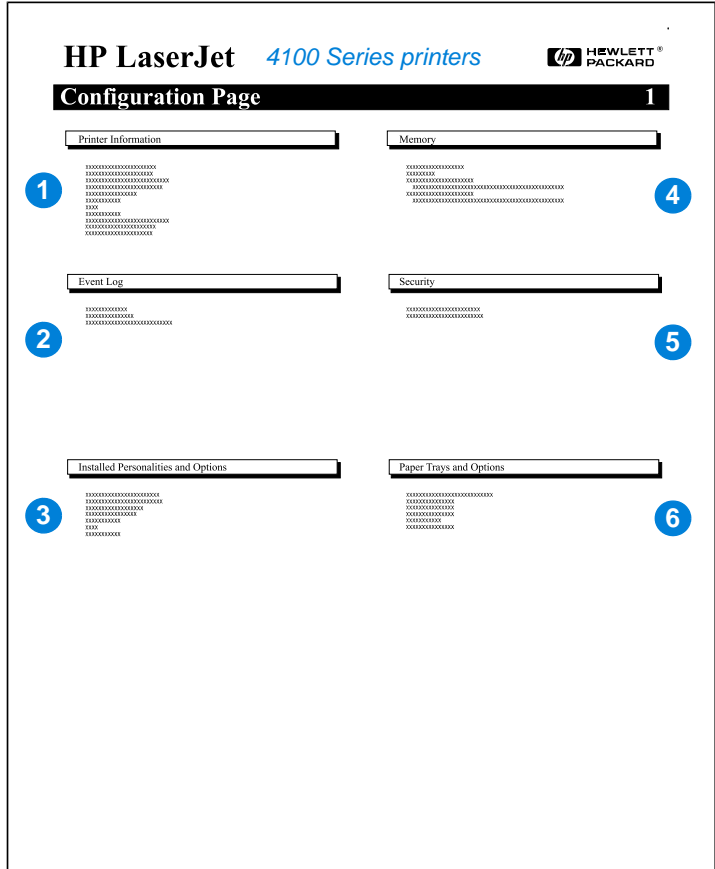

- |                                              |                                                                                                                                          |
|----------------------------------------------|------------------------------------------------------------------------------------------------------------------------------------------|
| <b>1</b> Printer Information                 | Lists the serial number, HP JetSend IP addresses, page counts, and other information for the printer.                                    |
| <b>2</b> Event Log                           | Lists the number of entries in the event log, the maximum number of entries viewable, and the last three entries.                        |
| <b>3</b> Installed Personalities and Options | Lists all printer languages that are installed (such as PCL and PS) and lists options that are installed in each DIMM slot and EIO slot. |
| <b>4</b> Memory                              | Lists printer memory, PCL Driver Work Space (DWS), and I/O buffering and resource saving information.                                    |
| <b>5</b> Security                            | Lists the status of the printer control panel lock, control panel password, and disk drive.                                              |
| <b>6</b> Paper Trays and Options             | Lists the size settings for all trays and lists optional paper handling accessories that are installed.                                  |

## Supplies status page

Use the supplies status page to obtain information about the toner cartridge installed in the printer, the amount of toner left in the toner cartridge, and the number of pages and jobs that have been processed. The page also lets you know when you should schedule the next preventative maintenance (see “Performing preventative maintenance” on page 93).



To print a supplies status page at the control panel:



- 1 Press **MENU** until `INFORMATION MENU` appears.
- 2 Press **ITEM** until `PRINT SUPPLIES STATUS PAGE` appears.
- 3 Press **SELECT** to print the page.



The next page contains an example of the supplies status page.

---

### Note

---

You can also obtain supplies status information from the embedded web server. For details, see “Embedded web server” on page 251.



## Supplies status page

**HP LaserJet 4100 series printers** **HEWLETT PACKARD**

### Supplies Status Page

Hewlett-Packard Supplies can be ordered on the internet at: <http://www.hp.com/ghp/buyonline.html> or by calling Hewlett Packard. (Please refer to your printer User Guide for the telephone number.)

**\*\*For highest print quality always use genuine Hewlett-Packard LaserJet Supplies.\*\***

#### Cartridge Information

HP Black Toner Gauge: 91%

HP Part Number: **C8061A**  
 Toner Low Reached: **NO**  
 Toner Out Reached: **NO**  
 Estimated Pages Remaining\*: **9,461**  
(\*Based on this printer's historical page coverage of 12%)

**Total Pages Printed: 778**

Page Count by Paper Size:

A3/Ledger:	0
Legal:	58
A4/Letter:	676
B5/Executive:	34
Envelope:	12
Custom/Other:	0

Number of Jobs Processed: 527

Cartridge Manufacture Date: 01/17/2001  
 Cartridge Serial Number: 98765432  
 Marked as Reordered: NO

#### Other Supplies Information

HP Maintenance Kit Gauge: 47%

HP Part Numbers:  
 110V C8057A  
 220V C8058A

#### Printer Information

Total Printer Page Count: 123,456  
 Preventative Maintenance Interval: 200,000  
 Pages until next Maintenance: 76,544  
 Serial Number of this printer: A-34598725

Please return your used HP cartridge to Hewlett-Packard. For more information see Planet Partners at: [http://www.hp.com/lsupplies/planet\\_recycle.html](http://www.hp.com/lsupplies/planet_recycle.html)

- |   |                         |                                                                                                                                                                                   |
|---|-------------------------|-----------------------------------------------------------------------------------------------------------------------------------------------------------------------------------|
| 1 | Supplies website        | Local website for ordering supplies through the Internet.                                                                                                                         |
| 2 | Cartridge information   | Information about the amount of toner available in the toner cartridge, toner cartridge part number, and estimated pages remaining for the amount of toner left in the cartridge. |
| 3 | Printing statistics     | Statistics on total number of pages and jobs processed.                                                                                                                           |
| 4 | Manufacture information | Toner cartridge manufacture date and serial number.                                                                                                                               |
| 5 | Recycling website       | Website for information about returning used HP toner cartridges.                                                                                                                 |
| 6 | Maintenance kit gauge   | A gauge to let you know what percentage of the maintenance kit has been used.                                                                                                     |
| 7 | Printer information     | Total printer page count, preventative maintenance interval, pages until next maintenance should be performed, and serial number of the printer.                                  |

## PCL or PS font list

Use the font lists to see which fonts are currently installed in the printer. (The font lists also show which fonts are resident on an optional hard disk accessory or flash DIMM.)



### To print a PCL or PS font list

- 1 At the printer control panel, press **MENU** until INFORMATION MENU appears.
- 2 Press **ITEM** until PRINT PCL FONT LIST or PRINT PS FONT LIST appears.
- 3 Press **SELECT** to print the font list.



The PS font list shows the PS fonts installed, and gives a sample of those fonts. The following describes the information that can be found on the PCL font list:

- **Font** gives the font names and samples.
- **Pitch/Point** indicates the pitch and point size of the font.
- **Escape Sequence** (a PCL 5e programming command) is used to select the designated font. (See the legend at the bottom of the font list page.)

---

### Note

---

For step-by-step instructions on using printer commands to select a font with DOS applications, see “Selecting PCL 5e fonts” on page 238.

- **Font #** is the number used to select fonts from the printer control panel (not the software application). Do not confuse the font # with the font ID, described below. The number indicates the DIMM slot where the font is stored.
  - **SOFT**: Downloaded fonts, which stay resident in the printer until other fonts are downloaded to replace them, or until the printer is turned off.
  - **INTERNAL**: Fonts that permanently reside in the printer.
- **Font ID** is the number you assign to soft fonts when you download them through software.



# 5 Service and support



## HP Customer Care Service and Support

### Online services

For 24-hour access to information, we suggest the services listed in this section.

### World Wide Web

Printer drivers, updated HP printer software, plus product and support information may be obtained from the following URLs:

in the U.S. <http://www.hp.com/support/lj4100>

Printer drivers may be obtained from the following websites:

in China <ftp://www.hp.com.cn/support/lj4100>

in Japan <ftp://www.jpn.hp.com/support/lj4100>

in Korea <http://www.hp.co.kr/support/lj4100>

in Taiwan <http://www.hp.com.tw/support/lj4100> or the local driver website <http://www.dds.com.tw>



## Software utilities and electronic information

Countries/regions	Contact information																										
U.S.	<p>Monday - Friday: 6:00 am - 10:00 pm MST Saturday: 9:00 am - 4:00 pm MST</p> <p>Phone: (661) 257-5565 Fax: (661) 257-6995 HP website: <a href="http://www.hp.com/">http://www.hp.com/</a></p> <p>Mail: Hewlett-Packard Co. P.O. Box 907 Santa Clarita, CA 91380-9007 USA</p>																										
Canada	Phone: (905) 206-4663																										
Europe	<p>The languages supported are also listed below beside the telephone numbers. Hours of operation are 7:30 am GMT (8:30 am CET) to 17:00 GMT (18:00 CET).</p> <table style="width: 100%; border-collapse: collapse;"> <thead> <tr> <th style="width: 60%;"></th> <th style="text-align: center; width: 20%;"><b>Within UK</b></th> <th style="text-align: center; width: 20%;"><b>Internationally</b></th> </tr> </thead> <tbody> <tr> <td>English speaking line</td> <td style="text-align: center;">01429 865511</td> <td style="text-align: center;">+44 1429 865511</td> </tr> <tr> <td>French speaking line</td> <td></td> <td style="text-align: center;">+44 1429 863343</td> </tr> <tr> <td>German speaking line</td> <td></td> <td style="text-align: center;">+44 1429 863353</td> </tr> <tr> <td>Italian speaking line</td> <td></td> <td style="text-align: center;">+44 1429 520013</td> </tr> <tr> <td>Spanish speaking line</td> <td></td> <td style="text-align: center;">+44 1429 520012</td> </tr> <tr> <td>Portuguese speaking line</td> <td></td> <td style="text-align: center;">+44 1429 890466</td> </tr> </tbody> </table>		<b>Within UK</b>	<b>Internationally</b>	English speaking line	01429 865511	+44 1429 865511	French speaking line		+44 1429 863343	German speaking line		+44 1429 863353	Italian speaking line		+44 1429 520013	Spanish speaking line		+44 1429 520012	Portuguese speaking line		+44 1429 890466					
	<b>Within UK</b>	<b>Internationally</b>																									
English speaking line	01429 865511	+44 1429 865511																									
French speaking line		+44 1429 863343																									
German speaking line		+44 1429 863353																									
Italian speaking line		+44 1429 520013																									
Spanish speaking line		+44 1429 520012																									
Portuguese speaking line		+44 1429 890466																									
Asia Pacific country/region	<table style="width: 100%; border-collapse: collapse;"> <tbody> <tr> <td style="width: 60%;">Australia</td> <td style="text-align: center;">+61 3 9272 8000</td> </tr> <tr> <td>China (Beijing)</td> <td style="text-align: center;">+86 10 65053888</td> </tr> <tr> <td>Hong Kong</td> <td style="text-align: center;">+65 740-4477</td> </tr> <tr> <td>India</td> <td style="text-align: center;">+91 (011) 682 6035</td> </tr> <tr> <td>Indonesia</td> <td style="text-align: center;">+65 740-4477</td> </tr> <tr> <td>Japan</td> <td style="text-align: center;">+81 3 53461891</td> </tr> <tr> <td>Korea</td> <td style="text-align: center;">+82 2 3270 0805</td> </tr> <tr> <td>Malaysia</td> <td style="text-align: center;">+65 740-4477</td> </tr> <tr> <td>New Zealand</td> <td style="text-align: center;">0800-445-543 (toll free) or (09) 356 6640</td> </tr> <tr> <td>Philippines</td> <td style="text-align: center;">+65 740-4477</td> </tr> <tr> <td>Singapore</td> <td style="text-align: center;">+65 740-4477</td> </tr> <tr> <td>Taiwan</td> <td style="text-align: center;">+886 (02) 717 0055</td> </tr> <tr> <td>Thailand</td> <td style="text-align: center;">+66 (02) 661-3900 ext 3224</td> </tr> </tbody> </table>	Australia	+61 3 9272 8000	China (Beijing)	+86 10 65053888	Hong Kong	+65 740-4477	India	+91 (011) 682 6035	Indonesia	+65 740-4477	Japan	+81 3 53461891	Korea	+82 2 3270 0805	Malaysia	+65 740-4477	New Zealand	0800-445-543 (toll free) or (09) 356 6640	Philippines	+65 740-4477	Singapore	+65 740-4477	Taiwan	+886 (02) 717 0055	Thailand	+66 (02) 661-3900 ext 3224
Australia	+61 3 9272 8000																										
China (Beijing)	+86 10 65053888																										
Hong Kong	+65 740-4477																										
India	+91 (011) 682 6035																										
Indonesia	+65 740-4477																										
Japan	+81 3 53461891																										
Korea	+82 2 3270 0805																										
Malaysia	+65 740-4477																										
New Zealand	0800-445-543 (toll free) or (09) 356 6640																										
Philippines	+65 740-4477																										
Singapore	+65 740-4477																										
Taiwan	+886 (02) 717 0055																										
Thailand	+66 (02) 661-3900 ext 3224																										





Countries/regions	Contact information
Latin America	<p><b>Argentina</b> 8:30 to 19:30 hrs. Buenos Aires: 787-8080</p>
	<p><b>Brazil</b> 8:00 to 19:00 hrs. São Paulo: 011-829-6612</p>
	<p><b>Chile</b> 8:30 to 18:30 hrs. Chile: 800-360999</p>
	<p><b>Colombia</b> Local dealers provide technical assistance</p>
	<p><b>Mexico “HP Contigo”</b> 8:00 to 18:00 hrs. Mexico: 01-800-4726684 and 01 800-4720684</p>
	<p><b>Venezuela</b> 8:00 to 18:00 hrs. Caracas: 800-47-888 207-8488</p>
<p>Technical Assistance for other Latin American countries is provided by local dealers.</p>	



## HP direct ordering for accessories or supplies

To order accessories or supplies:

- call (800) 752-0900 (U.S.) or (800) 387-3154 (Canada)
- visit the HP LaserJet supplies website that is local to your area (print a copy of the supplies status page to learn the URL, as described in “Supplies status page” on page 154)



## HP direct ordering for genuine HP parts

In the U.S., call (800) 227-8164.



## HP service parts information CD

This powerful, CD-based parts information tool is designed to give users fast, easy access to parts information such as pricing and recommended stocking lists for a wide range of HP products. To subscribe to this quarterly service in the U.S. or Canada, call (800) 336-5987. In Asia Pacific, call (65) 740-4484. Parts identification and pricing information worldwide can also be accessed via the World Wide Web at <http://www.hp.com/go/partsinfo>.



## HP Support Assistant CD

This support tool offers a comprehensive online information system designed to provide technical and product information on HP products. To subscribe to this quarterly service in the U.S. or Canada, call (800) 457-1762. In Hong Kong, Indonesia, Malaysia, or Singapore, call Mentor Media at (65) 740-4477.

## HP authorized resellers and support

To locate authorized HP resellers and support, call (800) 243-9816 (U.S.) or (800) 387-3867 (Canada).

## HP service agreements

Call (800) 743-8305 (U.S.) or (800) 268-1221 (Canada).



## HP SupportPacks

The HP SupportPack is a packaged service agreement that upgrades your basic LaserJet product warranty (1 year), and extends coverage to 5 years.

HP SupportPacks are sold by HP resellers and are available in either a shrink-wrap version for a 3-year service package only (you must register with HP to activate service) or an electronic version for a 1-, 2-, 3-, 4-, or 5-year service package (you can register by fax or on the World Wide Web).

For ordering and pricing details, contact your local HP reseller or visit the HP website at <http://www.hp.com/go/printerservices> for more information.



## HP fraud hotline

Call the HP fraud hotline (1-877-219-3183, toll-free in North America) when you install an HP LaserJet toner cartridge and the printer message says the cartridge is non-HP toner. HP will help determine if the product is genuine and take steps to resolve the problem.

Your toner cartridge might not be a genuine HP toner cartridge if you notice the following:

- you are experiencing a high number of problems with the toner cartridge
- the cartridge does not look like it usually does (for example, the pull tab or the box is different)



# Customer support options worldwide

“Worldwide country/region sales and service offices” on page 172 contains addresses and phone numbers for countries/regions not listed here.



## HP Customer Care Center and product repair assistance for the U.S. and Canada



For technical support and help in identifying whether a product needs repair, call (208) 323-2551 (U.S.) or (905) 206-4663 (Canada) Monday through Friday from 6 am to 6 pm (Mountain Time) free of charge during the warranty period. However, your standard long-distance phone charges still apply. Have your system nearby and your printer serial number ready when calling.



If you know your printer needs repair, call (800) 243-9816 to locate your nearest authorized HP service provider.

If the printer warranty has expired, post-warranty telephone assistance is available to answer your product questions. Call (900) 555-1500 (\$2.50\* per minute, U.S. only) or call (800) 999-1148 (\$25\* per call, Visa or MasterCard, U.S. and Canada) Monday through Friday from 7am to 6 pm (Mountain Time). *Charges begin only when you connect with a support technician. \*Prices subject to change.*



## European HP Customer Care Center language and in-country options available

Open Monday through Friday 8:30 - 18:00 Central European Time (CET)

HP provides a free telephone support service during the warranty period. By calling a telephone number listed below, you will be connected to a responsive team waiting to help you. If you require support after your warranty has expired, you can receive support for a fee through the same telephone number. The fee is charged on a per-incident basis. When calling HP, have the following information ready: product number, serial number, date of purchase, and description of the problem.

English	Ireland: 353 (0)1 662 5525 U.K.: 44 (0)171 512 5202 International: 44 (0)(171) 512 5202
Dutch	Belgium: 32 (0)2 6268806 Netherlands: 31 (0)20 606 8751
French	France: 33 (0)1 43 62 34 34 Belgium: 32 (0)2 626 8807 Switzerland: 41 (0)848 80 11 11
German	Germany: 49 (0)180 52 58 143 Austria: 43 (0)7114 201080
Norwegian	Norway: 47 22 11 6299
Danish	Denmark: 45 39 29 4099
Finnish	Finland: (358) (0)203 47 288
Swedish	Sweden: 46 (0)8 619 2170
Italian	Italy: 39 02 264 10350
Spanish	Spain: 34 902 321 123
Portuguese	Portugal: 351 (0)1 3176333



## In-country/region support numbers

HP provides a free telephone support service during the warranty period. By calling a telephone number listed below, you will be connected to a responsive team waiting to help you. If you require support after your warranty has expired, you can receive support for a fee through the same telephone number. The fee is charged on a per-incident basis. When calling HP, have the following information ready: product number, serial number, date of purchase, and description of the problem.

If you require support after your warranty has expired, additional product repair services, or if your country/region is not listed below, see “Worldwide country/region sales and service offices” on page 172.

Argentina	(541) 778 8380
Australia	61 3 8877 8000
Brazil	(011) 82 6612
Canada	(905) 206-4663
China	86 (0)10 6564 5959
Chile	800 360 999
Czech Republic	42 (0)2 6130 7310
Greece	30 (0)1 689 64 11
Hong Kong	800-96-7729
Hungary	36 (0)1) 382 1111
India	91 11 682 6035
Indonesia	62-21-350 3408
Japan	81-3-3335 8333
Korea (Seoul)	82-2-3270 0700
Korea outside Seoul	080 999 0700
Malaysia	60 (3) 295 2566
Mexico	01-800-472 6684
New Zealand	64 9 356 6640
Philippines	63 (2) 867 3551
Poland	48 22 519 06 00
Portugal	(351) (1) 301-7330
Russia	7 095797 3520
Singapore	65 272 5300
South Africa	27 86 000 1030
Switzerland	41 (01)848 80 11 11
Taiwan	886 (2) 2717 0055
Thailand	66 (2) 661 4000
Turkey	90 212 224 59 25
Venezuela	800 47 8488
Vietnam	84 (0) 8 823 4530



# Warranty information

For warranty statements, see “Hewlett-Packard limited warranty statement” on page 167 and “Limited warranty for toner cartridge life” on page 169. You can also locate printer warranties on the World Wide Web (see “World Wide Web” on page 157).



Service during and after the warranty period:

- If printer hardware fails during the warranty period, see “HP Customer Care Center and product repair assistance for the U.S. and Canada” on page 162 or “European HP Customer Care Center language and in-country options available” on page 163.
- If printer hardware fails after the warranty period, and you have an HP Maintenance Agreement or HP Support Pack, request service as specified in the agreement.
- If you do not have an HP Maintenance Agreement or HP Support Pack, contact an HP-authorized service or support provider (see “HP authorized resellers and support” on page 160).



If you are shipping equipment to be serviced, use the following repacking guidelines.

## Guidelines for repacking the printer

- Remove and retain any DIMMs (dual in-line memory modules) installed in the printer (see “Installing memory” on page 230).
- Remove and retain any optional accessories installed in the printer (such as the duplexer or hard disk).
- Remove and retain the toner cartridge.

### CAUTION

To prevent damage to the toner cartridge, store the cartridge in its original packing material, or store it so that it is not exposed to light.

- Use the original shipping container and packing material, if possible. (Shipping damage as a result of inadequate packing is the customer’s responsibility.) If you have already disposed of the printer’s packing material, contact a local mailing service for information on repacking the printer.
- If possible, include print samples and 50-100 sheets of paper or any other media that is not printing correctly.
- Include a completed copy of the Service Information Form (“Service information form” on page 166).
- HP recommends insuring the equipment for shipment.



# Service information form



---

<b>WHO IS RETURNING THE EQUIPMENT?</b>	Date: _____
Person to contact: _____	Phone: (    ) _____
Alternate contact: _____	Phone: (    ) _____
Return shipping address: _____	Special shipping instructions: _____

---

**WHAT IS BEING SENT?**

Model name: \_\_\_\_\_ Model number: \_\_\_\_\_ Serial number: \_\_\_\_\_

Please attach any relevant print-outs when returning equipment. DO NOT ship accessories that are not required to complete the repair (manuals, cleaning supplies, etc.).

**WHAT NEEDS TO BE DONE? (Attach a separate sheet if necessary.)**

- Describe the conditions of the failure. (What was the failure? What were you doing when the failure occurred? What software were you running? Is the failure repeatable?)
- If the failure is intermittent, how much time elapses between failures?
- Is the unit connected to any of the following? (Give manufacturer and model number.)  
Personal computer: \_\_\_\_\_ Modem: \_\_\_\_\_ Network: \_\_\_\_\_
- Additional comments: \_\_\_\_\_

**HOW WILL YOU PAY FOR THE REPAIR?**

Under warranty      Purchase/received date: \_\_\_\_\_  
(Enclose proof of purchase or receiving document with original received date.)

Maintenance contract number: \_\_\_\_\_

Purchase order number: \_\_\_\_\_

**Except for contract and warranty service, a purchase order number and/or authorized signature must accompany any request for service.** If standard repair prices do not apply, a minimum purchase order is required. Standard repair prices may be obtained by contacting an HP-authorized Repair Center.

Authorized signature: \_\_\_\_\_ Phone: \_\_\_\_\_

Billing address: \_\_\_\_\_ Special billing instructions: \_\_\_\_\_

---



# Hewlett-Packard limited warranty statement

## HP PRODUCT

HP LaserJet 4100, 4100N,  
4100TN, 4100DTN

## DURATION OF WARRANTY

1 year, return to HP or  
Authorized Dealer



1. HP warrants to you, the end-user customer, that HP hardware, accessories and supplies will be free from defects in materials and workmanship after the date of purchase, for the period specified above. If HP receives notice of such defects during the warranty period, HP will, at its option, either repair or replace products which prove to be defective. Replacement products may be either new or equivalent in performance to new.
2. HP warrants to you that HP software will not fail to execute its programming instructions after the date of purchase, for the period specified above, due to defects in material and workmanship when properly installed and used. If HP receives notice of such defects during the warranty period, HP will replace software which does not execute its programming instructions due to such defects.
3. HP does not warrant that the operation of HP products will be uninterrupted or error free. If HP is unable, within a reasonable time, to repair or replace any product to a condition as warranted, you will be entitled to a refund of the purchase price upon prompt return of the product.
4. HP products may contain remanufactured parts equivalent to new in performance or may have been subject to incidental use.
5. Warranty does not apply to defects resulting from (a) improper or inadequate maintenance or calibration, (b) software, interfacing, parts or supplies not supplied by HP, (c) unauthorized modification or misuse, (d) operation outside of the published environmental specifications for the product, or (e) improper site preparation or maintenance.
6. TO THE EXTENT ALLOWED BY LOCAL LAW, THE ABOVE WARRANTIES ARE EXCLUSIVE AND NO OTHER WARRANTY OR CONDITION, WHETHER WRITTEN OR ORAL, IS EXPRESSED OR IMPLIED AND HP SPECIFICALLY DISCLAIMS ANY IMPLIED WARRANTIES OR CONDITIONS OF MERCHANTABILITY, SATISFACTORY QUALITY, AND FITNESS FOR A PARTICULAR PURPOSE. Some countries, states or provinces do not allow limitations on the duration of an implied warranty, so the above limitation or exclusion might not apply to you. This warranty gives you specific legal rights and you might also have other rights that vary from country to country, state to state, or province to province.



7 TO THE EXTENT ALLOWED BY LOCAL LAW, THE REMEDIES IN THIS WARRANTY STATEMENT ARE YOUR SOLE AND EXCLUSIVE REMEDIES. EXCEPT AS INDICATED ABOVE, IN NO EVENT WILL HP OR ITS SUPPLIERS BE LIABLE FOR LOSS OF DATA OR FOR DIRECT, SPECIAL, INCIDENTAL, CONSEQUENTIAL (INCLUDING LOST PROFIT OR DATA), OR OTHER DAMAGE, WHETHER BASED IN CONTRACT, TORT, OR OTHERWISE. Some countries, states or provinces do not allow the exclusion or limitation of incidental or consequential damages, so the above limitation or exclusion may not apply to you.



THE WARRANTY TERMS CONTAINED IN THIS STATEMENT, EXCEPT TO THE EXTENT LAWFULLY PERMITTED, DO NOT EXCLUDE, RESTRICT OR MODIFY AND ARE IN ADDITION TO THE MANDATORY STATUTORY RIGHTS APPLICABLE TO THE SALE OF THIS PRODUCT TO YOU.



# Limited warranty for toner cartridge life

---

## Note

---

The warranty below applies to the toner cartridge that came with this printer. This warranty supersedes all previous warranties (7/19/96).



The HP toner cartridge is warranted to be free from defects in materials and workmanship for the life of the cartridge until the HP toner is depleted. Your HP toner is depleted when your printer indicates a toner-low message. HP will, at HP's option, either replace products that prove to be defective or refund your purchase price.



The warranty does not cover toner cartridges that have been refilled, are emptied, abused, misused, or tampered with in any way.



This limited warranty gives you specific legal rights. You may have other rights which vary from state to state, province to province, and country to country.

To the extent allowed by applicable law, in no event shall Hewlett-Packard Company be liable for any incidental, consequential, special, indirect, punitive, or exemplary damages or lost profits from any break of this warranty or otherwise.



# HP software license terms

**ATTENTION: USE OF THE SOFTWARE IS SUBJECT TO THE HP SOFTWARE LICENSE TERMS SET FORTH BELOW. USING THE SOFTWARE INDICATES YOUR ACCEPTANCE OF THESE LICENSE TERMS. IF YOU DO NOT ACCEPT THESE LICENSE TERMS, AND THE SOFTWARE IS BUNDLED WITH ANOTHER PRODUCT, YOU MAY RETURN THE ENTIRE UNUSED PRODUCT FOR A FULL REFUND.**



The following License Terms govern your use of the accompanying Software unless you have a separate signed agreement with HP.

## **License Grant**

HP grants you a license to Use one copy of the Software. “Use” means storing, loading, installing, executing, or displaying the Software. You may not modify the Software or disable any licensing or control features of the Software. If the Software is licensed for “concurrent use,” you may not allow more than the maximum number of authorized users to Use the Software concurrently.

## **Ownership**

The Software is owned and copyrighted by HP or its third party suppliers. Your license confers no title to, or ownership in, the Software and is not a sale of any rights in the Software. HP’s third party suppliers may protect their rights in the event of any violation of these License Terms.

## **Copies and Adaptations**

You may only make copies or adaptations of the Software for archival purposes or when copying or adaptation is an essential step in the authorized Use of the Software. You must reproduce all copyright notices in the original Software on all copies or adaptations. You may not copy the Software onto any public network.

## **No Disassembly or Decryption**

You may not disassemble or decompile the Software unless HP’s prior written consent is obtained. In some jurisdictions, HP’s consent may not be required for limited disassembly or decompilation. Upon request, you will provide HP with reasonably detailed information regarding any disassembly or decompilation. You may not decrypt the Software unless decryption is a necessary part of the operation of the Software.



## Transfer

Your license will automatically terminate upon any transfer of the Software. Upon transfer, you must deliver the Software, including any copies and related documentation, to the transferee. The transferee must accept these License Terms as a condition to the transfer.



## Termination

HP may terminate your license upon notice for failure to comply with any of these License Terms. Upon termination, you must immediately destroy the Software, together with all copies, adaptations, and merged portions in any form.



## Export Requirements

You may not export or reexport the Software or any copy or adaptation in violation of any applicable laws or regulations.



## U.S. Government Restricted Rights

The Software and any accompanying documentation have been developed entirely at private expense. They are delivered and licensed as “commercial computer software” as defined in DFARS 252.227-7013 (Oct 1988), DFARS 252.211-7015 (May 1991), or DFARS 252.227-7014 (Jun 1995), as a “commercial item” as defined in FAR 2.101 (a), or as “Restricted computer software” as defined in FAR 52.227-19 (Jun 1987) (or any equivalent agency regulation or contract clause), whichever is applicable. You have only those rights provided for such Software and any accompanying documentation by the applicable FAR or DFARS clause or the HP standard software agreement for the product involved.



# Worldwide country/region sales and service offices

## Note

Before calling an HP Sales and Service office, be sure to contact the appropriate Customer Care Center number listed in the “HP Customer Care Service and Support” section. Products should not be returned to these offices. Product return information is also available through the appropriate HP Customer Care Center (see “HP Customer Care Service and Support” on page 157).



## Europe

### Albania

Gener-AI sh.p.k.  
Hewlett-Packard Distributor  
Tirana Trade Centre  
Rr. 'Durrësit'  
Tirana  
Phone Number: +355-42-23519  
Fax: +355-42-27966

### Austria

#### Wien

Hewlett-Packard Ges.m.b.H  
Elektronische Meßtechnik  
Lieblgasse1  
1222 Vienna  
Phone Number: 01/25000-7006  
Fax: 01/25000-6558

### Belarus

Belhard  
709, 2 Melnicayte Street  
Minsk 220600  
Phone Number: 375-172-238985  
Fax: 375-172-268426

### Belgium

Hewlett-Packard Belgium S.A./N.V.  
Boulevard de la Woluwe 100-102  
B 1200 Brussels  
Phone Number: (32/2) 778-34-17  
Fax: (32/2) 778-34-14

### Bulgaria

S&T Bulgaria Ltd.  
Hewlett-Packard Distributor  
2, "Iatashka" St.  
Sofia 1618  
Phone Number: +359-2-955 9573  
Fax: +359-2-955 9290

### Croatia (local name: Hrvatska)

Hermes-Plus  
Hewlett-Packard Distributor  
Slandrove 2  
SE 1231 Crnuce  
Phone Number: 38-512 331061  
Fax: 38-512 331930

### Cyprus

Handled by G-Systems, Greece

### Czech Republic

Hewlett-Packard  
Ceskoslovenski sro  
Novodvorska 82  
14200 Praha 414  
Phone Number: +420-2-613-07310  
Fax: +420-2-474 3293

### Denmark

Hewlett-Packard A/S  
Kongevejen 25  
DK-3460 Birkerød  
Phone Number: (45) 45 99-10-00  
Fax: (45) 45-82-06-30  
E-Mail Address: test\_measurement@hp.dk



## Finland

Hewlett-Packard Oy  
Street Address:  
Piispankalliontie 17  
02200 ESPOO  
Finland  
P.O.Box Address:  
P.O. Box 68  
02201 ESPOO  
Phone Number: 358-9-8872 2100  
Fax: 358-9-8872 2923  
E-Mail Address: tmodirect@finland.hp.com

## France

Hewlett-Packard France  
Test et Mesure  
Z.A. de Courtaboeuf  
1 Avenue du Canada  
91947 Les Ulis  
Phone Number: 01 69 29 41 14  
Fax: 01 69 29 65 09

## Germany

### Böblingen

Hewlett-Packard GmbH  
Elektronische Meßtechnik  
Postfach 14 30  
71004 Böblingen  
Phone Number: 0180/524-63 30  
Fax: 0180/524-63 31

### Bad Homburg

Hewlett-Packard GmbH  
Elektronische Meßtechnik  
Hewlett-Packard Straße 1  
61352 Bad Homburg  
Phone Number: 0180/524-6330  
Fax: 0180/524-6331

### Berlin

Hewlett-Packard GmbH  
Elektronische Meßtechnik  
Lützowplatz 15  
10785 Berlin  
Phone Number: 0180/524-6330  
Fax: 0180/524-6331

### Hamburg

Hewlett-Packard GmbH  
Elektronische Meßtechnik  
Überseering 16  
22297 Hamburg  
Phone Number: 0180/524-6330  
Fax: 0180/524-6331

## Hannover

Hewlett-Packard GmbH  
Elektronische Meßtechnik  
Baumschulenallee 20-22  
30625 Hannover  
Phone Number: 0180/524-6330  
Fax: 0180/524-6331

## Leipzig

Hewlett-Packard GmbH  
Elektronische Meßtechnik  
Wehlitzer Strasse 2  
04435 Schkeuditz  
Phone Number: 0180/524-6330  
Fax: 0180/524-6331

## München

Hewlett-Packard GmbH  
Elektronische Meßtechnik  
Eschenstraße 5  
82024 Taufkirchen  
Phone Number: 0180/524-6330  
Fax: 0180/524-6331

## Nürnberg

Hewlett-Packard GmbH  
Elektronische Meßtechnik  
Emmericher Straße 13  
90411 Nürnberg  
Phone Number: 0180/524-6330  
Fax: 0180/524-6331

## Ratingen

Hewlett-Packard GmbH  
Elektronische Meßtechnik  
Pempelfurt Straße 1  
40882 Ratingen  
Phone Number: 0180/524-6330  
Fax: 0180/524-6331

## Waldbronn (Karlsruhe)

Hewlett-Packard GmbH  
Elektronische Meßtechnik  
Hewlett-Packard-Str. 8  
76337 Waldbronn  
Phone Number: 0180/524-6330  
Fax: 0180/524-6331

Hewlett-Packard GmbH  
Herrenberger Straße 130  
7030 Böblingen  
Phone Number: (49) 7031/14-0  
Fax: (49) 7031/14-2999



## Greece

G-Systems  
Hewlett-Packard Distributor  
76, Ymittou Street  
11634 Athens  
Phone Number: (30/1) 7264045  
Fax: (30/1) 7264020

## Hungary

Hewlett-Packard Magyarország  
KFT. Erzsébet  
királyne útja 1/c  
1146 Budapest  
Phone Number: (36) 1 4618110  
Fax: (36) 1 4618222

## Ireland

Hewlett-Packard Ireland Limited  
Hewlett-Packard House  
Stradbroke Road  
Blackrock, Co.  
Dublin Ireland  
Phone Number: 01 615 8222  
Fax: 01 284 5134

## Italy

### Napoli

Hewlett-Packard Italiana S.p.A.  
Via Emanuele Gianturco, 92/G  
80146 Napoli (Na)  
Phone Number: (39/81) 0-73-40-100  
Fax: (39/81) 0-73-40-216

### Roma Eur

Hewlett-Packard Italiana S.p.A.  
Viale del Tintoretto, 200  
00142 Roma Eur  
Phone Number: (39/6) 54-831  
Fax: (39/6) 54-01-661

### Torino

Hewlett-Packard Italiana S.p.A.  
Via Praglia 15  
10044 Pianezza (To)  
Phone Number: (39/11) - 9685.1  
Fax: (30/11) - 968.5899

For information on any products or services  
call: 02 92 122 241

Hewlett-Packard Italiana S.p.A.  
Via G. di Vittorio 9  
20063 Cernudsco s/N

## Milan

Phone Number: (39/2) 92-122-241  
Fax: (39/2) 92-104 069  
Kazakhstan  
Scan East  
Karasat-Batyr street 82  
Almaty 480012  
Phone Number: 7-3272-622020  
Fax: 7-3272-621843

## Macedonia, The Former Yugoslav Republic of

Hermes-Plus  
Hewlett-Packard Distributor  
Celovska 73  
61000 Ljubljana  
Slovenia  
Phone Number: 61/193322  
Fax: 61/55597

## Netherlands

Hewlett-Packard Nederland B.V.  
Postbox 667  
1180 AR Amstelveen  
Netherlands  
Phone Number: (31/20) 547-6669  
Fax: (31/20) 547-7765

## Norway

Hewlett-Packard Norge AS  
Drammensveien 169  
Postboks 60 Skøyen  
N-0212 OSLO  
Phone Number: +47 22 73 57 59  
Fax: +47 22 73 56 19  
E-Mail Address:  
test\_measurement@norway.hp.com

## Poland

Hewlett-Packard Polska  
Ochota Park Office  
Aleje Jerozolimskie 181 02-222 Warszawa  
Phone Number: +48 (22) 6087700  
Fax: +48 (022) 6087600





## Portugal

Hewlett-Packard Portugal S.A.  
Av. Marginal, Ed. Parque Oceano  
Piso 5°-G-St° Amaro de Oeiras  
2780 Oeiras  
Phone Number: (353/1) 482 8500  
Fax: (353/1) 441-7071

## Romania

S&T Romania SRL  
Hewlett-Packard Distributor  
Centrul Sitraco-Plata Unirii  
Bd. Dimitries Cantemir 1  
Etaj II-210 Sector 4  
Phone Number: +40 1 250 6175

## Bucuresti

Phone Number: (40/1) 3307320  
Additional phone number(s):  
(40/1) 3307217,  
(40/1) 3307218  
Fax: (40/1) 3307310  
Service Hot Line: (40/1) 3307300

## Russian Federation

Hewlett-Packard Company  
Representative Office  
Kosmodamianskaya naberezhnaya 52,  
Bldg. 1  
113054 Moscow  
Phone Number: +7 (095) 9169811  
Fax: +7 (095) 916848  
Slovakia (Slovak Republic)

## S&T Slovakia

Hewlett-Packard Distributor  
Polianky 5  
SK 844 J4 Bratislava  
Phone Number: (+4217) 82 20 26 or  
82 20 98  
Fax: (421) 7 763408

## Slovenia

Hermes-Plus  
Hewlett-Packard Distributor  
Slandraa 2  
1231 Ljubljana-Crnuce  
Phone Number: (386) 61-1895 200  
Fax: (386) 61 1895 201

## Spain

### Barcelona

Hewlett-Packard Española, S.A.  
Avda. Diagonal, 605  
08028 Barcelona  
Phone Number: 34 93 401 91 00  
Fax: 34 93 430 84 68

### Madrid

Hewlett-Packard Española, S.A.  
Crta N-VI km 16,500  
28230 Las Rozas, Madrid  
Phone Number: (34/91) 6311323  
Fax: (34/91) 6311469

### Sevilla

Hewlett-Packard Española, S.A.  
Avda. Luis de Morales, 32  
Edificio Forum, planta 3&supa;., módulo1  
41018 Sevilla  
Phone Number: 34-95-455 2600  
Fax: 34-95-455 2626

### Valencia

Hewlett-Packard Española, S.A.  
Plaza de América, 2 2 B  
Edificio Zurich  
46004 Valencia  
Phone Number: 34-96-398 2200  
Fax: 34-96-398 2230

### Vizcaya

Avda de Sugazarte  
Hewlett-Packard Española, S.A.  
Avda de Zugazarte, 8  
Edif El Abra, 4  
48930 Las Arenas, Guecho  
Phone Number: 34-94-481 80 00  
Fax: 34-94-481 80 40

## Sweden

### Kista

Hewlett-Packard Sverige AB  
Skalholtsgatan 9  
164 97 Kista  
Phone Number: (46/8) 444 22 77  
Fax: (46/8) 444 25 25  
E-Mail Address: test-  
measurement@sweden.hp.com



## Göteborg

Hewlett-Packard Sverige AB  
Vädursgatan 6  
Box 5328  
S-402 27 GÖTEBORG  
Sweden  
Phone Number: (46/31) 35 18 00  
Fax: (46/31) 35 18 99

## Switzerland

### Berne

Hewlett-Packard (Schweiz) AG  
Elektronische Meßtechnik  
Meriedweg 11  
3172 Niederwangen/Bern  
Phone Number: (01) 735 72 36  
Fax: (01) 735 77 03

### Geneva

Hewlett-Packard (Suisse) SA  
Elektronische Meßtechnik 39, rue de  
Veyrot  
1217 Meyrin 1  
Phone Number: (01) 735 72 36  
Fax: (01) 735 77 03

### Zürich

Hewlett-Packard (Schweiz) AG  
Elektronische Meßtechnik  
In der Luberzen 29  
8902 Urdorf/Zürich  
Phone Number: (01) 735 72 36  
Fax: (01) 735 77 03

## Turkey

### Ankara

Hewlett-Packard  
Bilgisayar ve Olcum Sistemleri A.S.  
Karum Is Merkezi No:461 (B-Asansoru)  
Iran Cad.No.21  
06680, Kavaklydere - Ankara  
Phone Number: (90/312) 468 87 70  
Fax: (90/312) 468 87 78

### Istanbul

Hewlett-Packard  
Bilgisayar ve Olcum Sistemleri A.S.  
19 Mayıs caddesi  
Nova/Baran Plaza K.12  
Sisli 80220  
Istanbul  
Phone Number: (90/212) 224 59 25 (12  
lines)  
Fax: (90/212) 224 59 39

## Ukraine

S&T Ukraine Ltd.  
50, Popudrenko Street  
243660 Kiev  
Phone Number: 380-44-559 4763  
Fax: 380-44-559 5033

## United Kingdom

Hewlett-Packard Limited (T4)  
Cain Road  
Bracknell  
Berkshire  
RG12 1HN  
Phone Number: 01344 366666  
Fax: 01344 362852  
Contact HP  
E-Mail Address: uktmo\_sales@hp.com

## Uzbekistan

ABM Worldwide Technologies  
15, Movaraunnakhr Street  
Tashkent 700060  
Phone Number: 7-3712-1333689  
Fax: 7-3712-406485

## Yugoslavia

IBIS Instruments  
Pariske Komune 22  
11070 N. Beograd  
Phone Number: 381-11-609650  
Fax: 381-11-699627



## Latin America and South America

### Argentina

Hewlett-Packard Argentina  
Montañeses 2140  
1428 Buenos Aires  
Phone Number: (54 1) 787-7115  
Fax: (54 1) 787-7287

### Belize

Atendido por El Salvador

### Bolivia

Atendido por Uruguay

### Brazil

#### São Paulo

Hewlett-Packard Brasil SA  
R. Aruna 125  
Tambore - Barueri - SP  
06460-101  
Phone Number: (011) 829-6612  
Fax: (011) 829-0018

#### Rio de Janeiro

Hewlett-Packard Brasil  
Rua Lauro Mueller, 116  
Grupo 803 Edifício Torre Rio Sul  
22290-160 Botafogo  
Rio de Janeiro  
Phone Number: (55-21) 541-4404  
Fax: (55-21) 295-2195

### Chile

ASC. S.A. (Multi-Industry)  
Los Alerces 2363  
Santiago, Chile  
Phone Number: (56-2) 237-0707  
Fax: (56-2) 239-7179

COASIN Chile Ltda. (Telecom)  
Holanda 1292  
Santiago, Chile  
Phone Number: (562) 225-0643  
Fax: (562) 274-4588

Rimpex Chile (Datacom)  
Avda. Pedro de Valdivia 1646  
Santiago, Chile  
Phone Number: 562-340-7701/7702  
Fax: 562-274-4107

### Colombia

Instrumentación Ltda.  
Calle 115 No. 11-A-10  
Bogotá, Colombia  
Phone Number: (57-1) 612-1313  
Fax: (57-1) 612-0805

Sycom, S.A. (Datacom)  
Avenida El Dorado 9010  
Bogotá, Colombia  
Phone Number: (57-1) 410-1303  
Fax: (57-1) 410-1196

### Costa Rica

COASIN COSTA RICA, S.A.  
Del Centro Cultural en San Pedro  
200 Mts Norte, 25 Mts Oeste  
Casa # 3552  
San José, Costa Rica  
Phone Number: (506) 283-8325  
Fax: (506) 225-6349

### Dominican Republic

Esacomp, S.A.  
Calle Seminario No. 55  
Ens. Piantini  
Santo Domingo, República Dominicana  
Phone Number: (809) 563-6350  
Fax: (809) 565-0332



## Ecuador

Complementos Electrónicos S.A.  
Av. General Enriquez 1800  
San Rafael, Ecuador  
Phone Number: (593-2) 334257  
Fax: (593-2) 331595

## El Salvador

SETISA  
Col. Roma  
Pje. Carbonell, No. 28  
San Salvador, El Salvador  
Phone Number: (503) 223-0993  
Fax: (503) 279-2077

## Guatemala

EPTTEL  
12 Ave. 17-35 Zona 10  
Guatemala  
Phone Number: (502) 363-0423  
Fax: (502) 363-0443

## Honduras

Atendido por Setisa, El Salvador

## Mexico

Hewlett-Packard de México SA de CV  
Dr. Atl No. 1, Desp. 102  
Edif. Tepeyac  
Zona Rio  
22320 Tijuana, B.C. México  
Phone Number: (66) 34-38-01  
Fax: (66) 34-38-04

Hewlett-Packard de México, S.A. de C.V.  
Prolongación Reforma 700  
Col. Lomas de Santa Fé  
01210 Mexico, D.F.  
Phone Number: (52-5) 258-4389/258-4392  
Fax: (52-5)258-4301  
HP DIRECT: 01-800-506-4800

Hewlett-Packard de Mexico S.A. de C.V.  
Rio Nilo 4049-12  
Cd. Juarez, Chih. 32310  
Mexico  
Phone Number: (52-16) 11-0777  
Fax: (52-16) 13-7622

## Nicaragua

Atendido por El Salvador

## Paraguay

Atendido por Uruguay

## Peru

COASIN Peru S.A. (Redes Privadas)  
Calle 1 - No. 891 CORPAC  
Lima 27, Peru  
Phone Number: (511) 224-3380  
Fax: (511) 224-1509

SATEL S.A. (Gobierno y redes publicas)  
Enrique Palacios No. 155  
Lima 18 - Peru  
Phone Number: (511) 446-2253/241-8085/  
446-0281  
Fax: (511) 444-0305

## Trinidad and Tobago

Borde Communications  
1 Valsayn Road  
Curepe, P.O. Box 897  
Port-of-Spain, Trinidad  
Phone Number: (809) 663-2087  
Fax: (809) 645-3352

## United States

Hewlett-Packard Company  
5200 Blue Lagoon Dr., #950  
Miami, FL 33126  
Phone Number: 305-265-5561  
Fax: 305-267-4288  
E-Mail Address: britton\_bentley@hp.com

## Uruguay

Conatel S.A.  
Ejido 1690  
Montevideo, Uruguay  
Phone Number: (598) 2-920314  
Fax: (598) 2-920660

## Venezuela

Hewlett-Packard de Venezuela  
3ra. Transversal Los Ruices Nrte  
Edf. Segre, Piso 1,2 y 3  
Caracas, Venezuela  
Phone Number: (58-2) 207-8357  
Fax: (58-2) 207-8361



## Asia and the Pacific

### Australia

#### Melbourne

Hewlett-Packard Australia Ltd.  
31-41 Joseph Street  
Blackburn, VIC 3130  
Phone Number: 1 800 629 485 (toll free)  
Additional phone number(s): (61 3) 9210  
5408  
Fax: (61 3) 9210-5489

#### Perth

Measurement Innovation (WA) Pty. Ltd.  
Kishorn Court  
Suite 3, 58 Kishorn Road  
Mount Pleasant, WA 6153  
Phone Number: (61/9) 316-2757  
Fax: (61/9) 316-1392  
Mobile: 61-18-33-6434

#### Sydney

Hewlett-Packard Australia Ltd.  
17-23 Talavera Road  
North Ryde, N.S.W. 2113  
Phone Number: (61/2) 9950-7444  
Fax: (61/2) 9888-9072

### Bangladesh

Jiu International Ltd  
60 East Tejturi Bazar, 2nd Floor  
Farmgate Dhaka  
Bangladesh  
Phone Number: 880-2-913-0480  
Fax: 880-2-871-034  
E-Mail Address: [jiu@bangla.net](mailto:jiu@bangla.net)

Brunei Darussalam  
Kompouter Wisman Sdn Bhd  
Block A, Unit 1, Ground Floor  
Abdul Razak Complex  
Jalan Gadong 3180

Negara Brunei Darussalem  
Phone Number: 673-2-423918/425603  
Fax: 673-2-441492  
Telex: 0809-2447

## China

### Beijing

China Hewlett-Packard Co. Ltd.  
10/F, HP Building  
No. 2 Dong San Huan Nan Lu  
Chao Yang District  
Beijing 100022, P. R. China  
Phone Numbers: 86-6564 3888

### Chengdu

China Hewlett-Packard Co. Ltd.  
22/F Daye Road  
No. 39 Daye Road  
Chengdu 610016 PRC  
Phone Number: (86/28) 666-3888  
Fax: (86/28) 666-5377

### Guangzhou

China Hewlett-Packard Co. Ltd.  
7/F T.P.Plaza  
9/109, Liu Hua Road  
Guangzhou 510010 PRC  
Phone Number: (86/20) 8669-3888  
Fax: (86/20) 8669-5074  
Telex: 44556 GPHGZ CN

### Shanghai

China Hewlett-Packard Co., Ltd.  
10-12/F Novel Building  
No. 887 Huai Hai Zhong Lu  
Shanghai, 200020  
Phone Number: (86/21) 6474-3888  
Fax: (86/21) 6267-8523  
Telex: 086-33577 CHPSB CN

### Shenyang

China Hewlett-Packard Co., Ltd.  
12/F Shenyang Sankei Torch  
Building No. 262 Shifu Road, Shenhe  
District  
Shenyang 110013 PRC  
Phone Number: (86/24) 2790170, 2790171  
Fax: (86/24) 2790232



## Xi'an Branch Office

3/F East New Technology  
Trade Center A16  
Yanta Lu Zhong Duan  
Xi'an 710054 PRC  
Phone Number: (86/29) 552 9379  
Fax: (86/29) 552 9243

## Hong Kong

Hewlett-Packard Co., Ltd.  
17-21/F Shell Tower, Times Square  
1 Matheson Street  
Causeway Bay  
Hong Kong SAR  
Phone Number: (852) 2599-7777  
Fax: (852) 2506-9256  
Hong Kong

Hewlett-Packard (HK) Ltd.  
17-21/F Shell Tower, Times Square  
1 Matheson Street  
Causeway Bay  
Hong Kong SAR  
Phone Number: (852) 2599-7889  
Fax: (852) 2506-9233

## Taiwan

Hewlett-Packard Taiwan Ltd.  
No. 20 Kao-Shuang Road  
Ping-Chen, 32404  
Taoyuan Hsieh  
Phone Number: (886/3) 492-9666  
Fax: (886/3) 492-9669

Hewlett-Packard Taiwan Ltd.  
12th Floor, 10 Syh-Wei 4th Road  
Kaohsiung  
Phone Number: (886/7) 330-1199  
Fax: (886/7) 330-8568

Hewlett-Packard Taiwan Ltd.  
10F, 540, Sec. 1  
Wen-Hsin Road  
Taichung  
Phone Number: (886/4) 327-0153  
Fax: (886/4) 326-5274

Hewlett-Packard Taiwan Ltd.  
Hewlett-Packard Building  
8/F No. 337, Fu-Hsing North Road  
Taipei 10483 Taiwan  
Phone Number: (886-2) 712-0404  
Fax: (886-2) 718-2928  
HP DIRECT Basic Tools free tel:  
080-212-535

## India

### Bangalore

Hewlett-Packard India Pvt. Ltd.  
Embassy Point  
150 Infantry Road  
Bangalore 560001  
Phone Number: (91/80) 225-3024 or 209-1808  
Fax: (91/80) 225-6186  
Telex: 845-2773 HP IN

### Calcutta

Hewlett-Packard India Pvt. Ltd.  
708 Central Plaza  
2/6 Sarat Bose Road  
Calcutta 700 020  
Phone Number: (91/33) 745 4755  
Additional phone number(s): 91-33-475-4755  
Fax: (91/33) 748 571

### Hyderabad

Hewlett-Packard India Pvt. Ltd.  
5-9-13 Taramandal Complex  
9th Floor, Saifabad  
Hyderabad 500 004  
Phone Number: (91/40) 232-679  
Fax: (91/40) 220.012 or 231.756  
Telex: 425-2422 HPIL IN

### Mumbai

Hewlett-Packard India Pvt. Ltd.  
Unit-3, B-Wing  
Ground Floor, Neelam Center  
Hind Cycle Road  
Worli, Mumbai 400 025  
Phone Number: (91/22) 493-4722 or 493-4723  
Additional phone number(s): 91-22-493-9978-79 or 91-22-493-9978-79  
Fax: (91/22) 493-7823  
Telex: 11-76812 HPIB IN

### New Delhi

Hewlett-Packard India Ltd.  
Chandiwalla Estate  
Ma Anandmai Ashram Marg, Kalkaji  
New Delhi 110 019  
Phone Number: (91-11) 682-6000  
Fax: (91-11) 682-6030



## Indonesia

### Bandung

P.T. Berca Hardayaperkasa  
Jalan Tengku Angkasa No. 33  
Bandung 40132  
Phone Number: (62-22) 250-8100  
Fax: (62-22) 250-6757

### Jakarta

P.T. Berca Hardayaperkasa  
Jalan Abdul Muis No. 62  
Jakarta 10160-Indonesia  
Phone Number: (62/21) 380 0902  
Fax: (62/21) 381 2044

## Korea, Republic of

### Seoul

Hewlett-Packard Korea Ltd.  
HP Korea House  
25-12 Yoido-dong  
Youngdeung po-ku  
Seoul 150-010  
Phone Number: (82/2)-769-0114  
Fax: (82/2) 784-7084

### Taegu

Hewlett-Packard Korea Ltd.  
18/F, Young Nam Tower B/D 111  
Shin Cheon-dong, Dong-Gu  
Taegu  
Phone Number: (82/53) 754-2666  
Fax: (82/53) 752-4696

### Taejeon

Samsung  
Hewlett-Packard Korea Ltd.  
8/F Hyundai Bldg,  
1298 Doosan-dong, Seo-gu  
Taejeon  
Phone Number: 82-42-480-2800  
Fax: 82-42-480-2828

## Malaysia

### Kuala Lumpur

Hewlett-Packard Sales (Malaysia) Sdn Bhd  
Ground Floor, Wisma Cyclecarri  
288 Jalan Raja Laut  
50350 Kuala Lumpur  
Phone Number: 1-800-88-8848 Toll Free  
Fax: (60/3) 298-9157

## Penang

Hewlett-Packard Sales (Malaysia) Sdn Bhd  
Bayan Lepas Free Trade Zone  
11900 Bayan Lepas  
Penang  
Phone Number: (60/4) 642-3502  
Fax: (60/4) 642-3511

## New Zealand

Hewlett-Packard New Zealand Ltd.  
186-190 Willis Street  
Wellington  
Phone Number: 0800-738-378  
(international 64-4-802-6800)  
Fax: (64-4) 802-6881

## Pakistan

### Islamabad

Mushko Electronics (Pvt) Ltd.  
68-W Sama Plaza, Blue Area, G-7  
Islamabad 44000  
Pakistan  
Phone Number: 92-51-828-459/810-950  
Fax: 92-51-816-190  
Telex: 54001 Muski Pk

### Karachi

Mushko Electronics (Pvt) Ltd.  
Oosman Chambers  
Abdullah Haroon Road  
Karachi 74400  
Phone Number: 92-21-566-0490  
Fax: 92-21-566-0801  
Telex: 29094 MUSKO PK

## Philippines

Hewlett-Packard Philippines Corporation  
9th Floor, Rufino Pacific Tower  
6784 Ayala Avenue  
Makati City 1229  
Phone Number: (63-2) 894-1451  
Fax: (63-2) 811-1080, 811-0635  
Online Sales: (63-2) 893-9959



## Singapore

Hewlett-Packard Singapore (Sales) Pte Ltd  
450 Alexandra Road  
Singapore 119960  
Phone Number: 65 275 3888  
Additional phone number(s):  
HP Direct: 1 800 292-8100  
Application Support: 65-374-4242  
Hardware Service Hotline: 65-375-8350  
Fax: 65 274 7887

## Sri Lanka

Precision Technical Services (PVT) Ltd.  
No. 2, R.A. De Mel Mawatha  
Colombo 00500  
Phone Number: (941) 597-860  
Fax: (941) 597-863

## Thailand

Hewlett-Packard (Thailand) Ltd.  
23rd-25th floor Vibulthani Tower 2  
3199 Rama IV Road  
Klong Toey, Bangkok 10110  
Phone Number: (66-2) 661-3900-34  
Fax: (66-2) 661-3946

## Vietnam

System Interlace  
39 Mai Hac De Street  
Hai Ba Trung District  
Hanoi  
Vietnam  
Phone Number: 844-229-808/9  
Fax: 844-229-553

## Japan

### Aichi

Hewlett-Packard Japan Ltd.  
Nagoya Kokusai Center Bldg.  
1-47-1 Nakono Nakamura-ku, Nagoya-shi  
Aichi 450

Hewlett-Packard Japan Ltd.  
Nakane-Nissei Bldg.  
4-25-18 Nishi-machi, Toyota-shi  
Aichi 471

### Akita

Hewlett-Packard Japan Ltd.  
Nihonseimei Akita Chuodori Bldg.  
4-2-7 Nakadori, Akita-shi  
Akita 010

### Chiba

Hewlett-Packard Japan Ltd.  
WBG Malibu East Bldg. 19F  
2-6 Nakase Mihama-ku, Chiba-shi  
Chiba 261-71

### Fukuoka

Hewlett-Packard Japan Ltd.  
Daisan Hakata-Kaisei Bldg.  
1-3-6 Hakataekiminami Hakata-ku,  
Fukuoka-shi  
Fukuoka 812

### Hiroshima

Hewlett-Packard Japan Ltd.  
Nissei-Heiwakoen Bldg.  
3-25 Nakajima-cho Naka-ku, Hiroshima-shi  
Hiroshima 730

### Hokkaido

Hewlett-Packard Japan Ltd.  
Sumitomo-seimei  
Sapporo Chuo Bldg.  
1-1-14 Minaminijo-higashi Chuo-ku,  
Sapporo-shi  
Hokkaido 060

### Hyogo

Hewlett-Packard Japan Ltd.  
1-3-2 Muroya Nishi-ku, Kobe-shi  
Hyogo 651-22





## Ibaraki

Hewlett-Packard Japan Ltd.  
Mito Yomiuri-Kaikan Bldg.  
2-4-2 Minami-machi, Mito-shi  
Ibaraki 310

Hewlett-Packard Japan Ltd.  
Tsukuba-Mitsui Bldg.  
1-6-1 Takezono, Tsukuba-shi  
Ibaraki 305

## Ishikawa

Hewlett-Packard Japan Ltd.  
Kanazawa MK Bldg.  
98-8 Sainen-machi, Kanazawa-shi  
Ishikawa 920

## Kanagawa

Hewlett-Packard Japan Ltd.  
3-2-2 Sakado  
Takatsu-ku, Kawasaki-shi  
Kanagawa 213

Hewlett-Packard Japan Ltd.  
9-32 Tamuracho, Atsugi-shi  
Kanagawa 243

## Kyoto

Hewlett-Packard Japan Ltd.  
Maeda SN Bldg.  
518 Akinono-cho Nijyo-Kudaru  
Karasuma, Nakagyo-ku  
Kyoto 604

## Miyagi

Hewlett-Packard Japan Ltd.  
Yamaguchi Bldg.  
1-1-31 Ichibancho Aoba-ku, Sendai-shi  
Miyagi 980

## Nagano

Hewlett-Packard Japan Ltd.  
Forum Honjo Bldg.  
2-4-1 Honjo, Matsumoto-shi  
Nagano 390

## Osaka

Hewlett-Packard Japan Ltd.  
Chuo Bldg.  
5-4-20 Nishinakajima  
Yodogawa-ku, Osaka-shi  
Osaka 532

## Saitama

Hewlett-Packard Japan Ltd.  
Mitsui-seimei Omiya  
Miyamachi Bldg. 2-96-1  
Miyamachi, Omiya-shi  
Saitama 330

Hewlett-Packard Japan Ltd.  
Nissei-Kumagaya Bldg.  
2-42 Miya-machi, Kumagaya-shi  
Saitama 360

## Shizuoka

Hewlett-Packard Japan Ltd.  
Kawasei-Rinkyo Bldg.  
6-6 Hosojima-cho Hamamatsu-shi  
Shizuoka 435

## Tochigi

Hewlett-Packard Japan Ltd.  
Chiyodaseimei-Utsunomiya Bldg.  
2-3-1 Odori, Utsunomiya-shi  
Tochigi 320

## Tokyo

Hewlett-Packard Japan Ltd.  
9-1 Takakura-cho, Hachioji-shi  
Tokyo 192-8510

Hewlett-Packard Japan Ltd.  
NAF Bldg.  
3-8-20 Takaido-higashi, Suginami-ku  
Tokyo 168



## Middle East and Africa

### Algeria

RTI Algeria  
26, Bis rue Mohammed Hadj-Ahmed  
(ex. Rue Jean Pierre Dinet)  
16035 Hydra  
Alger  
Algerie  
Phone Number: 213-2-606450

### Angola

Handled by HP South Africa

### Bahrain

BAMTEC  
P.O. Box 10373  
Capital centre  
Shop 116  
Road 1405  
Area 314  
Manama  
Phone Number: 9-73-275678  
Fax: 9-73-276669  
Telex: 8550 WAEL BN

### Egypt

ORASCOM  
Onsi Sawiris & Co  
P.O. Box 1191  
160, 26th July Street  
Aguza/Cairo  
Phone Number: (202) 3015287  
Fax: (202) 3442615  
Telex: 92768 orscm un

### Iran (Islamic Republic of)

Evertch  
11 bis, rue Toepffer  
1206 Geneve  
Phone Number: +41-22-346 92 92  
Fax: +41-22-346 86 91  
Telex: 421 787

### Israel

Computation and Measurement Systems  
(CMS) Ltd.  
11, Hashlosa Street  
Tel-Aviv 67060  
Phone Number: 972 (03) 538-03-80  
Fax: 972 (03) 537-50-55  
Telex: 371234 HPCMS

### Jordan

Scientific & Medical Supplies Co.  
P.O. Box 1387  
Amman  
Phone Number: (962/6) 62-49-07  
Fax: (962/6) 62-82-58  
Telex: 21456 sabco jo

### Kuwait

Al-Khaldiya Electronics & Electricals  
Equipment Co.  
P.O. Box 830  
Safat 13009  
Phone Number: (965) 48 13 049  
Fax: (965) 48 12 983

### Lebanon

Computer Information Systems C.I.S.  
Lebanon Street  
Chammas Bldg.  
P.O. Box 11-6274  
Dora-Beirut  
Phone Number: (961/1) 405-413  
Fax: (961/1) 601.906  
Tel/fax: (3579) 514-256 (Cyprus Based  
Line)  
Telex: 42309 chaxis le

### Malawi

Handled by HP South Africa

### Mauritius

Handled by HP South Africa



## Morocco

SICOTEL  
Complexe des Habous  
Tour C, avenue des Far  
Casablanca 01  
Phone Number: +212 (02) 31-22-70  
Fax: +212 (02) 31-65-45  
Telex: 27604

## Mozambique

Handled by  
HP South Africa

## Namibia

Handled by  
HP South Africa

## Nigeria

Management Information Systems Co. Ltd.  
3 Gerrard Road  
P.O. Box 53386  
Ikoyi, Lagos  
Phone Number: 234-1-2691307  
Fax: 234-1-2692755  
Telex: 23582 DATEC NG

## Oman

IMTAC LLC  
P.O. Box 51196  
Al Hayek Street  
Mina al Fahal  
Muscat  
Phone Number: (968) 707-727, (968) 707-723  
Fax: (968) 796-639, (968) 797-709

## Qatar

Qatar Datamations Systems  
Al Ahed Building, 5th floor  
Al Muthof Street  
Doha  
Phone Number: 974/43.99.00  
Fax: 974/43.21.54  
Telex: 4833

## Saudi Arabia

Modern Electronics Establishment  
P.O. Box 22015  
Prince Musad Ibn Abdulaziz St.  
Riyadh 11495  
Phone Number: (966/1) 476-3030  
Fax: (966/1) 476-2570  
Additional Fax: (966/1) 476-7649  
cable ROUFKO

Modern Electronics Establishment  
P.O. Box 22015  
al Nimer Building  
Riyadh 11495  
Phone Number: (01) 4624266  
Fax: (01) 4624404  
Additional Fax: (966/1) 476-7649

## South Africa

Hewlett-Packard South Africa (Pty.) Ltd.  
P.O. Box 120, Howard Place  
7450 Cape Town  
Phone Number: 27 21 658-6100  
Fax: 27 21 685-3785

Hewlett-Packard South Africa (Pty.) Ltd.  
Private Bag  
Wendywood 2148  
Phone Number: 27-11-806 1173  
Fax: 27-11-806 1213

## Tunisia

Precision Electronique  
5, rue de Chypre-Mutueller Ville  
1002 Tunis Belvedere  
Phone Number: (216/1) 785-037  
Additional phone number(s): (216/1) 890-672  
Fax: (216/1) 780-241  
Telex: (0409) 18238 TELEC TN



## United Arab Emirates

Emitac Ltd.  
Block RBS Arenco Bldg.  
Zabel Road  
P.O. Box 8391  
Dubai  
Phone Number: (971/4) 37-75-91  
Fax: (971/4) 37-08-99

Emitac Ltd.  
P.O. Box 2711  
Abu Dhabi  
Phone Number: (971/2) 77-04-19  
Fax: (971/2) 72-30-58

## Zambia

Handled by HP South Africa

## Zimbabwe

Handled by HP South Africa



# A

# Specifications



## Overview

This appendix includes:

- paper specifications
- printer specifications
- product compatibility matrix



# Paper specifications

HP LaserJet printers produce excellent print quality. This printer accepts a variety of media, such as cut-sheet paper (including recycled paper), envelopes, labels, transparencies, and custom-size paper. Paper properties such as weight, grain, and moisture content are important factors affecting printer performance and output quality.

The printer can use a variety of paper and other print media in accordance with the guidelines in this manual. Paper that does not meet these guidelines may cause the following problems:

- poor print quality
- increased paper jams
- premature wear on the printer, requiring repair

---

## Note

For best results, use only high quality media, such as HP brand paper and print media. Hewlett-Packard Company cannot recommend the use of other brands. Because they are not HP products, HP cannot influence or control their quality.

It is possible for paper to meet all of the guidelines in this manual and still not produce satisfactory results. This might be the result of improper handling, unacceptable temperature and humidity levels, or other variables over which Hewlett-Packard has no control.

Before purchasing a large quantity of paper, make sure it meets the requirements specified in this user guide and in the *HP LaserJet Printer Family Paper Specification Guide*. (To order the guide, see “Ordering information” on page 22, or visit the supplies website at <http://www.hp.com/go/ljsupplies>.) Always test paper before purchasing a large quantity.

---

## CAUTION

---

Using paper outside HP specifications may cause problems for the printer, requiring repair. This repair is not covered by the Hewlett-Packard warranty or service agreements.



## Supported sizes and weights of paper

### Supported sizes and weights of paper (one-sided printing) - tray 1<sup>a</sup>

Size	Dimensions <sup>b</sup>	Weight	Capacity <sup>c</sup>
Paper (custom minimum size)	76 by 127 mm (3 by 5 in)	60 to 199 g/m <sup>2</sup> (16 to 53 lb)	100 sheets of 75 g/m <sup>2</sup> (20 lb) paper
Paper (maximum size)	216 by 356 mm (8.5 by 14 in)		
Transparencies	Same as minimum and maximum paper sizes listed above.	Thickness: 0.099 to 0.114 mm 0.0039 to 0.0045 in	50 transparencies
Labels		Thickness: 0.127 mm to 0.178 mm (0.005 to 0.007 in)	50 labels
Envelopes		75 to 105 g/m <sup>2</sup> (20 to 28 lb)	10 envelopes

- See “Supported sizes and weights of paper - duplex printing accessory (duplexer)” on page 191 for two-sided printing.
- The printer supports a wide range of paper sizes. Check the printer software for supported sizes. To print custom-size paper, see “Printing cards, custom-size, and heavy paper” on page 63.
- Capacity may vary depending on paper weight and thickness, and environmental conditions.



## Supported sizes and weights of paper - trays 2, 3, and 4

Size	Dimensions <sup>a</sup>	Weight	Capacity <sup>b</sup>
Letter	216 by 279 mm (8.5 by 11 in)	60 to 105 g/m <sup>2</sup> (16 to 28 lb)	500 sheets of 75 g/m <sup>2</sup> (20 lb) paper  50 transparencies
A4	210 by 297 mm (8.3 by 11.7 in)		
Executive	191 by 267 mm (7.3 by 10.5 in)		
Executive (JIS) (custom <sup>c</sup> )	216 by 330 mm (8.5 by 13 in)		
16K (custom <sup>c</sup> )	197 by 273 mm (7.75 by 10.75 in)		
Legal	216 by 356 mm (8.5 by 14 in)		
B5 (ISO) (custom <sup>c</sup> )	176 by 250 mm (6.9 by 9.9 in)		
B5 (JIS)	182 by 257 mm (7.2 by 10 in)		
A5	148 by 210 mm (5.8 by 8.2 in)		
Custom <sup>c</sup>	148 by 210 mm to 216 by 356 mm (5.8 by 8.2 in to 8.5 by 14 in)		



- The printer supports a wide range of paper sizes. Check the printer software for supported sizes.
- Capacity may vary depending on paper weight and thickness and environmental conditions.
- To print custom-size paper, see “Printing cards, custom-size, and heavy paper” on page 63.





### Supported sizes and weights of paper - optional envelope feeder

Size	Dimensions	Weight	Capacity
Monarch (#7-3/4)	98.4 by 190.5 mm (3.88 by 7.50 in)	75 to 105 g/m <sup>2</sup> (20 to 28 lb)	75 envelopes
Commercial 10 (#10)	104.9 by 241.3 mm (4.13 by 9.5 in)		
DL ISO	110 by 220 mm (4.33 by 8.66 in)		
C5 ISO	162 by 229 mm (6.38 by 9.02 in)		
B5 ISO	176 by 250 mm (6.93 by 9.84 in)		



### Supported sizes and weights of paper - duplex printing accessory (duplexer)

Size	Dimensions	Weight
Letter	216 by 279 mm (8.5 by 11 in)	60 to 105 g/m <sup>2</sup> (16 to 28 lb)
A4	210 by 297 mm (8.3 by 11.7 in)	
Executive	184 by 267 mm (7.3 by 10.5 in)	
Legal	216 by 356 mm (8.5 by 14 in)	
B5 (JIS)	182 by 257 mm (7.2 by 10 in)	



## Supported types of paper

The printer supports the following types of paper:

- plain
- letterhead
- prepunched
- bond
- color
- rough
- preprinted
- transparency
- labels
- recycled
- card stock
- user-defined (5 types)



## Guidelines for using paper

For best results, use conventional 75 to 90 g/m<sup>2</sup> (20 to 24 lb) paper. Make sure the paper is of good quality, and free of cuts, nicks, tears, spots, loose particles, dust, wrinkles, voids, and curled or bent edges.

If you are unsure what type of paper you are loading (such as bond or recycled), check the label on the package of paper.

Some paper causes print quality problems, jamming, or damage to the printer.

Symptom	Problem with paper	Solution
Poor print quality or toner adhesion.	Too moist, too rough, too smooth, or embossed. Ragged edges. Faulty paper lot.	Try another kind of paper, between 100-250 Sheffield, 4-6% moisture content.
Dropouts, jamming, curl.	Stored improperly.	Store paper flat in its moisture-proof wrapping.
Increased gray background shading.	Too heavy. Too smooth.	Use lighter paper. Open the rear output bin. Use less smooth paper.
Excessive curl. Problems with feeding.	Too moist, wrong grain direction or short-grain construction.	Open the rear output bin. Use long-grain paper. Store paper in a drier environment.



---

**Note**

Do not use letterhead paper that is printed with low-temperature inks, such as those used in some types of thermography.

Do not use raised letterhead.

The printer uses heat and pressure to fuse toner to the paper. Make sure that any colored paper or preprinted forms use inks that are compatible with the printer's temperature of 230° C (446° F) for 0.05 second.

Avoid using paper that has been damaged due to having already been used in a printer or copier. (Do not print on both sides of envelopes, transparencies, or labels.)

---



## Paper weight equivalence table

Use this table to determine approximate equivalent points in weight specifications other than U.S. bond weight. For example, to determine the equivalent of 20 lb U.S. bond weight paper in U.S. cover weight, locate the bond weight (in row 3, second column) and scan across the row to the cover weight (in the fourth column). The equivalent is 28 lb.

Shaded areas indicate a standard weight for that grade.



U.S. postcard <sup>a</sup> thickness (mm)	U.S. bond weight (lb)	U.S. text/ book weight (lb)	U.S. cover weight (lb)	U.S. Bristol weight (lb)	U.S. index weight (lb)	U.S. tag weight (lb)	Metric weight (g/m <sup>2</sup> )
	16	41	22	27	33	37	60
	17	43	24	29	35	39	64
	20	50 <sup>b</sup>	28	34	42	46	75
	21	54	30	36	44	49	80
	24	60 <sup>b</sup>	33	41	50	55	90
	27	68	37	45	55	61	100
	28	70 <sup>b</sup>	39	49	58	65	105
	29	74	41	50	61	68	110
	32	80 <sup>b</sup>	44	55	67	74	120
	36	90	50	62	75	83	135
0.18	39	100	55	67	82	91	148
	40	101	55	68	83	92	150
0.20	43	110	60	74	90	100	163
	45	115	63	77	94	104	170
0.23	47	119	65	80	97	108	176
	51	128	70	86	105	117	190
	53	134	74	90	110	122	199
	54	137	75	93	113	125	203
	58	146	80	98	120	133	216
	65	165	90	111	135	150	244



U.S. postcard <sup>a</sup> thickness (mm)	U.S. bond weight (lb)	U.S. text/book weight (lb)	U.S. cover weight (lb)	U.S. Bristol weight (lb)	U.S. index weight (lb)	U.S. tag weight (lb)	Metric weight (g/m <sup>2</sup> )
	66	169	92	114	138	154	250
	67	171	94	115	140	155	253
	70	178	98	120	146	162	264
	72	183	100	123	150	166	271

- a. U.S. postcard measurements are approximate. Use for reference only.
- b. Text and book grades actually calculate out to 51, 61, 71, and 81, but are standardized to book/text weights of 50, 60, 70, and 80.



## Labels

### CAUTION

To avoid damaging the printer, use only labels recommended for use in laser printers.

If you have problems printing labels, use tray 1 and open the rear output bin.

Do not print on the same sheet of labels more than once—peeling and adhesive contamination might result.



### Label construction

When selecting labels, consider the quality of each component:

- **Adhesives:** The adhesive material should be stable at 230° C (446° F), the printer's maximum temperature.
- **Arrangement:** Only use labels with no exposed backing between them. Labels can peel off sheets with spaces between the labels, causing serious jams.
- **Curl:** Prior to printing, labels must lie flat with no more than 13 mm (0.5 in) of curl in any direction.
- **Condition:** Do not use labels with wrinkles, bubbles, or other indications of separation.

To print sheets of labels, see "Printing labels" on page 61.

## Transparencies

Transparencies used in the printer must be able to withstand 230° C (446° F), the printer's maximum temperature. Close the rear output bin to print transparencies to the top output bin.

If you have problems printing transparencies, use tray 1. Be sure to remove each transparency from the output tray to keep them from sticking together.

### CAUTION

To avoid damaging the printer, use only transparencies recommended for use in laser printers.

To print transparencies, see "Printing transparencies" on page 62.



# Envelopes

## Envelope construction

Envelope construction is critical. Envelope fold lines can vary considerably, not only between manufacturers, but also within a box from the same manufacturer. Successful printing on envelopes depends upon the quality of the envelopes.

When selecting envelopes, consider the components listed below. Many envelope manufacturers are now making envelopes optimized for laser printers.

- **Weight:** The weight of the envelope paper should be 75 to 105 g/m<sup>2</sup> (20 to 28 lb), or jamming may result.
- **Construction:** Prior to printing, envelopes should lie flat with less than 6 mm (0.25 in) curl, and should not contain air. (Envelopes that trap air may cause problems.)
- **Condition:** Make sure envelopes are not wrinkled, nicked, or otherwise damaged.
- **Sizes in tray 1:** From 76 by 127 mm (3 by 5 in) to 216 by 356 mm (8.5 by 14 in).
- **Sizes in the optional envelope feeder:** From Monarch (#7-3/4) (98.4 by 190.5 mm, or 3.88 by 7.50 in) to B5 (ISO) (176 by 250 mm, or 6.93 by 9.84 in).

If you do not have an optional envelope feeder, always print envelopes from tray 1 (see “Printing envelopes” on page 55). To print envelopes with the optional envelope feeder, see “Feeding envelopes automatically (optional envelope feeder)” on page 57. If envelopes curl, try opening the rear output bin.

## Envelopes with double-side-seams

Double-side-seam construction has vertical seams at both ends of the envelope rather than diagonal seams. This style may be more likely to wrinkle unless properly constructed. Be sure the seam extends all the way to the corner of the envelope.

## Envelopes with adhesive strips or flaps

Envelopes with a peel-off adhesive strip or with more than one flap that folds over to seal must use adhesives compatible with the heat and pressure in the printer. The extra flaps and strips might cause wrinkling, creasing, or jams.



## Envelope margins

The following table gives typical address margins for a Commercial #10 or DL envelope.

Type of address	Top margin	Left margin
Return address	15 mm (0.6 in)	15 mm (0.6 in)
Delivery address	51 mm (2 in)	89 mm (3.5 in)



### Note

For the best print quality, position margins no closer than 15 mm (0.6 in) from the edges of the envelope.

## Envelope storage

Proper storage of envelopes helps contribute to good print quality. Envelopes should be stored flat. If air is trapped in an envelope, creating an air bubble, then the envelope may wrinkle during printing.

## Card stock and heavy paper

Many types of card stock can be printed from tray 1, including index cards and postcards. Some card stock performs better than others because its construction is better suited for feeding through a laser printer.

For optimum printer performance, do not use paper heavier than 199 g/m<sup>2</sup> (53 lb) in tray 1 or 105 g/m<sup>2</sup> (28 lb) in other trays. Paper that is too heavy might cause misfeeds, stacking problems, paper jams, poor toner fusing, poor print quality, or excessive mechanical wear.

### Note

Printing on heavier paper may be possible if the tray is not filled to capacity, and short grain paper with a smoothness rating of 100 to 180 Sheffield is used.





## Card stock construction

- **Smoothness:** Card stock should have smoothness in the range of 100 to 180 Sheffield.
- **Construction:** Card stock should lie flat with less than 5 mm (0.2 in) of curl. It should be short grain paper to improve feeding and reduce wear on the printer.
- **Condition:** Make sure card stock is not wrinkled, nicked, or otherwise damaged.
- **Sizes:** Use only card stock within the following size ranges:
  - minimum: 76 by 127 mm (3 by 5 in)
  - maximum: 216 by 356 mm (8.5 by 14 in)

Before loading card stock in tray 1, make sure it is regular in shape and not damaged. Also, make sure the cards are not stuck together.

## Card stock guidelines

- If cards curl or jam, try printing from tray 1 and opening the rear output bin.
- Set margins at least 6 mm (0.24 in) away from the edges of the paper.



# Printer specifications

## Physical dimensions

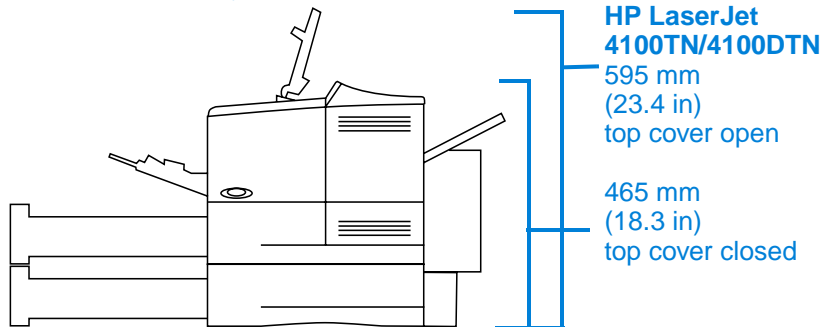
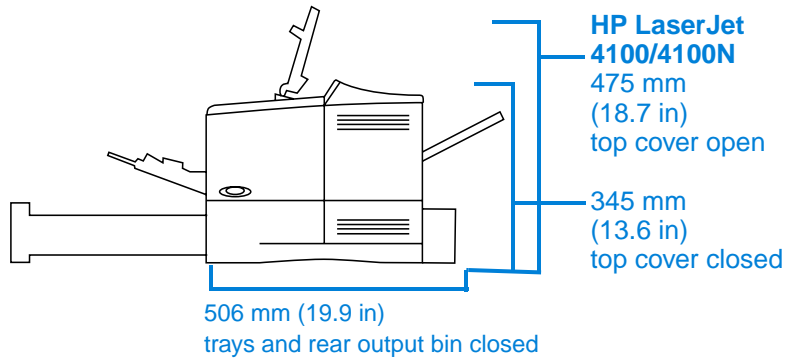
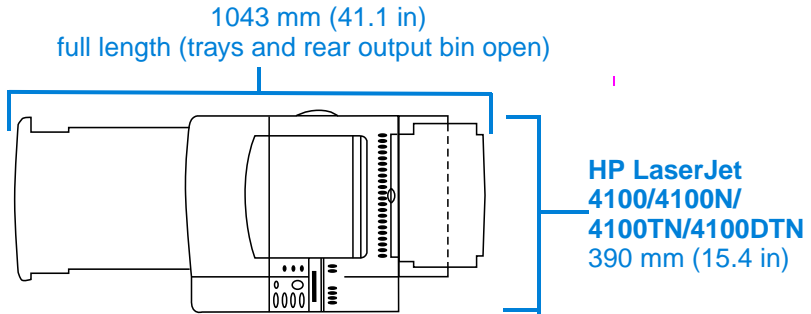

HP LaserJet 4100TN  
trays and rear output bin closed | 506 mm (19.9 in) |

HP LaserJet 4100DTN  
trays and rear output bin closed | 565 mm (22.2 in) |



## Printer weight (without toner cartridge)

HP LaserJet 4100/4100N printers	18 kg (39 lb)
HP LaserJet 4100TN printer	25 kg (55 lb)
HP LaserJet 4100DTN printer	28 kg (62 lb)



## Environmental specifications

### Electrical specifications

Printer model	Power consumption (average, in watts)			
	Printing	Standby	PowerSave	Off
HP LaserJet 4100	450	17	17	0
HP LaserJet 4100N	450	18	18	0
HP LaserJet 4100TN	450	19	19	0
HP LaserJet 4100DTN	450	20	20	0

Values are subject to change. See <http://www.hp.com/support/lj4100> for current information.

### Minimum recommended circuit capacity

100 to 127 Volt	10 amps
220 to 240 Volt	5 amps

### Power requirements (acceptable line voltage)

100 to 127 Volt	50/60 Hz
220 to 240 Volt	50/60 Hz



## Acoustic emissions (per ISO 9296)

Printer state	Sound power level <sup>a</sup>	Bystander position
Printing, 25 pages per minute (ppm)	$L_{Wad} = 6.6$ bels (A)	52 $L_{pAm}$ decibels (A)
PowerSave	$L_{wad} = 4.1$ bels (A)	26 $L_{pAm}$ decibels (A)

- a. You might want to install printers with sound power  $L_{Wad} \geq 6.3$  bels (A) or more in a separate room or cubicle.

## General specifications

Operating temperature	10 to 32° C (50 to 91° F)
Relative humidity	20 to 80%
Speed, in pages per minute (ppm)	Up to 25 ppm, letter-size paper Up to 24 ppm, A4-size paper
Expandable memory	Up to 256 MB total, combining standard and accessory memory DIMMs



# Product compatibility matrix

## Product compatibility matrix

Product	Product number	HP LaserJet printer		
		4000 series	4050 series	4100 series
Envelope feeder	C4122A	●	●	
	C8053A	●	●	●
Duplex printing accessory (duplexer)	C4123A	●	●	
	C8054A	●	●	●
<b>Toner cartridges</b>				
6,000 pages	C4127A	●	●	
10,000 pages	C4127X	●	●	
6,000 pages	C8061A	●	●	●
10,000 pages	C8061X	●	●	●
<b>Paper trays</b>				
500-sheet paper feeder and tray	C4124A	● <sup>a</sup>	● <sup>a</sup>	● <sup>b</sup>
500-sheet paper feeder and tray	C8055A	● <sup>a</sup>	● <sup>a</sup>	●
500-sheet universal replacement tray	C4125A	● <sup>a</sup>	● <sup>a</sup>	● <sup>b</sup>
500-sheet universal replacement tray	C8056A	● <sup>a</sup>	● <sup>a</sup>	●
500-sheet standard replacement tray	C3122A	● <sup>c</sup>	● <sup>c</sup>	● <sup>c</sup>
250-sheet standard replacement tray	C4126A	● <sup>a</sup>	● <sup>a</sup>	

a. "A5" size is detected as "custom" size.  
b. "A5" size is detected as "custom" size. Larger "custom" sizes might be detected as "A5" size.  
c. Supports only Letter, A4, and Legal sizes.



## Product compatibility matrix (continued)

Product	Product number	HP LaserJet printer		
		4000 series	4050 series	4100 series
<b>Memory</b>				
4 MB EDO DIMM	C4135A	●		
8 MB EDO DIMM	C4136A	●		
16 MB EDO DIMM	C4137A	●		
4 MB SDRAM DIMM	C4140A	●	●	●
8 MB SDRAM DIMM	C4141A	●	●	●
8 MB SDRAM DIMM	C7842A	●	●	●
16 MB SDRAM DIMM	C4142A	●	●	●
16 MB SDRAM DIMM	C7843A	●	●	●
24 MB SDRAM DIMM	C7844A	●	●	●
32 MB SDRAM DIMM	C4143A	●	●	●
32 MB SDRAM DIMM	C7845A	●	●	●
64 MB SDRAM DIMM	C3913A	●	●	●
64 MB SDRAM DIMM	C7846A	●	●	●
128 MB SDRAM DIMM	C9121A			●
2 MB flash DIMM	C4286A	●	●	●
4 MB flash DIMM	C4287A	●	●	●
<b>Font DIMMs</b>				
Traditional Chinese font DIMM (8 MB Asian ROM)	C4292A	●	●	●
Simplified Chinese font DIMM (8 MB Asian ROM)	C4293A	●	●	●
Korean font DIMM (8 MB Asian ROM)	D4838A	●	●	●
<b>Jet Direct EIO cards</b>				
Ethernet RJ-45 only	J3110A	●	●	●
Ethernet RJ-45 and BNC, LocalTalk	J3111A	●	●	●
Token Ring	J4167A	●	●	●
10/100Base-TX	J4169A	●	●	●
USB, LocalTalk, and Serial	J4135A	●	●	●
Fast Infrared Receiver (FIR) pod	C4103A		●	●
EIO hard disk	C2985B	●	●	●
<b>Preventative maintenance kits, user installable (consumable)</b>				
110V kit	C7851A	●	●	
220V kit	C7852A	●	●	
110V kit	C8057A			●
220V kit	C8058A			●



# B

# Control panel menus



## Overview

You can perform most routine printing tasks from the computer through the printer driver or software application. This is the most convenient way to control the printer, and will override the printer control panel settings. See the help files associated with the software, or for more information on accessing the printer driver, see “Access the Windows printer driver” on page 36.

You can also control the printer by changing settings in the printer’s control panel. Use the control panel to access printer features not supported by the printer driver or software application.

## Control panel menu map

You can print a menu map from the control panel that shows the *current* printer configuration (see “To print a control panel menu map” on page 32). This appendix lists all the items and *possible* values for the printer.

Some menus or menu items appear only when certain options are installed in the printer. For example, the Quick Copy Jobs menu appears only if the printer contains a hard disk accessory.



# Quick Copy Jobs Menu

This menu provides a list of the quick copy jobs stored on the printer's hard disk accessory. The user can print or delete these jobs from the control panel. See "Job retention features" on page 72 for more information about using this menu.



## Note

This menu appears only if you have a hard disk accessory installed and quick copy jobs are stored on it.



## Quick Copy Jobs Menu

Item	Value	Explanation
[JOBNAME]		The name of the person who owns the quick copy job.
COPIES=1	1 to 999 DELETE	The number of additional copies the user wants to print. 1-999: Prints the requested number of copies of the job. DELETE: Deletes the job from the printer's hard disk accessory.





# Private/Stored Jobs Menu

This menu provides a list of the stored jobs on the printer's hard disk accessory. The user can print or delete these jobs from the control panel. See "Printing a private job" on page 76 and "Storing a print job" on page 78 for more information about using this menu.



## Note

This menu appears only if you have a hard disk accessory installed and there are private or stored jobs on it.



## Private/Stored Jobs Menu

Item	Value	Explanation
[JOBNAME]		The name of the job stored on the printer's hard disk accessory.
PIN:0000		To print the job, the user must enter the Personal Identification Number (PIN) assigned to the job in the driver.
COPIES=1	1 to 999 DELETE	The number of copies the user wants to print. 1-999: Prints the requested number of copies of the job. DELETE: Deletes the job from the printer's hard disk accessory.



# Information Menu

This menu contains printer information pages that give details about the printer and its configuration. To print an information page, scroll to the desired page and press **SELECT**.



## Information Menu

Item	Explanation
PRINT MENU MAP	The menu map shows the layout and current settings of the control panel menu items. For more information, see “Checking the printer configuration” on page 151.
PRINT CONFIGURATION	The configuration page shows the printer’s current configuration. If an HP JetDirect print server card is installed (HP LaserJet 4100N/4100TN/4100DTN printers), a JetDirect configuration page will print out as well. For more information, see “Configuration page” on page 152.
PRINT PCL FONT LIST	The PCL font list shows all the PCL fonts currently available to the printer. For more information, see “PCL or PS font list” on page 156.
PRINT PS FONT LIST	The PS font list shows all the PS fonts currently available to the printer. For more information, see “PCL or PS font list” on page 156.
PRINT FILE DIRECTORY	This item appears only when a mass storage device (such as an optional flash DIMM or hard disk accessory) containing a recognized file system is installed in the printer. The file directory shows information for all installed mass storage devices. For more information, see “Printer memory and expansion” on page 229.
PRINT EVENT LOG	The event log lists printer events or errors.
SHOW EVENT LOG	This item allows you to view the most recent printer events on the control panel display. Press <b>-VALUE+</b> to scroll through the event log entries.
PRINT USAGE PAGE	The usage page shows the quantity of pages printed, as well as the paper source used. It also reflects the number of one-sided versus two-sided pages. <b>Note</b> This item will only show in the Information Menu if the hard disk accessory is installed in the printer. This item will generate a page containing information that can be used for accounting purposes.



## Information Menu (continued)

Item	Explanation
PRINT SUPPLIES STATUS	The supplies status page shows toner cartridge information, statistics on the total number of pages and jobs processed, toner cartridge manufacture date, serial number, page counts, and maintenance information.
PRINT PAPER PATH TEST	The paper path test can be used to verify that the paper path is working properly, or to troubleshoot problems with a type of paper. Choose the input tray, output bin, duplexer (if available), and number of copies.



# Paper Handling Menu

When paper handling settings are correctly configured through the control panel, you can print by choosing the type and size of paper from the printer driver or software application. For more information, see “Printing by type and size of paper (locking trays)” on page 70.

Some items in this menu (such as duplex and manual feed) can be accessed from a software application, or from the printer driver (if the appropriate driver is installed). Printer driver and software application settings override control panel settings. For more information, see “Using features in the printer driver” on page 65.



## Paper Handling Menu

Item	Values	Explanation
ENVELOPE FEEDER SIZE=COM10	For supported paper sizes, see “Supported sizes and weights of paper” on page 189.	This item appears only when the optional envelope feeder is installed. Set the value to correspond with the envelope size currently loaded in the envelope feeder.
ENVELOPE FEEDER TYPE=PLAIN	For supported paper types, see “Supported types of paper” on page 192.	This item appears only when the optional envelope feeder is installed. Set the value to correspond with the envelope type currently loaded in the envelope feeder.
TRAY 1 MODE= FIRST	FIRST CASSETTE	Determine how the printer will use tray 1. FIRST: If paper is loaded in tray 1, the printer will pull paper from that tray first. CASSETTE: A paper size must be assigned to tray 1 using the TRAY 1 SIZE option (the next item in this menu when TRAY 1 MODE=CASSETTE). This allows tray 1 to be used as a reserved tray. For more information, see “Customizing tray 1 operation” on page 69.
TRAY 1 SIZE= LETTER	For supported paper sizes, see “Supported sizes and weights of paper” on page 189.	This item appears only when TRAY 1 MODE=CASSETTE. Set the value to correspond with the paper size currently loaded in tray 1.



## Paper Handling Menu (continued)

Item	Values	Explanation
TRAY 1 TYPE= PLAIN	For supported paper types, see "Supported types of paper" on page 192.	This item appears only when TRAY 1 MODE=CASSETTE. Set the value to correspond with the paper type currently loaded in tray 1.
TRAY 2 TYPE= PLAIN	For supported paper types, see "Supported types of paper" on page 192.	Set the value to correspond with the paper type currently loaded in tray 2.
TRAY 3 TYPE= PLAIN	For supported paper types, see "Supported types of paper" on page 192.	This item appears only when an optional third paper tray is installed. Set the value to correspond with the paper type currently loaded in tray 3.
TRAY 4 TYPE= PLAIN	For supported paper types, see "Supported types of paper" on page 192.	This item appears only when an optional fourth paper tray is installed. Set the value to correspond with the paper type currently loaded in tray 4.
MANUAL FEED=OFF	OFF ON	Feed the paper manually from tray 1, rather than automatically from a tray. When MANUAL FEED=ON and tray 1 is empty, the printer goes offline when it receives a print job and displays MANUALLY FEED [PAPER SIZE]. For more information, see "Manually feeding paper from tray 1" on page 71.
DUPLEX=OFF	OFF ON	This item appears only when an optional duplexer is installed. Set the value to ON to print on both sides (duplex) or OFF to print on one side (simplex) of a sheet of paper. For more information, see "Printing both sides of paper (optional duplexer)" on page 49.
BINDING= LONG EDGE	LONG EDGE SHORT EDGE	This item appears only when an optional duplexer is installed and the duplex option is on. Choose the binding edge when duplexing (printing on both sides of paper). For more information, see "Layout options for printing both sides of paper" on page 52.



## Paper Handling Menu (continued)

Item	Values	Explanation
SMALL PAPER SPEED=NORMAL	NORMAL SLOW	<p>Select SLOW when alternately printing envelopes (or small paper) and standard paper sizes and print problems appear.</p> <p>Be sure to return the speed to NORMAL when finished.</p> <p>When slow is selected, the printer briefly pauses between pages to reduce a repeating image defect (see “Repeating image” on page 134).</p> <p>For more information, see “Printing envelopes” on page 55.</p>
CONFIGURE FUSER MODE MENU=NO	NO YES	<p>Configure the fuser mode associated with each paper type. (This is only necessary if you are experiencing loose toner problems printing on certain paper types.)</p> <p>NO: The fuser mode menu items are not accessible.</p> <p>YES: Additional items appear (see below).</p> <p><b>Note</b></p> <p>To see the default fuser mode for each paper type, select YES, scroll back to the Information Menu, and print a menu map (see “Information Menu” on page 208).</p>
[TYPE]= NORMAL	NORMAL LOW HIGH 1 HIGH 2	<p>This item appears only when CONFIGURE FUSER MODE MENU=YES. Most paper types are set to NORMAL fuser mode by default. The exceptions are as follows:</p> <p>ROUGH=HIGH 1</p> <p>TRANSPARENCY=LOW</p> <p>NORMAL fuser mode provides a fuser temperature for optimum results on most typical papers.</p> <p>LOW fuser mode provides a lower temperature, which can help reduce curl on light-weight paper. However, the toner might not adhere as well to the page.</p> <p>HIGH 1 fuser mode provides a higher fuser temperature. HIGH1 should be used with rough-textured or heavy paper if you are having trouble with toner adhering to the page.</p> <p>HIGH 2 fuser mode uses the same higher temperature as HIGH 1, but it also slows printer throughput, which creates the best fusing for very rough paper. HIGH 2 is available only for A4, Letter, and Legal sizes.</p>



# Printing Menu

Some items in this menu can be accessed from a software application, or from the printer driver (if the appropriate driver is installed). Printer driver and software application settings override control panel settings. For more information, see “Using features in the printer driver” on page 65.



## Printing Menu

Item	Values	Explanation
COPIES=1	1 to 999	Set the default number of copies by selecting any number from 1 to 999. Press <b>-VALUE+</b> once to change the setting by increments of 1, or hold down <b>-VALUE+</b> to scroll by increments of 10. <b>Note</b> It is best to set the number of copies from the printer driver or software application. (Driver and software settings override control panel settings.)
PAPER SIZE= LETTER (110V printers) or PAPER SIZE= A4 (220V printers) and ENVELOPE= COM10 (110V printers) or ENVELOPE= DL (220V printers)	For supported paper sizes, see “Supported sizes and weights of paper” on page 189.	Set the default image size for paper and envelopes. (The item name will change from paper to envelope as you scroll through the available sizes.)
CONFIGURE CUSTOM PAPER=NO	NO YES	NO: The custom paper menu items are not accessible. YES: The custom paper menu items appear (see below).



## Printing Menu (continued)

Item	Values	Explanation
UNIT OF MEASURE=INCHES (110V printers) or MILLIMETERS (220V printers)	INCHES MILLIMETERS	This item appears only when CONFIGURE CUSTOM PAPER=YES. Select the unit of measurement for the custom paper size.
X DIMENSION= 8.50 INCHES (110V printers) or 216 MILLIMETERS (220V printers)	For supported paper sizes, see "Supported sizes and weights of paper" on page 189.	This item appears only when CONFIGURE CUSTOM PAPER=YES. Use <b>-VALUE+</b> and <b>SELECT</b> to select the dimension to be fed into the printer (short edge) for custom paper size.
Y DIMENSION= 14.00 INCHES (110V printers) or 356 MILLIMETERS (220V printers)	For supported paper sizes, see "Supported sizes and weights of paper" on page 189.	This item appears only when CONFIGURE CUSTOM PAPER=YES. Use <b>-VALUE+</b> and <b>SELECT</b> to select the other dimension (long edge) for custom paper size.
ORIENTATION= PORTRAIT	PORTRAIT LANDSCAPE	Determine the default orientation of print on the page. <b>Note</b> It is best to set the page orientation from the printer driver or software application. (Driver and software settings override control panel settings.)
FORM LENGTH= 60 LINES (110V printers) or 64 LINES (220V printers)	5 to 128	Sets vertical spacing from 5 to 128 lines for default paper size. Press <b>-VALUE+</b> once to change the setting by increments of 1, or hold down <b>-VALUE+</b> to scroll by increments of 10.
PCL FONT SOURCE= INTERNAL	INTERNAL SOFT SLOT 1, 2, or 3	INTERNAL: Internal fonts. SOFT: Permanent soft fonts. SLOT 1, 2, or 3: Fonts stored in one of the three DIMM slots. <b>Note</b> It is best to set the font source from the printer driver or software application. (Driver and software settings override control panel settings.)





## Printing Menu (continued)

Item	Values	Explanation
PCL FONT NUMBER= 0	0 to 999	<p>The printer assigns a number to each font and lists them on the PCL font list (see “PCL or PS font list” on page 156). The font number appears in the Font # column of the printout.</p> <p><b>Note</b> It is best to set the font number from the printer driver or software application. (Driver and software settings override control panel settings.)</p>
PCL FONT PITCH= 10.00	0.44 to 99.99	<p>This item might not appear, depending on the font selected. Press <b>-VALUE+</b> once to change setting by increments of 0.01 for pitch, or hold down <b>-VALUE+</b> to scroll by increments of 1.</p> <p><b>Note</b> It is best to set the font pitch from the printer driver or software application. (Driver and software settings override control panel settings.)</p>
PCL FONT POINT SIZE=12.00	4.00 to 999.75	<p>This item might not appear, depending on the font selected. Press <b>-VALUE+</b> once to change setting by increments of 0.25 for point size, or hold down <b>-VALUE+</b> to scroll by increments of 1.</p> <p><b>Note</b> It is best to set the font point from the printer driver or software application. (Driver and software settings override control panel settings.)</p>
PCL SYMBOL SET= PC-8	PC-8 many others	<p>Select any one of several available symbol sets from the printer’s control panel. A symbol set is a unique grouping of all the characters in a font. PC-8 or PC-850 is recommended for line draw characters.</p> <p><b>Note</b> It is best to set the symbol set from the printer driver or software application. (Driver and software settings override control panel settings.)</p>



## Printing Menu (continued)

Item	Values	Explanation
COURIER FONT= REGULAR	REGULAR DARK	Select the version of Courier font to use:  REGULAR: The internal Courier font available on the HP LaserJet 4 series printers.  DARK: The internal Courier font available on the HP LaserJet III series printers.  Both fonts are not available at the same time.
WIDE A4=NO	NO YES	The Wide A4 setting changes the number of characters that can be printed on a single line of A4 paper.  NO: Up to 78 10-pitch characters can be printed on one line.  YES: Up to 80 10-pitch characters can be printed on one line.
OVERRIDE A4/LETTER=NO	NO YES	Choose YES to print on letter size paper when an A4 job is sent, but no A4 size paper is loaded in the printer (or to print on A4 size paper when a letter job is sent, but no letter paper is loaded in the printer).
APPEND CR TO LF= OFF	OFF ON	Select ON to append a carriage return to each line feed encountered in backward-compatible PCL jobs (pure text, no job control). Some environments, such as UNIX, indicate a new line using only the line feed control code. This option allows the user to append the required carriage return to each line feed.



# Print Quality Menu

Some items in this menu can be accessed from a software application, or from the printer driver (if the appropriate driver is installed). Printer driver and software application settings override control panel settings. For more information, see “Using features in the printer driver” on page 65.



## Print Quality Menu

Item	Values	Explanation
RESOLUTION= FASTRES 1200	300 600 FASTRES 1200 PRORES 1200	Select the resolution from the values listed below. All values print at the printer's full speed (24 ppm).  300: Produces draft print quality and can be used for compatibility with the HP LaserJet III family of printers.  600: Produces high print quality for text and can be used for compatibility with the HP LaserJet 4 family of printers.  FASTRES 1200: Produces 1200-dpi print quality for fast, high quality printing of business text and graphics.  PRORES 1200: Produces 1200-dpi printing for best quality of graphic images.  <b>Note</b> It is best to change the resolution from the printer driver or software application. (Driver and software settings override control panel settings.)
RET=MEDIUM	OFF LIGHT MEDIUM DARK	Use the printer's Resolution Enhancement technology (REt) setting to produce print with smooth angles, curves, and edges.  REt does not affect print quality when the print resolution is set to ProRes 1200. All other print resolutions, including FastRes 1200, benefit from REt.  <b>Note</b> It is best to change the REt setting from the printer driver or software application. (Driver and software settings override control panel settings.)



## Print Quality Menu (continued)

Item	Values	Explanation
ECONOMODE=OFF	OFF ON	<p>Turn EconoMode on (to save toner) or off (for high quality).</p> <p>EconoMode creates draft-quality printing by reducing the amount of toner on the printed page.</p> <p><b>Caution</b> HP does not recommend full-time use of EconoMode. (If EconoMode is used full-time, it is possible that the toner supply will outlast the mechanical parts in the toner cartridge.)</p> <p><b>Note</b> It is best to turn EconoMode on or off from the printer driver or software application. (Driver and software settings override control panel settings.)</p>
TONER DENSITY=3	1 2 3 4 5	<p>Lighten or darken the print on the page by changing the toner density setting. The settings range from 1 (light) to 5 (dark), but the default setting of 3 usually produces the best results.</p> <p>Use a lower toner density setting to save toner.</p> <p><b>Note</b> It is best to change the toner density from the printer driver or software application. (Driver and software settings override control panel settings.)</p>
AUTO CLEANING PAGE=OFF	ON OFF	<p>Turn the automatic cleaning page feature on or off (for cleaning the fuser).</p> <p>The default frequency is every 2,000 pages. The options are 1,000, 2,000, 5,000, 10,000, and 20,000 pages.</p> <p>For more information, see “Running the cleaning page automatically” on page 92.</p>
CREATE CLEANING PAGE	No value to select.	<p>Press <b>SELECT</b> to manually print a cleaning page (for cleaning toner from the fuser). Follow the instructions on the cleaning page.</p> <p>For more information, see “Running the cleaning page manually” on page 91.</p>
PROCESS CLEANING PAGE	No value to select.	<p>This item appears only after a cleaning page has been generated (as described above).</p> <p>Press <b>SELECT</b> to process the cleaning page.</p>



# Configuration Menu

Items in this menu affect the printer's behavior. Configure the printer according to your printing needs.



## Configuration Menu

Item	Values	Explanation
POWERSAVE TIME= 30 MINUTES	1 MINUTE 15 MINUTES 30 MINUTES 1 HOUR 2 HOURS 4 HOURS	<p>Set how long the printer remains idle before it enters PowerSave mode.</p> <p>PowerSave mode does the following:</p> <ul style="list-style-type: none"><li>• minimizes the amount of power consumed by the printer when it is idle</li><li>• reduces wear on the printer's electronic components (turns off the display's backlight)</li></ul> <p>When you send a print job, press a control panel key, open a paper tray, or open the top cover, the printer automatically comes out of PowerSave mode.</p> <p>For further information about PowerSave mode, see POWERSAVE in the "Resets Menu" on page 223.)</p>
TONER LOW= CONTINUE	CONTINUE STOP	<p>Determine how the printer behaves when toner is low. The message first appears when about 15% of the toner remains in the cartridge (about 1,500 pages remaining for the 10,000-page cartridge and about 900 pages remaining for the 6,000-page cartridge at 5% page coverage).</p> <p>CONTINUE: The printer will continue to print while the message displayed.</p> <p>STOP: The printer will stop and wait for further action.</p> <p>For more information, see "Toner low and toner out conditions" on page 87.</p>
TONER OUT= STOP	CONTINUE STOP	<p>Determine how the printer behaves when toner is out. The message first appears when the toner cartridge is out of toner.</p> <p>CONTINUE: The printer will continue to print with the message displayed.</p> <p>STOP: The printer will stop printing and further action is required.</p> <p>For more information, see "Toner low and toner out conditions" on page 87.</p>



## Configuration Menu (continued)

Item	Values	Explanation
CLEARABLE WARNINGS=JOB	JOB ON	<p>Set the amount of time that a clearable warning is displayed on the printer control panel.</p> <p>JOB: Warning messages display on the control panel until the end of the job from which they were generated.</p> <p>ON: Warning messages display on the control panel until <b>Go</b> is pressed.</p>
AUTO CONTINUE= ON	ON OFF	<p>Determine how the printer reacts to errors.</p> <p>ON: If an error occurs that prevents printing, the message will display, and the printer will go offline for 10 seconds before returning online.</p> <p>OFF: If an error occurs that prevents printing, the message will remain on the display and the printer will remain offline until <b>Go</b> is pressed.</p> <p>If the printer is on a network, you will probably want to turn AUTO CONTINUE to ON.</p>
JAM RECOVERY= AUTO	AUTO ON OFF	<p>Determine how the printer behaves when a paper jam occurs.</p> <p>AUTO: The printer automatically selects the best mode for printer jam recovery (usually ON). This is the default setting.</p> <p>ON: The printer automatically reprints pages after a paper jam is cleared.</p> <p>OFF: The printer does not reprint pages following a paper jam. Printing performance might be increased with this setting.</p>
MAINTENANCE MESSAGE=OFF	OFF	<p>This item appears only after the PERFORM PRINTER MAINTENANCE message displays.</p> <p>OFF: The PERFORM PRINTER MAINTENANCE message will be cleared but will return after 5% of the printer maintenance interval if the printer has been used without a new printer maintenance kit being installed.</p> <p>The message should be turned off only while waiting for the printer maintenance kit to be installed. If the required maintenance is not performed, the printer's performance will degrade.</p> <p>For more information, see "Performing preventative maintenance" on page 93. To order the Printer Maintenance Kit, see "Ordering information" page 22.</p>



## Configuration Menu (continued)

Item	Values	Explanation
PRINT PS ERRORS= OFF	OFF ON	Select ON to print the PS error page when PS errors occur.
RAM DISK=AUTO	OFF ON AUTO	<p>Determine how the RAM disk is configured. This item appears only if there is no optional hard disk accessory installed and the printer has at least 16 MB of memory.</p> <p>OFF: The RAM disk is disabled.</p> <p>ON: The RAM disk is enabled. Configure the amount of memory to be used through the following item: RAM DISK SIZE.</p> <p><b>Note</b> If the setting is changed from OFF to ON or from OFF to AUTO, the printer will automatically reinitialize when it becomes idle.</p>
QUICK COPY JOBS=32	1 to 50	Specifies the number of quick copy jobs that can be stored on the printer's hard disk accessory.
HELD JOB TIMEOUT=OFF	OFF 1 HOUR 4 HOURS 1 DAY 1 WEEK	Sets the amount of time that held jobs are kept before being automatically deleted from the queue.
PERSONALITY= AUTO	AUTO PCL PS	<p>Select the default printer language (personality). Possible values are determined by which valid languages are installed in the printer.</p> <p>Normally you should not change the printer language (the default is AUTO). If you change it to a specific printer language, the printer will not automatically switch from one language to another unless specific software commands are sent to the printer.</p>



# I/O Menu

Items in the I/O (input/output) Menu affect the communication between the printer and the computer.



## I/O Menu

Item	Values	Explanation
PARALLEL ADV COMMUNICATN=ON	ON OFF	Turn the bidirectional parallel communication on or off. The default is set for a bidirectional parallel port (IEEE-1284).  This setting allows the printer to send status readback messages to the computer. (Turning the parallel advanced functions on might slow language switching.)
PARALLEL HIGH SPEED=YES	YES NO	Select the speed at which data is transmitted to the printer.  YES: The printer accepts faster parallel communications used for connections with newer computers.  NO: The printer accepts slower parallel communications used for connections with older computers.
I/O TIMEOUT= 15 SECONDS	5 to 300	Select the I/O timeout period in seconds. (I/O timeout refers to the time, measured in seconds, that the printer waits before ending a print job.)  This setting allows you to adjust timeout for best performance. If data from other ports appear in the middle of your print job, increase the timeout value.  Press <b>-VALUE+</b> once to change settings by increments of 1, or hold down <b>-VALUE+</b> to scroll by increments of 10.





# Resets Menu

Use the reset and restore options on this menu with caution. You can lose buffered page data or printer configuration settings when you select these items. Only reset the printer under the following circumstances:

- you want to restore the printer's default settings
- communication between the printer and computer has been interrupted
- you are using both the serial and parallel I/O ports, and one of the ports is having problems

The reset and restore items in the Resets Menu will clear all memory in the printer, while **CANCEL JOB** clears only the current job.



## Note

Job retention features will be deleted if you do not have the hard disk accessory.

## Resets Menu

Item	Value	Explanation
NEW TONER CARTRIDGE=NO	NO YES	Change the value to YES only if you are using a non-HP toner cartridge. YES lets the printer know that a new non-HP toner cartridge has been installed and resets the toner gauge to full.
RESET MEMORY	No value to select.	This item clears the printer buffer and the active I/O input buffer, and resets the control panel to the current settings. Resetting memory during a print job can result in data loss.
RESTORE FACTORY SETTINGS	No value to select.	This item performs a simple reset and restores most of the factory (default) settings. This item also clears the input buffer for the active I/O. Resetting memory during a print job can result in data loss. Restoring factory settings does not affect network parameter settings on the HP JetDirect print server.



## Resets Menu

Item	Value	Explanation
POWERSAVE= ON	ON OFF	<p>This item turns PowerSave mode on or off. PowerSave mode does the following:</p> <ul style="list-style-type: none"><li>• minimizes the amount of power consumed by the printer when it is idle</li><li>• reduces wear on the printer's electronic components (turns off the display's backlight)</li></ul> <p>When you send a print job, press a control panel key, open a paper tray, or open the top cover, the printer automatically comes out of PowerSave mode.</p> <p>You can set how long the printer remains idle before it enters PowerSave mode (see the POWERSAVE TIME in the "Configuration Menu" on page 219).</p> <p><b>Note</b> PowerSave turns off the backlight on the display, but the display is still readable.</p>



# EIO Menu

The EIO (enhanced input/output) Menu appears only when an EIO device is installed in an EIO slot on the printer (such as an HP JetDirect print server). The items in the menu depend on the particular accessory product installed. If the printer contains an HP JetDirect print server EIO card, you can configure basic networking parameters using the EIO Menu. These and other parameters can also be configured through HP Web JetAdmin.



## EIO Menu

Item	Values	Explanation
CFG NETWORK=NO	NO YES	Select whether or not you want to access the HP JetDirect menu. NO: Bypass the HP JetDirect menu. YES: Access the HP JetDirect Menu. You must change this to YES each time you want to access the menu.
IPX/SPX=ON	ON OFF	Select whether the IPX/SPX protocol stack (in Novell NetWare networks, for example) is enabled (on) or disabled (off).
DLC/LLC=ON	ON OFF	Select whether the DLC/LLC protocol stack is enabled (on) or disabled (off).
TCP/IP=ON	ON OFF	Select whether the TCP/IP protocol stack is enabled (on) or disabled (off).
ATALK=ON	ON OFF	Select whether the Apple EtherTalk protocol stack is enabled (on) or disabled (off).



## EIO Menu (continued)

Item	Values	Explanation
CFG IPX/SPX=NO	NO YES	<p>Select whether you want to access the IPX/SPX menu and set IPX/SPX protocol parameters.</p> <p>NO: Bypass the IPX/SPX menu items. YES: Access the IPX/SPX menu items.</p> <p>In the IPX/SPX menu, you can specify the frame type parameter used on your network. The default is AUTO, to automatically set and limit the frame type to the first one detected.</p> <p>For Ethernet cards, frame type selections include EN_8023, EN_II, EN_8022, EN_SNAP.</p> <p>For Token Ring cards, frame type selections include TR_8022, TR_SNAP.</p> <p>In the IPX/SPX menu for Token Ring cards, you can also specify NetWare Source Routing parameters, which include SRC_RT=AUTO (default), OFF, SINGLE R, or ALL RT.</p>
CFG TCP/IP=NO	NO YES	<p>Select whether you want to access the TCP/IP menu and set TCP/IP protocol parameters.</p> <p>NO: Bypass the TCP/IP menu items. YES: Access the TCP/IP menu items</p> <p>In the TCP/IP Menu, you can specify BOOTP=YES or DHCP=YES for TCP/IP parameters to be automatically loaded from a bootP or DHCP server when the printer is turned on.</p> <p>If you specify BOOTP=NO and DHCP=NO, you can manually set the following TCP/IP parameters from the control panel: each byte of the IP address (IP), Subnet Mask (SM), Syslog Server (LG), and Default Gateway (GW). You can also manually set the Idle Timeout time period.</p> <p>Print an HP JetDirect configuration page to verify your settings. However, note that the print server might overwrite selected parameters with values that ensure proper operation.</p>



## EIO Menu (continued)

Item	Values	Explanation
CFG LINK=NO	NO YES	<p>Select whether you want to manually configure the HP JetDirect 10/100Base-TX print server's network link speed and communication mode. The HP JetDirect settings must match the network.</p> <p>NO: Bypass the link configuration menu items. YES: Access the link configuration menu items. One of the following link configurations can be set:</p> <p>AUTO: The print server will automatically configure itself to match the network's link speed and communication mode.</p> <p>10T HALF: 10 Mbps, half-duplex operation. 10T FULL: 10 Mbps, full-duplex operation. 100T HALF: 100 Mbps, half-duplex operation. 100T FULL: 100 Mbps, full-duplex operation.</p>





# C

# Printer memory and expansion



## Overview

The printer has three dual in-line memory module (DIMM) slots for upgrading with:

- more printer memory—DIMMs are available in 4, 8, 16, 32, 64, and 128 MB, for a maximum of 256 MB
- flash memory DIMMs—available in 2 and 4 MB; unlike standard printer memory, flash DIMMs can be used to permanently store downloaded items in the printer, even when the printer is off
- DIMM-based accessory fonts, macros, and patterns
- other DIMM-based printer languages and printer options

### Note

Single in-line memory modules (SIMMs) used on previous HP LaserJet printers are not compatible with the printer.

You might want to add more memory to the printer if you often print complex graphics or PS documents, print with the optional duplexer, use many downloaded fonts, or print at ProRes 1200. Added memory also gives you more flexibility in supporting job retention features, such as quick copying.

The printer has two enhanced input/output (EIO) slots for expanding the printer's capabilities with:

- a network card
- a connectivity card for serial, USB, or AppleTalk
- a mass storage device, such as a hard disk

For ordering information, see “Ordering information” on page 22.

To find out how much memory is installed in the printer, or to find out what is installed in the EIO slots, print a configuration page (see “Configuration page” on page 152).



# Installing memory

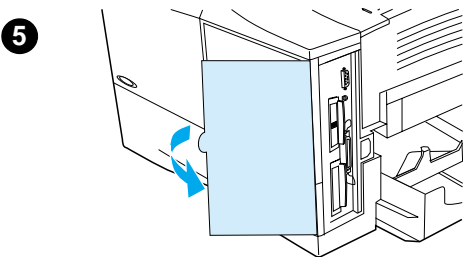
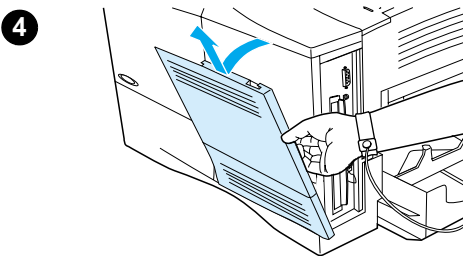
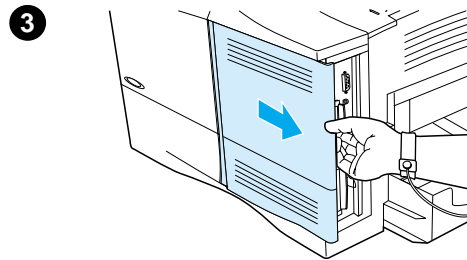
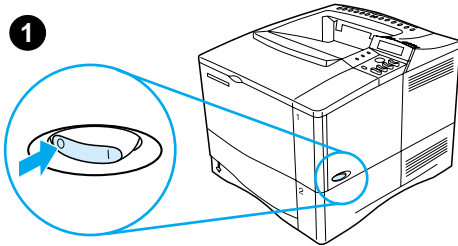

## CAUTION

Static electricity can damage dual in-line memory modules (DIMMs). When handling DIMMs, either wear an antistatic wrist strap or frequently touch the surface of the DIMM's antistatic package, then touch bare metal on the printer.

If you have not already done so, print a configuration page to find out how much memory is installed in the printer before adding more memory (see "Configuration page" on page 152).

- 1 Turn the printer off.
- 2 Unplug the power cord and disconnect any cables.
- 3 Grasp the cover (as illustrated) and pull it firmly toward the rear of the printer until it stops.
- 4 Remove the cover from the printer.
- 5 Open the DIMM access door by pulling on the metal tab.





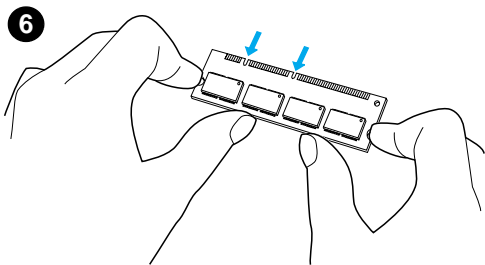

- 6 Remove the DIMM from the antistatic package. Hold the DIMM with fingers against the side edges and thumbs against the back edge. Align the notches on the DIMM with the DIMM slot. (Check that the locks on each side of the DIMM slot are open, or outward.)

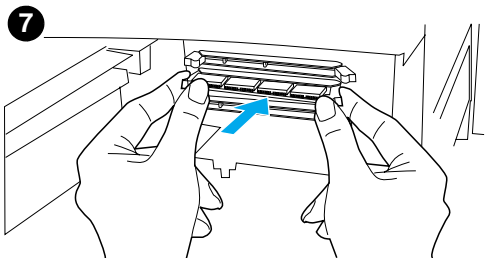

- 7 Press the DIMM straight into the slot (press firmly). Make sure the locks on each side of the DIMM snap inward into place. (To remove a DIMM, the locks must be released.)

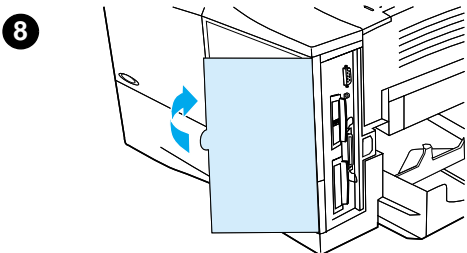

- 8 Close the DIMM access door. Make sure it locks into place.

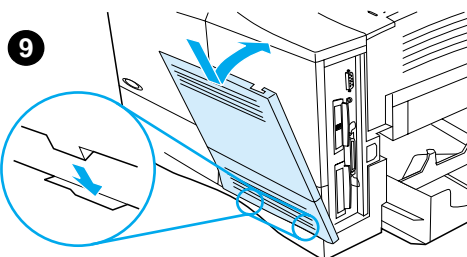

- 9 Set the bottom of the cover onto the printer. Make sure the bottom tabs on the cover fit into the corresponding slots in the printer. Rotate the cover up towards the printer.

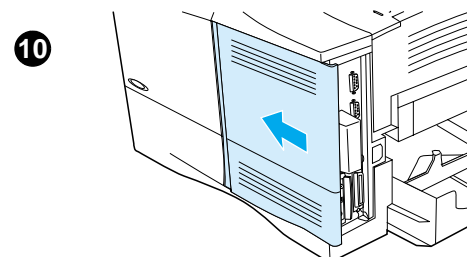

- 10 Slide the cover toward the front of the printer until it clicks into place. Reattach any cables and the power cord, then turn the printer on and test the DIMM (see “Checking memory installation” on page 232).



---

### CAUTION

Do not move or remove the DIMM in the lower slot.

---

- 8 Close the DIMM access door. Make sure it locks into place.

- 9 Set the bottom of the cover onto the printer. Make sure the bottom tabs on the cover fit into the corresponding slots in the printer. Rotate the cover up towards the printer.

- 10 Slide the cover toward the front of the printer until it clicks into place. Reattach any cables and the power cord, then turn the printer on and test the DIMM (see “Checking memory installation” on page 232).



# Checking memory installation

Follow this procedure to verify that DIMMs are installed correctly:

- 1 Check that the printer control panel displays **READY** when the printer is turned on. If an error message appears, a DIMM might have been incorrectly installed. Check the printer messages (see “Understanding printer messages” on page 111).
- 2 Print a new configuration page (see “Configuration page” on page 152).
- 3 Check the memory section on the configuration page and compare it to the configuration page printed before the DIMM installation. If the amount of memory has not increased, the DIMM might not be installed correctly (repeat the installation procedure) or the DIMM might be defective (try a new DIMM).



---

## Note

If you installed a printer language (personality), check the Installed Personalities and Options section on the configuration page. This area should list the new printer language.

# Saving resources (permanent resources)

Utilities or jobs that you download to the printer sometimes include resources (for example, fonts, macros, or patterns). Resources that are internally marked as permanent remain in the printer's memory until you turn the printer's power off.

Use the following guidelines if you make use of the PDL (page description language) ability to mark resources as permanent. For technical details, see an appropriate PDL reference for PCL or PS.

- Mark resources as permanent only when it is absolutely necessary that they remain in memory while the printer's power is turned on.
- Send permanent resources to the printer only at the beginning of a print job and not while the printer is printing.

---

## Note

Overusing permanent resources or downloading them while the printer is printing might decrease the printer's performance or its ability to print complex pages.



# Installing EIO cards/mass storage

Follow this procedure to install an EIO card or mass storage device:

- 1 Turn the printer off.
- 2 Remove the two screws and cover plate from the EIO 1 or EIO 2 slot on the back of the printer.
- 3 Install the EIO card or mass storage device in the EIO slot and tighten the screws. See the figure below for orientation of the EIO card.

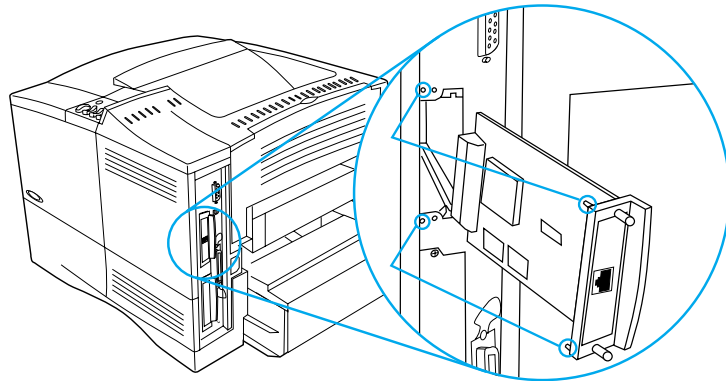

- 4 Turn the printer on and print a configuration page to verify that the new EIO device is recognized (see “Configuration page” on page 152).

---

## Note

---

For information on connecting an EIO card to a network and installing the network software, see “Printer software” on page 33 and also the getting started guide that came with the printer.

Use HP Resource Manager to manage fonts on a mass storage device (see “HP Resource Manager” on page 37). For more information, see the printer driver online help.

HP is constantly introducing new software tools for use with your printer and accessories. These tools are available from the Internet free of charge. See “Online services” on page 157 for how to visit the HP website for more information.





# D

# Printer commands



## Overview

Most software applications do not require you to enter printer commands. See your computer and software documentation to find the method for entering printer commands, if needed.

### PCL 5e

PCL 5e printer commands tell the printer which tasks to perform or which fonts to use. This appendix provides a quick reference for users who are already familiar with PCL 5e command structure.

### HP-GL/2

The printer has the ability to print vector graphics using the HP-GL/2 graphics language. Printing in the HP-GL/2 language requires that the printer leave PCL 5e language and enter HP-GL/2 mode, which can be done by sending the printer PCL 5e code. Some software applications switch languages through their drivers.

### PJL

HP's Printer Job Language (PJL) provides control above PCL 5e and other printer languages. The four major functions provided by PJL are: printer language switching, job separation, printer configuration, and status readback from the printer. PJL commands may be used to change printer default settings.

---

### Note

The table at the end of this appendix contains commonly used PCL 5e commands (see "Common PCL 5e printer commands" on page 239). For a complete listing and explanation of how to use PCL 5e, HP-GL/2, and PJL commands, see the *HP PCL/PJL Reference Set*, available on CD (HP part number 5961-0975).

---



# Understanding PCL 5e printer command syntax

Before using printer commands, compare these characters:

Lowercase l:	<i>l</i>	Uppercase O:	O
Number one:	1	Number 0:	Ø



Many printer commands use the lowercase letter l (*l*) and the number one (1), or the uppercase letter O (O) and the number zero (Ø). These characters may not appear on your screen as shown here. You must use the exact character and case specified for PCL 5e printer commands.



The figure below displays the elements of a typical printer command (in this instance, a command for page orientation).

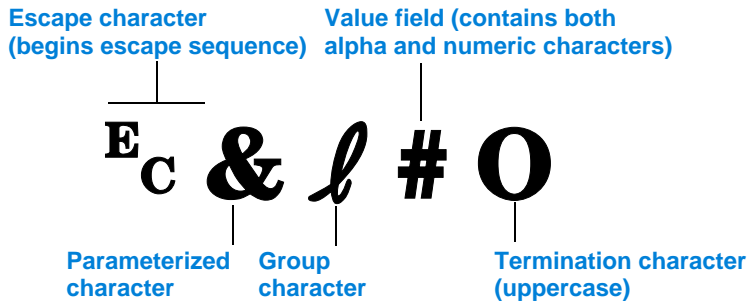

## Combining escape sequences

Escape sequences may be combined into one escape sequence string. There are three important rules to follow when combining code:

- 1 The first two characters after the  $\text{E}_C$  character (the parameterized and group characters—see the figure on the previous page) must be the same in all of the commands to be combined.
- 2 When combining escape sequences, change the uppercase (termination) character in each individual escape sequence to lower case.
- 3 The final character of the combined escape sequence must be uppercase.

The following is an example of an escape sequence string that would be sent to the printer to select legal paper, landscape orientation, and 8 lines per inch:

```
 $\text{E}_C\&l3A\text{E}_C\&l1O\text{E}_C\&l8D$ 
```

The following escape sequence sends the same printer commands by combining them into a shorter sequence:

```
 $\text{E}_C\&l3a1o8D$ 
```

## Entering escape characters

Printer commands always begin with the escape character ( $\text{E}_C$ ).

The following table shows how the escape character can be entered from various MS-DOS<sup>®</sup> software applications.

DOS software application	Entry	What appears
Lotus 1-2-3 and Symphony	Type $\backslash 027$	027
Microsoft Word for DOS	Hold down Alt and type 027 on the numeric keypad	←
WordPerfect for DOS	Type $\langle 27 \rangle$	$\langle 27 \rangle$
MS-DOS Edit	Hold down Ctrl-P, and press Esc	←
MS-DOS Edlin	Hold down Ctrl-V, and press [	^ [
dBase	?? CHR(27)+"command"	?? CHR(27)+" "



# Selecting PCL 5e fonts

The printer font list provides PCL 5e printer commands for selecting fonts (see “PCL or PS font list” on page 156 for information how to print the list). A sample section is shown below.

There is one variable box for entering symbol sets and one for entering point size. These variables must be filled in or the printer will use defaults. For example, if you want a symbol set that contains line-draw characters, select the 10U (PC-8) or 12U (PC-850) symbol set. Other common symbol set codes are listed in the table on beginning on the next page.



Font list

Font	Symbol set	Point size
Courier	Symbol set	Point size
CG Times	Symbol set	Point size
CG Times Bold	Symbol set	Point size
CG Times Bold Italic	Symbol set	Point size
CG Times Italic	Symbol set	Point size
CG Omega	Symbol set	Point size
CG Omega Bold	Symbol set	Point size
CG Omega Bold Italic	Symbol set	Point size
CG Omega Italic	Symbol set	Point size

- 1 Symbol set
- 2 Point size

## Note

Fonts are either “fixed” or “proportional” in spacing. The printer contains both fixed fonts (Courier, Letter Gothic, and Lineprinter) and proportional fonts (CG Times, Arial®, Times New Roman®, and others).

Fixed-spaced fonts are generally used in applications such as spreadsheets and databases, where it is important for columns to line up vertically. Proportional-spaced fonts are generally used in text and word processing applications.





# Common PCL 5e printer commands

## Common PCL 5e printer commands

	Function	Command	Options (#)
Job control commands	Reset	$E_C E$	n/a
	Number of copies	$E_C \& l \# X$	1 to 999
	2-sided/1-sided printing	$E_C \& l \# S$	0 = Simplex (1-sided) printing 1 = Duplex (2-sided) with long edge binding 2 = Duplex (2-sided) with short edge binding
Page control commands	Paper source	$E_C \& l \# H$	0 = prints or ejects current page 1 = Tray 2 2 = manual feed, paper 3 = manual feed, envelope 4 = Tray 1 5 = Tray 3 6 = Envelope Feeder 7 = auto select 8 = Tray 4 20-69 = external trays
	Paper size	$E_C \& l \# A$	1 = Executive 2 = Letter 3 = Legal 25 = A5 26 = A4 45 = B5-JIS 80 = Monarch envelope 81 = Commercial 10 envelope 90 = DL ISO envelope 91 = C5 ISO envelope 100 = B5 ISO envelope 101 = Custom
	Paper type	$E_C \& n \#$	5WdBond = Bond 6WdPlain = Plain 6WdColor = Color 7WdLabels = Labels 9WdRecycled = Recycled 11WdLetterhead = Letterhead 10WdCardstock = Cardstock 11WdPrepunched = Prepunched 11WdPreprinted = Preprinted 13WdTransparency = Transparency #WdCustompapertype = Custom <sup>1</sup>
	Orientation	$E_C \& l \# O$	0 = Portrait 1 = Landscape 2 = Reverse Portrait 3 = Reverse Landscape



## Common PCL 5e printer commands (continued)

	Function	Command	Options (#)
Page control commands (continued)	Top Margin	$E_C \& l \# E$	# = number of lines
	Text Length (bottom margin)	$E_C \& l \# F$	# = number of lines from top margin
	Left Margin	$E_C \& a \# L$	# = column number
	Right Margin	$E_C \& a \# M$	# = column number from left margin
	Horizontal Motion Index	$E_C \& k \# H$	1/120-inch increments (compresses print horizontally)
	Vertical Motion Index	$E_C \& l \# C$	1/48-inch increments (compresses print vertically)
	Line Spacing	$E_C \& l \# D$	# = lines per inch (1, 2, 3, 4, 5, 6, 12, 16, 24, 48)
	Perforation Skip	$E_C \& l \# L$	0 = disable 1 = enable
Cursor Positioning	Vertical Position (Rows)	$E_C \& a \# R$	# = row number
	Vertical Position (Dots)	$E_C \# p \# Y$	# = dot number (300 dots = 1 inch)
	Vertical Position (Decipoints)	$E_C \& a \# V$	# = decipoint number (720 decipoints = 1 inch)
	Horizontal Position (Columns)	$E_C \& a \# C$	# = column number
	Horizontal Position (Dots)	$E_C \# p \# X$	# = dot number (300 dots = 1 inch)
	Horizontal Position (Decipoints)	$E_C \& a \# H$	# = decipoint number (720 decipoints = 1 inch)
programming hints	End of Line Wrap	$E_C \& s \# C$	0 = Enable 1 = Disable
	Display Functions On	$E_C Y$	n/a
	Display Functions Off	$E_C Z$	n/a
Language selection	Enter PCL 5e Mode	$E_C \% \# A$	0 = Use previous PCL 5e cursor position 1 = Use current HP-GL/2 pen position
	Enter HP-GL/2 Mode	$E_C \% \# B$	0 = Use previous HP-GL/2 pen position 1 = Use current PCL 5e cursor position



## Common PCL 5e printer commands (continued)

Function	Command	Options (#)
Symbol Sets	$E_C(\#)$	8U = HP Roman-8 Symbol Set 10U = IBM Layout (PC-8) (code page 437) Default Symbol Set 12U = IBM Layout for Europe (PC-850) (code page 850) 8M = Math-8 19U = Windows 3.1 Latin 1 9E = Windows 3.1 Latin 2 (commonly used in Eastern Europe) 5T = Windows 3.1 Latin 5 (commonly used in Turkey) 579L = Wingdings Font
Primary Spacing	$E_C(s\#P)$	0 = fixed 1 = proportional
Primary Pitch	$E_C(s\#H)$	# = characters/inch
Set Pitch Mode <sup>2</sup>	$E_C\&k\#S$	0 = 10 4 = 12 (elite) 2 = 16.5 - 16.7 (compressed)
Primary Height	$E_C(s\#V)$	# = points
Primary Style	$E_C(s\#S)$	0 = upright (solid) 1 = italic 4 = condensed 5 = condensed italic
Primary Stroke Wt.	$E_C(s\#B)$	0 = medium (book or text) 1 = semi bold 3 = bold 4 = extra bold
Typeface	$E_C(s\#T)$	Print a PCL 5e font list to view the command for each internal font (page 190).

<sup>1</sup>For custom paper, replace "Custompapertype" with the name of the paper, and replace the "#" with the number of characters in the name, plus 1.

<sup>2</sup>The preferred method is to use the primary pitch command.



Font selection





# E

# Regulatory information



## FCC regulations

This equipment has been tested and found to comply with the limits for a Class B digital device, pursuant to Part 15 of the FCC rules. These limits are designed to provide reasonable protection against harmful interference in a residential installation. This equipment generates, uses, and can radiate radio frequency energy. If this equipment is not installed and used in accordance with the instructions, it may cause harmful interference to radio communications. However, there is no guarantee that interference will not occur in a particular installation. If this equipment does cause harmful interference to radio or television reception, which can be determined by turning the equipment off and on, the user is encouraged to try to correct the interference by one or more of the following measures:

- Reorient or relocate the receiving antenna.
- Increase separation between equipment and receiver.
- Connect equipment to an outlet on a circuit different from that to which the receiver is located.
- Consult your dealer or an experienced radio/TV technician.

---

### Note

Any changes or modifications to the printer that are not expressly approved by HP could void the user's authority to operate this equipment.

Use of a shielded interface cable is required to comply with the Class B limits of Part 15 of FCC rules.

---



# Environmental product stewardship program

## Protecting the environment

Hewlett-Packard Company is committed to providing quality products in an environmentally-sound manner. The HP LaserJet printer has been designed with several attributes to minimize impacts on the environment.

This HP LaserJet printer eliminates:

- **Ozone production**

The printer uses charging rollers in the electrophotographic process and therefore generates no appreciable ozone gas (O<sub>3</sub>).

This HP LaserJet printer design reduces:

- **Energy consumption**

Energy usage drops significantly while in low-power (PowerSave) mode. Not only does this save natural resources, but it also saves money without affecting the high performance of this printer. This product qualifies for ENERGY STAR. ENERGY STAR is a voluntary program established to encourage the development of energy-efficient office products.



ENERGY STAR is a U.S. registered service mark of the U.S. EPA. As an ENERGY STAR partner, Hewlett-Packard Company has determined that this product meets ENERGY STAR Guidelines for energy efficiency.

- **Toner consumption**

EconoMode uses significantly less toner, which might extend the life of the toner cartridge.

- **Paper use**

Depending on the type of software program in use, you can request that a number of pages of your document be printed on one sheet of paper. This N-up printing practice and the printer's automatic duplexing feature, which provides two-sided printing, can reduce paper usage and the resulting demands on natural resources.



This HP LaserJet printer also contributes to protecting the environment in the following ways:

- **Plastics marking for recycling**

Plastic parts over 25 grams have markings according to international standards that enhance the ability to identify plastics for recycling purposes at the end of the printer's life.



- **HP Planet Partners toner cartridge recycling program**



In over 25 countries, this product's toner cartridges can be returned to HP through the HP Planet Partners toner cartridge recycling program. Multi-lingual program information and instructions are included in



every new HP LaserJet toner cartridge and consumables package.

Since 1990, the HP Planet Partners toner cartridge recycling program has collected more than 39 million used LaserJet toner cartridges that otherwise might have been discarded in the world's landfills. The HP LaserJet toner cartridges go to a collection center and are bulk-shipped to our recycling partners, who disassemble the cartridge parts for recycling. Materials are separated and converted into raw materials for use by other industries to make a variety of useful products.

For more information about the Planet Partners recycling program, see <http://www.ljsupplies.com/planetpartners>.

- **U.S. recycling returns**

For U.S. returns, HP Planet partners is an easy-to-use, free-of-charge way to recycle HP LaserJet toner cartridges. If you use only a few cartridges per year, all you have to do is use the pre-paid delivery label and instructions you will find in every HP LaserJet toner cartridge box. For returning multiple cartridges, HP encourages bulk returns. Simply bundle two or more cartridges together and apply the single, pre-paid, and pre-addressed UPS label that is supplied in the package.

For returning large numbers of cartridges at one time, for additional mailing labels, or for more information call 1-800-340-2445 in the U.S. or visit the HP LaserJet supplies website at <http://www.ljsupplies.com/planetpartners>.



- **Non-U.S. recycling returns**

For non-U.S. returns, check the toner cartridge recycling information in the box for instructions on recycling in your country. If your country is not listed or for further information on the Planet Partners program, contact your local HP Sales and Service Office.



- **Recycled paper**

This printer is suited for the use of recycled papers when the paper meets the guidelines outlined in the *HP LaserJet Printer Family Paper Specification Guide*. See “Ordering information” on page 22 to order the guide. This printer is suitable for the use of recycled paper according to DIN 19309.



To ensure longevity of your HP LaserJet printer, HP provides the following:

- **Extended warranty**

HP SupportPack provides coverage for the HP hardware product and all HP-supplied internal components. The hardware maintenance covers a three-year period from date of the HP product purchase. The customer must purchase HP SupportPack within 90 days of the HP product purchase. Information on HP SupportPack is available (see “HP Customer Care Service and Support” on page 157).

- **Spare parts and consumables availability**

Spare parts and consumable supplies for this product will be made available for at least 5 years after production has stopped.

## Material safety data sheets

The Toner Cartridge/Drum material safety data sheet (MSDS) can be obtained by accessing <http://www.hp.com/go/msds> and selecting the HP LaserJet icon.

If you do not have access to the Internet, call U.S. HP FIRST (fax-on-demand service) for material safety data sheets:

- within the U.S. and Canada, call (800) 231-9300
- outside the U.S. and Canada, call (404) 329-2009

Select an Index to view a list of the available documents. Index 7 contains the material safety data sheets for printer products.





# Declaration of Conformity

according to ISO/IEC Guide 22 and EN 45014

**Manufacturer's Name:** Hewlett-Packard Company  
**Manufacturer's Address:** 11311 Chinden Boulevard  
Boise, Idaho 83714-1021, USA

## declares that the product

**Product Name:** HP LaserJet 4100 / 4100N / 4100TN / 4100DTN / 4100SE  
**Model Numbers:** C8049A / C8050A / C8051A / C8052A / C8048A  
**Product Options:** ALL

## conforms to the following Product Specifications:

**Safety:** IEC 950:1991+A1+A2+A3+A4 / EN 60950:1992+A1+A2+A3+A4+A11  
IEC 825-1:1993 +A1 / EN 60825-1:1994 +A11 Class 1 Laser/LED Product

**EMC:** CISPR 22:1997 / EN 55022:1998 Class B<sup>1</sup>  
EN 61000-3-2:1995  
EN 61000-3-3:1995  
EN 55024: 1998  
FCC Title 47 CFR, Part 15 Class B<sup>2</sup> / ICES-002, Issue 2  
AS / NZS 3548:1995

## Supplementary Information:

The product herewith complies with the requirements of the EMC Directive 89/336/EEC and the Low Voltage Directive 73/23/EEC, and carries the CE-Marking accordingly:

1. The product was tested in a typical configuration with Hewlett-Packard Personal Computer Systems.
2. This Device complies with Part 15 of the FCC Rules. Operation is subject to the following two Conditions:  
(1) this device may not cause harmful interference, and (2) this device must accept any interference received, including interference that may cause undesired operation.
3. Product exhibits Class A operation when connected to Local Area Network (LAN) cables using print server accessories.

**Boise, Idaho, USA  
February 2001**

## For regulatory topics ONLY, contact:

**Australia Contact:** Product Regulations Manager, Hewlett-Packard Australia Ltd., 31-41 Joseph Street, Blackburn, Victoria 3130, Australia

**European Contact:** Your Local Hewlett-Packard Sales and Service Office or Hewlett-Packard GmbH, Department HQ-TRE / Standards Europe, Herrenberger Straße 110-140, D-71034 Böblingen (FAX: +49-7031-14-3143)

**USA Contact:** Product Regulations Manager, Hewlett-Packard Company, PO Box 15, Mail Stop 160, Boise, ID 83707-0015 (Phone: 208-396-6000)



# Safety statements

## Laser safety statement

The Center for Devices and Radiological Health (CDRH) of the U.S. Food and Drug Administration has implemented regulations for laser products manufactured since August 1, 1976. Compliance is mandatory for products marketed in the United States. The printer is certified as a “Class 1” laser product under the U.S. Department of Health and Human Services (DHHS) Radiation Performance Standard according to the Radiation Control for Health and Safety Act of 1968. Since radiation emitted inside the printer is completely confined within protective housings and external covers, the laser beam cannot escape during any phase of normal user operation.



### WARNING!

Using controls, making adjustments, or performing procedures other than those specified in this user guide may result in exposure to hazardous radiation.

## Canadian DOC regulations

Complies with Canadian EMC Class B requirements.

«Conforme à la classe B des normes canadiennes de compatibilité électromagnétiques. «CEM».»

## EMI statement (Korea)

사용자 안내문 (B급 기기)

이 기기는 비업무용으로 전자파장해 검정을 받은 기기로서, 주거지역에서는 물론 모든 지역에서 사용할 수 있습니다.

## VCCI statement (Japan)

この装置は、情報処理装置等電波障害自主規制協議会（VCCI）の基準に基づくクラスB情報技術装置です。この装置は、家庭環境で使用することを目的としていますが、この装置がラジオやテレビジョン受信機に近接して使用されると、受信障害を引き起こすことがあります。

取り扱い説明書に従って正しい取り扱いをして下さい。



# Laser statement for Finland

## Luokan 1 laserlaite

### Klass 1 Laser Apparat

HP LaserJet 4100, 4100N, 4100TN, 4100DTN laserkirjoitin on käyttäjän kannalta turvallinen luokan 1 laserlaite. Normaalisissa käytössä kirjoittimen suojakotelointi estää lasersäteen pääsyn laitteen ulkopuolelle. Laitteen turvallisuusluokka on määritetty standardin EN 60825-1 (1994) mukaisesti.

### Varoitus!

Laitteen käyttäminen muulla kuin käyttöohjeessa mainitulla tavalla saattaa altistaa käyttäjän turvallisuusluokan 1 ylittävälle näkymättömälle lasersäteilylle.

### Varning!

Om apparaten används på annat sätt än i bruksanvisning specificerats, kan användaren utsättas för osynlig laserstrålning, som överskrider gränsen för laserklass 1.

### HUOLTO

HP LaserJet 4100, 4100N, 4100TN, 4100DTN -kirjoittimen sisällä ei ole käyttäjän huollettavissa olevia kohteita. Laitteen saa avata ja huoltaa ainoastaan sen huoltamiseen koulutettu henkilö. Tällaiseksi huoltotoimenpiteeksi ei katsota väriainekasetin vaihtamista, paperiradan puhdistusta tai muita käyttäjän käsikirjassa lueteltuja, käyttäjän tehtäväksi tarkoitettuja ylläpitotoimia, jotka voidaan suorittaa ilman erikoistyökaluja.

### Varo!

Mikäli kirjoittimen suojakotelo avataan, olet alttiina näkymättömälle lasersäteilylle laitteen ollessa toiminnassa. Älä katso säteeseen.



## Varning!

Om laserprinterns skyddshölje öppnas då apparaten är i funktion, utsätts användaren för osynlig laserstrålning. Betrakta ej strålen.

Tiedot laitteessa käytettävän laserdiodin säteilyominaisuuksista:

Aallonpituus 775-795 nm

Teho 5 mW

Luokan 3B laser



# F

# Embedded web server



## Overview

This printer comes equipped with an embedded web server. Accessing the embedded web server from your PC's standard web browser lets you obtain information about the printer, including:

- control panel messages
- consumable levels
- tray configuration
- printer control panel menu configuration
- printer configuration page
- printer event log
- printer usage (types of print jobs)
- network information

You can also use the embedded web server to perform the print job management functions that would usually be done at the printer control panel. These functions include:

- changing printer settings
- changing printer configuration
- canceling print jobs



# Accessing the embedded web server

---

## Note

---

To use the embedded web server, you must have an IP-based network and web browser.

Type the IP address assigned to the printer into your web browser to access the embedded web server. For example, if the printer's IP address is 123.456.789.123, you would enter `http://123.456.789.123` into your web browser.

If you do not know the IP address for the printer, it is listed on the printer configuration page. For more information about printing a configuration page, see "Configuration page" on page 152.



## Embedded web server pages

The embedded web server has three different sections for providing detailed information about the printer:

- Home pages
- Device pages
- Networking pages

The various sections for the embedded web server are located on the right side of your web browser screen. Click the section that you want to view. Under the different section is a list of additional websites that you might use frequently.

---

## Note

---

Each page in the embedded web server has access to Internet Help. For information regarding a particular page, click the Help icon.



## Home pages

The home pages of the embedded web server are the informational pages for the printer. These include:

- **Printer status page**  
This page shows the printer control panel and the message that is currently displayed. The different control panel status lights and buttons are also displayed, so you can change the printer control panel menu settings from this page. Consumable life levels and the input tray media configuration are also displayed.
- **Configuration page**  
The printer configuration page is displayed from this site in the embedded web server. For more information, see “Configuration page” on page 152.
- **Event log page**  
This page shows the printer event log. For more information, see “Event Log” on page 153.
- **Supplies page**  
This page shows the levels of the consumables for the printer.
- **Usage page**  
This page shows how much of each media type has been used by the printer.
- **Device identification page**  
This page lets you name the device for network management needs, and shows the IP address and server for the printer.



## Device pages

The device pages of the embedded web server allow you to configure the printer from your PC. These pages can be password protected. Always consult with your network administrator before changing the printer's configuration.

- **Configure printer page**  
This page lets you configure all of the printer's settings.
- **Alerts page**  
This page lets you configure who will be notified electronically for a variety of different printer events.
- **E-Mail page**  
The e-mail addresses of the people who will receive electronic notification of printer events are entered in this page.



- **Order supplies page**  
The remaining life of the different consumables is shown on this page, and the links to the HP website for ordering supplies is also displayed.
- **Contact information page**  
The name and e-mail address of the primary point of contact for information about the printer is entered into this page. The primary point of contact is usually the network administrator.
- **Security page**  
This page configures the password information for the embedded web server. Password information should only be configured by the network administrator.
- **Other links page**  
This page is used to enter other websites into the embedded web server. These sites are displayed on the navigational bar throughout the embedded web server pages.
- **Refresh rate page**  
This page configures how often the embedded web server obtains information from the printer regarding the printer's status.
- **Language page**  
The language that the embedded web server is displayed in is configured from this page.
- **Device identification page**  
This page lets you name the device for network management needs, and shows the IP address and server for the printer.



## Network pages

This section of the embedded web server allows the network administrator to configure the HP JetDirect card for the printer.





# Index

## Symbols

- ?
  - in control panel messages 31
  - on control panel 29

## Numerics

- 100-sheet paper tray. *See* tray 1
- 10Base-T cards, ordering 22
- 10Base-TX cards, ordering 22
- 1200 dpi, setting resolution to 217
- 2-sided printing. *See* duplexing
- 2-up printing 67
- 300 dpi, setting resolution to 217
- 3-hole punched paper 51
- 500-sheet paper tray
  - bad connection message 112
  - capacity 190
  - illustration 21
  - location 19
  - ordering 22
  - orienting paper for duplexing 51
  - orienting special paper 54
  - supported paper sizes and weights 190
- 600 dpi, setting resolution to 217

## A

- A4 paper
  - overriding with letter-size paper 216
  - setting number of characters on single line 216
- access denied menus locked message 32, 112
- accessing toner cartridge 20
- accessories
  - direct ordering 160
  - list and illustration 21
  - ordering 22
  - verifying installation 152
- accessory guides 14
- acoustic emissions 202
- Acrobat
  - Reader 10
  - using documents 9
  - website 12
- adding
  - memory 229
  - printer drivers 33
- additional drivers, obtaining 33

- adhesive
  - on envelopes 197
  - on labels 196
- adjusting trays 2, 3, 4 47
- administrator software on printer CD 33
- Adobe Acrobat
  - Reader 10
  - using documents 9
  - website 12
- agreements for service 160
- alerts page (embedded web server) 253
- alerts, configuring 94
- append CR to LF setting 216
- Apple EtherTalk setting 225
- Apple LaserWriter printer driver 40
- Apple Mac OS printer driver 34
- assigning a zone on the network 40
- Attention light 29
- authorized resellers 160
- Auto Cleaning Page setting 218
- auto continue setting 111, 220
- AutoCAD printer drivers 34

## B

- Background Printing (Macintosh) 144
- backlight, turning off 219
- bad duplexer connection message 112
- benefits of printer 16
- bidirectional parallel communication setting 222
- binding edge, setting 211
- binding options for duplexing 52
- bins. *See* output bins; rear output bin; top output bin
- black with white spots problem 136
- blank display 137
- booklets 66
- both sides, printing. *See* duplexing
- browsing with thumbnails in online user guide 11
- bundles for printer 18

## C

- cables
  - ordering 22
  - troubleshooting serial 139
- Canada DOC regulations 248
- Cancel Job key 30



- canceling print jobs
  - from control panel 30
  - with embedded web server 251
- capacity
  - 500-sheet paper tray 190
  - circuit 201
  - duplexer 191
  - envelope feeder 191
  - tray 1 189
  - trays 2, 3, 4 190
- card stock 198
- carriage return/line feed setting 216
- cartridges. *See* toner cartridges
- cassette mode
  - description 69
  - setting for tray 1 210
- CD
  - for HP Support Assistant 160
  - for service parts information 160
- CD for software and documentation
  - ordering 22
  - software included 33
- CFC usage 244
- CFG settings
  - IPX/SPX 226
  - Network 225
  - TCP/IP 226
- changing
  - control panel messages 40
  - printer driver settings 36
  - printer language 221
  - printer resolution 217
  - printer settings 40
  - printer settings with embedded web server 251
- characters
  - escape 237
  - garbled on screen 137
  - misformed 134
- checking
  - toner cartridge life expectancy 85
  - toner level 85
- chlorofluorocarbons 244
- Chooser, troubleshooting 143
- choosing right printer driver 37
- circuit capacity 201
- cleaning
  - fuser automatically 92
  - fuser manually 91
  - paper path 91
  - printer 88
  - toner from clothing 89
- cleaning page 91
  - setting to run automatically 218
  - setting to run manually 218
- clearable warnings setting 111, 220
- clearing
  - paper jam message from control panel 96
  - persistent messages 111
- clearing paper jams
  - from duplexer 104
  - from envelope feeder 100
  - from fuser area 107
  - from input tray areas 102
  - from output areas 106
  - from repeated jamming 110
  - from top cover and toner cartridge areas 98
  - locating source 97
  - clothing, cleaning toner from 89
- collating (mopying)
  - error messages 126
  - using 65
- combining escape sequences 237
- commands for printer
  - cursor positioning 240
  - description 235
  - font selection 241
  - HP-GL/2 235
  - job control 239
  - language selection 240
  - page control 239
  - PCL 235, 239
  - PJL 235
  - programming hints 240
  - selecting PCL fonts 238
  - syntax 236
- compact disc
  - for HP Support Assistant 160
  - for service parts information 160
- compact disc for software and documentation
  - ordering 33
  - software included 33
- compatibility
  - between printer products 203
  - SIMM 229
- configuration
  - bundles available for printer 18
  - current printer 205
  - obtaining information with embedded web browser 251
- Configuration Menu 111, 219
- configuration page
  - blank page prints 138
  - cannot print 138
  - description 153
  - location in control panel menus 208
  - printing 152
  - printing with embedded web server 251
- configuration page (embedded web server)



- 253
- configure printer page (embedded web server) 253
- configuring
  - alerts 94
  - control panel messages 40
  - custom paper 213
  - embedded web server language 254
  - fuser mode 212
  - HP JetDirect card with embedded web server 254
  - network parameters 225
  - Novell NetWare parameters 41
  - number of quick copy jobs 221
  - printer 13
  - printer drivers 36
  - printer for IP printing 40
  - printer password 40
  - printer personality (language) 221
  - printer reaction to errors 220
  - printers connected to network with HP JetDirect print server 41
  - RAM disk settings 221
  - response to toner low 87
  - response to toner out 87
  - toner low and toner out settings 219
- consumables. *See* supplies
- consumption
  - power 201
  - saving energy 244
  - saving paper 244
  - saving toner 244
- contact information page (embedded web server) 254
- control panel
  - ? label 29
  - ? message 31
  - changing settings 32
  - configuring messages 40
  - description 205
  - description and illustration 29
  - does not display READY message 137
  - keys 30
  - lights 29, 219
  - location 19
  - locking functions 40
  - menu map 32
  - messages 111
  - overriding settings 32
  - printing menu map 32
  - saving settings 30
  - settings overridden by printer driver and software commands 205
  - troubleshooting 137
  - wrong language 137
- control panel menus
  - access denied 32
  - accessing 32
  - Configuration 219
  - cycling through at control panel 30
  - EIO 225
  - exiting 30
  - I/O 222
  - Information 208
  - Paper Handling 210
  - Print Quality 217
  - Printing 213
  - Private/Stored Jobs Menu 207
  - Quick Copy Jobs Menu 206
  - Resets 223
- converting paper weights 194
- copies
  - printing additional 72
  - quick jobs 72
  - setting default number 213
  - setting number of private/stored jobs 207
  - setting number of quick 206
- country/region offices worldwide for
  - customer sales and service 172
- country/region sales and service offices 172
- Courier font, setting 216
- CR/LF (carriage return/line feed) setting 216
- creased paper problem 135
- Create Cleaning Page setting 218
- crooked page problem 134
- curled
  - envelopes 197
  - paper 192, 198
- curled paper problem 135
- current printer settings, checking 32, 151
- cursor positioning commands for printer 240
- custom paper
  - setting dimensions for short and long edges 214
  - setting option 213
  - setting units of measure 214
- customer service
  - worldwide country/region offices 172
- customer support
  - country/region sales and service offices worldwide 172
  - direct ordering for accessories and supplies 160
  - during and after warranty period 165
  - fraud hotline 161
  - HP Support Packs 161
  - language and in-country options 163
  - online product information 160
  - online services 157



- parts information 160
- service agreements 160
- worldwide support options 162
- Customization Utility 36
- customizing
  - See *also* configuring
  - tray 1 operating 69
  - trays used for printing 68
- custom-size paper
  - guidelines for printing 63
  - margins 63
  - printing 63
  - printing to rear output bin 45
  - setting paper size 63
  - supported sizes and weights in tray 1 189
  - supported sizes and weights in trays 2, 3, 4 190
- D**
- dark printing, setting toner density 218
- Data light 29
- data, transmitting speed 222
- dBase, entering escape characters in 237
- Declaration of Conformity (DOC)
  - Canadian 248
  - U.S. 247
- decreasing page view 10
- defaults
  - changing printer driver 36
  - image size for paper 213
  - number of copies 213
  - printer personality (language) 221
  - restoring settings 223
  - viewing settings 205
- defects repeating problem 133
- deleting
  - private jobs 77
  - private/stored jobs 207
  - quick copy 73
  - quick copy jobs 206
  - stored print jobs 79
- Desktop Printer Utility 33
- device identification page (embedded web server) 253, 254
- device pages (embedded web server) 253
- dimensions
  - printer 200
  - setting for long edge of paper 214
  - setting for short edge of custom paper 214
  - supported for duplexer 191
  - supported for envelopes in envelope feeder 191
  - supported for paper in tray 1 189
  - supported for paper in trays 2, 3, 4 190
- DIMMs
  - description 229
  - expanding 229
  - handling static electricity 230
  - illustration 21
  - installing 229
  - ordering 22
  - printing font list 156
- directory of files, printing 208
- disk
  - failure 112
  - failure (RAM) 116
  - file system full 113
  - file system full (RAM) 117
  - operation failed 113
  - operation failed (RAM) 117
  - write protected 113
- display panel. See control panel
- distributing printer drivers 36
- DLC/LLC setting 225
- DOC (Declaration of Conformity)
  - Canadian 248
  - U.S. 247
- documentation
  - accessory guides 14
  - additional information 13
  - Getting Started Guide* 13
  - HP Fast Infrared Receiver User Guide* 14
  - HP JetDirect Print Server Administrator's Guide* 13
  - online help 14
  - ordering 22
  - using online user guide 9
- DOS Edit, entering escape characters in 237
- DOS Edlin, entering escape characters in 237
- DOS, entering escape characters 237
- double-side-seam envelopes 197
- downloading
  - flash memory across networks 37
  - fonts 37
  - macros 37
- draft quality printing
  - setting 217
  - through EconoMode 218
- DRAMM DIMMs, ordering 22
- drivers, printer. See printer drivers
- dropouts
  - in printing 192
  - on page 131
- duplex printing accessory
  - bad connection message 112
  - capacity 191
  - clearing jams 104
  - illustration 21
  - installing 49



- ordering 22
  - paper orientation 51
  - supported paper sizes 49
  - supported paper sizes and weights 191
  - troubleshooting 110
  - using with rear output bin 50
  - duplexer. *See* duplex printing accessory
  - duplexing
    - binding options 52
    - booklets 66
    - description 49
    - guidelines 50
    - location of option in control panel menus 211
  - dust cover
    - location 20
    - tray 2 and duplexer 49
- E**
- EconoMode setting 218
  - edge of binding, setting 211
  - Edlin, entering escape characters in 237
  - EIO cards
    - description 21
    - installing 233
    - ordering 22
  - EIO Menu 225
  - EIO slots
    - description 229
    - learning what is installed 229
    - location 20
  - electrical specifications 201
  - e-mail page (embedded web server) 253
  - embedded web server
    - configuring language displayed in 254
    - configuring refresh rate 254
    - description 251
    - device pages 253
    - help 252
    - home pages 253
    - network pages 254
    - using 252
    - using to check toner level 85
    - using to configure alerts 94
    - using to order parts and accessories 22
  - EMI statement for Korea 248
  - emissions, acoustic 202
  - energy consumption 201, 244
  - Energy Star 244
  - enlarging page view 10
  - envelope feeder
    - bad connection message 112
    - capacity 191
    - clearing paper jams 100
    - envelope specifications 57
    - illustration 21
    - inserting and removing 58
    - load problems 113
    - loading 59
    - ordering 22
    - setting envelope size 210
    - setting size from control panel 71
    - setting type 210
    - specifications 55
    - supported paper sizes and weights 191
    - using 57
  - envelopes
    - adhesive strips or flaps 197
    - curled 197
    - double-side-seam 197
    - guidelines 55
    - handling flaps 197
    - loading in envelope feeder 59
    - margins 55, 198
    - printing 55
    - printing from envelope feeder 57
    - printing from tray 1 56
    - printing to rear output bin 45
    - setting size 210
    - setting type 210
    - solving repeated jams 110
    - specifications 55, 57, 197
    - storing 198
    - supported by envelope feeder 191
    - troubleshooting jams 197
    - wrinkled 55
  - environmental product stewardship 244
  - environmental specifications 201
  - equipment
    - defects 167
    - packing 165
    - returning 165
    - shipping 165
    - warranty 167, 246
  - equivalent weights to U.S. paper 194
  - error log. *See* event log
  - error messages. *See* messages
  - error page for PS 221
  - errors. *See* troubleshooting
  - escape characters
    - entering in DOS 237
    - examples 236
  - escape sequences
    - combining 237
    - selecting 156
  - Etalk setting 225
  - Ethernet cards, ordering 22
  - EtherTalk setting 225
  - event log 153
    - location in control panel control menus 208
    - printing with embedded web server 251



- viewing 208
  - event log page (embedded web server) 253
  - exiting control panel menus 30
  - expanding
    - memory 229
    - printer capability 229
  - extended warranty 246
  - extension for tray 1 46
- F**
- face-down output bin 44
  - face-up output bin 45
  - Fast Infrared (FIR)
    - description of receiver 80
    - IRDA compliance 148
    - ordering receiver 22
    - printing with 80
    - receiver port location 20
    - troubleshooting receiver 148
  - Fast Infrared Receiver User Guide* 14
  - FastRes 1200 217
  - FastRes resolution 16
  - FCC regulations 243
  - features of printer 16
  - feed rollers, replacing 93
  - feeding paper
    - manually from tray 1 71
    - problems 192
  - feeding paper manually 211
  - file directory, printing 208
  - finding words in online user guide 11
  - Finland laser statement 249
  - FIR (Fast Infrared). *See* Fast Infrared (FIR)
  - first page, printing different 67
  - Fit Page 10
  - Fit Visible 10
  - Fit Width 10
  - fixed-spaced fonts 238
  - flaps on envelopes 197
  - flash DIMMs
    - description 229
    - failure 114
    - ordering 22
    - write protected 114
  - flash file
    - failed operation 114
    - full 114
  - flash memory
    - downloading 37
    - initializing 37
  - Flip Pages Up binding option 52
  - flowchart for troubleshooting printer
    - problems 137
  - font list
    - description 156
    - printing 156
  - font lists. *See* PCL font list; PS font list fonts
    - fixed-space 238
    - information about 156
    - internal 156
    - not supported 33
    - on printer CD 33
    - ordering DIMMs 22
    - PCL bitmap 37
    - point sizes 238
    - printer features 16
    - printing list of 156
    - proportional-spaced 238
    - selecting PCL 238
    - selection commands for printer 241
    - setting Courier 216
    - setting number for PCL 215
    - setting PCL font point size 215
    - setting pitch for PCL 215
    - setting source 214
    - soft 156
    - symbol sets 238
    - troubleshooting for Macintosh 144
    - TrueType 37
    - verifying installed for printer 153
  - form length 214
  - form, Service Information 166
  - fraud hotline 161
  - frequent paper jams, solving 110
  - front panel. *See* control panel
  - fuser
    - cleaning 91
    - clearing jams 107
    - configuring mode 212
    - error message 122
    - location 20
    - paper wrapped around 116
    - removing 107
    - replacing 93
    - setting for rough and heavy paper 212
    - setting for transparencies 212
    - speed 16
- G**
- genuine HP toner cartridges 84
  - Getting Started Guide* 13
  - glossy paper, ordering 22
  - Go key 30
  - go to pages in online user guide 11
  - graphics
    - memory for printing complex 229
    - vector 235
  - gray background
    - problem 132
    - troubleshooting 192



- guidelines
  - card stock 63, 199
  - custom-size paper 63
  - duplexing 50
  - envelopes 55, 197
  - labels 61, 196
  - paper 188, 192
  - transparencies 62, 196
- H**
  - hard disk accessory
    - illustration 21
    - installing 233
    - ordering 22
  - hardware
    - defects 167
    - packing 165
    - returning 165
    - shipping 165
    - warranty 167, 246
  - heavy paper
    - fuser mode 212
    - printing 45, 63
    - specifications 198
  - held job
    - deleting 75
    - printing 74
  - held job timeout setting 221
  - help
    - ? control panel label 29
    - ? message 31
    - button in printer driver 37
    - embedded web server 252
    - exiting 31
    - fraud hotline 161
    - HP Support Assistant 160
    - language and in-country options 163
    - online services 157
    - online user guide 14, 31
    - printer driver 37
    - product repair assistance 162
    - screens 37
    - worldwide country/region sales and service offices 172
    - worldwide support options 162
  - high 1 and high 2 fuser mode settings 212
  - holding a job 74
  - home pages (embedded web server) 253
  - host systems 41
  - HP authorized resellers 160
  - HP Fast Infrared Receiver User Guide* 14
  - HP fraud hotline 161
  - HP JetAdmin software
    - using to set type and size settings 71
  - HP JetDirect print server
    - communicating with 150
    - illustration 21
    - installing 233
    - ordering cards 22
  - HP JetDirect Print Server Administrator's Guide* 13
  - HP JetDirect print server card
    - configuring network parameters 225
    - configuring with embedded web server 254
  - HP JetSend
    - description 38
    - installing 38
    - website 38
  - HP LaserJet paper 22
  - HP LaserJet Printing System 34
  - HP LaserJet Utility
    - description 40
    - on printer CD 33
  - HP Maintenance Agreement 165
  - HP Planet Partners program
    - description 245
    - website 245
  - HP Resource Manager
    - availability for Macintosh 37
    - description 37
    - where to install 33
  - HP Software License Terms 170
  - HP Support Assistant 160
  - HP SupportPacks 161, 246
  - HP UltraPrecise toner 16
  - HP Web JetAdmin 33
    - installing 41
    - using to check toner level 86
    - using to configure alerts 94
    - website 41
  - HP-GL/2 commands 235
  - HP-UX printer software 41
  - humidity specifications 202
- I**
  - I/O cards
    - description 21
    - installing 233
  - I/O communication settings 222
  - I/O Menu 222
  - I/O slots
    - description 229
    - learning what is installed 229
    - location 20
  - I/O timeout setting 222
  - IBM OS/2 printer driver 34
  - inches, setting for custom paper sizes 214
  - incorrect fonts 144
  - increasing page view 10
  - index cards 198
  - Information Menu 208



- infrared
    - installing software 80
    - printing with 80
  - input trays
    - bad connection message 112
    - cannot feed paper 112
    - clearing paper jams 102
    - empty condition message 117
    - location 19
    - locking 70
    - orienting paper for duplexing 51
    - understanding order used 68
  - input/output communication settings 222
  - inserting envelope feeder 58
  - installed personalities and options,
    - displayed on configuration page 153
  - installing
    - EIO cards 233
    - envelope feeder 58
    - HP JetSend 38
    - HP Resource Manager 37
    - HP Web JetAdmin 41
    - infrared software 80
    - mass storage devices 233
    - memory (DIMMs) 230
    - printer drivers 35
    - printers connected to network with HP
      - JetDirect print server 41
    - software 33
    - UNIX printer software 41
  - interface ports 20
  - internal fonts 156
  - IP address, displaying with embedded web
    - server 253
  - IP addresses, current 153
  - IP printing, configuring 40
  - IPX/SPX setting 225
  - IRDA compliance for Fast Infrared (FIR)
    - Receiver 148
  - Item key 30
- J**
- jam recovery setting 220
  - jams, paper. *See* paper jams
  - Japan VCCI statement 248
  - JetAdmin. *See* HP Web JetAdmin
  - JetDirect Print Server Administrator's Guide* 13
  - JetDirect print server. *See* HP JetDirect
    - print server
  - JetSend. *See* HP JetSend
  - job control commands for printer 239
  - job management 72
  - job retention 72
  - Job Storage Disk Error page 126
  - jobs
    - canceling 30
    - canceling with embedded web server 251
    - configuring timeout for held 221
    - deleting held 75
    - deleting private 77
    - deleting stored 79
    - formatted incorrectly 141
    - infrared 81
    - managing 72
    - not printing as expected 140
    - printing and deleting stored 207
    - printing private 76
    - printing stored 78
    - proofing and holding 74
    - quick copying 72
    - releasing private 76
    - retaining 72
    - setting number of private/stored 207
    - setting number of quick 206
    - specifying private 76
    - stop in the middle of printing 140
    - will not print 139
    - jumping to pages in online user guide 11
- K**
- keys on control panel 30
  - kit for printer maintenance
    - ordering 22
    - using 93
  - Korea EMI statement 248
- L**
- labels
    - orienting sheets 61
    - printing 61
    - printing to rear output bin 45
    - solving repeated jams 110
    - specifications 196
  - landscape orientation, setting 214
  - language page (embedded web server) 254
  - languages
    - not available for printer 116
    - options for customer service 163
    - printer features 16
    - printer selection commands 240
    - selecting printer personality default 221
    - setting for printer 221
    - switching printer 37
    - verifying installed for printer 153
    - wrong on control panel 137
    - wrong one displayed 137
  - laser safety statements
    - Finland 249
    - U.S. 248





LaserJet paper. See HP LaserJet paper  
 LaserJet Utility. See HP LaserJet Utility  
 LaserWriter printer driver 40  
 latest printer drivers 33  
 layout options  
     duplexing 52  
     printing multiple pages on one sheet 67  
 LEDs on control panel 29  
 length of printing on page 214  
 letterhead paper  
     duplexing 51  
     printing 53  
 letter-size paper, printing instead of A4 216  
 license for software 170  
 life expectancy for toner cartridges  
     checking 85  
     description 85  
 light printing  
     output problem 130  
     setting toner density 218  
 lights  
     on control panel 29  
     turning off (PowerSave) 219  
 line feed/carriage return setting 216  
 line voltage 201  
 lines  
     on page problem 131  
     on paper problem 135  
     setting number on page 214  
 linking to other websites from embedded  
     web server 254  
 loading  
     envelope feeder 59  
     envelopes in envelop feeder 57  
     envelopes in tray 1 56  
     tray 1 46  
     trays 2, 3, 4 47  
 LocalTalk cards, ordering 22  
 locating paper jams 97  
 locked menu message 112  
 locking  
     functions on control panel 40  
     trays 70  
 loose toner  
     problem 133  
     troubleshooting 192  
 Lotus 1-2-3, entering escape characters in  
     237  
**M**  
 Macintosh  
     availability of HP Resource Manager 37  
     HP LaserJet Utility 40  
     PPDs 35, 40, 145  
     printer drivers 37, 40  
     printing with infrared 80  
     renaming the printer 145  
     selecting alternate PPD 145  
     software 40  
     software on printer CD 33  
     troubleshooting flowchart 143  
 magnifying page view 10  
 maintenance  
     agreements 165  
     ordering kit 22  
     ordering parts 22  
     printer 93  
     repairs 162  
 maintenance message setting 220  
 manual cleaning page  
     running 91  
     setting 218  
 manual feed, setting 211  
 manually cleaning fuser 91  
 manually feeding paper 71  
 manuals. See documentation  
 map of control panel menus. See menu  
     map  
 margins  
     custom-size paper 63  
     envelopes 55, 198  
 marks on page problem 136  
 mass storage devices  
     installing 233  
     printing file directory 208  
 material safety data sheet (MSDS) 246  
 matrix of compatibility 203  
 maximum  
     paper size 189  
     printer temperature 193  
 measure, setting units of 214  
 media. See card stock; custom-size paper;  
     envelopes; HP LaserJet paper; index  
     cards; labels; letterhead paper;  
     paper; preprinted/prepunched paper;  
     special paper; transparencies  
 memory  
     changed settings message 115  
     checking installation 232  
     description 229  
     DIMM illustration 21  
     expansion 229  
     for printing complex graphics 229  
     full message 115  
     initializing 37  
     installation location 19  
     installing DIMMs 230  
     installing EIO cards/mass storage 233  
     insufficient 120  
     learning how much is installed 229  
     managing settings 232  
     shortage messages 115



- specifications 202
  - upgrading 229
  - Menu key 30
  - menu map
    - location in control panel menus 208
    - printing 32, 151
  - menu tree. *See* menu map
  - menus. *See* control panel menus
  - messages
    - clearing persistent 111
    - customizing 40
    - list, explanation, and recommended action 112
    - understanding 111
  - Microsoft Windows
    - configuring drivers 36
    - network software 33
    - printer drivers 35
    - printer fonts 16
    - printing with infrared 80
    - software included on printer CD 33
  - Microsoft Word for DOS, entering escape characters in 237
  - millimeters, setting for custom paper size 214
  - minimum paper size 189
  - misfeeding pages 141
  - misformed characters problem 134
  - model number for printer 20
  - mopying (collating)
    - error messages 126
    - using 65
  - moving around in online user guide 9
  - MS-DOS. *See* DOS
  - MSDS (material safety data sheet) 246
  - multi-purpose paper, ordering 22
  - multi-purpose tray. *See* tray 1
- N**
- naming
    - devices with embedded web server 253
    - printer 40
  - narrow paper, printing 53
  - navigating in online user guide 9
  - NetWare
    - configuring parameters 41
    - networks 36
    - setting 225
  - network
    - assigning zone 40
    - HP Web JetAdmin software for 41
  - network administrator software on printer CD 33
  - network pages (embedded web server) 254
  - networks
    - configuring parameters 225
    - HP Web JetAdmin 33
    - software 33
    - software for 41
    - troubleshooting Macintosh 143
  - noise emissions 202
  - notification of events, setting up 253
  - Novell NetWare
    - configuring parameters 41
    - networks 36
    - setting 225
  - numbers for printer, serial and model 20
  - n-up printing 67
- O**
- offline, sending printer 30
  - online help
    - ? message 31
    - exiting 31
    - printer 37
    - user guide 31
  - online operation, returning to 30
  - online services
    - description 157
    - direct ordering 160
    - HP Support Assistant 160
    - parts information 160
    - printer drivers, printer software, product and support information 157
    - software utilities 158
  - online user guide
    - browsing with thumbnails 11
    - finding information 10
    - finding words 11
    - magnifying page view 10
    - navigating 9
    - online help 14
    - paging through 11
    - printing 11
    - using online 9
  - operating systems
    - Red Hat Linux 41
    - Sun Solaris 41
    - supported 35
    - SuSE Linux 41
    - website for supported 41
  - operating temperature 202
  - order of trays used 68
  - order supplies page (embedded web server) 254
  - ordering
    - accessories and supplies 21
    - supplies through embedded web server 254
  - orientation
    - for duplexing 51



- orientation setting 214
- orienting
  - label sheets 61
  - special paper 54
  - transparencies 62
- OS/2 printer drivers 35
- other links page (embedded web server) 254
- output bins
  - clearing paper jams 106
  - location 20
  - using 44
- overhead transparencies. *See* transparencies
- override A4 with letter setting 216
- overriding printer settings 36
- ozone production 244

**P**

- packing equipment 165
- Page 134
- page control commands 239
- page count for printer 153
- paging through online user guide 9, 11
- paper
  - card stock 198
  - custom-size 45
  - guidelines for using 192
  - heavy 198
  - manually feeding 71
  - ordering 22
  - printing custom-size 63
  - problem symptoms, causes, and solutions 192
  - recycling 246
  - saving 244
  - settings for rough or heavy 212
  - specifications 188
  - supported weights and sizes 189
  - types supported 192
  - types to avoid 193
  - weight equivalences 194
- paper handling
  - available accessories 17
  - features 16
  - ordering accessories 22
- Paper Handling Menu 210
- paper jams
  - clearing from duplexer 104
  - clearing from envelope feeder 100
  - clearing from fuser area 107
  - clearing from output areas 106
  - clearing input tray areas 102
  - clearing top cover area 98
  - configuring alerts 94
  - configuring recovery behavior 220
  - locating 97
  - resolving repeated 110
- paper level indicator 19
- paper path
  - cleaning 91
  - test 209
- paper tray extension 46
- paper trays
  - adjustments 47
  - bad connection message 112
  - cannot feed paper 112
  - clearing jams 96, 102
  - empty condition message 117
  - loading 47
  - loading tray 1 46
  - location 19
  - locking 70
  - ordering 22
  - orienting paper for duplexing 51
- parallel communication setting 222
- parallel high speed setting 222
- parallel interface port 20
- partial page prints 130
- parts
  - after production has stopped 246
  - information on CD 160
  - location on printer 19
  - returning 165
  - shipping and packing 165
  - website for identification and pricing 160
- password
  - embedded web server 254
  - printer 40
- PC-8 symbol set 215
- PC-850 symbol set 215
- PCL
  - commands 235
  - printing font list 156
  - selecting fonts 238
  - setting as printer language 221
  - setting font number 215
  - setting font pitch 215
  - setting font point size 215
  - setting source of fonts 214
  - setting symbol set setting 215
- PCL 5e printer drivers
  - included with printer 35
  - when to use 37
- PCL 6 printer drivers
  - included with printer 35
  - when to use 37
- PCL bitmap fonts 37
- PCL command 239
- PCL font list
  - description 156
  - location in control panel menu maps 208



- printing 156
- PDF (portable document format) documents
  - browsing with thumbnails 11
  - finding information 10
  - finding words 11
  - icons 9
  - increasing and decreasing magnification 10
  - navigating 9
  - printing 11
  - using 9
  - viewing 10
- perform printer maintenance message 93
- permanent fonts 156
- permanent resources for printer 232
- personal identification number (PIN) for printing private/stored jobs 207
- personality (language), setting for printer 221
- Personality setting 221
- PhoneNET interface, ordering 22
- physical dimensions for printer 200
- pickup rollers, replacing 93
- PIN (personal identification number) for printing private/stored jobs 207
- pitch/point information 156
- PJL (Printer Job Language) commands 235
- Planet Partners program
  - description 245
  - website 245
- plastics, recycling 245
- portable document format (PDF) documents
  - browsing with thumbnails 11
  - finding information 10
  - finding words 11
  - icons 9
  - increasing and decreasing magnification 10
  - navigating 9
  - printing 11
  - using 9
  - viewing 10
- portrait orientation, setting 214
- ports
  - accessory interface 20
  - bidirectional parallel setting 222
  - FIR (Fast Infrared) receiver 20
  - locations 20
  - parallel interface 20
- postcards
  - paper weight equivalences 194
  - printing 63
  - specifications 198
- PostScript Level 2 emulation 35
- PostScript Printer Description files (PPDs). See PPDs (PostScript Printer Description files)
- PostScript Type 1 37
- PostScript Type 42 37
- PostScript. See PS
- power
  - connector location 20
  - consumption 201
  - requirements 201
  - saving 219, 244
  - standby 201
  - switch location 19
- PowerSave
  - mode 244
  - power consumption 201
  - setting 219
- PPDs (PostScript Printer Description files)
  - Macintosh 40
  - on printer CD 33
  - selecting alternate 145
- preprinted/prepunched paper
  - duplexing 51
  - printing 53
- preventative maintenance 93
- pricing for parts 160
- print cartridges. See toner cartridges
- print drivers. See printer drivers
- print jobs
  - canceling 30
  - configuring timeout for held 221
  - deleting held 75
  - deleting private 77
  - deleting stored 79
  - formatted incorrectly 141
  - infrared 81
  - managing 72
  - not printing as expected 140
  - printing private 76
  - printing stored 78
  - proofing and holding 74
  - quick copying 72
  - releasing private 76
  - retaining 72
  - setting number of quick 206
  - specifying private 76
  - stop in the middle of printing 140
  - will not print 139
- Print Quality Menu 217
- print quality problems
  - correcting 128
  - symptoms, causes, and solutions 192
- print resolution 217
- print servers, communicating with HP
  - JetDirect 150



- print speed 202, 217
- printer
  - cleaning 88
  - compatibility matrix 203
  - configurations 18
  - configuring settings with embedded web server 253
  - control panel description and illustration 29
  - current settings 151
  - dimensions 200
  - features and benefits 16
  - help software 37
  - maintenance 93
  - managing and troubleshooting remotely 41
  - managing internal resources 232
  - managing through network 41
  - maximum temperature 193
  - memory and expansion 229
  - naming 40
  - obtaining information with embedded web printer
    - browser 251
  - online help 31
  - operating systems supported 35
  - operating temperature 202
  - ordering supplies 22
  - overriding control panel settings 36
  - parts and locations 19
  - password 40
  - placing printer online or offline 30
  - pulling from wrong tray 142
  - relative 202
  - renaming for Macintosh 145
  - resetting 223
  - saving settings 66
  - setting up 13
  - setting up notification of events 253
  - software included on CD 33
  - space requirements 200
  - specifications 200
  - weight 201
- Printer Collation Error page 126
- printer commands
  - cursor positioning 240
  - description 235
  - font selection 241
  - language selection 240
  - PCL 235, 239
  - programming hints 240
  - syntax 236
- printer drivers
  - Apple LaserWriter 40
  - Apple LaserWriter 8 37
  - choosing the right one 37
  - configuring 36
  - configuring for duplexer 50
  - description 35
  - distributing 36
  - help software 37
  - included on printer CD 33
  - included with printer 35
  - infrared 80
  - Macintosh 40
  - Microsoft Windows 36
  - online help 14
  - OS/2 35
  - PCL 5e 37
  - PCL 6 37
  - PS 37
  - settings versus software program 32
  - troubleshooting Macintosh 143
  - website 157
- Printer Job Language (PJL) commands 235
- printer languages (personality), selecting default 221
- printer maintenance kit
  - ordering 22
  - using 93
- printer software
  - available on printer CD 33
  - website 157
- printer status page (embedded web server) 253
- printing
  - booklets 66
  - by type and size of paper 70
  - configuration page 152
  - control panel menu map 32
  - different first page 67
  - envelopes 55
  - envelopes from tray 1 56, 197
  - feeding paper manually 71
  - file directory 208
  - font list 156
  - for IP 40
  - heavy paper 63, 198
  - held jobs 74
  - labels 61
  - menu map 32, 151
  - multiple pages on one sheet 67
  - online user guide 11
  - paper path test 209
  - quick copy jobs 206
  - small or narrow paper 53
  - speed 202, 217
  - stops in the middle 140
  - stored jobs 78, 207
  - supplies status page 154
  - transparencies 62
  - usage page 208



- watermarks 66
  - with infrared receiver 80
  - Printing Menu 213
  - private job
    - deleting 77
    - printing 76
    - releasing 76
    - specifying 76
  - Private/Stored Jobs Menu 207
  - problems. *See* troubleshooting
  - Process Cleaning Page setting 218
  - product
    - compatibility matrix 203
    - repair 162
    - return 166
    - stewardship program 244
  - programming hint commands for printer 240
  - proof and hold feature 74
  - proofing a job 74
  - proportional-spaced fonts 238
  - ProRes resolution 16
  - protecting the environment 244
  - protocol settings 225
  - PS
    - error page prints 139
    - printing font list 156
    - setting as printer language 221
    - setting error page printing 221
  - PS font list
    - description 156
    - location in control panel menus 208
    - printing 156
  - PS printer drivers
    - included with printer 35
    - when to use 37
  - punched paper, printing 53
- Q**
- question mark (?)
    - in control panel messages 31
    - label on control panel 29
  - quick copy
    - additional copies 72
    - configuring number of stored jobs 221
    - deleting 73
    - description 72
    - printing 72
    - storing 72
  - Quick Copy Jobs Menu 206
  - Quick Sets 66
- R**
- RAM
    - disk problems 116
    - disk settings 221
  - Reader
    - website 12
  - Reader for Adobe Acrobat 10
  - ReadMe.txt file 33
  - ReadMe.wri file 33
  - Ready light 29
  - rear output bin
    - clearing paper jams 106
    - location 20
    - using 45
    - using with duplexer 50
  - rearoutput bin
    - location 19
  - recovery from jams, configuring behavior 220
  - recycled paper, ordering 22
  - recycling
    - non-U.S. returns 246
    - paper 246
    - plastics 245
    - toner cartridges 245
    - U.S. returns 245
  - Red Hat Linux 41
  - redistributing toner in the cartridge 86
  - refresh rate page (embedded web server) 254
  - regulations
    - Canada DOC 248
    - FCC 243
    - U.S. DOC 247
  - regulatory information 243
  - relative humidity specifications 202
  - remote printer management and troubleshooting 41
  - removing
    - envelope feeder 58
    - fuser 107
    - held print jobs 75
    - private jobs 77
    - private/stored jobs 207
    - quick copy 73
    - quick copy jobs 206
    - stored print jobs 79
  - renaming the printer for Macintosh 145
  - repacking equipment 165
  - repairs 162
  - repeated paper jams, solving 110
  - repeating
    - defects problem 133
    - image problem 134
    - paper jams 110
  - report on supplies usage 154
  - requirements
    - environmental 201
    - power 201
    - space 200



- resellers, HP authorized 160
- Reset Memory setting 223
- Resets Menu 223
- resetting the printer 223
- resolution
  - dpi capabilities 16
  - FastRes 16
  - levels of gray 16
  - ProRes 16
- Resolution Enhancement technology (REt)
  - setting 217
- resolution setting 217
- Resource Manager. *See* HP Resource Manager
- resource saving 232
- Restore Factory Settings 223
- restoring default settings 223
- resuming printing 30
- REt setting 217
- returning
  - equipment 165
  - toner cartridges in U.S. 245
  - toner cartridges outside the U.S. 246
- RIP ONCE 65
- rollers, replacing 93
- rough paper
  - printing 45
  - setting fuser mode for 212
- running the manual cleaning page 91

**S**

- safety statements
  - laser products 248
  - laser products in Finland 249
- saving
  - internal printer resources 232
  - paper 244
  - power 219, 244
  - printer settings 66
  - quick jobs 72
  - settings at control panel 30
  - toner 218, 244
- scaling page images 66
- securing information on configuration page 153
- security page (embedded web server) 254
- Select key 30
- serial cables, troubleshooting 139
- serial cards, ordering 22
- serial number
  - learning from configuration page 153
- serial number for printer
  - location 20
- service
  - agreements 160
  - HP SupportPacks 161
  - parts information on CD 160
  - See also* customer support
  - worldwide country/region offices 172
- Service Information form 166
- setting
  - binding edge 211
  - carriage return /line feed (CR/LF) option 216
  - cleaning page to run automatically 218
  - Courier font 216
  - custom paper option 213
  - custom paper sizes 63
  - default number of copies 213
  - default paper size 213
  - dimensions of short and long edges of
    - custom paper 214
  - draft quality printing through 300-dpi
    - resolution 217
  - duplex option 211
  - envelope type 210
  - fuser mode 212
  - manual feed 211
  - number of characters on line for A4 paper 216
  - number of lines on page 214
  - PCL font number 215
  - PCL font pitch 215
  - PCL font point size 215
  - PCL fonts 214
  - PCL symbol set 215
  - portrait or landscape orientation 214
  - response to toner low 87
  - response to toner lower 87
  - small paper speed 212
  - tray 1 mode 210
  - tray 1 option 69
  - tray 1 size 210
  - tray 1 to cassette 210
  - tray 1 type 211
  - tray 2 type 211
  - tray 3 type 211
  - tray 4 type 211
  - units of measure 214
- setting up printer 13
- settings
  - affecting printer messages 111
  - at control panel override printer driver and
    - software commands 205
  - auto continue 220
  - changing control panel 32
  - changing printer 40
  - changing printer driver 36
  - changing with embedded web server 251
  - clearable warnings 220
  - configuring 253
  - control panel 205



- cycling through and selecting at control panel 30
- envelope size 210
- input/output communication 222
- jam recovery 220
- maintenance message 220
- number of quick copy jobs 221
- printer driver versus software program 32
- printer personality (language) 221
- protocol 225
- PS error page 221
- RAM disk 221
- saving at control panel 30
- saving printer 66
- toner low and toner out 219
- verifying current 151
- viewing control panel 32
- shaking toner cartridges 86
- shelf life of toner cartridges 85
- shipping equipment 165
- SIMMs, compatibility with printer 229
- sizes 189
  - printing by 70
  - scaling pages 66
  - setting default image size for paper 213
  - setting for envelopes 210
  - setting for short and long edges of custom paper 214
  - setting for tray 1 210
  - supported for paper in duplexer 191
  - supported for paper in envelope feeder 191
  - supported for paper in tray 1 189
  - supported for paper in trays 2, 3, 4 190
- skewed page problem 134
- slides. See transparencies
- slow print speed problem 140
- slow printing, setting 212
- small paper
  - printing 45, 53
  - setting speed 212
- smearing on paper problem 132
- soft fonts 156
- soft fonts, setting 214
- soft gloss paper, ordering 22
- software
  - for Windows 36
  - help for printer drivers 37
  - included on printer CD 33
  - license 170
  - Macintosh 40
  - network 33, 41
  - utilities 158
- software CD
  - for printer 33
  - ordering 22
- Solaris
  - installing printer software 41
  - used with HP Web JetAdmin 41
- space requirements 200
- spare parts after production has stopped 246
- special paper
  - manually feeding 71
  - ordering 21
- specifications
  - acoustic emissions 202
  - card stock 198
  - electrical 201
  - envelope feeder 197
  - envelopes 197
  - environmental 201
  - general 202
  - heavy paper 198
  - humidity 202
  - labels 196
  - memory 202
  - paper 188
  - printer 200
  - transparencies 196
- specks on page problem 130
- speed
  - printer 16
  - printing 217
  - setting for small paper 212
  - slower than expected 140
  - transmitting data 222
- spots on page problem 136
- standby power consumption 201
- static electricity when installing memory 230
- stored jobs
  - deleting 207
  - printing 207
- storing
  - envelopes 198
  - print jobs 78
  - toner cartridges 85
- straight-through paper path 45
- Sun Solaris
  - installing printer software 41
  - used with HP Web JetAdmin 41
- supplies
  - after production has stopped 246
  - direct ordering 160
  - level of consumption 253
  - list and illustration 21
  - obtaining information with embedded web server 251
  - ordering 22
  - printing status page 154
  - recycling in U.S. 245





- recycling outside U.S. 246
- usage report 154
- website 245
- supplies page (embedded web server) 253
- supplies status page
  - description 155
  - location in control panel menus 209
  - printing 154
- Support Assistant 160
- support. *See* customer support
- SupportPacks 161, 246
- SuSE Linux 41
- switching printer languages 37, 221
- symbol set for PCL 215
- Symphony, entering escape characters in 237
- symptoms of output quality problems 128

**T**

- TCP/IP protocol, setting 226
- TCP/IP setting 225
- technical support. *See* customer support
- temperature
  - maximum printer 193
  - operating 202
- testing the paper path 209
- throughput of printer 16
- thumbnails, using to browse in online user guide 11
- timeouts
  - for held jobs 221
  - for input/output 222
- tire tracks on page problem 136
- Token Ring cards, configuring 226
- toner
  - checking level 85
  - cleaning from clothing 89, 98
  - density 218
  - fuser mode for best possible fusing 212
  - HP UltraPrecise 16
  - loose problem 133
  - non-HP detected 116
  - redistributing in cartridge 86
  - remaining in printer after paper jam 97
  - saving 244
  - smear problem 132
  - troubleshooting 192
- toner cartridges
  - authenticating 84
  - checking toner level 85
  - clearing paper jams 98
  - configuring toner low and toner out settings 219
  - disadvantages of non-HP 84
  - features 16
  - hotline to report fraud 161
  - installing 14
  - life expectancy 85
  - location 20
  - material safety data sheet (MSDS) 246
  - ordering 22
  - printing report on usage 154
  - recycling 245
  - shaking 86
  - shelf life 85
  - storing 85
  - supplies information available with genuine HP 84
  - warranty 169
- Toner Density setting 218
- toner low
  - configuring alerts 94
  - configuring response 87
  - description 87
- toner low setting 219
- toner out
  - configuring alerts 94
  - configuring response 87
  - description 87
- toner out setting 219
- top cover
  - clearing paper jams under 98
  - location 19
- top output bin
  - clearing paper jams 106
  - location 19
- tracks on page problem 136
- transfer rollers, replacing 93
- transmitting data, speed 222
- transparencies
  - fuser mode for 212
  - ordering 22
  - printing 44, 62
  - solving repeated jams 110
  - specifications 196
- tray 1
  - capacity 189
  - cassette vs. first mode 69
  - clearing paper jams 102
  - customizing operation 69
  - description 46
  - envelope specifications 197
  - feeding paper
    - setting for manual 211
  - load message 118
  - loading 46
  - location 19
  - orienting paper for duplexing 51
  - orienting special paper 54
  - printing envelopes 55
  - setting how printer will use (mode) 210
  - setting size 210



- setting size from control panel 70
- setting type 211
- supported paper sizes and weights 189
- tray 2
  - adjusting for paper 47
  - bad connection message 112
  - clearing paper jams 102
  - description 47
  - load message 118
  - loading 47
  - location 19
  - orienting paper for duplexing 51
  - orienting special paper 54
  - setting size from control panel 70
  - setting type 211
  - supported paper sizes and weights 190
- tray 3
  - adjusting for paper 47
  - bad connection message 112
  - clearing paper jams 102
  - description 47
  - load message 118
  - loading 47
  - orienting paper for duplexing 51
  - orienting special paper 54
  - setting size from control panel 70
  - setting type 211
  - supported paper sizes and weights 190
- tray 4
  - adjusting for paper 47
  - bad connection message 112
  - clearing paper jams 102
  - description 47
  - load message 118
  - loading 47
  - orienting paper for duplexing 51
  - orienting special paper 54
  - setting size from control panel 70
  - setting type 211
  - supported paper sizes and weights 190
- trays
  - clearing jams 102
  - location 19
  - obtaining configuration information with embedded web browser 251
  - ordering 22
- troubleshooting
  - control panel messages 111
  - flowchart 137
  - HP Fast Infrared Receiver 148
  - HP JetDirect print server communication 150
  - output quality problems 128
  - paper jams 96
  - print quality problems 192
  - repeated paper jams 110
  - summary of techniques 95
  - using information pages 151
  - TrueType fonts 37
  - two-up printing 67
  - type settings, printing by 70
- U**
  - UltraPrecise toner 16
  - unauthorized access, preventing 40
  - understanding tray order 68
  - units of measure, setting 214
  - UNIX printer installer 41
  - upgrading memory 229
  - usage page
    - printing from control panel 208
    - viewing from embedded web server 253
  - usage reporting 154
  - USB cards, ordering 22
  - user guide
    - browsing with thumbnails 11
    - finding information 10
    - finding words 11
    - magnifying page view 10
    - navigating 9
    - online help 14
    - paging through 11
    - printing 11
    - using online 9
  - utilities for software 158
- V**
  - Value+ key 30
  - VCCI statement for Japan 248
  - vector graphics 235
  - verifying
    - accessories installation 152
    - current settings 151
    - memory installation 232
  - vertical spacing, setting on page 214
  - vertical white lines problem 135
  - viewing
    - online user guide 10
    - PDF (portable document format) files 10
- W**
  - warnings setting 220
  - warranty
    - extended 246
    - hardware maintenance 246
    - information 165
    - printer 167
    - toner cartridge 169
  - watermarks
    - orienting paper for duplexing 51
    - printing 66



wavy paper problem 135  
Web JetAdmin. *See* HP Web JetAdmin  
web server. *See* embedded web server  
websites  
    Adobe Acrobat Reader 12  
    HP JetSend 38  
    HP Planet Partners program 245  
    HP Support Packs 161  
    HP Web JetAdmin 41  
    linking with embedded web server 254  
    material safety data sheet (MSDS) 246  
    parts identification and pricing 160  
    printer software 157  
    supplies 245  
    supported host systems 41  
weight  
    envelopes in envelope feeder 191  
    paper 189  
    paper equivalences 194  
    paper in duplexer 191  
    paper in tray 1 189  
    paper in trays 2, 3, 4 190  
    printer 201  
white lines problem 135  
white spots on black problem 136  
wide A4 setting 216  
Windows. *See* Microsoft Windows  
Word Perfect for DOS, entering escape  
    characters in 237  
worldwide country/region sales and service  
    offices 172  
wrinkled paper problem 135  
wrong printer selected for Macintosh 144  
wrong tray used for printing 142

## X

x dimension (short edge) of custom paper  
    214

## Y

y dimension (long edge) of paper 214

## Z

zone, assigning on the network 40  
zooming in and out of pages 10  
ZoomSmart 66









i n v e n t

copyright © 2002  
Hewlett-Packard Company

<http://www.hp.com/support/lj4100>