

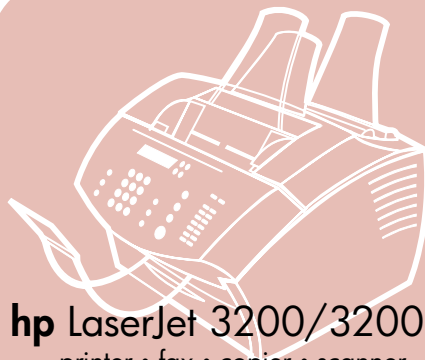

i n v e n t



hp LaserJet 3200/3200m
printer • fax • copier • scanner

**user
guide**

**LaserJet
all-in-one**



hp LaserJet 3200/3200m product

user guide

Copyright and License

© Hewlett-Packard Company 2002

All Rights Reserved. Except as allowed by copyright laws or herein, reproduction, adaptation, or translation without prior written permission is prohibited.

A user of the Hewlett-Packard printer associated with this user guide is granted a license to: a) print hard copies of this user guide for PERSONAL, INTERNAL, or COMPANY use subject to the restriction not to sell, resell, or otherwise distribute the hard copies; and b) place an electronic copy of this user guide on a network server provided access to the electronic copy is limited to PERSONAL, INTERNAL users of the Hewlett-Packard printer associated with this user guide.

Edition 5, 5/2003

The information contained in this document is subject to change without notice.

NOTICE TO U.S. GOVERNMENT USERS: RESTRICTED RIGHTS COMMERCIAL COMPUTER SOFTWARE: Use, duplication, or disclosure by the Government is subject to restrictions as set forth in subparagraph (c)(1)(ii) of the Rights in Technical Data Clause at DFARS 52.227-7013.

Material scanned by this product may be protected by governmental laws and other regulations, such as copyright laws. The customer is solely responsible for complying with all such laws and regulations.

Trademark Credits

Microsoft, Windows, and MS-DOS are U.S. registered trademarks of Microsoft Corporation. ENERGY STAR is a U.S. registered service mark of the U.S. EPA. CompuServe is a trademark of CompuServe, Inc. All other products mentioned herein may be trademarks of their respective companies.

This product is approved for use only in:

Australia, Canada, Hong Kong SAR, Ireland, Malaysia, New Zealand, Singapore, the United States, and the United Kingdom.

Local country/region laws may prohibit the use of this product outside of the countries/regions specified. It is strictly forbidden by law in most countries/regions to connect nonapproved telecommunications equipment (fax machines) to public telephone networks.



Safety Information

WARNING!

Potential Shock Hazard

Always follow basic safety precautions when using this product to reduce risk of injury from fire or electric shock.

- 1 Read and understand all instructions in the user guide.
- 2 Use only a grounded electrical outlet when connecting the HP LaserJet 3200 product to a power source. If you don't know whether the outlet is grounded, check with a qualified electrician.
- 3 Do not touch the contacts on the end of the telephone cord or any of the sockets on the HP LaserJet 3200 product. Replace damaged cords immediately.
- 4 Never install telephone wiring during a lightning storm.
- 5 Observe all warnings and instructions marked on the product.
- 6 Unplug this product from wall outlets and telephone jacks before cleaning.
- 7 Do not install or use this product near water or when you are wet.
- 8 Install the product securely on a stable surface.
- 9 Install the product in a protected location where no one can step on or trip over the line cord and the line cord will not be damaged.
- 10 If the product does not operate normally, see "Problem Solving and Product Maintenance," see chapter (starting on page 147).
- 11 Refer all servicing questions to qualified personnel.

Information regarding FCC Class B, Parts 15 and 68 requirements can be found in "Specifications." "Specifications" on page 227.

Contents

1 About This Guide

Introduction	11
Using this guide with your product functionality	12

2 Getting to Know the Product

Introduction	13
What you can do with the product	14
When the product is directly connected to a computer	14
When the product is connected to a network	16
Identifying product components	18
Control panel lights and keys	18
Identifying hardware parts	21
Selecting print media	23
Selecting media to print	23
Selecting items for faxing, copying, or scanning	25
Loading print media	26
Loading print media to be faxed, copied, or scanned	26
Loading media to be printed	28
Selecting the output path	31
Features available only through the software	32
Using the HP LaserJet Director	32
Using the HP LaserJet Document Manager (Windows) or the HP LaserJet Workplace (Mac OS)	35

3 Managing General Default Settings, Logs, and Reports

Introduction	37
Changing general default settings	38
Changing the default paper size for the paper input tray	38
Changing sound volume	39
Changing the language on the display panel	41
Restoring factory defaults	41
Managing logs and reports	42
Printing the fax activity log	43
Setting the fax activity log to print automatically	44
Printing a fax call report	45
Setting when the fax call report prints	45
Including the first page of each fax on the fax call report	46
Printing a one-touch, speed-dial, and group-dial report	47

Printing the control panel menu structure	47
Printing a configuration report.	48
Printing the block fax list	48
Printing a PCL font list	49
Printing a PostScript font list	49
Printing all fax reports	50
Printing a T.30 protocol trace report	50
Setting when the T.30 protocol trace report prints	51

4 Faxing

Introduction	53
Sending faxes	54
Sending faxes to one recipient	55
Quickly programming speed-dial codes or one-touch keys	55
Sending faxes to multiple recipients	57
Sending a fax at a future time	59
Redialing manually	60
Using the Contrast button to adjust the contrast for the current fax or copy job	61
Adjusting the resolution for the current job	62
Canceling the current fax job	64
Canceling a fax job using Fax Job Status	64
Receiving faxes	65
Receiving faxes when you hear fax tones	65
Reprinting faxes	66
Blocking or unblocking fax numbers	67
Advanced send fax features and settings	69
About speed-dial codes, one-touch keys, and group-dial codes	70
Programming speed-dial codes and one-touch keys	71
Programming a one-touch key for alternate long distance	73
Programming group-dial codes	74
Deleting all speed-dial codes, one-touch keys, and group-dials codes	76
Using Manual Dial	77
Sending a fax by dialing from a telephone	77
Inserting a pause or wait into a fax number	78
Using dialing characters	78
Changing the information in the fax header	79
Changing the default contrast and resolution for outgoing faxes.	81
Selecting tone- or pulse-dialing mode.	82
Changing how the product redials	83
Inserting a dial prefix.	84
Changing the detect dial tone setting	85

Advanced receive fax features and settings	86
Using fax forwarding	87
Requesting a fax from another fax machine (polling)	88
Clearing faxes from memory	89
Changing how the product answers incoming faxes.	90
Changing answer ring patterns	91
Enabling an extension phone	93
Changing the silence-detect mode	94
Changing autoreduction for incoming faxes	95
Enabling stamp received faxes	96
Setting error correction	97
Faxing using the software	98
Sending faxes from the software	98
Receiving faxes to your computer.	99
Customizing your own fax cover sheet	100

5 Printing

Introduction	103
Printer drivers	104
Choosing a printer driver.	104
Gaining access to the printer driver	105
Printer tasks	106
Printing on letterhead and envelopes	107
Printing on special media	109
Stopping a print job.	111
Saving toner when printing drafts	111
Printing on both sides of paper	112
Printing multiple pages on one sheet of paper	114
Creating and using watermarks	114
Printer settings	115
Changing the resolution	115
Saving printer settings for different print jobs	116
Printing Tips	117
Tips for printing custom sizes	117
Tips for printing envelopes	117
Tips for printing labels	118

6 Copying

Introduction	119
Copying tasks	120
Making black and white copies	121
Making color copies	122
Using the Contrast button to adjust the contrast for the current fax or copy job	122
Adjusting copy quality for the current job	123
Reducing or enlarging copies for the current job	123

Default Copy Settings	125
Changing the default copy quality.	126
Changing the default copy contrast	126
Changing the default copy size.	127
Changing the default copy collation	128
Changing the default number of copies	129

7 Scanning

Introduction	131
Scanning basics	132
Scanning from the product software	133
Starting a scan	133
Working with scanned items	136
About OCR software	138
Scanning from the product control panel.	139
Using the Scan key to scan	139
Adding or deleting scan destinations	140
Scanning with TWAIN-enabled software.	142
Sending scanned items as e-mail attachments.	143
Sending e-mail from the product.	143
Sending e-mail in an alternative mode	145

8 Problem Solving and Product Maintenance

Introduction	147
General troubleshooting checklist	148
Resolving fax problems.	149
Fax setup checklist	149
General fax problems	152
Sending fax problems	153
Receiving fax problems.	155
Resolving printing problems	159
General printing problems.	159
Printing problems when using MS-DOS	163
Resolving copying problems	164
Resolving scanning problems	166
Resolving paper feed problems.	170
Clearing jams from the printer path areas.	170
Clearing jams from the scanner path areas	177
Resolving image quality problems.	181
Resolving control panel error messages.	195
Common Macintosh problems.	202
Problems in the Chooser	203
Printing errors	204
USB problems.	204
Selecting an alternate PPD.	206
Renaming the printer driver	207

Resolving PostScript Errors	207
Restoring the factory defaults	209
Uninstalling the software	210
Product Maintenance	211
Cleaning the print paper path	211
Cleaning the scanner path	213
Recalibrating the scanner	216
Managing HP LaserJet toner cartridges	216
Using Memory (DIMMs)	220
Installing a new document scanner separation pad	225

Appendix A Specifications

Introduction	227
Product specifications	228
Overall specifications	228
Faxing specifications	229
Printing specifications	229
Copying specifications	230
Scanning specifications	230
Paper specifications	231
Supported paper sizes	231
Paper weight equivalence table (approximate)	232
Transportation	233
Laser safety statement	233
FCC regulations	234
FCC part 68 requirements	235
Telephone consumer protection act (U.S.)	236
IC CS-03 requirements	237
Regulatory information for European Union countries	238
New Zealand Telecom Regulatory Notices	238
Declaration of conformity	239
Canadian DOC regulations	240
Environmental product stewardship program	240
Material safety data sheet	243
Battery Specifications	243

Appendix B Service and Support Information

Warranty information	245
Hewlett-Packard limited warranty statement	245
Obtaining hardware service	247
Returning the unit	247
Service information form	248
Software license agreement	249
HP Customer Care	251

HP sales and service offices253
Worldwide Hewlett-Packard Country/Region	
Sales and Service Offices253
Ordering parts257
Ordering software259

Glossary

Index

1 About This Guide

Introduction

This user guide provides details for initiating tasks from the product control panel, changing infrequently used settings, resolving problems, and contacting HP support. This guide also provides an overview of how the software works.





Other resources for product information

You can obtain product information that is not included in this guide from the following resources:

- **Getting Started Guide** – You already referred to this guide when you set up the product. It includes specific information about setting up the product and installing the software.
- **Software Help** – The software Help includes overview information about and procedures performed using the software.
- **World Wide Web** – The following is a website created for the HP LaserJet 3200 product:
<http://www.hp.com/support/lj3200/>

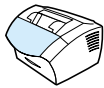
Using this guide with your product functionality

Because product functionality varies according to installation, all procedures in this guide will have one or more of the following icons above them to denote the location from which you can perform that procedure. This user guide focuses on control panel procedures, some of which you can also do from the software. More than one icon can appear above a procedure.

This icon	Appears
	For procedures you can do from the control panel.
	For procedures you can do from the HP LaserJet Director or software when the product is directly connected to <i>your computer</i> using a universal serial bus (USB) or parallel cable. For more information regarding these procedures, see the software Help.
	For procedures you can do from your computer if the product is connected to the network using a supported HP JetDirect print server.
	For procedures you can do from your Windows-compatible computer if the product is directly connected to <i>someone else's computer</i> using a parallel cable and the other person has Windows sharing available. The only procedures you can do are printing-related.

2 Getting to Know the Product

Introduction

The HP LaserJet 3200 product, a powerful business tool, gives you the capabilities of a full range of office equipment. With this product, you can:

- **Fax** – Use the product as a standalone fax machine to send and receive laser-quality faxes, as well as to perform advanced tasks such as forwarding faxes to another location. See “Faxing” on page 53 for more information.
- **Print** – Easily print documents at 1200 dots per inch (dpi) with a print speed of nine pages per minute. See “Printing” on page 103 for more information.
- **Copy** – Make superior laser-quality copies. You can make up to 99 copies of a 30-page original. You can also adjust the contrast, enlarge or reduce the copies, collate, and more. See “Copying” on page 119 for more information.
- **Scan** – Scan important color or black-and-white documents to create electronic files of them. Scan documents and save them on a website. Use the scanner to make a fax cover sheet, or scan documents for use with other software. You can also scan a document and attach it to an e-mail message (if you have a compatible e-mail program). See “Scanning” on page 131 for more information.
- **Use Software** – Use the software to store and organize documents so you can quickly find that invoice, receipt, or business card from weeks ago. See the software Help for more information about using the software.

This multifunction product helps increase your productivity by allowing you to do more than one task at a time. For example, send an electronic fax while the product makes copies, or scan a document while printing. See “What you can do with the product” on page 14.

What you can do with the product

The tables in this section show which functions will work when another function is already in use:

- When the product is directly connected to a computer, or
- When the product is connected to a network.

When the product is directly connected to a computer

This table shows what functions will work when another function is already in use if the product is directly connected to your computer.

If the product is:	Can I?						
	Send a print job	Receive a paper fax	Send a paper fax	Receive a PC fax	Send a PC fax	Scan to the PC	Copy
Printing a file	Yes. Prints when first print job ends.	Yes. Prints when first job ends.	Yes.	Yes.	Yes.	Yes.	No. Wait until print job ends.
Printing a paper fax	Yes. Prints when fax printing ends.	Yes. Prints when first job ends.	Yes.	Yes.	Yes.	Yes.	No. Wait until print job ends.
Receiving a paper fax	Yes. Prints when fax printing ends.	No. Phone line is in use.	Yes. Sends when first fax job ends.	No. Phone line is in use.	Yes. Sends when first fax job ends.	Yes.	Yes, if a print job is not activated.
Sending a paper fax	Yes.	No. Phone line is in use.	Yes. Sends when first fax job ends.	No. Phone line is in use.	Yes. Sends when first fax job ends.	Yes, if the document feeder tray is not in use.	Yes, if the document feeder tray is not in use.
Copying	Yes. Prints when copying ends.	Yes. Prints when copying ends.	Yes, if the document feeder tray is not in use.	Yes.	Yes.	Yes, if the document feeder tray is not in use.	No. Wait until print job ends.

If the product is:	Can I?						
	Send a print job	Receive a paper fax	Send a paper fax	Receive a PC fax	Send a PC fax	Scan to the PC	Copy
Receiving a PC fax	No.	No. Phone line is in use.	No. Sends when first fax job ends.	No. Phone line is in use.	No. Sends when first fax job ends.	No.	No.
Sending a PC fax	Yes.	No. Phone line is in use.	Yes. Sends when first fax job ends.	No. Phone line is in use.	Yes. Sends when first fax job ends.	Yes.	Yes.
Scanning	Yes.	Yes.	No. Document feeder tray is in use.	Yes.	Yes.	No. Document feeder tray is in use.	No. Document feeder tray is in use.

When the product is connected to a network

This table shows what functions will work when you or another network user are using some other function, and the product is connected to the network using a supported HP JetDirect print server.

If the product is:	Can I?						
	Send a print job	Receive a paper fax	Send a paper fax	Receive a PC fax	Send a PC fax	Scan to the PC	Copy
Printing a file	Yes. Prints when first print job ends.	Yes. Prints when file print job ends.	Yes.	No. Not available to network users.	Yes.	Yes.	No. Wait until print job ends.
Printing a paper fax	Yes. Prints when fax printing ends.	Yes. Prints when first job ends.	Yes.	No. Not available to network users.	Yes.	Yes.	No. Wait until print job ends.
Receiving a paper fax	Yes. Prints when fax printing ends.	No. Phone line is in use.	Yes. Sends when first fax job ends.	No. Not available to network users.	Yes. Sends when first fax job ends.	Yes.	Yes, if print job is not activated.
Sending a paper fax	Yes.	No. Phone line is in use.	Yes. Sends when first fax job ends.	No. Not available to network users.	Yes. Sends when first fax job ends.	Yes, if the document feeder tray is not in use.	Yes, if the document feeder tray is not in use.
Copying	Yes. Prints when copying ends.	Yes. Prints when copying ends.	Yes, if the document feeder tray is not in use.	No. Not available to network users.	Yes.	Yes, if the document feeder tray is not in use.	No. Wait until print job ends.
Receiving a PC fax	No. Network users cannot receive PC faxes.	No. Network users cannot receive PC faxes.	No. Network users cannot receive PC faxes.	No. Not available to network users.	No. Network users cannot receive PC faxes.	No. Network users cannot receive PC faxes.	No. Network users cannot receive PC faxes.
Sending a PC fax	Yes.	No. Phone line is in use.	Yes. Sends when first fax job ends.	No. Not available to network users.	Yes. Sends when first fax job ends.	Yes.	Yes.

If the product is:	Can I?						
	Send a print job	Receive a paper fax	Send a paper fax	Receive a PC fax	Send a PC fax	Scan to the PC	Copy
Scanning	Yes.	Yes.	No. Document feeder tray is in use.	No. Not available to network users.	Yes.	No. Document feeder tray is in use.	No. Document feeder tray is in use.

Identifying product components

The topics in this section familiarize you with the control panel and how to use it. They also provide graphics of the product to help identify the different external hardware parts.

- Control panel lights and keys
- Using the control panel menu structure
- Identifying hardware parts

Control panel lights and keys

The lights on the control panel provide the status of the product, and the keys are used to fax paper-based documents, make copies, scan documents, and adjust settings for the product. See “Using the control panel menu structure” on page 19 for more information about menu settings.

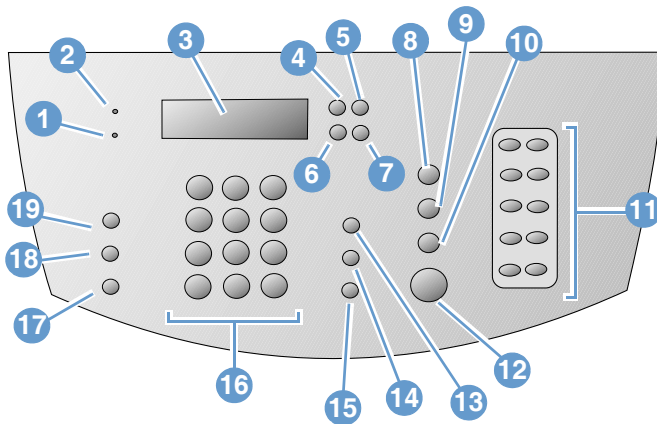

- | | |
|--------------------------------------------------------------------------------------------------------------------------------------------------------------------------------------------------------------------------------------------------------------------|-----------------------------------------------------------------------------------------------------------------------------------------------------------------------------------------------------------------------------------------------------------------------------------------------------------------------------------------------------------------------------------------------------------------------------|
| <p>1 Error light – When solid, indicates an error condition.</p> <p>3 Control Panel Display – Displays messages or Menu settings.</p> <p>5 Back Space key – Use to go up one level in the Menu settings or to backspace when typing text.</p> | <p>2 Ready Light – When solid, indicates the product is ready and has no error conditions. When blinking, indicates the product is processing a job.</p> <p>4 Enter/Menu key – Use to gain access to the Menu, save a selection, or go down one level in the Menu settings.</p> <p>6 Back Arrow key (<) – Use to scroll back through items at the same Menu level or to move back through text.</p> |
|--------------------------------------------------------------------------------------------------------------------------------------------------------------------------------------------------------------------------------------------------------------------|-----------------------------------------------------------------------------------------------------------------------------------------------------------------------------------------------------------------------------------------------------------------------------------------------------------------------------------------------------------------------------------------------------------------------------|

- | | |
|-----------------------------------------------------------------------------------------------------------------------------------------------------------------------------------------------------------------------------------------------------------------------------------------------------------------------------------------------------------------------------------------------------------------------------------------------------------------------------------------------------------------------------------------------------------------------------------------------------------------------------------------------------------------------------------------------------------------------------------------------------------------------------|---------------------------------------------------------------------------------------------------------------------------------------------------------------------------------------------------------------------------------------------------------------------------------------------------------------------------------------------------------------------------------------------------------------------------------------------------------------------------------------------------------------------------------------------------------------------------------------------------------------------------------------------------------------------------------------------|
| <p>7 Forward Arrow key (>) – Use to scroll forward through items at the same Menu level or to insert a space when typing text.</p> <p>9 Scan key – Starts the scan function.</p> <p>11 One-touch keypad – Use the keys on the one-touch keypad to store frequently dialed fax numbers.</p> <p>13 Volume key – Use to adjust the line monitor volume for incoming and outgoing fax sounds.</p> <p>15 Redial/Pause key – Press to redial the last fax number or to insert a pause into a fax number.</p> <p>17 Reduce/Enlarge key – Use to adjust the size of the current copy job.</p> <p>19 Contrast key – Use to adjust the contrast, or difference between light and dark areas, for the current fax or copy job.</p> | <p>8 Stop/Clear key – Stops or clears any action in progress, or exits the Menu settings.</p> <p>10 Copy key – Starts the copy function.</p> <p>12 Fax/Send key – Starts the fax function, or use to enter into manual dialing mode.</p> <p>14 Speed-Dial key – Press this key plus a one-, two-, or three-digit code on the numeric keys to fax to previously stored fax numbers.</p> <p>16 Numeric keys – Use to type codes and enter fax numbers. Also use to add letters when typing a name in the fax header or for speed-dials.</p> <p>18 Resolution key – Use to adjust the resolution, or sharpness, for the current fax or copy job.</p> |
|-----------------------------------------------------------------------------------------------------------------------------------------------------------------------------------------------------------------------------------------------------------------------------------------------------------------------------------------------------------------------------------------------------------------------------------------------------------------------------------------------------------------------------------------------------------------------------------------------------------------------------------------------------------------------------------------------------------------------------------------------------------------------------|---------------------------------------------------------------------------------------------------------------------------------------------------------------------------------------------------------------------------------------------------------------------------------------------------------------------------------------------------------------------------------------------------------------------------------------------------------------------------------------------------------------------------------------------------------------------------------------------------------------------------------------------------------------------------------------------|

Using the control panel menu structure

What follows is a hierarchical diagram of the control panel menu structure. You might want to refer to this menu structure while making changes to settings and features.

To print a copy of this menu structure, see “Printing the control panel menu structure” on page 47. To see which settings are currently selected, print a configuration report. See “Printing a configuration report” on page 48 for instructions.

The following is a general procedure for using the control panel menu.

To use the control panel keys:

- 1** Press **ENTER/MENU** to begin.
- 2** Use the **<** or **>** key to select one of the choices from the main Menu, and then press **ENTER/MENU**.
- 3** Use the **<** or **>** key to select one of the choices from the Submenu and press **ENTER/MENU**.
- 4** If applicable, use the **<** or **>** key to select one of the choices from the second Submenu and press **ENTER/MENU**.

Control panel main menu and first submenu

The following lists the choices in the control panel main menu and the corresponding first submenu.

Main Menu	Submenu
FAX JOB STATUS	
FAX FUNCTIONS	SEND FAX LATER STOP RECEIVE TO PC REPRINT LAST FAXES POLLING RECEIVE CLEAR STORED FAXES
TIME/DATE, HEADER	TIME/DATE FAX HEADER
COPY SETUP	DEFAULT QUALITY DEFAULT CONTRAST DEFAULT COLLATION DEFAULT # OF COPIES DEF. REDUCE/ENLARGE
REPORTS	FAX ACTIVITY LOG FAX CALL REPORT SPEED DIAL REPORT MENU STRUCTURE CONFIGURATION REPORT BLOCK FAX LIST PCL FONT LIST POSTSCRIPT FONTS ALL FAX REPORTS
FAX SETUP	SPEED DIALS FAX SEND SETUP FAX RECEIVE SETUP ALL FAXES
COMMON SETTINGS	LANGUAGE DEFAULT PAPER SIZE PRINT DENSITY VOLUME SETTINGS
SERVICE	SCAN CALIBRATION PRINT T .30 TRACE CLEANING MODE RESTORE DEFAULTS

Identifying hardware parts

The two graphics that follow show the external hardware parts of the product.

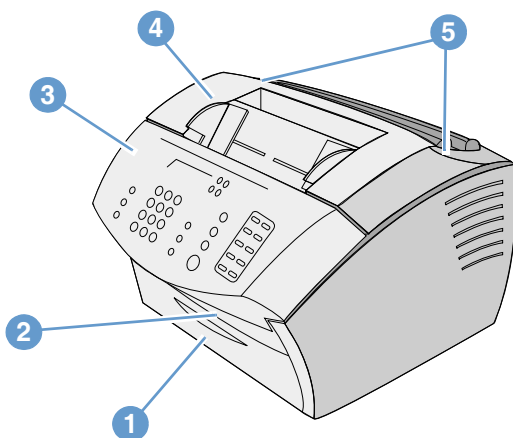

- 1 Front paper path door
- 2 Document output slot
- 3 Document release door/control panel
- 4 Printer door
- 5 Printer door release latches

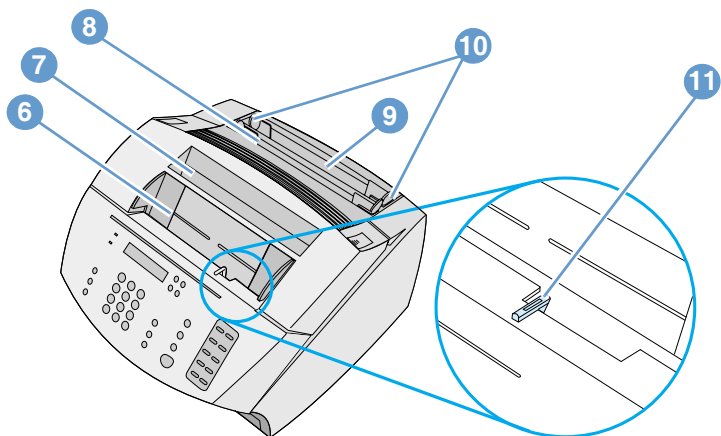

- 6** Document feeder tray
- 7** Paper output bin
- 8** Single-sheet input slot
- 9** Paper input tray
- 10** Paper input guides
- 11** Special media lever

Selecting print media

In this section you will find information on:

- Selecting media to print
- Selecting items for faxing, copying, or scanning

Selecting media to print

If available in your area, HP recommends that you use HP LaserJet or HP Multipurpose paper (because it has been designed specifically for use with your product), use or paper that meets HP's specifications. You can use paper with up to 100% recycled fiber content if it meets HP's specifications. To order HP paper or the *Print Media Guide* for HP LaserJet printers, see "Ordering parts" on page 257.

Highly textured stock, such as linen, might not print evenly. Very glossy papers might jam or repel toner. Multipart forms can wrinkle or get jammed in the product. And paper in poor condition, such as paper with tears, wrinkles, or bent edges, can jam.

Avoid envelopes that have a very slick finish, ones that have self-stick adhesives, or those with clasps or windows. Also avoid envelopes with thick, irregular, or curled edges, or areas that are wrinkled, torn, or otherwise damaged.

Use a sturdy envelope of approximately 16 to 27 pounds (7.25 to 12.25 kg) weight. Use tightly constructed envelopes, and make sure the folds are sharply creased.

Print media sizes

The paper input tray can hold up to 125 sheets of 20 lb (75 g/m²) print media. The single-sheet input slot is designed to hold one sheet. Both can be adjusted to hold media measuring from 3 by 5 inches (76.2 by 127 mm) to 8.5 by 14 inches (216 by 356 mm). This includes, but is not limited to, the following paper and envelope sizes:

Paper type	English	Metric
Letter	8.5 by 11 in	216 by 279 mm
Legal	8.5 by 14 in	216 by 356 mm
Executive	7.25 by 10.5 in	184 by 267 mm
A4	8.25 by 11.75 in	210 by 297 mm
COM10 Envelopes	4.125 by 9.5 in	105 by 241 mm
DL Envelopes	4.33 by 8.67 in	110 by 220 mm
C5 Envelopes	6.4 by 9 in	162 by 229 mm
B5 Envelopes	6.9 by 9.85 in	176 by 250 mm
Monarch Envelopes	3.875 by 7.5 in	98.5 by 190.5 mm
Other custom-size media	custom	custom

For information about how to print on special media, see “Printing on special media” on page 109.

Selecting items for faxing, copying, or scanning

The product can scan items of various sizes, from 2 by 3.5 inches (51 by 89 mm) (the size of a business card) to 8.5 by 14 inches (215 by 356 mm), and can fax and copy items ranging from 2 by 3.5 inches (51 by 89 mm) to 8.5 by 35 inches (215 by 889 mm).

The product accepts bond paper, onionskin paper, newspaper pages, magazine pages, recycled paper, transparencies, and photographs and other items in carrier sheets. Coarse papers scan more easily than smooth items. Slick papers can go through the product, although they may be more difficult to feed through. For best results, feed slick sheets one at a time and have the special media lever set correctly.

Perform the following actions to minimize the possibility of jams:

- Remove self-adhesive notes.
- Remove staples and paper clips.
- Straighten any curls or wrinkles in documents before putting them into the document feeder tray.
- Do not insert any document with glue, correction fluid, or wet ink on it.
- Do not insert gum-backed paper or labels.
- Place documents with tears, perforations, or punch holes in a carrier sheet, which you can buy or make. (See “To load special items” on page 27.)
- Avoid multiple-copy forms.

Loading print media

In this section you will find information on:

- Loading print media to be faxed, copied, or scanned
- Loading media to be printed
- Selecting the output path

Loading print media to be faxed, copied, or scanned

Whether you want to fax, copy, or scan, the procedure for loading the document is the same. If your document is on a standard-weight paper (from 12 to 28 lb, or 46 to 105 g/m²), see “To load normal print media” on page 26. If your document is a transparency, is in a carrier sheet, or is not on standard-weight paper, see “To load special items” on page 27.

To load normal print media

- 1 Adjust the guides in the document feeder tray to fit the size of the item you are loading.

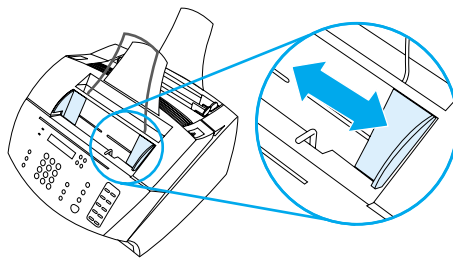

- 2 Place up to 30 pages top first, face down, into the document feeder tray.

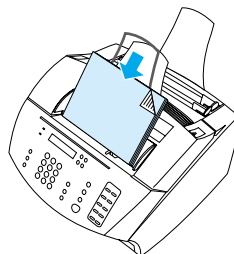

To load special items

When loading items to be faxed, copied, or scanned, you need to protect small, fragile, lightweight (less than 12 lb. or 46 g/m²), or irregularly sized items such as receipts, newspaper clippings, photographs, and old or worn documents.

- 1 Do one of the following:
 - Place the item in a carrier sheet. You can buy a carrier sheet, or you can make one by taping a transparency and piece of paper together along one of the short sides. Insert the item to be faxed, copied, or scanned into the carrier, and insert the carrier into the document feeder tray, taped edge first.
 - Using clear tape, tape the leading and trailing edges of the item to a sheet of letter- or A4-size paper. If the item is not square or rectangular, tape all edges of the item to the paper.
 - If you have use of a standard size copier, copy the item first and then send the copy through the scanner.
- 2 Adjust the guides in the document feeder tray to fit the size of the item you are loading.

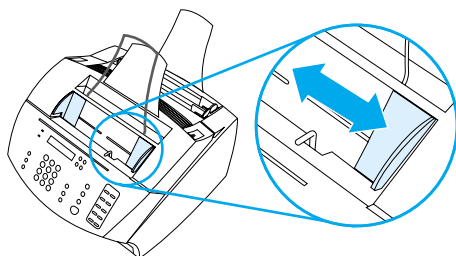

- 3 Locate the special media lever (see “Identifying hardware parts” on page 21) on the top edge of the control panel and move it to the right.

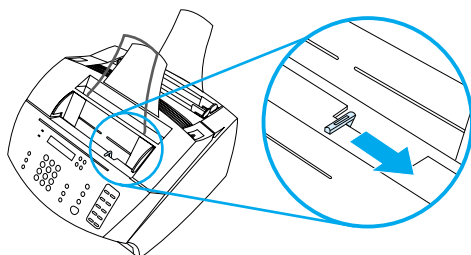

CAUTION

Do not move the lever after the product has begun sending the page.

- 4 Load only one sheet at a time, top first, face down, into the document feeder tray.

Note

If you are loading a business card, load it *long* edge first.

- 5 Move the special media lever back to the left after special items have been fed. A stack of regular pages sent with the lever to the right can go through in multiples, and can cause jams.

Loading media to be printed

You can load media to be printed in paper input tray or in the single-sheet input slot. See the instructions in this section for more information.

Loading the paper input tray

You can load up to 125 sheets of 20 lb (75 g/m²) media into the paper input tray, or you can feed one sheet at a time into the single-sheet input slot.

Note

Insert all media vertically (portrait orientation) into the paper input tray or single-sheet input slot. If you want to print horizontally (landscape orientation), make that selection through your software. The product cannot print on paper smaller than 3 by 5 inches (76.2 by 127 mm).

The product prints, copies, and prints received faxes using media from the paper input tray (or the single-sheet input slot).

To load the paper input tray

- 1 Adjust the guides on the paper input tray to fit the size of media you are loading.

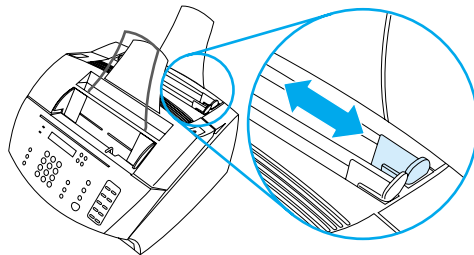

- 2 Insert up to 125 sheets of paper into the paper input tray. Be careful not to overfill the tray.

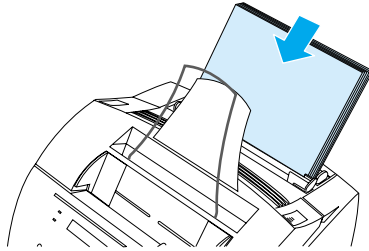

Note

When adding paper to an existing stack in the paper input tray, *always remove the existing paper* and realign it with the new paper before loading to reduce multiple feeds or jams.

Note

If you have loaded special media, make sure to choose the lower paper output path. See “To select the output path” on page 31.

- 3 Readjust the guides to center the stack.

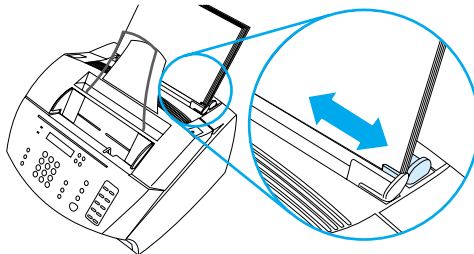

Using the single-sheet input slot

Using the single-sheet input slot, you can print one sheet of media at a time without using the paper input tray. The product takes media loaded in the single-sheet input slot before it takes media from the paper input tray.

Note

The single-sheet input slot is helpful when the first page of your job is different from the rest. For example, you might want the first page of your print job on letterhead, or you might want to print an envelope first.

To print using the single-sheet input slot

- 1 Adjust the guides on the single-sheet input slot to the approximate size of the sheet you are using.

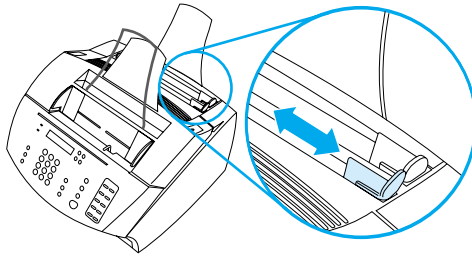

- 2 Insert one sheet of media into the single-sheet input slot. If loading special media or letterhead, insert media top first, facing forward.

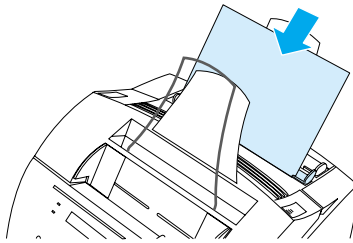

- 3 Readjust the guides to center the sheet.

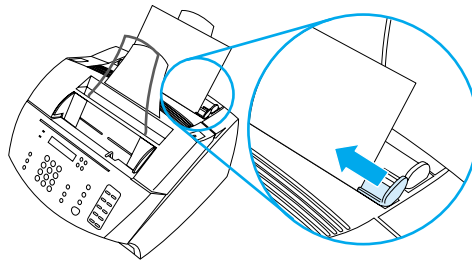

Note

If you have loaded special media, make sure to choose the lower paper output path. See “To select the output path” on page 31.

Selecting the output path

Selecting the output path determines whether printed media come out of the paper output bin or out of the front paper output slot. Choose the front paper output slot if you are printing on special media, such as 28 lb (100 g/m²) or heavier weight paper, envelopes, transparencies, or labels. This prevents wrinkling and paper curl.

To select the output path

- To use the paper output bin, make sure that the front paper path door is closed.

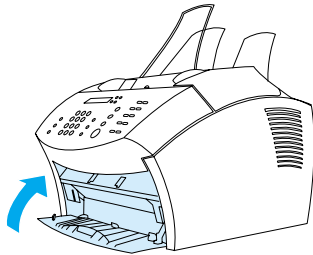

- Or -

- To eliminate curl, use the straight-through paper path by opening the front paper path door. All printed media coming out of the front paper output slot will be in reverse order.

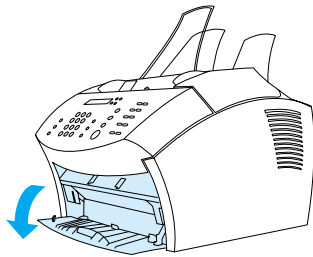

Note

To avoid jams, keep the area in front of the front paper path slot clear so that media can easily exit the slot, and make sure the front paper path door is completely open.

Features available only through the software

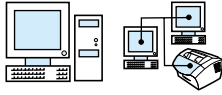

The tools and options described in the sections listed below are available only through the software that came with the HP LaserJet 3200 product.

- Using the HP LaserJet Director
- Using the HP LaserJet Document Manager (Windows) or the HP LaserJet Workplace (Mac OS)

Note

For more detailed information about how to use the tools or options, see the software Help.

Using the HP LaserJet Director

If your computer is directly connected to the product, the computer is on, and you have installed the software, the HP LaserJet Director appears when you load a document into the document feeder tray.

Note

The HP LaserJet Director is not supported for Microsoft Windows 95.

The HP LaserJet Director is a shortcut toolbar that allows you to process documents quickly using HP LaserJet 3200 tools, such as the scanner, copier, and fax machine. If you would like the HP LaserJet Director to *not* appear when a document is loaded into the document feeder tray, see “To turn off the HP LaserJet Director” on page 34.

If the product is connected to your computer using a supported HP JetDirect print server, the HP LaserJet Director will not appear when a document is loaded into the document feeder tray. To open the HP LaserJet Director in Microsoft Windows, click the HP LaserJet Director icon on the taskbar as shown below.

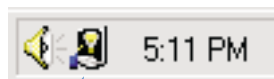

To open the HP LaserJet Director in the Mac OS, double-click the alias for the HP LaserJet Director that appears on the desktop as shown below.



The following examples of the HP LaserJet Director for Windows and the Mac OS shows only the default buttons.

Windows

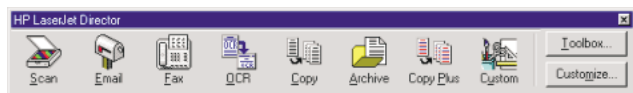

Mac OS



The following table explains the buttons that appear on the HP LaserJet Director.

Button	Description
Scan	Scans the document in the document feeder tray.
Email	Attaches a copy of the document in the document feeder tray to a new e-mail message, and displays the new message so you can address it and send it.
Fax	Opens the HP LaserJet Send Fax dialog box. From that dialog box you can add recipients, add a cover sheet, and then send the item.
OCR (Optical Character Recognition)	Scans the document in the document feeder tray and converts it to text that you can edit in a word processing program.
Copy	Opens the HP LaserJet Copier dialog box. From that dialog box you can adjust the number of copies, reduce or enlarge the copy, adjust the contrast and copy quality, and change the output paper size.
Archive	Scans the document in the document feeder tray and stores it in a default destination.
Toolbox (Windows) Tools (Mac OS)	Displays tools and Support help.
Customize	Displays the Customize dialog box where you can change settings for HP LaserJet Director.

To turn off the HP LaserJet Director

Use the following if you do not want the HP LaserJet Director to appear when a document is loaded into the document feeder tray.

Windows

- 1 On the **HP LaserJet Director** toolbar, click the **Customize** button.
- 2 Click the **Monitor Device** tab.
- 3 Clear the **Use the Director to Monitor Actions on the Device** check box, and then click **OK** to confirm that you want to turn off the HP LaserJet Director.
- 4 Click **Apply**, and then click **OK**.

Note

To restart the HP LaserJet Director after turning it off, click **Start**, point to **Programs**, point to **HP LaserJet 3200**, and then click **HP LaserJet Director**.

Mac OS

- 1 On the HP LaserJet Director toolbar, click the Customize button.
- 2 Click the General tab.
- 3 Click "Show the Document Assistant when paper is inserted into the scanner automatic document feeder" to deselect this option, and then click OK.
- 4 Click Apply, and then click OK.

Note

You can still open the HP LaserJet Director double-clicking the alias on the desktop.

Using the HP LaserJet Document Manager (Windows) or the HP LaserJet Workplace (Mac OS)

The HP LaserJet Document Manager for Windows-compatible computers or the HP LaserJet Workplace for Macintosh-compatible computers is a complete set of tools you can use to manage all your document input and output needs. With HP LaserJet Document Manager and HP LaserJet Workplace, you can:

- organize your document desktop.
- fax, print, scan, or copy documents using the product.
- make annotations to .HPD files (.HPD files are scanned documents that are saved using the HP LaserJet Document Manager or HP LaserJet Workplace).
- add simple graphics, such as rectangles, arrows, and freehand polygons, to documents.

See the software Help for more information about how to use the HP LaserJet Document Manager and HP LaserJet Workplace.

Note

The HP LaserJet Document Manager is not supported for Microsoft Windows 95.

3 Managing General Default Settings, Logs, and Reports

Introduction

This chapter contains the procedures for printing reports and altering general default settings for the product. For information about settings that pertain to faxing, printing, copying, or scanning, see the corresponding section. The instructions included in this section are those for the control panel.

Adjusting settings from the software is sometimes the easiest method. To gain access to default settings in the software on a Windows-compatible computer, click **Start**, point to **Programs**, point to **HP LaserJet 3200**, point to **Tools**, and then click **HP LaserJet Device Configure**. To gain access to default settings on a Macintosh-compatible computer, double-click the HP LaserJet Director alias on the desktop, click **Tools**, and then click **Device Configuration**.

CAUTION

When changing settings in a network environment, you are changing settings for all users.

Hint

You can find out what product settings are currently selected by printing a configuration report (see “Printing a configuration report” on page 48.)

For further instructions about adjusting product settings from the software, see the software Help.

Changing general default settings

This section contains instructions for:

- Changing the default paper size for the paper input tray
- Changing sound volume
- Changing the language on the display panel
- Restoring factory defaults

Changing the default paper size for the paper input tray

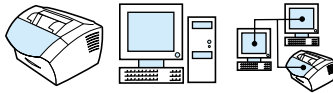

The paper size should be set to the size of paper you normally load in the paper input tray. The product uses this setting for copying, printing reports, and determining autoreduction for incoming faxes.

Note

The printing function does not use this setting. If you are loading special-size media for only your current print job, do not change this setting. After you have finished printing, reload the original paper.

To change the default paper size

- 1 Press **ENTER/MENU**.
- 2 Use the **<** or **>** key to select **COMMON SETTINGS**, and then press **ENTER/MENU**.
- 3 Use the **<** or **>** key to select **DEFAULT PAPER SIZE**, and then press **ENTER/MENU**.
- 4 Use the **<** or **>** key until the size of paper you have loaded appears. You can choose **LETTER**, **LEGAL**, or **A4**.
- 5 Press **ENTER/MENU** to save your selection.

Changing sound volume

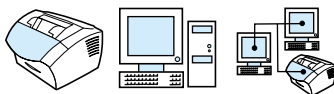

You can control the volume of the following:

- The fax sounds associated with incoming and outgoing faxes.
- The ring for incoming faxes.
- The alarm sound the product emits when it requires attention, such as when the printer door is open.
- The beeps emitted when you press control panel keys.

To change the fax sounds (line monitor) volume

Note

The default set at the factory is Soft.

- 1 Press **VOLUME**.
- 2 Use the **<** or **>** key to select **OFF**, **SOFT**, **MEDIUM**, or **LOUD**, and then press **ENTER/MENU** to save your selection.

To change ring volume

The ring volume is heard when the device is initially sending or receiving a call. The ring duration length is based on the local telecom ring pattern length.

Note

The default set at the factory for ring volume is Soft.

- 1 Press **ENTER/MENU**.
- 2 Use the **<** or **>** key to select **COMMON SETTINGS**, and then press **ENTER/MENU**.
- 3 Use the **<** or **>** key to select **VOLUME SETTINGS**, and then press **ENTER/MENU**.
- 4 Press the **>** key once to select **RING VOLUME**, and then press **ENTER/MENU**.
- 5 Use the **<** or **>** key to select **OFF**, **SOFT**, **MEDIUM**, or **LOUD**, and then press **ENTER/MENU** to save your selection.

To change the alarm volume

The alarm is heard when the device is presenting an alert or critical error message. The alarm duration length is either one or three seconds, based on the type of error.

Note

The default set at the factory for the alarm volume is Soft.

- 1 Press **ENTER/MENU**.
- 2 Use the < or > key to select **COMMON SETTINGS**, and then press **ENTER/MENU**.
- 3 Use the < or > key to select **VOLUME SETTINGS**, and then press **ENTER/MENU**.
- 4 Press **ENTER/MENU** to select **ALARM VOLUME**.
- 5 Use the < or > key to select **OFF**, **SOFT**, **MEDIUM**, or **LOUD**, and then press **ENTER/MENU** to save your selection.

To change control panel key press volume

The key press volume will be heard when a control panel key is pressed.

Note

The default set at the factory for the control panel key press is Soft.

- 1 Press **ENTER/MENU**.
- 2 Use the < or > key to select **COMMON SETTINGS**, and then press **ENTER/MENU**.
- 3 Use the < or > key to select **VOLUME SETTINGS**, and then press **ENTER/MENU**.
- 4 Use the < or > key to select **KEY PRESS VOLUME**, and then press **ENTER/MENU**.
- 5 Use the < or > key to select **OFF**, **SOFT**, **MEDIUM**, or **LOUD**, and then press **ENTER/MENU** to save your selection.

Changing the language on the display panel

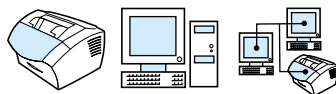

Use this procedure to have the control panel display messages and reports in a language other than the default for your country/region.

To change the language on the display panel

- 1 Press **ENTER/MENU**.
- 2 Use the **<** and **>** keys to select **Common Settings**, and then press **ENTER/MENU**.
- 3 Use the **<** and **>** keys to select **Language**, and then press **ENTER/MENU**.
- 4 Use the **<** and **>** keys to select the language you want.
- 5 Press **ENTER/MENU** to save your selection.

Restoring factory defaults



This procedure returns all settings to the factory defaults and clears the fax header name and phone number. (See “Changing the information in the fax header” on page 79 for information on how to add your information to the fax header.) This procedure does *not* clear fax numbers and names associated with one-touch keys and speed-dial codes or delete any pages stored in memory.

To restore factory defaults

- 1 Press **ENTER/MENU**.
- 2 Use the **<** or **>** key to select **SERVICE**, and then press **ENTER/MENU**.
- 3 Use the **<** or **>** key to select **RESTORE DEFAULTS**, press **ENTER/MENU**, and then press **ENTER/MENU** again to confirm your selection.

Managing logs and reports

This section contains the following procedures for printing reports and for establishing a schedule for printing certain reports:

- Printing the fax activity log
- Setting the fax activity log to print automatically
- Printing a fax call report
- Setting when the fax call report prints
- Including the first page of each fax on the fax call report
- Printing a one-touch, speed-dial, and group-dial report
- Printing the control panel menu structure
- Printing a configuration report
- Printing the block fax list
- Printing a PCL font list
- Printing a PostScript font list
- Printing all fax reports
- Printing a T.30 protocol trace report
- Setting when the T.30 protocol trace report prints

Printing the fax activity log



On demand, you can print a log of the last 40 faxes. This log includes entries for:

- All faxes received to the product
- All faxes sent from the control panel
- All faxes sent from the HP LaserJet Document Manager (for Windows-compatible computers directly connected to the product)
- All faxes sent from the HP Workplace (for Macintosh-compatible computers directly connected to the product)

Note

The HP LaserJet Document Manager is not supported for Microsoft Windows 95.

To print the fax activity log

- 1 Press **ENTER/MENU**.
- 2 Use the **<** or **>** key to select **REPORTS**, and then press **ENTER/MENU**.
- 3 Use the **<** or **>** key to select **FAX ACTIVITY LOG**, and then press **ENTER/MENU**.
- 4 Press **ENTER/MENU** to select **PRINT FAX LOG NOW**. The product exits the Menu settings and prints the log.

Setting the fax activity log to print automatically



The fax activity log provides a chronological history of the last 40 faxes that were received, sent, or deleted, as well as any errors that occurred. You can decide whether or not you want the fax log to print automatically after every 40 entries. The factory default is On.

To set when the fax log prints

- 1 Press **ENTER/MENU**.
- 2 Use the **<** or **>** key to select **REPORTS**, and then press **ENTER/MENU**.
- 3 Use the **<** or **>** key to select **FAX ACTIVITY LOG**.
- 4 Press **>** once to select **AUTO. LOG PRINTING**, and then press **ENTER/MENU**.
- 5 Use the **<** or **>** key to select **ON** or **OFF**, and then press **ENTER/MENU** to confirm your selection.

Printing a fax call report



A fax call report is a brief report indicating the status of the last sent or received fax. You can set the fax call report to print automatically. See “Setting when the fax call report prints” on page 45 for more information.

To print a fax call report

- 1 Press **ENTER/MENU**.
- 2 Use the **<** or **>** key to select **REPORTS**, and then press **ENTER/MENU**.
- 3 Use the **<** or **>** key to select **FAX CALL REPORT**, and then press **ENTER/MENU**.
- 4 Press **ENTER/MENU** to select **PRINT FAX CALL NOW**. The product exits the Menu settings and prints the report.

Setting when the fax call report prints

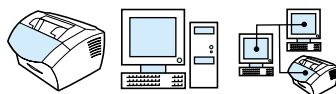

A fax call report contains information about the last sent or received fax. You can choose to have the report print for one of the following:

- Every Fax Error (the default)
- Send Fax Error
- Receive Fax Error
- Every Fax
- Send Fax Only
- Never

If you choose **Never**, you will have no indication that a fax failed to transmit unless you print a fax activity log.

To set when fax call reports print

- 1 Press **ENTER/MENU**.
- 2 Use the **<** or **>** key to select **REPORTS**, and then press **ENTER/MENU**.
- 3 Use the **<** or **>** key to select **FAX CALL REPORT**, and then press **ENTER/MENU**.
- 4 Press the **>** key once to select **PRINT REPORT**, and then press **ENTER/MENU**.
- 5 Use the **<** or **>** key to select the option for when you want the fax call reports to print.
- 6 Press **ENTER/MENU** to save the selection.

Including the first page of each fax on the fax call report

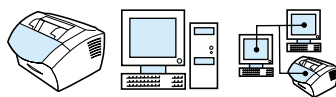

If this option is turned on, the fax call report will display a thumbnail (50% reduction) of the first page of the last fax that was sent or received. The default setting for the thumbnail is On.

To include the first page of each fax on the fax call report

- 1 Press **ENTER/MENU**.
- 2 Use the **<** or **>** key to select **REPORTS**, and then press **ENTER/MENU**.
- 3 Use the **<** or **>** key to select **FAX CALL REPORT**, and then press **ENTER/MENU**.
- 4 Use the **<** or **>** key to select **INCLUDE FIRST PAGE**, and then press **ENTER/MENU**.
- 5 Use the **<** or **>** key to select **ON** or **OFF**, and then press **ENTER/MENU** to confirm your selection.

Printing a one-touch, speed-dial, and group-dial report

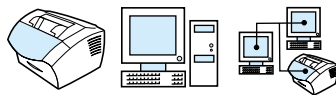

This report lists the fax numbers that are assigned to the one-touch keys and speed-dial and group-dial codes.

To print a one-touch, speed-dial and group-dial report

- 1 Press **ENTER/MENU**.
- 2 Use the **<** or **>** key to select **REPORTS**, and then press **ENTER/MENU**.
- 3 Use the **<** or **>** key to select **SPEED DIAL REPORT**, and then press **ENTER/MENU**. The product exits the Menu settings and prints the report.

Printing the control panel menu structure



Use this procedure if you'd like to print a copy of the control panel menu structure. This menu structure might be a useful reference as you alter settings in the menu.

To print the control panel menu structure

- 1 Press **ENTER/MENU**.
- 2 Use the **<** or **>** key to select **REPORTS**, and then press **ENTER/MENU**.
- 3 Use the **<** or **>** key to select **MENU STRUCTURE**, and then press **ENTER/MENU**. The product exits the Menu settings and prints the report.

Printing a configuration report

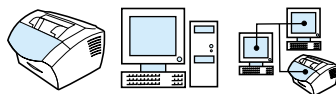

Print this report to show the current product settings.

To print a configuration report

- 1 Press **ENTER/MENU**.
- 2 Use the **<** or **>** key to select **REPORTS**, and then press **ENTER/MENU**.
- 3 Use the **<** or **>** key to select **CONFIGURATION REPORT**, and then press **ENTER/MENU**. The product exits the Menu settings and prints the report.

Printing the block fax list



Use this procedure to print a list of the blocked fax numbers. See “Blocking or unblocking fax numbers” on page 67.

To print the block fax list

- 1 Press **ENTER/MENU**.
- 2 Use the **<** or **>** key to select **REPORTS**, and then press **ENTER/MENU**.
- 3 Use the **<** or **>** key to select **BLOCK FAX LIST**, and then press **ENTER/MENU**. The product exits the Menu settings and prints the list.

Printing a PCL font list

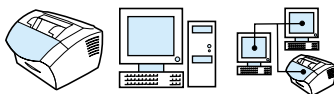

Use this procedure to print a list of the PCL fonts.

To print a PCL font list

- 1 Press **ENTER/MENU**.
- 2 Use the **<** or **>** key to select **REPORTS**, and then press **ENTER/MENU**.
- 3 Use the **<** or **>** key to select **PCL FONT LIST**, and then press **ENTER/MENU**. The product exits the Menu settings and prints the list.

Printing a PostScript font list

Use this procedure to print a list of the PostScript fonts available in the product memory.

To print a PostScript font list

- 1 Press **ENTER/MENU**.
- 2 Use the **<** or **>** key to select **REPORTS**, and then press **ENTER/MENU**.
- 3 Use the **<** or **>** key to select **POSTSCRIPT FONTS**, and then press **ENTER/MENU**. The product exits the Menu settings and prints the list.

Printing all fax reports



Use this procedure to print the following reports at one time:

- Fax activity log
- One-touch, speed-dial, and group-dial report
- Configuration report
- Block fax list

To print all fax reports

- 1 Press **ENTER/MENU**.
- 2 Use the **<** or **>** key to select **REPORTS**, and then press **ENTER/MENU**.
- 3 Use the **<** or **>** key to select **ALL FAX REPORTS**, and then press **ENTER/MENU**. The product exits the Menu settings and prints the reports.

Printing a T.30 protocol trace report



This report is used by service technicians to troubleshoot fax transmission issues.

To print a T.30 protocol trace report

- 1 Press **ENTER/MENU**.
- 2 Use the **<** or **>** key to select **SERVICE** and press **ENTER/MENU**.
- 3 Use the **<** or **>** key to select **PRINT T.30 TRACE** and press **ENTER/MENU**.
- 4 Use the **<** or **>** key to select **NOW** and press **ENTER/MENU**. The product exits the Menu settings and prints the reports.

Setting when the T.30 protocol trace report prints



You can set the T.30 protocol trace report to print:

- Never (the default)
- If an error occurs
- At the end of every send and received fax

To set when the T.30 protocol trace reports prints

- 1 Press `ENTER/MENU`.
- 2 Use the `<` or `>` key to select `SERVICE` and press `ENTER/MENU`.
- 3 Use the `<` or `>` key to select `PRINT T.30 TRACE` and press `ENTER/MENU`.
- 4 Use the `<` or `>` key to select the option for when you want the T.30 protocol trace report to print.
- 5 Press `ENTER/MENU` to save the selection.

4 Faxing

Introduction

All users can fax to and from the product. The product operates just like a regular fax machine; you do not have to install the software or have the computer on for it to work. From the control panel, you can send and receive paper faxes and adjust all settings needed for faxing.

Normally, received faxes are printed at the product. However, you can choose to have incoming faxes routed to your computer if it is directly connected to the product, or to another fax machine.

This section provides an overview of faxing capabilities from the control panel, as well as information about fax default settings.

Hint

You can find out what product settings are currently selected by printing a configuration report (see “Printing a configuration report” on page 48).

Sending faxes

This section contains the following topics:

- Sending faxes to one recipient
- Quickly programming speed-dial codes or one-touch keys
- Sending faxes to multiple recipients
- Sending a fax at a future time
- Redialing manually
- Using the Contrast button to adjust the contrast for the current fax or copy job
- Adjusting the resolution for the current job
- Resolution options
- Canceling the current fax job
- Canceling a fax job using Fax Job Status

Sending faxes to one recipient

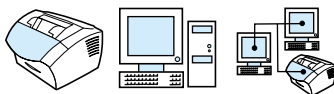

This procedure details how to send a fax to one recipient.

Hint

If you want to improve the quality of a paper document before faxing it, scan the document first and straighten or clean the image. Then, send it as a fax from the software. See the software Help for more information.

To send a fax

- 1 Dial the fax number using one of the following methods:
 - Use the numeric keys.
 - If the fax number you are calling has been assigned to a one-touch key, press that key.
 - If the fax number you are calling has a speed-dial code, press **SPEED DIAL**, enter the speed-dial code using the numeric keys, and press **ENTER/MENU**.

Note

When dialing using the numeric keys, include any pauses or other needed numbers, such as an area code, an access code for numbers outside a PBX system (usually a 9 or 0), or a long-distance prefix. See “Using dialing characters” on page 78 for more information.

- 2 Load the document into the document feeder tray.
- 3 Adjust any options, such as contrast or resolution.
- 4 Press **FAX/SEND**.

After the last page of the fax has exited the product, you can start sending another fax, copying, or scanning.

Hints

To fax to numbers you use regularly, you can assign a one-touch key or speed-dial code. See “About speed-dial codes, one-touch keys, and group-dial codes” on page 70 for instructions.

If you have electronic phone books available, you can use them for selecting recipients. Electronic phone books are generated with third-party applications. See the software Help for more information.

Quickly programming speed-dial codes or

one-touch keys



Use the following method to program speed-dial codes and one-touch keys easily from the product control panel.

To quickly program speed-dial codes or one-touch keys

Note

This procedure cannot be used to program a group-dial code. See “Programming group-dial codes” on page 74.

- 1 Do one of the following:

Press **SPEED DIAL** and enter an unprogrammed speed-dial code and press **ENTER/MENU**.

-Or-

Press an unprogrammed one-touch key.

The control panel display will notify you that the speed-dial code or one-touch key has not been programmed.

- 2 Press the **ENTER/MENU** to program the speed-dial codes or one-touch key.
- 3 Enter the fax number, and then press **ENTER/MENU**. Include any pauses, a hook flash, or other needed numbers, such as an area code, an access code for numbers outside a PBX system (usually a 9 or 0), or a long distance prefix. See “Using dialing characters” on page 78 for more information.

Note

When entering a fax number you can use a comma for a pause, use the letter R if you want the product to wait for a dial tone, and use the letter W for a hook flash.

- 4 Enter a name for the fax number. To do so, repeatedly press the numeric key for the letter you need until the letter appears. (See “Using dialing characters” on page 78 for a list of characters.) For example, if the first letter you need is a “C,” press **2** repeatedly until a C appears. Press **>** to go to the next space.
- 5 Press **ENTER/MENU** to save the information.

Sending faxes to multiple recipients

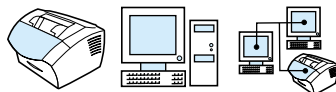

You can send a paper fax to several fax numbers at once. If you want to send a fax to a group of fax numbers you have assigned to a group-dial code, see “To send a fax using a group-dial code.” If you want to send to up to 20 numbers that do not have a group-dial code, see “To send a fax to an ad-hoc group.”

In the rare instance that your document does not fit into memory, you will need to send the document to each fax number one at a time, or use the HP LaserJet Director.

Note

The HP LaserJet Director is not supported for Microsoft Windows 95.

Hint

If you want to improve the quality of a paper document before faxing it, scan the document first and straighten or clean the image. Then, send it as a fax from the software. See the software Help for more information.

To send a fax using a group-dial code

- 1 Load the document into the document feeder tray.
- 2 Adjust any options, such as contrast or resolution.
- 3 Press the one-touch key for the group.
- Or -
Press **SPEED DIAL** and the group-dial code for the group, and then press **ENTER/MENU**.
- 4 Press **FAX/SEND**.

The product scans the document into memory and sends the fax to each fax number specified. If a number in the group is busy or does not answer and the redial settings are not set correctly, the product might not redial that number. If multiple redial attempts fail, the product will update the Fax Activity log with the error and then proceed to the next number in the group.

To send a fax to an ad-hoc group

- 1 Dial the first fax number using one of the following methods:
 - Use the numeric keys.
 - If the fax number you are calling has a one-touch key, press that key.
 - If the fax number you are calling has a speed-dial code, press **SPEED DIAL**, enter the speed-dial code using the numeric keys, and then press **ENTER/MENU**.
 - If you are calling multiple recipients assigned to a group-dial code, press the one-touch key for the group or press **SPEED DIAL** and the group-dial code for the group, and then press **ENTER/MENU**.

Note

When dialing using the numeric keys, include any pauses or other needed numbers, such as an area code, an access code for numbers outside a PBX system (usually a 9), or a long distance prefix. See “Using dialing characters” on page 78 for more information.

- 2 Press **ENTER/MENU**.
- 3 Repeat steps 1 and 2 to continue entering numbers.
- Or -
Go to the next step.
- 4 Load the document into the document feeder tray.
- 5 Adjust any options, such as contrast or resolution.
- 6 Press **FAX/SEND**.

The product sends the fax to each fax number. If a number in the group is busy or does not answer and the redial settings are not set correctly, the product might not redial that number. If multiple redial attempts fail, the product will update the Fax Activity log with the error and then proceed to the next number in the group.

Note

The fax activity log feature is not supported for Microsoft Windows 95 but you can print the fax activity log using the control panel. See “Printing the fax activity log” on page 43.

Sending a fax at a future time

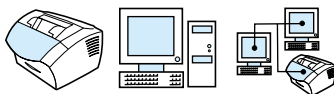

You can schedule a fax to be sent automatically at a future time to one or more people. When you complete this procedure, the product scans the document into memory and returns to the Ready state so you can do other tasks.

Note

This feature is not supported for Microsoft Windows 95.

If the product cannot transmit the fax at the scheduled time, it is indicated on the fax call report (if that option is turned on) or logged in the fax activity log. This can happen in the case of a no answer or if a busy results in the failure of redial attempts. (See “Setting when the fax call report prints” on page 45 or “Printing the fax activity log” on page 43 for more information.)

Hint

If you have set a fax to send at a future time but need to add something to it, you can send the additional information as another job. All faxes scheduled to go to the same fax number on the same date and time are delivered as individual faxes.

If a power failure occurs, any pending faxes will need to be rescheduled.

To send a fax at a future time

- 1 Load the document into the document feeder tray.
- 2 Press **ENTER/MENU**.
- 3 Use the **<** or **>** key to display **FAX FUNCTIONS** and then press **ENTER/MENU**.
- 4 Press **ENTER/MENU** to select **SEND FAX LATER** and press **ENTER/MENU**.
- 5 Use the numeric keys to enter the start time. If you are set to a 12-hour clock, use the **>** key to move the cursor past the fourth character to set A.M. or P.M. Select **1** for A.M. or select **2** for P.M., and then press **ENTER/MENU**.
- Or -
If you are set to a 24-hour clock, press **ENTER/MENU**.

- 6 Use the numeric keys to type the date, and then press **ENTER/MENU**.
- Or -
Accept the default date by pressing **ENTER/MENU**.
- 7 Type the fax number, enter the speed-dial code, or press the one-touch key. (This feature does not support ad hoc groups.)
Press **ENTER/MENU** or **FAX/SEND**.

The product scans the document into memory and sends it at the designated time.

Redialing manually



If you want to send another document to the last fax number dialed, use the following procedure to manually redial. If you are trying to resend the same document you sent the first time, you will probably want to wait until the automatic redials have stopped or you have stopped them yourself. Otherwise, the recipient might get the fax twice: once from the manual redial attempt and once from one of the automatic redial attempts.

Note

To stop the current redial attempt for a fax, see “Canceling the current fax job” on page 64. To cancel all pending, automatic redial attempts for a fax, see “Canceling a fax job using Fax Job Status.” To change when the product redials, see “Changing how the product redials” on page 83.

To redial manually

- 1 Load the document into the document feeder tray.
- 2 Press **REDIAL/PAUSE**.
- 3 Press **FAX/SEND**. The product redials the last number and attempts to send the fax.

Using the Contrast button to adjust the contrast for the current fax or copy job



The contrast setting affects the lightness or darkness of an outgoing fax as it is being sent or the resulting copy. Using the following procedure changes the contrast for the current job only. After the fax has been sent or the copy is made, the contrast setting returns to the default.

Note

To change the default contrast for outgoing faxes, see “Changing the default contrast and resolution for outgoing faxes” on page 81.

To adjust the contrast

- 1 Press **CONTRAST** to display the current contrast setting.
- 2 Use the **<** or **>** key to move the slider to the left to make the fax or copy lighter than the original, or move the slider to the right to make the fax or copy darker than the original.
- 3 Press **ENTER/MENU** to save the selection.

Adjusting the resolution for the current job

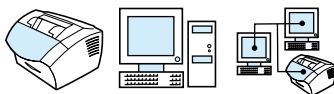

Resolution affects the quality, in dots per inch, of documents to be faxed. It also affects the transmission speed. For a discussion of which resolution to choose, see “Resolution options” below.

Use this procedure to change the resolution for the current job only. After the fax has been sent, the resolution setting returns to the default.

Note

To change the default resolution setting, see “Changing the default contrast and resolution for outgoing faxes” on page 81.

To adjust the resolution

- 1 Press **RESOLUTION** to display the current resolution setting.
- 2 Use the **<** or **>** key to scroll through the choices.
- 3 Press **ENTER/MENU** to save the selection.

Resolution options

Use this table to determine which resolution setting to choose for your fax. Note that each increase in quality lengthens transmission time.

Choose this resolution:	For this result:
Standard (203 by 98 dpi)	Standard quality for text. <ul style="list-style-type: none">• Use this setting when speed is more important than quality. This is the fastest of the resolution settings.• All fax machines can receive at this quality.• Words have better quality than graphics or photos at this setting.
Fine (203 by 196 dpi)	Higher quality for words. <ul style="list-style-type: none">• Use this setting for good all-around quality.• Most fax machines can receive at this setting. Fax machines that do not, will receive at Standard.• Words have better quality than graphics or photos at this setting.
Superfine (300 by 300 dpi)	Best quality for words. <ul style="list-style-type: none">• Words have better quality than graphics or photos at this setting.• Only a few fax machines receive at this mode. Fax machines that do not will receive at the highest supported resolution.

Choose this resolution:	For this result:
<p>Photo (halftone images scan up to 300 by 300 dpi)</p>	<p>Best quality for graphics and photos.</p> <ul style="list-style-type: none"> ● Use this setting when the quality of graphics and photos in the document is more important than the quality of words. ● Only a few fax machines receive at this mode. Fax machines that do not will receive at the highest supported resolution. ● The document will be scanned as a halftone image (which simulates shades of gray) at up to 300 by 300 dpi. ● This setting requires the longest transmission time.
<p>Draft</p>	<p>Available only by pressing RESOLUTION on the control panel. This setting provides the same quality as the Standard setting.</p>

Canceling the current fax job



Use this procedure to stop a single fax currently dialing or being transmitted or received.

To cancel the current fax job

Press **STOP/CLEAR** on the control panel. Any pages that have not already been transmitted are canceled.

Canceling a fax job using Fax Job Status



Use this procedure to cancel a fax that:

- Is waiting to redial after a busy signal or no answer.
- Is going to a group of numbers.
- Is scheduled to be sent at a future time.

To cancel a fax job using Job Status

- 1 Press **ENTER/MENU**.
- 2 Press **ENTER/MENU** to select **FAX JOB STATUS**.
- 3 Use the **<** or **>** key to scroll through the pending jobs until you reach the job you want to clear.
- 4 Press **ENTER/MENU** to select the job you want to cancel.
- 5 Press **ENTER/MENU** to confirm that you want the job to be canceled.

Receiving faxes

You can receive faxes to the product or to your computer. In general, incoming faxes to the product are automatically answered, however if you change what devices are connected to the same phone line to which the product is connected, you will need to change how the product answers incoming faxes. See the “Changing how the product answers incoming faxes” on page 90 topic in the “Advanced receive fax features and settings” section.

Follow the procedures in this section to manage faxes routed to the product.

- Receiving faxes when you hear fax tones
- Reprinting faxes
- Blocking or unblocking fax numbers

Receiving faxes when you hear fax tones



If you have a phone line that receives both fax and phone calls and you hear fax tones when you answer the phone, you can start the receiving process in one of two ways:

- If you are close to the product, press **FAX/SEND** on the control panel.
- When you answer any phone connected to the line (an extension phone) and hear fax tones, the product should begin answering the call automatically. If not, press **1-2-3**, in sequence on the telephone keypad, listen for fax transmission sounds, and then hang up.

Note

For the second method to work, the **Extension phone** setting must be set to **Yes**. See “Enabling an extension phone” on page 93 to check or change the setting.

Reprinting faxes



If a fax did not print because the toner ran out or if the fax printed on the wrong type of media, you can try to reprint it. The actual number of faxes stored for possible reprinting is determined by how much memory is available. The most recent fax prints first; the oldest fax prints last.

These faxes are continuously stored, and reprinting them does not clear them from memory. To clear these faxes from memory, see “Clearing faxes from memory” on page 89.

Note

You do not need to use this procedure if faxes did not print because of a jam or because the media ran out. During those situations, faxes are received to memory. As soon as you clear the jam or refill the media, faxes automatically resume printing.

To reprint faxes

- 1 Print a fax activity log to check which faxes may have been lost. See “Printing the fax activity log” on page 43 for instructions.
- 2 Press **ENTER/MENU**.
- 3 Press **>** once to display **FAX FUNCTIONS** and then press **ENTER/MENU**.
- 4 Use the **<** or **>** key to display **REPRINT LAST FAXES** and then press **ENTER/MENU**. The product begins reprinting the most recently printed faxes.

Note

To stop the printing at any time, press **STOP/CLEAR**.

Blocking or unblocking fax numbers



If there are people or businesses from whom you do not want to receive faxes, you can block their fax numbers using the control panel. You can block up to 30 fax numbers. When you block a fax number and someone from that number sends you a fax, the display panel indicates that the number is blocked, and the fax does not print and is not saved in memory. Faxes from blocked fax numbers appear in the fax activity log with a “discarded” designation.

Note

The fax activity log feature is not supported for Microsoft Windows 95 but you can print the fax activity log using the control panel. See “Printing the fax activity log” on page 43.

Note

To print a list of numbers you have blocked, see “Printing the block fax list” on page 48.

To block or unblock fax numbers using the control panel



You can unblock blocked fax numbers individually or all at one time.

- 1 Press **ENTER/MENU**.
- 2 Use the **<** or **>** key to select **FAX SETTINGS** and then press **ENTER/MENU**.
- 3 Use the **<** or **>** key to select **FAX RECEIVE SETUP** and then press **ENTER/MENU**.
- 4 Use the **<** or **>** key to select **BLOCK FAXES** and then press **ENTER/MENU**.
- 5 Do one of the following:
 - **To block a fax number:** use the **<** or **>** key to select **ADD ENTRY** and then press **ENTER/MENU**. Enter the fax number exactly as it appears in the header (including spaces), and then press **ENTER/MENU**. Enter a name for the blocked number, and then press **ENTER/MENU**.

- **To unblock a single fax number:** use the < or > key to select DELETE ENTRY and then press ENTER/MENU. Use the < or > key to select the fax number you want, and then press ENTER/MENU to confirm the deletions.
- **To unblock all blocked fax numbers:** use the < or > key to select CLEAR ALL and then press ENTER/MENU. Press ENTER/MENU again to confirm the deletions.

Advanced send fax features and settings

The section describes advanced procedures and settings you can use when sending faxes. The topics include:

- About speed-dial codes, one-touch keys, and group-dial codes
- Programming speed-dial codes and one-touch keys
- Programming a one-touch key for alternate long distance
- Programming group-dial codes
- Deleting all speed-dial codes, one-touch keys, and group-dials codes
- Using Manual Dial
- Sending a fax by dialing from a telephone
- Inserting a pause or wait into a fax number
- Using dialing characters
- Changing the information in the fax header
- Changing the default contrast and resolution for outgoing faxes
- Selecting tone- or pulse-dialing mode
- Changing how the product redials
- Inserting a dial prefix
- Changing the detect dial tone setting
- Clearing faxes from memory
- Setting error correction

About speed-dial codes, one-touch keys, and group-dial codes

To simplify the dialing process for a fax number you dial frequently from the control panel, store it in a one-touch key, speed-dial code, or group-dial code. In the phone book, there are a total of 250 codes available for the HP LaserJet 3200 product and 275 codes for the HP LaserJet 3200se and 3200m product that can be used for speed-dial codes and group-dial codes. For example, if you are using the HP LaserJet 3200se product and program 200 of the codes as speed-dials, the remaining 75 can be used for group-dials.

See the following procedures for more information about how to use speed-dial codes, one-touch keys, and group-dial codes:

- To program speed-dial codes and one-touch keys
- To delete speed-dial codes and one-touch keys
- To program a one-touch key for alternate long distance
- To program group-dial codes
- To delete group-dial codes
- To delete an individual in a group-dial code
- To delete all speed-dial codes, one-touch keys, and group-dials codes

Programming speed-dial codes and one-touch keys

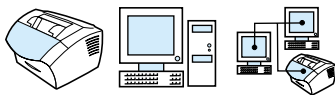

Speed-dial codes 1 through 10 are *also* associated with the corresponding one-touch key on the control panel. The one-touch keys can be used for speed-dial or group-dial codes. You can program all of the codes with speed-dials. A maximum of 50 characters can be entered for a single fax number.

Hint

Speed-dial codes and one-touch keys are more easily programmed from the software.

To program speed-dial codes and one-touch keys

- 1 Press **ENTER/MENU**.
- 2 Use the **<** or **>** key to select **FAX SETUP** and then press **ENTER/MENU**.
- 3 Press **ENTER/MENU** to select **SPEED DIALS**.
- 4 Press **ENTER/MENU** to select **INDIVIDUAL SETUP**.
- 5 Press **ENTER/MENU** to select **ADD INDIVIDUAL**.
- 6 Using the numeric keys, enter the number of the speed-dial code you want to associate with this fax number, and then press **ENTER/MENU**. Choosing 1 through 10 *also* associates the fax number with the corresponding one-touch key.

Note

When entering a fax number you can use a comma for a pause, the letter R if you want the product to wait for a dial tone, and use the letter W for a hook flash.

- 7 Using the numeric keys, enter the fax number. Include any pauses or other needed numbers, such as an area code, an access code for numbers outside a PBX system (usually a 9 or 0), or a long distance prefix.
- 8 Press **ENTER/MENU**.

- 9 Using the numeric keys, enter a name for the fax number. To do so, repeatedly press the numeric key for the letter you need until the letter appears. (See “Using dialing characters” on page 78 for a list of characters.) For example, if the first letter you need is a “C,” press 2 repeatedly until a C appears. Press > to go to the next space.

Note

To insert punctuation, press * repeatedly until the character you want appears and then press > to go to the next space. To delete a letter, press > until you reach the space to the right of the letter, and then press **BACK SPACE**.

- 10 Press **ENTER/MENU** to save the information.
- 11 If you have more speed-dial codes or one-touch keys to program, repeat steps 1 through 10.

To delete speed-dial codes and one-touch keys

- 1 Press **ENTER/MENU**.
- 2 Use the < or > key to select **FAX SETUP** and then press **ENTER/MENU**.
- 3 Press **ENTER/MENU** to select **SPEED DIALS**.
- 4 Press **ENTER/MENU** to select **INDIVIDUAL SETUP**.
- 5 Use the < or > key to select **DELETE INDIVIDUAL** and then press **ENTER/MENU**.
- 6 Using the numeric keys, enter the number of the speed-dial code you want to delete, and then press **ENTER/MENU**.
- 7 Press **ENTER/MENU** to confirm the deletion.

Programming a one-touch key for alternate long distance

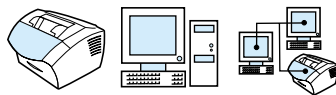

If you use an alternate long distance service, you can program a one-touch key to dial the service's access number before a fax number. When you need to use this one-touch key, press it, enter the fax number, and then press **FAX/SEND**. Both the access number and the fax number are then dialed together.

If the access number is used almost every time you dial a fax, it might be easier to program the access number as a dialing prefix (see "Inserting a dial prefix" on page 84). Use the procedure on this page if the access number has more than 10 numbers or if you only need to use the access number occasionally.

Hint

This procedure is more easily accomplished from the software.

To program a one-touch key for alternate long distance

- 1 Follow steps 1 through 6 of "Programming speed-dial codes and one-touch keys" on page 71. When entering the fax number, you might also have to do one or more of the following:
 - If you have to wait for an access tone at some point in the number, enter one or more three-second pauses by pressing **REDIAL/PAUSE**.
 - Enter a personal identification number (PIN), if applicable.
- 2 When you are finished entering the access number, press **REDIAL/PAUSE**. A pause at the end of the string tells the product not to dial this number until you dial the fax number.
- 3 Continue with steps 7 through 10 of "Programming speed-dial codes and one-touch keys" on page 71.

Programming group-dial codes

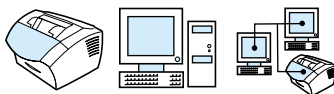

If you send information to the same group of people on a regular basis, you can program a group-dial code. You can program any of the remaining speed-dial codes with group-dial codes. Group-dial codes using numbers 1-10 are also associated with the corresponding one-touch key on the control panel. Any individual can be added to a group.

Each group member must have a programmed speed-dial code or one-touch key assigned to them before being added to the group-dial code. To print a list of which one-touch keys and speed-dial codes are programmed, see “Printing a one-touch, speed-dial, and group-dial report” on page 47.

This section contains the following procedures:

- To program group-dial codes
- To delete group-dial codes
- To delete an individual in a group-dial code

Hint

Group-dial codes are more easily programmed from the software. See the software Help for more information.

To program group-dial codes

- 1 Assign a speed-dial code to each fax number you want in this group. See “To delete speed-dial codes and one-touch keys” on page 72.
- 2 Press **ENTER/MENU**.
- 3 Use the **<** or **>** key to select **FAX SETUP** and then press **ENTER/MENU**.
- 4 Press **ENTER/MENU** to select **SPEED DIALS**.
- 5 Use the **<** or **>** key to select **GROUP SETUP** and then press **ENTER/MENU**.
- 6 Use the **<** or **>** key to select **ADD GROUP** and then press **ENTER/MENU**.

- 7 Using the numeric keys, enter the number you want to associate with this group and press **ENTER/MENU**. Choosing 1 through 10 also associates this group with the corresponding one-touch key.
- 8 Using the numeric keys, enter a name for the group. To do so, repeatedly press the numeric key for the letter you need until the letter appears. (See “Using dialing characters” on page 78 for a list of characters.) For example, if the first letter you need is a “C,” press **2** repeatedly until a **C** appears. Press **>** to go to the next space. After the name of the group has been typed, press **ENTER/MENU**.

Note

To delete a letter, press **>** until you reach the space to the right of the letter and then press **BACK SPACE**.

- 9 Press the one-touch key or choose the speed-dial code for the member you want, and then press **ENTER/MENU**. Press **ENTER/MENU** again to confirm the addition.
- 10 Repeat step 9 for each member you want to add.
- 11 When finished, press **STOP/CLEAR**.
- 12 If you have more group-dial codes to enter, press **ENTER/MENU** and repeat steps 1 through 12.

For instructions about using a group-dial code to send a fax, see “Sending faxes to multiple recipients” on page 57.

To delete group-dial codes

- 1 Press **ENTER/MENU**.
- 2 Use the **<** or **>** key to select **FAX SETUP** and then press **ENTER/MENU**.
- 3 Press **ENTER/MENU** to select **SPEED DIALS**.
- 4 Use the **<** or **>** key to select **GROUP SETUP** and then press **ENTER/MENU**.
- 5 Use the **<** or **>** key to select **DELETE GROUP** and then press **ENTER/MENU**.
- 6 Using the numeric keys, enter the number of the group-dial you want to delete and then press **ENTER/MENU**.
- 7 Press **ENTER/MENU** to confirm the deletion.

To delete an individual in a group-dial code

- 1 Press **ENTER/MENU**.

- 2 Use the < or > key to select **FAX SETUP** and then press **ENTER/MENU**.
- 3 Press **ENTER/MENU** to select **SPEED DIALS**.
- 4 Use the < or > key to select **GROUP SETUP** and then press **ENTER/MENU**.
- 5 Use the < or > key to select **DELETE * IN GROUP** and then press **ENTER/MENU**.
- 6 Use the < or > key to select the individual you would like to delete from the group.
- 7 Press **ENTER/MENU** to confirm the deletion.
- 8 Repeat steps 6 and 7 to delete other individuals from the group.
-Or-
Press **STOP/CLEAR** if you are finished.

Deleting all speed-dial codes, one-touch keys, and group-dials codes

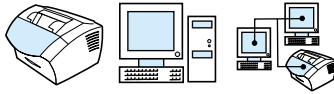

You can delete all speed-dial codes, one-touch keys, and group-dials codes that are programmed in the product.

CAUTION

Once speed-dial codes, one-touch keys, and group-dial codes are deleted, they cannot be recovered.

To delete all speed-dial codes, one-touch keys, and group-dials codes

- 1 Press **ENTER/MENU**.
- 2 Use the < or > key to select **FAX SETUP** and then press **ENTER/MENU**.
- 3 Press **ENTER/MENU** to select **SPEED DIALS**.
- 4 Use the < or > key to select **DELETE ALL ENTRIES** and then press **ENTER/MENU**.
- 5 Press **ENTER/MENU** to confirm the deletion.

Using Manual Dial



Normally, the product dials after you press **FAX/SEND**. At times, however, you might want the product to dial each number as you press it. For example, if you are charging your fax call to a calling card, you'll need to dial the fax number, wait for the acceptance tone of your telephone company, and then dial the calling card number. When dialing internationally, you might need to dial part of the number and then listen for dial tones before continuing to dial.

To use Manual Dial

- 1 Place the document in the document feeder tray.
- 2 Press **FAX/SEND**.
- 3 Begin dialing. The fax number dials as you press each digit. This allows you to wait for pauses, dial tones, international access tones, or calling card acceptance tones before continuing to dial.

Sending a fax by dialing from a telephone



At times, you might want to dial a fax number from a telephone connected to the same line as the product. For example, if you are sending a fax to a person whose product is in Manual mode, you can call first to let that person know the fax is coming.

To send a fax by dialing from a telephone

- 1 Place the document in the document feeder tray.
- 2 Pick up the handset of a phone connected to same line as the product and dial the fax number using the phone's or the product's numeric keys.
- 3 When the recipient answers, instruct the recipient to start the fax machine.
- 4 When you hear the fax tones, press **FAX/SEND** to begin transmitting the fax, and then hang up the phone.

Inserting a pause or wait into a fax number

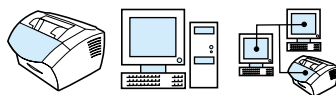

You can insert pauses into a fax number you are dialing or programming to a one-touch key, speed-dial code, or group-dial code. Pauses are often needed when dialing internationally or connecting to an outside line.

To insert a pause or wait

Press **REDIAL/PAUSE** to enter a three-second pause in your dialing sequence. A comma appears on the control panel display, indicating that the pause will occur at that point in the dialing sequence.

Using dialing characters



When using the control panel to type your name in the header or type a name for a one-touch key, speed-dial code, or group-dial code, you press a numeric key repeatedly until the letter you need appears. Then, you press **>** to select that letter and move to the next space.

This table shows you which letters and numbers appear on each numeric key when the default language is set to English:

Key number	Contains these characters
1	1
2	A B C 2
3	D E F 3
4	G H I 4
5	J K L 5
6	M N O 6
7	P Q R S 7
8	T U V 8
9	W X Y Z 9
0	0
*	() + - . / , " *
#	space #

Changing the information in the fax header

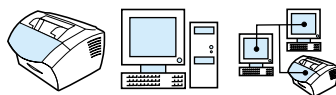

You already entered fax header information when you first set up the product. You only need this procedure to change the date, time, your fax number, and company name for the fax header.

Changing the date and time

The date and time information is included in the header that prints at the top of faxes you send. The time and date also appear on the control panel display when the product is idle.

To change the date and time:

- 1 Press **ENTER/MENU**.
- 2 Use the **<** or **>** key to select **TIME/DATE**, **HEADER** and then press **ENTER/MENU**.
- 3 Press **ENTER/MENU** to select **TIME/DATE**.
- 4 Use the **<** or **>** key to select a 12-hour or 24-hour clock, and then press **ENTER/MENU**.
- 5 Using the numeric keys, enter the current time.

Note

If you type a number incorrectly, press **BACK SPACE** until you reach the digit. Then type the number.

- 6 If you chose the 24-hour clock, press **ENTER/MENU**.
- Or -
If you chose the 12-hour clock, use the the **>** key to move the cursor past the fourth character. Select **1** for am or select **2** for pm, and then press **ENTER/MENU**.
- 7 Enter the current date using the numeric keys. Make sure to enter the month and day using both digits (for example, "05" for May), and then press **ENTER/MENU**.

Changing the fax number and company name

You already entered this information when installing the software or when you first set up the product. You only need this procedure if you want to change the information from the control panel.

The header contains information about your name or your company's name and your fax number. When a fax you sent arrives at its destination, this header is printed at the top of the page. **Filling in this information is a legal requirement.**

Hint

The fax header is more easily changed from the software. See the software Help for more information.

To change the fax number and company name

- 1 Press **ENTER/MENU**.
- 2 Use the **<** or **>** key to select **TIME/DATE**, **HEADER** and then press **ENTER/MENU**.
- 3 Use the **<** or **>** key to select **FAX HEADER** and then press **ENTER/MENU**.
- 4 Enter your fax number, and then press **ENTER/MENU**. To separate numbers, press **>** to insert spaces. To add a plus sign, press *****.
- 5 Use the numeric keys to add the name of your company. To do so, repeatedly press the numeric key for the letter you need until the letter appears. (See "Using dialing characters" on page 78 for a list of characters.) For example, if the first letter you need is a "C," press **2** repeatedly until a **C** appears. Use the **>** key to go to the next space.

Note

To insert punctuation, press ***** repeatedly until the character you want appears, and then press **>** to go to the next space. To delete a letter, press **<** or **>** until you reach the space to the right of the letter, and then press **BACK SPACE**.

- 6 When you have finished, press **ENTER/MENU**.

Changing the default contrast and resolution for outgoing faxes

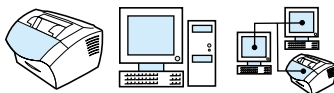

The contrast affects the lightness and darkness of an outgoing fax as it is being sent. Resolution affects the sharpness of outgoing faxes. It also affects the transmission speed of faxes. See “Resolution options” on page 62 for more information.

To change the default contrast

The default contrast is the contrast normally applied to items being faxed. The slider is set to the middle as the default contrast setting.

Note

If you only want to change the contrast for the current job, see “Using the Contrast button to adjust the contrast for the current fax or copy job” on page 61.

Hint

You might want to test the contrast settings on some documents before you set the default.

- 1 Press **ENTER/MENU**.
- 2 Use the **<** or **>** key to select **FAX SETUP** and then press **ENTER/MENU**.
- 3 Use the **<** or **>** key to select **FAX SEND SETUP** and then press **ENTER/MENU**.
- 4 Use the **<** or **>** key to select **DEFAULT CONTRAST**.
- 5 Use the **<** key to move the slider to the left to make the fax lighter than the original, or use the **>** key to move the slider to the right to make the fax darker than the original.
- 6 Press **ENTER/MENU** to save your selection.

To change the default resolution

The choices for this setting are Fine (the factory default), Standard, Superfine, and Photo. See “Resolution options” on page 62 for more information.

Note

If you only want to change the resolution for the fax job you are currently sending, see “Adjusting the resolution for the current job” on page 62.

- 1 Press **ENTER/MENU**.
- 2 Use the **<** or **>** key to select **FAX SETUP** and then press **ENTER/MENU**.
- 3 Use the **<** or **>** key to select **FAX SEND SETUP** and then press **ENTER/MENU**.
- 4 Press **ENTER/MENU** to select **DEFAULT RESOLUTION**.
- 5 Use the **<** or **>** key to select **FINE** (the default), **STANDARD**, **SUPERFINE**, or **PHOTO**.
- 6 Press **ENTER/MENU** to save your selection.

Selecting tone- or pulse-dialing mode

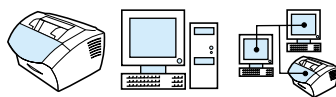

Use this procedure to set the product to tone- or pulse-dialing mode. You can use this procedure to set the product to tone- or pulse-dialing mode. The default is set to Tone. Leave this as Tone unless you know your telephone is incapable of tone dialing.

To select tone- or pulse-dialing

- 1 Press **ENTER/MENU**.
- 2 Use the **<** or **>** key to select **FAX SETUP** and then press **ENTER/MENU**.
- 3 Press **>** once to select **SEND SETUP** and then press **ENTER/MENU**.
- 4 Use the **<** or **>** key to select **DIALING MODE** and then press **ENTER/MENU**.
- 5 Use the **<** or **>** key to select **TONE** or **PULSE** and then press **ENTER/MENU** to save your selection.

Changing how the product redials

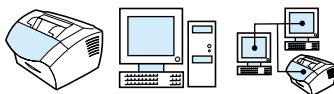

If the product was unable to send a fax because the receiving fax machine did not answer or was busy, the product will attempt to redial based on the Redial On Busy and Redial On No Answer options. Use the procedures in this section to turn these options on or off.

Note

The product will, by default, redial if the receiving fax machine is busy but will not, by default, redial if the receiving fax machine does not answer.

To turn the Redial On Busy option on or off

The product is set to redial busy numbers five times automatically.

- 1 Press **ENTER/MENU**.
- 2 Use the **<** or **>** key to select **FAX SETUP** and then press **ENTER/MENU**.
- 3 Use the **<** or **>** key to select **FAX SEND SETUP** and then press **ENTER/MENU**.
- 4 Use the **<** or **>** key to select **REDIAL ON BUSY** and then press **ENTER/MENU**.
- 5 Use the **<** or **>** key to select **ON** or **OFF** and then press **ENTER/MENU**.

To turn the Redial On No Answer on or off

The product is set to redial on no answer one time automatically in the United States and Canada, and two times automatically for all other countries/regions.

- 1 Press **ENTER/MENU**.
- 2 Use the **<** or **>** key to select **FAX SETUP** and then press **ENTER/MENU**.
- 3 Use the **<** or **>** key to select **FAX SEND SETUP** and then press **ENTER/MENU**.
- 4 Use the **<** or **>** key to select **REDIAL ON NO ANSWER** and then press **ENTER/MENU**.

- 5 Use the < or > key to select ON or OFF and then press ENTER/MENU.

Inserting a dial prefix

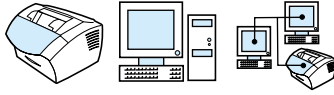

A dial prefix is a number or numbers automatically added to the beginning of every fax number you enter at the control panel or from the software. By default, this setting is Off. You may want to turn this setting on and enter a prefix if, for example, you have to dial a number such as “9” to get a phone line outside your company’s phone system.

While this setting is on, you can still dial a fax number without the dial prefix by using Manual Dial. See “Using Manual Dial” on page 77.

To set the dial prefix

- 1 Press ENTER/MENU.
- 2 Use the < or > key to select FAX SETUP and then press ENTER/MENU.
- 3 Press > once to select FAX SEND SETUP and then press ENTER/MENU.
- 4 Use the < or > key to select DIAL PREFIX and then press ENTER/MENU.
- 5 Use the < or > key to select ON or OFF and then press ENTER/MENU.
- 6 If you chose ON, use the numeric keys to enter the prefix, and then press ENTER/MENU. You can use numbers, pauses, and dialing symbols.

Changing the detect dial tone setting

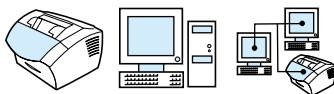

Normally the product waits for a dial tone before attempting to dial a fax number. If you are using the product on the same line as your phone, turn on the detect dial tone setting. This will prevent the product from sending a fax while someone is on the phone. In Australia, this setting by default is set to Off.

To change detect dial tone

- 1 Press **ENTER/MENU**.
- 2 Use the **<** or **>** key to select **FAX SETUP** and then press **ENTER/MENU**.
- 3 Press **>** once to select **FAX SEND SETUP** and then press **ENTER/MENU**.
- 4 Use the **<** or **>** key to select **DETECT DIAL TONE** and then press **ENTER/MENU**.
- 5 Use the **<** or **>** key to select **ON** or **OFF** and then press **ENTER/MENU**.

Advanced receive fax features and settings

The section describes more advanced procedures and settings you can use for receiving faxes. The topics include:

- Using fax forwarding
- Requesting a fax from another fax machine (polling)
- Receiving faxes to your computer
- Clearing faxes from memory
- Changing how the product answers incoming faxes
- Changing answer ring patterns
- Enabling an extension phone
- Changing the silence-detect mode
- Changing autoreduction for incoming faxes
- Enabling stamp received faxes
- Setting error correction

Using fax forwarding

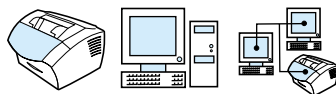

You can set your product to forward incoming faxes to another fax number. When the fax arrives at your product, it is stored in memory. Then, your product dials the fax number you have specified and sends the fax.

If it cannot forward a fax after repeated attempts because of an error, such as the number being busy and redials failing, your product will print the fax. If it runs out of memory while receiving a fax, it will terminate the incoming fax and only forward the pages and partial pages already stored in memory.

When using this feature, the product must be the one **receiving faxes** (not the computer) and the answer mode must be set to Automatic (see “Changing how the product answers incoming faxes” on page 90).

To use fax forwarding

- 1 Press **ENTER/MENU**.
- 2 Use the **<** or **>** key to select **FAX SETUP** and then press **ENTER/MENU**.
- 3 Use the **<** or **>** key to select **FAX RECEIVE SETUP** and then press **ENTER/MENU**.
- 4 Use the **<** or **>** key to select **FORWARD FAX** and then press **ENTER/MENU**.
- 5 Press **>** to select **ON** or **OFF** and then press **ENTER/MENU**.
- 6 If you choose to turn fax forwarding on, use the numeric keys to enter the fax number where you would like the fax to go, and then press **ENTER/MENU** to save your selection.

Requesting a fax from another fax machine (polling)

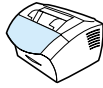

If someone else has set up a fax to be polled, you can request that the fax be sent to your product. (This is also known as polling another machine.)

To request a fax from another fax machine

- 1 Press **ENTER/MENU**.
- 2 Use the **<** or **>** key to select **FAX FUNCTIONS** and then press **ENTER/MENU**.
- 3 Use the **<** or **>** key to select **POLLING RECEIVE** and then press **ENTER/MENU**.
- 4 Use the numeric keys to enter the number of the fax machine from which you want to request the fax, and then press **ENTER/MENU**.

Your product dials the other fax machine and requests the fax.

Clearing faxes from memory



Only use this procedure if you are concerned someone else has access to your product and will try to reprint faxes in the reprint memory.

CAUTION

In addition to clearing the reprint memory, this procedure clears fax currently being sent, unsent faxes pending redial, faxes scheduled to be sent at a future time, and faxes not printed or forwarded.

To clear faxes from memory

- 1 Press **ENTER/MENU**.
- 2 Press **>** once to display **FAX FUNCTIONS** and then press **ENTER/MENU**.
- 3 Use the **<** or **>** key to select **CLEAR STORED FAXES** and then press **ENTER/MENU**.
- 4 Press **ENTER/MENU** to confirm the deletion.

Changing how the product answers incoming faxes

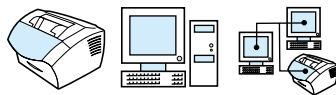

You set the answer mode when you set up the product. You will only need to change these settings if you change what devices are connected to this phone line.

To set the answer mode to automatic or manual

- 1 Press **ENTER/MENU**.
- 2 Use the **<** or **>** key to select **FAX SETUP** and then press **ENTER/MENU**.
- 3 Use the **<** or **>** key to select **FAX RECEIVE SETUP** and then press **ENTER/MENU**.
- 4 Press **ENTER/MENU** to select **ANSWER MODE**.
- 5 Use the **<** or **>** key to select **AUTOMATIC** or **MANUAL** and then press **ENTER/MENU** to save your selection.

Changing answer ring patterns

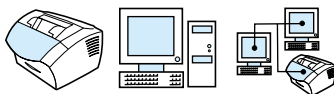

If you subscribe to ring pattern service with your telephone company, enable the product to detect ring patterns. If you do not have ring pattern service, and you change this setting, the product will not be able to receive faxes.

What is ring pattern service?

Ring pattern service, such as distinctive ring, is available from some local telephone companies. It allows you to have two or three phone numbers on one line. This costs less than paying for two or three separate lines. Each of the phone numbers has a different ring pattern. Ring patterns allow you to answer voice calls and allow the product to answer fax calls.

How do I get the service?

Call your local telephone company to check the availability and to subscribe. The service might not be available in all areas. Also, your telephone company might use a different name for this service.

If ring pattern service is available and you choose to subscribe to it, keep in mind the following:

- Determine which ring pattern is used for phone calls and which is used for fax calls.
- Make sure the telephone company assigns the correct ring pattern to the fax number. In New Zealand, it should be a double-ring pattern with long pauses. The product ignores other ring patterns.
- **Important! If you have an answering machine or computer voicemail on this line for the other phone number**, make sure the product's rings to answer is set to a *lower* number than the rings to answer on the answering machine or voicemail. In the case of ring pattern detection, the product must answer calls first in order to be able to receive fax calls.

How will I know if it's working?

After product installation is complete, ask someone you know to send you a fax. Make sure you provide the correct fax number.

To change answer ring patterns

Note

Do not change the All Rings default setting if you do not have ring pattern service from your telephone company. If you do not have ring pattern service, and you change this setting, the product might not be able to receive faxes.

- 1 Press **ENTER/MENU**.
- 2 Use the **<** or **>** key to select **FAX SETUP** and then press **ENTER/MENU**.
- 3 Use the **<** or **>** key to select **FAX RECEIVE SETUP** and then press **ENTER/MENU**.
- 4 Use the **<** or **>** key to select **ANSWER RING PATTERN** and then press **ENTER/MENU**.
- 5 Use the **<** or **>** key to select the ring pattern you want the product to use when answering incoming fax calls, and then press **ENTER/MENU** to save your selection.

Note

If you have an answering machine or computer voicemail connected to this line for the other phone number (on the single ring pattern), make sure the product's rings to answer is set to a *lower* number than the rings to answer on the answering machine or voicemail. If it is not, the product will be unable to receive fax calls.

Enabling an extension phone

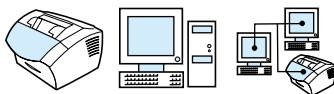

With this setting turned on, you can alert the product to pick up the incoming fax call by pressing 1-2-3 sequentially on the telephone keypad. The default is Yes. Turn this setting off *only* you have a service from your telephone company that also uses the 1-2-3 sequence, and the service will not work because of the conflict.

- 1 Press **ENTER/MENU**.
- 2 Use the < or > key to select **FAX SETUP** and then press **ENTER/MENU**.
- 3 Use the < or > key to select **FAX RECEIVE SETUP** and then press **ENTER/MENU**.
- 4 Use the < or > key to select **EXTENSION PHONE** and then press **ENTER/MENU**.
- 5 Use the < or > key to select **ON** or **OFF** and then press **ENTER/MENU** to save your selection.

Changing the silence-detect mode

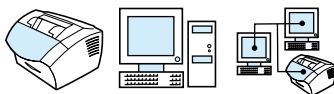

This setting controls whether or not you can receive faxes from older-model fax machines that do not emit a fax signal during fax transmissions. At the time of this publication, these silent-model fax machines represented very few of the fax machines in use.

The default setting is No. It should be changed only if you regularly receive faxes from someone with an older-model fax machine.

To change the silence detect mode

- 1 Press **ENTER/MENU**.
- 2 Use the **<** or **>** key to select **FAX SETUP** and then press **ENTER/MENU**.
- 3 Use the **<** or **>** key to select **FAX RECEIVE SETUP** and then press **ENTER/MENU**.
- 4 Use the **<** or **>** key to select **SILENCE DETECTION** and then press **ENTER/MENU**.
- 5 Use the **<** or **>** key to select **ON** or **OFF** and then press **ENTER/MENU** to save your selection.

Changing autoreduction for incoming faxes

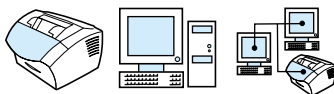

If the Fit To Page option is on, the product automatically reduces long faxes to fit on the paper. If the feature is turned off, long faxes print at full size on multiple pages.

If you have the page stamp option on, you may want to choose On. This reduces the size of incoming faxes just slightly to prevent the page stamp from forcing a received fax page onto two pages. The default for this setting is On.

Note

Make sure the paper size setting matches the size of paper loaded in the paper input tray. See “Changing the default paper size for the paper input tray” on page 38 for instructions.

To change autoreduction for incoming faxes

- 1 Press **ENTER/MENU**.
- 2 Use the **<** or **>** key to select **FAX SETUP** and then press **ENTER/MENU**.
- 3 Use the **<** or **>** key to select **FAX RECEIVE SETUP** and then press **ENTER/MENU**.
- 4 Use the **<** or **>** key to select **FIT TO PAGE** and then press **ENTER/MENU**.
- 5 Use the **<** or **>** key to select **ON** or **OFF** and then press **ENTER/MENU** to save your selection.

Enabling stamp received faxes

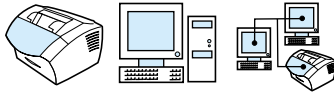

The product is set up to print the sender's identification at the top of each received fax. You can also choose to have your header information included to confirm the date and time the fax was received.

If you want the product to include your header information to each received fax, follow the procedure below. The default setting is Off.

Note

This option only applies to received faxes that are printed by the product.

To enable stamp received faxes

- 1 Press **ENTER/MENU**.
- 2 Use the **<** or **>** key to select **FAX SETUP** and then press **ENTER/MENU**.
- 3 Use the **<** or **>** key to select **FAX RECEIVE SETUP** and then press **ENTER/MENU**.
- 4 Use the **<** or **>** key to select **STAMP RECEIVED FAXES**, and then press **ENTER/MENU**.
- 5 Use the **<** or **>** key to select **ON** or **OFF** and then press **ENTER/MENU** to save your selection.

Setting error correction

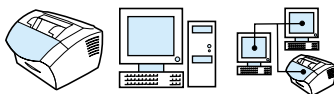

Normally, the product monitors the signals on the telephone line while it is sending or receiving a fax. If the product detects an error signal during the transmission and the Error Correction setting is on, the product can request that a portion of the fax be resent.

The factory default for this setting is On. Only change it to Off if you are having trouble sending or receiving a fax and want to accept the errors in the transmission. Turning the setting off might be useful when you are trying to send or receive a fax overseas or using a satellite telephone connection.

To set error correction

- 1 Press **ENTER/MENU**.
- 2 Use the **<** or **>** key to select **FAX SETUP** and then press **ENTER/MENU**.
- 3 Use the **<** or **>** key to select **ALL FAXES** and then press **ENTER/MENU**.
- 4 Use the **<** or **>** key to select **ERROR CORRECTION** and then press **ENTER/MENU**.
- 5 Use the **<** or **>** key to select **ON** or **OFF** and then press **ENTER/MENU** to save your selection.

Faxing using the software

This section contains some instructions about sending and receiving faxes using the software that came with the product, as well as creating your own cover page. All other software-related topics are covered in the software Help.

See the following topics in this guide to learn more about how to fax using the software:

- Sending faxes from the software
- Receiving faxes to your computer
- Customizing your own fax cover sheet

Note

The HP LaserJet Director and HP LaserJet Document Manager are not supported for Microsoft Windows 95, therefore you cannot fax using the software.

Sending faxes from the software

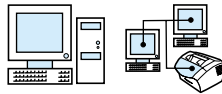

You can fax electronic documents from your computer if:

- the HP LaserJet product is connected directly to your computer or connected to your computer over the network using an HP JetDirect print server,
- the software is installed on your computer, and
- you are using Microsoft Windows 98, 2000, or NT 4.0, or Mac OS 8.6 or 9.0.

To send a fax from the software

The following are typical steps required to send a fax:

- 1 Select a document to fax. Documents can be:
 - opened in the HP LaserJet Workplace on Macintosh-compatible computers
 - opened in the HP LaserJet Document Manager on Windows-compatible computers
 - placed in the document feeder tray on the product.

- 2 Add one or more recipients on the **HP LaserJet Send Fax** dialog box.
- 3 Optionally, include a cover page.
- 4 Click **Send Now**.
-Or-
Click **Send Later** and select a delay date and time.

For more information on sending a fax using the HP LaserJet Workplace (Mac OS), the HP LaserJet Document Manager (Windows), or the HP LaserJet Director, the software Help.

Receiving faxes to your computer

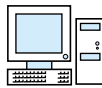

To receive faxes to your computer, you must enable the **Receive to PC** setting in the software. (See the software Help for instructions.)

If you have a phone line receiving both fax and voice calls (a shared line) and an answering machine or computer voicemail on the line, you must turn off the answering machine or voicemail to receive faxes to the computer. If you do not, either the answering system answers all calls, or the PC fax program does. Because of this limitation, most users choose to receive faxes to the product.

The **Receive to PC** setting can only be activated from the computer. If for any reason that computer is no longer available or accessible, you can use the procedure below to turn the **Receive to PC** setting off from the product control panel.

To turn the Receive to PC setting off from the control panel



- 1 Press **ENTER/MENU**.
- 2 Use the **<** or **>** key to select **FAX FUNCTIONS**, and then press **ENTER/MENU**.
- 3 Use the **<** or **>** key to select **STOP RECEIVE TO PC**, and then press **ENTER/MENU** to confirm your selection.

Note

Once the **Stop Receive to PC** setting has been selected, any faxes still in the product's memory are printed.

Customizing your own fax cover sheet

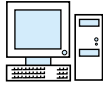

You can use the HP LaserJet Cover Page Editor to customize a fax cover sheet for all your outgoing fax transmissions. With the HP LaserJet Cover Page Editor, you can add text and images along with special fields that define such attributes as who the fax is for, who it is from, the date, and how many pages are in the fax.

Note

See the software Help for more information about fax cover sheets.

To customize your own fax cover sheet (Windows)

- 1 Click **Start**, point to **Programs**, point to **HP LaserJet 3200**, and then click **HP LaserJet Cover Page Editor**.
- 1 From the **File** menu, select **New**.
- 2 Select a standard page dimension.
- 3 Select the page orientation, either **Portrait** or **Landscape**.
- 4 Click **OK**.
- 5 Add objects to your fax cover sheet:
 - To add a special field, select one from the **Special Fields** list and click **Add to Page**.
 - To add an image, from the **Image** menu, select **Insert Image**.
 - To add text, click one of the text tools from the **Graphic** toolbar, click on the image, and enter the text.
 - To add drawing objects, click one of the shape tools from the **Graphic** toolbar, click the image, and draw the shape.
 - To move objects around the page, click to highlight them and drag them to their new location.
 - To add images from other applications, use the **Copy** and **Paste** commands.
- 6 On the **File** menu, click **Save**.

To customize your own fax cover sheet (Mac OS)

- 1 Open the HP LaserJet Workplace. In the File menu, choose New Cover Page. A new cover page opens in the page editor along with the Tools, Align, and Properties palettes.
- 2 In the File Menu, click Page Setup. Use the Page Setup dialog box to set the page size and orientation for the new cover sheet.
- 3 Click OK.
- 4 Add objects to your fax cover sheet:
 - To add a special field, select the Fax Field page in the Properties palette using the pull-down menu at the top of the palette. Use the list of Fax Fields to assign properties to elements on your cover page.
 - To add an image, in the Image menu, select Insert Image.
 - To add text, click one of the text tools from the Graphic toolbar, click on the image, and enter the text.
 - To add drawing objects, click one of the shape tools from the Graphic toolbar, click the image, and draw the shape.
 - To move objects around the page, click to highlight them and drag them to their new location.
 - To add images from other applications, use the Copy and Paste commands.
- 5 In the File menu, choose Save.

5 Printing

Introduction

This section introduces you to the basics of printing, as well as offering tips for performing printing tasks with special media. Typically, all print-related commands are executed through the program used to create the document, so look in your program's documentation for instructions about sending jobs to print.

You can print to the product if:

- The product is connected directly to a computer or to the network using a supported HP JetDirect print server, and the printer drivers for this product are installed. (If you installed the software, the printer drivers have been installed.) Other HP printer drivers do *not* work with this product.
- The person using the computer that is directly connected to the product allows other users on the network to print to it. See the computer documentation to enable Windows-sharing.

Printer drivers

Printer drivers access the product's features and allow the computer to communicate with the printer. This section discusses the printer drivers installed with the product software.

Choosing a printer driver

Choose a printer driver based on the way you use the product.

- Use the PCL 6 driver to take full advantage of the product's features. Unless complete backward compatibility with previous PCL drivers or older printers is necessary, the PCL 6 driver is recommended.
- Use the PCL 5e driver if you need print results to look consistent with those from older HP LaserJet printers. Certain features are not available in this driver. (Do not use the PCL 5e driver provided with this printer with older printers.)
- Use the PostScript (PS) driver for compatibility with PS needs. Certain printer features are not available in this driver.

Note

If your printer has PS capabilities, the printer automatically switches between PS emulation and PCL printer languages depending on the driver you have selected.

If you need help accessing your printer driver, see "Gaining access to the printer driver" on page 105.

Gaining access to the printer driver



After installation, you can gain access to printer settings through the printer driver from the product software or from another software application.

Operating System	Change default settings (across all applications)	Temporarily change settings (from a software application)
Windows 95 and 98	<ol style="list-style-type: none">1 From the Start menu, point to Settings, and then click Printers.2 Right-click the printer icon, and then click Properties.	From the File menu, click Print , and then click Properties . (The actual steps can vary; this is the most common method.)
Windows 2000 and NT 4.0	<ol style="list-style-type: none">1 From the Start menu, point to Settings, and then click Printers.2 Right-click the printer icon, and then click Document Defaults.	From the File menu, click Print , and then click Properties . (The actual steps can vary; this is the most common method.)
Mac OS	<ol style="list-style-type: none">1 In the File menu, choose Page Setup.2 Use the Page Setup dialog to set default options. The HP LaserJet 3200 product must be the device selected for printing in the Chooser.	<ol style="list-style-type: none">1 In the File menu, choose Print.2 Use the Print dialog box to set print options.

Printer tasks

Use the product to do the following procedures:

- Printing on letterhead and envelopes
- Printing on special media
- Stopping a print job
- Saving toner when printing drafts
- Printing on both sides of paper
- Printing multiple pages on one sheet of paper
- Creating and using watermarks

Printing on letterhead and envelopes



This section provides procedures for printing on letterhead and envelopes.

To print on letterhead

- 1 If you are printing a sheet of letterhead followed by regular sheets of paper, place a sheet of letterhead into the single-sheet input slot (A) and regular sheets of paper into the paper input tray (B).
-Or-
If you are printing several sheets of letterhead in succession, fill the paper input tray (B) with the letterhead.

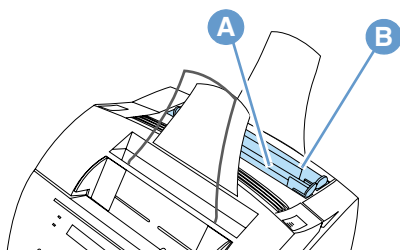

- 2 Insert the letterhead top first, print side up.

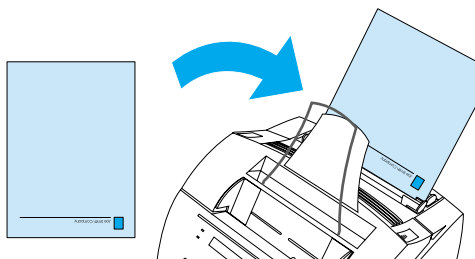

Note

When adding paper to an existing stack in the paper input tray, always remove and realign all paper before reloading to avoid multiple paper feeds. If printing on embossed or preprinted paper, make sure the paper meets HP's paper specifications. To order the *Print Media Guide* for HP LaserJet printers, see "Ordering parts" on page 257.

To print on envelopes

- 1 If you are printing one envelope followed by regular sheets of paper, place the envelope into the single-sheet input slot (A) and place regular sheets of paper into the paper input tray (B).
 - Or -
 - If you are printing several envelopes in succession, load seven to 10 envelopes at most into the paper input tray (B), depending on envelope construction and operating environment.
 - Or -
 - If you are printing only one envelope, use the single-sheet input slot (A).

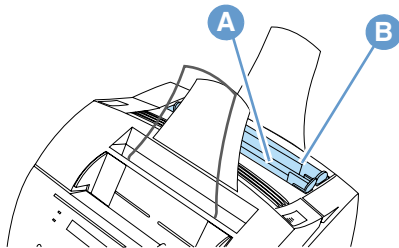

- 2 Insert the envelopes print side up, leading with the edge that will be stamped.

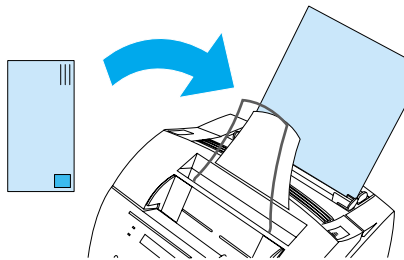

- 3 Open front paper path door to eliminate curled envelopes.

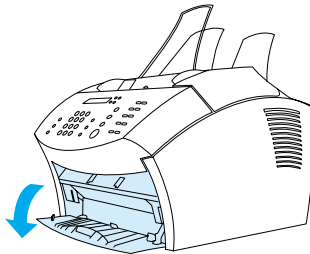

- 4 When you are finished printing envelopes, close the front paper path door.

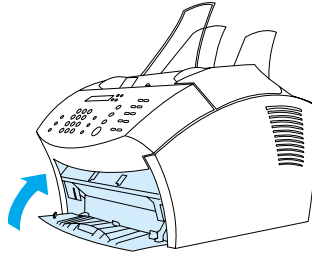

Printing on special media



The product is designed to print on a variety of media, including transparencies, envelopes, and custom-made paper. See “Selecting media to print” on page 23 for more information.

It is recommended that you use HP media or media that meets HP’s specifications. See “Ordering parts” on page 257 to order HP’s special media or refer to the *Print Media Guide* for HP LaserJet printers.

Note

To avoid transparency curl, remove the transparency as it comes out of the product and set it on a flat surface to cool.

To print on special media

- 1 Open the front paper path door. This is important when printing media such as postcards, transparencies, labels, envelopes, and heavy paper (28- to 42-lb [100- to 157-g/m²] bond weight).

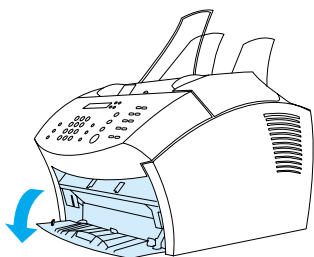

- 2 Do one of the following:
 - If you are printing on a single sheet of print media, adjust the guides on the single-sheet input slot to fit the approximate size of media you are using.

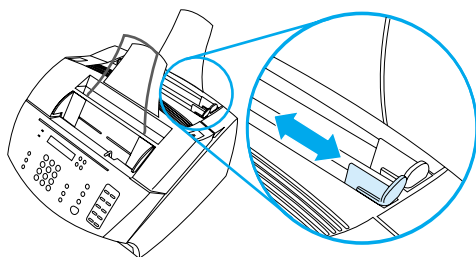

-Or

- If you are printing on multiple sheets of print media, adjust the guides on the paper input tray.

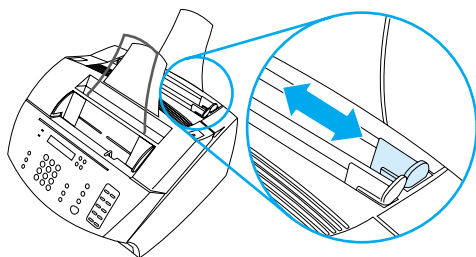

- 3 Insert the media print side forward and top side down into the single-sheet input slot or the paper input tray.
- 4 Readjust the guides to center the media.

- 5 Set the correct margins, paper size, and orientation in your software.
- 6 Choose **Print** in your software.
- 7 When you are finished, be sure to close the front paper path door.

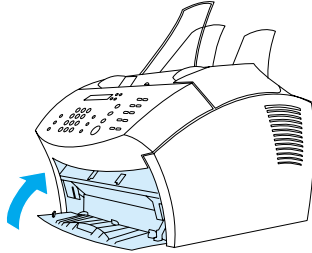

Stopping a print job

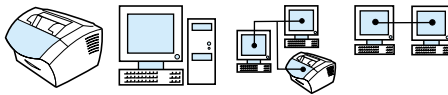

If your print job is currently printing, you can stop a print job by pressing **STOP/CLEAR** on the control panel.

CAUTION

Pressing **STOP/CLEAR** clears the job currently being processed by the product.

Saving toner when printing drafts



EconoMode (Save Toner) allows the printer to use less toner on each page. Selecting this option might extend the life of your toner cartridge and reduce your cost per page but will reduce print quality, so be sure to use it for drafts. You can select the EconoMode option from the printer driver. See “Gaining access to the printer driver” on page 105.

Printing on both sides of paper



Note

When using a Windows-compatible computer or a Macintosh-compatible computer, this option is not available with the PostScript printer driver that is provided with the product.

To print on both sides of the paper (manual duplexing), you must run the paper through the printer twice. You can print using the paper output bin or the straight-through output path. HP recommends using the paper output bin for light-weight paper. Use the straight-through output path for any heavy media or media that tends to curl when printed, such as envelopes and card stock.

Note

Manual duplexing can cause the printer to become dirty more quickly and reduce print quality. See “Cleaning the printer” if the printer becomes dirty.

The four print orientation options are shown below. These options are available when **Print on Both Sides (Manually)** is selected from the printer driver.

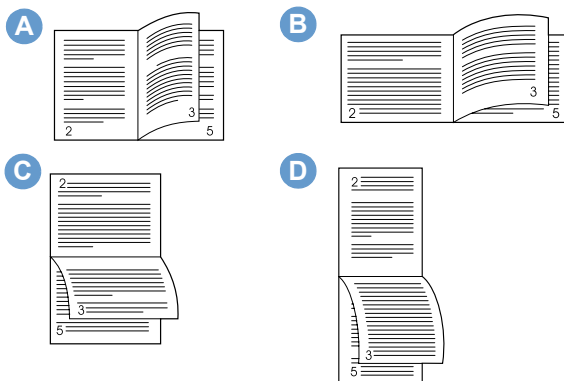

- A Flip pages sideways (portrait)** - This is the most common layout, with every printed image oriented right-side up. Facing pages are read from top to bottom on the left page, then from top to bottom on the right page.
- B Flip pages sideways (landscape)** - Each printed image is oriented right-side up. Facing pages are read from top to bottom on the left page, then from top to bottom on the right page.

- C Flip pages up (landscape)** - This layout is often used in accounting, data processing, and spreadsheet applications. Every other printed image is oriented upside-down. Facing pages are read continuously from top to bottom.
- D Flip pages up (portrait)** - This layout is often used with clipboards. Every other printed image is oriented upside-down. Facing pages are read continuously from top to bottom.

Use the instructions below to manually print on both sides of paper.

To print on both sides of paper

Note

When using a Windows-compatible computer or a Macintosh-compatible computer, this option is not available with the PostScript printer driver that is provided with the product.

CAUTION

Do not print on both sides of labels, transparencies, or vellum. Jamming and damage to the printer might result.

- 1 Gain access to the printer driver (see “Gaining access to the printer driver” on page 105).
- 2 Click the **Finishing** tab, and then click **Print on Both Sides (Manually)**.
- 3 Click **Straight Paper Path**, and then click **OK**.
- 4 Follow instructions on the screen to finish the print job.

Printing multiple pages on one sheet of paper



You can select the number of pages you want to print on a single sheet of paper. If you choose to print more than one page per sheet, the pages will appear decreased in size and arranged to fit on the sheet. You can specify up to 16 pages per printed sheet.

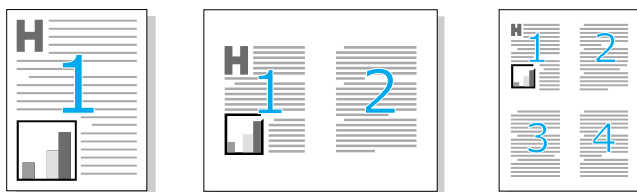

Creating and using watermarks



The Watermark option allows you to specify that text be placed in the background of an existing document. For example, you might want to have large gray letters reading “draft” or “confidential” placed diagonally across the first page or all pages of a document. See the example below.

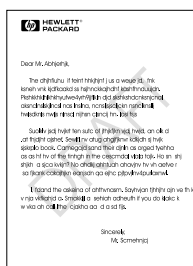

To gain access to the watermark option:

- 1 Access the printer driver (see “Gaining access to the printer driver” on page 105).
- 2 Click the **Effects** tab for Windows-compatible computers, or click the Finishing tab for Macintosh-compatible computers.

Printer settings

See the two sections listed below to learn more about the different settings for printing.

- Changing the resolution
- Saving printer settings for different print jobs

Note

For more information about how to use printer settings, see the software Help.

Changing the resolution



The printer's default print quality setting is Faster Printing (FastRes), which uses 1200 dpi to provide the best combination of print speed and print quality. If you need advanced print quality, you can choose custom settings. You can get to print quality settings from the printer driver.

The following options are available depending on the printer driver you are using.

- Faster Printing - FastRes 1200 (default), the alternate resolution for complex graphics or faster output
- Best Quality - ProRes 1200, for best print quality
- 600 dpi
- 300 dpi

Note

Changing resolution might change the formatting of your text.

Saving printer settings for different print jobs



The Quick Set feature allows you to save and reuse the current printer settings. Saved settings are called Quick Sets. For example, you might want to create a Quick Set for envelopes or for printing the first page of a document on letterhead.

For convenience, Quick Sets can be selected and saved from most printer driver tabs. You can also restore printer driver default settings by selecting **Defaults** from the **Quick Sets** list.

For more information, see the software Help.

Printing Tips

This section contains:

- Tips for printing custom sizes
- Tips for printing envelopes
- Tips for printing labels

For more information about using print media with HP LaserJet printers, refer to the *Print Media Guide* (see “Ordering parts” on page 257).

Tips for printing custom sizes

- Do not print on media smaller than 3 inches (76.2 mm) wide or 5 inches (127 mm) tall.
- Set margins of at least 0.25 inch (6.4 mm) in your software.
- Always insert media vertically (portrait orientation) into the product. If you want to print in landscape mode, make this selection through your software.

Tips for printing envelopes

- Low operating humidity (less than 50 percent relative humidity) often results in a background gray cast. (This is often most noticeable during the winter months.) For best results, print envelopes in an environment with humidity of 50 percent or more. Also, try to store envelopes in that same condition for at least 24 hours before printing. (Note that background gray cast is sometimes also evident just after installing a new toner cartridge.)
- If possible, verify that envelope adhesive can withstand temperatures up to 392° F (200° C). This is the temperature of the fusing assembly during printing.
- If envelopes are coming out wrinkled, try flattening the edges of the envelope with a ruler or other flat object before feeding it through the product. Or, try using a different brand of envelope.
- Keep the printer clean. Contaminants such as loose toner and paper dust can interfere with the printing process.

Tips for printing labels

- Do not use labels that are separating from the backing sheet or that are wrinkled or damaged in any way.
- Do not use any sheet of labels that has spaces in it where some of the labels have been removed.
- Do not feed a sheet of labels through your product more than once.
- If possible, verify that label adhesive can withstand temperatures up to 392° F (200° C). This is the temperature of the fusing assembly during printing.

6 Copying

Introduction

Anyone can make copies by using the control panel on the product. To use the HP LaserJet Director to make copies, your computer must be directly connected to the product.

This section provides information on how make copies from the product as well as how to change copy settings.

Hint

You can find out what product settings are currently selected by printing a configuration report (see “Printing a configuration report” on page 48).

Copying tasks

The product functions as a standalone copier — you do not have to have software installed or have the computer on to make copies.

Generally, making copies using the product's control panel is the easiest and fastest method. You can also adjust copy settings from the control panel. Use the software to collate large jobs or make color copies.

The topics in this section include:

- Making black and white copies
- Making color copies
- Using the Contrast button to adjust the contrast for the current fax or copy job
- Adjusting copy quality for the current job
- Reducing or enlarging copies for the current job

Making black and white copies

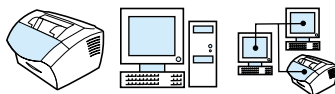

Use this procedure to make copies from the product. You can make up to 99 copies of a document that has as many as 30 pages (depending on the thickness of the pages). If pages of the document are longer than what is selected as the default paper size for the paper input tray, the copies will print on multiple sheets of paper. See “Changing the default paper size for the paper input tray” on page 38.

If you are copying small, fragile, lightweight (less than 12 lb. or 46 g/ m²), or irregularly sized items such as receipts, newspaper clippings, photographs, and old or worn documents, use the instructions for loading special items. See “To load special items” on page 27.

Note

The factory default for collation is On. With the collation on, multiple copies print in sets. For example, if you are making two copies of a three-page document, the copies print in this order: 1,2,3,1,2,3. See “Changing the default copy collation” on page 128 for more information and instructions on changing this setting.

You can change the default number of copies to any value from 1 to 99. See “Changing the default number of copies” on page 129.

In the rare instance that the document does not fit into memory when making multiple copies, only one copy will print and the control panel will notify you of the problem. To resolve the problem, try the following alternatives:

- Make just one copy at a time.
- Turn off the collation.
- Split the job into smaller jobs containing fewer pages.
- Use the HP LaserJet Director to make the copies.

To make black and white copies

- 1 Load the document into the document feeder tray.
- 2 Adjust any options, such as contrast or copy size.
- 3 If you are making only one copy, press **COPY**.
- Or -
If you are making multiple copies, enter the number of copies you want and press **COPY**.

Making color copies



You can create color copies by using the product to scan the original, and then using a color printer to print multiple copies. The HP LaserJet 3200 does not print in color. See the software help for more information about how to make color copies.

Using the Contrast button to adjust the contrast for the current fax or copy job



The contrast setting affects the lightness or darkness of an outgoing fax as it is being sent or the resulting copy. Using the following procedure changes the contrast for the current job only. After the fax has been sent or the copy is made, the contrast setting returns to the default.

Note

To change the default copy contrast, see “Changing the default copy contrast” on page 126.

To adjust the contrast

- 1 Press **CONTRAST** to display the current contrast setting.
- 2 Use the **<** or **>** key to move the slider to the left to make the fax or copy lighter than the original, or move the slider to the right to make the fax or copy darker than the original.
- 3 Press **ENTER/MENU** to save the selection.

Adjusting copy quality for the current job

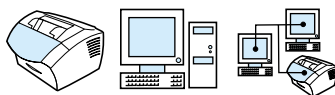

The default setting for copy quality is Text. This setting is the best for items that contain mostly text. When making a copy of a photo or graphic, you can select Photo to increase the quality. If you want to conserve toner and the copy quality is not that important, select Draft. To change the default copy quality, see “Changing the default copy quality” on page 126.

Note

If you want make a copy using Text copy quality, select Standard, Fine, or Superfine.

To adjust the copy quality

- 1 Press **RESOLUTION** to display the current resolution setting.
- 2 Use the **<** or **>** key to scroll through the choices and after selecting your choice, press **ENTER/MENU** to save the selection.

Reducing or enlarging copies for the current job

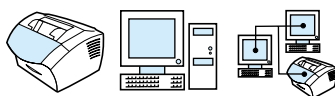

The product can reduce copies to as little as 25 percent of the original or enlarge copies to as much as 200 percent of the original. It can also make the following reductions or enlargements automatically: Letter to A4, A4 to Letter, Legal to Letter, Legal to A4. Using the procedure below changes the reduction or enlargement for the current job only.

Note

To change the default reduce or enlarge copy setting, see “Changing the default copy size” on page 127.

To reduce or enlarge copies

- 1 Press **REDUCE/ENLARGE**.
- 2 Enter the size to which you would like to reduce or enlarge the copies in this job. You can choose ORIGINAL (100%), LEGAL TO LETTER, LEGAL TO A4, or A4 TO LETTER, LETTER TO A4, or CUSTOM (25-200%).
- 3 Press **ENTER/MENU** to save your selection.
-Or-
If you chose CUSTOM (25-200%), type a percentage and press **ENTER/MENU**.

Note

You can change the default paper size in the paper input tray. This can be useful if you want to make Legal to Legal copies. See “Changing the default paper size for the paper input tray” on page 38.

Default Copy Settings

You can use the software to change the default copy settings. See the topics listed below for more information:

- Changing the default copy quality
- Changing the default copy contrast
- Changing the default copy size
- Changing the default copy collation
- Changing the default number of copies

Changing the default copy quality

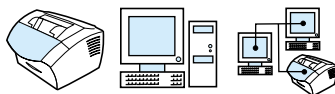

The choices for this setting are Text (the factory default), Photo, and Draft.

Note

If you only want to adjust the quality for the job you are currently copying, see “Adjusting copy quality for the current job” on page 123.

To change the default copy quality

- 1 Press **ENTER/MENU**.
- 2 Use the **<** or **>** key to select **COPY SETUP** and then press **ENTER/MENU**.
- 3 Use the **<** or **>** key to select **DEFAULT QUALITY** and then press **ENTER/MENU**.
- 4 Use the **<** or **>** key to select **TEXT** (the factory default), **PHOTO**, or **DRAFT**.
- 5 Press **ENTER/MENU** to save your selection.

Changing the default copy contrast

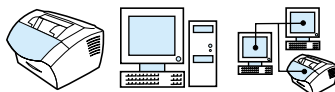

Contrast is the difference between the dark and light areas of an image. The slider is set to the middle as the default copy contrast setting.

Note

If you only want to adjust the contrast for the job you are currently copying, see “Using the Contrast button to adjust the contrast for the current fax or copy job” on page 122.

To change the default copy contrast

- 1 Press **ENTER/MENU**.
- 2 Use the **<** or **>** key to select **COPY SETUP**, and then press **ENTER/MENU**.
- 3 Use the **<** or **>** key to select **DEFAULT CONTRAST**.
- 4 Use the **<** or **>** key to move the slider to the left to make the copy lighter than the original, or move the slider to the right to make the copy darker than the original.
- 5 Press **ENTER/MENU** to save your selection.

Changing the default copy size

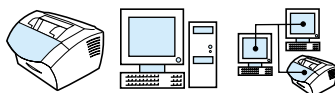

The default copy size is the size to which copies are normally reduced or enlarged. If you keep the factory default size set to **Original (100%)**, all copies will be the same size as the original document.

Note

If you only want to adjust the copy size for the job you are currently copying, see “Reducing or enlarging copies for the current job” on page 123.

To change the default copy size

- 1 Press **ENTER/MENU**.
- 2 Use the **<** or **>** key to select **COPY SETUP** and then press **ENTER/MENU**.
- 3 Use the **<** or **>** key to select **DEF. REDUCE/ENLARGE** and then press **ENTER/MENU**.
- 4 Use the **<** or **>** key to select the option for how you normally want to reduce or enlarge copies. You can choose **ORIGINAL (100%)**, **LEGAL TO LETTER**, **LEGAL TO A4**, or **A4 TO LETTER**, **LETTER TO A4**, or **CUSTOM (25-200%)**.
- 5 Press **ENTER/MENU** to save your selection.
-Or-
If you chose **CUSTOM (25-200%)**, type the percentage of the original size that you *normally* want for copies, and then press **ENTER/MENU** to save your selection.

Changing the default copy collation

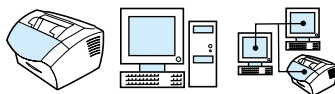

You can set the product to collate multiple copies into sets. For example, if you are making two copies of three pages and the collation is on, the pages print in this order: 1,2,3,1,2,3. If the collation is off, the pages print in this order: 1,1,2,2,3,3.

The collation setting you choose is in effect for all copies until you change the setting. The default set at the factory is On. This setting can also be set from the software. See the software Help for more information.

To use collation, the original document must fit into memory. When it does not, the product makes only one copy and displays a message notifying you of the change. If that happens, you have several alternatives for finishing the job:

- Split the job into smaller jobs containing fewer pages.
- Make only one copy of the document at a time.
- Turn off the collation.
- Use the HP LaserJet Copier program to copy and collate the job.

To set the default copy collation

- 1 Press **ENTER/MENU**.
- 2 Use the **<** or **>** key to select **COPY SETUP** and then press **ENTER/MENU**.
- 3 Press **ENTER/MENU** to select **DEFAULT COLLATION**.
- 4 Use the **<** or **>** key to select **ON** or **OFF**, and then press **ENTER/MENU** to save your selection.

Changing the default number of copies

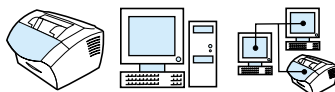

You can choose to have the default number of copies be any value from 1 to 99. The default set at the factory is 1.

To change the default number of copies

- 1 Press **ENTER/MENU**.
- 2 Use the **<** or **>** key to select **Copy Setup** and press **ENTER/MENU**.
- 3 Use the **<** or **>** key to select **default # of copies** and press **ENTER/MENU**.
- 4 Enter the number of copies from 1 to 99 that you want as the default.
- 5 Press **ENTER/MENU** to save your selection.

7 Scanning

Introduction

The product is capable of scanning at a 600 pixel-per-inch (ppi) resolution. The scanner allows color scanning, and increased detail in both color and black and white scans.

This section briefly covers scanning-related topics, such as how to scan using the software or from the product control panel, how the Optical Character Recognition (OCR) software works, and how to send a scanned item as an e-mail attachment.

For more detailed information about and instructions for scanning, beyond what is included in this user guide, see the software Help.

Scanning basics

The product offers three ways to scan an item. These include:

- **From the software:** Use the HP LaserJet Director to initiate a scan and then finish the scan using other software. For more information, see “Scanning from the product software” on page 133.
- **From the product:** Insert an item in the document feeder tray and press the **SCAN** key on the product’s control panel. The **SCAN** key can be programmed to scan to a destination. For more information, see “Adding or deleting scan destinations” on page 140.
- **From TWAIN-compliant software:** If you are using Microsoft Windows 95 and want to scan documents, you have to use a TWAIN-compliant application. For all other operating systems, using TWAIN-compliant software is optional. For more information, see “Scanning with TWAIN-enabled software” on page 142.

Note

To learn about OCR (Optical Character Recognition) software, see “About OCR software” on page 138.

Scanning from the product software

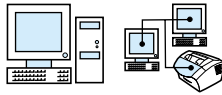

This section discusses the scanning method in two phases:

- 1 **Starting a scan** - this section shows how to use the HP LaserJet Director to start a scan, to choose scan settings, and to choose to scan all pages at once or scan page-by-page.
- 2 **Working with scanned items** - if you choose to scan page-by-page, this section explains the different ways you can edit a scanned item.

Starting a scan

You can start the scanning process from the HP LaserJet Director.

Note

The HP LaserJet Director is not supported for Microsoft Windows 95. If you are using Windows 95, see “Scanning with TWAIN-enabled software” on page 142.

To scan using the HP LaserJet Director

Windows

- 1 Place the item into the document feeder tray.

If the product is connected directly to your computer and the HP LaserJet Director opens after you insert an item into the document feeder tray, proceed to step 3.

-Or-

If you are on a network or the HP LaserJet Director does not automatically open, continue to step 2.

- 2 Open the HP LaserJet Director by clicking the HP LaserJet Director icon located on the taskbar.

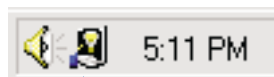

- 3 Click the **Scan** button on the HP LaserJet Director. The **HP LaserJet Scan Control Viewer** dialog box appears.

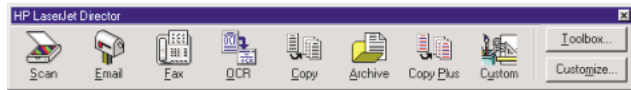

- 4 Select a scan destination.
- 5 Choose to scan in color by selecting the **Scan in color** check box. The product automatically scans in black and white if you do not select this check box.
- 6 Select whether you want to scan all pages at once or scan page-by-page.
If you choose to scan all pages at once, click **Scan**. The edits are saved and the rest of the pages are scanned automatically. The entire document is sent to the destination. If you send a scanned document to a file, a printer, or an e-mail application, a secondary dialog box appears and prompts you for additional information.
-Or-
If you choose to scan page-by-page, continue to the “Working with scanned items” section starting on page 136.

Mac OS

- 1 Place the item into the document feeder tray.

If the product is connected directly to your computer and the HP LaserJet Director opens after you insert an item into the document feeder tray, proceed to step 3.

-Or-

If you are on a network or the HP LaserJet Director does not automatically open, continue to step 2.

- 2 Double-click the alias for the HP LaserJet Director that appears on the desktop as shown below.



- 3 Click Scan on the HP LaserJet Director. The HP LaserJet Scan Control Viewer dialog box appears.

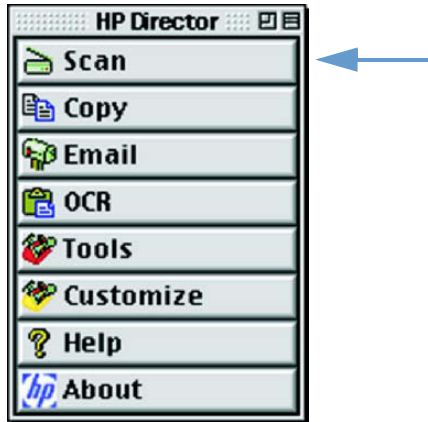

- 4 Select a scan destination.
- 5 To select the color scanning option, click "Scan in color." (The product automatically scans the selection in black and white if this option is not selected.)
- 6 Select whether you want to scan all pages at once or scan page-by-page.
If you choose to scan all pages at once, click Scan. The edits are saved and the rest of the pages are scanned automatically. The entire document is sent to the destination. If you send a scanned document to a file, a printer, or an e-mail application, a secondary dialog box appears and prompts you for additional information.
-Or-
If you choose to scan page-by-page, continue to the "Working with scanned items" section.

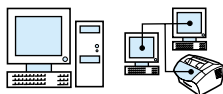

Working with scanned items



If you choose to scan page-by-page, you can perform editing functions on each page. Editing functions include lightening and darkening photo regions, adding or removing regions from the page, changing region types, and cropping sections.

To work with scanned items

- 1 Click **Scan First Page**. The first page is scanned and appears in the Preview window.
- 2 Choose one of the following Viewer modes by clicking its corresponding button on the toolbar located in the upper right corner of the Preview window.

To do this:	Click this button:
<p>Display the entire scanned page but not be able to edit regions. The only editing you can do is crop what you want to send to the destination. You select the area to send by drawing a rectangle around it.</p>	 Selection mode
<p>Display the entire scanned page with all regions outlined in color boxes that represent their region types. A region is any part of the image that the scanner software can recognize as a region type. For instance, all photographs on a page would be assigned a region type of Photo.</p> <p>In Edit Region mode, you create new regions, change existing region types, resize regions, delete regions, lighten and darken photo regions, and select which regions to send to the destination.</p>	 Edit Region mode
<p>Zoom into the Preview window. The contents of the Preview window doubles each time you zoom in. The contents are centered on the point where you clicked in the Preview window.</p>	 Zoom In mode

Zoom out of the Preview window, displaying the previous view, or the full page view (fully zoomed out).



Zoom Out mode

- 3** Click **Scan Next Page** to save any edits performed on the previous page and scan the next page in the document feeder tray. Repeat steps 2 and 3 for the remaining pages in the document feeder tray.
-Or-
Click **Send**. The edits are saved and the rest of the pages are scanned automatically. The entire document is sent to the destination.
- 4** If you send a scanned document to a file, a printer, or an e-mail application, a secondary dialog box appears and prompts you for additional information.

About OCR software

Optical Character Recognition (OCR) is a technology that recognizes letters in a scanned image and converts them into ASCII characters, or editable text. OCR programs convert some text more accurately than other text. Because OCR technology is never perfect, proofread all converted text carefully to ensure the characters have been correctly interpreted.

These types of text convert most accurately:

- text in standard fonts
- text in 9-point font or larger
- crisp, clear text
- black text on a white background

These types of text might convert less accurately:

- text close to non-text elements, such as bullets, lines, or graphics
- text in spreadsheets, tables, or forms
- letters that have gaps, that “bleed” along their edges, or that touch other letters
- underlined text
- text on colored paper

Note

Handwriting cannot be converted.

If you have problems with your OCR software, see "Problem Solving and Product Maintenance," or the OCR software Help for more information.

Scanning from the product control panel

You can scan documents entirely from the product control panel (without editing them) and send them to a destination, such as Microsoft Word or an e-mail address. These destinations can be added or deleted (see “Adding or deleting scan destinations” on page 140).

Note

This feature is not supported in Microsoft Windows 95.

Using the Scan key to scan

Using the **SCAN** key on the control panel to scan is a simple method to scan items (without editing them) and send them to a destination. The **SCAN** key can be programmed to scan to any destination supported by the HP LaserJet Director.

To scan using the Scan key

- 1 Place the item into the document feeder tray.
- 2 Press the **SCAN** key.
- 3 Use the **<** or **>** key to select a destination, and then. To add or delete destinations, see “Adding or deleting scan destinations” on page 140.

Adding or deleting scan destinations

You can program the **SCAN** key on the control panel to scan items and send them to a destination.

Each Windows-compatible computer connected directly to the product or on a network can designate up to five destinations. For networked environments, the default destination is Archive. The total number of destinations allowed on a network is 20. For Macintosh-compatible computers, you can choose only one destination for the **SCAN** key on the device.

The two procedures in the following section are for Windows and the Mac OS.

To add or delete scan destinations

Windows

- 1 Open the HP LaserJet Director by clicking the HP LaserJet Director icon located on the taskbar.

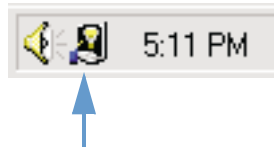

- 2 Click the **Customize** button on the HP LaserJet Director.

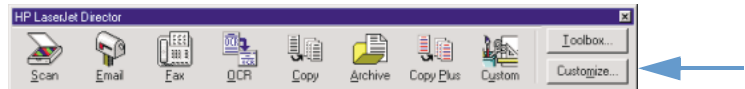

- 3 Select the **Perform this action when the device Scan button is pressed** check box.

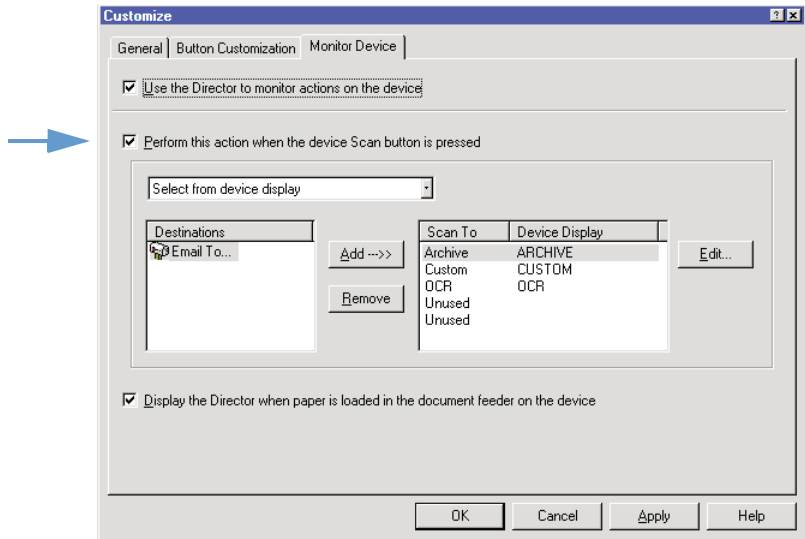

- 4 Select an item from the **Destination** list, and then click the **Add** button.
- 5 Click the **Edit** button.
- 6 Type the name of the destination how you want it to appear on the control panel display in the **Application Destination Name** box. If the destination you are adding is an e-mail address, type the e-mail address in the **Email Address** box.
- 7 Repeat steps 4 through 6 for other destinations.

Mac OS

- 1 Open the HP LaserJet Director by double-clicking the alias for the HP LaserJet Director that appears on the desktop as shown below.



- 2 Click the Customize button on the HP LaserJet Director.



- 3 In the General tab, click "Allow initiating a scan from the device" to select this option.
- 4 Select an item from the list, and then click Apply.

Note

You can choose only one destination for the **SCAN** key on the device.

- 5 Click OK to close the Customization dialog box.

Scanning with TWAIN-enabled software

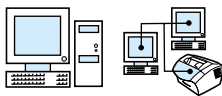

Note

If you are using Windows 95 and want to scan documents, you will have to use TWAIN-compliant software. For all other operating systems, using TWAIN-compliant software is optional.

The product is TWAIN-compliant and works with Windows- and Macintosh-based programs that support TWAIN-compliant scanning devices. While in a TWAIN-enabled program, you can access the scanning feature and scan an image directly into the open application. To do so, follow the program's instructions for acquiring an image using TWAIN. For more specific information, consult the documentation or software Help for the program.

Sending scanned items as e-mail attachments

The product and the software that came with the product work with compatible e-mail programs so you can e-mail documents in PDF format, but other options are also available depending on what file formats are supported by your e-mail program. The recipient can read and print these documents using Adobe Acrobat Reader, which can be downloaded free from Adobe's website.

This section describes the basics of using the product and the software with your e-mail program:

- Sending e-mail from the product
- Sending e-mail in an alternative mode

Note

You must already have an e-mail program and an active e-mail service provider to use the information in this section. (The software does *not* contain an e-mail program.) See the software Help for additional information.

Sending e-mail from the product

E-mail can be sent from the product using Windows 98, 2000, and NT 4.0, or Mac OS 8.6 and 9.0. It can also be done in Microsoft Windows 95 using a TWAIN-enabled program, and in alternative modes by attaching a scanned file to an e-mail.

To send e-mail using Microsoft Windows 98, 2000, and NT 4.0

- 1 Open the HP LaserJet Director by clicking the HP LaserJet Director icon located on the taskbar.

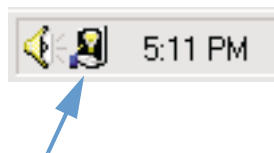

- 2 Click the **Email** button on the HP LaserJet Director.
- 3 Choose e-mail as the destination.
- 4 Click **Send**.

To send e-mail using Microsoft Windows 95

- 1 Open a TWAIN-enabled program to scan from the application.
- 2 Save the file.
- 3 Open your e-mail program.
- 4 Attach the document and send the e-mail.

Note

For more information, see “Scanning with TWAIN-enabled software.”

To send e-mail using Macintosh OS 8.6 and 9.0

- 1 Open the HP LaserJet Director by double-clicking the alias for the HP LaserJet Director that appears on the desktop as shown below.



- 2 Click the Email button on the HP LaserJet Director.



- 3 Choose e-mail as the destination.
- 4 If an e-mail appears with the scanned item attached, click Send.
-Or-
Follow the instructions on the wizard.

Sending e-mail in an alternative mode

You can use an alternative mode to send a document in e-mail if:

- You do not have a compatible e-mail program.
- The **Email** button does not appear on the HP LaserJet Director.
- If you do not have access to the HP LaserJet Director.

To e-mail in an alternative mode

- 1 Load the item into the document feeder tray.
- 2 Use the HP LaserJet Director or software to scan the document to the desktop or document viewer.
- 3 Save the file in the format you want.
- 4 Open your e-mail program and attach the file as you normally would.

8 Problem Solving and Product Maintenance

Introduction

This section offers solutions to problems that can occur while using this product. It also provides maintenance tasks to optimize product functionality.

Note

Most answers for software-related issues are in the software Help.

If the information in this section does not solve your problem, try to print a fax activity log or fax call report, and then contact HP.

General troubleshooting checklist

If the product does not work properly, first verify the following:

- The **Ready** (green) light is on and not blinking. If the **Error** (yellow) light is blinking, check the control panel display for a message.
- No error messages appear on the computer screen or on the product's control panel display.
- The power cord is securely connected to the product and plugged into a live electrical outlet.
- The parallel cable or the USB cable between the product and the computer or the HP JetDirect print server is connected securely or functioning properly. To check, try connecting a different size-C parallel cable or USB cable.
- The telephone cord between the product and the wall is securely connected.
- You can print a test page.
- There are not too many programs open when trying to perform a task. Close programs that are not in use, or restart the computer before attempting the task again.

Resolving fax problems

See the following sections to troubleshoot general fax issues, as well as issues that might occur when sending or receiving a fax:

- Fax setup checklist
- General fax problems
- Sending fax problems
- Receiving fax problems

Fax setup checklist

Use the following checklist to help you define what is causing any faxing problems you might be encountering.

Using the phone cord supplied with the product?

This product has been tested with the supplied phone cord to meet RJ 11 specifications.

Is the Fax/Phone line connector seated into the back of the product?

Does the Fax/Phone line connector securely fit into the back of product?

Gently pull on the Fax/Phone line connector to make sure that it is well-seated into the product.

Is the telephone wall jack working properly? (dial tone at wall jack)

Verify that a dial tone exists by attaching a single line phone to the wall jack. Can you hear a dial tone, and can you call out?

Is your phone line service dedicated, shared, PBX, or a roll-over?

- **Dedicated line:** A unique fax/phone number assigned to receive or send faxes; the phone cord is connected to the port located on the back of the product that is not labeled with the telephone icon.
- **Shared phone line:** A system where both phone calls and faxes are received or sent using the same phone number and phone line.
- **PBX system:** A business-environment phone system.
- **Roll-over lines:** A phone system feature where, when one incoming line is busy, the next call "rolls over" to the next available line. Try attaching the product to the first incoming phone line.
- **Distinctive ring service:** Make sure that the product is set to respond to the correct distinctive ring pattern assigned by your phone service provider.

Phone company services:

- **Phone Line Splitters:** Device used to split out two or more phone line jacks to connect phones or devices to the same phone line wall jack. Isolate line1 from line2 and connect the product directly to line1 or line2.
- **Surge protection device:** Device used between wall jack and product to protect product against electrical power passed through the phone lines and wall jacks. Can cause some fax communication problems; try direct phone cord connection from product to wall jack to ensure proper fax communication.

HP LaserJet product shared with another device:

Telephone answering machine (TAM)

An answering machine should be connected directly to the port located on the back of the product that is labeled with the telephone icon or should be shared on the same phone line extension.

- Set the product's Rings to Answer for one ring more than the Telephone Answering Machine is set. See the software Help for more information.
- If the product is connected to same phone line, but at a different extension, pick up the extension phone, wait 10 seconds, and then hang-up the extension phone. The product will respond to a fax tone and start to receive incoming faxes.
- Another option is to pickup the telephone, and press **1-2-3** in sequence, and wait three seconds.

General fax problems

Use the table in this section to resolve fax problems.

Problem	Cause	Solution
<p>No parallel or USB port is available, or the parallel or USB port is being shared by another device.</p>	<p>The product might need to be directly connected to the computer's parallel or USB port. It might not be able to share the parallel port with another device.</p>	<p>If you have a device such as an external disk drive or switch box connected to the parallel or USB port, try unhooking it and connecting the product directly to the computer parallel or USB port. If it works and you want to continue using both devices, you must use two parallel or USB ports on your computer.</p>
<p>Document stops feeding in the middle of faxing.</p>	<p>The maximum length of a page you can load is 35 inches (889 mm). Faxing of a longer page stops at 35 inches (889 mm).</p> <p>The minimum scannable page size is 2 by 3.5 inches (51 by 89 mm). If the item is too small, it can jam inside the scanner area.</p>	<p>If there is no jam and it has been less than a minute, wait a moment before pressing STOP/CLEAR.</p> <p>If there is a jam, see "Clearing jams from the scanner path areas" on page 177. Then, resend the job.</p> <p>If there is a jam, see "Clearing jams from the scanner path areas" on page 177.</p>
<p>Fax activity logs or fax call reports are printing at unwanted times.</p>	<p>The fax activity log or fax call reports settings are not correct.</p>	<p>Print a configuration report (see "Printing a configuration report" on page 48) and check when the reports print. See "Setting when the fax call report prints" on page 45 and "Setting the fax activity log to print automatically" on page 44 to change the settings.</p>
<p>The volume for sounds coming from the product is too high or too low.</p>	<p>The volume setting needs to be adjusted.</p>	<p>See "Changing sound volume" on page 39 for instructions about changing volume settings.</p>

Sending fax problems

Use the table in this section to solve problems that might occur when sending faxes.

Problem	Cause	Solution
Faxes quit during sending.	<p>The fax machine to which you are sending might be malfunctioning.</p> <p>Your phone line might not be working.</p>	<p>Try sending to another fax machine.</p> <p>Connect the product to a different phone line and try sending. Also, try connecting a phone directly to the phone line and making a call to check the phone line.</p>
The product is receiving faxes but is not sending them.	<p>If your product is on a PBX system, the PBX system might be generating a dial tone the product cannot detect.</p> <p>There might be a poor phone connection.</p> <p>The fax machine to which you are sending might be malfunctioning.</p> <p>Your phone line might not be working.</p>	<p>Disable the detect dial tone setting. See “Changing the detect dial tone setting” on page 85.</p> <p>Try again later.</p> <p>Try sending to another fax machine.</p> <p>Connect the product to a different phone line and try sending. Also, try connecting a phone directly to the phone line and making a call to check the phone line.</p>
Outgoing fax calls keep dialing.	<p>The product will automatically redial a fax number if the redial on busy option is set to on.</p>	<p>To stop the redials while the product is dialing, press STOP/CLEAR.</p> <p>See “Changing how the product redials” on page 83 if you need to change the setting.</p>
One-touch keys, speed-dial codes, or group-dial codes are not working.	<p>The one-touch key, speed-dial code, or group-dial code might not be programmed or programmed properly.</p>	<p>Print a one-touch, speed-dial, and group-dial report (see “Printing a one-touch, speed-dial, and group-dial report” on page 47) to see which numbers are programmed. Also check that the fax number (or e-mail address) was entered correctly. See “Programming group-dial codes” on page 74 to program or correct information.</p>

Problem	Cause	Solution
<p>Faxes you send are not arriving at the receiving fax machine.</p>	<p>The receiving fax machine might be off or have an error condition, such as being out of paper.</p> <p>A fax might be in memory because it is waiting to redial a busy number, there are other jobs ahead of it waiting to be sent, or the fax is set up for a delayed send.</p>	<p>Call the recipient to make sure the fax machine is on and ready to receive faxes.</p> <p>If a fax job is in memory for any of these reasons, an entry for the job appears in the fax log. Print the fax activity log (see "Printing the fax activity log" on page 43) and check the Status column for jobs with a Pending designation.</p>
<p>You cannot dial all of the numbers in a long fax number.</p>	<p>The maximum number of digits or characters that can be entered into a fax number is 50.</p>	<p>Try dialing the fax number in manual mode. See "Using Manual Dial" on page 77.</p>
<p>The fax forward option is on, but the product is printing received faxes instead of forwarding them.</p>	<p>When the fax forward option is turned on and a fax is received, the product will attempt to forward the fax several times. If it is not successful, the product will print the received fax.</p>	<p>Make sure that the fax machine to which you are forwarding the received faxes is on and ready to receive faxes.</p>

Receiving fax problems

Use the table in this section to solve problems that might occur when receiving faxes.

Problem	Cause	Solution
Unable to start receiving faxes from an extension phone.	<p>The Extension Phone setting might be disabled.</p> <p>The telephone cord might not be securely connected.</p>	<p>See “Enabling an extension phone” on page 93 for instructions about changing this setting.</p> <p>Check that the telephone cord is securely connected between the phone and the product (or other device connected to the product). Press 1-2-3 in sequence, wait for three seconds, and then hang up.</p>
Voice calls are not being received by the phone or answering machine connected to the line.	<p>The telephone cord might not be connected properly.</p> <p>The answer mode or rings to answer settings might not be set properly.</p> <p>The answering machine or phone might not be functioning.</p>	<p>See “Connecting the phone line” in the <i>Getting Started Guide</i> to check the installation. The product must be the first device connected to the phone line.</p> <p>See “Changing how the product answers incoming faxes” on page 90 to determine which settings you need. The rings to answer must be set higher than for the answering machine. See the software Help for more information.</p> <p>Connect the phone or answering machine directly to the phone line and see if it works by itself.</p>

Problem	Cause	Solution
<p>Incoming fax calls are not being answered by the product.</p>	<p>The answer mode might be set to Manual.</p> <p>The rings to answer setting might not be set correctly.</p> <p>The answer ring pattern feature might be turned on, but you do not have the service, or you do have the service, and the feature is not set correctly.</p> <p>The telephone cord might not be connected properly, or the telephone cord is not working.</p> <p>The product might be out of paper, and the memory is full.</p> <p>There might be too many devices connected to the phone line.</p> <p>The phone line might not be working.</p> <p>Fax forwarding might be enabled.</p> <p>A voice messaging service might be interfering with the product answering calls.</p>	<p>If the answer mode is set to Manual, the product never answers calls. You have to answer the phone and start receiving the fax yourself.</p> <p>Check the rings to answer setting for your configuration. See “Setting answer mode and rings-to-answer” in the <i>Getting Started Guide</i> to determine which settings you need.</p> <p>Check the answer ring pattern feature to make sure it is set properly. See “Changing answer ring patterns.” “Changing answer ring patterns” on page 91.</p> <p>See “Connecting the phone line” in the <i>Getting Started Guide</i> to check the installation, or replace the telephone cord.</p> <p>Refill the paper input tray. The product prints faxes received to memory and resumes answering fax calls.</p> <p>Try removing the last device connected and see if the product works. If not, keep removing devices and retrying.</p> <p>Connect the product to a jack for another phone line. Connect a telephone to the outlet in place of the product and try to make a telephone call to make sure the phone line is working.</p> <p>See “Using fax forwarding” “Using fax forwarding” on page 87 to disable fax forwarding.</p> <p>Do one of the following:</p> <ul style="list-style-type: none"> • Discontinue the messaging service. • Get a phone line dedicated to fax calls. • Set the product to answer in Manual mode. In Manual mode, you must start the fax receive process yourself. • Leave the product set to Automatic mode and lower the rings to answer for the product to a number below the rings to answer for the voice mail (see the <i>Getting Started Guide</i> for the limits in your country/region). The product will answer <i>all</i> incoming calls.

Problem	Cause	Solution
<p>Faxes do not print as expected.</p>	<p>The Receive to PC option might be selected.</p>	<p>Turn off the Receive to PC option in the HP LaserJet Device Configuration tool:</p> <ol style="list-style-type: none"> 1 Click Start, point to Programs, point to HP LaserJet 3200, point to Tools, and then click HP LaserJet Device Configuration. 2 Click the Fax tab, and then click the Receive tab. 3 Clear the Receive to PC check box, and then click OK.
<p>Faxes routed to the computer are being received by the product instead.</p>	<p>The computer could be turned off.</p> <p>The Receive to PC option might be turned off.</p>	<p>Check that the computer is turned on and that the power cord is securely connected to the product and plugged into a live electrical outlet.</p> <p>Turn on the Receive to PC option in the HP LaserJet Device Configuration tool:</p> <ol style="list-style-type: none"> 1 Click Start, point to Programs, point to HP LaserJet 3200, point to Tools, and then click HP LaserJet Device Configuration. 2 Click the Fax tab, and then click the Receive tab. 3 Select the Receive to PC check box, and then click OK.
<p>Faxes are transmitting or being received very slowly.</p>	<p>You might be sending or receiving a very complex fax, such as one with many graphics.</p> <p>The receiving fax machine might have a slow modem speed.</p> <p>The resolution at which the fax was sent or is being received is very high. A higher resolution typically results in better quality, but also requires a longer transmission time.</p> <p>If there is a poor phone line connection, the product and the receiving fax machine slow down the transmission to adjust for errors.</p>	<p>Complex faxes take longer to be sent or received.</p> <p>The product only sends the fax at the fastest modem speed the receiving fax machine can use.</p> <p>If you are receiving the fax, call and ask the sender to lower the resolution and resend the fax.</p> <p>If you are sending, lower the resolution and resend the fax. See "Adjusting the resolution for the current job" on page 62 to change the current resolution setting or "Changing the default contrast and resolution for outgoing faxes" on page 81 to check the default setting. The current resolution setting overrides the default.</p> <p>Hang up and resend the fax.</p> <p>Have the phone company check the phone line.</p>

Problem	Cause	Solution
Faxes are not printing or are printing incorrectly at the product.	<p>There is no media in the paper input tray.</p> <p>The Receive to PC option might be selected, and faxes are being received by the computer.</p>	<p>Load media. Any faxes received while the bin is empty are stored in memory and will print once the bin has been refilled.</p> <p>Check to see if the computer is receiving faxes:</p> <ol style="list-style-type: none"> 1 Click Start, point to Programs, point to HP LaserJet 3200, point to Tools, and then click HP LaserJet Device Configuration. 2 Click the Fax tab, and then click the Receive tab. 3 Clear the Receive to PC check box if it is selected, and then click OK.
Faxes are printing on two pages instead of one.	The autoreduction setting may not be set correctly.	If you want faxes to be reduced to fit on one page, the autoreduction setting should be on. If the setting is off, faxes may print on multiple pages. See "Changing autoreduction for incoming faxes" on page 95 to adjust the setting.
Received faxes are too light or are printing only on half of the page.	The product ran out of toner while printing a fax.	The product stores up to 10 of the most recently printed faxes. As soon as possible, replace the print cartridge and use the "Reprinting faxes" on page 66 procedure to try to reprint the fax.

Resolving printing problems

Use the sections listed below to resolve common printing problems:

- General printing problems
- Printing problems when using MS-DOS

Note

See also “Resolving image quality problems” on page 181.

General printing problems

Use the table in this section to solve printing problems.

Problem	Cause	Solution
No parallel port or USB port is available, or the parallel port or USB port is being shared by another device.	The product must be directly connected to the computer's parallel or USB port. It cannot share the parallel or USB port with another device.	If you have a device such as an external disk drive or switch box connected to the USB or parallel port and want to continue using it, you must use two parallel ports or USB ports on your computer.
Garbled text or unwanted characters are printing.	The parallel or USB cable might not be securely connected or may be faulty.	Make sure the parallel or USB cable is securely connected between the product and the computer. Try plugging in another size C parallel cable if you have one. If you have another parallel port on the computer, try connecting the cable to it. If you have another computer, try setting up the product with the other computer.
Printed pages are coming out in the incorrect order.	The incorrect output source might be selected, or the incorrect output setting has been chosen in the program from which you are printing.	Pages are sent to the paper output bin print in correct order. Pages are sent to the front paper output slot print in reverse order. Use the front paper output slot by opening the front paper path door. See “Selecting the output path” on page 31. If you need to print pages to the front paper output slot in correct order, select the reverse order output option in the program from which you are printing. See the program's documentation for more information.

Problem	Cause	Solution
<p>The product is not responding after “Print” is selected in the software, or you receive a message on the computer screen stating there was an error printing to the parallel or USB port.</p>	<p>The printer might be printing a complex image.</p> <p>The print job might be paused.</p> <p>The parallel or USB cable between the product and the computer might not be connected properly.</p> <p>The wrong printer was selected in your software.</p> <p>The software for your product is not configured for the correct port.</p> <p>The computer parallel port might not adequately support bidirectional communication.</p> <p>The product might not be receiving adequate power, or there are voltage fluctuations.</p> <p>Another device might be interfering.</p> <p>The parallel or USB cable is defective or the parallel or USB port on the computer is malfunctioning.</p>	<p>Allow extra time for the computer to send the image.</p> <p>Resume printing from the Printers window.</p> <p>Disconnect and reconnect the parallel or USB cable between the product and the computer.</p> <p>Check the printer selection menu in your program to see if you selected the correct product.</p> <p>Check your software’s printer selection menu to make sure it is connected to the correct port. If your computer has more than one parallel port, make sure the parallel cable is connected to the correct one.</p> <p>Ensure that the computer has a parallel port with a bidirectional data bus (EPP or unidirectional ports are not supported). Change the parallel port mode setting in the computer’s basic input output system (BIOS). HP recommends setting it to ECP or bidirectional, but other modes might also work. For instructions about changing the setting, see the computer documentation, or contact the computer manufacturer.</p> <p>Plug the product into a different power source.</p> <p>If there is another device connected to the computer parallel or USB port, disconnect it and connect the product directly to the computer parallel or USB port. You might also have to remove software for the other device before the product will work.</p> <p>Try plugging in another size C parallel cable or USB cable if you have one. If you have another parallel port on the computer, try plugging the cable into it instead.</p> <p>If you have another computer, try connecting the product to the other computer.</p>

Problem	Cause	Solution
The product is not responding after “Print” is selected in the software, or you receive a message on the computer screen stating there was an error printing to the parallel port.	<p>The product is malfunctioning.</p> <p>Another device is conflicting with the parallel port.</p>	<p>Try printing from another program. Try printing a configuration report (see “Printing a configuration report” on page 48).</p> <p>The product cannot share a parallel port. If you have a sound card, external hard drive, or network switchbox connected to the same parallel port as the product, the other device may be interfering. You must unhook the other device to connect and use the product, or you must use two parallel ports on the computer. You might need to add another parallel interface card. An ECP parallel interface card is strongly recommended. Please see your computer’s documentation for information about installing an additional parallel interface card or resolving conflicts.</p>
The image or words on printed pages are the wrong size.	The Layout (Pages-per-Sheet or N-Up) feature is selected in the program you are using (if it has this feature), or the reduction/enlargement setting is incorrect in the program or printer driver.	Check the settings in the program you are using or in the printer driver. See the software Help for printer driver issues.
When printing on both sides of the page, the print quality is reduced, pages curl, or duplexing results in incorrect or multiple-page feeds.	When you print on both sides, there will be a difference in the way the product performs. You can also experience incorrect or multiple feeds.	<p>Instead of duplexing manually, use the Layout (Pages-per-Sheet or N-Up) feature in the program from which you are printing, if available. See the program’s documentation for information.</p> <p>Allow the sheet to cool and flatten before printing the second side.</p> <p>Make sure the leading edges of sheets are not bent or curled.</p> <p>To minimize curl, set the paper path lever to the lower position (for the front paper output slot). This allows a straight-through paper path.</p> <p>If all printed pages are printing with poor quality, frequent use of duplexing might be the cause. See “Cleaning the print paper path” on page 211.</p>

Problem	Cause	Solution
<p>When printing from an MS-DOS program running in Windows, this message appears: “There was an error writing to LPT1: for the printer (name of a printer, unknown, or it is blank): Cannot access a port...”</p>	<p>The Spool MS-DOS Print Jobs check box might be selected for other printer drivers on your computer.</p>	<p>On the Windows 95 or 98 desktop, click the My Computer icon, and then double-click the Printers icon. Double-click the icon for the first printer and then click the Details tab. If there is a Port Settings button, click it. In the dialog box that opens, clear the Spool MS-DOS Print Jobs check box. If there is no Port Settings button or clicking it did not open a dialog box, then that printer is not interfering. Repeat the procedure for all other printers on the computer, except for the product.</p>

Printing problems when using MS-DOS

Use the information in this section to troubleshoot printing problems when printing from MS-DOS.

To establish basic communication to the product

- 1 For Windows 95 and 98, click **Start**, and then click **Shut Down**.
- 2 Click **Restart the computer in MS-DOS mode**.
- 3 At the command prompt, type **Dir>PRN** and then press ENTER on the keyboard.
- 4 Refer to the responses from the computer and possible solutions in the table below.

Response from computer	Results or needed action
Command prompt returned to computer after pressing ENTER on your keyboard.	The product begins printed the document, and then prints a listing of the directories on your computer's hard drive. Communication verified; return to Windows. -Or- If nothing prints, disconnect the product from the computer, and then reconnect. Hold down CTRL, and then press and release the PAUSE/BREAK keys. Try using a different parallel or USB cable.
Flashing cursor; command prompts did not return; keyboard is not responding.	Verify that the Ready light is on. Hold down CTRL, and then press and release the PAUSE/BREAK keys. Disconnect the product from the computer and then reconnect. Restart the computer. Try using a different parallel or USB cable.
MS-DOS message appears on computer screen: "Write fault error writing device PRN."	Verify that the Ready light is on. In Step 3 in the procedure above ("To establish basic communication to the product" on page 163), specify the port name when sending the directory (for example, Dir>LPT1). Verify that the power cord and parallel or USB cords are plugged into the proper ports. Disconnect the product from the computer, and then reconnect. Try using a different parallel or USB cable.

Resolving copying problems

See the table below to troubleshoot common copy problems. See also “Resolving image quality problems” on page 181 and “Resolving paper feed problems” on page 170.

Problem	Cause	Solution
<p>No parallel or USB port is available, or the parallel or USB port is being shared by another device.</p>	<p>If you are copying using the Document Director or the HP LaserJet Director, the product must be directly connected to the computer's parallel or USB port. It cannot share the parallel or USB port with another device.</p>	<p>If you have a device such as an external disk drive or switch box connected to the parallel or USB port and want to continue using it, you must install two parallel or USB ports on your computer.</p>
<p>Documents stop feeding in the middle of copying.</p>	<p>The maximum scannable page length is 35 inches (889 mm). If the page is longer, scanning stops at 35 inches (889 mm).</p> <p>The minimum scannable page size is 2 by 3.5 inches (51 by 89 mm). If the item is too small, it can jam inside the scanner.</p> <p>A business card (2 by 3.5 inches; 51 by 89 mm) was fed using the wrong orientation.</p>	<p>If there is a jam, see “Clearing jams from the scanner path areas” on page 177 and resend the job.</p> <p>To remove the page, see “Clearing jams from the scanner path areas” on page 177.</p> <p>To remove the page, see “Clearing jams from the scanner path areas” on page 177. Then, see “To load special items” on page 27.</p>
<p>Copies print on the wrong size media.</p>	<p>The page size might be set incorrectly.</p>	<p>Change the media size to the size you are copying. See “Changing the default paper size for the paper input tray” on page 38. Try reducing or enlarging the copies. See “Reducing or enlarging copies for the current job” on page 123.</p>
<p>Only one copy of a job printed, although multiple copies were specified.</p>	<p>The entire document to be copied must fit into memory, or only one copy prints.</p>	<p>Use the HP LaserJet Director to make multiple copies of large documents.</p> <p>-Or-</p> <p>Break the job into smaller jobs containing fewer pages.</p>

Problem	Cause	Solution
Either light or dark vertical lines run through the copy.	The scanner glass might be dirty.	Clean and recalibrate the scanner. See “Cleaning the scanner path” on page 213 and “Recalibrating the scanner” on page 216. See the “Resolving image quality problems” on page 181 section for more information.
Copies are too light or too dark.	The contrast might not be set correctly. The print cartridge might need to be replaced.	Adjust the contrast setting. See “Using the Contrast button to adjust the contrast for the current fax or copy job” on page 122. Or, try adjusting the print density setting from the control panel. Replace the print cartridge. See “Ordering parts” on page 257.
Copy quality of an image or text is poor.	The resolution might not be set correctly. The scanner path might be dirty.	See “Adjusting copy quality for the current job” on page 123. See “Cleaning the scanner path” on page 213.

Resolving scanning problems

See the table below to help you solve problems with quality of scans. See also “Resolving image quality problems” on page 181 and “Resolving paper feed problems” on page 170.

Problem	Cause	Solution
<p>The message on the computer screen says there was a problem opening scanner: Unable to activate TWAIN source.</p>	<p>The computer parallel port might not adequately support bidirectional communication.</p> <p>Another device such as an external drive or switchbox might be interfering.</p> <p>The wrong TWAIN source is selected within the program.</p>	<p>Ensure that the computer has a parallel port with a bidirectional data bus (EPP or unidirectional ports are not supported). Change the parallel port mode setting in the computer’s BIOS. HP recommends setting it to ECP or bidirectional, but other modes might also work. For instructions about changing the setting, see the computer documentation, or contact the computer manufacturer.</p> <p>If there is another device connected to the computer parallel port, disconnect it and connect the product directly to the computer parallel port. You might also have to remove software for the other device before the product will work. Or, use a second parallel port on the computer.</p> <p>Verify that the correct TWAIN source is selected. In the software, check the TWAIN source by clicking Select Source from the File menu.</p>
<p>No parallel port is available, or the parallel port is being shared by another device.</p>	<p>The product must be directly connected to the computer’s parallel port. It cannot share the parallel port with another device.</p>	<p>If you have a device such as an external disk drive or switch box connected to the parallel port and want to continue using it, you must use two parallel ports on your computer.</p>

Problem	Cause	Solution
<p>Scanner stops in the middle of scanning.</p>	<p>The maximum scannable page length is 35 inches (889 mm). If the page is longer, the scanner continues to scan, but it only keeps the first 35 inches (889 mm) of data on the page and discards the rest.</p> <p>The minimum scannable page size is 2 by 3.5 inches (51 by 89 mm). If the item is too small, it can jam inside the scanner area.</p> <p>A business card (2 by 3.5 inches; 51 by 89 mm) was fed using the wrong orientation.</p>	<p>Do not try to pull the page out, because you can damage the scanner. To remove the page, see “Clearing jams from the scanner path areas” on page 177.</p> <p>If you want to scan an item that is longer than 35 inches (889 mm), first copy the item onto multiple pages and then scan the copies.</p> <p>To remove the page, see “Clearing jams from the scanner path areas” on page 177.</p> <p>To remove the page, see “Clearing jams from the scanner path areas” on page 177. Then, see “To load special items” on page 27.</p>
<p>Scanning is extremely slow.</p>	<p>The parallel port or USB mode might not be set to its optimal setting.</p>	<p>Ensure that the computer has a parallel port with a bidirectional data bus (EPP or unidirectional ports are not supported). Change the parallel port mode setting in the computer’s BIOS. HP recommends setting it to ECP or bidirectional, but other modes might also work. For instructions on changing the setting, see the computer documentation, or contact the computer manufacturer.</p>
<p>The HP LaserJet Director blinks on and off on the computer screen, even when no document is loaded in the document feeder tray.</p>	<p>The product is connected to a parallel or USB port that is being shared with another device.</p>	<p>The product cannot be connected to the same parallel or USB port on the computer and on another device. You must install an additional parallel or USB port or disconnect one of the two.</p>
<p>Scanned items are not appearing on the computer.</p>	<p>The item might not have been saved as a file.</p>	<p>Make sure you save scanned items as files. See “About OCR software” on page 138.</p>

Problem	Cause	Solution
Scanned text is not editable.	If the item is in the software, the text cannot be edited. The text must be converted using an OCR program (one is included with the product) and then opened in a word-processing program.	From the desktop or viewer, click the link for your word-processing program (at the bottom of the window). The text is converted to editable text and opens as an untitled file in your word-processing program.
Not enough disk space.	The software requires at least 40 MB of available disk space for installation. More disk space might be needed if you are processing a complex image.	Try deleting unnecessary files or archiving older data to floppy disks or some other medium.
Either light or dark vertical lines run through the scanned image.	The scanner glass might be dirty.	Print a test page on the product. See "Printing a configuration report" on page 48. If the test page shows the line, see "Recalibrating the scanner" on page 216. Reprint a test page. If lines continue to appear, see "Resolving image quality problems" on page 181. If the test page does not show the line, clean and recalibrate the scanner. See "Cleaning the scanner path" on page 213 and "Recalibrating the scanner" on page 216.
Items lose their formatting or have strange formatting codes in them.	The correct word-processing program might not be associated with the link.	The link for your word-processing program should automatically appear. If it does not or is not working correctly, you must configure the word processor link, specifying the correct output word processor. See the software Help for instructions. If the problem persists, you might want to reinstall the software.
A high percentage of incorrect characters appear in an item that was converted with the OCR link.	The accuracy of the OCR link depends on the quality, size, and structure of the original document and on the quality of the scan itself.	To obtain the best possible results when using the OCR link, choose the scan setting for text and process only crisp, clear text. Tables, spreadsheets, and handwriting do not translate well. Scan text using the 300 dpi, 1 bit per pixel setting. See "About OCR software" on page 138. Print a document from a word-processing program, scan it, and then OCR it to see if the results are better. Calibrate the scanner. See "Cleaning the scanner path" on page 213.

Problem	Cause	Solution
Items loaded in the document feeder tray fall forward out of the tray.	The items are on very lightweight media.	Do not try to pull the page out, because you can damage the scanner. To remove the page, see "Clearing jams from the scanner path areas" on page 177. Then, curl or roll the item in the direction of the printed side, unroll it, and reload the item.

Resolving paper feed problems

Use the sections listed below resolve paper feed problems:

- Clearing jams from the printer path areas
- Clearing jams from the scanner path areas

Clearing jams from the printer path areas

Occasionally, media can become jammed in the paper input tray, single-sheet input slot, paper output bin, or front paper output slot. See “Identifying hardware parts” on page 21 for more information.

This section contains the following two topics:

- Causes and solutions of jams in printer path areas
- Clearing feed jams in the paper input areas

Causes and solutions of jams in printer path areas

The following list shows some possible causes:

- The media was loaded improperly.
- The paper input tray was overfilled.
- Additional media was added without unloading the bin and straightening all media first.
- The guides were not adjusted to the correct position.
- The paper output bin was too full.
- The paper path lever was adjusted while a job was printing.
- The printer door was opened while a job was printing.
- The media used does not meet HP’s specifications.
- The media used is smaller than 3 by 5 inches (76.2 by 127 mm).
- The power was interrupted while a job was printing.

Use the following table for specific causes and solutions for jams in the printer path parts.

Problem	Cause	Solution
Pages are coming out of the product curled or wrinkled.	Media used in the paper output bin is curled or wrinkled. Paper might not be stored properly.	Use the front paper output slot by pushing the paper path lever to the lower position. See "Selecting the output path" on page 31. Whenever possible, store paper in its sealed ream at room temperature.
Printed pages are coming out in the incorrect order.	The incorrect output source might be selected, or the incorrect output setting has been selected in the program from which you are printing.	Pages are sent to the paper output bin print in correct order. Pages are sent to the front paper output slot print in reverse order. Use the front paper output slot by pushing the paper path lever to the lower position. See "Selecting the output path" on page 31. If you need to print pages to the front paper output slot in correct order, select the reverse order output option in the program from which you are printing. See the program's documentation for more information.
Long pages are not feeding.	The maximum page length that the document feeder tray will accept is 35 inches (889 mm). If the page is longer, copying or faxing stops at 35 inches (889 mm).	Do not try to pull the page out, because you can damage the product. To remove the page, see Clearing jams from the scanner path areas (page 177). If you want to scan an item that is longer than 35 inches (889 mm), first copy the item onto multiple pages and then scan the copies.
Print is misaligned on the page (skewed pages).	The paper input tray might be too full. The paper guides might not be adjusted properly. The paper's weight or surface finish might not meet HP's specifications.	Try removing some of the media. Be sure to center the media with the guides. Also, verify that the guides are not adjusted too tightly or too loosely against the media. Print a self-test page from the control panel or from the software to verify the product is working correctly. See "Testing the hardware" in the <i>Getting Started Guide</i> . To order HP's paper specification guide, see "Ordering parts" on page 257.

Problem	Cause	Solution
Scanned items are crooked.	The document feeder tray guides might not be adjusted properly.	Be sure to center the media with the guides. Also, verify that the guides are not adjusted too tightly or too loosely against the media.
The product is frequently feeding multiple sheets or jams frequently from the paper input tray or single-sheet input slot (continued).	<p>A sensor may not be operating properly.</p> <p>The printer separation pad that prevents the product from feeding multiple sheets or jamming is dirty or worn.</p>	<p>Contact the Customer Service Center for service. See "HP sales and service offices" on page 253.</p> <p>Replace the printer separation pad. A printer separation pad installer can be ordered. See "Ordering parts" on page 257.</p>
Items loaded in the document feeder tray fall forward out of the tray.	The items are on very lightweight media.	Do not try to pull the page out, because you may damage the scanner. To remove the page, see "Clearing jams from the scanner path areas" on page 177. Then, curl or roll the item in the direction of the printed side, unroll it, and reload the item.

Problem	Cause	Solution
<p>The product is feeding multiple sheets or jams frequently from the paper input tray or single-sheet input slot.</p>	Guides are not adjusted properly.	Remove the media from the paper input tray or the single-sheet input slot. Tap the sides of the media stack together, then reinsert the stack. Or, reinsert the single sheet into the slot. Slide the guides against the sides of the stack in the paper input tray or against the single sheet in the single-sheet input slot to center the paper. Make sure the guides are not adjusted too tightly.
	Additional media was added to the paper input tray without unloading and straightening all of the media first.	Remove all of the media from the paper input tray. Tap the sides of the media stack together, and then reinsert the paper.
	The paper input tray is too full.	Remove some of the sheets. The paper input tray can hold up to 125 sheets of 20-lb (75g/m ²) bond weight paper (less for heavier paper) or up to 7 to 10 envelopes, depending on envelope construction and operating environment
	More than one sheet was placed in the single-sheet input slot.	Place only one sheet at a time in the single-sheet input slot. If printing more than one sheet of the same type of media, use the paper input tray.
	The paper was poorly cut by the manufacturer and is sticking together.	“Break” the ream of paper by curving it into an upside-down u-shape; this may effectively decrease multifeeds. You may also try turning the paper around to feed the opposite end first, or use a different type of paper.
	The paper does not meet HP’s specifications for print media.	Order HP’s paper specification guide. To order, see Ordering parts (page 257).
	The output capacity was exceeded in the paper output bin or front paper output slot.	Do not allow more than 125 sheets of 20-lb (75 g/m ²) bond weight paper (less for heavier paper) to fill the paper output bin. Do not allow media to stack up in front of the front paper output slot.
	The pick rollers are dirty and are not grabbing the paper.	See “Cleaning the print paper path” on page 211.

Clearing feed jams in the paper input areas

If most of the jammed media is visible from the paper input tray or single-sheet-input slot, carefully pull the jammed media straight up and out of the product using both hands. Realign the media, and reload it.

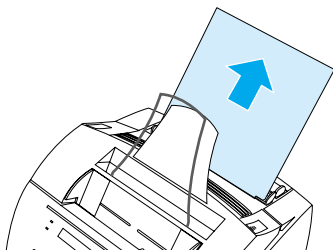

Note

Be sure to center media between the paper guides. Also, verify that the paper guides are adjusted snugly, but that they do not crinkle or bend the media.

The product, in most cases, reprints the jammed page and finishes the remainder of the job. Once your job has finished printing, check it to make sure all pages printed.

To clear a jam from the interior area

- 1 If the jam is not visible in the input area, use the two printer door release latches to pull open the printer door (the front paper path door opens automatically whenever the print door is opened).

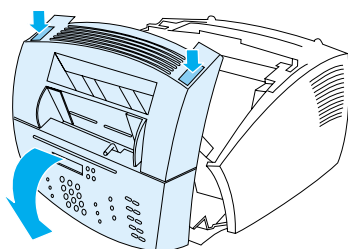

- 2 Remove the toner cartridge. Be sure to protect it from light while it is outside the product.

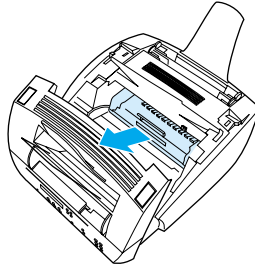

CAUTION

Avoid touching the long, black, sponge roller inside the product. Touching it can degrade output quality.

- 3 If the jam is in the toner cartridge area but has *not* reached the fuser and roller area, reach inside and carefully pull the sheet straight forward and out.

CAUTION

Do not pull the sheet straight up. This can damage the printer.

CAUTION

Only use your hands to remove jammed media. Using other objects can damage internal parts.

- 4 If the jam is between the rollers, grasp the sheet with both hands and slowly pull it straight up and out.

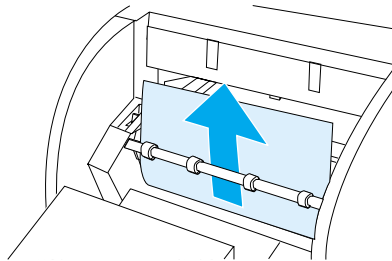

- 5 If the jam has entered the front output slot, grasp the sheet, and carefully pull it straight up and out.

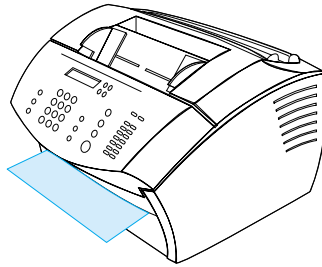

- 6 If the jam is only visible from the front of the front output slot, raise the front cover part way with one hand. With the other hand, grasp the sheet and pull it toward you.

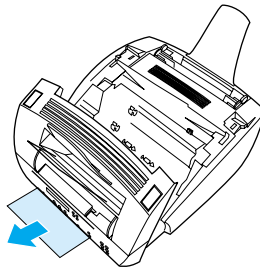

- 7 After removing all sheets and fragments of media, replace the toner cartridge, and close the printer door and the front paper path door.

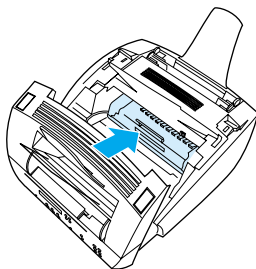

The product, in most cases, reprints the jammed page and finishes the rest of the job. Once your job has finished printing, check to make sure all pages printed.

Clearing jams from the scanner path areas

Occasionally, media can become jammed in the document feeder tray. See “Identifying hardware parts” on page 21 for more information.

This section contains the following two topics:

- Paper feed problems in scanner path areas
- Clearing jams from the scanner path area

Paper feed problems in scanner path areas

The following is a list of possible causes for jams in the scanning mechanism:

- Too many pages were loaded into the document feeder tray.
- A special media item was loaded but the special media lever was to the left.
- Multiple sheets of a document were loaded but the special media lever was to the right.
- The item loaded was torn, had frayed edges, or didn't meet the guidelines for documents (see “Selecting items for faxing, copying, or scanning” on page 25).
- The item was not loaded correctly.
- The item was smaller than 2 by 3.5 inches (51 by 89 mm) (the size of a business card).

Use the following table to solve problems related to moving media or documents through the scanner path parts.

Problem	Cause	Solution
<p>The product is feeding multiple sheets or jams frequently from the document feeder tray.</p>	<p>The special media lever might be in the incorrect position.</p> <p>Guides are not adjusted properly.</p> <p>The document feeder tray is too full.</p> <p>The item was too thick, too slick, or otherwise did not meet the recommended specifications.</p>	<p>The special media lever should be to the left if you are sending regular-weight media. The lever should be to the right if you are sending thick media, which can only be loaded one page at a time.</p> <p>Remove the document from the document feeder tray. Straighten the item, then reinsert it. Slide the guides against the sides of the items to center it. Make sure the guides are not adjusted too loosely.</p> <p>Remove some of the sheets. The document feeder tray can hold up to 30 pages, depending on the thickness of the pages.</p> <p>See "Selecting print media" on page 23.</p>
<p>Items loaded in the document feeder tray fall forward out of the tray.</p>	<p>The items are on very lightweight media.</p>	<p>Do not try to pull the page out, because you can damage the scanner. To remove the page, see "Clearing jams from the scanner path areas" on page 177. Then, curl or roll the item in the direction of the printed side, unroll it, and reload the item.</p>

Clearing jams from the scanner path area

Use the following procedure to clear jams from the scanner area

To clear jams from the scanner path area

- 1 Using both hands, pull the document release door (control panel) toward you.

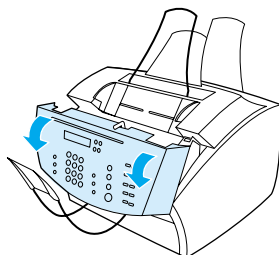

- 2 Remove any jammed media.

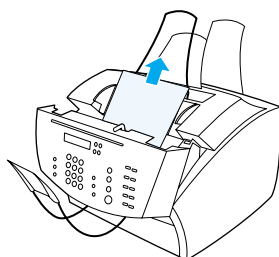

CAUTION

Only use your hands to remove jammed media. Using other objects can damage internal parts.

- 3 Make sure all pieces of media are removed, and then close the door.

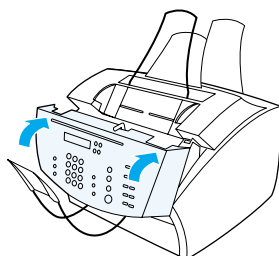

- 4 To prevent jams in the future, make sure the special media lever is in the correct position for the document you are loading. See “Loading print media” on page 26.

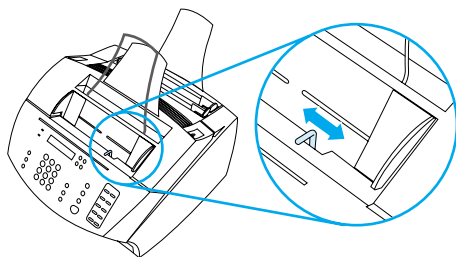

Resolving image quality problems

This section of the manual helps you define and resolve print quality problems. Often output quality problems can be handled quite easily by making sure that your printer is properly maintained or by using print media that meets HP specifications.

Use the examples below to determine which output quality problem you are experiencing, and then see the corresponding reference pages to troubleshoot.

Note

These examples consist of the most common methods to remedy print quality problems. If you still have problems after trying the suggested remedies, see “HP sales and service offices” on page 253.

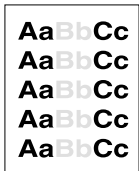

See “Light print (partial page)” on page 183



See “Light print (entire page)” on page 183

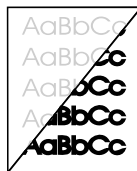

See “Sent faxes too light or too dark” on page 183

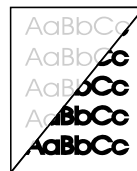

See “Scanned images too light or too dark” on page 190

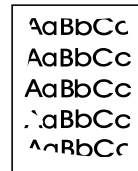

See “Edges of image not printing” on page 184



See “Dropouts” on page 184



See “Dropouts” on page 184

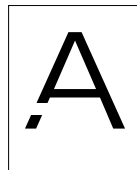

See “Dropouts” on page 184



See “Faded print or white streaks” on page 185

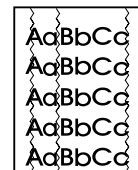

See “Lines” on page 185

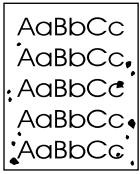

See "Specks" on page 186

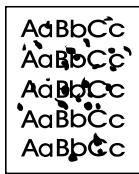

See "Stains or smudges" on page 186

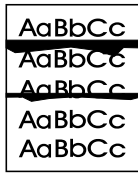

See "Horizontal black streaks or smears" on page 187



See "Repeating image" on page 187

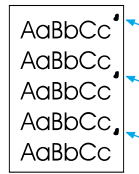

See "Repeating defects" on page 187



See "Toner smear" on page 188

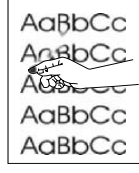

See "Loose toner" on page 188

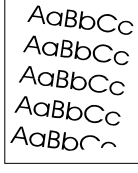

See "Page skew" on page 189

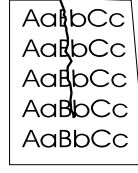

See "Wrinkles or creases" on page 193

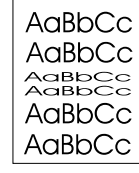

See "Misformed characters" on page 190

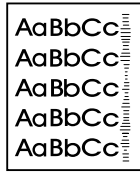

See "Tire tracks" on page 194

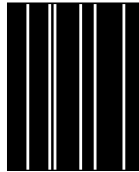

See "Vertical white lines" on page 191



See "Gray background" on page 189

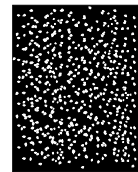

See "White spots on black" on page 191

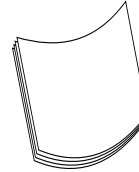

See "Curl or wave" on page 192



See "Black page" on page 192

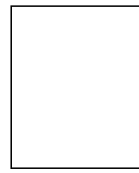

See "Blank pages" on page 193

Light print (partial page)

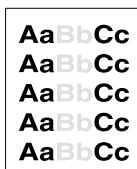

The toner cartridge might be low. Replace the toner cartridge.

Light print (entire page)

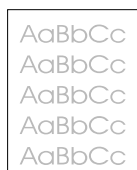

- 1 If you are printing, use the **Finishing** tab in your printer driver to turn EconoMode off.
- 2 At the control panel, use the COMMON SETTINGS menu to increase the toner density setting.
- 3 The contrast setting might be set to a lighter setting.
- 4 Try using a different type of media.

Sent faxes too light or too dark

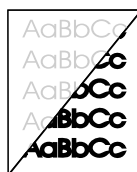

The contrast might not be set correctly. Adjust the contrast and resolution settings from the control panel or from the HP LaserJet Director.

Edges of image not printing

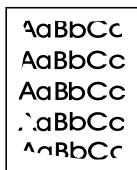

The product cannot print all the way to the edge of the media. The product has a minimum margin of 0.25 in (6.4 mm) on each edge. If printing or copying, the reduction setting might be set incorrectly.

- For printing, check the reduction setting in the Print window from within the program you are using.
- For copying, check the reduction setting on the control panel (see “Reducing or enlarging copies for the current job” on page 123) or from the HP LaserJet Director.

Dropouts

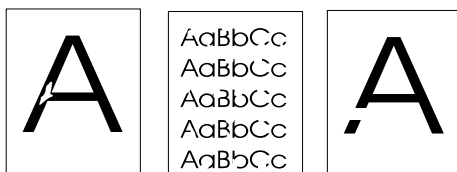

- 1 Make sure that the environmental specifications for the printer are maintained.
- 2 Remove the media from the paper insert tray, turn the stack over, and reinsert it. (The wrapper on many reams of paper has an arrow indicating the print side.) Try printing again.
- 3 Adjust the print density from the front panel.
- 4 Change the toner cartridge.

Faded print or white streaks



- 1 Check to see if the toner cartridge is getting low on toner.
- 2 Make sure the media you are using meets HP's paper specifications (for example, it might be too moist or too rough).
- 3 Toner density setting might need to be adjusted.
- 4 A part of the product might be damaged. See "Managing HP LaserJet toner cartridges" on page 216.
- 5 Adjust the setting from the front panel.
- 6 Contact the HP Customer Care for service.

Lines

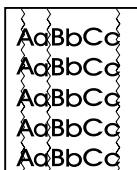

- 1 Print a few more pages to see if the problem corrects itself.
- 2 Clean the inside of the printer or run a manual cleaning page to clean the fuser.
- 3 Replace the toner cartridge.

Specks



Specks might appear on a page after a jam has been cleared.

- 1 Print a few more pages to see if the problem corrects itself.
- 2 If this problem occurs frequently, set up your printer to run a cleaning page automatically (see “Cleaning the print paper path” on page 211.)
- 3 Check for toner cartridge leaks. If the toner cartridge is leaking, replace it.

Stains or smudges

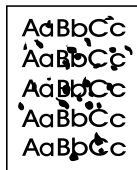

- 1 Make sure the media you are using meets HP’s paper specifications (for example, it might be too moist or too rough).
- 2 You might be printing on the wrong side of the media. Remove the media from the paper input tray, turn the stack over, and reinsert it. (The wrapper on many reams of paper has an arrow indicating the print side.)
- 3 The product might need cleaning.
- 4 The toner cartridge might be damaged. See “Ordering parts” on page 257 in HP’s paper specification guide.
- 5 See “Cleaning the scanner path” on page 213 and “Cleaning the print paper path” on page 211.
- 6 See “Managing HP LaserJet toner cartridges” on page 216. Replace the toner cartridge if maintenance procedures do not improve print quality.

Horizontal black streaks or smears

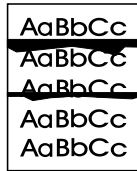

- 1 Check that the toner cartridge is properly installed.
- 2 Make sure you removed the entire length of the sealing tape from the toner cartridge before you installed it. If you did, the toner cartridge might be defective and need to be replaced. See “To install the toner cartridge” in the *Getting Started Guide*.

Note

The toner cartridge may still be under warranty. See “Warranty information” on page 245.

Repeating image



This type of defect might occur when using preprinted forms or a large quantity of narrow media.

- 1 Print a few more pages to see if the problem corrects itself.
- 2 Make sure that media type and quality meet HP specifications.

Repeating defects

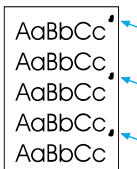

- 1 Print a few more pages to see if the problem corrects itself.
- 2 If the distance between defects is 1.5 in (38 mm) or 3.76 in (94 mm), the toner cartridge might need to be replaced.
- 3 See “Cleaning the print paper path” on page 211.

- 4 See the “Repeating image” on page 187 solution below.

Toner smear



See also “Loose toner” on page 188.

- 1 Print a few more pages to see if the problem corrects itself.
- 2 Try using a different type of paper.
- 3 Make sure that the environmental specifications for the printer are maintained (see “Overall specifications” on page 228).
- 4 Clean the inside of the printer or run a manual cleaning page to clean the fuser (see “Cleaning the print paper path” on page 211).
- 5 Replace the toner cartridge.

Loose toner

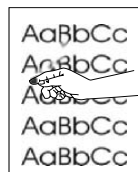

Loose toner, in this context, is defined as toner that can be rubbed off the page.

- 1 If you have observed a rougher texture on one side of your media, try printing on the smoother side.
- 2 Make sure that the environmental specifications for the printer are maintained (see “Overall specifications” on page 228).
- 3 Make sure that media type and quality meet HP specifications (see “Selecting print media” on page 23).

Page skew

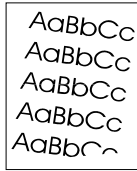

- 1 Remove some of the media from the paper input tray and try printing a few more pages to see if the problem corrects itself.
- 2 Verify that there are no torn pieces of media inside the printer.
- 3 Be sure to center the media with the paper guides. Also, verify that the paper guides are not adjusted too tightly or too loosely against the media.
- 4 Turn over the stack of paper in the tray. Also try rotating the paper 180°.
- 5 Print a self-test page from the control panel or from the software to verify that the product is working.
- 6 Make sure that media type and quality meet HP specifications. See “Product specifications” on page 228.
- 7 Make sure that the environmental specifications for the printer are maintained. See “Overall specifications”.

Gray background



- 1 Do not use paper that has already been run through the printer.
- 2 Print a few more pages to see if the problem corrects itself.
- 3 Turn over the stack of paper in the tray. Also try rotating the paper 180°.
- 4 At the printer control panel, use the Print Quality Menu to decrease the toner density setting.
- 5 Make sure that the environmental specifications for the printer are maintained. See “Overall specifications”.
- 6 Replace the toner cartridge.

Misformed characters

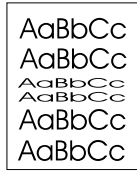

- 1 Print a few more pages to see if the problem corrects itself.
- 2 Make sure that the environmental specifications for the printer are maintained.

Scanned images are too light or too dark

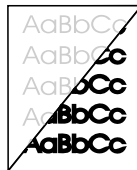

- 1 Adjust the resolution and/or contrast setting(s) from the dialog box that appears after you click **Scan** on the HP LaserJet Director.
- 2 If the original was on a colored media, including a brown recycled paper, the text might not be clear. Try adjusting the resolution, contrast, and/or brightness settings from the dialog box that appears after you click **Scan** on the HP LaserJet Director.
- 3 The product might need recalibration. See "Recalibrating the scanner" on page 216.

Vertical white lines

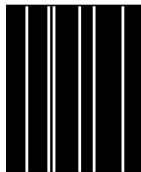

- 1 Print a few more pages to see if the problem corrects itself.
- 2 Make sure that media type and quality meet HP specifications.
- 3 Replace the toner cartridge.
- 4 If you noticed the lines on a copy output page or on a fax you sent to a recipient, scan an item and see if similar lines appear on the scanned image. (If the lines were on the scanned image, make a copy and check for the lines.) If similar lines appear, see “Recalibrating the scanner” on page 216.
- 5 The product’s internal mirror may be contaminated. Contact Customer Service Center for service. See “HP Customer Care” on page 251.

White spots on black

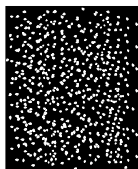

- 1 Print a few more pages to see if the problem corrects itself.
- 2 Make sure that media type and quality meet HP specifications.
- 3 Make sure that the environmental specifications for the printer are maintained.
- 4 Replace the toner cartridge.

Curl or wave

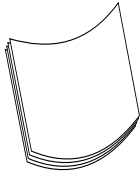

- 1 Turn over the stack of paper in the tray. Also, try rotating the paper 180°.
- 2 Make sure that media type and quality meet HP specifications.
- 3 Make sure that the environmental specifications for the printer are maintained.
- 4 Try printing to a different output bin.
- 5 If you are using lightweight and smooth media, try adjusting the setting in the printer driver for the type of paper you are using.
 - a Gain access to the printer driver (see “Gaining access to the printer driver” on page 105).
 - b Click the **Paper** tab.
 - c In the **Optimize for** list, select the type of paper you are using. This setting affects printer speed and fuser temperature.

Black page



- 1 The toner cartridge might not be installed correctly. Remove the toner cartridge and reinstall it.
- 2 The toner cartridge might be defective. The toner cartridge might still be under warranty. See “Warranty information” on page 245.
- 3 The product might need to be repaired if the problem continues after the toner cartridge has been replaced. See “Service and Support Information” on page 245.

Blank pages



If blank pages print occasionally:

- 1 If you are printing on media that has small dimensions and your page is blank, try printing on larger media to see where the image is printing. Adjust the margins accordingly.
- 2 Remove the paper from the paper input tray and align the edges of the paper. “Break” the ream of paper by curving it into an upside-down u-shape; this might decrease multifeeds. Try turning the paper around to feed the other end first.
- 3 Check your software’s printing configuration information. If you are using a word-processing program, check to see if a natural page break and a forced page break are close to each other.

If blank pages are always printing:

- 1 Make sure you removed the entire length of the sealing tape from the toner cartridge before you installed it.
- 2 Replace the toner cartridge.
- 3 Print a self-test page.

Wrinkles or creases

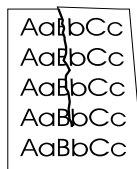

- 1 Print a few more pages to see if the problem corrects itself.
- 2 Make sure that the environmental specifications for the printer are maintained.
- 3 Turn over the stack of paper in the tray. Also, try rotating the paper 180°.
- 4 Make sure the media is loaded correctly, all adjustments have been made, and the media is under the corner tabs (see “Loading print media to be faxed, copied, or scanned” on page 26).

- 5 Make sure the media type and quality meet HP specifications.
- 6 If envelopes are creasing, try storing envelopes so that they lie flat.

Tire tracks

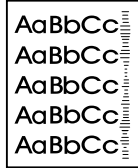

This defect occurs when the toner cartridge needs to be changed.
Replace the toner cartridge.

Resolving control panel error messages

These control panel error messages are listed alphabetically. Messages are accompanied by cause for the message and steps to take to resolve the problem.

Message	Cause	Solution
#### [GROUP NAME] ONE-TOUCH/SPEED DIAL	The product is waiting for you to press a programmed one-touch key or to enter a speed-dial code to a group-dial code.	Begin adding fax numbers to the group-dial code. See "Programming group-dial codes" on page 74.
50.X FUSER ERROR	The product has experienced an internal hardware error.	Disconnect the power cable from the product, wait at least 30 seconds, then reconnect the power cable and wait for the product to initialize. If the message does not clear, the product will need service.
51 LASER ERROR	The product has experienced an internal hardware error.	Disconnect the power cable from the product, wait at least 30 seconds, then reconnect the power cable and wait for the product to initialize. If the message does not clear, the product will need service.
52 SCANNER ERROR	The product has experienced an internal hardware error.	Disconnect the power cable from the product, wait at least 30 seconds, then reconnect the power cable and wait for the product to initialize. If the message does not clear, the product will need service.
53.X PRINTER ERROR	The product has experienced an internal hardware error.	Disconnect the power cable from the product, wait at least 30 seconds, then reconnect the power cable and wait for the product to initialize. If the message does not clear, the product will need service.
54.X PRINTER ERROR	The product has experienced an internal hardware error.	Disconnect the power cable from the product, wait at least 30 seconds, then reconnect the power cable and wait for the product to initialize. If the message does not clear, the product will need service.
55 DC CONTROLLER ERROR	The product has experienced an internal hardware error.	Disconnect the power cable from the product, wait at least 30 seconds, then reconnect the power cable and wait for the product to initialize. If the message does not clear, the product will need service.

Message	Cause	Solution
62.X PRINTER ERROR	The product has experienced an internal hardware error.	Disconnect the power cable from the product, wait at least 30 seconds, then reconnect the power cable and wait for the product to initialize. If the message does not clear, the product will need service.
79 SERVICE (####)	The product has experienced an internal hardware error.	Disconnect the power cable from the product, wait at least 30 seconds, then reconnect the power cable and wait for the product to initialize. If the message does not clear, the product will need service.
80 SERVICE (####)	The product has experienced an internal hardware error.	Disconnect the power cable from the product, wait at least 30 seconds, then reconnect the power cable and wait for the product to initialize. If the message does not clear, the product will need service.
81 SERVICE (####)	The product has experienced an internal hardware error.	Disconnect the power cable from the product, wait at least 30 seconds, then reconnect the power cable and wait for the product to initialize. If the message does not clear, the product will need service.
CANCELED COPY. CLEAR DOCUMENT FEEDER	The STOP/CLEAR key was pressed to cancel the current job while pages were feeding from the document feeder. The cancel process will not automatically clear the document feeder.	Pull the document release door open, remove the jammed item, and close the door. Then, clear the items in the document feeder tray and start over.
CANCELED FAX. CLEAR DOCUMENT FEEDER.	The STOP/CLEAR key was pressed to cancel the current job while pages were feeding from the document feeder tray. The cancel process will not automatically clear the document feeder.	Pull the document release door open, remove the jammed item, and close the door. Then, clear the items in the document feeder tray and start over.
CANCELED SCAN. CLEAR DOCUMENT FEEDER	The STOP/CLEAR key was pressed to cancel the current job while pages were feeding from the document feeder tray. The cancel process will not automatically clear the document feeder.	Pull the document release door open, remove the jammed item, and close the door. Then, clear the items in the document feeder tray and start over.
COMMUNICATION ERROR	Fax communication error occurred between the product and the sender or receiver.	Allow the product to retry sending the fax. Unplug the product telephone cord from the wall, plug in a telephone, and try making a call. Plug the product phone cord into a jack for another phone line. See "Resolving fax problems" on page 149.

Message	Cause	Solution
COPY COUNT SET TO 1	The product does not have enough memory to complete the collated copy job.	Continue completing the collated copy job.
DEVICE BUSY. TRY AGAIN LATER	The product is currently in use.	Wait for the product to finish the current job.
DEVICE ERROR. PRESS [ENTER] TO RESUME	There was an internal error in the product.	Press ENTER/MENU to resume the job.
DOCUMENT FEEDER JAM	A piece of media is jammed in the document feeder tray.	Open the document release door, clear the jam, close the document feeder tray, and reload the paper into the document feeder tray.
DOCUMENT FEEDER MISPICK. RELOAD MEDIA	Paper in the document feeder tray was not picked up.	Remove and reload the paper into the document feeder tray.
FAX DOES NOT ANSWER CANCELED SEND	Attempts to redial a fax number failed or the redial on no answer option was turned off.	Call the recipient to ensure that fax machine is on and ready. Check that you are dialing the correct fax number. Check that the redial on no answer option is enabled. Unplug the product telephone cord from the wall, plug in a telephone, and try making a call. Plug the product phone cord into a jack for another phone line. See "Resolving fax problems" on page 149.
FAX DOES NOT ANSWER REDIAL PENDING	You tried to send a fax, but the receiving fax line did not answer. The product attempts to redial after a few minutes.	Allow the product to retry sending the fax. Call the recipient to ensure that fax machine is on and ready. Check that you are dialing the correct fax number. Check that the redial on no answer option is enabled. Unplug the product telephone cord from the wall, plug in a telephone, and try making a call. Plug the product phone cord into a jack for another phone line. See "Resolving fax problems" on page 149.

Message	Cause	Solution
FAX MEMORY FULL CANCELING RECEIVE	During the fax transmission, the product ran out of memory. Only the pages that fit into memory will be printed.	Have sender resend the fax. If this problem persists, cancel all fax jobs, or clear the faxes from memory (see “Clearing faxes from memory” on page 89).
FAX MEMORY FULL CANCELING SEND	During the fax job, the memory filled. All pages of the fax have to be in memory for a fax job to work correctly. Only the pages that fit into memory were sent.	Cancel all fax jobs, or clear the faxes from memory (see “Clearing faxes from memory” on page 89).
FAX RECEIVE ERROR	An error occurred while trying to receive a fax.	Ask the sender to resend the fax. Try faxing back to sender or to another fax machine. Check that the telephone cord is securely connected by unplugging and replugging the cord. Check for a dial tone on the phone line by pressing FAX/SEND . Make sure the phone is working by disconnecting the product, plugging in a telephone to the phone line, and making a voice call. Connect the product to a different phone line.
FAX SEND ERROR	An error occurred while trying to send a fax.	Try resending the fax. Try faxing to another fax number. Check that the telephone cord is securely connected by unplugging and replugging the cord. Check for a dial tone on the phone line by pressing FAX/SEND . Make sure the phone is working by disconnecting the product, plugging in a telephone to the phone line, and making a voice call. Connect the product to a different phone line.
GROUP DIAL NOT ALLOWED IN GROUP	The speed-dial code you entered is programmed for a group. Adding a group-dial to another group-dial is not allowed.	Enter one-touch keys (programmed as an individual speed dial) or speed-dial codes to a group-dial
GROUP IS FULL. [FAX] TO STARTT	The maximum number of fax numbers that can be added to an ad-hoc group is 20.	Resend to the adhoc group using less fax numbers.
IN CLEANING MODE. PLEASE WAIT 1-3 MIN.	The product is running an internal cleaning cycle.	Wait for the product to finish the cleaning cycle. The message will clear when the cycle is finished. For more information about cleaning the product, see “Cleaning the print paper path” on page 211.

Message	Cause	Solution
INVALID DATE	An invalid date was entered, such as June 35.	Reenter the date.
INVALID TIME	An invalid time was entered, such as 25:99 PM.	Reenter the time.
JOB SETTINGS CLEARED	The product has cleared job settings.	Reenter any desired job settings.
MEMORY LOW. ONLY 1 COPY. PRESS [STOP]	The product completed making one copy. The remaining copies have been canceled due to low product memory.	Press ENTER/MENU to clear the error. Use the HP LaserJet Director to make multiple copies of large documents, or break the job into smaller jobs containing fewer pages.
MEMORY LOW. [STOP] TO CANCEL.	The product memory has been almost completely filled.	Allow the product to finish the job or press STOP/CLEAR to cancel the job.
NO DIAL TONE.	The product could not detect a dial tone.	Unplug the telephone cord from both the product and the wall, and replug the cord. Unplug the product telephone cord from the wall, plug in a telephone, and try making a call. Plug the product phone cord into a jack for another phone line. See "Changing the detect dial tone setting". See "Resolving fax problems" on page 149.
NO DOCUMENT SENT	The fax forwarding setting is on, and the product was unsuccessful in receiving a fax because of low memory or some other reason. The product deleted the incomplete received data before attempting to forward the deleted data.	Print the faxes in memory and have the sender resend the missing page(s) of the document.
NO FAX DETECTED	The product answered the incoming call but could not determine that the caller was a fax machine.	Ask the sender to try resending the fax. Unplug the product telephone cord from the wall, plug in a telephone, and try making a call. Plug the product phone cord into a jack for another phone line. See "Resolving fax problems".
NO FAX PAGES IN MEMORY TO REPRINT	The product attempted to execute "Reprint Last Fax" when nothing was in memory.	Receive a fax before attempting to use this option.
NOT ENOUGH MEMORY. TRY AGAIN LATER	There is not enough memory to start a new job.	Wait until the current job is finished before starting a new job.

Message	Cause	Solution
POWER FAIL RECOVERY. CHECKING SYSTEM	The product has detected a power failure and is performing a self-test.	The product should go back to the ready state on its own. If this message does not go away in a couple of minutes, disconnect the power cable from the product, wait at least 30 seconds, then reconnect the power cable, and wait for the product to initialize.
POWER FAIL RECOVERY. FAX SETTING RESET	The product has detected a power failure and the last update to the fax settings was corrupted. The product is resetting all fax settings back to the factory default settings.	Press ENTER/MENU to clear the error. The product should go back to the ready state.
POWER FAIL RECOVERY. PRINTING FAXES	The product has detected a power failure and is printing all of the faxes that it did not previously print.	The product prints all of the received faxes that it did not previously print. Once the faxes are printed, the product will go back to the ready state.
POWER FAIL RECOVERY. SEND: [FAX NUMBER]	The product has detected a power failure and has also detected unsent faxes and will try to resend them.	The product resends the unsent faxes. Once the faxes are sent, the product will go back to the ready state.
POWER OFF. CHECK DIMM #[1-3]	The DIMM in the indicated slot has failed.	Turn off the product and check the indicated DIMM.
PRINTER PAPER JAM CLEAR PAPER PATH	The product has detected that a jam has occurred.	Clear the jam. (See “Clearing jams from the printer path areas” on page 170.) The job should continue to print. If it does not, try reprinting the job.
PRINTER DOOR OPEN OR NO TONER CARTRIDGE	The printer door is open, or the toner cartridge is not installed properly.	Make sure the printer door is closed. Check the toner cartridge for proper installation. See “To install the toner cartridge” in the <i>Getting Started Guide</i> for instructions.
PRINTER PAPER TRAY IS EMPTY. ADD PAPER	The paper input tray is empty.	Load media. If media is already loaded, remove it. Check for and remove any jam, and then reload the paper stack in the paper input tray.
PRINTER TRAY MISPICK. [ENTER] TO RESUME	The print engine has failed to pick up a piece of media.	Reload the paper in the paper input tray, and press ENTER/MENU to continue the job.

Message	Cause	Solution
RECEIVING FAX BUSY CANCELED FAX	The fax line to which you were sending a fax was busy. The product has cancelled sending the fax.	Call the recipient to ensure that fax machine is on and ready. Check that you are dialing the correct fax number. Check that the redial on busy option is enabled. Press and hold STOP/CLEAR for seven seconds to check for a dial tone. Unplug the product telephone cord from the wall, plug in a telephone, and try making a call. Plug the product phone cord into a jack for another phone line. See "Resolving fax problems" on page 149.
RECEIVING FAX BUSY REDIAL PENDING	The fax line to which you were sending a fax was busy. The product automatically redials the busy number. (See "Changing how the product redials" on page 83.)	Allow the product to retry sending the fax. Call the recipient to ensure that fax machine is on and ready. Check that you are dialing the correct fax number. Unplug the product telephone cord from the wall, plug in a telephone, and try making a call. Plug the product phone cord into a jack for another phone line. See "Resolving fax problems" on page 149.
SCANNER RESERVED FOR PC SCAN	The product is being used to create a scan by a PC.	Wait until the PC scan has finished, cancel the scan from the PC software, or press STOP/CLEAR .
SCANNING ERROR. CANNOT CONNECT TO PC	The product cannot transmit scanned information to a PC.	Check the PC connection cable, and try the scan again.
SPEED DIAL (NUMBER) NOT PROGRAM-MED	The one-touch key or speed-dial code has not been programmed, and therefore cannot be added to a group.	Choose a speed-dial code to which you have already assigned a fax number. To check which speed-dial codes have been programmed, see "Printing a one-touch, speed-dial, and group-dial report" on page 47.

Common Macintosh problems

This section covers the following common Macintosh problems:

- Problems in the Chooser
- Printing errors
- USB problems
- Selecting an alternate PPD
- Renaming the printer driver
- Resolving PostScript Errors

Problems in the Chooser

Note

For more information about the Chooser, see the Mac OS Help on your computer.

Problem	Cause	Solution
The printer driver icon, scan icon, or fax icon does not appear in the Chooser.	Software was not installed correctly.	<p>Make sure you are using a high-quality cable.</p> <p>Make sure the product is on the correct network. Select the Network or AppleTalk Control Panel from Control Panels in the Apple menu, and then choose the correct network.</p> <p>Reinstall the product software.</p>
The printer driver does not automatically set up your selected printer even though you clicked Auto Setup in the Chooser.		<p>Reinstall the printer software. See the Getting Started Guide for installation instructions.</p>
Product name does not appear in the "Select a PostScript Printer" box in the Chooser.		<p>Make sure the cables are connected correctly, the product is on, and the Ready light is on.</p> <p>Make sure the correct printer driver has been selected in the Chooser.</p> <p>If the product resides on a network with multiple zones, make sure the correct zone is selected in the "AppleTalk Zones" box in the Chooser.</p> <p>Make sure AppleTalk is on. The button next to Active is selected in the Chooser. You may need to restart the computer to activate the change.</p>

Printing errors

For more information about the Chooser, see the Mac OS Help on your computer.

Problem	Cause	Solution
A print job was not sent to your desired printer.	Another printer with the same or similar name may have received your print job.	Check the AppleTalk name of the printer displayed on the self-test page. Make sure the cables are connected correctly, the product is on, and the Ready light is on.
An encapsulated PostScript (EPS) file does not print with the correct fonts.	This problem occurs with some software applications.	Try downloading the fonts contained in the EPS file to the product before printing. Send the file in ASCII format instead of binary encoding.
Your document is not printing with New York, Geneva, or Monaco fonts.		Select Options in the Page Setup dialog box to deselect substituted fonts.

USB problems

Use the table below to solve problems that might occur if the product is connected to your Macintosh using a USB cable.

Problem	Cause	Solution
Unable to print from a third-party USB card.	This error occurs when the software for USB printers is not installed.	When adding a third-party USB card, you might need Apple's USB Adapter Card Support software. The most current version of this software is available from Apple's website.

Problem	Cause	Solution
<p>The HP LaserJet USB product does not appear in the Macintosh Chooser after the driver is selected.</p>	<p>This problem is caused by either a software or hardware component.</p>	<p>Software troubleshooting Check that your Macintosh supports USB. Verify if your Macintosh has Mac OS 8.6 or later.</p> <p>Hardware troubleshooting Check that the printer is turned on. Verify that the USB cable is properly connected. Check that you are using the appropriate high-speed USB cable. Ensure that there are not too many USB devices drawing power from the chain. Disconnect all devices from the chain and connect the cable directly to the USB port on the host computer. Check to see if there are more than two non-powered USB hubs in a row on the chain. Disconnect all devices from the chain and connect the cable directly to the USB port on the host computer.</p> <p>Note: The iMac keyboard is a non-powered USB hub.</p>

Problem	Cause	Solution
<p>The HP LaserJet 3200 product does not appear in the All-in-one setup utility.</p>		<p>Software troubleshooting Check that your Macintosh supports USB. Verify if your Macintosh has Mac OS 8.6 or later.</p> <p>Hardware troubleshooting Check that the printer is turned on. Verify that the USB cable is properly connected. Check that you are using the appropriate high-speed USB cable. Ensure that there are not too many USB devices drawing power from the chain. Disconnect all devices from the chain and connect the cable directly to the USB port on the host computer. Check to see if there are more than two non-powered USB hubs in a row on the chain. Disconnect all devices from the chain and connect the cable directly to the USB port on the host computer.</p> <p>Note: The iMac keyboard is a non-powered USB hub.</p>

Selecting an alternate PPD

You can select an alternate PostScript Printer Description (PPD). PPDs, in combination with the printer driver, access the printer features and allow the computer to communicate with the product.

To select an alternate PPD

- 1 Open the Chooser from the Apple menu.
- 2 Click the HP LaserJet Print icon.
- 3 If you are on a network with multiple zones, select the zone in the AppleTalk Zones box where the printer is located.
- 4 Click the printer name you want to use in the Select a PostScript Printer box. (Double-clicking will immediately generate the next few steps.)
- 5 Click Setup. (This button may read Create for first-time setup.)

- 6 Click Select PPD.
- 7 Find the desired PPD in the list and click Select. If the desired PPD is not listed, choose one of the following options:
 - Select a PPD for a printer with similar features.
 - Select a PPD from another folder.
 - Select the generic PPD by clicking Use Generic. The generic PPD allows you to print, but limits your access to printer features.
- 8 In the Setup dialog box, click Select, and then click OK to return to the Chooser.

Note

If you manually select a PPD, an icon might not appear next to the selected printer in the Select a PostScript Printer box. In the Chooser, click Setup, click Printer Info, and then click Update Info to bring up the icon.

- 9 Close the Chooser.

Renaming the printer driver

If you are going to rename the printer driver, do this before selecting the printer in the Chooser. If you rename the printer driver after selecting it in the Chooser, you will have to go back into the Chooser and reselect it. Use the Set Printer Name feature in the HP LaserJet Utility to rename the printer driver.

Note

This will not work for the fax or scanner driver.

Resolving PostScript Errors

The following situations are PS language specific and may occur when several printer languages are being used.

To receive a printed or screen displayed message when PS errors occur, do one of the following:

- Open the Print Options dialog box and click the desired selection next to the PS Errors section.
- Open the HP LaserJet Device Configuration tool. On the Advanced tab, select the Print PS Errors check box.

Problem	Cause	Solution
The job prints in Courier (the printer's default typeface) instead of the typeface you requested.	The requested typeface is not downloaded. A personality switch may have been performed to print a PCL job just before the PS printing job was received.	Download the desired font and send the print job again. Verify the type and location of the font. Download to printer if applicable. Check with the software documentation.
A legal page prints with clipped margins.	Print job is too complex.	You may need to print your job at 600 dots per inch, reduce the complexity of the page, or install more memory.
A PS error page prints.	Print job may not be PS.	Make sure the print job is a PS job. Check to see whether the software application expected a setup or PS header file to be sent to the printer.
Limit Check Error	Print job is too complex.	You may need to print your job at 600 dots per inch, reduce the complexity of the page, or install more memory.
VM Error	Font Error	Select unlimited downloadable fonts from printer driver.
Range Check	Font Error	Select unlimited downloadable fonts from printer driver.

Restoring the factory defaults

If you would like to change all default settings back to the factory default settings, including the fax header and company name, following the instructions below.

To reset the product

- 1 Press **ENTER/MENU**.
- 2 Use the **<** or **>** key to select **SERVICE** and then press **ENTER/MENU**.
- 3 Use the **<** or **>** key to select **RESTORE DEFAULTS**, press **ENTER/MENU**, and then press **ENTER/MENU** again to confirm your selection.

Uninstalling the software

Use the procedures in this section to remove the HP LaserJet 3200 software from a Windows-compatible computer and Macintosh-compatible computer.

To uninstall the software on a Windows-compatible computer

The Uninstall option of the setup program allows you to remove the product and ReadIris software from your computer.

Note

To uninstall the software from Windows NT 4.0 or Windows 2000, you must log on with administrator privileges.

- 1 Click **Start**, point to **Programs**, point to **HP LaserJet 3200**, point to **Tools**, and then click **HP LaserJet 3200 Uninstaller**.
- 2 Follow the instructions on the screen.

To uninstall the software on a Macintosh-compatible computer

There is no uninstall utility available for the Macintosh version of the software. To uninstall the HP LaserJet 3200 software from a Macintosh-compatible computer, locate the items in the following table, drag them to the Trash, restart the computer, and empty the Trash.

Delete these items	Located in
<ul style="list-style-type: none">● HP All In One Software folder● ReadIris folder	Applications Folder
<ul style="list-style-type: none">● DRS6 Files folder● HP LaserJet 3200 Fax● HP LaserJet 3200 Print● HP LaserJet 3200 Scan● HP LaserJet 3200 USB● TWAIN Data Sources folder● HP Scan DS	System Folder: Extensions
<ul style="list-style-type: none">● HP LaserJet 3200 (PPD)	System Folder: Extensions: Printer Descriptions
<ul style="list-style-type: none">● All In One Prefs● ReadIris Prefs	System Folder: Preferences
<ul style="list-style-type: none">● HP LaserJet 3200 communications	System Folder: Startup Items

Product Maintenance

This section provides the following topics:

- Cleaning the print paper path
- Cleaning the scanner path
- Recalibrating the scanner
- Managing HP LaserJet toner cartridges
- Using Memory (DIMMs)
- Installing a new document scanner separation pad

Cleaning the print paper path

Use this process if you are discovering toner specks or dots on printouts. This process produces a page with toner debris, which should be discarded.

To clean the print paper path

Note

This process requires copier-grade paper to remove dust and toner from the print paper path. Do not use bond or rough paper.

- 1 Place the copier grade paper into the paper input tray.

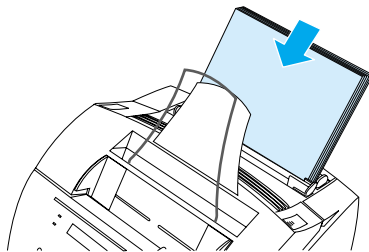

- 2 Ensure that the product is in the **READY** state, and then press **ENTER/MENU**.
- 3 Use the **<** or **>** key to select **SERVICE**, and then press **ENTER/MENU**.
- 4 Use the **<** or **>** key to select **CLEANING MODE**, and then press **ENTER/MENU**.
- 5 Press **ENTER/MENU** to start the cleaning mode.

The device displays the message `IN CLEANING MODE` until this process is completed.

Cleaning the scanner path

You might need to clean parts of the scanner if the ink on items you are scanning can be smudged with your hand, or if the items have excessive amounts of dust or dirt on them. You might also need to clean these parts if there are smudges or other marks on documents or scans of documents.

WARNING!

Before cleaning the HP LaserJet 3200 product, disconnect it from the power source.

To clean the scanner path

- 1 Press the two printer door release latches, and open the printer door.

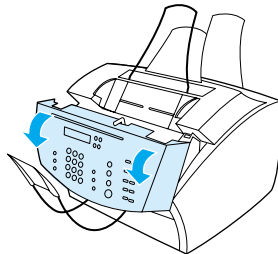

- 2 If the long, white strip on the inside of the document release door is dirty, clean it with a dry cotton swab. If there is still something on the strip, dab a swab in a small amount of isopropyl alcohol, and gently clean the strip.

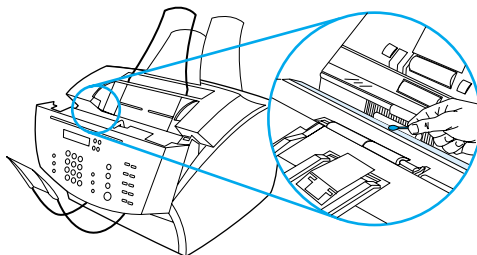

WARNING!

Alcohol is flammable. Keep it away from any open flame. Allow alcohol to dry completely before closing the printer and plugging in the power cord.

CAUTION

If you must use alcohol, only use a very small amount. Exposing internal parts to dripping alcohol can damage them.

- 3 If the long strip of glass opposite the long, white strip is dirty, clean it with a dry cotton swab. If there is still something on the glass strip, dab a swab in a small amount of isopropyl alcohol and gently clean the glass.

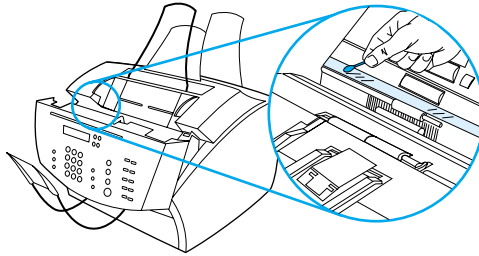

- 4 Inspect each of the six rollers in the scanner area for dirt or debris. Clean any dirty rollers with a lint-free cloth (such as lens tissues) dampened with a small amount of isopropyl alcohol.

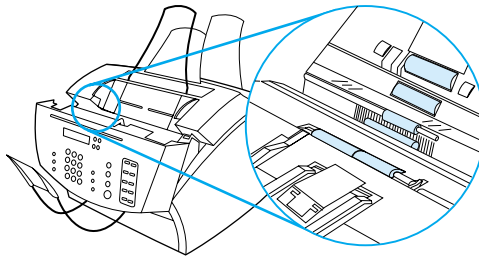

CAUTION

Do not spray alcohol or any other liquid directly into the HP LaserJet 3200 product. Doing so can damage the product.

- 5 Near the top, inside edge of the document release door, inspect the three pressure feet and pads for dirt or debris. If they are dirty, clean them with a lint-free cloth dampened with a small amount of alcohol.

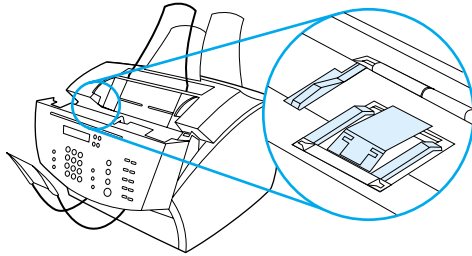

- 6 Using a dry, lint-free cloth, wipe rollers, pads, and feet in a side-to-side motion to remove loosened dirt.
- 7 After the alcohol inside the scanner area has dried completely, close the document release door.

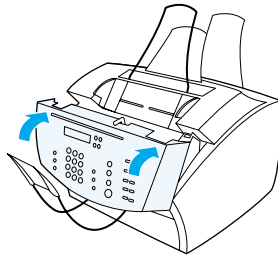

- 8 Go to “Recalibrating the scanner” on page 216.

Recalibrating the scanner

The HP LaserJet 3200 product was calibrated at the factory. However, you may need to recalibrate the scanner if you notice that sent faxes, copies, or items scanned to the computer have black or white lines running through them.

To recalibrate the scanner

- 1 Clean the HP LaserJet 3200 product before recalibrating it. (See “To clean the scanner path” on page 213.)
- 2 On the control panel, press **ENTER/MENU**.
- 3 Press the **<** key once to display **SERVICE** and press **ENTER/MENU**.
- 4 Use the **<** or **>** key to select **SCAN CALIBRATION** and press **ENTER/MENU**. After a few moments, the product prints a calibration report.

Managing HP LaserJet toner cartridges

It is recommended that you use HP LaserJet toner cartridges. HP has designed the product, toner cartridge, and toner formula to work together to give you optimal image quality and reliability from your product. To order an HP LaserJet toner cartridge, see “Ordering parts” on page 257.

You can expect a toner cartridge to print approximately 2,500 pages when you are printing typical business letters with text covering about 5 percent of the page. A page containing graphics uses more toner and shortens the life of the cartridge.

It is very important to replace the toner cartridge when it is near the end of its life, which is often indicated by areas of faded print. If the toner runs out while faxes are being received, the faxes print as blank pages and you can lose the faxes. You can attempt to reprint these faxes. See “To reprint faxes” on page 66 for instructions about attempting to reprint.

Recycling toner cartridges

To reduce landfill waste, HP has adopted a recycling program for empty toner cartridges. A postage-paid shipping label can be found inside the new HP LaserJet toner cartridge box. Since 1990, the HP LaserJet Toner Cartridge Recycling Program has collected more than 25 million used HP LaserJet cartridges that otherwise may have

been discarded in the world's landfills. To join this recycling effort, follow the instructions provided in the box that contains the new toner cartridge.

Extending toner life by redistributing toner

Areas of faded print are often an indicator that the toner cartridge is near the end of its toner life. You can temporarily reestablish print quality by redistributing the remaining toner in the cartridge. (This is typically successful only twice.)

To redistribute toner

- 1 Press the two printer door release latches and open the printer door.

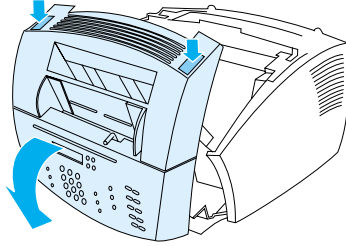

- 2 Using the handle on the toner cartridge, remove the toner cartridge from the product.

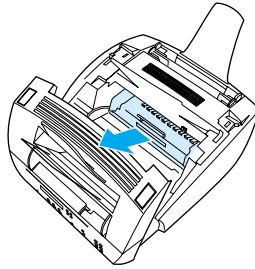

- 3 Shake the toner cartridge from side to side about two times per second to distribute the toner evenly.

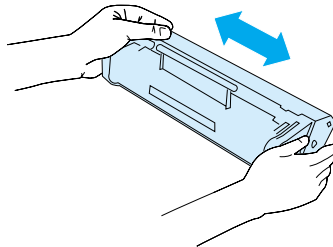

- 4 Hold the cartridge by the handle, with the arrows facing the product, and slide the cartridge into the black grooves in the product. Rotate the cartridge firmly into place, close the printer door, and close the front paper path door.

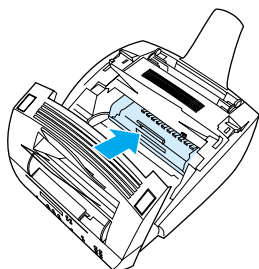

Using Memory (DIMMs)

The product has three slots for DIMMs (Dual in-line memory module). You can find the DIMMs by opening the printer memory door located on the back of the product. Two of the three slots are used but the remaining third DIMM (closest to the printer memory door) can be used for additional memory. You can purchase additional memory from HP (see “Ordering parts” on page 257).

Use the two topics in this section to install or remove memory.

Adding memory

Adding memory (RAM only) to the product will enable you to print more complex print jobs, store additional fonts, and store forms.

CAUTION

Static electricity can damage DIMMs. When handling DIMMs, either wear a grounded anti-static wrist strap, or frequently touch the surface of the DIMMs’ antistatic package and then touch bare metal on the printer.

To install a DIMM, follow the instructions below:

- 1 Unplug the product.

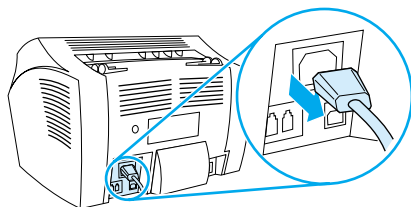

- 2 Open the product memory door by gently pulling out and upward on the bottom edge until the door supports itself.

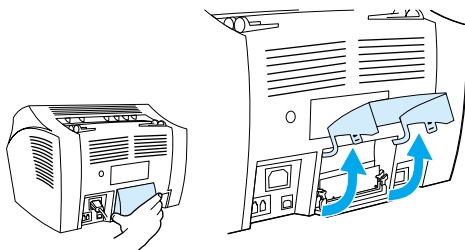

- 3 Remove the DIMM chip from the anti-static bag in which it came by grasping the chip on the top edge.

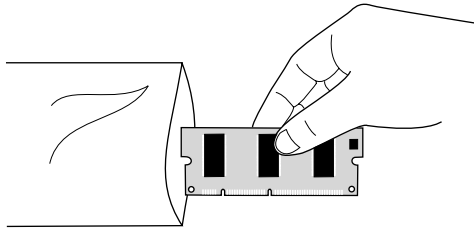

- 4 Position the DIMM chip over the outermost slot located closest to the printer memory door. The gold contacts should be pointing down and the cutouts should be on the left side.

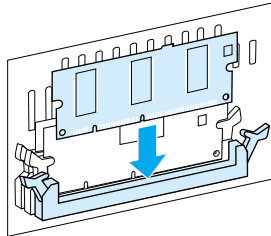

- 5 Carefully press the DIMM chip into the slot, ensuring it is straight and all the way down. The cam latches should rotate inward.

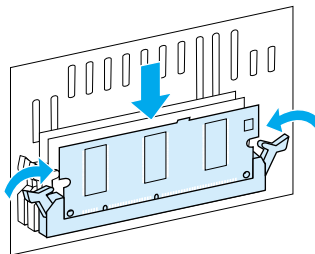

- 6 Lock the cam latches into place by pressing the handles towards each other.

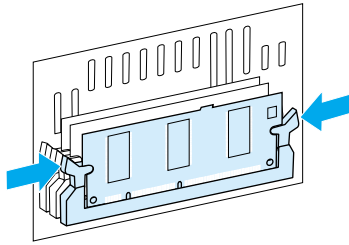

- 7 Close the product memory door.

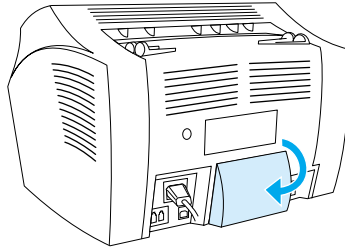

Testing the DIMM installation

To verify that the product registered the newly installed DIMM, print a configuration report. See “Printing a configuration report” on page 48. The configuration reports lists the amount of memory the product is using.

Removing DIMMs

To remove DIMMs, follow the instructions below:

CAUTION

Static electricity can damage DIMMs. When handling DIMMs, either wear a grounded anti-static wrist strap, or frequently touch the surface of the DIMMs' antistatic package, then touch bare metal on the product.

- 1 Unplug the product.

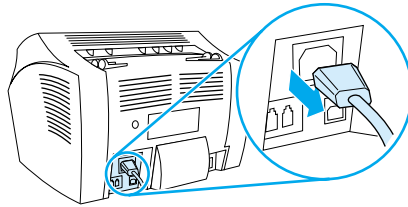

- 2 Open the product memory door by gently pulling out and upward on the bottom edge until the door supports itself.

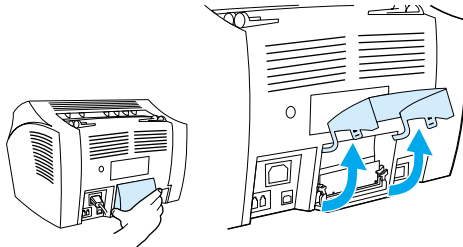

- 3 Unlock the cam latches by pressing them outward.

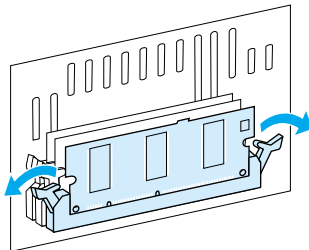

- 4 Grasp the DIMM chip on the top edge, gently pull straight up, and then remove the chip from the product.

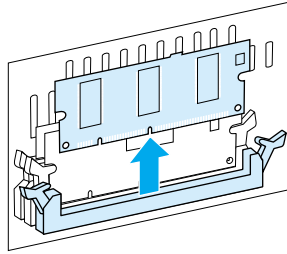

CAUTION

Store the DIMM chip in an antistatic bag.

- 5 Close the product memory door.

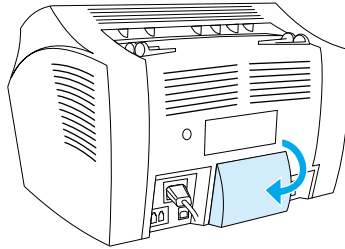

Installing a new document scanner separation pad

The document scanner separation pad is a user-replacable part that is ordered as part of a kit for the HP LaserJet 3200 product.

The separation pad kit for document scanner path — part number RY7-5055-000CN — contains three pieces:

- Document scanner separation pad
- Separation mylar
- Pad holder

When to replace the document scanner separation pad

Replace the document scanner separation pad when the document scanner feeds multiple sheets at once through the scanner path (double-feeds or multi-feeds). Recurring multi-feed problems indicate that the document scanner separation pad is worn.

To install a new document scanner separation pad

- 1 Open the document release door.
- 2 Rotate the strap on the left side of the product door to unhook the strap.
- 3 Grasp the separation pad and mylar sheet together (callout 1 in the graphic below) and lift them straight away from the document release door. This action should also release the pad holder (callout 2 in the graphic below).

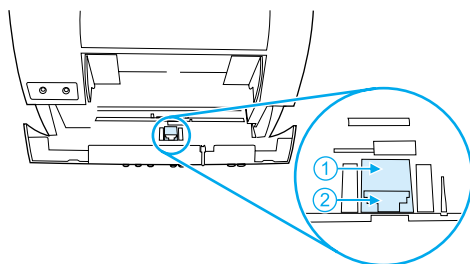

- 4 Press the new pad holder, with pad and mylar attached, into position. It should snap into place.
- 5 Rehook the strap and close the document release door.



Specifications

Introduction

This section contains product specifications and regulatory information.

Product specifications

This section provides the following specifications for the HP LaserJet 3200 product:

- Overall specifications
- Faxing specifications
- Printing specifications
- Copying specifications
- Scanning specifications

Overall specifications

Physical	
Height	10.8 in (272 mm)
Depth	15.4 in (390 mm)
Width	15.1 in (384 mm)
Weight (cartridge installed)	23.4 lb (10.6 kg)
Electrical	
Power requirements	100 to 127 volts +/-10% 50 to 60 hertz (for 110 volt units) 220 to 240 volts +/-10% 50 hertz (for 220 volt units)
Power consumption	Continuous copy mode: 135 watts Idle mode: 7 watts
Minimum recommended circuit capacity	4.2 amps (110 volts) 2 amps (220 volts)
Idle power	7 watts
Environmental	
Operating (working or standby)	Temperature: 15° to 32.5° C Humidity: 10% to 80% relative humidity (no condensation)
Storage (unplugged)	Temperature: -20° C to 40° C (toner cartridge) -20° C to 60° C (device) Humidity: 10% to 90% relative humidity (no condensation)
Location	Place product on sturdy, level surface in a well-ventilated area.
Memory	
Memory	8 megabytes (MB) (HP LaserJet 3200 and 3200se) 16 MB (HP LaserJet 3200m)

Faxing specifications

Description	Specification
Fax transmission speed	3 seconds/page (ITU-T Test Image #1)
Margins for printed pages	.25 in (6.3 mm) right and left .2 in (5.08 mm) top and bottom
Fax compatibility	ITU Group 3; ECM
Fax coding schemes	MH, MR, and MMR
Modem speed	Up to 33,600 bits per second (bps)
Speed dialing	Yes
Distinctive ring detect	Yes
Fax resolution	Standard: 203 by 98 dpi; Fine: 203 by 196 dpi; Superfine: 300 by 300 dpi (no halftone); Photo: 300 by 300 dpi (halftone enabled)

Printing specifications

Description	Specification
Print speed	9 pages per minute (ppm)
Printer Duty Cycle	7,000 single-sided pages per month
Print resolution	1200 dpi
PostScript (PS) Language and Fonts	PostScript Level 2 emulation with 35 built-in PS language fonts included
Automatic Language Switching	When optional printer languages (such as PostScript Level 2 emulation) are installed, the printer automatically determines and switches to the appropriate language for the print job

Copying specifications

Description	Specification
Copy speed	9 ppm
Multiple copies	Up to 99 per job
Copy reduction or enlargements	25 to 200%
Acoustic emissions (Per ISO 9296) while copying	6.3 Bel sound power level

Scanning specifications

Description	Specification
Margins for scanned items	.12 in (3.05 mm) right and left .16 in (4.06 mm) top and bottom
Scanner Duty Cycle	2,000 single-sided items per month
Scan resolution	600 PPI color

Paper specifications

HP LaserJet printers produce excellent print quality. This printer accepts a variety of media, such as cut-sheet paper (including recycled paper), envelopes, labels, transparencies, vellum, and custom-size paper. Properties such as weight, grain, and moisture content are important factors affecting printer performance and output quality.

The printer can use a variety of paper and other print media in accordance with the guidelines in this manual. Paper that does not meet these guidelines can cause the following problems:

- Poor print quality
- Increased jams
- Premature wear on the printer, requiring repair

For more information regarding paper or other print media that is not included in this user guide, refer to the *Print Media Guide* (see “Ordering parts” on page 257).

This section includes the following two topics:

- Supported paper sizes
- Paper weight equivalence table (approximate)

Supported paper sizes

Input for paper input tray and single-sheet input slot	
Maximum media size	8.5 by 14 inches (216 by 356 mm)
Minimum media size	3 by 5 inches (76.2 by 127 mm)
Paper input tray capacity	Up to 125 sheets of media 20 lb (75 g/m ²) weight or lighter, or up to 10 envelopes
Input for document feeder tray	
Maximum item size	8.5 by 35 inches (216 by 991 mm)
Minimum item size	2 by 3.5 inches (51 by 89 mm)
Document feeder capacity	Up to 30 pages of 12 to 28 lb (46 to 105 g/m ²) weight Fewer pages when more than 28 lb (105 g/m ²) weight One page at a time of 11 to 69 lb (42 to 260 g/m ²) weight using special media lever
Output	
Paper output bin capacity	Up to 100 sheets
Document output slot capacity	Up to 30 pages of an item of 28 lb (105 g/m ²) weight or lighter

Paper weight equivalence table (approximate)

The following table shows equivalent weights for different grades of paper you load for printing, copy output, and incoming faxes. Use this table to determine equivalent points in weight specifications other than U.S. bond weight. For example, to determine the equivalent of 20 lb. U.S. bond weight paper in U.S. cover weight, locate the bond weight in the second column and scan across the row to the cover weight (fourth column). The equivalent is 28 lb.

Shaded boxes indicate a commonly available standard weight for that grade. Text and book grades marked with an asterisk (*) actually calculate to 51, 61, 71, and 81 but are rounded to standard book/text weights of 50, 60, 70, and 80.

Note

For best results, use the paper paper output slot and special media lever when printing heavier paper. See “Selecting the output path.”

Bond wt. (17 x 22 in)	Text/Book wt. (25 x 38 in)	Cover wt. (20 x 26 in)	Bristol wt. (22.5 x 28.5 in)	Index wt. (25.5 x 30.5 in)	Tag wt. (24 x 36 in)	Metric wt.
16#	41#	22#	27#	33#	37#	60 g/m ²
17#	43#	24#	29#	35#	39#	64 g/m ²
20#	50# *	28#	34#	42#	46#	75 g/m ²
21#	54#	30#	36#	44#	49#	80 g/m ²
24#	60# *	33#	41#	50#	55#	90 g/m ²
27#	68#	37#	45#	55#	61#	100 g/m ²
28#	70# *	39#	49#	58#	65#	105 g/m ²
29#	74#	41#	50#	61#	68#	110 g/m ²
32#	80# *	44#	55#	67#	74#	120 g/m ²
36#	90#	50#	62#	75#	83#	135 g/m ²
39#	100#	55#	67#	82#	91#	148 g/m ²
40#	101#	55#	68#	83#	92#	150 g/m ²
43#	110#	60#	74#	90#	100#	163 g/m ²
45#	115#	63#	77#	94#	104#	170 g/m ²
47#	119#	65#	80#	97#	108#	176 g/m ²
51#	128#	70#	86#	105#	117#	190 g/m ²
53#	134#	74#	90#	110#	122#	199 g/m ²
54#	137#	75#	93#	113#	125#	203 g/m ²
58#	146#	80#	98#	120#	133#	216 g/m ²
65#	165#	90#	111#	135#	150#	244 g/m ²
66#	169#	92#	114#	138#	154#	250 g/m ²
67#	171#	94#	115#	140#	155#	253 g/m ²
70#	178#	98#	120#	146#	162#	264 g/m ²
72#	183#	100#	123#	150#	166#	271 g/m ²

Transportation

Refer to Non-operating Magnetic Field Emissions, IATA Packaging Instructions 902

Laser safety statement

The Center for Devices and Radiological Health (CDRH) of the U.S. Food and Drug Administration has implemented regulations for laser products manufactured since August 1, 1976. Compliance is mandatory for products marketed in the United States. This printer is certified as a “Class 1” laser product under the U.S. Department of Health and Human Services (DHHS) Radiation Performance Standard according to the Radiation Control for Health and Safety Act of 1968. Since radiation emitted inside this printer is completely confined within protective housings and external covers, the laser beam cannot escape during any phase of normal user operation.

WARNING!

Using controls, making adjustments, or performing procedures other than those specified in this manual can result in exposure to hazardous radiation.

FCC regulations

This equipment has been tested and found to comply with the limits for a Class B digital device, pursuant to Part 15 of the FCC rules. These limits are designed to provide reasonable protection against harmful interference in a residential installation. This equipment generates, uses, and can radiate radio frequency energy. If is not installed and used in accordance with the instructions, it may cause harmful interference to radio communications. However, there is no guarantee that interference will not occur in a particular installation.

If this equipment does cause harmful interference to radio or television reception, which can be determined by turning the equipment off and on, the user is encouraged to try to correct the interference by one or more of the following measures:

- Reorient or relocate the receiving antenna.
- Increase separation between equipment and receiver.
- Connect equipment to an outlet on a circuit different from that to which the receiver is located.
- Consult your dealer or an experienced radio/TV technician.

Note

Any changes or modifications to the printer that are not expressly approved by HP could void the user's authority to operate this equipment.

Note

Use of a shielded interface cable is required to comply with the Class B limits of Part 15 of FCC rules.

FCC part 68 requirements

This equipment complies with FCC rules, Part 68. On the back of this equipment is a label that contains, among other information, the FCC registration number and ringer equivalence number (REN) for this equipment. If requested, this information must be provided to the telephone company.

The REN is used to determine the quantity of devices which may be connected to the telephone line. Excessive RENs on the telephone line may result in the devices not ringing in response to an incoming call. In most, but not all, areas, the sum of the RENs should not exceed five (5.0). To be certain of the number of devices that may be connected to the line, as determined by the total RENs, contact the telephone company to determine the maximum REN for the calling area.

This equipment uses the following USOC jacks:

RJ11C

An FCC-compliant telephone cord and modular plug is provided with this equipment. This equipment is designed to be connected to the telephone network or premises wiring using a compatible modular jack which is Part 68 compliant.

This equipment cannot be used on telephone company-provided coin service. Connection to Party Line Service is subject to state tariffs.

If this equipment causes harm to the telephone network, the telephone company will notify you in advance that temporary discontinuance of service may be required. If advance notice isn't practical, the telephone company will notify the customer as soon as possible. Also, you will be advised of your right to file a complaint with the FCC if you believe it is necessary.

The telephone company may make changes in its facilities, equipment, operations, or procedures that could affect the operation of the equipment. If this happens, the telephone company will provide advance notice in order for you to make the necessary modifications in order to maintain uninterrupted service.

If trouble is experienced with this equipment, please see the numbers in the front of this manual for repair and (or) warranty information.

If the trouble is causing harm to the telephone network, the telephone company may request you remove the equipment from the network until the problem is resolved.

The following repairs can be done by the customer:

Replace any original equipment that came with the product. This includes the toner cartridge, the supports for trays and bins, the power cord and the telephone cord.

It is recommended that the customer install an AC surge arrestor in the AC outlet to which this device is connected. This is to avoid damage to the equipment caused by local lightning strikes and other electrical surges.

Telephone consumer protection act (U.S.)

The Telephone Consumer Protection Act of 1991 makes it unlawful for any person to use a computer or other electronic device, including fax machines, to send any message unless such message clearly contains, in a margin at the top or bottom of each transmitted page or on the first page of the transmission, the date and time it is sent and an identification of the business, other entity, or individual sending the message and the telephone number of the sending machine or such business, other entity, or individual. (The telephone number provided cannot be a 900 number or any other number for which charges exceed local or long-distance transmission charges.)

In order to program this information into your facsimile, please see "Changing the fax number and company name."

IC CS-03 requirements

NOTICE: The Industry Canada label identifies certified equipment. This certification means that the equipment meets certain telecommunications network protective, operational, and safety requirements as prescribed in the appropriate Terminal Equipment Technical Requirement document(s). The Department does not guarantee the equipment will operate to the user's satisfaction.

Before installing this equipment, users should ensure that it is permissible for the equipment to be connected to the facilities of the local telecommunications company. The equipment must also be installed using an acceptable method of connection. The customer should be aware that compliance with the above conditions may not prevent degradation of service in some situations.

Repairs to certified equipment should be coordinated by a representative designated by the supplier. Any repairs or alterations made by the user to this equipment, or equipment malfunctions, may give the telecommunications company cause to request the user to disconnect the equipment.

Users should ensure for their own protection that the electrical ground connections of the power utility, telephone lines, and internal metallic water pipe system, if present, are connected together. This precaution can be particularly important in rural areas.

Caution: Users should not attempt to make such connections themselves, but should contact the appropriate electric inspection authority, or electrician, as appropriate.

The Ringer Equivalence Number (REN) of this device is 0.7.

NOTICE: The Ringer Equivalence Number (REN) assigned to each terminal device provides an indication of the maximum number of terminals allowed to be connected to a telephone interface. The termination on an interface may consist of any combination of devices subject only to the requirement that the sum of the Ringer Equivalence Number of all the devices does not exceed 5.

The standard connecting arrangement code (telephone jack type) for equipment with direct connections to the telephone network is CA11A.

Regulatory information for European Union countries

This equipment has been designed to work in all of the countries of the European Economic Area (Public Switched Telephone Networks) only. Network compatibility is dependent on internal software settings. Contact your equipment supplier if it is necessary to use the equipment on a different telephone network. For further product support, contact Hewlett-Packard at the phone numbers provided in the front of this user guide.

New Zealand Telecom Regulatory Notices

This device may be subject to ringing or bell tinkle when certain other devices are connected to the same line. If this occurs, the problem should not be referred to the Telecom Faults Service.

This device may be subject to ringing or bell tinkle when calls are made from another device on the same line. If this occurs, the problem should not be referred to the Telecom Faults Service.

The grant of a Telepermit for any item of terminal equipment indicated on that Telecom has accepted that the item complies with minimum conditions for connection to its network. It indicated no endorsement of the product by Telecom, nor does it provide any sort of warranty. Above all, it provides no assurance that any item will work correctly in all respects with another item of Telepermitted equipment of a different make or model, nor does it imply that any product is compatible with all of Telecom's network services.

This equipment should not be used under any circumstances which may constitute a nuisance to other Telecom customers.

Declaration of conformity

according to ISO/IEC Guide 22 and EN 45014

Manufacturer's Name: Hewlett-Packard Company

Manufacturer's Address: 11311 Chinden Boulevard
Boise, Idaho 83714-1021, USA

declares, that the product

Product Name: LaserJet 3200 Series (Printer/Fax/Scanner/Copier)

Model Number: C7052A, C7053A, C7055A

Product Options: ALL

conforms to the following Product Specifications:

Safety: IEC60950:1991+A1+A2+A3+A4 / EN 60950:1992+A1+A2+A3+A4+A11
IEC60825-1:1993+A1 / EN 60825-1:1994+A11 Class 1 Laser/LED Product

EMC: CISPR 22:1997 / EN 55022:1998 Class B¹
CISPR 24:1997 / EN 55024:1998
IEC 61000-3-2:1995 / EN 61000-3-2:1995
IEC 61000-3-3:1994 / EN 61000-3-3:1995
FCC Title 47 CFR, Part 15 Class B² / ICES-002, Issue 2
AS / NZS 3548:1995

Supplementary Information:

The product herewith complies with the requirements of the Low Voltage Directive 73/23/EEC, the EMC Directive 89/336/EEC, and the R&TTE Directive 1999/5/EC (Annex II) and carries the CE-marking accordingly.

1) The product was tested in a typical configuration with Hewlett-Packard Personal Computer Systems.

2) This Device complies with part 15 of the FCC Rules. Operation is subject to the following two conditions: (1) this device may not cause harmful interference, and (2) this device must accept any interference received, including interference that may cause undesired operation.

April 18, 2000

For Compliance Information ONLY, contact:

Australia Contact: Product Regulations Manager, Hewlett-Packard Australia Ltd., 31-41 Joseph Street, Blackburn, Victoria 3130, Australia

European Contact: Your Local Hewlett-Packard Sales and Service Office or Hewlett-Packard GmbH, Department HQ-TRE / Standards Europe, Herrenberger Strasse 130, D-71034 Böblingen (FAX: +49-7031-14-3143)

USA Contact: Product Regulations Manager, Hewlett-Packard Company, PO Box 15, Mail Stop 160, Boise, ID, 83707-0015 (Phone: 208-396-6000)

Canadian DOC regulations

Complies with Canadian EMC Class B requirements.

Conforme à la classe B des normes canadiennes de compatibilité électromagnétiques. << CEM>>.

Environmental product stewardship program

Hewlett-Packard Company is committed to providing quality products in an environmentally sound manner. This HP LaserJet printer has been designed with several attributes to minimize impacts on our environment. Please visit HP's Commitment to the Environment website at <http://www.hp.com/abouthp/environment> for more information.

This HP LaserJet printer design eliminates:

Ozone production

This product generates no appreciable ozone gas (O₃).

This HP LaserJet printer design reduces:

Energy consumption

Energy usage drops to as little as 7 W while in low-power (PowerSave) mode. Not only does this save natural resources, but it also saves money without affecting the high performance of this product. This product qualifies for ENERGY STAR, which is a voluntary program to encourage the development of energy-efficient products.



ENERGY STAR is a U.S. registered service mark of the U.S. EPA. As an ENERGY STAR partner, Hewlett-Packard Company has determined that this product meets ENERGY STAR Guidelines for energy efficiency.

Toner consumption

Depending on the type of printer driver you have, you may be able to select a “draft” mode, which uses about 50% less toner, thereby extending the life of the toner cartridge. This is only available using printer driver properties when printing or making copies from the software.

Paper use

Depending on the type of program you use, you may be able to print two or four document pages on each printed page. This “N-up” printing practice and the printer’s manual duplex capability (two-sided printing) reduce paper usage and the resulting demands on natural resources.

Plastics

Plastic parts over 25 grams are marked according to international standards to enhance the ability to identify plastics for recycling purposes at the end of the product’s life.

LaserJet Printing Supplies

In many countries/regions, this product's printing supplies (e.g., toner cartridge, drum, fuser) can be returned to HP through the HP Planet Partners Printing Supplies Environmental Program. An easy-to-use and free takeback program is available in more than 25 countries/regions. Multilingual program information and instructions are included in every new HP LaserJet Toner Cartridge and Consumables package.

HP Printing Supplies Environmental Program Information

Since 1990, the HP Printing Supplies Environmental Program has collected more than 31 million used LaserJet toner cartridges that otherwise may have been discarded in the world's landfills. The HP LaserJet toner cartridges and consumables go to a collection center and bulk-shipped to our recycling partners who disassemble the cartridge for recycling. Materials are separated and converted into raw materials for use by other industries to make a variety of useful products.

For more information on the HP Printing Supplies Environmental Program, please contact your local HP Sales and Service Office.

Returns

For a more environmentally responsible return of used cartridges and consumables, HP encourages the use of bulk returns. Simply bundle two or more cartridges or consumables together and use the single, pre-paid, pre-addressed United Parcel Service (UPS) label that is supplied in the package.

For more information in *the U.S.* or Canada, call (1) (800) 340-2445 (U.S.) or (1) (800) 387-3867. Or, visit the HP LaserJet Supplies website at <http://www.ljsupplies.com/planetpartners/>.

For more information in *Mexico*, call 258-40-44 (Mexico City) or (1) (800) 900-7200 (outside Mexico City). Or, visit the website at <http://www.hp.com/latinamerica>.

All other customers should call their local HP Sales and Service Office (see "HP sales and service offices"), or visit the following websites for further information regarding availability of the HP Printing Supplies Environmental Program.

Latin America: <http://www.hp.com/latinamerica>

Asia/Pacific Countries/Regions:
<http://www.asiapacific.hp.com/planp1.htm>

Europe:
http://www.hp.com/pays/eur_supplies/english/planetpartners/

Paper

This printer is suited for the use of recycled papers when the paper meets the guidelines outlined in the *Print Media Guide* for HP LaserJet Printers. This printer is suited for the use of recycled paper according to DIN 19 309.

Material safety data sheet

The Material Safety Data Sheets (MSDS) for the toner cartridge and print drum can be obtained by going to HP's website at <http://www.hp.com/go/msds> and selecting **HP LaserJet Printer Supplies**. If you are in the U.S. or Canada and do not have access to the Internet, call U.S. HP First (fax-on-demand service) at 1-800-231-9300. Use Index number 7 for a listing of MSDS for the toner cartridge and print drum.

International customers without Internet access should call (404)-329-2009 for further information.

Battery Specifications

Battery material: Poly-carbon Monoflouride Lithium

Battery type: Button/Coin Cell Battery

Quantity per product: 1

Weight: about 1 gram

Lithium type: solid

Battery manufacturers: Rayovac, Madison, WI, USA; and Panasonic, Secaucus, NJ, USA.

B

Service and Support Information

Warranty information

Hewlett-Packard limited warranty statement

HP LaserJet 3200 product ONE-YEAR LIMITED WARRANTY

- 1 HP warrants to you, the end-user customer, that HP hardware, accessories, and supplies will be free from defects in materials and workmanship after the date of purchase, for the period specified above. If HP receives notice of such defects during the warranty period, HP will, at its option, either repair or replace products which prove to be defective. Replacement products may be either new or like-new.
- 2 HP warrants to you that HP software will not fail to execute its programming instructions after the date of purchase, for the period specified above, due to defects in material and workmanship when properly installed and used. If HP receives notice of such defects during the warranty period, HP will replace software media that does not execute its programming instructions due to such defects.
- 3 HP does not warrant that the operation of HP products will be uninterrupted or error free. If HP is unable, within a reasonable time, to repair or replace any product to a condition as warranted, you will be entitled to a refund of the purchase price upon prompt return of the product.
- 4 HP products may contain remanufactured parts equivalent to a new in performance or may have been subject to incidental use.

- 5 Warranty does not apply to defects resulting from (a) improper or inadequate maintenance or calibration; (b) software, interfacing, parts or supplies not supplied by HP; (c) unauthorized modification or misuse; (d) operation outside of the published environmental specifications for the product; or (d) improper site preparation or maintenance.
- 6 **HP MAKES NO OTHER EXPRESS WARRANTY OR CONDITION WHETHER WRITTEN OR ORAL.** TO THE EXTENT ALLOWED BY LOCAL LAW, ANY IMPLIED WARRANTY OR CONDITION OR MERCHANTABILITY, SATISFACTORY QUALITY, OR FITNESS FOR A PARTICULAR PURPOSE IS LIMITED TO THE DURATION OF THE EXPRESS WARRANTY SET FORTH ABOVE. Some countries, states, or provinces do not allow limitations on the duration of an implied warranty, so the above limitation or exclusion might not apply to you. This warranty gives you specific legal rights and you might also have other rights that vary from country to country, state to state, or province to province.
- 7 TO THE EXTENT ALLOWED BY LOCAL LAW, THE REMEDIES IN THIS WARRANTY STATEMENT ARE YOUR SOLE AND EXCLUSIVE REMEDIES. EXCEPT AS INDICATED ABOVE, IN NO EVENT WILL HP OR ITS SUPPLIERS BE LIABLE FOR LOSS OF DATA OR FOR DIRECT, SPECIAL, INCIDENTAL, CONSEQUENTIAL (INCLUDING LOST PROFIT OR DATA), OR OTHER DAMAGE, WHETHER BASED IN CONTRACT, TORT, OR OTHERWISE. Some countries, states or provinces do not allow the exclusion or limitation of incidental or consequential damages, so the above limitation or exclusion may not apply to you.
- 8 (AUSTRALIA AND NEW ZEALAND ONLY) THE WARRANTY TERMS CONTAINED IN THIS STATEMENT, EXCEPT TO THE EXTENT LAWFULLY PERMITTED, DO NOT EXCLUDE, RESTRICT OR MODIFY AND ARE IN ADDITION TO THE MANDATORY STATUTORY RIGHTS APPLICABLE TO THE SALE OF THIS PRODUCT TO YOU.

Obtaining hardware service

If your hardware should fail during the warranty period, HP offers the following support options:

- **HP repair services.** You can return the product to an HP repair center, depending on your location.
- **Express Exchange.** In the United States and Canada only, HP provides a reconditioned permanent replacement printer to you on the next working day for calls received before 2 p.m. PST.
- **HP authorized service provider.** In the United States and Canada, you can return the unit to a local authorized service dealer.
- **Express pick-up and delivery.** HP will arrange to pick up the product, repair it, and return it to you within five to 10 days, depending upon your location.

Returning the unit

When shipping equipment, HP recommends insuring it. Also, include a copy of your proof of purchase. Please also fill out the “Service information form” to ensure the most accurate repairs.

CAUTION

Shipping damage resulting from inadequate packaging is the customer’s responsibility. See “Repackaging guidelines” below.

Repackaging guidelines

- Remove and retain the toner cartridge.
- If possible, print a self-test page (see “Printing a configuration report”) before you turn off the unit, and send the self-test report with the unit.
- Include the completed copy of the Service information form below. Note on the form which items were returned.
- Use the original shipping container and packaging materials, if possible.
- Include samples that illustrate the problems you are having, if applicable.
- Include five sheets of the paper or other media that are causing trouble in printing, scanning, faxing, or copying.

Service information form

Who is returning the equipment? Person to contact:		
		Date:
		Phone:
Alternate contact:		Phone:
Return shipping address:		Special shipping instructions:
What is being sent?	Model number:	Serial number:
Please attach any relevant printouts when returning equipment. Do not ship accessories that are not required to complete the repair (manuals, cleaning supplies, etc.).		
What needs to be done?		
1. Describe the conditions of the failure. (What was the failure? What were you doing when the failure occurred? What software were you running? Is the failure repeatable?)		
2. If the failure is intermittent, how much time elapses between failures?		
3. Is the unit connected to any of the following? (Give manufacturer and model number.)		
Personal computer:	Modem:	Network:
Other:		
4. Additional comments:		

Software license agreement

ATTENTION: USE OF THE SOFTWARE IS SUBJECT TO THE HP SOFTWARE LICENSE TERMS SET FORTH BELOW. USING THE SOFTWARE INDICATES YOUR ACCEPTANCE OF THESE LICENSE TERMS. IF YOU DO NOT ACCEPT THESE LICENSE TERMS, YOU CAN RETURN THE SOFTWARE FOR A FULL REFUND. IF THE SOFTWARE IS BUNDLED WITH ANOTHER PRODUCT, YOU CAN RETURN THE ENTIRE UNUSED PRODUCT FOR A FULL REFUND.

HP SOFTWARE LICENSE TERMS

The following License Terms govern your use of the accompanying software unless you have a separate signed agreement with HP.

License Grant. HP grants you a license to use one copy of the software. "Use" means storing, loading, installing, executing, or displaying the software. You may not modify the software or disable any licensing or control features of the software. If the software is licensed for "concurrent use," you may not allow more than the maximum number of authorized users to use the software concurrently.

Ownership. The software is owned and copyrighted by HP or its third party suppliers. Your license confers no title to, or ownership in, the software and is not a sale of any rights in the software. HP's third party suppliers can protect their rights in the event of any violation of these License Terms.

Copies and Adaptations. You may only make copies or adaptations of the software for archival purposes or when copying or adaptation is an essential step in the authorized Use of the software. You must reproduce all copyright notices in the original software on all copies or adaptations. You may not copy the software onto any public network.

No Disassembly or Decryption. You may not disassemble or decompile the software unless HP's prior written consent is obtained. In some jurisdictions, HP's consent may not be required for limited disassembly or decompilation. Upon request, you will provide HP with reasonably detailed information regarding any disassembly or decompilation. You may not decrypt the software unless decryption is a necessary part of the operation of the software.

Transfer. Your license will automatically terminate upon any transfer of the software. Upon transfer, you must deliver the software, including any copies and related documentation, to the transferee. The transferee must accept these License Terms as a condition to the transfer.

Termination. HP may terminate your license upon notice for failure to comply with any of these License Terms. Upon termination, you must immediately destroy the software, together with all copies, adaptations, and merged portions in any form.

Export Requirements. You may not export or reexport the software or any copy or adaptation in violation of any applicable laws or regulations.

U.S. Government Restricted Rights. The software and any accompanying documentation have been developed entirely at private expense. They are delivered and licensed as “commercial computer software” as defined in DFARS 252.227-7013 (Oct 1988), DFARS 252.211-7015 (May 1991), or DFARS 252.227-7014 (Jun 1995), as a “commercial item” as defined in FAR 2.101 (a), or as “Restricted computer software” as defined in FAR 52.227-19 (Jun 1987) (or any equivalent agency regulation or contract clause), whichever is applicable. You have only those rights provided for such software and any accompanying documentation by the applicable FAR or DFARS clause or the HP standard software agreement for the product involved.

HP Customer Care

Along with your product, you receive a variety of support services from Hewlett-Packard and our support partners designed to give you the results you need, quickly and professionally.

Online Services: for 24-hour access to information over your modem, we suggest these services.

World Wide Web URL - For information specific to the HP LaserJet 3200 product: <http://www.hp.com/support/lj3200/>

America Online - America Online/Bertelsmann is available in the U.S., Austria, France, Germany, Switzerland, and the U.K. - Printer drivers, updated HP printer software, and support documentation are available to help answer your questions about HP products. Use Keyword HP to start your tour or in the U.S., call (1) (800) 827-6364 preferred customer #1118 to subscribe.

In Europe, call the appropriate number below:

Austria: 0222 58 58 485
France: ++353 1 704 90 00
Germany: 0180 531 31 64
Switzerland: 0848 80 10 11
United Kingdom: 0800 279 1234

CompuServe - Printer drivers, updated HP printer software, and interactive sharing of technical information with other members is available on CompuServe's HP User's forums (GO HP), or call (1) (800) 524-3388 and ask for representative #51 to subscribe. (CompuServe is also available in the U.K., France, Belgium, Switzerland, Germany, and Austria.)

Obtaining Software

Visit: <http://www.hp.com/go/support> (site is in English)

Call:

Australia: +61 3 8877 8000
Canada and US: (661) 257 5565
Ireland and the UK: +44 (0) 1429 865 511
Hong Kong SAR, Malaysia, and Singapore: +65 740 4477
New Zealand: +64 9 356 6640

For other contact information, see "Ordering software." "Ordering software" on page 259.

HP Direct Ordering for Accessories and Supplies (U.S. and Canada):

Call (1) (800) 538-8787 (U.S.) or (1) (800) 387-3154 (Canada).

HP Support Assistant compact disc (U.S., Canada, Malaysia, and Singapore):

This support tool offers a comprehensive online information system designed to provide technical and product information on HP products. To subscribe to this quarterly service in the U.S. or Canada, call (1) (800) 457-1762. In Malaysia, or Singapore, call Fulfill Plus at (65) 740-4477.

HP Service Information (U.S. and Canada):

To locate HP-authorized dealers, call (1) (800) 243-9816 in the U.S. or (1) (800) 387-3154 in Canada.

Customer Care Options Worldwide

In addition to the phone numbers listed below, the “HP sales and service offices” section on page 253 contains worldwide sales and service addresses and phone numbers.

HP Customer Care and Product Repair Assistance for the U.S. and Canada:

Call (208) 323-2551 in the United States or (905) 206-4663 in Canada Monday through Friday 6 am to 10 pm and Saturday 9 am to 4 pm (Mountain Time) free of charge during the warranty period. However, your standard long-distance phone charges still apply. Have your system nearby and your serial number ready when calling.

If you know your printer needs repair, call 1-800-243-9816 to locate your nearest HP-Authorized service provider, or call 208-323-2551 for HP centralized service dispatch.

Post-warranty telephone assistance is available to answer your product questions. Call (1) (900) 555-1500 (\$2.50* per minute, U.S. only) or call 1-800-999-1148 (\$25* per call, Visa or MasterCard, U.S. and Canada) Monday through Friday from 7 am to 6 pm and Saturday from 9 am to 3 pm (Mountain Time). *Charges begin only when you connect with a support technician. *Prices subject to change.*

European HP Customer Care and In-Country Support Open Monday through Friday 8:30-18:00 CET

HP provides a free telephone support service during the warranty period. By calling a telephone number listed below, you will be connected to a responsive team waiting to help you. If you require support after your warranty has expired, you can receive support for a fee through the same telephone number. The fee is charged on a per-incident basis. When calling HP, have the following information ready: product name and serial number, date of purchase, and description of the problem.

Ireland:	+353 (0)1 662 5525	English in other	
U.K.:	+44 20 171 512 5202	European countries:	+44 020-75125215
Greece:	+30 (0) 16196411		

In-country/region support

If you require telephone support, call the number below. If you require additional product repair services, see “HP sales and service offices” on page 253.

Australia: (61) (3) 8877-8000	New Zealand:	+64 9 356 6640
Hong Kong SAR: 800 96 7729	Singapore:	+65 272 5300
Malaysia: +60 3 295 2566		

HP sales and service offices

Before calling an HP Sales and Service office, be sure to contact the appropriate Customer Support Center number listed in “HP Customer Care” on page 251. Products should not be returned to the offices listed below.

Worldwide Hewlett-Packard Country/Region Sales and Service Offices

Argentina

Hewlett-Packard Argentina
Montañeses 2140
1428 Buenos Aires
Phone: (54) (1) 787-7115
Fax: (54) (1) 787-7287

Austria

Hewlett-Packard GmbH
Lieblgasse 1
A-1222 Vienna
Phone: (43) (1) 25000-555
Fax: (43) (1) 25000-500

China

China Hewlett-Packard Co. Ltd.
9/F, HP Building
No. 2 Dong San Huan Nan Lu
Chao Yang District
Beijing 100022, China
Phone: +86-10-6564-5959
Fax: +86-10-6566-8280

Australia

Hewlett-Packard Head office
Hewlett-Packard Australia Ltd.
31-41 Joseph Street
Blackburn, VIC 3130
Phone: (61) (3) 9272-2895
Fax: (61) (3) 898-7831

Service and Support
Hewlett-Packard
351 Burwood Hwy
Forest Hill
VIC 3131
Phone: (61) (3) 8877-5786

Belgium

Hewlett-Packard Belgium S.A. NV
Boulevard de la Woluwe-Woluwedal 100-102
B-1200 Brussels
Phone: (32) (2) 778-31-11
Fax: (32) (2) 763-06-13

Denmark

Hewlett-Packard A/S
Kongevej 25
DK-3460 Birkerød
Denmark
Phone: (45) 3929 4099
Fax: (45) 4281-5810

Finland

Hewlett-Packard Oy
Piispankalliontie 17
FIN-02200 Espoo
Phone: (358) (9) 887-21
Fax: (358) (9) 887-2477

Germany

Hewlett-Packard GmbH
Herrenberger Strasse 130
71034 Böblingen
Phone: (49) (0) 180 532-6222
(49) (0) 180 525-8143
Fax: (49) (0) 180 531-6122

Hong Kong SAR

Hewlett-Packard Asia Pacific Ltd.
19/F Cityplaza One,
111 King's Road, Taikoo Shing
Hong Kong SAR
Phone: (852) 2599-7777
Fax: (852) 2506-9261
Hardware Repair Center:
Phone: (852) 2599-7000
Extended Warranty Support:
Phone: (852) 2599-7000

Customer Information Center:
Phone: (852) 2599-7066

Israel

Hewlett-Packard Israel Ltd.
11, Hashlosha St.
Tel Aviv 67060
Phone: (972) (3) 5 38
03 00
Fax: (972) (3) 5 38
03 51
Customer Care Center
Phone: (972) (9) 9 52
48 48

Korea

Hewlett-Packard Korea, Ltd.
HP Korea House,
23-6 Yoido-dong,
Youngdeungpo-gu, Seoul 150-724, Korea
Yoido P.O. Box 595
Phone: (82) (2)2199-0114

France

Hewlett-Packard France
42 Quai du Point du Jour
F-92659 Boulogne Cedex
Phone: (33) (146) 10-1700
Fax: (33) (146) 10-1705

Greece

Hewlett-Packard Hellas
62 Kifissias Av.
Polis Center
Maroussi
151 25 Athens
Greece
Phone: (30) (1) 619-6411
Fax: (30) (1) 619-6512

Hungary

Hewlett-Packard Magyarország Kft.
Neumann János u. 1
H-1111 Budapest
Phone: (36) (1) 382-6666
Fax: (36) (1) 382-6777
Hardware Repair Center:
Phone: (36) (1) 343-0312
Customer Information Center:
Phone: (36) (1) 343-0310

Italy

Hewlett-Packard Italiana SpA
Via Giuseppe di Vittorio, 9
Cernusco Sul Naviglio
I-20063 (Milano)
Phone: (39) (2) 921-21
Fax: (39) (2) 921-
04473

México

Hewlett-Packard de México, S.A. de C.V.
Prolongación Reforma No. 700
Lomas de Santa Fe
01210 México, D.F.
Phone: 01-800-22147
Outside Mexico City
Phone: 01 800-90529

Middle-East Region

Hewlett-Packard Middle-East
P.O.-Box 17295
Jebel Ali Free Zone
Dubia, UAE
Phone: (97) 14 88 15
456
Fax: (97) 14 88 14
529

New Zealand

Hewlett-Packard (NZ) Limited
Ports of Auckland Building
Princes Wharf, Quay Street
P.O. Box 3860
Auckland
Phone: (64) (9) 356-
6640
Fax: (64) (9) 356-
6620
Hardware Repair Center and Extended
Warranty Support:
Phone: (64) (9) 0800-
733547
Customer Information Center:
Phone: (64) (9) 0800-
651651

Poland

Hewlett-Packard Polska
Al. Jerozolimskic 181
02-222 Warszawa
Phone: (48-22) 608-7700
Fax: (48-22) 608-76-00

Russian Federation

Hewlett-Packard Company
Representative Office
Kosmodamianskaya naberezhnaya 52,
Building 1
113054 Moscow
Phone: (7) (0) 95 797-3500
Fax: (7) (0) 95 797-3501

Netherlands

Hewlett-Packard Nederland BV
Startbaan 16
1187 XR Amstelveen
Postbox 667
NL-1180 AR Amstelveen
Phone: (31) (0) 20 547-
6666
Fax: (31) (0) 20 547-
7755

Norway

Hewlett-Packard Norge A/S
Postboks 60 Skøyen
Drammensveien 169
N-0212 Oslo
Phone: (47) 2273-5600
Fax: (47) 2273-5610

Portugal

Hewlett-Packard Portugal
Quinta da Fonte
Edificio Bartolomeu Dias
Porto Salvo
2780-667 Oeiras
Portugal
Phone: (351) (21) 4 82 85 00
Fax: (351) (21) 4 41 70 02

Singapore

Hewlett-Packard Singapore
(Sales) Pte Ltd
450 Alexandra Road
Singapore (119960)
Phone: (65) 275-3888
Fax: (65) 275-6839
Hardware Repair Center and Customer
Information Center:
Phone: (65) 272-5300
Extended Warranty Support:
Phone: (65) 272-5333

Spain

Hewlett-Packard Española, S.A.
Carretera de la Coruña km 16.500
E-28230 Las Rozas, Madrid
Phone: (34) 91-6311600
Fax: (34) 91-6311830

Switzerland

Hewlett-Packard (Schweiz) AG
In der Luberzen 29
CH-8902 Urdorf/Zürich
Phone: (41) (0848) 88 44 66
Fax: (41) (1) 735 77 00
Warranty Support:
(41) (0848) 80 11 11

United Kingdom

Hewlett-Packard Ltd.
Cain Road
Bracknell
Berkshire RG12 1HN
Phone: (44) (0) 8705 47 47 47
(44) (0) 207 512 5202
Fax: (44) (134) 436-3344

Sweden

Hewlett-Packard Sverige AB
Skalholtsgatan 9
S-164 97 Kista
Phone: (46) (8) 444-2000
Fax: (46) (8) 444-2666

Ukraine

Hewlett-Packard Trading S.A.
14, Bekhterevskiy Pereulok, Block E
04053 Kiev
Phone: (380) 44 490 61 20
Fax: (380) 44 490 61 21

Ordering parts

To order parts:

- Visit HP’s website at <http://www.partsdirect.hp.com>
- In the U.S., call HP Direct Ordering at (800) 538-8787 for most items. To order HP LaserJet paper, call (800) 471-4701.
- Or -
To find a dealer near you, or if your dealer is temporarily out of stock, call the HP Customer Information Center at (800) 752-0900.
- Outside the U.S., see “HP sales and service offices” for ordering locations and phone numbers.

The following table lists items available from HP:

	Item	Description or use	Part Number:
Printer memory	Synchronous dynamic random-access memory (SDRAM) dual in-line memory module (DIMM)	Allows more information to be stored in the product.	8 MB: C7842A 16 MB: C7843A 32 MB: C7845A 64 MB: C7846A
Printing supplies	HP LaserJet Toner Cartridge	Replacement toner cartridge for the HP LaserJet 3200.	C4092A
Cables and interface accessories	HP LaserJet size C printer parallel cable (IEEE-1284)	One of the methods of connectivity from the product to the computer.	C2946A (3 meters A to C) C2947A (10 meters A to C)
	USB cable	One of the methods of connectivity from the product to the computer.	C6518A
Replacement parts	Paper Input Support	Used to stabilize the paper once it is loaded into the paper input tray.	RB2-5493-000CN
	Paper Output Support	Used to stabilize the paper once it is printed.	RB2-5423-000CN
	Document Feeder Support	Used to stabilize the paper once it is loaded into the document feeder tray.	RB2-5437-000CN
	Document Output Support	Used to stabilize the paper once it is scanned, faxed, or copied.	RB2-5412-000CN
	Document Legal Extension		RB2-5407-000CN
	Overlay for one-touch keypad		RB2-5471-000CN
	Scanner Separation Pad Kit		RY7-5055-000CN
	Printer Separation Pad		RF5-2886-000CN
	Printer Pickup Roller		RB2-4026-000CN

JetDirect print servers	HP JetDirect print servers	Compatible with the HP LaserJet 3200 product.	70X (J4155A), 170X (J3258B), 300X (J3263), or 500X (J3265)
Supplementary documentation	<i>Print Media Guide</i> for HP LaserJet printers	A guide to using paper and other print media with HP LaserJet printers.	Hard copy: 5963-7863 HP's website: http://www.hp.com/support/ljpaperguide
Printing supplies	HP MultiPurpose Paper	HP brand paper for a variety of uses.	HPM1120 - High bright, 20 lb, 8.5 by 11 in
	HP LaserJet Paper	Premium HP brand paper for use with HP LaserJet prints.	HPJ1124 (Letter; CPH310 (A4)
	Transparencies	HP brand transparency film for use with HP LaserJet monochrome printers.	92296T (Letter); 92296U (A4)

Ordering software

To order the software if your CD is damaged or missing, contact Hewlett-Packard Support.

In the United States and Canada:

Request by Internet: <http://www.software.hp.com>
Request by Phone:
Request by Fax: 661-257-5565 (Mon. - Sat., 24 hours a day)
661-257-6995
Request by Mail:
U.S. Driver Fulfillment for Hewlett-Packard
P.O. Box 907
Santa Clarita, CA 91380-9007 USA

In Europe and the Middle East:

Request by Phone: +44 (0) 1429 865 511 (English)
+44 (0) 1429 863 343 (French)
+44 (0) 1429 863 353 (German)
+44 (0) 1429 520 013 (Italian)
+44 (0) 1429 890 466 (Portuguese)
+44 (0) 1429 520 012 (Spanish)
Request by Fax: +44 (0) 1429 866 000
Request by Mail: European Fulfillment for Hewlett-Packard
c/o Starpak International, LTD
P.O. Box 63
Hartlepool, Cleveland
TS25 2 YP
United Kingdom

In the Asia and Pacific countries/regions:

Request by Phone: Australia:61 3 8877 8000
China:+86 (10) 6564 5959
Hong Kong SAR, Malaysia, and Singapore:
+65 740 4477
India:+91 11 682 6035
Korea:+82 (2) 3270 0805
New Zealand:+64 9 356 6640
Taiwan:+888 (2) 2717 0055

Glossary

10-BaseT

A type of Ethernet network that uses twisted pair cabling to attach nodes to the network.

100-BaseTX

A type of Ethernet network, also known as Fast Ethernet, that uses twisted pair cabling to attach nodes to the network.

10/100-BaseTX

This term indicates that a product is compatible with both 10-BaseTX and 100-BaseTX. Many network products are compatible with both of these, including some HP JetDirect print server models.

actual size

The size of the page when it was scanned (not enlarged using zoom in or reduced using zoom out).

annotation

A word, note, mark, or highlighting added to an item.

bit depth

The number of bits used to process scanned images. The greater the number of bits, the more levels of gray that can be used to display the image.

.bmp file

A Microsoft Windows bitmap file that has the extension .bmp. A bitmap file defines an image (such as the image of a scanned page) as a pattern of dots (pixels).

BNC

A type of network connector generally used with coaxial network cabling. A BNC connector has two slots that lock onto two matching knobs on a network interface card when you twist the connector.

brightness

A measure of the overall intensity of the image. The lower the brightness value, the darker the image; the higher the value, the lighter the image will be.

Chooser

The Chooser is part of the Mac OS that lets you configure your computer system to print on any printer for which you have appropriate software. If you are part of an AppleTalk network system, you can use the Chooser to activate and select among devices (such as printers, file servers, or other computers) connected to the network.

collapse

The process of reducing a sticky note to an icon.

collate

The process of printing a multiple-copy job in sets. When collate is selected, the HP LaserJet 3200 product prints an entire set before printing additional copies. Otherwise, the device prints the desired number of copies of a page together before printing the following pages.

comma (,)

A comma in a dial sequence indicates that the fax machine will pause at that point in the dialing sequence.

contrast

The difference between the dark and light areas of an image. The lower the number value, the more closely the shades will resemble each other. The higher the number, the more the shades will stand out from each other.

container program

A program into which an OLE object is inserted. That program contains the object.

crop

To remove part of an image. The portion of the image that is selected remains, while the portion that is not selected is removed.

.dcx

A multi-page .PCX format where each page is a .PCX file. Since this is a multi-page format, it is widely used for receiving and sending faxes to and from the computer. A single DCX document can store up to 1,023 pages.

dedicated line

A single telephone line that is used exclusively for either voice calls or fax calls.

distinctive ring

A feature offered by some telephone companies in the Australia, Canada, New Zealand, the United States, and the United Kingdom that allows two or three phone numbers to be set up on the same telephone line. Each phone number has a different ring pattern, and the fax machine can be configured to recognize the distinctive ring of the fax number.

dots per inch (dpi)

A measurement of resolution used for scanning and printing. Generally, more dots per inch mean a higher resolution, a greater amount of visible detail in the image, and a larger file size.

EconoMode

Economode is a toner-saving feature on your HP LaserJet product. Economode reduces the amount of toner on a the printed page, so that the toner cartridge lasts longer. The printed result is similar to printing a document in draft mode.

e-mail (electronic mail)

An abbreviation for electronic mail. Software that you can use to electronically transmit items over a communications network.

Ethernet

A common type of local area network recognized as the industry standard. Ethernet is also known as IEEE 802.3. Information is broken into "packets" that are transmitted in order until they arrive at the destination without colliding with any other "packet." A network node is either transmitting or receiving a packet at any instant.

expand

A process to restore a collapsed sticky note from an icon to its original size.

fax

An abbreviation for facsimile. The electronic encoding of a printed page and the transmission of the electronic page over a telephone line. The product software can send items to electronic fax programs, which require a modem and fax software.

fax functions

Fax-related tasks you do from the control panel that only affect the current job, or that you only do once before returning to the Ready state, such as clearing memory. These functions are in their own section in the control panel menu.

fax settings

Fax-related items that when you set or change them continue to use the choice you make until you change them again. An example would be the number of times you set for the product to redial a busy number. These settings are in their own section of the control panel menu.

file format

The way the contents of a file are structured by a program or group of programs.

.gif

Graphics Interchange Format, an image used by CompuServe and other online formats.

grayscale

Shades of gray that represent light and dark portions of an image. Color images can also be converted to grayscale where colors are represented by various shades of gray.

halftone

An image type that simulates grayscale by varying the number of dots. Highly colored areas consist of a large number of dots, while lighter areas consist of a smaller number of dots.

.hpd

.HPD files are scanned documents that are saved using the HP LaserJet Document Manager.

HP JetDirect print server

An external, standalone print server. To use the HP LaserJet 3200 product on the network, you can connect the product (or a printer) to the print server, instead of a computer, using a parallel cable. The print server then connects to the network using a standard network

connector. For the HP LaserJet 3200 product and its supported HP JetDirect external prints servers, the connector can be 10-BaseT, 10/100BaseTX, BNC, or token ring.

HP LaserJet Director toolbar

An HP LaserJet 3200 product software screen used when working with documents. When the document is loaded into the document feeder tray and your computer is connected directly to the product, the HP LaserJet Director appears on the computer screen, allowing you to begin faxing, copying, or scanning the document.

HP Web JetAdmin software and HP JetAdmin software

Network peripheral management software that lets you configure and manage from a computer any peripheral connected to an HP JetDirect print server. For the HP LaserJet 3200 product, you may or may not need to use the HP JetAdmin or Web JetAdmin software (or bootp, DHCP, or telnet) to configure the product on the network.

hypertext links

A link from one part of a document to another. When a linked word or phrase or graphic is clicked, the user will jump to the linked word, phrase, or graphic.

IPX/SPX

A network protocol made popular by Novell, Inc. as the basic protocol in its Novell NetWare network operating system. In order for the HP LaserJet 3200 product to work on the network, you must have the TCP/IP or IPX/SPX network protocol running in addition to NetBEUI.

.jpg

(also JPEG) Joint Photographic Experts Group, an international standard for compressing digital photographic images.

link

A connection to a program or device that you can use to send information from the product software to other programs, such as e-mail, electronic fax, and OCR links.

Link Bar

The icons on the bottom of the desktop or viewer that represent programs installed on your computer, such as e-mail software.

linked program

A program installed on your computer that you can use with the product software. For example, you can use OCR software to translate a scanned item into text.

NetBEUI (NetBIOS Extended User Interface)

The network transport protocol used by all of Microsoft's network systems and IBM's LAN Server based systems. In order for the HP LaserJet 3200 product to work on the network, you must have the TCP/IP or IPX/SPX network protocol running in addition to NetBEUI. If you only have NetBEUI, you can only share the product on the network using Windows sharing. This means only the printing function is available to network users. (The local user can still use the full product functionality.)

NetWare

Novell, Inc.'s proprietary networking operating system for the PC environment. NetWare uses the IPX/SPX, NetBEUI, or TCP/IP network protocols. It supports MS-DOS, Microsoft Windows, OS/2, Macintosh and Unix clients. NetWare 2.2 is a 16-bit operating system, versions 4.x and 3.x are 32-bit operating systems.

node

A computer (server or user) or peripheral, such as the HP LaserJet 3200 product, that is connected to a network.

Optical Character Recognition (OCR) software

OCR software converts an electronic image of text, such as a scanned document, into a form word processor, spreadsheet, and database programs can use.

.pcx

A common graphic file format that many graphic programs accept the .pcx file format. This is a popular format in which to store scanned images.

portable document viewer

A mini-program that can be attached to an electronic document and e-mailed. The recipient will be able to view, annotate, and print the document, no matter what program was used to create the document.

PostScript fonts

Fonts defined in terms of the PostScript language, intended to be printed on a PS printer. PostScript fonts come as a screen font that appears on your monitor and a matching printer font used by the product to create your document.

PPD

PPD stands for PostScript Printer Description file. PPDs are used by the printer driver and applications to determine the features and PostScript commands supported in the product.

print server

See *HP JetDirect print server*.

printer driver

A printer driver is a program that enables your applications to access your product's features. A printer driver translates an application's formatting commands (such as page breaks and font selection) into a printer language (such as PostScript, PS, or PCL), and then sends the print file to the product.

Private Branch Exchange (PBX)

A small telephone switching system that typically is used by large businesses or universities to connect all telephone extensions within the organization. A PBX also connects to the public switched telephone network (PSTN) and may be either manual or dial, depending on the method used by extensions to place incoming or outgoing calls. Normally, the equipment is owned by the customer rather than leased from the telephone company.

public switched telephone network (PSTN)

The worldwide dial-up telephone network or a portion of that network. Users are assigned unique phone numbers, which allow them to connect to the PSTN through local telephone exchange companies. Often, this phrase is used when referring to data or other non-telephone services carried over a path initially established using normal telephone signaling and ordinary switched long distance telephone circuits.

resolution

The sharpness of an image, measured in dots per inch (dpi). The higher the dpi, the greater the resolution.

RJ45

A network connector that looks much like a standard telephone connector, except it is wider (it houses 8 wires instead of 4). Both Ethernet (10/100BaseTX) and Token Ring networks use this type of network connector.

shared line

A single telephone line that is used for both voice and fax calls.

sticky note

An annotation that is a multiline, resizable note. Similar to a paper sticky note, it covers the item information beneath it. You can move a sticky note or collapse it to an icon. You can search for words in a sticky note by using the Find command.

summary information

Information about the item, such as creator or keywords, that you can add to an item in the Summary Information dialog box to help you find the item quickly.

TCP/IP

The de facto standard Ethernet protocol. TCP/IP stands for (Transmission Control Protocol over Internet Protocol). In order for the HP LaserJet 3200 product to work on the network, you must have the TCP/IP or IPX/SPX network protocol running in addition to NetBEUI.

.tif

Stands for Tagged Image File Format. A .tif (or TIFF) is a graphic file format that was developed to capture scanned images. It is a format used on IBM-compatible computers, Macintosh computers, and UNIX computers. Many graphic programs accept the .tif file format.

Token ring

A local area network in which transmission conflicts are avoided by the granting of "tokens" that give permission to send. A network node keeps the token while transmitting a message, if it has a message to transmit, and then passes the token on to the next node. IEEE 802.5 is the most common type of token-ring network.

TrueType fonts

TrueType fonts use what-you-see-is-what-you-get (WYSIWYG) technology, which means that the printed output of TrueType fonts is identical to what appears on the screen.

TWAIN

An industry-standard for scanners and software. Using a TWAIN-compliant scanner with a TWAIN-compliant program, you can initiate a scan from within the program.

Twisted pair

A type of network cable commonly used in Ethernet networks.

Watermarks

A watermark adds background text to a document being printed. For example, you can print text in the background of your document stating that the document is "Confidential."

You can select from a set of predefined watermarks. Once you select a watermark, you can change the font, size, angle, and style, as well as determine whether the printer will place the watermark on the first page only or all pages.

Windows sharing

A method of peer-to-peer networking that uses Windows products. If you have a network installed, you can share resources with your co-workers, most commonly the HP LaserJet 3200 product, printers, and hard disks, by simply using Windows tools such as Explorer and Print Manager. When the HP LaserJet 3200 product (or any printer) is shared using Windows sharing, network users need to install the printer drivers using the Add Printers utility in the Windows Printers folder.

zoom in

To make a page larger on the screen so you can see more detail.

zoom out

To make a page smaller on the screen so you can have a broader view of the page.

Index

A

- access codes, dialing 55
- accessories and supplies 251
- acoustic emissions 230
- activity logs, printing 43
- adding
 - memory 220
 - paper 29
- ad-hoc groups, faxing to 58
- adjusting
 - automatic redialing 83
 - contrast, copy 122
 - contrast, fax 61
 - copy quality 123
 - guides 173
 - languages, display panel 41
 - resolution, faxes 62
 - resolution, printer 115
 - ring pattern 91
 - settings, default 37
 - volume 39
- agreement, software license 249
- alarm volume, adjusting 40
- alcohol, cleaning with 214
- alternate long distance service, one-touch
 - keys for 73
- annotations, making 35
- answer mode, changing 90
- answering machines
 - connecting 151
 - ring pattern settings 91
 - troubleshooting 155
- anti-static precautions 220
- archive button 34
- area codes, dialing 55
- arrow keys 18
- Asia Pacific, website for 242
- authorized service providers, HP 247
- automatic answer mode 90
- automatic log printing 44
- automatic redialing
 - adjusting 83
 - defaults 60
- autoreduction, faxes 95
- avoiding jams 25, 28, 29

B

- Back Arrow key 18
- Back Space key 18

battery

- specifications 243
- beeps, adjusting volume 40
- Best Quality print resolution 115
- bidirectional communications 160
- bins. *See* output bin, paper; input tray, paper
- black and white copying 121
- black pages, troubleshooting 192
- blank pages, troubleshooting 193
- blocking fax numbers
 - printing logs of 48
 - using control panel 67
- both sides, printing on
 - instructions for 112
 - troubleshooting 161
- breaking paper 173
- bulk returns 242
- business cards, loading 28
- busy signals
 - canceling faxes after 64
 - delayed faxing 59
 - group faxes 57
- buttons
 - control panel 18
 - HP LaserJet Director 33

C

- calibrating scanner 216
- call reports, printing 45
- calling cards, faxing with 77
- Canadian DOC regulations 240
- Canadian IC CS-03 statement 237
- canceling
 - faxes 64
 - print jobs 111
- capacity
 - circuit 228
 - paper trays and bins 231
 - single-sheet input slot 24
- carrier sheets 27
- cartridges. *See* toner cartridges
- changing
 - answer mode 90
 - automatic redialing 83
 - contrast, copy 122
 - contrast, fax 61
 - copy quality 123
 - fax headers 79

- languages, display panel 41
- resolution, faxes 62
- resolution, printer 115
- ring pattern 91
- settings, default 37
- volume 39
- characters
 - dropouts 184
 - entering from control panel 78
 - formatting codes 168
 - garbled 159
 - misformed 190
- checklists
 - fax setup 149
 - troubleshooting 148
- circuit capacity 228
- cleaning
 - alcohol 214
 - doors 213
 - glass 214
 - print path 211
 - rollers 214
 - scanner path 213
- clearing
 - document feeder 196
 - faxes from memory 89
 - jams in input areas 174
 - jams in interior area 174
 - jams in scanner path area 177, 179
- codes
 - See also* speed-dial codes; group-dial codes; one-touch keys
 - access 55
 - area 55
- coding schemes, fax 229
- collating copies
 - by default 121
 - changing defaults 128
- color copying 122
- communications, bidirectional 160
- compatibility, fax 229
- compliance
 - Canadian DOC regulations 240
 - contact information 239
 - FCC regulations 234
 - laser safety statements 233
- configuration reports, printing 48
- confirmation, sent fax 45
- conflicts, parallel ports 161
- conformity, declaration of 239
- connecting
 - Fax/Phone line connector 149
 - parallel ports 152
- consumables
 - ordering 257
 - recycling 241
- consumer protection act, telephone 236
- consumption, power 228
- contact information
 - compliance 239
 - sales and service offices 253
- contrast
 - control panel key 19
 - copy job settings, adjusting 122
 - copy settings, default 126
 - fax job settings, adjusting 61
 - fax settings, default 81
 - scanned images 190
 - troubleshooting 183
- control panel
 - blocking fax numbers 67
 - entering characters 78
 - entering numbers 79
 - error messages 195
 - icons for 12
 - identifying 18
 - key press volume, adjusting 40
 - keypad overlay part number 257
 - keys 18
 - languages, changing 41
 - letters, entering 80
 - lights 18
 - menu structure 19, 47
 - programming one-touch keys 56
 - programming speed-dial codes 56
- converting scans to text 138
- Copy key 19
- Copy quality
 - See also* image quality, troubleshooting defaults, adjusting 126
- Copy Setup menu 20
- copying
 - black and white 121
 - collating by default 121
 - color 122
 - contrast, adjusting 122
 - contrast, default settings 126
 - contrast, troubleshooting 165
 - control panel key 19
 - default size 127
 - enlarging 123
 - faxing during 14, 16
 - grayscale 121
 - HP LaserJet Director button 34
 - loading media 26
 - media, selecting 25
 - menus for 20
 - multiple tasks during 14, 16
 - number of copies, default 129
 - originals, loading 26
 - printing during 14, 16
 - quality adjustments 123

- reducing 123
- scanning during 14, 16
- specifications 230
- speed 230
- troubleshooting 164
- cover sheet 100
- creases, troubleshooting 193
- curling
 - preventing 31, 171
 - troubleshooting 192
- custom sizes, printing on 117
- Customer Care, HP 251
- customer support
 - See also* websites
 - HP Customer Care 251
 - ordering parts 257
 - repair services 247
 - sales and service offices 253
 - service information form 248
 - software, ordering 259
- customize button 34

D

- darkness. *See* contrast
- date, fax header
 - changing 79
 - invalid 199
 - menu for 20
- Date/Time Header menu 20
- day, entering on fax header 79
- declaration of conformity 239
- default settings
 - adjusting 38
 - copying 125
 - faxing 81
 - restoring 41
- defaults, restoring 209
- delaying faxes
 - canceling 64
 - clearing from memory 89
 - for future delivery 59
- deleting
 - all codes 76
 - faxes from memory 89
 - group-dial codes 75
 - one-touch keys 72
 - speed-dial codes 72
- depth 228
- devices, shared 152
- dial tone detection, disabling 85
- dial tones, none 199
- dialing
 - calling cards 77
 - character limits for 154
 - instructions for 55
 - international 77, 78

- manually 77
- pauses, inserting 78
- prefixes, inserting 84
- pulse 82
- telephone 77
- tone 82
- tone detection, disabling 85
- troubleshooting 197
- dimensions, product 228
- DIMMs
 - adding 220
 - ordering 257
 - removing 223
 - testing 222
- direct connections
 - multiple features, using 14
- direct ordering of accessories and supplies 251
- Director. *See* HP LaserJet Director
- disabling
 - dial tone detection 85
 - error correction 97
 - extension phone settings 93
- disk drives, external 152
- disk space, insufficient 168
- distinctive ringing
 - setting up 91
 - troubleshooting 156
- document feeder support
 - part number 257
- document feeder tray
 - capacity 231
 - identifying 22
 - paper sizes 231
- document legal extension, part number 257
- Document Manager
 - using 35
- document output slot
 - capacity 231
 - identifying 21
- document output support
 - part number 257
- document release door 21
- doors
 - cleaning 213
 - document release 21
 - identifying 21
- DOS, troubleshooting printing 163
- dots per inch. *See* resolution
- double-ringing 91
- double-sided printing
 - instructions for 112
 - troubleshooting 161
- dpi. *See* resolution
- draft mode 111

- Draft quality 126
- drivers, printer
 - part numbers 258
 - requirements for 103
- dropouts, character 184
- duplexing
 - instructions for 112
 - troubleshooting 161
- duty cycle
 - printer 229
 - scanner 230
 - toner cartridges 216

E

- EconoMode 111
- ECP ports 161
- edges not printing 184
- electrical specifications 228
- electronic mail. *See* e-mail
- electronic phone books
 - uninstalling 210
 - using 55
- e-mail
 - attaching files to 145
 - scanning to 143
- emissions
 - acoustic 230
 - ozone 240
- energy consumption 240
- Energy Star 240
- enlarging
 - control panel key for 19
 - copies 123
 - defaults, adjusting 127
 - range 230
- Enter/Menu key 18
- entering
 - characters 78
 - letters 80
 - numbers 79
 - punctuation 80
 - spaces 80
- envelopes
 - printing 108
 - selecting 23, 117
 - sizes for 24
- environmental specifications 228
- environmental stewardship program 240
- equivalence table, paper weight 232
- error correction 97
- Error light 18, 148
- error messages, resolving 195
- error reports, printing 45
- Europe, website for 242
- European support 252

- European Union regulatory information 238
- Express Exchange repair service 247
- extension phones
 - receiving faxes from 93
 - troubleshooting 155

F

- faded print, troubleshooting 183, 185
- FastRes 115
- fax compatibility 229
- fax confirmation report 45
- Fax Functions menu 20
- fax headers, changing 79
- fax logs
 - printing 43
 - stopping 152
- fax numbers
 - See also* group-dial codes; one-touch buttons; speed-dial codes
 - blocking 67
 - international 78
 - pauses, inserting 78
- fax reports
 - first page thumbnail, including 46
 - printing 45
 - stopping 152
- Fax Settings menu 20
- fax sounds, adjusting volume 39
- fax tones
 - receiving signal 65
 - silent, detecting 94
- Fax/Send key 19
- faxes
 - activity logs, printing 43
 - autoreduction, setting 95
 - blocked number logs, printing 48
 - call reports, printing 45
 - canceling 64
 - clearing from memory 89
 - confirmation report 45
 - contrast defaults, adjusting 81
 - contrast job settings, adjusting 61
 - cover sheet, customizing 100
 - default paper size 38
 - delayed sending 59
 - delayed, clearing 89
 - deleting from memory 89
 - error correction settings 97
 - extension phones, receiving from 93
 - feeding problems 152
 - forwarding 87
 - margins 229
 - not printing 158
 - polling 88
 - receiving 65

- receiving to computer 99
- reports, printing all 50
- reprinting 66
- requesting 88
- resolution defaults, adjusting 81
- resolution job settings, adjusting 62
- sending 55, 57
- stamping, enabling 96
- stopping 64
- transmission times 62
- troubleshooting 152
- faxing
 - See also* dialing
 - ad-hoc groups 58
 - canceling 64
 - contrast, adjusting 61
 - control panel key 19
 - copying during 15, 16
 - cover sheet, customizing 100
 - delayed sending 59
 - error correction settings 97
 - extension phones, receiving from 93
 - feeding problems 152
 - forwarding 87
 - group-dial codes, using 57
 - HP LaserJet Director button 34
 - loading media 26
 - manual dialing 77
 - media, selecting 25
 - menus for 20
 - multiple recipients 57
 - multiple tasks during 15, 16
 - one recipient 55
 - originals, loading 26
 - printing during 15, 16
 - receiving 65
 - receiving to computer 99
 - redialing manually 60
 - reprinting 66
 - resolution settings, adjusting 62
 - scanning during 15, 16
 - sending 55, 57, 98
 - setup checklist 149
 - software, using 98
 - specifications 229
 - speed 229
 - stopping 64
 - transmission times 62
 - troubleshooting 152
 - volume adjustments for 39
- FCC regulations 234
- features
 - icons for 12
 - multiple, using 14, 16
 - overview 13
- feeder support, document
 - part number 257
- feeder tray 22
- feeding problems
 - causes of 170
 - duplexing 161
 - faxing 152
 - paper input bin 173
 - scanner path 177
 - single-sheet input slot 173
- file formats, saving to 138
- fine fax resolution 62
- first page thumbnail 46
- font list, PCL 49
- font list, PostScript 49
- form, service information 248
- formatting codes, troubleshooting 168
- forms
 - multiple, avoiding 25
 - preprinted, troubleshooting 187
 - printing on 23
 - service information 248
- Forward Arrow key 19
- forwarding faxes 87
- front paper path door 21
- functionality, icons for 12

G

- glass, cleaning 214
- glossary of terms 261
- glossy paper, problems with 23
- graphics
 - See also* image quality, troubleshooting
 - adding using HP LaserJet Document Manager (Windows) or HP LaserJet Workplace (Mac OS) 35
 - converting to text 138
 - fax resolution 62, 63
 - saving scans as 138
- gray backgrounds, troubleshooting 189
- grounding 220
- group-dial codes
 - deleting 75
 - error messages 198
 - programming 74
 - sending faxes using 57
 - troubleshooting 153
- groups, faxing to 57, 58
- guides
 - adjusting 173
 - paper input 22

H

- headers, fax
 - changing 79
 - menus for 20
- heavy media
 - duplexing 112
 - equivalence table 232
 - output path for 31
 - printing on 110
- height 228
- horizontal printing 28
- HP authorized service providers 247
- HP Customer Care 251
 - European and in-country support 252
 - product repair assistance 252
 - worldwide options 252
- HP Direct Ordering 251
- HP JetDirect print servers
 - HP LaserJet Director 32
 - ordering 258
 - requirements for 103
- HP LaserJet Cover Page Editor 100
- HP LaserJet Director
 - buttons 32
 - icons for 12
 - scanning with 133
 - turning off 34
- HP LaserJet Document Manager
 - using 35
- HP LaserJet paper
 - ordering 258
 - using 23
- HP LaserJet Workplace
 - using 35
- HP Multipurpose paper
 - ordering 258
 - using 23
- HP Planet Partners Printing Supplies
 - Environmental Program 241
- HP repair services 247
- HP Sales and Service offices 253
- HP Support Assistant compact disc 251
- HP Workplace
 - using 35
- humidity, operating environment 228

I

- IC CS-03 requirements 237
- icons, user guide 12
- image quality, troubleshooting
 - black pages 192
 - character dropouts 184
 - characters, misformed 190
 - contrast 183, 190
 - dropouts 184

- edges not printing 184
- faded print 185
- gray backgrounds 189
- lines 185, 191
- loose toner 188
- repeating defects 187
- repeating images 187
- skewed pages 189
- smears 187, 188
- smudges 186
- specks 186
- stains 186
- streaks 185, 187
- tire tracks 194
- white lines 191
- white spots 191
- incoming calls, routing 156
- ink. *See* toner
- input bin, paper. *See* input tray, paper
- input guides, paper
 - adjusting 173
 - identifying 22
- input limit reached 198
- input slot, single-sheet
 - capacity 24
 - feeding problems with 173
 - identifying 22
 - paper sizes 231
 - using 29, 107
- input support, paper
 - part number 257
- input tray, paper
 - capacity 24, 231
 - default sizes, adjusting 38
 - feeding problems with 173
 - identifying 22
 - loading 28
- inserting paper 26, 28
- installing
 - memory 220
 - separation pads 225
- insuring shipments 247
- internal mirror, contaminated 191
- international faxing
 - dialing 77, 78
 - settings for 97
- irregular media, loading 27

J

- jams
 - clearing from input areas 174
 - clearing from interior area 174
 - clearing from scanner path 177, 179
 - error messages for 196
 - preventing 25, 28, 29

- JetDirect print servers
 - HP LaserJet Director 32
 - ordering 258
 - requirements for 103
- Job Status, canceling faxes from 64

K

- key press volume, adjusting 40
- keypad overlay, part number 257
- keys, control panel 18
- keys, numeric. *See* dialing; entering

L

- labels
 - printing 110
 - selecting output path for 31
 - specifications for 118
- landscape orientation 28
- languages
 - display panel, changing 41
- languages, control panel 78
- laser safety statement 233
- LaserJet Cover Page Editor 100
- LaserJet Director. *See* HP LaserJet Director
- LaserJet Document Manager. *See* HP LaserJet Document Manager
- LaserJet paper
 - ordering 258
 - using 23
- Latin America, website for 242
- legal extension, part number 257
- legal paper, extension for 257
- letterhead, printing 107
- letters, entering 80
- lever, special media
 - identifying 22
 - using 27, 109
- license, software 249
- life span
 - battery 243
 - life span, toner cartridges 216
- light print, troubleshooting 183
- lightness. *See* contrast
- lights, control panel 18, 148
- lightweight media, loading 27
- linen paper, avoiding 23
- lines, troubleshooting 168, 185
- lists. *See* logs; reports
- loading media 26, 28
- logs, fax activity
 - printing 43
 - stopping 152

- long distance dialing
 - alternate, one-touch keys for 73
 - prefixes 55
- loose toner, troubleshooting 188

M

- Macintosh
 - uninstalling software from 210
- maintenance 211
- making copies 121
- manual answer mode 90
- manual dialing 77
- manual redialing 60
- margins
 - faxing 229
 - scanning 230
- Material Safety Data Sheet 243
- media
 - See also* special media
 - adding 29
 - curling 192
 - duplexing sizes 113
 - heavy, output path for 31
 - heavy, printing on 110, 112
 - irregular, loading 27
 - loading 26, 28
 - narrow, troubleshooting 187
 - ordering 258
 - output path, selecting 31
 - selecting 23, 25
 - sizes, default adjustments 38
 - sizes, supported 24, 231
 - specification guide, ordering 258
 - specifications 23, 25, 231
 - storing 171
 - troubleshooting 173
 - types of 25
 - weight, equivalence table 232
 - wrinkling 193
 - wrong size, copying to 164
- memory
 - adding 220
 - clearing 89
 - collating, insufficient for 128
 - fax limitations 57
 - forwarding faxes 87
 - ordering 257
 - removing 223
 - reprinting faxes from 66
 - specifications 228
 - storing delayed faxes 59
 - testing 222
- menu structure, control panel 19, 47

- Mexico, website for 242
 - Microsoft Excel files. *See* Excel files
 - Microsoft Power Point files. *See* Power Point files
 - Microsoft Windows. *See* Windows
 - Microsoft Word files. *See* Word files
 - mirror, contaminated 191
 - misaligned print, troubleshooting 171
 - misfeeds. *See* feeding problems; jams
 - modem speed 157, 229
 - modes
 - answer, changing 90
 - EconoMode 111
 - scanning 136
 - silence detect 94
 - viewer 136
 - month, entering on fax header 79
 - MS-DOS, troubleshooting printing 163
 - multiple copies, troubleshooting 164
 - multiple features, using
 - direct connections 14
 - network connections 16
 - multiple feeds. *See* feeding problems; jams
 - multiple pages, printing on single sheet 114
 - multipurpose paper
 - ordering 258
 - using 23
 - multitasking 14, 16
- N**
- network connections
 - icons for 12
 - multiple features, using 16
 - settings changes in 37
 - New Zealand regulatory notices 238
 - newspaper clippings, loading 27
 - noise level, copying 230
 - not responding, troubleshooting 160
 - number of copies, default 129
 - numbers
 - See also* fax numbers; phone numbers
 - entering on control panel 79
 - part 257
 - numeric keys
 - identifying 19
 - using 55
- O**
- OCR (optical character recognition)
 - HP LaserJet Director button 34
 - troubleshooting 168
 - using 138
 - one-touch keypad
 - identifying 19
 - part number 257
 - one-touch keys
 - alternate long distance 73
 - deleting 72
 - group-dial codes 74
 - lists of numbers, printing 47
 - programming 56, 70
 - restoring defaults 41
 - troubleshooting 153
 - online support services 251
 - optical character recognition (OCR)
 - HP LaserJet Director button 34
 - troubleshooting 168
 - using 138
 - ordering
 - accessories and supplies 251
 - paper 258
 - paper specification guide 258
 - parts 257
 - software 259
 - orientation, page 28
 - output bin, paper
 - capacity 231
 - identifying 22
 - output path, selecting 31
 - output slot, document
 - capacity 231
 - identifying 21
 - output support, document
 - part number 257
 - output support, paper
 - part number 257
 - overlay, keypad 257
 - overseas faxing, settings for 97
 - ozone production 240
- P**
- packaging, for service 247
 - pads, separation
 - scanner 225
 - page order, troubleshooting 159
 - page orientation 28
 - page skew, troubleshooting 189
 - pages per minute 229
 - pages, multiple
 - faxes 158
 - on a single sheet 114
 - paper
 - See also* special media
 - adding 29
 - breaking 173
 - curling 192

- duplexing sizes 113
- heavy, output path for 31
- heavy, printing on 110, 112
- irregular, loading 27
- loading 26, 28
- narrow, troubleshooting 187
- ordering 258
- output path, selecting 31
- recycled 242
- reducing consumption 241
- selecting 23, 25
- sizes, default adjustments 38
- sizes, supported 24, 231
- specification guide, ordering 258
- specifications 23, 231
- sticking together 173
- storing 171
- troubleshooting 173
- types of 25
- weight, equivalence table 232
- wrinkling 193
- wrong size, copying to 164
- paper clips, removing 25
- paper input bin. *See* paper input tray
- paper input guides
 - adjusting 173
 - identifying 22
- paper input support
 - part number 257
- paper input tray
 - capacity 24, 231
 - default sizes, adjusting 38
 - feeding problems with 173
 - identifying 22
 - loading 28
- paper jams. *See* jams
- paper output bin
 - capacity 231
 - identifying 22
- paper output support
 - part number 257
- paper path front door 21
- parallel cables
 - ordering 257
 - troubleshooting 160
- parallel ports
 - connecting to 152
 - troubleshooting 160
- part numbers 257
- parts, identifying
 - control panel 18
 - printer path 21
 - scanner path 21
- parts, replacement
 - ordering 257
- paths
 - output, selecting 31
 - printer 21
 - scanner 21
- patterns, ringing 91
- pauses, inserting 19, 78
- PBX systems
 - dialing from 55
 - troubleshooting 153
- PC, receiving to 99
- PCL font list, printing 49
- percentage, copy size 127
- phone books, electronic
 - uninstalling 210
 - using 55
- phone cords 149
- phone lines
 - fax tones 65
 - splitters 150
 - troubleshooting 153
 - types of 150
- phone numbers
 - HP Sales and Service offices 253
 - ordering parts 257
- photo fax resolution 63
- Photo quality 126
- photographs, loading 27
- plastics, recycling 241
- polling faxes
 - clearing 89
 - instructions for 88
- ports. *See* parallel ports
- postcards, printing 110
- PostScript font list, printing 49
- power consumption 228, 240
- power loss
 - pending faxes, affect on 59
- power, troubleshooting 160
- prefixes, dialing 84
- preventing jams 25, 28, 29
- print cartridges. *See* toner cartridges
- print jobs, stopping 111
- print path, cleaning 211
- printer
 - drivers for 103
 - duty cycle 229
 - not responding 160
 - resolution, changing 115
 - settings 105
 - specifications 229
- printer door 21
- printer drivers
 - part numbers 258
 - requirements for 103
- printer path parts 21

- printing
 - blocked number logs 48
 - canceling 111
 - configuration report 48
 - copying during 14, 16
 - double-sided 112
 - envelopes 108
 - fax activity logs 43
 - faxing during 14, 16
 - letterhead 107
 - menu structure report 47
 - misaligned 171
 - multiple tasks during 14, 16
 - one-touch numbers 47
 - PCL font list 49
 - PostScript font list 49
 - scanning during 14, 16
 - special media 109
 - speed 229
 - speed-dial reports 47
 - stopping 111
 - thumbnails 114
 - troubleshooting 159
 - watermarks 114
 - wrong size pages 161
- problems, solving. *See* troubleshooting
- product repair assistance 252
- product specifications 228
- programming
 - group-dial codes 74
 - one-touch keys 56, 70
 - speed-dial codes 56, 70
- ProRes 115
- protocol trace report, printing 50
- pulse dialing 82
- punctuation, entering 80

Q

- quality
 - See also* image quality, troubleshooting
 - cleaning print path 211
 - copy 123
 - copy defaults, adjusting 126
 - EconoMode 111
 - fax resolution options 62
 - Photo 123
 - printer resolution 115
 - Text 123
 - troubleshooting 181
- Quick Sets
 - creating 116
 - uninstalling 210

R

- RAM
 - adding 220
 - ordering 257
 - removing 223
 - testing 222
- Ready light 18, 148
- recalibrating scanner 216
- receipts, loading 27
- receiving faxes
 - extension phones 93
 - from silent machines 94
 - instructions for 65
 - to computer 99
 - troubleshooting 155
- recycling
 - paper 242
 - plastics 241
 - supplies 241
 - toner cartridges 216
- Redial/Pause key 19
- redialing
 - automatic, adjusting 83
 - control panel key 19
 - delayed faxing 59
 - group faxes 57
 - manually 60
 - troubleshooting 197
- redistributing toner 217
- Reduce/Enlarge key 19
- reducing
 - control panel key for 19
 - copies 123
 - defaults, adjusting 127
 - fax size, automatic 95
 - range 230
- regulatory information
 - European Union 238
 - New Zealand 238
- release door, document 21
- release latches, printer door 21
- removing DIMMs 223
- repackaging guidelines 247
- repair assistance 252
- repair service
 - information form 248
 - obtaining 247
 - office locations 253
- repeating defects, troubleshooting 187
- repeating images, troubleshooting 187
- replacing
 - scanner separation pad 225

- reports
 - configuration 48
 - fax call 45
 - menu structure 47
 - one-touch numbers 47
 - printing all 50
 - speed-dial 47
 - T.30 protocol trace 50
 - unwanted 152
- Reports menu 20
- reprinting faxes 66
- resolution
 - control panel key 19
 - fax defaults 81
 - fax job settings 62
 - fax specifications 229
 - printer defaults 115
 - printer specifications 229
 - scanning 230
- restoring
 - factory defaults 41
 - restoring defaults 209
- returning supplies 241, 242
- ring pattern, changing 91
- ring volume, adjusting 39
- ringing
 - settings for 91
 - troubleshooting 155
- rollers
 - cleaning 214
 - jams between 174
- Roll-Over lines 150

- S**
- safety statement, laser 233
- sales and service offices 253
- satellite telephone connections, settings for 97
- saving
 - printer settings 116
 - scanned files 138
- saving toner 111
- Scan key
 - adding destinations for 140
 - locating 19
- scanner
 - duty cycle 230
 - mirror 168
 - recalibrating 216
 - separation pad, installing 225
 - separation pad, part number 257
- scanner path
 - cleaning 213
 - jams in 177, 179
 - parts, identifying 21
- scanning
 - attaching files to e-mail 145
 - contrast, adjusting 190
 - control panel key 19, 140
 - copying during 15, 17
 - crooked results, troubleshooting 172
 - e-mailing 143
 - faxing during 15, 17
 - file formats 138
 - HP LaserJet Director 133
 - loading media 26
 - margins 230
 - media, selecting 25
 - methods 136
 - multiple tasks during 15, 17
 - OCR, using 138
 - originals, loading 26
 - page by page 136
 - printing during 15, 17
 - saving 138
 - specifications 230
 - speed, troubleshooting 167
 - troubleshooting 166
 - TWAIN, using 142
- sealing tape, removing 187
- selecting
 - media 23, 25
 - output path 31
 - paper 23, 25
- sending faxes
 - ad-hoc groups 58
 - delaying 59
 - from memory 59
 - group-dial codes 57
 - multiple recipient 57
 - one recipient 55
 - troubleshooting 153
 - using software 98
- separation pads
 - installing scanner 225
 - part number 257
- servers. *See* HP JetDirect print servers; printer drivers
- service information form 248
- Service menu 20
- service, repair
 - information form 248
 - obtaining 247
 - office locations 253
- settings
 - adjusting defaults 37
 - autoreduction of faxes 95
 - configuration report 48
 - contrast, adjusting default 81
 - contrast, adjusting for current job 61, 122

- copy quality, adjusting defaults 126
- error correction 97
- extension phones 93
- factory defaults, restoring 41
- fax call reports 45
- logs, automatic printing 44
- menus for 20
- one-touch reports 47
- paper input bin defaults 38
- printer 105
- pulse dialing 82
- resolution, adjusting default 81
- resolution, printer 115
- restoring factory defaults 41
- ring pattern 91
- saving 116
- silence detect mode 94
- T.30 protocol trace report 51
- tone dialing 82
- volume, adjusting 39
- setup, types of 12
- sharing parallel ports 161
- sharing, Windows 12, 103
- sheet, cover 100
- shipping, for repair service 247
- silence detect mode, changing 94
- single-sheet input slot
 - capacity 24
 - feeding problems with 173
 - identifying 22
 - paper sizes 231
 - using 29, 107
- sizes
 - copy, default 127
 - custom 117
 - default for paper input tray 38
 - duplexing 113
 - paper 24, 231
 - wrong 161
- skewed pages, troubleshooting 171, 189
- slots. *See* output slot, document; single-sheet input slot
- slow
 - fax transmission 157
 - scanning 167
- smears, troubleshooting 187, 188
- smudges, troubleshooting 186
- software
 - See also* printer drivers
 - adjusting settings using 37
 - license agreement 249
 - ordering 259
 - sending faxes from 98
 - uninstalling 210
- solving problems. *See* troubleshooting
- sound volume, adjusting 39
- spaces, entering 80
- spare parts, ordering 257
- special media
 - custom sizes 117
 - letterhead 107
 - lever for 22, 109
 - loading 27
 - output path, selecting 31
 - printing on 109
- special media lever
 - identifying 22
 - using 27, 109
- specifications
 - battery 243
 - copying 230
 - electrical 228
 - environmental 228
 - fax 229
 - memory 228
 - paper 23, 231
 - paper guide, ordering 258
 - printer 229
 - product 228
 - scanning 230
 - transportation 233
- specks, troubleshooting 186
- speed
 - copying 230
 - EconoMode 111
 - fax transmission 157
 - faxing 229
 - modem 157, 229
 - printer resolution 115
 - printing 229
 - scanning 167
- speed-dial codes
 - control panel key 19
 - deleting 72
 - lists of numbers, printing 47
 - programming 56, 70
 - restoring defaults 41
 - troubleshooting 153, 201
- splitters, phone line 150
- spots, troubleshooting 191
- stains, troubleshooting 186
- stamp received faxes, enabling 96
- standard fax resolution 62
- staples, removing 25
- statements
 - declaration of conformity 239
 - FCC regulations 234
 - IC CS-03 237
 - laser safety 233
 - warranty 245
- static electricity 220
- Stop/Clear key 19

- stopping
 - faxes 64
 - print jobs 111
 - storing
 - group-dial codes 74
 - one-touch keys 74
 - paper 171
 - product 228
 - speed-dial codes 70
 - streaks, troubleshooting 185, 187
 - Superfine resolution 62
 - supplies
 - recycling 241
 - returning 241
 - supplies and accessories 251
 - Support Assistant compact disc 251
 - support, customer. *See* customer support
 - supports, part numbers 257
 - surge protectors 150
 - switch boxes, connecting to 152
- T**
- T.30 protocol trace report, printing 50
 - tape, removing from toner cartridge 187
 - Telephone Answering Machine (TAM).
 - See* answering machine
 - telephone consumer protection act 236
 - telephone, dialing from 77
 - temperature, operating environment 228
 - terminology list 261
 - testing memory installation 222
 - text
 - fax resolution 62
 - OCR conversions 138
 - prints poorly 159
 - Text quality 126
 - textured paper, avoiding 23
 - thumbnail, first page 46
 - thumbnails, printing 114
 - time
 - delayed faxing 59
 - entering 199
 - fax header, changing 79
 - fax transmission, adjusting 62
 - menu for setting 20
 - tire tracks, troubleshooting 194
 - tone dialing 82
 - toner
 - consumption 241
 - loose 188
 - low 183
 - redistributing 217
 - reprinting faxes 66
 - runs out while faxing 158
 - saving 111
 - smears 188
 - toner cartridges
 - duty cycle 216
 - installation, troubleshooting 187
 - life span 216
 - low 183
 - Material Data Safety Sheet 243
 - part numbers 257
 - protecting 175
 - recycling 216, 241
 - redistributing toner 217
 - removing before service 247
 - tones, dial 199
 - toolbars, HP LaserJet Director 32
 - toolbox button 34
 - trace report, T.30 protocol 50
 - transmission speed
 - adjusting 62
 - troubleshooting 157
 - transparencies
 - loading 27
 - ordering 258
 - printing 110
 - transportation 233
 - trays. *See* input tray, paper; document feeder tray; output bin, paper
 - troubleshooting
 - See also* jams; feeding problems
 - answer machines 155
 - black pages 192
 - blank pages 193
 - character dropouts 184
 - characters, formatting 168
 - characters, misformed 190
 - checklist 148
 - contrast, copying 165
 - contrast, scanning 190
 - copying 164
 - creases 193
 - crooked scans 172
 - curling paper 192
 - dialing 197
 - distinctive ringing 156
 - dropouts 184
 - edges not printing 184
 - faded print 183, 185
 - fax problems 152
 - fax setup 149
 - feeding problems 170
 - formatting codes 168
 - gray backgrounds 189
 - group-dial codes 153
 - image quality 181
 - incoming calls 156
 - light print 183
 - lines 185, 191
 - logs 152

- loose toner 188
- misaligned print 171
- MS-DOS printing 163
- narrow media 187
- not responding 160
- OCR 168
- one-touch buttons 153
- page order 159
- paper 173
- parallel ports 152
- PBX systems 153
- printer 159
- quality, image 181
- receiving faxes 155
- redialing 197
- repeating defects 187
- repeating images 187
- reports 152
- scanning 166
- sending faxes 153
- shared ports 152
- sizes, wrong 161
- skewed pages 171, 189
- smears 187, 188
- smudges 186
- specks 186
- speed, scanning 167
- speed-dial codes 153, 201
- stains 186
- streaks 185, 187
- tire tracks 194
- toner cartridge installation 187
- USB ports 160
- voice calls 155
- voice messaging services 156
- white spots 191
- wrinkling 193
- wrong size pages 161, 164
- turning off HP LaserJet Director 34
- TWAIN
 - troubleshooting 166
 - using 142

U

- unblocking fax numbers
 - control panel, using 67
- uninstalling software 210
- upgradable 220
- USB ports, troubleshooting 160
- user forums 251
- user guide
 - icons for 12

V

- viewer modes, scanner 136
- voice calls, troubleshooting 155
- voice mail
 - ring pattern settings 91
- voice messaging services,
 - troubleshooting 156
- voltage
 - fluctuations 160
 - power requirements 228
- Volume key 19
- volume, adjusting 39

W

- warranty 245
 - post-warrant assistance 252
- watermarks 114
- websites
 - Asia Pacific countries/regions 242
 - environmental stewardship 240
 - Europe 242
 - HP LaserJet 3200 11
 - HP LaserJet Supplies 242
 - Latin America 242
 - Material Data Safety Sheet 243
 - Mexico 242
 - product 11
 - product information 251
- weight
 - battery 243
 - paper, equivalence table 232
 - product 228
- white lines, troubleshooting 191
- white spots, troubleshooting 191
- white streaks, troubleshooting 185
- width 228
- Windows
 - sharing 103
 - uninstalling software from 210
- Workplace
 - using 35
- worldwide
 - customer care options 252
- wrinkling
 - preventing 31, 117, 171
 - troubleshooting 193
- wrist strap, anti-static 220



i n v e n t

Copyright© 2002
Hewlett-Packard company

<http://www.hp.com/support/lj3200>