



hp LaserJet 3380



i n v e n t

use



hp LaserJet 3380 all-in-one

User Guide _____

Copyright Information

© 2003 Copyright Hewlett-Packard Development Company, L.P.

Reproduction, adaptation, or translation without prior written permission is prohibited, except as allowed under the copyright laws.

The information contained herein is subject to change without notice.

The only warranties for HP products and services are set forth in the express warranty statements accompanying such products and services. Nothing herein should be construed as constituting an additional warranty. HP shall not be liable for technical or editorial errors or omissions contained herein.

A user of the Hewlett-Packard product associated with this user guide is granted a license to: a) print hard copies of this user guide for PERSONAL, INTERNAL or COMPANY use subject to the restriction not to sell, re-sell or otherwise distribute the hard copies; and b) place an electronic copy of this user guide on a network server, provided access to the electronic copy is limited to PERSONAL, INTERNAL users of the Hewlett-Packard product associated with this user guide.

Part number: Q2660-90902

Edition 2, 4/2009

Trademark Credits

Adobe® and PostScript® are trademarks of Adobe Systems Incorporated.

Microsoft®, Windows®, and Windows NT® are U.S. registered trademarks of Microsoft Corporation.

UNIX® is a registered trademark of The Open Group.

Energy Star® and the Energy Star logo® are U.S. registered marks of the United States Environmental Protection Agency.

All other products mentioned herein may be trademarks of their respective companies.

Table of contents

1 Getting to know your device

Identifying the HP LaserJet 3380 all-in-one	2
Package contents	2
Device features	3
Identifying the hardware components	4
HP LaserJet 3380 all-in-one hardware components	4
Identifying the device control panel components	5
Device control panel components	5
Identifying the software components	6
Print-media specifications	7
Supported media weights and sizes	7

2 Changing the settings by using the hp toolbox or the device control panel

Using the hp toolbox	10
Supported operating systems	10
Supported browsers	10
To view the hp toolbox	10
The hp toolbox sections	11
Using the device control panel	13
Printing a configuration page	13
Printing a device control panel menu map	13
Restoring the factory-set defaults	13
Changing the device control panel display language	14
Changing the default media size	14
Using the device volume controls	14

3 Printing

Printing by using manual feed	18
To print by using manual feed	18
Stopping or canceling a print job	19
Printer drivers	20
Changing print settings	20
Understanding print-quality settings	22
To temporarily change print-quality settings	22
To change print-quality settings for all future jobs	22
To use EconoMode (to save toner)	23
Optimizing print quality for media types	24
To gain access to the optimizing feature	24
Device media specifications	25
Guidelines for using media	26
Paper	26
Common media problems table	26
Labels	26

Transparencies	27
Envelopes	27
Card stock and heavy media	28
Selecting media for the automatic document feeder (ADF)	30
Automatic document feeder (ADF) specifications	30
Printing on envelopes	31
To print on one envelope	31
To print on multiple envelopes	32
Printing on transparencies and labels	34
To print on transparencies or labels	34
Printing on letterhead and preprinted forms	36
To print on letterhead and preprinted forms	36
Printing on custom-sized media or card stock	37
To print on custom-sized media or card stock	37
Printing on both sides of the media (manual duplexing)	38
To duplex manually on lightweight media	38
To duplex manually on heavy media or card stock (straight-through media path)	39
Printing multiple pages on a single sheet of media	42
To print multiple pages on a single sheet (Windows)	42
To print multiple pages on a single sheet (Macintosh)	42
Printing booklets	43
To print booklets	43
Printing watermarks	45
To use the watermark feature	45

4 Copying

Loading originals to copy	48
To load originals onto the flatbed scanner	48
To load originals into the automatic document feeder (ADF) input tray	49
Starting a copy job	50
Canceling a copy job	50
Adjusting the copy quality	51
To adjust the copy quality for the current job	51
To adjust the default copy quality	51
Adjusting the lighter/darker (contrast) setting	52
To adjust the lighter/darker setting for the current job	52
To adjust the default lighter/darker setting	52
Reducing or enlarging copies	53
To reduce or enlarge copies for the current job	53
To change the default copy size	54
Changing the copy-collation setting	55
To change the copy-collation setting for the current job	55
To change the default copy-collation setting	55
Changing the number of copies	56
To change the number of copies for the current job	56
To change the default number of copies	56
Copying photos, two-sided originals, or books	57
To copy a photo	57
To copy a multiple-page stack of two-sided originals	57
To copy a book	58

5 Scanning

Loading originals to scan	60
Loading originals onto the flatbed scanner	60
Loading originals into the automatic document feeder (ADF) input tray	61

Understanding scanning methods	62
Scanning from the device (Windows)	63
Programming the device Scan-to button	63
Scanning to e-mail	63
Scanning to a folder (Windows only)	63
Canceling a scan job	65
Scanning a photo or a book	66
Scanning a photo	66
Scanning a book	66
Scanning by using hp LaserJet Scan software (Windows)	68
Scanning to e-mail	68
To scan to a file	69
Scanning to another software program	69
Scanning to the Readiris OCR software	70
Scanning from the device and HP Director (Macintosh)	71
Scanning to e-mail	71
Scanning to a file	71
Scanning to a software program	72
Using page-by-page scanning	72
Scanning by using TWAIN-compliant and WIA-compliant software	73
Using TWAIN-compliant and WIA-compliant software	73
Scanning by using OCR	74
Readiris	74
Scanner resolution and color	75
Resolution and color guidelines	75
Color	76

6 Faxing

.....	78
-------	----

7 Cleaning and maintenance

Cleaning the outside of the device	80
To clean the exterior	80
To clean the glass	80
To clean the lid backing	81
Cleaning the print-cartridge area	82
To clean the print-cartridge area	82
Cleaning the media path	84
To clean the media path	84
Cleaning the pickup roller	85
To clean the pickup roller	85
Replacing the pickup roller	86
To replace the pickup roller	86
Replacing the device separation pad	88
To replace the device separation pad	88
Installing an ADF	91
To install a replacement ADF	91
Replacing an ADF pickup roller assembly	93
Removing and replacing the device control panel cover	95

8 Troubleshooting

Device does not turn on	98
Is power reaching the device?	98
Pages print but are totally blank	99

Is the sealing tape still in the print cartridge?	99
Does the document contain blank pages?	99
Does the configuration page print?	99
Is the original loaded correctly?	99
Pages did not print	100
Does a message appear on your computer screen?	100
Is media being pulled into the device correctly?	100
Are media jams present?	100
Is the parallel or USB Device Cable (A/B) working, and is it connected correctly?	100
Are other devices running on your computer?	100
Pages printed, but a problem exists	101
Is the print quality poor?	101
Is the printed page different from what appears onscreen?	101
Are the device settings appropriate for the print media?	101
Onscreen error messages appear	102
Printer not responding/error writing to LPT1	102
Cannot access port (in use by another application)	102
Paper-handling problems exist	103
Print is skewed (crooked)	103
More than one sheet feeds at one time	103
Device does not pull media from the media input tray	103
Media curls when fed through device	103
Printed page is different from what appears onscreen	104
Is the text garbled, incorrect, or incomplete?	104
Are graphics or text missing? Are there blank pages?	104
Is the page format different from the format on another printer?	105
Is graphics quality poor?	105
Media jams occur in the printer	106
To clear a media jam	106
To clear other media jams	107
Tips to avoid media jams	108
Print quality is unacceptable	109
Light print or fade	109
Toner specks	109
Dropouts	110
Vertical lines	110
Gray background	111
Toner smear	111
Loose toner	112
Vertical repetitive defects	112
Misformed characters	113
Page skew	113
Curl or wave	114
Wrinkles or creases	114
Toner scatter outline	115
Device control panel error messages appear	116
Resolving common error messages	116
Critical error messages	116
Alert messages	117
Warning messages	117
No copy came out	119
Is media loaded in the input tray?	119
Is the original loaded correctly?	119
Copies are blank, or images are missing or faded	120
Has the sealing tape been removed from the print cartridge?	120
Is the print cartridge low on toner?	120

Is the original of poor quality?	120
Does the original have a colored background?	120
Copy quality is unacceptable	121
Preventing problems	121
Media jams occur in the automatic document feeder (ADF)	122
Typical automatic document feeder (ADF) jam locations	122
To clear a media jam from the automatic document feeder (ADF)	122
Copy defects are apparent	125
Vertical white or faded stripes	125
Blank pages	125
Wrong original was copied	126
Too light or dark	126
Unwanted lines	126
Black dots or streaks	126
Unclear text	126
Reduced size	126
Scanned image is of poor quality	127
Is the original a second-generation photo or picture?	127
Is the image quality better when the document is printed?	127
Is the image skewed (crooked)?	127
Does the scanned image show blotting, lines, vertical white stripes, or any other defect?	127
Do graphics look different from the original?	127
Part of the image did not scan	128
Was the original loaded correctly?	128
Does the original have a colored background?	128
Are text or images on the back of a two-sided original appearing in the scan?	128
Is the original longer than 381 mm (15 inches)?	128
Is the original too small?	128
Are you using HP Director? (Macintosh only)	128
Is the media size correct?	128
The scan takes too long	129
Is your resolution or color level set too high?	129
Is your software set to scan in color?	129
Did you send a print job or copy job before you tried to scan?	129
Is your computer set for bidirectional communication?	129
Error messages appear	130
Common scanning error messages	130
The scanner did nothing	131
Is the original loaded correctly?	131
Scan quality is unacceptable	132
Preventing problems	132
Blank pages	132
Too light or dark	133
Unwanted lines	133
Black dots or streaks	133
Unclear text	133

Appendix A Specifications

HP LaserJet 3380 all-in-one	137
HP LaserJet 3380 all-in-one specifications	137
HP LaserJet 3380 all-in-one battery	139

Appendix B Regulatory Information

.....	141
-------	-----

FCC regulations	142
Telephone consumer protection act (United States)	144
IC CS-03 requirements	145
Regulatory information for the European Union countries/regions	146
Safety statements	147
Laser safety statement	147
Canada DOC regulations	147
Laser statement for Finland	148
Korean EMI statement	148
Australia	149
Declaration of Conformity	150
Environmental product stewardship program	151
Protecting the environment	151
Ozone production	151
Energy consumption	151
Toner consumption	151
Paper use	151
Plastics	151
HP LaserJet printing supplies	152
HP printing supplies returns and recycling program information	152
U.S. returns	152
Non-U.S. returns	152
Paper	152
Material restrictions	152
Netherlands	153
For more information	153
Material safety data sheets	154

Appendix C HP limited warranty statement

HP LaserJet 3380 all-in-one ONE-YEAR LIMITED WARRANTY	155
---	-----

Appendix D HP parts and accessories

Ordering HP parts and accessories	158
HP parts and accessories charts	158
HP LaserJet print cartridges	160
HP policy on non-HP print cartridges	160
To install a print cartridge	160
Storing print cartridges	160
Print cartridge life expectancy	160
Recycling print cartridges	160
Saving toner	161
DIMMs (memory or font)	162
To test a DIMM installation or removal	162
To install a DIMM	162
To remove a DIMM	164

Appendix E Service and support

Obtaining hardware service	168
To obtain hardware service	168
Extended warranty	169
Service information form	170

Glossary

Index

1

Getting to know your device

Use these topics to acquaint yourself with your new HP LaserJet 3380 all-in-one:

- [Identifying the HP LaserJet 3380 all-in-one](#)
- [Device features](#)
- [Identifying the hardware components](#)
- [Identifying the device control panel components](#)
- [Identifying the software components](#)
- [Print-media specifications](#)

Identifying the HP LaserJet 3380 all-in-one

Use the following illustration to make sure that the package contents are complete.

Package contents

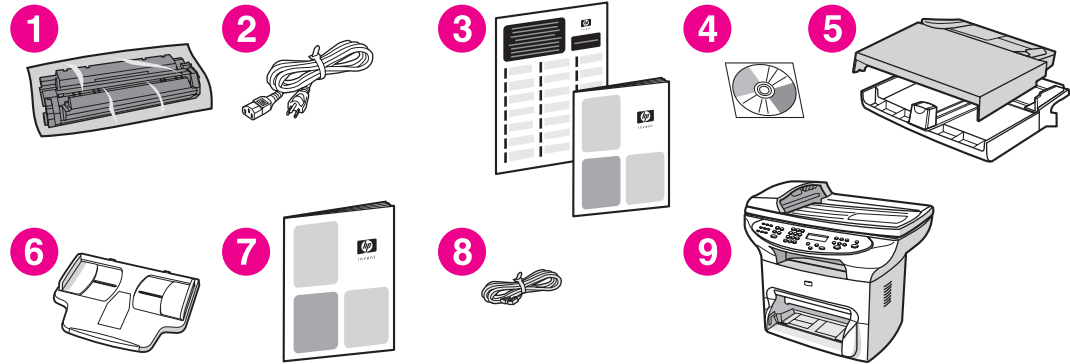

- 1 Print cartridge
- 2 Power cord
- 3 Getting started guide and support flyer
- 4 CD-ROM containing device software and electronic user guide
- 5 250-sheet media input tray and priority input tray
- 6 Automatic document feeder (ADF) input tray
- 7 Fax guide
- 8 Phone cord
- 9 HP LaserJet 3380 all-in-one

Note

Use the phone cord and the power cord that came with the device. Using other phone cords or power cords can adversely affect the performance of the device.

Learn more about the device by using these sources of information:

- **HP toolbox.** Use this software component to perform many of the tasks described in this user guide and to set print, fax, copy, and scan settings.
- **The start guide.** Use this guide to set up the device, connect it to your computer, and install the software.
- **The fax guide.** Use this guide to set up and use the fax functions of the device.

Device features

Speed	<ul style="list-style-type: none">• Prints and copies up to 20 pages per minute (ppm), and first page out in 8 seconds
Paper handling	<ul style="list-style-type: none">• A legal-size flatbed scanner, a 50-page automatic document feeder (ADF), a 250-sheet media input tray, and a 10-sheet priority input tray
Memory	<ul style="list-style-type: none">• 32 megabytes (MB) of random-access memory (RAM) (9 MB for the system and 23 MB of RAM available to the user), and a dual inline memory module (DIMM) slot for adding fonts and memory
Connectivity	<ul style="list-style-type: none">• A universal serial bus (USB) port (compatible with 2.0 specifications) and an IEEE 1284-B parallel port
Print	<ul style="list-style-type: none">• Up to 1,200 by 1,200 dpi resolution, and PCL 6 and Adobe PostScript emulation (Level 2)
Fax	<ul style="list-style-type: none">• Full-functionality fax capabilities with a V.34 fax, including a phone book, fax polling, delayed-fax features, and 4 MB of Flash memory for storing up to 250 pages
Copy	<ul style="list-style-type: none">• Reduce/enlarge feature, and up to 20 ppm automatic collation
Scan	<ul style="list-style-type: none">• 24-bit, 600 dpi (9,600 interpolated) color scanning

Identifying the hardware components

Use the following illustrations to identify the hardware components.

HP LaserJet 3380 all-in-one hardware components

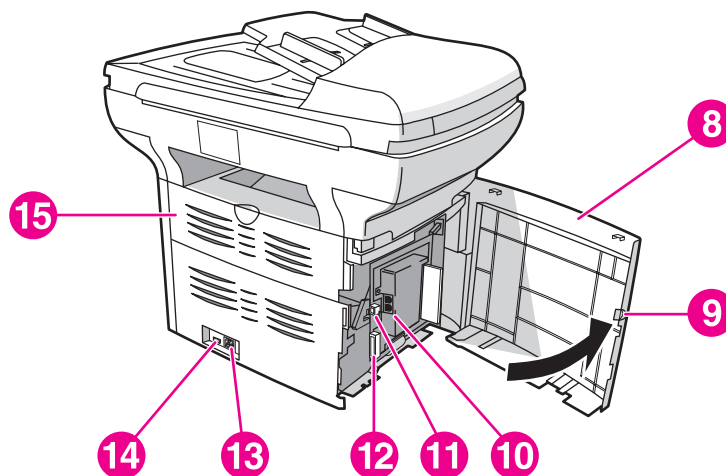
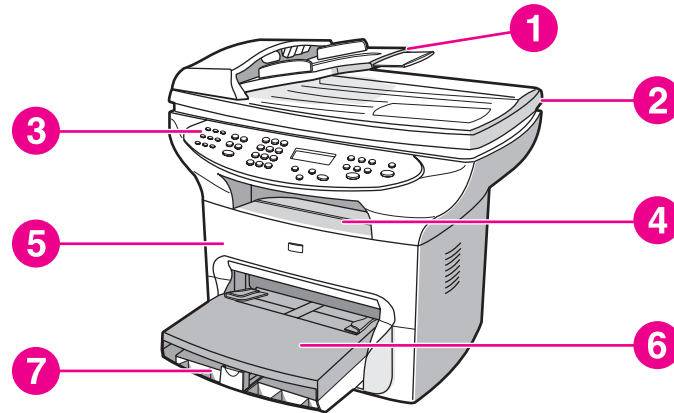

- 1 Automatic document feeder (ADF) input tray
- 2 Flatbed scanner lid
- 3 Device control panel
- 4 Output bin
- 5 Print cartridge door
- 6 Priority input tray
- 7 Media input tray
- 8 Left side panel
- 9 Left side panel latch
- 10 Fax interface ports
- 11 USB port
- 12 Parallel port
- 13 Power receptacle
- 14 Power switch
- 15 Straight-through output door

Identifying the device control panel components

Use the following illustration to identify the device control panel components.

Device control panel components

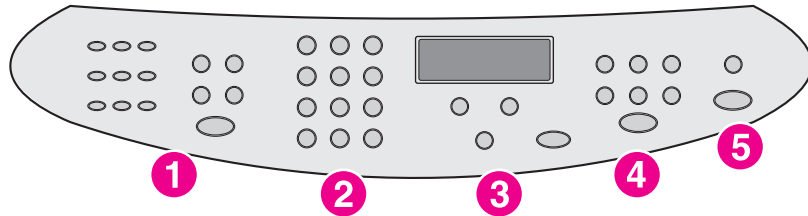

- 1 **Fax controls.** Use the fax controls to send and receive faxes and to change commonly used fax settings. See the fax guide for information about using the fax controls.
- 2 **Alphanumeric buttons.** Use the alphanumeric buttons to type data into the device control panel display and to dial phone numbers for faxing. For information about using alphanumeric button characters, see the fax guide.
- 3 **Menu and cancel controls.** Use these controls to select menu options, determine the device status, and cancel the current job.
- 4 **Copy controls.** Use these controls to change commonly used default settings and to start copying. For instructions about copying, see [Copying](#).
- 5 **Scan controls.** Use these controls to scan to e-mail or a folder. For instructions about scanning, see [Scanning](#).

Identifying the software components

Note

The software components that are installed depend on the operating system (OS) and the installation type. See the start guide for more information.

The following software items are included with the device:

- HP toolbox
- HP LaserJet Scan
- TWAIN or WIA Scan Driver
- HP LaserJet Fax
- Readiris OCR (not installed with other software; separate installation is required)
- Printer drivers (PCL 6, PCL 5e, PostScript Level 2 emulation)
- Installer/uninstaller

Print-media specifications

For optimum results, use conventional 75 g/m² to 90 g/m² (20 to 24 lb) photocopy paper. Verify that the paper is of good quality and is free of cuts, nicks, tears, spots, loose particles, dust, wrinkles, curls, or bent edges.

Note

The printer supports a wide range of standard and custom sizes of print media. The capacity of trays and bins can vary depending on media weight and thickness and environmental conditions. Smoothness—100 to 250 (Sheffield).

Use only transparencies designed for use with HP LaserJet printers.

Supported media weights and sizes

Media input tray paper sizes

Media input tray	Dimensions	Weight or thickness	Capacity
Minimum-size paper	76 by 127 mm (3 by 5 in)	60 to 163 g/m ² (16 to 43 lb bond)	250 sheets (75 g/m ² ; 20 lb bond)
Maximum-size paper	216 by 356 mm (8.5 by 14 in)	60 to 163 g/m ² (16 to 43 lb bond)	250 sheets (75 g/m ² ; 20 lb bond)
Minimum-size glossy paper	76 by 127 mm (3 by 5 in)	75 to 120 g/m ² (20 to 32 lb bond)	Maximum stack height: 30 mm (1.18 in)
Maximum-size glossy paper	216 by 356 mm (8.5 by 14 in)	75 to 120 g/m ² (20 to 32 lb bond)	Maximum stack height: 30 mm (1.18 in)
Minimum-size transparencies	76 by 127 mm (3 by 5 in)	0.10 to 0.13 mm thick (4 to 5 mils thick)	125 sheets
Maximum-size transparencies	216 by 356 mm (8.5 by 14 in)	0.10 to 0.13 mm thick (4 to 5 mils thick)	125 sheets
Minimum-size envelopes	90 by 160 mm (3.5 by 6.3 in)	75 to 105 g/m ² (20 to 28 lb bond)	30 envelopes
Maximum-size envelopes	178 by 254 mm (7 by 10 in)	75 to 105 g/m ² (20 to 28 lb bond)	30 envelopes
Minimum-size label	76 by 127 mm (3 by 5 in)	60 to 216 g/m ² (22 to 80 lb cover)	100 sheets
Maximum-size label	216 by 356 mm (8.5 by 14 in)	60 to 216 g/m ² (22 to 80 lb cover)	100 sheets
Minimum-size card stock	76 by 127 mm (3 by 5 in)	135 to 163 g/m ² (36 to 43 lb bond)	100 sheets
Maximum-size card stock	216 by 356 mm (8.5 by 14 in)	135 to 163 g/m ² (36 to 43 lb bond)	100 sheets

Note

The following table lists the standard sizes of media that the device supports in the priority input tray.

Priority input tray paper sizes

Priority input tray	Dimensions	Weight or thickness	Capacity
Minimum-size paper	76 by 127 mm (3 by 5 in)	60 to 163 g/m ² (16 to 43 lb bond)	10 sheets (75 g/m ² ; 20 lb bond)
Maximum-size paper	216 by 356 mm (8.5 by 14 in)	60 to 163 g/m ² (16 to 43 lb bond)	10 sheets (75 g/m ² ; 20 lb bond)
Minimum-size glossy paper	76 by 127 mm (3 by 5 in)	75 to 120 g/m ² (20 to 32 lb bond)	Maximum stack height: 1.5 mm (0.06 in)
Maximum-size glossy paper	216 by 356 mm (8.5 by 14 in)	75 to 120 g/m ² (20 to 32 lb bond)	Maximum stack height: 1.5 mm (0.06 in)
Minimum-size transparencies	76 by 127 mm (3 by 5 in)	0.10 to 0.13 mm thick (4 to 5 mils thick)	5 sheets
Maximum-size transparencies	216 by 356 mm (8.5 by 14 in)	0.10 to 0.13 mm thick (4 to 5 mils thick)	5 sheets
Minimum-size envelopes	76 by 127 mm (3 by 5 in)	60 to 90 g/m ² (16 to 24 lb bond)	Individual envelopes
Maximum-size envelopes	216 by 356 mm (8.5 by 14 in)	60 to 90 g/m ² (16 to 24 lb bond)	Individual envelopes
Minimum-size label	76 by 127 mm (3 by 5 in)	60 to 216 g/m ² (22 to 80 lb cover)	4 sheets
Maximum-size label	216 by 356 mm (8.5 by 14 in)	60 to 216 g/m ² (22 to 80 lb cover)	4 sheets
Minimum-size card stock	76 by 127 mm (3 by 5 in)	135 to 163 g/m ² (36 to 43 lb bond)	4 sheets
Maximum-size card stock	216 by 356 mm (8.5 by 14 in)	135 to 163 g/m ² (36 to 43 lb bond)	4 sheets

Automatic document feeder (ADF) paper sizes

ADF	Dimensions	Weight or thickness	Capacity
Minimum-size paper	127 by 127 mm (5 by 5 in)	60 to 90 g/m ² (16 to 24 lb bond)	50 sheets (75 g/m ² ; 20 lb bond)
Maximum-size paper	215.9 by 381 mm (8.5 by 15 in)	60 to 90 g/m ² (16 to 24 lb bond)	50 sheets (75 g/m ² ; 20 lb bond)

2

Changing the settings by using the hp toolbox or the device control panel

You can change the settings for the device by using the HP toolbox or the device control panel. Often, the easier method for changing the device settings is to use the HP toolbox.

The following table lists some of the settings that you can change by using the HP toolbox and the device control panel. For information about how to use the HP toolbox to change settings, see the HP toolbox Help. You can open the HP toolbox Help by clicking **How Do I** on the left side of the HP toolbox window. (See [Using the hp toolbox](#) for information about how to gain access to the HP toolbox.) For information about how to use the device control panel to change the device settings, review the information in this chapter.

Note

Settings that are established in the software program take precedence over printer-driver settings. Printer-driver settings override the HP toolbox and device control panel settings.

Setting or feature	HP toolbox	Device control panel
Restore the factory-set defaults.	X	X
Print information pages, such as the configuration page, device control panel menu map, and usage page.	X	X
Change the device control panel display language.	X	X
Change the HP toolbox language.	X	
Set up status alerts.	X	
Configure the fax-send and fax-receive settings.	X	X
View or forward faxes that have been received to the computer.	X	
Configure the scan to e-mail or a folder setting.	X	
Change the copy settings.	X	X
Add, delete, or modify the destinations in the Fax Phone Book.	X	X
Gain access to the online user guide.	X	
Check the device status remotely.	X	

Using the hp toolbox

The HP toolbox is a Web application that you can use for the following tasks.

- Monitor the device status.
- View and configure the device settings for print, fax, copy, and scan.
- View troubleshooting and "How do I" information.
- View online documentation.
- View alerts about a particular event or condition on the device.

You can view the HP toolbox when the device is directly connected to a computer, or when the device is connected to a network. You must have performed a complete software installation to use the HP toolbox.

Note

You do not need Internet access to open and use the HP toolbox. However, if you click a link in the **Other Links** area, you must have Internet access to go to the site associated with the link. For more information, see [Other links](#).

Supported operating systems

The HP toolbox is supported for the following operating systems:

- Windows 98, Windows Millennium Edition (Me), Windows 2000, and Windows XP
- Mac OS X v10.1 and v10.2

Note

The transmission control protocol/Internet protocol (TCP/IP) must be installed in the operating system for the HP toolbox to function.

Supported browsers

To use the HP toolbox, you must have one of the following browsers:

- Microsoft Internet Explorer 5.5 or later
- Netscape Navigator 6.23 or later

All pages can be printed from the browser.

To view the hp toolbox

Open the HP toolbox in one of the following ways:

- On the desktop, double-click the HP toolbox icon .
- Double-click the Status Client icon that is located in the system tray, which is at the far right of the taskbar.
- On the **Start** menu, point to **HP LaserJet**, and then select **hp Toolbox**.

The HP toolbox opens in a Web browser.

Note

After you open the URL, you can bookmark it so that you can return to it quickly in the future.

The hp toolbox sections

The HP toolbox contains the following sections:

- **Status** tab
- **Fax** tab
- **Scan to...** tab
- **Troubleshooting** tab
- **Documentation** tab

Other links

Each page in the HP toolbox contains links to the HP website for device registration and device support, and links for ordering supplies. You must have Internet access to use any of these links. If you use a dial-up connection and did not connect when you first opened the HP toolbox, you must connect before you can view these websites.

Status tab

The **Status** tab has links to the following main pages:

- **Device Status.** View device status information. This page indicates device conditions such as a media jam or an empty input tray. After you correct a problem with the device, click **Refresh** to update the device status.
- **Set up Status Alerts.** Use alerts to configure the device to notify you automatically of device alerts. From this page you can turn alerts on or off, specify when the device sends an alert, and select the type of alert (either a pop-up message or a taskbar icon) that you want to receive. To activate status alert settings, click **Apply**.
- **View Configuration.** View settings available for the device. This page also displays any accessories that have been installed, such as DIMMs. The **View Configuration** page displays the same information that is shown on the configuration page.
- **Print Info pages.** Print the configuration page and other information pages that are available for the device.

Fax tab

The **Fax** tab has links to the following main pages:

- **Fax Tasks**
- **Fax Phone Book**
- **Fax Send Log**
- **Fax Data Properties**
- **Fax Reports**
- **Detailed Fax Settings**

Note

For more information about fax functions and features, see the fax guide.

Scan-to... tab

The **Scan-to...** tab has links to the following main pages:

- **Scan to E-mail or a Folder**
- **Scan Preferences**

Note

You must set up the scan preferences before you can scan from the computer or use the **SCAN TO** button on the device control panel.

Troubleshooting tab

The **Troubleshooting** tab has links to various device troubleshooting information, such as how to clear a media jam; how to resolve print-quality problems; and how to resolve fax, copy, or scan problems.

Documentation tab

The **Documentation** tab contains links to the following information sources:

- **User Guide.** The user guide contains information about using the device, warranty, specifications, and support. The user guide is available in both HTML and PDF format.
- **Late Breaking News.** This document contains late-breaking information about the device. It is available in English only.

Using the device control panel

You can also configure settings at the device control panel. This section describes how to perform the following tasks:

- [Printing a configuration page](#)
- [Printing a device control panel menu map](#)
- [Restoring the factory-set defaults](#)
- [Changing the device control panel display language](#)
- [Changing the default media size](#)
- [Using the device volume controls](#)
- [Changing print settings](#)

Printing a configuration page

You can see which device settings are currently selected by printing a configuration page.

To print a configuration page

1. Press **MENU/ENTER**.
2. Use the **<** or the **>** button to select **Reports**, and then press **MENU/ENTER**.
3. Use the **<** or the **>** button to select **Config report**, and then press **MENU/ENTER**.

The device exits the menu settings and prints the report.

Printing a device control panel menu map

You can see all of your device control panel menu options by printing a device control panel menu map.

To print a device control panel menu map

1. On the device control panel, press **MENU/ENTER**.
2. Use the **<** or the **>** button to select **Reports**, and then press **MENU/ENTER**.
3. Use the **<** or the **>** button to select **Menu structure**, and then press **MENU/ENTER**.

A menu map prints, showing all of the device control panel menu options.

Restoring the factory-set defaults

Restoring the factory-set defaults returns all of the settings to the factory defaults and clears the fax header name and phone number. (See the fax guide for information about how to add your information to the fax header.) This procedure clears fax numbers and names that are associated with one-touch keys and speed-dial codes, and deletes any pages that are stored in the memory. The procedure then automatically restarts the device.

To restore the factory-set defaults

1. Press **MENU/ENTER**.
2. Use the **<** or the **>** button to select **Service**, and then press **MENU/ENTER**.
3. Use the **<** or the **>** button to select **Restore defaults**, press **MENU/ENTER**, and then press **MENU/ENTER** again to confirm your selection.

The device automatically restarts.

Changing the device control panel display language

Use this procedure to have reports print in, and messages on the the device control panel display appear in, a language other than the default for your country/region.

Note

The Demo page only prints in English.

To change the device control panel display language

1. Press **MENU/ENTER**.
2. Use the **<** or the **>** button to select **Common settings**, and then press **MENU/ENTER**.
3. Use the **<** or the **>** button to select **Language**, and then press **MENU/ENTER**.
4. Use the **<** or the **>** button to select the language that you want.
5. Press **MENU/ENTER** to save your selection.

The device automatically restarts.

Changing the default media size

The media size should be set to the size of media that you normally load in the media input tray. The device uses this setting for copying, printing reports, printing faxes, and determining autoreduction for incoming faxes.

To change the default media size

1. Press **MENU/ENTER**.
2. Use the **<** or the **>** button to select **Common settings**, and then press **MENU/ENTER**.
3. Use the **<** or the **>** button to select **Def. paper size**, and then press **MENU/ENTER**.
4. Use the **<** or the **>** button until the size of media that you have loaded appears. You can select **Letter**, **Legal**, or **A4**.
5. Press **MENU/ENTER** to save your selection.

Using the device volume controls

You can control the volume of the following sounds:

- The alarm sound that the device emits when it requires attention, such as when the device door is open.
- The beeps that are emitted when you press the device control panel buttons.

- The phone line sounds for outgoing faxes.
- The ring volume for incoming faxes.

To change the alarm volume

The alarm sounds when the device is presenting an alert or critical error message. The alarm duration length is either one or three seconds, depending on the type of error.

1. Press **MENU/ENTER**.
2. Use the **<** or the **>** button to select **Common settings**, and then press **MENU/ENTER**.
3. Use the **<** or the **>** button to select **Volume settings**, and then press **MENU/ENTER**.
4. Press **MENU/ENTER** to select **Alarm volume**.
5. Use the **<** or the **>** button to select **Off**, **Soft**, **Medium**, or **Loud**.
6. Press **MENU/ENTER** to save your selection.

Note

The factory-set default for the alarm volume is **Soft**.

To change the volume for the fax

This setting determines the volume of various fax sounds that occur when the device is sending or receiving fax jobs.

1. Press **VOLUME**.
2. Press the **<** or the **>** button to select **Off**, **Soft**, **Medium**, or **Loud**.
3. Press **MENU/ENTER** to save your selection.

Note

The factory-set default is **Soft**.

To change the ring volume of the fax

The fax ring sounds when the device is initially sending or receiving a call. The ring duration length depends on the local telecom ring-pattern length.

1. Press **MENU/ENTER**.
2. Use the **<** or the **>** button to select **Common settings**, and then press **MENU/ENTER**.
3. Use the **<** or the **>** button to select **Volume settings**, and then press **MENU/ENTER**.
4. Press the **<** or the **>** button once to select **Ring volume**, and then press **MENU/ENTER**.
5. Use the **<** or the **>** button to select **Off**, **Soft**, **Medium**, or **Loud**.
6. Press **MENU/ENTER** to save your selection.

Note

The factory-set default is **Soft**.

To change the device control panel key-press volume

The key-press volume controls the sound that is made when a device control panel button is pressed.

1. Press **MENU/ENTER**.
2. Use the **<** or the **>** button to select **Common settings**, and then press **MENU/ENTER**.

3. Use the < or the > button to select **Volume settings**, and then press MENU/ENTER.
4. Use the < or the > button to select **Key Press volume**, and then press MENU/ENTER.
5. Use the < or the > button to select **Off, Soft, Medium, or Loud**.
6. Press MENU/ENTER to save your selection.

Note

The factory-set default for the device control panel key-press volume is **Soft**.

3

Printing

Use the following information to perform printing tasks with the device control panel.

- [Printing by using manual feed](#)
- [Stopping or canceling a print job](#)
- [Printer drivers](#)
- [Understanding print-quality settings](#)
- [Optimizing print quality for media types](#)
- [Device media specifications](#)
- [Guidelines for using media](#)
- [Selecting media for the automatic document feeder \(ADF\)](#)
- [Printing on envelopes](#)
- [Printing on transparencies and labels](#)
- [Printing on letterhead and preprinted forms](#)
- [Printing on custom-sized media or card stock](#)
- [Printing on both sides of the media \(manual duplexing\)](#)
- [Printing multiple pages on a single sheet of media](#)
- [Printing booklets](#)
- [Printing watermarks](#)

Printing by using manual feed

Use manual feed when printing on mixed media (for example, printing on an envelope, then printing a letter, then an envelope, and so on). Load an envelope in the priority input tray and load the letterhead in the media input tray.

To print by using manual feed

1. Open the device properties or printer setup (printer driver) in the software program.
2. On the **Paper** tab or the **Paper/Quality** tab (the **Paper Type/Quality** tab for some Macintosh drivers), select **Manual Feed** from the **Source is:** or **Paper Source** drop-down list. (For instructions about opening the printer driver from the computer, see [Changing print settings](#).)
3. Send the print job.
4. After you have changed the setting, wait until **Manual feed** appears on the device control panel, and then press **MENU/ENTER** to print each job.

Stopping or canceling a print job

If your print job is currently printing, you can cancel it by pressing **CANCEL** on the device control panel.

CAUTION

Pressing **CANCEL** clears the job that the device is currently processing. If more than one process is running (for example, the device is printing a document while receiving a fax), pressing **CANCEL** clears the process that currently appears on the device control panel.

You can also cancel a print job from a software program or a print queue.

To stop the print job immediately, remove the remaining print media from the device. After printing stops, use one of the following options:

- **Device control panel:** To cancel the print job, press and release **CANCEL** on the device control panel.
- **Software program:** Typically, a dialog box appears briefly on the computer screen, allowing you to cancel the print job.
- **Windows print queue:** If a print job is waiting in a print queue (computer memory) or print spooler, delete the job there. Go to the **Printer** screen in Windows 98, Windows Me, Windows 2000, and Windows XP. Click **Start**, **Settings**, and **Printers**. Double-click the device icon to open the window, select your print job, and then click **Delete**.
- **Desktop print queue (Macintosh):** Open the printer queue by double-clicking the printer icon in the **Finder**. Then highlight the print job and click **Trash**.

Printer drivers

When you installed the device software, you selected one of the following printer drivers:

PCL 6 driver (default driver): Use the PCL 6 driver to take full advantage of the device features. Unless complete backward compatibility with previous printer control language (PCL) drivers or older printers is necessary, the PCL 6 driver is recommended.

PCL 5e driver: Use the PCL 5e driver if you need print results to look consistent with those from older HP LaserJet printers. Certain features (FastRes 1200, ProRes 1200, and 300 dpi) are not available in this driver. (Do not use the PCL 5e driver that is provided with this device with older printers.)

PS driver: Use the PostScript® (PS) driver for compatibility with PS needs. Certain features (manual duplexing, printing booklets, watermarks, and printing more than four pages per sheet) are not available with this driver.

Note

The device automatically switches between PS emulation and PCL printer languages depending on the driver that you have selected. The PS emulation emulates Adobe® PostScript Level 2. For information about gaining access to your printer driver see [Changing print settings](#).

Changing print settings

After installation, you can gain access to print settings from the device printer driver or from another software program. These settings do not affect other users on a network.

Use one of the following methods to change the print settings:

You can also change some of the printer settings through the HP toolbox. For more information about the HP toolbox, see [Using the hp toolbox](#).

To change default settings across all programs (Windows)

Windows 98, Windows Me, and Windows XP Home: From the **Start** menu, point to **Settings**, and then click **Printers**. Right-click the device icon, and then click **Properties**. Make the necessary changes to the settings, and then click **OK**.

Windows NT 4.0, Windows 2000, and Windows XP Professional: From the **Start** menu, point to **Settings**, and then click **Printers**. For Windows 2000, right-click the device icon, and then click **Printing Preferences**. For Windows NT 4.0, right-click the device icon, and then click **Document Defaults**. Make the necessary changes to the settings, and then click **OK**.

Note

The actual steps can vary; these are the most common methods.

To change default settings across all programs (Macintosh)

Macintosh OS 9.1:

1. From the Macintosh desktop, select **File**, and then select **Print Desktop**.
2. In the printer group box, select **HP All-in-one**.
3. Make the necessary changes to the settings.
4. Click the **Save Settings** option.
5. Click **Cancel**.

Macintosh OS X:

1. Open a document in a text-editing software program.
2. Select **File**, and then select **Print**.
3. Make the appropriate changes to the default settings.
4. On the settings options, click **Save Custom Setting**.
5. To invoke the settings when printing a document, select the **Custom** option in the **Saved Settings** section.

To change settings for a print job (Windows)

On the **File** menu, click **Print**. In the **Print** dialog box, click **Properties**. Change the settings that you want to apply for the current print job, and then click **OK**.

To change settings for a print job (Macintosh)

On the **File** menu, select **Print**. Use the **Print** dialog box to set print options.

Note

The actual steps can vary; these are the most common methods.

Understanding print-quality settings

Print-quality settings affect how light or dark the print is on the page and the style in which the graphics are printed. You can also use the print-quality settings to optimize the print quality for a specific media type. See [Optimizing print quality for media types](#) for more information.

You can change the settings in the device properties to accommodate the types of jobs that you are printing. The following settings are available, depending on the printer driver that you are using:

- **Best Quality (ProRes 1200):** This setting produces 1,200-dots-per-inch (dpi) resolution and provides the best print quality.
- **Faster Printing (FastRes 1200):** The resolution is rendered differently so that the job can print faster. This is the default setting.
- **600 dpi**
- **300 dpi**
- **Custom:** This setting produces the same resolution as the Faster Printing setting, but you can change the scale patterns.
- **EconoMode (Save Toner):** Text is printed with less toner. This setting is useful when you are printing drafts. You can use this setting independently of other print-quality settings.

Note

Changing the resolution can change the formatting of your text.

To temporarily change print-quality settings

To change the print-quality settings only for the current software program, open the properties through the **Print Setup** menu in the program that you are using to print. See [Changing print settings](#) for more information.

To change print-quality settings for all future jobs

Note

For Macintosh instructions, see [Changing print settings](#) for more information.

For Windows 98, Windows 2000, and Windows Me:

1. In the Windows system tray, click **Start**, select **Settings**, and then click **Printers**.
2. Right-click the device icon.
3. Click **Properties** (in Windows 2000, you can also click **Printing Preferences**).
4. Change the settings, and click **OK**.

For Windows XP:

1. In the Windows system tray, click **Start**, select **Settings**, and then click **Printers and Faxes**.
2. Right-click the device icon.
3. Click **Properties**, or click **Printing Preferences**.
4. Change the settings, and click **OK**.

To use EconoMode (to save toner)

EconoMode is a feature that allows the printer to use less toner per page. Selecting this option extends the life of the toner supply and reduces the cost per page. However, it also reduces print quality. The printed image is lighter, but it is adequate for printing drafts or proofs.

Hewlett-Packard does not recommend full-time use of EconoMode. If EconoMode is used full-time when the average toner coverage is significantly less than five percent, it is possible that the toner supply will outlast the mechanical parts in the print cartridge. If print quality begins to degrade under these circumstances, you will need to install a new print cartridge, even if toner remains in the cartridge.

Note

Not all device features are available for all printer drivers or operating systems. See the device properties (driver) online Help for information about available features for the driver.

1. To enable EconoMode, open the printer properties (or printing preferences in Windows 2000 and Windows XP). See [Changing print settings](#) for more information.
2. On the **Paper/Quality** tab or the **Finishing** tab (the **Paper Type/Quality** tab for some Macintosh drivers), select the **EconoMode** check box.

Note

See [To change print-quality settings for all future jobs](#) for instructions about using the EconoMode setting for all future print jobs.

Optimizing print quality for media types

Media-type settings control the temperature of the device fuser. You can change the settings for the media that you are using to optimize the print quality. The following are the media types that you can optimize for:

- plain paper
- preprinted paper
- prepunched paper
- letterhead
- transparency
- labels
- bond paper
- recycled paper
- color paper
- light paper (less than 75 g/m² or 20 lb)
- heavy paper (90 to 105 g/m² or 24 to 28 lb)
- card stock (105 to 176 g/m² or 28 to 47 lb)
- envelope
- rough paper

To gain access to the optimizing feature

You can gain access to the optimizing feature on the **Paper** tab or the **Paper/Quality** tab in the device properties (printer driver). For more information, see [Changing print settings](#).

Note

Printing speeds might vary depending on the type and size of media used.

You might need to change the setting back to optimize for the type of media on which you normally print.

Device media specifications

HP LaserJet devices produce excellent print quality. The device prints on a variety of media, such as cut-sheet paper (including recycled paper), envelopes, labels, transparencies, and custom-sized media. Properties such as weight, grain, and moisture content are important factors affecting device performance and output quality.

The device can use a variety of paper and other print media in accordance with the guidelines in this user guide. Media that does not meet these guidelines might cause the following problems:

- poor print quality
- increased media jams
- premature wear on the device, requiring repair

For best results, use only HP-brand paper and print media. Hewlett-Packard Company cannot recommend the use of other brands. Because they are not HP products, HP cannot influence or control their quality.

It is possible for media to meet all of the guidelines in this user guide and still not produce satisfactory results. This might be the result of improper handling, unacceptable temperature and humidity levels, or other variables over which Hewlett-Packard has no control.

Before you purchase a large quantity of media, make sure that it meets the requirements specified in this user guide and in the *HP LaserJet Printer Family Print Media Guide*. (See [Ordering HP parts and accessories](#) for more information about ordering the guidelines.) Always test media before you purchase a large quantity.

CAUTION

Using media that does not meet Hewlett-Packard specifications might cause problems for the device, requiring repair. This repair is not covered by the Hewlett-Packard warranty or service agreements.

Note

For information about supported media sizes, weights, and other specifications, see [Print-media specifications](#).

Guidelines for using media

Use the guidelines in this section when selecting and using print media.

Paper

For best results, use conventional paper. Make sure that the paper is of good quality and free of cuts, nicks, tears, spots, loose particles, dust, wrinkles, voids, and curled or bent edges.

If you are unsure about what type of paper you are loading (such as bond or recycled), check the label on the package.

Some paper causes print-quality problems, jamming, or damage to the device.

Note

Do not use letterhead that is printed with low-temperature inks, such as those used in some types of thermography.

Do not use raised letterhead.

The device uses heat and pressure to fuse toner to the media. Make sure that any colored media or preprinted forms use inks that are compatible with the device temperature (200° C or 392° F for 0.1 second).

Common media problems table

Symptom	Problem with media	Solution
Poor print quality or toner adhesion, or problems with feeding.	Too moist, too rough, too smooth, or embossed. Faulty media lot.	Try another kind of media between 100 and 250 Sheffield and 4 to 6 percent moisture content.
Dropouts, jamming, or curl.	Media has been stored improperly.	Store media flat in its moisture-proof wrapping.
Increased gray background shading.	The media weight is too heavy.	Use lighter media.
Excessive curl, or problems with feeding.	Too moist, wrong grain direction, or short-grain construction.	Use long-grain media. Print by using the straight-through media path.
Jamming, or damage to device.	Cutouts or perforations.	Do not use media with cutouts or perforations.
Problems with feeding.	Ragged edges.	Use good-quality media.

Labels

Note

For best results, use only HP-brand labels. To order HP supplies, visit <http://www.hp.com>.

When selecting labels, consider the quality of the following factors:

- **Adhesives:** The adhesive material should be stable at 200° C (392° F), the device maximum temperature.
- **Arrangement:** Use only labels that have no exposed backing between them. Labels can peel off sheets that have spaces between the labels, causing serious jams.
- **Curl:** Before printing, labels must lie flat with no more than 13 mm (0.5 inch) of curl in any direction.
- **Condition:** Do not use labels that have wrinkles, bubbles, or other indications of separation. Never use a sheet of labels that has already been run through the device.

Transparencies

Transparencies must be able to withstand 200° C (392° F), the device maximum temperature.

Envelopes

When selecting envelopes, consider the quality of the following factors.

Envelope construction

Envelope construction is critical. Envelope fold lines can vary considerably, not only between manufacturers, but also within a box from the same manufacturer. Successful printing on envelopes depends on the quality of the envelopes, which includes the following factors:

- **Weight:** The weight of the envelope paper should not exceed 105 g/m² (28 lb), or jamming might result.
- **Construction:** Before printing, envelopes should lie flat with less than 6 mm (0.25 inch) curl and should not contain air. Envelopes that trap air might cause problems.
- **Condition:** Make sure that the envelopes are not wrinkled, nicked, or otherwise damaged.
- **Sizes:** Supported envelope sizes range from 90 by 160 mm (3.5 by 6.3 inches) to 178 by 254 mm (7 by 10 inches).

Envelopes with double-side seams

An envelope with double-side-seam construction has vertical seams at both ends of the envelope rather than diagonal seams. This style is more likely to wrinkle during printing. Make sure that the seam extends all the way to the corner of the envelope as shown in the following illustration:

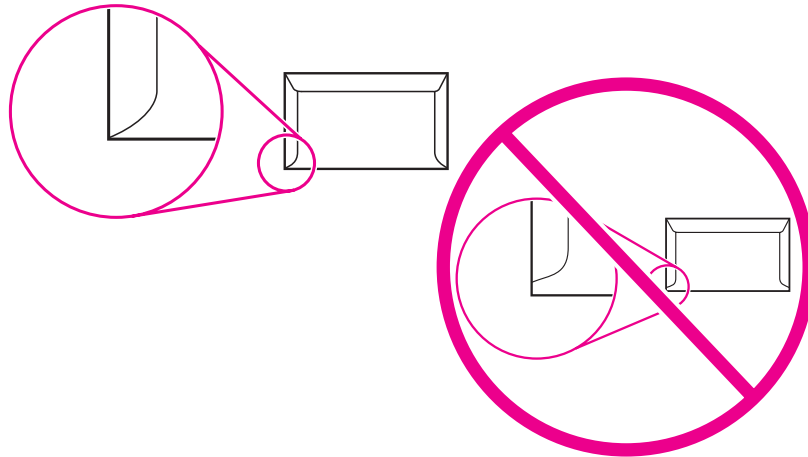

Envelopes with adhesive strips or flaps

Envelopes with a peel-off adhesive strip or with more than one flap that folds over to seal must use adhesives that are compatible with the heat and pressure in the device (200° C or 392° F). The extra flaps and strips might cause wrinkling, creasing, or jams.

Envelope storage

Proper storage of envelopes contributes to good print quality. You should store envelopes flat. If air is trapped in an envelope, creating an air bubble, the envelope might wrinkle during printing.

Card stock and heavy media

You can print on many types of card stock from the input trays, including index cards and postcards. Some card stock performs better than others because the construction is better suited for feeding through a laser device.

For optimum device performance, do not use media heavier than 157 g/m² (42 lb). Media that is too heavy might cause misfeeds, stacking problems, media jams, poor toner fusing, poor print quality, or excessive mechanical wear.

Note

You might be able to print on heavier media if you do not fill the input trays to capacity and if you use media with a smoothness rating of 100 to 180 Sheffield.

Card stock construction

- **Smoothness:** 135 to 157 g/m² (36 to 42 lb) card stock should have a smoothness rating of 100 to 180 Sheffield. 60 to 135 g/m² (16 to 36 lb) card stock should have a smoothness rating of 100 to 250 Sheffield.
- **Construction:** Card stock should lie flat with less than 5 mm (0.2 inch) of curl.

- **Condition:** Make sure that the card stock is not wrinkled, nicked, or otherwise damaged.
- **Sizes:** Use card stock that is within the following size ranges only:
 - **Minimum:** 76 by 127 mm (3 by 5 inches)
 - **Maximum:** 216 by 356 mm (8.5 by 14 inches)

Card stock guidelines

- If the card stock curls or jams, print by using the straight-through media path.
- Set margins at least 2 mm (0.08 inch) away from the edges.

Selecting media for the automatic document feeder (ADF)

Use the following guidelines when selecting media for the ADF.

Automatic document feeder (ADF) specifications

- **Input capacity:** The ADF holds up to 50 sheets of flat, 60 to 90 g/m² (16 to 24 lb), copier-grade paper.
- **Media size:** Use copier-grade paper that is within the following size ranges only:
 - **Minimum:** 127 by 127 mm (5 by 5 inches)
 - **Maximum:** 215.9 by 381 mm (8.5 by 15 inches)

Note

Use the flatbed scanner for faxing, copying, and scanning if the media is fragile, thin, or thick. The flatbed scanner provides the best fax, copy, and scan quality. The ADF is recommended for paper faxing, copying, and scanning.

Printing on envelopes

Use one of the following methods to print on envelopes.

- [To print on one envelope](#)
- [To print on multiple envelopes](#)

To print on one envelope

Use only envelopes that are recommended for laser printers. See [Device media specifications](#) for more information.

Note

Use the priority input tray for printing on one envelope. Use the media input tray for printing on multiple envelopes.

1. To prevent the envelope from curling as it exits the printer, open the straight-through output door.

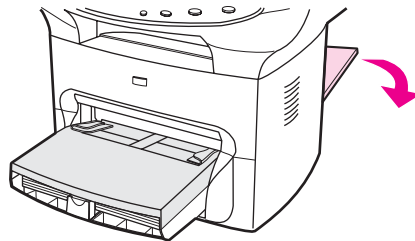

2. Before loading the envelope, slide the media guides outward so that they are slightly wider than the envelope.

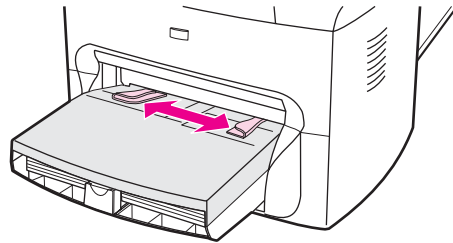

3. If the envelope has a flap that folds along the long edge, place the flap-fold edge to the left, with the side to be printed on facing up. If the envelope has a flap that folds along the short edge, feed that edge into the device first, with the side to be printed on facing up.

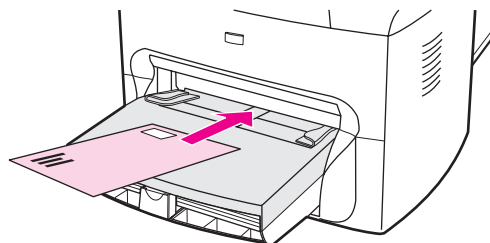

- Adjust the media guides to the width of the envelope.

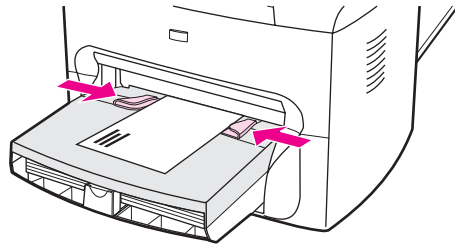

- For Windows printer drivers, on the **Paper** tab or the **Paper/Quality** tab, select **Envelope** from the **Type is:** drop-down list.

For Macintosh printer drivers, on the **Paper/Quality** tab or the **Paper** tab (the **Paper Type/Quality** tab for some Macintosh drivers), select **Envelope** as the media type.

Note

Not all device features are available for all printer drivers or operating systems. See the device properties (driver) online Help for information about the available features for the driver.

- Print on the envelope.

To print on multiple envelopes

Use only envelopes that are recommended for laser printers. See [Device media specifications](#) for more information.

Note

Use the priority input tray for printing on one envelope. Use the media input tray for printing on multiple envelopes.

- To prevent the envelopes from curling as they exit the printer, open the straight-through output door and remove the priority input tray.

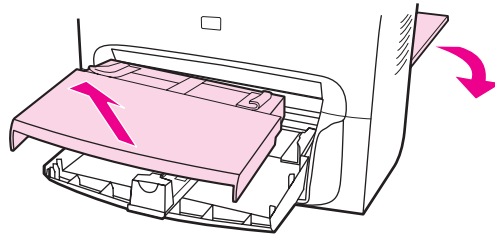

- Before loading the envelopes, slide the media guides outward so that they are slightly wider than the envelopes.

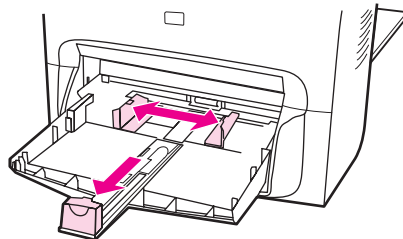

3. If the envelopes have a flap that folds along the long edge, place the flap-fold edge to the left, with the side to be printed on facing up. If the envelopes have a flap that folds along the short edge, feed that edge into the device first, with the side to be printed on facing up.

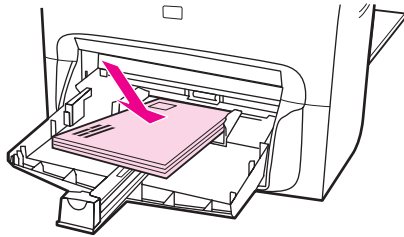

4. Adjust the media guides to the length and width of the envelopes.

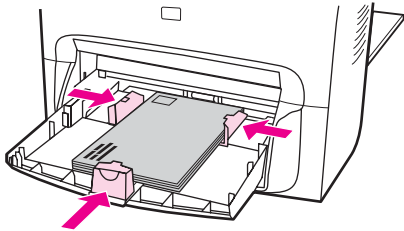

5. For Windows printer drivers, on the **Paper** tab or the **Paper/Quality** tab, select **Envelope** from the **Type is:** drop-down list.

For Macintosh printer drivers, on the **Paper/Quality** tab or the **Paper** tab (the **Paper Type/Quality** tab for some Macintosh drivers), select **Envelope** as the media type.

Note

Not all device features are available for all printer drivers or operating systems. See the device properties (driver) online Help for information about the available features for the driver.

6. Print on the envelopes.
7. Replace the priority input tray.

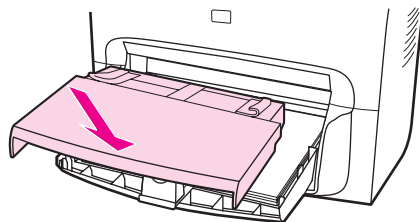

Printing on transparencies and labels

Use only transparencies and labels that are recommended for use in laser printers, such as HP transparency film and HP laser-quality labels. See [Device media specifications](#) for more information.

CAUTION

Inspect the media to make sure that it is not wrinkled or curled and that it does not have any torn edges or missing labels. Do not send the labels through the device more than once. The adhesive can damage the device.

To print on transparencies or labels

CAUTION

Be sure to set the correct media type in the device settings (printer driver) as instructed in the following procedure. The device adjusts the fuser temperature according to the media type setting. When printing on special media such as transparencies or labels, this adjustment prevents the fuser from damaging the media as it passes through the device.

1. Open the straight-through output door on the back of the device.

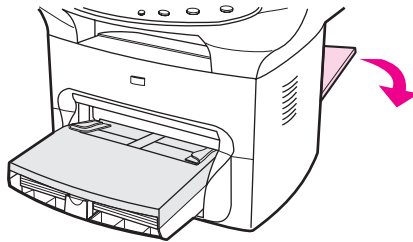

2. Load a single page in the priority input tray or load multiple pages in the media input tray. Make sure that the top of the media is forward and the side to be printed on (the rough side of transparencies) is facing up.

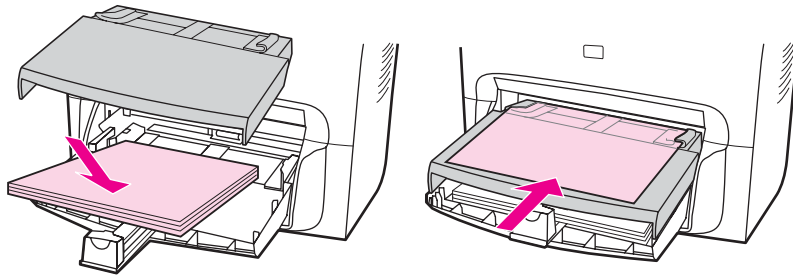

3. Adjust the media guides.

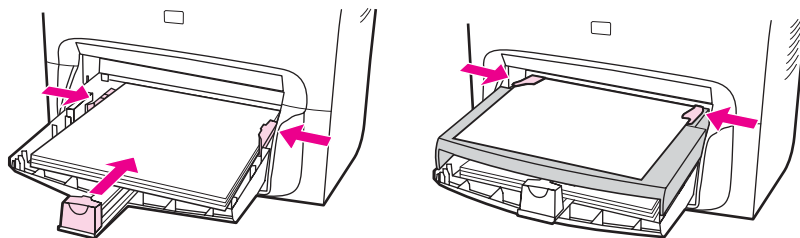

4. For Windows printer drivers, on the **Paper** tab or the **Paper/Quality** tab, select the correct media type from the **Type is:** drop-down list.

For Macintosh printer drivers, on the **Paper/Quality** tab or the **Paper** tab (the **Paper Type/Quality** tab for some Macintosh drivers), select the correct media type.

Note

Not all device features are available for all printer drivers or operating systems. See the device properties (driver) online Help for information about the available features for the driver.

5. Print the document. Remove the media from the back of the device as it exits to prevent it from sticking together, and place the printed pages on a flat surface.

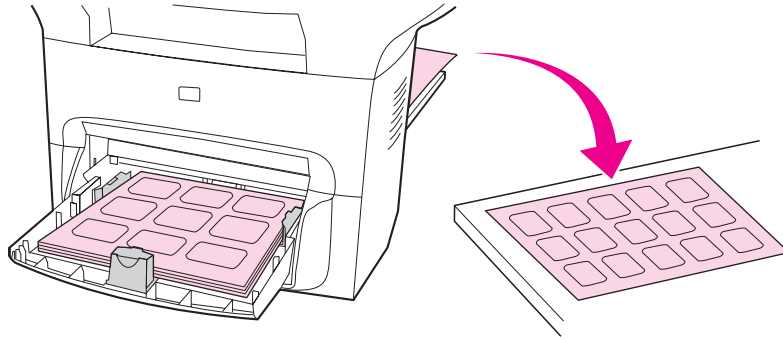

Printing on letterhead and preprinted forms

Only use letterhead or preprinted forms that are recommended for use in laser printers, such as HP laser-quality letterhead and preprinted forms. See [Device media specifications](#) for more information.

Use these instructions to print documents on letterhead or preprinted forms.

To print on letterhead and preprinted forms

1. Load the media with the top forward and the side to be printed on facing up.
2. Adjust the media guides to fit the width of the media.
3. Print the document.

Note

To print a single-page cover letter on letterhead, followed by a multiple-page document, load the standard paper in the media input tray first, and then load the letterhead into the priority input tray. The device automatically prints from the priority input tray first.

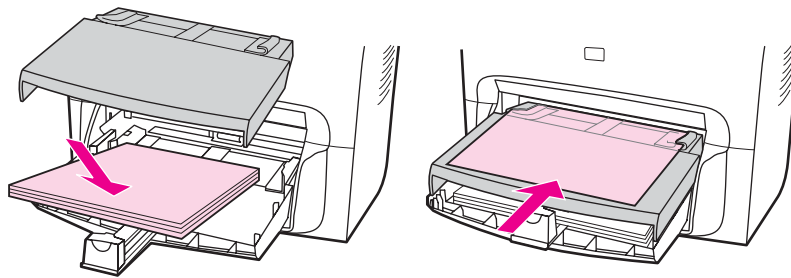

Printing on custom-sized media or card stock

The device can print on custom-sized media and card stock that is between 76 by 127 mm (3 by 5 inches) and 216 by 356 mm (8.5 by 14 inches) in size. Depending on the media, you can print up to 10 sheets from the priority input slot. Use the media input tray for more than 10 sheets.

Note

Make sure that the sheets are not stuck together before you load them.

To print on custom-sized media or card stock

1. Open the straight-through output door.

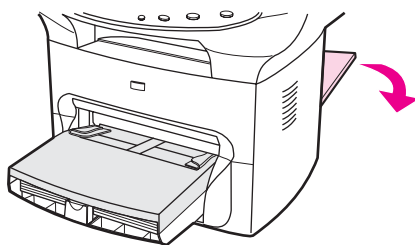

2. Load the media with the narrow side forward and the side to be printed on facing up. Adjust the side and rear media guides to fit the media.

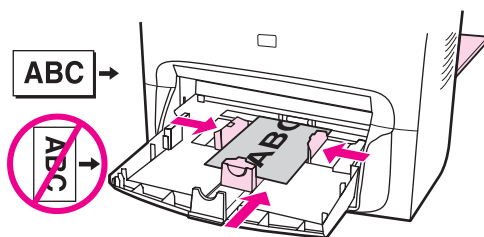

3. For Windows printer drivers, on the **Paper** tab or the **Paper/Quality** tab, click **Custom**. Specify the dimensions of the custom-sized media.

For Macintosh printer drivers, on the **Paper/Quality** tab or the **Paper** tab (the **Paper Type/Quality** tab for some Macintosh drivers), select the custom size option. Specify the dimensions of the custom-sized media.

Note

Not all device features are available for all printer drivers or operating systems. See the device properties (driver) online Help for information about the available features for the driver.

4. If printing on card stock, do one of the following:

For Windows printer drivers, on the **Paper** tab or the **Paper/Quality** tab, select **Cardstock** from the **Type is:** drop-down list.

For Macintosh printer drivers, on the **Paper/Quality** tab or the **Paper** tab (the **Paper Type/Quality** tab for some Macintosh drivers), select **Cardstock**.

5. Print the document.

Printing on both sides of the media (manual duplexing)

To print on both sides of the media (manual duplexing), you must send the media through the device twice. You can print by using the normal output path or the straight-through media path. Hewlett-Packard recommends that you use the normal output path for lightweight paper and use the straight-through media path for any heavy media or media that curls when it is printed.

See the following topics for more information:

[To duplex manually on lightweight media](#)

[To duplex manually on heavy media or card stock \(straight-through media path\)](#)

Note

The printer driver also contains instructions and graphics for manually duplexing.

Manual duplexing can cause the device to become dirty, which reduces print quality. If the device becomes dirty, see [Cleaning and maintenance](#) for instructions.

To duplex manually on lightweight media

1. Make sure that the straight-through output door is closed.

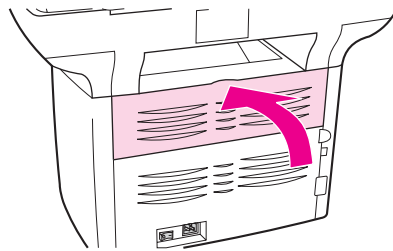

2. In the software program, open the device properties (printer driver). For instructions, see [To change settings for a print job \(Windows\)](#) or [To change settings for a print job \(Macintosh\)](#).
3. On the **Finishing** tab (the **Paper Type/Quality** tab for some Macintosh drivers), select **Print on Both Sides**. Make sure that **Straight Paper Path** is *not* selected.

Note

If the **Print on Both Sides** option is dimmed or unavailable, open the device properties (printer driver). For instructions, see [To change default settings across all programs \(Windows\)](#) or [To change default settings across all programs \(Macintosh\)](#). On the **Device Settings** tab or the **Configure** tab, select **Allow Manual Duplexing**, and then click **OK**. Repeat steps 2 and 3.

Not all device features are available for all printer drivers or operating systems. See the device properties (driver) online Help for information about the available features for the driver.

4. Print the document.

5. After side one has been printed, remove the remaining media from the input tray, and set it aside until after you finish your manual duplexing job.

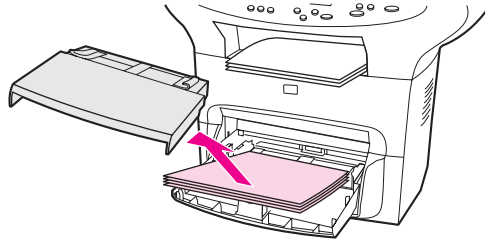

6. Gather the printed pages, keep the printed side facing down, and straighten the stack.

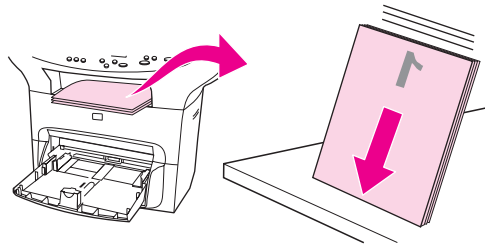

7. Place the stack of media in the input tray again. Side one should be facing down with the bottom edge feeding into the device first. Replace the priority input tray.

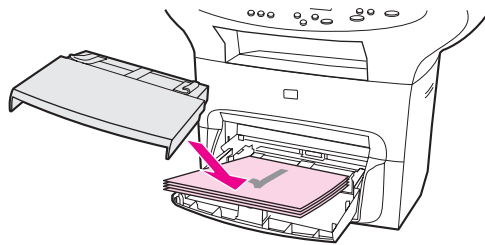

8. Click **OK** (on the computer screen), and then wait for side two to print.

To duplex manually on heavy media or card stock (straight-through media path)

For heavy media, such as card stock, use the straight-through media path.

1. Load the media, and open the straight-through output door on the back of the device.

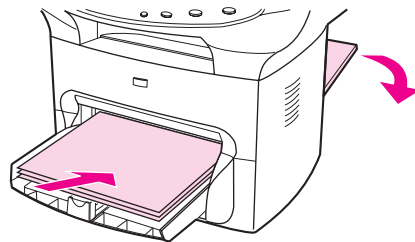

2. In the software program, open the device properties (printer driver). For instructions, see [To change settings for a print job \(Windows\)](#) or [To change settings for a print job \(Macintosh\)](#).

3. On the **Finishing** tab (the **Paper Type/Quality** tab for some Macintosh drivers), select the option to **Print on Both Sides**. Make sure that **Straight Paper Path** is selected.

Note

If the **Print on Both Sides** option is dimmed or unavailable, open the device properties (printer driver). For instructions, see [To change default settings across all programs \(Windows\)](#) or [To change default settings across all programs \(Macintosh\)](#). On the **Device Settings** tab or the **Configure** tab, select **Allow Manual Duplexing**, and then click **OK**. Repeat steps 2 and 3.

Not all device features are available for all printer drivers or operating systems. See the device properties (driver) online Help for information about the available features for the driver.

4. Print the document.

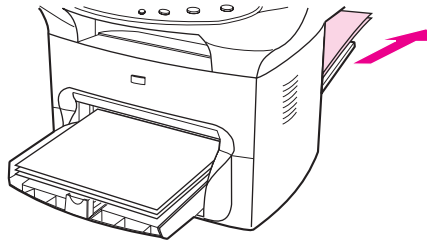

5. After side one has been printed, remove the remaining media from the input tray and set it aside until after you finish your manual duplexing job.

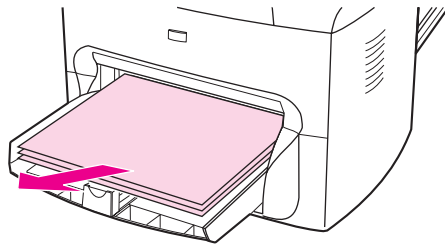

6. Gather the printed pages, turn the printed side down, and straighten the stack before placing it in the input tray again. Side one should be facing down with the bottom edge feeding into the device first.

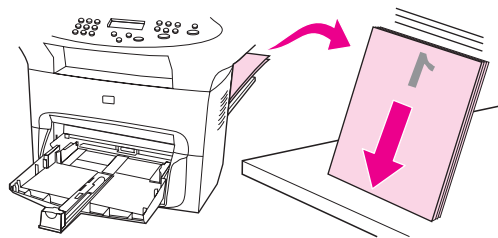

7. Replace the priority input tray.

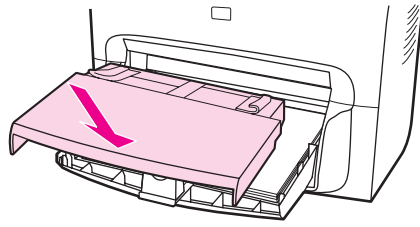

8. Click **OK** (on the computer screen), and then wait for side two to print.

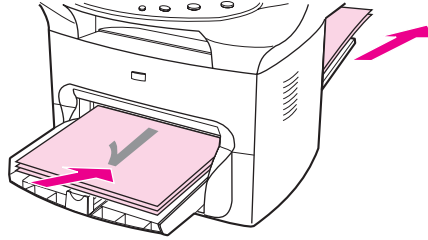

Printing multiple pages on a single sheet of media

You can select the number of pages that you want to print on a single sheet of media. If you choose to print more than one page per sheet, the pages appear smaller and are arranged on the sheet in the order that they would otherwise be printed. You can specify up to 9 pages per sheet of media for Macintosh, or up to 16 for Windows.

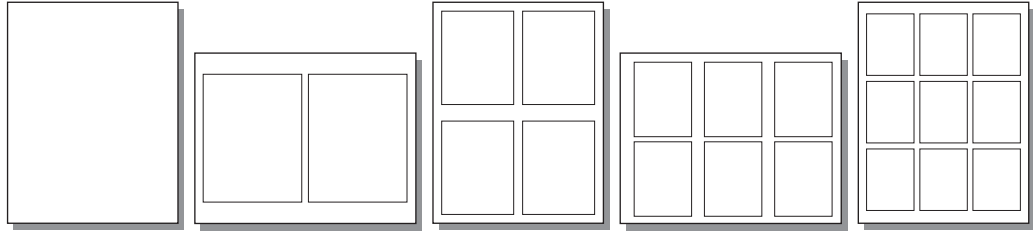

To print multiple pages on a single sheet (Windows)

1. In the software program, open the device properties (printer driver). See [Changing print settings](#) for instructions.
2. On the **Finishing** tab under **Pages Per Sheet**, select the number of pages per sheet that you want to print. You can print up to 16 pages per sheet.
3. Select the check box for page borders if you want the printed pages to have borders. Use the drop-down list to select the order in which pages are printed on the sheet.

To print multiple pages on a single sheet (Macintosh)

1. In the **General** drop-down list, select **Layout**.
2. In the **Pages Per Sheet** drop-down list, select the number of pages per sheet to print. You can print up to nine pages per sheet.

Printing booklets

Note

Printing booklets is not supported for Macintosh OS X.

You can print booklets on letter, legal, or A4 print media.

To print booklets

1. Load the print media, and make sure that the straight-through output door is closed.

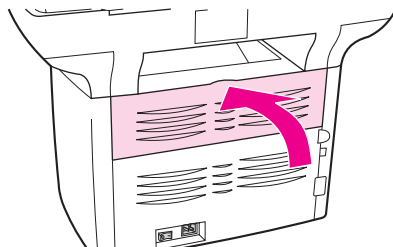

2. In the software program, open the device properties (printer driver). For instructions, see [To change settings for a print job \(Windows\)](#) or [To change settings for a print job \(Macintosh\)](#).
3. On the **Finishing** tab (the **Paper Type/Quality** tab for some Macintosh drivers), select **Print on Both Sides**. Make sure that **Straight Paper Path** is *not* selected.

Note

If the **Print on Both Sides** option is dimmed or unavailable, open the device properties (printer driver). For instructions, see [To change default settings across all programs \(Windows\)](#) or [To change default settings across all programs \(Macintosh\)](#). On the **Device Settings** tab or the **Configure** tab, select **Allow Manual Duplexing**, and then click **OK**. Repeat steps 2 and 3.

Not all device features are available for all printer drivers or operating systems. See the device properties (driver) online Help for information about the available features for the driver.

4. Set the number of pages per sheet to two. Select the appropriate binding option, and click **OK**.
5. Print the booklet.
6. After side one has been printed, remove the remaining media from the input tray, and set it aside until your booklet job is complete.

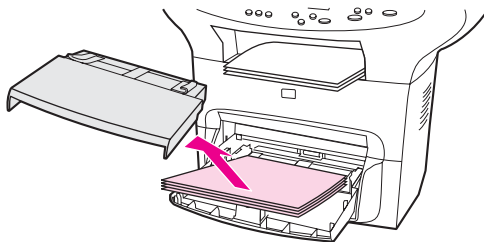

7. Gather the printed pages, turn the printed side down, and straighten the stack of media.

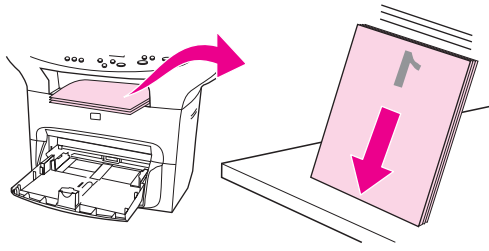

8. Place the pages from side one in the input tray again. Side one should be facing down with the bottom edge feeding into the device first.

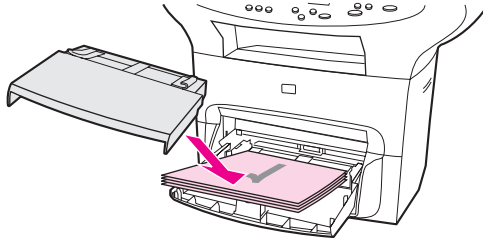

9. Click **OK** (on the computer screen), and then wait for side two to print.

10. Fold and staple the pages.

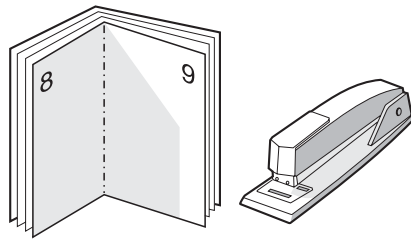

Printing watermarks

Note

Printing watermarks is not supported for Macintosh OS X.

You can use the watermark option to print text “underneath” (in the background) of an existing document. For example, you might want to have large gray letters that spell Draft or Confidential printed diagonally across the first page or all of the pages of a document.

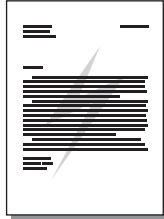

To use the watermark feature

1. In the software program, open the device properties (printer driver). See [Changing print settings](#) for instructions.
2. On the **Effects** tab (Windows) or the **Watermark/Overlay** screen (Macintosh), select the watermark that you want to print on the document. To print the watermark on only the first page of the document, select the **First Page Only** check box.

4

Copying

Use these instructions to perform copying tasks with your device:

- [Loading originals to copy](#)
- [Starting a copy job](#)
- [Canceling a copy job](#)
- [Adjusting the copy quality](#)
- [Adjusting the lighter/darker \(contrast\) setting](#)
- [Reducing or enlarging copies](#)
- [Changing the copy-collation setting](#)
- [Changing the number of copies](#)
- [Copying photos, two-sided originals, or books](#)

Note

Many of the functions that are described in this chapter also can be performed by using the HP toolbox. For instructions about using the HP toolbox, see [Using the hp toolbox](#).

Loading originals to copy

Use these instructions to load originals into your device for copying. For the best quality copies, use the flatbed scanner. See [Selecting media for the automatic document feeder \(ADF\)](#) for information about choosing original documents for copying.

To load originals onto the flatbed scanner

1. Make sure that the automatic document feeder (ADF) contains no media.
2. Lift the flatbed scanner cover.
3. Place the original document face-down on the flatbed scanner with the upper, left corner of the document located in the lower-right corner of the glass.
4. Gently close the lid.
5. The document is ready to be copied.

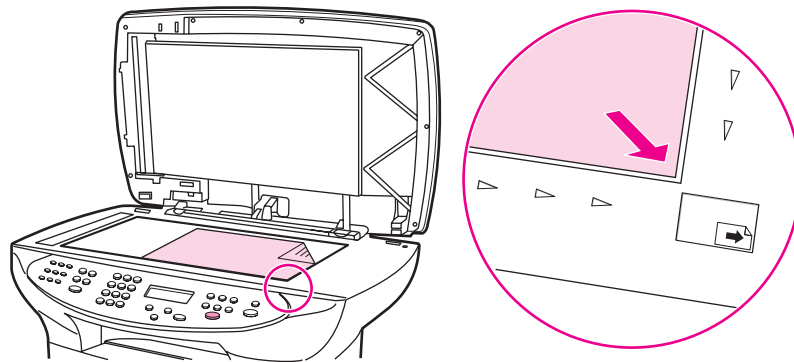

CAUTION

To prevent damaging the device, do not allow the scanner lid to fall onto the flatbed scanner surface. Always close the scanner lid when the device is not in use.

To load originals into the automatic document feeder (ADF) input tray

Note

ADF capacity is up to 50 sheets of 75 g/m² (20 lb) media (depending on the thickness of the media), or until the ADF input tray is full.

The minimum size for media in the ADF is 127 by 127 mm (5 by 5 inches). For smaller sizes use the flatbed scanner. The maximum size for media in the ADF is 215.9 by 381 mm (8.5 by 15 inches).

1. Make sure that the flatbed scanner contains no media.
2. Close the flatbed scanner cover and put the top end of the original media stack into the ADF input tray, with the media stack face-up and the first page to be copied on top of the stack.

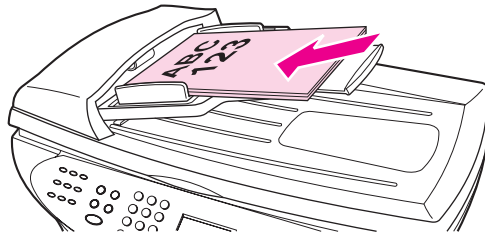

3. Slide the media stack into the ADF until the media does not move any farther.
4. Adjust the media guides until they are snug against the media.

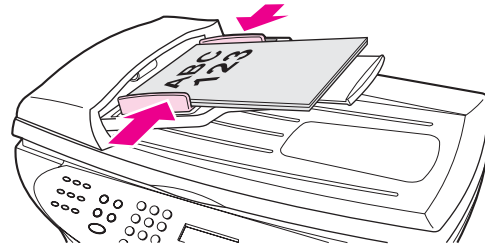

5. The document is now ready to be copied.

CAUTION

To prevent damaging the device, do not use an original that contains correction tape, correction fluid, or staples.

Starting a copy job

To make copies with your device, use the following instructions.

1. Load your original document onto the flatbed scanner face-down (one page at a time) with the upper, left corner of the document located in the lower-right corner of the glass.

OR

Load your original document face-up into the automatic document feeder (ADF) input tray.

2. Press **PAPER SIZE** to set the copy output size to Letter, Legal, or A4.
3. Press **START/COPY** on the device control panel to start copying.
4. Repeat the process for each copy.

For more detailed instructions about loading originals onto the flatbed scanner or into the ADF input tray, see [Loading originals to copy](#).

Note

If originals are loaded in the ADF input tray and are also on the flatbed scanner, the device automatically scans from the ADF regardless of whether an original has been placed on the flatbed scanner.

Canceling a copy job

To cancel a copy job, press **CANCEL** on the device control panel. If more than one process is running, pressing **CANCEL** clears the process that currently appears on the device control panel display.

Note

If you cancel a copy job, clear the original document from the flatbed scanner or from the automatic document feeder (ADF).

Adjusting the copy quality

The factory-set default for copy quality is **Text**. This setting is the best for items that contain mostly text.

When making a copy of a photo or graphic, you can select the **Photo** setting to increase the quality of your copy, or select the **Best Photo** setting for the highest photo quality.

If you want to conserve toner, and the copy quality is not as important, select **Draft**.

To adjust the copy quality for the current job

1. On the device control panel, press **QUALITY** to see the current quality setting for the copy.
2. Use the **<** or the **>** button to scroll through the quality setting options.
3. Select a resolution setting, and then press **START/COPY** to save the selection and immediately start the copy job, or press **MENU/ENTER** to save the selection without starting the job.

Note

The change in this setting remains active for about two minutes after the copy job has been completed. During this time, **Settings=Custom** appears on the device control panel display.

To adjust the default copy quality

1. On the device control panel, press **MENU/ENTER**.
2. Use the **<** or the **>** button to select **Copy setup**, and then press **MENU/ENTER**.
3. Press **MENU/ENTER** to select **Default Quality**.
4. Use the **<** or the **>** button to scroll through the choices.
5. Press **MENU/ENTER** to save the selection.

Adjusting the lighter/darker (contrast) setting

The lighter/darker setting affects the lightness or darkness (contrast) of the copy. Use the following procedure to change the contrast for the current copy job only.

To adjust the lighter/darker setting for the current job

1. On the device control panel, press **LIGHTER/DARKER** to see the current contrast setting.
2. Use the **<** or the **>** button to adjust the setting. Move the slider to the left to make the copy lighter than the original, or move the slider to the right to make the copy darker than the original.
3. Press **START/COPY** to save the selection and immediately start the copy job, or press **MENU/ENTER** to save the selection without starting the job.

Note

The change in the setting remains active for about two minutes after the copy job has been completed. During this time, **Settings=Custom** appears on the device control panel display.

To adjust the default lighter/darker setting

1. On the device control panel, press **MENU/ENTER**.
2. Use the **<** or the **>** button to select **Copy setup**, and then press **MENU/ENTER**.
3. Use the **<** or the **>** button to select **Def. Light/Dark**, and then press **MENU/ENTER**.
4. Use the **<** or the **>** button to adjust the setting. Move the slider to the left to make all of the copies lighter than the original, or move the slider to the right to make all of the copies darker than the original.
5. Press **MENU/ENTER** to save the selection.

Reducing or enlarging copies

The device can reduce copies to as little as 25 percent of the original or enlarge copies to as much as 400 percent of the original. It can also make the following reductions or enlargements automatically:

- **Original=100%**
- **Lgl > Ltr=78%**
- **Lgl > A4=83%**
- **A4 > Ltr=94%**
- **Ltr > A4=97%**
- **Full Page=91%**
- **Fit to page**
- **2 pages/sheet**
- **4 pages/sheet**
- **Custom: 25-400%**

Note

When using the **Fit to page** setting, copy from the flatbed scanner only.

When using the **2 pages/sheet** or **4 pages/sheet** setting, copy from the automatic document feeder (ADF) only. Also, after selecting the **2 pages/sheet** or **4 pages/sheet** option, you must select the page orientation (portrait or landscape).

To reduce or enlarge copies for the current job

To reduce or enlarge copies for the current job only, use the following instructions.

Note

The change in the setting remains active for about two minutes after the copy job has been completed. During this time, **Settings=Custom** appears on the device control panel display.

1. On the device control panel, press **REDUCE/ENLARGE**.
2. Select the size to which you would like to reduce or enlarge the copies in this job. You can select **Original=100%**, **Ltr > A4=97%**, **A4 > Ltr=94%**, **Lgl > Ltr=78%**, **Lgl > A4=83%**, **Full Page=91%**, **Fit to page**, **2 pages/sheet**, **4 pages/sheet**, or **Custom: 25-400%**.

If you select **Custom: 25-400%**, type a percentage by using the alphanumeric buttons.

If you select **2 pages/sheet** or **4 pages/sheet**, select the orientation (portrait or landscape).

3. Press **START/COPY** to save the selection and immediately start the copy job, or press **MENU/ENTER** to save the selection without starting the job.

Note

You must change the default media size in the media input tray to match the output size, or part of your copy might be cut off. For instructions, see [Changing the default media size](#).

To change the default copy size

Note

The default copy size is the size to which copies are normally reduced or enlarged. If you keep the factory-default size setting of **Original=100%**, all copies will be the same size as the original document.

1. Press **MENU/ENTER**.
2. Use the **<** or the **>** button to select **Copy setup**, and then press **MENU/ENTER**.
3. Use the **<** or the **>** button to select **Def. Redu/Enlrg**, and then press **MENU/ENTER**.
4. Use the **<** or the **>** button to select the option for how you normally want to reduce or enlarge copies. You can select **Original=100%**, **Ltr > A4=97%**, **A4 > Ltr=94%**, **Lgl > Ltr=78%**, **Lgl > A4=83%**, **Full Page=91%**, **Fit to page**, **2 pages/sheet**, **4 pages/sheet**, or **Custom: 25-400%**.

If you select **Custom: 25-400%**, type in the percentage of the original size that you normally want for copies.

If you select **2 pages/sheet** or **4 pages/sheet**, select the orientation (portrait or landscape).

5. Press **MENU/ENTER** to save your selection.

Changing the copy-collation setting

You can set the device to automatically collate multiple copies into sets. For example, if you are making two copies of three pages and the automatic collation is on, the pages print in this order: 1,2,3,1,2,3. If automatic collation is off, the pages print in this order: 1,1,2,2,3,3.

To use the automatic collation, the original document must fit into the memory. If it does not, the device makes only one copy and a message appears notifying you of the change. If that happens, use one of the following methods to finish the job:

- Split the job into smaller jobs that contain fewer pages.
- Make only one copy of the document at a time.
- Turn off the automatic collation.
- If using the **Best Photo** quality setting, try using the **Photo** setting instead.

The collation setting you select is in effect for all copies until you change the setting.

The collation setting can also be changed from the device software. For instructions about changing settings from the device software, see [Changing print settings](#).

To change the copy-collation setting for the current job

To change the copy-collation setting for the current job, press **COLLATION** on the device control panel.

If the copy-collation setting is **On**, press **COLLATION** to turn it **Off** for the current job. If the copy-collation setting is **Off**, press **COLLATION** to turn it **On** for the current job.

Note

The change in the setting remains active for about two minutes after the copy job has been completed. During this time, **Settings=Custom** appears on the device control panel display.

To change the default copy-collation setting

1. On the device control panel, press **MENU/ENTER**.
2. Use the **<** or the **>** button to select **Copy setup**, and then press **MENU/ENTER**.
3. Press **MENU/ENTER** to select **Def. Collation**.
4. Use the **<** or the **>** button to select **On** or **Off**.
5. Press **MENU/ENTER** to save your selection.

Note

The factory-set default for automatic copy collation is **On**.

Changing the number of copies

You can choose to have the default number of copies be any number from 1 to 99.

To change the number of copies for the current job

1. On the device control panel, press **# OF COPIES** and use the **<** or the **>** button to increase or decrease the quantity that appears on the device control panel display.

OR

Use the alphanumeric buttons to type the number of copies (between 1 and 99) that you want to make for your current job.

2. Press **START/COPY** to begin copying your job.

Note

The change in the setting remains active for about two minutes after the copy job has been completed. During this time, **Settings=Custom** appears on the device control panel display.

To change the default number of copies

1. On the device control panel, press **MENU/ENTER**.
2. Use the **<** or the **>** button to select **Copy setup**, and then press **MENU/ENTER**.
3. Use the **<** or the **>** button to select **Def. # of copies**, and then press **MENU/ENTER**.
4. Use the alphanumeric buttons to type the number of copies (between 1 and 99) that you want as the default.
5. Press **MENU/ENTER** to save your selection.

Note

The factory-set default for the number of copies is **1**.

Copying photos, two-sided originals, or books

To copy a photo

1. Place the photo on the flatbed scanner with the picture-side down and the top, left corner of the photo in the lower-right corner of the glass.

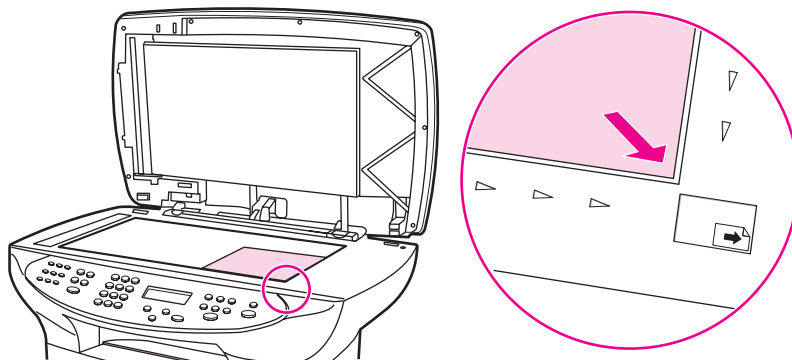

2. Gently close the lid.
3. You are now ready to copy the photo by using one of the scanning methods. See [Understanding scanning methods](#) for more information.

To copy a multiple-page stack of two-sided originals

1. Load the stack of originals to be copied into the automatic document feeder (ADF) with the first page facing up, and with the top of the page leading into the ADF.

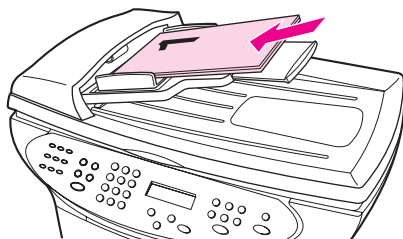

2. Press **START/COPY**. The odd-numbered pages are copied and printed.
3. Remove the stack from the ADF output tray and reload the stack with the last page facing up, and with the top of the page leading into the ADF.

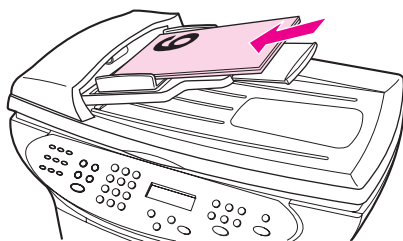

4. Press **START/COPY**. The even-numbered pages are copied and printed.
5. Collate the odd- and even-numbered printed copies.

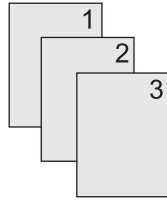

To copy a book

1. Lift the lid and place the book on the flatbed scanner with the page that you want to copy at the lower-right corner of the glass.

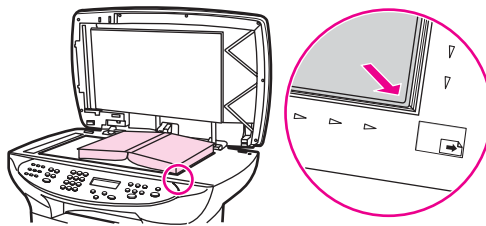

2. Gently close the lid.

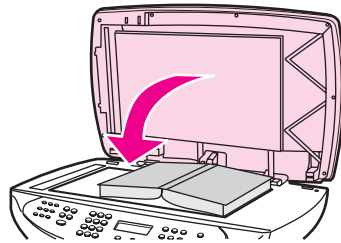

3. Gently press down on the lid to press the book to the flatbed scanner surface.

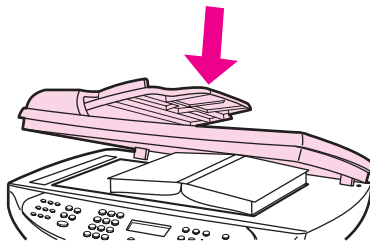

4. Press **START/COPY**, or use one of the other scanning methods to copy the book. See [Understanding scanning methods](#) for more information.

5

Scanning

Use the following instructions to perform scanning tasks:

- [Loading originals to scan](#)
- [Understanding scanning methods](#)
- [Scanning from the device \(Windows\)](#)
- [Canceling a scan job](#)
- [Scanning a photo or a book](#)
- [Scanning by using hp LaserJet Scan software \(Windows\)](#)
- [Scanning from the device and HP Director \(Macintosh\)](#)
- [Scanning by using TWAIN-compliant and WIA-compliant software](#)
- [Scanning by using OCR](#)
- [Scanner resolution and color](#)

Loading originals to scan

Use these instructions to load originals into the device for scanning. For the best quality scans, use the flatbed scanner. See [Selecting media for the automatic document feeder \(ADF\)](#) for information about choosing original documents for scanning.

Loading originals onto the flatbed scanner

1. Make sure that the automatic document feeder (ADF) is free of media.
2. Lift the flatbed scanner lid.
3. Place the original document face-down on the flatbed scanner with the top, left corner of the document at the lower-right corner of the glass.
4. Gently close the lid.
5. The document is ready to be scanned.

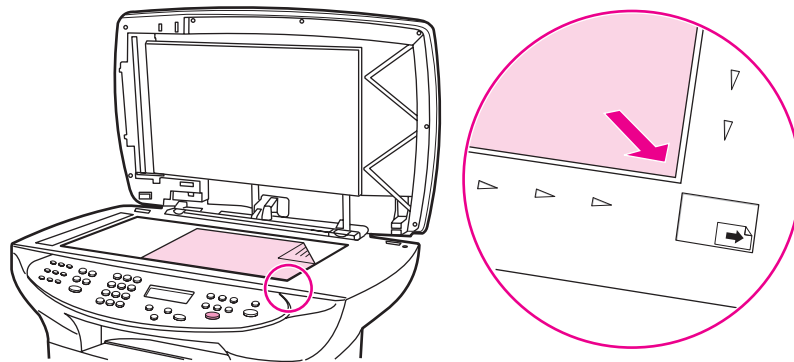

CAUTION

To prevent damaging the device, do not allow the scanner lid to fall onto the flatbed scanner surface. Always close the scanner lid when the device is not in use.

Loading originals into the automatic document feeder (ADF) input tray

Note

The ADF capacity is up to 50 sheets of 75 g/m² (20-lb) media (depending on the thickness of the media), or fewer sheets if the stack fills the ADF input tray.

The minimum size for media in the ADF is 127 by 127 mm (5 by 5 inches). For smaller sizes, use the flatbed scanner. The maximum size for media in the ADF is 215.9 mm wide by 381 mm long (8.5 by 15 inches).

1. Make sure that no media is on the flatbed scanner.
2. Close the flatbed scanner cover and put the top end of the stack of originals into the ADF input tray, with the media stack face-up and the first page to be scanned on top of the stack.

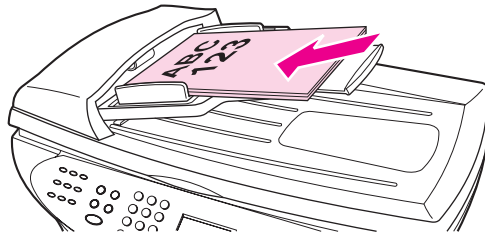

3. Slide the stack into the ADF until it does not move any farther.
4. Adjust the media guides until they are snug against the stack.

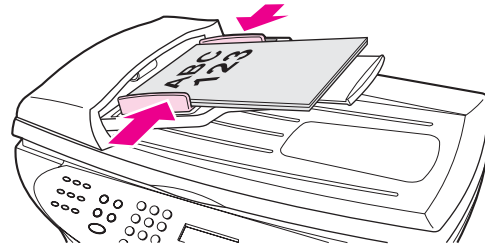

5. The originals are now ready to be scanned.

CAUTION

To prevent damaging the device, do not use an original that contains correction tape, correction fluid, or staples.

Understanding scanning methods

You can scan an item in the following ways.

- **Scan from the device:** Start scanning directly from the device by using the device control panel scan buttons. The **SCAN TO** button can be programmed to scan to a folder (Windows only) or to scan to e-mail. For more information, see [Scanning from the device \(Windows\)](#).
- **Scan from hp LaserJet Scan software (Windows):** Press **START SCAN** on the device control panel to start the hp LaserJet Scan program. You can also start hp LaserJet Scan software directly from the computer. For more information, see [Scanning by using hp LaserJet Scan software \(Windows\)](#).

Note

HP LaserJet Scan software is not supported for networked connections.

- **Scan from HP Director (Macintosh):** Insert an original into the automatic document feeder (ADF) to open the HP Director window. You can also start the HP Director from the computer by clicking the HP Director Dock alias (OS X only) or desktop alias. For more information, see [Scanning from the device and HP Director \(Macintosh\)](#).
- **Scan from TWAIN-compliant or WIA-compliant software:** For more information, see [Scanning by using TWAIN-compliant and WIA-compliant software](#).

Note

To learn about and use optical character recognition (OCR) software, install the Readiris program from the software CD-ROM.

Scanning from the device (Windows)

Note

For information about scanning from the device for Macintosh, see [Scanning from the device and HP Director \(Macintosh\)](#)

Use the following instructions to scan directly from the device control panel.

Note

For the best scan quality, place your originals directly onto the flatbed scanner, rather than loading them into the automatic document feeder (ADF) input tray.

The computer that is connected to the device must be turned on.

Programming the device Scan-to button

To program the device **SCAN TO** button, you must gain access to the device settings. Open the HP toolbox and click the **Scan-to...** tab. For more information, see the HP toolbox Help.

Scanning to e-mail

To scan to e-mail by using the **SCAN TO** button on the device, use the following procedure.

Note

To use this feature in Windows, an e-mail recipient must be programmed in the **Scan-to...** tab. See [Programming the device Scan-to button](#). For Macintosh, set up this function from the **Monitor Device** tab. See the HP Director online Help.

1. Load the originals that are to be scanned face-up in the automatic document feeder (ADF) input tray. Adjust the media guides to hold the originals in place.

OR

Lift the flatbed scanner lid and load the original that is to be scanned face-down on the flatbed scanner with the top, left corner of the document at the lower-right corner of the glass. Gently close the lid.

2. Press **SCAN TO** on the device control panel.
3. Use the **<** or the **>** button to select an e-mail recipient.
4. Press **START SCAN** or **MENU/ENTER**. The scanned item is attached to an e-mail message, which is then sent automatically to the e-mail recipient that you selected in step 3.

Scanning to a folder (Windows only)

To scan to a folder by using the **SCAN TO** button on the device, use the following instructions.

Note

To use this feature in Windows, a folder must be set up in the **Scan-to...** tab prior to use. See [Programming the device Scan-to button](#).

1. Load the originals that are to be scanned face-up in the automatic document feeder (ADF) input tray, with the top of the document forward, and adjust the media guides.

OR

Lift the flatbed scanner lid and load the original that is to be scanned face-down on the flatbed scanner with the top, left corner of the document located in the lower-right corner of the glass. Gently close the lid.

2. Press **SCAN TO** on the device control panel.
3. Use the **<** or the **>** button to select a folder.
4. Press **START SCAN** or **MENU/ENTER**. The document is scanned to a file, which is then saved in the folder that you selected in step 3.

Canceling a scan job

To cancel a scan job, use one of the following procedures.

- Press **CANCEL** on the device control panel.
- Click the **Cancel** button in the onscreen dialog box.

If you cancel a scan job, remove the original document from the flatbed scanner or from the automatic document feeder (ADF) input tray.

Note

These procedures vary with Macintosh operating systems.

Scanning a photo or a book

Use the following procedures to scan a photo or a book.

Scanning a photo

1. Place the photo on the flatbed scanner with the picture-side down and the top, left corner of the photo in the lower-right corner of the glass.

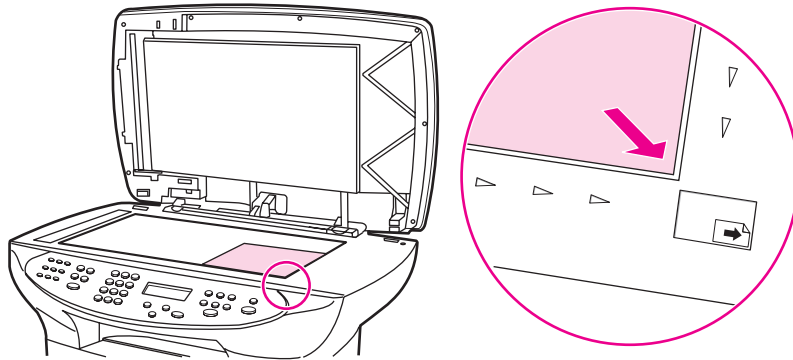

2. Gently close the lid.
3. You are now ready to scan the photo by using one of the scanning methods. See [Understanding scanning methods](#) for more information.

Scanning a book

1. Lift the lid and place the book on the flatbed scanner with the page that you want to scan at the lower-right corner of the glass.

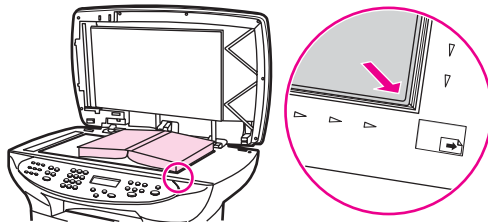

2. Gently close the lid.

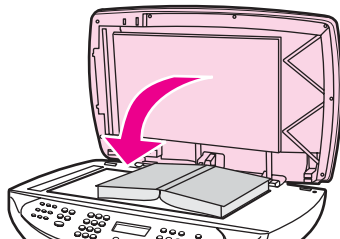

3. Gently press down on the lid to press the book to the flatbed scanner surface.

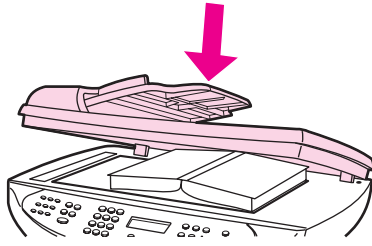

4. You are now ready to scan the book by using one of the scanning methods. See [Understanding scanning methods](#) for more information.

Scanning by using hp LaserJet Scan software (Windows)

Use the HP LaserJet Scan software program to scan an item to any of the following:

- e-mail
- a folder
- another software program that you specify
- the Readiris OCR program, if it is installed on the computer

For more detailed instructions about loading original documents into the automatic document feeder (ADF), see [Loading originals to scan](#).

Scanning to e-mail

1. Load the originals that are to be scanned face-up in the automatic document feeder (ADF) input tray. Adjust the media guides to hold the originals in place.

OR

Lift the flatbed scanner lid and load the original that is to be scanned face-down on the flatbed scanner with the top, left corner of the document at the lower-right corner of the glass. Gently close the lid.

2. On the computer, click **Start**, select **Hewlett-Packard**, select **hp LaserJet 3380**, and then select **Scan**.

OR

Press **START SCAN** on the device. HP LaserJet Scan software opens on the computer.

3. In the HP LaserJet Scan dialog box, select **Send it through e-mail**.
4. Click **Settings**.
5. Set the scanning options that you want, and then click **OK** to return to the HP LaserJet Scan dialog box.

Note

You can save the settings using the **Quick Sets** option on the **General** tab. If you then select the check box after saving a Quick Set, the saved settings will be the default settings the next time you scan to e-mail.

6. Click **Scan**. The original is scanned, attached to a new e-mail message, and sent automatically.

Note

If no e-mail recipient is entered on the **E-mail** tab, the original is scanned and attached to a new e-mail message, but is not sent. You can then enter an e-mail recipient, add text or other attachments, and then send the message.

The options that you set in step 5 are for the current job only, unless you save them as a Quick Set.

To scan to a file

1. Load the originals that are to be scanned face-up in the automatic document feeder (ADF) input tray. Adjust the media guides to hold the originals in place.

OR

Lift the flatbed scanner lid and load the original that is to be scanned face-down on the flatbed scanner with the top, left corner of the document at the lower-right corner of the glass. Gently close the lid.

2. On the computer, click **Start**, select **Hewlett-Packard**, select **hp LaserJet 3380**, and then select **Scan**.

OR

Press **START SCAN** on the device. HP LaserJet Scan software opens on the computer.

3. In the HP LaserJet Scan dialog box, select **Send it to a file**.
4. Click **Settings**.
5. Set the scanning options that you want, and then click **OK** to return to the HP LaserJet Scan dialog box.
6. Click **Scan**. If prompted, enter a file name.

Note

The options that you set in step 5 are for the current job only, unless you save them as a Quick Set.

Scanning to another software program

Scanning to another software program allows you to scan to a program that is not TWAIN-compliant or WIA-compliant.

1. Load the originals that are to be scanned face-up in the automatic document feeder (ADF) input tray. Adjust the media guides to hold the originals in place.

OR

Lift the flatbed scanner lid and load the original that is to be scanned face-down on the flatbed scanner with the top, left corner of the document at the lower-right corner of the glass. Gently close the lid.

2. On the computer, click **Start**, select **Hewlett-Packard**, select **hp LaserJet 3380**, and then select **Scan**.

OR

Press **START SCAN** on the device. HP LaserJet Scan software opens on the computer.

3. In the HP LaserJet Scan dialog box, select **Send it to another software application**.
4. Click **Settings**.
5. Set the options that you want. On the **Other Applications** tab, click **Browse** to locate the program's executable file, which has the file extension ".exe." You can also type the location of the executable file.

Note

You can save the settings using the **Quick Sets** option on the **General** tab. If you then select the check box after saving a Quick Set, the saved settings will be the default settings the next time you scan to another software program.

6. Select the file type that is supported by this software program.

7. Click **OK** to return to the HP LaserJet Scan dialog box.
8. Click **Scan**.

Note

The options that you set in step 5 are for the current job only, unless you save them as a Quick Set.

Scanning to the Readiris OCR software

1. Load the originals that are to be scanned face-up in the automatic document feeder (ADF) input tray. Adjust the media guides to hold the originals in place.

OR

Lift the flatbed scanner lid and load the original that is to be scanned face-down on the flatbed scanner with the top, left corner of the document at the lower-right corner of the glass. Gently close the lid.

2. On the computer, click **Start**, select **Hewlett-Packard**, select **hp LaserJet 3380**, and then select **Scan**.

OR

Press **START SCAN** on the device. HP LaserJet Scan software opens on the computer.

3. In the HP LaserJet Scan dialog box, select **Send it to the Readiris OCR software**.
4. Click **Scan**.

Note

Readiris must be installed on the computer before the device can scan to the Readiris OCR program. The software CD-ROM that came with the device includes the Readiris OCR program.

Scanning from the device and HP Director (Macintosh)

The procedures described in this section are for Macintosh OS X. Procedures for Macintosh OS Classic might vary.

For more information about tasks and settings described in this section, see the HP Director online Help.

For more detailed instructions about loading original documents onto the flatbed scanner or into the automatic document feeder (ADF) input tray, see [Loading originals to scan](#).

Scanning to e-mail

1. Load the originals that are to be scanned face-up in the automatic document feeder (ADF) input tray. Adjust the media guides to hold the originals in place.

OR

Lift the flatbed scanner lid and load the original that is to be scanned face-down on the flatbed scanner with the top, left corner of the document at the lower-right corner of the glass. Gently close the lid.

2. Press **SCAN TO** on the device control panel.
3. Use the **<** or the **>** button to select an e-mail program such as Apple Mail.
4. Press **START SCAN** on the device control panel. The original is scanned. The e-mail program that you selected in step 3 opens on the computer. A blank e-mail message opens with the scanned document as an attachment.

Note

If you start the scan by clicking **Scan to Email** in HP Director, the original is scanned to the default e-mail program.

5. Enter an e-mail recipient, add text or other attachments, and then send the message.

Scanning to a file

1. Load the originals that are to be scanned face-up in the automatic document feeder (ADF) input tray. Adjust the media guides to hold the originals in place.

OR

Lift the flatbed scanner lid and load the original that is to be scanned face-down on the flatbed scanner with the top, left corner of the document at the lower-right corner of the glass. Gently close the lid.

2. If the device is connected directly to your computer, the HP Director opens after you insert an item into the ADF input tray.

OR

If you are scanning from the flatbed scanner (or if the HP Director does not automatically open), double-click the desktop alias for the HP Director.

3. In the HP Director, click **HP Scan**. A preview scan of the original appears.
4. Click the **Save As** icon.
5. Enter a name for the file and a file type .

6. Click **Save**. The original is scanned and saved.
7. Click **Done** to close HP Scan.

Scanning to a software program

To scan to a software program, you scan an item using the program itself. Any TWAIN-compliant program can scan an image. If the program you are using is not TWAIN-compliant, you can save the scanned image to a file and then place, open, or import the file in the software program. For more information, see [Scanning by using TWAIN-compliant and WIA-compliant software](#).

Using page-by-page scanning

Note

For best results, load originals in the automatic document feeder (ADF) input tray, not the flatbed scanner.

1. Load the originals that are to be scanned face-up in the ADF input tray. Adjust the media guides to hold the originals in place.
2. If the device is connected directly to your computer, the HP Director opens after you insert an item into the automatic document feeder ADF input tray. If the HP Director does not automatically open, double-click the desktop alias for the HP Director.
3. To open the HP Scan dialog box, click the **HP Scan** button in the HP Director.
4. Specify an image type.
5. Click **Scan**.
6. After the scan process has finished, click **Scan next page**.
7. Repeat step 6 for each page of the original.
8. After all of the pages have been scanned, click **Send Now!**.

OR

Click the **Save As** icon to save the pages to a file.

Scanning by using TWAIN-compliant and WIA-compliant software

The device is TWAIN-compliant and Windows Imaging Application (WIA)-compliant. The device works with Windows-based and Macintosh-based programs that support TWAIN-compliant or WIA-compliant scanning devices.

Note

If the software program you are using is not TWAIN-compliant or WIA-compliant, see [Scanning to another software program](#).

Using TWAIN-compliant and WIA-compliant software

While you are in a TWAIN-enabled or WIA-enabled program, you can gain access to the scanning feature and scan an image directly into the open program. For more information, see the Help file or the documentation that came with your TWAIN-compliant or WIA-compliant software program.

Scanning from a TWAIN-enabled program

Note

The Macintosh device software complies with TWAIN version 1.9 requirements.

Generally, a software program is TWAIN-enabled if it has a command such as **Acquire**, **File Acquire**, **Scan**, **Import New Object**, **Insert from**, or **Scanner**. If you are unsure whether the program is compliant or you do not know what the command is called, see the software program Help or documentation.

When scanning from a TWAIN-enabled program, the HP LaserJet Scan software might start automatically. If HP LaserJet Scan software starts, you can make changes while you are previewing the image. If the software program does not start automatically, the image goes to the TWAIN-enabled program immediately.

To scan from a TWAIN-enabled program

Start the scan from within the TWAIN-enabled program. See the software program Help or documentation for information about the commands and steps to use.

Scanning from a WIA-enabled program (Windows XP only)

WIA is another way to scan an image directly into a software program, such as Microsoft® Word. WIA uses Microsoft software to scan, instead of HP LaserJet Scan software.

Generally, a software program is WIA-enabled if it has a command such as **Picture/From Scanner or Camera** in the Insert or File menu. If you are unsure whether the program is WIA-enabled, see the software program Help or documentation.

To scan from a WIA-enabled program

Start the scan from within the WIA-enabled program. See the software program Help or documentation for information about the commands and steps to use.

OR

In the Cameras and Scanner folder, double-click the device icon. This opens the standard WIA-enabled software program, which enables you to scan to a file.

Scanning by using OCR

You can use OCR software to import scanned text into your preferred word-processing program for editing.

Readiris

The software CD-ROM includes the Readiris OCR program. If you want to use the Readiris program, install it from the software CD-ROM, and then follow the instructions in the online Help.

Scanner resolution and color

If you are printing a scanned image, and the quality is not what you expected, you might have selected a resolution or color setting in the scanner software that does not match your needs. Resolution and color affect the following features of scanned images:

- Image clarity
- Texture of gradations (smooth or rough)
- Scan time
- File size

Resolution is measured in dots per inch (dpi). Color, grayscale, and black and white define the number of colors possible. You can adjust the scanner hardware resolution to up to 600 dpi. The software can perform an enhanced resolution up to 9,600 dpi. You can set color and grayscale at 1 bit (black and white), or at 8 bit (256 levels of gray) to 24 bit (true color).

The resolution and color guidelines table lists simple tips that you can follow to meet your scanning needs.

Note

Setting the resolution and color to a high value can create large files that take up disk space and slow the scanning process. Before setting the resolution and color, determine how you are going to use the scanned image.

Note

The best resolution for color and grayscale images is achieved by scanning from the flatbed scanner rather than from the automatic document feeder (ADF) input tray.

Resolution and color guidelines

The following table describes the recommended resolution and color settings for different types of scan jobs.

Intended use	Recommended resolution	Recommended color settings
Fax	150 dpi	<ul style="list-style-type: none">• Black and White
E-mail	150 dpi	<ul style="list-style-type: none">• Black and White, if the image does not require smooth gradation• Grayscale, if the image requires smooth gradation• Color, if the image is in color
Edit text	300 dpi	<ul style="list-style-type: none">• Black and White
Print (graphics or text)	600 dpi for complex graphics, or if you want to significantly enlarge the document 300 dpi for normal graphics and text 150 dpi for photos	<ul style="list-style-type: none">• Black and White for text and line art• Grayscale for shaded or colored graphics and photos• Color, if the image is in color

Intended use	Recommended resolution	Recommended color settings
Display on screen	75 dpi	<ul style="list-style-type: none"> • Black and White for text • Grayscale for graphics and photos • Color, if the image is in color

Color

You can set the color values to the following settings when scanning.

Setting	Recommended use
Color	Use this setting for high-quality color photos or documents in which the color is important.
Black and White	Use this setting for text documents.
Grayscale	Use this setting when file size is an issue or when you want a document or photograph to be scanned quickly.

6

Faxing

For instructions about using the device fax functionality, see the fax guide that came with the device.

7

Cleaning and maintenance

Use the following topics to learn about basic cleaning and maintenance tasks:

- [Cleaning the outside of the device](#)
- [Cleaning the print-cartridge area](#)
- [Cleaning the media path](#)
- [Cleaning the pickup roller](#)
- [Replacing the pickup roller](#)
- [Replacing the device separation pad](#)
- [Installing an ADF](#)
- [Replacing an ADF pickup roller assembly](#)
- [Removing and replacing the device control panel cover](#)

Cleaning the outside of the device

To clean the exterior

Use a soft, damp, lint-free cloth to wipe dust, smudges, and stains off of the exterior of the device.

To clean the glass

Dirty glass, from fingerprints, smudges, hair, and so on, slows down performance and affects the accuracy of special features, such as fit-to-page and copy. Use the following procedure to clean the glass.

1. Turn off the device, unplug the power cord from the electrical socket, and then raise the lid.
2. Clean the glass by using a soft cloth or sponge that has been moistened with nonabrasive glass cleaner.

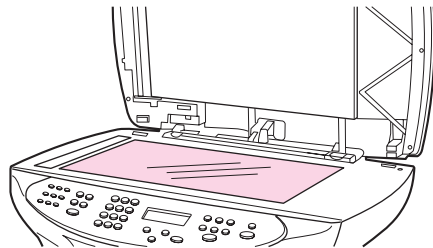

CAUTION

Do not use abrasives, acetone, benzene, ammonia, ethyl alcohol, or carbon tetrachloride on any part of the device; these can damage the device. Do not place liquids directly on the glass. They might seep under it and damage the device.

3. Clean the scanner strip by using a soft cloth or sponge that has been moistened with nonabrasive glass cleaner.

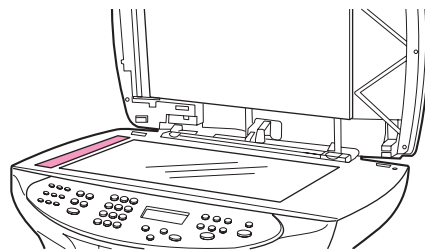

4. Dry the glass with a chamois or cellulose sponge to prevent spotting.

Note

In certain areas of California, air pollution control regulations restrict the use of liquid Isopropyl Alcohol (IPA) as a cleaning agent. In those areas of California, please disregard the previous recommendations and use a dry, lint-free cloth. The cloth may be moistened with water if desired.

To clean the lid backing

Minor debris can accumulate on the white document lid backing that is located underneath the device lid. Use the following procedure to clean the lid backing.

1. Turn off the device, unplug the power cord from the electrical socket, and then raise the lid.

Note

Turn off the power switch.

2. Clean the white document lid backing with a soft cloth or sponge that has been moistened with a mild soap and warm water.

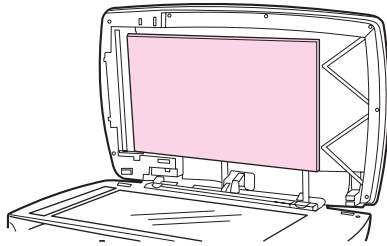

3. Wash the backing gently to loosen debris; do not scrub the backing.
4. Dry the backing with a chamois or soft cloth.

CAUTION

Do not use paper-based wipes as these might scratch the backing.

5. If this does not clean the backing thoroughly, repeat the previous steps by using isopropyl alcohol, and then wipe the backing with a damp cloth to remove any residual alcohol.

Note

In certain areas of California, air pollution control regulations restrict the use of liquid Isopropyl Alcohol (IPA) as a cleaning agent. In those areas of California, please disregard the previous recommendations and use a dry, lint-free cloth. The cloth may be moistened with water if desired.

Cleaning the print-cartridge area

You do not need to clean the print-cartridge area often. However, cleaning this area can improve the quality of your printed sheets. During the printing process, paper, toner, and dust particles can accumulate inside the device. Over time, this buildup can cause print-quality problems, such as toner specks or smearing. To correct and prevent these types of problems, you can clean the print-cartridge area and the media path.

To clean the print-cartridge area

WARNING!

Wait for the device to cool before beginning this procedure.

1. Before cleaning the device, turn the device off and unplug the power cord.

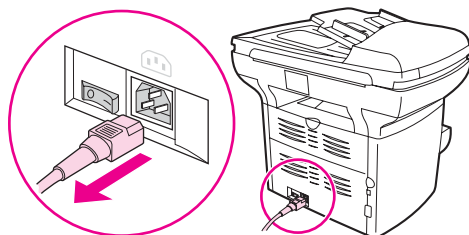

2. Open the print-cartridge door, and remove the print cartridge.

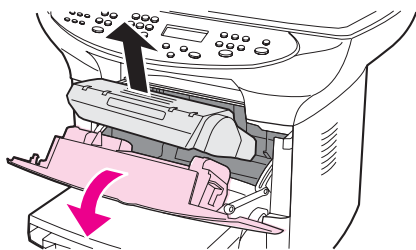

CAUTION

To prevent damage, do not expose the print cartridge to light. Cover the print cartridge, if necessary. Also, do not touch the black sponge transfer roller inside the device. By doing so, you can damage the device.

3. Use a dry, lint-free cloth, or an HP toner cloth (part number 5090-3379) to wipe any residue from the media-path area and the print-cartridge cavity.

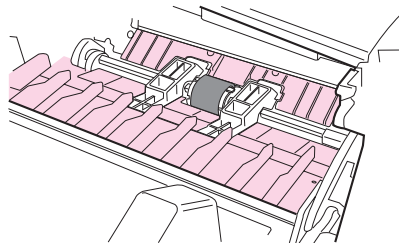

4. Replace the print cartridge, and close the print cartridge door.

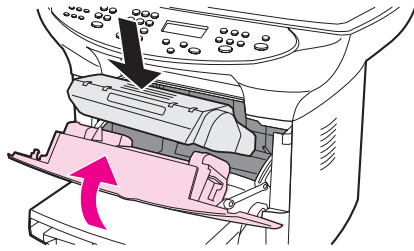

5. Plug the device in, and turn on the power switch.

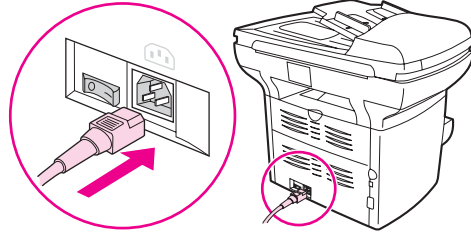

Note

Do not spray or use water inside the device.

If toner gets on your clothing or other fabric, wipe off the toner with a dry cloth. Wash the items in cold water and air-dry them. If toner gets on your hands, wash your hands in cold water.

CAUTION

Hot water or heat from a dryer can set toner into fabric.

Cleaning the media path

If you are experiencing toner specks or dots on the printouts, clean the media path.

To clean the media path

1. Press **MENU/ENTER**.
2. Use the **<** or the **>** button to find the **Service** menu.
3. Press **MENU/ENTER**.
4. Use the **<** or the **>** button to find **Cleaning Mode**.
5. Press **MENU/ENTER**.

Cleaning the pickup roller

If the device regularly picks up too many sheets of media or no sheets at all, you might need to clean or replace the pickup roller. Before replacing the pickup roller, try to clean it. To clean the pickup roller, follow the instructions below.

To clean the pickup roller

Remove the pickup roller as described in steps 1 through 5 of [Replacing the pickup roller](#).

1. Dampen a lint-free cloth with warm water, and use it to clean the roller.

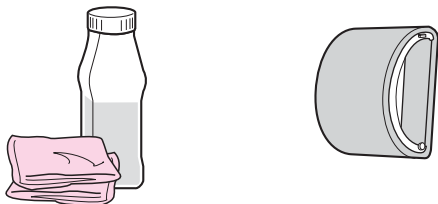

WARNING!

Do not use abrasives, acetone, benzene, ammonia, ethyl alcohol, or carbon tetrachloride on any part of the device; these can damage the device.

2. Using a dry, lint-free cloth, wipe the pickup roller to remove loosened dirt.

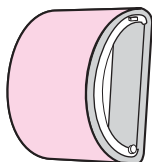

3. Allow the pickup roller to dry completely before you reinstall it in the device (see steps 6 through 9 of [Replacing the pickup roller](#)).

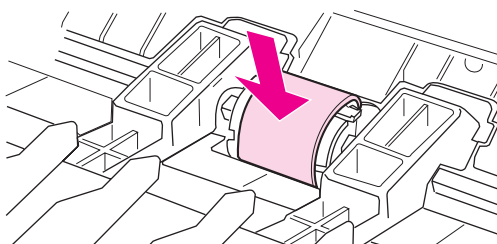

Replacing the pickup roller

See [Ordering HP parts and accessories](#) to order a new pickup roller.

To replace the pickup roller

CAUTION

Failure to complete this procedure might damage the device.

1. Turn off the device and unplug the power cord. Allow the device to cool.

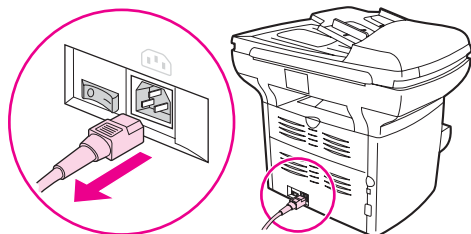

2. Open the print-cartridge door, and remove the print cartridge.

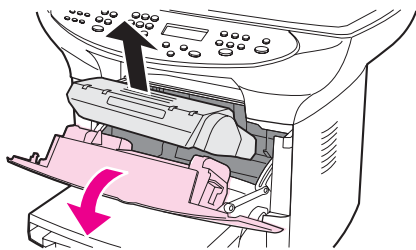

CAUTION

To prevent damage, do not expose the print cartridge to light. Cover the print cartridge, if necessary. Also, do not touch the black sponge transfer roller inside the device. Touching the black sponge roller can damage the device.

3. Find the pickup roller.

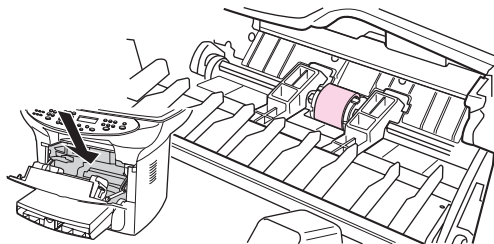

4. Release the small, white tabs on either side of the pickup roller, and rotate the pickup roller toward the front.

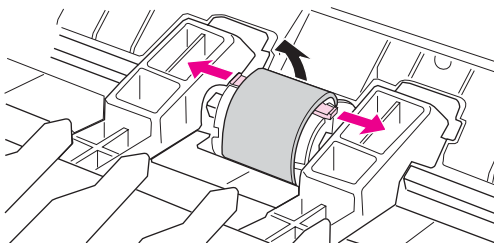

5. Gently pull the pickup roller up and out.

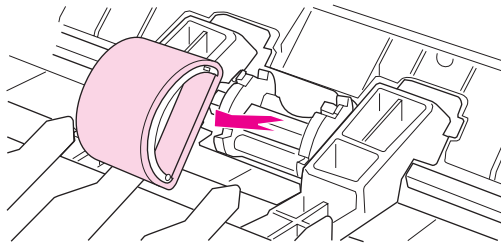

6. Position the new or cleaned part in the slot that held the pickup roller previously. See [Cleaning the pickup roller](#) for instructions.

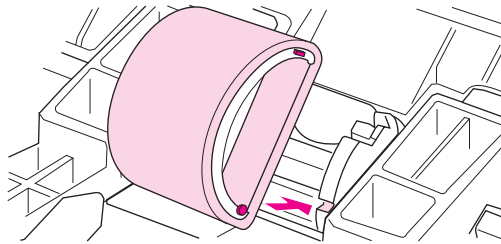

Note

Circular and rectangular pegs on each side prevent you from incorrectly positioning the pickup roller.

7. Rotate the top of the new pickup roller away from you until both sides snap into place.

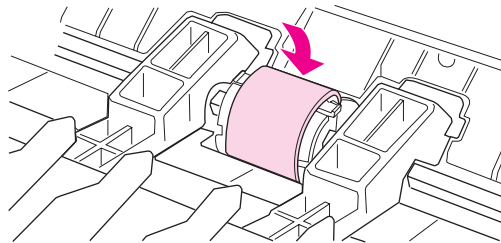

Note

Touching the black sponge roller can damage the device.

8. Reinstall the print cartridge, and close the print-cartridge door.

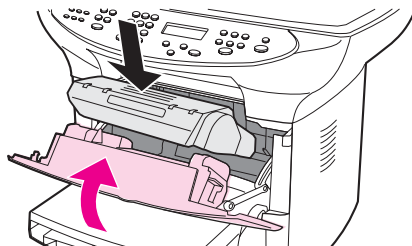

9. Plug the device in, and then turn on the power switch.

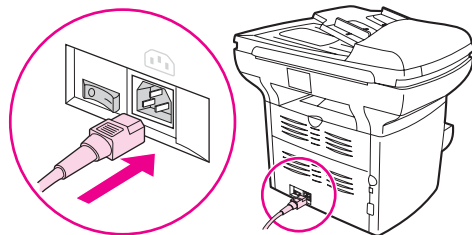

Replacing the device separation pad

If the input tray feeds more than one sheet at a time, you might need to replace the device separation pad. Recurring feed problems indicate that the device separation pad is worn. If your device is under warranty, call customer support. If your device is not under warranty, see [Ordering HP parts and accessories](#) to order a new device separation pad.

Note

Before you replace the separation pad, clean the pickup roller. See [Cleaning the pickup roller](#) for instructions.

To replace the device separation pad

1. Turn off the device and unplug the power cord. Allow the device to cool.

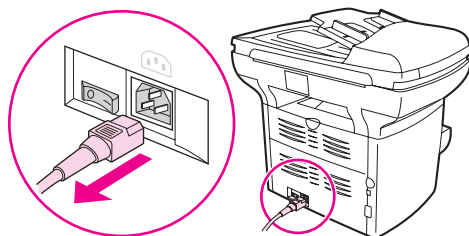

2. Remove the input trays.

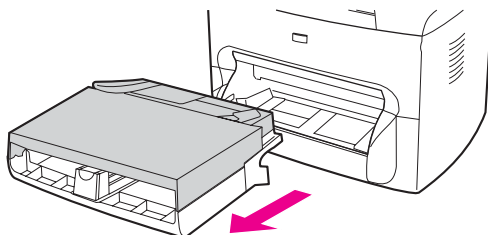

3. Find the blue separation pad.

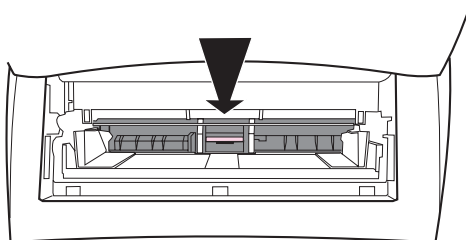

4. To pry the separation pad up from the spring-loaded base, insert a flat-blade screwdriver in the slot under the separation pad and twist until the tabs are free.

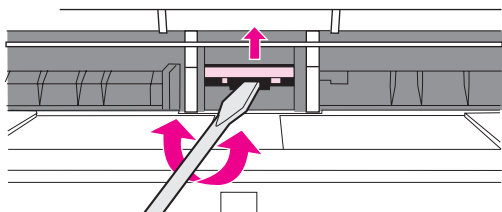

Note

Touching the black sponge roller can damage the device.

5. Reach in through the opening, push the spring-loaded base down (1) with one hand, and pull the separation pad up (2) with the other hand.

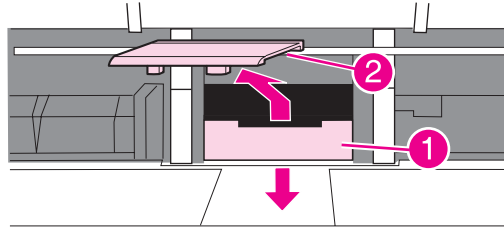

6. With one hand, position the new separation pad in the slot that held the previous separation pad (1). With the other hand, reach through the input tray opening and push down the spring-loaded base (2).

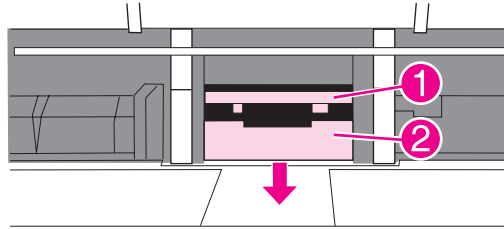

Note

The tab on the right is larger, which helps you position it correctly.

7. Snap both sides of the separation pad firmly into place.

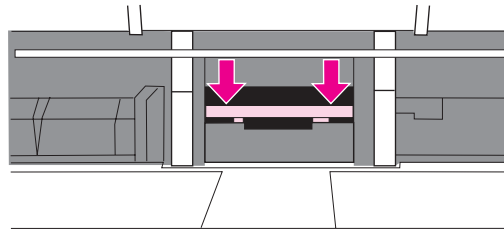

CAUTION

Make sure that the separation pad is straight and that no space exists between the separation pad and the spring-loaded base. If the separation pad is not straight or you see space on one side, remove the separation pad, make sure that the larger tab is on the right, reinsert the separation pad, and snap both sides into place.

8. Reinsert the print cartridge, and close the print-cartridge door.

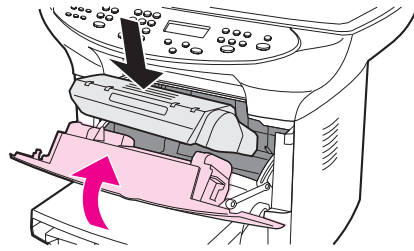

9. Plug the device in, and turn on the power switch.

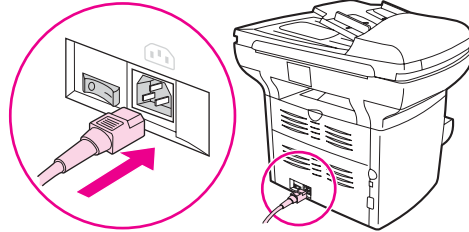

Note

If the pad is not properly positioned, the device might be noisy or the media might not feed at all.

Installing an ADF

If you are experiencing repeated jams in the automatic document feeder (ADF), you might need to replace it. See for information about ordering a replacement ADF.

To install a replacement ADF

1. Remove the flatbed scanner lid by opening it and gently lifting straight up.

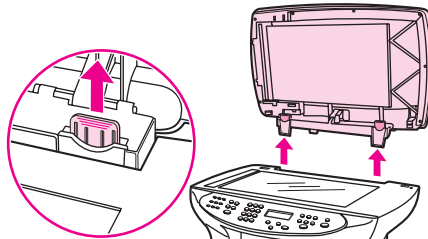

Note

If you are replacing an existing ADF, you must first pull up both hinge tabs before lifting the ADF up and out of the device.

2. On the new ADF, unfold the hinges and pull up the tab on each hinge.

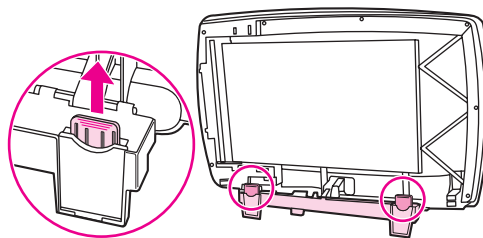

3. Install the new ADF by inserting the hinges straight down into the device.

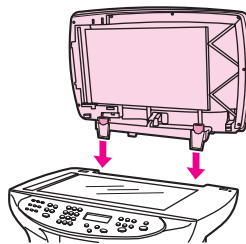

4. Push down on both tabs until they click.

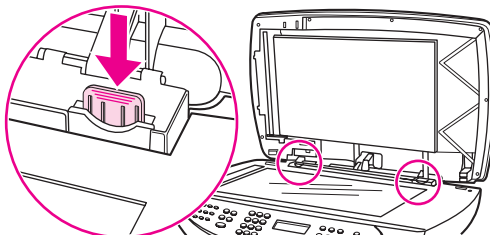

5. Gently close the ADF lid.

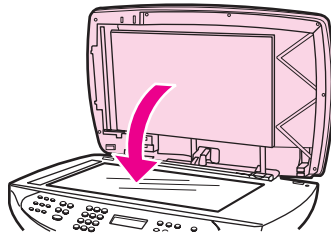

CAUTION

To avoid damaging the device, do not allow the ADF lid to fall onto the flatbed scanner. Always close the ADF lid when the device is not in use.

6. Install the ADF input tray by aligning the two tabs on the input tray with the two grooves in the ADF lid and sliding the tray into the grooves until it snaps into place.

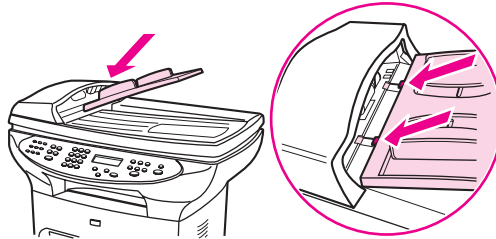

Replacing an ADF pickup roller assembly

If your ADF has trouble picking paper, replace the ADF pickup roller assembly. See [Ordering HP parts and accessories](#) to order an ADF pickup roller assembly. To remove the existing assembly, follow the instructions below.

1. Turn off the device and unplug the power cord.

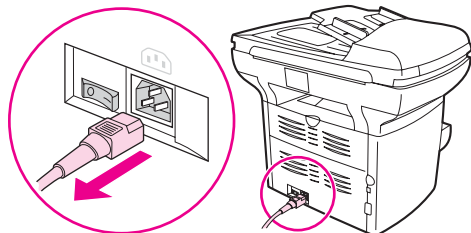

2. Remove the input tray and open the ADF cover.

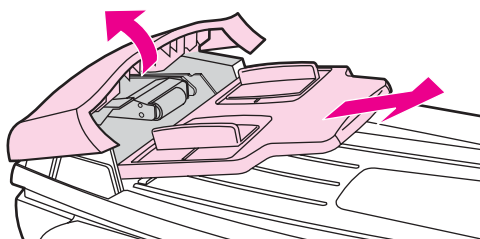

3. Press the round green button while lifting the green lever. Rotate the green lever until it stops in the open position. The old pickup roller assembly should remain on the black surface.

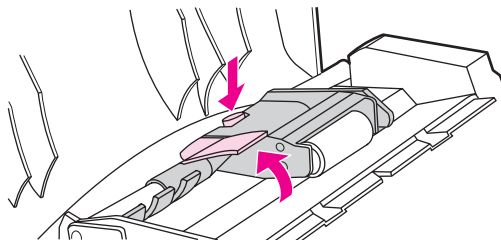

4. Remove the old assembly and put the new one in exactly the same place. The largest roller goes in back, and the gear side is away from you.

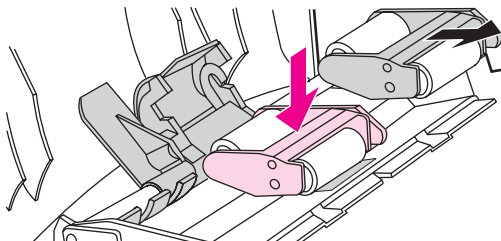

5. Lower the green lever so that the flat green part fits between the rollers. Press down on the green lever until you hear it snap into place.

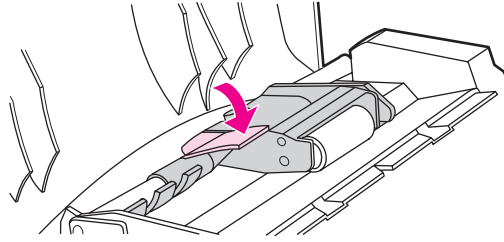

6. To check for proper installation, lift the green lever until it remains open. The new pickup roller assembly should be secured to the lever assembly and should not fall out.

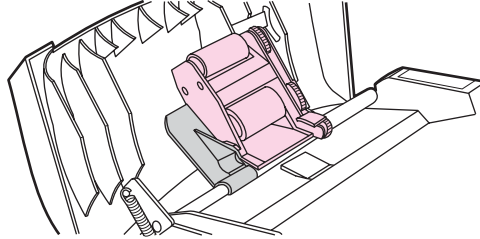

7. Make sure that both sides of the assembly are secured by the green hooks.

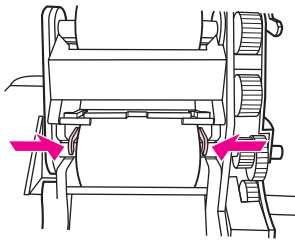

8. Lower the green lever assembly and close the ADF lid. Reinstall the input tray.

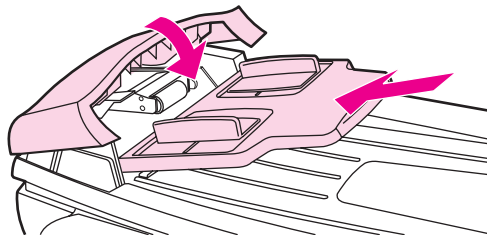

Note

If you are experiencing jams in the ADF, you might want to order a new ADF. See [Installing an ADF](#).

9. Plug the device in, and turn on the power switch.

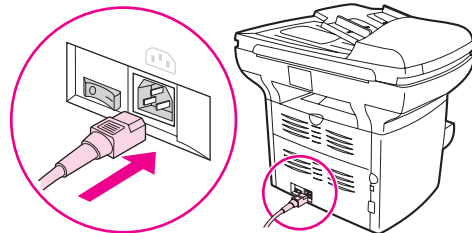

Removing and replacing the device control panel cover

1. Turn off the device and unplug the power cord.

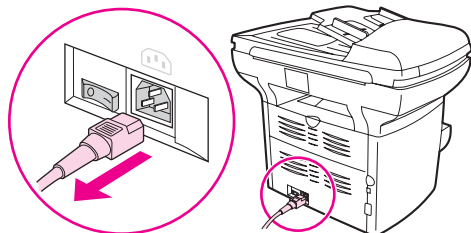

2. Remove the existing device control panel cover by lifting up on both sides of the cover edges until all of the snaps are disengaged. Set the old cover aside.

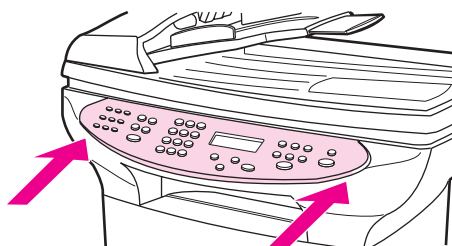

CAUTION

Be careful not to touch any components or buttons inside the exposed device control panel area.

3. Align the new device control panel cover at the lower notch. The cover notch should align with the inside of the device.

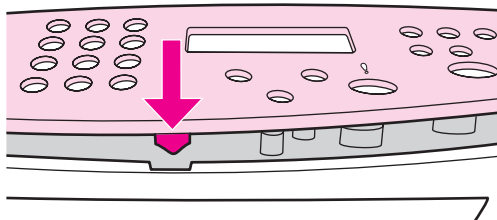

4. Press down until all the snaps are engaged, and then press outward until the device control panel cover is secured.

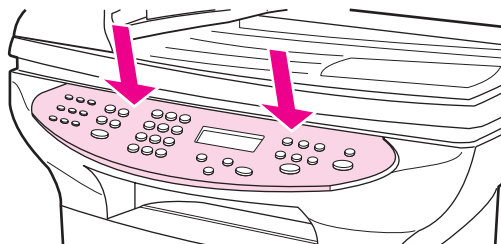

5. Plug the device in, and turn on the power switch.

8

Troubleshooting

Use this section to find tips for solving problems with the device.

- [Device does not turn on](#)
- [Pages print but are totally blank](#)
- [Pages did not print](#)
- [Pages printed, but a problem exists](#)
- [Onscreen error messages appear](#)
- [Paper-handling problems exist](#)
- [Printed page is different from what appears onscreen](#)
- [Media jams occur in the printer](#)
- [Print quality is unacceptable](#)
- [Device control panel error messages appear](#)
- [No copy came out](#)
- [Copies are blank, or images are missing or faded](#)
- [Copy quality is unacceptable](#)
- [Media jams occur in the automatic document feeder \(ADF\)](#)
- [Copy defects are apparent](#)
- [Scanned image is of poor quality](#)
- [Part of the image did not scan](#)
- [The scan takes too long](#)
- [Error messages appear](#)
- [The scanner did nothing](#)
- [Scan quality is unacceptable](#)

Note

Many of the functions that are described in this chapter also can be performed by using the HP toolbox. For instructions about using the HP toolbox, see [Changing the settings by using the hp toolbox or the device control panel](#).

Device does not turn on

Try the tips in this section if the device does not turn on.

Is power reaching the device?

- If you are using a power strip, make sure that the power strip is turned on. Or, try plugging the device directly into the power outlet.
- Test the power outlet to make sure that it is working.
- If you have plugged the device into a switched outlet, make sure that the switch is on.
- Make sure that the power is turned on.

WARNING!

If the problem persists after you try the preceding remedies, the device might be experiencing a mechanical failure. Unplug the device from the power outlet and contact HP. See the support flyer that came with the device for information about contacting HP.

Pages print but are totally blank

Try the tips in this section if pages exit the device, but have nothing printed on them.

Is the sealing tape still in the print cartridge?

The sealing tape might still be in the print cartridge. Remove the print cartridge and pull out the sealing tape. Reinstall the print cartridge. Try printing the document again.

Does the document contain blank pages?

The document might contain blank pages. Check the document that you are printing to see if content appears on all of the pages.

Does the configuration page print?

To check the device, print a configuration page. See [Printing a configuration page](#) for instructions.

Is the original loaded correctly?

If you are making a copy, the original might be loaded incorrectly. The original must be loaded into the automatic document feeder (ADF) with the print-side facing up. If the original is loaded print-side down, the copy prints out blank.

Pages did not print

Try these tips when the device does not print any pages.

Does a message appear on your computer screen?

See [Onscreen error messages appear](#) for more information.

Is media being pulled into the device correctly?

See [Paper-handling problems exist](#) for more information.

Are media jams present?

See [Media jams occur in the automatic document feeder \(ADF\)](#) or [Media jams occur in the printer](#) for more information.

Is the parallel or USB Device Cable (A/B) working, and is it connected correctly?

The parallel or USB Device Cable (A/B) might be defective. Try the following remedies:

- Disconnect the parallel or USB Device Cable (A/B) at both ends and reconnect it.
- Try printing a job that has printed in the past.
- Try using a different IEEE 1284-B-compliant parallel cable or USB Device Cable (A/B). See [Ordering HP parts and accessories](#).
- Contact the manufacturer of your computer about changing parallel port settings to an extended capabilities port (ECP) mode.

Are other devices running on your computer?

- The device might not share a parallel port. If you have an external hard drive or network switchbox that is connected to the same port as the device, the other device might be interfering. To connect and use the device, you must disconnect the other device or you must use two parallel ports on the computer.
- You might need to add another interface card. Hewlett-Packard strongly recommends an ECP parallel interface card.

Pages printed, but a problem exists

Try these tips when pages are printed, but a problem exists.

Is the print quality poor?

See [Print quality is unacceptable](#) for more information.

Is the printed page different from what appears onscreen?

See [Printed page is different from what appears onscreen](#) for more information.

Are the device settings appropriate for the print media?

See [Paper-handling problems exist](#) for more information.

Onscreen error messages appear

If the following messages appear onscreen, use the appropriate procedures to remedy the problem.

Printer not responding/error writing to LPT1

Check the following conditions:

- Is the device in the **Ready** state?
- Are the power cord and IEEE 1284-B-compliant parallel or USB Device Cable (A/B) correctly connected?
- Are other printer drivers installed on the computer?

Try the following remedies:

- Disconnect the power cord and the IEEE 1284-B-compliant parallel or USB Device Cable (A/B) at both ends and reconnect them.
- Use another IEEE 1284-B-compliant parallel or USB Device Cable (A/B).
- Make sure that another device or printer is not selected as the default printer.

Cannot access port (in use by another application)

A device conflict exists. This might occur if another device is installed on your computer and is running status software. The status software dominates the parallel port on the computer and denies the device access to the port.

Try the following remedies:

- Disable all of the status windows for other devices.
- Make sure that the device port setting is correct. Change the port settings on the **Details** tab or the **Ports** tab in the device properties.
- Make sure that bidirectional support is disabled. On the **Details** tab or the **Ports** tab in the device properties, make sure that the bidirectional support option is not selected.

Paper-handling problems exist

Print is skewed (crooked)

Are the media guides adjusted properly?

Remove all media from the input tray, straighten the stack, and load the media in the input tray again. Adjust the media guides to the width and length of the media that you are using and try reprinting. See [Device media specifications](#) or the start guide for more information.

More than one sheet feeds at one time

Is the media input tray too full?

See the start guide for more information.

Is the media wrinkled, folded, or damaged?

Make sure the media is not wrinkled, folded, or damaged. Try media from a new or different package.

Is the device separation pad worn?

See [Replacing the device separation pad](#) for more information.

Device does not pull media from the media input tray

Is the device in manual feed mode?

Try one of the following:

- If **Manual feed** appears on the device control panel display, press **MENU/ENTER** to print the job.
- Make sure that the device is not in manual feed mode and print your job again.

Is the pickup roller dirty or damaged?

Clean or replace the pickup roller and print your job again. See [Cleaning the pickup roller](#) or [Replacing the pickup roller](#) for instructions.

Media curls when fed through device

- Open the straight-through output door to print straight through.
- See [Curl or wave](#) for more information.

Printed page is different from what appears onscreen

Try the tips in this section when what is printed on the page differs from what appears onscreen.

Is the text garbled, incorrect, or incomplete?

To verify that the device is functioning, print a configuration page . See [Printing a configuration page](#) for instructions. If the configuration page prints successfully, try the following:

- Disconnect the cable and reconnect it at both ends.
- Try printing a job that has printed correctly in the past.
- If possible, attach the cable and device to another computer, and then try printing a job that you know has printed correctly.
- Try using a new IEEE 1284-B-compliant parallel or USB Device Cable (A/B). See [Ordering HP parts and accessories](#) for information.
- The wrong printer driver might have been selected when the software was installed. Make sure that the device is selected in the device properties.
- A problem might exist with your software program. Try printing from another software program.

Are graphics or text missing? Are there blank pages?

- Make sure that the document does not contain blank pages.
- The sealing tape might still be in the print cartridge. Remove the print cartridge, and pull out the sealing tape.
- Reinstall the print cartridge. See the start guide for instructions.
- To check the device, print a configuration page. See [Printing a configuration page](#) for instructions.
- The graphic settings in the device properties might not be correct for the type of job that you are printing. Try a different graphic setting in the device properties. See [Changing print settings](#) for more information.
- The printer driver might not work for the type of job that you are printing. Try using a different printer driver.

Note

If you use a different printer driver, some device features might not be available.

Is the page format different from the format on another printer?

If you used an older or different printer driver (printer software) to create the document or the device properties settings in the software are different, the page format might change when you try to print using your new printer driver or settings. To help eliminate this problem, try the following remedies:

- Create documents and print them using the same printer driver (printer software) and device properties settings regardless of which HP LaserJet device you use to print the documents.
- Change the resolution, media size, font settings, and other settings. See [Changing print settings](#) for more information.

Is graphics quality poor?

The graphics settings might be unsuitable for your print job. Try the following:

- Check the graphic settings, such as resolution, in the device properties and adjust them as necessary. See [Changing print settings](#) for more information.
- Try using a different printer driver (printer software).

Note

If you use a different printer driver, some device features might not be available.

Media jams occur in the printer

Occasionally, media becomes jammed during a print job. Try the following remedies before you attempt to clear the jam:

- Make sure that you are printing with media that meets specifications. See [Device media specifications](#) for more information.
- Make sure that you are printing with media that is not wrinkled, folded, or damaged.
- Make sure that the device is clean. See [Cleaning the media path](#) for more information.
- Make sure that the input trays are loaded properly and are not too full. See the getting started guide for information about loading input trays.
- If you are printing to the straight-through output path, close and open the door again to make sure that the green pressure release levers are closed.

To clear a media jam

CAUTION

Media jams might result in loose toner on the page. If you get any toner on your clothes, wash them in cold water. Hot water will permanently set the toner into the fabric. If you get any toner on your hands, wash them in cold water.

Do not use a sharp object, such as a pencil or scissors, to remove jammed media.

1. Open the print cartridge door and the straight-through output door.

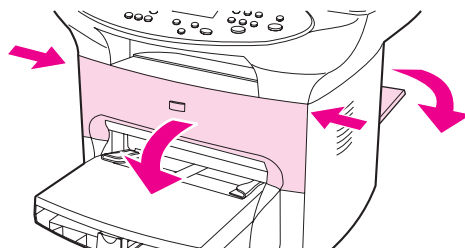

2. Rotate the green pressure release levers at the back of the device downward. If you can remove the media from the front of the device without removing the print cartridge, do so, and continue with step 4.

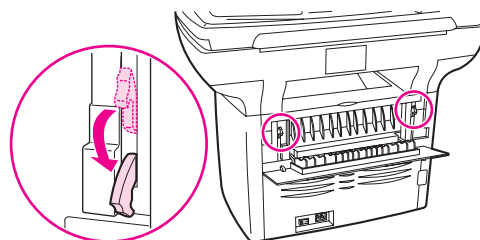

3. Grasp the handle on the print cartridge, remove the print cartridge, and set it aside.

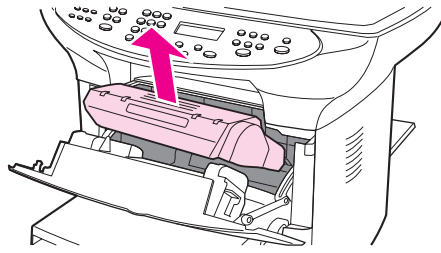

CAUTION

To prevent damage to the print cartridge, do not expose it to light any longer than necessary. Place the print cartridge in a paper bag or other opaque container until you can place it back in the device.

4. With both hands, grasp the side of the media that is most visible (this includes the middle), and carefully pull it free from the device.

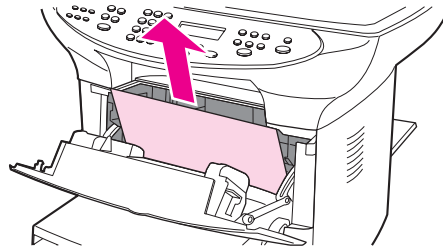

5. When you have removed the jammed media, replace the print cartridge, and close the print cartridge door and the straight-through output door.

Note

The pressure release levers automatically close when you close the straight-through output door.

6. After clearing a media jam, you might need to turn the device off, and then turn it on again.

Note

When you add new media, remove all of the media from the input tray, straighten the stack after adding the new media, and then place the stack in the tray.

To clear other media jams

CAUTION

Do not use a sharp object, such as a pencil or scissors, to remove jammed media.

If the media has crumpled and jammed in the back of the device, open the straight-through output door. Gently pull the media out of the rollers. Close the straight-through output door.

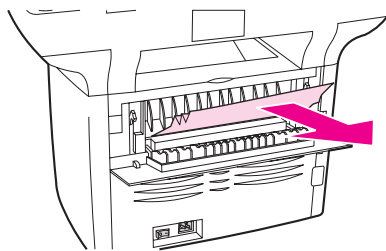

If the media has jammed where it exits the device, grasp the leading edge of the media and pull the media out through the output bin.

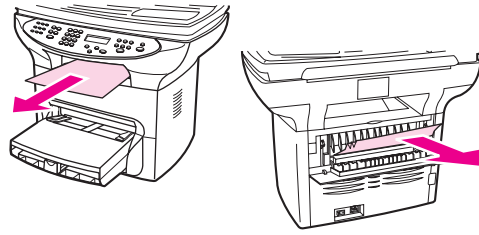

Note

If you turned the device off before clearing the media jam, turn it on again, and then resend the printing or copying job.

If the media has jammed in the automatic document feeder (ADF), see [Media jams occur in the automatic document feeder \(ADF\)](#).

Tips to avoid media jams

- Make sure that the input tray is not overfilled. The input tray capacity varies depending on the type of media that you are using.
- Check that the input tray is securely in place.
- Do not add media to the input tray while the device is printing.
- Use only HP-recommended media types. See [Device media specifications](#) for more information about media types.
- Do not let media stack up in the output bin. The media type and the amount of toner used affect the output bin capacity.

Print quality is unacceptable

This section provides information about identifying and correcting print defects.

Note

Check the power connection. Make sure that the power cord is firmly connected to both the device and the power supply box. Plug the power cord into a grounded AC power outlet.

Hewlett-Packard does not recommend the use of uninterruptible power supply (UPS) battery-backup devices or surge suppressors with this device. Many surge suppressors and battery-backups can cause print defects.

Light print or fade

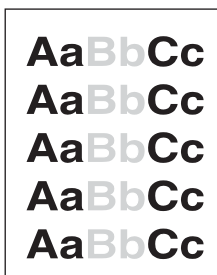

- The toner supply is low. See [HP LaserJet print cartridges](#) for more information.
- The media might not meet Hewlett-Packard media specifications (for example, the media is too moist or too rough). See [Device media specifications](#) for more information. If the whole page is light, the print density adjustment is too light or EconoMode might be turned on. Adjust the print density and turn off EconoMode in the device properties. See [Saving toner](#) for more information.

Toner specks

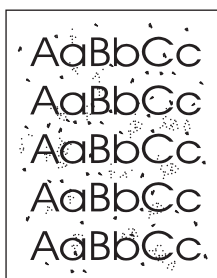

- The media might not meet Hewlett-Packard media specifications (for example, the media is too moist or too rough). See [Device media specifications](#) for more information.
- The device might need to be cleaned. See [Cleaning the media path](#) for instructions.

Dropouts

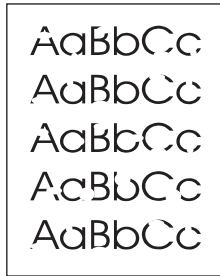

- A single sheet of media might be defective. Try reprinting the job.
- The moisture content of the media is uneven or the media has moist spots on the surface. Try printing on different media. See [Device media specifications](#) for more information.
- The media lot is bad. The manufacturing processes can cause some areas to reject toner. Try a different type of media.
- The print cartridge might be defective. See [HP LaserJet print cartridges](#) for more information.
- Check **Type is:** on the **Paper** tab or the **Paper/Quality** tab of the printer driver (the **Paper Type/Quality** tab for some Macintosh drivers), and make sure that it is set to the appropriate media. See [Optimizing print quality for media types](#) for more information.

Note

If these steps do not correct the problem, contact an HP-authorized dealer or service representative. See the support flyer that came with your device for information about contacting HP.

Vertical lines

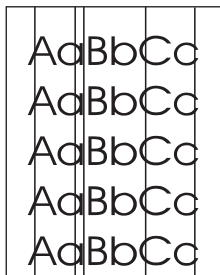

- Make sure that the priority input tray is in place.
- The photosensitive drum inside the print cartridge might be scratched. Try installing a new HP print cartridge. See the start guide for instructions.

Gray background



- Make sure that the priority input tray is in place.
- Decrease the print density setting by using the HP toolbox. This decreases the amount of background shading. See the device software Help for more information.
- Change the media to a lighter basis weight. See [Device media specifications](#) for more information.
- Check the device environment. Very dry (low humidity) conditions can increase the amount of background shading.
- Install a new HP print cartridge. See the start guide for instructions.

Toner smear

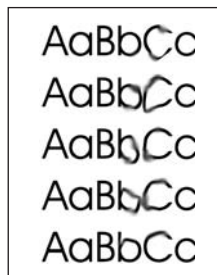

- The fuser temperature might be too low. Check **Type is:** on the **Paper** tab or the **Paper/Quality** tab of the printer driver (the **Paper Type/Quality** tab for some Macintosh drivers), and make sure that it is set to the appropriate media. See [Optimizing print quality for media types](#) for more information.
- If toner smears appear on the leading edge of the media, the media guides might be dirty. Wipe the media guides with a dry, lint-free cloth. See [Cleaning the media path](#) for more information.
- Check the media type and quality.
- Try installing a new HP print cartridge. See the start guide for instructions.

Loose toner

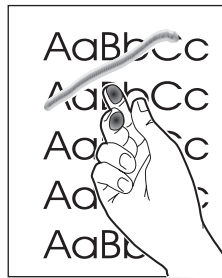

- Check **Type is:** on the **Paper** tab or the **Paper/Quality** tab of the printer driver (the **Paper Type/Quality** tab for some Macintosh drivers), and select the media that you are using. See [Optimizing print quality for media types](#) for instructions. This feature is also available in the HP toolbox.
- Clean the inside of the device. See [Cleaning and maintenance](#) for instructions.
- Check the media type and quality. See [Device media specifications](#) for more information.
- Try installing a new HP print cartridge. See the start guide for instructions.
- Plug the device directly into an alternating current (AC) outlet instead of into a power strip.

Vertical repetitive defects



- The print cartridge might be damaged. If a repetitive mark occurs at the same spot on the page, install a new HP print cartridge. See the start guide for instructions.
- The internal parts might have toner on them. See [Cleaning and maintenance](#) for more information. If the defects occur on the back of the page, the problem will probably correct itself after a few more pages are printed.
- Check **Type is:** on the **Paper** tab or the **Paper/Quality** tab of the printer driver (the **Paper Type/Quality** tab for some Macintosh drivers), and select the media that you are using. See [Optimizing print quality for media types](#) for more information. This feature is also available in the HP toolbox.

Misformed characters

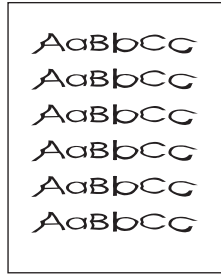

- If characters are improperly formed, producing hollow images, the print media that you are using might be too slick. Try a different media. See [Device media specifications](#) for more information.
- If characters are improperly formed, producing a wavy effect, the device might need service. Print a configuration page. See [Printing a configuration page](#) for more information.
- If the characters are improperly formed, contact an HP-authorized dealer or service representative. See the support flyer that came with your device for more information about contacting HP.

Page skew

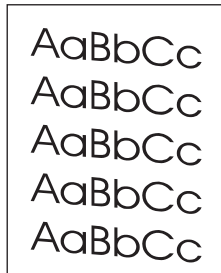

- Make sure that the media is loaded correctly and that the media guides are not too tight or too loose against the media stack. See the start guide for information about loading input trays.
- The automatic document feeder (ADF) input tray might be too full. See the start guide for information about loading input trays.
- Check the media type and quality. See [Device media specifications](#) for more information.

Curl or wave

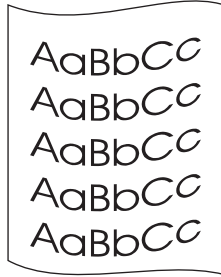

- Check the media type and quality. Both high temperature and humidity can cause media to curl. See [Device media specifications](#) for more information.
- The media might have been in the input tray for a long time. Turn over the stack of media in the input tray. Also, try rotating the media 180° in the input tray.
- Open the straight-through output door and try printing by using the straight-through media path.
- The fuser temperature might be too high. See [Optimizing print quality for media types](#) for instructions. This feature is also available in the HP toolbox.

You can also adjust the fuser temperature using the device control panel. The **Less paper curl** setting in the **Service** menu sets the fuser temperature to the lowest setting. The factory-set default is **Off**. Use the following instructions to turn this setting on.

1. On the device control panel, press **MENU/ENTER**.
2. Use the **<** or the **>** button to select **Service**, and then press **MENU/ENTER**.
3. Use the **<** or the **>** button to select **Less paper curl**, and then press **MENU/ENTER**.

Wrinkles or creases

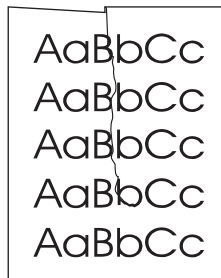

- Make sure that the media is loaded properly. See the start guide for information about loading input trays.
- Check the media type and quality. See [Device media specifications](#) for more information.
- Open the straight-through output door and try printing by using the straight-through media path.
- Turn over the stack of media in the tray. Also, try rotating the media 180° in the input tray.

Toner scatter outline

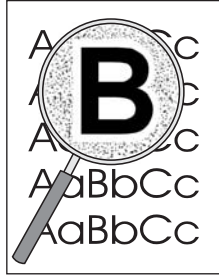

- If large amounts of toner have scattered around the characters, the media might be resisting the toner. (A small amount of toner scatter is normal for laser printing.) Try a different media type. See [Device media specifications](#) for more information.
- Turn over the stack of media in the tray.
- Use media that is designed for laser printers. See [Device media specifications](#) for more information.

Device control panel error messages appear

This section contains information about error messages that can appear on the device control panel display, and how to clear them.

Resolving common error messages

The following messages are the most common error messages that can appear on the device control panel display.

Door open or no print cartridge

The print cartridge door is open or no print cartridge has been installed. Make sure that you have correctly installed the print cartridge in the device. For information about installing the print cartridge, see the start guide.

After you have checked the print cartridge, close the print cartridge door securely.

When the problem is solved, the device either completes the current job or returns to the **Ready** state.

Printer tray is empty. Add paper

The device is out of print media. Load media into the media input tray or the priority input tray. For information about loading media into the input trays, see the start guide.

If media is already loaded, remove the stack of media, check for and clear any media jams, and reload the input tray.

When the problem is solved, the device either completes the current job or returns to the **Ready** state.

Critical error messages

When a critical error occurs, the current copying or scanning job stops and one of the following messages appears on the device control panel:

- **50 Fuser Error**
- **51 Laser Error**
- **52 Scanner Error**
- **57 Fan Error**
- **79 Error**
- **CCD Scanner Error**
- **Scanner Bulb failure**

If one of these messages appears on the device control panel display, the device is experiencing a critical device error. Unplug the device for five minutes, and then plug it back in. If the error persists, contact HP customer service at the number provided on the support flyer included with the device, or visit <http://www.hp.com>.

Alert messages

Alert messages indicate that some action must be performed, such as adding print media or clearing a jam. When an alert message appears, the device automatically stops the current task and does not proceed until someone attends to the situation. After you correct the error, the device either completes the task or returns to the **Ready** state. The exception to this is when you want to use the main menus system. Then the device changes the display so that you can use the menus system.

The following messages are generic alert messages that might appear on the device control panel display:

- **Doc feeder jam**
Clear, Reload
- **Document feeder**
mispick. Reload
- **Door open or no**
print cartridge
- **Manual feed**
Press [enter]
- **Memory is low**
Press [enter]
- **No paper pickup**
[enter] to continue
- **No print**
cartridge
- **Printer jam**
Clear paper path
- **Printer tray is**
empty. Add paper

Note

See [Media jams occur in the automatic document feeder \(ADF\)](#) or [Media jams occur in the printer](#) for more information about media jams.

Warning messages

Warning messages are important enough to warrant notification. They are of short duration, but the condition that they describe might affect the completion of the task or the quality of the output. When a warning message appears, the active job might be canceled. The message appears on the device control panel display for five seconds.

The following messages are generic warning messages that might appear on the device control panel display:

- **Device error**
[enter] to cont.
- **Device is busy**
Try again later
- **Engine comm.**
error
- **Memory is low**
Try again later
- **Page too complex**
[enter] to cont.
- **Settings cleared**

If a warning message is related to a printing task and the auto continue setting is on, then the message appears for 10 seconds. If you do not press **MENU/ENTER** or **CANCEL**, the device continues processing the print job. If the auto continue setting is off, then the print-related warning message appears until you either press **MENU/ENTER** to proceed, or press **CANCEL** to cancel the job.

Note

The auto continue setting is available in the printer driver and the HP toolbox. To find out whether the auto continue setting is turned on, print a configuration page. See [Printing a configuration page](#) for more information.

No copy came out

Is media loaded in the input tray?

Load media in the device. See the start guide for more information.

Is the original loaded correctly?

Make sure that the original is loaded correctly:

- **Automatic document feeder (ADF) input tray:** The original should be loaded top down in the ADF input tray, with the side to be copied facing up. Insert the original into the ADF until it stops. See [Loading originals to scan](#) for more information.
- **Flatbed scanner:** Place the original document face-down on the flatbed scanner with the top, left corner of the document at the lower-right corner of the glass.

Copies are blank, or images are missing or faded

Has the sealing tape been removed from the print cartridge?

The sealing tape might not have been removed from the print cartridge. Remove the print cartridge from the device, pull out the sealing tape, and reinstall the print cartridge. See the start guide for information about installing a print cartridge.

Is the print cartridge low on toner?

If the print cartridge is low on toner, the copies appear faded.

Is the original of poor quality?

The accuracy of the copy depends on the quality and size of the original. If your original is too light, the copy might not be able to compensate, even if you adjust the contrast.

Does the original have a colored background?

Colored backgrounds might cause images in the foreground to blend into the background, or the background might appear in a different shade.

Copy quality is unacceptable

This section provides information about the following topics:

- Preventing problems
- Identifying and correcting copy/scan defects

Preventing problems

The following are a few simple steps you can take to improve copy quality:

- Copy from the flatbed scanner. This will produce a higher quality copy than copying from the ADF.
- Use quality originals.
- Load the media correctly. If the media is loaded incorrectly, it might skew, causing unclear images and problems with the OCR application. See the start guide for instructions.
- Open or close the straight-through output door on the device to accommodate the copy job. If you are copying to standard-weight media, use the output bin (door closed). If you are copying to heavy media, use the straight-through media path (door open).
- If your device frequently feeds more than one page at a time, replace the separation pad. For more information, see [Replacing the device separation pad](#).
- Use or make a carrier sheet to protect your originals.

Note

Recurring feed problems indicate the copier/separation pad is worn. See [Ordering HP parts and accessories](#) to order a new separation pad. See [Replacing the device separation pad](#) for more information about replacing the separation pad.

Media jams occur in the automatic document feeder (ADF)

Occasionally, media becomes jammed during a copy, scan, or fax job.

You are notified of a media jam by a software error message and the **Doc feeder jam Clear, Reload** message that appears on the device control panel display.

- The ADF input tray is loaded incorrectly or is too full. See [Loading originals to scan](#) for more information.
- The media does not meet HP specifications. See [Selecting media for the automatic document feeder \(ADF\)](#) for more information.

Typical automatic document feeder (ADF) jam locations

- Input tray areas: If the page is sticking out of the input tray, try to remove it gently from the input tray without tearing the page. If you feel resistance, see [To clear a media jam from the automatic document feeder \(ADF\)](#) for instructions.
- Output paths: If the page is sticking out of the output bin, try to remove it gently without tearing the page. If you feel resistance, see [To clear a media jam from the automatic document feeder \(ADF\)](#) for instructions.
- Intermediate location: If the page is sticking out of both the input tray and into the output area, see [To clear a media jam from the automatic document feeder \(ADF\)](#) for instructions.

To clear a media jam from the automatic document feeder (ADF)

1. Remove the ADF input tray and open the ADF cover.

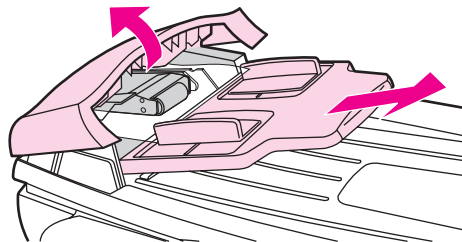

2. Remove the jam cleanout part. Using both hands, lift up on the two handles until the part unsnaps. Rotate and lift out the cleanout part and set it aside.

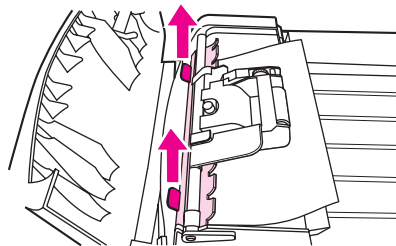

3. Lifting the green lever, rotate the pick mechanism until it stays open.

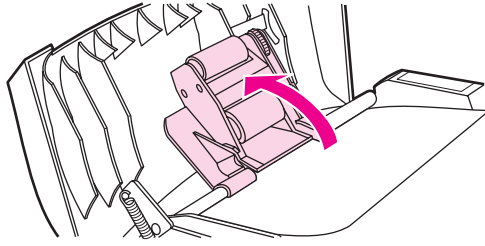

4. Gently try to remove the page without tearing it. If you feel resistance, go to the next step.

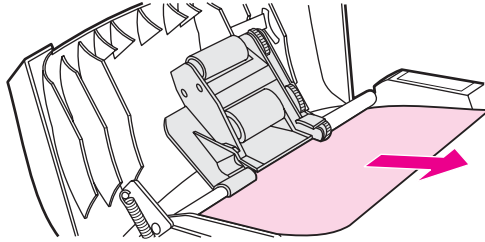

5. Open the ADF lid and gently loosen the media by using both hands.

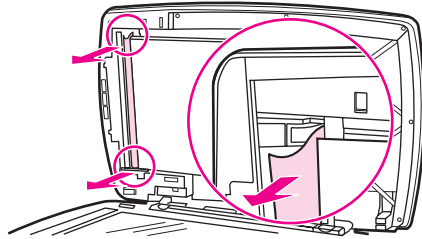

6. When the media is free, gently pull it out in the direction shown.

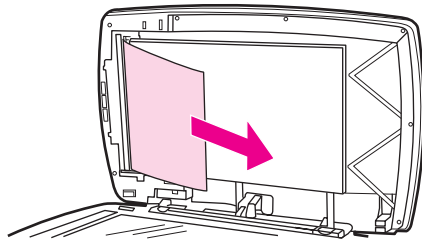

7. Close the lid to the flatbed scanner.

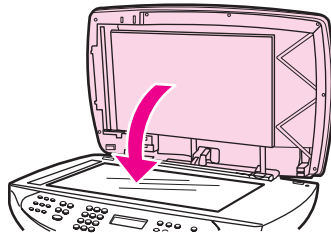

- Lower the green lever.

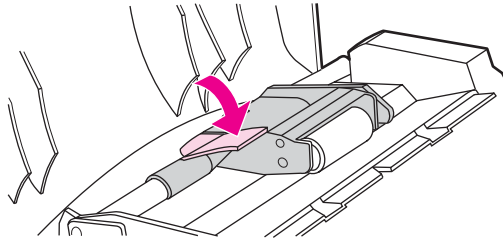

- Reinstall the cleanout part by inserting it as shown. Push down on the two tabs until the part snaps into place. Install the cleanout part correctly, because future jamming might occur if the cleanout part is not replaced correctly.

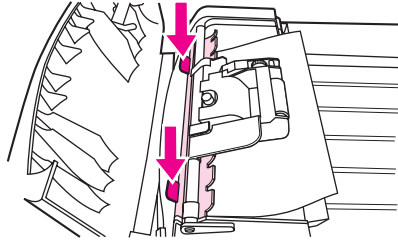

- Close the ADF lid and replace the ADF input tray.

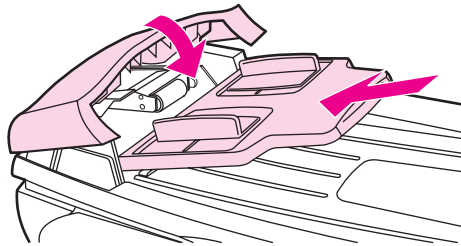

Copy defects are apparent

Vertical white or faded stripes

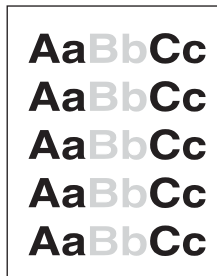

- The media might not meet Hewlett-Packard media specifications (for example, the media is too moist or too rough). See [Device media specifications](#) for more information.
- The toner might be low. See the start guide for information about installing a print cartridge.

Blank pages

- The original might have been loaded upside down. In the automatic document feeder (ADF), load the original with the narrow side forward and the side to be scanned facing up. See [Loading originals to scan](#) for instructions.
- If blank pages are printing when you scan from the flatbed scanner, make sure that the original document is loaded correctly. Place the original document face-down on the flatbed scanner with the upper-left corner of the document at the lower-right corner of the glass.
- Make sure that the automatic document feeder (ADF) is empty.
- The media might not meet Hewlett-Packard media specifications (for example, the media is too moist or too rough). See [Device media specifications](#) for more information.
- The toner might be out. See the start guide for information about installing a print cartridge.
- The tape might not have been removed from the print cartridge. See the start guide for information about installing a print cartridge.

Wrong original was copied

- Make sure that the automatic document feeder (ADF) is empty.

Too light or dark

- Try adjusting the settings.
- Make sure that the copy-quality settings are correct. See [Adjusting the copy quality](#) for more information.

Unwanted lines

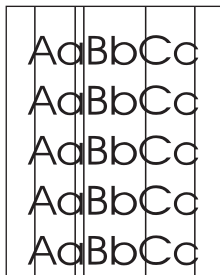

- Make sure that the priority input tray is in place.
- Try cleaning the flatbed scanner. See [Cleaning the outside of the device](#) for instructions.
- The photosensitive drum inside the print cartridge might be scratched. Install a new HP print cartridge. See the start guide for information about installing a print cartridge.

Black dots or streaks

- Ink, glue, correction fluid, or another unwanted substance might be on the automatic document feeder (ADF) or flatbed scanner. Try cleaning the device. See [Cleaning the outside of the device](#) for instructions.

Unclear text

- Try adjusting the settings.
- Make sure that the copy-quality settings are correct. See [Adjusting the copy quality](#) for more information.
- See the device software Help for more information about changing the settings.

Reduced size

- The software settings might be set to reduce the scanned image.
- See the HP toolbox Help for more information about changing the settings.

Scanned image is of poor quality

Is the original a second-generation photo or picture?

Reprinted photographs, such as those in newspapers or magazines, are printed by using tiny dots of ink that make an interpretation of the original photograph, which dramatically decreases the quality. Often, the ink dots form unwanted patterns that can be detected when the image is scanned, printed, or appears onscreen. If the following suggestions do not solve your problem, you might need to use a better-quality version of the original.

- To eliminate the patterns, try reducing the size of the image after scanning.
- Print the scanned image to see if the quality is better.
- Make sure that your resolution and color settings are correct for the type of scan job that you are performing. See [Scanner resolution and color](#) for more information.
- For best results, use the flatbed scanner for scanning rather than the ADF.

Is the image quality better when the document is printed?

The image that appears on the screen is not always an accurate representation of the quality of the scan.

- Try adjusting your computer monitor settings to use more colors (or levels of gray). Typically, you make this adjustment by opening **Display** on the Windows control panel.
- Try adjusting the resolution and color settings in the scanner software. See [Scanner resolution and color](#) for more information.

Is the image skewed (crooked)?

The original might have been loaded incorrectly. Be sure to use the media guides when you load the originals into the automatic document feeder (ADF). See [Loading originals to scan](#) for more information.

Does the scanned image show blotting, lines, vertical white stripes, or any other defect?

If the scanner is dirty, the image that it produces does not have optimum clarity. See [Cleaning the outside of the device](#) for instructions.

Do graphics look different from the original?

The graphics settings might not be suitable for the type of scan job that you are performing. Try changing the graphics settings. See [Scanner resolution and color](#) for more information.

Part of the image did not scan

Was the original loaded correctly?

Make sure that you loaded the original correctly. See [Loading originals to scan](#) for instructions.

Does the original have a colored background?

Colored backgrounds can cause images in the foreground to blend into the background. Try adjusting the settings before you scan the original or enhancing the image after you scan the original. See [Scanner resolution and color](#) for more information.

Are text or images on the back of a two-sided original appearing in the scan?

Two-sided originals can "bleed" text or images from the back side to the scan if the originals are printed on media that is too thin or too transparent.

Is the original longer than 381 mm (15 inches)?

The maximum scannable length is 381 mm (15 inches) when you use the automatic document feeder (ADF). If the page exceeds the maximum length, the scanner stops. (Copies can be longer.)

CAUTION

Do not try to pull the original from the document feeder (ADF); you might damage the scanner or your original. See [Media jams occur in the automatic document feeder \(ADF\)](#) for instructions.

Is the original too small?

The minimum size that the flatbed scanner supports is 25 by 25 mm (1 by 1 inches). The minimum size that the document feeder (ADF) supports is 127 by 127 mm (5 by 5 inches). The original might be jammed. See [Media jams occur in the automatic document feeder \(ADF\)](#) for instructions.

Are you using HP Director? (Macintosh only)

Your default property settings for HP Director might be set to automatically perform a specific task other than the one that you are attempting. See the device software Help for instructions about changing the properties in HP Director.

Is the media size correct?

In Scan settings, make sure that the input media size is large enough for the document that you are scanning. See [Scanner resolution and color](#) for more information.

The scan takes too long

Is your resolution or color level set too high?

If you set the resolution and color level too high, the scan job takes longer and results in larger files. To obtain good results when scanning or copying, it is important that you use the correct resolution and color level settings for your job. See [Scanner resolution and color](#) for more information.

Is your software set to scan in color?

The system default is color, which takes longer to scan even when scanning a monochrome original. If you acquire an image through TWAIN or WIA, you can change the settings so that the original scans in grayscale or black-and-white. See the device software Help for details.

Did you send a print job or copy job before you tried to scan?

If you sent a print job or copy job before you tried to scan, the scan will start if the scanner is not busy. However, the printer and scanner share memory, which means that the scan might be slower.

Is your computer set for bidirectional communication?

See the documentation that came with your computer to change the basic input/output settings (BIOS). The recommended bidirectional setting for the parallel port is ECP. The USB connection is always bidirectional.

Error messages appear

If one of the following messages appears on the screen, use this information to remedy the problem.

Common scanning error messages

This section describes common scanning error messages. The most common scanning error messages include the following:

- **Unable to activate TWAIN source**
- **An error occurred while acquiring the image**
- **Scanner initialization failed**
- **Error communicating with scanner**

Make sure that you have connected the USB Device Cable (A/B) or IEEE 1284-B-compliant parallel cable to the correct port on the back of your computer. If you have another port, try attaching the cable to the other port. Make sure that you have an EPP-(bidirectional) or ECP-compliant parallel port on your computer. An EPP parallel port is the minimum requirement; use of an ECP parallel port is strongly recommended. See the documentation that came with your computer for more information about your port.

Some devices might not share the parallel port with the device. If you have an external hard drive, or you have a network switchbox connected to the same USB or parallel port as the device, the other device might be interfering. To connect and use the device, you must disconnect the other device or you must use two ports on the computer. You might need to add another parallel interface card. Hewlett-Packard strongly recommends that you use an ECP parallel interface card. See the documentation that came with your computer for more information about installing an additional parallel interface card or resolving device conflicts.

Verify that the correct TWAIN source is selected. In the software, check the TWAIN source by selecting **Select Scanner** from the **File** menu.

The scanner did nothing

Is the original loaded correctly?

Make sure that the original is loaded correctly:

- **ADF input tray:** Top down in the ADF input tray, with the side to be scanned face-up. See [Loading originals into the automatic document feeder \(ADF\) input tray](#) for more information.
- **Flatbed scanner:** Place the original document face-down on the flatbed scanner with the top, left corner of the document at the lower-right corner of the glass.

Scan quality is unacceptable

This section provides information about improving scan quality by preventing or correcting problems.

Preventing problems

The following are a few simple steps you can take to improve copy and scan quality:

- Use the flatbed scanner, rather than the automatic document feeder (ADF), to scan.
- Use high-quality originals.
- Load the media correctly. If the media is loaded incorrectly, it might skew, which causes unclear images. See the start guide for instructions.
- Adjust the software settings according to how you plan to use the scanned page. See [Scanner resolution and color](#) for more information.
- If your device frequently feeds more than one page at a time, replace the separation pad. For more information, see [Replacing the device separation pad](#).
- Recurring feed problems indicate that the separation pad is worn. See [Ordering HP parts and accessories](#) to order a new separation pad. See [Replacing the device separation pad](#) for more information about replacing the separation pad.
- Use or make a carrier sheet to protect your originals.
- Clean the scanner glass.

Blank pages

- The original might have been loaded upside down. In the automatic document feeder (ADF), put the top end of the stack of originals into the ADF, with the media stack face-up and the first page to be scanned on top of the stack. See [Loading originals to scan](#) for instructions.
- If you are producing blank pages when you scan from the flatbed, make sure that the original document is loaded correctly. Place the original document face-down on the flatbed scanner with the top, left corner of the document at the lower-right corner of the glass. Also, make sure that the ADF is empty.

Too light or dark

- Try adjusting the settings.

Make sure you have the correct resolution and color settings. See [Scanner resolution and color](#) for more information.

Unwanted lines

- Ink, glue, correction fluid, or an unwanted substance might be on the glass. Try cleaning the flatbed scanner surface. See [Cleaning the outside of the device](#) for instructions.

Black dots or streaks

- Ink, glue, correction fluid, or an unwanted substance might be on the glass. Try cleaning the flatbed scanner surface. See [Cleaning the outside of the device](#) for instructions.

Unclear text

- Try adjusting the settings.

Make sure you have the correct resolution and color settings. See [Scanner resolution and color](#) for more information.

A

Specifications

See these sections for specifications information about the following:

- [HP LaserJet 3380 all-in-one](#)

Physical specifications

Product	Height	Depth	Width	Weight
HP LaserJet 3380 all-in-one	496 mm (19.5 in)	520.7 mm (20.5 in)	546.1 mm (21.5 in)	15.9 kg (35 lbs)

Environmental specifications

Category	Specification
Operating environment (the device is plugged into an AC outlet)	<ul style="list-style-type: none">• Temperature: 15° to 32.5° C (59° to 90.5° F)• Humidity: 10 percent to 80 percent relative humidity (no condensation)
Storage environment (the device is not plugged into an AC outlet)	<ul style="list-style-type: none">• Temperature: -20° to 40° C (-4° to 104° F)• Humidity: Less than 95 percent relative humidity (with no condensation)

Electrical specifications¹

Item	110-volt models	220-volt models
Power supply	110 to 127 V (+/- 10 %) 50 to 60 Hz (+/- 2 Hz)	220 to 240 V (+/- 10 %) 50 to 60 Hz (+/- 2 Hz)
Power consumption (typical)		
During printing	330 W (average)	330 W (average)
During standby	14 W (average)	14 W (average)
Power Save mode	9 W (average)	9 W (average)
Off mode	0 W (average)	0 W (average)
Heat output		
During printing	BTU/hr	BTU/hr
Minimum recommended circuit capacity	4.5 A	2.3 A

¹The values are subject to change. See <http://www.hp.com/support/lj3380> for the most current information. The power sources are not interchangeable.

Acoustic emissions¹

Activity level	Operator (<1m)	Bystander (1m)	Sound power
Active	LpAm56 dB (A)	LpAm48 dB (A)	LWAd6.1 Bels (A)
Idle	LpAmN/A dB (A) (inaudible)	LpAmN/A dB (A) (inaudible)	LWAdN/A Bels (A) (inaudible)

¹The values are subject to change. See <http://www.hp.com/support/lj3380> for the most current information. During other operations, acoustic emissions can vary.

HP LaserJet 3380 all-in-one

- [HP LaserJet 3380 all-in-one specifications](#)
- [Regulatory Information](#)

HP LaserJet 3380 all-in-one specifications

Printer capacities and ratings	
Print speed	<ul style="list-style-type: none"> • 20 pages per minute (ppm) for letter-size paper and 19 ppm for A4-size paper • First page out in less than 10 seconds
Media input tray capacity	250 sheets of regular-weight, 75-g/m ² (20-lb) paper, or up to 30 envelopes
Priority input tray capacity	10 sheets of regular-weight, 75-g/m ² (20-lb) paper, or 1 envelope
Output bin capacity	Up to 125 sheets of regular-weight, 75-g/m ² (20-lb) paper
Minimum paper size	76 by 127 mm (3 by 5 inches)
Maximum paper size	216 by 356 mm (8.5 by 14 inches)
Media weight	<ul style="list-style-type: none"> • Output bin: 60 to 105 g/m² (16 to 28 lb) • Straight-through media path: 60 to 163 g/m² (16 to 43 lb)
Base memory	4 MB of ROM/Flash and 32 MB of RAM (9 MB for the device and 23 MB available to the user)
Upgrade-memory expansion	One dual inline memory module (DIMM) slot available for a 32 or 64 MB RAM DIMM
Print resolution	1,200 dots per inch (dpi)
Duty cycle	<ul style="list-style-type: none"> • 10,000 single-sided pages per month (maximum) • 1,000 single-sided pages per month (average)
PCL (Printer Control Language)	Level 5e and 6
PostScript (PS)	Emulates Adobe PostScript® Level 2
Copier capacities and ratings	
Copy speed	Up to 20 ppm
Multiple copies	Up to 99 per job
Copy reduction or enlargement	25 percent to 400 percent
Acoustic emissions (per ISO 9296) while copying	6.6 Bel sound power level

Scanner capacities and ratings	
Margins for scanned items	3.05 mm (0.12 inch), right and left 4.06 mm (0.16 inch), top and bottom
Scanner Duty Cycle	2,000 single-sided items per month
Scan resolution	600 dpi color
Automatic document feeder (ADF) input tray specifications	
Input capacity	Up to 50 sheets of flat-60 g/m ² to 75-g/m ² (16 to 20 lb) media
Media weight	60 to 90 g/m ² (16 to 24 lb)
Media size	127 by 127 mm (5 by 5 inches) to 215.9 mm by 381 mm (8.5 by 15 inches)
Speed	Up to 14 ppm for letter-size or A4-size media
Duty cycle	1,000 pages per month
Memory specifications	
DIMMs	32 or 64 MB RAM DIMM 100 pin, 66 MHz minimum speed
Port availability	
USB	Compatible with 2.0 specifications
Parallel	<ul style="list-style-type: none"> • IEEE 1284-B level 2 device with an IEEE 1284-B receptacle • Set the host computer to ECP (enhanced capabilities mode)
Fax capabilities and ratings	
Fax transmission speed	3 seconds per page (ITU-T Test Image #1)
Right/left margins for printed pages	6.3 mm (0.25 inch)
Top/bottom margins for printed pages	5.08 mm (0.2 inch)
Fax compatibility	ITU Group 3; ECM
Fax coding schemes	MH, MR, and MMR
Modem speed	Up to 33,600 bits per second (bps)
Speed dialing	Yes
Distinctive ring detect	Yes
Fax resolution (standard)	203 by 98 dpi
Fax resolution (fine)	203 by 196 dpi
Fax resolution (superfine)	300 by 300 dpi (no halftone)
Fax resolution (photo)	300 by 300 dpi (halftone enabled)

HP LaserJet 3380 all-in-one battery

Battery material	Polycarbon Monoflouride Lithium
Battery type	Button or coin cell battery
Quantity per device	1
Weight	Approximately 1 gram
Lithium type	Solid

B

Regulatory Information

See these sections for regulatory information:

- [FCC regulations](#)
- [Telephone consumer protection act \(United States\)](#)
- [IC CS-03 requirements](#)
- [Regulatory information for the European Union countries/regions](#)
- [Safety statements](#)
- [Declaration of Conformity](#)
- [Environmental product stewardship program](#)
- [Material safety data sheets](#)

FCC regulations

This equipment has been tested and found to comply with the limits for a Class B digital device, pursuant to Part 15 of the FCC rules. These limits are designed to provide reasonable protection against harmful interference in a residential installation. This equipment generates, uses, and can radiate radio frequency energy. If not installed and used in accordance with the instructions, it may cause harmful interference to radio communications. However, there is no guarantee that interference will not occur in a particular installation. If this equipment does cause harmful interference to radio or television reception, which can be determined by turning the equipment off and on, the user is encouraged to try to correct the interference by one or more of the following measures:

- Reorient or relocate the receiving antenna.
- Increase separation between equipment and receiver.
- Connect equipment to an outlet on a circuit different from that to which the receiver is located.
- Consult your dealer or an experienced radio/TV technician.

Note

Any changes or modifications to the printer that are not expressly approved by HP could void the user's authority to operate this equipment.

Note

Use of a shielded interface cable is required to comply with the Class B limits of Part 15 of FCC rules.

FCC Part 68 Requirements (United States)

This equipment complies with FCC rules, Part 68. On the back of this equipment is a label that contains, among other information, the FCC registration number and ringer equivalence number (REN) for this equipment. If requested, this information must be provided to the telephone company. The REN is used to determine the quantity of devices which may be connected to the telephone line. Excessive RENs on the telephone line may result in the devices not ringing in response to an incoming call. In most, but not all, areas, the sum of the RENs should not exceed five (5.0). To be certain of the number of devices that may be connected to the line, as determined by the total RENs, contact the telephone company to determine the maximum REN for the calling area.

This equipment uses the following USOC jacks: RJ11C.

An FCC-compliant telephone cord and modular plug is provided with this equipment. This equipment is designed to be connected to the telephone network or premises wiring using a compatible modular jack which is Part 68 compliant. This equipment cannot be used on telephone company-provided coin service. Connection to Party Line Service is subject to state tariffs. If this equipment causes harm to the telephone network, the telephone company will notify you in advance that temporary discontinuance of service may be required. If advance notice isn't practical, the telephone company will notify the customer as soon as possible. Also, you will be advised of your right to file a complaint with the FCC if you believe it is necessary. The telephone company may make changes in its facilities, equipment, operations, or procedures that could affect the operation of the equipment. If this happens, the telephone company will provide advance notice in order for you to make the necessary modifications in order to maintain uninterrupted service. If trouble is experienced with this equipment, please see the numbers in the front of this manual for repair and (or) warranty information. If the trouble is causing harm to the telephone network, the telephone company may request you remove the equipment from the network until the problem is resolved. The following repairs can be done by the customer: Replace any original equipment that came with the product. This includes the print cartridge, the supports for trays and bins, the power cord, and the telephone cord. It is recommended that the customer install an AC surge arrester in the AC outlet to which this device is connected. This is to avoid damage to the equipment caused by local lightning strikes and other electrical surges.

Telephone consumer protection act (United States)

The Telephone Consumer Protection Act of 1991 makes it unlawful for any person to use a computer or other electronic device, including fax machines, to send any message unless such message clearly contains, in a margin at the top or bottom of each transmitted page or on the first page of the transmission, the date and time it is sent and an identification of the business, other entity, or individual sending the message and the telephone number of the sending machine or such business, other entity, or individual. (The telephone number provided cannot be a 900 number or any other number for which charges exceed local or long-distance transmission charges.) In order to program this information into your facsimile, please see the fax guide.

IC CS-03 requirements

NOTICE: The Industry Canada label identifies certified equipment. This certification means the equipment meets certain telecommunications network protective, operational, and safety requirements as prescribed in the appropriate Terminal Equipment Technical Requirement document(s). The Department does not guarantee the equipment will operate to the user's satisfaction. Before installing this equipment, users should ensure that it is permissible for the equipment to be connected to the facilities of the local telecommunications company. The equipment must also be installed using an acceptable method of connection. The customer should be aware that compliance with the above conditions may not prevent degradation of service in some situations. Repairs to certified equipment should be coordinated by a representative designated by the supplier. Any repairs or alterations made by the user to this equipment, or equipment malfunctions, may give the telecommunications company cause to request the user to disconnect the equipment. Users should ensure for their own protection that the electrical ground connections of the power utility, telephone lines, and internal metallic water pipe system, if present, are connected together. This precaution can be particularly important in rural areas.

CAUTION

Users should not attempt to make such connections themselves, but should contact the appropriate electric inspection authority, or electrician, as appropriate. The Ringer Equivalence Number (REN) of this device is 0.7.

Notice: The Ringer Equivalence Number (REN) assigned to each terminal device provides an indication of the maximum number of terminals allowed to be connected to a telephone interface. The termination on an interface may consist of any combination of devices subject only to the requirement that the sum of the Ringer Equivalence Number of all the devices does not exceed five (5.0). The standard connecting arrangement code (telephone jack type) for equipment with direct connections to the telephone network is CA11A.

Regulatory information for the European Union countries/regions

This equipment has been designed to work in all of the countries/regions of the European Economic Area (Public Switched Telephone Networks) only. Network compatibility is dependent on internal software settings. Contact your equipment supplier if it is necessary to use the equipment on a different telephone network. For further product support, contact Hewlett-Packard at the phone numbers provided in the support flyer that came with the product.

Safety statements

Laser safety statement

The Center for Devices and Radiological Health (CDRH) of the U.S. Food and Drug Administration has implemented regulations for laser products manufactured since August 1, 1976. Compliance is mandatory for products marketed in the United States. This printer is certified as a "Class 1" laser product under the U.S. Department of Health and Human Services (DHHS) Radiation Performance Standard according to the Radiation Control for Health and Safety Act of 1968. Since radiation emitted inside this printer is completely confined within protective housings and external covers, the laser beam cannot escape during any phase of normal user operation.

WARNING!

Using controls, making adjustments, or performing procedures other than those specified in this manual can result in exposure to hazardous radiation.

Canada DOC regulations

This equipment complies with Canadian EMC Class B requirements.

Conforme à la classe B des normes canadiennes de compatibilité électromagnétiques. << CEM>>.

Laser statement for Finland

LASERTURVALLISUUS

LUOKAN 1 LASERLAITE

KLASS 1 LASER APPARAT

HP LaserJet 3380 all-in-one-laserkirjoitin on käyttäjän kannalta turvallinen luokan 1 laserlaite. Normaalisessa käytössä kirjoittimen suojakotelointi estää lasersäteen pääsyn laitteen ulkopuolelle.

Laitteen turvallisuusluokka on määritetty standardin EN 60825-1:1994 + A11:1996 + A2:2001 mukaisesti.

VAROITUS!

Laitteen käyttäminen muulla kuin käyttöohjeessa mainitulla tavalla saattaa altistaa käyttäjän turvallisuusluokan 1 ylittävälle näkymättömälle lasersäteilylle.

VARNING!

Om apparaten används på annat sätt än i bruksanvisning specificerats, kan användaren utsättas för osynlig laserstrålning, som överskrider gränsen för laserklass 1.

HUOLTO

HP LaserJet 3380 all-in-one-kirjoittimen sisällä ei ole käyttäjän huollettavissa olevia kohteita. Laitteen saa avata ja huoltaa ainoastaan sen huoltamiseen koulutettu henkilö. Tällaiseksi huoltotoimenpiteeksi ei katsota väriainekasetin vaihtamista, paperiradan puhdistusta tai muita käyttäjän käsikirjassa lueteltuja, käyttäjän tehtäväksi tarkoitettuja ylläpitotoimia, jotka voidaan suorittaa ilman erikoistyökaluja.

VARO!

Mikäli kirjoittimen suojakotelo avataan, olet alttiina näkymättömälle lasersäteilylle laitteen ollessa toiminnassa. Älä katso säteeseen.

VARNING!

Om laserprinterns skyddshölje öppnas då apparaten är i funktion, utsättas användaren för osynlig laserstrålning. Betrakta ej strålen.

Tiedot laitteessa käytettävän laserdiodin säteilyominaisuuksista:

Aallonpituus 770-795 nm

Teho 5 mW

Luokan 3B laser

Korean EMI statement

사용자 안내문 (B급 기기)

이 기기는 비업무용으로 전자파장애 검정을 받은 기기로서, 주거지역에서는 물론 모든 지역에서 사용할 수 있습니다.

Australia

This equipment complies with Australian EMC requirements.

Declaration of Conformity

Declaration of Conformity

according to ISO/IEC Guide 22 and EN 45014

Manufacturer's Name: Hewlett-Packard Company
Manufacturer's Address: 11311 Chinden Boulevard
Boise, Idaho 83714-1021, U.S.A.

declares that the product

Product Name: LaserJet 3380 all-in-one
Product Number: Q2660A (Regulatory Model³: BOISB-0303-00)
Product Options: All

conforms to the following Product Specifications:

Safety: IEC 60950:1999 / EN 60950:2000
IEC 60825-1:1993 + A1:1996 + A2:2001 / EN 60825-1:1994 + A11:1996 + A2:2001 (Class 1 Laser/LED Product)
GB4943-1995

EMC: CISPR 22:1998 / EN 55022:1998 - Class B¹
EN 61000-3-2:1995 / A14:2000
EN 61000-3-3:1995
EN 55024:1998
FCC Title 47 CFR, Part 15 Class B² / ICES-003, Issue 3
GB9254-1998
Telecom: TBR-21:1998; EG 201 121:1998

Supplementary Information:

The product herewith complies with the requirements of the EMC Directive 89/336/EEC, the Low Voltage Directive 73/23/EEC, the R&TTE Directive 1995/5/EC (Annex II), and carries the CE-Marking accordingly:

¹ The product was tested in a typical configuration with Hewlett-Packard Personal Computer Systems.

² This Device complies with Part 15 of the FCC Rules. Operation is subject to the following two Conditions: (1) this device may not cause harmful interference, and (2) this device must accept any interference received, including interference that may cause undesired operation.

³ For regulatory purposes, this product is assigned a Regulatory model number. This number should not be confused with the marketing name (HP LaserJet 3380) or the product number (Q2660A).

Boise, Idaho 83713, U.S.A.

November 1, 2003

For regulatory topics only:

Australia Contact Product Regulations Manager, Hewlett-Packard Australia, Ltd. 31-41 Joseph Street, Blackburn, Victoria 3130, Australia.

European Contact Your Local Hewlett-Packard Sales and Service Office or Hewlett-Packard GmbH, Department HQ-TRE / Standards Europe, Herrenberger Strasse 140, Böblingen, D-71034, (+49-7031-14-3143)

U.S.A. Contact Product Relations Manager, Hewlett-Packard Company PO Box 15, Mail Stop 160 Boise, ID 83707-0015, U.S.A. (208-396-6000)

Environmental product stewardship program

Protecting the environment

Hewlett-Packard Company is committed to providing quality products in an environmentally sound manner. This product has been designed with several attributes to minimize impacts on our environment.

Ozone production

This product generates no appreciable ozone gas (O₃).

Energy consumption

Energy usage drops significantly while in Power Save mode, which saves natural resources and saves money without affecting the high performance of this product. This product qualifies for ENERGY STAR® (version 1.0), which is a voluntary program to encourage the development of energy-efficient office products.



ENERGY STAR® is a U.S. registered service mark of the U.S. Environmental Protection Agency. As an ENERGY STAR® Partner, Hewlett-Packard Company has determined this product meets ENERGY STAR® Guidelines (version 1.0) for energy efficiency. For more information, see <http://www.energystar.gov>.

Toner consumption

EconoMode/Toner Miser uses significantly less toner, which might extend the life of the print cartridge.

Paper use

This product's manual duplex feature (two-sided printing, see [Printing on both sides of the media \(manual duplexing\)](#)), and printing multiple pages on one page can reduce paper usage and the resulting demands on natural resources.

Plastics

Plastic parts over 25 grams are marked according to international standards that enhance the ability to identify plastics for recycling purposes at the end of the product's life.

HP LaserJet printing supplies

In many countries/regions, this product's printing supplies (for example, print cartridge, drum, fuser) can be returned to HP through the HP Printing Supplies Returns and Recycling Program. An easy to use and free takeback program is available in over 48 countries/regions. Multi-lingual program information and instructions are included in every new HP LaserJet print cartridge and consumables package.

HP printing supplies returns and recycling program information

Since 1990, the HP Printing Supplies Returns and Recycling Program has collected millions of used LaserJet print cartridges that otherwise may have been discarded in the world's landfills. The HP LaserJet print cartridges and supplies are collected and bulk shipped to our resource and recovery partners who disassemble the cartridge. After a thorough quality inspection, selected parts are reclaimed for use in new cartridges. Remaining materials are separated and converted into raw materials for use by other industries to make a variety of useful products.

U.S. returns

For a more environmentally responsible return of used cartridges and supplies, HP encourages the use of bulk returns. Simply bundle two or more cartridges together and use the single, pre-paid, pre-addressed UPS label that is supplied in the package. For more information in the U.S., call (1) (800) (340-2445) or visit the HP LaserJet Supplies website at <http://www.hp.com/recycle>.

Non-U.S. returns

Non-U.S. customers should call the local HP Sales and Service Office or visit the <http://www.hp.com/recycle> web site for further information regarding availability of the HP Supplies Returns and Recycling Program.

Paper

This product is capable of using recycled papers when the paper meets the guidelines outlined in the Print Media Guide. See [Device media specifications](#) for more information. This product is suitable for the use of recycled paper according to DIN 19309.

Material restrictions

This HP product contains mercury in the fluorescent lamp or scanner that may require special handling at end-of-life.

This HP product contains lead in solder.

This HP product contains a battery that might require special handling at end of life.

Type:	Lithium Carbon Monofluoride (solid button cell)
-------	---

Weight:	approx. 1 gram
Location:	on formatter PC board (one battery per product)
User Removable:	No

For recycling information, you can contact <http://www.hp.com/go/recycle> or contact your local authorities or the Electronics Industries Alliance: <http://www.eiae.org>.

Nederlands

Toepassing: De batterij wordt gebruikt als reserve-energiebron voor de tijd klok (die wordt gebruikt voor het faxgedeelte van het apparaat).

Locatie van de batterij: De batterij wordt bij de fabricage/distributie van het product op de formatter gesoldeerd.

Voorschriften:

- Richtlijn van de Europese Unie met betrekking tot batterijen: Deze batterij komt niet in aanmerking voor de richtlijnen.
- Bijzondere bepaling A45 voor UN-standaard: Deze batterij is een niet-gevaarlijk artikel.

Levensduur: De batterij is ontworpen om minstens even lang mee te gaan als het product.

Batterijfabrikanten: Rayovac, Madison, WI, USA; and Panasonic, Secaucus, NJ, USA.

Het ontwerp en de specificaties kunnen zonder kennisgeving worden gewijzigd.



For more information

On HP's environmental programs, including:

- Product environmental profile sheet for this and many related HP products
- HP's commitment to the environment
- HP's environmental management system
- HP's end-of-life product return and recycling program
- Material Safety Data Sheets

See: <http://www.hp.com/go/environment> or <http://www.hp.com/hpinfo/community/environment/>.

Material safety data sheets

Material Safety Data Sheets (MSDS) can be obtained by contacting the HP LaserJet Supplies web site at <http://www.hp.com/hpinfo/community/environment/productinfo/safety.htm>.



HP limited warranty statement

HP LaserJet 3380 all-in-one ONE-YEAR LIMITED WARRANTY

HP PRODUCT
HP LaserJet 3380 all-in-one

DURATION OF LIMITED WARRANTY
One year

HP warrants to you, the end-user customer, that HP hardware, accessories, and supplies will be free from defects in materials and workmanship after the date of purchase, for the period specified above. If HP receives notice of such defects during the warranty period, HP will, at its option, either repair or replace products which prove to be defective. Replacement products may be either new or equivalent in performance to new.

HP warrants to you that HP software will not fail to execute its programming instructions after the date of purchase, for the period specified above, due to defects in material and workmanship when properly installed and used. If HP receives notice of such defects during the warranty period, HP will replace software which does not execute its programming instructions due to such defects.

HP does not warrant that the operation of HP products will be uninterrupted or error free. If HP is unable, within a reasonable time, to repair or replace any product to a condition as warranted, you will be entitled to a refund of the purchase price upon prompt return of the product.

HP products may contain remanufactured parts equivalent to new in performance or may have been subject to incidental use.

Warranty does not apply to defects resulting from (a) improper or inadequate maintenance or calibration, (b) software, interfacing, parts, or supplies not supplied by HP, (c) unauthorized modification or misuse, (d) operation outside of the published environmental specifications for the product, or (e) improper site preparation or maintenance. TO THE EXTENT ALLOWED BY LOCAL LAW, THE ABOVE WARRANTIES ARE EXCLUSIVE AND NO OTHER WARRANTY OR CONDITION, WHETHER WRITTEN OR ORAL, IS EXPRESSED OR IMPLIED AND HP SPECIFICALLY DISCLAIMS ANY IMPLIED WARRANTIES OR CONDITIONS OF MERCHANTABILITY, SATISFACTORY QUALITY, AND FITNESS FOR A PARTICULAR PURPOSE. Some countries/regions, states, or provinces do not allow limitations on the duration of an implied warranty, so the above limitation or exclusion might not apply to you. This warranty gives you specific legal rights and you might also have other rights that vary from country/region to country/region, state to state, or province to province.

HP's limited warranty is valid in any country/region or locality where HP has a support presence for this product and where HP has marketed this product. The level of warranty service you receive may vary according to local standards. HP will not alter form, fit, or function of the product to make it operate in a country/region for which it was never intended to function for legal or regulatory reasons.

TO THE EXTENT ALLOWED BY LOCAL LAW, THE REMEDIES IN THIS WARRANTY STATEMENT ARE YOUR SOLE AND EXCLUSIVE REMEDIES. EXCEPT AS INDICATED ABOVE, IN NO EVENT WILL HP OR ITS SUPPLIERS BE LIABLE FOR LOSS OF DATA OR FOR DIRECT, SPECIAL, INCIDENTAL, CONSEQUENTIAL (INCLUDING LOST PROFIT OR DATA), OR OTHER DAMAGE, WHETHER BASED IN CONTRACT, TORT, OR OTHERWISE. Some countries/regions, states, or provinces do not allow the exclusion or limitation of incidental or consequential damages, so the above limitation or exclusion may not apply to you.

THE WARRANTY TERMS CONTAINED IN THIS STATEMENT, EXCEPT TO THE EXTENT LAWFULLY PERMITTED, DO NOT EXCLUDE, RESTRICT, OR MODIFY AND ARE IN ADDITION TO THE MANDATORY STATUTORY RIGHTS APPLICABLE TO THE SALE OF THIS PRODUCT TO YOU.

D

HP parts and accessories

Use the following topics to find out about ordering parts and accessories for your device:

- [Ordering HP parts and accessories](#)
- [HP LaserJet print cartridges](#)
- [DIMMs \(memory or font\)](#)

Ordering HP parts and accessories

HP parts and accessories charts

You can increase the device's capabilities with optional accessories and supplies. Use accessories and supplies designed specifically for your HP LaserJet 3380 all-in-one to ensure optimum performance.

Accessories

Product name	Description	Part number
Dual inline memory modules (DIMMs)	<ul style="list-style-type: none">• 8 MB• 16 MB• 32 MB• 64 MB	<ul style="list-style-type: none">• C7842A• C7843A• C7845A• C7846A
Cables and interface accessories	<ul style="list-style-type: none">• 2-meter IEEE-1284 parallel cable• 3-meter IEEE-1284 parallel cable• 2-meter USB Device Cable (A/B)	<ul style="list-style-type: none">• C2950A• C2951A• 8121-0539
Automatic document feeder (ADF)	If your device did not come with an ADF, use this part number to order one.	C9143A

Printing supplies

Product name	Description	Part number
HP multipurpose paper	HP brand paper for a variety of uses (1 box of 10 reams, 500 sheets each).	HPM1120
HP LaserJet paper	Premium HP brand paper for use with HP LaserJet printers (1 box of 10 reams, 500 sheets each).	HPJ1124
HP multipurpose paper	HP brand paper for a variety of uses (1 box of 10 reams, 500 sheets each).	HPM1120
HP LaserJet paper	Premium HP brand paper for use with HP LaserJet printers (1 box of 10 reams, 500 sheets each).	HPJ1124

Product name	Description	Part number
HP LaserJet transparency film	<ul style="list-style-type: none"> • HP brand transparency film for use with HP LaserJet monochrome printers. • HP brand transparency film for use with HP LaserJet monochrome printers. 	<ul style="list-style-type: none"> • 92296U (A4) • 92296T (letter)
Print cartridges	Replacement print cartridges for the HP LaserJet 3380 all-in-one. 2,500 page cartridge	C7115A
Print cartridges	Replacement print cartridges for the HP LaserJet 3380 all-in-one. 3,500 page cartridge	C7115X

Supplementary documentation

Product name	Description	Part number
Guidelines for Paper and Other Print Media	A guide to using paper and other print media with HP LaserJet printers.	5963-7863

Replacement parts

Product name	Description	Part number
Paper pickup roller	Used to pick the paper from the paper input tray and advance it through the device.	RL1-0303-000CN
Media input tray	Used to hold media for the device.	RG0-1121-000CN
Priority input tray	Used to feed special media or for printing a first page.	RG0-1122-000CN
Automatic document feeder (ADF) input tray	Used to feed documents into the scanner.	C9143-60102
Separation pad for the device	Used to keep multiple sheets from feeding through the device path.	RF0-1014-000CN
ADF pickup roller assembly	Used to pick the media from the ADF input tray and advance it through the ADF.	C7309-60068
ADF	If your ADF breaks, use this part number to order one (includes flatbed scanner lid).	C9143-60108

HP LaserJet print cartridges

This section contains the following information about HP LaserJet print cartridges:

- [HP LaserJet print cartridges](#)

HP policy on non-HP print cartridges

Hewlett-Packard Company cannot recommend the use of non-HP print cartridges, either new, refilled, or remanufactured. Because they are not HP products, HP cannot influence their design or control their quality. Service or repair required as a result of using a non-HP print cartridge will not be covered under the printer warranty.

Note

The warranty does not apply to defects resulting from software, interfacing, or parts not supplied by HP.

To install a print cartridge

For information about how to install a print cartridge, see the start guide.

Storing print cartridges

Do not remove the print cartridge from its package until you are ready to use it. Some HP LaserJet print cartridge packages are stamped with an alphanumeric date code. This code represents a 30-month period beyond the date of production in order to facilitate efficient inventory management processes between HP and its resellers. It does not serve as an indication of toner life (shelf-life) or relate in any way to warranty terms and conditions.

CAUTION

To prevent damage to the print cartridge, do not expose it to light.

Print cartridge life expectancy

The life of the print cartridge depends on the amount of toner that your print jobs require. When printing text at 5 percent coverage, the standard print cartridge (C7115A) lasts an average of 2,500 pages. The extended life print cartridge (C7115X) lasts an average of 3,500 pages. This assumes that you set the print density to 3 and turn EconoMode off (these are the default settings).

Recycling print cartridges

Since 1990, the HP Printing Supplies Returns and Recycling Program has collected millions of used LaserJet print cartridges that otherwise may have been discarded in the world's landfills. The HP LaserJet print cartridges and supplies are collected and bulk shipped to our resource and recovery partners who disassemble the cartridge. After a thorough quality inspection, selected parts are reclaimed for use in new cartridges. Remaining materials are separated and converted into raw materials for use by other industries to make a variety of useful products.

U.S. returns

For a more environmentally responsible return of used cartridges and supplies, HP encourages the use of bulk returns. Simply bundle two or more cartridges together and use the single, pre-paid, pre-addressed UPS label that is supplied in the package. For more information in the U.S., call (800) 340-2445, or visit the HP LaserJet Supplies website at <http://www.hp.com/recycle>.

Saving toner

To save toner, select the EconoMode option in your device properties settings. (For more information, see [To use EconoMode \(to save toner\)](#).) While in EconoMode (Save Toner), the device uses less toner on each page. Selecting this option extends the life of the print cartridge and reduces your cost per page, but it also reduces print quality. HP does not recommend full-time use of EconoMode. See [Print cartridge life expectancy](#) for more information.

DIMMs (memory or font)

If you add a dual inline memory module (DIMM) to the device, you can perform more complex device tasks or add additional fonts.

Use this information to manage DIMMs with the device:

- [To test a DIMM installation or removal](#)
- [To install a DIMM](#)
- [To remove a DIMM](#)

To test a DIMM installation or removal

After installing or removing a memory DIMM, you can test your work by printing a configuration page and checking the Memory Available that appears on the page. For more information, see [Printing a configuration page](#). This does not apply if you have installed a font DIMM.

To install a DIMM

CAUTION

Handling a DIMM without wearing a grounded, antistatic device might damage the DIMM. Do not touch the contacts on the side of the DIMM.

1. Turn off the device and unplug the power cord.

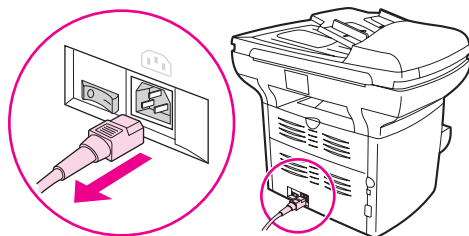

2. Open the print cartridge door and the left side panel.

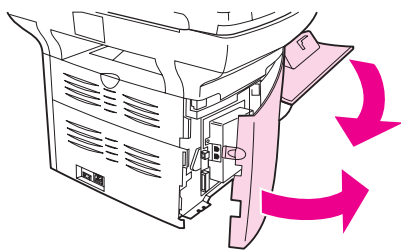

3. Remove the DIMM from the antistatic bag it came in, grasping the DIMM on the top edge.

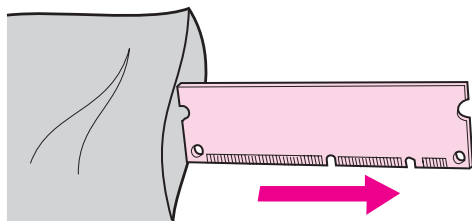

4. Position the DIMM in front of the slot located inside the left side panel. The gold contacts should be pointing toward the device and the cutouts should be at the top and bottom.

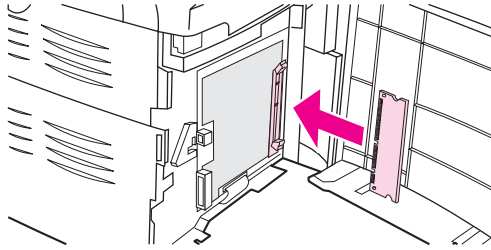

5. Carefully press the DIMM into the slot, making sure that it is straight and pushed in all the way (1). The cam latches, located at the top and bottom, should rotate inward. To snap the cam latches into place, press the handles toward each other (2).

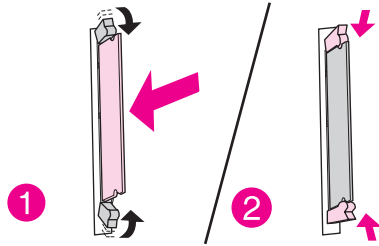

6. Close the left side panel and the print cartridge door.

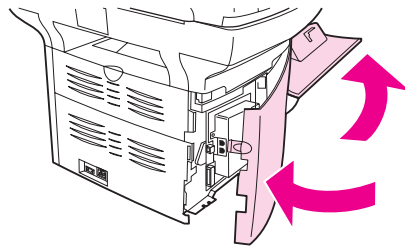

7. Plug the device in, and turn on the power switch.

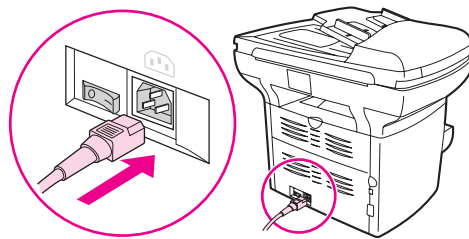

To remove a DIMM

CAUTION

Handling a DIMM without wearing a grounded, antistatic device might damage the DIMM. Do not touch the contacts on the side of the DIMM.

1. Turn off the device and unplug the power cord.

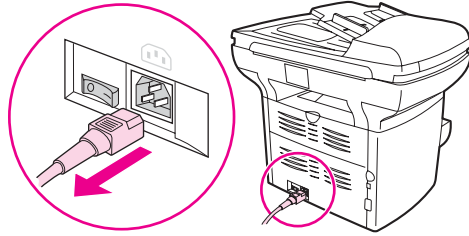

2. Open the print cartridge door and the left side panel.

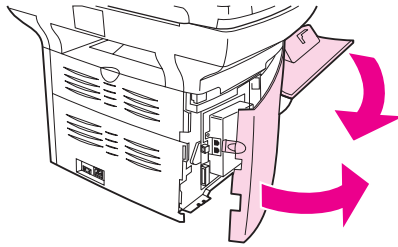

3. To unlock the cam latches, press them outward (1). Grasp the DIMM on the edge, gently pull straight out, and remove the DIMM from the device (2).

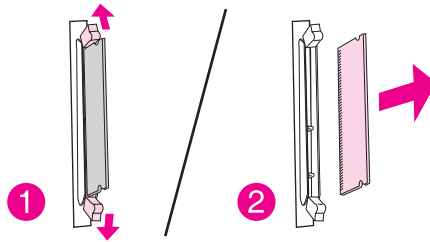

Note

Store the DIMM in an antistatic bag.

4. Close the left side panel and the print cartridge door.

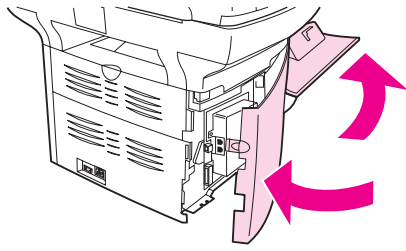

5. Plug the device in, and turn on the power switch.

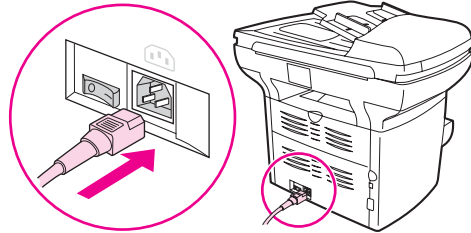

E

Service and support

Use these topics to learn about obtaining device service and support.

- [Obtaining hardware service](#)
- [Extended warranty](#)
- [Service information form](#)

Obtaining hardware service

Note

Warranty service and support options might vary depending on your country/region. For additional support information, visit <http://www.hp.com>.

To obtain hardware service

If your hardware should fail during the warranty period, HP offers the following support options:

- **HP repair services.** You can return the device to an HP repair center, depending on your location. You can also obtain telephone support by calling the appropriate telephone number listed on the support flyer that came with the device.
- **HP authorized service provider.** You can return the unit to a local authorized service dealer.

Returning the unit

When shipping equipment, HP recommends insuring it. Also, include a copy of your proof of purchase. Please also fill out the [Service information form](#) to ensure the most accurate repairs.

CAUTION

Shipping damage resulting from inadequate packaging is the customer's responsibility. See the following repackaging guidelines.

Repackaging guidelines

- If possible, print a self-test page (see [Printing a configuration page](#)) before you turn off the unit, and send the self-test report with the unit.
- Remove and retain the print cartridge.

CAUTION

Toner left in the device during shipping can damage the device.

- Include the completed copy of the service information form below. Note on the form which items were returned.
- Use the original shipping container and packaging materials, if possible.
- Include samples that illustrate the problems you are having, if applicable.
- Include five sheets of the paper or other media that are causing trouble in printing, scanning, faxing, or copying. Seal the paper or media in an airtight bag.

Extended warranty

In most countries/regions, HP CarePack provides additional—beyond standard warranty—coverage for the HP device and all HP-supplied internal components. This hardware maintenance can uplift the standard warranty (for example, from next-day to same-day service) and/or extend it up to five years. The HP CarePack can provide Express Exchange or onsite service. For more information, contact the Customer Care Service and Support group. See the support flyer that came with your device for the appropriate phone numbers and information.

Service information form

Who is returning the equipment?		Date:
Person to contact:		Phone:
Alternate contact:		Phone:
Return shipping address:		Special shipping instructions:
What is being sent?	Model number:	Serial number:
Please attach any relevant printouts when returning equipment. Do not ship accessories that are not required to complete the repair (for example, media trays, manuals, and cleaning supplies).		
What needs to be done?		
1. Describe the conditions of the failure (What was the failure? What were you doing when the failure occurred? What software were you running? Can you make the failure reoccur?).		
2. If the failure is intermittent, how much time elapses between failures?		
3. Is the unit connected to any of the following? (Please provide manufacturer and model numbers.)		
Personal Computer:	Modem:	Network:
4. Additional comments:		

Glossary

1284-B

The 1284 parallel port standard was developed by the Institute of Electrical and Electronics Engineers (IEEE). The term "1284-B" refers to a specific connector type on the end of the parallel cable that attaches to the peripheral (for example, a printer). A 1284-B connector is larger than a 1284-C connector, for example.

ADF

Automatic document feeder. The ADF is used to automatically feed originals into the device for copying, scanning, or faxing.

all-in-one

A designation given to HP devices that can perform several functions, such as printing, faxing, copying, and scanning.

browser

Short for Web browser, a software program that is used to locate and open Web pages.

collate

The process of printing a multiple-copy job in sets. When collate is selected, the device prints an entire set before printing additional copies. Otherwise, the device prints the specified number of copies of one page before printing the subsequent pages.

contrast

The difference between the dark and light areas of an image. The lower the number value, the more closely the shades resemble each other. The higher the number, the more the shades appear separate from each other.

DIMMs

Dual inline memory module, a small circuit board that holds memory. A single in-line memory module (SIMM) has a 32-bit path to the memory, whereas a DIMM has a 64-bit path.

dots per inch (dpi)

A measurement of resolution that is used for scanning and printing. Generally, more dots per inch result in a higher resolution, more visible detail in the image, and a larger file size.

dpi

See dots per inch (dpi).

EconoMode

EconoMode is a toner-saving feature on the device. EconoMode reduces the amount of toner on a printed page, so that the print cartridge lasts longer. The printed result is similar to printing a document in draft mode.

ECP

Extended capabilities port, a parallel-port standard for computers that supports bidirectional communication between the computer and attached devices (such as a printer).

e-mail (electronic mail)

An abbreviation for electronic mail. Software that can be used to electronically transmit items over a communications network.

file format

The way the contents of a file are structured by a program or group of programs.

grayscale

Shades of gray that represent light and dark portions of an image when color images are converted to grayscale; colors are represented by various shades of gray.

halftone

An image type that simulates grayscale by varying the number of dots. Highly colored areas consist of a large number of dots, while lighter areas consist of a smaller number of dots.

HP Director toolbar

Available for Macintosh only. A software screen that is used when working with documents. When the document is loaded into the automatic document feeder (ADF) and the computer is connected directly to the device, the HP Director appears on the computer screen to initiate faxing, copying, or scanning.

HP toolbox

The HP toolbox is a Web page that opens in a Web browser and provides access to the device management and troubleshooting tools, embedded Web server, and device documentation.

link

A connection to a program or device that can be used to send information from the device software to other programs, such as e-mail, electronic fax, and OCR links.

Optical Character Recognition (OCR) software

OCR software converts an electronic image of text, such as a scanned document, into a form that word processor, spreadsheet, and database programs can use.

parallel cable

See 1284-B.

printer driver

A printer driver is a program that software programs use to gain access to a device's features. A printer driver translates a software program's formatting commands (such as page breaks and font selection) into a printer language (such as PostScript or PCL), and then sends the print file to the device.

Readiris

An optical character recognition (OCR) program that was developed by I.R.I. S. and that is included with the device software.

resolution

The sharpness of an image, measured in dots per inch (dpi). The higher the dpi, the greater the resolution.

surge protector

A device that protects a power supply and communications lines from electrical surges.

TWAIN

An industry standard for scanners and software. By using a TWAIN-compliant scanner with a TWAIN-compliant program, a scan can be initiated from within the program.

URL

Uniform resource locator, the global address of documents and resources on the Internet. The first part of the address indicates what protocol to use, the second part specifies the IP address or the domain name where the resource is located.

USB (compatible with 2.0 specifications)

Universal serial bus (USB) is a standard that was developed by the USB Implementers Forum, Inc., to connect computers and peripherals. Unlike the parallel port, USB is designed to concurrently connect a single computer USB port to multiple peripherals.

watermarks

A watermark adds background text to a document that is being printed. For example, "Confidential" can be printed in the background text of a document to indicate that the document is confidential. A selection can be made from a set of predefined watermarks, and the font, size, angle, and style can be changed. The printer can place the watermark on the first page only or all pages.

WIA

Windows Imaging Architecture (WIA) is an imaging architecture that is available in Windows Me and Windows XP. A scan can be initiated from within these operating systems by using a WIA-compliant scanner.

Index

Symbols/Numerics

- 2-sided originals
 - copying 57
- 2-sided printing 38
- 300 dpi print-quality setting 22
- 600 dpi print-quality setting 22

A

- accessories and parts 158
- acoustic emissions 136, 137
- acoustic emissions while copying 137
- ADF
 - clearing jams 122
 - duty cycle 138
 - input tray 4
 - loading input tray 60
 - media specifications 8
 - ordering 158
 - ordering parts 159
 - output bin 4
 - pickup roller assembly, changing 93
 - selecting media 30
 - specifications 30, 138
- adjusting
 - contrast default for copying 52
 - contrast for current copy job 52
 - copy quality 51
 - default copy size 53
 - device control panel key-press volume 15
 - languages, device control panel display 14
 - settings 9
 - settings from the computer 20
 - volume 14
- alarm volume
 - adjusting 15
- alcohol, cleaning with 80
- alert messages 117
- Australia
 - EMC statement 149
- automatic document feeder. *See* ADF

B

- battery specifications 139
- Best Quality (ProRes 1200) print-quality setting 22
- black and white scanning 76
- black dots 126
- blank pages 99, 125

- booklets, printing 43
- books
 - copying 57
- box contents 2
- buttons on the device control panel 5

C

- Canada DOC regulations 147
- canceling
 - copy jobs 50
 - print jobs 19
 - scan jobs 65
- card stock
 - media sizes and weights 7
 - printing 37
 - specifications 28
- changing
 - device control panel display language 14
 - number of copies 56
 - print quality settings 22
 - settings from the computer 20
 - settings, default 9, 20
 - volume 14
- characters
 - dropouts 110
 - misformed 113
 - unclear 126
- cleaning
 - exterior 80
 - glass 80
 - lid backing 81
 - pickup roller 85
 - printer media path 84
- clearing jams
 - ADF 122
 - device 106
- collating copies
 - changing defaults 55
 - description 55
- color scanning 75
- components 4
- contrast
 - setting default for copying 52
 - setting for current copy job 52
- copier capacities and ratings 137
- copy contrast setting
 - adjusting default 52

- adjusting for current copy job 52
- copy quality
 - adjusting 51
 - defaults, adjusting 52
 - See *a/so* image quality, troubleshooting, copy quality
- copy quality, improving and preventing problems 121
- copying
 - acoustic emissions 137
 - adjusting default copy size 53
 - book 58, 66
 - books 57
 - canceling 50
 - changing number of copies 56
 - enlarging 53
 - loading originals 48
 - multipage stack of 2-sided originals 57
 - photos 57
 - quality, improving unacceptable 121
 - reducing 53
 - reduction and enlargement capability 137
 - speed 137
 - starting a job 50
 - troubleshooting 119, 120, 121, 125
- cover for device control panel, replacing 95
- creases, troubleshooting 114
- critical error messages 116
- curling, troubleshooting 114
- custom media
 - printing 37
- Custom print-quality setting 22
- customer support
 - form, service 170
 - hardware service 168

D

- dark copying 126
- darkness
 - setting default for copying 52
 - setting for current copy job 52
- Declaration of Conformity 147, 150
- default settings
 - adjusting 20
 - restoring 13
- device
 - scanning from 63
 - separation pad, changing 88
- device control panel
 - components 5
 - key-press volume, adjusting 15
 - languages, changing 14
 - location 4
 - messages 116
 - printing configuration page 13
 - printing menu map 13
- device control panel components
 - fax controls 5
- device control panel cover, replacing 95

- device features 3
- dimensions, device 135
- DIMM
 - installing 162
 - removing 164
 - testing installation or removal 162
- DIMMs
 - specifications 138
- documentation
 - ordering 159
- draft-quality printing 23
- drivers, printer, requirements for 20
- dropouts, character 110
- duplexing, manual 38
- duty cycle
 - ADF 138
 - device 137
 - scanner 138

E

- e-mail, scanning to 63
- EconoMode 23
- EconoMode (Save Toner) print-quality setting 22
- electrical specifications
 - device 136
- EMC statement for Australia 149
- EMI statement for Korea 148
- energy consumption 151
- ENERGY STAR 151
- enlarging
 - copies 53
- envelopes
 - media sizes and weights 7
 - printing 31
 - specifications for 27
- Environmental Product Stewardship Program 151
- environmental specifications 135
- equipment components 4
- error messages
 - computer screen 102, 130
 - device control panel 116
- European Union regulatory information 146
- Express Exchange repair service 168
- extended warranty 169

F

- factory settings
 - restoring 13
- Faster Printing (FastRes 1200) print-quality setting 22
- FastRes 1200 print-quality setting 22
- fax sounds
 - adjusting volume 15
- faxing
 - controls 5
 - margins 138
 - resolution 138
 - speed 138

- FCC regulations 142
- features 3
- feeding manually 18
- Finland laser safety 148
- folder, scanning to a 63
- forms
 - printing 36
 - service information 170

G

- glass, cleaning 80
- glossary of terms 171
- graphics
 - look different from original when scanned 127
 - poor quality 105
- graphics, missing 104
- gray backgrounds, troubleshooting 111
- grayscale scanning 76

H

- hardware components 4
- hardware service 168
- heat output 136
- height, device 135
- HP Director, scanning with 71
- HP LaserJet 3380 all-in-one
 - features 2
 - package contents 2
- HP LaserJet Fax 6
- HP LaserJet Printer Family Print Media Guide 25
- HP LaserJet Scan software, scanning with 68
- HP limited warranty statement 155
- HP repair services 168
- HP SupportPack 169
- HP toolbox 6
- humidity
 - specifications 135

I

- IC CS-03 requirements 145
- image quality, troubleshooting
 - black dots 126, 133
 - blank copies 120
 - blank pages 99, 125, 132
 - characters, misformed 113
 - curl or wave 114
 - dropouts 110
 - faded images 120
 - faded print 109
 - graphics 127
 - gray backgrounds 111
 - improving and preventing problems 121
 - light or dark print 126
 - light print 109
 - lines 110, 133
 - loose toner 112
 - missing images 120

- reduced size 126
- repeating defects 112
- skewed pages 113, 127
- smears 111
- specks 109
- streaks 126, 133
- unclear text 126
- unwanted lines 126
- vertical repetitive defects 112
- vertical white or faded stripes 125

- input tray, media
 - ordering 159
- input tray, paper
 - capacity, main 137
 - capacity, priority 137
 - illustration 4
 - media specifications 7
- installing
 - print cartridge 160

J

- jams
 - ADF, typical locations 122
 - clearing 106
 - preventing 108

K

- key-press volume
 - adjusting 15
- Korean EMI statement 148

L

- labels
 - media sizes and weights 7
 - printing 34
 - specifications for 26
- language for device control panel display
 - changing 14
- laser safety statement 147
- length, device 135
- letterhead, printing 36
- life expectancy for print cartridges 160
- light copying 126
- light print 109
- lightness
 - setting default for copying 52
 - setting for current copy job 52
- limited one-year warranty 155
- lines on copy
 - unwanted 126
- lines, telephone. See telephone lines
- loading
 - originals 48, 49, 60, 61
- loose toner, troubleshooting 112
- LPT1, error printing to 102

M

- manual duplexing
 - heavy media 39
 - lightweight media 38
- manual feed 18
- margins
 - faxing 138
- margins for scanned items 138
- material restrictions 152
- Material Safety Data Sheets (MSDS) 154
- media
 - common problems 26
 - guidelines 26
 - optimizing print quality 24
 - size, maximum 137
 - size, minimum 137
 - sizes, default adjustments 14
 - specifications 7, 25
 - weight 137
- media path, cleaning 84
- memory
 - base 137
 - DIMM 138
 - specifications 138
 - upgrade expansion 137
- messages
 - alert 117
 - critical error 116
 - warning 117
- misformed characters 113
- modem speed 138
- MSDS (Material Safety Data Sheets) 154
- multiple pages, printing on single sheet 42

N

- n-up printing 42

O

- OCR (optical character recognition)
 - software 6
 - using 74
- operating environment, specifications 135
- ordering accessories and parts 158
- output bin
 - capacity 137
 - illustration 4
- ozone production 151

P

- package contents 2
- page-by-page scanning 72
- pages
 - blank 99
 - different from what appears onscreen 104
 - different than on another printer 105
 - not printing 100
- paper

- common problems 26
- guidelines 26
- optimizing print quality 24
- size, maximum 137
- size, minimum 137
- sizes, default adjustments 14
- specifications 7, 25
- weight 137
- See *also* special media
- paper path, cleaning 84
- parallel port 4, 138
- part numbers 158
- parts and accessories 158
- path of media, cleaning 84
- PCL 5e printer driver 20
- PCL 6 printer driver 20
- phone lines. See telephone lines
- photo scanning
 - troubleshooting 127
- photos
 - copying 57
- physical specifications
 - device 135
- pickup roller
 - changing 86
 - cleaning 85
- picture scanning
 - troubleshooting 127
- port availability 138
- ports
 - cannot access 102
 - on printer 4, 138
- PostScript printer driver 20
- power problems 98
- power receptacle 4
- power specifications
 - device 136
- power switch 4
- PowerSave mode 136
- preprinted forms, printing 36
- print cartridge
 - cleaning 82
 - HP policy on non-HP print cartridges 160
 - installing 160
 - life expectancy 160
 - recycling 160
 - storing 160
- print cartridges
 - saving toner 161
- print jobs, canceling 19
- print quality
 - changing 22
 - improving unacceptable 109
 - optimizing for media types 24
- print-quality
 - understanding settings 22
- printer

- capacities and ratings 137
- drivers, requirements for 20
- media path cleaning 84
- printing
 - booklets 43
 - both sides of media 38
 - canceling 19
 - card stock 37
 - custom media 37
 - device control panel menu map 13
 - envelopes 31
 - letterhead 36
 - multiple pages on a single sheet 42
 - preprinted forms 36
 - speed 137
 - transparencies and labels 34
 - troubleshooting 98, 118
 - using manual feed 18
 - watermarks 45
- priority input tray
 - media specifications 8
- product numbers 158
- programming
 - scan-to button 63
- ProRes 1200 print-quality setting 22
- PS printer driver 20
- R**
- Readiris OCR 6
- recycling
 - print cartridges 160
- recycling program 152
- reduced size 126
- reducing
 - copies 53
- regulatory information 141
- repackaging guidelines 168
- repair services 168
- repeating defects, troubleshooting 112
- replacement parts, ordering 159
- replacing
 - ADF pickup roller assembly 93
 - device control panel cover 95
 - pickup roller 86
- resolution
 - faxing 138
 - printing 137
 - scanning 75, 138
- restoring factory settings 13
- returning the unit 168
- returns for supplies 152
- ring volume
 - adjusting 15
- S**
- safety
 - statements 147
- saving print cartridge toner 161
- scan quality
 - identifying and correcting defects 132
 - improving and preventing problems 132
 - troubleshooting 127
- scanner
 - no response 131
- scanner capacities and ratings 138
- scanning
 - black and white 76
 - book 58, 66
 - canceling 65
 - color 75
 - error messages 130
 - grayscale 76
 - HP Director 71
 - LaserJet Scan 68
 - loading originals 60
 - margins 138
 - methods 62
 - OCR, using 74
 - page-by-page 72
 - photos 57, 66
 - quality, improving unacceptable 132
 - resolution 75, 138
 - takes too long 129
 - to a file 69
 - to a folder 63
 - to e-mail 63
 - troubleshooting 127
 - TWAIN, using 73
 - WIA, using 73
- separation pad, ordering 159
- service
 - hardware 168
 - information form 170
- settings
 - changing defaults 9
 - changing for print quality 22
 - changing from the computer 20
 - restoring factory default 13
- shipping damage 168
- size
 - media 7
 - printer 135
- size reduced 126
- skewed pages 113
- smear toner 111
- software components 6
- specifications
 - ADF 138
 - automatic document feeder (ADF) 30
 - battery 139
 - card stock and heavy media 28
 - copier capacities and ratings 137
 - envelopes 27
 - labels 26

- media 7, 25
 - memory 138
 - printer capacities and ratings 137
 - scanner capacities and ratings 138
 - transparencies 27
 - specs on media 109
 - speed
 - copy 137
 - fax 138
 - modem 138
 - print 137
 - standby power specifications 136
 - statements
 - Australian EMC 149
 - Declaration of Conformity 147, 150
 - extended warranty 169
 - FCC Part 68 requirements 142
 - FCC regulations 142
 - Finland laser 148
 - IC CS-03 requirements 145
 - Korean EMI 148
 - laser safety 147
 - regulations 142
 - telephone consumer protection act 144
 - warranty 155
 - stopping. *See* canceling
 - storage environment, specifications 135
 - storing print cartridges 160
 - streaks 126
 - supplies
 - ordering 158
 - support, customer. *See* customer support
 - SupportPack 169
- T**
- telephone consumer protection act 144
 - telephone lines
 - fax tone volume, adjusting 15
 - telephone port 4
 - temperature
 - specifications 135
 - terminology 171
 - text
 - garbled, incorrect, or incomplete 104
 - missing 104, 128
 - toner
 - consumption 151
 - loose 112
 - saving 23, 161
 - scattered outline 115
 - smear 111
 - specks 109
 - transparencies
 - media sizes and weights 7
 - printing 34
 - specifications for 27
 - troubleshooting
 - black dots 133
 - blank pages 99, 120, 132
 - characters, misformed 113
 - copy output 119
 - copying 119
 - creases 114
 - curled media 103
 - curling paper 114
 - device separation pad 103
 - dropouts 110
 - error messages 102
 - faded print 109
 - feeding problems 100
 - graphics 104, 105, 127
 - gray backgrounds 111
 - light print 109
 - lines 110, 133
 - list of problems 97
 - loose toner 112
 - media guides 103
 - media jams 106
 - media problems 26
 - not responding 98, 100, 102
 - pages not printing 100
 - paper 128
 - parallel ports 102
 - pickup roller 103
 - power on 98
 - printer 98, 118
 - quality, image 127
 - repeating defects 112
 - scanning 127
 - sizes, wrong 128
 - skewed pages 113, 127
 - skewed print 103
 - smears 111
 - specks 109, 115
 - streaks 133
 - text problems 104, 128, 133
 - too dark 133
 - too light 133
 - vertical repetitive defects 112
 - wrinkles 114
 - See also* image quality, troubleshooting
 - turn on, device does not 98
 - TWAIN
 - error message 130
 - scanning with 73
 - two-sided originals
 - copying 57
 - two-sided printing 38
- U**
- unclear text 126
 - uninstaller 6
 - upgrading memory 137
 - USB

port 4, 138

V

vertical lines 110

vertical repetitive defects 112

vertical white or faded stripes 125

volume

adjusting 14

device control panel key-press, adjusting 15

volume, adjusting 14

W

warning messages 117

warranty

extended 169

limited one-year 155

watermarks, printing 45

weight

ADF media 138

media 7, 137

printer 135

white or faded stripes 125

WIA

scanning with 73

width, device 135

wrinkling, troubleshooting 114



i n v e n t

© 2003 Hewlett-Packard Development Company, LP

www.hp.com/support/lj3380



Q2660-90902