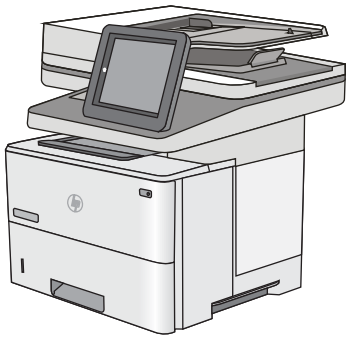


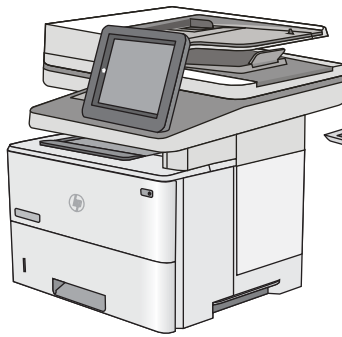


# LaserJet Pro M501 LaserJet Enterprise M506 LaserJet Enterprise MFP M527

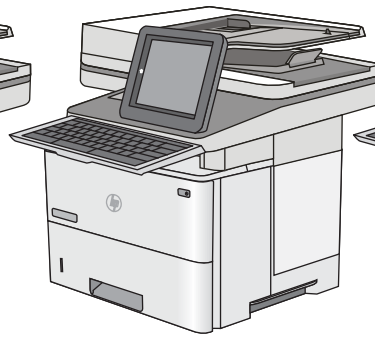
## Repair Manual



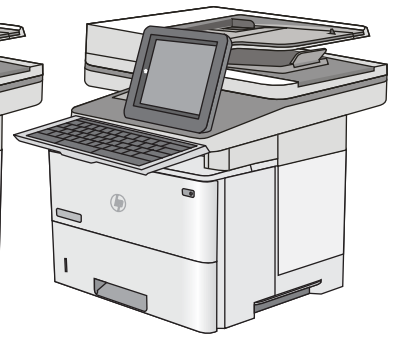
M527dn



M527f



M527c



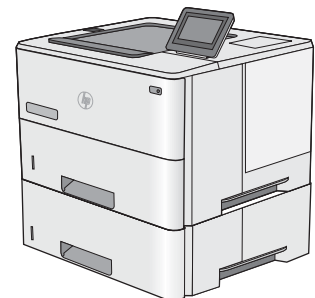
M527z



M501n  
M506n



M501dn  
M506dn



M506x



[www.hp.com/support/ljM501](http://www.hp.com/support/ljM501)  
[www.hp.com/support/ljM506](http://www.hp.com/support/ljM506)  
[www.hp.com/support/ljM527MFP](http://www.hp.com/support/ljM527MFP)  
For printer part removal and part number  
information, see the Troubleshooting Manual.





**HP LaserJet Pro M501, HP LaserJet  
Enterprise M506, and LaserJet Enterprise  
MFP M527**

**Repair Manual**

**Copyright and License**

© Copyright 2016 HP Development Company, L.P.

Reproduction, adaptation, or translation without prior written permission is prohibited, except as allowed under the copyright laws.


The information contained herein is subject to change without notice.

The only warranties for HP products and services are set forth in the express warranty statements accompanying such products and services. Nothing herein should be construed as constituting an additional warranty. HP shall not be liable for technical or editorial errors or omissions contained herein.


Edition 3, 9/2017


## Conventions used in this guide

---


 **TIP:** Helpful hints or shortcuts.

**Reinstallation tip:** Reinstallation helpful hints, shortcuts, or considerations.

 **NOTE:** Information that explains a concept or how to complete a task.

 **IMPORTANT:** Information that help the user to avoid potential printer error conditions.

 **CAUTION:** Procedures that the user must follow to avoid losing data or damaging the printer.

 **WARNING!** Procedures that the user must follow to avoid personal injury, catastrophic loss of data, or extensive damage to the printer.

---



## For additional service and support information

HP service personnel, go to the Service Access Work Bench (SAW) at <http://h41302.www4.hp.com/km/saw/home.do>.

Channel partners, go to HP Channel Services Network (CNS) at <https://h30125.www3.hp.com/hpcsn>.

At these locations, find information on the following topics:

- Install and configure
- Printer specification
- Up-to-date control panel message (CPMD) troubleshooting
- Solutions for printer issues and emerging issues
- Remove and replace part instructions and videos
- Service advisories
- Warranty and regulatory information

To access HP PartSurfer information from any mobile device, go to <http://partsurfermobile.hp.com/> or scan the Quick Response (QR) code below.







---

# Table of contents

<b>1 Removal and replacement .....</b>	<b>1</b>
For additional service and support .....	2
Removal and replacement strategy .....	3
Introduction .....	3
Considerations during removal and replacement .....	3
Electrostatic discharge .....	4
Required tools .....	4
Fastener types .....	5
Service approach .....	6
Before performing service .....	6
After performing service .....	6
Post service tests .....	6
Print quality test .....	6
Open the secondary service menu from a LCD control panel (M501) .....	6
Copy-quality test (M527 models) .....	7
Fax-quality test (M527 models) .....	7
Parts removal order .....	7
Removal and replacement procedures .....	8
Customer self-repair (CSR) A parts and assemblies .....	8
Removal and replacement: Toner cartridge .....	9
Introduction .....	9
Step 1: Remove the toner cartridge .....	10
Step 2: Unpack the replacement toner cartridge .....	11
Step 3: Install the toner cartridge .....	12
Removal and replacement: Staple cartridge (M527) .....	14
Introduction .....	14
Step 1: Remove the staple cartridge .....	14
Step 3: Unpack the replacement staple cartridge .....	15
Step 3: Install the staple cartridge .....	16
Removal and replacement: embedded MultiMedia Card (eMMC) (M506/M527dn) .....	18
Introduction .....	18
Step 1: Remove the formatter cover .....	19

Step 2: Remove the embedded MultiMedia Card (eMMC) .....	19
Step 3: Unpack the replacement eMMC .....	20
Step 4: Install the eMMC .....	21
Step 5: Install the formatter cover .....	21
Step 6: Reinstall the printer firmwar .....	22
Removal and replacement: Hard-disk drive (HDD) (M527c/f/z) .....	23
Introduction .....	23
Step 1: Remove the formatter cover .....	24
Step 2: Remove the hard-disk drive (HDD) .....	24
Step 3: Unpack the replacement assembly .....	25
Step 4: Install the HDD .....	26
Step 5: Install the formatter cover .....	27
Step 6: Reinstall the printer firmwar .....	27
Removal and replacement: Dual in-line memory module (DIMM) (M506/M527) .....	29
Introduction .....	29
Step 1: Remove the formatter cover .....	30
Step 2: Remove the hard-disk drive (HDD) .....	30
Step 3: Remove the dual in-line memory module (DIMM) .....	31
Step 4: Unpack the replacement DIMM .....	33
Step 5: Install the dual in-line memory module (DIMM) .....	33
Step 6: Install the hard-disk drive (HDD) .....	35
Step 7: Install the formatter cover .....	37
Removal and replacement: Transfer roller .....	38
Introduction .....	38
Step 1: Remove the toner cartridge .....	39
Step 2: Remove the transfer roller .....	40
Step 3: Unpack the replacement roller .....	42
Step 4: Install the transfer roller .....	42
Step 5: Install the toner cartridge .....	43
Removal and replacement: Control panel (M527) .....	45
Introduction .....	45
Step 1: Remove the control panel (M527) .....	45
Step 2: Unpack the replacement control panel .....	50
Step 3: Install the control panel (M527) .....	50
Removal and replacement: Control panel (M506x) .....	57
Introduction .....	57
Step 1: Remove the control panel (M506x) .....	57
Step 2: Unpack the replacement control panel .....	60
Step 3: Install the control panel (M527) .....	60
Removal and replacement: White backing (M527) .....	64
Introduction .....	64

Step 1: Remove the white backing (M527) .....	64
Step 2: Unpack the replacement white backing .....	67
Step 3: Install the white backing (M527) .....	68
Removal and replacement: Retention clips (M527) .....	71
Introduction .....	71
Step 1: Remove the retention clips .....	71
Step 2: Unpack the replacement retention clips .....	67
Step 3: Install the retention clips .....	74
Removal and replacement: Keyboard assembly (M527c/z) .....	78
Introduction .....	78
Step 1: Remove the keyboard (M527c/z) .....	78
Step 2: Unpack the replacement assembly .....	82
Step 3: Install the keyboard (M527c/z) .....	82
Customer self-repair (CSR) B parts and assemblies .....	86
Removal and replacement: Multipurpose tray (Tray 1) pickup roller and separation pad .....	87
Introduction .....	87
Step 1: Remove the roller .....	88
Step 2: Remove the separation pad assembly .....	89
Step 3: Unpack the replacement roller and pad .....	91
Step 4: Install the separation pad assembly .....	92
Step 5: Install the roller .....	94
Removal and replacement: Tray 2-x roller kit .....	96
Introduction .....	96
Step 1: Remove the tray .....	97
Step 2: Remove the pickup and feed roller assembly .....	98
Step 3: Remove the separation roller assembly .....	99
Step 4: Unpack the replacement assemblies .....	100
Step 5: Install the separation roller assembly .....	101
Step 6: Install the pickup and feed roller assembly .....	102
Step 7: Install the tray .....	105
Removal and replacement: Control panel (M501) .....	106
Introduction .....	106
Step 1: Remove the control panel (M501) .....	106
Step 2: Unpack the replacement assembly .....	109
Step 3: Install the control panel (M501) .....	109
Field replaceable units (FRUs) / Bench repairable units (BRUs) .....	114
Removal and replacement: External panels, covers, and doors .....	114
Removal and replacement: Formatter cover .....	115
Removal and replacement: Control-panel cover (M527) .....	119
Removal and replacement: Top-rear cover (M527) .....	124

Removal and replacement: Top-left cover (M527) .....	134
Removal and replacement: Document feeder (M527) .....	139
Removal and replacement: Cartridge door assembly .....	158
Removal and replacement: Rear door assembly .....	169
Removal and replacement: Right cover .....	174
Removal and replacement: Left cover .....	197
Removal and replacement: Stapler door or stapler blank cover (M527) ..	216
Removal and replacement: Stapler stationary (inner) cover (M527) .....	223
Removal and replacement: Top cover (M527) .....	234
Removal and replacement: Top cover (M501/M506) .....	292
Removal and replacement: Paper delivery tray (output bin) .....	336
Removal and replacement: Sub-scanner assembly (SSA) (M527) .....	139
Removal and replacement: Integrated-scanner assembly (ISA) (M527) ..	462
Removal and replacement: Internal parts and assemblies .....	487
Removal and replacement: Scanner control board (M527) .....	488
Removal and replacement: Near field communication printed-circuit assembly (M506x/M527z) .....	507
Removal and replacement: Wireless printed-circuit board (WiFi) (M506x) .....	514
Removal and replacement: Wireless printed-circuit board (M527z) .....	538
Removal and replacement: Fuser .....	542
Removal and replacement: Stapler unit (M527c/f/z) .....	553
Removal and replacement: Formatter .....	566
Removal and replacement: Laser/scanner assembly .....	584
Removal and replacement: Formatter case .....	659
Removal and replacement: Fan (FM1) .....	744
Removal and replacement: Fan (FM2) .....	768
Removal and replacement: Fuser power supply (FPS) .....	855
Removal and replacement: DC controller .....	944
Removal and replacement: High-voltage power supply .....	197
Removal and replacement: Low-voltage power supply .....	1056
Removal and replacement: Trays .....	1147
Removal and replacement: Tray 2 .....	1147
Introduction .....	1147
Step 1: Remove the tray .....	1147
Step 2: Unpack the replacement tray .....	1148
Step 3: Install the tray .....	1149
Removal and replacement: Tray 3 .....	1151
Introduction .....	1151
Step 1: Remove the tray .....	1151
Step 2: Unpack the replacement tray .....	1152

Step 3: Install the tray .....	1153
Removal and replacement: Accessories .....	1155
550-sheet paper feeder .....	1156
Removal and replacement: Optional 550-sheet paper feeder .....	1156
Removal and replacement: Document feeder rollers (M527) .....	1162
Introduction .....	1162
Step 1: Remove the document feeder pickup and feed roller assembly	1163
Step 2: Remove the document feeder separation roller assembly .....	1164
Step 3: Unpack the replacement assemblies .....	1165
Step 4: Install the document feeder separation roller assembly .....	1166
Step 5: Install the document feeder pickup and feed roller assembly ...	1168
Step 6: Reset the firmware counter .....	1169
Removal and replacement: Fax printed-circuit board (M527c/f/z) .....	1171
Introduction .....	1171
Step 1: Remove the formatter cover .....	1172
Step 2: Remove the fax printed-circuit board (PCA) .....	1172
Step 3: Unpack the replacement fax PCA .....	1174
Step 4: Install the fax PCA .....	1174
Step 5: Install the formatter cover .....	1177
Install accessory: Internal USB ports (M527) .....	23
Introduction .....	1178
Step 1: Remove the formatter cover .....	1179
Step 2: Remove the fax (M527c/f/z) .....	1179
Step 3: Unpack the accessory .....	1181
Step 4: Install the internal USB ports module .....	1182
Step 5: Install the fax (M527c/f/z) .....	1184
Step 6: Install the formatter cover .....	1187
Install accessory: Internal USB ports (M506) .....	23
Introduction .....	1188
Step 1: Remove the formatter cover .....	1189
Step 2: Unpack the accessory .....	1189
Step 3: Install the internal USB ports module .....	1189
Step 4: Install the formatter cover .....	37
<b>2 Parts and diagrams .....</b>	<b>1193</b>
For additional service and support information .....	1194
Assembly locations .....	1195
Printer front view (M501/M506) .....	1195
Printer front view (M527) .....	1196
Product back view (M501/M506) .....	1197
Product back view (M527) .....	1198

Order parts, accessories, and supplies .....	1199
Ordering .....	1199
Orderable parts .....	1199
Supplies and accessories .....	1199
Customer self-repair kits .....	1201
Related documentation and software .....	1202
How to use the parts lists and diagrams .....	1202
Parts and diagrams: Document feeder and scanner whole units .....	1204
Parts and diagrams Covers .....	1206
Covers (M501/M506) .....	1206
Covers (M527) .....	1208
Parts and diagrams: Internal assemblies .....	1210
Internal assemblies (1 of 4) .....	1210
Internal assemblies (2 of 4) .....	1212
Internal assemblies (3 of 4) .....	1214
Internal assemblies (4 of 4) .....	1216
Parts and diagrams: Accessories .....	1218
1x550-sheet paper feeder .....	1218
Alphabetical parts list .....	1220
Numerical parts list .....	1227
<b>Index .....</b>	<b>1235</b>

---

# List of tables

Table 2-1	Supplies and Accessories (M501)	1199
Table 2-2	Supplies and Accessories (M506)	1199
Table 2-3	Supplies and Accessories (M527)	1200
Table 2-4	Document feeder and scanner whole units (M527 only)	1205
Table 2-5	Covers (M501/M506)	1207
Table 2-6	Covers (M527)	1209
Table 2-7	Internal assemblies (1 of 4)	1211
Table 2-8	Internal assemblies (2 of 4)	1213
Table 2-9	Internal assemblies (3 of 4)	1215
Table 2-10	Internal assemblies (4 of 4)	1217
Table 2-11	1x550-sheet paper feeder	1219





---

# List of figures

Figure 1-1	Screwdrivers .....	4
Figure 1-2	Screw size chart .....	5
Figure 1-3	Press the cartridge-door-release button .....	10
Figure 1-4	Open the toner-cartridge door .....	10
Figure 1-5	Remove the toner cartridge .....	11
Figure 1-6	Recycle and unpack .....	11
Figure 1-7	Install the toner cartridge .....	12
Figure 1-8	Close the toner-cartridge door .....	13
Figure 1-9	Open the stapler door .....	15
Figure 1-10	Remove the staple cartridge .....	15
Figure 1-11	Recycle and unpack .....	16
Figure 1-12	Install the staple cartridge .....	16
Figure 1-13	Close the stapler door .....	17
Figure 1-14	Remove the formatter cover .....	19
Figure 1-15	Remove the eMMC .....	20
Figure 1-16	Install the eMMC .....	21
Figure 1-17	Install the formatter cover .....	21
Figure 1-18	Remove the formatter cover .....	24
Figure 1-19	Release the HDD .....	24
Figure 1-20	Remove the HDD .....	25
Figure 1-21	Locate the slot in the sheet-metal .....	26
Figure 1-22	Install the HDD .....	26
Figure 1-23	Install the HDD .....	27
Figure 1-24	Install the formatter cover .....	27
Figure 1-25	Remove the formatter cover .....	30
Figure 1-26	Release the HDD .....	31
Figure 1-27	Remove the HDD .....	31
Figure 1-28	Remove the DIMM (M506) .....	32
Figure 1-29	Release the DIMM (M527) .....	32
Figure 1-30	Remove the DIMM (M527) .....	33
Figure 1-31	Install the DIMM (M506) .....	34
Figure 1-32	Insert the DIMM (M527) .....	34

Figure 1-33	Install the DIMM (M527)	35
Figure 1-34	Locate the slot in the sheet-metal	36
Figure 1-35	Install the HDD	36
Figure 1-36	Install the HDD	37
Figure 1-37	Install the formatter cover	37
Figure 1-38	Press the cartridge-door-release button	39
Figure 1-39	Open the toner-cartridge door	39
Figure 1-40	Remove the toner cartridge	40
Figure 1-41	Release the retainer clip	40
Figure 1-42	Release the roller	41
Figure 1-43	Remove the roller	41
Figure 1-44	Remove the retainer clip	42
Figure 1-45	Recycle and unpack	42
Figure 1-46	Install the holder	43
Figure 1-47	Install the roller and retainer clip	43
Figure 1-48	Install the toner cartridge	44
Figure 1-49	Close the toner-cartridge door	44
Figure 1-50	Open the document feeder	46
Figure 1-51	Release five tabs	46
Figure 1-52	Remove the cover	47
Figure 1-53	Disconnect the FFC (M527c/z)	47
Figure 1-54	Disconnect connectors	48
Figure 1-55	Remove USB cable and NFC PCA	48
Figure 1-56	Remove three screws	49
Figure 1-57	Remove the control panel	49
Figure 1-58	Recycle and unpack	50
Figure 1-59	Open the control panel	50
Figure 1-60	Check the keyboard flat cable (M527c/z)	51
Figure 1-61	Locate the hooks and slots	51
Figure 1-62	Install the control-panel	52
Figure 1-63	Install three screws	53
Figure 1-64	Connect the connectors	54
Figure 1-65	Install the USB cable and NFC PCA	54
Figure 1-66	Connect the flat cable (M527z)	55
Figure 1-67	Position the control-panel cover on the printer	55
Figure 1-68	Engage five tabs	56
Figure 1-69	Close the document feeder	56
Figure 1-70	Tilt the control panel up	58
Figure 1-71	Remove the cover	58
Figure 1-72	Remove two screws	59
Figure 1-73	Turn the control panel over	59

Figure 1-74	Remove the control panel .....	60
Figure 1-75	Recycle and unpack .....	60
Figure 1-76	Connect the cables .....	61
Figure 1-77	Install the control panel .....	61
Figure 1-78	Rotate the control-panel base down .....	62
Figure 1-79	Install two screws .....	62
Figure 1-80	Install the cover .....	63
Figure 1-81	Open the document feeder .....	65
Figure 1-82	Remove the white backing .....	65
Figure 1-83	Check the retention clips .....	66
Figure 1-84	Check the retention clip spring .....	66
Figure 1-85	Install the retention clip .....	67
Figure 1-86	Press the retention clip .....	67
Figure 1-87	Recycle and unpack .....	68
Figure 1-88	Install the white backing .....	68
Figure 1-89	Close the document feeder .....	69
Figure 1-90	Check the white backing .....	69
Figure 1-91	Close the document feeder .....	70
Figure 1-92	Open the document feeder .....	72
Figure 1-93	Remove the white backing .....	72
Figure 1-94	Loosen damaged clips .....	73
Figure 1-95	Remove the retention clip .....	73
Figure 1-96	Recycle and unpack .....	74
Figure 1-97	Check the retention clip spring .....	74
Figure 1-98	Install the retention clip .....	75
Figure 1-99	Press the retention clip .....	75
Figure 1-100	Install the white backing .....	76
Figure 1-101	Close the document feeder .....	76
Figure 1-102	Check the white backing .....	77
Figure 1-103	Close the document feeder .....	77
Figure 1-104	Tilt up the control panel and open the document feeder .....	79
Figure 1-105	Remove the control-panel cover .....	79
Figure 1-106	Remove the cover .....	80
Figure 1-107	Release the keyboard fla cable .....	80
Figure 1-108	Slide the tray out .....	81
Figure 1-109	Disengage the tabs .....	81
Figure 1-110	Remove the keyboard .....	82
Figure 1-111	Recycle and unpack .....	82
Figure 1-112	Install the FFC .....	83
Figure 1-113	Install the keyboard .....	83
Figure 1-114	Check the fla cable .....	84

Figure 1-115	Close the fla cable latch .....	84
Figure 1-116	Install the control-panel cover .....	85
Figure 1-117	Engage five tabs .....	85
Figure 1-118	Open the toner-cartridge door .....	88
Figure 1-119	Release two tabs .....	88
Figure 1-120	Remove the roller .....	89
Figure 1-121	Release one tab .....	89
Figure 1-122	Move the roller carriage out of the way .....	90
Figure 1-123	Remove the separation pad assembly .....	90
Figure 1-124	Remove the spring .....	91
Figure 1-125	Recycle and unpack .....	91
Figure 1-126	Install the spring .....	92
Figure 1-127	Align the assembly with the holder .....	92
Figure 1-128	Install the pad assembly .....	93
Figure 1-129	Slide the roller carriage to the left .....	93
Figure 1-130	Install the roller .....	94
Figure 1-131	Engage two tabs .....	94
Figure 1-132	Close the toner-cartridge door .....	95
Figure 1-133	Pull the tray out until it stops .....	97
Figure 1-134	Release and remove the tray .....	98
Figure 1-135	Locate the roller assembly .....	98
Figure 1-136	Compress the spring-loaded shaft .....	99
Figure 1-137	Remove the roller assembly .....	99
Figure 1-138	Release the assembly .....	100
Figure 1-139	Remove the assembly .....	100
Figure 1-140	Recycle and unpack .....	101
Figure 1-141	Install the assembly in the slot .....	101
Figure 1-142	Install the assembly .....	102
Figure 1-143	Check the installation .....	102
Figure 1-144	Check the pin on the assembly .....	103
Figure 1-145	Install the roller assembly .....	103
Figure 1-146	Decompress the spring-loaded shaft .....	104
Figure 1-147	Check the installation .....	104
Figure 1-148	Install the tray .....	105
Figure 1-149	Close the tray .....	105
Figure 1-150	Remove the formatter cover .....	107
Figure 1-151	Disconnect one fla cable .....	107
Figure 1-152	Locate two tabs .....	108
Figure 1-153	Release the control panel .....	108
Figure 1-154	Remove the control panel .....	109
Figure 1-155	Recycle and unpack .....	109

Figure 1-156	Position the control panel over the printer .....	110
Figure 1-157	Engage the tabs with the slots .....	110
Figure 1-158	Install the flat cable .....	111
Figure 1-159	Rotate the rear edge of the control panel down .....	111
Figure 1-160	Make sure that the tabs snap into place .....	112
Figure 1-161	Connect one flat cable .....	112
Figure 1-162	Install the formatter cover .....	113
Figure 1-163	Remove the formatter cover (M501) .....	116
Figure 1-164	Remove the formatter cover (M506/M527) .....	116
Figure 1-165	Recycle and unpack .....	117
Figure 1-166	Install the formatter cover (M501) .....	117
Figure 1-167	Install the formatter cover (M506/M527) .....	118
Figure 1-168	Open the document feeder .....	120
Figure 1-169	Release five tabs .....	120
Figure 1-170	Remove the cover .....	121
Figure 1-171	Recycle and unpack .....	121
Figure 1-172	Position the control-panel cover on the printer .....	122
Figure 1-173	Engage five tabs .....	122
Figure 1-174	Close the document feeder .....	123
Figure 1-175	Remove the formatter cover .....	125
Figure 1-176	Release two tabs .....	125
Figure 1-177	Release two tabs .....	126
Figure 1-178	Slide the cover .....	126
Figure 1-179	Remove the cover .....	127
Figure 1-180	Remove one screw .....	127
Figure 1-181	Rotate the cover .....	128
Figure 1-182	Release one boss .....	128
Figure 1-183	Remove the cover .....	129
Figure 1-184	Recycle and unpack .....	129
Figure 1-185	Engage one boss .....	130
Figure 1-186	Install the cover .....	130
Figure 1-187	Install one screw .....	131
Figure 1-188	Slide the cover .....	131
Figure 1-189	Engage two tabs .....	132
Figure 1-190	Engage two tabs .....	132
Figure 1-191	Install the formatter cover .....	133
Figure 1-192	Release two tabs .....	135
Figure 1-193	Release two tabs .....	135
Figure 1-194	Slide the cover .....	136
Figure 1-195	Remove the cover .....	136
Figure 1-196	Recycle and unpack .....	137

Figure 1-197	Slide the cover .....	137
Figure 1-198	Engage two tabs .....	138
Figure 1-199	Engage two tabs .....	138
Figure 1-200	Remove the formatter cover .....	140
Figure 1-201	Release two tabs .....	141
Figure 1-202	Release two tabs .....	141
Figure 1-203	Slide the cover .....	142
Figure 1-204	Remove the cover .....	142
Figure 1-205	Remove one screw .....	143
Figure 1-206	Rotate the cover .....	143
Figure 1-207	Release one boss .....	144
Figure 1-208	Remove the cover .....	144
Figure 1-209	Remove the cover .....	145
Figure 1-210	Disconnect the FFC, ground cable, and connectors .....	145
Figure 1-211	Open the document feeder .....	146
Figure 1-212	Raise the document feeder .....	146
Figure 1-213	Release two tabs .....	147
Figure 1-214	Remove the document feeder .....	147
Figure 1-215	Recycle and unpack .....	148
Figure 1-216	Install the document feeder .....	148
Figure 1-217	Lower the document feeder .....	149
Figure 1-218	Connect the FFC, ground cable, and connectors .....	149
Figure 1-219	Connect the FFC, ground cable, and connectors .....	150
Figure 1-220	Check the retention clip spring .....	150
Figure 1-221	Install the retention clip .....	151
Figure 1-222	Press the retention clip .....	151
Figure 1-223	Install the white backing .....	152
Figure 1-224	Close the document feeder .....	152
Figure 1-225	Check the white backing .....	153
Figure 1-226	Close the document feeder .....	153
Figure 1-227	Engage one boss .....	154
Figure 1-228	Install the cover .....	154
Figure 1-229	Install one screw .....	155
Figure 1-230	Slide the cover .....	155
Figure 1-231	Engage two tabs .....	156
Figure 1-232	Engage two tabs .....	156
Figure 1-233	Install the formatter cover .....	157
Figure 1-234	Pull the tray out until it stops .....	159
Figure 1-235	Release and remove the tray .....	159
Figure 1-236	Release the support shaft .....	160
Figure 1-237	Remove the support shaft .....	160

Figure 1-238	Remove the guide .....	161
Figure 1-239	Release the pressure-release link .....	161
Figure 1-240	Release the door .....	162
Figure 1-241	Release the left-side retainer arm .....	162
Figure 1-242	Remove the door .....	163
Figure 1-243	Recycle and unpack .....	163
Figure 1-244	Engage the left-side retainer arm .....	164
Figure 1-245	Install the door .....	164
Figure 1-246	Install the pressure-release link .....	165
Figure 1-247	Install the guide .....	165
Figure 1-248	Align the hinge .....	166
Figure 1-249	Install the support shaft .....	167
Figure 1-250	Install the tray .....	168
Figure 1-251	Close the tray .....	168
Figure 1-252	Remove two screws .....	170
Figure 1-253	Rotate the bottom of the cover .....	170
Figure 1-254	Remove the cover .....	171
Figure 1-255	Recycle and unpack .....	171
Figure 1-256	Install the cover .....	172
Figure 1-257	Rotate the bottom of the cover .....	172
Figure 1-258	Install two screws .....	173
Figure 1-259	Pull the tray out until it stops .....	175
Figure 1-260	Release and remove the tray .....	175
Figure 1-261	Remove the formatter cover (M501) .....	176
Figure 1-262	Remove the formatter cover (M506/M527) .....	176
Figure 1-263	Release the support shaft .....	177
Figure 1-264	Remove the support shaft .....	177
Figure 1-265	Remove the guide .....	178
Figure 1-266	Release the pressure-release link .....	178
Figure 1-267	Release the door .....	179
Figure 1-268	Release the left-side retainer arm .....	179
Figure 1-269	Remove the door .....	180
Figure 1-270	Remove two screws .....	180
Figure 1-271	Rotate the bottom of the cover .....	181
Figure 1-272	Remove the cover .....	181
Figure 1-273	Locate the tabs and bosses .....	182
Figure 1-274	Remove two screws .....	182
Figure 1-275	Release one boss .....	183
Figure 1-276	Release two bosses .....	183
Figure 1-277	Release one tab .....	184
Figure 1-278	Release one tab .....	184

Figure 1-279	Remove the cover .....	185
Figure 1-280	Recycle and unpack .....	185
Figure 1-281	Locate the tabs and bosses .....	186
Figure 1-282	Install the cover .....	187
Figure 1-283	Engage one tab .....	187
Figure 1-284	Engage one tab .....	188
Figure 1-285	Engage two bosses .....	188
Figure 1-286	Engage one boss .....	189
Figure 1-287	Install two screws .....	189
Figure 1-288	Install the cover .....	190
Figure 1-289	Rotate the bottom of the cover .....	190
Figure 1-290	Install two screws .....	191
Figure 1-291	Engage the left-side retainer arm .....	191
Figure 1-292	Install the door .....	192
Figure 1-293	Install the pressure-release link .....	192
Figure 1-294	Install the guide .....	193
Figure 1-295	Align the hinge .....	193
Figure 1-296	Install the support shaft .....	194
Figure 1-297	Install the formatter cover (M501) .....	195
Figure 1-298	Install the formatter cover (M506/M527) .....	195
Figure 1-299	Install the tray .....	196
Figure 1-300	Close the tray .....	196
Figure 1-301	Pull the tray out until it stops .....	198
Figure 1-302	Release and remove the tray .....	198
Figure 1-303	Release the support shaft .....	199
Figure 1-304	Remove the support shaft .....	199
Figure 1-305	Remove the guide .....	200
Figure 1-306	Release the pressure-release link .....	200
Figure 1-307	Release the door .....	201
Figure 1-308	Release the left-side retainer arm .....	201
Figure 1-309	Remove the door .....	202
Figure 1-310	Remove two screws .....	202
Figure 1-311	Rotate the bottom of the cover .....	203
Figure 1-312	Remove the cover .....	203
Figure 1-313	Locate of the tabs and bosses .....	204
Figure 1-314	Remove one screw .....	204
Figure 1-315	Release one boss and three tabs .....	205
Figure 1-316	Release two tabs .....	205
Figure 1-317	Remove the cover .....	206
Figure 1-318	Recycle and unpack .....	207
Figure 1-319	Locate of the tabs and bosses .....	207



Figure 1-320	Install the cover .....	208
Figure 1-321	Engage two tabs .....	208
Figure 1-322	Engage three tabs and one boss .....	209
Figure 1-323	Install one screw .....	209
Figure 1-324	Install the cover .....	210
Figure 1-325	Rotate the bottom of the cover .....	210
Figure 1-326	Install two screws .....	211
Figure 1-327	Engage the left-side retainer arm .....	211
Figure 1-328	Install the door .....	212
Figure 1-329	Install the pressure-release link .....	212
Figure 1-330	Install the guide .....	213
Figure 1-331	Align the hinge .....	213
Figure 1-332	Install the support shaft .....	214
Figure 1-333	Install the tray .....	215
Figure 1-334	Close the tray .....	215
Figure 1-335	Remove the formatter cover .....	217
Figure 1-336	Open the door or release the cover .....	217
Figure 1-337	Release the upper hinge or remove the cover .....	218
Figure 1-338	Release the lower hinge .....	218
Figure 1-339	Remove the door .....	219
Figure 1-340	Recycle and unpack .....	219
Figure 1-341	Install the door or cover .....	220
Figure 1-342	Engage the lower hinge or engage the cover .....	220
Figure 1-343	Engage the upper hinge .....	221
Figure 1-344	Close the door .....	221
Figure 1-345	Install the formatter cover .....	222
Figure 1-346	Remove the formatter cover .....	224
Figure 1-347	Open the door or release the cover .....	224
Figure 1-348	Release the upper hinge or remove the cover .....	225
Figure 1-349	Release the lower hinge .....	225
Figure 1-350	Remove the door .....	226
Figure 1-351	Locate the tabs .....	226
Figure 1-352	Release one tab .....	227
Figure 1-353	Release one tab .....	227
Figure 1-354	Remove the cover .....	228
Figure 1-355	Recycle and unpack .....	228
Figure 1-356	Locate the tabs .....	229
Figure 1-357	Install the cover .....	229
Figure 1-358	Engage one tab .....	230
Figure 1-359	Engage one tab .....	230
Figure 1-360	Install the door or cover .....	231

Figure 1-361	Engage the lower hinge or engage the cover .....	231
Figure 1-362	Engage the upper hinge .....	232
Figure 1-363	Close the door .....	232
Figure 1-364	Install the formatter cover .....	233
Figure 1-365	Pull the tray out until it stops .....	236
Figure 1-366	Release and remove the tray .....	236
Figure 1-367	Remove the formatter cover .....	237
Figure 1-368	Disconnect three connectors .....	237
Figure 1-369	Release the fax PCA .....	238
Figure 1-370	Remove the fax PCA .....	238
Figure 1-371	Open the door or release the cover .....	239
Figure 1-372	Release the upper hinge or remove the cover .....	239
Figure 1-373	Release the lower hinge .....	240
Figure 1-374	Remove the door .....	240
Figure 1-375	Locate the tabs .....	241
Figure 1-376	Release one tab .....	241
Figure 1-377	Release one tab .....	242
Figure 1-378	Remove the cover .....	242
Figure 1-379	Release two tabs .....	243
Figure 1-380	Release two tabs .....	243
Figure 1-381	Slide the cover .....	244
Figure 1-382	Remove the cover .....	244
Figure 1-383	Remove one screw .....	245
Figure 1-384	Rotate the cover .....	245
Figure 1-385	Release one boss .....	246
Figure 1-386	Remove the cover .....	246
Figure 1-387	Remove two screws .....	247
Figure 1-388	Rotate the bottom of the cover .....	247
Figure 1-389	Remove the cover .....	248
Figure 1-390	Release the support shaft .....	249
Figure 1-391	Remove the support shaft .....	249
Figure 1-392	Remove the guide .....	250
Figure 1-393	Release the pressure-release link .....	250
Figure 1-394	Release the door .....	251
Figure 1-395	Release the left-side retainer arm .....	251
Figure 1-396	Remove the door .....	252
Figure 1-397	Locate of the tabs and bosses .....	252
Figure 1-398	Remove one screw .....	253
Figure 1-399	Release one boss and three tabs .....	253
Figure 1-400	Release two tabs .....	254
Figure 1-401	Remove the cover .....	254

Figure 1-402	Remove one screw .....	255
Figure 1-403	Disconnect cables and connectors .....	255
Figure 1-404	Disconnect connectors and remove screws .....	256
Figure 1-405	Slide the ISA towards the back of the printer .....	256
Figure 1-406	Remove the ISA .....	257
Figure 1-407	Locate the tabs and bosses .....	257
Figure 1-408	Remove two screws .....	258
Figure 1-409	Release one boss .....	258
Figure 1-410	Release two bosses .....	259
Figure 1-411	Release one tab .....	259
Figure 1-412	Release one tab .....	260
Figure 1-413	Remove the cover .....	260
Figure 1-414	Remove one screw and the plate .....	261
Figure 1-415	Remove three screws .....	261
Figure 1-416	Remove three screws .....	262
Figure 1-417	Release one boss .....	262
Figure 1-418	Rotate the front of the cover up .....	263
Figure 1-419	Remove the cover .....	263
Figure 1-420	Recycle and unpack .....	264
Figure 1-421	Install the cover .....	264
Figure 1-422	Rotate the front of the cover down .....	265
Figure 1-423	Engage one boss .....	265
Figure 1-424	Install three screws .....	266
Figure 1-425	Install three screws .....	266
Figure 1-426	Install one screw and the plate .....	267
Figure 1-427	Locate the tabs and bosses .....	267
Figure 1-428	Install the cover .....	268
Figure 1-429	Engage one tab .....	268
Figure 1-430	Engage one tab .....	269
Figure 1-431	Engage two bosses .....	269
Figure 1-432	Engage one boss .....	270
Figure 1-433	Install two screws .....	270
Figure 1-434	Locate the ISA mounting pins and slots .....	271
Figure 1-435	Install the ISA .....	271
Figure 1-436	Slide the ISA towards the front of the printer .....	272
Figure 1-437	Install screws and connect connectors .....	272
Figure 1-438	Connect cables and connectors .....	273
Figure 1-439	Install one screw .....	273
Figure 1-440	Locate of the tabs and bosses .....	274
Figure 1-441	Install the cover .....	274
Figure 1-442	Engage two tabs .....	275

Figure 1-443	Engage three tabs and one boss .....	275
Figure 1-444	Install one screw .....	276
Figure 1-445	Engage the left-side retainer arm .....	276
Figure 1-446	Install the door .....	277
Figure 1-447	Install the pressure-release link .....	277
Figure 1-448	Install the guide .....	278
Figure 1-449	Align the hinge .....	278
Figure 1-450	Install the support shaft .....	279
Figure 1-451	Install the cover .....	280
Figure 1-452	Rotate the bottom of the cover .....	280
Figure 1-453	Install two screws .....	281
Figure 1-454	Engage one boss .....	281
Figure 1-455	Install the cover .....	282
Figure 1-456	Install one screw .....	282
Figure 1-457	Slide the cover .....	283
Figure 1-458	Engage two tabs .....	283
Figure 1-459	Engage two tabs .....	284
Figure 1-460	Locate the tabs .....	284
Figure 1-461	Install the cover .....	285
Figure 1-462	Engage one tab .....	285
Figure 1-463	Engage one tab .....	286
Figure 1-464	Install the door or cover .....	286
Figure 1-465	Engage the lower hinge or engage the cover .....	287
Figure 1-466	Engage the upper hinge .....	287
Figure 1-467	Close the door .....	288
Figure 1-468	Locate the slots in the sheet-metal .....	288
Figure 1-469	Install the fax PCA .....	289
Figure 1-470	Engage the fax PCA .....	289
Figure 1-471	Connect three connectors .....	290
Figure 1-472	Install the formatter cover .....	290
Figure 1-473	Install the tray .....	291
Figure 1-474	Close the tray .....	291
Figure 1-475	Pull the tray out until it stops .....	293
Figure 1-476	Release and remove the tray .....	294
Figure 1-477	Tilt the control panel up .....	294
Figure 1-478	Remove the cover .....	295
Figure 1-479	Remove two screws .....	295
Figure 1-480	Turn the control panel over .....	296
Figure 1-481	Remove the control panel .....	296
Figure 1-482	Remove the formatter cover (M501) .....	297
Figure 1-483	Remove the formatter cover (M506/M527) .....	297

Figure 1-484	Disconnect one flat cable .....	298
Figure 1-485	Locate two tabs .....	298
Figure 1-486	Release the control panel .....	299
Figure 1-487	Remove the control panel .....	299
Figure 1-488	Remove two screws .....	300
Figure 1-489	Rotate the bottom of the cover .....	300
Figure 1-490	Remove the cover .....	301
Figure 1-491	Release the support shaft .....	302
Figure 1-492	Remove the support shaft .....	302
Figure 1-493	Remove the guide .....	303
Figure 1-494	Release the pressure-release link .....	303
Figure 1-495	Release the door .....	304
Figure 1-496	Release the left-side retainer arm .....	304
Figure 1-497	Remove the door .....	305
Figure 1-498	Locate the tabs and bosses .....	305
Figure 1-499	Remove two screws .....	306
Figure 1-500	Release one boss .....	306
Figure 1-501	Release two bosses .....	307
Figure 1-502	Release one tab .....	307
Figure 1-503	Release one tab .....	308
Figure 1-504	Remove the cover .....	308
Figure 1-505	Locate of the tabs and bosses .....	309
Figure 1-506	Remove one screw .....	309
Figure 1-507	Release one boss and three tabs .....	310
Figure 1-508	Release two tabs .....	310
Figure 1-509	Remove the cover .....	311
Figure 1-510	Remove two screws .....	311
Figure 1-511	Release one cable retainer .....	312
Figure 1-512	Release one boss .....	312
Figure 1-513	Remove the cover .....	313
Figure 1-514	Transfer the HIP and/or USB covers .....	314
Figure 1-515	Recycle and unpack .....	314
Figure 1-516	Install the cover .....	315
Figure 1-517	Engage one boss .....	315
Figure 1-518	Install one cable retainer .....	316
Figure 1-519	Install two screws .....	316
Figure 1-520	Locate of the tabs and bosses .....	317
Figure 1-521	Install the cover .....	317
Figure 1-522	Engage two tabs .....	318
Figure 1-523	Engage three tabs and one boss .....	318
Figure 1-524	Install one screw .....	319

Figure 1-525	Locate the tabs and bosses .....	319
Figure 1-526	Install the cover .....	320
Figure 1-527	Engage one tab .....	320
Figure 1-528	Engage one tab .....	321
Figure 1-529	Engage two bosses .....	321
Figure 1-530	Engage one boss .....	322
Figure 1-531	Install two screws .....	322
Figure 1-532	Engage the left-side retainer arm .....	323
Figure 1-533	Install the door .....	323
Figure 1-534	Install the pressure-release link .....	324
Figure 1-535	Install the guide .....	324
Figure 1-536	Align the hinge .....	325
Figure 1-537	Install the support shaft .....	326
Figure 1-538	Install the cover .....	327
Figure 1-539	Rotate the bottom of the cover .....	327
Figure 1-540	Install two screws .....	328
Figure 1-541	Position the control panel over the printer .....	328
Figure 1-542	Engage the tabs with the slots .....	329
Figure 1-543	Install the fla cable .....	329
Figure 1-544	Rotate the rear edge of the control panel down .....	330
Figure 1-545	Make sure that the tabs snap into place .....	330
Figure 1-546	Connect one fla cable .....	331
Figure 1-547	Install the formatter cover (M501) .....	331
Figure 1-548	Install the formatter cover (M506/M527) .....	332
Figure 1-549	Connect the cables .....	332
Figure 1-550	Install the control panel .....	333
Figure 1-551	Rotate the control-panel base down .....	333
Figure 1-552	Install two screws .....	334
Figure 1-553	Install the cover .....	334
Figure 1-554	Install the tray .....	335
Figure 1-555	Close the tray .....	335
Figure 1-556	Tilt the control panel up .....	338
Figure 1-557	Remove the cover .....	338
Figure 1-558	Remove two screws .....	339
Figure 1-559	Turn the control panel over .....	339
Figure 1-560	Remove the control panel .....	340
Figure 1-561	Pull the tray out until it stops .....	340
Figure 1-562	Release and remove the tray .....	341
Figure 1-563	Remove the formatter cover (M501) .....	341
Figure 1-564	Remove the formatter cover (M506/M527) .....	342
Figure 1-565	Disconnect three connectors .....	342

Figure 1-566	Release the fax PCA .....	343
Figure 1-567	Remove the fax PCA .....	343
Figure 1-568	Open the door or release the cover .....	344
Figure 1-569	Release the upper hinge or remove the cover .....	344
Figure 1-570	Release the lower hinge .....	345
Figure 1-571	Remove the door .....	345
Figure 1-572	Locate the tabs .....	346
Figure 1-573	Release one tab .....	346
Figure 1-574	Release one tab .....	347
Figure 1-575	Remove the cover .....	347
Figure 1-576	Release two tabs .....	348
Figure 1-577	Release two tabs .....	348
Figure 1-578	Slide the cover .....	349
Figure 1-579	Remove the cover .....	349
Figure 1-580	Remove one screw .....	350
Figure 1-581	Rotate the cover .....	350
Figure 1-582	Release one boss .....	351
Figure 1-583	Remove the cover .....	351
Figure 1-584	Remove two screws .....	352
Figure 1-585	Rotate the bottom of the cover .....	352
Figure 1-586	Remove the cover .....	353
Figure 1-587	Release the support shaft .....	354
Figure 1-588	Remove the support shaft .....	354
Figure 1-589	Remove the guide .....	355
Figure 1-590	Release the pressure-release link .....	355
Figure 1-591	Release the door .....	356
Figure 1-592	Release the left-side retainer arm .....	356
Figure 1-593	Remove the door .....	357
Figure 1-594	Locate the tabs and bosses .....	357
Figure 1-595	Remove two screws .....	358
Figure 1-596	Release one boss .....	358
Figure 1-597	Release two bosses .....	359
Figure 1-598	Release one tab .....	359
Figure 1-599	Release one tab .....	360
Figure 1-600	Remove the cover .....	360
Figure 1-601	Locate of the tabs and bosses .....	361
Figure 1-602	Remove one screw .....	361
Figure 1-603	Release one boss and three tabs .....	362
Figure 1-604	Release two tabs .....	362
Figure 1-605	Remove the cover .....	363
Figure 1-606	Remove one screw .....	364

Figure 1-607	Disconnect cables and connectors .....	364
Figure 1-608	Disconnect connectors and remove screws .....	365
Figure 1-609	Slide the ISA towards the back of the printer .....	365
Figure 1-610	Remove the ISA .....	366
Figure 1-611	Remove one screw and the plate .....	366
Figure 1-612	Remove three screws .....	367
Figure 1-613	Remove three screws .....	367
Figure 1-614	Release one boss .....	368
Figure 1-615	Rotate the front of the cover up .....	368
Figure 1-616	Remove the cover .....	369
Figure 1-617	Remove two screws .....	369
Figure 1-618	Release one cable retainer .....	370
Figure 1-619	Release one boss .....	370
Figure 1-620	Remove the cover .....	371
Figure 1-621	Release two tabs .....	371
Figure 1-622	Remove the bin .....	372
Figure 1-623	Recycle and unpack .....	372
Figure 1-624	Install the bin .....	373
Figure 1-625	Install the cover .....	374
Figure 1-626	Engage one boss .....	374
Figure 1-627	Install one cable retainer .....	375
Figure 1-628	Install two screws .....	375
Figure 1-629	Install the cover .....	376
Figure 1-630	Rotate the front of the cover down .....	376
Figure 1-631	Engage one boss .....	377
Figure 1-632	Install three screws .....	377
Figure 1-633	Install three screws .....	378
Figure 1-634	Install one screw and the plate .....	378
Figure 1-635	Locate the ISA mounting pins and slots .....	271
Figure 1-636	Install the ISA .....	379
Figure 1-637	Slide the ISA towards the front of the printer .....	380
Figure 1-638	Install screws and connect connectors .....	380
Figure 1-639	Connect cables and connectors .....	381
Figure 1-640	Install one screw .....	381
Figure 1-641	Locate of the tabs and bosses .....	382
Figure 1-642	Install the cover .....	382
Figure 1-643	Engage two tabs .....	383
Figure 1-644	Engage three tabs and one boss .....	383
Figure 1-645	Install one screw .....	384
Figure 1-646	Locate the tabs and bosses .....	384
Figure 1-647	Install the cover .....	385



Figure 1-648	Engage one tab .....	385
Figure 1-649	Engage one tab .....	386
Figure 1-650	Engage two bosses .....	386
Figure 1-651	Engage one boss .....	387
Figure 1-652	Install two screws .....	387
Figure 1-653	Engage the left-side retainer arm .....	388
Figure 1-654	Install the door .....	388
Figure 1-655	Install the pressure-release link .....	389
Figure 1-656	Install the guide .....	389
Figure 1-657	Align the hinge .....	390
Figure 1-658	Install the support shaft .....	391
Figure 1-659	Install the cover .....	392
Figure 1-660	Rotate the bottom of the cover .....	392
Figure 1-661	Install two screws .....	393
Figure 1-662	Engage one boss .....	393
Figure 1-663	Install the cover .....	394
Figure 1-664	Install one screw .....	394
Figure 1-665	Slide the cover .....	395
Figure 1-666	Engage two tabs .....	395
Figure 1-667	Engage two tabs .....	396
Figure 1-668	Locate the tabs .....	396
Figure 1-669	Install the cover .....	397
Figure 1-670	Engage one tab .....	397
Figure 1-671	Engage one tab .....	398
Figure 1-672	Install the door or cover .....	398
Figure 1-673	Engage the lower hinge or engage the cover .....	399
Figure 1-674	Engage the upper hinge .....	399
Figure 1-675	Close the door .....	400
Figure 1-676	Locate the slots in the sheet-metal .....	401
Figure 1-677	Install the fax PCA .....	401
Figure 1-678	Engage the fax PCA .....	402
Figure 1-679	Connect three connectors .....	402
Figure 1-680	Install the formatter cover (M501) .....	403
Figure 1-681	Install the formatter cover (M506/M527) .....	403
Figure 1-682	Install the tray .....	404
Figure 1-683	Close the tray .....	404
Figure 1-684	Connect the cables .....	405
Figure 1-685	Install the control panel .....	405
Figure 1-686	Rotate the control-panel base down .....	406
Figure 1-687	Install two screws .....	406
Figure 1-688	Install the cover .....	407

Figure 1-689	Open the document feeder .....	409
Figure 1-690	Remove the white backing .....	410
Figure 1-691	Check the retention clips .....	410
Figure 1-692	Check the retention clip spring .....	411
Figure 1-693	Install the retention clip .....	411
Figure 1-694	Press the retention clip .....	412
Figure 1-695	Release five tabs .....	412
Figure 1-696	Remove the cover .....	413
Figure 1-697	Disconnect the FFC (M527c/z) .....	413
Figure 1-698	Disconnect connectors .....	414
Figure 1-699	Release the USB and disconnect the NFC PCA .....	414
Figure 1-700	Remove three screws .....	415
Figure 1-701	Remove the control panel .....	415
Figure 1-702	Remove the formatter cover .....	416
Figure 1-703	Disconnect three connectors .....	416
Figure 1-704	Release the fax PCA .....	417
Figure 1-705	Remove the fax PCA .....	417
Figure 1-706	Open the door or release the cover .....	418
Figure 1-707	Release the upper hinge or remove the cover .....	418
Figure 1-708	Release the lower hinge .....	419
Figure 1-709	Remove the door .....	419
Figure 1-710	Locate the tabs .....	420
Figure 1-711	Release one tab .....	420
Figure 1-712	Release one tab .....	421
Figure 1-713	Remove the cover .....	421
Figure 1-714	Release two tabs .....	422
Figure 1-715	Release two tabs .....	422
Figure 1-716	Slide the cover .....	423
Figure 1-717	Remove the cover .....	423
Figure 1-718	Remove one screw .....	424
Figure 1-719	Rotate the cover .....	424
Figure 1-720	Release one boss .....	425
Figure 1-721	Remove the cover .....	425
Figure 1-722	Disconnect all of the connectors .....	426
Figure 1-723	Remove three screws .....	426
Figure 1-724	Remove one ferrite .....	427
Figure 1-725	Remove one ferrite .....	427
Figure 1-726	Remove the ferrite from the FFC .....	428
Figure 1-727	Slide the SCB out .....	428
Figure 1-728	Remove the SCB .....	429
Figure 1-729	Remove the cover .....	429

Figure 1-730	Disconnect the FFC and the ground cable .....	430
Figure 1-731	Raise the document feeder .....	430
Figure 1-732	Release two tabs .....	431
Figure 1-733	Remove the document feeder .....	431
Figure 1-734	Remove one screw .....	432
Figure 1-735	Disconnect cables and connectors .....	432
Figure 1-736	Remove four screws .....	433
Figure 1-737	Release the SSA .....	433
Figure 1-738	Remove the SSA .....	434
Figure 1-739	Recycle and unpack .....	434
Figure 1-740	Locate the SSA mounting pins and slots .....	435
Figure 1-741	Install the SSA .....	435
Figure 1-742	Engage the SSA .....	436
Figure 1-743	Install four screws .....	436
Figure 1-744	Connect cables and connectors .....	437
Figure 1-745	Install one screw .....	437
Figure 1-746	Keyboard cover mounting slots and tabs (M527dn and M527f) .....	438
Figure 1-747	Install the keyboard cover (M527dn and M527f) .....	438
Figure 1-748	Check the keyboard cover (M527dn and M527f) .....	439
Figure 1-749	Install the document feeder .....	439
Figure 1-750	Lower the document feeder .....	440
Figure 1-751	Connect the FFC and the ground cable .....	440
Figure 1-752	Install the cover and screw .....	441
Figure 1-753	Install the SCB .....	441
Figure 1-754	Slide the SCB in .....	442
Figure 1-755	Install the ferrite on the FFC .....	442
Figure 1-756	Install the ferrite in the holder .....	443
Figure 1-757	Install the ferrite in the holder .....	443
Figure 1-758	Install three screws .....	444
Figure 1-759	Connect all of the connectors .....	444
Figure 1-760	Engage one boss .....	445
Figure 1-761	Install the cover .....	445
Figure 1-762	Install one screw .....	446
Figure 1-763	Slide the cover .....	446
Figure 1-764	Engage two tabs .....	447
Figure 1-765	Engage two tabs .....	447
Figure 1-766	Locate the tabs .....	448
Figure 1-767	Install the cover .....	448
Figure 1-768	Engage one tab .....	449
Figure 1-769	Engage one tab .....	449
Figure 1-770	Install the door or cover .....	450

Figure 1-771	Engage the lower hinge or engage the cover .....	450
Figure 1-772	Engage the upper hinge .....	451
Figure 1-773	Close the door .....	451
Figure 1-774	Locate the slots in the sheet-metal .....	452
Figure 1-775	Install the fax PCA .....	452
Figure 1-776	Engage the fax PCA .....	453
Figure 1-777	Connect three connectors .....	453
Figure 1-778	Install the formatter cover .....	454
Figure 1-779	Check the keyboard fla cable (M527c/z) .....	454
Figure 1-780	Locate the hooks and slots .....	455
Figure 1-781	Install the control-panel .....	455
Figure 1-782	Install three screws .....	456
Figure 1-783	Connect the connectors .....	456
Figure 1-784	Install the USB cable and connect the NFC PCA .....	457
Figure 1-785	Connect the fla cable (M527z) .....	458
Figure 1-786	Position the control-panel cover on the printer .....	458
Figure 1-787	Engage five tabs .....	459
Figure 1-788	Close the document feeder .....	459
Figure 1-789	Install the white backing .....	460
Figure 1-790	Close the document feeder .....	460
Figure 1-791	Check the white backing .....	461
Figure 1-792	Close the document feeder .....	461
Figure 1-793	Remove the formatter cover .....	462
Figure 1-794	Disconnect three connectors .....	462
Figure 1-795	Release the fax PCA .....	463
Figure 1-796	Remove the fax PCA .....	463
Figure 1-797	Open the door or release the cover .....	464
Figure 1-798	Release the upper hinge or remove the cover .....	464
Figure 1-799	Release the lower hinge .....	465
Figure 1-800	Remove the door .....	465
Figure 1-801	Locate the tabs .....	466
Figure 1-802	Release one tab .....	466
Figure 1-803	Release one tab .....	467
Figure 1-804	Remove the cover .....	467
Figure 1-805	Release two tabs .....	468
Figure 1-806	Release two tabs .....	468
Figure 1-807	Slide the cover .....	469
Figure 1-808	Remove the cover .....	469
Figure 1-809	Remove one screw .....	470
Figure 1-810	Rotate the cover .....	470
Figure 1-811	Release one boss .....	471

Figure 1-812	Remove the cover .....	471
Figure 1-813	Remove one screw .....	472
Figure 1-814	Disconnect cables and connectors .....	472
Figure 1-815	Disconnect connectors and remove screws .....	473
Figure 1-816	Slide the ISA towards the back of the printer .....	473
Figure 1-817	Remove the ISA .....	474
Figure 1-818	Locate the ISA mounting pins and slots .....	271
Figure 1-819	Install the ISA .....	475
Figure 1-820	Slide the ISA towards the front of the printer .....	475
Figure 1-821	Install screws and connect connectors .....	476
Figure 1-822	Connect cables and connectors .....	476
Figure 1-823	Install one screw .....	477
Figure 1-824	Engage one boss .....	477
Figure 1-825	Install the cover .....	478
Figure 1-826	Install one screw .....	478
Figure 1-827	Slide the cover .....	479
Figure 1-828	Engage two tabs .....	479
Figure 1-829	Engage two tabs .....	480
Figure 1-830	Locate the tabs .....	480
Figure 1-831	Install the cover .....	481
Figure 1-832	Engage one tab .....	481
Figure 1-833	Engage one tab .....	482
Figure 1-834	Install the door or cover .....	482
Figure 1-835	Engage the lower hinge or engage the cover .....	483
Figure 1-836	Engage the upper hinge .....	483
Figure 1-837	Close the door .....	484
Figure 1-838	Locate the slots in the sheet-metal .....	484
Figure 1-839	Install the fax PCA .....	485
Figure 1-840	Engage the fax PCA .....	485
Figure 1-841	Connect three connectors .....	486
Figure 1-842	Install the formatter cover .....	486
Figure 1-843	Remove the formatter cover .....	489
Figure 1-844	Release two tabs .....	490
Figure 1-845	Release two tabs .....	490
Figure 1-846	Slide the cover .....	491
Figure 1-847	Remove the cover .....	491
Figure 1-848	Remove one screw .....	492
Figure 1-849	Rotate the cover .....	492
Figure 1-850	Release one boss .....	493
Figure 1-851	Remove the cover .....	493
Figure 1-852	Disconnect all of the connectors .....	494

Figure 1-853	Remove three screws .....	494
Figure 1-854	Remove one ferrite .....	495
Figure 1-855	Remove one ferrite .....	495
Figure 1-856	Remove the ferrite from the FFC .....	496
Figure 1-857	Slide the SCB out .....	496
Figure 1-858	Remove the SCB .....	497
Figure 1-859	Remove two screws .....	497
Figure 1-860	Remove the cover .....	498
Figure 1-861	Recycle and unpack .....	498
Figure 1-862	Install the cover .....	499
Figure 1-863	Install two screws .....	499
Figure 1-864	Install the SCB .....	500
Figure 1-865	Slide the SCB in .....	500
Figure 1-866	Install the ferrite on the FFC .....	501
Figure 1-867	Install the ferrite in the holder .....	501
Figure 1-868	Install the ferrite in the holder .....	502
Figure 1-869	Install three screws .....	502
Figure 1-870	Connect all of the connectors .....	503
Figure 1-871	Engage one boss .....	503
Figure 1-872	Install the cover .....	504
Figure 1-873	Install one screw .....	504
Figure 1-874	Slide the cover .....	505
Figure 1-875	Engage two tabs .....	505
Figure 1-876	Engage two tabs .....	506
Figure 1-877	Install the formatter cover .....	506
Figure 1-878	Open the document feeder .....	508
Figure 1-879	Release five tabs .....	508
Figure 1-880	Remove the cover .....	509
Figure 1-881	Release two tabs .....	509
Figure 1-882	Remove the NFC PCA .....	510
Figure 1-883	Recycle and unpack .....	510
Figure 1-884	Connect one FFC .....	511
Figure 1-885	Install the NFC PCA .....	511
Figure 1-886	Position the control-panel cover on the printer .....	512
Figure 1-887	Engage five tabs .....	512
Figure 1-888	Close the document feeder .....	513
Figure 1-889	Pull the tray out until it stops .....	515
Figure 1-890	Release and remove the tray .....	516
Figure 1-891	Remove the formatter cover .....	516
Figure 1-892	Remove two screws .....	517
Figure 1-893	Rotate the bottom of the cover .....	517

Figure 1-894	Remove the cover .....	518
Figure 1-895	Release the support shaft .....	519
Figure 1-896	Remove the support shaft .....	519
Figure 1-897	Remove the guide .....	520
Figure 1-898	Release the pressure-release link .....	520
Figure 1-899	Release the door .....	521
Figure 1-900	Release the left-side retainer arm .....	521
Figure 1-901	Remove the door .....	522
Figure 1-902	Locate the tabs and bosses .....	522
Figure 1-903	Remove two screws .....	523
Figure 1-904	Release one boss .....	523
Figure 1-905	Release two bosses .....	524
Figure 1-906	Release one tab .....	524
Figure 1-907	Release one tab .....	525
Figure 1-908	Remove the cover .....	525
Figure 1-909	Remove the WiFi PCA .....	526
Figure 1-910	Recycle and unpack .....	526
Figure 1-911	Install the WiFi PCA .....	527
Figure 1-912	Locate the tabs and bosses .....	527
Figure 1-913	Install the cover .....	528
Figure 1-914	Engage one tab .....	528
Figure 1-915	Engage one tab .....	529
Figure 1-916	Engage two bosses .....	529
Figure 1-917	Engage one boss .....	530
Figure 1-918	Install two screws .....	530
Figure 1-919	Engage the left-side retainer arm .....	531
Figure 1-920	Install the door .....	531
Figure 1-921	Install the pressure-release link .....	532
Figure 1-922	Install the guide .....	532
Figure 1-923	Align the hinge .....	533
Figure 1-924	Install the support shaft .....	534
Figure 1-925	Install the cover .....	535
Figure 1-926	Rotate the bottom of the cover .....	535
Figure 1-927	Install two screws .....	536
Figure 1-928	Install the formatter cover .....	536
Figure 1-929	Install the tray .....	537
Figure 1-930	Close the tray .....	537
Figure 1-931	Remove the formatter cover .....	539
Figure 1-932	Remove the WiFi PCA .....	539
Figure 1-933	Recycle and unpack .....	540
Figure 1-934	Install the WiFi PCA .....	540

Figure 1-935	Install the formatter cover .....	541
Figure 1-936	Remove two screws .....	543
Figure 1-937	Rotate the bottom of the cover .....	543
Figure 1-938	Remove the cover .....	544
Figure 1-939	Remove the cover .....	544
Figure 1-940	Disconnect two connectors .....	545
Figure 1-941	Disconnect one connector .....	545
Figure 1-942	Remove four screws .....	546
Figure 1-943	Release the pressure-release arm .....	546
Figure 1-944	Remove the fuser .....	547
Figure 1-945	Recycle and unpack .....	547
Figure 1-946	Install the fuser .....	548
Figure 1-947	Engage the pressure-release arm .....	548
Figure 1-948	Install four screws .....	549
Figure 1-949	Connect one connector .....	549
Figure 1-950	Connect two connectors .....	550
Figure 1-951	Install the cover .....	550
Figure 1-952	Install the cover .....	551
Figure 1-953	Rotate the bottom of the cover .....	551
Figure 1-954	Install two screws .....	552
Figure 1-955	Remove the formatter cover .....	554
Figure 1-956	Open the door or release the cover .....	554
Figure 1-957	Release the upper hinge or remove the cover .....	555
Figure 1-958	Release the lower hinge .....	555
Figure 1-959	Remove the door .....	556
Figure 1-960	Locate the tabs .....	556
Figure 1-961	Release one tab .....	557
Figure 1-962	Release one tab .....	557
Figure 1-963	Remove the cover .....	558
Figure 1-964	Disconnect one connector and remove one screw .....	558
Figure 1-965	Remove the stapler unit .....	559
Figure 1-966	Recycle and unpack .....	559
Figure 1-967	Install the stapler unit .....	560
Figure 1-968	Install one screw and connect one connector .....	560
Figure 1-969	Locate the tabs .....	561
Figure 1-970	Install the cover .....	561
Figure 1-971	Engage one tab .....	562
Figure 1-972	Engage one tab .....	562
Figure 1-973	Install the door or cover .....	563
Figure 1-974	Engage the lower hinge or engage the cover .....	563
Figure 1-975	Engage the upper hinge .....	564



Figure 1-976	Close the door .....	564
Figure 1-977	Install the formatter cover .....	565
Figure 1-978	Remove the formatter cover (M501) .....	568
Figure 1-979	Remove the formatter cover (M506/M527) .....	568
Figure 1-980	Disconnect three connectors .....	569
Figure 1-981	Release the fax PCA .....	569
Figure 1-982	Remove the fax PCA .....	570
Figure 1-983	Release the HDD .....	570
Figure 1-984	Remove the HDD .....	571
Figure 1-985	Remove the eMMC .....	572
Figure 1-986	Remove the DIMM (M506) .....	573
Figure 1-987	Release the DIMM (M527) .....	573
Figure 1-988	Remove the DIMM (M527) .....	574
Figure 1-989	Remove the formatter (M501) .....	574
Figure 1-990	Remove the formatter (M506/M527) .....	575
Figure 1-991	Recycle and unpack .....	575
Figure 1-992	Install the formatter (M501) .....	576
Figure 1-993	Install the formatter (M506/M527) .....	576
Figure 1-994	Install the DIMM (M506) .....	577
Figure 1-995	Insert the DIMM (M527) .....	577
Figure 1-996	Install the DIMM (M527) .....	578
Figure 1-997	Install the eMMC .....	579
Figure 1-998	Locate the slot in the sheet-metal .....	579
Figure 1-999	Install the HDD .....	580
Figure 1-1000	Install the HDD .....	580
Figure 1-1001	Locate the slots in the sheet-metal .....	581
Figure 1-1002	Install the fax PCA .....	581
Figure 1-1003	Engage the fax PCA .....	582
Figure 1-1004	Connect three connectors .....	582
Figure 1-1005	Install the formatter cover (M501) .....	583
Figure 1-1006	Install the formatter cover (M506/M527) .....	583
Figure 1-1007	Tilt the control panel up .....	586
Figure 1-1008	Remove the cover .....	586
Figure 1-1009	Remove two screws .....	587
Figure 1-1010	Turn the control panel over .....	587
Figure 1-1011	Remove the control panel .....	588
Figure 1-1012	Pull the tray out until it stops .....	588
Figure 1-1013	Release and remove the tray .....	589
Figure 1-1014	Remove the formatter cover (M501) .....	589
Figure 1-1015	Remove the formatter cover (M506/M527) .....	590
Figure 1-1016	Disconnect three connectors .....	590

Figure 1-1017	Release the fax PCA .....	591
Figure 1-1018	Remove the fax PCA .....	591
Figure 1-1019	Open the door or release the cover .....	592
Figure 1-1020	Release the upper hinge or remove the cover .....	592
Figure 1-1021	Release the lower hinge .....	593
Figure 1-1022	Remove the door .....	593
Figure 1-1023	Locate the tabs .....	594
Figure 1-1024	Release one tab .....	594
Figure 1-1025	Release one tab .....	595
Figure 1-1026	Remove the cover .....	595
Figure 1-1027	Release two tabs .....	596
Figure 1-1028	Release two tabs .....	596
Figure 1-1029	Slide the cover .....	597
Figure 1-1030	Remove the cover .....	597
Figure 1-1031	Remove one screw .....	598
Figure 1-1032	Rotate the cover .....	598
Figure 1-1033	Release one boss .....	599
Figure 1-1034	Remove the cover .....	599
Figure 1-1035	Remove two screws .....	600
Figure 1-1036	Rotate the bottom of the cover .....	600
Figure 1-1037	Remove the cover .....	601
Figure 1-1038	Release the support shaft .....	602
Figure 1-1039	Remove the support shaft .....	602
Figure 1-1040	Remove the guide .....	603
Figure 1-1041	Release the pressure-release link .....	603
Figure 1-1042	Release the door .....	604
Figure 1-1043	Release the left-side retainer arm .....	604
Figure 1-1044	Remove the door .....	605
Figure 1-1045	Locate the tabs and bosses .....	605
Figure 1-1046	Remove two screws .....	606
Figure 1-1047	Release one boss .....	606
Figure 1-1048	Release two bosses .....	607
Figure 1-1049	Release one tab .....	607
Figure 1-1050	Release one tab .....	608
Figure 1-1051	Remove the cover .....	608
Figure 1-1052	Locate of the tabs and bosses .....	609
Figure 1-1053	Remove one screw .....	609
Figure 1-1054	Release one boss and three tabs .....	610
Figure 1-1055	Release two tabs .....	610
Figure 1-1056	Remove the cover .....	611
Figure 1-1057	Remove one screw .....	612

Figure 1-1058	Disconnect cables and connectors .....	612
Figure 1-1059	Disconnect connectors and remove screws .....	613
Figure 1-1060	Slide the ISA towards the back of the printer .....	613
Figure 1-1061	Remove the ISA .....	614
Figure 1-1062	Remove one screw and the plate .....	614
Figure 1-1063	Remove three screws .....	615
Figure 1-1064	Remove three screws .....	615
Figure 1-1065	Release one boss .....	616
Figure 1-1066	Rotate the front of the cover up .....	616
Figure 1-1067	Remove the cover .....	617
Figure 1-1068	Remove two screws .....	617
Figure 1-1069	Release one cable retainer .....	618
Figure 1-1070	Release one boss .....	618
Figure 1-1071	Remove the cover .....	619
Figure 1-1072	Disconnect one FFC .....	619
Figure 1-1073	Remove the antistatic foam pad .....	620
Figure 1-1074	Disconnect one connector .....	620
Figure 1-1075	Remove four screws .....	621
Figure 1-1076	Remove the laser/scanner .....	621
Figure 1-1077	Recycle and unpack .....	622
Figure 1-1078	Install the laser/scanner .....	622
Figure 1-1079	Install four screws .....	623
Figure 1-1080	Connect one connector .....	623
Figure 1-1081	Install the antistatic foam pad .....	624
Figure 1-1082	Disconnect one FFC .....	624
Figure 1-1083	Install the cover .....	625
Figure 1-1084	Engage one boss .....	625
Figure 1-1085	Install one cable retainer .....	626
Figure 1-1086	Install two screws .....	626
Figure 1-1087	Install the cover .....	627
Figure 1-1088	Rotate the front of the cover down .....	627
Figure 1-1089	Engage one boss .....	628
Figure 1-1090	Install three screws .....	628
Figure 1-1091	Install three screws .....	629
Figure 1-1092	Install one screw and the plate .....	629
Figure 1-1093	Locate the ISA mounting pins and slots .....	271
Figure 1-1094	Install the ISA .....	630
Figure 1-1095	Slide the ISA towards the front of the printer .....	631
Figure 1-1096	Install screws and connect connectors .....	631
Figure 1-1097	Connect cables and connectors .....	632
Figure 1-1098	Install one screw .....	632

Figure 1-1099	Locate of the tabs and bosses .....	633
Figure 1-1100	Install the cover .....	633
Figure 1-1101	Engage two tabs .....	634
Figure 1-1102	Engage three tabs and one boss .....	634
Figure 1-1103	Install one screw .....	635
Figure 1-1104	Locate the tabs and bosses .....	635
Figure 1-1105	Install the cover .....	636
Figure 1-1106	Engage one tab .....	636
Figure 1-1107	Engage one tab .....	637
Figure 1-1108	Engage two bosses .....	637
Figure 1-1109	Engage one boss .....	638
Figure 1-1110	Install two screws .....	638
Figure 1-1111	Engage the left-side retainer arm .....	639
Figure 1-1112	Install the door .....	639
Figure 1-1113	Install the pressure-release link .....	640
Figure 1-1114	Install the guide .....	640
Figure 1-1115	Align the hinge .....	641
Figure 1-1116	Install the support shaft .....	642
Figure 1-1117	Install the cover .....	643
Figure 1-1118	Rotate the bottom of the cover .....	643
Figure 1-1119	Install two screws .....	644
Figure 1-1120	Engage one boss .....	644
Figure 1-1121	Install the cover .....	645
Figure 1-1122	Install one screw .....	645
Figure 1-1123	Slide the cover .....	646
Figure 1-1124	Engage two tabs .....	646
Figure 1-1125	Engage two tabs .....	647
Figure 1-1126	Locate the tabs .....	647
Figure 1-1127	Install the cover .....	648
Figure 1-1128	Engage one tab .....	648
Figure 1-1129	Engage one tab .....	649
Figure 1-1130	Install the door or cover .....	649
Figure 1-1131	Engage the lower hinge or engage the cover .....	650
Figure 1-1132	Engage the upper hinge .....	650
Figure 1-1133	Close the door .....	651
Figure 1-1134	Locate the slots in the sheet-metal .....	652
Figure 1-1135	Install the fax PCA .....	652
Figure 1-1136	Engage the fax PCA .....	653
Figure 1-1137	Connect three connectors .....	653
Figure 1-1138	Install the formatter cover (M501) .....	654
Figure 1-1139	Install the formatter cover (M506/M527) .....	654

Figure 1-1140	Install the tray .....	655
Figure 1-1141	Close the tray .....	655
Figure 1-1142	Connect the cables .....	656
Figure 1-1143	Install the control panel .....	656
Figure 1-1144	Rotate the control-panel base down .....	657
Figure 1-1145	Install two screws .....	657
Figure 1-1146	Install the cover .....	658
Figure 1-1147	Tilt the control panel up .....	661
Figure 1-1148	Remove the cover .....	662
Figure 1-1149	Remove two screws .....	662
Figure 1-1150	Turn the control panel over .....	663
Figure 1-1151	Remove the control panel .....	663
Figure 1-1152	Pull the tray out until it stops .....	664
Figure 1-1153	Release and remove the tray .....	664
Figure 1-1154	Remove the formatter cover (M501) .....	665
Figure 1-1155	Remove the formatter cover (M506/M527) .....	665
Figure 1-1156	Release the HDD .....	666
Figure 1-1157	Remove the HDD .....	666
Figure 1-1158	Disconnect three connectors .....	667
Figure 1-1159	Release the fax PCA .....	667
Figure 1-1160	Remove the fax PCA .....	668
Figure 1-1161	Remove the formatter (M501) .....	668
Figure 1-1162	Remove the formatter (M506/M527) .....	669
Figure 1-1163	Open the door or release the cover .....	669
Figure 1-1164	Release the upper hinge or remove the cover .....	670
Figure 1-1165	Release the lower hinge .....	670
Figure 1-1166	Remove the door .....	671
Figure 1-1167	Locate the tabs .....	671
Figure 1-1168	Release one tab .....	672
Figure 1-1169	Release one tab .....	672
Figure 1-1170	Remove the cover .....	673
Figure 1-1171	Release two tabs .....	673
Figure 1-1172	Release two tabs .....	674
Figure 1-1173	Slide the cover .....	674
Figure 1-1174	Remove the cover .....	675
Figure 1-1175	Remove one screw .....	675
Figure 1-1176	Rotate the cover .....	676
Figure 1-1177	Release one boss .....	676
Figure 1-1178	Remove the cover .....	677
Figure 1-1179	Remove two screws .....	677
Figure 1-1180	Rotate the bottom of the cover .....	678

Figure 1-1181	Remove the cover .....	678
Figure 1-1182	Release the support shaft .....	679
Figure 1-1183	Remove the support shaft .....	679
Figure 1-1184	Remove the guide .....	680
Figure 1-1185	Release the pressure-release link .....	680
Figure 1-1186	Release the door .....	681
Figure 1-1187	Release the left-side retainer arm .....	681
Figure 1-1188	Remove the door .....	682
Figure 1-1189	Locate the tabs and bosses .....	682
Figure 1-1190	Remove two screws .....	683
Figure 1-1191	Release one boss .....	683
Figure 1-1192	Release two bosses .....	684
Figure 1-1193	Release one tab .....	684
Figure 1-1194	Release one tab .....	685
Figure 1-1195	Remove the cover .....	685
Figure 1-1196	Locate of the tabs and bosses .....	686
Figure 1-1197	Remove one screw .....	686
Figure 1-1198	Release one boss and three tabs .....	687
Figure 1-1199	Release two tabs .....	687
Figure 1-1200	Remove the cover .....	688
Figure 1-1201	Remove one screw .....	689
Figure 1-1202	Disconnect cables and connectors .....	689
Figure 1-1203	Disconnect connectors and remove screws .....	690
Figure 1-1204	Slide the ISA towards the back of the printer .....	690
Figure 1-1205	Remove the ISA .....	691
Figure 1-1206	Remove one screw and the plate .....	691
Figure 1-1207	Remove three screws .....	692
Figure 1-1208	Remove three screws .....	692
Figure 1-1209	Release one boss .....	693
Figure 1-1210	Rotate the front of the cover up .....	693
Figure 1-1211	Remove the cover .....	694
Figure 1-1212	Remove two screws .....	694
Figure 1-1213	Release one cable retainer .....	695
Figure 1-1214	Release one boss .....	695
Figure 1-1215	Remove the cover .....	696
Figure 1-1216	Release two tabs .....	696
Figure 1-1217	Remove the bin .....	697
Figure 1-1218	Remove the sheet-metal plate .....	697
Figure 1-1219	Pass all cables and wire harnesses through the opening .....	698
Figure 1-1220	Remove one screw .....	698
Figure 1-1221	Remove the guide .....	699

Figure 1-1222	Remove four screws .....	699
Figure 1-1223	Remove five screws .....	700
Figure 1-1224	Disconnect one connector .....	700
Figure 1-1225	Release the formatter case .....	701
Figure 1-1226	Remove the formatter case .....	701
Figure 1-1227	Recycle and unpack .....	702
Figure 1-1228	Position the formatter case against the chassis .....	702
Figure 1-1229	Install the formatter case .....	703
Figure 1-1230	Connect one connector .....	703
Figure 1-1231	Install five screws .....	704
Figure 1-1232	Install four screws .....	704
Figure 1-1233	Install the guide .....	705
Figure 1-1234	Install one screw .....	705
Figure 1-1235	Pass all cables and wire harnesses through the opening .....	706
Figure 1-1236	Remove the sheet-metal plate .....	706
Figure 1-1237	Install the bin .....	707
Figure 1-1238	Install the cover .....	708
Figure 1-1239	Engage one boss .....	708
Figure 1-1240	Install one cable retainer .....	709
Figure 1-1241	Install two screws .....	709
Figure 1-1242	Install the cover .....	710
Figure 1-1243	Rotate the front of the cover down .....	710
Figure 1-1244	Engage one boss .....	711
Figure 1-1245	Install three screws .....	711
Figure 1-1246	Install three screws .....	712
Figure 1-1247	Install one screw and the plate .....	712
Figure 1-1248	Locate the ISA mounting pins and slots .....	271
Figure 1-1249	Install the ISA .....	713
Figure 1-1250	Slide the ISA towards the front of the printer .....	714
Figure 1-1251	Install screws and connect connectors .....	714
Figure 1-1252	Connect cables and connectors .....	715
Figure 1-1253	Install one screw .....	715
Figure 1-1254	Locate the tabs and bosses .....	716
Figure 1-1255	Install the cover .....	716
Figure 1-1256	Engage two tabs .....	717
Figure 1-1257	Engage three tabs and one boss .....	717
Figure 1-1258	Install one screw .....	718
Figure 1-1259	Locate the tabs and bosses .....	718
Figure 1-1260	Install the cover .....	719
Figure 1-1261	Engage one tab .....	719
Figure 1-1262	Engage one tab .....	720

Figure 1-1263	Engage two bosses .....	720
Figure 1-1264	Engage one boss .....	721
Figure 1-1265	Install two screws .....	721
Figure 1-1266	Engage the left-side retainer arm .....	722
Figure 1-1267	Install the door .....	722
Figure 1-1268	Install the pressure-release link .....	723
Figure 1-1269	Install the guide .....	723
Figure 1-1270	Align the hinge .....	724
Figure 1-1271	Install the support shaft .....	725
Figure 1-1272	Install the cover .....	726
Figure 1-1273	Rotate the bottom of the cover .....	726
Figure 1-1274	Install two screws .....	727
Figure 1-1275	Engage one boss .....	727
Figure 1-1276	Install the cover .....	728
Figure 1-1277	Install one screw .....	728
Figure 1-1278	Slide the cover .....	729
Figure 1-1279	Engage two tabs .....	729
Figure 1-1280	Engage two tabs .....	730
Figure 1-1281	Locate the tabs .....	730
Figure 1-1282	Install the cover .....	731
Figure 1-1283	Engage one tab .....	731
Figure 1-1284	Engage one tab .....	732
Figure 1-1285	Install the door or cover .....	732
Figure 1-1286	Engage the lower hinge or engage the cover .....	733
Figure 1-1287	Engage the upper hinge .....	733
Figure 1-1288	Close the door .....	734
Figure 1-1289	Install the formatter (M501) .....	734
Figure 1-1290	Install the formatter (M506/M527) .....	735
Figure 1-1291	Locate the slots in the sheet-metal .....	735
Figure 1-1292	Install the fax PCA .....	736
Figure 1-1293	Engage the fax PCA .....	736
Figure 1-1294	Connect three connectors .....	737
Figure 1-1295	Locate the slot in the sheet-metal .....	737
Figure 1-1296	Install the HDD .....	738
Figure 1-1297	Install the HDD .....	738
Figure 1-1298	Install the formatter cover (M501) .....	739
Figure 1-1299	Install the formatter cover (M506/M527) .....	739
Figure 1-1300	Install the tray .....	740
Figure 1-1301	Close the tray .....	740
Figure 1-1302	Connect the cables .....	741
Figure 1-1303	Install the control panel .....	741



Figure 1-1304	Rotate the control-panel base down .....	742
Figure 1-1305	Install two screws .....	742
Figure 1-1306	Install the cover .....	743
Figure 1-1307	Pull the tray out until it stops .....	745
Figure 1-1308	Release and remove the tray .....	746
Figure 1-1309	Release the support shaft .....	747
Figure 1-1310	Remove the support shaft .....	747
Figure 1-1311	Remove the guide .....	748
Figure 1-1312	Release the pressure-release link .....	748
Figure 1-1313	Release the door .....	749
Figure 1-1314	Release the left-side retainer arm .....	749
Figure 1-1315	Remove the door .....	750
Figure 1-1316	Remove two screws .....	750
Figure 1-1317	Rotate the bottom of the cover .....	751
Figure 1-1318	Remove the cover .....	751
Figure 1-1319	Locate of the tabs and bosses .....	752
Figure 1-1320	Remove one screw .....	752
Figure 1-1321	Release one boss and three tabs .....	753
Figure 1-1322	Release two tabs .....	753
Figure 1-1323	Remove the cover .....	754
Figure 1-1324	Disconnect one connector .....	754
Figure 1-1325	Remove the fan duct .....	755
Figure 1-1326	Remove the fil bias assembly .....	755
Figure 1-1327	Remove the fan .....	756
Figure 1-1328	Recycle and unpack .....	756
Figure 1-1329	Install the fan .....	757
Figure 1-1330	Install the fil bias assembly .....	757
Figure 1-1331	Install the fan duct .....	758
Figure 1-1332	Connect one connector .....	758
Figure 1-1333	Locate of the tabs and bosses .....	759
Figure 1-1334	Install the cover .....	759
Figure 1-1335	Engage two tabs .....	760
Figure 1-1336	Engage three tabs and one boss .....	760
Figure 1-1337	Install one screw .....	761
Figure 1-1338	Install the cover .....	761
Figure 1-1339	Rotate the bottom of the cover .....	762
Figure 1-1340	Install two screws .....	762
Figure 1-1341	Engage the left-side retainer arm .....	763
Figure 1-1342	Install the door .....	763
Figure 1-1343	Install the pressure-release link .....	764
Figure 1-1344	Install the guide .....	764

Figure 1-1345	Align the hinge .....	765
Figure 1-1346	Install the support shaft .....	766
Figure 1-1347	Install the tray .....	767
Figure 1-1348	Close the tray .....	767
Figure 1-1349	Tilt the control panel up .....	770
Figure 1-1350	Remove the cover .....	771
Figure 1-1351	Remove two screws .....	771
Figure 1-1352	Turn the control panel over .....	772
Figure 1-1353	Remove the control panel .....	772
Figure 1-1354	Pull the tray out until it stops .....	773
Figure 1-1355	Release and remove the tray .....	773
Figure 1-1356	Remove the formatter cover (M501) .....	774
Figure 1-1357	Remove the formatter cover (M506/M527) .....	774
Figure 1-1358	Release the HDD .....	775
Figure 1-1359	Remove the HDD .....	775
Figure 1-1360	Disconnect three connectors .....	776
Figure 1-1361	Release the fax PCA .....	776
Figure 1-1362	Remove the fax PCA .....	777
Figure 1-1363	Remove the formatter (M501) .....	777
Figure 1-1364	Remove the formatter (M506/M527) .....	778
Figure 1-1365	Open the door or release the cover .....	778
Figure 1-1366	Release the upper hinge or remove the cover .....	779
Figure 1-1367	Release the lower hinge .....	779
Figure 1-1368	Remove the door .....	780
Figure 1-1369	Locate the tabs .....	780
Figure 1-1370	Release one tab .....	781
Figure 1-1371	Release one tab .....	781
Figure 1-1372	Remove the cover .....	782
Figure 1-1373	Release two tabs .....	782
Figure 1-1374	Release two tabs .....	783
Figure 1-1375	Slide the cover .....	783
Figure 1-1376	Remove the cover .....	784
Figure 1-1377	Remove one screw .....	784
Figure 1-1378	Rotate the cover .....	785
Figure 1-1379	Release one boss .....	785
Figure 1-1380	Remove the cover .....	786
Figure 1-1381	Remove two screws .....	786
Figure 1-1382	Rotate the bottom of the cover .....	787
Figure 1-1383	Remove the cover .....	787
Figure 1-1384	Release the support shaft .....	788
Figure 1-1385	Remove the support shaft .....	788

Figure 1-1386	Remove the guide .....	789
Figure 1-1387	Release the pressure-release link .....	789
Figure 1-1388	Release the door .....	790
Figure 1-1389	Release the left-side retainer arm .....	790
Figure 1-1390	Remove the door .....	791
Figure 1-1391	Locate the tabs and bosses .....	791
Figure 1-1392	Remove two screws .....	792
Figure 1-1393	Release one boss .....	792
Figure 1-1394	Release two bosses .....	793
Figure 1-1395	Release one tab .....	793
Figure 1-1396	Release one tab .....	794
Figure 1-1397	Remove the cover .....	794
Figure 1-1398	Locate of the tabs and bosses .....	795
Figure 1-1399	Remove one screw .....	795
Figure 1-1400	Release one boss and three tabs .....	796
Figure 1-1401	Release two tabs .....	796
Figure 1-1402	Remove the cover .....	797
Figure 1-1403	Remove one screw .....	798
Figure 1-1404	Disconnect cables and connectors .....	798
Figure 1-1405	Disconnect connectors and remove screws .....	799
Figure 1-1406	Slide the ISA towards the back of the printer .....	799
Figure 1-1407	Remove the ISA .....	800
Figure 1-1408	Remove one screw and the plate .....	800
Figure 1-1409	Remove three screws .....	801
Figure 1-1410	Remove three screws .....	801
Figure 1-1411	Release one boss .....	802
Figure 1-1412	Rotate the front of the cover up .....	802
Figure 1-1413	Remove the cover .....	803
Figure 1-1414	Remove two screws .....	803
Figure 1-1415	Release one cable retainer .....	804
Figure 1-1416	Release one boss .....	804
Figure 1-1417	Remove the cover .....	805
Figure 1-1418	Release two tabs .....	805
Figure 1-1419	Remove the bin .....	806
Figure 1-1420	Remove the sheet-metal plate .....	806
Figure 1-1421	Pass all cables and wire harnesses through the opening .....	807
Figure 1-1422	Remove one screw .....	807
Figure 1-1423	Remove the guide .....	808
Figure 1-1424	Remove four screws .....	808
Figure 1-1425	Remove fiv screws .....	809
Figure 1-1426	Disconnect one connector .....	809

Figure 1-1427	Release the formatter case .....	810
Figure 1-1428	Remove the formatter case .....	810
Figure 1-1429	Disconnect one connector .....	811
Figure 1-1430	Release two tabs .....	811
Figure 1-1431	Remove the fan .....	812
Figure 1-1432	Recycle and unpack .....	812
Figure 1-1433	Install the fan .....	813
Figure 1-1434	Connect one connector .....	813
Figure 1-1435	Position the formatter case against the chassis .....	814
Figure 1-1436	Install the formatter case .....	814
Figure 1-1437	Connect one connector .....	815
Figure 1-1438	Install five screws .....	815
Figure 1-1439	Install four screws .....	816
Figure 1-1440	Install the guide .....	816
Figure 1-1441	Install one screw .....	817
Figure 1-1442	Pass all cables and wire harnesses through the opening .....	817
Figure 1-1443	Remove the sheet-metal plate .....	818
Figure 1-1444	Install the bin .....	818
Figure 1-1445	Install the cover .....	819
Figure 1-1446	Engage one boss .....	819
Figure 1-1447	Install one cable retainer .....	820
Figure 1-1448	Install two screws .....	820
Figure 1-1449	Install the cover .....	821
Figure 1-1450	Rotate the front of the cover down .....	821
Figure 1-1451	Engage one boss .....	822
Figure 1-1452	Install three screws .....	822
Figure 1-1453	Install three screws .....	823
Figure 1-1454	Install one screw and the plate .....	823
Figure 1-1455	Locate the ISA mounting pins and slots .....	271
Figure 1-1456	Install the ISA .....	824
Figure 1-1457	Slide the ISA towards the front of the printer .....	825
Figure 1-1458	Install screws and connect connectors .....	825
Figure 1-1459	Connect cables and connectors .....	826
Figure 1-1460	Install one screw .....	826
Figure 1-1461	Locate of the tabs and bosses .....	827
Figure 1-1462	Install the cover .....	827
Figure 1-1463	Engage two tabs .....	828
Figure 1-1464	Engage three tabs and one boss .....	828
Figure 1-1465	Install one screw .....	829
Figure 1-1466	Locate the tabs and bosses .....	829
Figure 1-1467	Install the cover .....	830

Figure 1-1468	Engage one tab .....	830
Figure 1-1469	Engage one tab .....	831
Figure 1-1470	Engage two bosses .....	831
Figure 1-1471	Engage one boss .....	832
Figure 1-1472	Install two screws .....	832
Figure 1-1473	Engage the left-side retainer arm .....	833
Figure 1-1474	Install the door .....	833
Figure 1-1475	Install the pressure-release link .....	834
Figure 1-1476	Install the guide .....	834
Figure 1-1477	Align the hinge .....	835
Figure 1-1478	Install the support shaft .....	836
Figure 1-1479	Install the cover .....	837
Figure 1-1480	Rotate the bottom of the cover .....	837
Figure 1-1481	Install two screws .....	838
Figure 1-1482	Engage one boss .....	838
Figure 1-1483	Install the cover .....	839
Figure 1-1484	Install one screw .....	839
Figure 1-1485	Slide the cover .....	840
Figure 1-1486	Engage two tabs .....	840
Figure 1-1487	Engage two tabs .....	841
Figure 1-1488	Locate the tabs .....	841
Figure 1-1489	Install the cover .....	842
Figure 1-1490	Engage one tab .....	842
Figure 1-1491	Engage one tab .....	843
Figure 1-1492	Install the door or cover .....	843
Figure 1-1493	Engage the lower hinge or engage the cover .....	844
Figure 1-1494	Engage the upper hinge .....	844
Figure 1-1495	Close the door .....	845
Figure 1-1496	Install the formatter (M501) .....	845
Figure 1-1497	Install the formatter (M506/M527) .....	846
Figure 1-1498	Locate the slots in the sheet-metal .....	846
Figure 1-1499	Install the fax PCA .....	847
Figure 1-1500	Engage the fax PCA .....	847
Figure 1-1501	Connect three connectors .....	848
Figure 1-1502	Locate the slot in the sheet-metal .....	848
Figure 1-1503	Install the HDD .....	849
Figure 1-1504	Install the HDD .....	849
Figure 1-1505	Install the formatter cover (M501) .....	850
Figure 1-1506	Install the formatter cover (M506/M527) .....	850
Figure 1-1507	Install the tray .....	851
Figure 1-1508	Close the tray .....	851

Figure 1-1509	Connect the cables .....	852
Figure 1-1510	Install the control panel .....	852
Figure 1-1511	Rotate the control-panel base down .....	853
Figure 1-1512	Install two screws .....	853
Figure 1-1513	Install the cover .....	854
Figure 1-1514	Tilt the control panel up .....	857
Figure 1-1515	Remove the cover .....	858
Figure 1-1516	Remove two screws .....	858
Figure 1-1517	Turn the control panel over .....	859
Figure 1-1518	Remove the control panel .....	859
Figure 1-1519	Pull the tray out until it stops .....	860
Figure 1-1520	Release and remove the tray .....	860
Figure 1-1521	Remove the formatter cover (M501) .....	861
Figure 1-1522	Remove the formatter cover (M506/M527) .....	861
Figure 1-1523	Release the HDD .....	862
Figure 1-1524	Remove the HDD .....	862
Figure 1-1525	Disconnect three connectors .....	863
Figure 1-1526	Release the fax PCA .....	863
Figure 1-1527	Remove the fax PCA .....	864
Figure 1-1528	Remove the formatter (M501) .....	864
Figure 1-1529	Remove the formatter (M506/M527) .....	865
Figure 1-1530	Open the door or release the cover .....	865
Figure 1-1531	Release the upper hinge or remove the cover .....	866
Figure 1-1532	Release the lower hinge .....	866
Figure 1-1533	Remove the door .....	867
Figure 1-1534	Locate the tabs .....	867
Figure 1-1535	Release one tab .....	868
Figure 1-1536	Release one tab .....	868
Figure 1-1537	Remove the cover .....	869
Figure 1-1538	Release two tabs .....	869
Figure 1-1539	Release two tabs .....	870
Figure 1-1540	Slide the cover .....	870
Figure 1-1541	Remove the cover .....	871
Figure 1-1542	Remove one screw .....	871
Figure 1-1543	Rotate the cover .....	872
Figure 1-1544	Release one boss .....	872
Figure 1-1545	Remove the cover .....	873
Figure 1-1546	Remove two screws .....	873
Figure 1-1547	Rotate the bottom of the cover .....	874
Figure 1-1548	Remove the cover .....	874
Figure 1-1549	Release the support shaft .....	875

Figure 1-1550	Remove the support shaft .....	875
Figure 1-1551	Remove the guide .....	876
Figure 1-1552	Release the pressure-release link .....	876
Figure 1-1553	Release the door .....	877
Figure 1-1554	Release the left-side retainer arm .....	877
Figure 1-1555	Remove the door .....	878
Figure 1-1556	Locate the tabs and bosses .....	878
Figure 1-1557	Remove two screws .....	879
Figure 1-1558	Release one boss .....	879
Figure 1-1559	Release two bosses .....	880
Figure 1-1560	Release one tab .....	880
Figure 1-1561	Release one tab .....	881
Figure 1-1562	Remove the cover .....	881
Figure 1-1563	Locate of the tabs and bosses .....	882
Figure 1-1564	Remove one screw .....	882
Figure 1-1565	Release one boss and three tabs .....	883
Figure 1-1566	Release two tabs .....	883
Figure 1-1567	Remove the cover .....	884
Figure 1-1568	Remove one screw .....	885
Figure 1-1569	Disconnect cables and connectors .....	885
Figure 1-1570	Disconnect connectors and remove screws .....	886
Figure 1-1571	Slide the ISA towards the back of the printer .....	886
Figure 1-1572	Remove the ISA .....	887
Figure 1-1573	Remove one screw and the plate .....	887
Figure 1-1574	Remove three screws .....	888
Figure 1-1575	Remove three screws .....	888
Figure 1-1576	Release one boss .....	889
Figure 1-1577	Rotate the front of the cover up .....	889
Figure 1-1578	Remove the cover .....	890
Figure 1-1579	Remove two screws .....	890
Figure 1-1580	Release one cable retainer .....	891
Figure 1-1581	Release one boss .....	891
Figure 1-1582	Remove the cover .....	892
Figure 1-1583	Release two tabs .....	892
Figure 1-1584	Remove the bin .....	893
Figure 1-1585	Remove the sheet-metal plate .....	893
Figure 1-1586	Pass all cables and wire harnesses through the opening .....	894
Figure 1-1587	Remove one screw .....	894
Figure 1-1588	Remove the guide .....	895
Figure 1-1589	Remove four screws .....	895
Figure 1-1590	Remove five screws .....	896

Figure 1-1591	Disconnect one connector .....	896
Figure 1-1592	Release the formatter case .....	897
Figure 1-1593	Remove the formatter case .....	897
Figure 1-1594	Disconnect three connectors .....	898
Figure 1-1595	Remove one screw .....	898
Figure 1-1596	Release four tabs .....	899
Figure 1-1597	Remove the assembly .....	899
Figure 1-1598	Recycle and unpack .....	900
Figure 1-1599	Install the assembly .....	900
Figure 1-1600	Engage four tabs .....	901
Figure 1-1601	Install one screw .....	901
Figure 1-1602	Connect three connectors .....	902
Figure 1-1603	Position the formatter case against the chassis .....	902
Figure 1-1604	Install the formatter case .....	903
Figure 1-1605	Connect one connector .....	903
Figure 1-1606	Install five screws .....	904
Figure 1-1607	Install four screws .....	904
Figure 1-1608	Install the guide .....	905
Figure 1-1609	Install one screw .....	905
Figure 1-1610	Pass all cables and wire harnesses through the opening .....	906
Figure 1-1611	Remove the sheet-metal plate .....	906
Figure 1-1612	Install the bin .....	907
Figure 1-1613	Install the cover .....	908
Figure 1-1614	Engage one boss .....	908
Figure 1-1615	Install one cable retainer .....	909
Figure 1-1616	Install two screws .....	909
Figure 1-1617	Install the cover .....	910
Figure 1-1618	Rotate the front of the cover down .....	910
Figure 1-1619	Engage one boss .....	911
Figure 1-1620	Install three screws .....	911
Figure 1-1621	Install three screws .....	912
Figure 1-1622	Install one screw and the plate .....	912
Figure 1-1623	Locate the ISA mounting pins and slots .....	271
Figure 1-1624	Install the ISA .....	913
Figure 1-1625	Slide the ISA towards the front of the printer .....	914
Figure 1-1626	Install screws and connect connectors .....	914
Figure 1-1627	Connect cables and connectors .....	915
Figure 1-1628	Install one screw .....	915
Figure 1-1629	Locate of the tabs and bosses .....	916
Figure 1-1630	Install the cover .....	916
Figure 1-1631	Engage two tabs .....	917



Figure 1-1632	Engage three tabs and one boss .....	917
Figure 1-1633	Install one screw .....	918
Figure 1-1634	Locate the tabs and bosses .....	918
Figure 1-1635	Install the cover .....	919
Figure 1-1636	Engage one tab .....	919
Figure 1-1637	Engage one tab .....	920
Figure 1-1638	Engage two bosses .....	920
Figure 1-1639	Engage one boss .....	921
Figure 1-1640	Install two screws .....	921
Figure 1-1641	Engage the left-side retainer arm .....	922
Figure 1-1642	Install the door .....	922
Figure 1-1643	Install the pressure-release link .....	923
Figure 1-1644	Install the guide .....	923
Figure 1-1645	Align the hinge .....	924
Figure 1-1646	Install the support shaft .....	925
Figure 1-1647	Install the cover .....	926
Figure 1-1648	Rotate the bottom of the cover .....	926
Figure 1-1649	Install two screws .....	927
Figure 1-1650	Engage one boss .....	927
Figure 1-1651	Install the cover .....	928
Figure 1-1652	Install one screw .....	928
Figure 1-1653	Slide the cover .....	929
Figure 1-1654	Engage two tabs .....	929
Figure 1-1655	Engage two tabs .....	930
Figure 1-1656	Locate the tabs .....	930
Figure 1-1657	Install the cover .....	931
Figure 1-1658	Engage one tab .....	931
Figure 1-1659	Engage one tab .....	932
Figure 1-1660	Install the door or cover .....	932
Figure 1-1661	Engage the lower hinge or engage the cover .....	933
Figure 1-1662	Engage the upper hinge .....	933
Figure 1-1663	Close the door .....	934
Figure 1-1664	Install the formatter (M501) .....	934
Figure 1-1665	Install the formatter (M506/M527) .....	935
Figure 1-1666	Locate the slots in the sheet-metal .....	935
Figure 1-1667	Install the fax PCA .....	936
Figure 1-1668	Engage the fax PCA .....	936
Figure 1-1669	Connect three connectors .....	937
Figure 1-1670	Locate the slot in the sheet-metal .....	937
Figure 1-1671	Install the HDD .....	938
Figure 1-1672	Install the HDD .....	938

Figure 1-1673	Install the formatter cover (M501) .....	939
Figure 1-1674	Install the formatter cover (M506/M527) .....	939
Figure 1-1675	Install the tray .....	940
Figure 1-1676	Close the tray .....	940
Figure 1-1677	Connect the cables .....	941
Figure 1-1678	Install the control panel .....	941
Figure 1-1679	Rotate the control-panel base down .....	942
Figure 1-1680	Install two screws .....	942
Figure 1-1681	Install the cover .....	943
Figure 1-1682	Tilt the control panel up .....	946
Figure 1-1683	Remove the cover .....	947
Figure 1-1684	Remove two screws .....	947
Figure 1-1685	Turn the control panel over .....	948
Figure 1-1686	Remove the control panel .....	948
Figure 1-1687	Pull the tray out until it stops .....	949
Figure 1-1688	Release and remove the tray .....	949
Figure 1-1689	Remove the formatter cover (M501) .....	950
Figure 1-1690	Remove the formatter cover (M506/M527) .....	950
Figure 1-1691	Release the HDD .....	951
Figure 1-1692	Remove the HDD .....	951
Figure 1-1693	Disconnect three connectors .....	952
Figure 1-1694	Release the fax PCA .....	952
Figure 1-1695	Remove the fax PCA .....	953
Figure 1-1696	Remove the formatter (M501) .....	953
Figure 1-1697	Remove the formatter (M506/M527) .....	954
Figure 1-1698	Open the door or release the cover .....	954
Figure 1-1699	Release the upper hinge or remove the cover .....	955
Figure 1-1700	Release the lower hinge .....	955
Figure 1-1701	Remove the door .....	956
Figure 1-1702	Locate the tabs .....	956
Figure 1-1703	Release one tab .....	957
Figure 1-1704	Release one tab .....	957
Figure 1-1705	Remove the cover .....	958
Figure 1-1706	Release two tabs .....	958
Figure 1-1707	Release two tabs .....	959
Figure 1-1708	Slide the cover .....	959
Figure 1-1709	Remove the cover .....	960
Figure 1-1710	Remove one screw .....	960
Figure 1-1711	Rotate the cover .....	961
Figure 1-1712	Release one boss .....	961
Figure 1-1713	Remove the cover .....	962

Figure 1-1714	Remove two screws .....	962
Figure 1-1715	Rotate the bottom of the cover .....	963
Figure 1-1716	Remove the cover .....	963
Figure 1-1717	Release the support shaft .....	964
Figure 1-1718	Remove the support shaft .....	964
Figure 1-1719	Remove the guide .....	965
Figure 1-1720	Release the pressure-release link .....	965
Figure 1-1721	Release the door .....	966
Figure 1-1722	Release the left-side retainer arm .....	966
Figure 1-1723	Remove the door .....	967
Figure 1-1724	Locate the tabs and bosses .....	967
Figure 1-1725	Remove two screws .....	968
Figure 1-1726	Release one boss .....	968
Figure 1-1727	Release two bosses .....	969
Figure 1-1728	Release one tab .....	969
Figure 1-1729	Release one tab .....	970
Figure 1-1730	Remove the cover .....	970
Figure 1-1731	Locate of the tabs and bosses .....	971
Figure 1-1732	Remove one screw .....	971
Figure 1-1733	Release one boss and three tabs .....	972
Figure 1-1734	Release two tabs .....	972
Figure 1-1735	Remove the cover .....	973
Figure 1-1736	Remove one screw .....	974
Figure 1-1737	Disconnect cables and connectors .....	974
Figure 1-1738	Disconnect connectors and remove screws .....	975
Figure 1-1739	Slide the ISA towards the back of the printer .....	975
Figure 1-1740	Remove the ISA .....	976
Figure 1-1741	Remove one screw and the plate .....	976
Figure 1-1742	Remove three screws .....	977
Figure 1-1743	Remove three screws .....	977
Figure 1-1744	Release one boss .....	978
Figure 1-1745	Rotate the front of the cover up .....	978
Figure 1-1746	Remove the cover .....	979
Figure 1-1747	Remove two screws .....	979
Figure 1-1748	Release one cable retainer .....	980
Figure 1-1749	Release one boss .....	980
Figure 1-1750	Remove the cover .....	981
Figure 1-1751	Release two tabs .....	981
Figure 1-1752	Remove the bin .....	982
Figure 1-1753	Remove the sheet-metal plate .....	982
Figure 1-1754	Pass all cables and wire harnesses through the opening .....	983

Figure 1-1755	Remove one screw .....	983
Figure 1-1756	Remove the guide .....	984
Figure 1-1757	Remove four screws .....	984
Figure 1-1758	Remove five screws .....	985
Figure 1-1759	Disconnect one connector .....	985
Figure 1-1760	Release the formatter case .....	986
Figure 1-1761	Remove the formatter case .....	986
Figure 1-1762	Disconnect all connectors and FFCs .....	987
Figure 1-1763	Remove the DCC .....	987
Figure 1-1764	Recycle and unpack .....	988
Figure 1-1765	Install the DCC .....	989
Figure 1-1766	Connect all connectors and FFCs .....	989
Figure 1-1767	Position the formatter case against the chassis .....	990
Figure 1-1768	Install the formatter case .....	990
Figure 1-1769	Connect one connector .....	991
Figure 1-1770	Install five screws .....	991
Figure 1-1771	Install four screws .....	992
Figure 1-1772	Install the guide .....	992
Figure 1-1773	Install one screw .....	993
Figure 1-1774	Pass all cables and wire harnesses through the opening .....	993
Figure 1-1775	Remove the sheet-metal plate .....	994
Figure 1-1776	Install the bin .....	994
Figure 1-1777	Install the cover .....	995
Figure 1-1778	Engage one boss .....	995
Figure 1-1779	Install one cable retainer .....	996
Figure 1-1780	Install two screws .....	996
Figure 1-1781	Install the cover .....	997
Figure 1-1782	Rotate the front of the cover down .....	997
Figure 1-1783	Engage one boss .....	998
Figure 1-1784	Install three screws .....	998
Figure 1-1785	Install three screws .....	999
Figure 1-1786	Install one screw and the plate .....	999
Figure 1-1787	Locate the ISA mounting pins and slots .....	271
Figure 1-1788	Install the ISA .....	1000
Figure 1-1789	Slide the ISA towards the front of the printer .....	1001
Figure 1-1790	Install screws and connect connectors .....	1001
Figure 1-1791	Connect cables and connectors .....	1002
Figure 1-1792	Install one screw .....	1002
Figure 1-1793	Locate the tabs and bosses .....	1003
Figure 1-1794	Install the cover .....	1003
Figure 1-1795	Engage two tabs .....	1004

Figure 1-1796	Engage three tabs and one boss .....	1004
Figure 1-1797	Install one screw .....	1005
Figure 1-1798	Locate the tabs and bosses .....	1005
Figure 1-1799	Install the cover .....	1006
Figure 1-1800	Engage one tab .....	1006
Figure 1-1801	Engage one tab .....	1007
Figure 1-1802	Engage two bosses .....	1007
Figure 1-1803	Engage one boss .....	1008
Figure 1-1804	Install two screws .....	1008
Figure 1-1805	Engage the left-side retainer arm .....	1009
Figure 1-1806	Install the door .....	1009
Figure 1-1807	Install the pressure-release link .....	1010
Figure 1-1808	Install the guide .....	1010
Figure 1-1809	Align the hinge .....	1011
Figure 1-1810	Install the support shaft .....	1012
Figure 1-1811	Install the cover .....	1013
Figure 1-1812	Rotate the bottom of the cover .....	1013
Figure 1-1813	Install two screws .....	1014
Figure 1-1814	Engage one boss .....	1014
Figure 1-1815	Install the cover .....	1015
Figure 1-1816	Install one screw .....	1015
Figure 1-1817	Slide the cover .....	1016
Figure 1-1818	Engage two tabs .....	1016
Figure 1-1819	Engage two tabs .....	1017
Figure 1-1820	Locate the tabs .....	1017
Figure 1-1821	Install the cover .....	1018
Figure 1-1822	Engage one tab .....	1018
Figure 1-1823	Engage one tab .....	1019
Figure 1-1824	Install the door or cover .....	1019
Figure 1-1825	Engage the lower hinge or engage the cover .....	1020
Figure 1-1826	Engage the upper hinge .....	1020
Figure 1-1827	Close the door .....	1021
Figure 1-1828	Remove the formatter (M501) .....	1021
Figure 1-1829	Remove the formatter (M506/M527) .....	1022
Figure 1-1830	Locate the slots in the sheet-metal .....	1023
Figure 1-1831	Install the fax PCA .....	1023
Figure 1-1832	Engage the fax PCA .....	1024
Figure 1-1833	Connect three connectors .....	1024
Figure 1-1834	Locate the slot in the sheet-metal .....	1025
Figure 1-1835	Install the HDD .....	1025
Figure 1-1836	Install the HDD .....	1026

Figure 1-1837	Install the formatter cover (M501) .....	1026
Figure 1-1838	Install the formatter cover (M506/M527) .....	1027
Figure 1-1839	Install the tray .....	1027
Figure 1-1840	Close the tray .....	1028
Figure 1-1841	Connect the cables .....	1028
Figure 1-1842	Install the control panel .....	1029
Figure 1-1843	Rotate the control-panel base down .....	1029
Figure 1-1844	Install two screws .....	1030
Figure 1-1845	Install the cover .....	1030
Figure 1-1846	Pull the tray out until it stops .....	1032
Figure 1-1847	Release and remove the tray .....	1033
Figure 1-1848	Release the support shaft .....	1034
Figure 1-1849	Remove the support shaft .....	1034
Figure 1-1850	Remove the guide .....	1035
Figure 1-1851	Release the pressure-release link .....	1035
Figure 1-1852	Release the door .....	1036
Figure 1-1853	Release the left-side retainer arm .....	1036
Figure 1-1854	Remove the door .....	1037
Figure 1-1855	Remove two screws .....	1037
Figure 1-1856	Rotate the bottom of the cover .....	1038
Figure 1-1857	Remove the cover .....	1038
Figure 1-1858	Locate of the tabs and bosses .....	1039
Figure 1-1859	Remove one screw .....	1039
Figure 1-1860	Release one boss and three tabs .....	1040
Figure 1-1861	Release two tabs .....	1040
Figure 1-1862	Remove the cover .....	1041
Figure 1-1863	Disconnect the connectors .....	1041
Figure 1-1864	Remove two screws .....	1042
Figure 1-1865	Release one tab .....	1042
Figure 1-1866	Remove the HVPS .....	1043
Figure 1-1867	Check the spring .....	1043
Figure 1-1868	Recycle and unpack .....	1044
Figure 1-1869	Check the spring .....	1044
Figure 1-1870	Install the HVPS .....	1045
Figure 1-1871	Engage one tab .....	1045
Figure 1-1872	Install two screws .....	1046
Figure 1-1873	Connect the connectors .....	1046
Figure 1-1874	Locate of the tabs and bosses .....	1047
Figure 1-1875	Install the cover .....	1047
Figure 1-1876	Engage two tabs .....	1048
Figure 1-1877	Engage three tabs and one boss .....	1048

Figure 1-1878	Install one screw .....	1049
Figure 1-1879	Install the cover .....	1049
Figure 1-1880	Rotate the bottom of the cover .....	1050
Figure 1-1881	Install two screws .....	1050
Figure 1-1882	Engage the left-side retainer arm .....	1051
Figure 1-1883	Install the door .....	1051
Figure 1-1884	Install the pressure-release link .....	1052
Figure 1-1885	Install the guide .....	1052
Figure 1-1886	Align the hinge .....	1053
Figure 1-1887	Install the support shaft .....	1054
Figure 1-1888	Install the tray .....	1055
Figure 1-1889	Close the tray .....	1055
Figure 1-1890	Tilt the control panel up .....	1058
Figure 1-1891	Remove the cover .....	1059
Figure 1-1892	Remove two screws .....	1059
Figure 1-1893	Turn the control panel over .....	1060
Figure 1-1894	Remove the control panel .....	1060
Figure 1-1895	Pull the tray out until it stops .....	1061
Figure 1-1896	Release and remove the tray .....	1061
Figure 1-1897	Remove the formatter cover (M501) .....	1062
Figure 1-1898	Remove the formatter cover (M506/M527) .....	1062
Figure 1-1899	Release the HDD .....	1063
Figure 1-1900	Remove the HDD .....	1063
Figure 1-1901	Disconnect three connectors .....	1064
Figure 1-1902	Release the fax PCA .....	1064
Figure 1-1903	Remove the fax PCA .....	1065
Figure 1-1904	Remove the formatter (M501) .....	1065
Figure 1-1905	Remove the formatter (M506/M527) .....	1066
Figure 1-1906	Open the door or release the cover .....	1066
Figure 1-1907	Release the upper hinge or remove the cover .....	1067
Figure 1-1908	Release the lower hinge .....	1067
Figure 1-1909	Remove the door .....	1068
Figure 1-1910	Locate the tabs .....	1068
Figure 1-1911	Release one tab .....	1069
Figure 1-1912	Release one tab .....	1069
Figure 1-1913	Remove the cover .....	1070
Figure 1-1914	Release two tabs .....	1070
Figure 1-1915	Release two tabs .....	1071
Figure 1-1916	Slide the cover .....	1071
Figure 1-1917	Remove the cover .....	1072
Figure 1-1918	Remove one screw .....	1072

Figure 1-1919	Rotate the cover .....	1073
Figure 1-1920	Release one boss .....	1073
Figure 1-1921	Remove the cover .....	1074
Figure 1-1922	Remove two screws .....	1074
Figure 1-1923	Rotate the bottom of the cover .....	1075
Figure 1-1924	Remove the cover .....	1075
Figure 1-1925	Release the support shaft .....	1076
Figure 1-1926	Remove the support shaft .....	1076
Figure 1-1927	Remove the guide .....	1077
Figure 1-1928	Release the pressure-release link .....	1077
Figure 1-1929	Release the door .....	1078
Figure 1-1930	Release the left-side retainer arm .....	1078
Figure 1-1931	Remove the door .....	1079
Figure 1-1932	Locate the tabs and bosses .....	1079
Figure 1-1933	Remove two screws .....	1080
Figure 1-1934	Release one boss .....	1080
Figure 1-1935	Release two bosses .....	1081
Figure 1-1936	Release one tab .....	1081
Figure 1-1937	Release one tab .....	1082
Figure 1-1938	Remove the cover .....	1082
Figure 1-1939	Locate of the tabs and bosses .....	1083
Figure 1-1940	Remove one screw .....	1083
Figure 1-1941	Release one boss and three tabs .....	1084
Figure 1-1942	Release two tabs .....	1084
Figure 1-1943	Remove the cover .....	1085
Figure 1-1944	Remove one screw .....	1086
Figure 1-1945	Disconnect cables and connectors .....	1086
Figure 1-1946	Disconnect connectors and remove screws .....	1087
Figure 1-1947	Slide the ISA towards the back of the printer .....	1087
Figure 1-1948	Remove the ISA .....	1088
Figure 1-1949	Remove one screw and the plate .....	1088
Figure 1-1950	Remove three screws .....	1089
Figure 1-1951	Remove three screws .....	1089
Figure 1-1952	Release one boss .....	1090
Figure 1-1953	Rotate the front of the cover up .....	1090
Figure 1-1954	Remove the cover .....	1091
Figure 1-1955	Remove two screws .....	1091
Figure 1-1956	Release one cable retainer .....	1092
Figure 1-1957	Release one boss .....	1092
Figure 1-1958	Remove the cover .....	1093
Figure 1-1959	Release two tabs .....	1093



Figure 1-1960	Remove the bin .....	1094
Figure 1-1961	Remove the sheet-metal plate .....	1094
Figure 1-1962	Pass all cables and wire harnesses through the opening .....	1095
Figure 1-1963	Remove one screw .....	1095
Figure 1-1964	Remove the guide .....	1096
Figure 1-1965	Remove four screws .....	1096
Figure 1-1966	Remove five screws .....	1097
Figure 1-1967	Disconnect one connector .....	1097
Figure 1-1968	Release the formatter case .....	1098
Figure 1-1969	Remove the formatter case .....	1098
Figure 1-1970	Move the power-switch assembly .....	1099
Figure 1-1971	Disconnect one connector .....	1099
Figure 1-1972	Disconnect two connectors .....	1100
Figure 1-1973	Remove two screws .....	1100
Figure 1-1974	Release one tab .....	1101
Figure 1-1975	Release the LVPS .....	1101
Figure 1-1976	Remove the LVPS .....	1102
Figure 1-1977	Recycle and unpack .....	1102
Figure 1-1978	Install the LVPS .....	1103
Figure 1-1979	Engage one tab .....	1103
Figure 1-1980	Install two screws .....	1104
Figure 1-1981	Connect two connectors .....	1104
Figure 1-1982	Connect one connector .....	1105
Figure 1-1983	Install the power-switch assembly .....	1105
Figure 1-1984	Position the formatter case against the chassis .....	1106
Figure 1-1985	Install the formatter case .....	1106
Figure 1-1986	Connect one connector .....	1107
Figure 1-1987	Install five screws .....	1107
Figure 1-1988	Install four screws .....	1108
Figure 1-1989	Install the guide .....	1108
Figure 1-1990	Install one screw .....	1109
Figure 1-1991	Pass all cables and wire harnesses through the opening .....	1109
Figure 1-1992	Remove the sheet-metal plate .....	1110
Figure 1-1993	Install the bin .....	1110
Figure 1-1994	Install the cover .....	1111
Figure 1-1995	Engage one boss .....	1111
Figure 1-1996	Install one cable retainer .....	1112
Figure 1-1997	Install two screws .....	1112
Figure 1-1998	Install the cover .....	1113
Figure 1-1999	Rotate the front of the cover down .....	1113
Figure 1-2000	Engage one boss .....	1114

Figure 1-2001	Install three screws .....	1114
Figure 1-2002	Install three screws .....	1115
Figure 1-2003	Install one screw and the plate .....	1115
Figure 1-2004	Locate the ISA mounting pins and slots .....	271
Figure 1-2005	Install the ISA .....	1116
Figure 1-2006	Slide the ISA towards the front of the printer .....	1117
Figure 1-2007	Install screws and connect connectors .....	1117
Figure 1-2008	Connect cables and connectors .....	1118
Figure 1-2009	Install one screw .....	1118
Figure 1-2010	Locate of the tabs and bosses .....	1119
Figure 1-2011	Install the cover .....	1119
Figure 1-2012	Engage two tabs .....	1120
Figure 1-2013	Engage three tabs and one boss .....	1120
Figure 1-2014	Install one screw .....	1121
Figure 1-2015	Locate the tabs and bosses .....	1121
Figure 1-2016	Install the cover .....	1122
Figure 1-2017	Engage one tab .....	1122
Figure 1-2018	Engage one tab .....	1123
Figure 1-2019	Engage two bosses .....	1123
Figure 1-2020	Engage one boss .....	1124
Figure 1-2021	Install two screws .....	1124
Figure 1-2022	Engage the left-side retainer arm .....	1125
Figure 1-2023	Install the door .....	1125
Figure 1-2024	Install the pressure-release link .....	1126
Figure 1-2025	Install the guide .....	1126
Figure 1-2026	Align the hinge .....	1127
Figure 1-2027	Install the support shaft .....	1128
Figure 1-2028	Install the cover .....	1129
Figure 1-2029	Rotate the bottom of the cover .....	1129
Figure 1-2030	Install two screws .....	1130
Figure 1-2031	Engage one boss .....	1130
Figure 1-2032	Install the cover .....	1131
Figure 1-2033	Install one screw .....	1131
Figure 1-2034	Slide the cover .....	1132
Figure 1-2035	Engage two tabs .....	1132
Figure 1-2036	Engage two tabs .....	1133
Figure 1-2037	Locate the tabs .....	1133
Figure 1-2038	Install the cover .....	1134
Figure 1-2039	Engage one tab .....	1134
Figure 1-2040	Engage one tab .....	1135
Figure 1-2041	Install the door or cover .....	1135

Figure 1-2042	Engage the lower hinge or engage the cover .....	1136
Figure 1-2043	Engage the upper hinge .....	1136
Figure 1-2044	Close the door .....	1137
Figure 1-2045	Install the formatter (M501) .....	1137
Figure 1-2046	Install the formatter (M506/M527) .....	1138
Figure 1-2047	Locate the slots in the sheet-metal .....	1138
Figure 1-2048	Install the fax PCA .....	1139
Figure 1-2049	Engage the fax PCA .....	1139
Figure 1-2050	Connect three connectors .....	1140
Figure 1-2051	Locate the slot in the sheet-metal .....	1140
Figure 1-2052	Install the HDD .....	1141
Figure 1-2053	Install the HDD .....	1141
Figure 1-2054	Install the formatter cover (M501) .....	1142
Figure 1-2055	Install the formatter cover (M506/M527) .....	1142
Figure 1-2056	Install the tray .....	1143
Figure 1-2057	Close the tray .....	1143
Figure 1-2058	Connect the cables .....	1144
Figure 1-2059	Install the control panel .....	1144
Figure 1-2060	Rotate the control-panel base down .....	1145
Figure 1-2061	Install two screws .....	1145
Figure 1-2062	Install the cover .....	1146
Figure 1-2063	Pull the tray out until it stops .....	1148
Figure 1-2064	Release and remove the tray .....	1148
Figure 1-2065	Recycle and unpack .....	1149
Figure 1-2066	Install the tray .....	1149
Figure 1-2067	Close the tray .....	1150
Figure 1-2068	Pull the tray out of the printer .....	1152
Figure 1-2069	Release and remove the tray .....	1152
Figure 1-2070	Recycle and unpack .....	1153
Figure 1-2071	Install the tray .....	1153
Figure 1-2072	Close the tray .....	1154
Figure 1-2073	Open the tray .....	1157
Figure 1-2074	Unlock the front accessory lock .....	1157
Figure 1-2075	Unlock the rear accessory lock .....	1157
Figure 1-2076	Close the tray .....	1158
Figure 1-2077	Lift the printer oÃ of the accessory .....	1158
Figure 1-2078	Recycle and unpack .....	1159
Figure 1-2079	Remove shipping tape .....	1159
Figure 1-2080	Open the tray .....	1160
Figure 1-2081	Lock the front accessory lock .....	1160
Figure 1-2082	Lock the rear accessory lock .....	1160

Figure 1-2083	Install the tray number plate .....	1161
Figure 1-2084	Close the tray .....	1161
Figure 1-2085	Open the door .....	1163
Figure 1-2086	Raise the blue lever .....	1163
Figure 1-2087	Remove the roller assembly .....	1164
Figure 1-2088	Open the cover .....	1164
Figure 1-2089	Remove the cover .....	1165
Figure 1-2090	Remove the roller assembly .....	1165
Figure 1-2091	Recycle and unpack .....	1166
Figure 1-2092	Install the roller assembly .....	1166
Figure 1-2093	Install the roller cover .....	1167
Figure 1-2094	Close the roller cover .....	1167
Figure 1-2095	Push down on the roller cover .....	1168
Figure 1-2096	Install the roller assembly .....	1168
Figure 1-2097	Close the blue lever .....	1169
Figure 1-2098	Close the door .....	1169
Figure 1-2099	Remove the formatter cover .....	1172
Figure 1-2100	Disconnect three connectors .....	1172
Figure 1-2101	Release the fax PCA .....	1173
Figure 1-2102	Remove the fax PCA .....	1173
Figure 1-2103	Locate the slots in the sheet-metal .....	1175
Figure 1-2104	Install the fax PCA .....	1175
Figure 1-2105	Engage the fax PCA .....	1176
Figure 1-2106	Connect three connectors .....	1176
Figure 1-2107	Install the formatter cover .....	1177
Figure 1-2108	Remove the formatter cover .....	1179
Figure 1-2109	Disconnect three connectors .....	1180
Figure 1-2110	Release the fax PCA .....	1180
Figure 1-2111	Remove the fax PCA .....	1181
Figure 1-2112	Recycle and unpack .....	1181
Figure 1-2113	Install the PCA in the holder .....	1182
Figure 1-2114	Connect one cable .....	1182
Figure 1-2115	Position the internal USB ports module .....	1183
Figure 1-2116	Install the internal USB ports module .....	1183
Figure 1-2117	Install the wire harness .....	1184
Figure 1-2118	Connect one connector .....	1184
Figure 1-2119	Locate the slots in the sheet-metal .....	1185
Figure 1-2120	Install the fax PCA .....	1185
Figure 1-2121	Engage the fax PCA .....	1186
Figure 1-2122	Connect three connectors .....	1186
Figure 1-2123	Install the formatter cover .....	1187

Figure 1-2124	Remove the formatter cover .....	1189
Figure 1-2125	Recycle and unpack .....	1189
Figure 1-2126	Install the PCA in the holder .....	1190
Figure 1-2127	Connect the wire harness .....	1190
Figure 1-2128	Install the internal USB ports module .....	1191
Figure 1-2129	Connect one connector .....	1191
Figure 1-2130	Connect one connector .....	1192
Figure 1-2131	Install the formatter cover .....	1192
Figure 2-1	Document feeder and image scanner assembly (M527 only) .....	1204



---

# 1 Removal and replacement

- [For additional service and support](#)
- [Removal and replacement strategy](#)
- [Service approach](#)
- [Removal and replacement procedures](#)

## For additional service and support

HP service personnel, go to the Service Access Work Bench (SAW) at <http://h41302.www4.hp.com/km/saw/home.do>.

Channel partners, go to HP Channel Services Network (CSN) at <https://h30125.www3.hp.com/hpcsn>.

At these locations, find information on the following topics:

- Install and configure
- Printer specification
- Up-to-date control panel message (CPMD) troubleshooting
- Solutions for printer issues and emerging issues
- Remove and replace part instructions and videos
- Service advisories
- Warranty and regulatory information

To access HP PartSurfer information from any mobile device, go to <http://partsurfermobile.hp.com/> or scan the Quick Response (QR) code below.





# Removal and replacement strategy

## Introduction

The printer uses a field repair strategy. Defective parts are diagnosed and replaced at the Field Replaceable Unit (FRU) or Bench Repairable Unit (BRU) assembly level. Repair normally begins by using the printer internal diagnostics and the following two-step process:

1. Isolate the problem to the major system (for example, the network, server, or printer).
2. Identify the cause of failures according to the printer troubleshooting service manual and follow the disassembly procedures to replace the defective parts or the consumable parts.

After locating a faulty part, the printer can usually be repaired at the assembly level by replacing FRUs or BRUs. Some mechanical assemblies might need to be repaired at the subassembly level. HP does not support replacement of components on the printed circuit assemblies.

The user replaces toner cartridges as they are depleted. Additional instructions about other user-replaceable parts are provided in this section.

The printer tracks the amount of use on the customer-replaceable supplies by keeping a page count. The printer prompts the user to replace certain items when a supply is depleted or a specific number of pages have been printed.

Swapping toner cartridges between products might cause a misrepresentation of supply life values and is not recommended.

## Considerations during removal and replacement

This chapter describes the FRUs or BRUs only.

Replacing FRUs or BRUs is generally the reverse of removal. Notes are included to provide directions for difficult or critical replacement procedures.

HP does not support repairing individual subassemblies or troubleshooting to the printed-circuit assembly (PCA) component level.

---

**⚠ WARNING!** Never operate or service the printer with the protective cover removed from the laser scanner assembly. The reflected beam, although invisible, can cause damage to the eyes.


The sheet-metal parts can have sharp edges. Be careful when handling sheet-metal parts.

Turn the printer off, wait 5 seconds, and then remove the power cord before attempting to service the printer. *If this warning is not followed, severe injury can result as well as damage to the printer.* The power must be on for certain functional checks during troubleshooting. However, the power cord must be disconnected during parts removal. AC voltage is still present inside the printer when the power switch is in the **oA** position. The power cord must be *disconnected* before servicing the printer.


**⚠ CAUTION:** Incorrectly routed or loose wire harnesses might interfere with other internal components or assemblies and be damaged, pinched, or frayed. Make sure that wire harnesses are correctly routed and retained when installing assemblies.

Do not bend or fold the flexible cables (FFCs) during removal or installation.


Do not expose toner cartridges to strong light even for a short time.

 **IMPORTANT:** When an assembly is removed that includes a rating plate or tag (or a printer code label), make sure to transfer the plate or tag (or code label) to the replacement assembly.

Do not replace the formatter, DC controller, and eMMC PCA or hard-disk drive simultaneously during a single printer servicing. Doing so might cause the printer to become unstable or inoperable.



 **NOTE:** During assembly removal and replacement, or if the printer is moved, remove the toner cartridge or cartridges.

Toner is a non-poisonous substance composed of plastic and a small number of colored components. If toner gets on the skin or clothing, wipe it off with dry tissue paper and wash in cold water. Hot water sets toner and it might be difficult or impossible, to remove. Toner easily breaks down vinyl materials, so avoid letting toner contact vinyl.

 **TIP:** Some figure might show assemblies removed or installed that have not yet been removed or installed at that specific step. However, the procedures are correct for this printer and the target assembly. Always thoroughly read the instructions that accompany each figure

---

## Electrostatic discharge


 **CAUTION:**  Some parts are sensitive to electrostatic discharge (ESD). Look for the ESD reminder when removing printer parts. Always perform service work at an ESD-protected workstation or mat. If an ESD workstation or mat is not available, touch the sheet-metal chassis to provide a static ground *before* touching an ESD-sensitive assembly.

Protect the ESD-sensitive assemblies by placing them in ESD pouches when they are out of the printer.

---

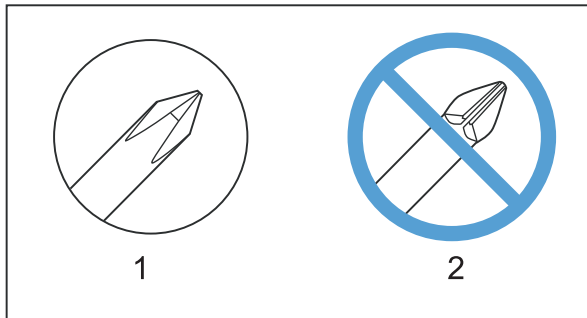
## Required tools

- #2 Phillips screwdriver with a magnetic tip and a 152-mm (6-in) shaft length
- Small, flat-blade screwdriver
- Needle-nose pliers
- ESD strap (if one is available)
- Penlight

 **CAUTION:** Always use a Phillips screwdriver (callout 1). Do not use a Pozidriv screwdriver (callout 2) or any motorized screwdriver. These can damage screws or screw threads.

---

**Figure 1-1** Screwdrivers



## Fastener types

**⚠ WARNING!** Make sure that assemblies are replaced with the correct screw type. Using the incorrect screw (for example, substituting a long screw for the correct shorter screw) can cause damage to the printer or interfere with printer operation. Do not mix screws that are removed from one assembly with the screws that are removed from another assembly.

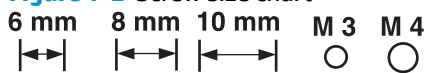
**📝 NOTE:** To install a self-tapping screw, first turn it counterclockwise to align it with the existing thread pattern, and then carefully turn it clockwise to tighten. Do not overtighten. If a self-tapping screw hole becomes stripped, repair the screw hole or replace the affected assembly.

Always take note of the length, diameter, color, type, and location of each removed screw. Make sure that screws are installed in the original location they were removed from during reinstallation.

### Fasteners used in the printer

- Screw, BH M3X10
- Screw, with washer, M3X8
- Screw, D M3X8
- Screw, machine, truss head, M3X6


**Figure 1-2** Screw size chart



# Service approach

## Before performing service

---

 **WARNING!** Turn the printer off, wait 30 seconds, and then remove the power cable before attempting to service the printer. *If this warning is not followed, severe injury and damage to the printer can result.* The power must be on for certain functional checks during troubleshooting. However, the power to the printer should be disconnected during parts removal.

---

1. Remove all paper.
2. Place the printer on an ESD mat (if available). If an ESD workstation or mat is not available, touching the sheet-metal chassis to provide a static ground *before* touching an ESD-sensitive assembly.
3. Remove the toner cartridge or toner cartridges.
4. Remove the trays.


## After performing service

1. Reinstall the toner cartridge or toner cartridges.
2. Reinstall the trays.
3. Return all paper to the trays.
4. Plug in the power cable and turn on the printer.
5. Perform print-quality tests by printing from a host computer or control panel.
6. Perform print-quality tests by copying from the document feeder or flatbed glass (M527 only).

## Post service tests


### Print quality test

Use the print quality troubleshooting pages to help diagnose and solve print-quality problems. For more information, see the printer troubleshooting manual.

 **NOTE:** To get further assistance in print quality troubleshooting, go to [www.hp.com/support/www.hp.com/support/ljM501](http://www.hp.com/support/www.hp.com/support/ljM501), [www.hp.com/support/www.hp.com/support/ljM506](http://www.hp.com/support/www.hp.com/support/ljM506), [www.hp.com/support/ljM527MFP](http://www.hp.com/support/ljM527MFP) and select PQ Troubleshooting Tools.

---

### Open the secondary service menu from a LCD control panel (M501)

1. Make sure the printer is in the Ready state.
2. At the printer control panel, press the **OK** button to open the menus.
3. Press the left arrow button, and then quickly press the **Cancel**  button.
4. The printer returns to the Ready state. Press the **OK** button to reopen the menus.
5. Select the **2ndary Service** menu, and then press the **OK** button.
6. Use the arrow buttons to navigate the **2ndary Service** menu.

### Copy-quality test (M527 models)

1. Verify that you have completed the necessary reassembly steps.
2. Ensure that the input tray contains clean, unmarked paper.
3. With the power cord attached, turn on the printer.
4. Verify that the expected start up sounds occur.
5. Print a configuratio page, and then verify that the expected printing sounds occur.
6. Place the configuratio page in the document feeder or on the flatbe glass.
7. Print a copy job, and then verify the results.
8. Clean the outside of the printer with a damp cloth.

### Fax-quality test (M527 models)

1. Place the configuratio page in the document feeder.
2. Type a valid fax number, and send the fax job.
3. Verify that the send quality and the receive quality meet expectations.

### Parts removal order

For procedures and/or steps that require identifying the right, left, or rear side of the printer, face the front of the printer for correct orientation.

# Removal and replacement procedures

## Customer self-repair (CSR) A parts and assemblies

Customer Self-Repair (CSR) parts are available for many HP LaserJet printers to reduce repair time. More information about the CSR program and benefit can be found at [www.hp.com/go/csr-support](http://www.hp.com/go/csr-support) and [www.hp.com/go/csr-faq](http://www.hp.com/go/csr-faq).

Genuine HP replacement parts can be ordered at [www.hp.com/buy/parts](http://www.hp.com/buy/parts) or by contacting an HP-authorized service or support provider. When ordering, one of the following will be needed: part number, serial number (found on back of printer), printer number, or printer name.

- Parts listed as **A**: Easy
- Parts listed as **B**: Difficult and/or requires tools



**NOTE:** For a complete list of CSRs, see the customer self-repair kits table in the printer repair manual (parts chapter).

- [Removal and replacement: Toner cartridge](#)
- [Removal and replacement: Staple cartridge \(M527\)](#)
- [Removal and replacement: embedded MultiMedia Card \(eMMC\) \(M506/M527dn\)](#)
- [Removal and replacement: Hard-disk drive \(HDD\) \(M527c/f/z\)](#)
- [Removal and replacement: Dual in-line memory module \(DIMM\) \(M506/M527\)](#)
- [Removal and replacement: Transfer roller](#)
- [Removal and replacement: Control panel \(M527\)](#)
- [Removal and replacement: Control panel \(M506x\)](#)
- [Removal and replacement: White backing \(M527\)](#)
- [Removal and replacement: Retention clips \(M527\)](#)
- [Removal and replacement: Keyboard assembly \(M527c/z\)](#)

## Removal and replacement: Toner cartridge

- [Introduction](#)
- [Step 1: Remove the toner cartridge](#)
- [Step 2: Unpack the replacement toner cartridge](#)
- [Step 3: Install the toner cartridge](#)


### Introduction

This document provides the procedures to remove and replace the toner cartridge.

### Before performing service

#### Turn the printer power off

- Disconnect the power cable.

 **WARNING!** To avoid damage to the printer, turn the printer off wait 30 seconds, and then remove the power cable before attempting to service the printer.

Use the table below to identify the correct part number for your printer. To order the part, go to [www.hp.com/buy/parts](http://www.hp.com/buy/parts).

Toner cartridge part number	
CF287A	HP 872A Black Original LaserJet Toner Cartridge
	Standard-capacity replacement black toner cartridge
CF287X	HP 872X High Yield Black Original LaserJet Toner Cartridge
	High-capacity replacement black toner cartridge

### Required tools

- No special tools are required to remove this part.

### After performing service

#### Turn the printer power on

- Connect the power cable.
- Use the power switch to turn the power on.

### Post service test

Make sure that the printer initializes to a **Ready** state.

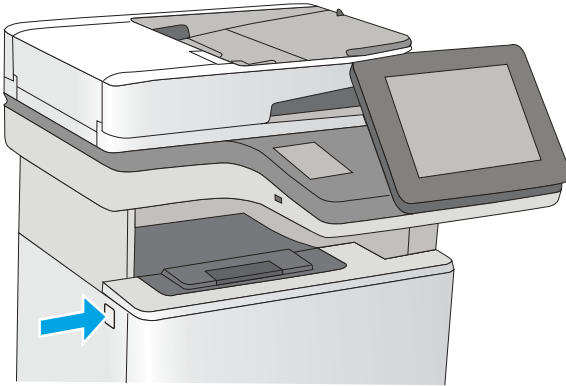
Print a configuratio page to make sure that the printer is functioning correctly.

## Step 1: Remove the toner cartridge

The M527 printer is shown in this section. However, the procedure is correct for the M501 and M506 printers.

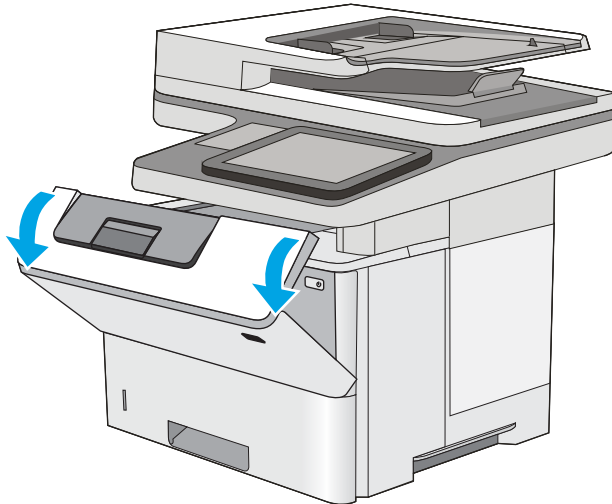
1. Press the cartridge-door-release button.

**Figure 1-3** Press the cartridge-door-release button



2. Open the toner-cartridge door.

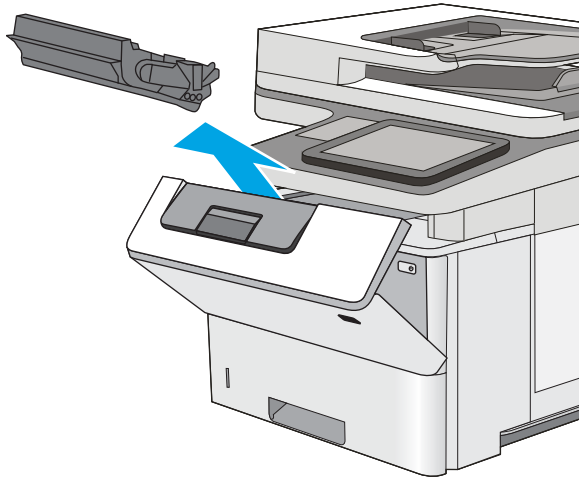
**Figure 1-4** Open the toner-cartridge door





3. Remove the toner cartridge from the printer.

**Figure 1-5** Remove the toner cartridge



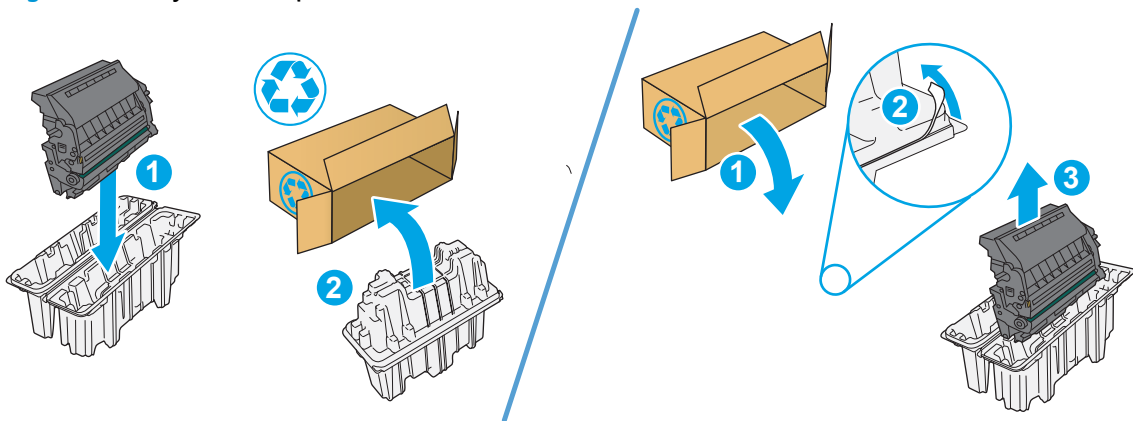
### Step 2: Unpack the replacement toner cartridge

Unpack the replacement part from the packaging.

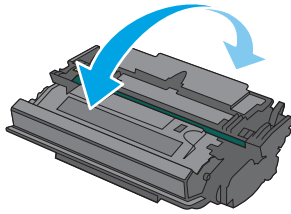
<http://www8.hp.com/us/en/hp-information/environment/product-recycling.html>

 **NOTE:** HP recommends responsible disposal of the defective part.

**Figure 1-6** Recycle and unpack



 **NOTE:** When installing a replacement toner cartridge, hold both ends of the toner cartridge and rock it back and forth 5-6 times.



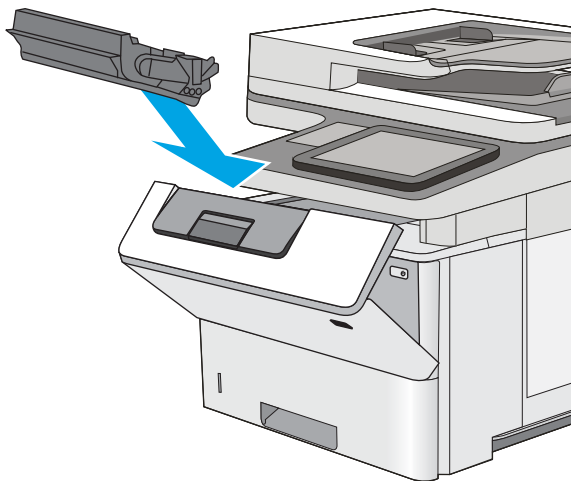
---

### Step 3: Install the toner cartridge

The M527 printer is shown in this section. However, the procedure is correct for the M501 and M506 printers.

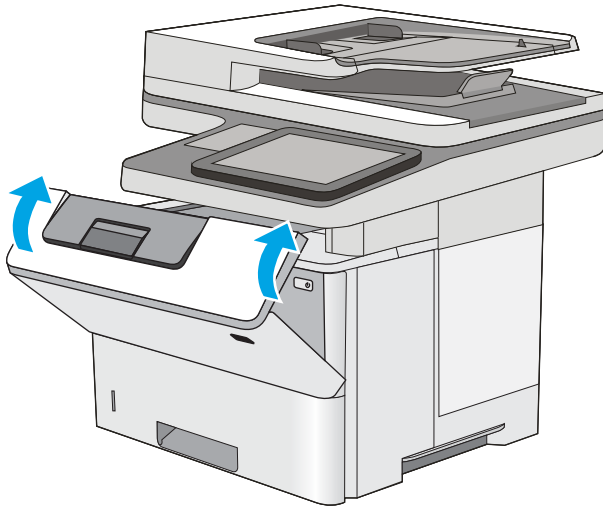
1. Align the toner cartridge with the tracks inside the printer, and install the toner cartridge until it is firmly seated.

**Figure 1-7** Install the toner cartridge



2. Close the toner-cartridge door.

**Figure 1-8** Close the toner-cartridge door



## Removal and replacement: Staple cartridge (M527)



**NOTE:** M527c/f/z printers only.

- [Introduction](#)
- [Step 1: Remove the staple cartridge](#)
- [Step 3: Unpack the replacement staple cartridge](#)
- [Step 3: Install the staple cartridge](#)

### Introduction

This document provides the procedures to remove and replace the staple cartridge.

### Before performing service

Use the table below to identify the correct part number for your printer. To order the part, go to [www.hp.com/buy/parts](http://www.hp.com/buy/parts).

Staple cartridge part number	
Q7432A	HP staple cartridge pack

### Required tools

- No special tools are required to remove this part.

### After performing service

#### Turn the printer power on

- Connect the power cable.
- Use the power switch to turn the power on.

### Post service test

Make sure that the printer initializes to a **Ready** state.

Print a configuration page to make sure that the printer is functioning correctly.

### Step 1: Remove the staple cartridge



**NOTE:** M527c/f/z printers only.

1. Open the stapler door.

**Figure 1-9** Open the stapler door



2. Pull the staple cartridge straight out of the printer to remove it.

**Figure 1-10** Remove the staple cartridge



### Step 3: Unpack the replacement staple cartridge

Unpack the replacement part from the packaging.

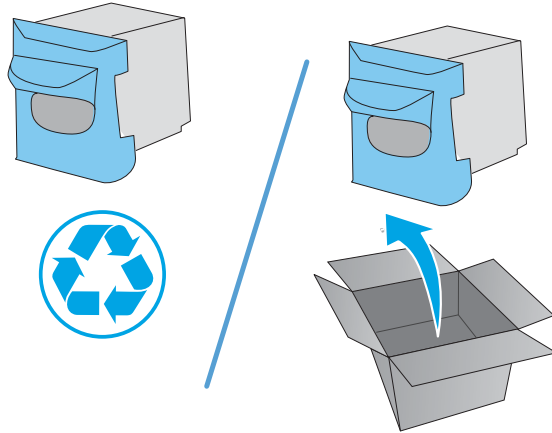
<http://www8.hp.com/us/en/hp-information/environment/product-recycling.html>

---


 **NOTE:** HP recommends responsible disposal of the defective part.

---

**Figure 1-11** Recycle and unpack



### Step 3: Install the staple cartridge

 **NOTE:** M527c/f/z printers only.

1. Push the staple cartridge straight into the printer to install it.

**Figure 1-12** Install the staple cartridge



2. Close the stapler door.

**Figure 1-13** Close the stapler door



## Removal and replacement: embedded MultiMedia Card (eMMC) (M506/M527dn)

 **NOTE:** M506 (all) and M527dn printers only.

- [Introduction](#)
- [Step 1: Remove the formatter cover](#)
- [Step 2: Remove the embedded MultiMedia Card \(eMMC\)](#)
- [Step 3: Unpack the replacement eMMC](#)
- [Step 4: Install the eMMC](#)
- [Step 5: Install the formatter cover](#)
- [Step 6: Reinstall the printer firmwar](#)


### Introduction



This document provides the procedures to remove and replace the embedded MultiMedia Card (eMMC).


### Before performing service


#### Turn the printer power off

- Disconnect the power cable.

 **WARNING!** To avoid damage to the printer, turn the printer off wait 30 seconds, and then remove the power cable before attempting to service the printer.

 **CAUTION:**  This part contains components that are electrostatic discharge (ESD) sensitive. To reduce the possibility of ESD damage, always touch the sheet-metal chassis to ground yourself before touching an ESD sensitive part.

 **IMPORTANT:** Do not replace the formatter, DC controller, and eMMC PCA simultaneously during a single printer servicing. Doing so might cause the printer to become unstable or inoperable.

 **NOTE:** Data stored on the eMMC is not secure and cannot be encrypted.

Use the table below to identify the correct part number for your printer. To order the part, go to [www.hp.com/buy/parts](http://www.hp.com/buy/parts).

embedded MultiMedia Card (eMMC) kit part number		
<b>B5L32-60002</b> (M527dn)	embedded MultiMedia Card (eMMC) with instruction guide	embedded MultiMedia Card (eMMC) with instruction guide
<b>B5L32-67901</b> (M506)		

### Required tools

No special tools are required to install this part.



## After performing service

### Turn the printer power on

- Connect the power cable.
- Use the power switch to turn the power on.

### Post service test

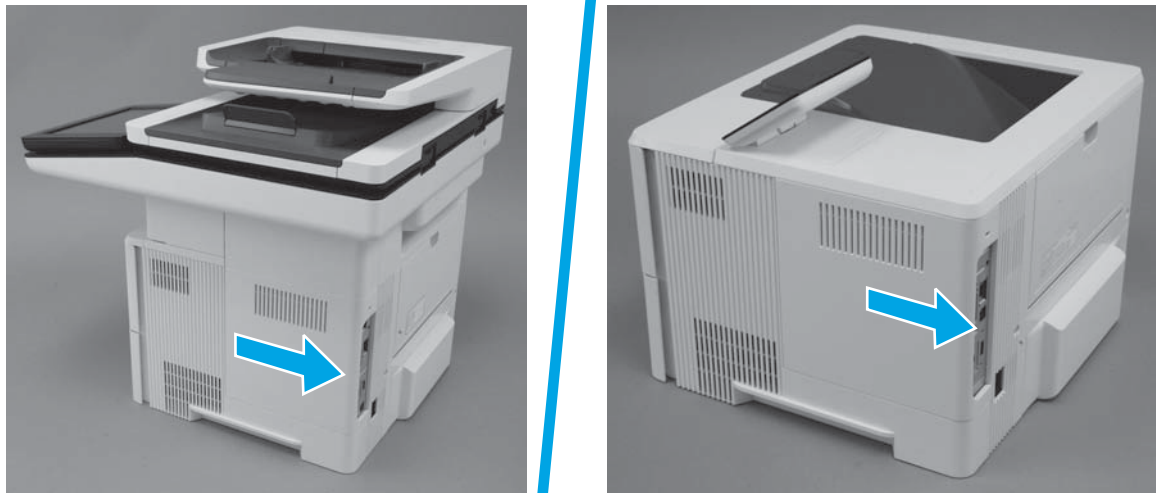
Make sure that the printer initializes to a **Ready** state.

Print a configuration page to make sure that the printer is functioning correctly.

### Step 1: Remove the formatter cover


- ▲ Slide the cover toward the rear of the printer to remove it.

**Figure 1-14** Remove the formatter cover



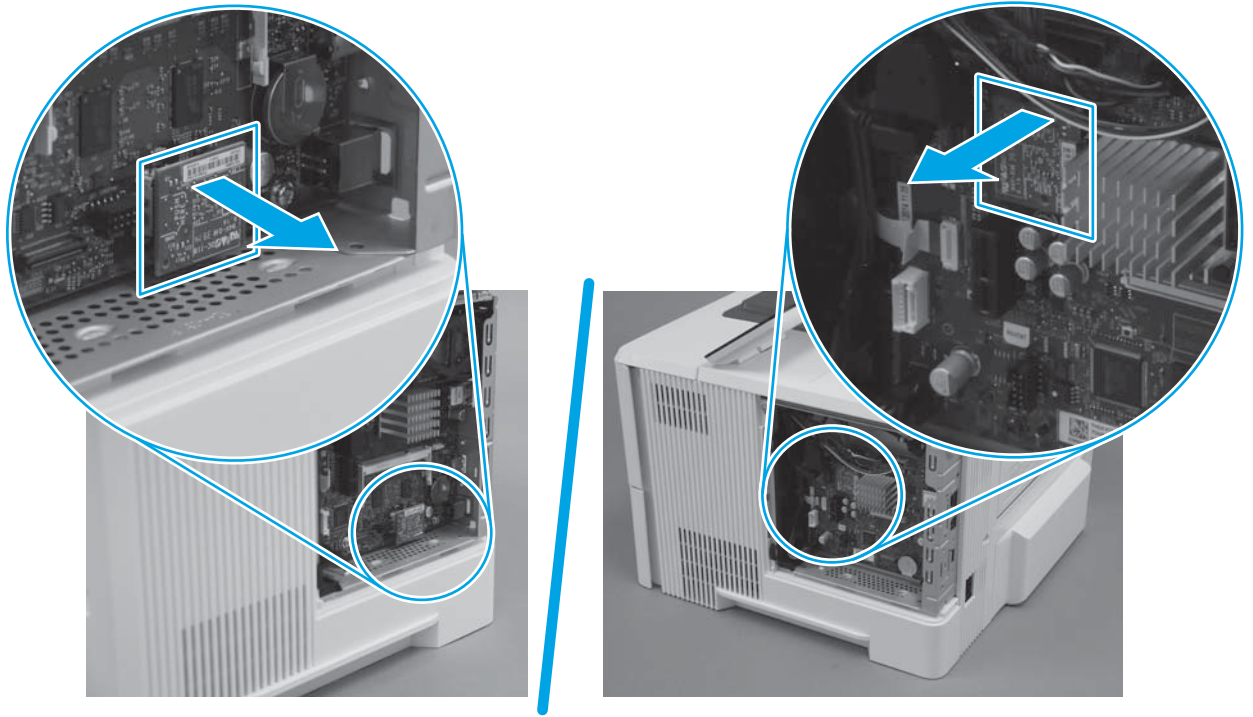
### Step 2: Remove the embedded MultiMedia Card (eMMC)

 **CAUTION:**  ESD-sensitive part.

 **NOTE:** M506 (all) and M527dn printers only.

- ▲ Locate the eMMC component on the formatter, and then pull it straight out of the formatter to remove it.

**Figure 1-15** Remove the eMMC




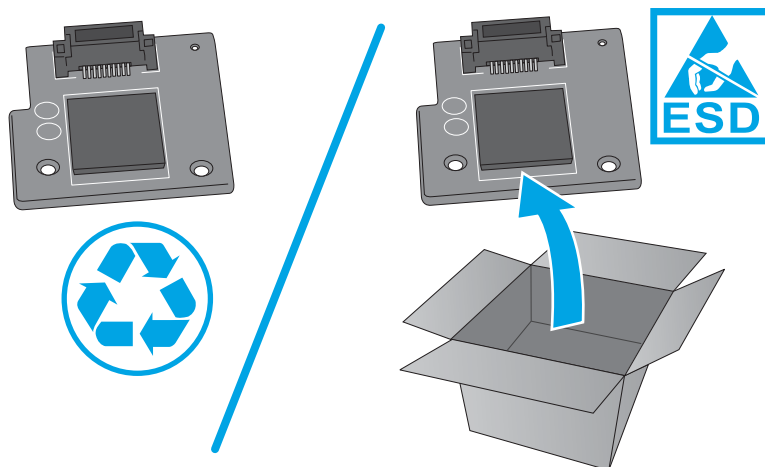
### Step 3: Unpack the replacement eMMC

Unpack the replacement assembly from the packaging.

 **CAUTION:**  ESD-sensitive part.


<http://www8.hp.com/us/en/hp-information/environment/product-recycling.html>

 **NOTE:** HP recommends responsible disposal of the defective assembly.




#### Step 4: Install the eMMC

 **CAUTION:**  ESD-sensitive part.

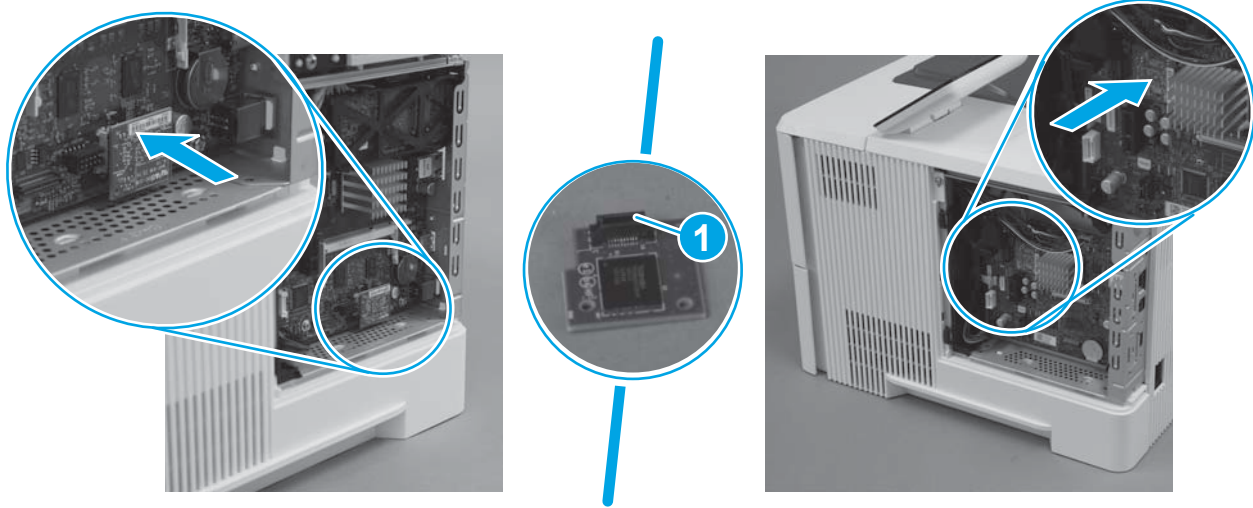
 **NOTE:** M506 (all) and M527dn printers only.

▲ Align the connector on the replacement eMMC (callout 1) with the connector on the formatter, and then push the eMMC onto the formatter to install it.

 **IMPORTANT:** Push on the eMMC at the location shown by the arrow. Ignore any “Push here” label on the eMMC itself. Make sure that the eMMC is fully seated in the connector .

 **NOTE:** The eMMC can only be installed in one direction on the formatter.

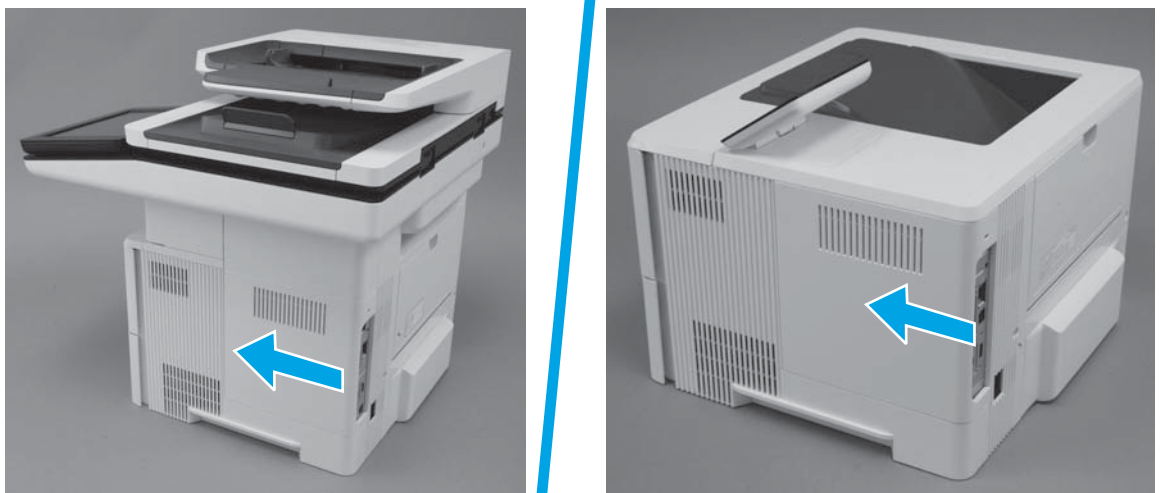
**Figure 1-16** Install the eMMC



#### Step 5: Install the formatter cover

▲ Slide it toward the front of the printer to install it.

**Figure 1-17** Install the formatter cover



## Step 6: Reinstall the printer firmware



---

**NOTE:** If this installation is a replacement eMMC, use the following steps to reinstall the firmware

---

1. Go to [www.hp.com/go/futuresmart](http://www.hp.com/go/futuresmart).
2. Select **Upgrade now**.
3. Find your Enterprise printer model.
4. Select the link to open the firmware download page.
5. Select **OS Independent** from the list of operating systems.
6. Under the **Firmware** section, find the file for multiple operating systems.
7. Select **Download**.



---

**NOTE:** To view installation instructions, go to [www.hp.com/go/futuresmart](http://www.hp.com/go/futuresmart). Select **Upgrade now**, and then select **How to perform a firmware update**.

---

## Removal and replacement: Hard-disk drive (HDD) (M527c/f/z)



**NOTE:** M527c/f/z printers only (optional for the M527dn and all M506 printers).

- [Introduction](#)
- [Step 1: Remove the formatter cover](#)
- [Step 2: Remove the hard-disk drive \(HDD\)](#)
- [Step 3: Unpack the replacement assembly](#)
- [Step 4: Install the HDD](#)
- [Step 5: Install the formatter cover](#)
- [Step 6: Reinstall the printer firmwar](#)

### Introduction

This document provides the procedures to remove and replace the hard-disk drive (HDD).

### Before performing service


#### Turn the printer power off

- Disconnect the power cable.



**WARNING!** To avoid damage to the printer, turn the printer off wait 30 seconds, and then remove the power cable before attempting to service the printer.



**CAUTION:**  This part contains components that are electrostatic discharge (ESD) sensitive. To reduce the possibility of ESD damage, always touch the sheet-metal chassis to ground yourself before touching an ESD sensitive part.

Use the table below to identify the correct part number for your printer. To order the part, go to [www.hp.com/buy/parts](http://www.hp.com/buy/parts).

Hard-disk drive (HDD) kit part numbers	
<b>B5L29-67903</b>	500 GB secure hard-disk drive (HDD) accessory (M506, M527) with instruction guide
<b>5851-6712</b>	320 GB hard-disk drive (HDD) (M527) with instruction guide

### Required tools

No special tools are required to install this part.

### After performing service

#### Turn the printer power on

- Connect the power cable.
- Use the power switch to turn the power on.

## Post service test

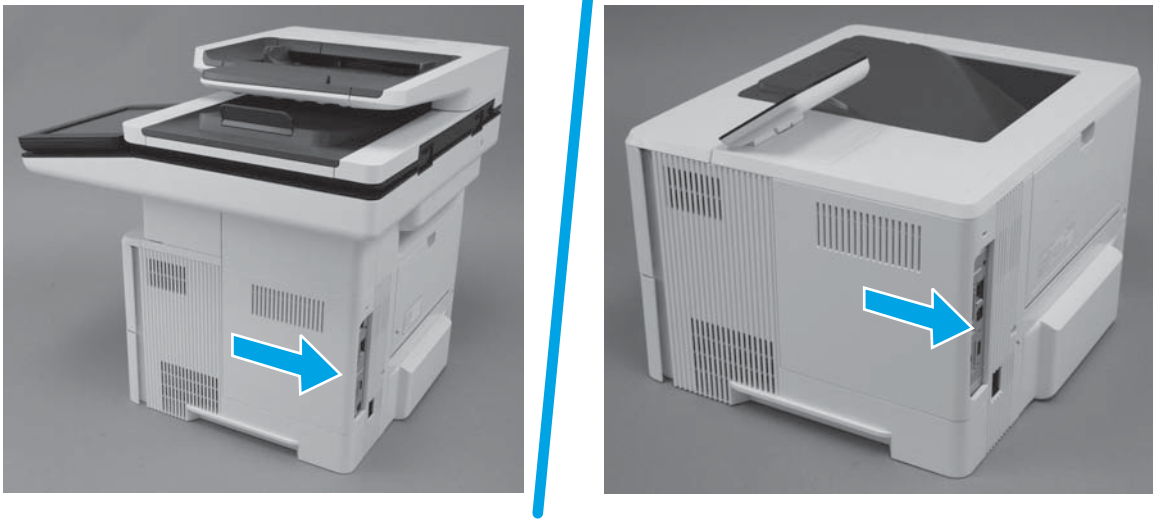
Make sure that the printer initializes to a **Ready** state.

Print a configuration page to make sure that the printer is functioning correctly.

## Step 1: Remove the formatter cover

- ▲ Slide the cover toward the rear of the printer to remove it.

**Figure 1-18** Remove the formatter cover

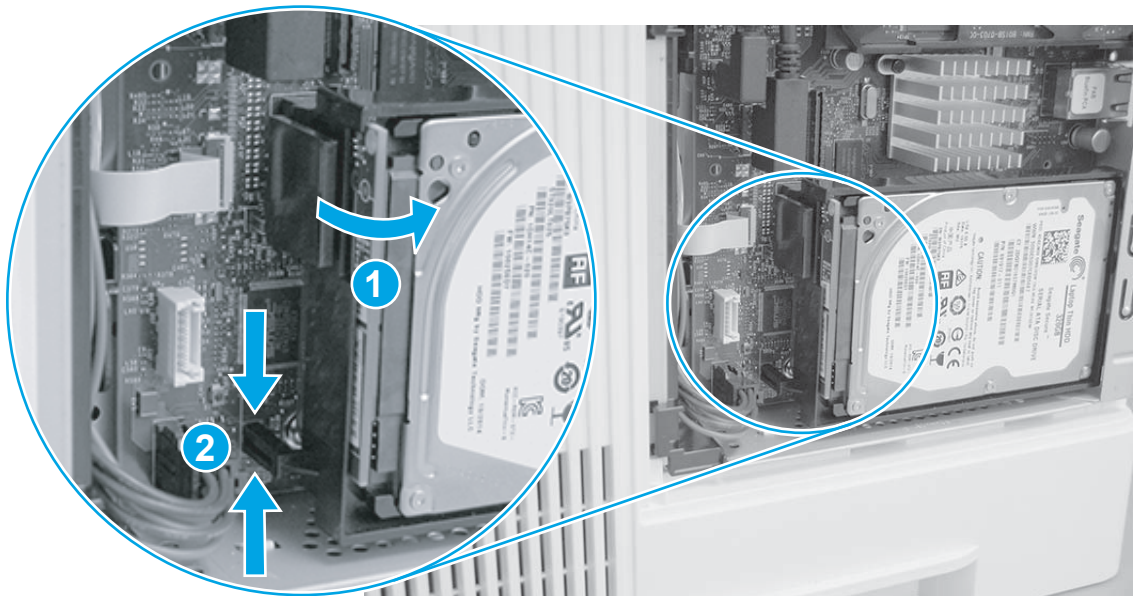


## Step 2: Remove the hard-disk drive (HDD)

**CAUTION:**  ESD-sensitive part.

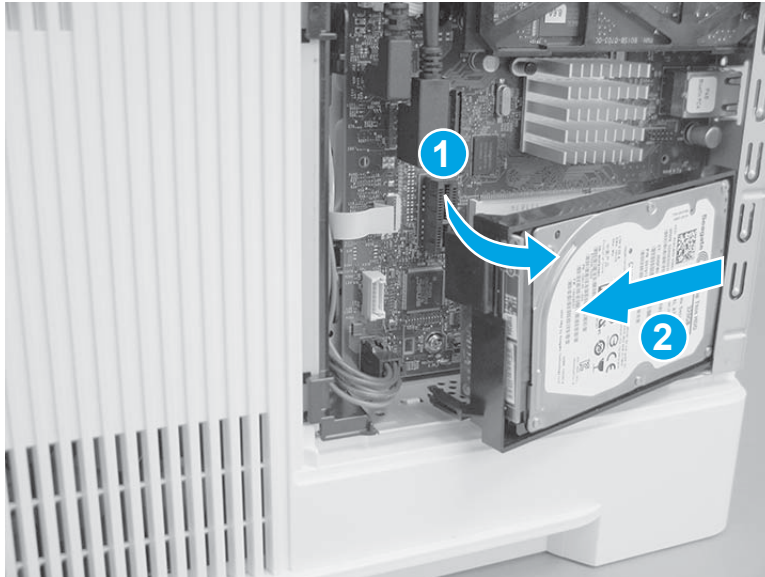
1. Release the locking connector (callout 1), and then pinch the retainer (callout 2) to release it.

**Figure 1-19** Release the HDD



2. Rotate the connector end of the HDD out and away from the formatter (callout 1), and then slide it as shown (callout 2) to remove it.

**Figure 1-20** Remove the HDD



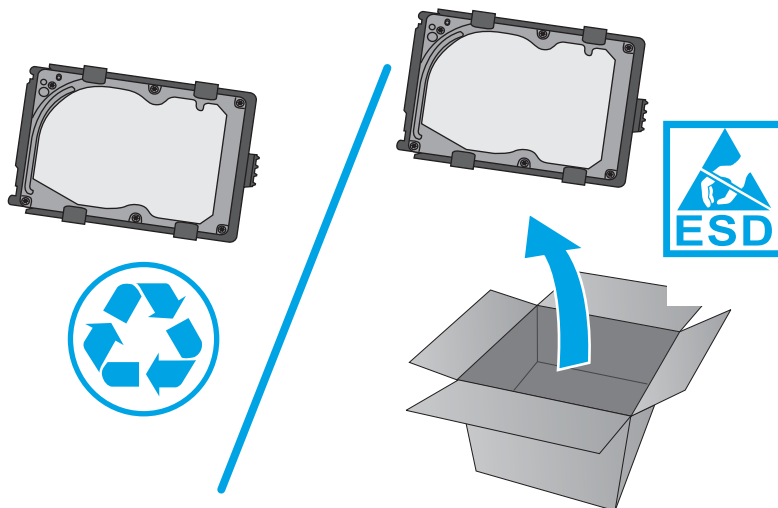
### Step 3: Unpack the replacement assembly

Unpack the replacement assembly from the packaging.

 **CAUTION:**  ESD-sensitive part.

<http://www8.hp.com/us/en/hp-information/environment/product-recycling.html>


 **NOTE:** HP recommends responsible disposal of the defective assembly.



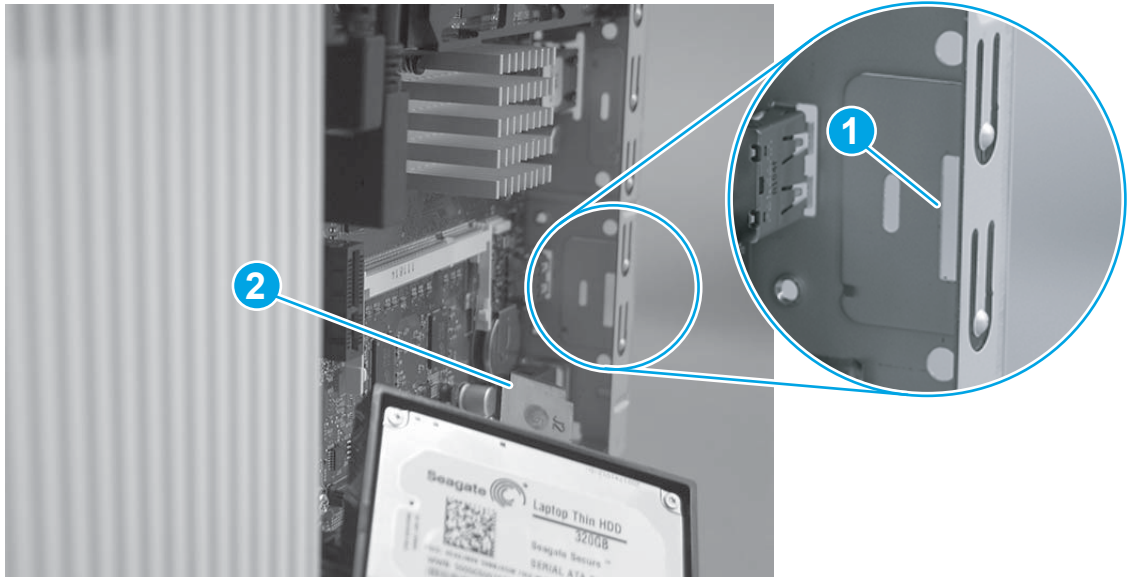
## Step 4: Install the HDD

 **CAUTION:**  ESD-sensitive part.

1. Before proceeding, take note of the location of the slot (callout 1) in the sheet-metal where the HDD cradle mounting tab (callout 2) must be installed.

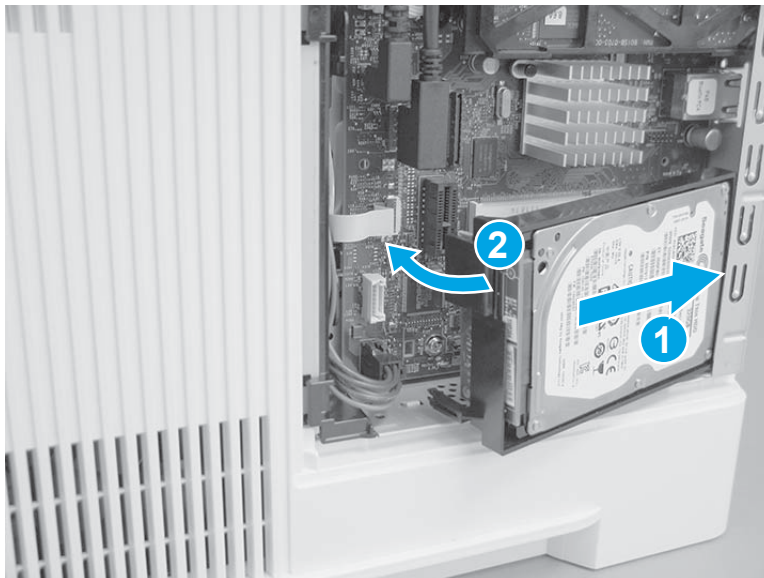
 **CAUTION:** This portion of the sheet-metal is a knock-out plate (callout 1). Do not push on it with sufficient force to detach it when installing the HDD.

**Figure 1-21** Locate the slot in the sheet-metal



2. Insert the HDD cradle mounting tab in the slot in the sheet-metal (callout 1), and then rotate the connector end (callout 2) of the HDD toward the formatter.

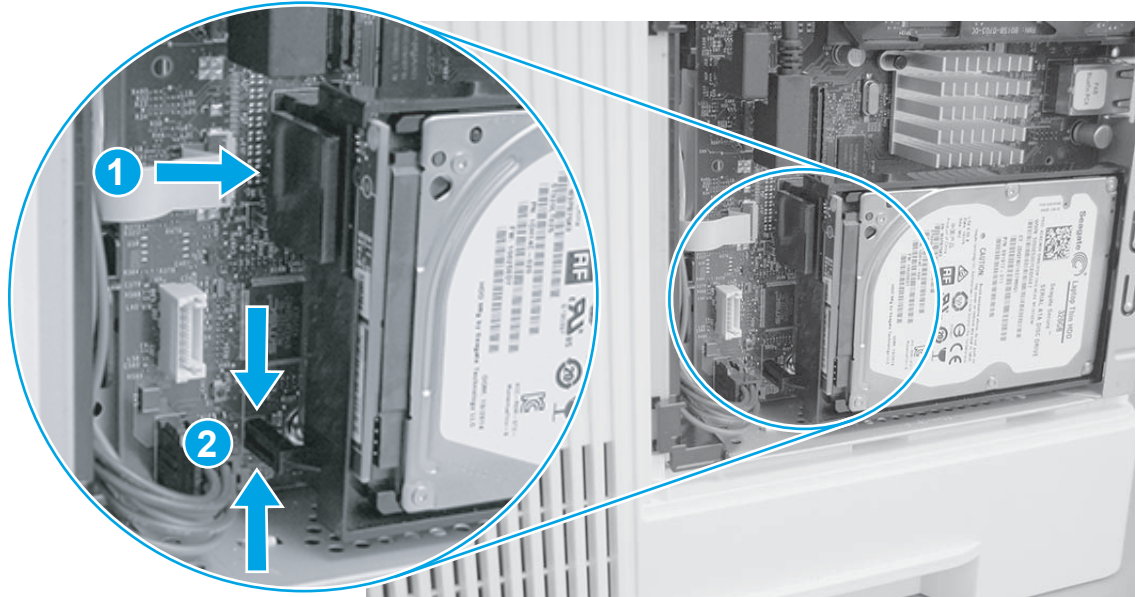
**Figure 1-22** Install the HDD





3. Make sure that the locking connector (callout 1) latches and that the standoA (callout 2) engages with the slot in the formatter (it might be necessary to pinch the retainer to engage it with the slot).

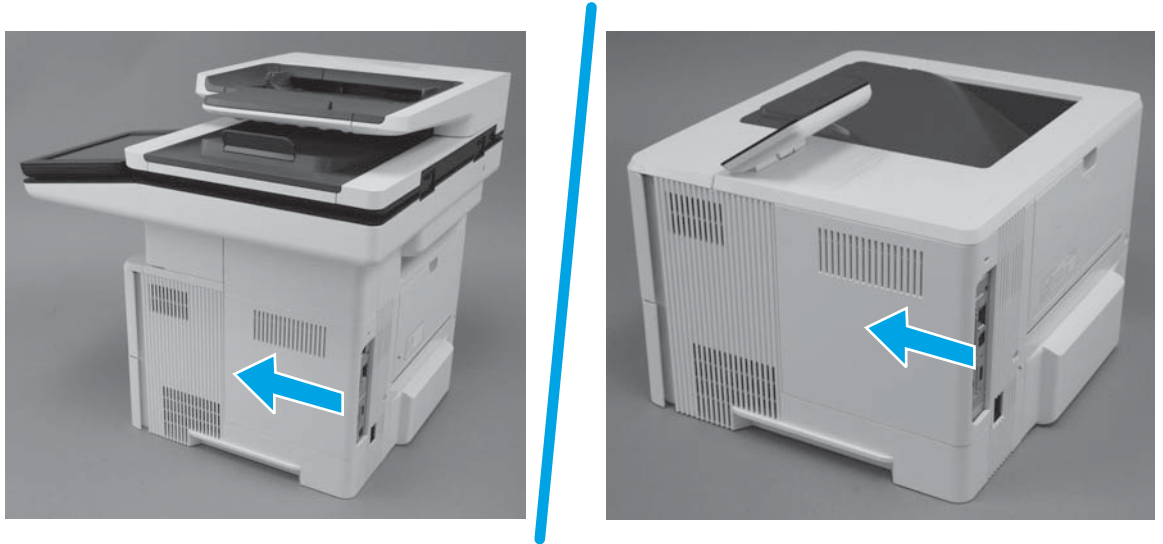
**Figure 1-23** Install the HDD



#### Step 5: Install the formatter cover

- ▲ Slide it toward the front of the printer to install it.

**Figure 1-24** Install the formatter cover



#### Step 6: Reinstall the printer firmware

 **NOTE:** If this installation is a replacement HDD, use the following steps to reinstall the firmware

1. Go to [www.hp.com/go/futuresmart](http://www.hp.com/go/futuresmart).
2. Select **Upgrade now**.
3. Find your Enterprise printer model.

4. Select the link to open the firmwar download page.
5. Select **OS Independent** from the list of operating systems.
6. Under the **Firmware** section, fin the fil for multiple operating systems.
7. Select **Download**.



---

**NOTE:** To view installation instructions, go to [www.hp.com/go/futuresmart](http://www.hp.com/go/futuresmart). Select **Upgrade now**, and then select **How to perform a firmware update**.

---

## Removal and replacement: Dual in-line memory module (DIMM) (M506/M527)

- [Introduction](#)
- [Step 1: Remove the formatter cover](#)
- [Step 2: Remove the hard-disk drive \(HDD\)](#)
- [Step 3: Remove the dual in-line memory module \(DIMM\)](#)
- [Step 4: Unpack the replacement DIMM](#)
- [Step 5: Install the dual in-line memory module \(DIMM\)](#)
- [Step 6: Install the hard-disk drive \(HDD\)](#)
- [Step 7: Install the formatter cover](#)

### Introduction


This document provides the procedures to remove and replace the dual in-line memory module (DIMM).

### Before performing service



#### Turn the printer power off

- Disconnect the power cable.

---

 **WARNING!** To avoid damage to the printer, turn the printer off wait 30 seconds, and then remove the power cable before attempting to service the printer.

---

 **CAUTION:**  This part contains components that are electrostatic discharge (ESD) sensitive. To reduce the possibility of ESD damage, always touch the sheet-metal chassis to ground yourself before touching an ESD sensitive part.

---

Use the table below to identify the correct part number for your printer. To order the part, go to [www.hp.com/buy/parts](http://www.hp.com/buy/parts).

---

Dual in-line memory module (DIMM) kit part number	
<b>E5K48-67902</b>	Dual in-line memory module (DIMM) with instruction guide (M527)
<b>G6W84-67902</b>	Slim dual in-line memory module (DIMM) with instruction guide (M506)

---

### Required tools

No special tools are required to install this part.

### After performing service

#### Turn the printer power on

- Connect the power cable.
- Use the power switch to turn the power on.

## Post service test

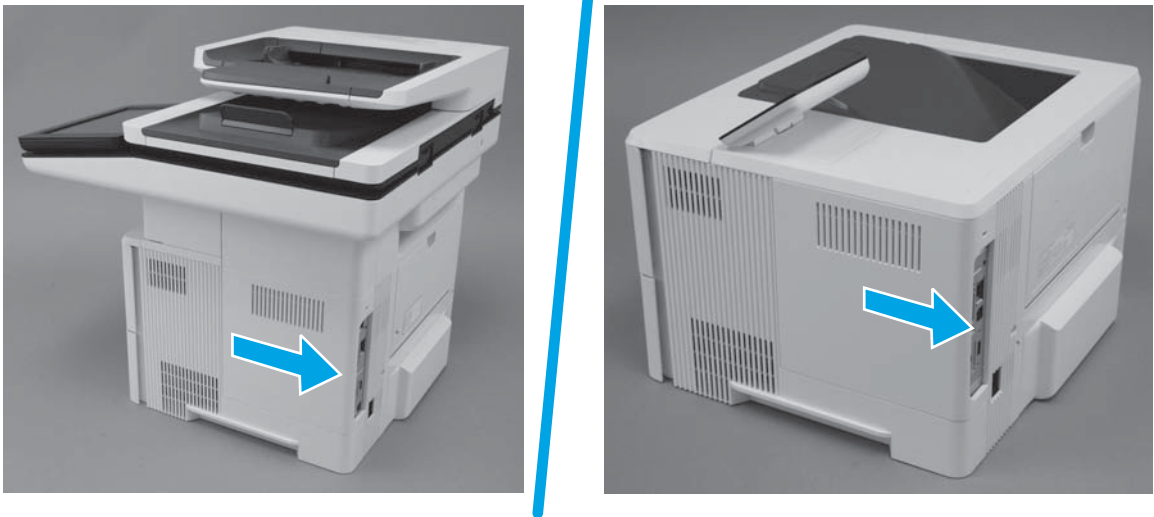
Make sure that the printer initializes to a **Ready** state.

Print a configuration page to make sure that the printer is functioning correctly.


### Step 1: Remove the formatter cover

- ▲ Slide the cover toward the rear of the printer to remove it.

**Figure 1-25** Remove the formatter cover



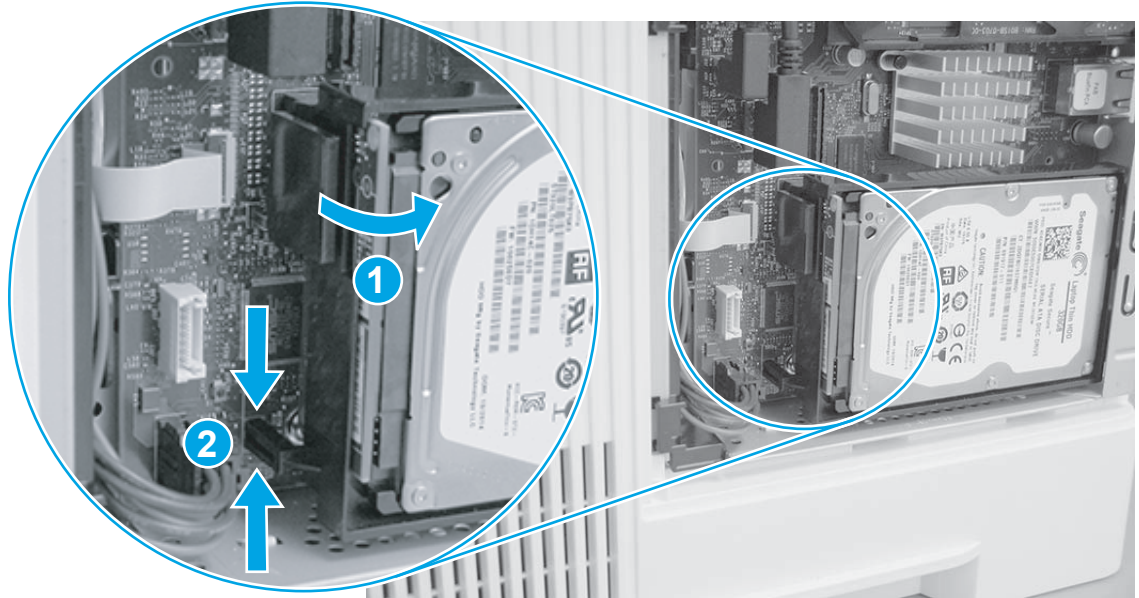
### Step 2: Remove the hard-disk drive (HDD)

 **NOTE:** HDD models only. For all other models, skip this step and go to [Step 3: Remove the dual in-line memory module \(DIMM\) on page 31](#).

 **CAUTION:**  ESD-sensitive part.

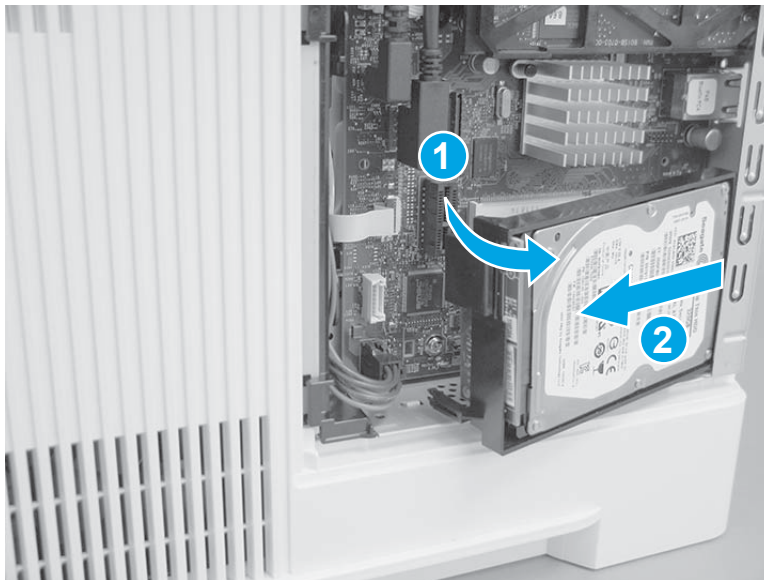
1. Release the locking connector (callout 1), and then pinch the retainer (callout 2) to release it.

**Figure 1-26** Release the HDD



2. Rotate the connector end of the HDD out and away from the formatter (callout 1), and then slide it as shown (callout 2) to remove it.

**Figure 1-27** Remove the HDD



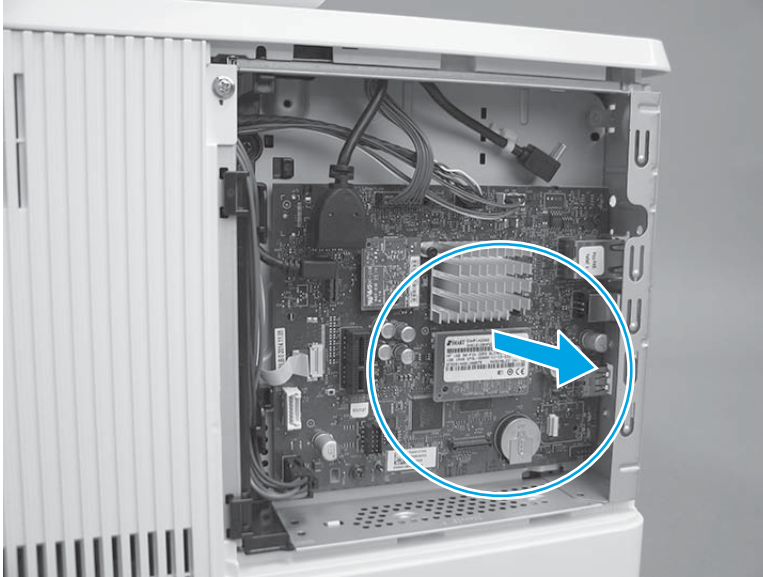
### Step 3: Remove the dual in-line memory module (DIMM)

 **CAUTION:**  ESD-sensitive part.

 **NOTE:** The M506 printers use a Slim dual in-line memory module (DIMM).

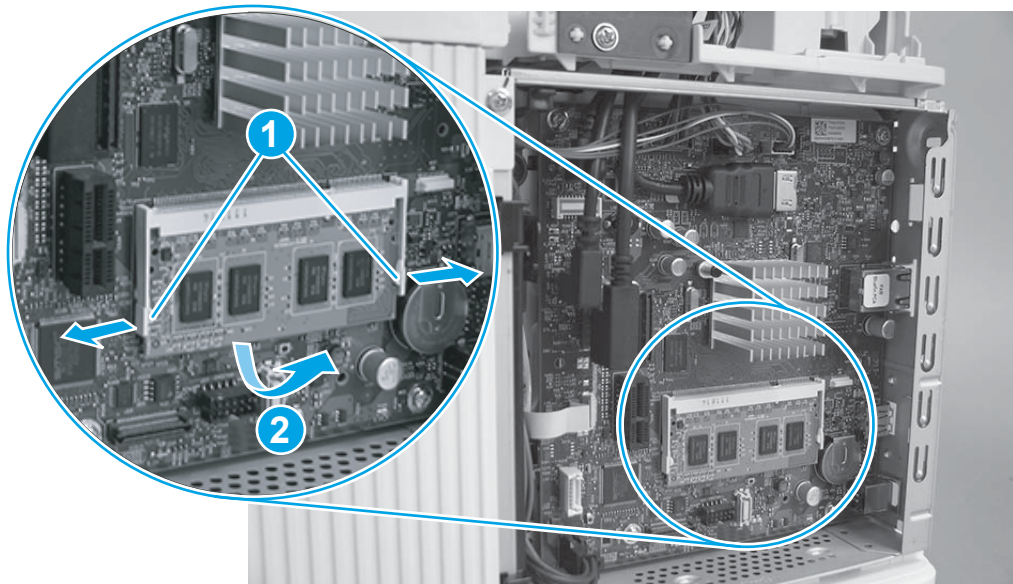
1. **M506 only:** Locate the DIMM component on the formatter, and then pull it straight out of the formatter to remove it.

**Figure 1-28** Remove the DIMM (M506)



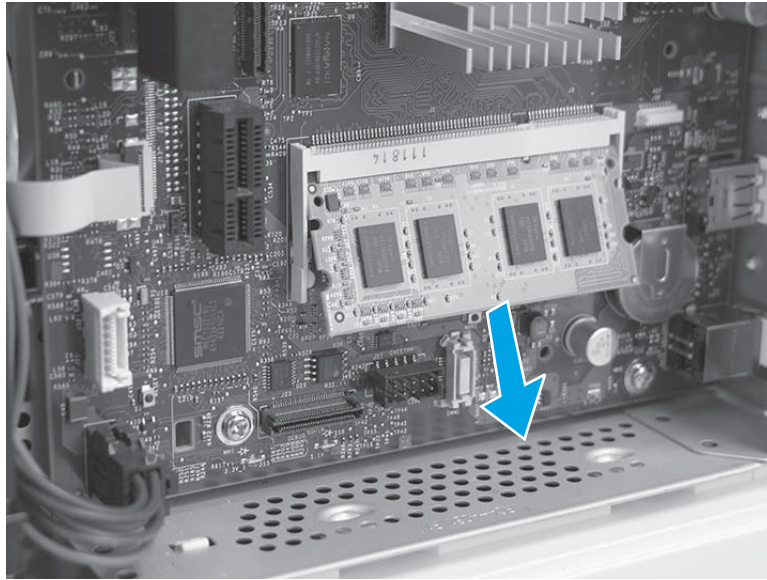
2. **M527 only:** Do the following
  - a. Locate the DIMM component on the formatter, release two locking arms (callout 1), and then let the bottom edge of the DIMM rotate away from the holder (callout 2).

**Figure 1-29** Release the DIMM (M527)



- b. Pull the DIMM down and away from the holder to remove it.

**Figure 1-30** Remove the DIMM (M527)



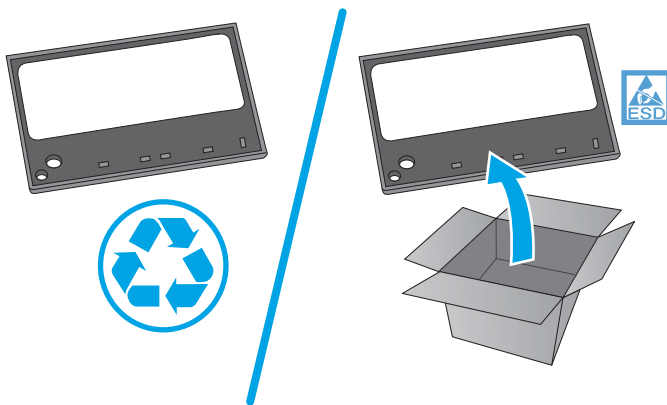
#### Step 4: Unpack the replacement DIMM

Unpack the replacement assembly from the packaging.

 **CAUTION:**  ESD-sensitive part.

<http://www8.hp.com/us/en/hp-information/environment/product-recycling.html>

 **NOTE:** HP recommends responsible disposal of the defective assembly.



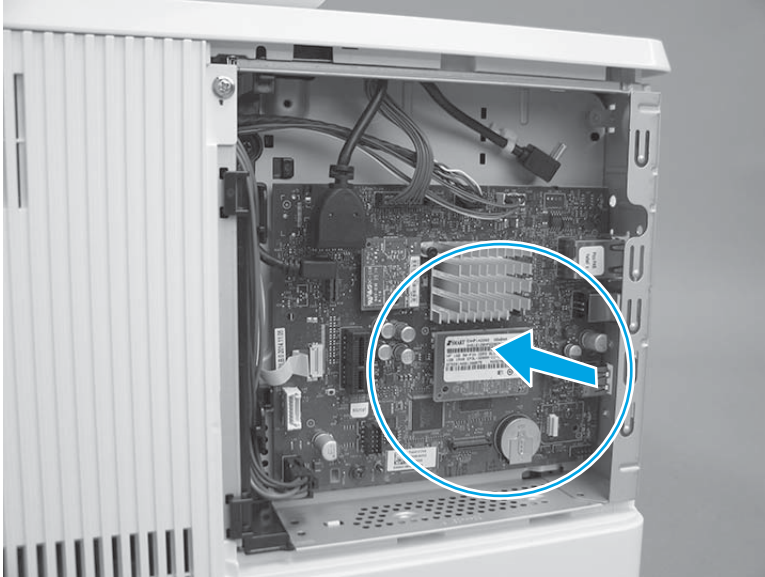
#### Step 5: Install the dual in-line memory module (DIMM)

 **CAUTION:**  ESD-sensitive part.

 **NOTE:** The M506 printers use a Slim dual in-line memory module (DIMM).


1. **M506 only:** Push the DIMM straight on the connector to install it.

**Figure 1-31** Install the DIMM (M506)



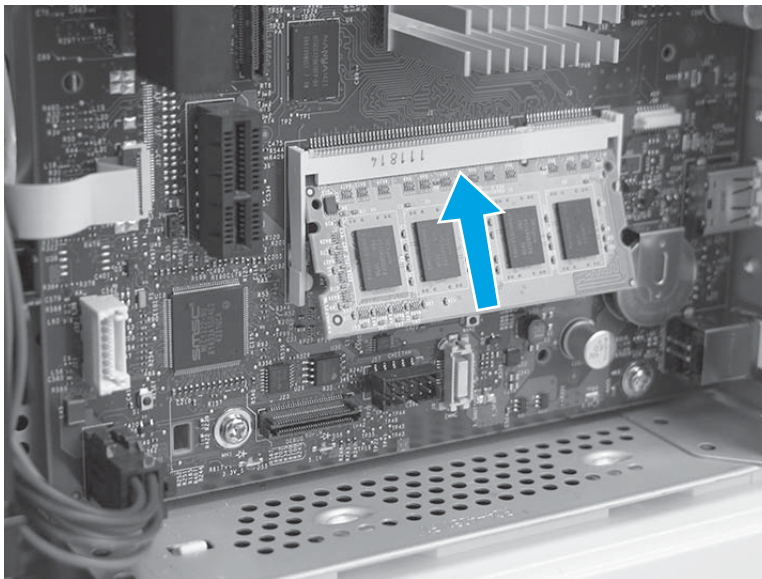
2. **M527 only:** Do the following
  - a. Insert the top edge of the DIMM in the holder.

---

 **Reinstallation tip:** The DIMM is keyed and can only be inserted in the holder one way.

---

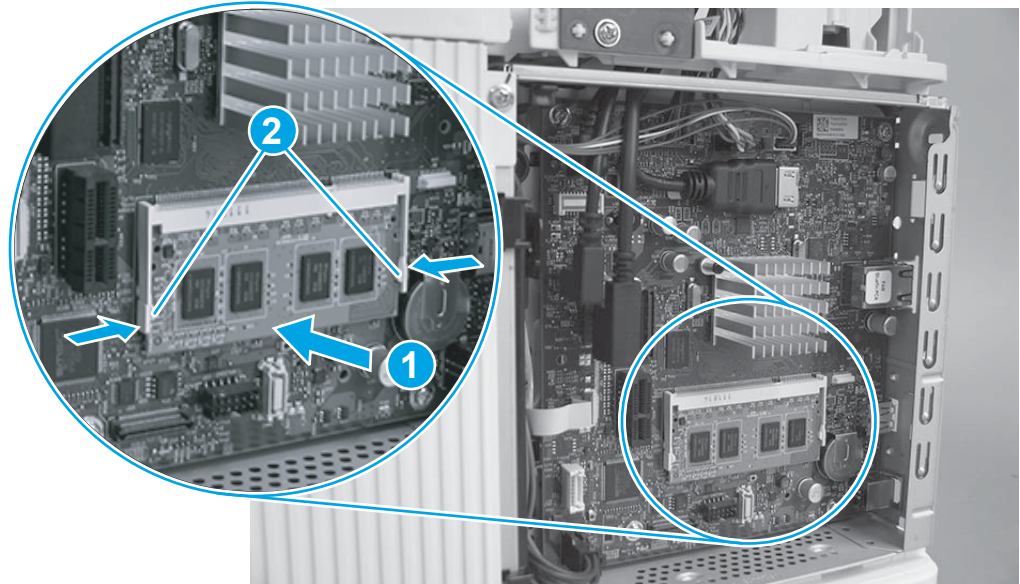
**Figure 1-32** Insert the DIMM (M527)






- b. Rotate the bottom edge of the DIMM toward the holder (callout 1), and then make sure that the two locking arms snap into place (callout 2).

**Figure 1-33** Install the DIMM (M527)




### Step 6: Install the hard-disk drive (HDD)

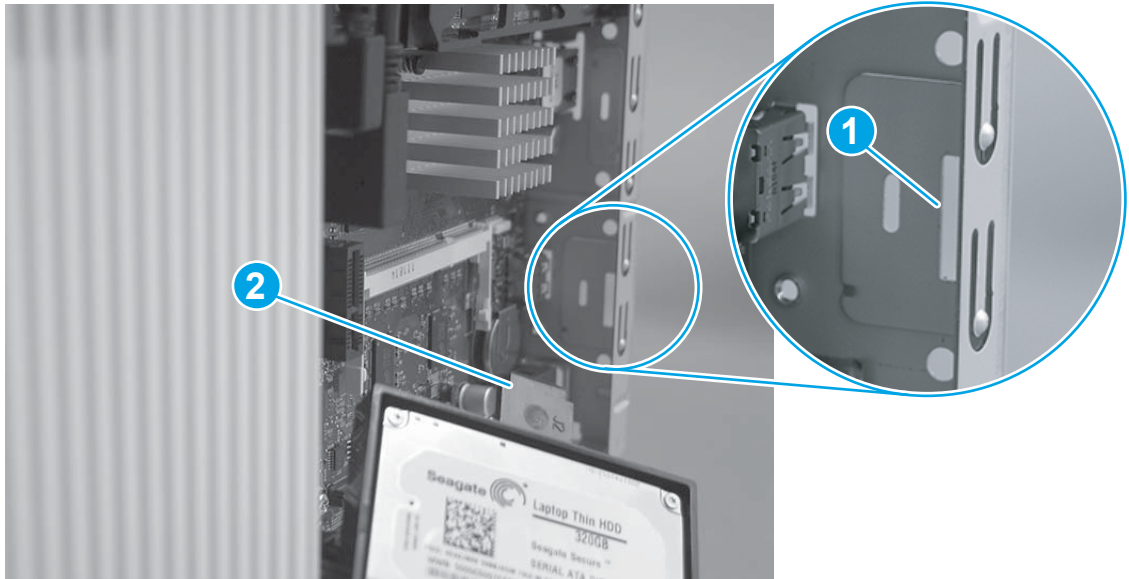
 **NOTE:** HDD models only. For all other models, skip this step and go to [Step 7: Install the formatter cover on page 37](#).

 **CAUTION:**  ESD-sensitive part.

1. Before proceeding, take note of the location of the slot (callout 1) in the sheet-metal where the HDD cradle mounting tab (callout 2) must be installed.

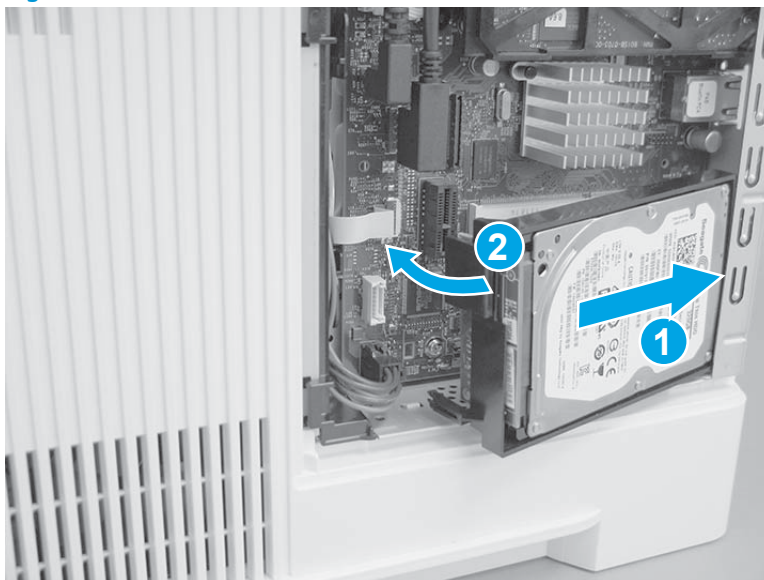
 **CAUTION:** This portion of the sheet-metal is a knock-out plate (callout 1). Do not push on it with sufficient force to detach it when installing the HDD.

**Figure 1-34** Locate the slot in the sheet-metal



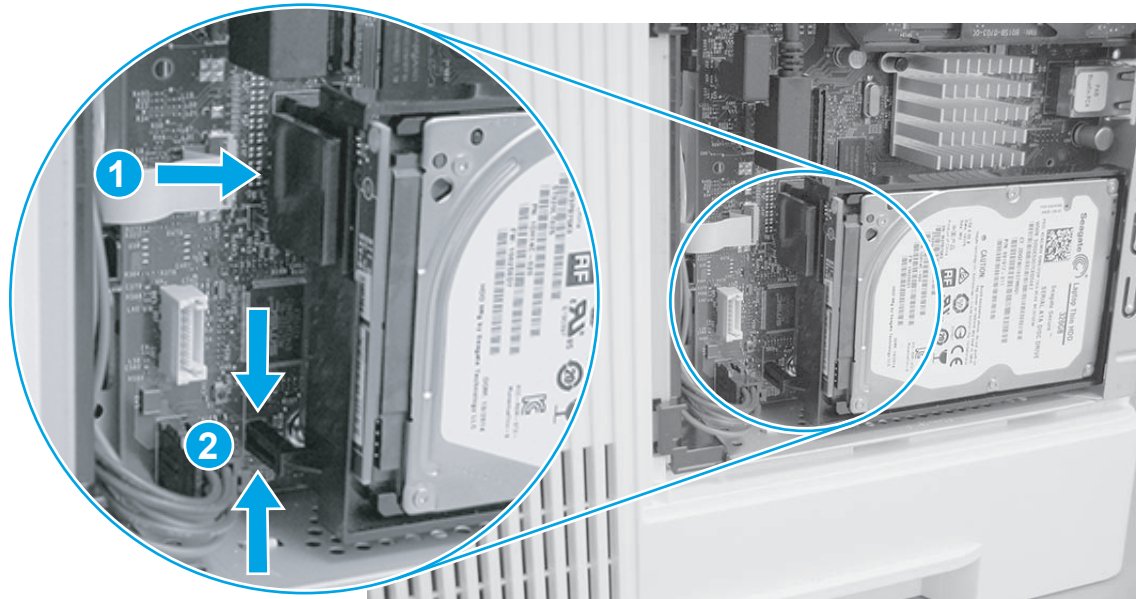
2. Insert the HDD cradle mounting tab in the slot in the sheet-metal (callout 1), and then rotate the connector end (callout 2) of the HDD toward the formatter.

**Figure 1-35** Install the HDD



3. Make sure that the locking connector (callout 1) latches and that the standoA (callout 2) engages with the slot in the formatter (it might be necessary to pinch the retainer to engage it with the slot).

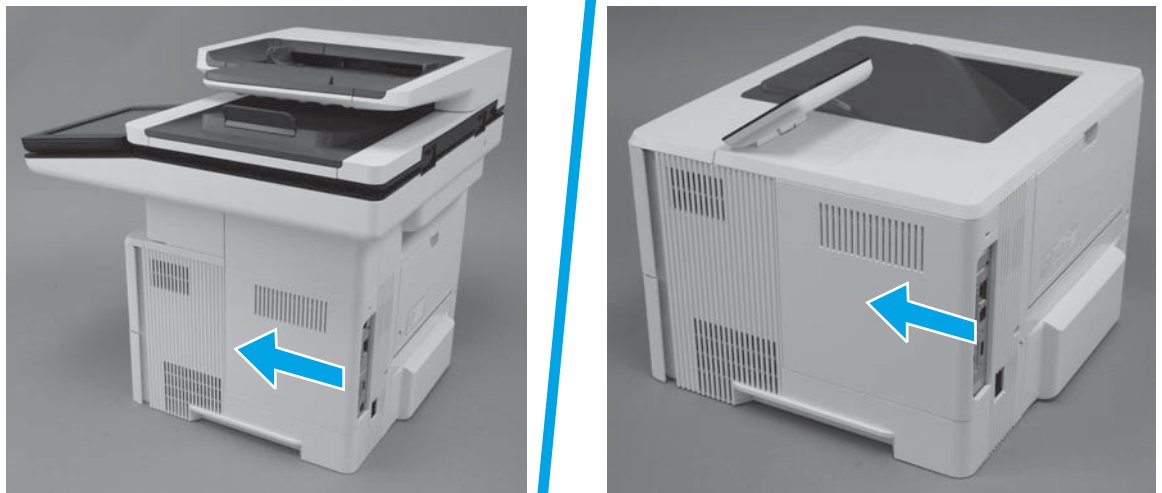
**Figure 1-36** Install the HDD



#### Step 7: Install the formatter cover

- ▲ Slide it toward the front of the printer to install it.

**Figure 1-37** Install the formatter cover



## Removal and replacement: Transfer roller



**NOTE:** The figure in this section show the M527. However, the procedure is correct for the M501 and M506 printers.

- [Introduction](#)
- [Step 1: Remove the toner cartridge](#)
- [Step 2: Remove the transfer roller](#)
- [Step 3: Unpack the replacement roller](#)
- [Step 4: Install the transfer roller](#)
- [Step 5: Install the toner cartridge](#)

### Introduction

This document provides the procedures to remove and replace the transfer roller.

### Before performing service

#### Turn the printer power off

- Disconnect the power cable.



**WARNING!** To avoid damage to the printer, turn the printer off wait 30 seconds, and then remove the power cable before attempting to service the printer.

Use the table below to identify the correct part number for your printer. To order the part, go to [www.hp.com/buy/parts](http://www.hp.com/buy/parts).

Transfer roller part number
-----------------------------

<b>F2A68-67910</b>
--------------------

Transfer roller with instruction guide
--

### Required tools

- No special tools are required to remove this part.

### After performing service

#### Turn the printer power on

- Connect the power cable.
- Use the power switch to turn the power on.

### Post service test

Make sure that the printer initializes to a **Ready** state.

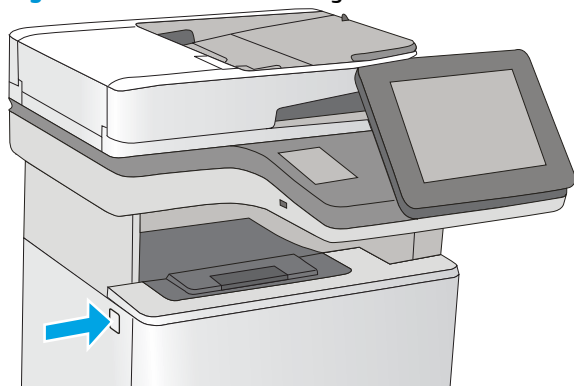
Print a configuration page to make sure that the printer is functioning correctly.

## Step 1: Remove the toner cartridge

The M527 printer is shown in this section. However, the procedure is correct for the M501 and M506 printers.

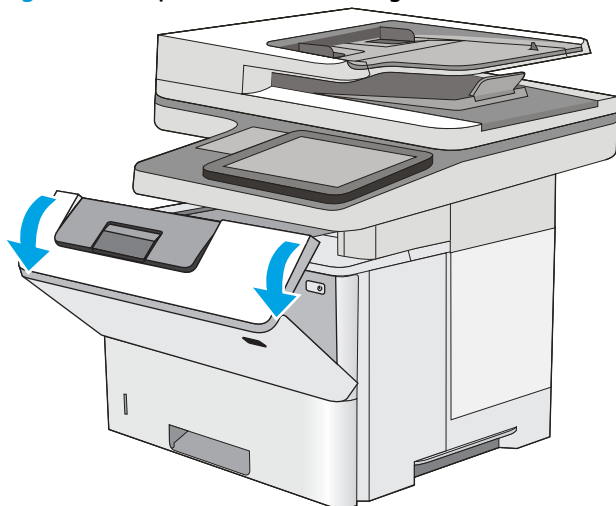
1. Press the cartridge-door-release button.

**Figure 1-38** Press the cartridge-door-release button



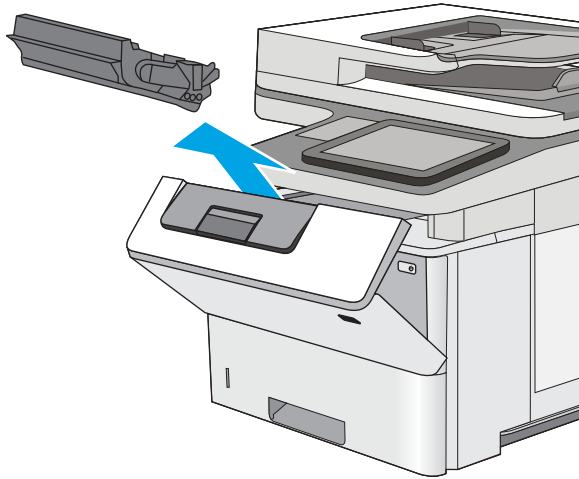
2. Open the toner-cartridge door.

**Figure 1-39** Open the toner-cartridge door



3. Remove the toner cartridge from the printer.

**Figure 1-40** Remove the toner cartridge

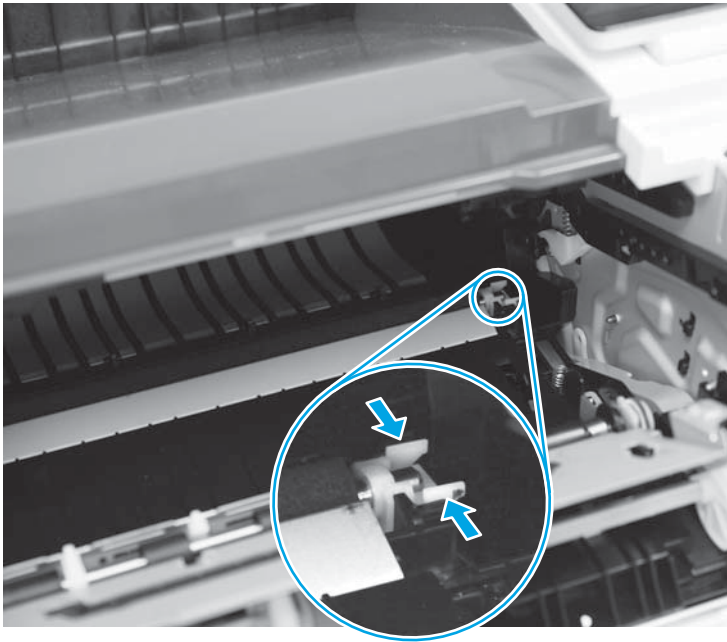


### Step 2: Remove the transfer roller

1. Push in on the two white tabs on the right-side retainer clip to release them.

 **NOTE:** The right end of the roller slightly springs up when the tabs are released.

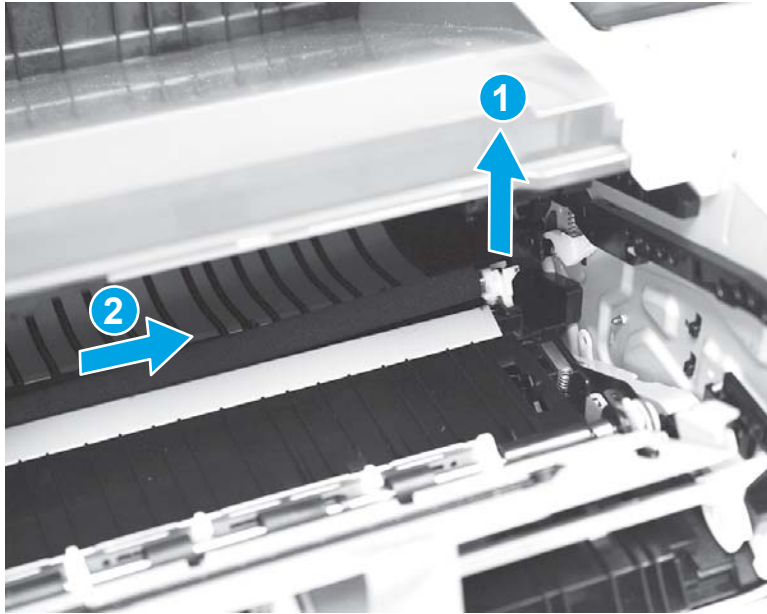
**Figure 1-41** Release the retainer clip



2. Grasp the silver shaft end of the roller or the white retainer clip, raise the right-end of the roller up, and then slide the roller to the right to release the left-end of the roller shaft.

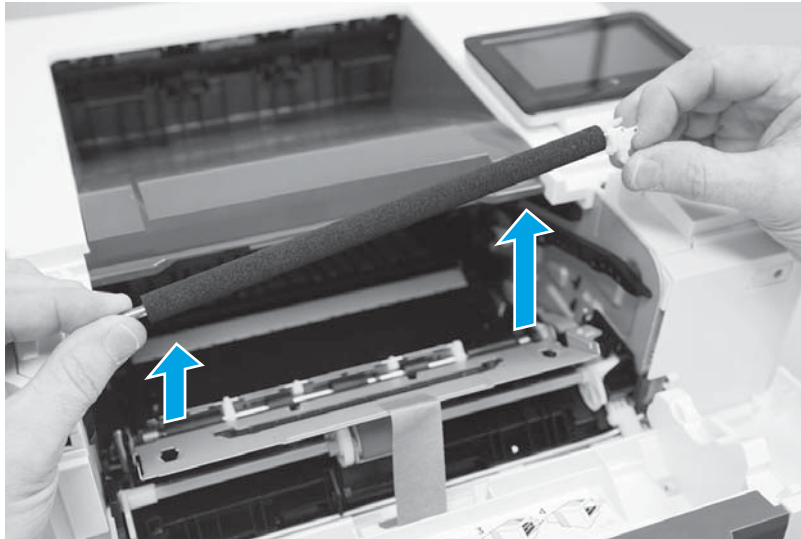
**CAUTION:** The retainer clip is not captive. Do not drop it into the product when handling the roller.

**Figure 1-42** Release the roller



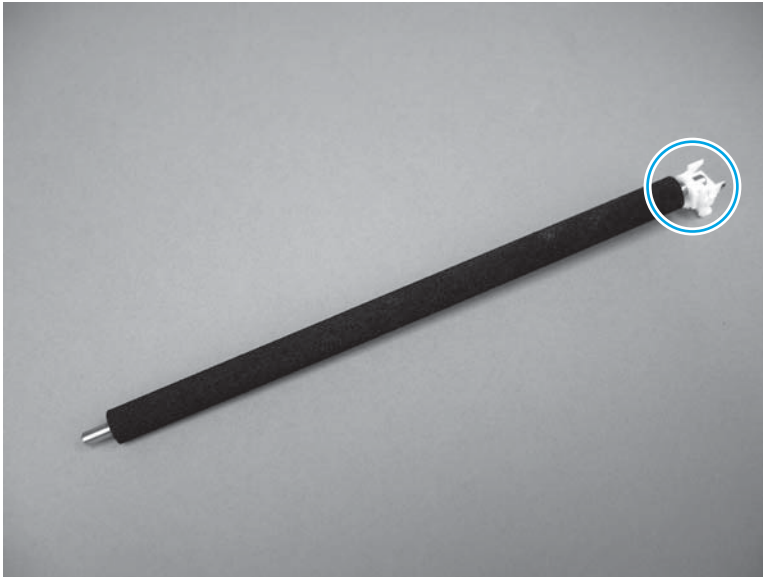
3. Remove the transfer roller from the printer.

**Figure 1-43** Remove the roller



4. Remove the clip from the right end of the transfer roller. Set the clip aside, it will be installed on the replacement roller.

**Figure 1-44** Remove the retainer clip



### Step 3: Unpack the replacement roller

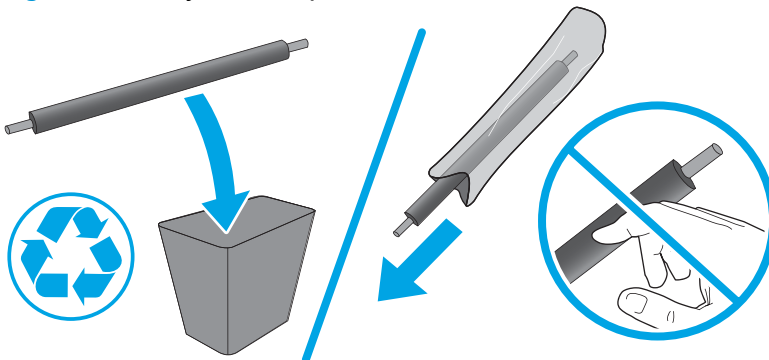
Unpack the replacement part from the packaging.

<http://www8.hp.com/us/en/hp-information/environment/product-recycling.html>

**CAUTION:** Do not touch the black spongy portion of the roller. Skin oils can cause image-quality problems.

**NOTE:** HP recommends responsible disposal of the defective part.

**Figure 1-45** Recycle and unpack



### Step 4: Install the transfer roller

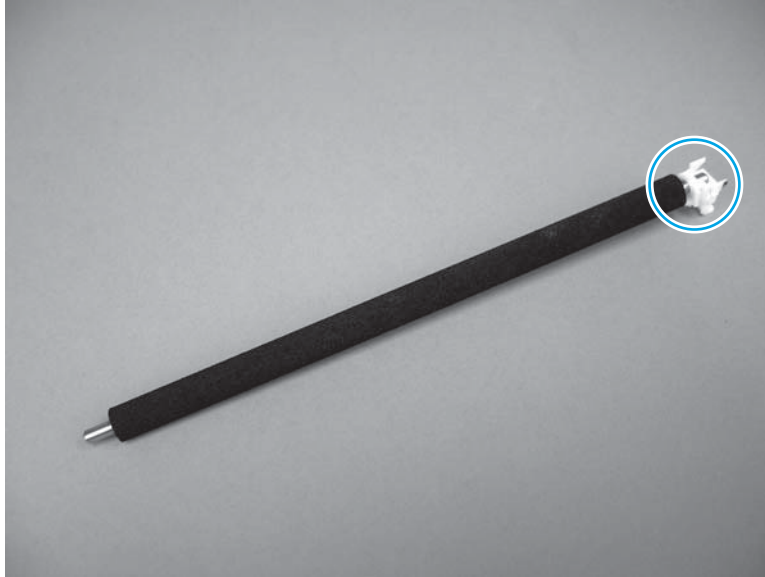
**CAUTION:** Do not touch the black spongy portion of the roller. Skin oils can cause image-quality problems.

1. From the discarded transfer roller, install the clip on either end of the replacement transfer roller.

**CAUTION:** Avoid touching the black spongy part of the roller. Skin oils deposited on the rollers might cause print quality problems. HP recommends washing your hands before handling the roller.

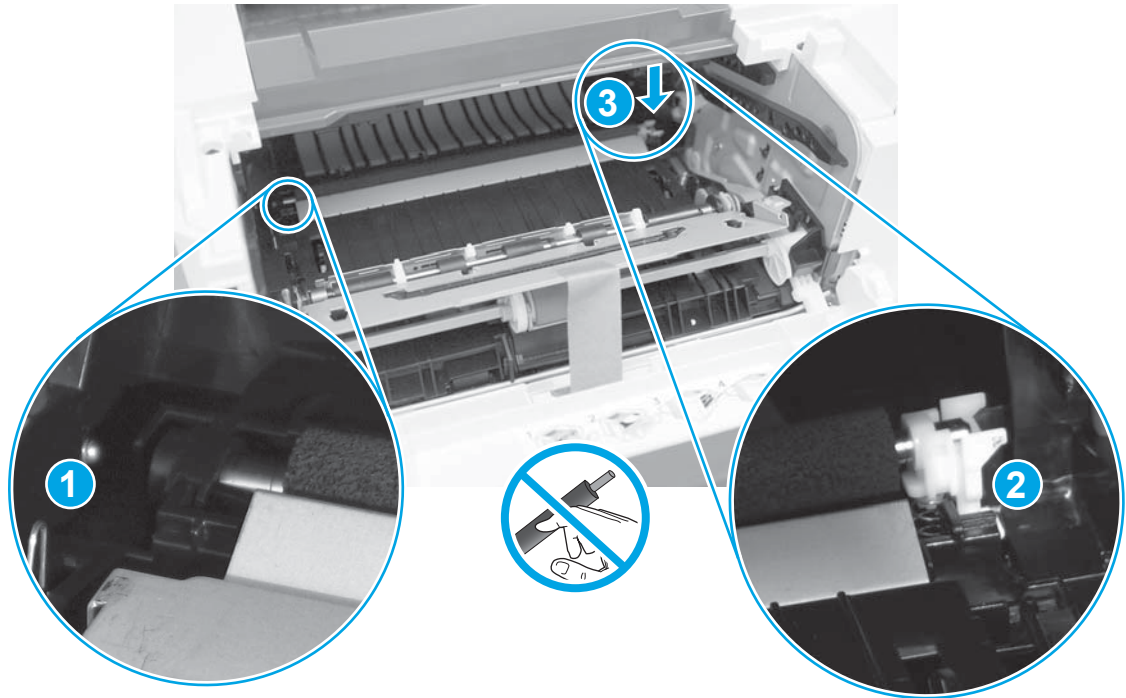


**Figure 1-46** Install the holder



2. Place the left (shaft) end of the roller in the retainer clip (callout 1), lower the right end (with the clip) into place making sure that the clip and spring are aligned (callout 2), and then push down (callout 3) on the clip until it snaps in place.

**Figure 1-47** Install the roller and retainer clip

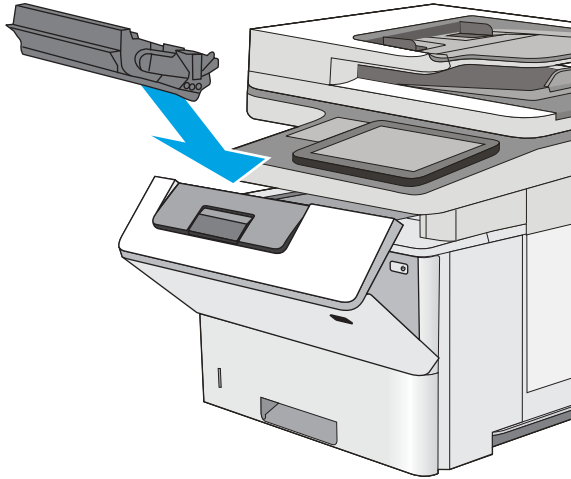


### Step 5: Install the toner cartridge

The M527 printer is shown in this section. However, the procedure is correct for the M501 and M506 printers.

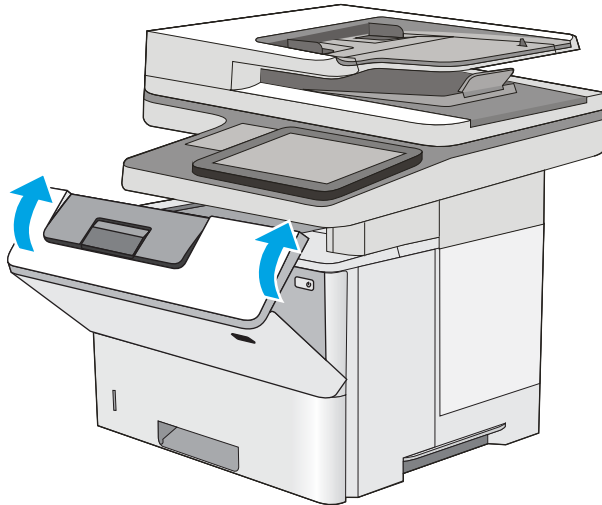
1. Align the toner cartridge with the tracks inside the printer, and install the toner cartridge until it is firmly seated.

**Figure 1-48** Install the toner cartridge



2. Close the toner-cartridge door.

**Figure 1-49** Close the toner-cartridge door



## Removal and replacement: Control panel (M527)

- [Introduction](#)
- [Step 1: Remove the control panel \(M527\)](#)
- [Step 2: Unpack the replacement control panel](#)
- [Step 3: Install the control panel \(M527\)](#)

### Introduction


This document provides the procedures to remove and replace the M527 control panel.

### Before performing service

#### Turn the printer power off

- Disconnect the power cable.

---

 **WARNING!** To avoid damage to the printer, turn the printer off wait 30 seconds, and then remove the power cable before attempting to service the printer.

---

Use the table below to identify the correct part number for your printer. To order the part, go to [www.hp.com/buy/parts](http://www.hp.com/buy/parts).

---

Control panel (M527) part number	
<b>B5L47-67018</b>	Control panel (M527) with instruction guide

---

### Required tools

- #2 Phillips screwdriver with a magnetic tip.

### After performing service

#### Turn the printer power on

- Connect the power cable.
- Use the power switch to turn the power on.

### Post service test

Make sure that the printer initializes to a **Ready** state.

Print a configuratio page to make sure that the printer is functioning correctly.

### Step 1: Remove the control panel (M527)

1. Open the document feeder.

---

 **NOTE:** If the control panel is not fully tilted forward, tilt it forward now until it stops.

---

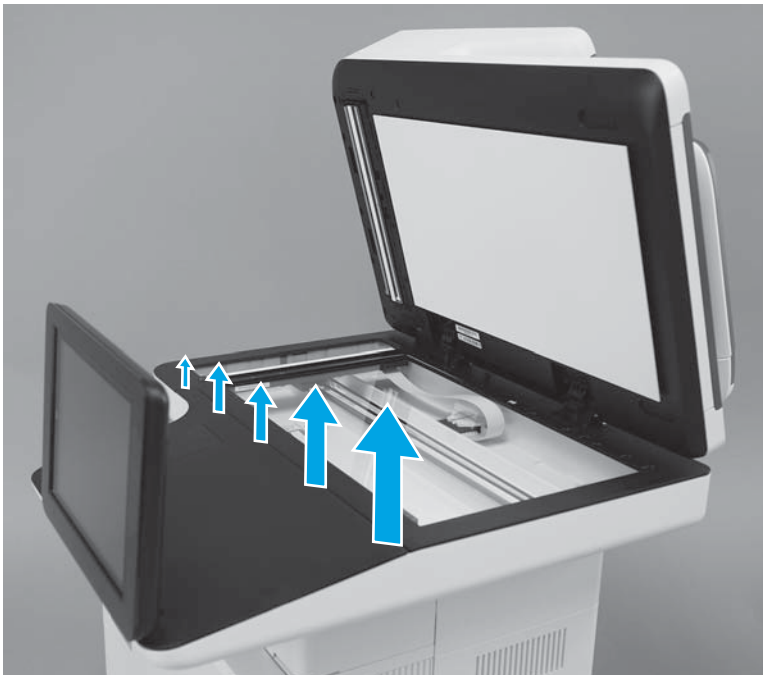
**Figure 1-50** Open the document feeder



2. Beginning at the right side of the control-panel cover, carefully release five tabs along the top edge of the cover.

 **NOTE:** The thin black-plastic cover will separate from the white-plastic control-panel base.

**Figure 1-51** Release five tabs



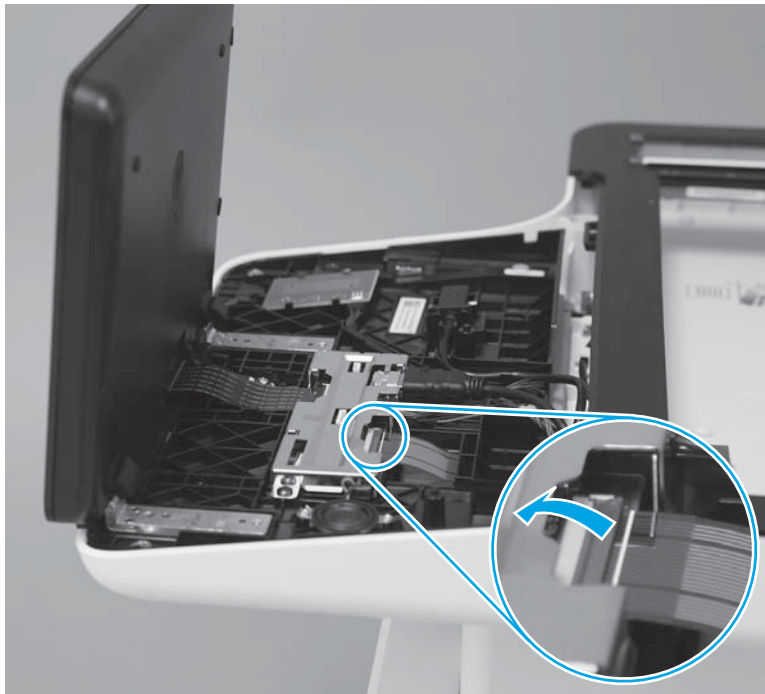
3. Continue to rotate the top edge of the cover away from the printer, and then remove the cover.

**Figure 1-52** Remove the cover



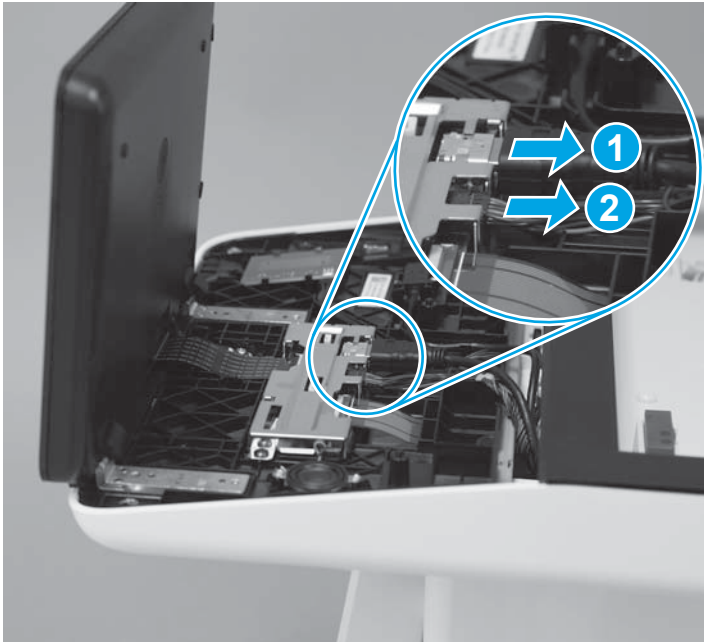
4. **M527c/z only:** Open the connector latch to release the keyboard flat cable.

**Figure 1-53** Disconnect the FFC (M527c/z)




5. Disconnect one HDMI cable (callout 1) and one connector (callout 2).

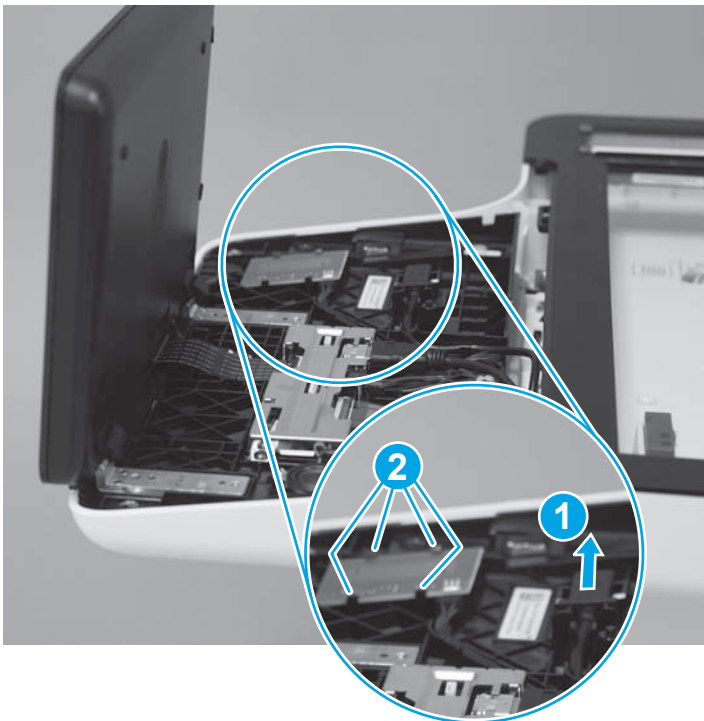
**Figure 1-54** Disconnect connectors




6. Remove the USB cable (callout 1) from the holder.

 **NOTE: M527z only:** Release four tabs (callout 2), and then remove the near-field communication (NFC) printed circuit board.

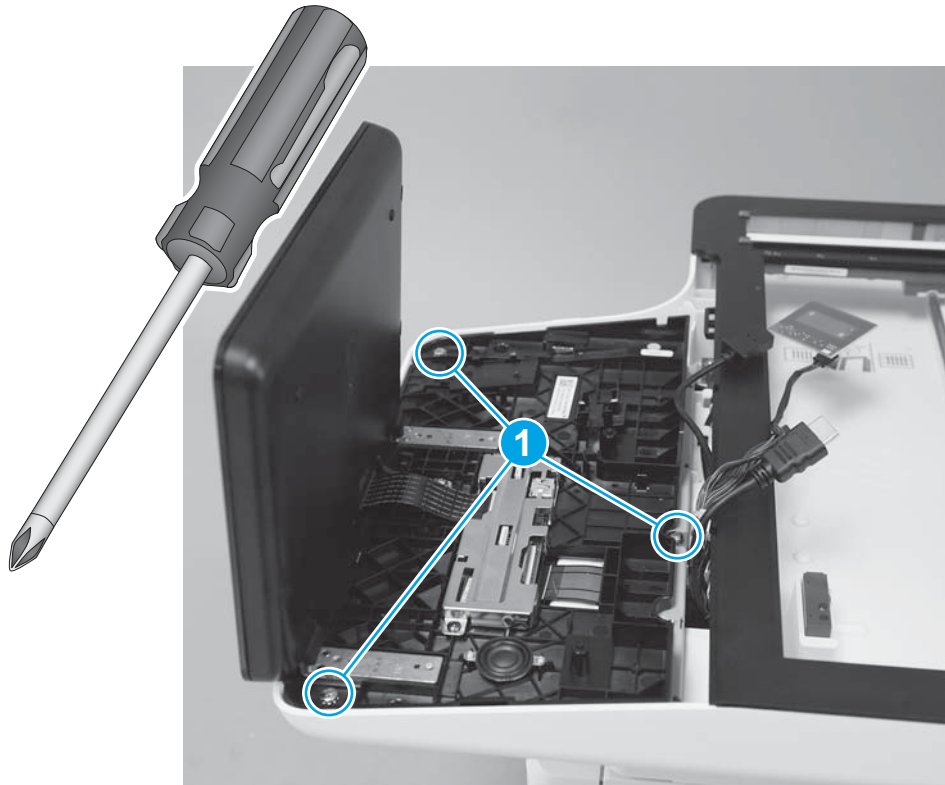
**Figure 1-55** Remove USB cable and NFC PCA



7. Remove three screws (callout 1).

 **TIP:** The screwdriver (supplied with the kit) has a reversible shaft. Simply pull the shaft out of the handle, and then reinstall it with the desired end facing out.

**Figure 1-56** Remove three screws



8. Lift the front of the control panel of the printer (callout 1), and then slide it toward the front of the printer (callout 2) to remove it.

**Figure 1-57** Remove the control panel




## Step 2: Unpack the replacement control panel

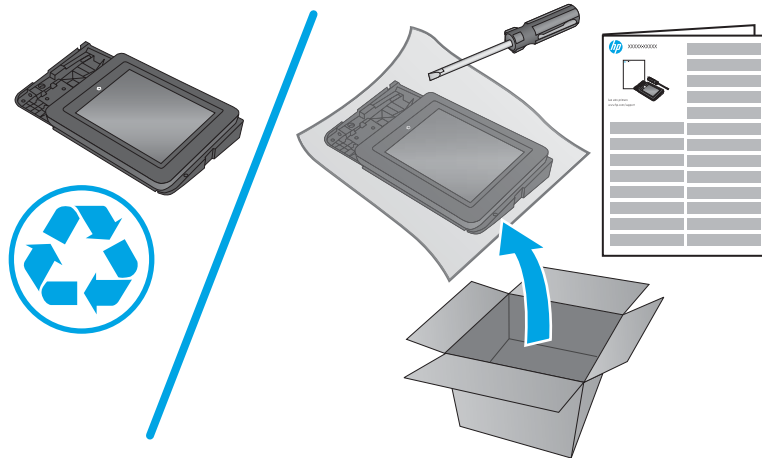
Unpack the replacement part from the packaging.

<http://www8.hp.com/us/en/hp-information/environment/product-recycling.html>

 **NOTE:** HP recommends responsible disposal of the defective part.

 **TIP:** Don't forget to remove the protective film on the touchscreen of the replacement control panel.

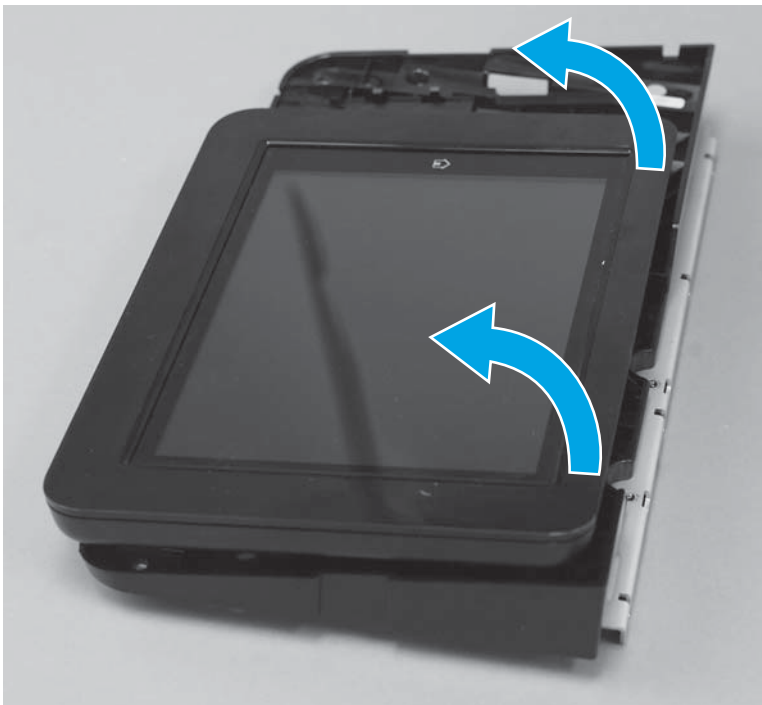
**Figure 1-58** Recycle and unpack



## Step 3: Install the control panel (M527)

1. Tilt the replacement control panel away from the base plate.

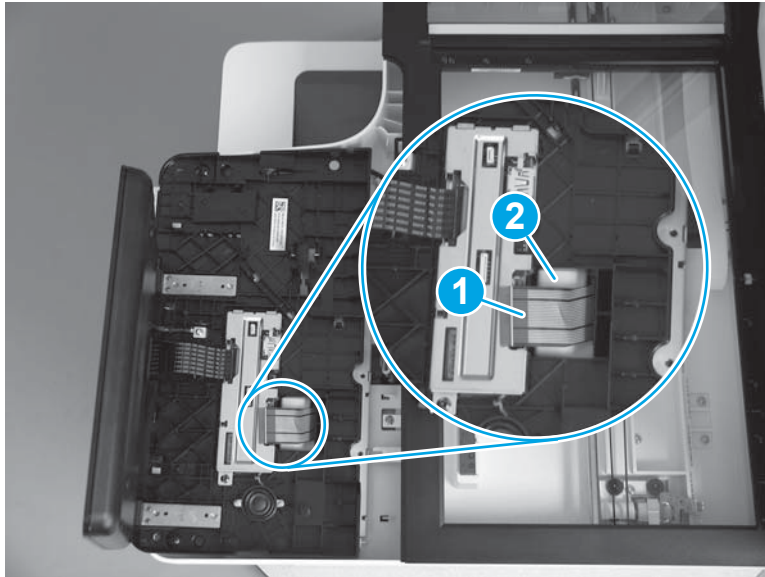
**Figure 1-59** Open the control panel






- M527c/z only:** Make sure to feed the keyboard flange cable (callout 1) passes through the opening (callout 3) in the control-panel base when installing the control panel.

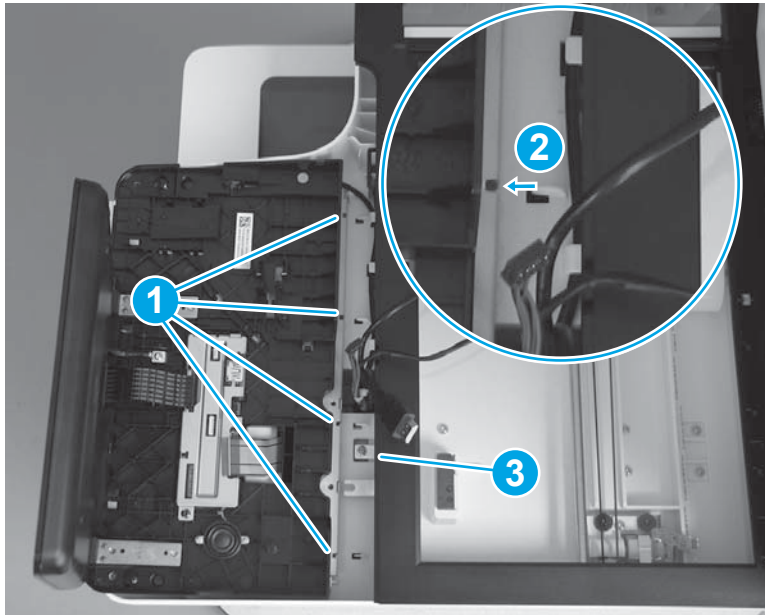
**Figure 1-60** Check the keyboard flange cable (M527c/z)




- Locate the four hooks on the printer and matching slots in the control-panel base (callout 1). The hooks fit into the slots (callout 2) when the assembly is installed.

 **NOTE:** Make sure that the grounding clip (callout 3) is on top of the assembly base when it is installed.

**Figure 1-61** Locate the hooks and slots




4. Position the rear edge of the control panel in the printer (callout 1), and then lower the front edge down (callout 2) to install it.

 **NOTE:** If the control panel is difficult to install, make sure that the hooks, slots, and grounding clip are correctly engaged. See step 3.

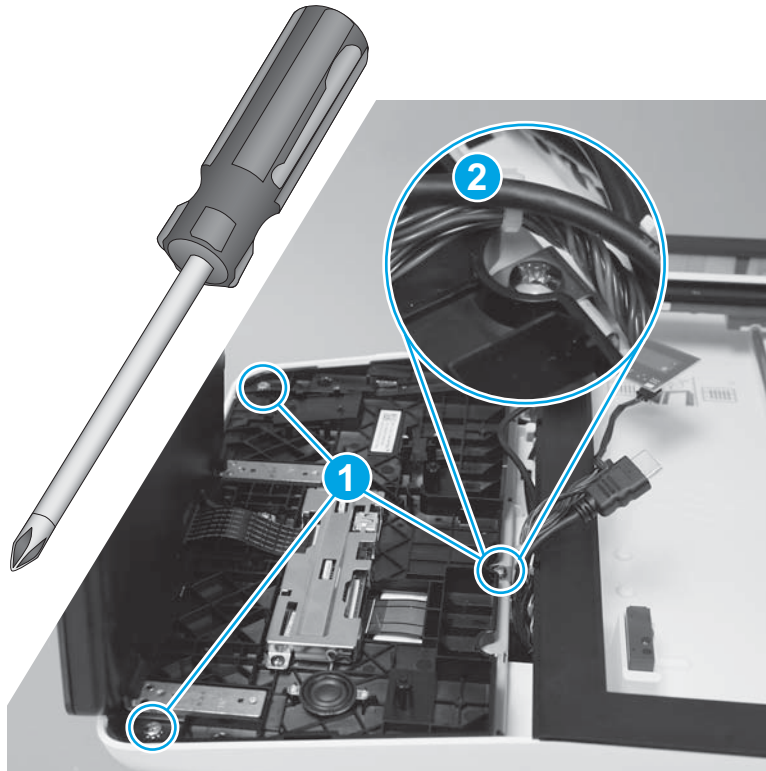
**Figure 1-62** Install the control-panel



5. Install three screws (callout 1), make sure that the grounding clip is correctly installed (callout 2).

 **TIP:** The screwdriver (supplied with the kit) has a reversible shaft. Simply pull the shaft out of the handle, and then reinstall it with the desired end facing out.

**Figure 1-63** Install three screws




6. Connect one HDMI cable (callout 1) and one connector (callout 2).

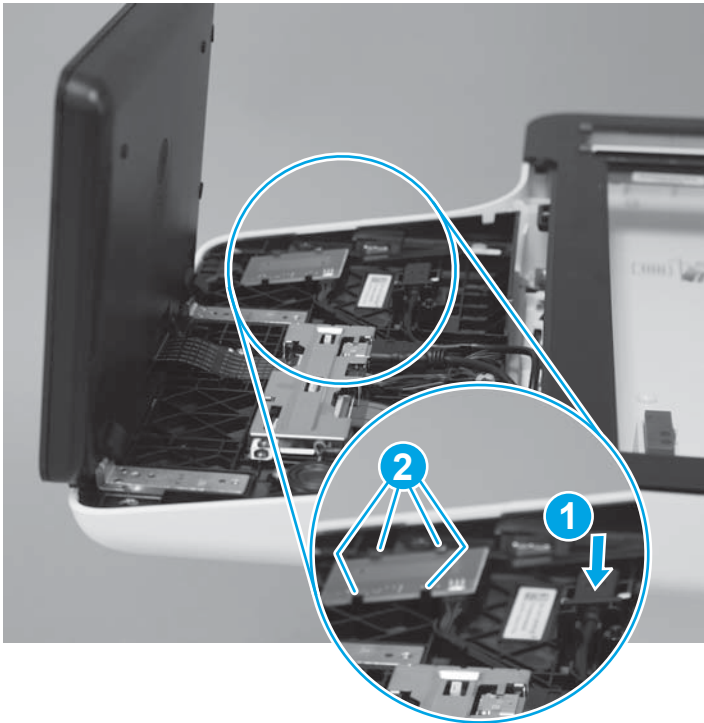
**Figure 1-64** Connect the connectors




7. Install the USB cable (callout 1) in the holder.


 **NOTE:** **M527z only:** Install the near-field communication (NFC) printed circuit board under the four tabs (callout 2).

**Figure 1-65** Install the USB cable and NFC PCA

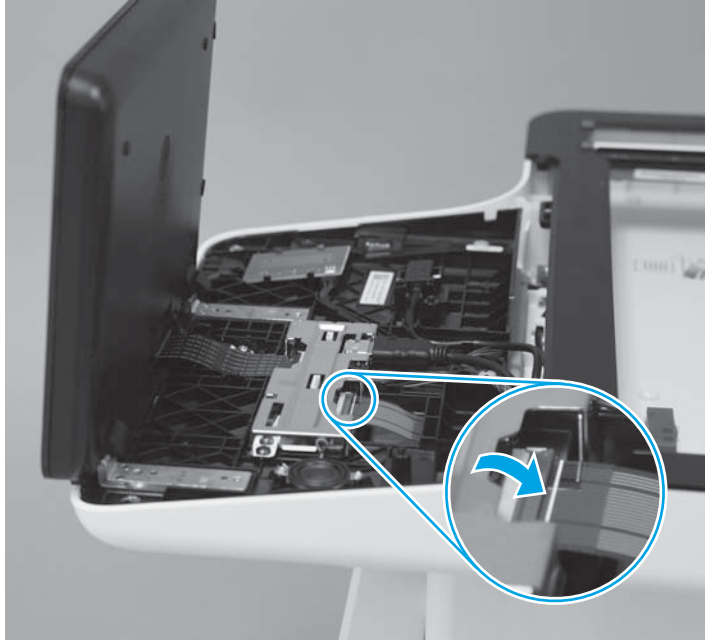


- 8. M527z only:** Position the keyboard fla cable in the connector, and then close the connector latch.

 **IMPORTANT:** Slightly tug on the cable to make sure that it is fully captured in the connector.

 **NOTE:** When the connector latch is closed and the cable is correctly installed, the white line on the cable is parallel to the connector latch.

**Figure 1-66** Connect the fla cable (M527z)



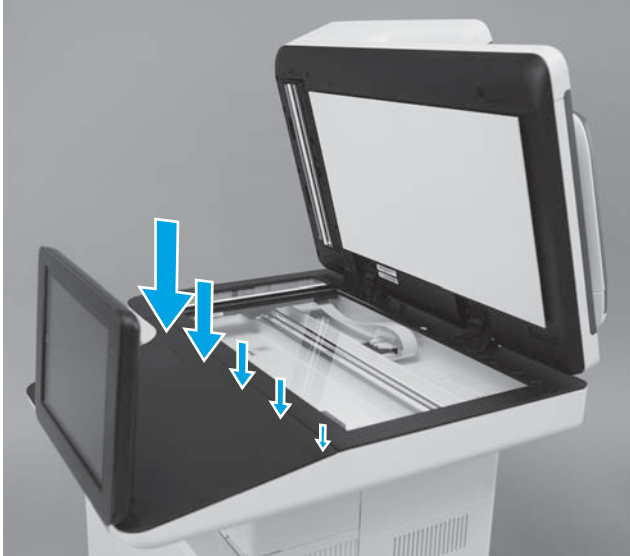
- 9.** Position the control-panel cover on the printer.

**Figure 1-67** Position the control-panel cover on the printer



10. Beginning at the left side of the control-panel cover, carefully engage five tabs along the top edge of the cover.


**Figure 1-68** Engage five tabs



11. Close the document feeder.

---

 **NOTE:** Adjust the control panel to the desired angle.

 **Reinstallation tip:** If the keyboard is unresponsive after turning the printer on, check the flat cable installed in step 8. Reinstall the cable if necessary.

---

**Figure 1-69** Close the document feeder



## Removal and replacement: Control panel (M506x)

- [Introduction](#)
- [Step 1: Remove the control panel \(M506x\)](#)
- [Step 2: Unpack the replacement control panel](#)
- [Step 3: Install the control panel \(M527\)](#)


### Introduction

This document provides the procedures to remove and replace the M506x control panel.

### Before performing service

#### Turn the printer power off

- Disconnect the power cable.

 **WARNING!** To avoid damage to the printer, turn the printer off wait 30 seconds, and then remove the power cable before attempting to service the printer.

Use the table below to identify the correct part number for your printer. To order the part, go to [www.hp.com/buy/parts](http://www.hp.com/buy/parts).

Control panel (M506x) part number	
<b>B5L24-67903</b>	Control panel (M506x) with instruction guide

### Required tools

 **NOTE:** A reversible-shaft screwdriver is supplied with this kit.

- Small flat-blad screwdriver.
- #2 Phillips screwdriver with a magnetic tip.

### After performing service

#### Turn the printer power on

- Connect the power cable.
- Use the power switch to turn the power on.

### Post service test

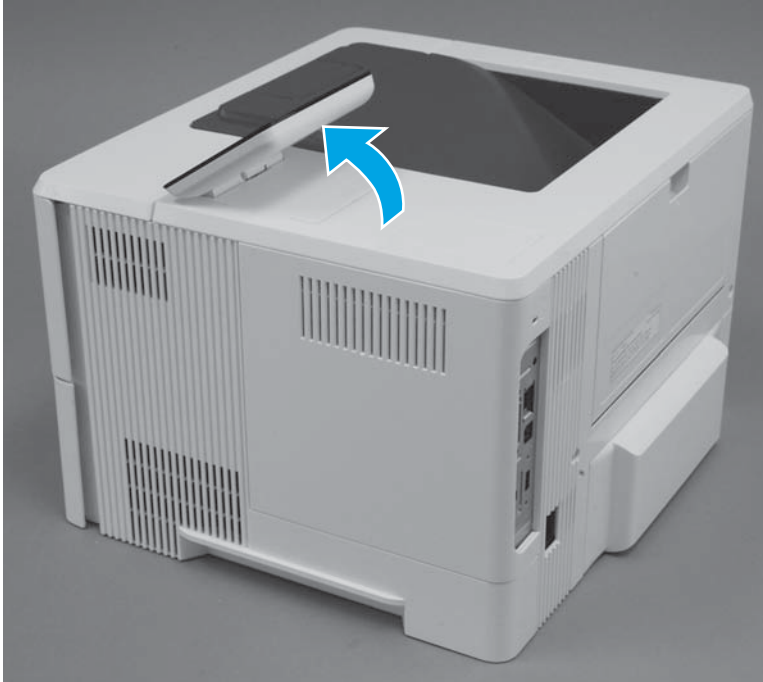
Make sure that the printer initializes to a **Ready** state.

Access the menus by using the printer control panel, and then print a configuratio page to make sure that the printer is functioning correctly.

### Step 1: Remove the control panel (M506x)

1. Tilt the control panel to the fully raised position.

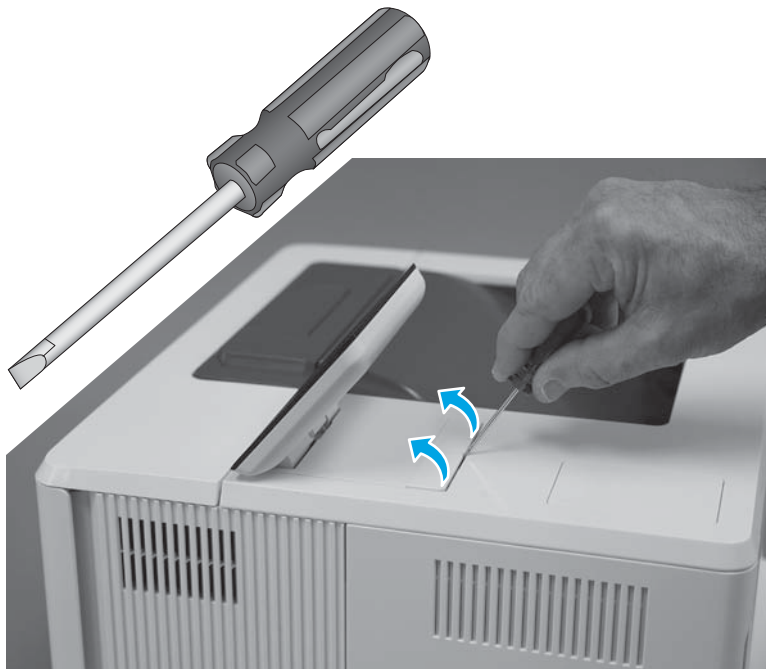
**Figure 1-70** Tilt the control panel up



2. Use the small flat-blad screwdriver supplied in the kit to release the control-panel screws cover, and then remove the cover.


**TIP:** The screwdriver has a reversible shaft. Simply pull the shaft out of the handle, and then reinstall it with the desired end facing out.

**Figure 1-71** Remove the cover

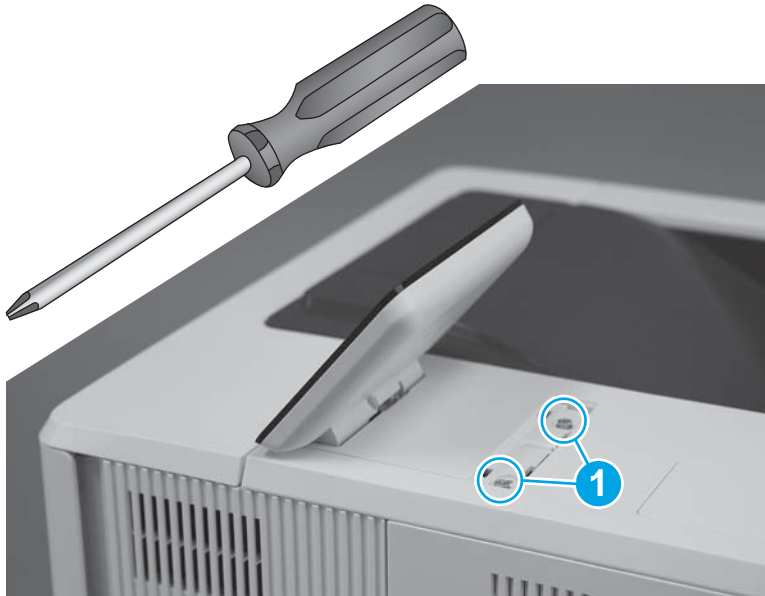




3. Use the small Phillips screwdriver supplied in the kit to remove two screws (callout 1).

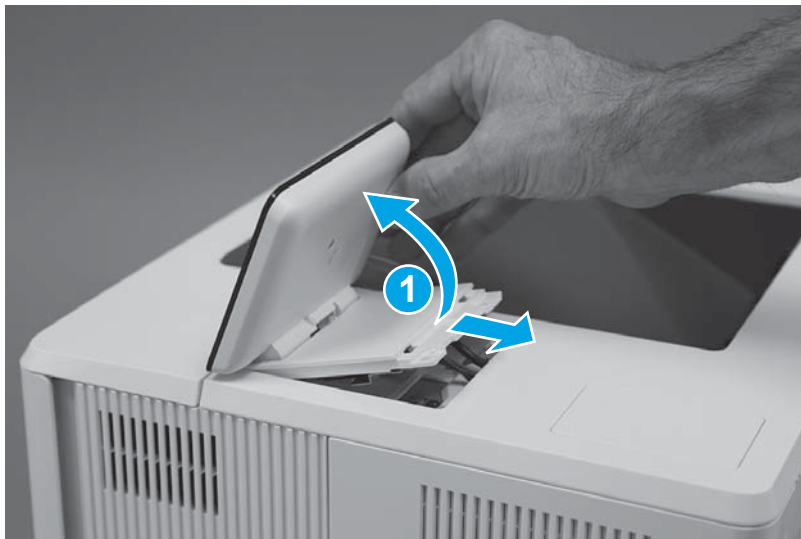
 **IMPORTANT:** Store the screws in a secure place where they cannot fall down into the printer.

**Figure 1-72** Remove two screws



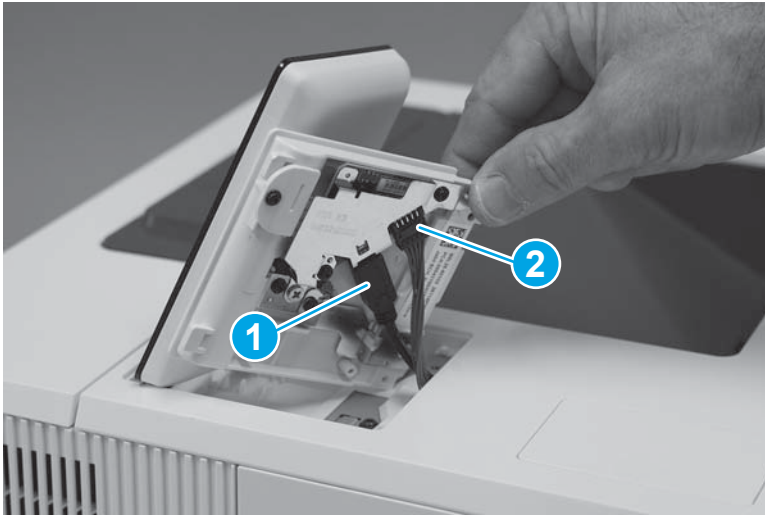
4. Turn the control panel over (callout 1), to gain access to the bottom side.

**Figure 1-73** Turn the control panel over



5. Disconnect one HDMI cable (callout 1), one connector (callout 2), and then remove the control panel.

**Figure 1-74** Remove the control panel




### Step 2: Unpack the replacement control panel

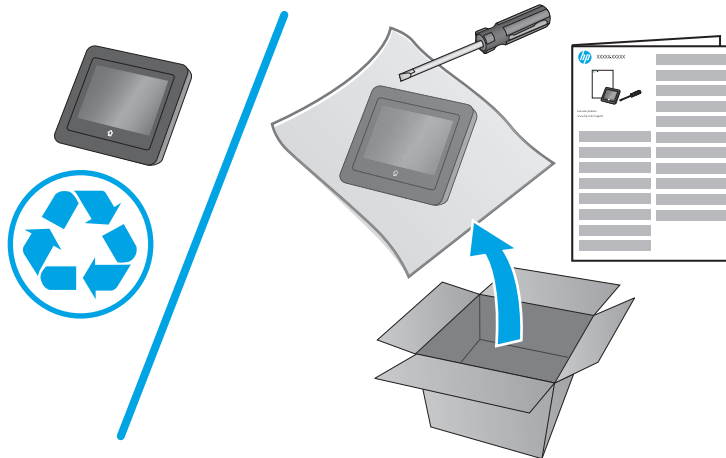
Unpack the replacement part from the packaging.

<http://www8.hp.com/us/en/hp-information/environment/product-recycling.html>

 **NOTE:** HP recommends responsible disposal of the defective part.

 **TIP:** Don't forget to remove the protective film on the touchscreen of the replacement control panel.

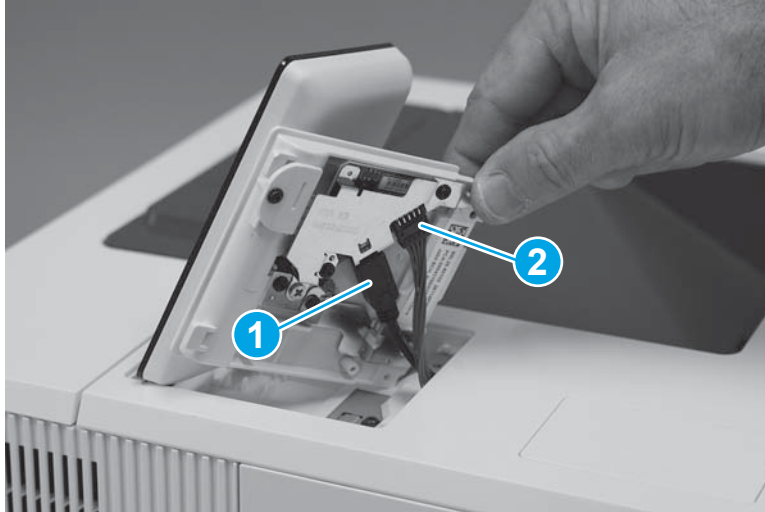
**Figure 1-75** Recycle and unpack



### Step 3: Install the control panel (M527)

1. Connect one HDMI cable (callout 1), one connector (callout 2).

**Figure 1-76** Connect the cables



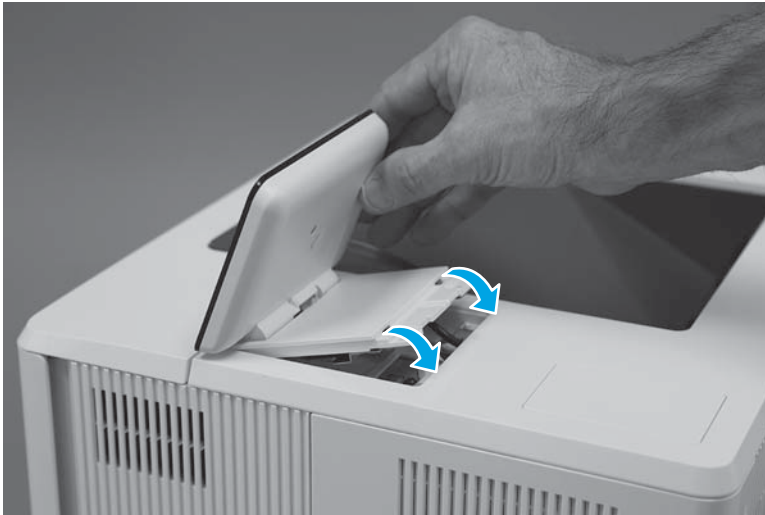
2. Install the tabs (callout 1) on the front of the control panel in the slots (callout 2) on the printer top cover.

**Figure 1-77** Install the control panel



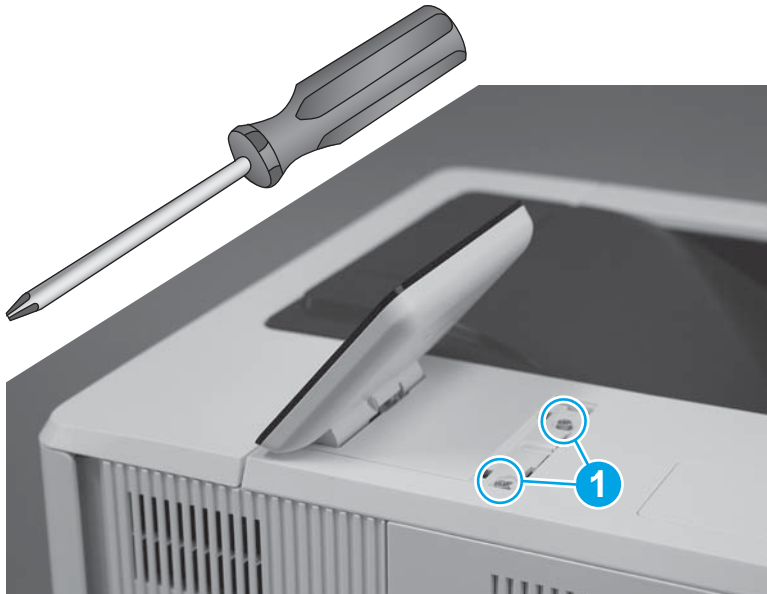
3. Rotate the control-panel base down onto the printer.

**Figure 1-78** Rotate the control-panel base down




4. Use the small Phillips screwdriver supplied in the kit to install two screws (callout 1).

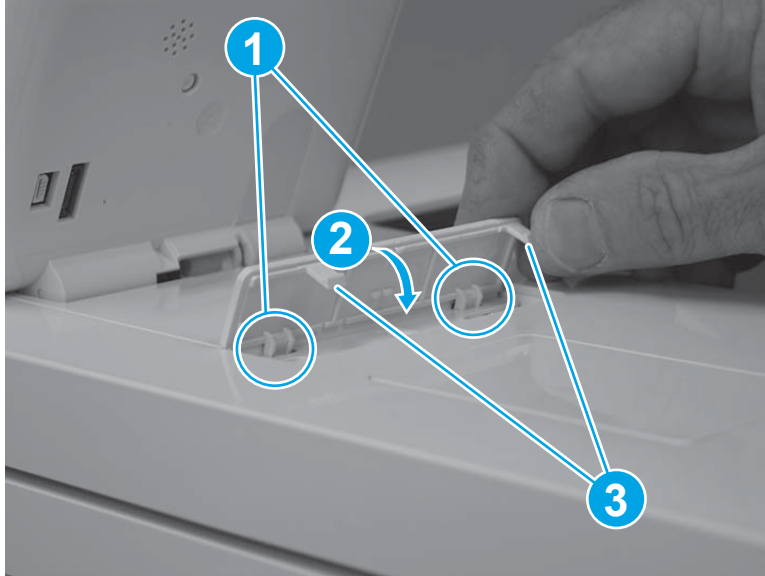
**Figure 1-79** Install two screws



5. Position the screw cover mounting feet into the slots in the top cover (callout 1), and then rotate the cover down (callout 2) to install it.

 **NOTE:** Press down on the cover firmly to make sure that the tabs (callout 3) snap into place.

**Figure 1-80** Install the cover



## Removal and replacement: White backing (M527)



**NOTE:** M527 printers only.

- [Introduction](#)
- [Step 1: Remove the white backing \(M527\)](#)
- [Step 2: Unpack the replacement white backing](#)
- [Step 3: Install the white backing \(M527\)](#)

### Introduction

This document provides the procedures to remove and replace the white backing (M527).

### Before performing service

#### Turn the printer power off

- Disconnect the power cable.



**WARNING!** To avoid damage to the printer, turn the printer off wait 30 seconds, and then remove the power cable before attempting to service the printer.

Use the table below to identify the correct part number for your printer. To order the part, go to [www.hp.com/buy/parts](http://www.hp.com/buy/parts).

White backing (M527) part number	
5851-6570	White backing kit (M527) with instruction guide <sup>1</sup>

<sup>1</sup> This kit includes the white backing retention clips.

### Required tools

No special tools are required for this assembly.

### After performing service

#### Turn the printer power on

- Connect the power cable.
- Use the power switch to turn the power on.

### Post service test

No service test for this assembly.

### Step 1: Remove the white backing (M527)



**NOTE:** M527 printers only.

1. Open the document feeder.

**Figure 1-81** Open the document feeder




2. Remove the white backing.

**Figure 1-82** Remove the white backing




3. If any of the retention clips (callout 1) remain attached to the white backing (or are damaged), go to step 4.

 **NOTE:** If none of the retention clips remain attached to the white backing, skip the remaining substeps in this removal procedure.

**Figure 1-83** Check the retention clips



4. Verify that the spring is positioned correctly on the retention clip.

 **NOTE:** If any of the retention clips or springs are damaged, replace them with the clips supplied in the kit.

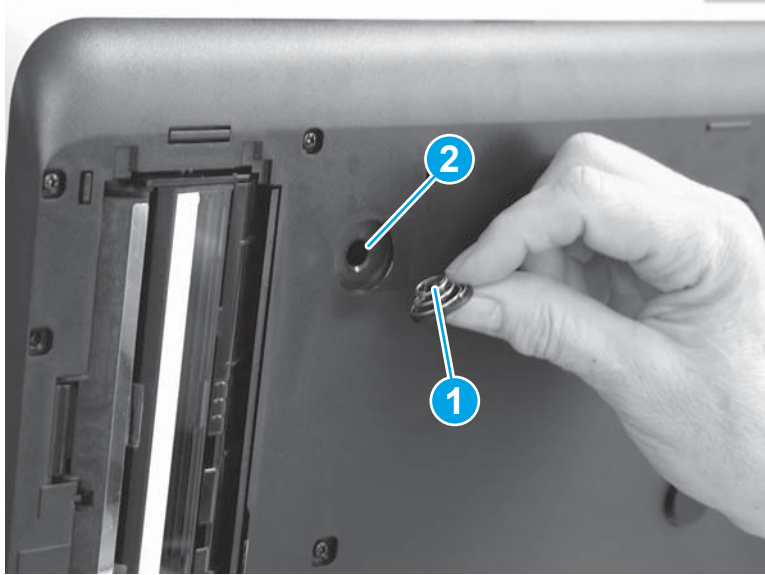
**Figure 1-84** Check the retention clip spring





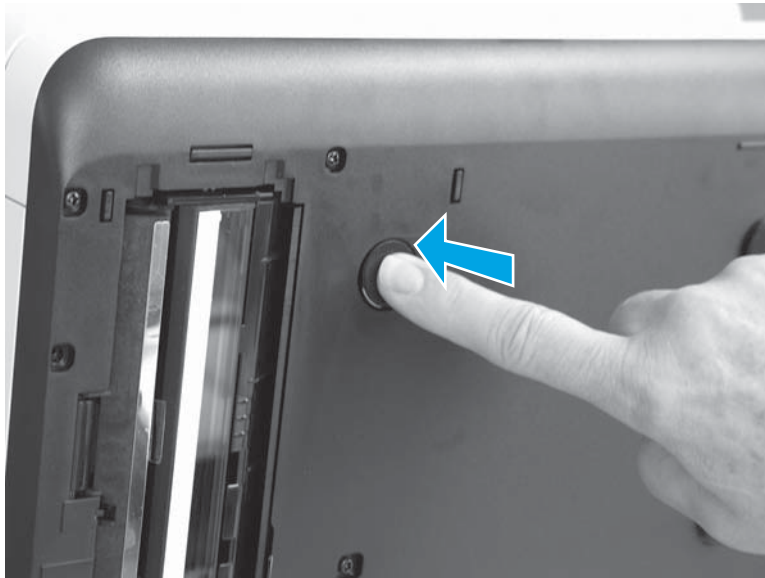
5. Install the replacement clip (callout 1) in the slot (callout 2) in the document feeder.

**Figure 1-85** Install the retention clip



6. Press the clip to make sure it is securely installed.

**Figure 1-86** Press the retention clip



### Step 2: Unpack the replacement white backing

Unpack the replacement part from the packaging.

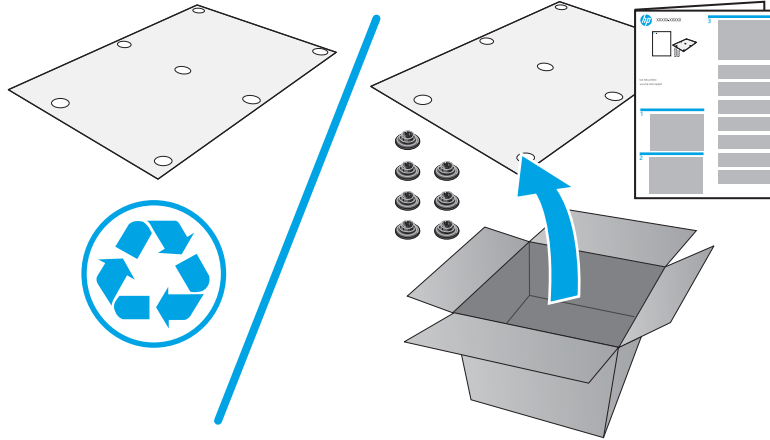
<http://www8.hp.com/us/en/hp-information/environment/product-recycling.html>

---


 **NOTE:** HP recommends responsible disposal of the defective part.

---

**Figure 1-87** Recycle and unpack



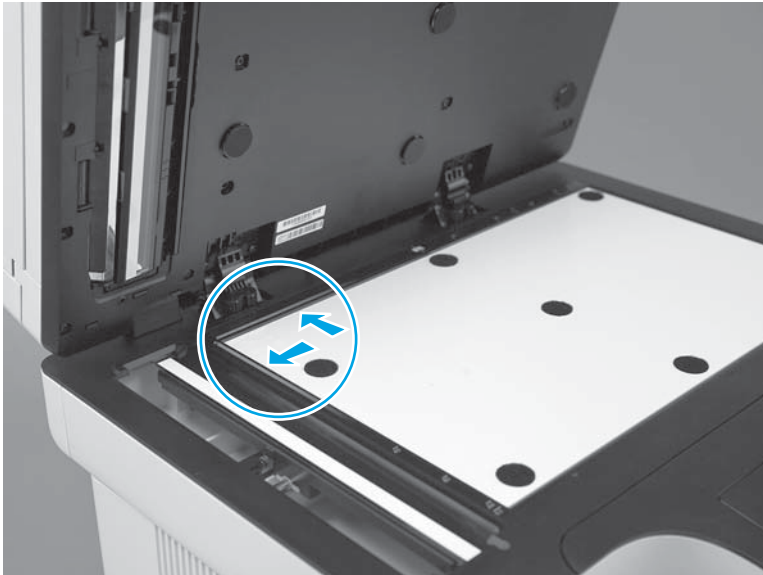
### Step 3: Install the white backing (M527)

 **NOTE:** M527 printers only.

1. Place the replacement white backing, on the flatbed scanner glass as shown.

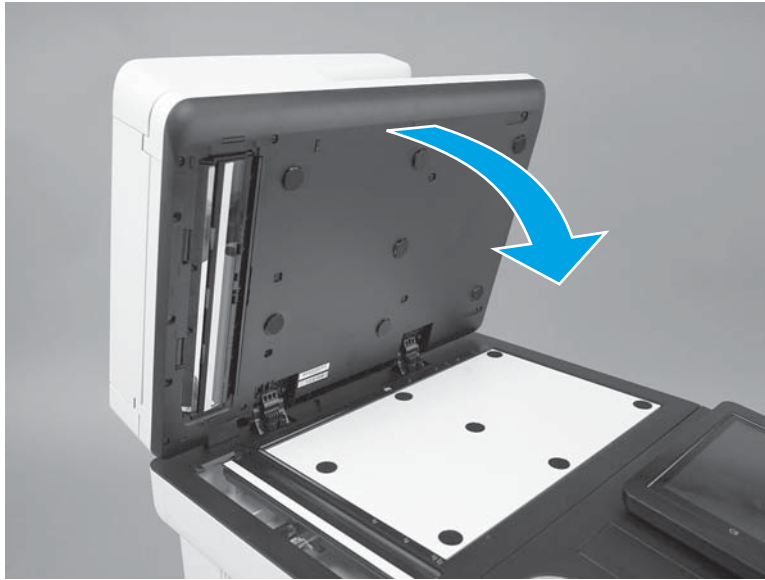
 **NOTE:** Place the corner of the backing that does not have a hook-and-loop fastener in the upper-left corner of the scanner glass.

**Figure 1-88** Install the white backing



2. Close the document feeder.

**Figure 1-89** Close the document feeder



3. Open the document feeder and make sure that the white backing is securely attached.

**Figure 1-90** Check the white backing



4. Close the document feeder.

**Figure 1-91** Close the document feeder



## Removal and replacement: Retention clips (M527)



**NOTE:** M577 printers only.

- [Introduction](#)
- [Step 1: Remove the retention clips](#)
- [Step 2: Unpack the replacement retention clips](#)
- [Step 3: Install the retention clips](#)

### Introduction

This document provides the procedures to remove and replace the M527 retention clips.

### Before performing service

#### Turn the printer power off

- Disconnect the power cable.



**WARNING!** To avoid damage to the printer, turn the printer off wait 30 seconds, and then remove the power cable before attempting to service the printer.

Use the table below to identify the correct part number for your printer. To order the part, go to [www.hp.com/buy/parts](http://www.hp.com/buy/parts).

Retention clips (M527) part number	
5851-6573	Retention clips kit (M527) with instruction guide

### Required tools

No special tools are required for this assembly.

### After performing service

#### Turn the printer power on

- Connect the power cable.
- Use the power switch to turn the power on.

### Step 1: Remove the retention clips

1. Open the document feeder.

**Figure 1-92** Open the document feeder




2. Remove the white backing.

**Figure 1-93** Remove the white backing



3. If needed, remove any damaged retention clips from the document feeder.

 **TIP:** Use the edge of a coin to loosen the clip.

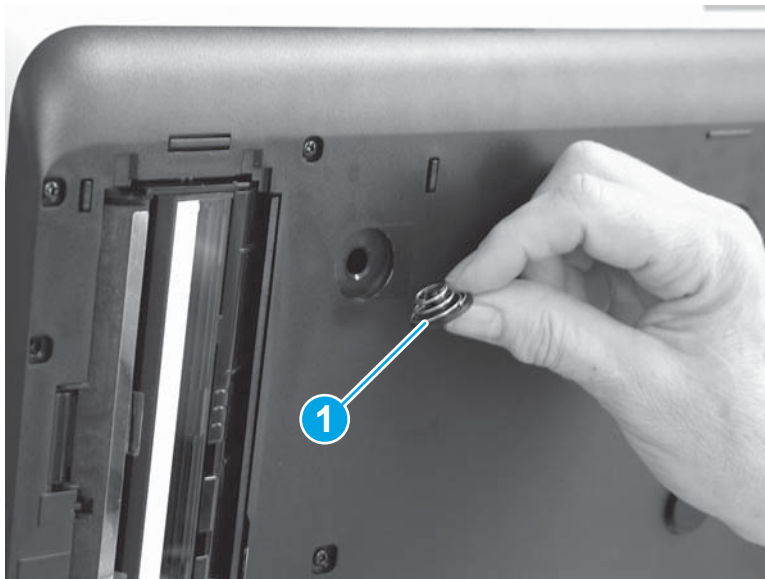
---

**Figure 1-94** Loosen damaged clips



4. Remove the retention clip (callout 1).

**Figure 1-95** Remove the retention clip



### Step 2: Unpack the replacement retention clips

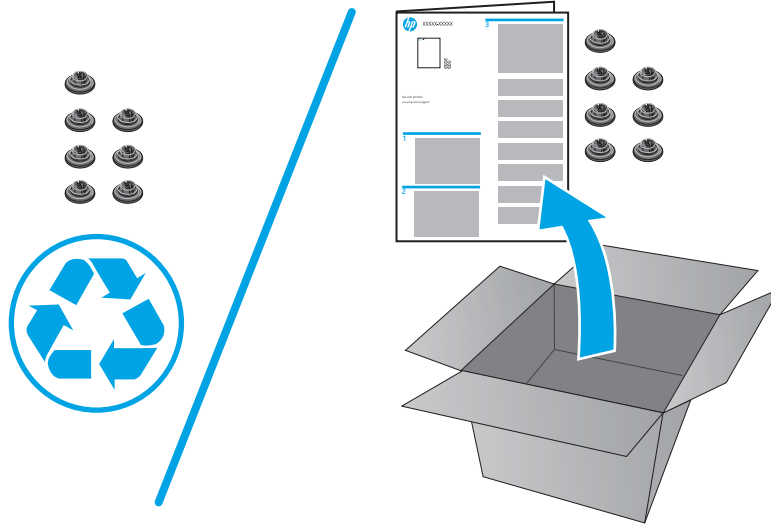
Unpack the replacement part from the packaging.

For complete information on HP's recycling programs, go to [Product return and recycling](#).

 **NOTE:** HP recommends responsible disposal of the defective part.

---

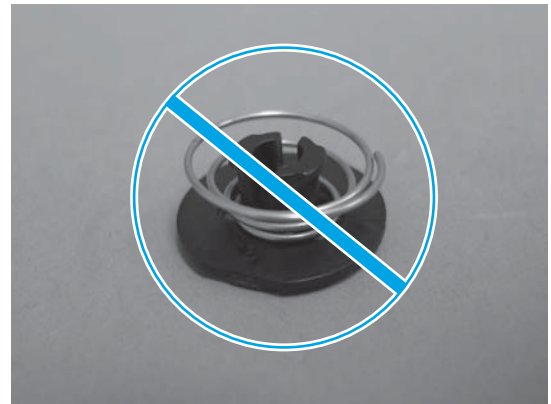
**Figure 1-96** Recycle and unpack



**Step 3: Install the retention clips**

1. If a spring comes oÅ of a retention clip, make sure that it is correctly repositioned on the clip.

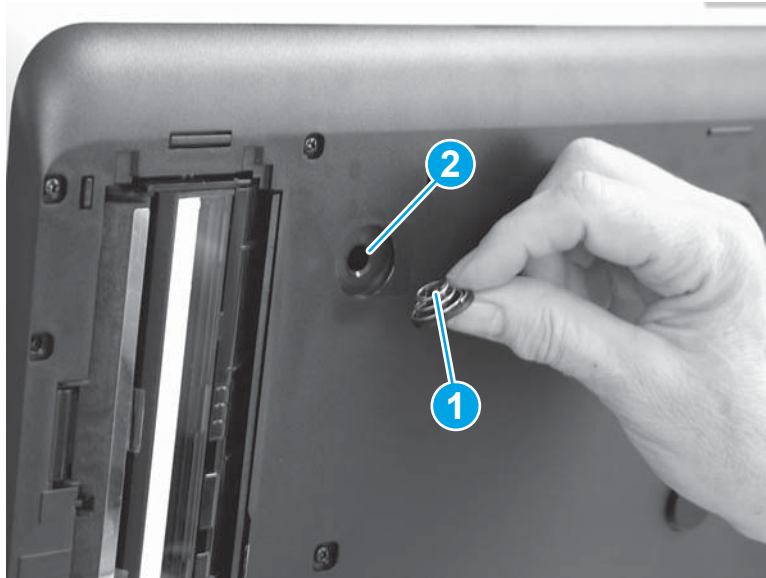
**Figure 1-97** Check the retention clip spring





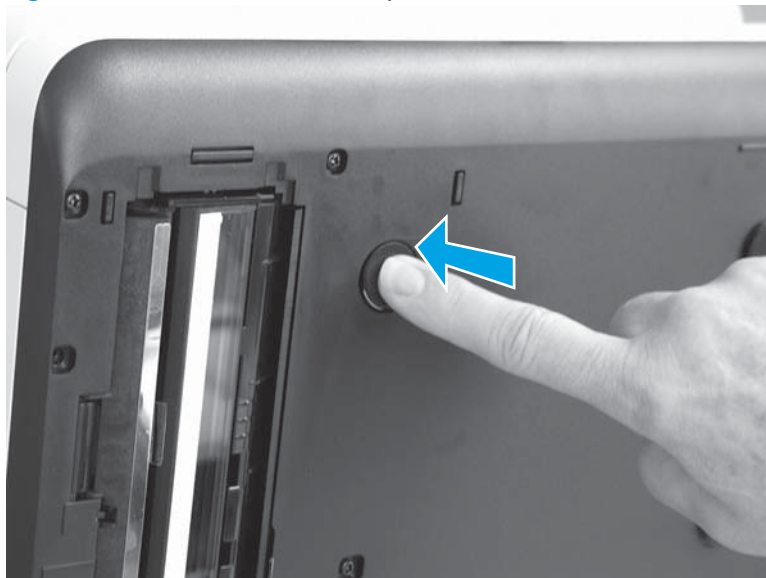
2. Install the clip (callout 1) in the opening (callout 2) in the document feeder.

**Figure 1-98** Install the retention clip




3. Press the clip to make sure it is securely installed.

**Figure 1-99** Press the retention clip



4. Place the white backing, on the flatbed scanner glass as shown.

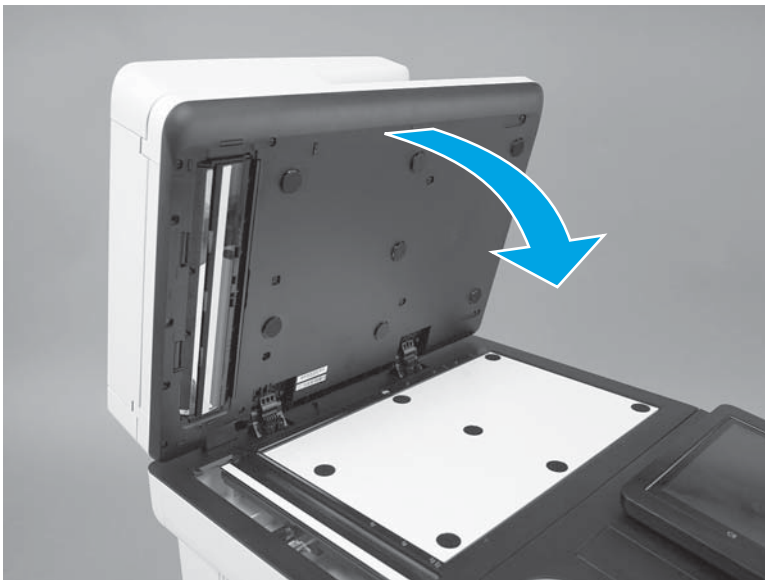
 **NOTE:** Place the corner of the backing that does not have a hook-and-loop fastener in the upper-left corner of the scanner glass.

**Figure 1-100** Install the white backing



5. Close the document feeder.

**Figure 1-101** Close the document feeder



6. Open the document feeder and make sure that the white backing is securely attached.

**Figure 1-102** Check the white backing




7. Close the document feeder.

**Figure 1-103** Close the document feeder



## Removal and replacement: Keyboard assembly (M527c/z)

 **NOTE:** M527c/z printers only.

- [Introduction](#)
- [Step 1: Remove the keyboard \(M527c/z\)](#)
- [Step 2: Unpack the replacement assembly](#)
- [Step 3: Install the keyboard \(M527c/z\)](#)


### Introduction

This document provides the procedures to remove and replace the keyboard assembly (M527c/z).

### Before performing service

#### Turn the printer power off

- Disconnect the power cable.

 **WARNING!** To avoid damage to the printer, turn the printer off wait 30 seconds, and then remove the power cable before attempting to service the printer.

Use the table below to identify the correct part number for your printer. To order the part, go to [www.hp.com/buy/parts](http://www.hp.com/buy/parts).

Keyboard (M527c/z) part number	
<b>B5L47-67019</b>	Keyboard assembly (US) kit (M527c/z) with instruction guide
<b>B5L47-67020</b>	Keyboard assembly (UK) kit (M527c/z) with instruction guide

### Required tools

No special tools are required for this assembly.

### After performing service


#### Turn the printer power on

- Connect the power cable.
- Use the power switch to turn the power on.

### Post service test

Use the physical keyboard (in the same way the virtual touchscreen keyboard is used) to make sure that it is correctly functioning.

### Step 1: Remove the keyboard (M527c/z)

 **NOTE:** M527c/z printers only.

1. Tilt up the control panel (callout 1) and open the document feeder (callout 2).

**Figure 1-104** Tilt up the control panel and open the document feeder



2. Beginning at the right side of the control-panel cover, carefully release five tabs along the top edge of the cover.



**NOTE:** The thin black-plastic cover will separate from the white plastic control-panel base.

**Figure 1-105** Remove the control-panel cover



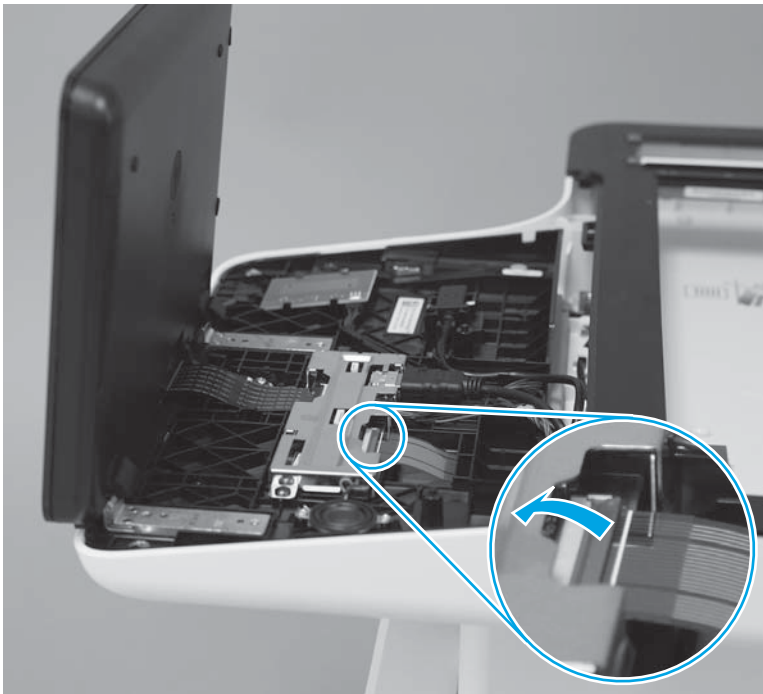
3. Continue to rotate the top edge of the cover away from the printer, and then remove the cover.

**Figure 1-106** Remove the cover



4. Open the connector latch to release the keyboard flat cable.

**Figure 1-107** Release the keyboard flat cable



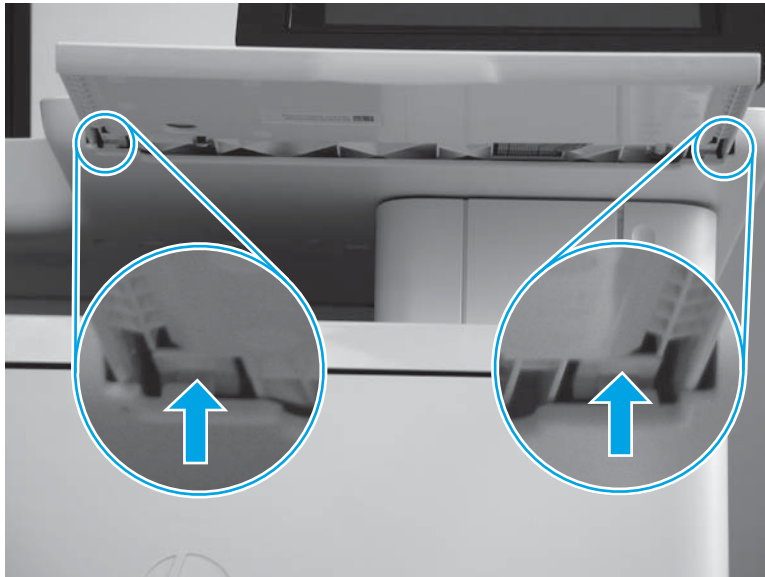
5. Slide the keyboard tray out until it stops.

**Figure 1-108** Slide the tray out



6. Push up on the keyboard tray to release two tabs on the bottom of the tray, and then slide the tray toward you to disengage the tabs.

**Figure 1-109** Disengage the tabs



7. Slide the keyboard tray all the way out of the printer to remove it.

**Figure 1-110** Remove the keyboard



### Step 2: Unpack the replacement assembly

Unpack the replacement part from the packaging.

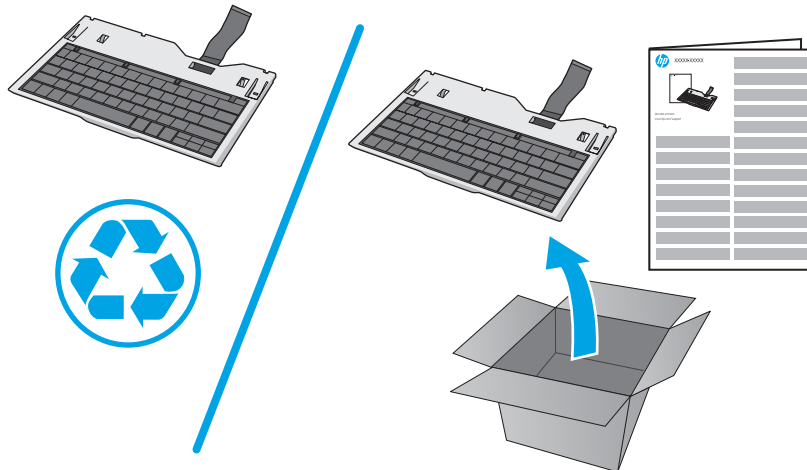
<http://www8.hp.com/us/en/hp-information/environment/product-recycling.html>

---

 **NOTE:** HP recommends responsible disposal of the defective part.


---

**Figure 1-111** Recycle and unpack



### Step 3: Install the keyboard (M527c/z)

---

 **NOTE:** M527c/z printers only.

---

1. Position the flange cable (callout 1) on the keyboard into the keyboard slot (callout 2).



**Figure 1-112** Install the FFC



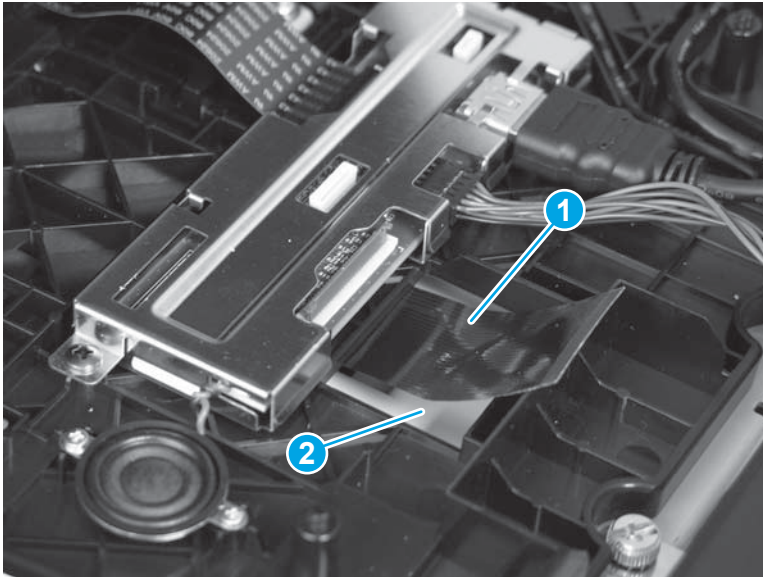
2. Slide the keyboard tray into the slot.

**Figure 1-113** Install the keyboard





3. If the fla cable (callout 1) is not in the opening (callout 2) in the control panel base, carefully reach in and thread the fla cable through the opening.

**Figure 1-114** Check the fla cable

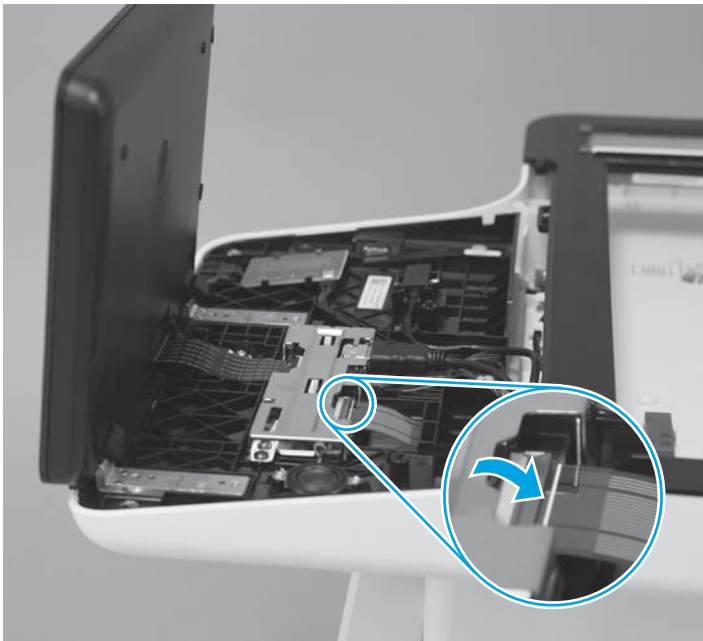


4. Position the keyboard fla cable in the connector, and then close the connector latch.

 **IMPORTANT:** Slightly tug on the cable to make sure that it is fully captured in the connector.

 **NOTE:** When the connector latch is closed and the cable is correctly installed, the white line on the cable is parallel to the connector latch.

**Figure 1-115** Close the fla cable latch




5. Position the control-panel cover on the printer.

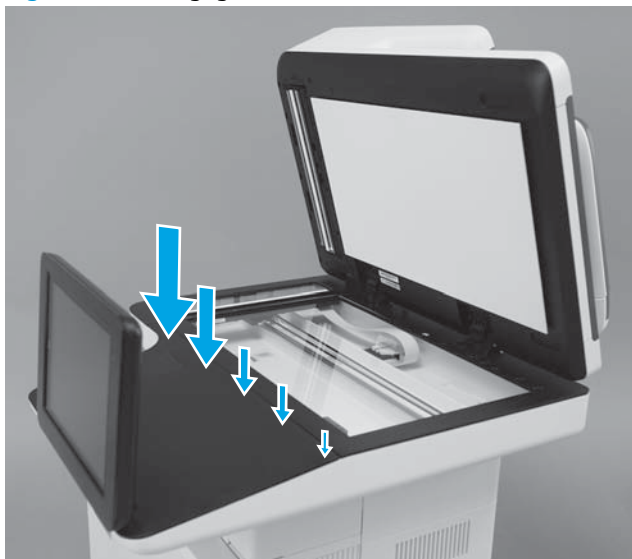
**Figure 1-116** Install the control-panel cover



6. Beginning at the left side of the control-panel cover, carefully push down along the top edge of the cover to engage five tabs.

 **NOTE:** If the keyboard is unresponsive after turning the printer on, check the flat cable installed in step 4. Reinstall the cable if necessary.

**Figure 1-117** Engage five tabs



## Customer self-repair (CSR) B parts and assemblies

Customer Self-Repair (CSR) parts are available for many HP LaserJet printers to reduce repair time. More information about the CSR program and benefit can be found at [www.hp.com/go/csr-support](http://www.hp.com/go/csr-support) and [www.hp.com/go/csr-faq](http://www.hp.com/go/csr-faq).

Genuine HP replacement parts can be ordered at [www.hp.com/buy/parts](http://www.hp.com/buy/parts) or by contacting an HP-authorized service or support provider. When ordering, one of the following will be needed: part number, serial number (found on back of printer), printer number, or printer name.

- Parts listed as **A**: Easy
- Parts listed as **B**: Difficult and/or requires tools



**NOTE:** For a complete list of CSRs, see the customer self-repair kits table in the printer repair manual (parts chapter).

---

- [Removal and replacement: Multipurpose tray \(Tray 1\) pickup roller and separation pad](#)
- [Removal and replacement: Tray 2-x roller kit](#)
- [Removal and replacement: Control panel \(M501\)](#)

## Removal and replacement: Multipurpose tray (Tray 1) pickup roller and separation pad



**NOTE:** The figure in this section show the M506. However, the procedure is correct for the M501 and M527 printers.

- [Introduction](#)
- [Step 1: Remove the roller](#)
- [Step 2: Remove the separation pad assembly](#)
- [Step 3: Unpack the replacement roller and pad](#)
- [Step 4: Install the separation pad assembly](#)
- [Step 5: Install the roller](#)

### Introduction

This document provides the procedures to remove and replace the Multipurpose (MP) tray (Tray 1) roller, pickup and separation pad.

### Before performing service

#### Turn the printer power off

- Disconnect the power cable.



**WARNING!** To avoid damage to the printer, turn the printer off wait 30 seconds, and then remove the power cable before attempting to service the printer.



**TIP:** The figure in this procedure show the toner cartridge removed. While not necessary, it might be easier to replace the rollers and separation pad with the toner cartridge removed.

Use the table below to identify the correct part number for your printer. To order the part, go to [www.hp.com/buy/parts](http://www.hp.com/buy/parts).

MP tray (Tray 1) roller, pickup and separation pad part number	
F2A68-67914	Tray 1 pickup roller, separation pad, and spring kit with instruction guide

### Required tools

- No special tools are required to remove these parts.

### After performing service

#### Turn the printer power on

- Connect the power cable.
- Use the power switch to turn the power on.

### Post service test

Make sure that the printer initializes to a **Ready** state.

Print a page from Tray 1 to make sure that the printer is functioning correctly.


### Step 1: Remove the roller

1. Open the toner-cartridge door.

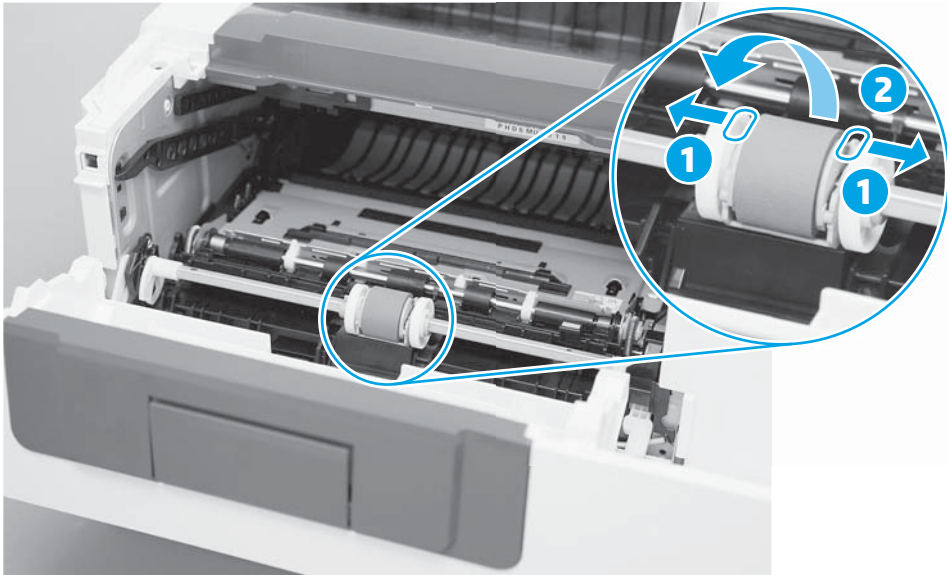
**Figure 1-118** Open the toner-cartridge door



2. Release two tabs between the roller collar and roller (callout 1), and then rotate the top of the roller out and away from the printer (callout 2).

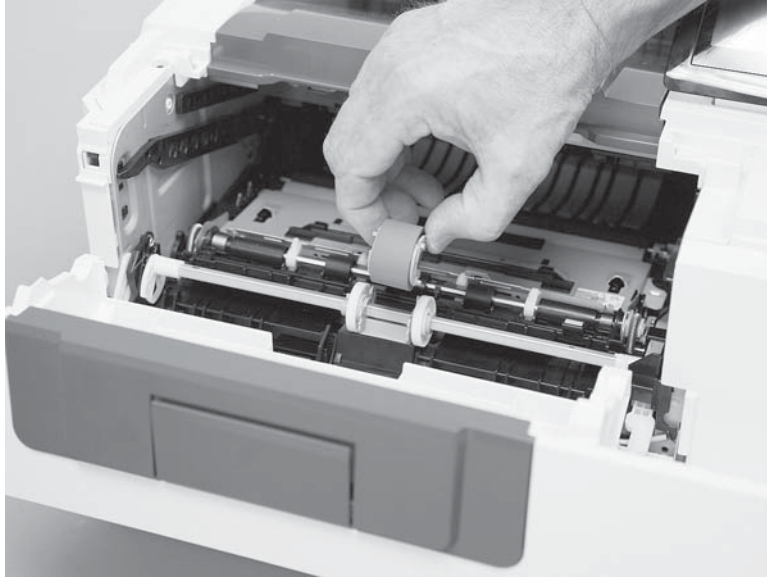
 **TIP:** Pushing down on the top of the roller might make it easier to release the tabs.

**Figure 1-119** Release two tabs



3. Remove the roller.

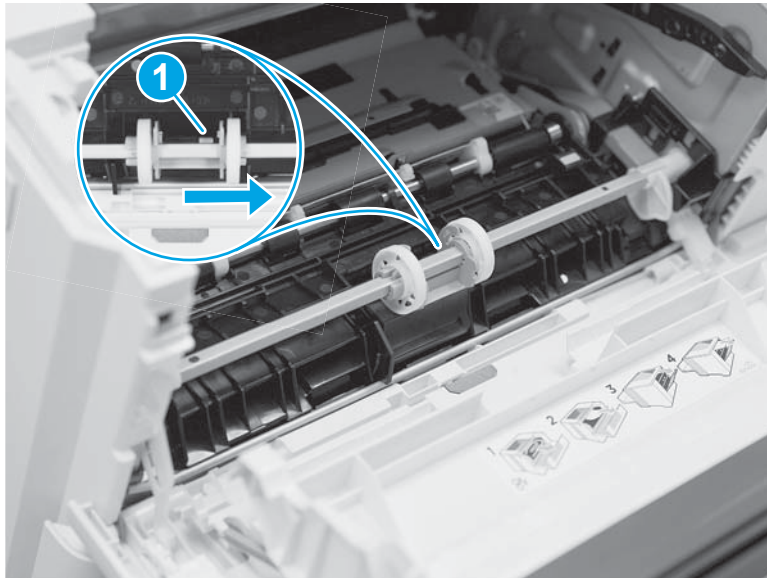
**Figure 1-120** Remove the roller




**Step 2: Remove the separation pad assembly**

1. Locate the tab on the back-side of the roller holder (callout 1), push down on the tab, and then move the roller holder to the right to release it.

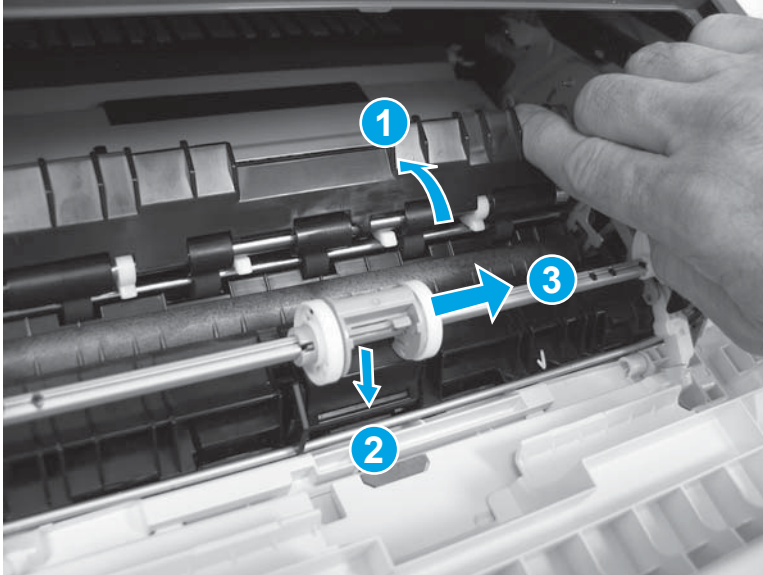
**Figure 1-121** Release one tab




2. Open the registration-jam access plate (callout 1), depress the separation pad holder (callout 2), and then to slide the roller holder all the way to the right (callout 3).

 **TIP:** After moving the roller out of the way, release the registration-jam access plate. The roller holds the plate out of the way.

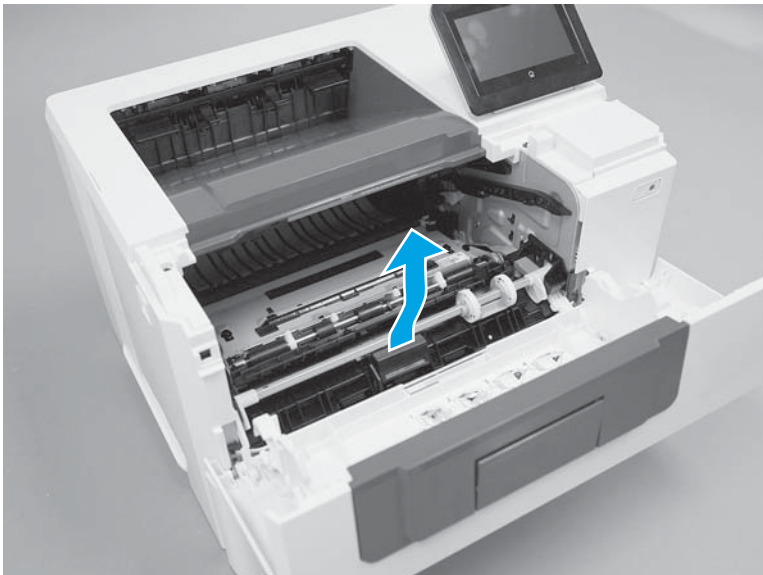
**Figure 1-122** Move the roller carriage out of the way



3. Remove the separation pad assembly.

 **NOTE:** The spring under the assembly is not captive and can be easily lost.


**Figure 1-123** Remove the separation pad assembly



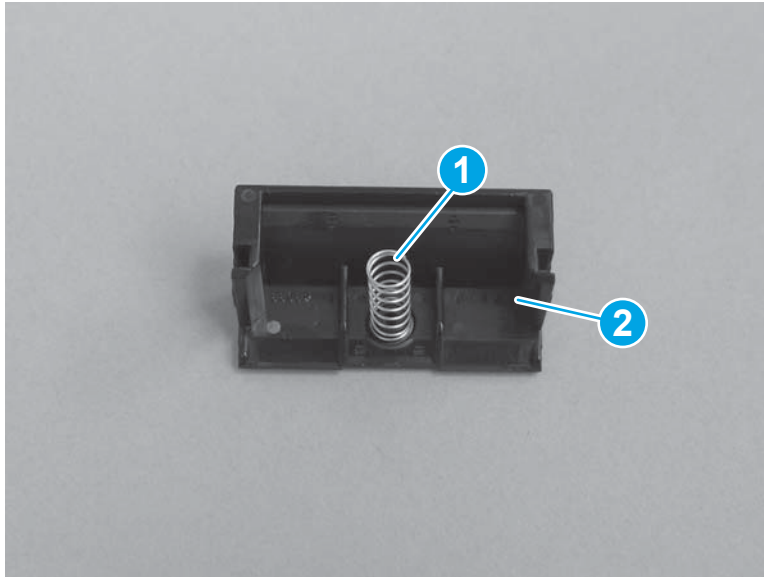


4. Remove the spring (callout 1) from the separation pad assembly (callout 2).

 **NOTE:** Retain this spring. It must be installed on the replacement separation pad.

 **TIP:** If the spring is damaged or lost, a replacement spring is included in the kit.


**Figure 1-124** Remove the spring



### Step 3: Unpack the replacement roller and pad

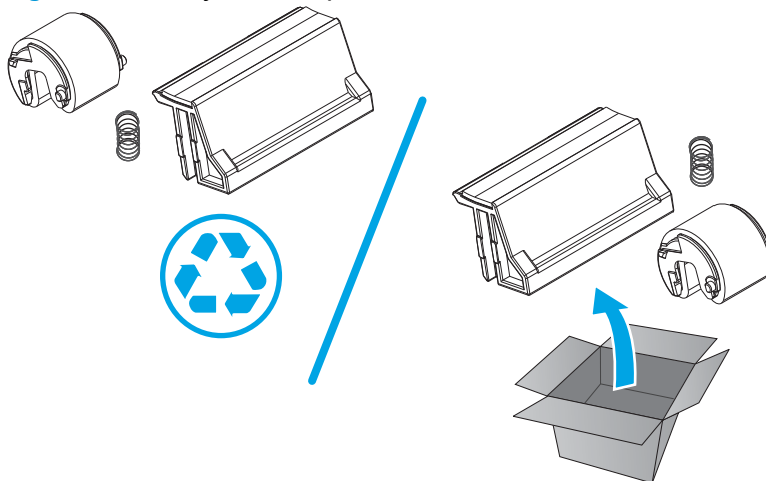
Unpack the replacement part from the packaging.

<http://www8.hp.com/us/en/hp-information/environment/product-recycling.html>

 **CAUTION:** Do not touch the gray spongy portion of the replacement roller or the black rubber portion of the pad assembly. Skin oils on the roller can cause paper handling problems.

 **NOTE:** HP recommends responsible disposal of the defective part.

**Figure 1-125** Recycle and unpack

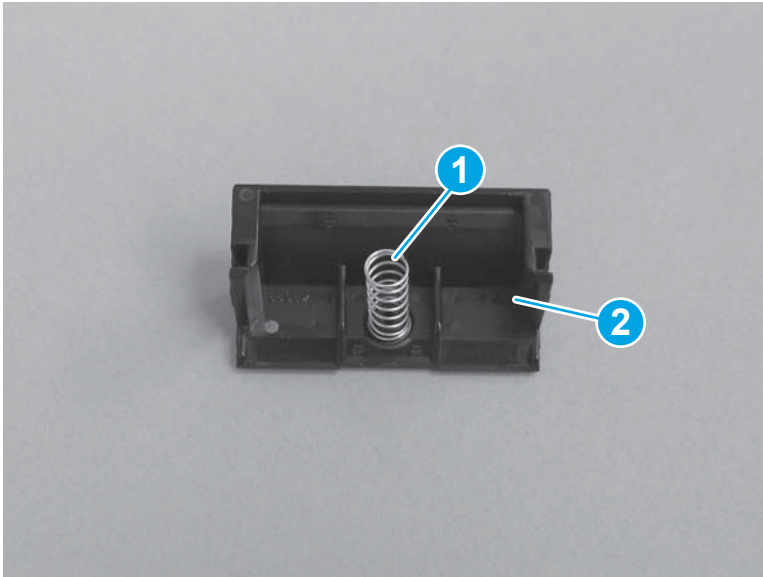


#### Step 4: Install the separation pad assembly

**CAUTION:** Do not touch the black rubber portion of the pad assembly. Skin oils on the pad can cause paper handling problems. HP recommends washing your hands before handling the assembly.

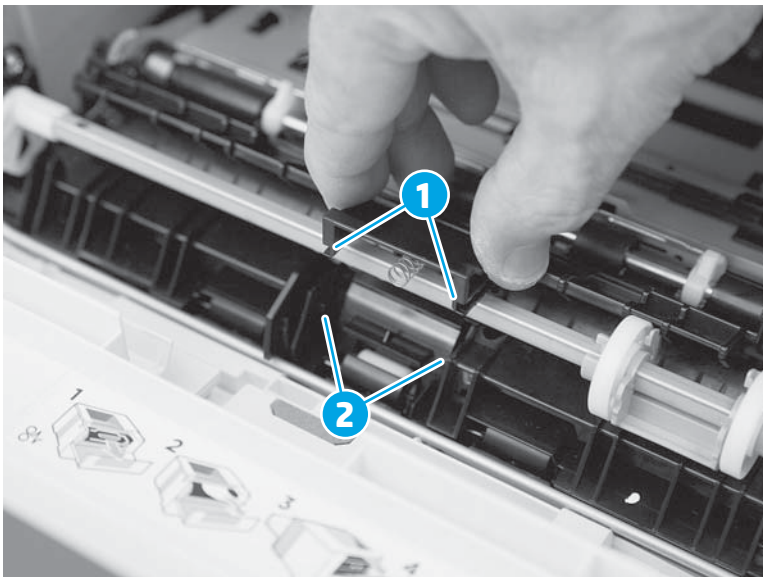
1. Install the spring (callout 1) from the discarded separation pad assembly (or use the one supplied in this kit) on to the replacement assembly (callout 2).

**Figure 1-126** Install the spring




2. Align the slots in the assembly (callout 1) with the rails on the holder (callout 2).

**Figure 1-127** Align the assembly with the holder




3. Install the pad assembly into the holder.

 **Reinstallation tip:** The separation pad should freely move up and down on the spring when correctly installed. If the pad does not freely move, remove it, check the spring, and then reinstall it.

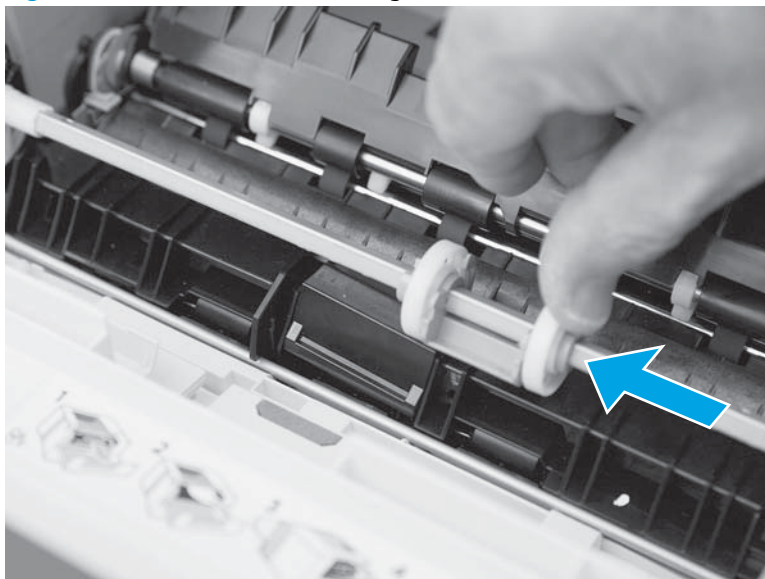
**Figure 1-128** Install the pad assembly



4. Slide the roller carriage back to the center of the shaft (the locking tab snaps into place).

 **NOTE:** Slightly depress the separation pad so that the roller carriage can slide over it.

**Figure 1-129** Slide the roller carriage to the left



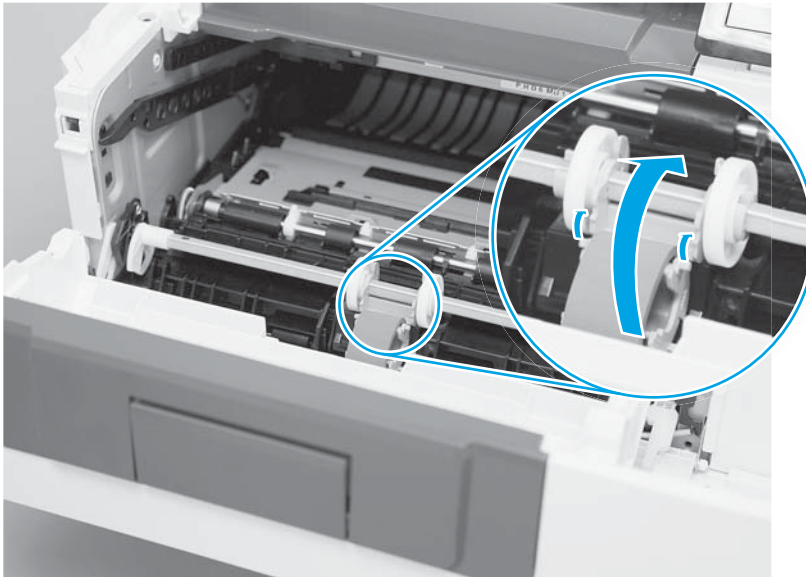
## Step 5: Install the roller

**CAUTION:** Do not touch the gray spongy portion of the replacement roller. Skin oils on the roller can cause paper handling problems. HP recommends washing your hands before handling the assembly.

1. Place the pins on the under-side of the pickup roller in the slots on the holder, and then rotate the top of the roller up and toward the printer.

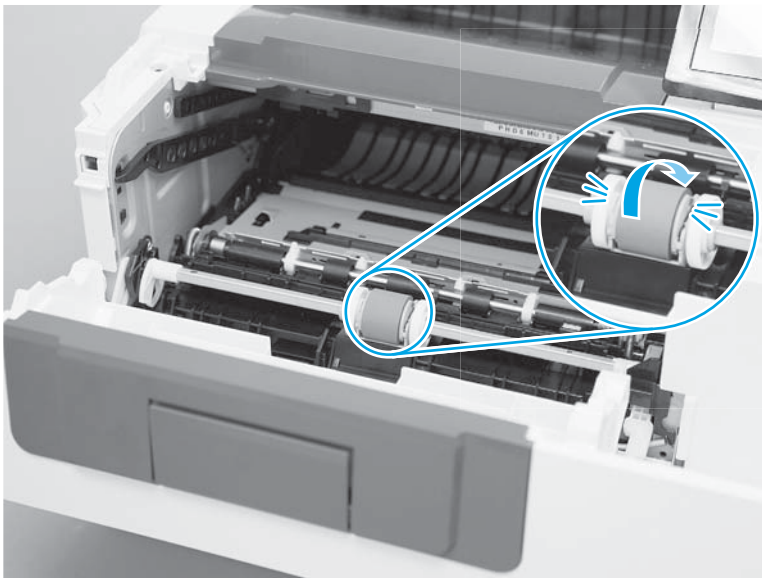
**NOTE:** In this step, you start with the roller upside down, and then rotate it up and into its final installed position.

**Figure 1-130** Install the roller



2. Continue to rotate the top of the roller toward the printer until two tabs snap into place.

**Figure 1-131** Engage two tabs



3. Close the toner-cartridge door.



**NOTE:** If the toner cartridge was removed, do not forget to reinstall it.

---

**Figure 1-132** Close the toner-cartridge door



## Removal and replacement: Tray 2-x roller kit



**NOTE:** The figure in this section show the M506 and M527 Tray 2. However, the procedure is correct for replacing the Tray 2 pickup and feed roller and separation roller assemblies in the M501, as well as the optional Tray 3, Tray 4, and Tray 5 accessories.

The M501 only supports one optional input accessory (Tray 3).

- [Introduction](#)
- [Step 1: Remove the tray](#)
- [Step 2: Remove the pickup and feed roller assembly](#)
- [Step 3: Remove the separation roller assembly](#)
- [Step 4: Unpack the replacement assemblies](#)
- [Step 5: Install the separation roller assembly](#)
- [Step 6: Install the pickup and feed roller assembly](#)
- [Step 7: Install the tray](#)

### Introduction

This document provides the procedures to remove and replace the paper pickup and feed roller and separation roller assemblies (trays 2-x).

### Before performing service

#### Turn the printer power off

- Disconnect the power cable.



**WARNING!** To avoid damage to the printer, turn the printer off wait 30 seconds, and then remove the power cable before attempting to service the printer.

Use the table below to identify the correct part number for your printer. To order the part, go to [www.hp.com/buy/parts](http://www.hp.com/buy/parts).

---

#### Paper pickup and feed roller and separation roller assemblies (Tray 2-x) part number

---

**J8H60-67903**

Trays 2-3 roller kit with instruction guide (M501)

**F2A68-67913**

Trays 2-x roller kit with instruction guide (M506/M527)

---

### Required tools

- No special tools are required to remove this part.

## After performing service

### Turn the printer power on

- Connect the power cable.
- Use the power switch to turn the power on.

### Post service test

Make sure that the printer initializes to a **Ready** state.

Print a page from the tray that the roller assemblies were replaced in to make sure that the printer is functioning correctly.

### Step 1: Remove the tray

1. Pull the tray straight out of the printer until it stops.

**Figure 1-133** Pull the tray out until it stops



2. Lift the front of the tray, and then pull it out of the printer to remove it.

**Figure 1-134** Release and remove the tray



### Step 2: Remove the pickup and feed roller assembly

**CAUTION:** When handling the roller assembly, do not touch the gray spongy portion of the rollers. Skin oils on the rollers can cause paper handling problems. HP recommends washing your hands before handling the assembly.

**NOTE:** The figure in this section show the M506 and M527 Tray 2. However, the procedure is correct for replacing the Tray 2 pickup and feed roller and separation roller assemblies in the M501, as well as the optional Tray 3, Tray 4, and Tray 5 accessories.

1. Look up into the tray cavity to locate the roller assembly.

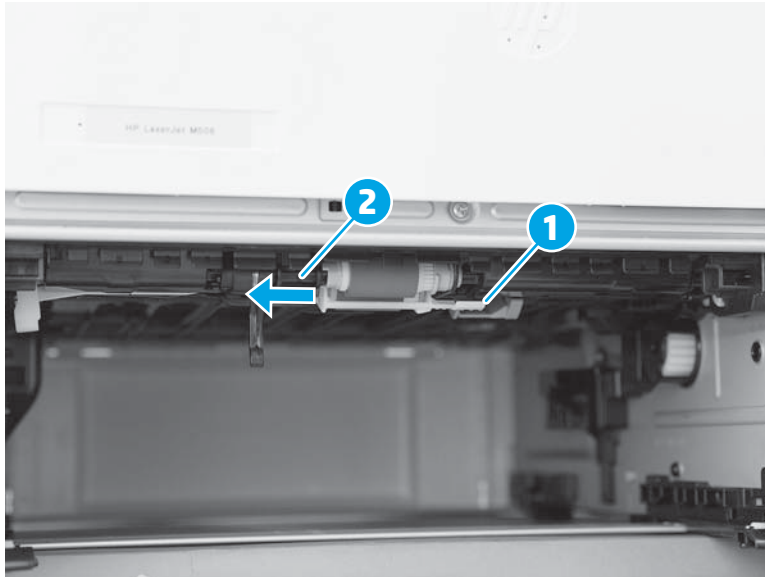
**Figure 1-135** Locate the roller assembly





2. Grasp the white tab on the roller holder (callout 1), and then slide the roller assembly to the left to compress the spring loaded shaft (callout 2).

**Figure 1-136** Compress the spring-loaded shaft



3. With the spring loaded shaft depressed, rotate the right side of the roller assembly down and towards you to release it.

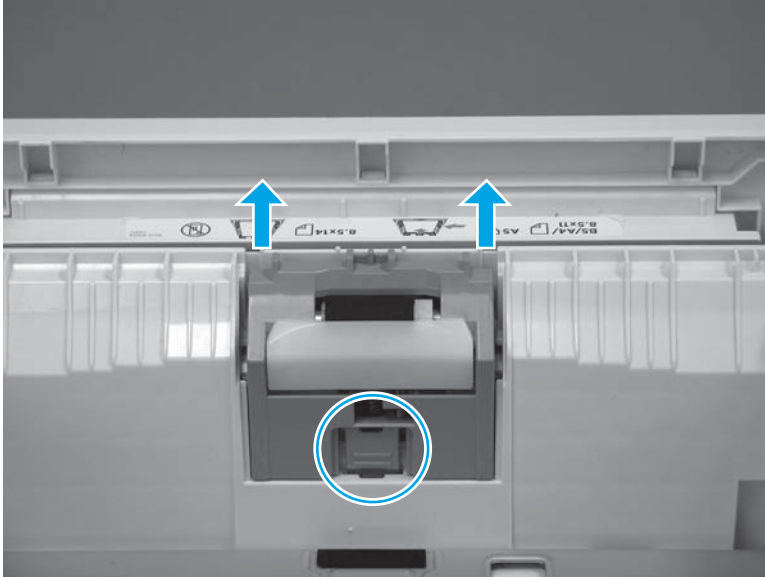
**Figure 1-137** Remove the roller assembly




### Step 3: Remove the separation roller assembly

1. At the removed tray, release one tab (callout 1), and then pull the separation roller assembly straight up to release it.

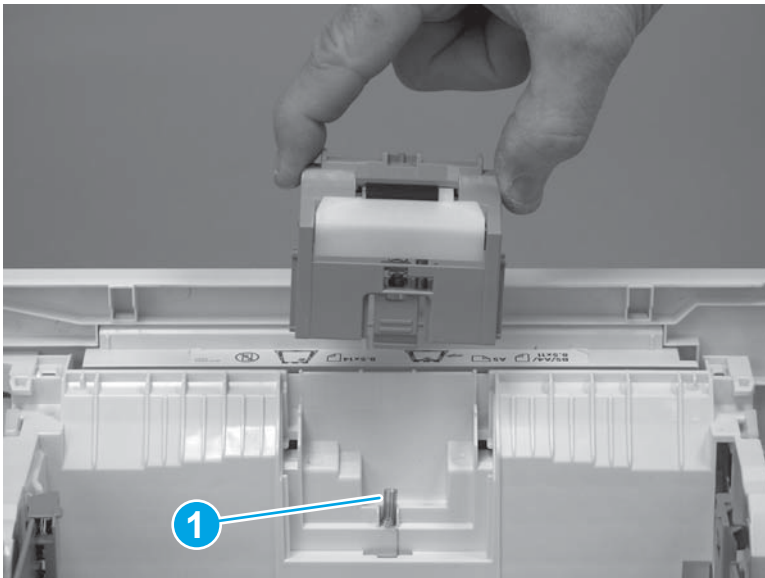
**Figure 1-138** Release the assembly



2. Remove the separation roller assembly.

 **NOTE:** The spring under the separation roller assembly is not captive. Do not lose the spring when removing or installing the separation pad assembly.

**Figure 1-139** Remove the assembly



#### Step 4: Unpack the replacement assemblies

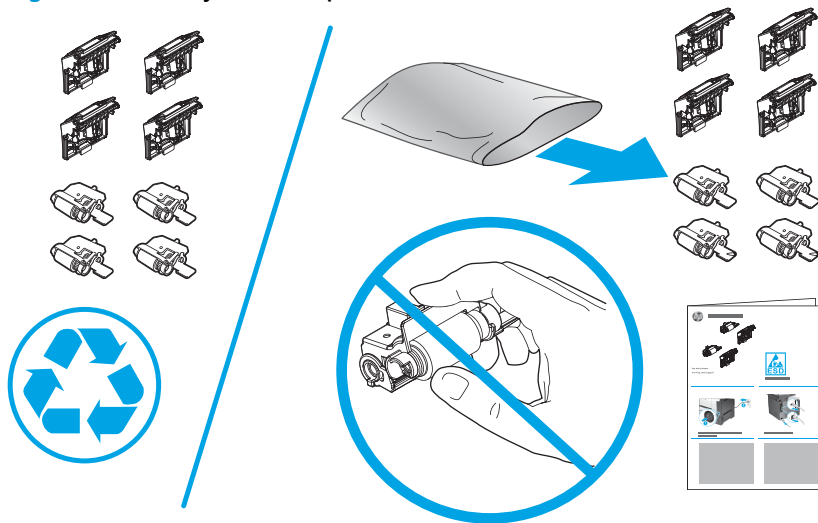
Unpack the replacement part from the packaging.

<http://www8.hp.com/us/en/hp-information/environment/product-recycling.html>

 **NOTE:** HP recommends responsible disposal of the defective part.

**TIP:** The number of roller assemblies in the kit depends on the specific printer kit. The figure below shows the M506/M527 kit contents. For the M501 kit, only two sets of roller assemblies are supplied (one each for Tray 2 and the optional paper feeder accessory).

**Figure 1-140** Recycle and unpack

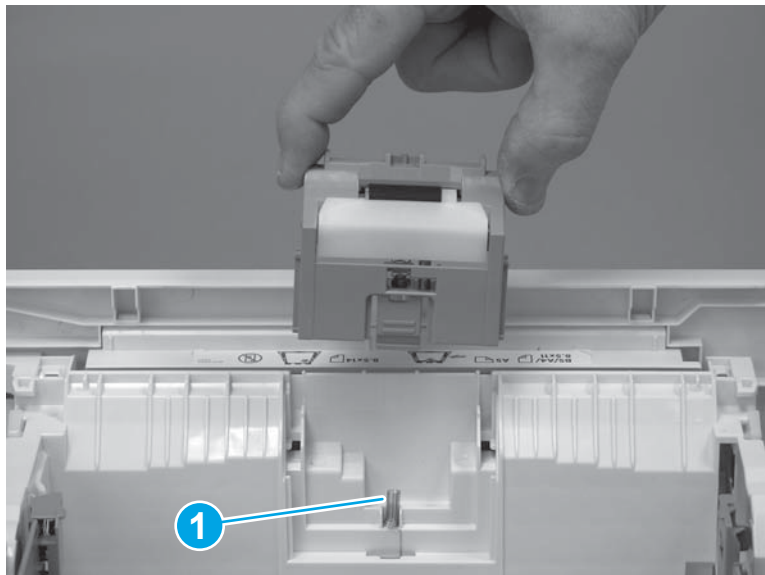


### Step 5: Install the separation roller assembly

1. Make sure that the spring is in place (callout 1), and then install the replacement assembly in the slot in the tray.

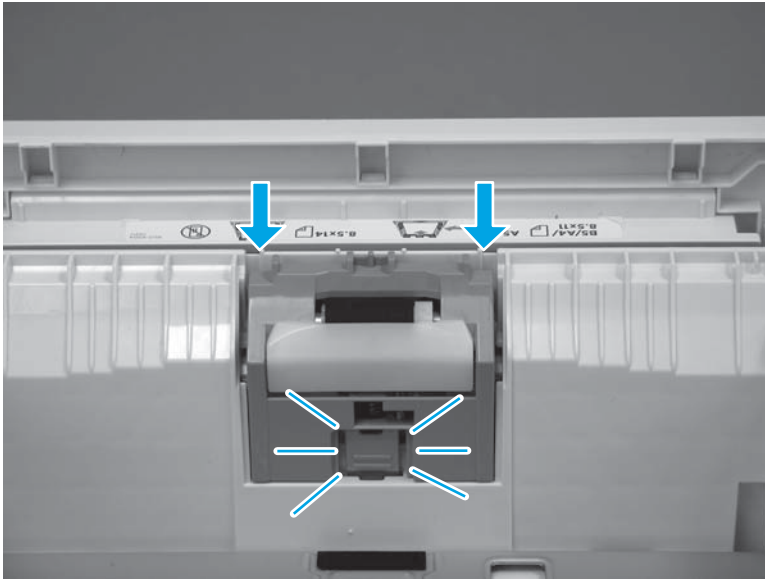
**NOTE:** The spring under the separation roller assembly is not captive. Do not lose the spring when removing or installing the separation pad assembly.

**Figure 1-141** Install the assembly in the slot



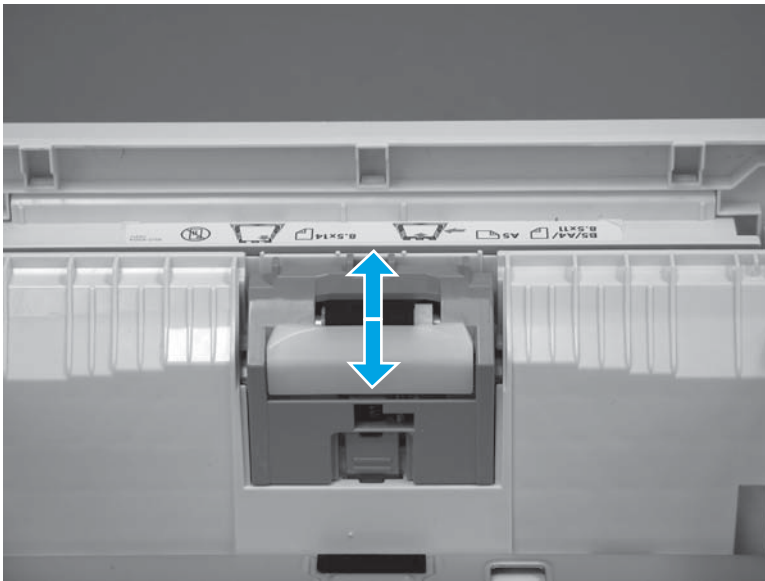
2. Push the assembly straight down until the tab snaps into place.

**Figure 1-142** Install the assembly



3. Repeatedly push down on and then release the separation pad. If the assembly is correctly installed it should freely move up and down in the holder. If it does not move freely, remove it and then reinstall it (see step 1).

**Figure 1-143** Check the installation



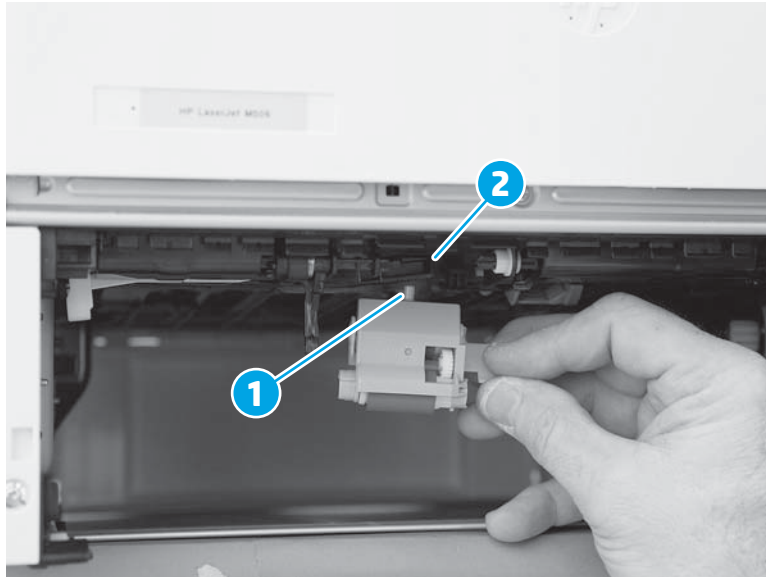
### Step 6: Install the pickup and feed roller assembly

**CAUTION:** When handling the roller assembly, do not touch the gray spongy portion of the rollers. Skin oils on the rollers can cause paper handling problems. HP recommends washing your hands before handling the assembly.

**NOTE:** The figure in this section show the M506 and M527 Tray 2. However, the procedure is correct for replacing the Tray 2 pickup and feed roller and separation roller assemblies in the M501, as well as the optional Tray 3, Tray 4, and Tray 5 accessories.

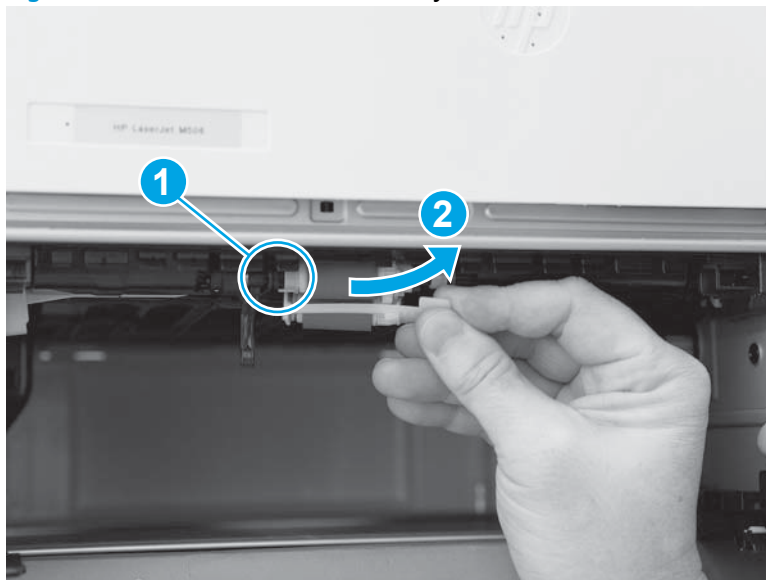
1. When the assembly is installed, the actuator pin (callout 1) on the roller assembly must be installed in the slot (callout 2) in the actuator arm.

**Figure 1-144** Check the pin on the assembly



2. Position the left end of the assembly on the spring loaded shaft (callout 1), keep the roller holder parallel to the underside of the printer, and then rotate the right end up and into the printer (callout 2).

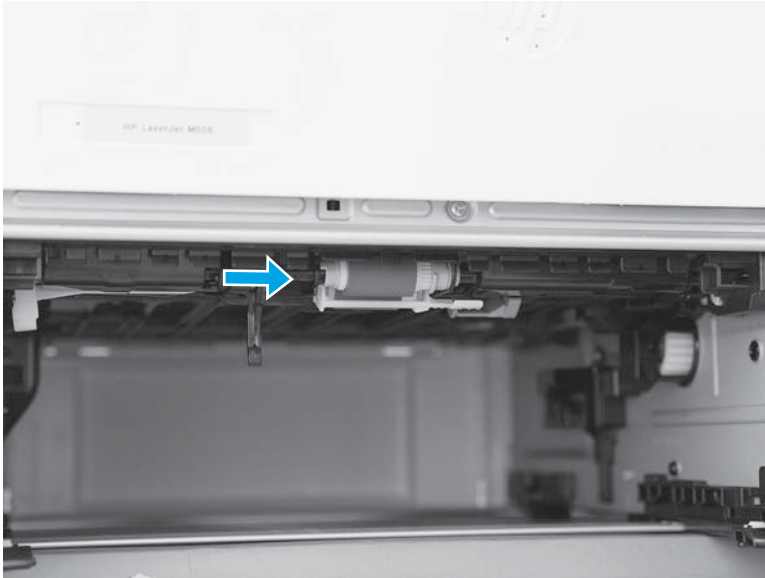
**Figure 1-145** Install the roller assembly




3. Slowly release the depressed spring loaded shaft to allow the right end of the roller assembly to engage with the right-side drive shaft.

Make sure that the right side of the assembly is fully engaged with the right-side drive shaft.

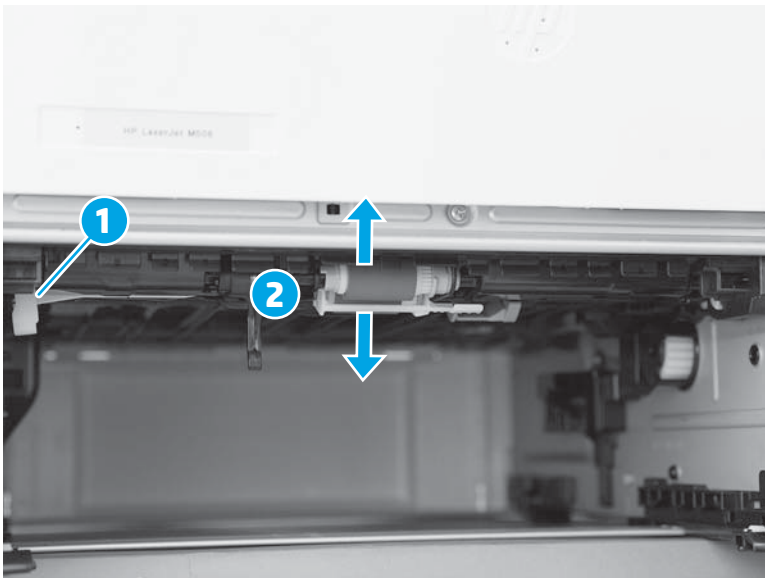
**Figure 1-146** Decompress the spring-loaded shaft



4. To check the installation, repeatedly push up and release, the tray actuator (callout 1) and observe the roller assembly. If the assembly is correctly installed, it moves up and down (callout 2).

 **NOTE:** If the assembly does not properly move, remove it and then reinstall it, making sure that the pin on the assembly is installed in the slot in the actuator arm. See [Figure 1-144 Check the pin on the assembly on page 103](#).

**Figure 1-147** Check the installation



## Step 7: Install the tray

1. With the tray at a slight angle, align the sides of the tray with the rails in the accessory, and then partially slide the tray into the printer.

**Figure 1-148** Install the tray



2. Push the tray straight into the accessory to close it.

**Figure 1-149** Close the tray



## Removal and replacement: Control panel (M501)

- [Introduction](#)
- [Step 1: Remove the control panel \(M501\)](#)
- [Step 2: Unpack the replacement assembly](#)
- [Step 3: Install the control panel \(M501\)](#)


### Introduction

This document provides the procedures to remove and replace the M501 control panel.

### Before performing service

#### Turn the printer power off

- Disconnect the power cable.

 **WARNING!** To avoid damage to the printer, turn the printer off wait 30 seconds, and then remove the power cable before attempting to service the printer.

Use the table below to identify the correct part number for your printer. To order the part, go to [www.hp.com/buy/parts](http://www.hp.com/buy/parts).

---

Control panel (M501) part number	
----------------------------------	--

---

<b>J8H60-67904</b>
--------------------

Control panel (M501) with instruction guide
---

---

### Required tools

- Small flat-blad screwdriver.

### After performing service

#### Turn the printer power on

- Connect the power cable.
- Use the power switch to turn the power on.

### Post service test

Make sure that the printer initializes to a **Ready** state.

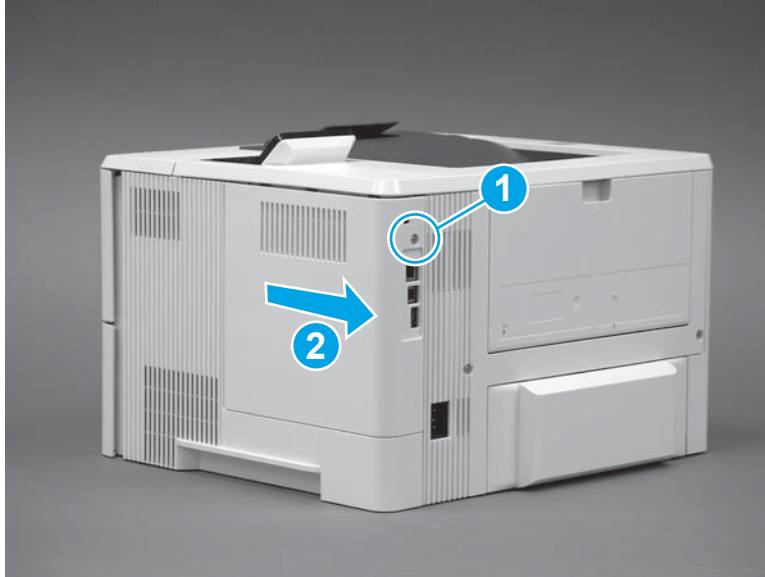
Access the menus by using the printer control panel, and then print a configuration page to make sure that the printer is functioning correctly.

### Step 1: Remove the control panel (M501)

1. Remove one screw (callout 1), and then slide the cover toward the rear of the printer to remove it (callout 2).

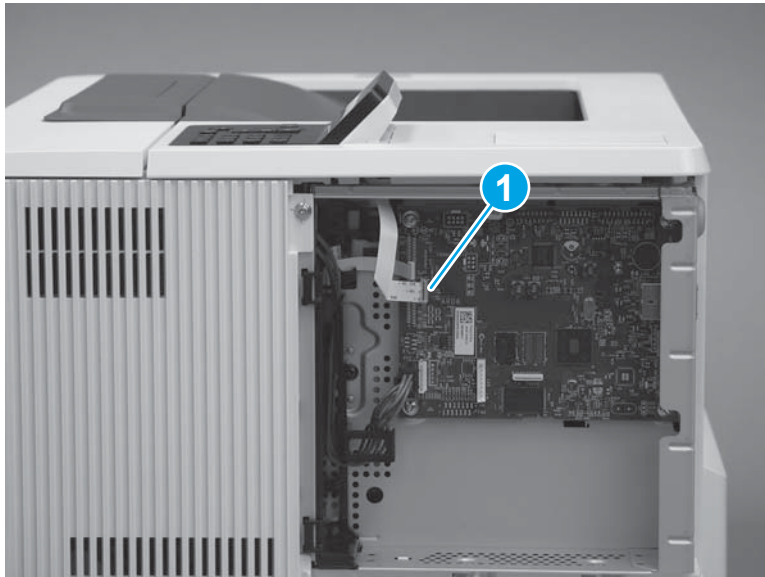


**Figure 1-150** Remove the formatter cover



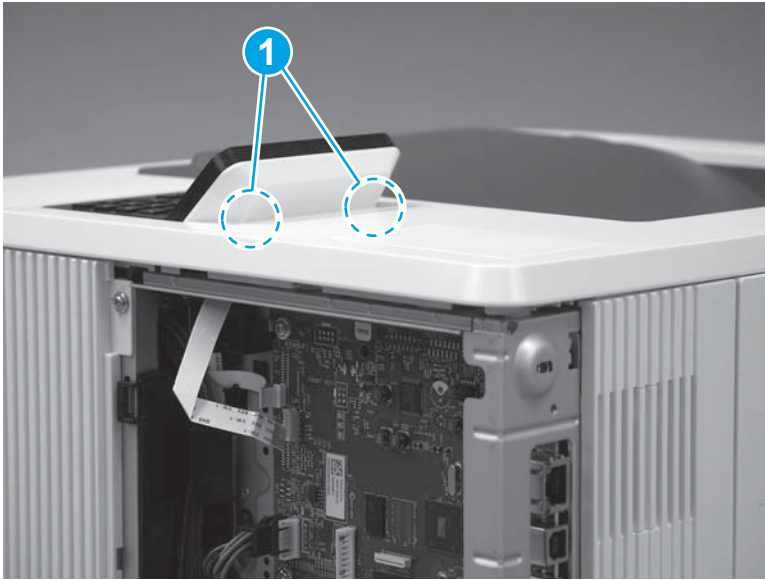
2. Disconnect one fla cable (callout 1).

**Figure 1-151** Disconnect one fla cable




3. Locate two tabs (callout 1) along the rear edge of the control panel.

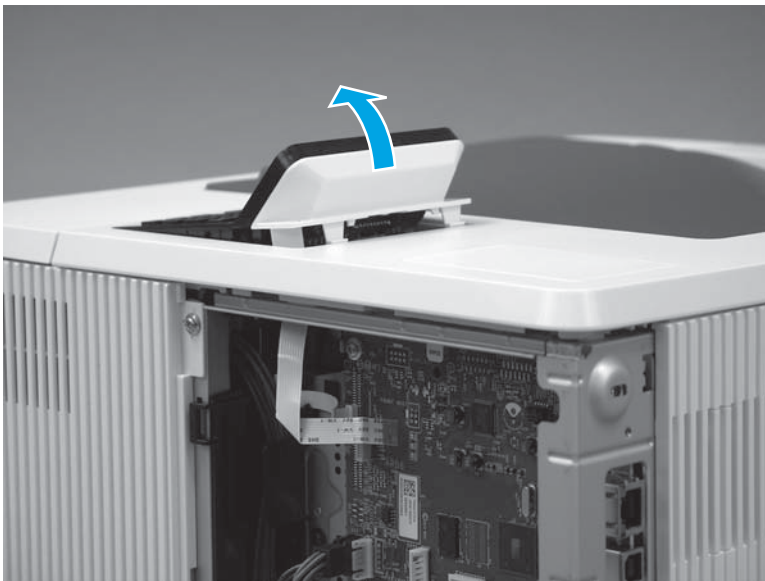
**Figure 1-152** Locate two tabs



4. Release the two tabs, and then rotate the rear edge of the control panel up and away from the printer.

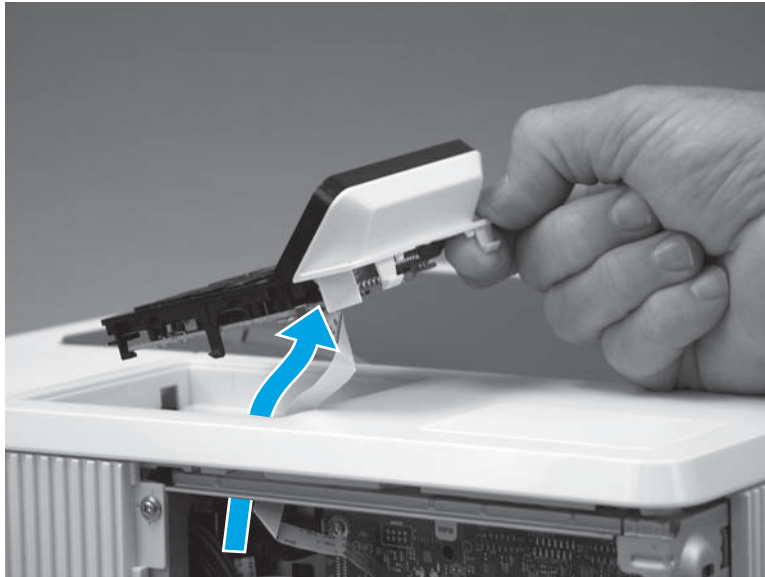
 **TIP:** Use a small flat-blad screw driver to release the two tabs.

**Figure 1-153** Release the control panel



5. Pass the flat cable attached to the control panel through the opening in the printer chassis, and then remove the control panel.

**Figure 1-154** Remove the control panel



### Step 2: Unpack the replacement assembly

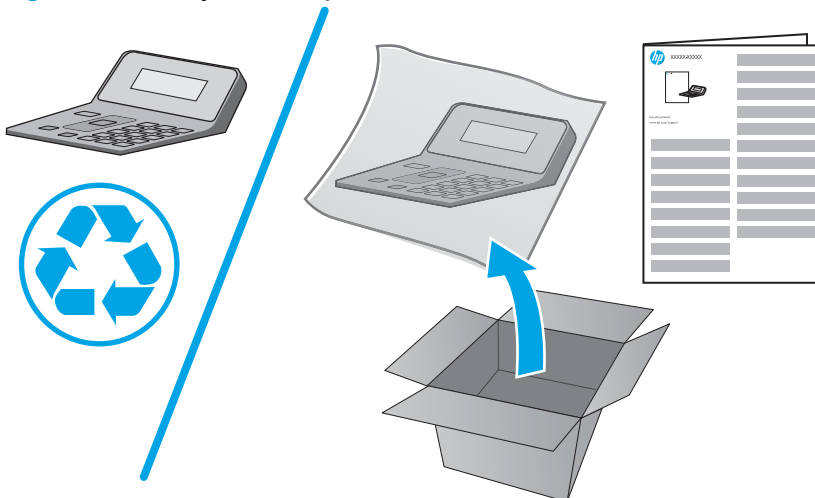
Unpack the replacement part from the packaging.

<http://www8.hp.com/us/en/hp-information/environment/product-recycling.html>

 **NOTE:** HP recommends responsible disposal of the defective part.

 **TIP:** Don't forget to remove the protective film on the display of the replacement control panel.

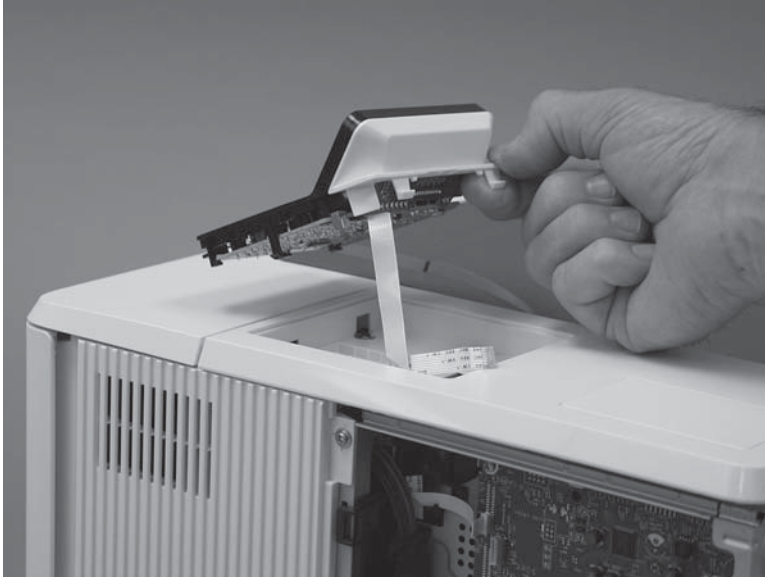
**Figure 1-155** Recycle and unpack



### Step 3: Install the control panel (M501)

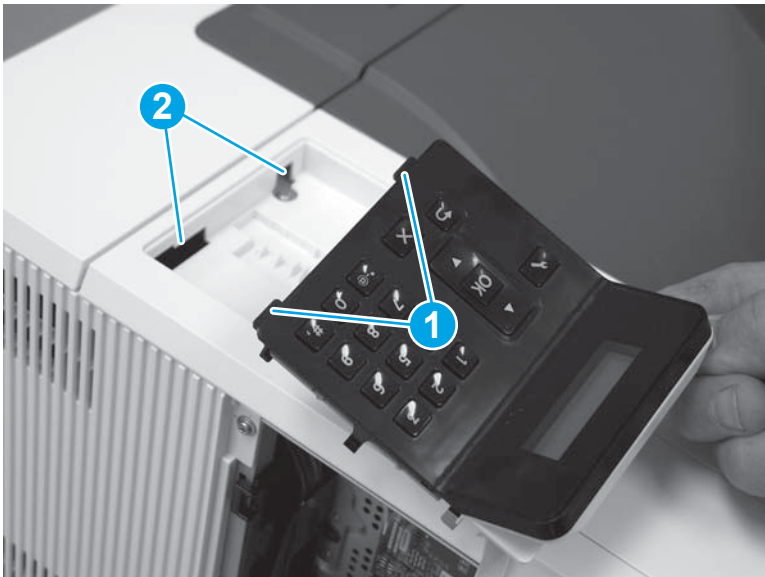
1. Position the replacement control panel over the printer.

**Figure 1-156** Position the control panel over the printer



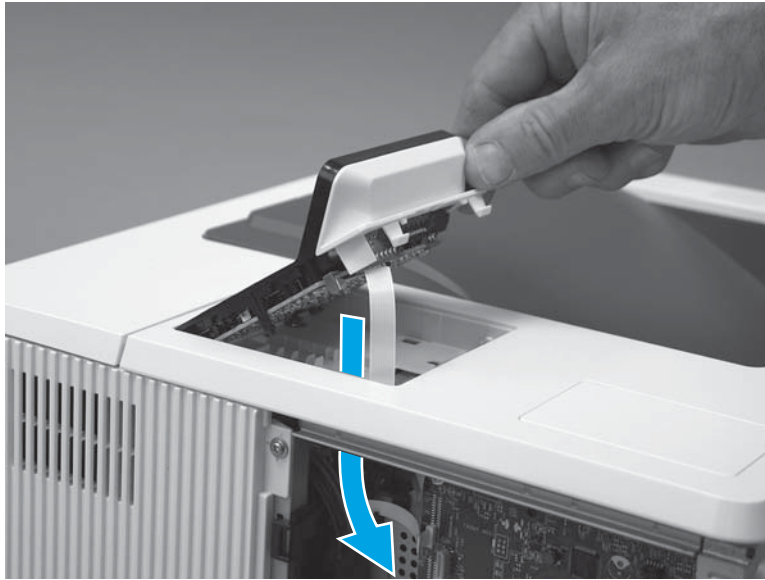
2. Engage the tabs (callout 1) on the front side of the control panel into the slots in the top cover (callout 2).

**Figure 1-157** Engage the tabs with the slots



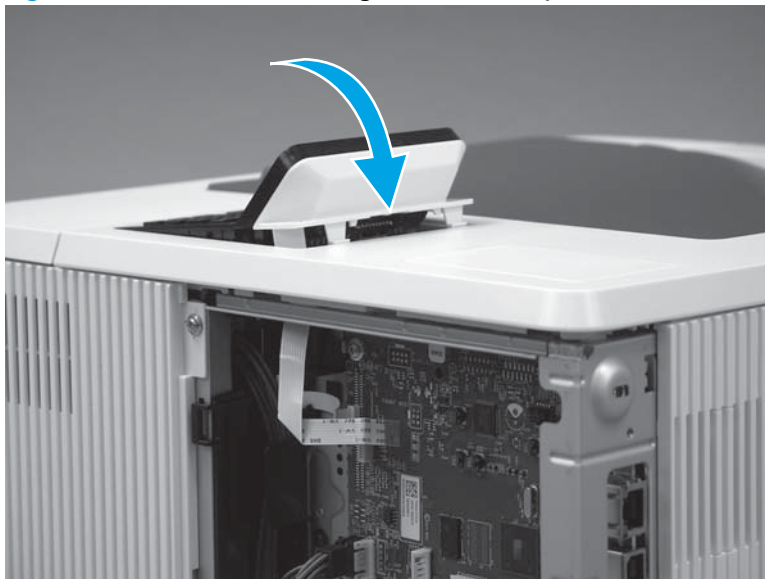
3. Carefully pass the flat cable through the opening in the printer chassis.

**Figure 1-158** Install the flat cable



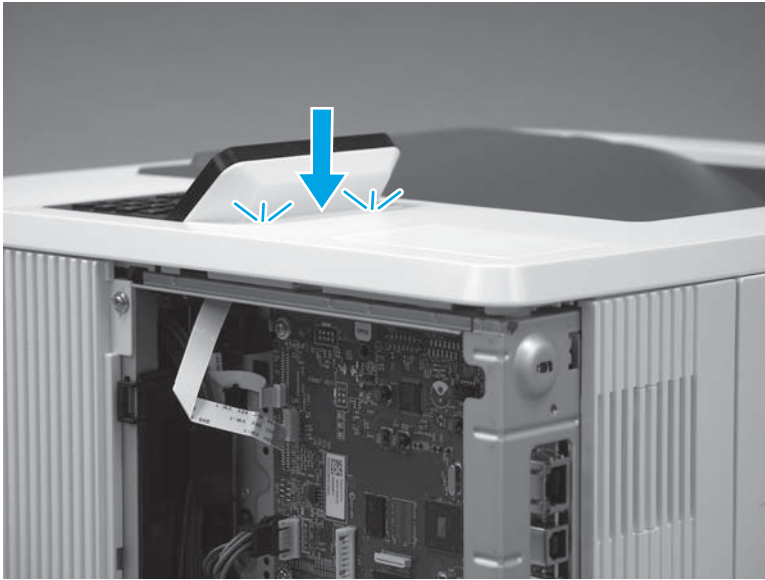
4. With the front tabs engaged, rotate the rear edge of the control panel down and onto the printer to engage the rear tabs.

**Figure 1-159** Rotate the rear edge of the control panel down



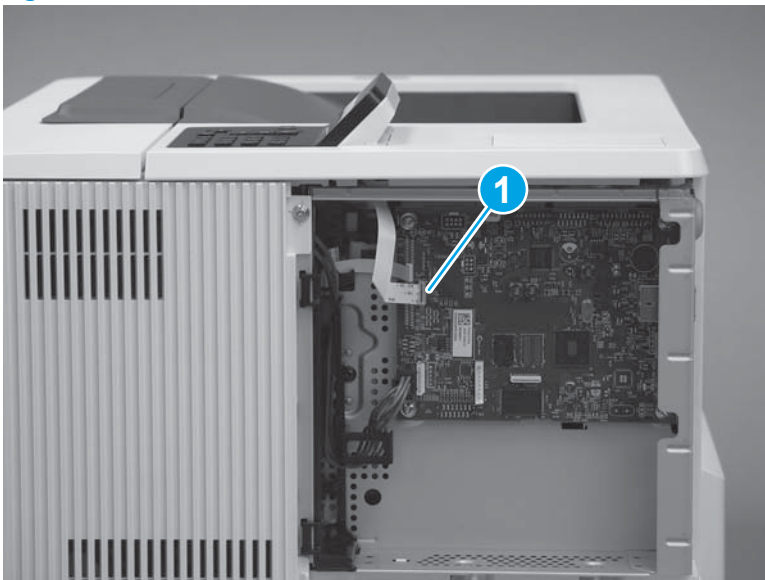
5. Firmly push down on the rear edge of the control panel to make sure that the tabs snap into place.

**Figure 1-160** Make sure that the tabs snap into place



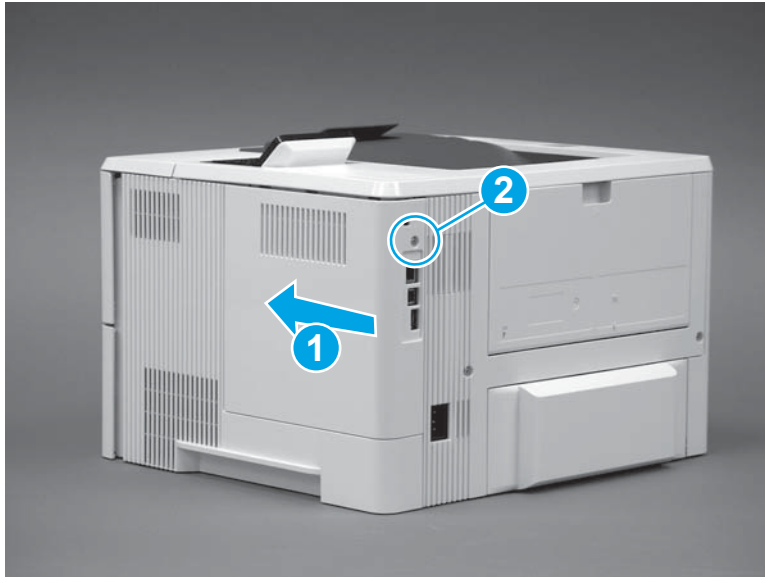
6. Connect one fla cable (callout 1).

**Figure 1-161** Connect one fla cable



7. Slide the formatter cover towards the front of the printer to install it (callout 1), and then install one screw (callout 2).

**Figure 1-162** Install the formatter cover



## Field replaceable units (FRUs) / Bench repairable units (BRUs)

### Removal and replacement: External panels, covers, and doors

- [Removal and replacement: Formatter cover](#)
- [Removal and replacement: Control-panel cover \(M527\)](#)
- [Removal and replacement: Top-rear cover \(M527\)](#)
- [Removal and replacement: Top-left cover \(M527\)](#)
- [Removal and replacement: Document feeder \(M527\)](#)
- [Removal and replacement: Cartridge door assembly](#)
- [Removal and replacement: Rear door assembly](#)
- [Removal and replacement: Right cover](#)
- [Removal and replacement: Left cover](#)
- [Removal and replacement: Stapler door or stapler blank cover \(M527\)](#)
- [Removal and replacement: Stapler stationary \(inner\) cover \(M527\)](#)
- [Removal and replacement: Top cover \(M527\)](#)
- [Removal and replacement: Top cover \(M501/M506\)](#)
- [Removal and replacement: Paper delivery tray \(output bin\)](#)
- [Removal and replacement: Sub-scanner assembly \(SSA\) \(M527\)](#)
- [Removal and replacement: Integrated-scanner assembly \(ISA\) \(M527\)](#)



## Removal and replacement: Formatter cover

- [Introduction](#)
- [Step 1: Remove the formatter cover](#)
- [Step 2: Unpack the replacement assembly](#)
- [Step 3: Install the formatter cover](#)

### Introduction

This document provides the procedures to remove and replace the formatter cover.

### Before performing service

#### Turn the printer power off

- Disconnect the power cable.

**⚠ WARNING!** To avoid damage to the printer, turn the printer off wait 30 seconds, and then remove the power cable before attempting to service the printer.

Use the table below to identify the correct part number for your printer. To order the part, go to [www.hp.com/buy/parts](http://www.hp.com/buy/parts).

Formatter cover part number	
RC4-4200-000CN	Formatter cover (M501)
RM2-5725-000CN	Formatter cover (M506)
RM2-5717-000CN	Formatter cover (M527)

### Required tools

- No special tools are needed to remove or install this assembly.

### After performing service

#### Turn the printer power on

- Connect the power cable.
- Use the power switch to turn the power on.

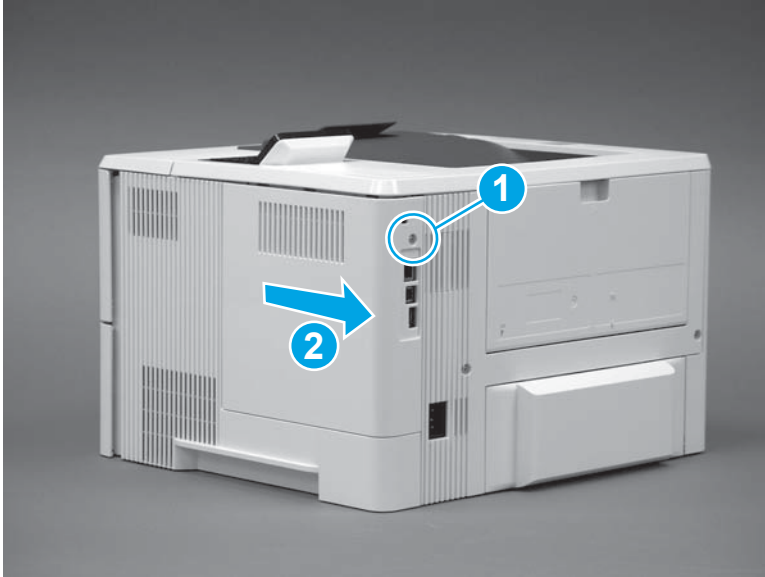
### Post service test

No post service test are available for this assembly.

### Step 1: Remove the formatter cover

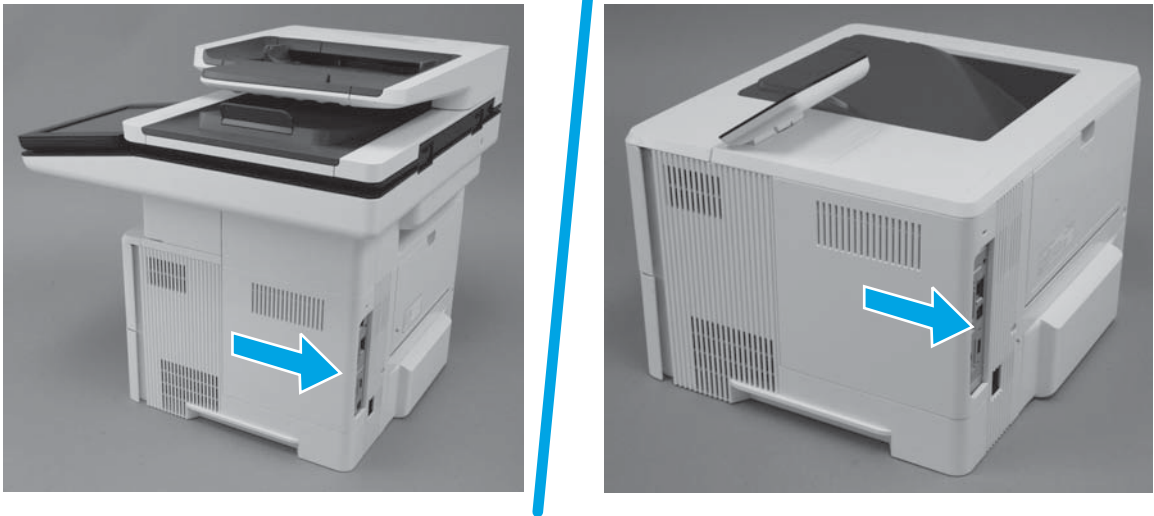
1. **M501:** Remove one screw (callout 1), and then slide the cover toward the rear of the printer to remove it (callout 2).

**Figure 1-163** Remove the formatter cover (M501)



2. **M506/M527:** Slide the cover toward the rear of the printer to remove it.

**Figure 1-164** Remove the formatter cover (M506/M527)



### Step 2: Unpack the replacement assembly

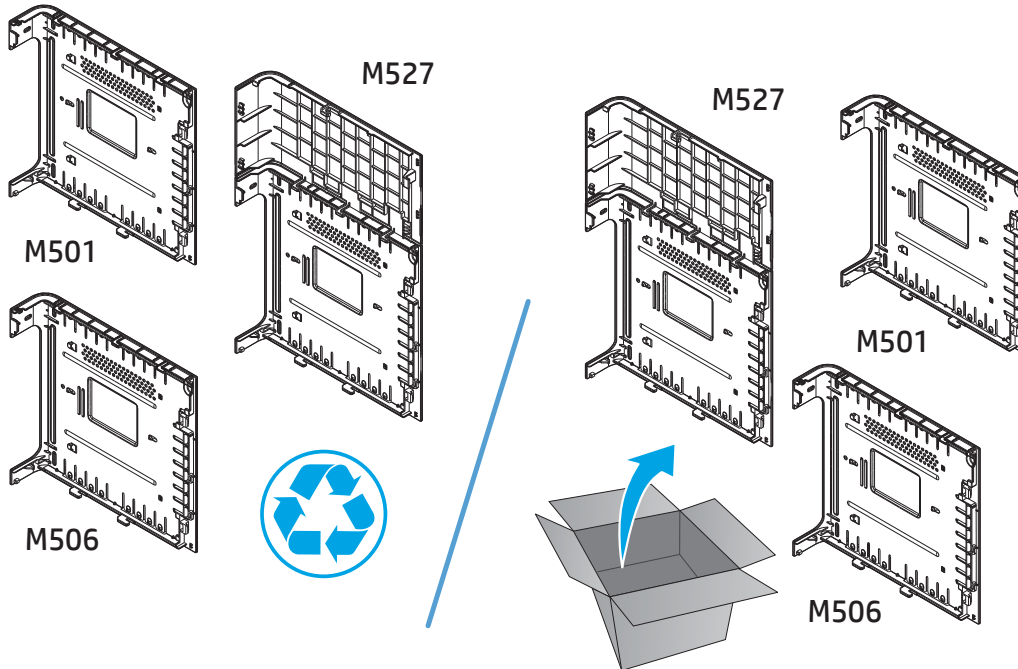
Unpack the replacement part from the packaging.

<http://www8.hp.com/us/en/hp-information/environment/product-recycling.html>



**NOTE:** HP recommends responsible disposal of the defective part.

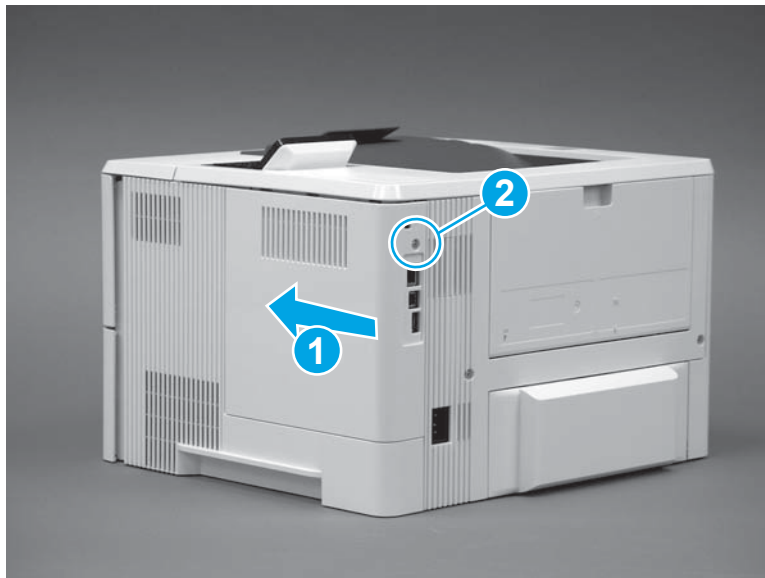
**Figure 1-165** Recycle and unpack



**Step 3: Install the formatter cover**

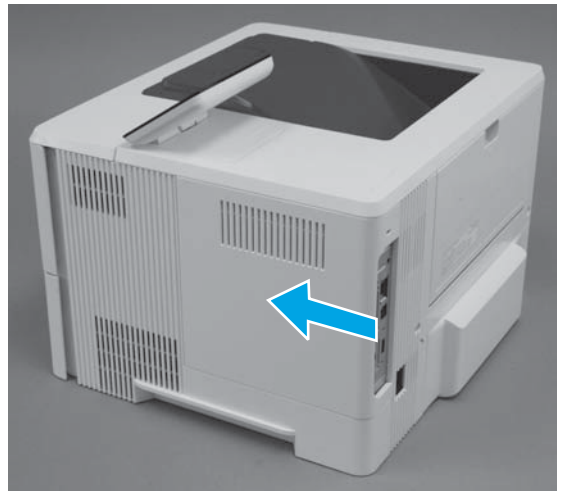
1. **M501:** Slide it toward the front of the printer to install it (callout 1), and then install one screw (callout 2).

**Figure 1-166** Install the formatter cover (M501)



2. **M506/M527:** Slide it toward the front of the printer to install it.

**Figure 1-167** Install the formatter cover (M506/M527)



## Removal and replacement: Control-panel cover (M527)

- [Introduction](#)
- [Step 1: Remove the control-panel cover \(M527\)](#)
- [Step 2: Unpack the replacement cover](#)
- [Step 3: Install the control-panel cover \(M527\)](#)


### Introduction

This document provides the procedures to remove and replace the control-panel cable cover (M527).

### Before performing service

#### Turn the printer power off

- Disconnect the power cable.

 **WARNING!** To avoid damage to the printer, turn the printer off, wait 30 seconds, and then remove the power cable before attempting to service the printer.

Use the table below to identify the correct part number for your printer. To order the part, go to [www.hp.com/buy/parts](http://www.hp.com/buy/parts).

Control-panel cover (M527) part number	
B5L46-60117	Control-panel cover (M527)

### Required tools

No special tools are required for this assembly.

### After performing service

#### Turn the printer power on

- Connect the power cable.
- Use the power switch to turn the power on.

### Post service test

No service test for this assembly.

### Step 1: Remove the control-panel cover (M527)

1. If the document feeder is not open, open it now.

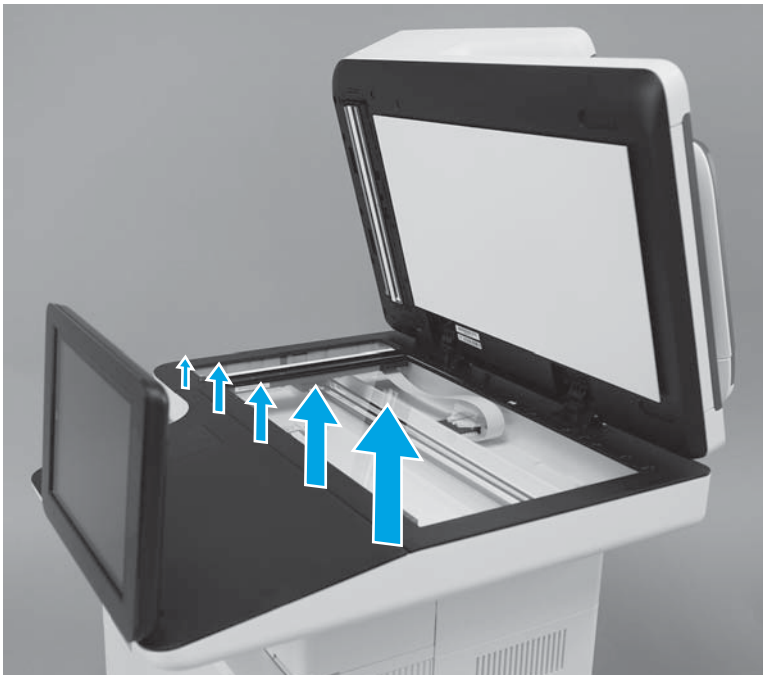
 **NOTE:** If the control panel is not fully tilted forward, tilt it forward now until it stops.

**Figure 1-168** Open the document feeder



2. Beginning at the right side of the control-panel cover, carefully release five tabs along the top edge of the cover.

**Figure 1-169** Release five tabs



3. Continue to rotate the top edge of the cover away from the printer, and then remove the cover.

**Figure 1-170** Remove the cover



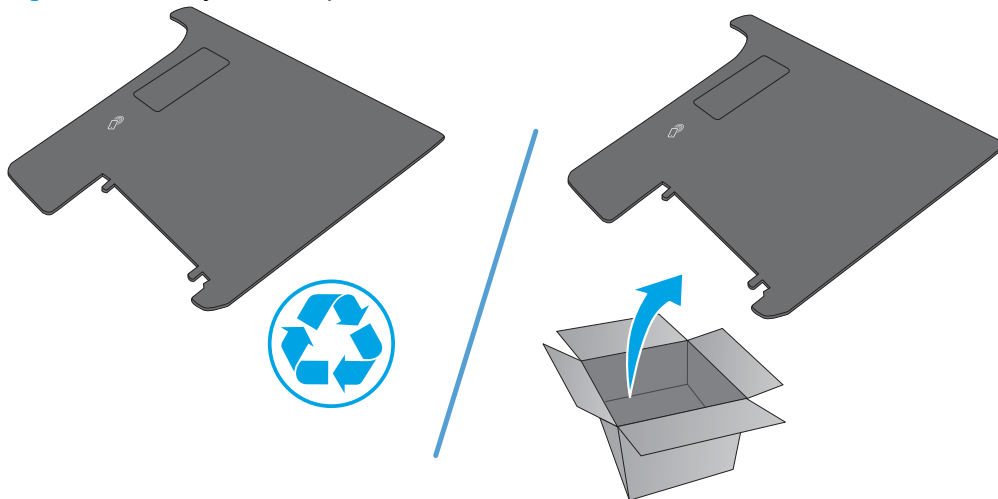
### Step 2: Unpack the replacement cover

Unpack the replacement part from the packaging.

<http://www8.hp.com/us/en/hp-information/environment/product-recycling.html>

 **NOTE:** HP recommends responsible disposal of the defective part.

**Figure 1-171** Recycle and unpack



### Step 3: Install the control-panel cover (M527)

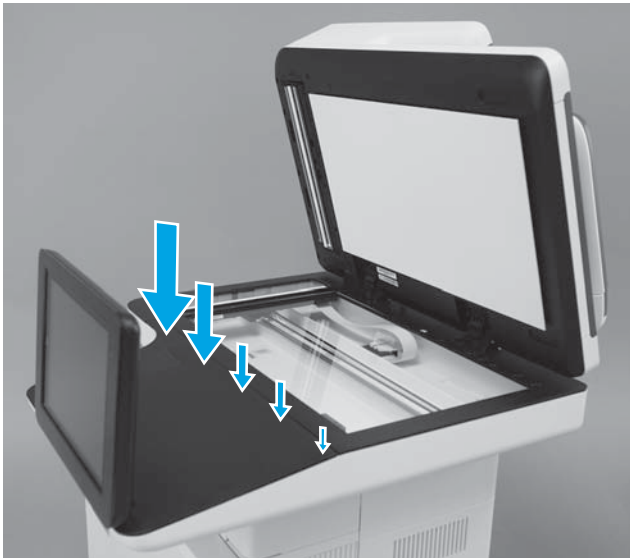
1. Position the control-panel cover on the printer.

**Figure 1-172** Position the control-panel cover on the printer



2. Beginning at the left side of the control-panel cover, carefully engage five tabs along the top edge of the cover.

**Figure 1-173** Engage five tabs





3. Close the document feeder.

 **NOTE:** Adjust the control panel to the desired angle.

---

**Figure 1-174** Close the document feeder



## Removal and replacement: Top-rear cover (M527)



**NOTE:** M527 printers only.

- [Introduction](#)
- [Step 1: Remove the formatter cover](#)
- [Step 2: Remove the top-left cover](#)
- [Step 3: Remove the top-rear cover](#)
- [Step 4: Unpack the replacement cover](#)
- [Step 5: Install the top-rear cover](#)
- [Step 6: Install the top-left cover](#)
- [Step 7: Install the formatter cover](#)

### Introduction

This document provides the procedures to remove and replace the top-rear cover (M527).

### Before performing service

#### Turn the printer power off

- Disconnect the power cable.



**WARNING!** To avoid damage to the printer, turn the printer off wait 30 seconds, and then remove the power cable before attempting to service the printer.

Use the table below to identify the correct part number for your printer. To order the part, go to [www.hp.com/buy/parts](http://www.hp.com/buy/parts).

Top-rear cover (M527) part number	
RC4-3002-000CN	Cover, top rear

### Required tools

- No special tools are needed to remove or install this assembly.

### After performing service

#### Turn the printer power on

- Connect the power cable.
- Use the power switch to turn the power on.

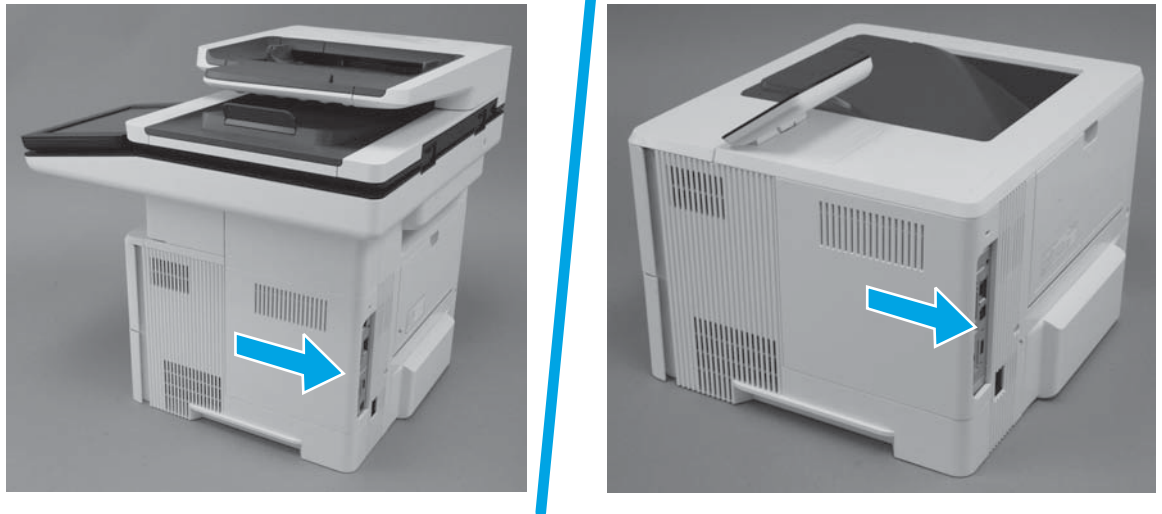
### Post service test

No post service test are available for this assembly.

### Step 1: Remove the formatter cover

- ▲ Slide the cover toward the rear of the printer to remove it.

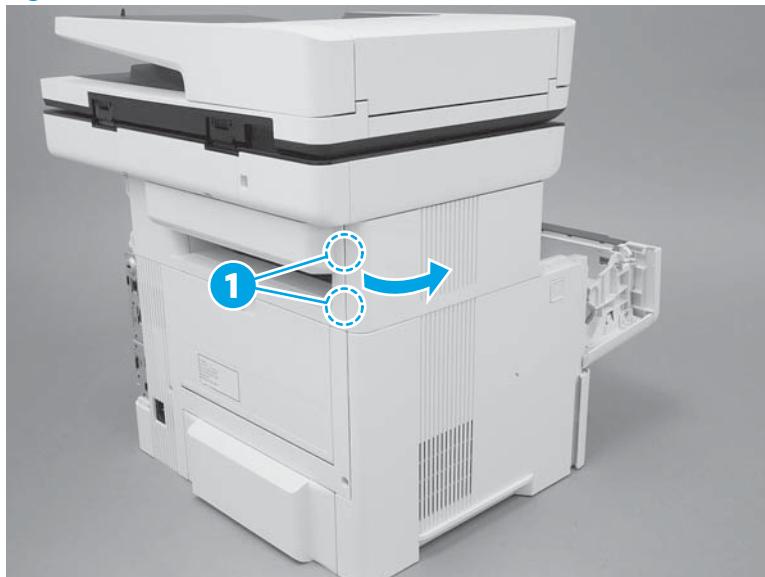
**Figure 1-175** Remove the formatter cover



### Step 2: Remove the top-left cover

1. Open the toner-cartridge door, release two tabs (callout 1), and then rotate the rear edge of the cover away from the printer.

**Figure 1-176** Release two tabs



2. Continue to rotate the cover away from the printer to release two more tabs at the middle of the cover.

**Figure 1-177** Release two tabs



3. Slide the cover toward the rear of the printer to release two bosses at the front of the cover.

**Figure 1-178** Slide the cover



4. Remove the cover.

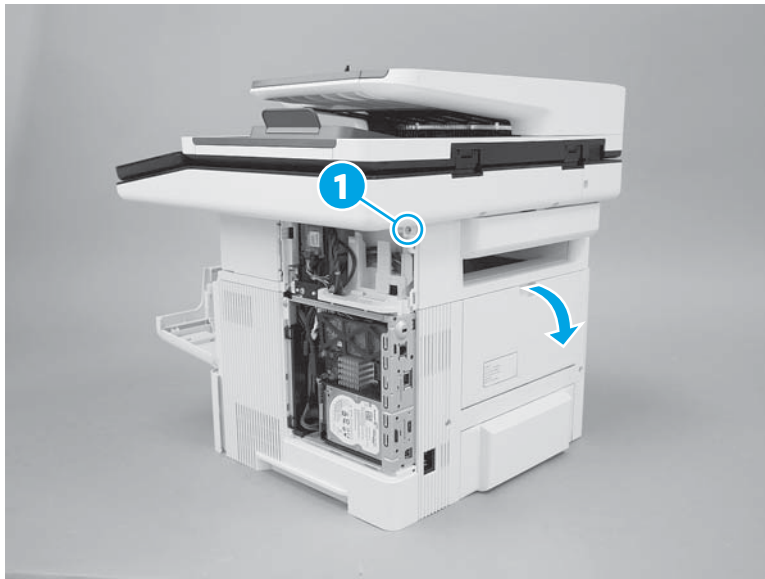
**Figure 1-179** Remove the cover



**Step 3: Remove the top-rear cover**

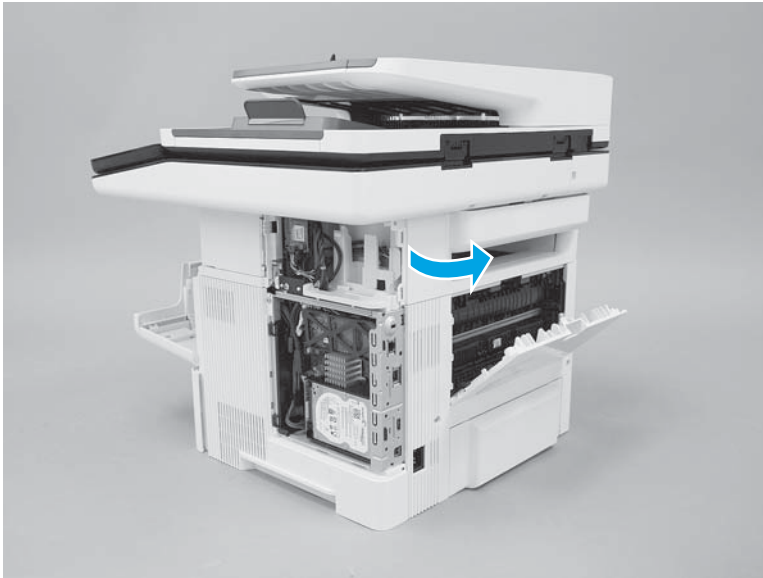
1. Remove one screw (callout 1), and then open the rear door.

**Figure 1-180** Remove one screw



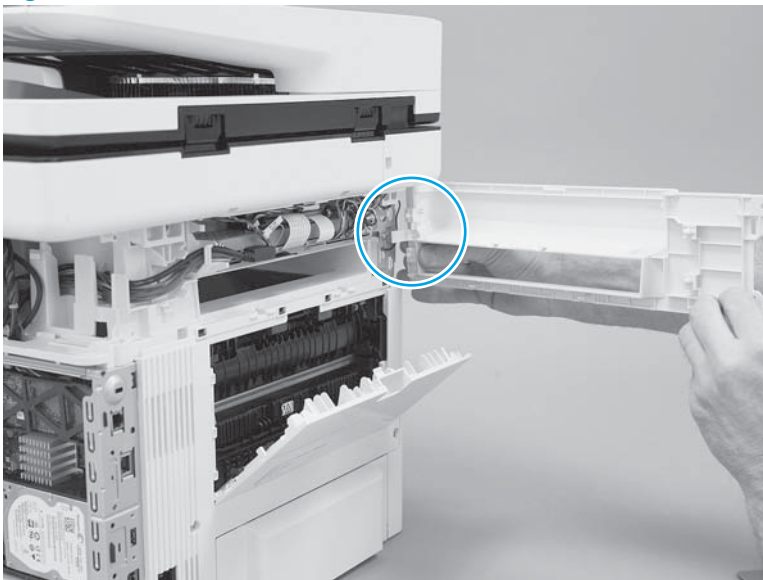
2. Rotate the exposed edge of the cover away from the printer (as shown).

**Figure 1-181** Rotate the cover



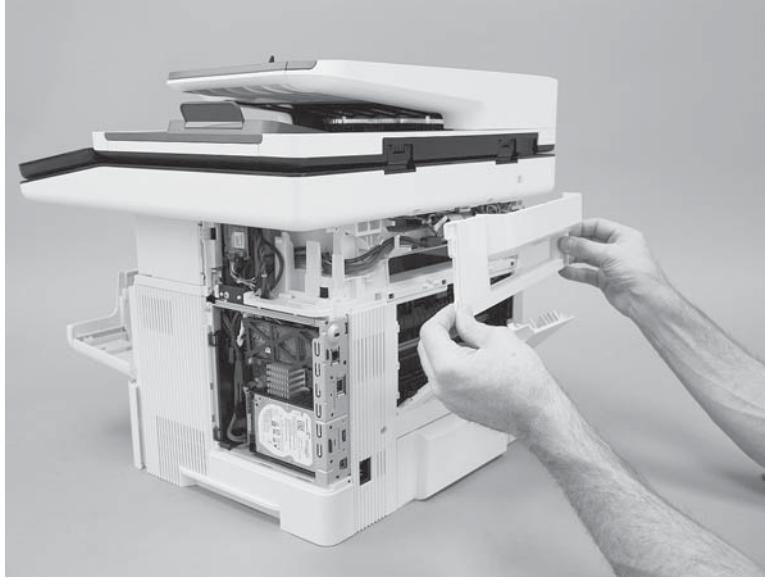
3. Continue to rotate the cover away from the printer to release one boss.

**Figure 1-182** Release one boss



4. Remove the cover.

**Figure 1-183** Remove the cover



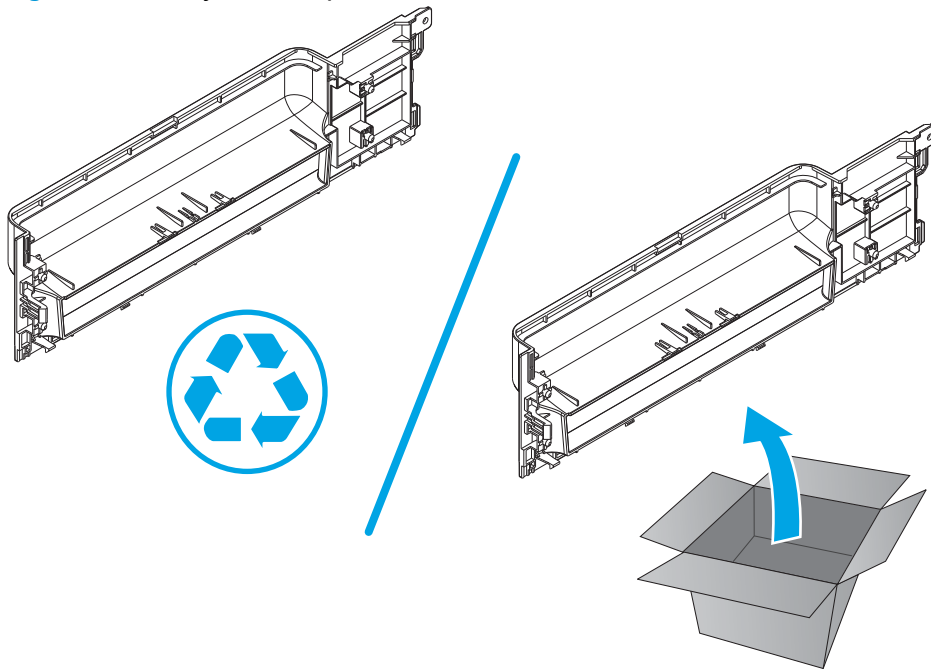
#### Step 4: Unpack the replacement cover

Unpack the replacement part from the packaging.

<http://www8.hp.com/us/en/hp-information/environment/product-recycling.html>

 **NOTE:** HP recommends responsible disposal of the defective part.

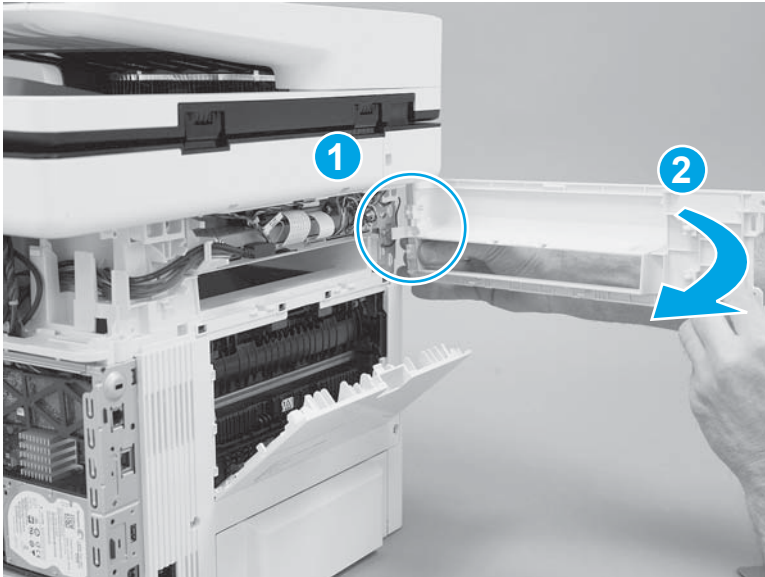
**Figure 1-184** Recycle and unpack



### Step 5: Install the top-rear cover

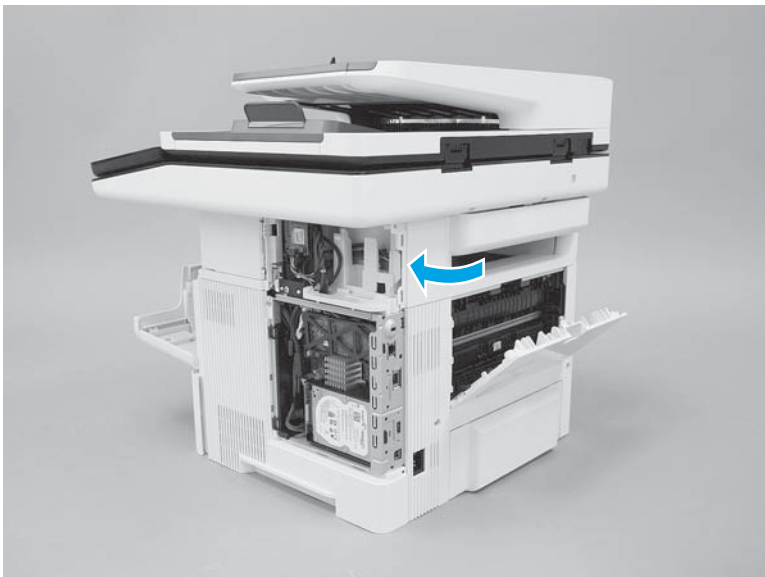
1. Engage one boss (callout 1), and then rotate the cover towards the printer (callout 2).

**Figure 1-185** Engage one boss



2. Continue to rotate the cover toward the printer to install it.

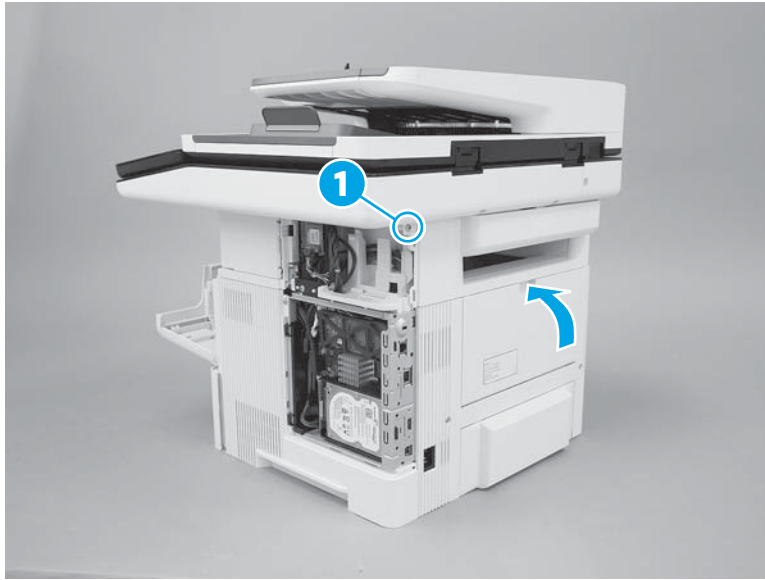
**Figure 1-186** Install the cover





3. Install one screw (callout 1), and then close the rear door.

**Figure 1-187** Install one screw



#### **Step 6: Install the top-left cover**

1. Position the front edge of the cover on the printer, and then slide the cover toward the front of the printer to engage two bosses at the front of the cover.

**Figure 1-188** Slide the cover




2. Rotate the cover towards the printer to engage two tabs at the middle of the cover.

**Figure 1-189** Engage two tabs



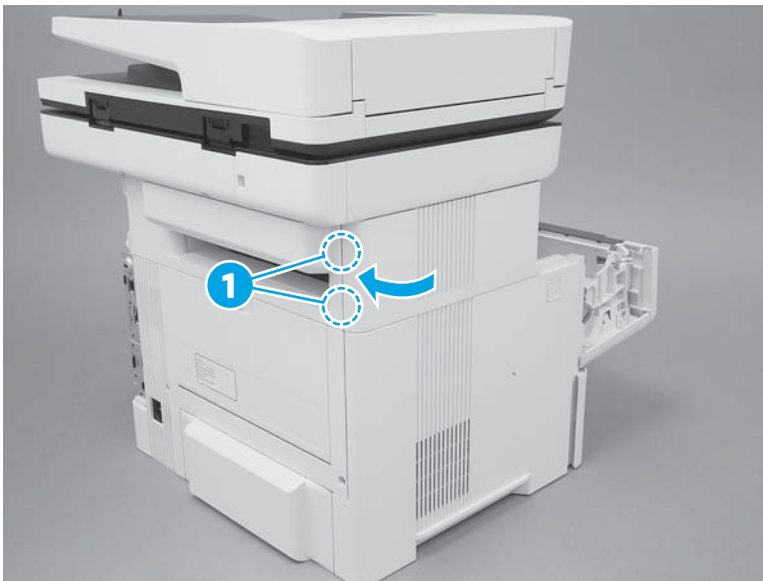
3. Continue to rotate the cover onto the printer to engage two tabs (callout 1) at the rear edge of the cover.

---

 **NOTE:** Close the toner-cartridge door.

---

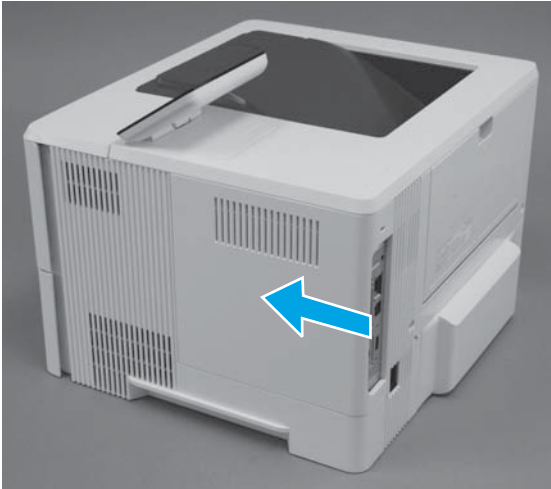
**Figure 1-190** Engage two tabs



### Step 7: Install the formatter cover

- ▲ Slide it toward the front of the printer to install it.

**Figure 1-191** Install the formatter cover



## Removal and replacement: Top-left cover (M527)



**NOTE:** M527 printers only.

- [Introduction](#)
- [Step 1: Remove the top-left cover](#)
- [Step 2: Unpack the replacement cover](#)
- [Step 3: Install the top-left cover](#)


### Introduction

This document provides the procedures to remove and replace the top-left cover (M527).

### Before performing service

#### Turn the printer power off

- Disconnect the power cable.

 **WARNING!** To avoid damage to the printer, turn the printer off wait 30 seconds, and then remove the power cable before attempting to service the printer.

Use the table below to identify the correct part number for your printer. To order the part, go to [www.hp.com/buy/parts](http://www.hp.com/buy/parts).

Top-left cover (M527) part number	
RC4-4147-000CN	Cover, top left

### Required tools

- No special tools are needed to remove or install this assembly.

### After performing service

#### Turn the printer power on

- Connect the power cable.
- Use the power switch to turn the power on.

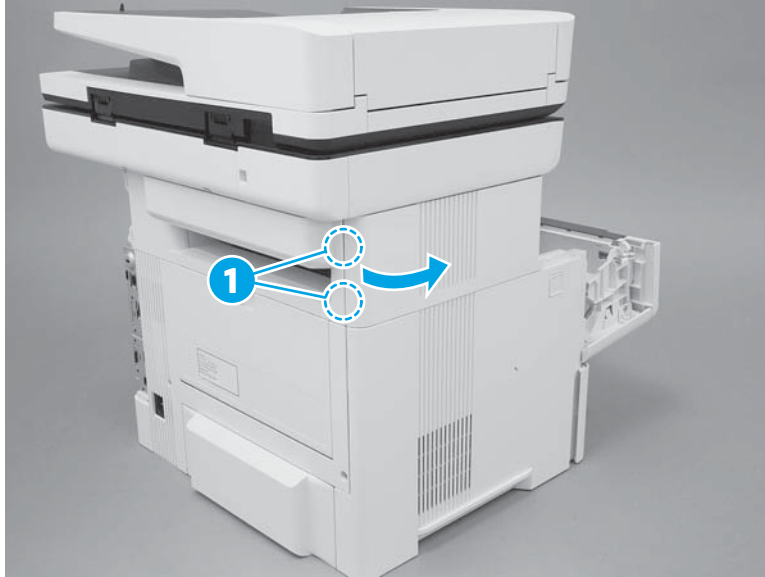
### Post service test

No post service test are available for this assembly.

### Step 1: Remove the top-left cover

1. Open the toner-cartridge door, release two tabs (callout 1), and then rotate the rear edge of the cover away from the printer.

**Figure 1-192** Release two tabs



2. Continue to rotate the cover away from the printer to release two more tabs at the middle of the cover.

**Figure 1-193** Release two tabs



3. Slide the cover toward the rear of the printer to release two bosses at the front of the cover.

**Figure 1-194** Slide the cover



4. Remove the cover.

**Figure 1-195** Remove the cover



### Step 2: Unpack the replacement cover

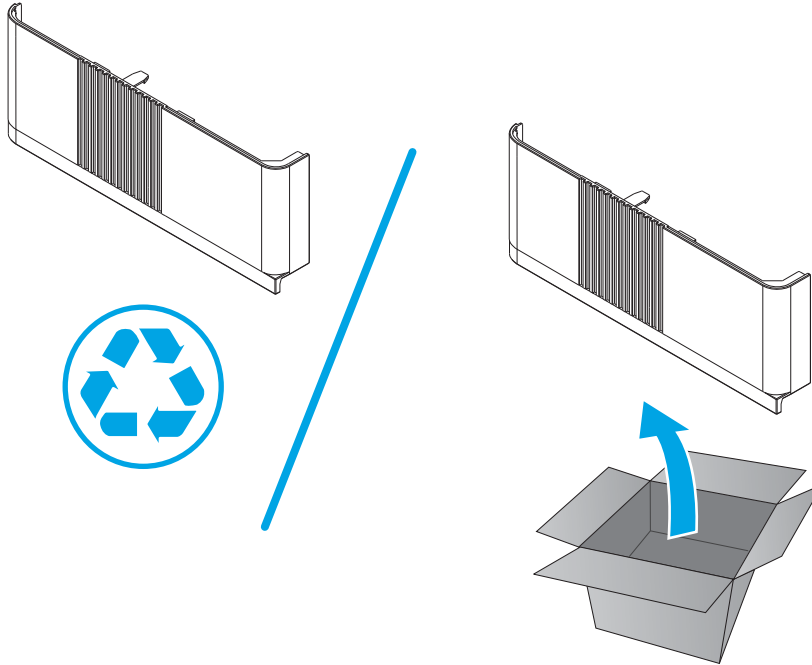
Unpack the replacement part from the packaging.

<http://www8.hp.com/us/en/hp-information/environment/product-recycling.html>



**NOTE:** HP recommends responsible disposal of the defective part.

**Figure 1-196** Recycle and unpack



**Step 3: Install the top-left cover**

1. Position the front edge of the cover on the printer, and then slide the cover toward the front of the printer to engage two bosses at the front of the cover.

**Figure 1-197** Slide the cover




2. Rotate the cover towards the printer to engage two tabs at the middle of the cover.

**Figure 1-198** Engage two tabs



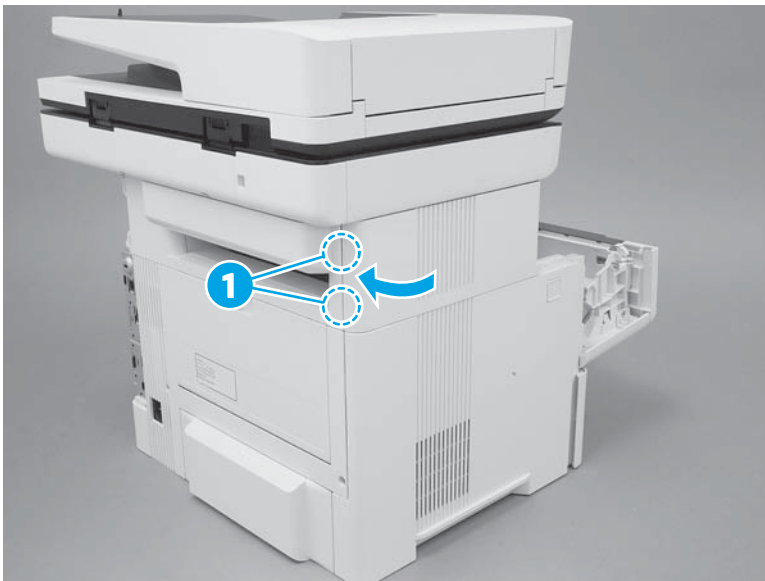
3. Continue to rotate the cover onto the printer to engage two tabs (callout 1) at the rear edge of the cover.

---

 **NOTE:** Close the toner-cartridge door.

---

**Figure 1-199** Engage two tabs





## Removal and replacement: Document feeder (M527)

- [Introduction](#)
- [Step 1: Remove the formatter cover](#)
- [Step 2: Remove the top-left cover](#)
- [Step 3: Remove the top-rear cover](#)
- [Step 4: Remove the document feeder](#)
- [Step 5: Unpack the replacement assembly](#)
- [Step 6: Install the document feeder](#)
- [Step 7: Install the retention clips and white backing](#)
- [Step 8: Install the top-rear cover](#)
- [Step 9: Install the top-left cover](#)
- [Step 10: Install the formatter cover](#)
- [Step 11: Reset the firmware counter](#)

### Introduction

This document provides the procedures to remove and replace the document feeder (M527).

### Before performing service

#### Turn the printer power off

- Disconnect the power cable.

**⚠ WARNING!** To avoid damage to the printer, turn the printer off, wait 30 seconds, and then remove the power cable before attempting to service the printer.

Use the table below to identify the correct part number for your printer. To order the part, go to [www.hp.com/buy/parts](http://www.hp.com/buy/parts).

Document feeder (M527) part number	
<b>B5L47-67902</b>	ADF whole unit (document feeder; M506n/dn/x and M527dn/f) kit with instruction guide <sup>1</sup>
<b>B5L47-67901</b>	ADF whole unit (document feeder; M527 c/z) kit with instruction guide <sup>1</sup>

<sup>1</sup> This kit includes a replacement white backing and white backing retention clips.

### Required tools

- #2 Phillips screwdriver with a magnetic tip.
- Small flat-blade screwdriver.

## After performing service

### Turn the printer power on

- Connect the power cable.
- Use the power switch to turn the power on.

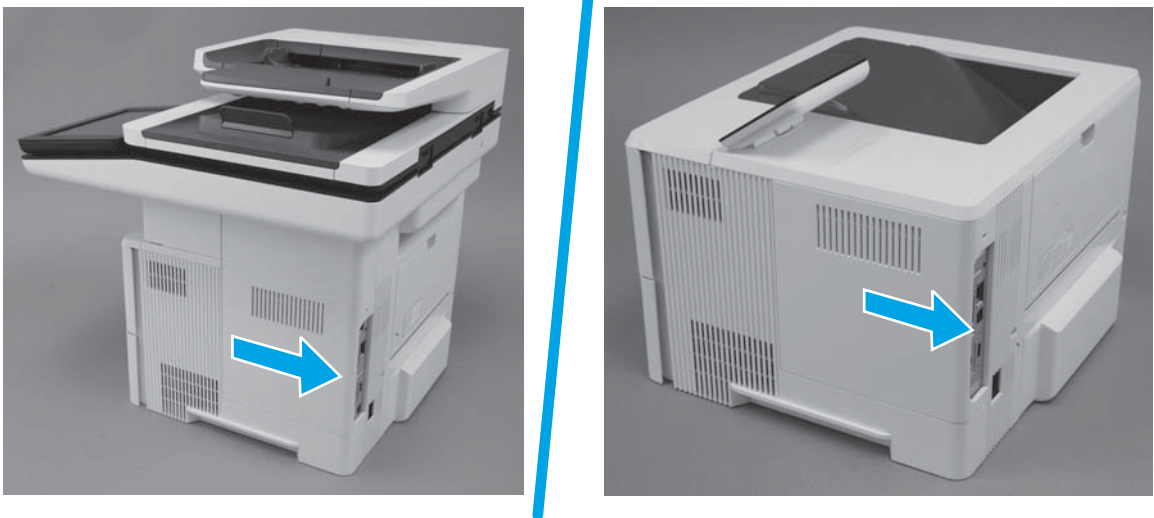
### Post service test

Use the document feeder to make a copy to make sure that it is properly functioning.

### Step 1: Remove the formatter cover

- ▲ Slide the cover toward the rear of the printer to remove it.

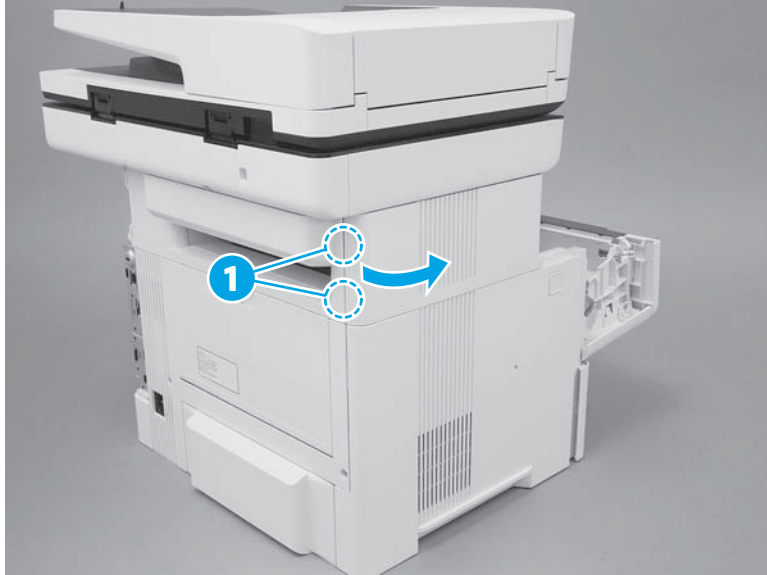
**Figure 1-200** Remove the formatter cover



### Step 2: Remove the top-left cover

1. Open the toner-cartridge door, release two tabs (callout 1), and then rotate the rear edge of the cover away from the printer.

**Figure 1-201** Release two tabs



2. Continue to rotate the cover away from the printer to release two more tabs at the middle of the cover.

**Figure 1-202** Release two tabs



3. Slide the cover toward the rear of the printer to release two bosses at the front of the cover.

**Figure 1-203** Slide the cover



4. Remove the cover.

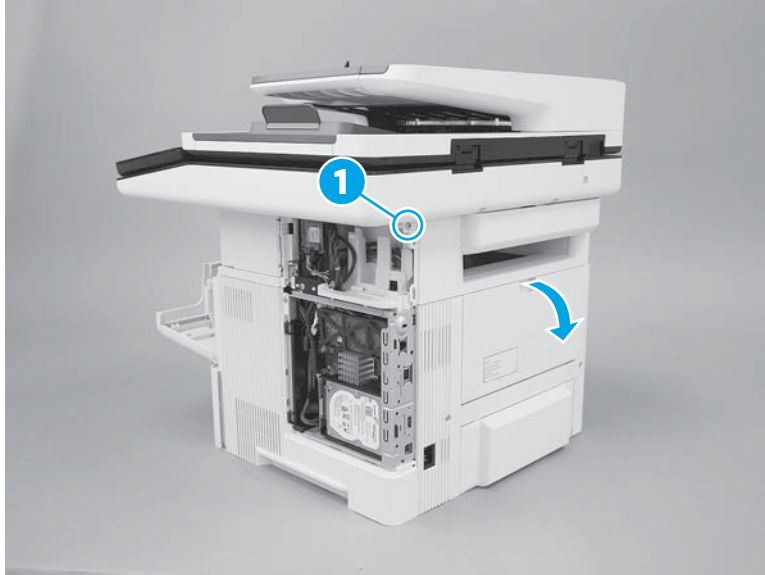
**Figure 1-204** Remove the cover



### **Step 3: Remove the top-rear cover**

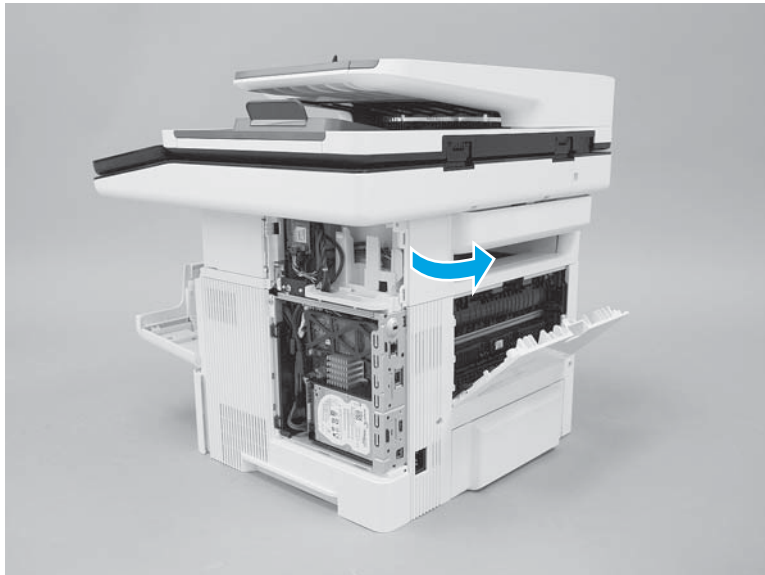
1. Remove one screw (callout 1), and then open the rear door.

**Figure 1-205** Remove one screw



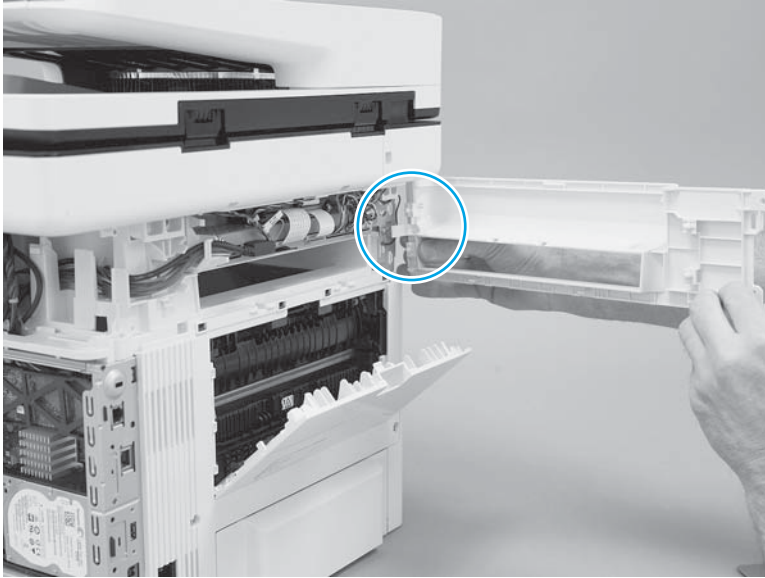
2. Rotate the exposed edge of the cover away from the printer (as shown).

**Figure 1-206** Rotate the cover



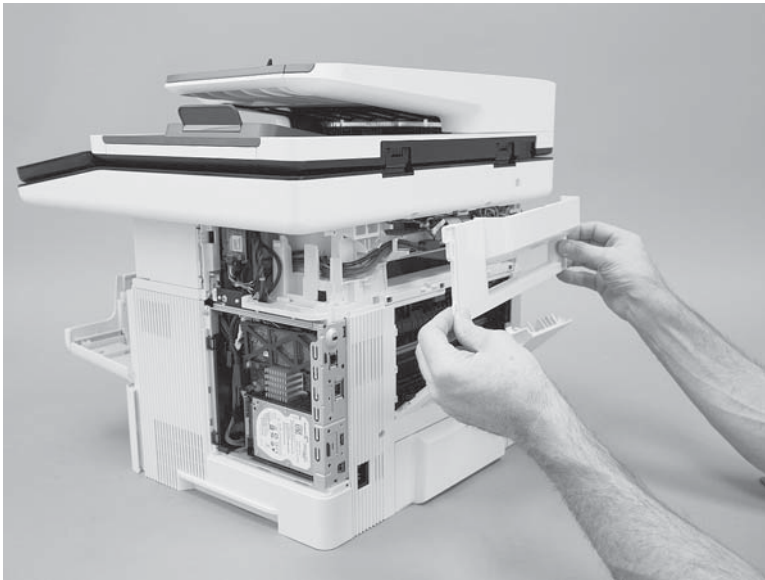
3. Continue to rotate the cover away from the printer to release one boss.

**Figure 1-207** Release one boss




4. Remove the cover.

**Figure 1-208** Remove the cover



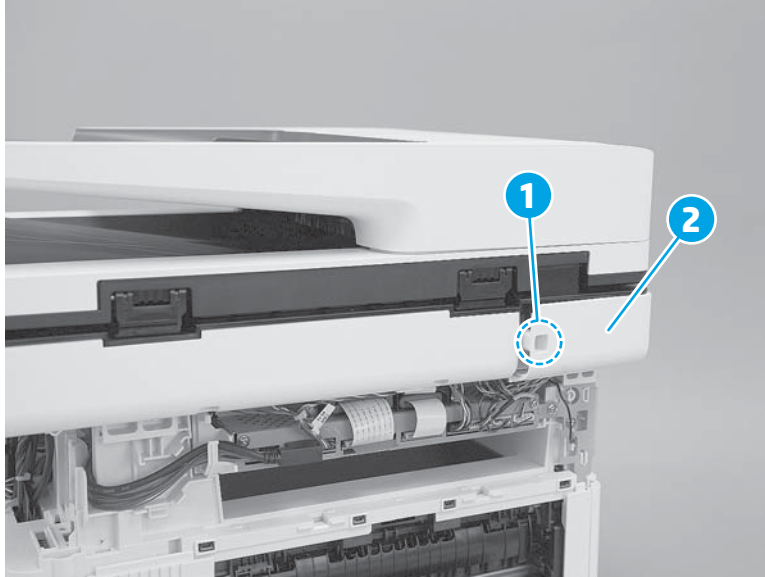
#### Step 4: Remove the document feeder

---

 **NOTE:** M527 printers only.

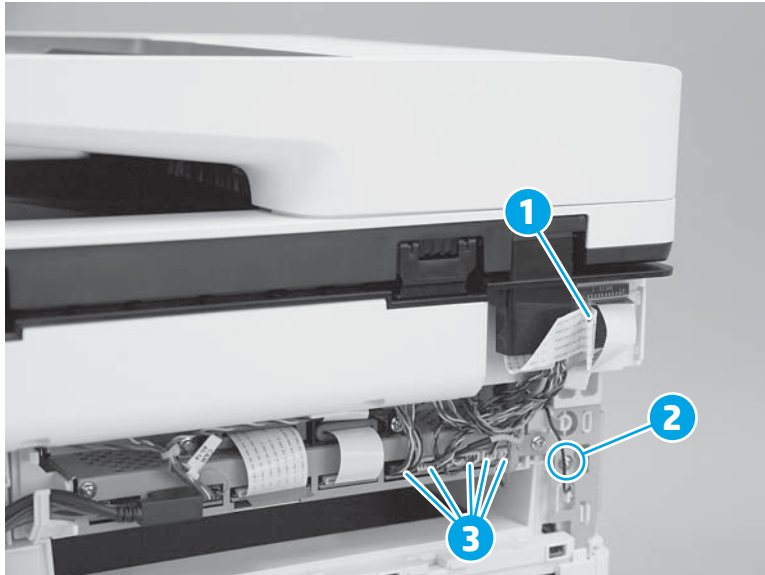
1. Remove one screw (callout 1), and then remove the cable cover (callout 2).

**Figure 1-209** Remove the cover



2. Disconnect one flat-flexible cable (FFC; callout 1), remove one ground screw (callout 2), and then disconnect five connectors (callout 3).

**Figure 1-210** Disconnect the FFC, ground cable, and connectors




3. Open the document feeder.

**Figure 1-211** Open the document feeder



4. Tilt the document feeder back until it stops (callout 1), and then lift it up until it stops (callout 2).


 **NOTE:** The tabs are located on the front side (scanner flatbed glass) of the hinges. Use the figure above to locate the tabs.

**Figure 1-212** Raise the document feeder






5. Support the document feeder, and then use a small flat-blade screwdriver to release two tabs on the document feeder hinges.

 **NOTE:** The tabs are located on the front side (scanner flatbed glass) of the hinges. Use the figure below to locate the tabs.

**Figure 1-213** Release two tabs



6. Lift the document feeder up to remove it.

 **NOTE:** While removing the document feeder, carefully pass the wire harnesses and the FFC through the opening in the scanner.

**Figure 1-214** Remove the document feeder

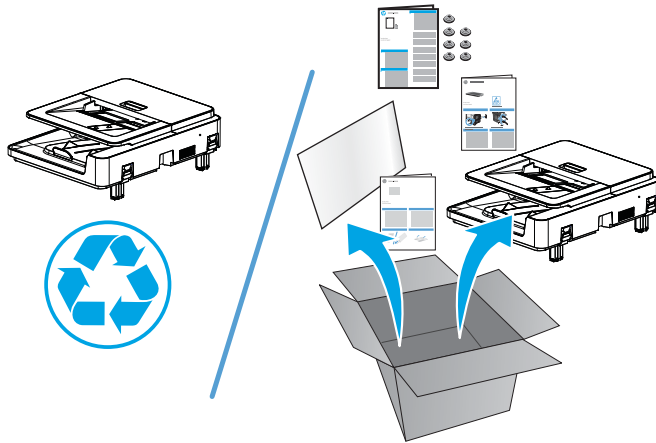


### Step 5: Unpack the replacement assembly


Unpack the replacement part from the packaging.

 **NOTE:** HP recommends responsible disposal of the defective part.

**Figure 1-215** Recycle and unpack



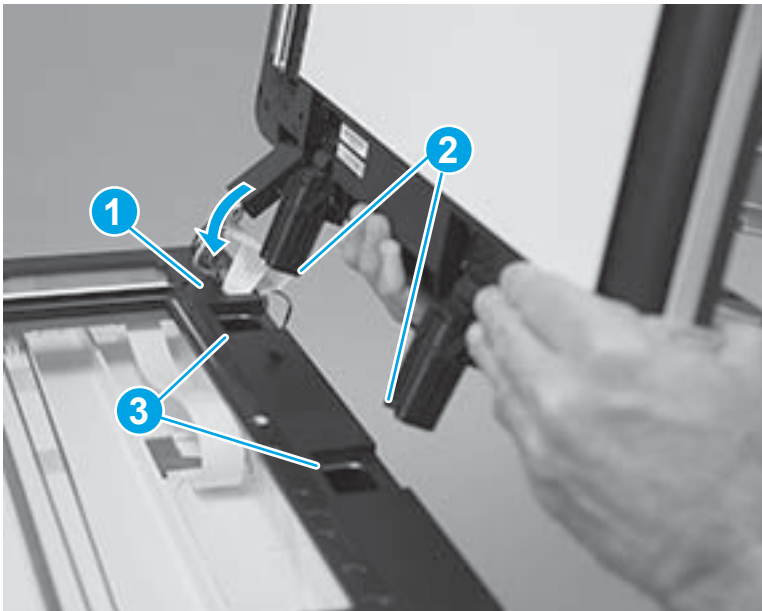
### Step 6: Install the document feeder

 **NOTE:** M527 printers only.

A replacement document feeder is shown in this procedure (white backing not installed). However, the install steps are valid for all document feeders.

1. Pass the flat cable and wire harness on the replacement document feeder through the hole in the scanner chassis (callout 1), and then align the hinges (callout 2) with the slots (callout 3) in the chassis.

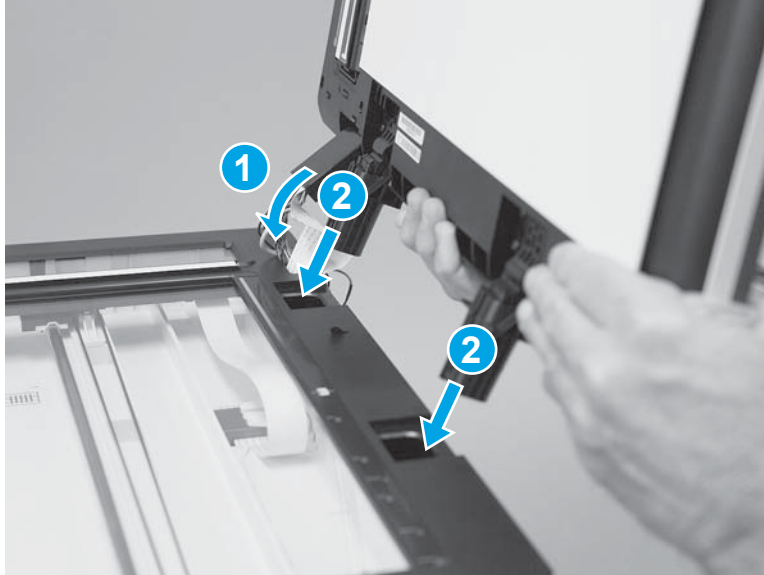
**Figure 1-216** Install the document feeder



2. Continue to pass the flat cable and wire through the opening in the chassis (callout 1), and then insert the hinges (callout 2) into the slots.

**CAUTION:** Do not damage the flat cable or wire harnesses when the cable guide (callout 1) is installed in its slot.

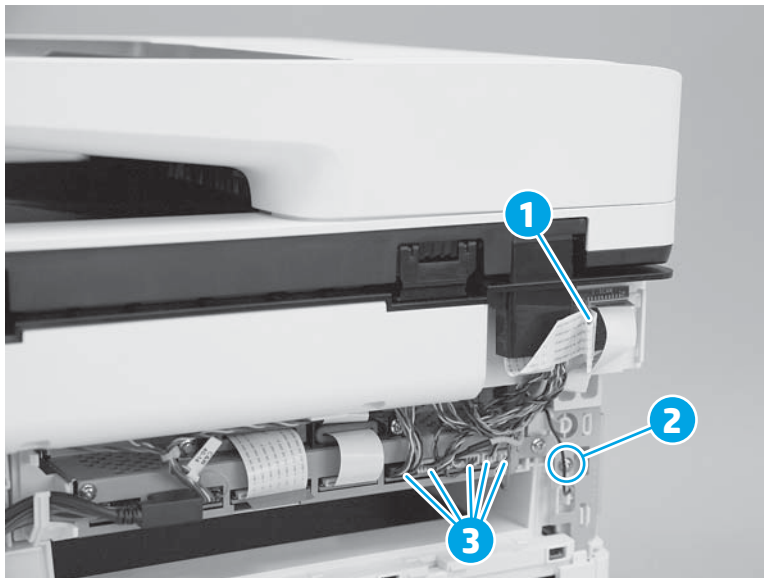
**Figure 1-217** Lower the document feeder




3. Connect one FFC (callout 1), install one ground screw (callout 2), and then connect five connectors (callout 3).

**TIP:** Close the document feeder as shown to make it easier to connect the connectors and install the ground screw.

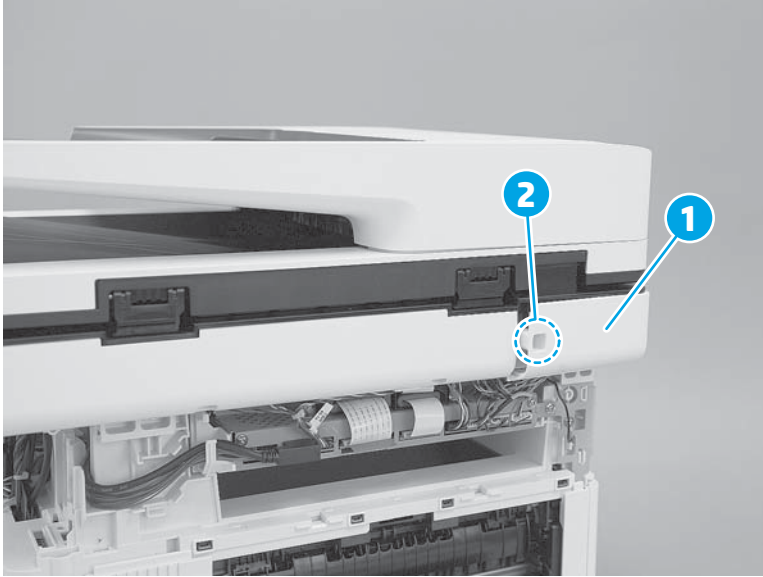
**Figure 1-218** Connect the FFC, ground cable, and connectors




4. Connect one FFC (callout 1), install one ground screw (callout 2), and then connect five connectors (callout 3).

 **TIP:** Close the document feeder as shown to make it easier to connect the connectors and install the ground screw.

**Figure 1-219** Connect the FFC, ground cable, and connectors



### Step 7: Install the retention clips and white backing

 **NOTE:** This step is for replacement document feeders only, otherwise skip this step and go to [Step 8: Install the top-rear cover on page 153](#).

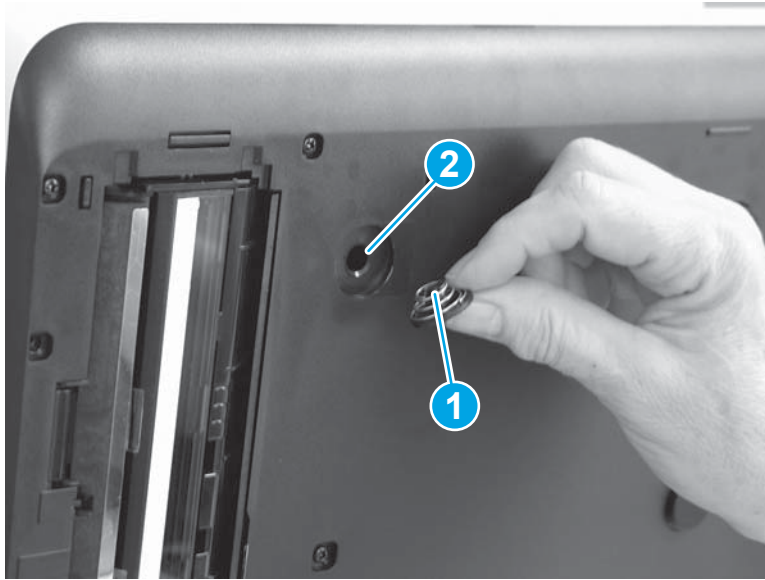
1. If a spring comes off of a retention clip, make sure that it is correctly repositioned on the clip.

**Figure 1-220** Check the retention clip spring



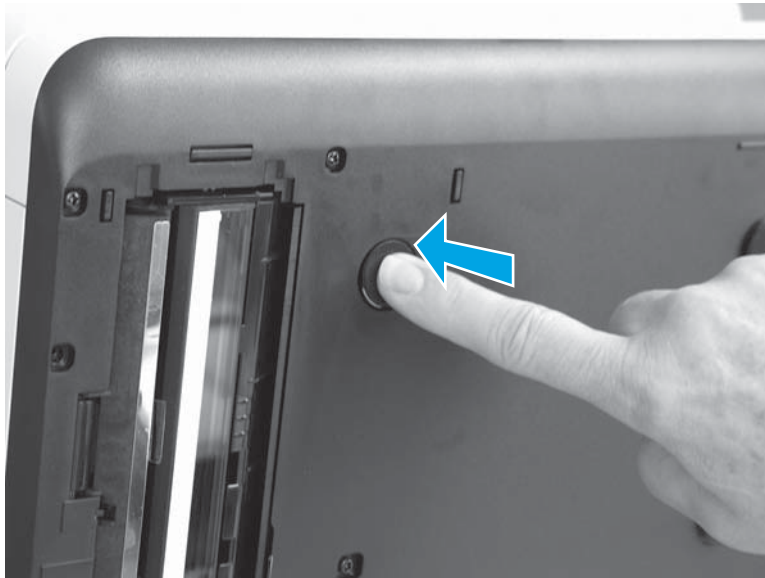
2. Install the clip (callout 1) in the opening (callout 2) in the document feeder.

**Figure 1-221** Install the retention clip




3. Press the clip to make sure it is securely installed.

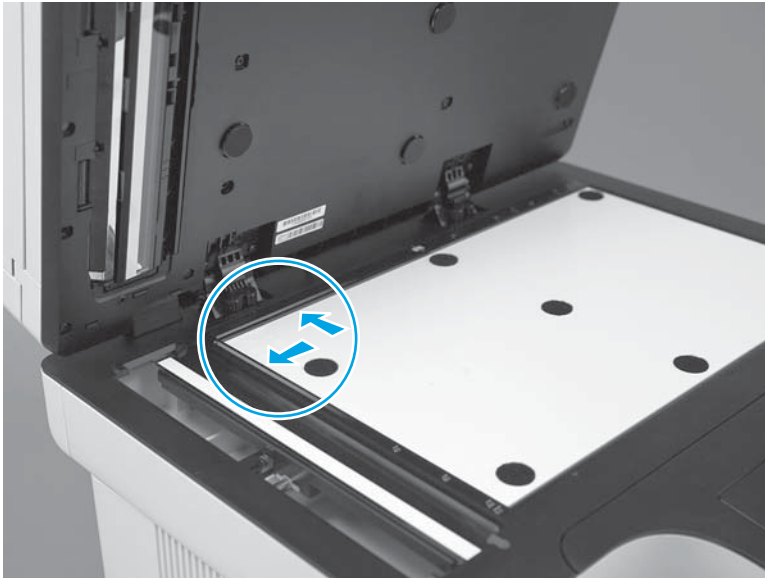
**Figure 1-222** Press the retention clip



4. Place the white backing, on the flatbed scanner glass as shown.

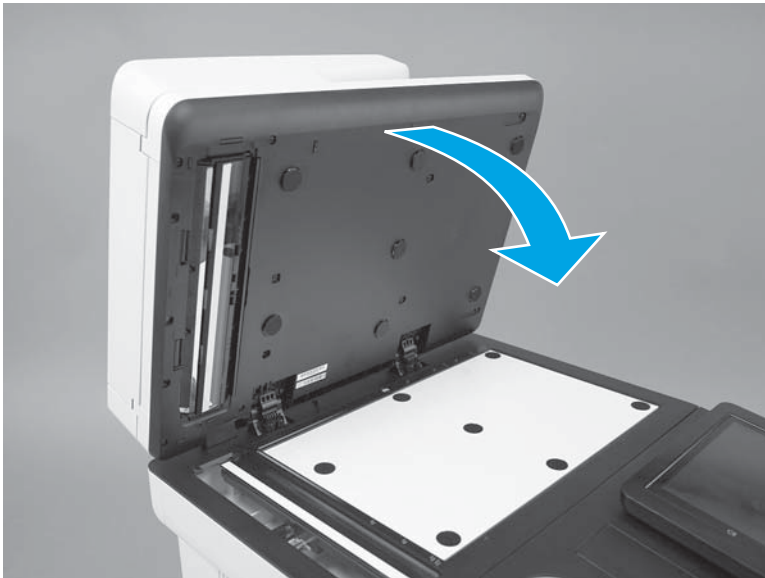
 **NOTE:** Place the corner of the backing that does not have a hook-and-loop fastener in the upper-left corner of the scanner glass.

**Figure 1-223** Install the white backing



5. Close the document feeder.

**Figure 1-224** Close the document feeder



6. Open the document feeder and make sure that the white backing is securely attached.

**Figure 1-225** Check the white backing



7. Close the document feeder.

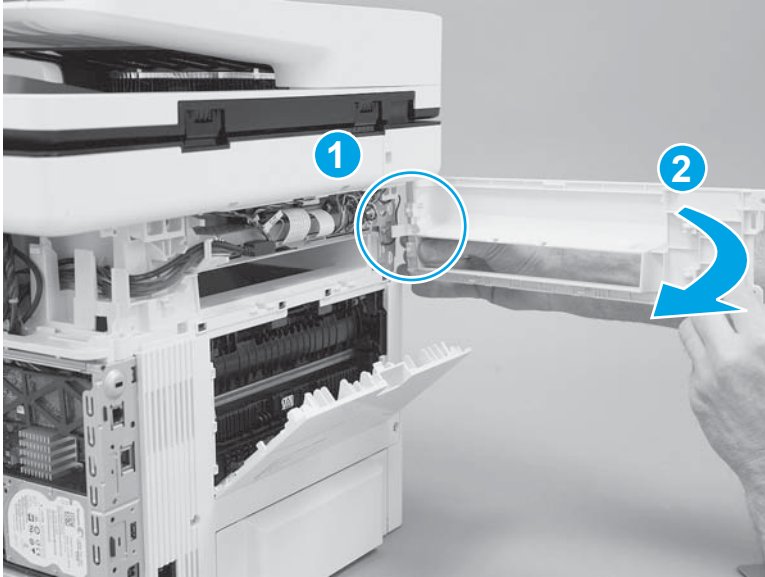
**Figure 1-226** Close the document feeder



### **Step 8: Install the top-rear cover**

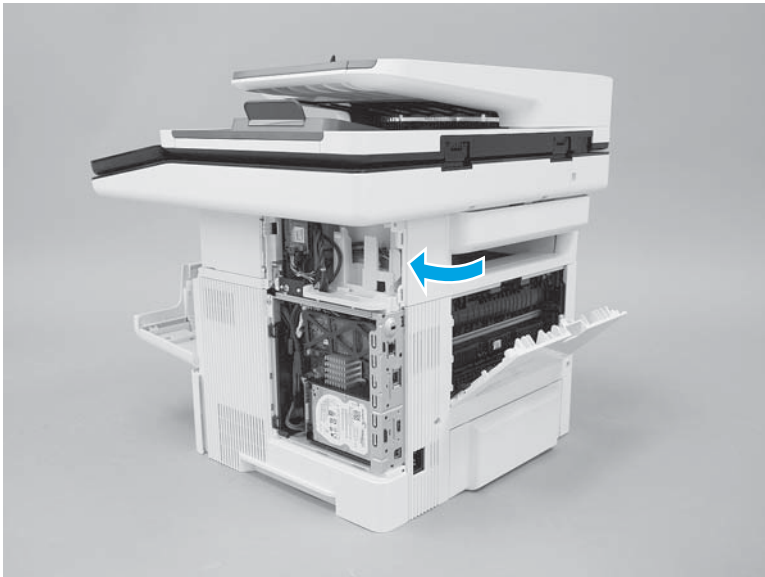
1. Engage one boss (callout 1), and then rotate the cover towards the printer (callout 2).

**Figure 1-227** Engage one boss



2. Continue to rotate the cover toward the printer to install it.

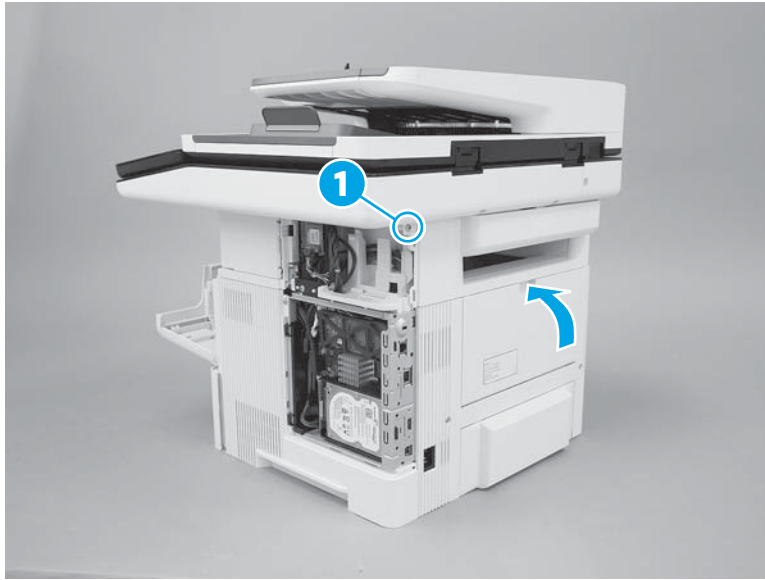
**Figure 1-228** Install the cover





3. Install one screw (callout 1), and then close the rear door.

**Figure 1-229** Install one screw



#### **Step 9: Install the top-left cover**

1. Position the front edge of the cover on the printer, and then slide the cover toward the front of the printer to engage two bosses at the front of the cover.

**Figure 1-230** Slide the cover




2. Rotate the cover towards the printer to engage two tabs at the middle of the cover.

**Figure 1-231** Engage two tabs



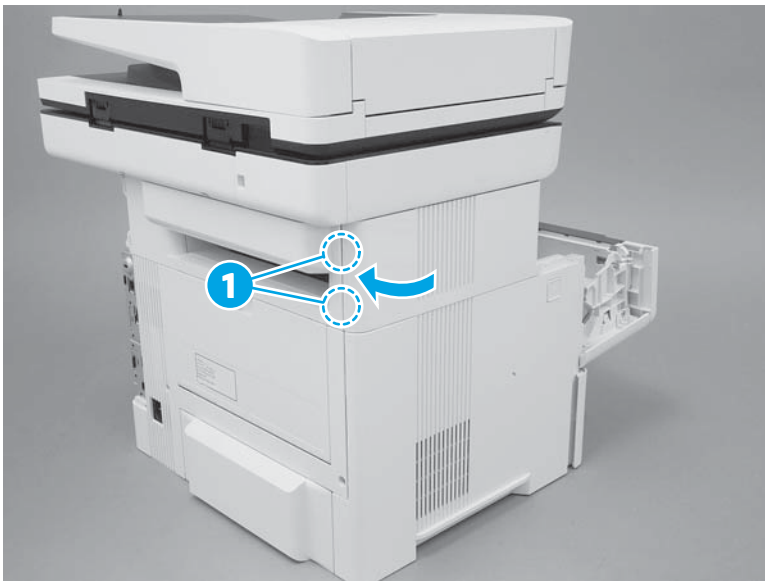
3. Continue to rotate the cover onto the printer to engage two tabs (callout 1) at the rear edge of the cover.

---

 **NOTE:** Close the toner-cartridge door.

---

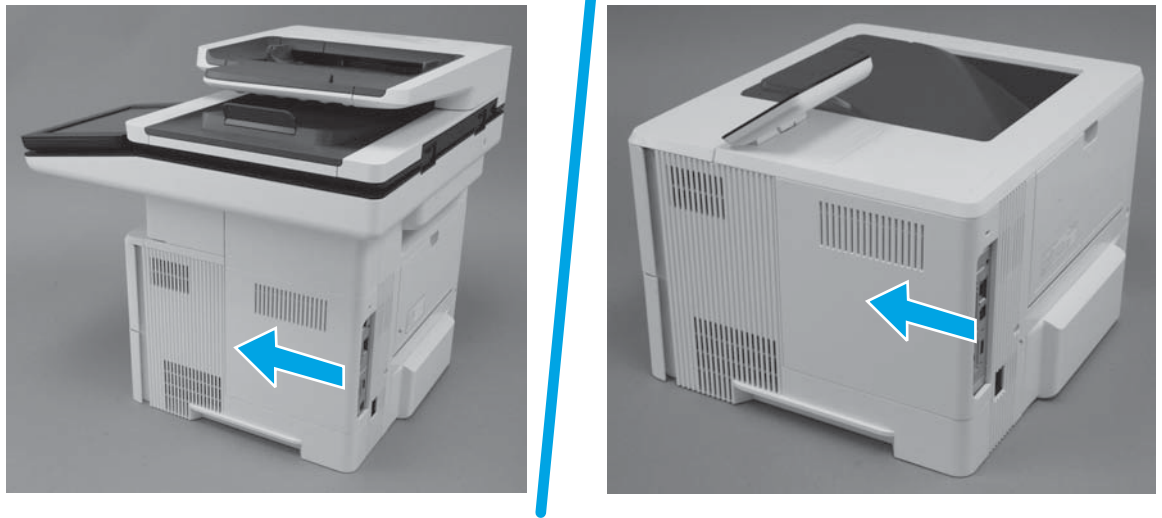
**Figure 1-232** Engage two tabs



### Step 10: Install the formatter cover

- ▲ Slide it toward the front of the printer to install it.

**Figure 1-233** Install the formatter cover



### Step 11: Reset the firmware counter

1. From the Home screen on the control panel, scroll to and touch the [Device Maintenance](#) button.
2. Scroll to and touch the [Service](#) button.
3. On the sign-in screen, select the [Service Access Code](#) option from the drop-down list.
4. Enter the following service access code for this printer: 10052715.
5. Scroll to and touch the [Cycle Counts](#) item.
6. Reset the following items:
  - [Document Feeder Kit Interval](#); set to zero
  - [ADF Count](#); set to zero

## Removal and replacement: Cartridge door assembly

- [Introduction](#)
- [Step 1: Remove the tray](#)
- [Step 2: Remove the cartridge door assembly](#)
- [Step 3: Unpack the replacement assembly](#)
- [Step 4: Install the cartridge door assembly](#)
- [Step 5: Install the tray](#)


### Introduction

This document provides the procedures to remove and replace the cartridge door assembly.

### Before performing service

#### Turn the printer power off

- Disconnect the power cable.

 **WARNING!** To avoid damage to the printer, turn the printer off wait 30 seconds, and then remove the power cable before attempting to service the printer.

Use the table below to identify the correct part number for your printer. To order the part, go to [www.hp.com/buy/parts](http://www.hp.com/buy/parts).

Cartridge door (toner) part number	
<b>F2A76-67912</b>	Cartridge door assembly kit (M527; all) with instruction guide <sup>1</sup>
<b>F2A68-667919</b>	Cartridge door assembly kit (M506n/dn) with instruction guide <sup>1</sup>
<b>F2A68-67920</b>	Cartridge door assembly kit (M506x) with instruction guide <sup>1</sup>
<b>RM2-5677-000CN</b>	Cartridge door assembly (M501)
<b>J8H60-40001</b>	Nameplate, LaserJet Pro M501
<b>Hinge, cartridge door left</b>	RC4-3010-000CN
<b>Link, pressure release</b>	RC4-4479-000CN

<sup>1</sup> This kit includes the printer nameplates.

### Required tools

- Small flat-blad screwdriver.

### After performing service

#### Turn the printer power on

- Connect the power cable.
- Use the power switch to turn the power on.

## Post service test

Make sure that the toner-cartridge door correctly opens and closes.

### Step 1: Remove the tray

1. Pull the tray straight out of the printer until it stops.

**Figure 1-234** Pull the tray out until it stops



2. Lift the front of the tray, and then pull it out of the printer to remove it.

**Figure 1-235** Release and remove the tray



### Step 2: Remove the cartridge door assembly

---

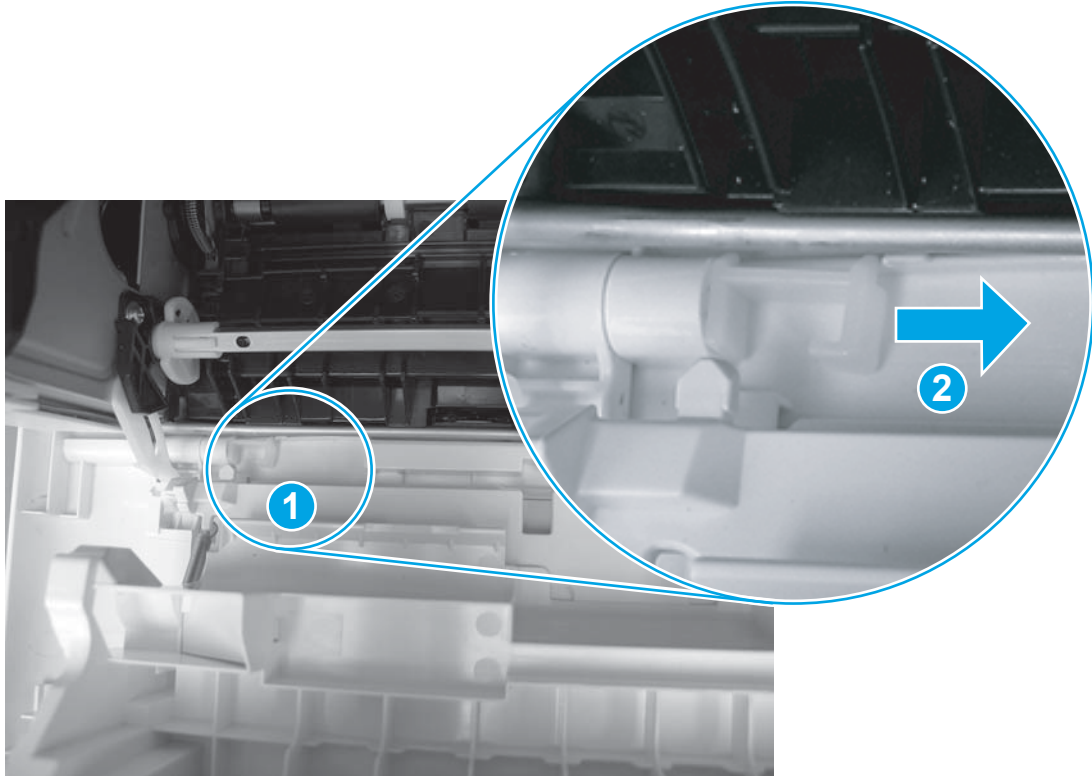
 **NOTE:** If the toner cartridge was not removed prior to servicing the printer, remove it now.

---

1. Release the support shaft (callout 1), and then slide it toward the center of the door (callout 2).

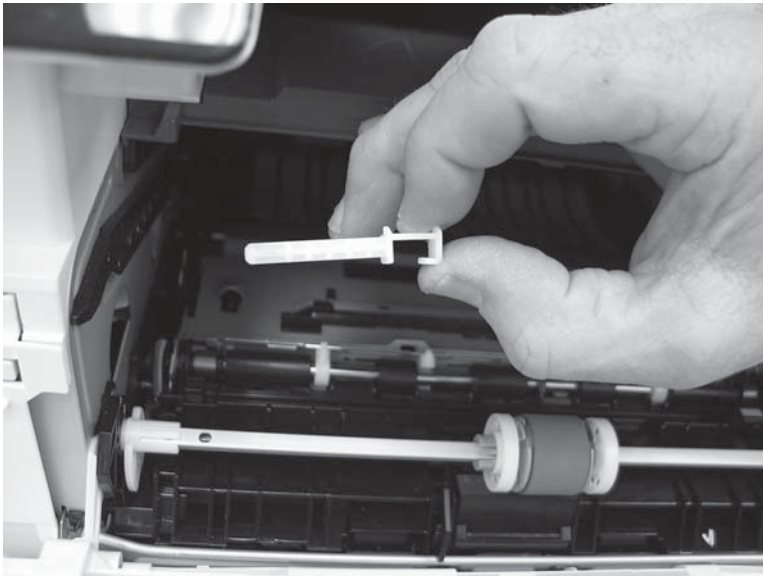
 **TIP:** It might be easier to release the support shaft by using a small flat-blad screwdriver.

**Figure 1-236** Release the support shaft



2. Remove the support shaft.

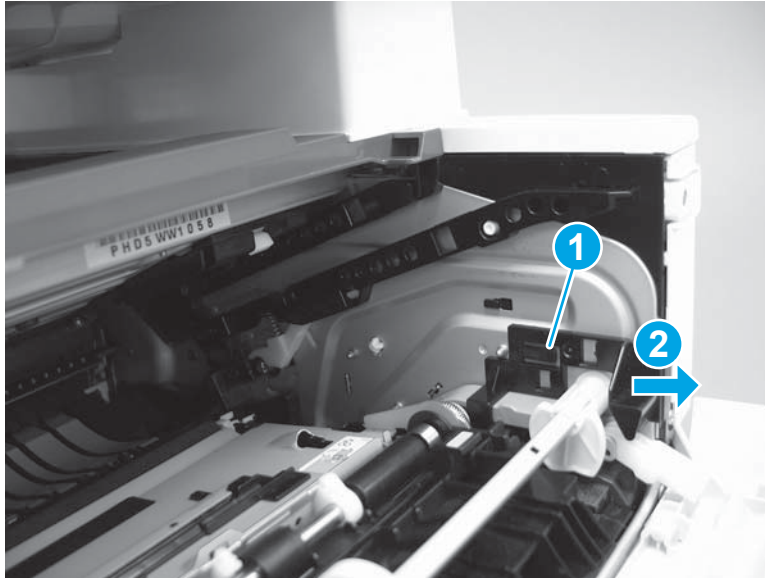
**Figure 1-237** Remove the support shaft



3. Release one tab (callout 1), and then slide the guide out of the printer (callout 2).

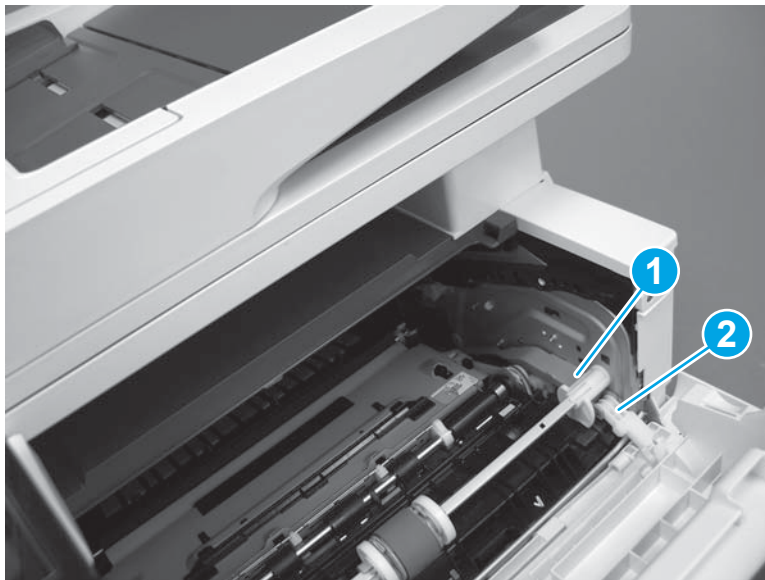
**CAUTION:** Be careful, the tab (callout 1) can be easily broken.

**Figure 1-238** Remove the guide



4. Use a small flat-blade screwdriver to gently pry the white-plastic door arm (callout 1) off of the gray-plastic pressure-release link (callout 2) to release the door arm.

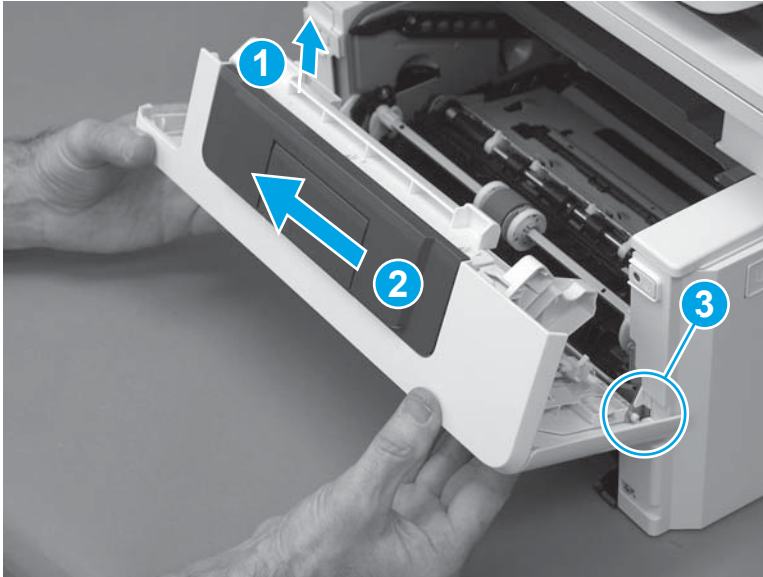
**Figure 1-239** Release the pressure-release link



5. With the door in the partially closed position, slightly raise the left end (callout 1; raise it over the sheet-metal hinge boss), and then slide the door to the left (callout 2) to release the right hinge (callout 3).

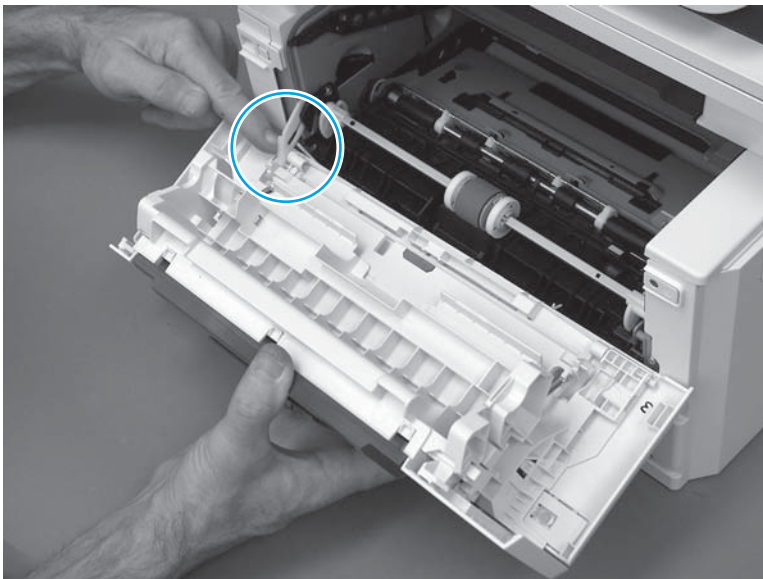
**⚠ CAUTION:** The door is still attached to the printer by the left-side retainer arm. Do not attempt to completely remove the door.

**Figure 1-240** Release the door



6. Rotate the door away from the printer until the keyed pin on the left-side retainer arm can disengage from the door.

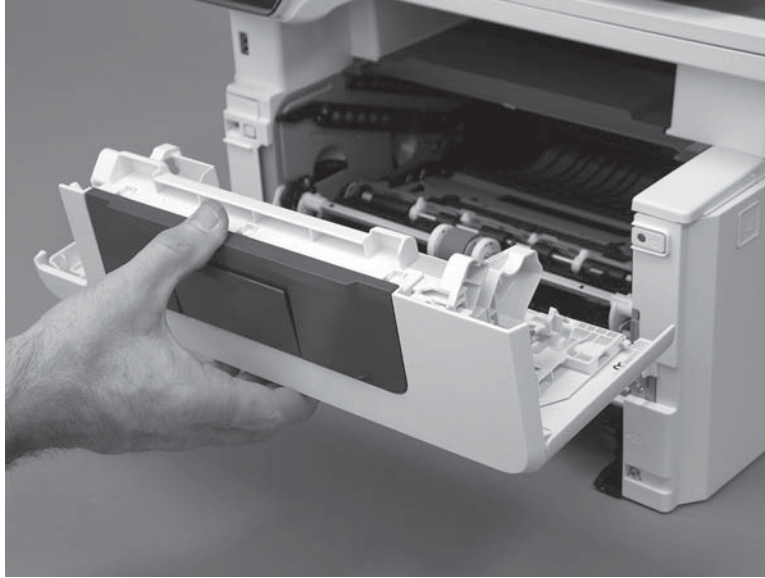
**Figure 1-241** Release the left-side retainer arm





7. Remove the door.

**Figure 1-242** Remove the door



### Step 3: Unpack the replacement assembly

Unpack the replacement part from the packaging.

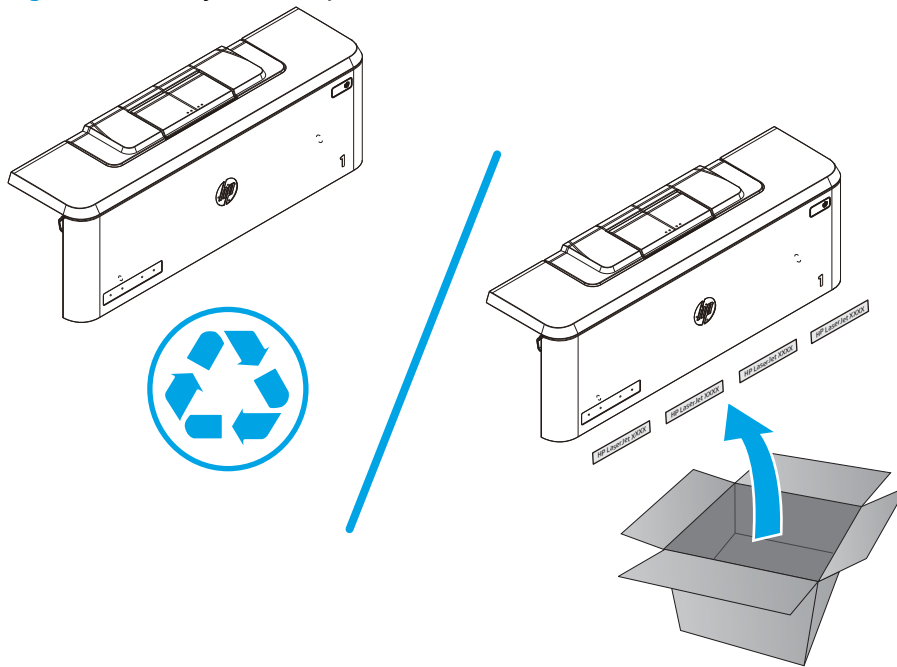
<http://www8.hp.com/us/en/hp-information/environment/product-recycling.html>

---

 **NOTE:** HP recommends responsible disposal of the defective part.

---

**Figure 1-243** Recycle and unpack

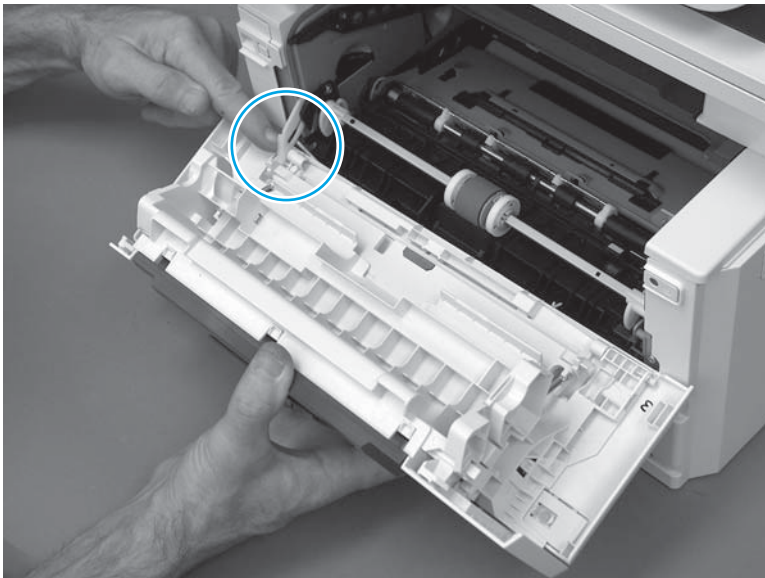


#### Step 4: Install the cartridge door assembly

1. Position the door close to the printer, and then engage the keyed pin on the left-side retainer arm with the hole in the door.


 **TIP:** It might be easier to engage the keyed pin with the hole by using a small flat-blad screwdriver.

**Figure 1-244** Engage the left-side retainer arm

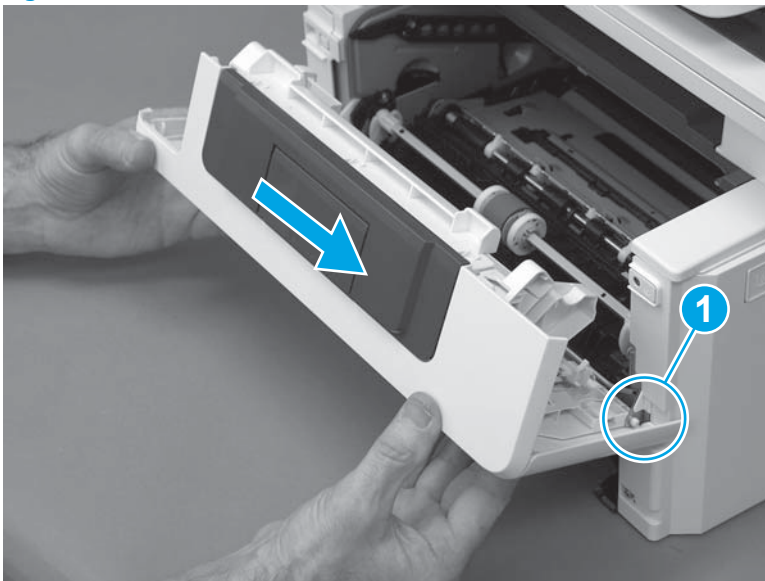


2. Engage the right-side door hinge pin with the hole in the chassis (callout 1).


 **NOTE:** There are two right-side hinge pins (not shown in callout 1).

 **TIP:** Keep a finger pressed on the left-side retainer arm so that it does not disengage from the door.

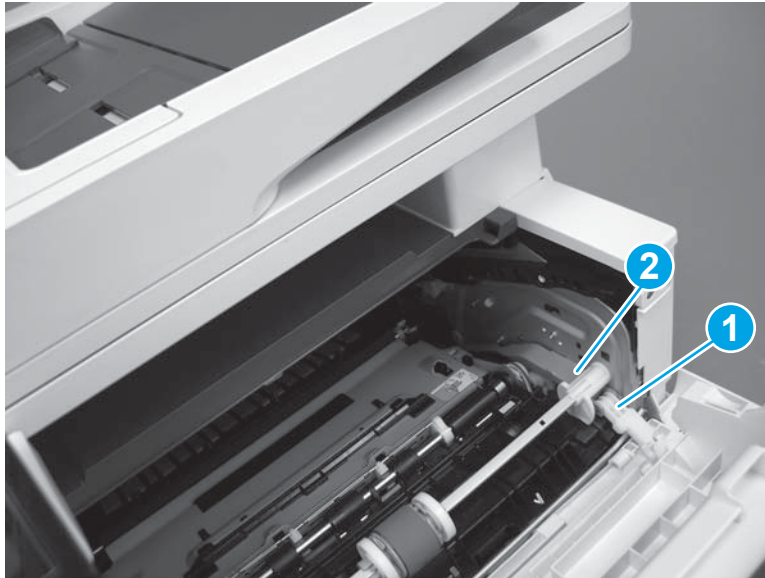
**Figure 1-245** Install the door



3. Install the gray-plastic pressure-release link (callout 1) onto the white-plastic door arm (callout 2).

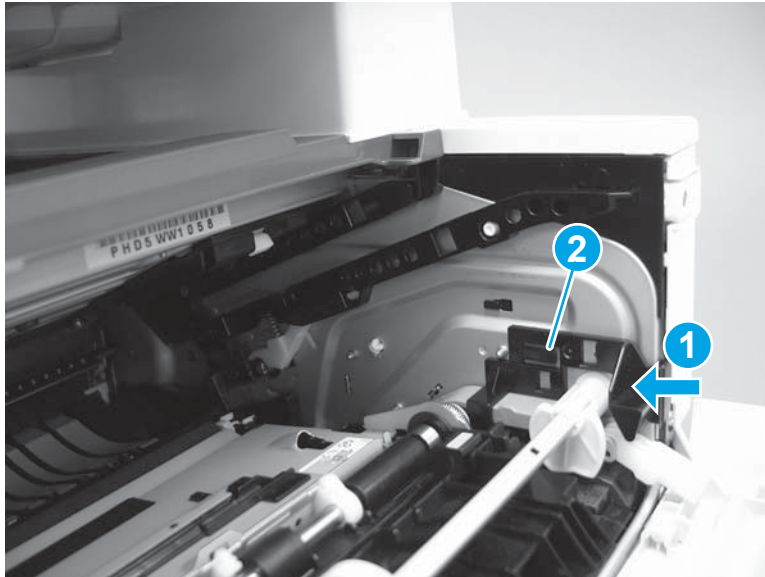
 **IMPORTANT:** Make sure that the arm snaps on to the link. Partially close and open the door to verify that the link (callout 2) moves in and out of the printer as the door closes/opens.

**Figure 1-246** Install the pressure-release link



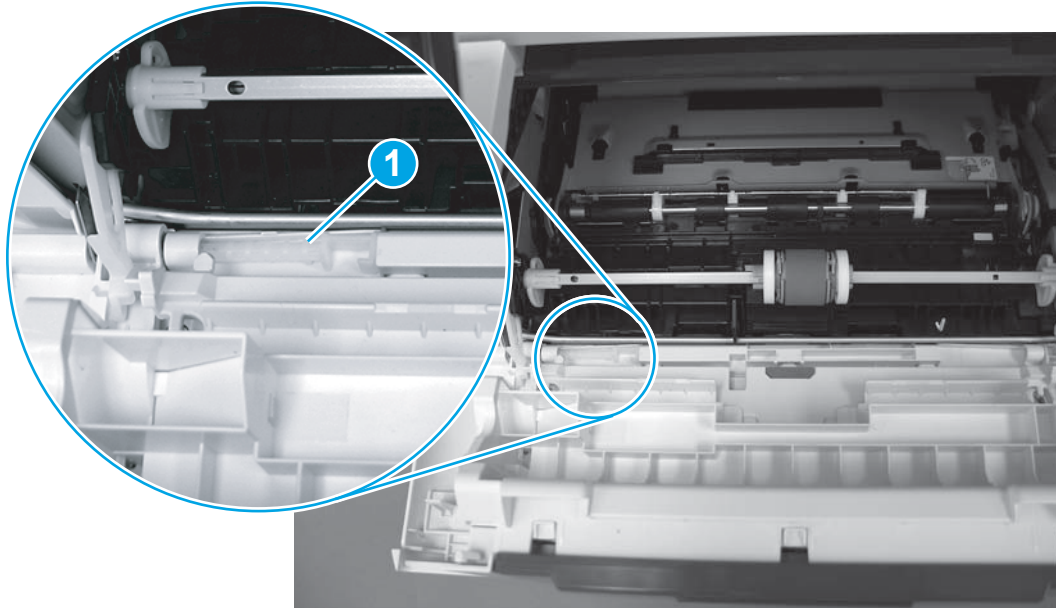
4. Slide the guide into the printer (callout 1), and then make sure that the tab (callout 2) snaps into place to secure the guide to the chassis.

**Figure 1-247** Install the guide





5. Position the support shaft on the door, and then align the left-side hinge on the door with the hole in the chassis (callout 1).

**Figure 1-248** Align the hinge

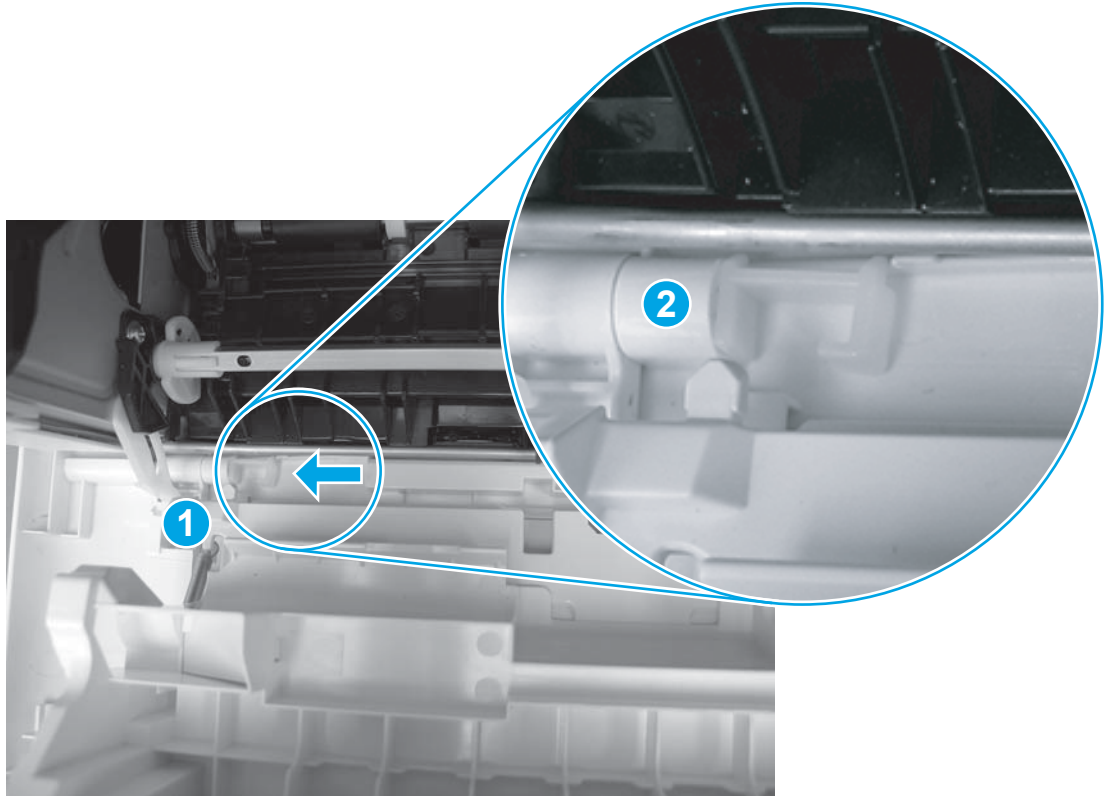


6. Push the shaft towards the left side of the printer to install it (callout 1).

 **NOTE:** Make sure that the support shaft is fully installed and correctly orientated (callout 2) so that it will not interfere with the door opening and closing.

 **Reinstallation tip:** If a replacement door was installed, make sure to install the nameplate (supplied in the kit) corresponding to the printer on the door.

**Figure 1-249** Install the support shaft



#### Step 5: Install the tray

1. With the tray at a slight angle, align the sides of the tray with the rails in the accessory, and then partially slide the tray into the printer.

**Figure 1-250** Install the tray



2. Push the tray straight into the accessory to close it.

**Figure 1-251** Close the tray



## Removal and replacement: Rear door assembly

- [Introduction](#)
- [Step 1: Remove the rear door assembly](#)
- [Step 2: Unpack the replacement assembly](#)
- [Step 3: Install the rear door assembly](#)

### Introduction

This document provides the procedures to remove and replace the rear door assembly.

### Before performing service

#### Turn the printer power off

- Disconnect the power cable.

**⚠ WARNING!** To avoid damage to the printer, turn the printer off wait 30 seconds, and then remove the power cable before attempting to service the printer.

Use the table below to identify the correct part number for your printer. To order the part, go to [www.hp.com/buy/parts](http://www.hp.com/buy/parts).

Rear door assembly part number	
<b>RM2-5726-000CN</b>	Rear door assembly (M527/M506/M501 duplex models)
<b>RM2-5712-000CN</b>	Rear door assembly (M506/M501 simplex models)

### Required tools

- #2 Phillips screwdriver with a magnetic tip.

### After performing service

#### Turn the printer power on

- Connect the power cable.
- Use the power switch to turn the power on.

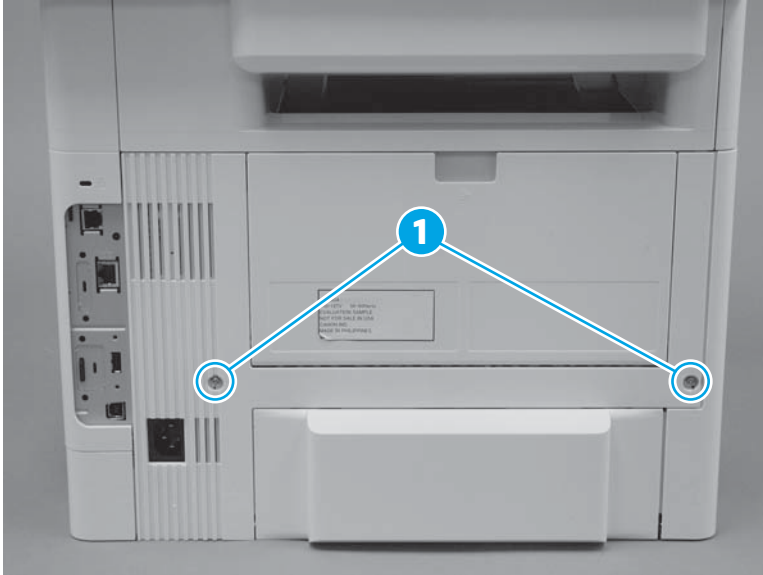
### Post service test

Print a configuration page to make sure that the printer is functioning correctly.

### Step 1: Remove the rear door assembly

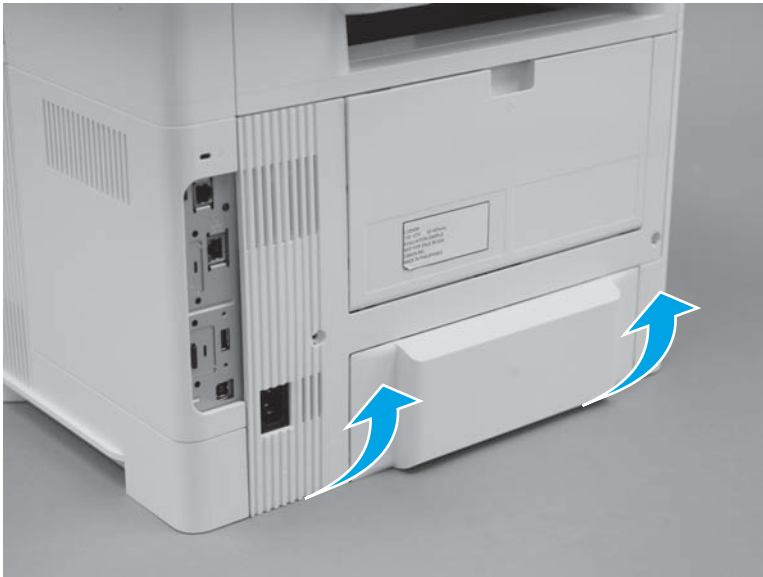
1. At the rear of the printer, remove two screws (callout 1).

**Figure 1-252** Remove two screws



2. Rotate the bottom edge of the assembly away from the printer to release it.

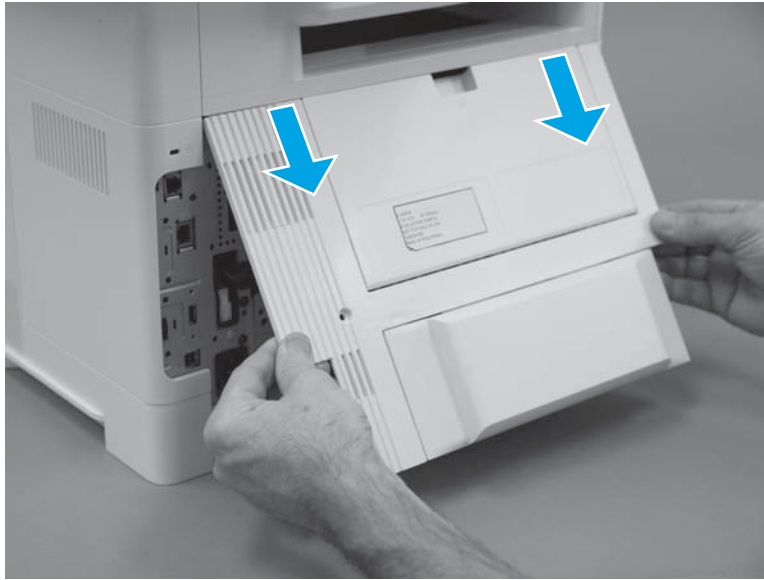
**Figure 1-253** Rotate the bottom of the cover





3. Pull down on the assembly to remove it.

**Figure 1-254** Remove the cover



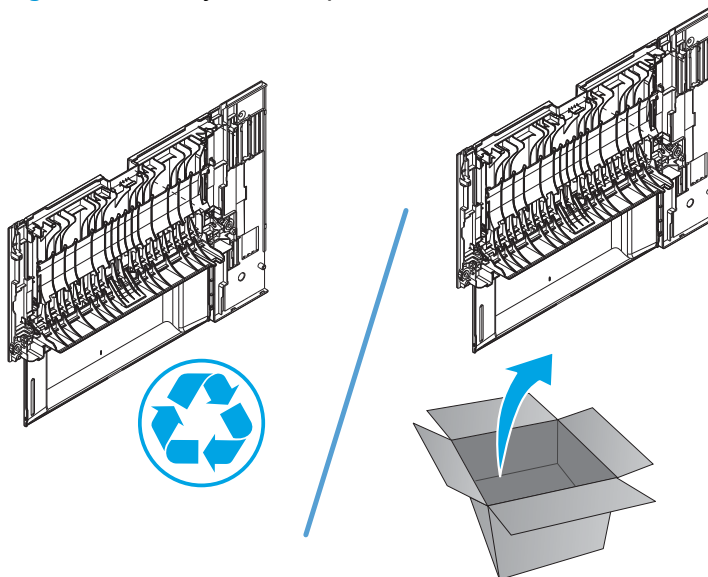
### Step 2: Unpack the replacement assembly

Unpack the replacement part from the packaging.

<http://www8.hp.com/us/en/hp-information/environment/product-recycling.html>

 **NOTE:** HP recommends responsible disposal of the defective part.

**Figure 1-255** Recycle and unpack



### Step 3: Install the rear door assembly

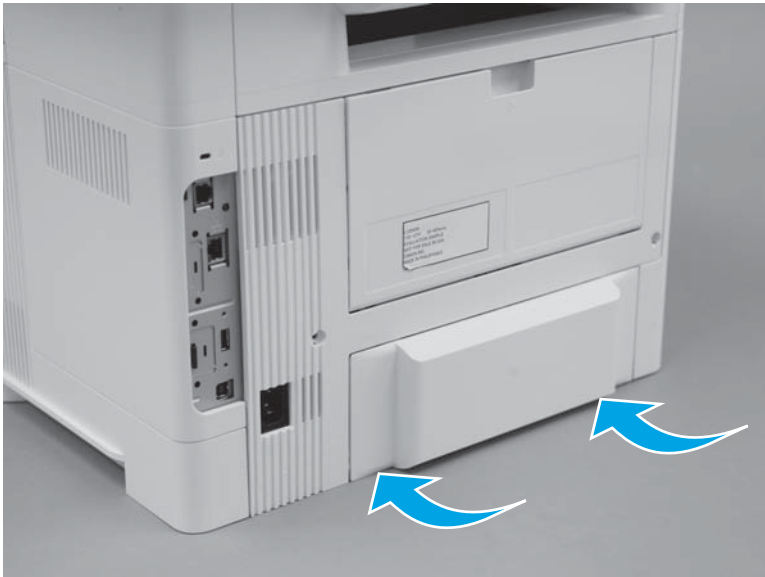
1. Engage the top edge of the assembly with the printer.

**Figure 1-256** Install the cover



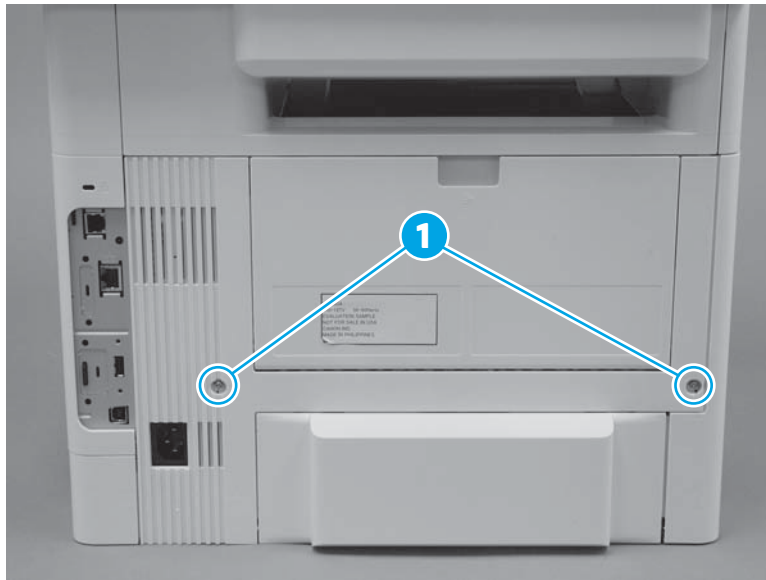
2. Rotate the bottom edge of the cover towards the printer.

**Figure 1-257** Rotate the bottom of the cover



3. Install two screws (callout 1).

**Figure 1-258** Install two screws



## Removal and replacement: Right cover

- [Introduction](#)
- [Step 1: Remove the tray](#)
- [Step 2: Remove the formatter cover](#)
- [Step 3: Remove the cartridge door assembly](#)
- [Step 4: Remove the rear door assembly](#)
- [Step 5: Remove the right cover](#)
- [Step 6: Unpack the replacement cover](#)
- [Step 7: Install the right cover](#)
- [Step 8: Install the rear door assembly](#)
- [Step 9: Install the cartridge door assembly](#)
- [Step 10: Install the formatter cover](#)
- [Step 11: Install the tray](#)


### Introduction

This document provides the procedures to remove and replace the right cover.

### Before performing service

#### Turn the printer power off

- Disconnect the power cable.

 **WARNING!** To avoid damage to the printer, turn the printer off wait 30 seconds, and then remove the power cable before attempting to service the printer.

Use the table below to identify the correct part number for your printer. To order the part, go to [www.hp.com/buy/parts](http://www.hp.com/buy/parts).

Right cover part number	
RC4-4437-000CN	Right cover

### Required tools

- #2 Phillips screwdriver with a magnetic tip.

### After performing service

#### Turn the printer power on

- Connect the power cable.
- Use the power switch to turn the power on.

## Post service test

Make sure that the printer initializes to a **Ready** state.

### Step 1: Remove the tray

1. Pull the tray straight out of the printer until it stops.

**Figure 1-259** Pull the tray out until it stops



2. Lift the front of the tray, and then pull it out of the printer to remove it.

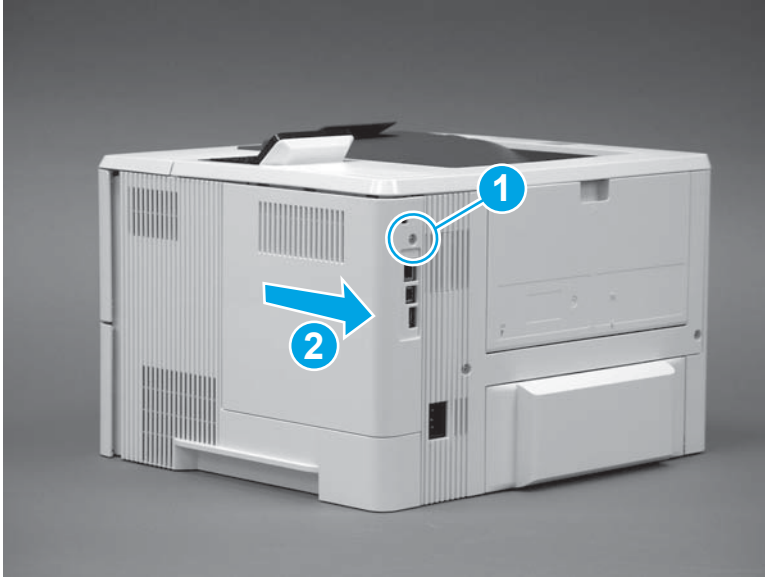
**Figure 1-260** Release and remove the tray



### Step 2: Remove the formatter cover

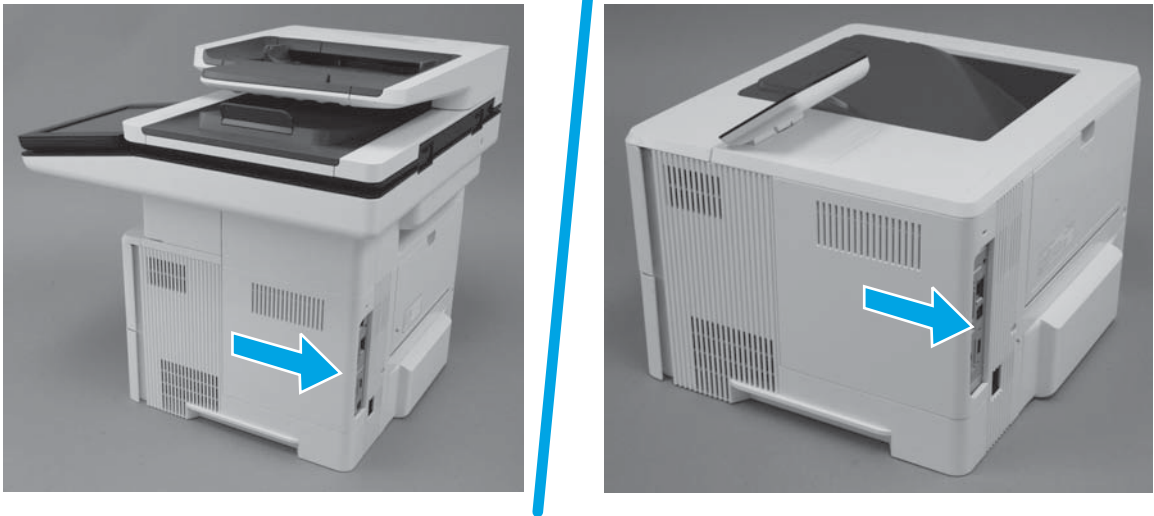
1. **M501:** Remove one screw (callout 1), and then slide the cover toward the rear of the printer to remove it (callout 2).

**Figure 1-261** Remove the formatter cover (M501)



2. **M506/M527:** Slide the cover toward the rear of the printer to remove it.

**Figure 1-262** Remove the formatter cover (M506/M527)



### Step 3: Remove the cartridge door assembly



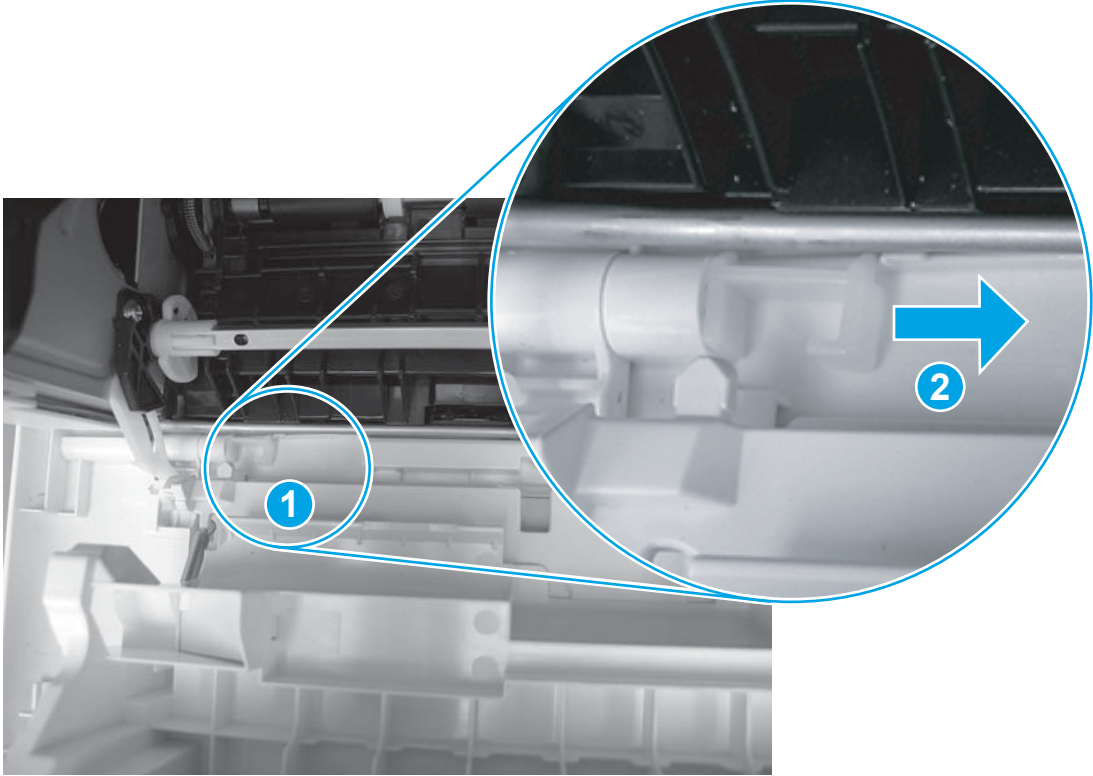
**NOTE:** If the toner cartridge was not removed prior to servicing the printer, remove it now.

1. Release the support shaft (callout 1), and then slide it toward the center of the door (callout 2).



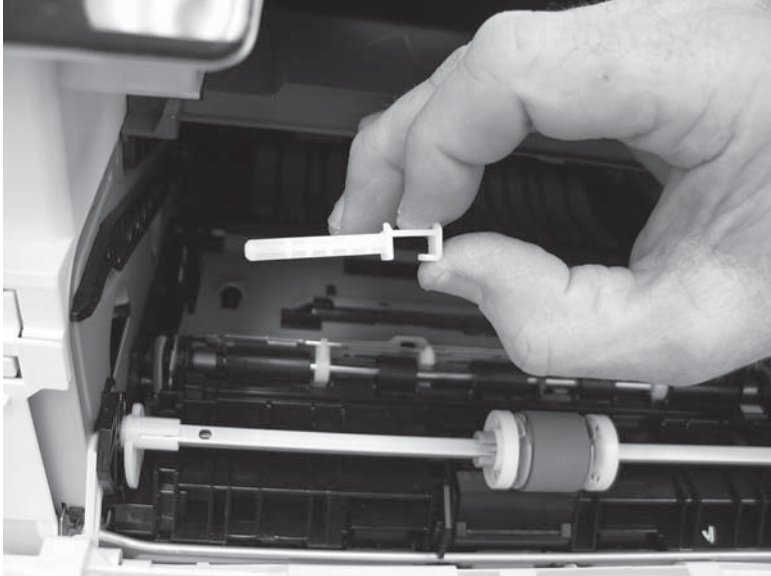
**TIP:** It might be easier to release the support shaft by using a small flat-blade screwdriver.

**Figure 1-263** Release the support shaft



- 2. Remove the support shaft.

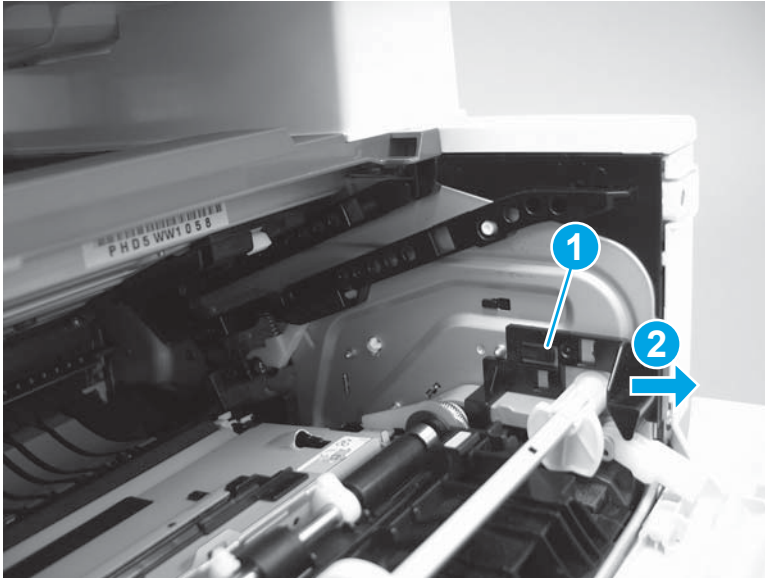
**Figure 1-264** Remove the support shaft



3. Release one tab (callout 1), and then slide the guide out of the printer (callout 2).

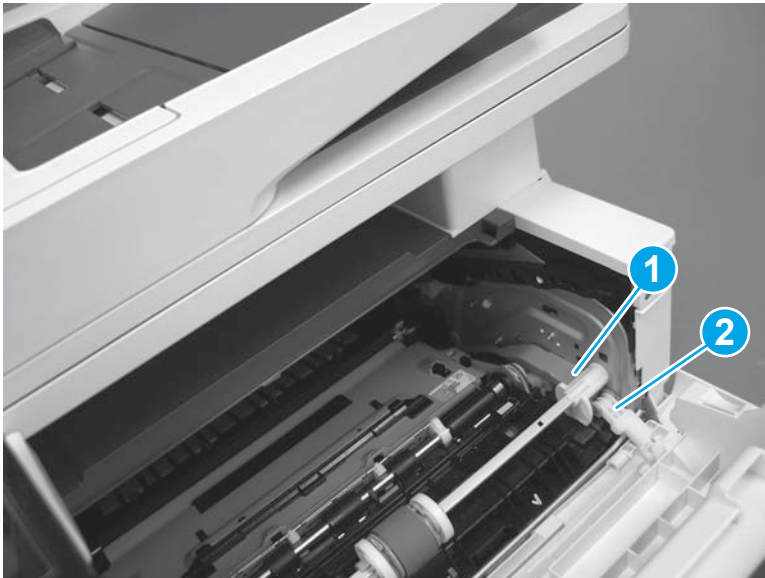
**⚠ CAUTION:** Be careful, the tab (callout 1) can be easily broken.

**Figure 1-265** Remove the guide



4. Use a small flat-blad screwdriver to gently pry the white-plastic door arm (callout 1) off of the gray-plastic pressure-release link (callout 2) to release the door arm.

**Figure 1-266** Release the pressure-release link

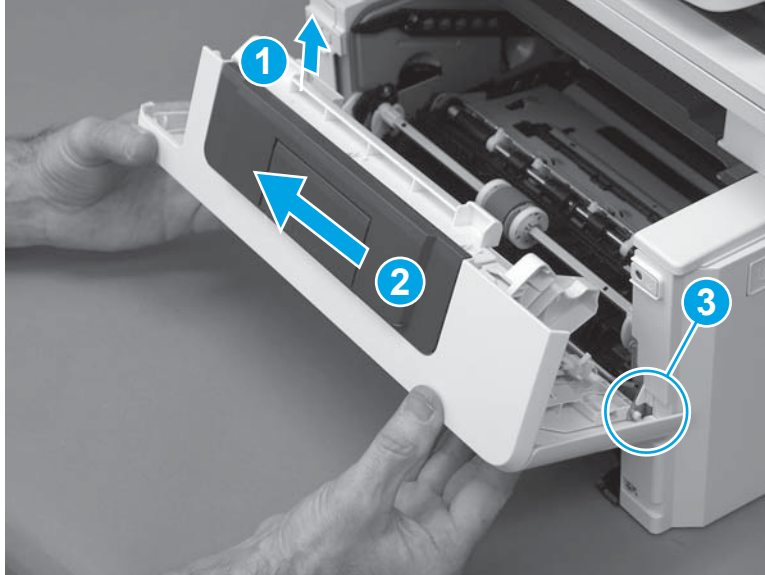




5. With the door in the partially closed position, slightly raise the left end (callout 1; raise it over the sheet-metal hinge boss), and then slide the door to the left (callout 2) to release the right hinge (callout 3).

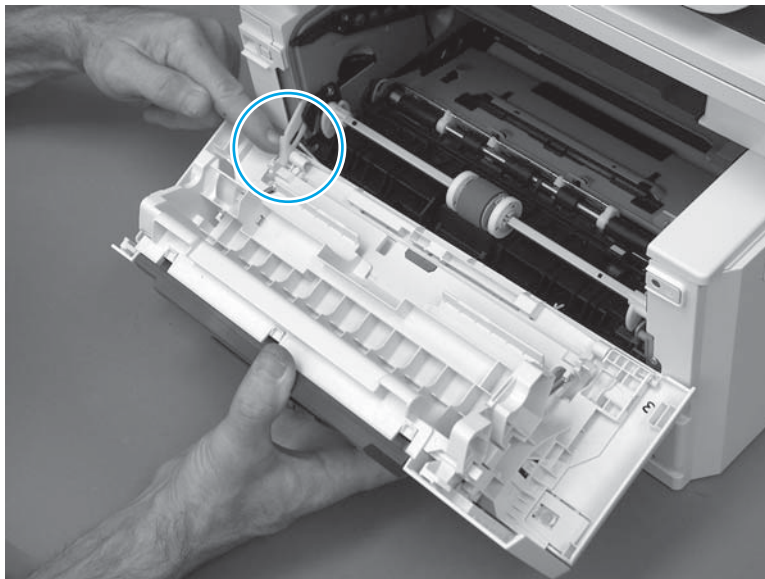
**CAUTION:** The door is still attached to the printer by the left-side retainer arm. Do not attempt to completely remove the door.

**Figure 1-267** Release the door



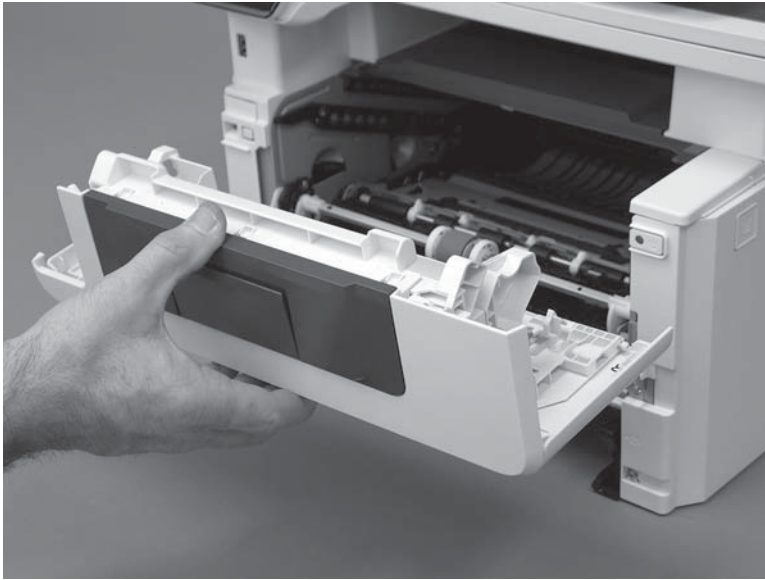
6. Rotate the door away from the printer until the keyed pin on the left-side retainer arm can disengage from the door.

**Figure 1-268** Release the left-side retainer arm



7. Remove the door.

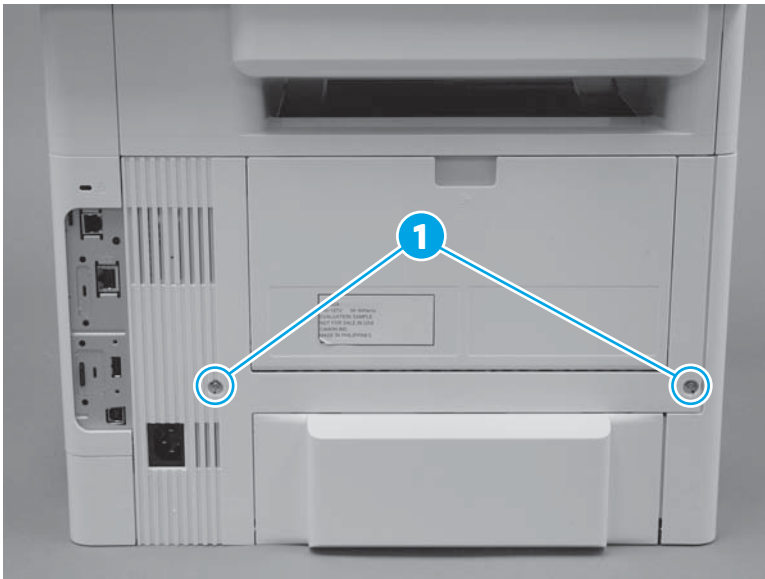
**Figure 1-269** Remove the door



#### Step 4: Remove the rear door assembly

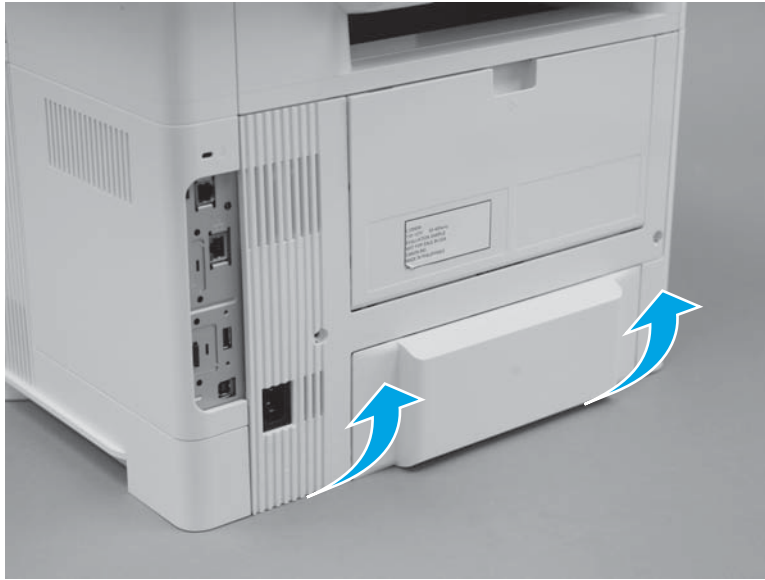
1. At the rear of the printer, remove two screws (callout 1).

**Figure 1-270** Remove two screws



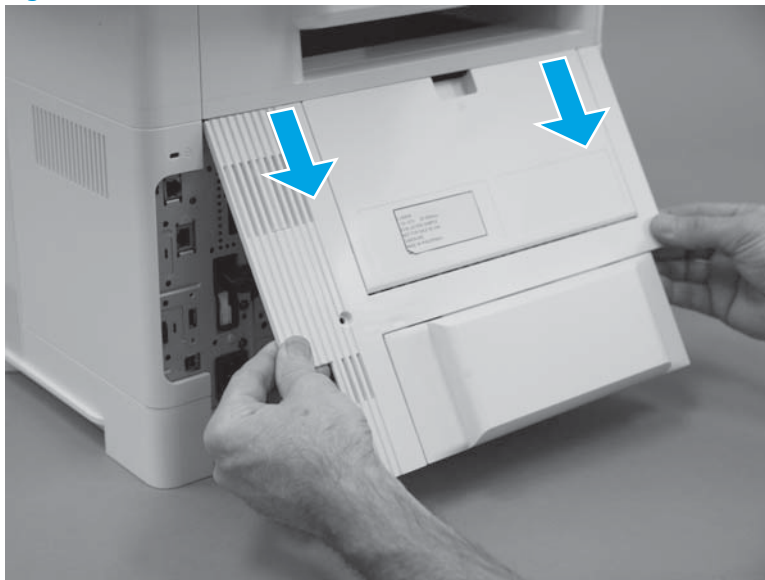
2. Rotate the bottom edge of the assembly away from the printer to release it.

**Figure 1-271** Rotate the bottom of the cover




3. Pull down on the assembly to remove it.


**Figure 1-272** Remove the cover



### Step 5: Remove the right cover

---

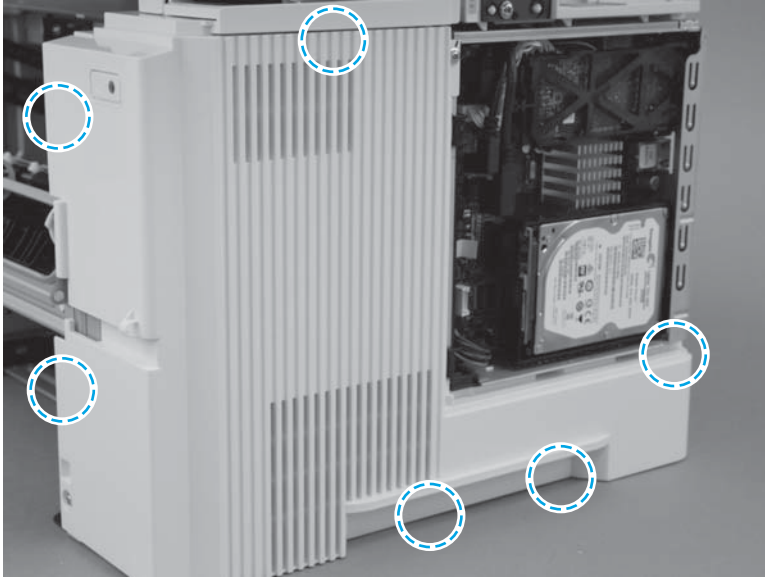
 **IMPORTANT:** The black-plastic cassette front and rear guides (located inside the tray cavity) can be easily dislodged. Do not lose the guides when the cover is removed or installed.

 **NOTE:** The M527 printer is shown in this procedure. However, this procedure is valid for the M501/M506 printers.

---

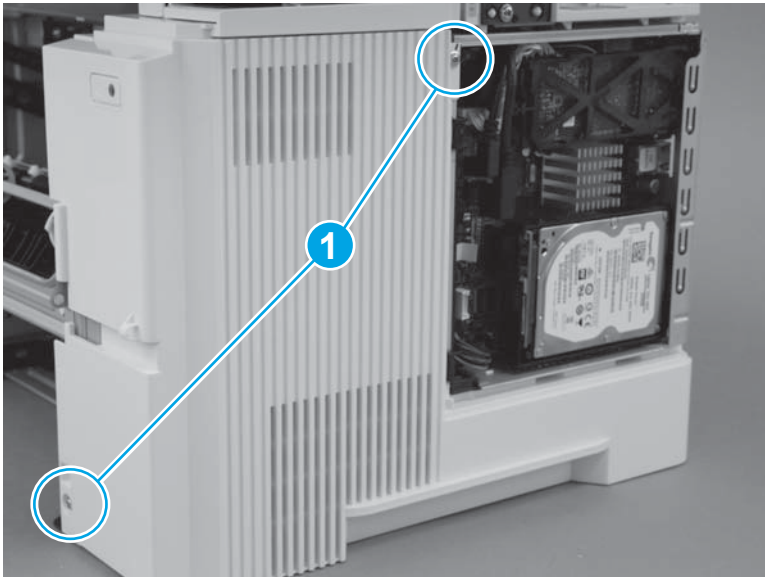
1. Before proceeding, take note of the location of the tabs and bosses on the inside of the cover.

**Figure 1-273** Locate the tabs and bosses



2. Remove two screws (callout 1).

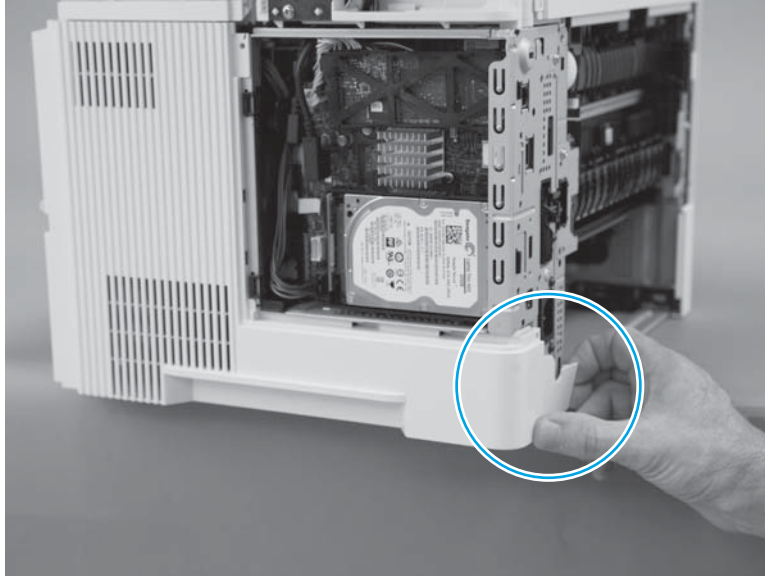
**Figure 1-274** Remove two screws



3. At the rear of the printer, release one boss.

**CAUTION:** It might be easier to remove the cover with the printer slightly hanging over the edge of the workspace. Do not let the printer tip and fall off of the workspace when removing the cover.

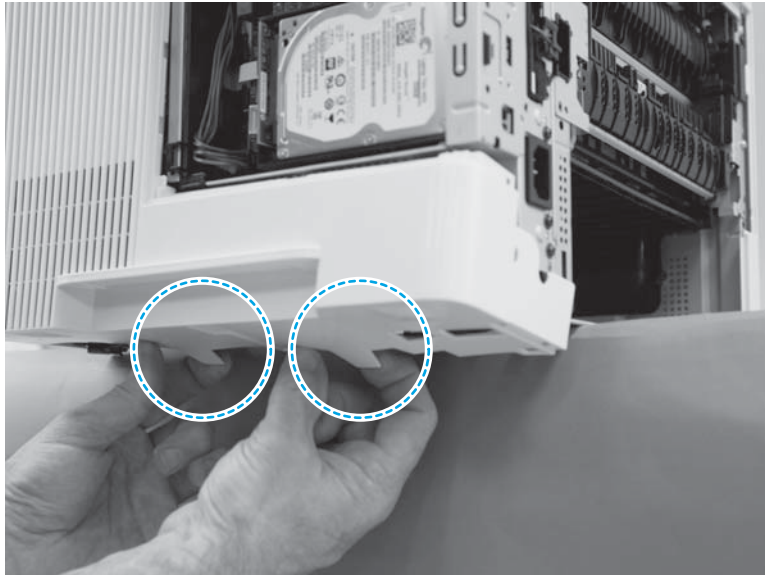
**Figure 1-275** Release one boss



4. At the bottom edge of the cover, release two bosses.

**CAUTION:** It might be easier to remove the cover with the printer slightly hanging over the edge of the workspace. Do not let the printer tip and fall off of the workspace when removing the cover.

**Figure 1-276** Release two bosses

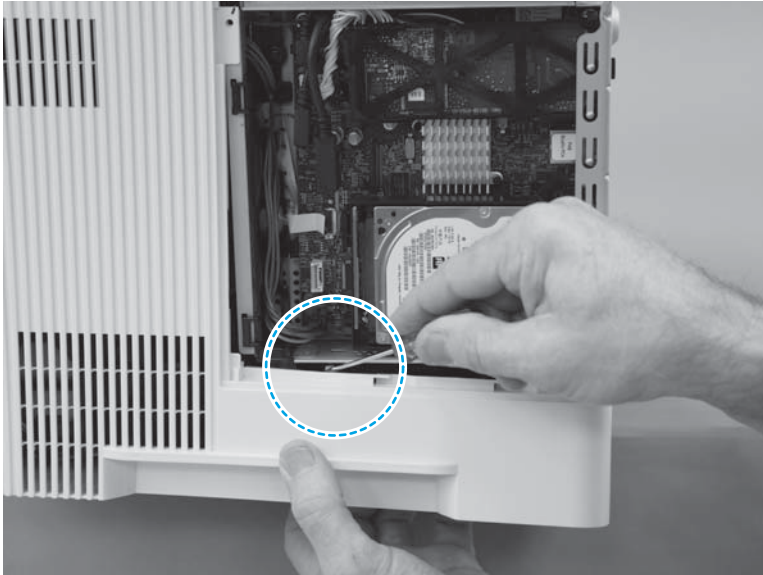


5. Near the formatter, release one tab.

**CAUTION:** It might be easier to remove the cover with the printer slightly hanging over the edge of the workspace. Do not let the printer tip and fall off of the workspace when removing the cover.

**TIP:** Hold the bottom of the cover away from the printer, and then use a small flat-blade screw driver to easily release this tab.

**Figure 1-277** Release one tab

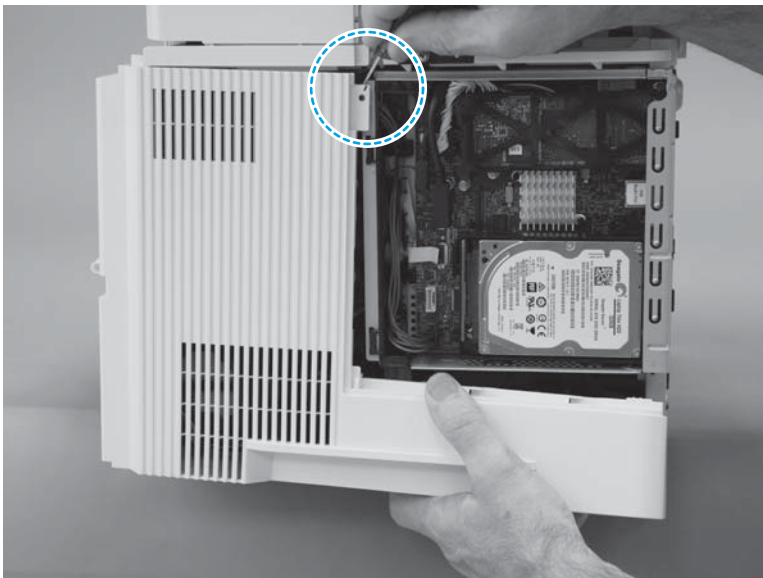


6. At the top rear edge of the cover, release one tab.

**CAUTION:** It might be easier to remove the cover with the printer slightly hanging over the edge of the workspace. Do not let the printer tip and fall off of the workspace when removing the cover.

**TIP:** Use a small flat-blade screw driver to easily release this tab.

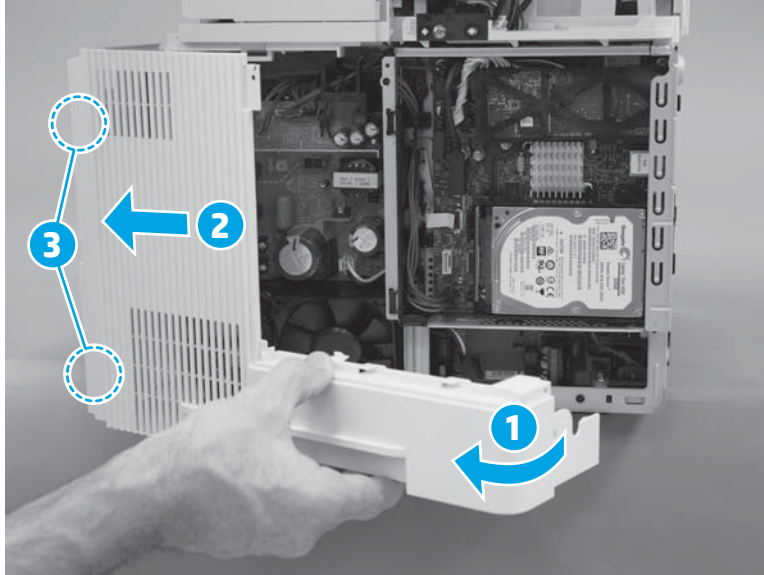
**Figure 1-278** Release one tab



7. Rotate the rear of the cover away from the printer (callout 1), slide the cover toward the front of the printer (callout 2) to release two bosses (callout 3), and then remove the cover.

**CAUTION:** It might be easier to remove the cover with the printer slightly hanging over the edge of the workspace. Do not let the printer tip and fall off of the workspace when removing the cover.

**Figure 1-279** Remove the cover



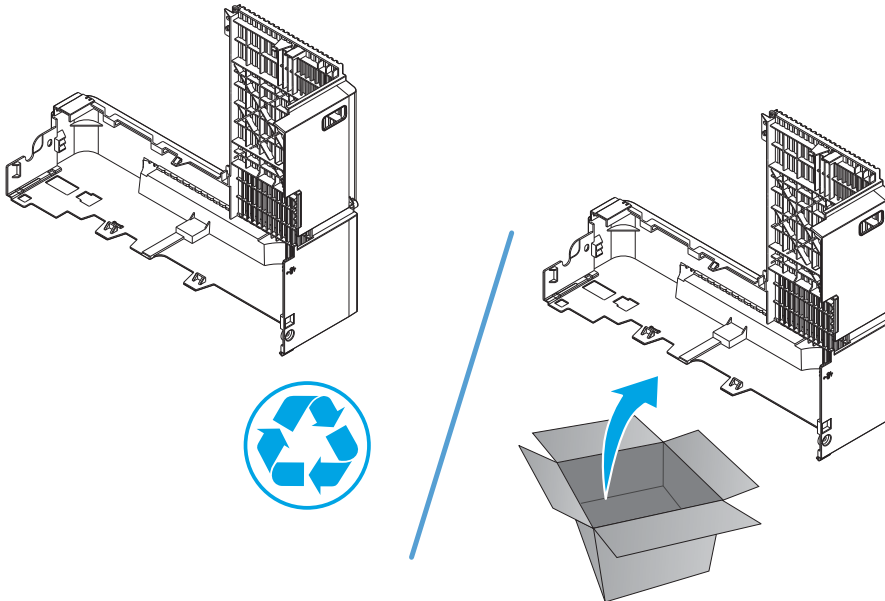
### Step 6: Unpack the replacement cover

Unpack the replacement part from the packaging.


<http://www8.hp.com/us/en/hp-information/environment/product-recycling.html>


**NOTE:** HP recommends responsible disposal of the defective part.

**Figure 1-280** Recycle and unpack



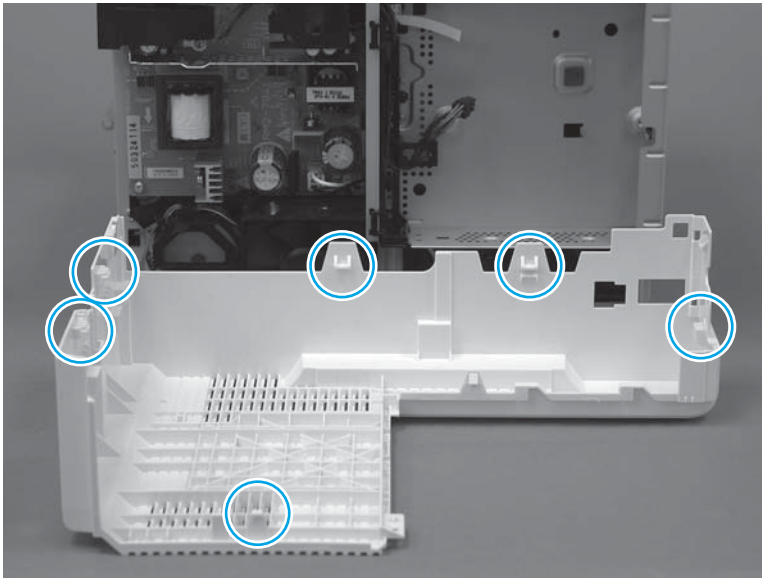
## Step 7: Install the right cover

 **IMPORTANT:** The black-plastic cassette front and rear guides (located inside the tray cavity) can be easily dislodged. Do not lose the guides when the cover is removed or installed.

 **NOTE:** The M527 printer is shown in this procedure. However, this procedure is valid for the M501/M506 printers.

1. Before proceeding, take note of the location of the tabs and bosses on the inside of the cover.

**Figure 1-281** Locate the tabs and bosses



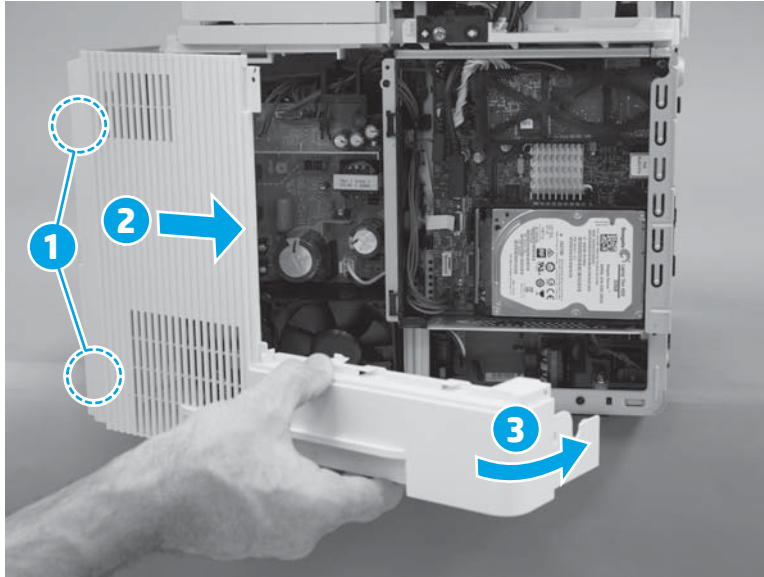


2. At the front of the cover engage two bosses (callout 1/2), and then rotate the rear of the cover toward the printer (callout 3).

**CAUTION:** It might be easier to install the cover with the printer slightly hanging over the edge of the workspace. Do not let the printer tip and fall off of the workspace when removing the cover.

**TIP:** Make sure that the power switch at the front of the printer is positioned in the opening in the cover and that it does not interfere with the cover installation.

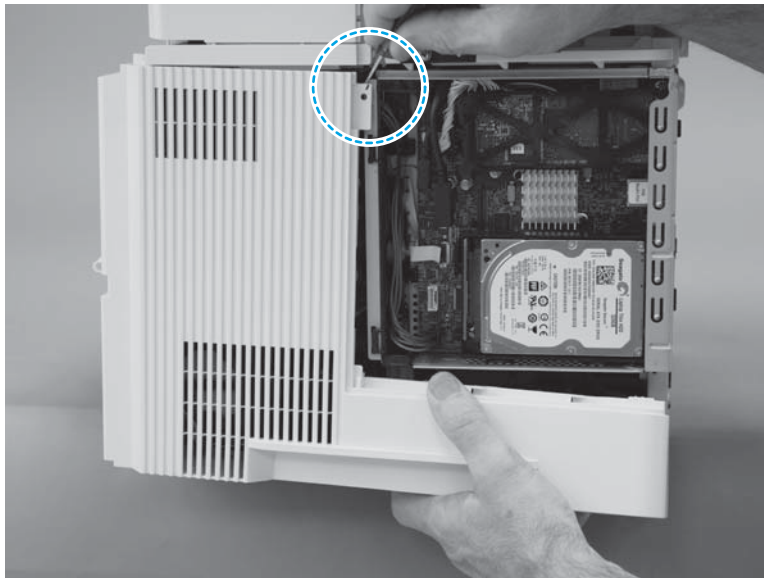
**Figure 1-282** Install the cover



3. At the top rear edge of the cover, engage one tab.

**CAUTION:** It might be easier to install the cover with the printer slightly hanging over the edge of the workspace. Do not let the printer tip and fall off of the workspace when removing the cover.

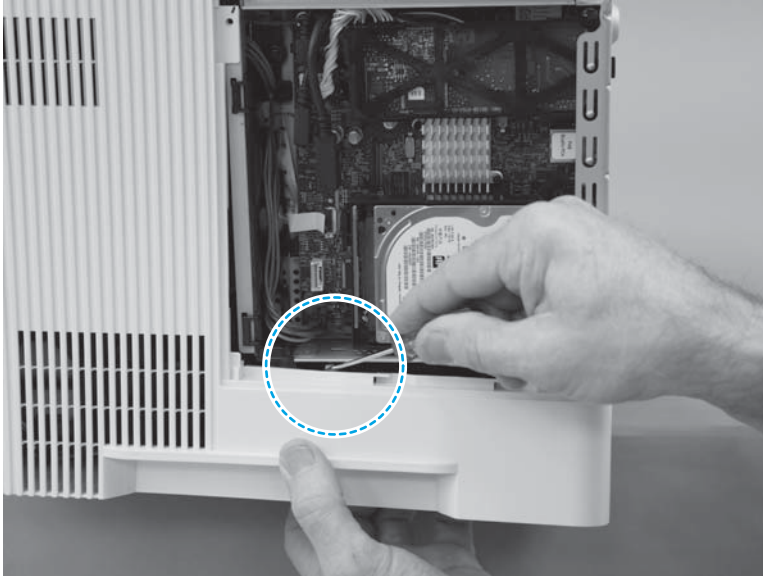
**Figure 1-283** Engage one tab



4. Near the formatter, engage one tab.

**CAUTION:** It might be easier to install the cover with the printer slightly hanging over the edge of the workspace. Do not let the printer tip and fall off of the workspace when removing the cover.

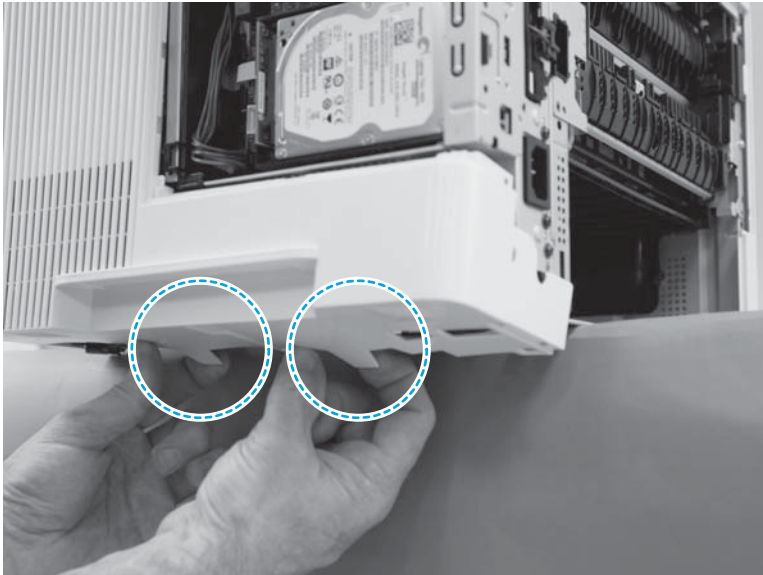
**Figure 1-284** Engage one tab



5. At the bottom edge of the cover, engage two bosses.

**CAUTION:** It might be easier to install the cover with the printer slightly hanging over the edge of the workspace. Do not let the printer tip and fall off of the workspace when removing the cover.

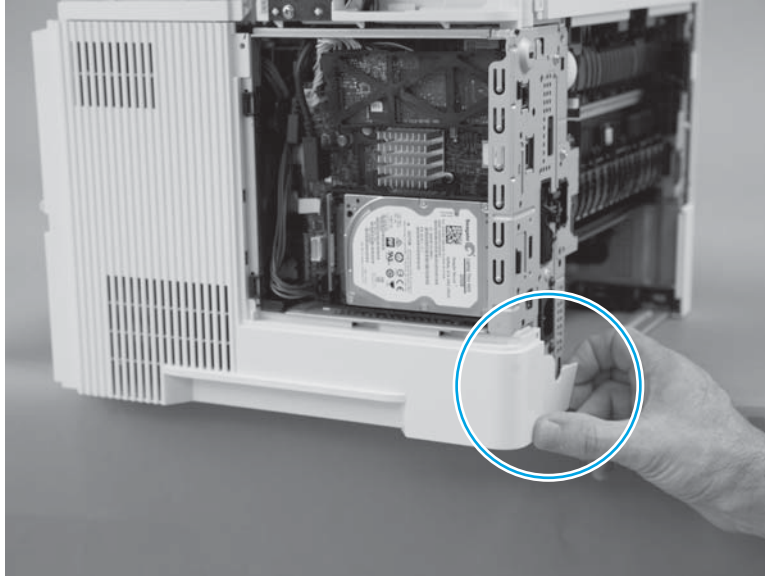
**Figure 1-285** Engage two bosses



6. At the rear of the printer, engage one boss.

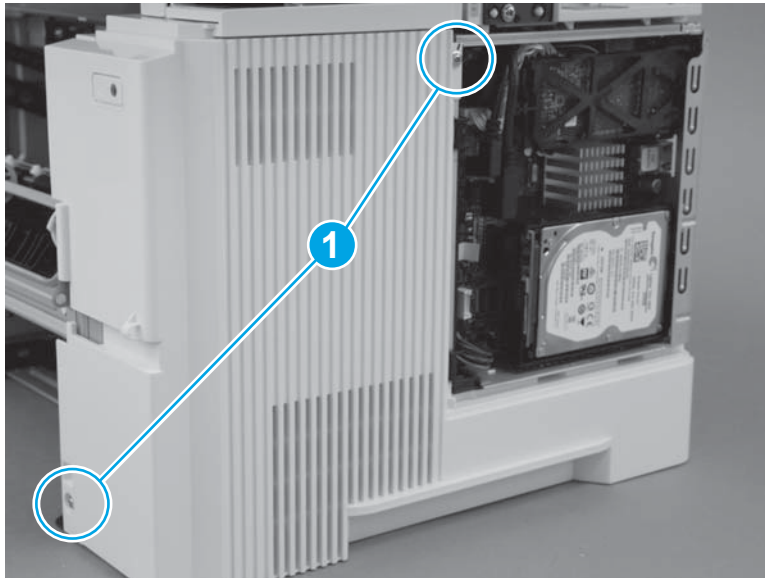
**⚠ CAUTION:** It might be easier to install the cover with the printer slightly hanging over the edge of the workspace. Do not let the printer tip and fall off of the workspace when removing the cover.

**Figure 1-286** Engage one boss



7. Install two screws (callout 1).

**Figure 1-287** Install two screws



### Step 8: Install the rear door assembly

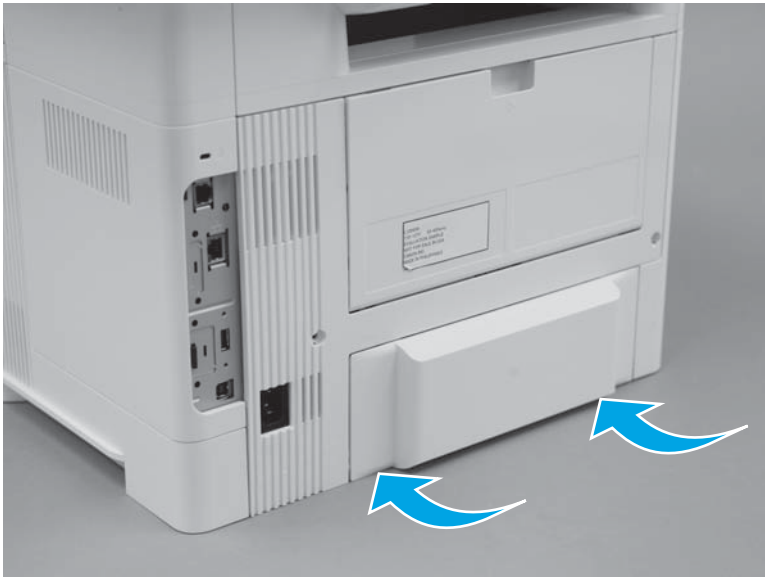
1. Engage the top edge of the assembly with the printer.

**Figure 1-288** Install the cover



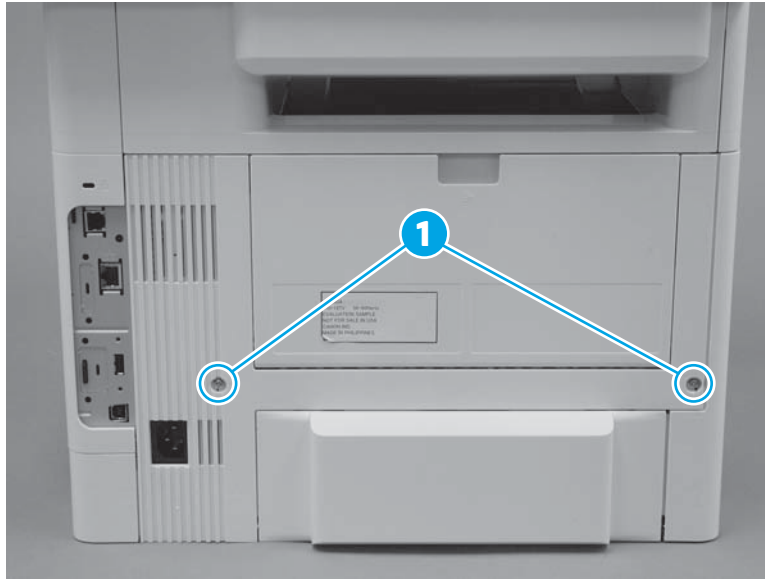
2. Rotate the bottom edge of the cover towards the printer.

**Figure 1-289** Rotate the bottom of the cover




3. Install two screws (callout 1).

**Figure 1-290** Install two screws

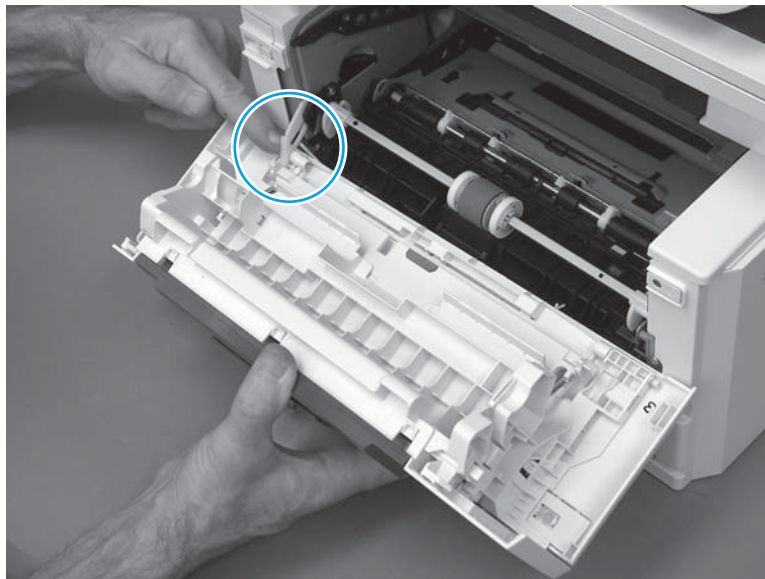


### Step 9: Install the cartridge door assembly


1. Position the door close to the printer, and then engage the keyed pin on the left-side retainer arm with the hole in the door.


 **TIP:** It might be easier to engage the keyed pin with the hole by using a small flat-blad screwdriver.

**Figure 1-291** Engage the left-side retainer arm

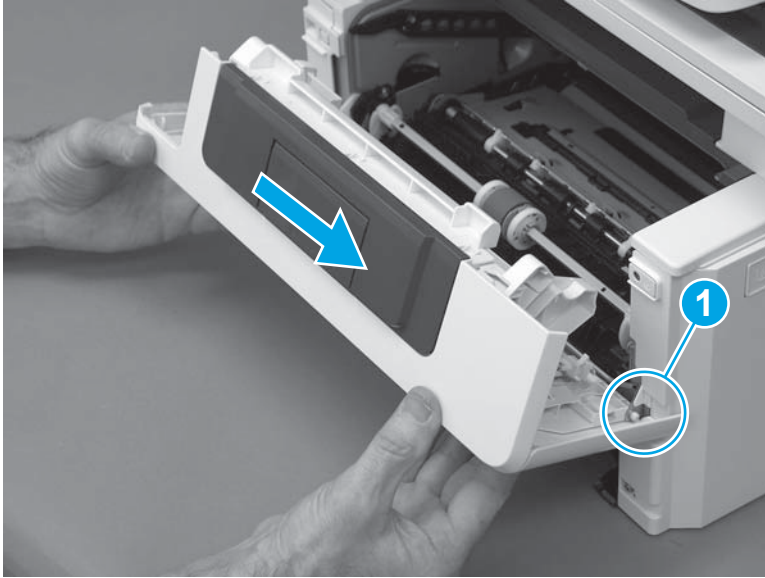


- Engage the right-side door hinge pin with the hole in the chassis (callout 1).

 **NOTE:** There are two right-side hinge pins (not shown in callout 1).

 **TIP:** Keep a finger pressed on the left-side retainer arm so that it does not disengage from the door.

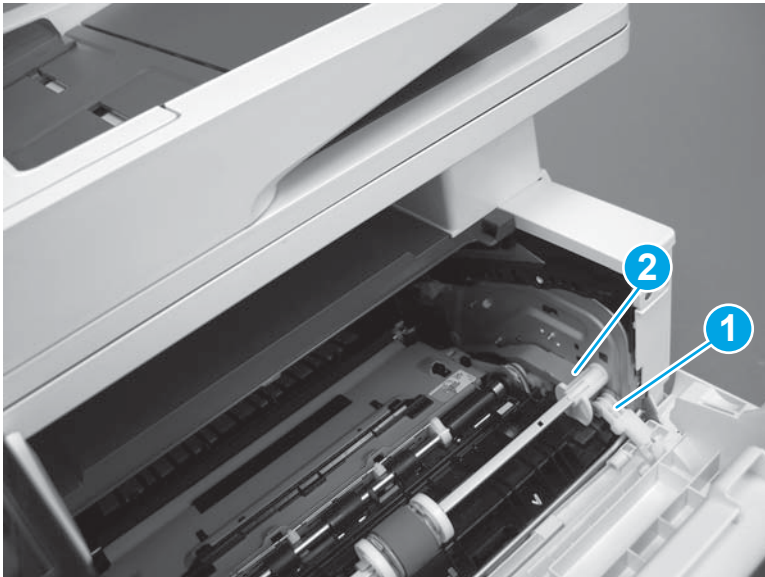
**Figure 1-292** Install the door



- Install the gray-plastic pressure-release link (callout 1) onto the white-plastic door arm (callout 2).

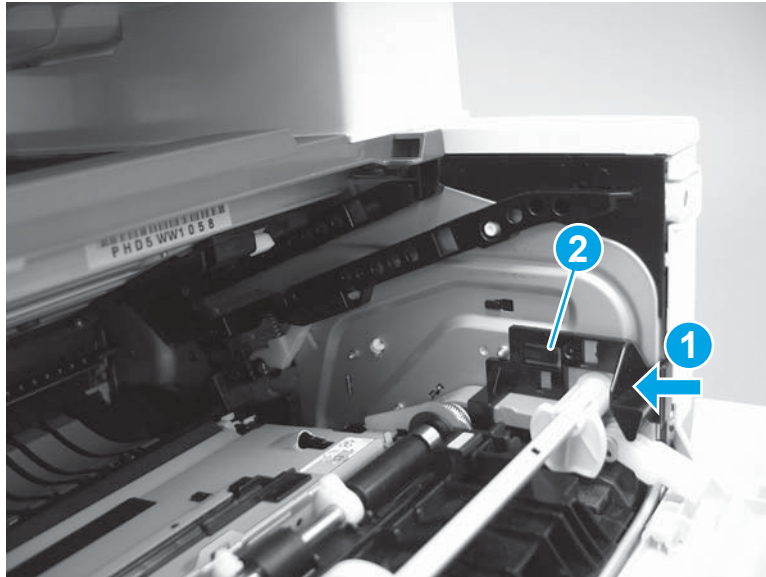
 **IMPORTANT:** Make sure that the arm snaps on to the link. Partially close and open the door to verify that the link (callout 2) moves in and out of the printer as the door closes/opens.

**Figure 1-293** Install the pressure-release link



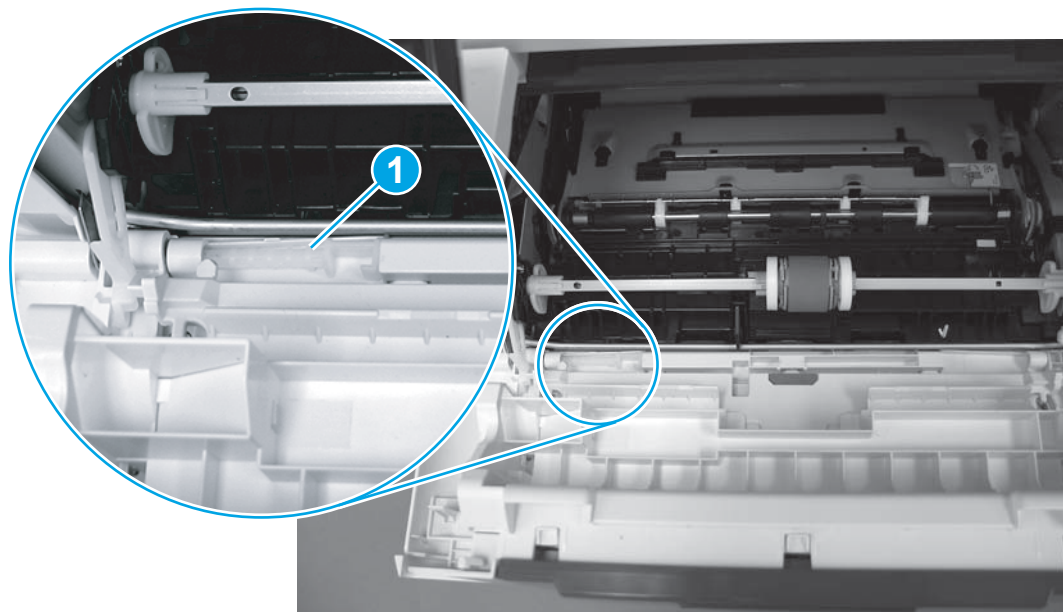
4. Slide the guide into the printer (callout 1), and then make sure that the tab (callout 2) snaps into place to secure the guide to the chassis.

**Figure 1-294** Install the guide





5. Position the support shaft on the door, and then align the left-side hinge on the door with the hole in the chassis (callout 1).

**Figure 1-295** Align the hinge

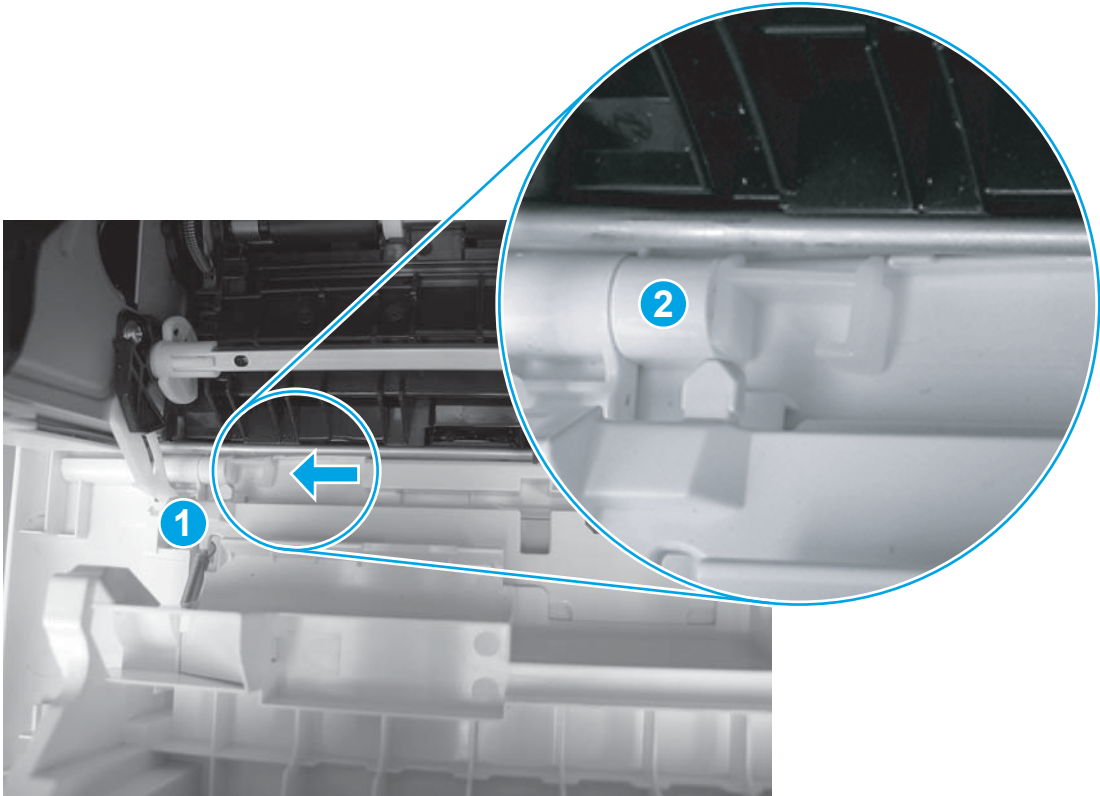


6. Push the shaft towards the left side of the printer to install it (callout 1).

 **NOTE:** Make sure that the support shaft is fully installed and correctly orientated (callout 2) so that it will not interfere with the door opening and closing.

 **Reinstallation tip:** If a replacement door was installed, make sure to install the nameplate (supplied in the kit) corresponding to the printer on the door.

**Figure 1-296** Install the support shaft

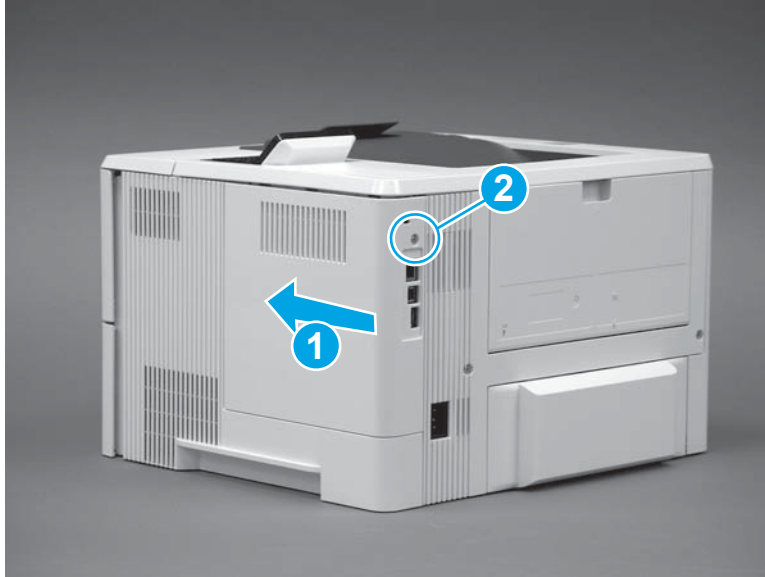


#### Step 10: Install the formatter cover

1. **M501:** Slide it toward the front of the printer to install it (callout 1), and then install one screw (callout 2).

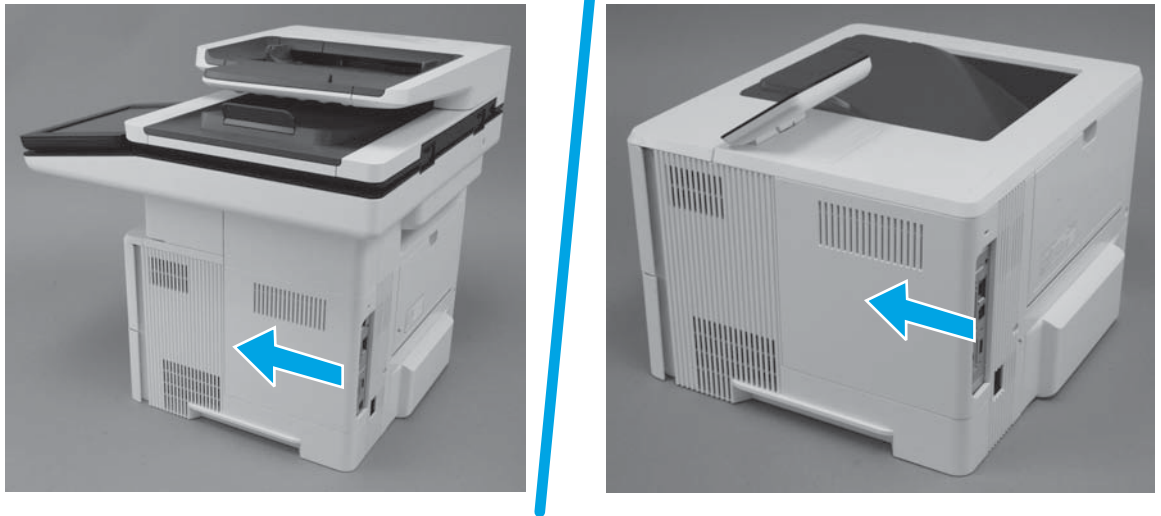


**Figure 1-297** Install the formatter cover (M501)



2. **M506/M527:** Slide it toward the front of the printer to install it.

**Figure 1-298** Install the formatter cover (M506/M527)



### Step 11: Install the tray

1. With the tray at a slight angle, align the sides of the tray with the rails in the accessory, and then partially slide the tray into the printer.

**Figure 1-299** Install the tray



2. Push the tray straight into the accessory to close it.

**Figure 1-300** Close the tray



## Removal and replacement: Left cover

- [Introduction](#)
- [Step 1: Remove the tray](#)
- [Step 2: Remove the cartridge door assembly](#)
- [Step 3: Remove the rear door assembly](#)
- [Step 4: Remove the left cover](#)
- [Step 5: Unpack the replacement cover](#)
- [Step 6: Install the left cover](#)
- [Step 7: Install the rear door assembly](#)
- [Step 8: Install the cartridge door assembly](#)
- [Step 9: Install the tray](#)


### Introduction

This document provides the procedures to remove and replace the left cover.

### Before performing service

#### Turn the printer power off

- Disconnect the power cable.

 **WARNING!** To avoid damage to the printer, turn the printer off, wait 30 seconds, and then remove the power cable before attempting to service the printer.

Use the table below to identify the correct part number for your printer. To order the part, go to [www.hp.com/buy/parts](http://www.hp.com/buy/parts).

Left cover part number	
RM2-5727-000CN	Left cover

### Required tools

- #2 Phillips screwdriver with a magnetic tip.

### After performing service

#### Turn the printer power on

- Connect the power cable.
- Use the power switch to turn the power on.

### Post service test

Make sure that the printer initializes to a **Ready** state.

## Step 1: Remove the tray

1. Pull the tray straight out of the printer until it stops.

**Figure 1-301** Pull the tray out until it stops



2. Lift the front of the tray, and then pull it out of the printer to remove it.

**Figure 1-302** Release and remove the tray



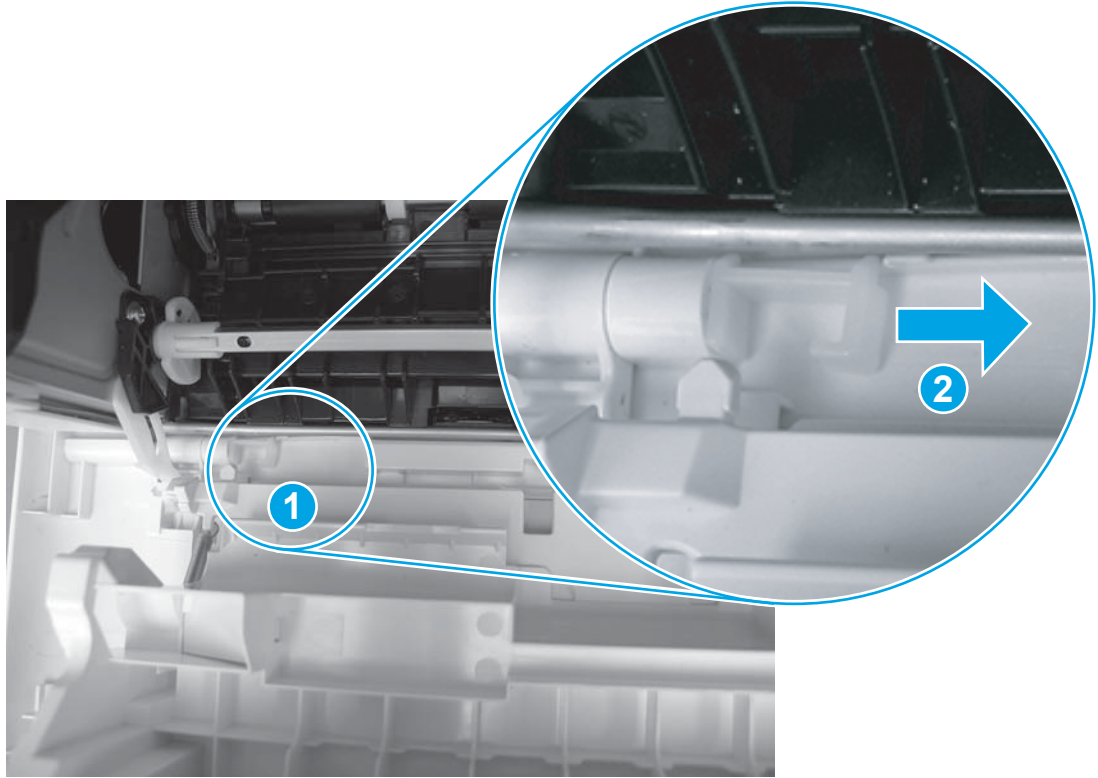
## Step 2: Remove the cartridge door assembly

 **NOTE:** If the toner cartridge was not removed prior to servicing the printer, remove it now.

1. Release the support shaft (callout 1), and then slide it toward the center of the door (callout 2).

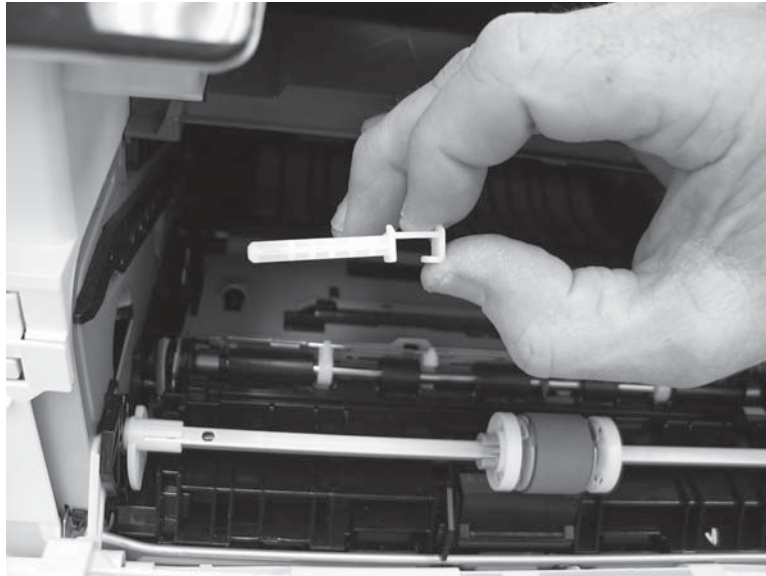
 **TIP:** It might be easier to release the support shaft by using a small flat-blade screwdriver.

**Figure 1-303** Release the support shaft



2. Remove the support shaft.

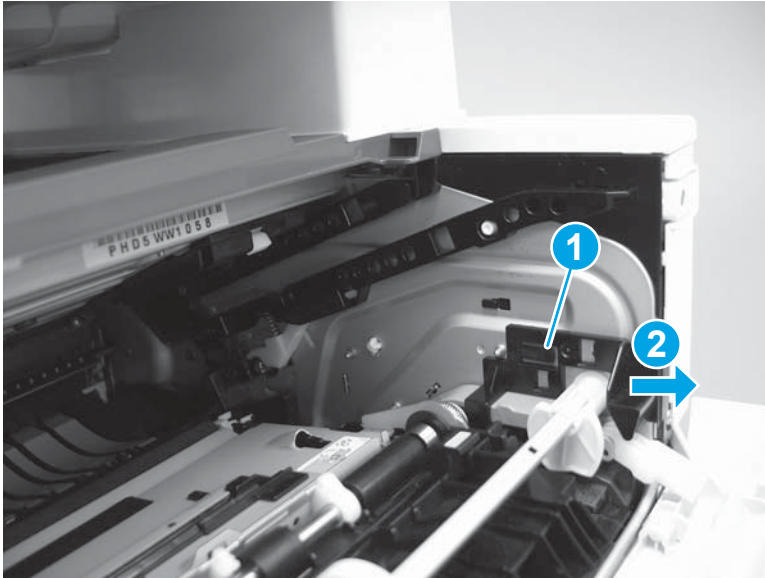
**Figure 1-304** Remove the support shaft



3. Release one tab (callout 1), and then slide the guide out of the printer (callout 2).

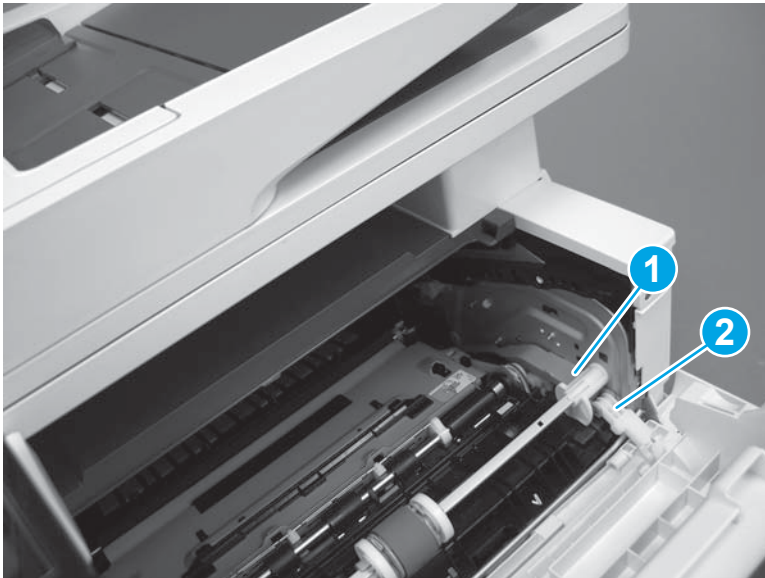
**⚠ CAUTION:** Be careful, the tab (callout 1) can be easily broken.

**Figure 1-305** Remove the guide



4. Use a small flat-blad screwdriver to gently pry the white-plastic door arm (callout 1) off of the gray-plastic pressure-release link (callout 2) to release the door arm.

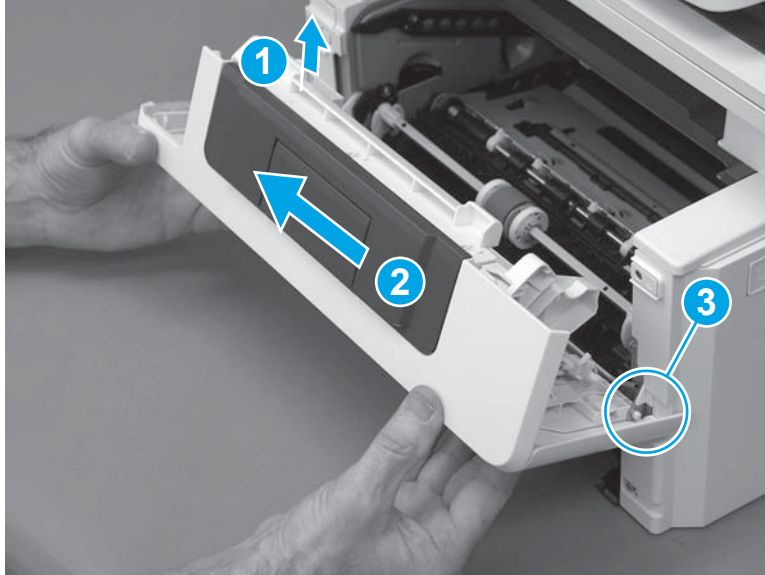
**Figure 1-306** Release the pressure-release link



5. With the door in the partially closed position, slightly raise the left end (callout 1; raise it over the sheet-metal hinge boss), and then slide the door to the left (callout 2) to release the right hinge (callout 3).

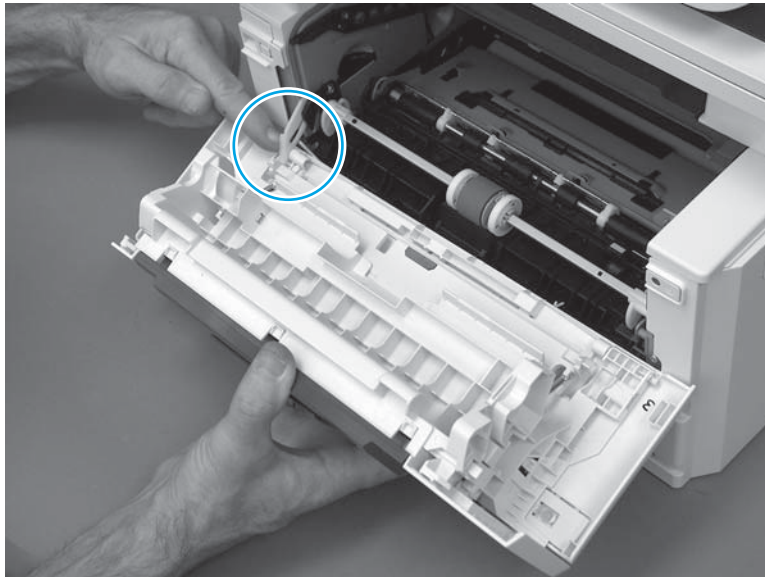
**CAUTION:** The door is still attached to the printer by the left-side retainer arm. Do not attempt to completely remove the door.

**Figure 1-307** Release the door



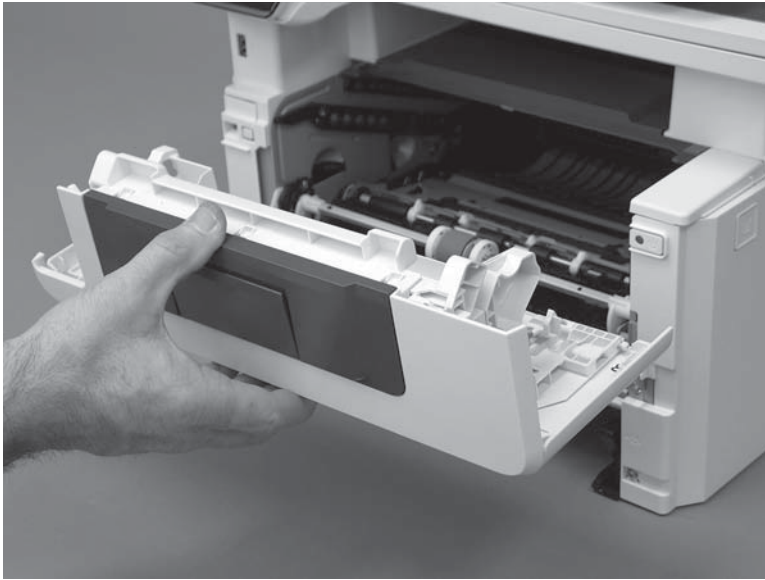
6. Rotate the door away from the printer until the keyed pin on the left-side retainer arm can disengage from the door.

**Figure 1-308** Release the left-side retainer arm



7. Remove the door.

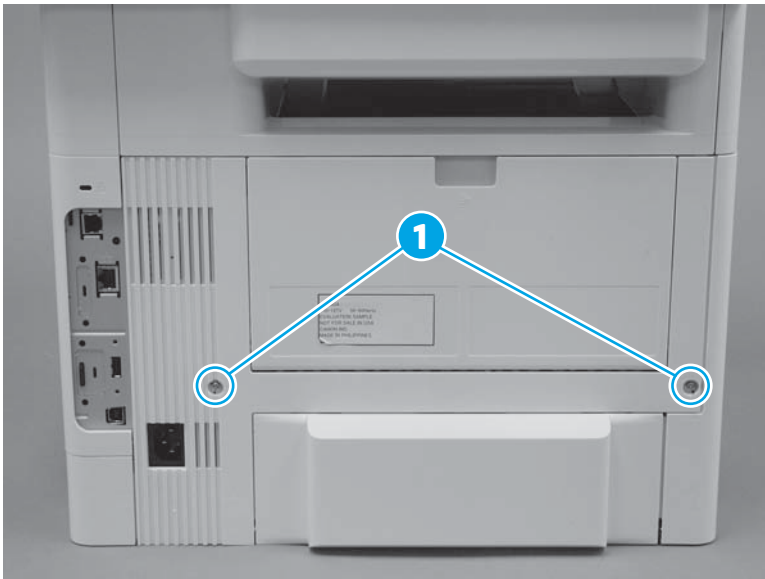
**Figure 1-309** Remove the door



### Step 3: Remove the rear door assembly

1. At the rear of the printer, remove two screws (callout 1).

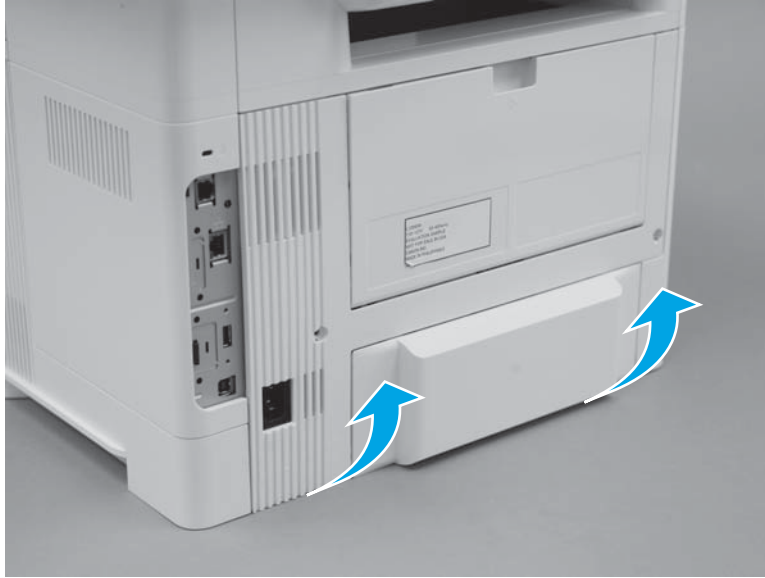
**Figure 1-310** Remove two screws





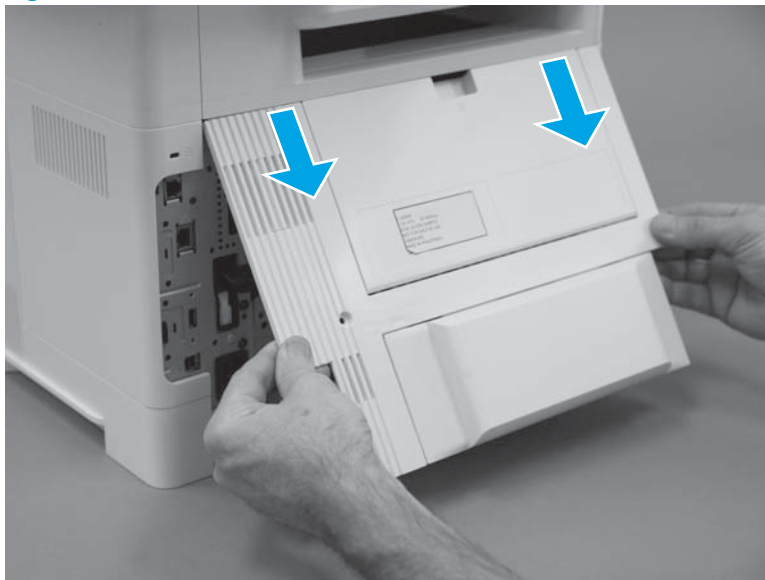
2. Rotate the bottom edge of the assembly away from the printer to release it.

**Figure 1-311** Rotate the bottom of the cover




3. Pull down on the assembly to remove it.


**Figure 1-312** Remove the cover



#### Step 4: Remove the left cover

---

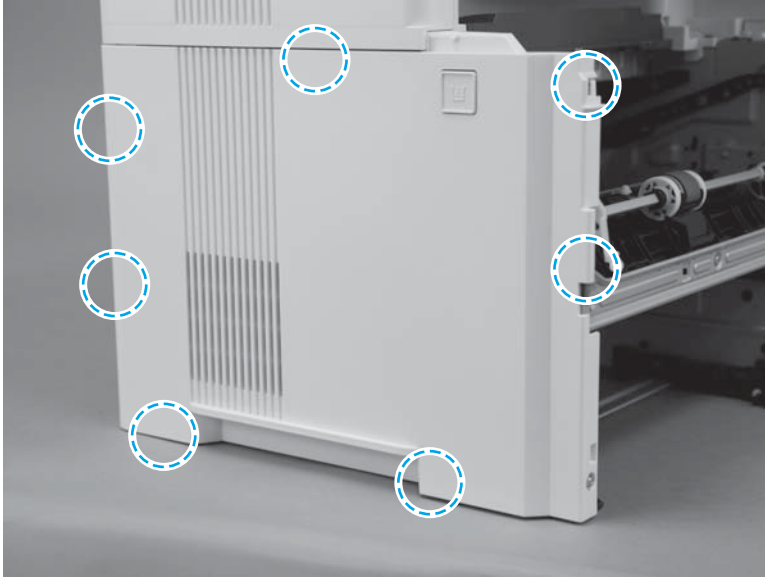
 **IMPORTANT:** The black-plastic cassette front and rear guides (located inside the tray cavity) can be easily dislodged. Do not lose the guides when the cover is removed or installed.

 **NOTE:** The M527 printer is shown in this procedure. However, this procedure is valid for the M501/M506 printers.

---

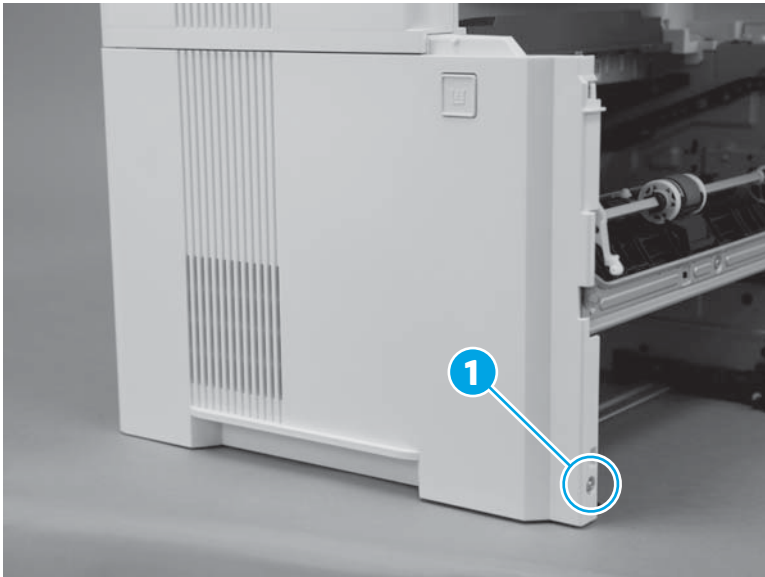
1. Before proceeding, take note of the location of the tabs and bosses on the inside of the cover.

**Figure 1-313** Locate of the tabs and bosses



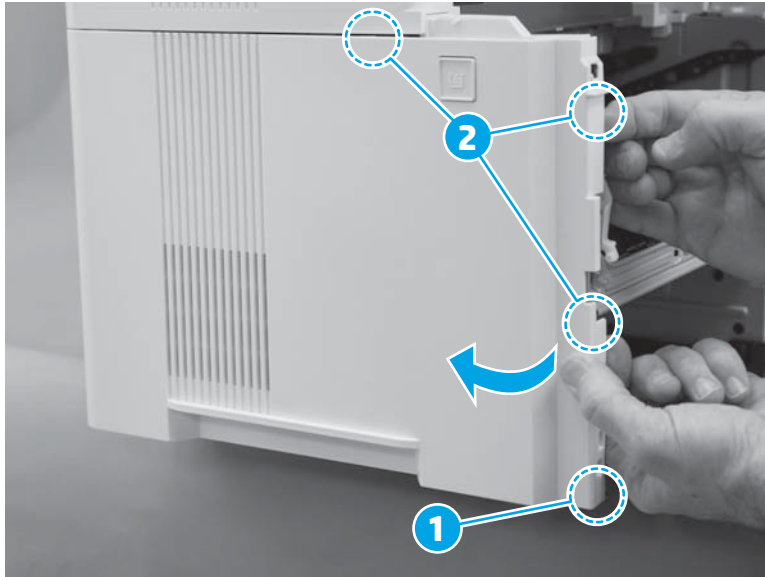
2. Remove one screw (callout 1).

**Figure 1-314** Remove one screw



3. At the front of the printer, release one boss (callout 1), and then rotate the front edge of the cover away from the printer to release three tabs (callout 2).

**Figure 1-315** Release one boss and three tabs




4. At the bottom edge of the cover, release two tabs.

**Figure 1-316** Release two tabs



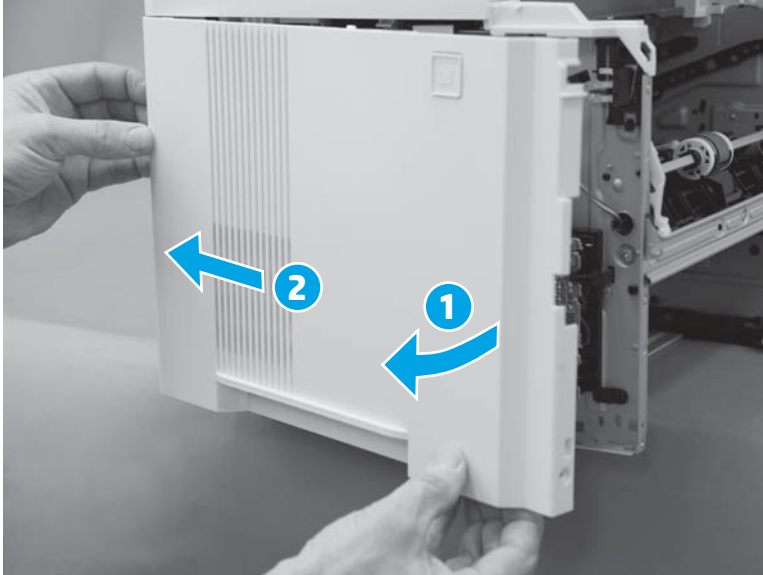
5. Continue to rotate the front edge of the cover away from the printer (callout 1), and then slide the cover toward the rear of the printer (callout 2) to remove it.

---

 **NOTE:** If the cover is difficult to rotate or slide as shown below, make sure that the bottom tabs (released in the previous step) are completely disengaged from the chassis.

---

**Figure 1-317** Remove the cover



#### Step 5: Unpack the replacement cover

Unpack the replacement part from the packaging.

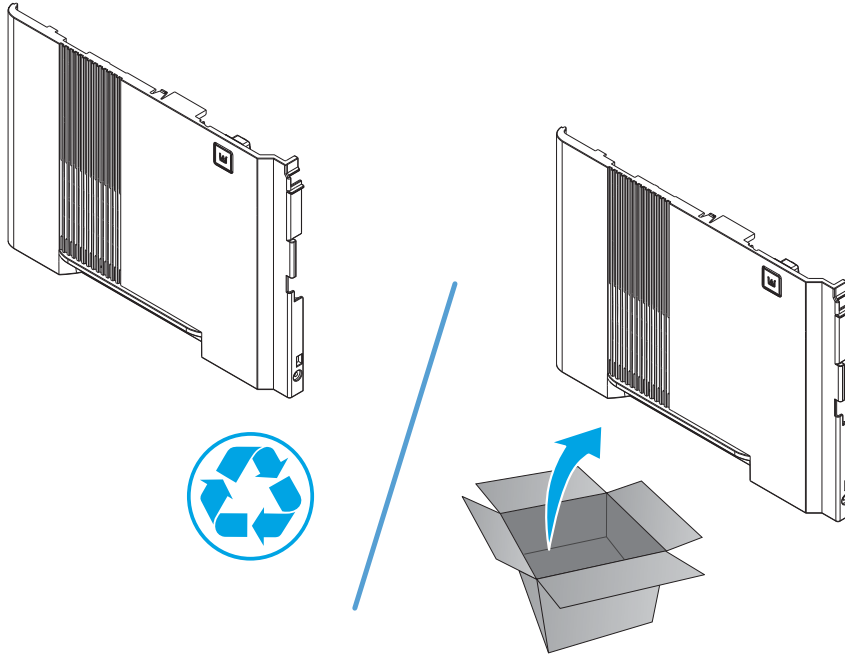
<http://www8.hp.com/us/en/hp-information/environment/product-recycling.html>

---


 **NOTE:** HP recommends responsible disposal of the defective part.


---

**Figure 1-318** Recycle and unpack



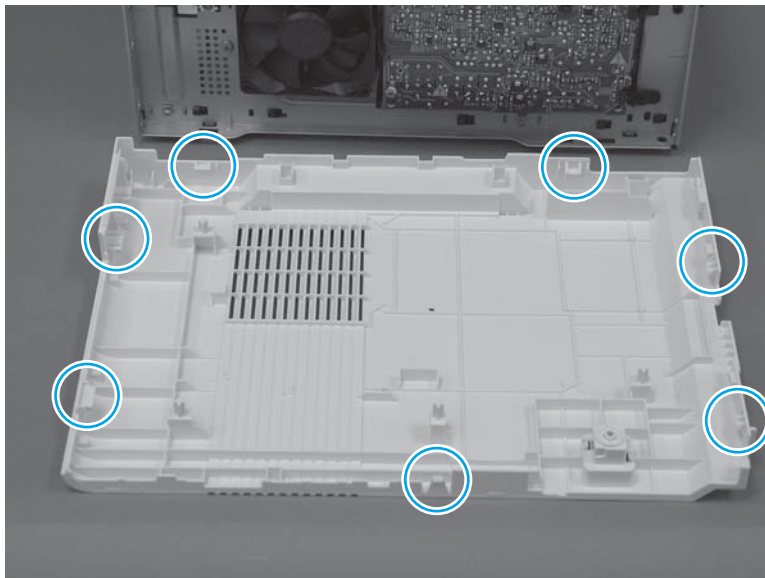
### Step 6: Install the left cover

 **IMPORTANT:** The black-plastic cassette front and rear guides (located inside the tray cavity) can be easily dislodged. Do not lose the guides when the cover is removed or installed.

 **NOTE:** The M527 printer is shown in this procedure. However, this procedure is valid for the M501/M506 printers.

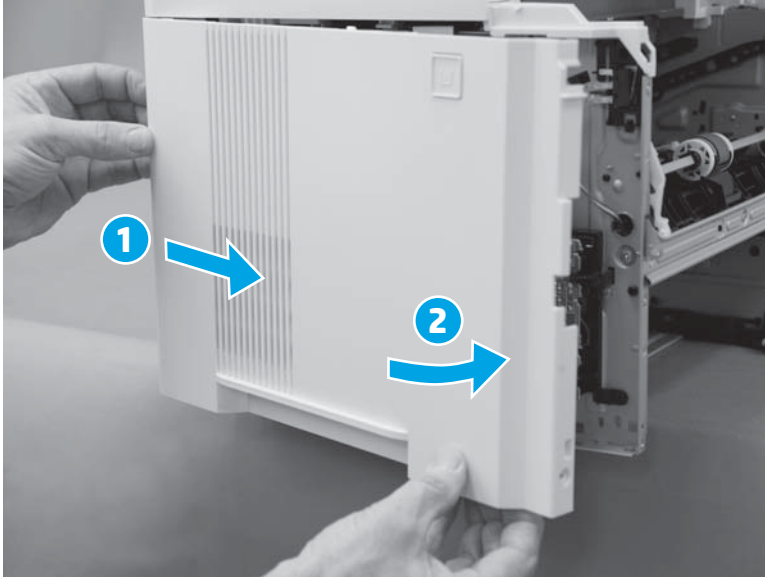
1. Before proceeding, take note of the location of the tabs and bosses on the inside of the cover.

**Figure 1-319** Locate of the tabs and bosses



2. Engage the rear edge of the cover (callout 1), and then rotate the rear edge of the cover toward the printer (callout 2).

**Figure 1-320** Install the cover



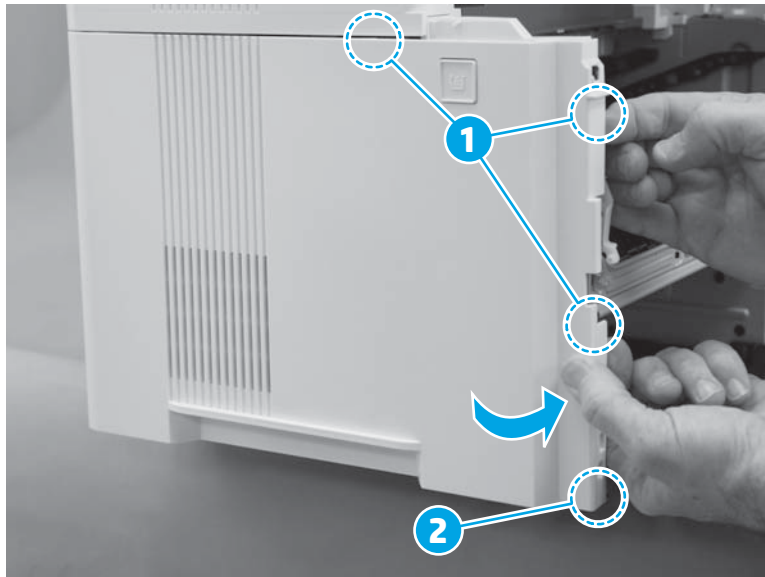
3. At the bottom edge of the cover, engage two tabs.

**Figure 1-321** Engage two tabs



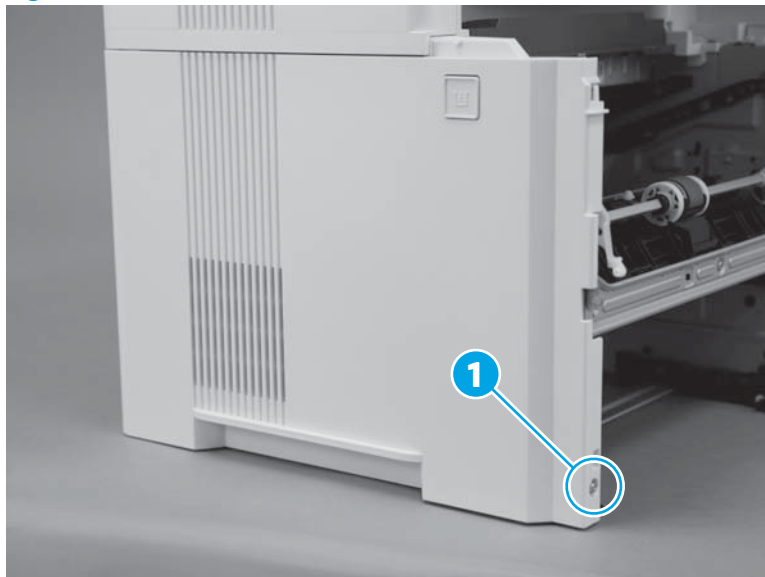
4. At the front of the printer, engage three tabs (callout 1), and then continue to rotate the front edge of the cover toward the printer to engage one boss (callout 2).

**Figure 1-322** Engage three tabs and one boss



5. Install one screw (callout 1).

**Figure 1-323** Install one screw



### Step 7: Install the rear door assembly

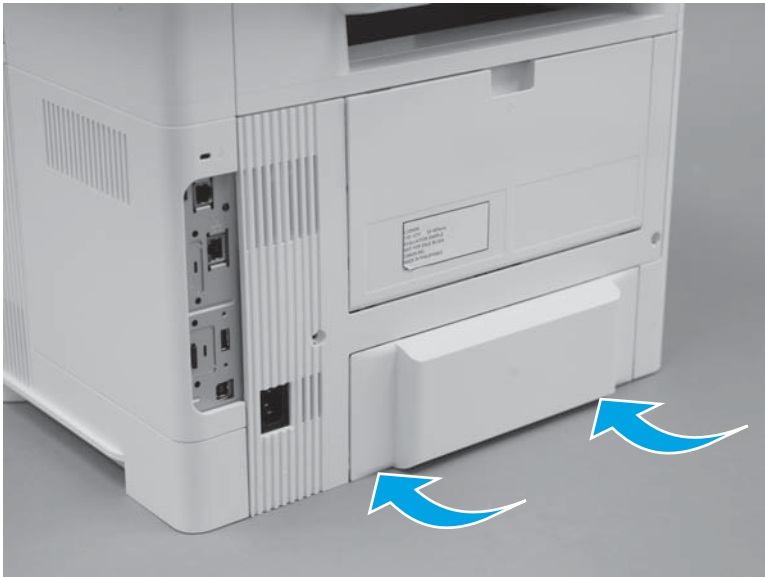
1. Engage the top edge of the assembly with the printer.

**Figure 1-324** Install the cover



2. Rotate the bottom edge of the cover towards the printer.

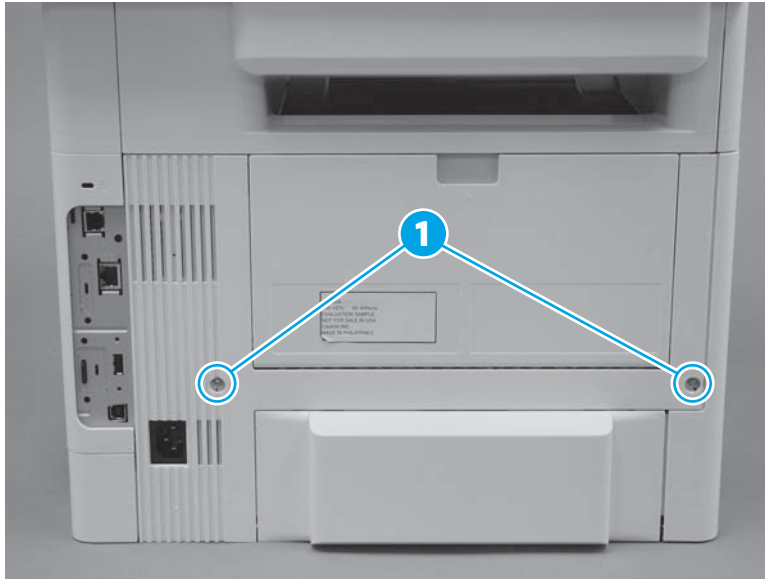
**Figure 1-325** Rotate the bottom of the cover






3. Install two screws (callout 1).

**Figure 1-326** Install two screws

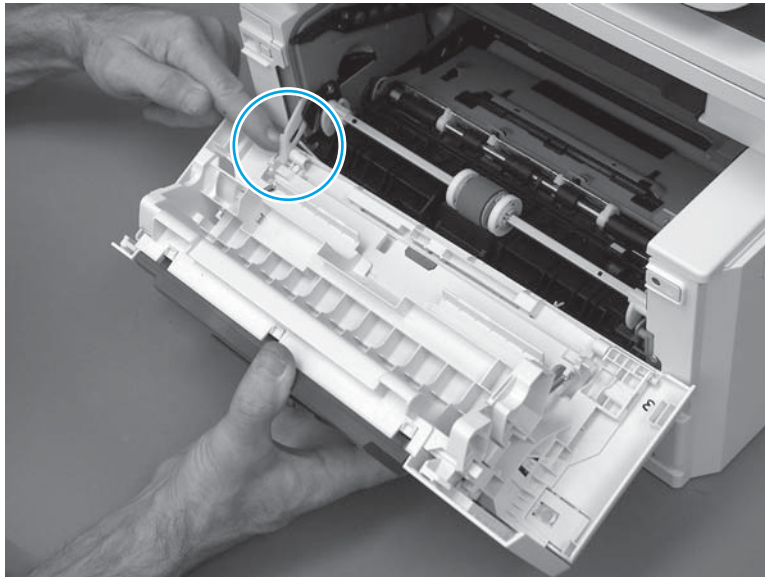


### Step 8: Install the cartridge door assembly


1. Position the door close to the printer, and then engage the keyed pin on the left-side retainer arm with the hole in the door.


 **TIP:** It might be easier to engage the keyed pin with the hole by using a small flat-blad screwdriver.

**Figure 1-327** Engage the left-side retainer arm

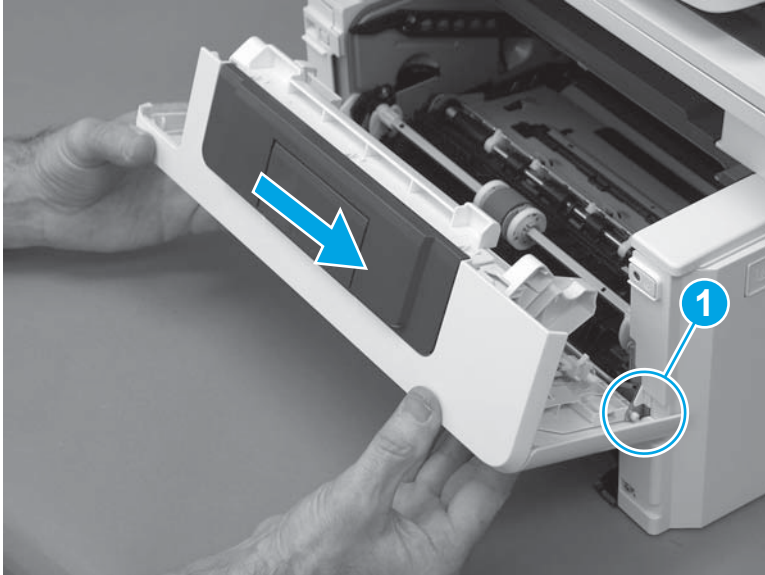


- Engage the right-side door hinge pin with the hole in the chassis (callout 1).

 **NOTE:** There are two right-side hinge pins (not shown in callout 1).

 **TIP:** Keep a finger pressed on the left-side retainer arm so that it does not disengage from the door.

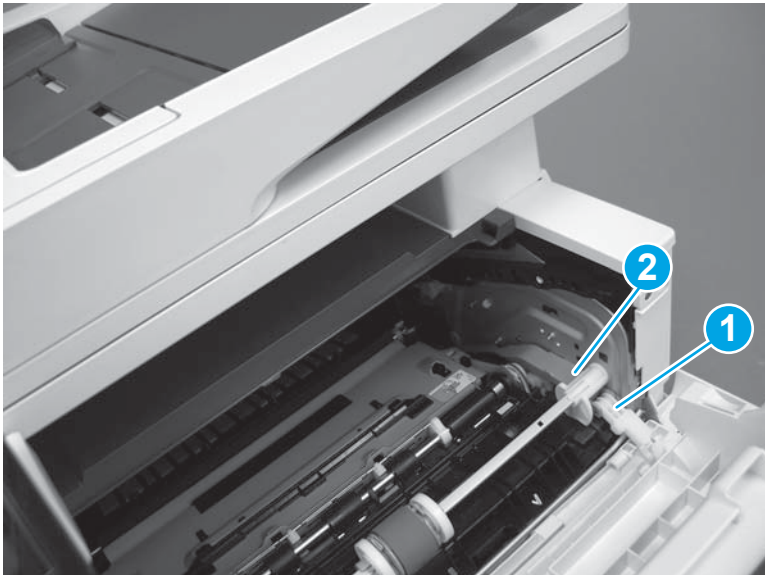
**Figure 1-328** Install the door



- Install the gray-plastic pressure-release link (callout 1) onto the white-plastic door arm (callout 2).

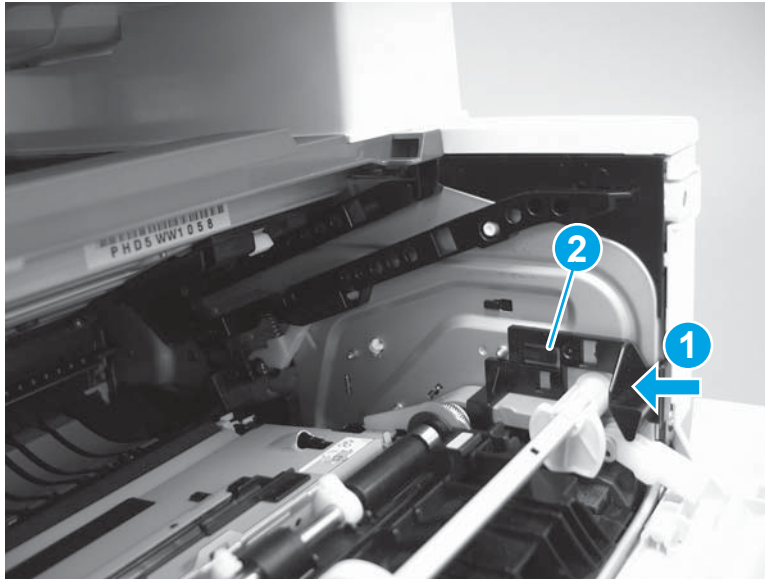
 **IMPORTANT:** Make sure that the arm snaps on to the link. Partially close and open the door to verify that the link (callout 2) moves in and out of the printer as the door closes/opens.

**Figure 1-329** Install the pressure-release link



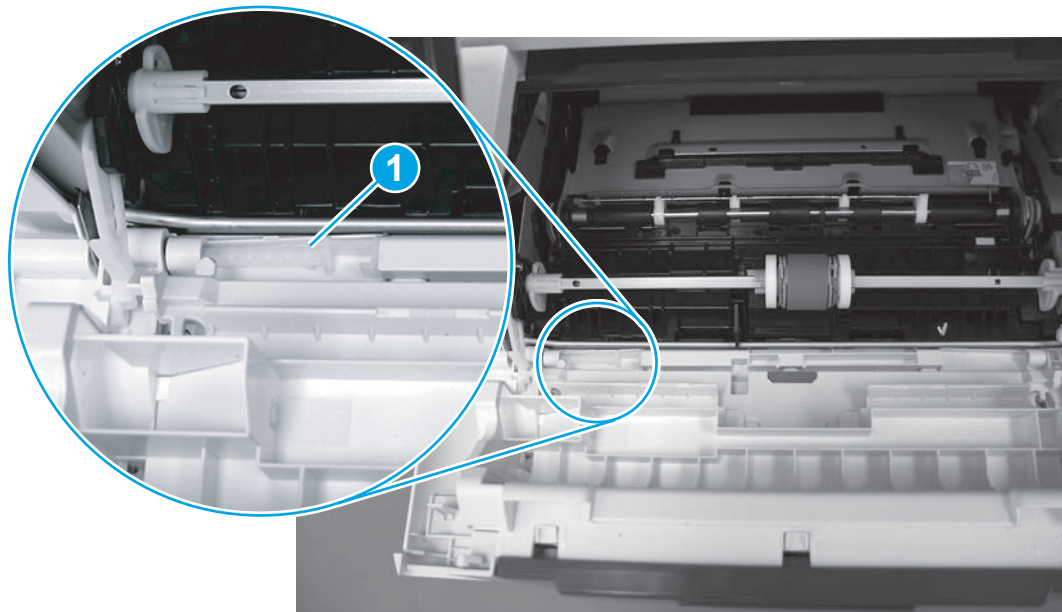
4. Slide the guide into the printer (callout 1), and then make sure that the tab (callout 2) snaps into place to secure the guide to the chassis.

**Figure 1-330** Install the guide





5. Position the support shaft on the door, and then align the left-side hinge on the door with the hole in the chassis (callout 1).

**Figure 1-331** Align the hinge

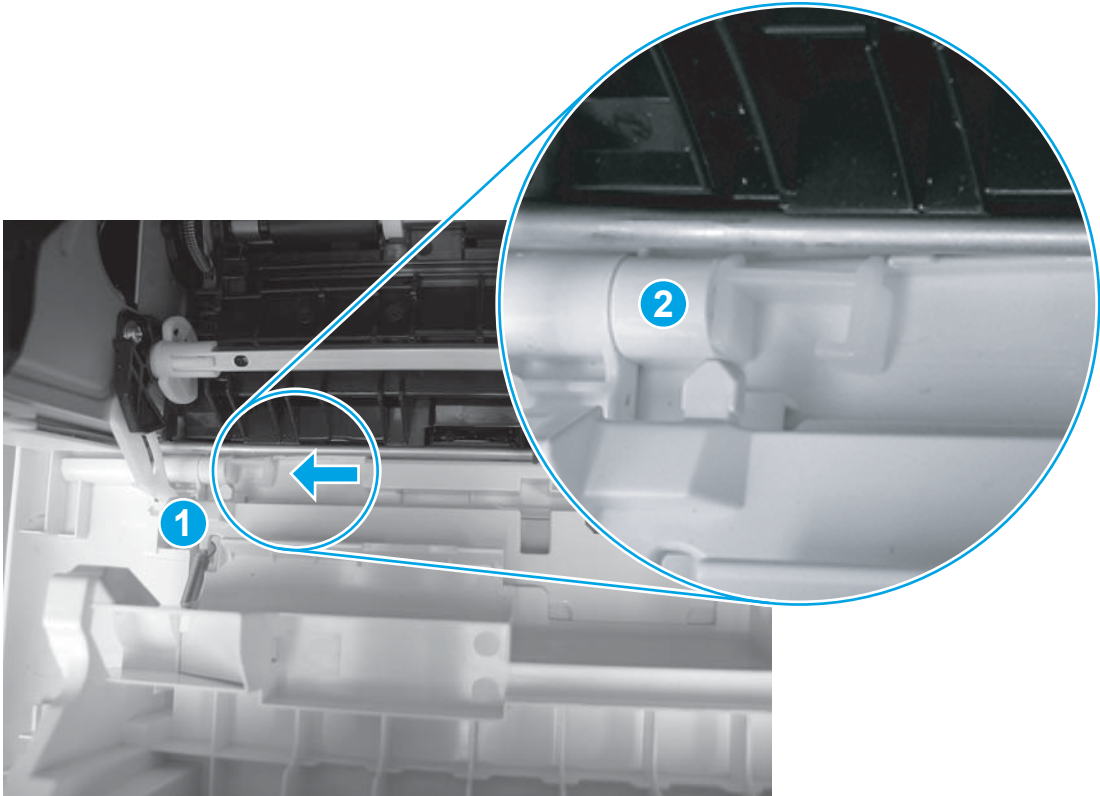


6. Push the shaft towards the left side of the printer to install it (callout 1).

 **NOTE:** Make sure that the support shaft is fully installed and correctly orientated (callout 2) so that it will not interfere with the door opening and closing.

 **Reinstallation tip:** If a replacement door was installed, make sure to install the nameplate (supplied in the kit) corresponding to the printer on the door.

**Figure 1-332** Install the support shaft



### Step 9: Install the tray

1. With the tray at a slight angle, align the sides of the tray with the rails in the accessory, and then partially slide the tray into the printer.

**Figure 1-333** Install the tray



2. Push the tray straight into the accessory to close it.

**Figure 1-334** Close the tray



## Removal and replacement: Stapler door or stapler blank cover (M527)

- [Introduction](#)
- [Step 1: Remove the formatter cover](#)
- [Step 2: Remove the stapler door](#)
- [Step 3: Unpack the replacement assembly](#)
- [Step 4: Install the stapler door](#)
- [Step 5: Install the formatter cover](#)


### Introduction

This document provides the procedures to remove and replace the stapler door or stapler blank cover.

### Before performing service

#### Turn the printer power off

- Disconnect the power cable.

 **WARNING!** To avoid damage to the printer, turn the printer off, wait 30 seconds, and then remove the power cable before attempting to service the printer.

Use the table below to identify the correct part number for your printer. To order the part, go to [www.hp.com/buy/parts](http://www.hp.com/buy/parts).

Stapler door or stapler blank cover part number	
<b>F2A76-40004</b>	Stapler door (M527c/f/z)
<b>F2A76-40005</b>	Stapler blank cover (M527dn)

### Required tools

- Small flat-blade screw driver

### After performing service

#### Turn the printer power on

- Connect the power cable.
- Use the power switch to turn the power on.

### Post service test

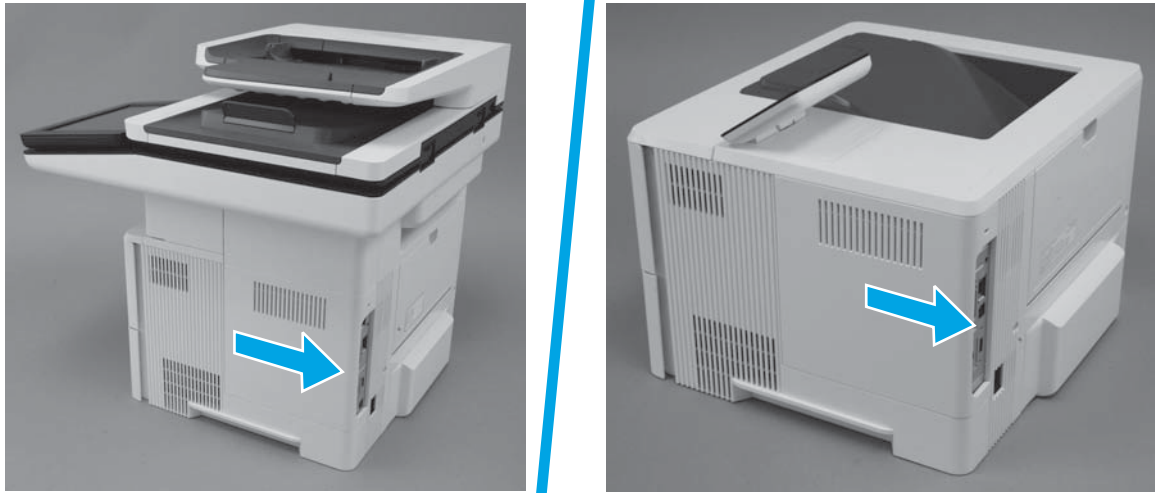
Make sure that the printer initializes to a **Ready** state.

For stapler models, staple two pages together.

### Step 1: Remove the formatter cover

- ▲ Slide the cover toward the rear of the printer to remove it.

**Figure 1-335** Remove the formatter cover

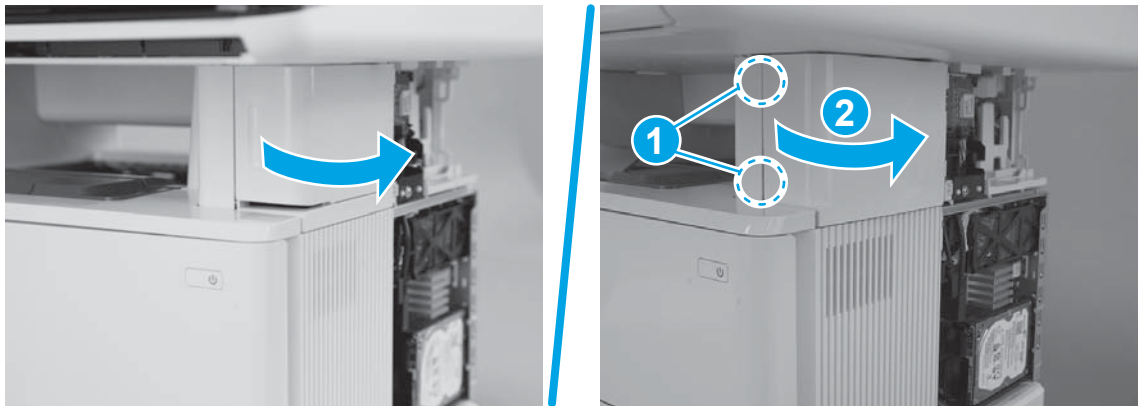


### Step 2: Remove the stapler door

The M527dn does not have a convenience stapler.

1. Do one of the following:
  - **M527c/f/z:** Open the stapler door.
  - **M527dn:** Use a small flat-blad screw driver to release two tabs (callout 1), and then rotate the cover away from the printer (callout 2).

**Figure 1-336** Open the door or release the cover



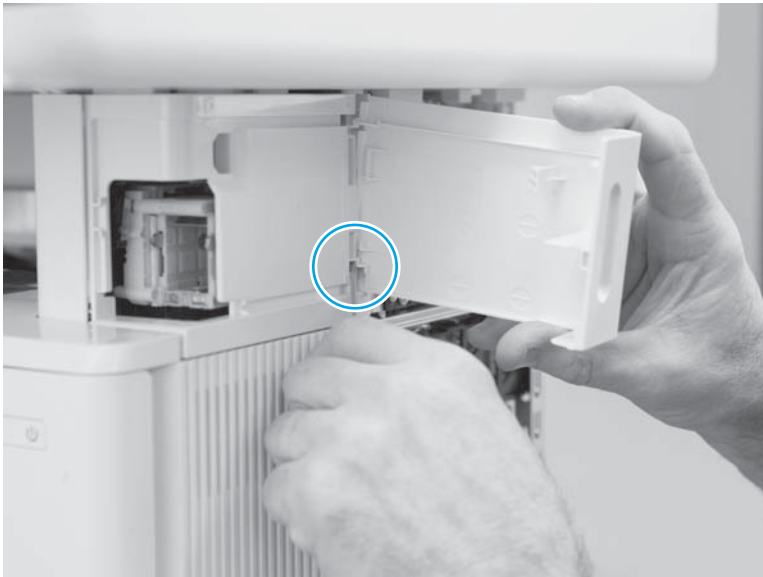
2. Do one of the following:
  - **M527c/f/z:** Use a small flat-blad screwdriver to release the upper hinge.
  - **M527dn:** Slide the cover toward the front of the printer to remove it.

**Figure 1-337** Release the upper hinge or remove the cover



- 3. M527c/f/z:** Use a small flat-blad screwdriver to release the lower hinge.

**Figure 1-338** Release the lower hinge





4. **M527c/f/z:** Remove the door.

**Figure 1-339** Remove the door



### Step 3: Unpack the replacement assembly

Unpack the replacement part from the packaging.

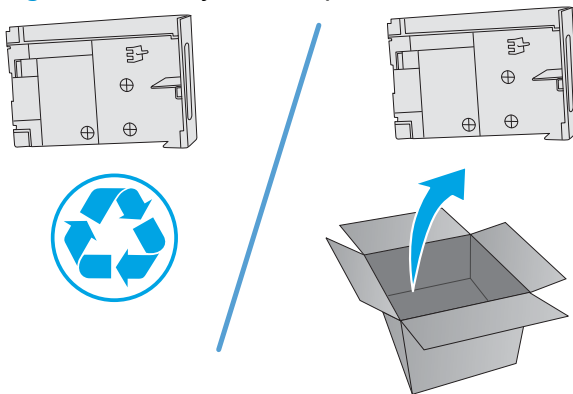
<http://www8.hp.com/us/en/hp-information/environment/product-recycling.html>

---

 **NOTE:** HP recommends responsible disposal of the defective part.


---

**Figure 1-340** Recycle and unpack



### Step 4: Install the stapler door

---

 **NOTE:** The M527dn does not have a convenience stapler.

---

1. Do one of the following:
  - **M527c/f/z:** Position the door near the printer.
  - **M527dn:** Position the cover on the printer.

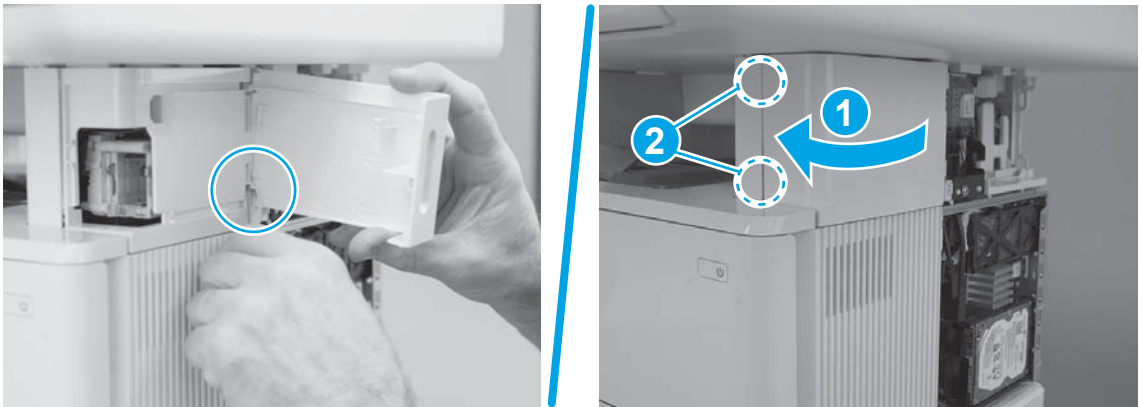
**Figure 1-341** Install the door or cover



2.

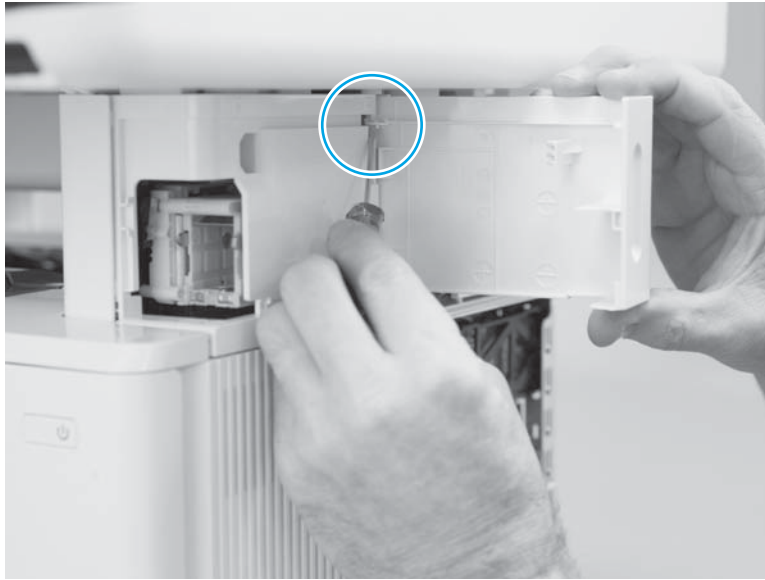
- **M527c/f/z:** Engage the lower hinge.
- **M527dn:** Rotate the cover towards the printer (callout 1), and then make sure that the two tabs (callout 2) snap into place to install the cover.

**Figure 1-342** Engage the lower hinge or engage the cover



3. **M527c/f/z:** Engage the upper hinge.

**Figure 1-343** Engage the upper hinge



4. **M527c/f/z:** Close the stapler door.

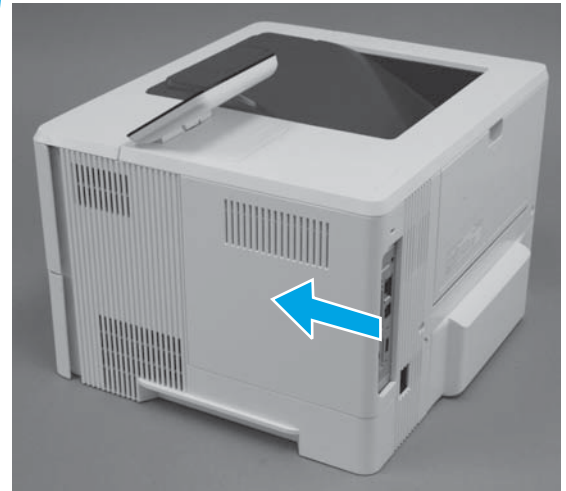
**Figure 1-344** Close the door



### Step 5: Install the formatter cover

- ▲ Slide it toward the front of the printer to install it.

**Figure 1-345** Install the formatter cover



## Removal and replacement: Stapler stationary (inner) cover (M527)



**NOTE:** M527c/f/z printers only.

- [Introduction](#)
- [Step 1: Remove the formatter cover](#)
- [Step 2: Remove the stapler door](#)
- [Step 3: Remove the stapler stationary \(inner\) cover](#)
- [Step 4: Unpack the replacement cover](#)
- [Step 5: Install the stapler stationary \(inner\) cover](#)
- [Step 6: Install the stapler door](#)
- [Step 7: Install the formatter cover](#)

### Introduction

This document provides the procedures to remove and replace the cassette stapler stationary (inner) cover.

### Before performing service

#### Turn the printer power off

- Disconnect the power cable.



**WARNING!** To avoid damage to the printer, turn the printer off, wait 30 seconds, and then remove the power cable before attempting to service the printer.

Use the table below to identify the correct part number for your printer. To order the part, go to [www.hp.com/buy/parts](http://www.hp.com/buy/parts).

Stapler stationary (inner) cover part number	
F2A76-40003	Stapler stationary (inner) cover (M527c/f/z)

### Required tools

- Small flat-blade screw driver—152.4 mm (6 in) shaft

### After performing service

#### Turn the printer power on

- Connect the power cable.
- Use the power switch to turn the power on.

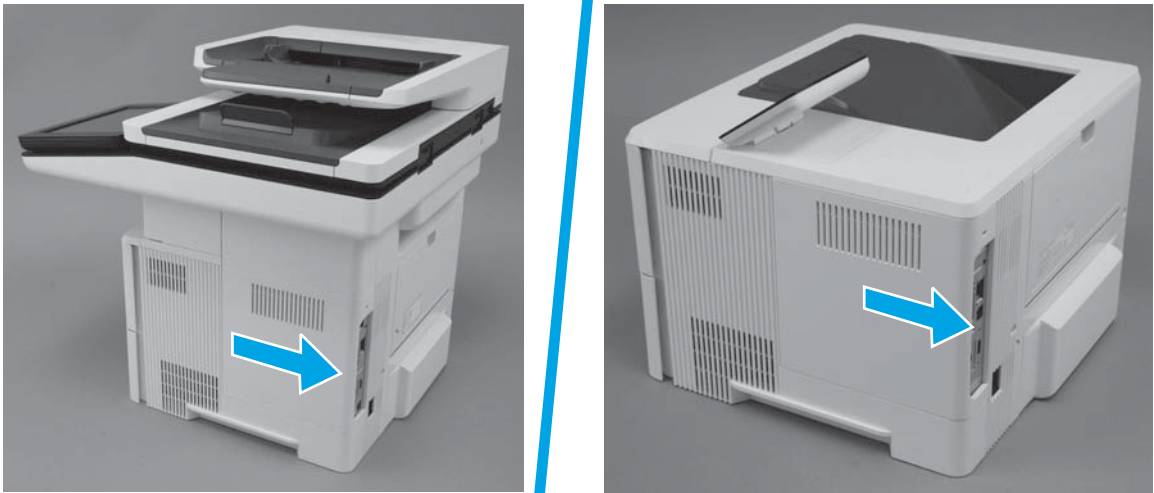
### Post service test

Make sure that the printer initializes to a **Ready** state.

### Step 1: Remove the formatter cover

- ▲ Slide the cover toward the rear of the printer to remove it.

Figure 1-346 Remove the formatter cover

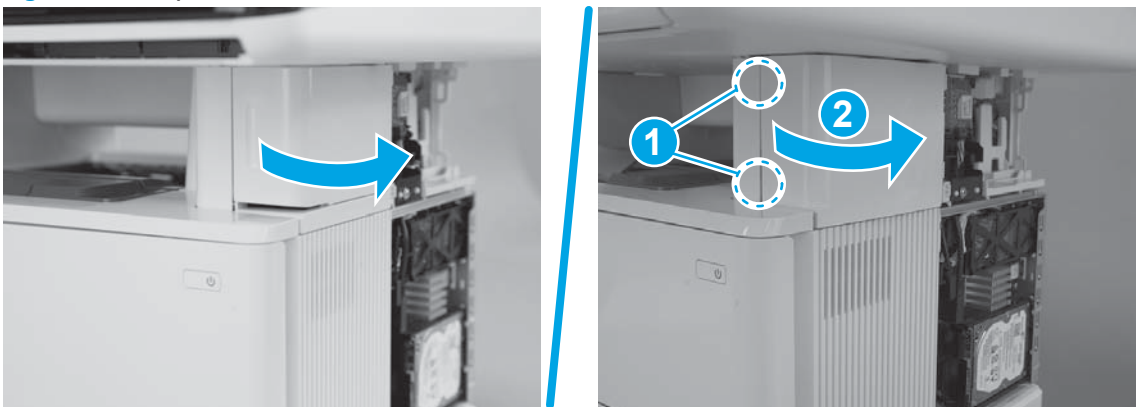


### Step 2: Remove the stapler door

The M527dn does not have a convenience stapler.

1. Do one of the following:
  - **M527c/f/z:** Open the stapler door.
  - **M527dn:** Use a small flat-blad screw driver to release two tabs (callout 1), and then rotate the cover away from the printer (callout 2).

Figure 1-347 Open the door or release the cover



2. Do one of the following:
  - **M527c/f/z:** Use a small flat-blad screwdriver to release the upper hinge.
  - **M527dn:** Slide the cover toward the front of the printer to remove it.

**Figure 1-348** Release the upper hinge or remove the cover



3. **M527c/f/z:** Use a small flat-blad screwdriver to release the lower hinge.

**Figure 1-349** Release the lower hinge



4. **M527c/f/z:** Remove the door.

**Figure 1-350** Remove the door



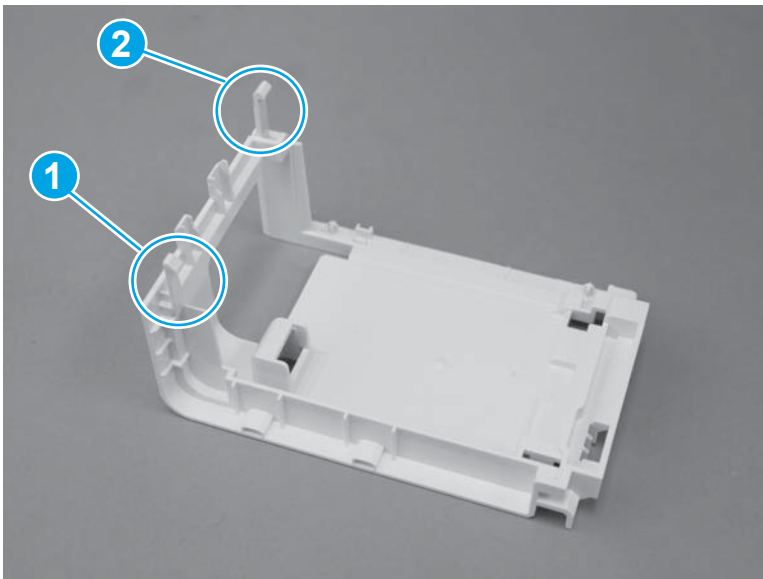
### Step 3: Remove the stapler stationary (inner) cover



**NOTE:** M527c/f/z printers only.

1. Before proceeding, take note of the locations of the upper tab (callout 1) and the lower tab (callout 2) on the stapler stationary (inner) cover.

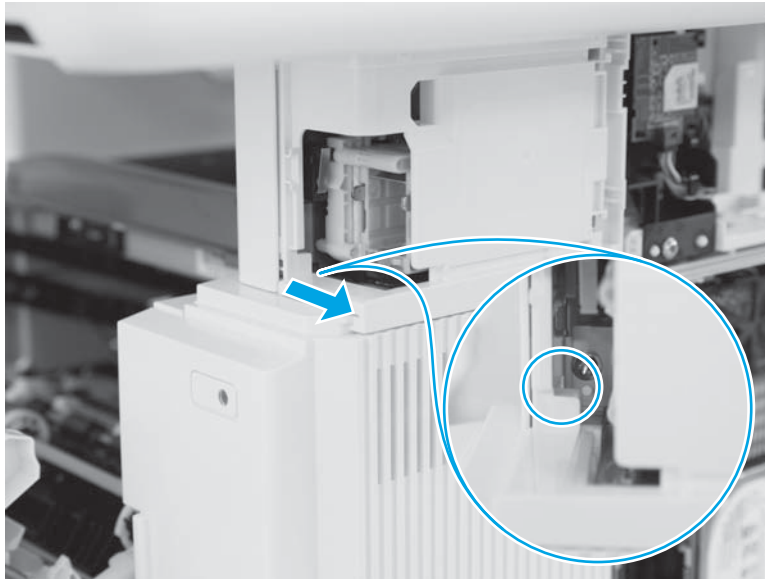
**Figure 1-351** Locate the tabs





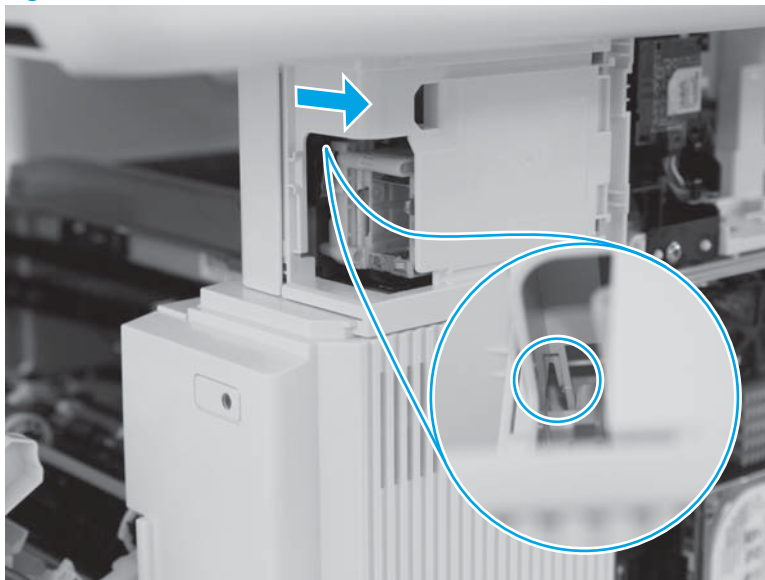
2. Use a long-shaft small flat-blad screwdriver to release the lower tab.

**Figure 1-352** Release one tab



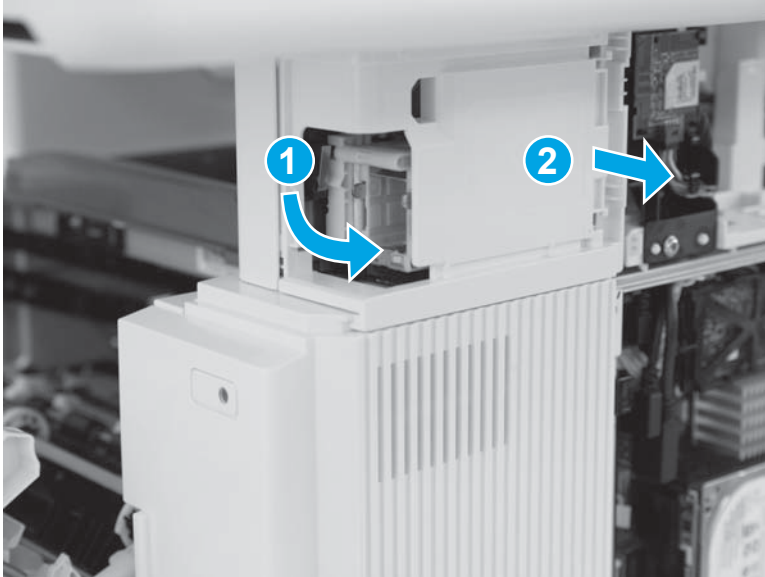
3. Use a long-shaft small flat-blad screwdriver to release the upper tab.

**Figure 1-353** Release one tab



4. With the tabs disengaged the front of the cover is released. Rotate the front of the cover away from the printer (callout 1) to release the rear of the cover (callout 2), and then remove it.

**Figure 1-354** Remove the cover



#### Step 4: Unpack the replacement cover

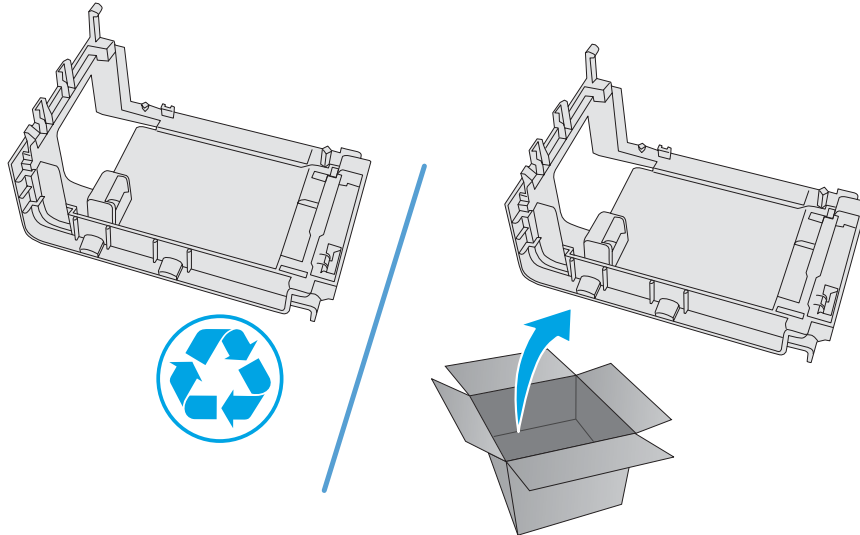
Unpack the replacement part from the packaging.

<http://www8.hp.com/us/en/hp-information/environment/product-recycling.html>




**NOTE:** HP recommends responsible disposal of the defective part.

**Figure 1-355** Recycle and unpack

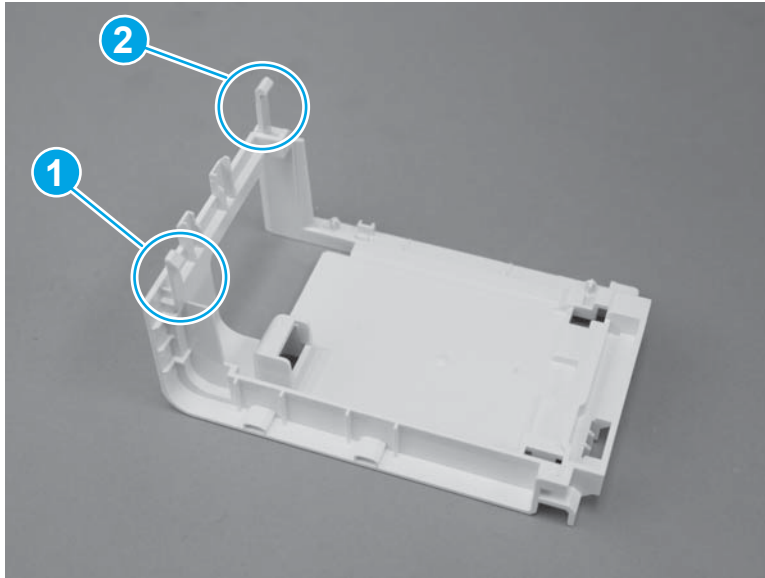


## Step 5: Install the stapler stationary (inner) cover

 **NOTE:** M527c/f/z printers only.

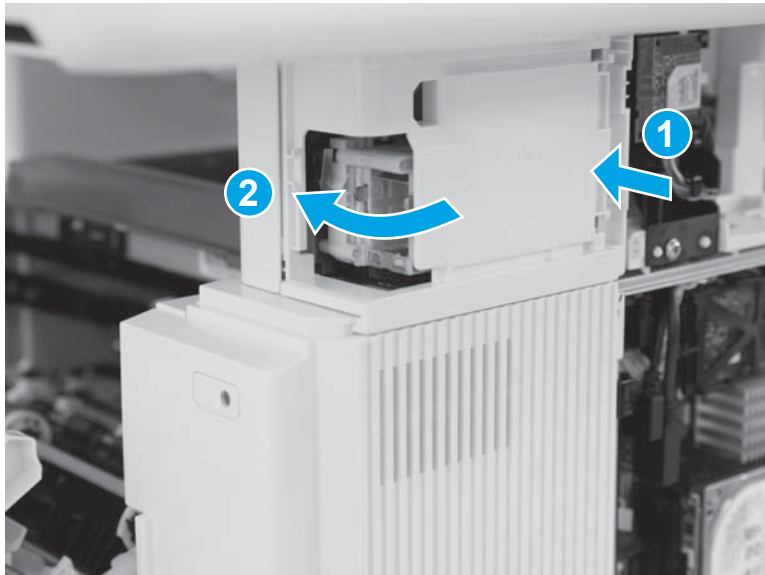
1. Before proceeding, take note of the locations of the upper tab (callout 1) and the lower tab (callout 2) on the stapler stationary (inner) cover.

**Figure 1-356** Locate the tabs



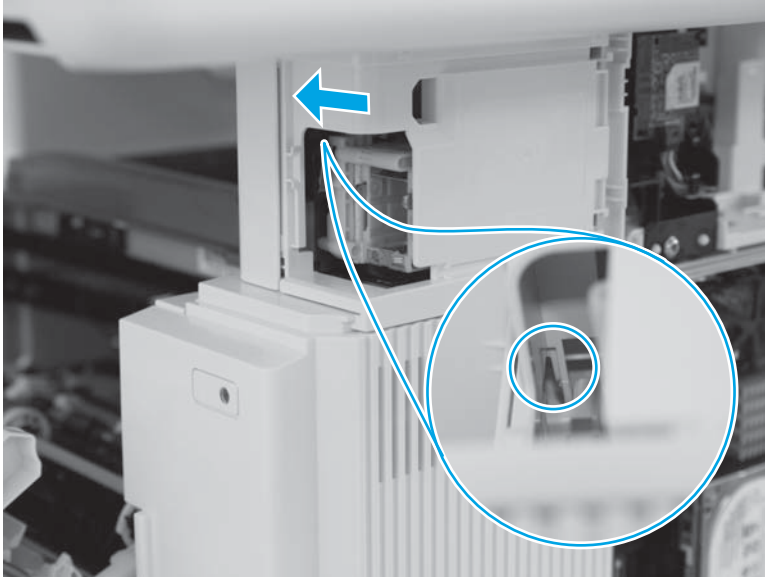
2. Engage the rear edge of the cover with the printer (callout 1), and then rotate the front edge of the cover onto the printer (callout 2) to engage the two tabs.

**Figure 1-357** Install the cover



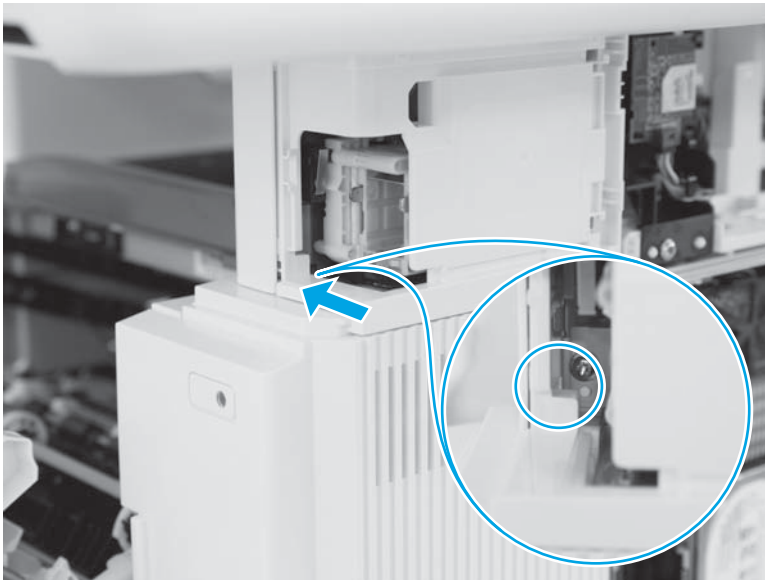
3. Verify that the upper tab is engaged.

**Figure 1-358** Engage one tab



4. Verify that the lower tab is engaged.

**Figure 1-359** Engage one tab



### Step 6: Install the stapler door



**NOTE:** The M527dn does not have a convenience stapler.

1. Do one of the following:
  - **M527c/f/z:** Position the door near the printer.
  - **M527dn:** Position the cover on the printer.

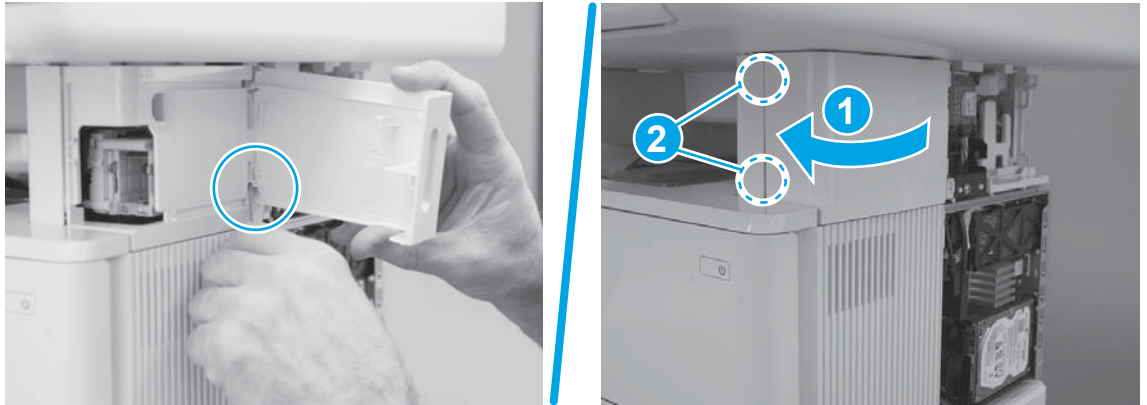
**Figure 1-360** Install the door or cover



2.

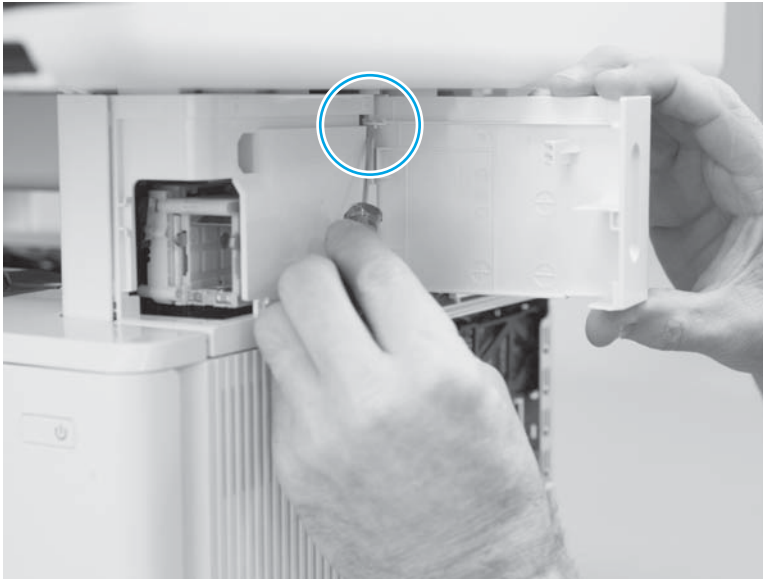
- **M527c/f/z:** Engage the lower hinge.
- **M527dn:** Rotate the cover towards the printer (callout 1), and then make sure that the two tabs (callout 2) snap into place to install the cover.

**Figure 1-361** Engage the lower hinge or engage the cover



3. **M527c/f/z:** Engage the upper hinge.

**Figure 1-362** Engage the upper hinge



4. **M527c/f/z:** Close the stapler door.

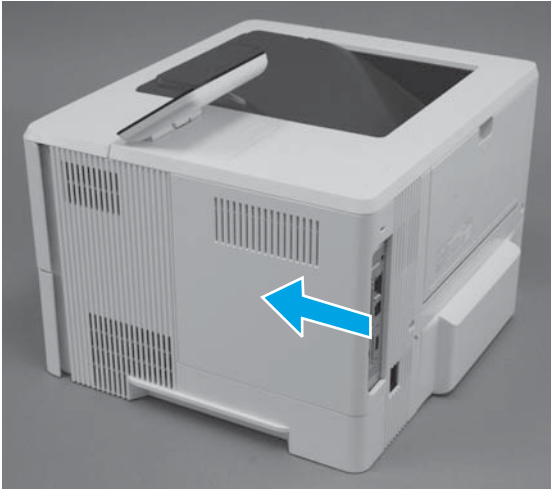
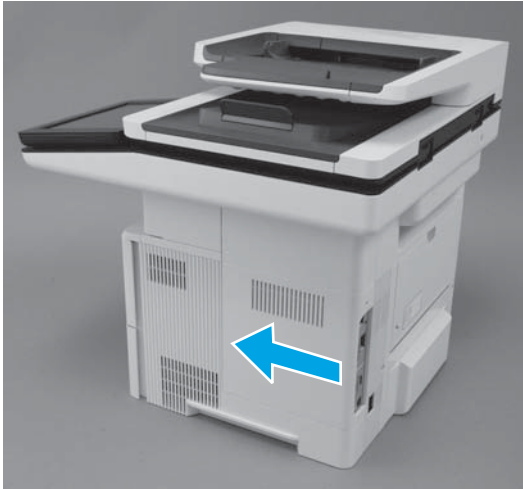
**Figure 1-363** Close the door



### Step 7: Install the formatter cover

- ▲ Slide it toward the front of the printer to install it.

**Figure 1-364** Install the formatter cover



## Removal and replacement: Top cover (M527)

- [Introduction](#)
- [Step 1: Remove the tray](#)
- [Step 2: Remove the formatter cover](#)
- [Step 3: Remove the fax PCA \(M527\)](#)
- [Step 4: Remove the stapler door or stapler blank cover \(M527\)](#)
- [Step 5: Remove the stapler stationary \(inner\) cover \(M527\)](#)
- [Step 6: Remove the top-left cover](#)
- [Step 7: Remove the top-rear cover](#)
- [Step 8: Remove the rear door assembly](#)
- [Step 9: Remove the cartridge door assembly](#)
- [Step 10: Remove the left cover](#)
- [Step 11: Remove the integrated scanner assembly \(M527\)](#)
- [Step 12: Remove the right cover](#)
- [Step 13: Remove the top cover \(M527\)](#)
- [Step 14: Unpack the replacement cover](#)
- [Step 15: Install the top cover \(M527\)](#)
- [Step 16: Install the right cover](#)
- [Step 17: Install the integrated scanner assembly \(M527\)](#)
- [Step 18: Install the left cover](#)
- [Step 19: Install the cartridge door assembly](#)
- [Step 20: Install the rear door assembly](#)
- [Step 20: Install the top-rear cover](#)
- [Step 21: Install the top-left cover](#)
- [Step 22: Install the stapler stationary \(inner\) cover \(M527\)](#)
- [Step 23: Install the stapler door or stapler blank cover \(M527\)](#)
- [Step 24: Install the fax PCA \(M527\)](#)
- [Step 25: Install the formatter cover](#)
- [Step 26: Install the tray](#)

### Introduction


This document provides the procedures to remove and replace the top cover (M527).



## Before performing service

### Turn the printer power off

- Disconnect the power cable.

 **WARNING!** To avoid damage to the printer, turn the printer off, wait 30 seconds, and then remove the power cable before attempting to service the printer.

Use the table below to identify the correct part number for your printer. To order the part, go to [www.hp.com/buy/parts](http://www.hp.com/buy/parts).

Top cover (M527) part number	
RM2-5718-000CN	Top cover (M527)

### Required tools

- #2 Phillips screwdriver with a magnetic tip.
- Small flat-blade screw driver

### After performing service

#### Turn the printer power on

- Connect the power cable.
- Use the power switch to turn the power on.

#### Post service test

Make sure that the printer initializes to a **Ready** state.

Print a configuration page to make sure that the printer is functioning correctly.

#### Step 1: Remove the tray

1. Pull the tray straight out of the printer until it stops.

**Figure 1-365** Pull the tray out until it stops



2. Lift the front of the tray, and then pull it out of the printer to remove it.

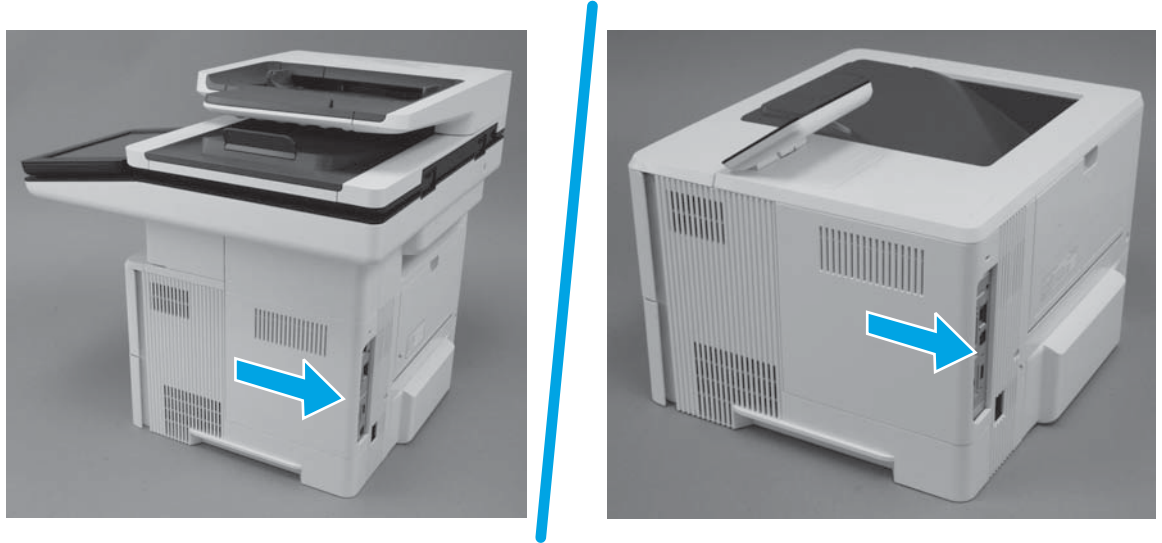
**Figure 1-366** Release and remove the tray



## Step 2: Remove the formatter cover

- ▲ Slide the cover toward the rear of the printer to remove it.

**Figure 1-367** Remove the formatter cover



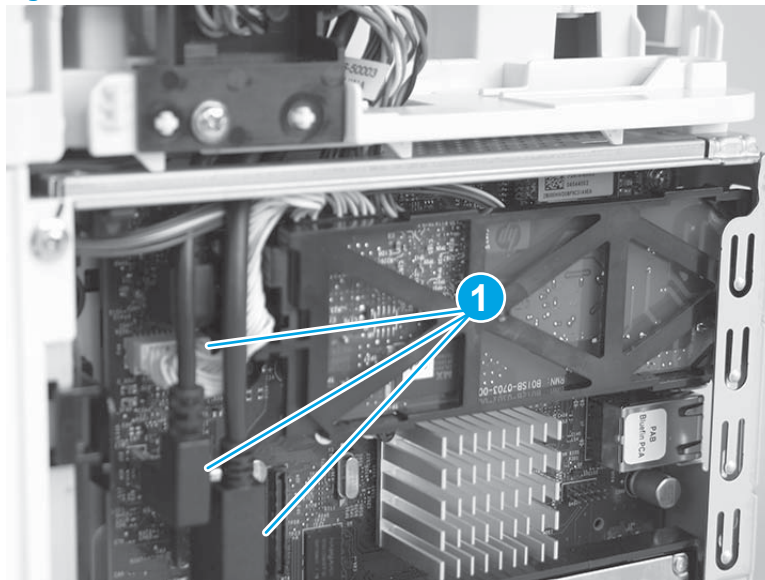
**Step 3: Remove the fax PCA (M527)**

 **CAUTION:**  ESD-sensitive part.

 **NOTE:** M527c/f/z printers only (optional for the M527dn).

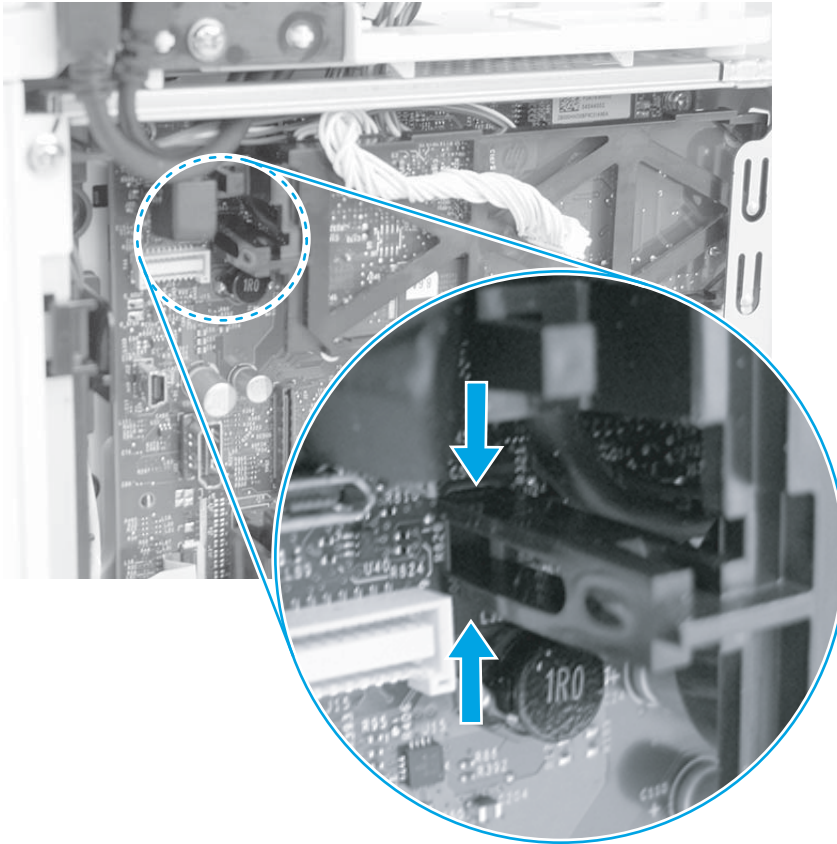
1. Disconnect three connectors (callout 1).

**Figure 1-368** Disconnect three connectors



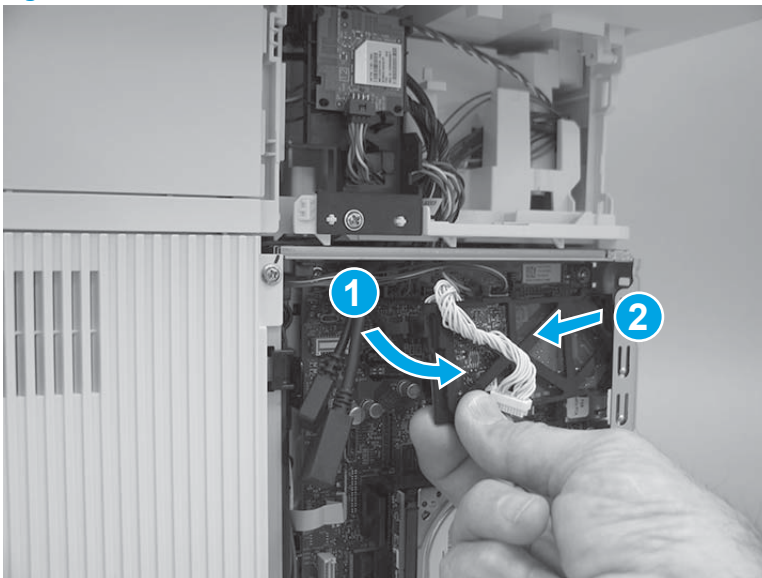
2. Pinch the retainer to release it.

**Figure 1-369** Release the fax PCA



3. Rotate the connector end of the fax PCA out and away from the formatter (callout 1), and then slide it as shown (callout 2) to remove it.

**Figure 1-370** Remove the fax PCA



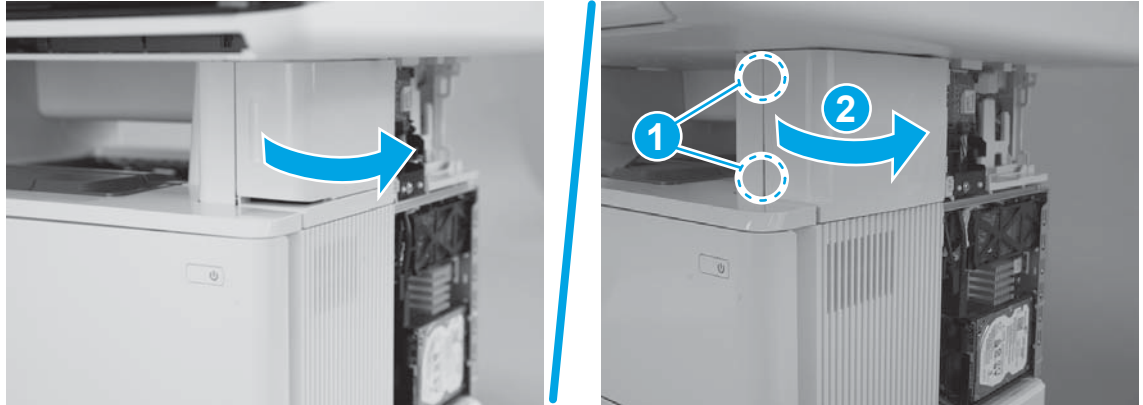
#### Step 4: Remove the stapler door or stapler blank cover (M527)

The M527dn does not have a convenience stapler.

1. Do one of the following:

- **M527c/f/z:** Open the stapler door.
- **M527dn:** Use a small flat-blad screw driver to release two tabs (callout 1), and then rotate the cover away from the printer (callout 2).

**Figure 1-371** Open the door or release the cover



2. Do one of the following:

- **M527c/f/z:** Use a small flat-blad screwdriver to release the upper hinge.
- **M527dn:** Slide the cover toward the front of the printer to remove it.

**Figure 1-372** Release the upper hinge or remove the cover



3. **M527c/f/z:** Use a small flat-blad screwdriver to release the lower hinge.

**Figure 1-373** Release the lower hinge




4. **M527c/f/z:** Remove the door.

**Figure 1-374** Remove the door



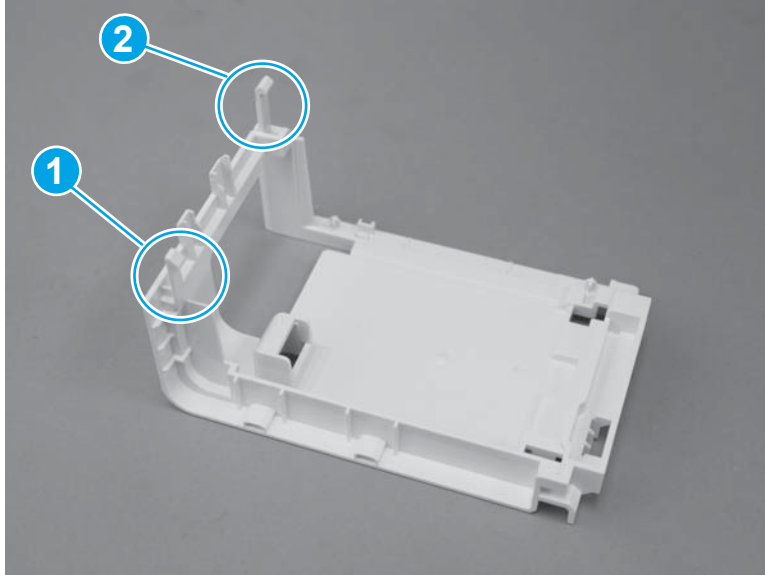
### Step 5: Remove the stapler stationary (inner) cover (M527)

---

 **NOTE:** M527c/f/z printers only.

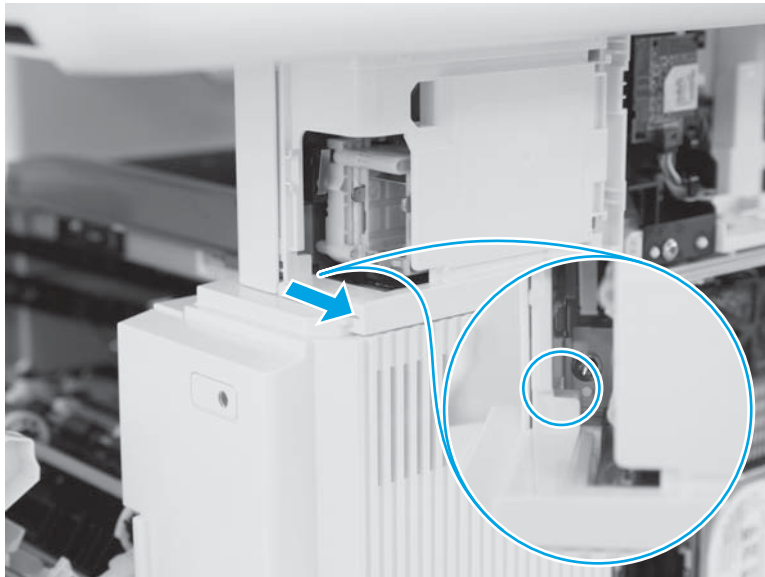
1. Before proceeding, take note of the locations of the upper tab (callout 1) and the lower tab (callout 2) on the stapler stationary (inner) cover.

**Figure 1-375** Locate the tabs



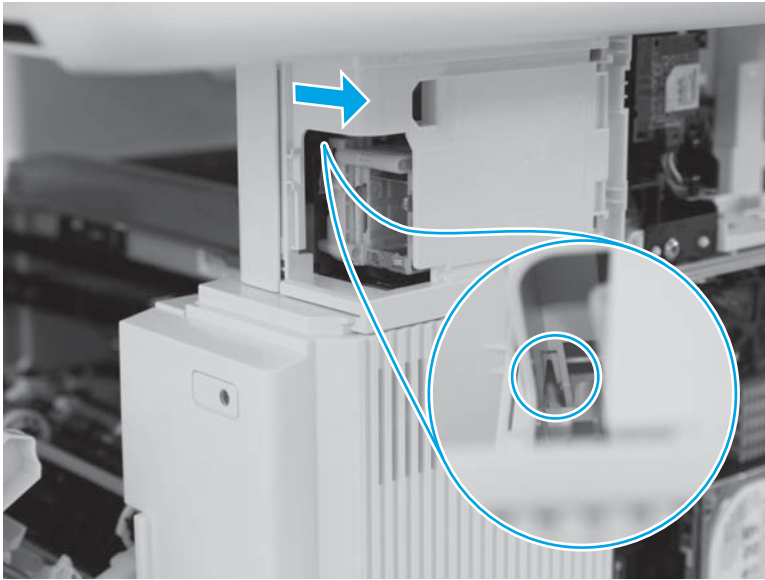
2. Use a long-shaft small flat-blad screwdriver to release the lower tab.

**Figure 1-376** Release one tab



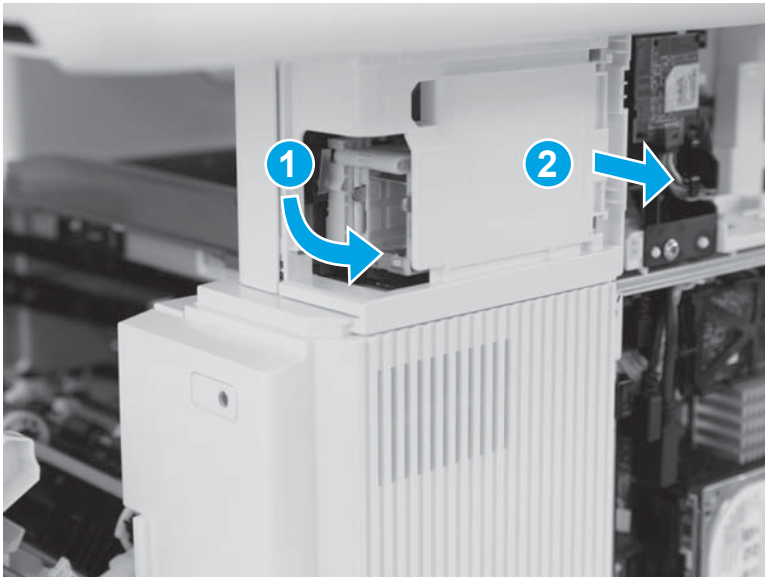
3. Use a long-shaft small flat-blad screwdriver to release the upper tab.

**Figure 1-377** Release one tab



4. With the tabs disengaged the front of the cover is released. Rotate the front of the cover away from the printer (callout 1) to release the rear of the cover (callout 2), and then remove it.

**Figure 1-378** Remove the cover

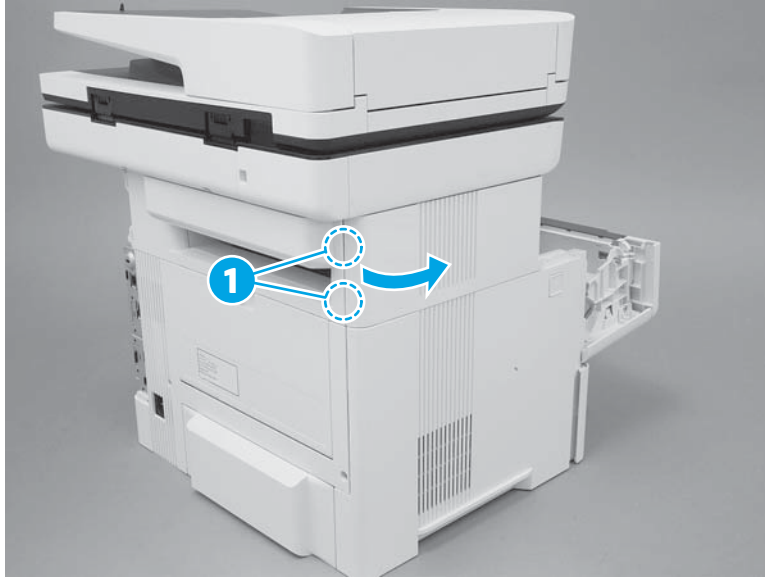


#### **Step 6: Remove the top-left cover**

1. Open the toner-cartridge door, release two tabs (callout 1), and then rotate the rear edge of the cover away from the printer.



**Figure 1-379** Release two tabs



2. Continue to rotate the cover away from the printer to release two more tabs at the middle of the cover.

**Figure 1-380** Release two tabs



3. Slide the cover toward the rear of the printer to release two bosses at the front of the cover.

**Figure 1-381** Slide the cover



4. Remove the cover.

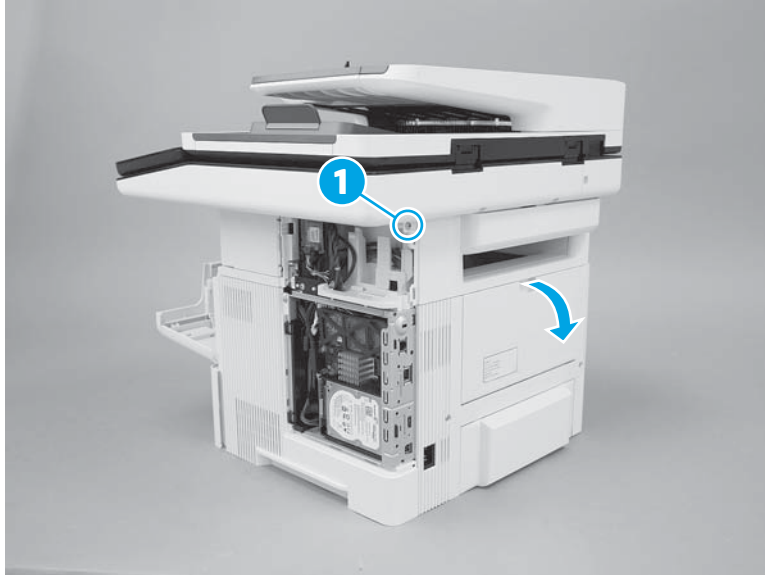
**Figure 1-382** Remove the cover



### **Step 7: Remove the top-rear cover**

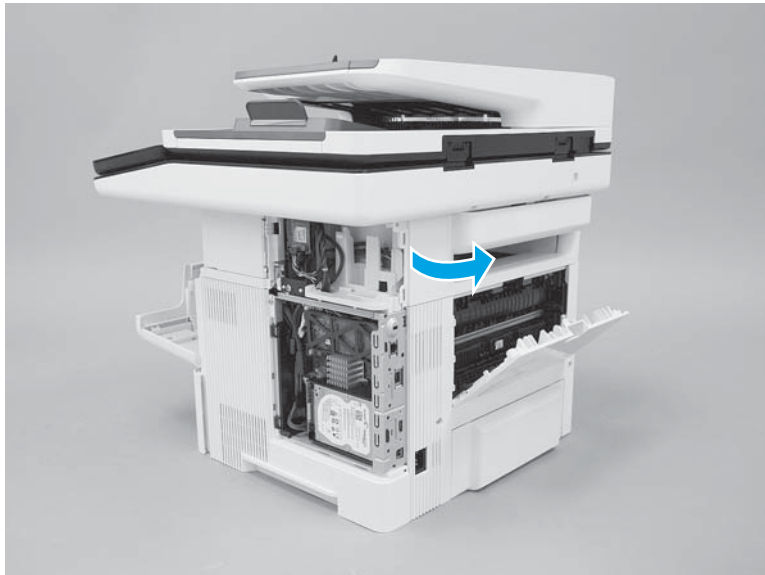
1. Remove one screw (callout 1), and then open the rear door.

**Figure 1-383** Remove one screw



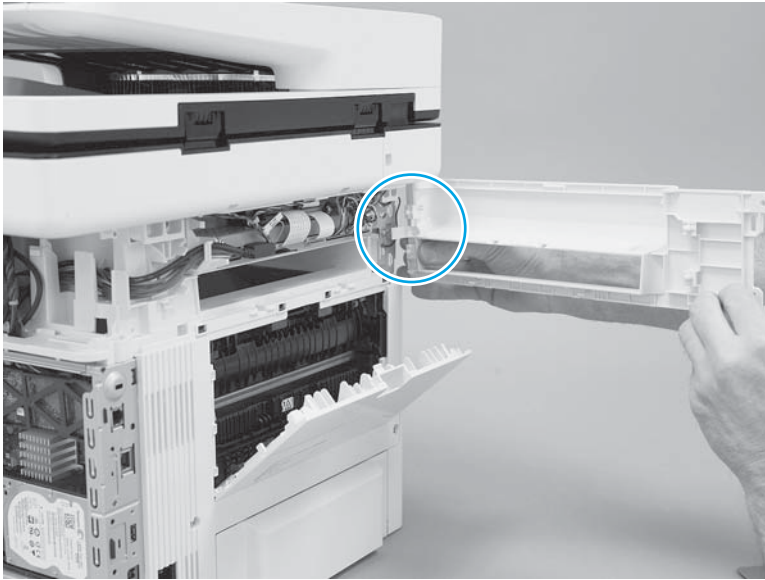
2. Rotate the exposed edge of the cover away from the printer (as shown).

**Figure 1-384** Rotate the cover



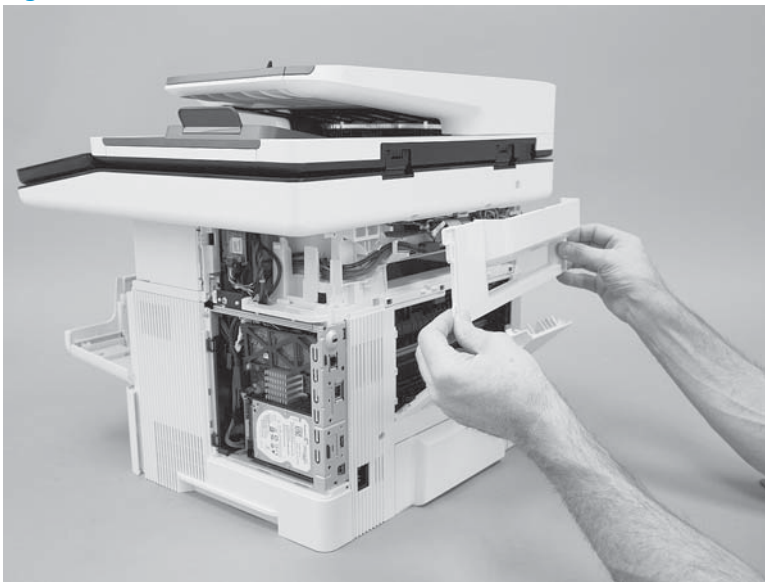
3. Continue to rotate the cover away from the printer to release one boss.

**Figure 1-385** Release one boss



4. Remove the cover.

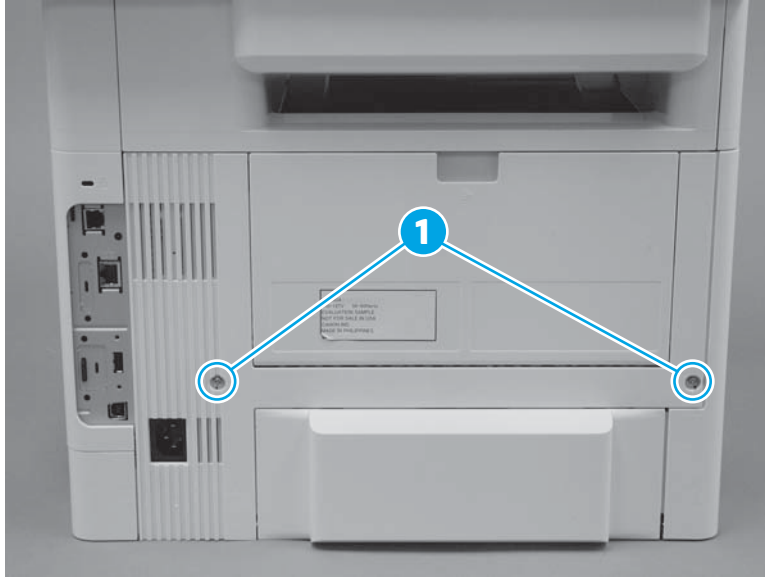
**Figure 1-386** Remove the cover



### **Step 8: Remove the rear door assembly**

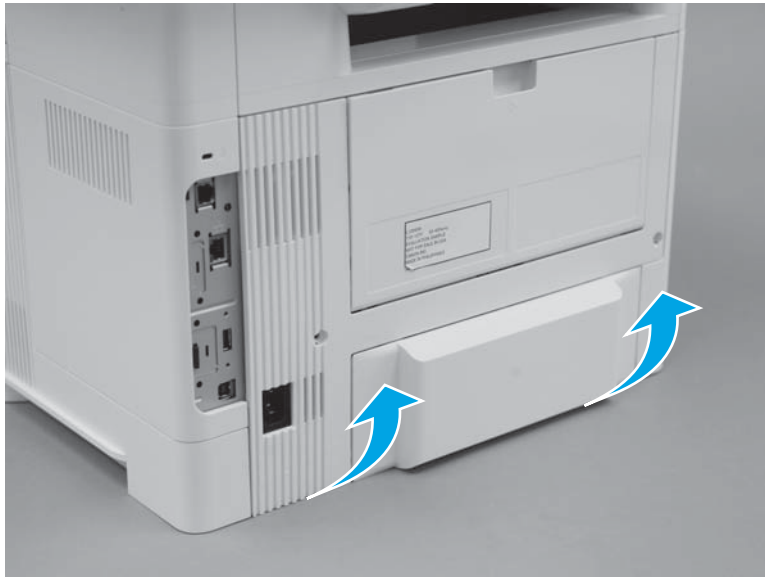
1. At the rear of the printer, remove two screws (callout 1).

**Figure 1-387** Remove two screws



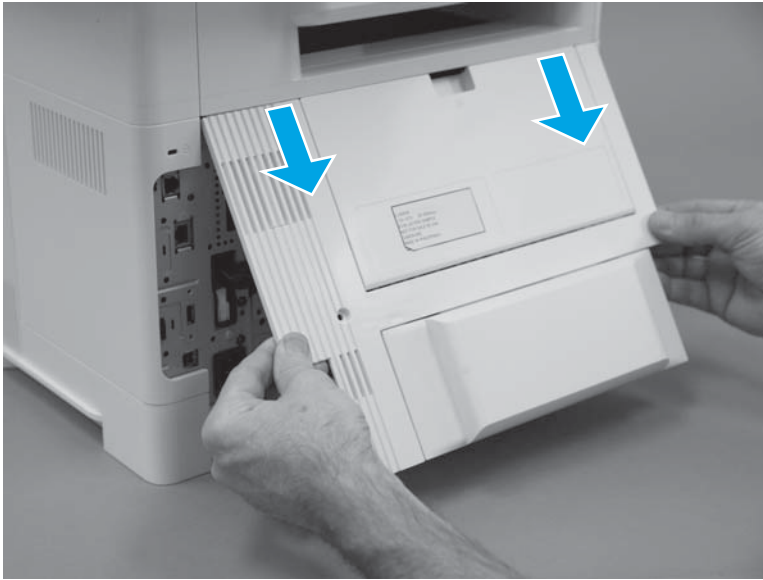
2. Rotate the bottom edge of the assembly away from the printer to release it.

**Figure 1-388** Rotate the bottom of the cover



3. Pull down on the assembly to remove it.

**Figure 1-389** Remove the cover



### Step 9: Remove the cartridge door assembly



---

**NOTE:** If the toner cartridge was not removed prior to servicing the printer, remove it now.

---

1. Release the support shaft (callout 1), and then slide it toward the center of the door (callout 2).

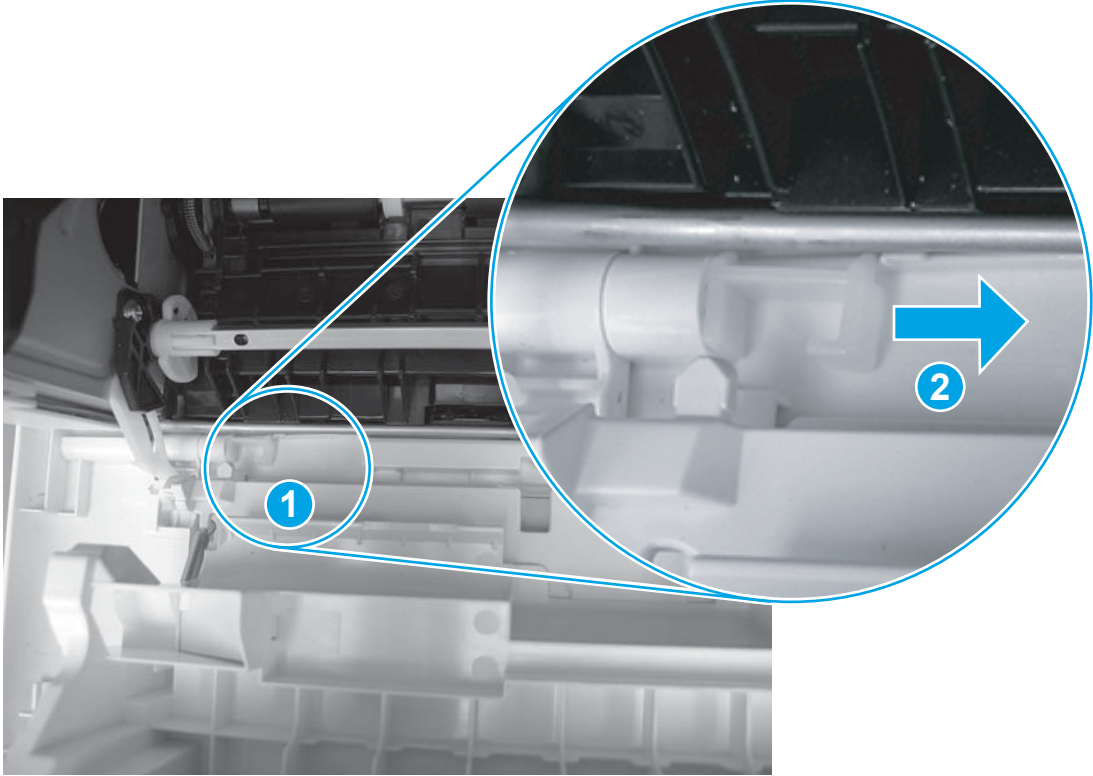


---

**TIP:** It might be easier to release the support shaft by using a small flat-blad screwdriver.

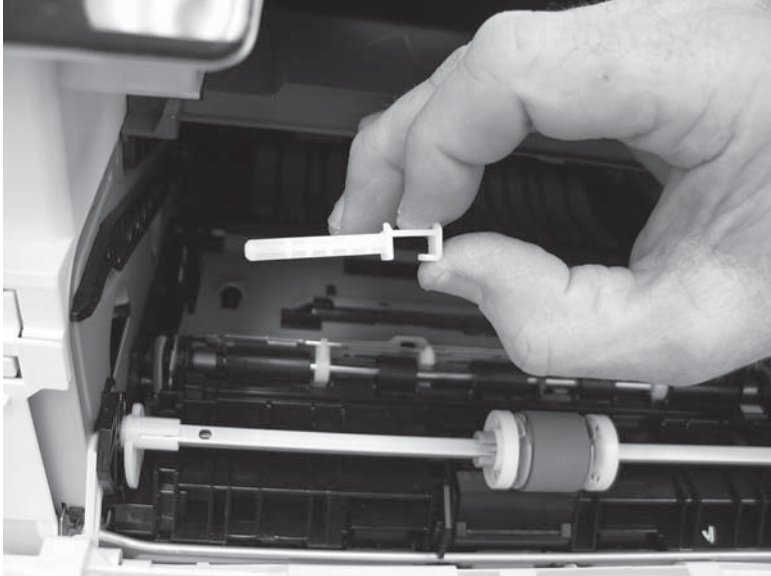
---

**Figure 1-390** Release the support shaft



- 2. Remove the support shaft.

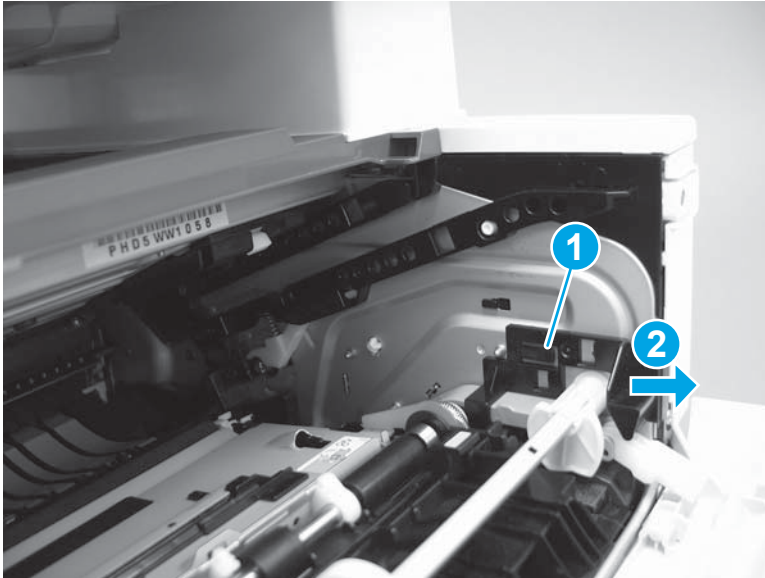
**Figure 1-391** Remove the support shaft



3. Release one tab (callout 1), and then slide the guide out of the printer (callout 2).

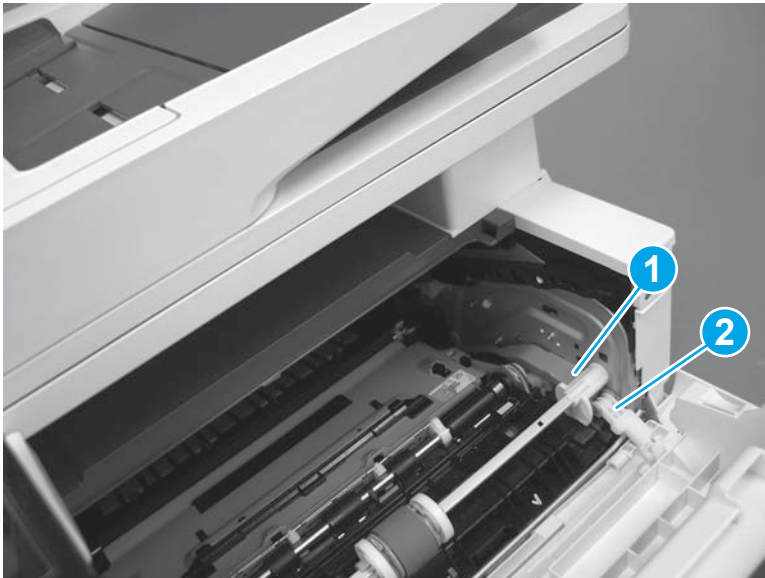
**⚠ CAUTION:** Be careful, the tab (callout 1) can be easily broken.

**Figure 1-392** Remove the guide



4. Use a small flat-blad screwdriver to gently pry the white-plastic door arm (callout 1) off of the gray-plastic pressure-release link (callout 2) to release the door arm.

**Figure 1-393** Release the pressure-release link

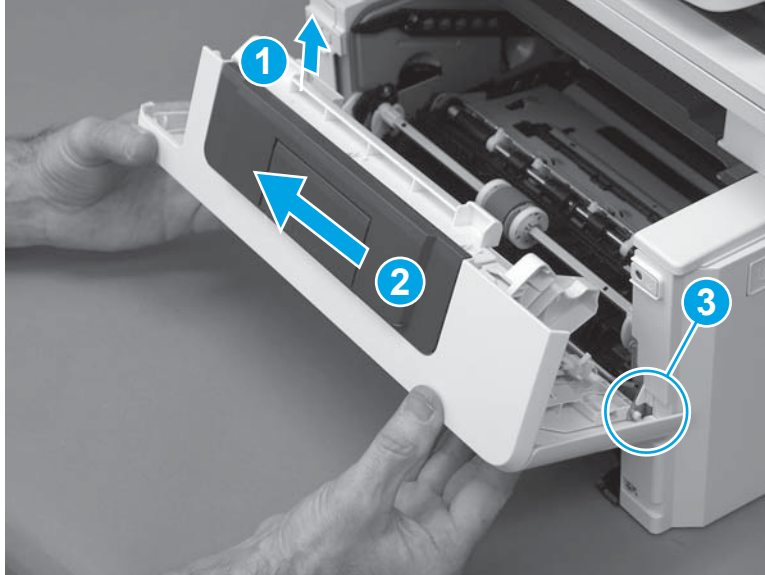




5. With the door in the partially closed position, slightly raise the left end (callout 1; raise it over the sheet-metal hinge boss), and then slide the door to the left (callout 2) to release the right hinge (callout 3).

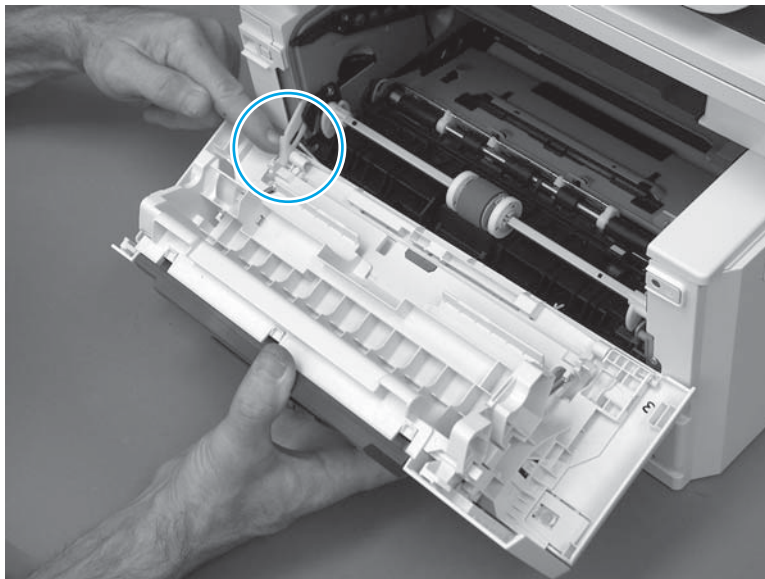
**CAUTION:** The door is still attached to the printer by the left-side retainer arm. Do not attempt to completely remove the door.

**Figure 1-394** Release the door



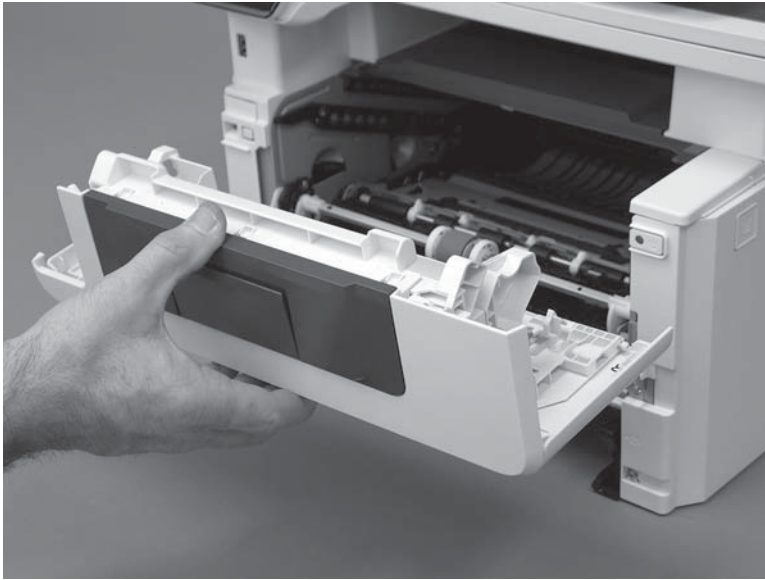
6. Rotate the door away from the printer until the keyed pin on the left-side retainer arm can disengage from the door.

**Figure 1-395** Release the left-side retainer arm





7. Remove the door.

**Figure 1-396** Remove the door



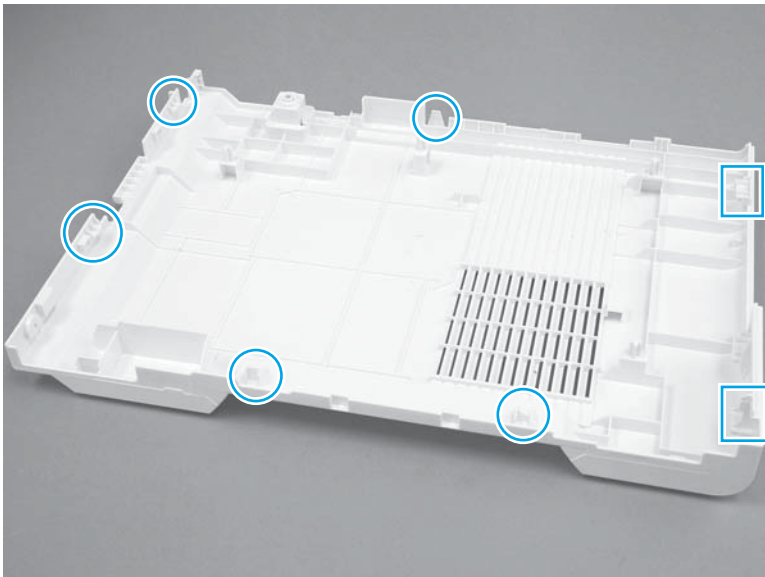
#### Step 10: Remove the left cover

 **IMPORTANT:** The black-plastic cassette front and rear guides (located inside the tray cavity) can be easily dislodged. Do not lose the guides when the cover is removed or installed.

 **NOTE:** The M527 printer is shown in this procedure. However, this procedure is valid for the M506 printer.

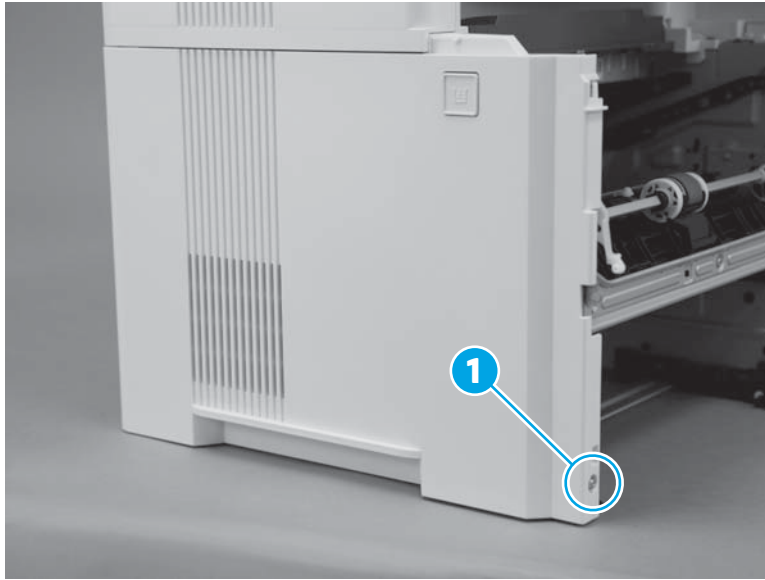
1. Before proceeding, take note of the location of the tabs and bosses on the inside of the cover.

**Figure 1-397** Locate of the tabs and bosses



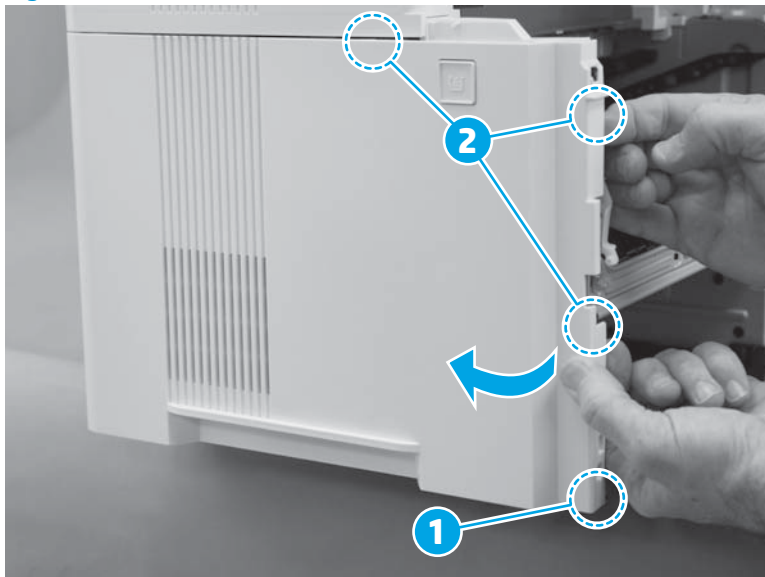
2. Remove one screw (callout 1).

**Figure 1-398** Remove one screw



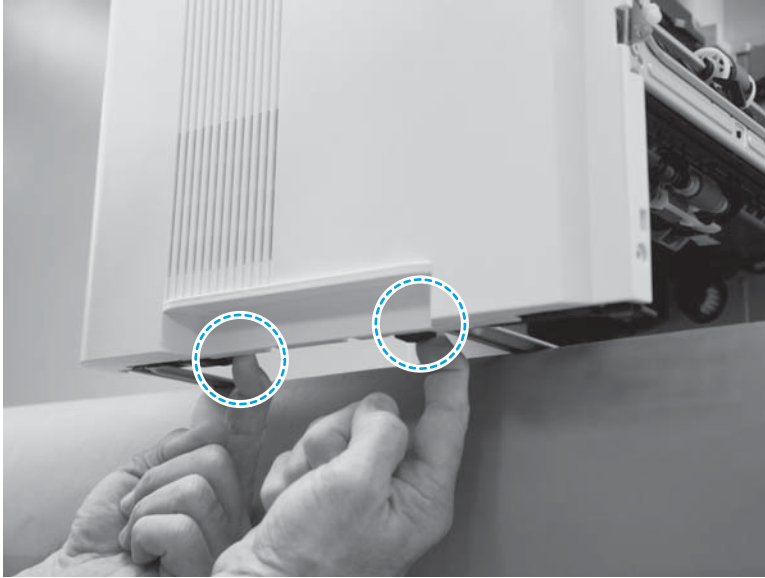
3. At the front of the printer, release one boss (callout 1), and then rotate the front edge of the cover away from the printer to release three tabs (callout 2).

**Figure 1-399** Release one boss and three tabs




4. At the bottom edge of the cover, release two tabs.

**Figure 1-400** Release two tabs



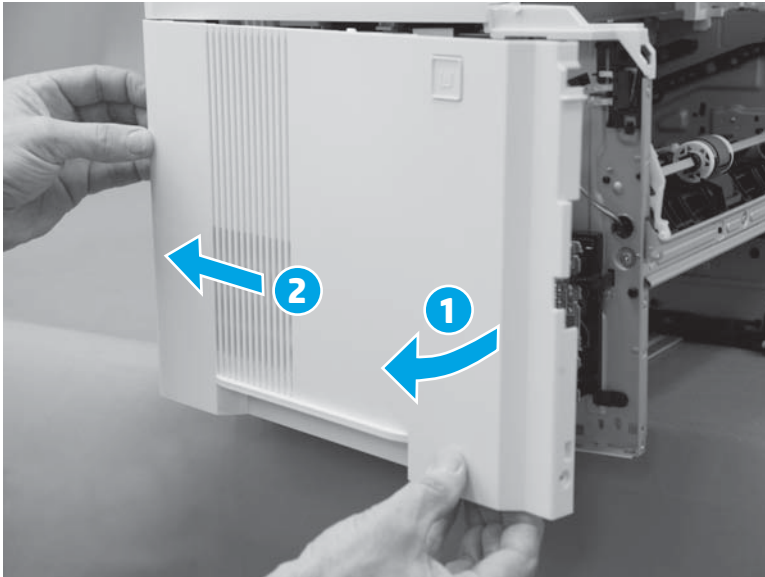
5. Continue to rotate the front edge of the cover away from the printer (callout 1), and then slide the cover toward the rear of the printer (callout 2) to remove it.

---

 **NOTE:** If the cover is difficult to rotate or slide as shown below, make sure that the bottom tabs (released in the previous step) are completely disengaged from the chassis.


---

**Figure 1-401** Remove the cover




### Step 11: Remove the integrated scanner assembly (M527)

---

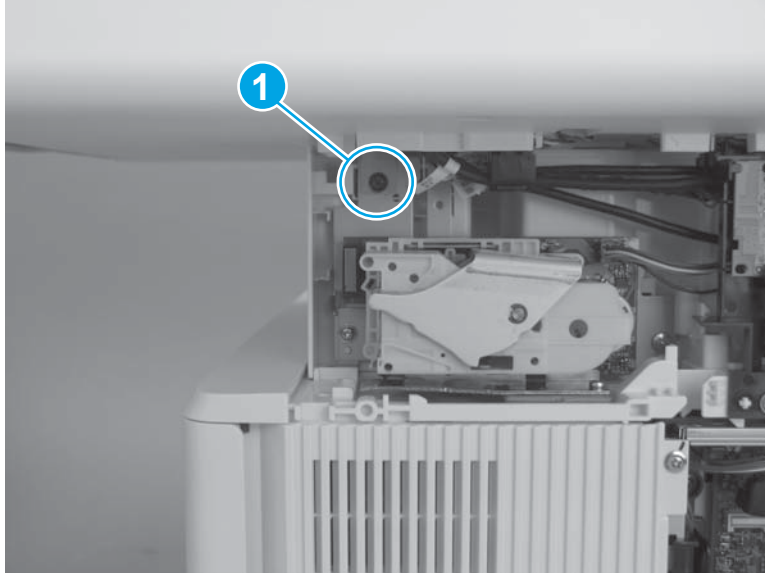
 **NOTE:** The ISA includes the document feeder, sub-scanner assembly (SSA), and the scanner control board (SCB)

---

1. Remove one screw (callout 1).


 **IMPORTANT:** This screw fastens the ISA ground plate to the printer chassis. Do not lose this screw.

**Figure 1-402** Remove one screw

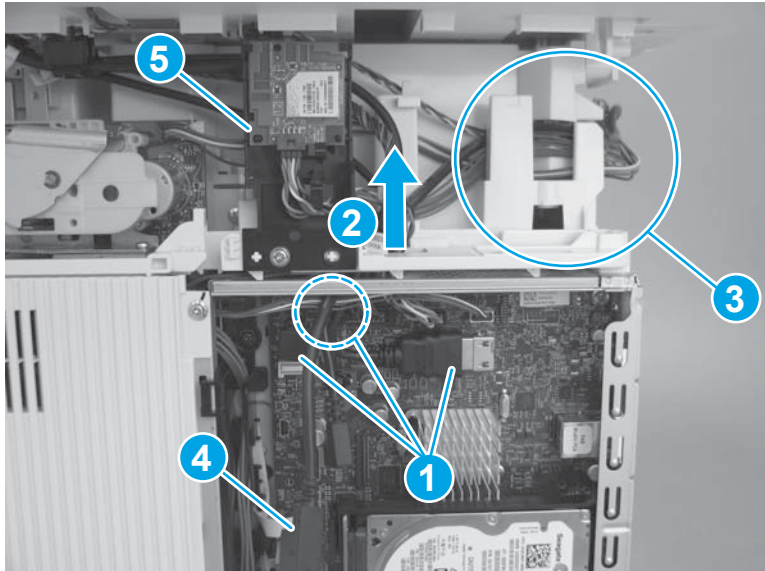


2. Disconnect three connectors (callout 1), pass the wire harnesses and cables through the opening in the cover (callout 2), and then release them from the retainers (callout 3).

 **NOTE:** One cable (callout 4) does not need to pass through the opening in the cover.

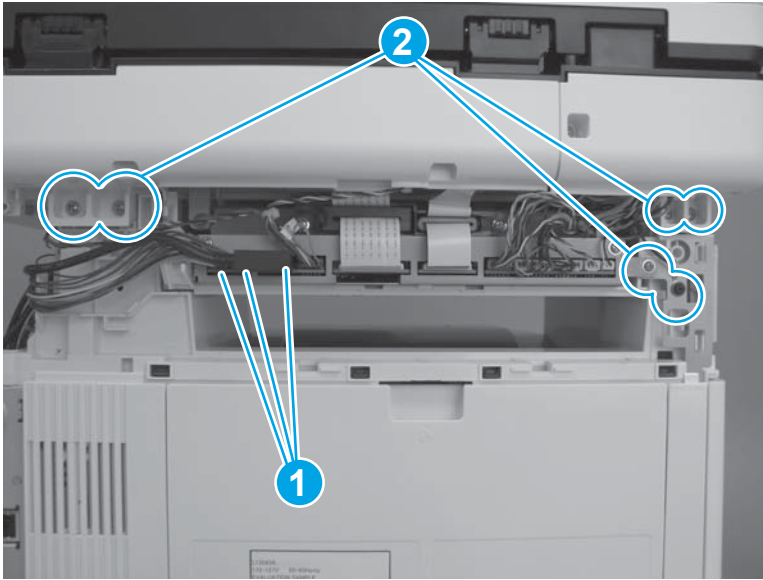
 **TIP:** It might be easier if the WiFi PCA and holder (callout 5) is detached from the printer, and then moved out of the way.

**Figure 1-403** Disconnect cables and connectors



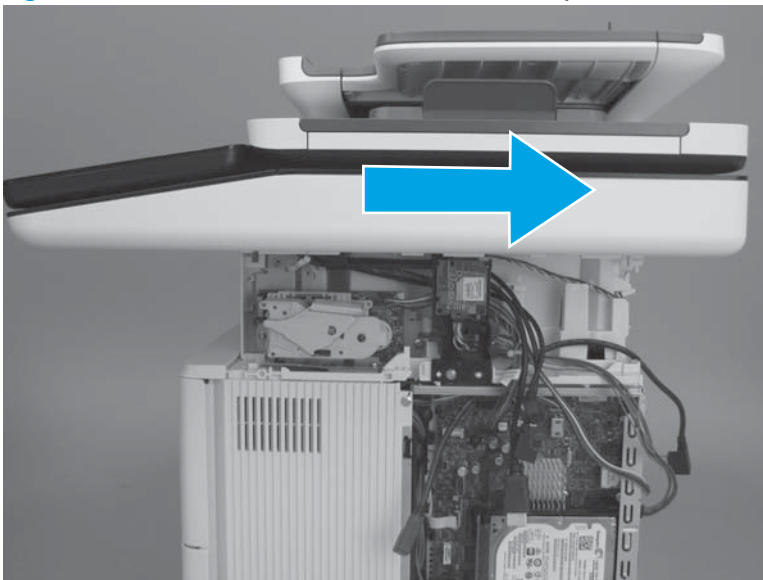
3. Disconnect three connectors (callout 1), and then remove six screws (callout 2).

**Figure 1-404** Disconnect connectors and remove screws



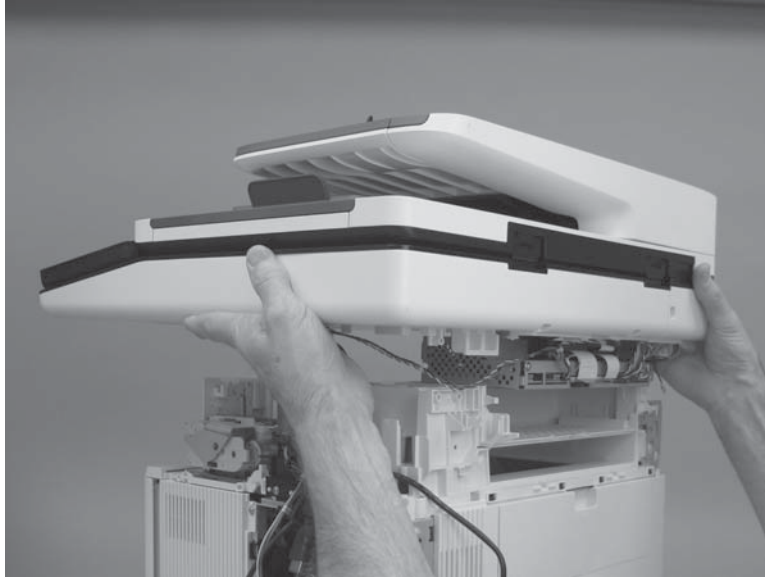
4. Slightly slide the ISA towards the back of the printer to release it.

**Figure 1-405** Slide the ISA towards the back of the printer





5. Remove the ISA.

**Figure 1-406** Remove the ISA



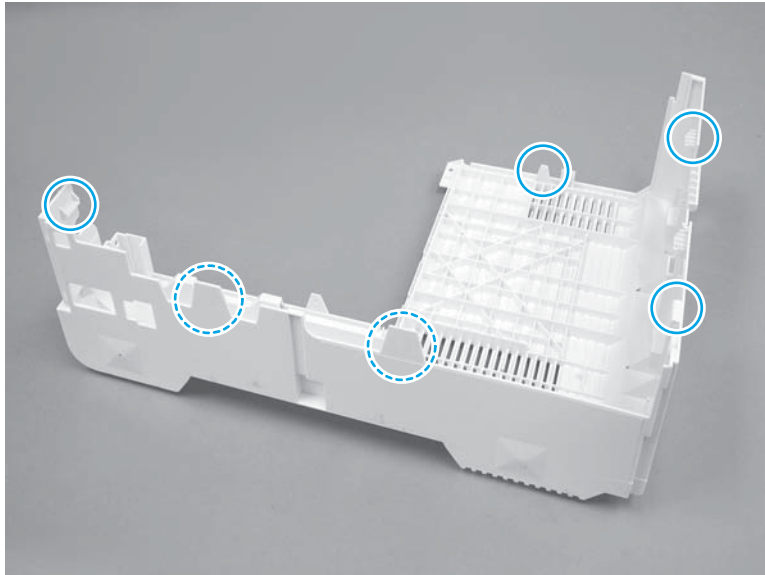
### Step 12: Remove the right cover

 **IMPORTANT:** The black-plastic cassette front and rear guides (located inside the tray cavity) can be easily dislodged. Do not lose the guides when the cover is removed or installed.

 **NOTE:** The M527 printer is shown in this procedure. However, this procedure is valid for the M506 printer.

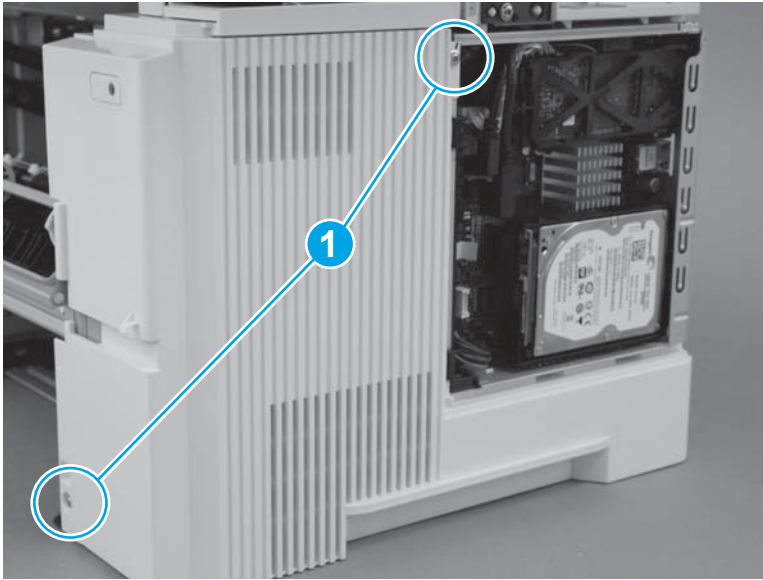
1. Before proceeding, take note of the location of the tabs and bosses on the inside of the cover.

**Figure 1-407** Locate the tabs and bosses



2. Remove two screws (callout 1).

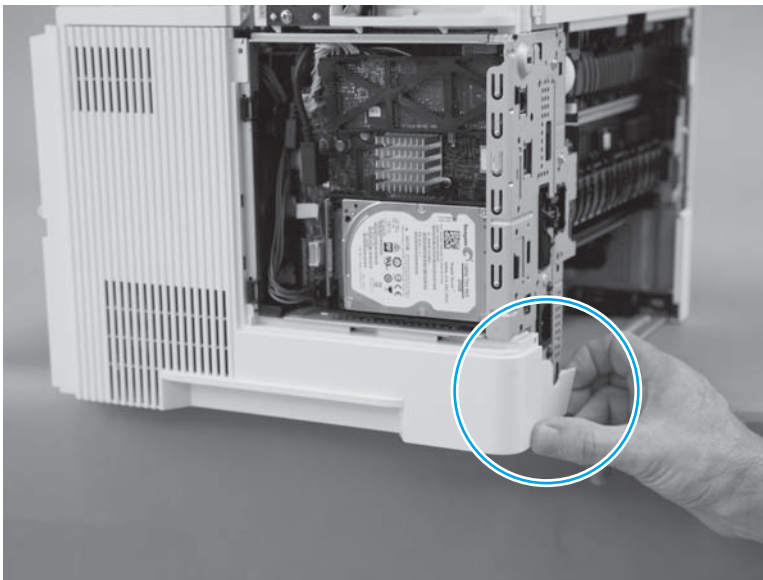
**Figure 1-408** Remove two screws



3. At the rear of the printer, release one boss.

**CAUTION:** It might be easier to remove the cover with the printer slightly hanging over the edge of the workspace. Do not let the printer tip and fall off of the workspace when removing the cover.

**Figure 1-409** Release one boss

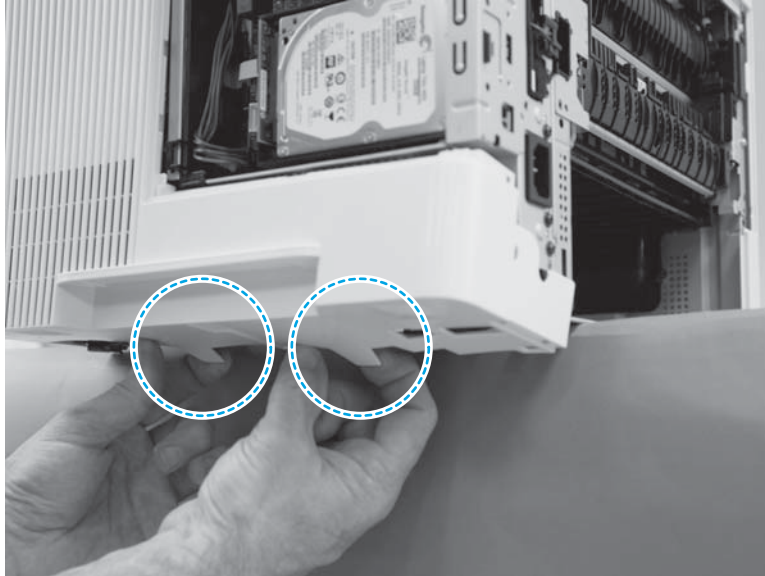




4. At the bottom edge of the cover, release two bosses.

**CAUTION:** It might be easier to remove the cover with the printer slightly hanging over the edge of the workspace. Do not let the printer tip and fall off of the workspace when removing the cover.

**Figure 1-410** Release two bosses

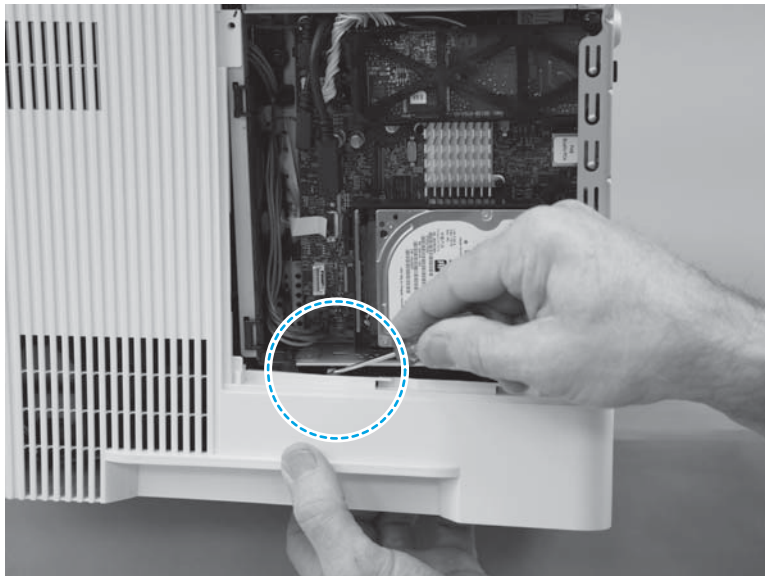


5. Near the formatter, release one tab.

**CAUTION:** It might be easier to remove the cover with the printer slightly hanging over the edge of the workspace. Do not let the printer tip and fall off of the workspace when removing the cover.

**TIP:** Hold the bottom of the cover away from the printer, and then use a small flat-bladed screw driver to easily release this tab.

**Figure 1-411** Release one tab

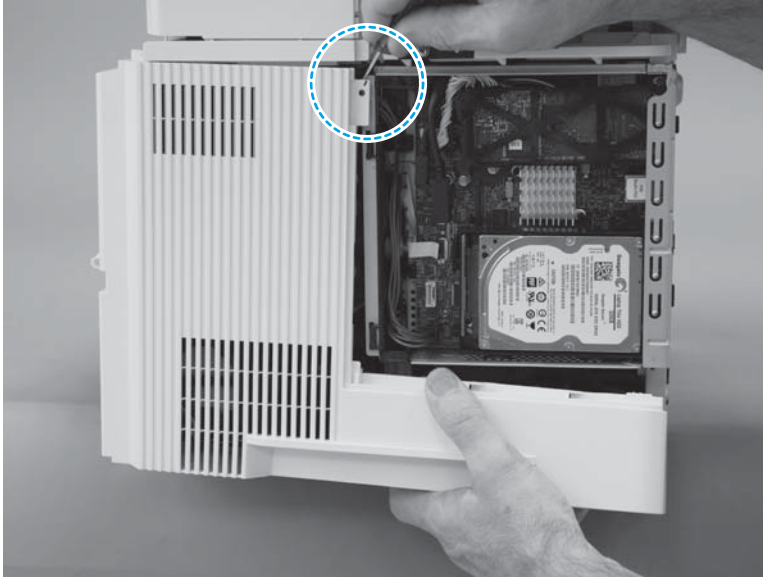


- At the top rear edge of the cover, release one tab.

**CAUTION:** It might be easier to remove the cover with the printer slightly hanging over the edge of the workspace. Do not let the printer tip and fall off of the workspace when removing the cover.

**TIP:** Use a small flat-blade screw driver to easily release this tab.

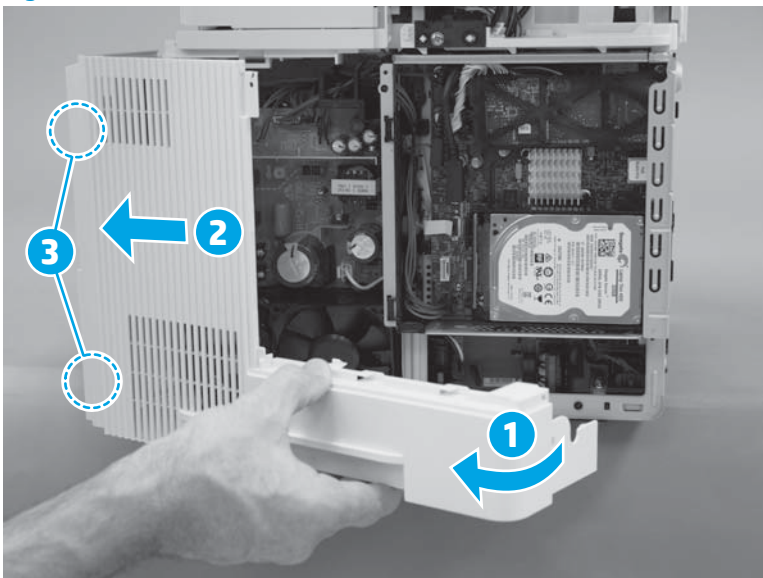
**Figure 1-412** Release one tab



- Rotate the rear of the cover away from the printer (callout 1), slide the cover toward the front of the printer (callout 2) to release two bosses (callout 3), and then remove the cover.

**CAUTION:** It might be easier to remove the cover with the printer slightly hanging over the edge of the workspace. Do not let the printer tip and fall off of the workspace when removing the cover.

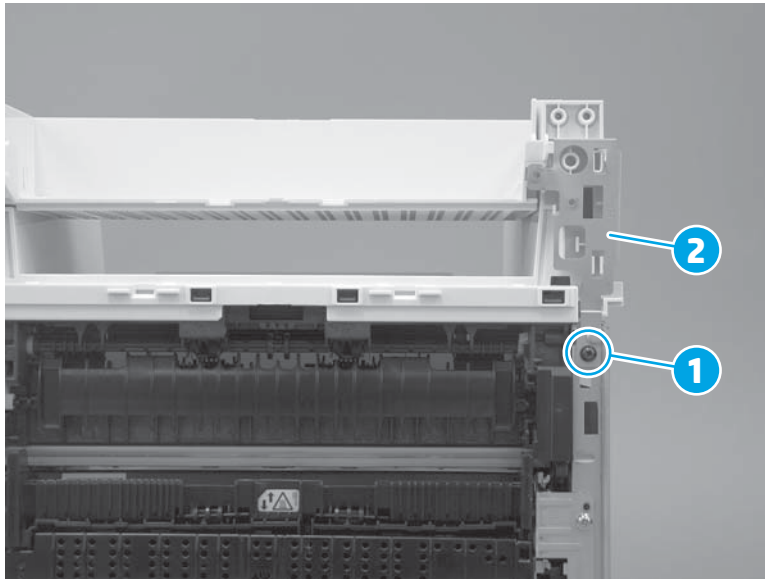
**Figure 1-413** Remove the cover



### Step 13: Remove the top cover (M527)

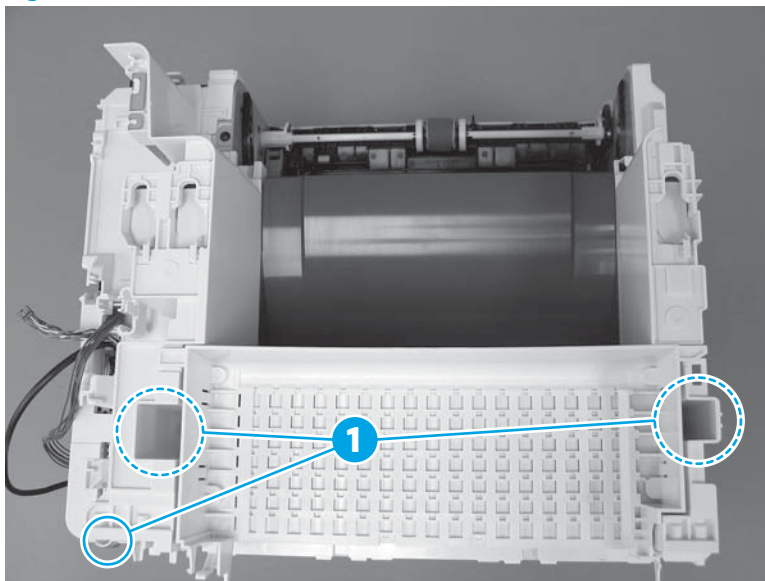
1. At the front right of the printer, remove one screw (callout 1), and then remove the sheet-metal plate (callout 2).

**Figure 1-414** Remove one screw and the plate




2. At the top rear of the printer, remove three screws (callout 1).

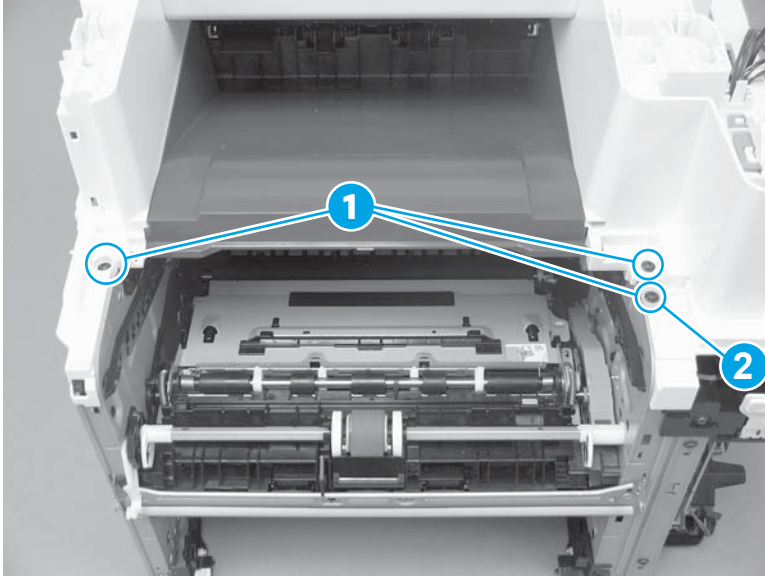
**Figure 1-415** Remove three screws



3. At the top front of the printer, remove three screws (callout 1).

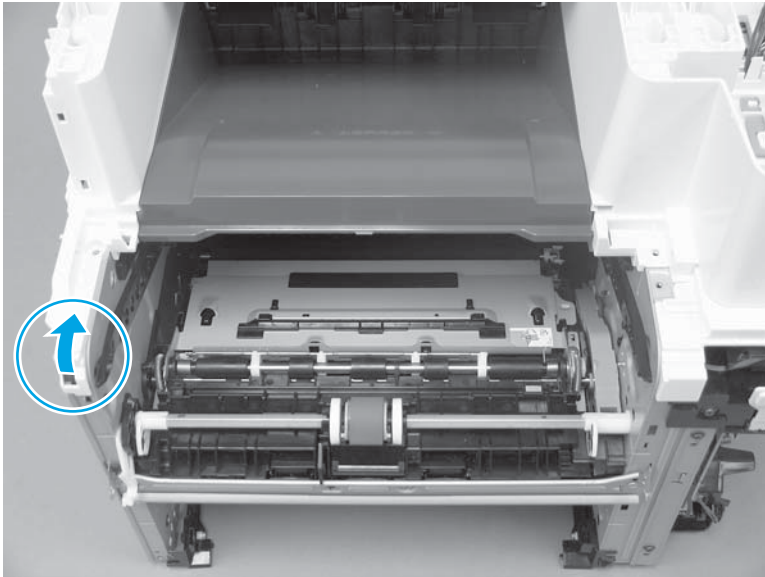
 **NOTE:** The screw (callout 2) on the lower-right portion of the cover is a different color than the other two screws, and is surrounded by sheet-metal. It might appear that this screw does not need to be removed. Remove this screw.

**Figure 1-416** Remove three screws



4. At the front left of the printer, release one boss.

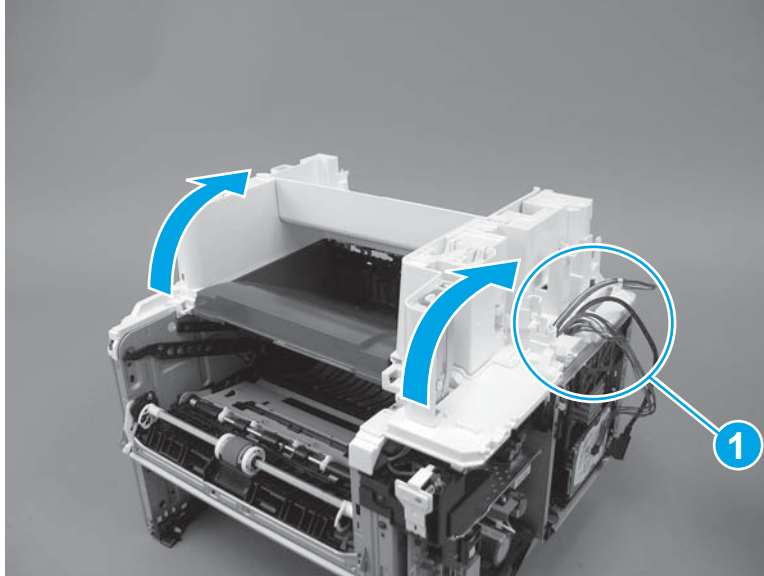
**Figure 1-417** Release one boss



5. Rotate the front of the cover up and away from the printer.

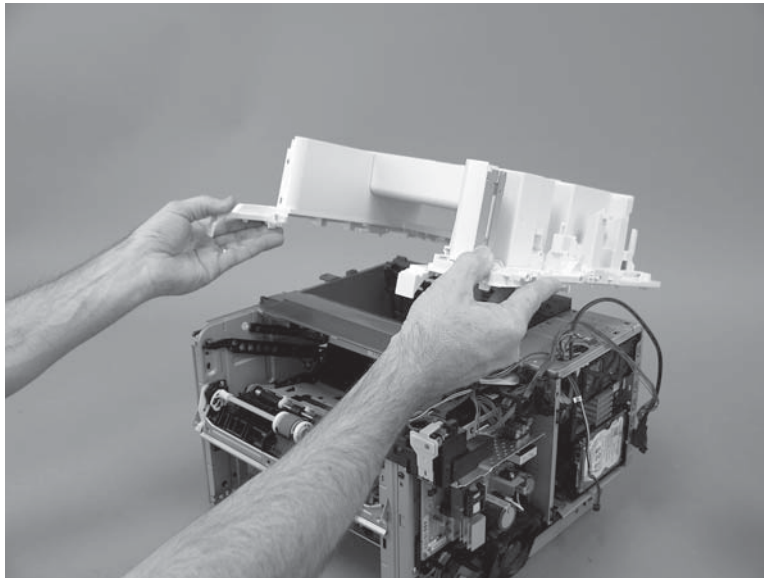
**CAUTION:** As the cover is rotated up, carefully pass the cables and wire harnesses the hole in the cover (callout 1).

**Figure 1-418** Rotate the front of the cover up



6. Remove the cover.

**Figure 1-419** Remove the cover



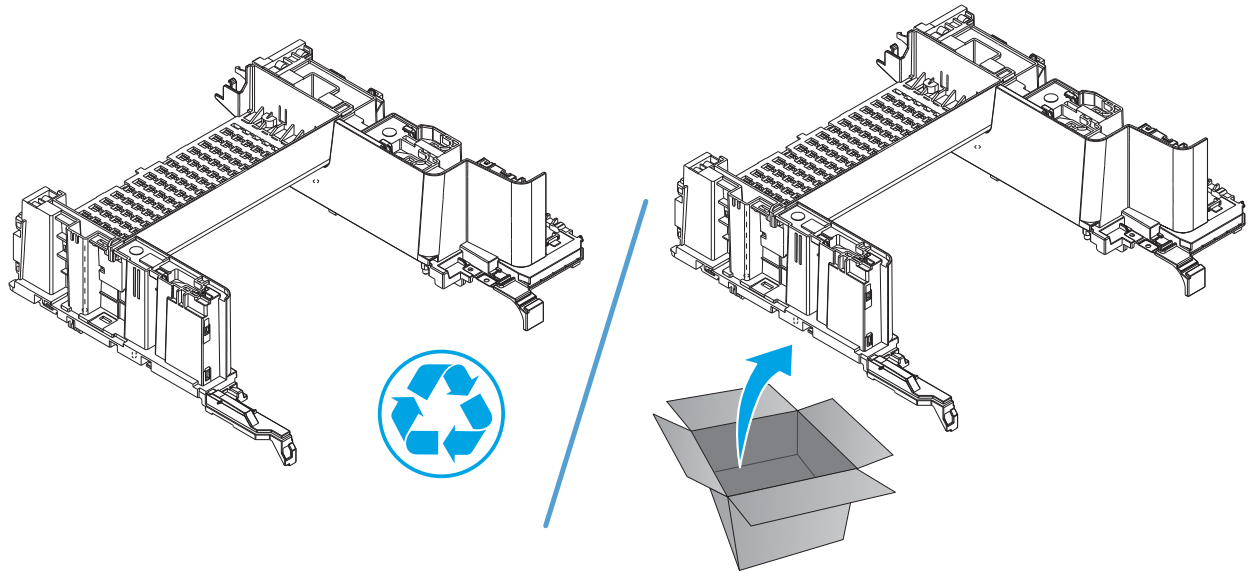
#### Step 14: Unpack the replacement cover

Unpack the replacement part from the packaging.

<http://www8.hp.com/us/en/hp-information/environment/product-recycling.html>

**NOTE:** HP recommends responsible disposal of the defective part.

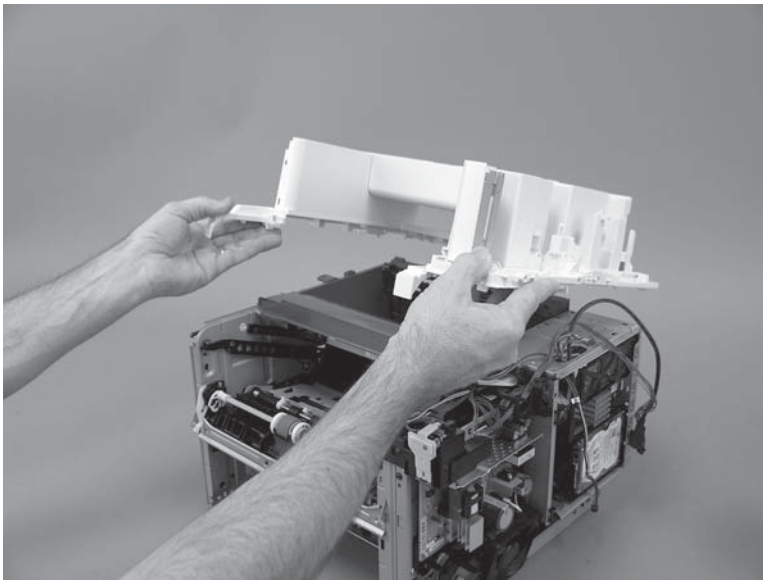
**Figure 1-420** Recycle and unpack



**Step 15: Install the top cover (M527)**

1. Position the rear edge of the cover on the chassis.

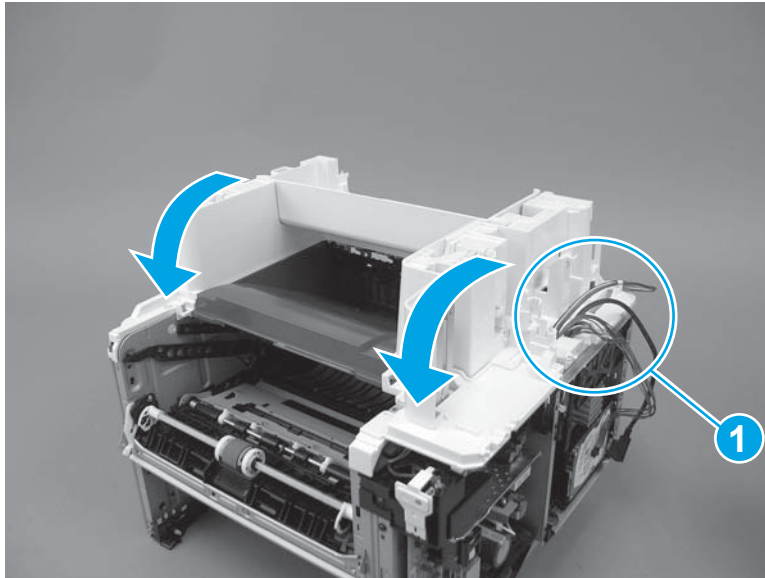
**Figure 1-421** Install the cover



2. Rotate the front of the cover down onto the printer.

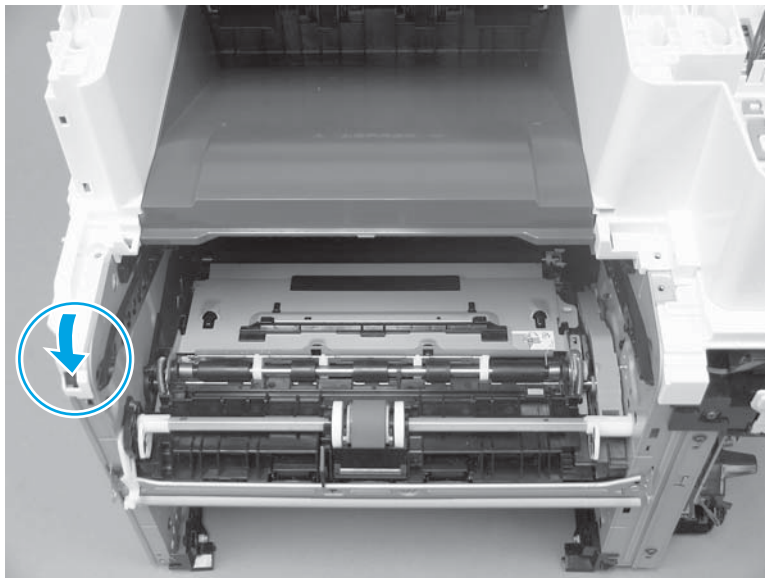
**CAUTION:** As the cover is rotated down, carefully pass the cables and wire harnesses the hole in the cover (callout 1).

**Figure 1-422** Rotate the front of the cover down



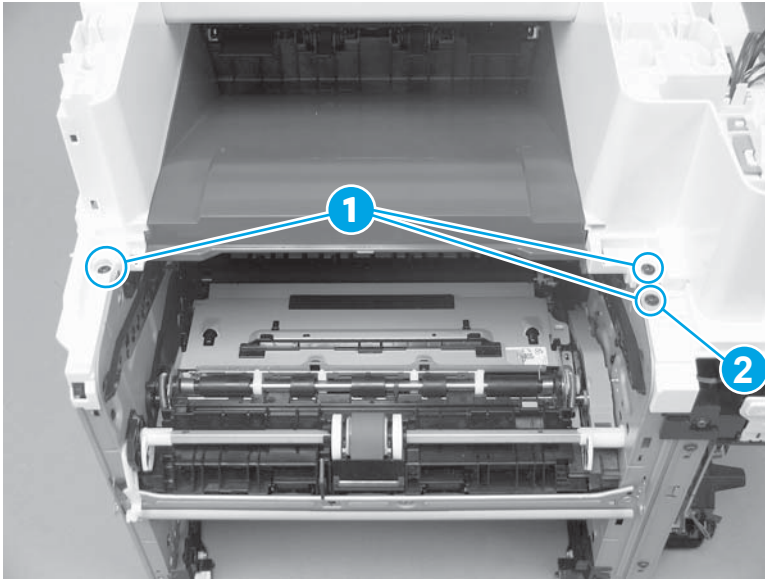
3. At the front left of the printer, engage one boss.

**Figure 1-423** Engage one boss




4. At the top front of the printer, install three screws (callout 1).

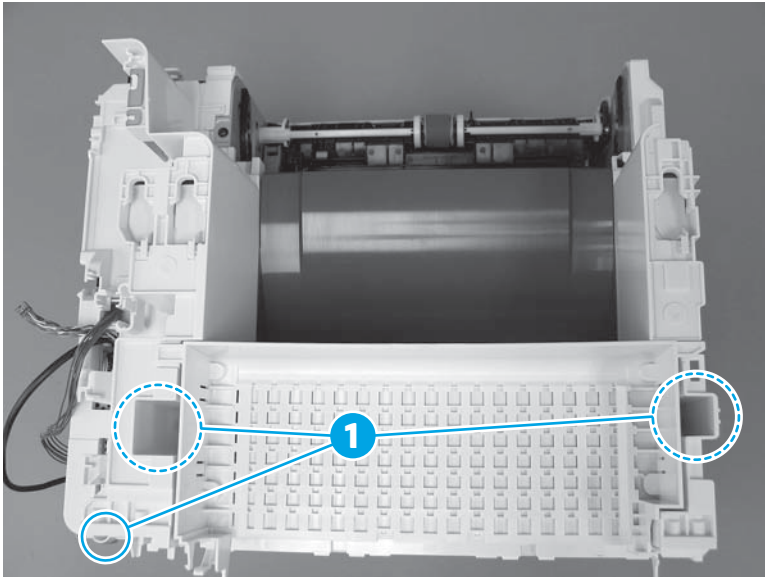
**Figure 1-424** Install three screws



5. At the top rear of the printer, install three screws (callout 1).

 **NOTE:** The screw (callout 2) on the lower-right portion of the cover is a different color than the other two screws, and is surrounded by sheet-metal. It might appear that this screw does not need to be removed. Remove this screw.

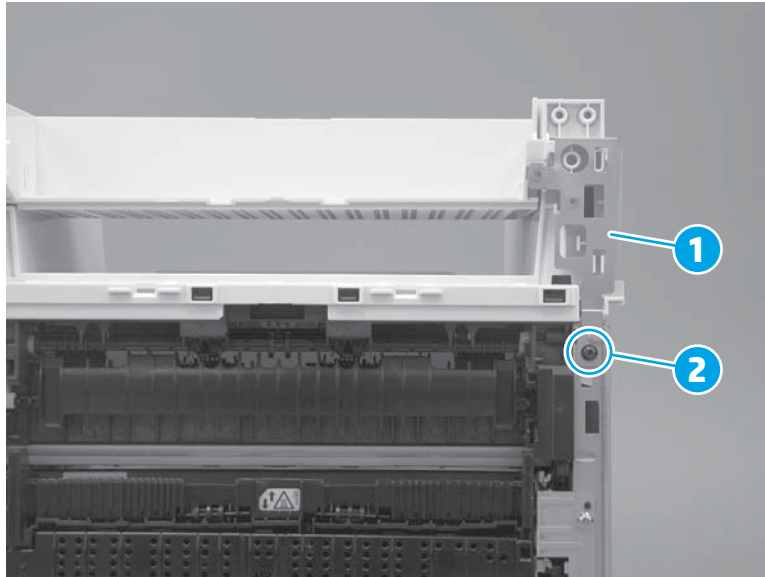
**Figure 1-425** Install three screws







6. At the front right of the printer, install the sheet-metal plate (callout 1), and then install one screw (callout 2).

**Figure 1-426** Install one screw and the plate



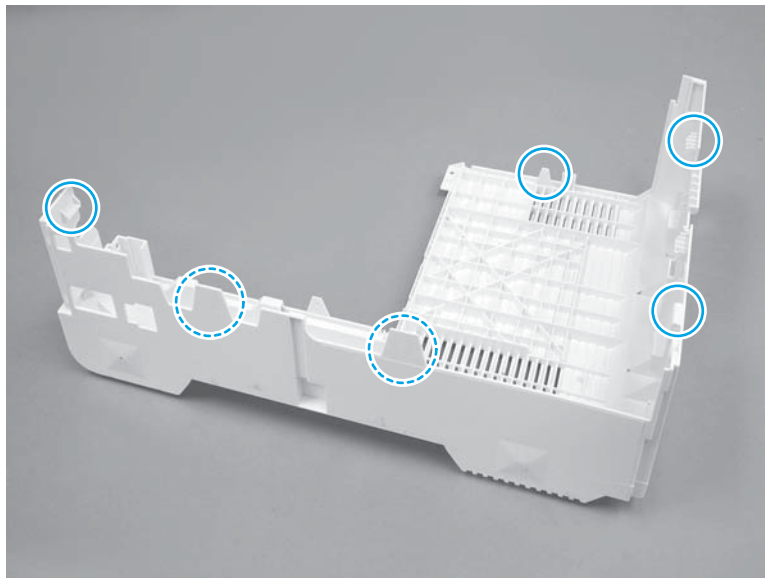
### Step 16: Install the right cover

 **IMPORTANT:** The black-plastic cassette front and rear guides (located inside the tray cavity) can be easily dislodged. Do not lose the guides when the cover is removed or installed.

 **NOTE:** The M527 printer is shown in this procedure. However, this procedure is valid for the M506 printer.

1. Before proceeding, take note of the location of the tabs and bosses on the inside of the cover.

**Figure 1-427** Locate the tabs and bosses

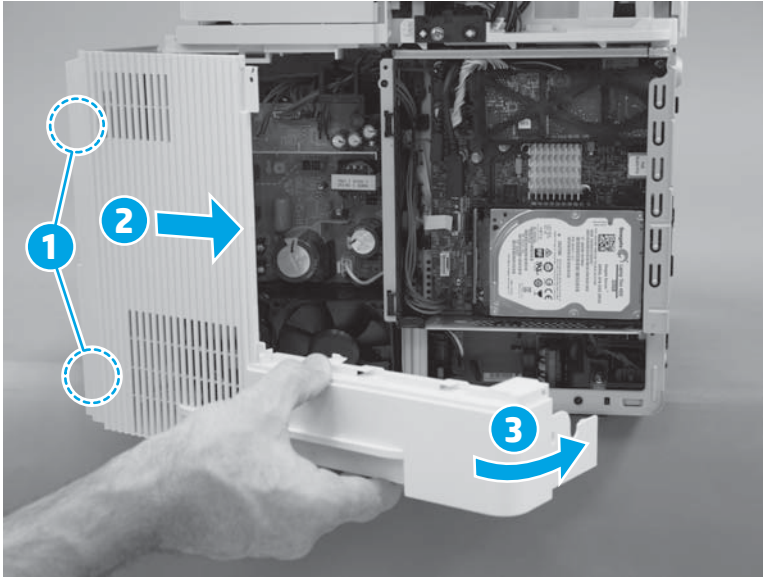


2. At the front of the cover engage two bosses (callout 1/2), and then rotate the rear of the cover toward the printer (callout 3).

**CAUTION:** It might be easier to install the cover with the printer slightly hanging over the edge of the workspace. Do not let the printer tip and fall off the workspace when removing the cover.

**TIP:** Make sure that the power switch at the front of the printer is positioned in the opening in the cover and that it does not interfere with the cover installation.

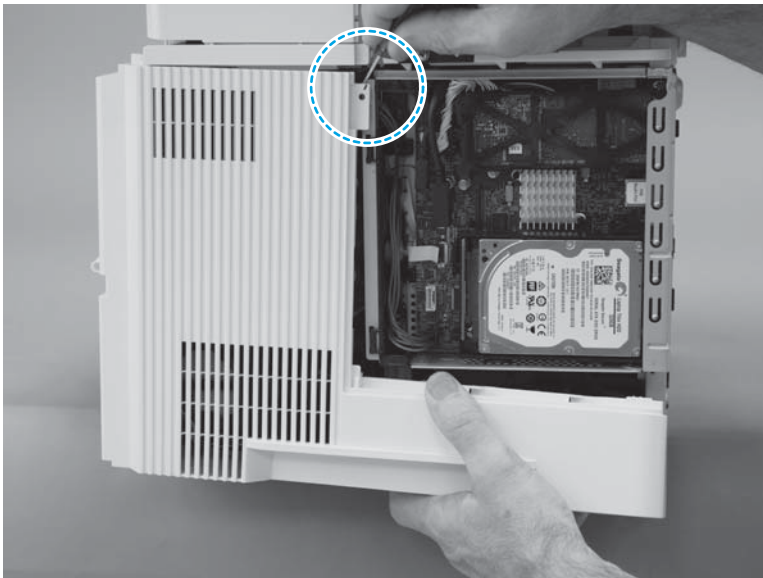
**Figure 1-428** Install the cover



3. At the top rear edge of the cover, engage one tab.

**CAUTION:** It might be easier to install the cover with the printer slightly hanging over the edge of the workspace. Do not let the printer tip and fall off the workspace when removing the cover.

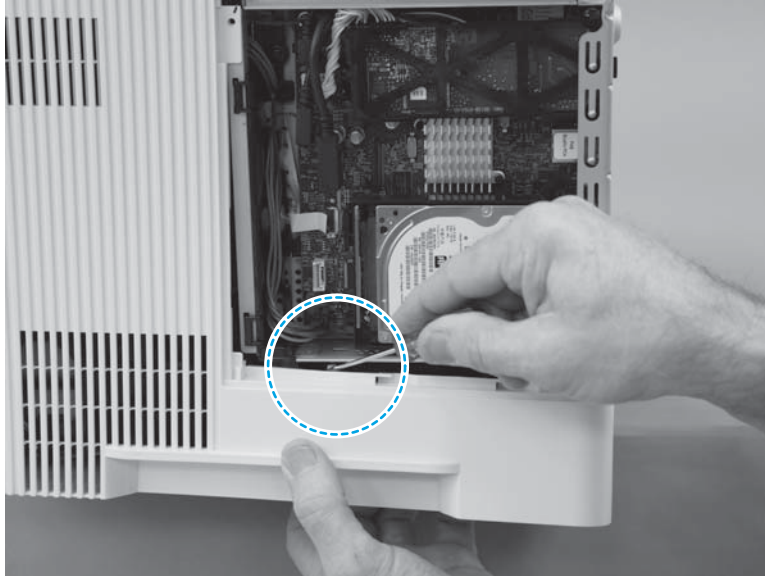
**Figure 1-429** Engage one tab



4. Near the formatter, engage one tab.

**CAUTION:** It might be easier to install the cover with the printer slightly hanging over the edge of the workspace. Do not let the printer tip and fall off of the workspace when removing the cover.

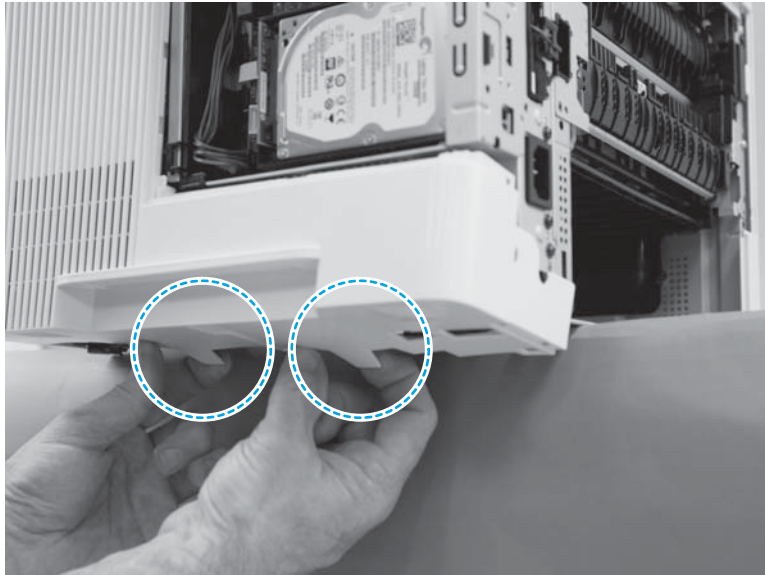
**Figure 1-430** Engage one tab



5. At the bottom edge of the cover, engage two bosses.

**CAUTION:** It might be easier to install the cover with the printer slightly hanging over the edge of the workspace. Do not let the printer tip and fall off of the workspace when removing the cover.

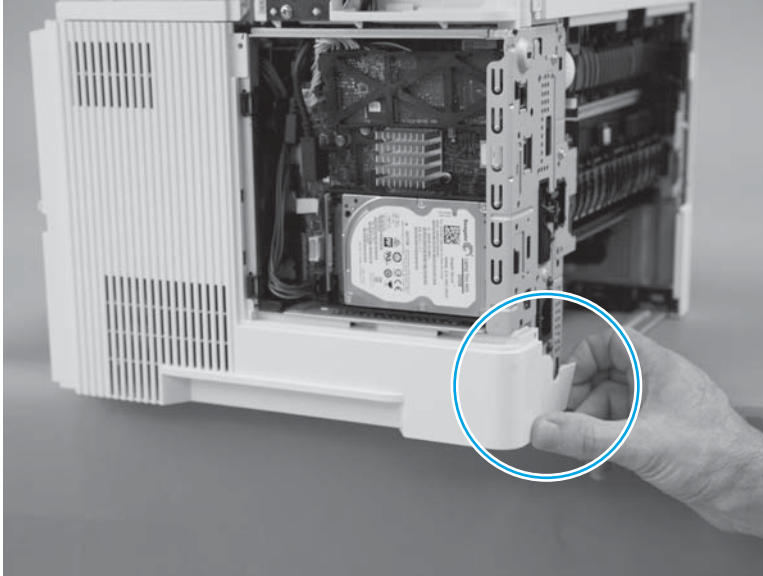
**Figure 1-431** Engage two bosses



6. At the rear of the printer, engage one boss.

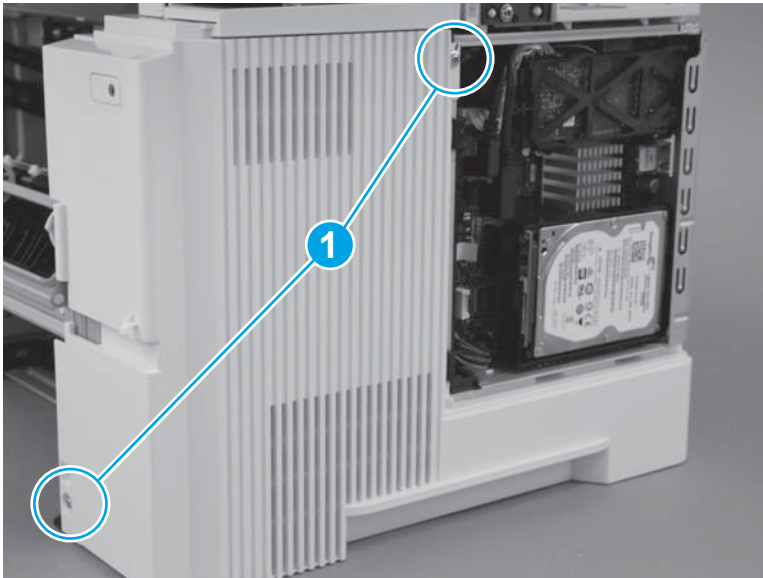
**⚠ CAUTION:** It might be easier to install the cover with the printer slightly hanging over the edge of the workspace. Do not let the printer tip and fall off of the workspace when removing the cover.

**Figure 1-432** Engage one boss



7. Install two screws (callout 1).

**Figure 1-433** Install two screws

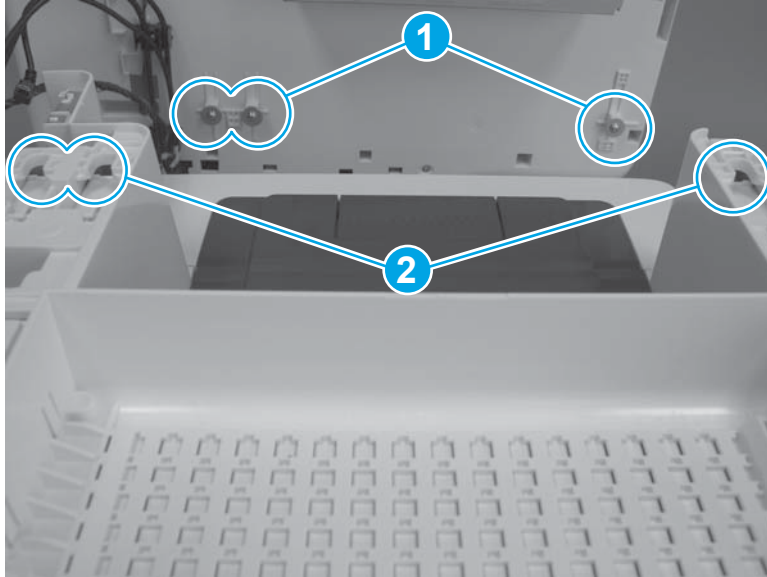


### Step 17: Install the integrated scanner assembly (M527)


**📝 NOTE:** The ISA includes the document feeder, sub-scanner assembly (SSA), and the scanner control board (SCB)

1. Before proceeding, locate the ISA mounting pins (callout 1) on the bottom of the ISA and the slots (callout 2) on the printer base.

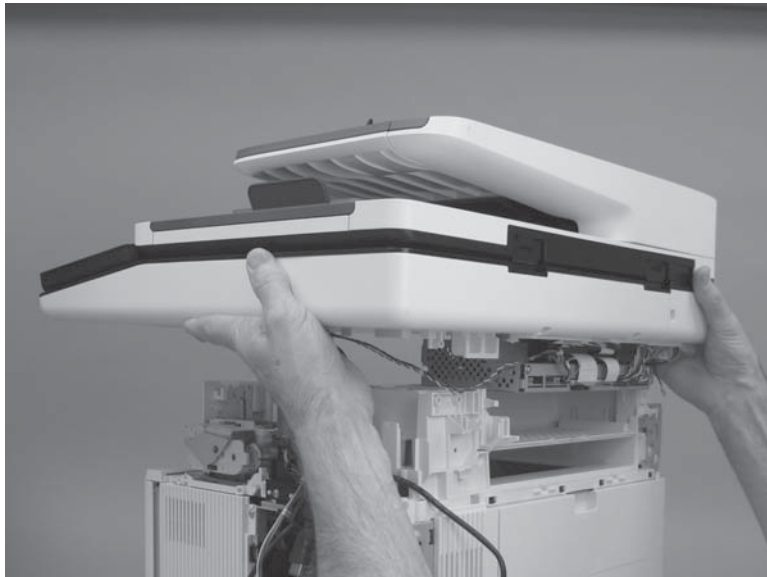
**Figure 1-434** Locate the ISA mounting pins and slots



2. Position the ISA on the printer base with the pins in the slots.

 **NOTE:** To locate the pins and slots, see the previous step.

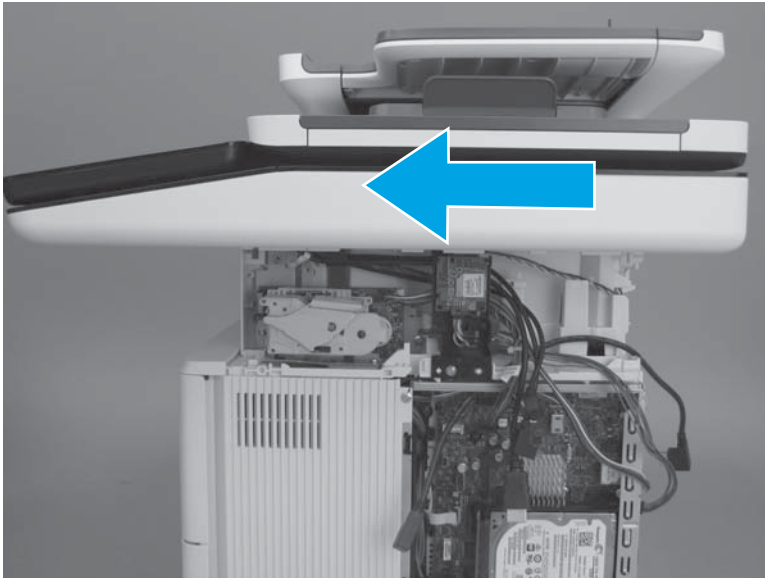
**Figure 1-435** Install the ISA



3. Slightly slide the ISA towards the front of the printer to engage it.

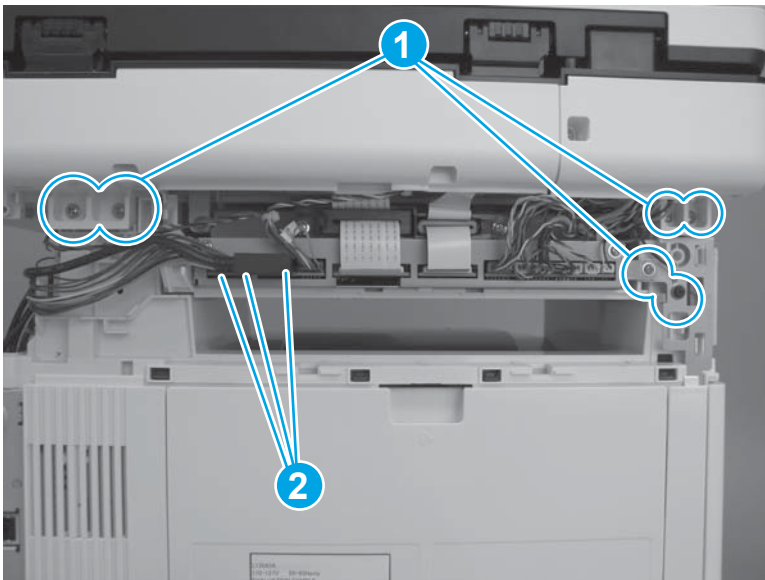
**CAUTION:** Make sure that none of the wire harnesses or cables are caught underneath the assembly when installing it.

**Figure 1-436** Slide the ISA towards the front of the printer




4. Install six screws (callout 1), and then connect three connectors (callout 2).

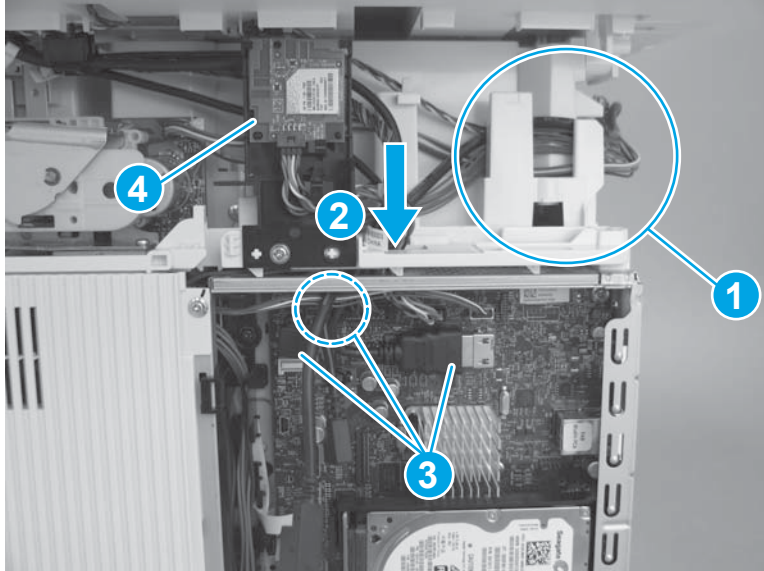
**Figure 1-437** Install screws and connect connectors



5. Install the wire harnesses and cables in the retainers (callout 1), pass them through the opening in the cover (callout 2), and then connect three connectors (callout 3).

 **TIP:** If the WiFi PCA and holder (callout 4) was detached from the printer and then moved out of the way, reinstall it now.

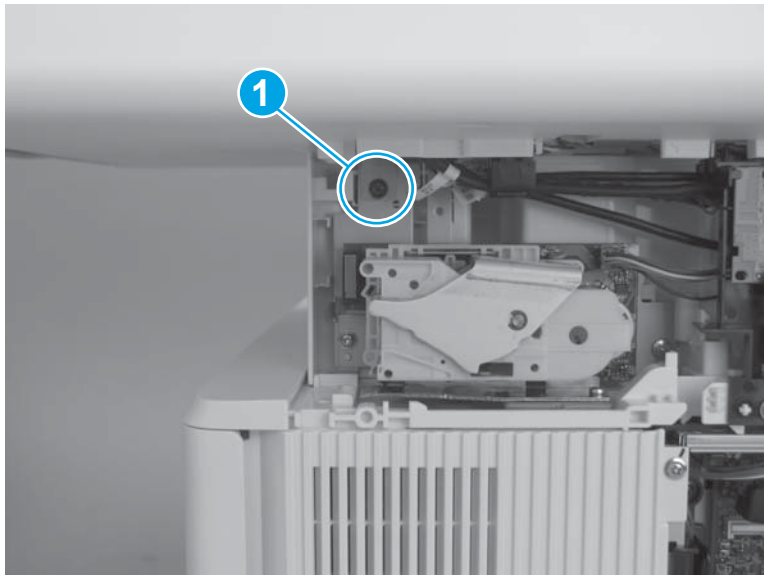
**Figure 1-438** Connect cables and connectors




6. Install one screw (callout 1).


 **IMPORTANT:** This screw fastens the ISA ground plate to the printer chassis. This screw must be installed.

**Figure 1-439** Install one screw



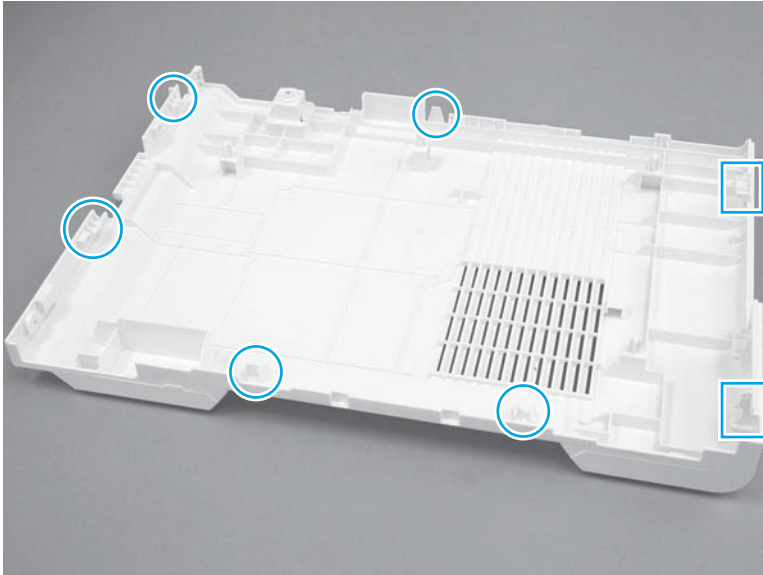
## Step 18: Install the left cover

 **IMPORTANT:** The black-plastic cassette front and rear guides (located inside the tray cavity) can be easily dislodged. Do not lose the guides when the cover is removed or installed.

 **NOTE:** The M527 printer is shown in this procedure. However, this procedure is valid for the M506 printer.

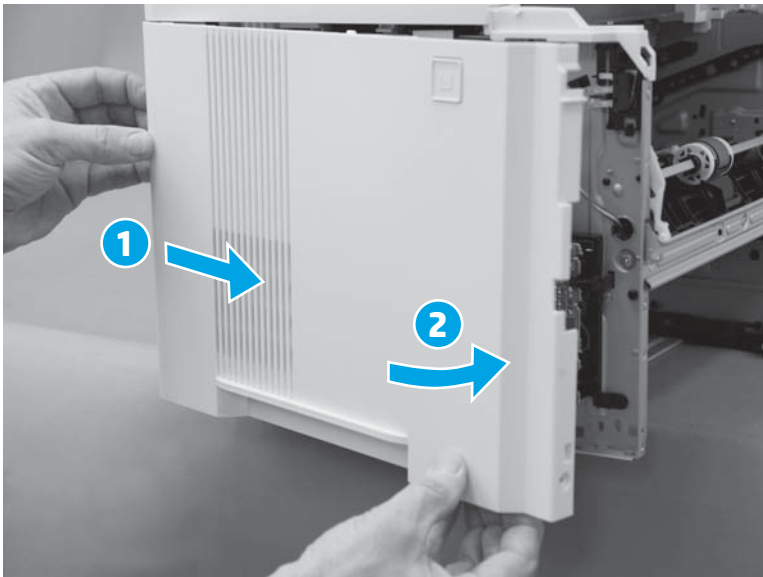
1. Before proceeding, take note of the location of the tabs and bosses on the inside of the cover.

**Figure 1-440** Locate of the tabs and bosses



2. Engage the rear edge of the cover (callout 1), and then rotate the rear edge of the cover toward the printer (callout 2).

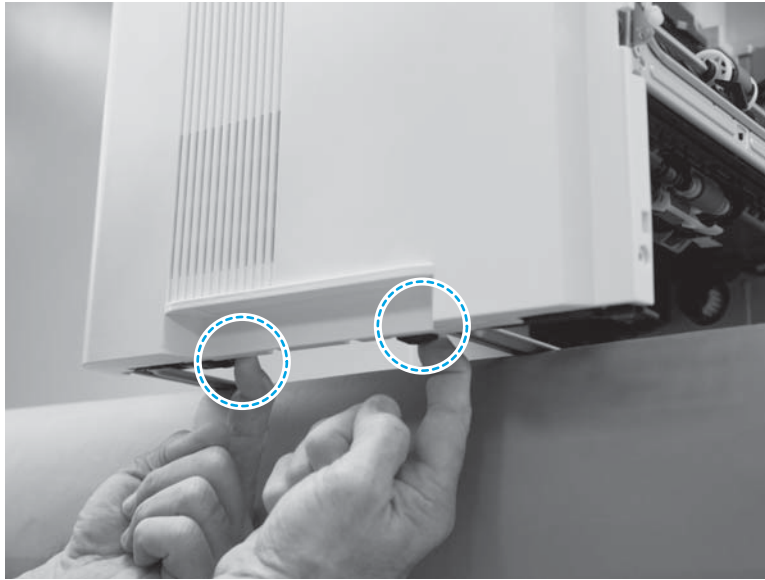
**Figure 1-441** Install the cover





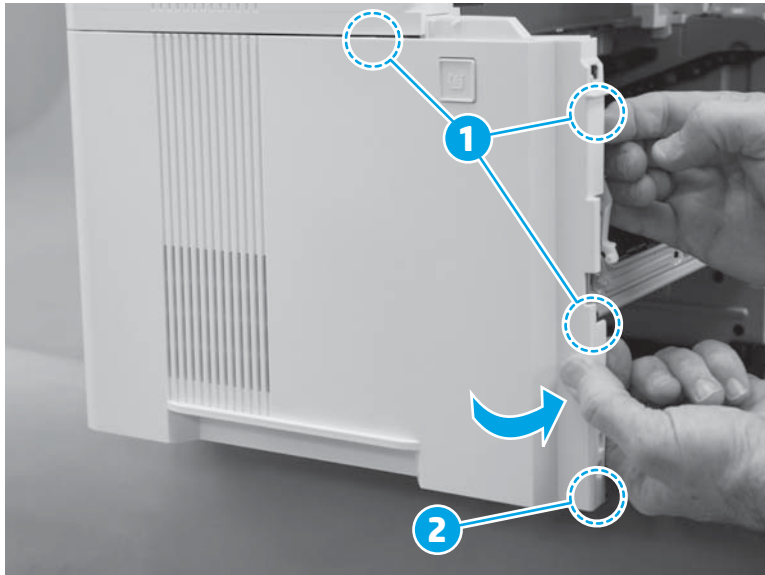
3. At the bottom edge of the cover, engage two tabs.

**Figure 1-442** Engage two tabs



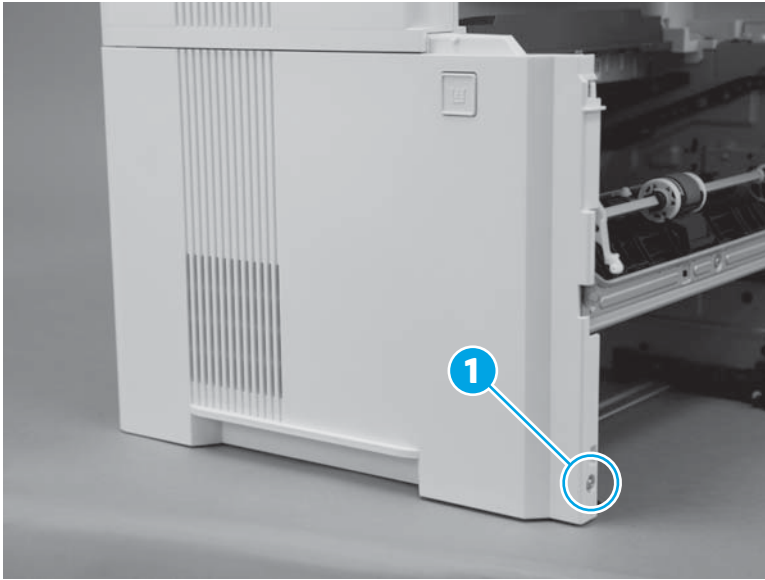
4. At the front of the printer, engage three tabs (callout 1), and then continue to rotate the front edge of the cover toward the printer to engage one boss (callout 2).

**Figure 1-443** Engage three tabs and one boss




5. Install one screw (callout 1).

**Figure 1-444** Install one screw

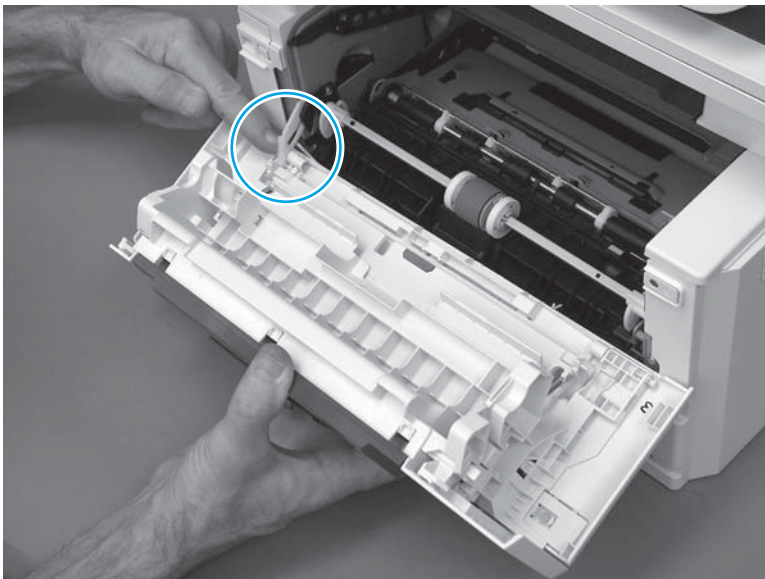


### Step 19: Install the cartridge door assembly

1. Position the door close to the printer, and then engage the keyed pin on the left-side retainer arm with the hole in the door.


 **TIP:** It might be easier to engage the keyed pin with the hole by using a small flat-blad screwdriver.

**Figure 1-445** Engage the left-side retainer arm

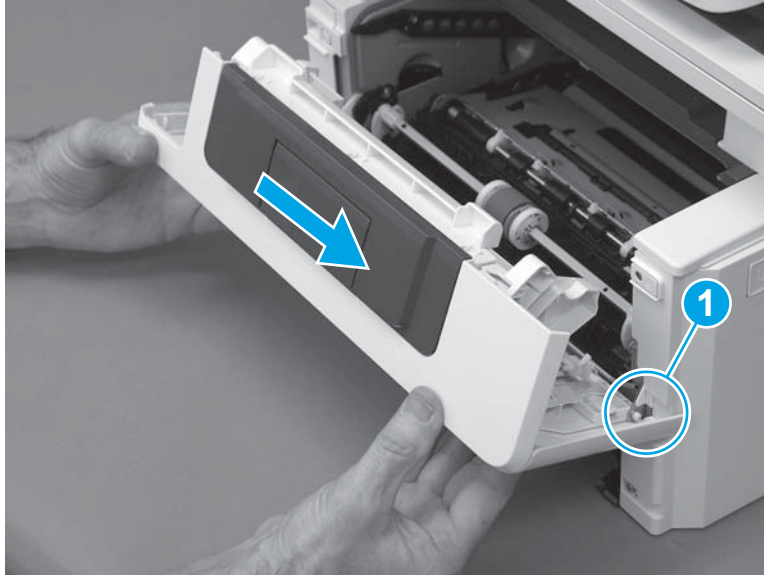


- Engage the right-side door hinge pin with the hole in the chassis (callout 1).

 **NOTE:** There are two right-side hinge pins (not shown in callout 1).

 **TIP:** Keep a finger pressed on the left-side retainer arm so that it does not disengage from the door.

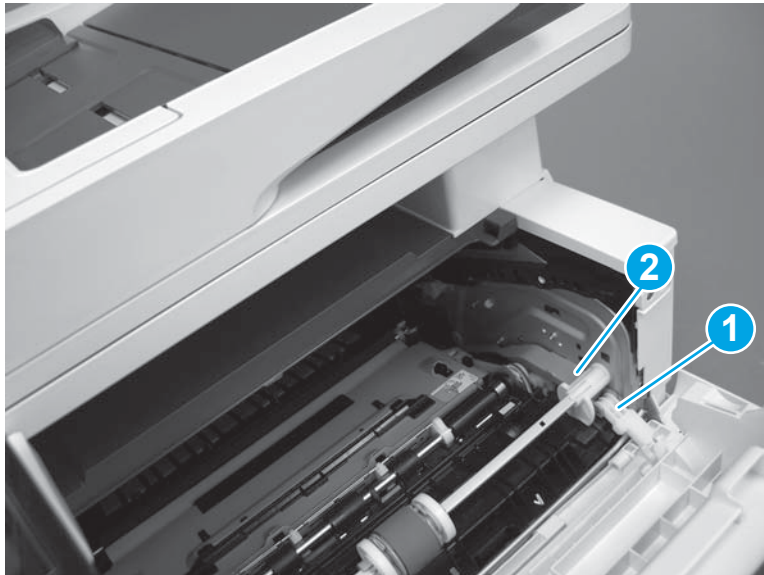
**Figure 1-446** Install the door



- Install the gray-plastic pressure-release link (callout 1) onto the white-plastic door arm (callout 2).

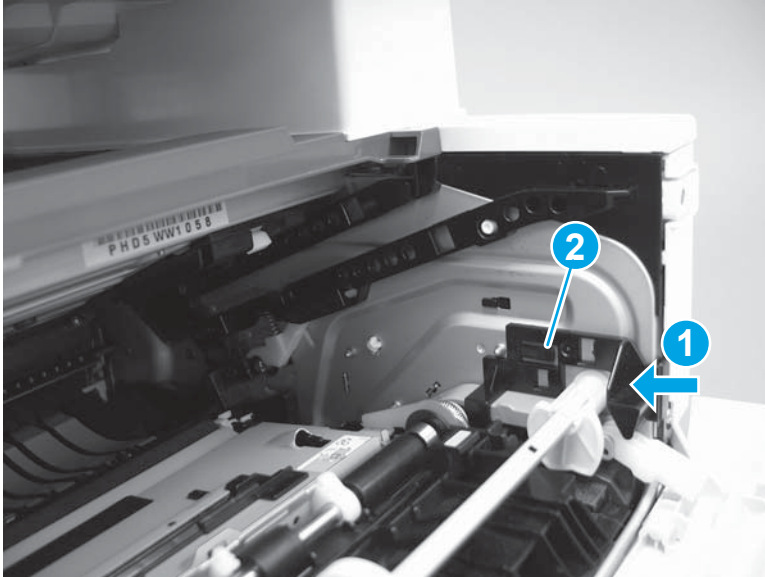
 **IMPORTANT:** Make sure that the arm snaps on to the link. Partially close and open the door to verify that the link (callout 2) moves in and out of the printer as the door closes/opens.

**Figure 1-447** Install the pressure-release link



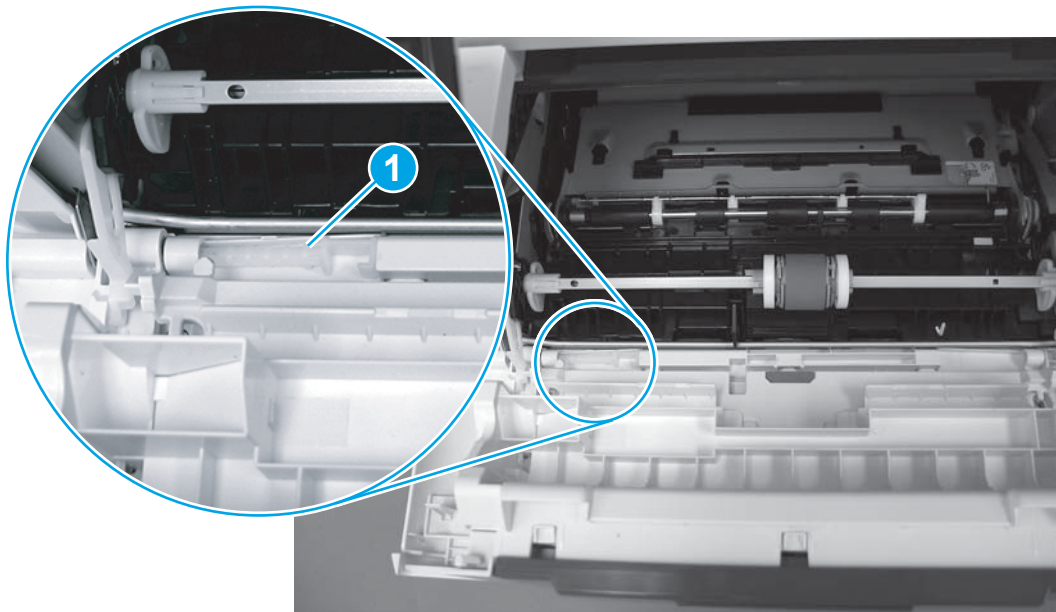
4. Slide the guide into the printer (callout 1), and then make sure that the tab (callout 2) snaps into place to secure the guide to the chassis.

**Figure 1-448** Install the guide





5. Position the support shaft on the door, and then align the left-side hinge on the door with the hole in the chassis (callout 1).

**Figure 1-449** Align the hinge

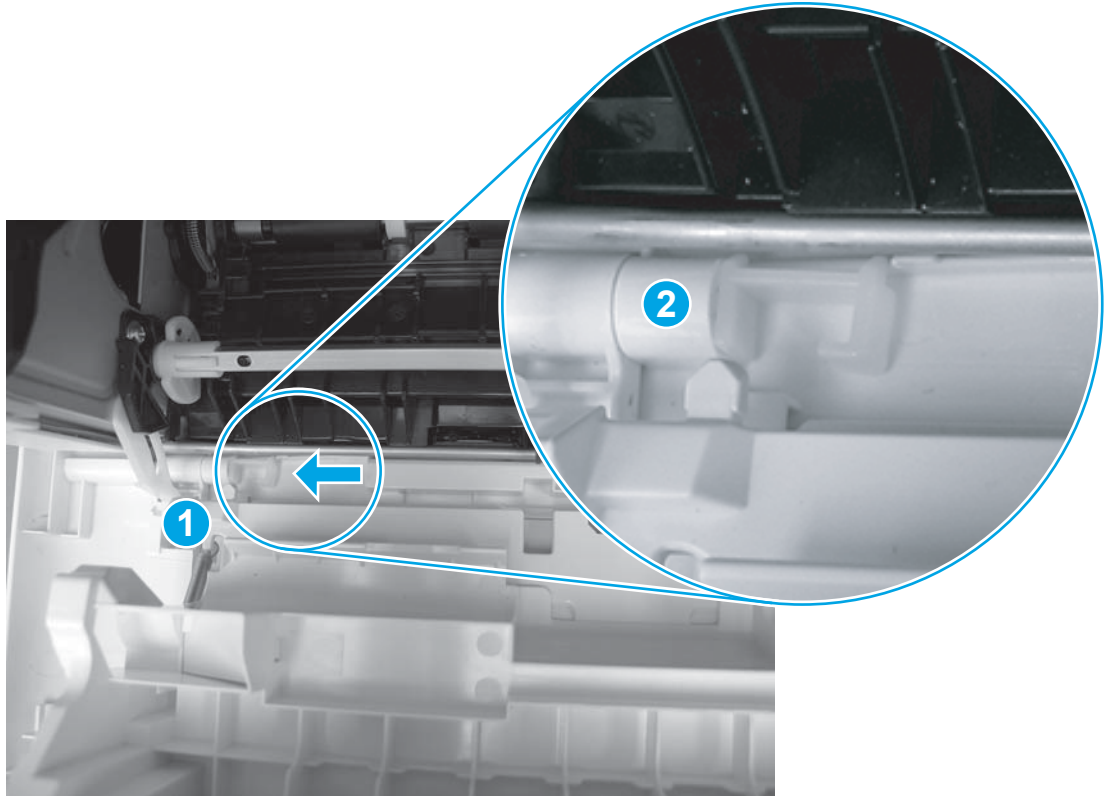


6. Push the shaft towards the left side of the printer to install it (callout 1).

 **NOTE:** Make sure that the support shaft is fully installed and correctly orientated (callout 2) so that it will not interfere with the door opening and closing.

 **Reinstallation tip:** If a replacement door was installed, make sure to install the nameplate (supplied in the kit) corresponding to the printer on the door.

**Figure 1-450** Install the support shaft



### Step 20: Install the rear door assembly

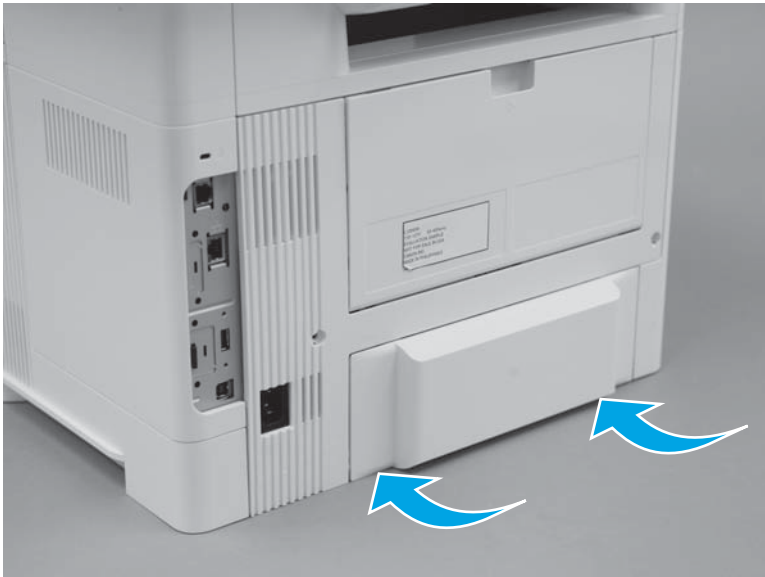
1. Engage the top edge of the assembly with the printer.

**Figure 1-451** Install the cover



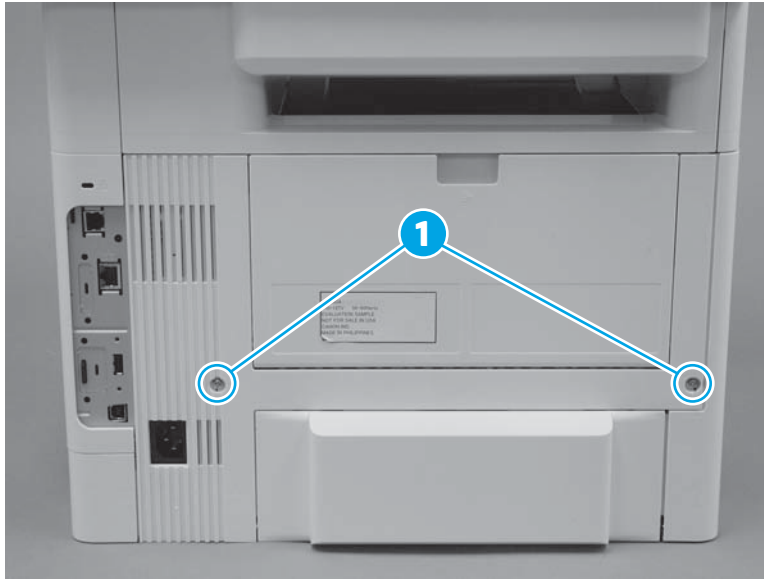
2. Rotate the bottom edge of the cover towards the printer.

**Figure 1-452** Rotate the bottom of the cover



3. Install two screws (callout 1).

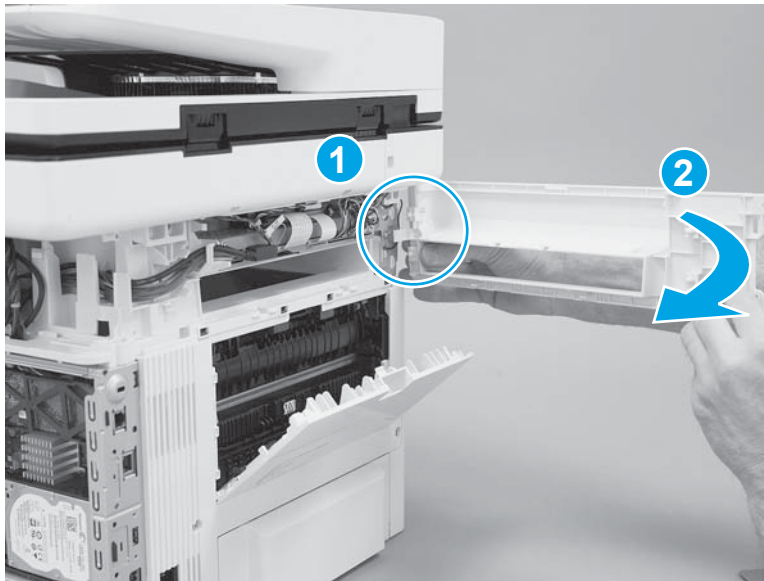
**Figure 1-453** Install two screws



#### Step 20: Install the top-rear cover

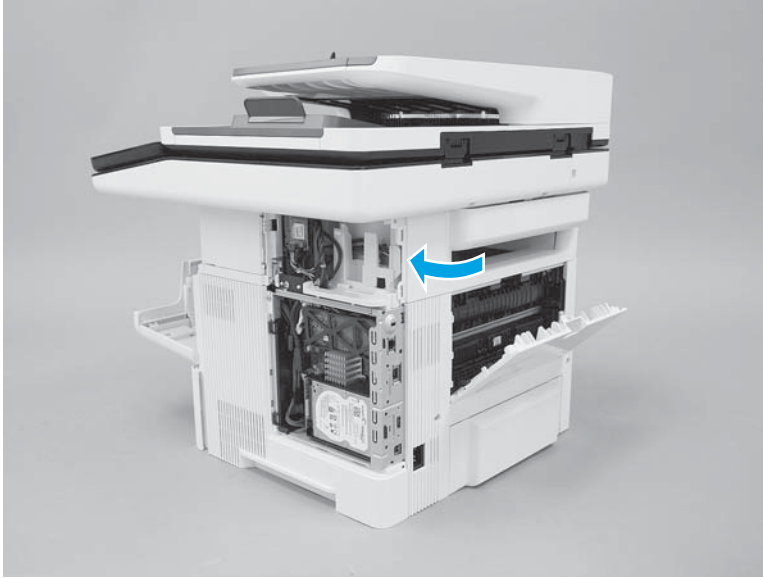
1. Engage one boss (callout 1), and then rotate the cover towards the printer (callout 2).

**Figure 1-454** Engage one boss



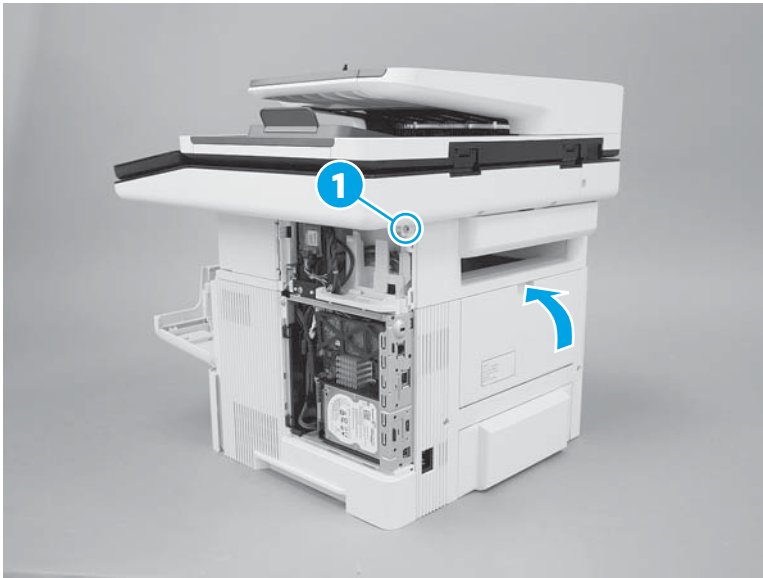
2. Continue to rotate the cover toward the printer to install it.

**Figure 1-455** Install the cover



3. Install one screw (callout 1), and then close the rear door.

**Figure 1-456** Install one screw



### Step 21: Install the top-left cover

1. Position the front edge of the cover on the printer, and then slide the cover toward the front of the printer to engage two bosses at the front of the cover.



**Figure 1-457** Slide the cover




2. Rotate the cover towards the printer to engage two tabs at the middle of the cover.

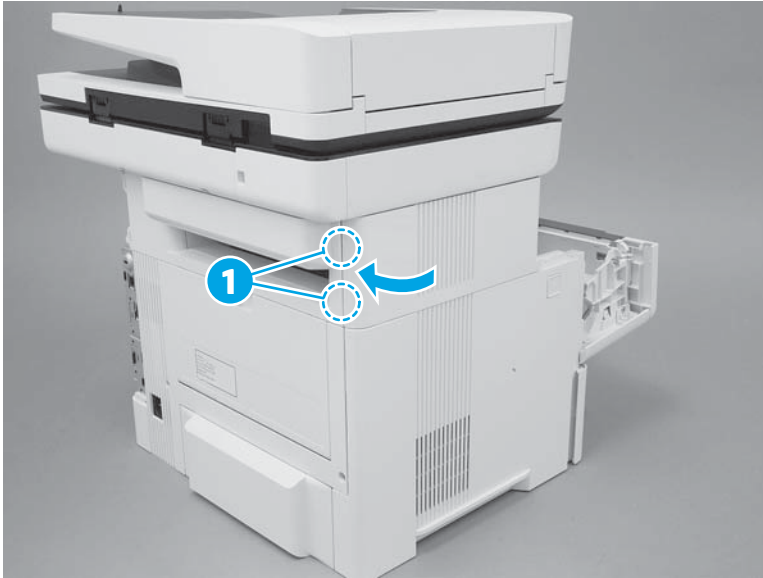
**Figure 1-458** Engage two tabs




3. Continue to rotate the cover onto the printer to engage two tabs (callout 1) at the rear edge of the cover.

 **NOTE:** Close the toner-cartridge door.

**Figure 1-459** Engage two tabs

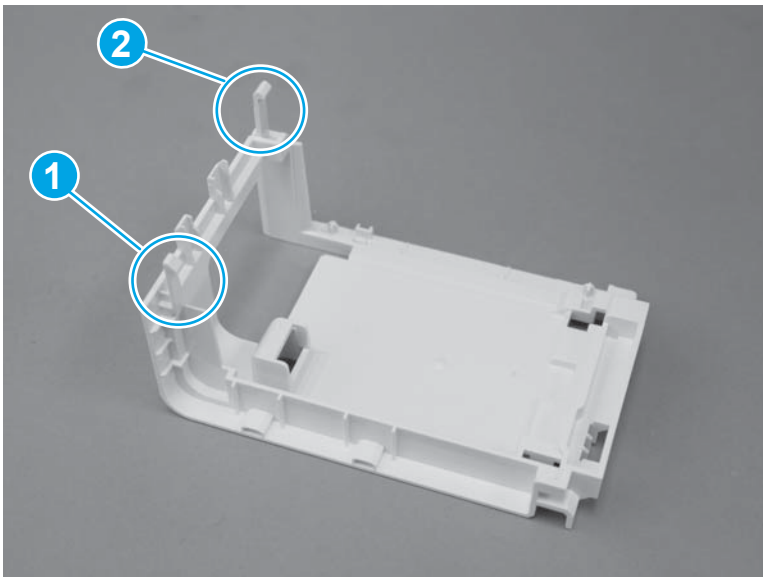


#### Step 22: Install the stapler stationary (inner) cover (M527)

 **NOTE:** M527c/f/z printers only.

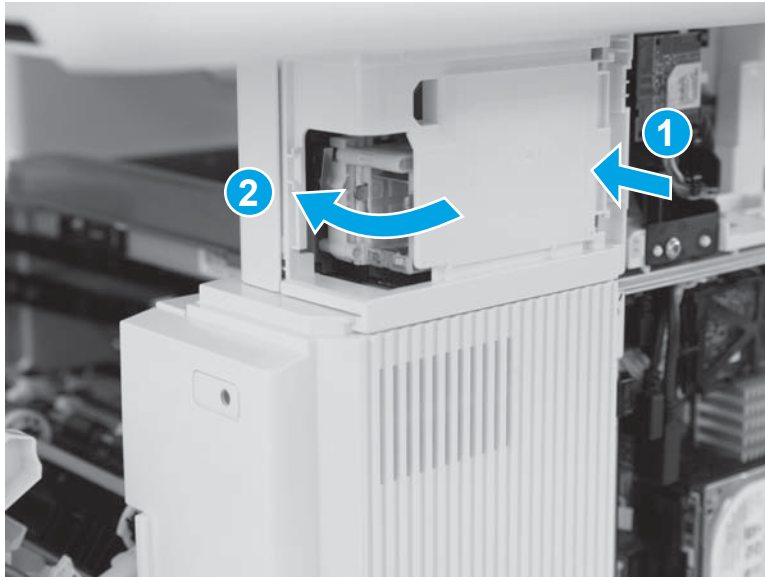
1. Before proceeding, take note of the locations of the upper tab (callout 1) and the lower tab (callout 2) on the stapler stationary (inner) cover.

**Figure 1-460** Locate the tabs



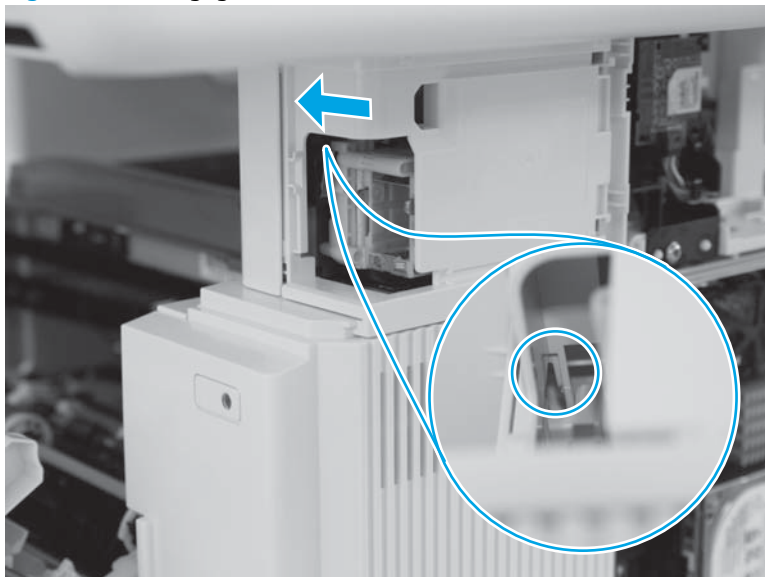
- Engage the rear edge of the cover with the printer (callout 1), and then rotate the front edge of the cover onto the printer (callout 2) to engage the two tabs.

**Figure 1-461** Install the cover



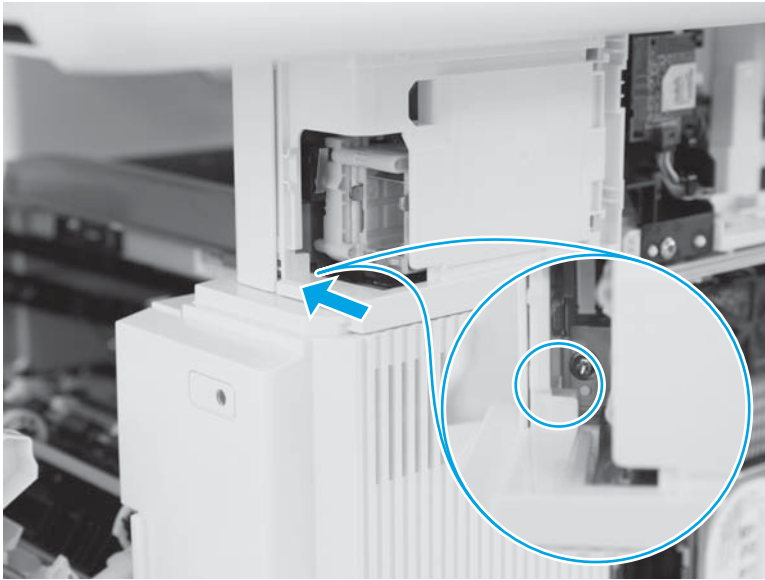
- Verify that the upper tab is engaged.

**Figure 1-462** Engage one tab




4. Verify that the lower tab is engaged.

**Figure 1-463** Engage one tab



### Step 23: Install the stapler door or stapler blank cover (M527)

 **NOTE:** The M527dn does not have a convenience stapler.

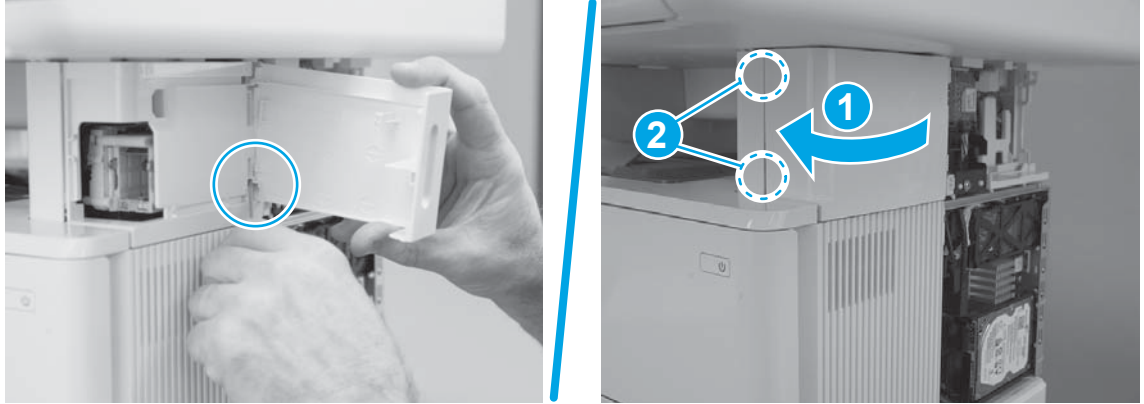
1. Do one of the following:
  - **M527c/f/z:** Position the door near the printer.
  - **M527dn:** Position the cover on the printer.

**Figure 1-464** Install the door or cover



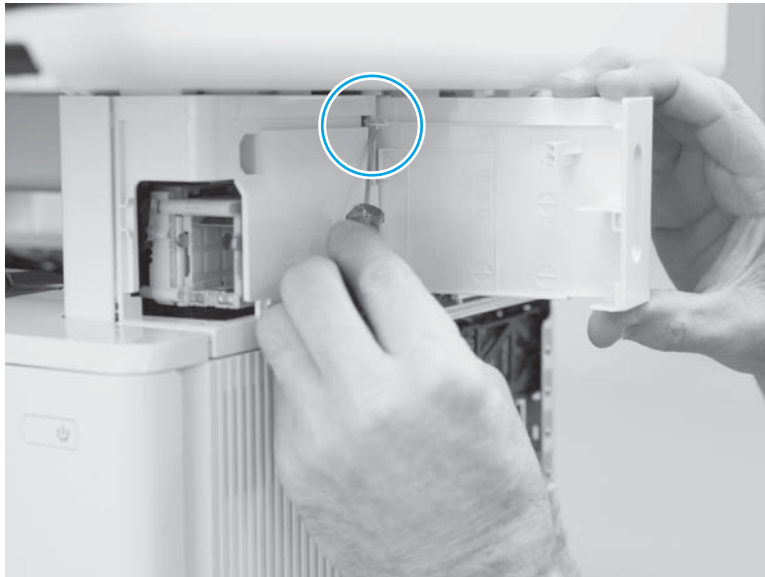
2.
  - **M527c/f/z:** Engage the lower hinge.
  - **M527dn:** Rotate the cover towards the printer (callout 1), and then make sure that the two tabs (callout 2) snap into place to install the cover.

**Figure 1-465** Engage the lower hinge or engage the cover



3. **M527c/f/z:** Engage the upper hinge.

**Figure 1-466** Engage the upper hinge




4. **M527c/f/z:** Close the stapler door.

**Figure 1-467** Close the door



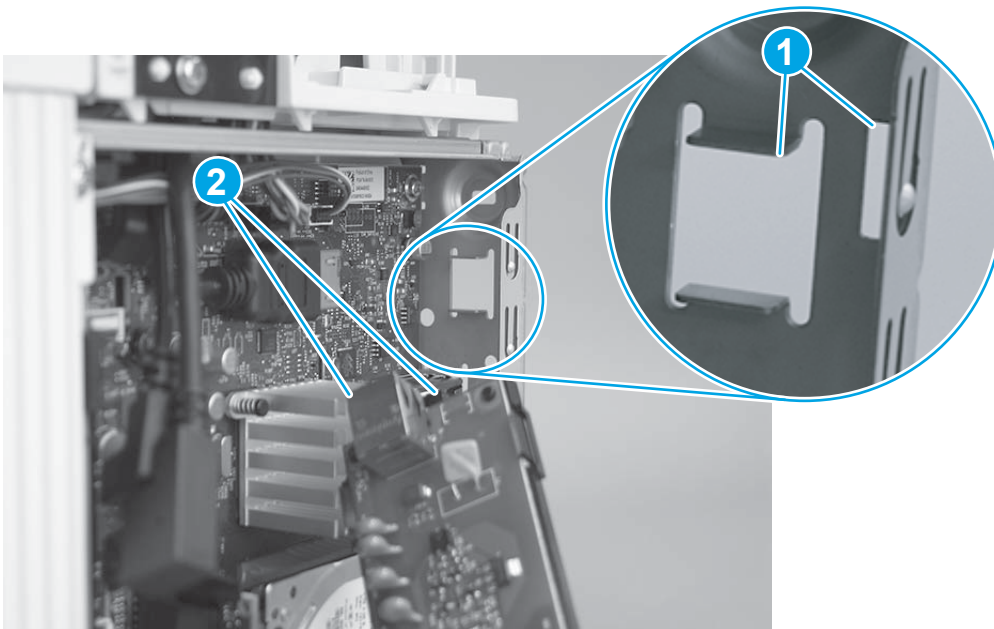
#### Step 24: Install the fax PCA (M527)

 **CAUTION:**  ESD-sensitive part.

 **NOTE:** M527c/f/z printers only (optional for the M527dn).

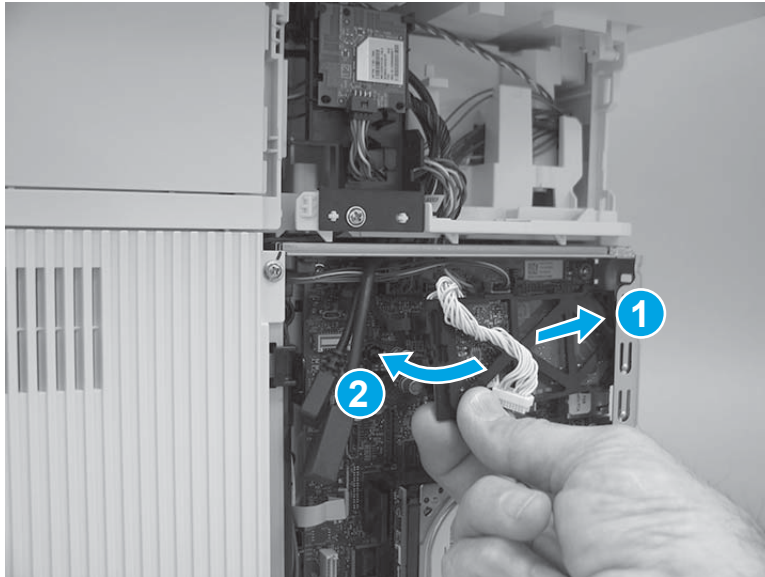
1. Before proceeding, take note of the location of the slots (callout 1) in the sheet-metal where the fax PCA cradle mounting tab and fax port (callout 2) must be installed.

**Figure 1-468** Locate the slots in the sheet-metal



2. Insert the fax PCA cradle mounting tab and fax port in the slots in the sheet-metal plate (callout 1), and then rotate the connector end of the fax PCA toward the formatter (callout 2).

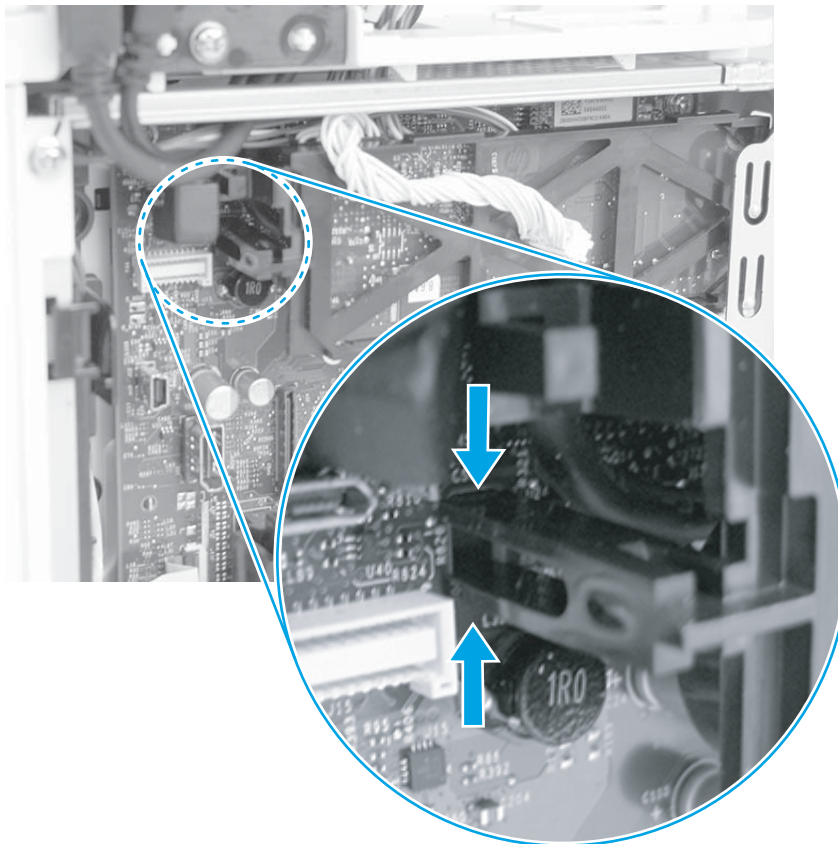
**Figure 1-469** Install the fax PCA



3. Engage the retainer with the slot in the formatter.

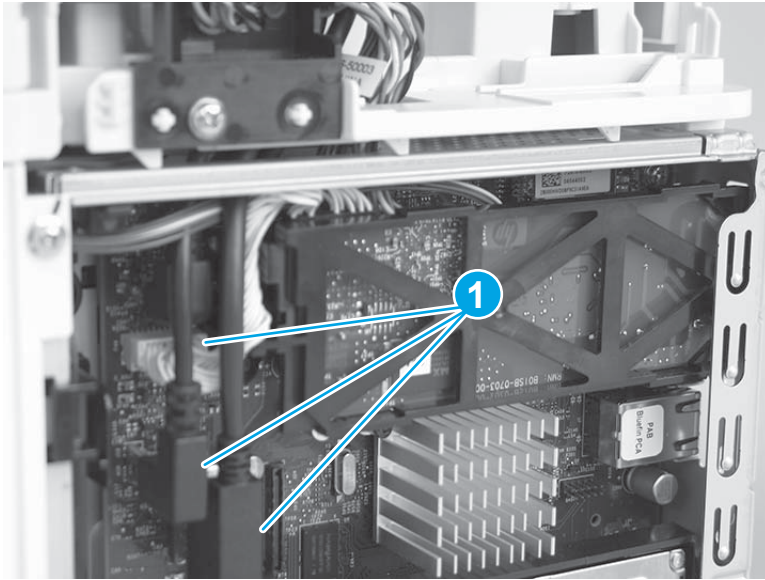
 **Reinstallation tip:** Pinch the retainer to easily engage it with the slot.

**Figure 1-470** Engage the fax PCA



4. Connect three connectors (callout 1).

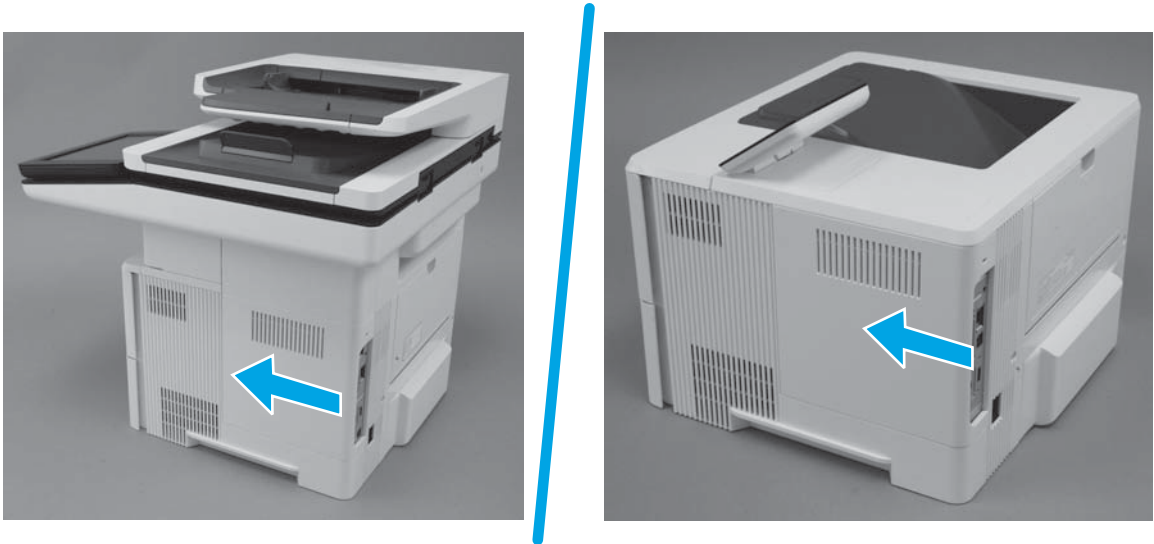
**Figure 1-471** Connect three connectors



#### Step 25: Install the formatter cover

- ▲ Slide it toward the front of the printer to install it.

**Figure 1-472** Install the formatter cover



#### Step 26: Install the tray

1. With the tray at a slight angle, align the sides of the tray with the rails in the accessory, and then partially slide the tray into the printer.



**Figure 1-473** Install the tray



2. Push the tray straight into the accessory to close it.

**Figure 1-474** Close the tray



## Removal and replacement: Top cover (M501/M506)

- [Introduction](#)
- [Step 1: Remove the tray](#)
- [Step 2: Remove the control panel \(M506x\)](#)
- [Step 3: Remove the formatter cover](#)
- [Step 4: Remove the control panel \(M501\)](#)
- [Step 5: Remove the rear door assembly](#)
- [Step 6: Remove the cartridge door assembly](#)
- [Step 7: Remove the right cover](#)
- [Step 8: Remove the left cover](#)
- [Step 9: Remove the top cover \(M501/M506\)](#)
- [Step 10: Unpack the replacement cover](#)
- [Step 11: Install the top cover \(M501/M506\)](#)
- [Step 12: Install the left cover](#)
- [Step 13: Install the right cover](#)
- [Step 14: Install the cartridge door assembly](#)
- [Step 15: Install the rear door assembly](#)
- [Step 16: Install the control panel \(M501\)](#)
- [Step 17: Install the formatter cover](#)
- [Step 18: Install the control panel \(M506x\)](#)
- [Step 19: Install the tray](#)

### Introduction


This document provides the procedures to remove and replace the top cover (M506).

### Before performing service

#### Turn the printer power off

- Disconnect the power cable.

---

 **WARNING!** To avoid damage to the printer, turn the printer off wait 30 seconds, and then remove the power cable before attempting to service the printer.

---

Use the table below to identify the correct part number for your printer. To order the part, go to [www.hp.com/buy/parts](http://www.hp.com/buy/parts).

Top cover (M506) part number	
RM2-5735-000CN	Top cover (M501)
RM2-5687-000CN	Top cover (M506; simplex)
RM2-5728-000CN	Top cover (M506; duplex LCD)
RM2-5686-000CN	Top cover (M506; duplex MF)

### Required tools

- #2 Phillips screwdriver with a magnetic tip.

### After performing service

#### Turn the printer power on

- Connect the power cable.
- Use the power switch to turn the power on.

### Post service test

Make sure that the printer initializes to a **Ready** state.

Print a configuration page to make sure that the printer is functioning correctly.

### Step 1: Remove the tray

1. Pull the tray straight out of the printer until it stops.

**Figure 1-475** Pull the tray out until it stops



2. Lift the front of the tray, and then pull it out of the printer to remove it.

**Figure 1-476** Release and remove the tray



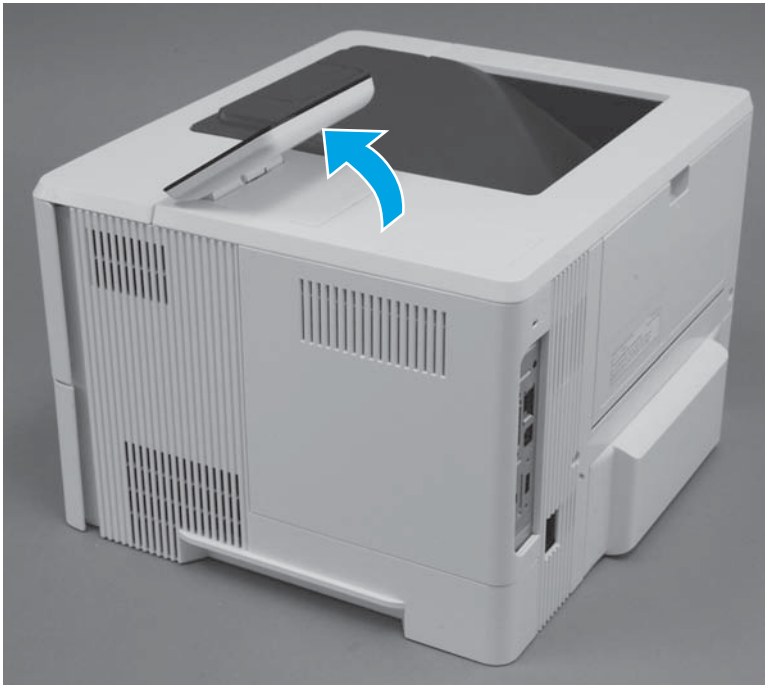
### Step 2: Remove the control panel (M506x)



**NOTE:** This step is for the M506x printer. For all other printers, skip this step and proceed to [Step 3: Remove the formatter cover on page 296](#).

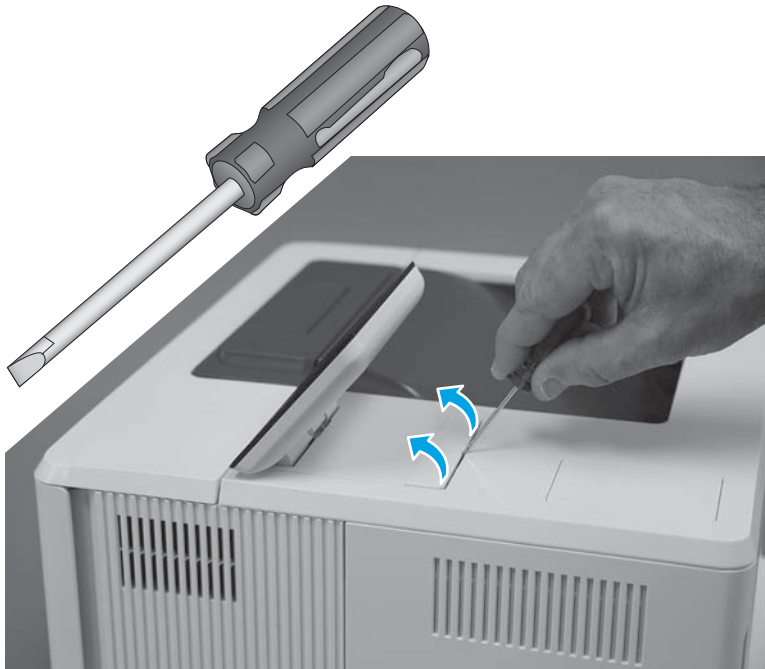
1. Tilt the control panel to the fully raised position.

**Figure 1-477** Tilt the control panel up




2. Use a small flat-blad screwdriver to release the control-panel screws cover, and then remove the cover.

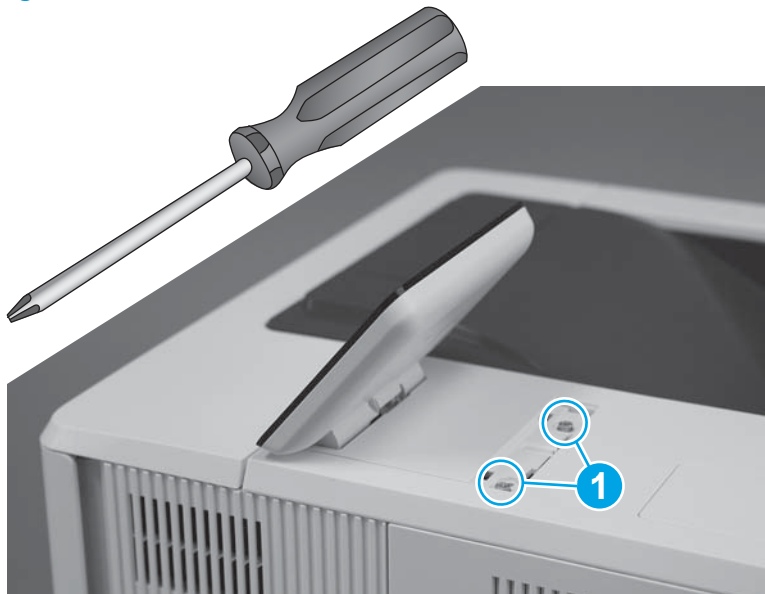
**Figure 1-478** Remove the cover



3. Use a small Phillips screwdriver to remove two screws (callout 1).

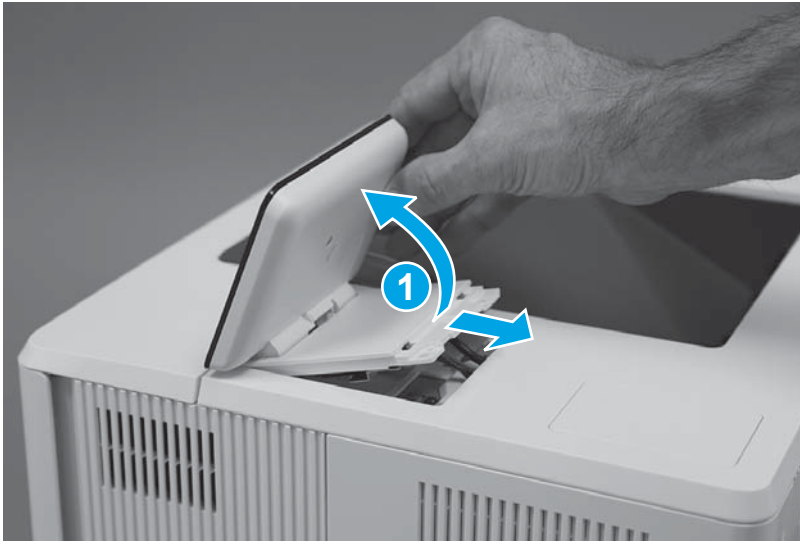
 **IMPORTANT:** Store the screws in a secure place where they cannot fall down into the printer.

**Figure 1-479** Remove two screws



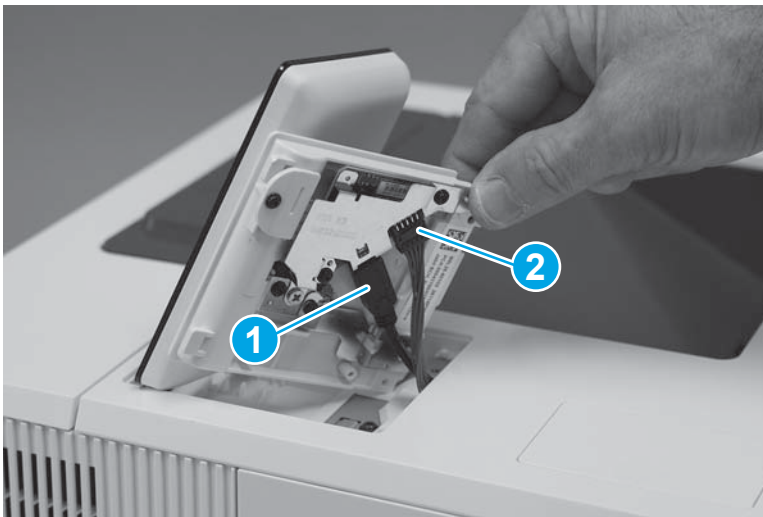
4. Turn the control panel over (callout 1), to gain access to the bottom side.

**Figure 1-480** Turn the control panel over



5. Disconnect one HDMI cable (callout 1), one connector (callout 2), and then remove the control panel.

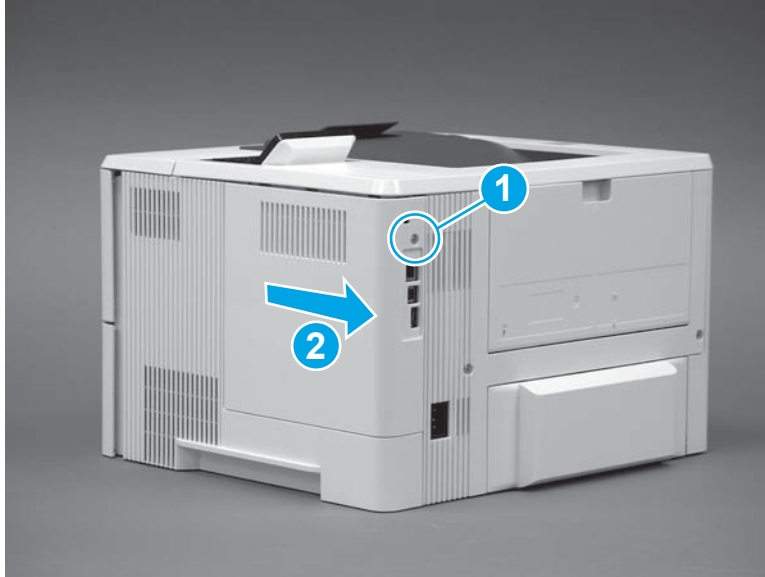
**Figure 1-481** Remove the control panel



### Step 3: Remove the formatter cover

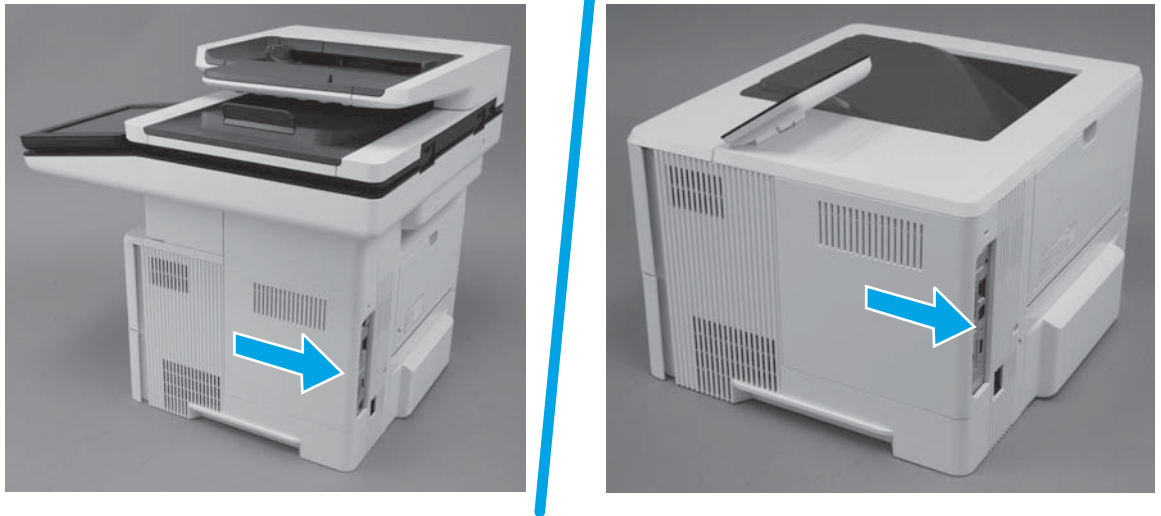
1. **M501:** Remove one screw (callout 1), and then slide the cover toward the rear of the printer to remove it (callout 2).

**Figure 1-482** Remove the formatter cover (M501)



2. **M506/M527:** Slide the cover toward the rear of the printer to remove it.

**Figure 1-483** Remove the formatter cover (M506/M527)

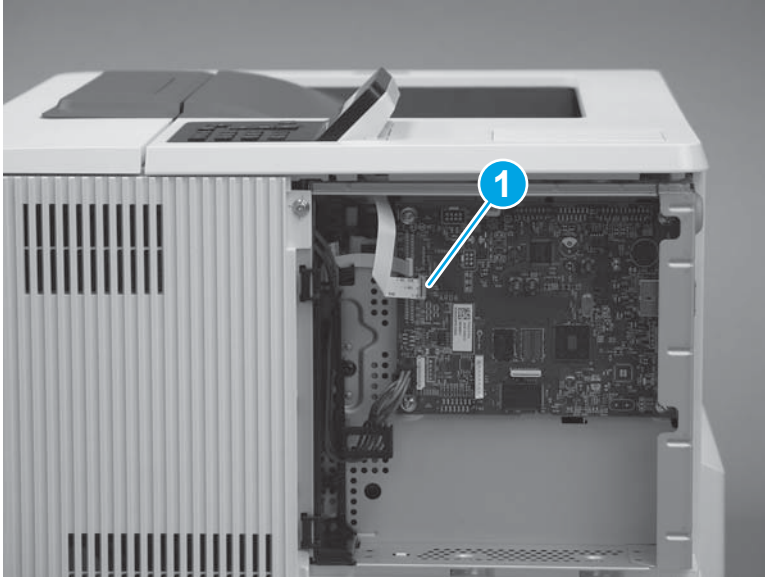


#### Step 4: Remove the control panel (M501)

 **NOTE:** This step is for the M501 printer. For all other printers, skip this step and proceed to [Step 5: Remove the rear door assembly on page 299](#).

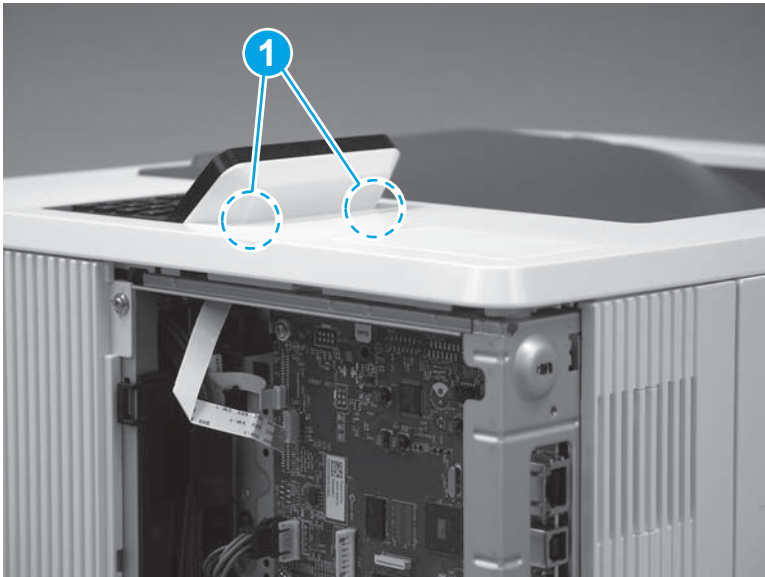
1. Disconnect one fla cable (callout 1).

**Figure 1-484** Disconnect one fla cable




2. Locate two tabs (callout 1) along the rear edge of the control panel.

**Figure 1-485** Locate two tabs





3. Release the two tabs, and then rotate the rear edge of the control panel up and away from the printer.

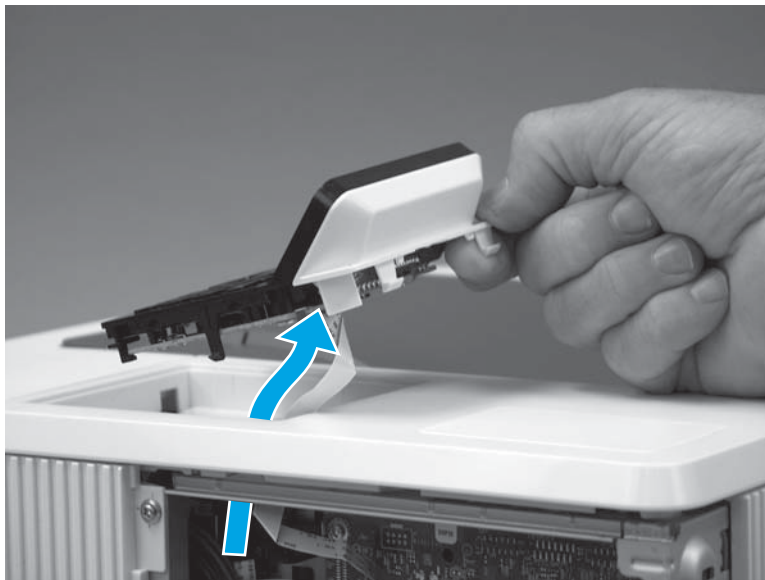
 **TIP:** Use a small flat-blad screw driver to release the two tabs.

**Figure 1-486** Release the control panel



4. Pass the flat cable attached to the control panel through the opening in the printer chassis, and then remove the control panel.

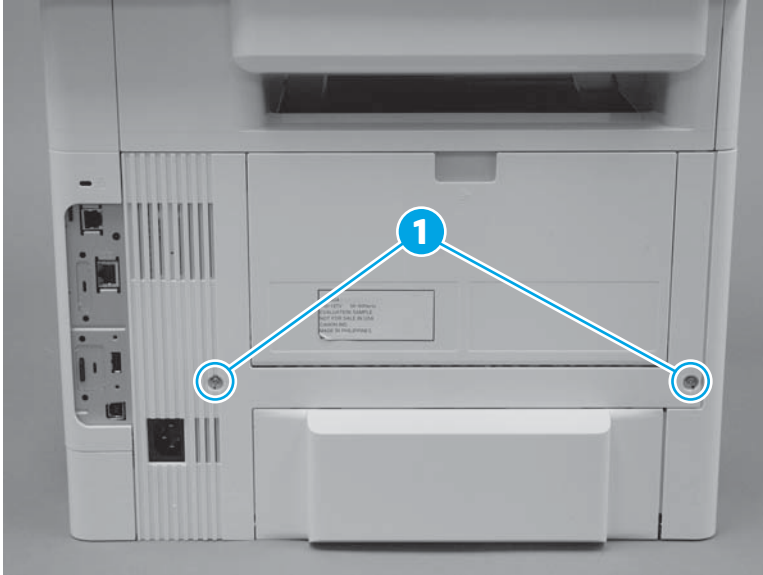
**Figure 1-487** Remove the control panel



#### Step 5: Remove the rear door assembly

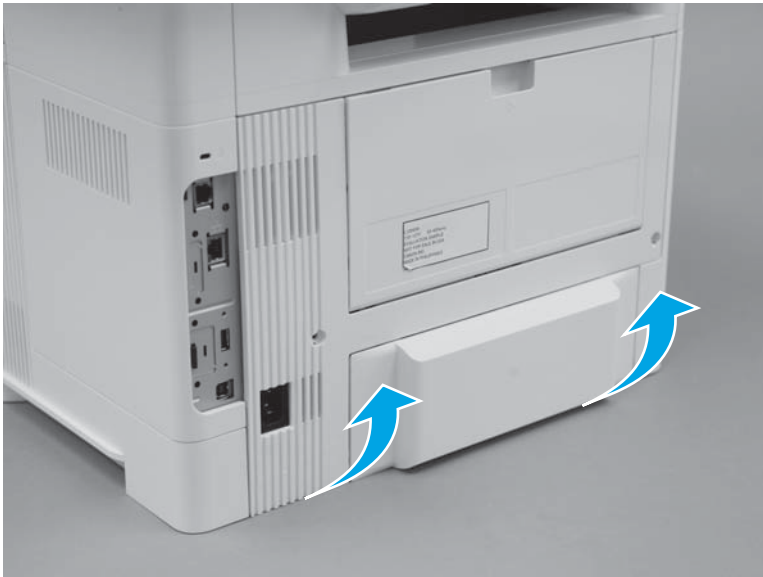
1. At the rear of the printer, remove two screws (callout 1).

**Figure 1-488** Remove two screws



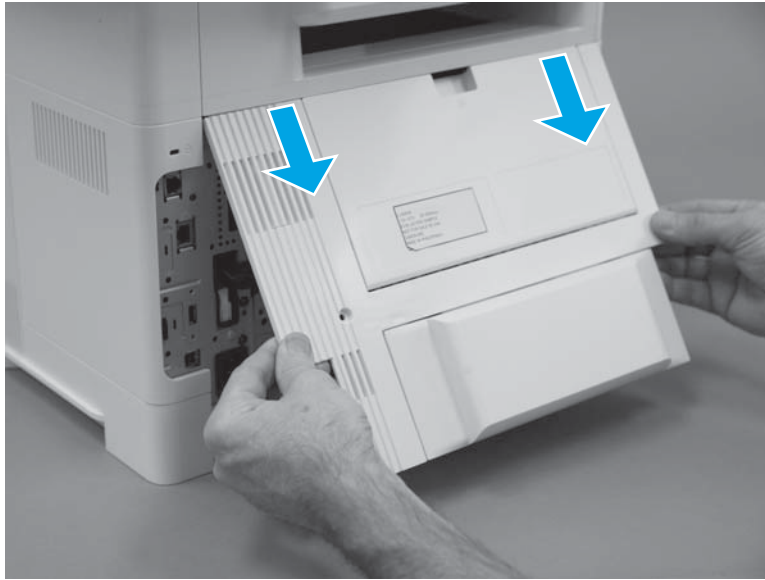
2. Rotate the bottom edge of the assembly away from the printer to release it.

**Figure 1-489** Rotate the bottom of the cover



3. Pull down on the assembly to remove it.

**Figure 1-490** Remove the cover



#### Step 6: Remove the cartridge door assembly

---

 **NOTE:** If the toner cartridge was not removed prior to servicing the printer, remove it now.

---

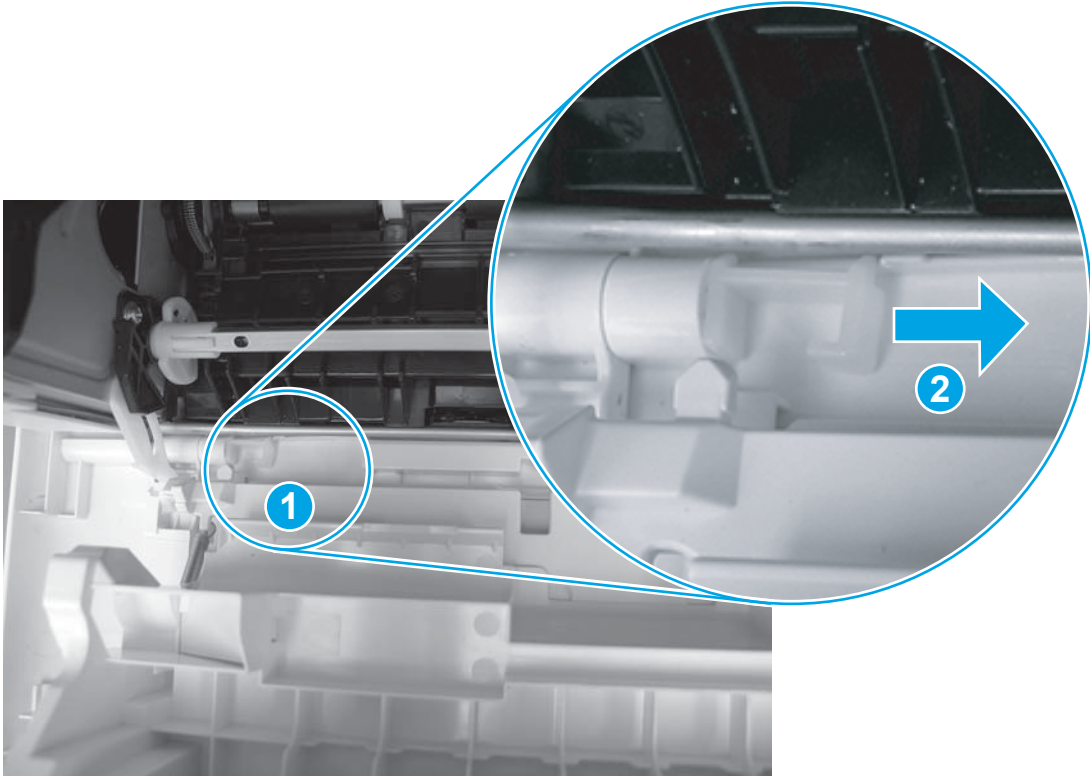
1. Release the support shaft (callout 1), and then slide it toward the center of the door (callout 2).

---

 **TIP:** It might be easier to release the support shaft by using a small flat-blad screwdriver.

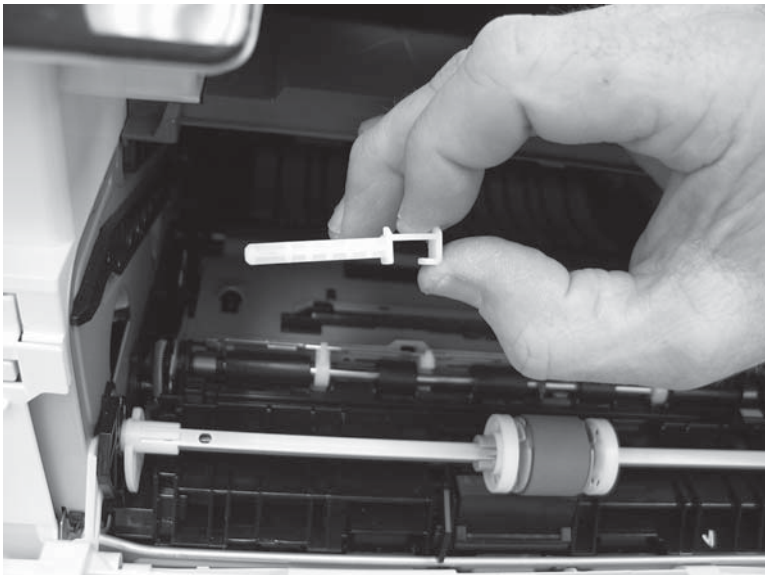
---

**Figure 1-491** Release the support shaft



2. Remove the support shaft.

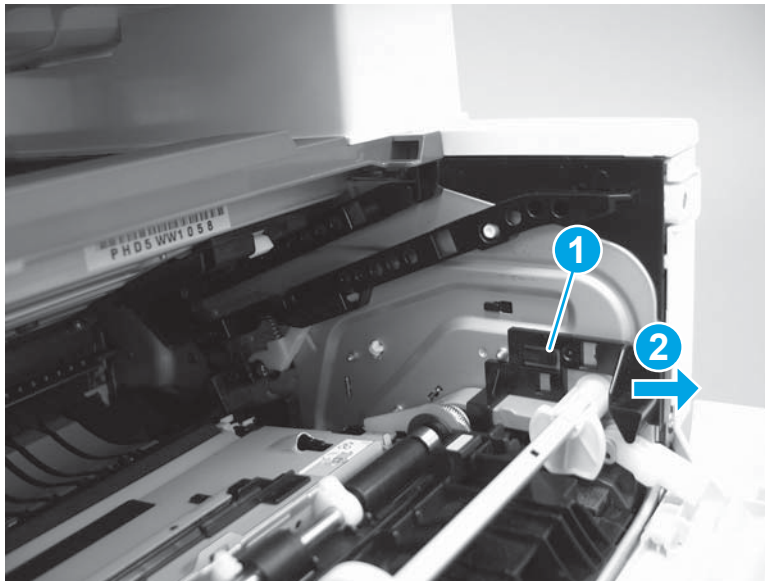
**Figure 1-492** Remove the support shaft



3. Release one tab (callout 1), and then slide the guide out of the printer (callout 2).

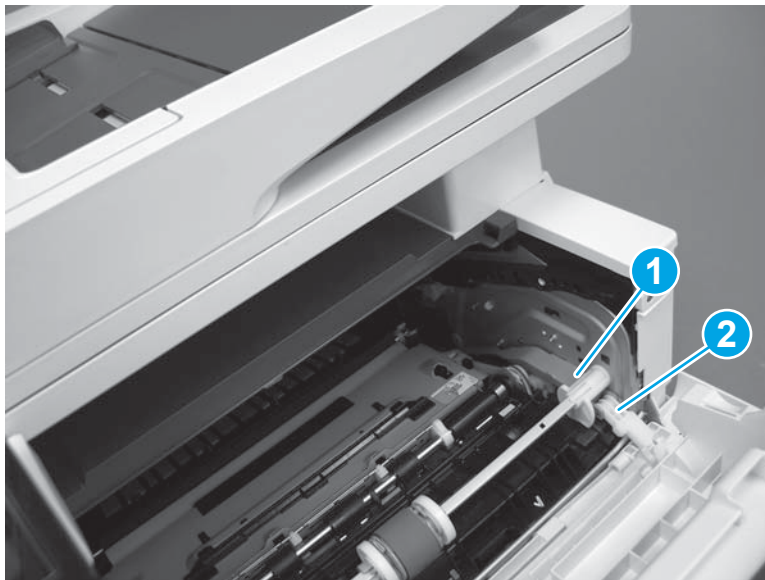
**CAUTION:** Be careful, the tab (callout 1) can be easily broken.

**Figure 1-493** Remove the guide



4. Use a small flat-blade screwdriver to gently pry the white-plastic door arm (callout 1) off of the gray-plastic pressure-release link (callout 2) to release the door arm.

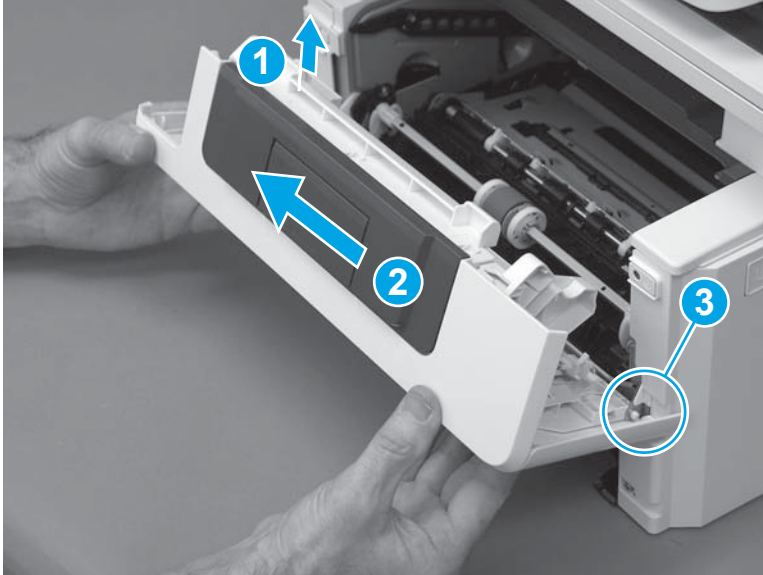
**Figure 1-494** Release the pressure-release link



5. With the door in the partially closed position, slightly raise the left end (callout 1; raise it over the sheet-metal hinge boss), and then slide the door to the left (callout 2) to release the right hinge (callout 3).

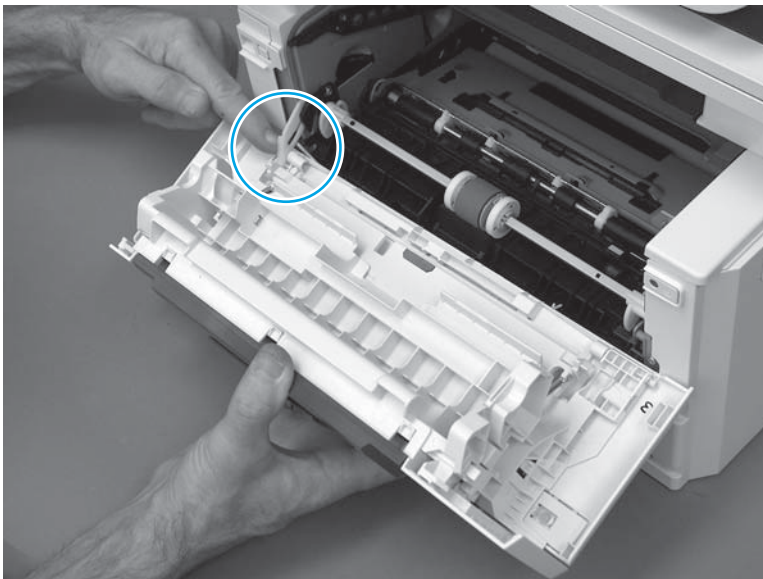
**⚠ CAUTION:** The door is still attached to the printer by the left-side retainer arm. Do not attempt to completely remove the door.

**Figure 1-495** Release the door



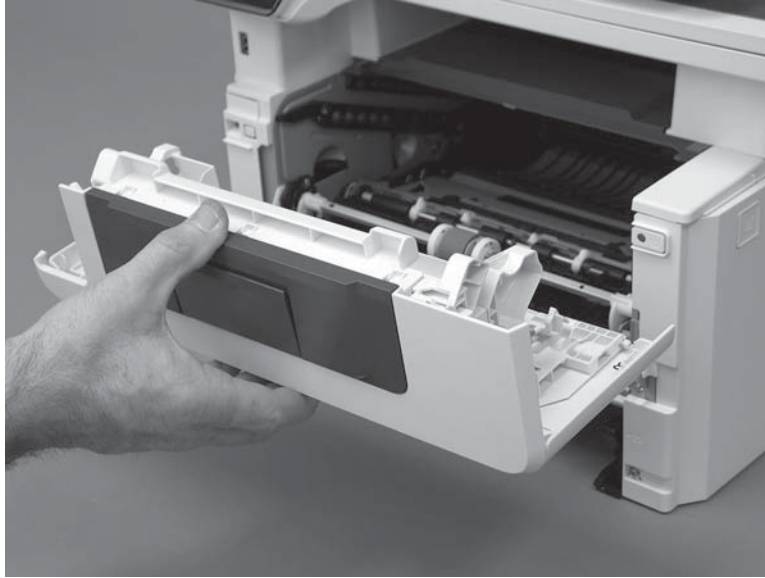
6. Rotate the door away from the printer until the keyed pin on the left-side retainer arm can disengage from the door.

**Figure 1-496** Release the left-side retainer arm





7. Remove the door.

**Figure 1-497** Remove the door



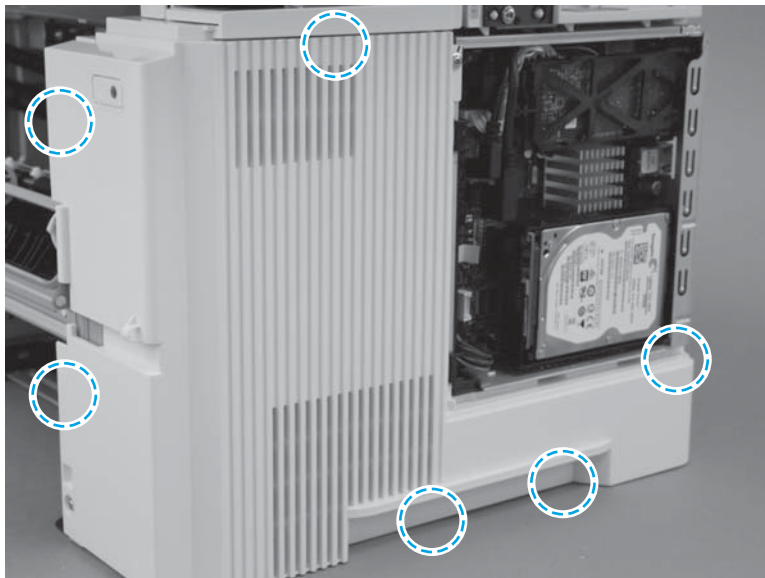
#### Step 7: Remove the right cover

 **IMPORTANT:** The black-plastic cassette front and rear guides (located inside the tray cavity) can be easily dislodged. Do not lose the guides when the cover is removed or installed.

 **NOTE:** The M527 printer is shown in this procedure. However, this procedure is valid for the M501/M506 printers.

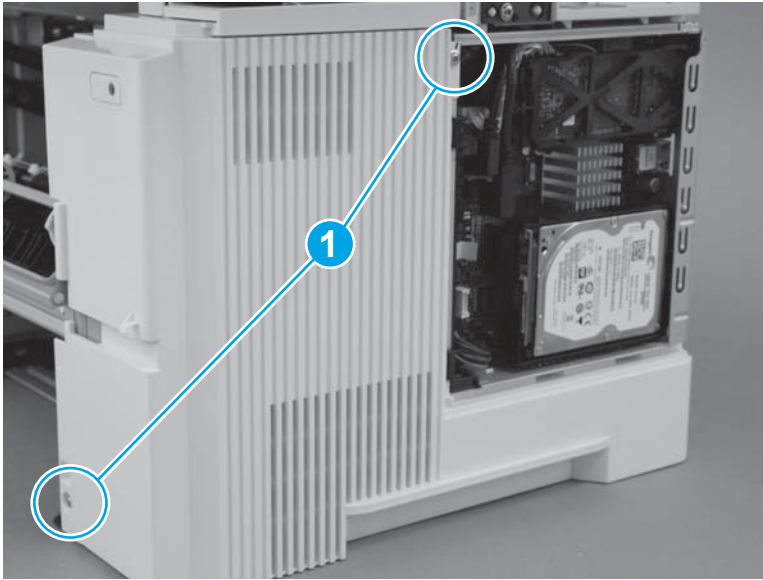
1. Before proceeding, take note of the location of the tabs and bosses on the inside of the cover.

**Figure 1-498** Locate the tabs and bosses



2. Remove two screws (callout 1).

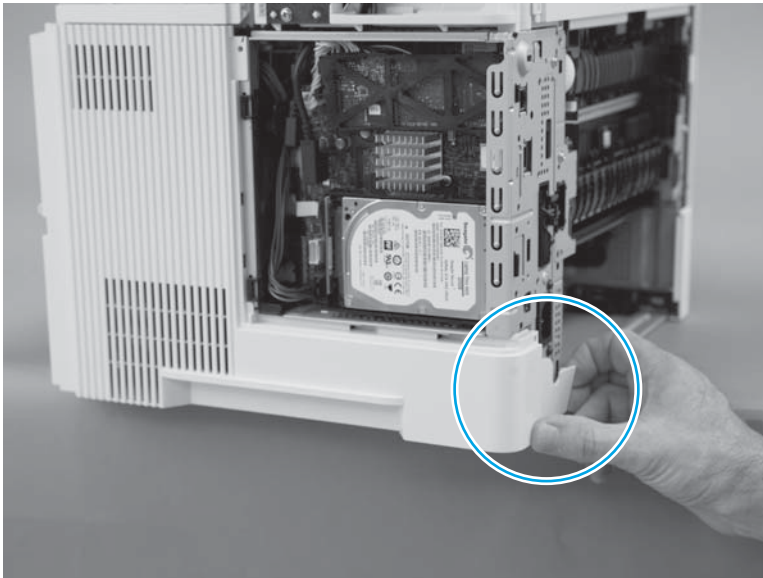
**Figure 1-499** Remove two screws



3. At the rear of the printer, release one boss.

**CAUTION:** It might be easier to remove the cover with the printer slightly hanging over the edge of the workspace. Do not let the printer tip and fall off of the workspace when removing the cover.

**Figure 1-500** Release one boss

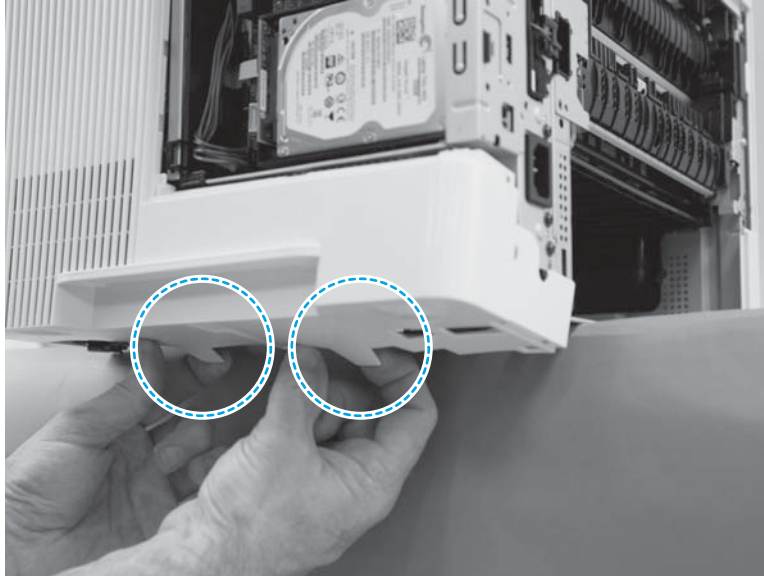




4. At the bottom edge of the cover, release two bosses.

**CAUTION:** It might be easier to remove the cover with the printer slightly hanging over the edge of the workspace. Do not let the printer tip and fall off of the workspace when removing the cover.

**Figure 1-501** Release two bosses

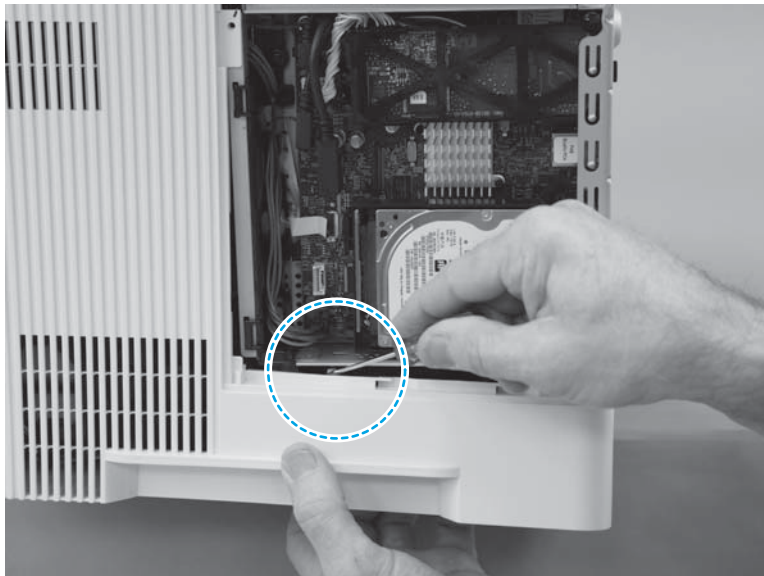


5. Near the formatter, release one tab.

**CAUTION:** It might be easier to remove the cover with the printer slightly hanging over the edge of the workspace. Do not let the printer tip and fall off of the workspace when removing the cover.

**TIP:** Hold the bottom of the cover away from the printer, and then use a small flat-blade screw driver to easily release this tab.

**Figure 1-502** Release one tab

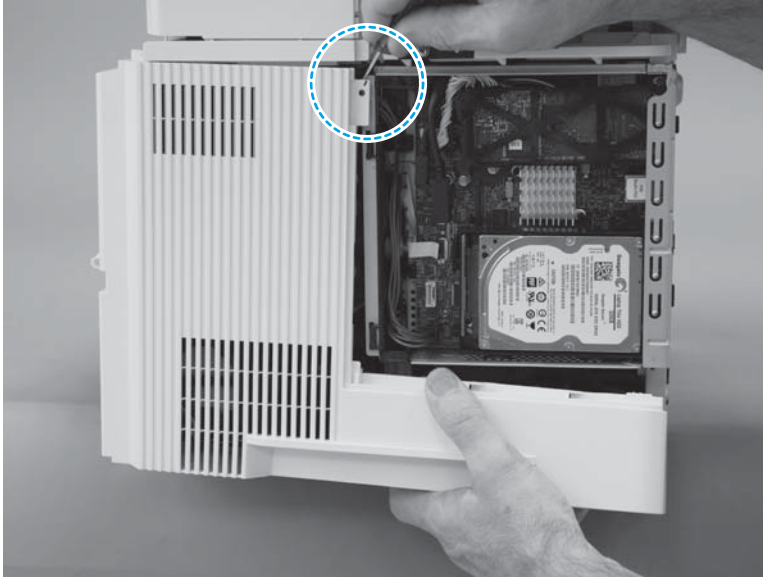


6. At the top rear edge of the cover, release one tab.

**CAUTION:** It might be easier to remove the cover with the printer slightly hanging over the edge of the workspace. Do not let the printer tip and fall off of the workspace when removing the cover.

**TIP:** Use a small flat-blade screw driver to easily release this tab.

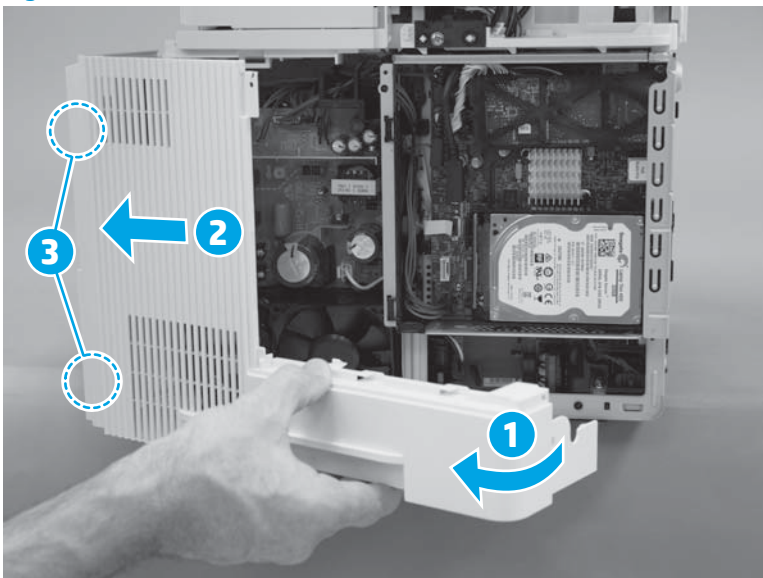
**Figure 1-503** Release one tab




7. Rotate the rear of the cover away from the printer (callout 1), slide the cover toward the front of the printer (callout 2) to release two bosses (callout 3), and then remove the cover.


**CAUTION:** It might be easier to remove the cover with the printer slightly hanging over the edge of the workspace. Do not let the printer tip and fall off of the workspace when removing the cover.

**Figure 1-504** Remove the cover



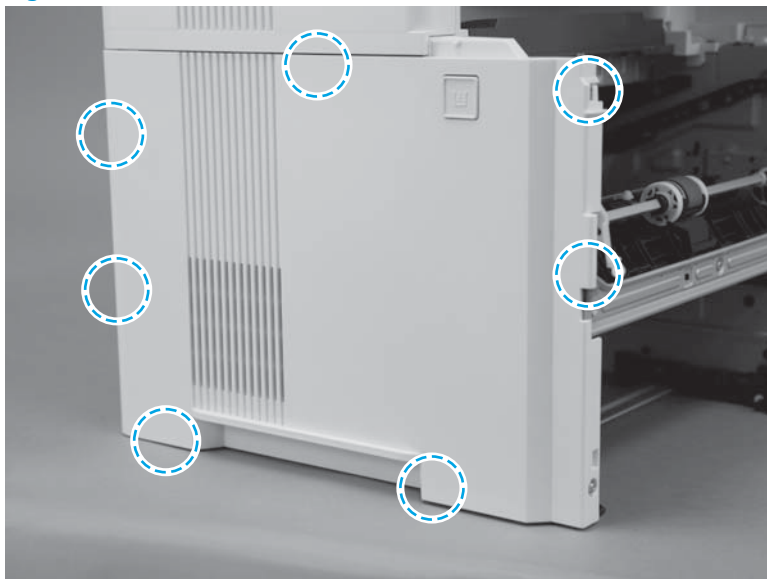
## Step 8: Remove the left cover

 **IMPORTANT:** The black-plastic cassette front and rear guides (located inside the tray cavity) can be easily dislodged. Do not lose the guides when the cover is removed or installed.

 **NOTE:** The M527 printer is shown in this procedure. However, this procedure is valid for the M501/M506 printers.

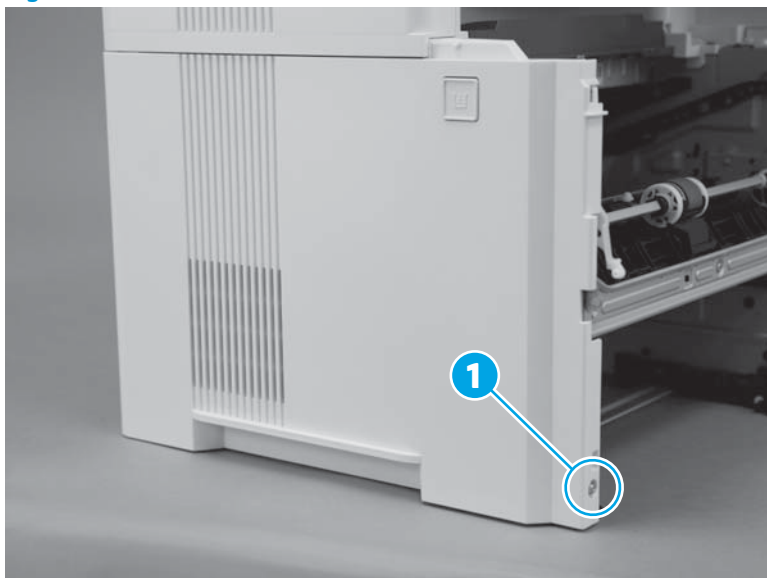
1. Before proceeding, take note of the location of the tabs and bosses on the inside of the cover.

**Figure 1-505** Locate of the tabs and bosses



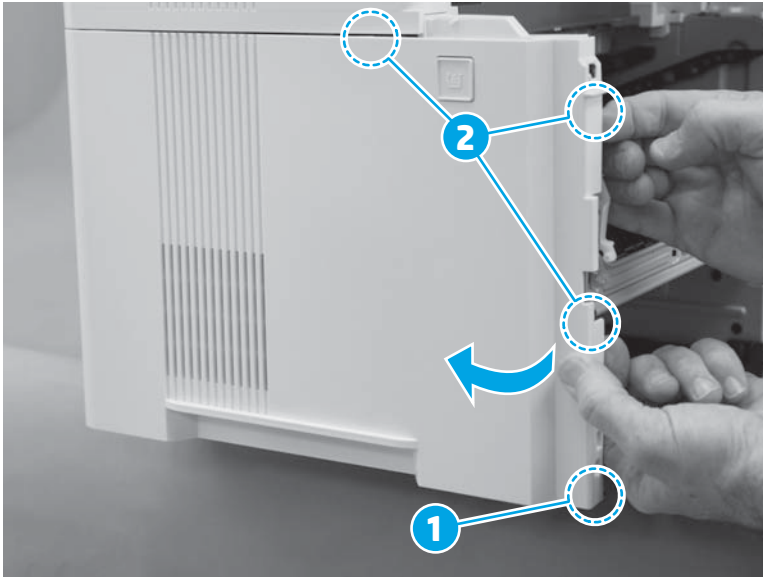
2. Remove one screw (callout 1).

**Figure 1-506** Remove one screw



3. At the front of the printer, release one boss (callout 1), and then rotate the front edge of the cover away from the printer to release three tabs (callout 2).

**Figure 1-507** Release one boss and three tabs




4. At the bottom edge of the cover, release two tabs.

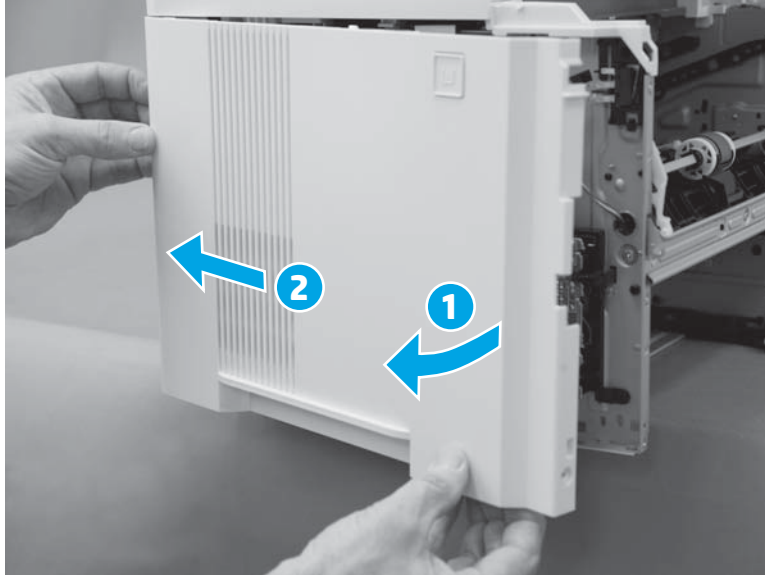
**Figure 1-508** Release two tabs



5. Continue to rotate the front edge of the cover away from the printer (callout 1), and then slide the cover toward the rear of the printer (callout 2) to remove it.

 **NOTE:** If the cover is difficult to rotate or slide as shown below, make sure that the bottom tabs (released in the previous step) are completely disengaged from the chassis.

**Figure 1-509** Remove the cover

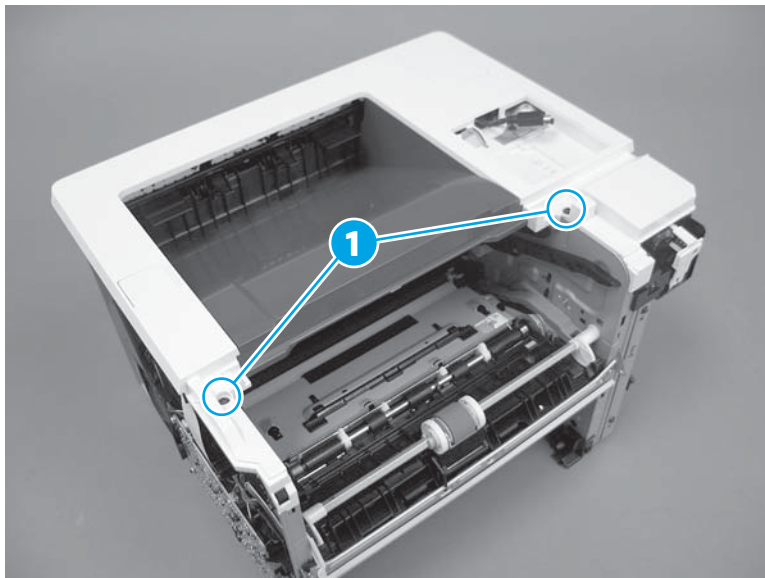


### Step 9: Remove the top cover (M501/M506)


The M506x is shown in this procedure. However, the steps are correct for all M506 models and the M501 printer.

1. Remove two screws (callout 1).

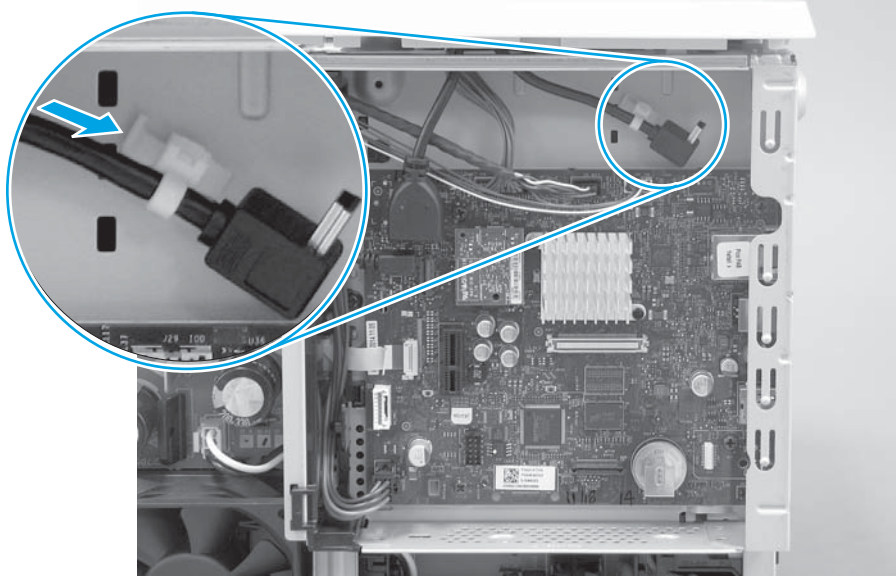
**Figure 1-510** Remove two screws



- M506 only:** Release one cable retainer from the chassis.

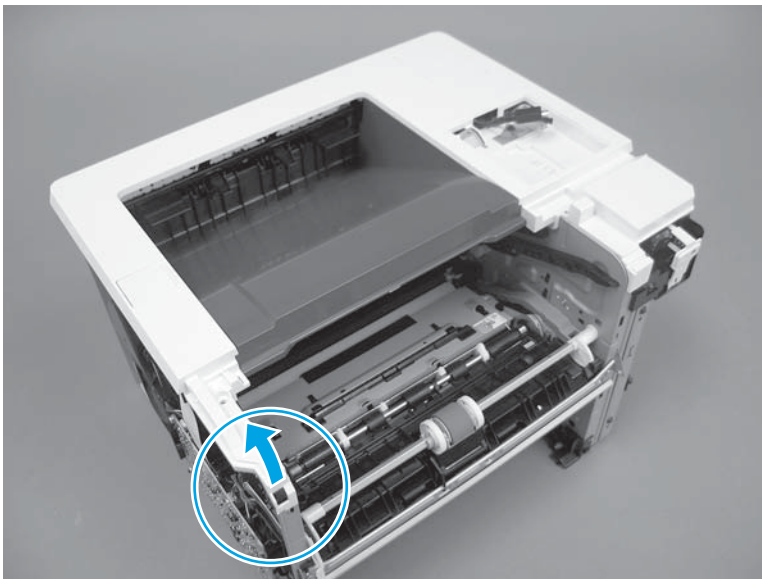
 **TIP:** Depress the tab on the retainer to release it.

**Figure 1-511** Release one cable retainer



- Release one boss.

**Figure 1-512** Release one boss



4. Rotate the front of the cover up and away from the printer, and then remove the cover.

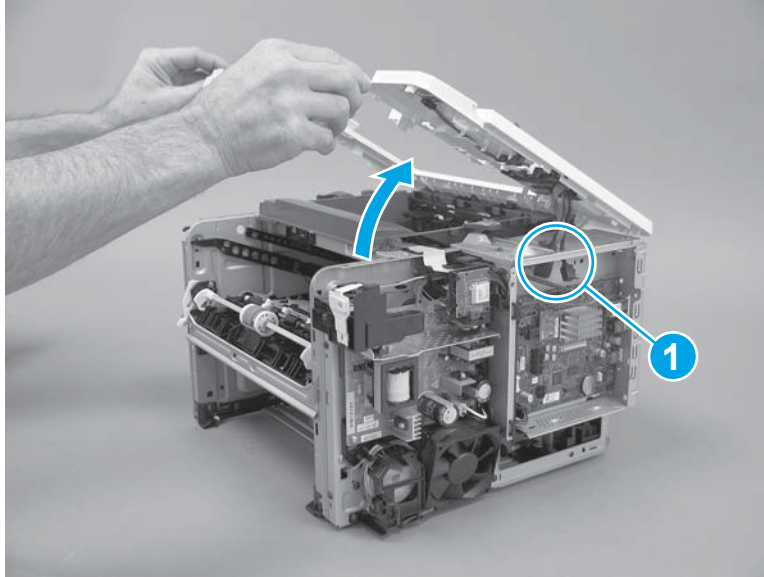
---

**CAUTION:** **M506x only:** As the cover is rotated up, carefully pass the cables the hole in the chassis (callout 1).

**NOTE:** **LCD control panel models only:** Disconnect the control panel before removing the cover.

---

**Figure 1-513** Remove the cover



#### Step 10: Unpack the replacement cover

Unpack the replacement part from the packaging.

<http://www8.hp.com/us/en/hp-information/environment/product-recycling.html>

---

**NOTE:** HP recommends responsible disposal of the defective part.

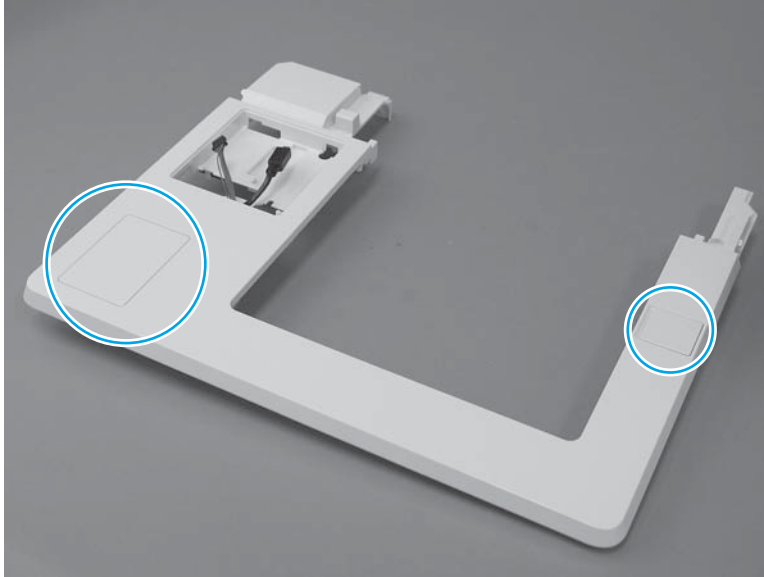
Transfer the hardware integration pocket (HIP) and/or universal serial bus (USB) covers from the discarded top cover to the replacement top cover.

---

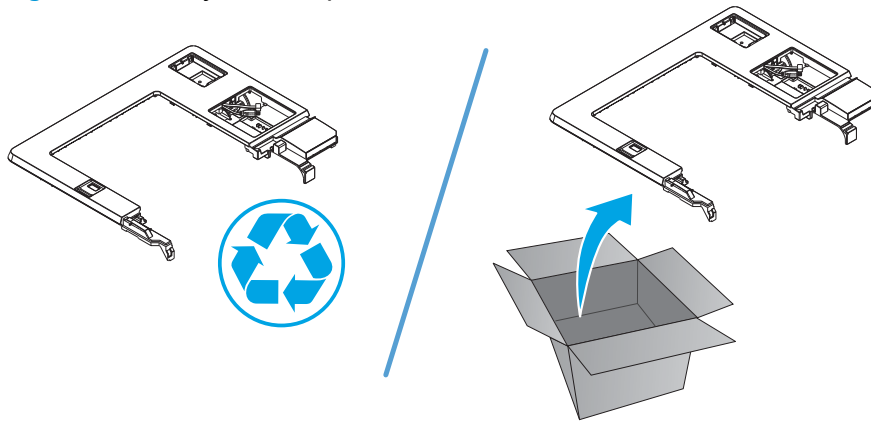
**NOTE:** **M506 only:** The duplex MF and LCD models have both the HIP and USB covers. The simplex LCD model has only the USB cover.

---

**Figure 1-514** Transfer the HIP and/or USB covers



**Figure 1-515** Recycle and unpack



### Step 11: Install the top cover (M501/M506)

The M506x is shown in this procedure. However, the steps are correct for all M506 models and the M501 printer.

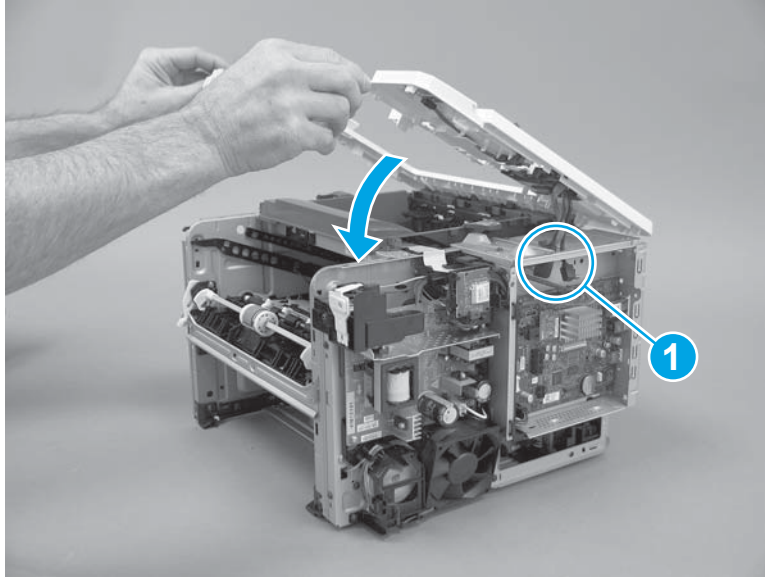
1. Position the rear edge of the cover on the printer, and then rotate the front of the cover down onto the printer.

**CAUTION:** **M506x only:** As the cover is rotated down, carefully pass the cables the hole in the chassis (callout 1).

**NOTE:** **LCD control panel models only:** Pass the cables through the opening in the cover, and then connect the control panel after installing the cover.

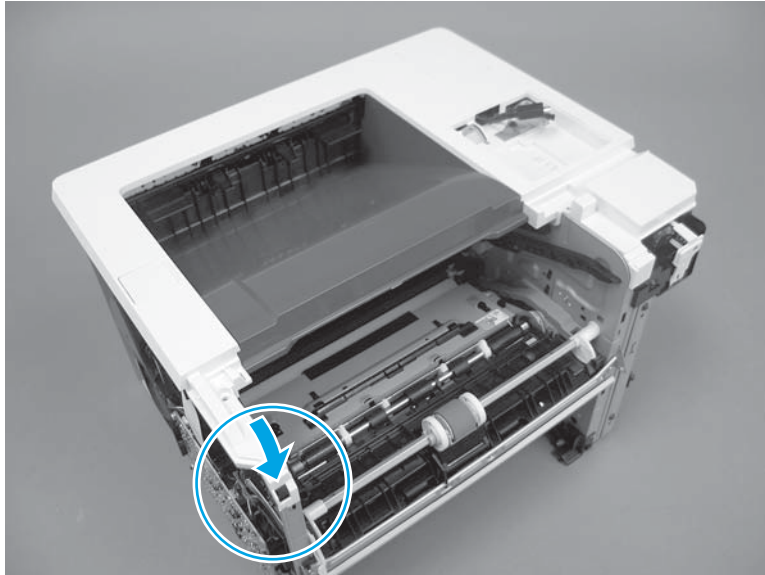


**Figure 1-516** Install the cover




2. Engage one boss.

**Figure 1-517** Engage one boss



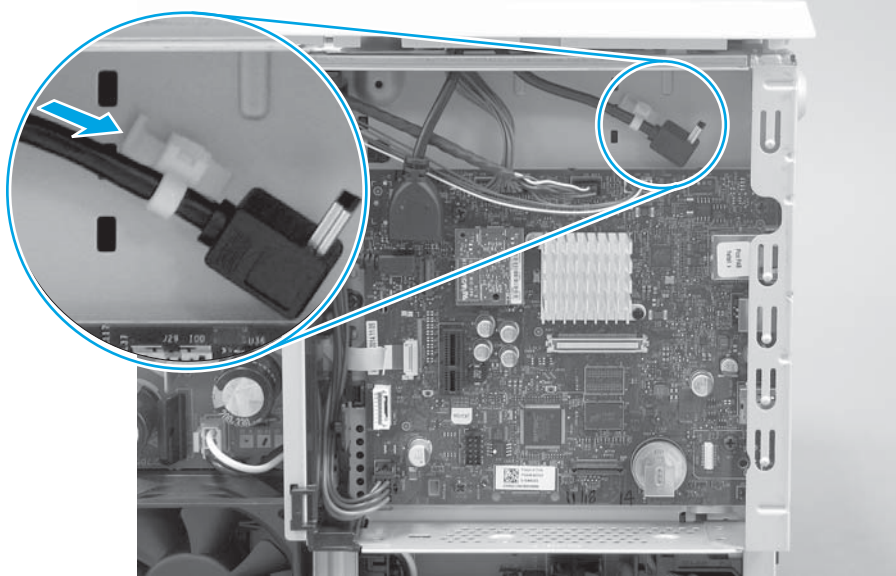
- M506 only:** Install one cable retainer on the chassis.

---

 **TIP:** Depress the tab on the retainer to install it.

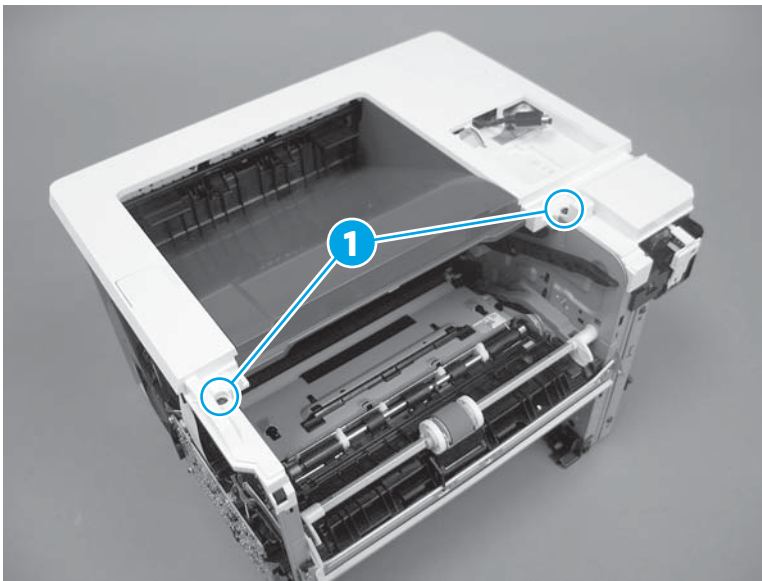
---

**Figure 1-518** Install one cable retainer




- Install two screws (callout 1).


**Figure 1-519** Install two screws



## Step 12: Install the left cover

---

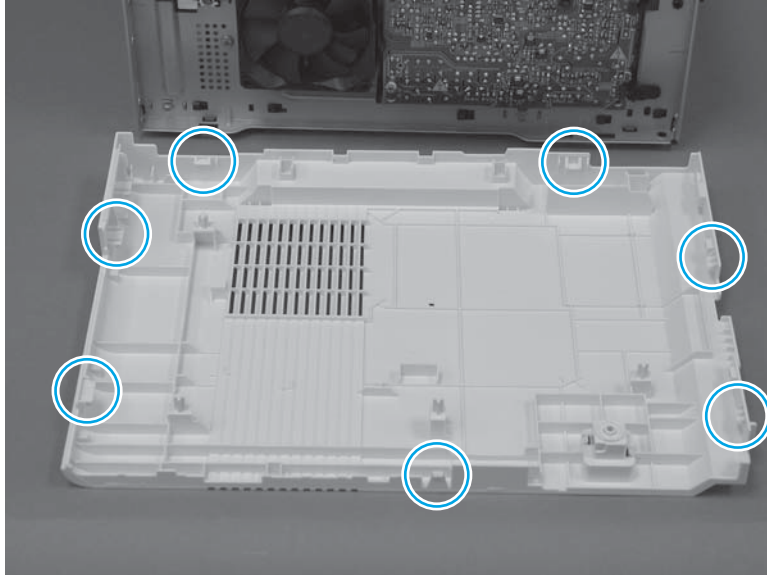
 **IMPORTANT:** The black-plastic cassette front and rear guides (located inside the tray cavity) can be easily dislodged. Do not lose the guides when the cover is removed or installed.

 **NOTE:** The M527 printer is shown in this procedure. However, this procedure is valid for the M501/M506 printers.

---

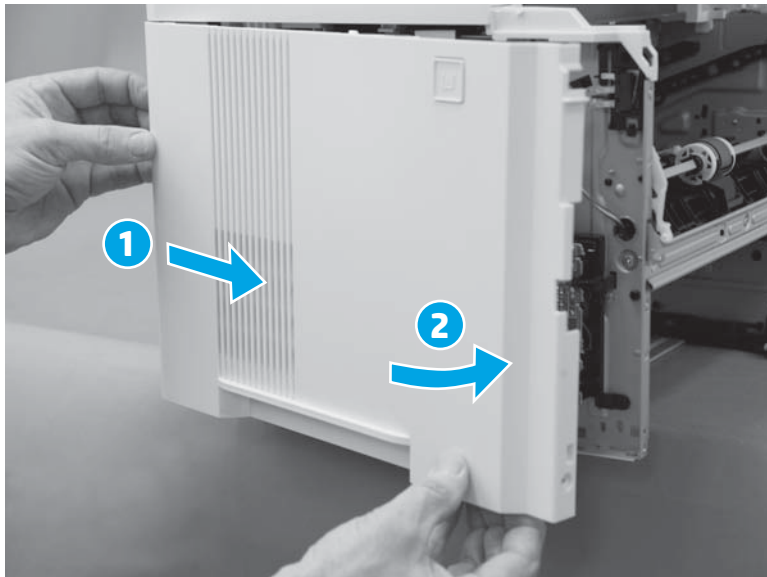
- Before proceeding, take note of the location of the tabs and bosses on the inside of the cover.

**Figure 1-520** Locate of the tabs and bosses



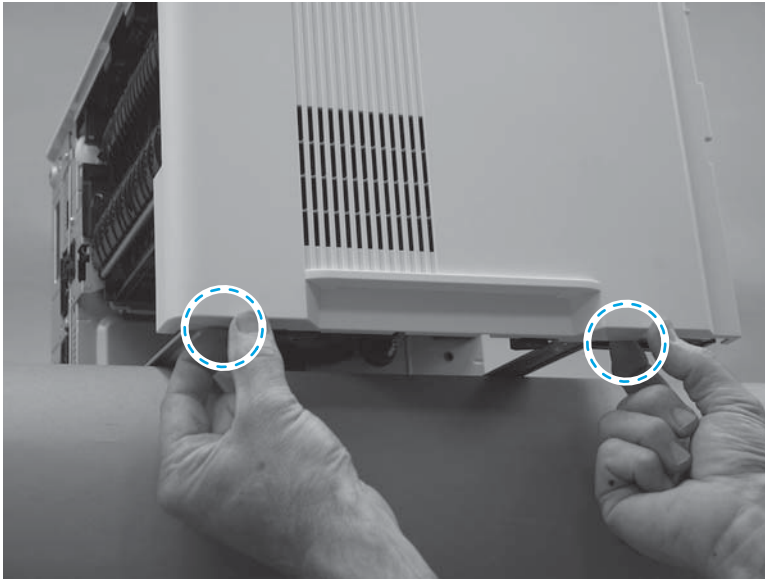
2. Engage the rear edge of the cover (callout 1), and then rotate the rear edge of the cover toward the printer (callout 2).

**Figure 1-521** Install the cover



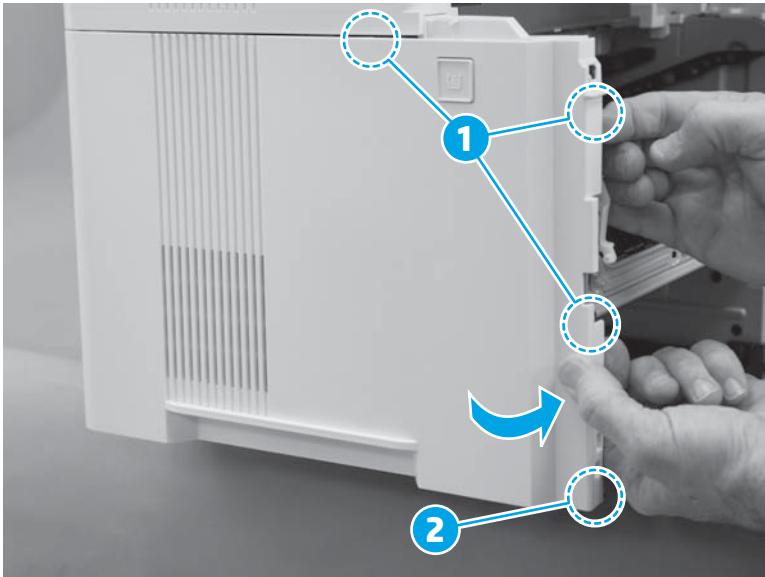
3. At the bottom edge of the cover, engage two tabs.

**Figure 1-522** Engage two tabs



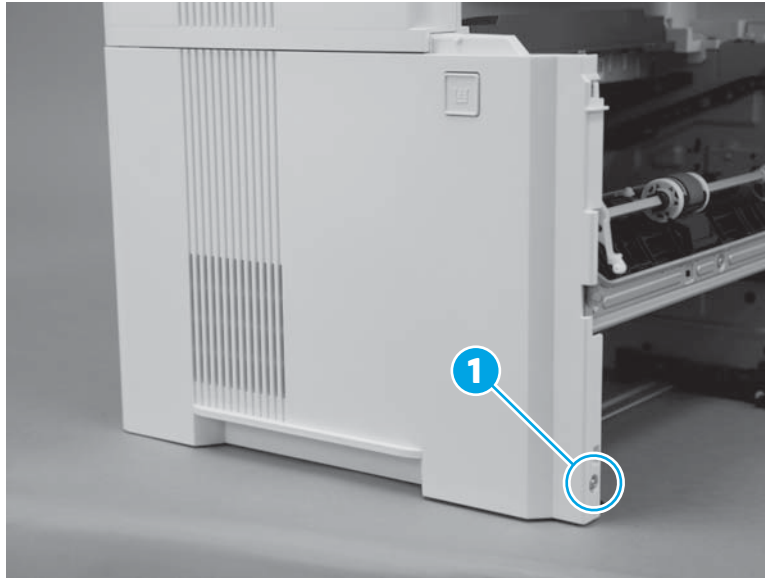
4. At the front of the printer, engage three tabs (callout 1), and then continue to rotate the front edge of the cover toward the printer to engage one boss (callout 2).

**Figure 1-523** Engage three tabs and one boss





5. Install one screw (callout 1).

**Figure 1-524** Install one screw



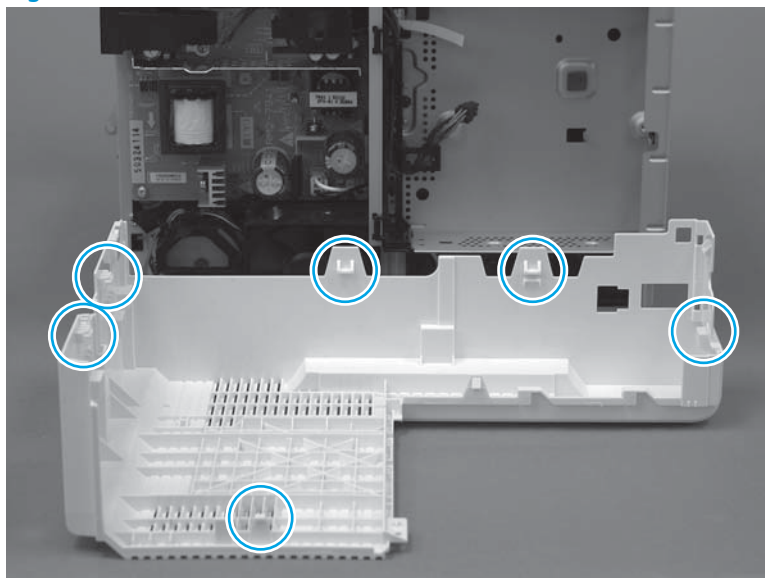
### Step 13: Install the right cover

 **IMPORTANT:** The black-plastic cassette front and rear guides (located inside the tray cavity) can be easily dislodged. Do not lose the guides when the cover is removed or installed.

 **NOTE:** The M527 printer is shown in this procedure. However, this procedure is valid for the M501/M506 printers.

1. Before proceeding, take note of the location of the tabs and bosses on the inside of the cover.

**Figure 1-525** Locate the tabs and bosses

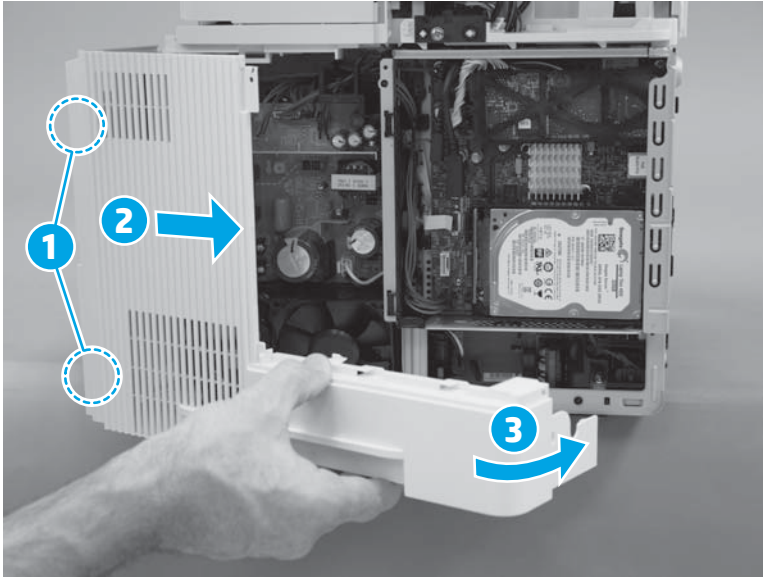


2. At the front of the cover engage two bosses (callout 1/2), and then rotate the rear of the cover toward the printer (callout 3).

**CAUTION:** It might be easier to install the cover with the printer slightly hanging over the edge of the workspace. Do not let the printer tip and fall off the workspace when removing the cover.

**TIP:** Make sure that the power switch at the front of the printer is positioned in the opening in the cover and that it does not interfere with the cover installation.

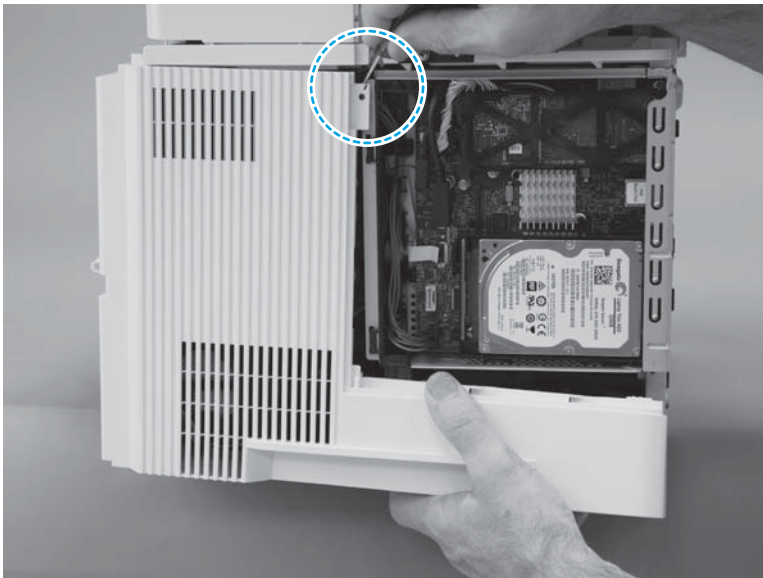
**Figure 1-526** Install the cover



3. At the top rear edge of the cover, engage one tab.

**CAUTION:** It might be easier to install the cover with the printer slightly hanging over the edge of the workspace. Do not let the printer tip and fall off the workspace when removing the cover.

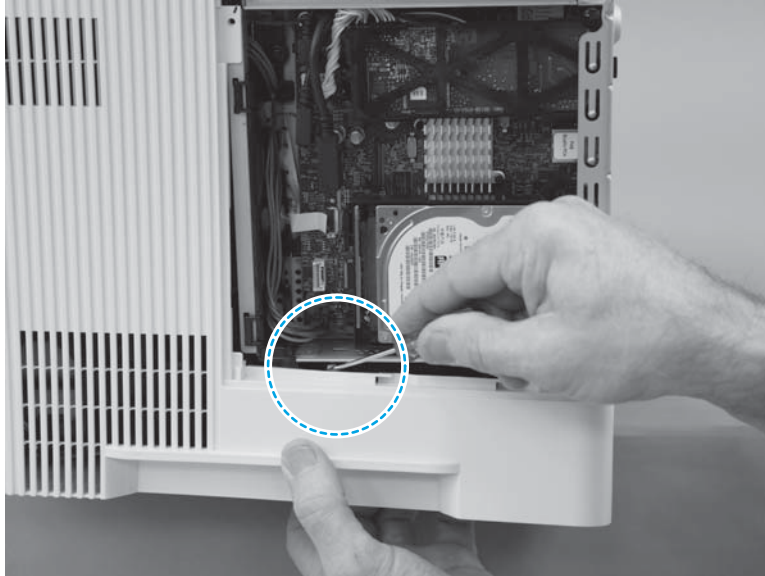
**Figure 1-527** Engage one tab



4. Near the formatter, engage one tab.

**CAUTION:** It might be easier to install the cover with the printer slightly hanging over the edge of the workspace. Do not let the printer tip and fall off of the workspace when removing the cover.

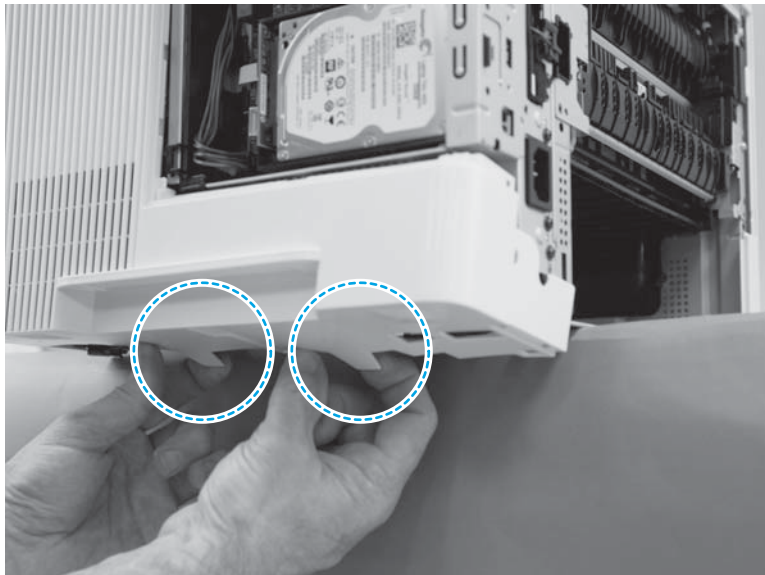
**Figure 1-528** Engage one tab



5. At the bottom edge of the cover, engage two bosses.

**CAUTION:** It might be easier to install the cover with the printer slightly hanging over the edge of the workspace. Do not let the printer tip and fall off of the workspace when removing the cover.

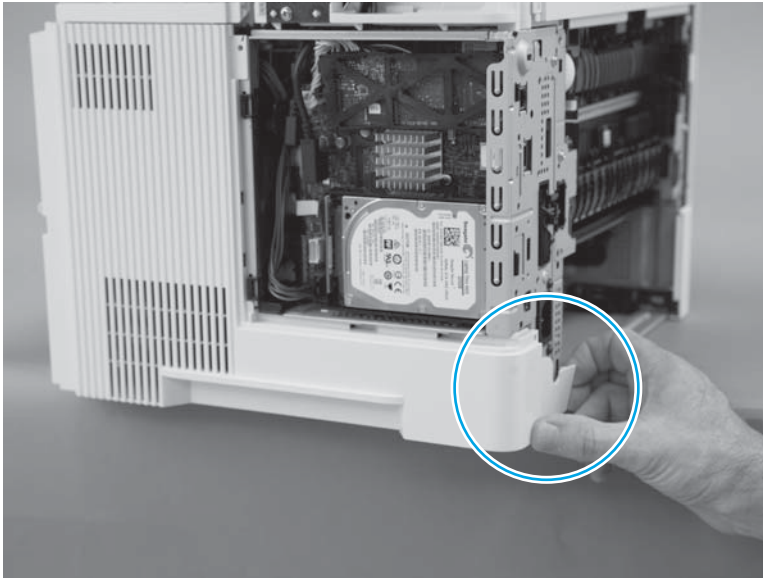
**Figure 1-529** Engage two bosses



6. At the rear of the printer, engage one boss.

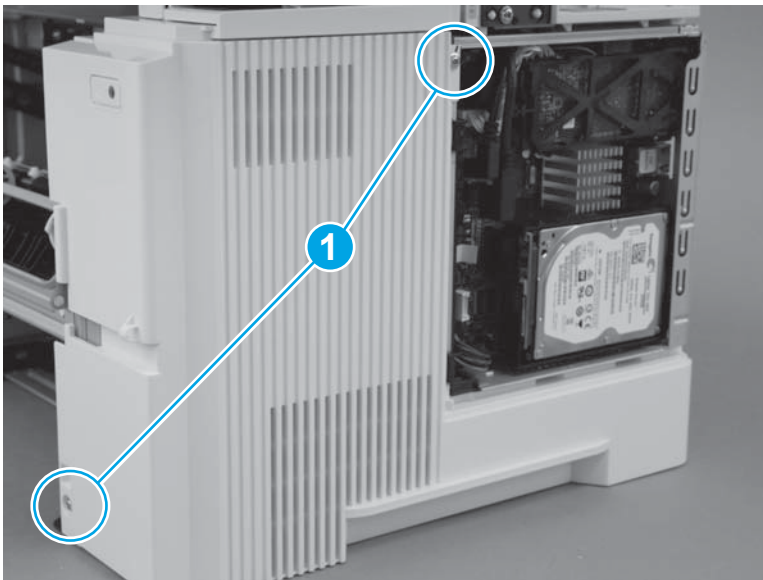
**⚠ CAUTION:** It might be easier to install the cover with the printer slightly hanging over the edge of the workspace. Do not let the printer tip and fall off of the workspace when removing the cover.

**Figure 1-530** Engage one boss



7. Install two screws (callout 1).

**Figure 1-531** Install two screws



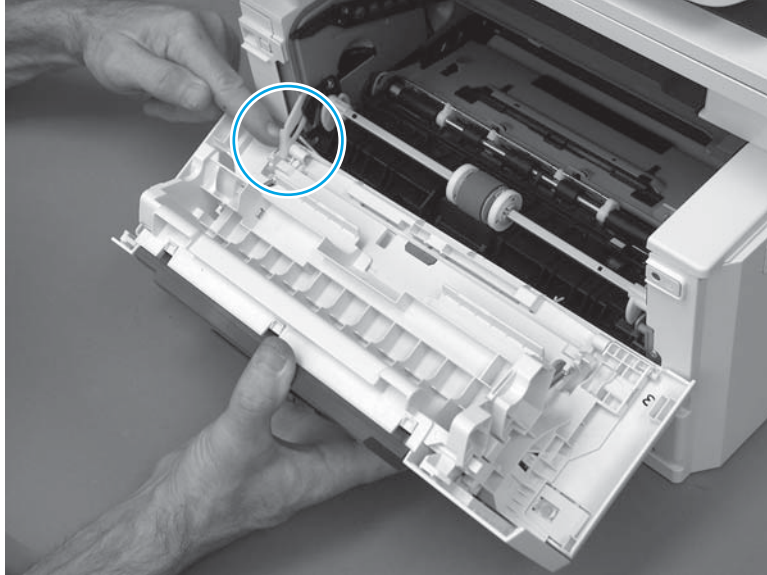
#### Step 14: Install the cartridge door assembly

1. Position the door close to the printer, and then engage the keyed pin on the left-side retainer arm with the hole in the door.

**💡 TIP:** It might be easier to engage the keyed pin with the hole by using a small flat-blade screwdriver.




**Figure 1-532** Engage the left-side retainer arm

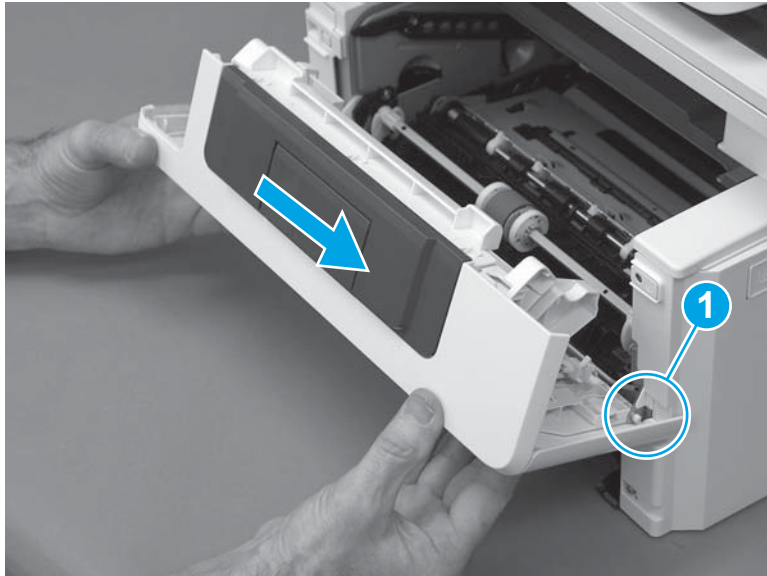


2. Engage the right-side door hinge pin with the hole in the chassis (callout 1).


 **NOTE:** There are two right-side hinge pins (not shown in callout 1).

 **TIP:** Keep a finger pressed on the left-side retainer arm so that it does not disengage from the door.

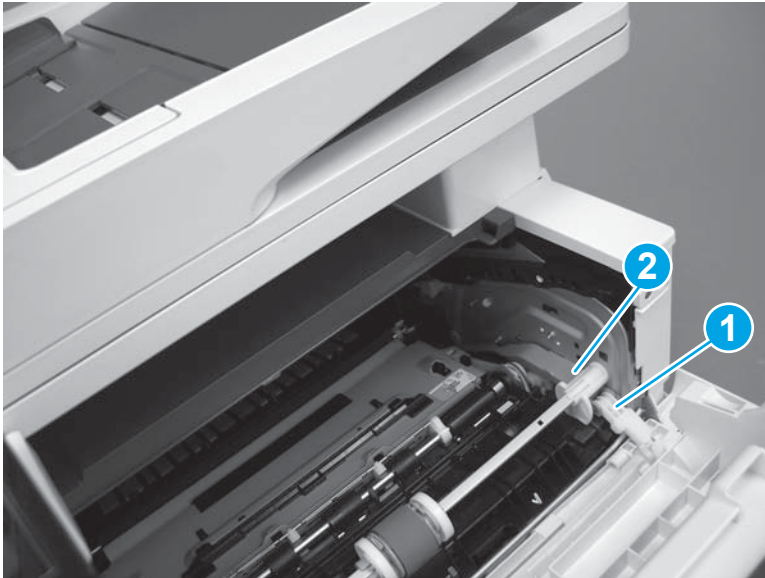
**Figure 1-533** Install the door



3. Install the gray-plastic pressure-release link (callout 1) onto the white-plastic door arm (callout 2).

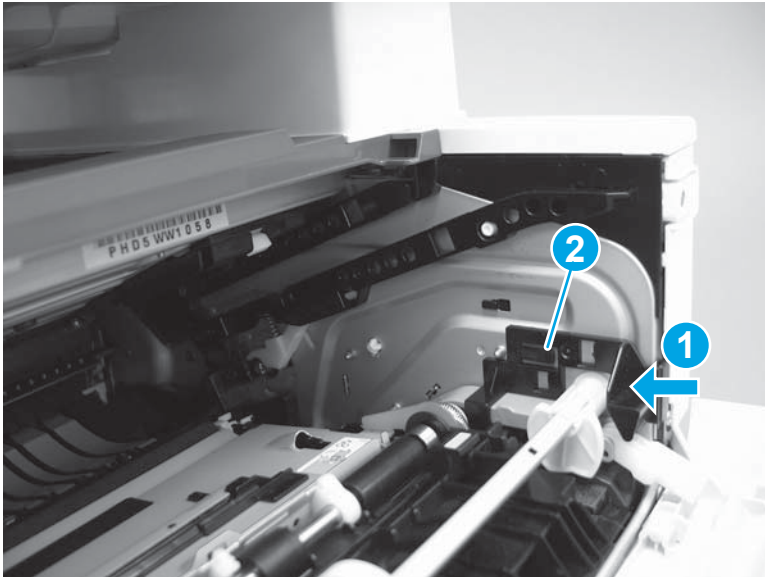
 **IMPORTANT:** Make sure that the arm snaps on to the link. Partially close and open the door to verify that the link (callout 2) moves in and out of the printer as the door closes/opens.

**Figure 1-534** Install the pressure-release link



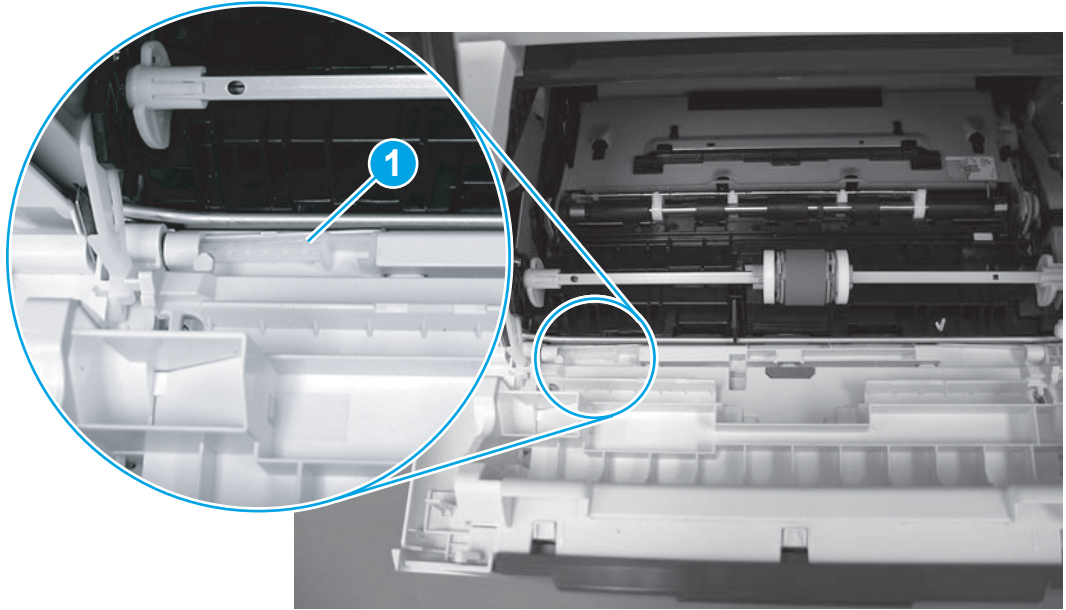
4. Slide the guide into the printer (callout 1), and then make sure that the tab (callout 2) snaps into place to secure the guide to the chassis.

**Figure 1-535** Install the guide





5. Position the support shaft on the door, and then align the left-side hinge on the door with the hole in the chassis (callout 1).

**Figure 1-536** Align the hinge

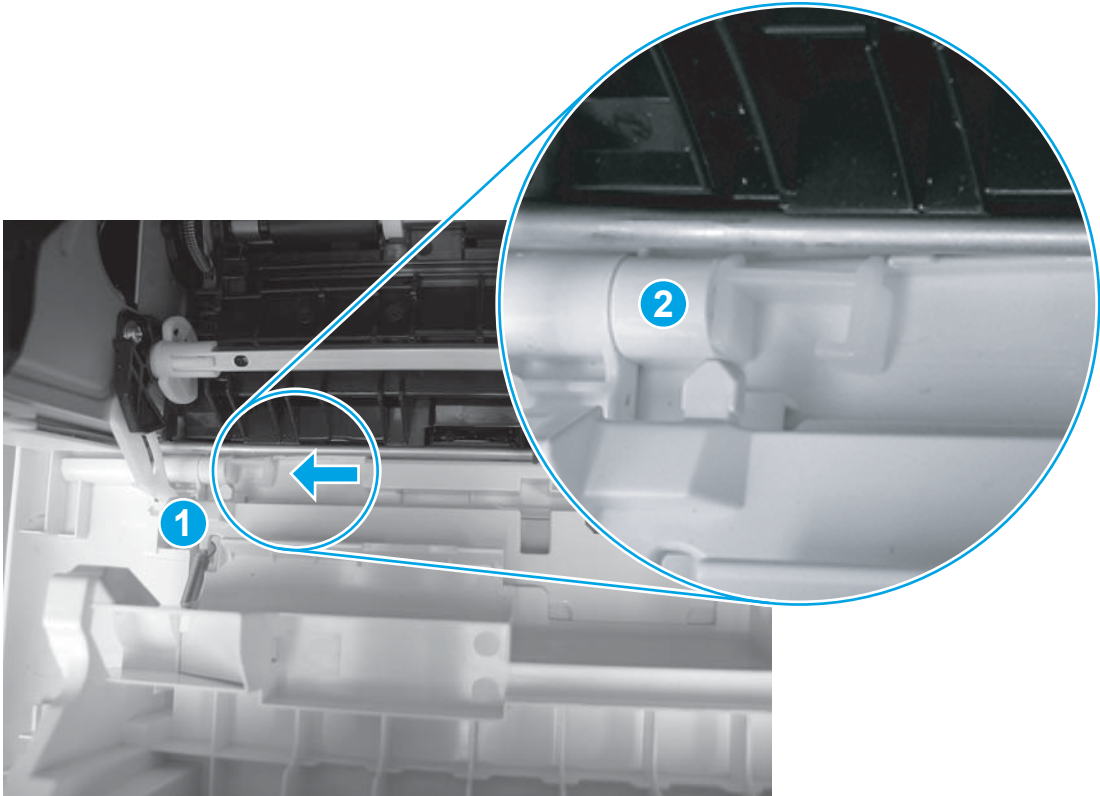


6. Push the shaft towards the left side of the printer to install it (callout 1).

 **NOTE:** Make sure that the support shaft is fully installed and correctly orientated (callout 2) so that it will not interfere with the door opening and closing.

 **Reinstallation tip:** If a replacement door was installed, make sure to install the nameplate (supplied in the kit) corresponding to the printer on the door.

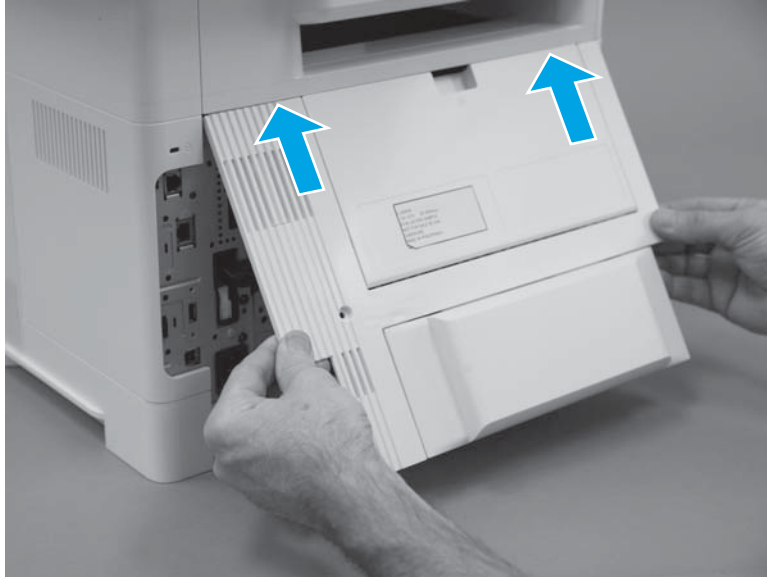
**Figure 1-537** Install the support shaft



### Step 15: Install the rear door assembly

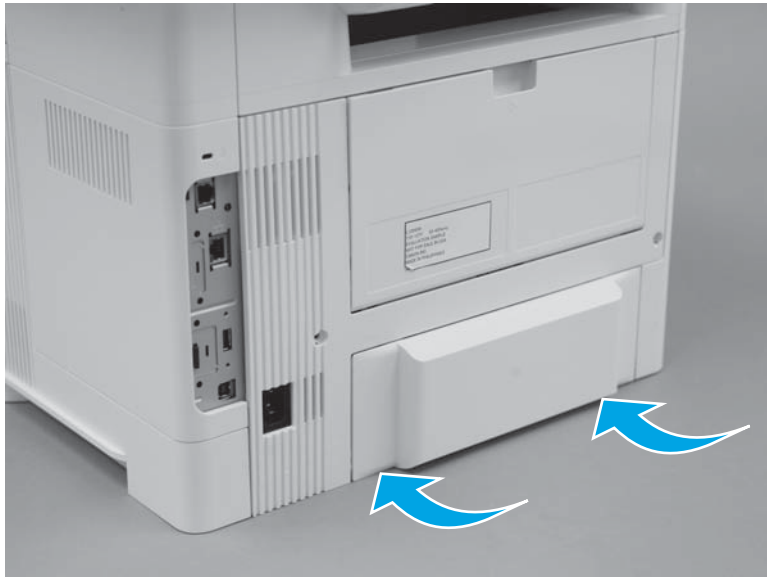
1. Engage the top edge of the assembly with the printer.

**Figure 1-538** Install the cover



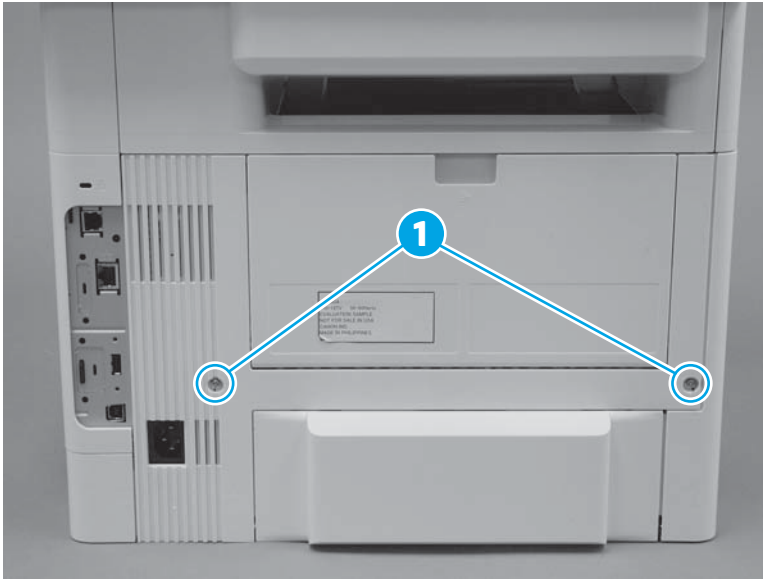
2. Rotate the bottom edge of the cover towards the printer.

**Figure 1-539** Rotate the bottom of the cover



3. Install two screws (callout 1).

**Figure 1-540** Install two screws



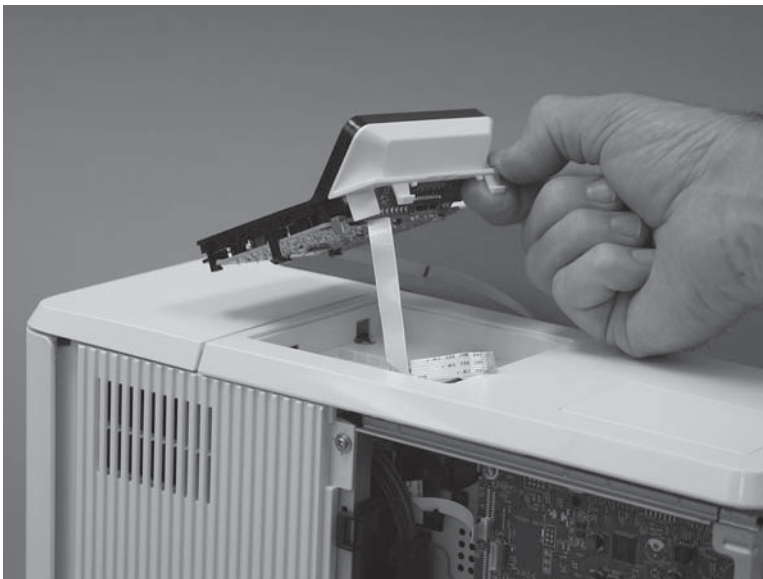
#### Step 16: Install the control panel (M501)



**NOTE:** This step is for the M501 printer. For all other printers, skip this step and proceed to [Step 17: Install the formatter cover on page 331](#).

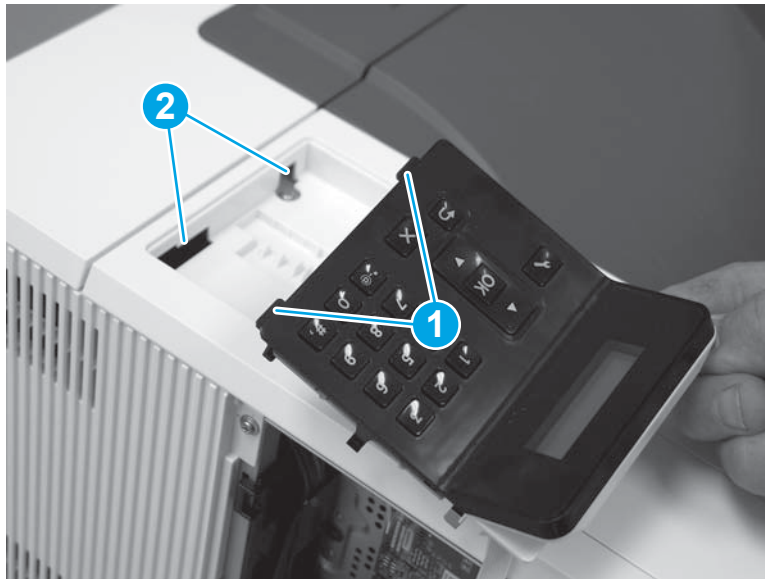
1. Position the replacement control panel over the printer.

**Figure 1-541** Position the control panel over the printer



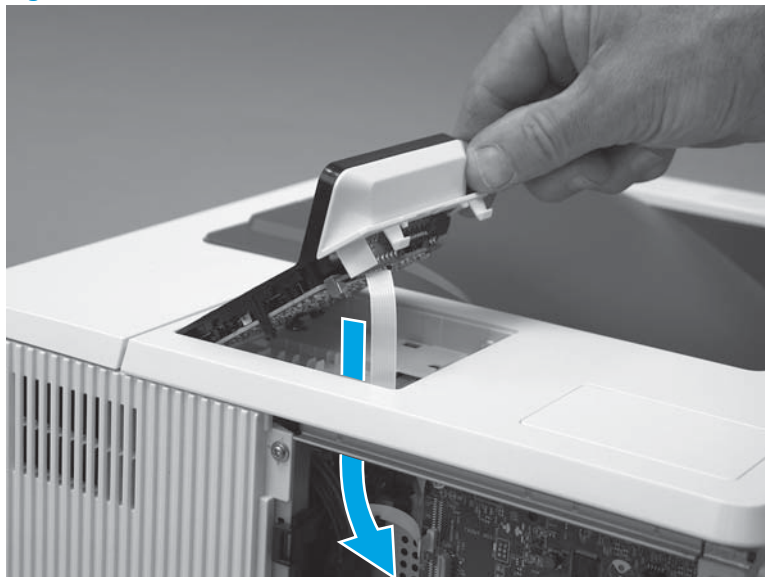
2. Engage the tabs (callout 1) on the front side of the control panel into the slots in the top cover (callout 2).

**Figure 1-542** Engage the tabs with the slots



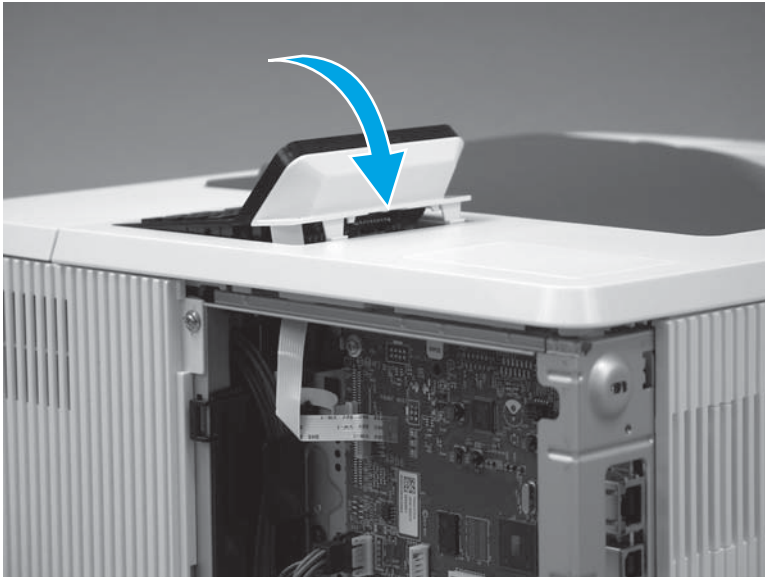
3. Carefully pass the fla cable through the opening in the printer chassis.

**Figure 1-543** Install the fla cable



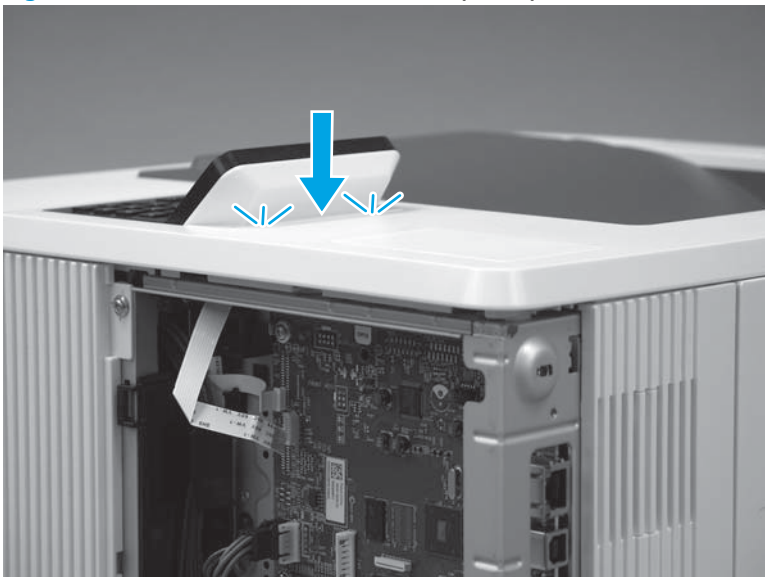
4. With the front tabs engaged, rotate the rear edge of the control panel down and onto the printer to engage the rear tabs.

**Figure 1-544** Rotate the rear edge of the control panel down



5. Firmly push down on the rear edge of the control panel to make sure that the tabs snap into place.

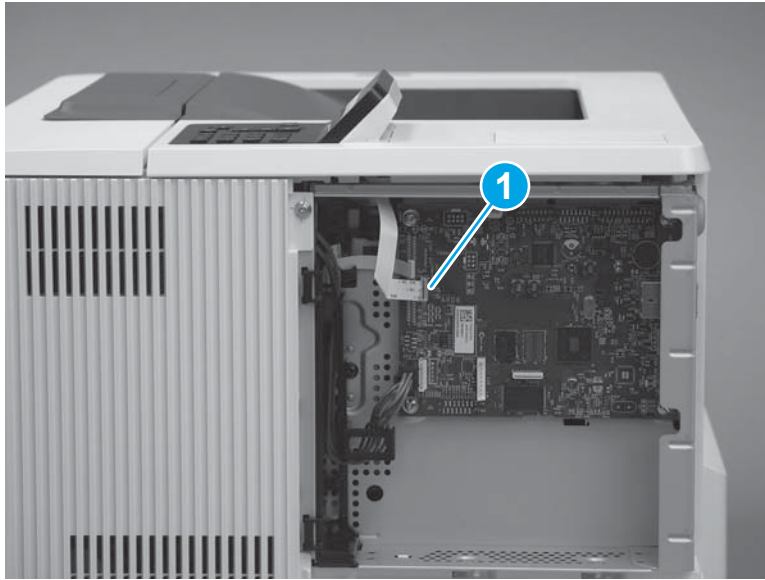
**Figure 1-545** Make sure that the tabs snap into place





6. Connect one flat cable (callout 1).

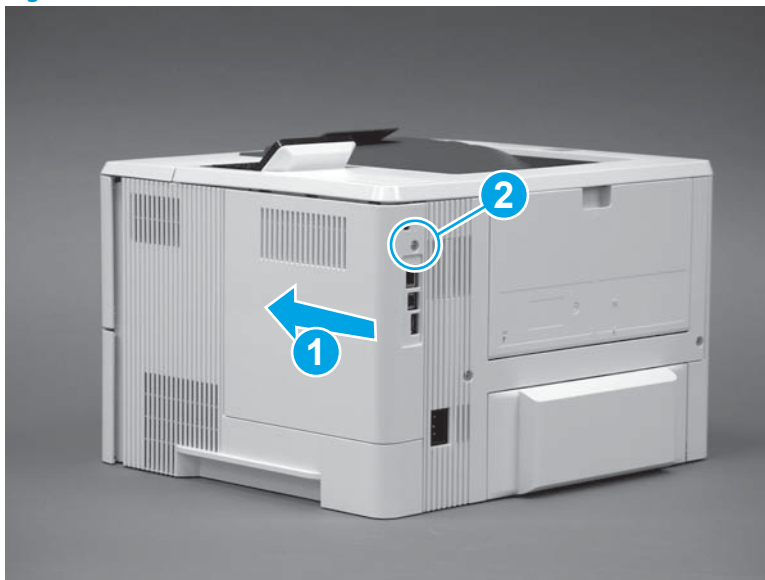
**Figure 1-546** Connect one flat cable



#### Step 17: Install the formatter cover

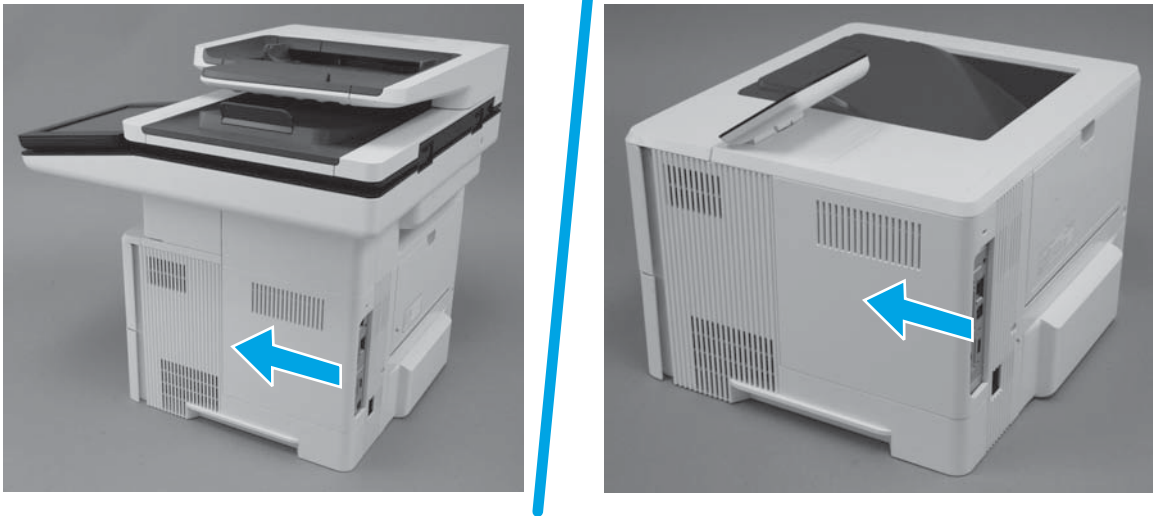
1. **M501:** Slide it toward the front of the printer to install it (callout 1), and then install one screw (callout 2).

**Figure 1-547** Install the formatter cover (M501)




2. **M506/M527:** Slide it toward the front of the printer to install it.

**Figure 1-548** Install the formatter cover (M506/M527)

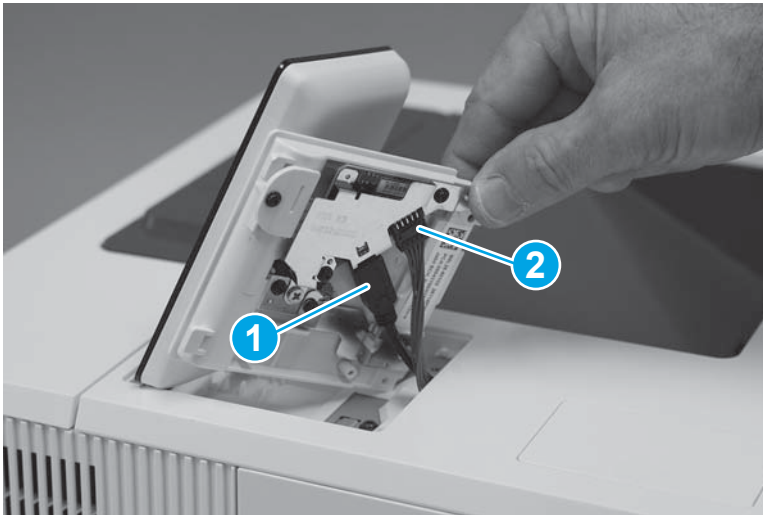


### Step 18: Install the control panel (M506x)

 **NOTE:** This step is for the M506x printer. For all other printers, skip this step and proceed to [Step 19: Install the tray on page 334](#).

1. Connect one HDMI cable (callout 1), one connector (callout 2).

**Figure 1-549** Connect the cables



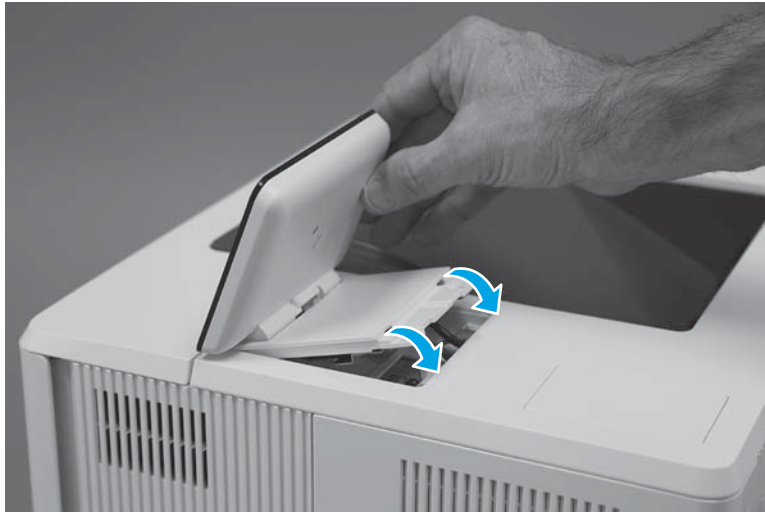
2. Install the tabs (callout 1) on the front of the control panel in the slots (callout 2) on the printer top cover.

**Figure 1-550** Install the control panel



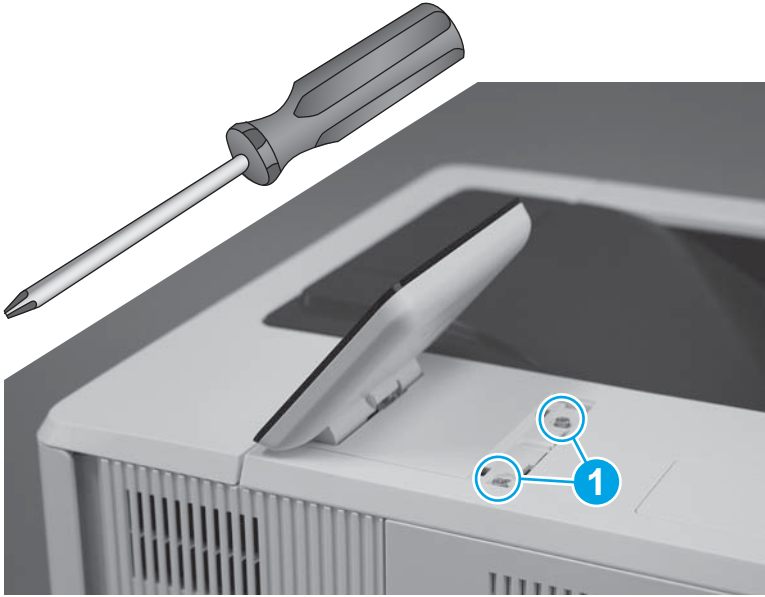
3. Rotate the control-panel base down onto the printer.

**Figure 1-551** Rotate the control-panel base down



4. Use a small Phillips screwdriver to install two screws (callout 1).

**Figure 1-552** Install two screws

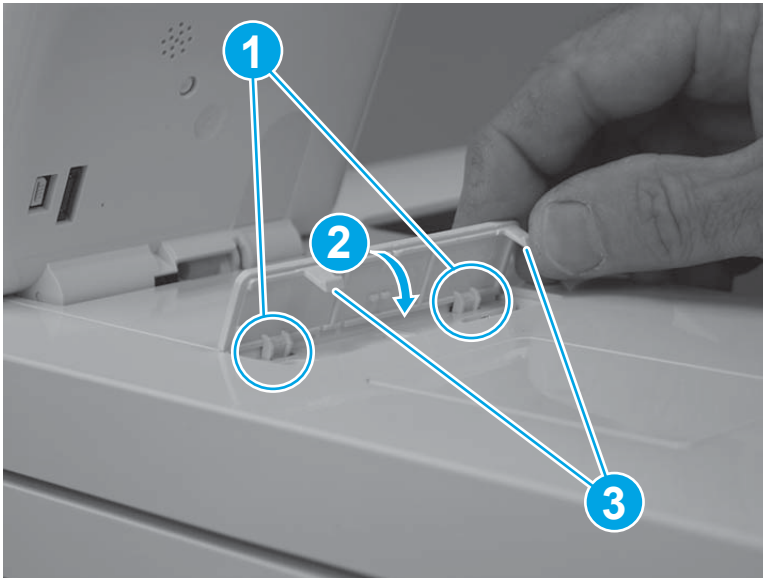


5. Position the screw cover mounting feet into the slots in the top cover (callout 1), and then rotate the cover down (callout 2) to install it.



**NOTE:** Press down on the cover firmly to make sure that the tabs (callout 3) snap into place.

**Figure 1-553** Install the cover



### Step 19: Install the tray

1. With the tray at a slight angle, align the sides of the tray with the rails in the accessory, and then partially slide the tray into the printer.

**Figure 1-554** Install the tray



2. Push the tray straight into the accessory to close it.

**Figure 1-555** Close the tray



## Removal and replacement: Paper delivery tray (output bin)

- [Introduction](#)
- [Step 1: Remove the control panel \(M506x\)](#)
- [Step 2: Remove the tray](#)
- [Step 3: Remove the formatter cover](#)
- [Step 4: Remove the fax PCA \(M527\)](#)
- [Step 5: Remove the stapler door or stapler blank cover \(M527\)](#)
- [Step 6: Remove the stapler stationary \(inner\) cover \(M527\)](#)
- [Step 7: Remove the top-left cover](#)
- [Step 8: Remove the top-rear cover](#)
- [Step 9: Remove the rear door assembly](#)
- [Step 10: Remove the cartridge door assembly](#)
- [Step 11: Remove the right cover](#)
- [Step 12: Remove the left cover](#)
- [Step 13: Remove the integrated scanner assembly \(M527\)](#)
- [Step 14: Remove the top cover \(M527\)](#)
- [Step 15: Remove the top cover \(M501/M506\)](#)
- [Step 16: Remove the paper delivery tray \(output bin\)](#)
- [Step 17: Unpack the replacement bin](#)
- [Step 18: Install the paper delivery tray \(output bin\)](#)
- [Step 19: Install the top cover \(M501/M506\)](#)
- [Step 20: Install the top cover \(M527\)](#)
- [Step 21: Install the integrated scanner assembly \(M527\)](#)
- [Step 22: Install the left cover](#)
- [Step 23: Install the right cover](#)
- [Step 24: Install the cartridge door assembly](#)
- [Step 25: Install the rear door assembly](#)
- [Step 26: Install the top-rear cover](#)
- [Step 27: Install the top-left cover](#)
- [Step 28: install the stapler stationary \(inner\) cover \(M527\)](#)
- [Step 29: Install the stapler door or stapler blank cover \(M527\)](#)

- [Step 30: Install the fax PCA \(M527\)](#)
- [Step 31: Install the formatter cover](#)
- [Step 32: Install the tray](#)
- [Step 33: Install the control panel \(M506x\)](#)


## Introduction

This document provides the procedures to remove and replace the paper delivery tray (output bin).

## Before performing service

### Turn the printer power off

- Disconnect the power cable.

 **WARNING!** To avoid damage to the printer, turn the printer off, wait 30 seconds, and then remove the power cable before attempting to service the printer.

Use the table below to identify the correct part number for your printer. To order the part, go to [www.hp.com/buy/parts](http://www.hp.com/buy/parts).

Paper delivery tray (output bin) part number	
RC4-4439-000CN	Paper delivery tray (output bin)

## Required tools

- #2 Phillips screwdriver with a magnetic tip.
- Small flat-blade screwdriver

## After performing service

### Turn the printer power on


- Connect the power cable.
- Use the power switch to turn the power on.

## Post service test

Make sure that the printer initializes to a **Ready** state.

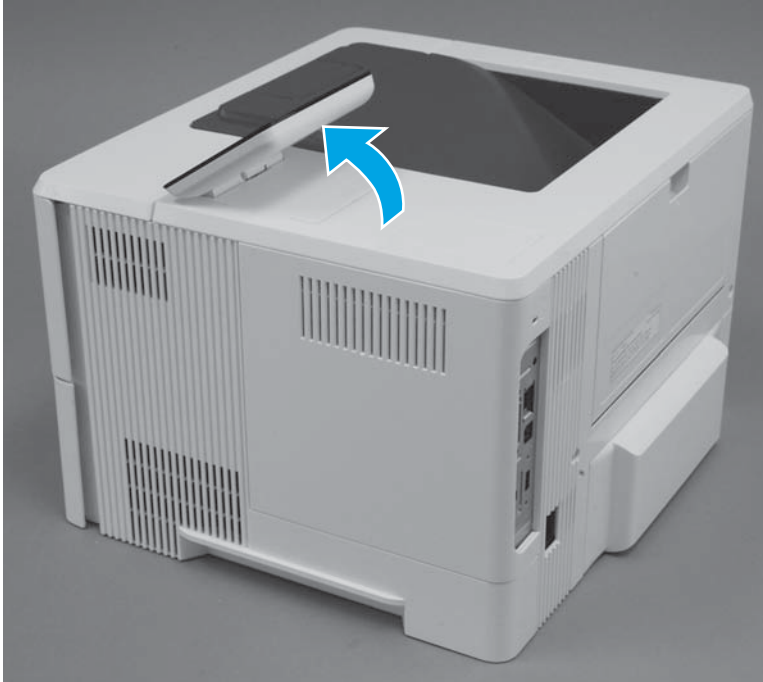
Print a configuration page to make sure that the printer is functioning correctly.

## Step 1: Remove the control panel (M506x)

 **NOTE:** This step is for the M506x printer. For all other printers, skip this step and proceed to [Step 2: Remove the tray on page 340](#).

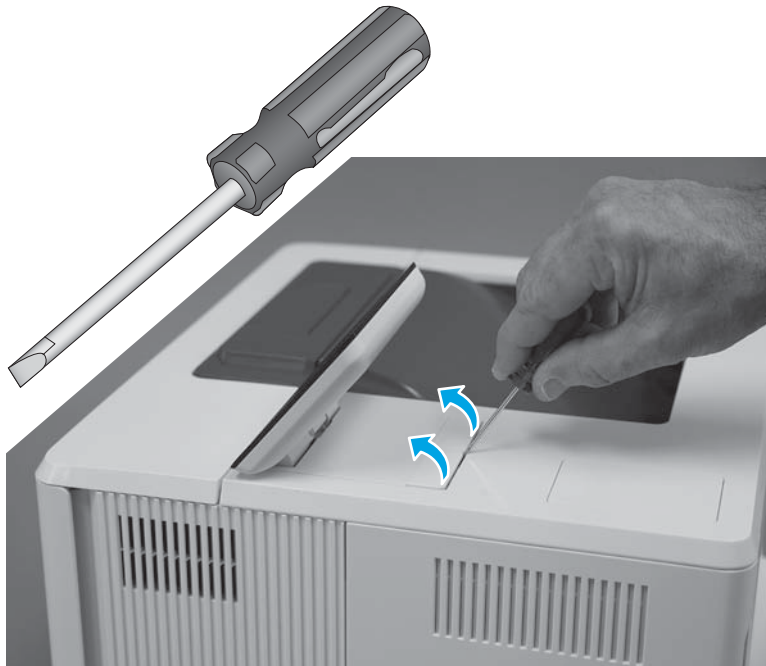
1. Tilt the control panel to the fully raised position.

**Figure 1-556** Tilt the control panel up



2. Use a small flat-blad screwdriver to release the control-panel screws cover, and then remove the cover.

**Figure 1-557** Remove the cover

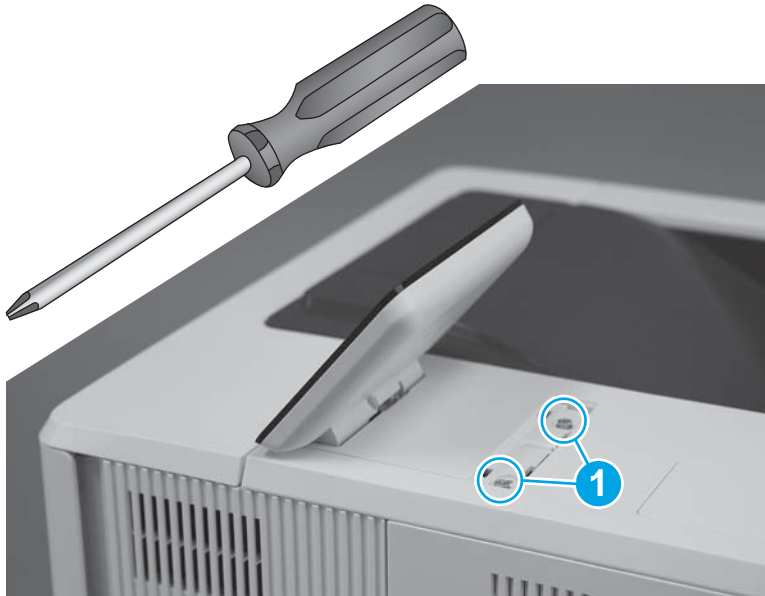




3. Use a small Phillips screwdriver to remove two screws (callout 1).

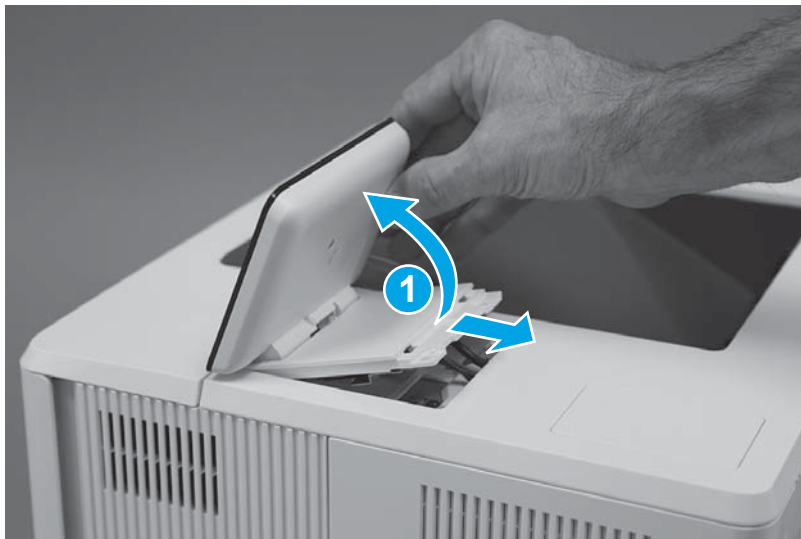
 **IMPORTANT:** Store the screws in a secure place where they cannot fall down into the printer.

**Figure 1-558** Remove two screws



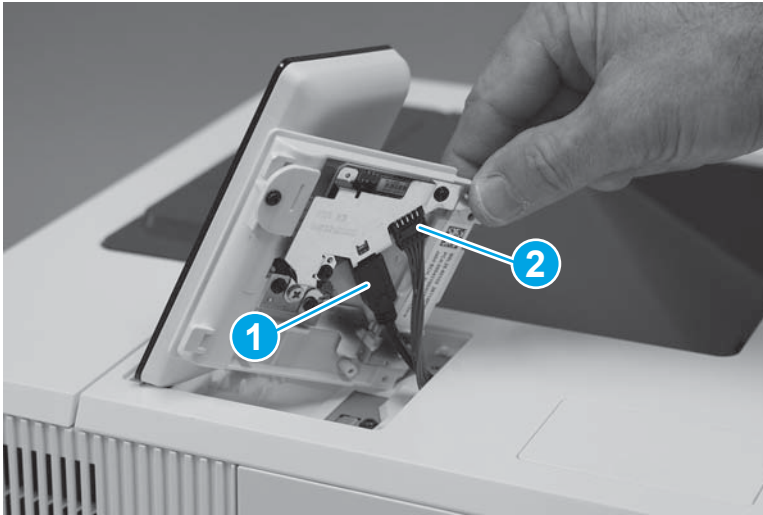
4. Turn the control panel over (callout 1), to gain access to the bottom side.

**Figure 1-559** Turn the control panel over



5. Disconnect one HDMI cable (callout 1), one connector (callout 2), and then remove the control panel.

**Figure 1-560** Remove the control panel



### Step 2: Remove the tray

1. Pull the tray straight out of the printer until it stops.

**Figure 1-561** Pull the tray out until it stops



2. Lift the front of the tray, and then pull it out of the printer to remove it.

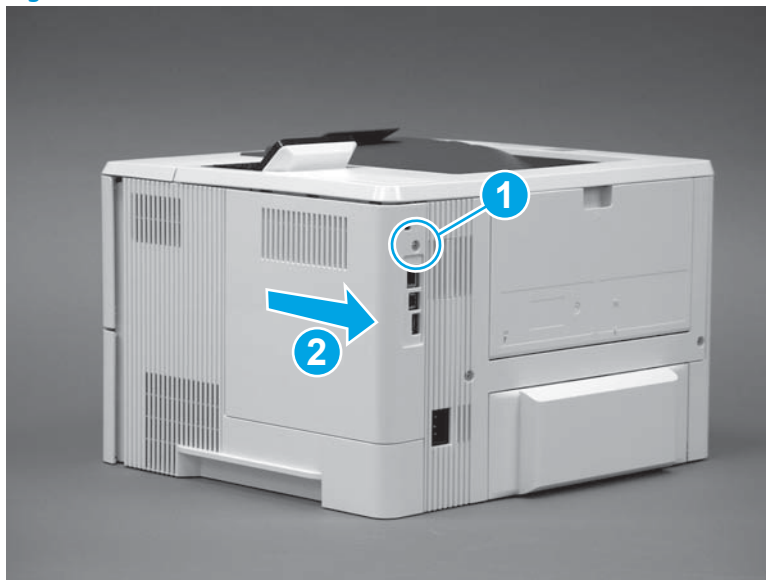
**Figure 1-562** Release and remove the tray



### Step 3: Remove the formatter cover

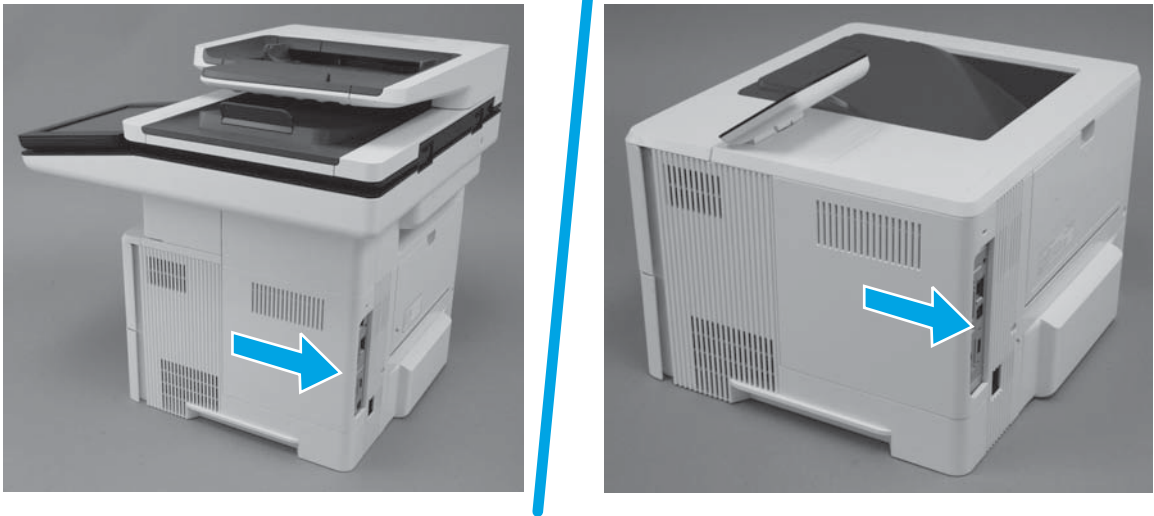
1. **M501:** Remove one screw (callout 1), and then slide the cover toward the rear of the printer to remove it (callout 2).

**Figure 1-563** Remove the formatter cover (M501)




2. **M506/M527:** Slide the cover toward the rear of the printer to remove it.


**Figure 1-564** Remove the formatter cover (M506/M527)



#### Step 4: Remove the fax PCA (M527)

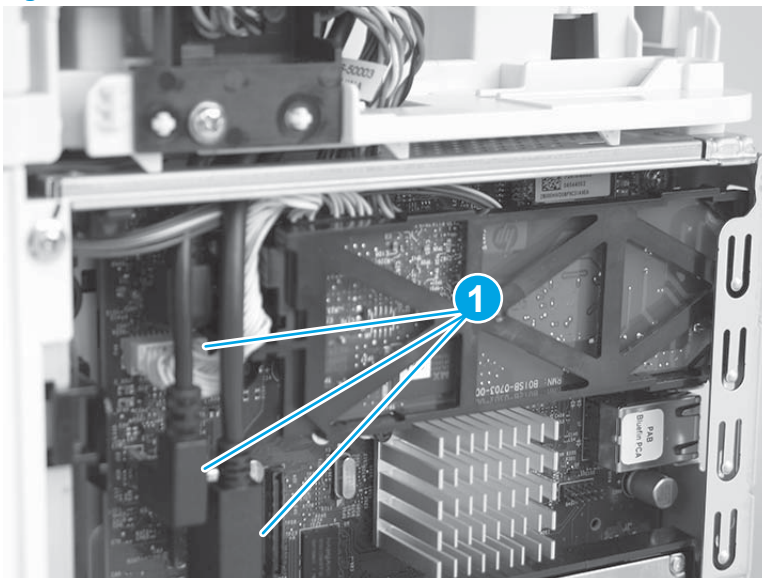
 **NOTE:** This step is for the M527 printer. For the M501/M506, skip this step and go to [Step 9: Remove the rear door assembly on page 351](#).

 **CAUTION:**  ESD-sensitive part.

 **NOTE:** M527c/f/z printers only (optional for the M527dn).

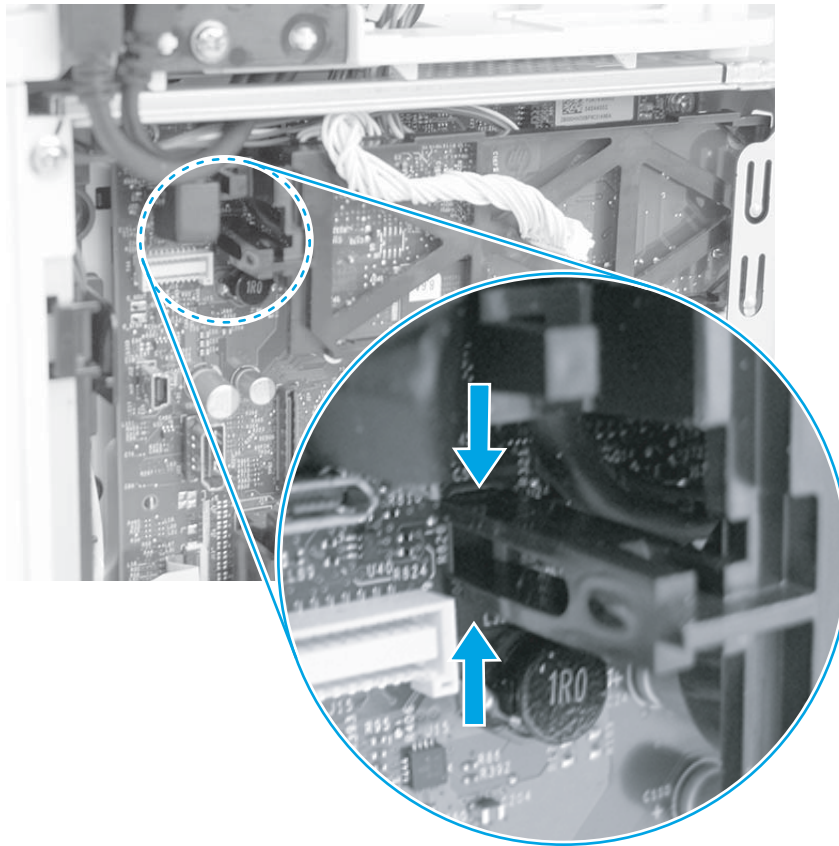
1. Disconnect three connectors (callout 1).

**Figure 1-565** Disconnect three connectors



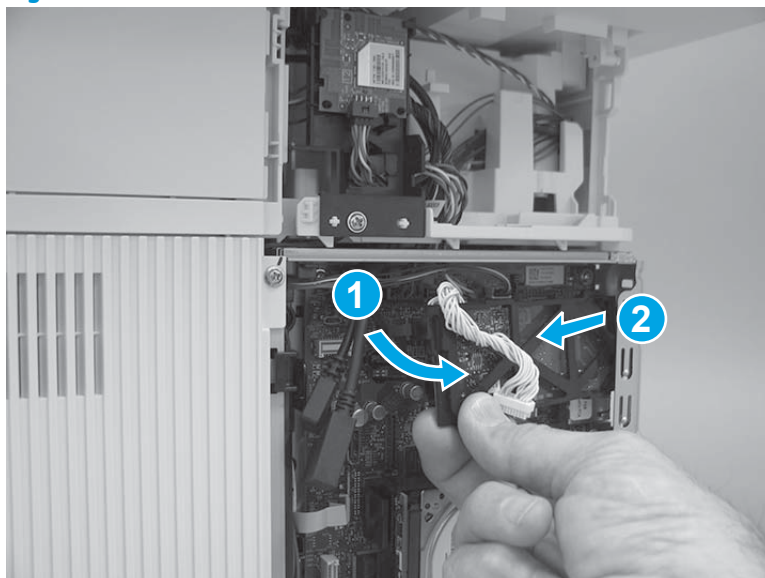
2. Pinch the retainer to release it.

**Figure 1-566** Release the fax PCA



3. Rotate the connector end of the fax PCA out and away from the formatter (callout 1), and then slide it as shown (callout 2) to remove it.

**Figure 1-567** Remove the fax PCA



## Step 5: Remove the stapler door or stapler blank cover (M527)

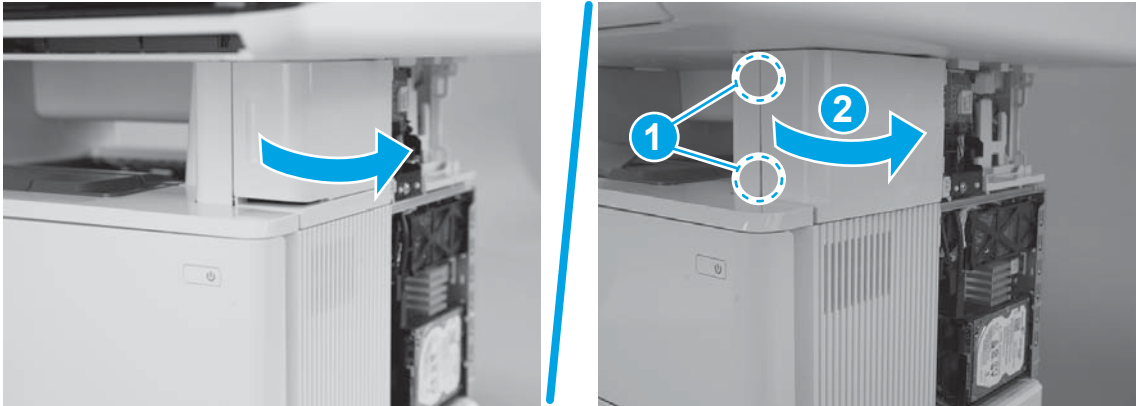
 **NOTE:** This step is for the M527 printer. For the M501/M506, skip this step and go to [Step 9: Remove the rear door assembly on page 351](#).

The M527dn does not have a convenience stapler.

1. Do one of the following:

- **M527c/f/z:** Open the stapler door.
- **M527dn:** Use a small flat-blad screw driver to release two tabs (callout 1), and then rotate the cover away from the printer (callout 2).

**Figure 1-568** Open the door or release the cover



2. Do one of the following:

- **M527c/f/z:** Use a small flat-blad screwdriver to release the upper hinge.
- **M527dn:** Slide the cover toward the front of the printer to remove it.

**Figure 1-569** Release the upper hinge or remove the cover



3. **M527c/f/z:** Use a small flat-blad screwdriver to release the lower hinge.

**Figure 1-570** Release the lower hinge





4. **M527c/f/z:** Remove the door.

**Figure 1-571** Remove the door



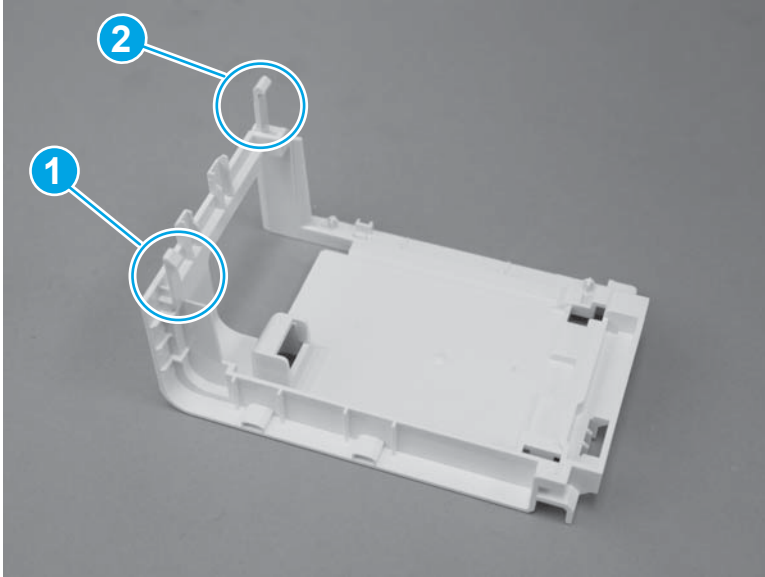
#### Step 6: Remove the stapler stationary (inner) cover (M527)

 **NOTE:** This step is for the M527c/f/z printers. For the M501, M506 and M527dn, skip this step and go to [Step 9: Remove the rear door assembly on page 351](#).

 **NOTE:** M527c/f/z printers only.

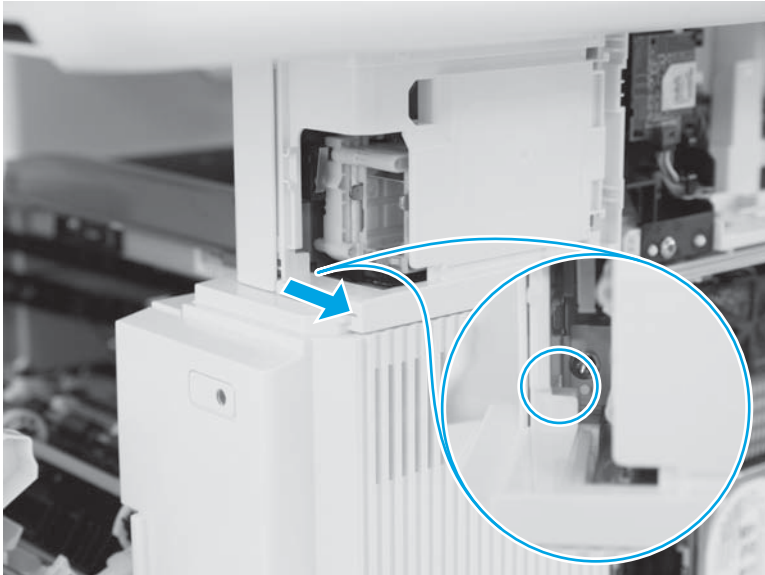
1. Before proceeding, take note of the locations of the upper tab (callout 1) and the lower tab (callout 2) on the stapler stationary (inner) cover.

**Figure 1-572** Locate the tabs



2. Use a long-shaft small flat-blad screwdriver to release the lower tab.

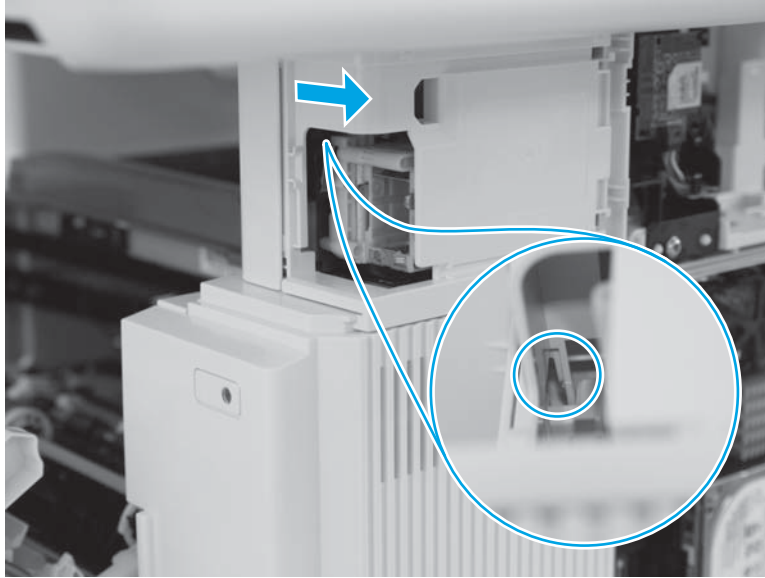
**Figure 1-573** Release one tab





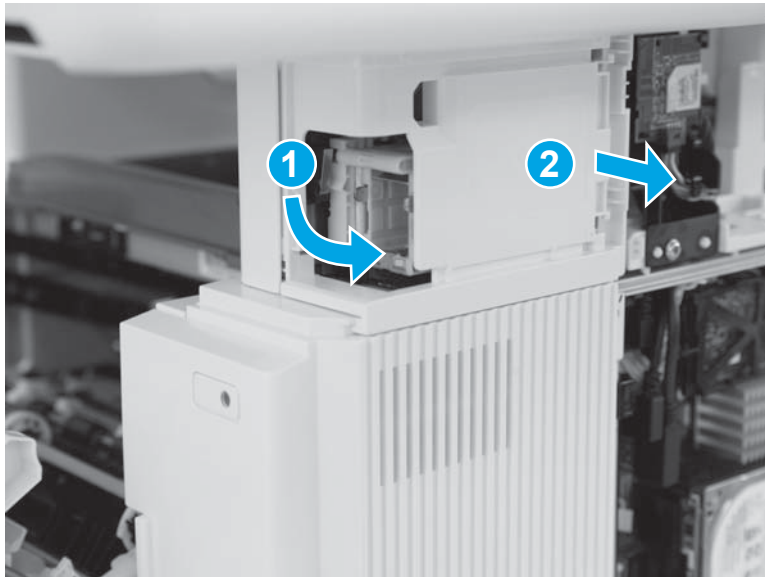
3. Use a long-shaft small flat-blad screwdriver to release the upper tab.

**Figure 1-574** Release one tab




4. With the tabs disengaged the front of the cover is released. Rotate the front of the cover away from the printer (callout 1) to release the rear of the cover (callout 2), and then remove it.

**Figure 1-575** Remove the cover

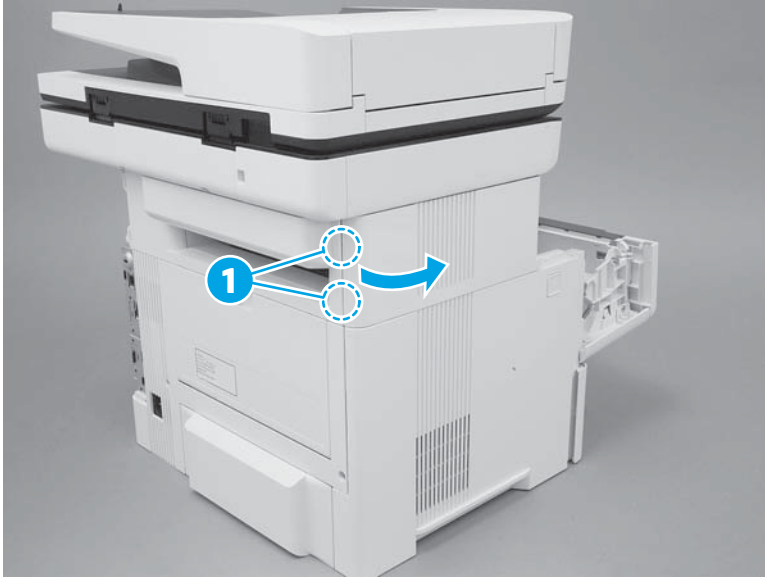


### Step 7: Remove the top-left cover

 **NOTE:** This step is for the M527 printer. For the M501/M506, skip this step and go to [Step 9: Remove the rear door assembly on page 351](#).

1. Open the toner-cartridge door, release two tabs (callout 1), and then rotate the rear edge of the cover away from the printer.

**Figure 1-576** Release two tabs



2. Continue to rotate the cover away from the printer to release two more tabs at the middle of the cover.

**Figure 1-577** Release two tabs



3. Slide the cover toward the rear of the printer to release two bosses at the front of the cover.

**Figure 1-578** Slide the cover




4. Remove the cover.

**Figure 1-579** Remove the cover



#### Step 8: Remove the top-rear cover

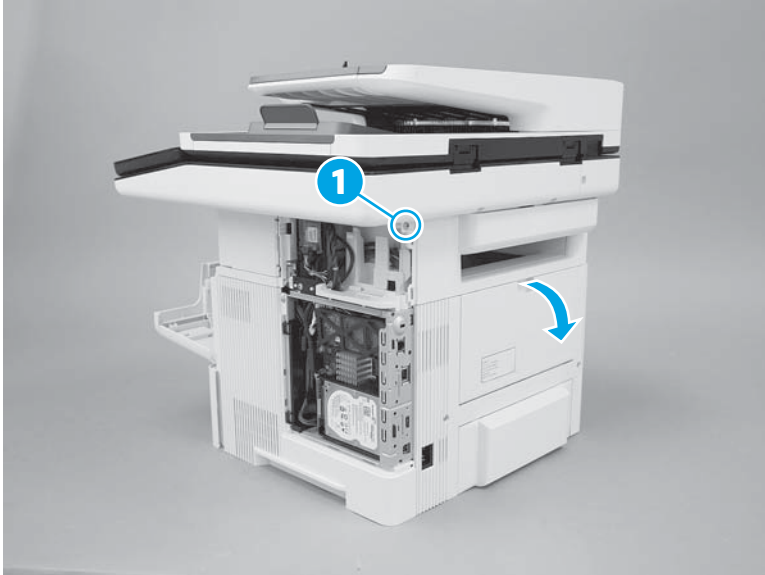
---

 **NOTE:** This step is for the M527 printer. For the M501/M506, skip this step and go to [Step 9: Remove the rear door assembly on page 351](#).

---

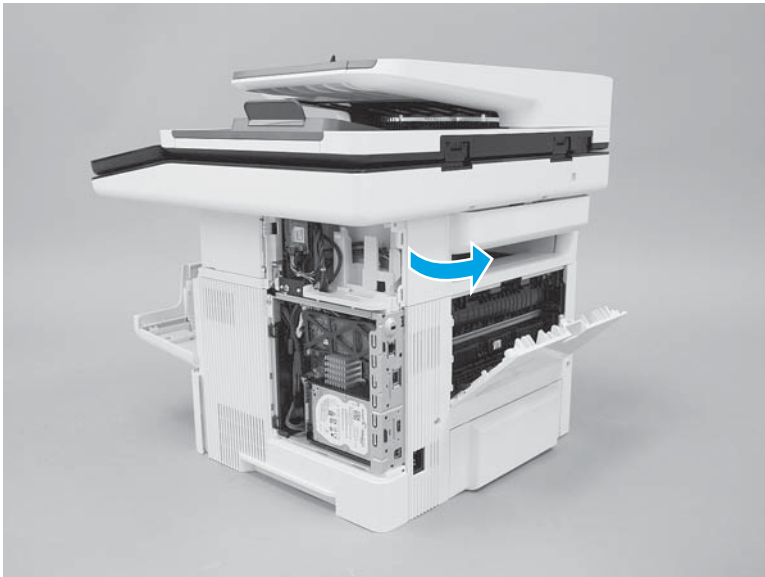
1. Remove one screw (callout 1), and then open the rear door.

**Figure 1-580** Remove one screw



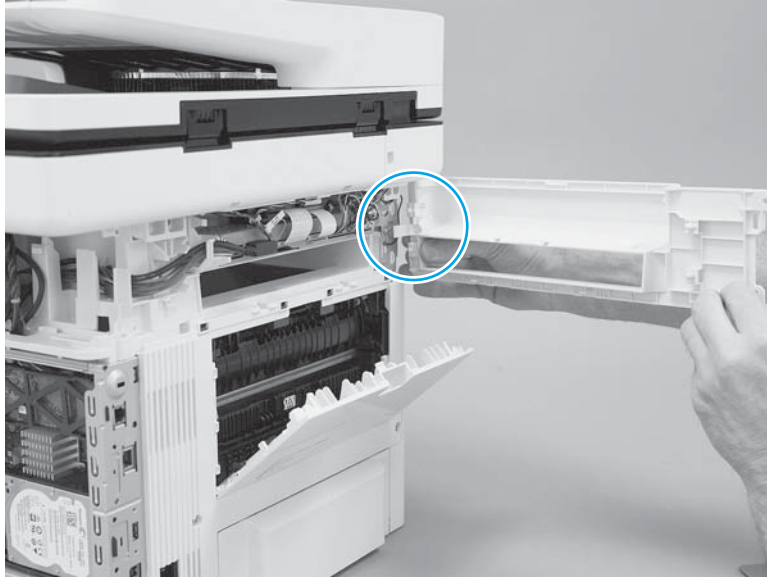
2. Rotate the exposed edge of the cover away from the printer (as shown).

**Figure 1-581** Rotate the cover



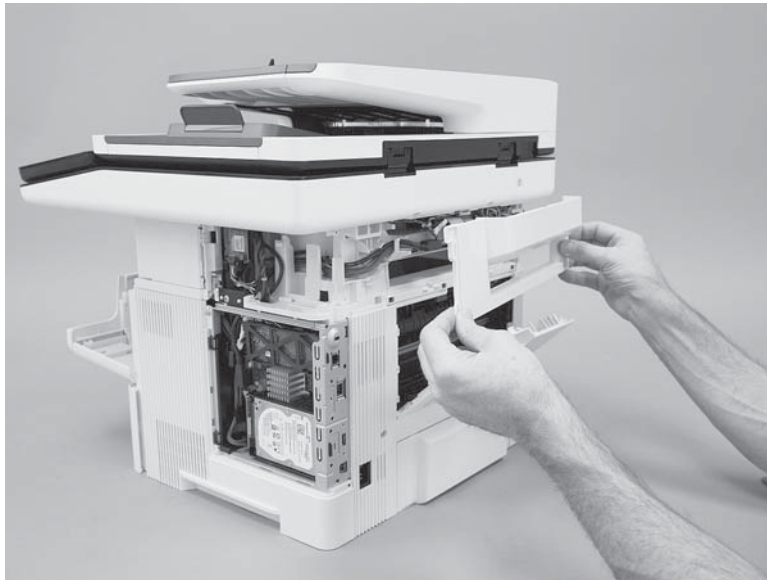
3. Continue to rotate the cover away from the printer to release one boss.

**Figure 1-582** Release one boss



4. Remove the cover.

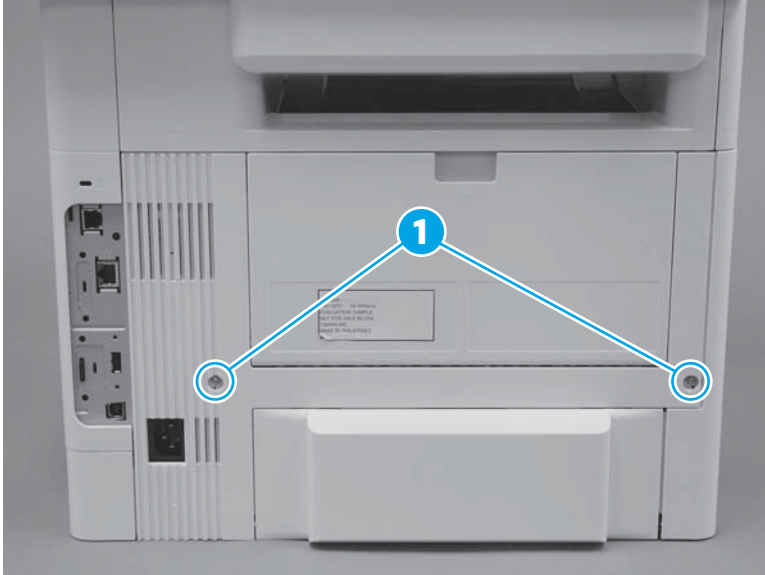
**Figure 1-583** Remove the cover



### Step 9: Remove the rear door assembly

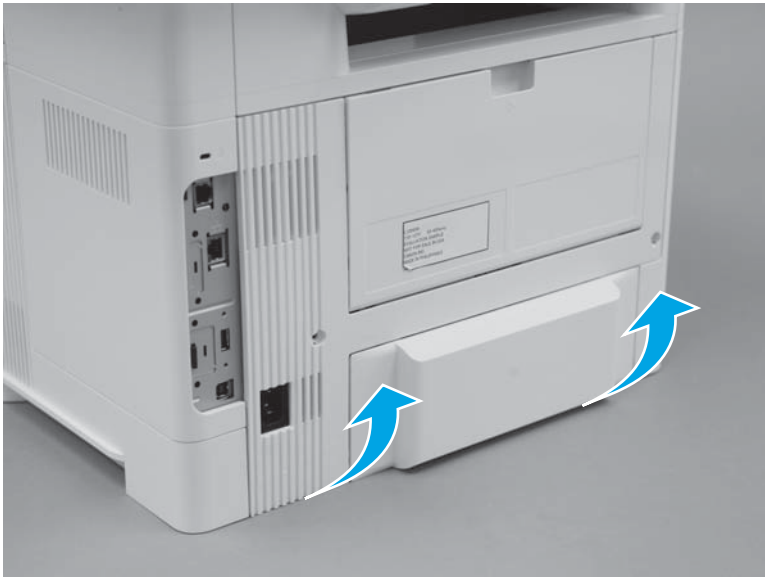
1. At the rear of the printer, remove two screws (callout 1).

**Figure 1-584** Remove two screws



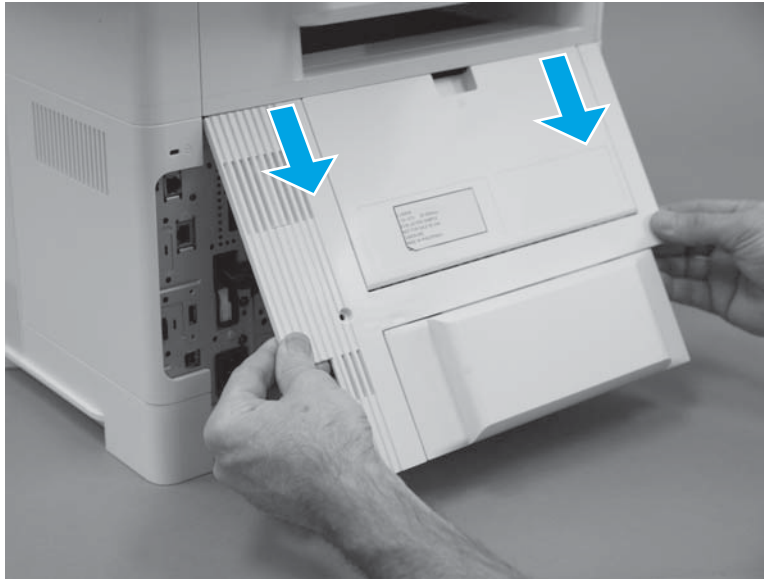
2. Rotate the bottom edge of the assembly away from the printer to release it.

**Figure 1-585** Rotate the bottom of the cover



3. Pull down on the assembly to remove it.

**Figure 1-586** Remove the cover



#### Step 10: Remove the cartridge door assembly



---

**NOTE:** If the toner cartridge was not removed prior to servicing the printer, remove it now.

---

1. Release the support shaft (callout 1), and then slide it toward the center of the door (callout 2).

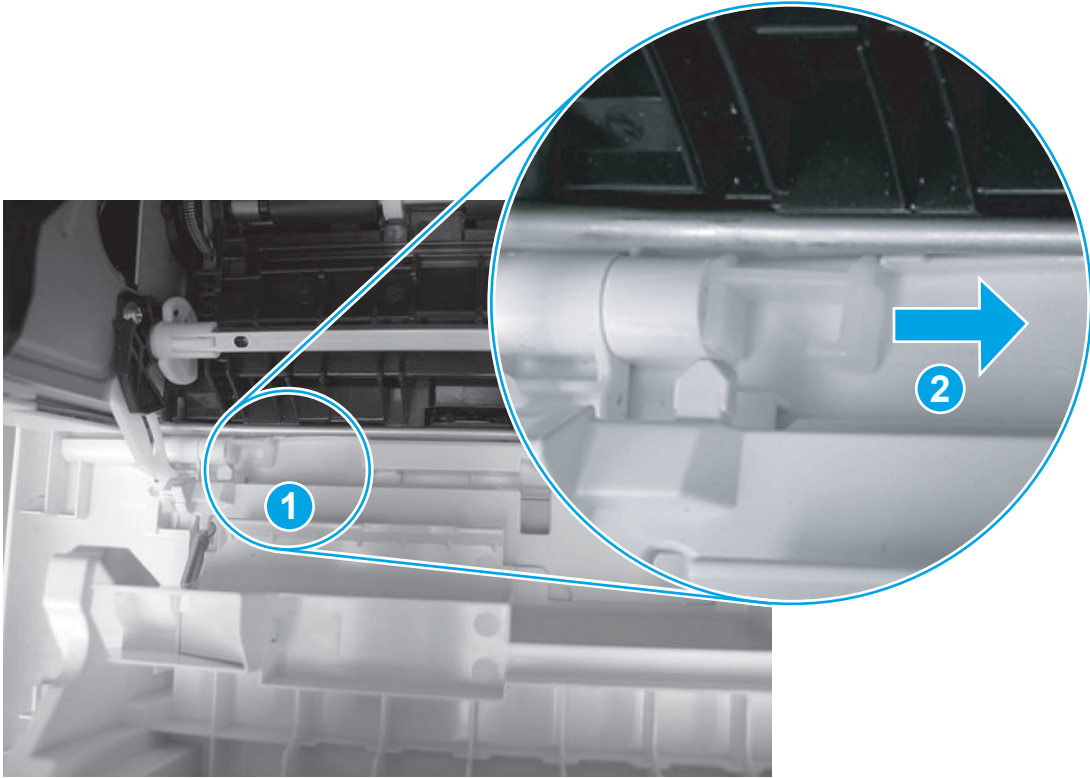


---

**TIP:** It might be easier to release the support shaft by using a small flat-blad screwdriver.

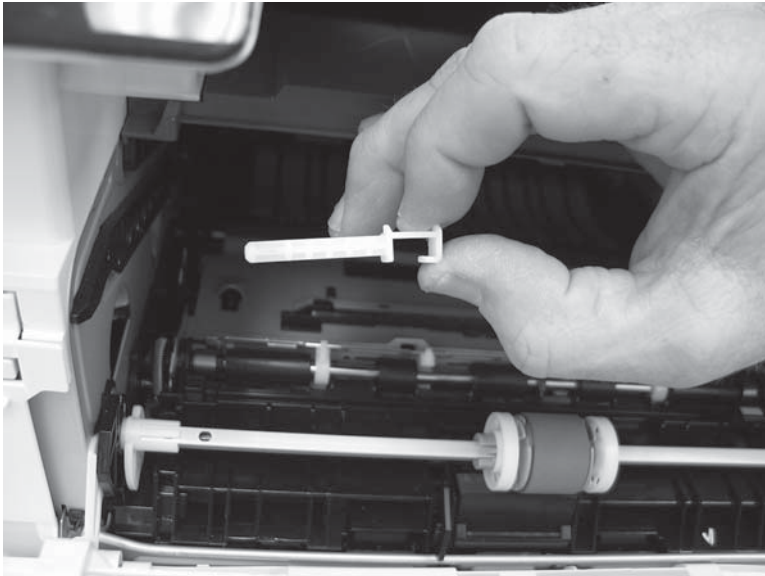
---

**Figure 1-587** Release the support shaft



2. Remove the support shaft.

**Figure 1-588** Remove the support shaft

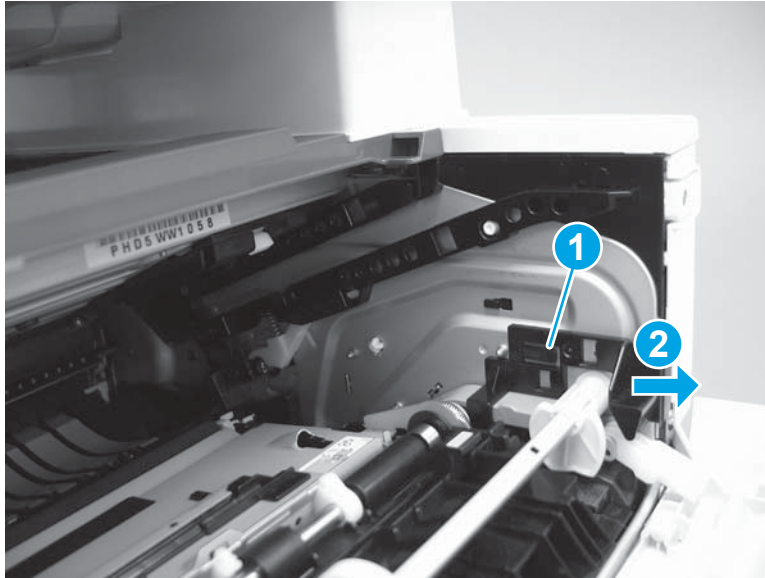




3. Release one tab (callout 1), and then slide the guide out of the printer (callout 2).

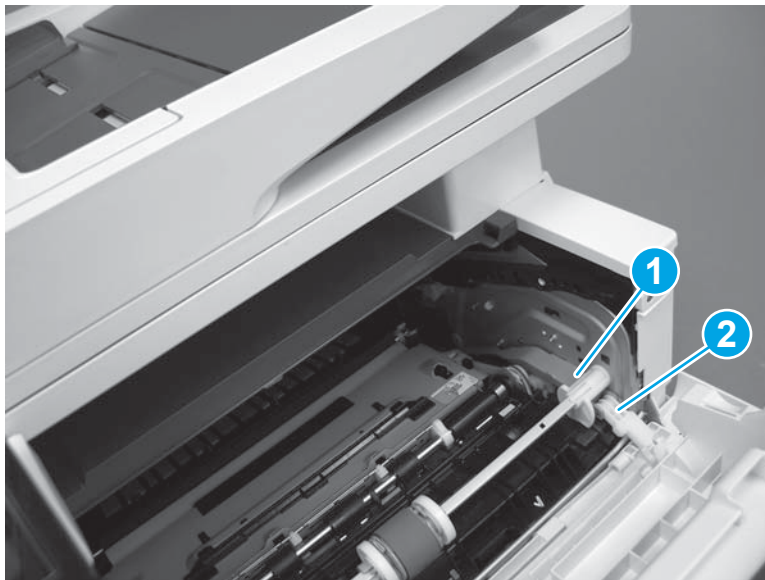
**CAUTION:** Be careful, the tab (callout 1) can be easily broken.

**Figure 1-589** Remove the guide



4. Use a small flat-blade screwdriver to gently pry the white-plastic door arm (callout 1) off of the gray-plastic pressure-release link (callout 2) to release the door arm.

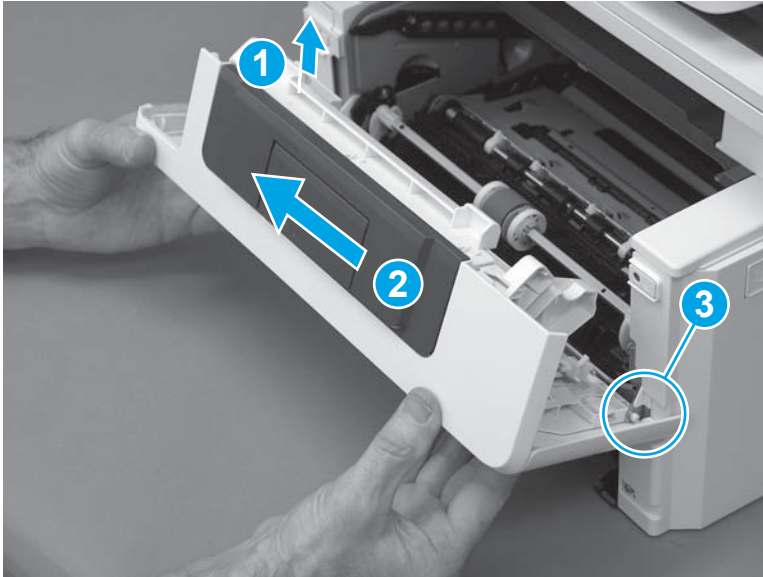
**Figure 1-590** Release the pressure-release link



5. With the door in the partially closed position, slightly raise the left end (callout 1; raise it over the sheet-metal hinge boss), and then slide the door to the left (callout 2) to release the right hinge (callout 3).

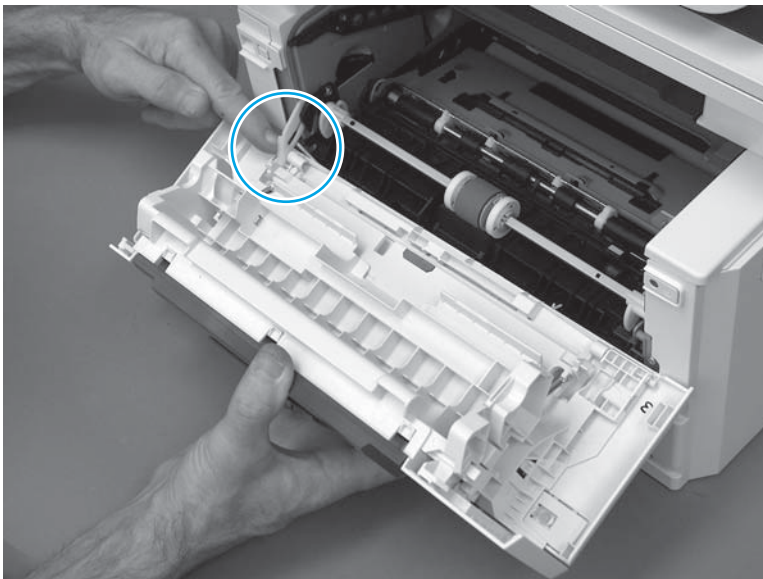
**⚠ CAUTION:** The door is still attached to the printer by the left-side retainer arm. Do not attempt to completely remove the door.

**Figure 1-591** Release the door



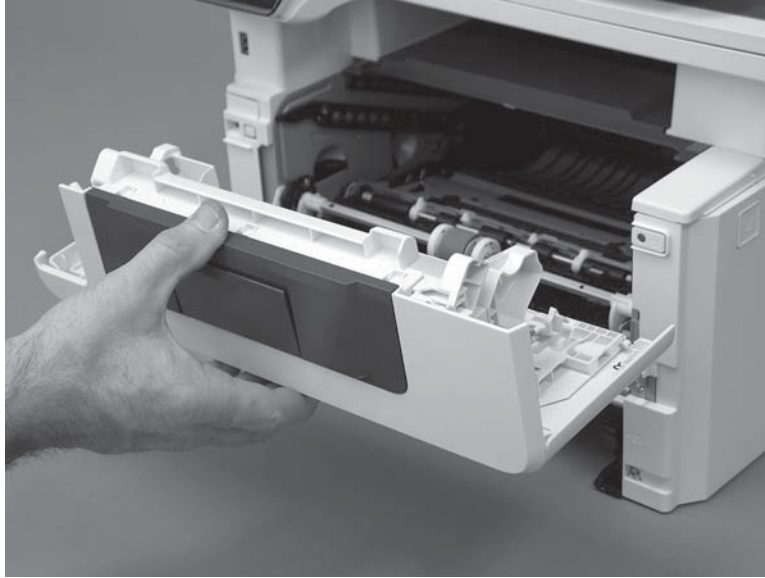
6. Rotate the door away from the printer until the keyed pin on the left-side retainer arm can disengage from the door.

**Figure 1-592** Release the left-side retainer arm





7. Remove the door.

**Figure 1-593** Remove the door



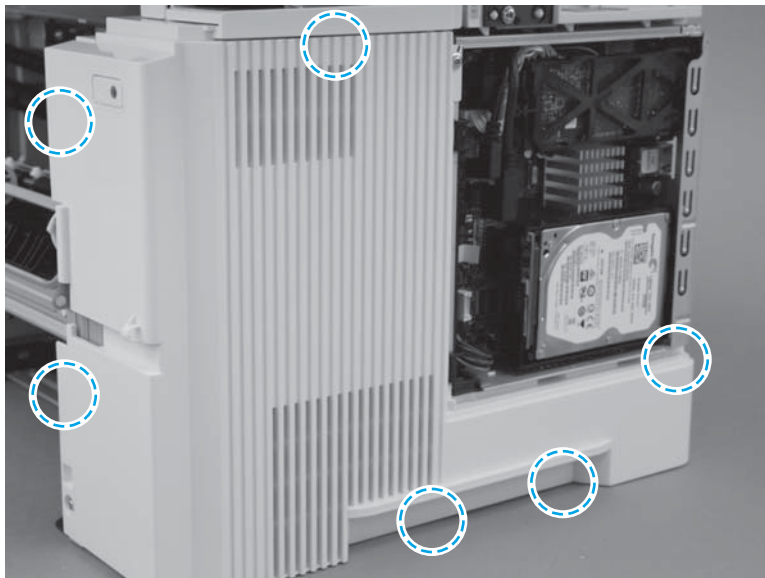
### Step 11: Remove the right cover

 **IMPORTANT:** The black-plastic cassette front and rear guides (located inside the tray cavity) can be easily dislodged. Do not lose the guides when the cover is removed or installed.

 **NOTE:** The M527 printer is shown in this procedure. However, this procedure is valid for the M501/M506 printers.

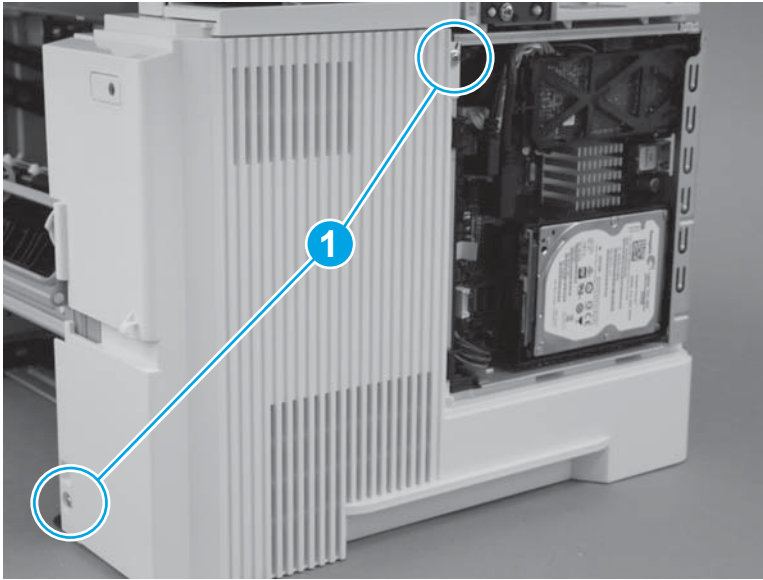
1. Before proceeding, take note of the location of the tabs and bosses on the inside of the cover.

**Figure 1-594** Locate the tabs and bosses



2. Remove two screws (callout 1).

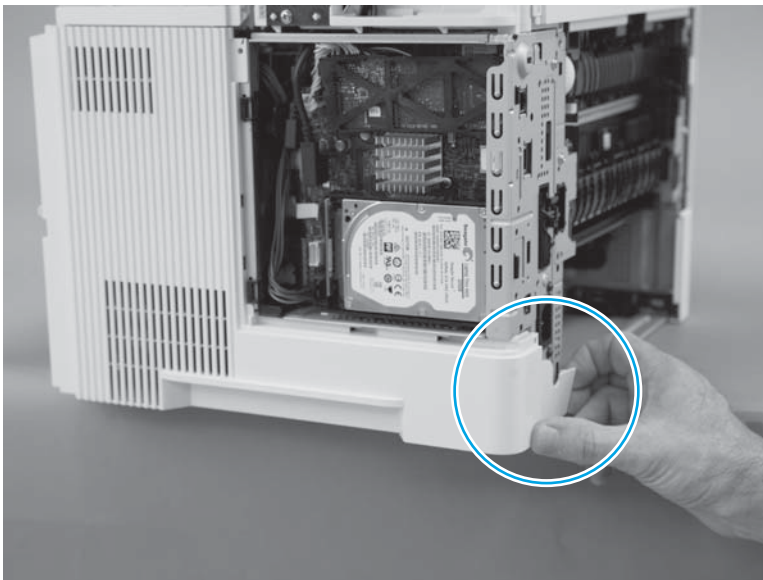
**Figure 1-595** Remove two screws



3. At the rear of the printer, release one boss.

**CAUTION:** It might be easier to remove the cover with the printer slightly hanging over the edge of the workspace. Do not let the printer tip and fall off of the workspace when removing the cover.

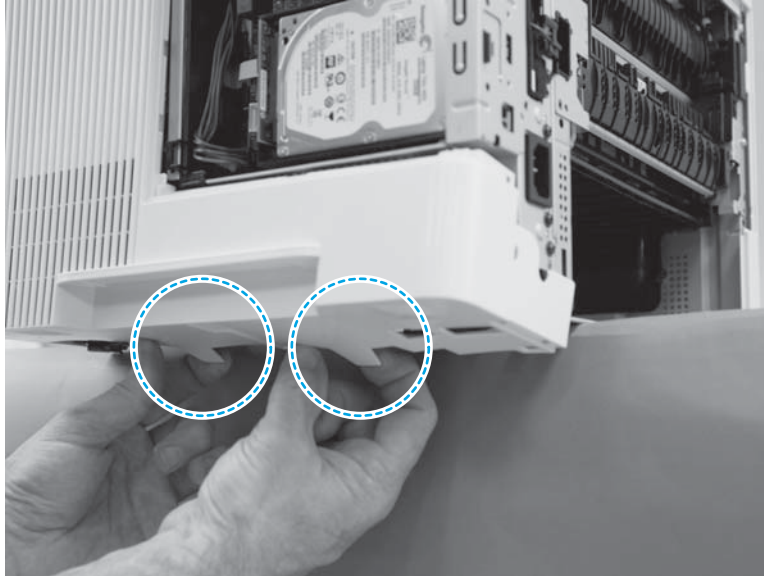
**Figure 1-596** Release one boss



4. At the bottom edge of the cover, release two bosses.

**CAUTION:** It might be easier to remove the cover with the printer slightly hanging over the edge of the workspace. Do not let the printer tip and fall off of the workspace when removing the cover.

**Figure 1-597** Release two bosses

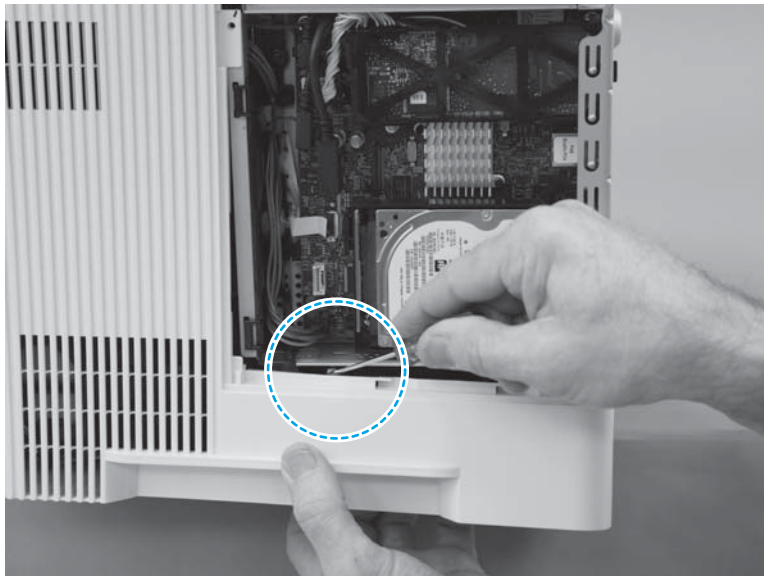


5. Near the formatter, release one tab.

**CAUTION:** It might be easier to remove the cover with the printer slightly hanging over the edge of the workspace. Do not let the printer tip and fall off of the workspace when removing the cover.

**TIP:** Hold the bottom of the cover away from the printer, and then use a small flat-blade screw driver to easily release this tab.

**Figure 1-598** Release one tab

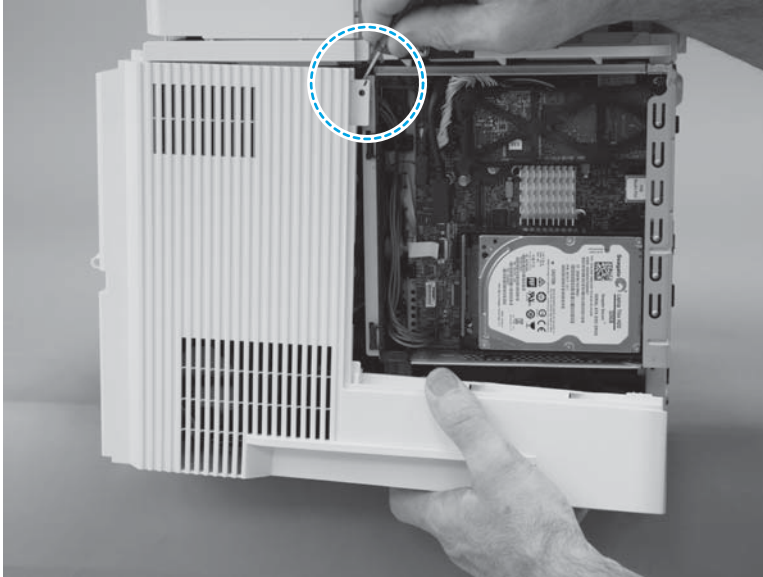


6. At the top rear edge of the cover, release one tab.

**CAUTION:** It might be easier to remove the cover with the printer slightly hanging over the edge of the workspace. Do not let the printer tip and fall off of the workspace when removing the cover.

**TIP:** Use a small flat-blade screw driver to easily release this tab.

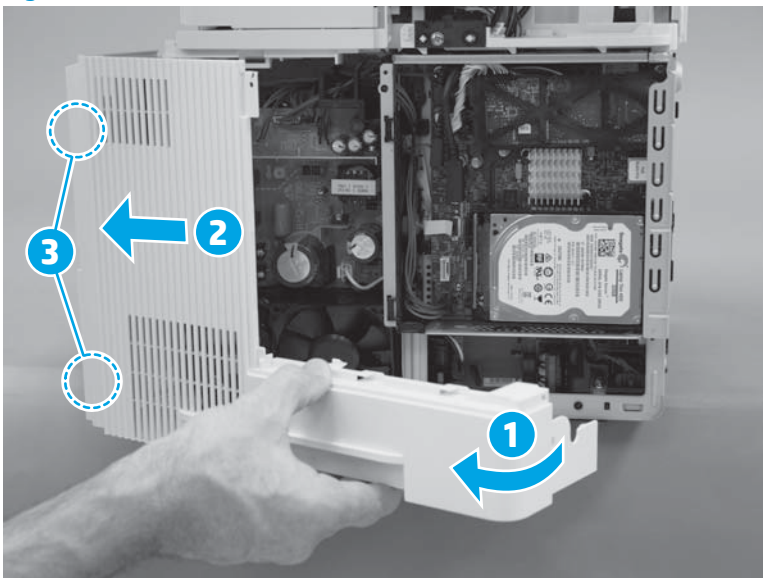
**Figure 1-599** Release one tab




7. Rotate the rear of the cover away from the printer (callout 1), slide the cover toward the front of the printer (callout 2) to release two bosses (callout 3), and then remove the cover.


**CAUTION:** It might be easier to remove the cover with the printer slightly hanging over the edge of the workspace. Do not let the printer tip and fall off of the workspace when removing the cover.

**Figure 1-600** Remove the cover



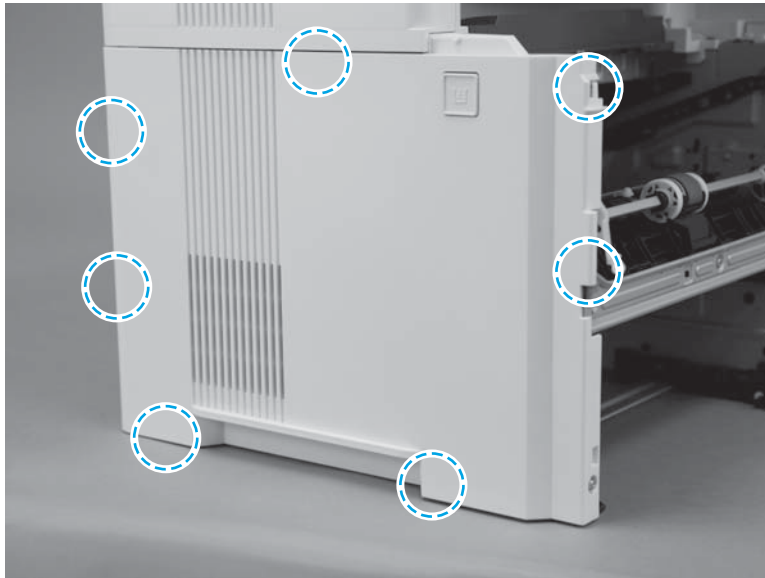
## Step 12: Remove the left cover

 **IMPORTANT:** The black-plastic cassette front and rear guides (located inside the tray cavity) can be easily dislodged. Do not lose the guides when the cover is removed or installed.

 **NOTE:** The M527 printer is shown in this procedure. However, this procedure is valid for the M501/M506 printers.

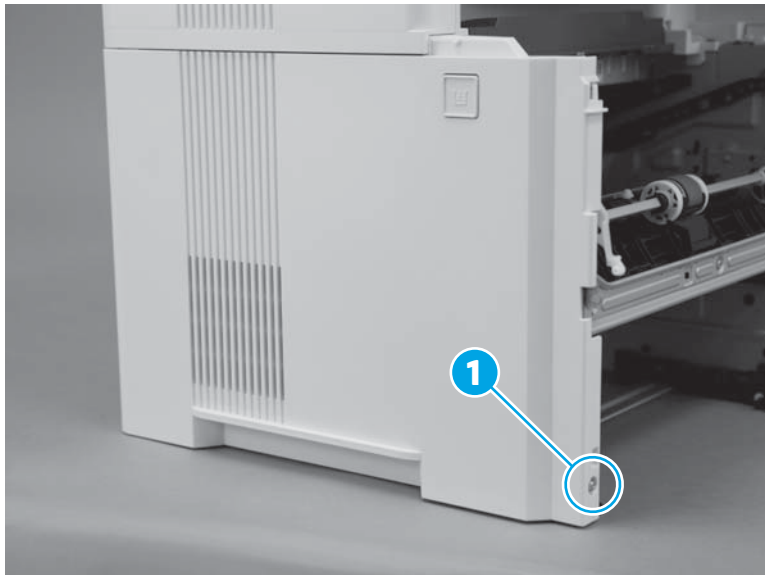
1. Before proceeding, take note of the location of the tabs and bosses on the inside of the cover.

**Figure 1-601** Locate of the tabs and bosses



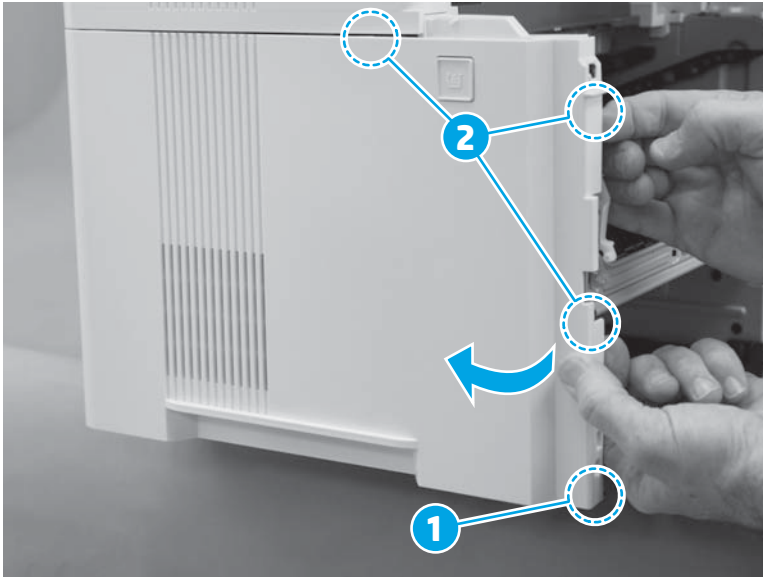
2. Remove one screw (callout 1).

**Figure 1-602** Remove one screw



3. At the front of the printer, release one boss (callout 1), and then rotate the front edge of the cover away from the printer to release three tabs (callout 2).

**Figure 1-603** Release one boss and three tabs



4. At the bottom edge of the cover, release two tabs.


**Figure 1-604** Release two tabs





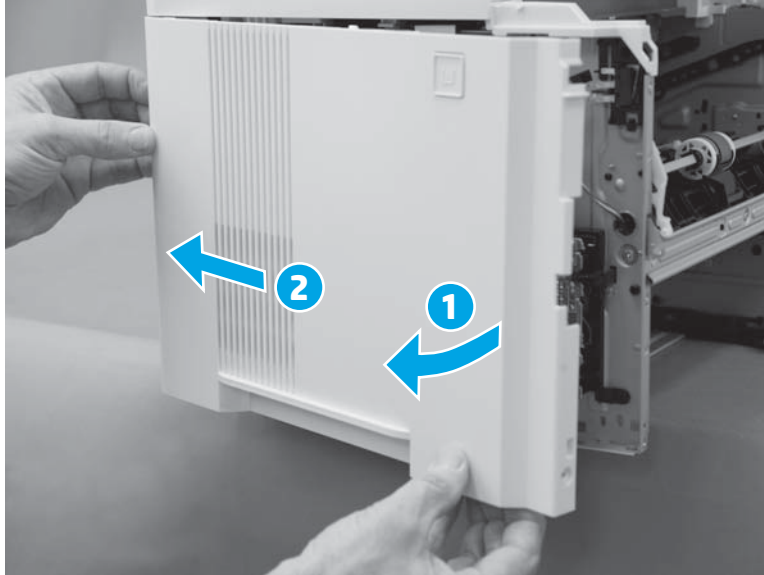
5. Continue to rotate the front edge of the cover away from the printer (callout 1), and then slide the cover toward the rear of the printer (callout 2) to remove it.

---

 **NOTE:** If the cover is difficult to rotate or slide as shown below, make sure that the bottom tabs (released in the previous step) are completely disengaged from the chassis.


---

**Figure 1-605** Remove the cover




### Step 13: Remove the integrated scanner assembly (M527)

---

 **NOTE:** This step is for the M527 printer. For the M501/M506, skip this step and go to [Step 15: Remove the top cover \(M501/M506\) on page 369](#).

---

 **NOTE:** The ISA includes the document feeder, sub-scanner assembly (SSA), and the scanner control board (SCB)

---

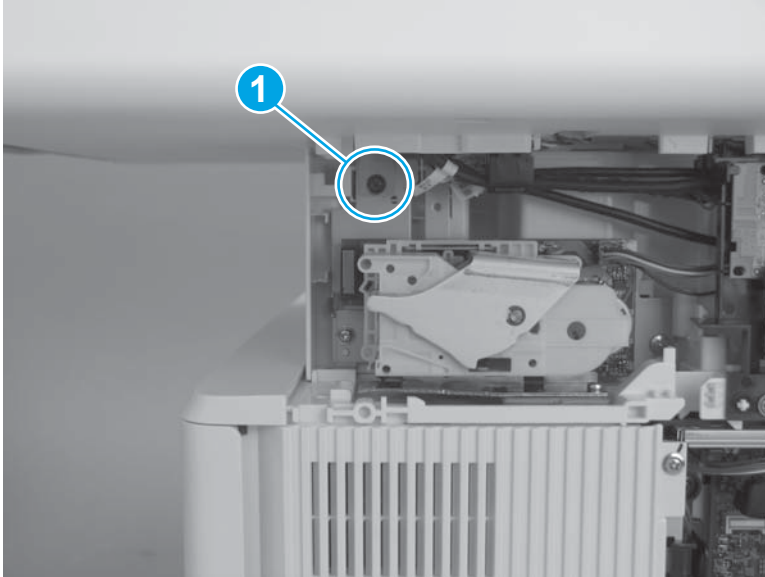
1. Remove one screw (callout 1).

---

 **IMPORTANT:** This screw fastens the ISA ground plate to the printer chassis. Do not lose this screw.


---

**Figure 1-606** Remove one screw

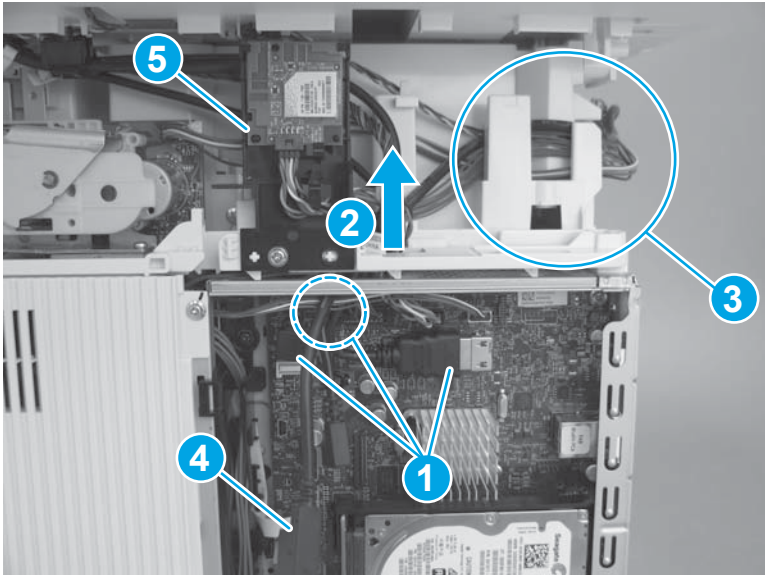


2. Disconnect three connectors (callout 1), pass the wire harnesses and cables through the opening in the cover (callout 2), and then release them from the retainers (callout 3).

 **NOTE:** One cable (callout 4) does not need to pass through the opening in the cover.

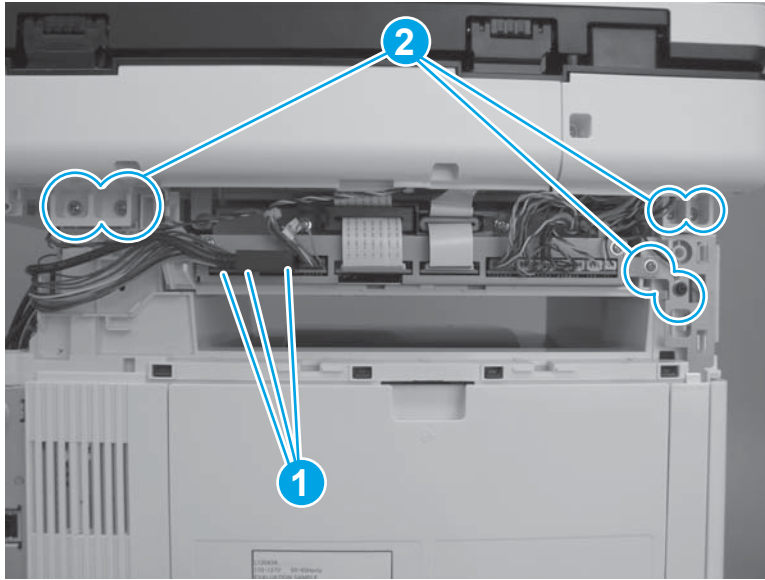
 **TIP:** It might be easier if the WiFi PCA and holder (callout 5) is detached from the printer, and then moved out of the way.

**Figure 1-607** Disconnect cables and connectors



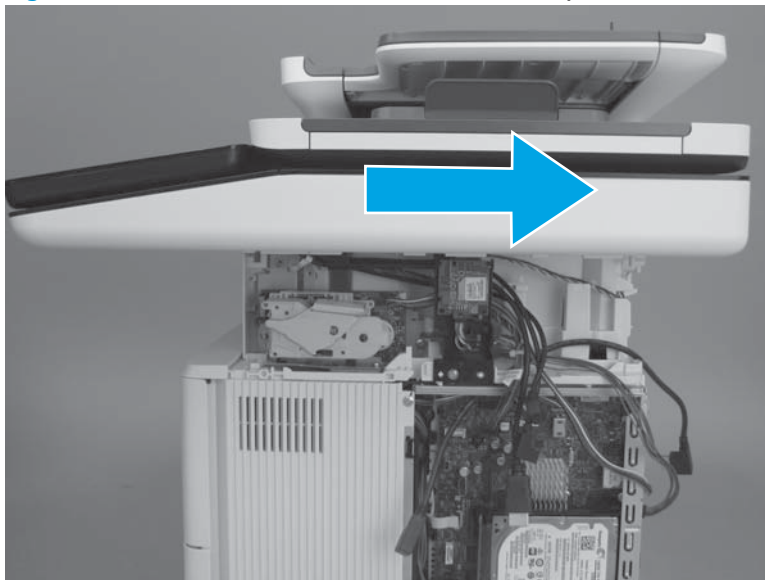
3. Disconnect three connectors (callout 1), and then remove six screws (callout 2).

**Figure 1-608** Disconnect connectors and remove screws



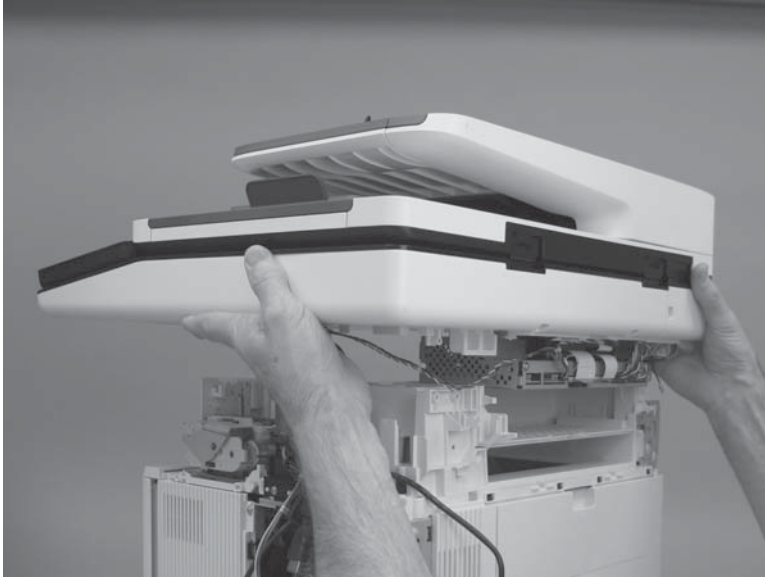
4. Slightly slide the ISA towards the back of the printer to release it.

**Figure 1-609** Slide the ISA towards the back of the printer



5. Remove the ISA.

**Figure 1-610** Remove the ISA



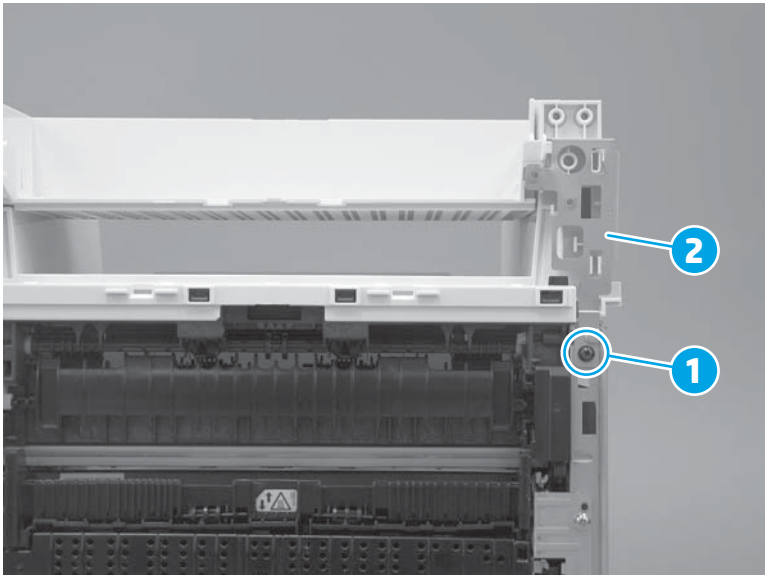
#### Step 14: Remove the top cover (M527)



**NOTE:** This step is for the M527 printer. For the M501/M506, skip this step and go to [Step 15: Remove the top cover \(M501/M506\) on page 369](#).

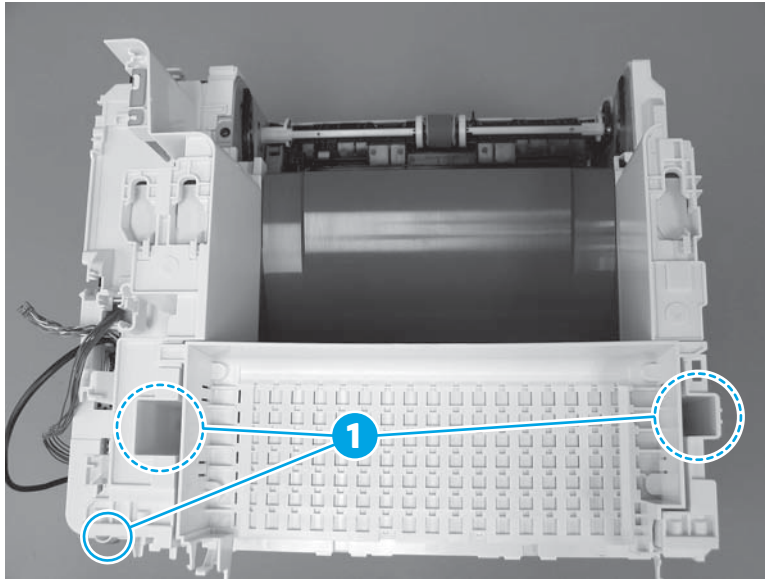
1. At the front right of the printer, remove one screw (callout 1), and then remove the sheet-metal plate (callout 2).

**Figure 1-611** Remove one screw and the plate




2. At the top rear of the printer, remove three screws (callout 1).

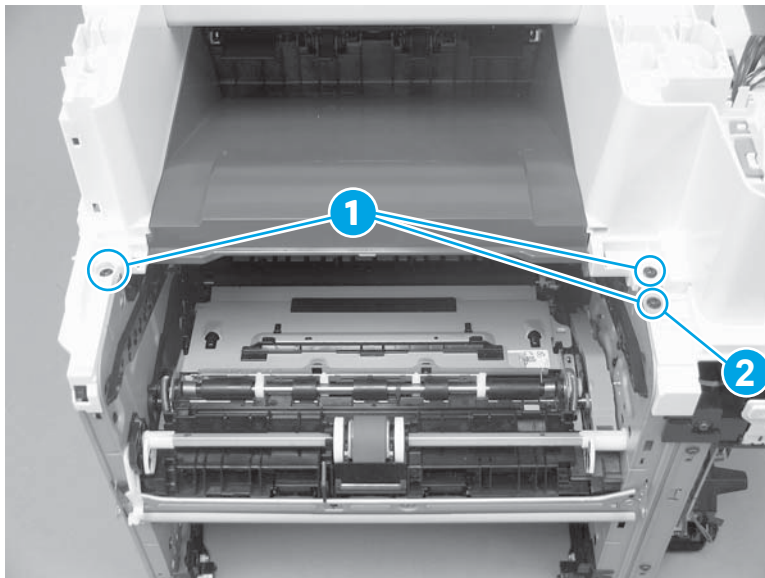
**Figure 1-612** Remove three screws



3. At the top front of the printer, remove three screws (callout 1).

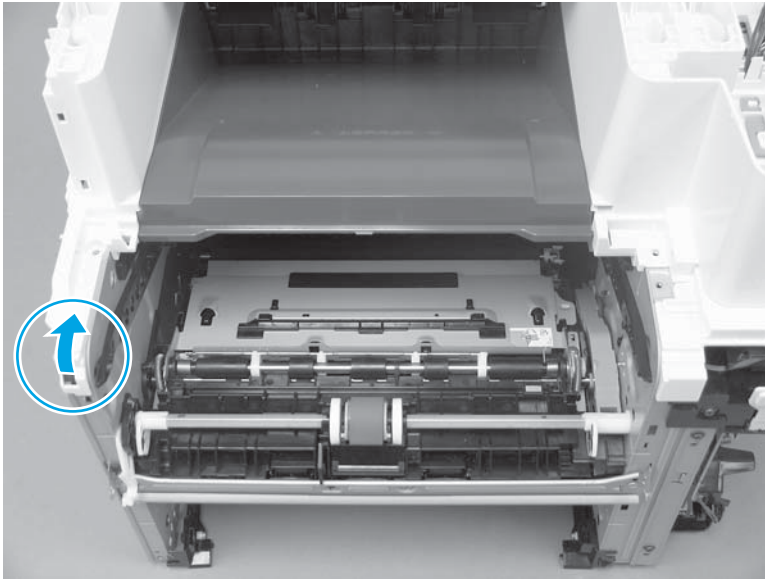
 **NOTE:** The screw (callout 2) on the lower-right portion of the cover is a different color than the other two screws, and is surrounded by sheet-metal. It might appear that this screw does not need to be removed. Remove this screw.

**Figure 1-613** Remove three screws



4. At the front left of the printer, release one boss.

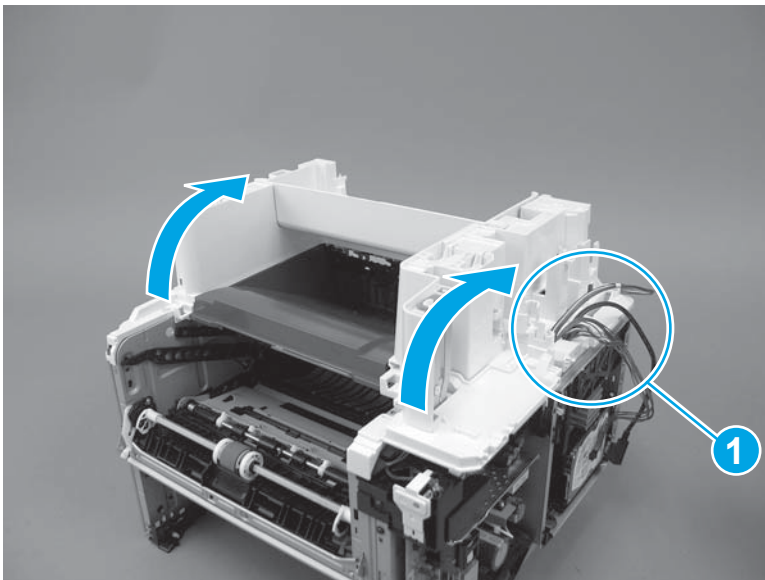
**Figure 1-614** Release one boss



5. Rotate the front of the cover up and away from the printer.

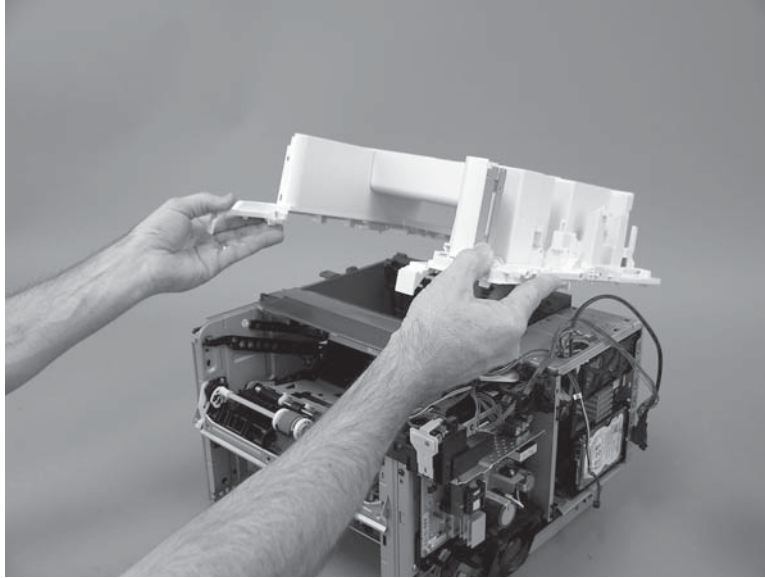
**CAUTION:** As the cover is rotated up, carefully pass the cables and wire harnesses the hole in the cover (callout 1).

**Figure 1-615** Rotate the front of the cover up




6. Remove the cover.

**Figure 1-616** Remove the cover



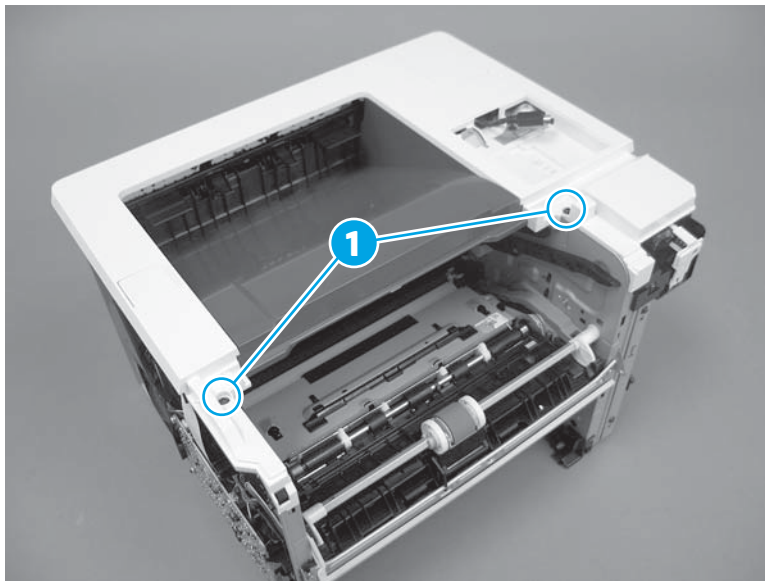
#### Step 15: Remove the top cover (M501/M506)

 **NOTE:** This step is for the M506 printer. For the M527, skip this step and go to [Step 16: Remove the paper delivery tray \(output bin\) on page 371](#).


The M506x is shown in this procedure. However, the steps are correct for all M506 models and the M501 printer.

1. Remove two screws (callout 1).

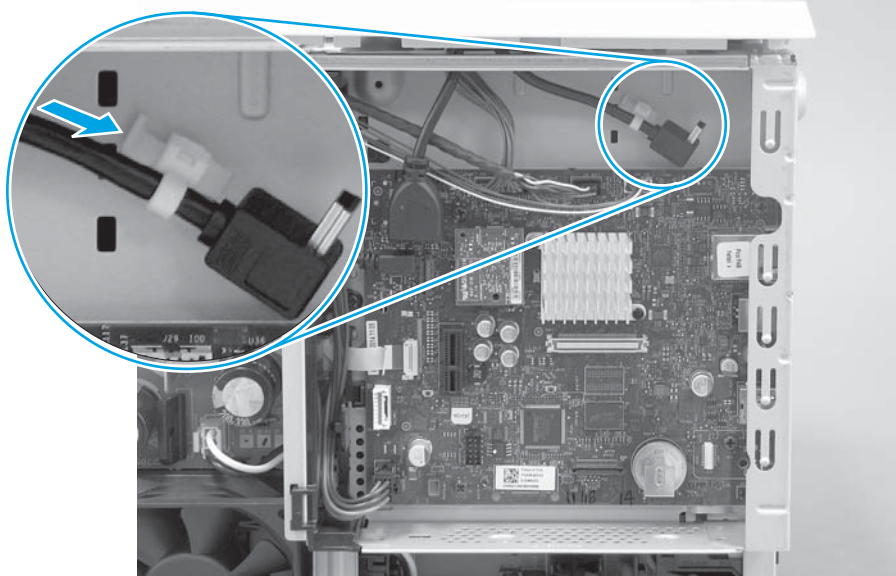
**Figure 1-617** Remove two screws



2. **M506 only:** Release one cable retainer from the chassis.

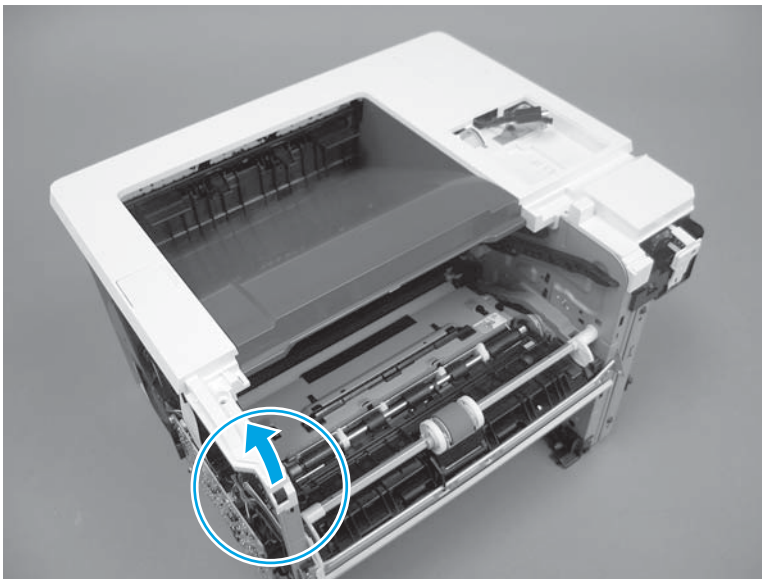
 **TIP:** Depress the tab on the retainer to release it.

**Figure 1-618** Release one cable retainer



3. Release one boss.

**Figure 1-619** Release one boss





4. Rotate the front of the cover up and away from the printer, and then remove the cover.

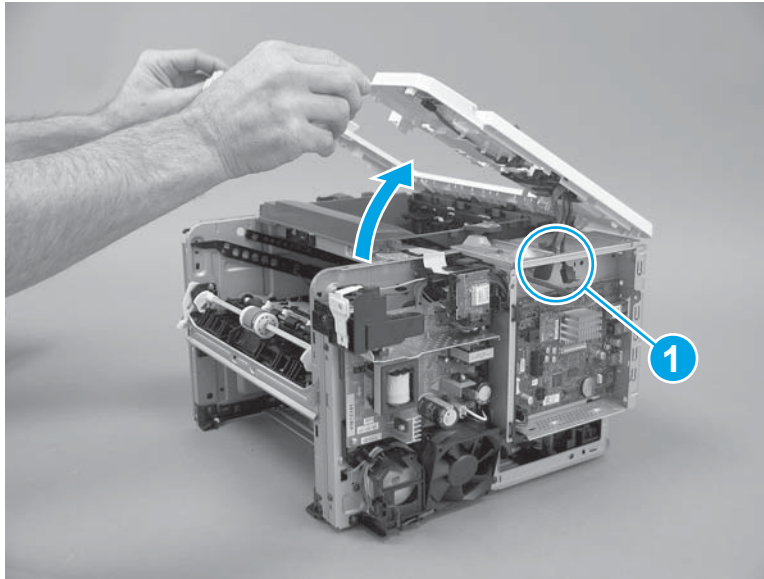
---

**CAUTION:** **M506x only:** As the cover is rotated up, carefully pass the cables the hole in the chassis (callout 1).

**NOTE:** **LCD control panel models only:** Disconnect the control panel before removing the cover.

---

**Figure 1-620** Remove the cover



#### Step 16: Remove the paper delivery tray (output bin)

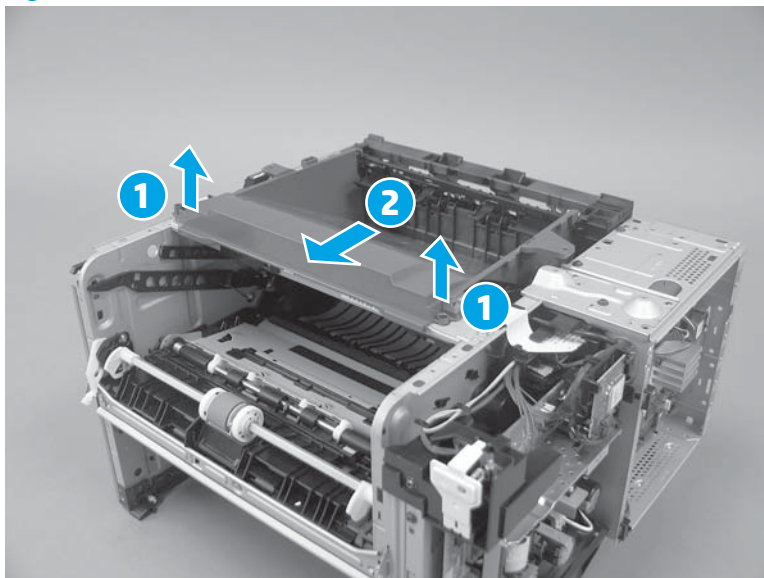
---

**NOTE:** This procedure shows the M506 printer. However, this procedure is valid for the M527 printer.

---

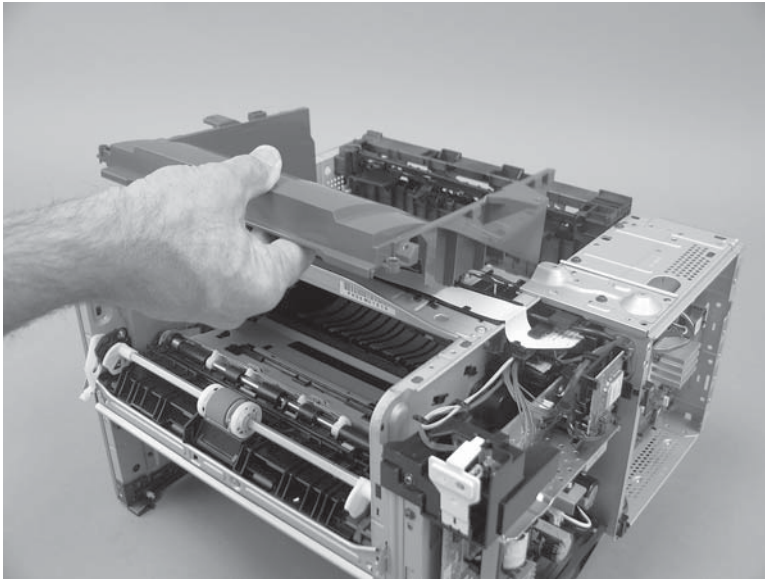
1. Release two tabs (callout 1), and then slide the cover toward the front of the printer (callout 2).

**Figure 1-621** Release two tabs



2. Remove the bin.

**Figure 1-622** Remove the bin



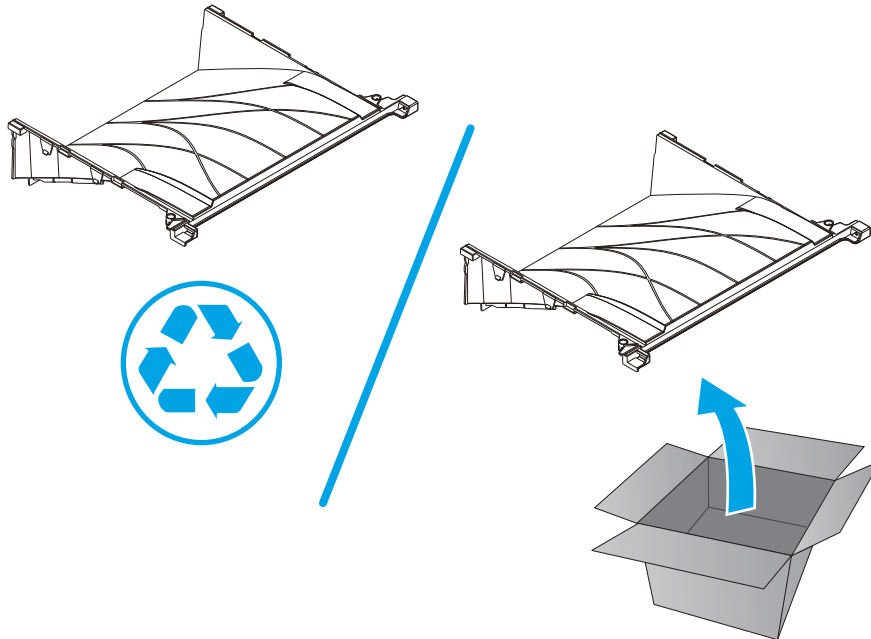
### Step 17: Unpack the replacement bin

Unpack the replacement part from the packaging.


<http://www8.hp.com/us/en/hp-information/environment/product-recycling.html>

 **NOTE:** HP recommends responsible disposal of the defective part.

**Figure 1-623** Recycle and unpack



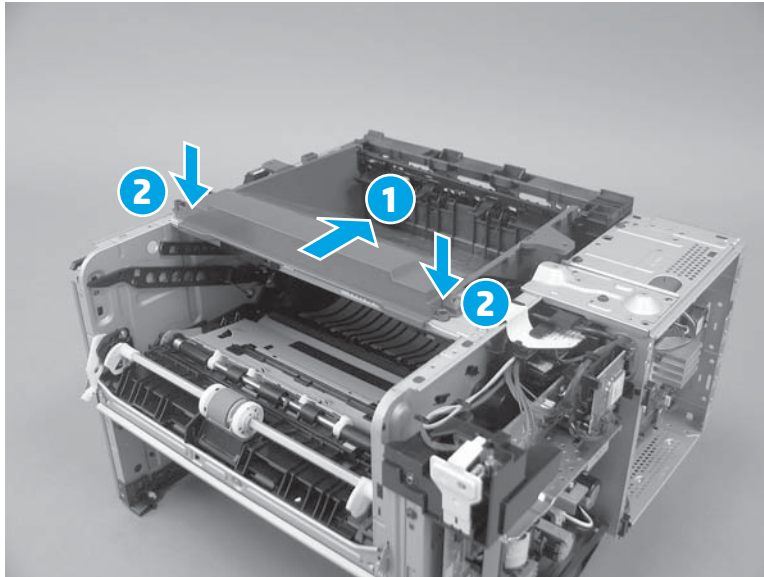
## Step 18: Install the paper delivery tray (output bin)

 **NOTE:** This procedure shows the M506 printer. However, this procedure is valid for the M527 printer.


- ▲ Position the bin on the printer (callout 1), and then push down to engage two tabs (callout 2).

 **NOTE:** Position the tabs along the rear edge of the bin on the printer in the slots in the chassis.

**Figure 1-624** Install the bin




## Step 19: Install the top cover (M501/M506)

 **NOTE:** This step is for the M501/M506 printers. For the M527, skip this step and go to [Step 20: Install the top cover \(M527\) on page 375](#).

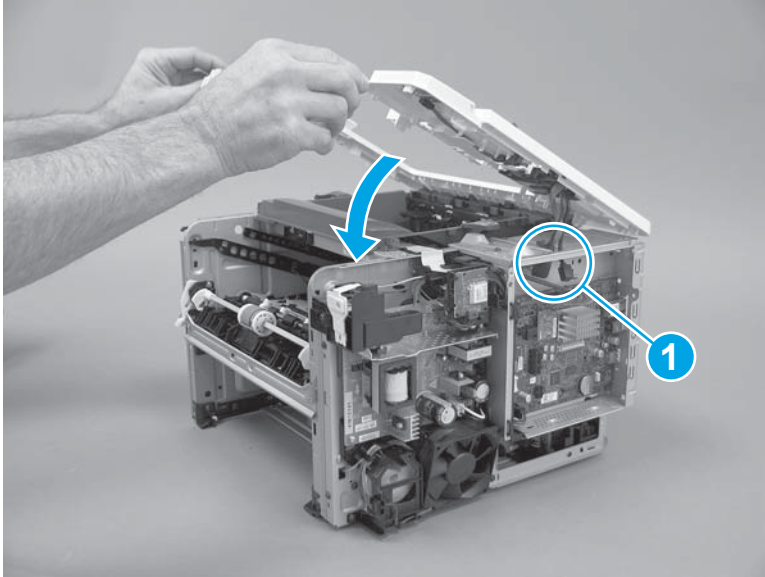
The M506x is shown in this procedure. However, the steps are correct for all M506 models and the M501 printer.

1. Position the rear edge of the cover on the printer, and then rotate the front of the cover down onto the printer.

 **CAUTION: M506x only:** As the cover is rotated down, carefully pass the cables the hole in the chassis (callout 1).

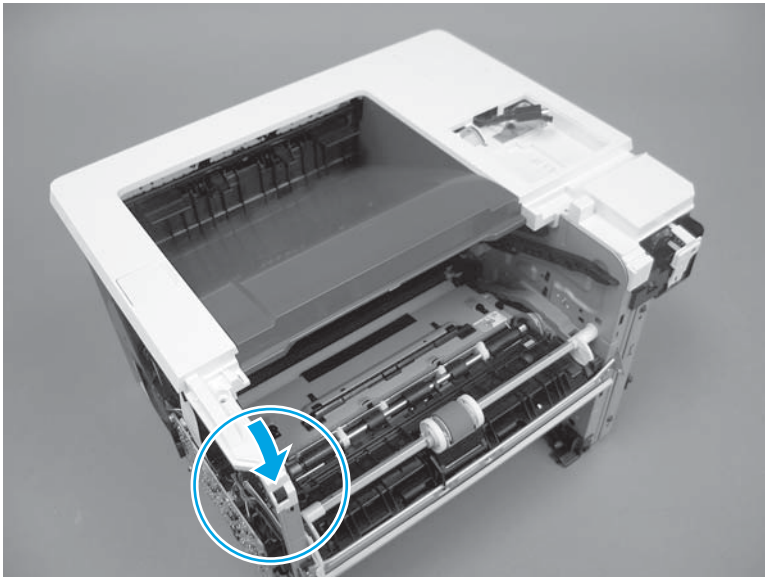
 **NOTE: LCD control panel models only:** Pass the cables through the opening in the cover, and then connect the control panel after installing the cover.

**Figure 1-625** Install the cover




2. Engage one boss.

**Figure 1-626** Engage one boss



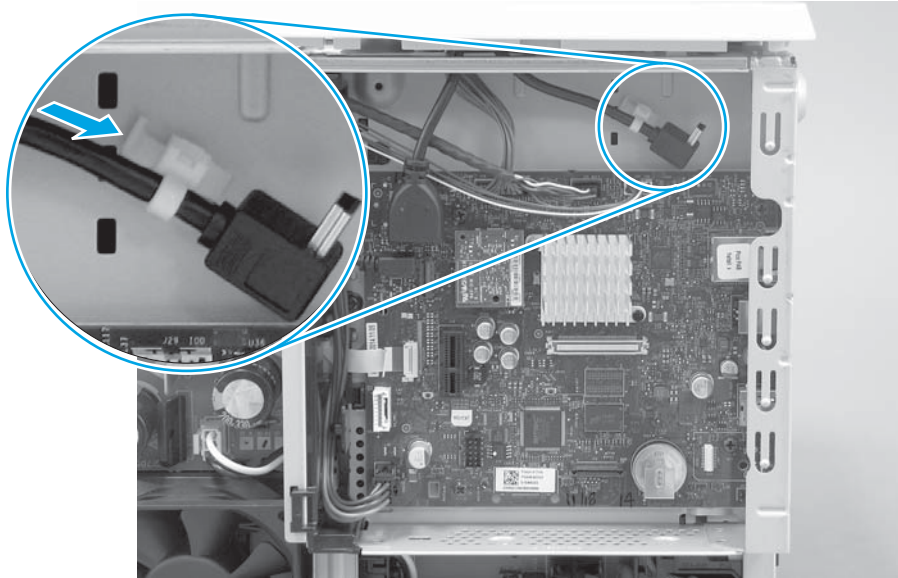
- M506 only:** Install one cable retainer on the chassis.

---

 **TIP:** Depress the tab on the retainer to install it.

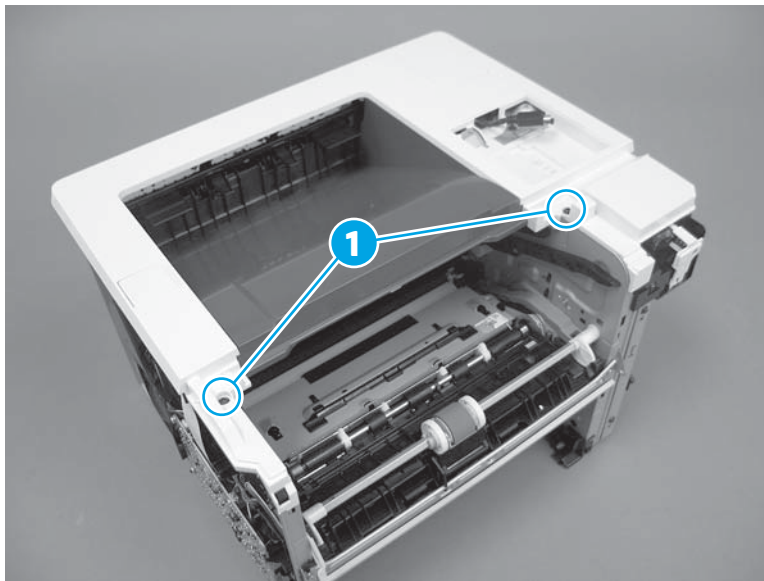
---

**Figure 1-627** Install one cable retainer




- Install two screws (callout 1).

**Figure 1-628** Install two screws



### Step 20: Install the top cover (M527)

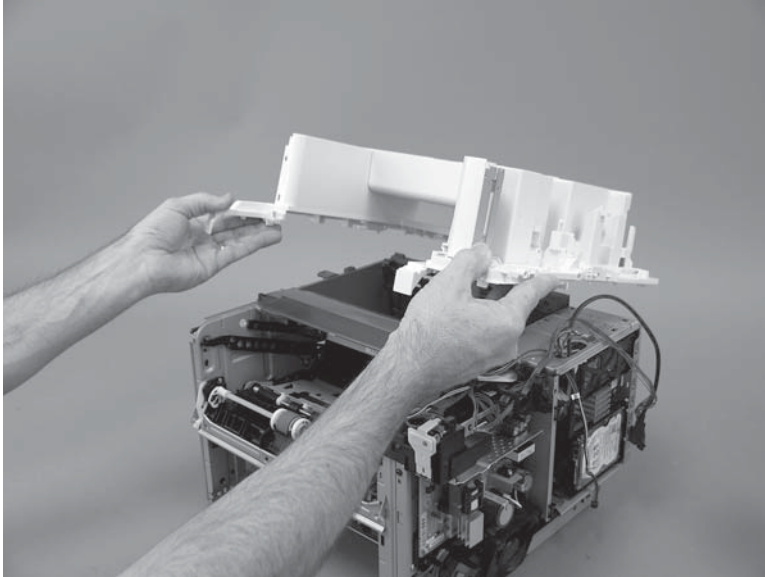
---

 **NOTE:** This step is for the M527 printer. For the M501/M506, skip this step and go to [Step 22: Install the left cover on page 382](#).

---

- Position the rear edge of the cover on the chassis.

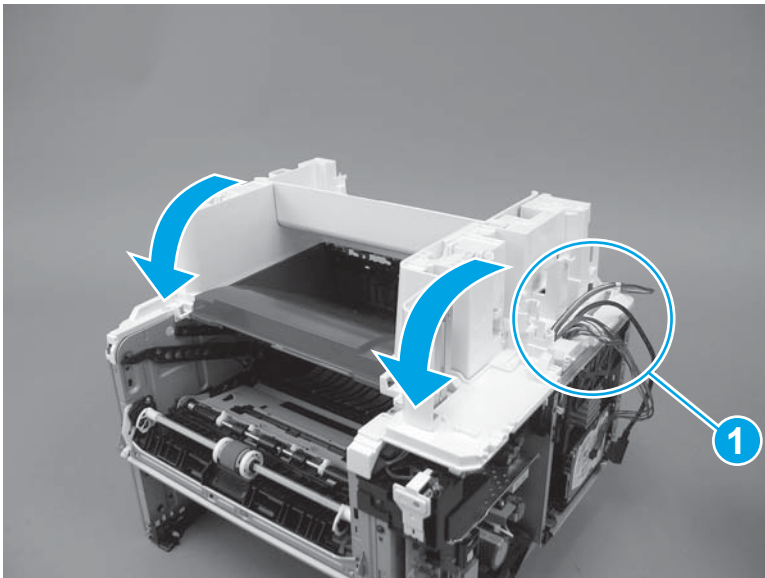
**Figure 1-629** Install the cover



2. Rotate the front of the cover down onto the printer.

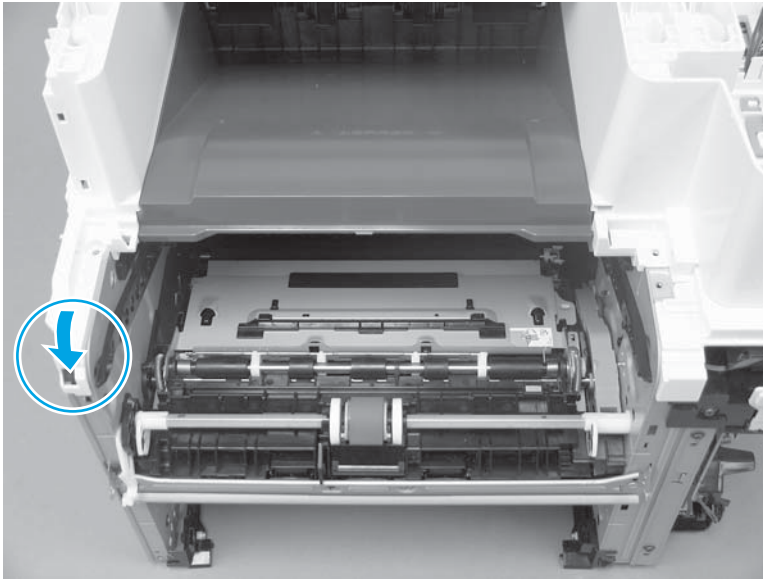
**⚠ CAUTION:** As the cover is rotated down, carefully pass the cables and wire harnesses the hole in the cover (callout 1).

**Figure 1-630** Rotate the front of the cover down



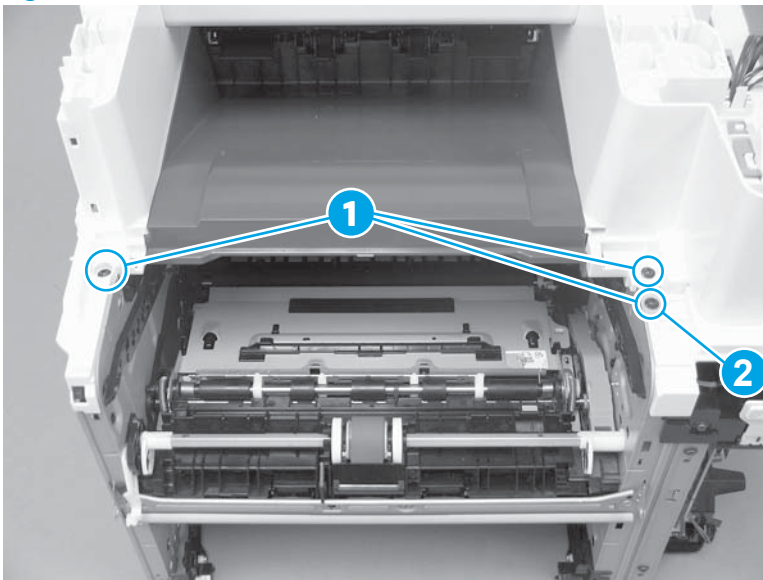
3. At the front left of the printer, engage one boss.

**Figure 1-631** Engage one boss




4. At the top front of the printer, install three screws (callout 1).

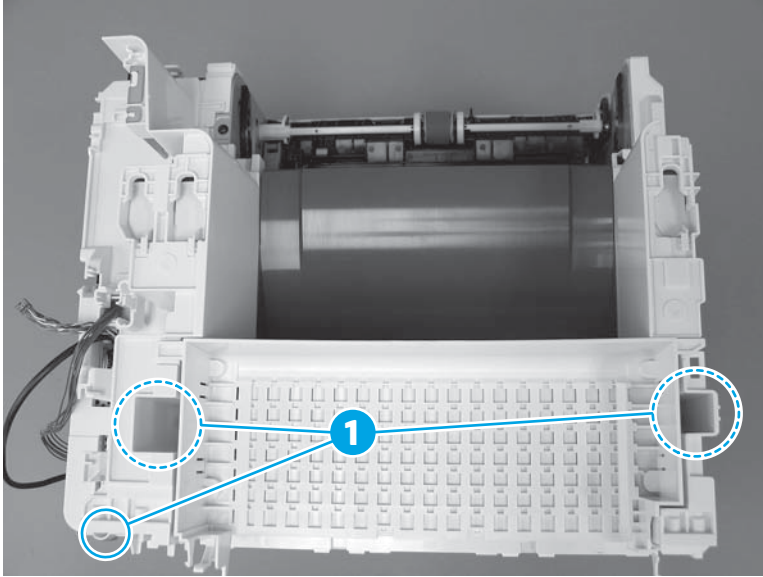
**Figure 1-632** Install three screws



5. At the top rear of the printer, install three screws (callout 1).

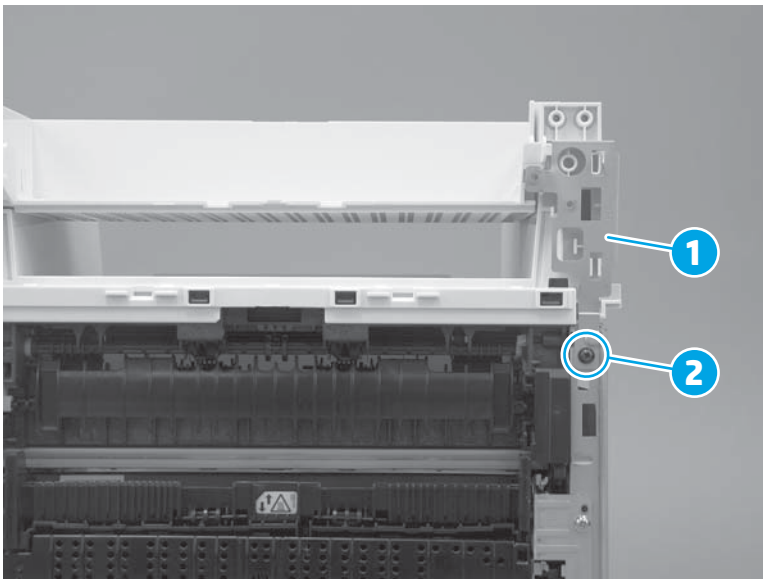
 **NOTE:** The screw (callout 2) on the lower-right portion of the cover is a different color than the other two screws, and is surrounded by sheet-metal. It might appear that this screw does not need to be removed. Remove this screw.

**Figure 1-633** Install three screws




6. At the front right of the printer, install the sheet-metal plate (callout 1), and then install one screw (callout 2).

**Figure 1-634** Install one screw and the plate




### Step 21: Install the integrated scanner assembly (M527)

 **NOTE:** This step is for the M527 printer. For the M501/M506, skip this step and go to [Step 22: Install the left cover on page 382](#).



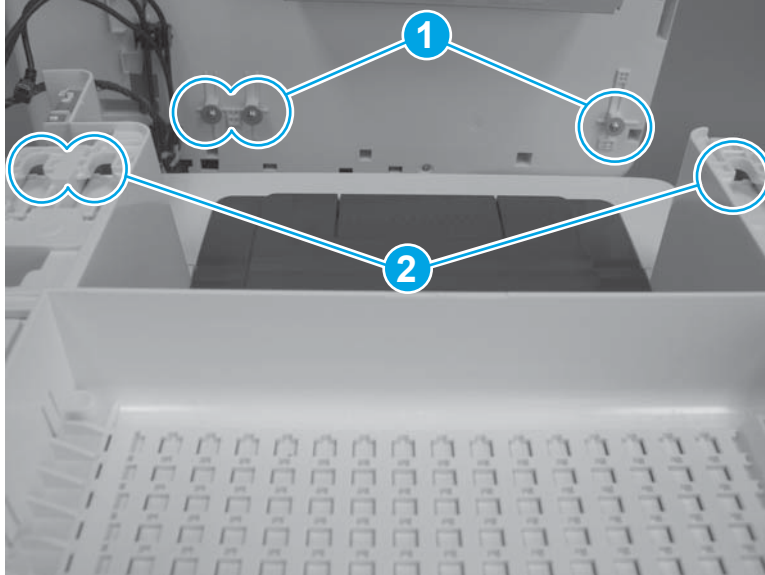
---

 **NOTE:** The ISA includes the document feeder, sub-scanner assembly (SSA), and the scanner control board (SCB)

---


1. Before proceeding, locate the ISA mounting pins (callout 1) on the bottom of the ISA and the slots (callout 2) on the printer base.

**Figure 1-635** Locate the ISA mounting pins and slots



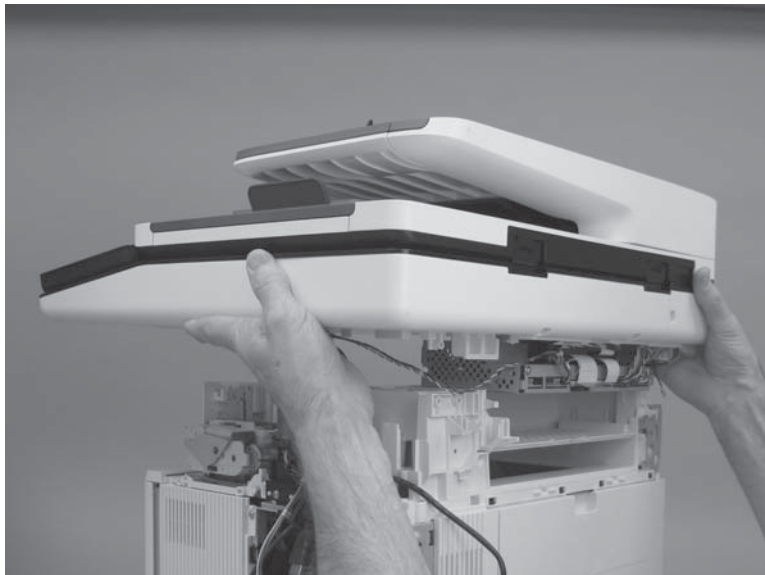
2. Position the ISA on the printer base with the pins in the slots.

---

 **NOTE:** To locate the pins and slots, see the previous step.

---

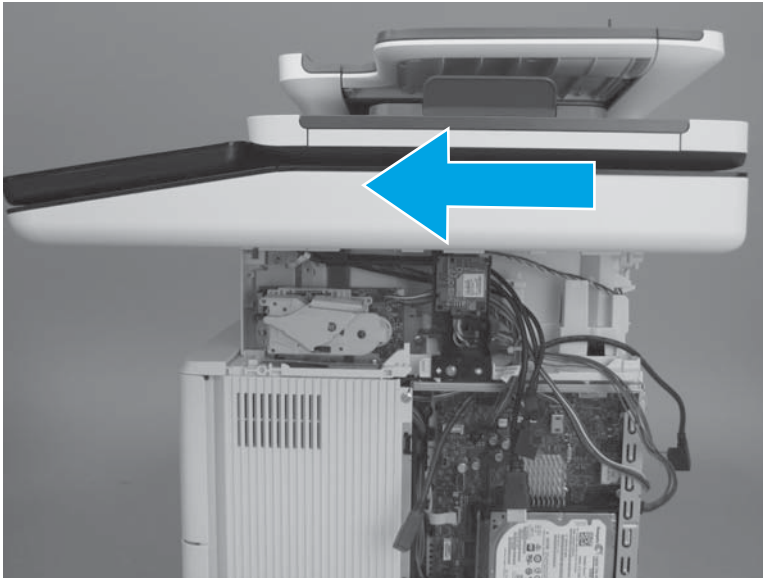
**Figure 1-636** Install the ISA



3. Slightly slide the ISA towards the front of the printer to engage it.

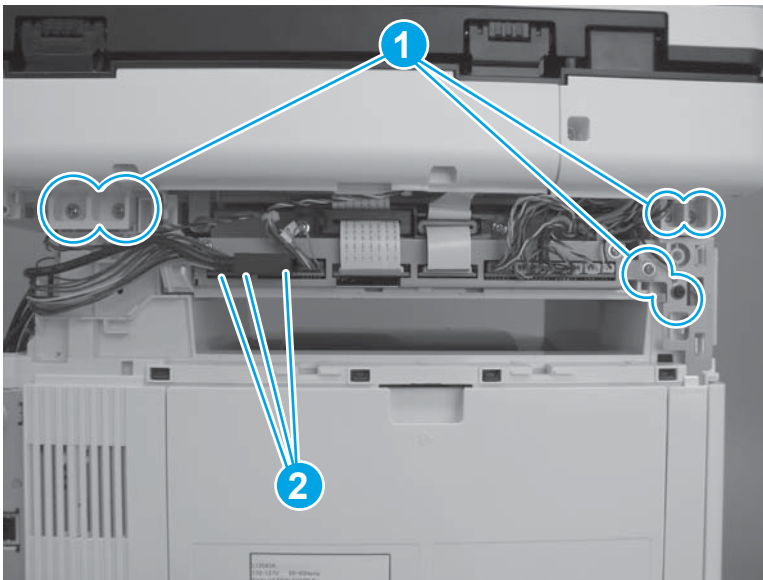
**⚠ CAUTION:** Make sure that none of the wire harnesses or cables are caught underneath the assembly when installing it.

**Figure 1-637** Slide the ISA towards the front of the printer




4. Install six screws (callout 1), and then connect three connectors (callout 2).

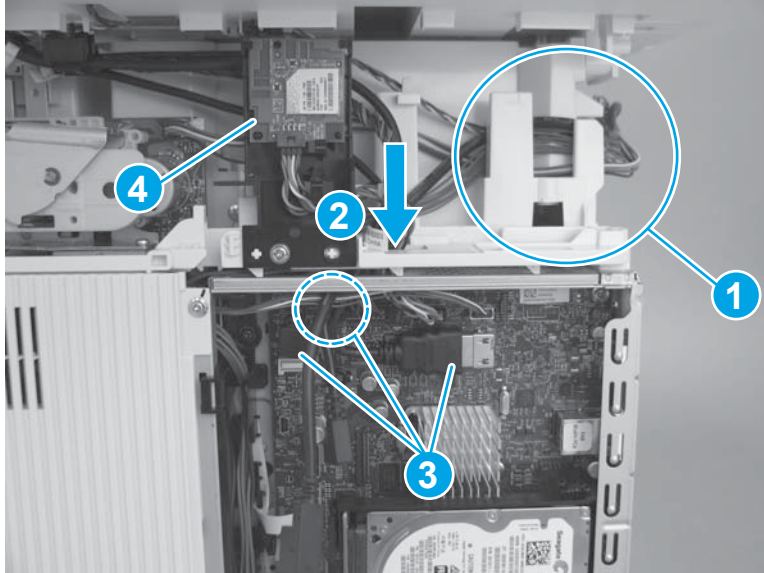
**Figure 1-638** Install screws and connect connectors



5. Install the wire harnesses and cables in the retainers (callout 1), pass them through the opening in the cover (callout 2), and then connect three connectors (callout 3).

 **TIP:** If the WiFi PCA and holder (callout 4) was detached from the printer and then moved out of the way, reinstall it now.

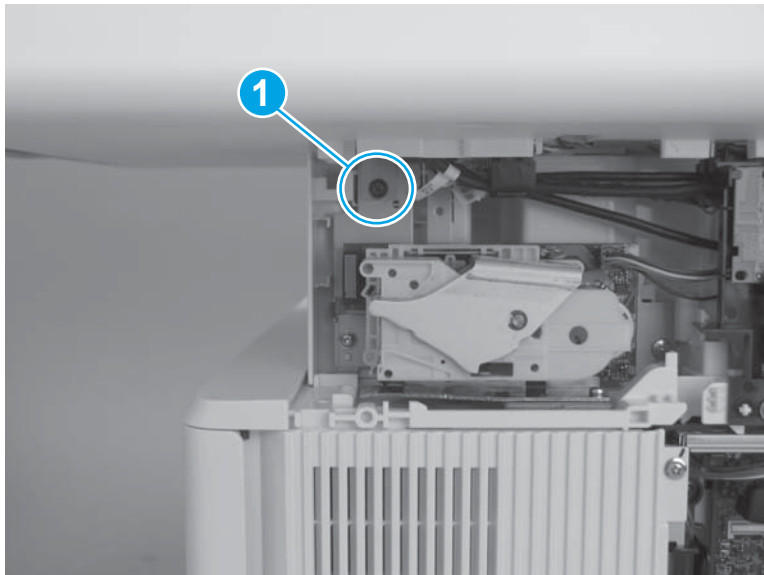
**Figure 1-639** Connect cables and connectors




6. Install one screw (callout 1).


 **IMPORTANT:** This screw fastens the ISA ground plate to the printer chassis. This screw must be installed.

**Figure 1-640** Install one screw



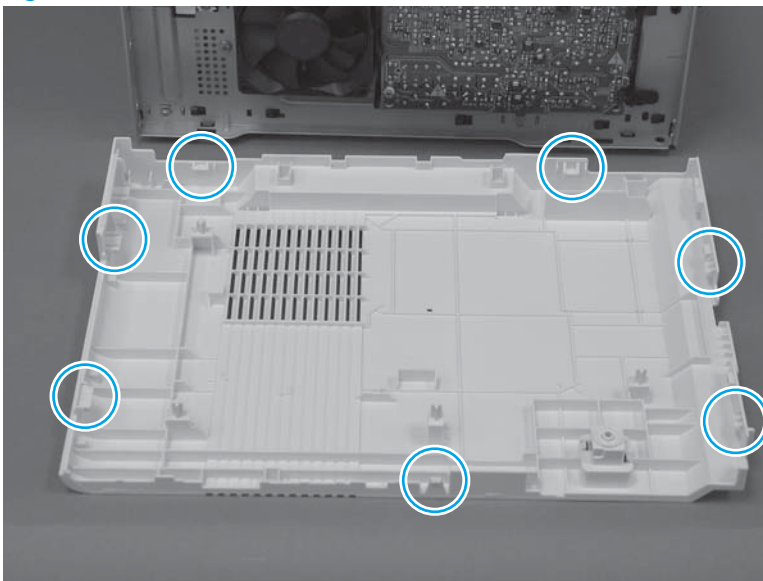
## Step 22: Install the left cover

 **IMPORTANT:** The black-plastic cassette front and rear guides (located inside the tray cavity) can be easily dislodged. Do not lose the guides when the cover is removed or installed.

 **NOTE:** The M527 printer is shown in this procedure. However, this procedure is valid for the M501/M506 printers.

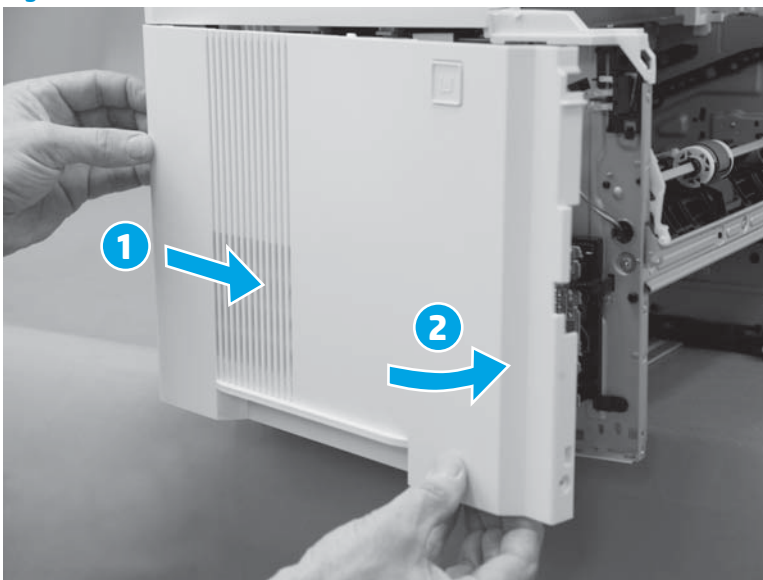
1. Before proceeding, take note of the location of the tabs and bosses on the inside of the cover.

**Figure 1-641** Locate of the tabs and bosses



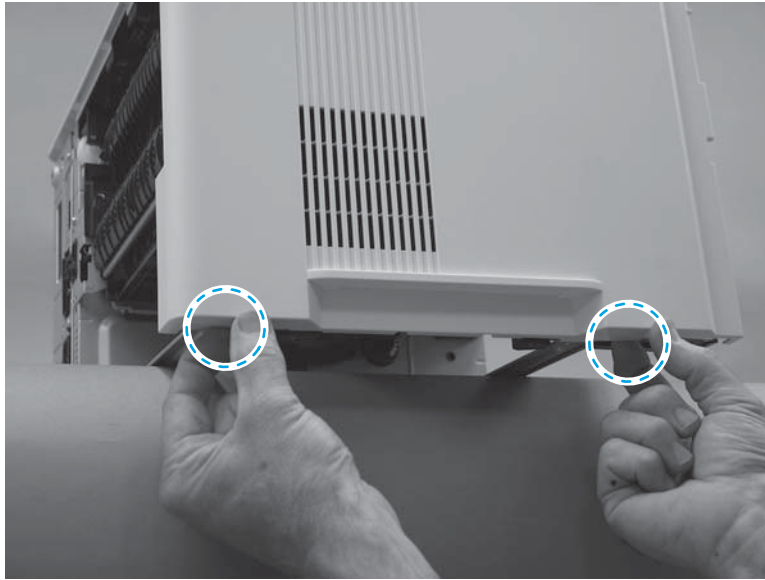
2. Engage the rear edge of the cover (callout 1), and then rotate the rear edge of the cover toward the printer (callout 2).

**Figure 1-642** Install the cover



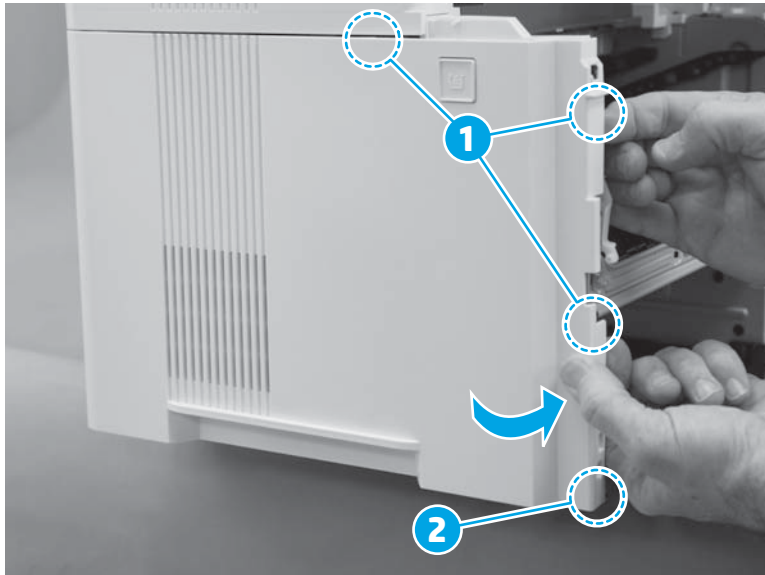
3. At the bottom edge of the cover, engage two tabs.

**Figure 1-643** Engage two tabs



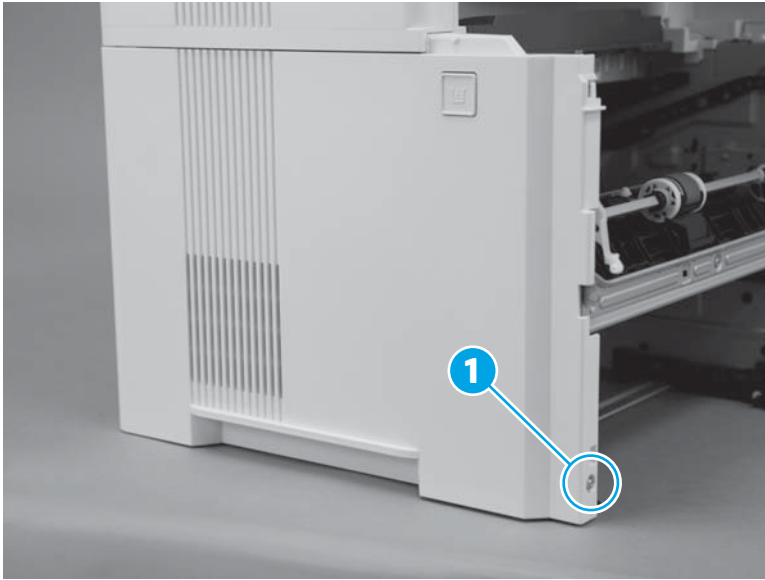
4. At the front of the printer, engage three tabs (callout 1), and then continue to rotate the front edge of the cover toward the printer to engage one boss (callout 2).

**Figure 1-644** Engage three tabs and one boss





5. Install one screw (callout 1).

**Figure 1-645** Install one screw



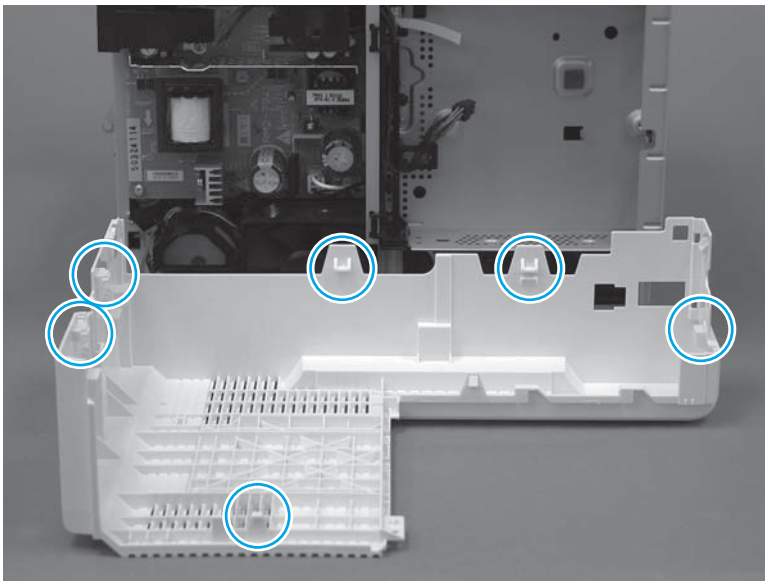
### Step 23: Install the right cover

 **IMPORTANT:** The black-plastic cassette front and rear guides (located inside the tray cavity) can be easily dislodged. Do not lose the guides when the cover is removed or installed.

 **NOTE:** The M527 printer is shown in this procedure. However, this procedure is valid for the M501/M506 printers.

1. Before proceeding, take note of the location of the tabs and bosses on the inside of the cover.

**Figure 1-646** Locate the tabs and bosses

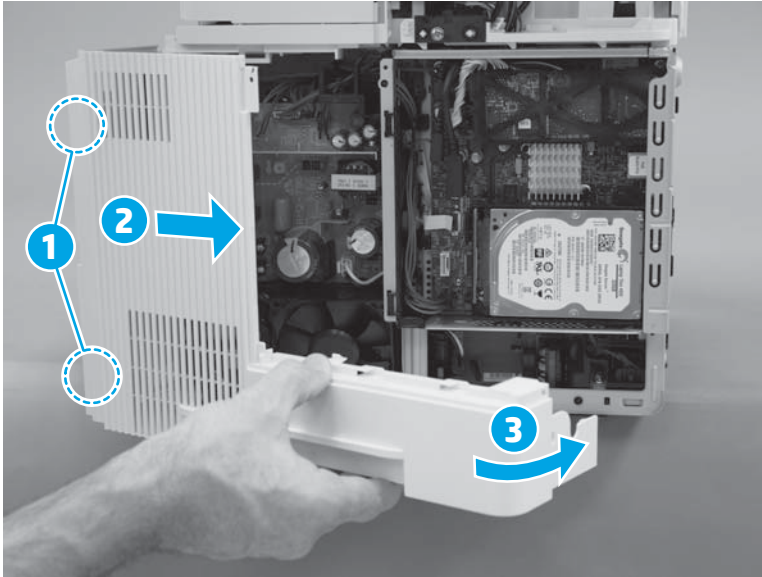


2. At the front of the cover engage two bosses (callout 1/2), and then rotate the rear of the cover toward the printer (callout 3).

**CAUTION:** It might be easier to install the cover with the printer slightly hanging over the edge of the workspace. Do not let the printer tip and fall off of the workspace when removing the cover.

**TIP:** Make sure that the power switch at the front of the printer is positioned in the opening in the cover and that it does not interfere with the cover installation.

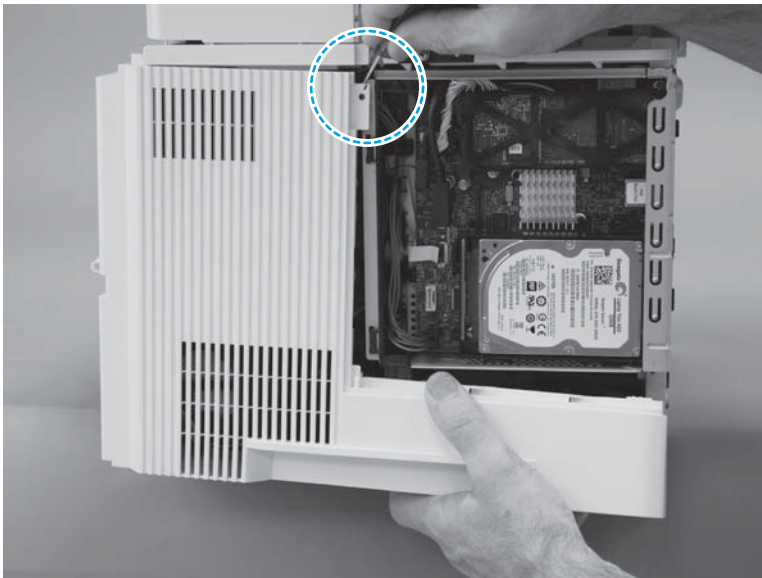
**Figure 1-647** Install the cover



3. At the top rear edge of the cover, engage one tab.

**CAUTION:** It might be easier to install the cover with the printer slightly hanging over the edge of the workspace. Do not let the printer tip and fall off of the workspace when removing the cover.

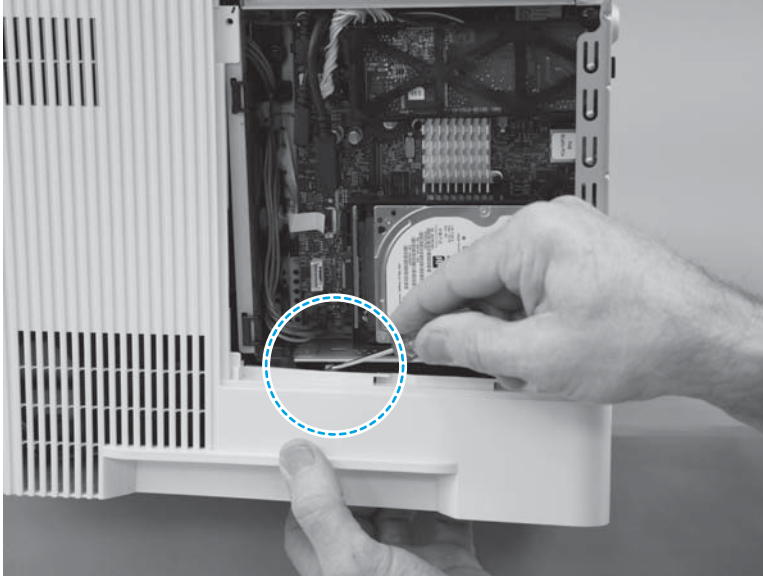
**Figure 1-648** Engage one tab



4. Near the formatter, engage one tab.

**CAUTION:** It might be easier to install the cover with the printer slightly hanging over the edge of the workspace. Do not let the printer tip and fall off of the workspace when removing the cover.

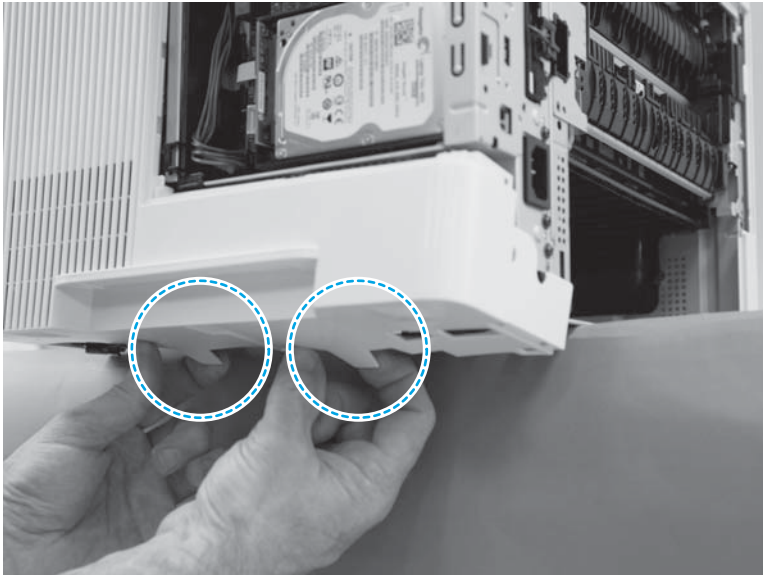
**Figure 1-649** Engage one tab



5. At the bottom edge of the cover, engage two bosses.

**CAUTION:** It might be easier to install the cover with the printer slightly hanging over the edge of the workspace. Do not let the printer tip and fall off of the workspace when removing the cover.

**Figure 1-650** Engage two bosses

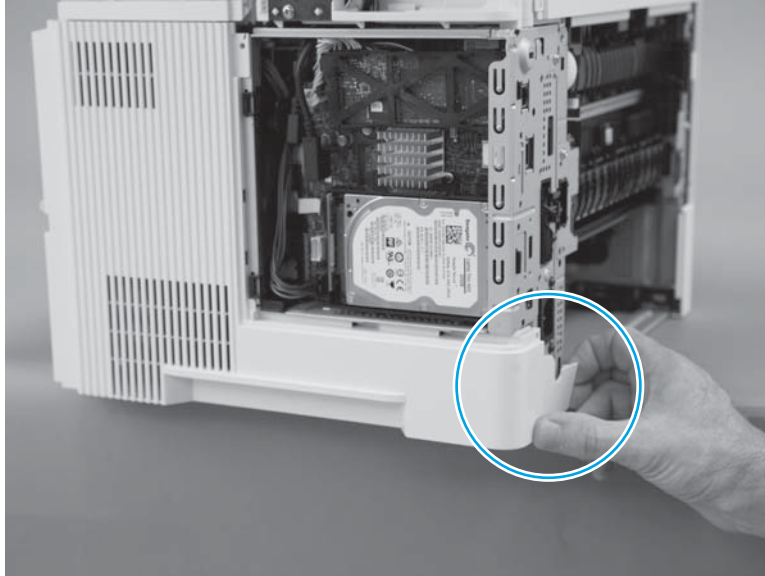




6. At the rear of the printer, engage one boss.

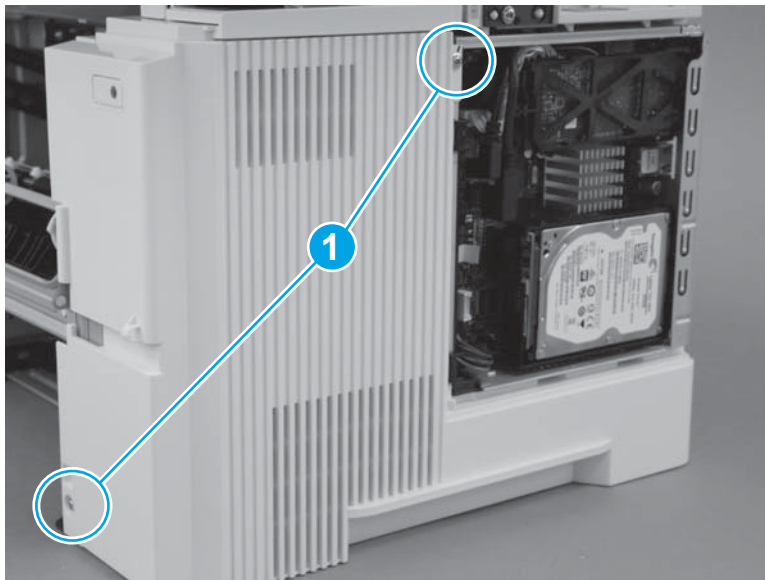
**CAUTION:** It might be easier to install the cover with the printer slightly hanging over the edge of the workspace. Do not let the printer tip and fall off of the workspace when removing the cover.

**Figure 1-651** Engage one boss



7. Install two screws (callout 1).

**Figure 1-652** Install two screws

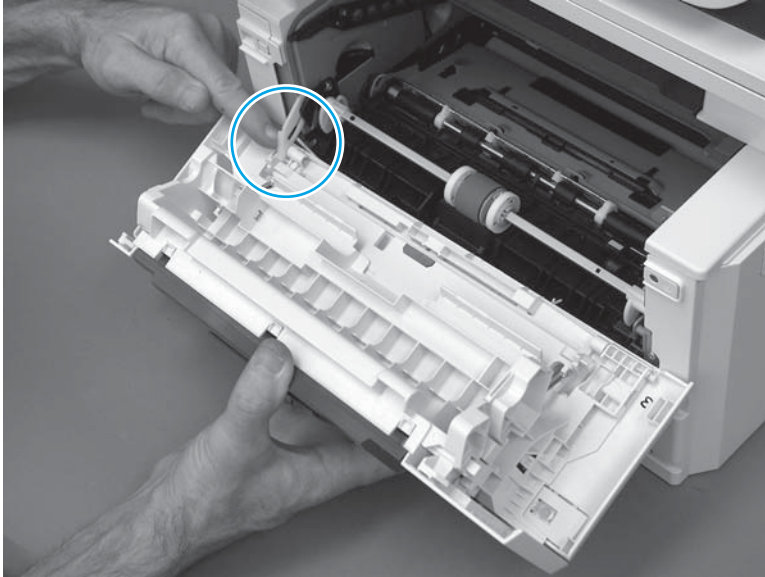


#### Step 24: Install the cartridge door assembly


1. Position the door close to the printer, and then engage the keyed pin on the left-side retainer arm with the hole in the door.


**TIP:** It might be easier to engage the keyed pin with the hole by using a small flat-blade screwdriver.

**Figure 1-653** Engage the left-side retainer arm

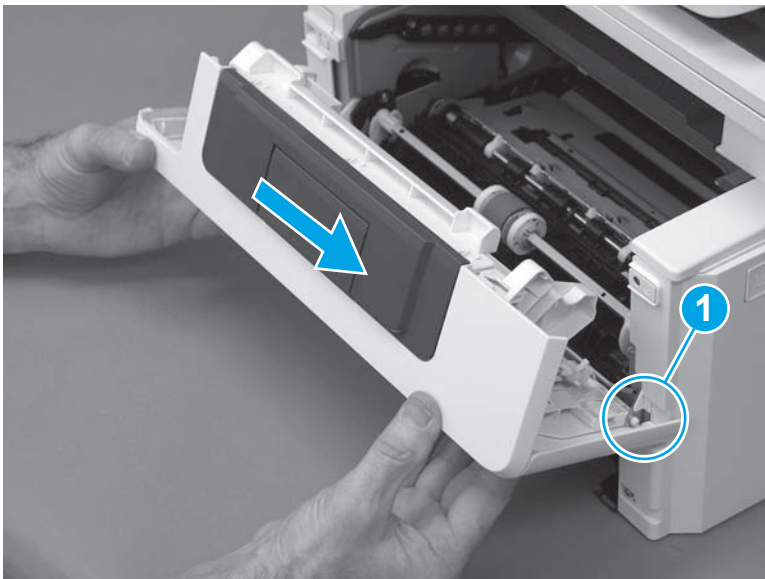


2. Engage the right-side door hinge pin with the hole in the chassis (callout 1).


 **NOTE:** There are two right-side hinge pins (not shown in callout 1).

 **TIP:** Keep a finger pressed on the left-side retainer arm so that it does not disengage from the door.

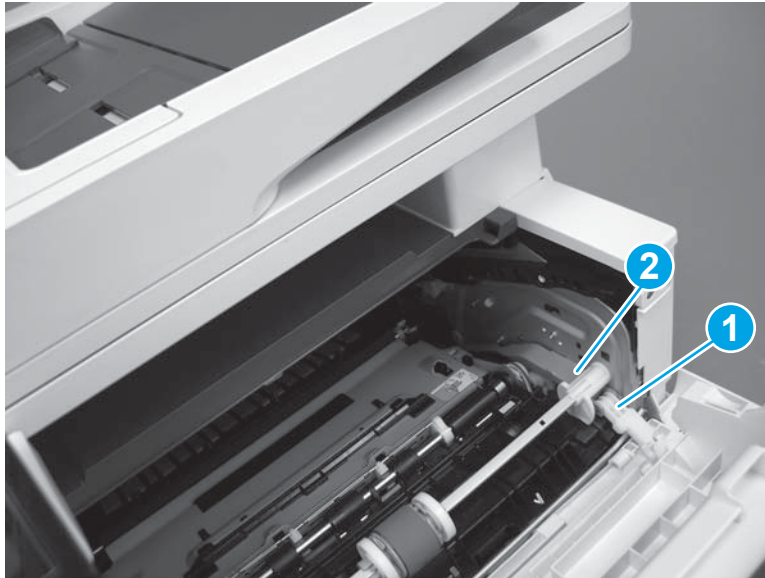
**Figure 1-654** Install the door



3. Install the gray-plastic pressure-release link (callout 1) onto the white-plastic door arm (callout 2).

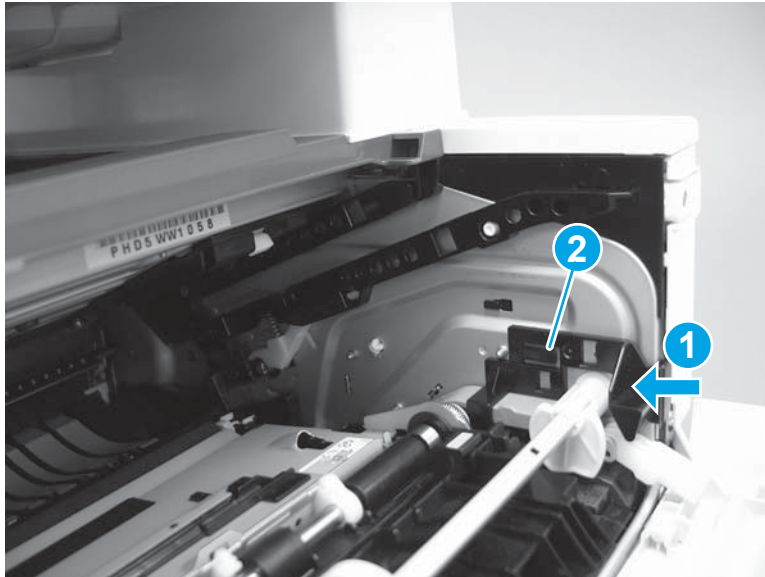
 **IMPORTANT:** Make sure that the arm snaps on to the link. Partially close and open the door to verify that the link (callout 2) moves in and out of the printer as the door closes/opens.

**Figure 1-655** Install the pressure-release link



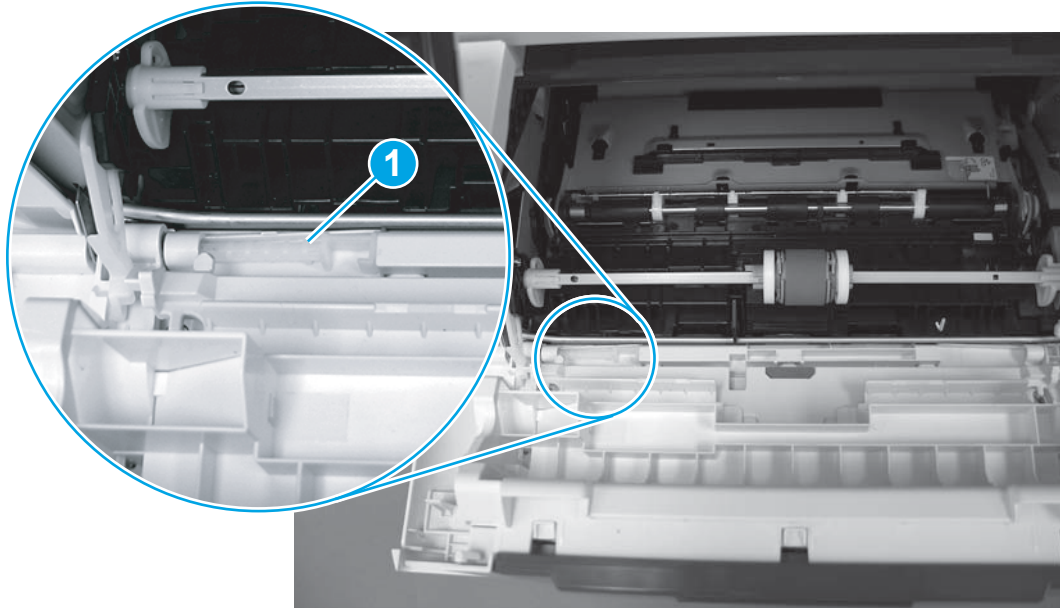
4. Slide the guide into the printer (callout 1), and then make sure that the tab (callout 2) snaps into place to secure the guide to the chassis.

**Figure 1-656** Install the guide





5. Position the support shaft on the door, and then align the left-side hinge on the door with the hole in the chassis (callout 1).

**Figure 1-657** Align the hinge

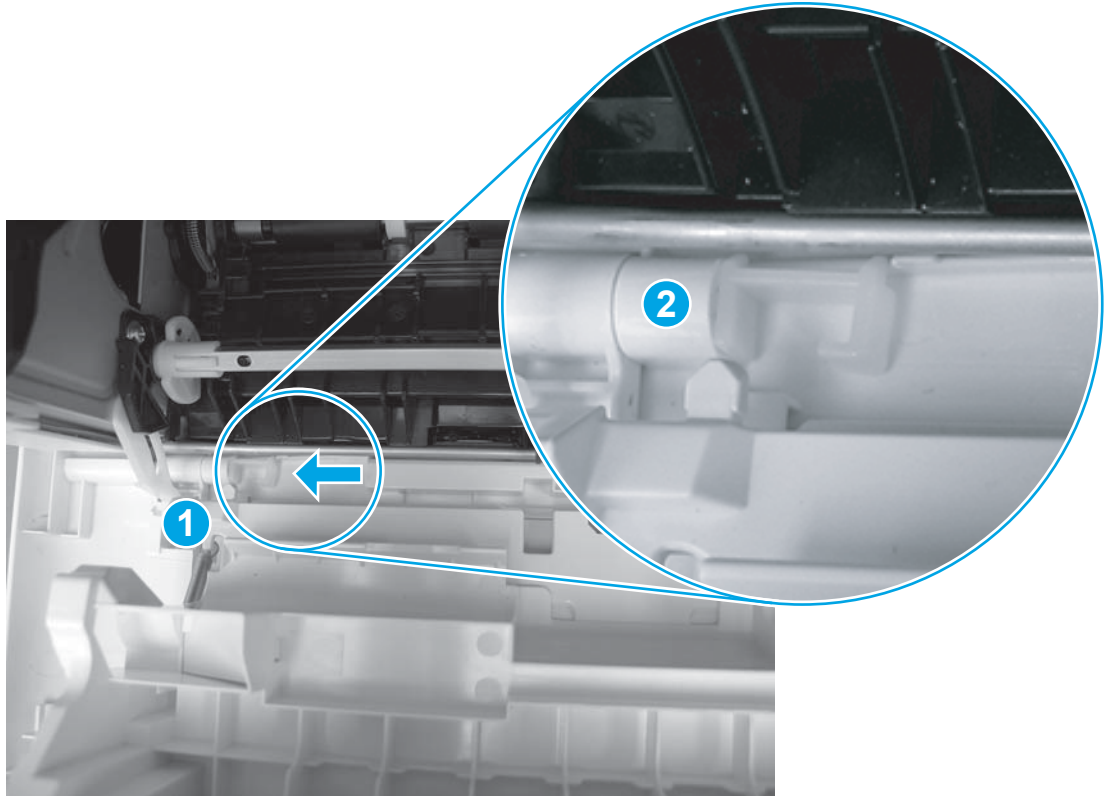


6. Push the shaft towards the left side of the printer to install it (callout 1).

 **NOTE:** Make sure that the support shaft is fully installed and correctly orientated (callout 2) so that it will not interfere with the door opening and closing.

 **Reinstallation tip:** If a replacement door was installed, make sure to install the nameplate (supplied in the kit) corresponding to the printer on the door.

**Figure 1-658** Install the support shaft



#### Step 25: Install the rear door assembly

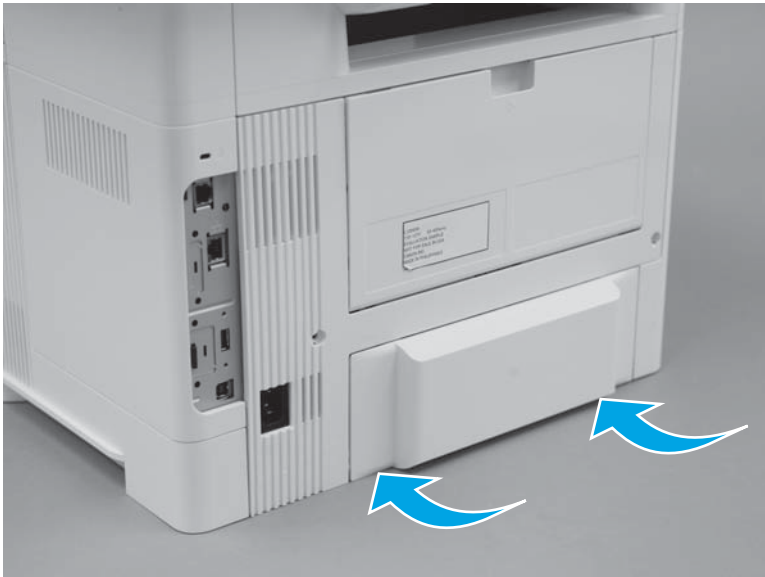
1. Engage the top edge of the assembly with the printer.

**Figure 1-659** Install the cover



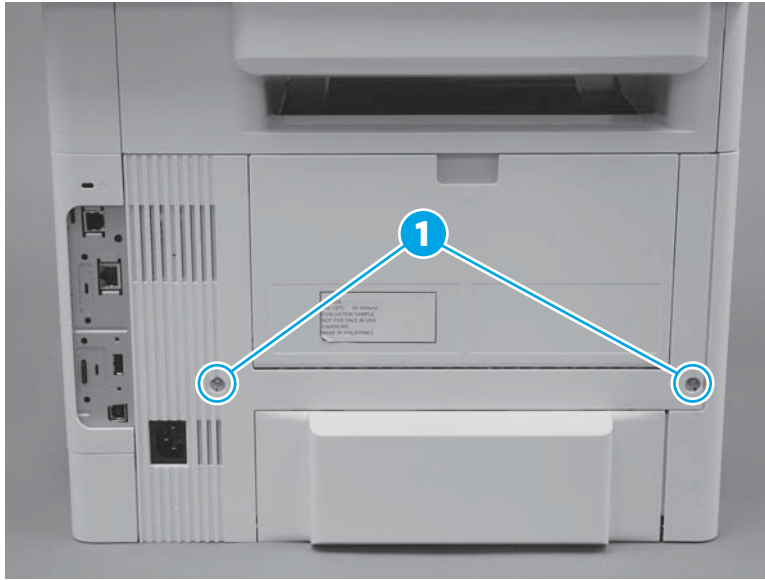
2. Rotate the bottom edge of the cover towards the printer.

**Figure 1-660** Rotate the bottom of the cover




3. Install two screws (callout 1).

**Figure 1-661** Install two screws

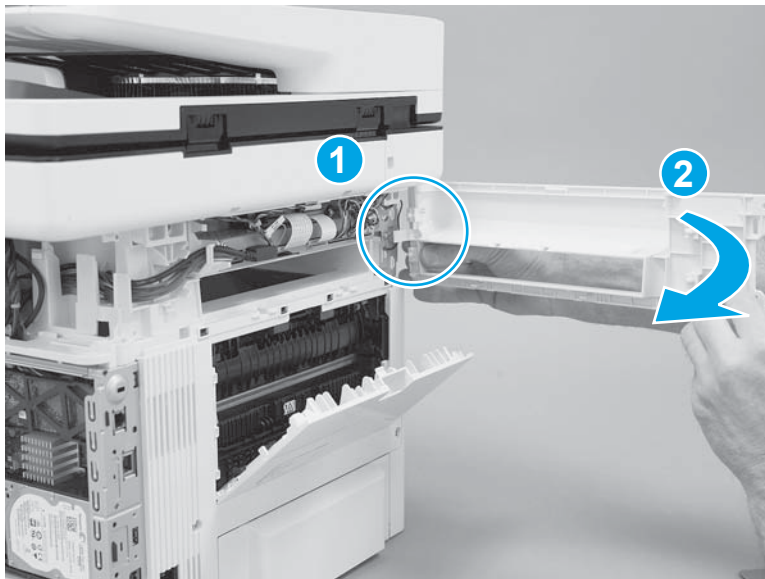


### Step 26: Install the top-rear cover

 **NOTE:** This step is for the M527 printer. For the M506, skip this step and go to [Step 31: Install the formatter cover on page 403](#).

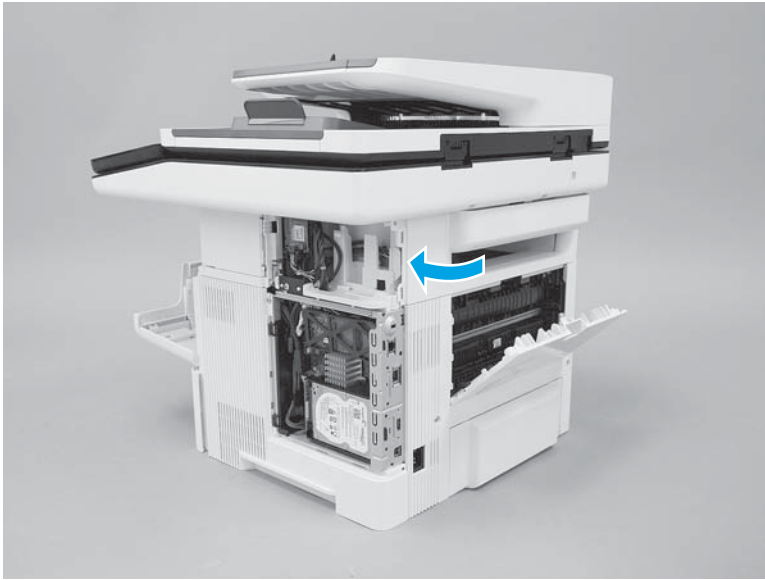
1. Engage one boss (callout 1), and then rotate the cover towards the printer (callout 2).

**Figure 1-662** Engage one boss



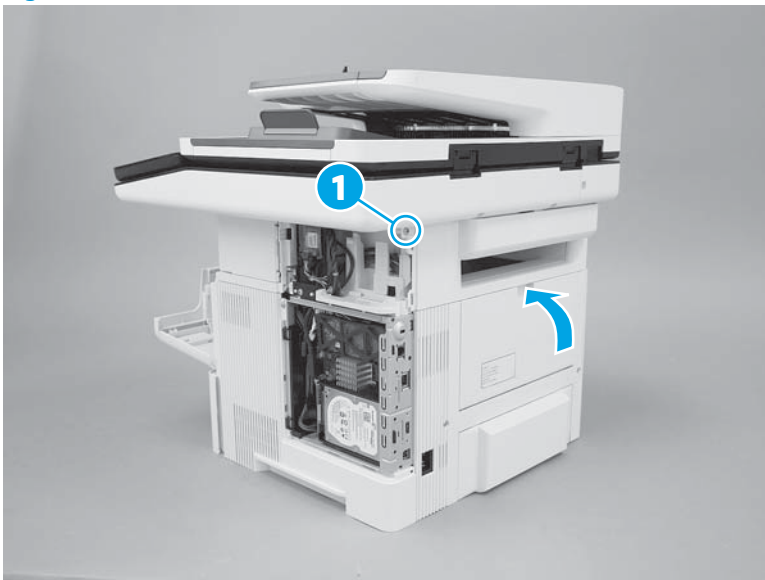
2. Continue to rotate the cover toward the printer to install it.

**Figure 1-663** Install the cover



3. Install one screw (callout 1), and then close the rear door.

**Figure 1-664** Install one screw



### Step 27: Install the top-left cover



**NOTE:** This step is for the M527 printer. For the M506, skip this step and go to [Step 31: Install the formatter cover on page 403](#).

1. Position the front edge of the cover on the printer, and then slide the cover toward the front of the printer to engage two bosses at the front of the cover.



**Figure 1-665** Slide the cover




2. Rotate the cover towards the printer to engage two tabs at the middle of the cover.

**Figure 1-666** Engage two tabs



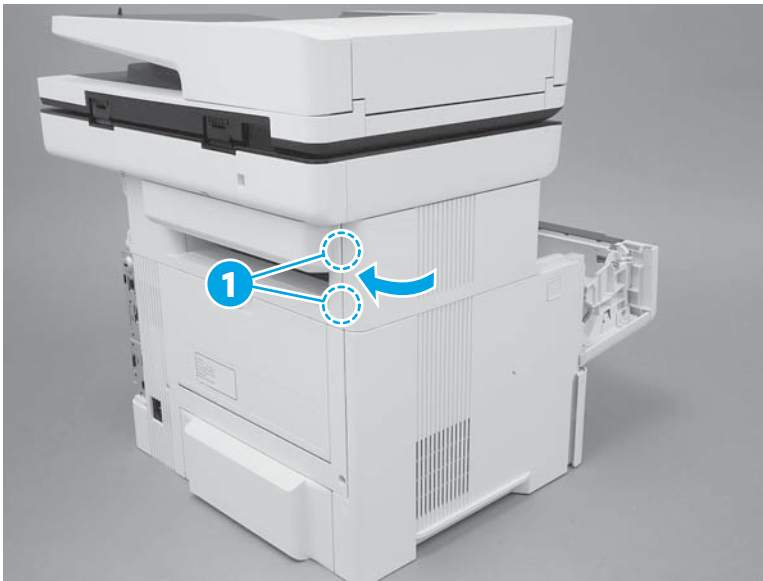
3. Continue to rotate the cover onto the printer to engage two tabs (callout 1) at the rear edge of the cover.

---

 **NOTE:** Close the toner-cartridge door.


---

**Figure 1-667** Engage two tabs




### Step 28: install the stapler stationary (inner) cover (M527)

---

 **NOTE:** This step is for the M527c/f/z printers. For the M501/M506, skip this step and go to [Step 31: Install the formatter cover on page 403](#). For the M527dn, skip this step and go to [Step 29: Install the stapler door or stapler blank cover \(M527\) on page 398](#).

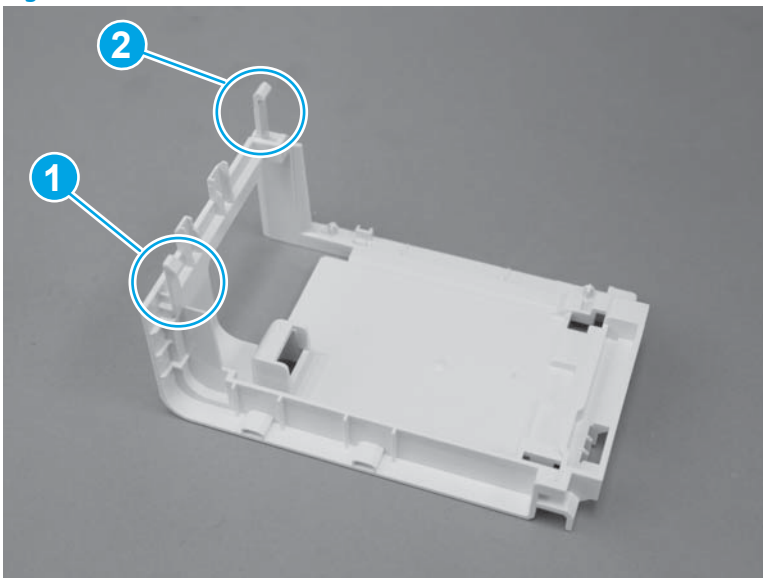
---

 **NOTE:** M527c/f/z printers only.

---

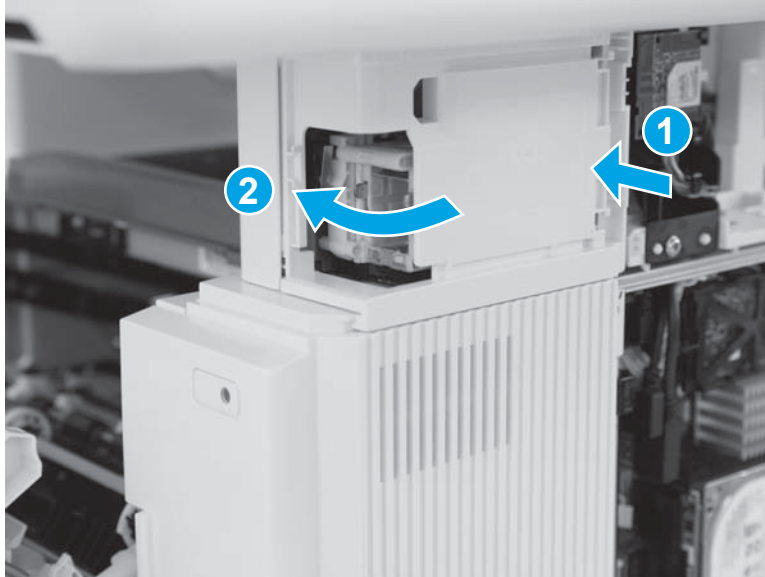
1. Before proceeding, take note of the locations of the upper tab (callout 1) and the lower tab (callout 2) on the stapler stationary (inner) cover.

**Figure 1-668** Locate the tabs



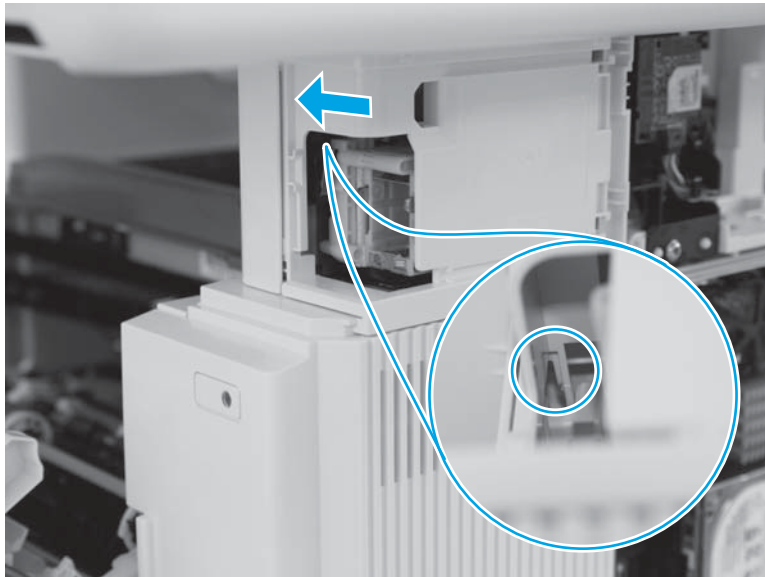
- Engage the rear edge of the cover with the printer (callout 1), and then rotate the front edge of the cover onto the printer (callout 2) to engage the two tabs.

**Figure 1-669** Install the cover



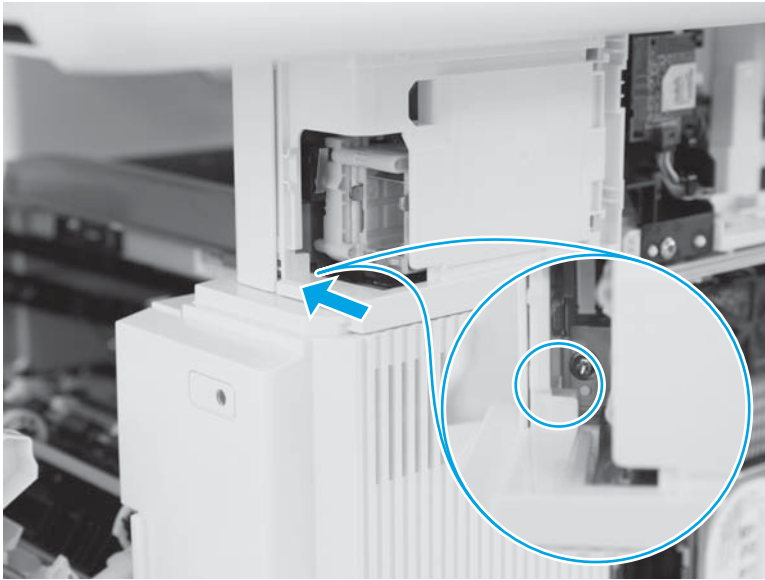
- Verify that the upper tab is engaged.

**Figure 1-670** Engage one tab





4. Verify that the lower tab is engaged.

**Figure 1-671** Engage one tab



### Step 29: Install the stapler door or stapler blank cover (M527)

 **NOTE:** This step is for the M527 printer. For the M501/M506, skip this step and go to [Step 31: Install the formatter cover on page 403](#).

 **NOTE:** The M527dn does not have a convenience stapler.

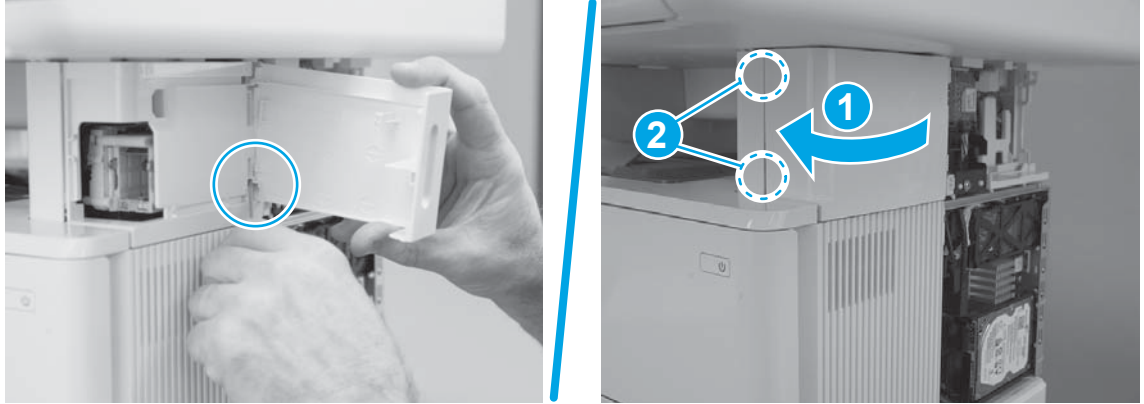
1. Do one of the following:
  - **M527c/f/z:** Position the door near the printer.
  - **M527dn:** Position the cover on the printer.

**Figure 1-672** Install the door or cover



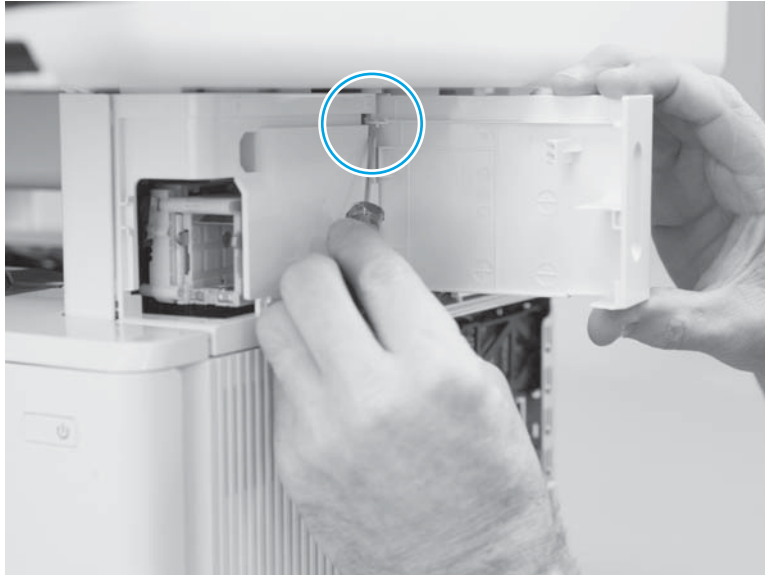
2.
  - **M527c/f/z:** Engage the lower hinge.
  - **M527dn:** Rotate the cover towards the printer (callout 1), and then make sure that the two tabs (callout 2) snap into place to install the cover.

**Figure 1-673** Engage the lower hinge or engage the cover



3. **M527c/f/z:** Engage the upper hinge.

**Figure 1-674** Engage the upper hinge




4. **M527c/f/z:** Close the stapler door.

**Figure 1-675** Close the door




### Step 30: Install the fax PCA (M527)

---

 **NOTE:** This step is for the M527 printer. For the M501/M506, skip this step and go to [Step 31: Install the formatter cover on page 403](#).

---

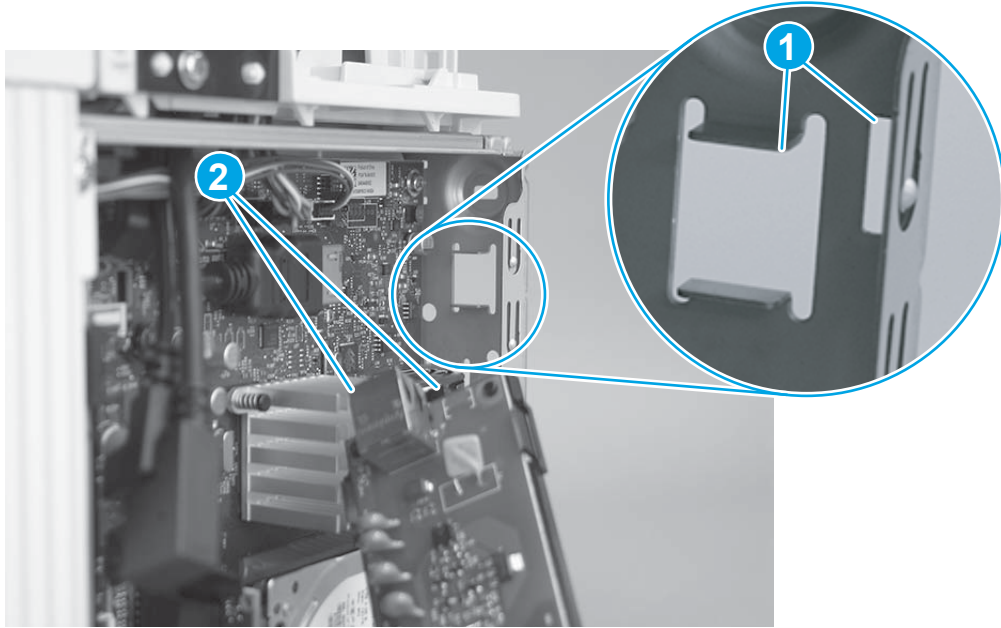
 **CAUTION:**  ESD-sensitive part.

 **NOTE:** M527c/f/z printers only (optional for the M527dn).

---

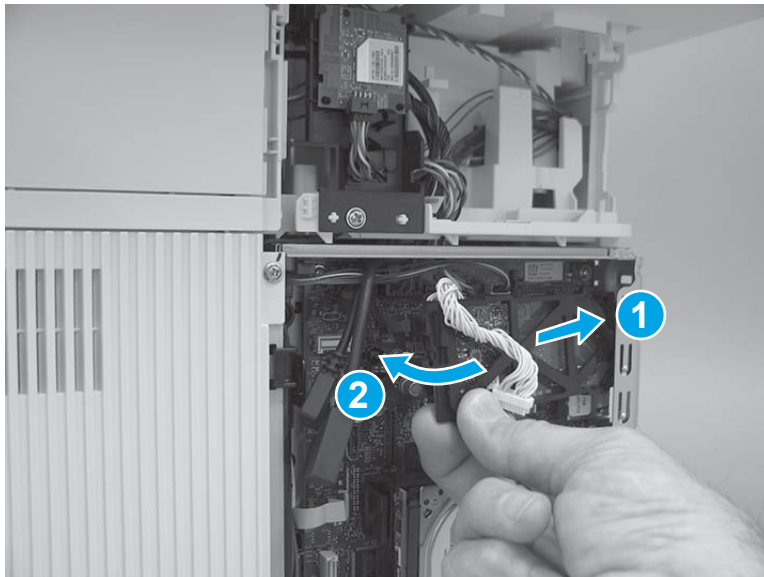
1. Before proceeding, take note of the location of the slots (callout 1) in the sheet-metal where the fax PCA cradle mounting tab and fax port (callout 2) must be installed.

**Figure 1-676** Locate the slots in the sheet-metal



2. Insert the fax PCA cradle mounting tab and fax port in the slots in the sheet-metal plate (callout 1), and then rotate the connector end of the fax PCA toward the formatter (callout 2).

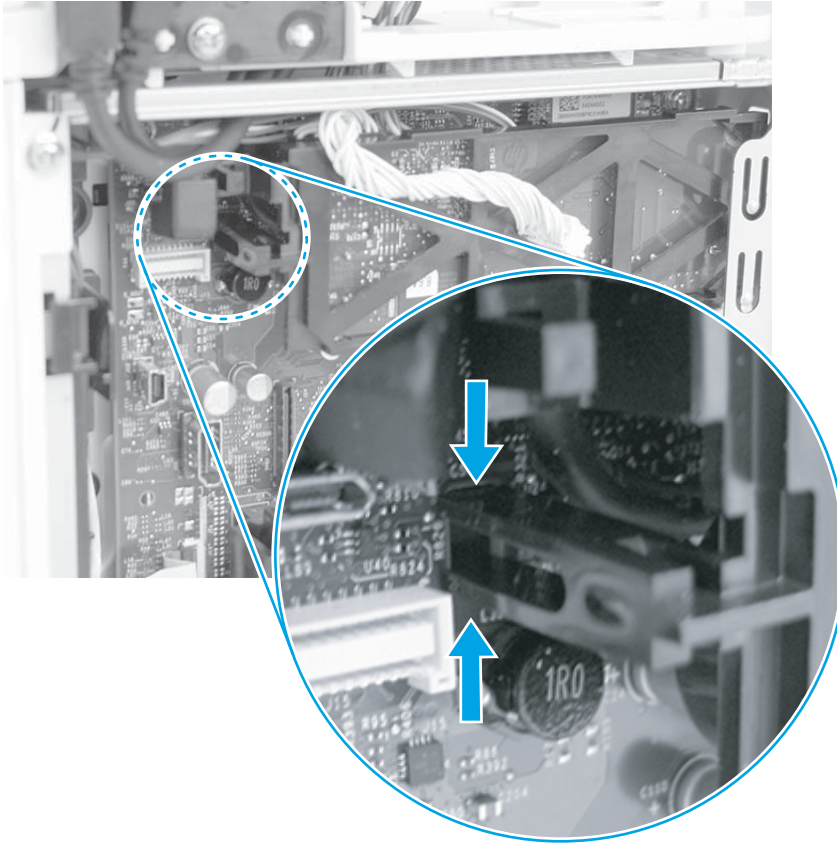
**Figure 1-677** Install the fax PCA



- Engage the retainer with the slot in the formatter.

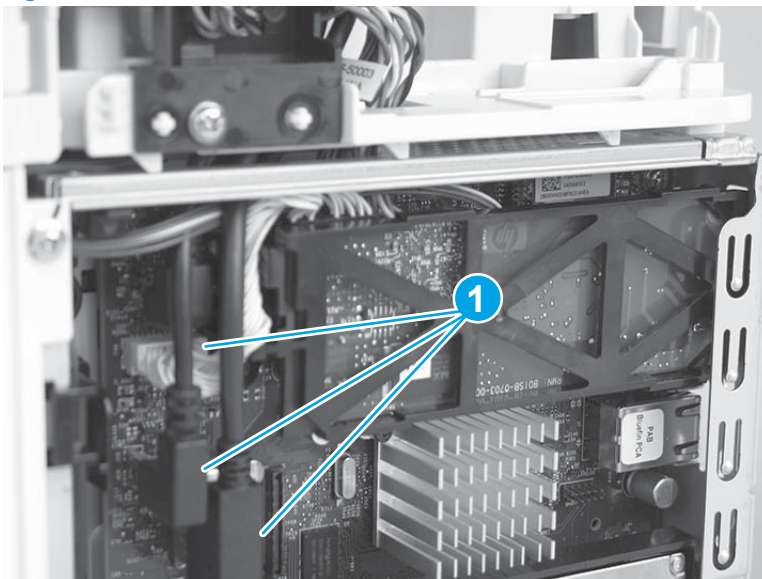
 **Reinstallation tip:** Pinch the retainer to easily engage it with the slot.

**Figure 1-678** Engage the fax PCA



- Connect three connectors (callout 1).

**Figure 1-679** Connect three connectors

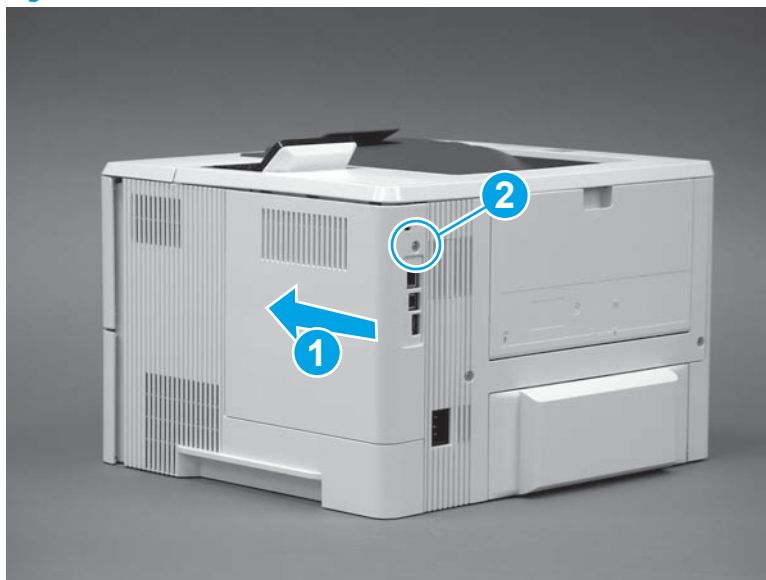




### Step 31: Install the formatter cover

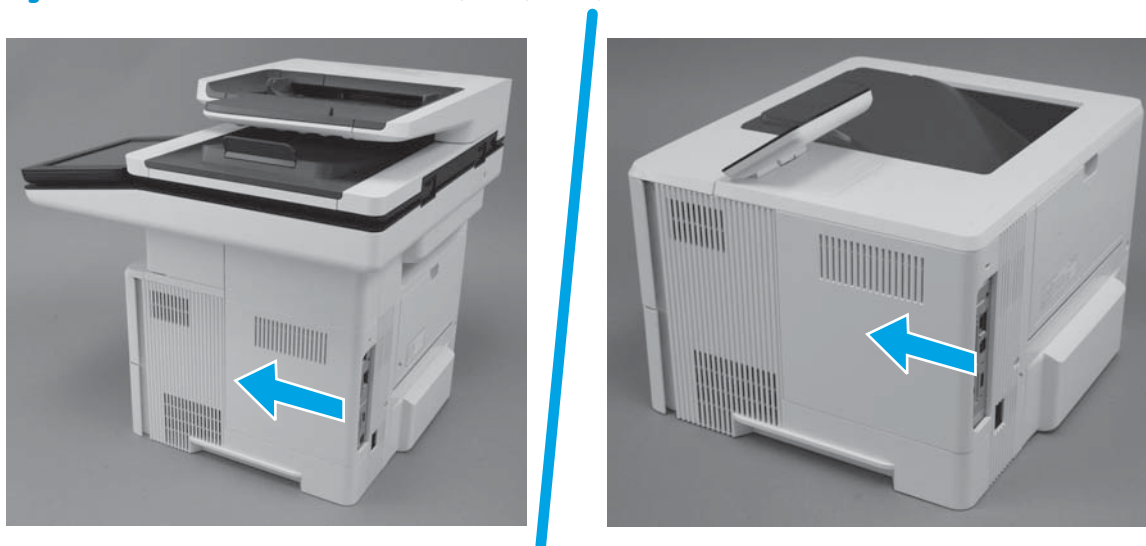
1. **M501:** Slide it toward the front of the printer to install it (callout 1), and then install one screw (callout 2).

**Figure 1-680** Install the formatter cover (M501)



2. **M506/M527:** Slide it toward the front of the printer to install it.

**Figure 1-681** Install the formatter cover (M506/M527)



### Step 32: Install the tray

1. With the tray at a slight angle, align the sides of the tray with the rails in the accessory, and then partially slide the tray into the printer.

**Figure 1-682** Install the tray



2. Push the tray straight into the accessory to close it.

**Figure 1-683** Close the tray



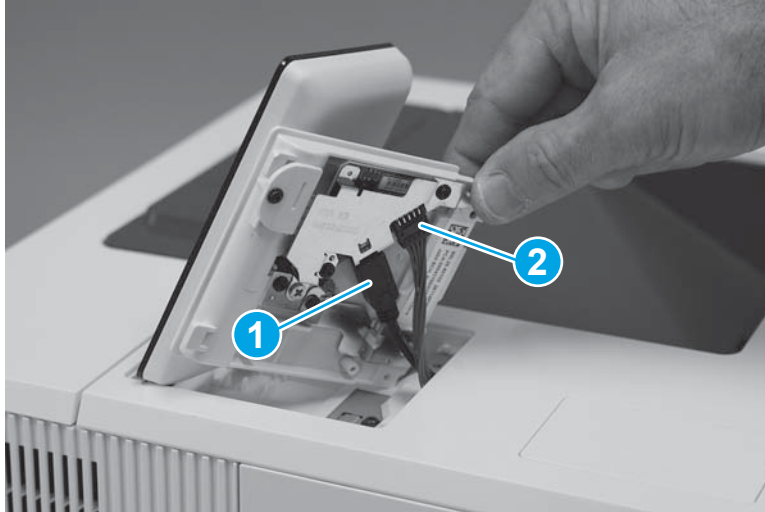
### Step 33: Install the control panel (M506x)



**NOTE:** M506x model only.

1. Connect one HDMI cable (callout 1), one connector (callout 2).

**Figure 1-684** Connect the cables



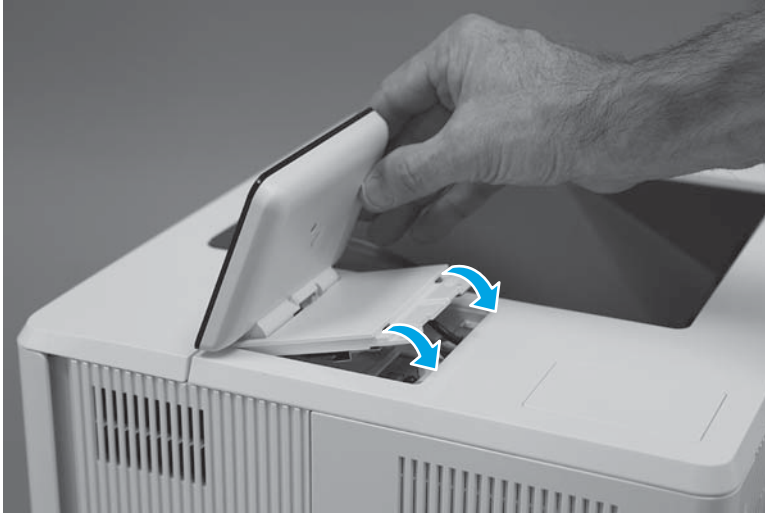
2. Install the tabs (callout 1) on the front of the control panel in the slots (callout 2) on the printer top cover.

**Figure 1-685** Install the control panel



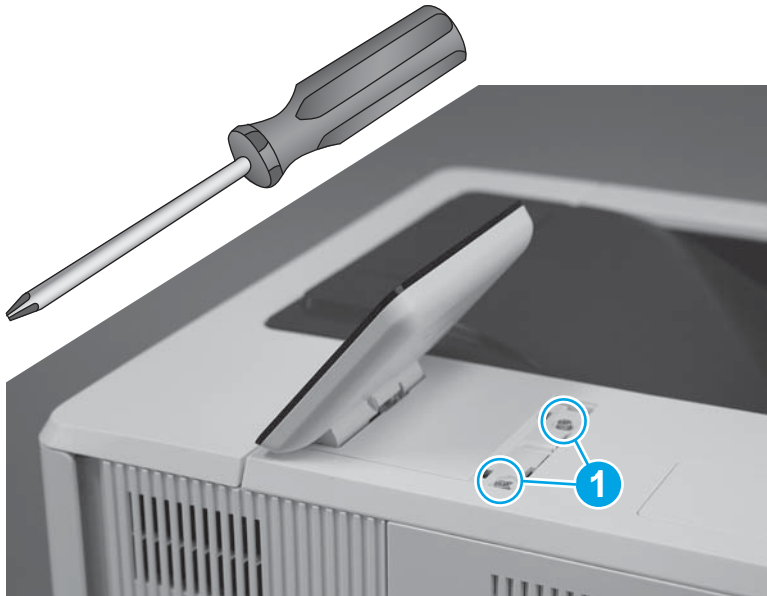
3. Rotate the control-panel base down onto the printer.

**Figure 1-686** Rotate the control-panel base down




4. Use a small Phillips screwdriver to install two screws (callout 1).

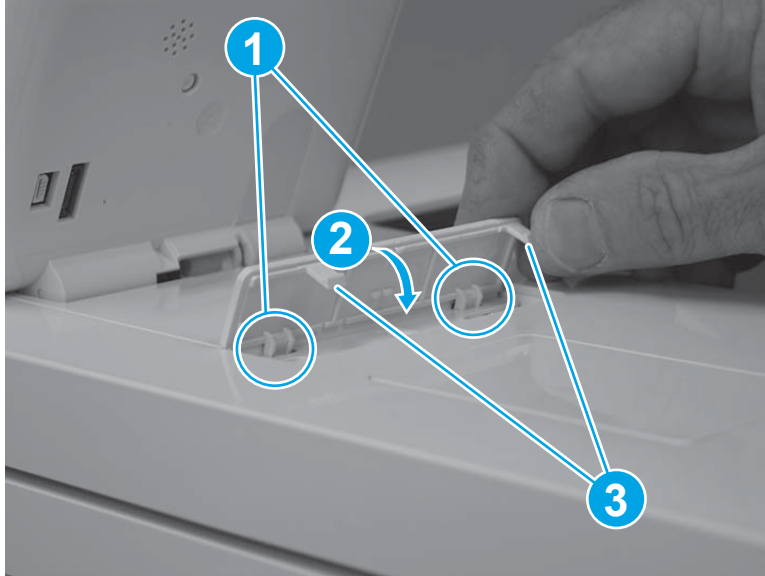
**Figure 1-687** Install two screws



5. Position the screw cover mounting feet into the slots in the top cover (callout 1), and then rotate the cover down (callout 2) to install it.

 **NOTE:** Press down on the cover firmly to make sure that the tabs (callout 3) snap into place.

**Figure 1-688** Install the cover



## Removal and replacement: Sub-scanner assembly (SSA) (M527)

---



**NOTE:** M527 printers only.

---

- [Introduction](#)
- [Step 1: Remove the white backing \(M527\)](#)
- [Step 2: Remove the control panel \(M527\)](#)
- [Step 3: Remove the formatter cover](#)
- [Step 4: Remove the fax PCA](#)
- [Step 5: Remove the stapler door or stapler blank cover \(M527\)](#)
- [Step 6: Remove the stapler stationary \(inner\) cover \(M527\)](#)
- [Step 7: Remove the top-left cover](#)
- [Step 8: Remove the top-rear cover](#)
- [Step 9: Remove the scanner control board \(SCB\)](#)
- [Step 10: Remove the sub-scanner assembly \(SSA\)](#)
- [Step 12: Unpack the replacement SSA](#)
- [Step 12: Install the SSA](#)
- [Step 13: Install the SCB](#)
- [Step 14: Install the top-rear cover](#)
- [Step 15: Install the top-left cover](#)
- [Step 16: Install the stapler stationary \(inner\) cover \(M527\)](#)
- [Step 17: Install the stapler door or stapler blank cover \(M527\)](#)
- [Step 18: Install the fax PCA](#)
- [Step 19: Install the formatter cover](#)
- [Step 20: Install the control panel \(M527\)](#)
- [Step 21: Install the white backing \(M527\)](#)

### Introduction

This document provides the procedures to remove and replace the sub-scanner assembly (SSA).

### Before performing service

#### Turn the printer power off

- Disconnect the power cable.



**WARNING!** To avoid damage to the printer, turn the printer off wait 30 seconds, and then remove the power cable before attempting to service the printer.

---

Use the table below to identify the correct part number for your printer. To order the part, go to [www.hp.com/buy/parts](http://www.hp.com/buy/parts).

Sub-scanner assembly (SSA) part number	
CF377-60104	Sub-scanner assembly (SSA) kit with instruction guide <sup>1</sup>

<sup>1</sup> This kit includes a replacement white backing and white backing retention clips.

### Required tools

- Small flat-blade screwdriver.
- #2 Phillips screwdriver with a magnetic tip.

### After performing service

#### Turn the printer power on

- Connect the power cable.
- Use the power switch to turn the power on.


### Post service test

Make sure that the printer initializes to a **Ready** state.

Print a configuration page, and then make a copy using the flatbed glass to make sure that it is properly functioning.

Print a configuration page, and then make a copy using the document feeder to make sure that it is properly functioning.

### Step 1: Remove the white backing (M527)

 **NOTE:** M527 printers only.

1. Open the document feeder.

**Figure 1-689** Open the document feeder




2. Remove the white backing.

**Figure 1-690** Remove the white backing



3. If any of the retention clips (callout 1) remain attached to the white backing (or are damaged), go to step 4.

---

 **NOTE:** If none of the retention clips remain attached to the white backing, skip the remaining substeps in this removal procedure.


---

**Figure 1-691** Check the retention clips

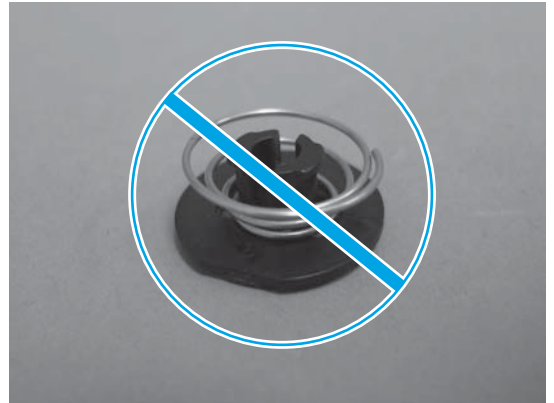




4. Verify that the spring is positioned correctly on the retention clip.

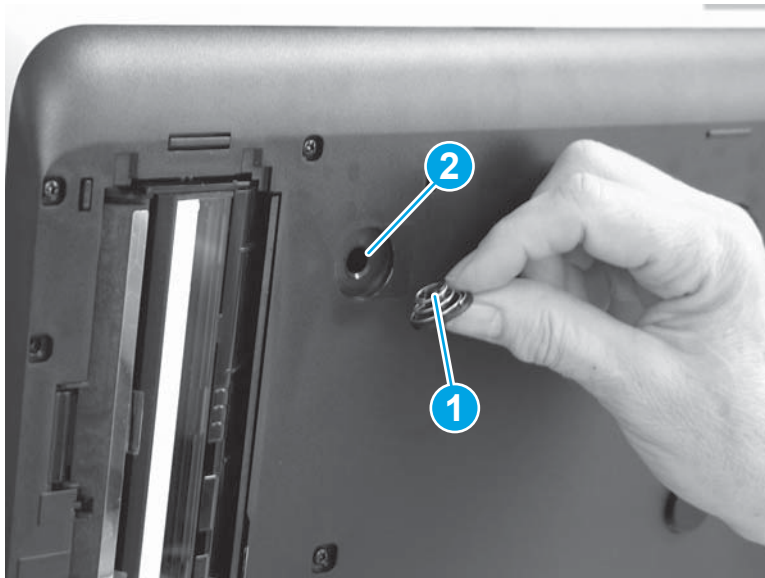
 **NOTE:** If any of the retention clips or springs are damaged, replace them with the clips supplied in the kit.

**Figure 1-692** Check the retention clip spring



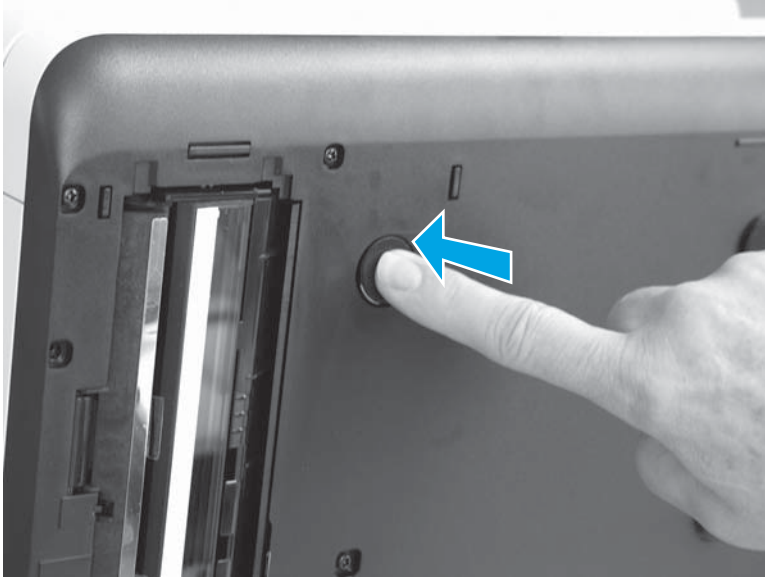
5. Install the replacement clip (callout 1) in the slot (callout 2) in the document feeder.

**Figure 1-693** Install the retention clip



6. Press the clip to make sure it is securely installed.

**Figure 1-694** Press the retention clip

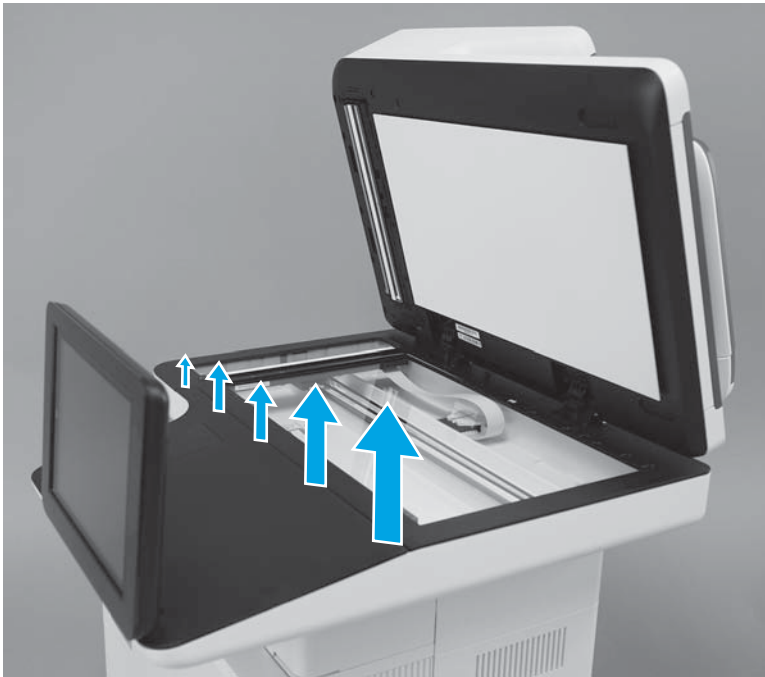


### Step 2: Remove the control panel (M527)

1. Beginning at the right side of the control-panel cover, carefully release five tabs along the top edge of the cover.

 **NOTE:** The thin black-plastic cover will separate from the white-plastic control-panel base.

**Figure 1-695** Release five tabs



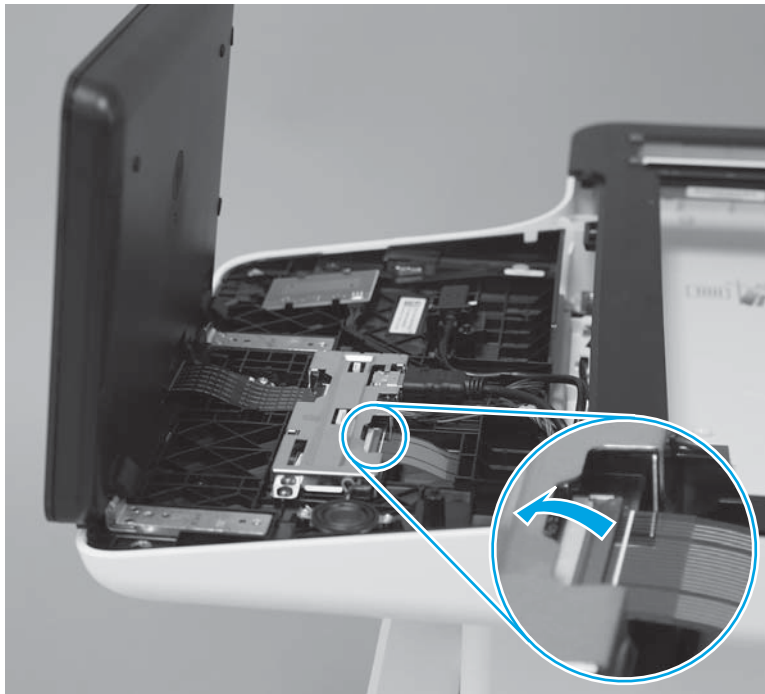
2. Continue to rotate the top edge of the cover away from the printer, and then remove the cover.

**Figure 1-696** Remove the cover



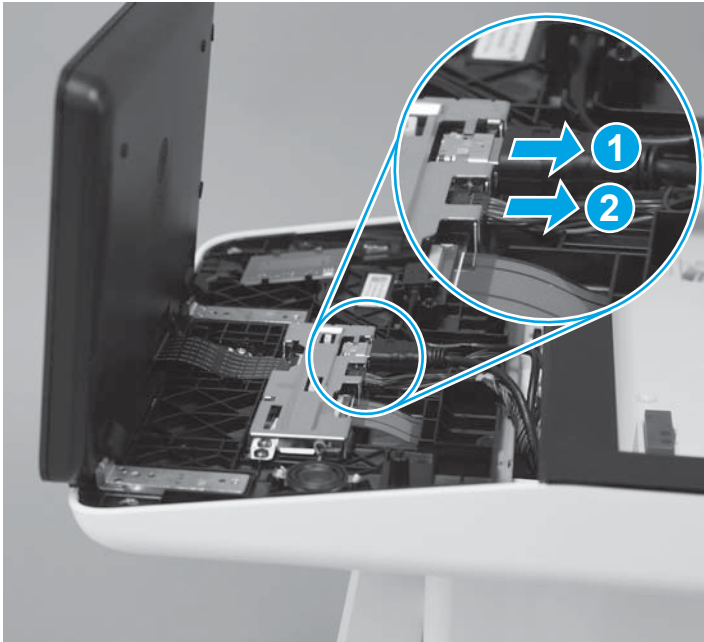
3. **M527c/z only:** Open the connector latch to release the keyboard flat cable.

**Figure 1-697** Disconnect the FFC (M527c/z)



4. Disconnect one HDMI cable (callout 1) and one connector (callout 2).

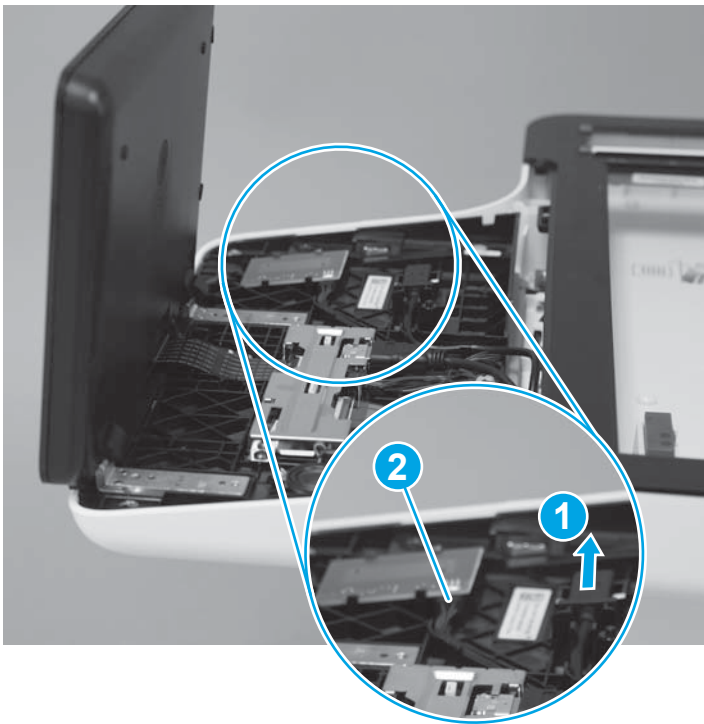
**Figure 1-698** Disconnect connectors



5. Release the USB cable (callout 1) from the holder.

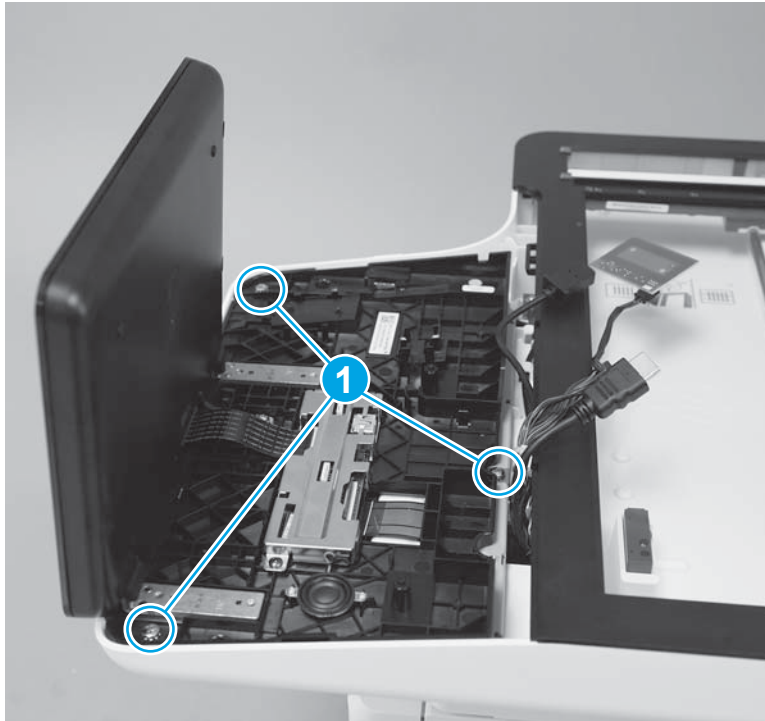
 **NOTE:** **M527z only:** Disconnect one connector (callout 2).

**Figure 1-699** Release the USB and disconnect the NFC PCA



6. Remove three screws (callout 1).

**Figure 1-700** Remove three screws



7. Lift the front of the control panel of the printer (callout 1), and then slide it toward the front of the printer (callout 2) to remove it.

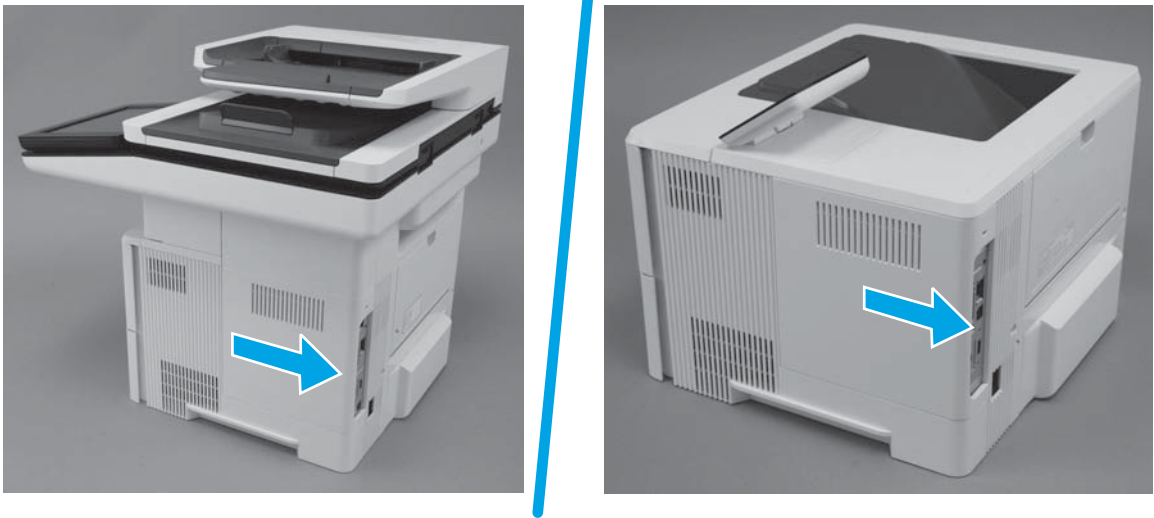
**Figure 1-701** Remove the control panel



### Step 3: Remove the formatter cover

- ▲ Slide the cover toward the rear of the printer to remove it.

**Figure 1-702** Remove the formatter cover



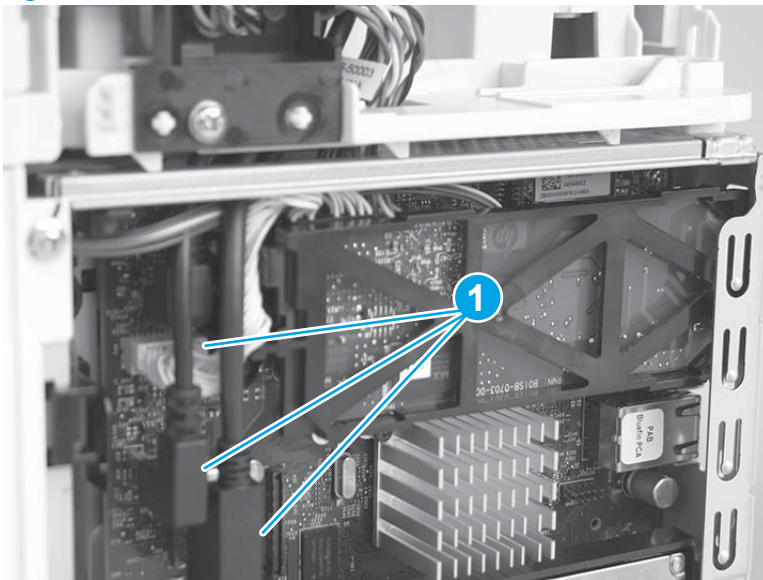
**Step 4: Remove the fax PCA**

 **CAUTION:**  ESD-sensitive part.

 **NOTE:** M527c/f/z printers only (optional for the M527dn).

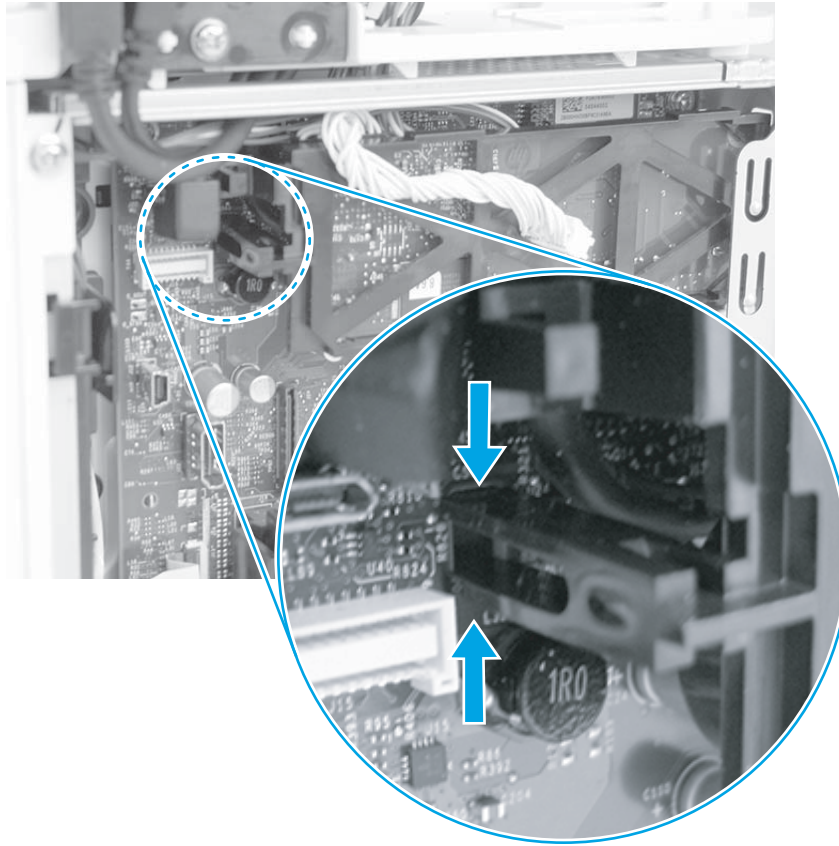
1. Disconnect three connectors (callout 1).

**Figure 1-703** Disconnect three connectors



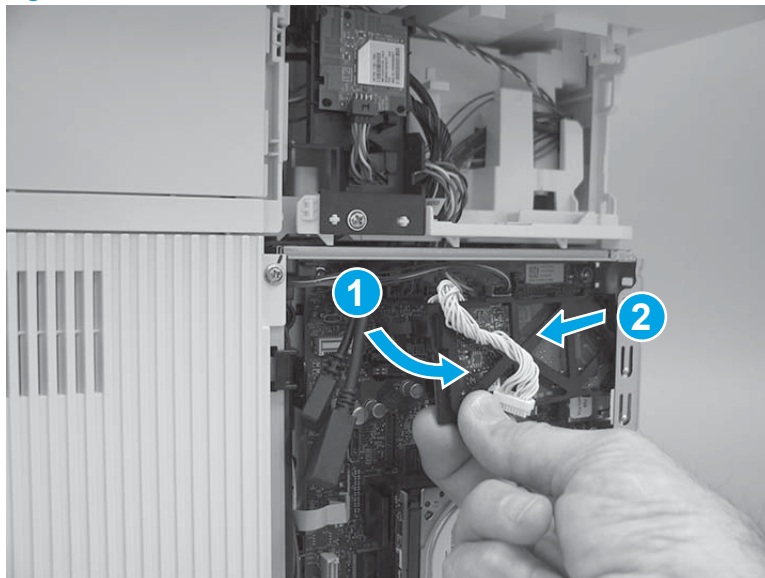
2. Pinch the retainer to release it.

**Figure 1-704** Release the fax PCA



3. Rotate the connector end of the fax PCA out and away from the formatter (callout 1), and then slide it as shown (callout 2) to remove it.

**Figure 1-705** Remove the fax PCA



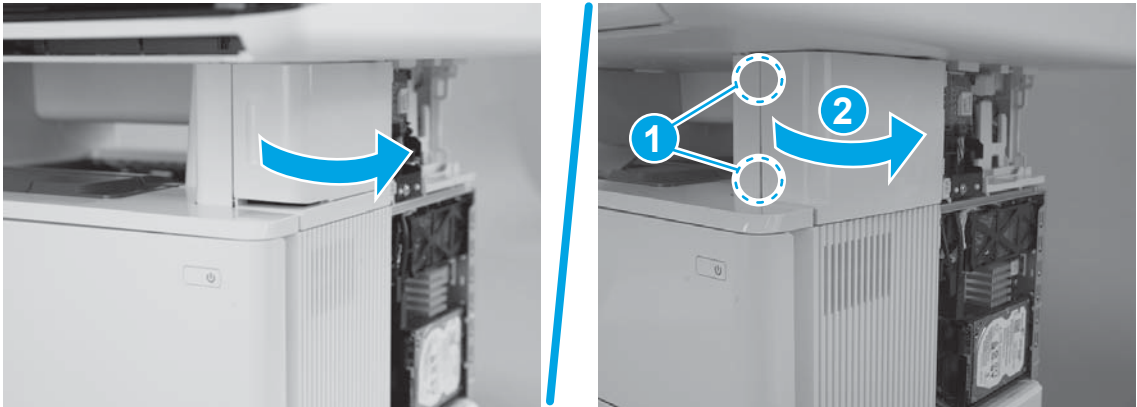
## Step 5: Remove the stapler door or stapler blank cover (M527)

The M527dn does not have a convenience stapler.

### 1. Do one of the following:

- **M527c/f/z:** Open the stapler door.
- **M527dn:** Use a small flat-blad screw driver to release two tabs (callout 1), and then rotate the cover away from the printer (callout 2).

**Figure 1-706** Open the door or release the cover



### 2. Do one of the following:

- **M527c/f/z:** Use a small flat-blad screwdriver to release the upper hinge.
- **M527dn:** Slide the cover toward the front of the printer to remove it.

**Figure 1-707** Release the upper hinge or remove the cover





3. **M527c/f/z:** Use a small flat-blad screwdriver to release the lower hinge.

**Figure 1-708** Release the lower hinge




4. **M527c/f/z:** Remove the door.

**Figure 1-709** Remove the door




#### Step 6: Remove the stapler stationary (inner) cover (M527)

---

 **NOTE:** This step is for the M527c/f/z printers. For the M527dn, skip this step and go to [Step 7: Remove the top-left cover on page 421](#).

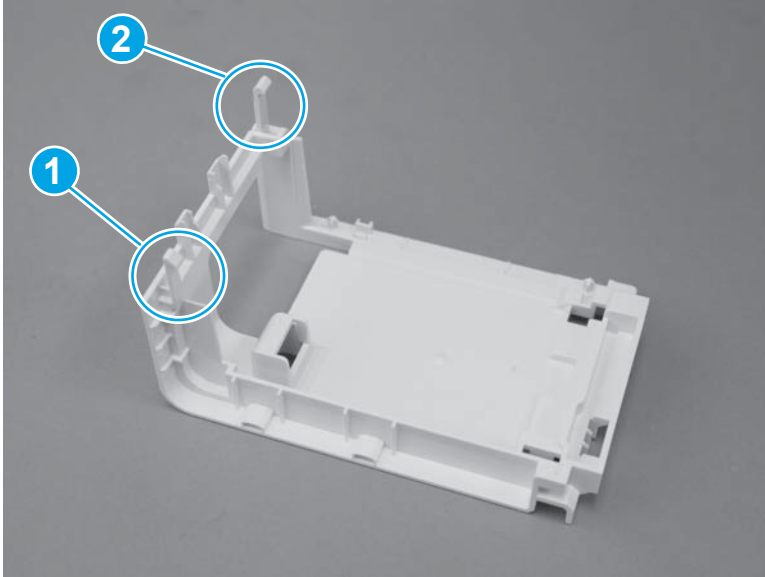
---

 **NOTE:** M527c/f/z printers only.

---

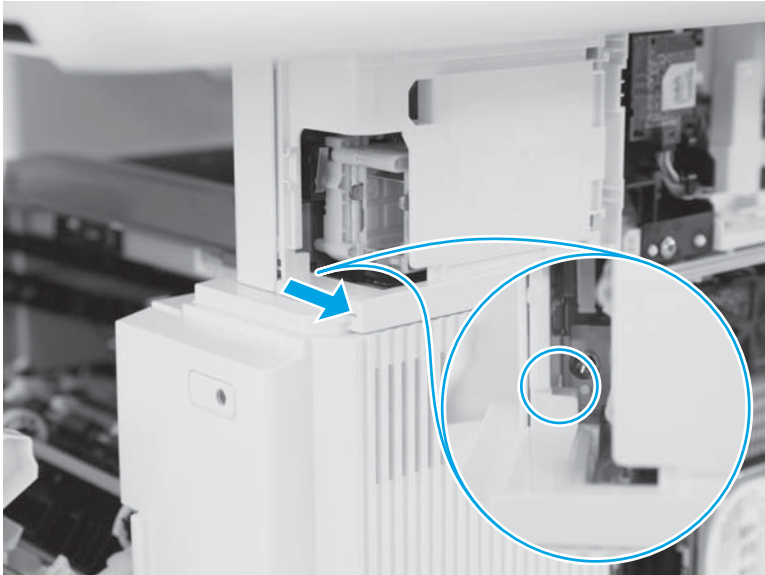
1. Before proceeding, take note of the locations of the upper tab (callout 1) and the lower tab (callout 2) on the stapler stationary (inner) cover.

**Figure 1-710** Locate the tabs



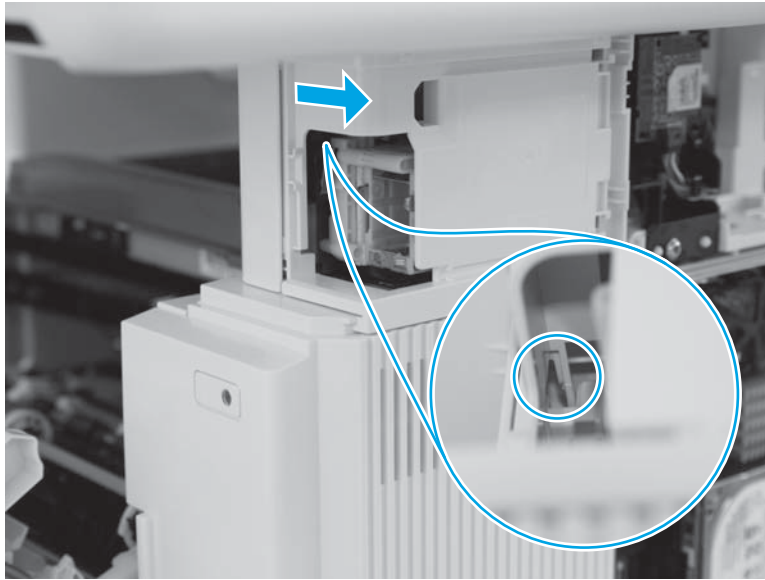
2. Use a long-shaft small flat-blad screwdriver to release the lower tab.

**Figure 1-711** Release one tab



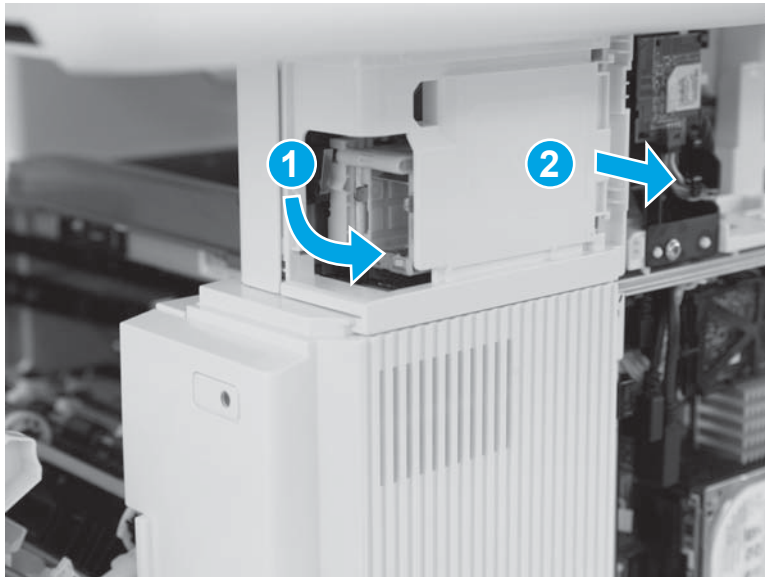
3. Use a long-shaft small flat-blad screwdriver to release the upper tab.

**Figure 1-712** Release one tab



4. With the tabs disengaged the front of the cover is released. Rotate the front of the cover away from the printer (callout 1) to release the rear of the cover (callout 2), and then remove it.

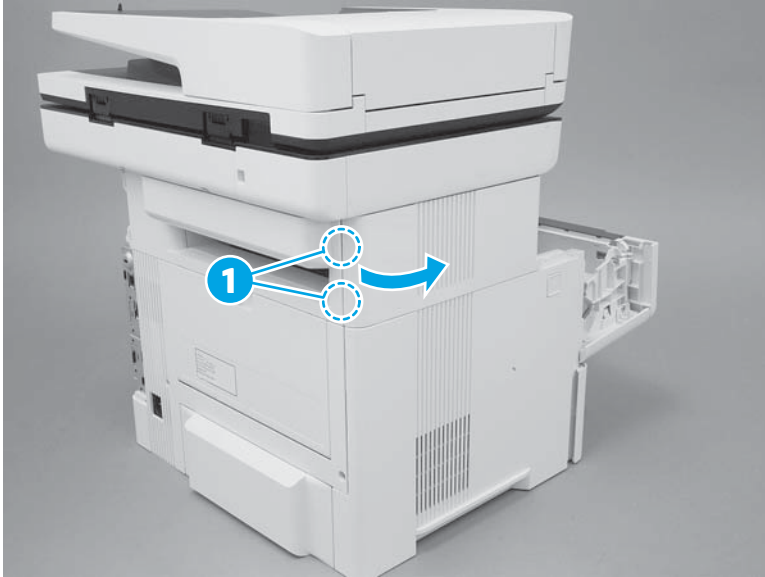
**Figure 1-713** Remove the cover



#### **Step 7: Remove the top-left cover**

1. Open the toner-cartridge door, release two tabs (callout 1), and then rotate the rear edge of the cover away from the printer.

**Figure 1-714** Release two tabs



2. Continue to rotate the cover away from the printer to release two more tabs at the middle of the cover.

**Figure 1-715** Release two tabs



3. Slide the cover toward the rear of the printer to release two bosses at the front of the cover.

**Figure 1-716** Slide the cover



4. Remove the cover.

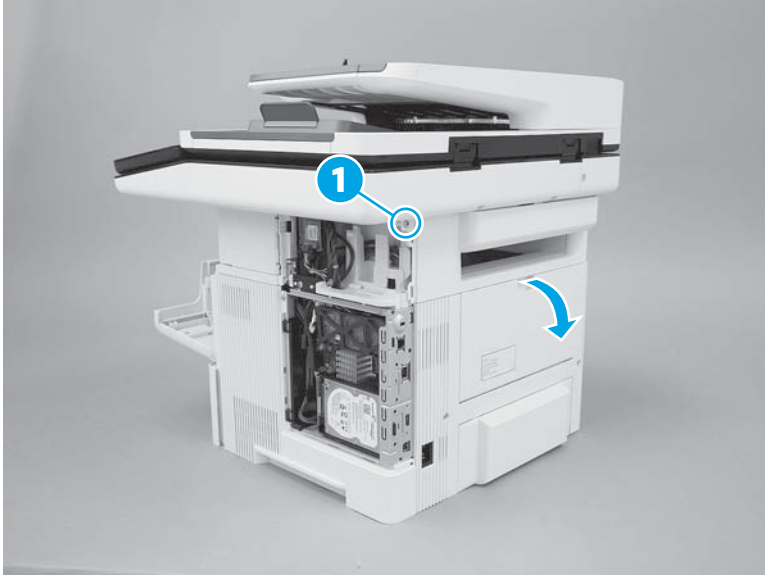
**Figure 1-717** Remove the cover



#### **Step 8: Remove the top-rear cover**

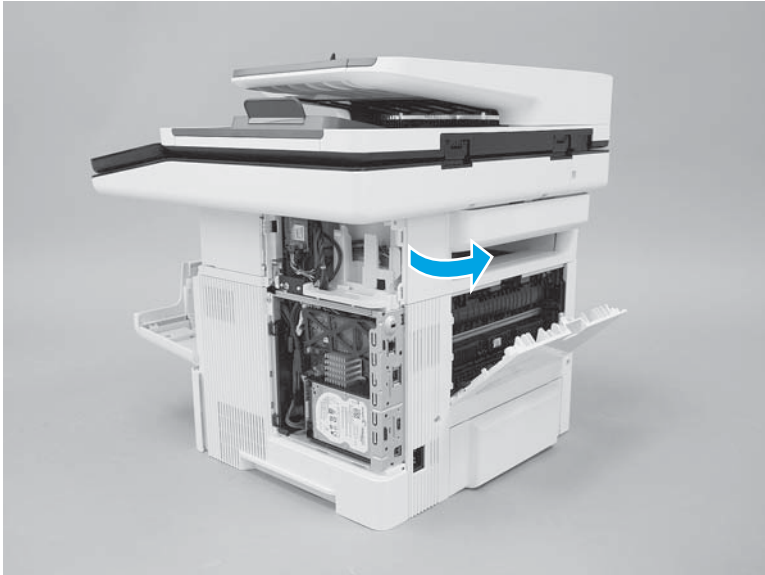
1. Remove one screw (callout 1), and then open the rear door.

**Figure 1-718** Remove one screw



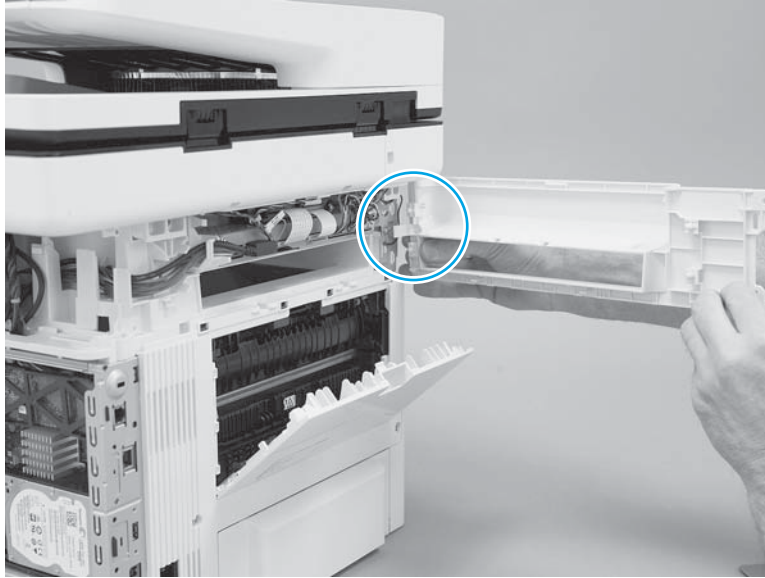
2. Rotate the exposed edge of the cover away from the printer (as shown).

**Figure 1-719** Rotate the cover



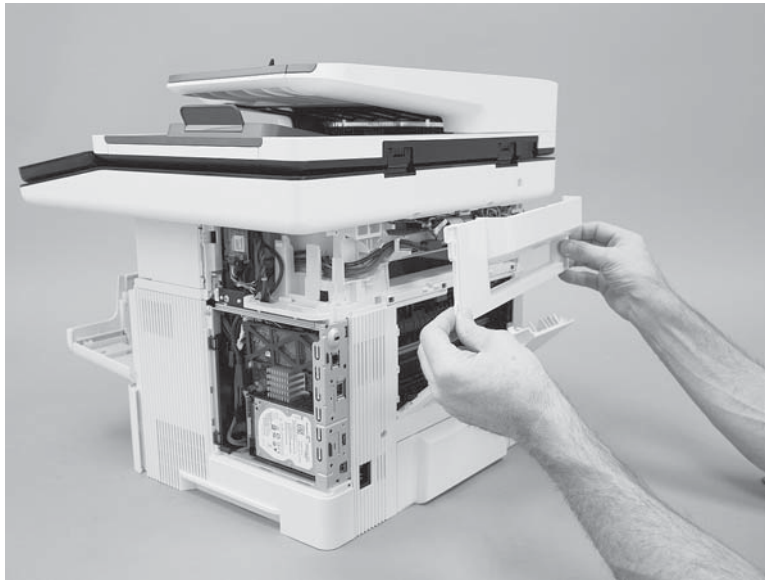
3. Continue to rotate the cover away from the printer to release one boss.

**Figure 1-720** Release one boss




4. Remove the cover.

**Figure 1-721** Remove the cover




### Step 9: Remove the scanner control board (SCB)

---

 **NOTE:** M527 printers only.

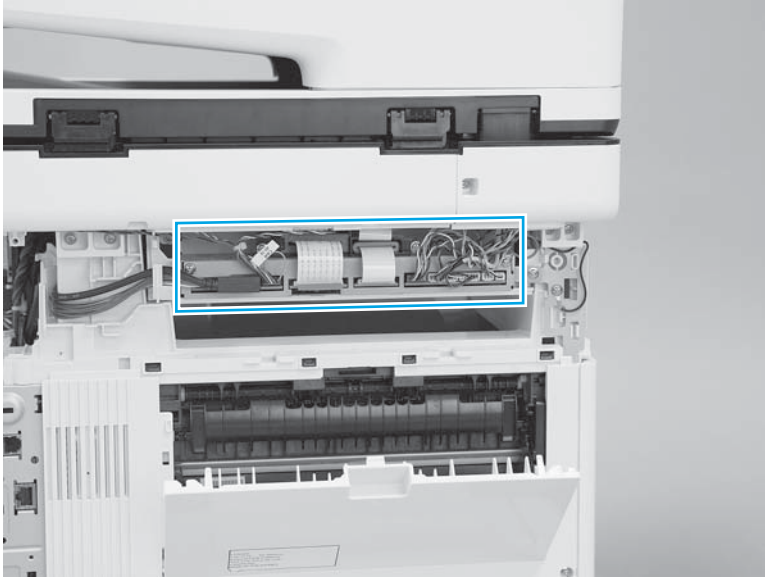
---

1. Disconnect all of the connectors from the SCB.

 **Reinstallation tip:** There are eight wire-harness connectors, two flat-flexible cables (FFCs), and one high definition multimedia interface (HDMI) cable connector.

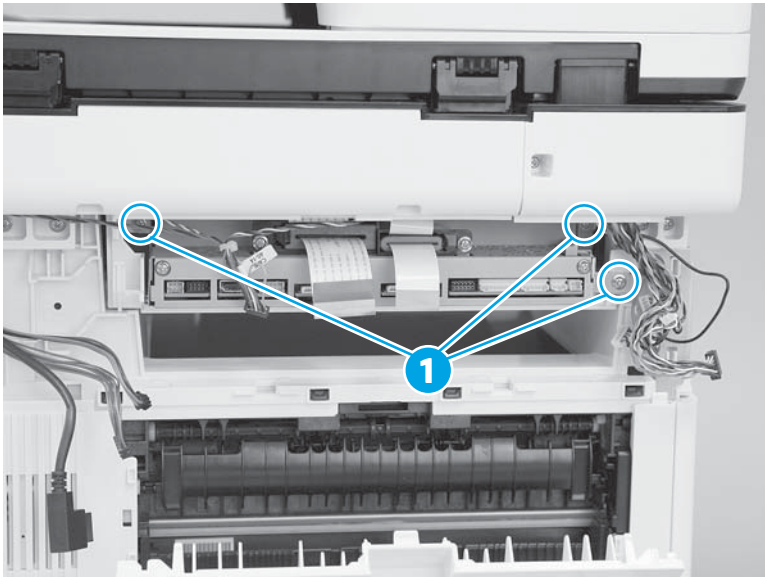
---

**Figure 1-722** Disconnect all of the connectors



2. Remove three screws (callout 1).

**Figure 1-723** Remove three screws

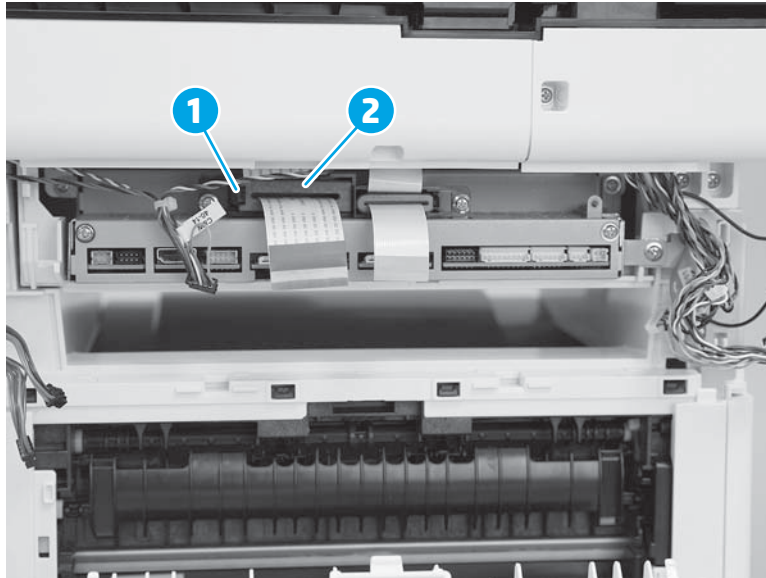




3. Release one tab (callout 1), and then remove one ferrite from the holder (callout 2).

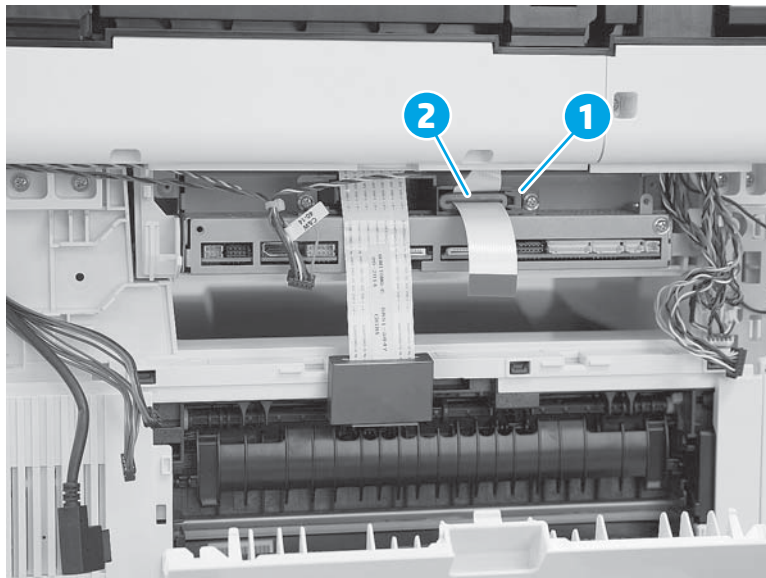
 **NOTE:** The ferrite does not need to be removed from the FFC. Simply let it slide down the FFC until it stops, and then let it hang out of the way.

**Figure 1-724** Remove one ferrite



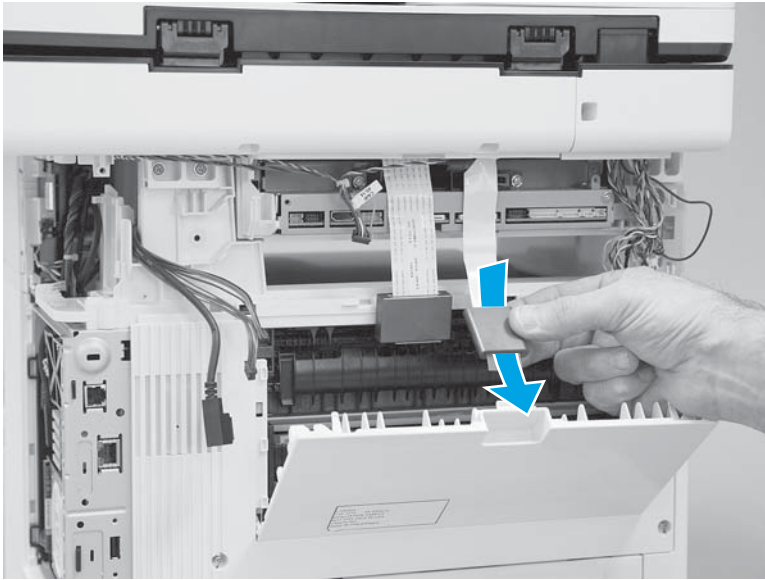
4. Release one tab (callout 1), and then remove one ferrite from the holder (callout 2).

**Figure 1-725** Remove one ferrite



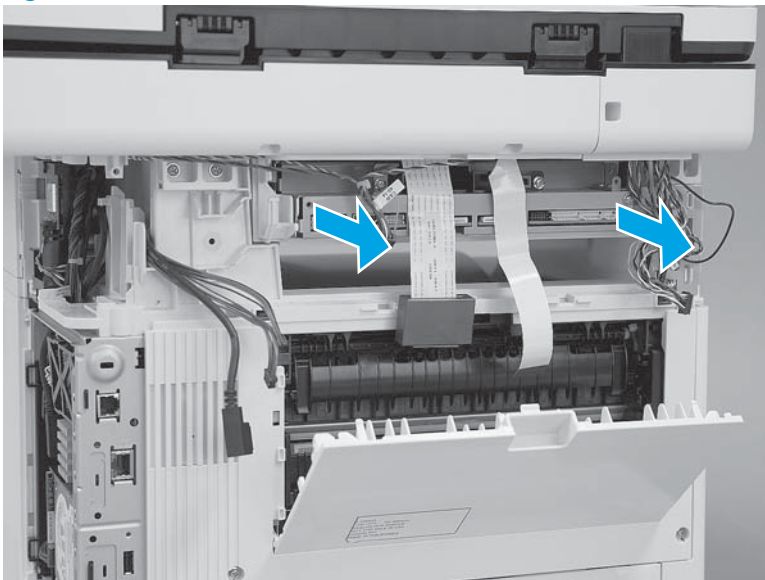
5. Slide the ferrite down the FFC to remove it.

**Figure 1-726** Remove the ferrite from the FFC



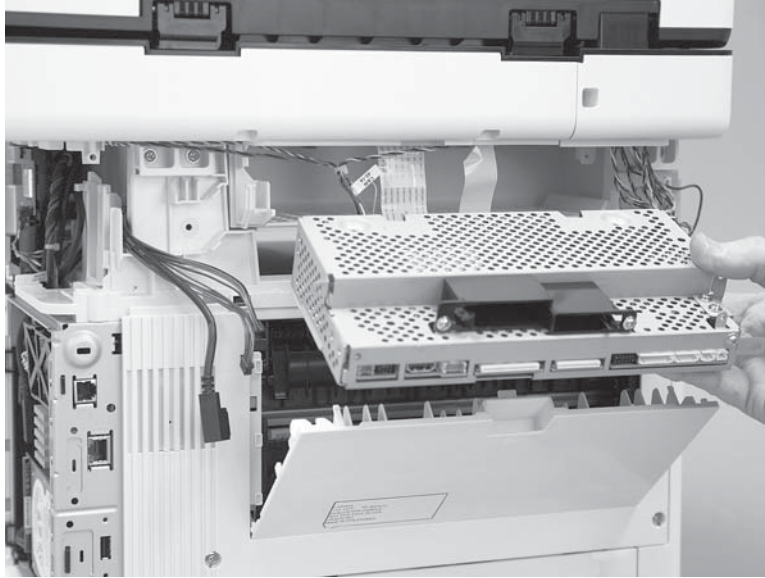
6. Slide the SCB straight out of the printer.

**Figure 1-727** Slide the SCB out




7. Remove the SCB.

**Figure 1-728** Remove the SCB



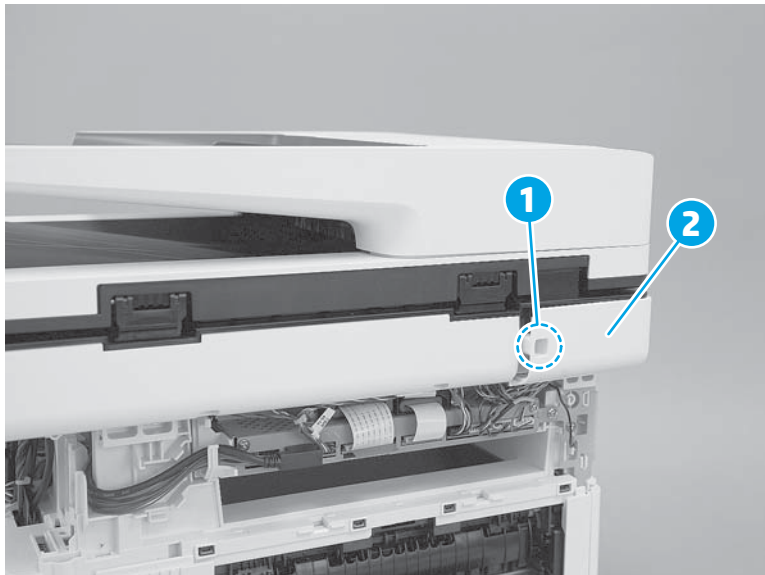
#### Step 10: Remove the sub-scanner assembly (SSA)

 **NOTE:** M527 printers only.

The SCB is shown installed in this step. However, the procedure for removing the document feeder is correct for this printer.

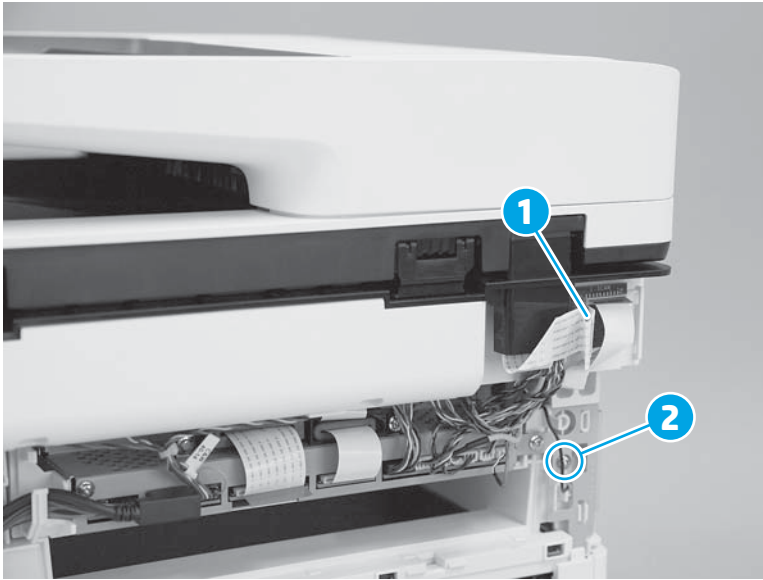
1. Remove one screw (callout 1), and then remove the cable cover (callout 2).

**Figure 1-729** Remove the cover



2. Disconnect one flat-flexib cable (FFC; callout 1), and then remove one ground screw (callout 2).

**Figure 1-730** Disconnect the FFC and the ground cable




3. Tilt the document feeder back until it stops (callout 1), and then lift it up until it stops (callout 2).

**Figure 1-731** Raise the document feeder




4. Support the document feeder, and then use a small flat-blad screwdriver to release two tabs on the document feeder hinges.

 **NOTE:** The tabs are located on the front side (scanner flatbed glass) of the hinges. Use the figure above to locate the tabs.

**Figure 1-732** Release two tabs



5. Lift the document feeder up to remove it.

 **NOTE:** While removing the document feeder, carefully pass the wire harnesses and the FFC through the opening in the scanner.

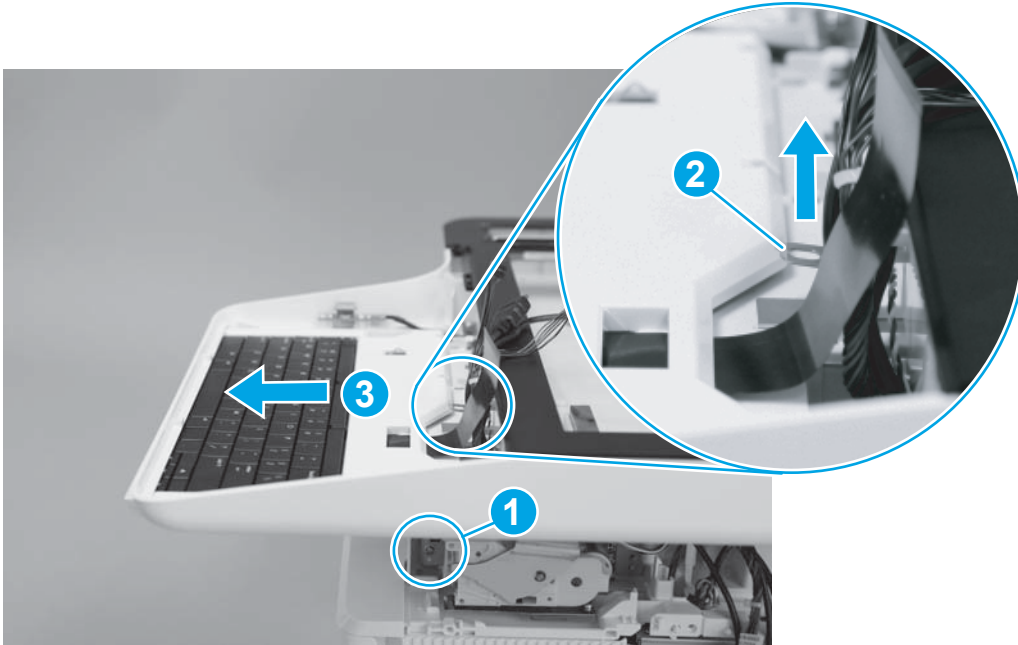
**Figure 1-733** Remove the document feeder




6. Remove one screw (callout 1), and then remove the control panel grounding clip (callout 2).

 **NOTE:** M527c/z only: Remove the keyboard (callout 3).

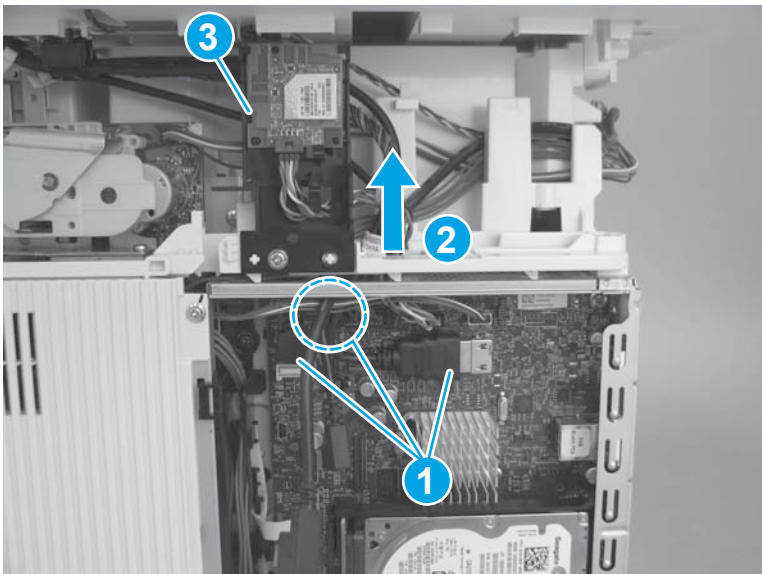
**Figure 1-734** Remove one screw



7. Disconnect three connectors (callout 1), and then pass the wire harnesses and cables through the opening in the cover (callout 2).

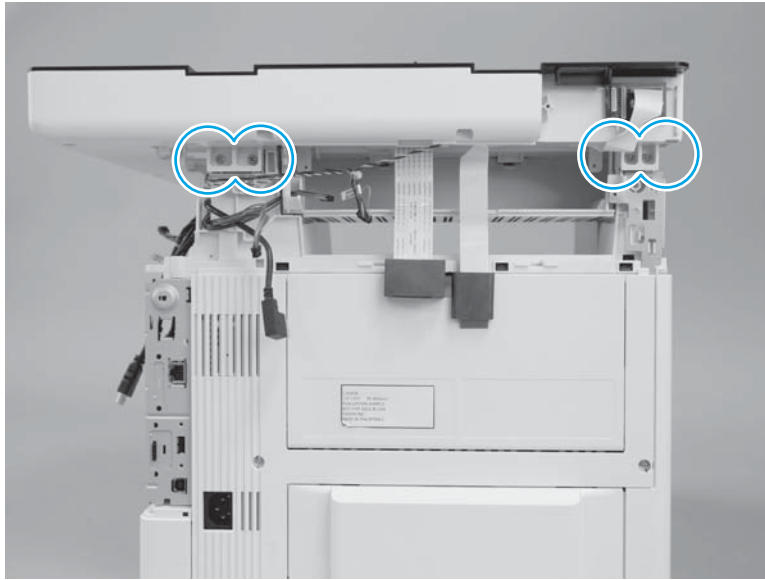
 **TIP:** It might be easier if the WiFi PCA and holder (callout 3) is detached from the printer, and then moved out of the way.

**Figure 1-735** Disconnect cables and connectors



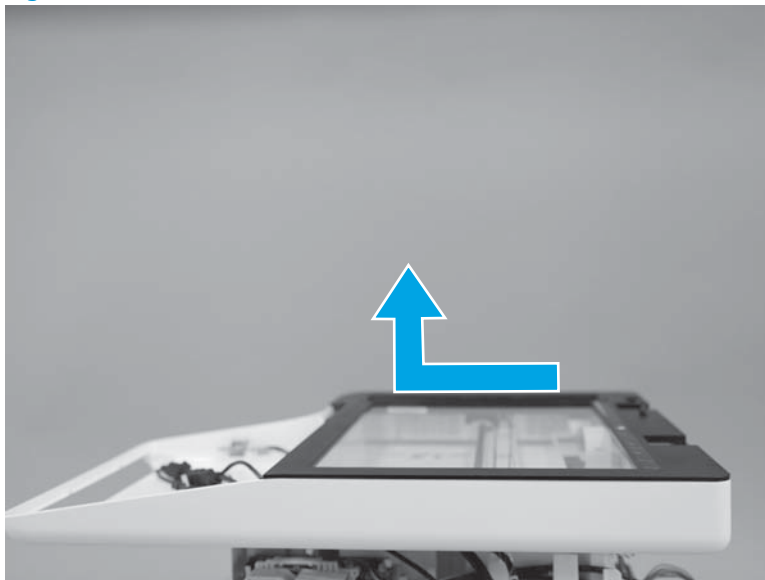
8. Remove four screws.

**Figure 1-736** Remove four screws



9. Slide the SSA toward the front of the printer to release it.

**Figure 1-737** Release the SSA



10. Remove the SSA.

**Figure 1-738** Remove the SSA



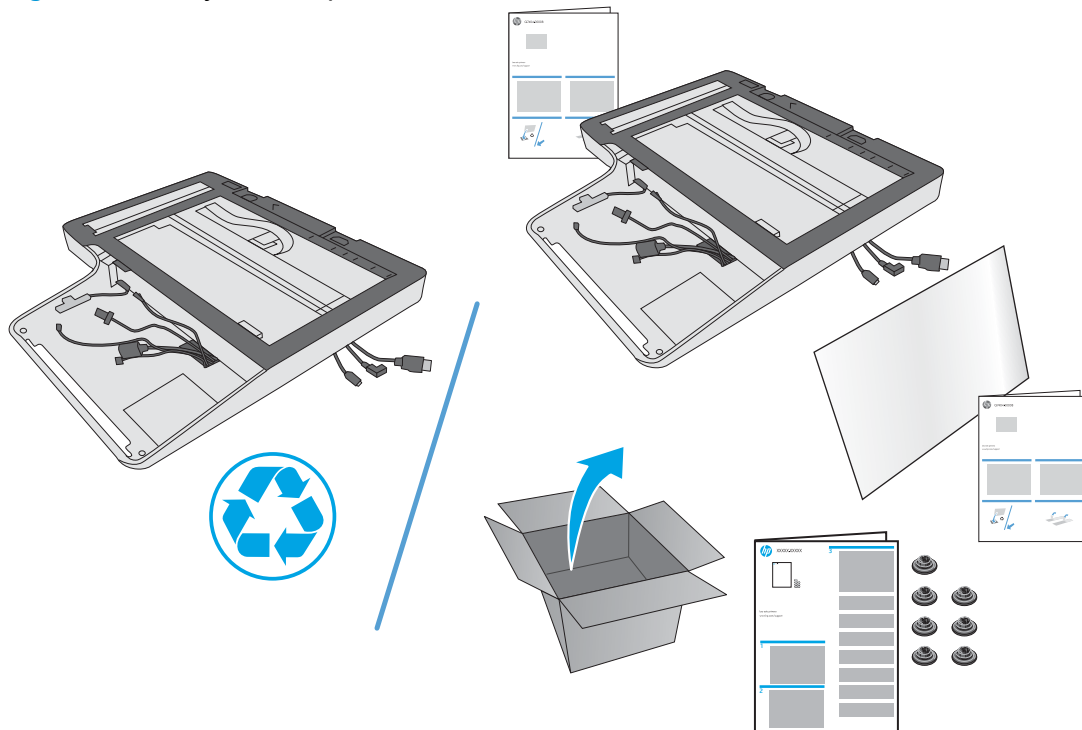
**Step 12: Unpack the replacement SSA**

Unpack the replacement part from the packaging.

<http://www8.hp.com/us/en/hp-information/environment/product-recycling.html>


 **NOTE:** HP recommends responsible disposal of the defective part.

**Figure 1-739** Recycle and unpack



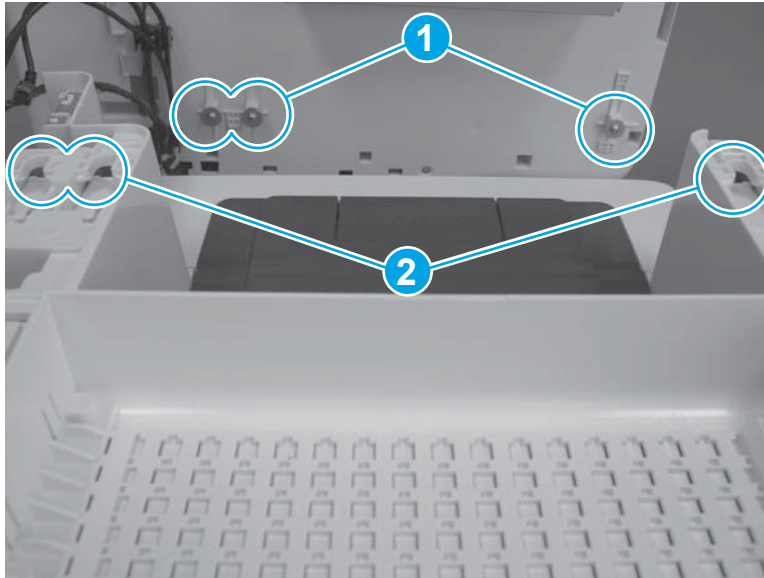


## Step 12: Install the SSA

 **NOTE:** M527 printers only.

1. Before proceeding, locate the SSA mounting pins (callout 1) on the bottom of the SSA and the slots (callout 2) on the printer base.

**Figure 1-740** Locate the SSA mounting pins and slots



2. Position the ISA on the printer base with the pins in the slots.

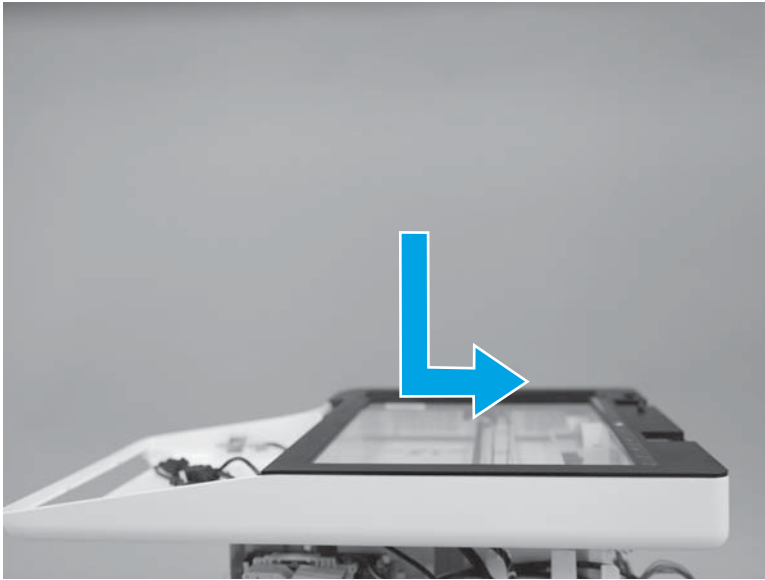
 **NOTE:** To locate the pins and slots, see [Figure 1-740 Locate the SSA mounting pins and slots on page 435](#).

**Figure 1-741** Install the SSA



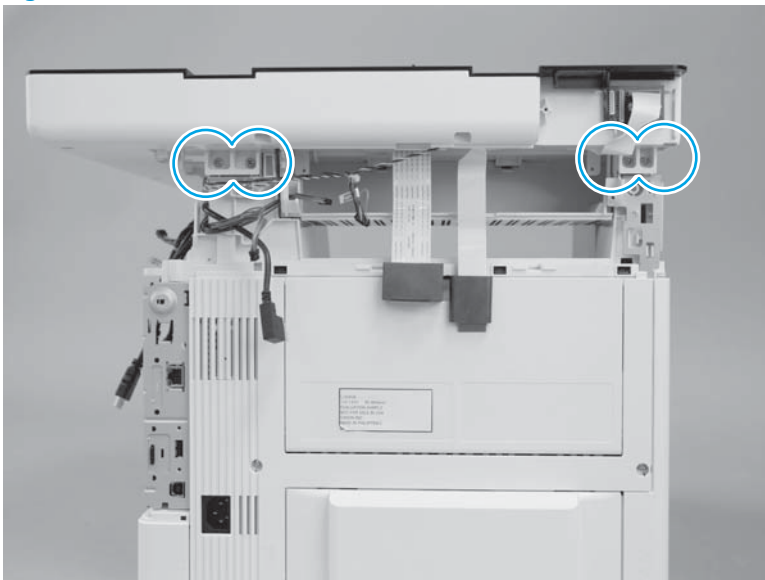
3. Slide the SSA toward the rear of the printer to engage it with the printer base.

**Figure 1-742** Engage the SSA




4. Install four screws.

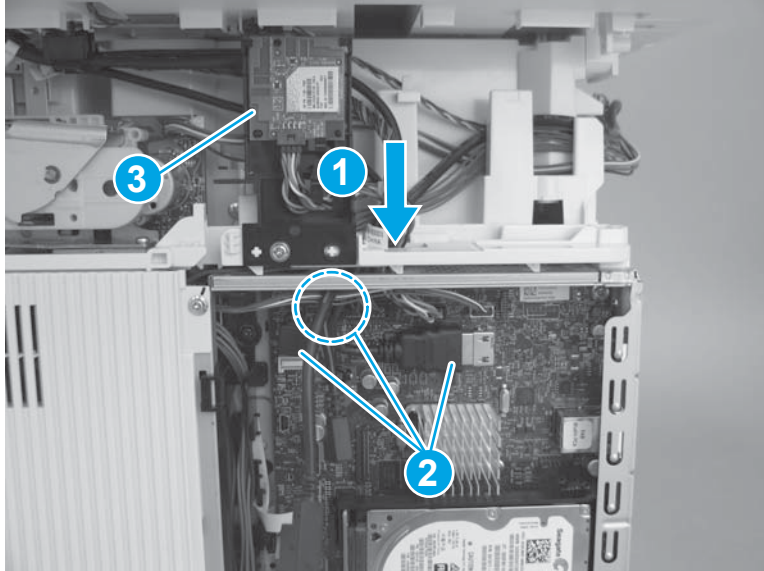
**Figure 1-743** Install four screws



5. Install the wire harnesses and cables in the retainers (callout 1), pass them through the opening in the cover (callout 2), and then connect three connectors (callout 3).

 **TIP:** If the WiFi PCA and holder (callout 3) was detached from the printer and then moved out of the way, reinstall it now.

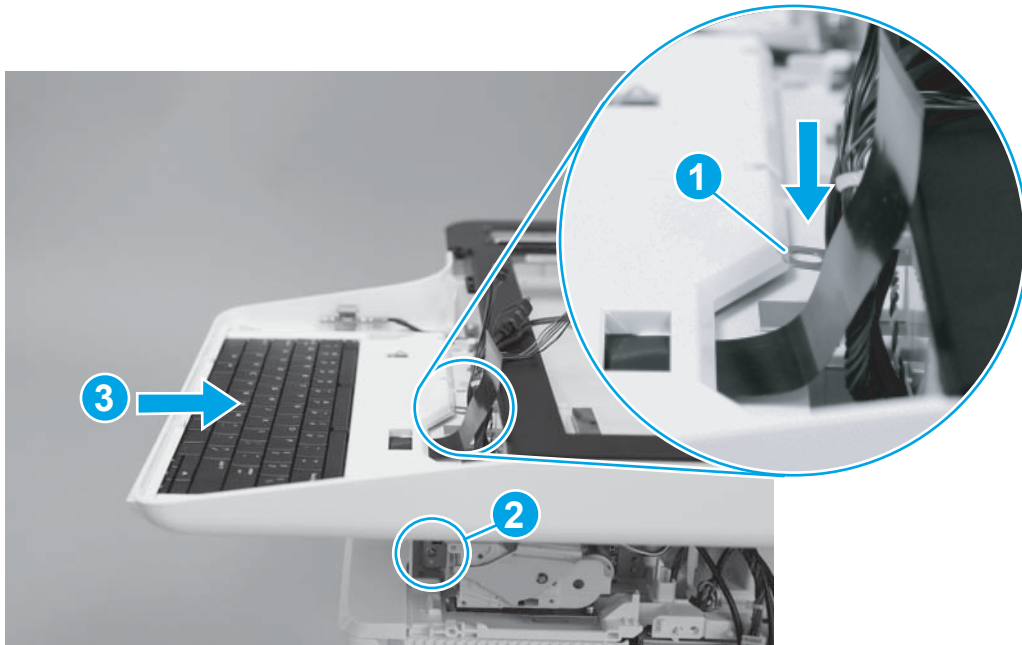
**Figure 1-744** Connect cables and connectors



6. Install the control panel ground clip (callout 1), and then install one screw (callout 2).

 **NOTE:** M527c/z only: Install the keyboard (callout 3).

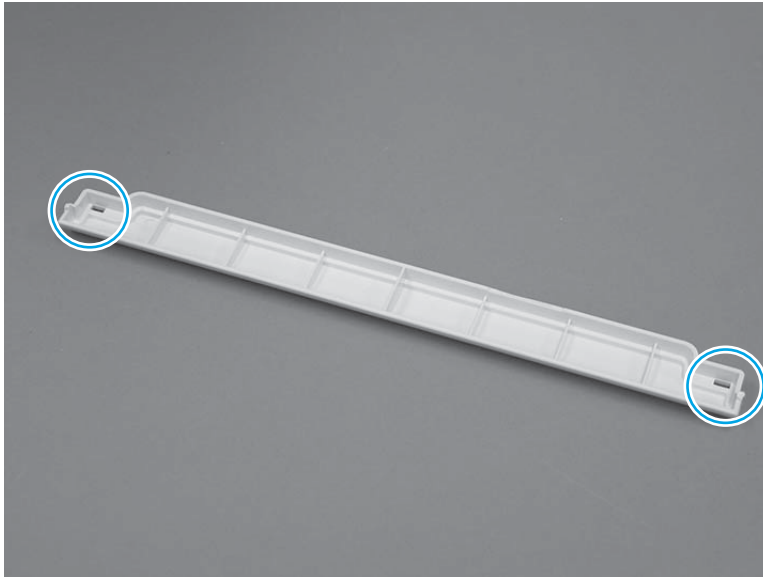
**Figure 1-745** Install one screw



7. **M527dn and M527f only:** Do the following:

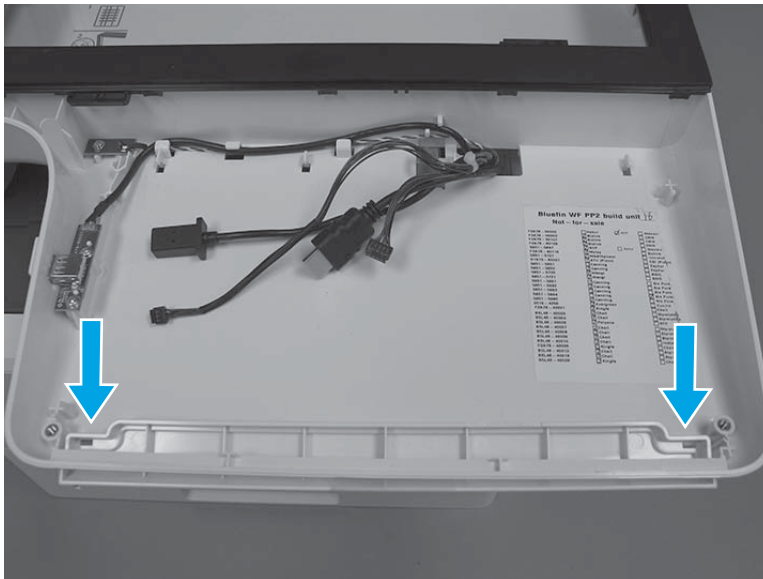
- a. Before proceeding, take note of mounting slots and tabs on the keyboard cover (supplied in the kit).

**Figure 1-746** Keyboard cover mounting slots and tabs (M527dn and M527f)



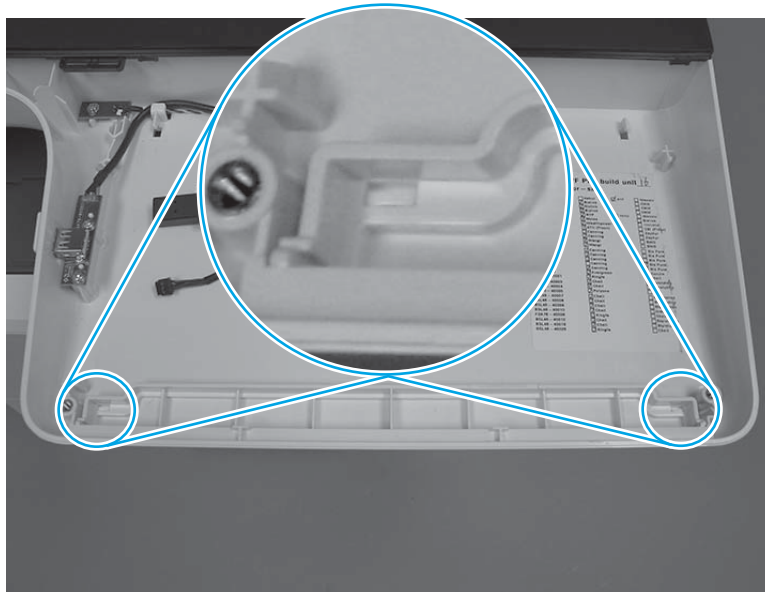
- b. Position the keyboard cover in the opening on the replacement SSA, and then rotate it until it snaps into place.

**Figure 1-747** Install the keyboard cover (M527dn and M527f)



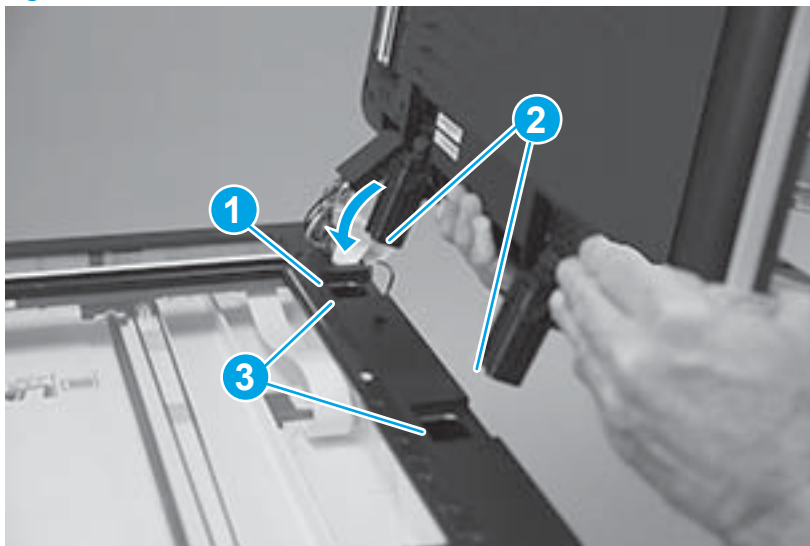
- c. Make sure that the cover is properly installed—the tabs snap into place and the slots snap over the bosses.

**Figure 1-748** Check the keyboard cover (M527dn and M527f)



- 8. Pass the document feeder cable and wire harness through the hole in the scanner chassis (callout 1), and then align the hinges (callout 2) with the slots (callout 3) in the chassis.

**Figure 1-749** Install the document feeder



- Continue to pass the flat cable and wire through the opening in the chassis (callout 1), and then insert the hinges (callout 2) into the slots.

**⚠ CAUTION:** Do not damage the flat cable or wire harnesses when the cable guide (callout 1) is installed in its slot.

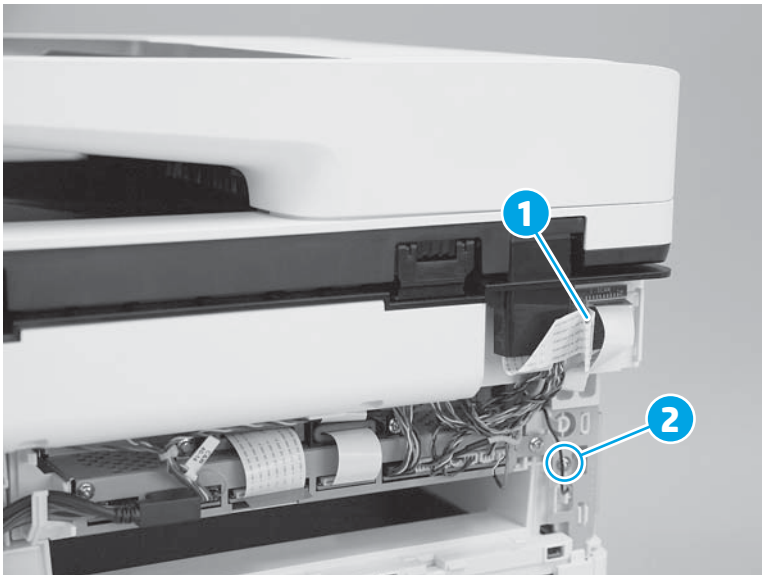
**Figure 1-750** Lower the document feeder



- Connect one FFC (callout 1), and then install one ground screw (callout 2).

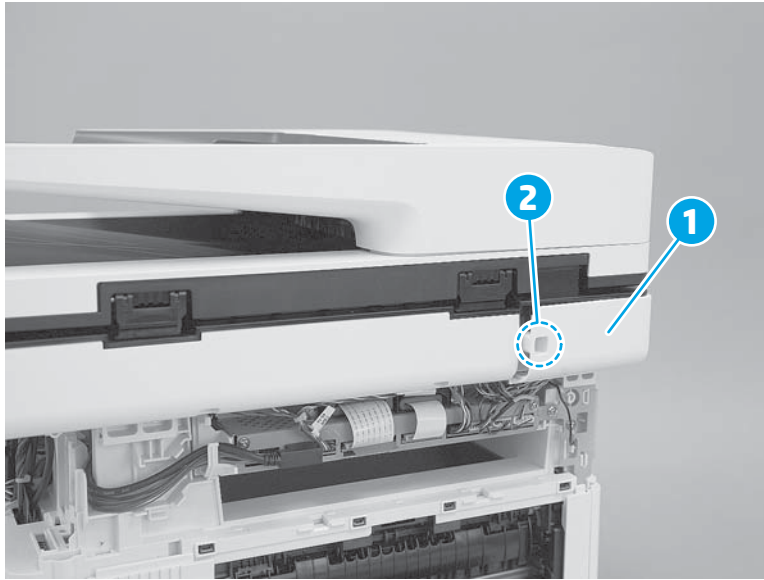
**💡 TIP:** Close the document feeder as shown to make it easier to connect the FFC and install the ground screw.

**Figure 1-751** Connect the FFC and the ground cable




11. Install the cable cover (callout 1), and then install 1 screw (callout 2)

**Figure 1-752** Install the cover and screw



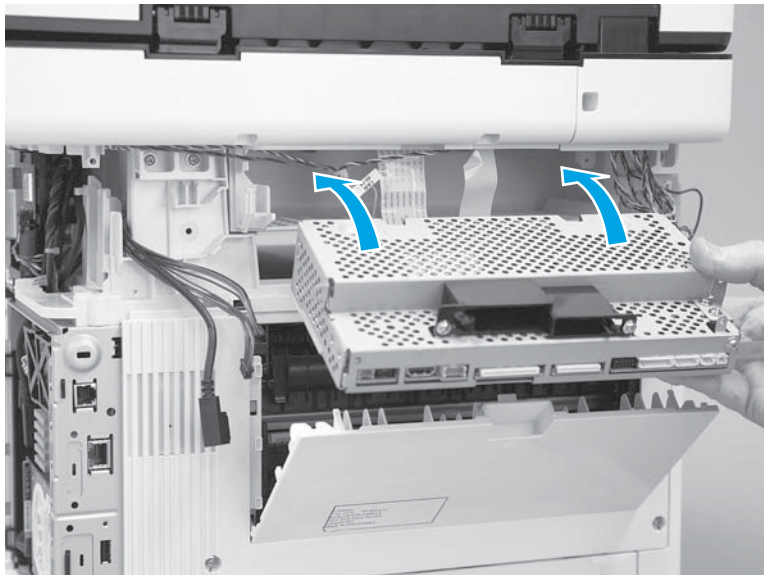
### Step 13: Install the SCB

 **NOTE:** M527 printers only.

1. Position the SCB in the printer.

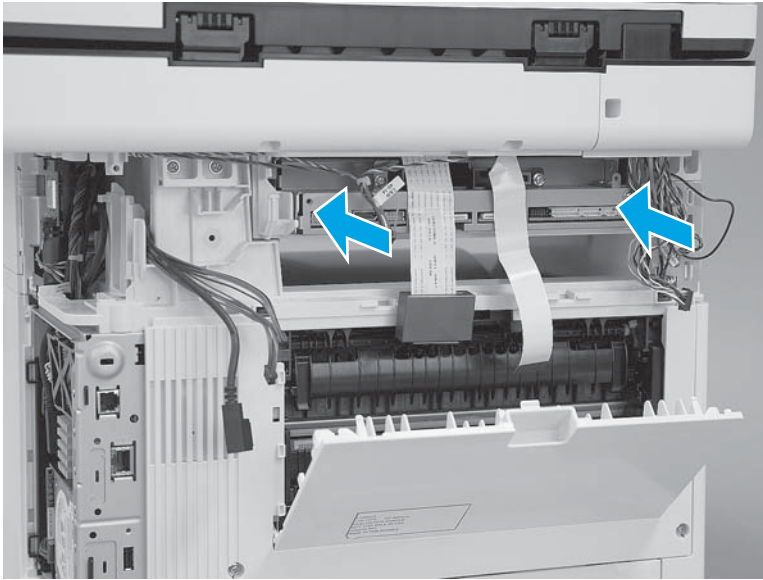
 **CAUTION:** To prevent damaging the FFCs, carefully hold them out of the way while installing the SCB.

**Figure 1-753** Install the SCB



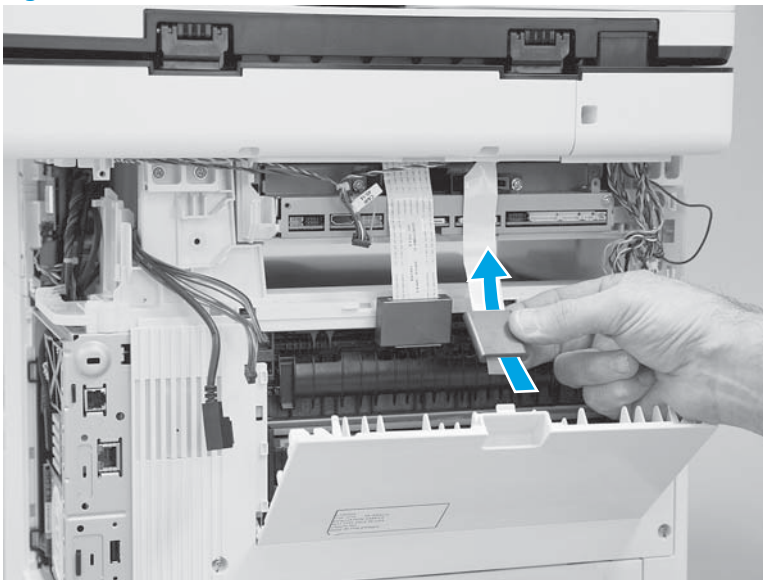
2. Slide the SCB straight into the printer until it stops.

**Figure 1-754** Slide the SCB in



3. Slide the ferrite up the FFC to install it.

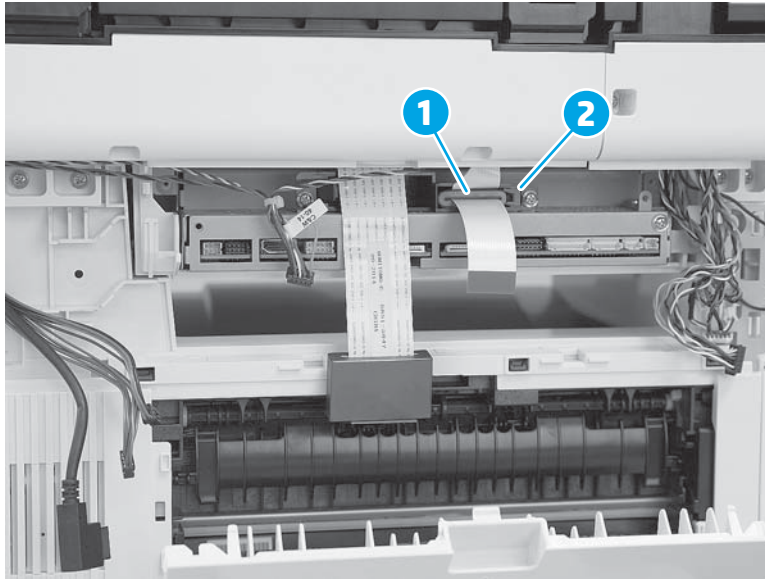
**Figure 1-755** Install the ferrite on the FFC





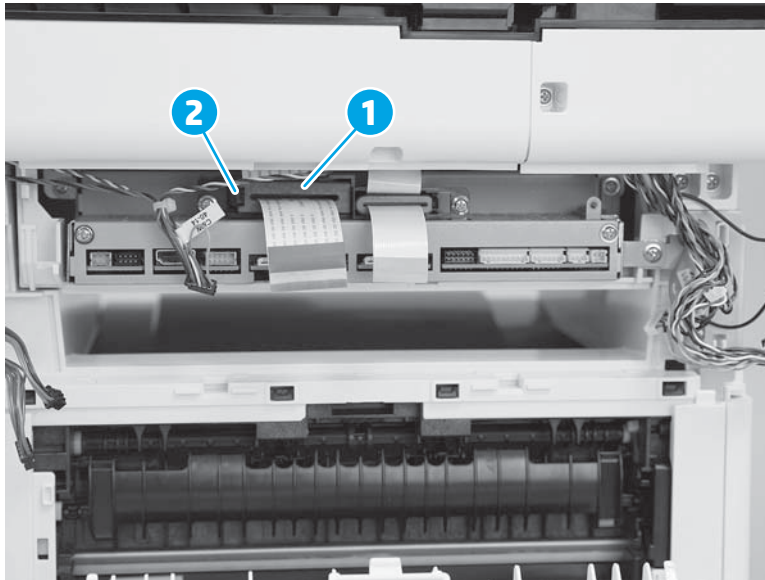
4. Install the ferrite in the holder (callout 1). Make sure that the tab (callout 2) snaps over the ferrite.

**Figure 1-756** Install the ferrite in the holder



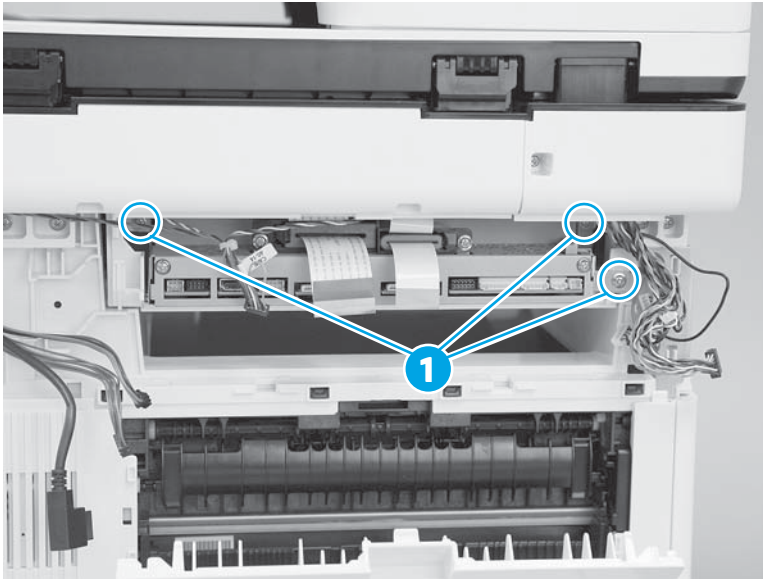
5. Install the ferrite in the holder (callout 1). Make sure that the tab (callout 2) snaps over the ferrite.

**Figure 1-757** Install the ferrite in the holder




6. Install three screws (callout 1).

**Figure 1-758** Install three screws



7. Connect all of the connectors to the SCB.

 **Reinstallation tip:** There are eight wire-harness connectors, two flat-flexible cables (FFCs), and one high definition multimedia interface (HDMI) cable connector.

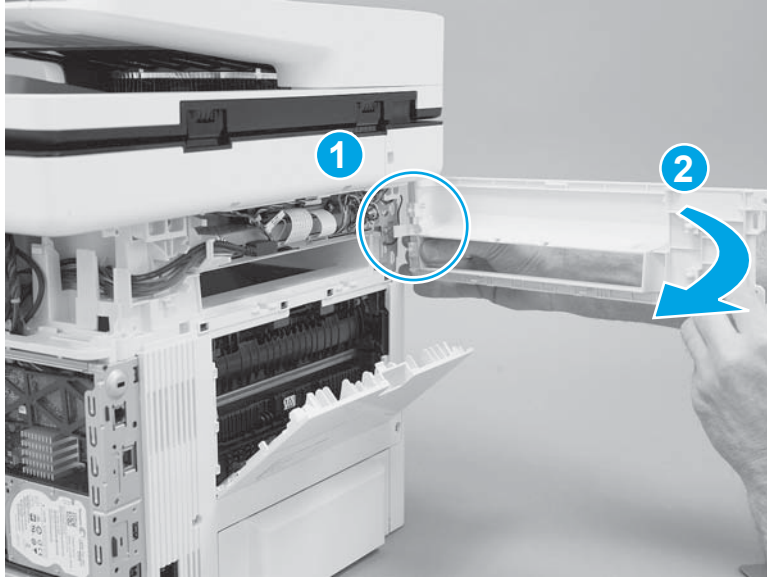
**Figure 1-759** Connect all of the connectors



#### Step 14: Install the top-rear cover

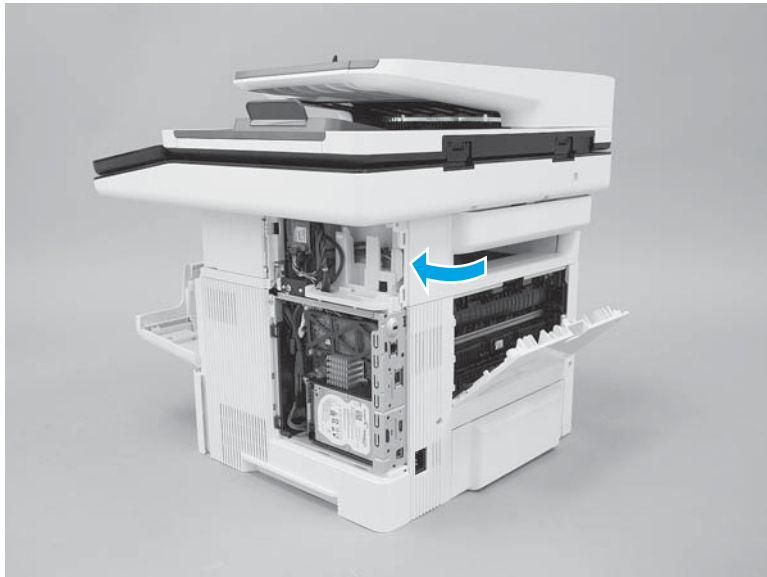
1. Engage one boss (callout 1), and then rotate the cover towards the printer (callout 2).

**Figure 1-760** Engage one boss



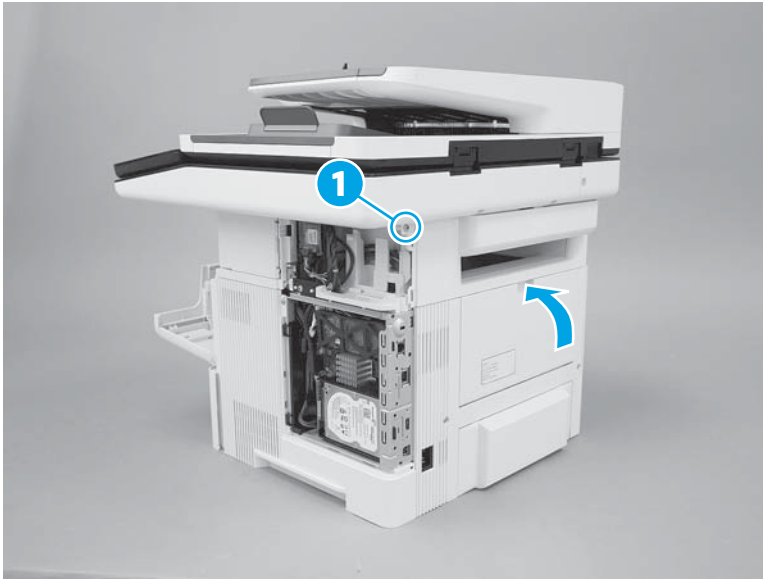
2. Continue to rotate the cover toward the printer to install it.

**Figure 1-761** Install the cover



3. Install one screw (callout 1), and then close the rear door.

**Figure 1-762** Install one screw



#### **Step 15: Install the top-left cover**

1. Position the front edge of the cover on the printer, and then slide the cover toward the front of the printer to engage two bosses at the front of the cover.

**Figure 1-763** Slide the cover




2. Rotate the cover towards the printer to engage two tabs at the middle of the cover.

**Figure 1-764** Engage two tabs



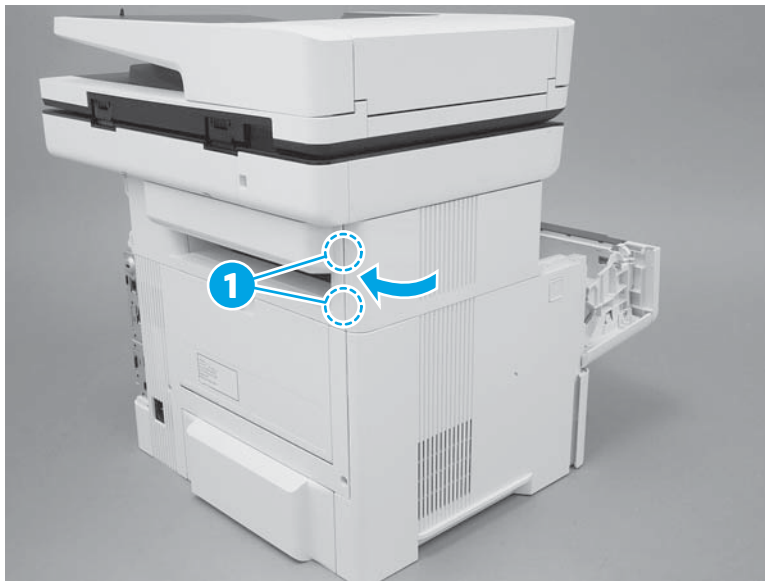
3. Continue to rotate the cover onto the printer to engage two tabs (callout 1) at the rear edge of the cover.

---

 **NOTE:** Close the toner-cartridge door.

---

**Figure 1-765** Engage two tabs




### Step 16: Install the stapler stationary (inner) cover (M527)

---

 **NOTE:** This step is for the M527c/f/z printers. For the M527dn, skip this step and go to [Step 17: Install the stapler door or stapler blank cover \(M527\) on page 449](#).

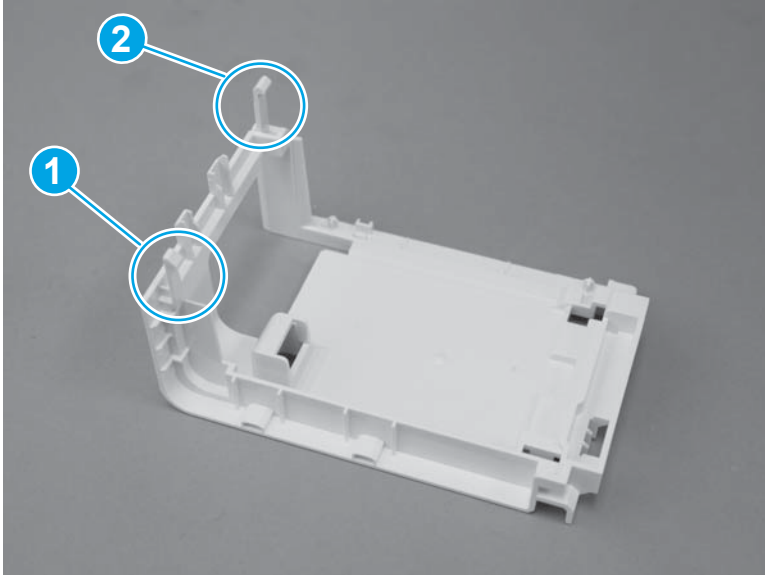
---

 **NOTE:** M527c/f/z printers only.

---

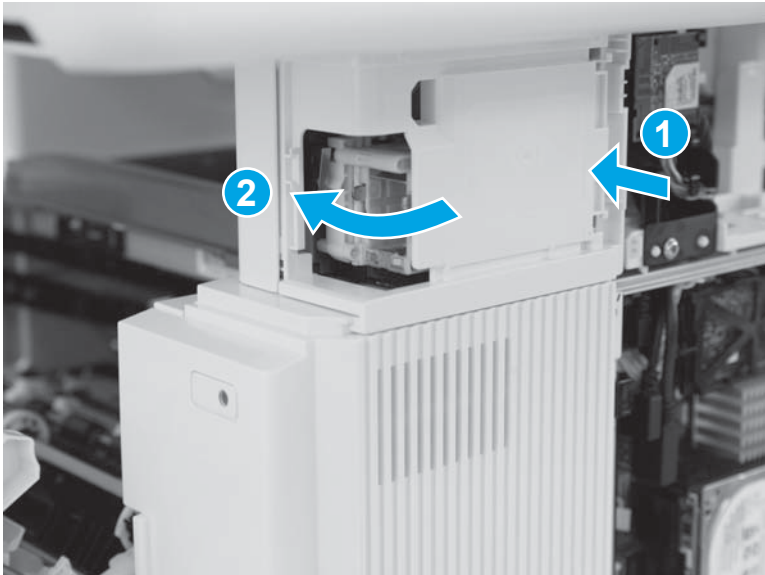
1. Before proceeding, take note of the locations of the upper tab (callout 1) and the lower tab (callout 2) on the stapler stationary (inner) cover.

**Figure 1-766** Locate the tabs



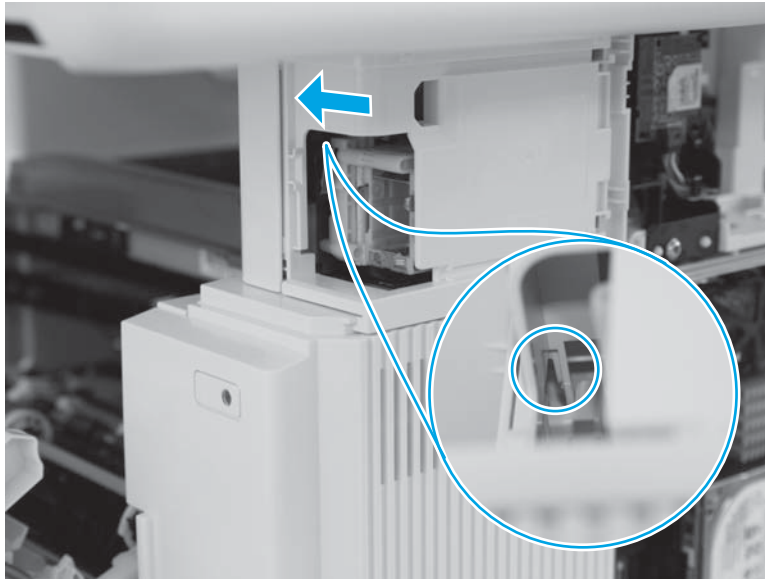
2. Engage the rear edge of the cover with the printer (callout 1), and then rotate the front edge of the cover onto the printer (callout 2) to engage the two tabs.

**Figure 1-767** Install the cover



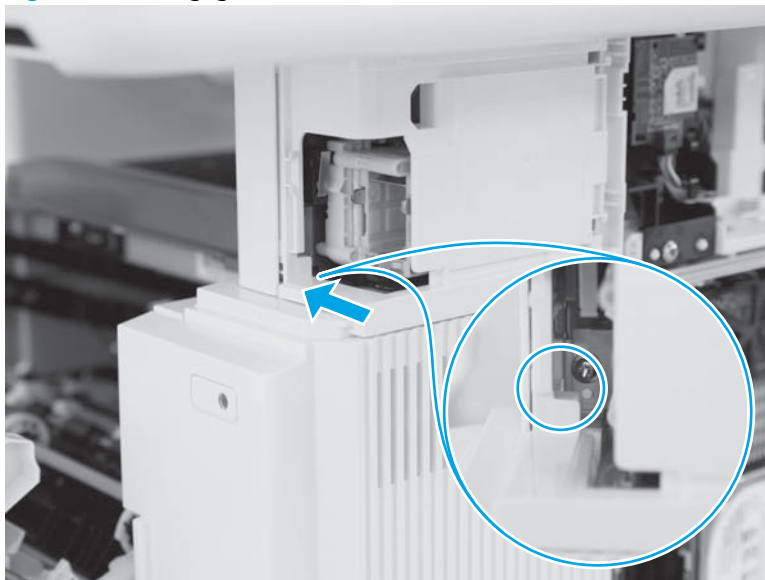
3. Verify that the upper tab is engaged.

**Figure 1-768** Engage one tab




4. Verify that the lower tab is engaged.

**Figure 1-769** Engage one tab



### Step 17: Install the stapler door or stapler blank cover (M527)

 **NOTE:** The M527dn does not have a convenience stapler.

1. Do one of the following:
  - **M527c/f/z:** Position the door near the printer.
  - **M527dn:** Position the cover on the printer.

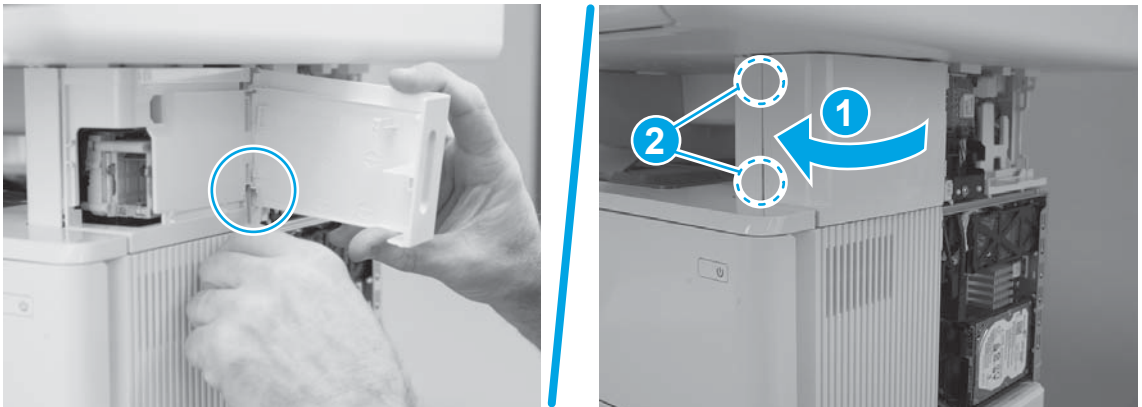
**Figure 1-770** Install the door or cover



2.

- **M527c/f/z:** Engage the lower hinge.
- **M527dn:** Rotate the cover towards the printer (callout 1), and then make sure that the two tabs (callout 2) snap into place to install the cover.

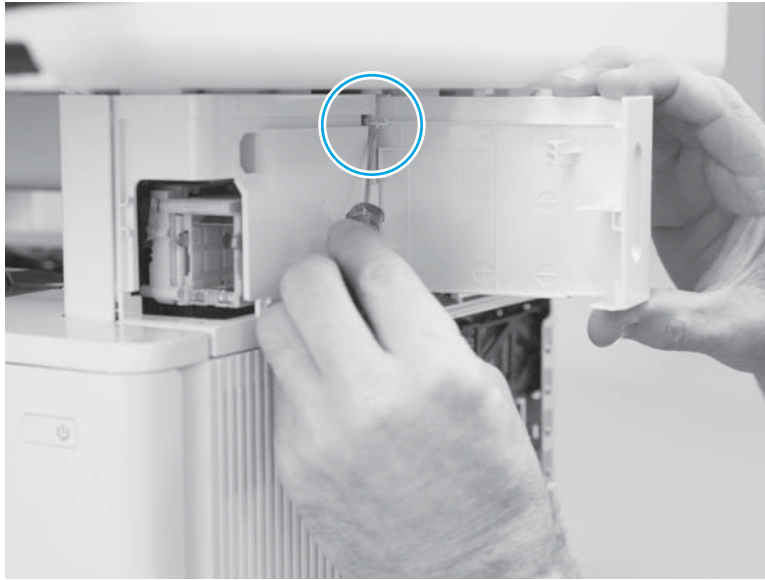
**Figure 1-771** Engage the lower hinge or engage the cover





3. **M527c/f/z:** Engage the upper hinge.

**Figure 1-772** Engage the upper hinge




4. **M527c/f/z:** Close the stapler door.

**Figure 1-773** Close the door



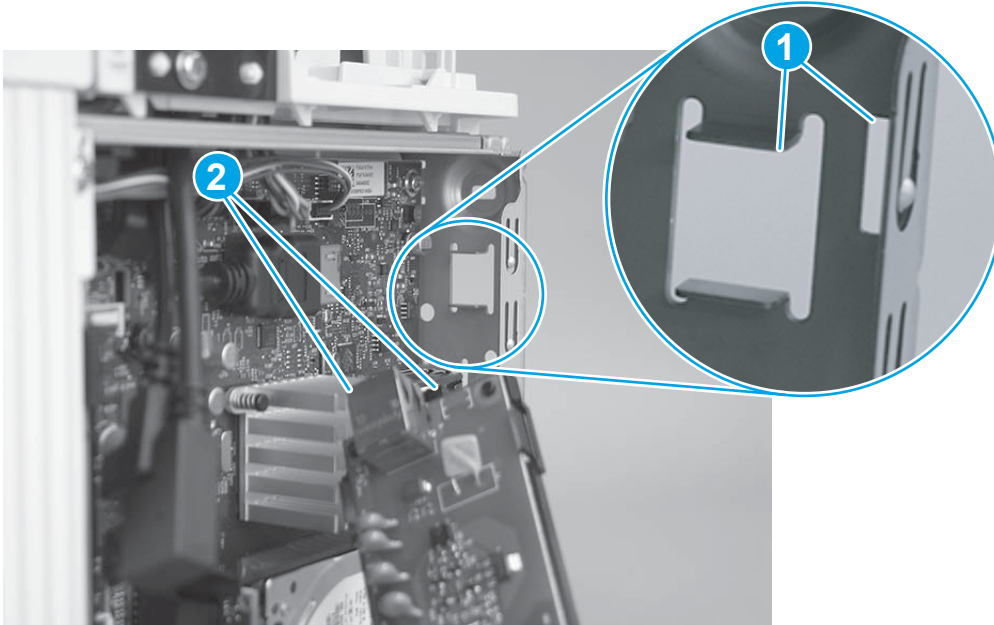
### Step 18: Install the fax PCA

 **CAUTION:**  ESD-sensitive part.

 **NOTE:** M527c/f/z printers only (optional for the M527dn).

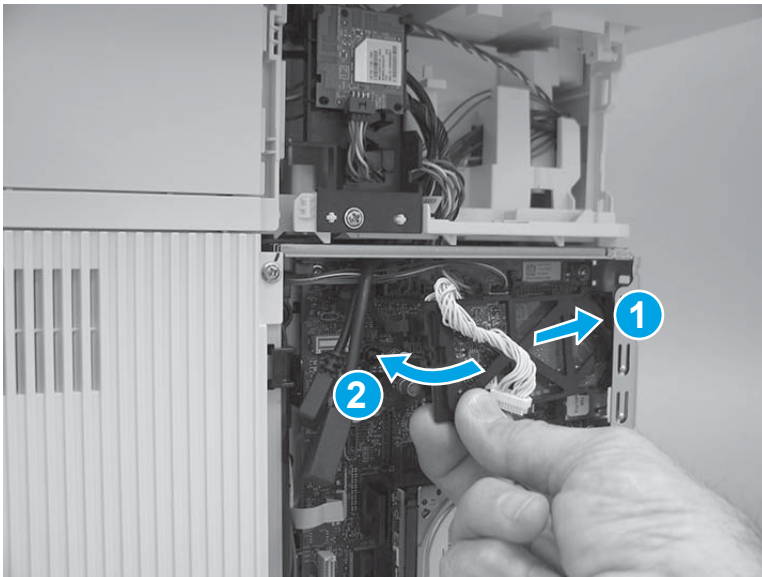
1. Before proceeding, take note of the location of the slots (callout 1) in the sheet-metal where the fax PCA cradle mounting tab and fax port (callout 2) must be installed.

**Figure 1-774** Locate the slots in the sheet-metal



2. Insert the fax PCA cradle mounting tab and fax port in the slots in the sheet-metal plate (callout 1), and then rotate the connector end of the fax PCA toward the formatter (callout 2).

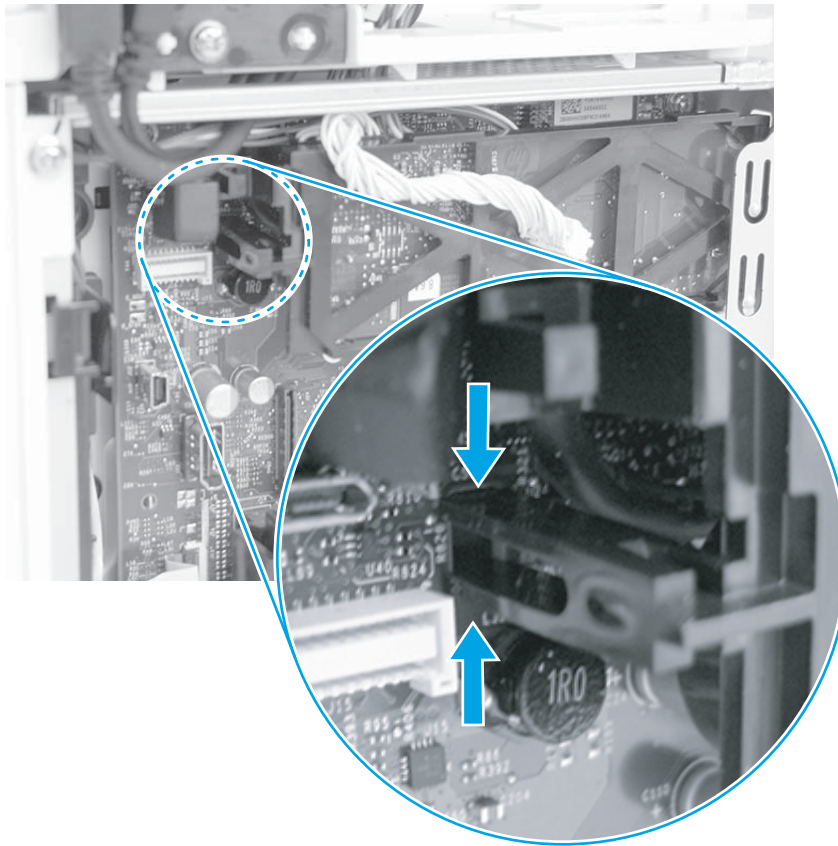
**Figure 1-775** Install the fax PCA



- Engage the retainer with the slot in the formatter.

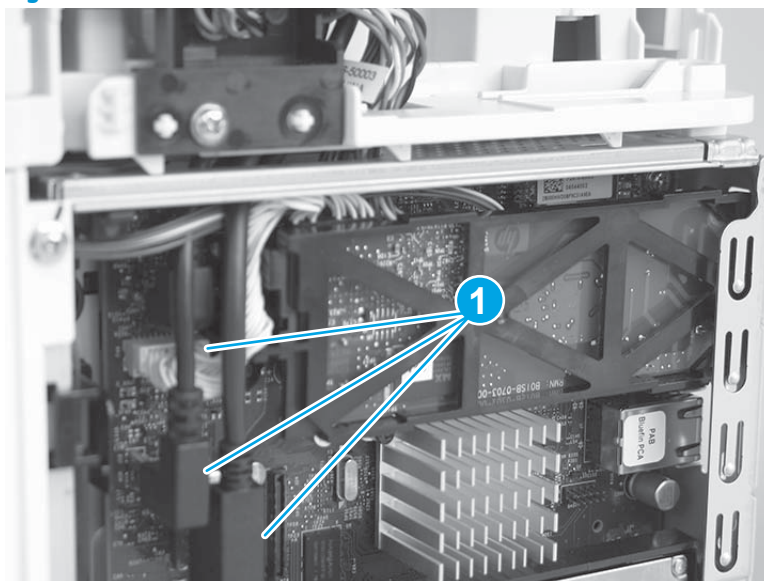
 **Reinstallation tip:** Pinch the retainer to easily engage it with the slot.

**Figure 1-776** Engage the fax PCA



- Connect three connectors (callout 1).

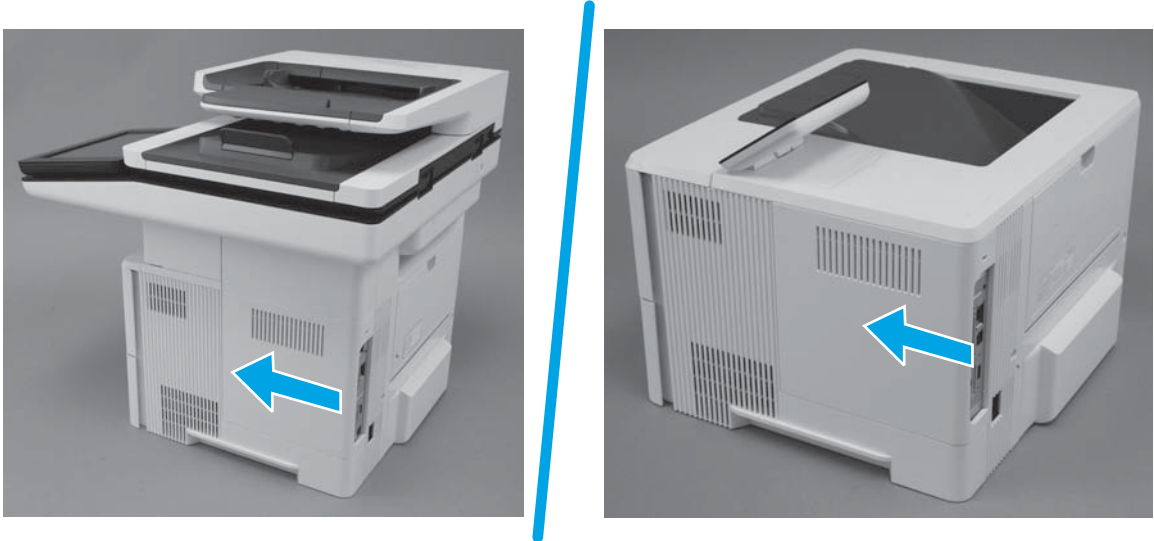
**Figure 1-777** Connect three connectors



### Step 19: Install the formatter cover

- ▲ Slide it toward the front of the printer to install it.

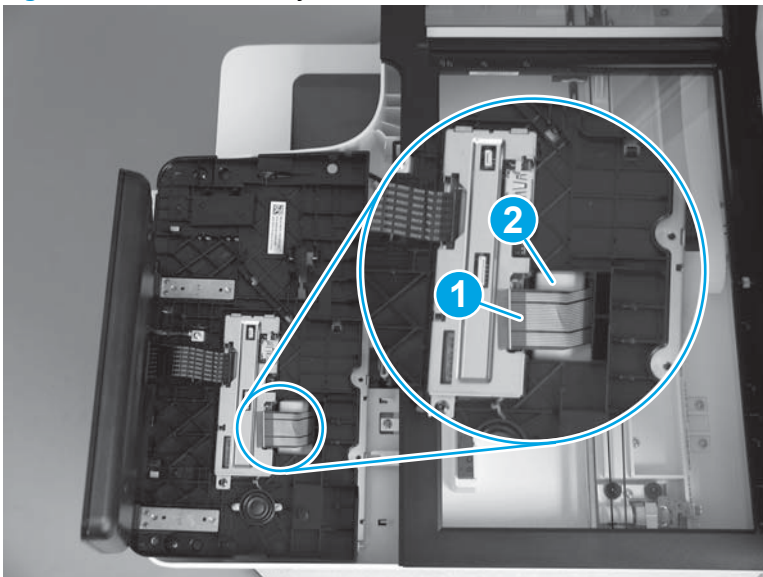
**Figure 1-778** Install the formatter cover




### Step 20: Install the control panel (M527)

1. **M527c/z only:** Make sure to feed the keyboard flange cable (callout 1) passes through the opening (callout 3) in the control-panel base when installing the control panel.

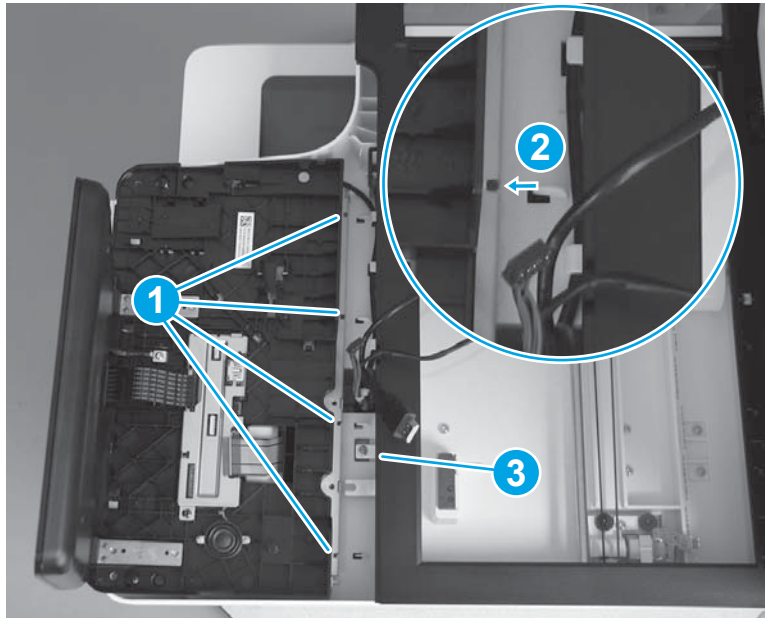
**Figure 1-779** Check the keyboard flange cable (M527c/z)




2. Locate the four hooks on the printer and matching slots in the control-panel base (callout 1). The hooks fit into the slots (callout 2) when the assembly is installed.

 **NOTE:** Make sure that the grounding clip (callout 3) is on top of the assembly base when it is installed.

**Figure 1-780** Locate the hooks and slots



3. Position the rear edge of the control panel in the printer (callout 1), and then lower the front edge down (callout 2) to install it.

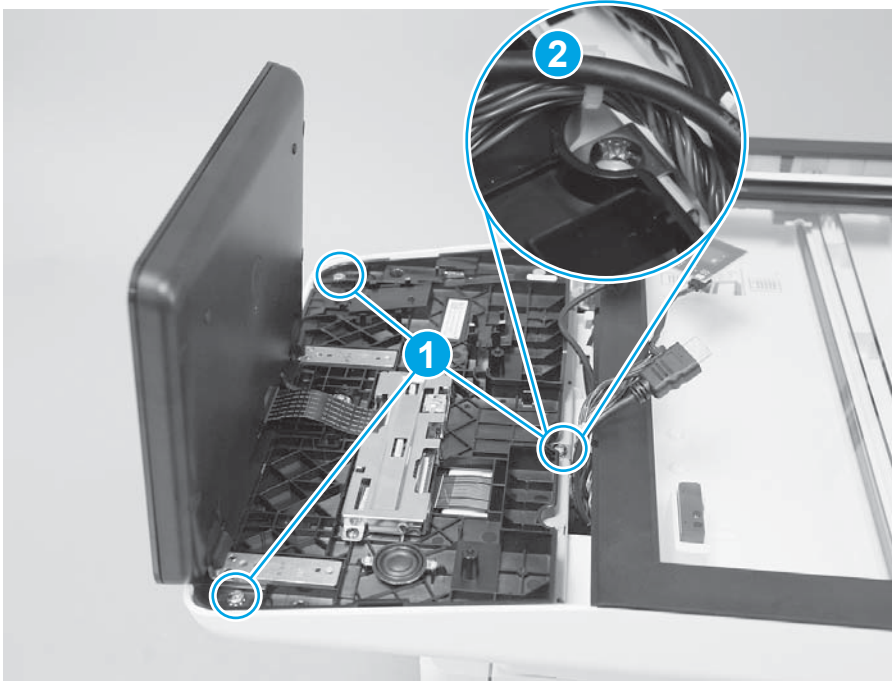
 **NOTE:** If the control panel is difficult to install, make sure that the hooks, slots, and grounding clip are correctly engaged. See step 3.

**Figure 1-781** Install the control-panel



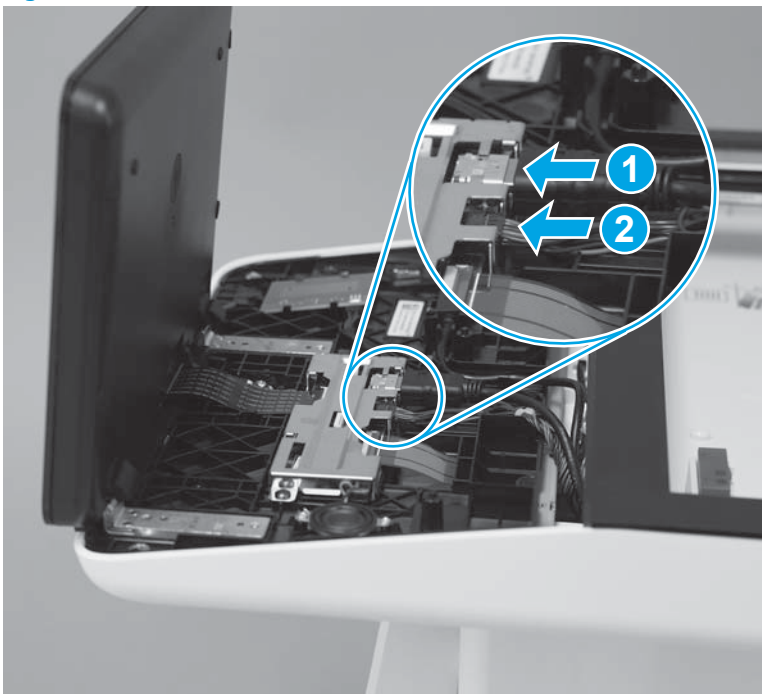
4. Install three screws (callout 1), make sure that the grounding clip is correctly installed (callout 2).

**Figure 1-782** Install three screws



5. Connect one HDMI cable (callout 1) and one connector (callout 2).

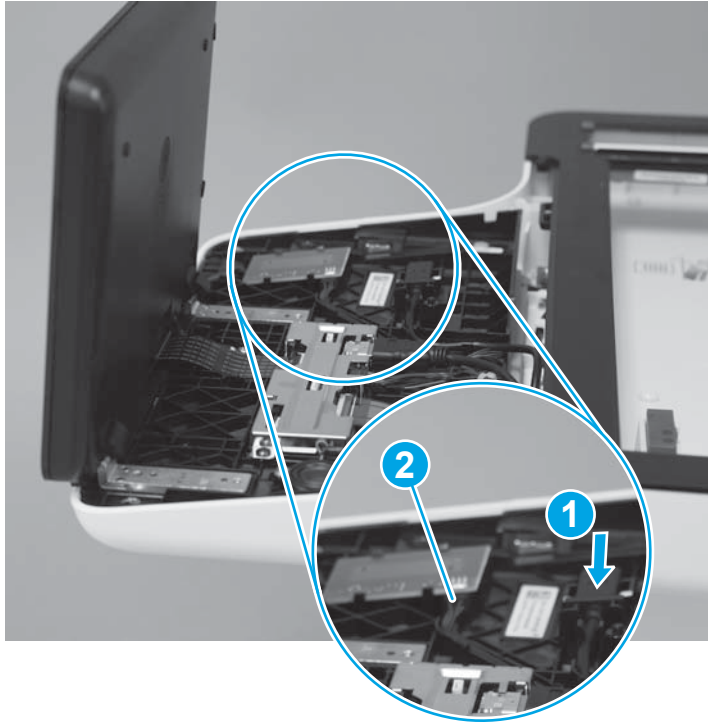
**Figure 1-783** Connect the connectors



6. Install the USB cable (callout 1) in the holder.


 **NOTE:** **M527c/z only:** Connect one connector (callout 2).

**Figure 1-784** Install the USB cable and connect the NFC PCA

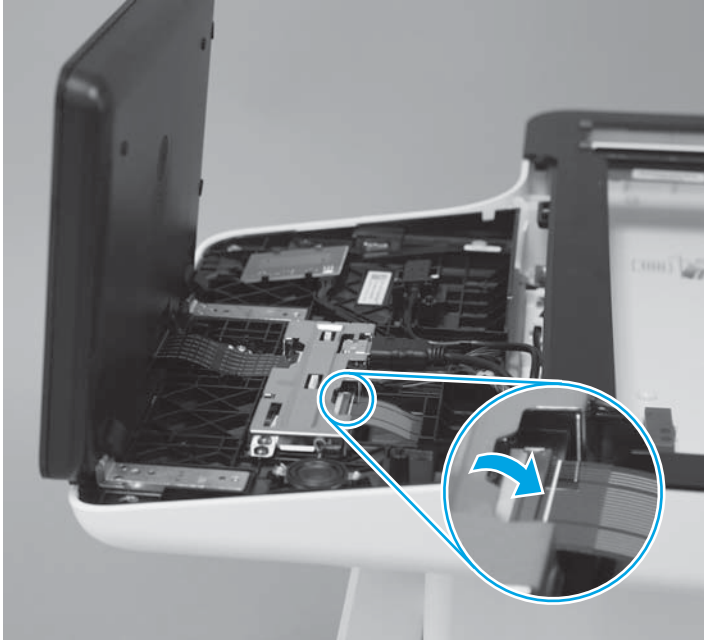


7. **M527z only:** Position the keyboard flat cable in the connector, and then close the connector latch.

 **IMPORTANT:** Slightly tug on the cable to make sure that it is fully captured in the connector.

 **NOTE:** When the connector latch is closed and the cable is correctly installed, the white line on the cable is parallel to the connector latch.

**Figure 1-785** Connect the flat cable (M527z)



8. Position the control-panel cover on the printer.

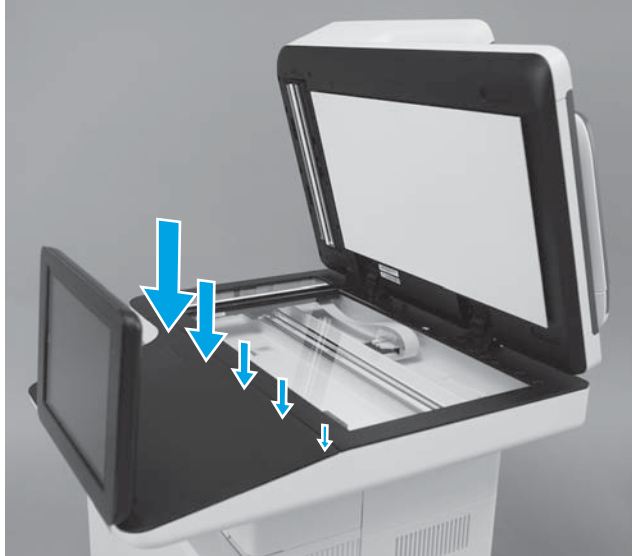
**Figure 1-786** Position the control-panel cover on the printer





9. Beginning at the left side of the control-panel cover, carefully engage five tabs along the top edge of the cover.


**Figure 1-787** Engage five tabs



10. Close the document feeder.

---

 **NOTE:** Adjust the control panel to the desired angle.

 **Reinstallation tip:** If the keyboard is unresponsive after turning the printer on, check the flat cable installed in step 8. Reinstall the cable if necessary.


---

**Figure 1-788** Close the document feeder




### Step 21: Install the white backing (M527)

---

 **NOTE:** M527 printers only.

---

1. Place the replacement white backing, on the flatbed scanner glass as shown.

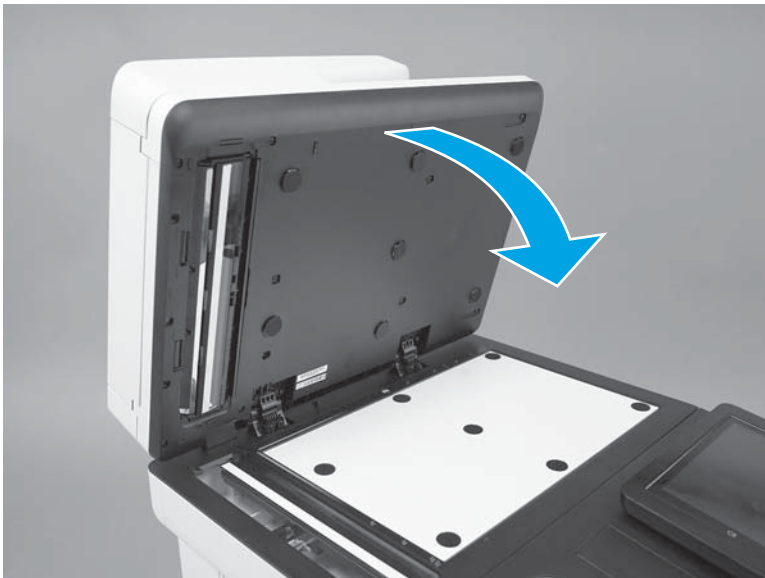
 **NOTE:** Place the corner of the backing that does not have a hook-and-loop fastener in the upper-left corner of the scanner glass.

**Figure 1-789** Install the white backing



2. Close the document feeder.

**Figure 1-790** Close the document feeder



3. Open the document feeder and make sure that the white backing is securely attached.

**Figure 1-791** Check the white backing



4. Close the document feeder.

**Figure 1-792** Close the document feeder

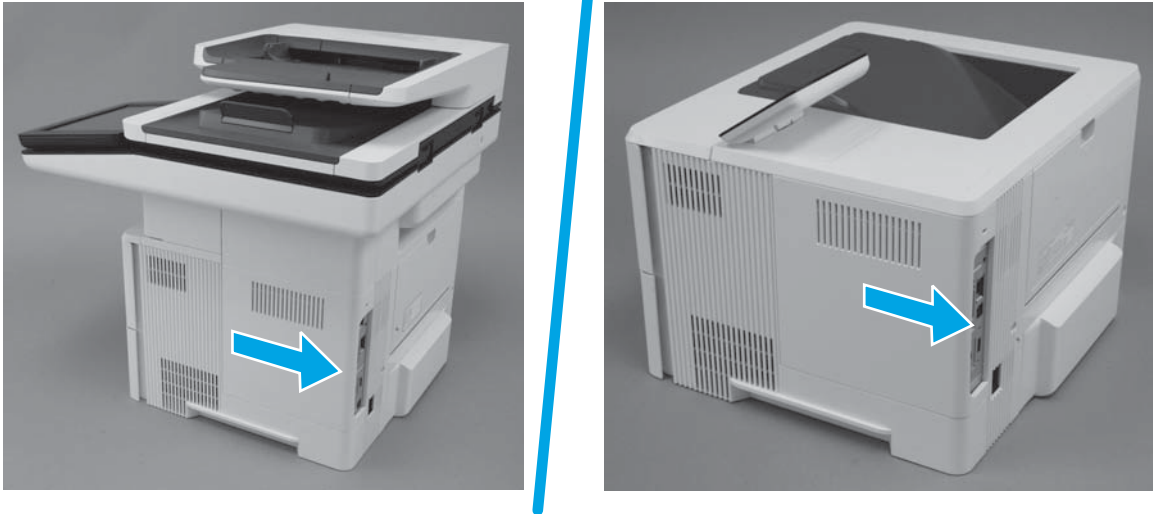


## Removal and replacement: Integrated-scanner assembly (ISA) (M527)

### Step 1: Remove the formatter cover

- ▲ Slide the cover toward the rear of the printer to remove it.

**Figure 1-793** Remove the formatter cover



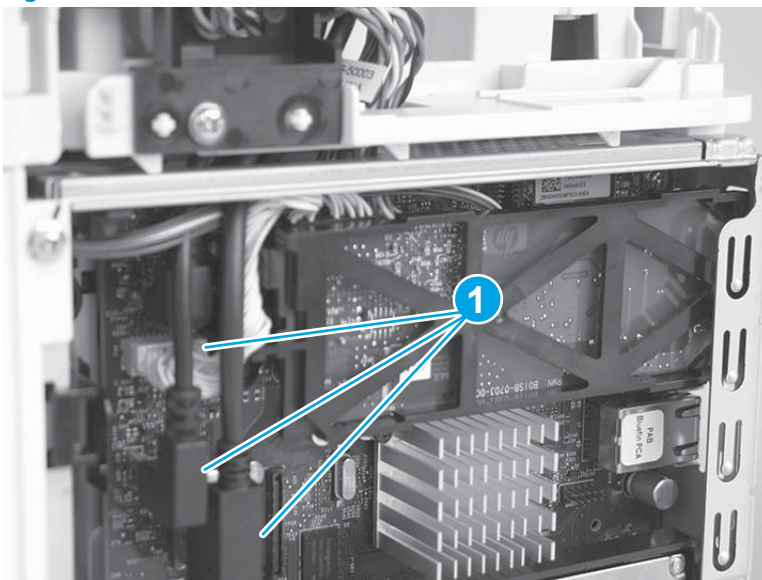
### Step 2: Remove the fax PCA

**CAUTION:**  ESD-sensitive part.

**NOTE:** M527c/f/z printers only (optional for the M527dn).

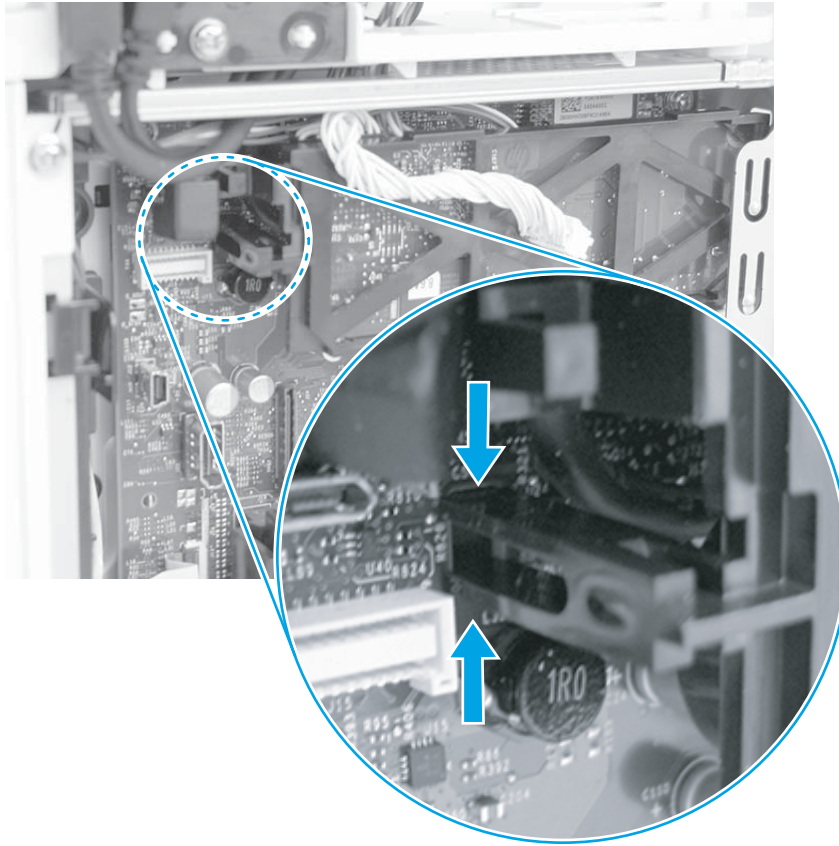
1. Disconnect three connectors (callout 1).

**Figure 1-794** Disconnect three connectors



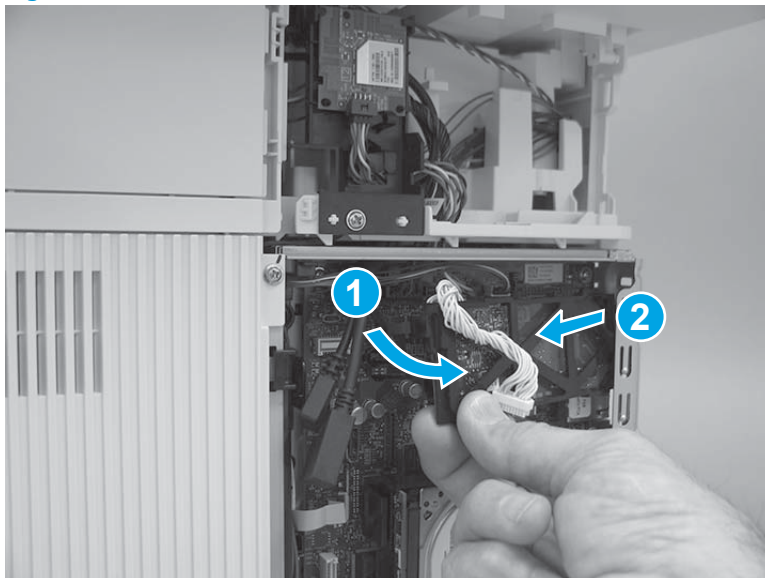
2. Pinch the retainer to release it.

**Figure 1-795** Release the fax PCA



3. Rotate the connector end of the fax PCA out and away from the formatter (callout 1), and then slide it as shown (callout 2) to remove it.

**Figure 1-796** Remove the fax PCA



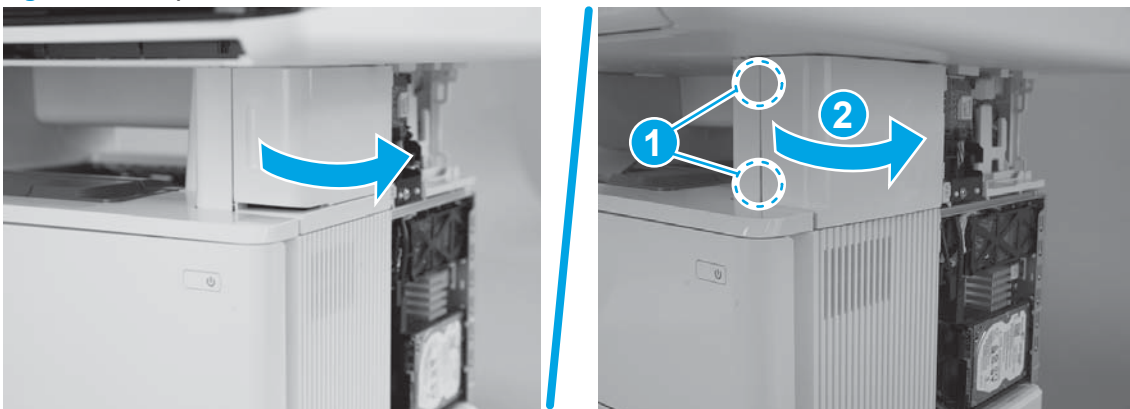
### Step 3: Remove the stapler door or stapler blank cover (M527)

The M527dn does not have a convenience stapler.

1. Do one of the following:

- **M527c/f/z:** Open the stapler door.
- **M527dn:** Use a small flat-blad screw driver to release two tabs (callout 1), and then rotate the cover away from the printer (callout 2).

**Figure 1-797** Open the door or release the cover



2. Do one of the following:

- **M527c/f/z:** Use a small flat-blad screwdriver to release the upper hinge.
- **M527dn:** Slide the cover toward the front of the printer to remove it.

**Figure 1-798** Release the upper hinge or remove the cover



3. **M527c/f/z:** Use a small flat-blad screwdriver to release the lower hinge.

**Figure 1-799** Release the lower hinge




4. **M527c/f/z:** Remove the door.

**Figure 1-800** Remove the door




#### **Step 4: Remove the stapler stationary (inner) cover (M527)**

---

 **NOTE:** This step is for the M527c/f/z printers. For the M527dn, skip this step and go to [Step 5: Remove the top-left cover on page 467](#).

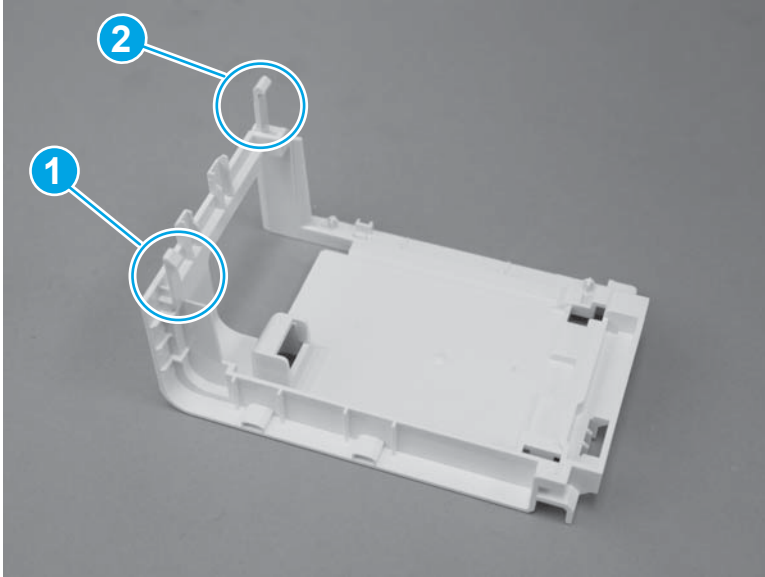
---

 **NOTE:** M527c/f/z printers only.

---

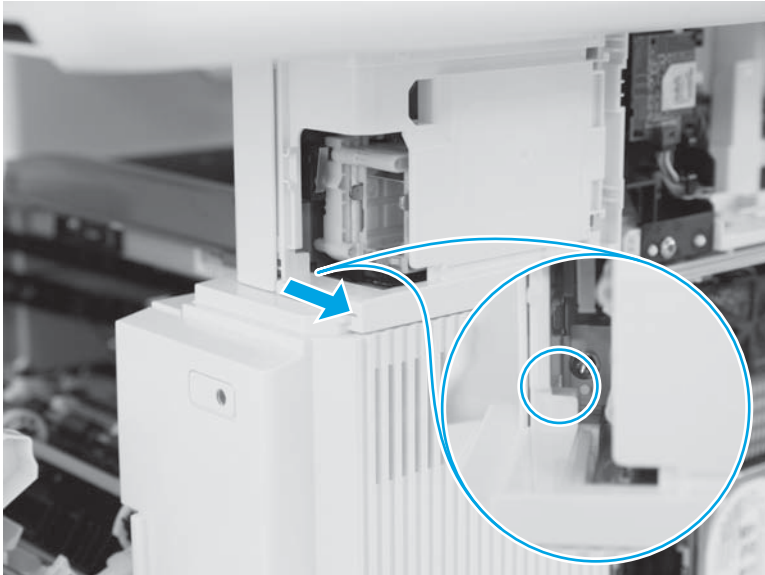
1. Before proceeding, take note of the locations of the upper tab (callout 1) and the lower tab (callout 2) on the stapler stationary (inner) cover.

**Figure 1-801** Locate the tabs



2. Use a long-shaft small flat-blad screwdriver to release the lower tab.

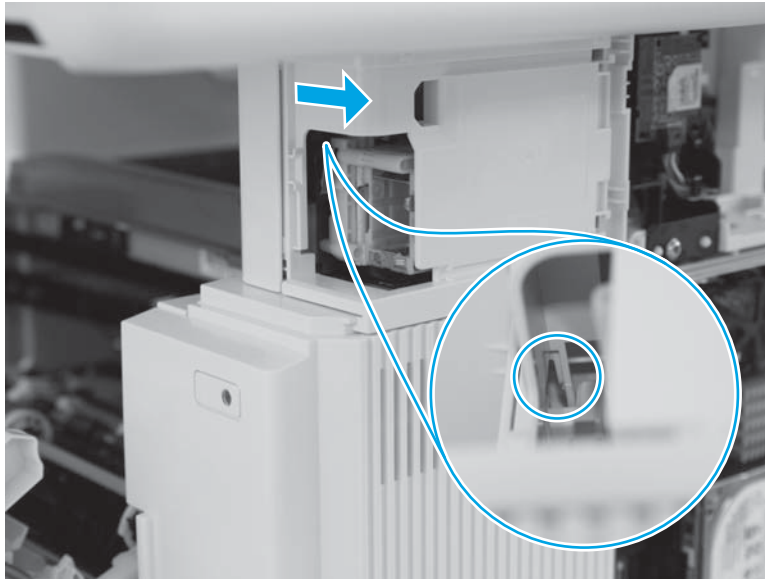
**Figure 1-802** Release one tab





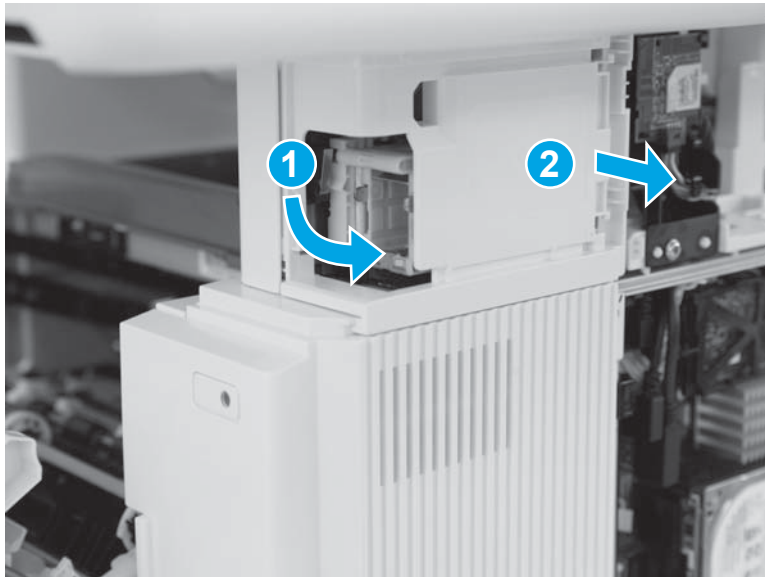
3. Use a long-shaft small flat-blad screwdriver to release the upper tab.

**Figure 1-803** Release one tab



4. With the tabs disengaged the front of the cover is released. Rotate the front of the cover away from the printer (callout 1) to release the rear of the cover (callout 2), and then remove it.

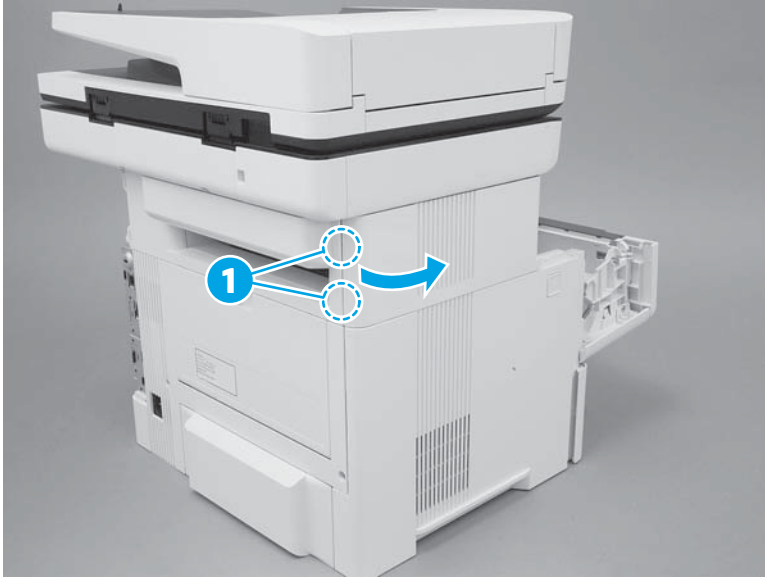
**Figure 1-804** Remove the cover



#### **Step 5: Remove the top-left cover**

1. Open the toner-cartridge door, release two tabs (callout 1), and then rotate the rear edge of the cover away from the printer.

**Figure 1-805** Release two tabs



2. Continue to rotate the cover away from the printer to release two more tabs at the middle of the cover.

**Figure 1-806** Release two tabs



3. Slide the cover toward the rear of the printer to release two bosses at the front of the cover.

**Figure 1-807** Slide the cover



4. Remove the cover.

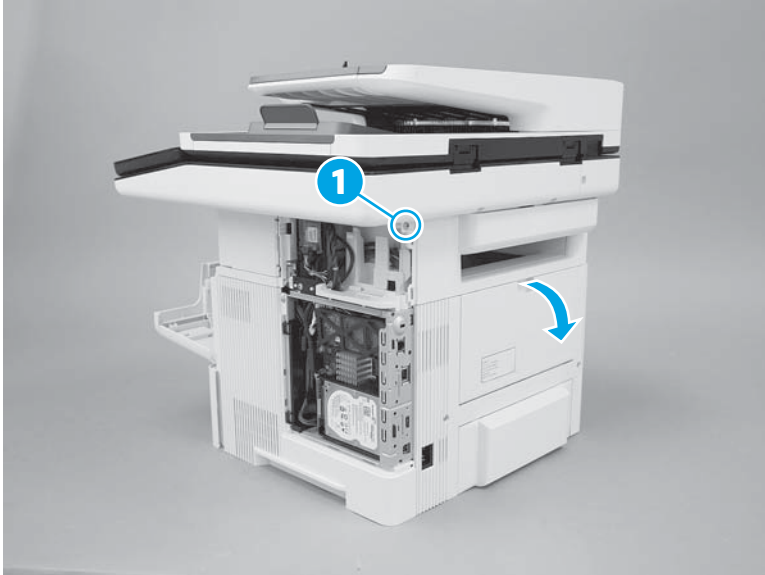
**Figure 1-808** Remove the cover



#### **Step 6: Remove the top-rear cover**

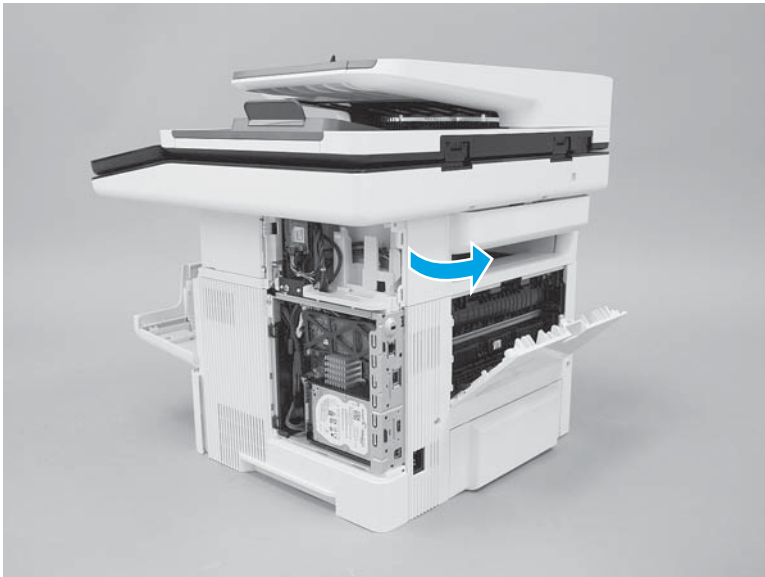
1. Remove one screw (callout 1), and then open the rear door.

**Figure 1-809** Remove one screw



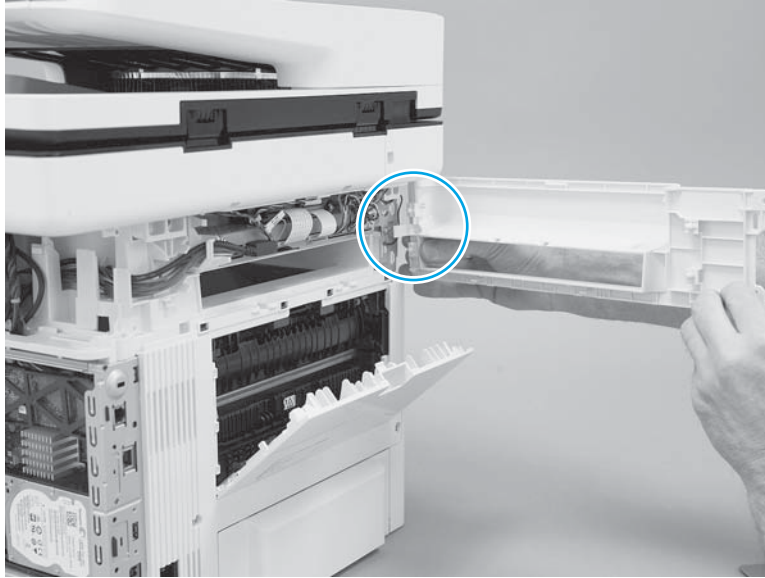
2. Rotate the exposed edge of the cover away from the printer (as shown).

**Figure 1-810** Rotate the cover



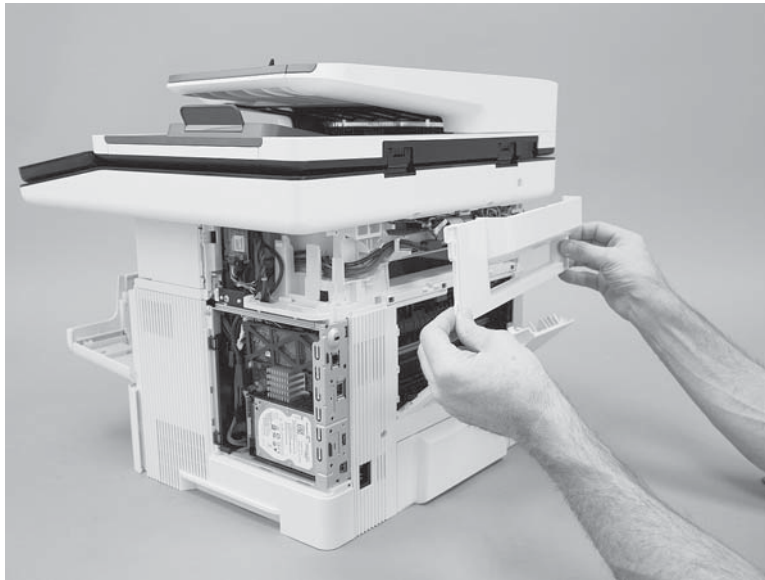
3. Continue to rotate the cover away from the printer to release one boss.

**Figure 1-811** Release one boss




4. Remove the cover.

**Figure 1-812** Remove the cover




### Step 7: Remove the integrated-scanner assembly (ISA)

---

 **NOTE:** The ISA includes the document feeder, sub-scanner assembly (SSA), and the scanner control board (SCB)

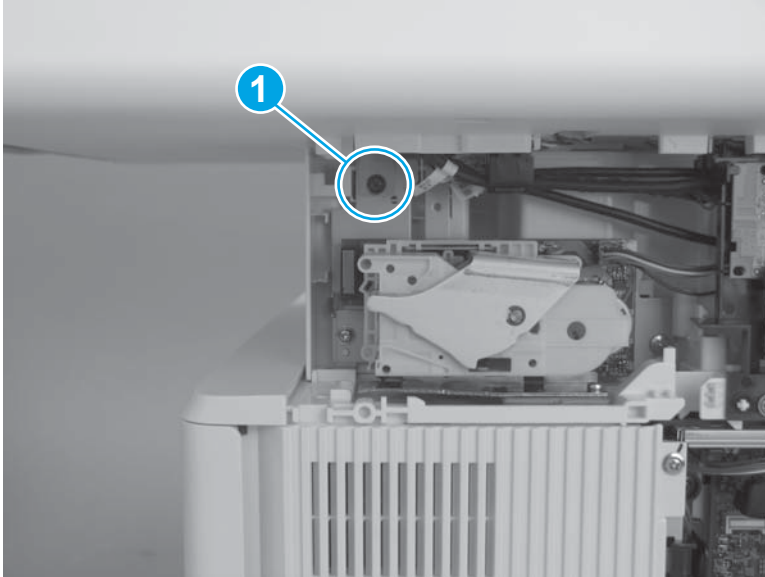
---

1. Remove one screw (callout 1).


 **IMPORTANT:** This screw fastens the ISA ground plate to the printer chassis. Do not lose this screw.


---

**Figure 1-813** Remove one screw

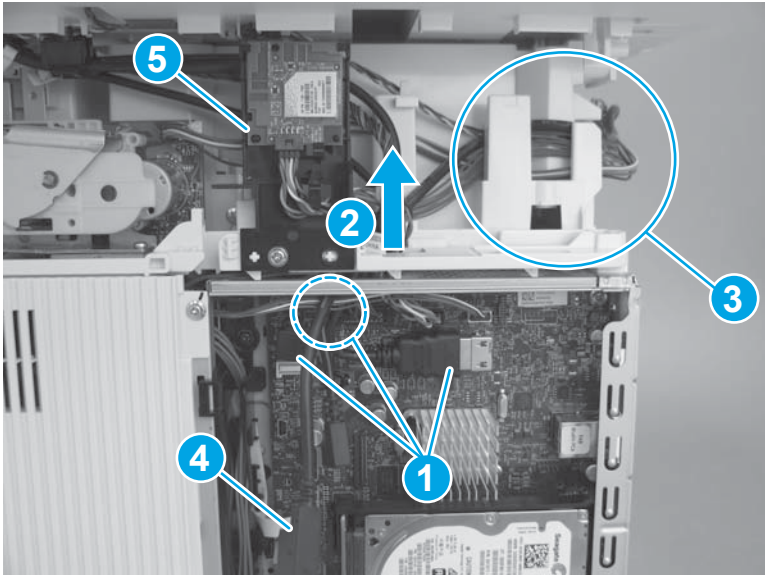


2. Disconnect three connectors (callout 1), pass the wire harnesses and cables through the opening in the cover (callout 2), and then release them from the retainers (callout 3).

 **NOTE:** One cable (callout 4) does not need to pass through the opening in the cover.

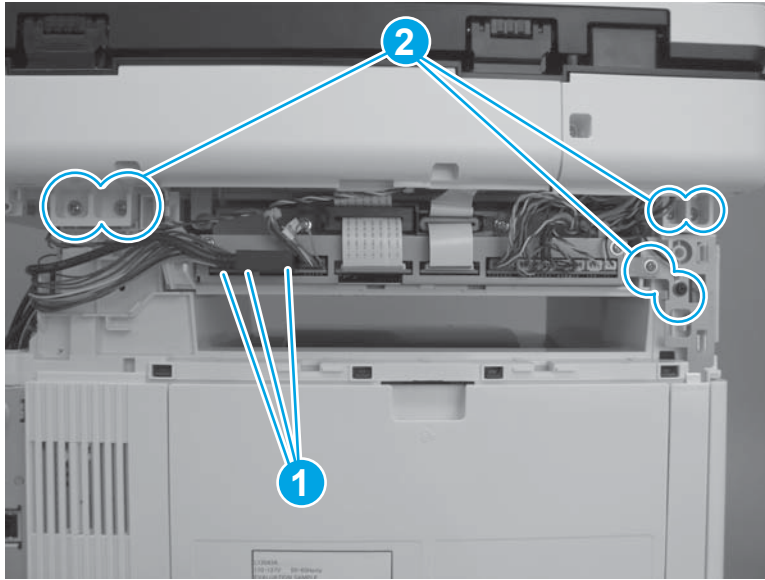
 **TIP:** It might be easier if the WiFi PCA and holder (callout 5) is detached from the printer, and then moved out of the way.

**Figure 1-814** Disconnect cables and connectors



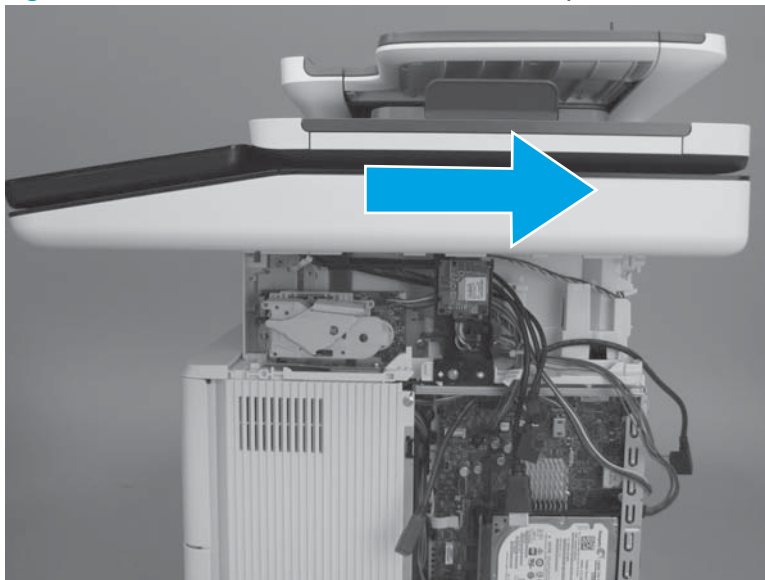
3. Disconnect three connectors (callout 1), and then remove six screws (callout 2).

**Figure 1-815** Disconnect connectors and remove screws



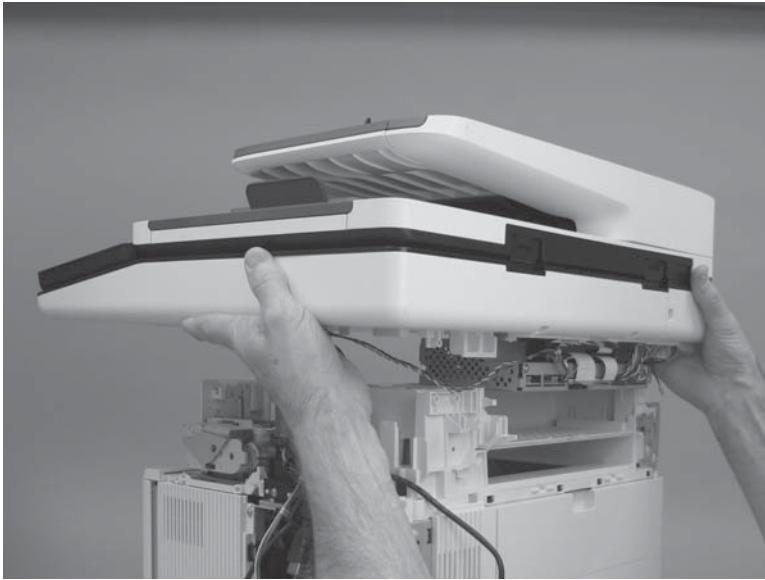
4. Slightly slide the ISA towards the back of the printer to release it.

**Figure 1-816** Slide the ISA towards the back of the printer



5. Remove the ISA.

**Figure 1-817** Remove the ISA



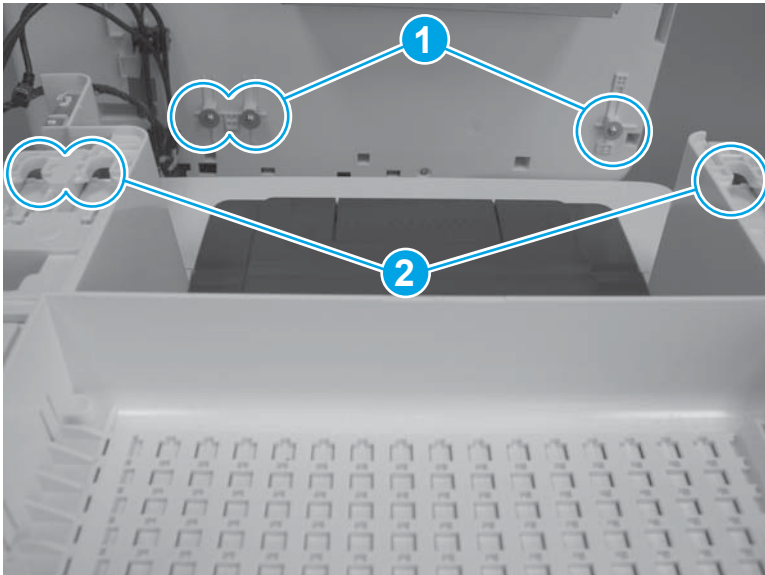
### Step 8: Install the ISA



**NOTE:** The ISA includes the document feeder, sub-scanner assembly (SSA), and the scanner control board (SCB)


1. Before proceeding, locate the ISA mounting pins (callout 1) on the bottom of the ISA and the slots (callout 2) on the printer base.

**Figure 1-818** Locate the ISA mounting pins and slots

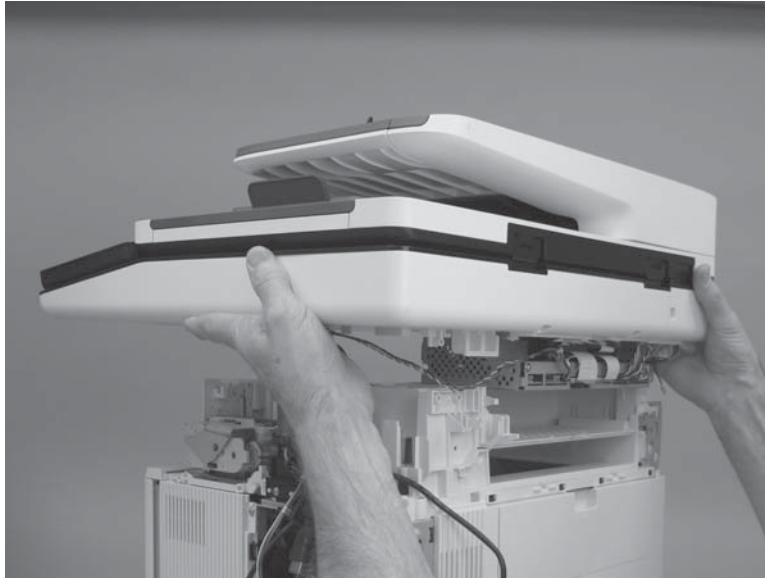





2. Position the ISA on the printer base with the pins in the slots.

 **NOTE:** To locate the pins and slots, see the previous step.

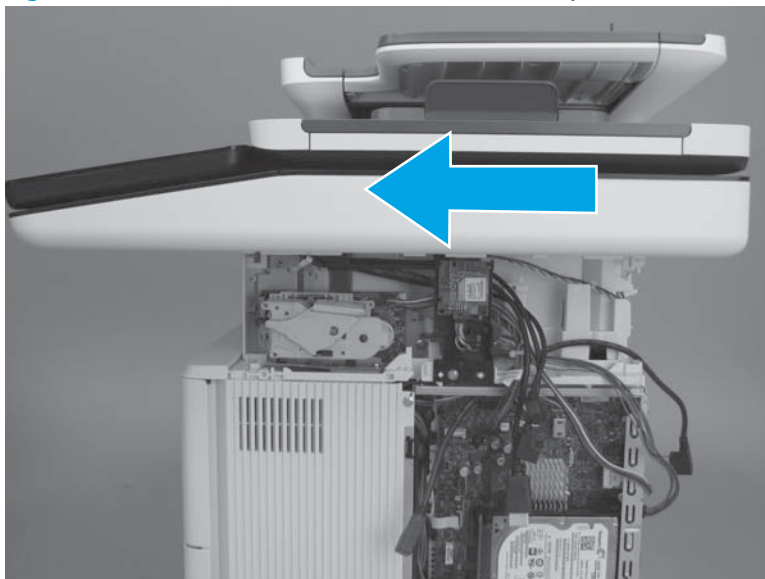
**Figure 1-819** Install the ISA



3. Slightly slide the ISA towards the front of the printer to engage it.

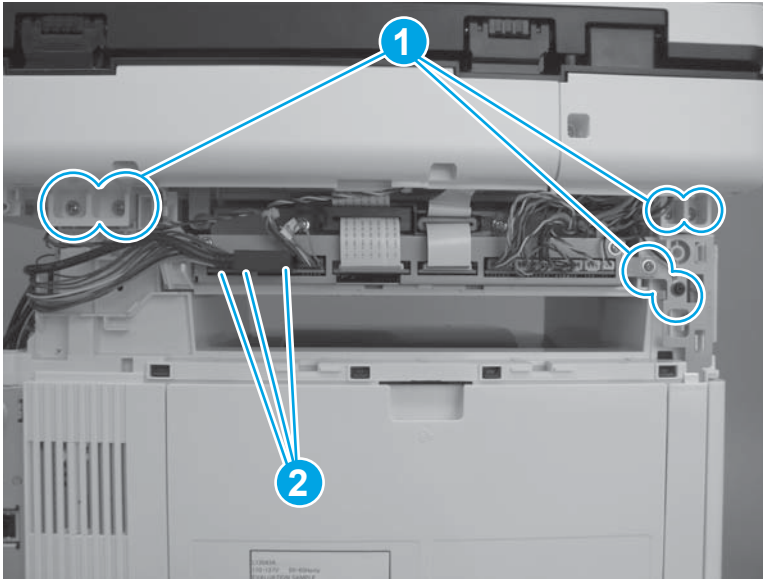
 **CAUTION:** Make sure that none of the wire harnesses or cables are caught underneath the assembly when installing it.

**Figure 1-820** Slide the ISA towards the front of the printer



4. Install six screws (callout 1), and then connect three connectors (callout 2).

**Figure 1-821** Install screws and connect connectors



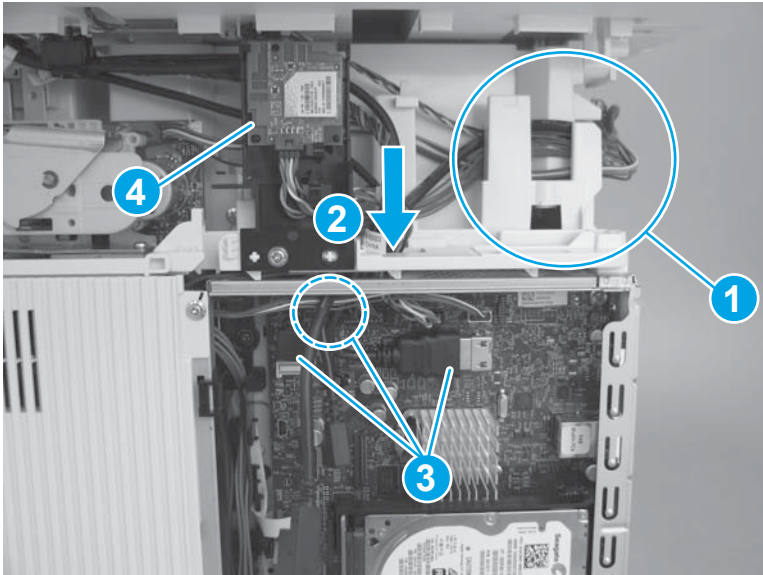
5. Install the wire harnesses and cables in the retainers (callout 1), pass them through the opening in the cover (callout 2), and then connect three connectors (callout 3).

---

**TIP:** If the WiFi PCA and holder (callout 4) was detached from the printer and then moved out of the way, reinstall it now.

---

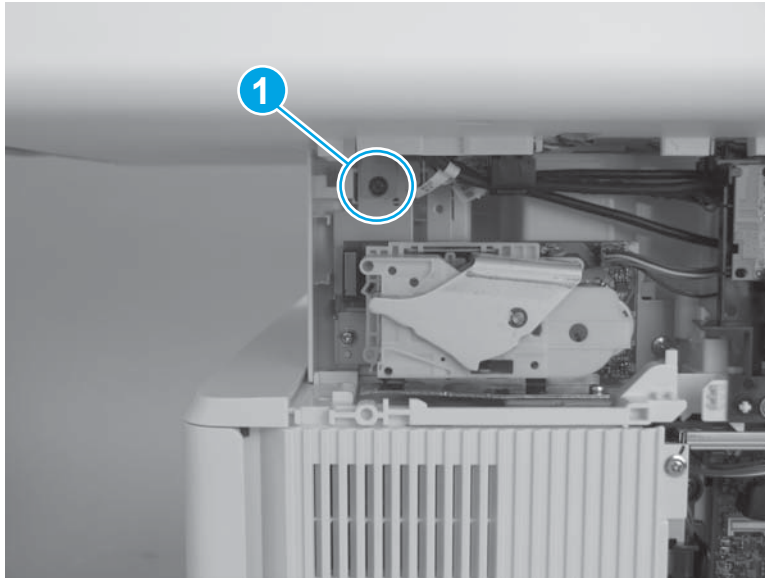
**Figure 1-822** Connect cables and connectors



6. Install one screw (callout 1).

 **IMPORTANT:** This screw fastens the ISA ground plate to the printer chassis. This screw must be installed.

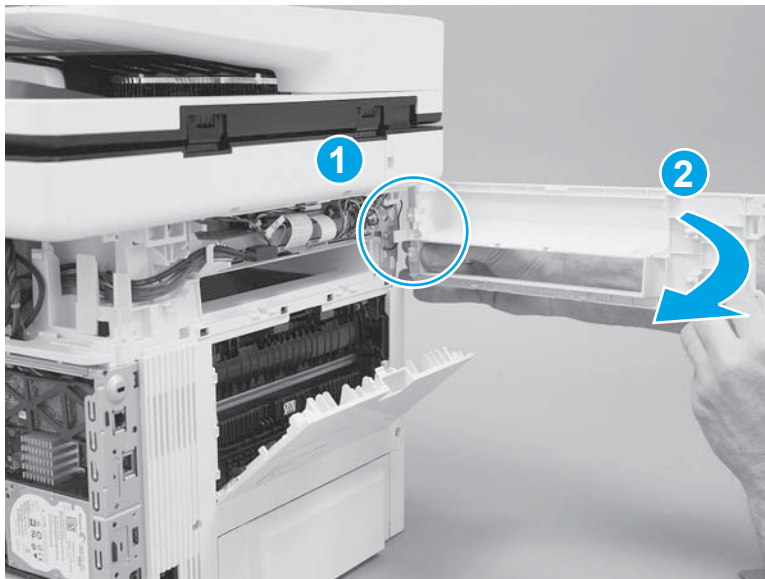
**Figure 1-823** Install one screw



### Step 9: Install the top-rear cover

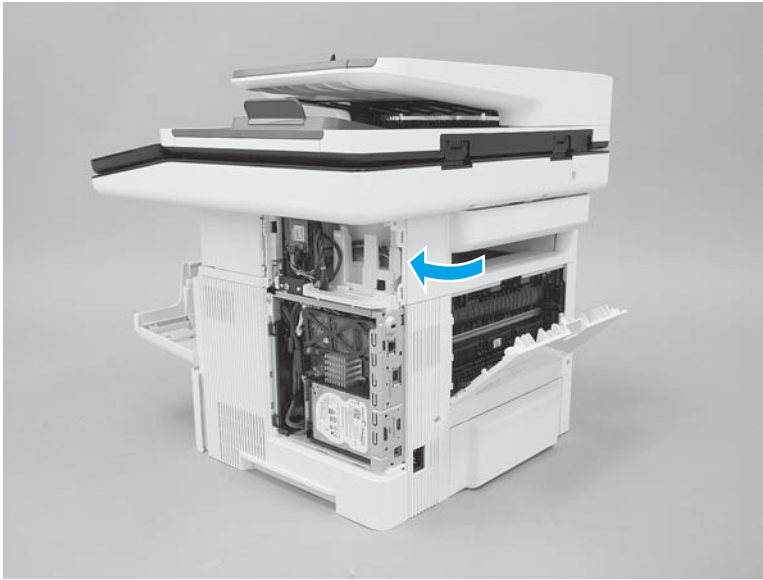
1. Engage one boss (callout 1), and then rotate the cover towards the printer (callout 2).

**Figure 1-824** Engage one boss



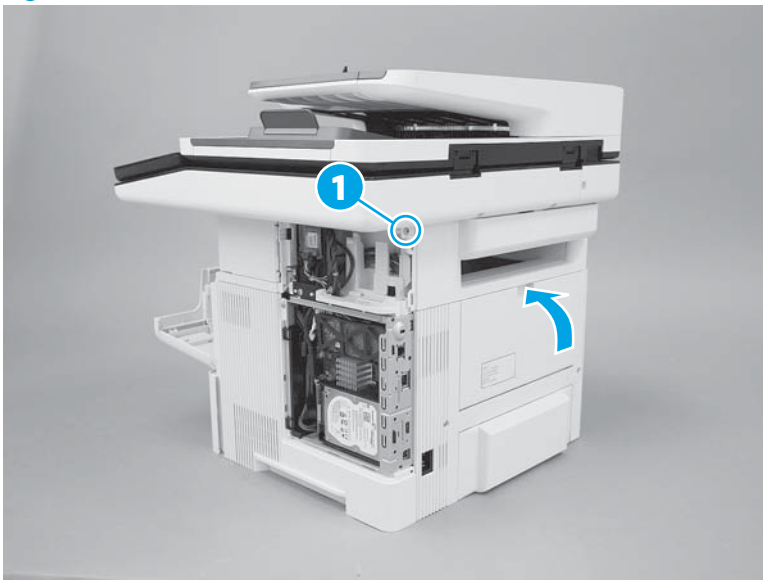
2. Continue to rotate the cover toward the printer to install it.

**Figure 1-825** Install the cover



3. Install one screw (callout 1), and then close the rear door.

**Figure 1-826** Install one screw



### Step 10: Install the top-left cover

1. Position the front edge of the cover on the printer, and then slide the cover toward the front of the printer to engage two bosses at the front of the cover.

**Figure 1-827** Slide the cover




2. Rotate the cover towards the printer to engage two tabs at the middle of the cover.

**Figure 1-828** Engage two tabs



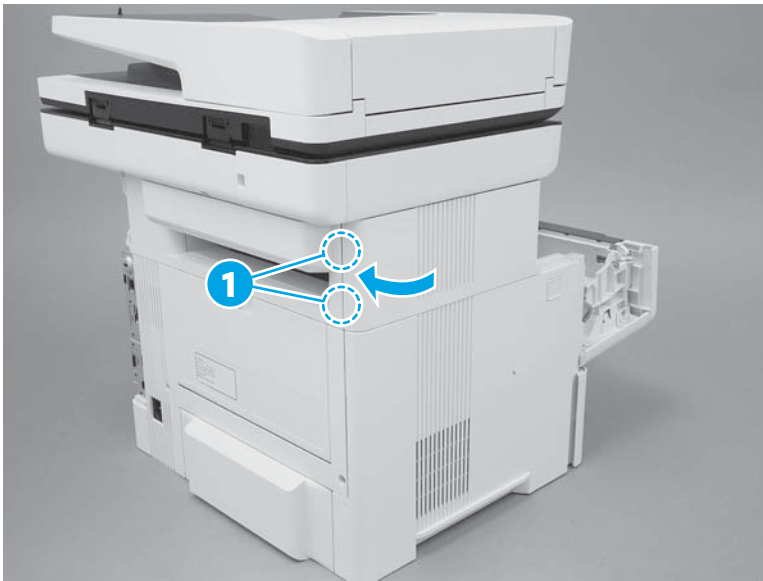
3. Continue to rotate the cover onto the printer to engage two tabs (callout 1) at the rear edge of the cover.

---

 **NOTE:** Close the toner-cartridge door.

---

**Figure 1-829** Engage two tabs




### Step 11: Install the stapler stationary (inner) cover (M527)

---

 **NOTE:** This step is for the M527c/f/z printers. For the M527dn, skip this step and go to [Step 12: Install the stapler door or stapler blank cover \(M527\) on page 482](#).

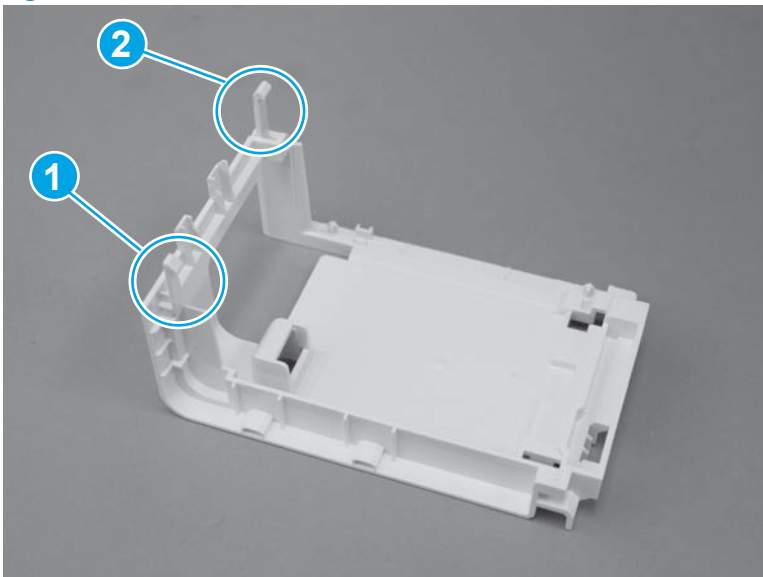
---

 **NOTE:** M527c/f/z printers only.

---

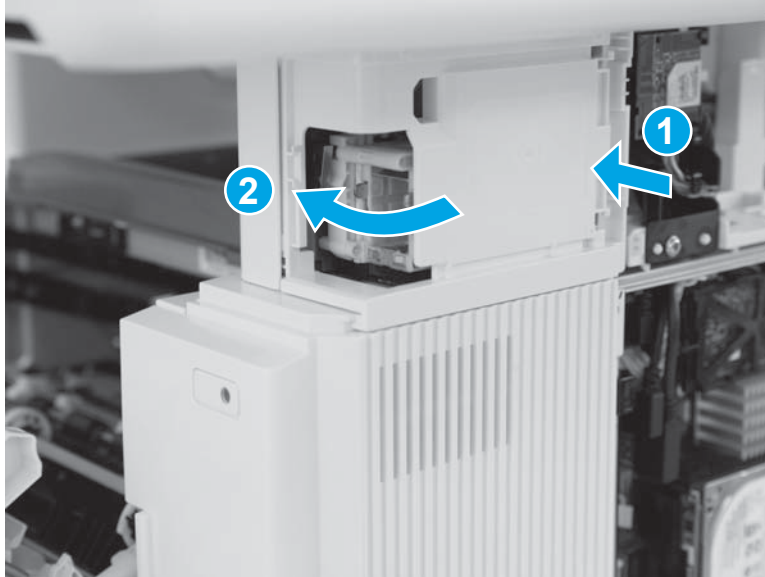
1. Before proceeding, take note of the locations of the upper tab (callout 1) and the lower tab (callout 2) on the stapler stationary (inner) cover.

**Figure 1-830** Locate the tabs



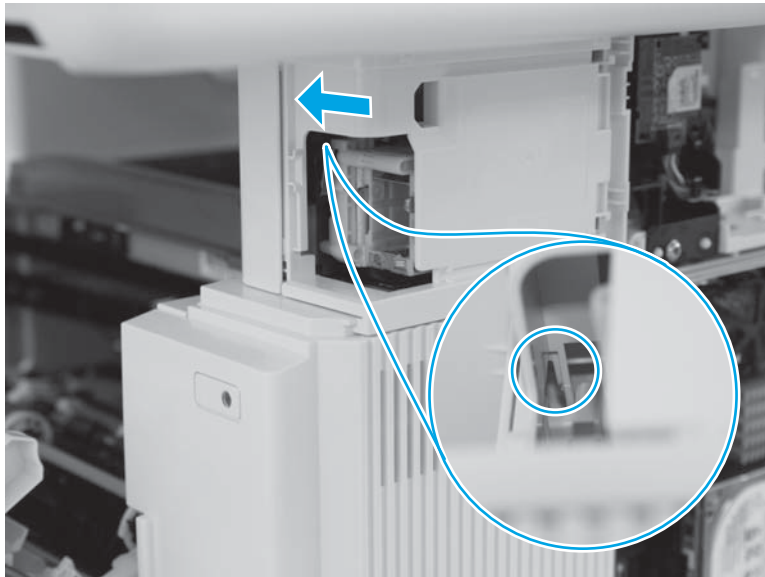
- Engage the rear edge of the cover with the printer (callout 1), and then rotate the front edge of the cover onto the printer (callout 2) to engage the two tabs.

**Figure 1-831** Install the cover



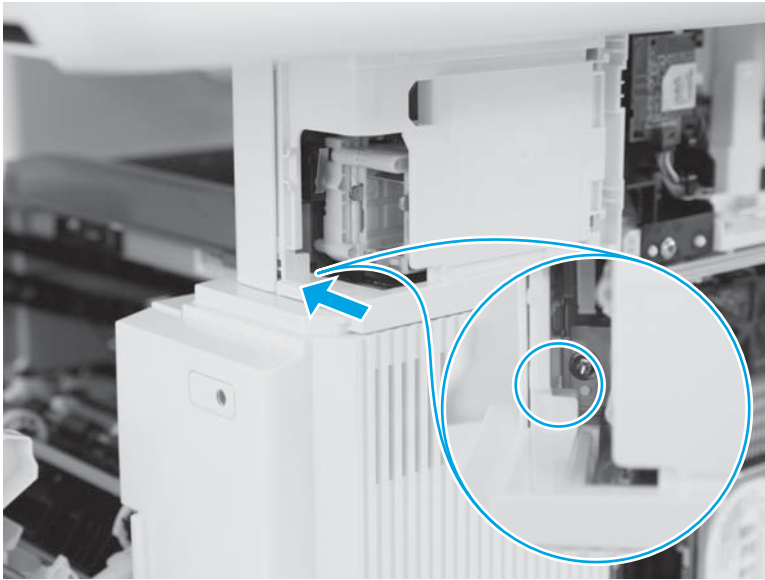
- Verify that the upper tab is engaged.

**Figure 1-832** Engage one tab



4. Verify that the lower tab is engaged.

**Figure 1-833** Engage one tab



### Step 12: Install the stapler door or stapler blank cover (M527)



**NOTE:** The M527dn does not have a convenience stapler.

1. Do one of the following:
  - **M527c/f/z:** Position the door near the printer.
  - **M527dn:** Position the cover on the printer.

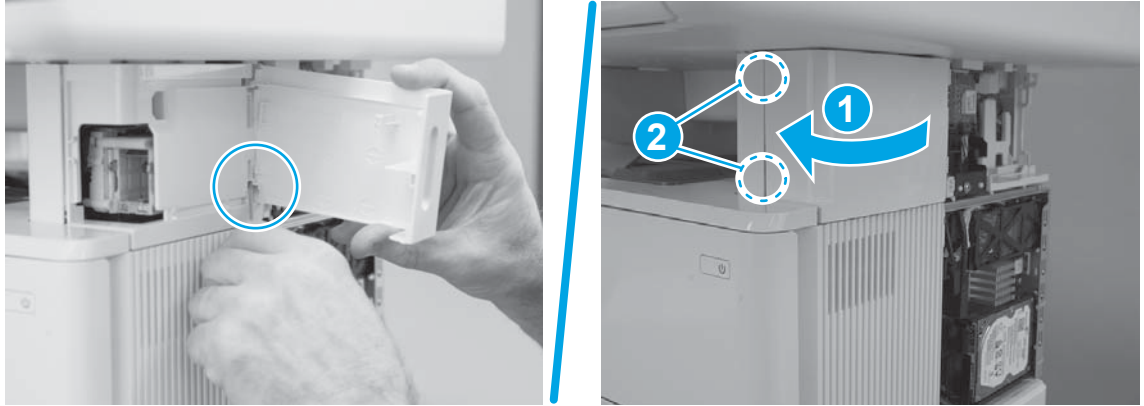
**Figure 1-834** Install the door or cover



2.
  - **M527c/f/z:** Engage the lower hinge.
  - **M527dn:** Rotate the cover towards the printer (callout 1), and then make sure that the two tabs (callout 2) snap into place to install the cover.

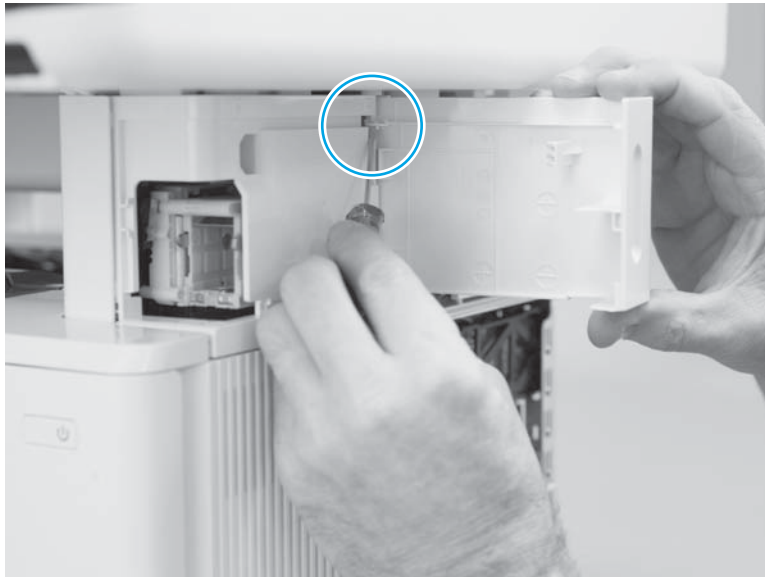


**Figure 1-835** Engage the lower hinge or engage the cover



3. **M527c/f/z:** Engage the upper hinge.

**Figure 1-836** Engage the upper hinge




4. **M527c/f/z:** Close the stapler door.

**Figure 1-837** Close the door



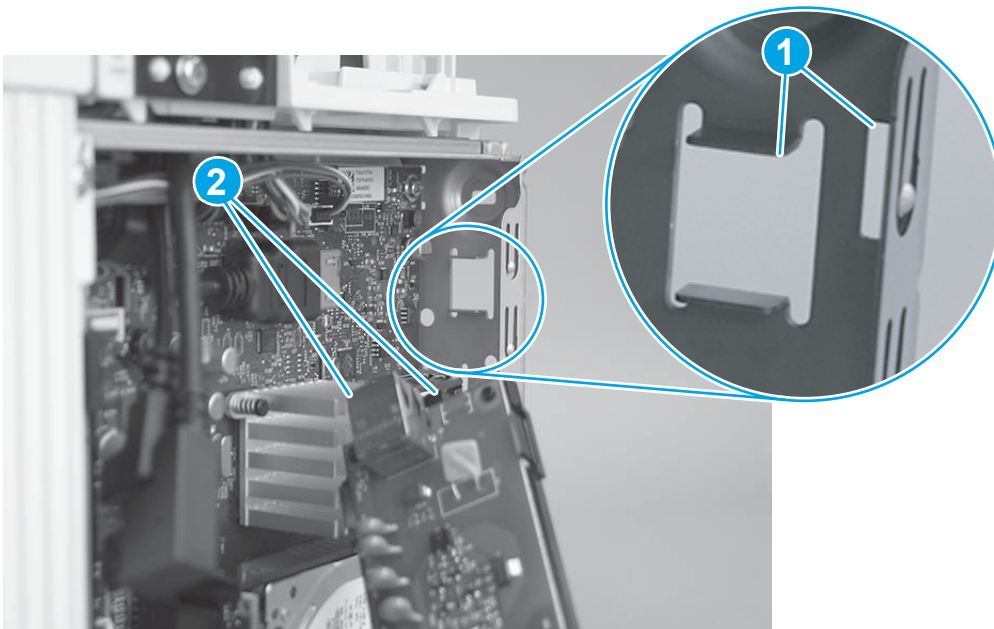
### Step 13: Install the fax PCA

 **CAUTION:**  ESD-sensitive part.

 **NOTE:** M527c/f/z printers only (optional for the M527dn).

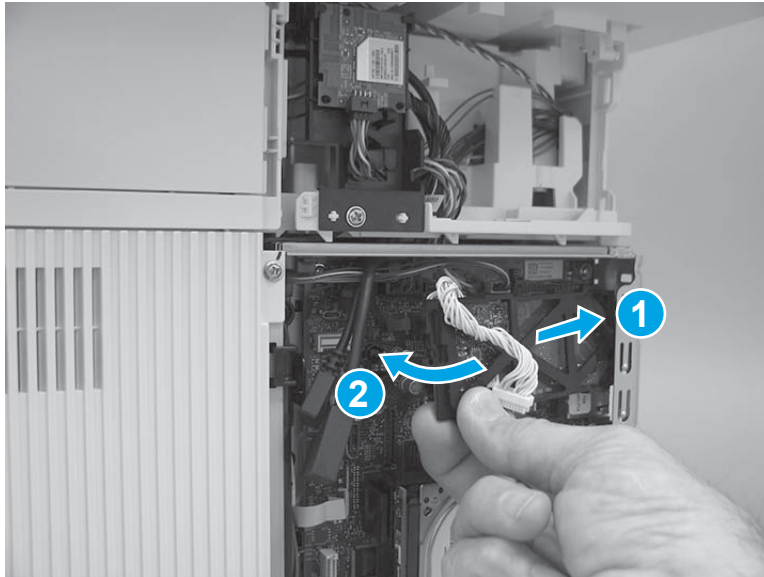
1. Before proceeding, take note of the location of the slots (callout 1) in the sheet-metal where the fax PCA cradle mounting tab and fax port (callout 2) must be installed.

**Figure 1-838** Locate the slots in the sheet-metal




2. Insert the fax PCA cradle mounting tab and fax port in the slots in the sheet-metal plate (callout 1), and then rotate the connector end of the fax PCA toward the formatter (callout 2).

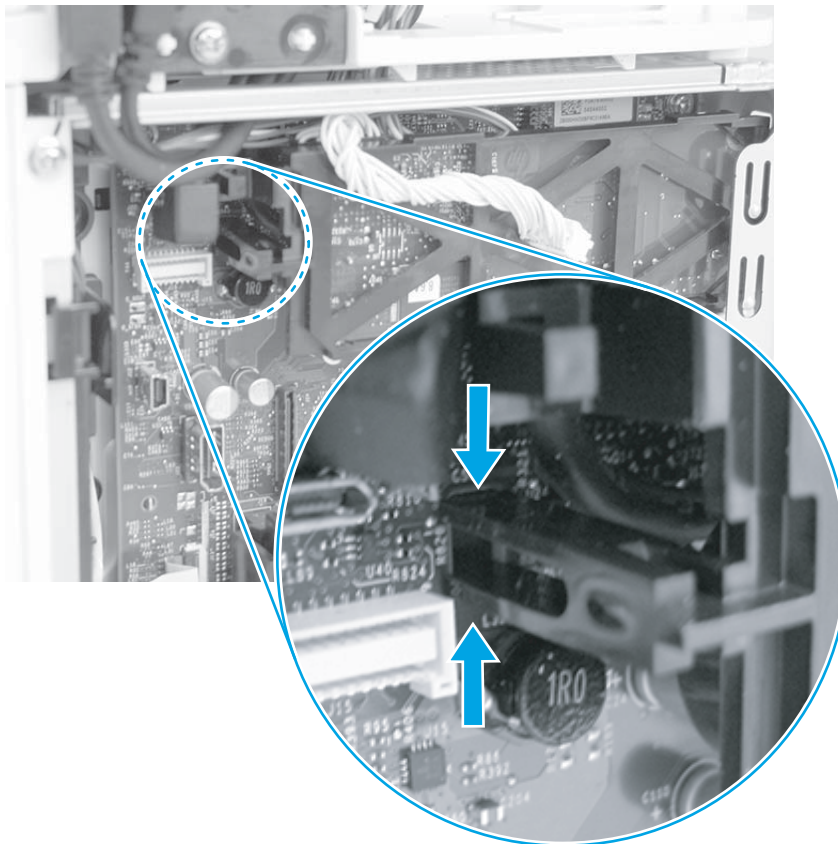
**Figure 1-839** Install the fax PCA



3. Engage the retainer with the slot in the formatter.

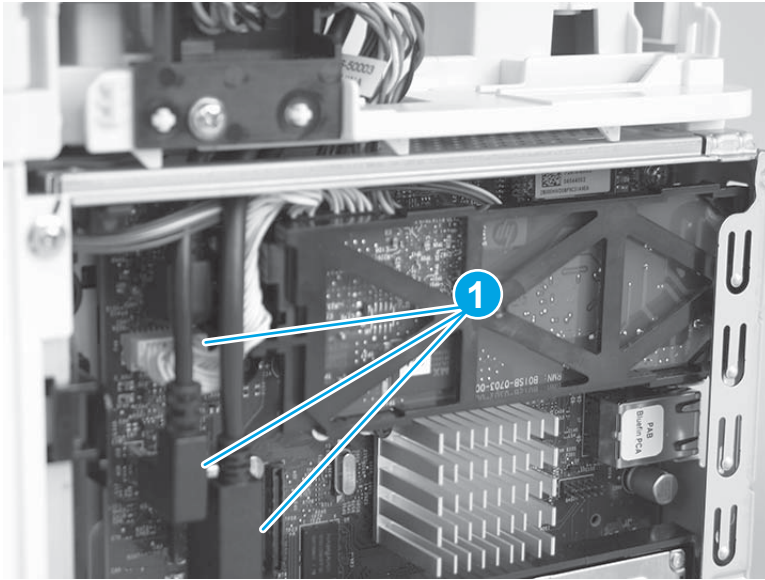
 **Reinstallation tip:** Pinch the retainer to easily engage it with the slot.

**Figure 1-840** Engage the fax PCA



4. Connect three connectors (callout 1).

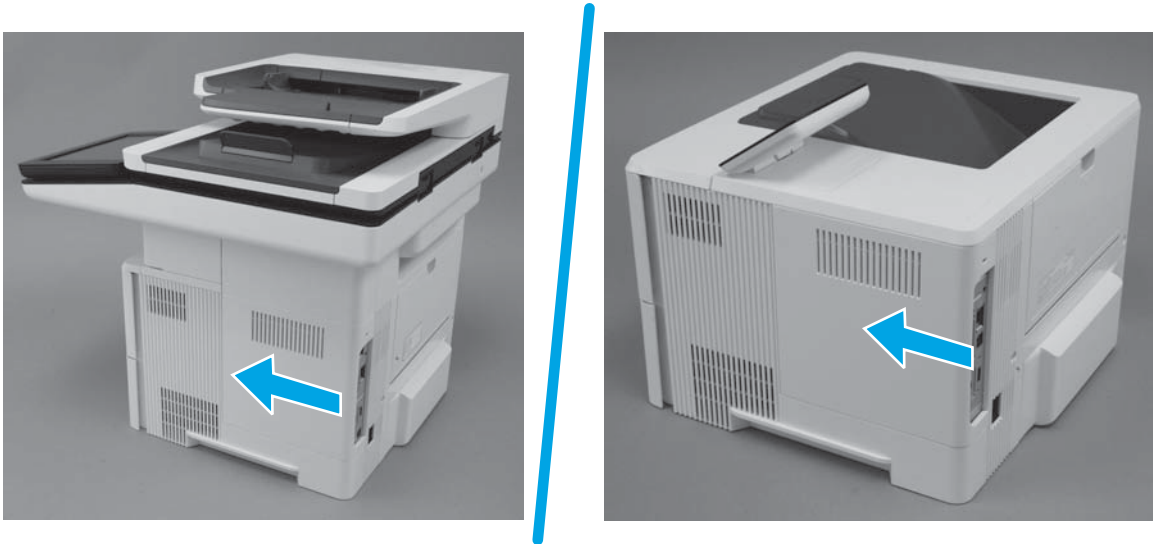
**Figure 1-841** Connect three connectors



**Step 14: Install the formatter cover**

- ▲ Slide it toward the front of the printer to install it.

**Figure 1-842** Install the formatter cover



## Removal and replacement: Internal parts and assemblies

- [Removal and replacement: Scanner control board \(M527\)](#)
- [Removal and replacement: Near field communication printed-circuit assembly \(M506x/M527z\)](#)
- [Removal and replacement: Wireless printed-circuit board \(WiFi\) \(M506x\)](#)
- [Removal and replacement: Wireless printed-circuit board \(M527z\)](#)
- [Removal and replacement: Fuser](#)
- [Removal and replacement: Stapler unit \(M527c/f/z\)](#)
- [Removal and replacement: Formatter](#)
- [Removal and replacement: Laser/scanner assembly](#)
- [Removal and replacement: Formatter case](#)
- [Removal and replacement: Fan \(FM1\)](#)
- [Removal and replacement: Fan \(FM2\)](#)
- [Removal and replacement: Fuser power supply \(FPS\)](#)
- [Removal and replacement: DC controller](#)
- [Removal and replacement: High-voltage power supply](#)
- [Removal and replacement: Low-voltage power supply](#)

## Removal and replacement: Scanner control board (M527)



**NOTE:** M527 printers only.

- [Introduction](#)
- [Step 1: Remove the formatter cover](#)
- [Step 2: Remove the top-left cover \(M527\)](#)
- [Step 3: Remove the top-rear cover \(M527\)](#)
- [Step 4: Remove the scanner control board \(SCB\)](#)
- [Step 5: Remove the SCB top cover](#)
- [Step 6: Unpack the replacement assembly](#)
- [Step 7: Install the SCB top cover](#)
- [Step 8: Install the SCB](#)
- [Step 9: Install the top-rear cover \(M527\)](#)
- [Step 10: Install the top-left cover \(M527\)](#)
- [Step 11: Install the formatter cover](#)


### Introduction

This document provides the procedures to remove and replace the scanner control board (SCB) (M527).

### Before performing service

#### Turn the printer power off

- Disconnect the power cable.

 **WARNING!** To avoid damage to the printer, turn the printer off wait 30 seconds, and then remove the power cable before attempting to service the printer.

Use the table below to identify the correct part number for your printer. To order the part, go to [www.hp.com/buy/parts](http://www.hp.com/buy/parts).

---

Scanner control board (M527) part number	
--	--

---

<b>B5L47-67903</b>
--------------------

Scanner control board (M527) <sup>1</sup> kit with instruction guide
--

---

<sup>1</sup> M527 printers only.

### Required tools

- No special tools are required for this assembly.

## After performing service

### Turn the printer power on

- Connect the power cable.
- Use the power switch to turn the power on.

### Post service test

Make sure that the printer initializes to a **Ready** state.

Print a configuration page to make sure that the printer is functioning correctly.

### Step 1: Remove the formatter cover

- ▲ Slide the cover toward the rear of the printer to remove it.

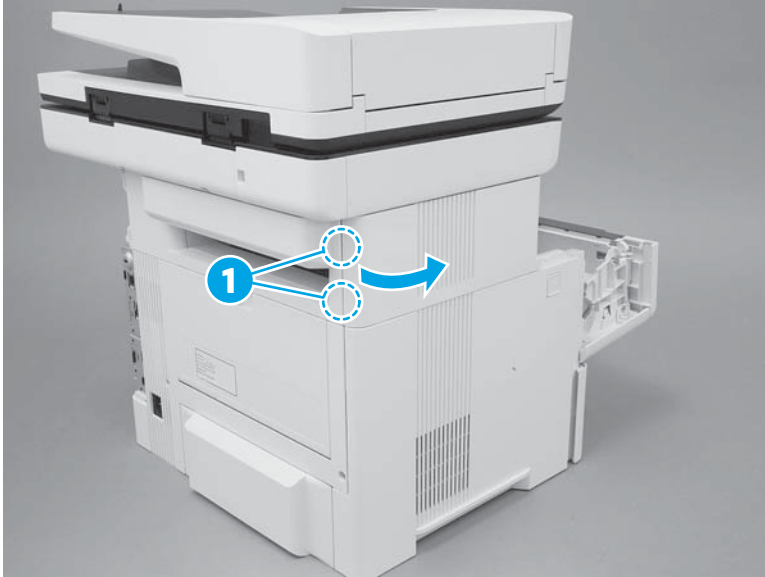
**Figure 1-843** Remove the formatter cover



### Step 2: Remove the top-left cover (M527)

1. Open the toner-cartridge door, release two tabs (callout 1), and then rotate the rear edge of the cover away from the printer.

**Figure 1-844** Release two tabs



2. Continue to rotate the cover away from the printer to release two more tabs at the middle of the cover.

**Figure 1-845** Release two tabs





3. Slide the cover toward the rear of the printer to release two bosses at the front of the cover.

**Figure 1-846** Slide the cover



4. Remove the cover.

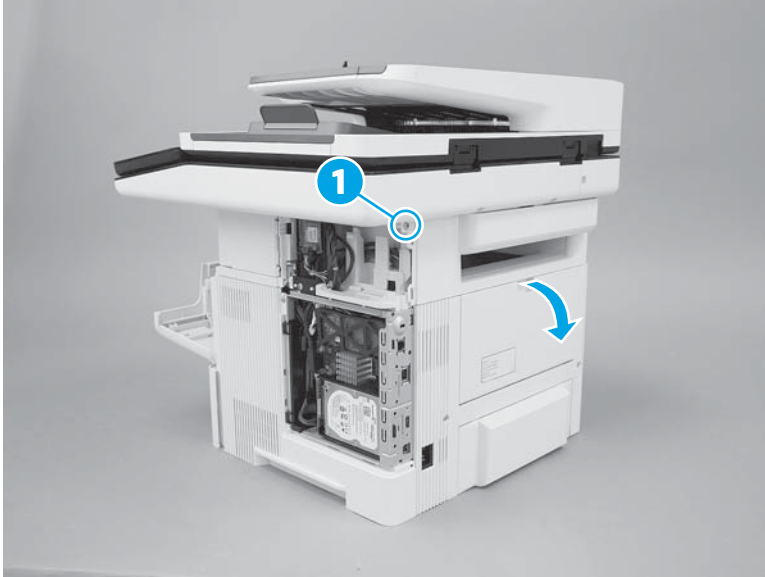
**Figure 1-847** Remove the cover



### **Step 3: Remove the top-rear cover (M527)**

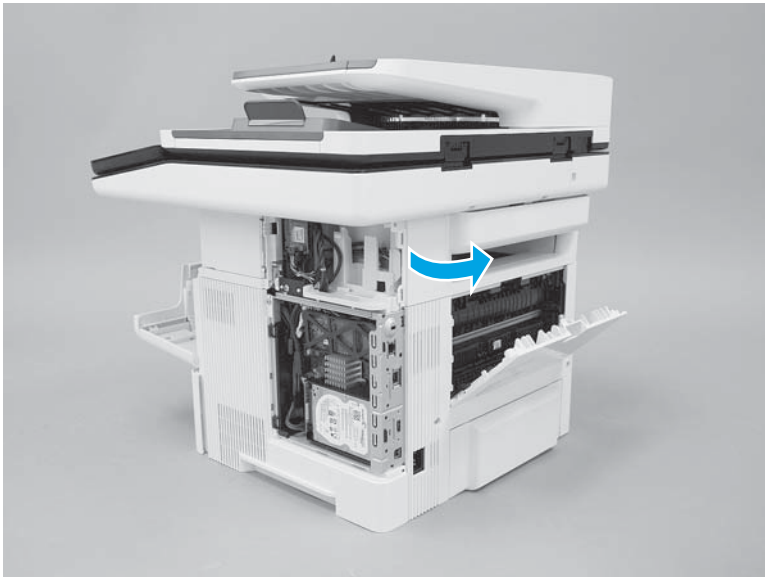
1. Remove one screw (callout 1), and then open the rear door.

**Figure 1-848** Remove one screw



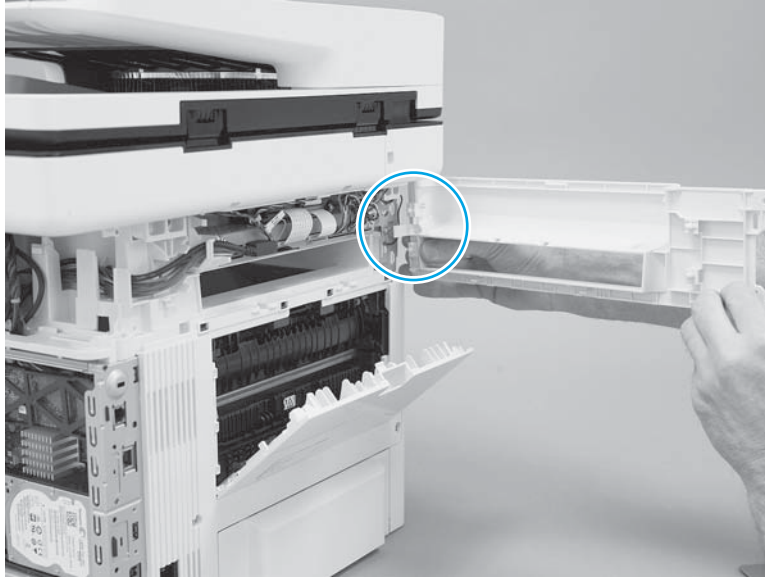
2. Rotate the exposed edge of the cover away from the printer (as shown).

**Figure 1-849** Rotate the cover



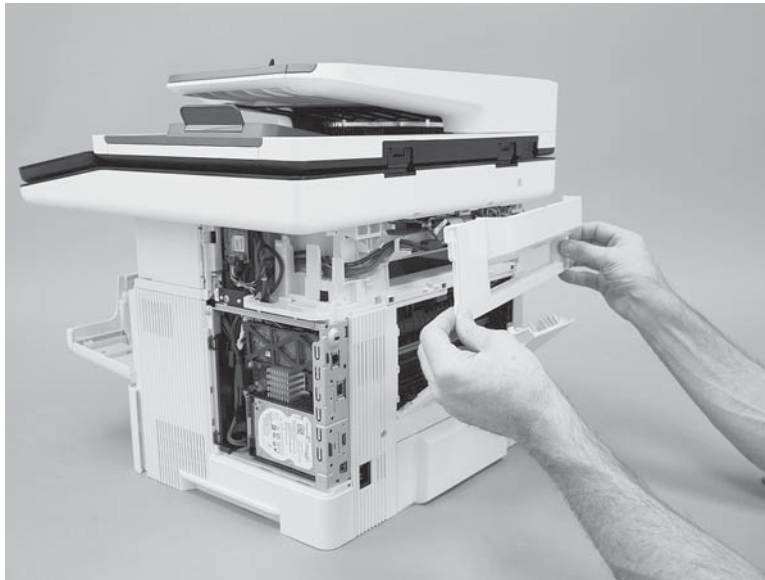
3. Continue to rotate the cover away from the printer to release one boss.

**Figure 1-850** Release one boss




4. Remove the cover.

**Figure 1-851** Remove the cover




#### Step 4: Remove the scanner control board (SCB)

---

 **NOTE:** M527 printers only.

---

1. Disconnect all of the connectors from the SCB.

 **Reinstallation tip:** There are eight wire-harness connectors, two flat-flexible cables (FFCs), and one high definition multimedia interface (HDMI) cable connector.

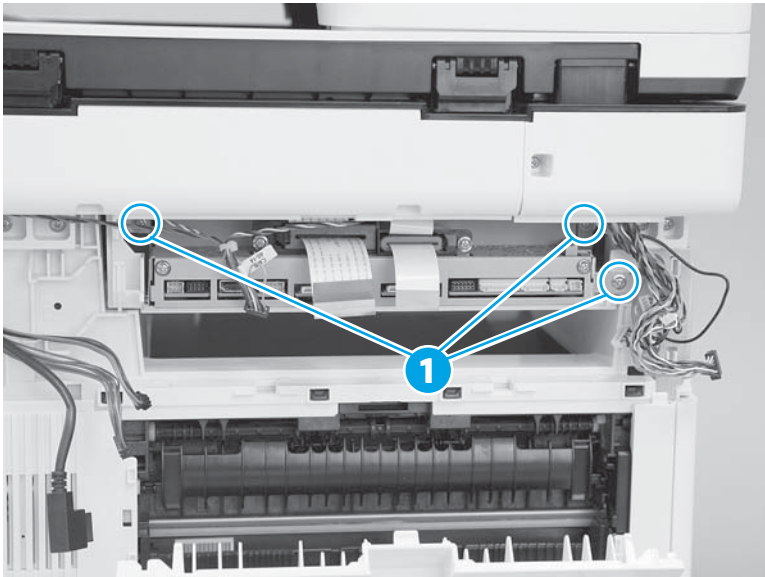
---

**Figure 1-852** Disconnect all of the connectors



2. Remove three screws (callout 1).

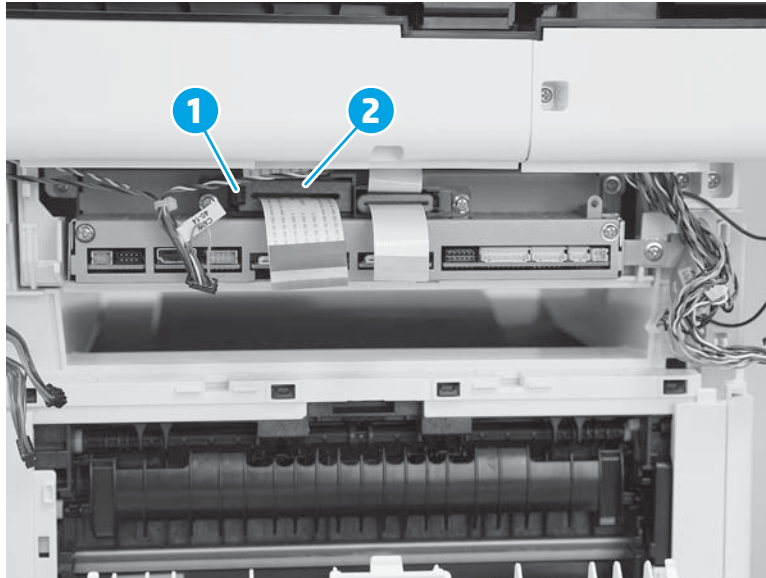
**Figure 1-853** Remove three screws



3. Release one tab (callout 1), and then remove one ferrite from the holder (callout 2).

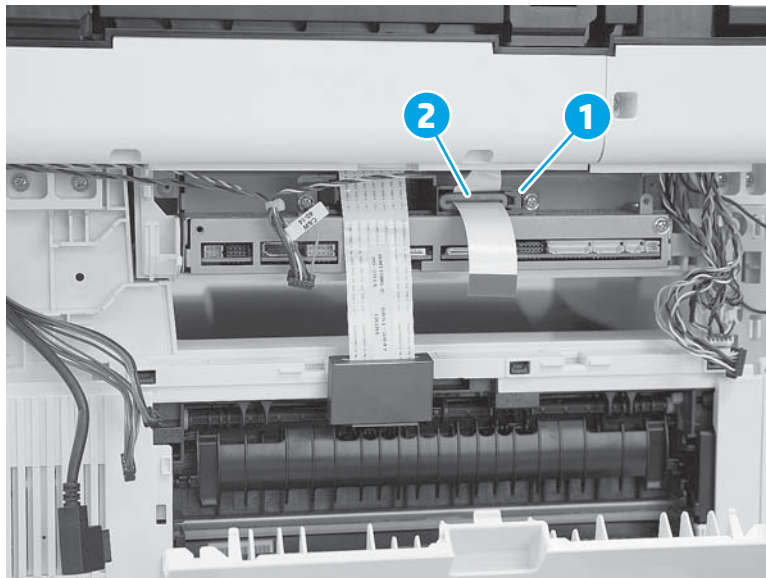
 **NOTE:** The ferrite does not need to be removed from the FFC. Simply let it slide down the FFC until it stops, and then let it hang out of the way.

**Figure 1-854** Remove one ferrite



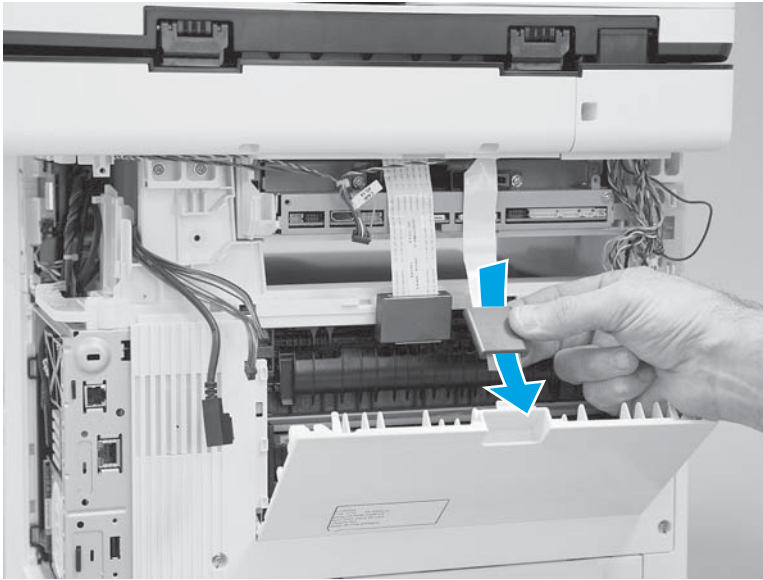
4. Release one tab (callout 1), and then remove one ferrite from the holder (callout 2).

**Figure 1-855** Remove one ferrite



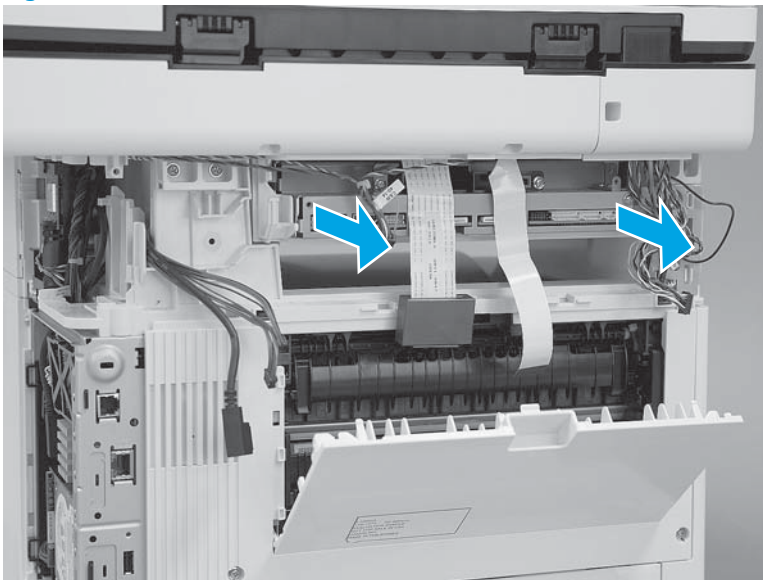
5. Slide the ferrite down the FFC to remove it.

**Figure 1-856** Remove the ferrite from the FFC



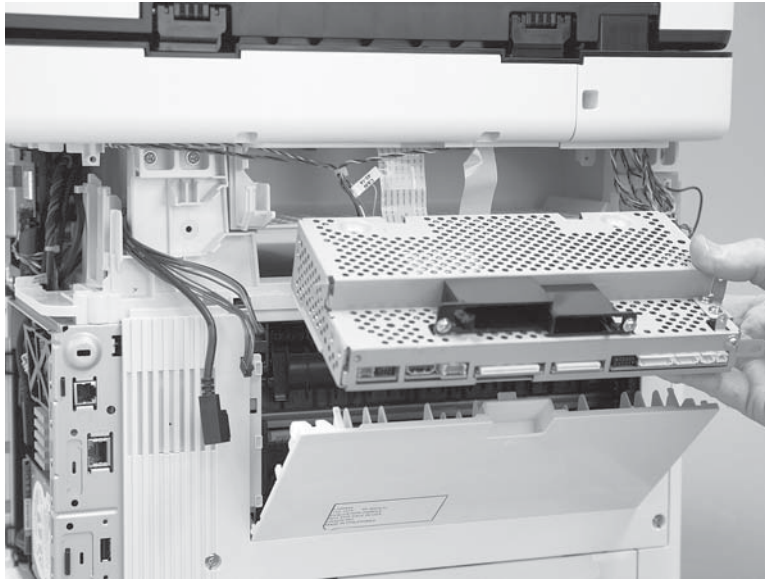
6. Slide the SCB straight out of the printer.

**Figure 1-857** Slide the SCB out




7. Remove the SCB.

**Figure 1-858** Remove the SCB

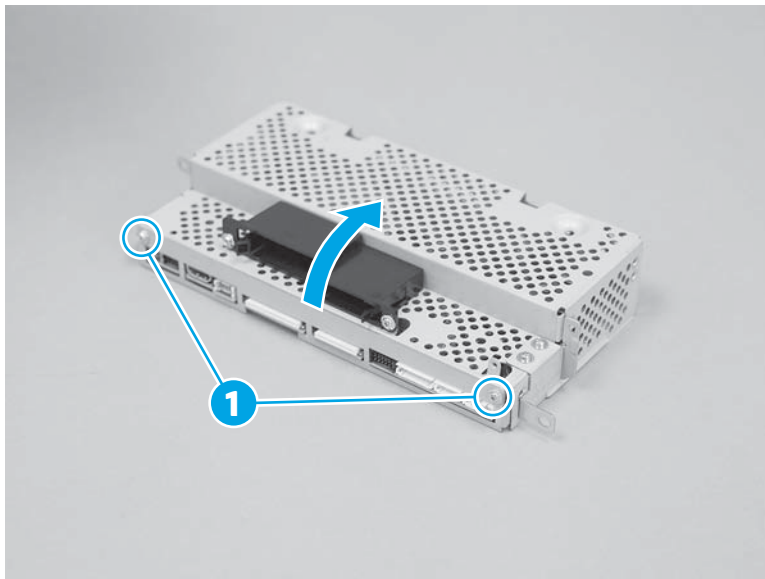


#### Step 5: Remove the SCB top cover

 **NOTE:** M527 printers only.

1. Remove two screws (callout 1), and then rotate the front edge of the cover up and off the SCB to release it.

**Figure 1-859** Remove two screws



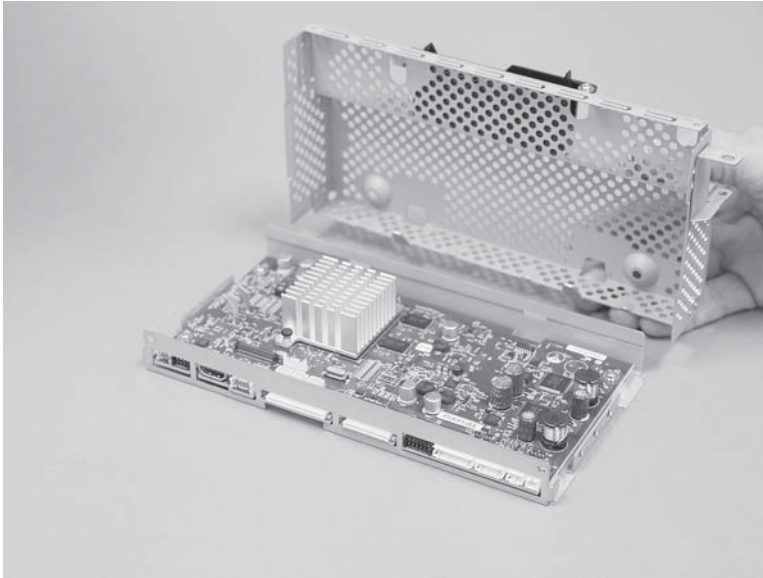
2. Remove the SCB top cover.

---

 **NOTE:** Save the top cover. It must be installed on the replacement SCB.

---

**Figure 1-860** Remove the cover



### Step 6: Unpack the replacement assembly

Unpack the replacement part from the packaging.

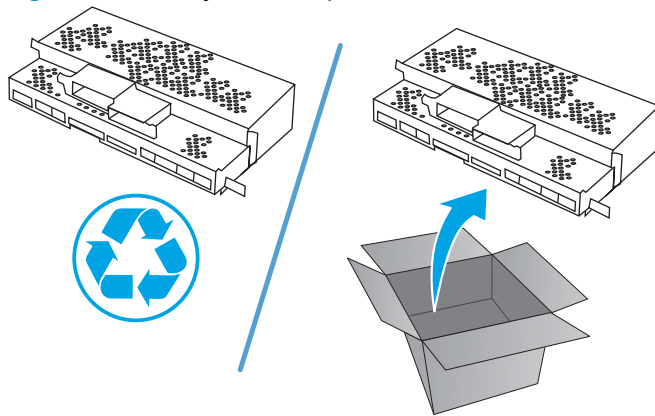
<http://www8.hp.com/us/en/hp-information/environment/product-recycling.html>

---

 **NOTE:** HP recommends responsible disposal of the defective part.


---

**Figure 1-861** Recycle and unpack



### Step 7: Install the SCB top cover

---

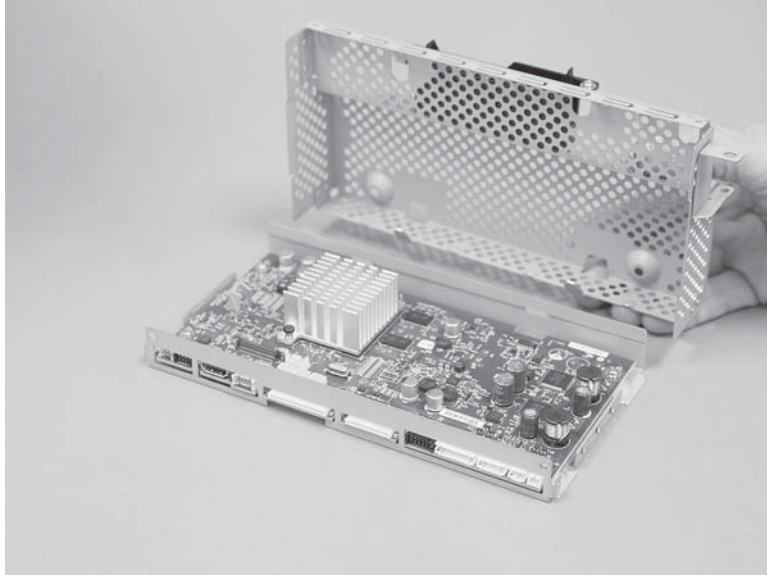
 **NOTE:** M527 printers only.

---

1. Position the rear edge of the SCB top cover on the replacement SCB assembly.

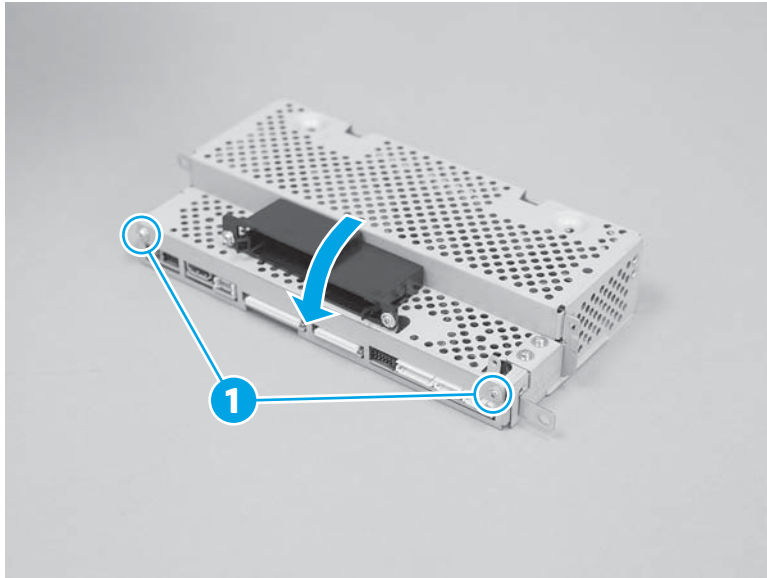


**Figure 1-862** Install the cover



2. Rotate the front edge of the cover down and onto the SCB assembly, and then install two screws (callout 1).

**Figure 1-863** Install two screws



### Step 8: Install the SCB



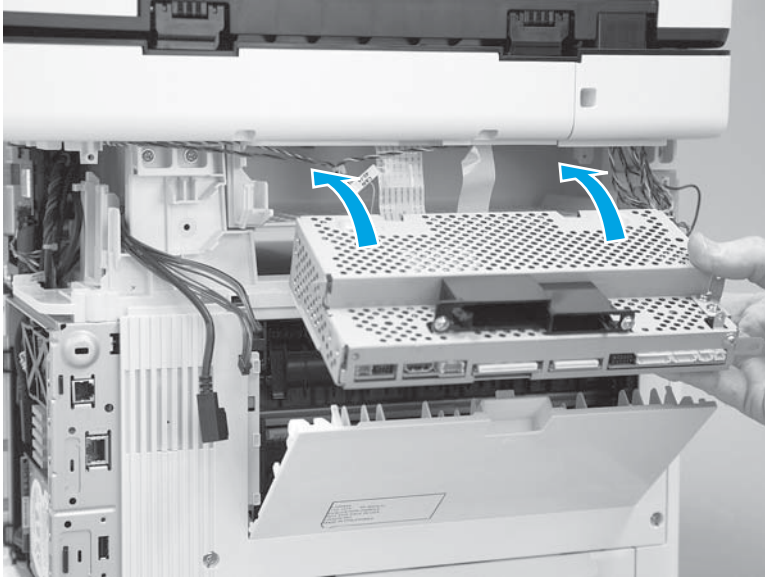
**NOTE:** M527 printers only.

1. Position the SCB in the printer.



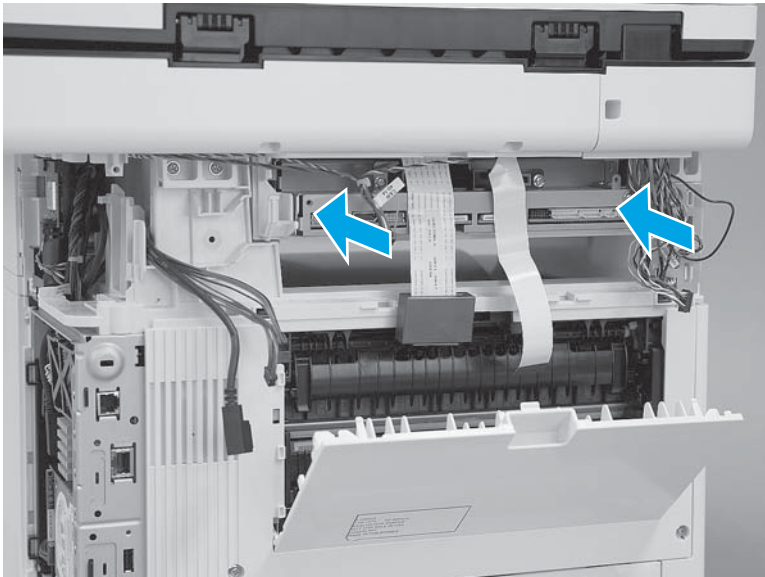
**CAUTION:** To prevent damaging the FFCs, carefully hold them out of the way while installing the SCB.

**Figure 1-864** Install the SCB



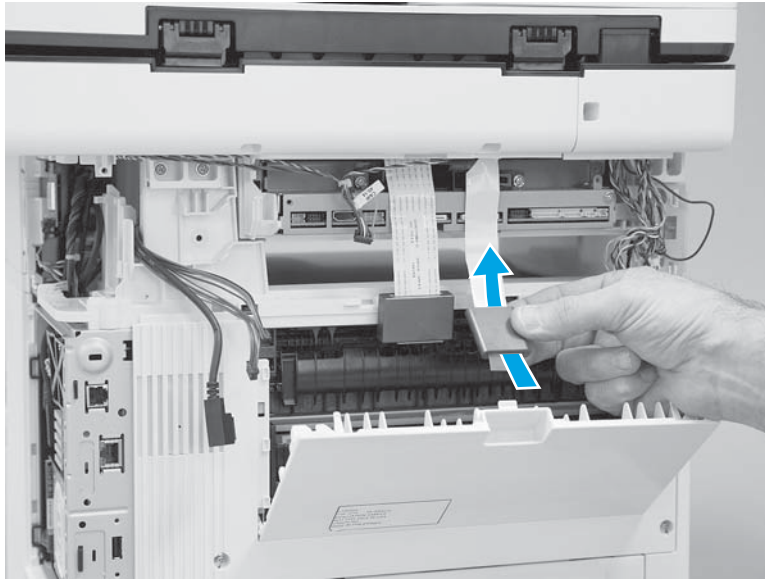
2. Slide the SCB straight into the printer until it stops.

**Figure 1-865** Slide the SCB in



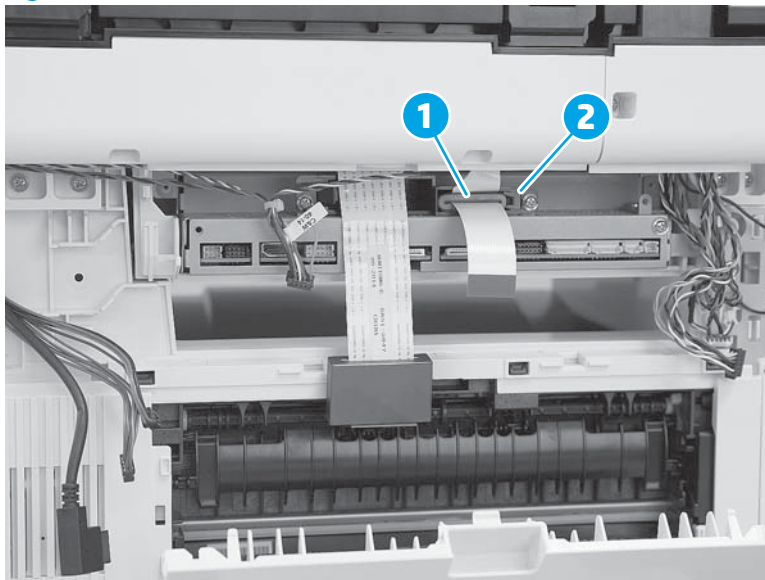
3. Slide the ferrite up the FFC to install it.

**Figure 1-866** Install the ferrite on the FFC



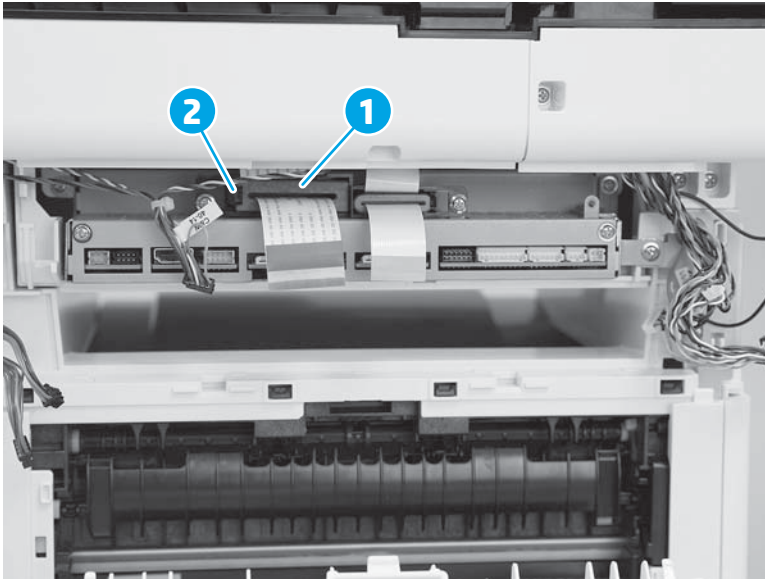
4. Install the ferrite in the holder (callout 1). Make sure that the tab (callout 2) snaps over the ferrite.

**Figure 1-867** Install the ferrite in the holder



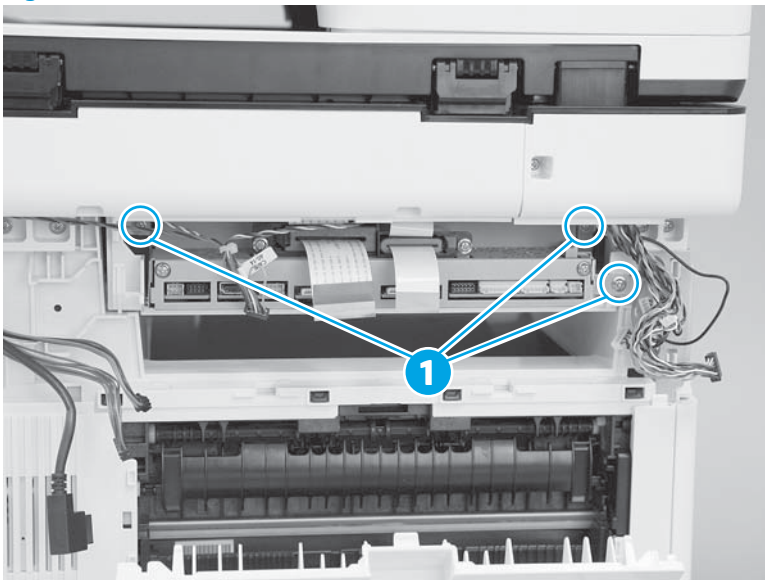
5. Install the ferrite in the holder (callout 1). Make sure that the tab (callout 2) snaps over the ferrite.

**Figure 1-868** Install the ferrite in the holder




6. Install three screws (callout 1).

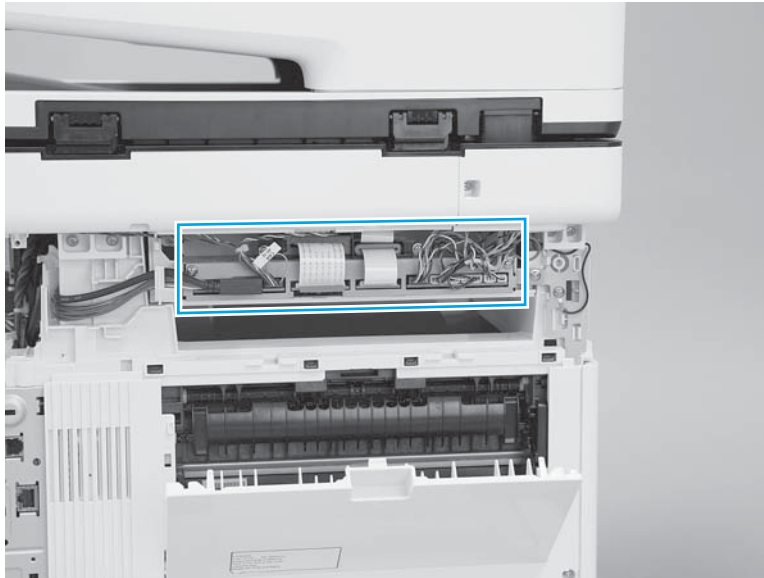
**Figure 1-869** Install three screws



7. Connect all of the connectors to the SCB.

 **Reinstallation tip:** There are eight wire-harness connectors, two flat-flexib cables (FFCs), and one high definitio multimedia interface (HDMI) cable connector.

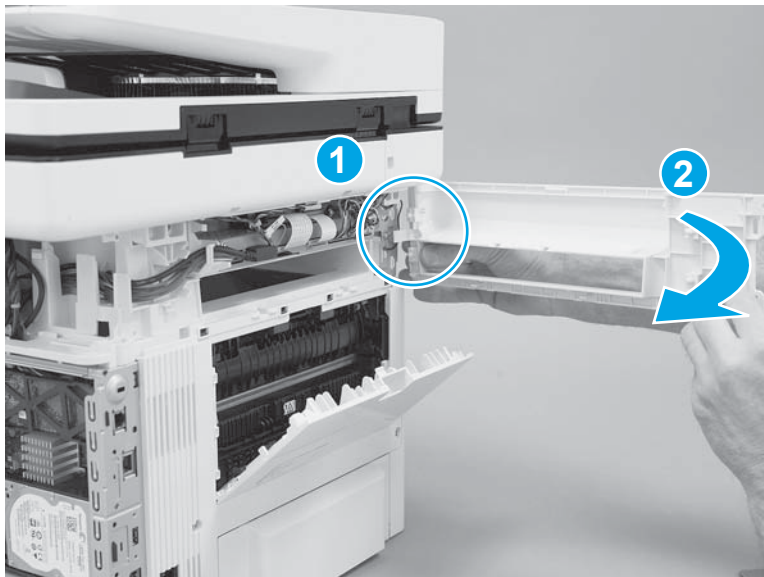
**Figure 1-870** Connect all of the connectors



### Step 9: Install the top-rear cover (M527)

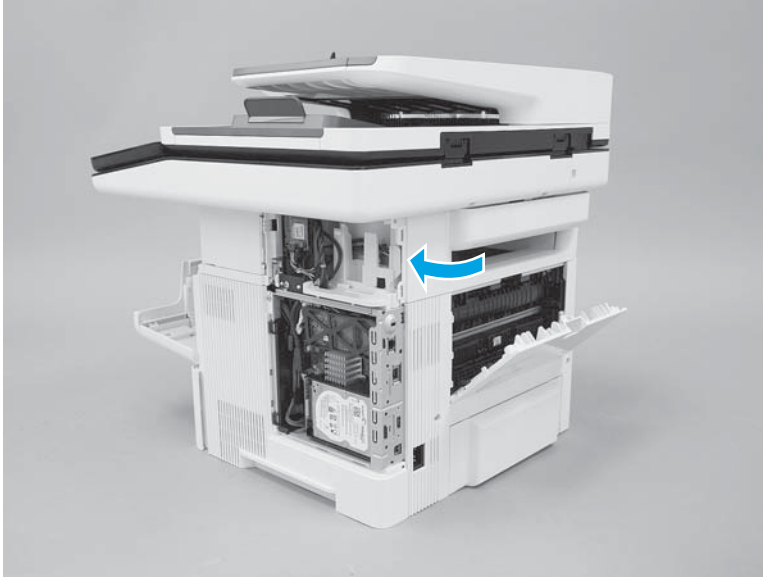
1. Engage one boss (callout 1), and then rotate the cover towards the printer (callout 2).

**Figure 1-871** Engage one boss



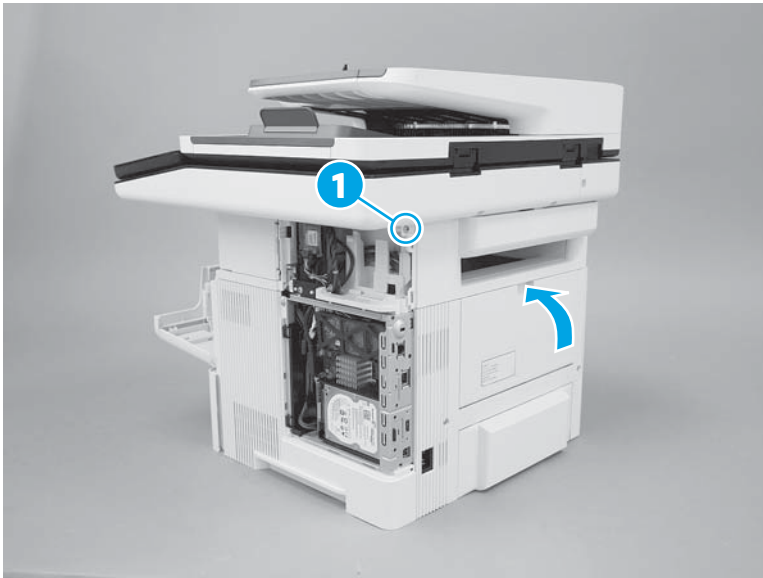
2. Continue to rotate the cover toward the printer to install it.

**Figure 1-872** Install the cover



3. Install one screw (callout 1), and then close the rear door.

**Figure 1-873** Install one screw



### **Step 10: Install the top-left cover (M527)**

1. Position the front edge of the cover on the printer, and then slide the cover toward the front of the printer to engage two bosses at the front of the cover.

**Figure 1-874** Slide the cover




2. Rotate the cover towards the printer to engage two tabs at the middle of the cover.

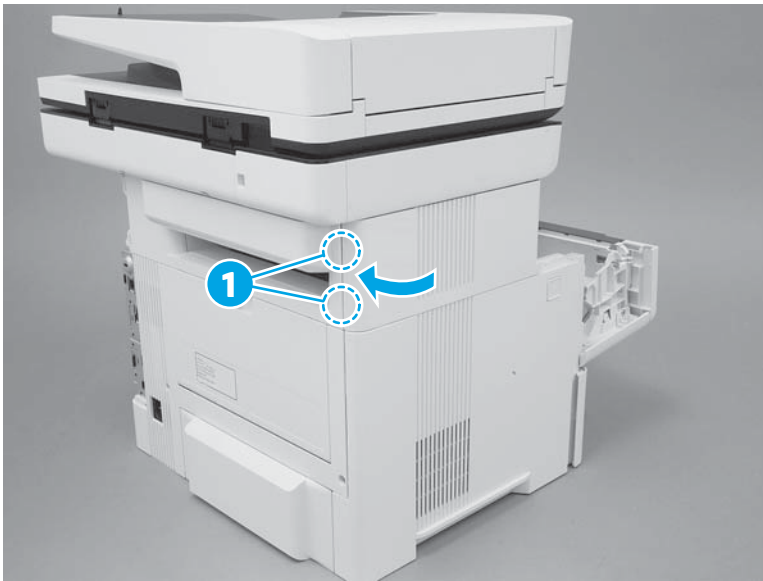
**Figure 1-875** Engage two tabs



3. Continue to rotate the cover onto the printer to engage two tabs (callout 1) at the rear edge of the cover.

 **NOTE:** Close the toner-cartridge door.

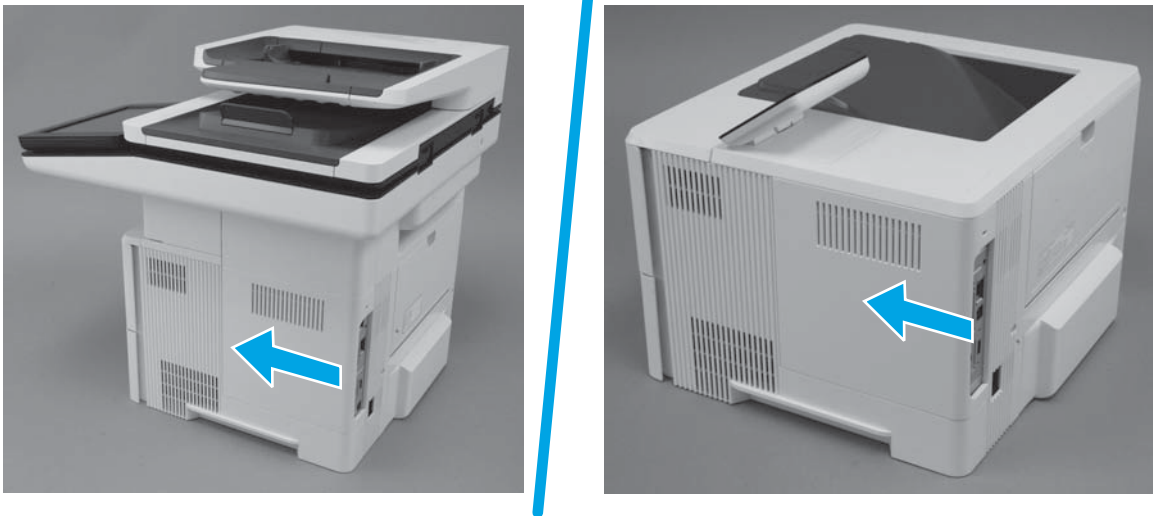
**Figure 1-876** Engage two tabs



### Step 11: Install the formatter cover

- ▲ Slide it toward the front of the printer to install it.

**Figure 1-877** Install the formatter cover





## Removal and replacement: Near field communication printed-circuit assembly (M506x/M527z)

 **NOTE:** M506x and M527z models only.

- [Introduction](#)
- [Step 1: Remove the control-panel cover \(M527\)](#)
- [Step 2: Remove the NFC PCA](#)
- [Step 3: Unpack the replacement PCA](#)
- [Step 4: Install the NFC PCA](#)
- [Step 5: Install the control-panel cover \(M527\)](#)


### Introduction

This document provides the procedures to remove and replace the near field communication (NFC) printed-circuit assembly (PCA) (M506x and M527z models only).

### Before performing service

#### Turn the printer power off

- Disconnect the power cable.

 **WARNING!** To avoid damage to the printer, turn the printer off, wait 30 seconds, and then remove the power cable before attempting to service the printer.

Use the table below to identify the correct part number for your printer. To order the part, go to [www.hp.com/buy/parts](http://www.hp.com/buy/parts).

Near field communication (NFC) PCA part number	
<b>B5L24-60001</b>	Near field communication (NFC) PCA <sup>1</sup>

<sup>1</sup> M506x and M527z models only.

### Required tools

- No special tools are required for this assembly.

### After performing service

#### Turn the printer power on

- Connect the power cable.
- Use the power switch to turn the power on.

### Post service test

Make sure that the printer initializes to a **Ready** state.

Use a NFC enabled device to print a job from the printer.

## Step 1: Remove the control-panel cover (M527)

1. If the document feeder is not open, open it now.

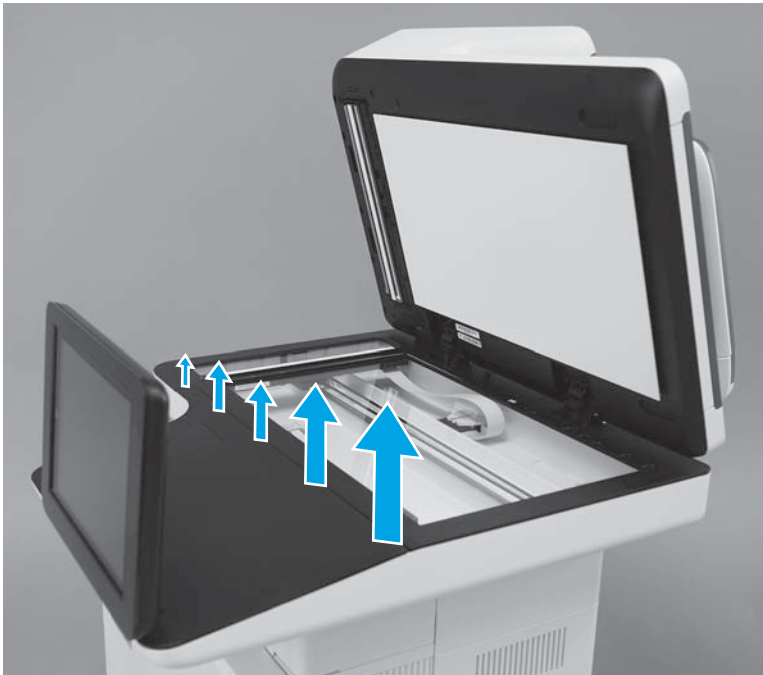
 **NOTE:** If the control panel is not fully tilted forward, tilt it forward now until it stops.

**Figure 1-878** Open the document feeder



2. Beginning at the right side of the control-panel cover, carefully release five tabs along the top edge of the cover.

**Figure 1-879** Release five tabs



3. Continue to rotate the top edge of the cover away from the printer, and then remove the cover.

**Figure 1-880** Remove the cover

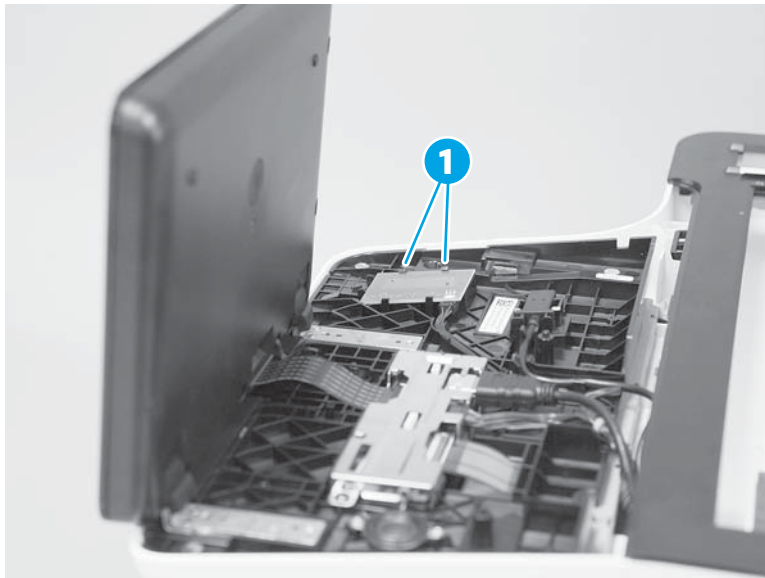


## Step 2: Remove the NFC PCA

 **NOTE:** M506x and M527z models only.

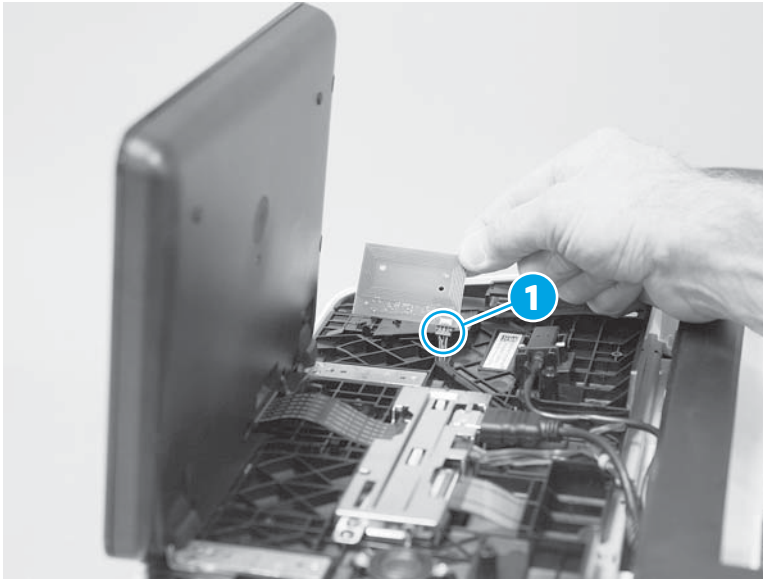
1. Release two tabs (callout 1).

**Figure 1-881** Release two tabs



2. Turn the NFC PCA over to access the bottom side, disconnect one connector (callout 1), and then remove the NFC PCA.

**Figure 1-882** Remove the NFC PCA



### Step 3: Unpack the replacement PCA

Unpack the replacement part from the packaging.

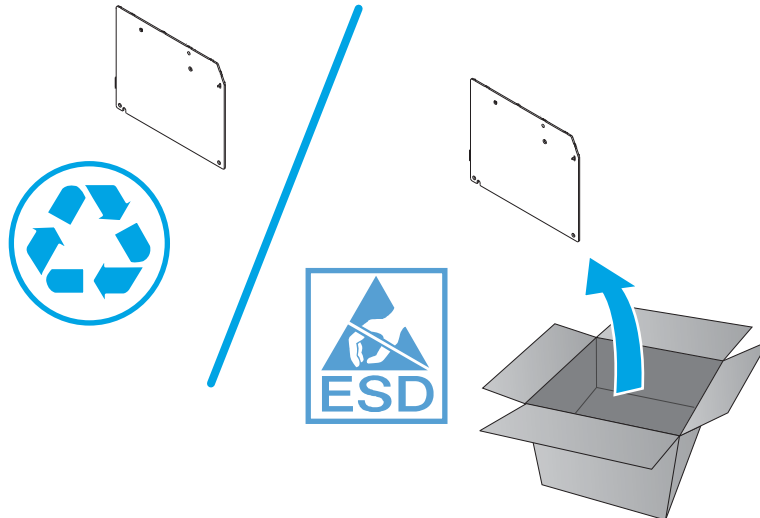
<http://www8.hp.com/us/en/hp-information/environment/product-recycling.html>

---

 **NOTE:** HP recommends responsible disposal of the defective part.

---

**Figure 1-883** Recycle and unpack



### Step 4: Install the NFC PCA

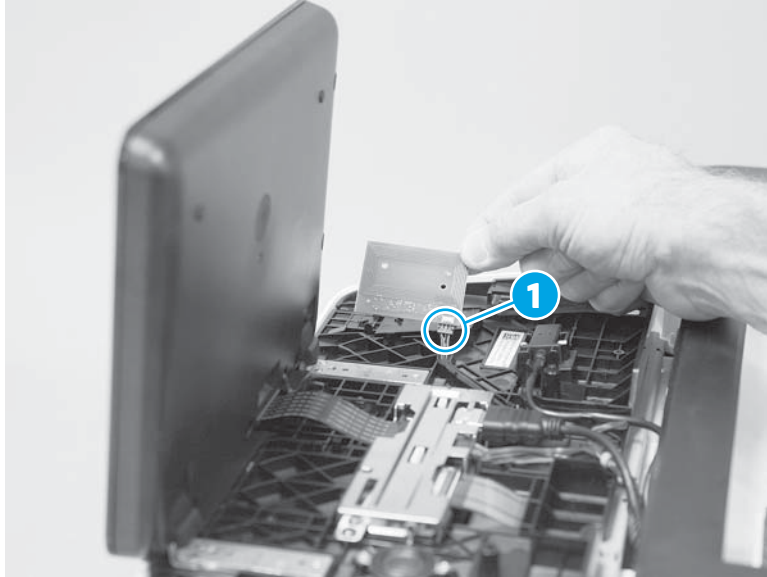
---

 **NOTE:** M506x and M527z models only.

---

1. Connect one connector (callout 1).

**Figure 1-884** Connect one FFC

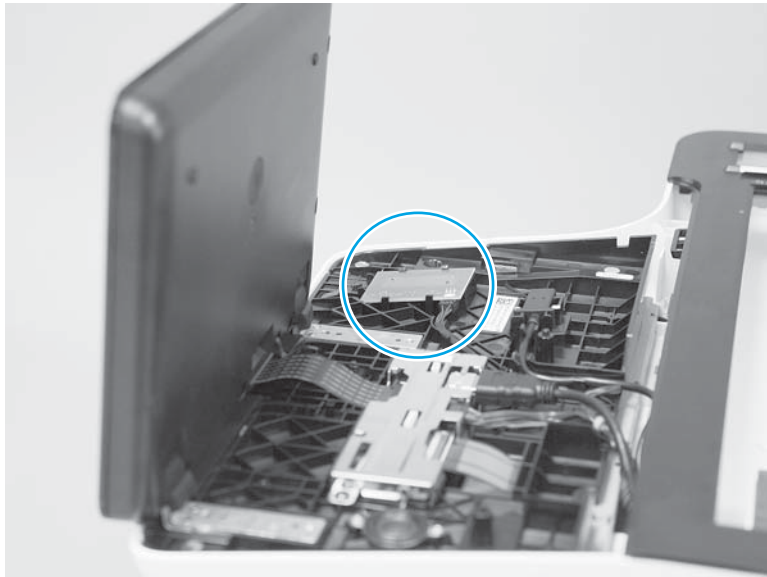


2. Install the NFC PCA on the holder.



**NOTE:** Make sure that the NFC is positioned under all four tabs on the holder.

**Figure 1-885** Install the NFC PCA



### Step 5: Install the control-panel cover (M527)

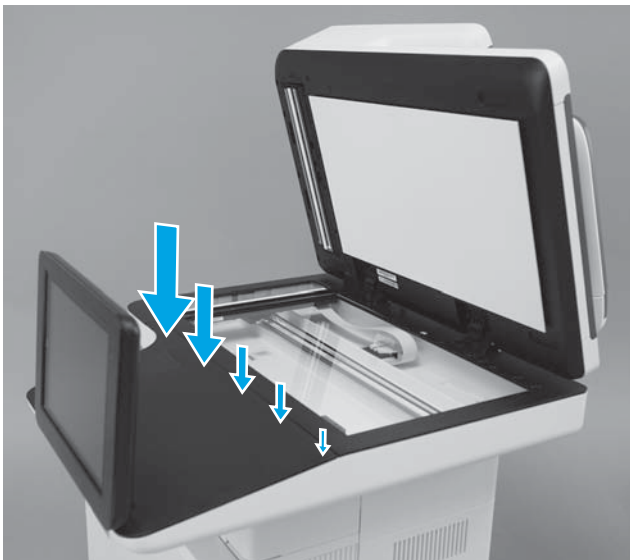
1. Position the control-panel cover on the printer.

**Figure 1-886** Position the control-panel cover on the printer



2. Beginning at the left side of the control-panel cover, carefully engage five tabs along the top edge of the cover.

**Figure 1-887** Engage five tabs



3. Close the document feeder.

 **NOTE:** Adjust the control panel to the desired angle.

---

**Figure 1-888** Close the document feeder



## Removal and replacement: Wireless printed-circuit board (WiFi) (M506x)



**NOTE:** M506x models only.

- [Introduction](#)
- [Step 1: Remove the tray](#)
- [Step 2: Remove the formatter cover](#)
- [Step 3: Remove the rear door assembly](#)
- [Step 4: Remove the cartridge door assembly](#)
- [Step 5: Remove the right cover](#)
- [Step 6: Remove the wireless PCA \(WiFi\) \(M506x\)](#)
- [Step 7: Unpack the replacement PCA](#)
- [Step 8: Install the wireless PCA \(WiFi\) \(M506x\)](#)
- [Step 9: Install the right cover](#)
- [Step 10: Install the cartridge door assembly](#)
- [Step 11: Install the rear door assembly](#)
- [Step 12: Install the formatter cover](#)
- [Step 13: Install the tray](#)

### Introduction

This document provides the procedures to remove and replace the wireless PCA (M506x).

### Before performing service

#### Turn the printer power off

- Disconnect the power cable.



**WARNING!** To avoid damage to the printer, turn the printer off wait 30 seconds, and then remove the power cable before attempting to service the printer.

Use the table below to identify the correct part number for your printer. To order the part, go to [www.hp.com/buy/parts](http://www.hp.com/buy/parts).

Wireless PCA part number	
1150-7968	Wireless PCA <sup>1</sup>

<sup>1</sup> M506x models only.

### Required tools

- #2 Phillips screwdriver with a magnetic tip.



## After performing service

### Turn the printer power on

- Connect the power cable.
- Use the power switch to turn the power on.

### Post service test

Use a wireless device to print a job from the printer.

### Step 1: Remove the tray

1. Pull the tray straight out of the printer until it stops.

**Figure 1-889** Pull the tray out until it stops



2. Lift the front of the tray, and then pull it out of the printer to remove it.

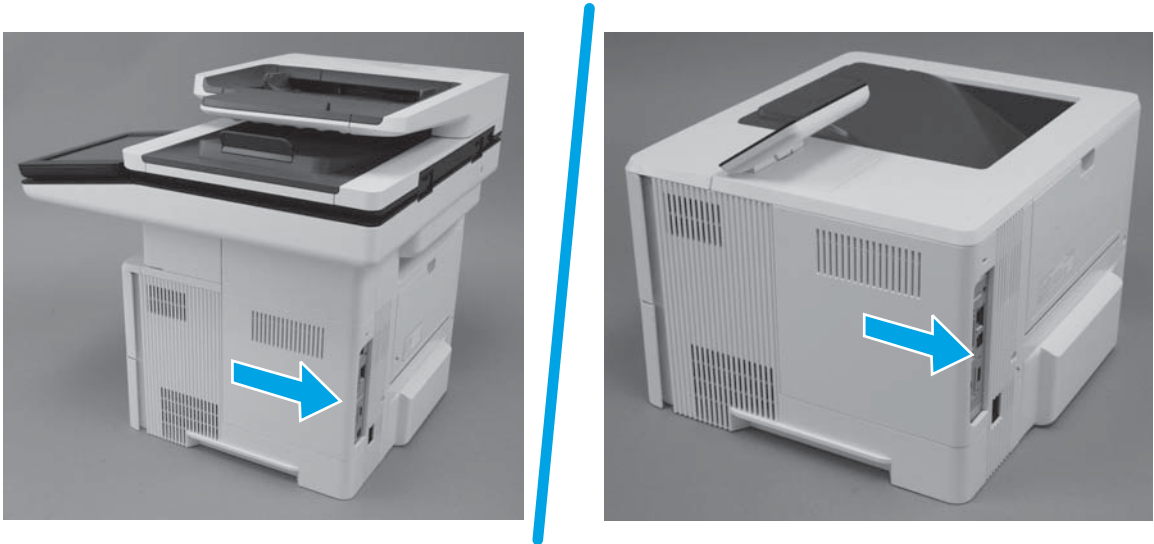
**Figure 1-890** Release and remove the tray



### Step 2: Remove the formatter cover

- ▲ Slide the cover toward the rear of the printer to remove it.

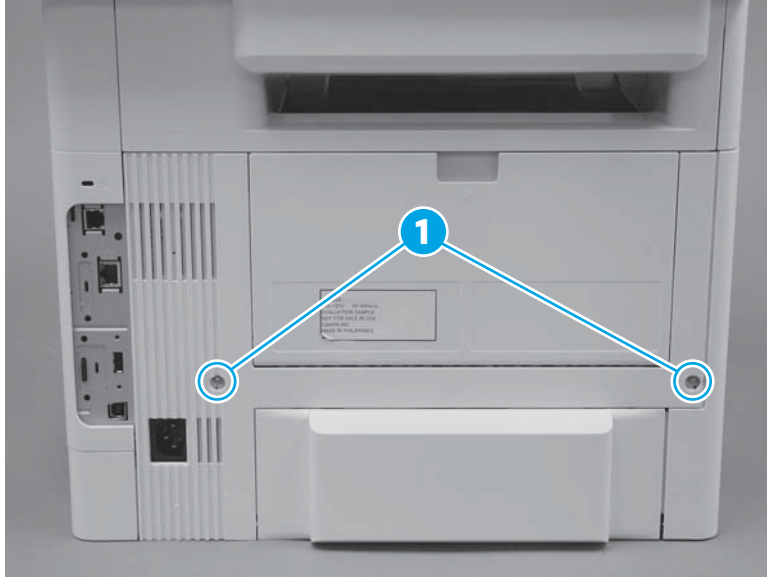
**Figure 1-891** Remove the formatter cover



### Step 3: Remove the rear door assembly

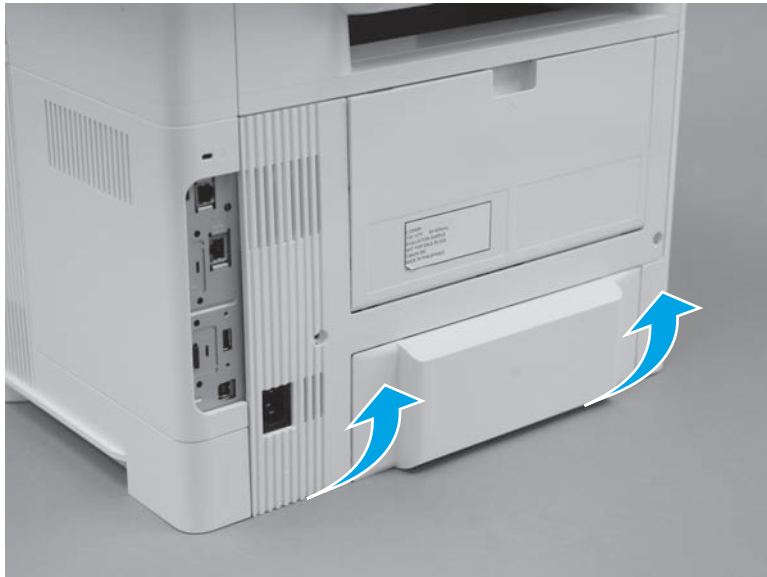
1. At the rear of the printer, remove two screws (callout 1).

**Figure 1-892** Remove two screws



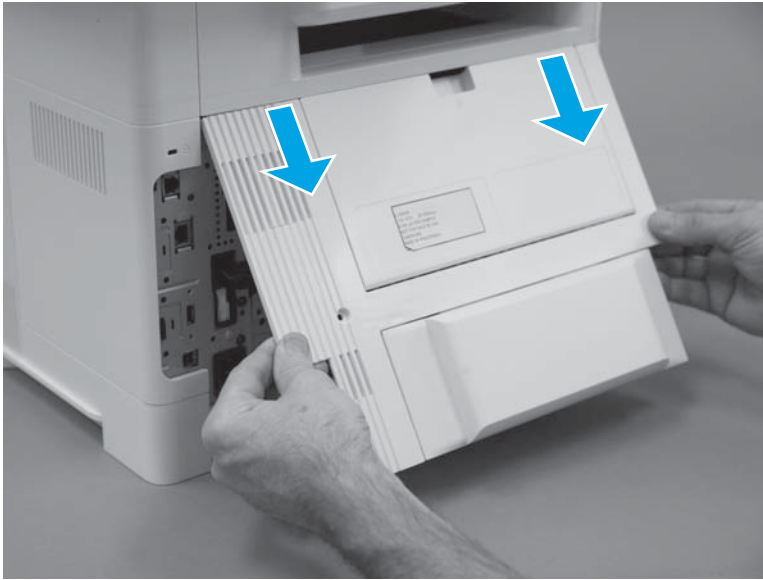
2. Rotate the bottom edge of the assembly away from the printer to release it.

**Figure 1-893** Rotate the bottom of the cover



3. Pull down on the assembly to remove it.

**Figure 1-894** Remove the cover



#### Step 4: Remove the cartridge door assembly



---

**NOTE:** If the toner cartridge was not removed prior to servicing the printer, remove it now.

---

1. Release the support shaft (callout 1), and then slide it toward the center of the door (callout 2).

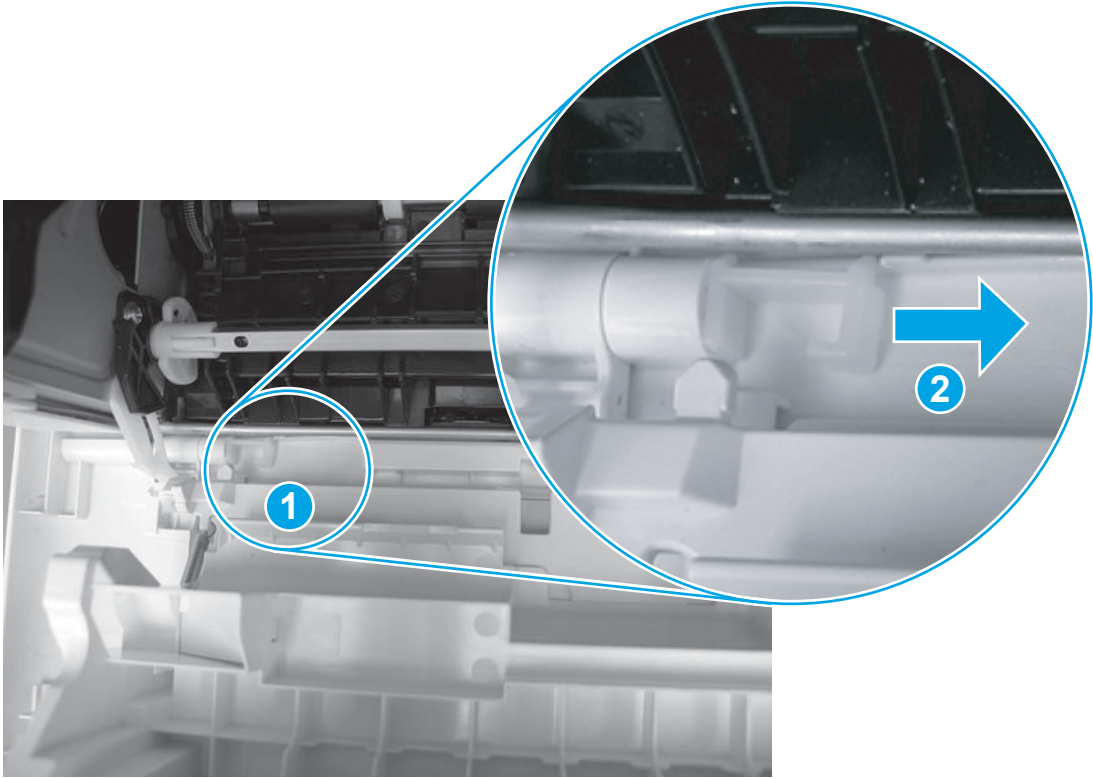


---

**TIP:** It might be easier to release the support shaft by using a small flat-blade screwdriver.

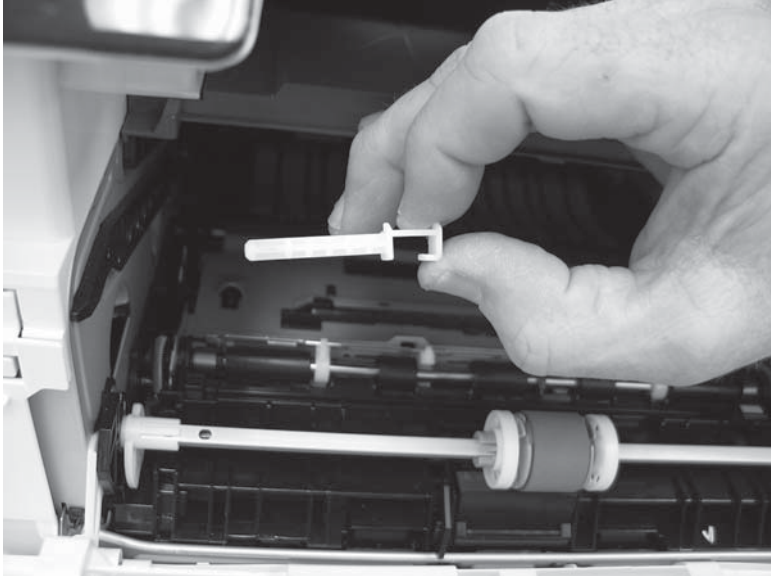
---

**Figure 1-895** Release the support shaft



- 2. Remove the support shaft.

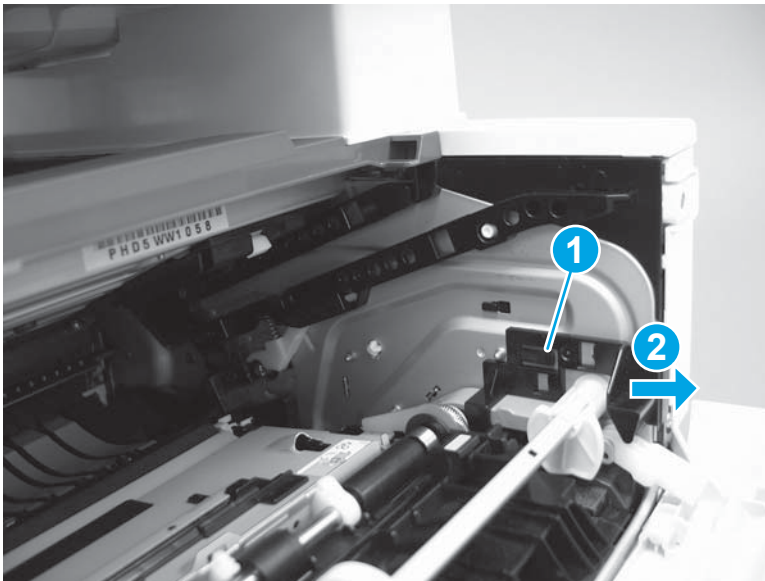
**Figure 1-896** Remove the support shaft



3. Release one tab (callout 1), and then slide the guide out of the printer (callout 2).

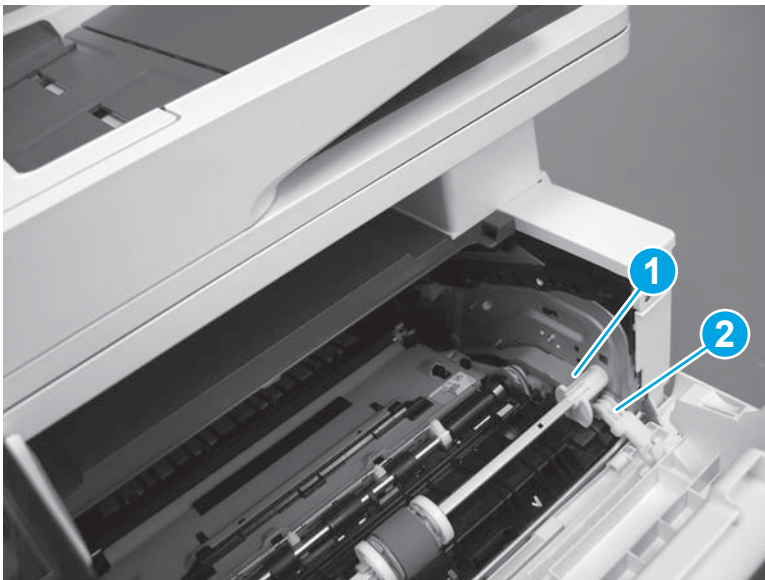
**⚠ CAUTION:** Be careful, the tab (callout 1) can be easily broken.

**Figure 1-897** Remove the guide



4. Use a small flat-blad screwdriver to gently pry the white-plastic door arm (callout 1) off of the gray-plastic pressure-release link (callout 2) to release the door arm.

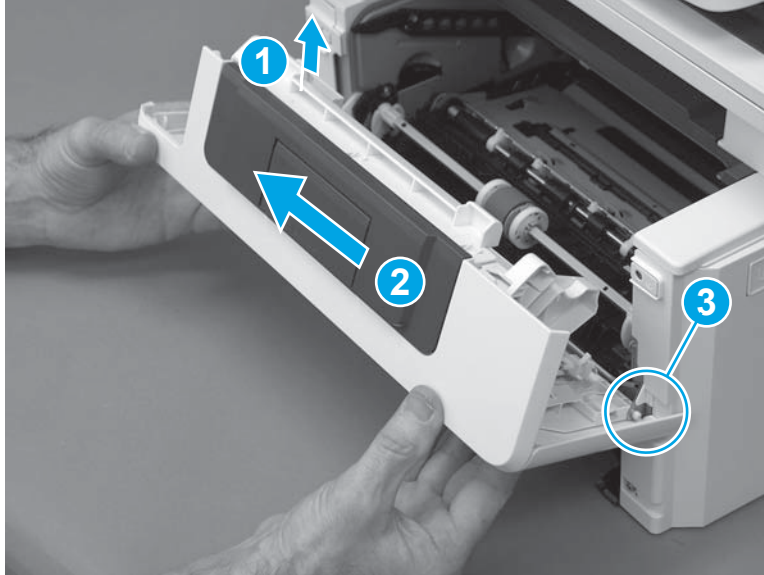
**Figure 1-898** Release the pressure-release link



5. With the door in the partially closed position, slightly raise the left end (callout 1; raise it over the sheet-metal hinge boss), and then slide the door to the left (callout 2) to release the right hinge (callout 3).

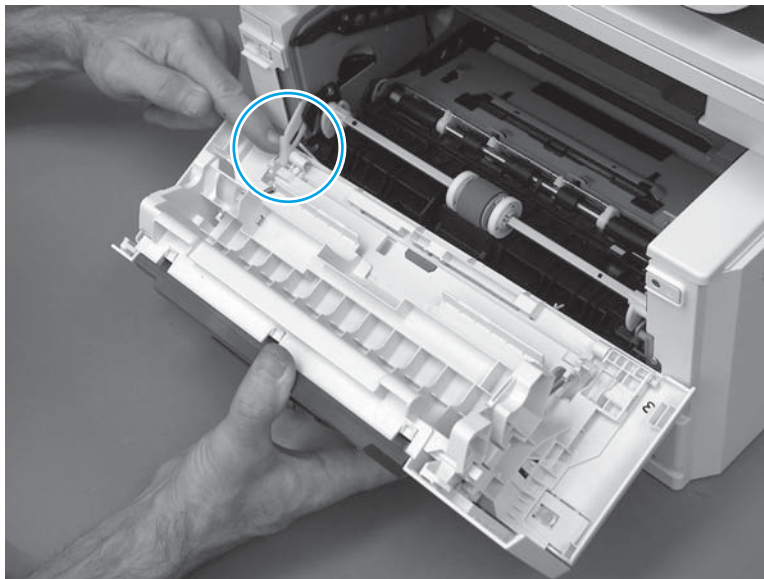
**CAUTION:** The door is still attached to the printer by the left-side retainer arm. Do not attempt to completely remove the door.

**Figure 1-899** Release the door



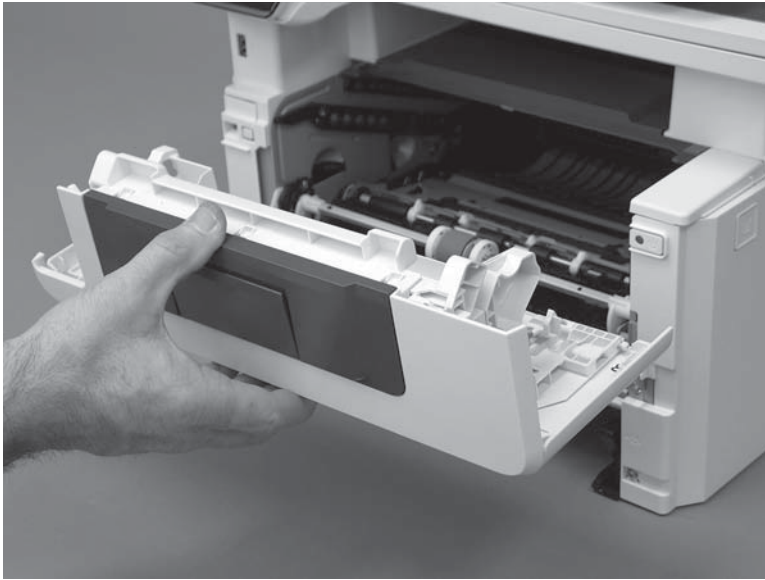
6. Rotate the door away from the printer until the keyed pin on the left-side retainer arm can disengage from the door.

**Figure 1-900** Release the left-side retainer arm





7. Remove the door.

**Figure 1-901** Remove the door



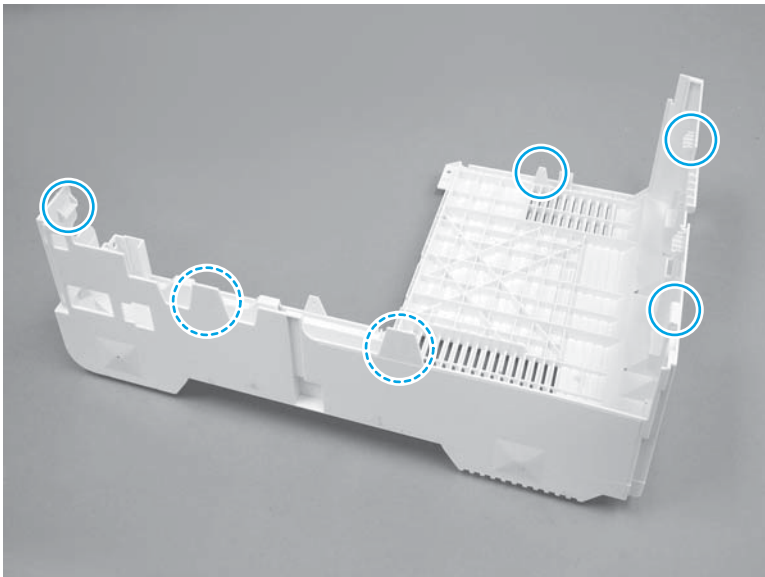
#### Step 5: Remove the right cover

 **IMPORTANT:** The black-plastic cassette front and rear guides (located inside the tray cavity) can be easily dislodged. Do not lose the guides when the cover is removed or installed.

 **NOTE:** The M527 printer is shown in this procedure. However, this procedure is valid for the M506 printer.

1. Before proceeding, take note of the location of the tabs and bosses on the inside of the cover.

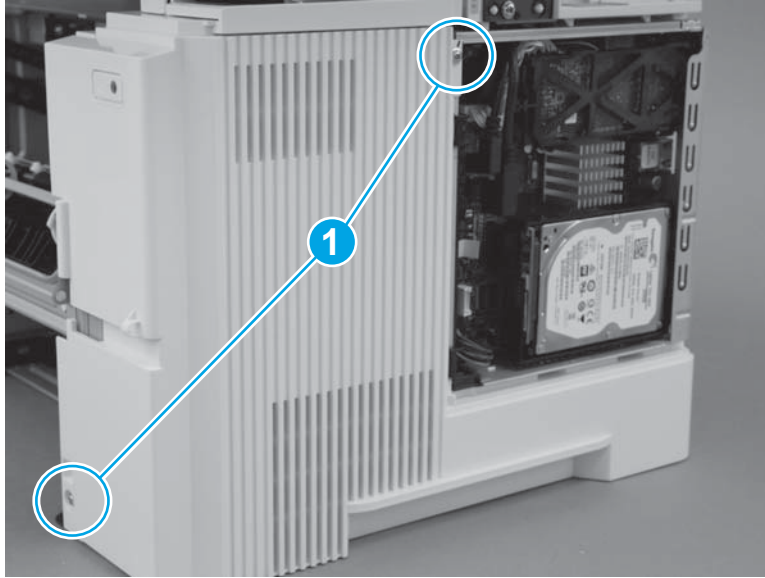
**Figure 1-902** Locate the tabs and bosses





2. Remove two screws (callout 1).

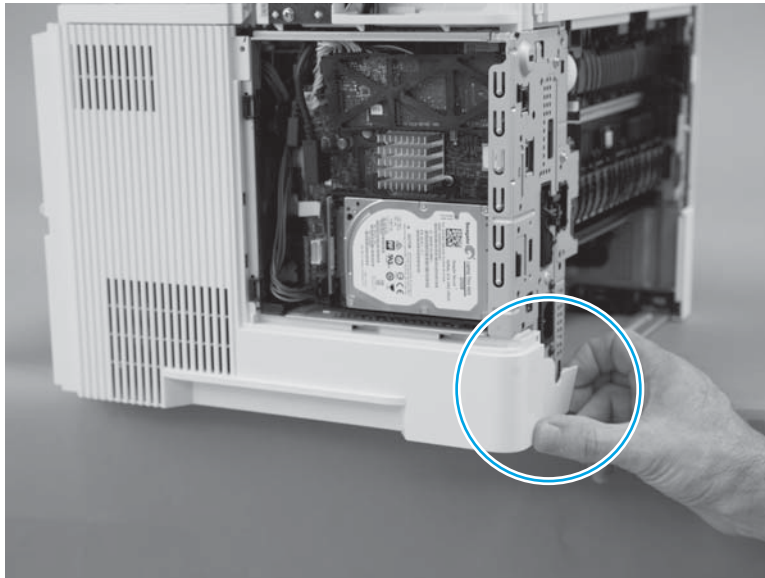
**Figure 1-903** Remove two screws



3. At the rear of the printer, release one boss.

**⚠ CAUTION:** It might be easier to remove the cover with the printer slightly hanging over the edge of the workspace. Do not let the printer tip and fall off of the workspace when removing the cover.

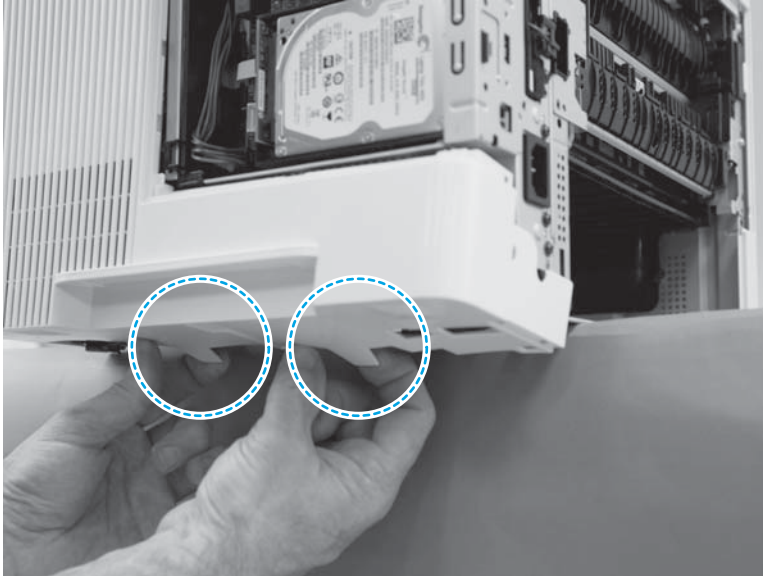
**Figure 1-904** Release one boss



4. At the bottom edge of the cover, release two bosses.

**CAUTION:** It might be easier to remove the cover with the printer slightly hanging over the edge of the workspace. Do not let the printer tip and fall off of the workspace when removing the cover.

**Figure 1-905** Release two bosses

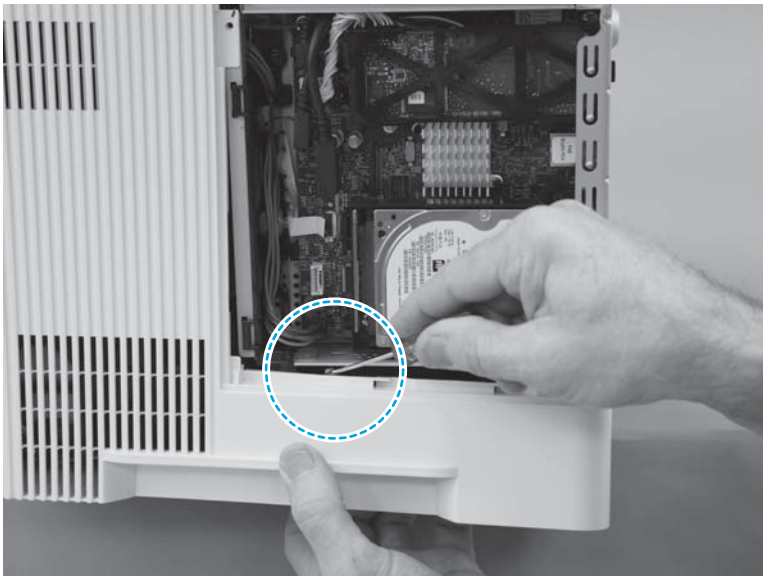


5. Near the formatter, release one tab.

**CAUTION:** It might be easier to remove the cover with the printer slightly hanging over the edge of the workspace. Do not let the printer tip and fall off of the workspace when removing the cover.

**TIP:** Hold the bottom of the cover away from the printer, and then use a small flat-blade screw driver to easily release this tab.

**Figure 1-906** Release one tab

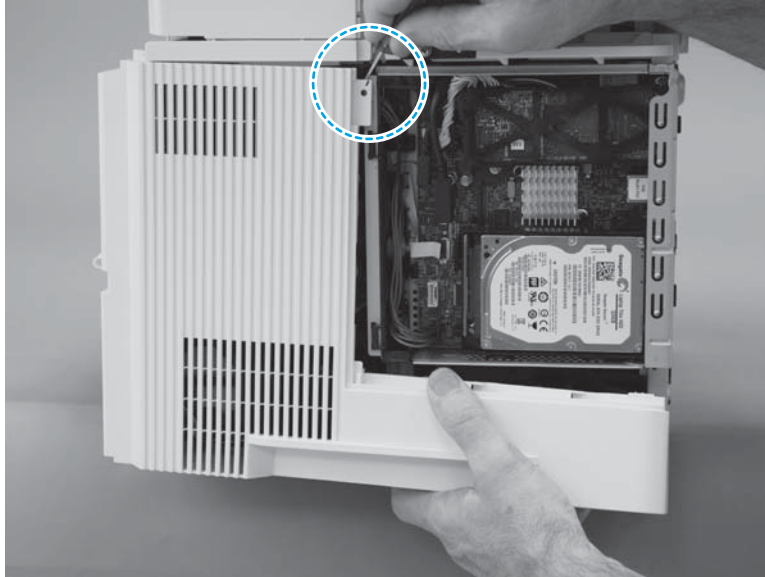


- At the top rear edge of the cover, release one tab.

**CAUTION:** It might be easier to remove the cover with the printer slightly hanging over the edge of the workspace. Do not let the printer tip and fall off of the workspace when removing the cover.

**TIP:** Use a small flat-blade screw driver to easily release this tab.

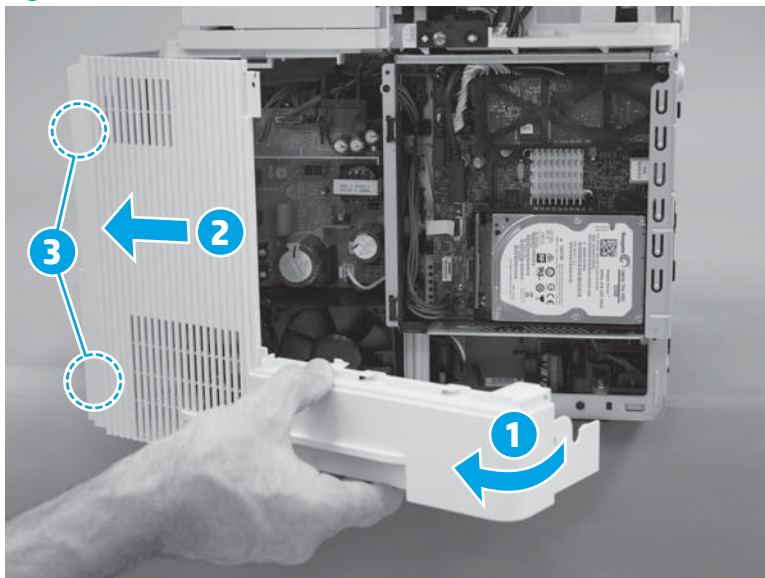
**Figure 1-907** Release one tab




- Rotate the rear of the cover away from the printer (callout 1), slide the cover toward the front of the printer (callout 2) to release two bosses (callout 3), and then remove the cover.

**CAUTION:** It might be easier to remove the cover with the printer slightly hanging over the edge of the workspace. Do not let the printer tip and fall off of the workspace when removing the cover.

**Figure 1-908** Remove the cover

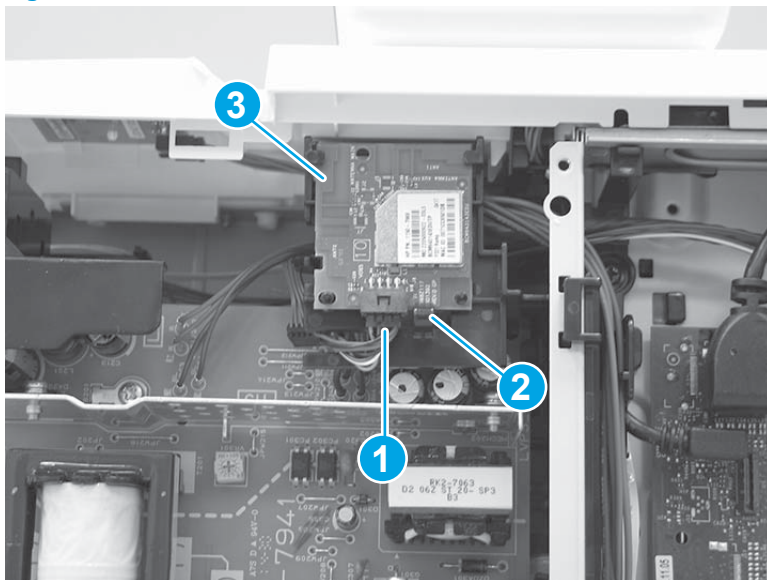


## Step 6: Remove the wireless PCA (WiFi) (M506x)

 **NOTE:** M506x models only.

- ▲ Disconnect one connector (callout 1) release one tab (callout 2), and then remove the wireless PCA (callout 3).

**Figure 1-909** Remove the WiFi PCA



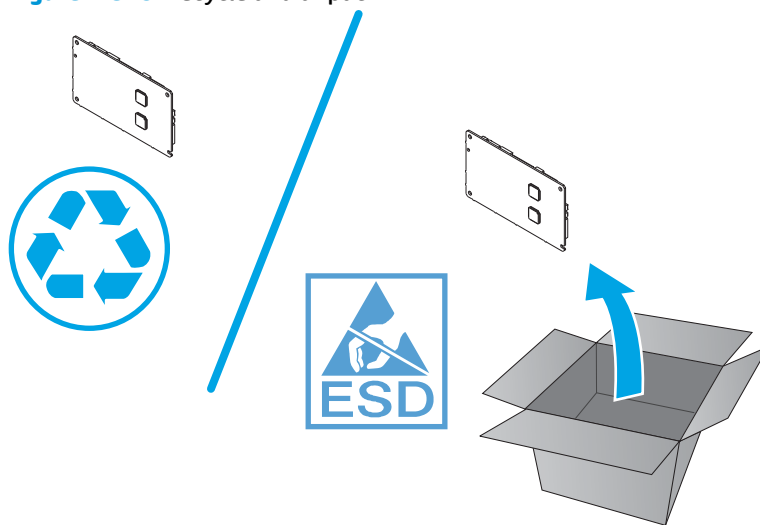
## Step 7: Unpack the replacement PCA

Unpack the replacement part from the packaging.

<http://www8.hp.com/us/en/hp-information/environment/product-recycling.html>

 **NOTE:** HP recommends responsible disposal of the defective part.

**Figure 1-910** Recycle and unpack

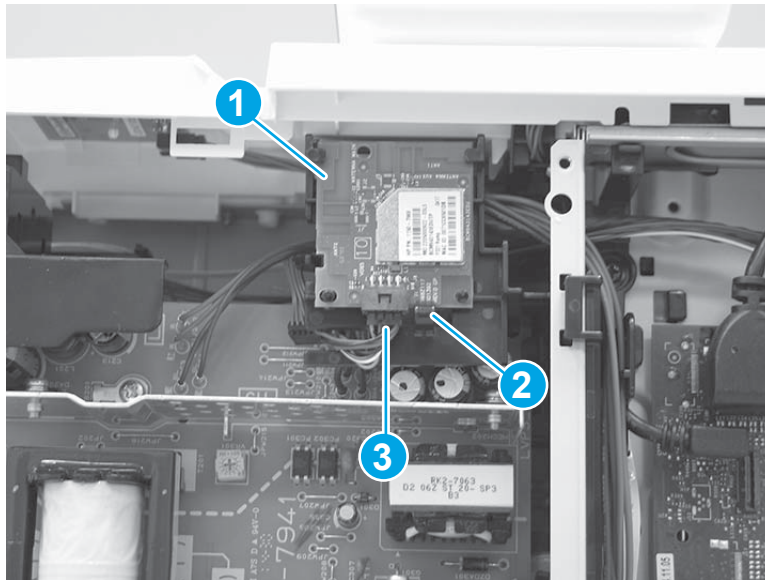


## Step 8: Install the wireless PCA (WiFi) (M506x)


 **NOTE:** M506x models only.


- ▲ Position the wireless PCA on the holder (callout 1), make sure that the tab snaps into place (callout 2), and then connect one connector (callout 3).

**Figure 1-911** Install the WiFi PCA



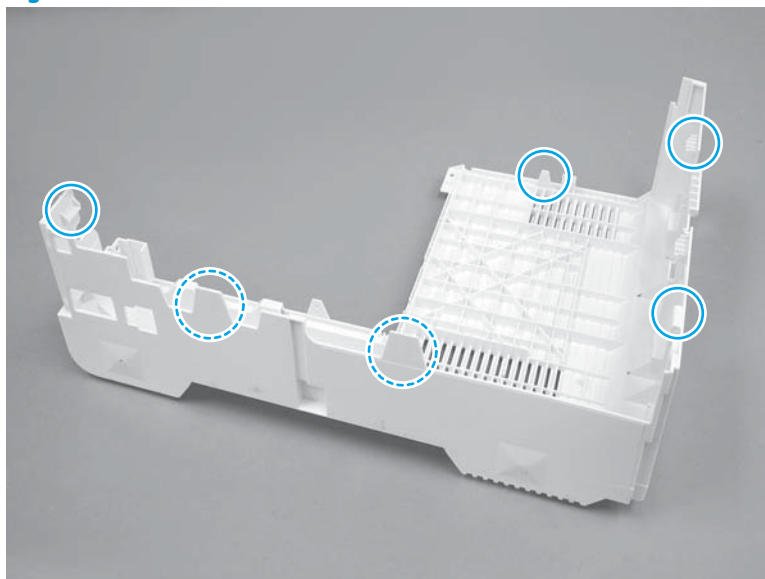
## Step 9: Install the right cover

 **IMPORTANT:** The black-plastic cassette front and rear guides (located inside the tray cavity) can be easily dislodged. Do not lose the guides when the cover is removed or installed.

 **NOTE:** The M527 printer is shown in this procedure. However, this procedure is valid for the M506 printer.

1. Before proceeding, take note of the location of the tabs and bosses on the inside of the cover.

**Figure 1-912** Locate the tabs and bosses

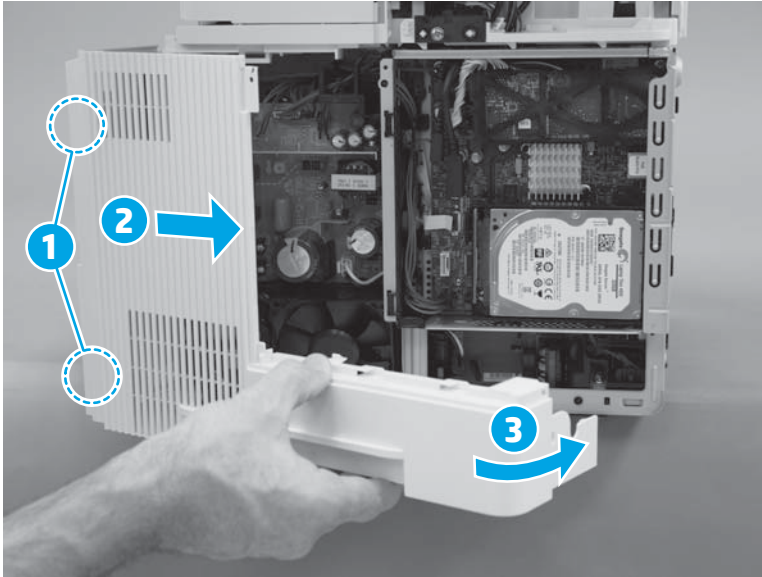


2. At the front of the cover engage two bosses (callout 1/2), and then rotate the rear of the cover toward the printer (callout 3).

**CAUTION:** It might be easier to install the cover with the printer slightly hanging over the edge of the workspace. Do not let the printer tip and fall off the workspace when removing the cover.

**TIP:** Make sure that the power switch at the front of the printer is positioned in the opening in the cover and that it does not interfere with the cover installation.

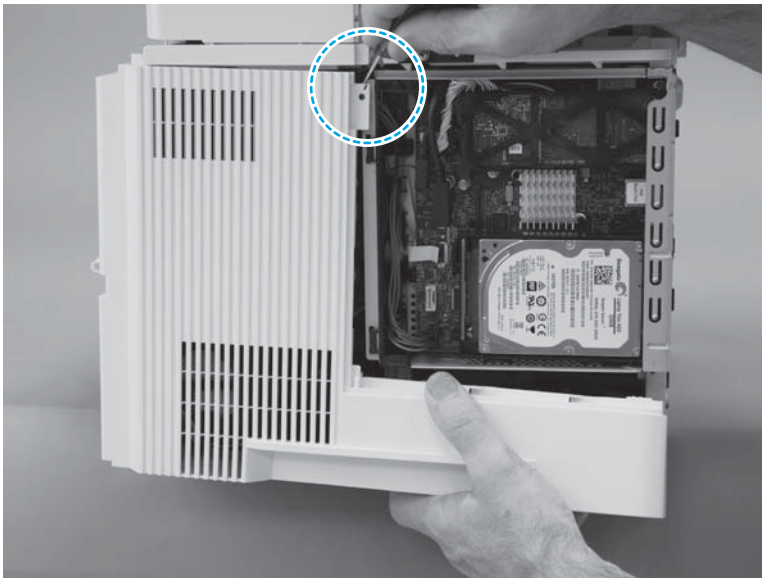
**Figure 1-913** Install the cover



3. At the top rear edge of the cover, engage one tab.

**CAUTION:** It might be easier to install the cover with the printer slightly hanging over the edge of the workspace. Do not let the printer tip and fall off the workspace when removing the cover.

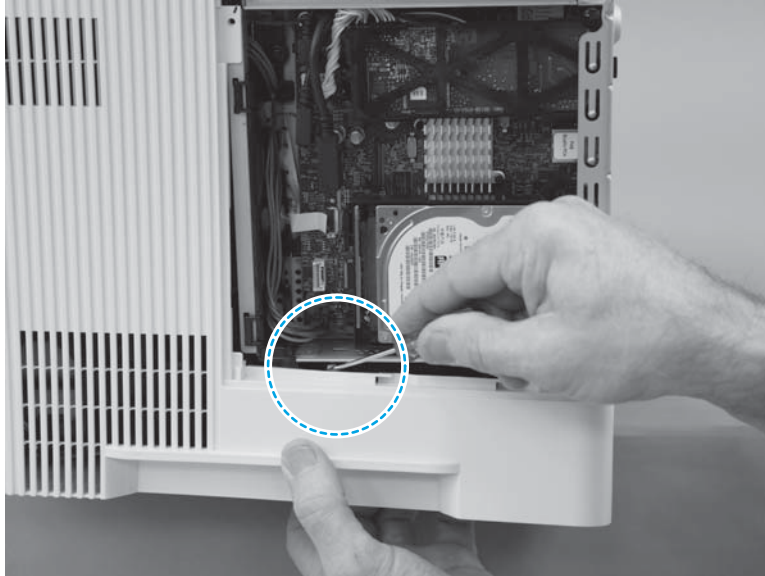
**Figure 1-914** Engage one tab



4. Near the formatter, engage one tab.

**CAUTION:** It might be easier to install the cover with the printer slightly hanging over the edge of the workspace. Do not let the printer tip and fall off of the workspace when removing the cover.

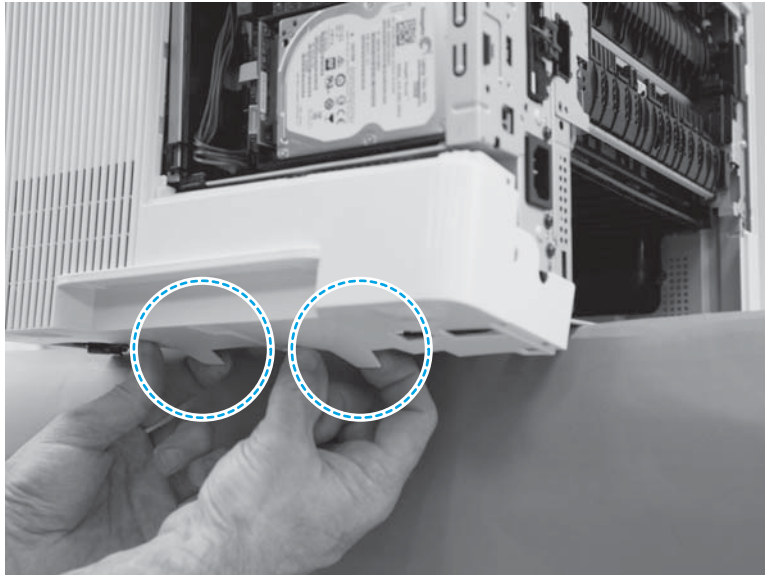
**Figure 1-915** Engage one tab



5. At the bottom edge of the cover, engage two bosses.

**CAUTION:** It might be easier to install the cover with the printer slightly hanging over the edge of the workspace. Do not let the printer tip and fall off of the workspace when removing the cover.

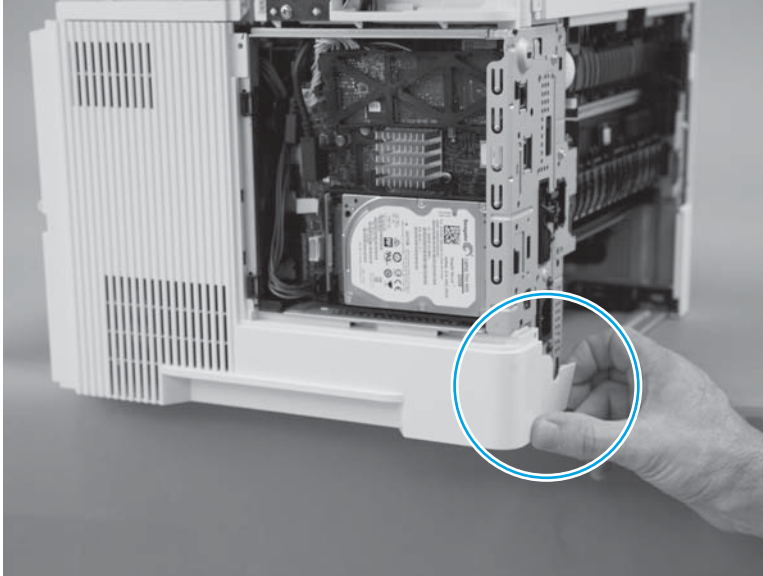
**Figure 1-916** Engage two bosses



6. At the rear of the printer, engage one boss.

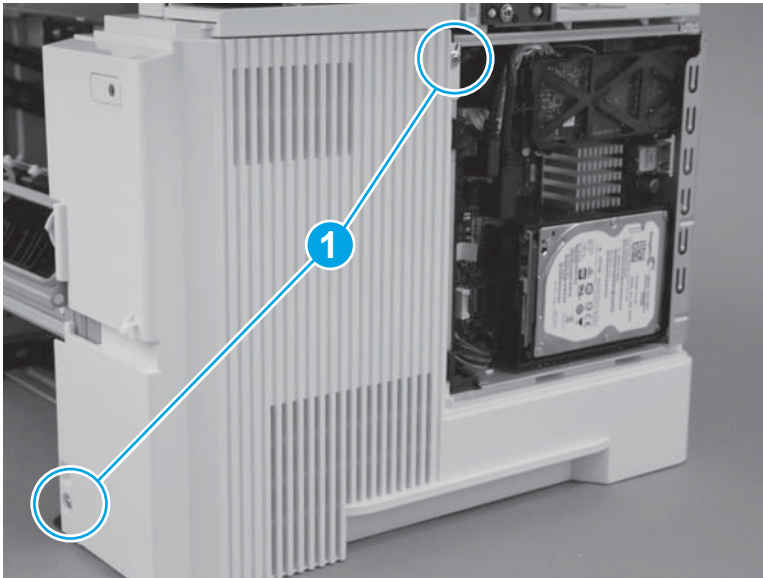
**⚠ CAUTION:** It might be easier to install the cover with the printer slightly hanging over the edge of the workspace. Do not let the printer tip and fall off of the workspace when removing the cover.

**Figure 1-917** Engage one boss



7. Install two screws (callout 1).

**Figure 1-918** Install two screws



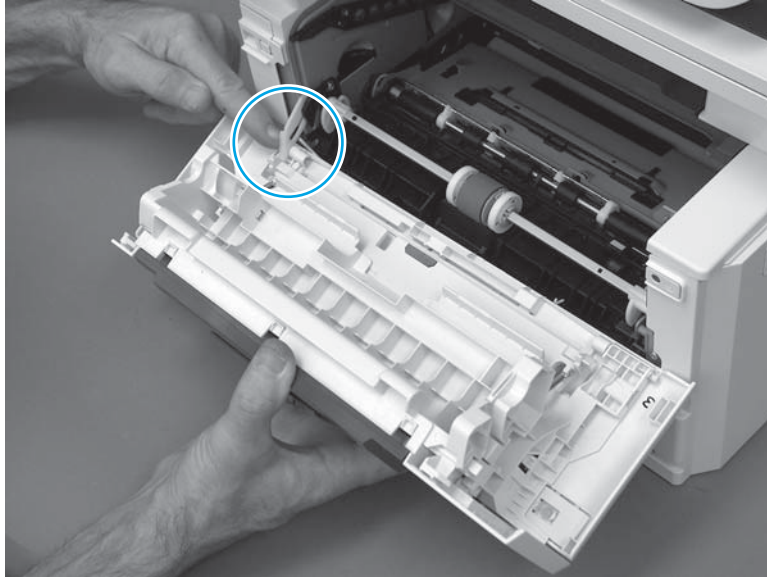
### Step 10: Install the cartridge door assembly

1. Position the door close to the printer, and then engage the keyed pin on the left-side retainer arm with the hole in the door.

**💡 TIP:** It might be easier to engage the keyed pin with the hole by using a small flat-blad screwdriver.





**Figure 1-919** Engage the left-side retainer arm



2. Engage the right-side door hinge pin with the hole in the chassis (callout 1).

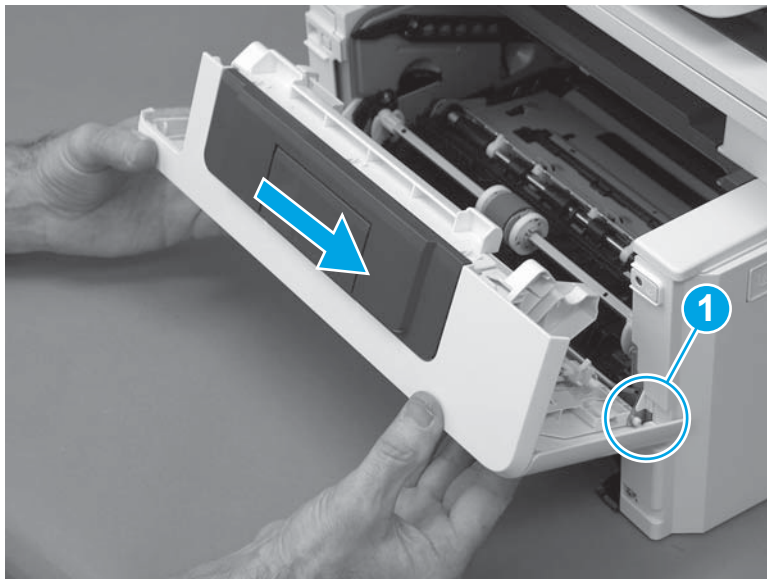
---

 **NOTE:** There are two right-side hinge pins (not shown in callout 1).


 **TIP:** Keep a finger pressed on the left-side retainer arm so that it does not disengage from the door.

---

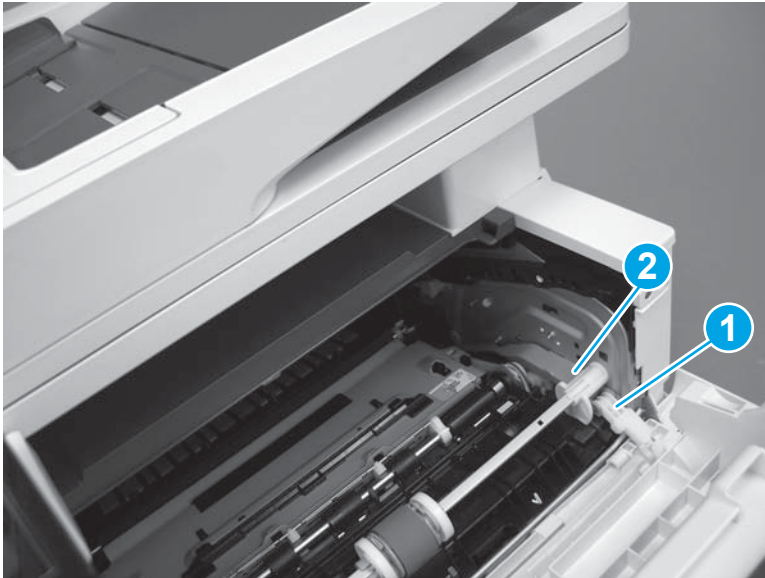
**Figure 1-920** Install the door



3. Install the gray-plastic pressure-release link (callout 1) onto the white-plastic door arm (callout 2).

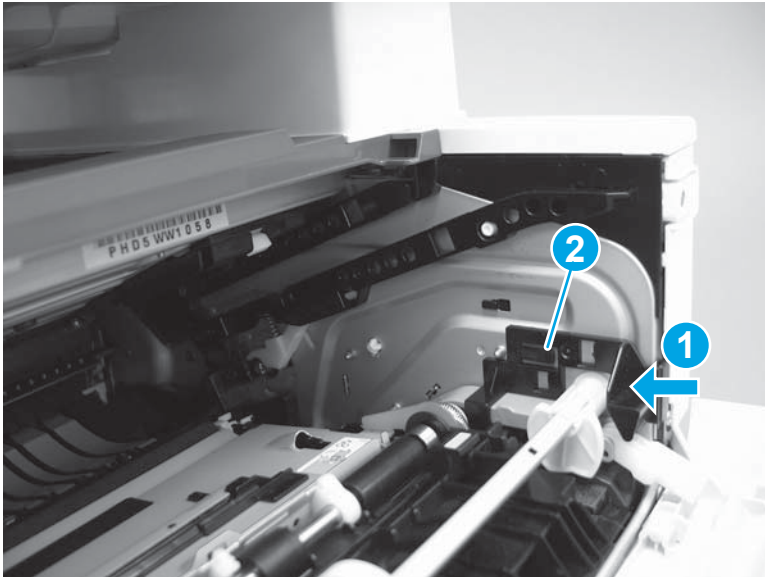
 **IMPORTANT:** Make sure that the arm snaps on to the link. Partially close and open the door to verify that the link (callout 2) moves in and out of the printer as the door closes/opens.

**Figure 1-921** Install the pressure-release link



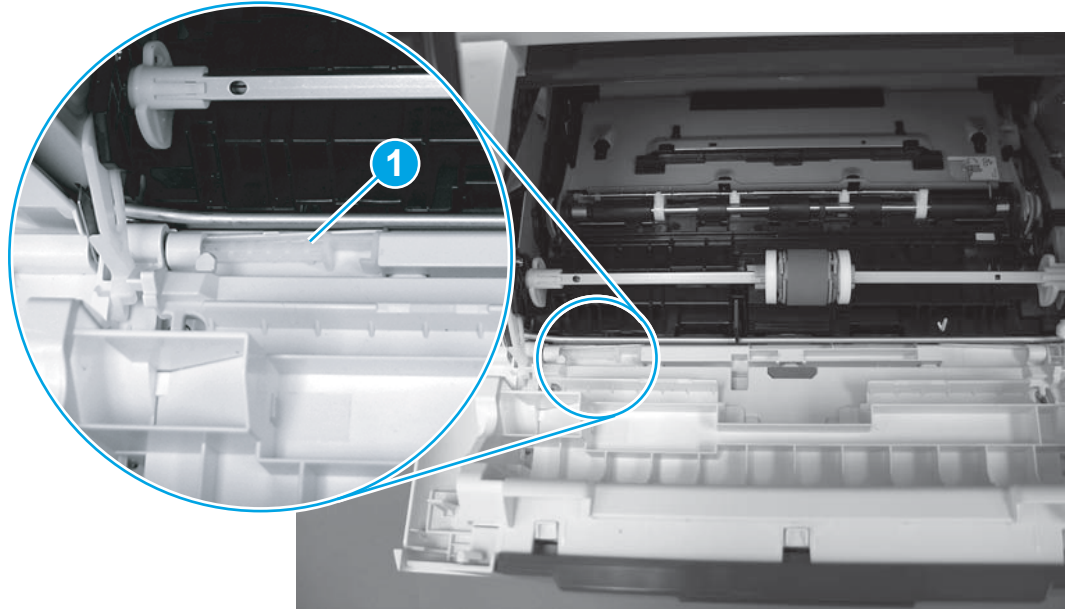
4. Slide the guide into the printer (callout 1), and then make sure that the tab (callout 2) snaps into place to secure the guide to the chassis.

**Figure 1-922** Install the guide





5. Position the support shaft on the door, and then align the left-side hinge on the door with the hole in the chassis (callout 1).

**Figure 1-923** Align the hinge

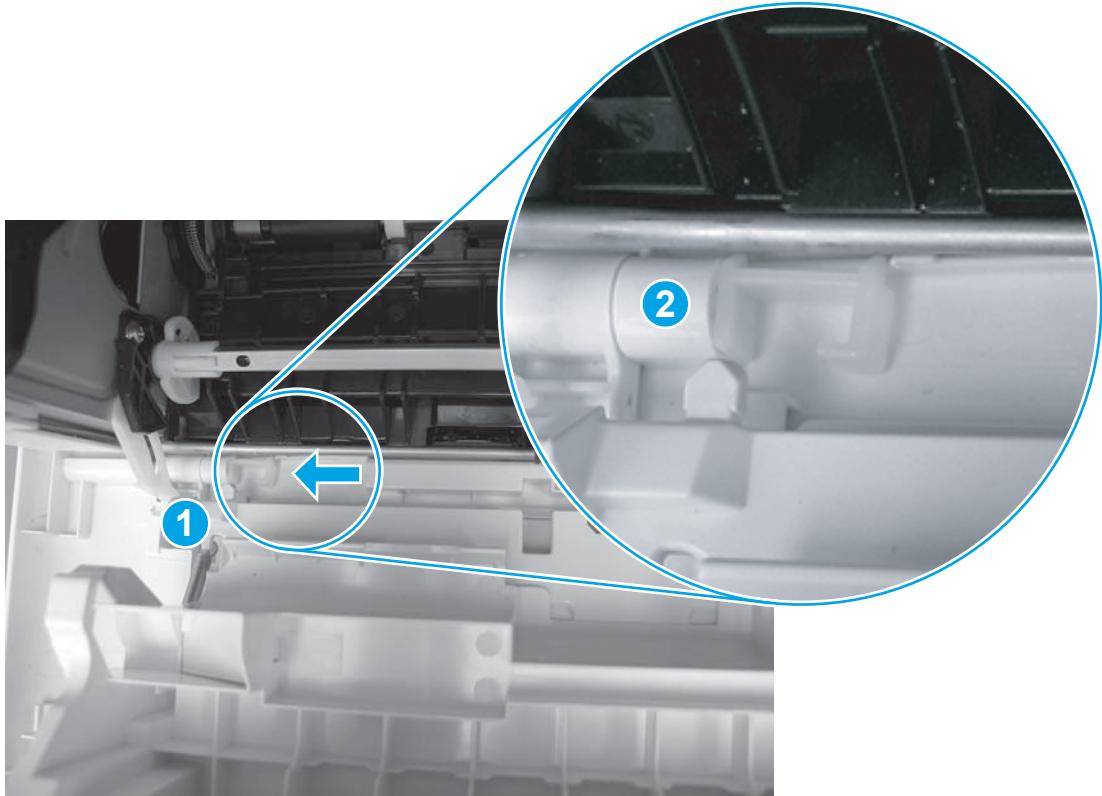


6. Push the shaft towards the left side of the printer to install it (callout 1).

 **NOTE:** Make sure that the support shaft is fully installed and correctly orientated (callout 2) so that it will not interfere with the door opening and closing.

 **Reinstallation tip:** If a replacement door was installed, make sure to install the nameplate (supplied in the kit) corresponding to the printer on the door.

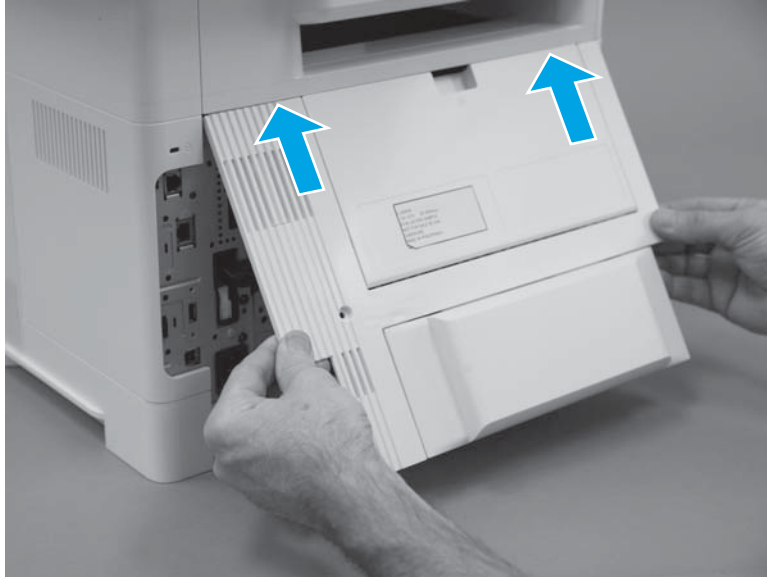
**Figure 1-924** Install the support shaft



### Step 11: Install the rear door assembly

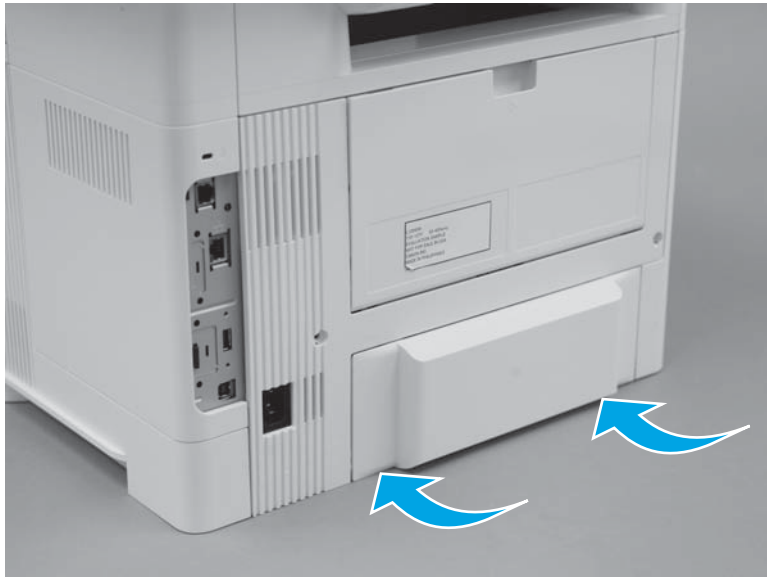
1. Engage the top edge of the assembly with the printer.

**Figure 1-925** Install the cover



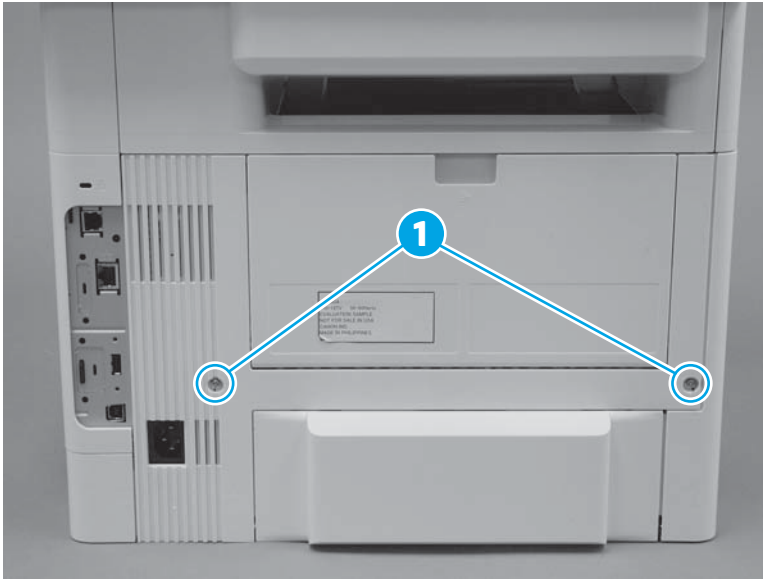
2. Rotate the bottom edge of the cover towards the printer.

**Figure 1-926** Rotate the bottom of the cover



3. Install two screws (callout 1).

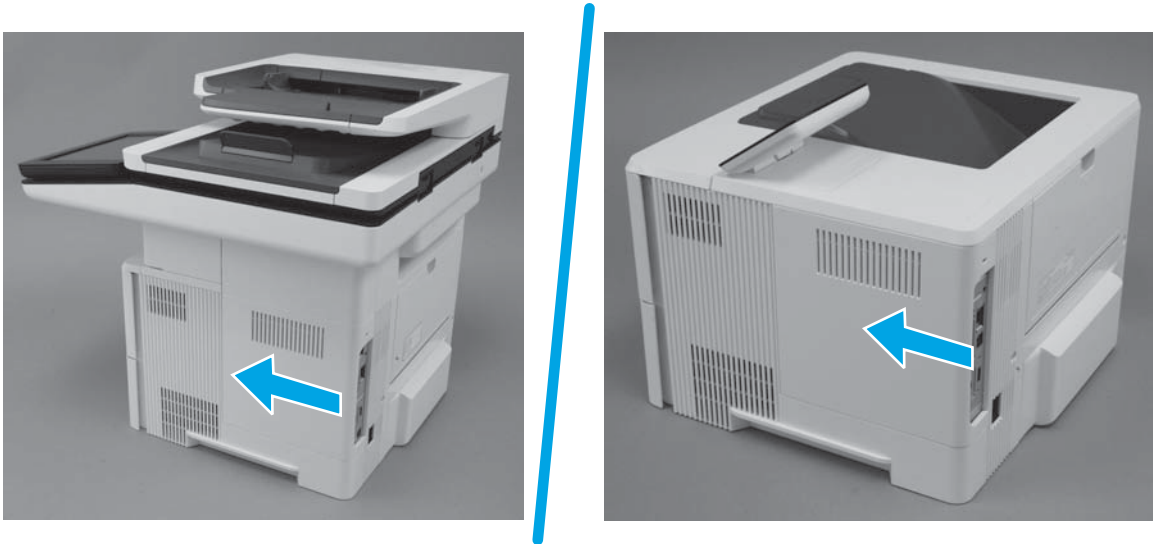
**Figure 1-927** Install two screws



### Step 12: Install the formatter cover

- ▲ Slide it toward the front of the printer to install it.

**Figure 1-928** Install the formatter cover



### Step 13: Install the tray

1. With the tray at a slight angle, align the sides of the tray with the rails in the accessory, and then partially slide the tray into the printer.

**Figure 1-929** Install the tray



2. Push the tray straight into the accessory to close it.

**Figure 1-930** Close the tray



## Removal and replacement: Wireless printed-circuit board (M527z)



**NOTE:** M527z models only.

- [Introduction](#)
- [Step 1: Remove the formatter cover](#)
- [Step 2: Remove the wireless PCA \(WiFi\) \(M527z\)](#)
- [Step 3: Unpack the replacement PCA](#)
- [Step 4: Install the wireless PCA \(WiFi\) \(M527z\)](#)
- [Step 5: Install the formatter cover](#)

### Introduction

This document provides the procedures to remove and replace the wireless PCA (M527z).

### Before performing service

#### Turn the printer power off

- Disconnect the power cable.



**WARNING!** To avoid damage to the printer, turn the printer off wait 30 seconds, and then remove the power cable before attempting to service the printer.

Use the table below to identify the correct part number for your printer. To order the part, go to [www.hp.com/buy/parts](http://www.hp.com/buy/parts).

Wireless PCA part number (M527z)	
1150-7968	Wireless PCA <sup>1</sup>

<sup>1</sup> M527z models only.

### Required tools

- No special tools are required to remove or replace this part.

### After performing service

#### Turn the printer power on

- Connect the power cable.
- Use the power switch to turn the power on.

### Post service test

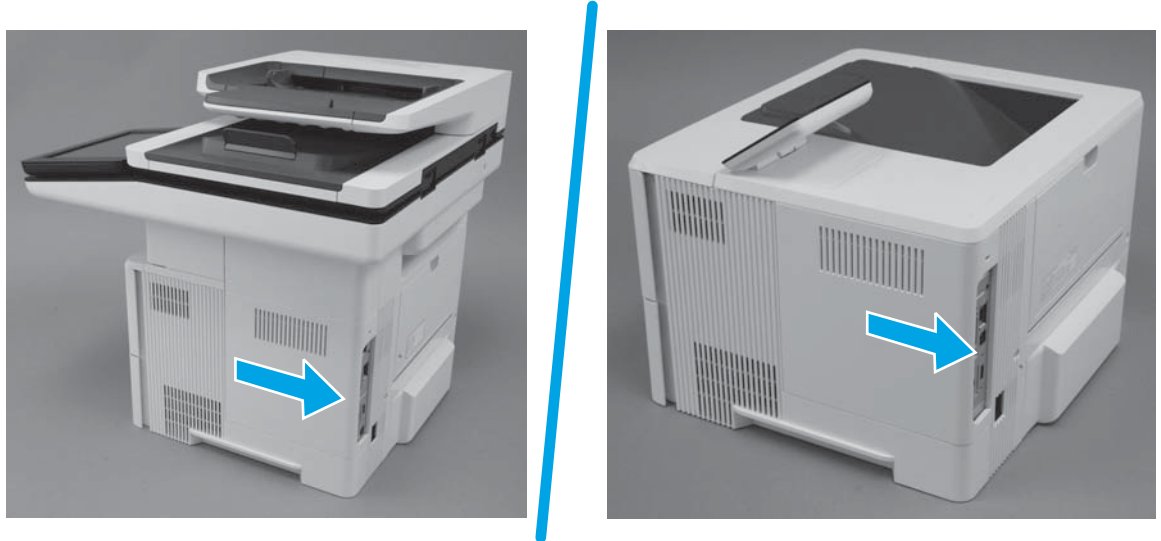
Use a wireless device to print a job from the printer.

### Step 1: Remove the formatter cover


- ▲ Slide the cover toward the rear of the printer to remove it.



**Figure 1-931** Remove the formatter cover

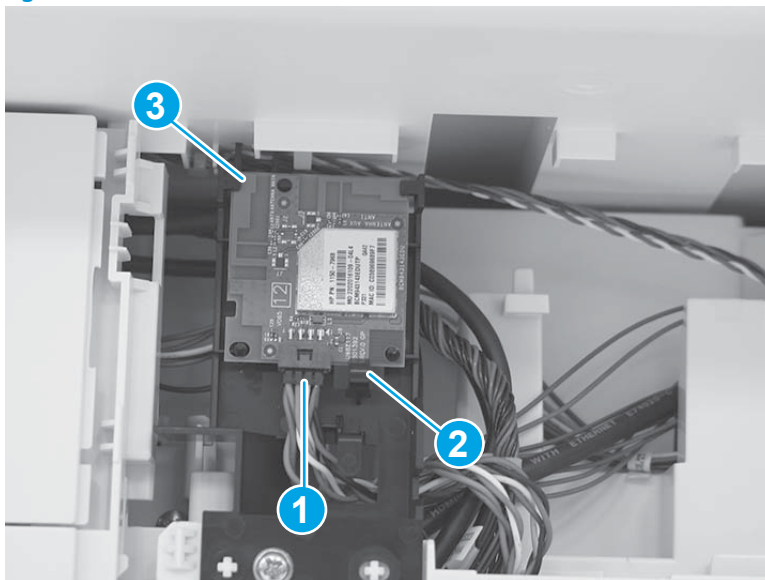


### Step 2: Remove the wireless PCA (WiFi) (M527z)

 **NOTE:** M527z models only.

- ▲ Disconnect one connector (callout 1) release one tab (callout 2), and then remove the wireless PCA (callout 3).

**Figure 1-932** Remove the WiFi PCA



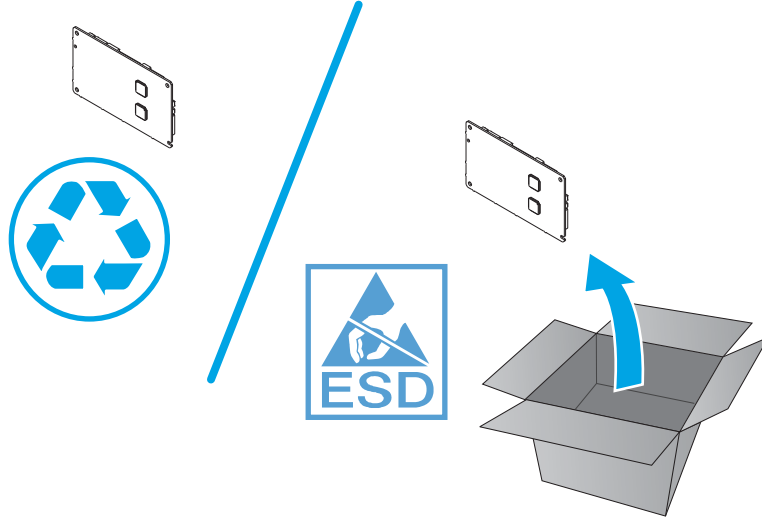
### Step 3: Unpack the replacement PCA

Unpack the replacement part from the packaging.


<http://www8.hp.com/us/en/hp-information/environment/product-recycling.html>

 **NOTE:** HP recommends responsible disposal of the defective part.

**Figure 1-933** Recycle and unpack

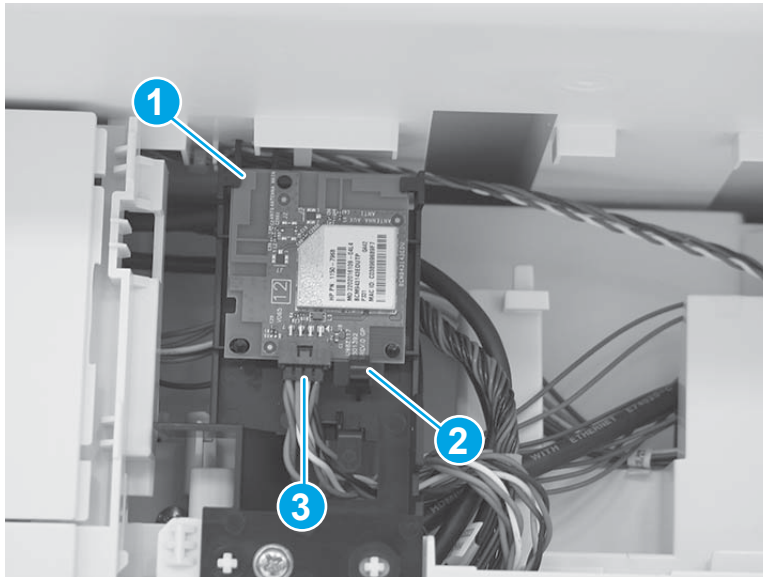


**Step 4: Install the wireless PCA (WiFi) (M527z)**

 **NOTE:** M527z models only.

- ▲ Position the wireless PCA on the holder (callout 1), make sure that the tab snaps into place (callout 2), and then connect one connector (callout 3).

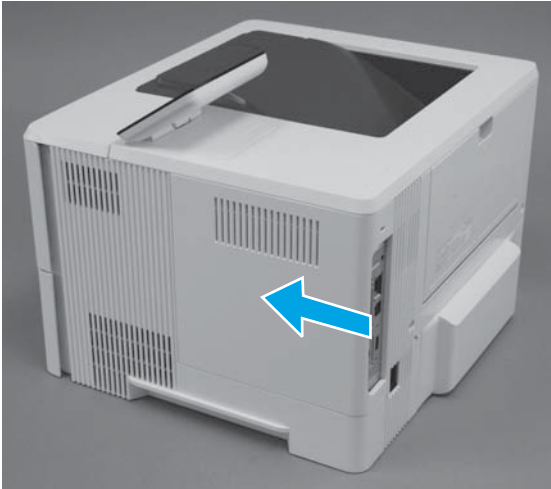
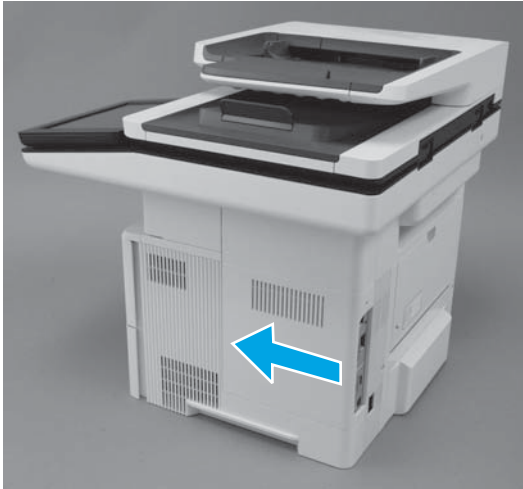
**Figure 1-934** Install the WiFi PCA



**Step 5: Install the formatter cover**

- ▲ Slide it toward the front of the printer to install it.

**Figure 1-935** Install the formatter cover



## Removal and replacement: Fuser

- [Introduction](#)
- [Step 1: Remove the rear door assembly](#)
- [Step 2: Remove the fuser](#)
- [Step 3: Unpack the replacement assembly](#)
- [Step 4: Install the fuser](#)
- [Step 5: Install the rear door assembly](#)


### Introduction

This document provides the procedures to remove and replace the fuser.


### Before performing service

#### Turn the printer power off

- Disconnect the power cable.

 **WARNING!** To avoid damage to the printer, turn the printer off wait 30 seconds, and then remove the power cable before attempting to service the printer.

Make sure the correct voltage fuser is installed in the printer.

 **CAUTION:** The fuser is hot. Wait at least 30 minutes after turning the printer oÃ before removing the fuser.

Use the table below to identify the correct part number for your printer. To order the part, go to [www.hp.com/buy/parts](http://www.hp.com/buy/parts).

Fuser part number	
RM2-7948-000CN	Fuser (110V/127V)
RM2-7949-000CN	Fuser (220V/240V)

### Required tools

- #2 Phillips screwdriver with a magnetic tip.

### After performing service

#### Turn the printer power on

- Connect the power cable.
- Use the power switch to turn the power on.

### Post service test

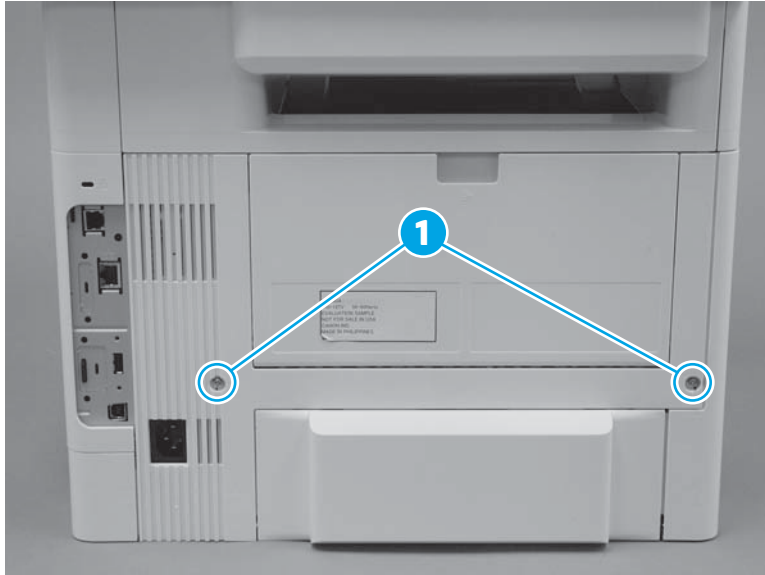
Make sure that the printer initializes to a **Ready** state.

Print a configuration page to make sure that the printer is functioning correctly.

**Step 1: Remove the rear door assembly**

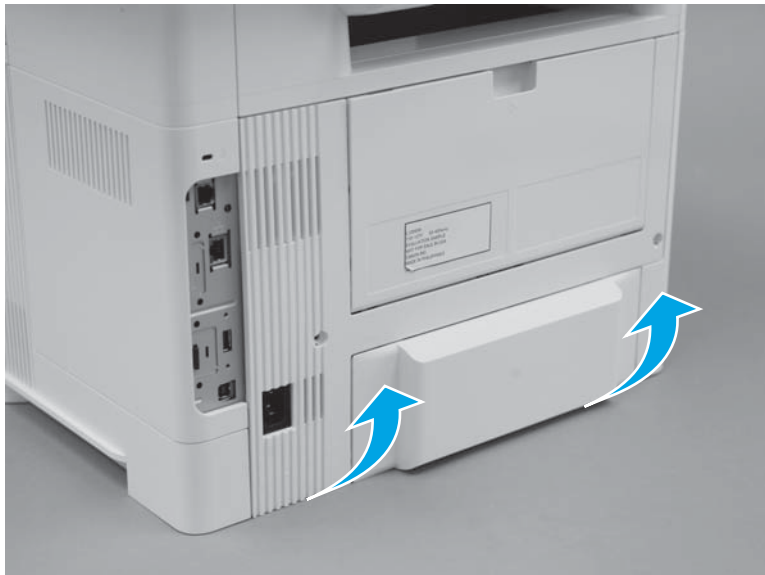
1. At the rear of the printer, remove two screws (callout 1).

**Figure 1-936** Remove two screws



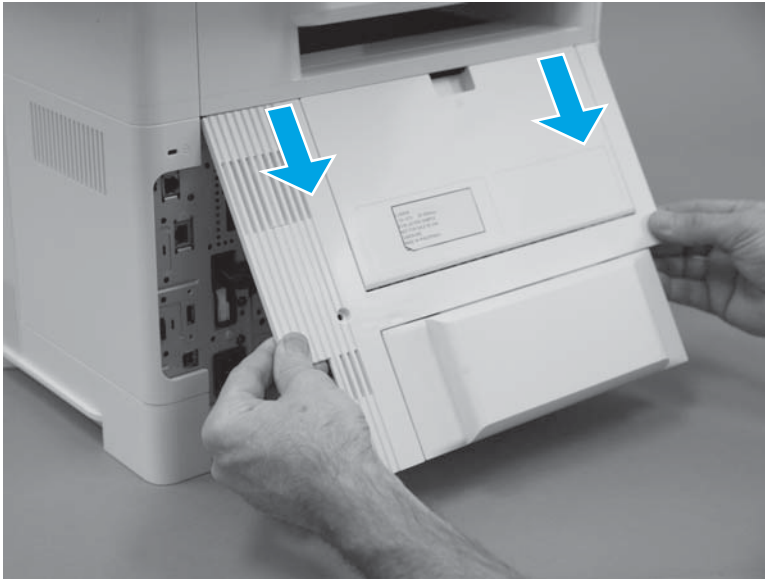
2. Rotate the bottom edge of the assembly away from the printer to release it.

**Figure 1-937** Rotate the bottom of the cover



3. Pull down on the assembly to remove it.

**Figure 1-938** Remove the cover



## Step 2: Remove the fuser

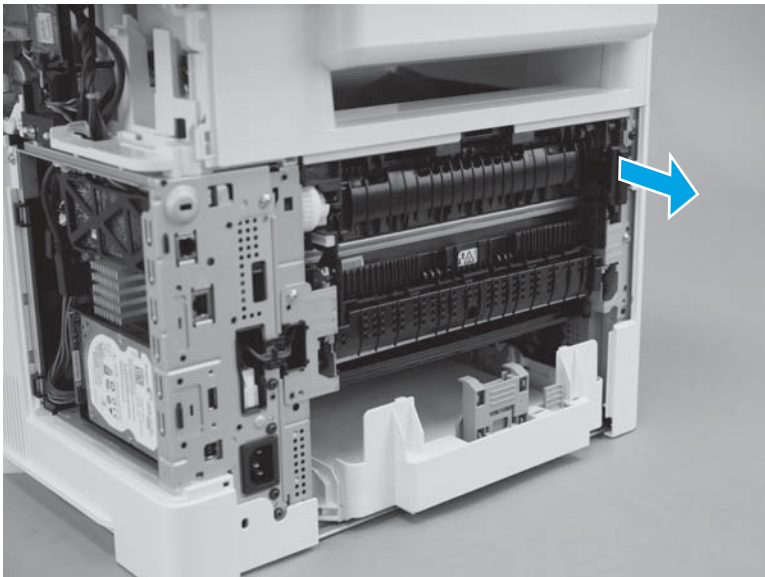


**NOTE:** The M527 printer is shown in this procedure. However, the procedure is valid for the M506 printer.

The formatter cover is shown oã in the following figures. However, it does not need to be removed to remove the fuser.

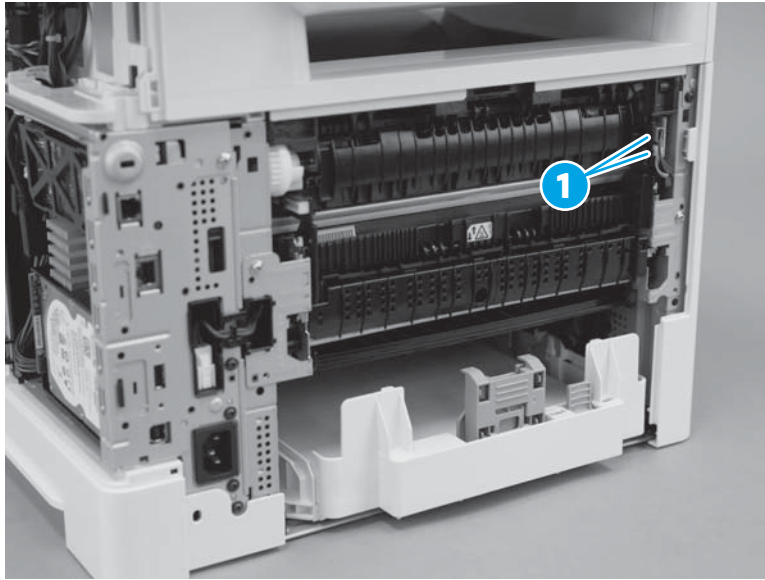
1. Remove the connector cover.

**Figure 1-939** Remove the cover



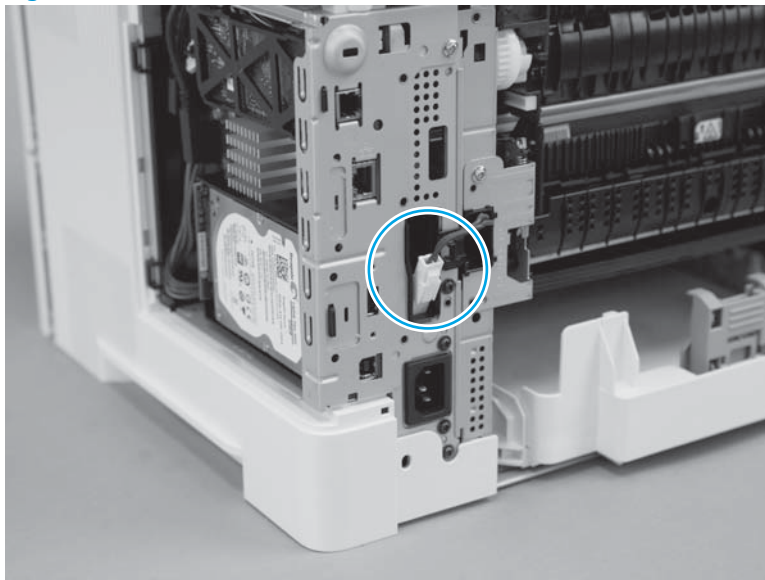
2. Disconnect two connectors (callout 1).

**Figure 1-940** Disconnect two connectors



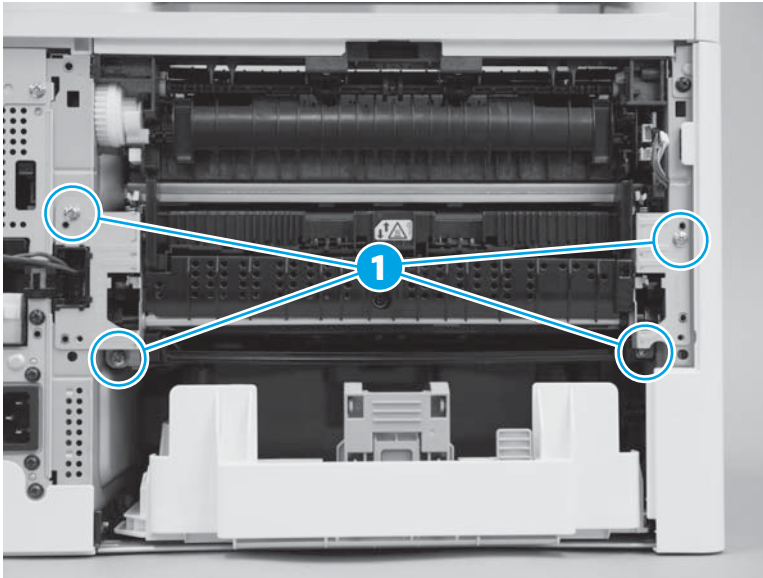
3. Disconnect one connector.

**Figure 1-941** Disconnect one connector



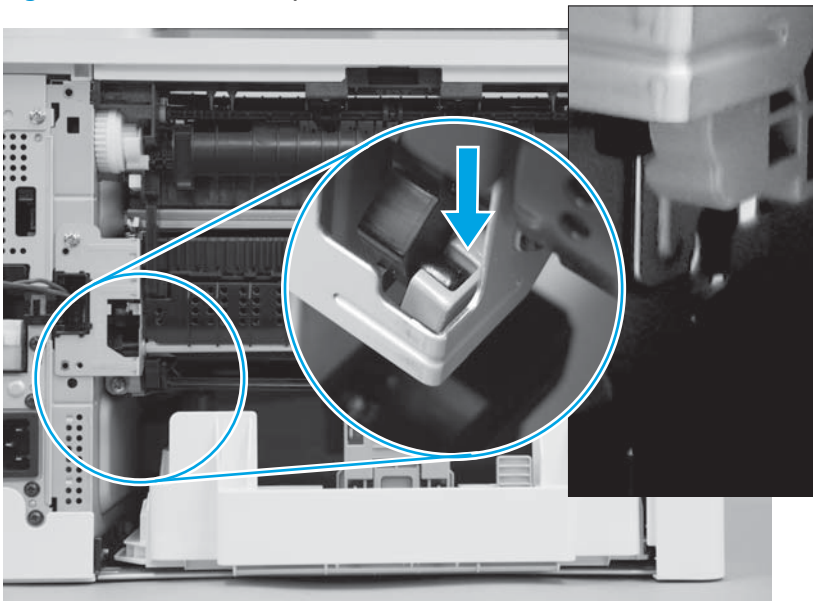
4. Remove four screws (callout 1).

**Figure 1-942** Remove four screws



5. Pull down on the fuser-shutter arm to release it from the fuser.

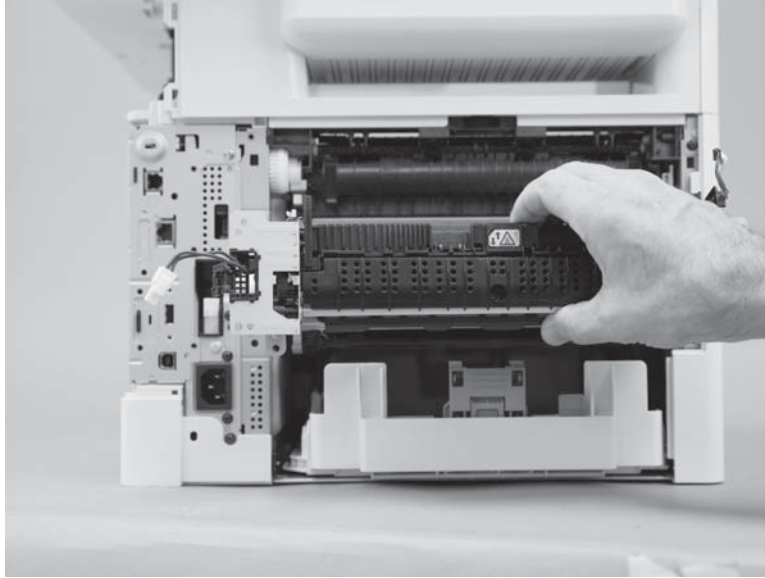
**Figure 1-943** Release the pressure-release arm





6. Slide the fuser straight out of the printer.

**Figure 1-944** Remove the fuser



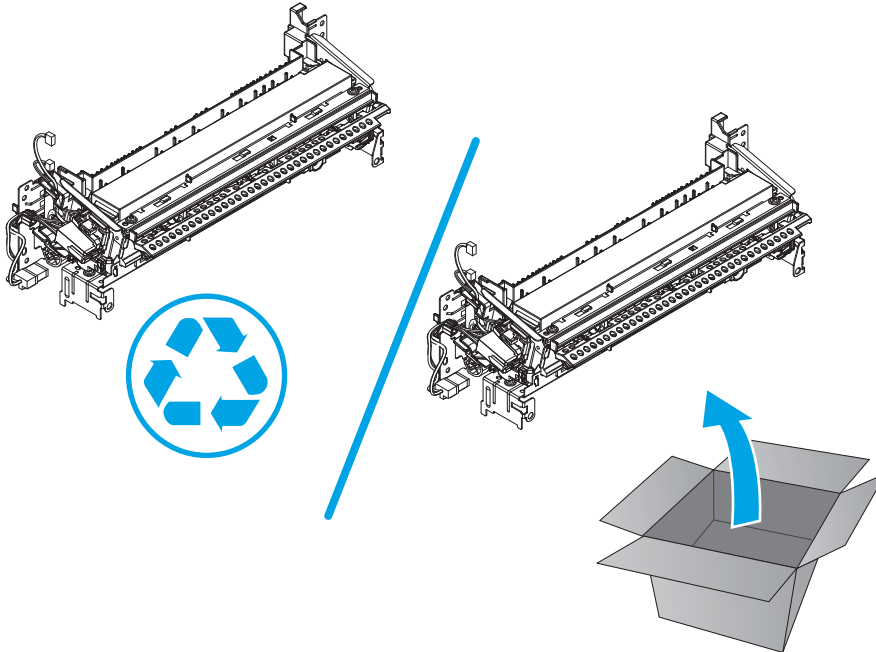
### Step 3: Unpack the replacement assembly

Unpack the replacement part from the packaging.


<http://www8.hp.com/us/en/hp-information/environment/product-recycling.html>

 **NOTE:** HP recommends responsible disposal of the defective part.

**Figure 1-945** Recycle and unpack



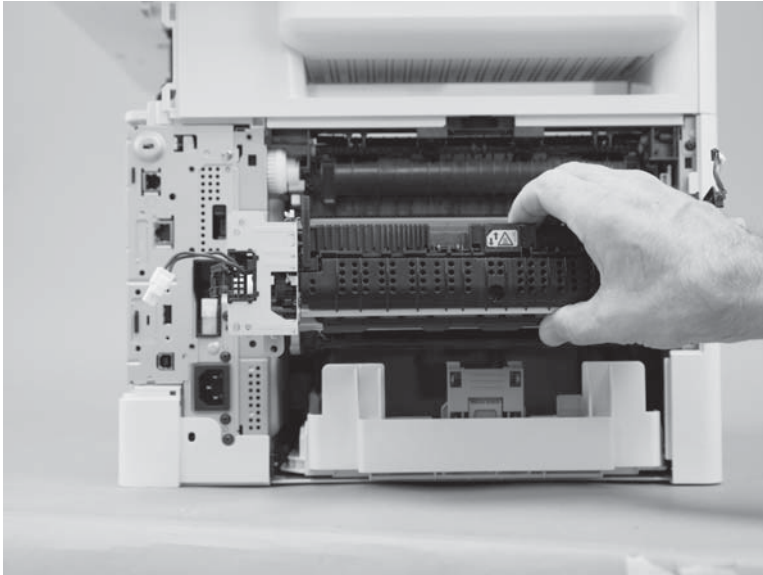
## Step 4: Install the fuser

 **NOTE:** The M527 printer is shown in this procedure. However, the procedure is valid for the M506 printer.

The formatter cover is shown open in the following figures. However, it does not need to be removed to remove the fuser.

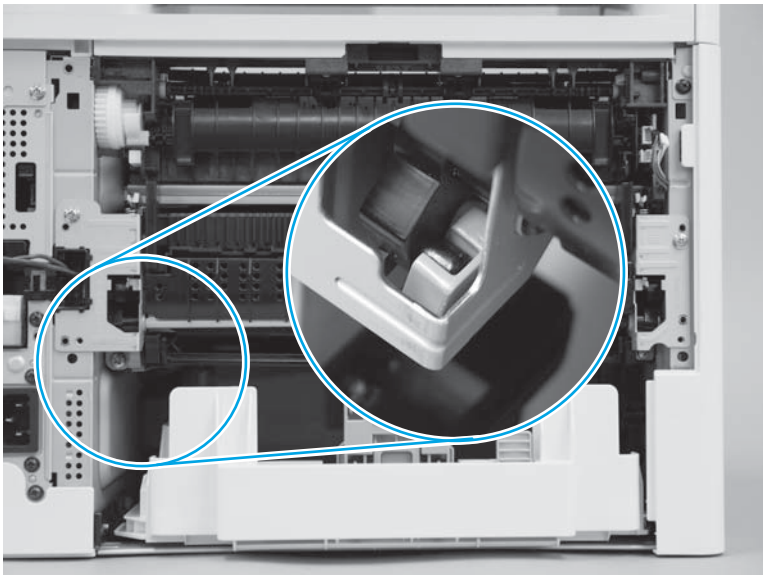
1. Slide the fuser straight into the printer to install it.

**Figure 1-946** Install the fuser



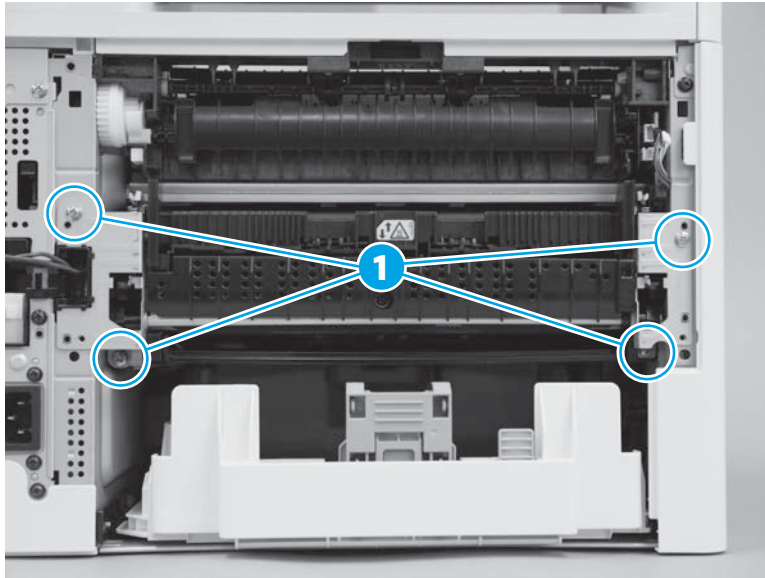
2. At the lower-left corner of the fuser, push up on the fuser-shutter arm to engage it with the fuser.

**Figure 1-947** Engage the pressure-release arm



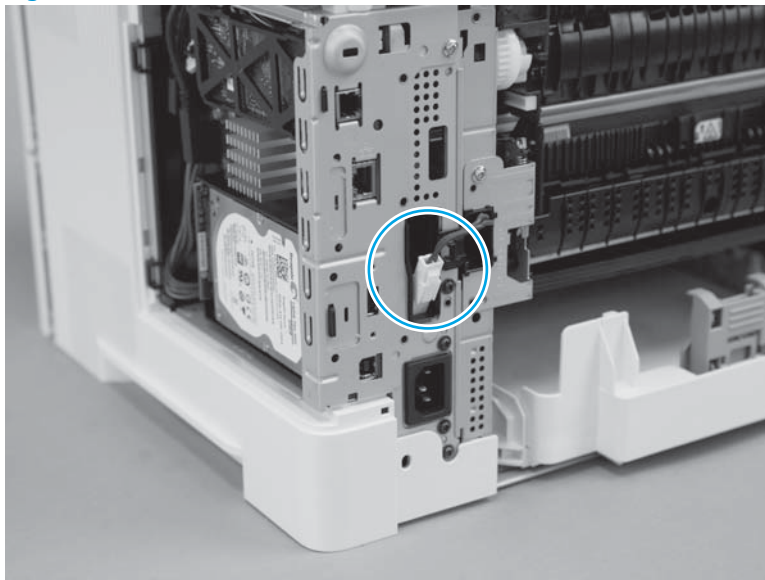
3. Install four screws (callout 1).

**Figure 1-948** Install four screws



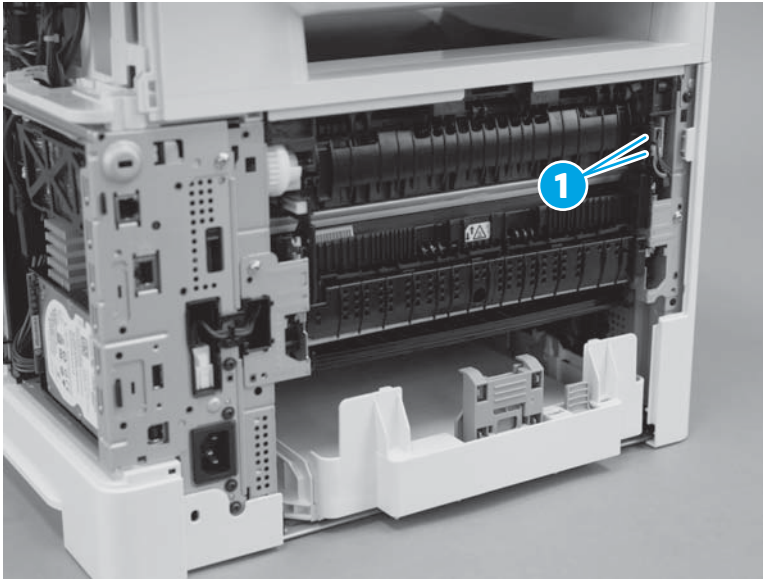
4. Connect one connector.

**Figure 1-949** Connect one connector



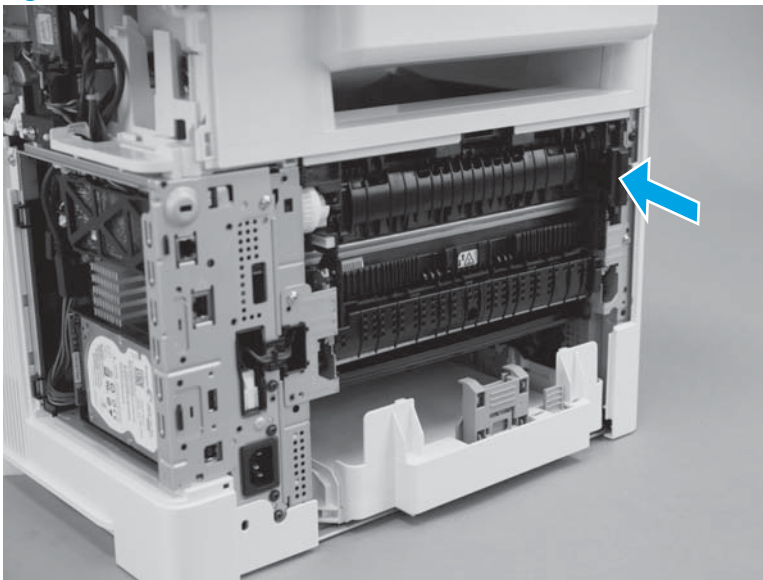
5. Connect two connectors (callout 1).

**Figure 1-950** Connect two connectors



6. Install the connector cover.

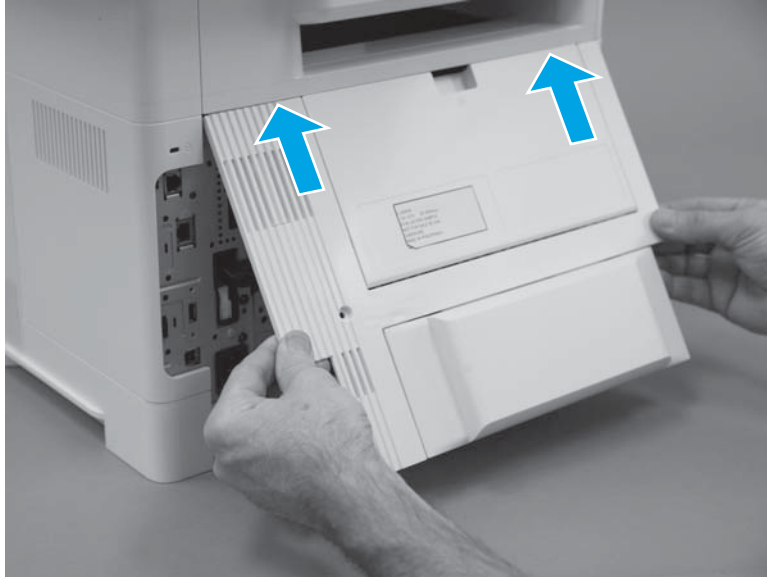
**Figure 1-951** Install the cover



### **Step 5: Install the rear door assembly**

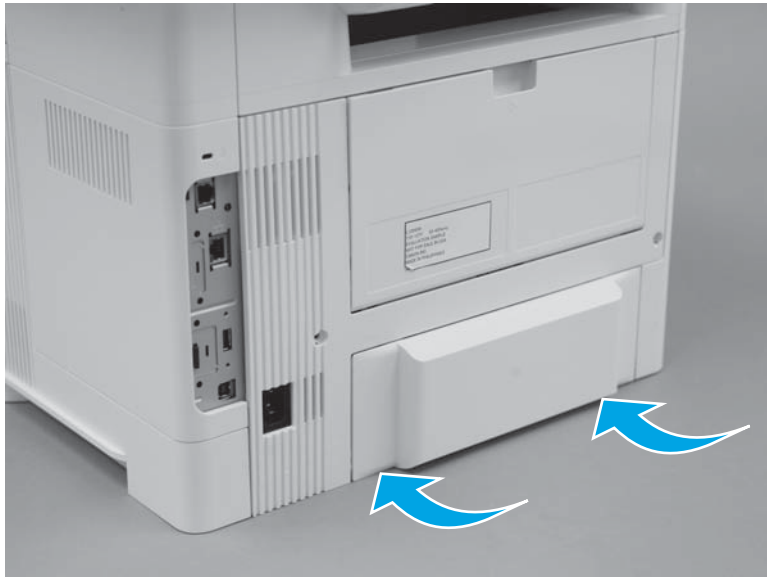
1. Engage the top edge of the assembly with the printer.

**Figure 1-952** Install the cover



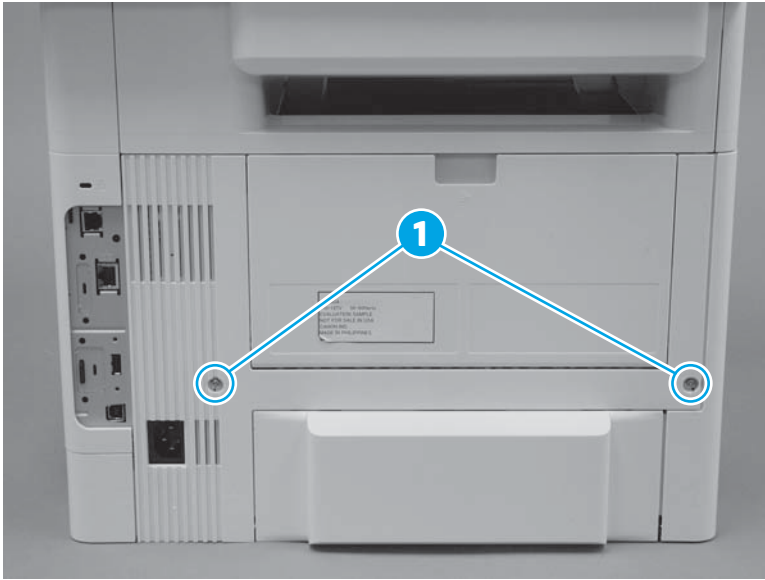
2. Rotate the bottom edge of the cover towards the printer.

**Figure 1-953** Rotate the bottom of the cover




3. Install two screws (callout 1).

**Figure 1-954** Install two screws



## Removal and replacement: Stapler unit (M527c/f/z)

 **NOTE:** The M527dn does not have a convenience stapler.

- [Introduction](#)
- [Step 1: Remove the formatter cover](#)
- [Step 2: Remove the stapler door \(M527\)](#)
- [Step 3: Remove the stapler stationary \(inner\) cover \(M527\)](#)
- [Step 4: Remove the stapler unit](#)
- [Step 5: Unpack the replacement assembly](#)
- [Step 6: Install the stapler unit](#)
- [Step 7: Install the stapler stationary \(inner\) cover \(M527\)](#)
- [Step 8: Install the stapler door \(M527\)](#)
- [Step 9: Install the formatter cover](#)


### Introduction

This document provides the procedures to remove and replace the cassette stapler unit (M527).

### Before performing service

#### Turn the printer power off

- Disconnect the power cable.

 **WARNING!** To avoid damage to the printer, turn the printer off, wait 30 seconds, and then remove the power cable before attempting to service the printer.

Use the table below to identify the correct part number for your printer. To order the part, go to [www.hp.com/buy/parts](http://www.hp.com/buy/parts).

Stapler unit part number	
<b>B5L46-60102</b>	Stapler unit (M527c/f/z)

### Required tools

- Small flat-blade screw driver
- Small flat-blade screw driver—152.4 mm (6 in) shaft

### After performing service

#### Turn the printer power on

- Connect the power cable.
- Use the power switch to turn the power on.

## Post service test

Use the convenience stapler to staple two pages together to test its operation.

### Step 1: Remove the formatter cover

- ▲ Slide the cover toward the rear of the printer to remove it.

**Figure 1-955** Remove the formatter cover

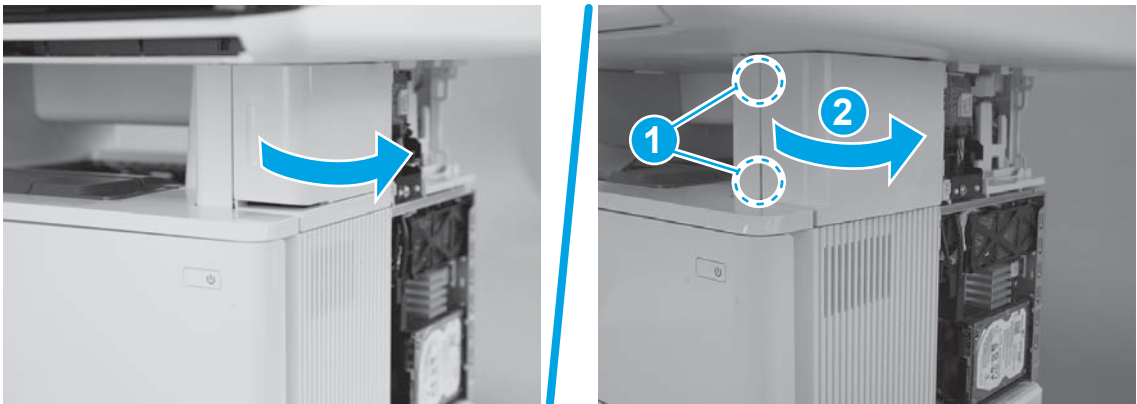


### Step 2: Remove the stapler door (M527)

The M527dn does not have a convenience stapler.

1. Do one of the following:
  - **M527c/f/z**: Open the stapler door.
  - **M527dn**: Use a small flat-blad screw driver to release two tabs (callout 1), and then rotate the cover away from the printer (callout 2).

**Figure 1-956** Open the door or release the cover

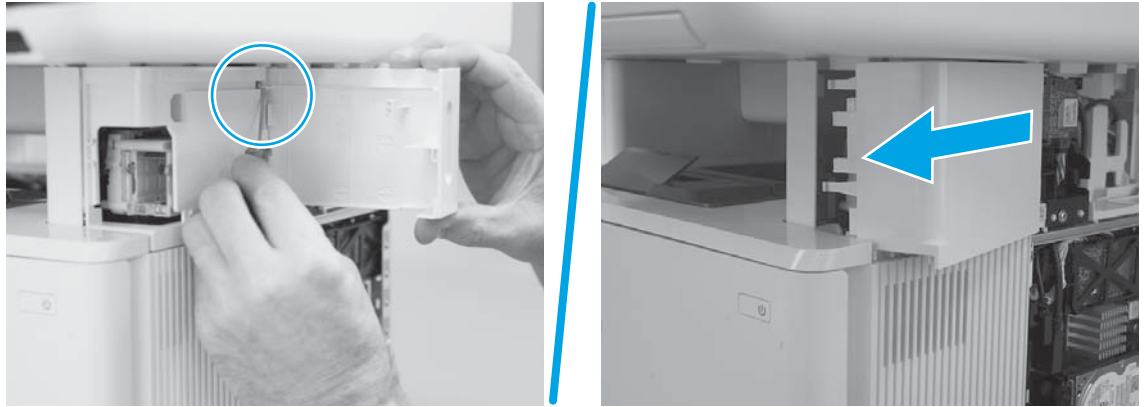


2. Do one of the following:



- **M527c/f/z:** Use a small flat-blad screwdriver to release the upper hinge.
- **M527dn:** Slide the cover toward the front of the printer to remove it.

**Figure 1-957** Release the upper hinge or remove the cover



3. **M527c/f/z:** Use a small flat-blad screwdriver to release the lower hinge.

**Figure 1-958** Release the lower hinge



4. **M527c/f/z:** Remove the door.

**Figure 1-959** Remove the door



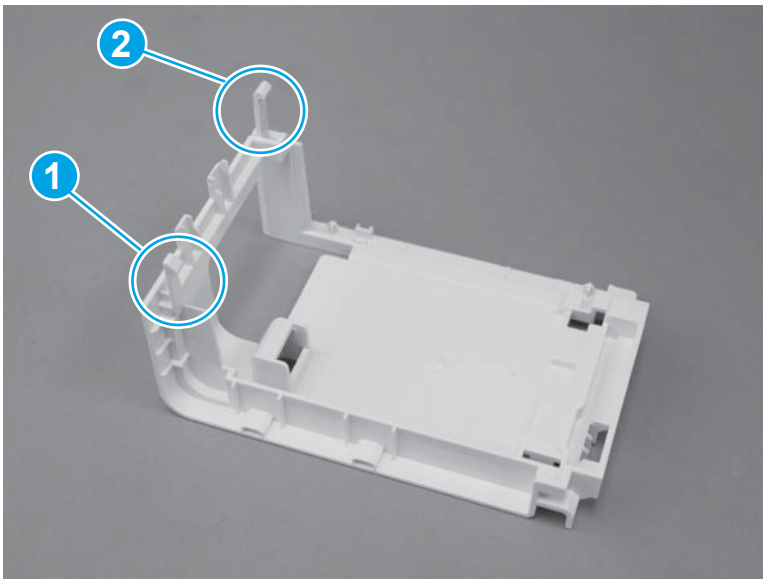
### Step 3: Remove the stapler stationary (inner) cover (M527)



**NOTE:** M527c/f/z printers only.

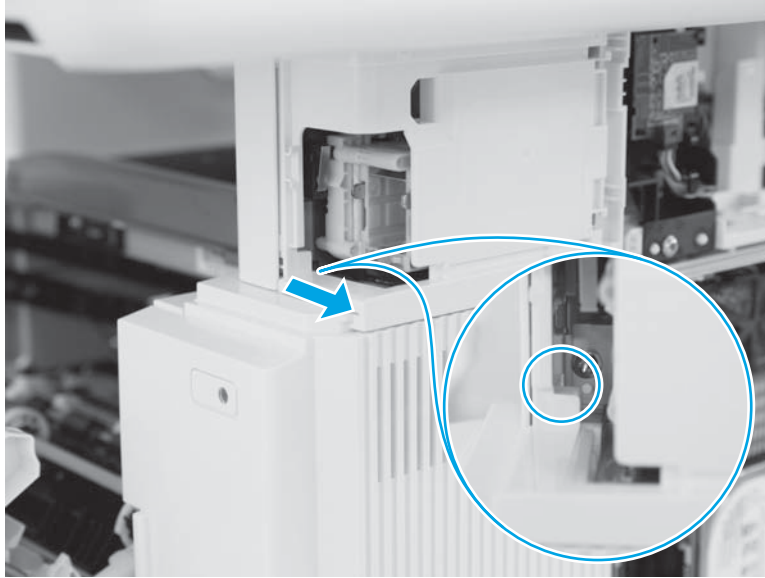
1. Before proceeding, take note of the locations of the upper tab (callout 1) and the lower tab (callout 2) on the stapler stationary (inner) cover.

**Figure 1-960** Locate the tabs



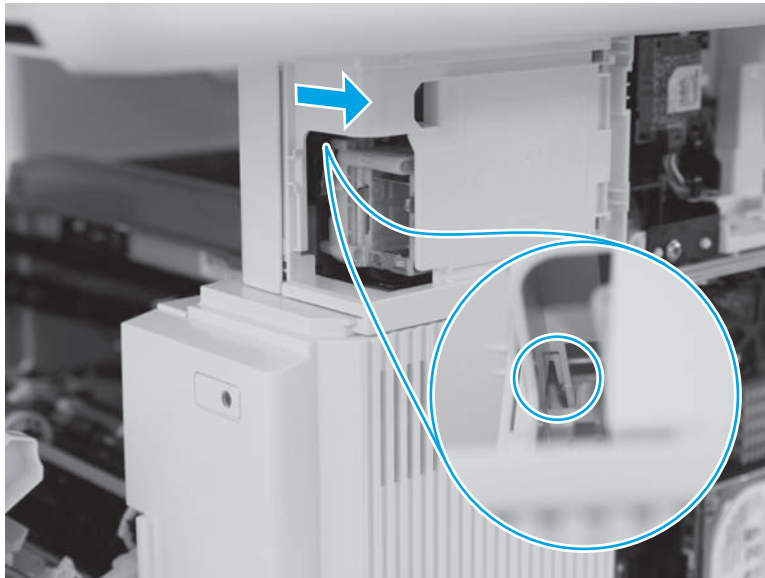
2. Use a long-shaft small flat-blad screwdriver to release the lower tab.

**Figure 1-961** Release one tab



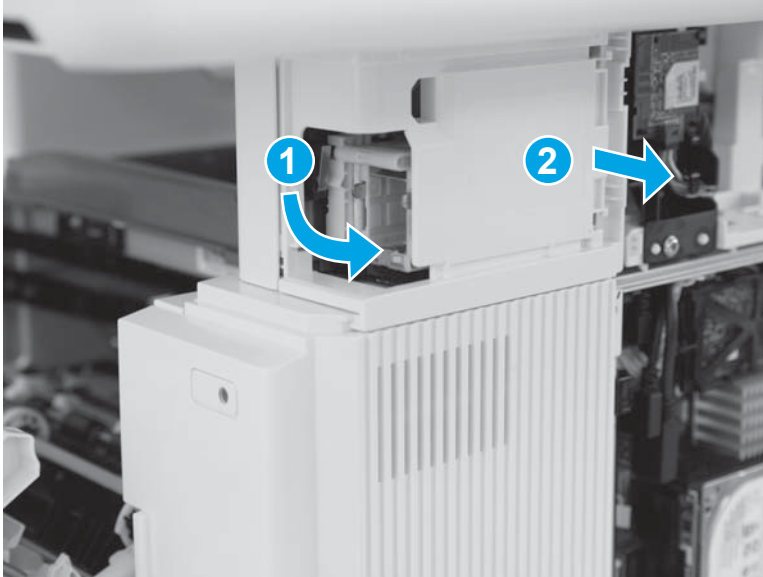
3. Use a long-shaft small flat-blad screwdriver to release the upper tab.

**Figure 1-962** Release one tab




4. With the tabs disengaged the front of the cover is released. Rotate the front of the cover away from the printer (callout 1) to release the rear of the cover (callout 2), and then remove it.

**Figure 1-963** Remove the cover

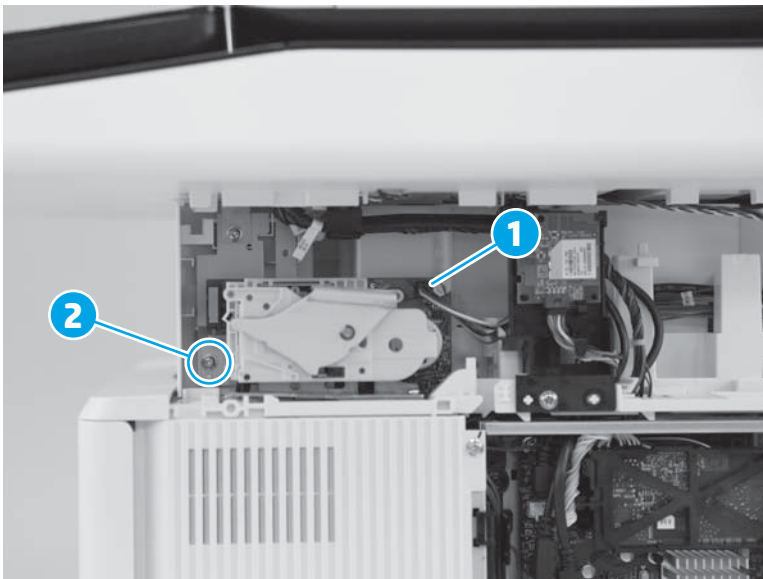


#### Step 4: Remove the stapler unit

 **NOTE:** M527 printer only.

1. Disconnect one connector (callout 1), and then remove one screw (callout 2).

**Figure 1-964** Disconnect one connector and remove one screw



2. Remove the stapler unit.

**Figure 1-965** Remove the stapler unit



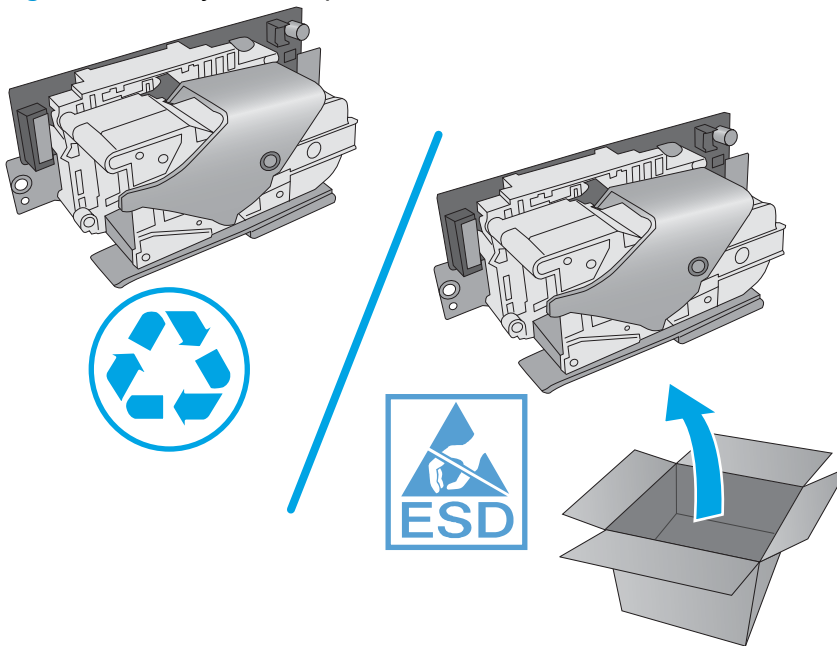
### Step 5: Unpack the replacement assembly

Unpack the replacement part from the packaging.


<http://www8.hp.com/us/en/hp-information/environment/product-recycling.html>

 **NOTE:** HP recommends responsible disposal of the defective part.

**Figure 1-966** Recycle and unpack



## Step 6: Install the stapler unit

 **NOTE:** M527 printer only.

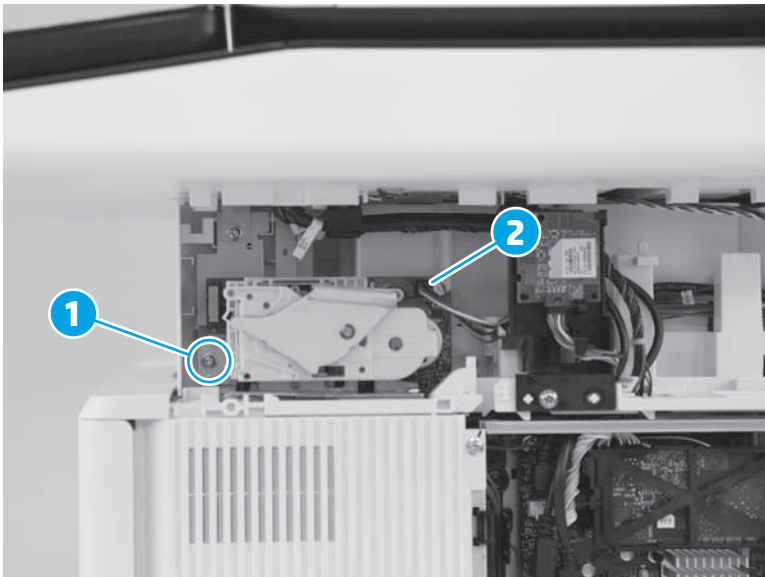
1. Position the stapler unit on the chassis.

**Figure 1-967** Install the stapler unit




2. Install one screw (callout 1), and then connect one connector (callout 2).

**Figure 1-968** Install one screw and connect one connector

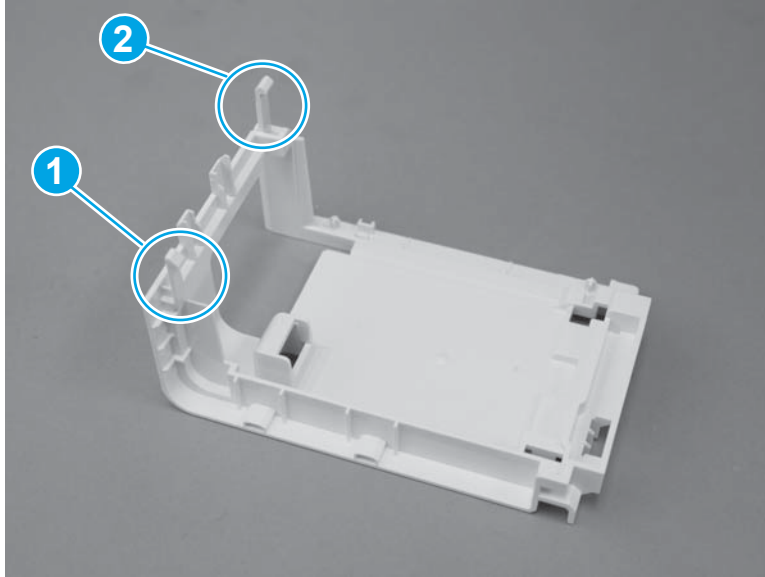


## Step 7: Install the stapler stationary (inner) cover (M527)

 **NOTE:** M527c/f/z printers only.

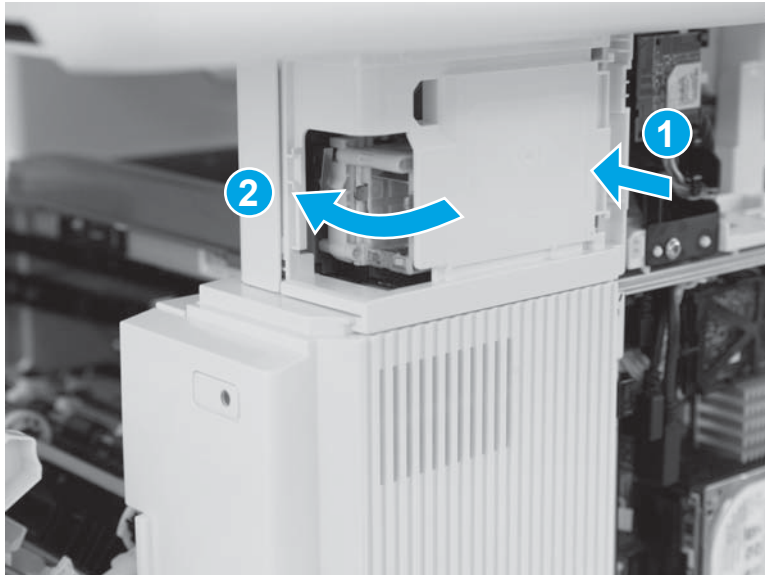
1. Before proceeding, take note of the locations of the upper tab (callout 1) and the lower tab (callout 2) on the stapler stationary (inner) cover.

**Figure 1-969** Locate the tabs



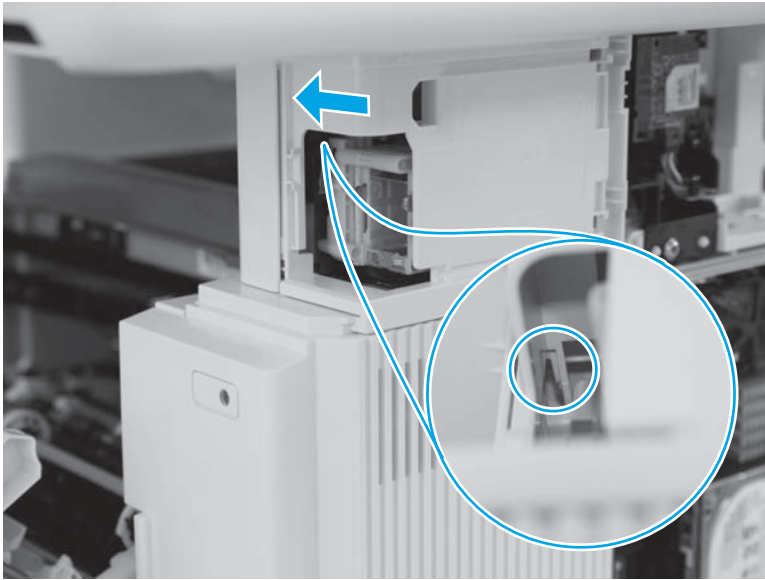
2. Engage the rear edge of the cover with the printer (callout 1), and then rotate the front edge of the cover onto the printer (callout 2) to engage the two tabs.

**Figure 1-970** Install the cover



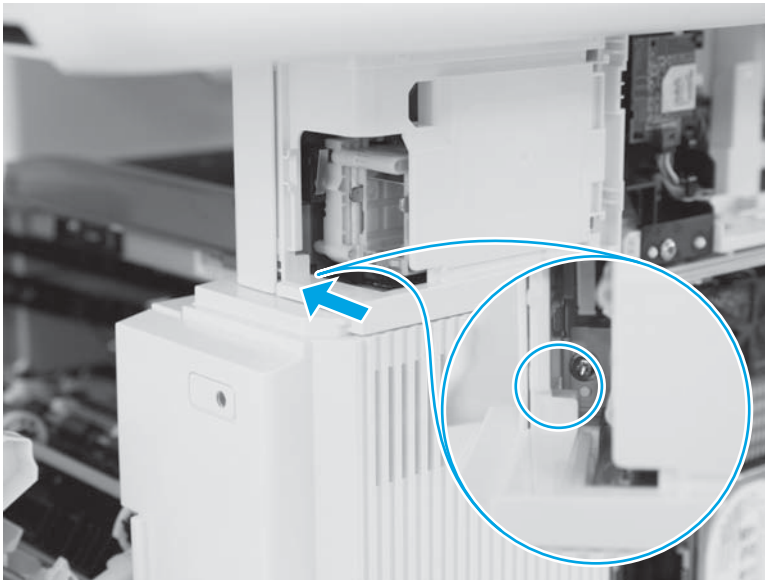
3. Verify that the upper tab is engaged.

**Figure 1-971** Engage one tab




4. Verify that the lower tab is engaged.

**Figure 1-972** Engage one tab



### Step 8: Install the stapler door (M527)

 **NOTE:** The M527dn does not have a convenience stapler.

1. Do one of the following:
  - **M527c/f/z:** Position the door near the printer.
  - **M527dn:** Position the cover on the printer.



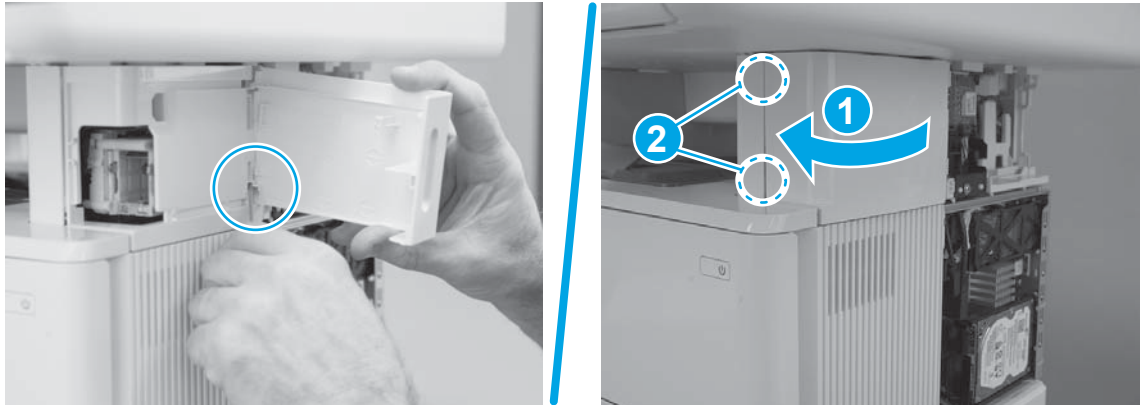
**Figure 1-973** Install the door or cover



2.

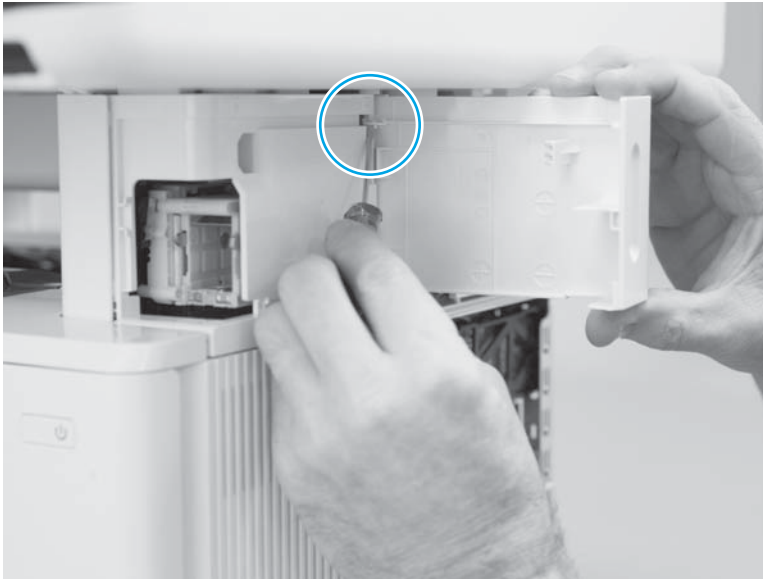
- **M527c/f/z:** Engage the lower hinge.
- **M527dn:** Rotate the cover towards the printer (callout 1), and then make sure that the two tabs (callout 2) snap into place to install the cover.

**Figure 1-974** Engage the lower hinge or engage the cover



3. **M527c/f/z:** Engage the upper hinge.

**Figure 1-975** Engage the upper hinge



4. **M527c/f/z:** Close the stapler door.

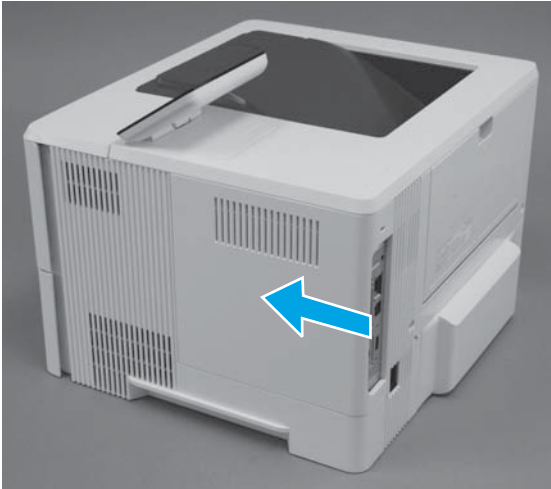
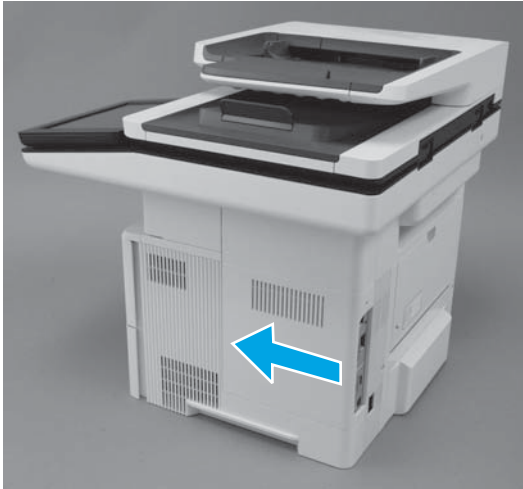
**Figure 1-976** Close the door



### Step 9: Install the formatter cover


- ▲ Slide it toward the front of the printer to install it.

**Figure 1-977** Install the formatter cover



## Removal and replacement: Formatter

---

 **IMPORTANT: M506/M527:** Take note of all empty connectors on the PCA before disconnecting any wire harnesses or flat-flexible cables (FFCs). Some empty connectors might not be visible until other items—like the hard-disk drive—are removed, so pay close attention while removing the formatter and accessory items.

---

- [Introduction](#)
- [Step 1: Remove the formatter cover](#)
- [Step 2: Remove the fax PCA](#)
- [Step 3: Remove the hard-disk drive \(HDD\)](#)
- [Step 4: Remove the embedded MultiMedia Card \(eMMC\)](#)
- [Step 5: Remove the dual in-line memory module \(DIMM\)](#)
- [Step 6: Remove the formatter](#)
- [Step 7: Unpack the replacement formatter](#)
- [Step 8: Install the formatter](#)
- [Step 9: Install the dual in-line memory module \(DIMM\)](#)
- [Step 10: Install the embedded MultiMedia Card \(eMMC\)](#)
- [Step 11: Install the hard-disk drive \(HDD\)](#)
- [Step 12: Install the fax PCA](#)
- [Step 13: Install the formatter cover](#)

### Introduction


This document provides the procedures to remove and replace the formatter.

### Before performing service


#### Turn the printer power off

- Disconnect the power cable.

---

 **WARNING!** To avoid damage to the printer, turn the printer off, wait 30 seconds, and then remove the power cable before attempting to service the printer.

---

 **IMPORTANT: M506/M527:** Take note of all empty connectors on the PCA before disconnecting any wire harnesses or flat-flexible cables (FFCs). Some empty connectors might not be visible until other items—like the hard-disk drive—are removed, so pay close attention while removing the formatter and accessory items.

---

Use the table below to identify the correct part number for your printer. To order the part, go to [www.hp.com/buy/parts](http://www.hp.com/buy/parts).

---

Formatter part numbers	
<b>F2A76-67910</b>	Formatter (M527) with instruction guide
<b>F2A68-67915</b>	Formatter (M506n and M506dn) with instruction guide
<b>F2A68-67916</b>	Formatter (M506x) with instruction guide
<b>J8H60-67901</b>	Formatter (M501n)
<b>J8H60-67902</b>	Formatter (M501n; China)
<b>J8H61-67901</b>	Formatter (M501dn)
<b>J8H61-67902</b>	Formatter (M501dn; China)

---

### Required tools

- #2 Phillips screwdriver with a magnetic tip.

### After performing service

#### Turn the printer power on

- Connect the power cable.
- Use the power switch to turn the power on.

### Post service test

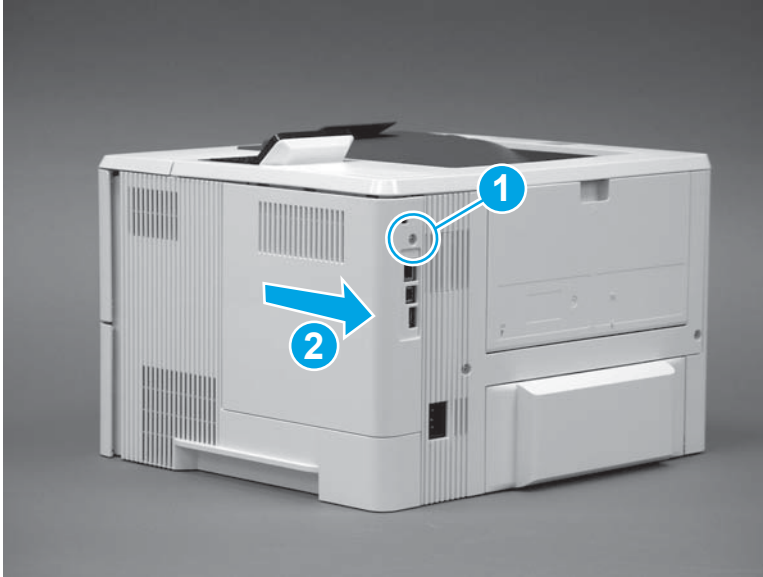
Make sure that the printer initializes to a **Ready** state.

Print a configuration page to make sure that the printer is functioning correctly.

### Step 1: Remove the formatter cover

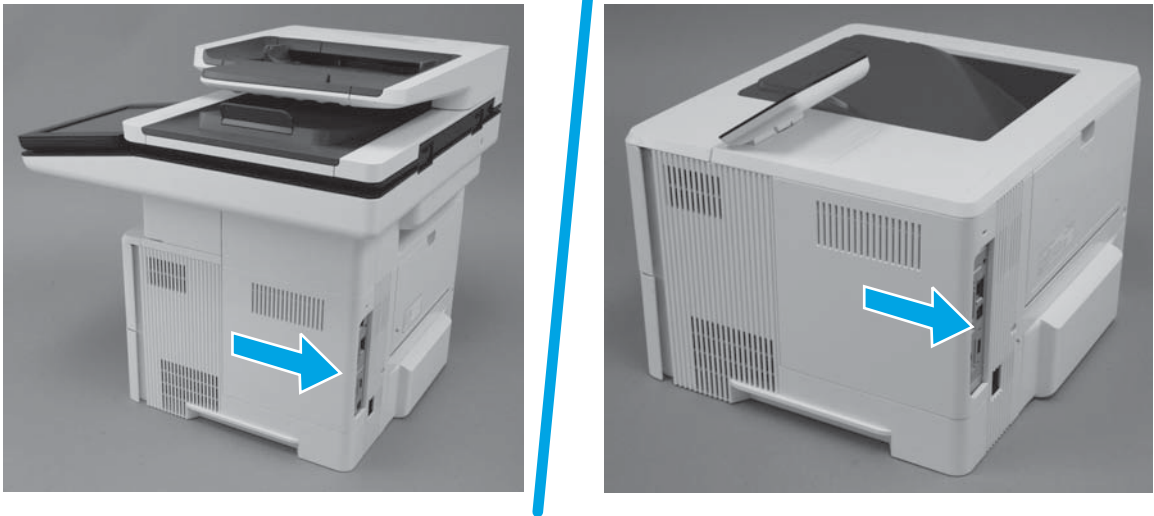
1. **M501:** Remove one screw (callout 1), and then slide the cover toward the rear of the printer to remove it (callout 2).

**Figure 1-978** Remove the formatter cover (M501)




2. **M506/M527:** Slide the cover toward the rear of the printer to remove it.


**Figure 1-979** Remove the formatter cover (M506/M527)



## Step 2: Remove the fax PCA

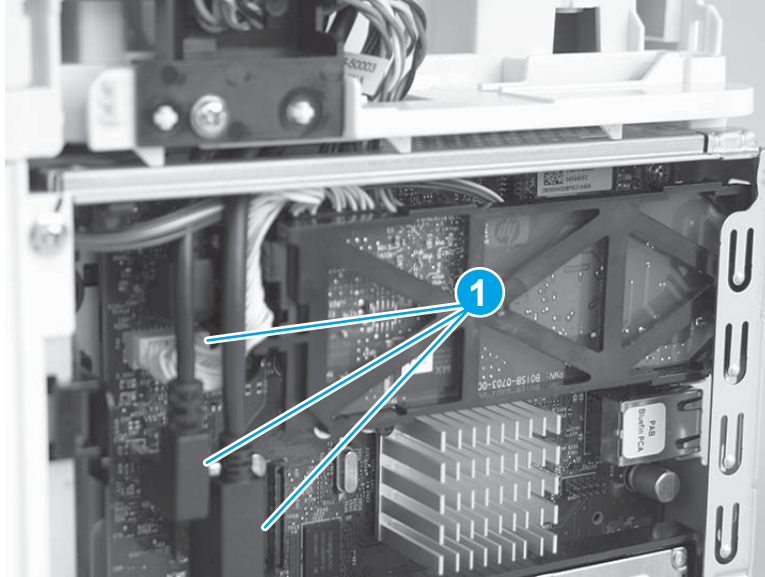
 **NOTE:** Fax models only. For all other models, skip this step and go to [Step 3: Remove the hard-disk drive \(HDD\) on page 570](#). For the M501 printer, skip this step and go to [Step 6: Remove the formatter on page 574](#).

 **CAUTION:**  ESD-sensitive part.

 **NOTE:** M527c/f/z printers only (optional for the M527dn).

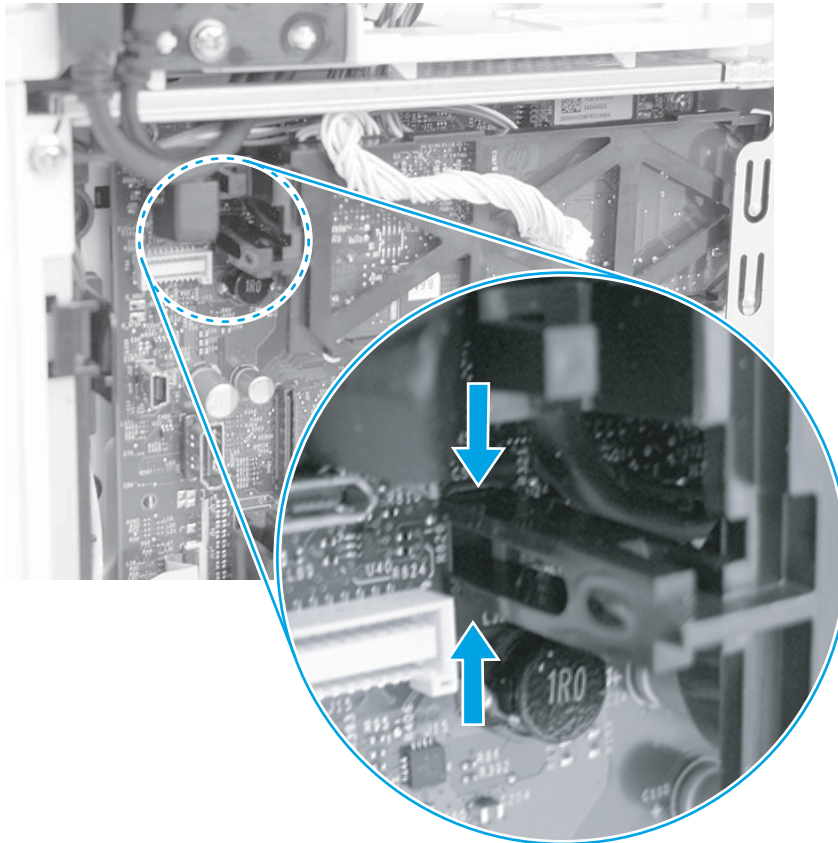
1. Disconnect three connectors (callout 1).

**Figure 1-980** Disconnect three connectors



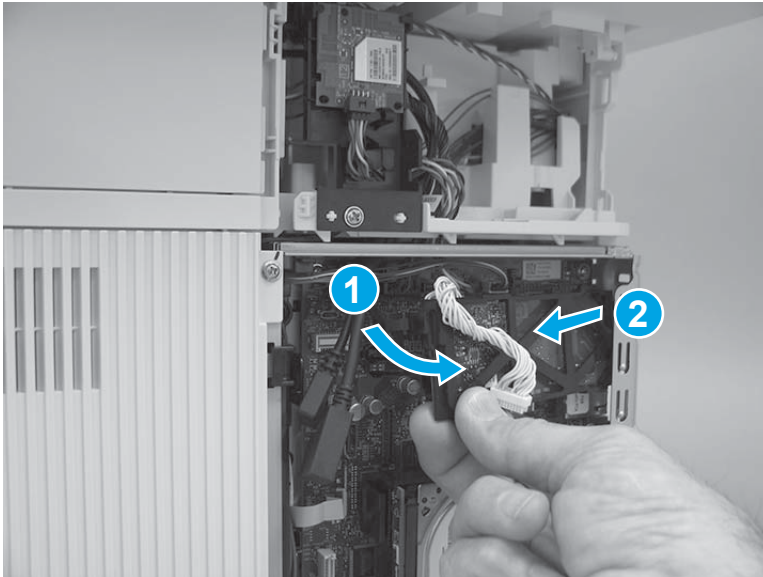
2. Pinch the retainer to release it.

**Figure 1-981** Release the fax PCA




3. Rotate the connector end of the fax PCA out and away from the formatter (callout 1), and then slide it as shown (callout 2) to remove it.

**Figure 1-982** Remove the fax PCA



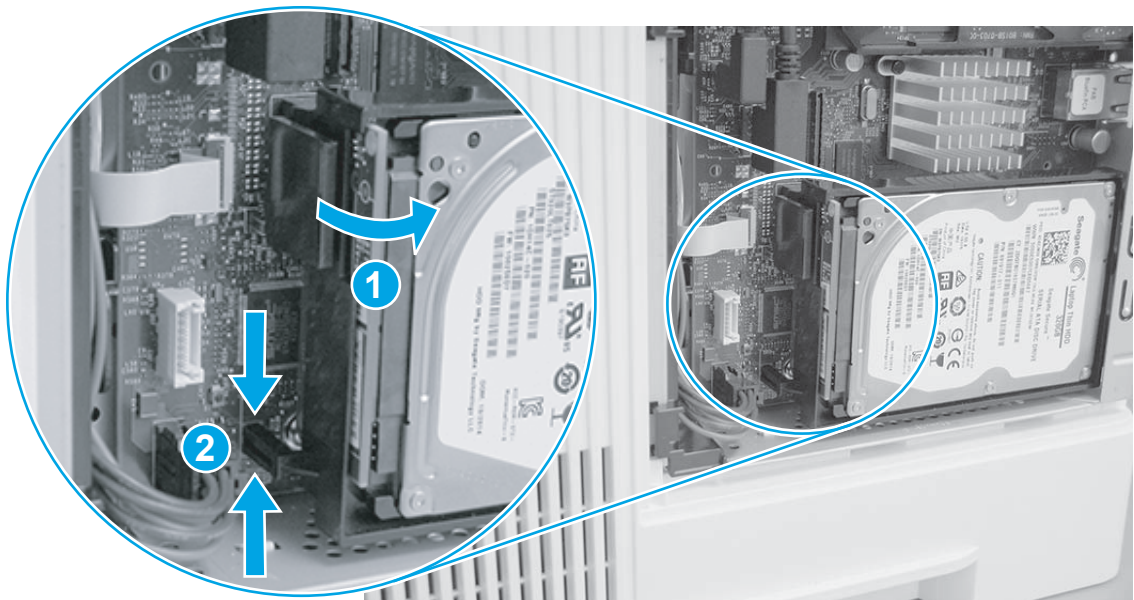
### Step 3: Remove the hard-disk drive (HDD)

 **NOTE:** HDD models only. For all other models, skip this step and go to [Step 4: Remove the embedded MultiMedia Card \(eMMC\) on page 571](#). For the M501 printer, skip this step and go to [Step 6: Remove the formatter on page 574](#).

 **CAUTION:**  ESD-sensitive part.

1. Release the locking connector (callout 1), and then pinch the retainer (callout 2) to release it.

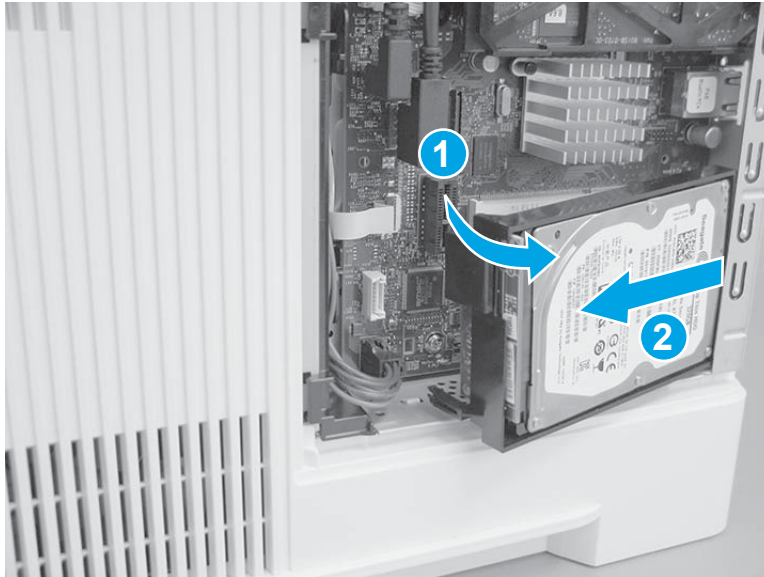
**Figure 1-983** Release the HDD






2. Rotate the connector end of the HDD out and away from the formatter (callout 1), and then slide it as shown (callout 2) to remove it.

**Figure 1-984** Remove the HDD



#### Step 4: Remove the embedded MultiMedia Card (eMMC)


---

 **NOTE:** M506 printers and M527dn models only. For all other printers and models, skip this step and go to [Step 5: Remove the dual in-line memory module \(DIMM\) on page 572](#). For the M501 printer, skip this step and go to [Step 6: Remove the formatter on page 574](#).

---

 **CAUTION:**  ESD-sensitive part.

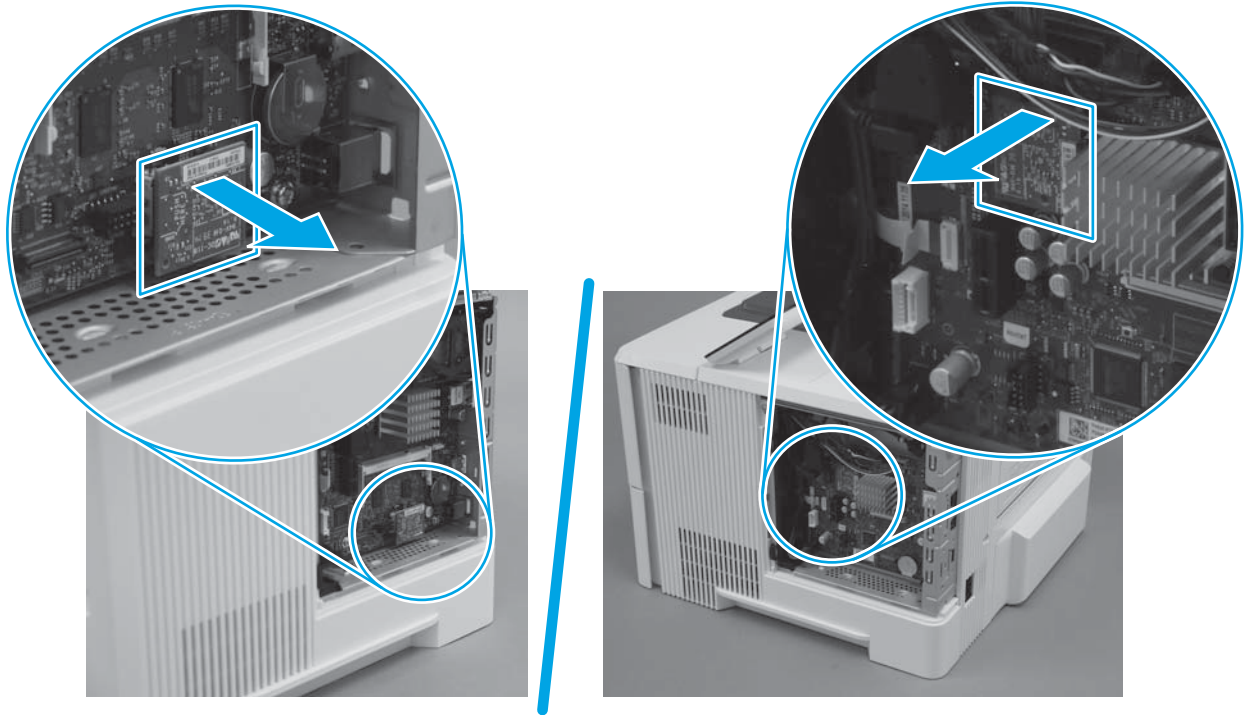
---

 **NOTE:** M506 (all) and M527dn printers only.

---

- ▲ Locate the eMMC component on the formatter, and then pull it straight out of the formatter to remove it.

**Figure 1-985** Remove the eMMC



#### Step 5: Remove the dual in-line memory module (DIMM)

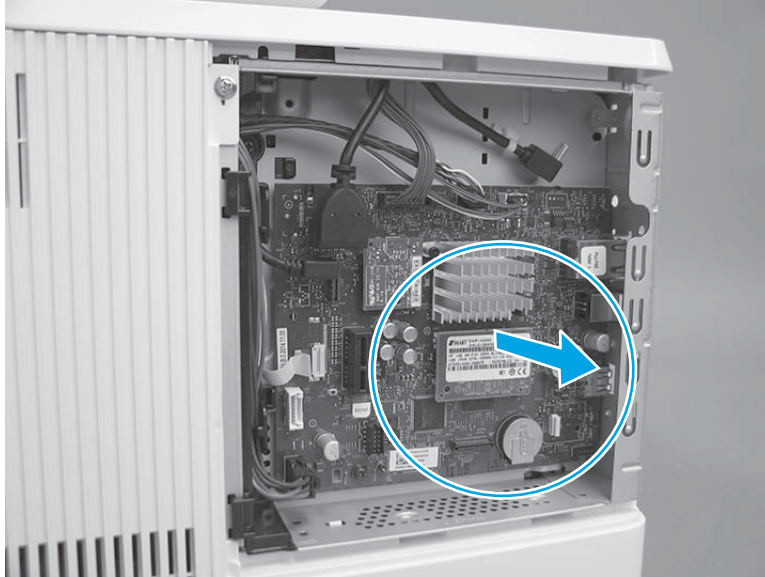
 **NOTE:** M506 and M527 printers only. For the M501 printer, skip this step and go to [Step 6: Remove the formatter on page 574](#).

 **CAUTION:**  ESD-sensitive part.

 **NOTE:** The M506 printers use a Slim dual in-line memory module (DIMM).

1. **M506 only:** Locate the DIMM component on the formatter, and then pull it straight out of the formatter to remove it.

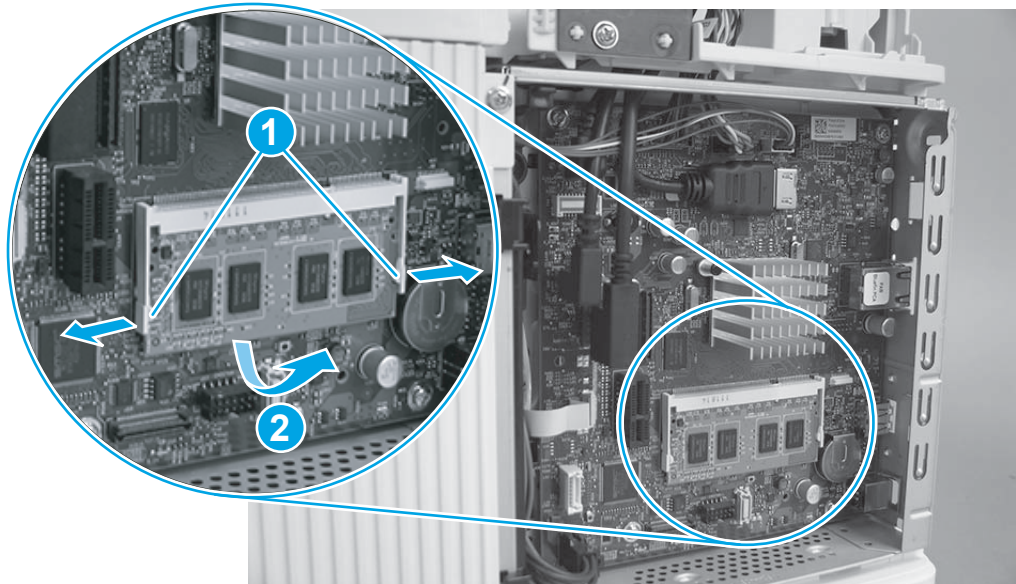
**Figure 1-986** Remove the DIMM (M506)



**2. M527 only:** Do the following

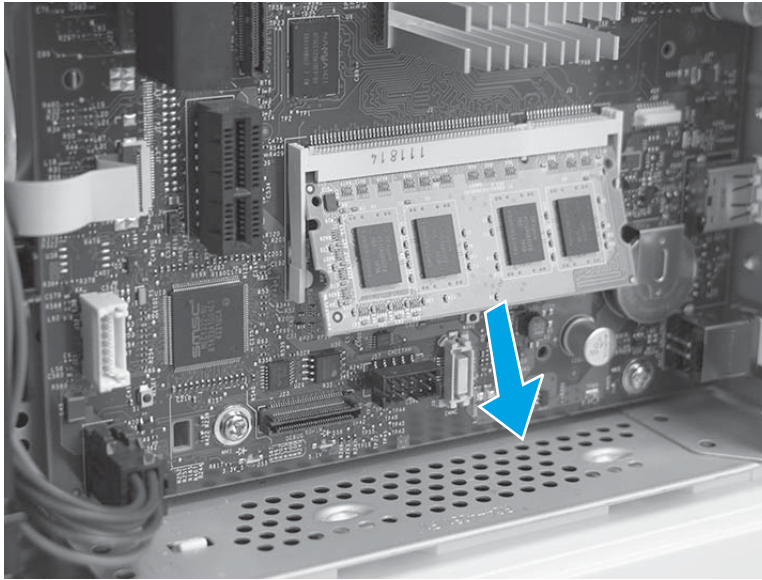
- a. Locate the DIMM component on the formatter, release two locking arms (callout 1), and then let the bottom edge of the DIMM rotate away from the holder (callout 2).

**Figure 1-987** Release the DIMM (M527)



- b. Pull the DIMM down and away from the holder to remove it.

**Figure 1-988** Remove the DIMM (M527)

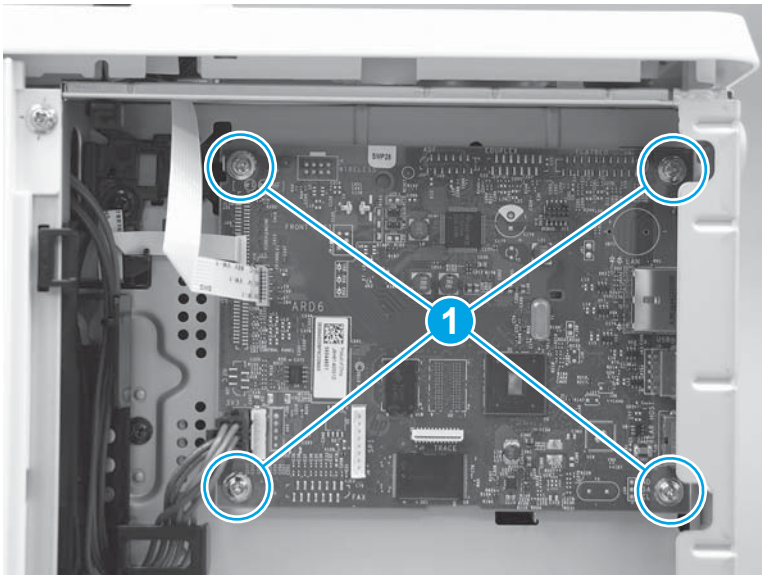


### Step 6: Remove the formatter


**IMPORTANT:** **M506/M527:** Take note of all empty connectors on the PCA before disconnecting any wire harnesses or flat-flexible cables (FFCs). Some empty connectors might not be visible until other items—like the hard-disk drive—are removed, so pay close attention while removing the formatter and accessory items.

1. **M501:** Disconnect all of the connectors and FFCs, remove four screws (callout 1), and then remove the formatter.

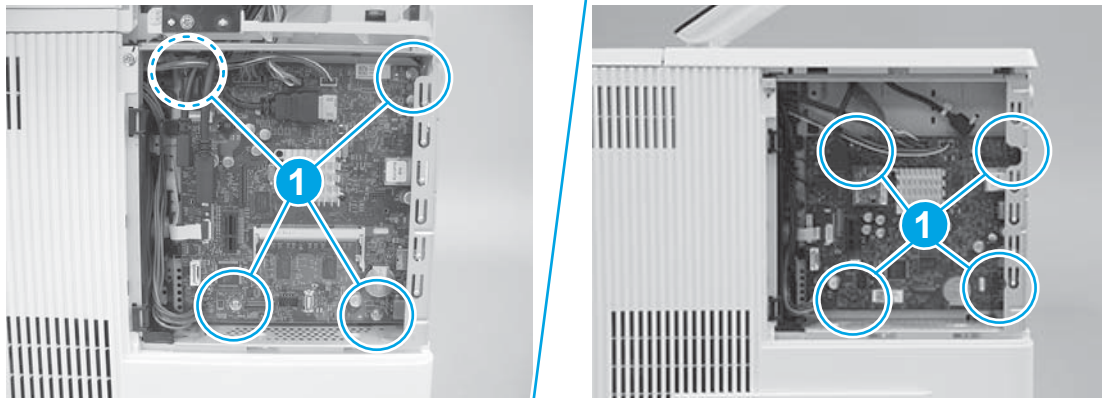
**Figure 1-989** Remove the formatter (M501)



2. **M506/M527:** Disconnect all of the connectors and FFCs, remove four screws (callout 1), and then remove the formatter.

 **IMPORTANT:** Take note of all empty connectors on the formatter before disconnecting any wire harnesses or flat-flexible cables (FFCs). Some empty connectors might not be visible until other items—like the hard-disk drive—are removed, so pay close attention while removing the formatter and accessories items.

**Figure 1-990** Remove the formatter (M506/M527)



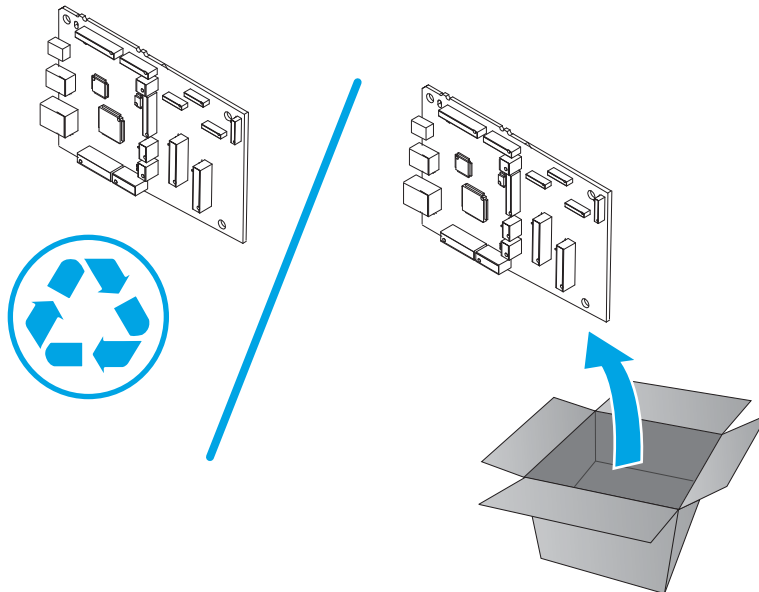
### Step 7: Unpack the replacement formatter

Unpack the replacement part from the packaging.


<http://www8.hp.com/us/en/hp-information/environment/product-recycling.html>

 **NOTE:** HP recommends responsible disposal of the defective part.

**Figure 1-991** Recycle and unpack

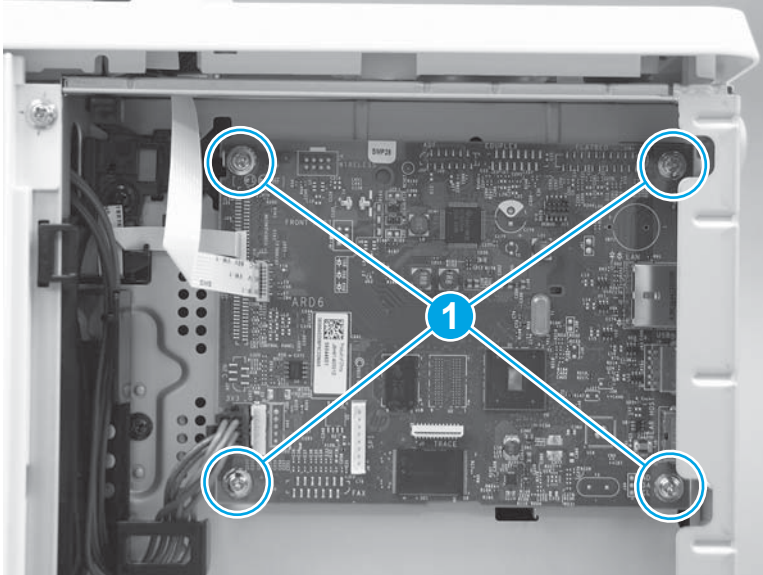


## Step 8: Install the formatter


 **IMPORTANT:** **M506/M527:** Take note of all empty connectors on the PCA before disconnecting any wire harnesses or flat-flexible cables (FFCs). Some empty connectors might not be visible until other items—like the hard-disk drive—are removed, so pay close attention while removing the formatter and accessory items.

1. **M501:** Position the formatter on the chassis, install four screws (callout 1), and then connect all of the connectors and FFCs.

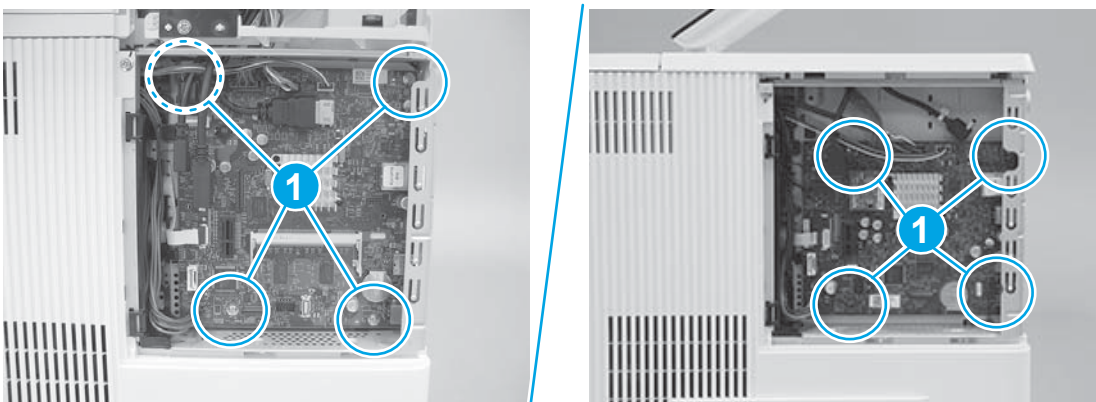
**Figure 1-992** Install the formatter (M501)



2. **M506/M527:** Position the formatter on the chassis, install four screws (callout 1), and then connect all of the connectors and FFCs.

 **IMPORTANT:** Some connectors might need be empty if other items—for example a fax PCA—will be installed later.

**Figure 1-993** Install the formatter (M506/M527)



## Step 9: Install the dual in-line memory module (DIMM)

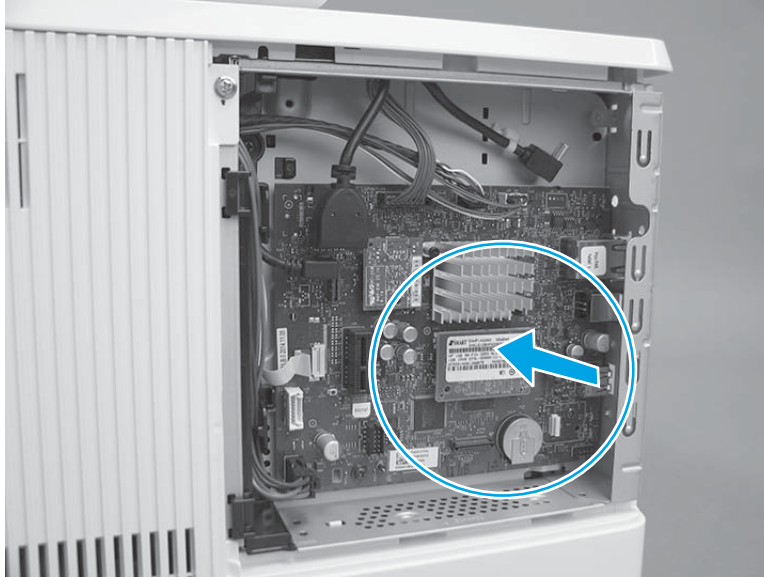
 **NOTE:** M506 and M527 printers only. For the M501 printer, skip this step and go to [Step 13: Install the formatter cover on page 583](#).

 **CAUTION:**  ESD-sensitive part.


 **NOTE:** The M506 printers use a Slim dual in-line memory module (DIMM).

1. **M506 only:** Push the DIMM straight on the connector to install it.

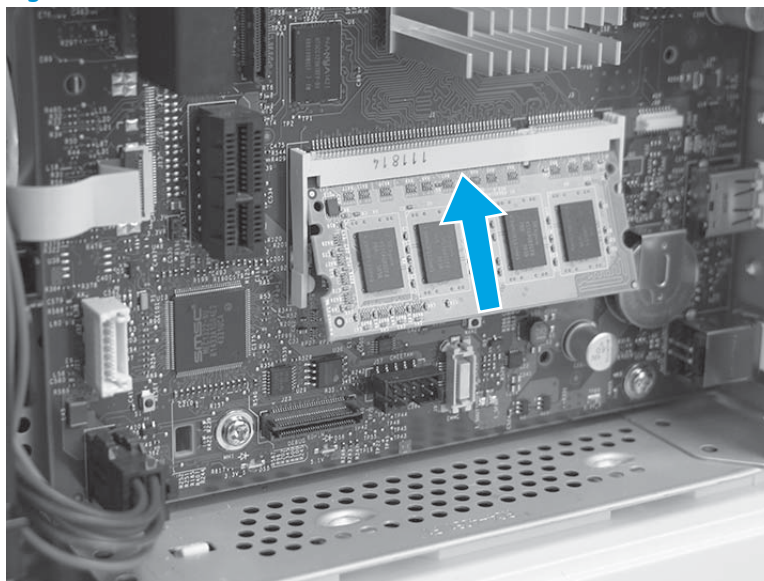
**Figure 1-994** Install the DIMM (M506)



2. **M527 only:** Do the following
  - a. Insert the top edge of the DIMM in the holder.

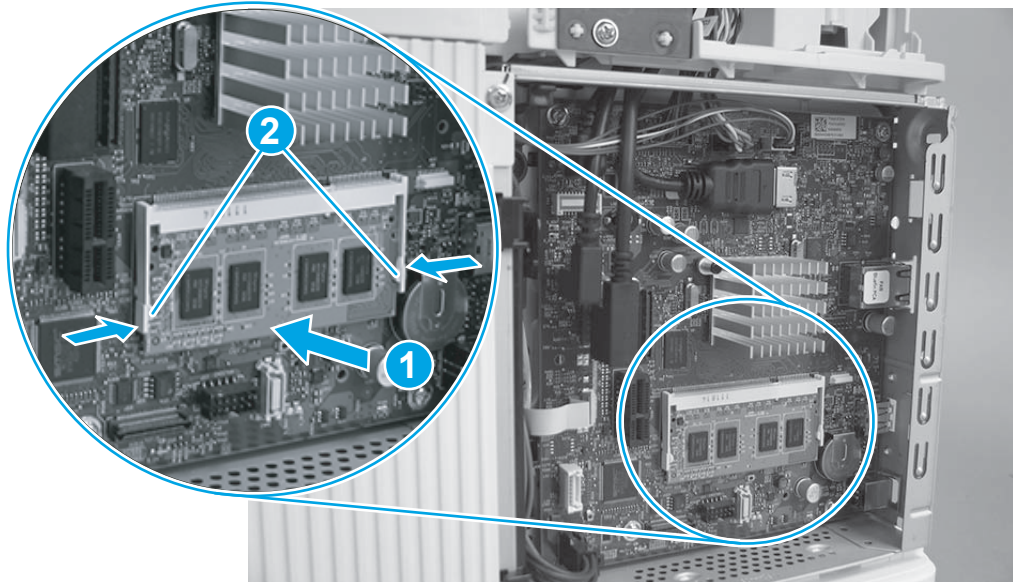
 **Reinstallation tip:** The DIMM is keyed and can only be inserted in the holder one way.

**Figure 1-995** Insert the DIMM (M527)




- b. Rotate the bottom edge of the DIMM toward the holder (callout 1), and then make sure that the two locking arms snap into place (callout 2).


**Figure 1-996** Install the DIMM (M527)




### Step 10: Install the embedded MultiMedia Card (eMMC)

 **NOTE:** M506 printers and M527dn models only. For all other M527 models, skip this step and go to [Step 11: Install the hard-disk drive \(HDD\) on page 579](#). For the M501 printer, skip this step and go to [Step 13: Install the formatter cover on page 583](#).

 **CAUTION:**  ESD-sensitive part.

 **NOTE:** M506 (all) and M527dn printers only.

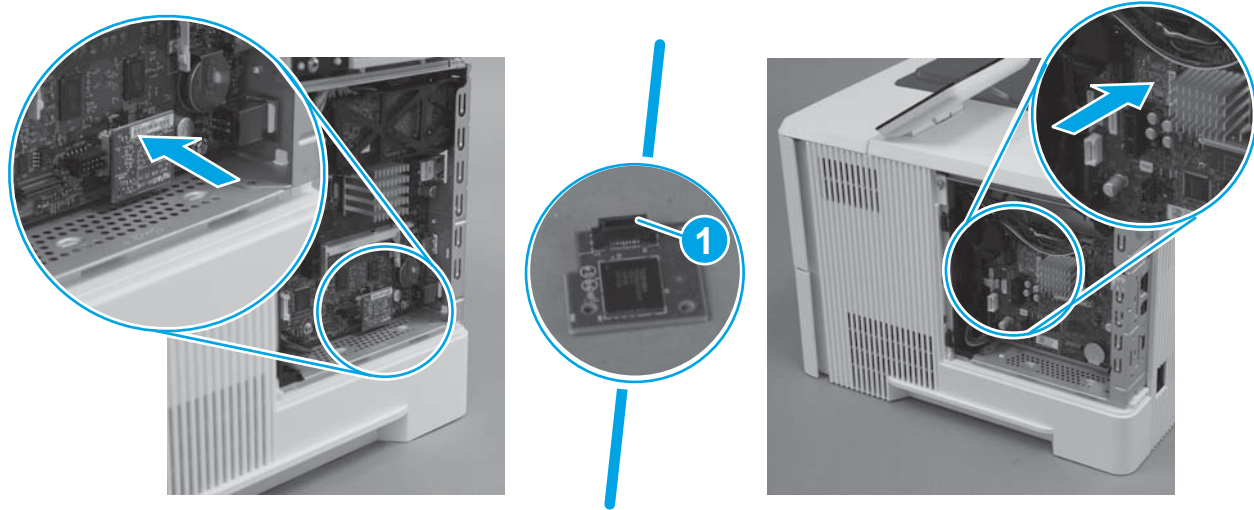
- ▲ Align the connector on the replacement eMMC (callout 1) with the connector on the formatter, and then push the eMMC onto the formatter to install it.

 **IMPORTANT:** Push on the eMMC at the location shown by the arrow. Ignore any “Push here” label on the eMMC itself. Make sure that the eMMC is fully seated in the connector .


 **NOTE:** The eMMC can only be installed in one direction on the formatter.



**Figure 1-997** Install the eMMC




### Step 11: Install the hard-disk drive (HDD)

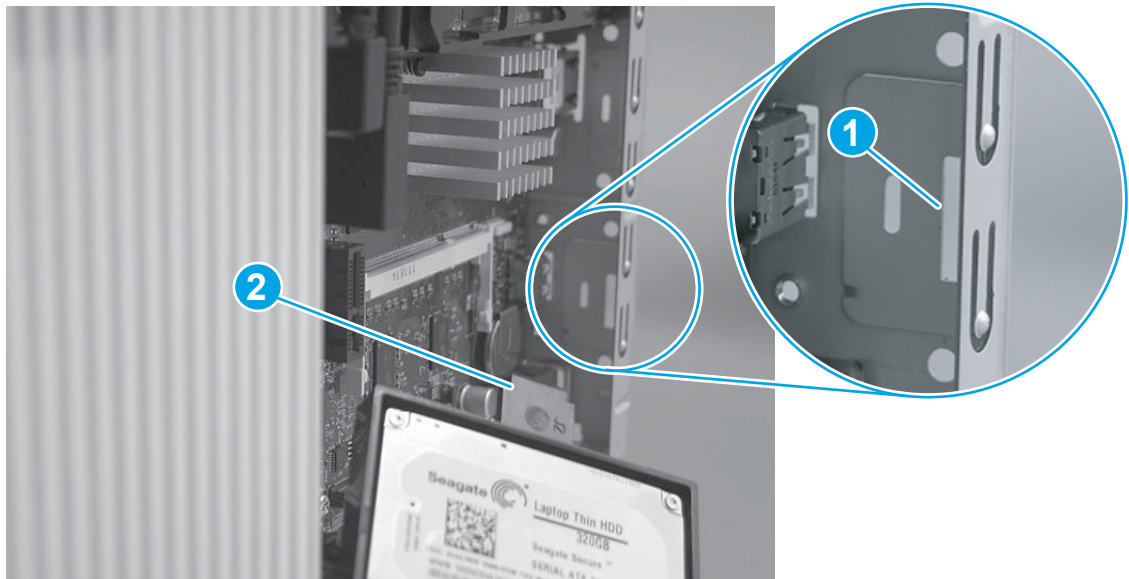
 **NOTE:** HDD models only. For all other models, skip this step and go to [Step 12: Install the fax PCA on page 580](#). For the M501 printer, skip this step and go to [Step 13: Install the formatter cover on page 583](#).

 **CAUTION:**  ESD-sensitive part.

1. Before proceeding, take note of the location of the slot (callout 1) in the sheet-metal where the HDD cradle mounting tab (callout 2) must be installed.

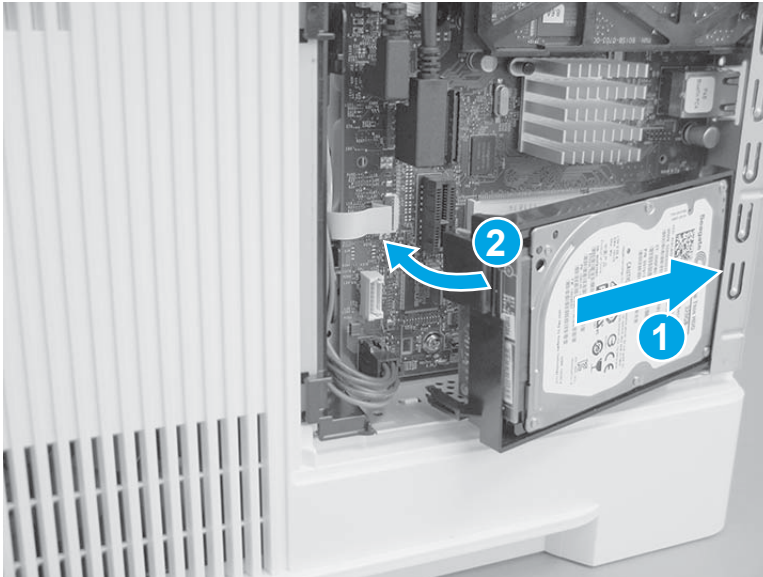
 **CAUTION:** This portion of the sheet-metal is a knock-out plate (callout 1). Do not push on it with sufficient force to detach it when installing the HDD.

**Figure 1-998** Locate the slot in the sheet-metal



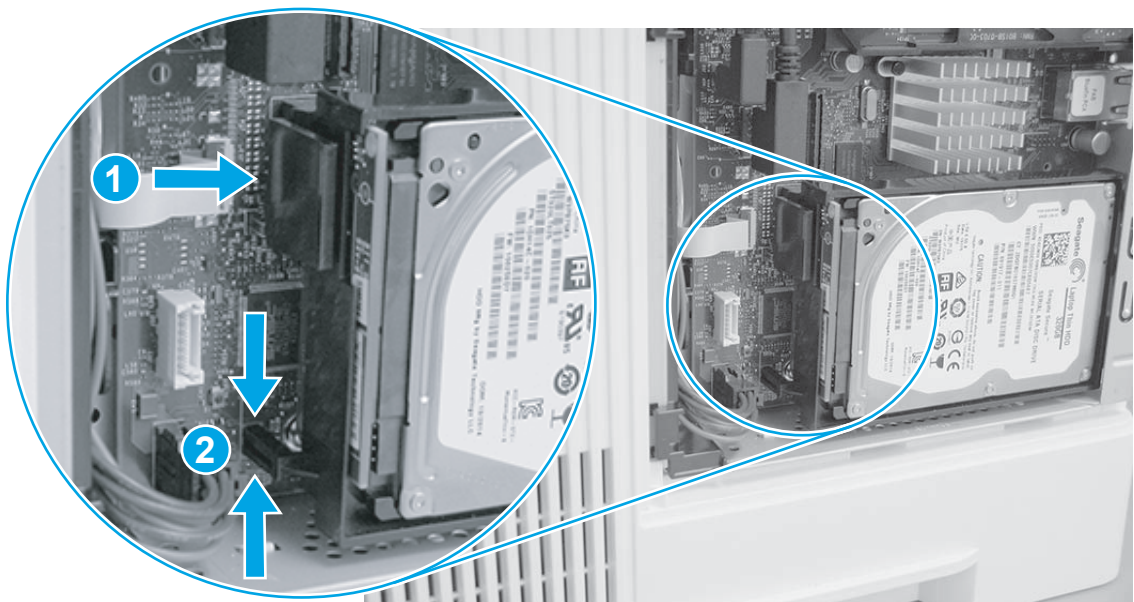
2. Insert the HDD cradle mounting tab in the slot in the sheet-metal (callout 1), and then rotate the connector end (callout 2) of the HDD toward the formatter.

**Figure 1-999** Install the HDD



3. Make sure that the locking connector (callout 1) latches and that the standoffs (callout 2) engage with the slot in the formatter (it might be necessary to pinch the retainer to engage it with the slot).

**Figure 1-1000** Install the HDD




## Step 12: Install the fax PCA



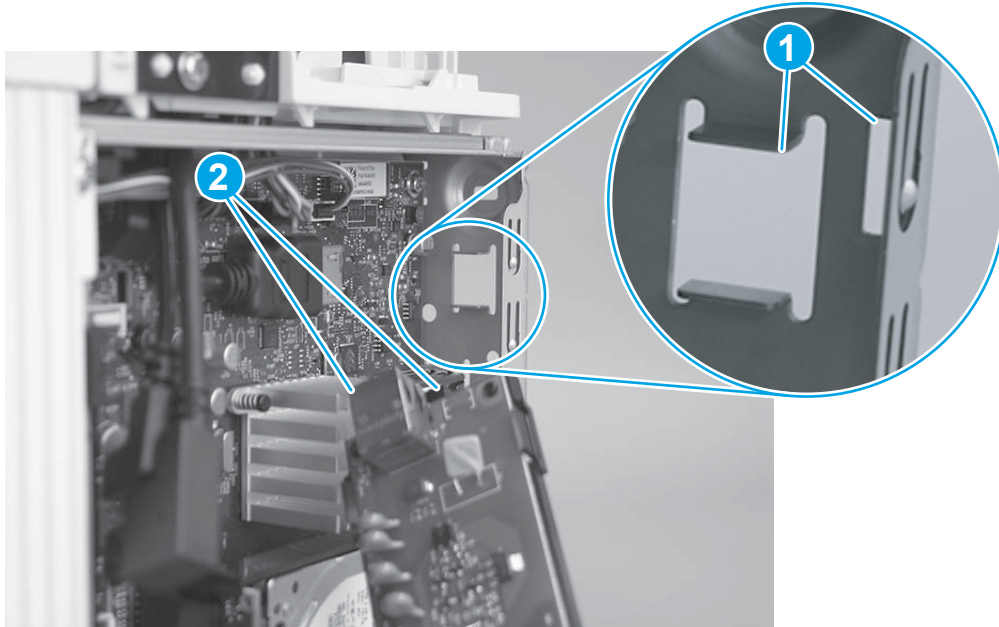
**NOTE:** Fax models only. For all other models and printers, skip this step and go to [Step 13: Install the formatter cover on page 583](#).

 **CAUTION:**  ESD-sensitive part.

 **NOTE:** M527c/f/z printers only (optional for the M527dn).

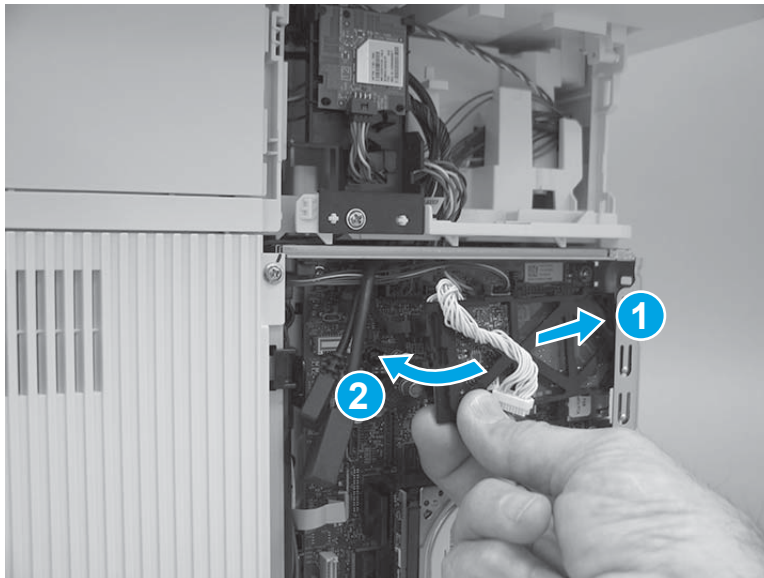
1. Before proceeding, take note of the location of the slots (callout 1) in the sheet-metal where the fax PCA cradle mounting tab and fax port (callout 2) must be installed.

**Figure 1-1001** Locate the slots in the sheet-metal



2. Insert the fax PCA cradle mounting tab and fax port in the slots in the sheet-metal plate (callout 1), and then rotate the connector end of the fax PCA toward the formatter (callout 2).

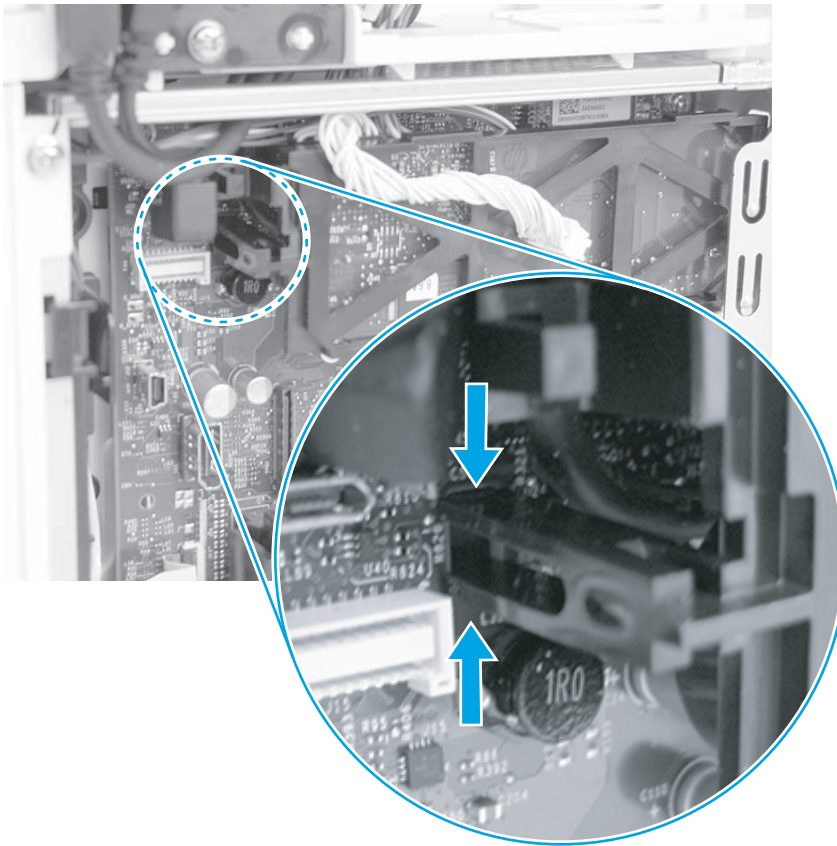
**Figure 1-1002** Install the fax PCA



- Engage the retainer with the slot in the formatter.

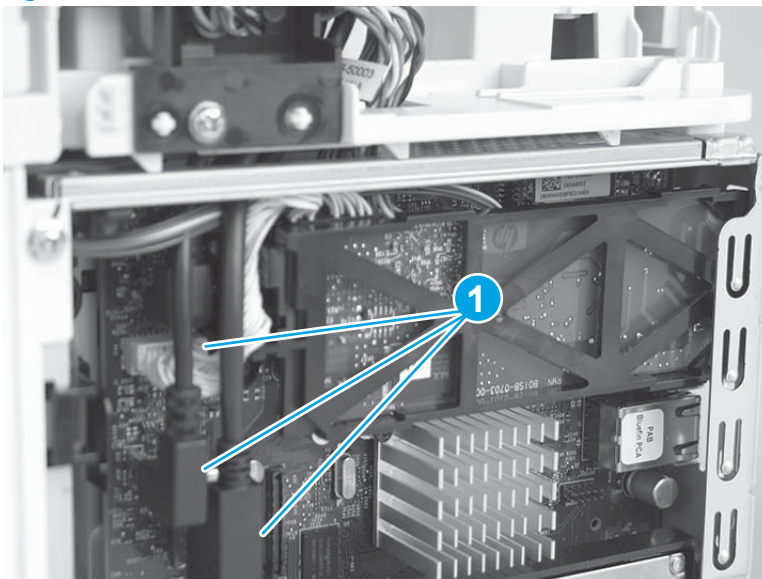
 **Reinstallation tip:** Pinch the retainer to easily engage it with the slot.

**Figure 1-1003** Engage the fax PCA



- Connect three connectors (callout 1).

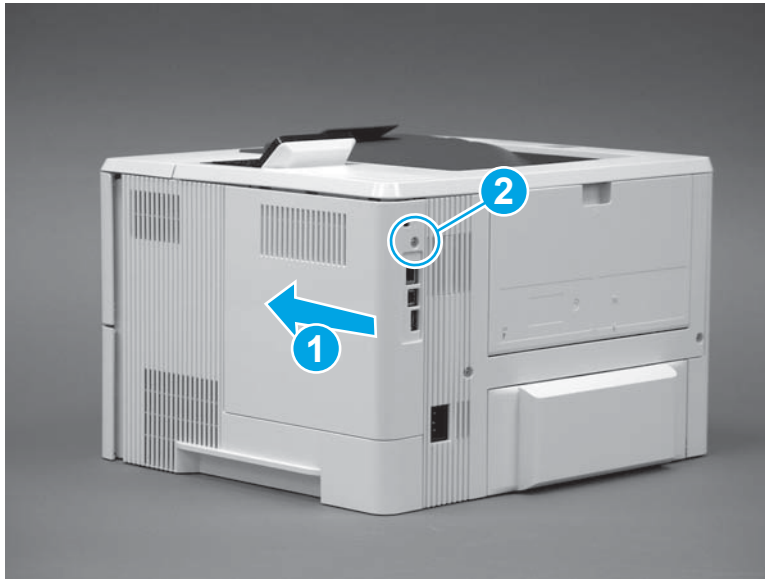
**Figure 1-1004** Connect three connectors



### Step 13: Install the formatter cover

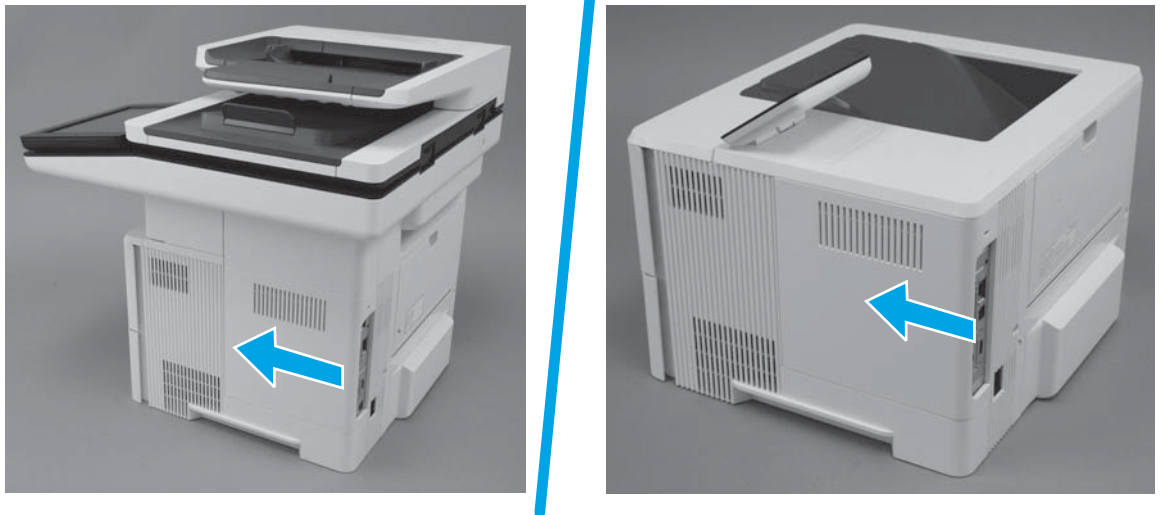
1. **M501:** Slide it toward the front of the printer to install it (callout 1), and then install one screw (callout 2).

**Figure 1-1005** Install the formatter cover (M501)



2. **M506/M527:** Slide it toward the front of the printer to install it.

**Figure 1-1006** Install the formatter cover (M506/M527)



## Removal and replacement: Laser/scanner assembly



**IMPORTANT:** Some figure might show assemblies removed or installed that have not yet been removed or installed at that specific step. However, the procedures are correct for this printer and the target assembly. Always thoroughly read the instructions that accompany each figure

---

- [Introduction](#)
- [Step 1: Remove the control panel \(M506x\)](#)
- [Step 2: Remove the tray](#)
- [Step 3: Remove the formatter cover](#)
- [Step 4: Remove the fax PCA \(M527\)](#)
- [Step 5: Remove the stapler door or stapler blank cover \(M527\)](#)
- [Step 6: Remove the stapler stationary \(inner\) cover \(M527\)](#)
- [Step 7: Remove the top-left cover \(M527\)](#)
- [Step 8: Remove the top-rear cover \(M527\)](#)
- [Step 9: Remove the rear door assembly](#)
- [Step 10: Remove the cartridge door assembly](#)
- [Step 11: Remove the right cover](#)
- [Step 12: Remove the left cover](#)
- [Step 13: Remove the integrated scanner assembly \(M527\)](#)
- [Step 14: Remove the top cover \(M527\)](#)
- [Step 15: Remove the top cover \(M501/M506\)](#)
- [Step 16: Remove the laser/scanner assembly](#)
- [Step 17: Unpack the replacement assembly](#)
- [Step 18: Install the laser/scanner assembly](#)
- [Step 19: Install the top cover \(M501/M506\)](#)
- [Step 20: Install the top cover \(M527\)](#)
- [Step 21: Install the integrated scanner assembly \(M527\)](#)
- [Step 22: Install the left cover](#)
- [Step 23: Install the right cover](#)
- [Step 24: Install the cartridge door assembly](#)
- [Step 25: Install the rear door assembly](#)
- [Step 26: Install the top-rear cover \(M527\)](#)
- [Step 27: Install the top-left cover \(M527\)](#)

- [Step 28: Install the stapler stationary \(inner\) cover \(M527\)](#)
- [Step 29: Install the stapler door or stapler blank cover \(M527\)](#)
- [Step 30: Install the fax PCA \(M527\)](#)
- [Step 31: Install the formatter cover](#)
- [Step 32: Install the tray](#)
- [Step 33: Install the control panel \(M506x\)](#)


## Introduction

This document provides the procedures to remove and replace the laser/scanner assembly.

## Before performing service

### Turn the printer power off

- Disconnect the power cable.

 **WARNING!** To avoid damage to the printer, turn the printer off wait 30 seconds, and then remove the power cable before attempting to service the printer.

Use the table below to identify the correct part number for your printer. To order the part, go to [www.hp.com/buy/parts](http://www.hp.com/buy/parts).

Laser/scanner assembly part number	
RM2-5528-000CN	Laser/scanner assembly

## Required tools

- #2 Phillips screwdriver with a magnetic tip.

## After performing service

### Turn the printer power on


- Connect the power cable.
- Use the power switch to turn the power on.

## Post service test

Make sure that the printer initializes to a **Ready** state.

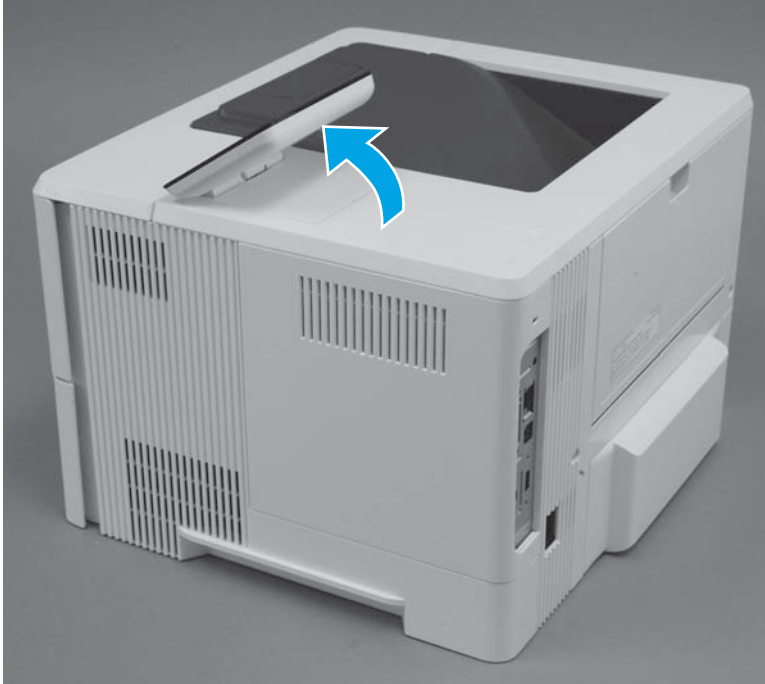
Print a configuration page to make sure that the printer is functioning correctly.

## Step 1: Remove the control panel (M506x)

 **NOTE:** M506x model only. For all other models, skip this step and proceed to [Step 2: Remove the tray on page 588](#).

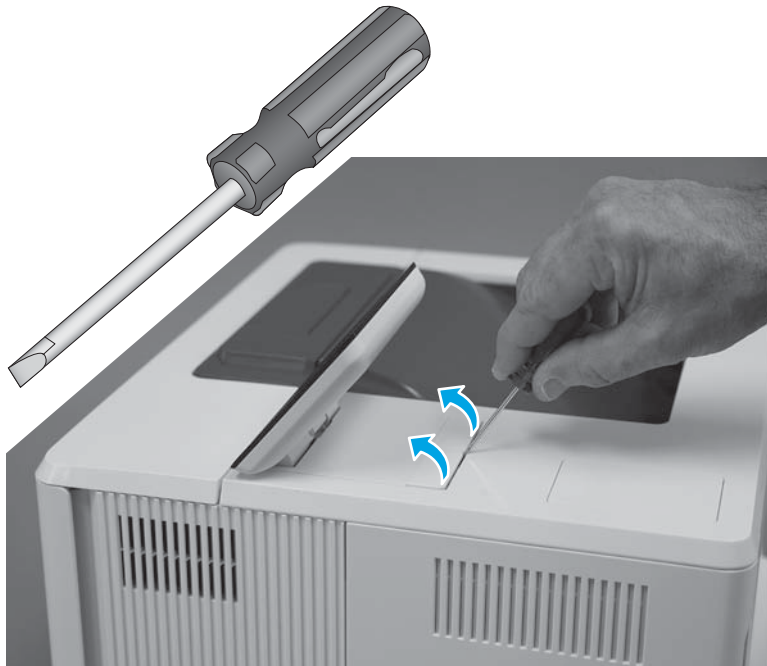
1. Tilt the control panel to the fully raised position.

**Figure 1-1007** Tilt the control panel up



2. Use a small flat-blad screwdriver to release the control-panel screws cover, and then remove the cover.

**Figure 1-1008** Remove the cover

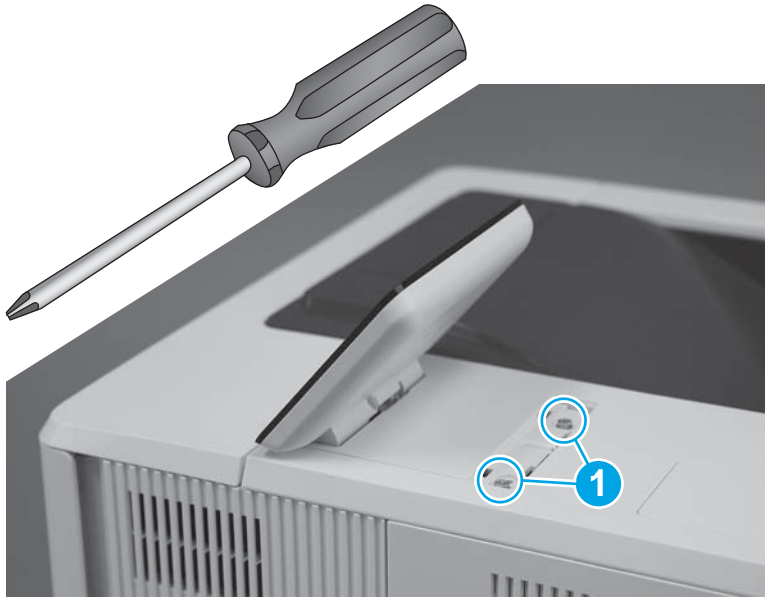




3. Use a small Phillips screwdriver to remove two screws (callout 1).

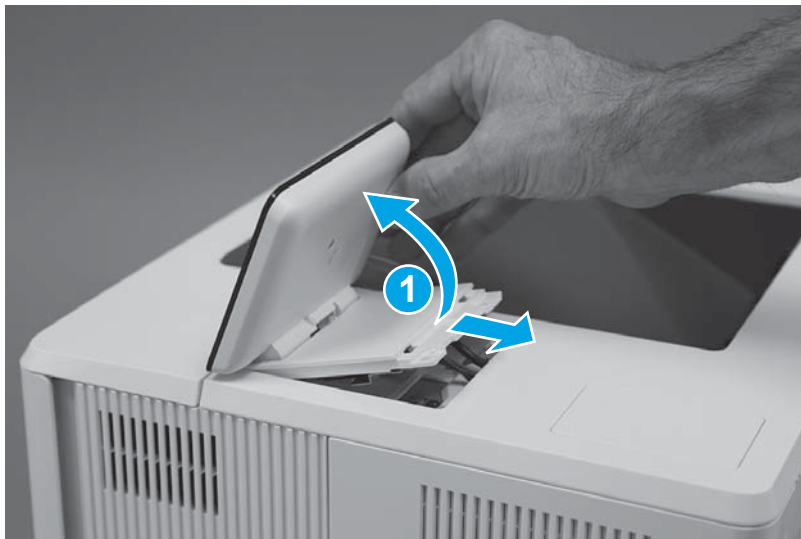
 **IMPORTANT:** Store the screws in a secure place where they cannot fall down into the printer.

**Figure 1-1009** Remove two screws



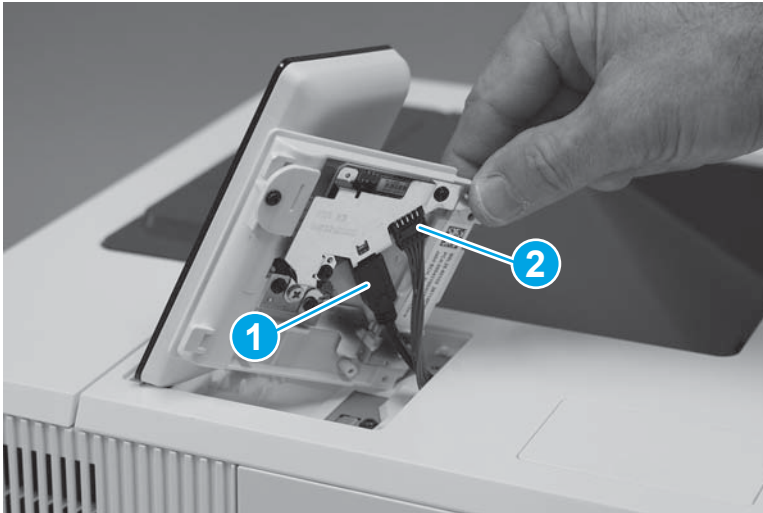
4. Turn the control panel over (callout 1), to gain access to the bottom side.

**Figure 1-1010** Turn the control panel over



5. Disconnect one HDMI cable (callout 1), one connector (callout 2), and then remove the control panel.

**Figure 1-1011** Remove the control panel



### Step 2: Remove the tray

1. Pull the tray straight out of the printer until it stops.

**Figure 1-1012** Pull the tray out until it stops



2. Lift the front of the tray, and then pull it out of the printer to remove it.

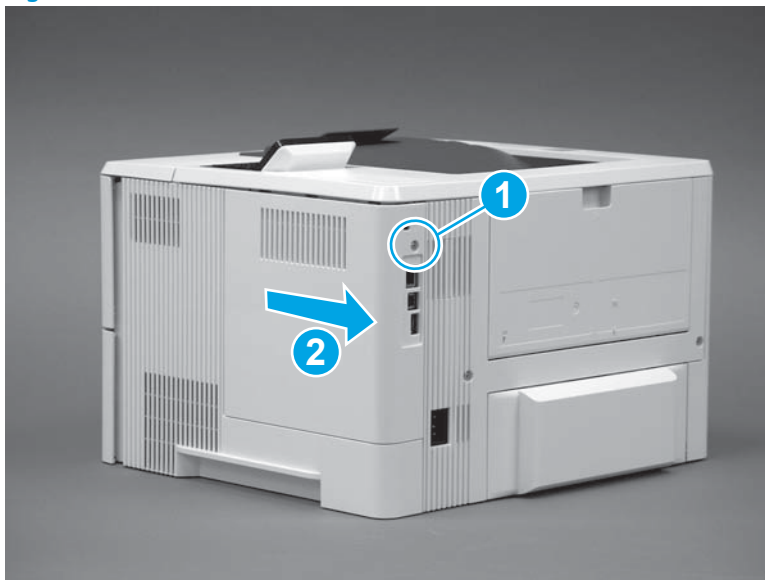
**Figure 1-1013** Release and remove the tray



### Step 3: Remove the formatter cover

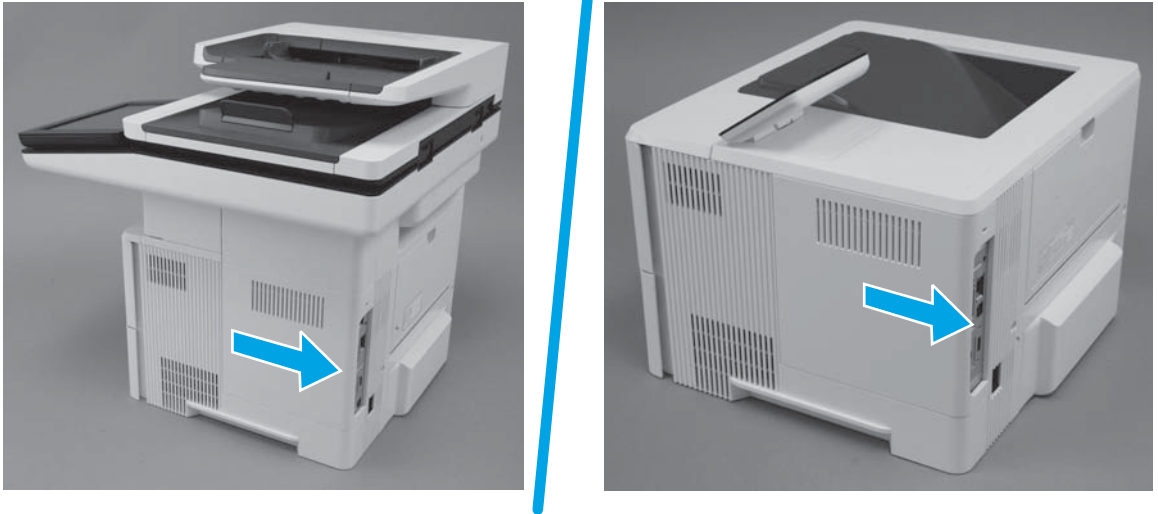
1. **M501:** Remove one screw (callout 1), and then slide the cover toward the rear of the printer to remove it (callout 2).

**Figure 1-1014** Remove the formatter cover (M501)




2. **M506/M527:** Slide the cover toward the rear of the printer to remove it.

**Figure 1-1015** Remove the formatter cover (M506/M527)



#### Step 4: Remove the fax PCA (M527)

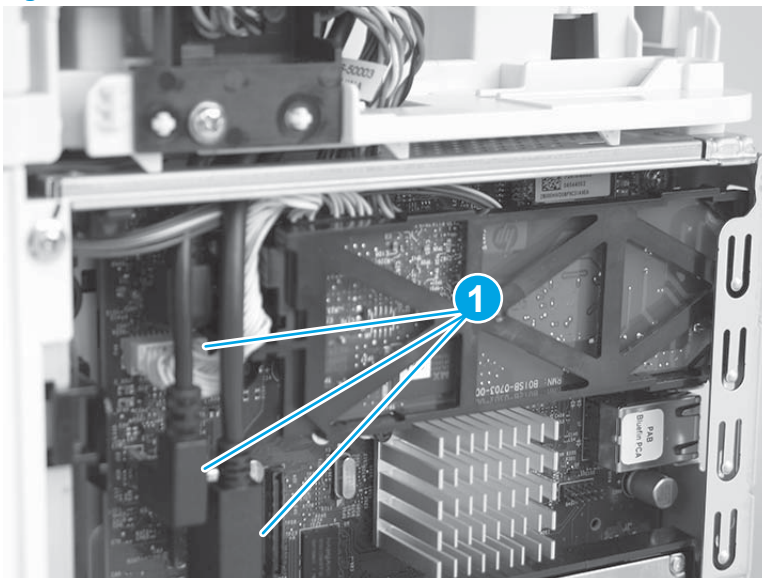
 **NOTE:** This step is for the M527 printers. For the M501/M506, skip this step and go to [Step 9: Remove the rear door assembly on page 599](#).

 **CAUTION:**  ESD-sensitive part.

 **NOTE:** M527c/f/z printers only (optional for the M527dn).

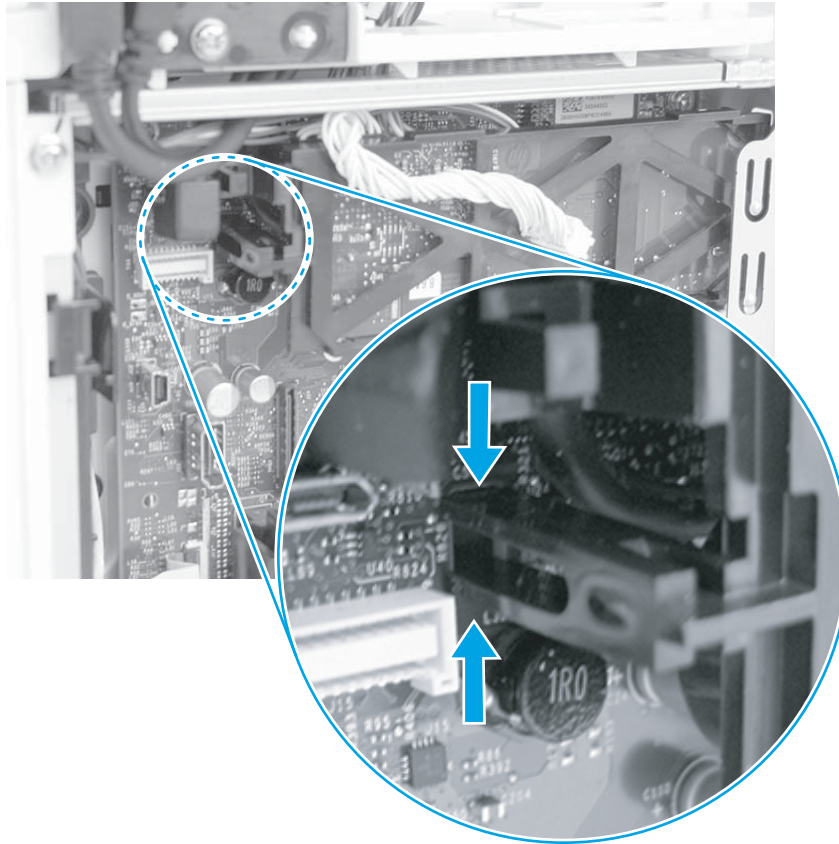
1. Disconnect three connectors (callout 1).

**Figure 1-1016** Disconnect three connectors



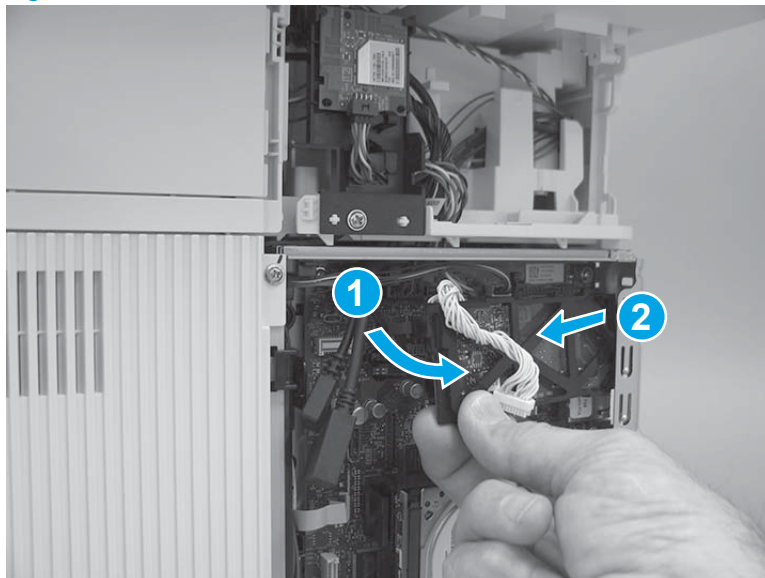
2. Pinch the retainer to release it.

**Figure 1-1017** Release the fax PCA




3. Rotate the connector end of the fax PCA out and away from the formatter (callout 1), and then slide it as shown (callout 2) to remove it.

**Figure 1-1018** Remove the fax PCA



## Step 5: Remove the stapler door or stapler blank cover (M527)

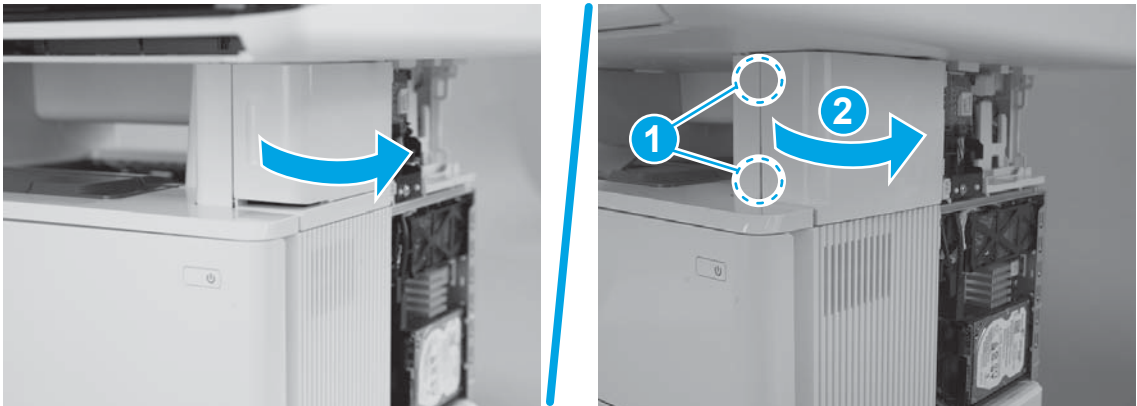
 **NOTE:** This step is for the M527 printer. For the M501/M506, skip this step and go to [Step 9: Remove the rear door assembly on page 599](#).

The M527dn does not have a convenience stapler.

1. Do one of the following:

- **M527c/f/z:** Open the stapler door.
- **M527dn:** Use a small flat-blad screw driver to release two tabs (callout 1), and then rotate the cover away from the printer (callout 2).

**Figure 1-1019** Open the door or release the cover



2. Do one of the following:

- **M527c/f/z:** Use a small flat-blad screwdriver to release the upper hinge.
- **M527dn:** Slide the cover toward the front of the printer to remove it.

**Figure 1-1020** Release the upper hinge or remove the cover



3. **M527c/f/z:** Use a small flat-blad screwdriver to release the lower hinge.

**Figure 1-1021** Release the lower hinge





4. **M527c/f/z:** Remove the door.

**Figure 1-1022** Remove the door



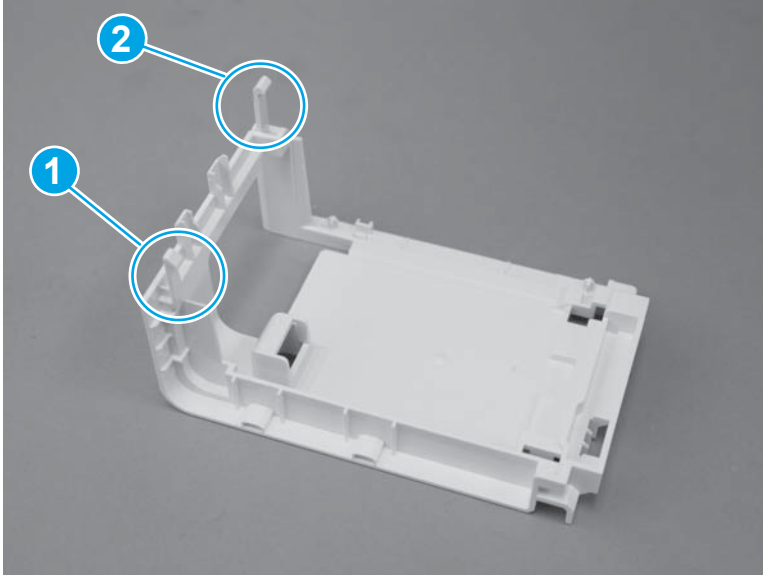
### Step 6: Remove the stapler stationary (inner) cover (M527)

 **NOTE:** This step is for the M527c/f/z printers. For the M501/M506, skip this step and go to [Step 9: Remove the rear door assembly on page 599](#). For the M527dn, skip this step and go to [Step 7: Remove the top-left cover \(M527\) on page 595](#).

 **NOTE:** M527c/f/z printers only.

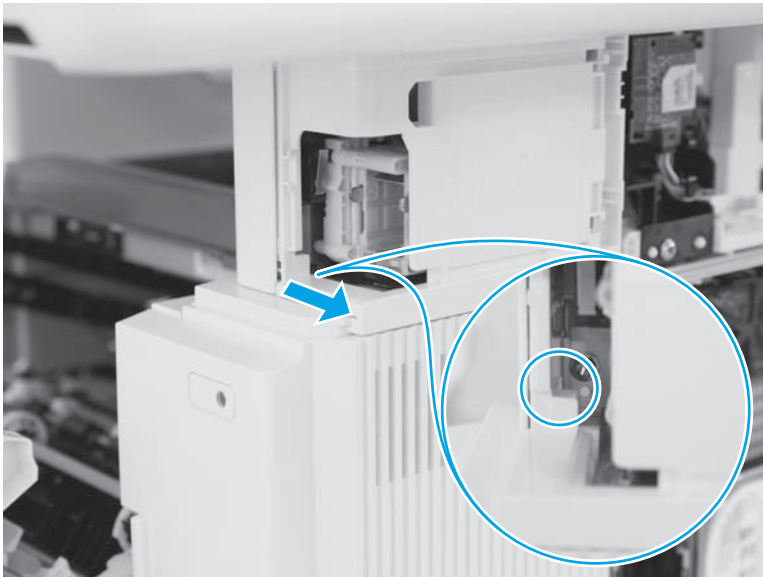
1. Before proceeding, take note of the locations of the upper tab (callout 1) and the lower tab (callout 2) on the stapler stationary (inner) cover.

**Figure 1-1023** Locate the tabs



2. Use a long-shaft small flat-blad screwdriver to release the lower tab.

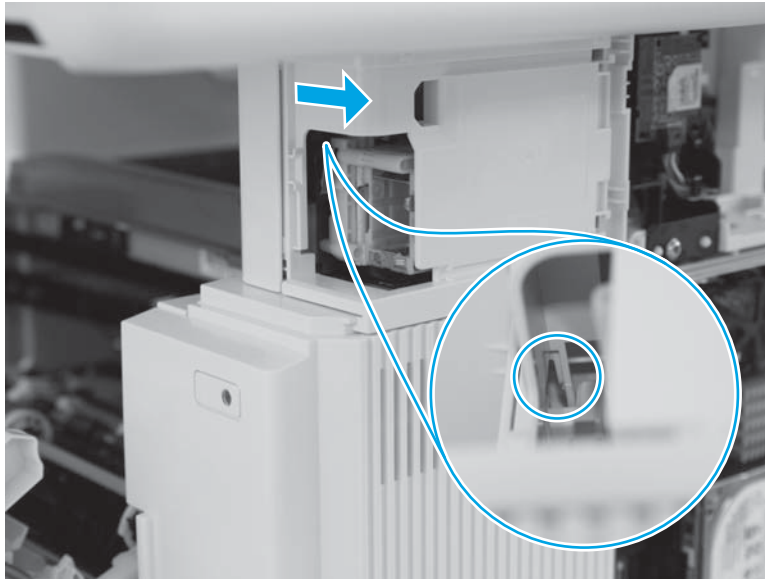
**Figure 1-1024** Release one tab





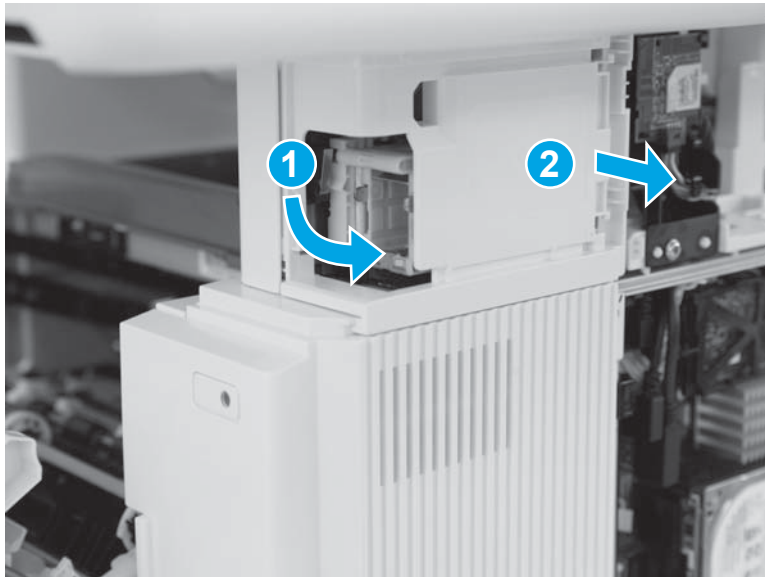
3. Use a long-shaft small flat-blad screwdriver to release the upper tab.

**Figure 1-1025** Release one tab




4. With the tabs disengaged the front of the cover is released. Rotate the front of the cover away from the printer (callout 1) to release the rear of the cover (callout 2), and then remove it.

**Figure 1-1026** Remove the cover

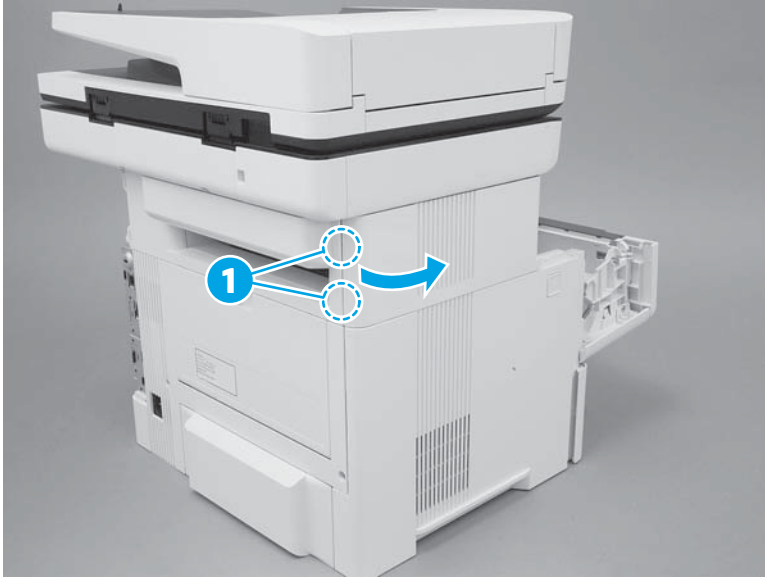


### Step 7: Remove the top-left cover (M527)

 **NOTE:** This step is for the M527 printer. For the M501/M506, skip this step and go to [Step 9: Remove the rear door assembly on page 599](#).

1. Open the toner-cartridge door, release two tabs (callout 1), and then rotate the rear edge of the cover away from the printer.

**Figure 1-1027** Release two tabs



2. Continue to rotate the cover away from the printer to release two more tabs at the middle of the cover.

**Figure 1-1028** Release two tabs



3. Slide the cover toward the rear of the printer to release two bosses at the front of the cover.

**Figure 1-1029** Slide the cover




4. Remove the cover.

**Figure 1-1030** Remove the cover



#### **Step 8: Remove the top-rear cover (M527)**

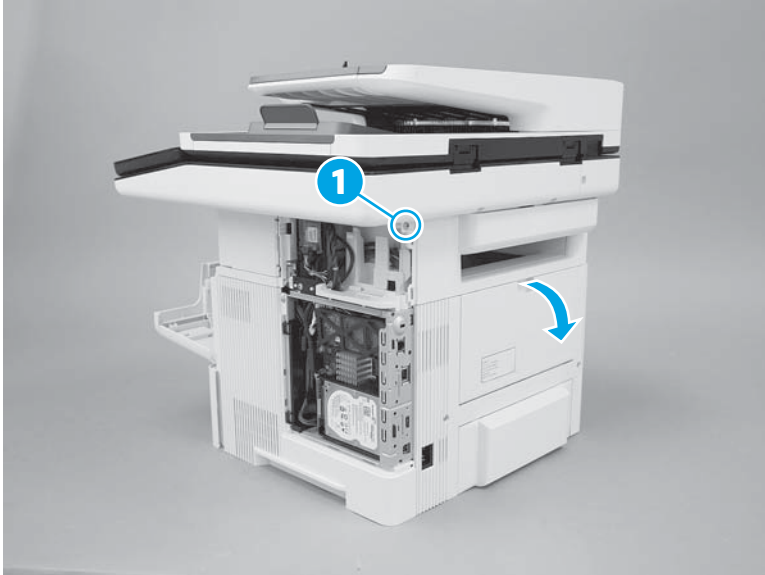
---

 **NOTE:** This step is for the M527 printer. For the M501/M506, skip this step and go to [Step 9: Remove the rear door assembly on page 599](#).

---

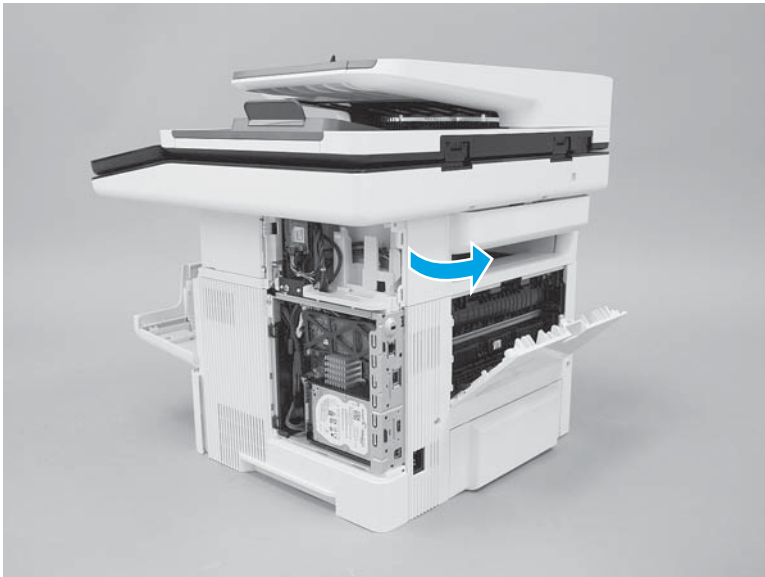
1. Remove one screw (callout 1), and then open the rear door.

**Figure 1-1031** Remove one screw



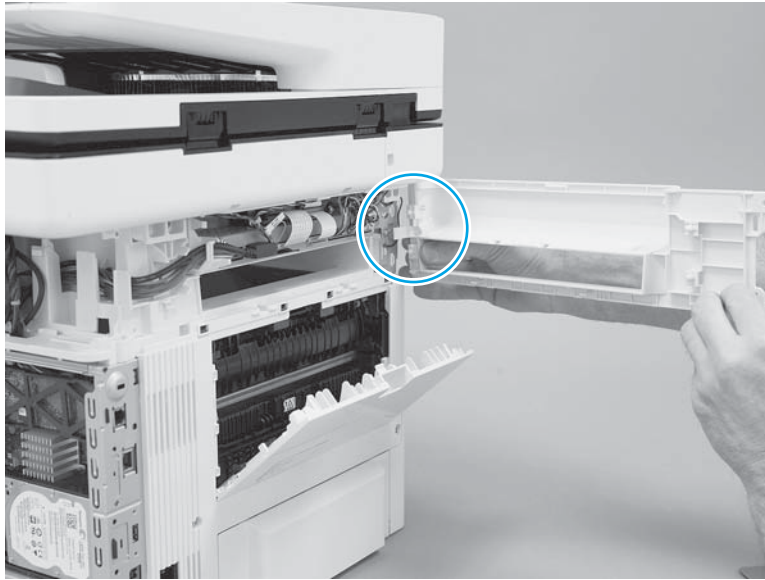
2. Rotate the exposed edge of the cover away from the printer (as shown).

**Figure 1-1032** Rotate the cover



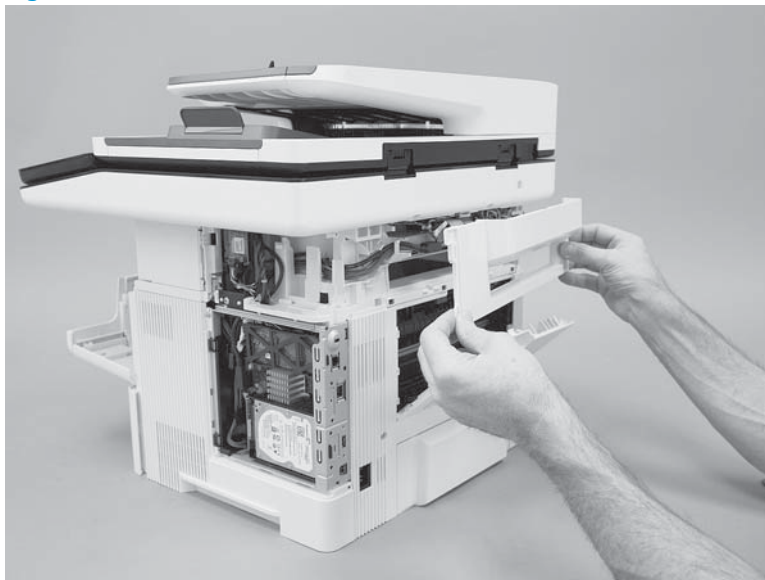
3. Continue to rotate the cover away from the printer to release one boss.

**Figure 1-1033** Release one boss



4. Remove the cover.

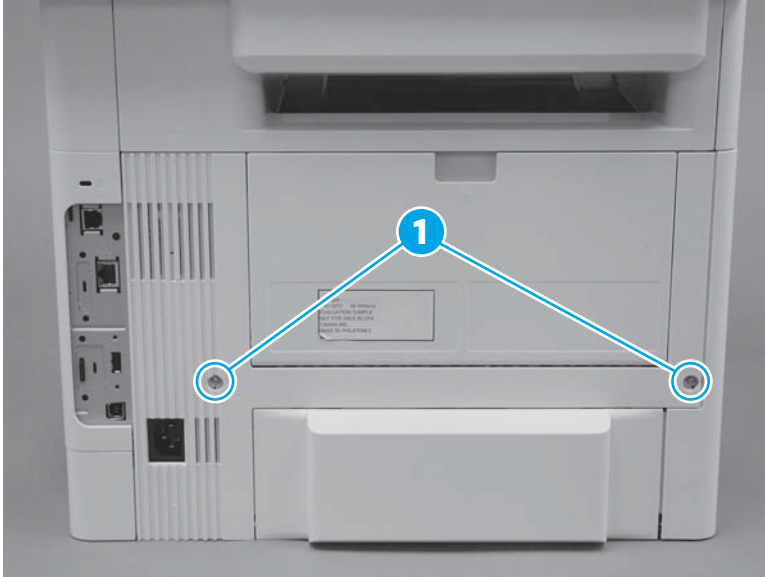
**Figure 1-1034** Remove the cover



### Step 9: Remove the rear door assembly

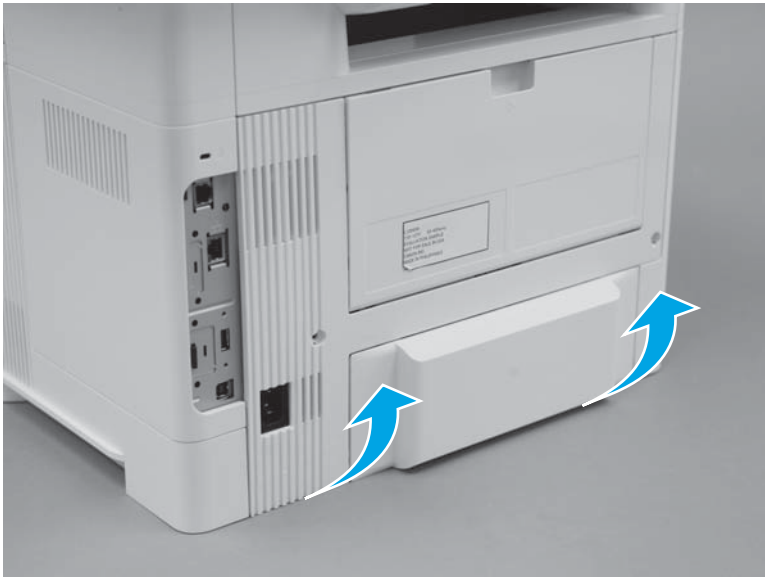
1. At the rear of the printer, remove two screws (callout 1).

**Figure 1-1035** Remove two screws



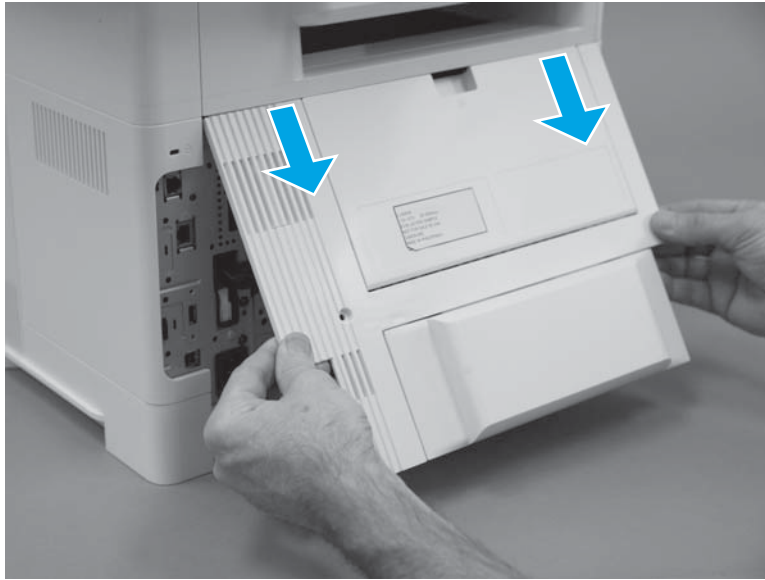
2. Rotate the bottom edge of the assembly away from the printer to release it.

**Figure 1-1036** Rotate the bottom of the cover




3. Pull down on the assembly to remove it.

**Figure 1-1037** Remove the cover



#### Step 10: Remove the cartridge door assembly

---

 **NOTE:** If the toner cartridge was not removed prior to servicing the printer, remove it now.

---

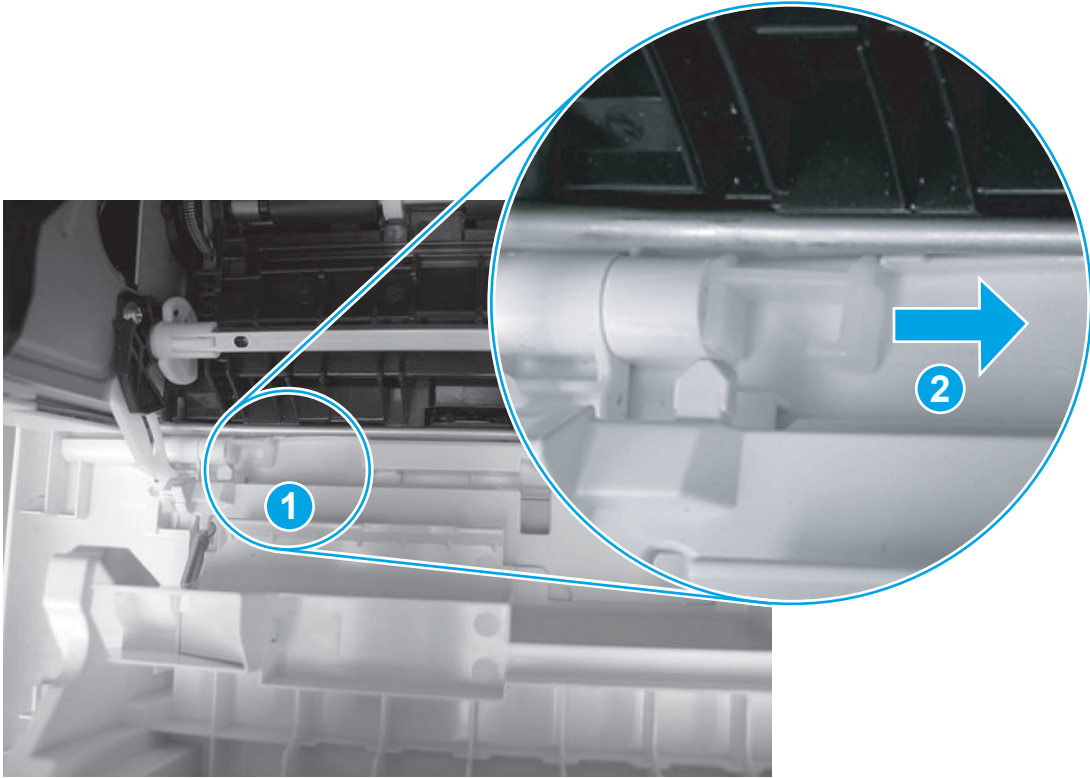
1. Release the support shaft (callout 1), and then slide it toward the center of the door (callout 2).

---

 **TIP:** It might be easier to release the support shaft by using a small flat-blad screwdriver.

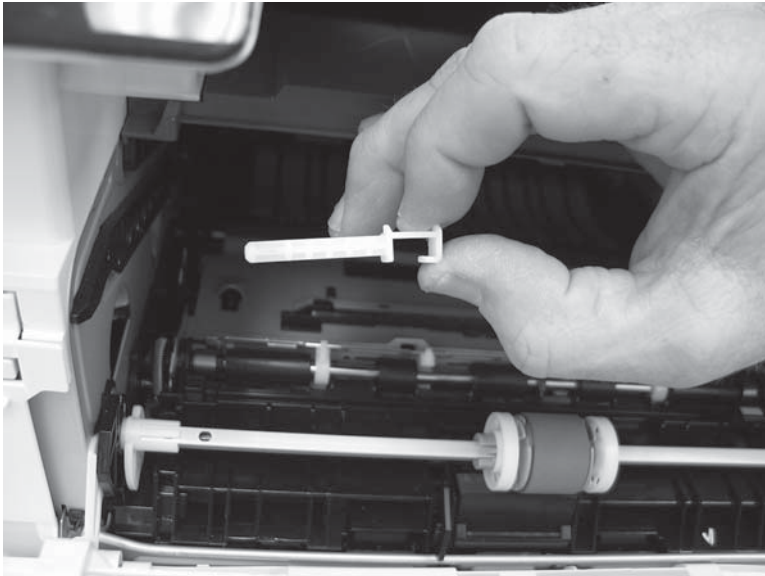
---

**Figure 1-1038** Release the support shaft



2. Remove the support shaft.

**Figure 1-1039** Remove the support shaft

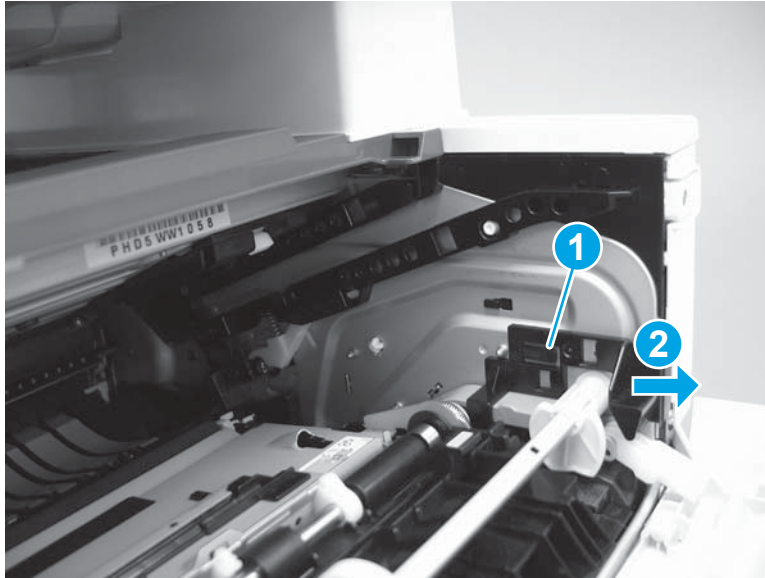




3. Release one tab (callout 1), and then slide the guide out of the printer (callout 2).

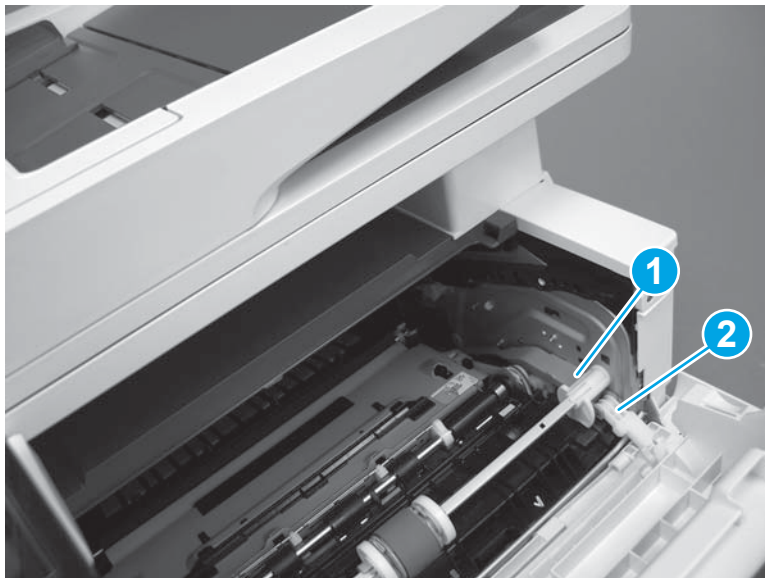
**CAUTION:** Be careful, the tab (callout 1) can be easily broken.

**Figure 1-1040** Remove the guide



4. Use a small flat-blade screwdriver to gently pry the white-plastic door arm (callout 1) off of the gray-plastic pressure-release link (callout 2) to release the door arm.

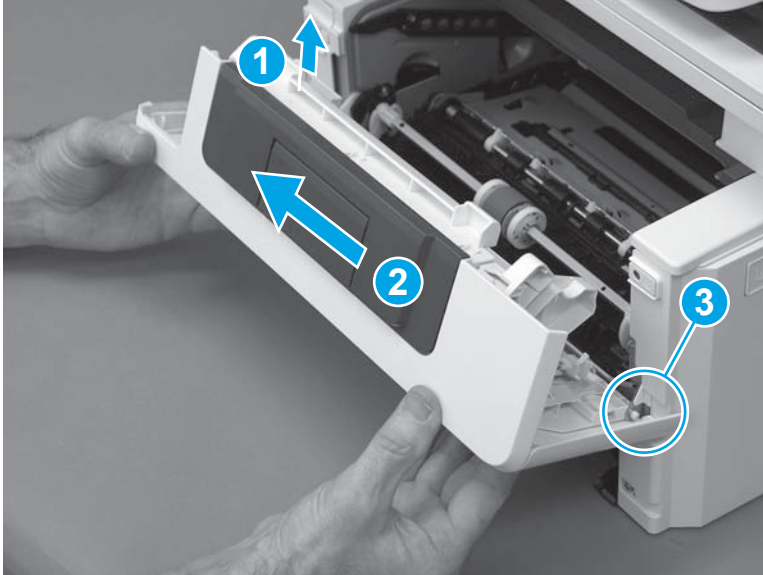
**Figure 1-1041** Release the pressure-release link



5. With the door in the partially closed position, slightly raise the left end (callout 1; raise it over the sheet-metal hinge boss), and then slide the door to the left (callout 2) to release the right hinge (callout 3).

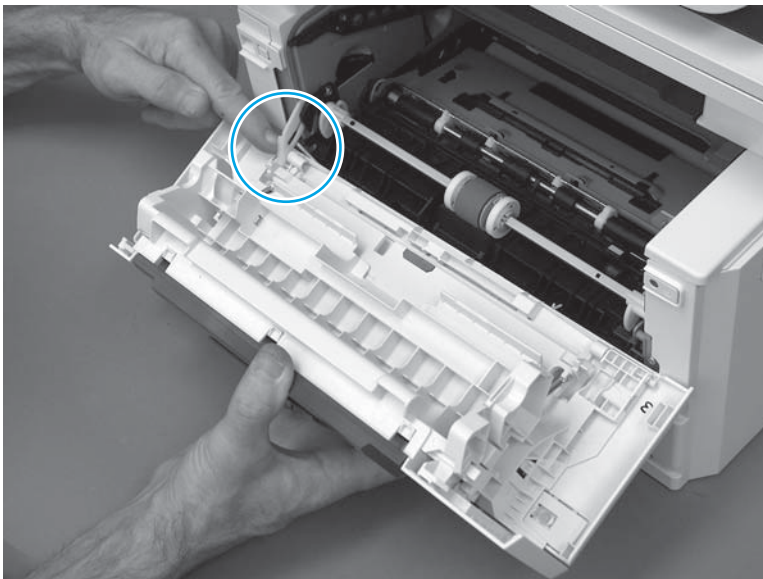
**⚠ CAUTION:** The door is still attached to the printer by the left-side retainer arm. Do not attempt to completely remove the door.

**Figure 1-1042** Release the door



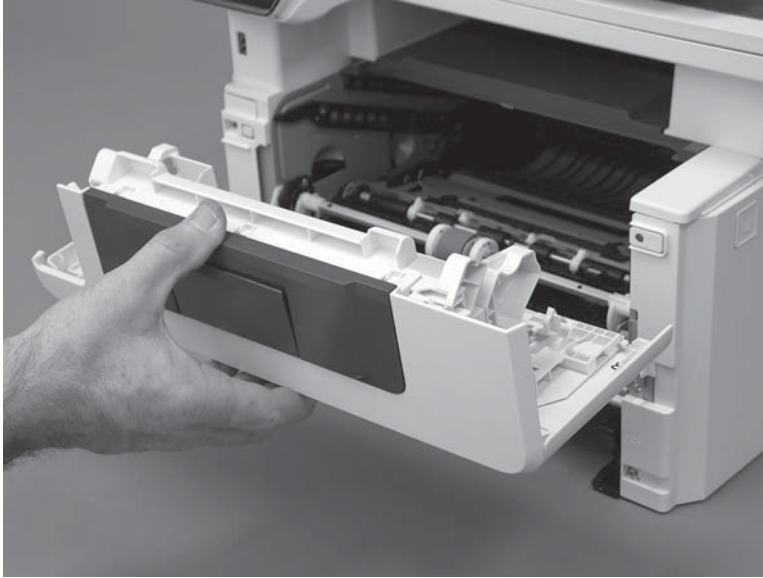
6. Rotate the door away from the printer until the keyed pin on the left-side retainer arm can disengage from the door.

**Figure 1-1043** Release the left-side retainer arm





7. Remove the door.

**Figure 1-1044** Remove the door



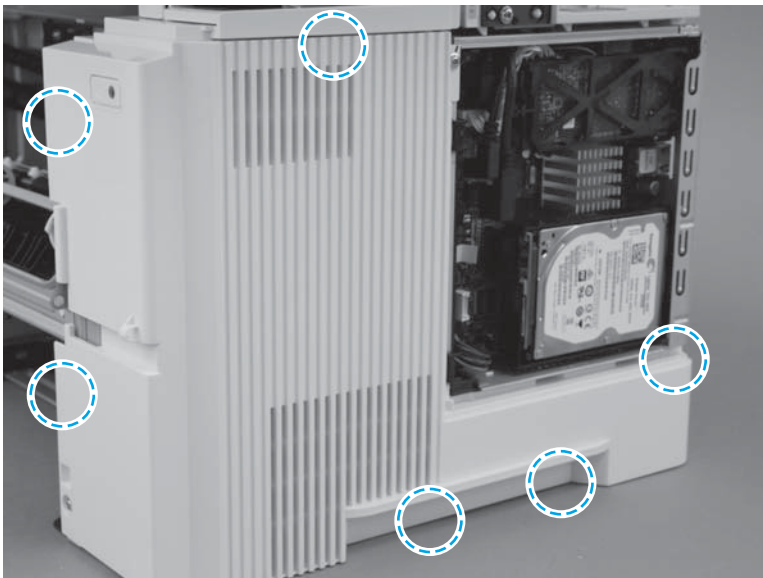
### Step 11: Remove the right cover

 **IMPORTANT:** The black-plastic cassette front and rear guides (located inside the tray cavity) can be easily dislodged. Do not lose the guides when the cover is removed or installed.

 **NOTE:** The M527 printer is shown in this procedure. However, this procedure is valid for the M501/M506 printers.

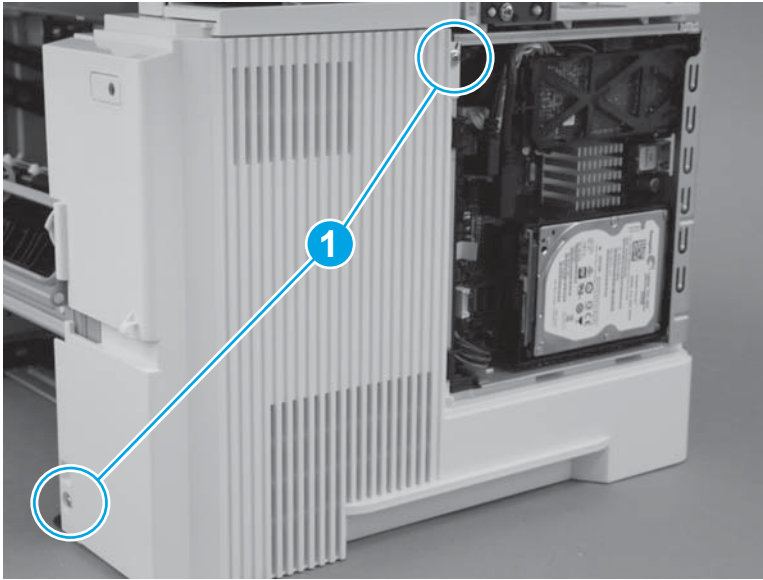
1. Before proceeding, take note of the location of the tabs and bosses on the inside of the cover.

**Figure 1-1045** Locate the tabs and bosses



2. Remove two screws (callout 1).

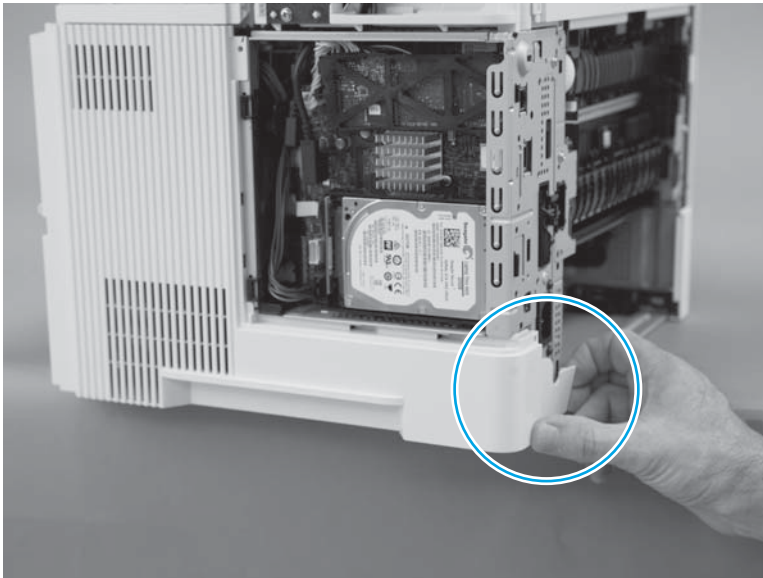
**Figure 1-1046** Remove two screws



3. At the rear of the printer, release one boss.

**CAUTION:** It might be easier to remove the cover with the printer slightly hanging over the edge of the workspace. Do not let the printer tip and fall off of the workspace when removing the cover.

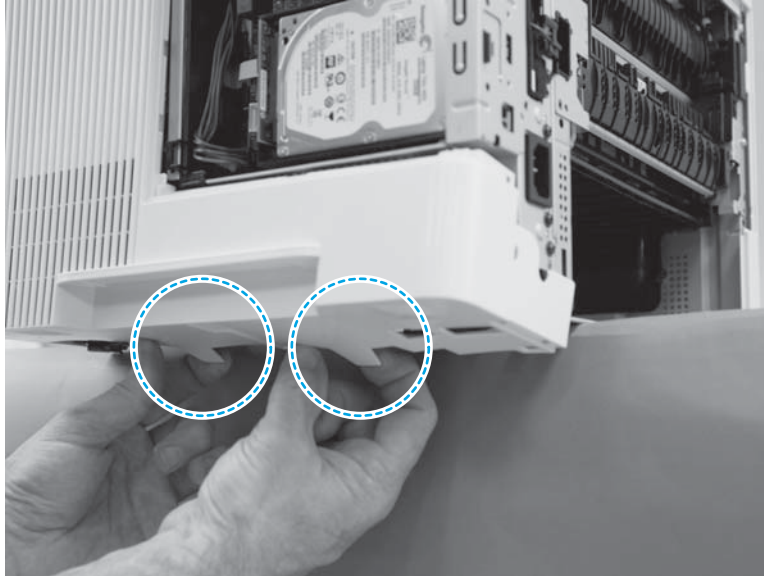
**Figure 1-1047** Release one boss



4. At the bottom edge of the cover, release two bosses.

**CAUTION:** It might be easier to remove the cover with the printer slightly hanging over the edge of the workspace. Do not let the printer tip and fall off of the workspace when removing the cover.

**Figure 1-1048** Release two bosses

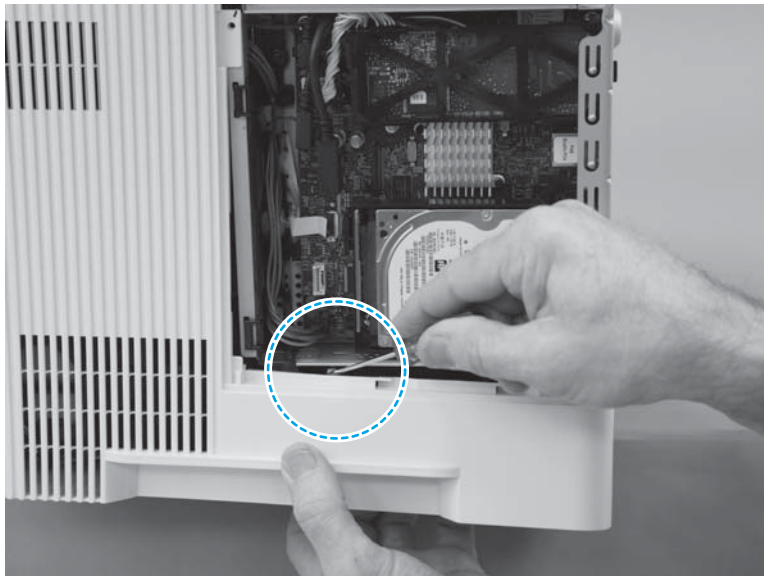


5. Near the formatter, release one tab.

**CAUTION:** It might be easier to remove the cover with the printer slightly hanging over the edge of the workspace. Do not let the printer tip and fall off of the workspace when removing the cover.

**TIP:** Hold the bottom of the cover away from the printer, and then use a small flat-blade screw driver to easily release this tab.

**Figure 1-1049** Release one tab

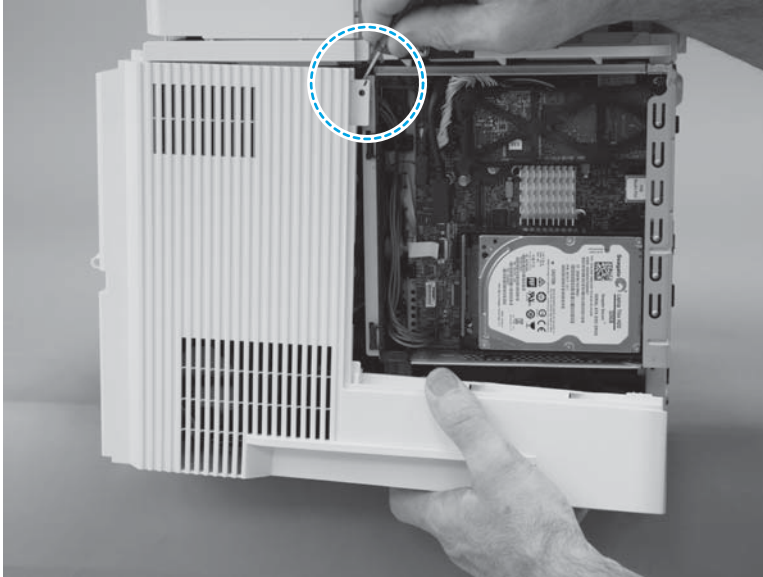


6. At the top rear edge of the cover, release one tab.

**CAUTION:** It might be easier to remove the cover with the printer slightly hanging over the edge of the workspace. Do not let the printer tip and fall off of the workspace when removing the cover.

**TIP:** Use a small flat-blade screw driver to easily release this tab.

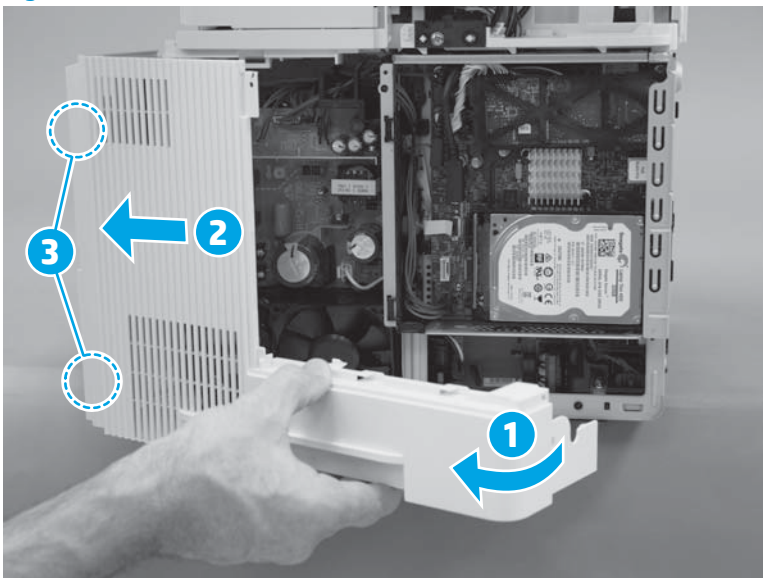
**Figure 1-1050** Release one tab




7. Rotate the rear of the cover away from the printer (callout 1), slide the cover toward the front of the printer (callout 2) to release two bosses (callout 3), and then remove the cover.


**CAUTION:** It might be easier to remove the cover with the printer slightly hanging over the edge of the workspace. Do not let the printer tip and fall off of the workspace when removing the cover.

**Figure 1-1051** Remove the cover



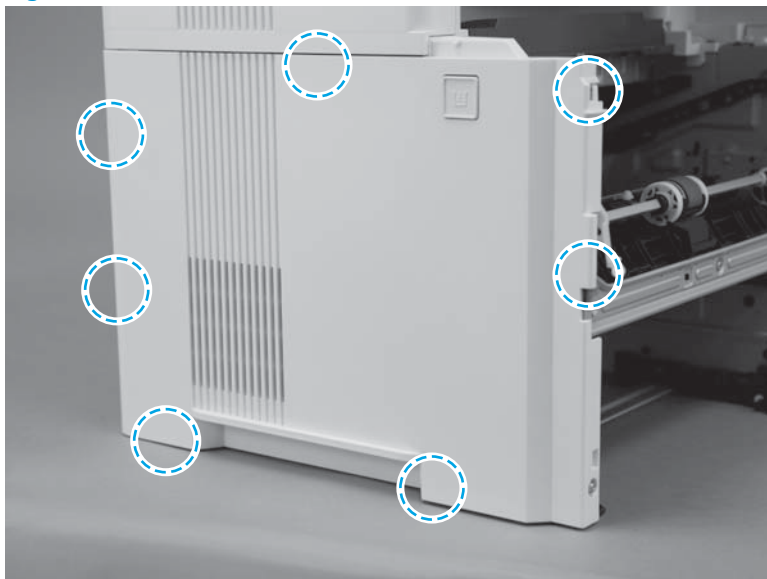
## Step 12: Remove the left cover

 **IMPORTANT:** The black-plastic cassette front and rear guides (located inside the tray cavity) can be easily dislodged. Do not lose the guides when the cover is removed or installed.

 **NOTE:** The M527 printer is shown in this procedure. However, this procedure is valid for the M501/M506 printers.

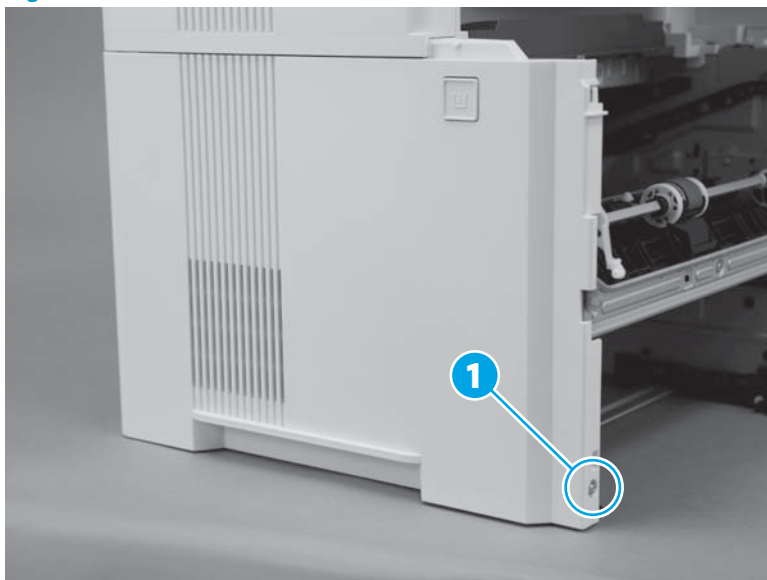
1. Before proceeding, take note of the location of the tabs and bosses on the inside of the cover.

**Figure 1-1052** Locate of the tabs and bosses



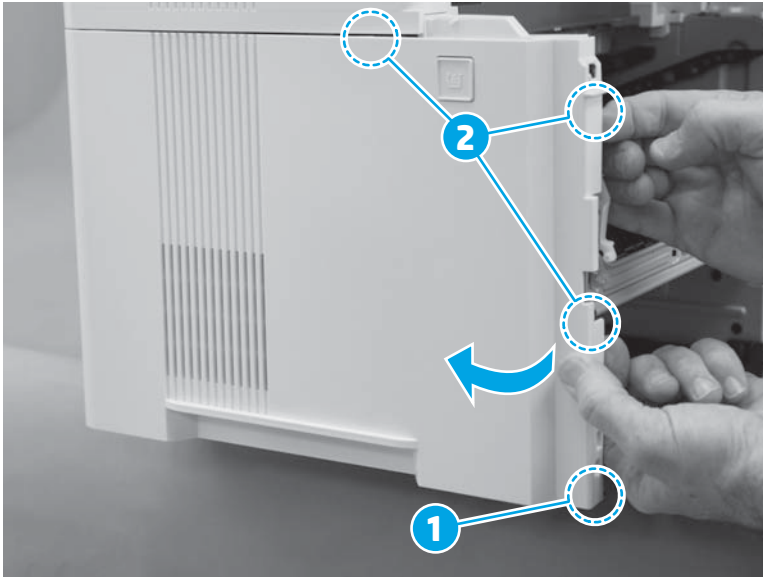
2. Remove one screw (callout 1).

**Figure 1-1053** Remove one screw



3. At the front of the printer, release one boss (callout 1), and then rotate the front edge of the cover away from the printer to release three tabs (callout 2).

**Figure 1-1054** Release one boss and three tabs




4. At the bottom edge of the cover, release two tabs.

**Figure 1-1055** Release two tabs

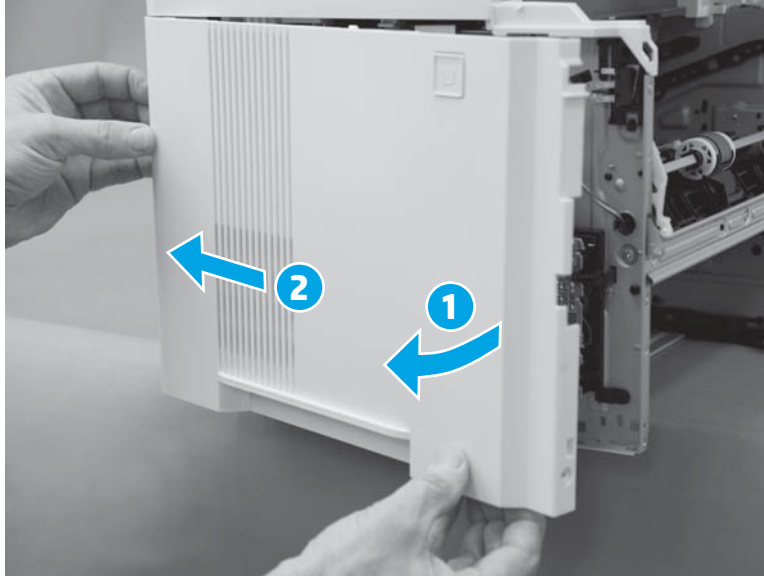





5. Continue to rotate the front edge of the cover away from the printer (callout 1), and then slide the cover toward the rear of the printer (callout 2) to remove it.


 **NOTE:** If the cover is difficult to rotate or slide as shown below, make sure that the bottom tabs (released in the previous step) are completely disengaged from the chassis.


**Figure 1-1056** Remove the cover



### Step 13: Remove the integrated scanner assembly (M527)

 **IMPORTANT:** Some figure might show assemblies removed or installed that have not yet been removed or installed at that specific step. However, the procedures are correct for this printer and the target assembly. Always thoroughly read the instructions that accompany each figure

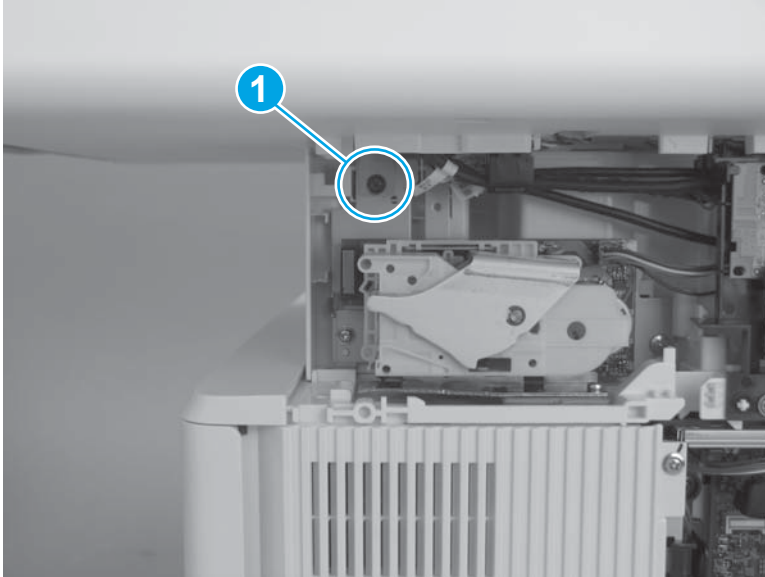
 **NOTE:** This step is for the M527 printer. For the M501/M506, skip this step and go to [Step 15: Remove the top cover \(M501/M506\) on page 617](#).

 **NOTE:** The ISA includes the document feeder, sub-scanner assembly (SSA), and the scanner control board (SCB)

1. Remove one screw (callout 1).


 **IMPORTANT:** This screw fastens the ISA ground plate to the printer chassis. Do not lose this screw.

**Figure 1-1057** Remove one screw

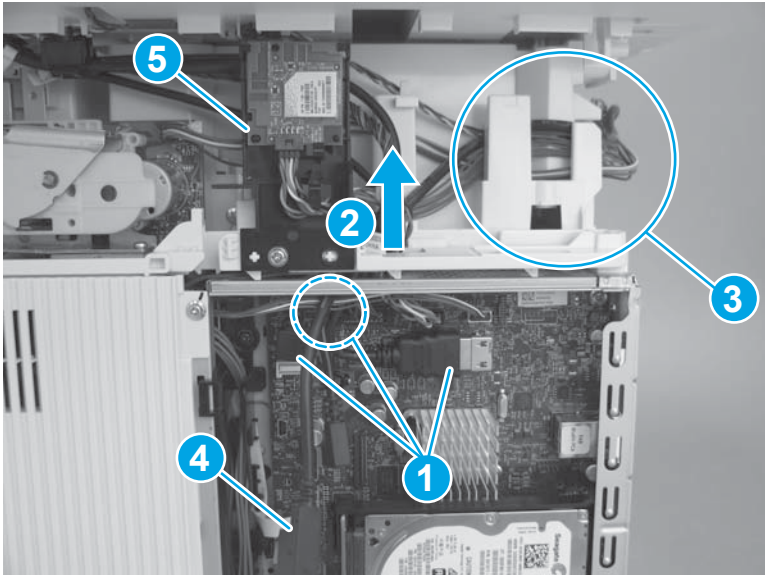


2. Disconnect three connectors (callout 1), pass the wire harnesses and cables through the opening in the cover (callout 2), and then release them from the retainers (callout 3).

 **NOTE:** One cable (callout 4) does not need to pass through the opening in the cover.

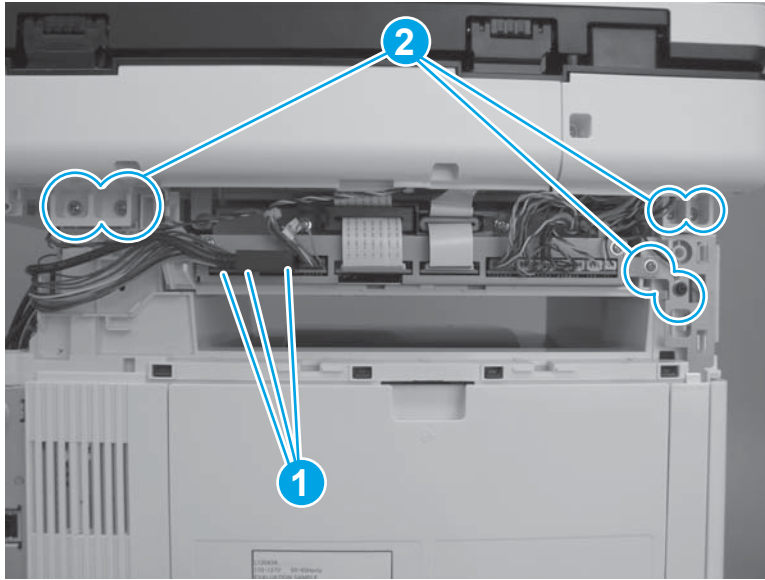
 **TIP:** It might be easier if the WiFi PCA and holder (callout 5) is detached from the printer, and then moved out of the way.

**Figure 1-1058** Disconnect cables and connectors



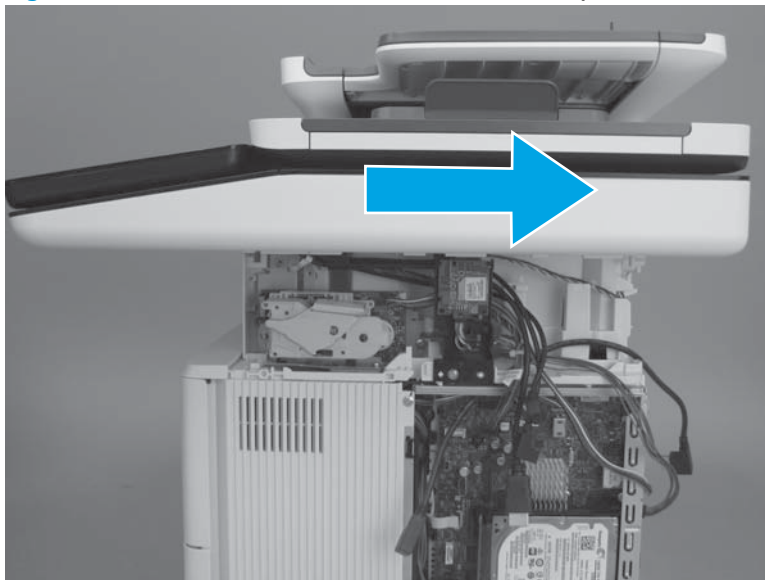
3. Disconnect three connectors (callout 1), and then remove six screws (callout 2).

**Figure 1-1059** Disconnect connectors and remove screws



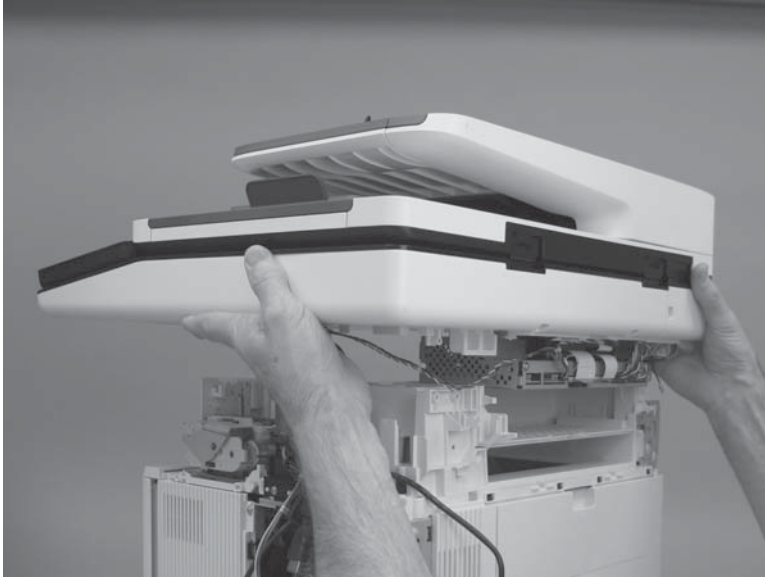
4. Slightly slide the ISA towards the back of the printer to release it.

**Figure 1-1060** Slide the ISA towards the back of the printer



5. Remove the ISA.

**Figure 1-1061** Remove the ISA



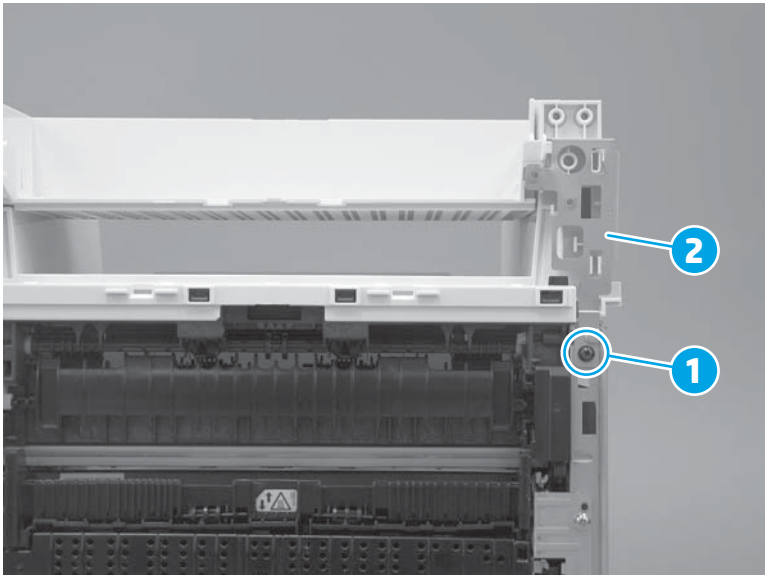
#### Step 14: Remove the top cover (M527)



**NOTE:** This step is for the M527 printer. For the M501/M506, skip this step and go to [Step 15: Remove the top cover \(M501/M506\)](#) on page 617.

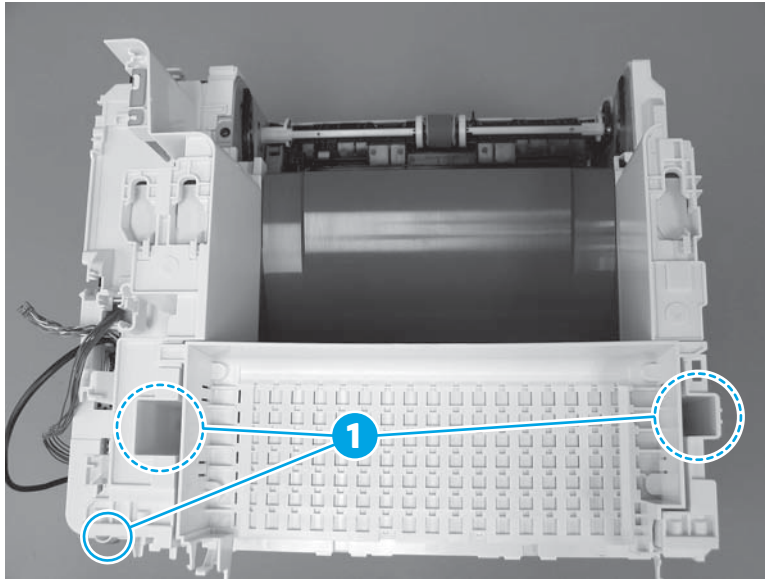
1. At the front right of the printer, remove one screw (callout 1), and then remove the sheet-metal plate (callout 2).

**Figure 1-1062** Remove one screw and the plate




2. At the top rear of the printer, remove three screws (callout 1).

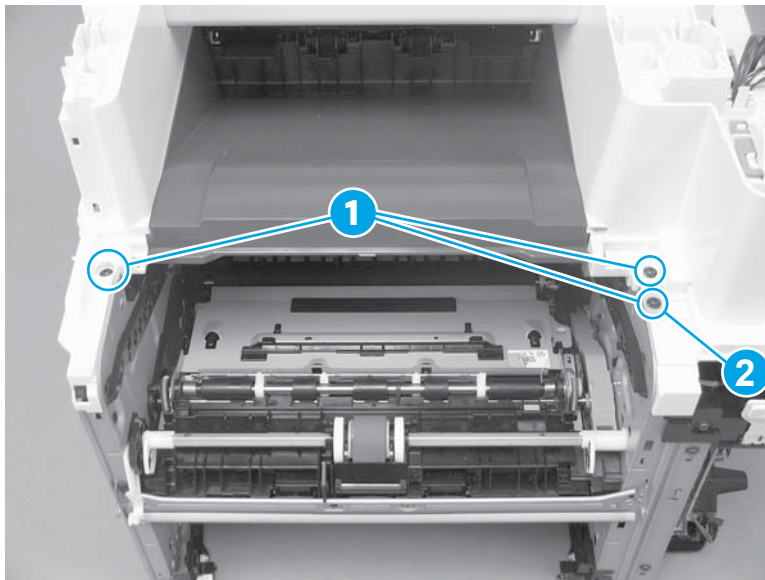
**Figure 1-1063** Remove three screws



3. At the top front of the printer, remove three screws (callout 1).

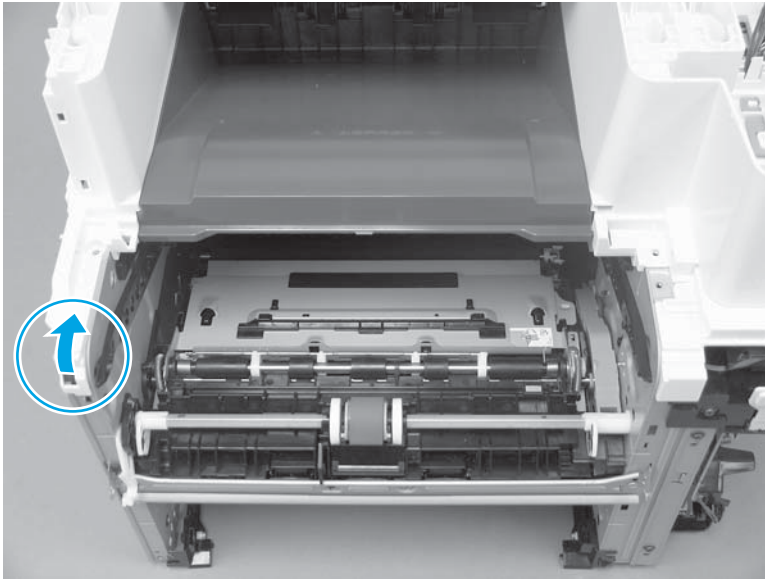
 **NOTE:** The screw (callout 2) on the lower-right portion of the cover is a different color than the other two screws, and is surrounded by sheet-metal. It might appear that this screw does not need to be removed. Remove this screw.

**Figure 1-1064** Remove three screws



4. At the front left of the printer, release one boss.

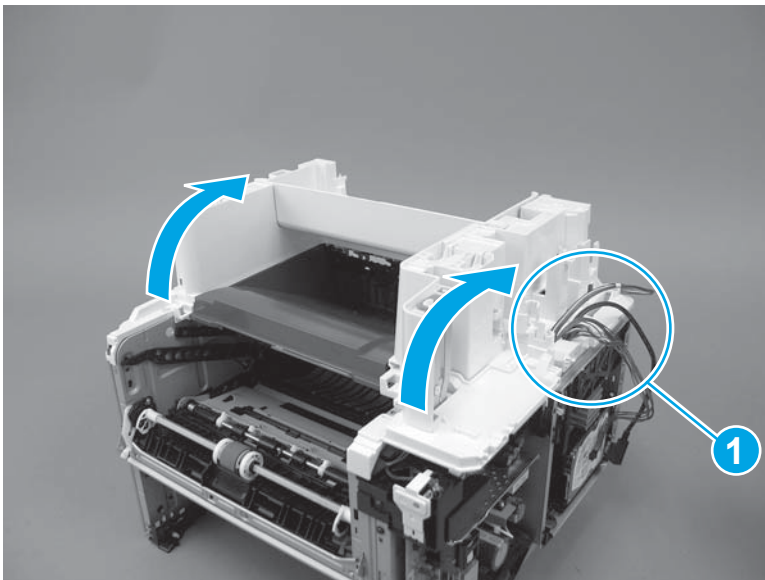
**Figure 1-1065** Release one boss



5. Rotate the front of the cover up and away from the printer.

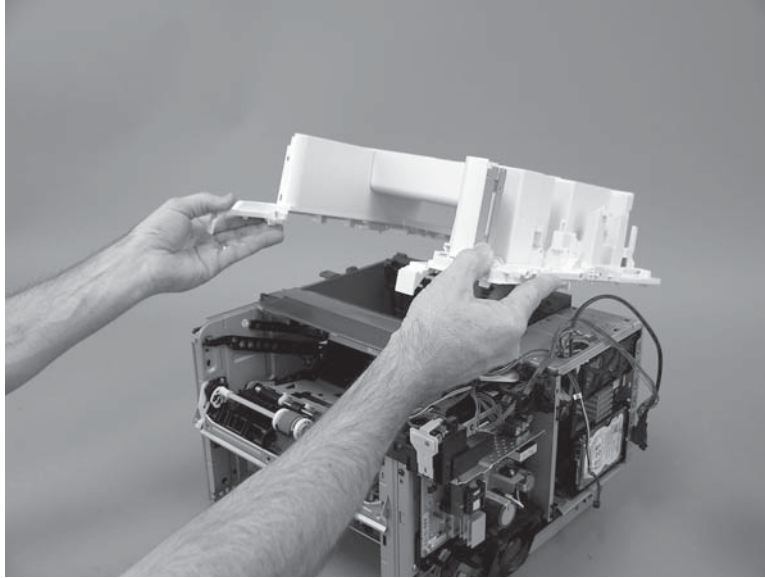
**CAUTION:** As the cover is rotated up, carefully pass the cables and wire harnesses the hole in the cover (callout 1).

**Figure 1-1066** Rotate the front of the cover up



6. Remove the cover.

**Figure 1-1067** Remove the cover



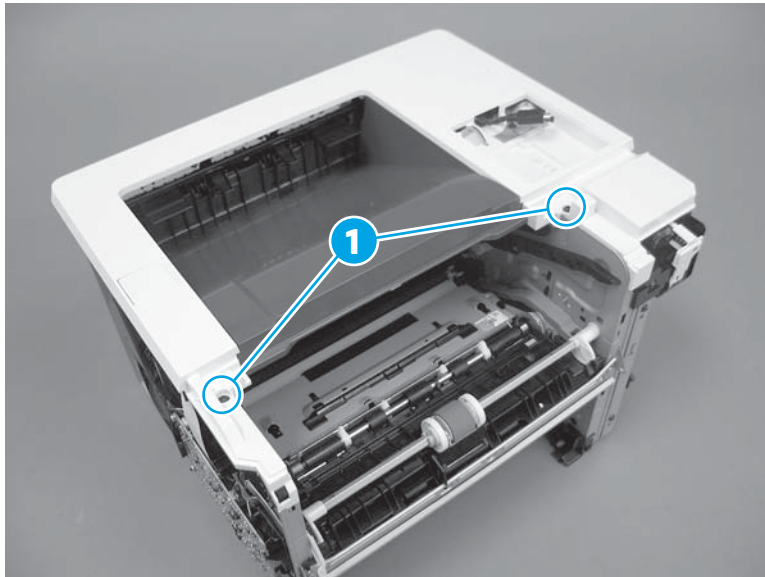
#### Step 15: Remove the top cover (M501/M506)



**NOTE:** This step is for the M501/M506 printers. For the M527, skip this step and go to [Step 16: Remove the laser/scanner assembly on page 619](#).

1. Remove two screws (callout 1).

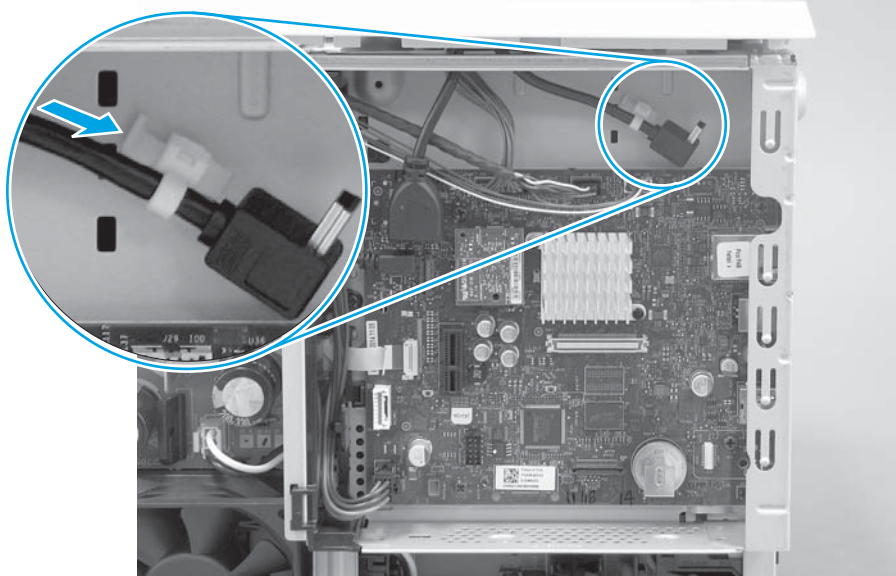
**Figure 1-1068** Remove two screws



2. Release one cable retainer from the chassis.

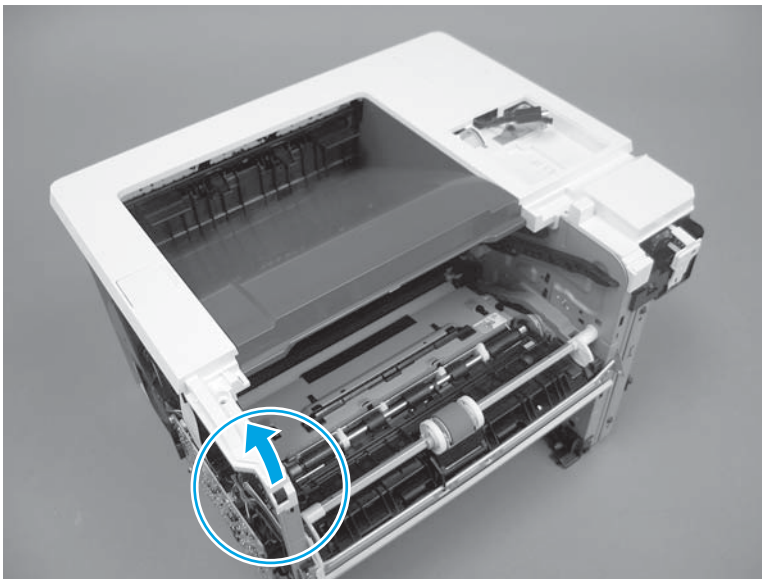
 **TIP:** Depress the tab on the retainer to release it.

**Figure 1-1069** Release one cable retainer



3. Release one boss.

**Figure 1-1070** Release one boss



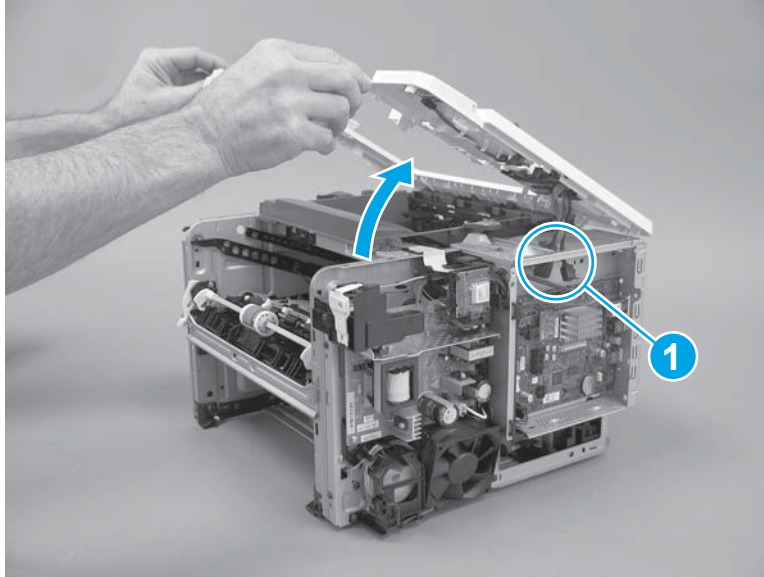


4. Rotate the front of the cover up and away from the printer, and then remove the cover.

**CAUTION:** **M506x only:** As the cover is rotated up, carefully pass the cables the hole in the chassis (callout 1).

**NOTE:** **LCD control panel models only:** Disconnect the control panel before removing the cover.

**Figure 1-1071** Remove the cover

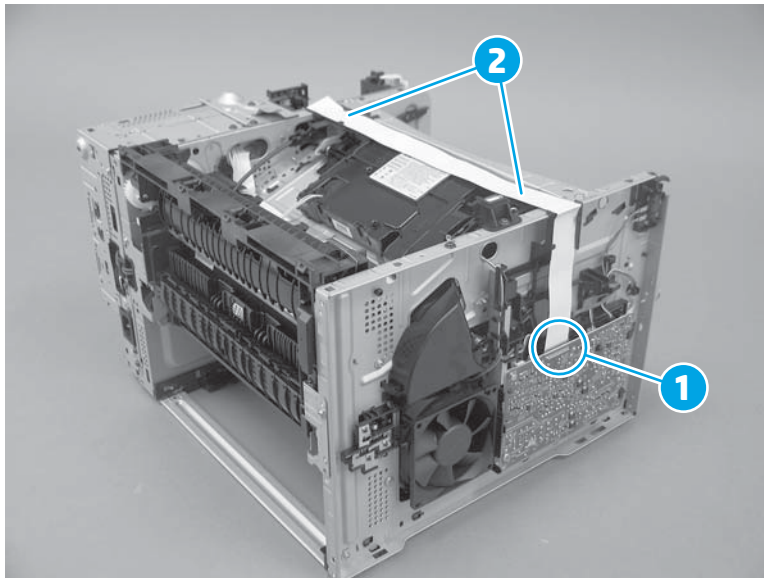


#### Step 16: Remove the laser/scanner assembly


**NOTE:** The M506 printer is shown in this procedure. However, the procedure is valid for the M527.

1. Disconnect one flat-flexible cable (FFC; callout 1), release the FFC from the retainers (callout 2), and then move it out of the way.

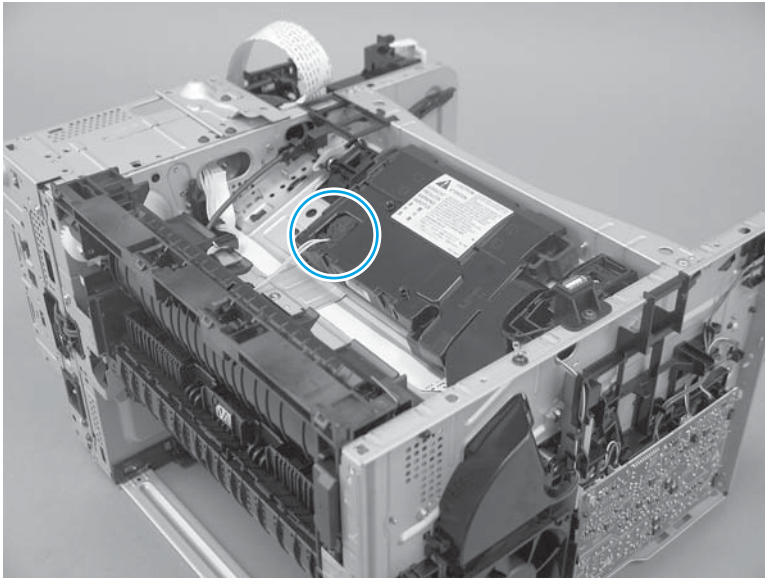
**Figure 1-1072** Disconnect one FFC



2. Remove the antistatic foam pad.

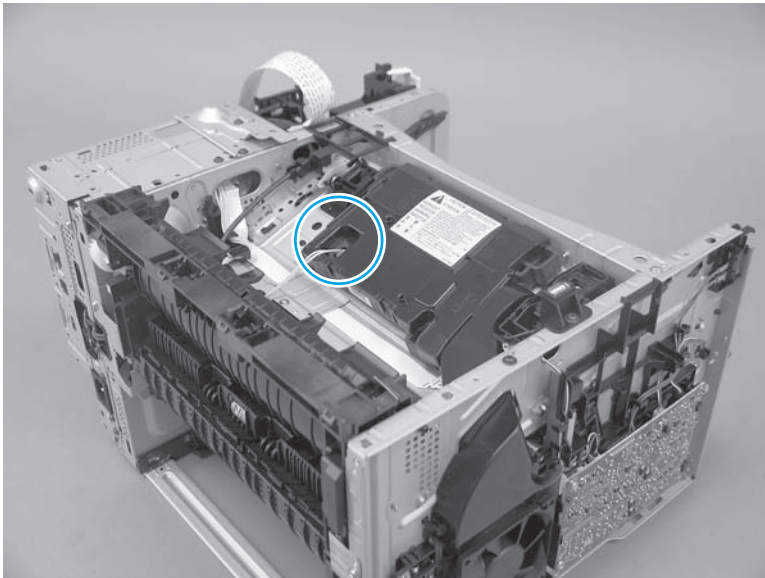
 **Reinstallation tip:** Set the antistatic foam pad aside. It must be installed on the replacement laser/ scanner.

**Figure 1-1073** Remove the antistatic foam pad



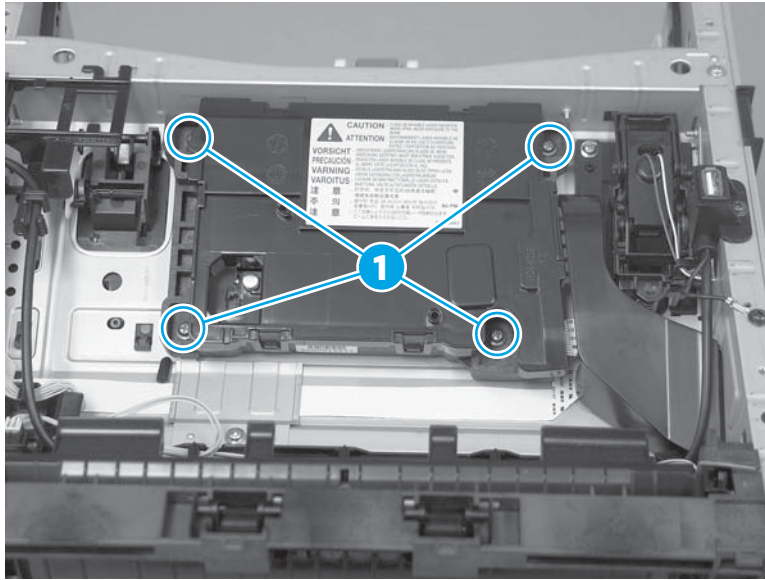
3. Disconnect one connector.

**Figure 1-1074** Disconnect one connector



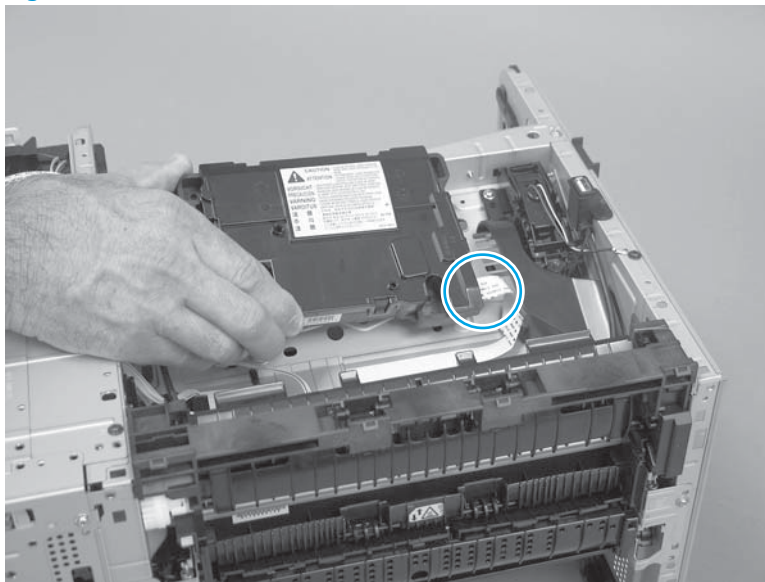
4. Remove four screws (callout 1).

**Figure 1-1075** Remove four screws



5. Disconnect one FFC, and then remove the laser/scanner.

**Figure 1-1076** Remove the laser/scanner



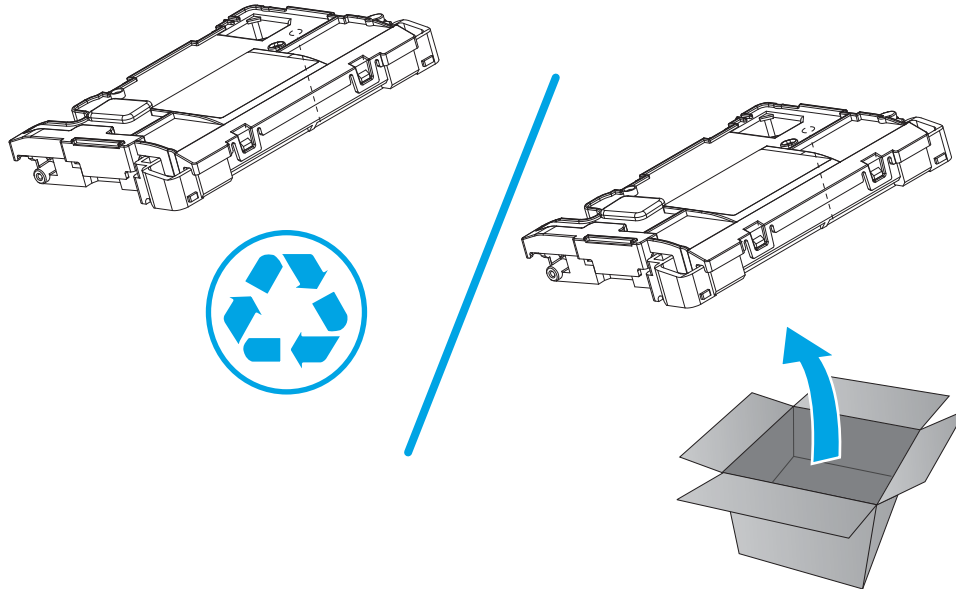
### Step 17: Unpack the replacement assembly

Unpack the replacement part from the packaging.


<http://www8.hp.com/us/en/hp-information/environment/product-recycling.html>

 **NOTE:** HP recommends responsible disposal of the defective part.

**Figure 1-1077** Recycle and unpack

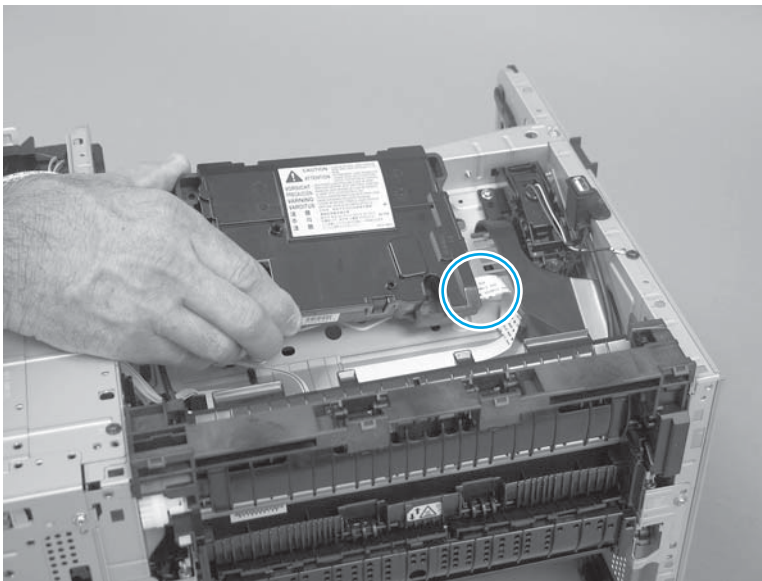


**Step 18: Install the laser/scanner assembly**

 **NOTE:** The M506 printer is shown in this procedure. However, the procedure is valid for the M527.

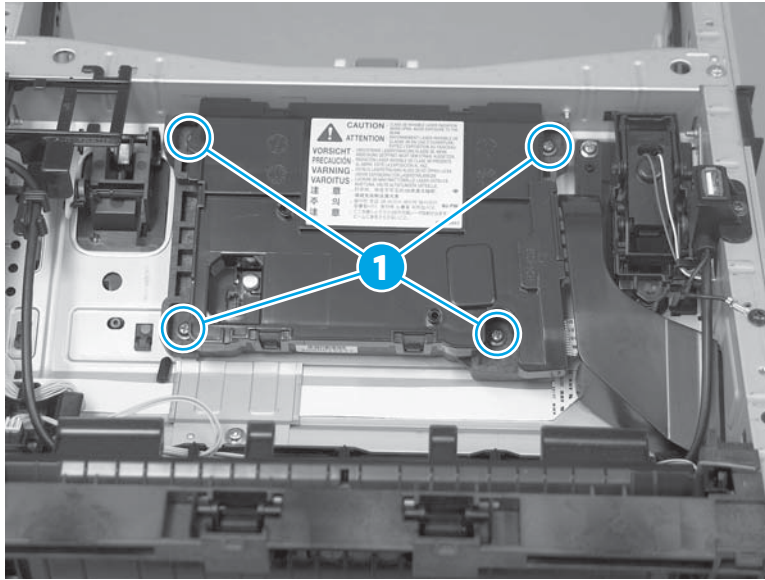
1. Connect one FFC, and then install the laser/scanner in the printer.

**Figure 1-1078** Install the laser/scanner



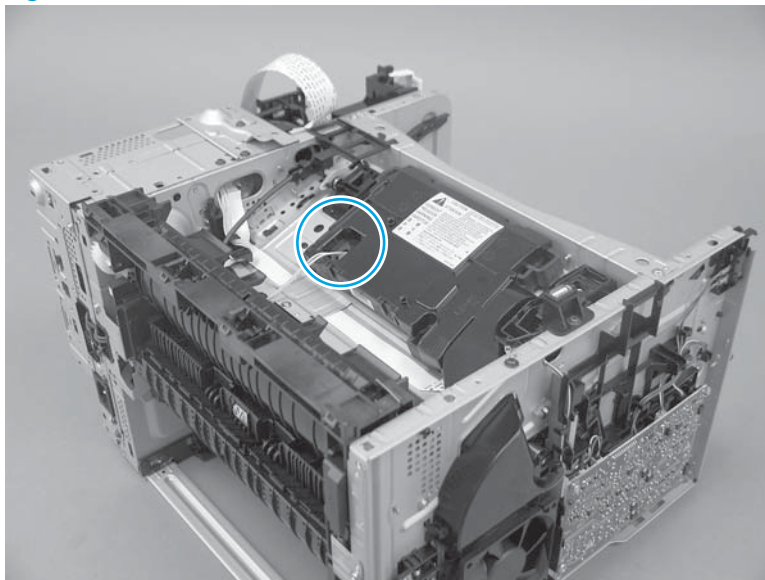
2. Install four screws (callout 1).

**Figure 1-1079** Install four screws



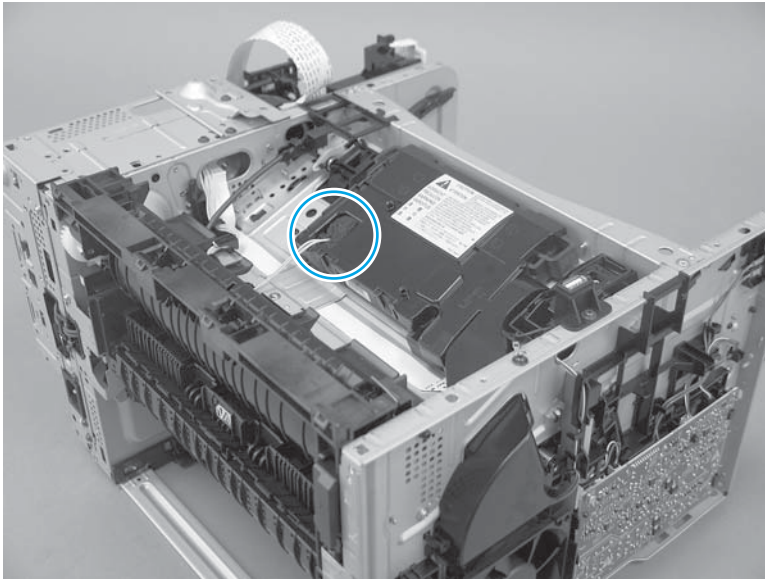
3. Connect one connector.

**Figure 1-1080** Connect one connector



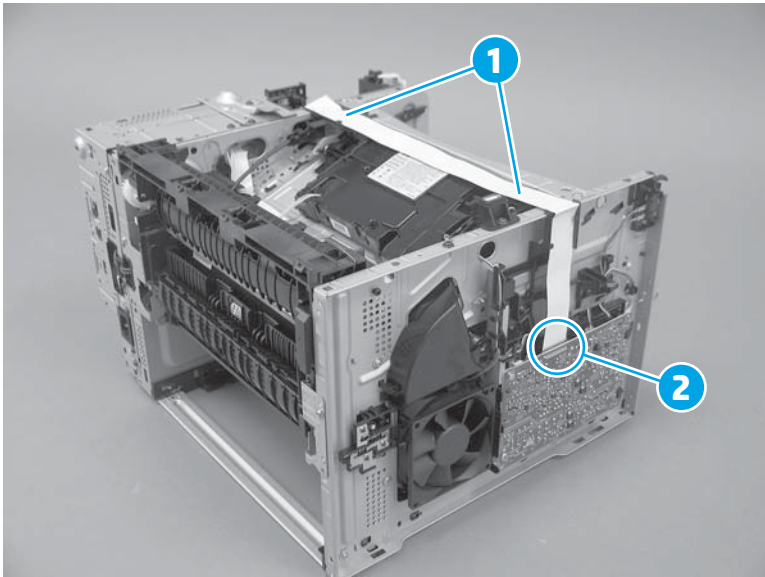
4. Install the antistatic foam pad.

**Figure 1-1081** Install the antistatic foam pad



5. Install the FFC in the retainers (callout 1), and then connect the FFC (callout 2) to the high-voltage power supply (HVPS).

**Figure 1-1082** Disconnect one FFC



### Step 19: Install the top cover (M501/M506)




**NOTE:** This step is for the M501/M506 printers. For the M527, skip this step and go to [Step 20: Install the top cover \(M527\) on page 626](#).

1. Position the rear edge of the cover on the printer, and then rotate the front of the cover down onto the printer.

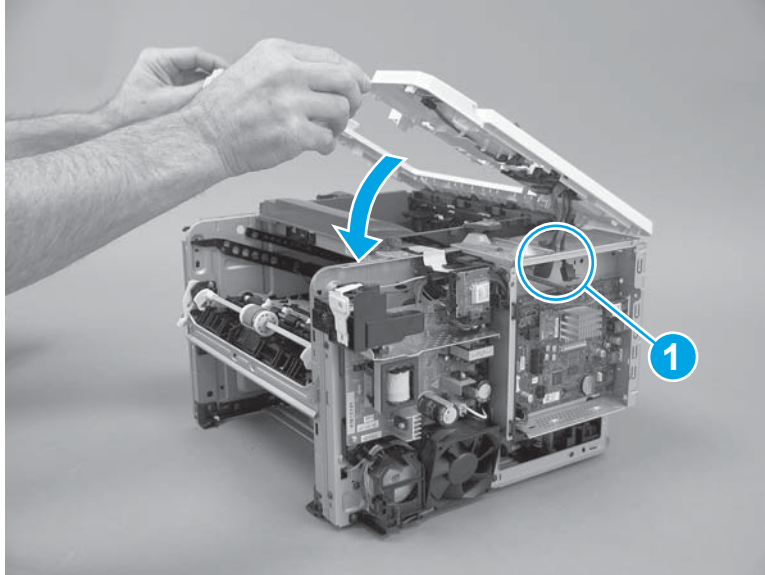


**CAUTION: M506x only:** As the cover is rotated down, carefully pass the cables the hole in the chassis (callout 1).

 **NOTE: LCD control panel models only:** Pass the cables through the opening in the cover, and then connect the control panel after installing the cover.

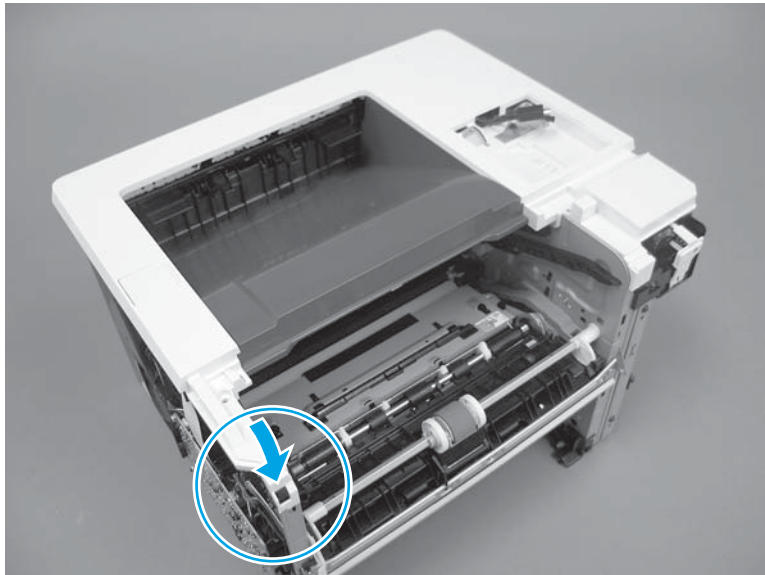
---

**Figure 1-1083** Install the cover




2. Engage one boss.

**Figure 1-1084** Engage one boss



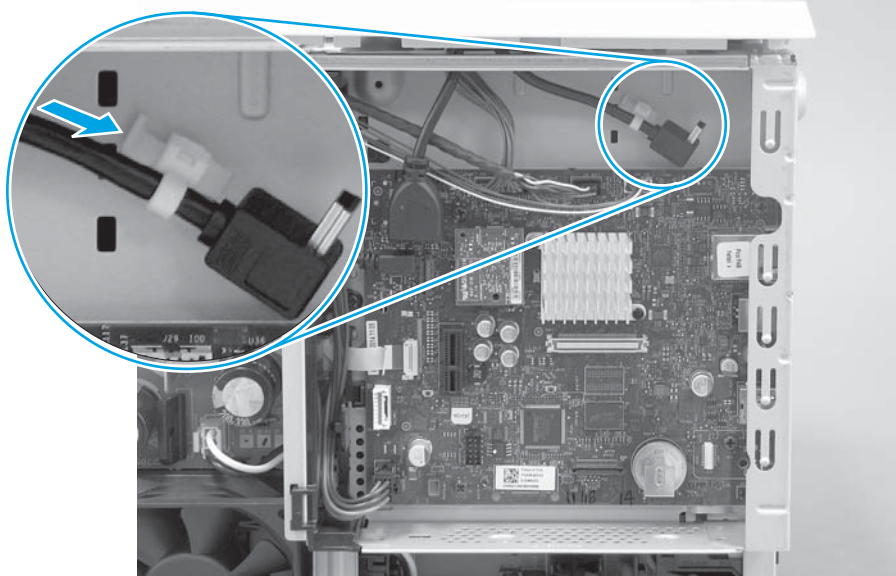
3. Install one cable retainer on the chassis.

---

 **TIP:** Depress the tab on the retainer to install it.

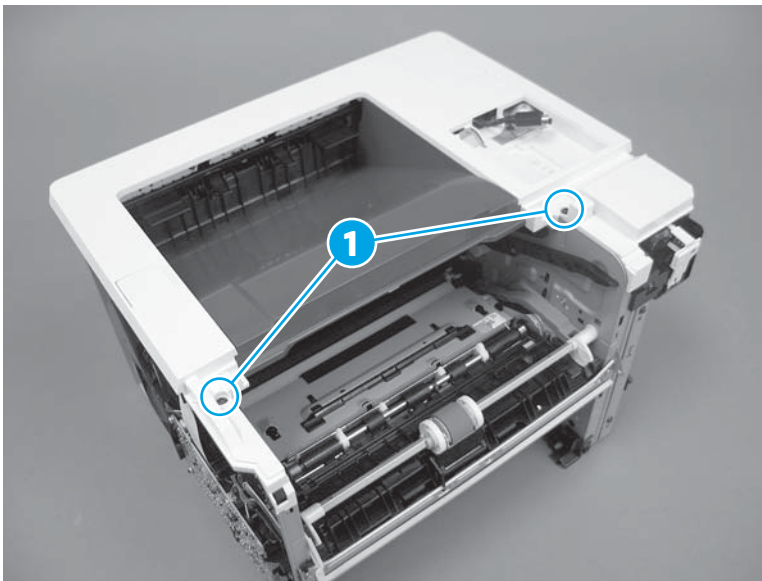
---

**Figure 1-1085** Install one cable retainer




4. Install two screws (callout 1).

**Figure 1-1086** Install two screws



### Step 20: Install the top cover (M527)

---

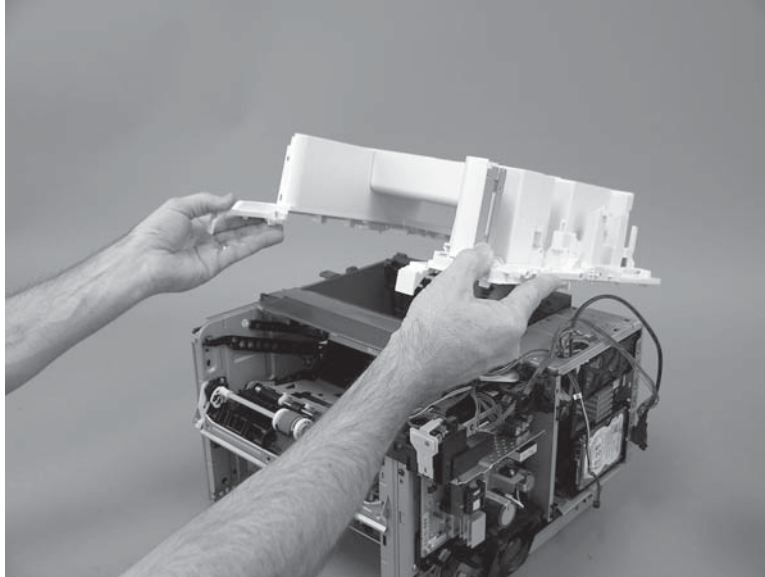
 **NOTE:** This step is for the M527 printer. For the M501/M506, skip this step and go to [Step 22: Install the left cover on page 633](#).

---

1. Position the rear edge of the cover on the chassis.



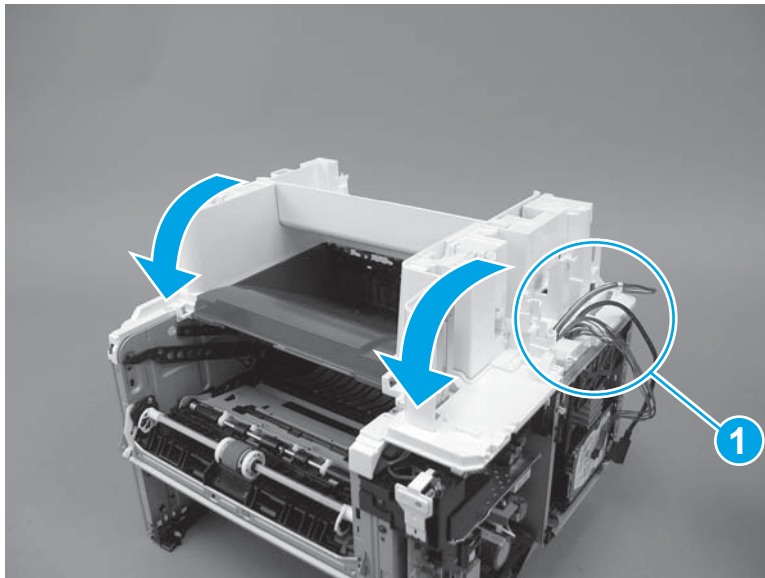
**Figure 1-1087** Install the cover



2. Rotate the front of the cover down onto the printer.

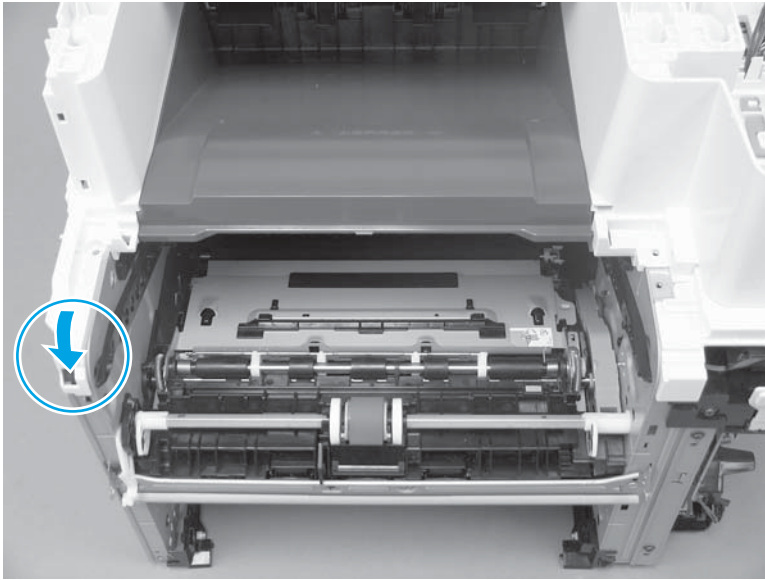
**CAUTION:** As the cover is rotated down, carefully pass the cables and wire harnesses the hole in the cover (callout 1).

**Figure 1-1088** Rotate the front of the cover down



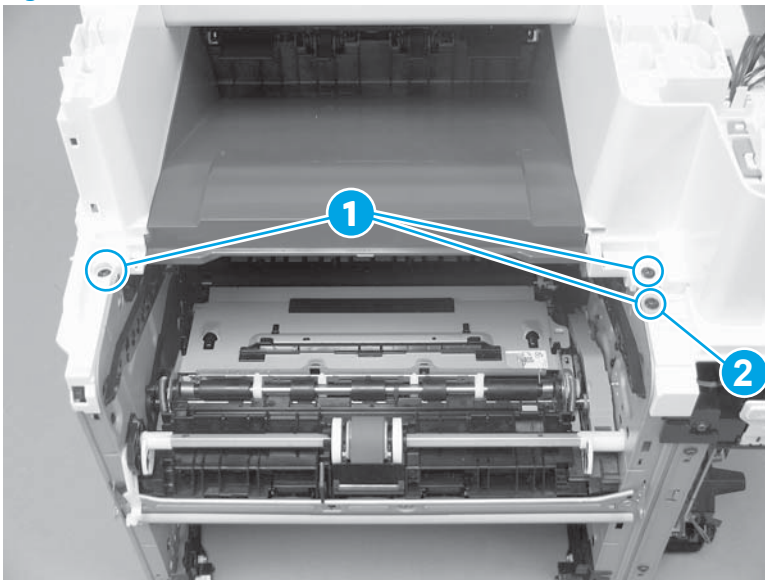
3. At the front left of the printer, engage one boss.

**Figure 1-1089** Engage one boss




4. At the top front of the printer, install three screws (callout 1).

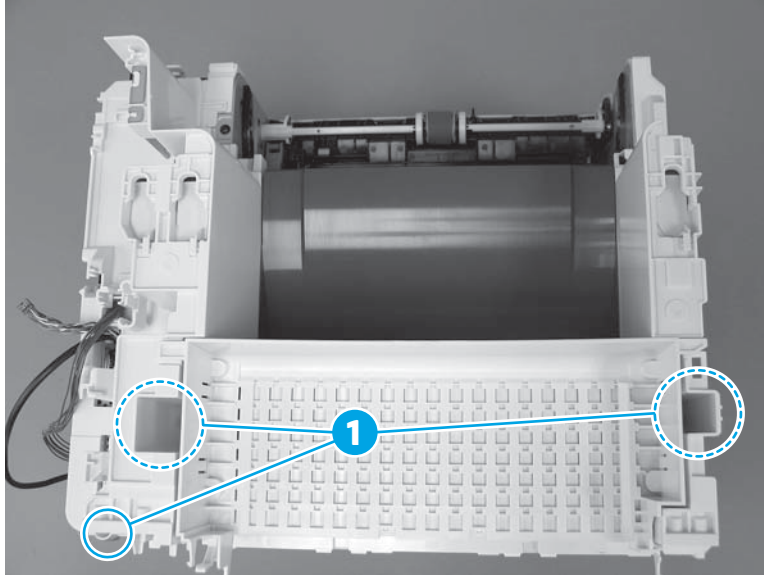
**Figure 1-1090** Install three screws



5. At the top rear of the printer, install three screws (callout 1).

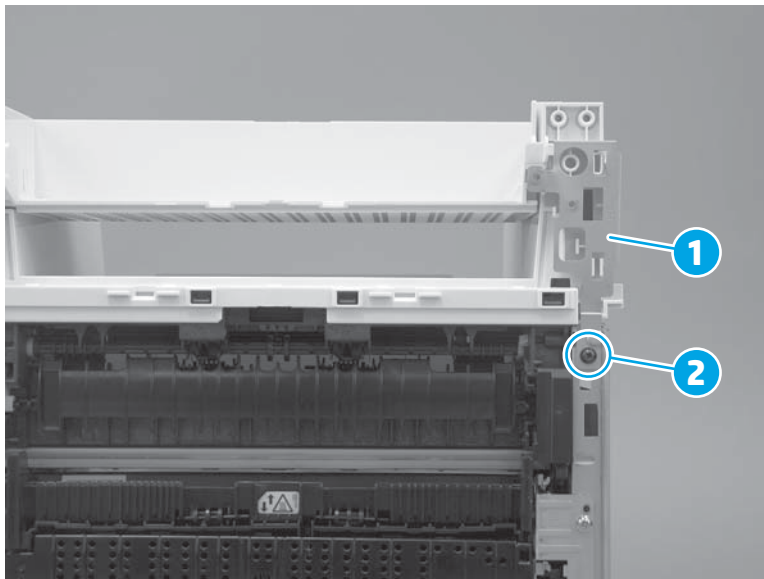
 **NOTE:** The screw (callout 2) on the lower-right portion of the cover is a different color than the other two screws, and is surrounded by sheet-metal. It might appear that this screw does not need to be removed. Remove this screw.

**Figure 1-1091** Install three screws





6. At the front right of the printer, install the sheet-metal plate (callout 1), and then install one screw (callout 2).

**Figure 1-1092** Install one screw and the plate




### Step 21: Install the integrated scanner assembly (M527)

 **IMPORTANT:** Some figure might show assemblies removed or installed that have not yet been removed or installed at that specific step. However, the procedures are correct for this printer and the target assembly. Always thoroughly read the instructions that accompany each figure

 **NOTE:** This step is for the M527 printer. For the M501/M506, skip this step and go to [Step 22: Install the left cover on page 633](#).

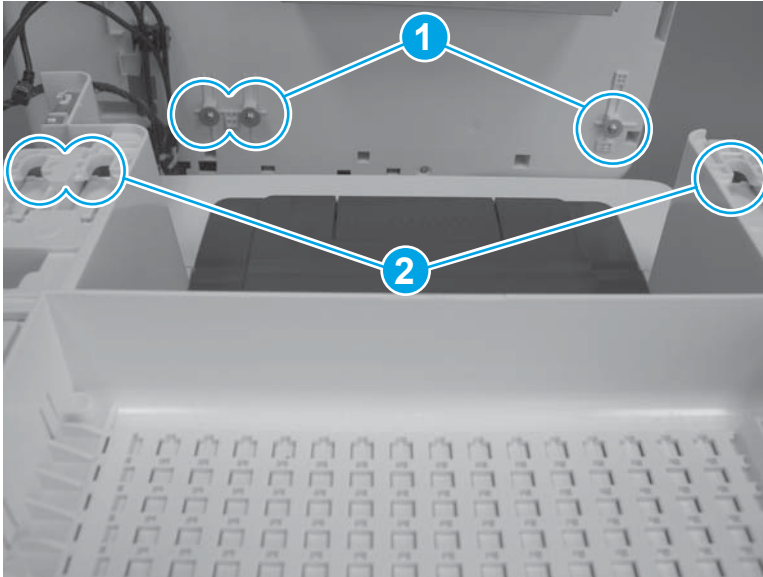
---

 **NOTE:** The ISA includes the document feeder, sub-scanner assembly (SSA), and the scanner control board (SCB)


---

1. Before proceeding, locate the ISA mounting pins (callout 1) on the bottom of the ISA and the slots (callout 2) on the printer base.

**Figure 1-1093** Locate the ISA mounting pins and slots

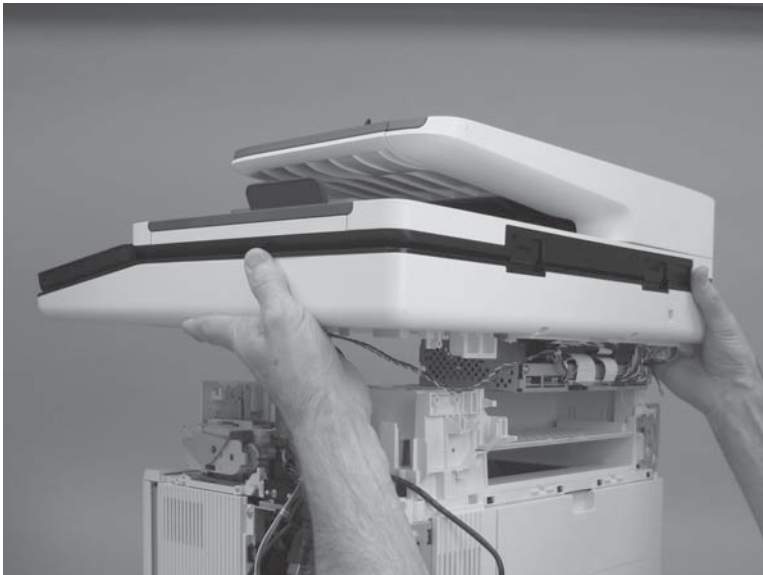


2. Position the ISA on the printer base with the pins in the slots.

 **NOTE:** To locate the pins and slots, see the previous step.

---

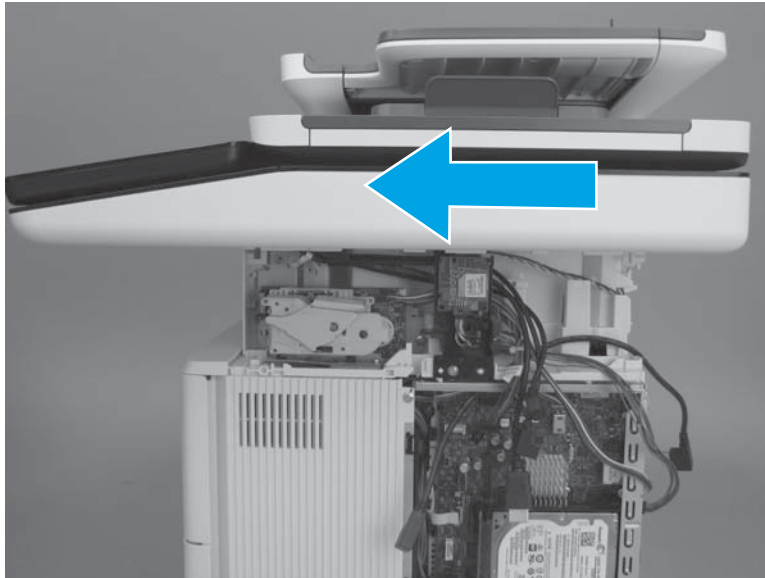
**Figure 1-1094** Install the ISA



3. Slightly slide the ISA towards the front of the printer to engage it.

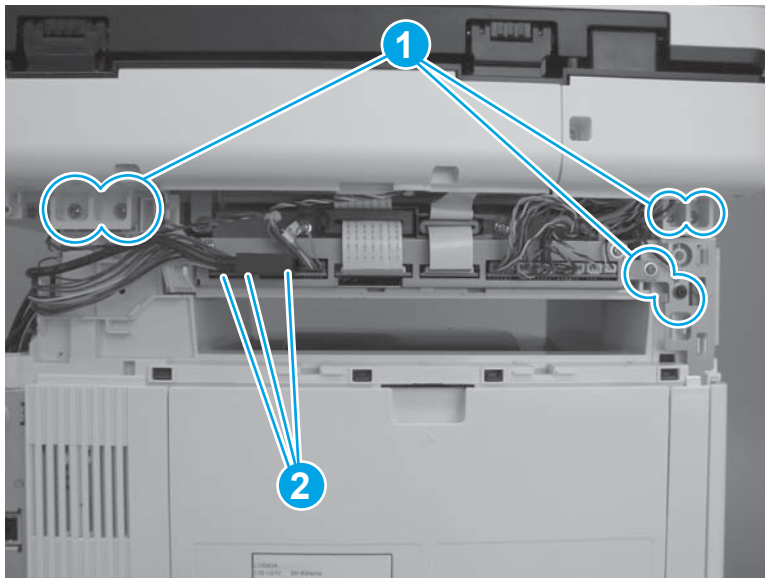
**CAUTION:** Make sure that none of the wire harnesses or cables are caught underneath the assembly when installing it.

**Figure 1-1095** Slide the ISA towards the front of the printer




4. Install six screws (callout 1), and then connect three connectors (callout 2).

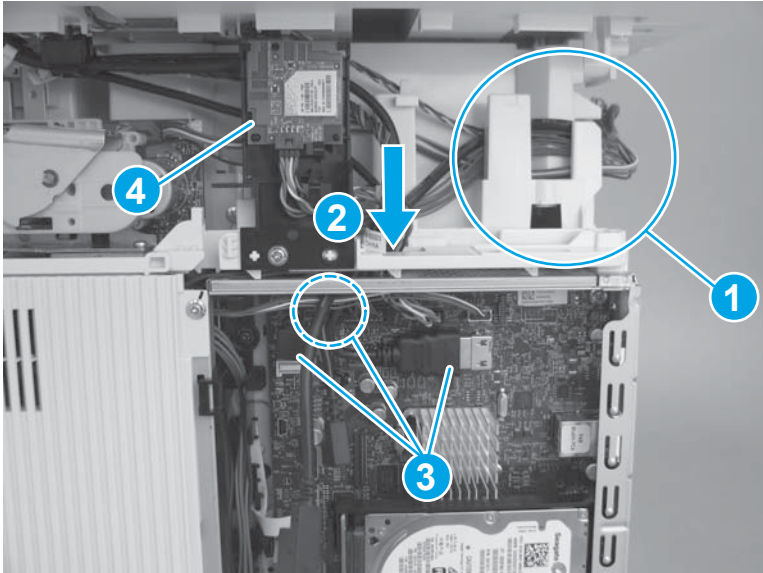
**Figure 1-1096** Install screws and connect connectors



5. Install the wire harnesses and cables in the retainers (callout 1), pass them through the opening in the cover (callout 2), and then connect three connectors (callout 3).

 **TIP:** If the WiFi PCA and holder (callout 4) was detached from the printer and then moved out of the way, reinstall it now.

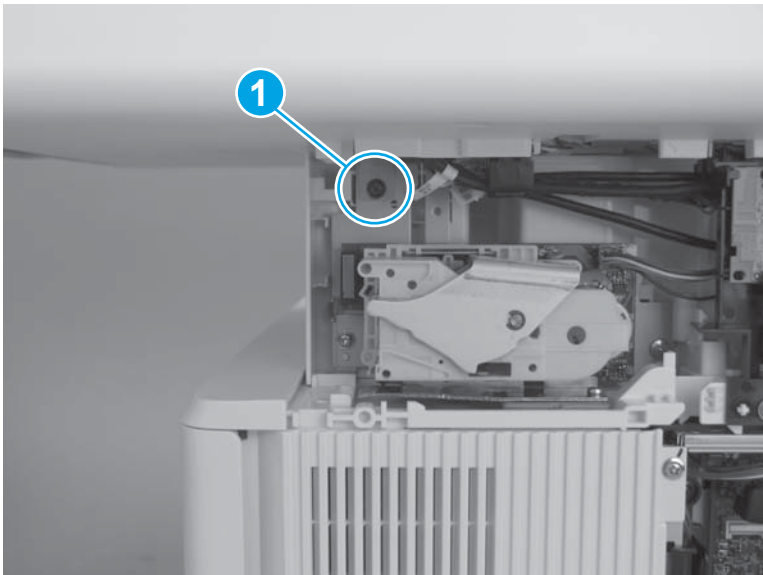
**Figure 1-1097** Connect cables and connectors




6. Install one screw (callout 1).


 **IMPORTANT:** This screw fastens the ISA ground plate to the printer chassis. This screw must be installed.

**Figure 1-1098** Install one screw



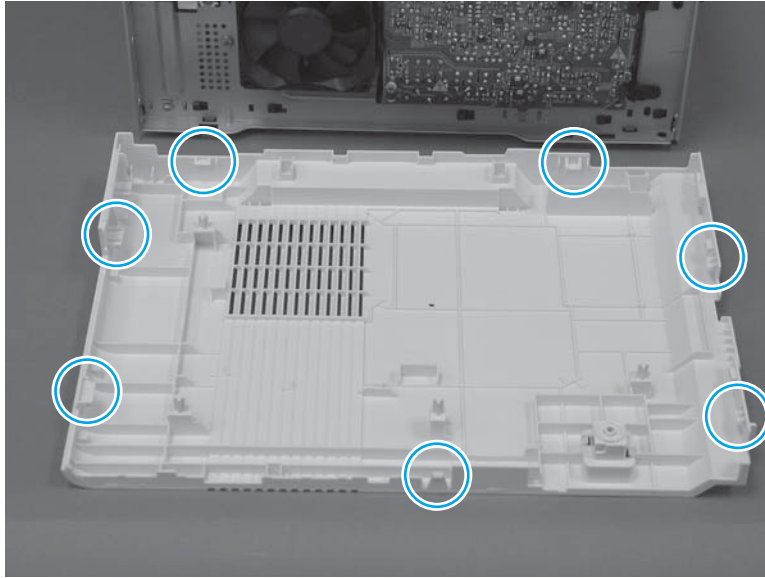
## Step 22: Install the left cover

 **IMPORTANT:** The black-plastic cassette front and rear guides (located inside the tray cavity) can be easily dislodged. Do not lose the guides when the cover is removed or installed.

 **NOTE:** The M527 printer is shown in this procedure. However, this procedure is valid for the M501/M506 printers.

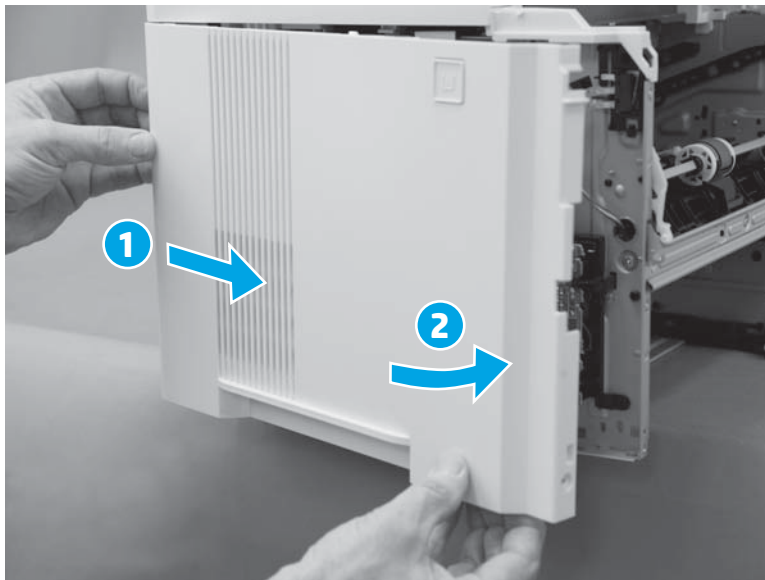
1. Before proceeding, take note of the location of the tabs and bosses on the inside of the cover.

**Figure 1-1099** Locate of the tabs and bosses



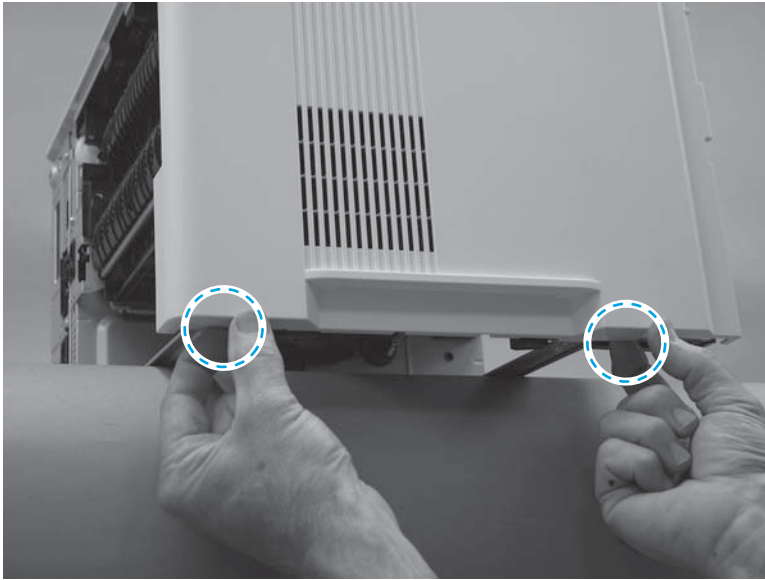
2. Engage the rear edge of the cover (callout 1), and then rotate the rear edge of the cover toward the printer (callout 2).

**Figure 1-1100** Install the cover



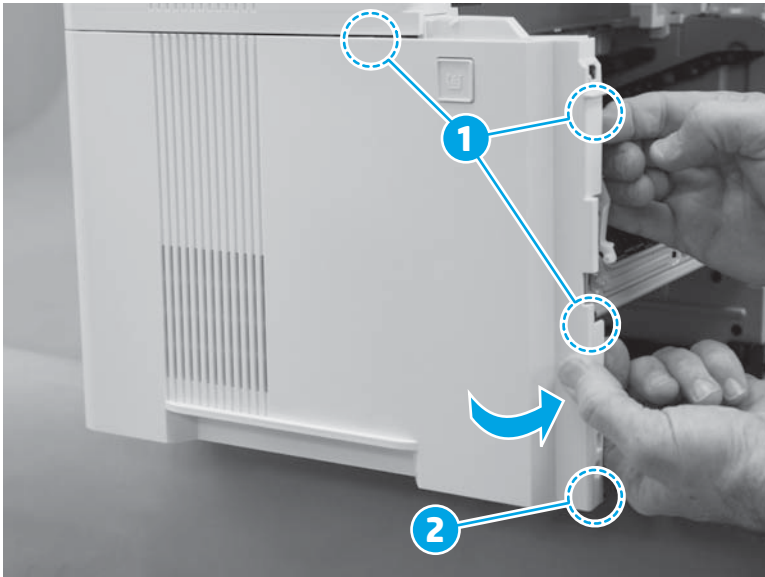
3. At the bottom edge of the cover, engage two tabs.

**Figure 1-1101** Engage two tabs



4. At the front of the printer, engage three tabs (callout 1), and then continue to rotate the front edge of the cover toward the printer to engage one boss (callout 2).

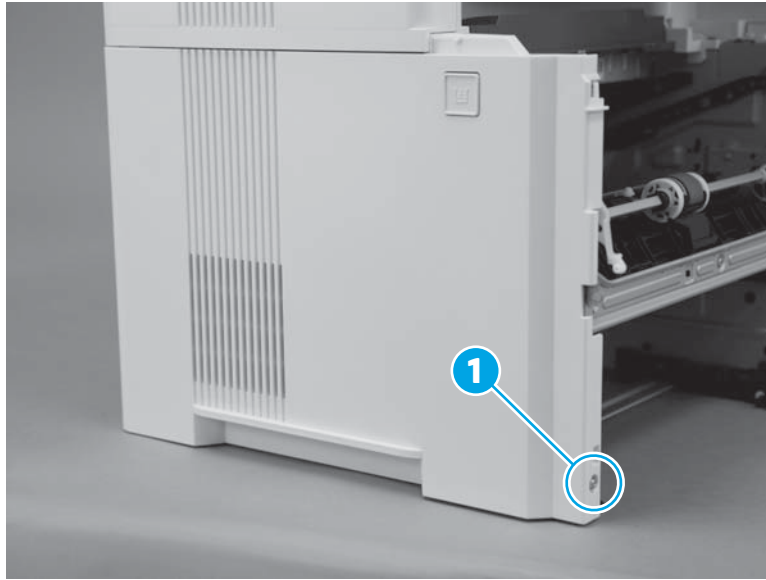
**Figure 1-1102** Engage three tabs and one boss







5. Install one screw (callout 1).

**Figure 1-1103** Install one screw



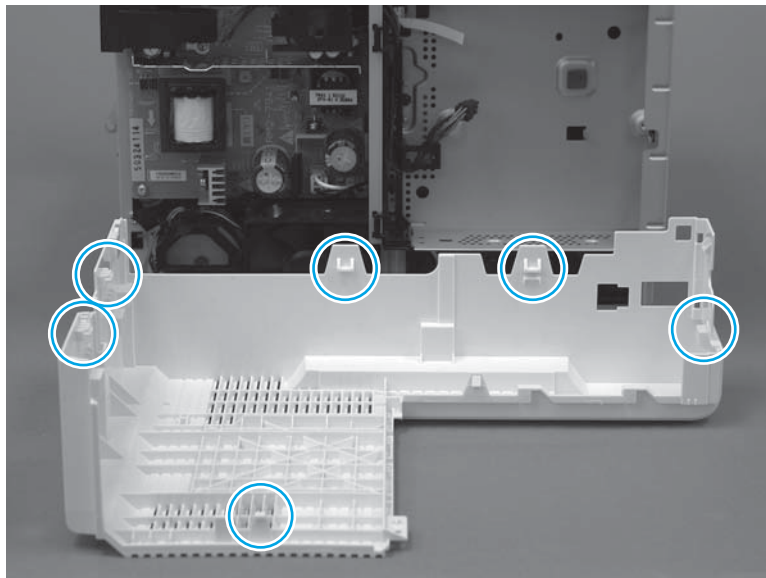
### Step 23: Install the right cover

 **IMPORTANT:** The black-plastic cassette front and rear guides (located inside the tray cavity) can be easily dislodged. Do not lose the guides when the cover is removed or installed.

 **NOTE:** The M527 printer is shown in this procedure. However, this procedure is valid for the M501/M506 printers.

1. Before proceeding, take note of the location of the tabs and bosses on the inside of the cover.

**Figure 1-1104** Locate the tabs and bosses

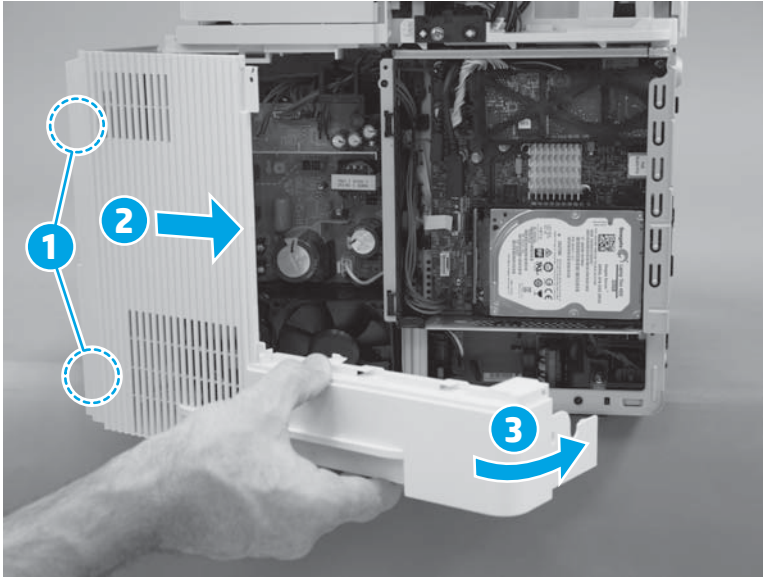


2. At the front of the cover engage two bosses (callout 1/2), and then rotate the rear of the cover toward the printer (callout 3).

**CAUTION:** It might be easier to install the cover with the printer slightly hanging over the edge of the workspace. Do not let the printer tip and fall off the workspace when removing the cover.

**TIP:** Make sure that the power switch at the front of the printer is positioned in the opening in the cover and that it does not interfere with the cover installation.

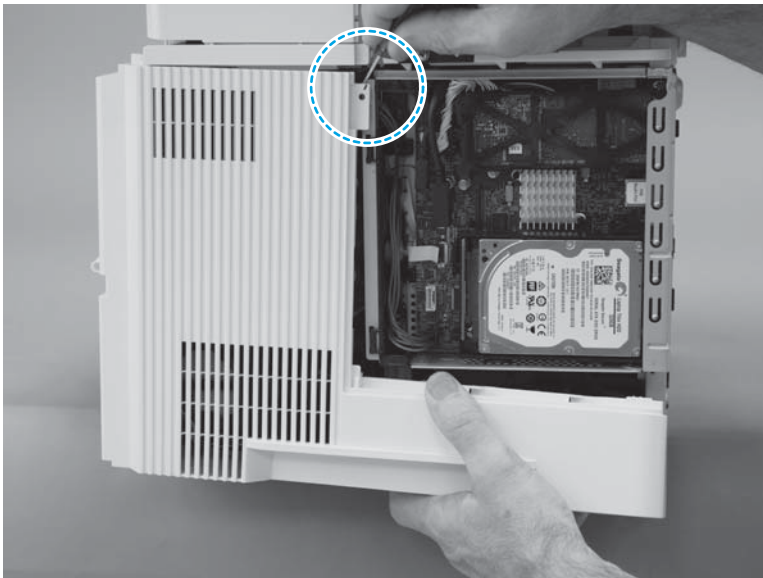
**Figure 1-1105** Install the cover



3. At the top rear edge of the cover, engage one tab.

**CAUTION:** It might be easier to install the cover with the printer slightly hanging over the edge of the workspace. Do not let the printer tip and fall off the workspace when removing the cover.

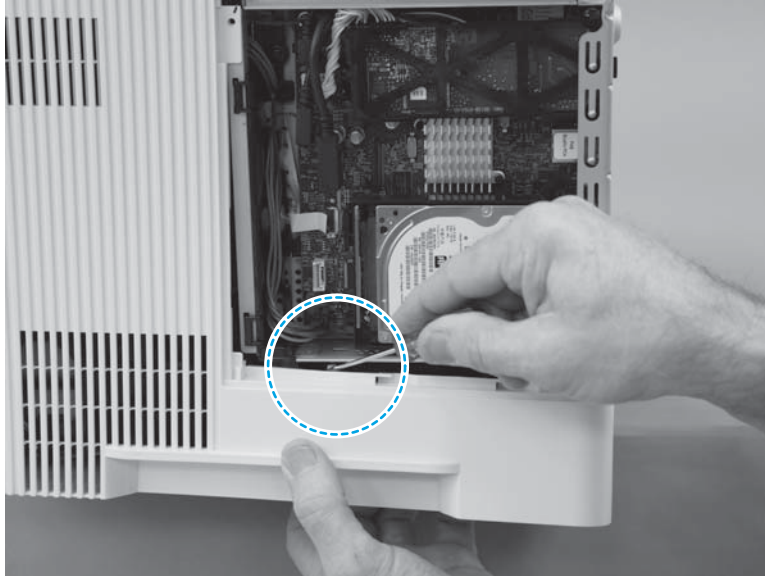
**Figure 1-1106** Engage one tab



4. Near the formatter, engage one tab.

**CAUTION:** It might be easier to install the cover with the printer slightly hanging over the edge of the workspace. Do not let the printer tip and fall off of the workspace when removing the cover.

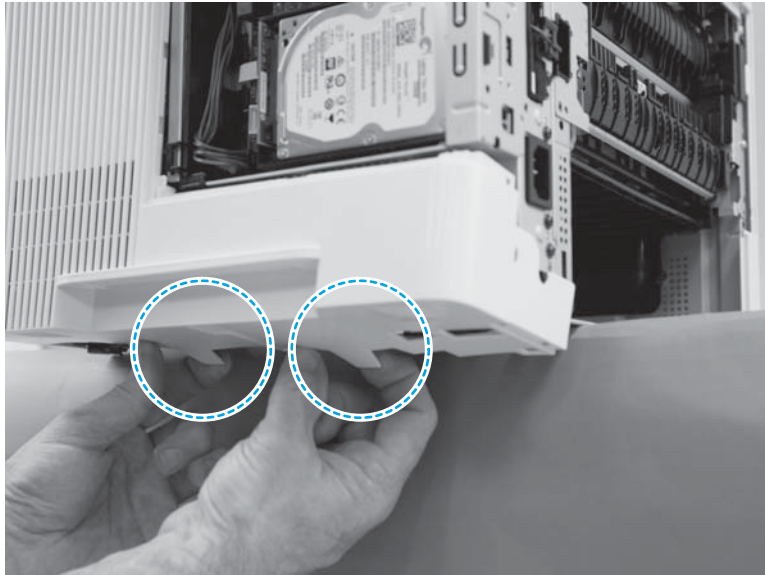
**Figure 1-1107** Engage one tab



5. At the bottom edge of the cover, engage two bosses.

**CAUTION:** It might be easier to install the cover with the printer slightly hanging over the edge of the workspace. Do not let the printer tip and fall off of the workspace when removing the cover.

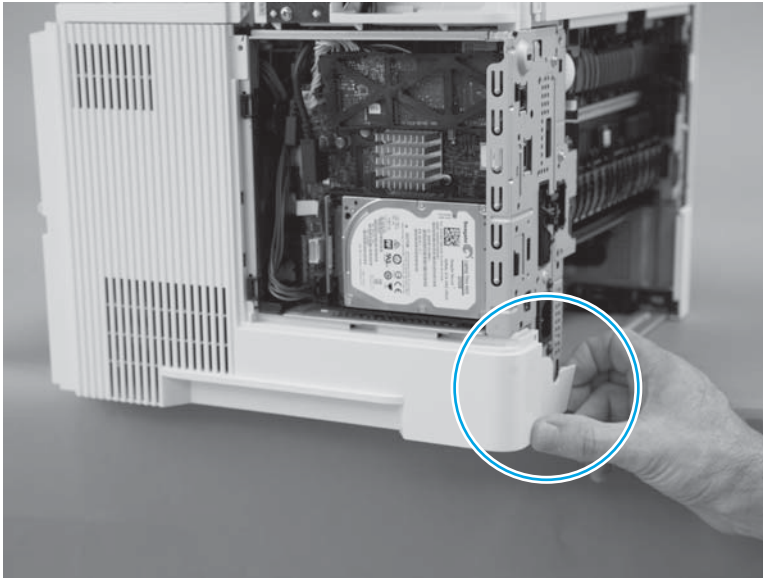
**Figure 1-1108** Engage two bosses



6. At the rear of the printer, engage one boss.

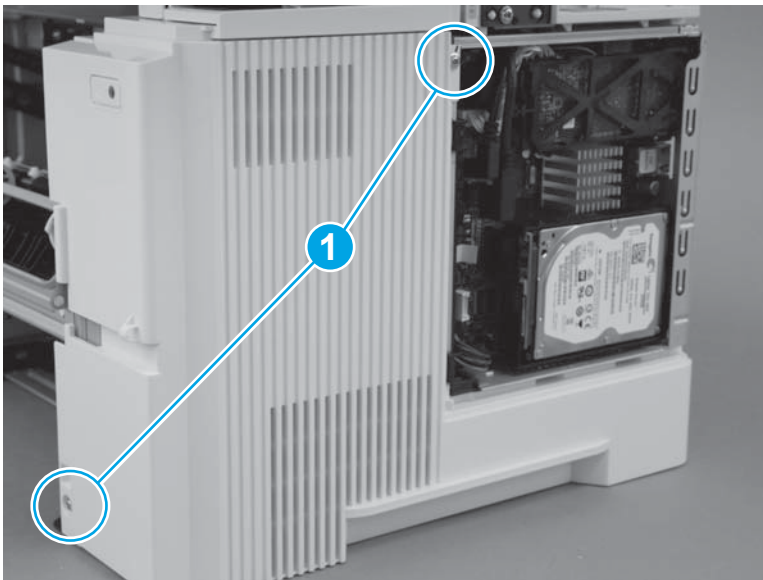
**⚠ CAUTION:** It might be easier to install the cover with the printer slightly hanging over the edge of the workspace. Do not let the printer tip and fall off of the workspace when removing the cover.

**Figure 1-1109** Engage one boss



7. Install two screws (callout 1).

**Figure 1-1110** Install two screws

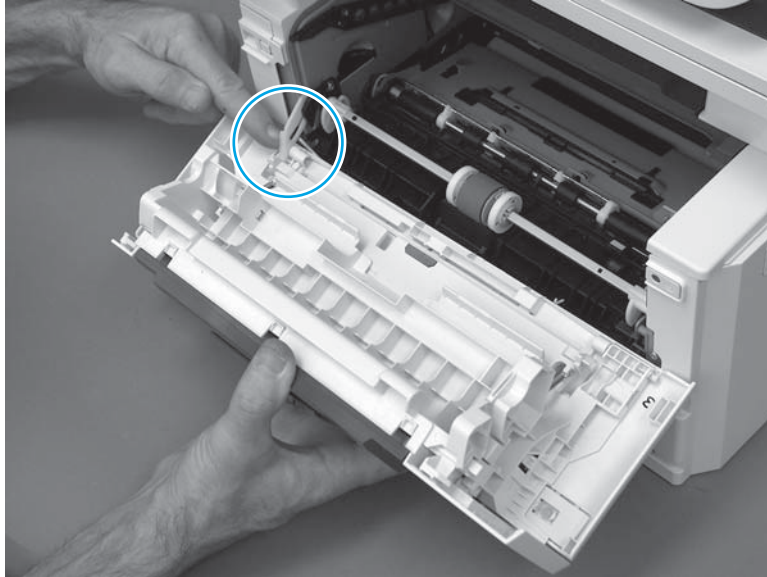


#### Step 24: Install the cartridge door assembly


1. Position the door close to the printer, and then engage the keyed pin on the left-side retainer arm with the hole in the door.


**💡 TIP:** It might be easier to engage the keyed pin with the hole by using a small flat-blad screwdriver.

**Figure 1-1111** Engage the left-side retainer arm

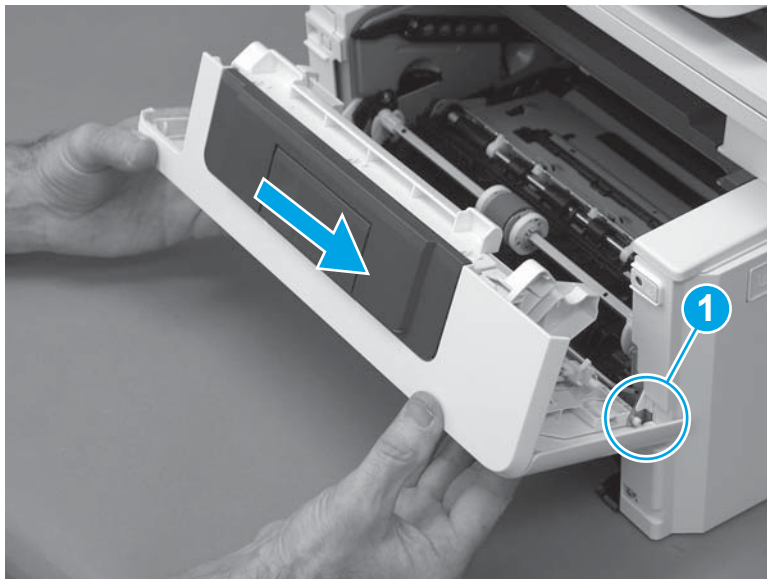


2. Engage the right-side door hinge pin with the hole in the chassis (callout 1).


 **NOTE:** There are two right-side hinge pins (not shown in callout 1).

 **TIP:** Keep a finger pressed on the left-side retainer arm so that it does not disengage from the door.

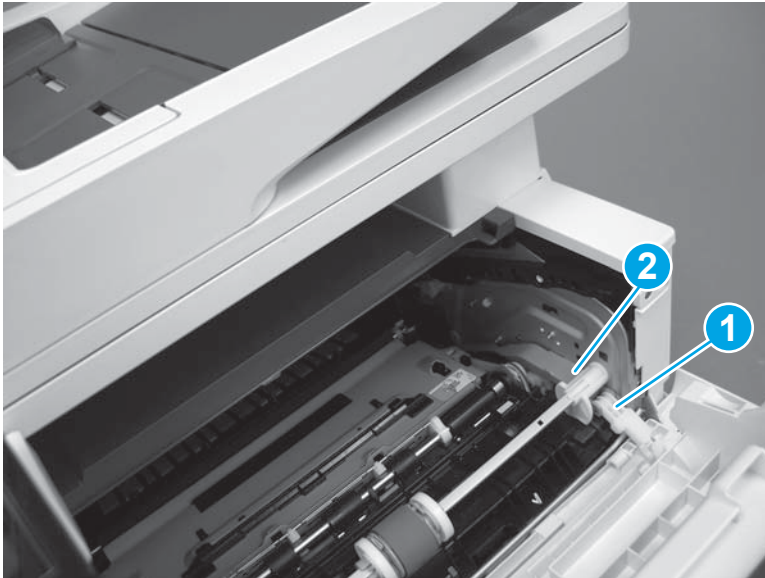
**Figure 1-1112** Install the door



3. Install the gray-plastic pressure-release link (callout 1) onto the white-plastic door arm (callout 2).

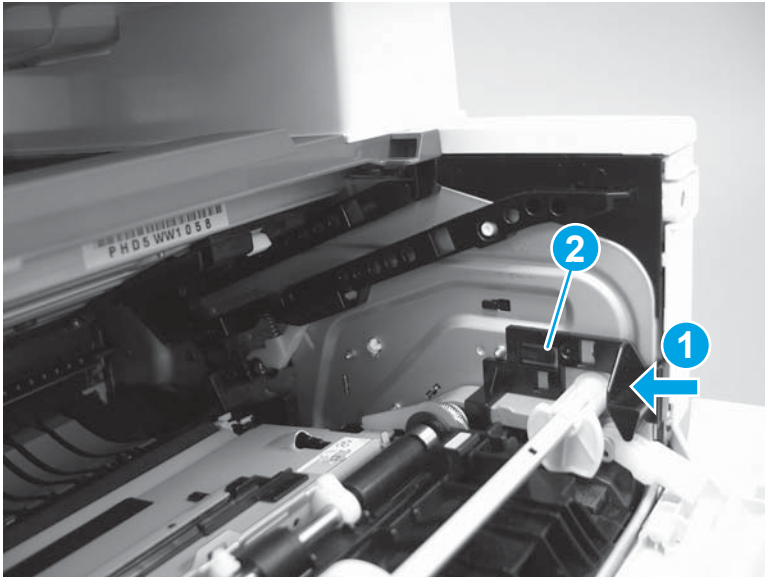
 **IMPORTANT:** Make sure that the arm snaps on to the link. Partially close and open the door to verify that the link (callout 2) moves in and out of the printer as the door closes/opens.

**Figure 1-1113** Install the pressure-release link



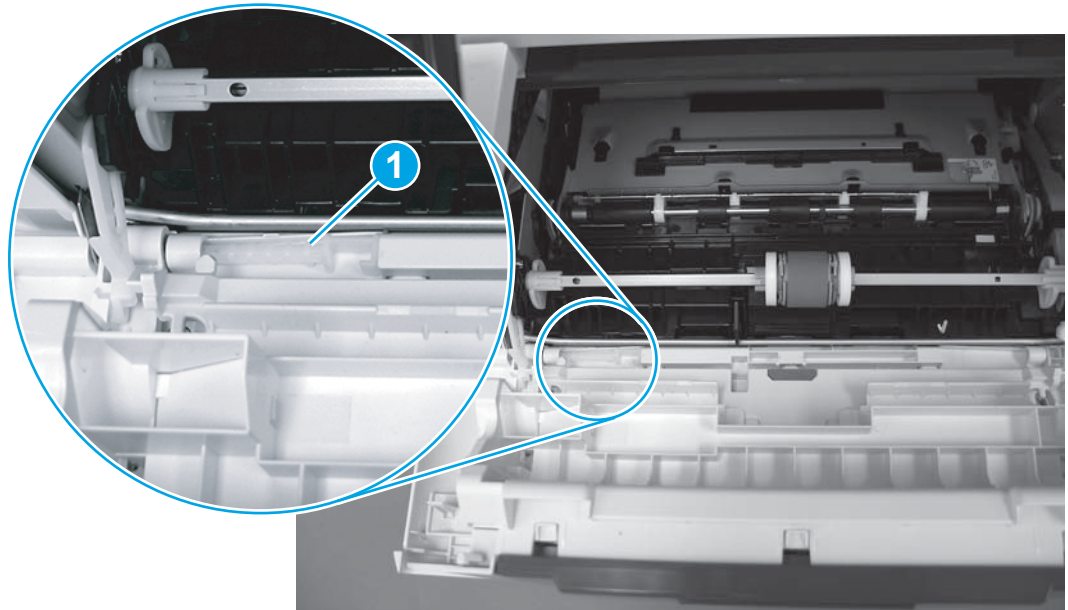
4. Slide the guide into the printer (callout 1), and then make sure that the tab (callout 2) snaps into place to secure the guide to the chassis.

**Figure 1-1114** Install the guide





5. Position the support shaft on the door, and then align the left-side hinge on the door with the hole in the chassis (callout 1).

**Figure 1-1115** Align the hinge

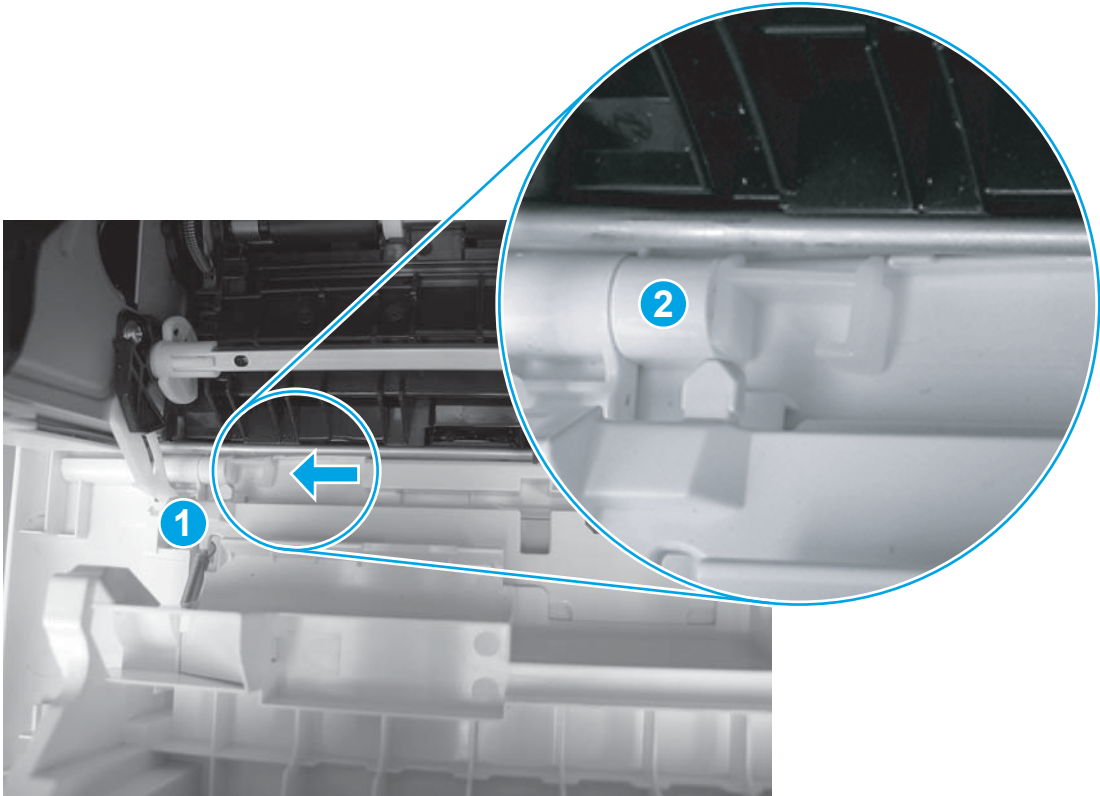


6. Push the shaft towards the left side of the printer to install it (callout 1).

 **NOTE:** Make sure that the support shaft is fully installed and correctly orientated (callout 2) so that it will not interfere with the door opening and closing.

 **Reinstallation tip:** If a replacement door was installed, make sure to install the nameplate (supplied in the kit) corresponding to the printer on the door.

**Figure 1-1116** Install the support shaft

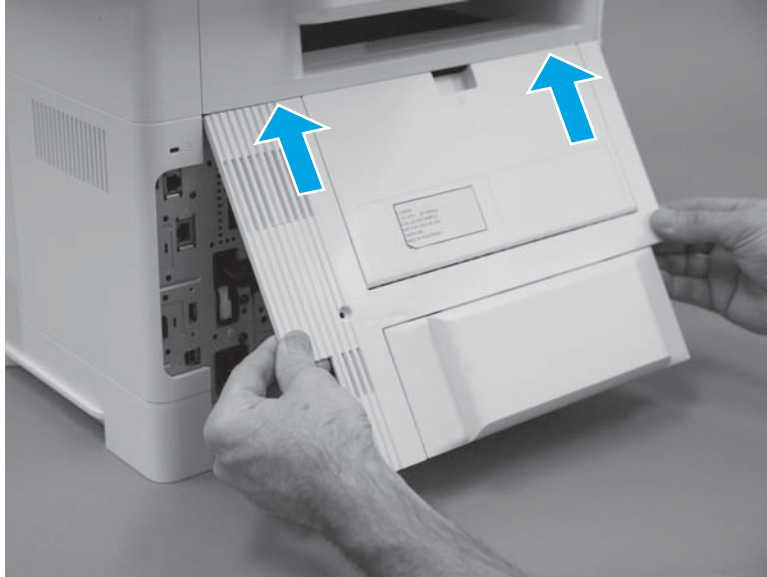


### Step 25: Install the rear door assembly

1. Engage the top edge of the assembly with the printer.

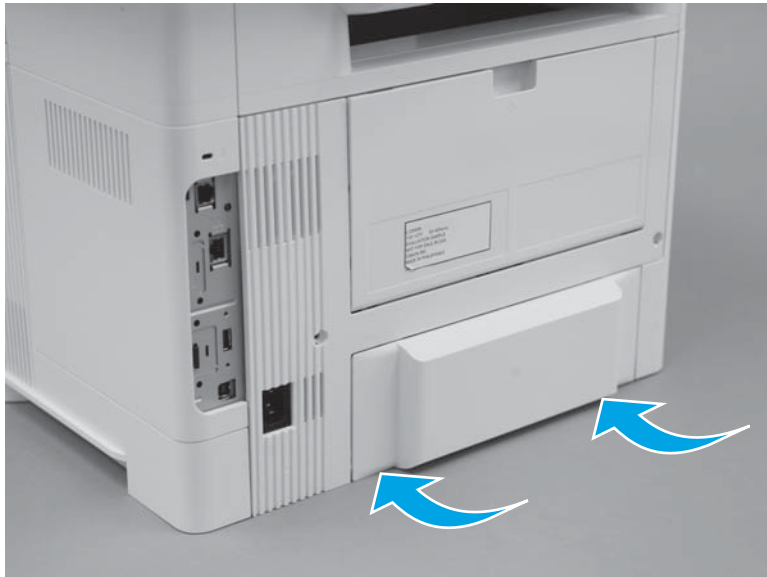


**Figure 1-1117** Install the cover



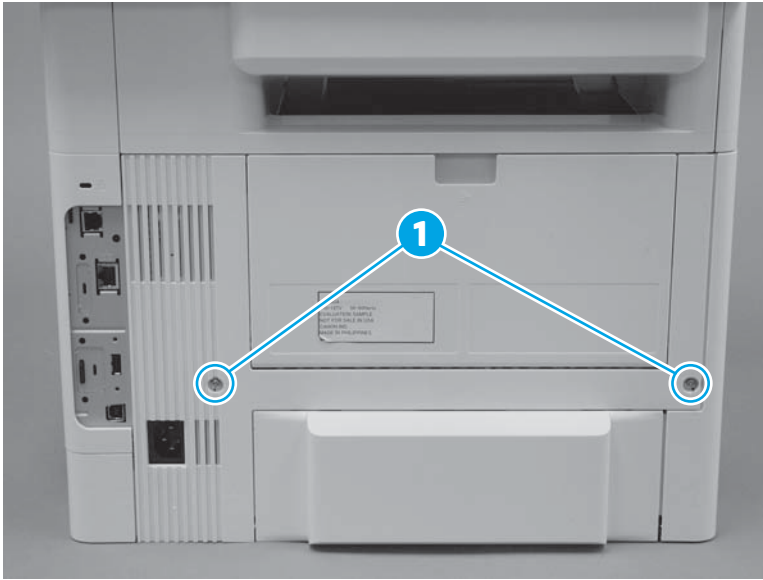
2. Rotate the bottom edge of the cover towards the printer.

**Figure 1-1118** Rotate the bottom of the cover



3. Install two screws (callout 1).

**Figure 1-1119** Install two screws



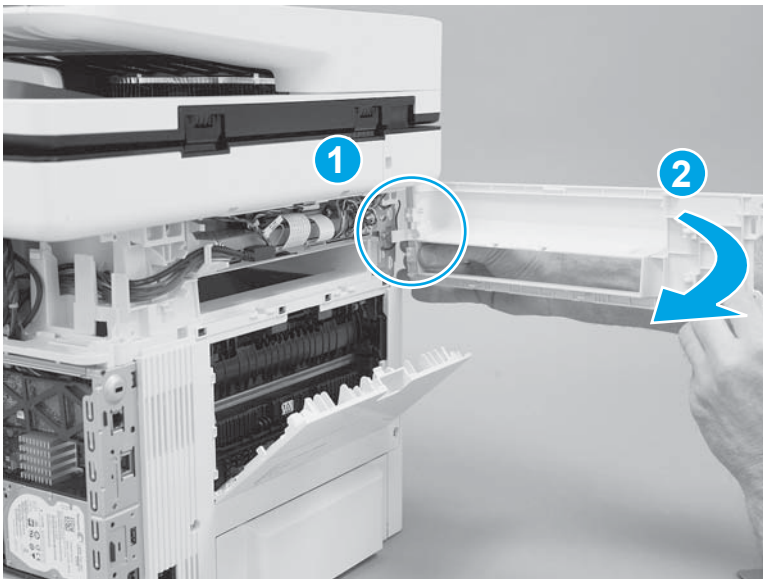
### Step 26: Install the top-rear cover (M527)



**NOTE:** This step is for the M527 printer. For the M501/M506, skip this step and go to [Step 31: Install the formatter cover on page 654](#).

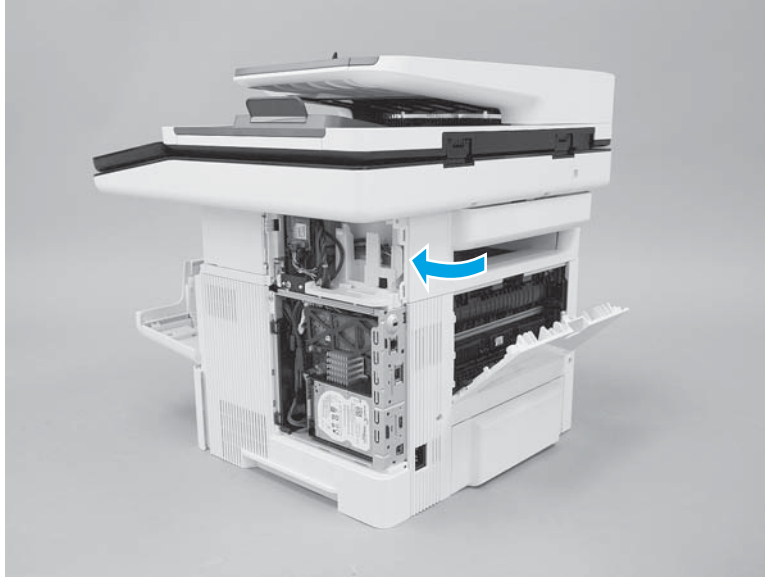
1. Engage one boss (callout 1), and then rotate the cover towards the printer (callout 2).

**Figure 1-1120** Engage one boss



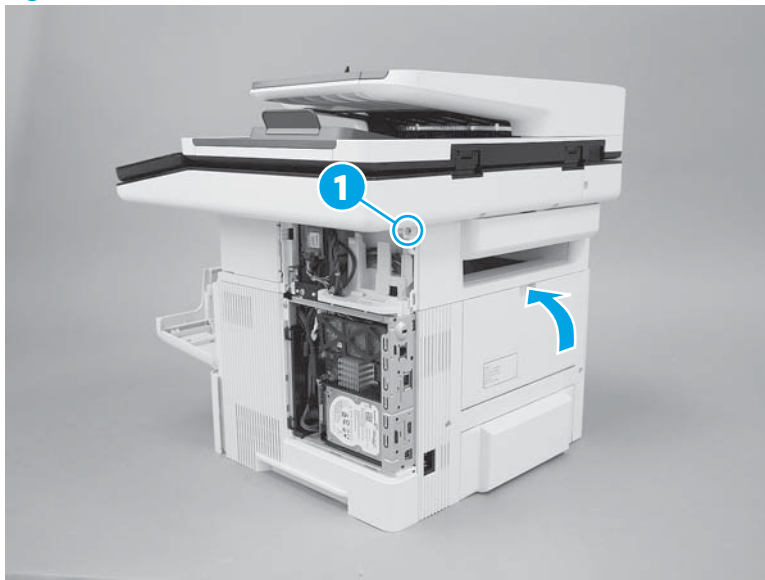
2. Continue to rotate the cover toward the printer to install it.

**Figure 1-1121** Install the cover




3. Install one screw (callout 1), and then close the rear door.

**Figure 1-1122** Install one screw



### Step 27: Install the top-left cover (M527)

 **NOTE:** This step is for the M527 printer. For the M501/M506, skip this step and go to [Step 31: Install the formatter cover on page 654](#).

1. Position the front edge of the cover on the printer, and then slide the cover toward the front of the printer to engage two bosses at the front of the cover.

**Figure 1-1123** Slide the cover




2. Rotate the cover towards the printer to engage two tabs at the middle of the cover.

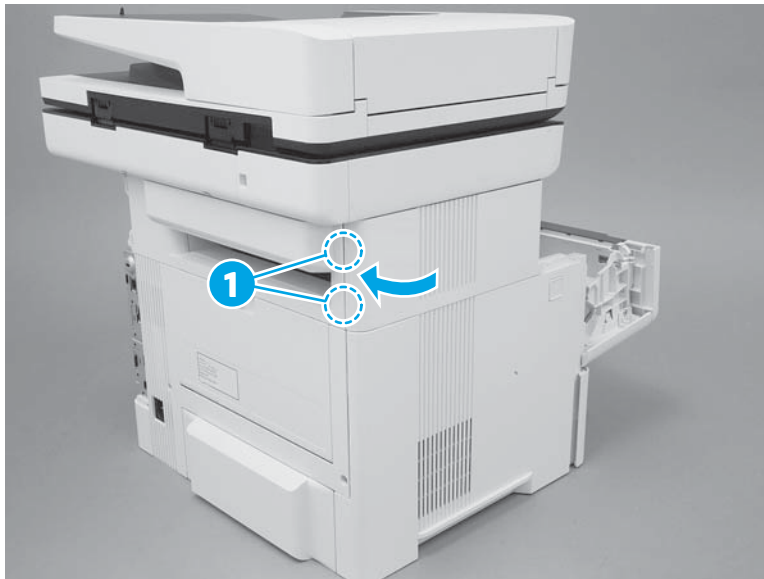
**Figure 1-1124** Engage two tabs




3. Continue to rotate the cover onto the printer to engage two tabs (callout 1) at the rear edge of the cover.


 **NOTE:** Close the toner-cartridge door.

**Figure 1-1125** Engage two tabs



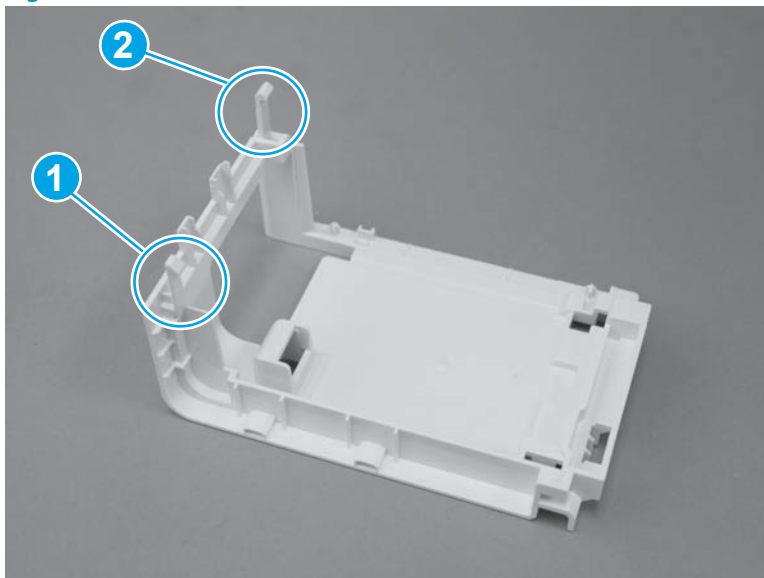
### Step 28: Install the stapler stationary (inner) cover (M527)

 **NOTE:** This step is for the M527c/f/z printers. For the M501/M506, skip this step and go to [Step 31: Install the formatter cover on page 654](#). For the M527dn, skip this step and go to [Step 29: Install the stapler door or stapler blank cover \(M527\) on page 649](#).

 **NOTE:** M527c/f/z printers only.

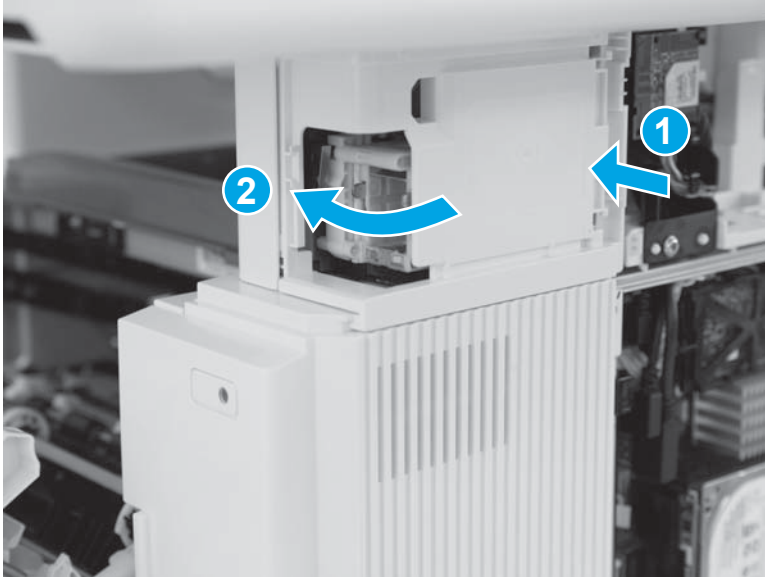
1. Before proceeding, take note of the locations of the upper tab (callout 1) and the lower tab (callout 2) on the stapler stationary (inner) cover.

**Figure 1-1126** Locate the tabs



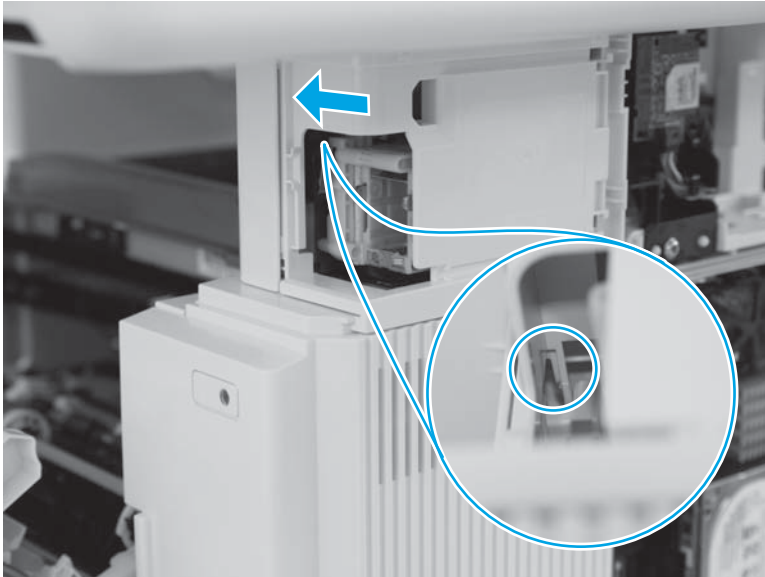
2. Engage the rear edge of the cover with the printer (callout 1), and then rotate the front edge of the cover onto the printer (callout 2) to engage the two tabs.

**Figure 1-1127** Install the cover



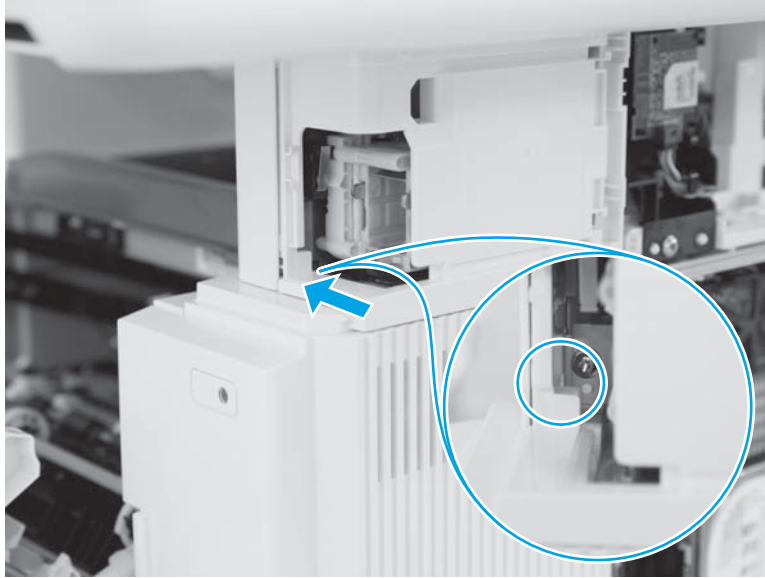
3. Verify that the upper tab is engaged.

**Figure 1-1128** Engage one tab




4. Verify that the lower tab is engaged.

**Figure 1-1129** Engage one tab



### Step 29: Install the stapler door or stapler blank cover (M527)

 **NOTE:** This step is for the M527 printer. For the M501/M506, skip this step and go to [Step 31: Install the formatter cover on page 654](#).

 **NOTE:** The M527dn does not have a convenience stapler.

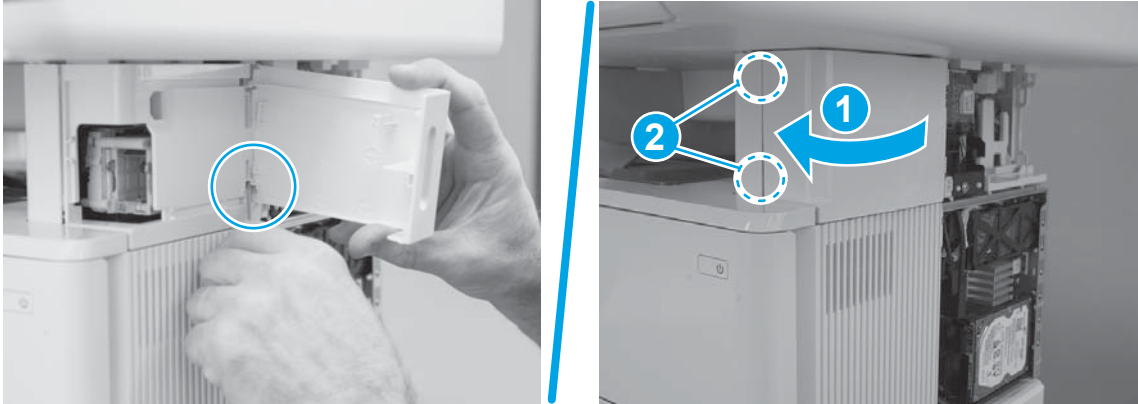
1. Do one of the following:
  - **M527c/f/z:** Position the door near the printer.
  - **M527dn:** Position the cover on the printer.

**Figure 1-1130** Install the door or cover



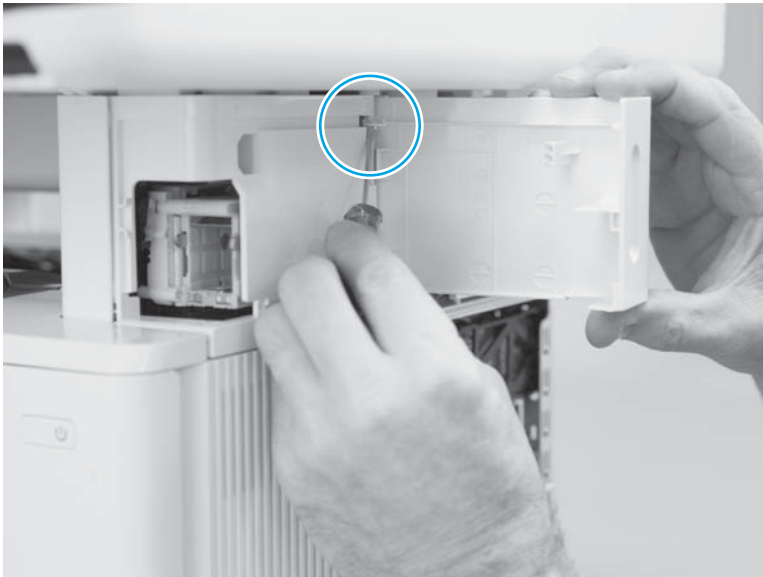
2.
  - **M527c/f/z:** Engage the lower hinge.
  - **M527dn:** Rotate the cover towards the printer (callout 1), and then make sure that the two tabs (callout 2) snap into place to install the cover.

**Figure 1-1131** Engage the lower hinge or engage the cover



3. **M527c/f/z:** Engage the upper hinge.

**Figure 1-1132** Engage the upper hinge






4. **M527c/f/z:** Close the stapler door.

**Figure 1-1133** Close the door




### Step 30: Install the fax PCA (M527)

---

 **NOTE:** This step is for the M527 printer. For the M501/M506, skip this step and go to [Step 31: Install the formatter cover on page 654](#).

---

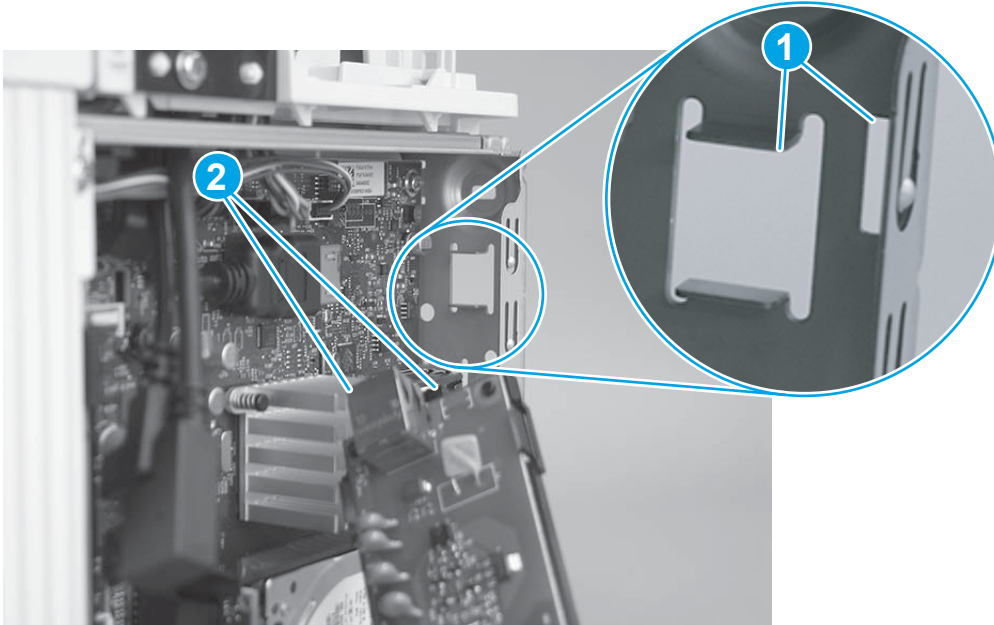
 **CAUTION:**  ESD-sensitive part.

 **NOTE:** M527c/f/z printers only (optional for the M527dn).

---

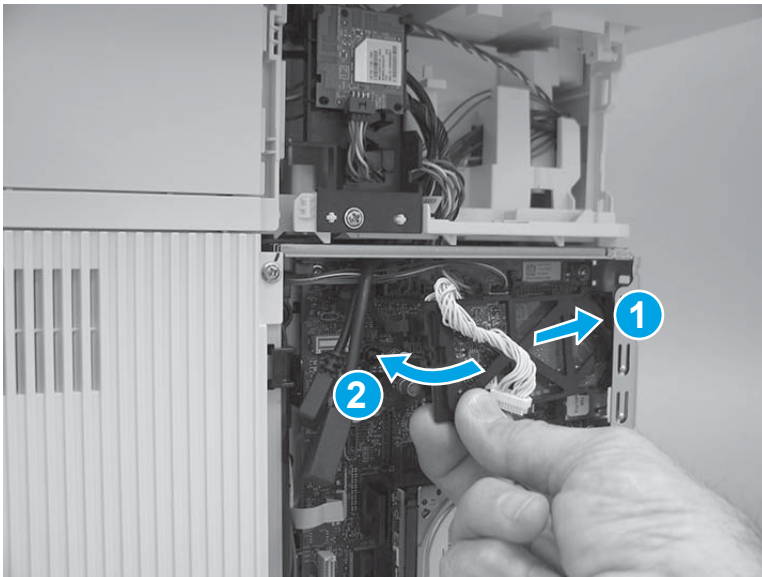
1. Before proceeding, take note of the location of the slots (callout 1) in the sheet-metal where the fax PCA cradle mounting tab and fax port (callout 2) must be installed.

**Figure 1-1134** Locate the slots in the sheet-metal



2. Insert the fax PCA cradle mounting tab and fax port in the slots in the sheet-metal plate (callout 1), and then rotate the connector end of the fax PCA toward the formatter (callout 2).

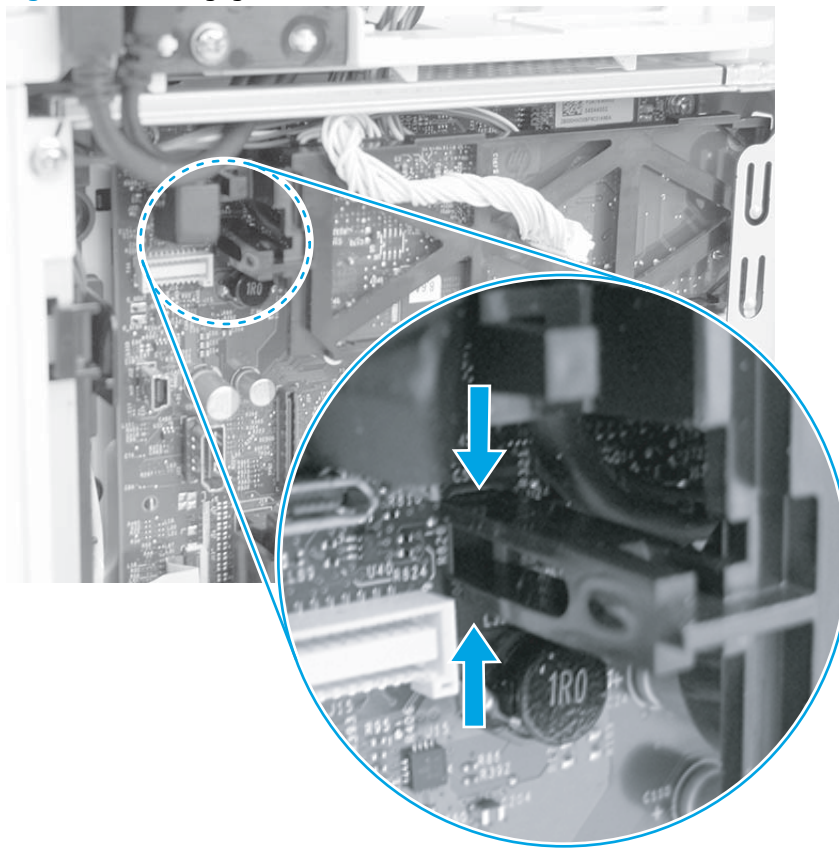
**Figure 1-1135** Install the fax PCA



- Engage the retainer with the slot in the formatter.

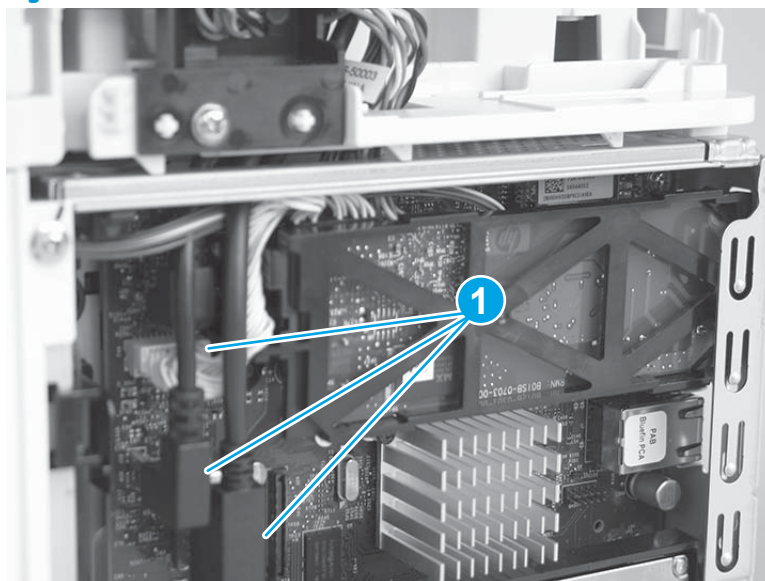
 **Reinstallation tip:** Pinch the retainer to easily engage it with the slot.

**Figure 1-1136** Engage the fax PCA



- Connect three connectors (callout 1).

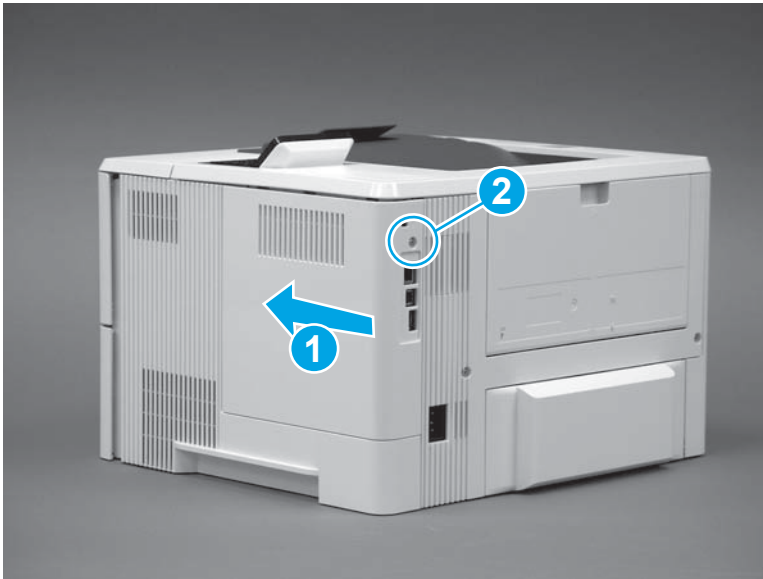
**Figure 1-1137** Connect three connectors



### Step 31: Install the formatter cover

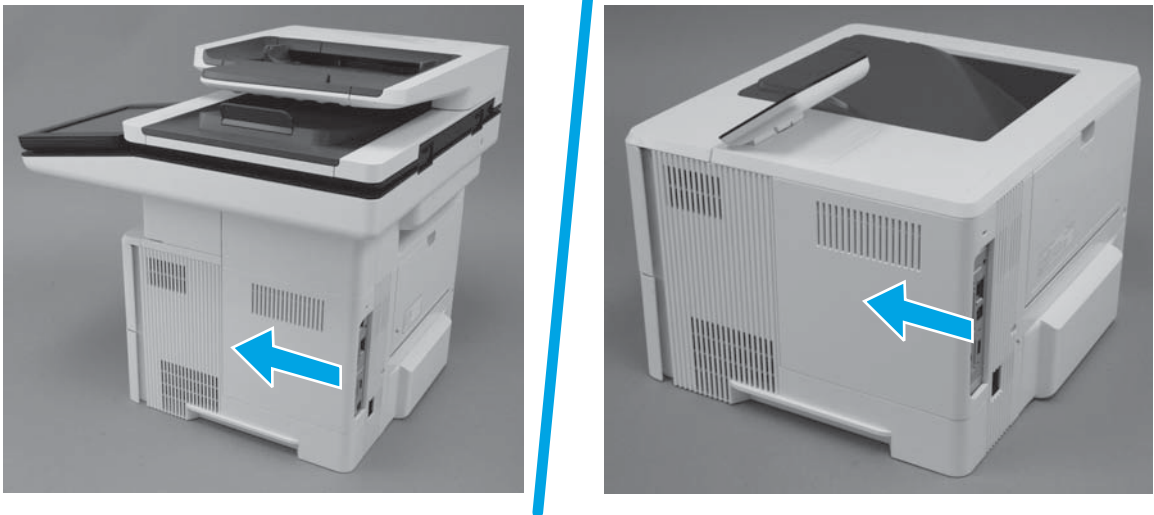
1. **M501:** Slide it toward the front of the printer to install it (callout 1), and then install one screw (callout 2).

**Figure 1-1138** Install the formatter cover (M501)



2. **M506/M527:** Slide it toward the front of the printer to install it.

**Figure 1-1139** Install the formatter cover (M506/M527)



### Step 32: Install the tray

1. With the tray at a slight angle, align the sides of the tray with the rails in the accessory, and then partially slide the tray into the printer.

**Figure 1-1140** Install the tray



2. Push the tray straight into the accessory to close it.

**Figure 1-1141** Close the tray



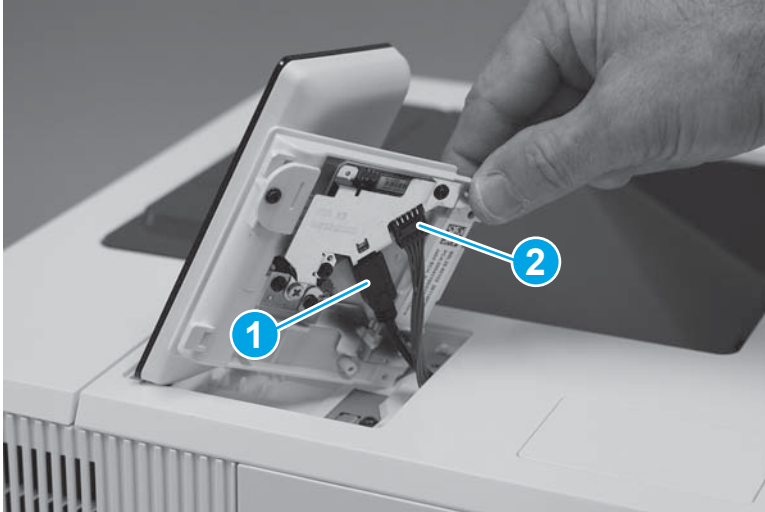
### Step 33: Install the control panel (M506x)



**NOTE:** M506x model only.

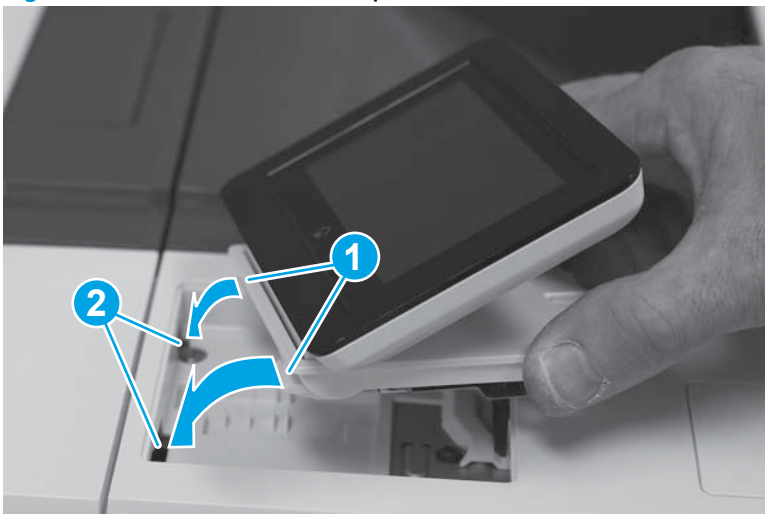
1. Connect one HDMI cable (callout 1), one connector (callout 2).

**Figure 1-1142** Connect the cables



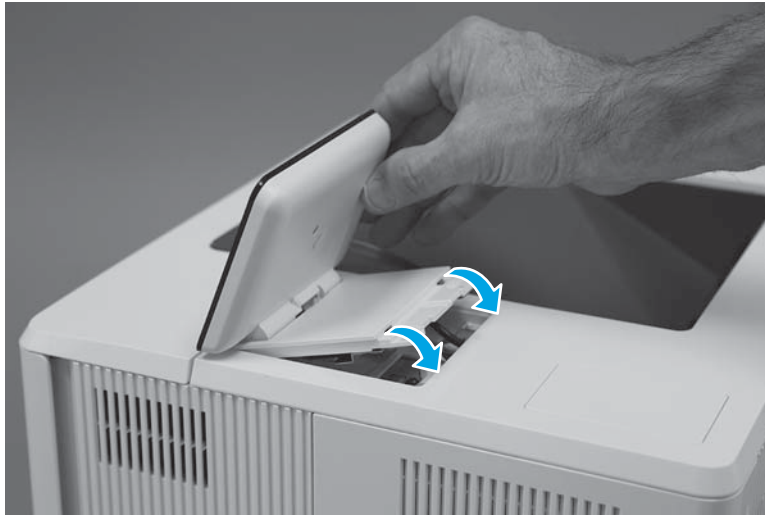
2. Install the tabs (callout 1) on the front of the control panel in the slots (callout 2) on the printer top cover.

**Figure 1-1143** Install the control panel



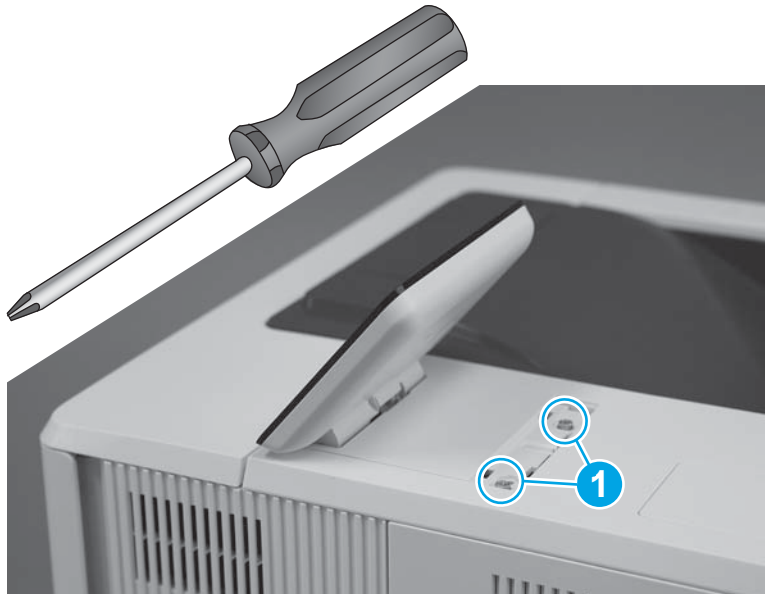
3. Rotate the control-panel base down onto the printer.

**Figure 1-1144** Rotate the control-panel base down



4. Use a small Phillips screwdriver to install two screws (callout 1).

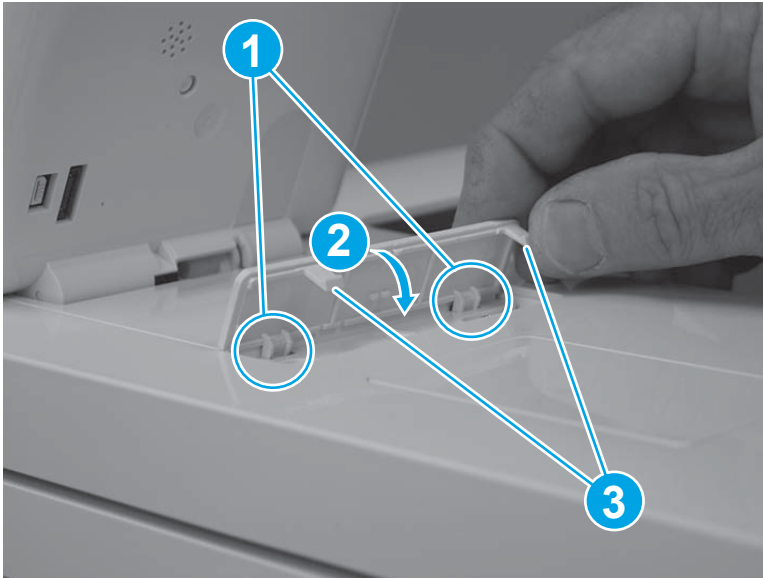
**Figure 1-1145** Install two screws



5. Position the screw cover mounting feet into the slots in the top cover (callout 1), and then rotate the cover down (callout 2) to install it.


 **NOTE:** Press down on the cover firmly to make sure that the tabs (callout 3) snap into place.

**Figure 1-1146** Install the cover





## Removal and replacement: Formatter case

 **IMPORTANT:** Some figure might show assemblies removed or installed that have not yet been removed or installed at that specific step. However, the procedures are correct for this printer and the target assembly. Always thoroughly read the instructions that accompany each figure

- [Introduction](#)
- [Step 1: Remove the control panel \(M506x\)](#)
- [Step 2: Remove the tray](#)
- [Step 3: Remove the formatter cover](#)
- [Step 4: Remove the hard-disk drive \(HDD\)](#)
- [Step 5: Remove the fax PCA \(M527\)](#)
- [Step 6: Remove the formatter](#)
- [Step 7: Remove the stapler door or stapler blank cover \(M527\)](#)
- [Step 8: Remove the stapler stationary \(inner\) cover \(M527\)](#)
- [Step 9: Remove the top-left cover \(M527\)](#)
- [Step 10: Remove the top-rear cover \(M527\)](#)
- [Step 11: Remove the rear door assembly](#)
- [Step 12: Remove the cartridge door assembly](#)
- [Step 13: Remove the right cover](#)
- [Step 14: Remove the left cover](#)
- [Step 15: Remove the integrated scanner assembly \(M527\)](#)
- [Step 16: Remove the top cover \(M527\)](#)
- [Step 17: Remove the top cover \(M501/M506\)](#)
- [Step 18: Remove the paper delivery tray \(output bin\)](#)
- [Step 19: Remove the formatter case](#)
- [Step 20: Unpack the replacement formatter case](#)
- [Step 21: Install the formatter case](#)
- [Step 22: Install the paper delivery tray \(output bin\)](#)
- [Step 23: Install the top cover \(M501/M506\)](#)
- [Step 24: Install the top cover \(M527\)](#)
- [Step 25: Install the integrated scanner assembly \(M527\)](#)
- [Step 26: Install the left cover](#)
- [Step 27: Install the right cover](#)

- [Step 28: Install the cartridge door assembly](#)
- [Step 29: Install the rear door assembly](#)
- [Step 30: Install the top-rear cover \(M527\)](#)
- [Step 31: Install the top-left cover \(M527\)](#)
- [Step 32: Install the stapler stationary \(inner\) cover \(M527\)](#)
- [Step 33: Install the stapler door or blank cover \(M527\)](#)
- [Step 34: Install the formatter](#)
- [Step 35: Install the fax PCA \(M527\)](#)
- [Step 36: Install the hard-disk drive \(HDD\)](#)
- [Step 37: Install the formatter cover](#)
- [Step 38: Install the tray](#)
- [Step 39: Install the control panel \(M506x\)](#)

## Introduction


This document provides the procedures to remove and replace the formatter case.

## Before performing service

### Turn the printer power off

- Disconnect the power cable.

---

 **WARNING!** To avoid damage to the printer, turn the printer off wait 30 seconds, and then remove the power cable before attempting to service the printer.

---

Use the table below to identify the correct part number for your printer. To order the part, go to [www.hp.com/buy/parts](http://www.hp.com/buy/parts).

Formatter case part number	
<b>RL2-0895-000CN</b>	Case, formatter (M527)
<b>RL2-0885-000CN</b>	Case, formatter (M506)
<b>RL2-0888-000CN</b>	Case, formatter (M501)

## Required tools

- Small flat-blad screwdriver.
- #2 Phillips screwdriver with a magnetic tip.

## After performing service

### Turn the printer power on

- Connect the power cable.
- Use the power switch to turn the power on.


### Post service test

Make sure that the printer initializes to a **Ready** state.

Print a configuration page to make sure that the printer is functioning correctly.

### Step 1: Remove the control panel (M506x)

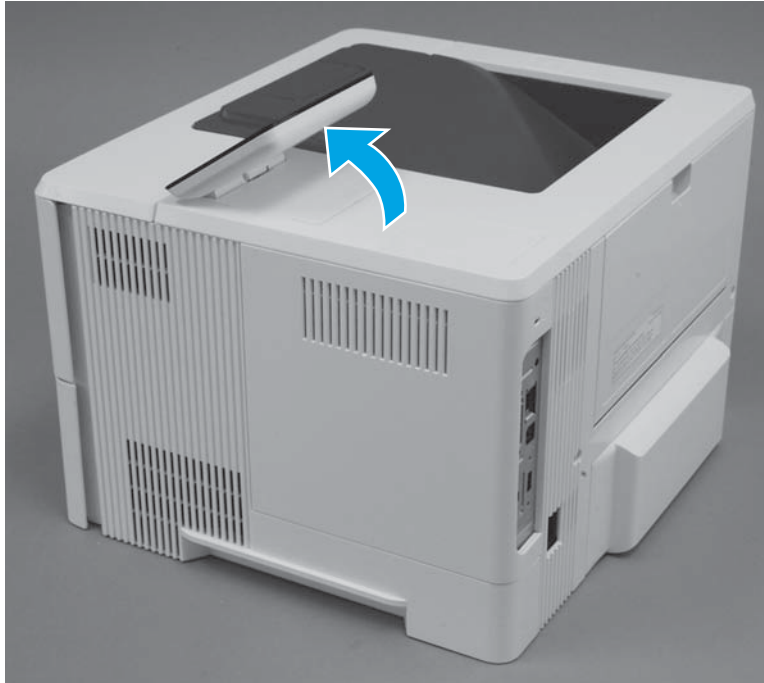
---

 **NOTE:** This step is for the M506x printer. For all other printers, skip this step and proceed to [Step 2: Remove the tray on page 663](#).

---

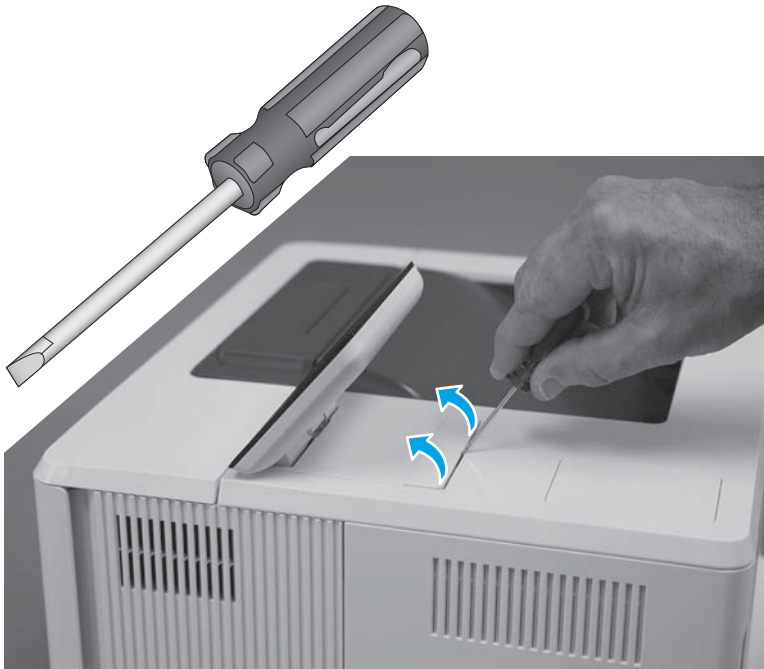
1. Tilt the control panel to the fully raised position.

**Figure 1-1147** Tilt the control panel up



2. Use a small flat-blad screwdriver to release the control-panel screws cover, and then remove the cover.

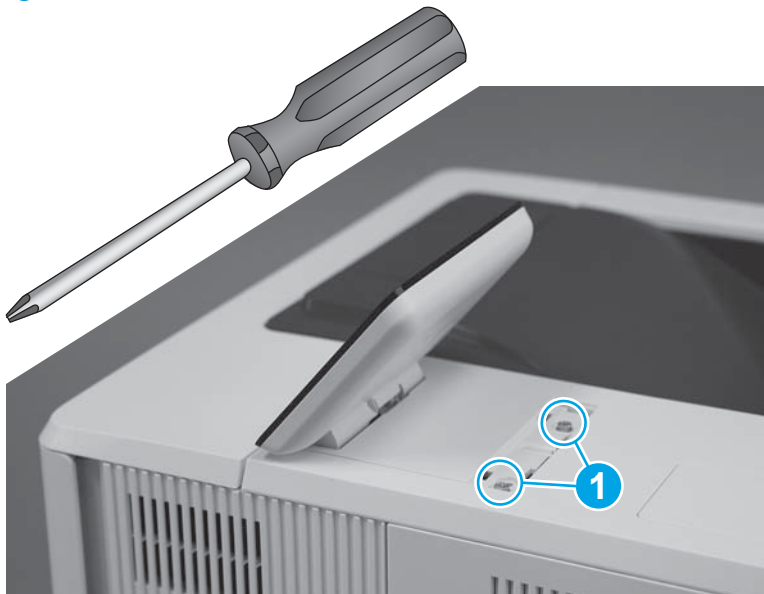
**Figure 1-1148** Remove the cover



3. Use a small Phillips screwdriver to remove two screws (callout 1).

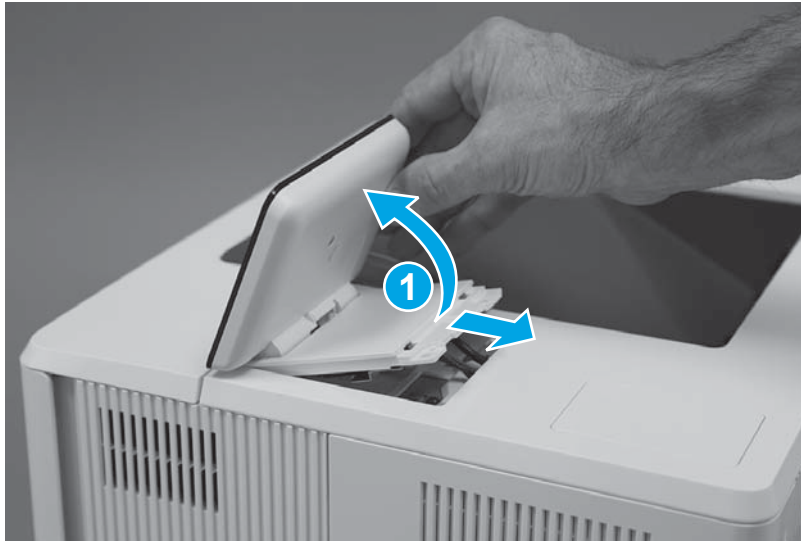
 **IMPORTANT:** Store the screws in a secure place where they cannot fall down into the printer.

**Figure 1-1149** Remove two screws



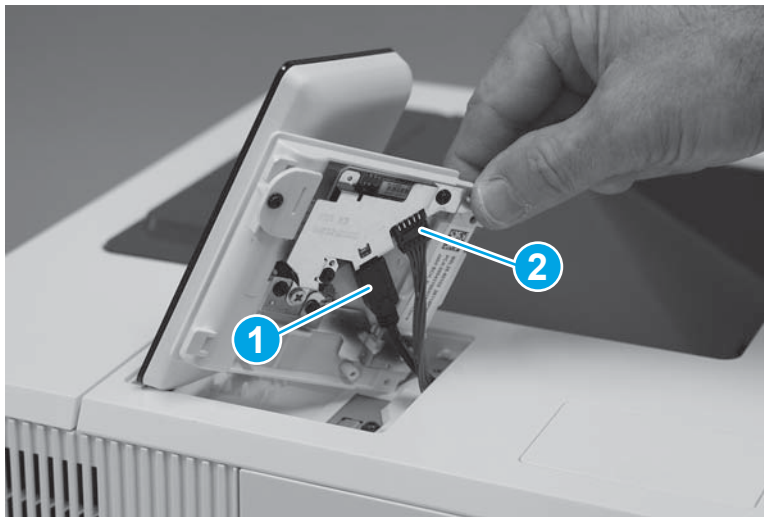
4. Turn the control panel over (callout 1), to gain access to the bottom side.

**Figure 1-1150** Turn the control panel over



5. Disconnect one HDMI cable (callout 1), one connector (callout 2), and then remove the control panel.

**Figure 1-1151** Remove the control panel



## Step 2: Remove the tray

1. Pull the tray straight out of the printer until it stops.

**Figure 1-1152** Pull the tray out until it stops



2. Lift the front of the tray, and then pull it out of the printer to remove it.

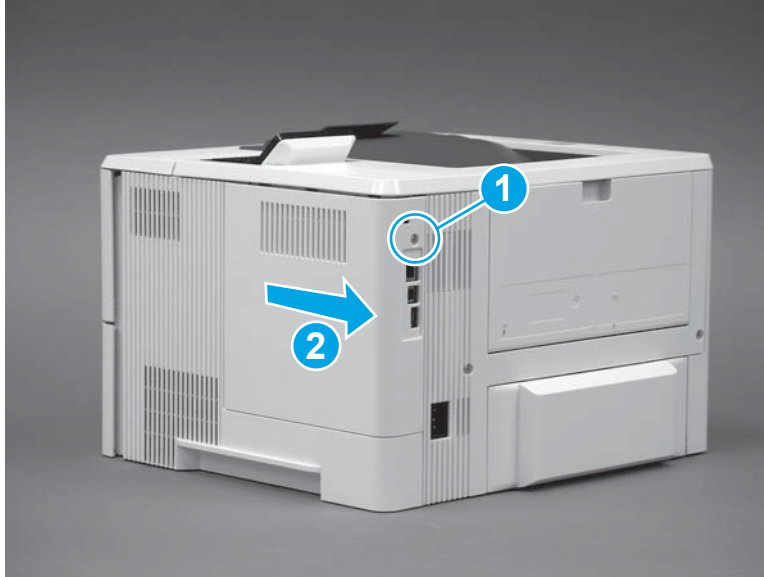
**Figure 1-1153** Release and remove the tray



### Step 3: Remove the formatter cover

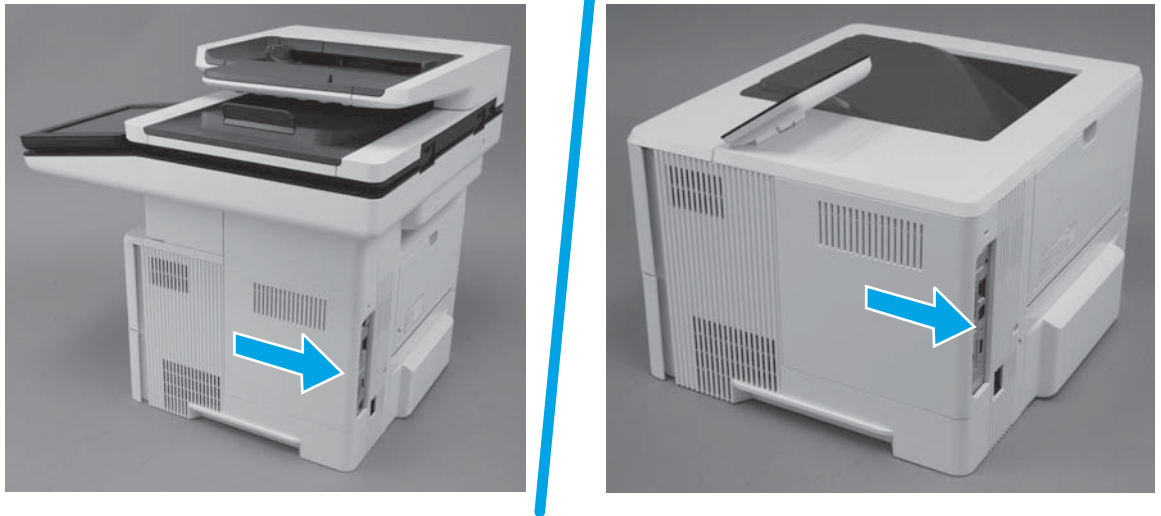
1. **M501:** Remove one screw (callout 1), and then slide the cover toward the rear of the printer to remove it (callout 2).

**Figure 1-1154** Remove the formatter cover (M501)




2. **M506/M527:** Slide the cover toward the rear of the printer to remove it.

**Figure 1-1155** Remove the formatter cover (M506/M527)



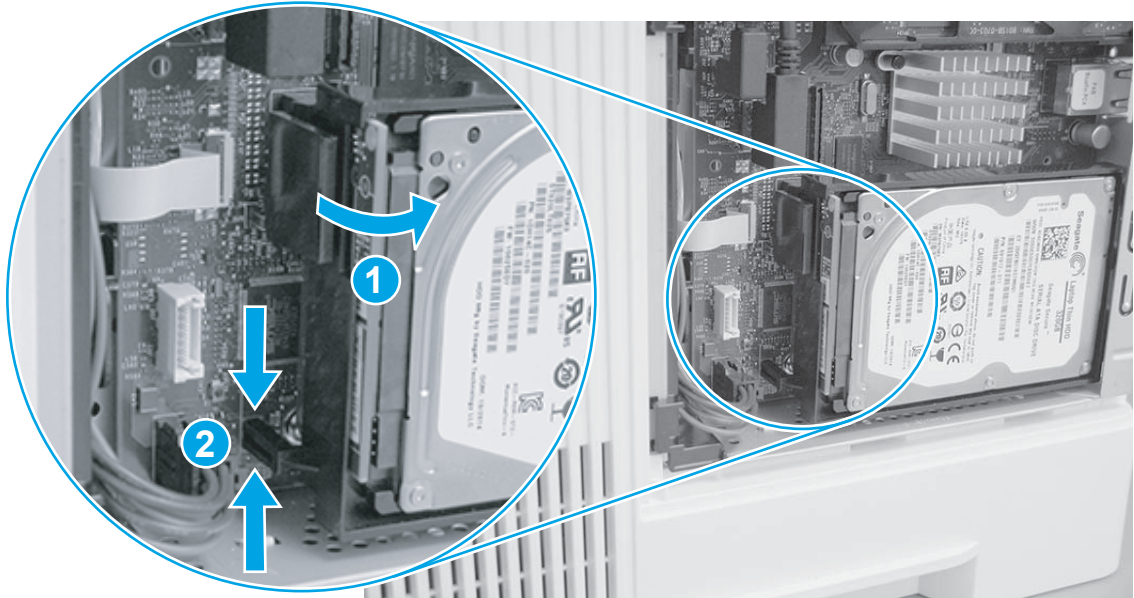
#### Step 4: Remove the hard-disk drive (HDD)

 **NOTE:** If the HDD is not installed, skip this step and go to [Step 5: Remove the fax PCA \(M527\) on page 666](#).

 **CAUTION:**  ESD-sensitive part.

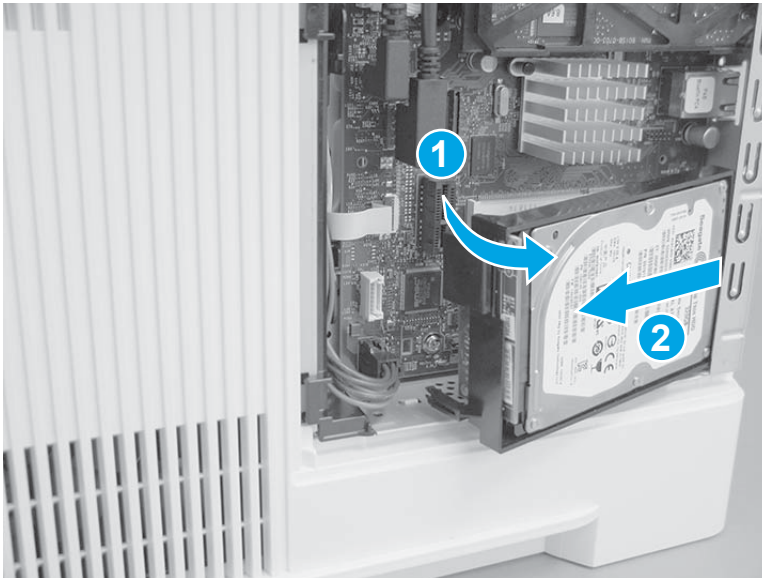
1. Release the locking connector (callout 1), and then pinch the retainer (callout 2) to release it.

**Figure 1-1156** Release the HDD




2. Rotate the connector end of the HDD out and away from the formatter (callout 1), and then slide it as shown (callout 2) to remove it.


**Figure 1-1157** Remove the HDD



### Step 5: Remove the fax PCA (M527)

 **NOTE:** If the fax PCA is not installed, skip this step and go to [Step 6: Remove the formatter on page 668](#).

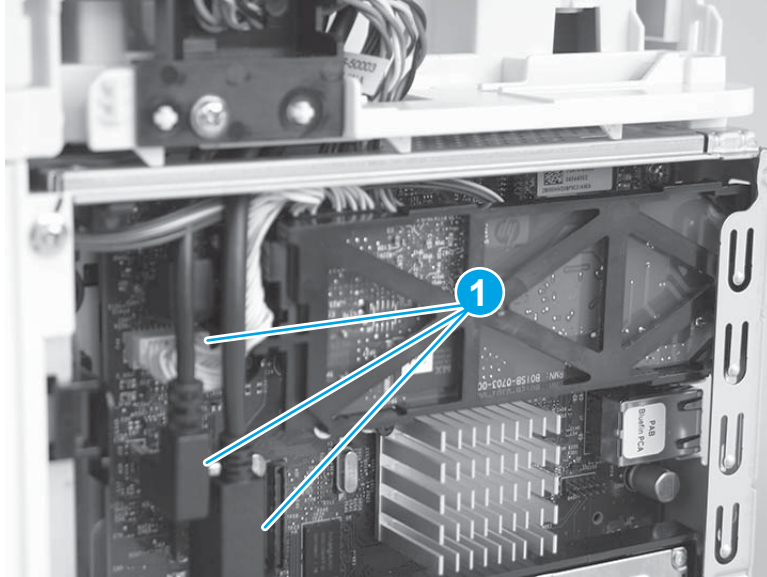
 **CAUTION:**  ESD-sensitive part.

 **NOTE:** M527c/f/z printers only (optional for the M527dn).

1. Disconnect three connectors (callout 1).

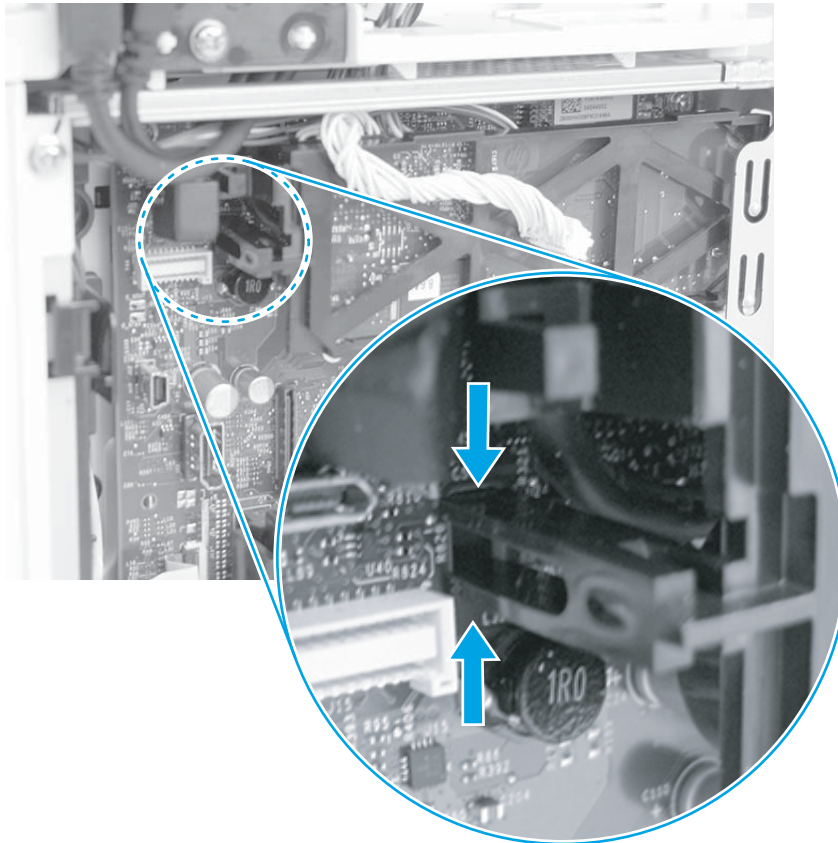


**Figure 1-1158** Disconnect three connectors



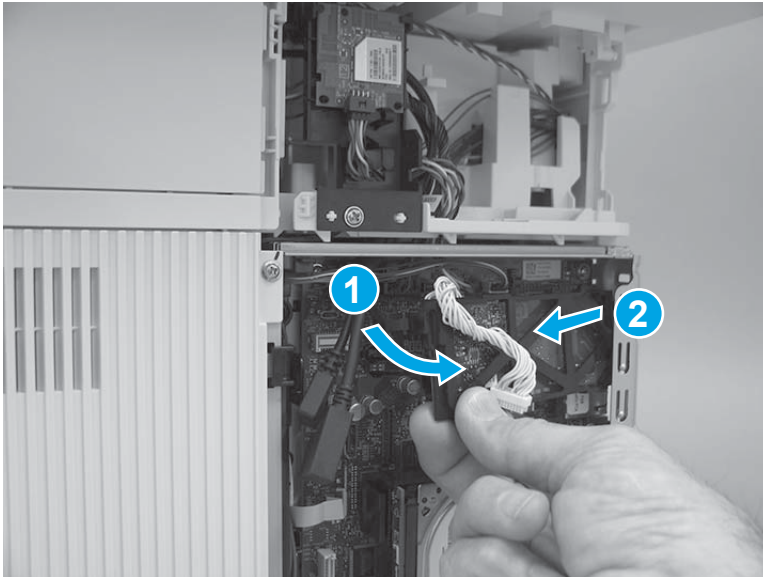
2. Pinch the retainer to release it.

**Figure 1-1159** Release the fax PCA




3. Rotate the connector end of the fax PCA out and away from the formatter (callout 1), and then slide it as shown (callout 2) to remove it.

**Figure 1-1160** Remove the fax PCA

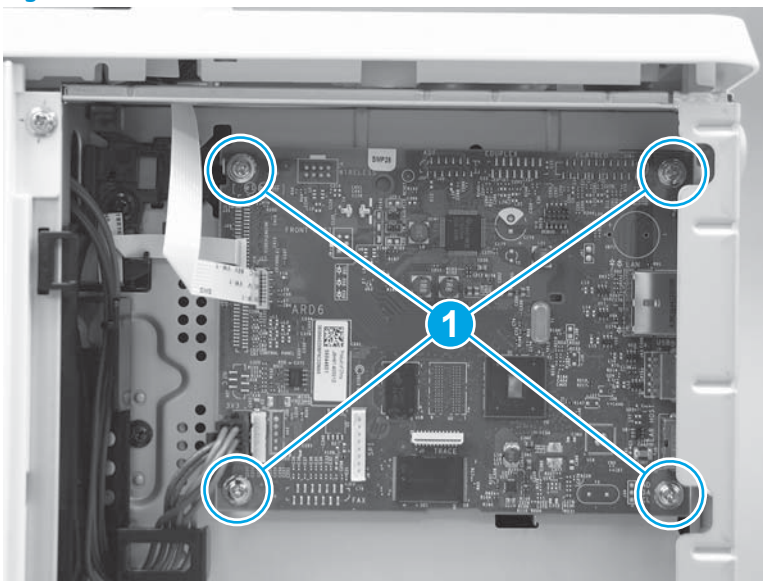


### Step 6: Remove the formatter


 **IMPORTANT:** **M506/M527:** Take note of all empty connectors on the PCA before disconnecting any wire harnesses or flat-flexible cables (FFCs). Some empty connectors might not be visible until other items—like the hard-disk drive—are removed, so pay close attention while removing the formatter and accessory items.

1. **M501:** Disconnect all of the connectors and FFCs, remove four screws (callout 1), and then remove the formatter.

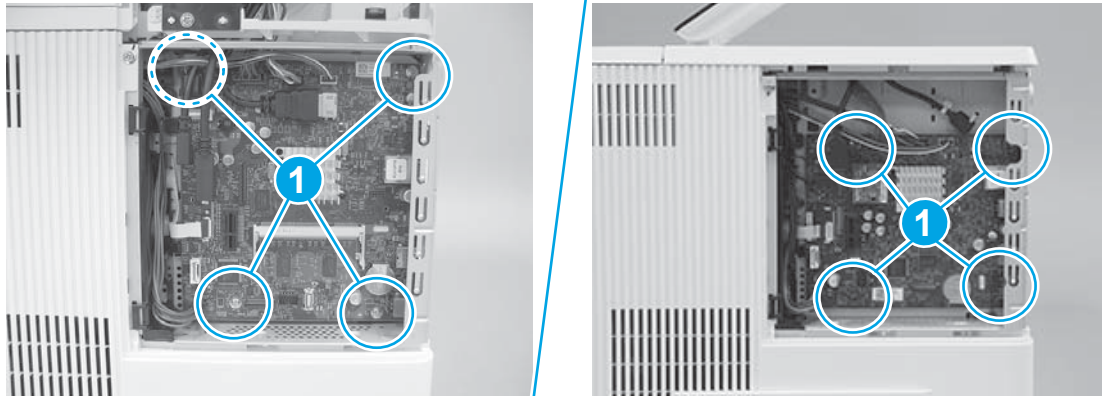
**Figure 1-1161** Remove the formatter (M501)




2. **M506/M527:** Disconnect all of the connectors and FFCs, remove four screws (callout 1), and then remove the formatter.

 **IMPORTANT:** Take note of all empty connectors on the formatter before disconnecting any wire harnesses or flat-flexible cables (FFCs). Some empty connectors might not be visible until other items—like the hard-disk drive—are removed, so pay close attention while removing the formatter and accessories items.

**Figure 1-1162** Remove the formatter (M506/M527)



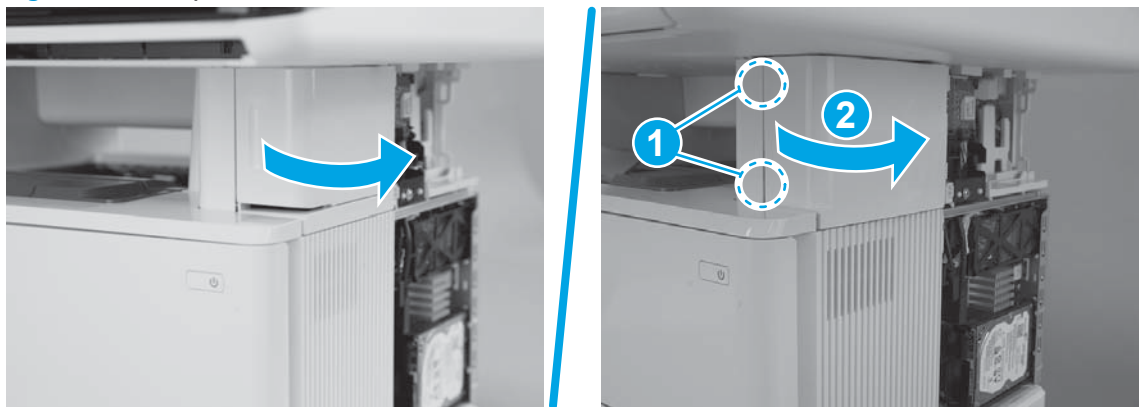
### Step 7: Remove the stapler door or stapler blank cover (M527)

 **NOTE:** This step is for the M527 printers. For the M501/M506, skip this step and go to [Step 11: Remove the rear door assembly on page 677](#). For the M527dn, skip this step and go to [Step 9: Remove the top-left cover \(M527\) on page 673](#).

The M527dn does not have a convenience stapler.

1. Do one of the following:
  - **M527c/f/z:** Open the stapler door.
  - **M527dn:** Use a small flat-blade screw driver to release two tabs (callout 1), and then rotate the cover away from the printer (callout 2).

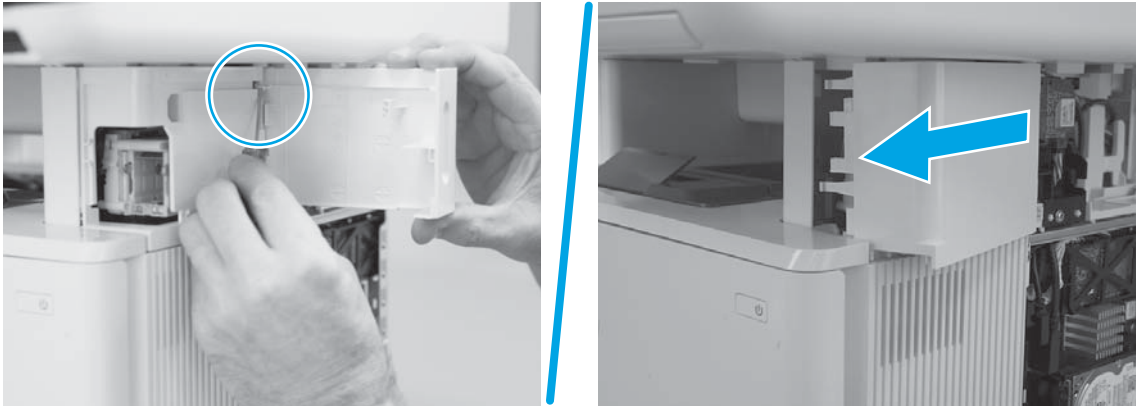
**Figure 1-1163** Open the door or release the cover



2. Do one of the following:

- **M527c/f/z:** Use a small flat-blad screwdriver to release the upper hinge.
- **M527dn:** Slide the cover toward the front of the printer to remove it.

**Figure 1-1164** Release the upper hinge or remove the cover



3. **M527c/f/z:** Use a small flat-blad screwdriver to release the lower hinge.

**Figure 1-1165** Release the lower hinge





4. **M527c/f/z:** Remove the door.

**Figure 1-1166** Remove the door



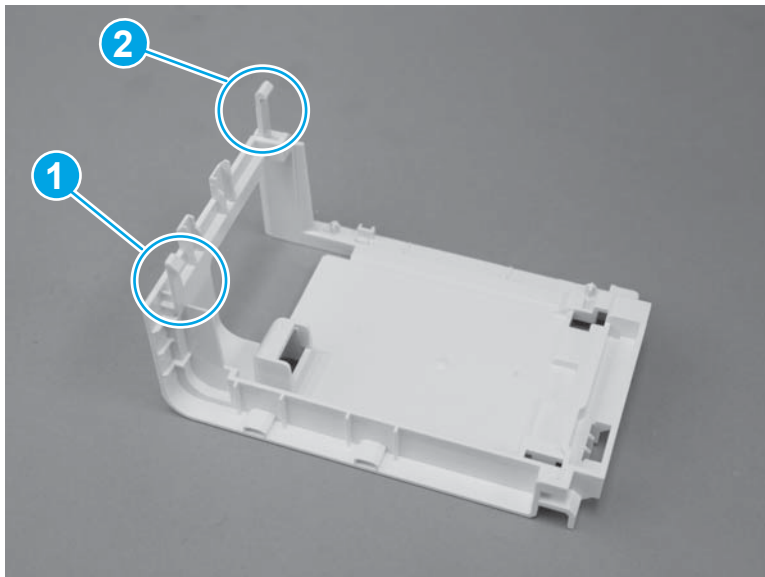
#### Step 8: Remove the stapler stationary (inner) cover (M527)

 **NOTE:** This step is for the M527c/f/z printers. For the M501/M506, skip this step and go to [Step 11: Remove the rear door assembly on page 677](#). For the M527dn, skip this step and go to [Step 9: Remove the top-left cover \(M527\) on page 673](#).

 **NOTE:** M527c/f/z printers only.

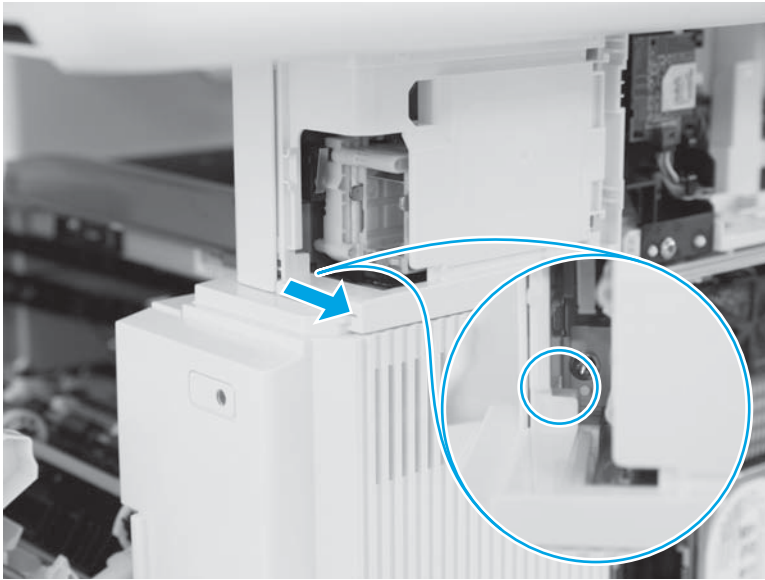
1. Before proceeding, take note of the locations of the upper tab (callout 1) and the lower tab (callout 2) on the stapler stationary (inner) cover.

**Figure 1-1167** Locate the tabs



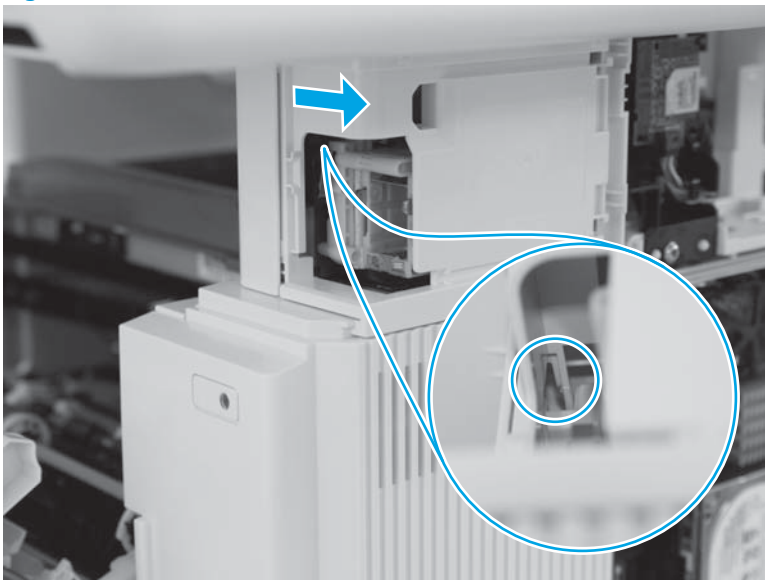
2. Use a long-shaft small flat-blad screwdriver to release the lower tab.

**Figure 1-1168** Release one tab



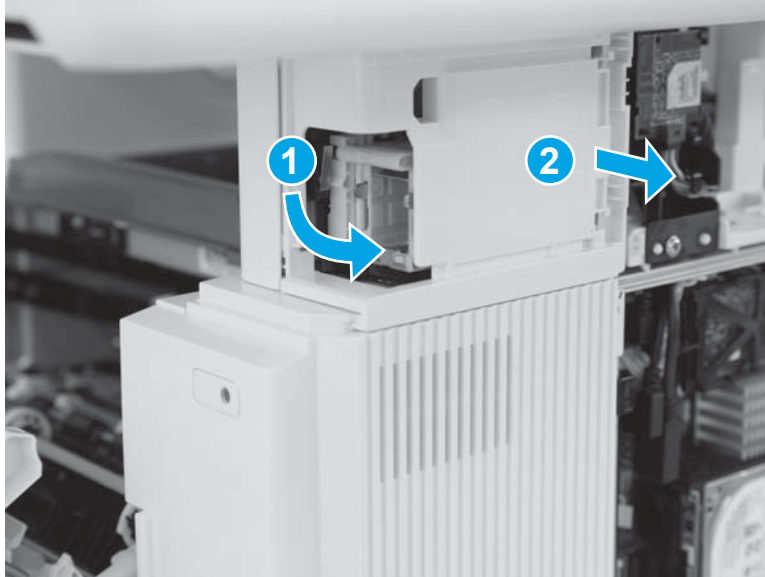
3. Use a long-shaft small flat-blad screwdriver to release the upper tab.

**Figure 1-1169** Release one tab




4. With the tabs disengaged the front of the cover is released. Rotate the front of the cover away from the printer (callout 1) to release the rear of the cover (callout 2), and then remove it.

**Figure 1-1170** Remove the cover

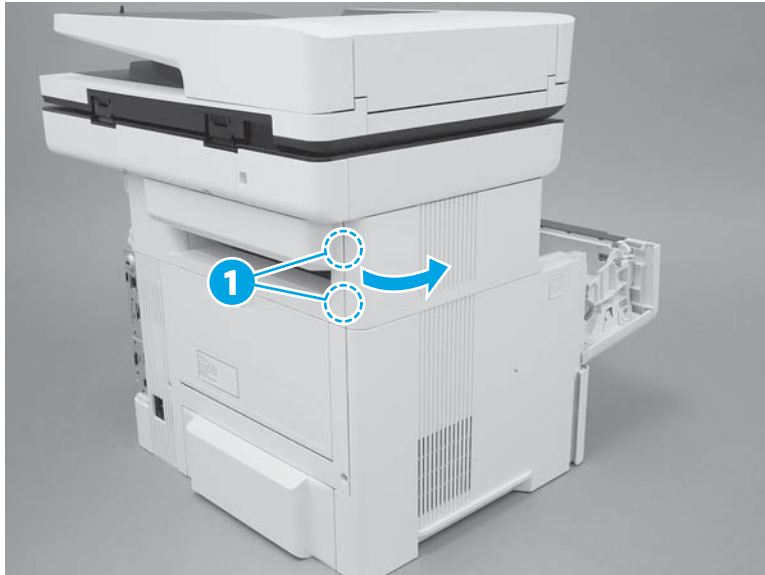


#### Step 9: Remove the top-left cover (M527)

 **NOTE:** This step is for the M527 printer. For the M501/M506, skip this step and go to [Step 11: Remove the rear door assembly on page 677](#).

1. Open the toner-cartridge door, release two tabs (callout 1), and then rotate the rear edge of the cover away from the printer.

**Figure 1-1171** Release two tabs



2. Continue to rotate the cover away from the printer to release two more tabs at the middle of the cover.

**Figure 1-1172** Release two tabs



3. Slide the cover toward the rear of the printer to release two bosses at the front of the cover.

**Figure 1-1173** Slide the cover






4. Remove the cover.

**Figure 1-1174** Remove the cover

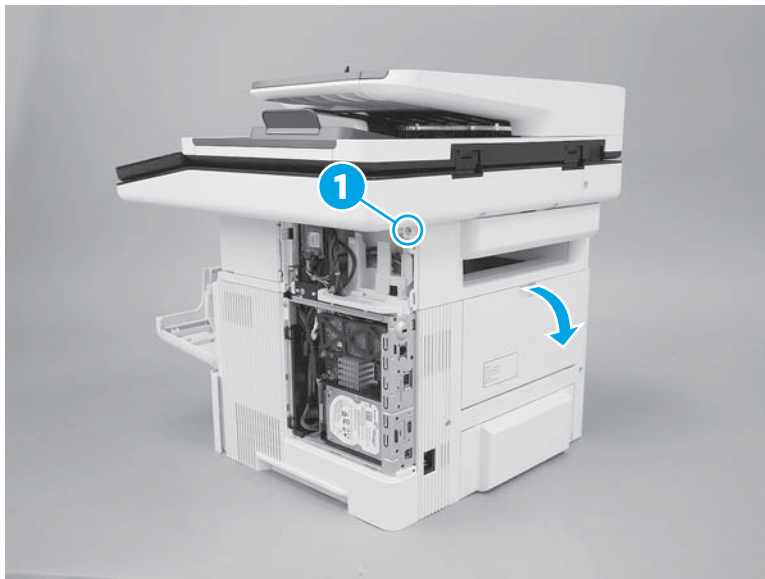


#### Step 10: Remove the top-rear cover (M527)

 **NOTE:** This step is for the M527 printer. For the M501/M506, skip this step and go to [Step 11: Remove the rear door assembly on page 677](#).

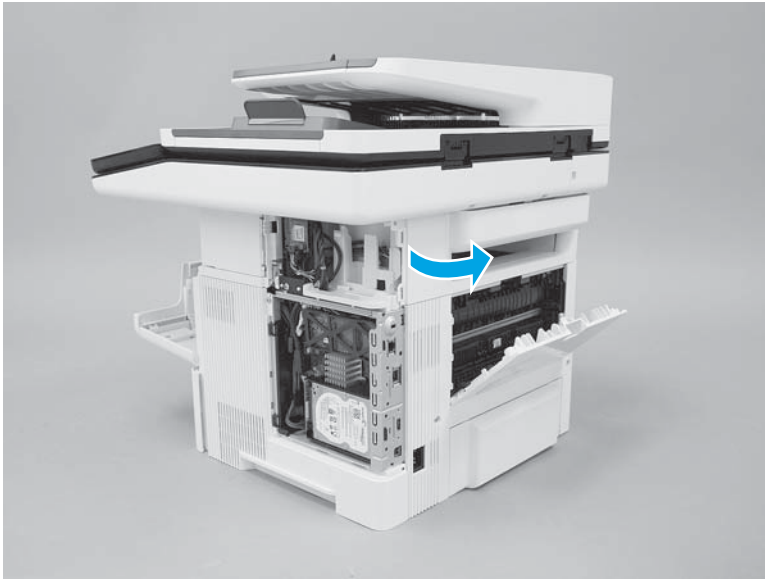
1. Remove one screw (callout 1), and then open the rear door.

**Figure 1-1175** Remove one screw



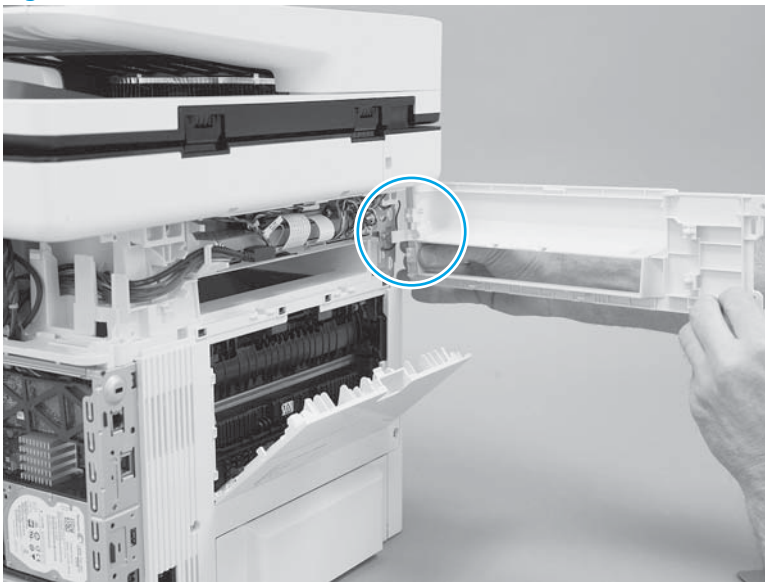
2. Rotate the exposed edge of the cover away from the printer (as shown).

**Figure 1-1176** Rotate the cover



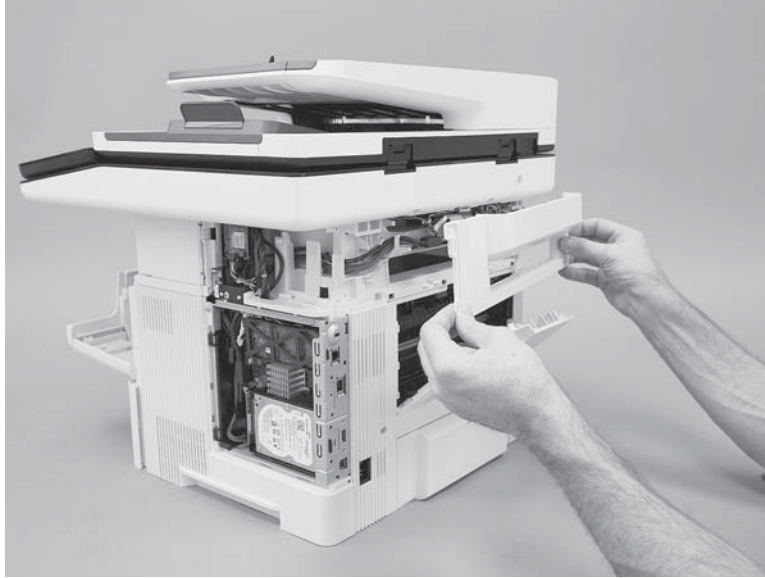
3. Continue to rotate the cover away from the printer to release one boss.

**Figure 1-1177** Release one boss



4. Remove the cover.

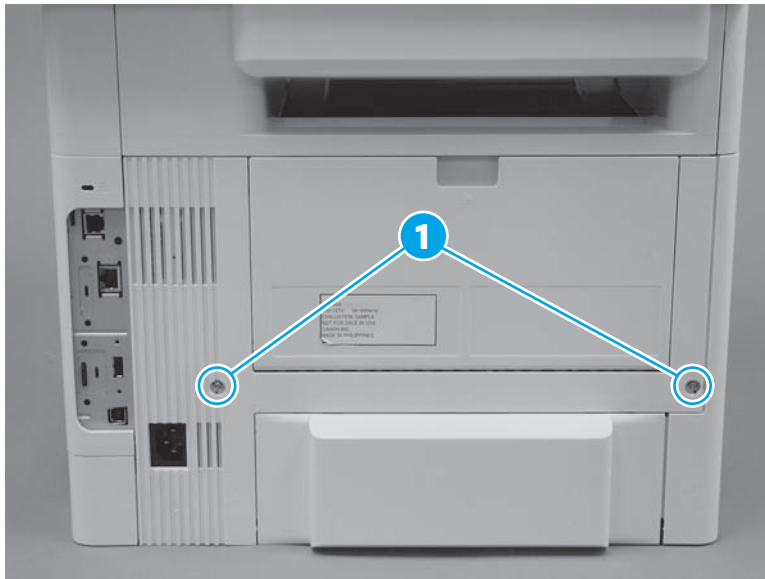
**Figure 1-1178** Remove the cover



### Step 11: Remove the rear door assembly

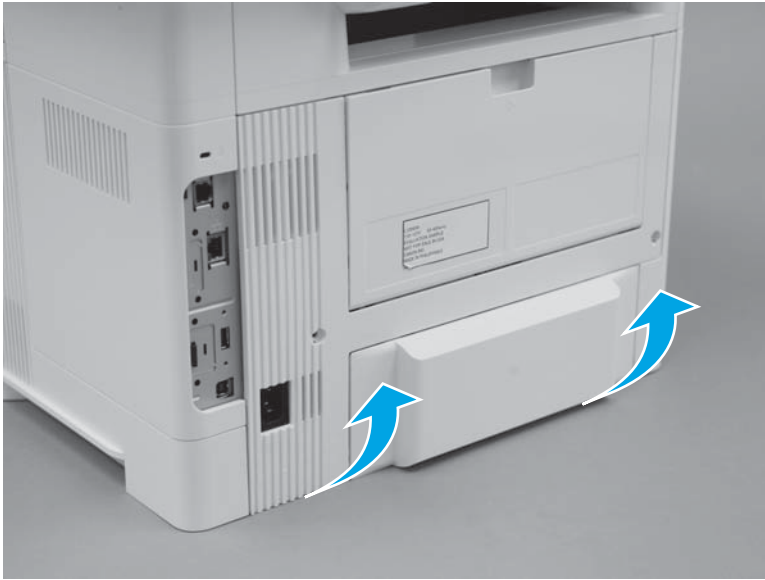
1. At the rear of the printer, remove two screws (callout 1).

**Figure 1-1179** Remove two screws



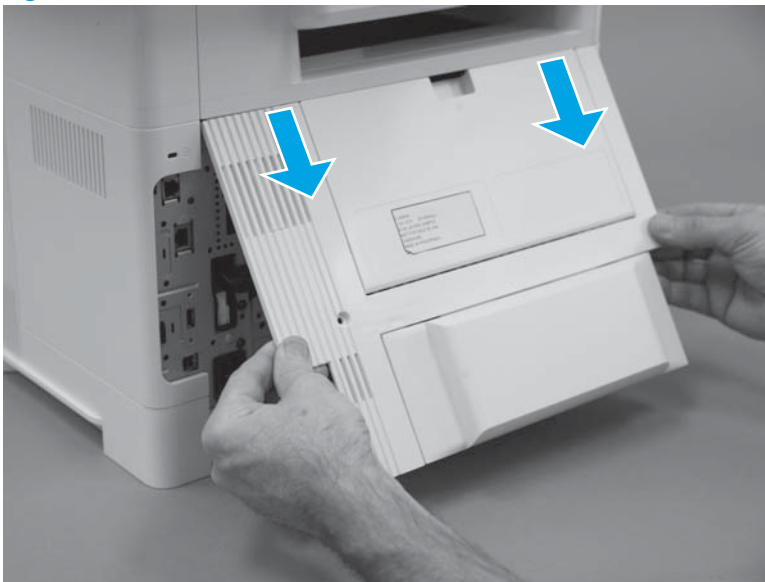
2. Rotate the bottom edge of the assembly away from the printer to release it.

**Figure 1-1180** Rotate the bottom of the cover



3. Pull down on the assembly to remove it.

**Figure 1-1181** Remove the cover



### Step 12: Remove the cartridge door assembly



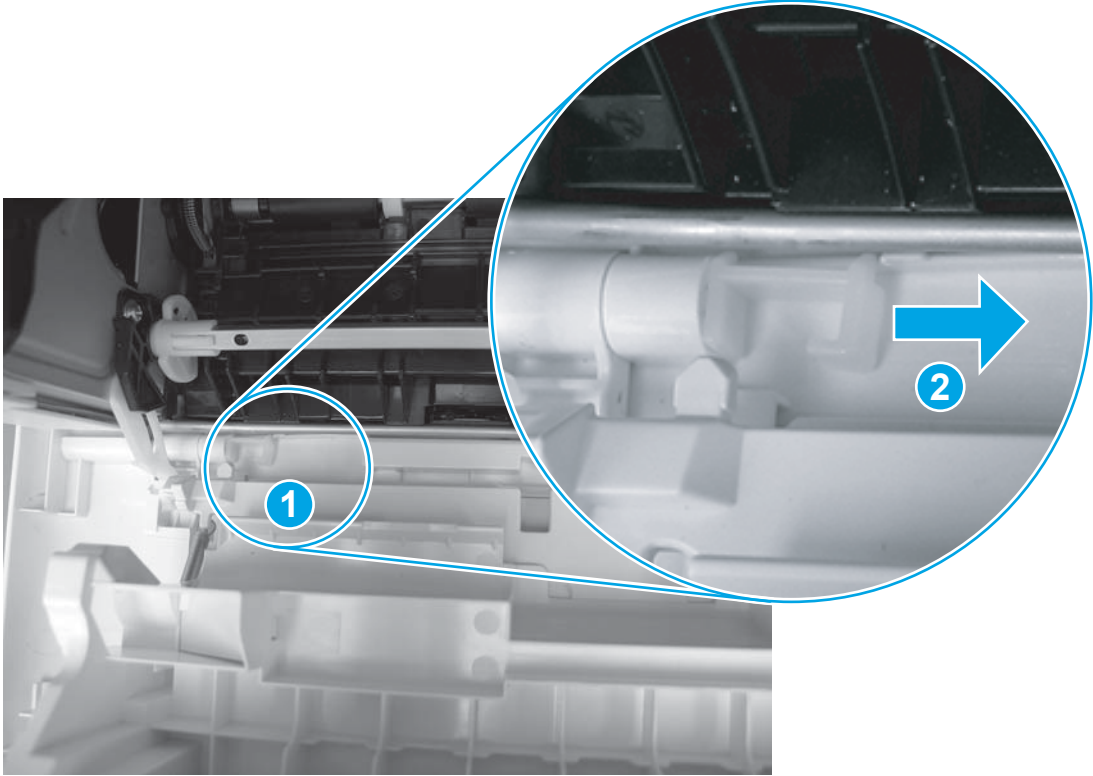
**NOTE:** If the toner cartridge was not removed prior to servicing the printer, remove it now.

1. Release the support shaft (callout 1), and then slide it toward the center of the door (callout 2).



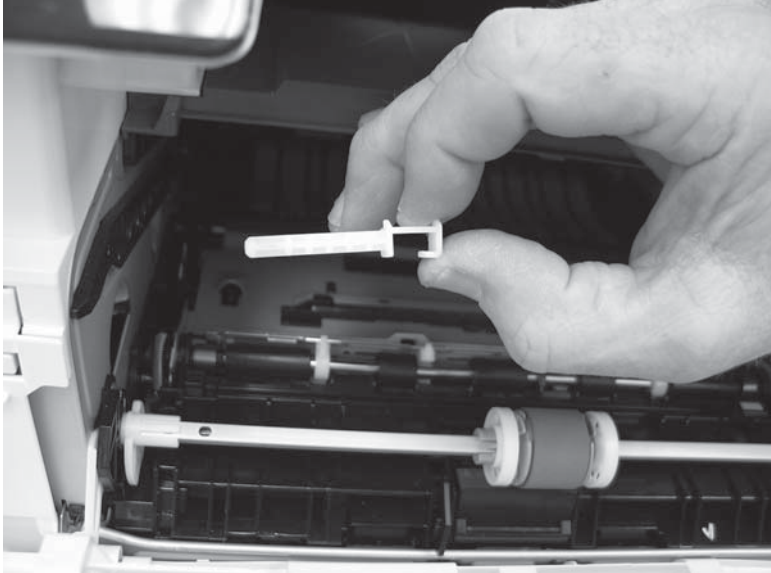
**TIP:** It might be easier to release the support shaft by using a small flat-blade screwdriver.

**Figure 1-1182** Release the support shaft



- 2. Remove the support shaft.

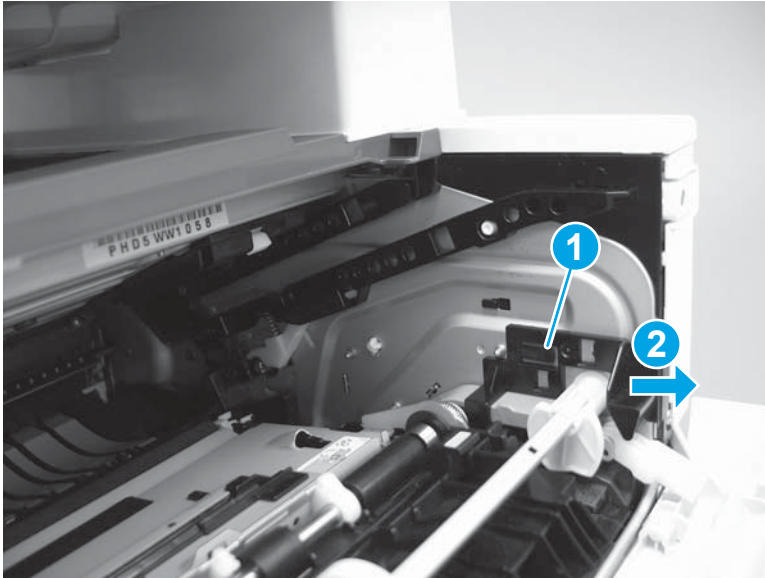
**Figure 1-1183** Remove the support shaft



3. Release one tab (callout 1), and then slide the guide out of the printer (callout 2).

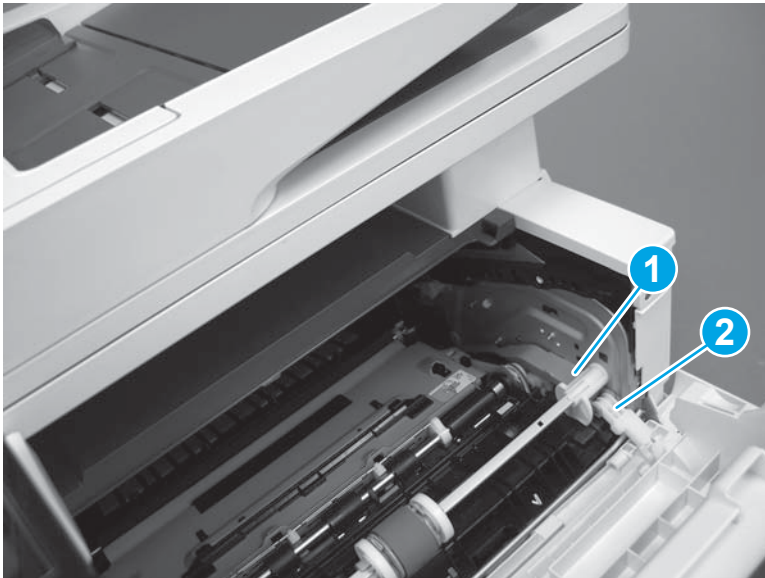
**⚠ CAUTION:** Be careful, the tab (callout 1) can be easily broken.

**Figure 1-1184** Remove the guide



4. Use a small flat-blad screwdriver to gently pry the white-plastic door arm (callout 1) off of the gray-plastic pressure-release link (callout 2) to release the door arm.

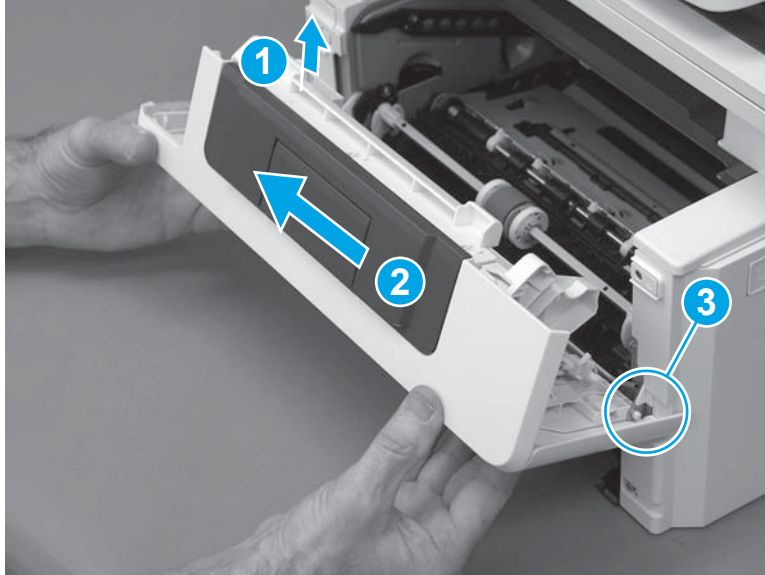
**Figure 1-1185** Release the pressure-release link



5. With the door in the partially closed position, slightly raise the left end (callout 1; raise it over the sheet-metal hinge boss), and then slide the door to the left (callout 2) to release the right hinge (callout 3).

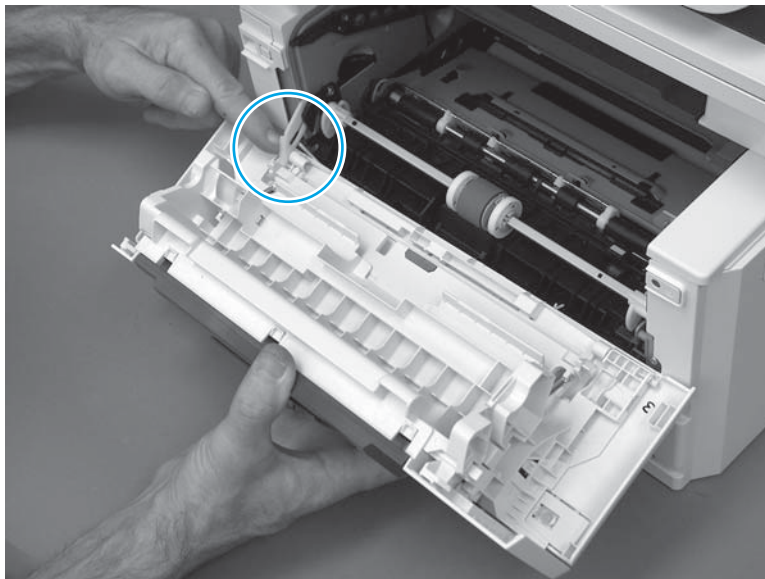
**CAUTION:** The door is still attached to the printer by the left-side retainer arm. Do not attempt to completely remove the door.

**Figure 1-1186** Release the door



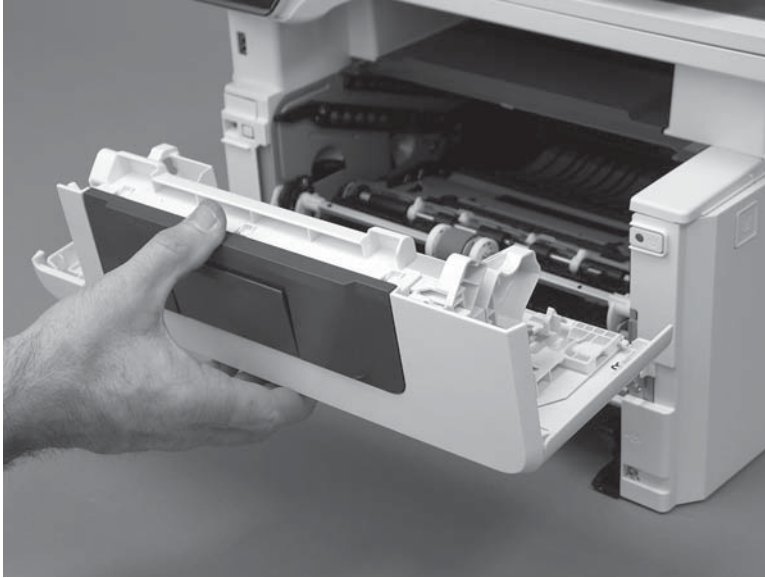
6. Rotate the door away from the printer until the keyed pin on the left-side retainer arm can disengage from the door.

**Figure 1-1187** Release the left-side retainer arm





7. Remove the door.

**Figure 1-1188** Remove the door



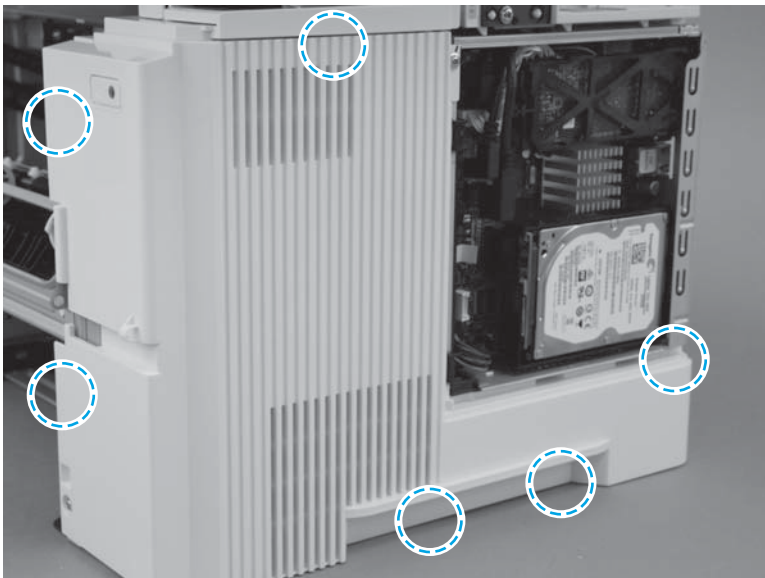
### Step 13: Remove the right cover

 **IMPORTANT:** The black-plastic cassette front and rear guides (located inside the tray cavity) can be easily dislodged. Do not lose the guides when the cover is removed or installed.

 **NOTE:** The M527 printer is shown in this procedure. However, this procedure is valid for the M501/M506 printers.

1. Before proceeding, take note of the location of the tabs and bosses on the inside of the cover.

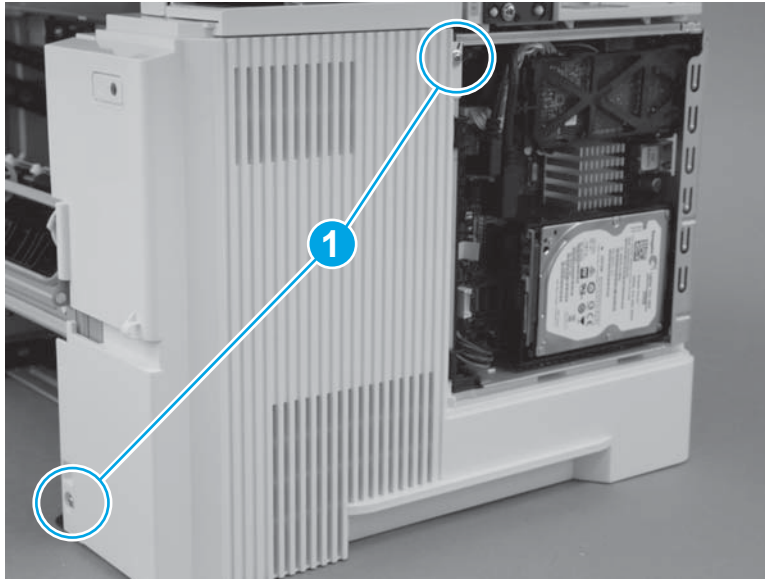
**Figure 1-1189** Locate the tabs and bosses





2. Remove two screws (callout 1).

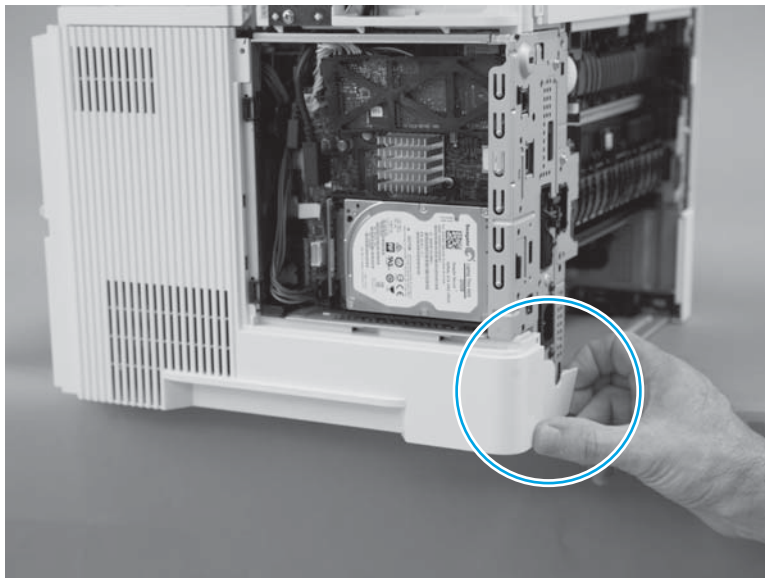
**Figure 1-1190** Remove two screws



3. At the rear of the printer, release one boss.

**⚠ CAUTION:** It might be easier to remove the cover with the printer slightly hanging over the edge of the workspace. Do not let the printer tip and fall off of the workspace when removing the cover.

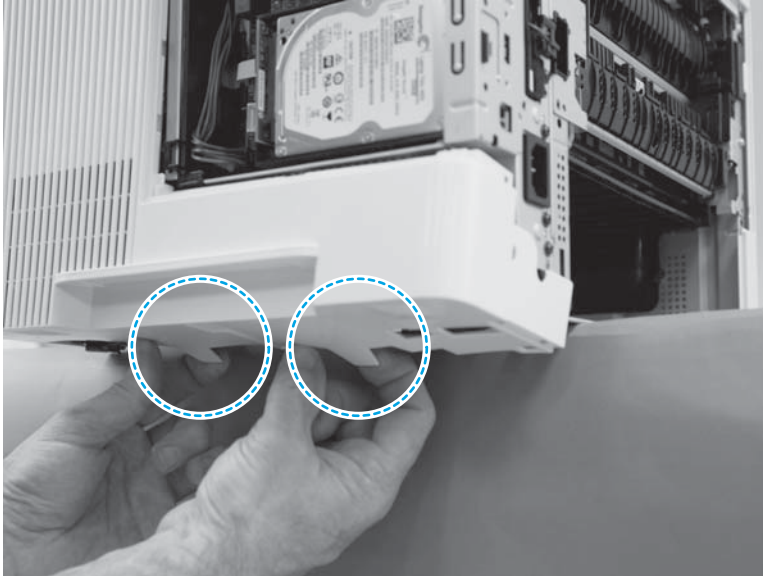
**Figure 1-1191** Release one boss



4. At the bottom edge of the cover, release two bosses.

**⚠ CAUTION:** It might be easier to remove the cover with the printer slightly hanging over the edge of the workspace. Do not let the printer tip and fall off the workspace when removing the cover.

**Figure 1-1192** Release two bosses

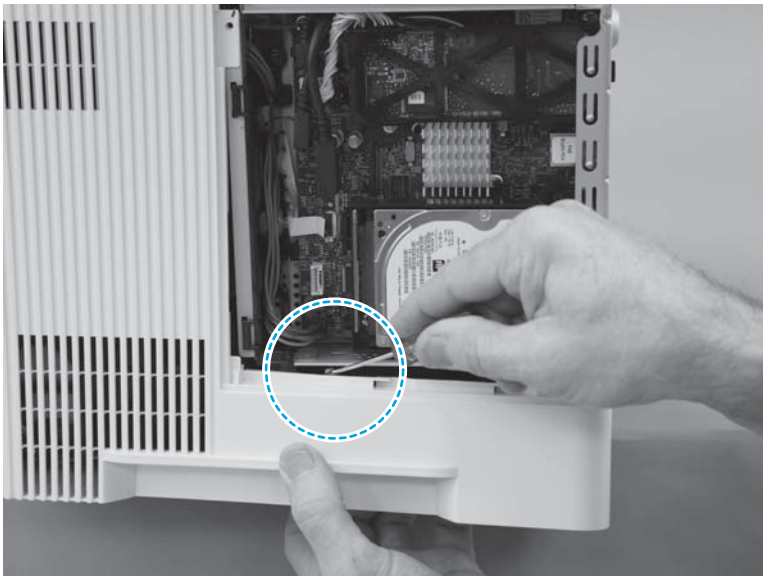


5. Near the formatter, release one tab.

**⚠ CAUTION:** It might be easier to remove the cover with the printer slightly hanging over the edge of the workspace. Do not let the printer tip and fall off the workspace when removing the cover.

**💡 TIP:** Hold the bottom of the cover away from the printer, and then use a small flat-blade screw driver to easily release this tab.

**Figure 1-1193** Release one tab

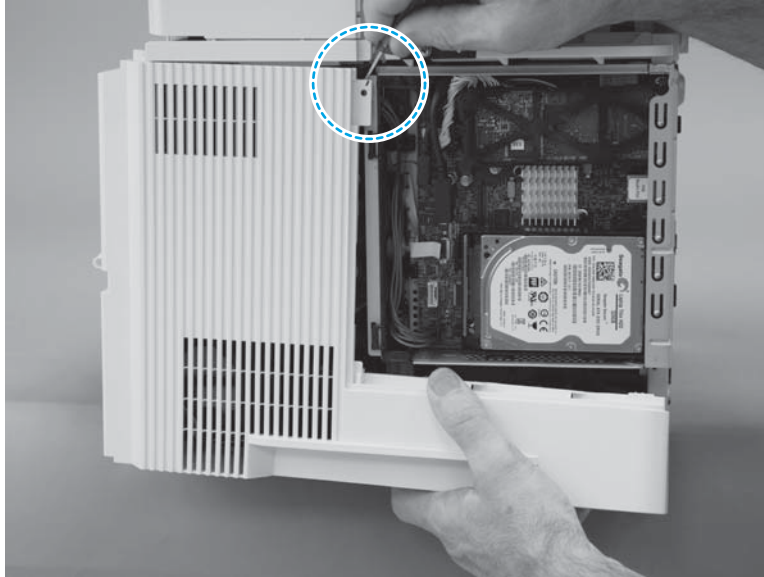


6. At the top rear edge of the cover, release one tab.

**CAUTION:** It might be easier to remove the cover with the printer slightly hanging over the edge of the workspace. Do not let the printer tip and fall off of the workspace when removing the cover.

**TIP:** Use a small flat-blade screw driver to easily release this tab.

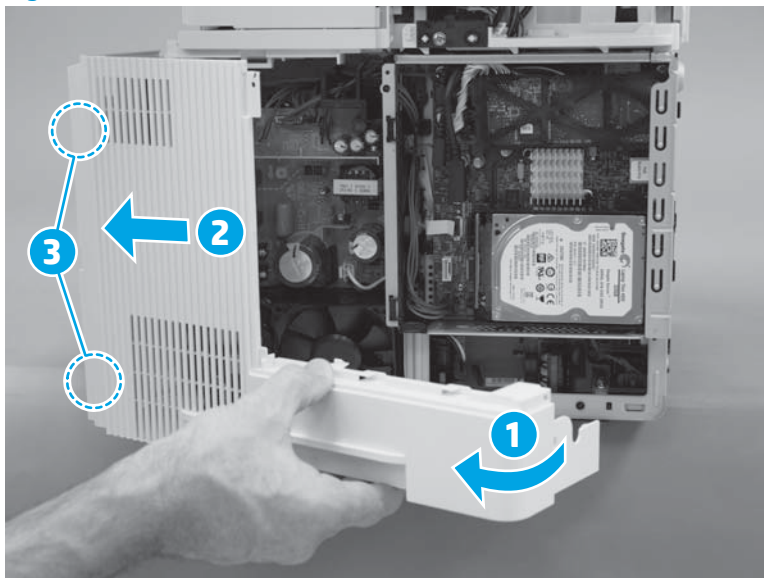
**Figure 1-1194** Release one tab




7. Rotate the rear of the cover away from the printer (callout 1), slide the cover toward the front of the printer (callout 2) to release two bosses (callout 3), and then remove the cover.


**CAUTION:** It might be easier to remove the cover with the printer slightly hanging over the edge of the workspace. Do not let the printer tip and fall off of the workspace when removing the cover.

**Figure 1-1195** Remove the cover



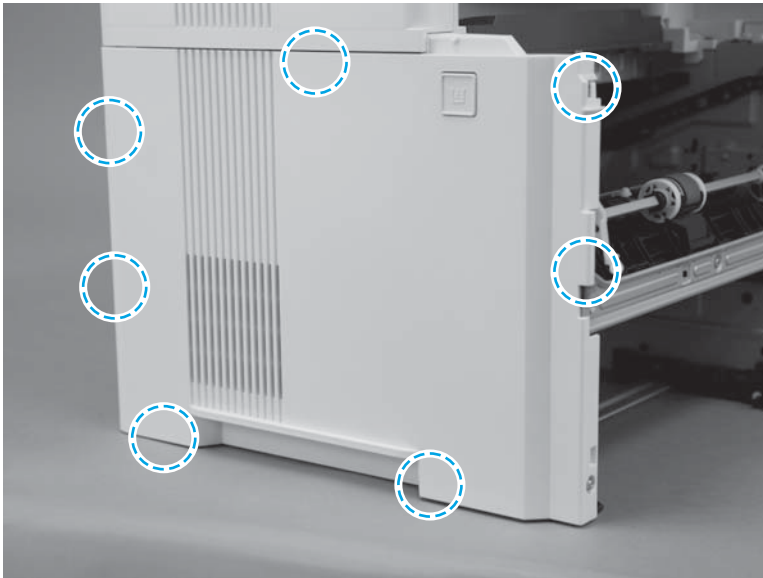
## Step 14: Remove the left cover

 **IMPORTANT:** The black-plastic cassette front and rear guides (located inside the tray cavity) can be easily dislodged. Do not lose the guides when the cover is removed or installed.

 **NOTE:** The M527 printer is shown in this procedure. However, this procedure is valid for the M501/M506 printers.

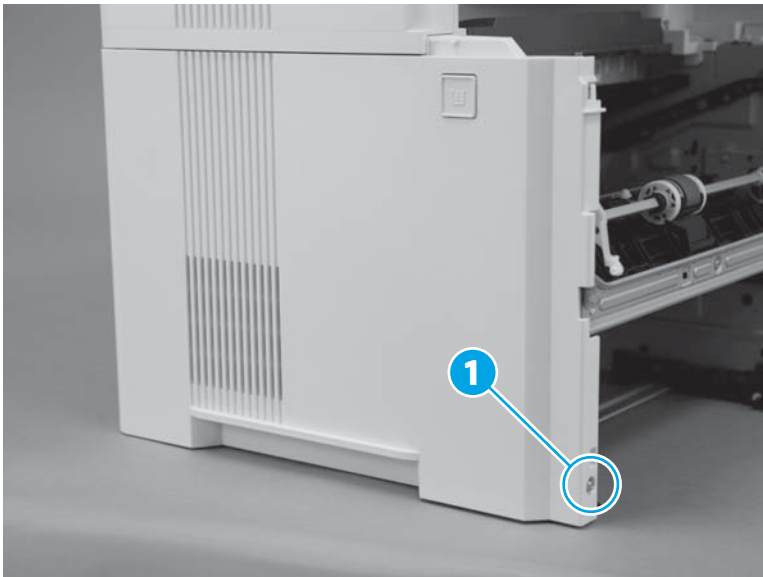
1. Before proceeding, take note of the location of the tabs and bosses on the inside of the cover.

**Figure 1-1196** Locate of the tabs and bosses



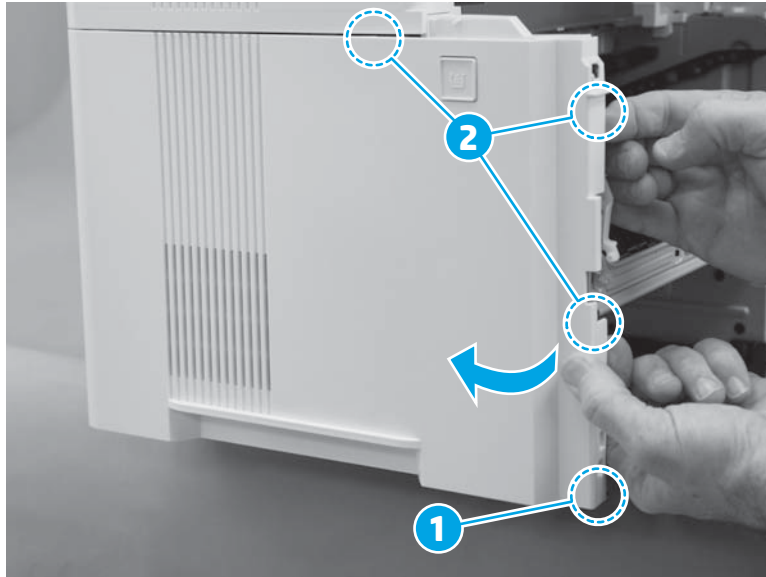
2. Remove one screw (callout 1).

**Figure 1-1197** Remove one screw



3. At the front of the printer, release one boss (callout 1), and then rotate the front edge of the cover away from the printer to release three tabs (callout 2).

**Figure 1-1198** Release one boss and three tabs




4. At the bottom edge of the cover, release two tabs.

**Figure 1-1199** Release two tabs



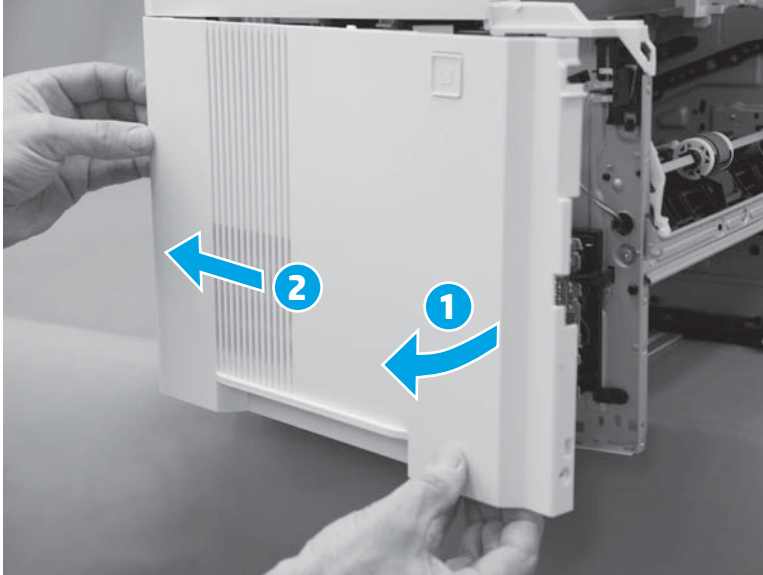
5. Continue to rotate the front edge of the cover away from the printer (callout 1), and then slide the cover toward the rear of the printer (callout 2) to remove it.

---

 **NOTE:** If the cover is difficult to rotate or slide as shown below, make sure that the bottom tabs (released in the previous step) are completely disengaged from the chassis.


---


**Figure 1-1200** Remove the cover




### Step 15: Remove the integrated scanner assembly (M527)

---

 **IMPORTANT:** Some figure might show assemblies removed or installed that have not yet been removed or installed at that specific step. However, the procedures are correct for this printer and the target assembly. Always thoroughly read the instructions that accompany each figure

 **NOTE:** This step is for the M527 printer. For the M501/M506, skip this step and go to [Step 17: Remove the top cover \(M501/M506\) on page 694](#).

---

 **NOTE:** The ISA includes the document feeder, sub-scanner assembly (SSA), and the scanner control board (SCB)

---

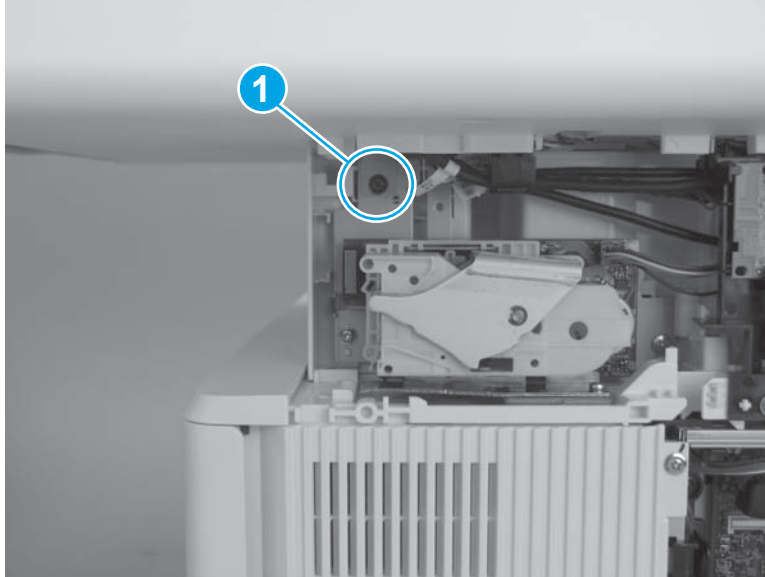
1. Remove one screw (callout 1).

---

 **IMPORTANT:** This screw fastens the ISA ground plate to the printer chassis. Do not lose this screw.


---

**Figure 1-1201** Remove one screw

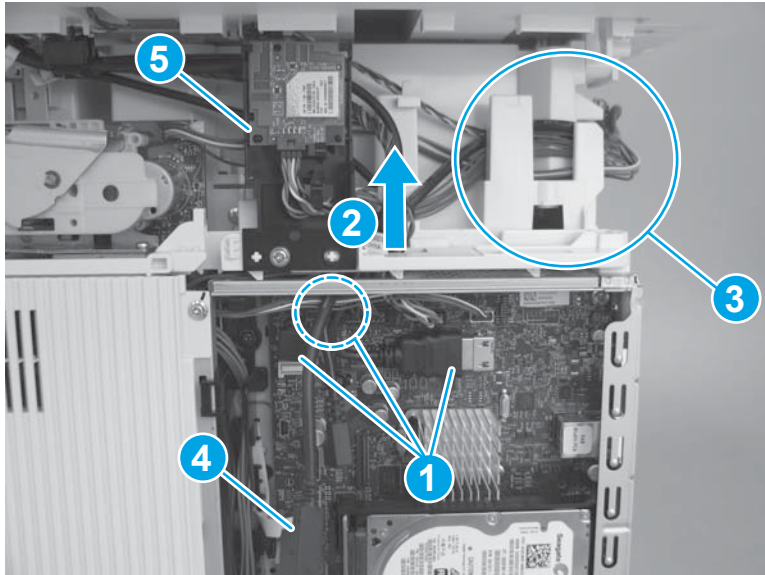


2. Disconnect three connectors (callout 1), pass the wire harnesses and cables through the opening in the cover (callout 2), and then release them from the retainers (callout 3).

 **NOTE:** One cable (callout 4) does not need to pass through the opening in the cover.

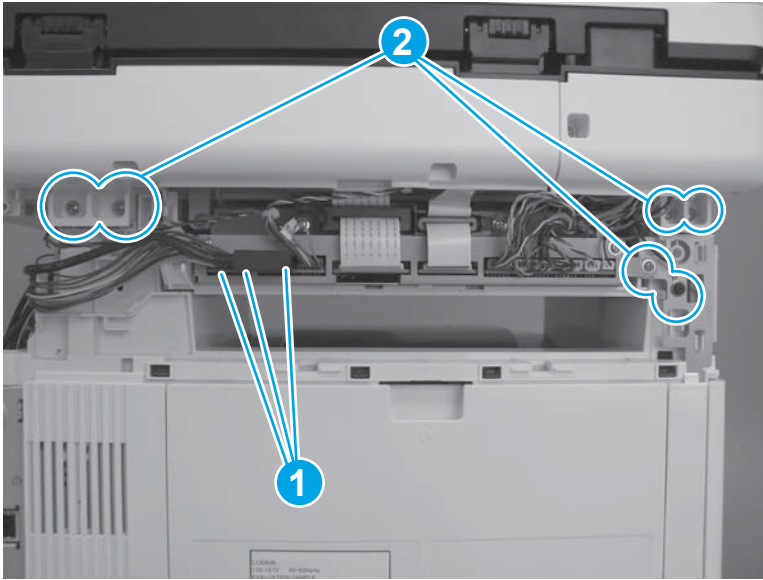
 **TIP:** It might be easier if the WiFi PCA and holder (callout 5) is detached from the printer, and then moved out of the way.

**Figure 1-1202** Disconnect cables and connectors



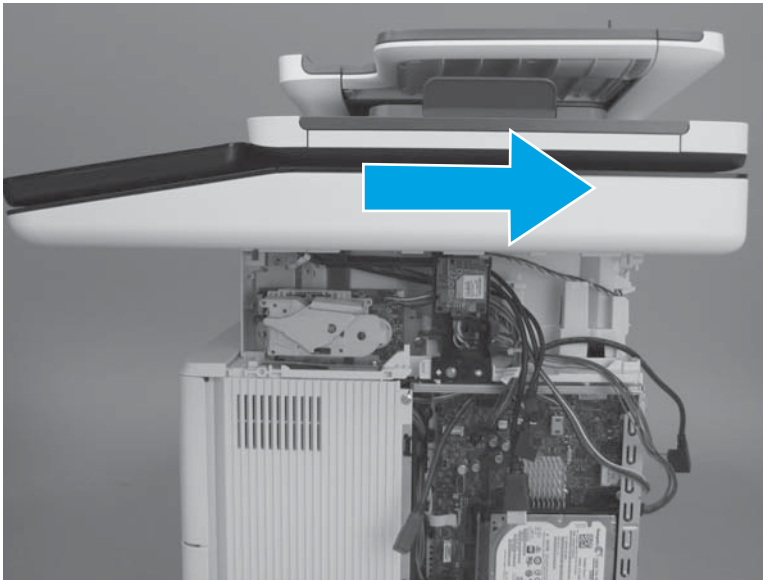
3. Disconnect three connectors (callout 1), and then remove six screws (callout 2).

**Figure 1-1203** Disconnect connectors and remove screws



4. Slightly slide the ISA towards the back of the printer to release it.

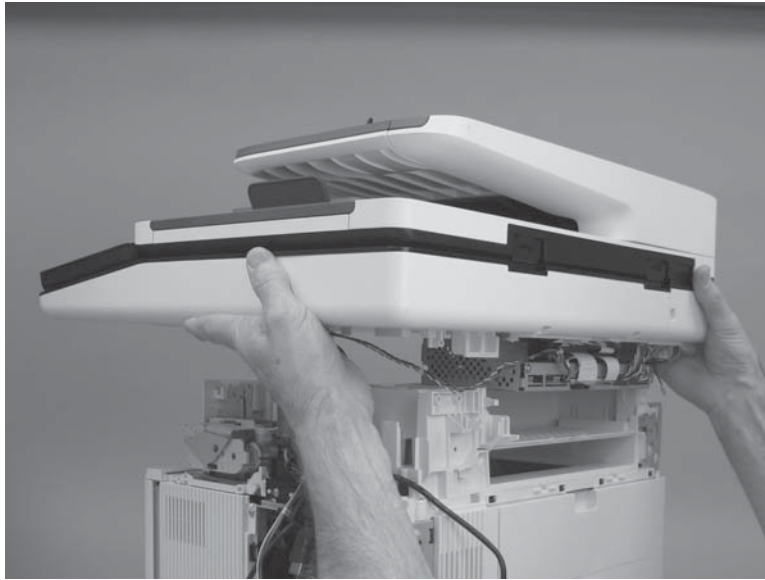
**Figure 1-1204** Slide the ISA towards the back of the printer






5. Remove the ISA.

**Figure 1-1205** Remove the ISA

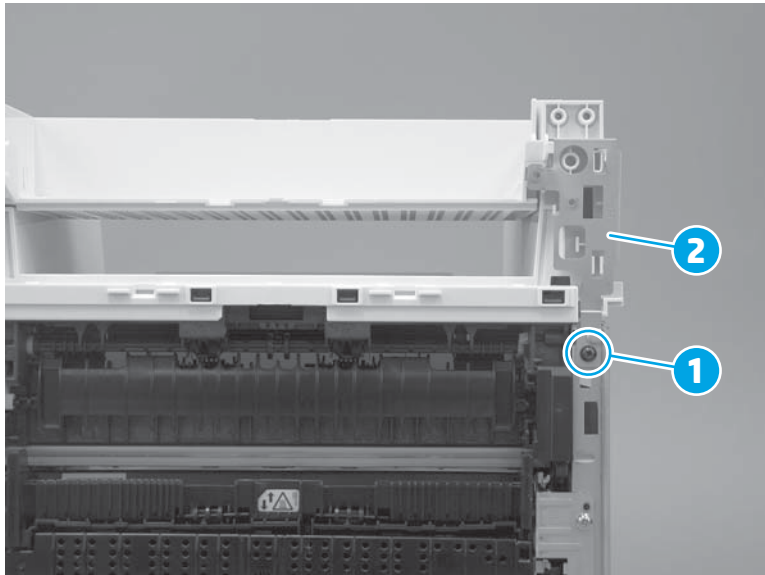


#### Step 16: Remove the top cover (M527)

 **NOTE:** This step is for the M527 printer. For the M506/M506, skip this step and go to [Step 17: Remove the top cover \(M501/M506\) on page 694](#).

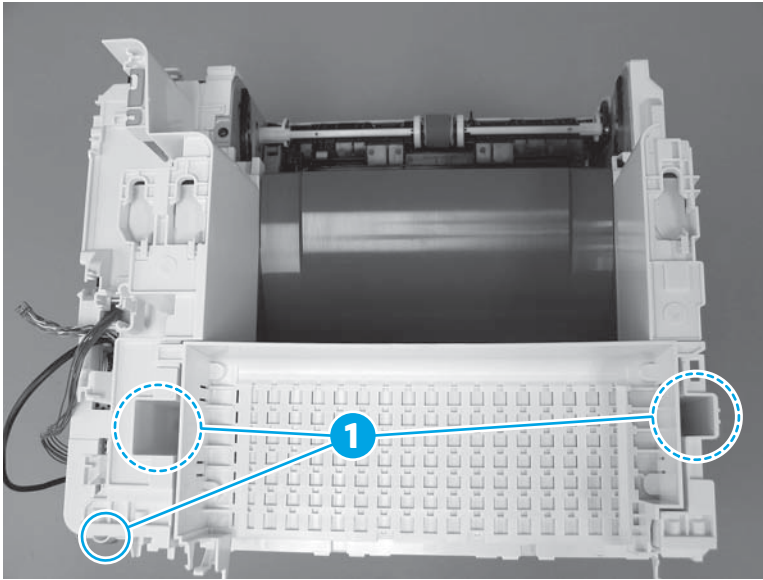
1. At the front right of the printer, remove one screw (callout 1), and then remove the sheet-metal plate (callout 2).

**Figure 1-1206** Remove one screw and the plate




2. At the top rear of the printer, remove three screws (callout 1).

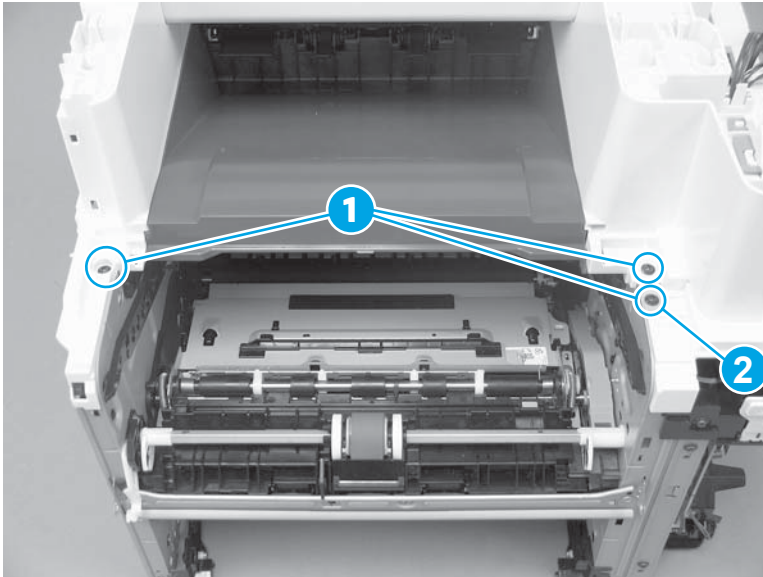
**Figure 1-1207** Remove three screws



3. At the top front of the printer, remove three screws (callout 1).

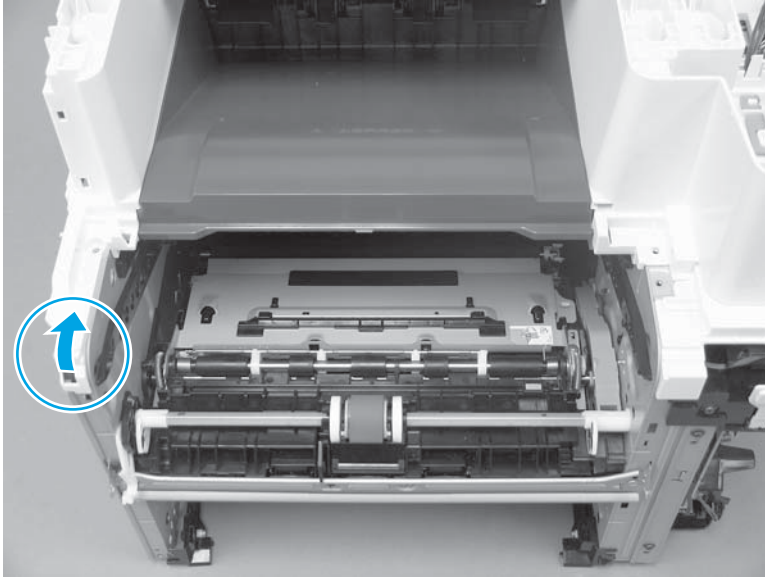
 **NOTE:** The screw (callout 2) on the lower-right portion of the cover is a different color than the other two screws, and is surrounded by sheet-metal. It might appear that this screw does not need to be removed. Remove this screw.

**Figure 1-1208** Remove three screws



4. At the front left of the printer, release one boss.

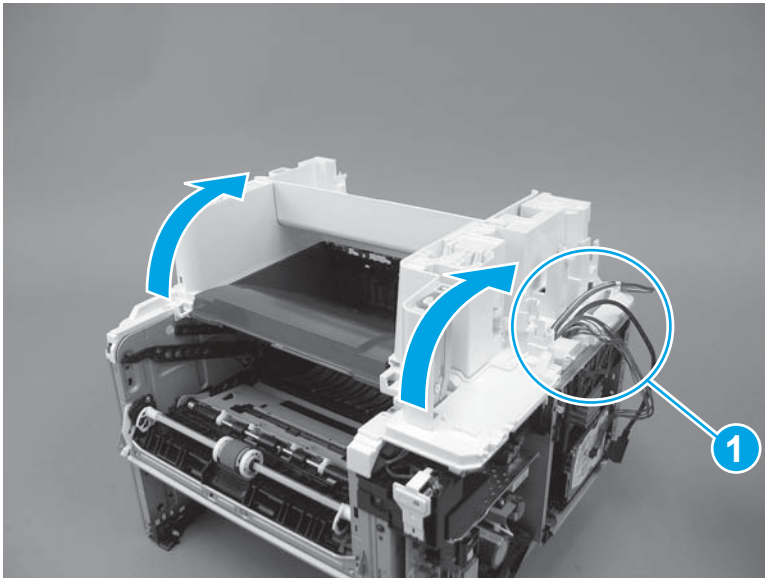
**Figure 1-1209** Release one boss



5. Rotate the front of the cover up and away from the printer.

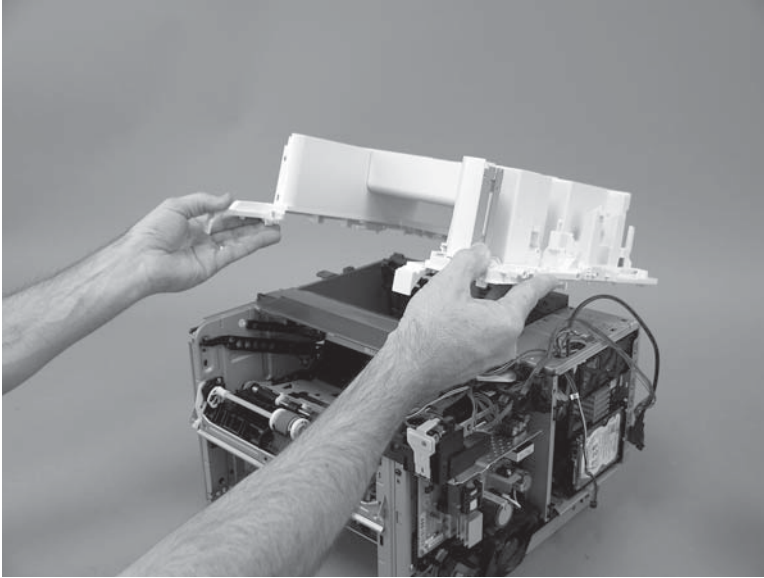
**⚠ CAUTION:** As the cover is rotated up, carefully pass the cables and wire harnesses the hole in the cover (callout 1).

**Figure 1-1210** Rotate the front of the cover up



6. Remove the cover.

**Figure 1-1211** Remove the cover



### Step 17: Remove the top cover (M501/M506)

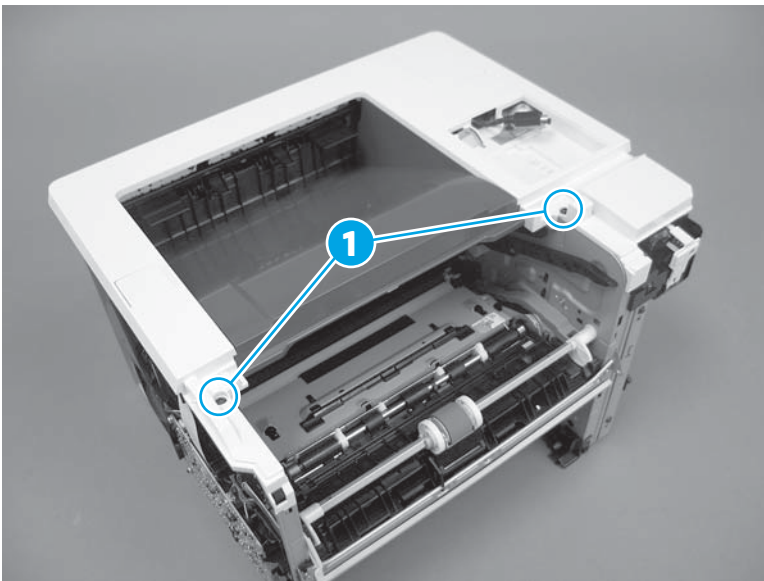


**NOTE:** This step is for the M501/M506 printers. For the M527, skip this step and go to [Step 19: Remove the formatter case on page 697](#).


The M506x is shown in this procedure. However, the steps are correct for all M506 models and the M501 printer.

1. Remove two screws (callout 1).

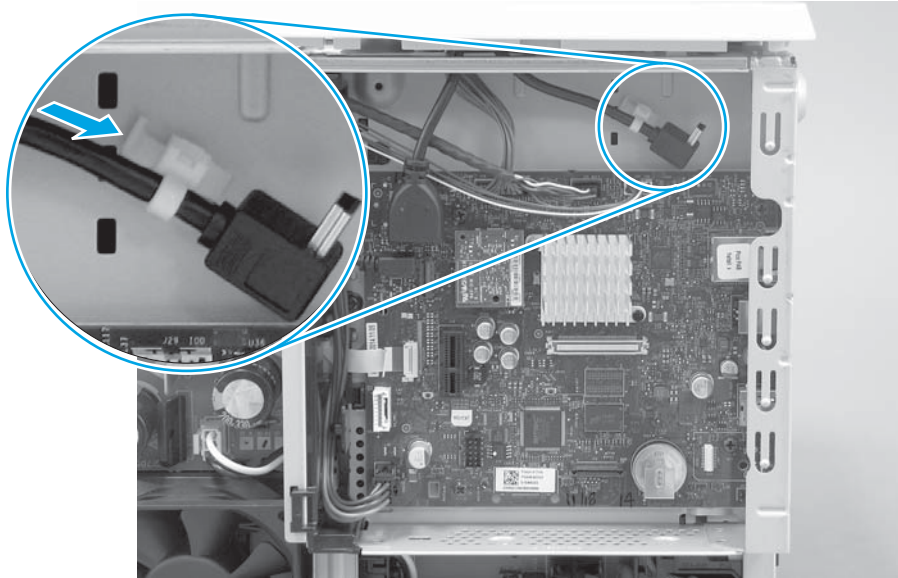
**Figure 1-1212** Remove two screws



2. **M506 only:** Release one cable retainer from the chassis.

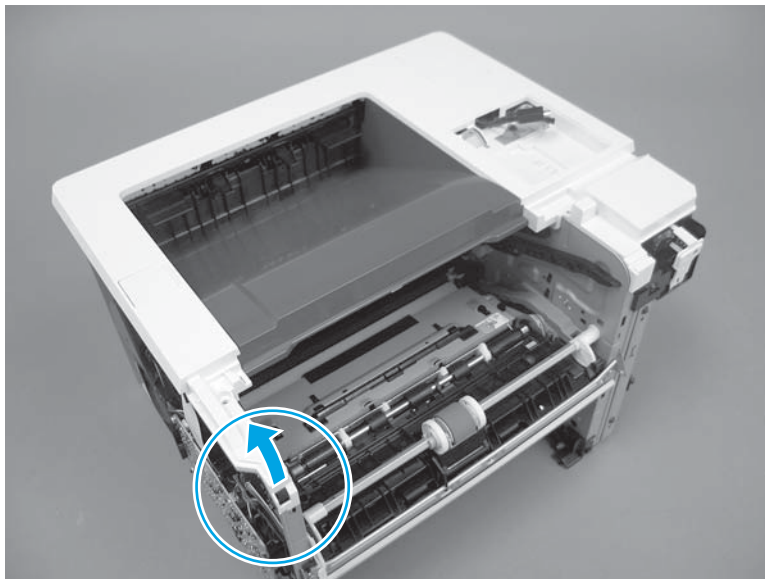
 **TIP:** Depress the tab on the retainer to release it.

**Figure 1-1213** Release one cable retainer



3. Release one boss.

**Figure 1-1214** Release one boss

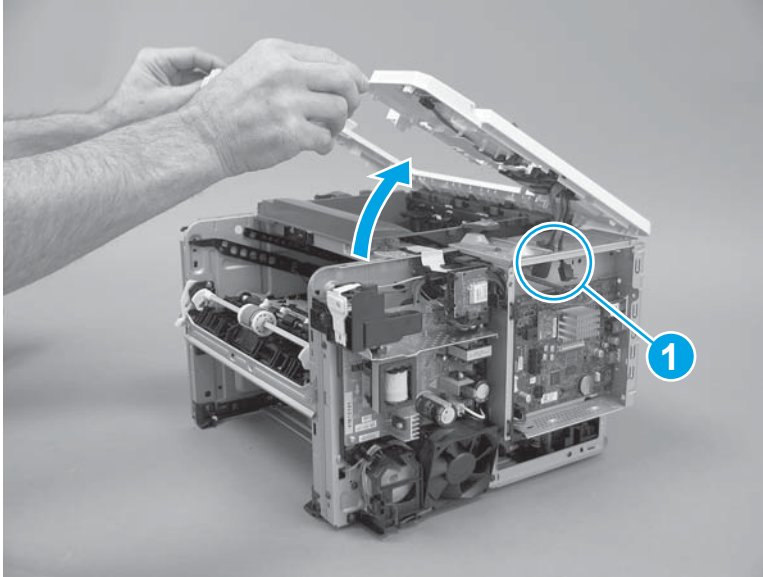


4. Rotate the front of the cover up and away from the printer, and then remove the cover.

**CAUTION:** **M506x only:** As the cover is rotated up, carefully pass the cables the hole in the chassis (callout 1).

**NOTE:** **LCD control panel models only:** Disconnect the control panel before removing the cover.

**Figure 1-1215** Remove the cover

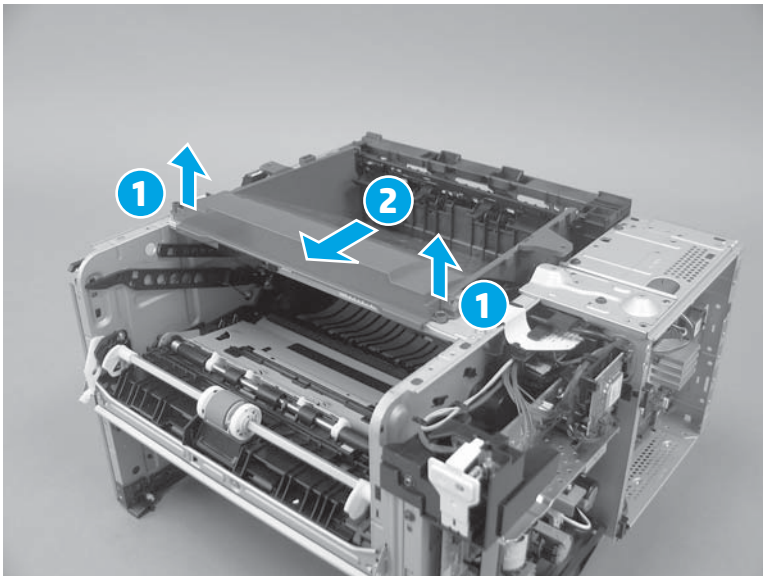


#### Step 18: Remove the paper delivery tray (output bin)

**NOTE:** This procedure shows the M506 printer. However, this procedure is valid for the M527 printer.

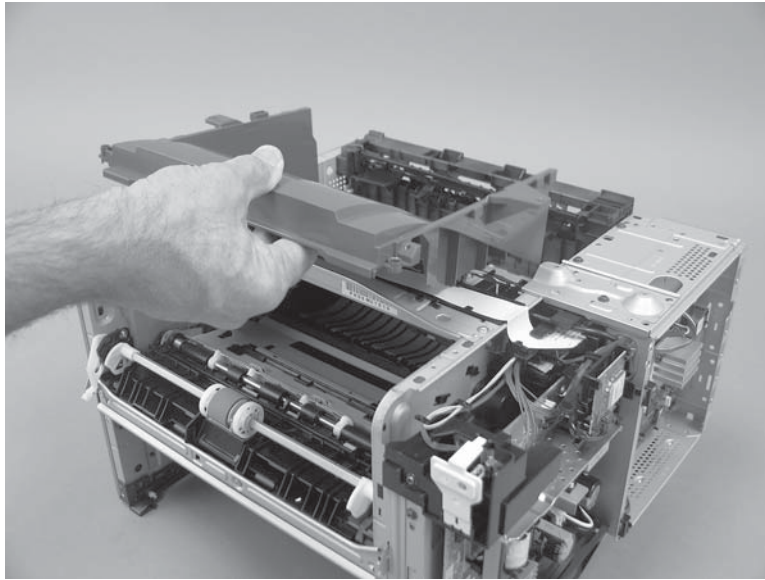
1. Release two tabs (callout 1), and then slide the cover toward the front of the printer (callout 2).

**Figure 1-1216** Release two tabs



2. Remove the bin.

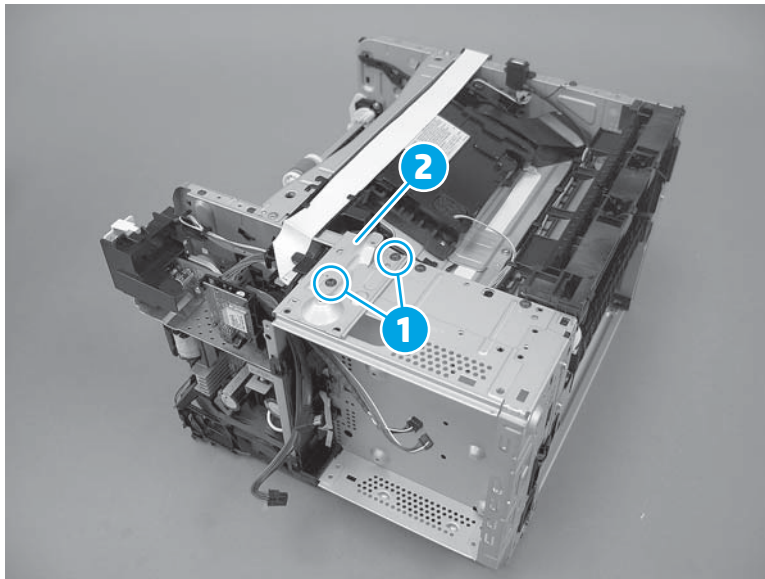
**Figure 1-1217** Remove the bin




#### Step 19: Remove the formatter case

1. **M506 only:** Remove two screws (callout 1), and then remove the sheet-metal plate (callout 2).

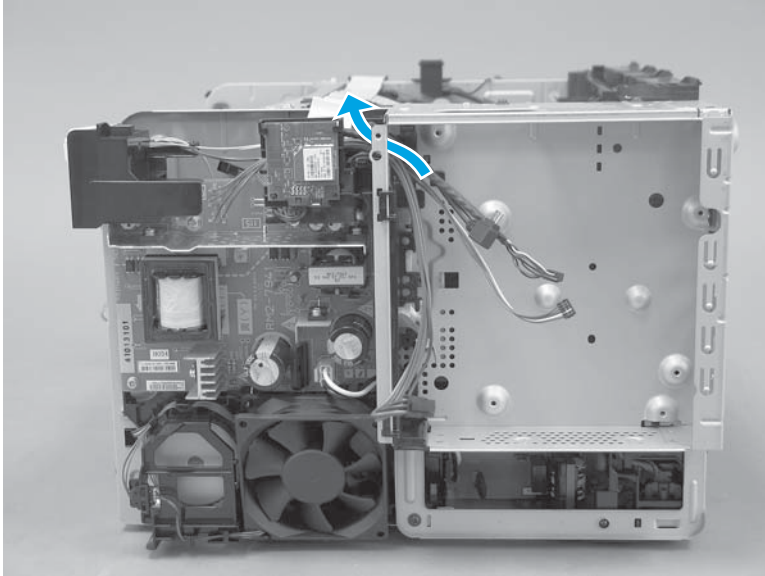
**Figure 1-1218** Remove the sheet-metal plate



- Carefully pass all cables and wire harnesses through the opening in the formatter case.

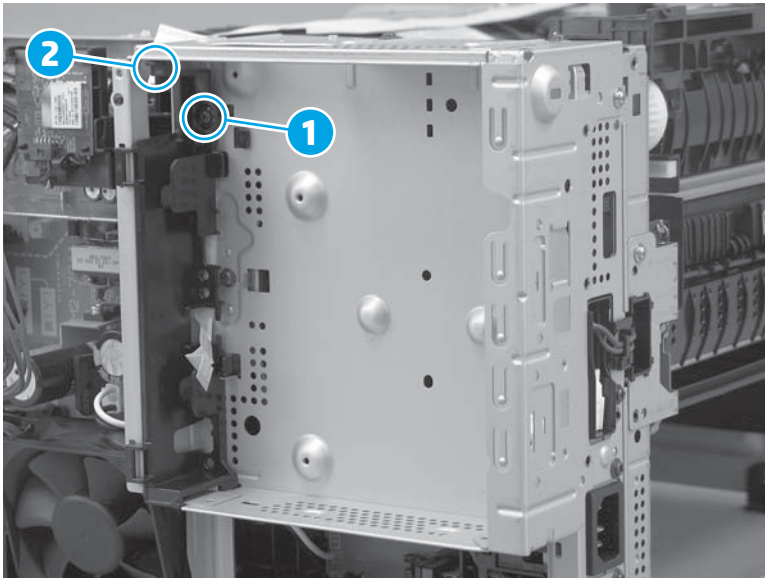
 **NOTE:** The figure below shows the M506 printer. However this step is valid for the M501/M527 printers—there will be a different number of cables and wire harnesses.

**Figure 1-1219** Pass all cables and wire harnesses through the opening



- Remove one screw (callout 1), and then push down on one tab (callout 2) to release it.

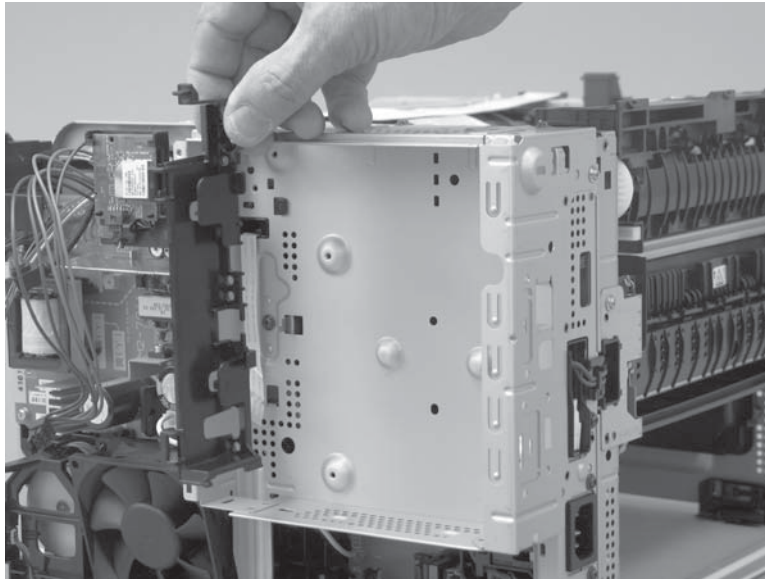
**Figure 1-1220** Remove one screw





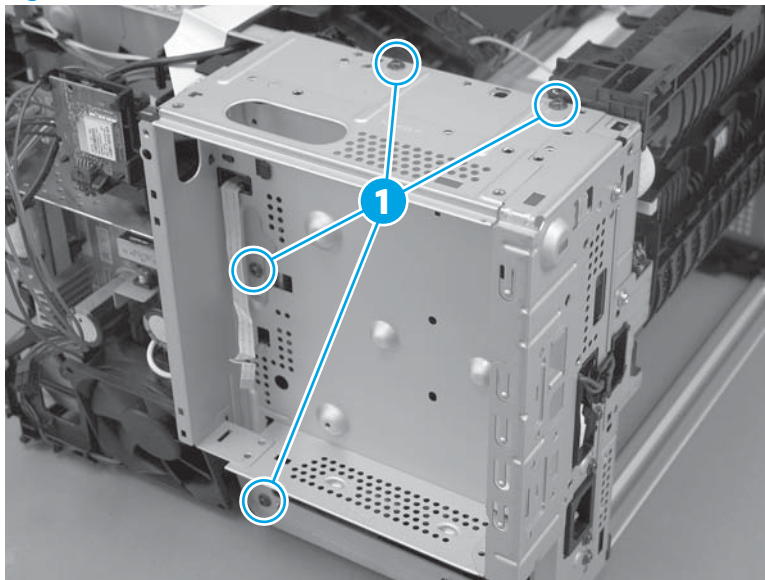
4. Remove the guide.

**Figure 1-1221** Remove the guide



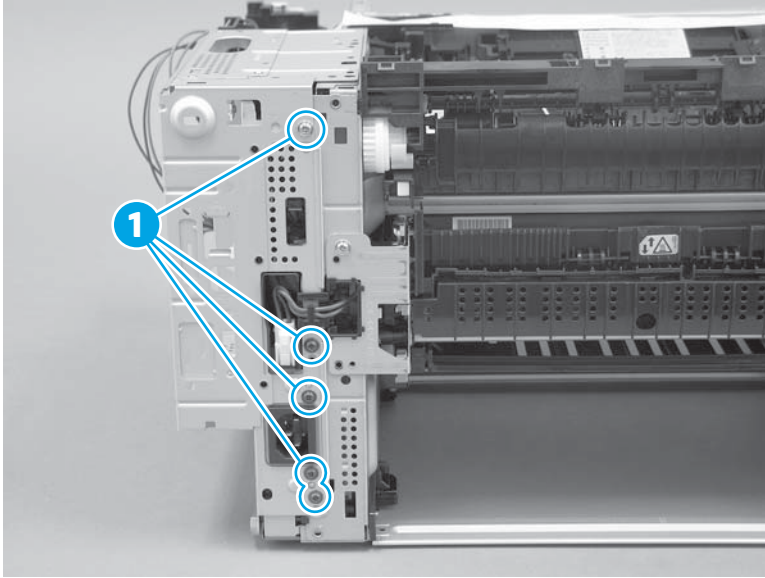
5. Remove four screws (callout 1).

**Figure 1-1222** Remove four screws



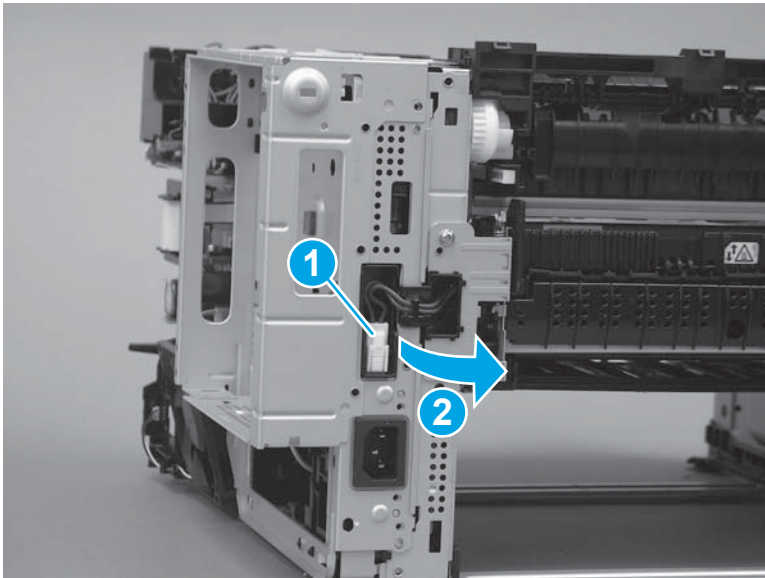
6. Remove five screws (callout 1).

**Figure 1-1223** Remove five screws



7. Disconnect one connector (callout 1), and then move the guide out of the way (callout 2).

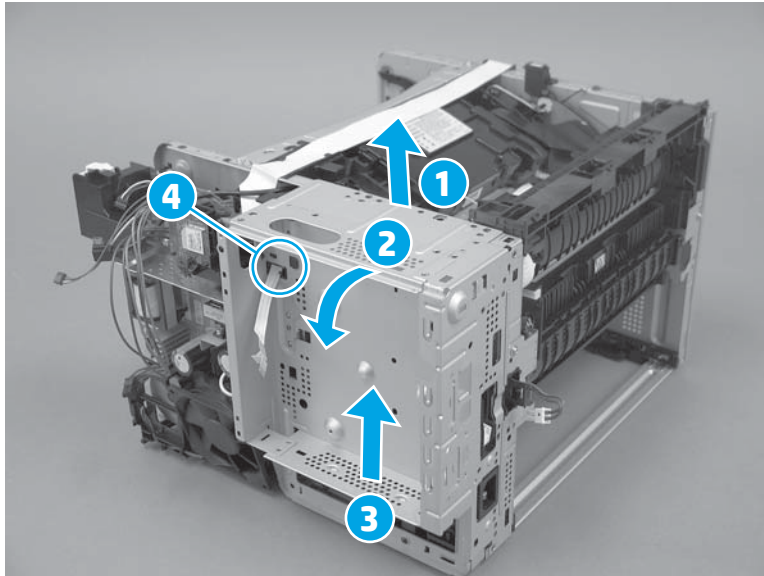
**Figure 1-1224** Disconnect one connector



- Slightly lift up the formatter case (callout 1), rotate the top of the case away from the chassis (callout 2), and then lift up the case to release it (callout 3).

**CAUTION:** Pass the FFC through the opening (callout 4) in the formatter while removing the case.

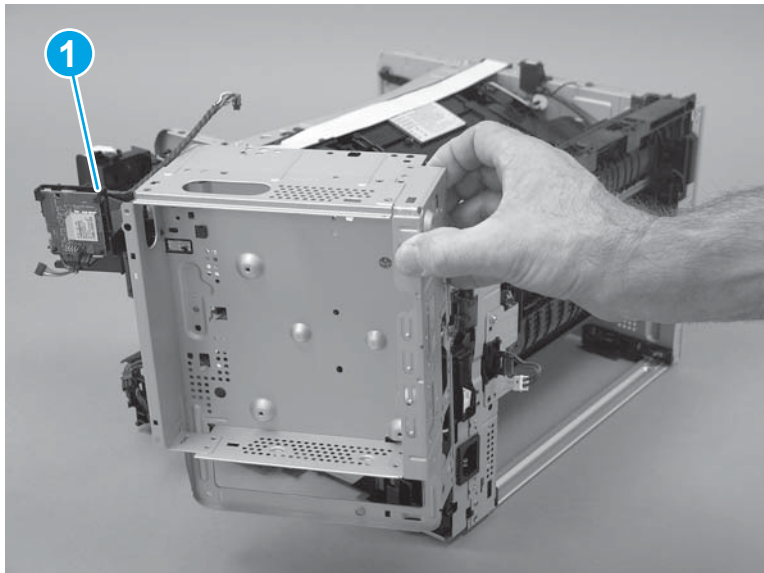
**Figure 1-1225** Release the formatter case



- Remove the formatter case.

**NOTE:** **M506 only:** If the formatter case is being replaced, make sure that the WiFi PCA and bracket (callout 1) are transferred to the replacement case.

**Figure 1-1226** Remove the formatter case



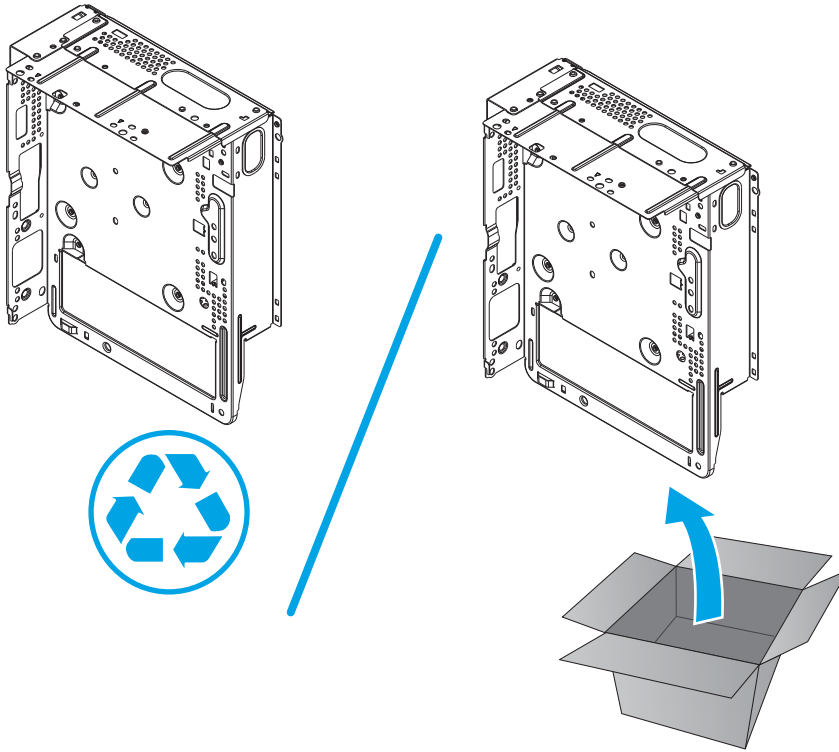
## Step 20: Unpack the replacement formatter case

Unpack the replacement part from the packaging.

<http://www8.hp.com/us/en/hp-information/environment/product-recycling.html>


 **NOTE:** HP recommends responsible disposal of the defective part.

**Figure 1-1227** Recycle and unpack

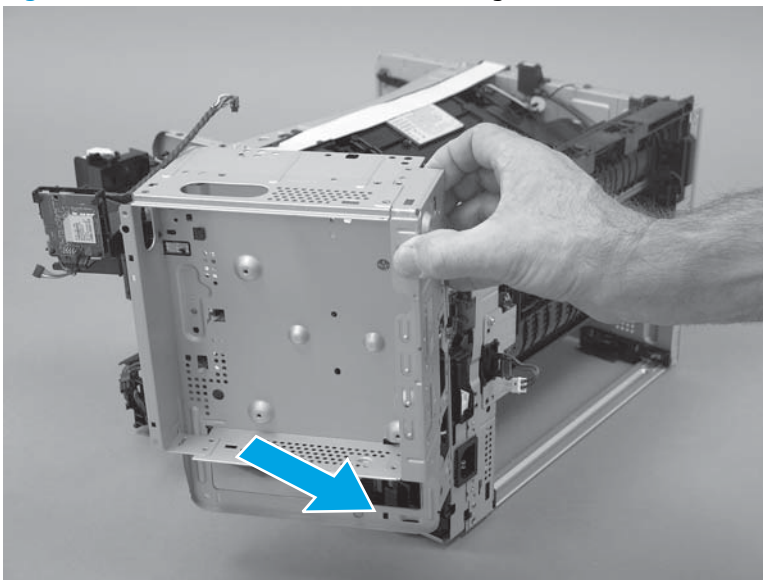


### Step 21: Install the formatter case

1. Position the bottom edge of the formatter case against the chassis.

 **NOTE: M506 only:** If the formatter case is being replaced, make sure that the WiFi PCA and bracket (callout 1) are transferred to the replacement case.

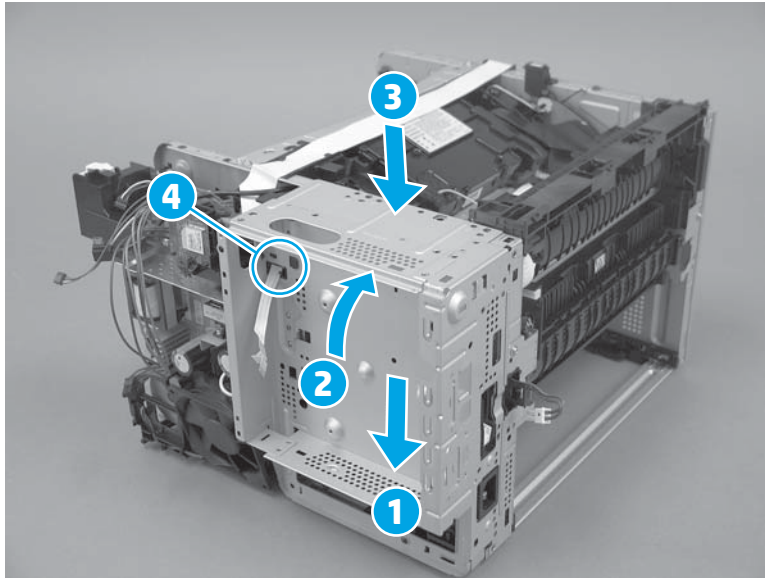
**Figure 1-1228** Position the formatter case against the chassis



2. With the bottom of the formatter case against the chassis (callout 1), rotate the top of the case toward the chassis (callout 2), and slide the case down into place to install it (callout 3).

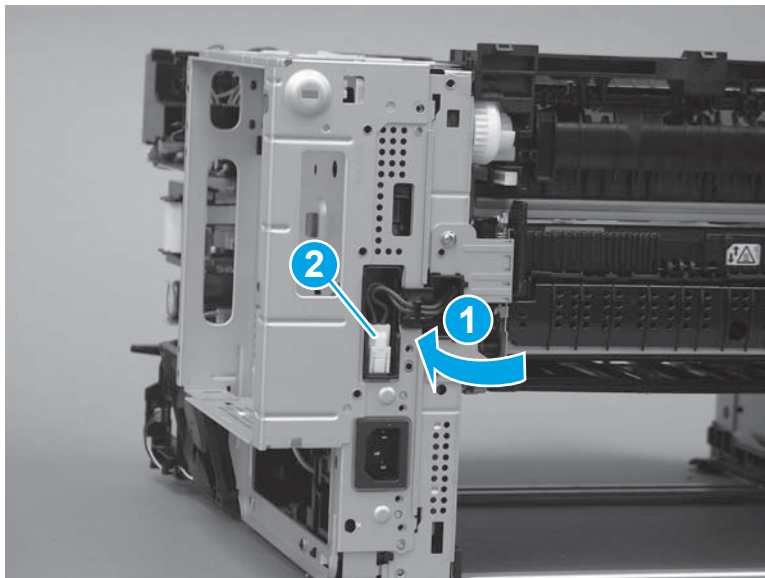
**CAUTION:** Pass the FFC through the opening (callout 4) in the formatter while installing the case.

**Figure 1-1229** Install the formatter case



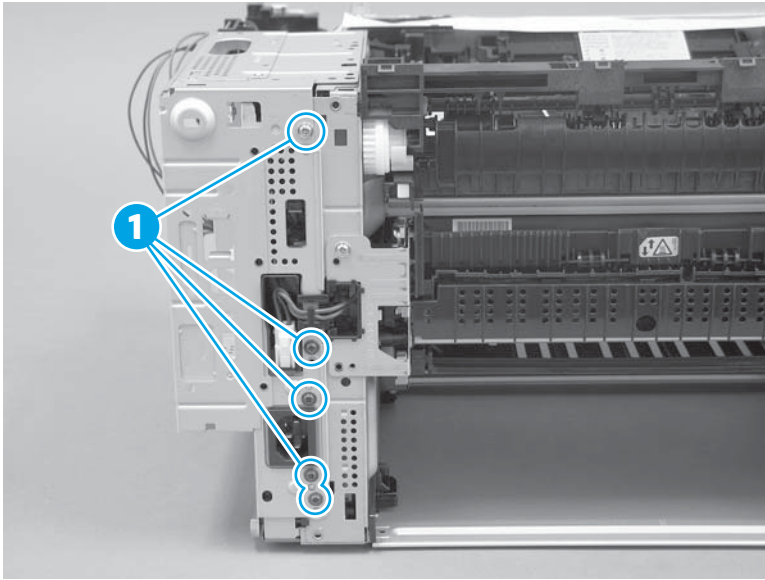
3. Reposition the guide (callout 1), and then connect one connector (callout 2).

**Figure 1-1230** Connect one connector



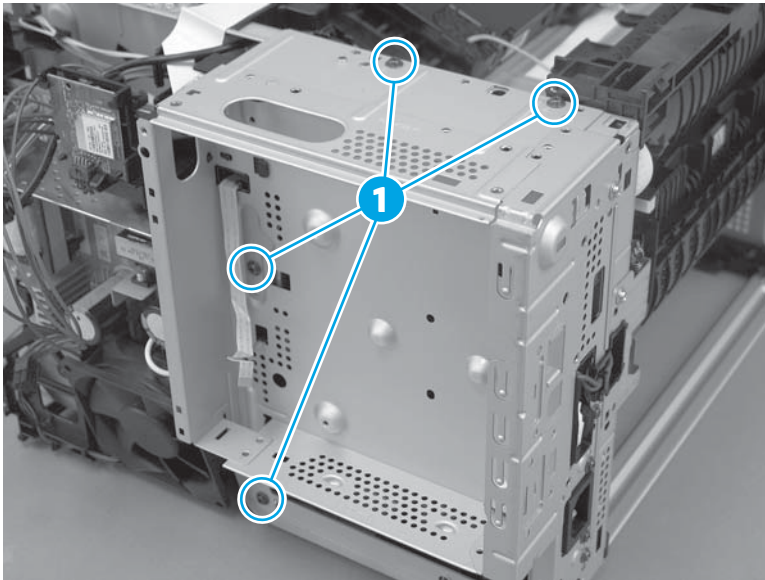
4. Install five screws (callout 1).

**Figure 1-1231** Install five screws



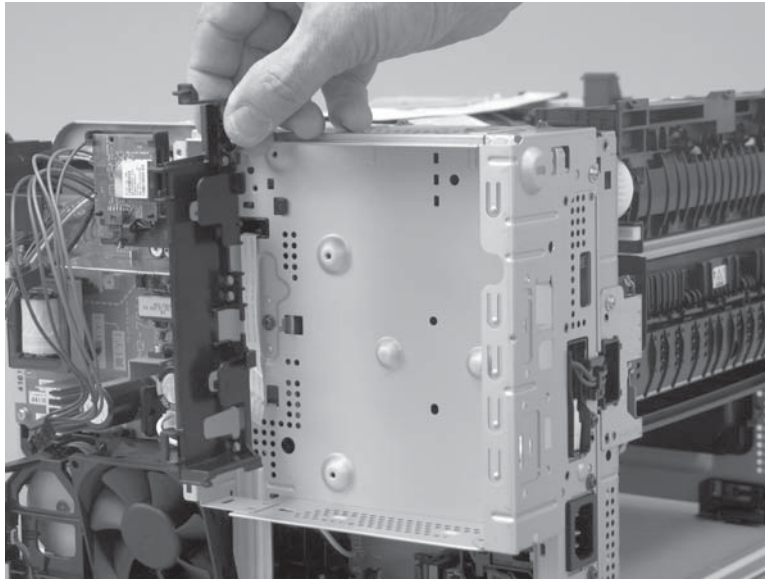
5. Install four screws (callout 1).

**Figure 1-1232** Install four screws




6. Install the guide.

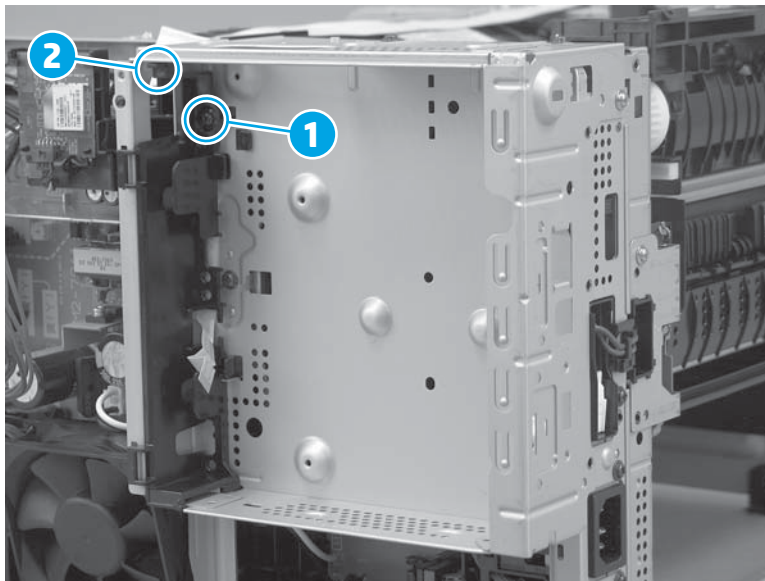
**Figure 1-1233** Install the guide




7. Install one screw (callout 1).

 **NOTE:** Make sure that the tab (callout 2) is engaged.

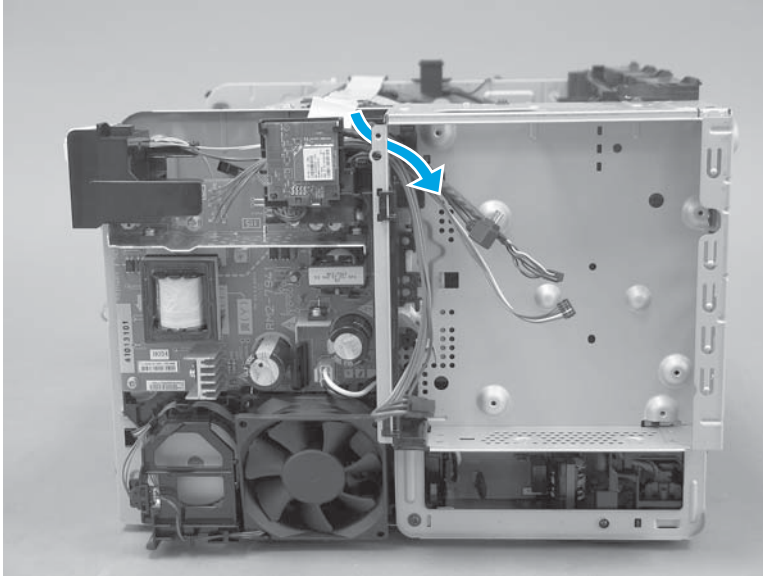
**Figure 1-1234** Install one screw



- Carefully pass all cables and wire harnesses through the opening in the formatter case.

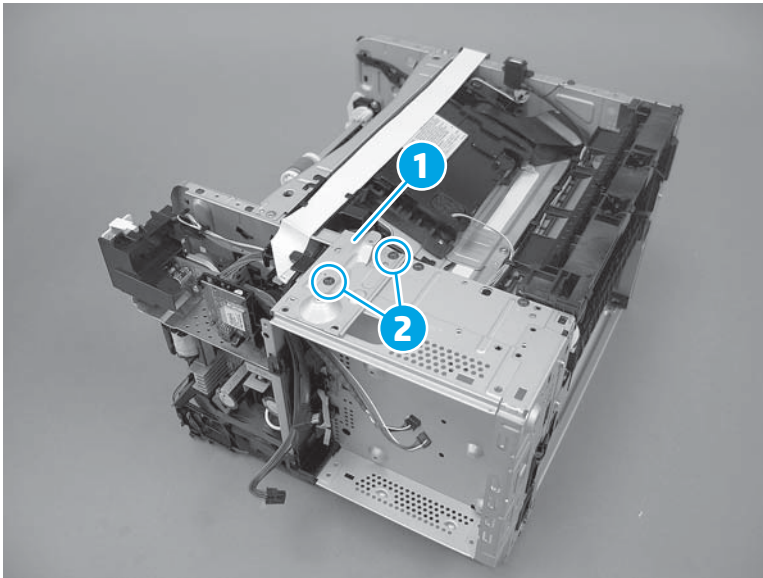
 **NOTE:** The figure below shows the M506 printer. However this step is valid for the M501/M527 printers—there will be a different number of cables and wire harnesses.

**Figure 1-1235** Pass all cables and wire harnesses through the opening




- M506 only:** Install the sheet-metal plate (callout 1), and then install two screws (callout 2).


**Figure 1-1236** Remove the sheet-metal plate



## Step 22: Install the paper delivery tray (output bin)

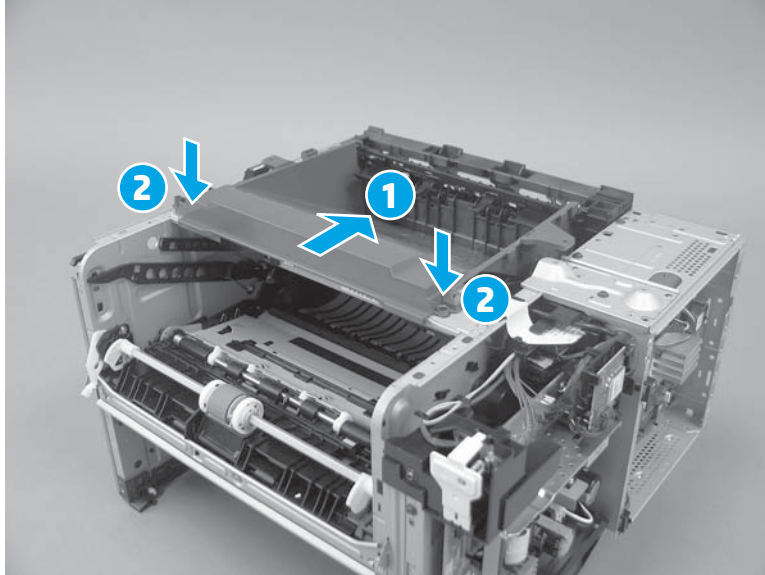
 **NOTE:** This procedure shows the M506 printer. However, this procedure is valid for the M527 printer.

- Position the bin on the printer (callout 1), and then push down to engage two tabs (callout 2).


 **NOTE:** Position the tabs along the rear edge of the bin on the printer in the slots in the chassis.



**Figure 1-1237** Install the bin




### Step 23: Install the top cover (M501/M506)

 **NOTE:** This step is for the M501/M506 printers. For the M527, skip this step and go to [Step 24: Install the top cover \(M527\) on page 709](#).

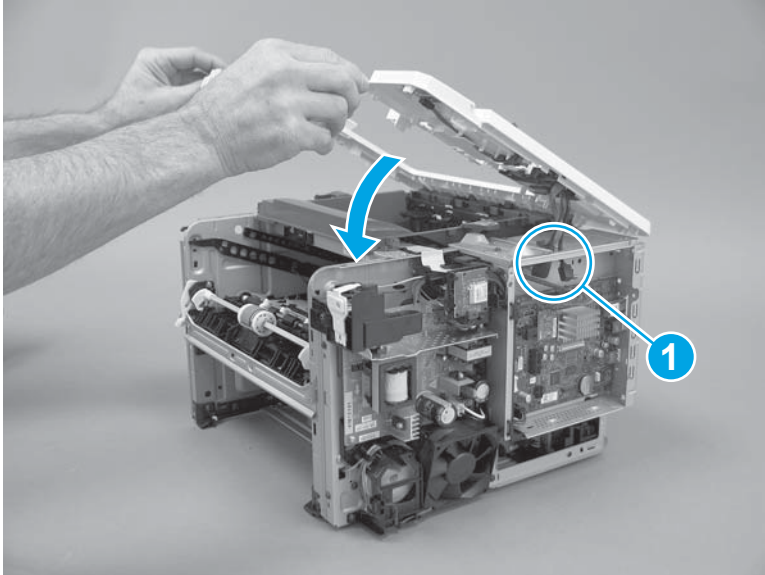
The M506x is shown in this procedure. However, the steps are correct for all M506 models and the M501 printer.

1. Position the rear edge of the cover on the printer, and then rotate the front of the cover down onto the printer.

 **CAUTION: M506x only:** As the cover is rotated down, carefully pass the cables the hole in the chassis (callout 1).

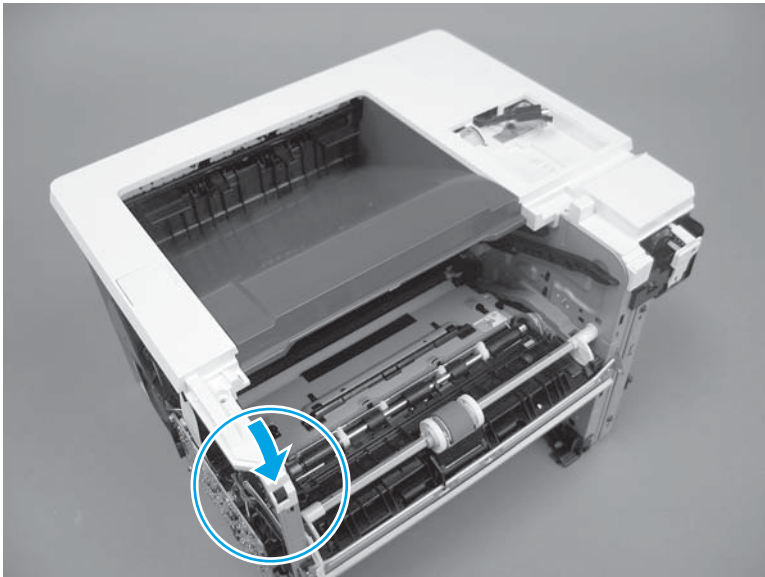
 **NOTE: LCD control panel models only:** Pass the cables through the opening in the cover, and then connect the control panel after installing the cover.

**Figure 1-1238** Install the cover




2. Engage one boss.

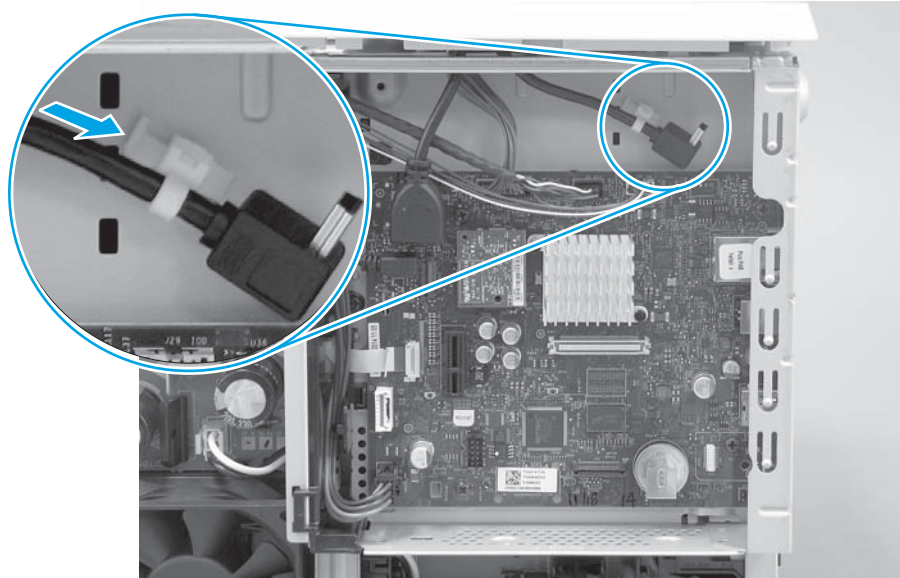
**Figure 1-1239** Engage one boss



- M506 only:** Install one cable retainer on the chassis.

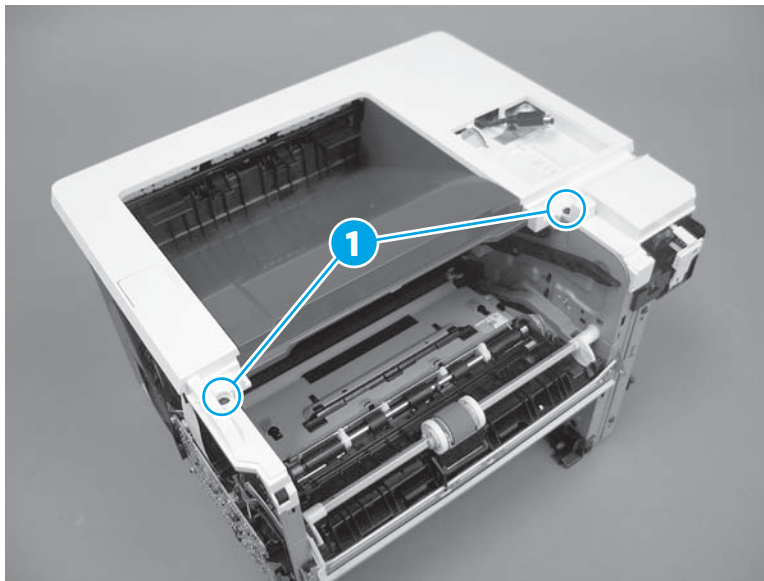
 **TIP:** Depress the tab on the retainer to install it.

**Figure 1-1240** Install one cable retainer




- Install two screws (callout 1).

**Figure 1-1241** Install two screws

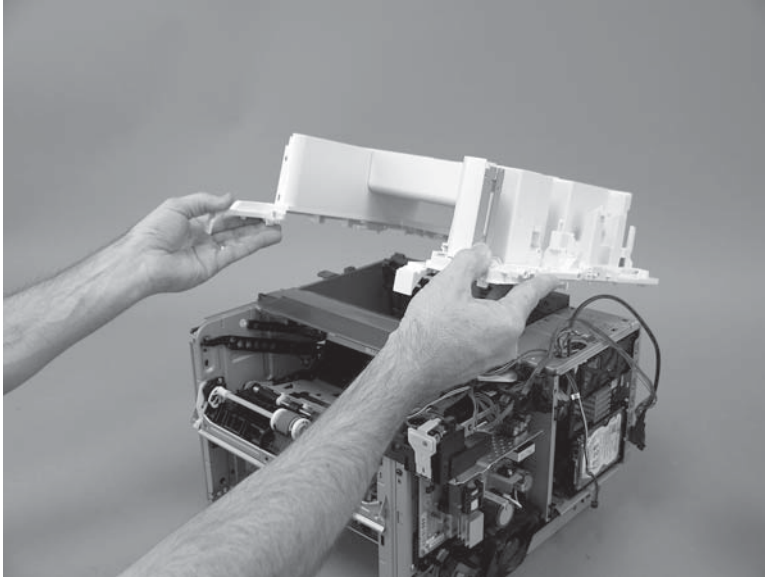


#### Step 24: Install the top cover (M527)

 **NOTE:** This step is for the M527 printer. For the M501/M506, skip this step and go to [Step 26: Install the left cover on page 716](#).

- Position the rear edge of the cover on the chassis.

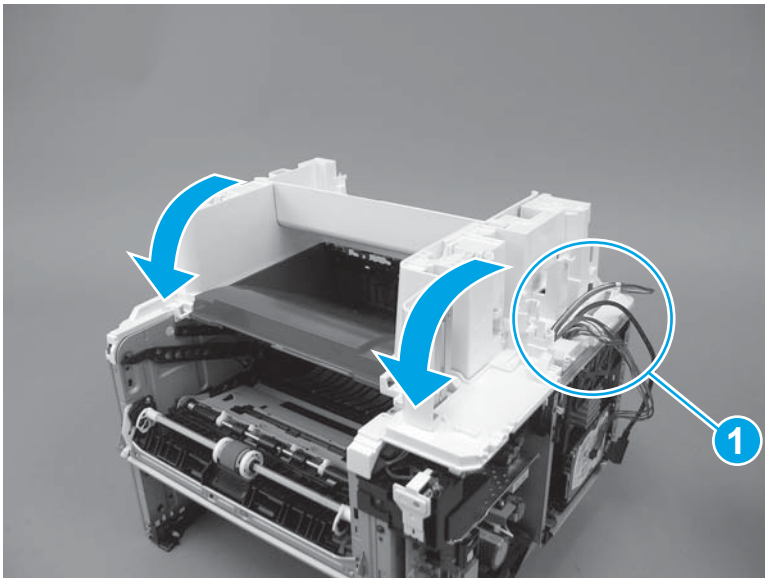
**Figure 1-1242** Install the cover



2. Rotate the front of the cover down onto the printer.

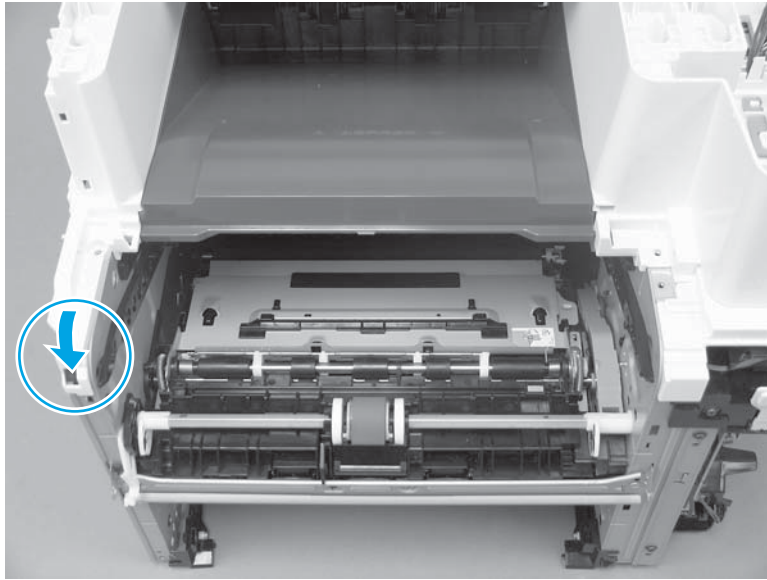
**⚠ CAUTION:** As the cover is rotated down, carefully pass the cables and wire harnesses the hole in the cover (callout 1).

**Figure 1-1243** Rotate the front of the cover down



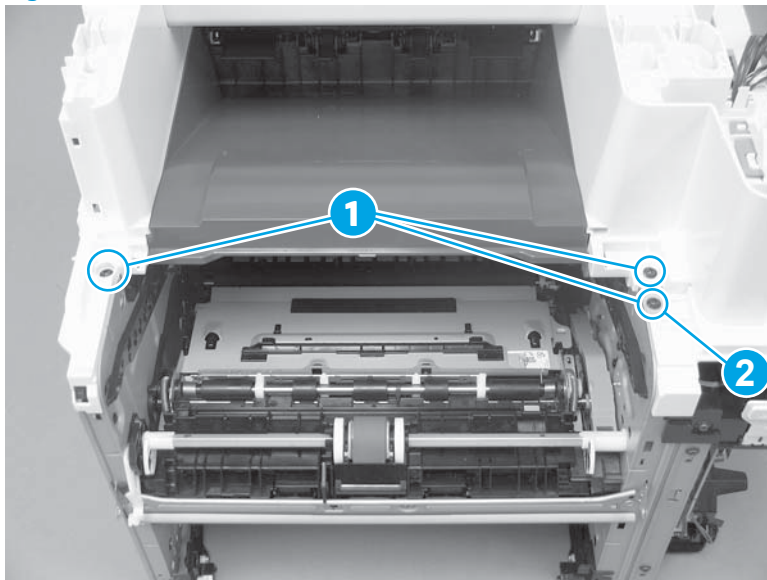
3. At the front left of the printer, engage one boss.

**Figure 1-1244** Engage one boss




4. At the top front of the printer, install three screws (callout 1).

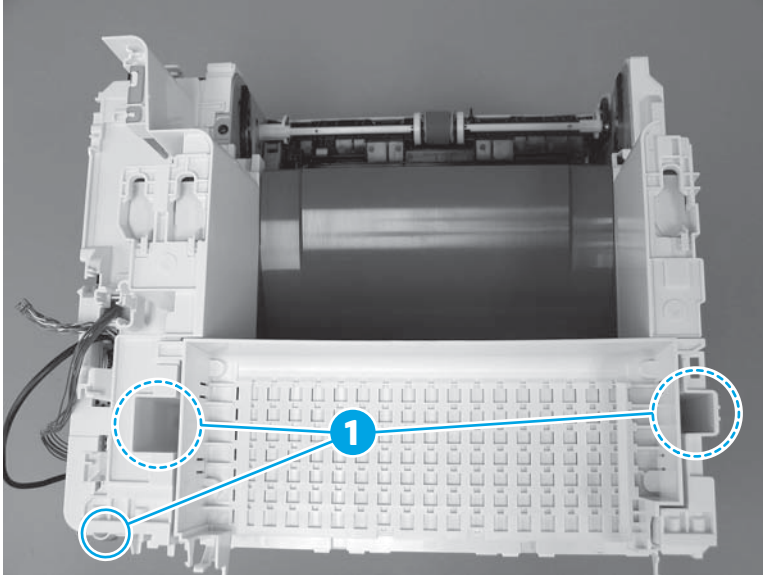
**Figure 1-1245** Install three screws



5. At the top rear of the printer, install three screws (callout 1).

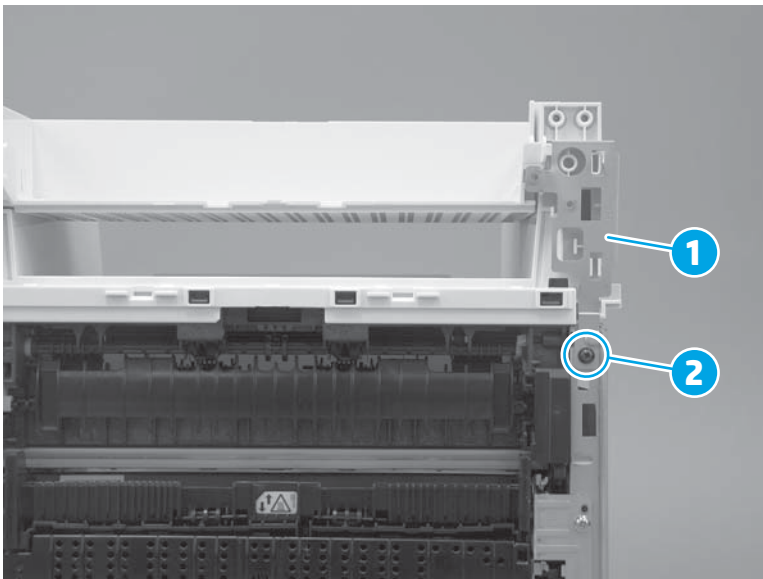
 **NOTE:** The screw (callout 2) on the lower-right portion of the cover is a different color than the other two screws, and is surrounded by sheet-metal. It might appear that this screw does not need to be removed. Remove this screw.

**Figure 1-1246** Install three screws





6. At the front right of the printer, install the sheet-metal plate (callout 1), and then install one screw (callout 2).

**Figure 1-1247** Install one screw and the plate




### Step 25: Install the integrated scanner assembly (M527)

 **IMPORTANT:** Some figure might show assemblies removed or installed that have not yet been removed or installed at that specific step. However, the procedures are correct for this printer and the target assembly. Always thoroughly read the instructions that accompany each figure

 **NOTE:** This step is for the M527 printer. For the M501/M506, skip this step and go to [Step 26: Install the left cover on page 716](#).

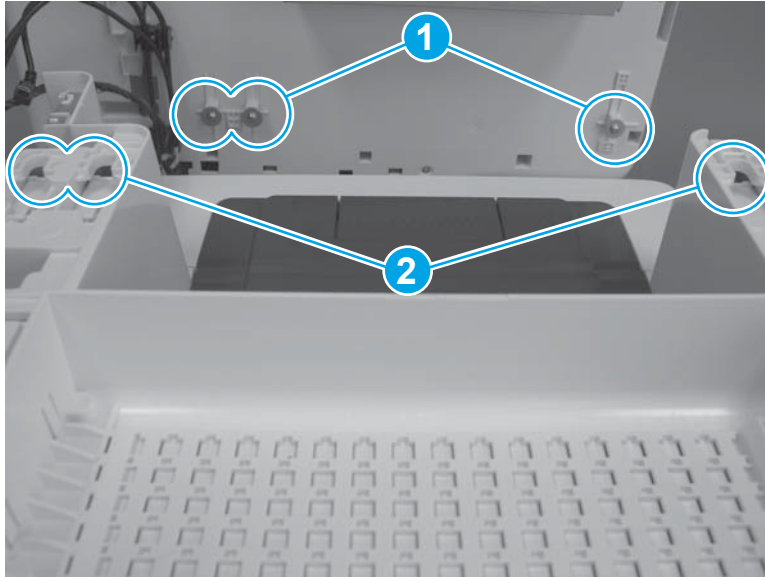
---

 **NOTE:** The ISA includes the document feeder, sub-scanner assembly (SSA), and the scanner control board (SCB)


---

1. Before proceeding, locate the ISA mounting pins (callout 1) on the bottom of the ISA and the slots (callout 2) on the printer base.

**Figure 1-1248** Locate the ISA mounting pins and slots

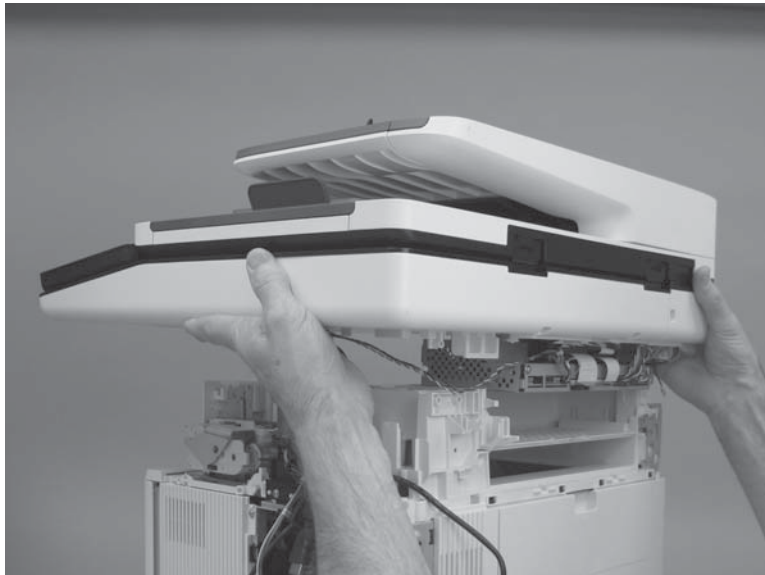


2. Position the ISA on the printer base with the pins in the slots.

 **NOTE:** To locate the pins and slots, see the previous step.

---

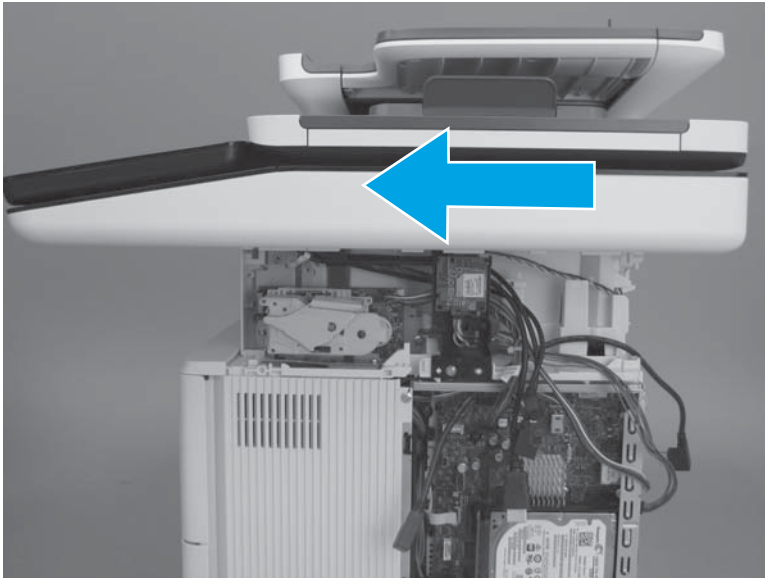
**Figure 1-1249** Install the ISA



3. Slightly slide the ISA towards the front of the printer to engage it.

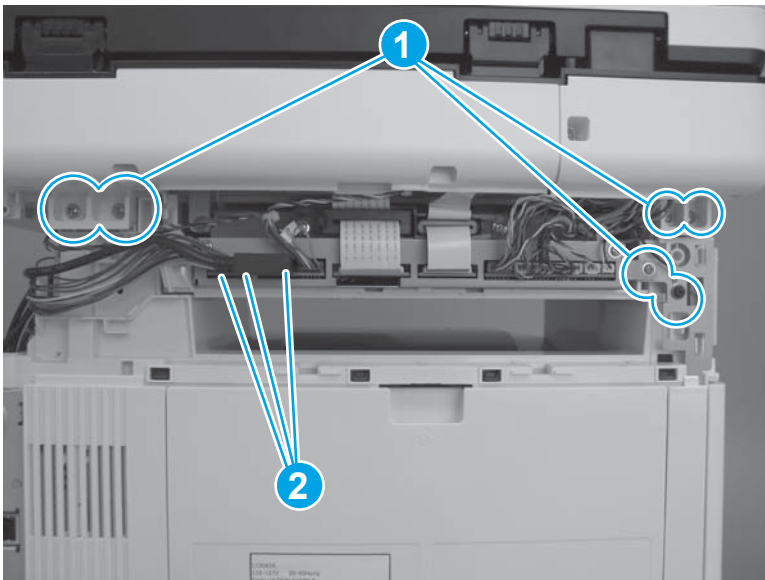
**⚠ CAUTION:** Make sure that none of the wire harnesses or cables are caught underneath the assembly when installing it.

**Figure 1-1250** Slide the ISA towards the front of the printer




4. Install six screws (callout 1), and then connect three connectors (callout 2).

**Figure 1-1251** Install screws and connect connectors

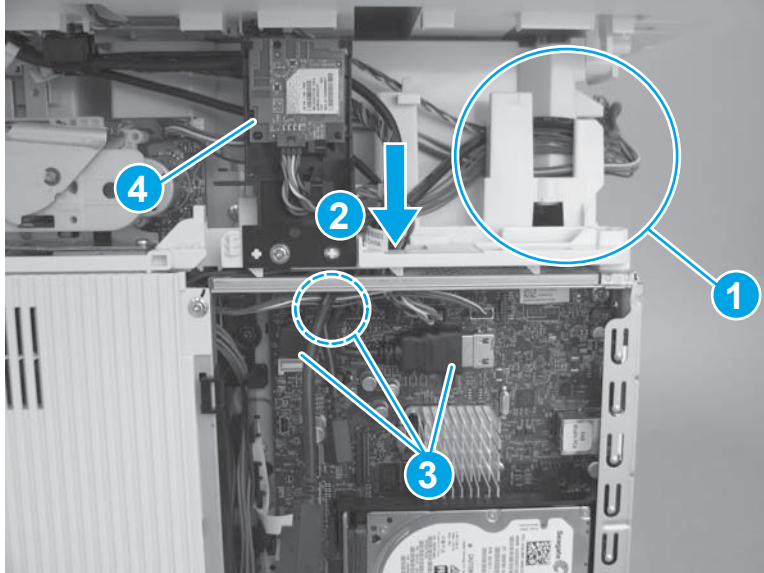




5. Install the wire harnesses and cables in the retainers (callout 1), pass them through the opening in the cover (callout 2), and then connect three connectors (callout 3).

 **TIP:** If the WiFi PCA and holder (callout 4) was detached from the printer and then moved out of the way, reinstall it now.

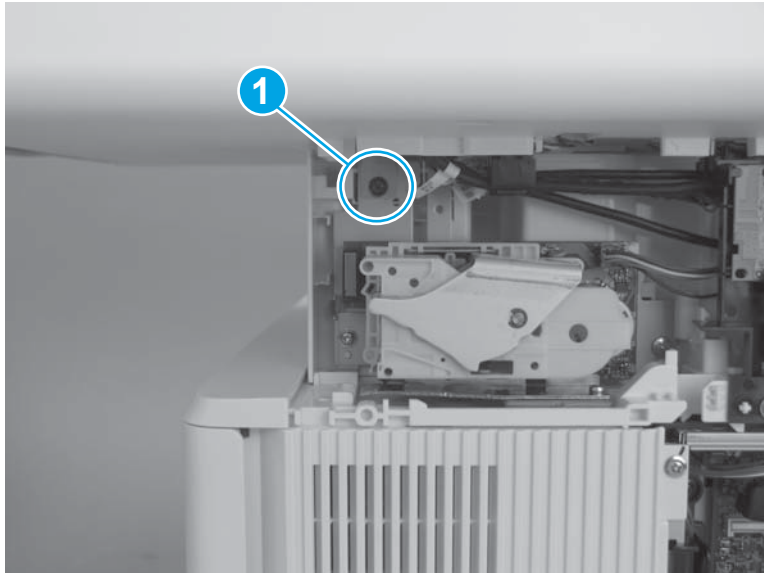
**Figure 1-1252** Connect cables and connectors




6. Install one screw (callout 1).


 **IMPORTANT:** This screw fastens the ISA ground plate to the printer chassis. This screw must be installed.

**Figure 1-1253** Install one screw



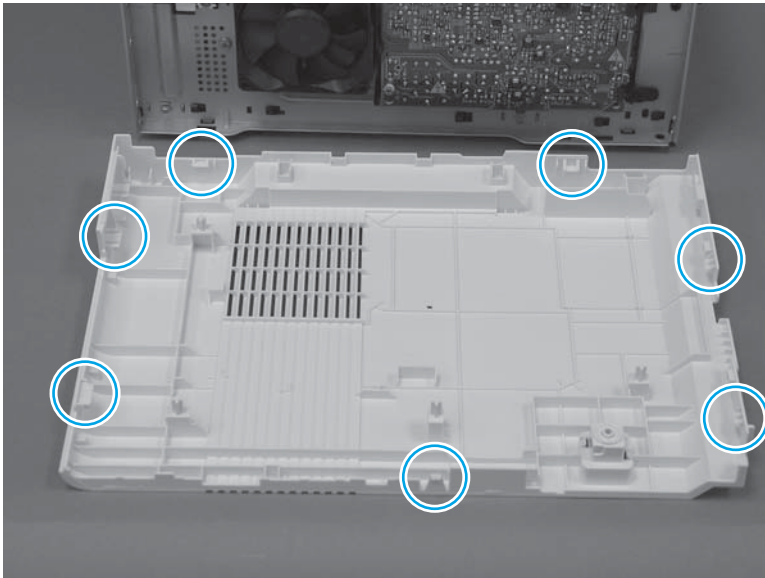
## Step 26: Install the left cover

 **IMPORTANT:** The black-plastic cassette front and rear guides (located inside the tray cavity) can be easily dislodged. Do not lose the guides when the cover is removed or installed.

 **NOTE:** The M527 printer is shown in this procedure. However, this procedure is valid for the M501/M506 printers.

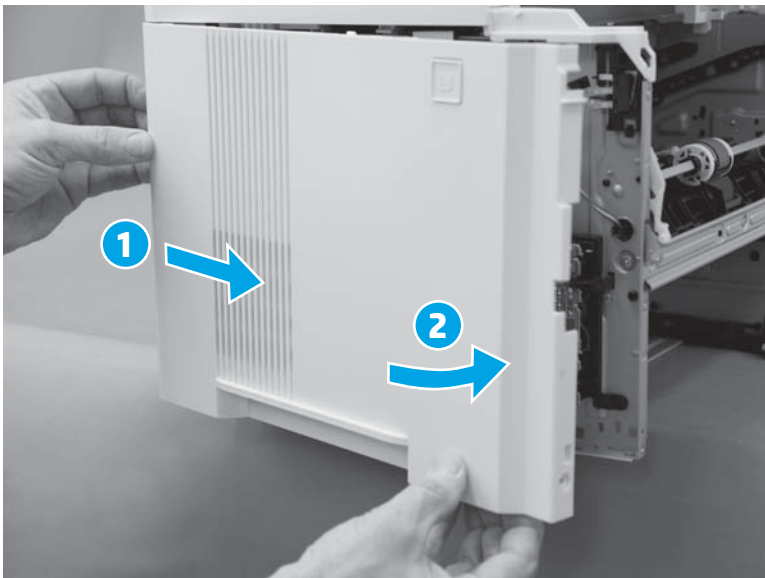
1. Before proceeding, take note of the location of the tabs and bosses on the inside of the cover.

**Figure 1-1254** Locate of the tabs and bosses



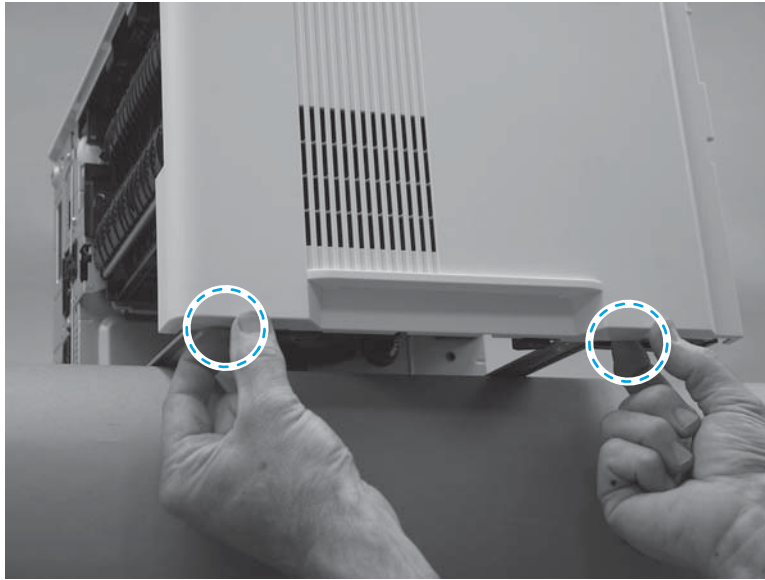
2. Engage the rear edge of the cover (callout 1), and then rotate the rear edge of the cover toward the printer (callout 2).

**Figure 1-1255** Install the cover



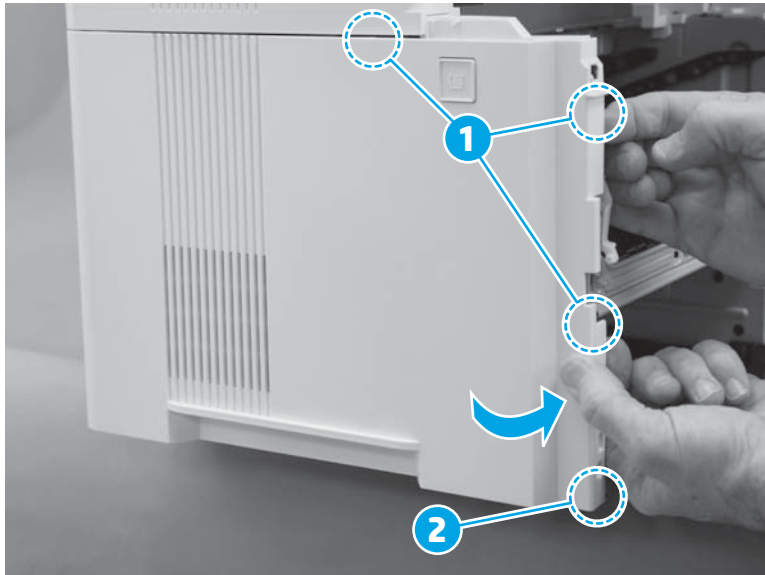
3. At the bottom edge of the cover, engage two tabs.

**Figure 1-1256** Engage two tabs



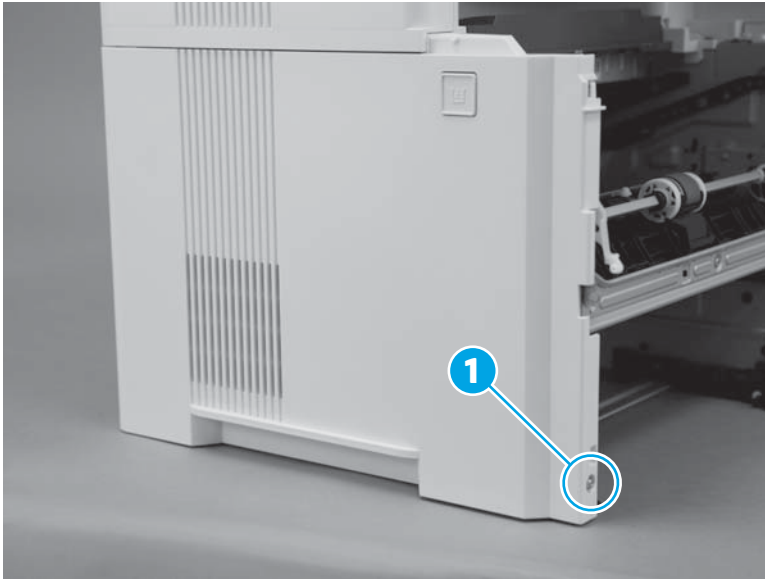
4. At the front of the printer, engage three tabs (callout 1), and then continue to rotate the front edge of the cover toward the printer to engage one boss (callout 2).

**Figure 1-1257** Engage three tabs and one boss





5. Install one screw (callout 1).

**Figure 1-1258** Install one screw



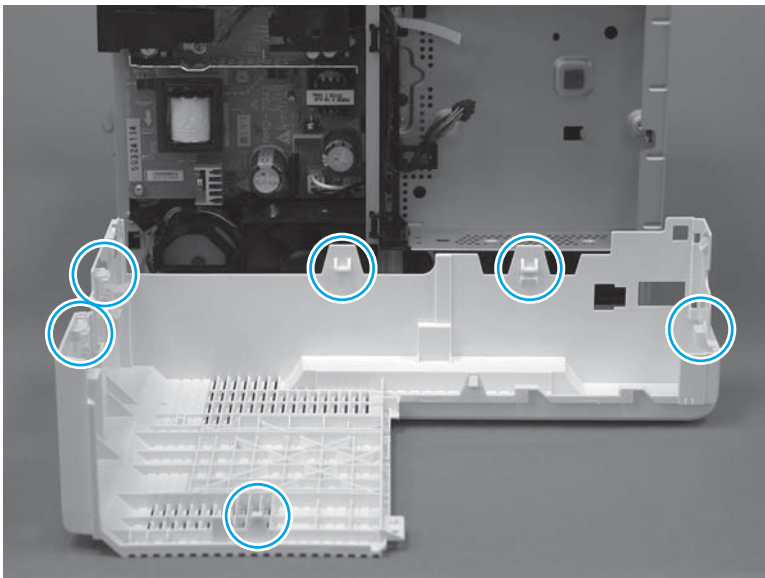
### Step 27: Install the right cover

 **IMPORTANT:** The black-plastic cassette front and rear guides (located inside the tray cavity) can be easily dislodged. Do not lose the guides when the cover is removed or installed.

 **NOTE:** The M527 printer is shown in this procedure. However, this procedure is valid for the M501/M506 printers.

1. Before proceeding, take note of the location of the tabs and bosses on the inside of the cover.

**Figure 1-1259** Locate the tabs and bosses

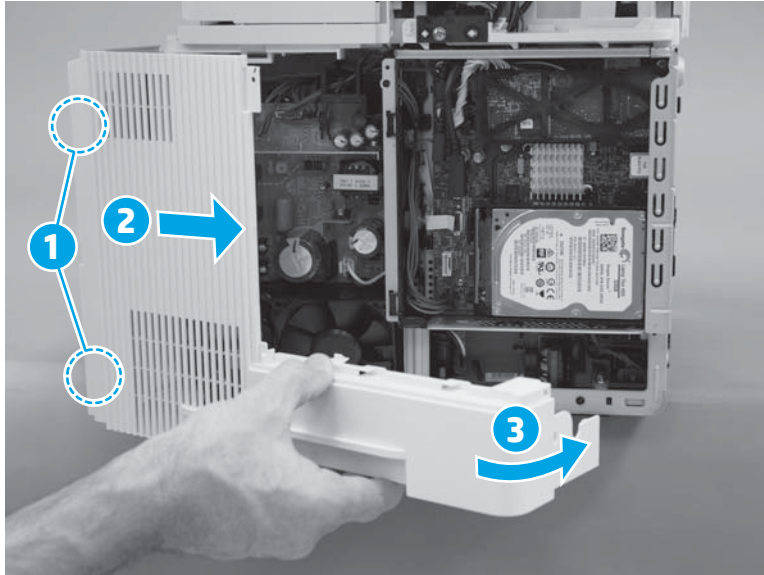


2. At the front of the cover engage two bosses (callout 1/2), and then rotate the rear of the cover toward the printer (callout 3).

**CAUTION:** It might be easier to install the cover with the printer slightly hanging over the edge of the workspace. Do not let the printer tip and fall off of the workspace when removing the cover.

**TIP:** Make sure that the power switch at the front of the printer is positioned in the opening in the cover and that it does not interfere with the cover installation.

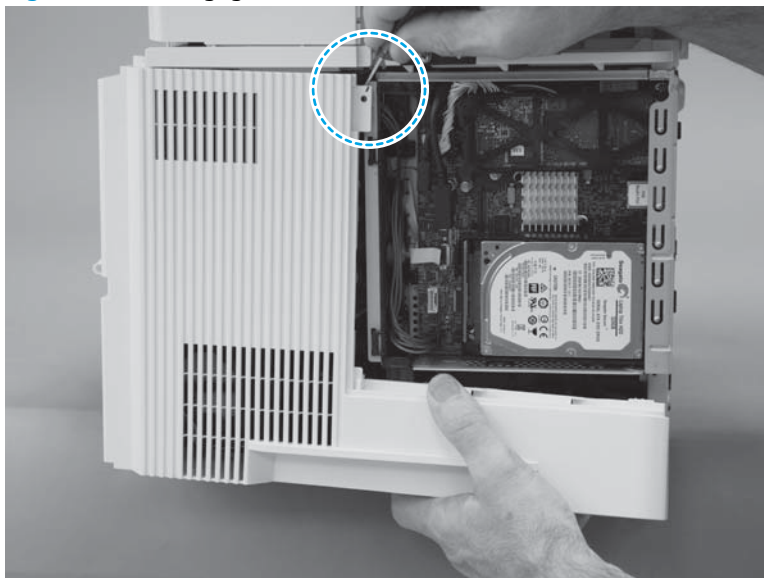
**Figure 1-1260** Install the cover



3. At the top rear edge of the cover, engage one tab.

**CAUTION:** It might be easier to install the cover with the printer slightly hanging over the edge of the workspace. Do not let the printer tip and fall off of the workspace when removing the cover.

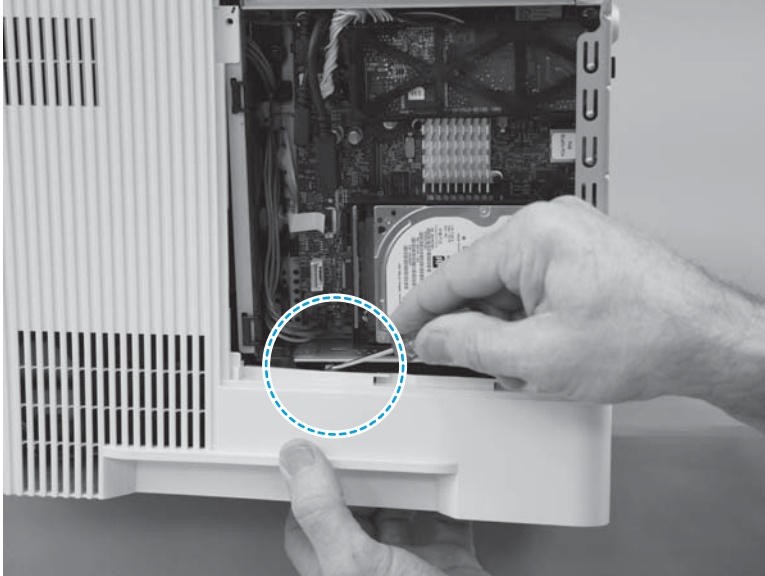
**Figure 1-1261** Engage one tab



4. Near the formatter, engage one tab.

**CAUTION:** It might be easier to install the cover with the printer slightly hanging over the edge of the workspace. Do not let the printer tip and fall off of the workspace when removing the cover.

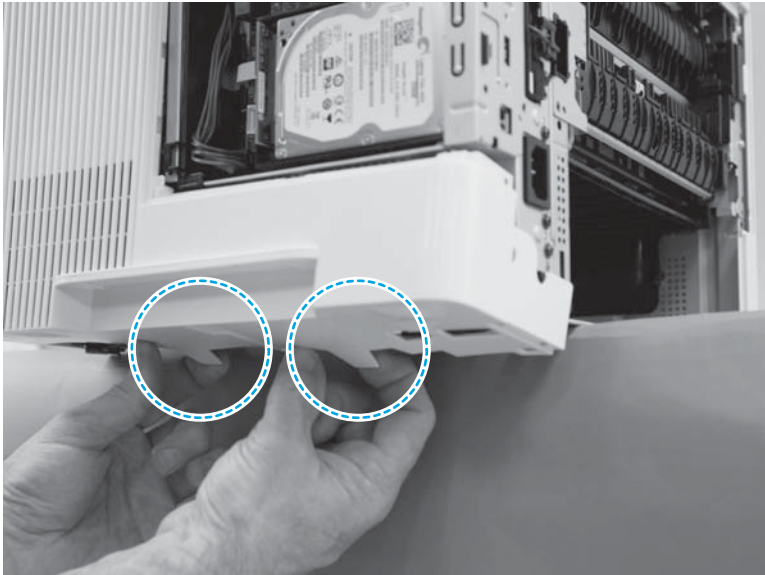
**Figure 1-1262** Engage one tab



5. At the bottom edge of the cover, engage two bosses.

**CAUTION:** It might be easier to install the cover with the printer slightly hanging over the edge of the workspace. Do not let the printer tip and fall off of the workspace when removing the cover.

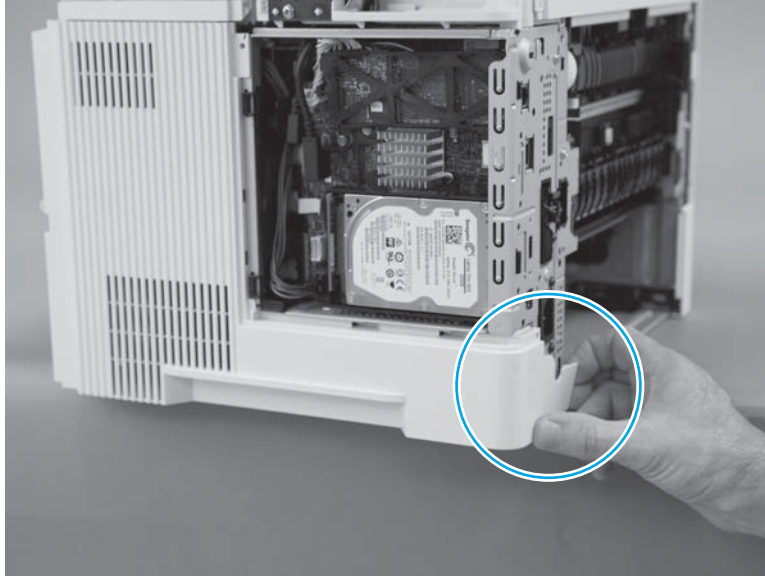
**Figure 1-1263** Engage two bosses



6. At the rear of the printer, engage one boss.

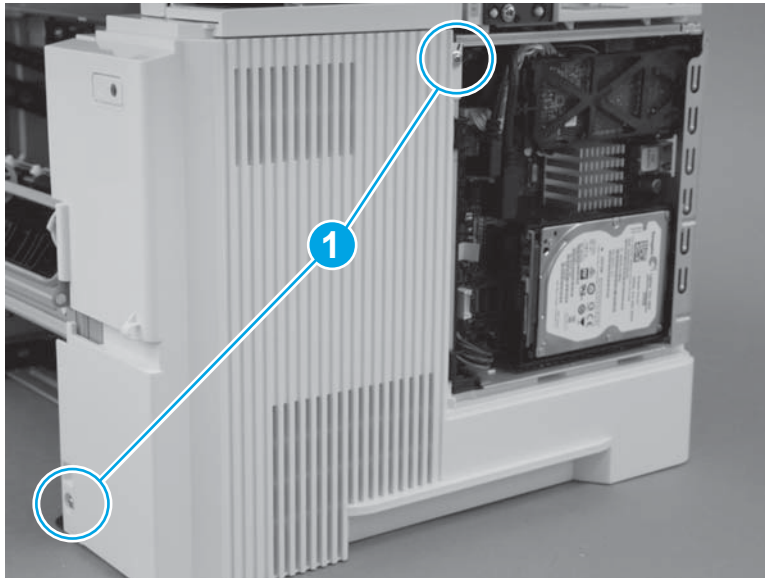
**CAUTION:** It might be easier to install the cover with the printer slightly hanging over the edge of the workspace. Do not let the printer tip and fall off of the workspace when removing the cover.

**Figure 1-1264** Engage one boss



7. Install two screws (callout 1).

**Figure 1-1265** Install two screws

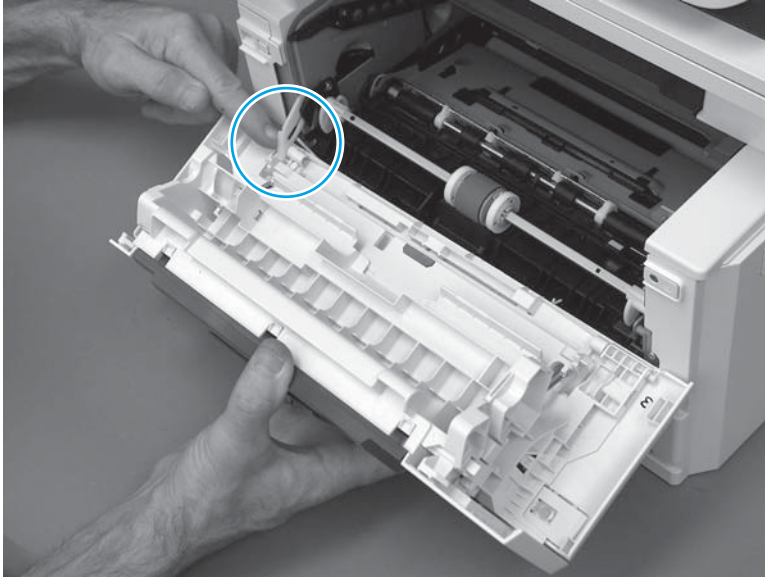


### Step 28: Install the cartridge door assembly


1. Position the door close to the printer, and then engage the keyed pin on the left-side retainer arm with the hole in the door.


**TIP:** It might be easier to engage the keyed pin with the hole by using a small flat-blade screwdriver.

**Figure 1-1266** Engage the left-side retainer arm

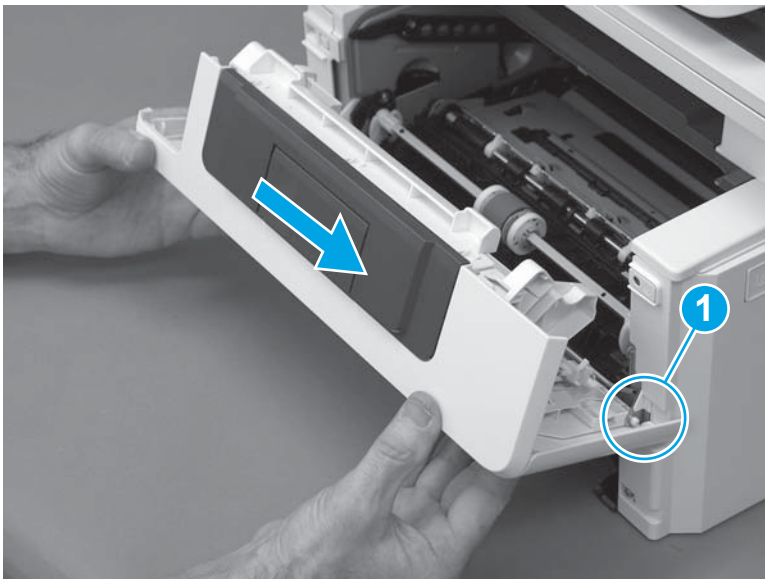


2. Engage the right-side door hinge pin with the hole in the chassis (callout 1).

 **NOTE:** There are two right-side hinge pins (not shown in callout 1).


 **TIP:** Keep a finger pressed on the left-side retainer arm so that it does not disengage from the door.

**Figure 1-1267** Install the door

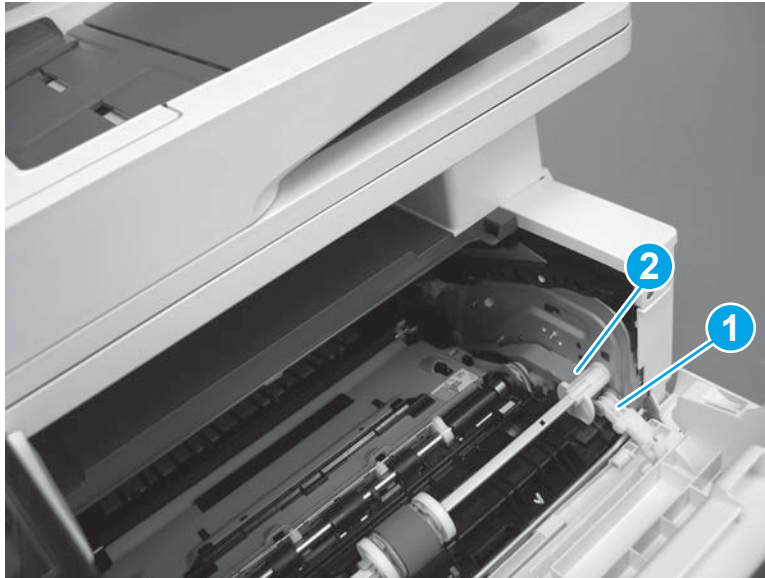




3. Install the gray-plastic pressure-release link (callout 1) onto the white-plastic door arm (callout 2).

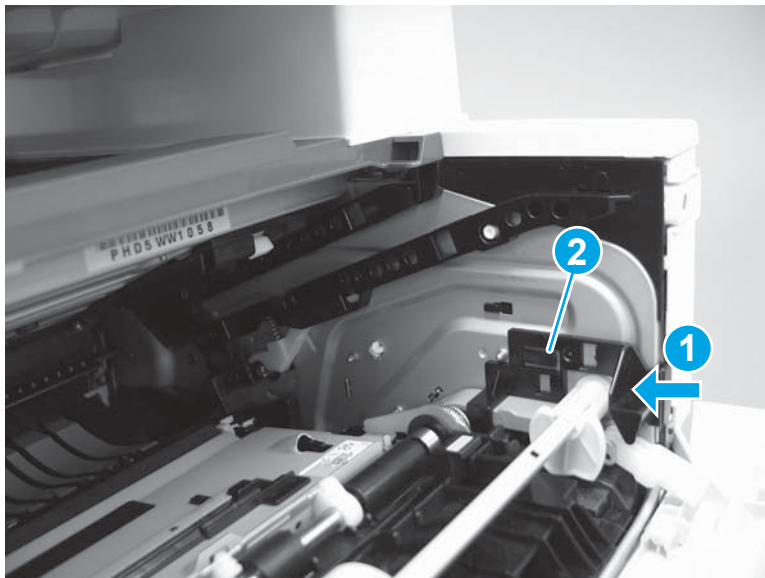
 **IMPORTANT:** Make sure that the arm snaps on to the link. Partially close and open the door to verify that the link (callout 2) moves in and out of the printer as the door closes/opens.

**Figure 1-1268** Install the pressure-release link



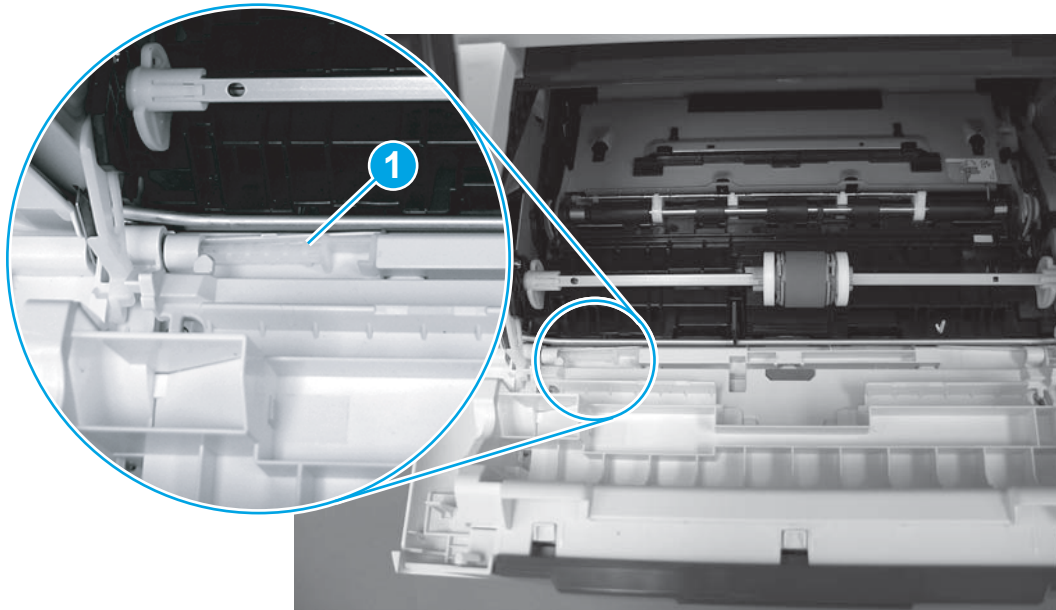
4. Slide the guide into the printer (callout 1), and then make sure that the tab (callout 2) snaps into place to secure the guide to the chassis.

**Figure 1-1269** Install the guide





5. Position the support shaft on the door, and then align the left-side hinge on the door with the hole in the chassis (callout 1).

**Figure 1-1270** Align the hinge

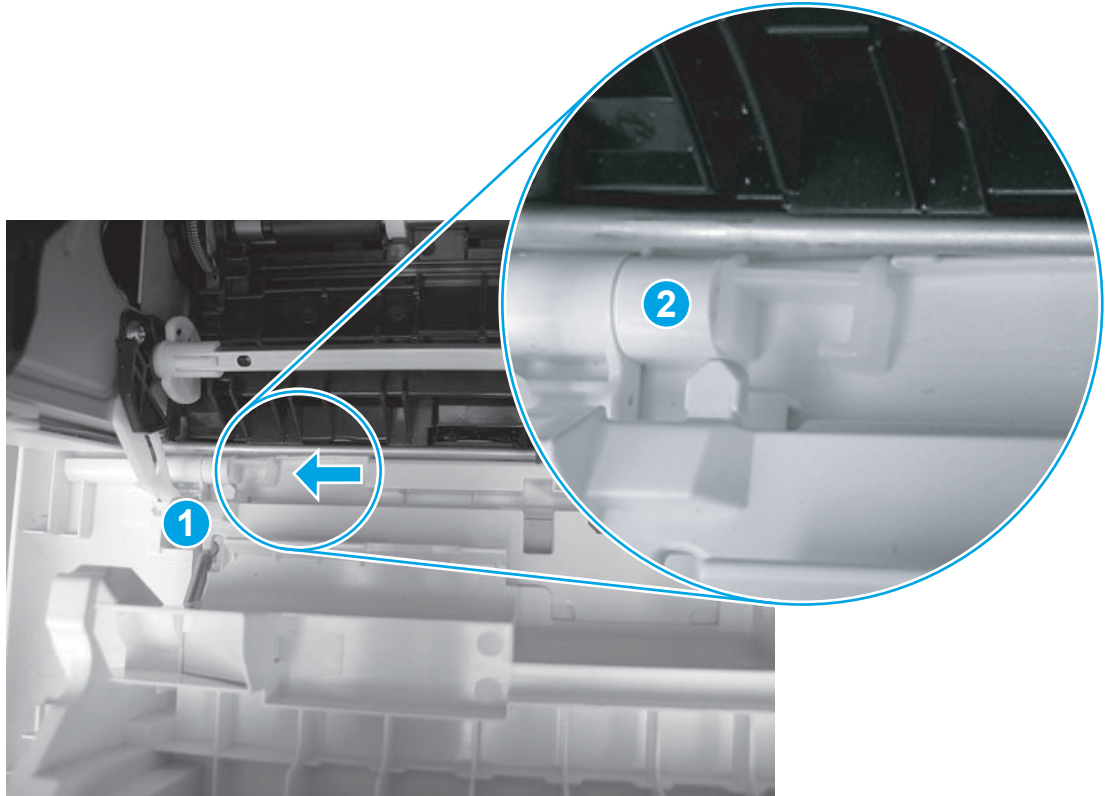


6. Push the shaft towards the left side of the printer to install it (callout 1).

 **NOTE:** Make sure that the support shaft is fully installed and correctly orientated (callout 2) so that it will not interfere with the door opening and closing.

 **Reinstallation tip:** If a replacement door was installed, make sure to install the nameplate (supplied in the kit) corresponding to the printer on the door.

**Figure 1-1271** Install the support shaft



### Step 29: Install the rear door assembly

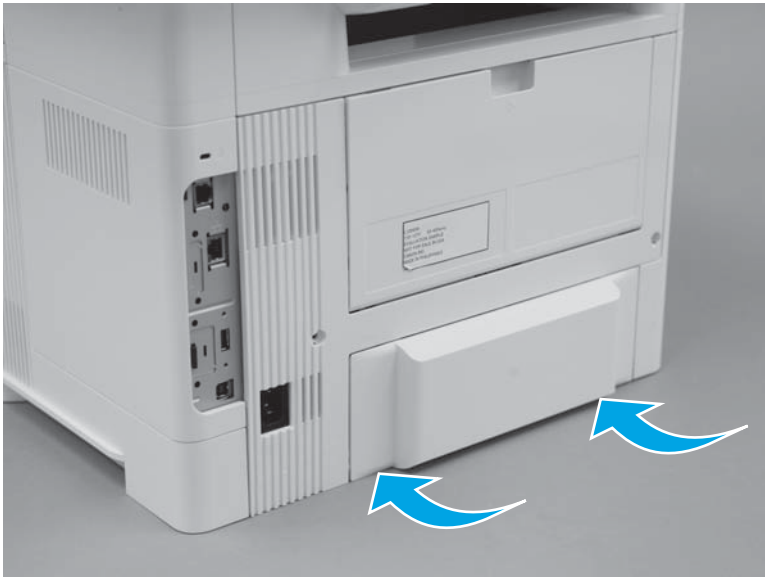
1. Engage the top edge of the assembly with the printer.

**Figure 1-1272** Install the cover



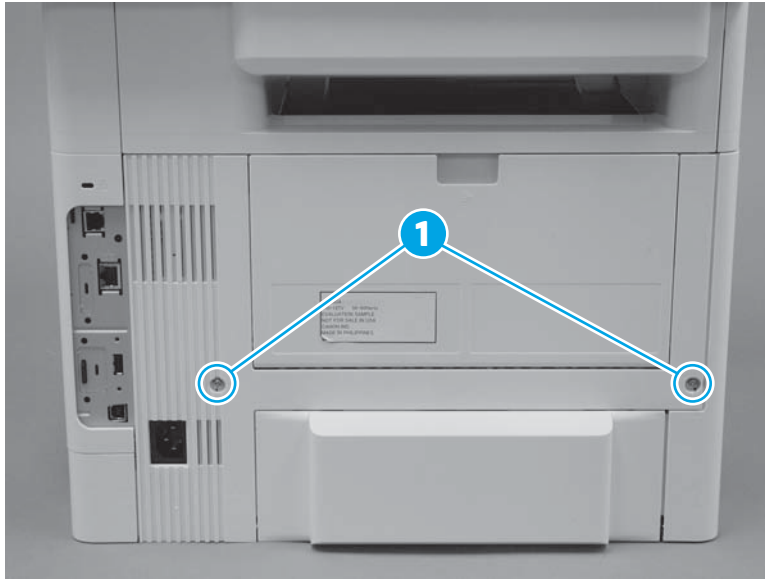
2. Rotate the bottom edge of the cover towards the printer.

**Figure 1-1273** Rotate the bottom of the cover




3. Install two screws (callout 1).

**Figure 1-1274** Install two screws

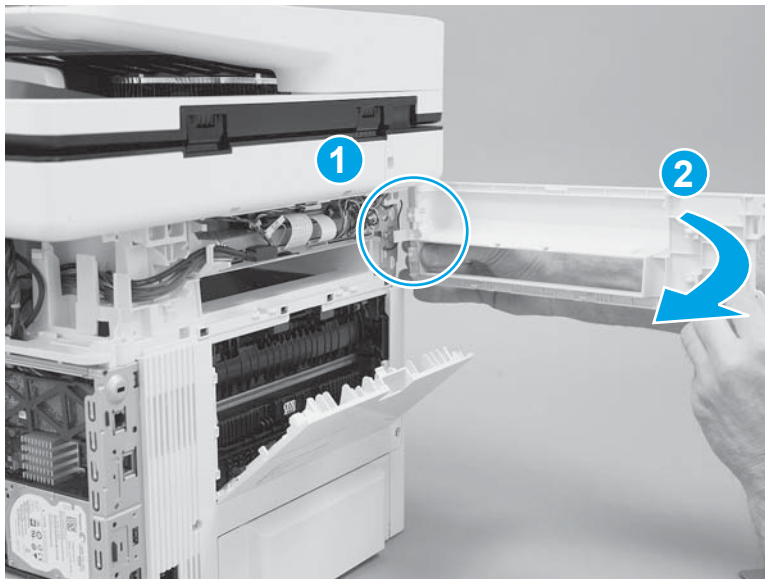


### Step 30: Install the top-rear cover (M527)

 **NOTE:** This step is for the M527 printer. For the M501/M506, skip this step and go to [Step 34: Install the formatter on page 734](#).

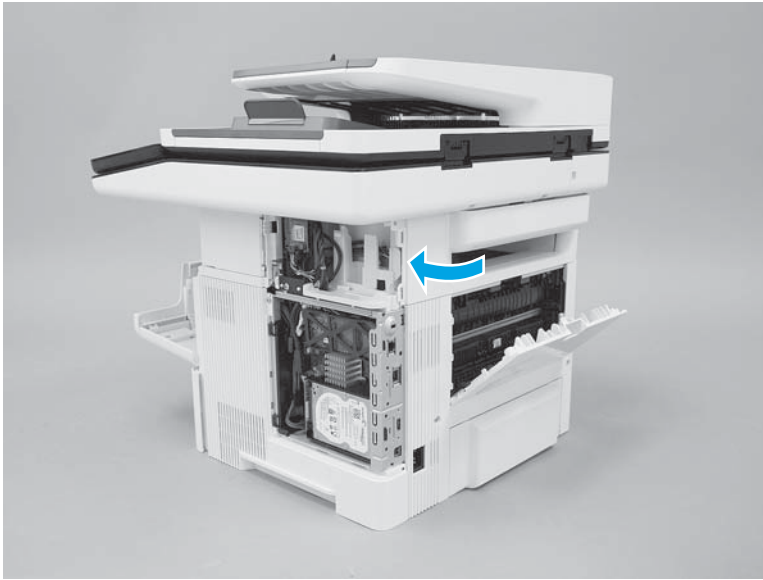
1. Engage one boss (callout 1), and then rotate the cover towards the printer (callout 2).

**Figure 1-1275** Engage one boss



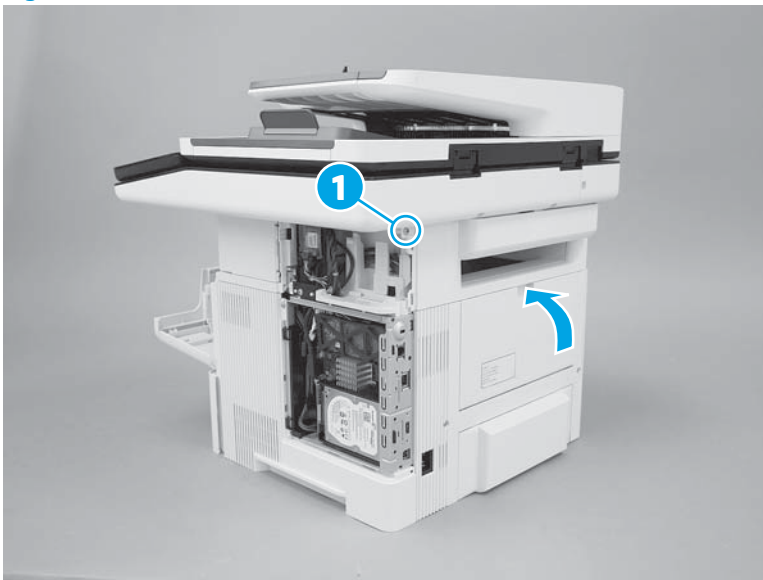
2. Continue to rotate the cover toward the printer to install it.

**Figure 1-1276** Install the cover



3. Install one screw (callout 1), and then close the rear door.

**Figure 1-1277** Install one screw



### Step 31: Install the top-left cover (M527)



**NOTE:** This step is for the M527 printer. For the M501/M506, skip this step and go to [Step 34: Install the formatter on page 734](#).

1. Position the front edge of the cover on the printer, and then slide the cover toward the front of the printer to engage two bosses at the front of the cover.

**Figure 1-1278** Slide the cover




2. Rotate the cover towards the printer to engage two tabs at the middle of the cover.

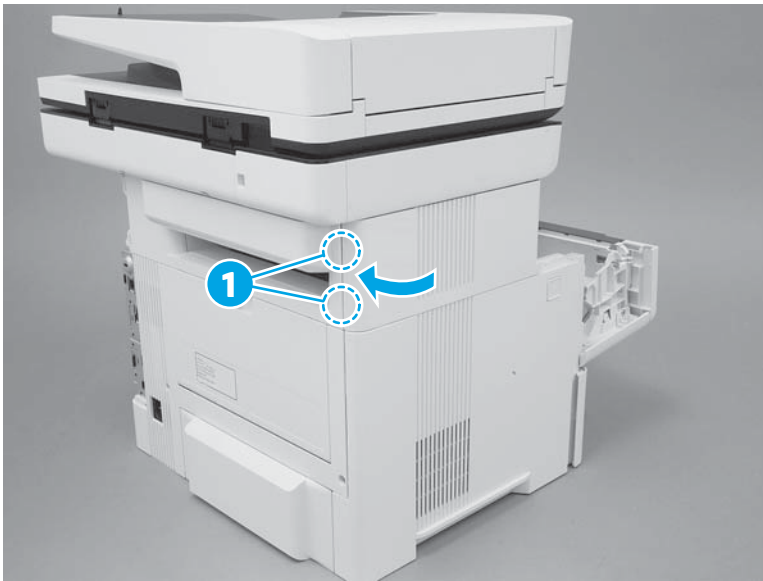
**Figure 1-1279** Engage two tabs




3. Continue to rotate the cover onto the printer to engage two tabs (callout 1) at the rear edge of the cover.


 **NOTE:** Close the toner-cartridge door.

**Figure 1-1280** Engage two tabs



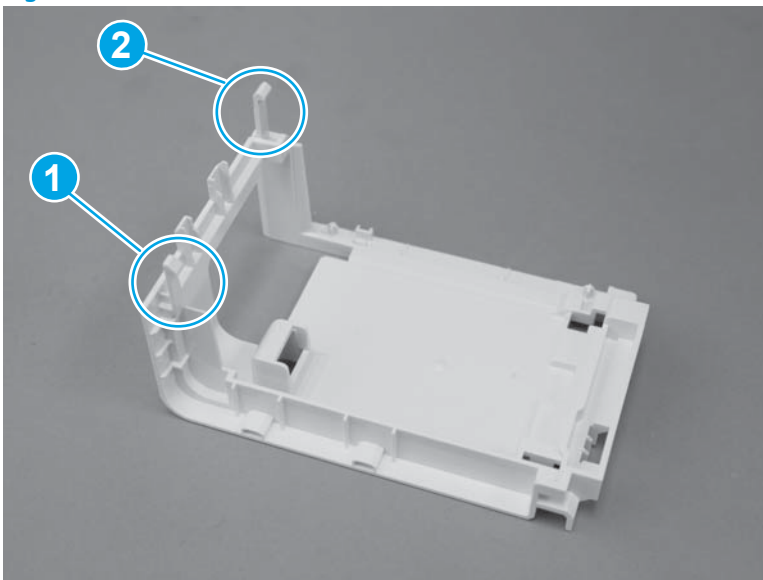
### Step 32: Install the stapler stationary (inner) cover (M527)

 **NOTE:** This step is for the M527c/f/z printers. For the M501/M506, skip this step and go to [Step 34: Install the formatter on page 734](#). For the M527dn, skip this step and go to [Step 33: Install the stapler door or blank cover \(M527\) on page 732](#).

 **NOTE:** M527c/f/z printers only.

1. Before proceeding, take note of the locations of the upper tab (callout 1) and the lower tab (callout 2) on the stapler stationary (inner) cover.

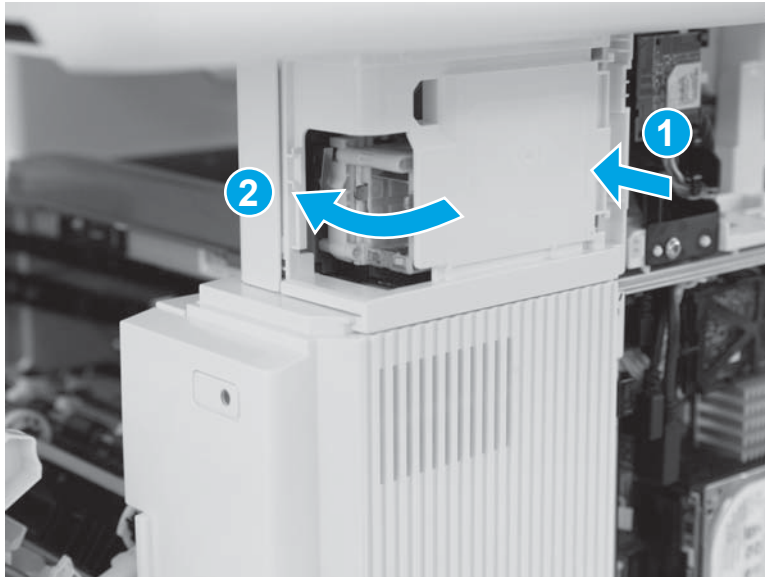
**Figure 1-1281** Locate the tabs





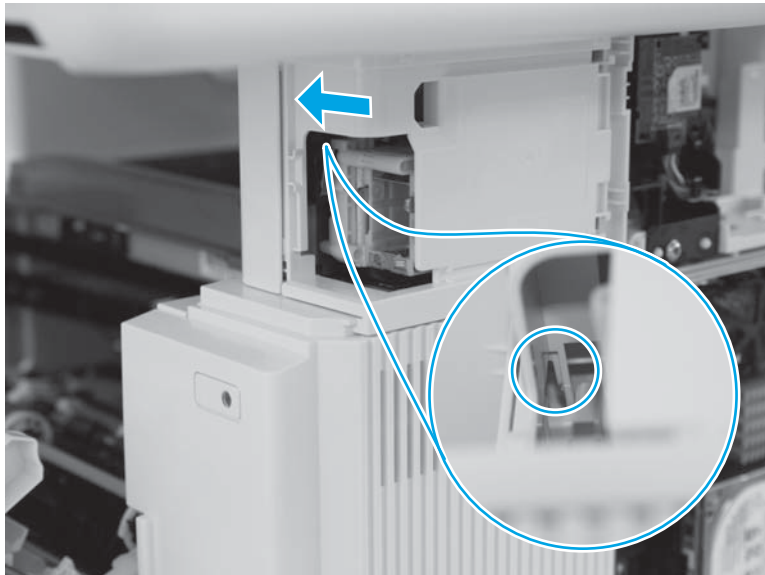
- Engage the rear edge of the cover with the printer (callout 1), and then rotate the front edge of the cover onto the printer (callout 2) to engage the two tabs.

**Figure 1-1282** Install the cover



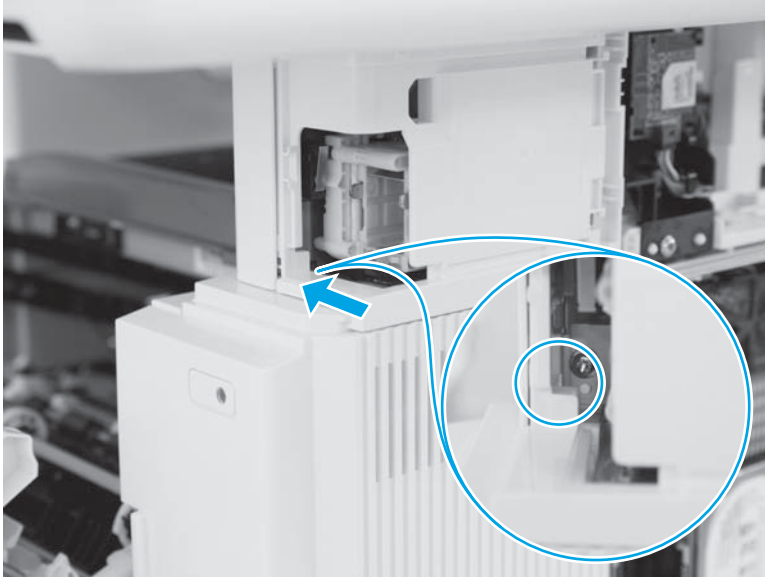
- Verify that the upper tab is engaged.

**Figure 1-1283** Engage one tab




4. Verify that the lower tab is engaged.

**Figure 1-1284** Engage one tab



### Step 33: Install the stapler door or blank cover (M527)

 **NOTE:** This step is for the M527 printers. For the M501M506, skip this step and go to [Step 34: Install the formatter on page 734](#).

 **NOTE:** The M527dn does not have a convenience stapler.

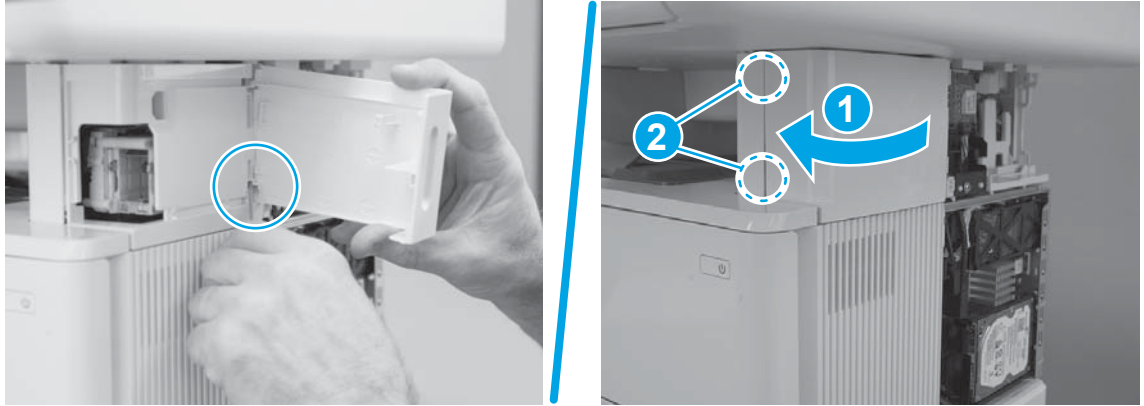
1. Do one of the following:
  - **M527c/f/z:** Position the door near the printer.
  - **M527dn:** Position the cover on the printer.

**Figure 1-1285** Install the door or cover



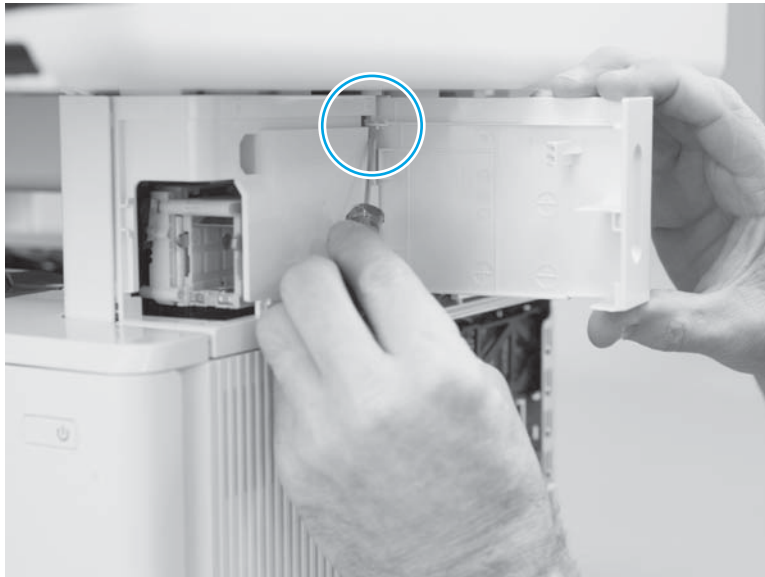
2.
  - **M527c/f/z:** Engage the lower hinge.
  - **M527dn:** Rotate the cover towards the printer (callout 1), and then make sure that the two tabs (callout 2) snap into place to install the cover.

**Figure 1-1286** Engage the lower hinge or engage the cover



3. **M527c/f/z:** Engage the upper hinge.

**Figure 1-1287** Engage the upper hinge



4. **M527c/f/z:** Close the stapler door.

**Figure 1-1288** Close the door



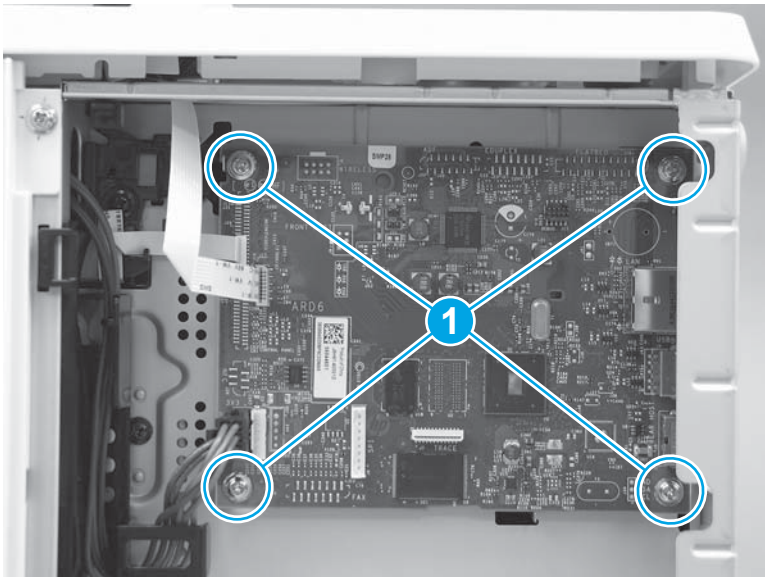
#### Step 34: Install the formatter




**IMPORTANT: M506/M527:** Take note of all empty connectors on the PCA before disconnecting any wire harnesses or flat-flexible cables (FFCs). Some empty connectors might not be visible until other items—like the hard-disk drive—are removed, so pay close attention while removing the formatter and accessory items.

1. **M501:** Position the formatter on the chassis, install four screws (callout 1), and then connect all of the connectors and FFCs.

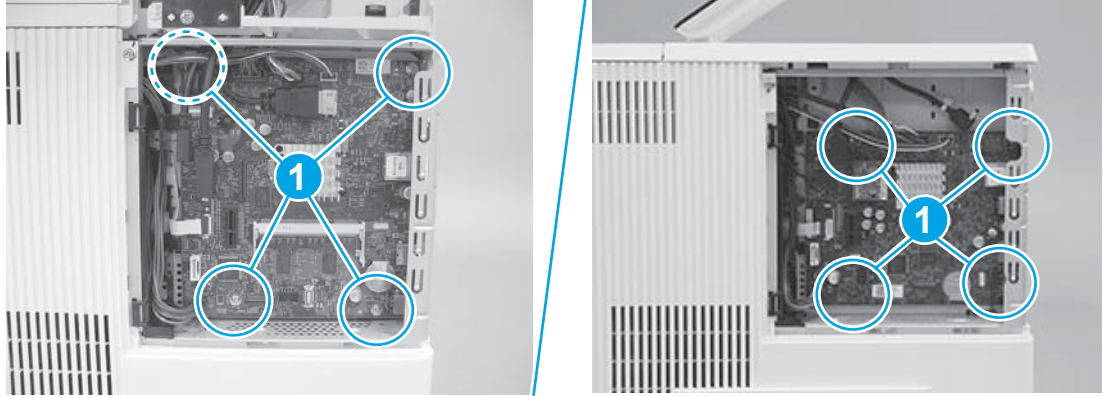
**Figure 1-1289** Install the formatter (M501)




2. **M506/M527:** Position the formatter on the chassis, install four screws (callout 1), and then connect all of the connectors and FFCs.

 **IMPORTANT:** Some connectors might need be empty if other items—for example a fax PCA—will be installed later.


**Figure 1-1290** Install the formatter (M506/M527)



### Step 35: Install the fax PCA (M527)

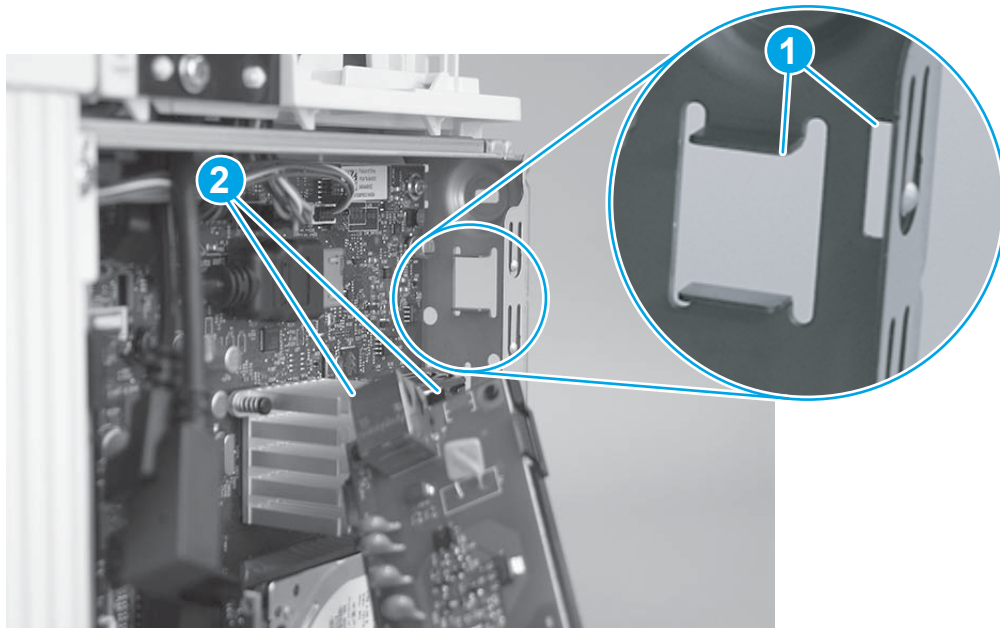
 **NOTE:** If the fax PCA is not installed, skip this step and go to [Step 36: Install the hard-disk drive \(HDD\)](#) on page 737.

 **CAUTION:**  ESD-sensitive part.

 **NOTE:** M527c/f/z printers only (optional for the M527dn).

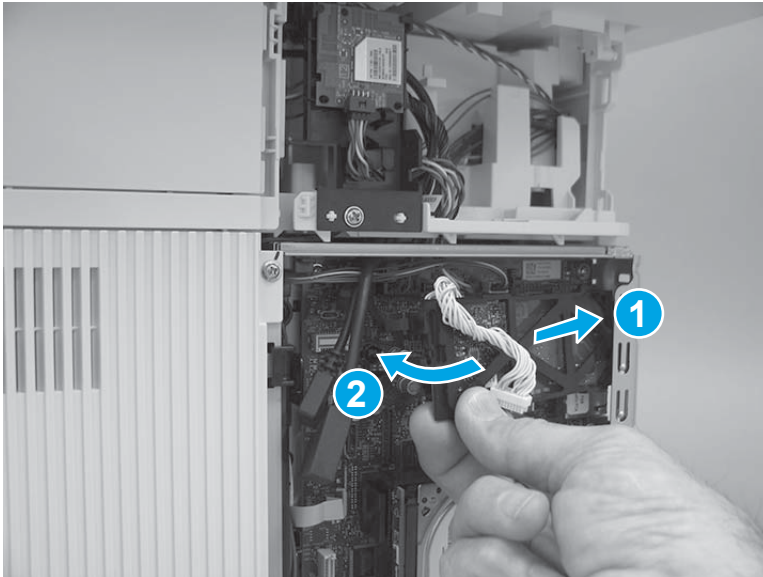
1. Before proceeding, take note of the location of the slots (callout 1) in the sheet-metal where the fax PCA cradle mounting tab and fax port (callout 2) must be installed.

**Figure 1-1291** Locate the slots in the sheet-metal




2. Insert the fax PCA cradle mounting tab and fax port in the slots in the sheet-metal plate (callout 1), and then rotate the connector end of the fax PCA toward the formatter (callout 2).

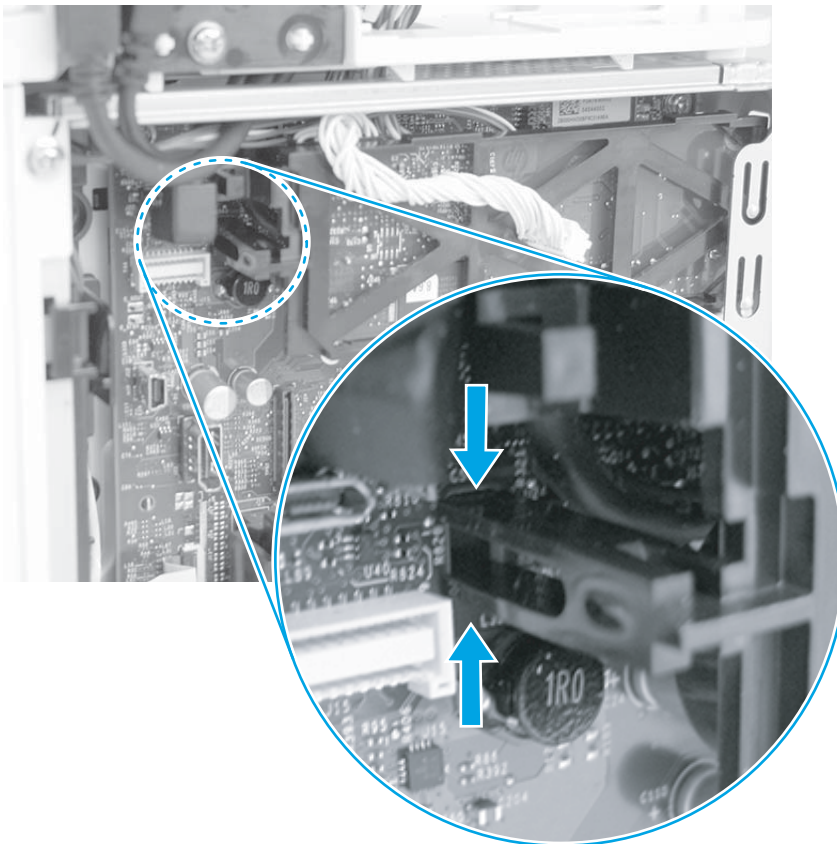
**Figure 1-1292** Install the fax PCA



3. Engage the retainer with the slot in the formatter.

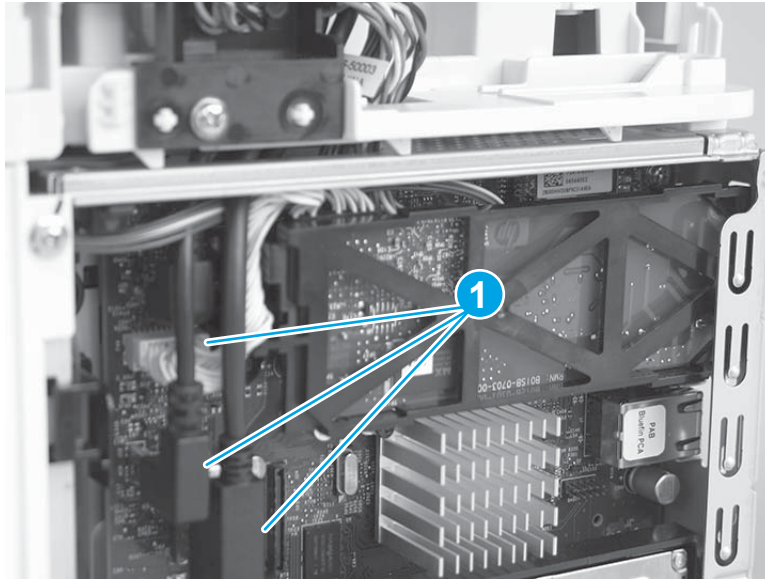
 **Reinstallation tip:** Pinch the retainer to easily engage it with the slot.

**Figure 1-1293** Engage the fax PCA




4. Connect three connectors (callout 1).

**Figure 1-1294** Connect three connectors




### Step 36: Install the hard-disk drive (HDD)

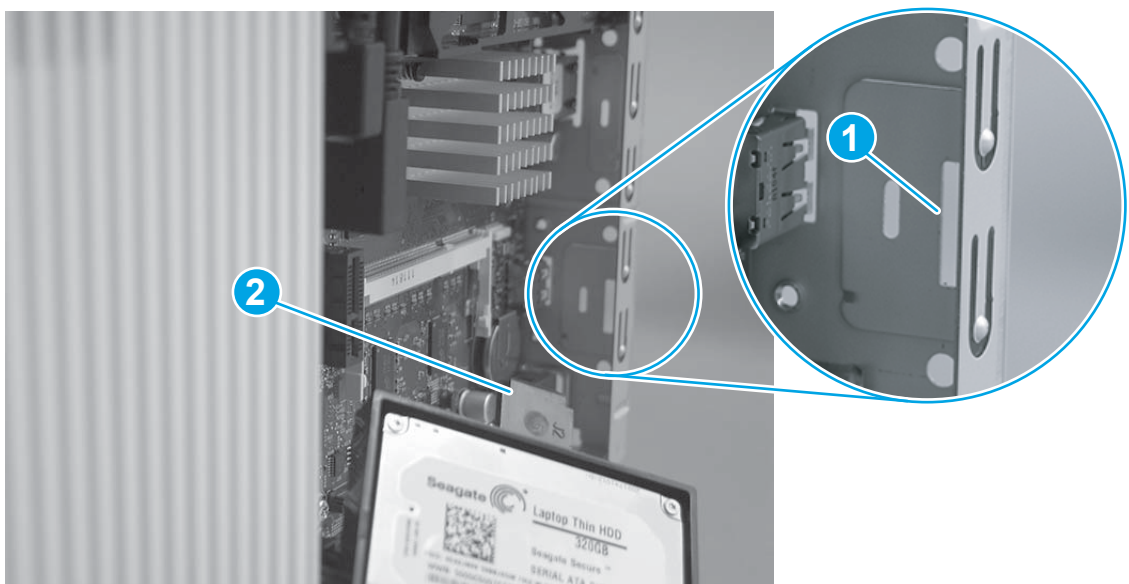
 **NOTE:** If the HDD is not installed, skip this step and go to [Step 37: Install the formatter cover on page 738](#).

 **CAUTION:**  ESD-sensitive part.

1. Before proceeding, take note of the location of the slot (callout 1) in the sheet-metal where the HDD cradle mounting tab (callout 2) must be installed.

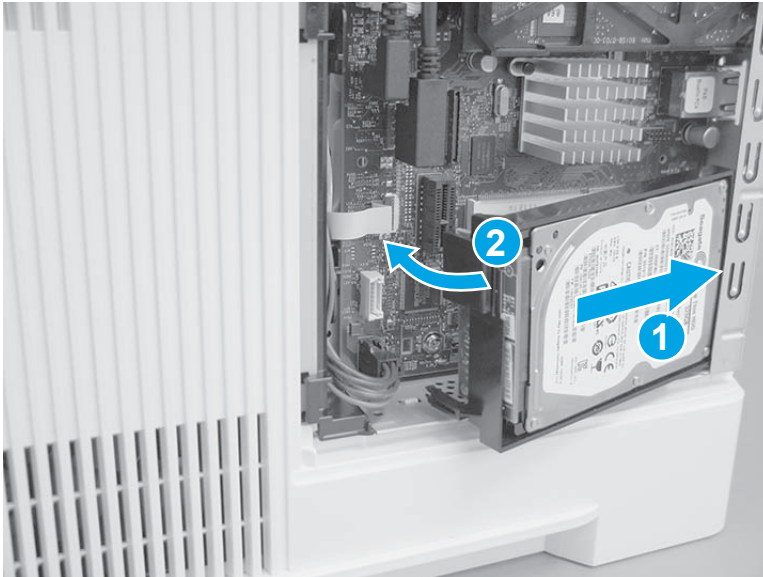
 **CAUTION:** This portion of the sheet-metal is a knock-out plate (callout 1). Do not push on it with sufficient force to detach it when installing the HDD.

**Figure 1-1295** Locate the slot in the sheet-metal



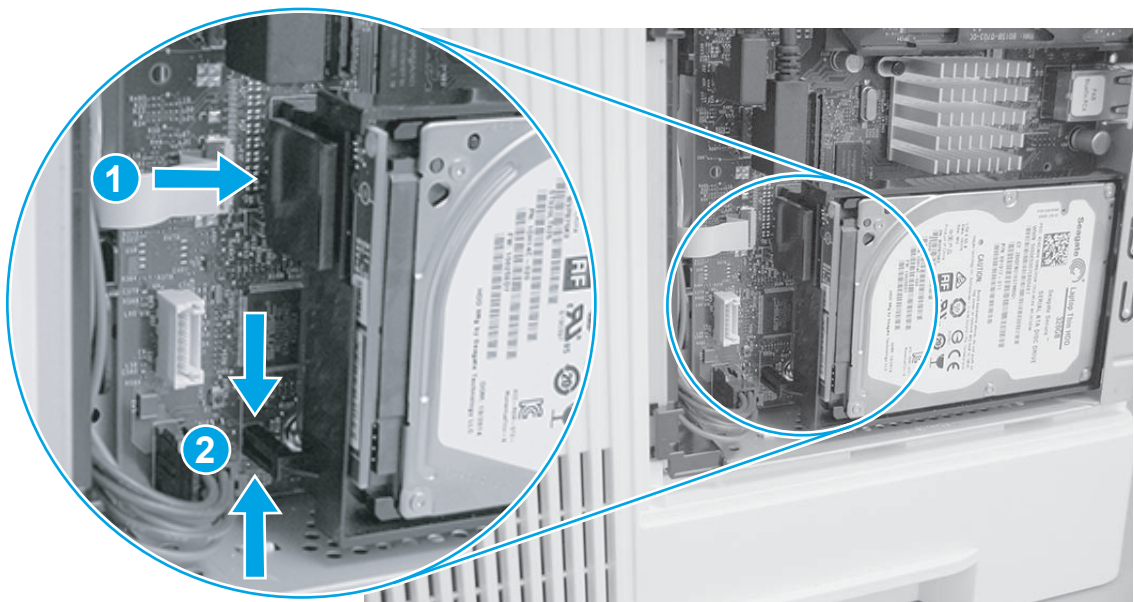
2. Insert the HDD cradle mounting tab in the slot in the sheet-metal (callout 1), and then rotate the connector end (callout 2) of the HDD toward the formatter.

**Figure 1-1296** Install the HDD



3. Make sure that the locking connector (callout 1) latches and that the standoffs (callout 2) engage with the slot in the formatter (it might be necessary to pinch the retainer to engage it with the slot).

**Figure 1-1297** Install the HDD

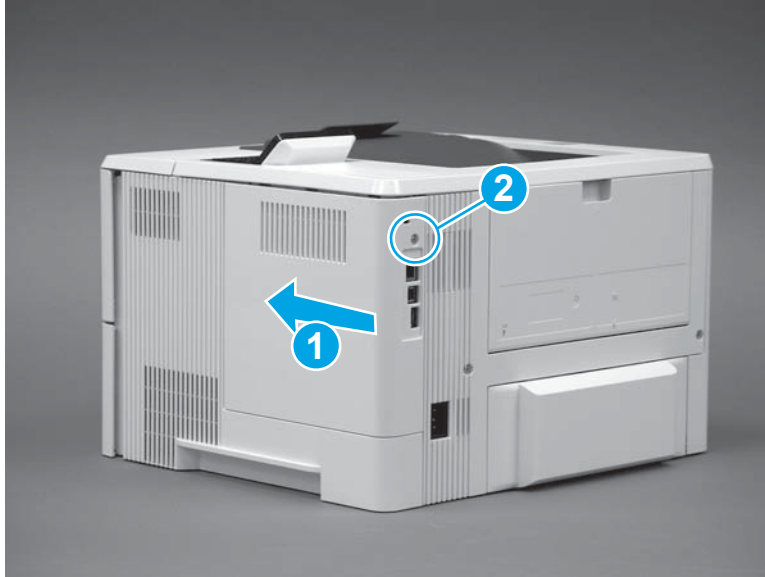


### Step 37: Install the formatter cover

1. **M501**: Slide it toward the front of the printer to install it (callout 1), and then install one screw (callout 2).

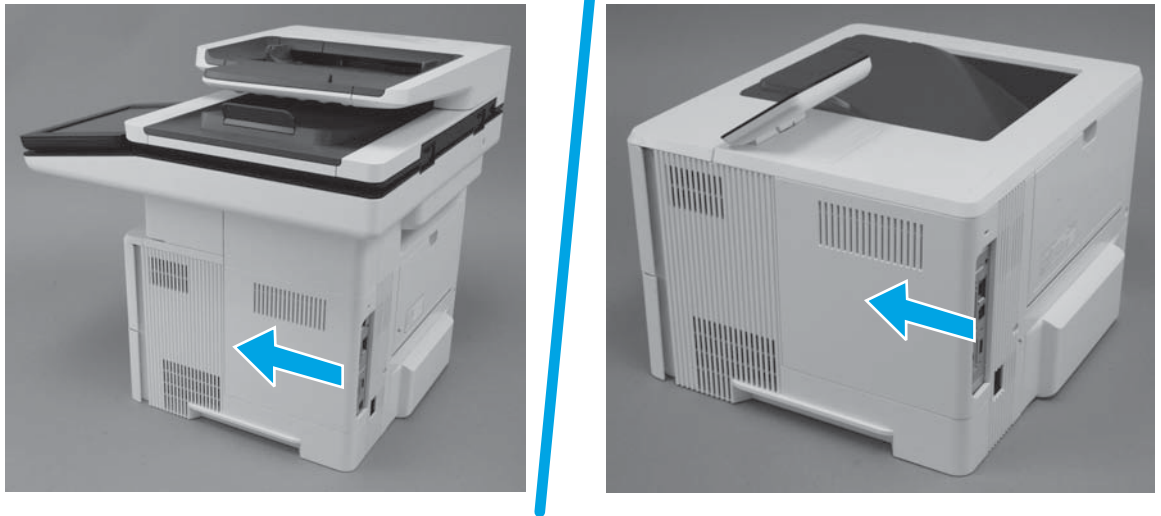


**Figure 1-1298** Install the formatter cover (M501)



2. **M506/M527:** Slide it toward the front of the printer to install it.

**Figure 1-1299** Install the formatter cover (M506/M527)



### Step 38: Install the tray

1. With the tray at a slight angle, align the sides of the tray with the rails in the accessory, and then partially slide the tray into the printer.

**Figure 1-1300** Install the tray



2. Push the tray straight into the accessory to close it.

**Figure 1-1301** Close the tray



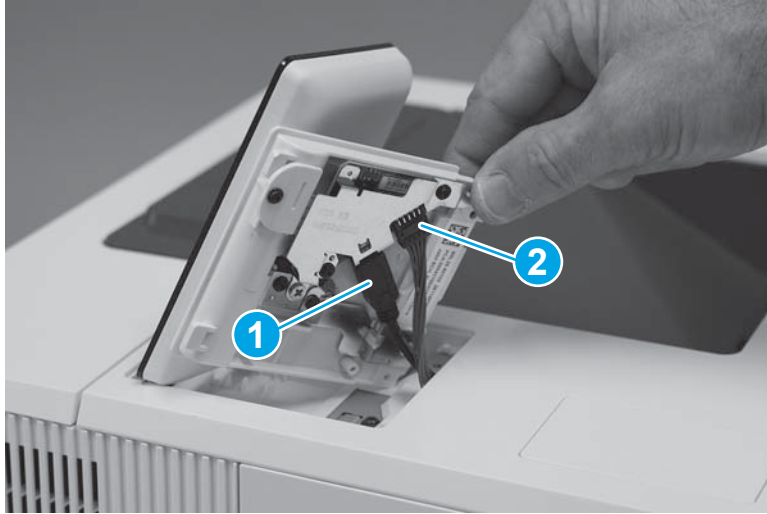
### Step 39: Install the control panel (M506x)



**NOTE:** M506x model only.

1. Connect one HDMI cable (callout 1), one connector (callout 2).

**Figure 1-1302** Connect the cables



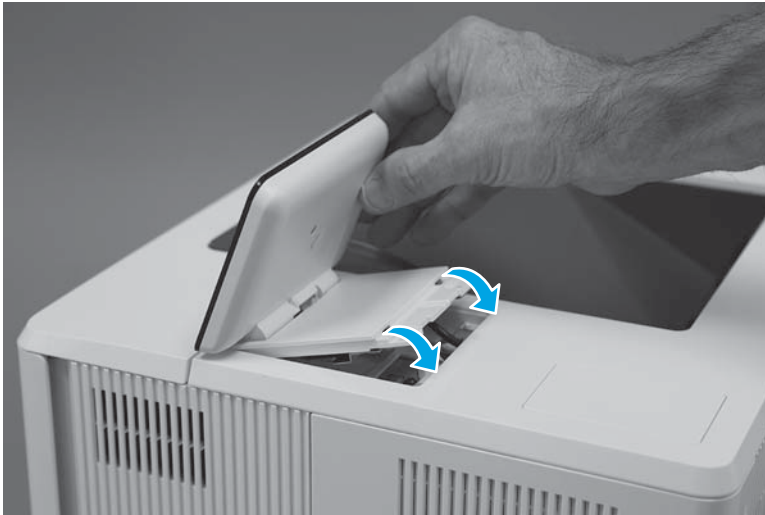
2. Install the tabs (callout 1) on the front of the control panel in the slots (callout 2) on the printer top cover.

**Figure 1-1303** Install the control panel



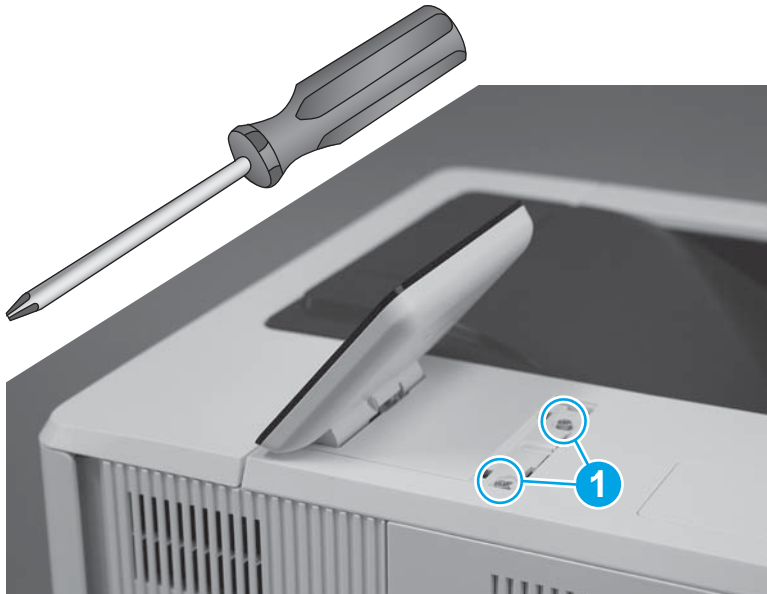
3. Rotate the control-panel base down onto the printer.

**Figure 1-1304** Rotate the control-panel base down




4. Use a small Phillips screwdriver to install two screws (callout 1).

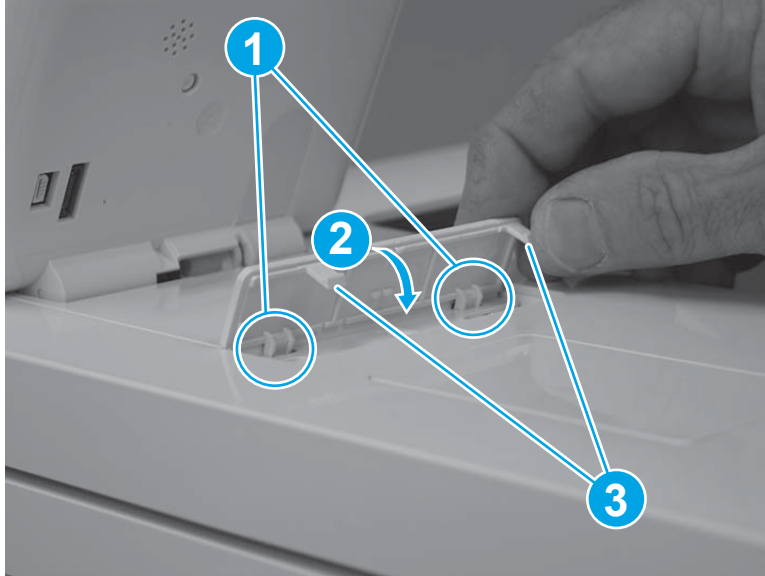
**Figure 1-1305** Install two screws



5. Position the screw cover mounting feet into the slots in the top cover (callout 1), and then rotate the cover down (callout 2) to install it.

 **NOTE:** Press down on the cover firmly to make sure that the tabs (callout 3) snap into place.

**Figure 1-1306** Install the cover



## Removal and replacement: Fan (FM1)

- [Introduction](#)
- [Step 1: Remove the tray](#)
- [Step 2: Remove the cartridge door assembly](#)
- [Step 3: Remove the rear door assembly](#)
- [Step 4: Remove the left cover](#)
- [Step 4: Remove the fan \(FM1\)](#)
- [Step 5: Unpack the replacement assembly](#)
- [Step 6: Install the fan \(FM1\) and fan bracket](#)
- [Step 6: Install the left cover](#)
- [Step 7: Install the rear door assembly](#)
- [Step 8: Install the cartridge door assembly](#)
- [Step 9: Install the tray](#)


### Introduction

This document provides the procedures to remove and replace the fan (FM1).

### Before performing service

#### Turn the printer power off

- Disconnect the power cable.

 **WARNING!** To avoid damage to the printer, turn the printer off wait 30 seconds, and then remove the power cable before attempting to service the printer.

Use the table below to identify the correct part number for your printer. To order the part, go to [www.hp.com/buy/parts](http://www.hp.com/buy/parts).

Fan (FM1) part number	
RK2-8068-000CN	Fan (FM1)

### Required tools

- Small flat-blad screwdriver.
- #2 Phillips screwdriver with a magnetic tip.

## After performing service

### Turn the printer power on

- Connect the power cable.
- Use the power switch to turn the power on.

### Post service test

Make sure that the printer initializes to a **Ready** state.

### Step 1: Remove the tray

1. Pull the tray straight out of the printer until it stops.

**Figure 1-1307** Pull the tray out until it stops



2. Lift the front of the tray, and then pull it out of the printer to remove it.

**Figure 1-1308** Release and remove the tray



### Step 2: Remove the cartridge door assembly



---

**NOTE:** If the toner cartridge was not removed prior to servicing the printer, remove it now.

---

1. Release the support shaft (callout 1), and then slide it toward the center of the door (callout 2).



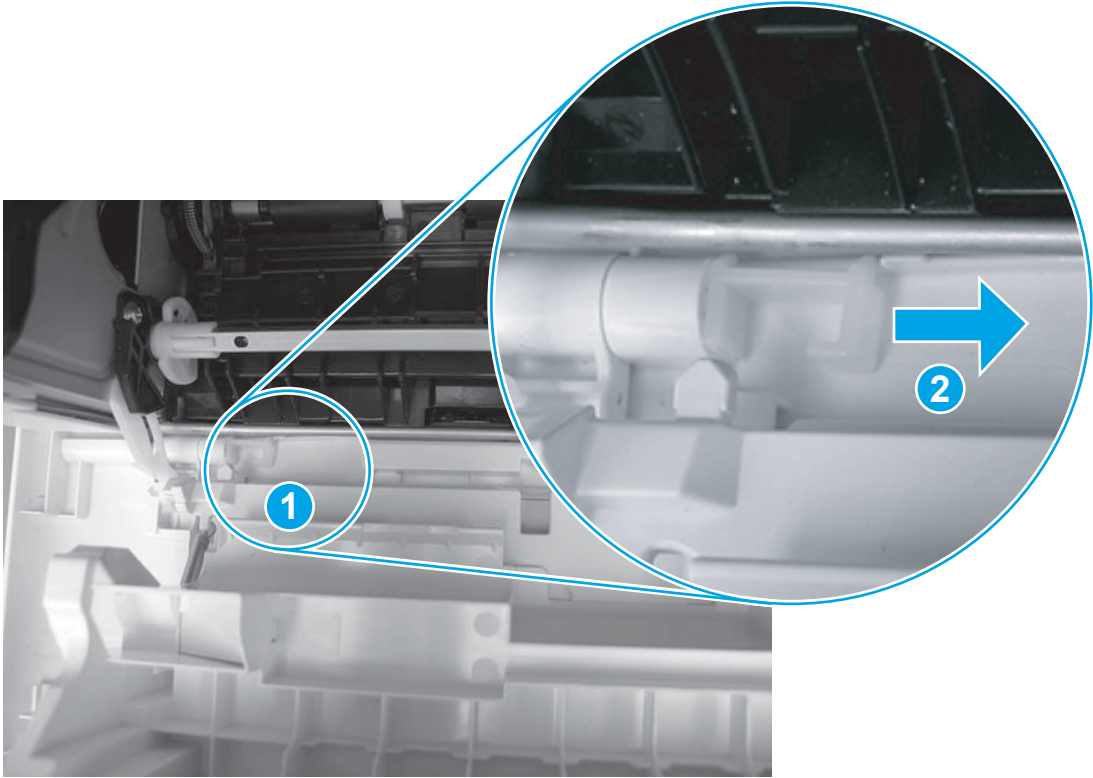
---

**TIP:** It might be easier to release the support shaft by using a small flat-blade screwdriver.

---

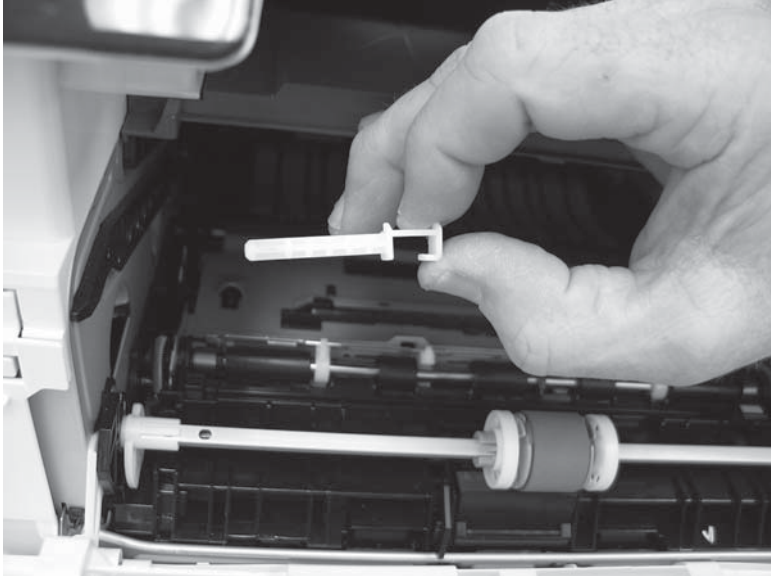


**Figure 1-1309** Release the support shaft



- 2. Remove the support shaft.

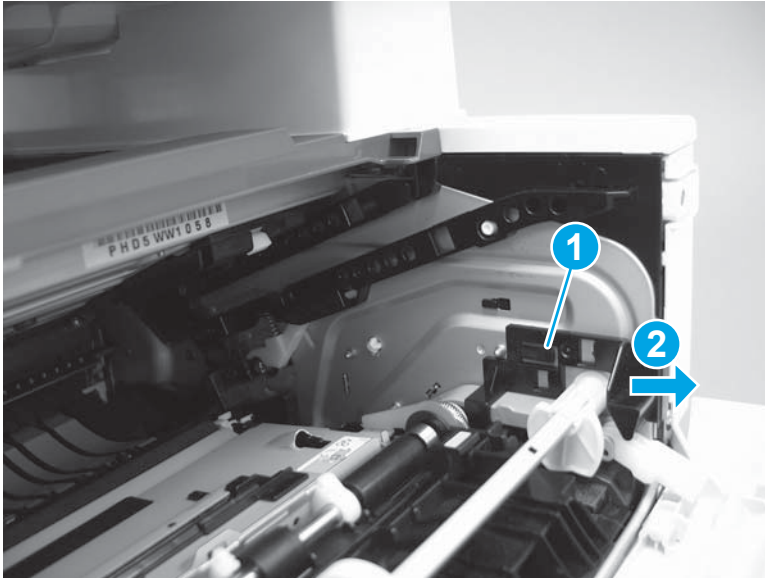
**Figure 1-1310** Remove the support shaft



3. Release one tab (callout 1), and then slide the guide out of the printer (callout 2).

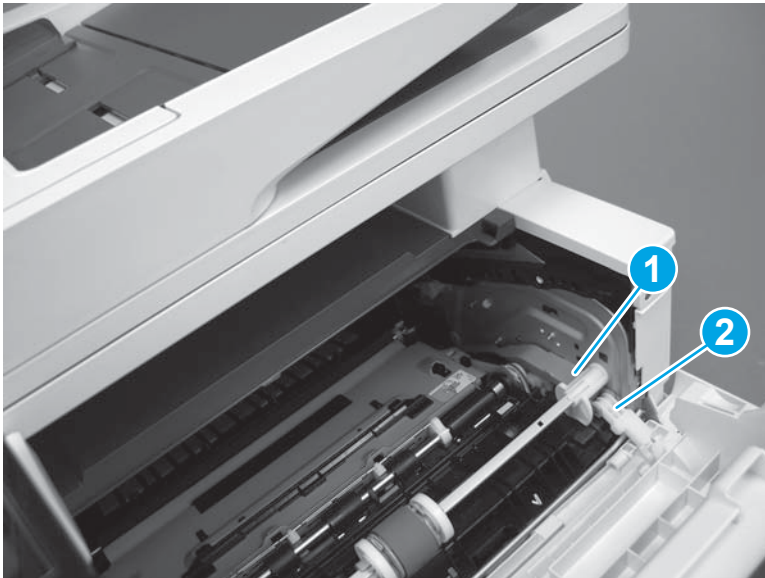
**⚠ CAUTION:** Be careful, the tab (callout 1) can be easily broken.

**Figure 1-1311** Remove the guide



4. Use a small flat-blad screwdriver to gently pry the white-plastic door arm (callout 1) off of the gray-plastic pressure-release link (callout 2) to release the door arm.

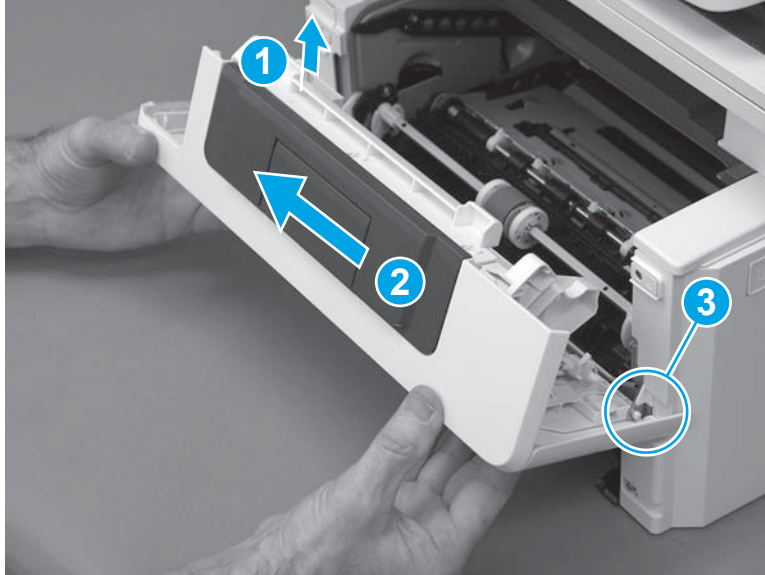
**Figure 1-1312** Release the pressure-release link



5. With the door in the partially closed position, slightly raise the left end (callout 1; raise it over the sheet-metal hinge boss), and then slide the door to the left (callout 2) to release the right hinge (callout 3).

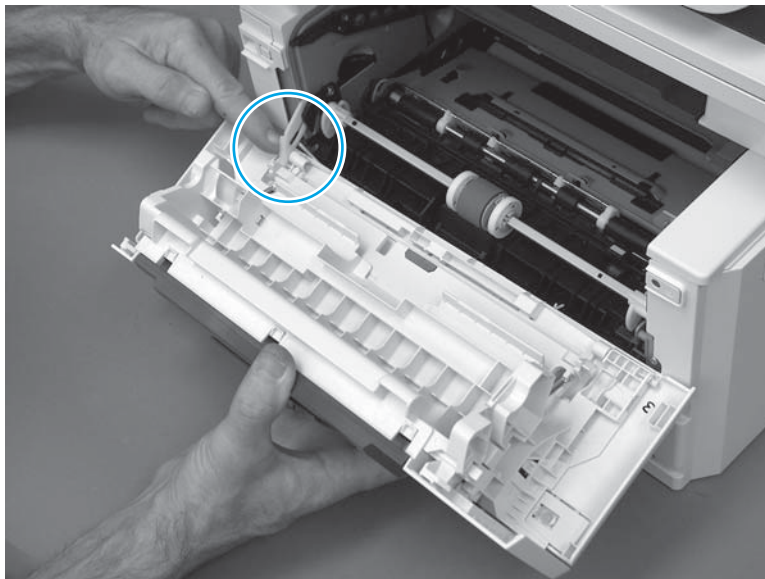
**CAUTION:** The door is still attached to the printer by the left-side retainer arm. Do not attempt to completely remove the door.

**Figure 1-1313** Release the door



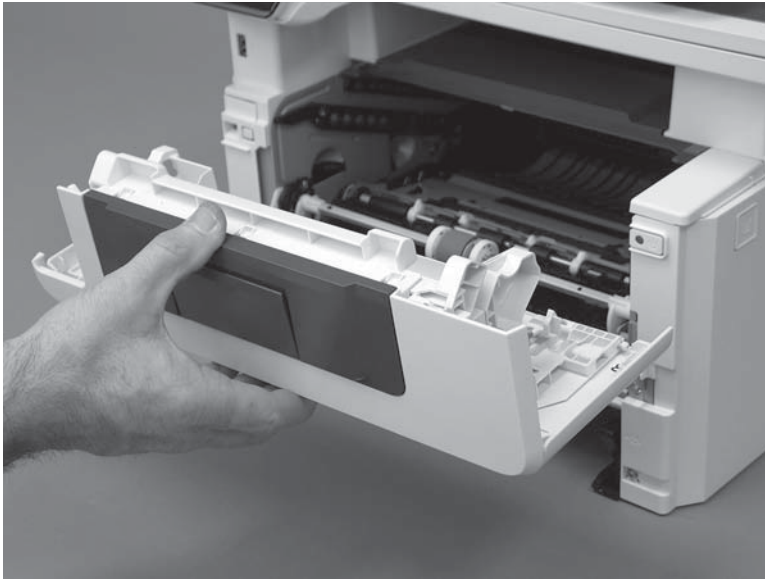
6. Rotate the door away from the printer until the keyed pin on the left-side retainer arm can disengage from the door.

**Figure 1-1314** Release the left-side retainer arm



7. Remove the door.

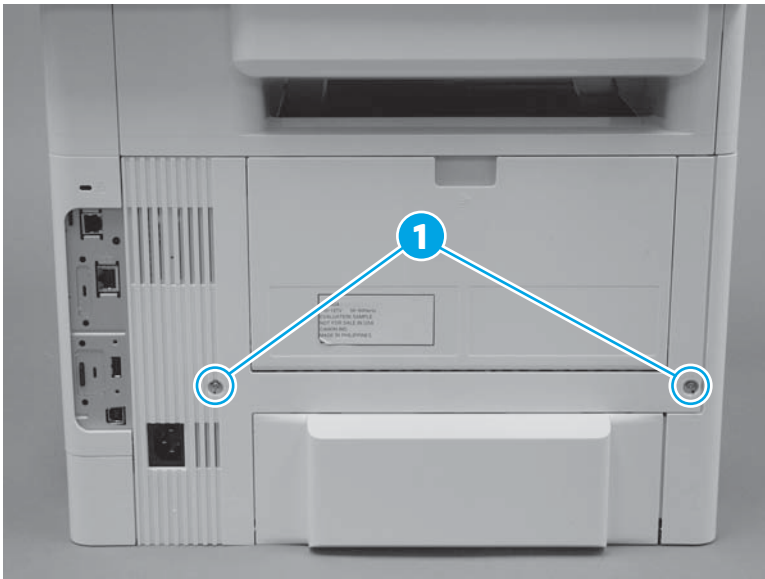
**Figure 1-1315** Remove the door



### Step 3: Remove the rear door assembly

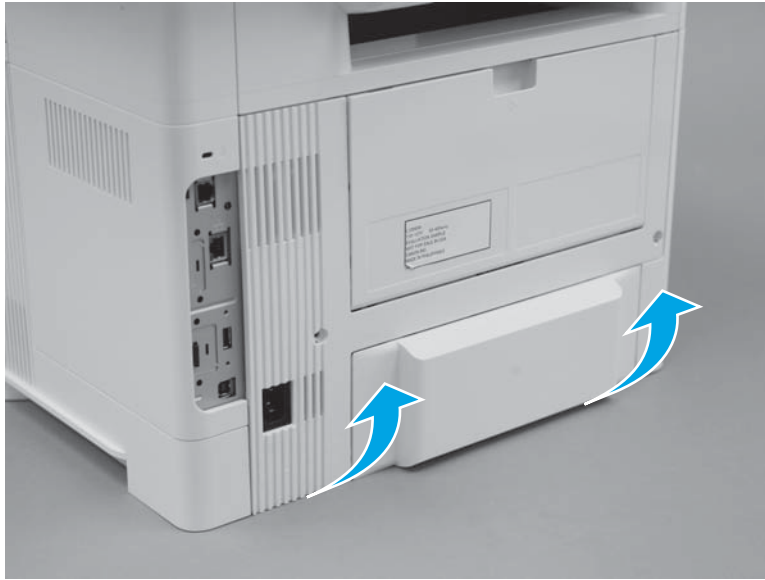
1. At the rear of the printer, remove two screws (callout 1).

**Figure 1-1316** Remove two screws



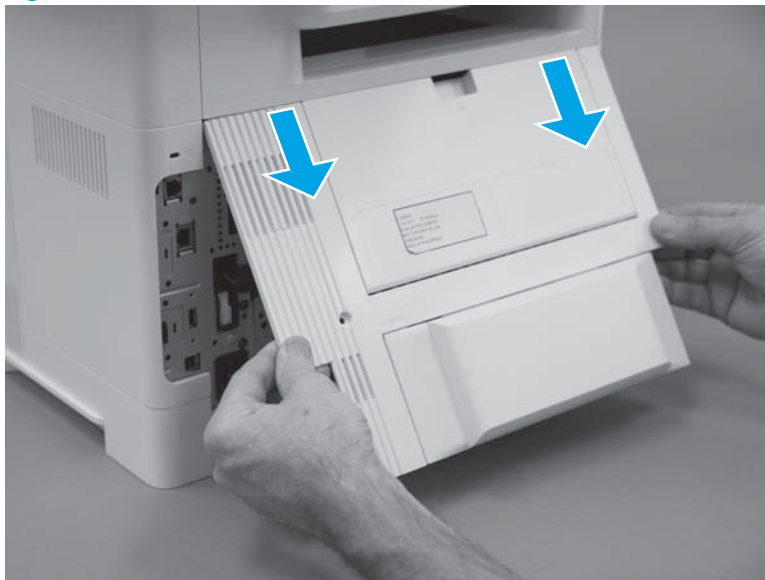
2. Rotate the bottom edge of the assembly away from the printer to release it.

**Figure 1-1317** Rotate the bottom of the cover




3. Pull down on the assembly to remove it.


**Figure 1-1318** Remove the cover



#### Step 4: Remove the left cover

---

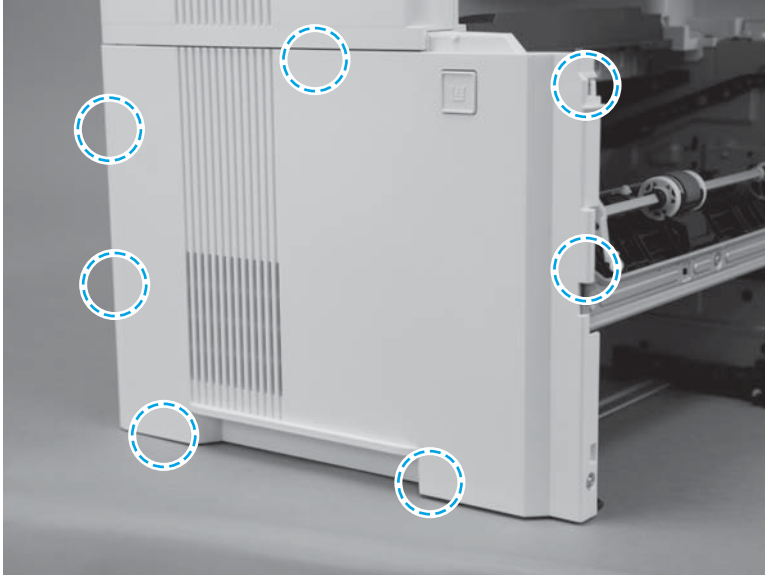
 **IMPORTANT:** The black-plastic cassette front and rear guides (located inside the tray cavity) can be easily dislodged. Do not lose the guides when the cover is removed or installed.

 **NOTE:** The M527 printer is shown in this procedure. However, this procedure is valid for the M501/M506 printers.

---

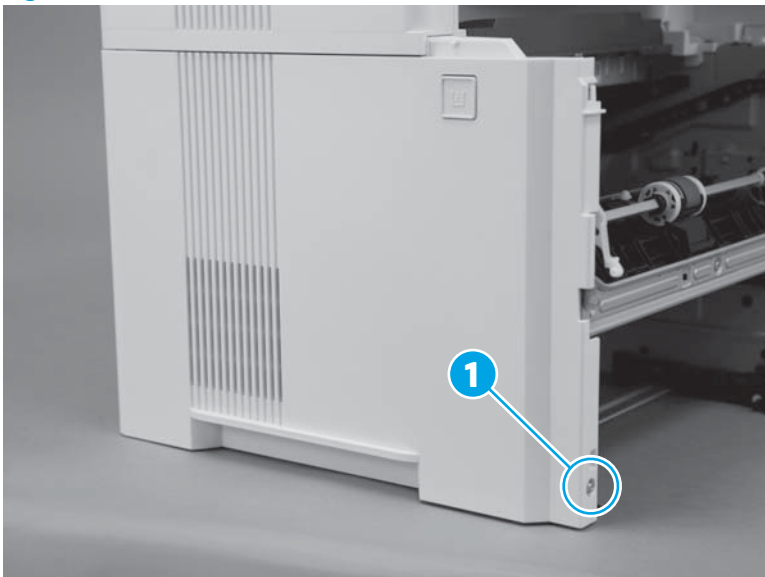
1. Before proceeding, take note of the location of the tabs and bosses on the inside of the cover.

**Figure 1-1319** Locate of the tabs and bosses



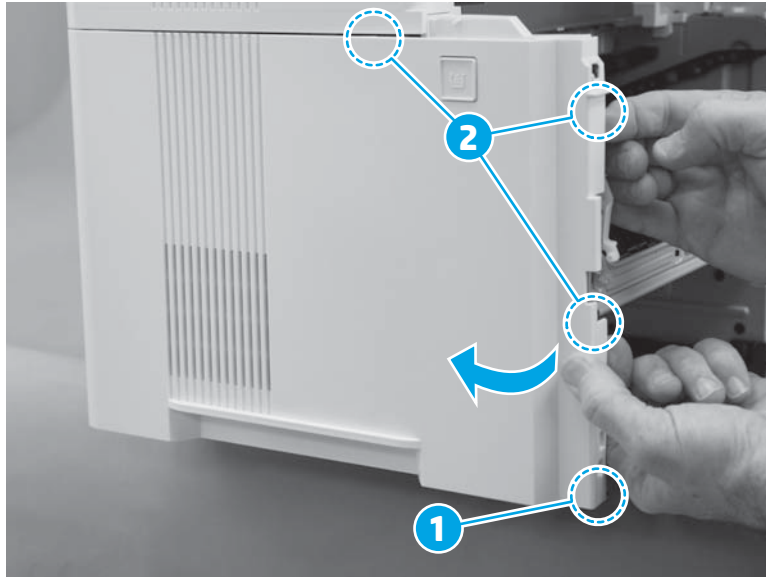
2. Remove one screw (callout 1).

**Figure 1-1320** Remove one screw



3. At the front of the printer, release one boss (callout 1), and then rotate the front edge of the cover away from the printer to release three tabs (callout 2).

**Figure 1-1321** Release one boss and three tabs




4. At the bottom edge of the cover, release two tabs.

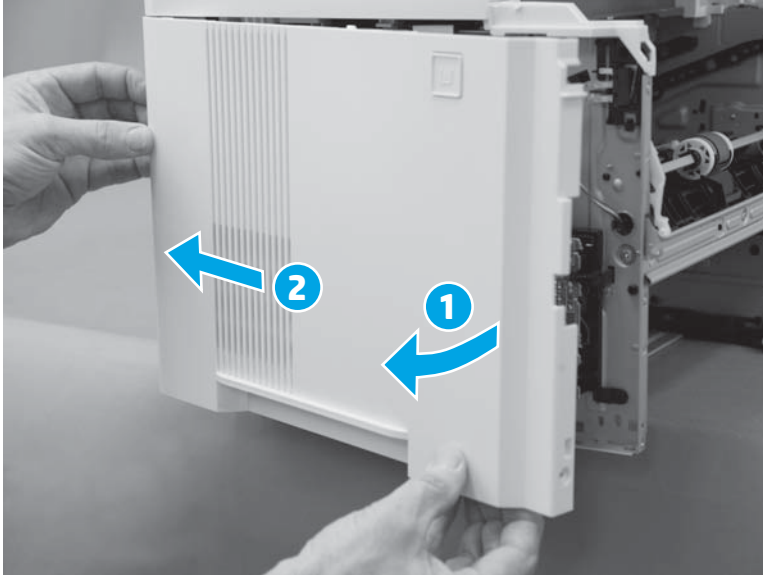
**Figure 1-1322** Release two tabs



5. Continue to rotate the front edge of the cover away from the printer (callout 1), and then slide the cover toward the rear of the printer (callout 2) to remove it.

 **NOTE:** If the cover is difficult to rotate or slide as shown below, make sure that the bottom tabs (released in the previous step) are completely disengaged from the chassis.

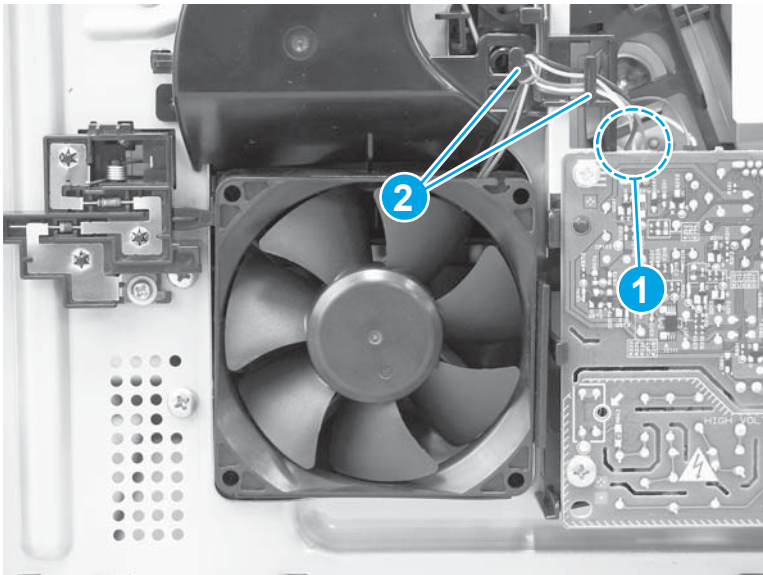
**Figure 1-1323** Remove the cover



#### Step 4: Remove the fan (FM1)

1. At the left side of the printer, disconnect one connector (callout 1), and then release the wire harness from the retainer (callout 2).

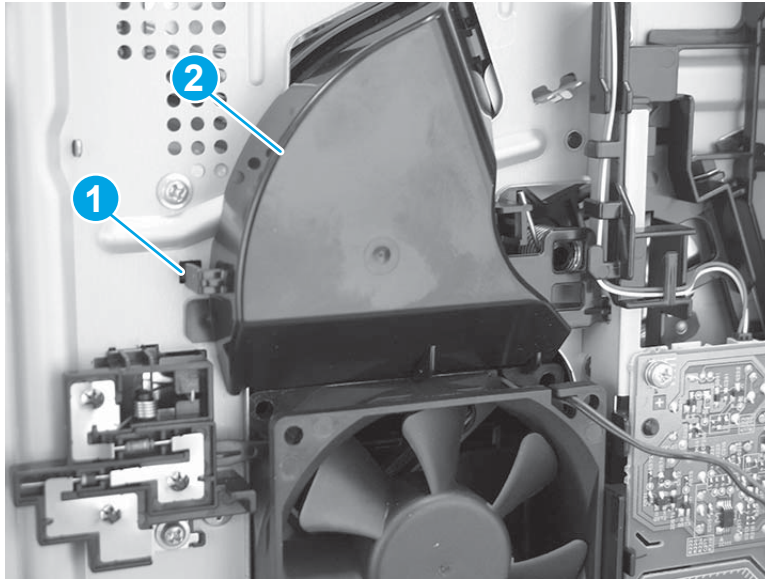
**Figure 1-1324** Disconnect one connector





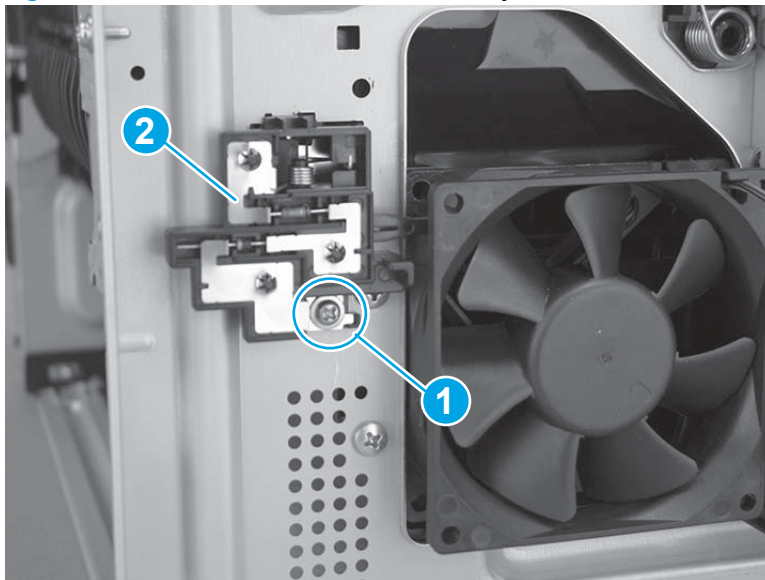
2. Release one tab (callout 1), and then remove the fan duct (callout 2).

**Figure 1-1325** Remove the fan duct



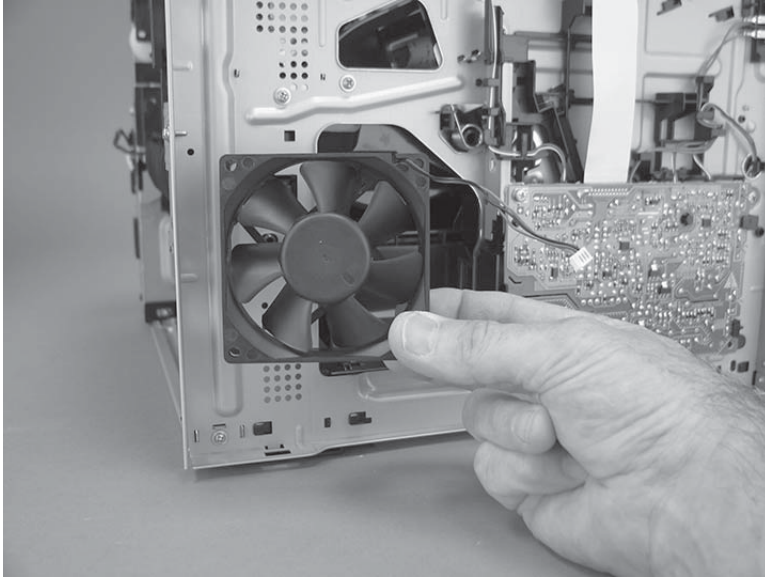
3. Remove one screw (callout 1), and then remove the filter bias assembly (callout 2).

**Figure 1-1326** Remove the filter bias assembly



4. Remove the fan (callout 2).

**Figure 1-1327** Remove the fan



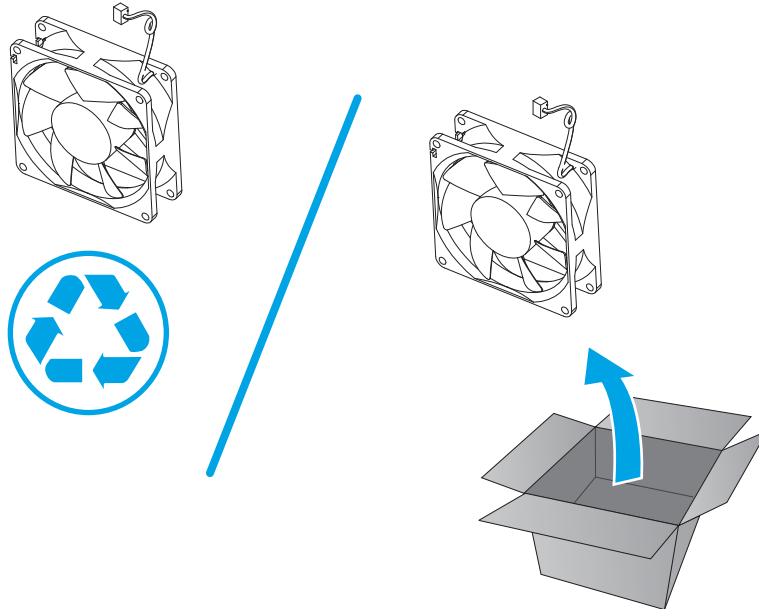
#### Step 5: Unpack the replacement assembly

Unpack the replacement part from the packaging.

<http://www8.hp.com/us/en/hp-information/environment/product-recycling.html>

 **NOTE:** HP recommends responsible disposal of the defective part.

**Figure 1-1328** Recycle and unpack

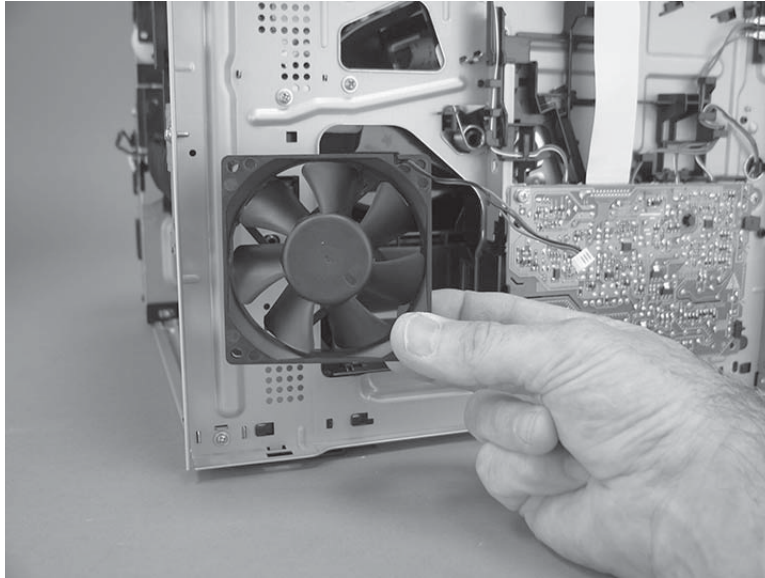


#### Step 6: Install the fan (FM1) and fan bracket

1. Position the fan in the holder.

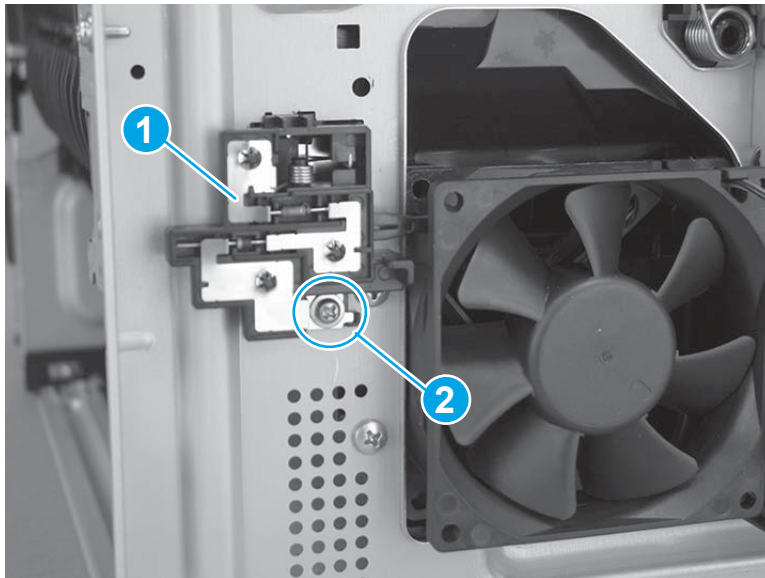
**CAUTION:** The fan must be correctly installed so that air is drawn into the printer. Make sure that the two arrows embossed on the top-side of the fan body (near the wire harness)—which indicate air flow direction—face upward and into the printer.

**Figure 1-1329** Install the fan



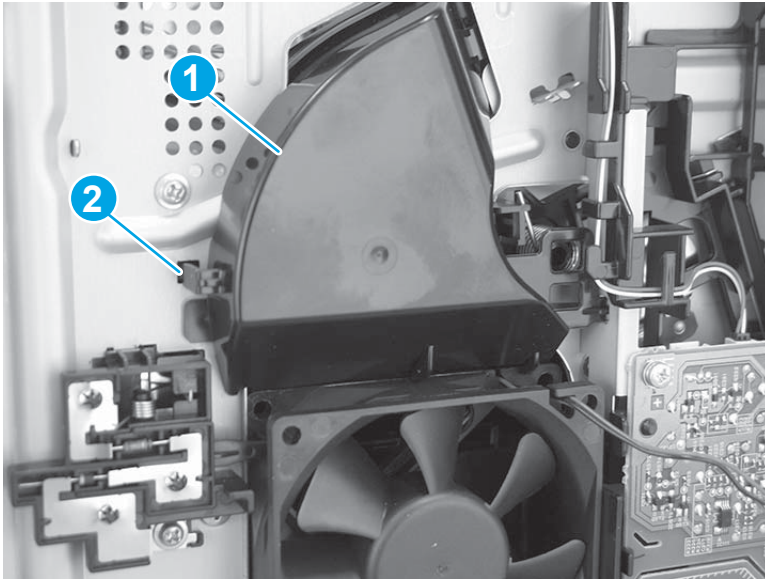
2. Install the filament bias assembly (callout 1), and then install one screw (callout 2).

**Figure 1-1330** Install the filament bias assembly



3. Install the fan duct (callout 1). Make sure that the tab (callout 2) is engaged.

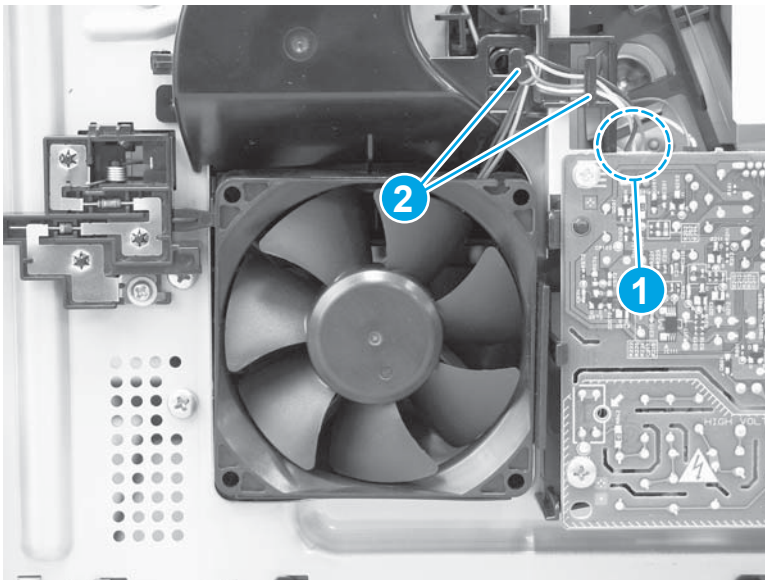
**Figure 1-1331** Install the fan duct




4. Install the wire harness in the retainer (callout 1), and then connect one connector (callout 2).


 **Reinstallation tip:** It might be easier to connect the connector first and then install the wire harness in the retainer.

**Figure 1-1332** Connect one connector



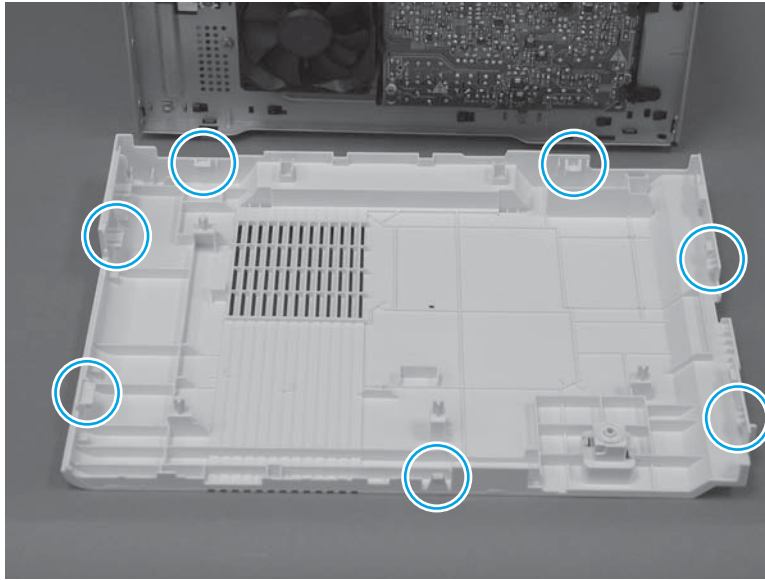
### Step 6: Install the left cover

 **IMPORTANT:** The black-plastic cassette front and rear guides (located inside the tray cavity) can be easily dislodged. Do not lose the guides when the cover is removed or installed.

 **NOTE:** The M527 printer is shown in this procedure. However, this procedure is valid for the M501/M506 printers.

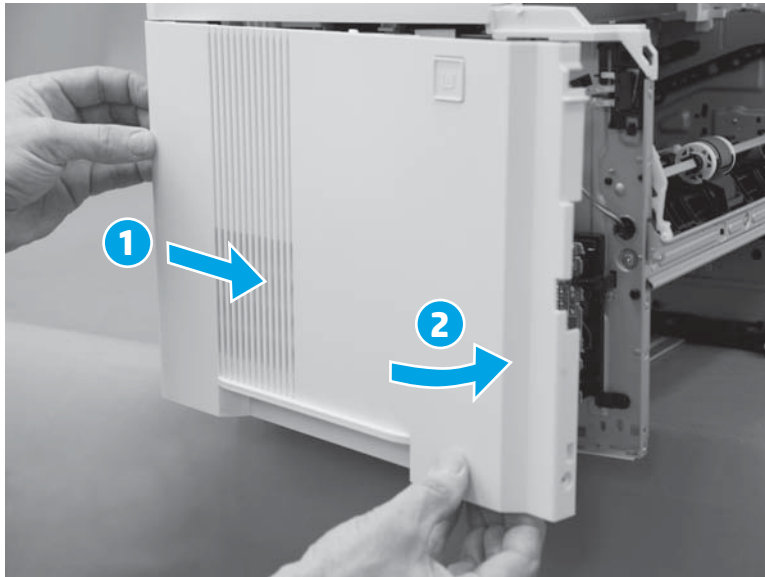
1. Before proceeding, take note of the location of the tabs and bosses on the inside of the cover.

**Figure 1-1333** Locate of the tabs and bosses



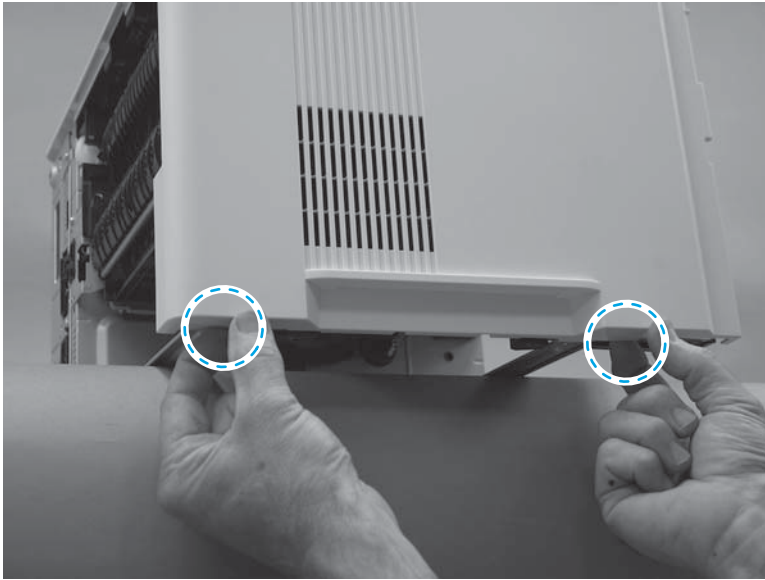
2. Engage the rear edge of the cover (callout 1), and then rotate the rear edge of the cover toward the printer (callout 2).

**Figure 1-1334** Install the cover



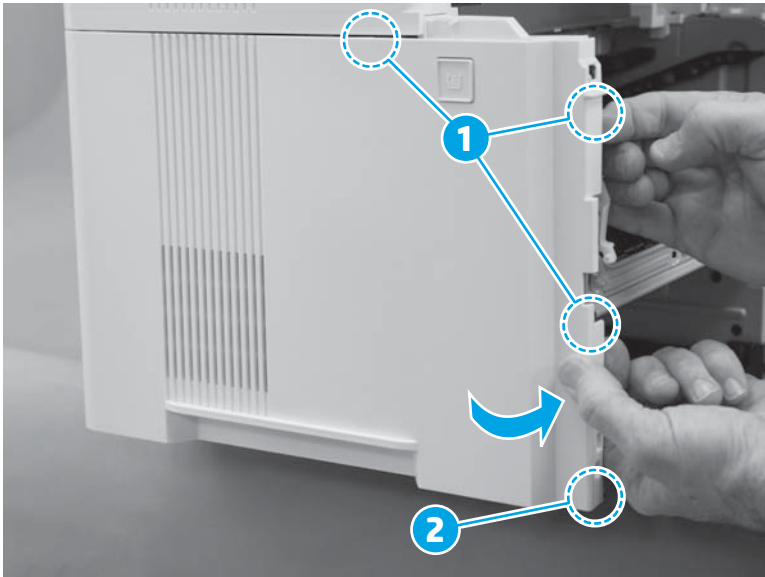
3. At the bottom edge of the cover, engage two tabs.

**Figure 1-1335** Engage two tabs



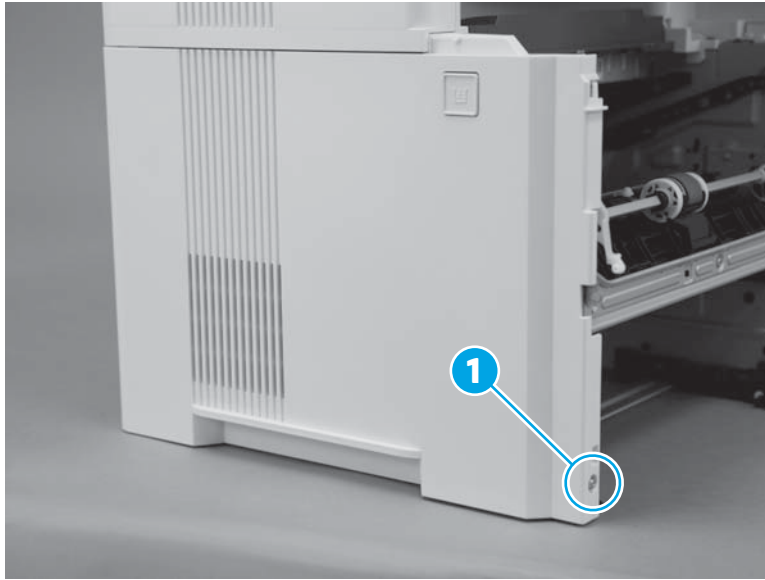
4. At the front of the printer, engage three tabs (callout 1), and then continue to rotate the front edge of the cover toward the printer to engage one boss (callout 2).

**Figure 1-1336** Engage three tabs and one boss



5. Install one screw (callout 1).

**Figure 1-1337** Install one screw



### Step 7: Install the rear door assembly

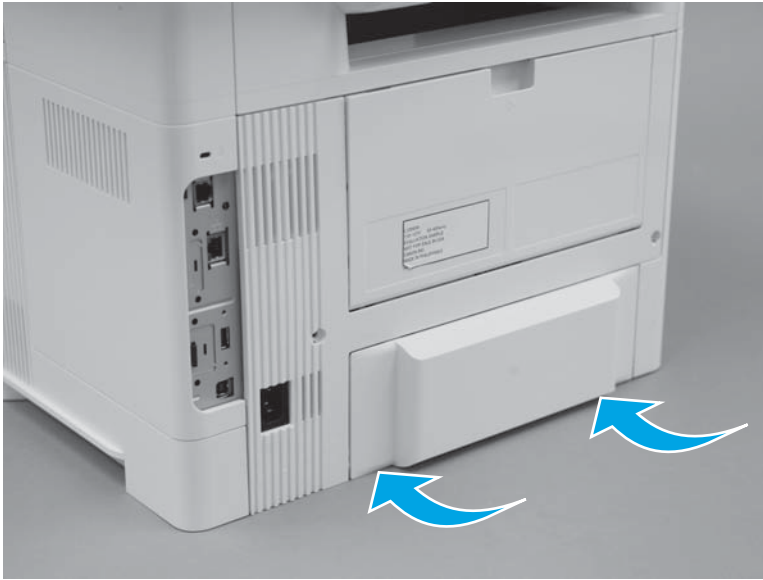
1. Engage the top edge of the assembly with the printer.

**Figure 1-1338** Install the cover



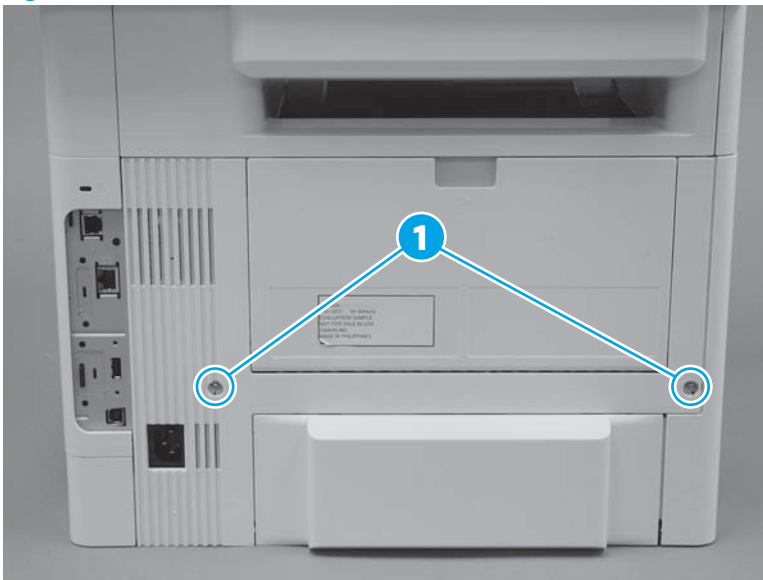
2. Rotate the bottom edge of the cover towards the printer.

**Figure 1-1339** Rotate the bottom of the cover




3. Install two screws (callout 1).

**Figure 1-1340** Install two screws



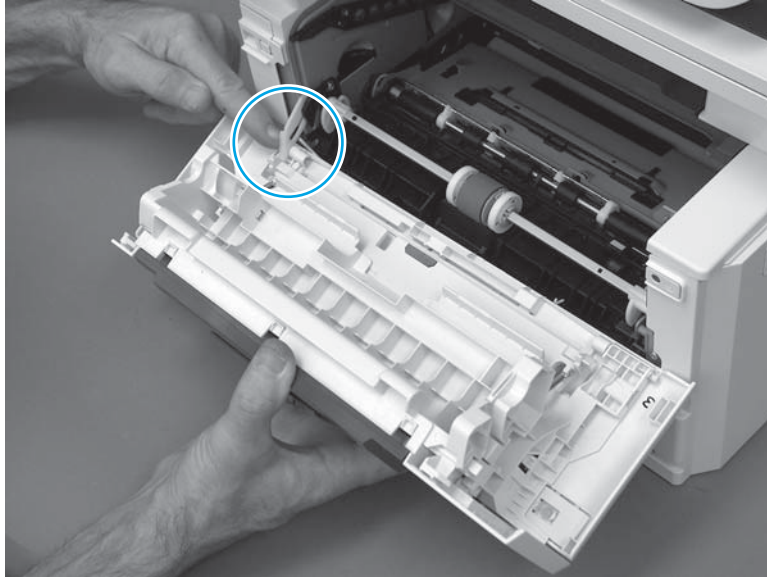
### Step 8: Install the cartridge door assembly

1. Position the door close to the printer, and then engage the keyed pin on the left-side retainer arm with the hole in the door.


 **TIP:** It might be easier to engage the keyed pin with the hole by using a small flat-blad screwdriver.




**Figure 1-1341** Engage the left-side retainer arm

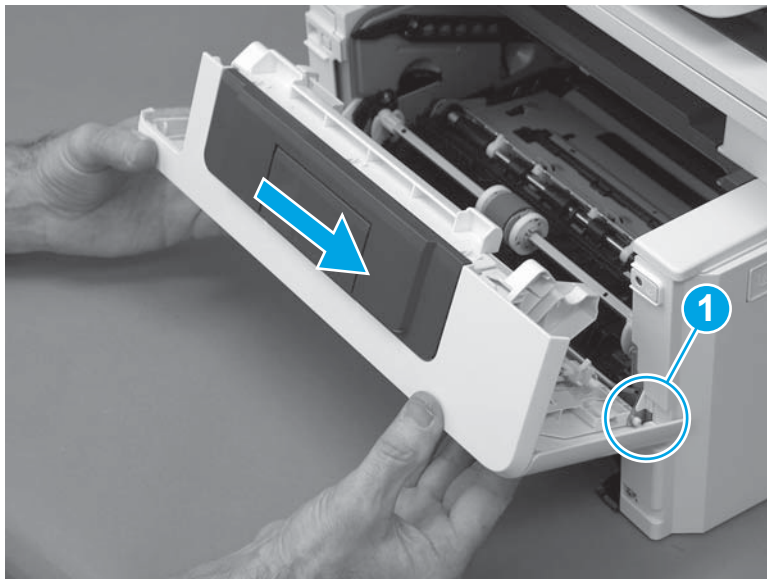


2. Engage the right-side door hinge pin with the hole in the chassis (callout 1).


 **NOTE:** There are two right-side hinge pins (not shown in callout 1).

 **TIP:** Keep a finger pressed on the left-side retainer arm so that it does not disengage from the door.

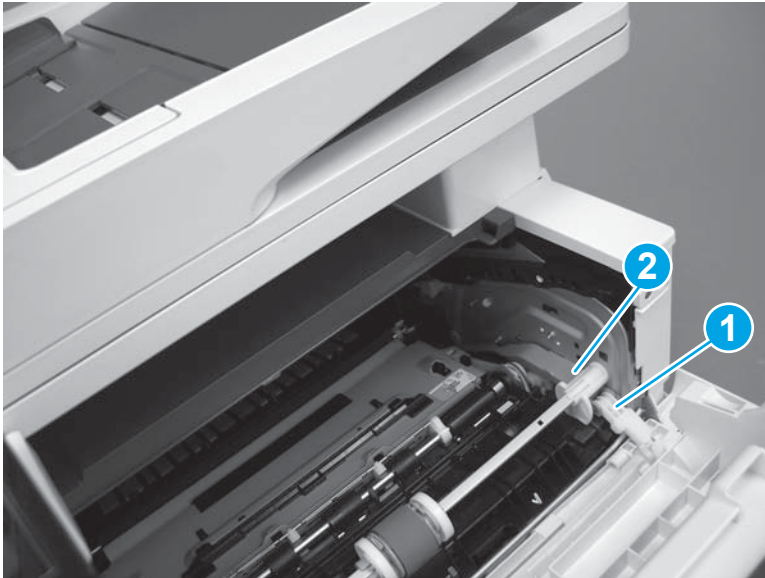
**Figure 1-1342** Install the door



3. Install the gray-plastic pressure-release link (callout 1) onto the white-plastic door arm (callout 2).

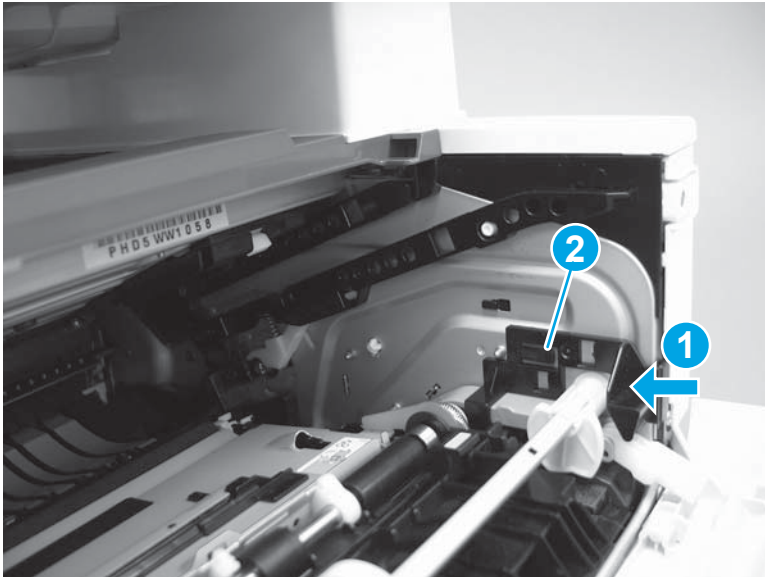
 **IMPORTANT:** Make sure that the arm snaps on to the link. Partially close and open the door to verify that the link (callout 2) moves in and out of the printer as the door closes/opens.

**Figure 1-1343** Install the pressure-release link



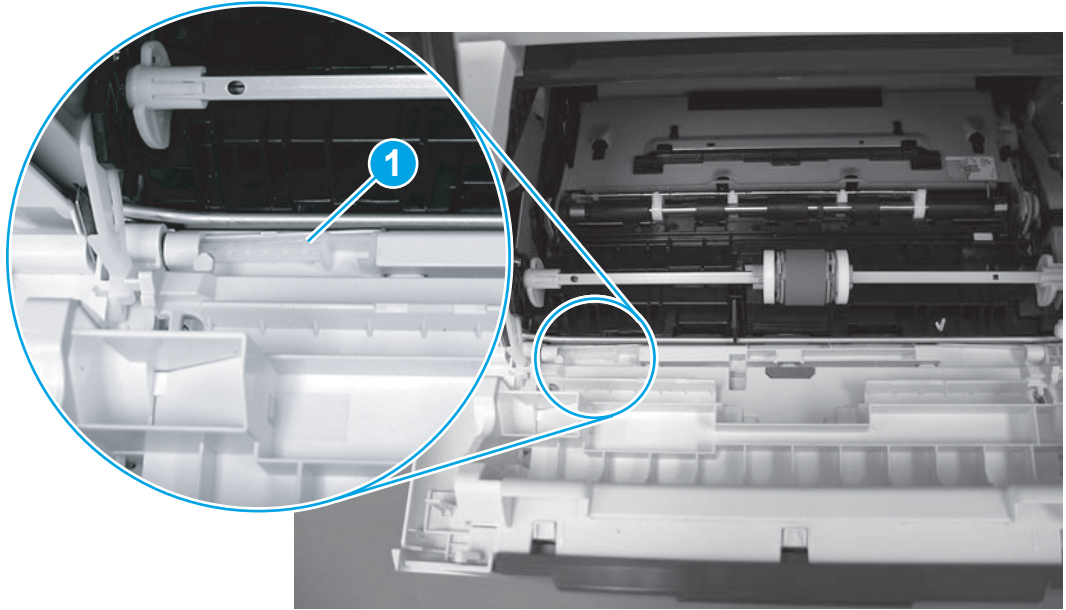
4. Slide the guide into the printer (callout 1), and then make sure that the tab (callout 2) snaps into place to secure the guide to the chassis.

**Figure 1-1344** Install the guide





5. Position the support shaft on the door, and then align the left-side hinge on the door with the hole in the chassis (callout 1).

**Figure 1-1345** Align the hinge

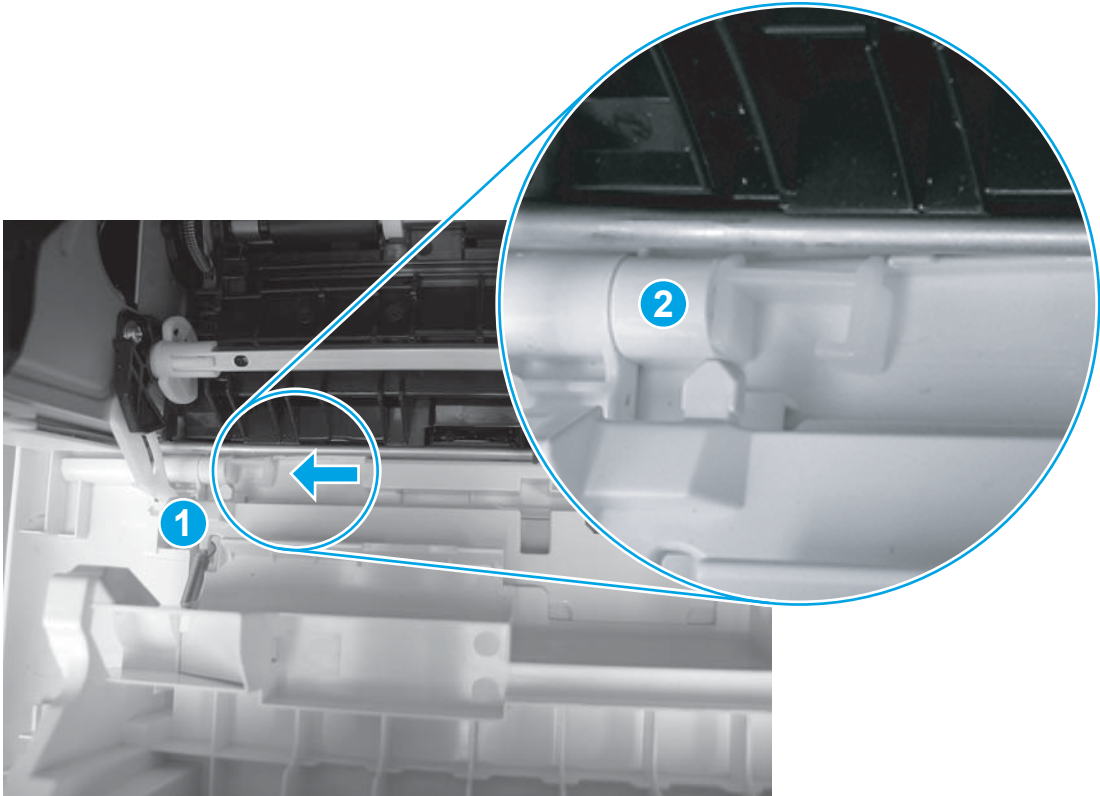


6. Push the shaft towards the left side of the printer to install it (callout 1).

 **NOTE:** Make sure that the support shaft is fully installed and correctly orientated (callout 2) so that it will not interfere with the door opening and closing.

 **Reinstallation tip:** If a replacement door was installed, make sure to install the nameplate (supplied in the kit) corresponding to the printer on the door.

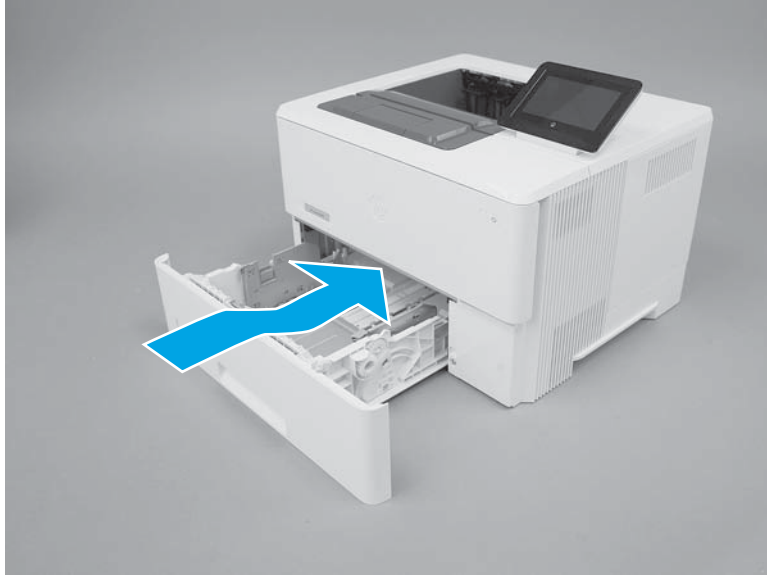
**Figure 1-1346** Install the support shaft



### Step 9: Install the tray

1. With the tray at a slight angle, align the sides of the tray with the rails in the accessory, and then partially slide the tray into the printer.

**Figure 1-1347** Install the tray



2. Push the tray straight into the accessory to close it.

**Figure 1-1348** Close the tray



## Removal and replacement: Fan (FM2)



**IMPORTANT:** Some figure might show assemblies removed or installed that have not yet been removed or installed at that specific step. However, the procedures are correct for this printer and the target assembly. Always thoroughly read the instructions that accompany each figure

---

- [Introduction](#)
- [Step 1: Remove the control panel \(M506x\)](#)
- [Step 2: Remove the tray](#)
- [Step 3: Remove the formatter cover](#)
- [Step 4: Remove the hard-disk drive \(HDD\)](#)
- [Step 5: Remove the fax PCA \(M527\)](#)
- [Step 6: Remove the formatter](#)
- [Step 7: Remove the stapler door or stapler blank cover \(M527\)](#)
- [Step 8: Remove the stapler stationary \(inner\) cover \(M527\)](#)
- [Step 9: Remove the top-left cover \(M527\)](#)
- [Step 10: Remove the top-rear cover \(M527\)](#)
- [Step 11: Remove the rear door assembly](#)
- [Step 12: Remove the cartridge door assembly](#)
- [Step 13: Remove the right cover](#)
- [Step 14: Remove the left cover](#)
- [Step 15: Remove the integrated scanner assembly \(M527\)](#)
- [Step 16: Remove the top cover \(M527\)](#)
- [Step 17: Remove the top cover \(M501/M506\)](#)
- [Step 18: Remove the paper delivery tray \(output bin\)](#)
- [Step 19: Remove the formatter case](#)
- [Step 20: Remove the fan \(FM2\)](#)
- [Step 21: Unpack the replacement assembly](#)
- [Step 22: Install the fan \(FM2\)](#)
- [Step 23: Install the formatter case](#)
- [Step 24: Install the paper delivery tray \(output bin\)](#)
- [Step 25: Install the top cover \(M501/M506\)](#)
- [Step 26: Install the top cover \(M527\)](#)
- [Step 27: Install the integrated scanner assembly \(M527\)](#)

- [Step 28: Install the left cover](#)
- [Step 29: Install the right cover](#)
- [Step 30: Install the cartridge door assembly](#)
- [Step 31: Install the rear door assembly](#)
- [Step 32: Install the top-rear cover \(M527\)](#)
- [Step 33: Install the top-left cover \(M527\)](#)
- [Step 34: Install the stapler stationary \(inner\) cover \(M527\)](#)
- [Step 35: Install the stapler door or stapler blank cover \(M527\)](#)
- [Step 36: Install the formatter](#)
- [Step 37: Install the fax PCA \(M527\)](#)
- [Step 38: Install the hard-disk drive \(HDD\)](#)
- [Step 39: Install the formatter cover](#)
- [Step 40: Install the tray](#)
- [Step 41: Install the control panel \(M506x\)](#)

## Introduction

This document provides the procedures to remove and replace the fan (FM1).

## Before performing service

### Turn the printer power off

- Disconnect the power cable.

**⚠ WARNING!** To avoid damage to the printer, turn the printer off wait 30 seconds, and then remove the power cable before attempting to service the printer.

Use the table below to identify the correct part number for your printer. To order the part, go to [www.hp.com/buy/parts](http://www.hp.com/buy/parts).

Fan (FM2) part number	
RK2-8068-000CN	Fan (FM2)

## Required tools

- Small flat-blade screwdriver
- #2 Phillips screwdriver with a magnetic tip.

## After performing service


### Turn the printer power on

- Connect the power cable.
- Use the power switch to turn the power on.

### Post service test

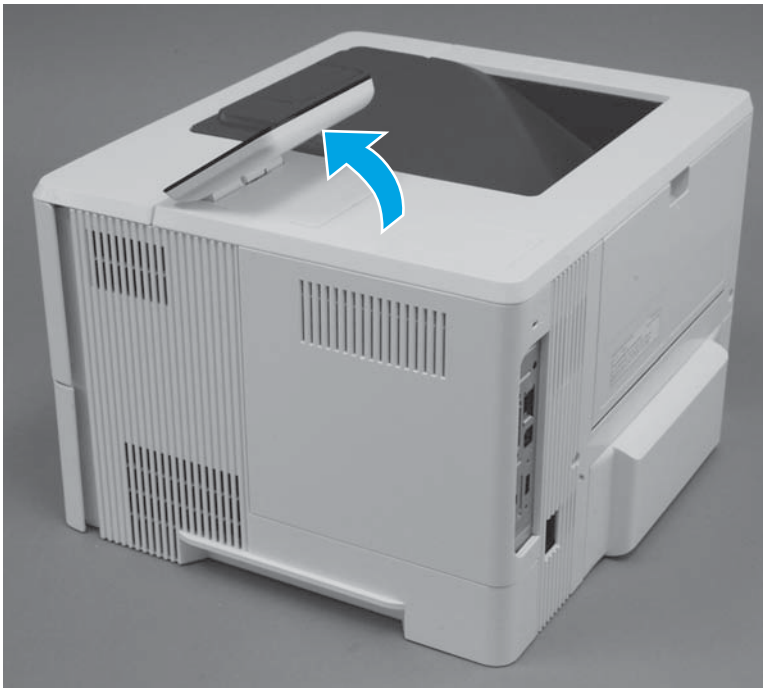
Make sure that the printer initializes to a **Ready** state.

### Step 1: Remove the control panel (M506x)

 **NOTE:** This step is for for the M506x printer. For all other printers, skip this step and proceed to [Step 2: Remove the tray on page 772](#).

1. Tilt the control panel to the fully raised position.

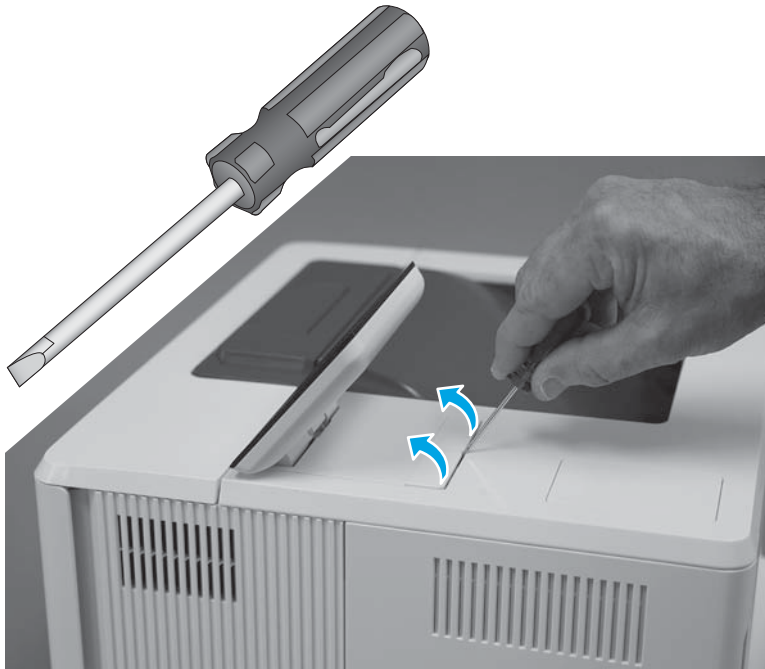
**Figure 1-1349** Tilt the control panel up





2. Use a small flat-blad screwdriver to release the control-panel screws cover, and then remove the cover.

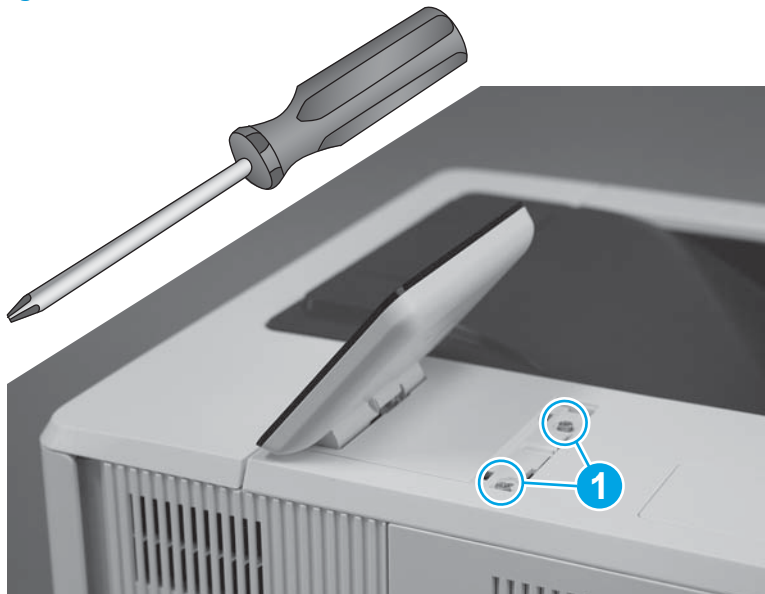
**Figure 1-1350** Remove the cover



3. Use a small Phillips screwdriver to remove two screws (callout 1).

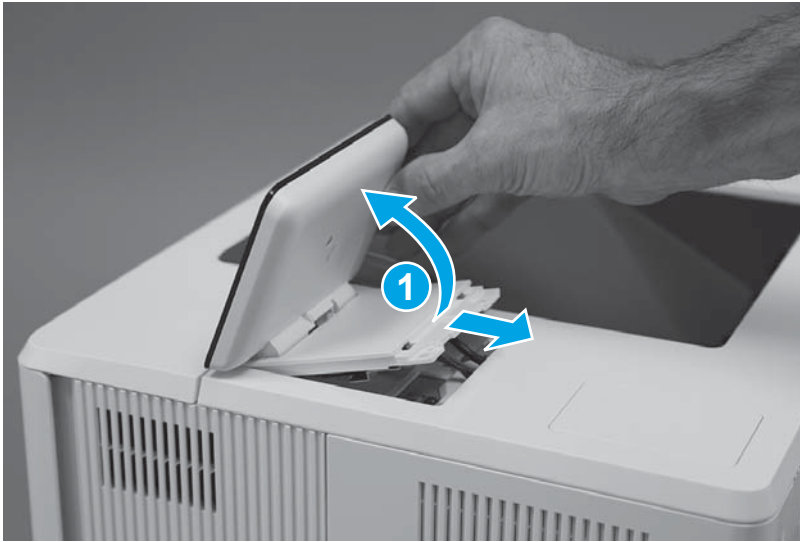
 **IMPORTANT:** Store the screws in a secure place where they cannot fall down into the printer.

**Figure 1-1351** Remove two screws



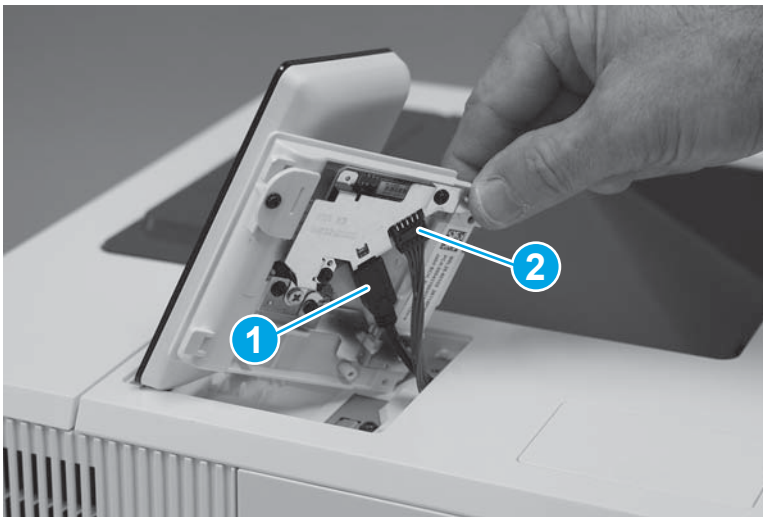
4. Turn the control panel over (callout 1), to gain access to the bottom side.

**Figure 1-1352** Turn the control panel over



5. Disconnect one HDMI cable (callout 1), one connector (callout 2), and then remove the control panel.

**Figure 1-1353** Remove the control panel



### Step 2: Remove the tray

1. Pull the tray straight out of the printer until it stops.

**Figure 1-1354** Pull the tray out until it stops



2. Lift the front of the tray, and then pull it out of the printer to remove it.

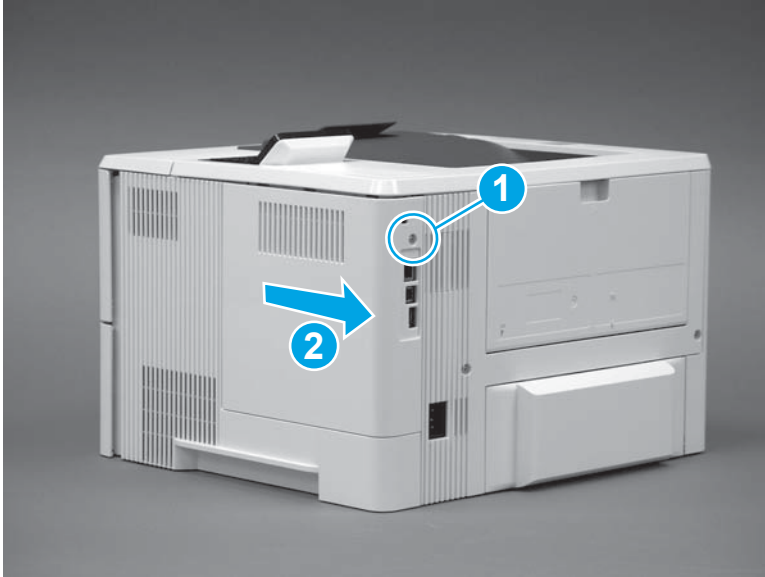
**Figure 1-1355** Release and remove the tray



### Step 3: Remove the formatter cover

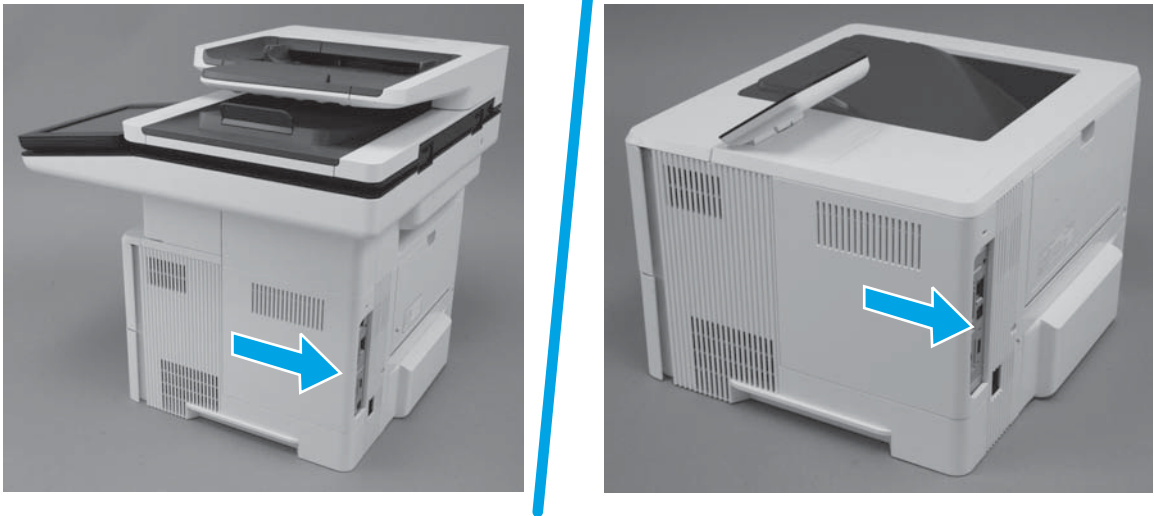
1. **M501:** Remove one screw (callout 1), and then slide the cover toward the rear of the printer to remove it (callout 2).

**Figure 1-1356** Remove the formatter cover (M501)



2. **M506/M527:** Slide the cover toward the rear of the printer to remove it.

**Figure 1-1357** Remove the formatter cover (M506/M527)



#### Step 4: Remove the hard-disk drive (HDD)



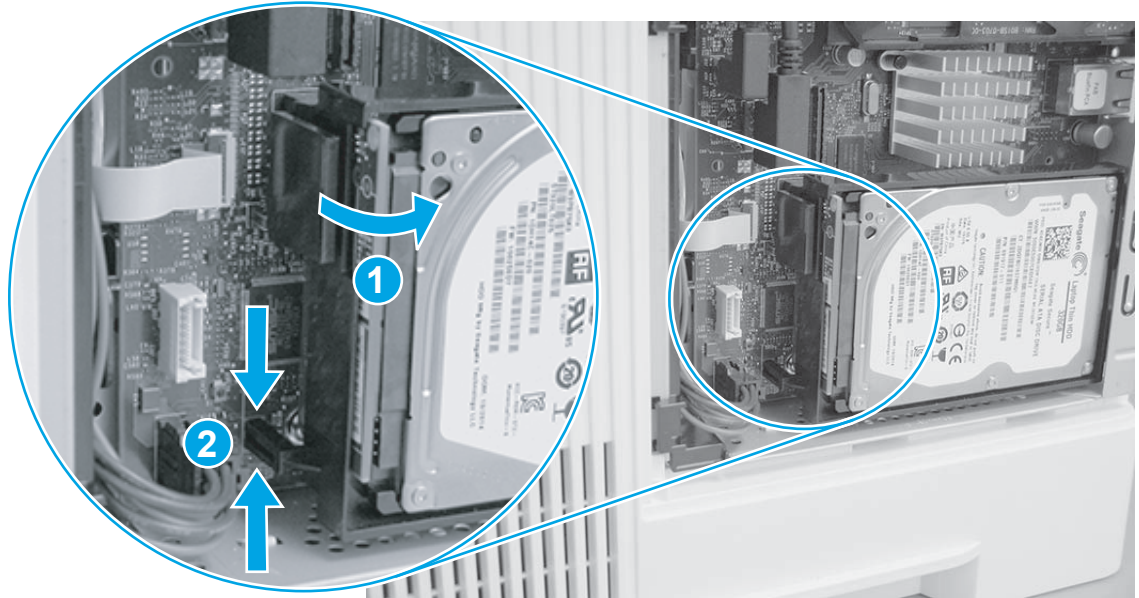
**NOTE:** If the HDD is not installed, skip this step and go to [Step 5: Remove the fax PCA \(M527\) on page 775](#).



**CAUTION:**  ESD-sensitive part.

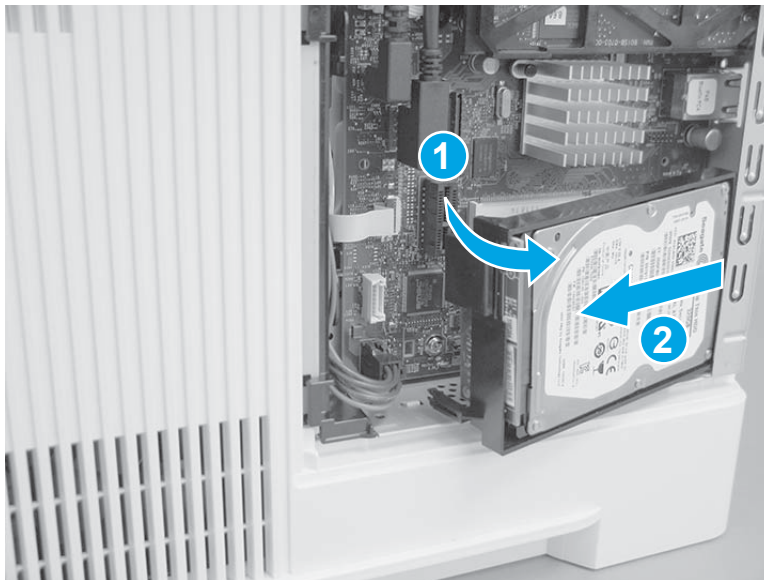
1. Release the locking connector (callout 1), and then pinch the retainer (callout 2) to release it.

**Figure 1-1358** Release the HDD




2. Rotate the connector end of the HDD out and away from the formatter (callout 1), and then slide it as shown (callout 2) to remove it.


**Figure 1-1359** Remove the HDD



### Step 5: Remove the fax PCA (M527)

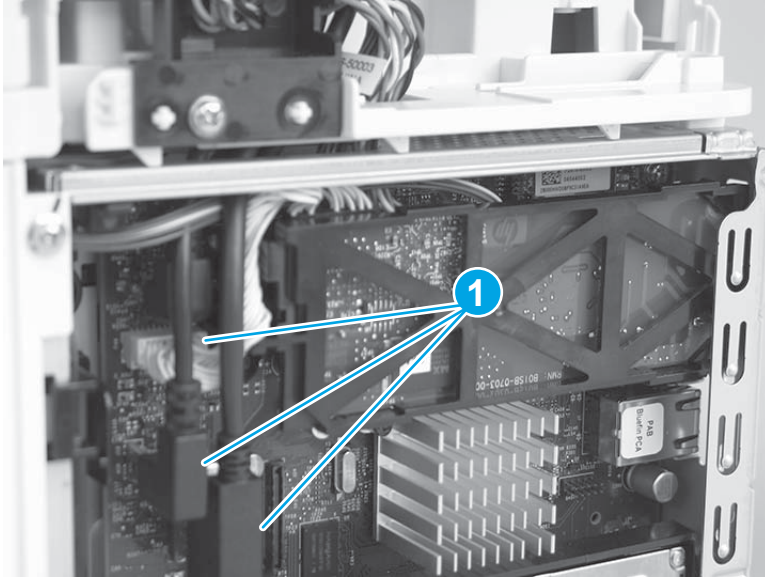
 **NOTE:** If the fax PCA is not installed, skip this step and go to [Step 6: Remove the formatter on page 777](#).

 **CAUTION:**  ESD-sensitive part.

 **NOTE:** M527c/f/z printers only (optional for the M527dn).

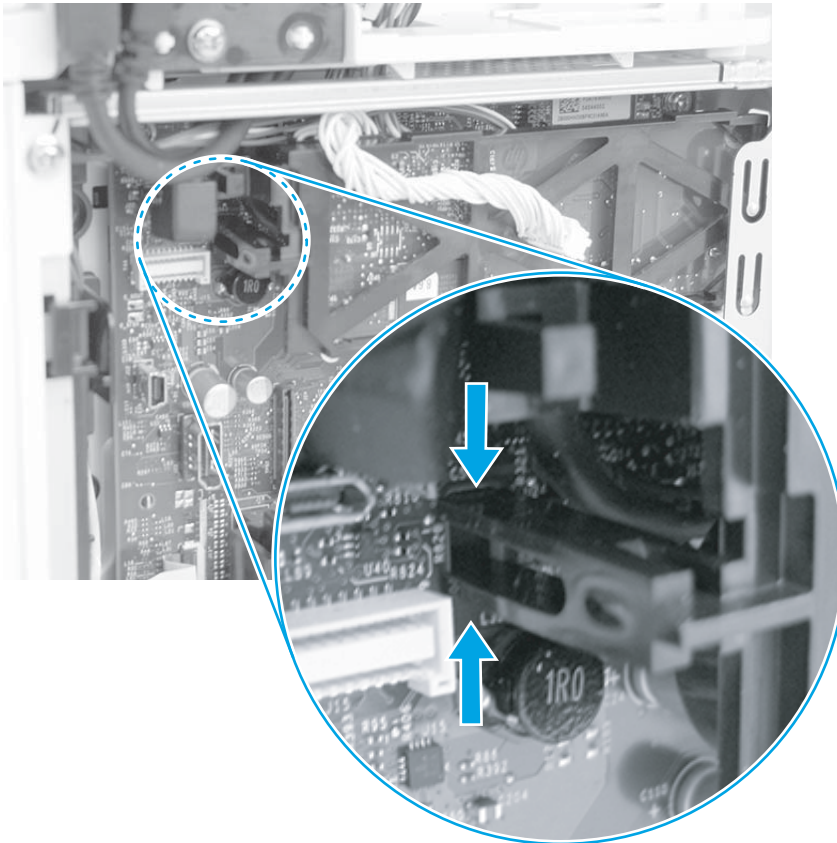
1. Disconnect three connectors (callout 1).

**Figure 1-1360** Disconnect three connectors



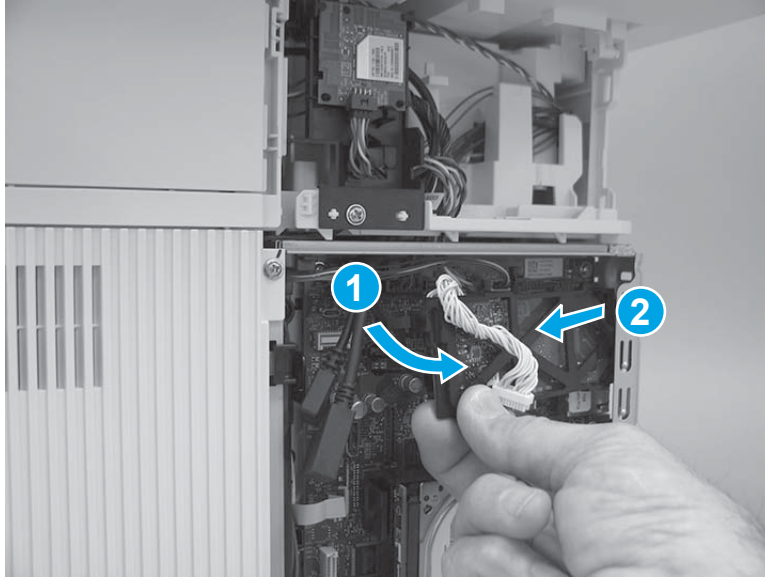
2. Pinch the retainer to release it.

**Figure 1-1361** Release the fax PCA




3. Rotate the connector end of the fax PCA out and away from the formatter (callout 1), and then slide it as shown (callout 2) to remove it.

**Figure 1-1362** Remove the fax PCA

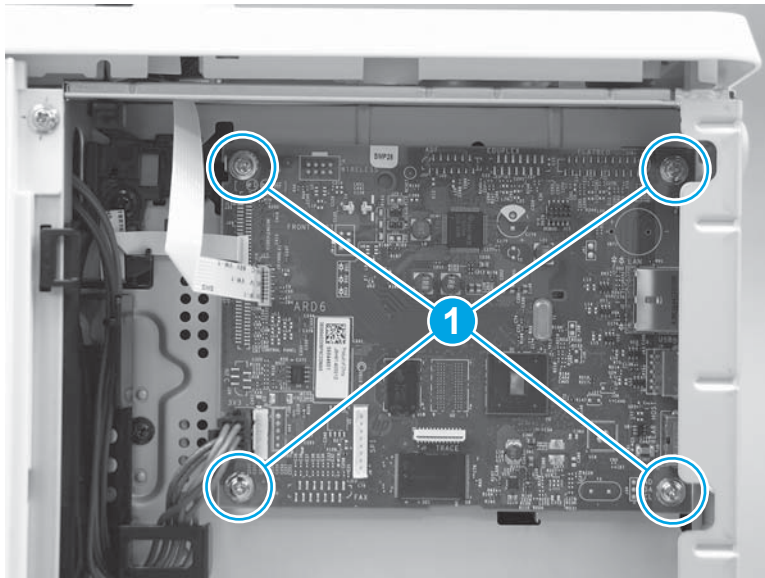


#### Step 6: Remove the formatter


 **IMPORTANT:** **M506/M527:** Take note of all empty connectors on the PCA before disconnecting any wire harnesses or flat-flexible cables (FFCs). Some empty connectors might not be visible until other items—like the hard-disk drive—are removed, so pay close attention while removing the formatter and accessory items.

1. **M501:** Disconnect all of the connectors and FFCs, remove four screws (callout 1), and then remove the formatter.

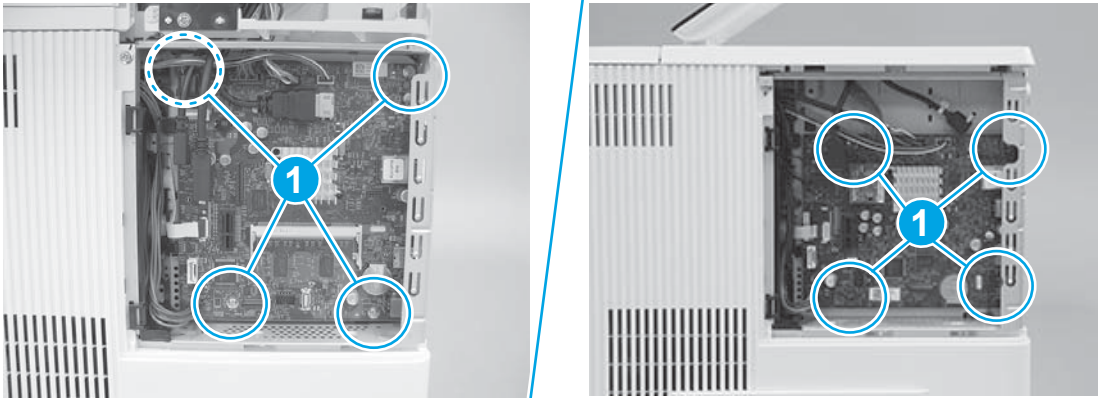
**Figure 1-1363** Remove the formatter (M501)




2. **M506/M527:** Disconnect all of the connectors and FFCs, remove four screws (callout 1), and then remove the formatter.

 **IMPORTANT:** Take note of all empty connectors on the formatter before disconnecting any wire harnesses or flat-flexible cables (FFCs). Some empty connectors might not be visible until other items—like the hard-disk drive—are removed, so pay close attention while removing the formatter and accessories items.

**Figure 1-1364** Remove the formatter (M506/M527)



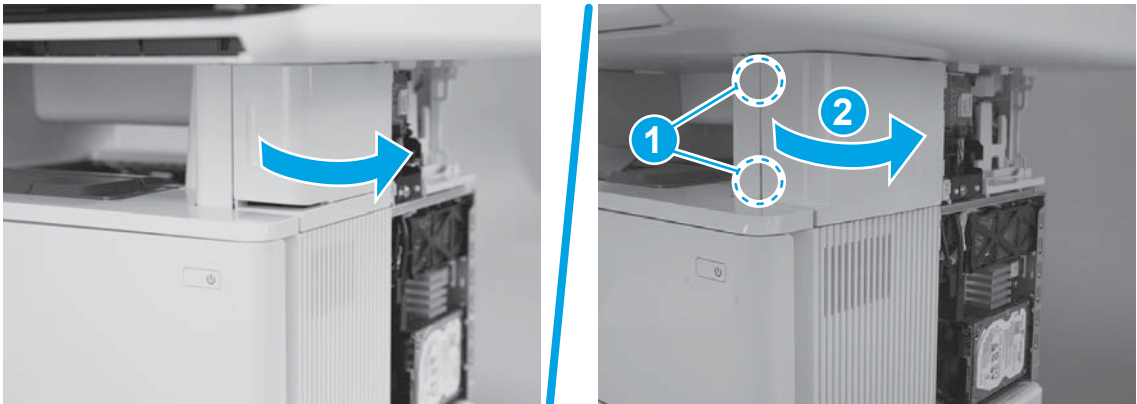
### Step 7: Remove the stapler door or stapler blank cover (M527)

 **NOTE:** This step is for the M527 printer. For the M501/M506, skip this step and go to [Step 11: Remove the rear door assembly on page 786](#).

The M527dn does not have a convenience stapler.

1. Do one of the following:
  - **M527c/f/z:** Open the stapler door.
  - **M527dn:** Use a small flat-blade screwdriver to release two tabs (callout 1), and then rotate the cover away from the printer (callout 2).

**Figure 1-1365** Open the door or release the cover



2. Do one of the following:
  - **M527c/f/z:** Use a small flat-blade screwdriver to release the upper hinge.
  - **M527dn:** Slide the cover toward the front of the printer to remove it.

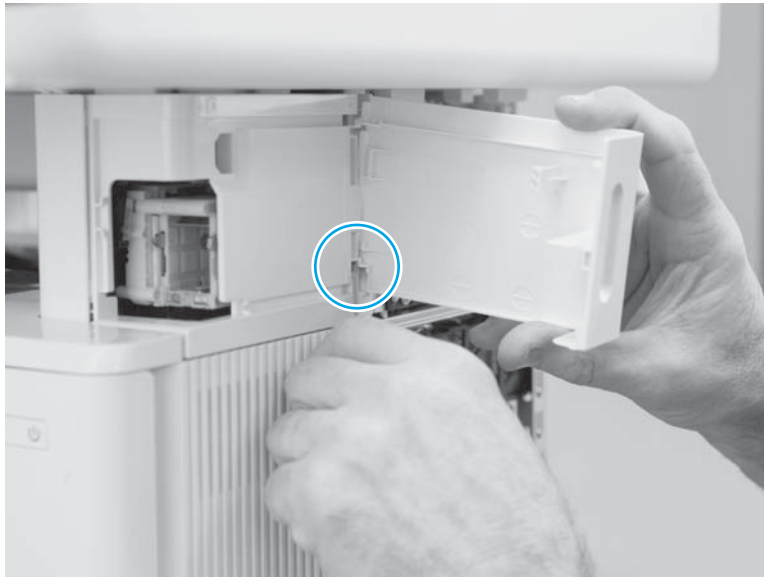


**Figure 1-1366** Release the upper hinge or remove the cover



3. **M527c/f/z:** Use a small flat-bladed screwdriver to release the lower hinge.

**Figure 1-1367** Release the lower hinge



4. **M527c/f/z:** Remove the door.

**Figure 1-1368** Remove the door



#### Step 8: Remove the stapler stationary (inner) cover (M527)



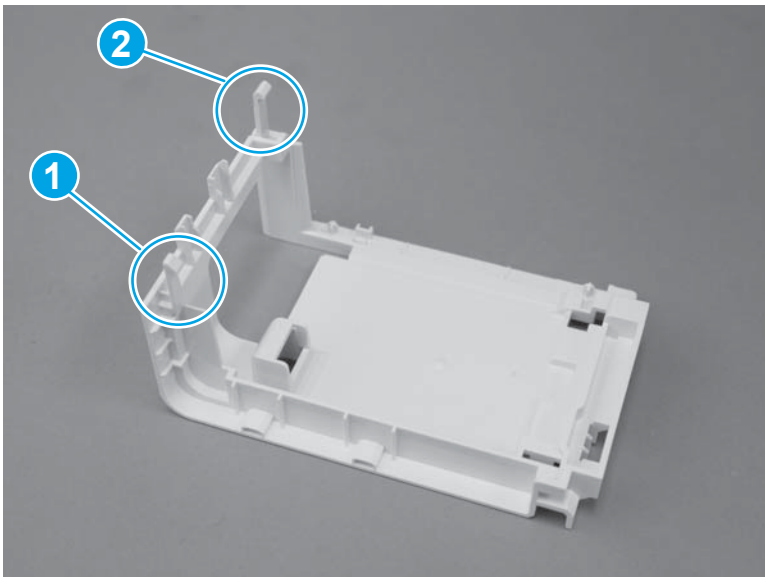
**NOTE:** This step is for the M527c/f/z printers. For the M501/M506, skip this step and go to [Step 11: Remove the rear door assembly on page 786](#). For the M527dn, skip this step and go to [Step 9: Remove the top-left cover \(M527\) on page 782](#).



**NOTE:** M527c/f/z printers only.

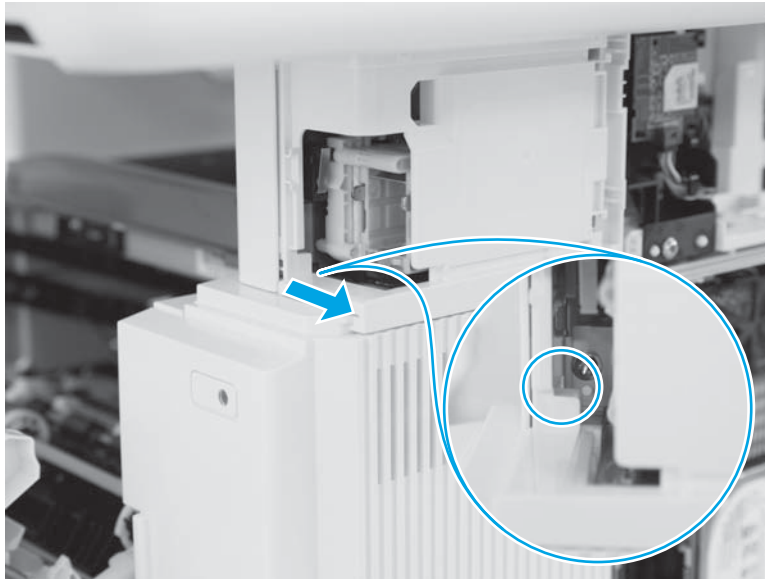
1. Before proceeding, take note of the locations of the upper tab (callout 1) and the lower tab (callout 2) on the stapler stationary (inner) cover.

**Figure 1-1369** Locate the tabs



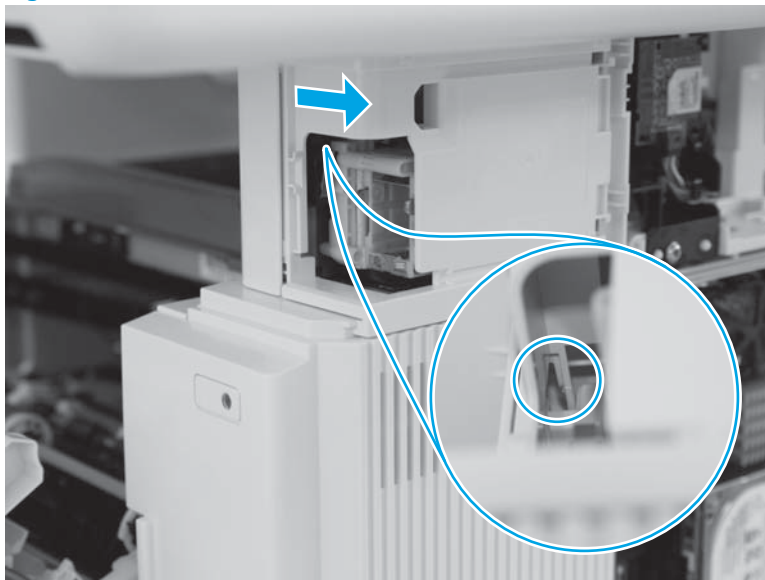
2. Use a long-shaft small flat-blad screwdriver to release the lower tab.

**Figure 1-1370** Release one tab



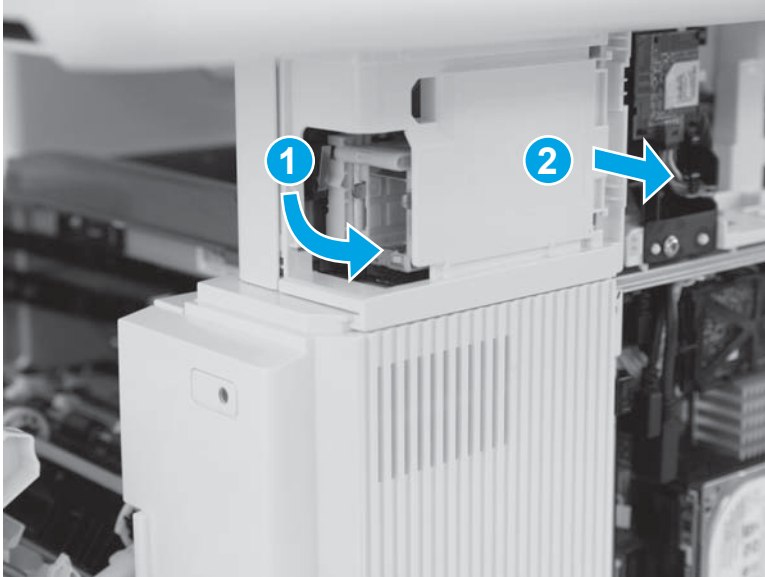
3. Use a long-shaft small flat-blad screwdriver to release the upper tab.

**Figure 1-1371** Release one tab



4. With the tabs disengaged the front of the cover is released. Rotate the front of the cover away from the printer (callout 1) to release the rear of the cover (callout 2), and then remove it.

**Figure 1-1372** Remove the cover



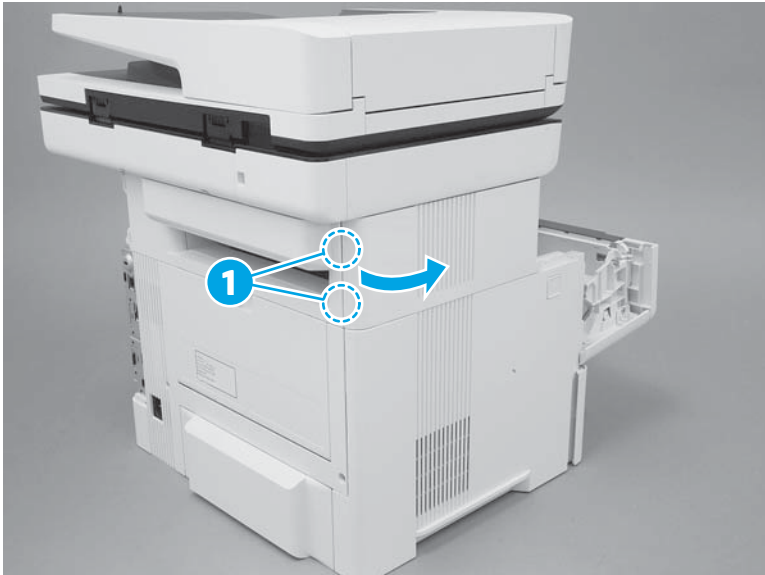
#### Step 9: Remove the top-left cover (M527)



**NOTE:** This step is for the M527 printer. For the M501/M506, skip this step and go to [Step 11: Remove the rear door assembly on page 786](#).

1. Open the toner-cartridge door, release two tabs (callout 1), and then rotate the rear edge of the cover away from the printer.

**Figure 1-1373** Release two tabs



2. Continue to rotate the cover away from the printer to release two more tabs at the middle of the cover.

**Figure 1-1374** Release two tabs



3. Slide the cover toward the rear of the printer to release two bosses at the front of the cover.

**Figure 1-1375** Slide the cover



4. Remove the cover.

**Figure 1-1376** Remove the cover



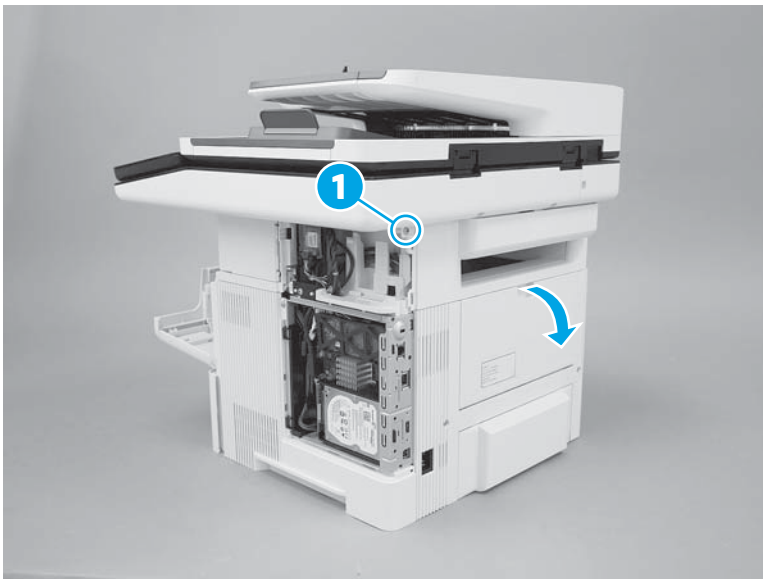
#### Step 10: Remove the top-rear cover (M527)



**NOTE:** This step is for the M527 printer. For the M501/M506, skip this step and go to [Step 11: Remove the rear door assembly on page 786](#).

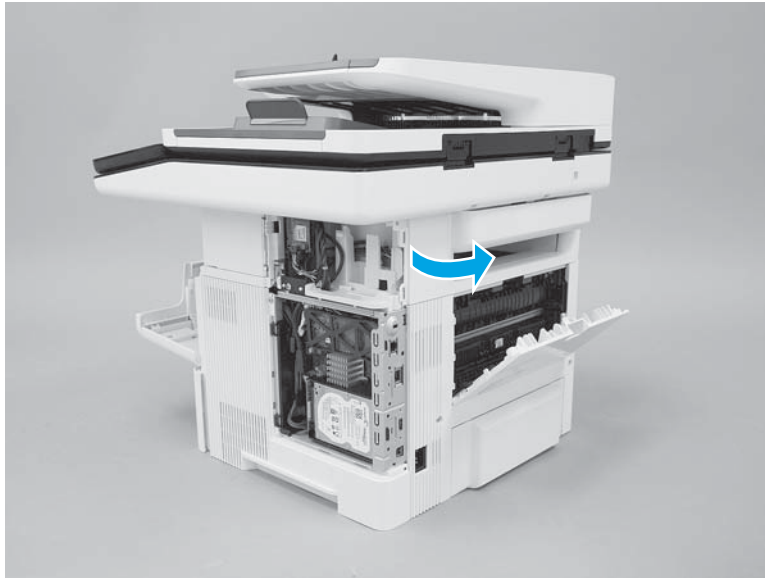
1. Remove one screw (callout 1), and then open the rear door.

**Figure 1-1377** Remove one screw



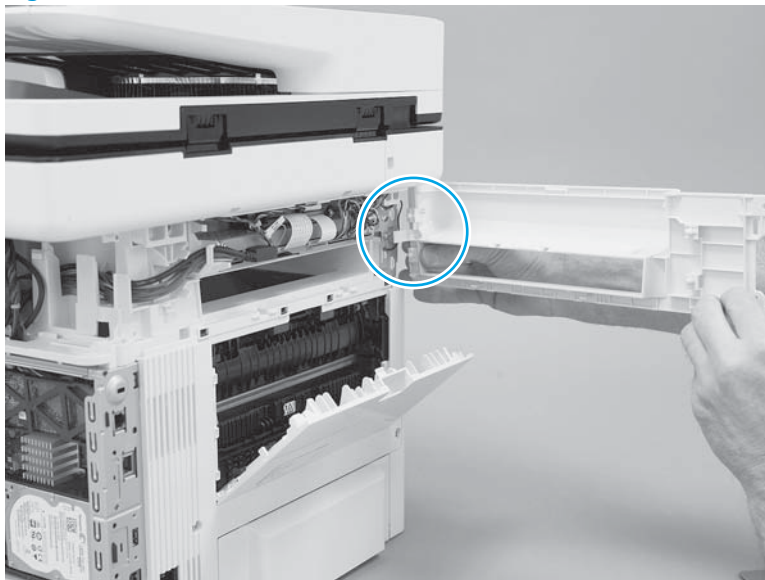
2. Rotate the exposed edge of the cover away from the printer (as shown).

**Figure 1-1378** Rotate the cover



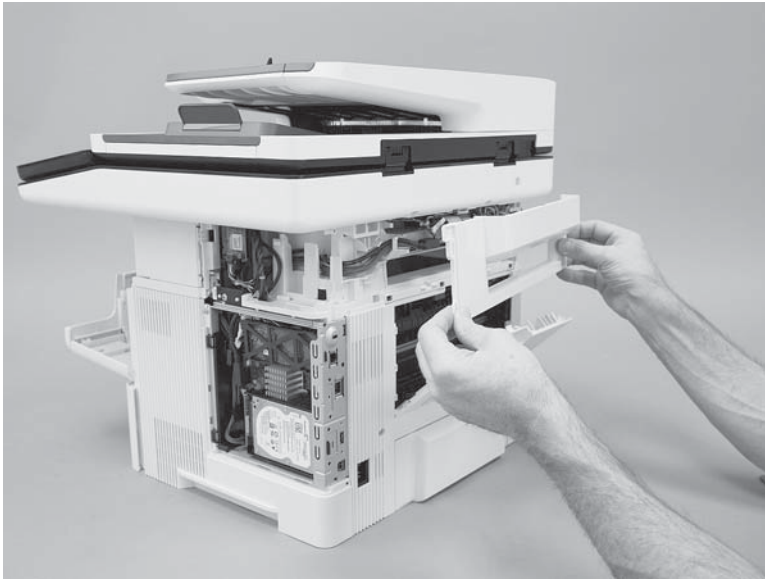
3. Continue to rotate the cover away from the printer to release one boss.

**Figure 1-1379** Release one boss



4. Remove the cover.

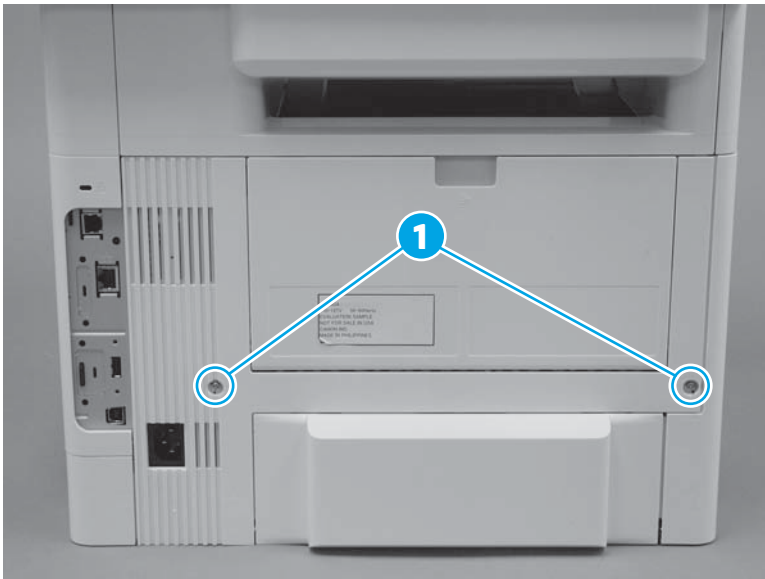
**Figure 1-1380** Remove the cover



### Step 11: Remove the rear door assembly

1. At the rear of the printer, remove two screws (callout 1).

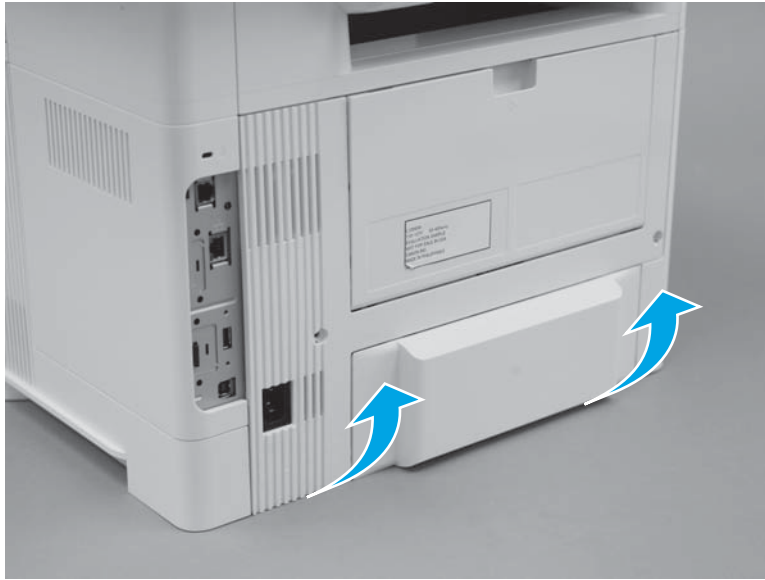
**Figure 1-1381** Remove two screws





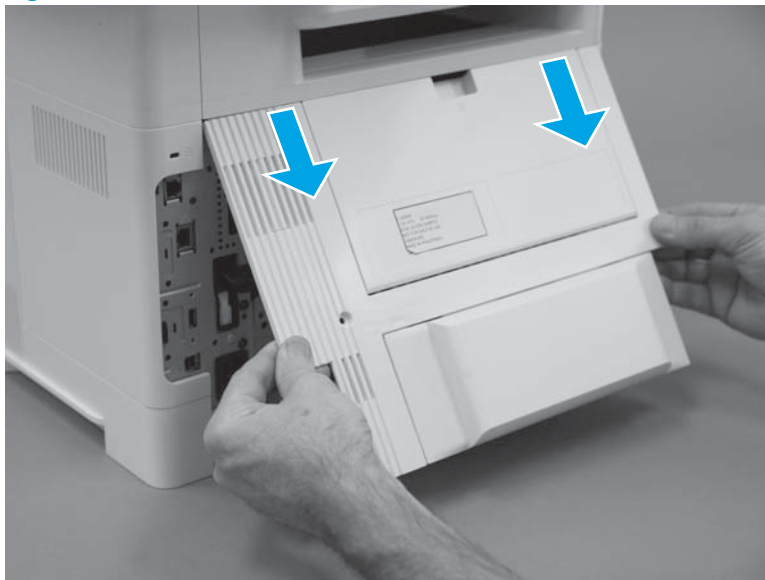
2. Rotate the bottom edge of the assembly away from the printer to release it.

**Figure 1-1382** Rotate the bottom of the cover



3. Pull down on the assembly to remove it.

**Figure 1-1383** Remove the cover



### Step 12: Remove the cartridge door assembly

---

 **NOTE:** If the toner cartridge was not removed prior to servicing the printer, remove it now.

---

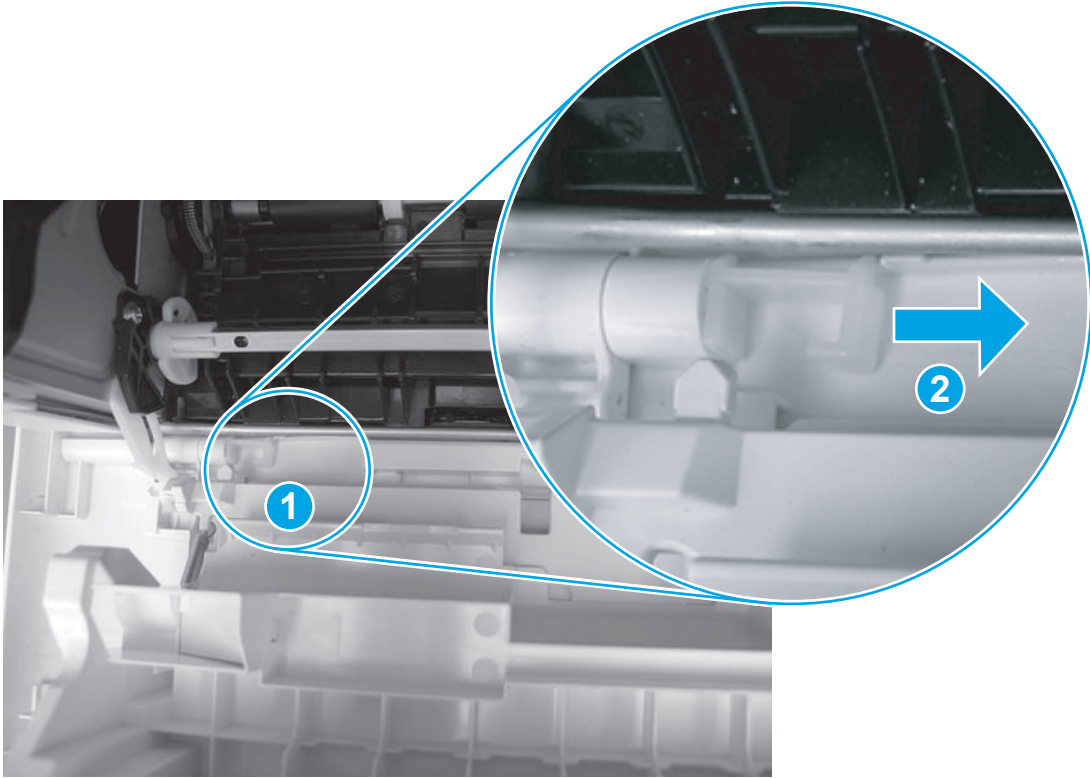
1. Release the support shaft (callout 1), and then slide it toward the center of the door (callout 2).

---

 **TIP:** It might be easier to release the support shaft by using a small flat-blad screwdriver.

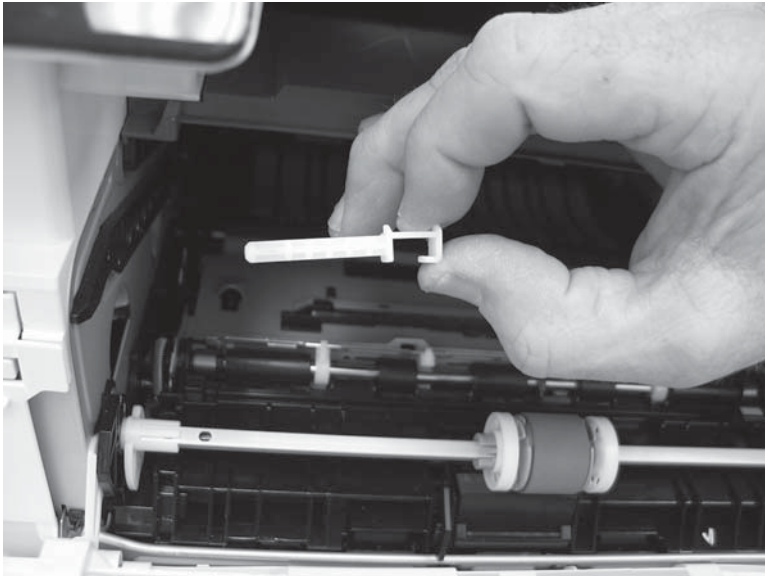
---

**Figure 1-1384** Release the support shaft



2. Remove the support shaft.

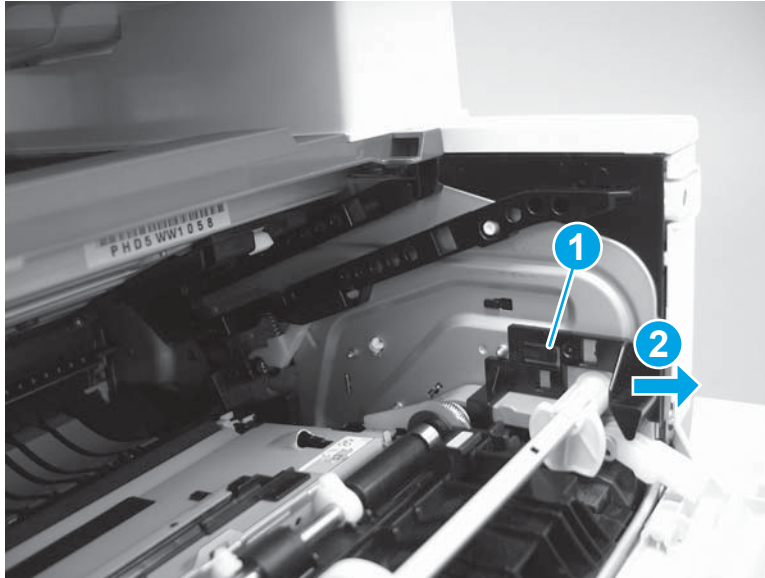
**Figure 1-1385** Remove the support shaft



3. Release one tab (callout 1), and then slide the guide out of the printer (callout 2).

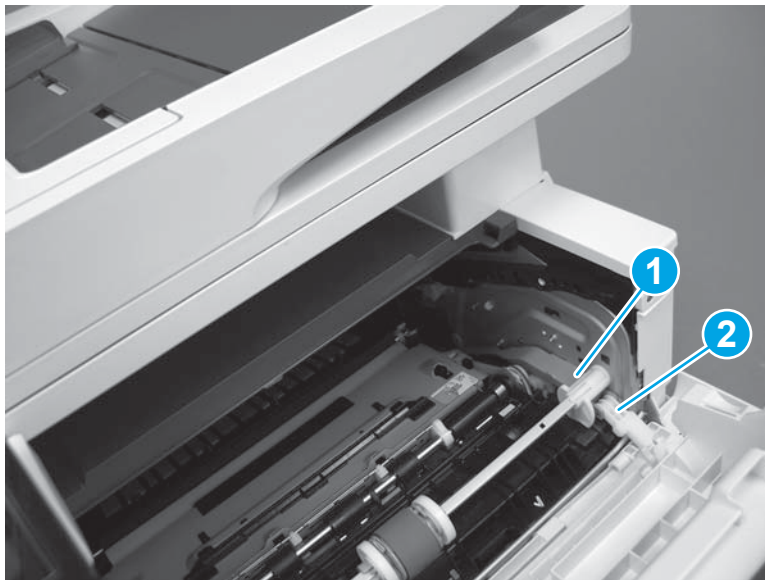
**CAUTION:** Be careful, the tab (callout 1) can be easily broken.

**Figure 1-1386** Remove the guide



4. Use a small flat-blade screwdriver to gently pry the white-plastic door arm (callout 1) off of the gray-plastic pressure-release link (callout 2) to release the door arm.

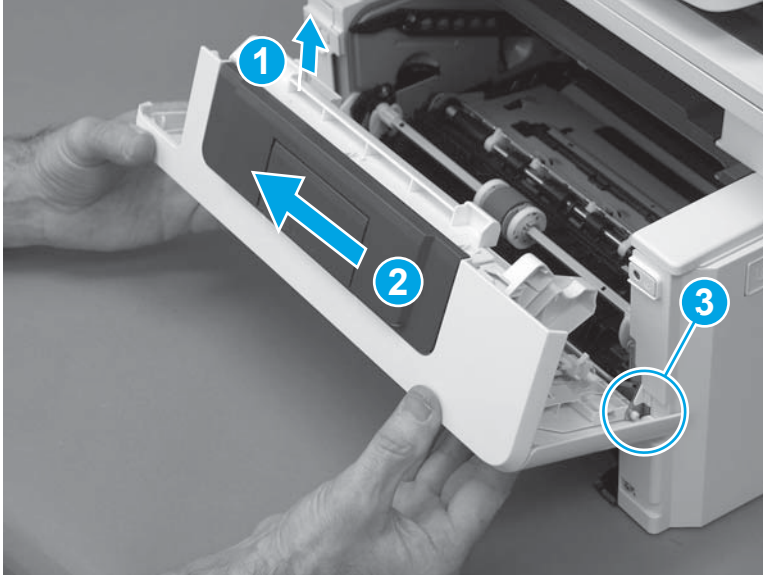
**Figure 1-1387** Release the pressure-release link



5. With the door in the partially closed position, slightly raise the left end (callout 1; raise it over the sheet-metal hinge boss), and then slide the door to the left (callout 2) to release the right hinge (callout 3).

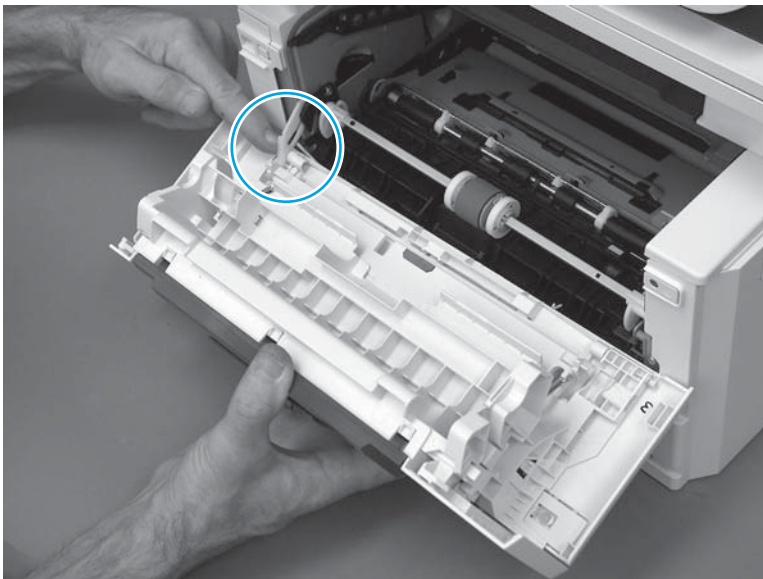
**⚠ CAUTION:** The door is still attached to the printer by the left-side retainer arm. Do not attempt to completely remove the door.

**Figure 1-1388** Release the door



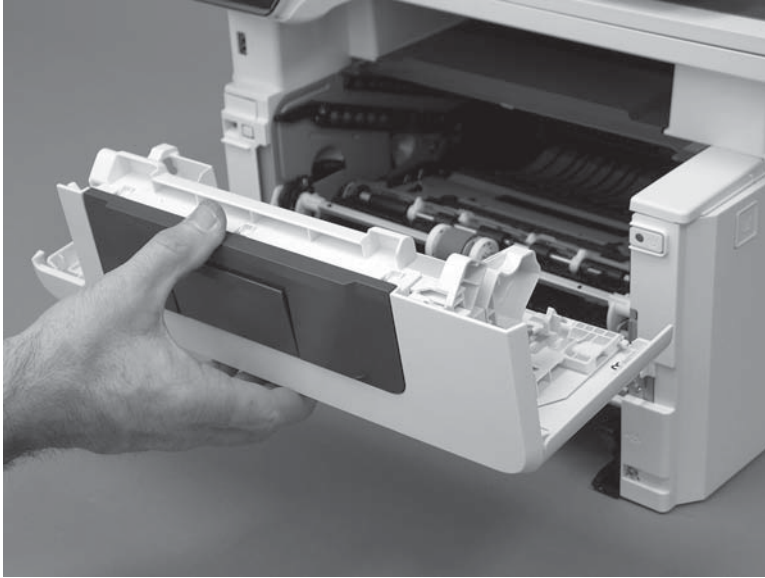
6. Rotate the door away from the printer until the keyed pin on the left-side retainer arm can disengage from the door.

**Figure 1-1389** Release the left-side retainer arm





7. Remove the door.

**Figure 1-1390** Remove the door



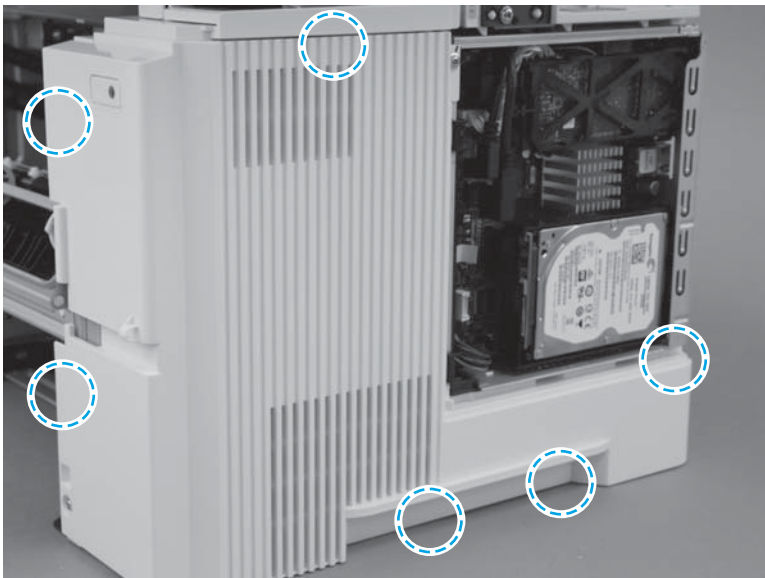
### Step 13: Remove the right cover

 **IMPORTANT:** The black-plastic cassette front and rear guides (located inside the tray cavity) can be easily dislodged. Do not lose the guides when the cover is removed or installed.

 **NOTE:** The M527 printer is shown in this procedure. However, this procedure is valid for the M501/M506 printers.

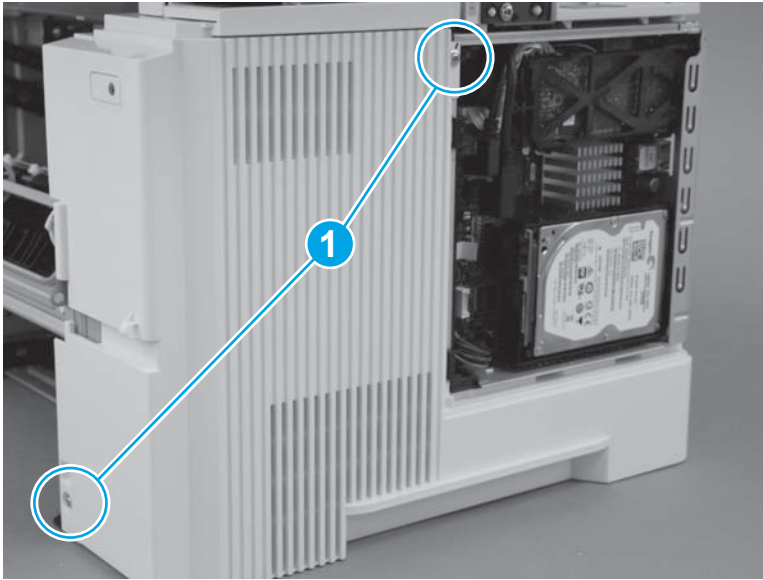
1. Before proceeding, take note of the location of the tabs and bosses on the inside of the cover.

**Figure 1-1391** Locate the tabs and bosses



2. Remove two screws (callout 1).

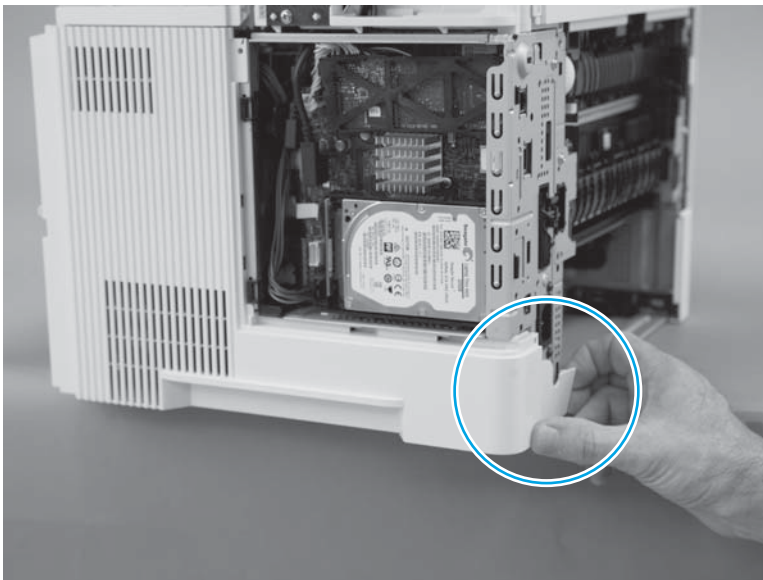
**Figure 1-1392** Remove two screws



3. At the rear of the printer, release one boss.

**CAUTION:** It might be easier to remove the cover with the printer slightly hanging over the edge of the workspace. Do not let the printer tip and fall off of the workspace when removing the cover.

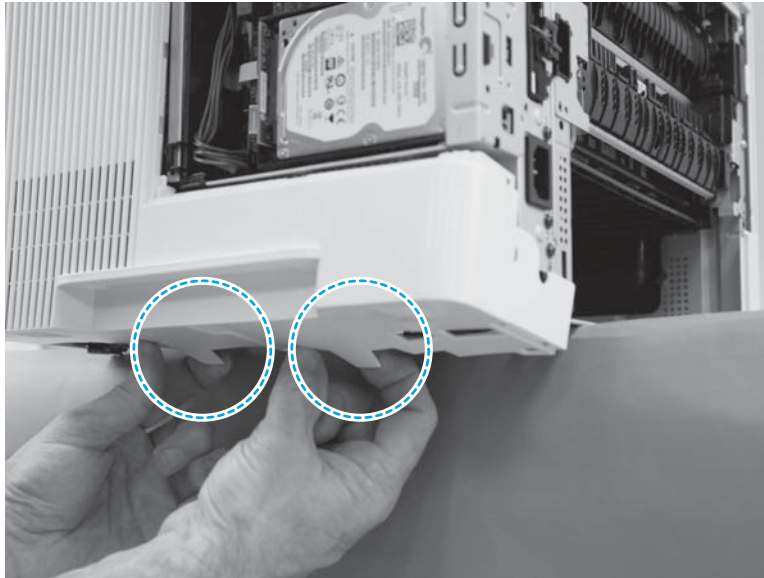
**Figure 1-1393** Release one boss



4. At the bottom edge of the cover, release two bosses.

**CAUTION:** It might be easier to remove the cover with the printer slightly hanging over the edge of the workspace. Do not let the printer tip and fall off of the workspace when removing the cover.

**Figure 1-1394** Release two bosses

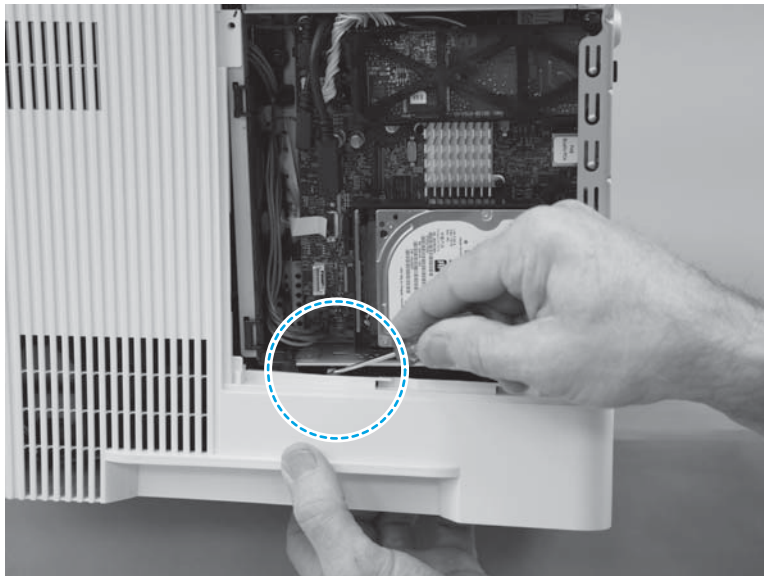


5. Near the formatter, release one tab.

**CAUTION:** It might be easier to remove the cover with the printer slightly hanging over the edge of the workspace. Do not let the printer tip and fall off of the workspace when removing the cover.

**TIP:** Hold the bottom of the cover away from the printer, and then use a small flat-blade screw driver to easily release this tab.

**Figure 1-1395** Release one tab

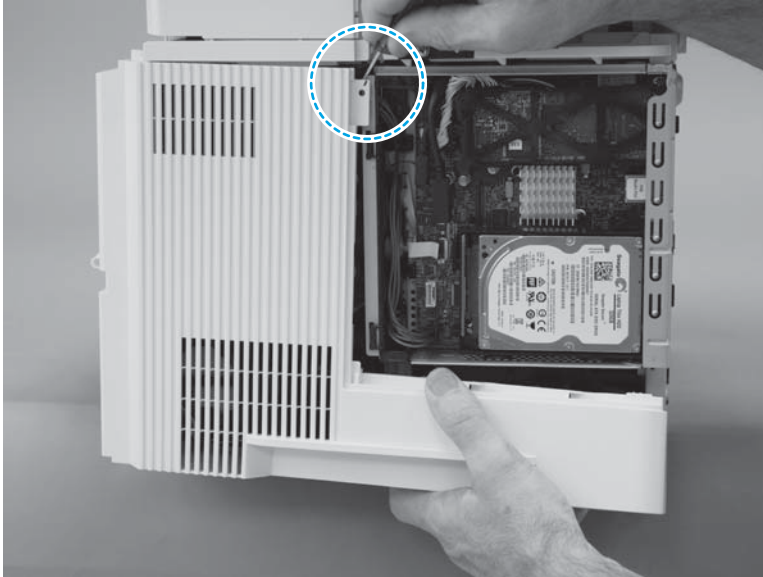


- At the top rear edge of the cover, release one tab.

**CAUTION:** It might be easier to remove the cover with the printer slightly hanging over the edge of the workspace. Do not let the printer tip and fall off of the workspace when removing the cover.

**TIP:** Use a small flat-blade screw driver to easily release this tab.

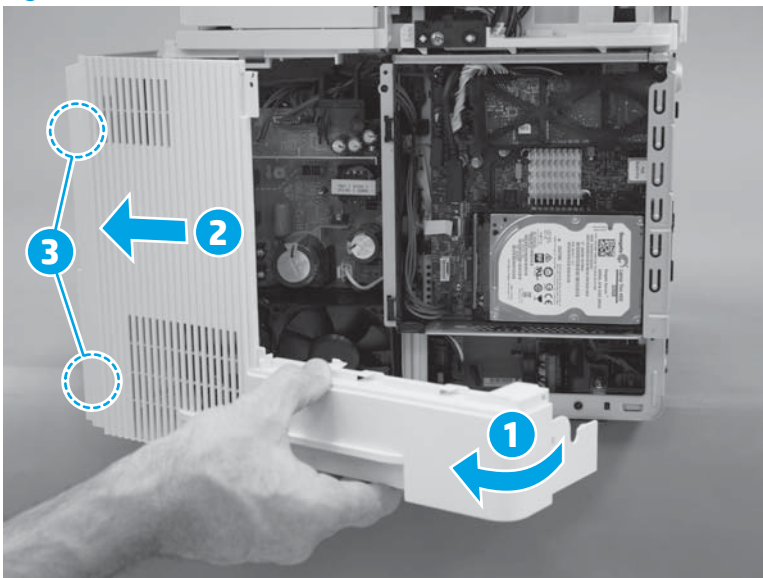
**Figure 1-1396** Release one tab



- Rotate the rear of the cover away from the printer (callout 1), slide the cover toward the front of the printer (callout 2) to release two bosses (callout 3), and then remove the cover.


**CAUTION:** It might be easier to remove the cover with the printer slightly hanging over the edge of the workspace. Do not let the printer tip and fall off of the workspace when removing the cover.


**Figure 1-1397** Remove the cover





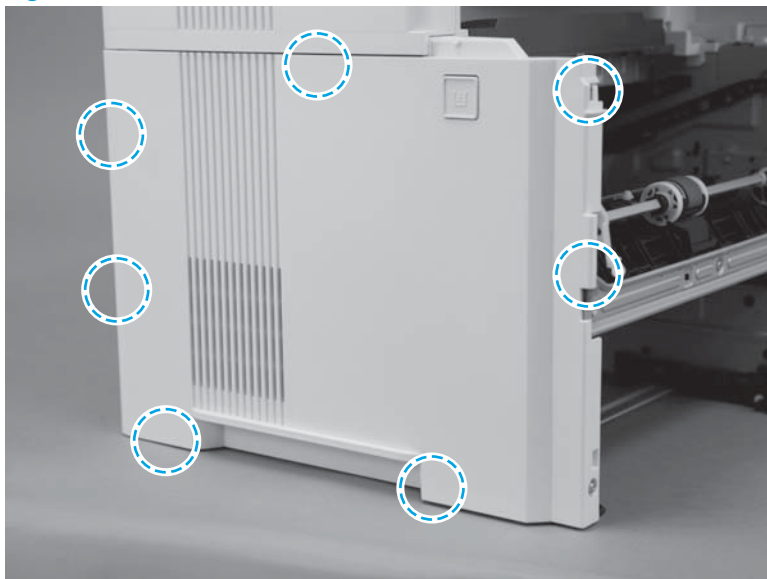
## Step 14: Remove the left cover

 **IMPORTANT:** The black-plastic cassette front and rear guides (located inside the tray cavity) can be easily dislodged. Do not lose the guides when the cover is removed or installed.

 **NOTE:** The M527 printer is shown in this procedure. However, this procedure is valid for the M501/M506 printers.

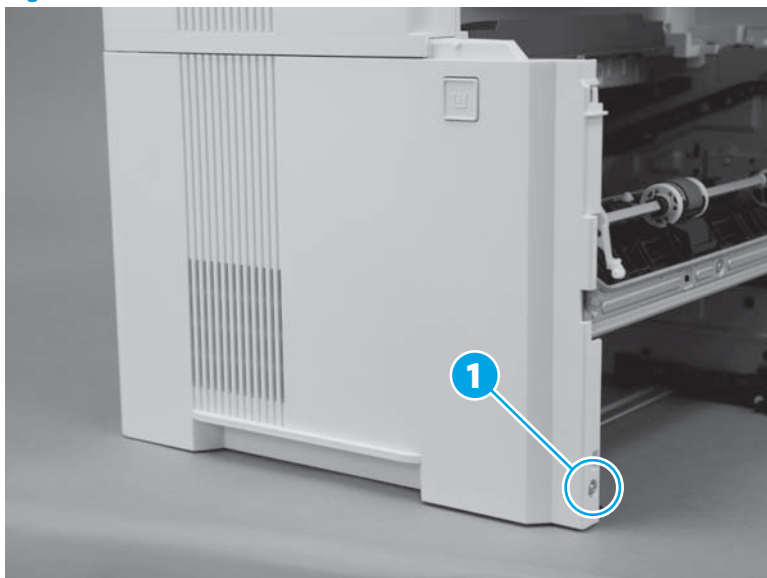
1. Before proceeding, take note of the location of the tabs and bosses on the inside of the cover.

**Figure 1-1398** Locate of the tabs and bosses



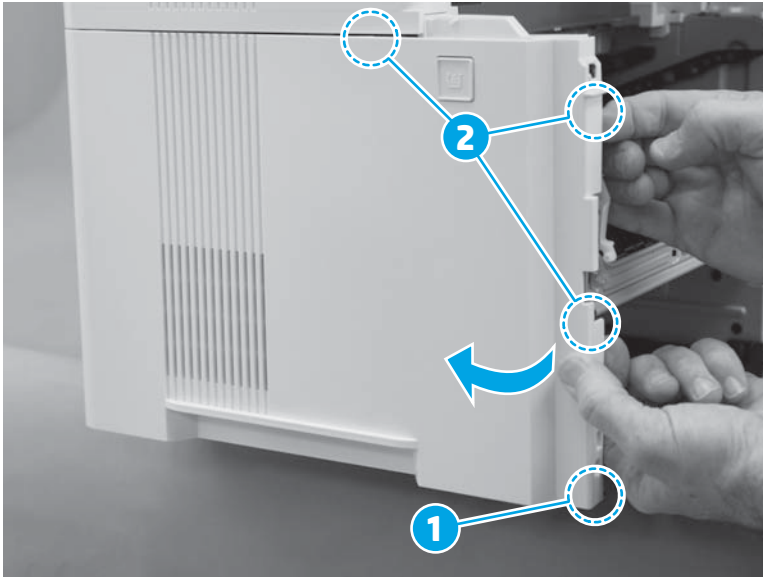
2. Remove one screw (callout 1).

**Figure 1-1399** Remove one screw



3. At the front of the printer, release one boss (callout 1), and then rotate the front edge of the cover away from the printer to release three tabs (callout 2).

**Figure 1-1400** Release one boss and three tabs




4. At the bottom edge of the cover, release two tabs.

**Figure 1-1401** Release two tabs



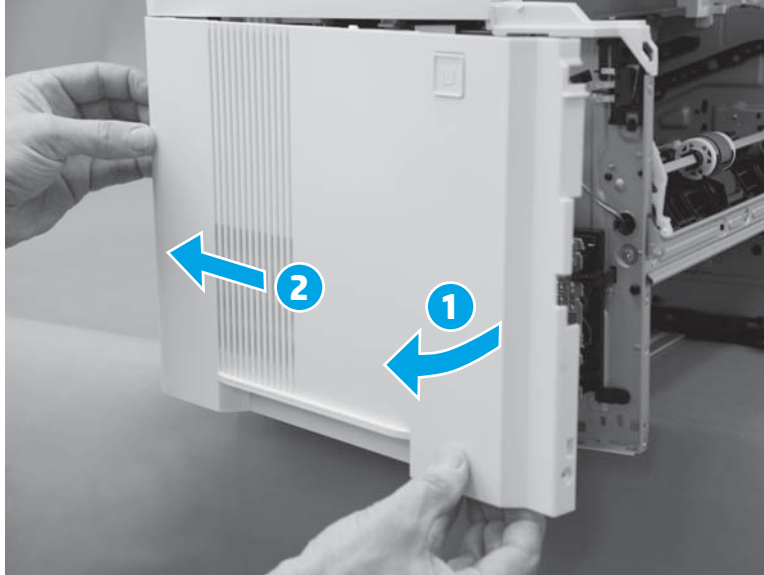
5. Continue to rotate the front edge of the cover away from the printer (callout 1), and then slide the cover toward the rear of the printer (callout 2) to remove it.

---

 **NOTE:** If the cover is difficult to rotate or slide as shown below, make sure that the bottom tabs (released in the previous step) are completely disengaged from the chassis.


---


**Figure 1-1402** Remove the cover




### Step 15: Remove the integrated scanner assembly (M527)

---

 **IMPORTANT:** Some figure might show assemblies removed or installed that have not yet been removed or installed at that specific step. However, the procedures are correct for this printer and the target assembly. Always thoroughly read the instructions that accompany each figure

 **NOTE:** This step is for the M527 printer. For the M501/M506, skip this step and go to [Step 17: Remove the top cover \(M501/M506\) on page 803](#).


---

 **NOTE:** The ISA includes the document feeder, sub-scanner assembly (SSA), and the scanner control board (SCB)

---

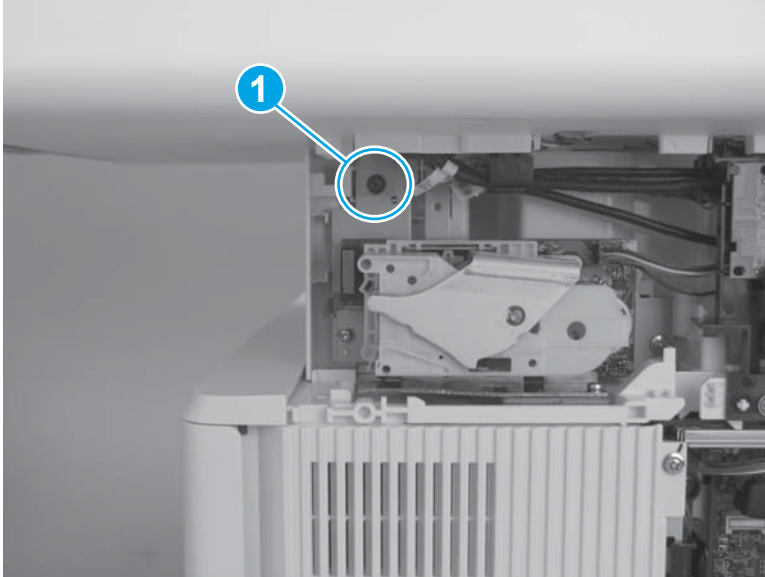
1. Remove one screw (callout 1).

---


 **IMPORTANT:** This screw fastens the ISA ground plate to the printer chassis. Do not lose this screw.


---

**Figure 1-1403** Remove one screw

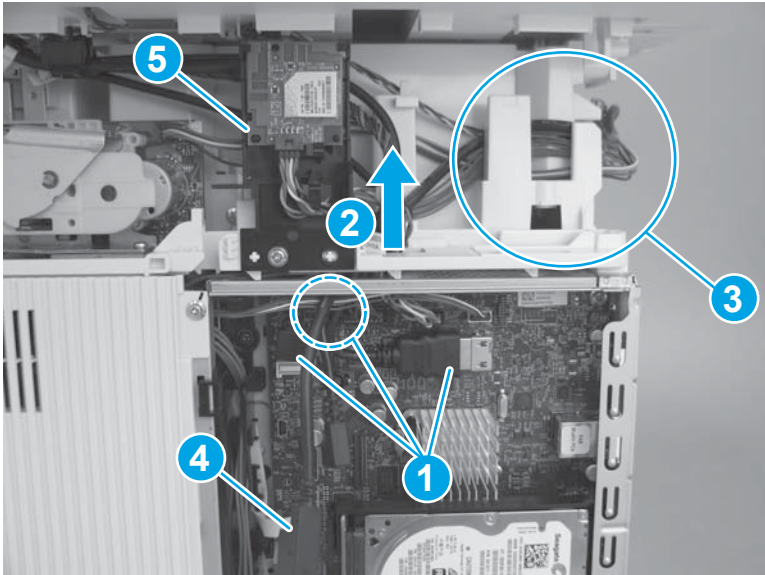


2. Disconnect three connectors (callout 1), pass the wire harnesses and cables through the opening in the cover (callout 2), and then release them from the retainers (callout 3).

 **NOTE:** One cable (callout 4) does not need to pass through the opening in the cover.

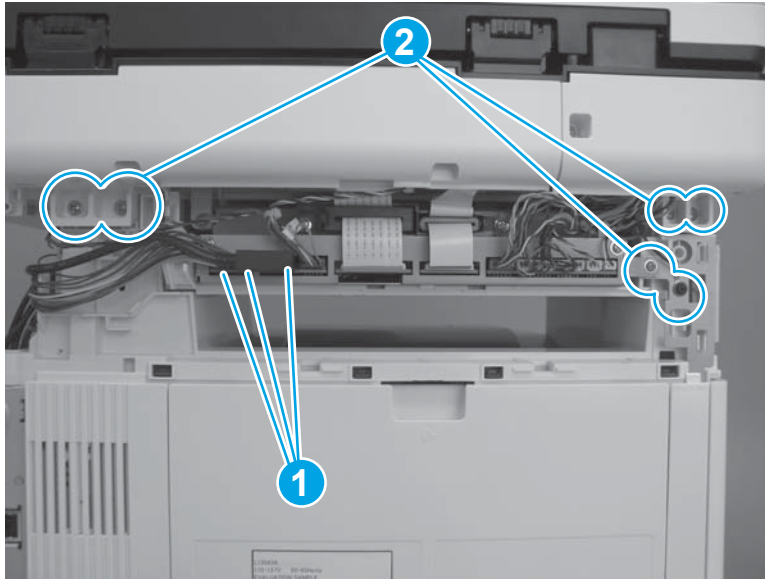
 **TIP:** It might be easier if the WiFi PCA and holder (callout 5) is detached from the printer, and then moved out of the way.

**Figure 1-1404** Disconnect cables and connectors



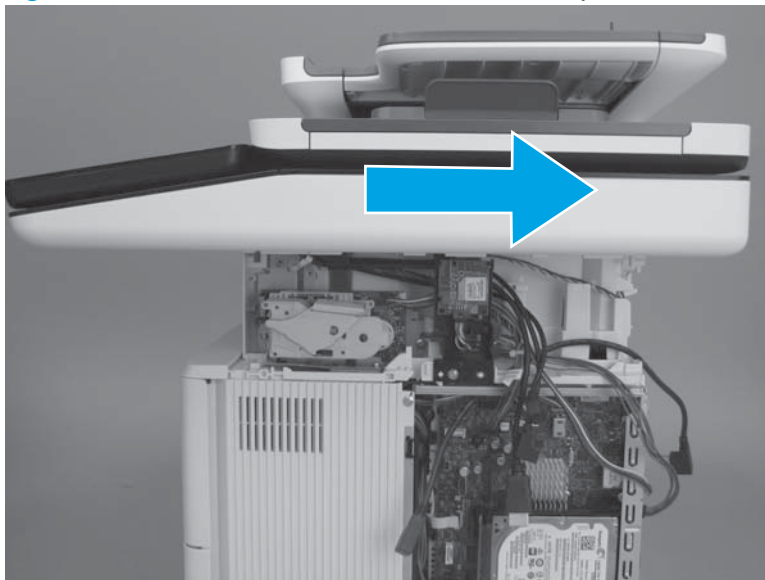
3. Disconnect three connectors (callout 1), and then remove six screws (callout 2).

**Figure 1-1405** Disconnect connectors and remove screws



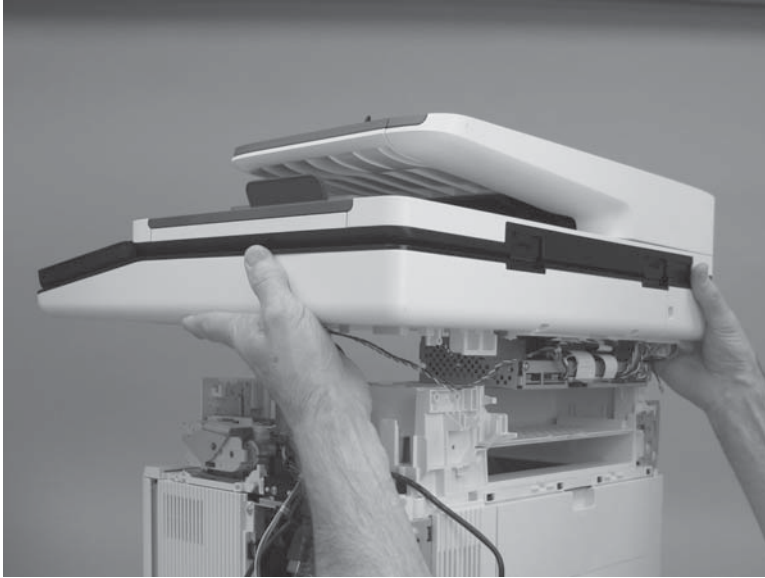
4. Slightly slide the ISA towards the back of the printer to release it.

**Figure 1-1406** Slide the ISA towards the back of the printer



5. Remove the ISA.

**Figure 1-1407** Remove the ISA



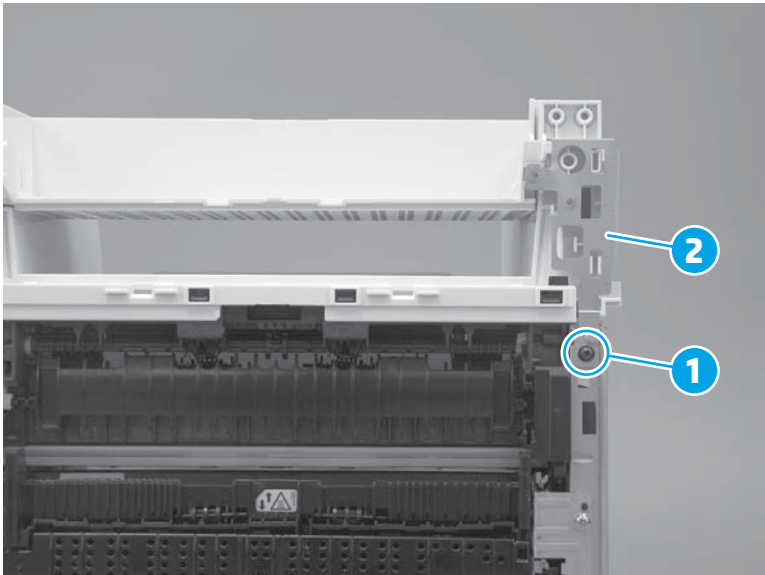
#### Step 16: Remove the top cover (M527)



**NOTE:** This step is for the M527 printer. For the M501/M506, skip this step and go to [Step 17: Remove the top cover \(M501/M506\) on page 803](#).

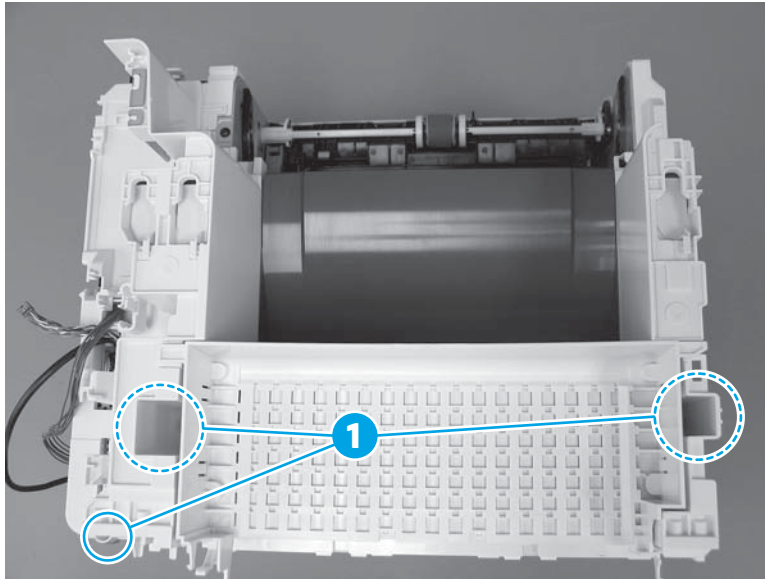
1. At the front right of the printer, remove one screw (callout 1), and then remove the sheet-metal plate (callout 2).

**Figure 1-1408** Remove one screw and the plate




2. At the top rear of the printer, remove three screws (callout 1).

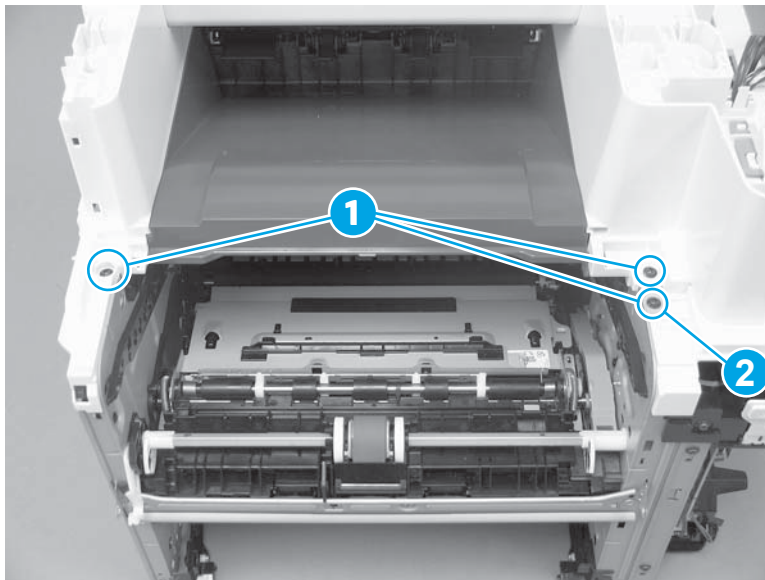
**Figure 1-1409** Remove three screws



3. At the top front of the printer, remove three screws (callout 1).

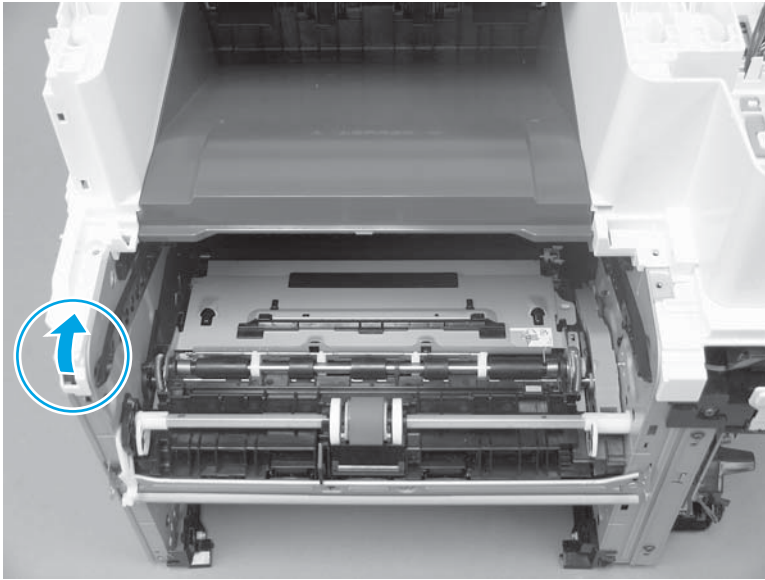
 **NOTE:** The screw (callout 2) on the lower-right portion of the cover is a different color than the other two screws, and is surrounded by sheet-metal. It might appear that this screw does not need to be removed. Remove this screw.

**Figure 1-1410** Remove three screws



4. At the front left of the printer, release one boss.

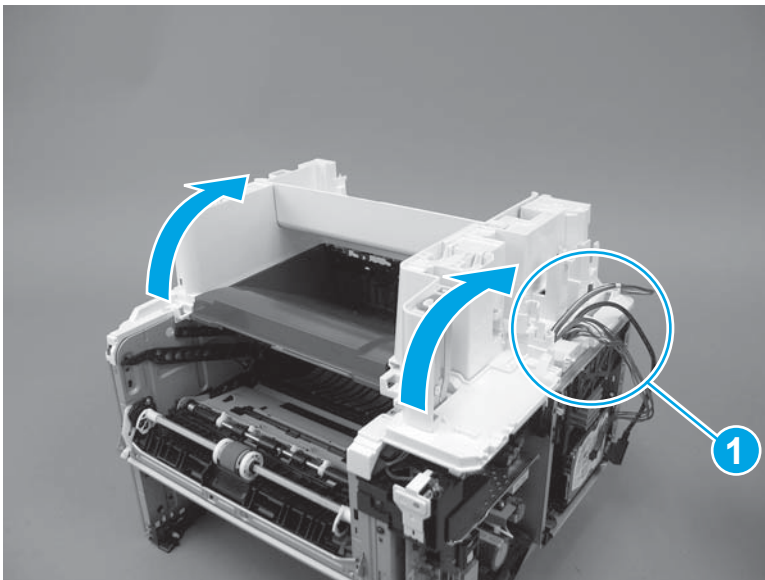
**Figure 1-1411** Release one boss



5. Rotate the front of the cover up and away from the printer.

**CAUTION:** As the cover is rotated up, carefully pass the cables and wire harnesses the hole in the cover (callout 1).

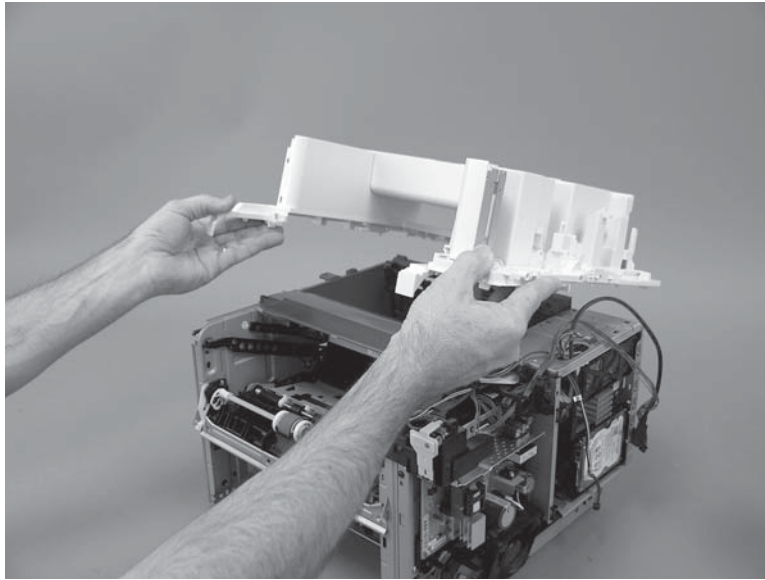
**Figure 1-1412** Rotate the front of the cover up






6. Remove the cover.

**Figure 1-1413** Remove the cover



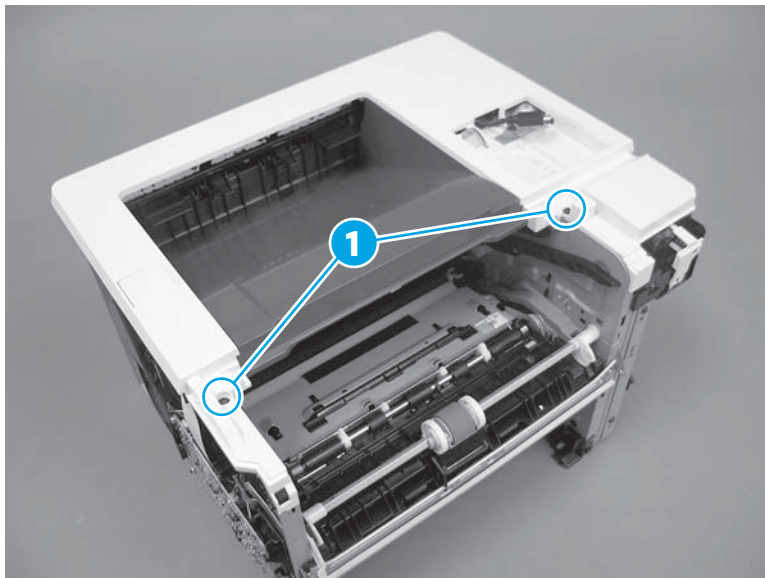
### Step 17: Remove the top cover (M501/M506)

 **NOTE:** This step is for the M501/M506 printer. For the M527, skip this step and go to [Step 19: Remove the formatter case on page 806](#).


The M506x is shown in this procedure. However, the steps are correct for all M506 models and the M501 printer.

1. Remove two screws (callout 1).

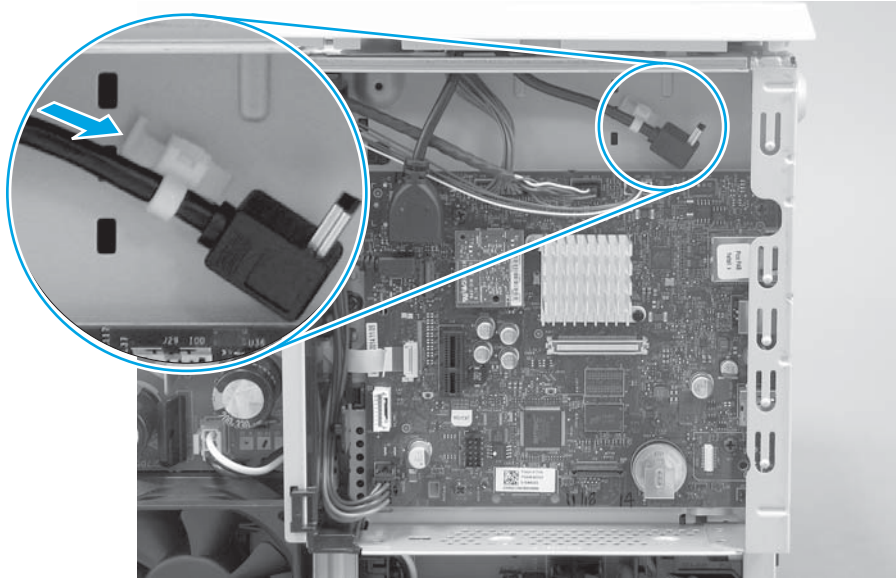
**Figure 1-1414** Remove two screws



2. **M506 only:** Release one cable retainer from the chassis.

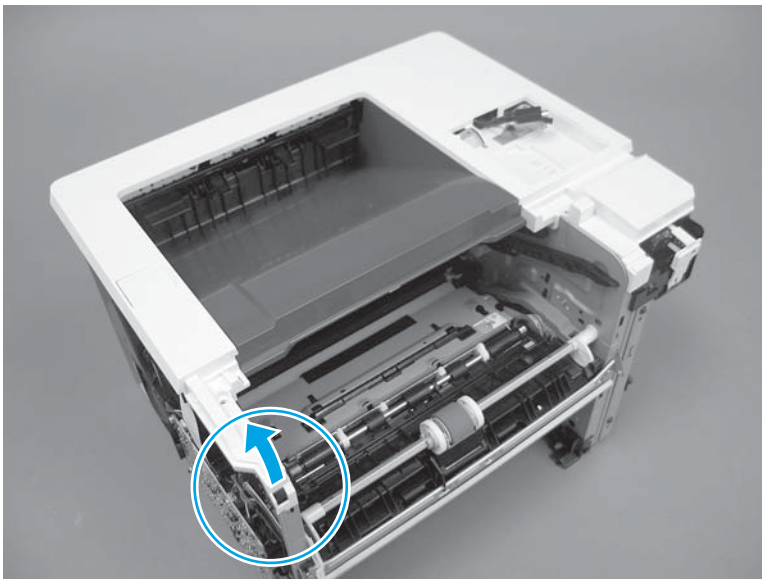
 **TIP:** Depress the tab on the retainer to release it.

**Figure 1-1415** Release one cable retainer



3. Release one boss.

**Figure 1-1416** Release one boss

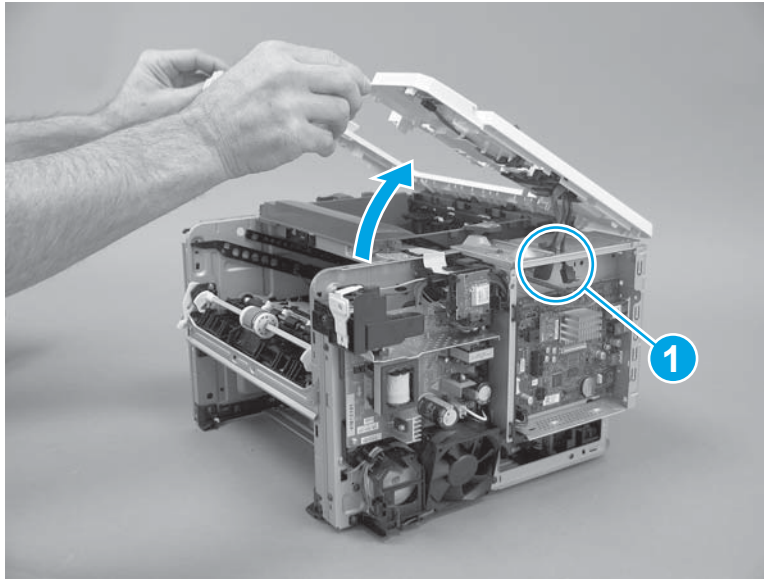


4. Rotate the front of the cover up and away from the printer, and then remove the cover.

**CAUTION:** **M506x only:** As the cover is rotated up, carefully pass the cables the hole in the chassis (callout 1).

**NOTE:** **LCD control panel models only:** Disconnect the control panel before removing the cover.

**Figure 1-1417** Remove the cover

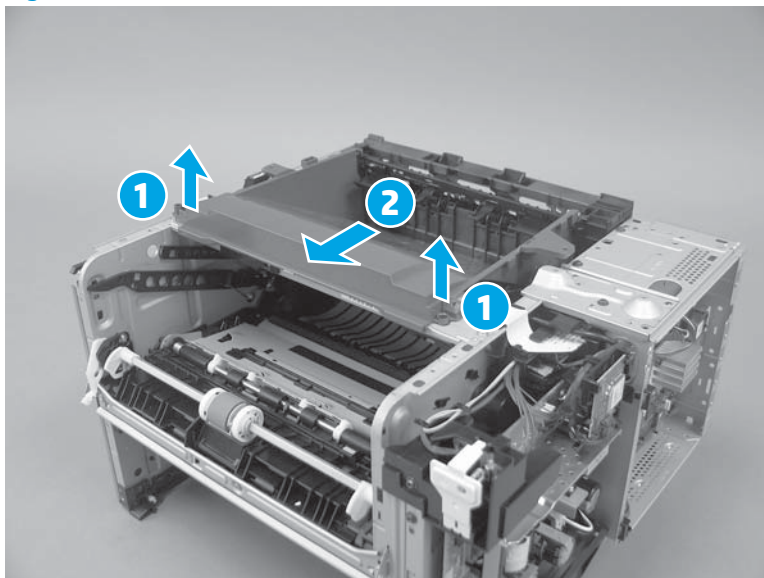


#### Step 18: Remove the paper delivery tray (output bin)

**NOTE:** This procedure shows the M506 printer. However, this procedure is valid for the M527 printer.

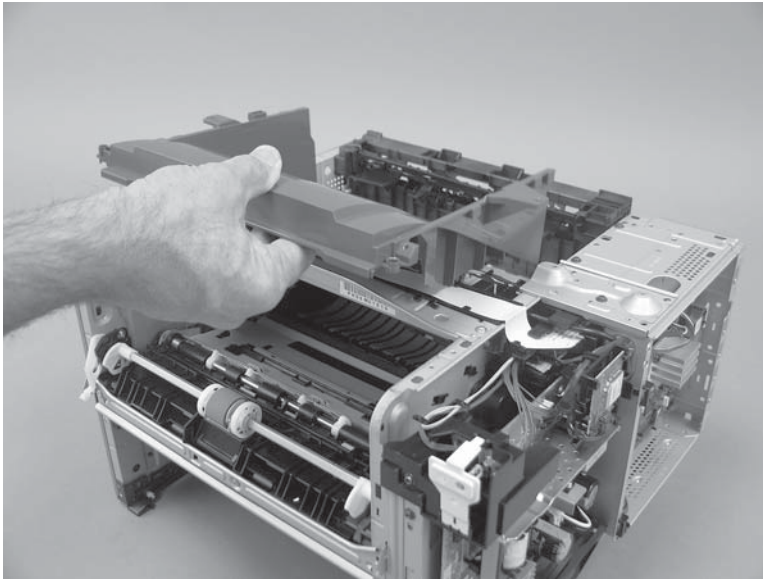
1. Release two tabs (callout 1), and then slide the cover toward the front of the printer (callout 2).

**Figure 1-1418** Release two tabs



2. Remove the bin.

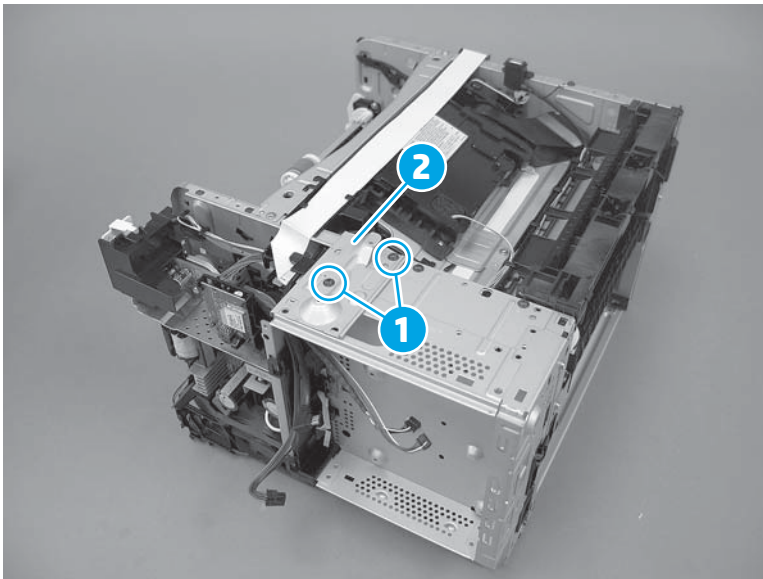
**Figure 1-1419** Remove the bin




#### Step 19: Remove the formatter case

1. **M506 only:** Remove two screws (callout 1), and then remove the sheet-metal plate (callout 2).

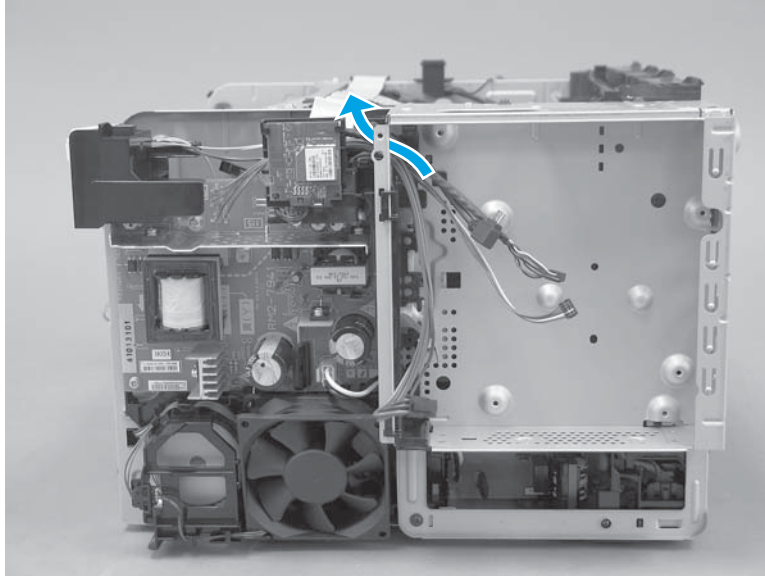
**Figure 1-1420** Remove the sheet-metal plate



- Carefully pass all cables and wire harnesses through the opening in the formatter case.

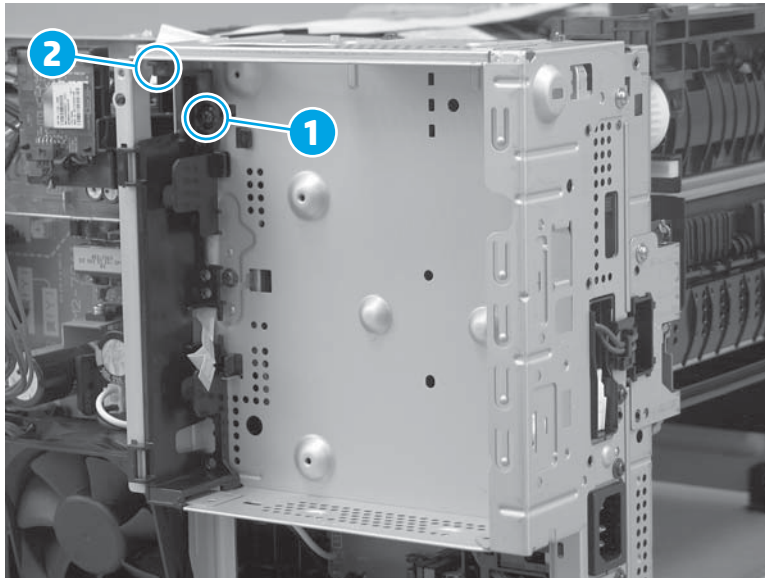
 **NOTE:** The figure below shows the M506 printer. However this step is valid for the M501/M527 printers—there will be a different number of cables and wire harnesses.

**Figure 1-1421** Pass all cables and wire harnesses through the opening



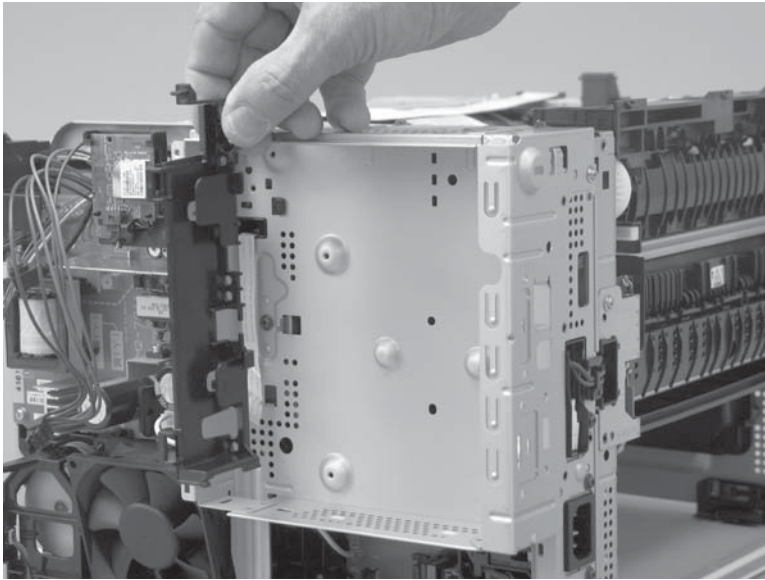
- Remove one screw (callout 1), and then push down on one tab (callout 2) to release it.

**Figure 1-1422** Remove one screw



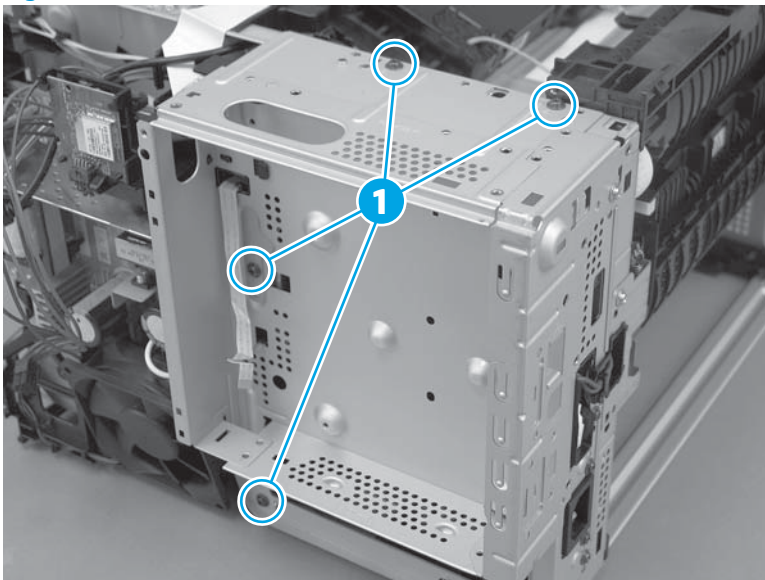
4. Remove the guide.

**Figure 1-1423** Remove the guide



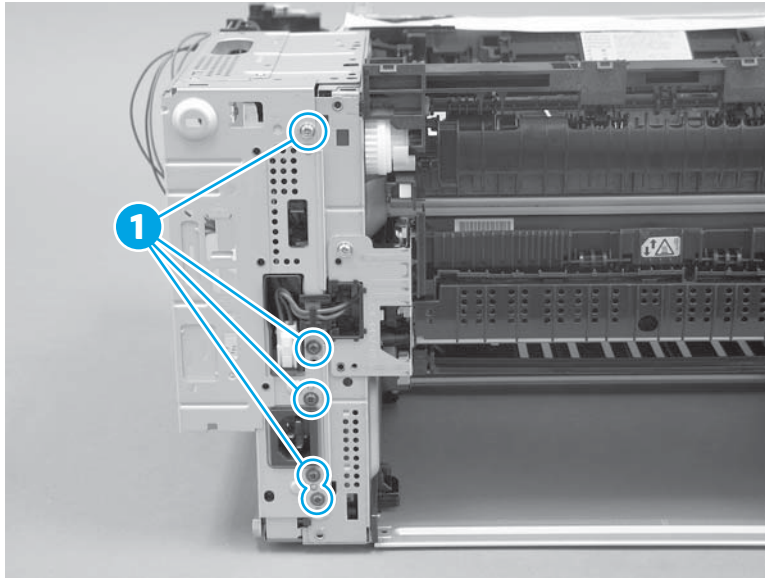
5. Remove four screws (callout 1).

**Figure 1-1424** Remove four screws



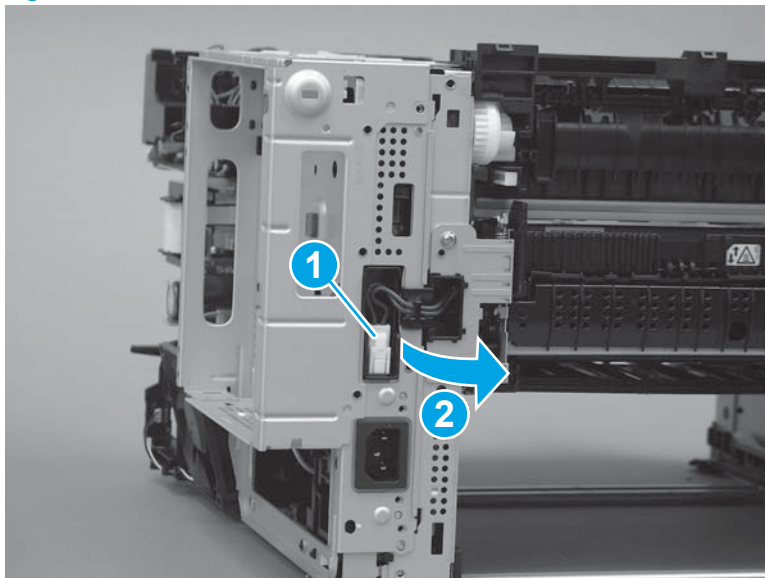
6. Remove five screws (callout 1).

**Figure 1-1425** Remove five screws



7. Disconnect one connector (callout 1), and then move the guide out of the way (callout 2).

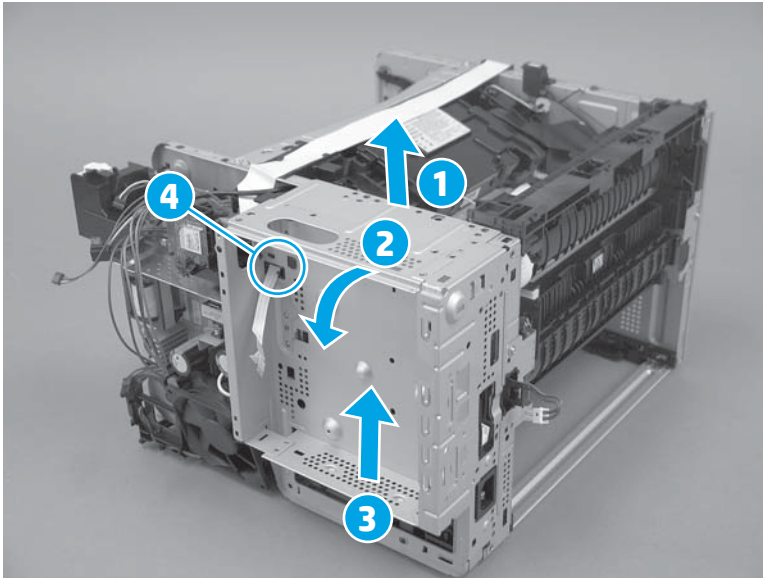
**Figure 1-1426** Disconnect one connector



8. Slightly lift up the formatter case (callout 1), rotate the top of the case away from the chassis (callout 2), and then lift up the case to release it (callout 3).

**CAUTION:** Pass the FFC through the opening (callout 4) in the formatter while removing the case.

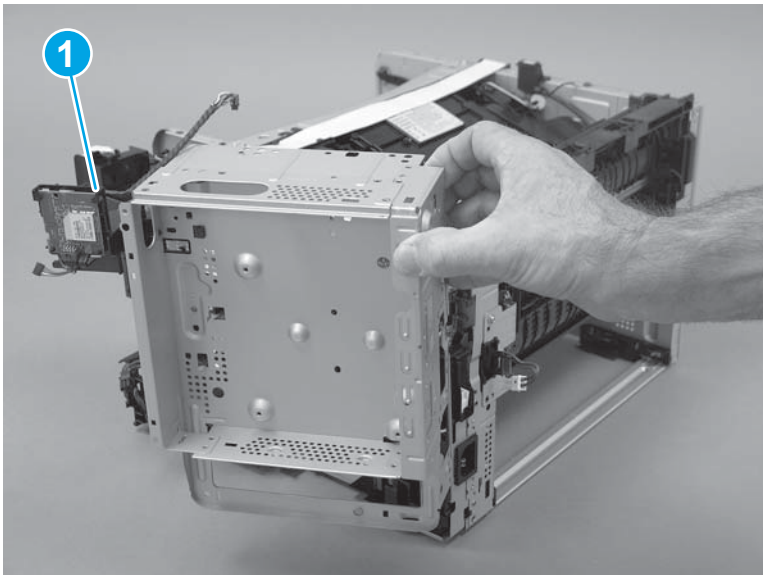
**Figure 1-1427** Release the formatter case



9. Remove the formatter case.

**NOTE:** **M506 only:** If the formatter case is being replaced, make sure that the WiFi PCA and bracket (callout 1) are transferred to the replacement case.

**Figure 1-1428** Remove the formatter case

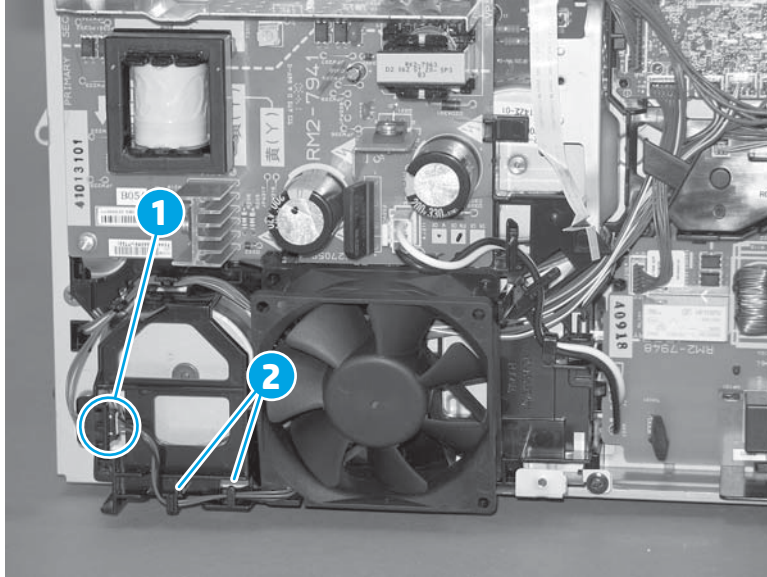


### Step 20: Remove the fan (FM2)

1. Disconnect one connector (callout 1), and then release the wire harness from the retainer (callout 2).

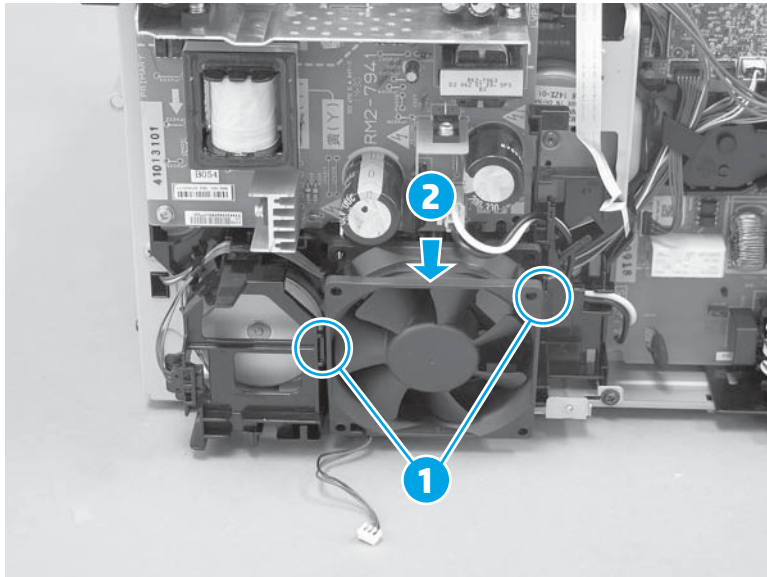


**Figure 1-1429** Disconnect one connector



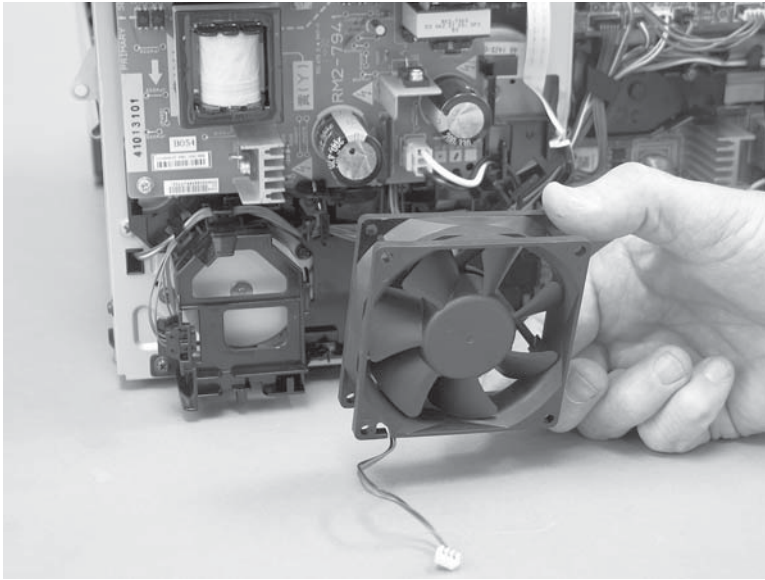
2. Release two tabs (callout 1), and then rotate the top of the fan out and away from the printer (callout 2).

**Figure 1-1430** Release two tabs



3. Remove the fan.

**Figure 1-1431** Remove the fan



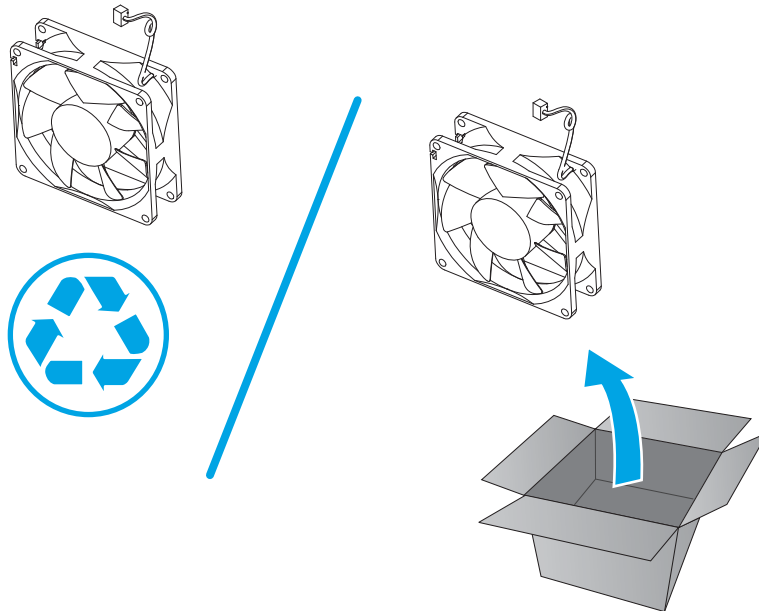
### Step 21: Unpack the replacement assembly

Unpack the replacement part from the packaging.

<http://www8.hp.com/us/en/hp-information/environment/product-recycling.html>

 **NOTE:** HP recommends responsible disposal of the defective part.

**Figure 1-1432** Recycle and unpack

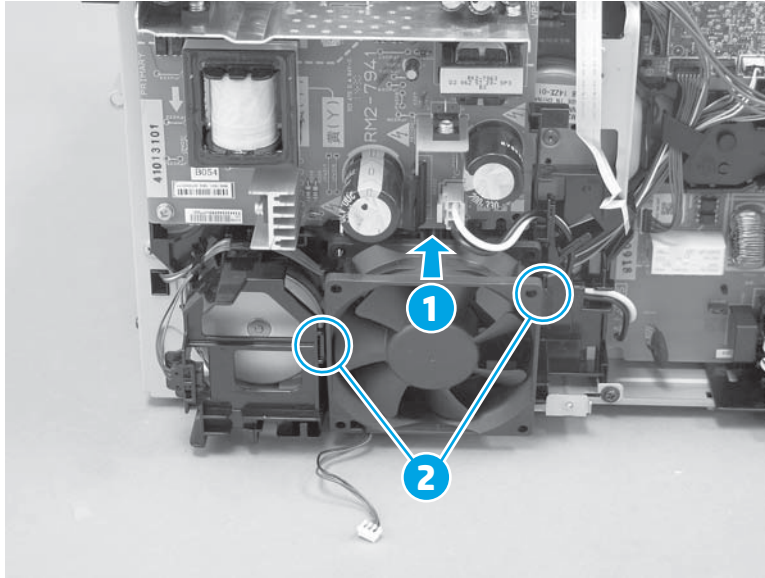


### Step 22: Install the fan (FM2)

1. Position the fan in the bracket. Make sure that the two tabs (callout 1) snap into place on the fan.

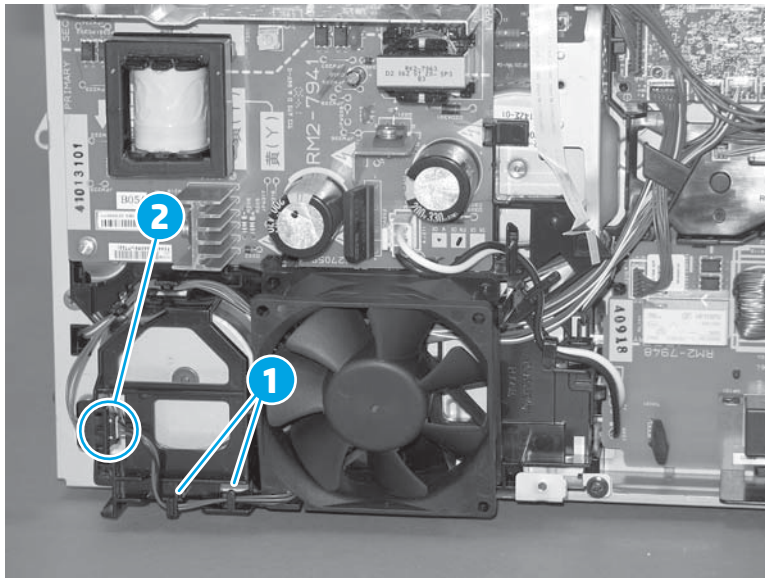
**CAUTION:** The fan must be correctly installed so that air is drawn into the printer. Make sure that the two arrows embossed on the right-side of the fan body—which indicate air flow direction—face downward and into the printer.

**Figure 1-1433** Install the fan



2. Install the wire harness on the retainer (callout 2), and then connect one connector (callout 2).

**Figure 1-1434** Connect one connector

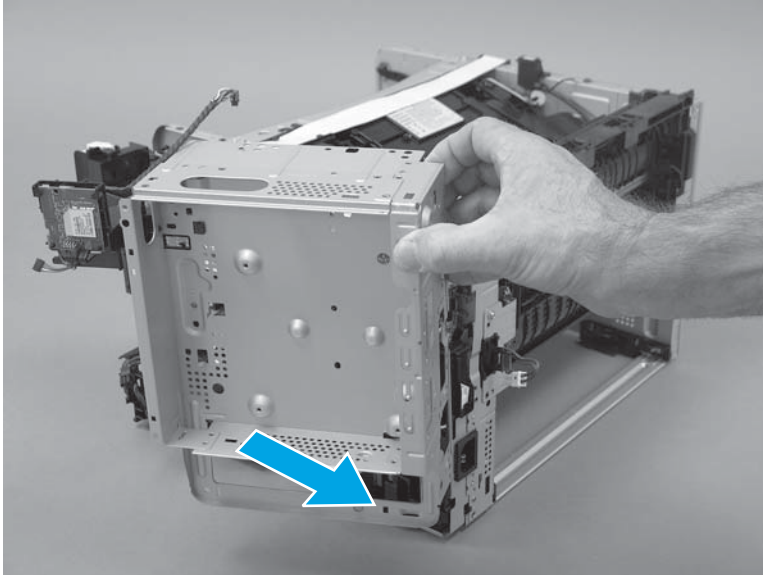


### Step 23: Install the formatter case

1. Position the bottom edge of the formatter case against the chassis.

**NOTE:** **M506 only:** If the formatter case is being replaced, make sure that the WiFi PCA and bracket (callout 1) are transferred to the replacement case.

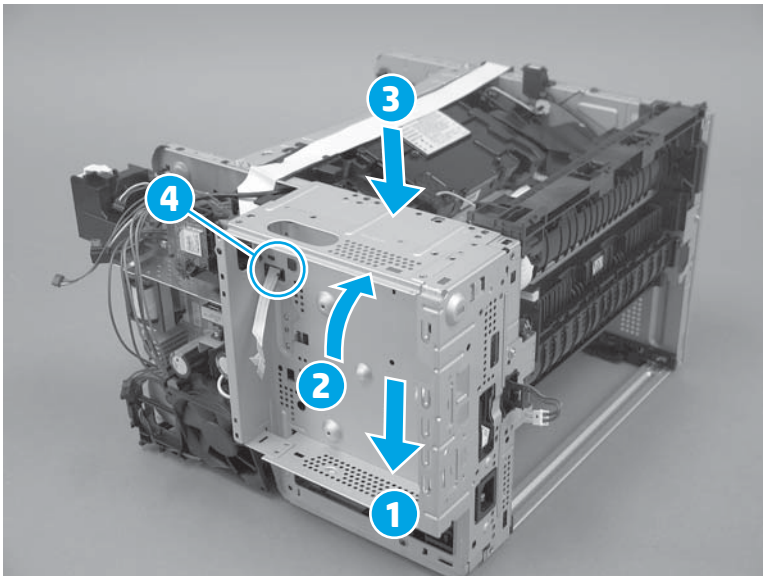
**Figure 1-1435** Position the formatter case against the chassis



2. With the bottom of the formatter case against the chassis (callout 1), rotate the top of the case toward the chassis (callout 2), and slide the case down into place to install it (callout 3).

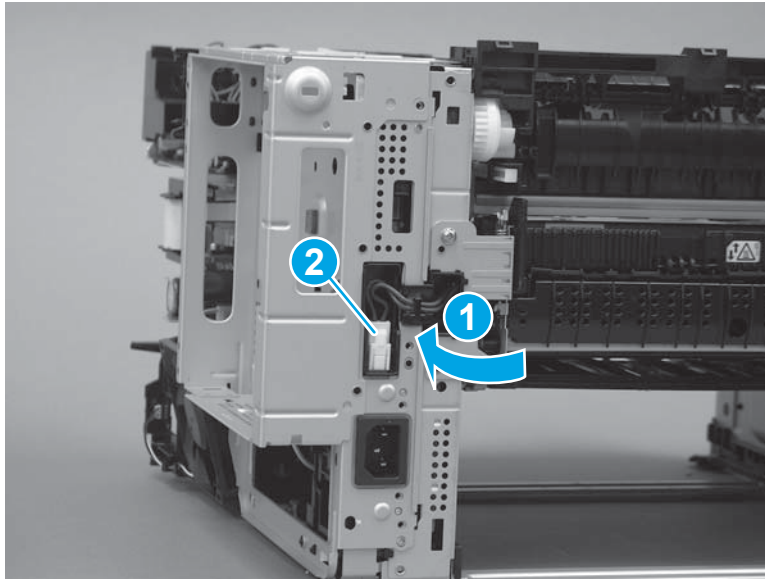
**CAUTION:** Pass the FFC through the opening (callout 4) in the formatter while installing the case.

**Figure 1-1436** Install the formatter case



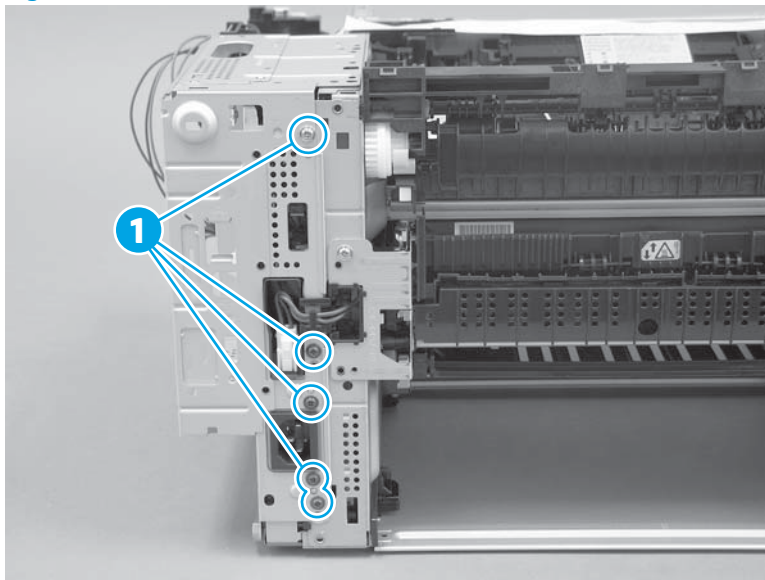
3. Reposition the guide (callout 1), and then connect one connector (callout 2).

**Figure 1-1437** Connect one connector



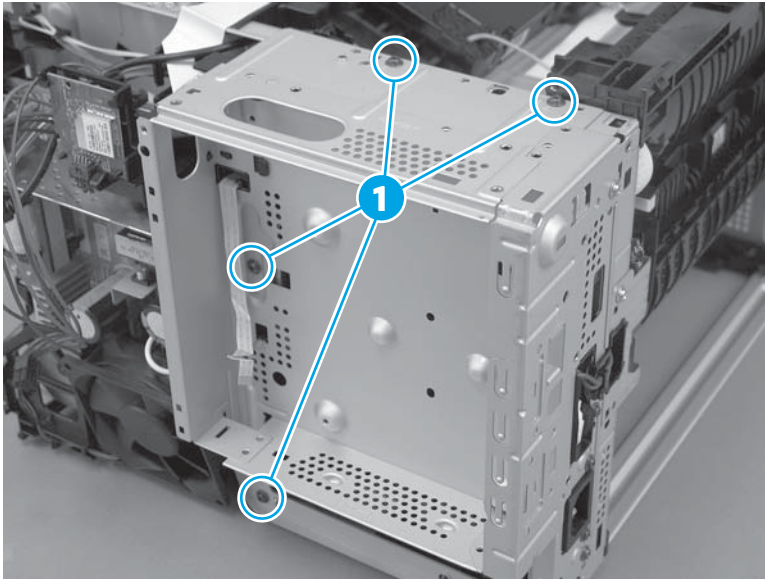
4. Install five screws (callout 1).

**Figure 1-1438** Install five screws



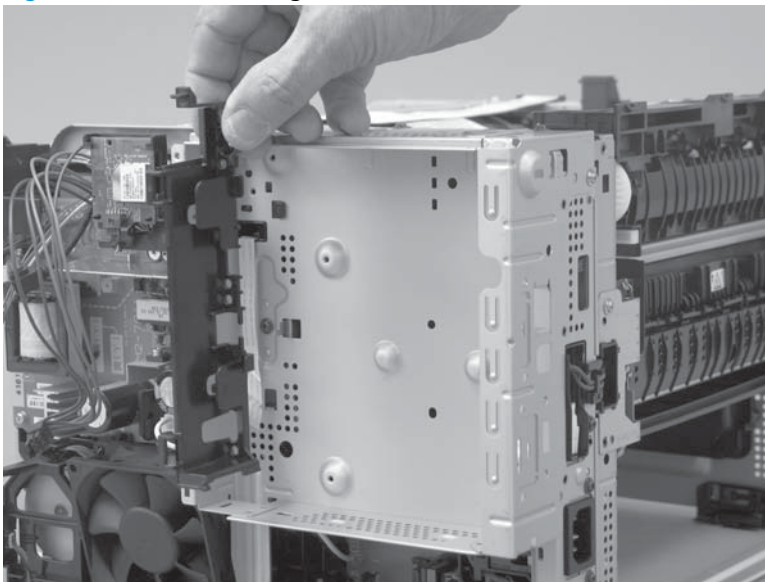
5. Install four screws (callout 1).

**Figure 1-1439** Install four screws



6. Install the guide.

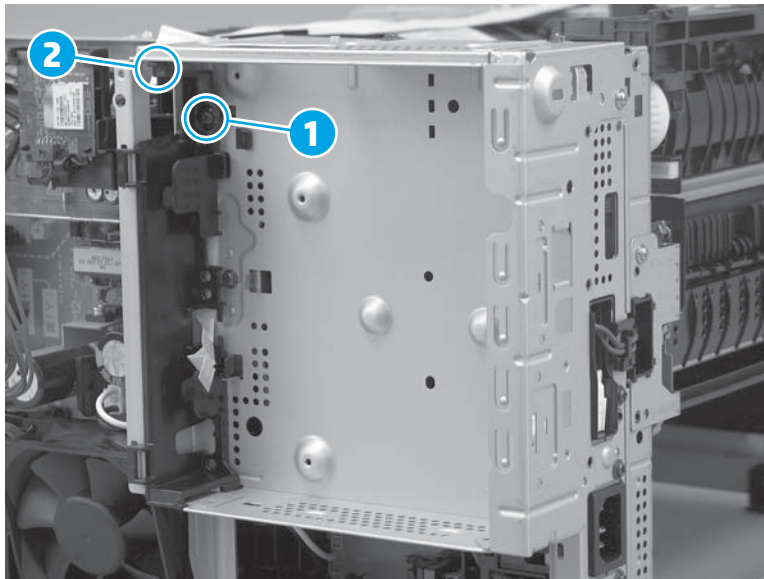
**Figure 1-1440** Install the guide




7. Install one screw (callout 1).

 **NOTE:** Make sure that the tab (callout 2) is engaged.

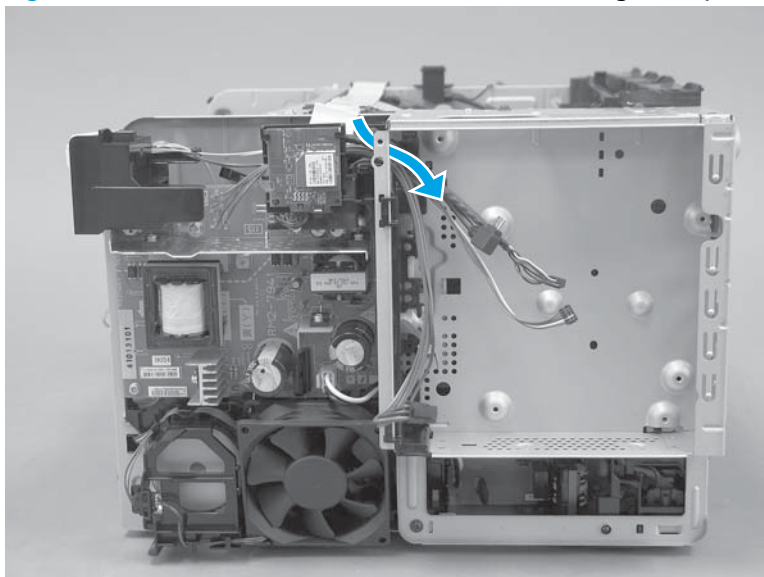
**Figure 1-1441** Install one screw



8. Carefully pass all cables and wire harnesses through the opening in the formatter case.

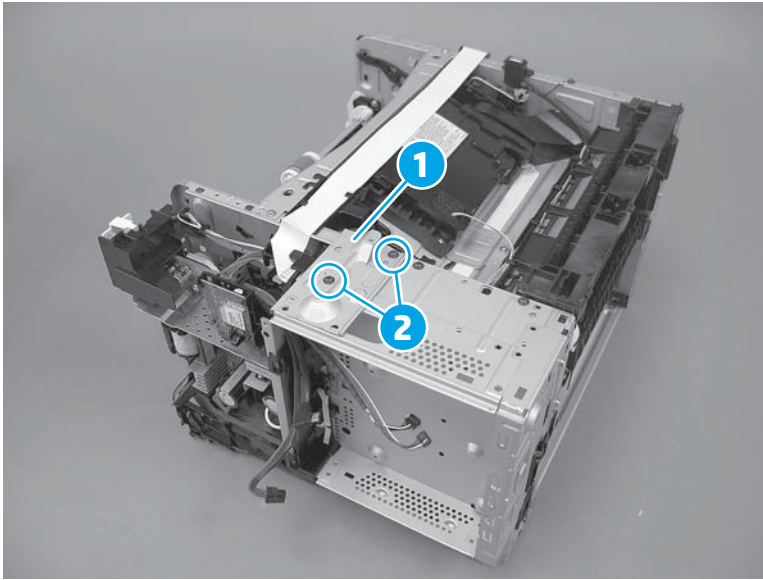
 **NOTE:** The figure below shows the M506 printer. However this step is valid for the M501/M527 printers—there will be a different number of cables and wire harnesses.

**Figure 1-1442** Pass all cables and wire harnesses through the opening




9. **M506 only:** Install the sheet-metal plate (callout 1), and then install two screws (callout 2).


**Figure 1-1443** Remove the sheet-metal plate



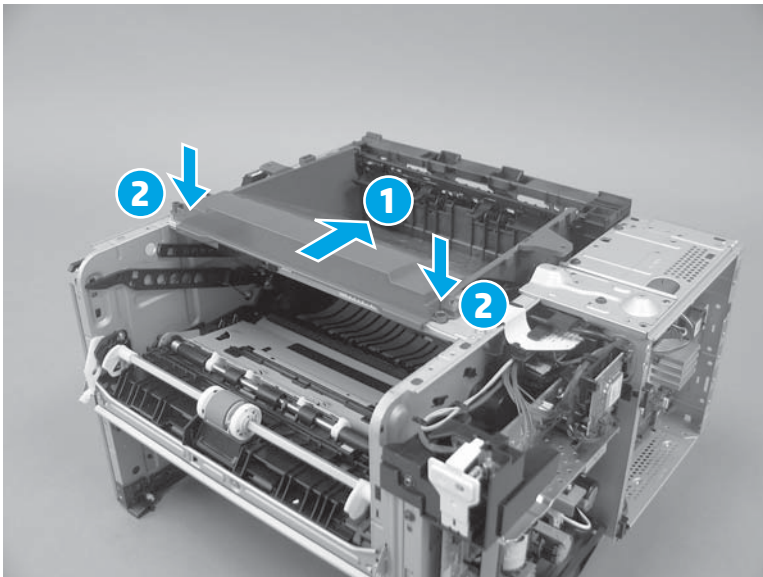
**Step 24: Install the paper delivery tray (output bin)**

 **NOTE:** This procedure shows the M506 printer. However, this procedure is valid for the M527 printer.


- ▲ Position the bin on the printer (callout 1), and then push down to engage two tabs (callout 2).

 **NOTE:** Position the tabs along the rear edge of the bin on the printer in the slots in the chassis.

**Figure 1-1444** Install the bin



**Step 25: Install the top cover (M501/M506)**

 **NOTE:** This step is for the M501/M506 printer. For the M527, skip this step and go to [Step 26: Install the top cover \(M527\) on page 820](#).



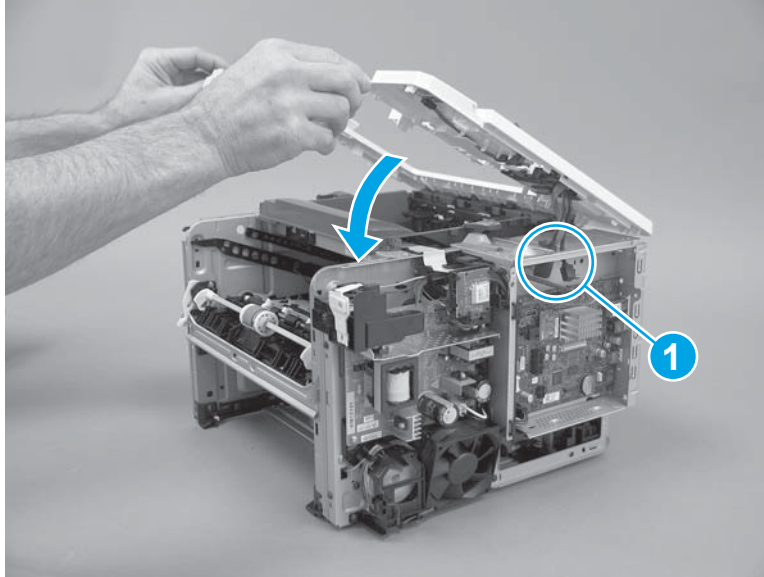
The M506x is shown in this procedure. However, the steps are correct for all M506 models and the M501 printer.

1. Position the rear edge of the cover on the printer, and then rotate the front of the cover down onto the printer.

**CAUTION:** **M506x only:** As the cover is rotated down, carefully pass the cables the hole in the chassis (callout 1).

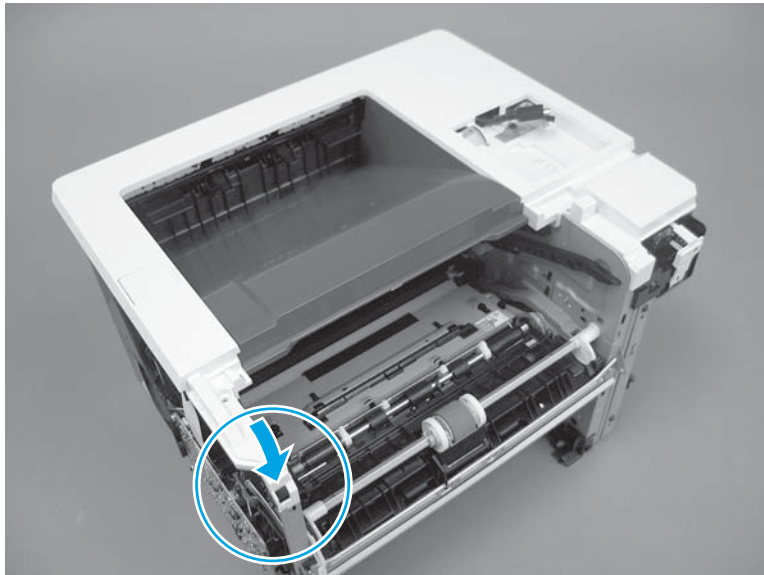
**NOTE:** **LCD control panel models only:** Pass the cables through the opening in the cover, and then connect the control panel after installing the cover.

**Figure 1-1445** Install the cover




2. Engage one boss.

**Figure 1-1446** Engage one boss



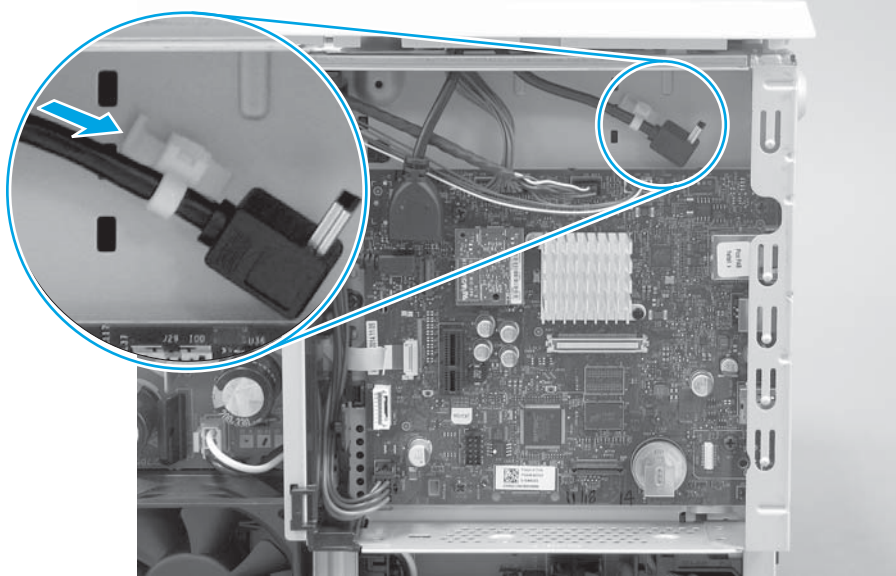
3. **M506 only:** Install one cable retainer on the chassis.

---

 **TIP:** Depress the tab on the retainer to install it.

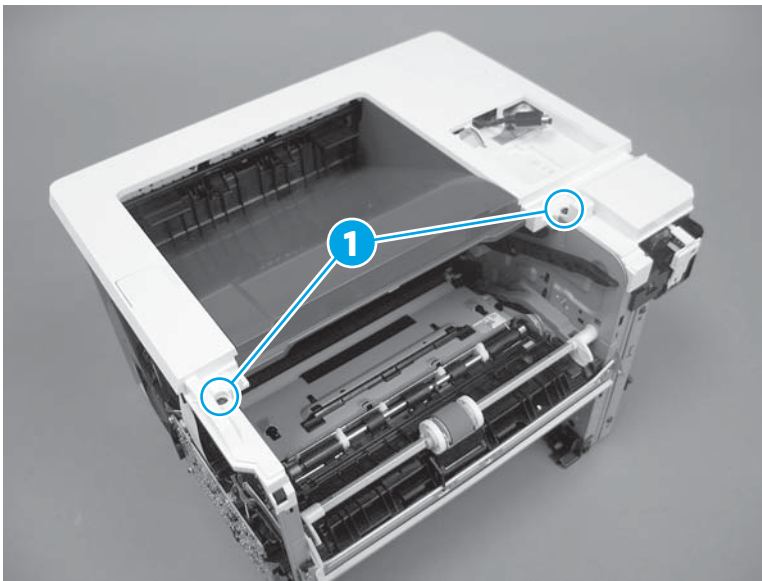
---

**Figure 1-1447** Install one cable retainer




4. Install two screws (callout 1).

**Figure 1-1448** Install two screws



### Step 26: Install the top cover (M527)

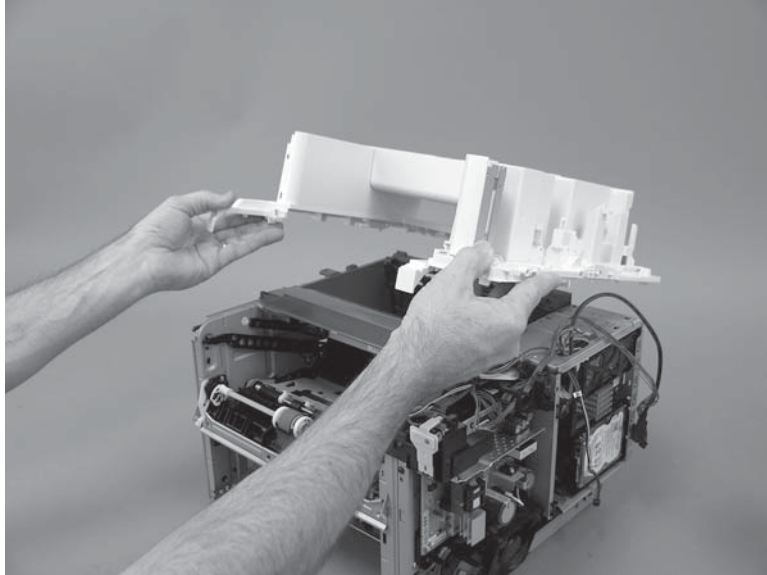
---

 **NOTE:** This step is for the M527 printer. For the M501/M506, skip this step and go to [Step 28: Install the left cover on page 827](#).

---

1. Position the rear edge of the cover on the chassis.

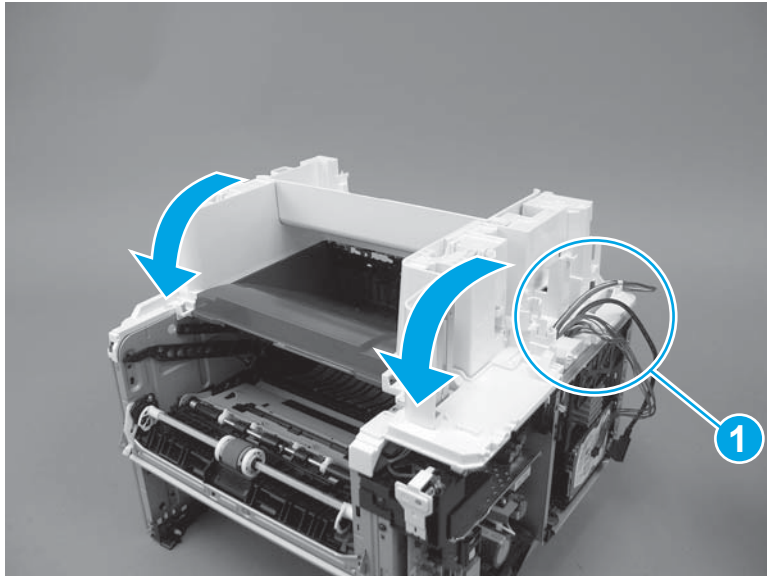
**Figure 1-1449** Install the cover



2. Rotate the front of the cover down onto the printer.

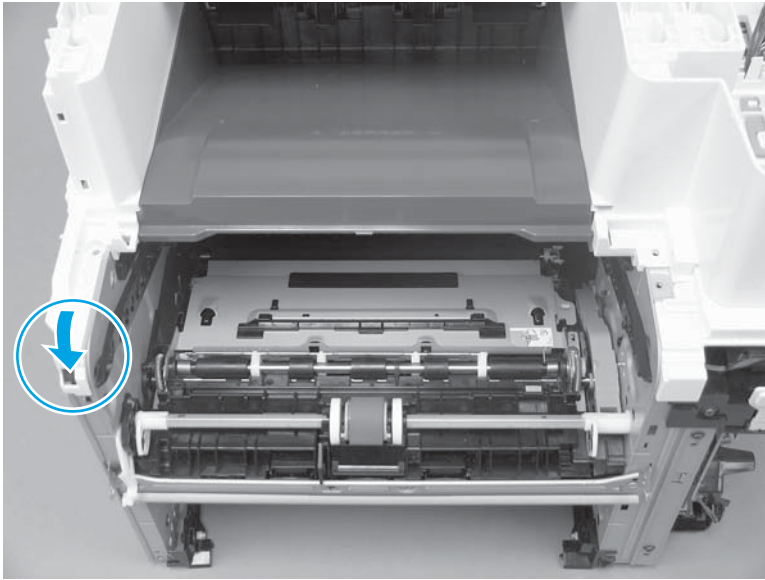
**CAUTION:** As the cover is rotated down, carefully pass the cables and wire harnesses the hole in the cover (callout 1).

**Figure 1-1450** Rotate the front of the cover down



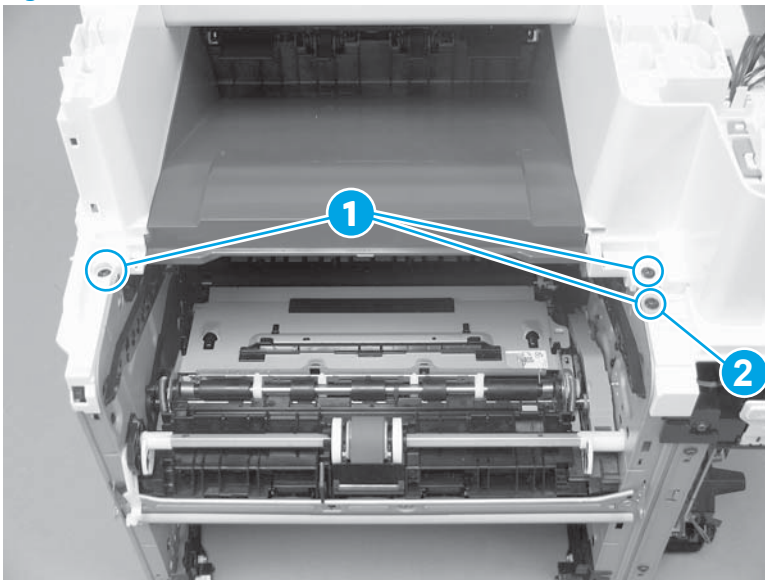
3. At the front left of the printer, engage one boss.

**Figure 1-1451** Engage one boss




4. At the top front of the printer, install three screws (callout 1).

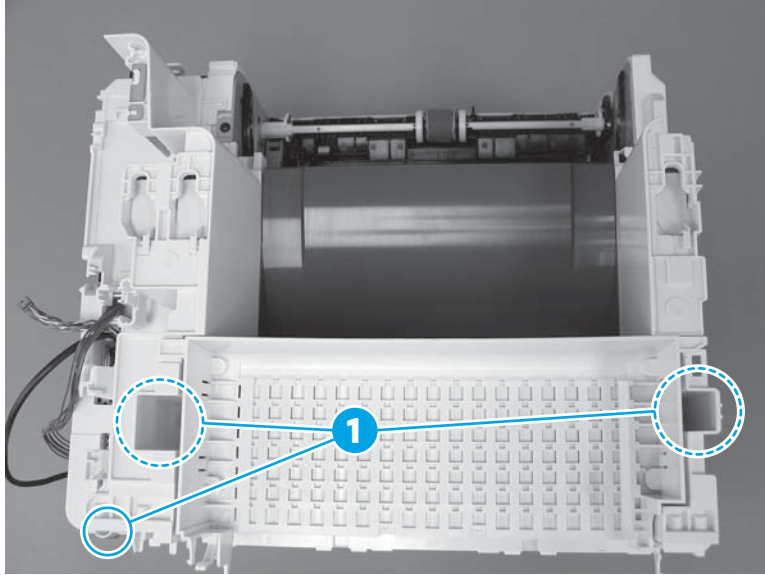
**Figure 1-1452** Install three screws



5. At the top rear of the printer, install three screws (callout 1).

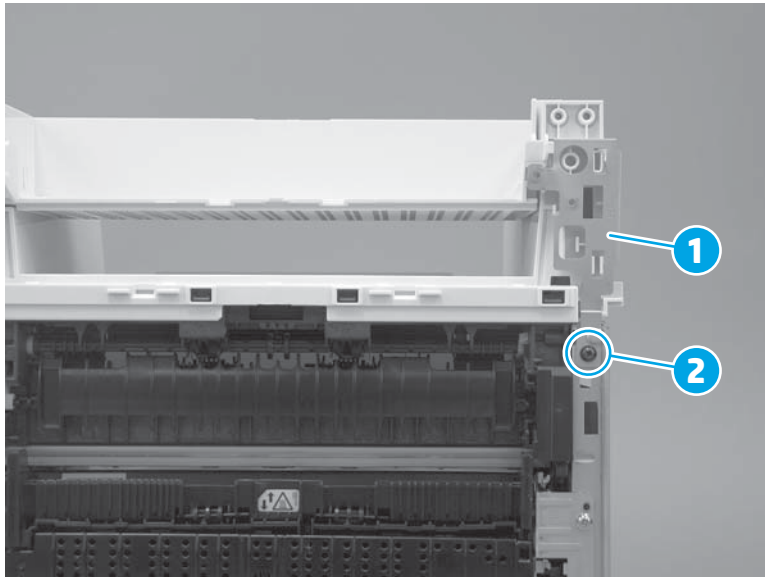
 **NOTE:** The screw (callout 2) on the lower-right portion of the cover is a different color than the other two screws, and is surrounded by sheet-metal. It might appear that this screw does not need to be removed. Remove this screw.

**Figure 1-1453** Install three screws





6. At the front right of the printer, install the sheet-metal plate (callout 1), and then install one screw (callout 2).

**Figure 1-1454** Install one screw and the plate




### Step 27: Install the integrated scanner assembly (M527)

 **IMPORTANT:** Some figure might show assemblies removed or installed that have not yet been removed or installed at that specific step. However, the procedures are correct for this printer and the target assembly. Always thoroughly read the instructions that accompany each figure

 **NOTE:** This step is for the M527 printer. For the M501/M506, skip this step and go to [Step 28: Install the left cover on page 827](#).

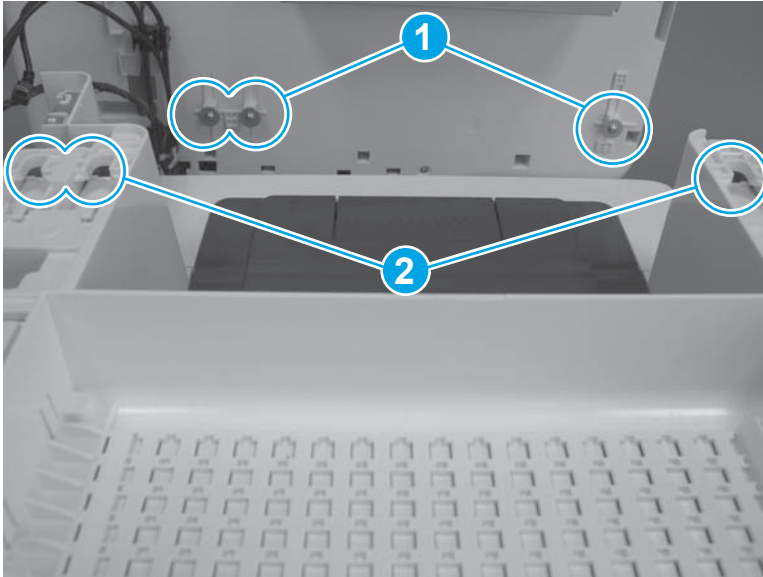
---

 **NOTE:** The ISA includes the document feeder, sub-scanner assembly (SSA), and the scanner control board (SCB)


---

1. Before proceeding, locate the ISA mounting pins (callout 1) on the bottom of the ISA and the slots (callout 2) on the printer base.

**Figure 1-1455** Locate the ISA mounting pins and slots

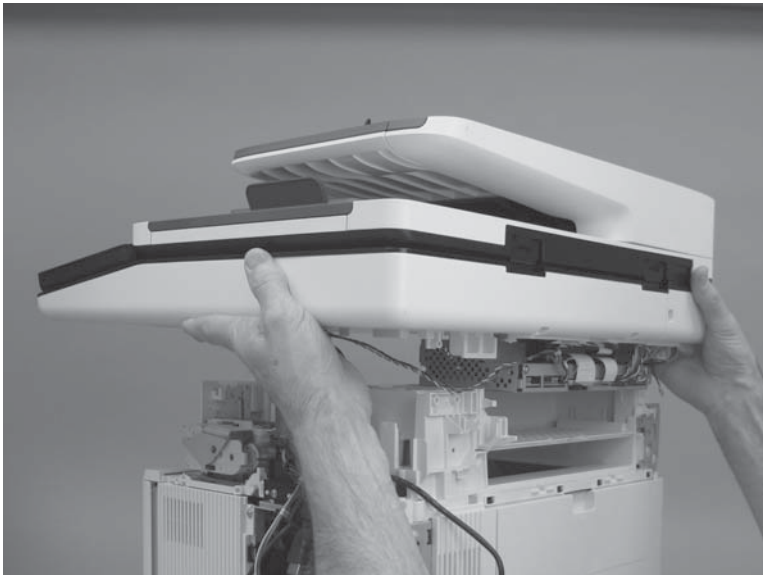


2. Position the ISA on the printer base with the pins in the slots.

 **NOTE:** To locate the pins and slots, see the previous step.

---

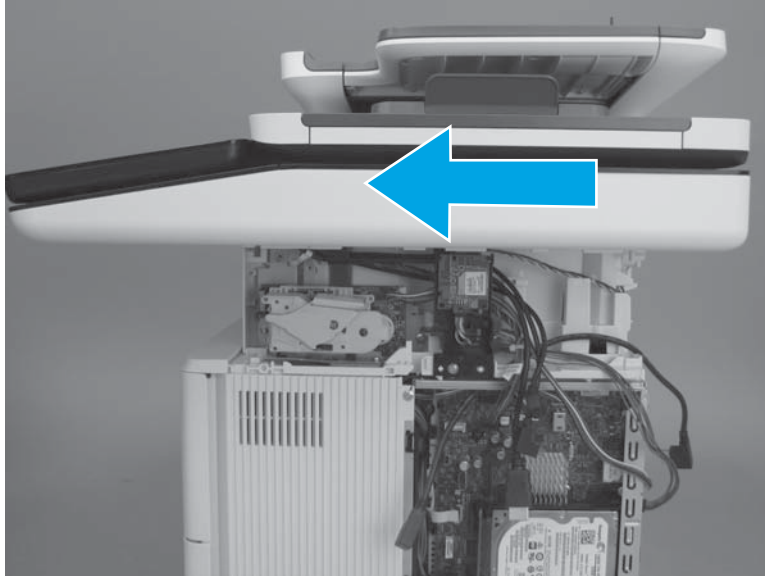
**Figure 1-1456** Install the ISA



3. Slightly slide the ISA towards the front of the printer to engage it.

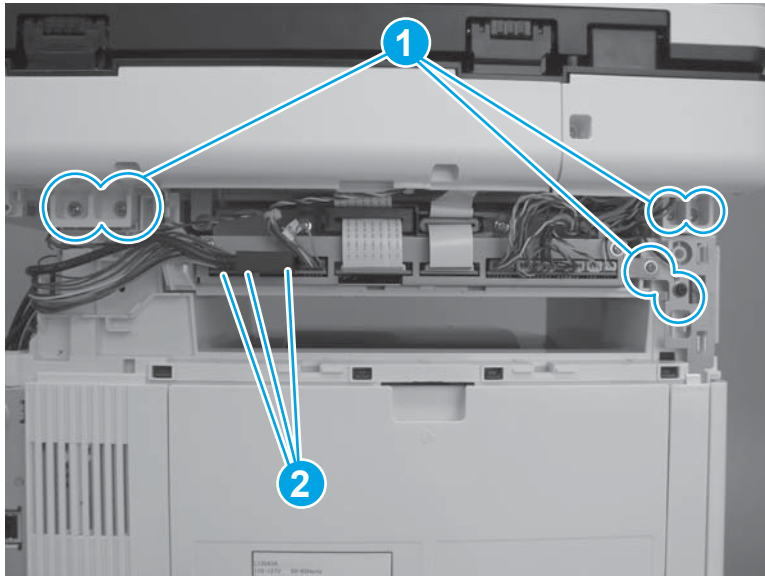
**CAUTION:** Make sure that none of the wire harnesses or cables are caught underneath the assembly when installing it.

**Figure 1-1457** Slide the ISA towards the front of the printer




4. Install six screws (callout 1), and then connect three connectors (callout 2).

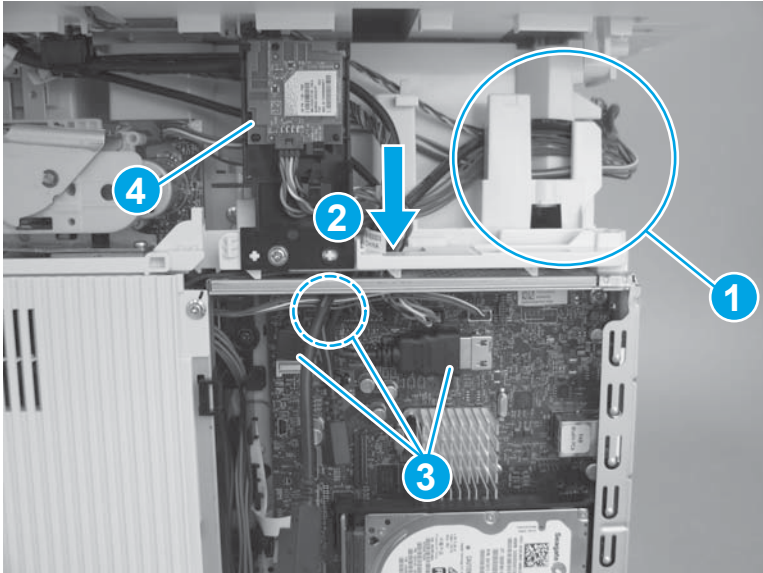
**Figure 1-1458** Install screws and connect connectors



5. Install the wire harnesses and cables in the retainers (callout 1), pass them through the opening in the cover (callout 2), and then connect three connectors (callout 3).

 **TIP:** If the WiFi PCA and holder (callout 4) was detached from the printer and then moved out of the way, reinstall it now.

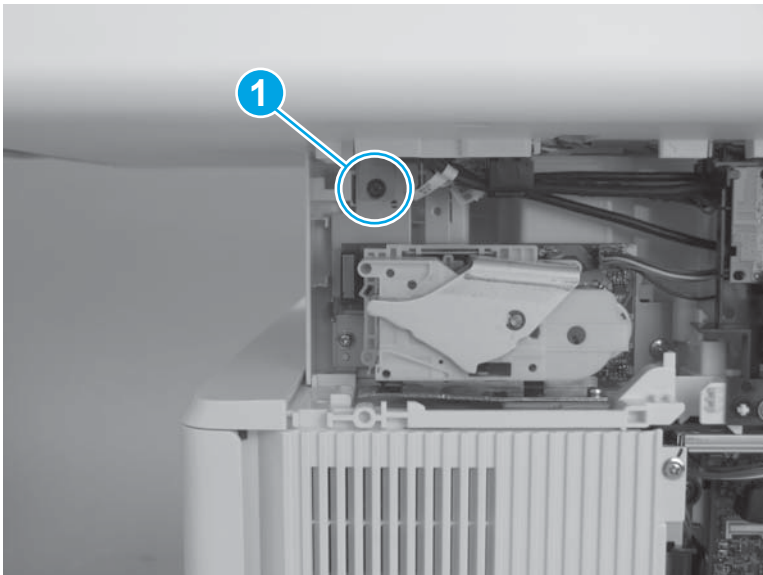
**Figure 1-1459** Connect cables and connectors



6. Install one screw (callout 1).


 **IMPORTANT:** This screw fastens the ISA ground plate to the printer chassis. This screw must be installed.


**Figure 1-1460** Install one screw





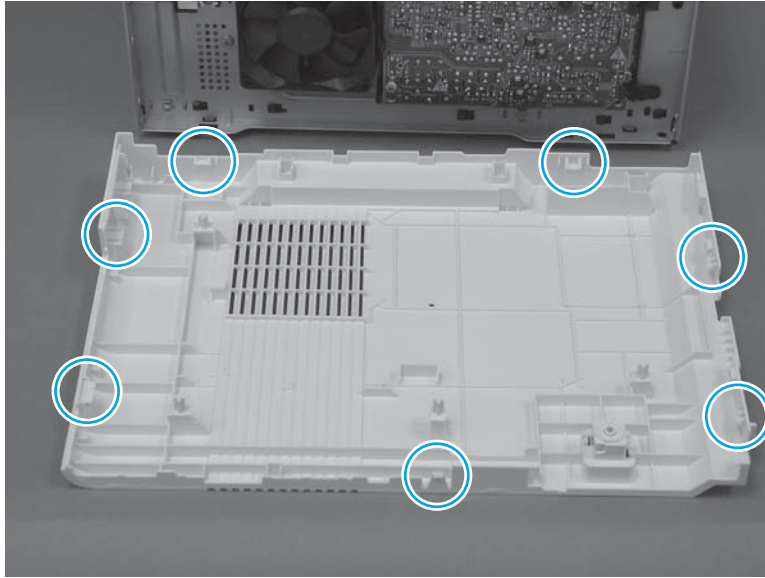
## Step 28: Install the left cover

 **IMPORTANT:** The black-plastic cassette front and rear guides (located inside the tray cavity) can be easily dislodged. Do not lose the guides when the cover is removed or installed.

 **NOTE:** The M527 printer is shown in this procedure. However, this procedure is valid for the M501/M506 printers.

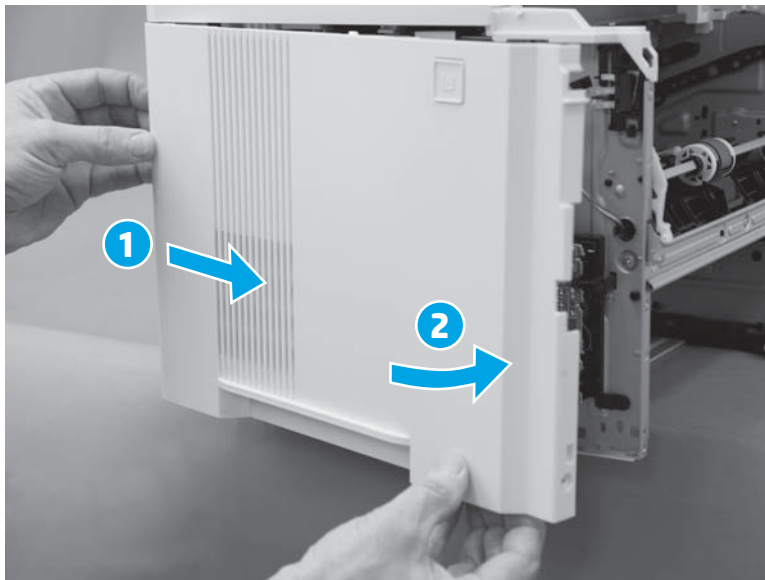
1. Before proceeding, take note of the location of the tabs and bosses on the inside of the cover.

**Figure 1-1461** Locate of the tabs and bosses



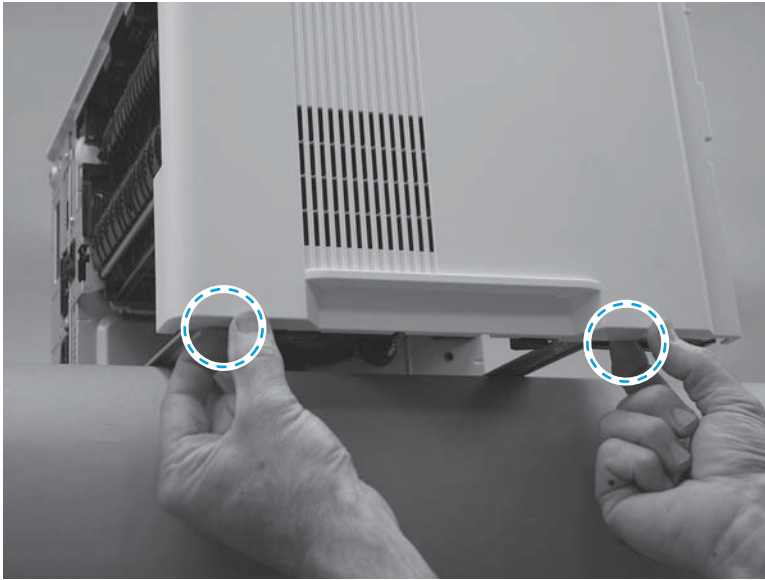
2. Engage the rear edge of the cover (callout 1), and then rotate the rear edge of the cover toward the printer (callout 2).

**Figure 1-1462** Install the cover



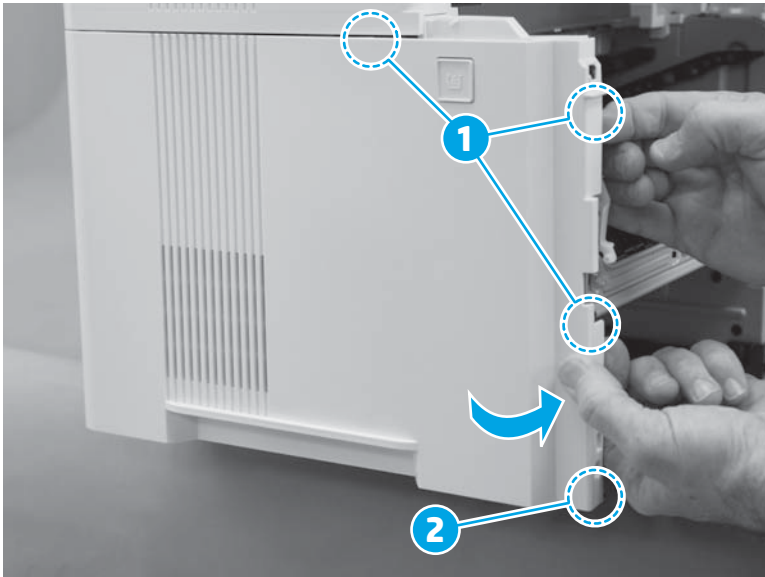
3. At the bottom edge of the cover, engage two tabs.

**Figure 1-1463** Engage two tabs



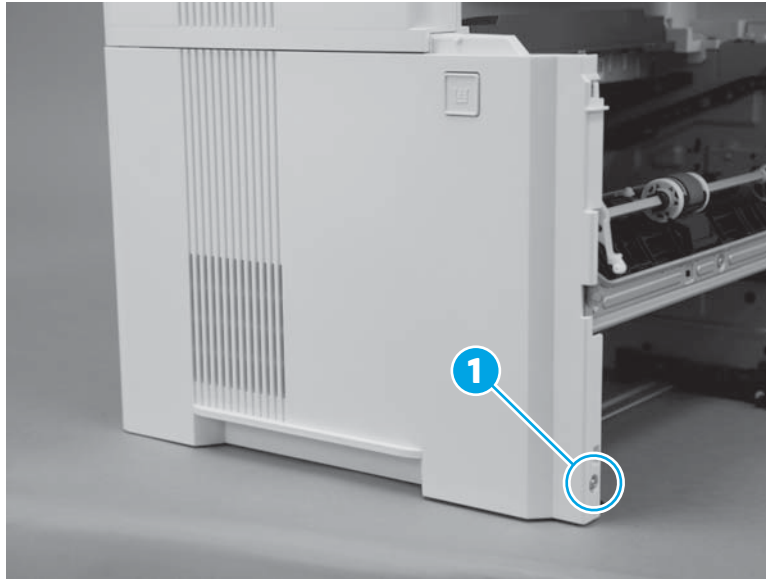
4. At the front of the printer, engage three tabs (callout 1), and then continue to rotate the front edge of the cover toward the printer to engage one boss (callout 2).

**Figure 1-1464** Engage three tabs and one boss





5. Install one screw (callout 1).

**Figure 1-1465** Install one screw



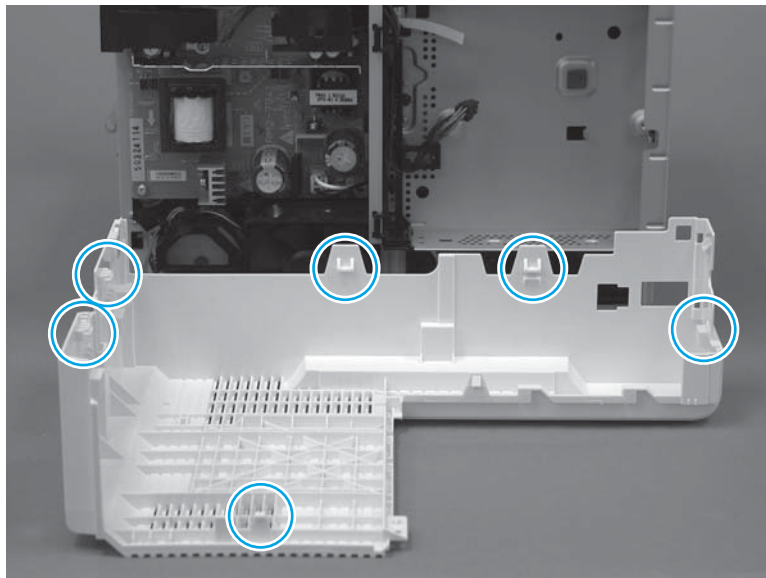
### Step 29: Install the right cover

 **IMPORTANT:** The black-plastic cassette front and rear guides (located inside the tray cavity) can be easily dislodged. Do not lose the guides when the cover is removed or installed.

 **NOTE:** The M527 printer is shown in this procedure. However, this procedure is valid for the M501/M506 printers.

1. Before proceeding, take note of the location of the tabs and bosses on the inside of the cover.

**Figure 1-1466** Locate the tabs and bosses

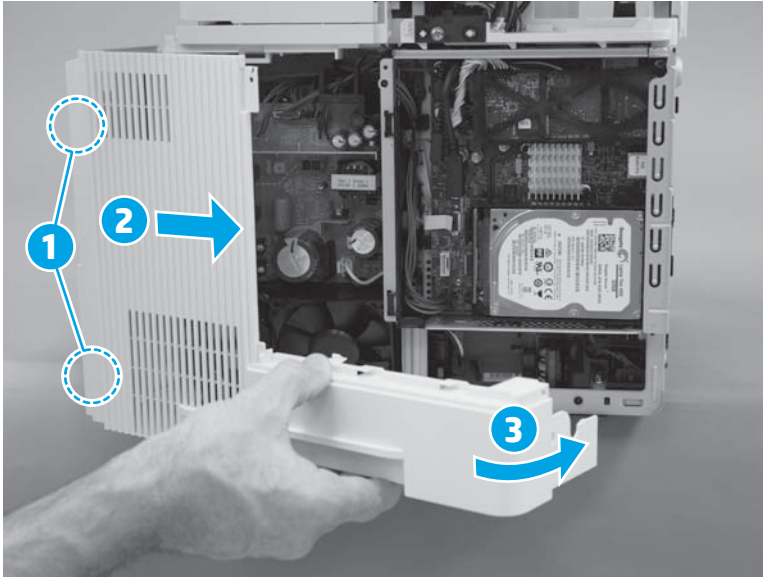


2. At the front of the cover engage two bosses (callout 1/2), and then rotate the rear of the cover toward the printer (callout 3).

**CAUTION:** It might be easier to install the cover with the printer slightly hanging over the edge of the workspace. Do not let the printer tip and fall off the workspace when removing the cover.

**TIP:** Make sure that the power switch at the front of the printer is positioned in the opening in the cover and that it does not interfere with the cover installation.

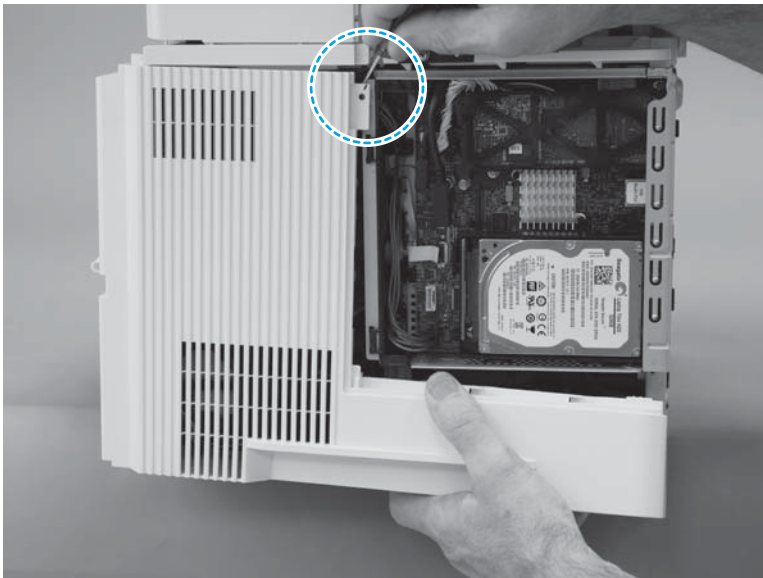
**Figure 1-1467** Install the cover



3. At the top rear edge of the cover, engage one tab.

**CAUTION:** It might be easier to install the cover with the printer slightly hanging over the edge of the workspace. Do not let the printer tip and fall off the workspace when removing the cover.

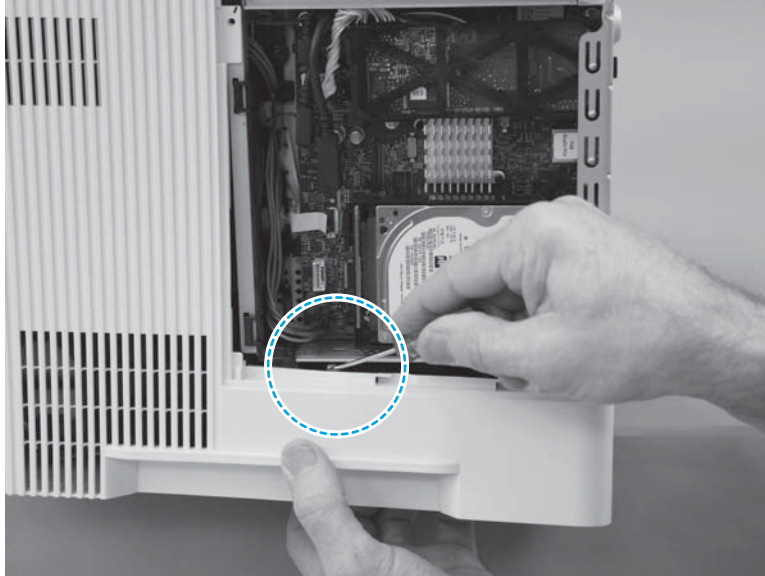
**Figure 1-1468** Engage one tab



4. Near the formatter, engage one tab.

**CAUTION:** It might be easier to install the cover with the printer slightly hanging over the edge of the workspace. Do not let the printer tip and fall off of the workspace when removing the cover.

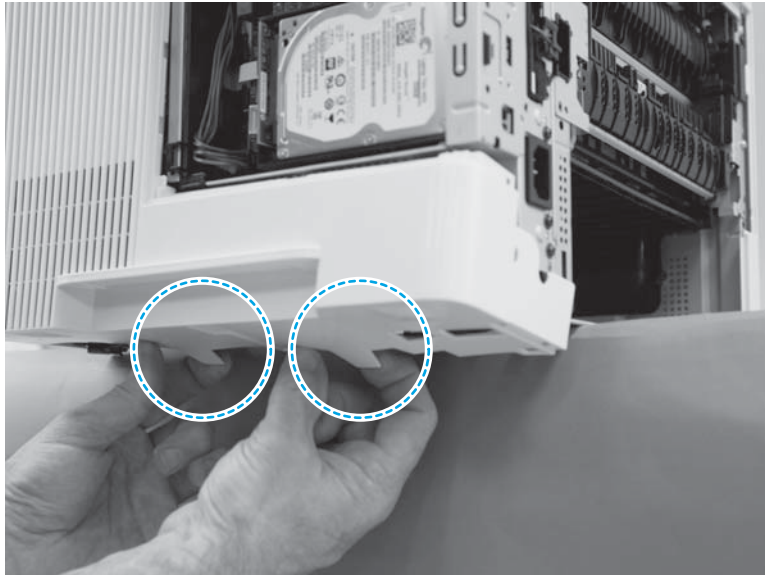
**Figure 1-1469** Engage one tab



5. At the bottom edge of the cover, engage two bosses.

**CAUTION:** It might be easier to install the cover with the printer slightly hanging over the edge of the workspace. Do not let the printer tip and fall off of the workspace when removing the cover.

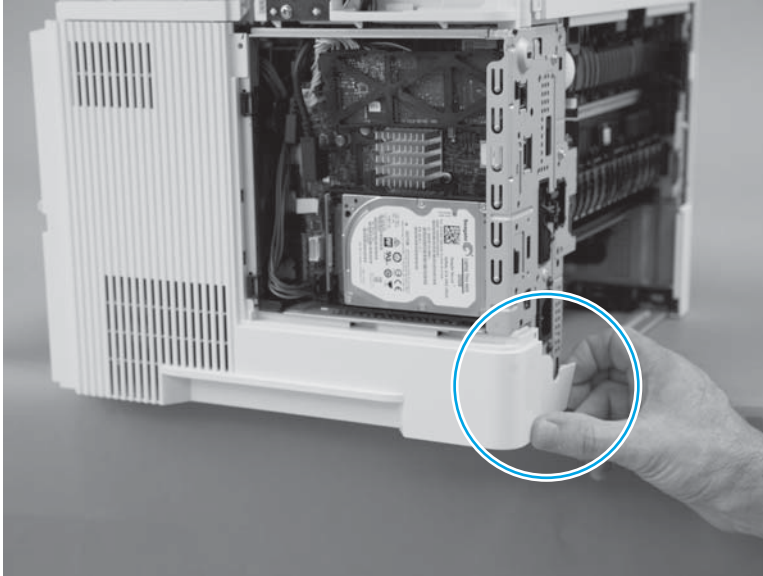
**Figure 1-1470** Engage two bosses



6. At the rear of the printer, engage one boss.

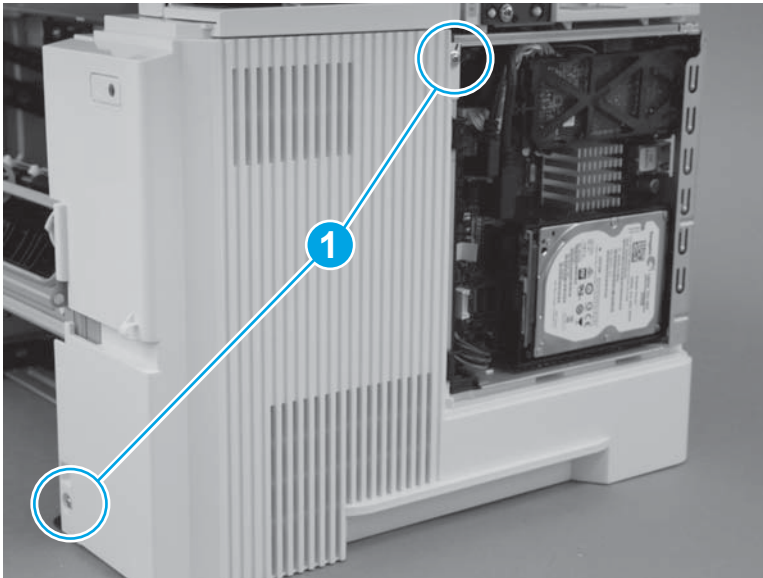
**⚠ CAUTION:** It might be easier to install the cover with the printer slightly hanging over the edge of the workspace. Do not let the printer tip and fall off of the workspace when removing the cover.

**Figure 1-1471** Engage one boss



7. Install two screws (callout 1).

**Figure 1-1472** Install two screws

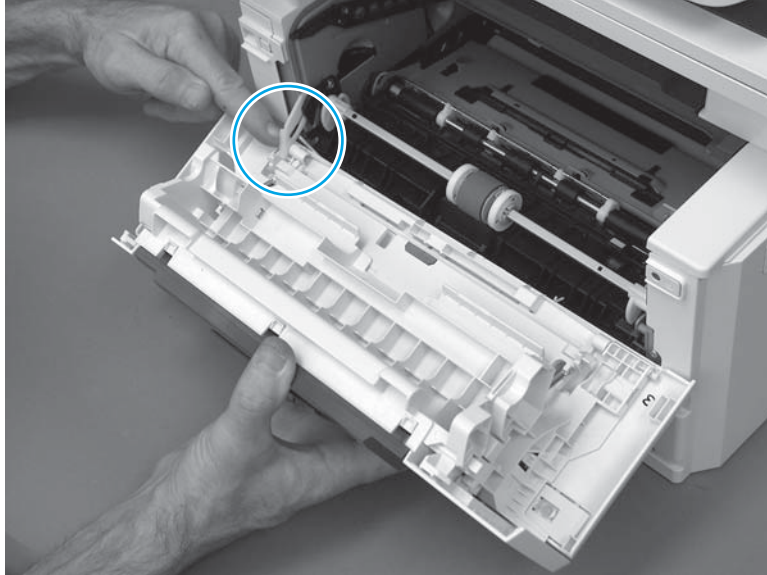


### Step 30: Install the cartridge door assembly

1. Position the door close to the printer, and then engage the keyed pin on the left-side retainer arm with the hole in the door.


**💡 TIP:** It might be easier to engage the keyed pin with the hole by using a small flat-blad screwdriver.


**Figure 1-1473** Engage the left-side retainer arm



2. Engage the right-side door hinge pin with the hole in the chassis (callout 1).

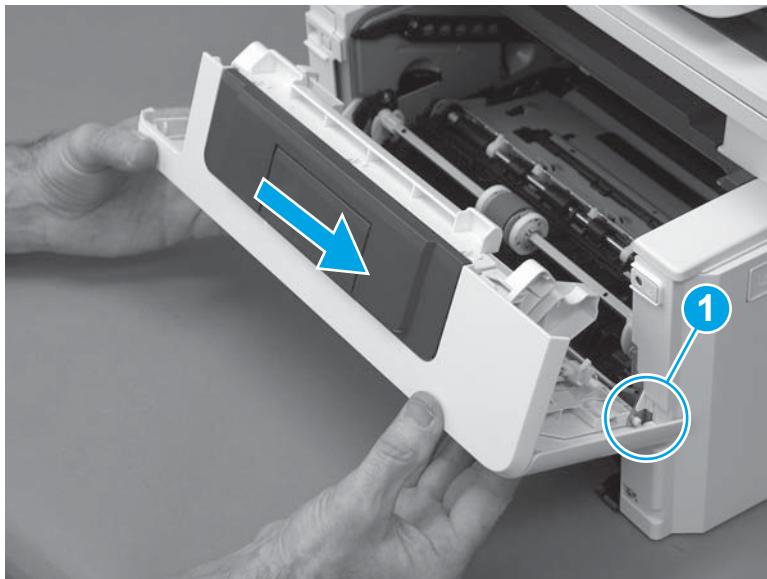
---

 **NOTE:** There are two right-side hinge pins (not shown in callout 1).


 **TIP:** Keep a finger pressed on the left-side retainer arm so that it does not disengage from the door.

---

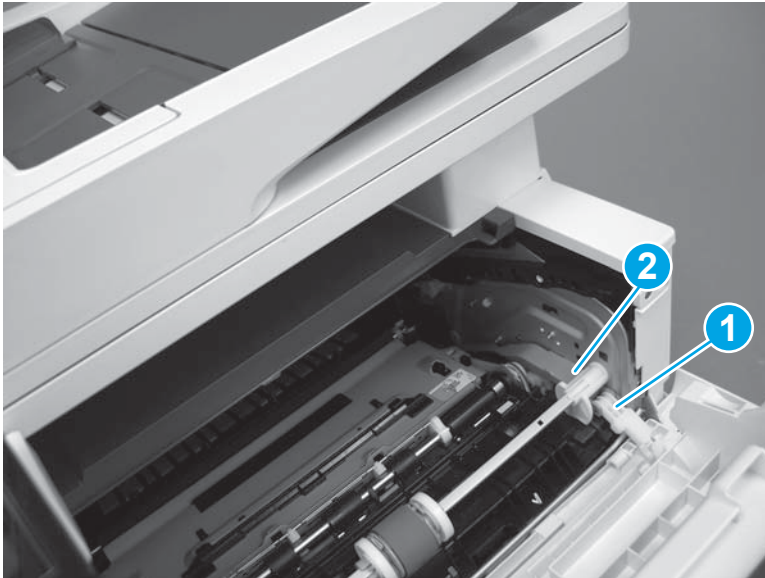
**Figure 1-1474** Install the door



3. Install the gray-plastic pressure-release link (callout 1) onto the white-plastic door arm (callout 2).

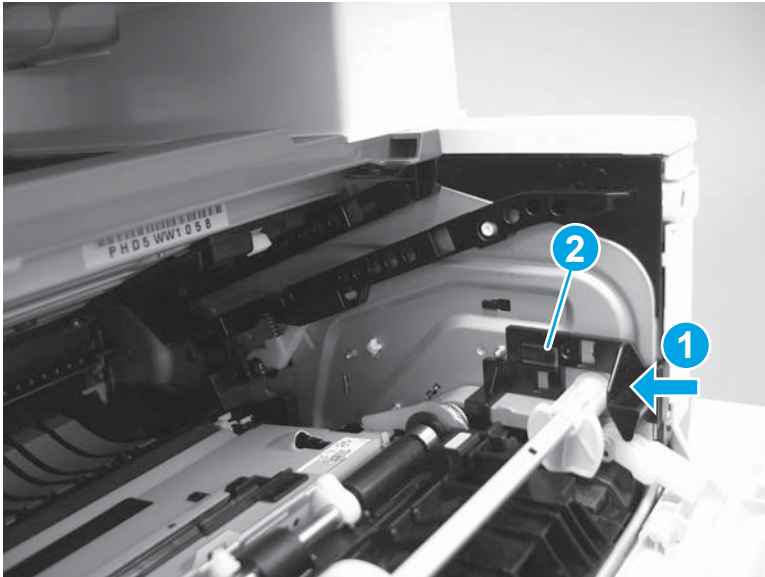
 **IMPORTANT:** Make sure that the arm snaps on to the link. Partially close and open the door to verify that the link (callout 2) moves in and out of the printer as the door closes/opens.

**Figure 1-1475** Install the pressure-release link



4. Slide the guide into the printer (callout 1), and then make sure that the tab (callout 2) snaps into place to secure the guide to the chassis.

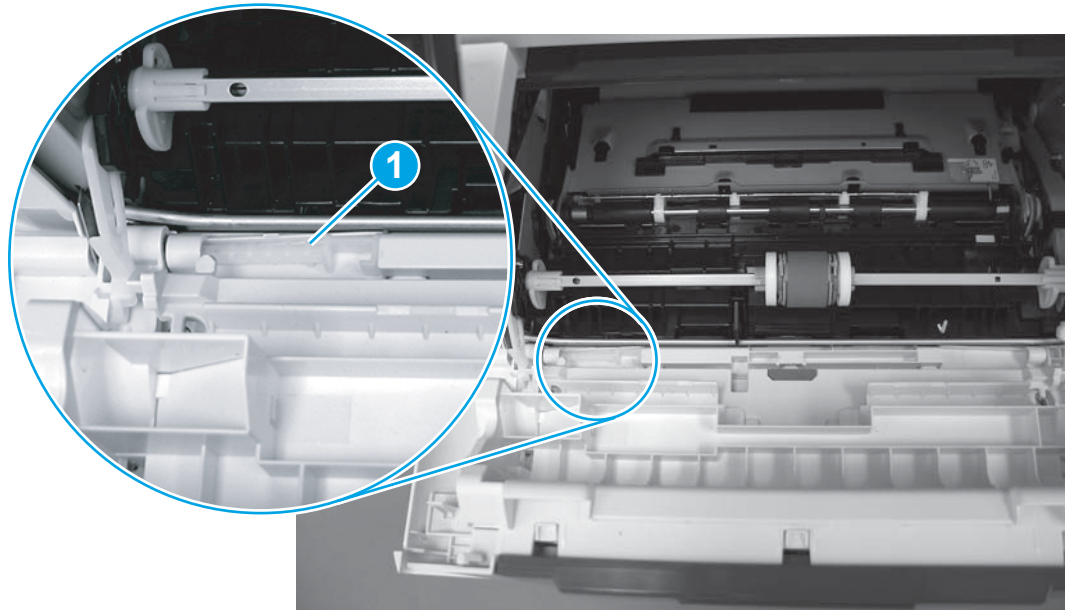
**Figure 1-1476** Install the guide







5. Position the support shaft on the door, and then align the left-side hinge on the door with the hole in the chassis (callout 1).

**Figure 1-1477** Align the hinge

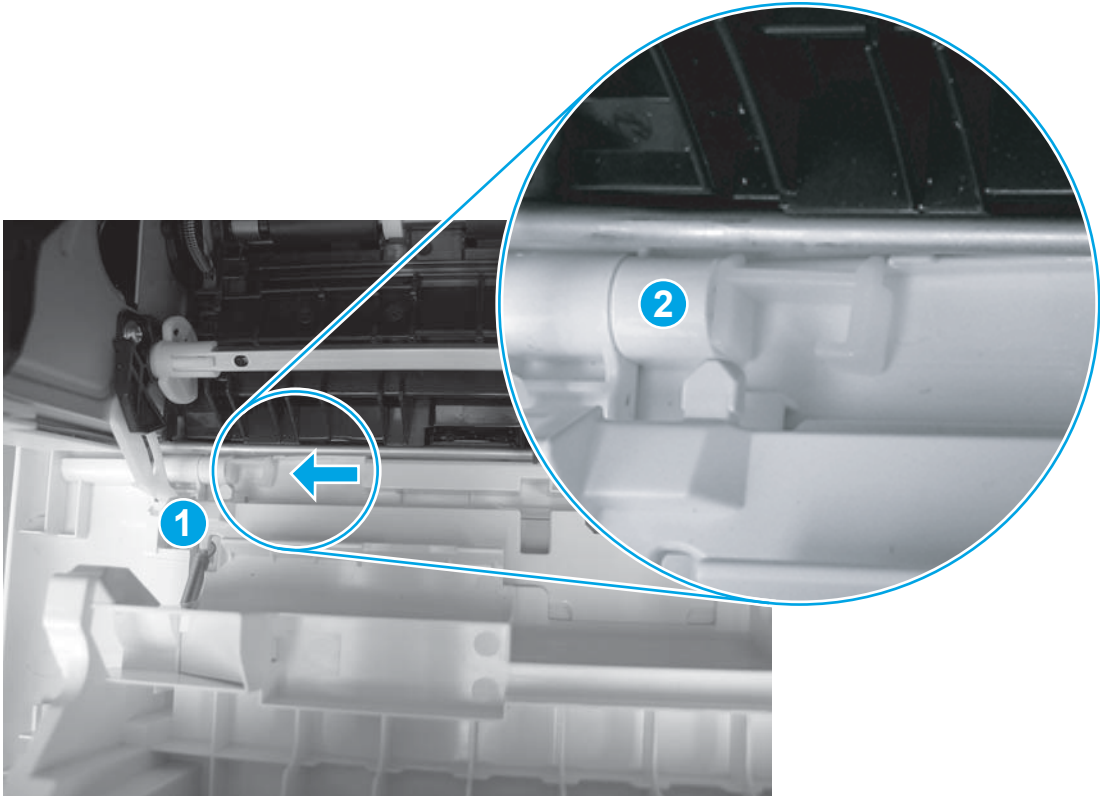


6. Push the shaft towards the left side of the printer to install it (callout 1).

 **NOTE:** Make sure that the support shaft is fully installed and correctly orientated (callout 2) so that it will not interfere with the door opening and closing.

 **Reinstallation tip:** If a replacement door was installed, make sure to install the nameplate (supplied in the kit) corresponding to the printer on the door.

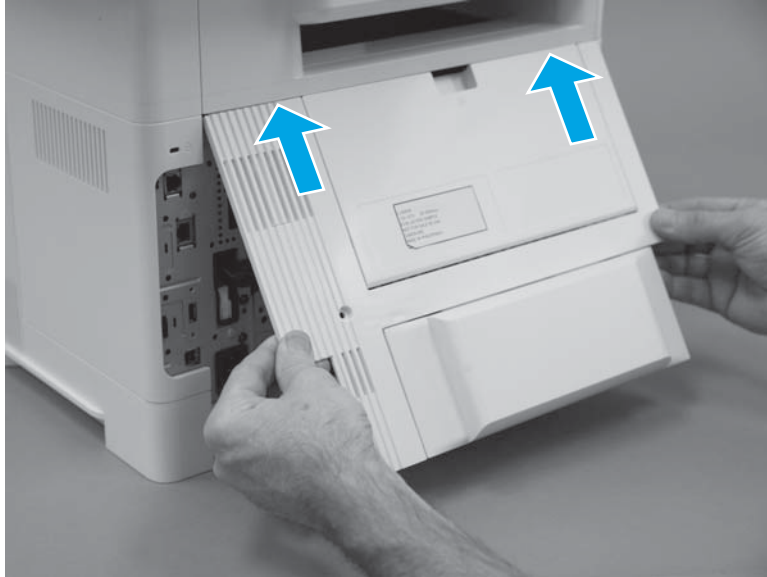
**Figure 1-1478** Install the support shaft



### Step 31: Install the rear door assembly

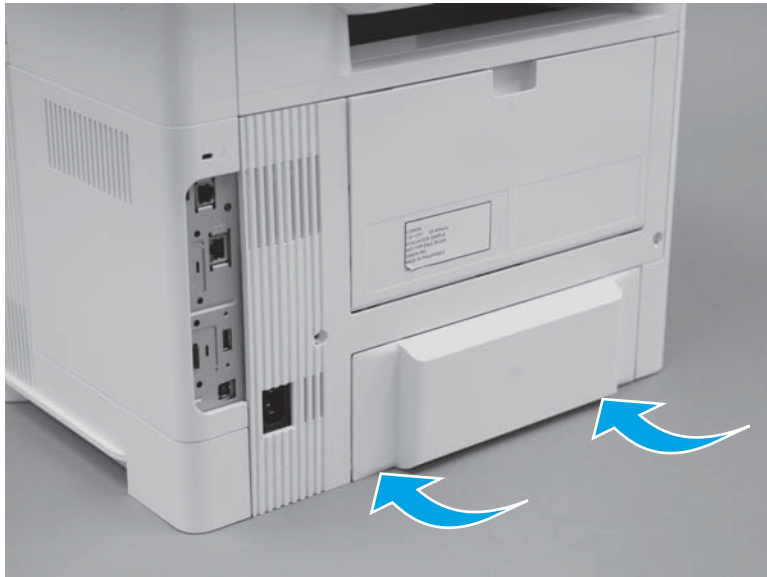
1. Engage the top edge of the assembly with the printer.

**Figure 1-1479** Install the cover



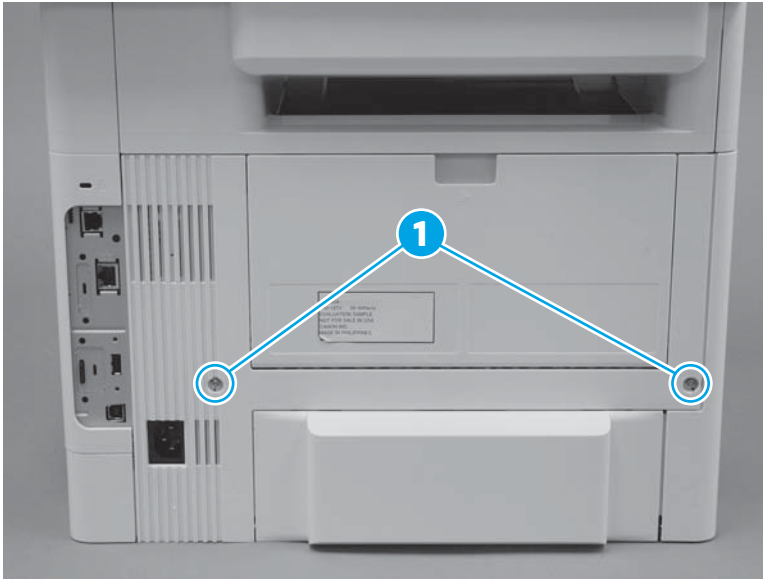
2. Rotate the bottom edge of the cover towards the printer.

**Figure 1-1480** Rotate the bottom of the cover



3. Install two screws (callout 1).

**Figure 1-1481** Install two screws



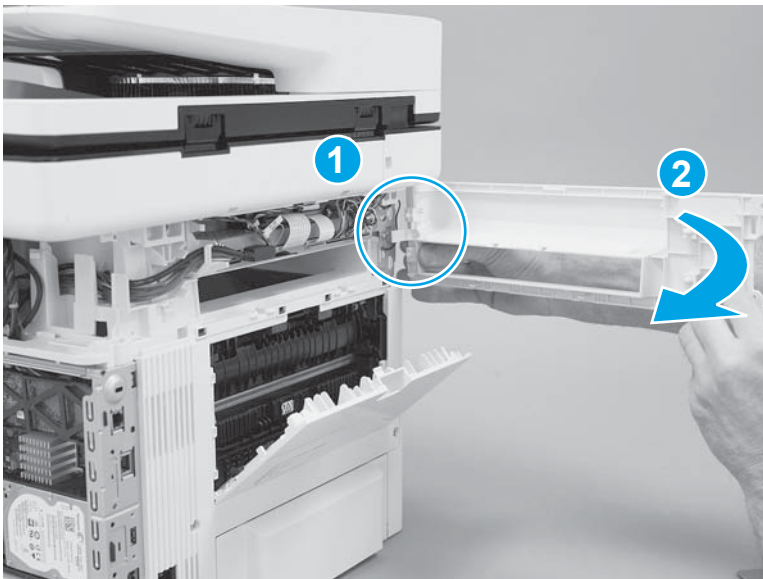
### Step 32: Install the top-rear cover (M527)



**NOTE:** This step is for the M527 printer. For the M501/M506, skip this step and go to [Step 36: Install the formatter on page 845](#).

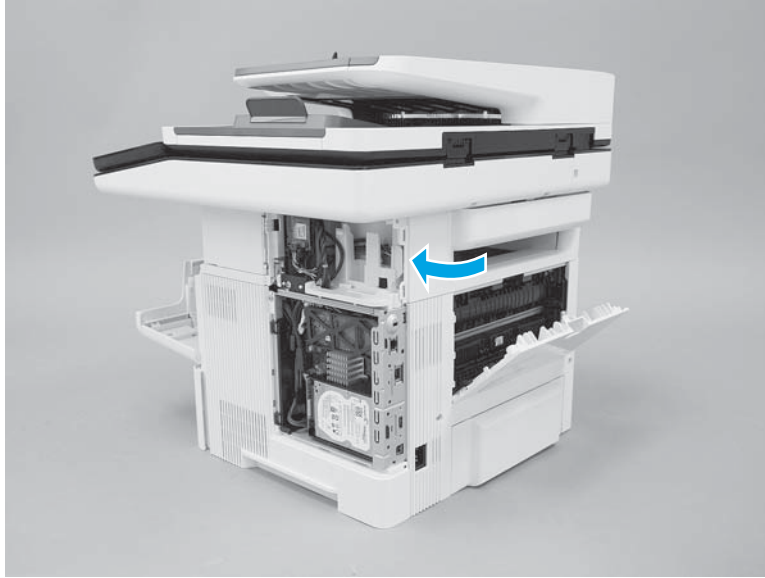
1. Engage one boss (callout 1), and then rotate the cover towards the printer (callout 2).

**Figure 1-1482** Engage one boss



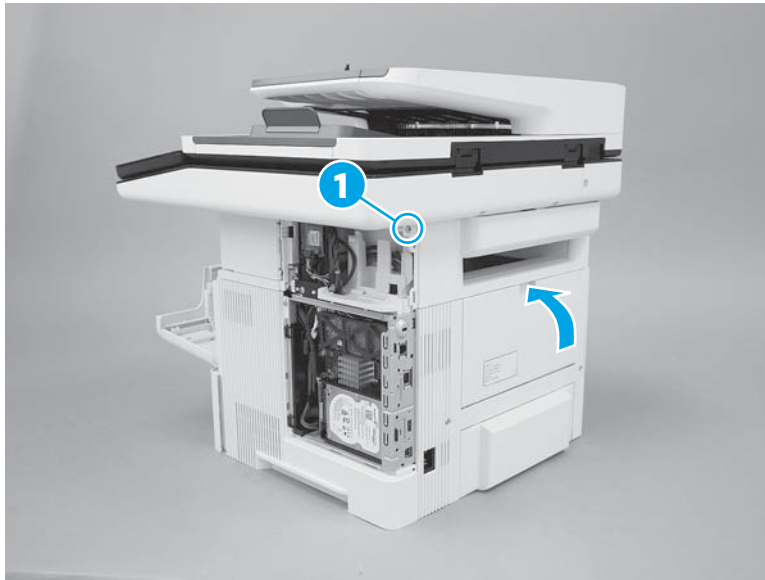
2. Continue to rotate the cover toward the printer to install it.

**Figure 1-1483** Install the cover




3. Install one screw (callout 1), and then close the rear door.

**Figure 1-1484** Install one screw



### Step 33: Install the top-left cover (M527)

 **NOTE:** This step is for the M527 printer. For the M501/M506, skip this step and go to [Step 36: Install the formatter on page 845](#).

1. Position the front edge of the cover on the printer, and then slide the cover toward the front of the printer to engage two bosses at the front of the cover.

**Figure 1-1485** Slide the cover




2. Rotate the cover towards the printer to engage two tabs at the middle of the cover.

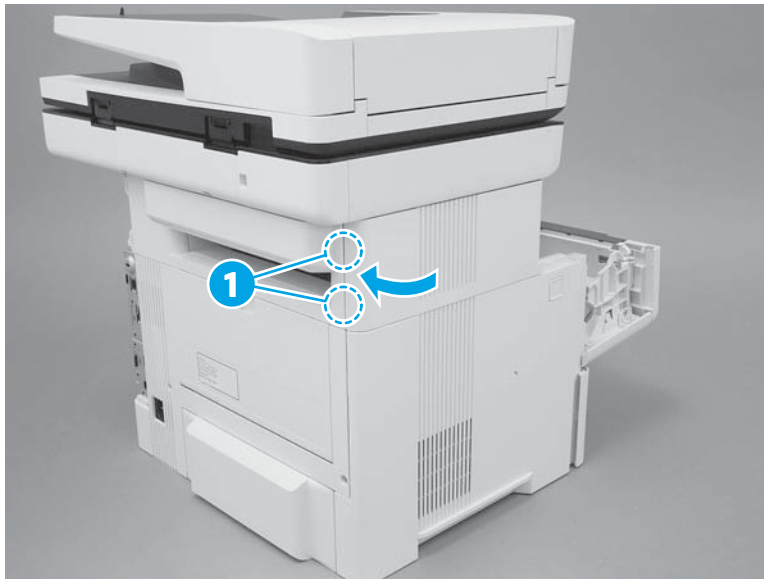
**Figure 1-1486** Engage two tabs




3. Continue to rotate the cover onto the printer to engage two tabs (callout 1) at the rear edge of the cover.


 **NOTE:** Close the toner-cartridge door.

**Figure 1-1487** Engage two tabs



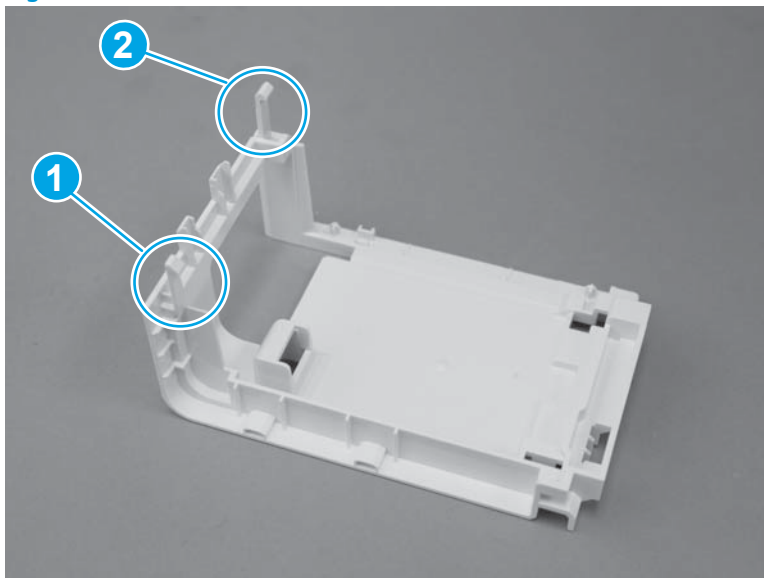
#### Step 34: Install the stapler stationary (inner) cover (M527)

 **NOTE:** This step is for the M527c/f/z printers. For the M501/M506, skip this step and go to [Step 36: Install the formatter on page 845](#). For the M527dn, skip this step and go to [Step 35: Install the stapler door or stapler blank cover \(M527\) on page 843](#).

 **NOTE:** M527c/f/z printers only.

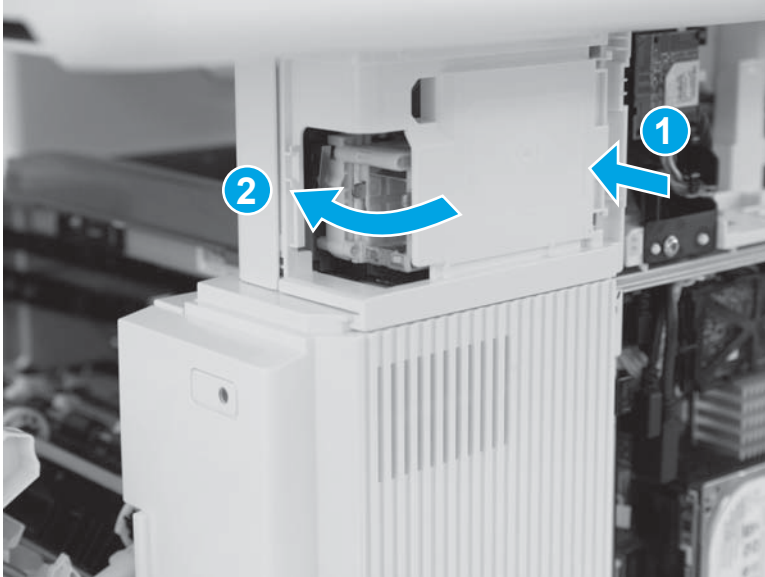
1. Before proceeding, take note of the locations of the upper tab (callout 1) and the lower tab (callout 2) on the stapler stationary (inner) cover.

**Figure 1-1488** Locate the tabs



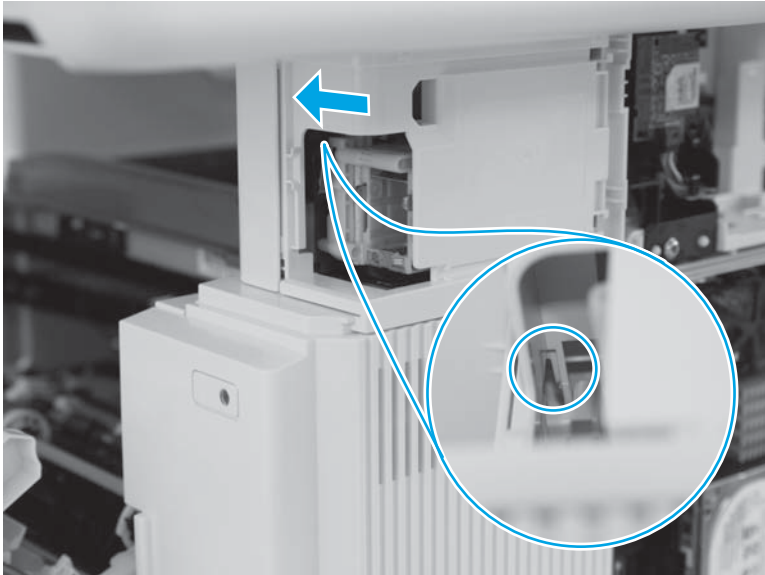
- Engage the rear edge of the cover with the printer (callout 1), and then rotate the front edge of the cover onto the printer (callout 2) to engage the two tabs.

**Figure 1-1489** Install the cover



- Verify that the upper tab is engaged.

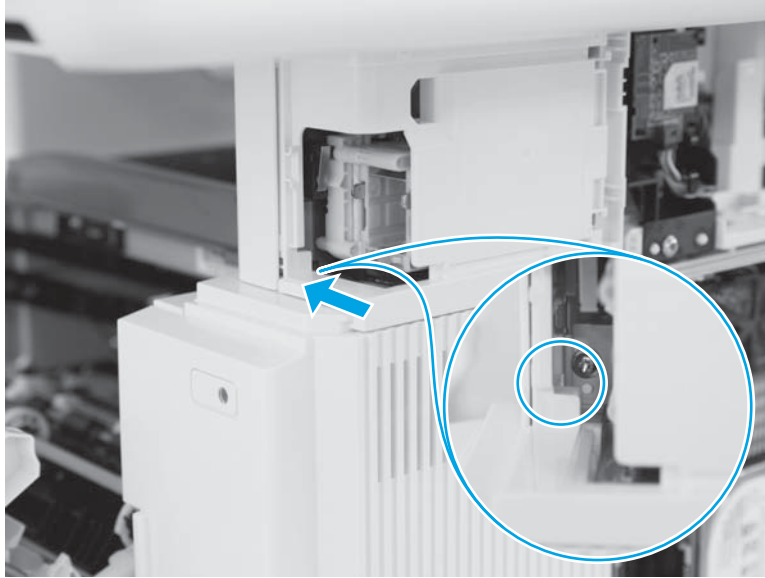
**Figure 1-1490** Engage one tab







4. Verify that the lower tab is engaged.

**Figure 1-1491** Engage one tab



### Step 35: Install the stapler door or stapler blank cover (M527)

 **NOTE:** This step is for the M527 printer. For the M506, skip this step and go to [Step 36: Install the formatter on page 845](#).

 **NOTE:** The M527dn does not have a convenience stapler.

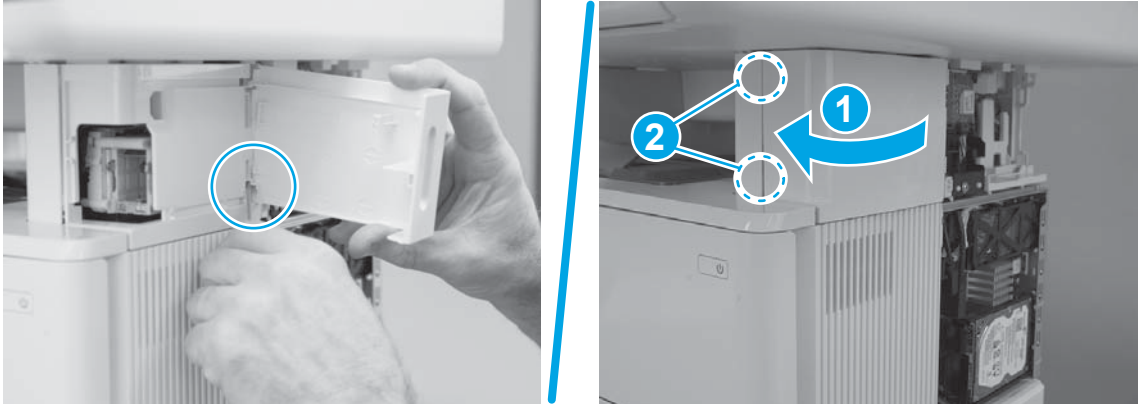
1. Do one of the following:
  - **M527c/f/z:** Position the door near the printer.
  - **M527dn:** Position the cover on the printer.

**Figure 1-1492** Install the door or cover



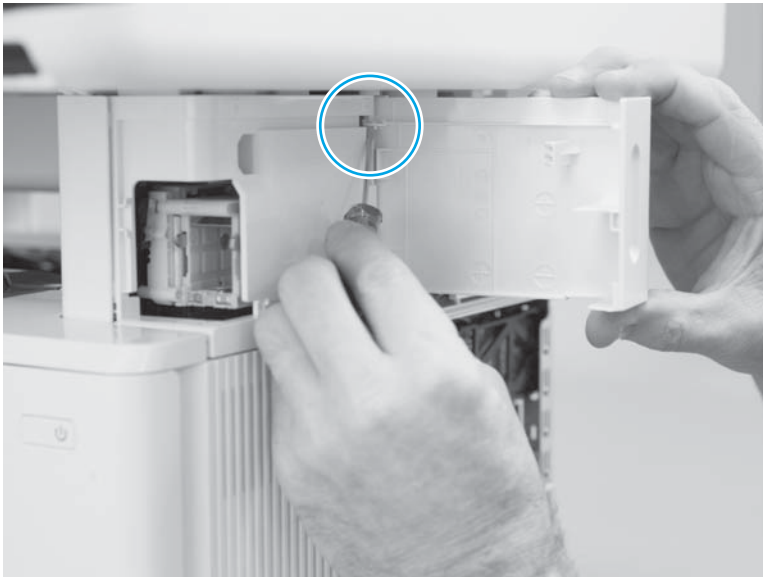
2.
  - **M527c/f/z:** Engage the lower hinge.
  - **M527dn:** Rotate the cover towards the printer (callout 1), and then make sure that the two tabs (callout 2) snap into place to install the cover.

**Figure 1-1493** Engage the lower hinge or engage the cover



3. **M527c/f/z:** Engage the upper hinge.

**Figure 1-1494** Engage the upper hinge




4. **M527c/f/z:** Close the stapler door.

**Figure 1-1495** Close the door

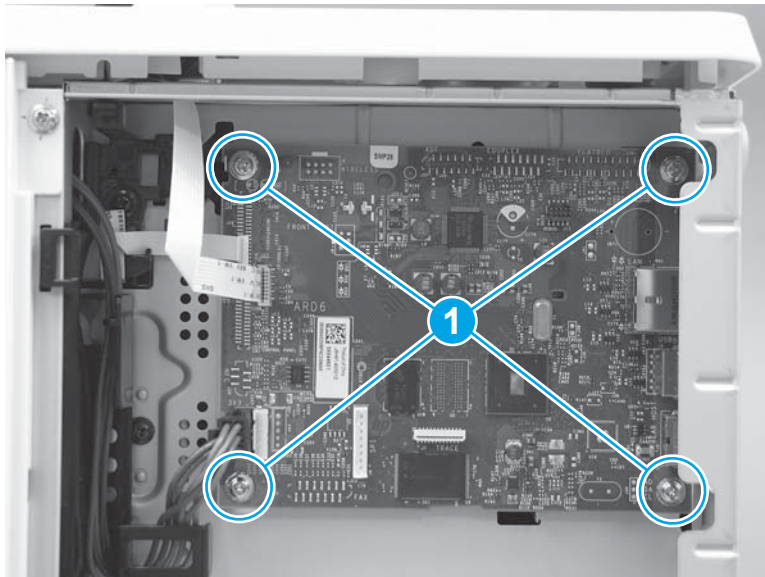


### Step 36: Install the formatter


 **IMPORTANT:** **M506/M527:** Take note of all empty connectors on the PCA before disconnecting any wire harnesses or flat-flexible cables (FFCs). Some empty connectors might not be visible until other items—like the hard-disk drive—are removed, so pay close attention while removing the formatter and accessory items.

1. **M501:** Position the formatter on the chassis, install four screws (callout 1), and then connect all of the connectors and FFCs.

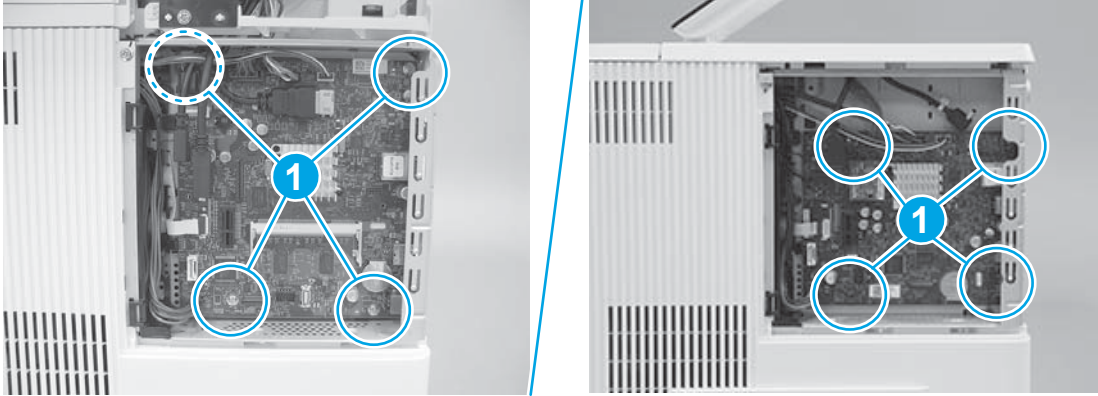
**Figure 1-1496** Install the formatter (M501)




2. **M506/M527:** Position the formatter on the chassis, install four screws (callout 1), and then connect all of the connectors and FFCs.

 **IMPORTANT:** Some connectors might need be empty if other items—for example a fax PCA—will be installed later.


**Figure 1-1497** Install the formatter (M506/M527)



### Step 37: Install the fax PCA (M527)

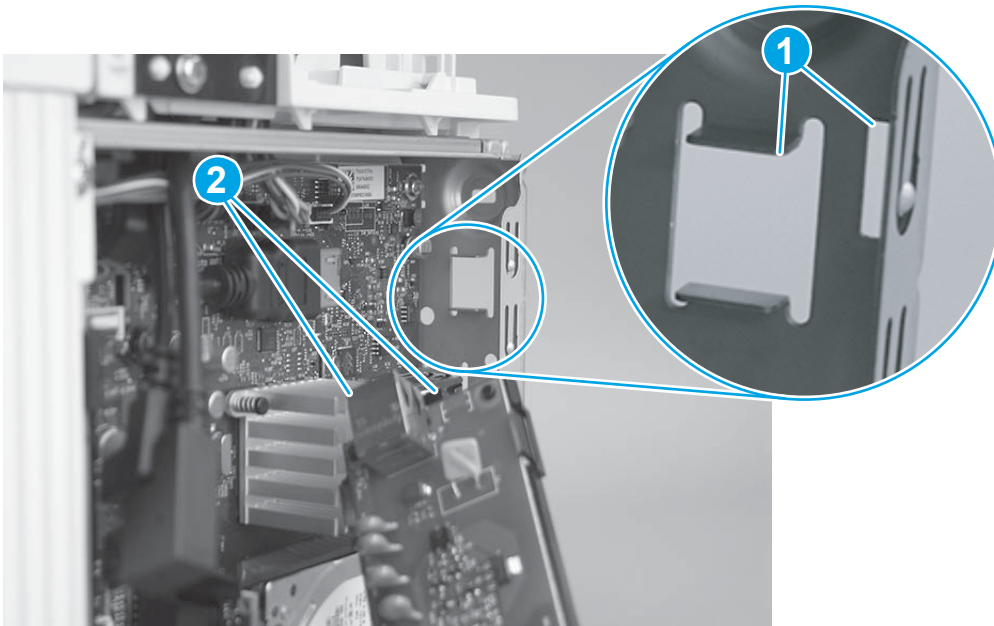
 **NOTE:** If the fax PCA is not installed, skip this step and go to [Step 38: Install the hard-disk drive \(HDD\) on page 848](#).

 **CAUTION:**  ESD-sensitive part.

 **NOTE:** M527c/f/z printers only (optional for the M527dn).

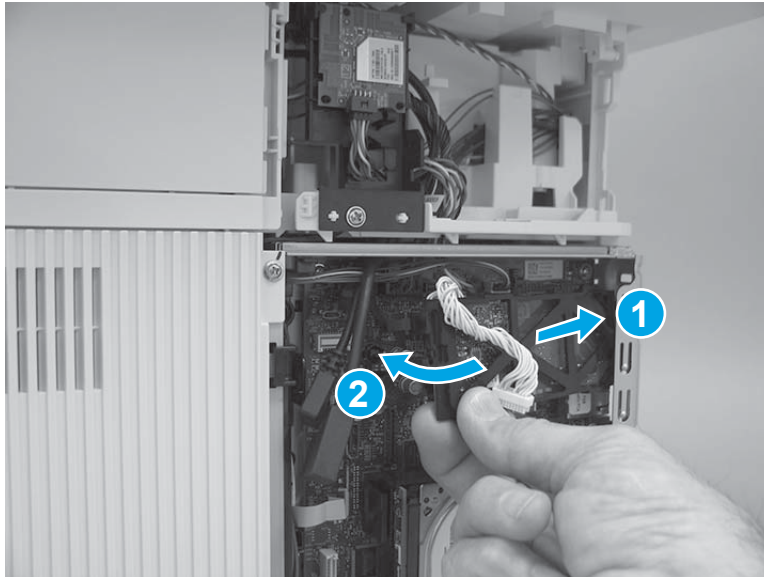
1. Before proceeding, take note of the location of the slots (callout 1) in the sheet-metal where the fax PCA cradle mounting tab and fax port (callout 2) must be installed.

**Figure 1-1498** Locate the slots in the sheet-metal



2. Insert the fax PCA cradle mounting tab and fax port in the slots in the sheet-metal plate (callout 1), and then rotate the connector end of the fax PCA toward the formatter (callout 2).

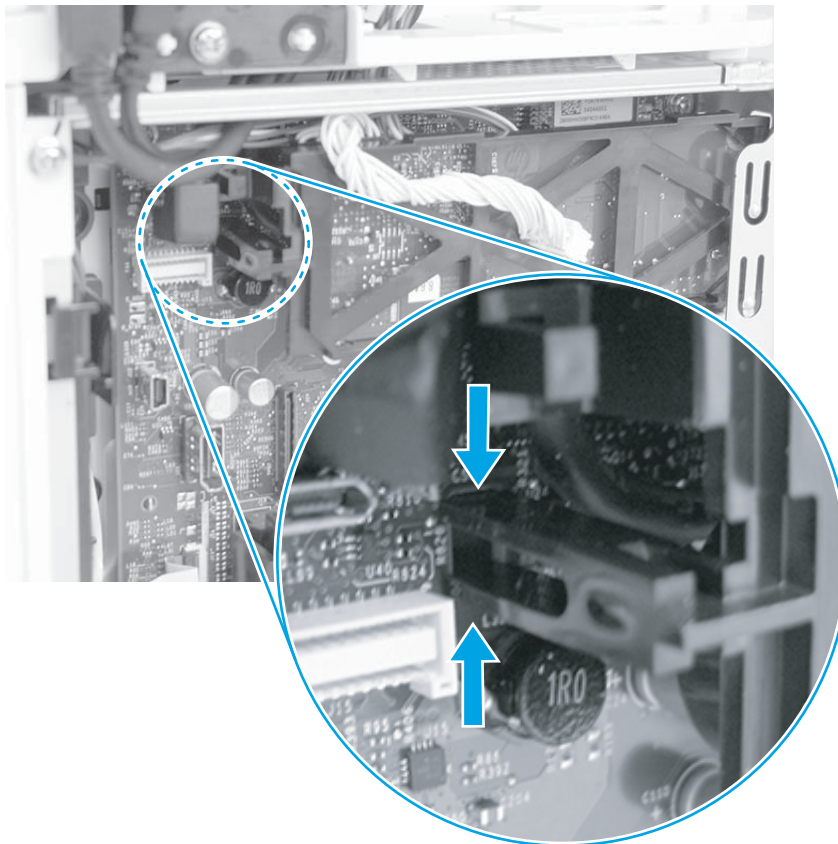
**Figure 1-1499** Install the fax PCA



3. Engage the retainer with the slot in the formatter.

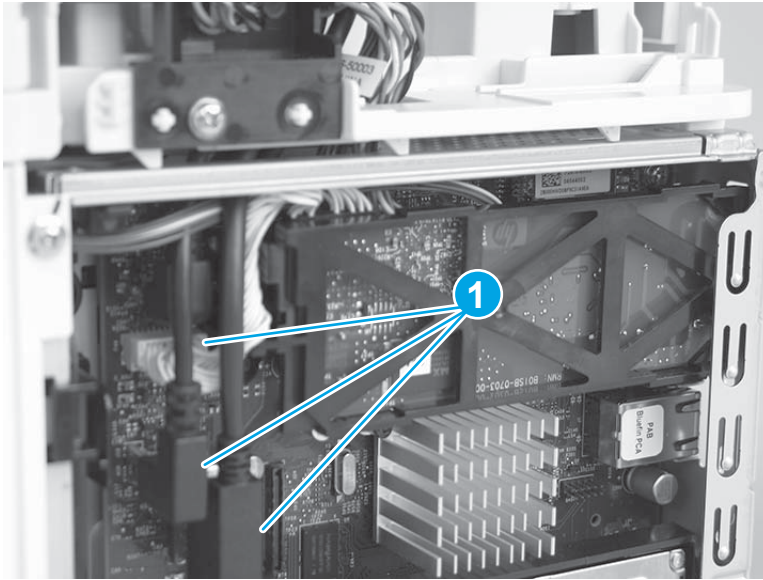
 **Reinstallation tip:** Pinch the retainer to easily engage it with the slot.

**Figure 1-1500** Engage the fax PCA




4. Connect three connectors (callout 1).

**Figure 1-1501** Connect three connectors




### Step 38: Install the hard-disk drive (HDD)

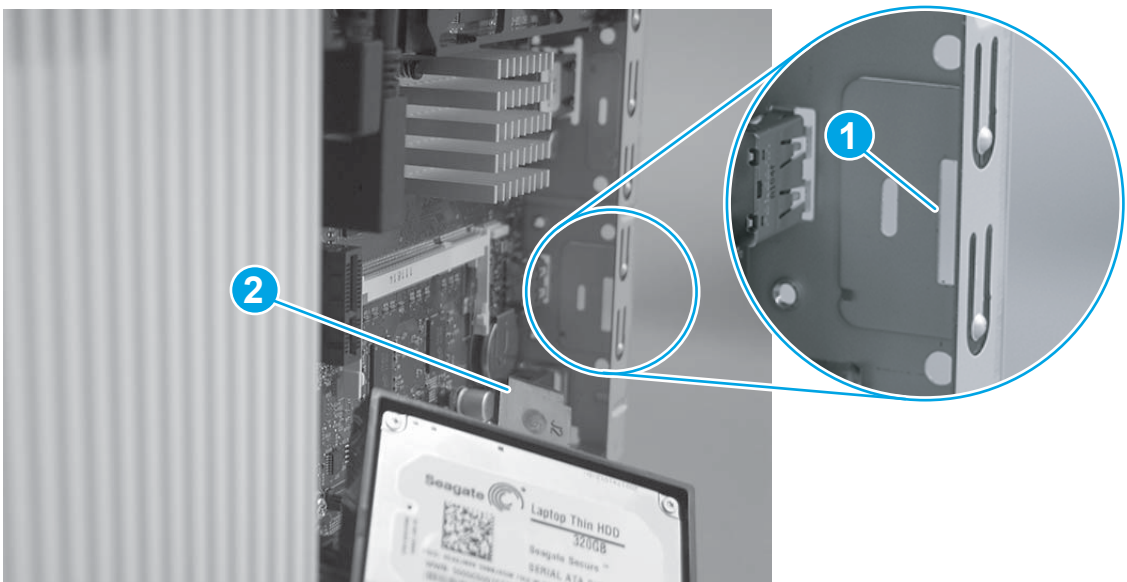
 **NOTE:** If the HDD is not installed, skip this step and go to [Step 39: Install the formatter cover on page 849](#).

 **CAUTION:**  ESD-sensitive part.

1. Before proceeding, take note of the location of the slot (callout 1) in the sheet-metal where the HDD cradle mounting tab (callout 2) must be installed.

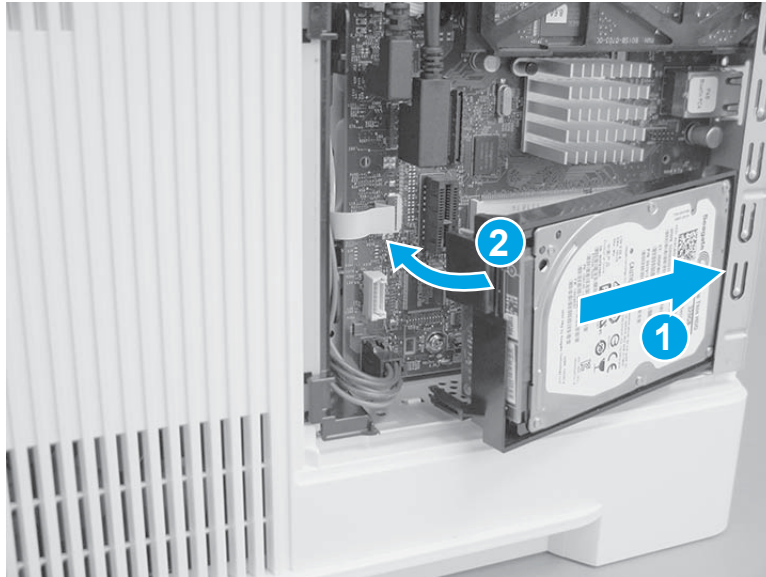
 **CAUTION:** This portion of the sheet-metal is a knock-out plate (callout 1). Do not push on it with sufficient force to detach it when installing the HDD.

**Figure 1-1502** Locate the slot in the sheet-metal



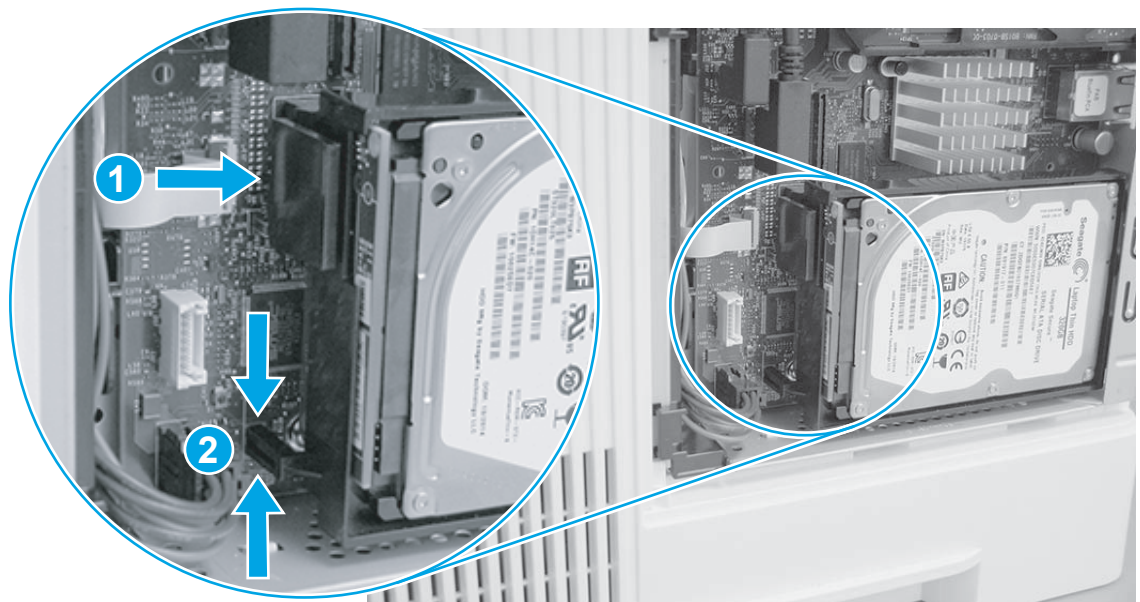
2. Insert the HDD cradle mounting tab in the slot in the sheet-metal (callout 1), and then rotate the connector end (callout 2) of the HDD toward the formatter.

**Figure 1-1503** Install the HDD



3. Make sure that the locking connector (callout 1) latches and that the standoA (callout 2) engages with the slot in the formatter (it might be necessary to pinch the retainer to engage it with the slot).

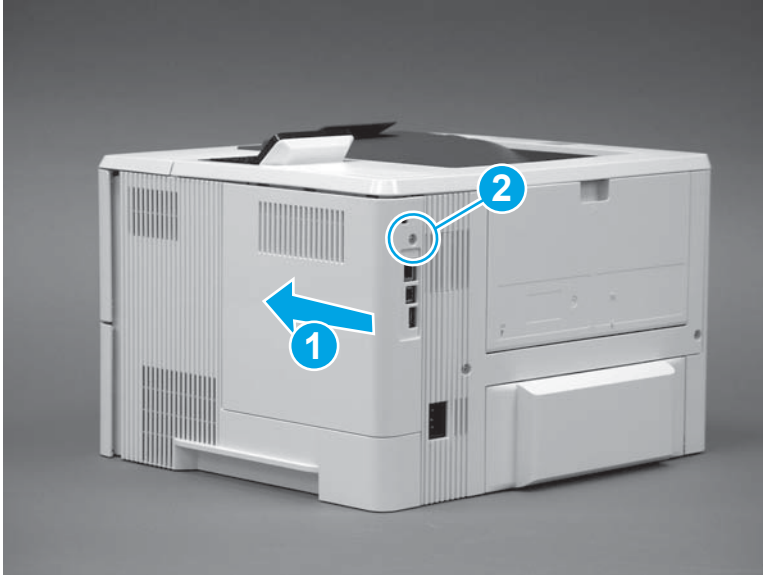
**Figure 1-1504** Install the HDD



### Step 39: Install the formatter cover

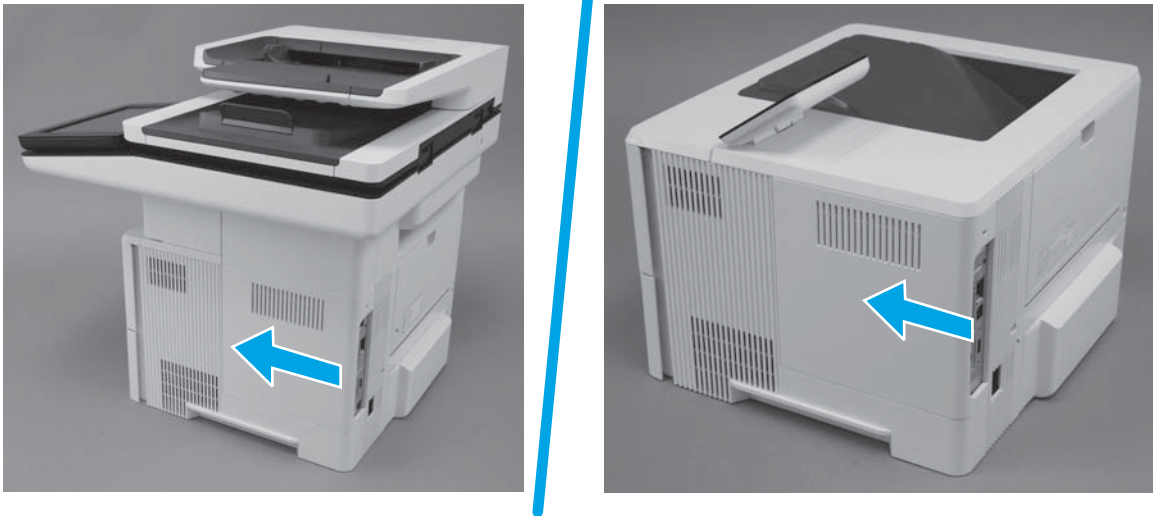
1. **M501**: Slide it toward the front of the printer to install it (callout 1), and then install one screw (callout 2).

**Figure 1-1505** Install the formatter cover (M501)



2. **M506/M527:** Slide it toward the front of the printer to install it.

**Figure 1-1506** Install the formatter cover (M506/M527)



#### Step 40: Install the tray

1. With the tray at a slight angle, align the sides of the tray with the rails in the accessory, and then partially slide the tray into the printer.



**Figure 1-1507** Install the tray




2. Push the tray straight into the accessory to close it.

**Figure 1-1508** Close the tray



#### Step 41: Install the control panel (M506x)

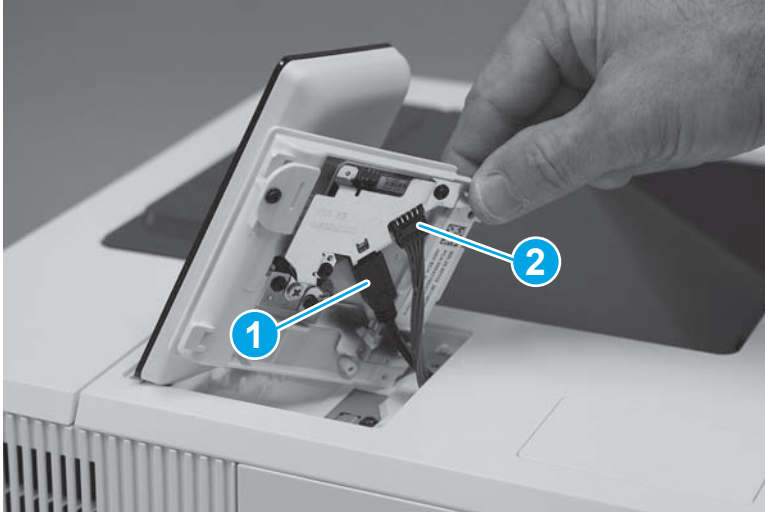
---

 **NOTE:** M506x model only.

---

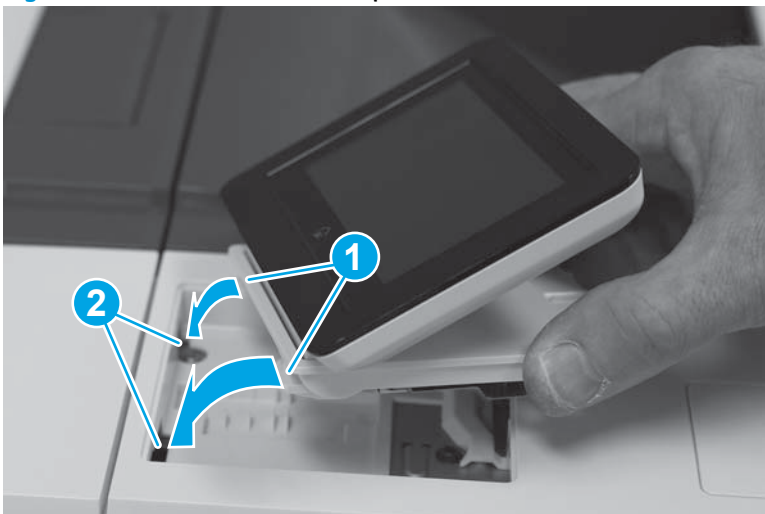
1. Connect one HDMI cable (callout 1), one connector (callout 2).

**Figure 1-1509** Connect the cables



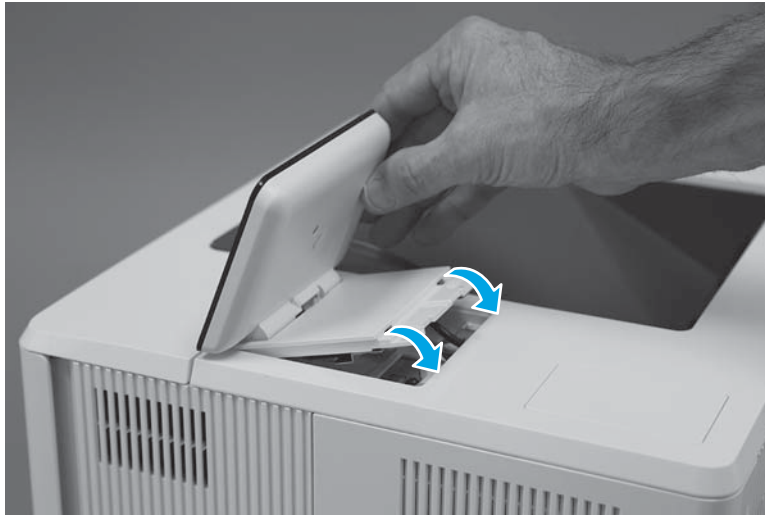
2. Install the tabs (callout 1) on the front of the control panel in the slots (callout 2) on the printer top cover.

**Figure 1-1510** Install the control panel



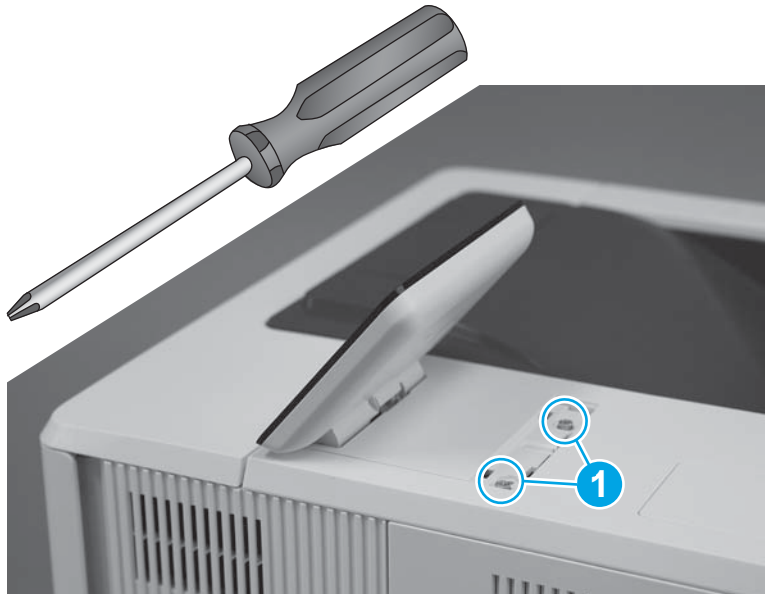
3. Rotate the control-panel base down onto the printer.

**Figure 1-1511** Rotate the control-panel base down




4. Use a small Phillips screwdriver to install two screws (callout 1).

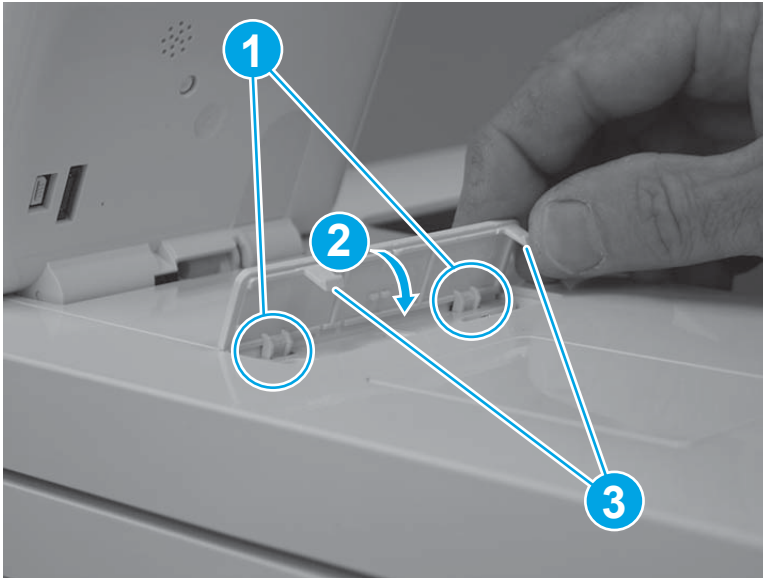
**Figure 1-1512** Install two screws




5. Position the screw cover mounting feet into the slots in the top cover (callout 1), and then rotate the cover down (callout 2) to install it.

 **NOTE:** Press down on the cover firmly to make sure that the tabs (callout 3) snap into place.

**Figure 1-1513** Install the cover



## Removal and replacement: Fuser power supply (FPS)

 **IMPORTANT:** Some figure might show assemblies removed or installed that have not yet been removed or installed at that specific step. However, the procedures are correct for this printer and the target assembly. Always thoroughly read the instructions that accompany each figure

- [Introduction](#)
- [Step 1: Remove the control panel \(M506x\)](#)
- [Step 2: Remove the tray](#)
- [Step 3: Remove the formatter cover](#)
- [Step 4: Remove the hard-disk drive \(HDD\)](#)
- [Step 5: Remove the fax PCA \(M527\)](#)
- [Step 6: Remove the formatter](#)
- [Step 7: Remove the stapler door or stapler blank cover \(M527\)](#)
- [Step 8: Remove the stapler stationary \(inner\) cover \(M527\)](#)
- [Step 9: Remove the top-left cover \(M527\)](#)
- [Step 10: Remove the top-rear cover \(M527\)](#)
- [Step 11: Remove the rear door assembly](#)
- [Step 12: Remove the cartridge door assembly](#)
- [Step 13: Remove the right cover](#)
- [Step 14: Remove the left cover](#)
- [Step 15: Remove the integrated scanner assembly \(M527\)](#)
- [Step 16: Remove the top cover \(M527\)](#)
- [Step 17: Remove the top cover \(M501/M506\)](#)
- [Step 18: Remove the paper delivery tray \(output bin\)](#)
- [Step 19: Remove the formatter case](#)
- [Step 20: Remove the fuser power supply \(FPS\)](#)
- [Step 21: Unpack the replacement power supply](#)
- [Step 22: Install the fuser power supply \(FPS\)](#)
- [Step 23: Install the formatter case](#)
- [Step 24: Install the paper delivery tray \(output bin\)](#)
- [Step 25: Install the top cover \(M501/M506\)](#)
- [Step 26: Install the top cover \(M527\)](#)
- [Step 27: Install the integrated scanner assembly \(M527\)](#)

- [Step 28: Install the left cover](#)
- [Step 29: Install the right cover](#)
- [Step 30: Install the cartridge door assembly](#)
- [Step 31: Install the rear door assembly](#)
- [Step 32: Install the top-rear cover \(M527\)](#)
- [Step 33: Install the top-left cover \(M527\)](#)
- [Step 34: Install the stapler stationary \(inner\) cover \(M527\)](#)
- [Step 35: Install the stapler door or stapler blank cover \(M527\)](#)
- [Step 36: Install the formatter](#)
- [Step 37: Install the fax PCA \(M527\)](#)
- [Step 38: Install the hard-disk drive \(HDD\)](#)
- [Step 39: Install the formatter cover](#)
- [Step 40: Install the tray](#)
- [Step 41: Install the control panel \(M506x\)](#)

## Introduction


This document provides the procedures to remove and replace the fuser power supply (FPS).

 **TIP:** The FPS includes the optional paper feeder connector (Jetlink accessory tray connector).

## Before performing service

### Turn the printer power off

- Disconnect the power cable.

 **WARNING!** To avoid damage to the printer, turn the printer off wait 30 seconds, and then remove the power cable before attempting to service the printer.

Use the table below to identify the correct part number for your printer. To order the part, go to [www.hp.com/buy/parts](http://www.hp.com/buy/parts).

Fuser power supply (FPS) part number	
<b>RM2-7948-000CN</b>	Fixing (fuser) power supply (FPS; 110V-127V)
<b>RM2-7949-000CN</b>	Fixing (fuser) power supply (FPS; 220V-240V)

## Required tools

- Small flat-blade screwdriver
- #2 Phillips screwdriver with a magnetic tip.

## After performing service


### Turn the printer power on

- Connect the power cable.
- Use the power switch to turn the power on.

### Post service test

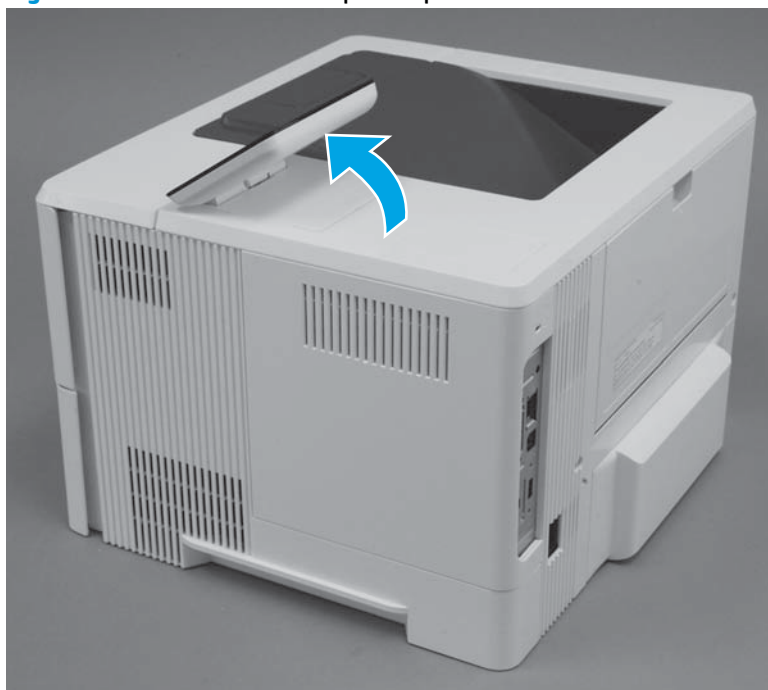
Make sure that the printer initializes to a **Ready** state.

### Step 1: Remove the control panel (M506x)

 **NOTE:** This step is for the M506x printer. For all other printers, skip this step and proceed to [Step 2: Remove the tray on page 859](#).

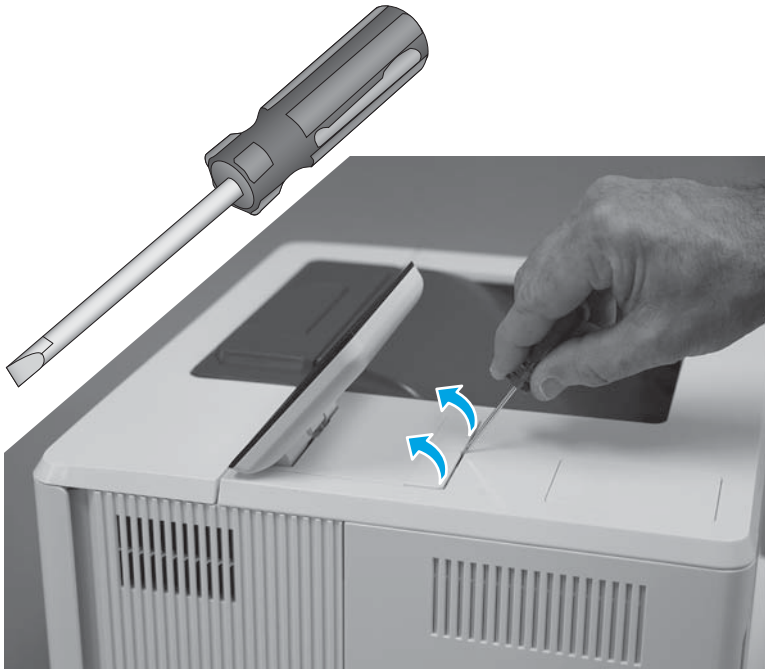
1. Tilt the control panel to the fully raised position.

**Figure 1-1514** Tilt the control panel up



2. Use a small flat-blad screwdriver to release the control-panel screws cover, and then remove the cover.

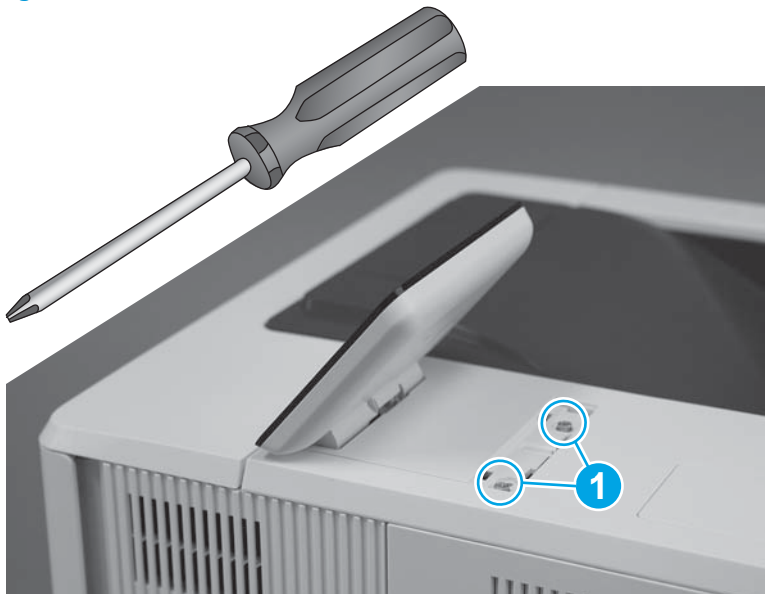
**Figure 1-1515** Remove the cover



3. Use a small Phillips screwdriver to remove two screws (callout 1).

 **IMPORTANT:** Store the screws in a secure place where they cannot fall down into the printer.

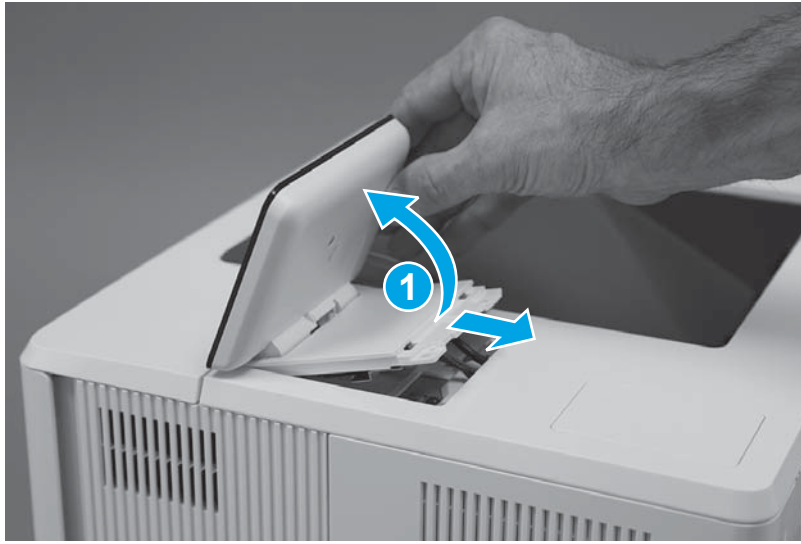
**Figure 1-1516** Remove two screws





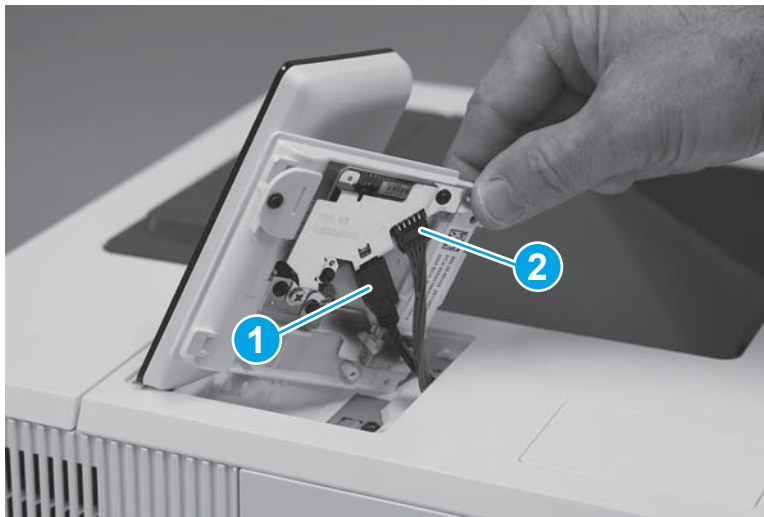
4. Turn the control panel over (callout 1), to gain access to the bottom side.

**Figure 1-1517** Turn the control panel over



5. Disconnect one HDMI cable (callout 1), one connector (callout 2), and then remove the control panel.

**Figure 1-1518** Remove the control panel



### Step 2: Remove the tray

1. Pull the tray straight out of the printer until it stops.

**Figure 1-1519** Pull the tray out until it stops



2. Lift the front of the tray, and then pull it out of the printer to remove it.

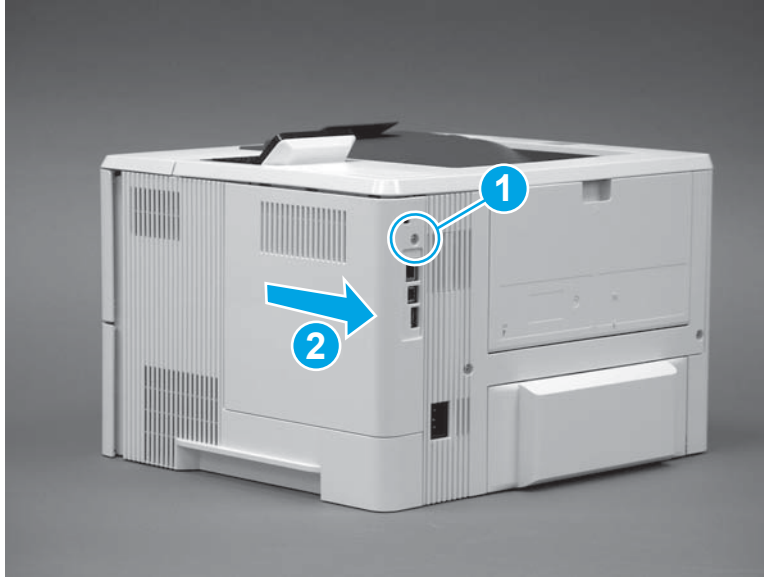
**Figure 1-1520** Release and remove the tray



### Step 3: Remove the formatter cover

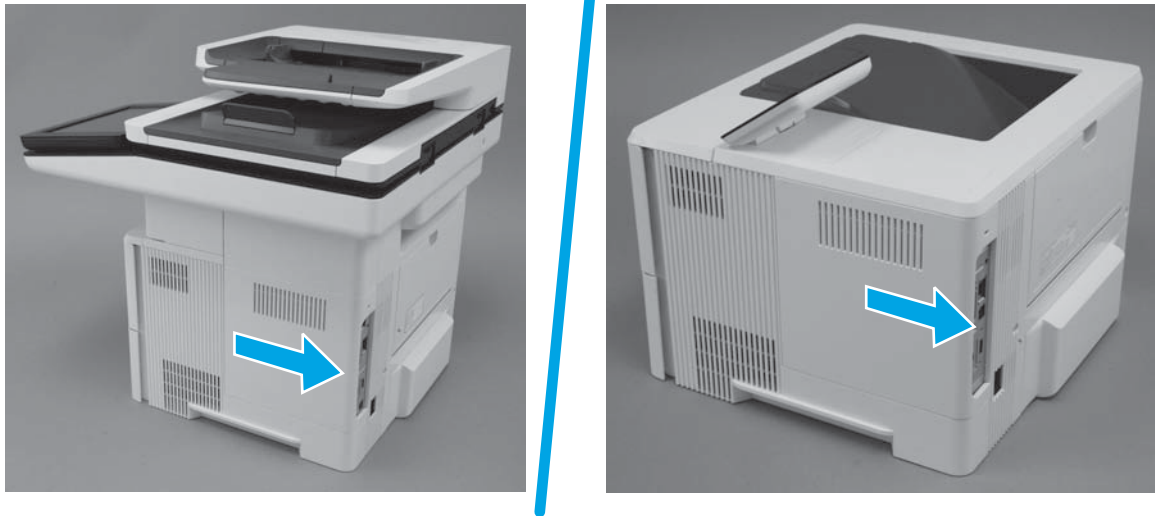
1. **M501:** Remove one screw (callout 1), and then slide the cover toward the rear of the printer to remove it (callout 2).

**Figure 1-1521** Remove the formatter cover (M501)




2. **M506/M527:** Slide the cover toward the rear of the printer to remove it.

**Figure 1-1522** Remove the formatter cover (M506/M527)



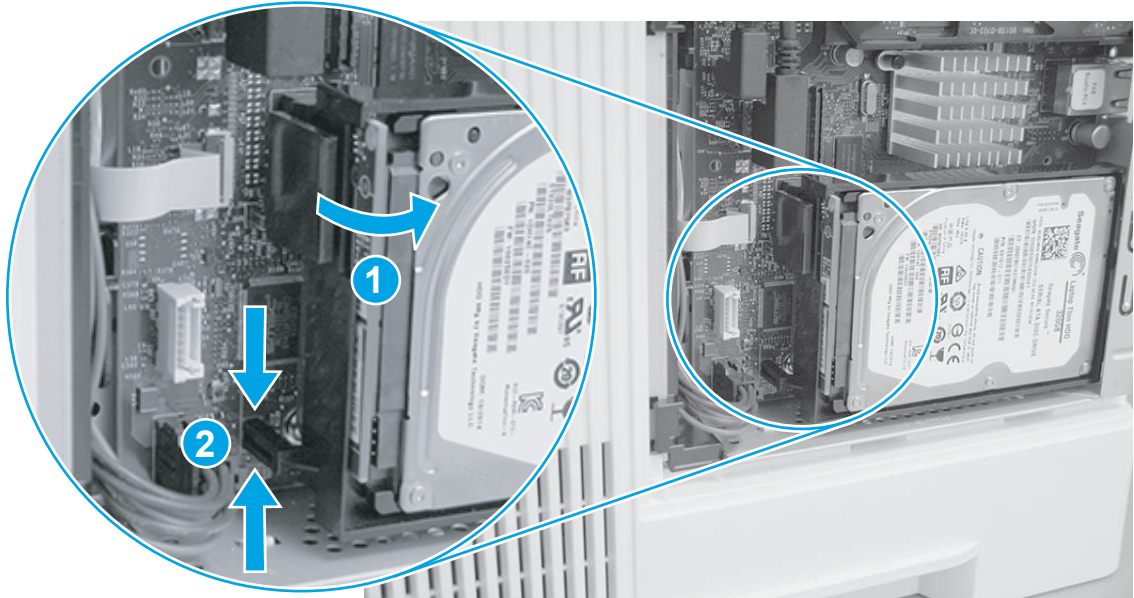
#### Step 4: Remove the hard-disk drive (HDD)

 **NOTE:** If the HDD is not installed, skip this step and go to [Step 5: Remove the fax PCA \(M527\) on page 862.](#)

 **CAUTION:**  ESD-sensitive part.

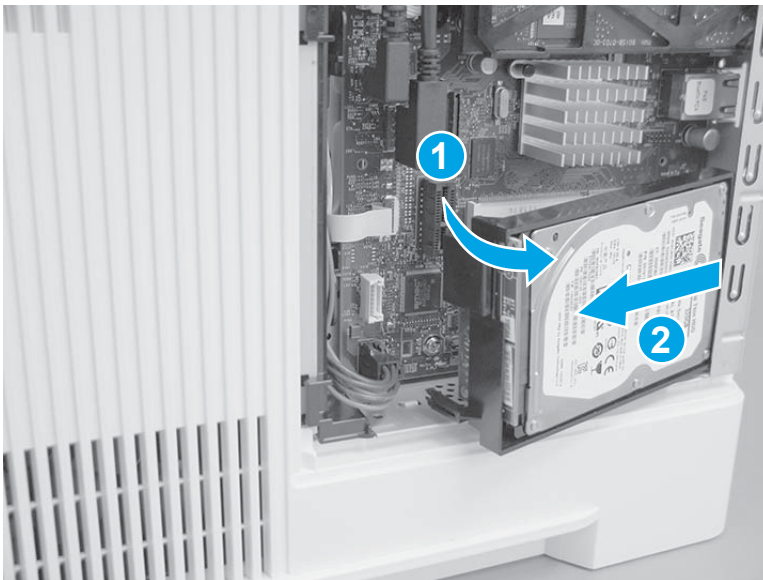
1. Release the locking connector (callout 1), and then pinch the retainer (callout 2) to release it.

**Figure 1-1523** Release the HDD




2. Rotate the connector end of the HDD out and away from the formatter (callout 1), and then slide it as shown (callout 2) to remove it.


**Figure 1-1524** Remove the HDD



### Step 5: Remove the fax PCA (M527)

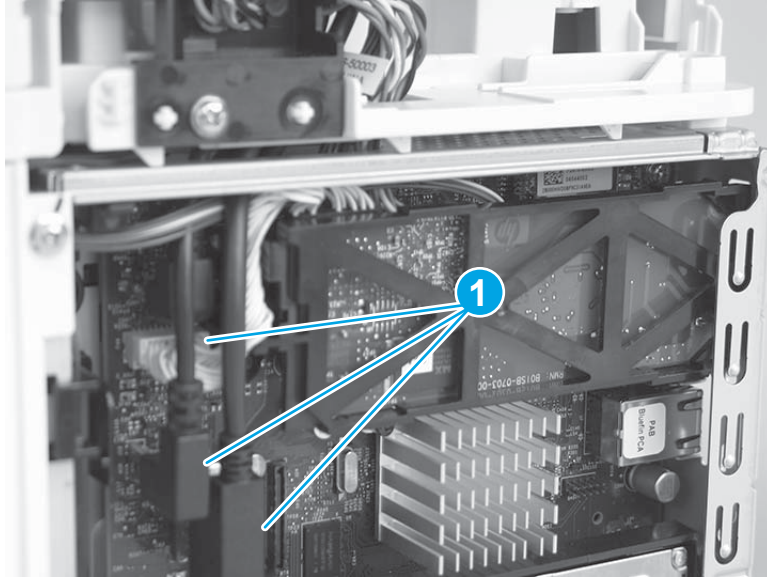
 **NOTE:** If the fax PCA is not installed, skip this step and go to [Step 6: Remove the formatter on page 864](#).

 **CAUTION:**  ESD-sensitive part.

 **NOTE:** M527c/f/z printers only (optional for the M527dn).

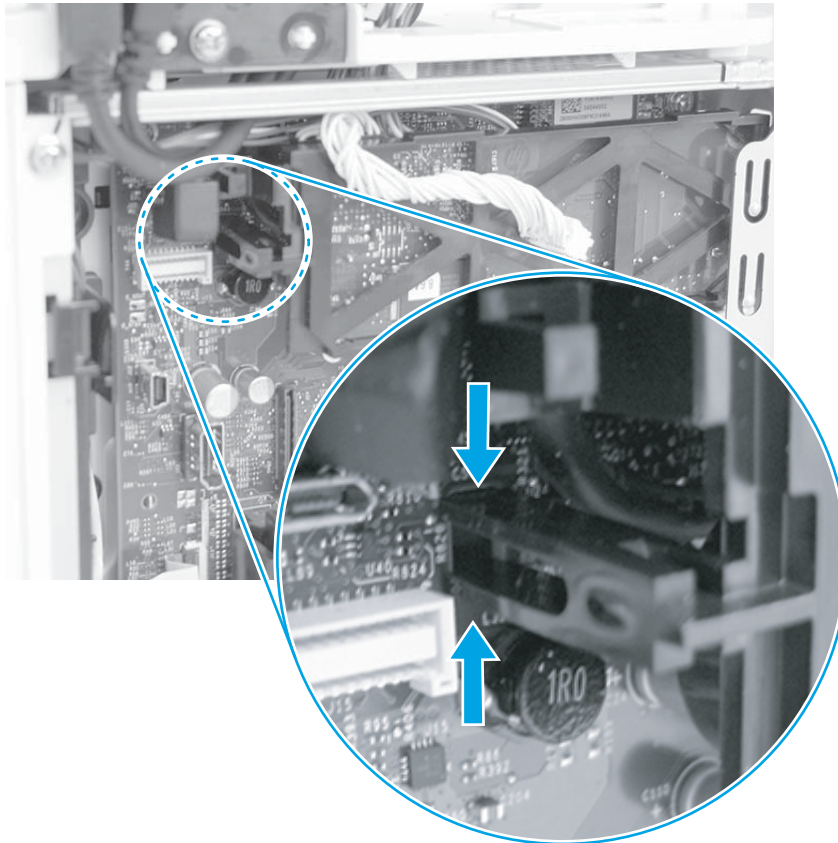
1. Disconnect three connectors (callout 1).

**Figure 1-1525** Disconnect three connectors



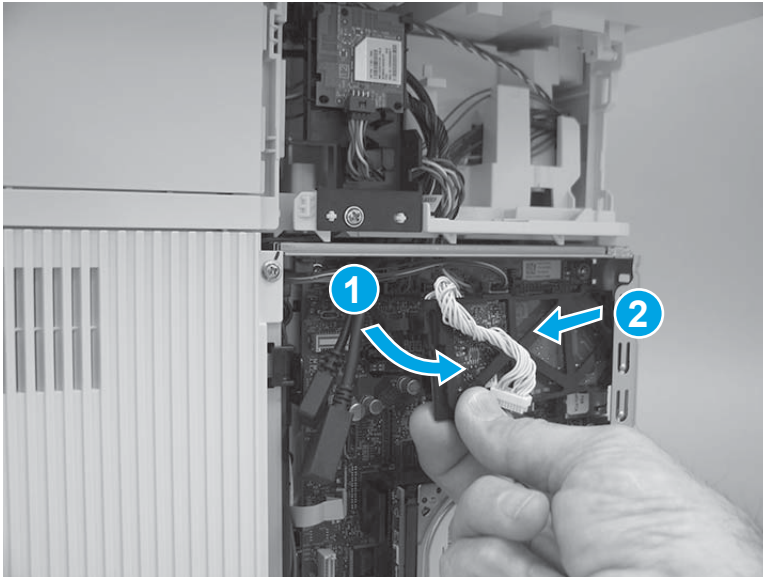
2. Pinch the retainer to release it.

**Figure 1-1526** Release the fax PCA




3. Rotate the connector end of the fax PCA out and away from the formatter (callout 1), and then slide it as shown (callout 2) to remove it.

**Figure 1-1527** Remove the fax PCA

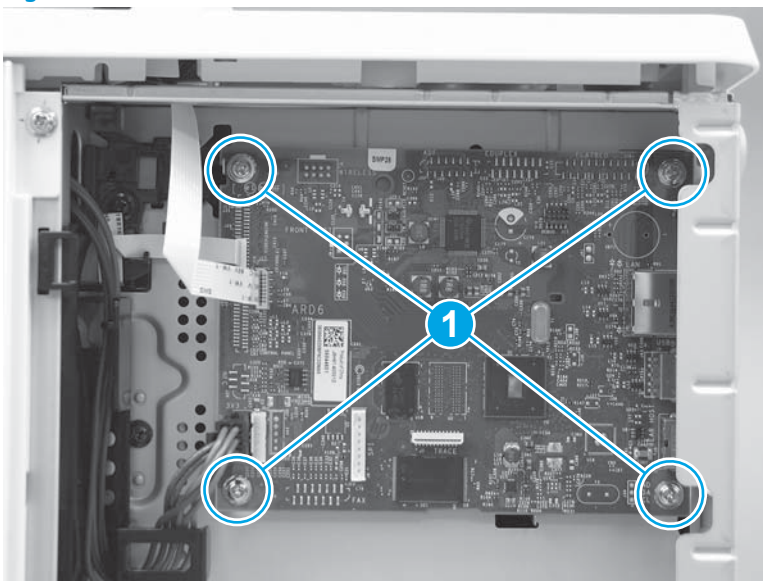


#### Step 6: Remove the formatter


 **IMPORTANT:** **M506/M527:** Take note of all empty connectors on the PCA before disconnecting any wire harnesses or flat-flexible cables (FFCs). Some empty connectors might not be visible until other items—like the hard-disk drive—are removed, so pay close attention while removing the formatter and accessory items.

1. **M501:** Disconnect all of the connectors and FFCs, remove four screws (callout 1), and then remove the formatter.

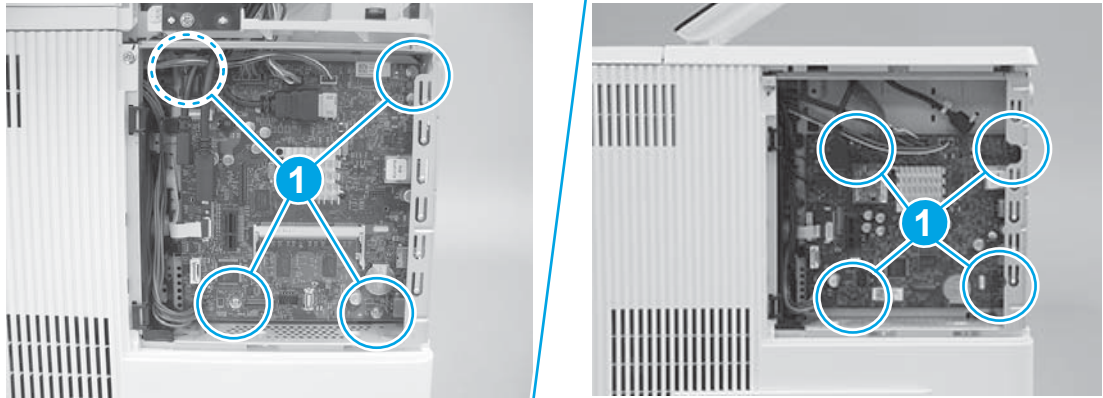
**Figure 1-1528** Remove the formatter (M501)




2. **M506/M527:** Disconnect all of the connectors and FFCs, remove four screws (callout 1), and then remove the formatter.

 **IMPORTANT:** Take note of all empty connectors on the formatter before disconnecting any wire harnesses or flat-flexible cables (FFCs). Some empty connectors might not be visible until other items—like the hard-disk drive—are removed, so pay close attention while removing the formatter and accessories items.

**Figure 1-1529** Remove the formatter (M506/M527)



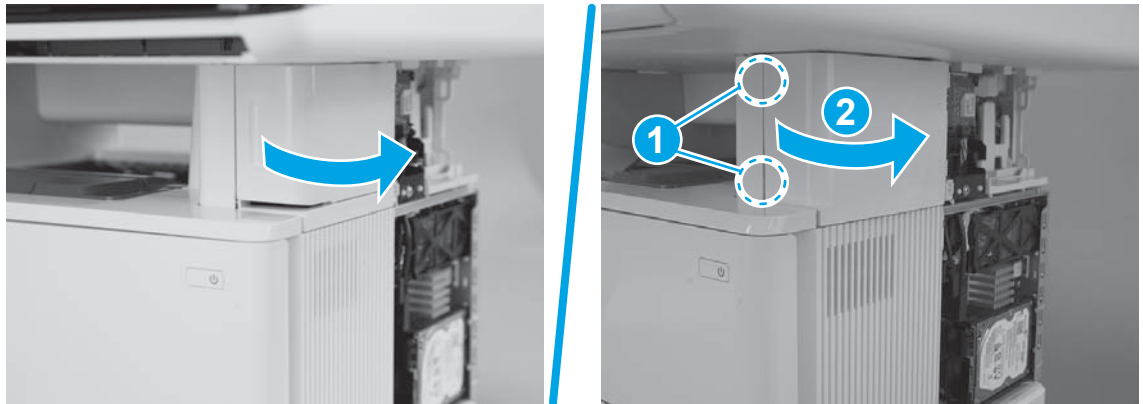
### Step 7: Remove the stapler door or stapler blank cover (M527)

 **NOTE:** This step is for the M527 printer. For the M501/M506, skip this step and go to [Step 11: Remove the rear door assembly on page 873](#).

The M527dn does not have a convenience stapler.

1. Do one of the following:
  - **M527c/f/z:** Open the stapler door.
  - **M527dn:** Use a small flat-blade screwdriver to release two tabs (callout 1), and then rotate the cover away from the printer (callout 2).

**Figure 1-1530** Open the door or release the cover



2. Do one of the following:
  - **M527c/f/z:** Use a small flat-blade screwdriver to release the upper hinge.
  - **M527dn:** Slide the cover toward the front of the printer to remove it.

**Figure 1-1531** Release the upper hinge or remove the cover



3. **M527c/f/z:** Use a small flat-blad screwdriver to release the lower hinge.

**Figure 1-1532** Release the lower hinge







4. **M527c/f/z:** Remove the door.

**Figure 1-1533** Remove the door



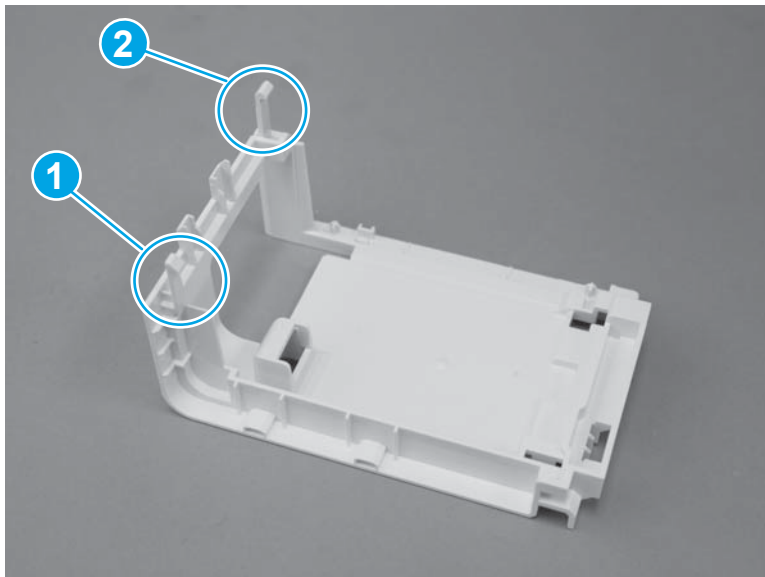
#### Step 8: Remove the stapler stationary (inner) cover (M527)

 **NOTE:** This step is for the M527c/f/z printers. For the M501/M506, skip this step and go to [Step 11: Remove the rear door assembly on page 873](#). For the M527dn, skip this step and go to [Step 9: Remove the top-left cover \(M527\) on page 869](#).

 **NOTE:** M527c/f/z printers only.

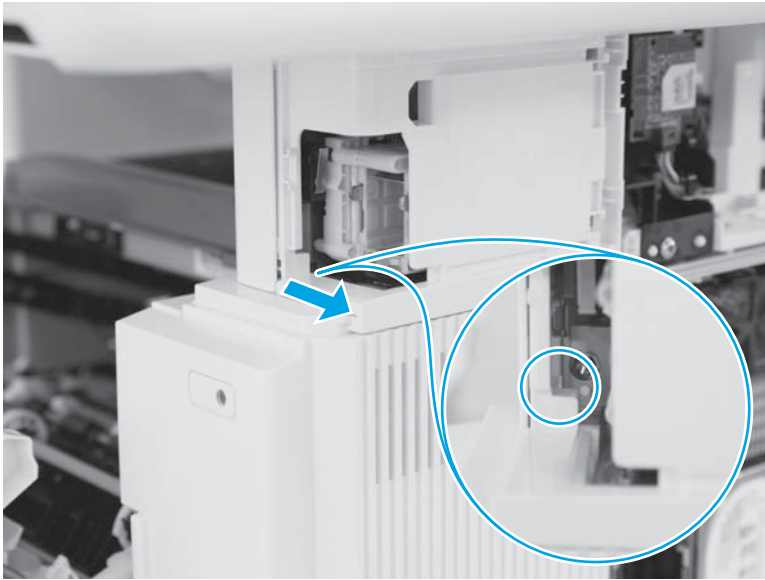
1. Before proceeding, take note of the locations of the upper tab (callout 1) and the lower tab (callout 2) on the stapler stationary (inner) cover.

**Figure 1-1534** Locate the tabs



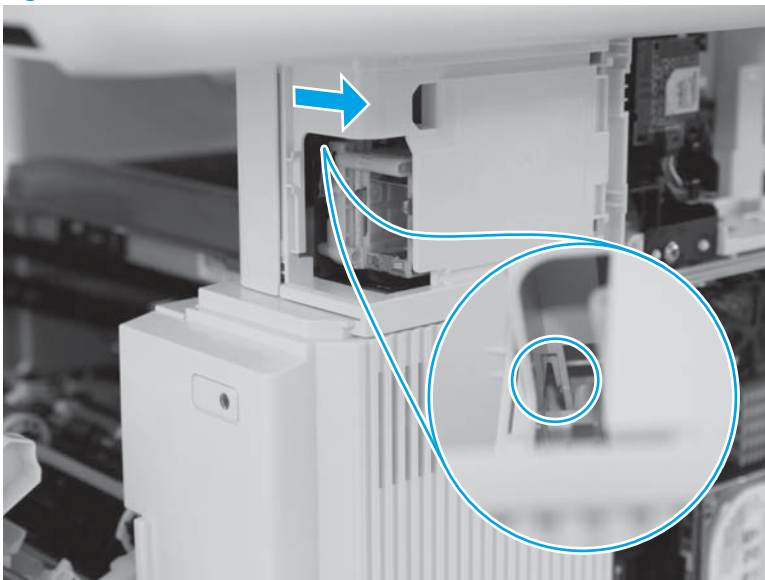
2. Use a long-shaft small flat-blad screwdriver to release the lower tab.

**Figure 1-1535** Release one tab



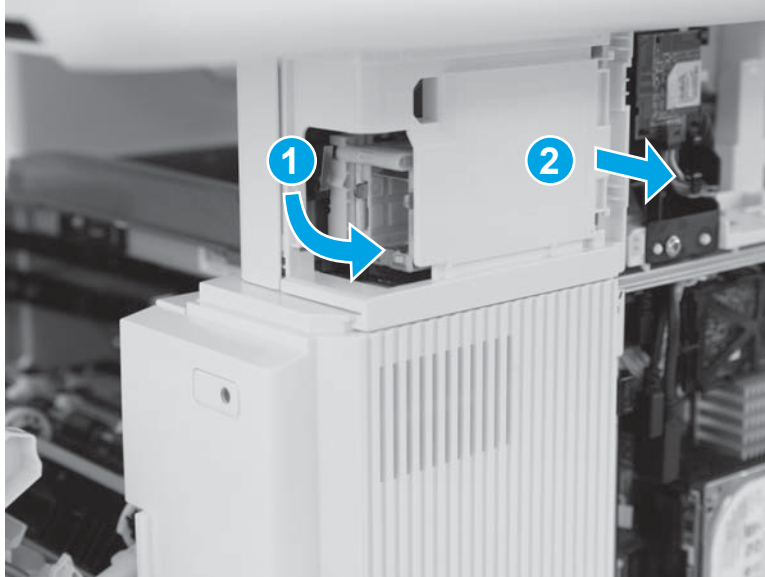
3. Use a long-shaft small flat-blad screwdriver to release the upper tab.

**Figure 1-1536** Release one tab




4. With the tabs disengaged the front of the cover is released. Rotate the front of the cover away from the printer (callout 1) to release the rear of the cover (callout 2), and then remove it.

**Figure 1-1537** Remove the cover

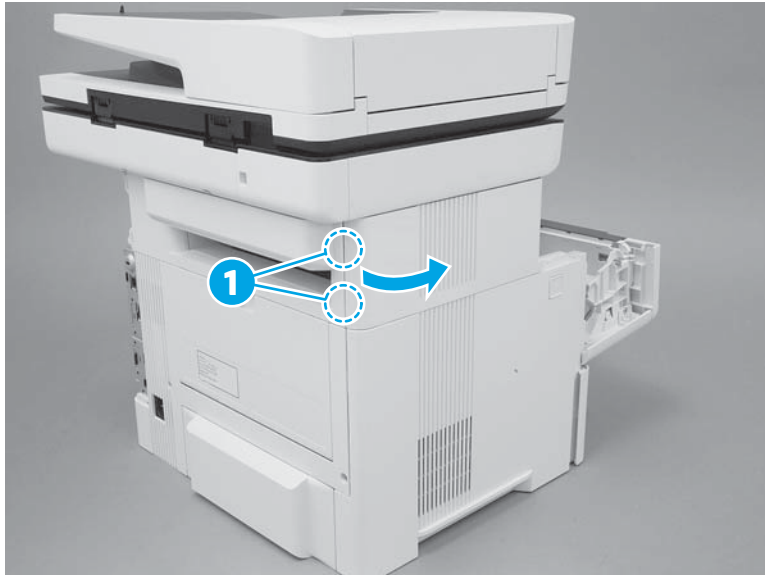


#### Step 9: Remove the top-left cover (M527)

 **NOTE:** This step is for the M527 printer. For the M501/M506, skip this step and go to [Step 11: Remove the rear door assembly on page 873](#).

1. Open the toner-cartridge door, release two tabs (callout 1), and then rotate the rear edge of the cover away from the printer.

**Figure 1-1538** Release two tabs



2. Continue to rotate the cover away from the printer to release two more tabs at the middle of the cover.

**Figure 1-1539** Release two tabs



3. Slide the cover toward the rear of the printer to release two bosses at the front of the cover.

**Figure 1-1540** Slide the cover




4. Remove the cover.

**Figure 1-1541** Remove the cover

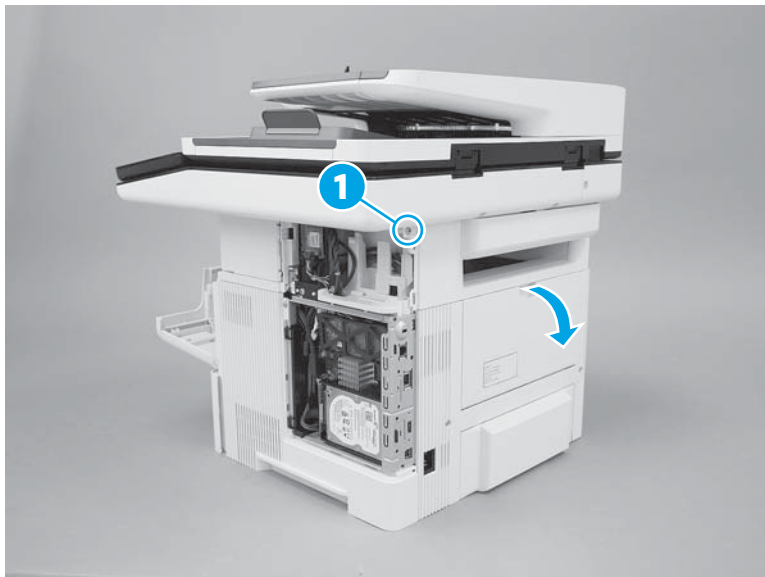


#### Step 10: Remove the top-rear cover (M527)

 **NOTE:** This step is for the M527 printer. For the M501/M506, skip this step and go to [Step 11: Remove the rear door assembly on page 873](#).

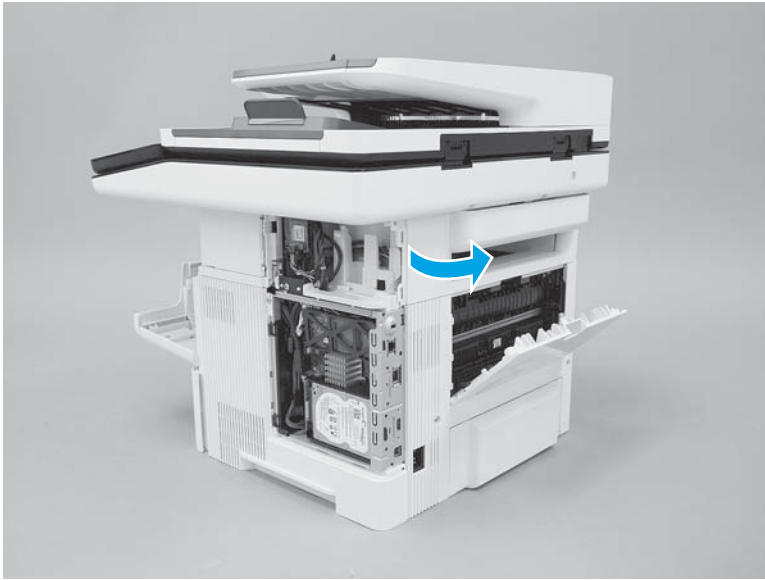
1. Remove one screw (callout 1), and then open the rear door.

**Figure 1-1542** Remove one screw



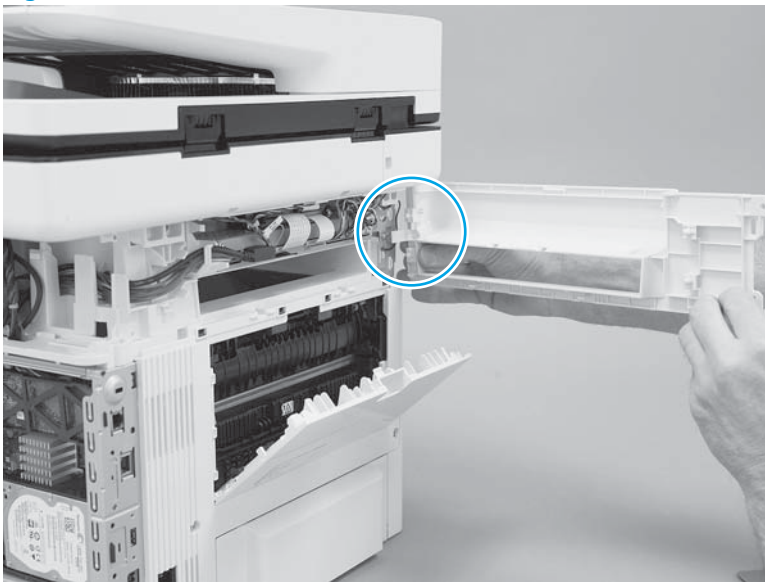
2. Rotate the exposed edge of the cover away from the printer (as shown).

**Figure 1-1543** Rotate the cover



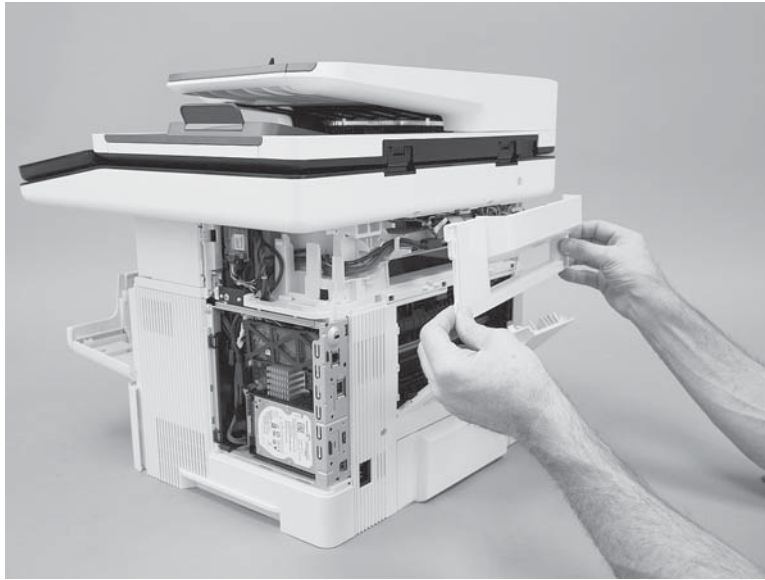
3. Continue to rotate the cover away from the printer to release one boss.

**Figure 1-1544** Release one boss



4. Remove the cover.

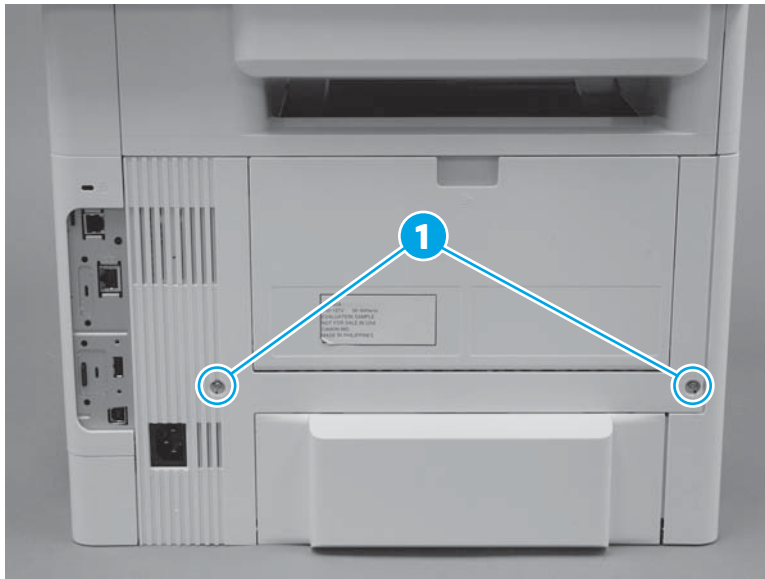
**Figure 1-1545** Remove the cover



### Step 11: Remove the rear door assembly

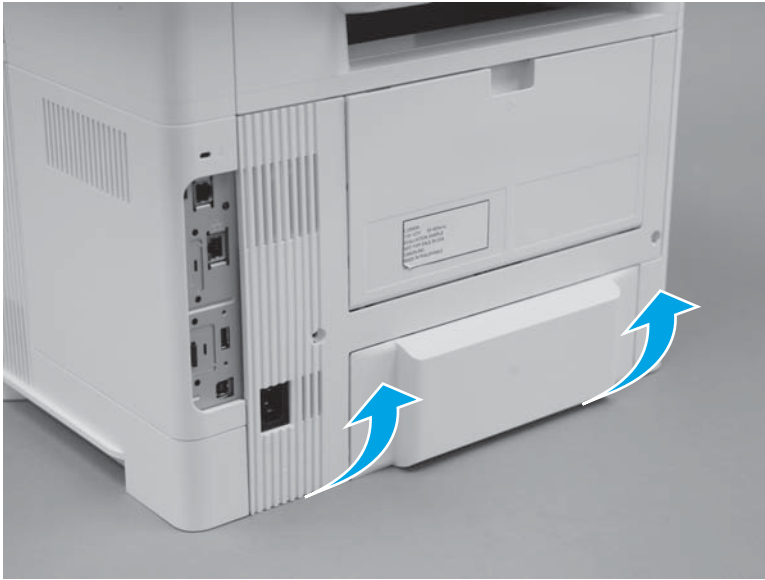
1. At the rear of the printer, remove two screws (callout 1).

**Figure 1-1546** Remove two screws



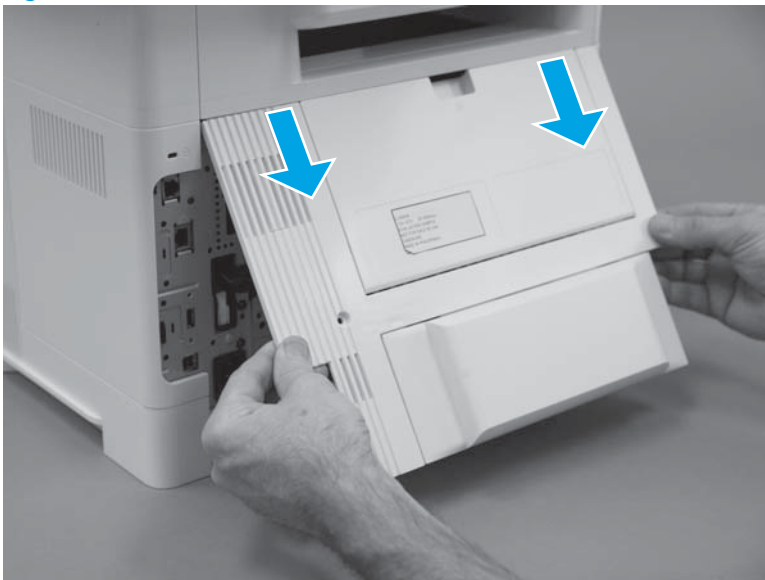
2. Rotate the bottom edge of the assembly away from the printer to release it.

**Figure 1-1547** Rotate the bottom of the cover



3. Pull down on the assembly to remove it.

**Figure 1-1548** Remove the cover



### Step 12: Remove the cartridge door assembly

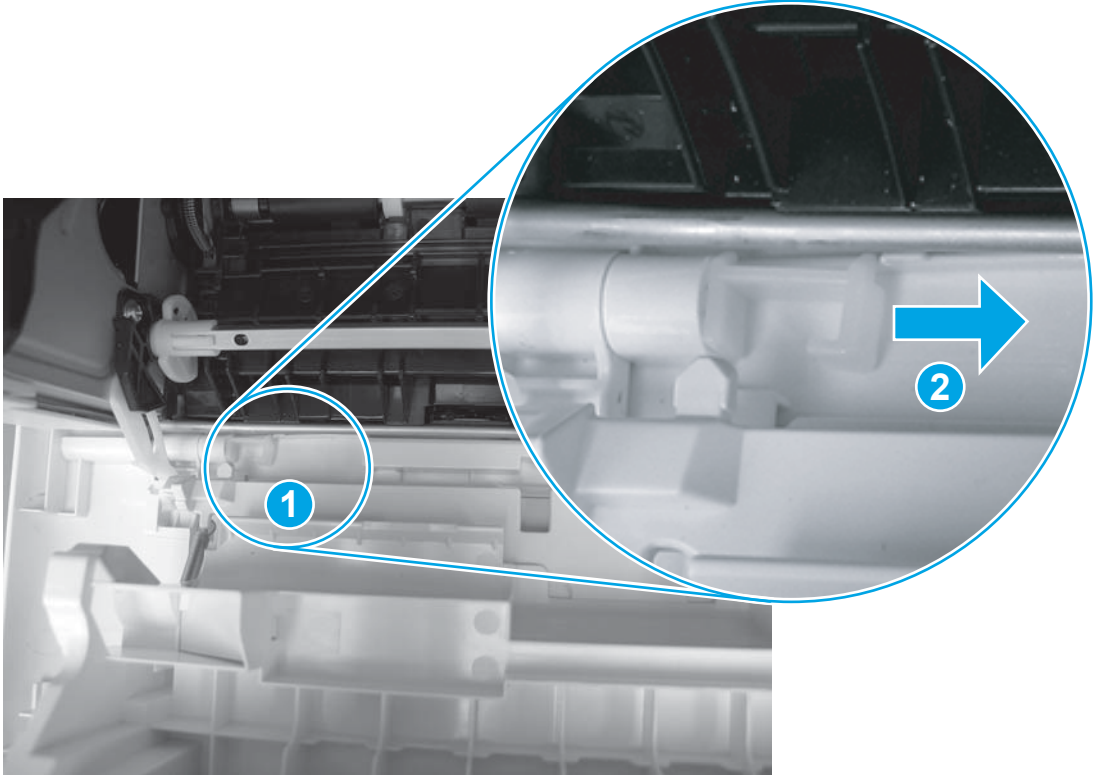
 **NOTE:** If the toner cartridge was not removed prior to servicing the printer, remove it now.

1. Release the support shaft (callout 1), and then slide it toward the center of the door (callout 2).

 **TIP:** It might be easier to release the support shaft by using a small flat-blad screwdriver.

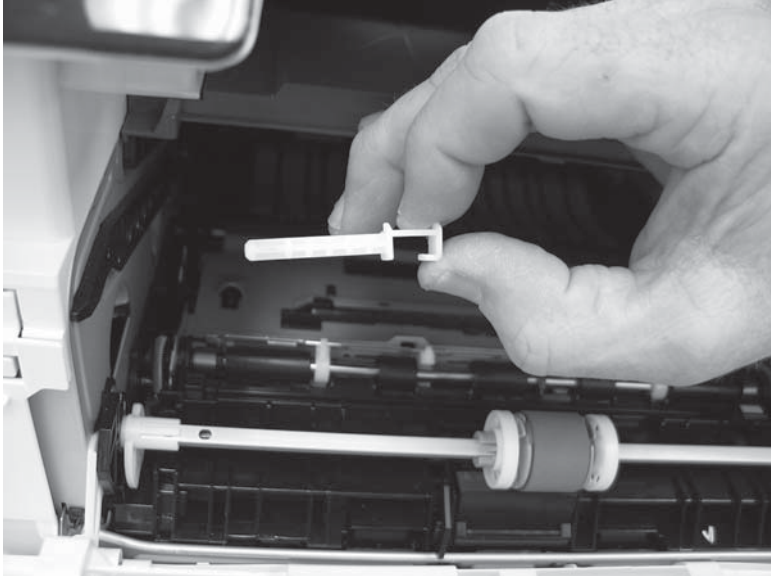


**Figure 1-1549** Release the support shaft



- 2. Remove the support shaft.

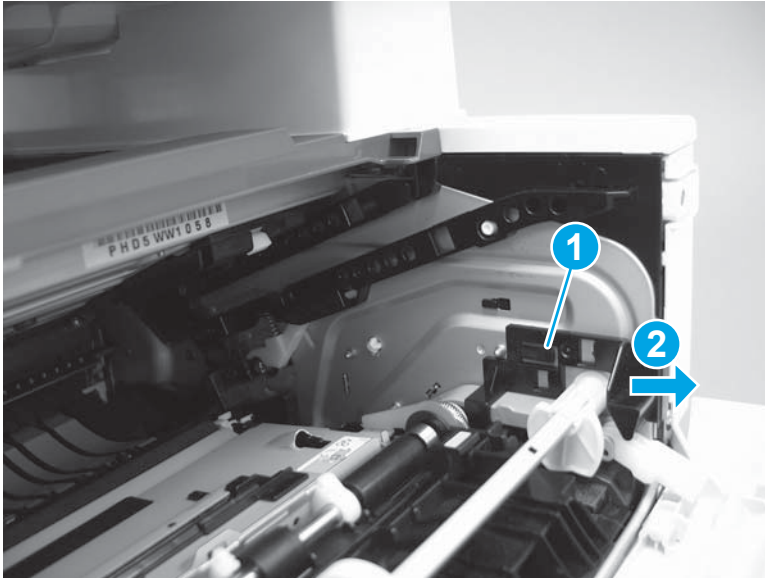
**Figure 1-1550** Remove the support shaft



3. Release one tab (callout 1), and then slide the guide out of the printer (callout 2).

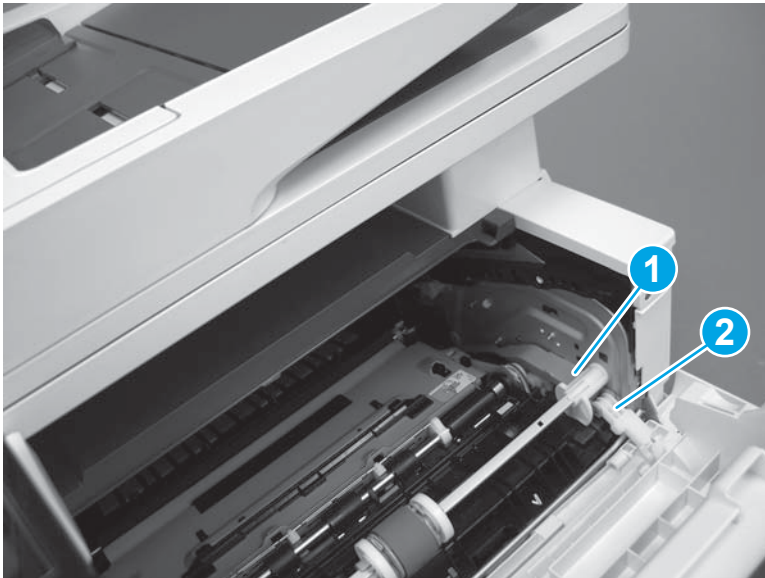
**⚠ CAUTION:** Be careful, the tab (callout 1) can be easily broken.

**Figure 1-1551** Remove the guide



4. Use a small flat-blad screwdriver to gently pry the white-plastic door arm (callout 1) off of the gray-plastic pressure-release link (callout 2) to release the door arm.

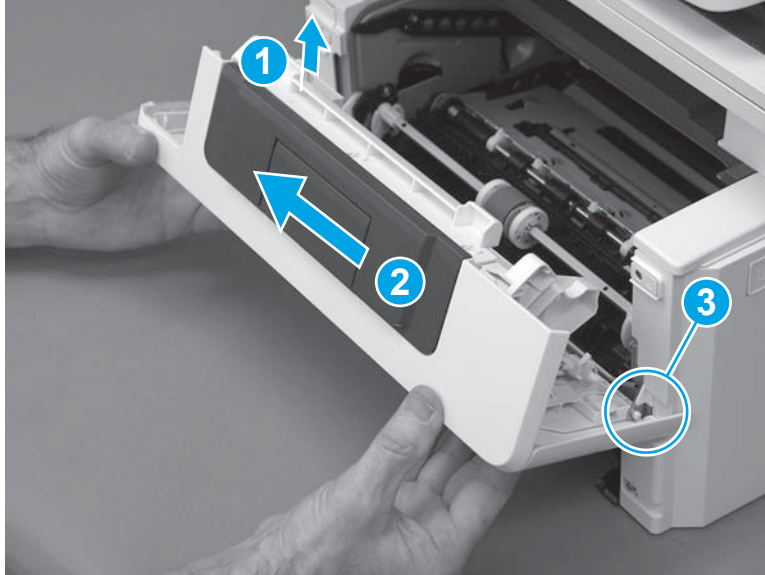
**Figure 1-1552** Release the pressure-release link



5. With the door in the partially closed position, slightly raise the left end (callout 1; raise it over the sheet-metal hinge boss), and then slide the door to the left (callout 2) to release the right hinge (callout 3).

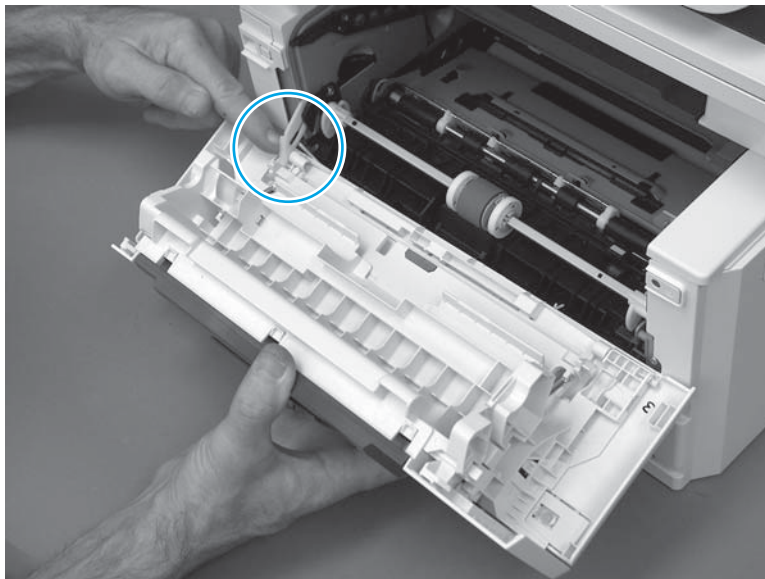
**CAUTION:** The door is still attached to the printer by the left-side retainer arm. Do not attempt to completely remove the door.

**Figure 1-1553** Release the door



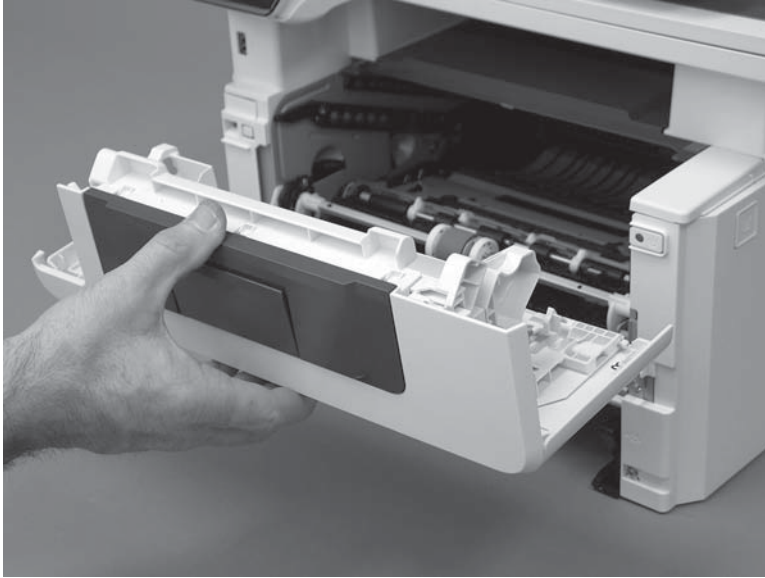
6. Rotate the door away from the printer until the keyed pin on the left-side retainer arm can disengage from the door.

**Figure 1-1554** Release the left-side retainer arm





7. Remove the door.

**Figure 1-1555** Remove the door



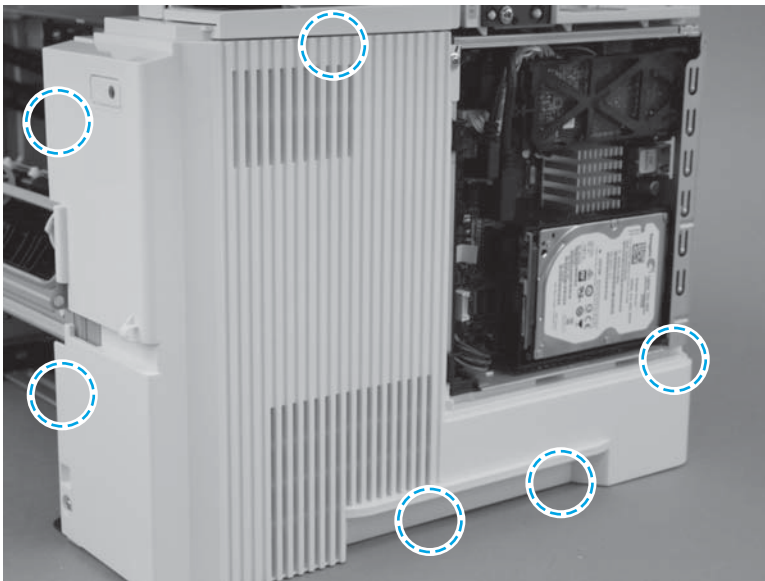
### Step 13: Remove the right cover

 **IMPORTANT:** The black-plastic cassette front and rear guides (located inside the tray cavity) can be easily dislodged. Do not lose the guides when the cover is removed or installed.

 **NOTE:** The M527 printer is shown in this procedure. However, this procedure is valid for the M501/M506 printers.

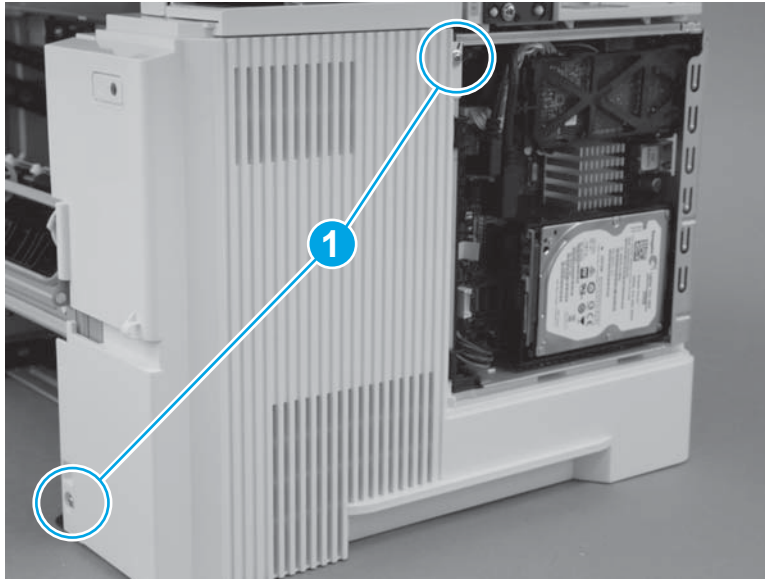
1. Before proceeding, take note of the location of the tabs and bosses on the inside of the cover.

**Figure 1-1556** Locate the tabs and bosses



2. Remove two screws (callout 1).

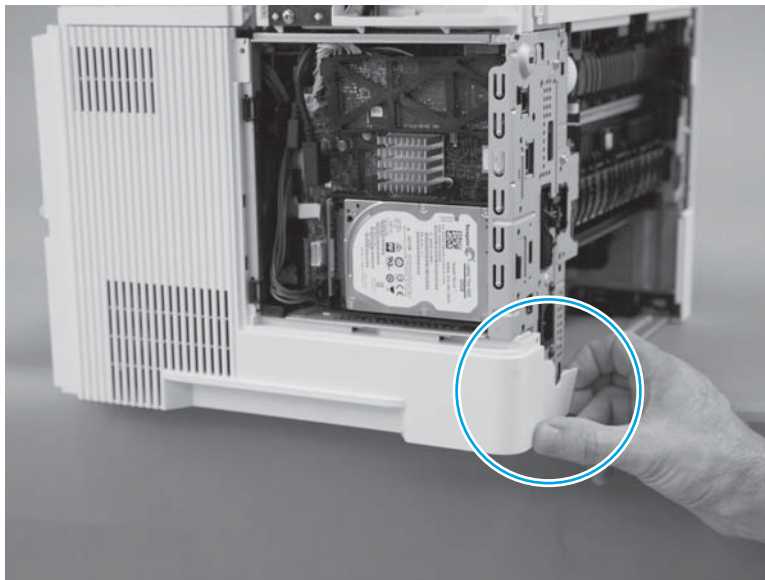
**Figure 1-1557** Remove two screws



3. At the rear of the printer, release one boss.

**⚠ CAUTION:** It might be easier to remove the cover with the printer slightly hanging over the edge of the workspace. Do not let the printer tip and fall off of the workspace when removing the cover.

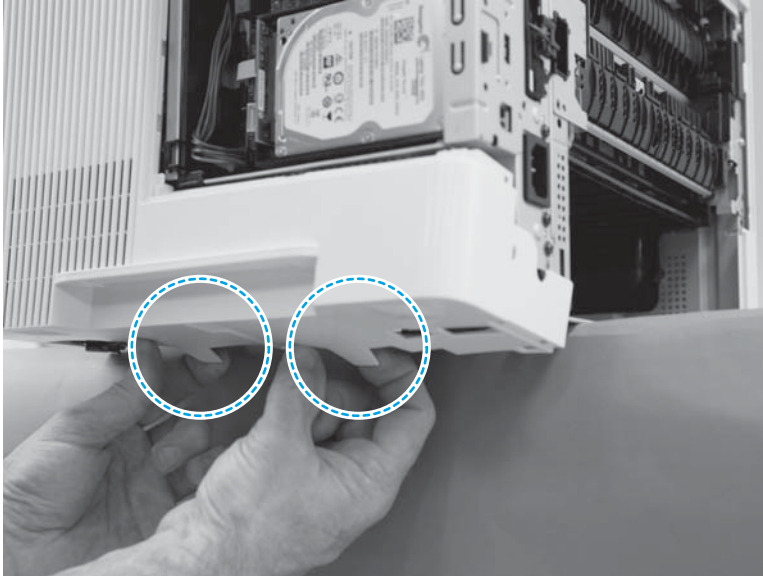
**Figure 1-1558** Release one boss



4. At the bottom edge of the cover, release two bosses.

**CAUTION:** It might be easier to remove the cover with the printer slightly hanging over the edge of the workspace. Do not let the printer tip and fall off the workspace when removing the cover.

**Figure 1-1559** Release two bosses

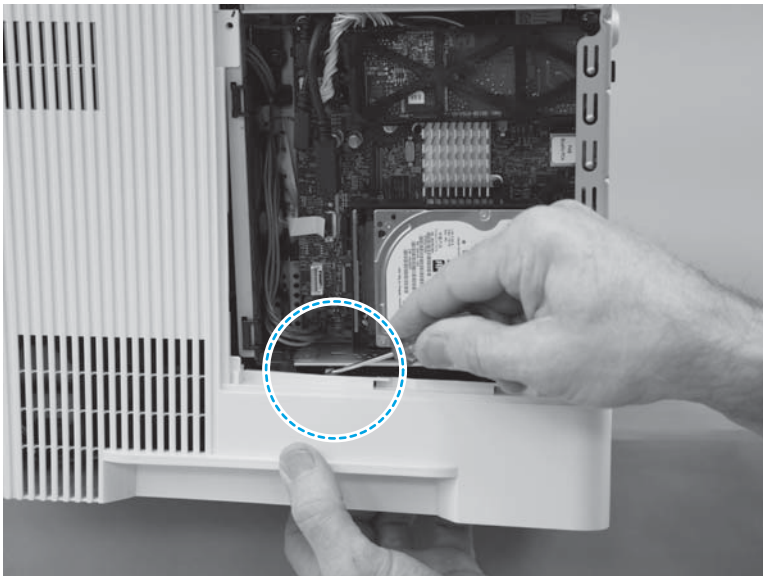


5. Near the formatter, release one tab.

**CAUTION:** It might be easier to remove the cover with the printer slightly hanging over the edge of the workspace. Do not let the printer tip and fall off the workspace when removing the cover.

**TIP:** Hold the bottom of the cover away from the printer, and then use a small flat-blade screw driver to easily release this tab.

**Figure 1-1560** Release one tab

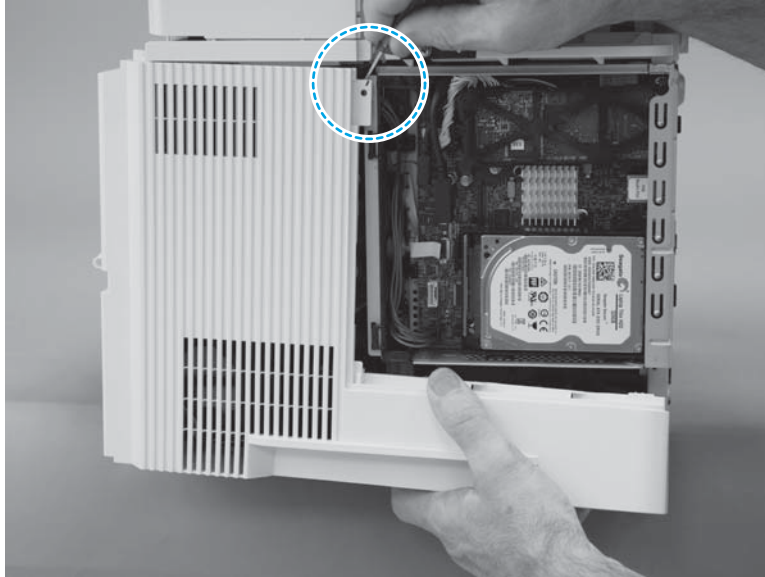


- At the top rear edge of the cover, release one tab.

**CAUTION:** It might be easier to remove the cover with the printer slightly hanging over the edge of the workspace. Do not let the printer tip and fall off of the workspace when removing the cover.

**TIP:** Use a small flat-blade screw driver to easily release this tab.

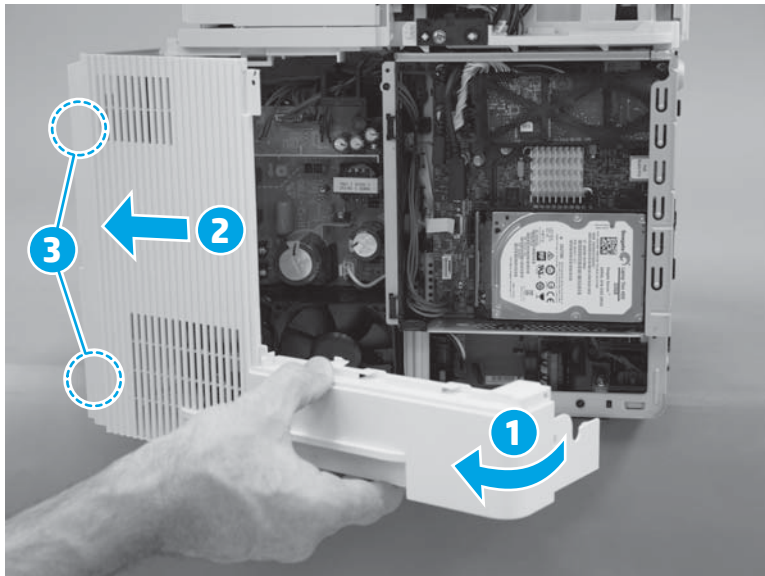
**Figure 1-1561** Release one tab




- Rotate the rear of the cover away from the printer (callout 1), slide the cover toward the front of the printer (callout 2) to release two bosses (callout 3), and then remove the cover.


**CAUTION:** It might be easier to remove the cover with the printer slightly hanging over the edge of the workspace. Do not let the printer tip and fall off of the workspace when removing the cover.

**Figure 1-1562** Remove the cover



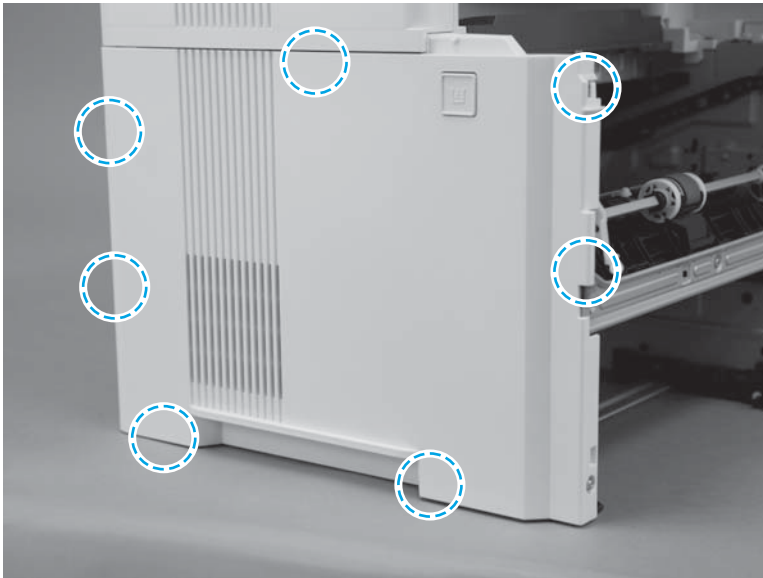
## Step 14: Remove the left cover

 **IMPORTANT:** The black-plastic cassette front and rear guides (located inside the tray cavity) can be easily dislodged. Do not lose the guides when the cover is removed or installed.

 **NOTE:** The M527 printer is shown in this procedure. However, this procedure is valid for the M501/M506 printers.

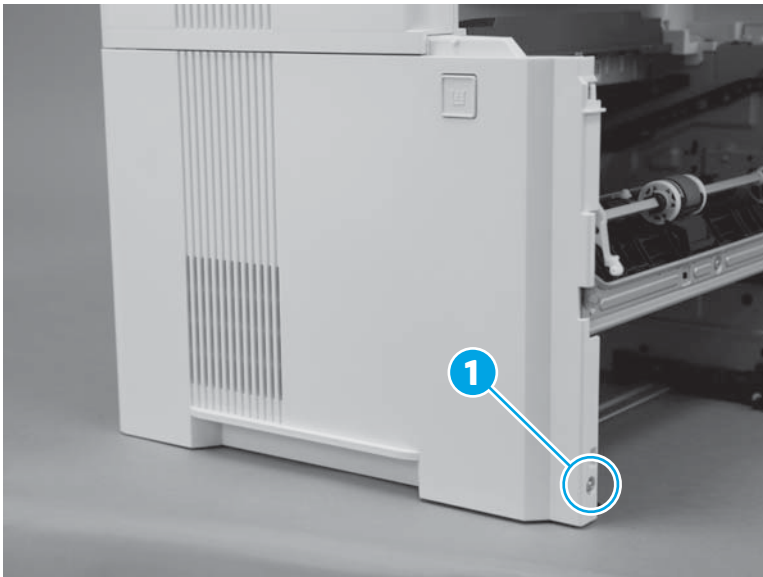
1. Before proceeding, take note of the location of the tabs and bosses on the inside of the cover.

**Figure 1-1563** Locate of the tabs and bosses



2. Remove one screw (callout 1).

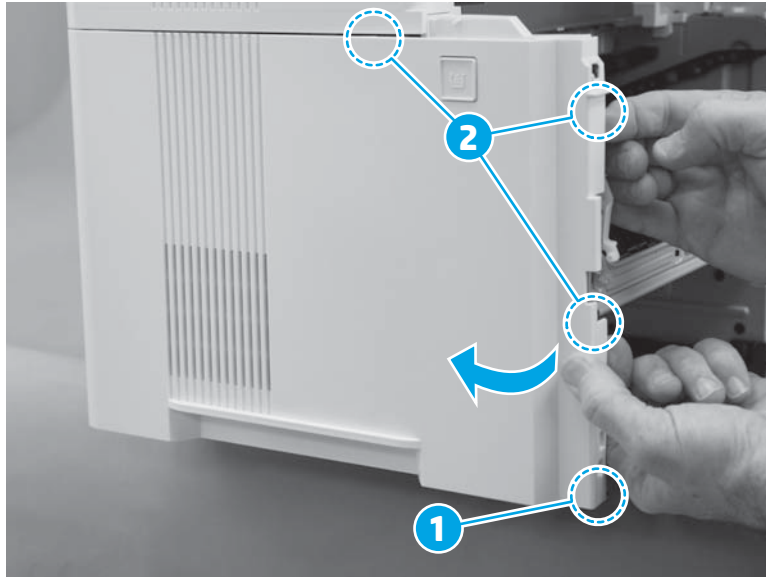
**Figure 1-1564** Remove one screw





3. At the front of the printer, release one boss (callout 1), and then rotate the front edge of the cover away from the printer to release three tabs (callout 2).

**Figure 1-1565** Release one boss and three tabs




4. At the bottom edge of the cover, release two tabs.

**Figure 1-1566** Release two tabs



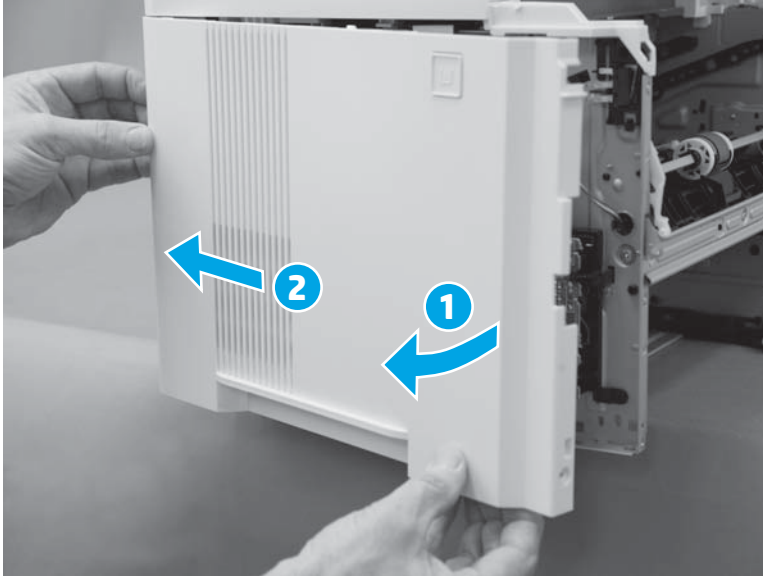
5. Continue to rotate the front edge of the cover away from the printer (callout 1), and then slide the cover toward the rear of the printer (callout 2) to remove it.

---

 **NOTE:** If the cover is difficult to rotate or slide as shown below, make sure that the bottom tabs (released in the previous step) are completely disengaged from the chassis.


---


**Figure 1-1567** Remove the cover




### Step 15: Remove the integrated scanner assembly (M527)

---

 **IMPORTANT:** Some figure might show assemblies removed or installed that have not yet been removed or installed at that specific step. However, the procedures are correct for this printer and the target assembly. Always thoroughly read the instructions that accompany each figure

 **NOTE:** This step is for the M527 printer. For the M501/M506, skip this step and go to [Step 17: Remove the top cover \(M501/M506\) on page 890](#).

---

 **NOTE:** The ISA includes the document feeder, sub-scanner assembly (SSA), and the scanner control board (SCB)

---

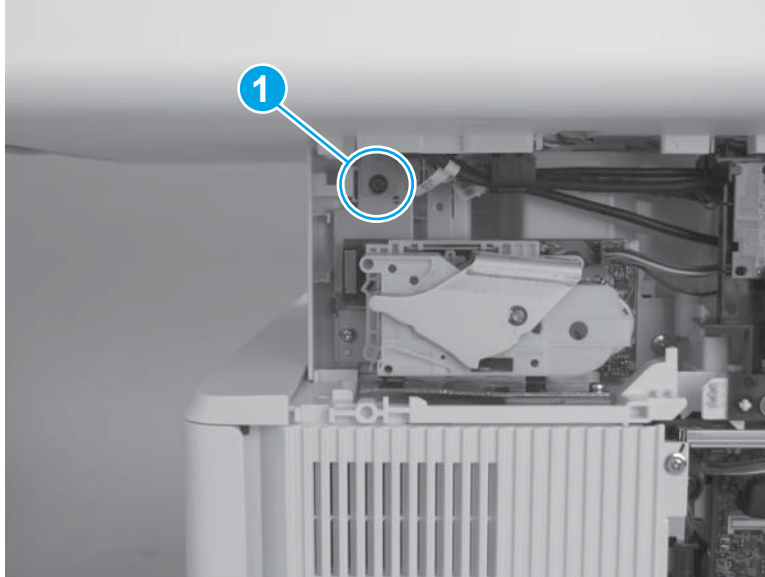
1. Remove one screw (callout 1).

---


 **IMPORTANT:** This screw fastens the ISA ground plate to the printer chassis. Do not lose this screw.


---

**Figure 1-1568** Remove one screw

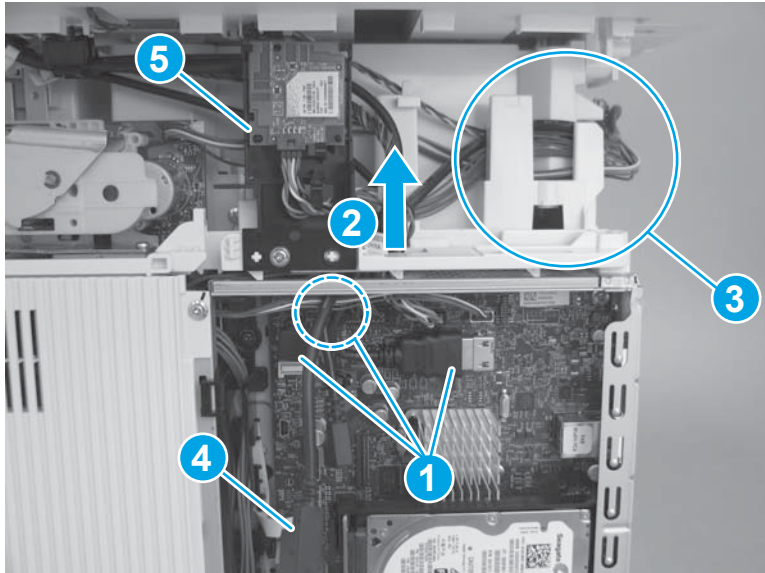


2. Disconnect three connectors (callout 1), pass the wire harnesses and cables through the opening in the cover (callout 2), and then release them from the retainers (callout 3).

 **NOTE:** One cable (callout 4) does not need to pass through the opening in the cover.

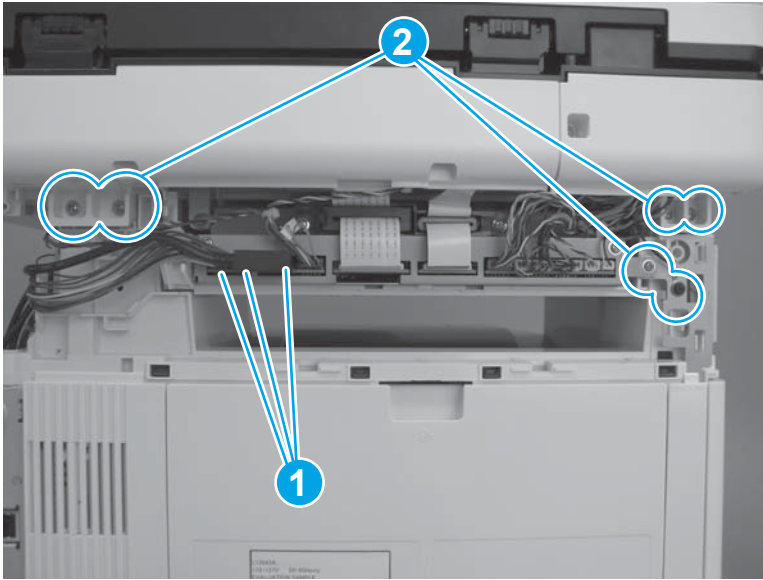
 **TIP:** It might be easier if the WiFi PCA and holder (callout 5) is detached from the printer, and then moved out of the way.

**Figure 1-1569** Disconnect cables and connectors



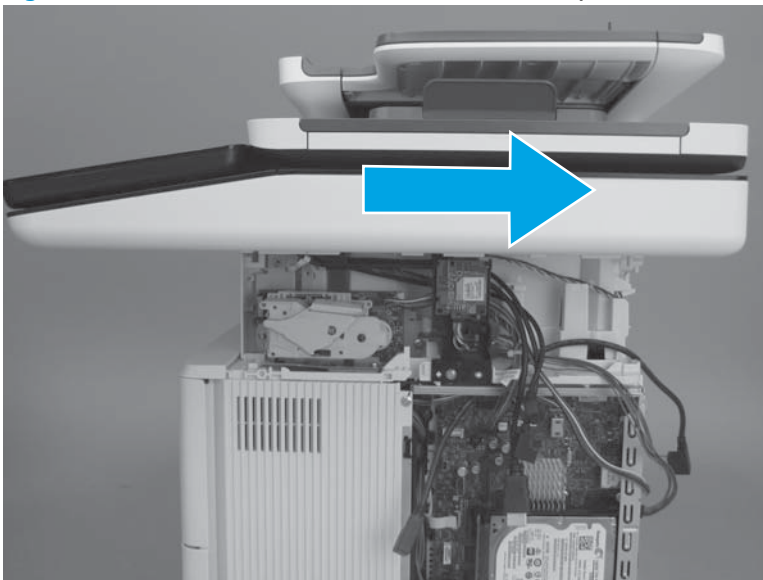
3. Disconnect three connectors (callout 1), and then remove six screws (callout 2).

**Figure 1-1570** Disconnect connectors and remove screws



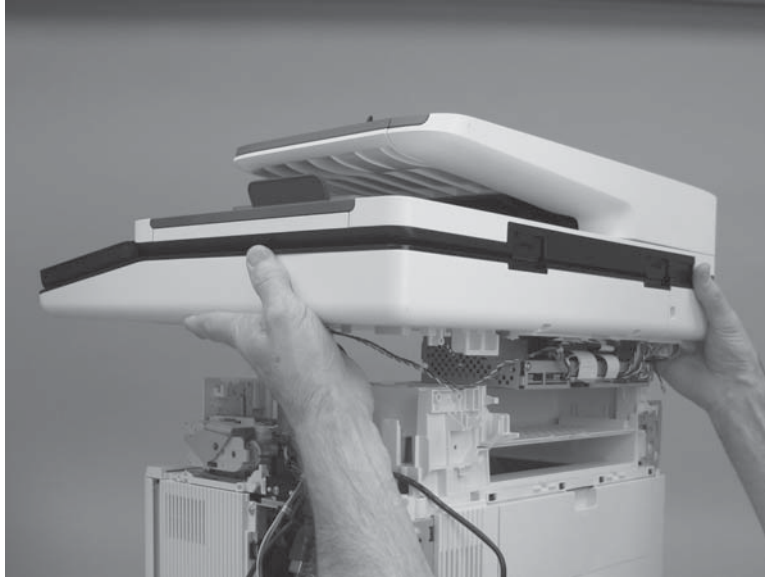
4. Slightly slide the ISA towards the back of the printer to release it.

**Figure 1-1571** Slide the ISA towards the back of the printer




5. Remove the ISA.

**Figure 1-1572** Remove the ISA

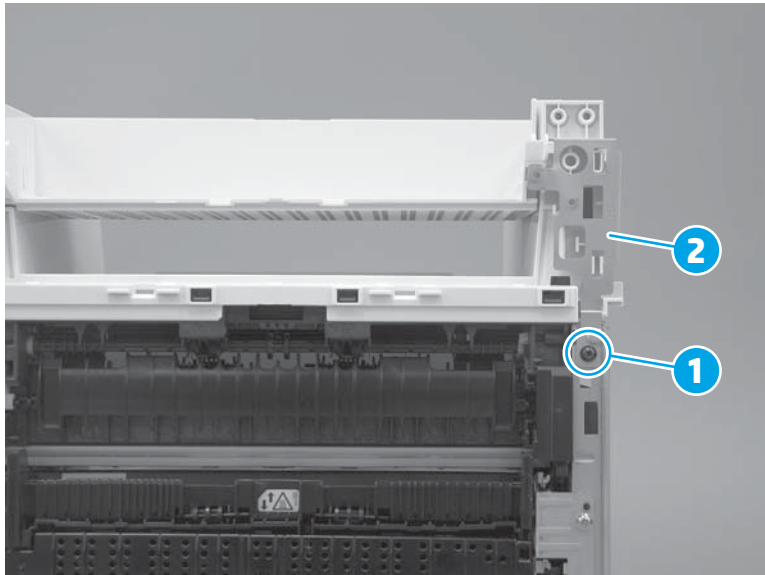


#### Step 16: Remove the top cover (M527)

 **NOTE:** This step is for the M527 printer. For the M501/M506, skip this step and go to [Step 17: Remove the top cover \(M501/M506\) on page 890](#).

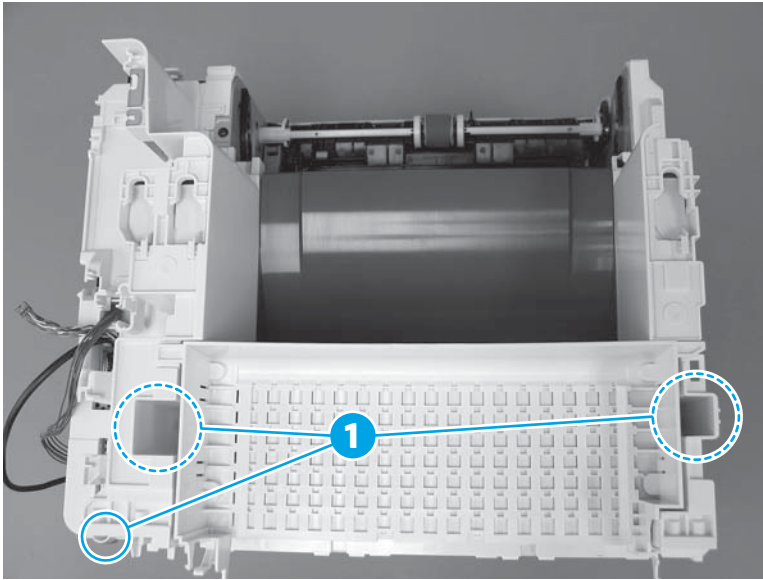
1. At the front right of the printer, remove one screw (callout 1), and then remove the sheet-metal plate (callout 2).

**Figure 1-1573** Remove one screw and the plate




2. At the top rear of the printer, remove three screws (callout 1).

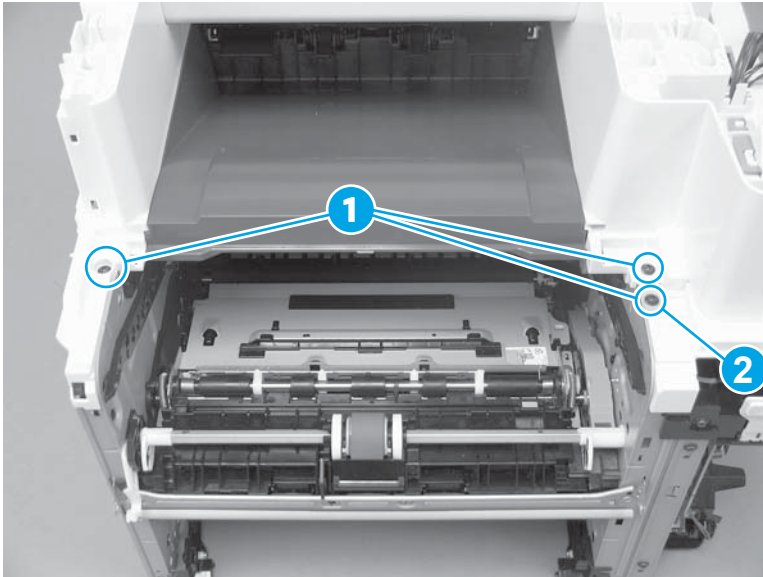
**Figure 1-1574** Remove three screws



3. At the top front of the printer, remove three screws (callout 1).

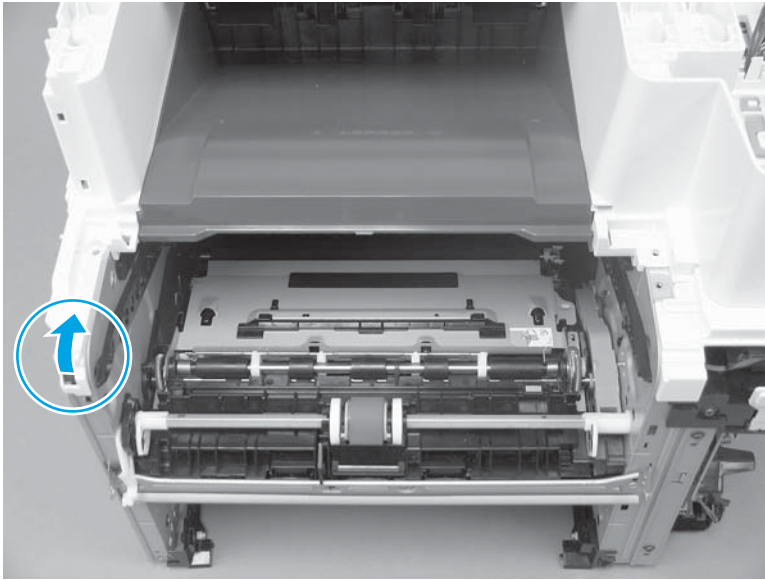
 **NOTE:** The screw (callout 2) on the lower-right portion of the cover is a different color than the other two screws, and is surrounded by sheet-metal. It might appear that this screw does not need to be removed. Remove this screw.

**Figure 1-1575** Remove three screws



4. At the front left of the printer, release one boss.

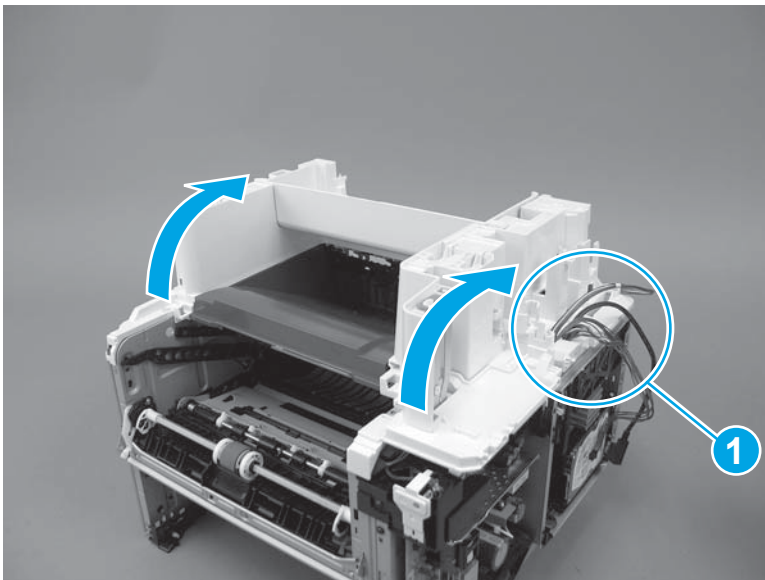
**Figure 1-1576** Release one boss



5. Rotate the front of the cover up and away from the printer.

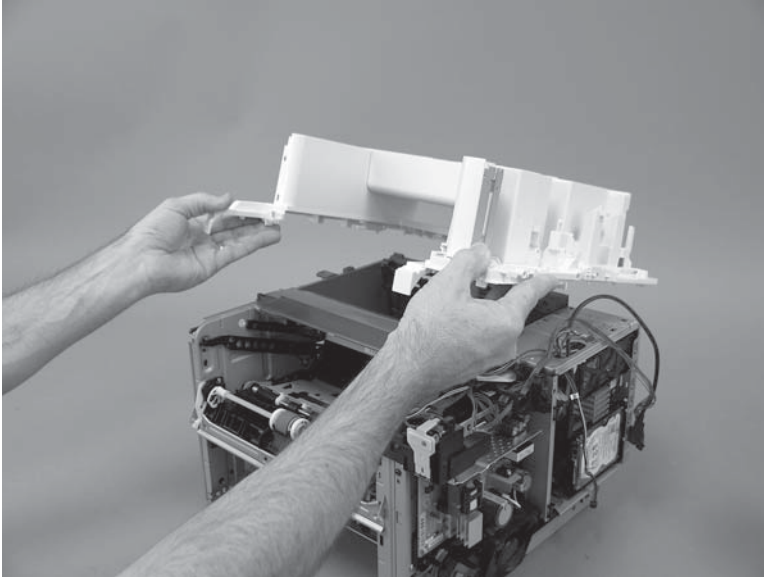
**CAUTION:** As the cover is rotated up, carefully pass the cables and wire harnesses the hole in the cover (callout 1).

**Figure 1-1577** Rotate the front of the cover up



6. Remove the cover.

**Figure 1-1578** Remove the cover



### Step 17: Remove the top cover (M501/M506)

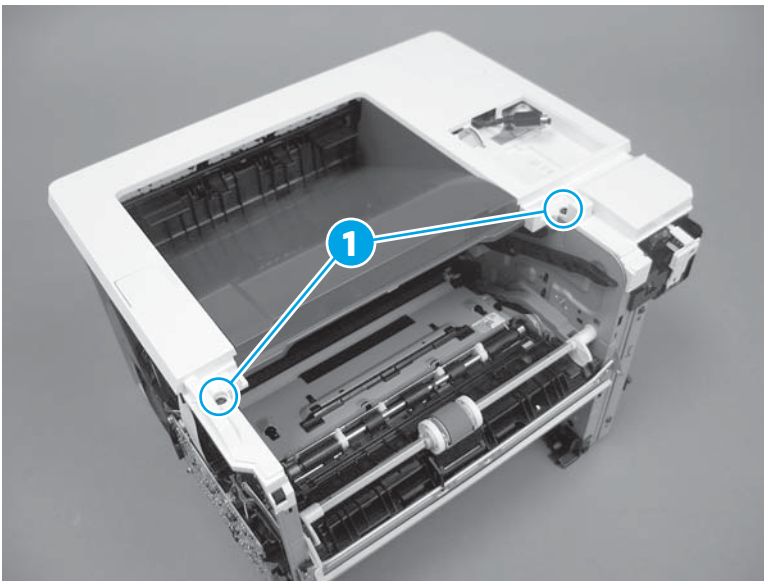


**NOTE:** This step is for the M501/M506 printers. For the M527, skip this step and go to [Step 19: Remove the formatter case on page 893](#).

The M506x is shown in this procedure. However, the steps are correct for all M506 models and the M501 printer.


1. Remove two screws (callout 1).

**Figure 1-1579** Remove two screws

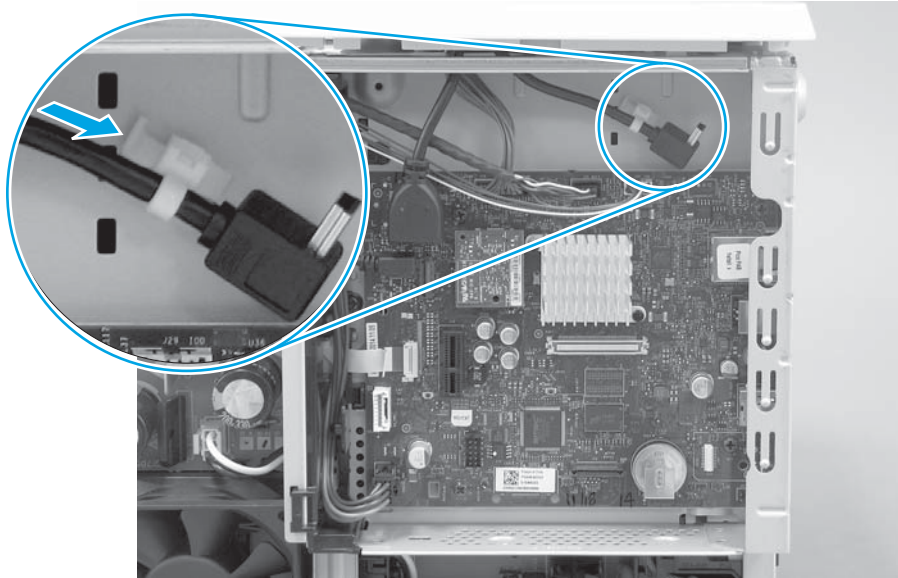




2. **M506 only:** Release one cable retainer from the chassis.

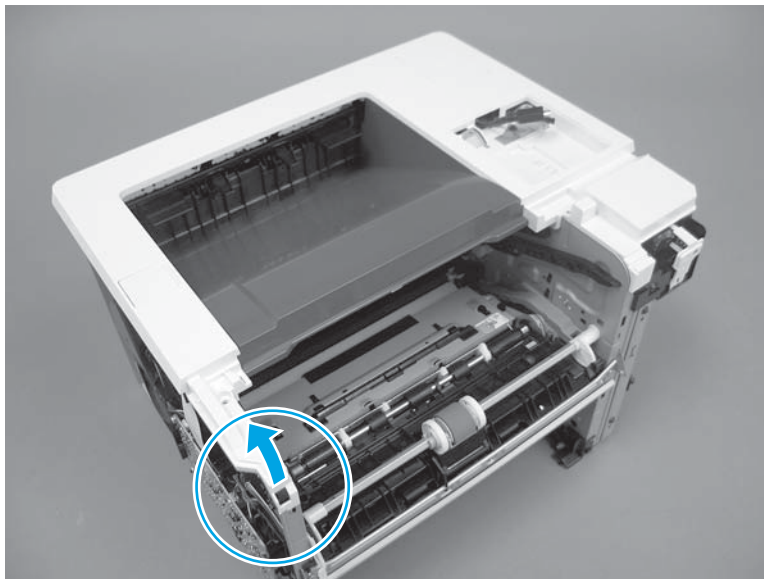
 **TIP:** Depress the tab on the retainer to release it.

**Figure 1-1580** Release one cable retainer



3. Release one boss.

**Figure 1-1581** Release one boss

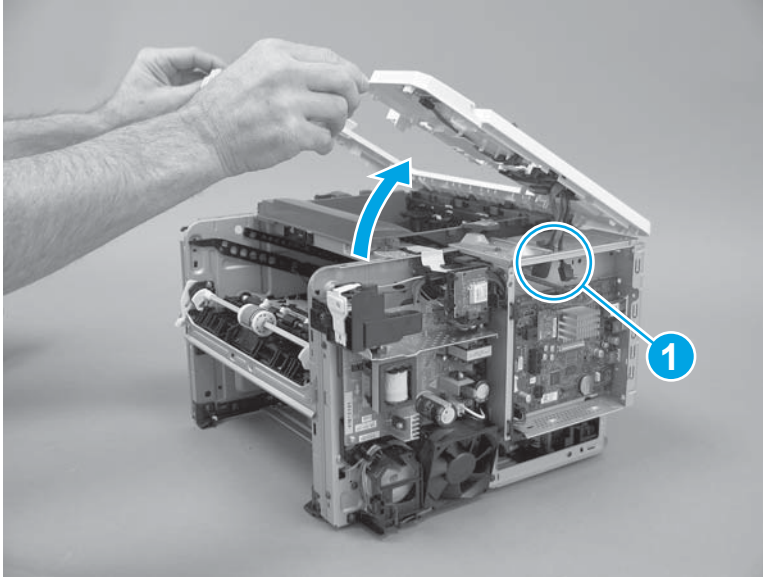


4. Rotate the front of the cover up and away from the printer, and then remove the cover.

**CAUTION:** **M506x only:** As the cover is rotated up, carefully pass the cables the hole in the chassis (callout 1).

**NOTE:** **LCD control panel models only:** Disconnect the control panel before removing the cover.

**Figure 1-1582** Remove the cover

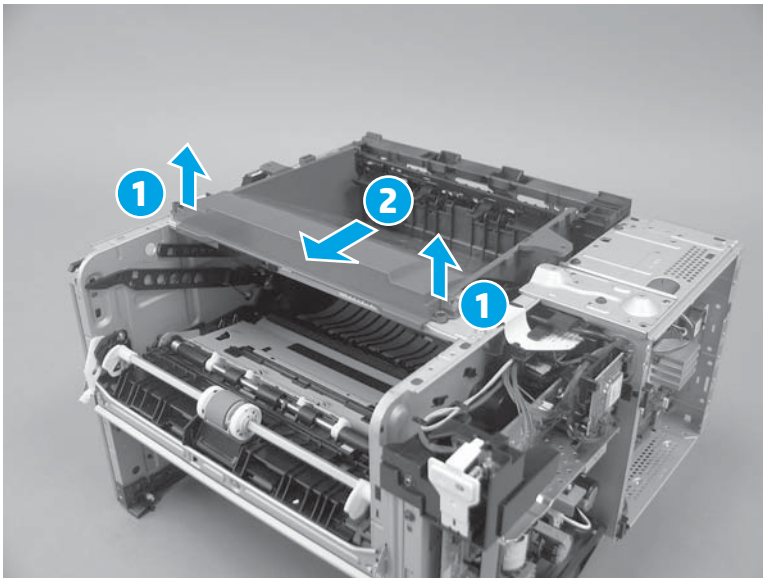


#### Step 18: Remove the paper delivery tray (output bin)

**NOTE:** This procedure shows the M506 printer. However, this procedure is valid for the M527 printer.

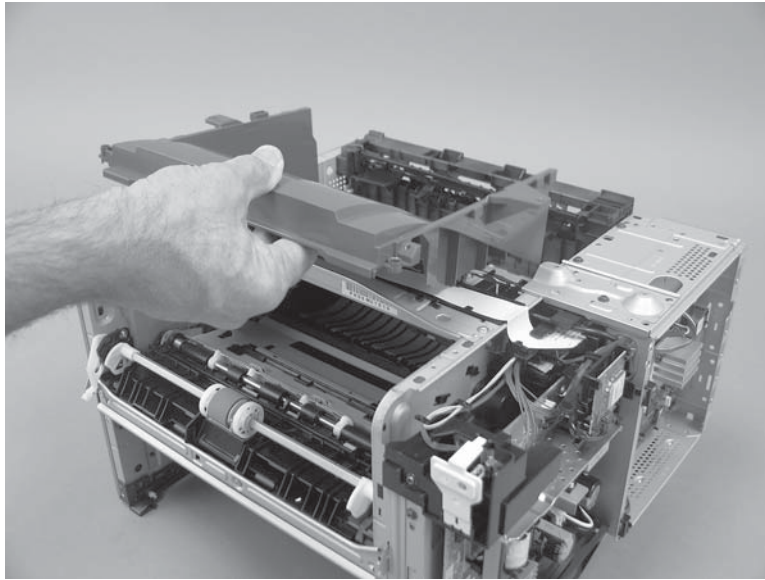
1. Release two tabs (callout 1), and then slide the cover toward the front of the printer (callout 2).

**Figure 1-1583** Release two tabs



2. Remove the bin.

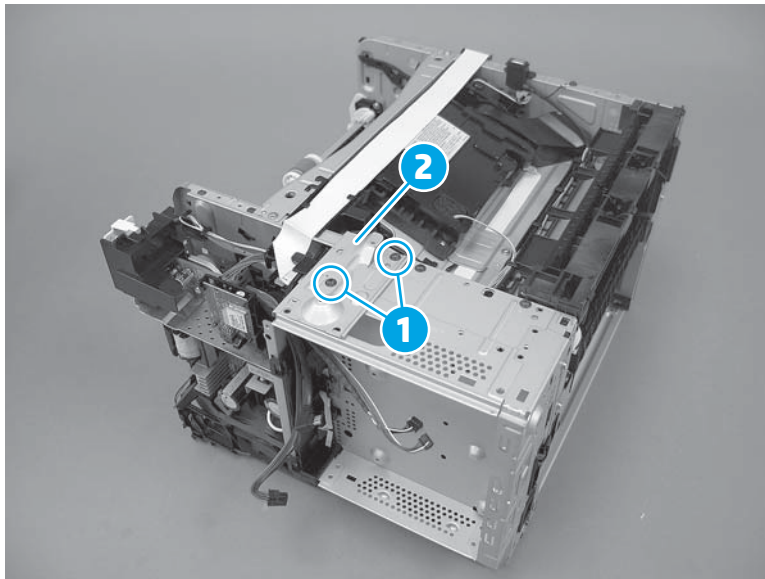
**Figure 1-1584** Remove the bin




#### Step 19: Remove the formatter case

1. **M506 only:** Remove two screws (callout 1), and then remove the sheet-metal plate (callout 2).

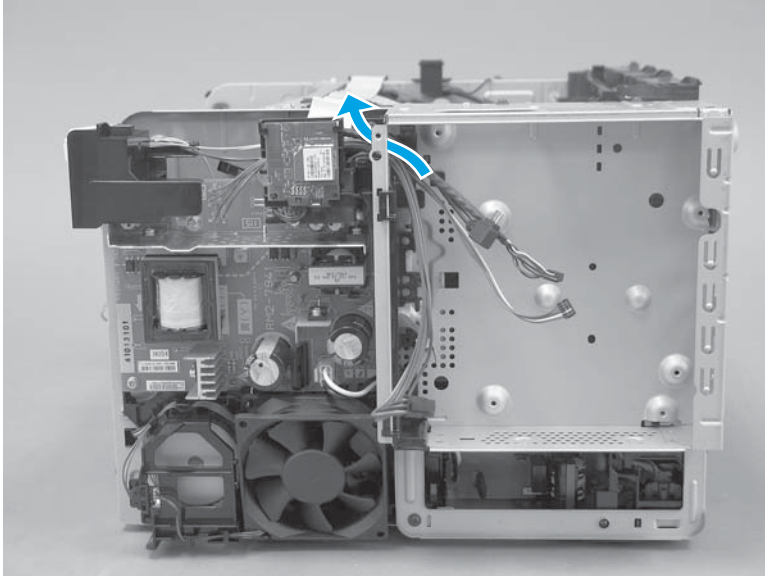
**Figure 1-1585** Remove the sheet-metal plate



- Carefully pass all cables and wire harnesses through the opening in the formatter case.

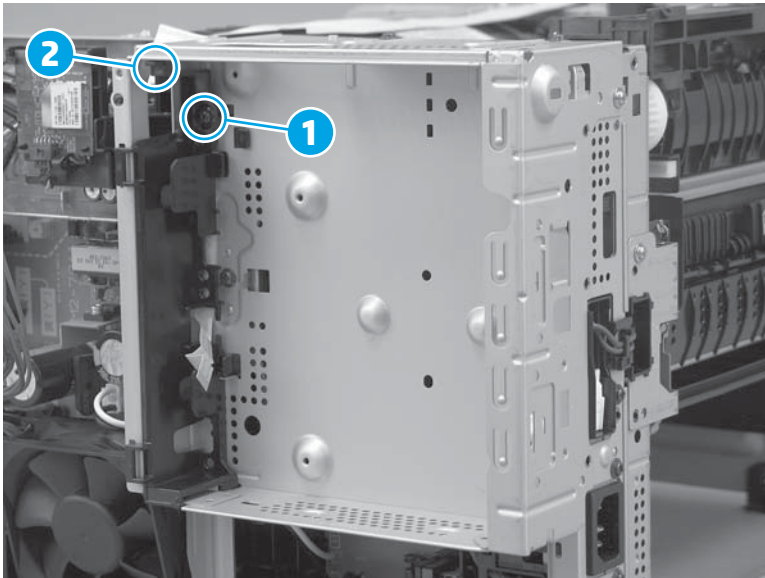
 **NOTE:** The figure below shows the M506 printer. However this step is valid for the M501/M527 printers—there will be a different number of cables and wire harnesses.

**Figure 1-1586** Pass all cables and wire harnesses through the opening



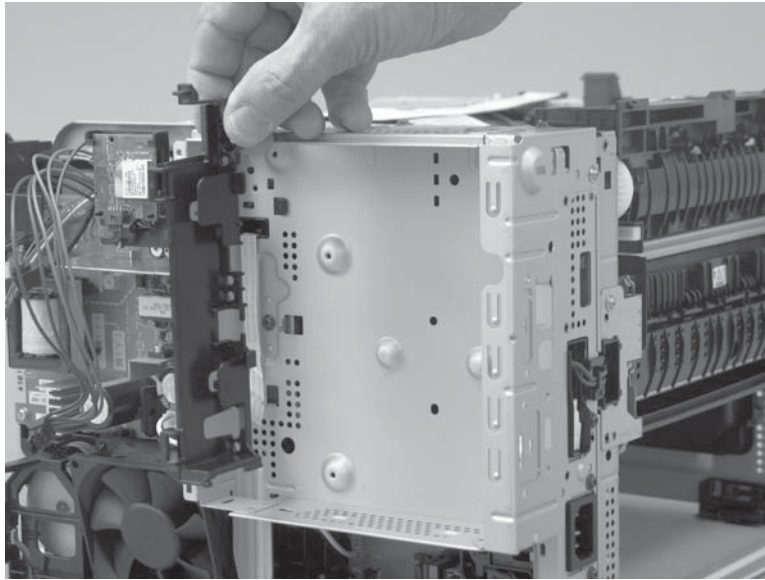
- Remove one screw (callout 1), and then push down on one tab (callout 2) to release it.

**Figure 1-1587** Remove one screw



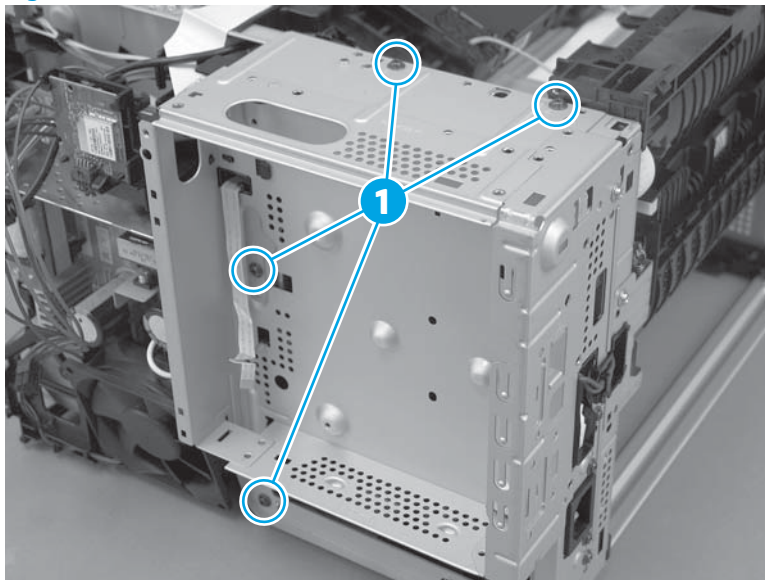
4. Remove the guide.

**Figure 1-1588** Remove the guide



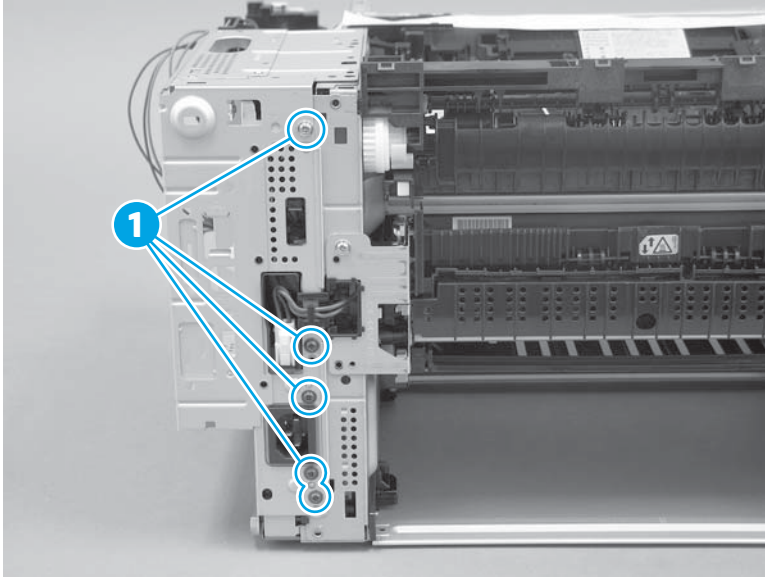
5. Remove four screws (callout 1).

**Figure 1-1589** Remove four screws



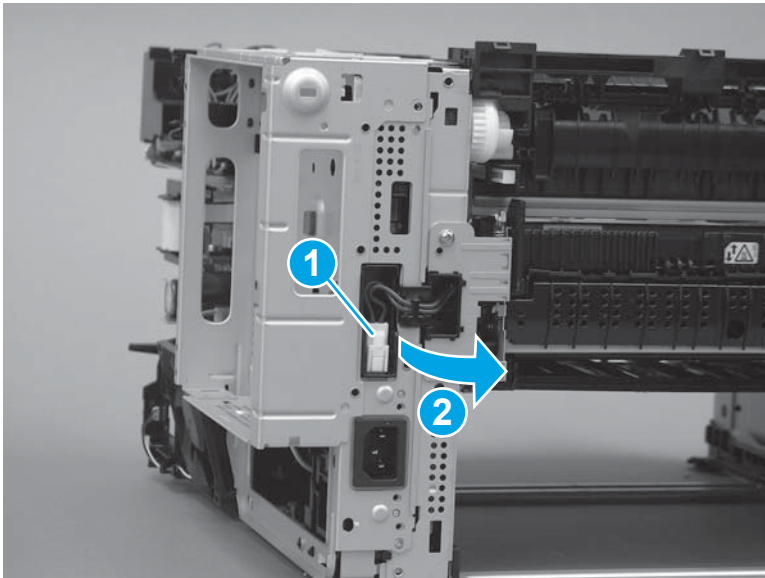
6. Remove five screws (callout 1).

**Figure 1-1590** Remove five screws



7. Disconnect one connector (callout 1), and then move the guide out of the way (callout 2).

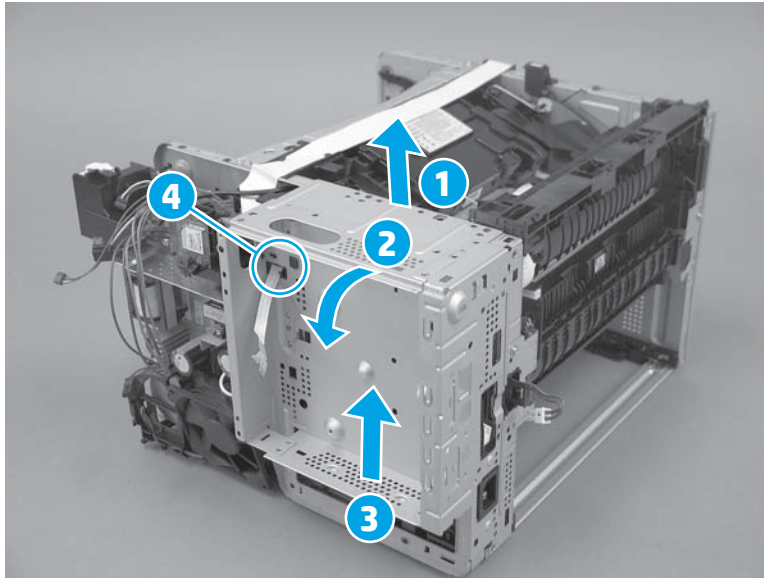
**Figure 1-1591** Disconnect one connector



8. Slightly lift up the formatter case (callout 1), rotate the top of the case away from the chassis (callout 2), and then lift up the case to release it (callout 3).

**CAUTION:** Pass the FFC through the opening (callout 4) in the formatter while removing the case.

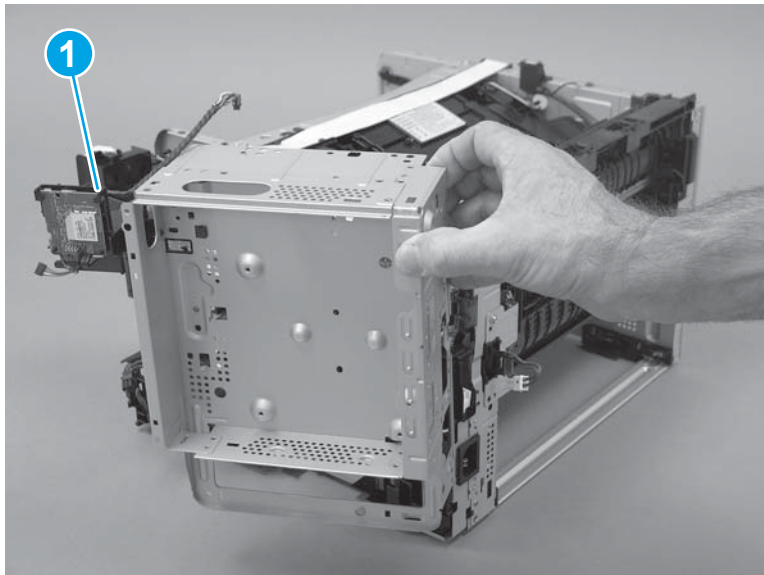
**Figure 1-1592** Release the formatter case



9. Remove the formatter case.

**NOTE:** **M506 only:** If the formatter case is being replaced, make sure that the WiFi PCA and bracket (callout 1) are transferred to the replacement case.

**Figure 1-1593** Remove the formatter case

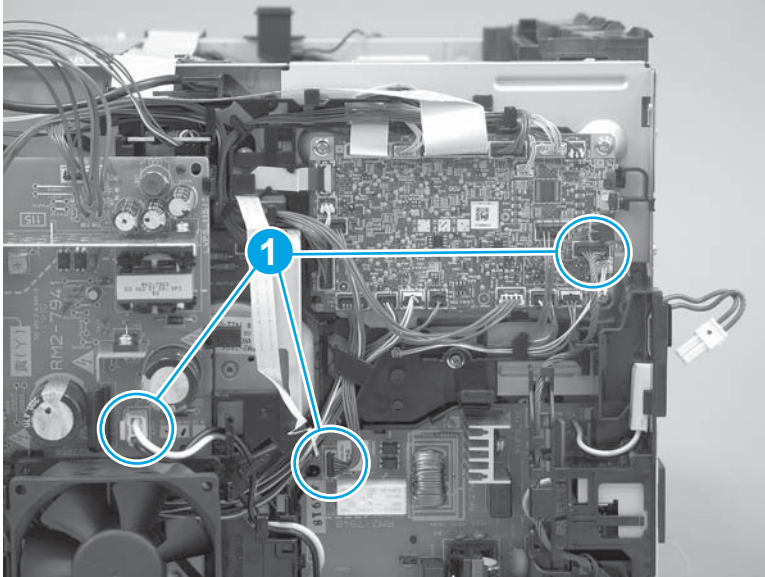


## Step 20: Remove the fuser power supply (FPS)

**TIP:** The FPS includes the optional paper feeder connector (Jetlink accessory tray connector).

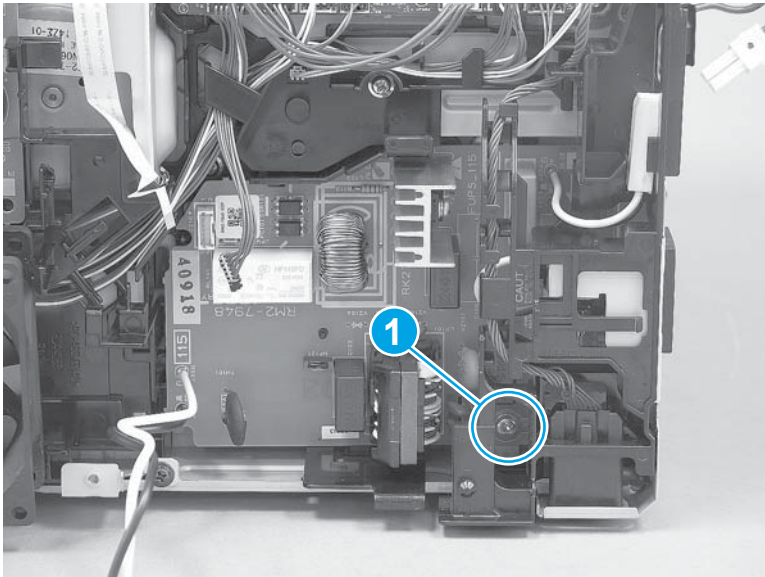
1. Disconnect three connectors (callout 1).

**Figure 1-1594** Disconnect three connectors



2. Remove one screw (callout 1).

**Figure 1-1595** Remove one screw

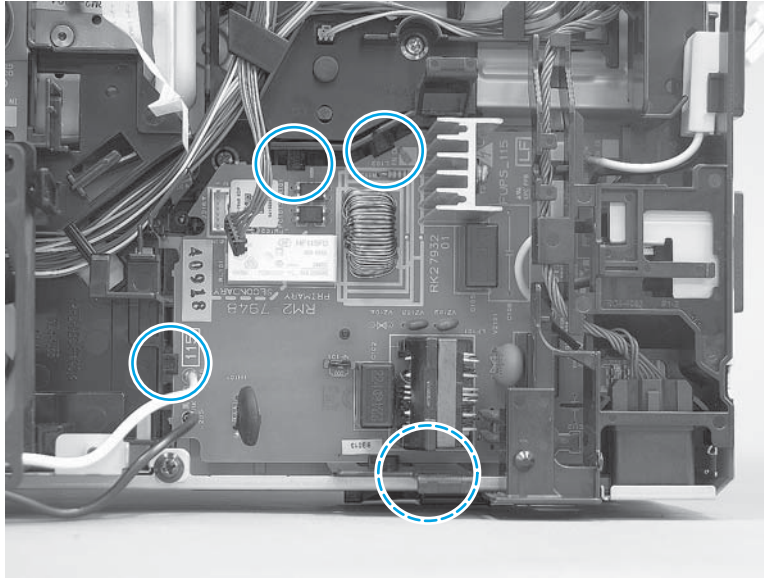




3. Release four tabs.

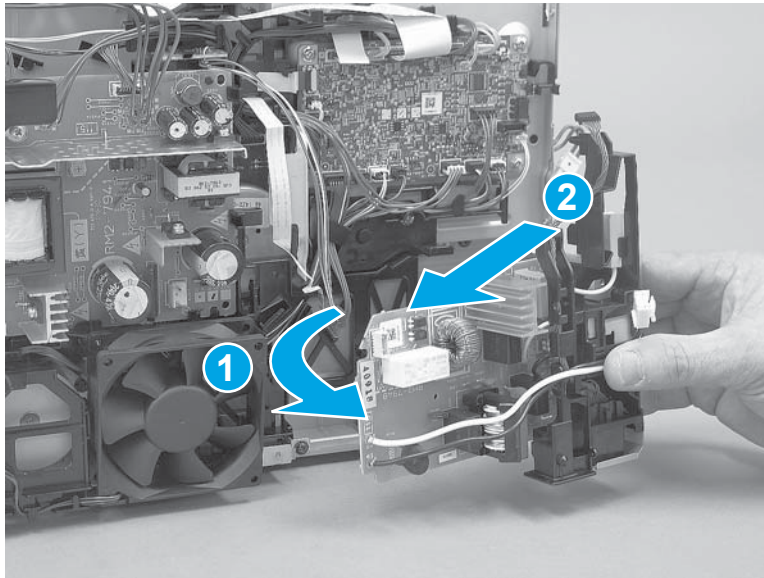
 **TIP:** It might be easier to release the upper two tabs by using a small flat-blad screw driver.

**Figure 1-1596** Release four tabs



4. Rotate the left end of the assembly out and away from the printer (callout 1), slide the assembly to the left to release the right side alignment pins (callout 2), and then remove the assembly.

**Figure 1-1597** Remove the assembly



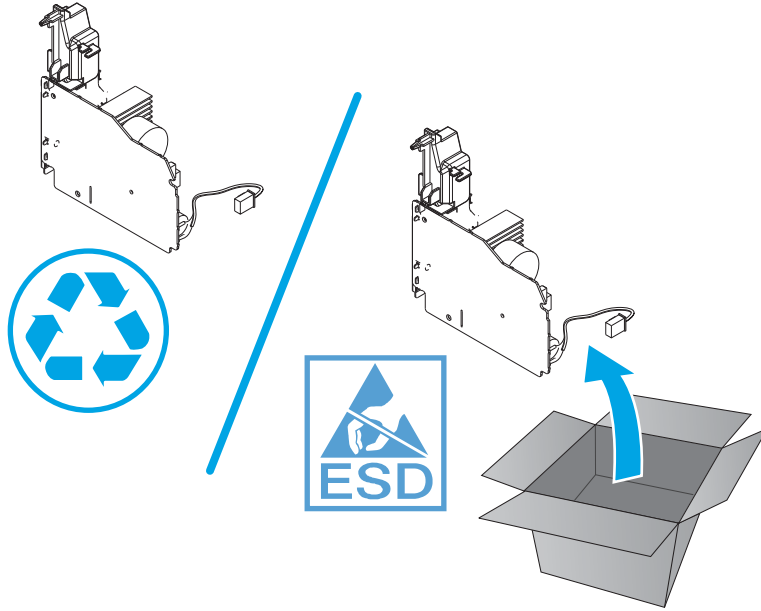
### Step 21: Unpack the replacement power supply

Unpack the replacement part from the packaging.


<http://www8.hp.com/us/en/hp-information/environment/product-recycling.html>

 **NOTE:** HP recommends responsible disposal of the defective part.

**Figure 1-1598** Recycle and unpack

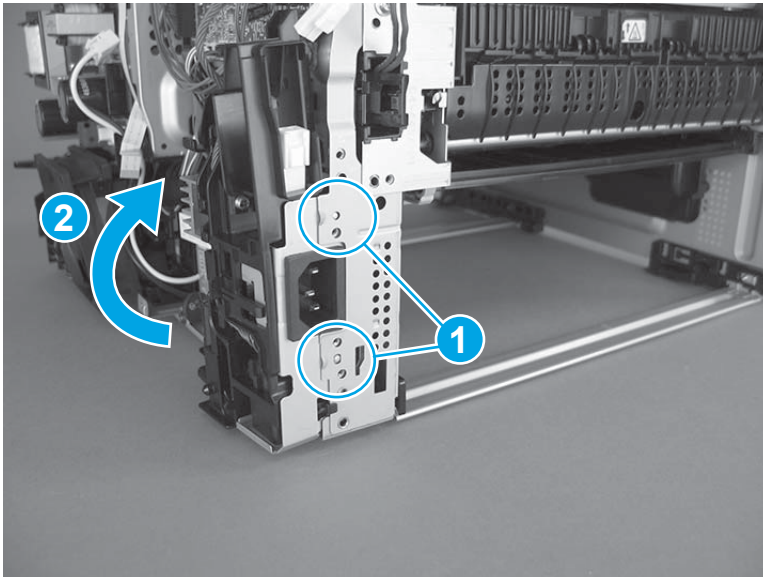


**Step 22: Install the fuser power supply (FPS)**

 **TIP:** The FPS includes the optional paper feeder connector.

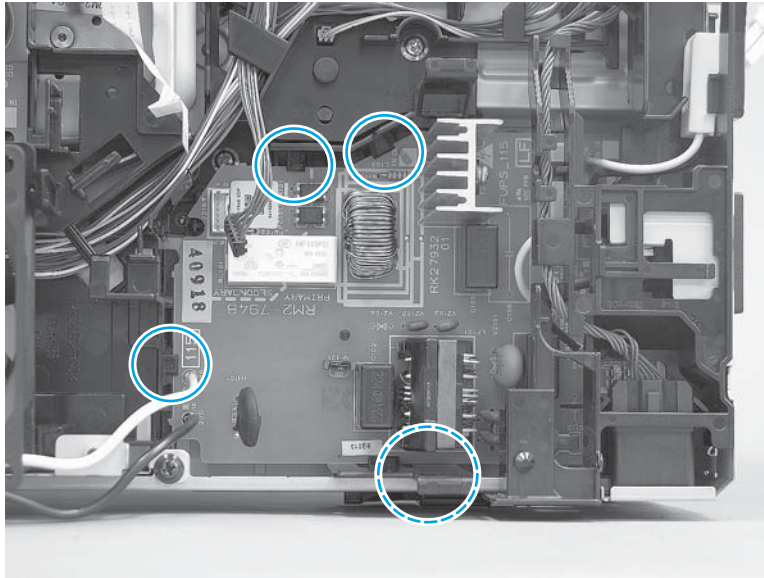
1. Position the alignment pins on the assembly in the holes in the chassis (callout 1), and then rotate the left end of the assembly into the printer (callout 2).

**Figure 1-1599** Install the assembly



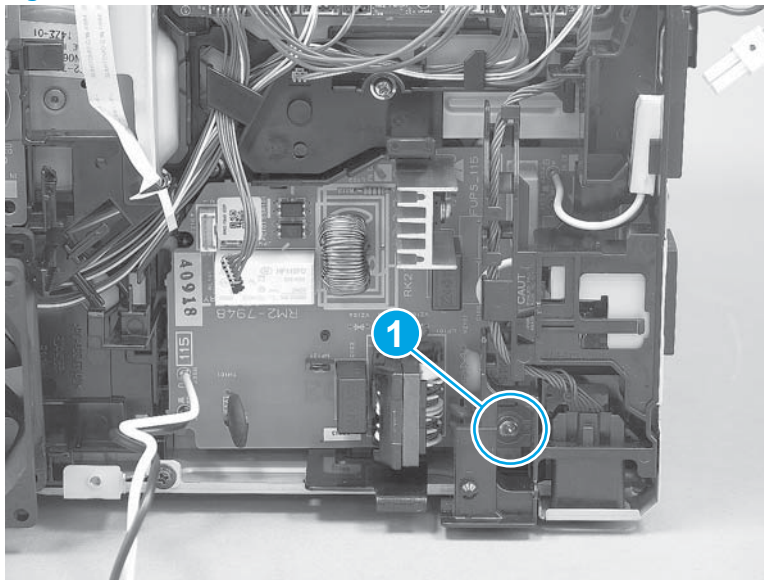
2. Engage four tabs.

**Figure 1-1600** Engage four tabs



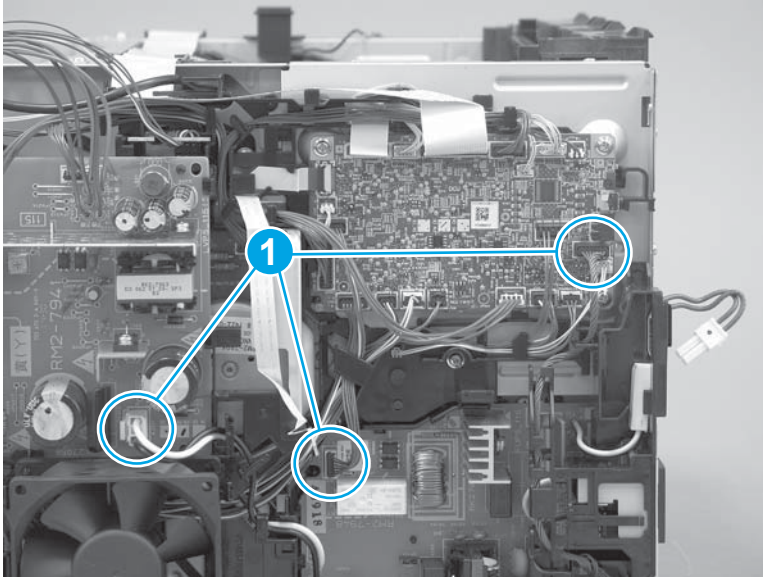
3. Install one screw (callout 1).

**Figure 1-1601** Install one screw




4. Connect three connectors (callout 1).

**Figure 1-1602** Connect three connectors

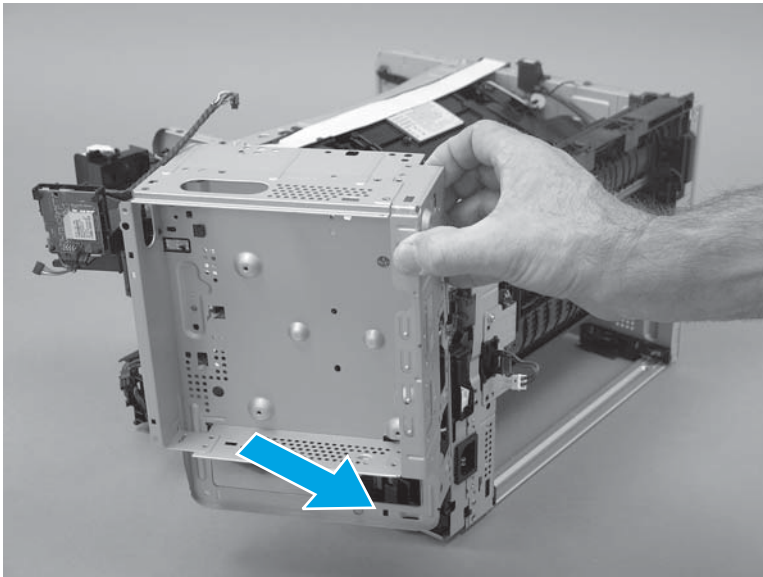


### Step 23: Install the formatter case

1. Position the bottom edge of the formatter case against the chassis.

 **NOTE: M506 only:** If the formatter case is being replaced, make sure that the WiFi PCA and bracket (callout 1) are transferred to the replacement case.

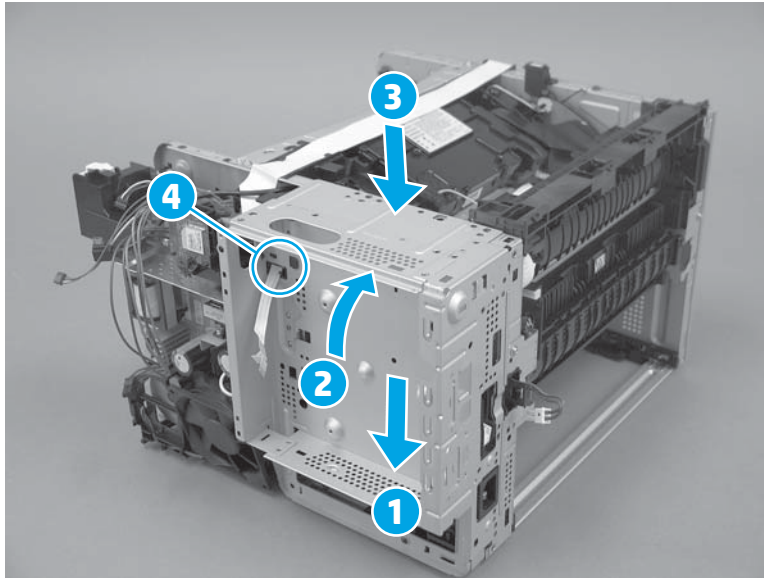
**Figure 1-1603** Position the formatter case against the chassis



2. With the bottom of the formatter case against the chassis (callout 1), rotate the top of the case toward the chassis (callout 2), and slide the case down into place to install it (callout 3).

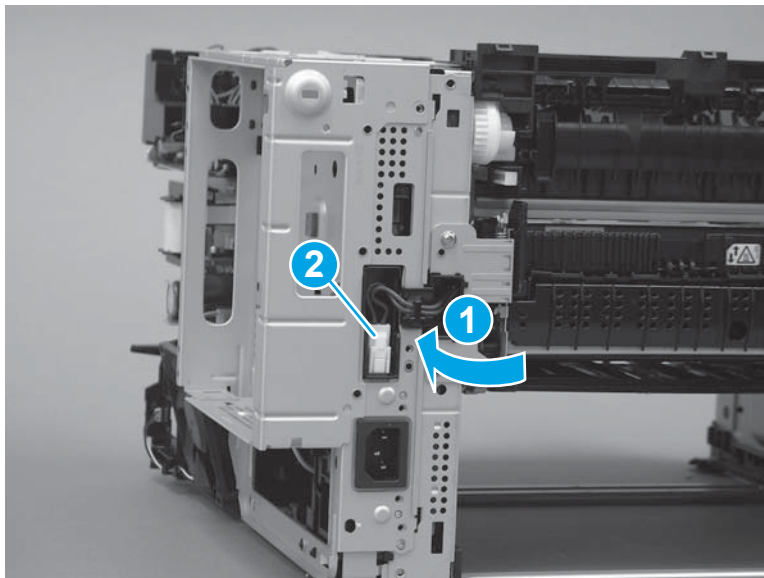
**CAUTION:** Pass the FFC through the opening (callout 4) in the formatter while installing the case.

**Figure 1-1604** Install the formatter case



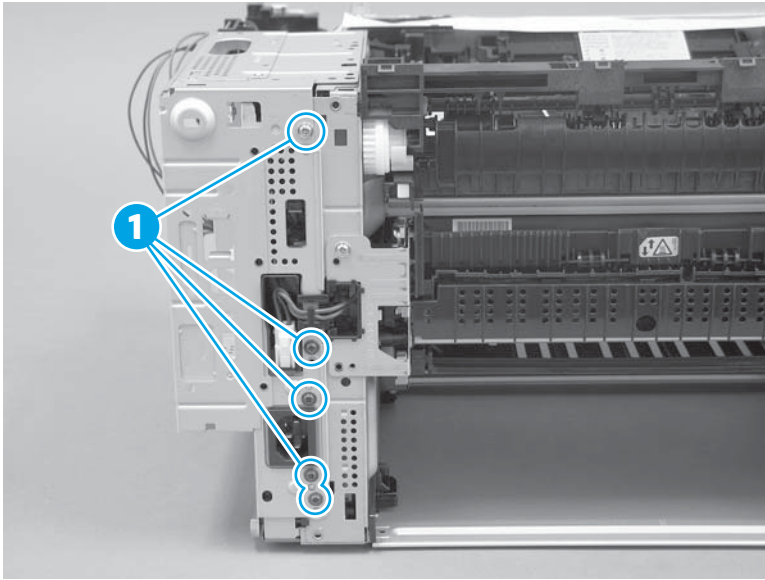
3. Reposition the guide (callout 1), and then connect one connector (callout 2).

**Figure 1-1605** Connect one connector



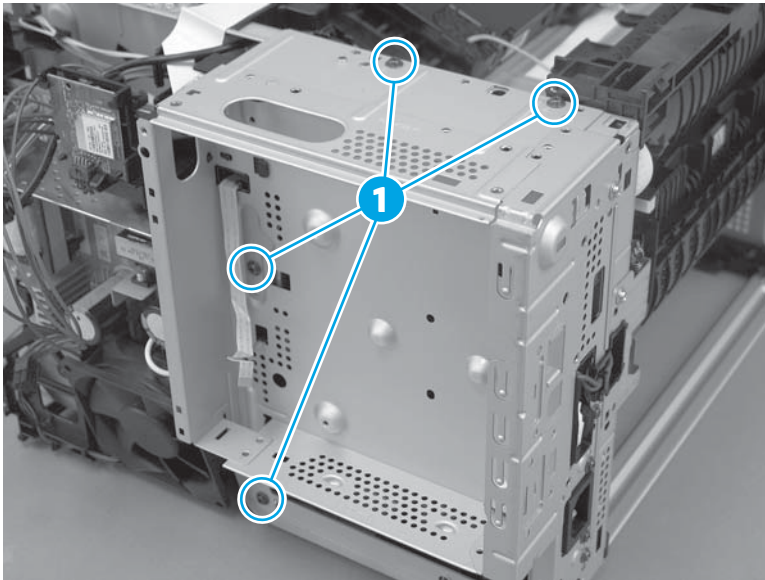
4. Install five screws (callout 1).

**Figure 1-1606** Install five screws



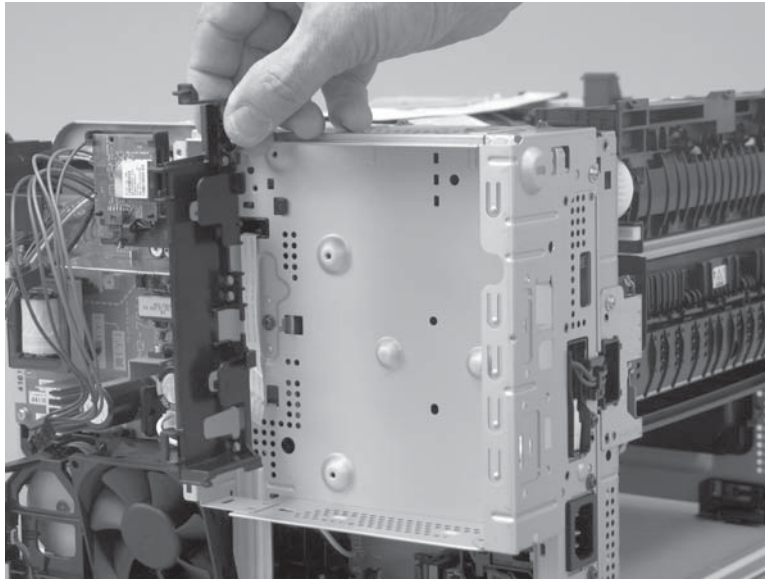
5. Install four screws (callout 1).

**Figure 1-1607** Install four screws




6. Install the guide.

**Figure 1-1608** Install the guide



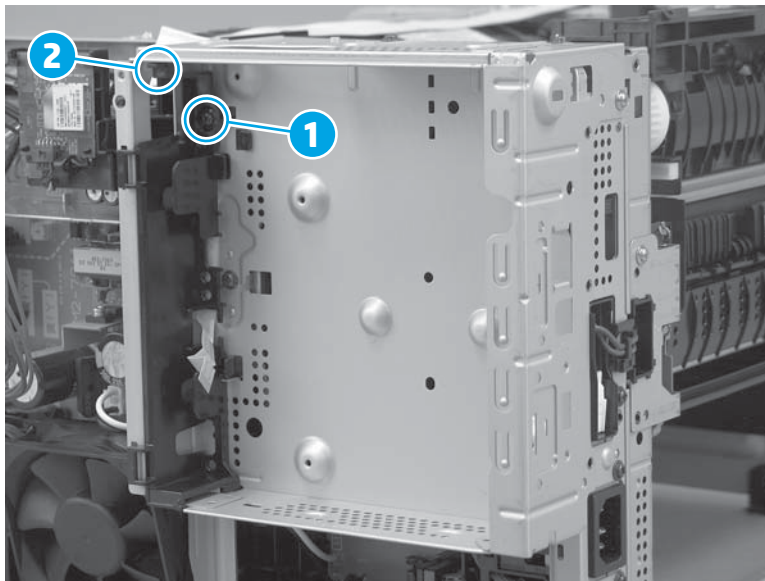
7. Install one screw (callout 1).

---


 **NOTE:** Make sure that the tab (callout 2) is engaged.

---

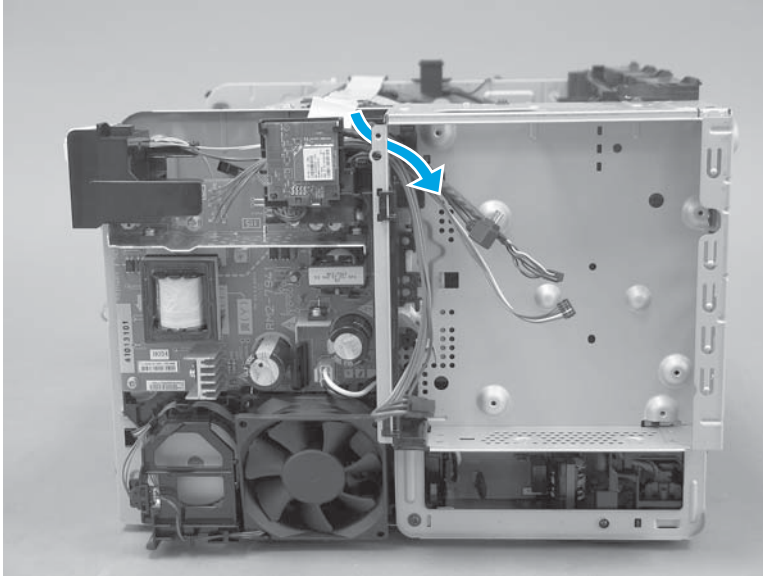
**Figure 1-1609** Install one screw



- Carefully pass all cables and wire harnesses through the opening in the formatter case.

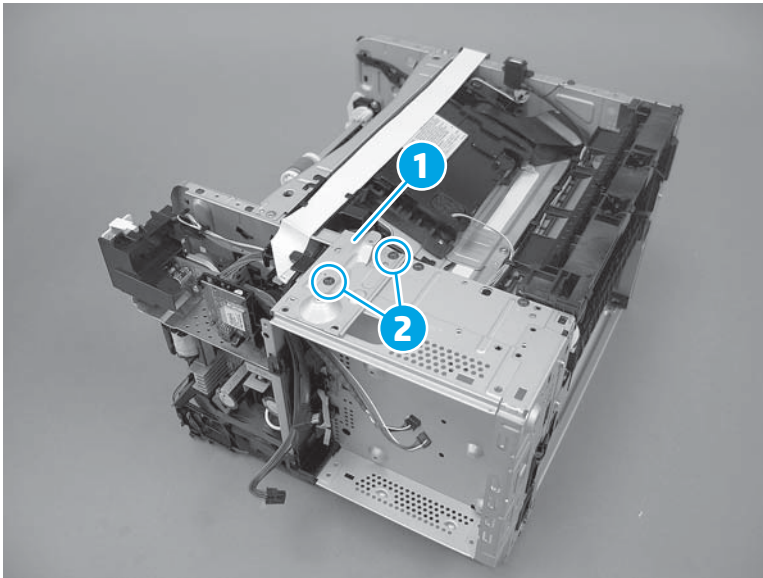
 **NOTE:** The figure below shows the M506 printer. However this step is valid for the M501/M527 printers—there will be a different number of cables and wire harnesses.

**Figure 1-1610** Pass all cables and wire harnesses through the opening




- M506 only:** Install the sheet-metal plate (callout 1), and then install two screws (callout 2).

**Figure 1-1611** Remove the sheet-metal plate



#### Step 24: Install the paper delivery tray (output bin)

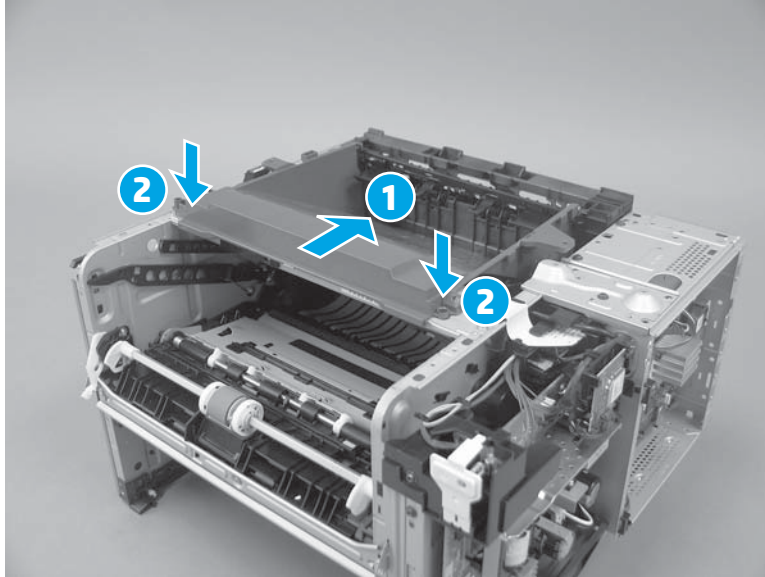
 **NOTE:** This procedure shows the M506 printer. However, this procedure is valid for the M527 printer.

- Position the bin on the printer (callout 1), and then push down to engage two tabs (callout 2).


 **NOTE:** Position the tabs along the rear edge of the bin on the printer in the slots in the chassis.



**Figure 1-1612** Install the bin




### Step 25: Install the top cover (M501/M506)

 **NOTE:** This step is for the M501/M506 printers. For the M527, skip this step and go to [Step 26: Install the top cover \(M527\) on page 909](#).

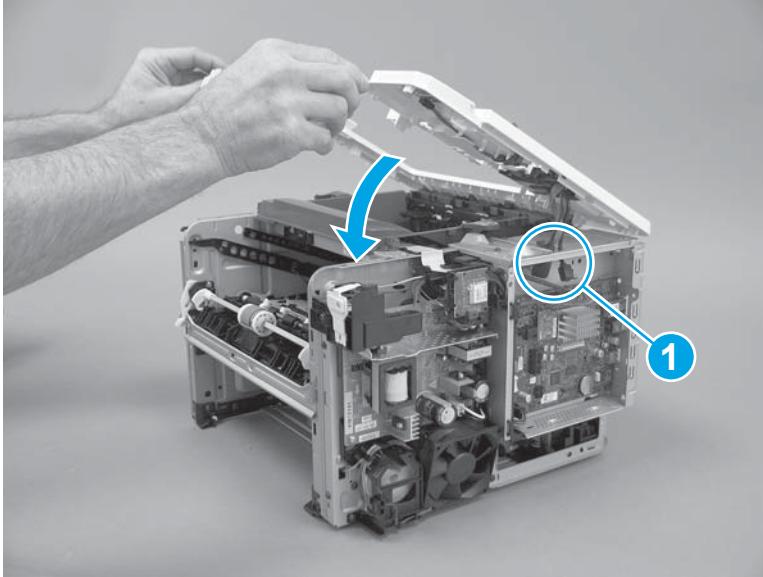
The M506x is shown in this procedure. However, the steps are correct for all M506 models and the M501 printer.

1. Position the rear edge of the cover on the printer, and then rotate the front of the cover down onto the printer.

 **CAUTION: M506x only:** As the cover is rotated down, carefully pass the cables the hole in the chassis (callout 1).

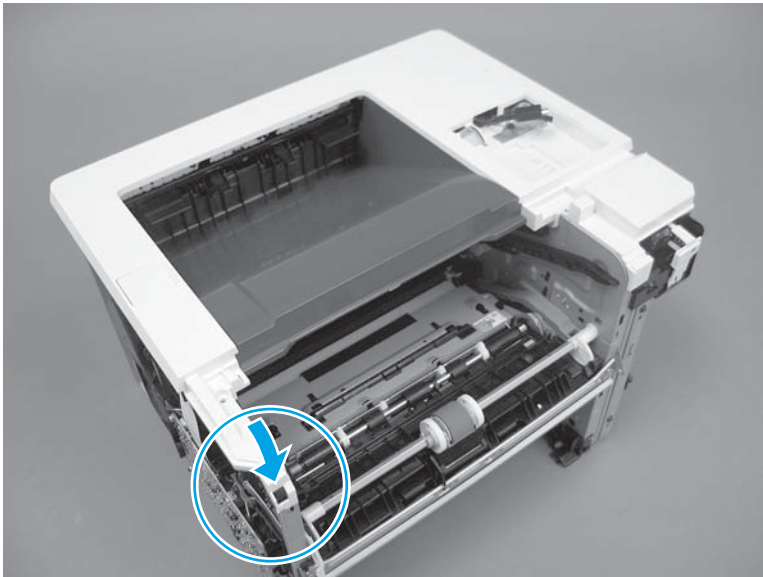
 **NOTE: LCD control panel models only:** Pass the cables through the opening in the cover, and then connect the control panel after installing the cover.

**Figure 1-1613** Install the cover




2. Engage one boss.

**Figure 1-1614** Engage one boss



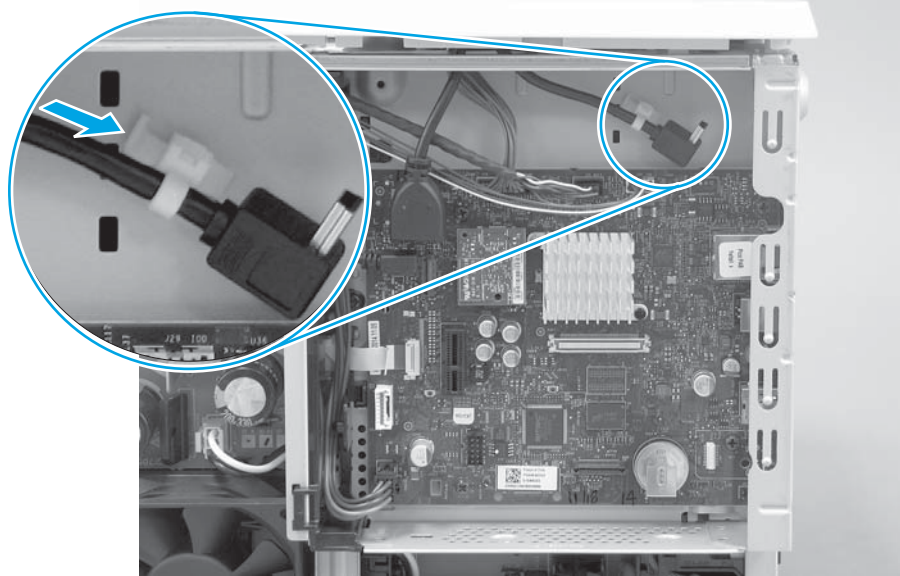
- M506 only:** Install one cable retainer on the chassis.

---

 **TIP:** Depress the tab on the retainer to install it.

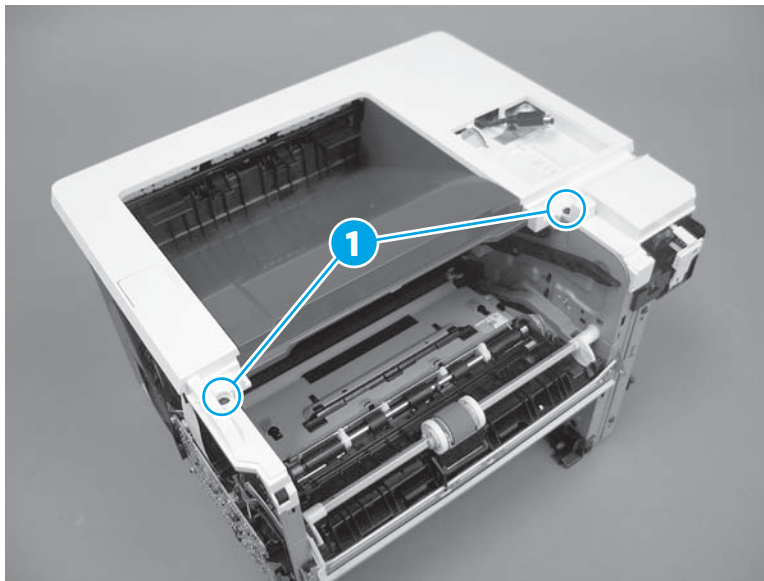
---

**Figure 1-1615** Install one cable retainer




- Install two screws (callout 1).

**Figure 1-1616** Install two screws



### Step 26: Install the top cover (M527)

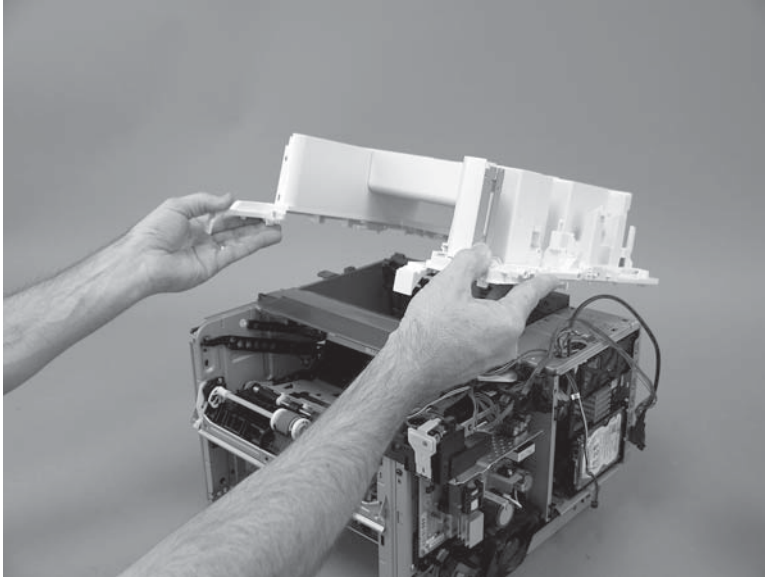
---

 **NOTE:** This step is for the M527 printer. For the M506/M506, skip this step and go to [Step 28: Install the left cover on page 916](#).

---

- Position the rear edge of the cover on the chassis.

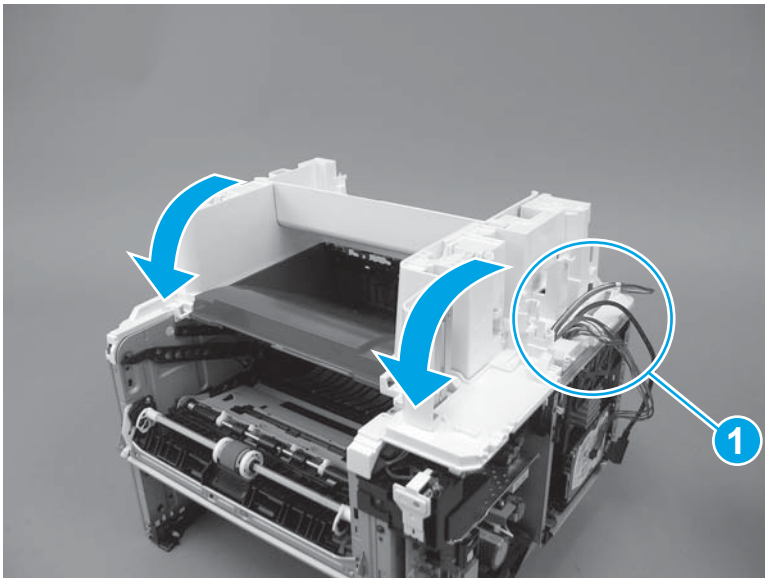
**Figure 1-1617** Install the cover



2. Rotate the front of the cover down onto the printer.

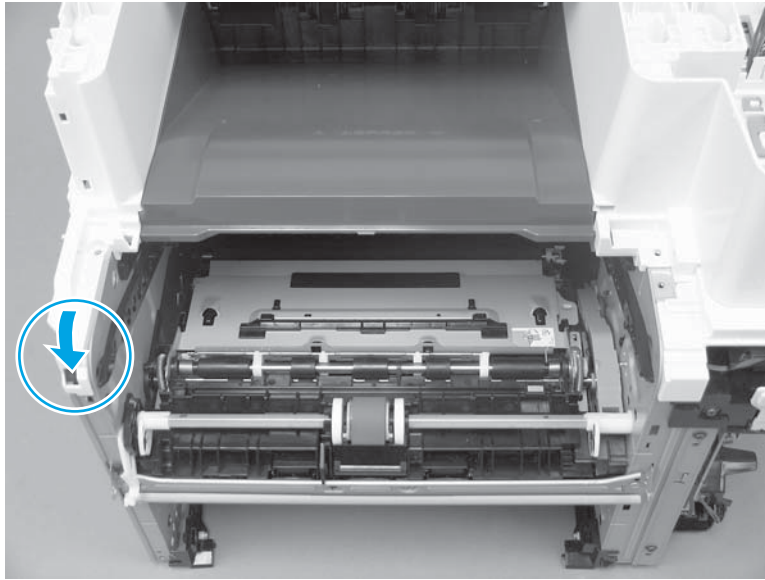
**⚠ CAUTION:** As the cover is rotated down, carefully pass the cables and wire harnesses the hole in the cover (callout 1).

**Figure 1-1618** Rotate the front of the cover down



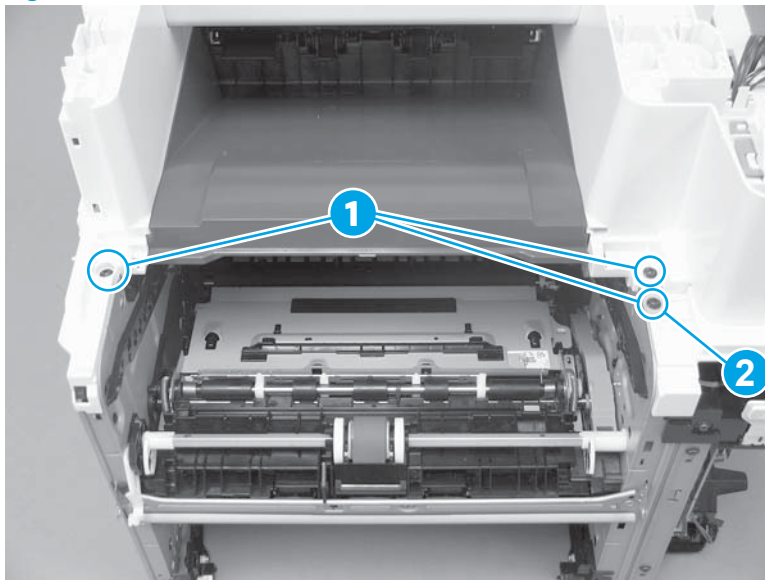
3. At the front left of the printer, engage one boss.

**Figure 1-1619** Engage one boss




4. At the top front of the printer, install three screws (callout 1).

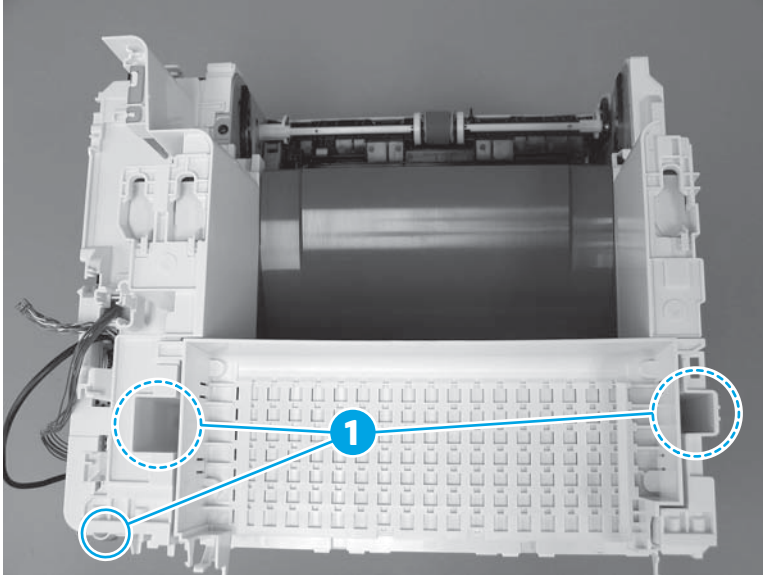
**Figure 1-1620** Install three screws



5. At the top rear of the printer, install three screws (callout 1).

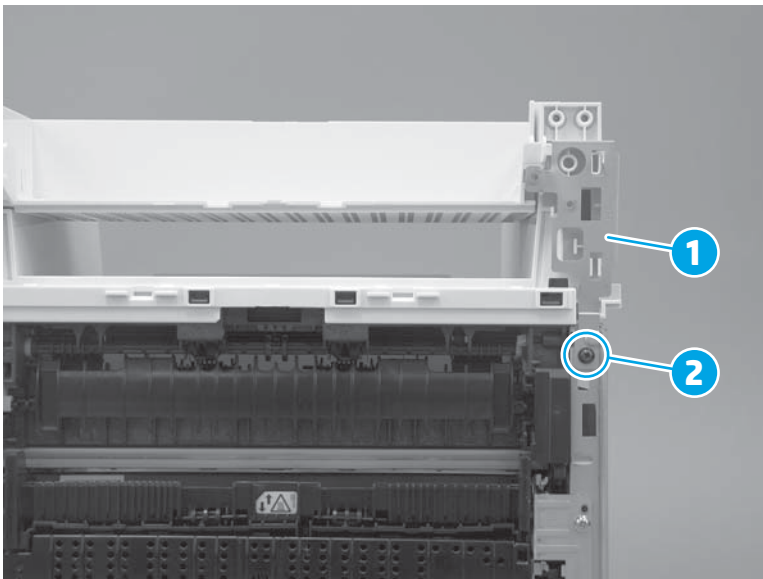
 **NOTE:** The screw (callout 2) on the lower-right portion of the cover is a different color than the other two screws, and is surrounded by sheet-metal. It might appear that this screw does not need to be removed. Remove this screw.

**Figure 1-1621** Install three screws





6. At the front right of the printer, install the sheet-metal plate (callout 1), and then install one screw (callout 2).

**Figure 1-1622** Install one screw and the plate




### Step 27: Install the integrated scanner assembly (M527)

 **IMPORTANT:** Some figure might show assemblies removed or installed that have not yet been removed or installed at that specific step. However, the procedures are correct for this printer and the target assembly. Always thoroughly read the instructions that accompany each figure

 **NOTE:** This step is for the M527 printer. For the M501/M506, skip this step and go to [Step 28: Install the left cover on page 916](#).

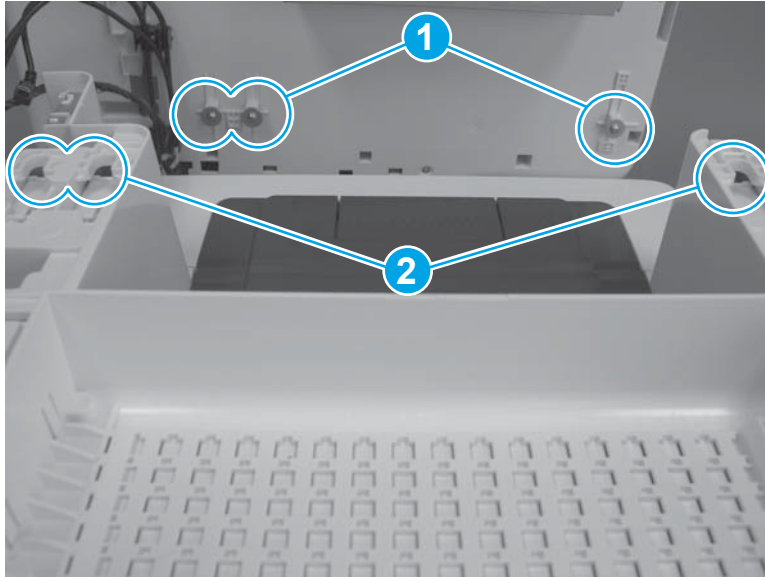
---

 **NOTE:** The ISA includes the document feeder, sub-scanner assembly (SSA), and the scanner control board (SCB)


---

1. Before proceeding, locate the ISA mounting pins (callout 1) on the bottom of the ISA and the slots (callout 2) on the printer base.

**Figure 1-1623** Locate the ISA mounting pins and slots

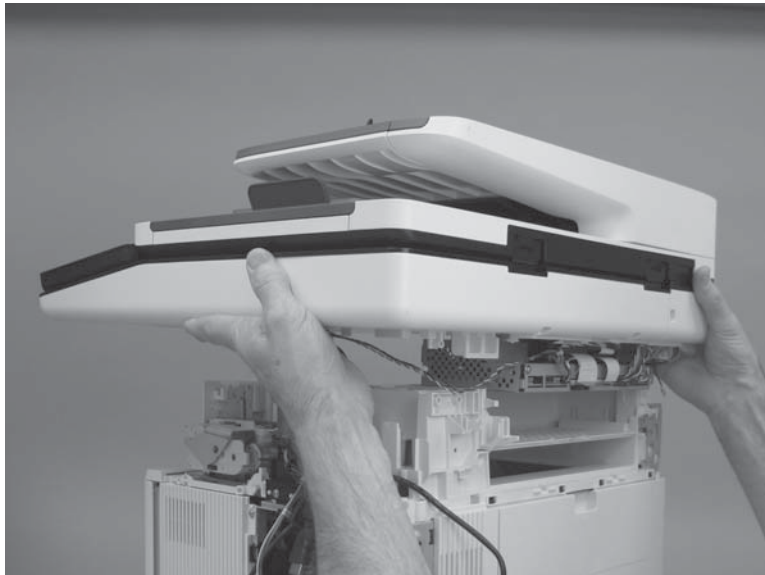


2. Position the ISA on the printer base with the pins in the slots.

 **NOTE:** To locate the pins and slots, see the previous step.

---

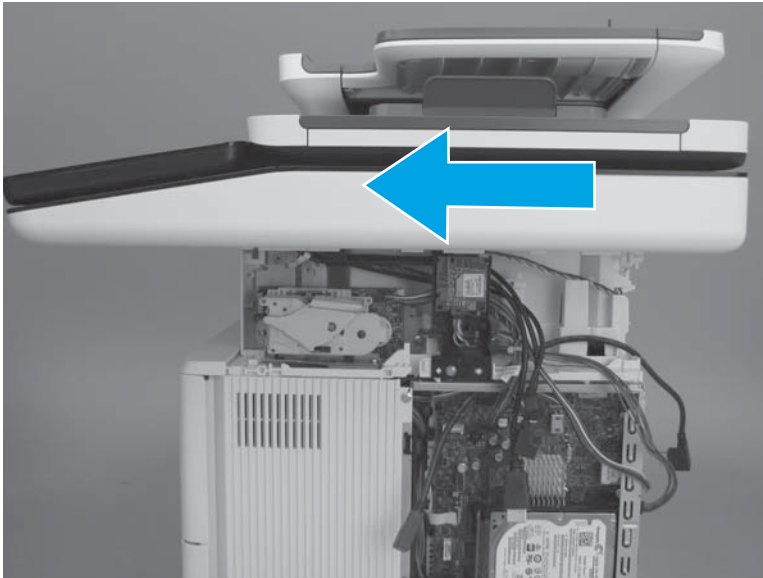
**Figure 1-1624** Install the ISA



3. Slightly slide the ISA towards the front of the printer to engage it.

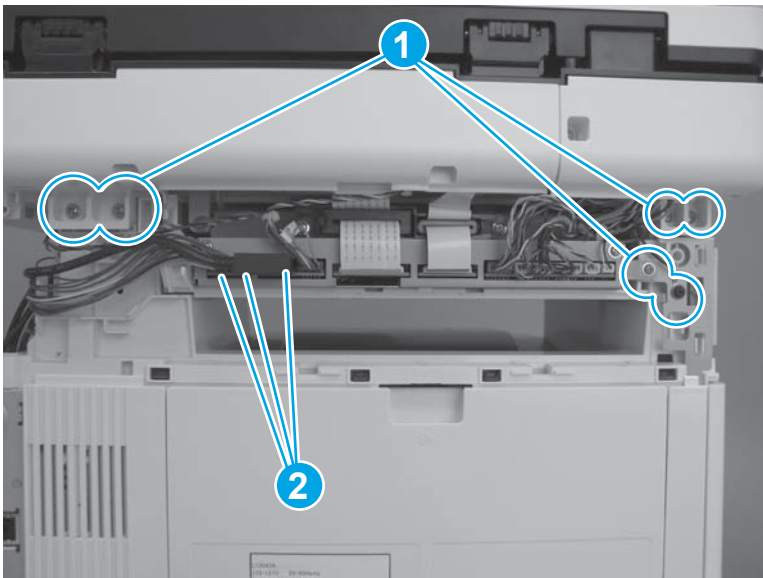
**⚠ CAUTION:** Make sure that none of the wire harnesses or cables are caught underneath the assembly when installing it.

**Figure 1-1625** Slide the ISA towards the front of the printer




4. Install six screws (callout 1), and then connect three connectors (callout 2).

**Figure 1-1626** Install screws and connect connectors

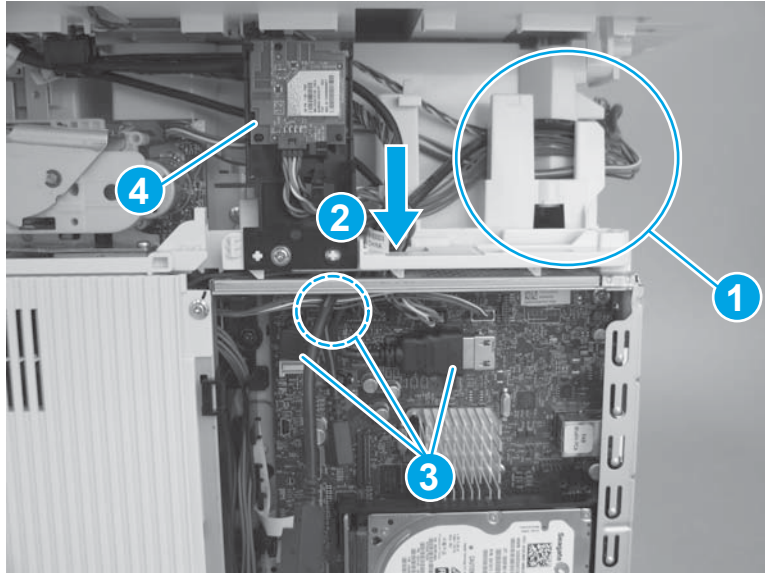





5. Install the wire harnesses and cables in the retainers (callout 1), pass them through the opening in the cover (callout 2), and then connect three connectors (callout 3).

 **TIP:** If the WiFi PCA and holder (callout 4) was detached from the printer and then moved out of the way, reinstall it now.

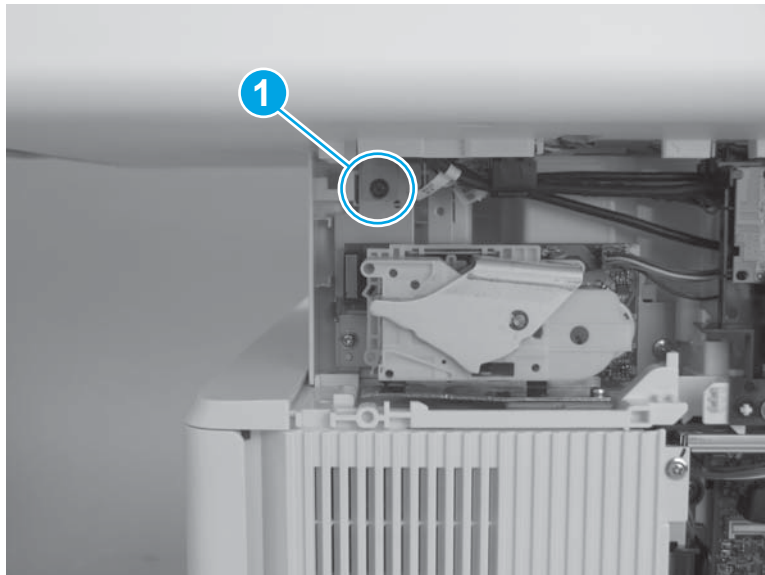
**Figure 1-1627** Connect cables and connectors



6. Install one screw (callout 1).

 **IMPORTANT:** This screw fastens the ISA ground plate to the printer chassis. This screw must be installed.

**Figure 1-1628** Install one screw



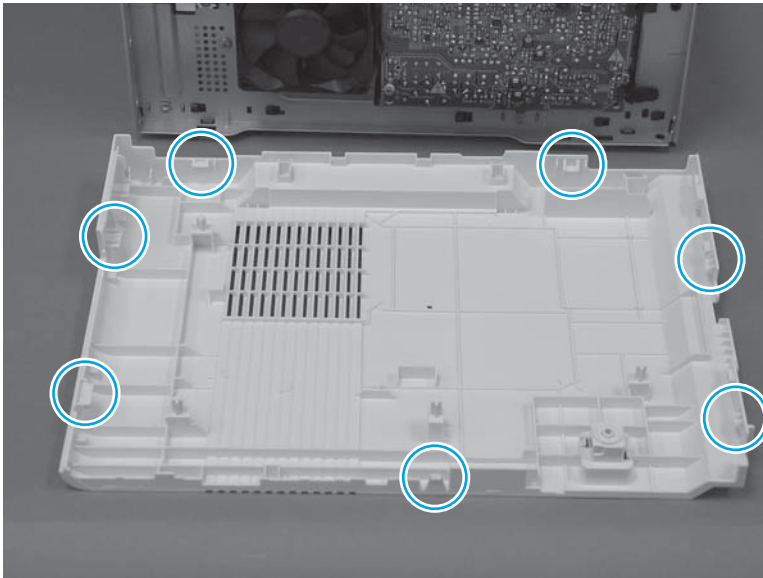
## Step 28: Install the left cover

**IMPORTANT:** The black-plastic cassette front and rear guides (located inside the tray cavity) can be easily dislodged. Do not lose the guides when the cover is removed or installed.

**NOTE:** The M527 printer is shown in this procedure. However, this procedure is valid for the M501/M506 printers.

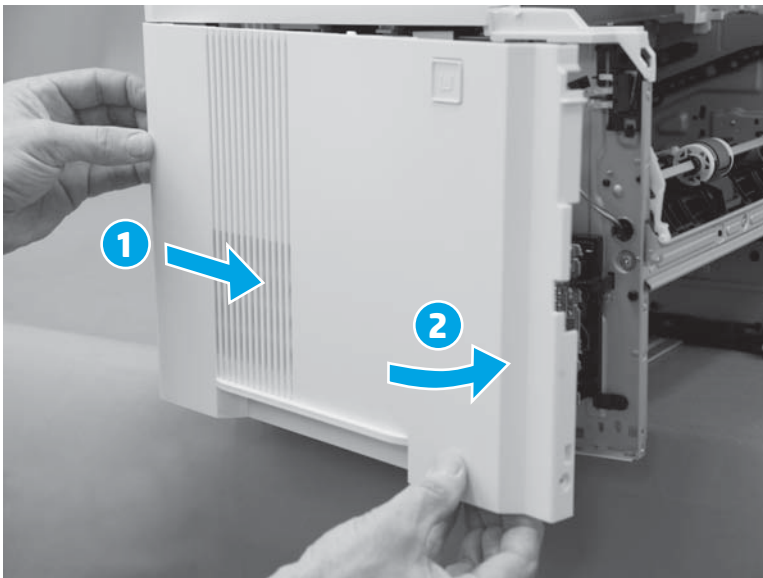
1. Before proceeding, take note of the location of the tabs and bosses on the inside of the cover.

**Figure 1-1629** Locate of the tabs and bosses



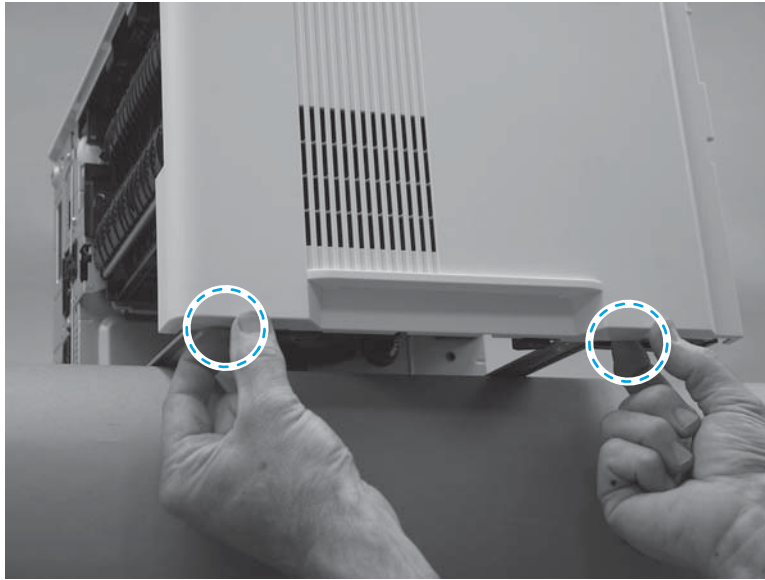
2. Engage the rear edge of the cover (callout 1), and then rotate the rear edge of the cover toward the printer (callout 2).

**Figure 1-1630** Install the cover



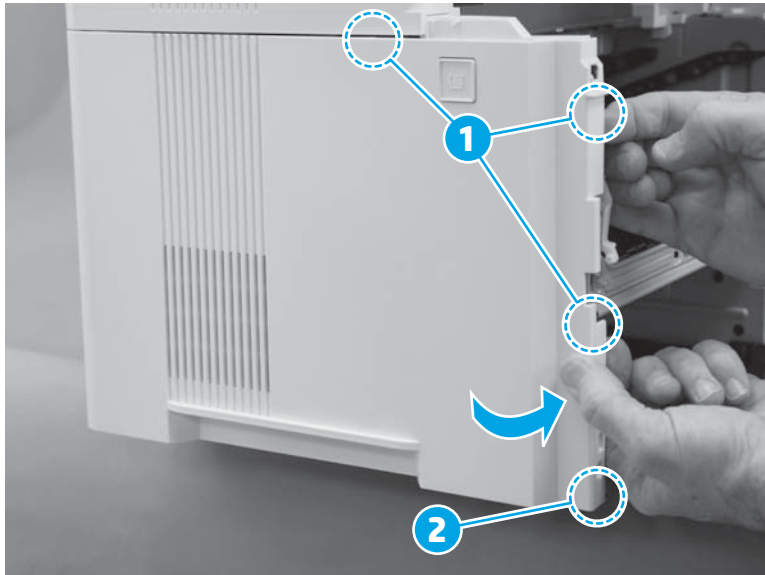
3. At the bottom edge of the cover, engage two tabs.

**Figure 1-1631** Engage two tabs



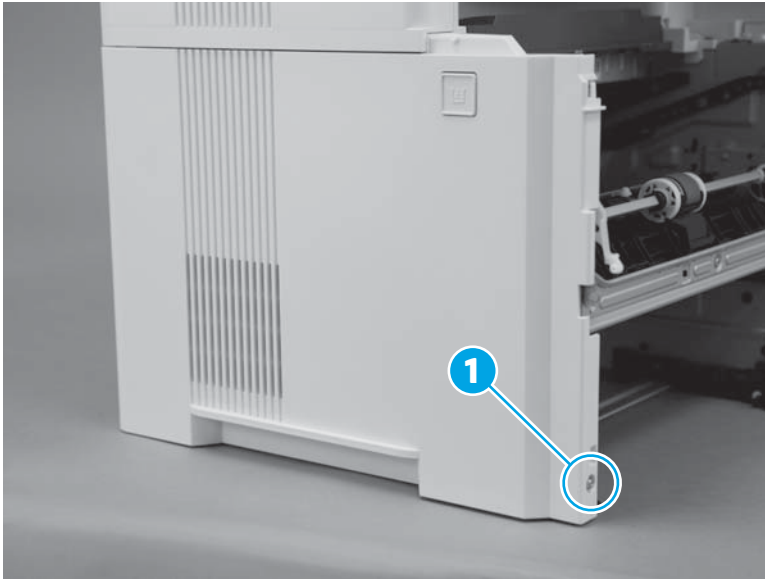
4. At the front of the printer, engage three tabs (callout 1), and then continue to rotate the front edge of the cover toward the printer to engage one boss (callout 2).

**Figure 1-1632** Engage three tabs and one boss





5. Install one screw (callout 1).

**Figure 1-1633** Install one screw



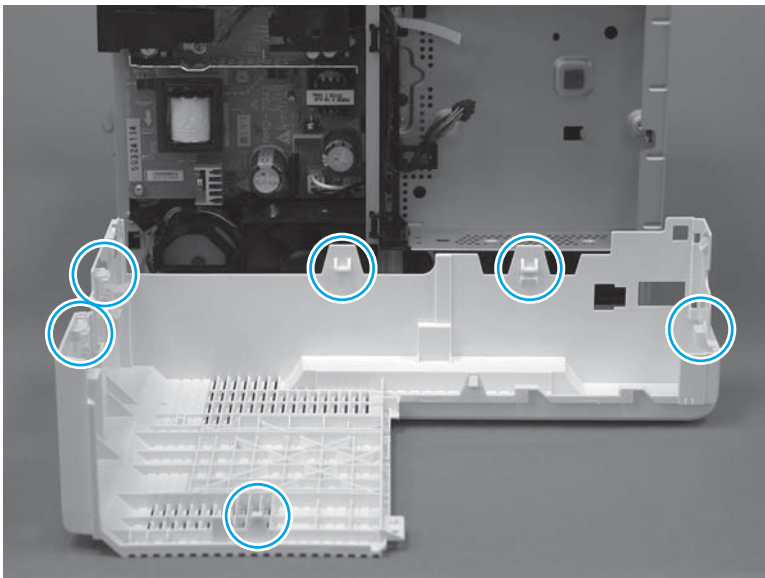
### Step 29: Install the right cover

 **IMPORTANT:** The black-plastic cassette front and rear guides (located inside the tray cavity) can be easily dislodged. Do not lose the guides when the cover is removed or installed.

 **NOTE:** The M527 printer is shown in this procedure. However, this procedure is valid for the M501/M506 printers.

1. Before proceeding, take note of the location of the tabs and bosses on the inside of the cover.

**Figure 1-1634** Locate the tabs and bosses

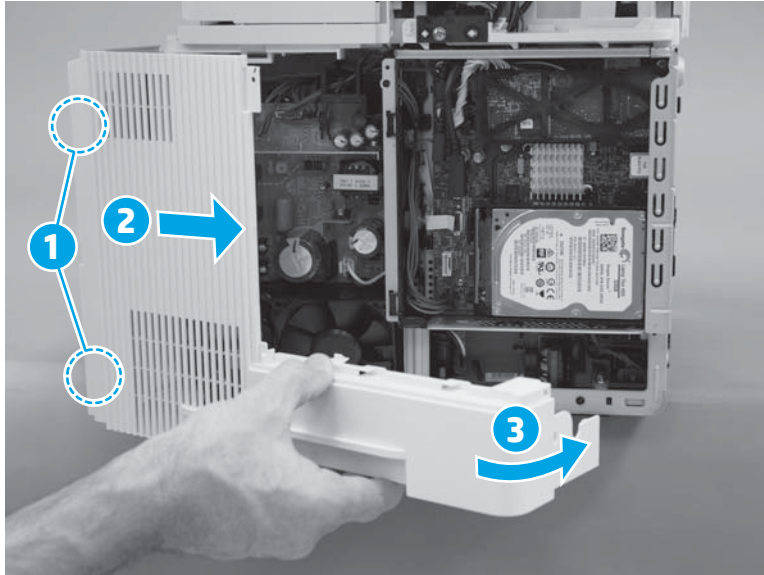


2. At the front of the cover engage two bosses (callout 1/2), and then rotate the rear of the cover toward the printer (callout 3).

**CAUTION:** It might be easier to install the cover with the printer slightly hanging over the edge of the workspace. Do not let the printer tip and fall off of the workspace when removing the cover.

**TIP:** Make sure that the power switch at the front of the printer is positioned in the opening in the cover and that it does not interfere with the cover installation.

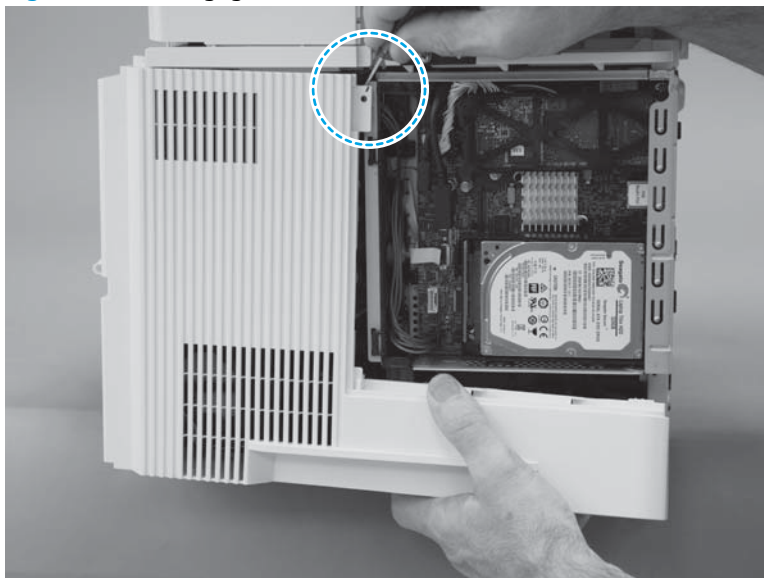
**Figure 1-1635** Install the cover



3. At the top rear edge of the cover, engage one tab.

**CAUTION:** It might be easier to install the cover with the printer slightly hanging over the edge of the workspace. Do not let the printer tip and fall off of the workspace when removing the cover.

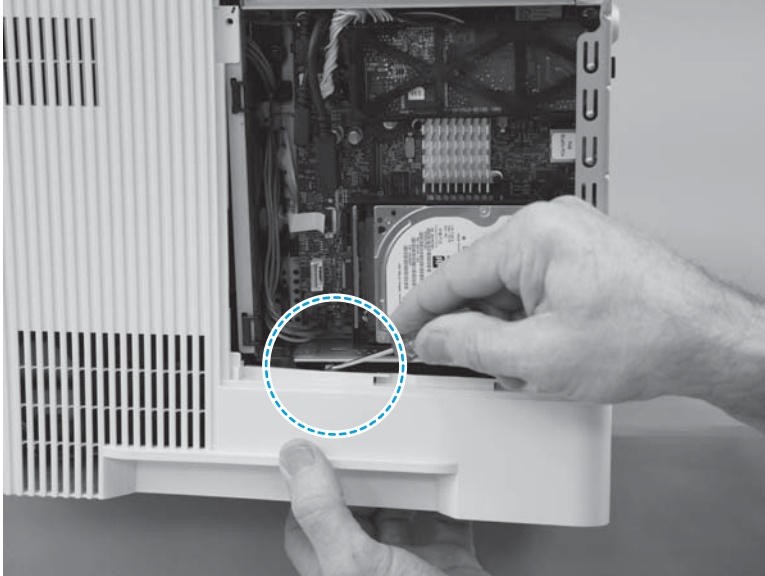
**Figure 1-1636** Engage one tab



4. Near the formatter, engage one tab.

**CAUTION:** It might be easier to install the cover with the printer slightly hanging over the edge of the workspace. Do not let the printer tip and fall off of the workspace when removing the cover.

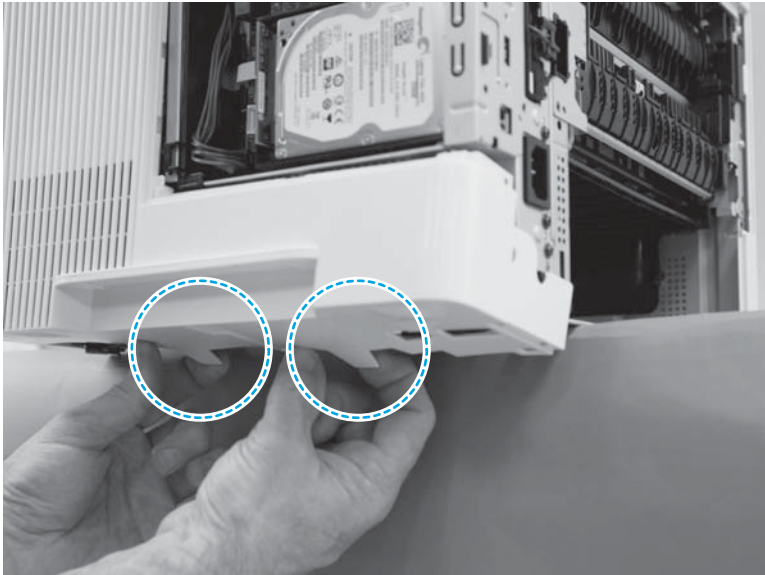
**Figure 1-1637** Engage one tab



5. At the bottom edge of the cover, engage two bosses.

**CAUTION:** It might be easier to install the cover with the printer slightly hanging over the edge of the workspace. Do not let the printer tip and fall off of the workspace when removing the cover.

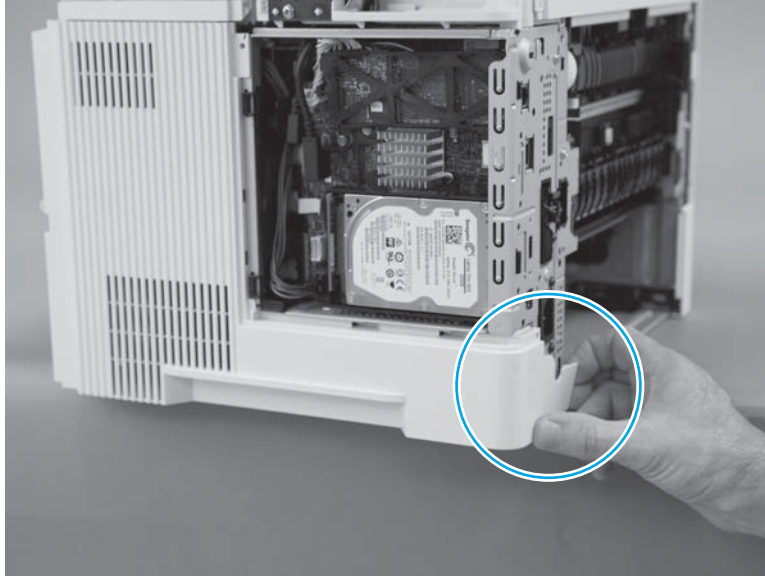
**Figure 1-1638** Engage two bosses



6. At the rear of the printer, engage one boss.

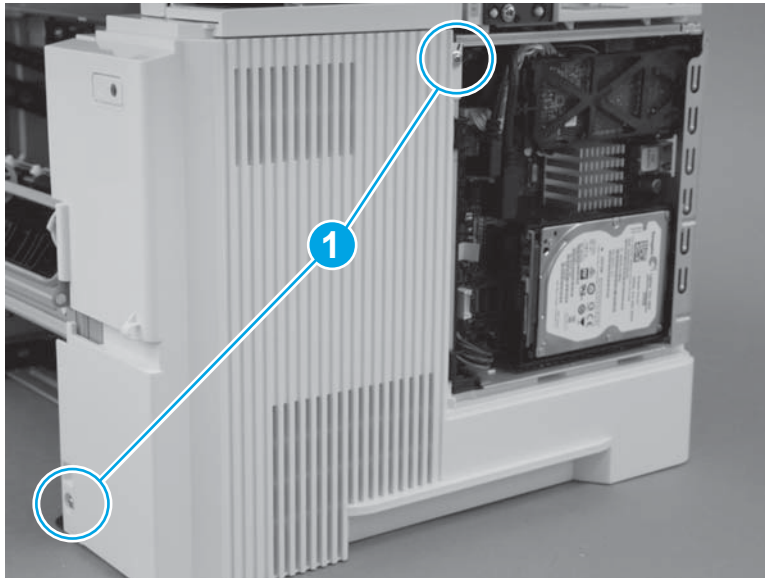
**CAUTION:** It might be easier to install the cover with the printer slightly hanging over the edge of the workspace. Do not let the printer tip and fall off of the workspace when removing the cover.

**Figure 1-1639** Engage one boss



7. Install two screws (callout 1).

**Figure 1-1640** Install two screws

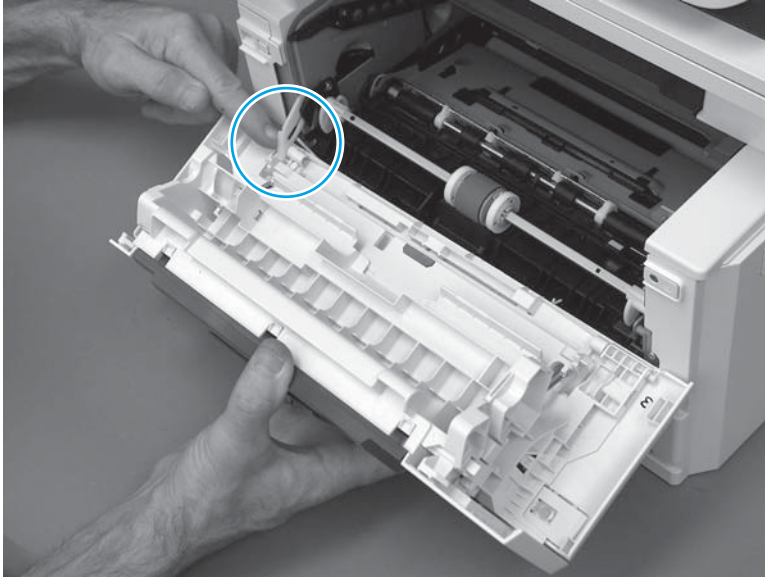


### Step 30: Install the cartridge door assembly

1. Position the door close to the printer, and then engage the keyed pin on the left-side retainer arm with the hole in the door.


**TIP:** It might be easier to engage the keyed pin with the hole by using a small flat-blade screwdriver.

**Figure 1-1641** Engage the left-side retainer arm

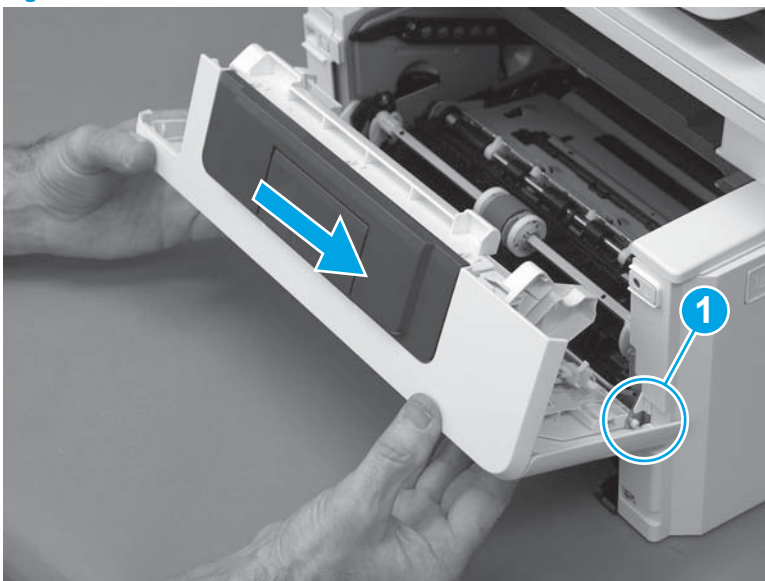


2. Engage the right-side door hinge pin with the hole in the chassis (callout 1).

 **NOTE:** There are two right-side hinge pins (not shown in callout 1).


 **TIP:** Keep a finger pressed on the left-side retainer arm so that it does not disengage from the door.

**Figure 1-1642** Install the door

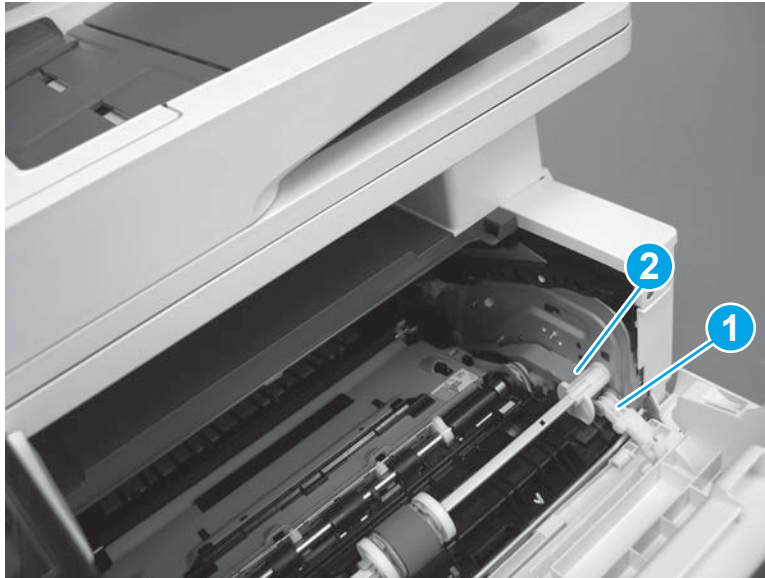




3. Install the gray-plastic pressure-release link (callout 1) onto the white-plastic door arm (callout 2).

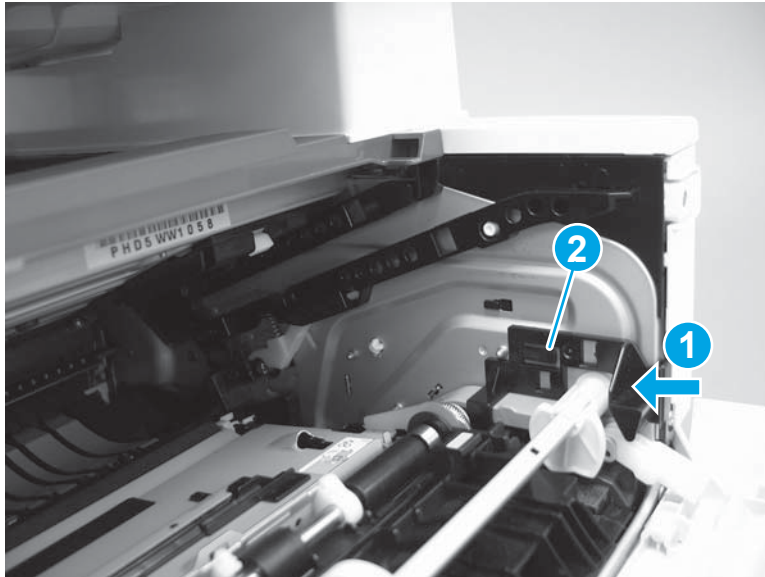
 **IMPORTANT:** Make sure that the arm snaps on to the link. Partially close and open the door to verify that the link (callout 2) moves in and out of the printer as the door closes/opens.

**Figure 1-1643** Install the pressure-release link



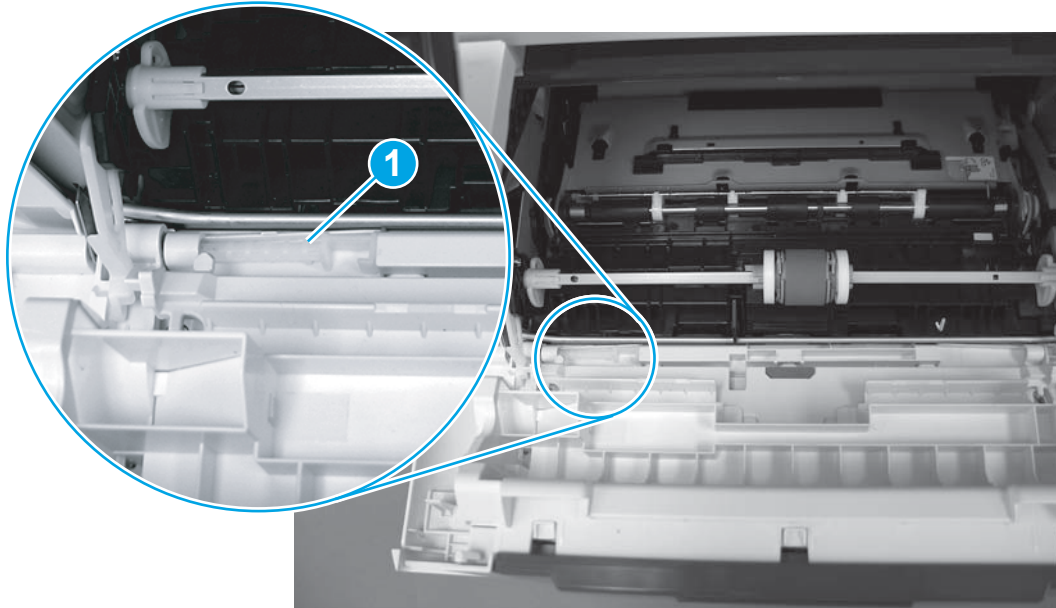
4. Slide the guide into the printer (callout 1), and then make sure that the tab (callout 2) snaps into place to secure the guide to the chassis.

**Figure 1-1644** Install the guide





5. Position the support shaft on the door, and then align the left-side hinge on the door with the hole in the chassis (callout 1).

**Figure 1-1645** Align the hinge

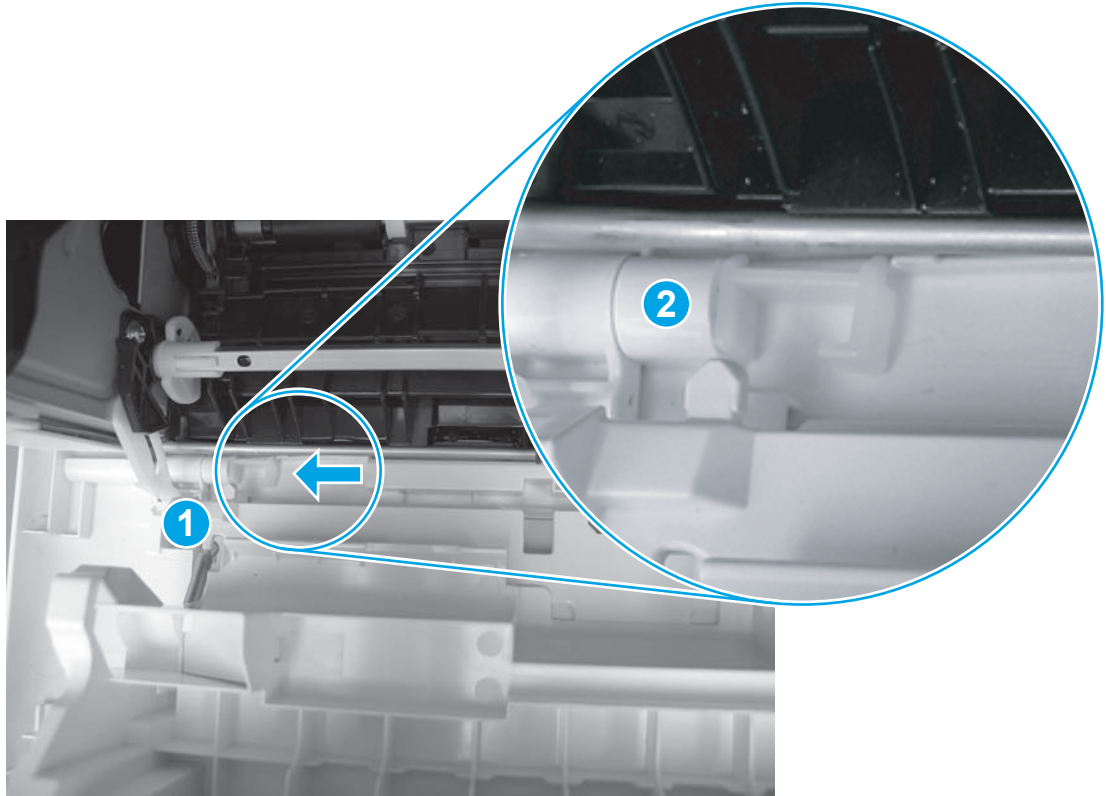


6. Push the shaft towards the left side of the printer to install it (callout 1).

 **NOTE:** Make sure that the support shaft is fully installed and correctly orientated (callout 2) so that it will not interfere with the door opening and closing.

 **Reinstallation tip:** If a replacement door was installed, make sure to install the nameplate (supplied in the kit) corresponding to the printer on the door.

**Figure 1-1646** Install the support shaft



### Step 31: Install the rear door assembly

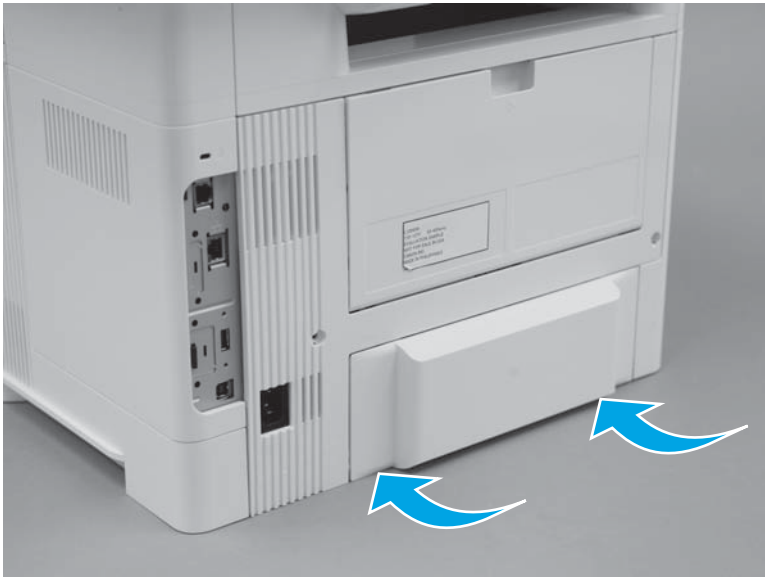
1. Engage the top edge of the assembly with the printer.

**Figure 1-1647** Install the cover



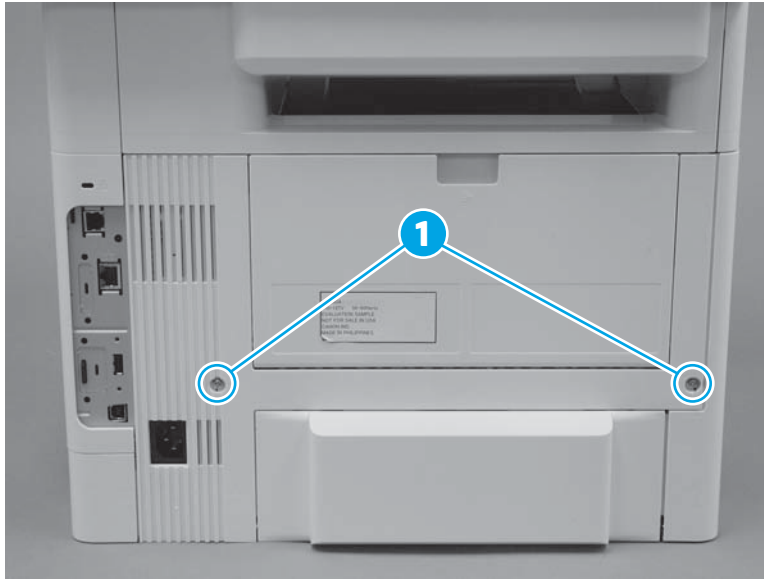
2. Rotate the bottom edge of the cover towards the printer.

**Figure 1-1648** Rotate the bottom of the cover




3. Install two screws (callout 1).

**Figure 1-1649** Install two screws

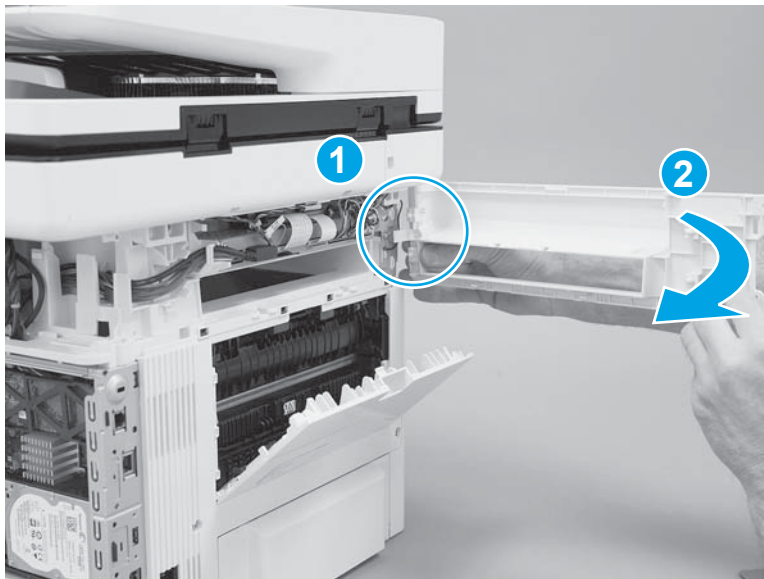


### Step 32: Install the top-rear cover (M527)

 **NOTE:** This step is for the M527 printer. For the M501/M506, skip this step and go to [Step 36: Install the formatter on page 934](#).

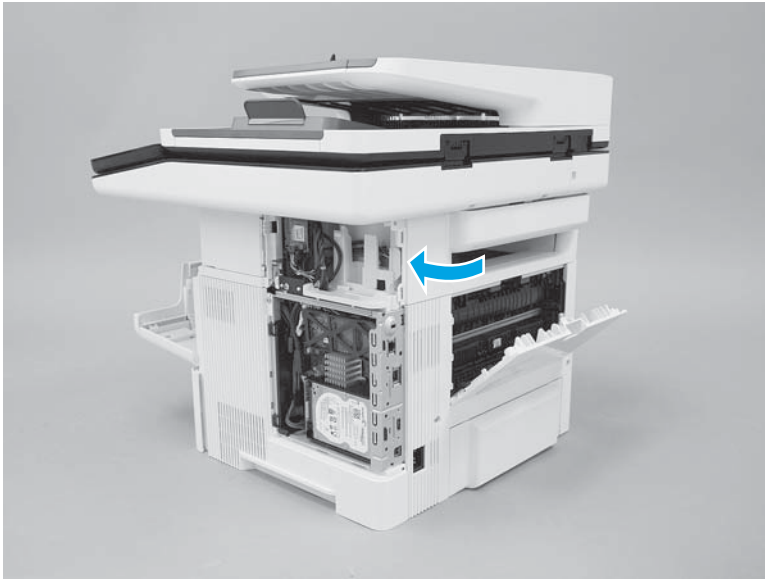
1. Engage one boss (callout 1), and then rotate the cover towards the printer (callout 2).

**Figure 1-1650** Engage one boss



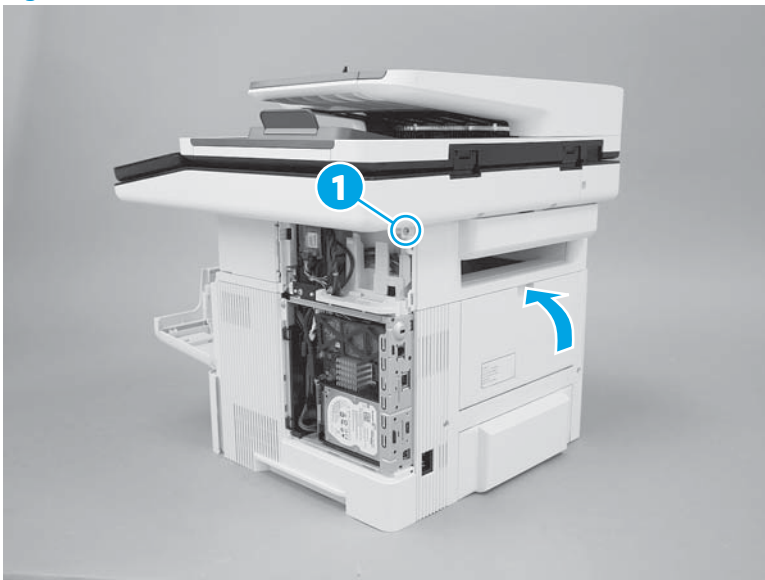
2. Continue to rotate the cover toward the printer to install it.

**Figure 1-1651** Install the cover



3. Install one screw (callout 1), and then close the rear door.

**Figure 1-1652** Install one screw



### Step 33: Install the top-left cover (M527)



**NOTE:** This step is for the M527 printer. For the M501/M506, skip this step and go to [Step 36: Install the formatter on page 934](#).

1. Position the front edge of the cover on the printer, and then slide the cover toward the front of the printer to engage two bosses at the front of the cover.

**Figure 1-1653** Slide the cover




2. Rotate the cover towards the printer to engage two tabs at the middle of the cover.

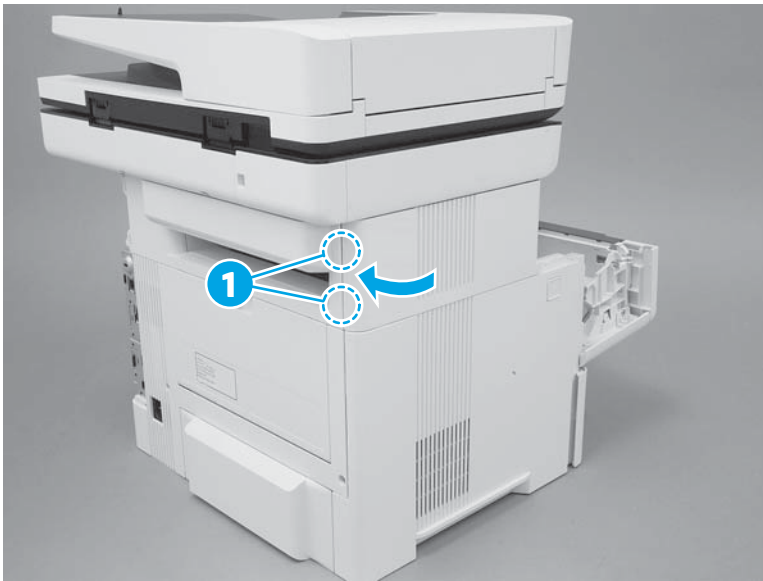
**Figure 1-1654** Engage two tabs




3. Continue to rotate the cover onto the printer to engage two tabs (callout 1) at the rear edge of the cover.


 **NOTE:** Close the toner-cartridge door.

**Figure 1-1655** Engage two tabs



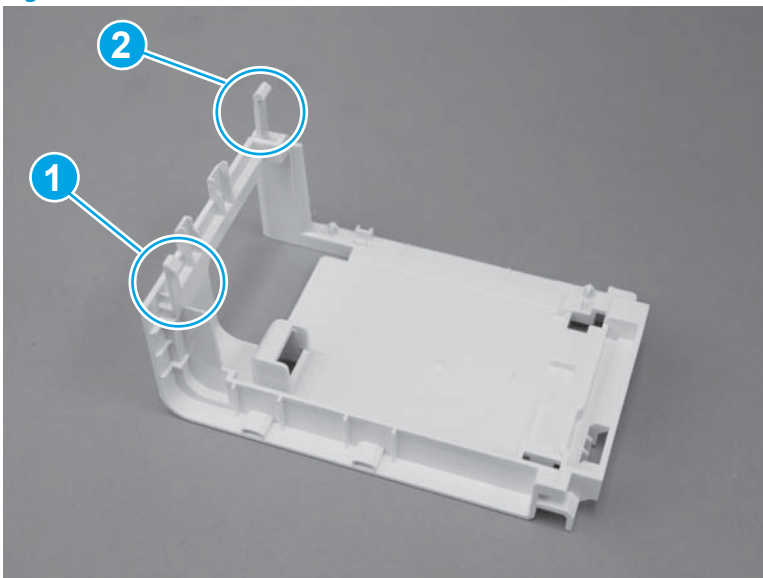
#### Step 34: Install the stapler stationary (inner) cover (M527)

 **NOTE:** This step is for the M527c/f/z printers. For the M501/M506, skip this step and go to [Step 36: Install the formatter on page 934](#). For the M527dn, skip this step and go to [Step 35: Install the stapler door or stapler blank cover \(M527\) on page 932](#).

 **NOTE:** M527c/f/z printers only.

1. Before proceeding, take note of the locations of the upper tab (callout 1) and the lower tab (callout 2) on the stapler stationary (inner) cover.

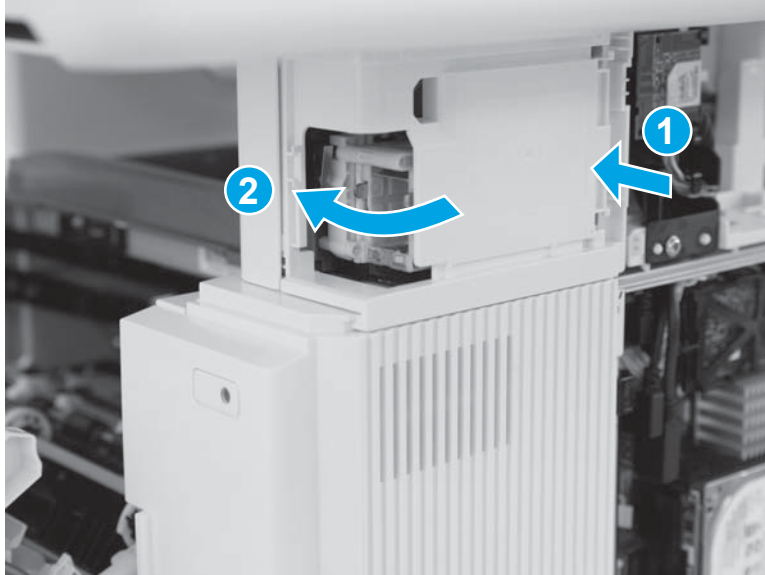
**Figure 1-1656** Locate the tabs





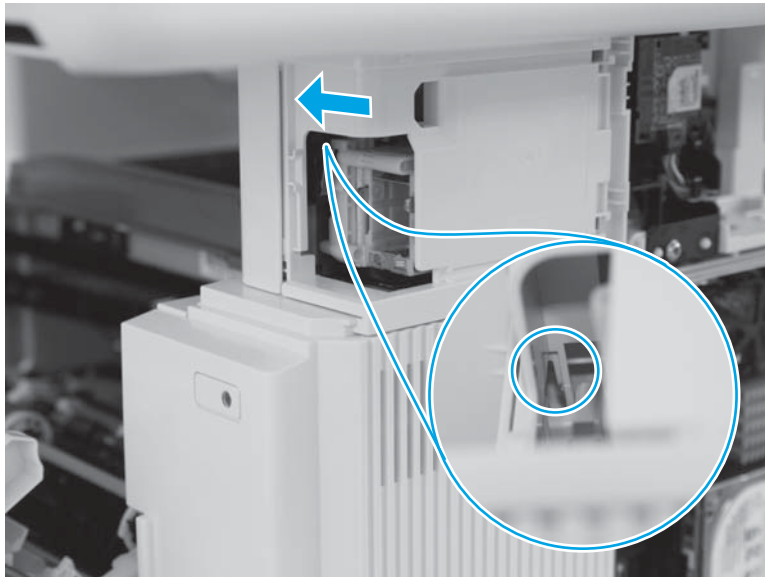
- Engage the rear edge of the cover with the printer (callout 1), and then rotate the front edge of the cover onto the printer (callout 2) to engage the two tabs.

**Figure 1-1657** Install the cover



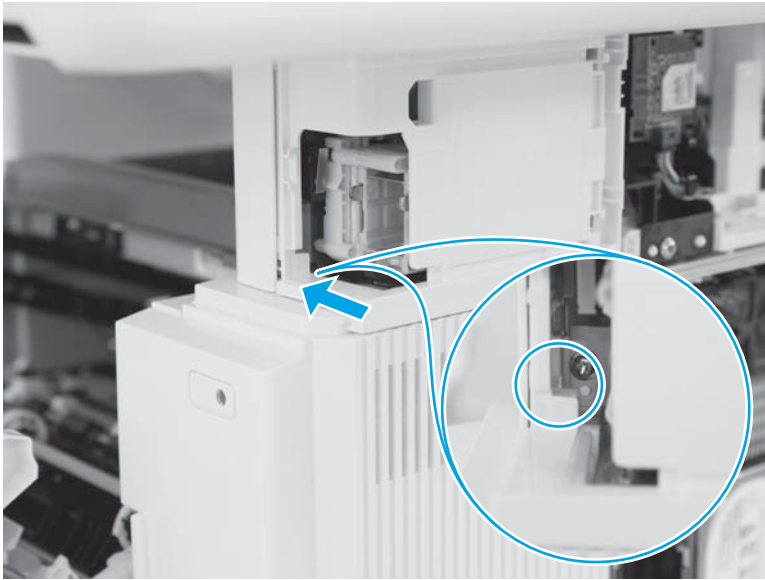
- Verify that the upper tab is engaged.

**Figure 1-1658** Engage one tab





4. Verify that the lower tab is engaged.

**Figure 1-1659** Engage one tab



### Step 35: Install the stapler door or stapler blank cover (M527)

 **NOTE:** This step is for the M527 printer. For the M501/M506, skip this step and go to [Step 36: Install the formatter on page 934](#).

 **NOTE:** The M527dn does not have a convenience stapler.

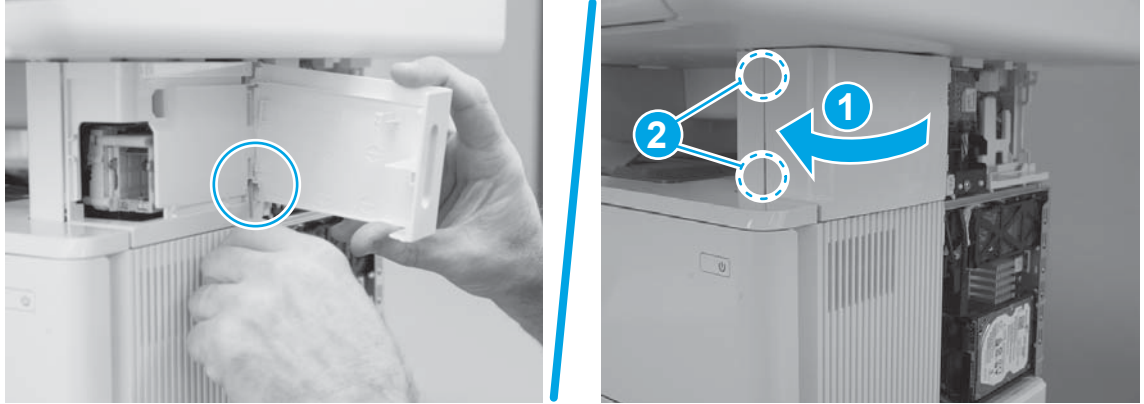
1. Do one of the following:
  - **M527c/f/z:** Position the door near the printer.
  - **M527dn:** Position the cover on the printer.

**Figure 1-1660** Install the door or cover



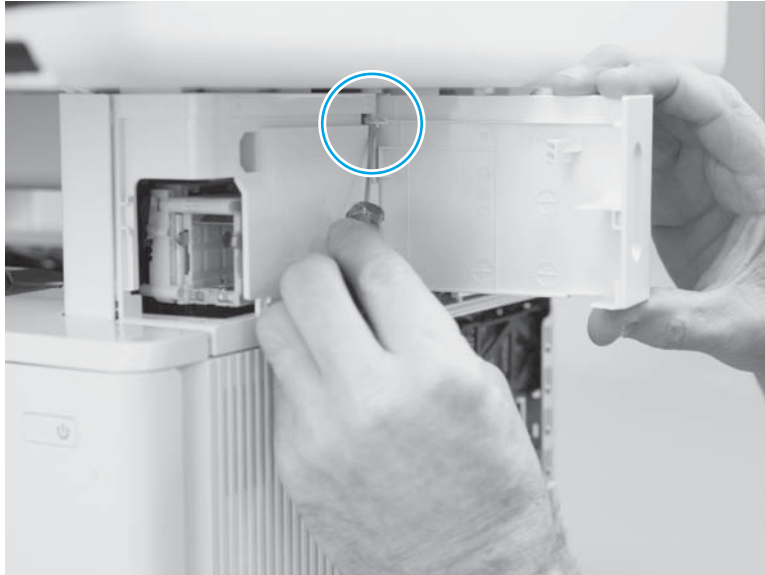
2.
  - **M527c/f/z:** Engage the lower hinge.
  - **M527dn:** Rotate the cover towards the printer (callout 1), and then make sure that the two tabs (callout 2) snap into place to install the cover.

**Figure 1-1661** Engage the lower hinge or engage the cover



3. **M527c/f/z:** Engage the upper hinge.

**Figure 1-1662** Engage the upper hinge




4. **M527c/f/z:** Close the stapler door.

**Figure 1-1663** Close the door

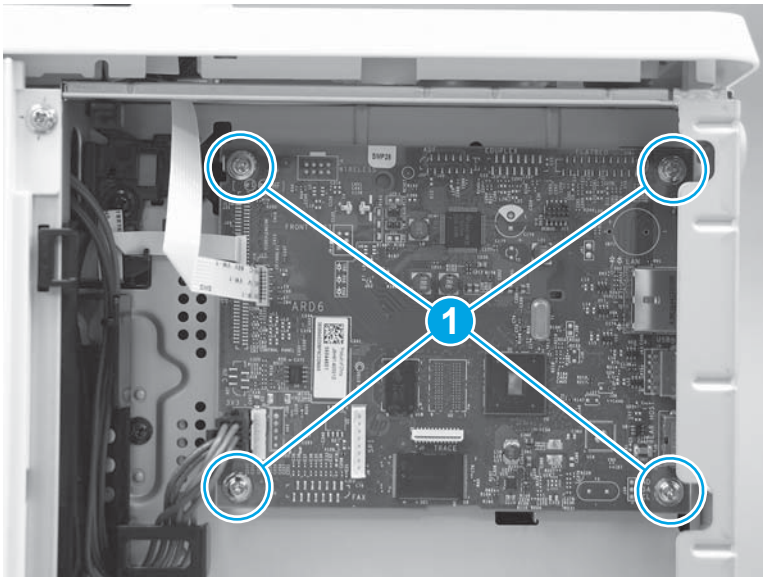


### Step 36: Install the formatter

 **IMPORTANT:** **M506/M527:** Take note of all empty connectors on the PCA before disconnecting any wire harnesses or flat-flexible cables (FFCs). Some empty connectors might not be visible until other items—like the hard-disk drive—are removed, so pay close attention while removing the formatter and accessory items.

1. **M501:** Position the formatter on the chassis, install four screws (callout 1), and then connect all of the connectors and FFCs.

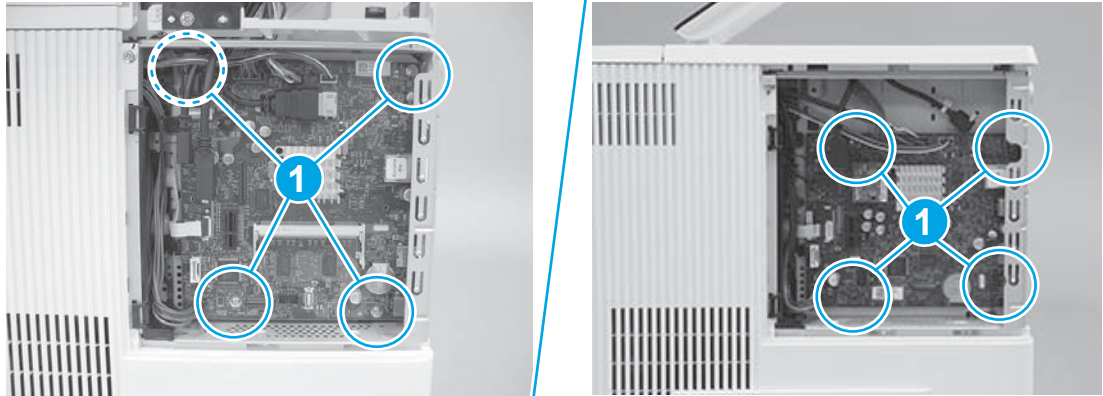
**Figure 1-1664** Install the formatter (M501)




2. **M506/M527:** Position the formatter on the chassis, install four screws (callout 1), and then connect all of the connectors and FFCs.

 **IMPORTANT:** Some connectors might need be empty if other items—for example a fax PCA—will be installed later.


**Figure 1-1665** Install the formatter (M506/M527)



### Step 37: Install the fax PCA (M527)

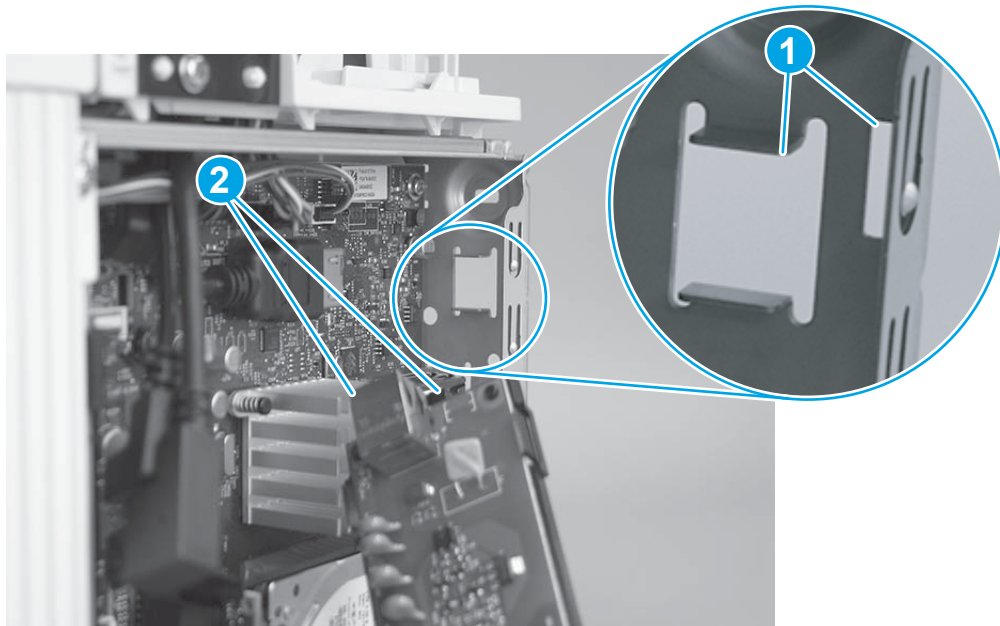
 **NOTE:** If the fax PCA is not installed, skip this step and go to [Step 38: Install the hard-disk drive \(HDD\)](#) on page 937.

 **CAUTION:**  ESD-sensitive part.

 **NOTE:** M527c/f/z printers only (optional for the M527dn).

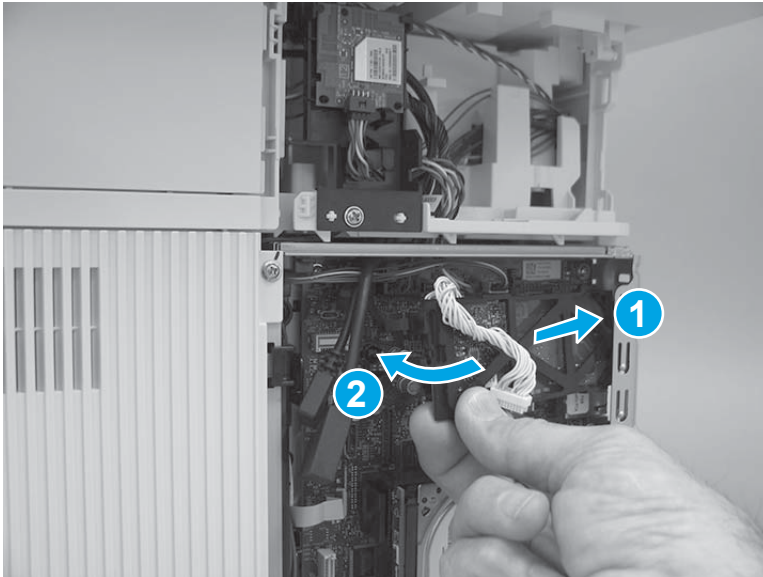
1. Before proceeding, take note of the location of the slots (callout 1) in the sheet-metal where the fax PCA cradle mounting tab and fax port (callout 2) must be installed.

**Figure 1-1666** Locate the slots in the sheet-metal




2. Insert the fax PCA cradle mounting tab and fax port in the slots in the sheet-metal plate (callout 1), and then rotate the connector end of the fax PCA toward the formatter (callout 2).

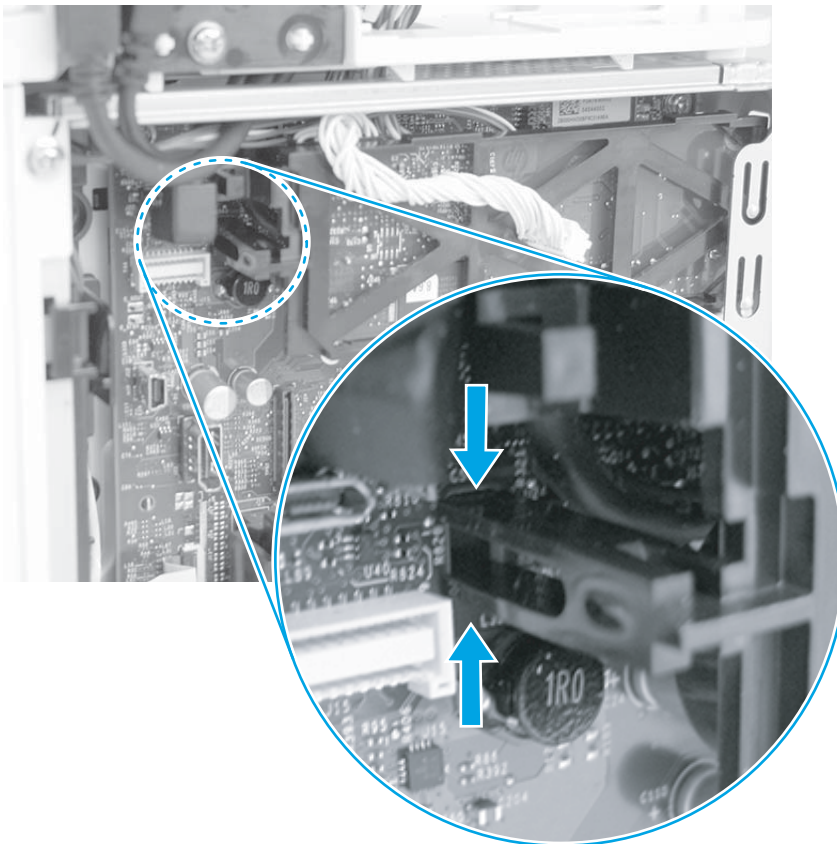
**Figure 1-1667** Install the fax PCA



3. Engage the retainer with the slot in the formatter.

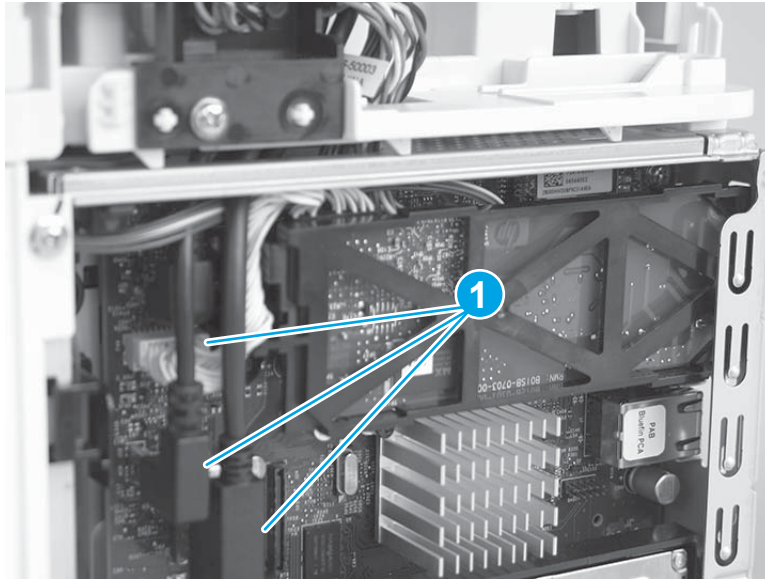
 **Reinstallation tip:** Pinch the retainer to easily engage it with the slot.

**Figure 1-1668** Engage the fax PCA




4. Connect three connectors (callout 1).

**Figure 1-1669** Connect three connectors




### Step 38: Install the hard-disk drive (HDD)

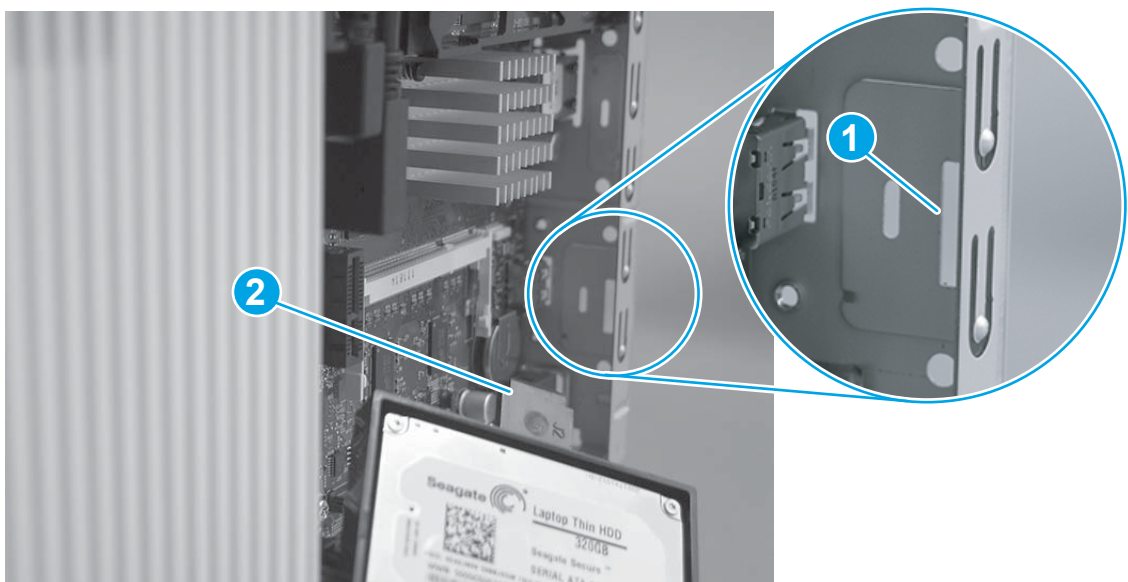
 **NOTE:** If the HDD is not installed, skip this step and go to [Step 39: Install the formatter cover on page 938](#).

 **CAUTION:**  ESD-sensitive part.

1. Before proceeding, take note of the location of the slot (callout 1) in the sheet-metal where the HDD cradle mounting tab (callout 2) must be installed.

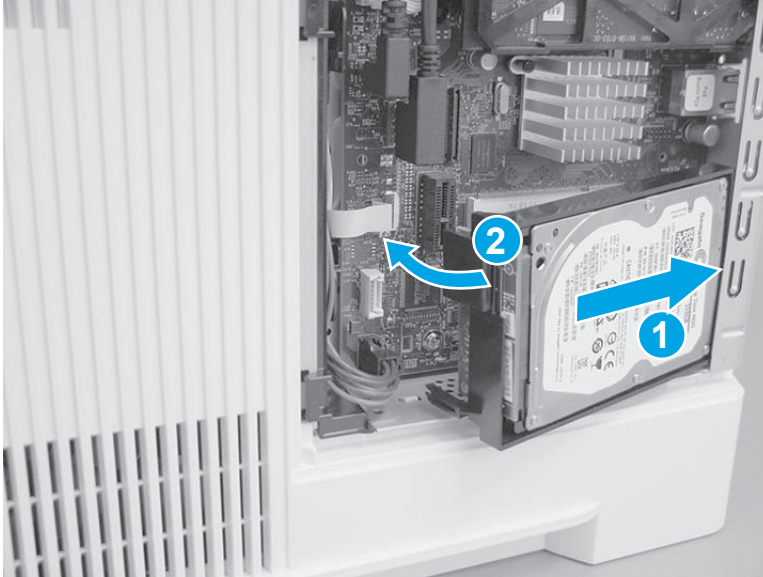
 **CAUTION:** This portion of the sheet-metal is a knock-out plate (callout 1). Do not push on it with sufficient force to detach it when installing the HDD.

**Figure 1-1670** Locate the slot in the sheet-metal



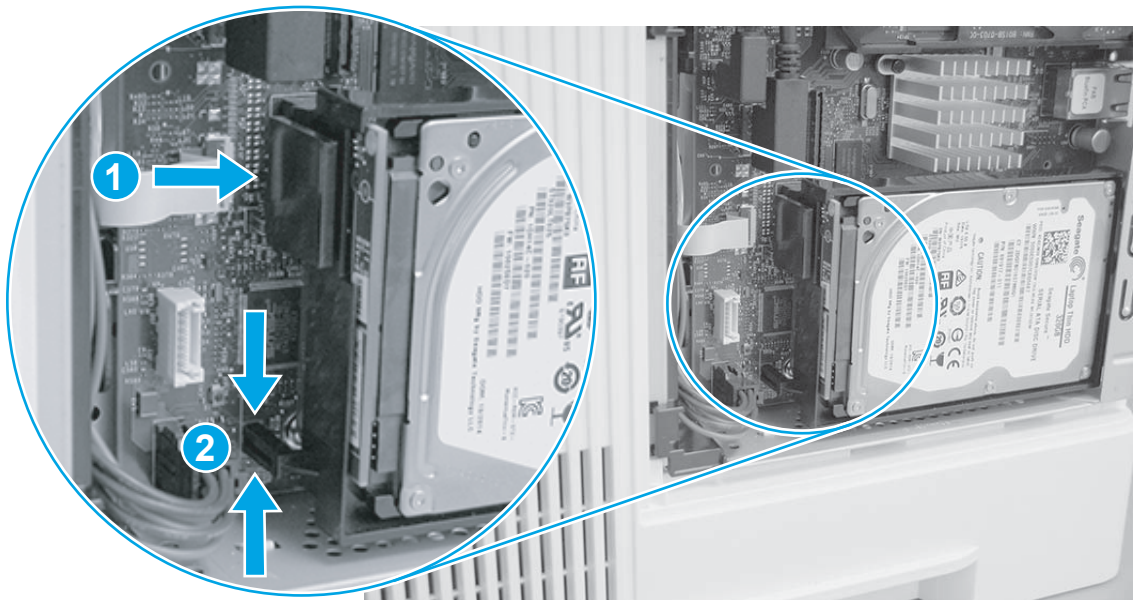
2. Insert the HDD cradle mounting tab in the slot in the sheet-metal (callout 1), and then rotate the connector end (callout 2) of the HDD toward the formatter.

**Figure 1-1671** Install the HDD



3. Make sure that the locking connector (callout 1) latches and that the standoffs (callout 2) engages with the slot in the formatter (it might be necessary to pinch the retainer to engage it with the slot).

**Figure 1-1672** Install the HDD

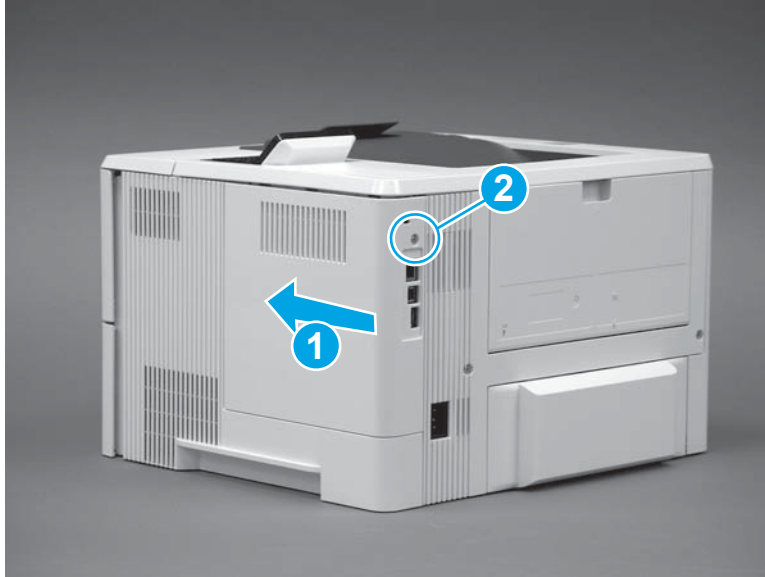


### Step 39: Install the formatter cover

1. **M501**: Slide it toward the front of the printer to install it (callout 1), and then install one screw (callout 2).

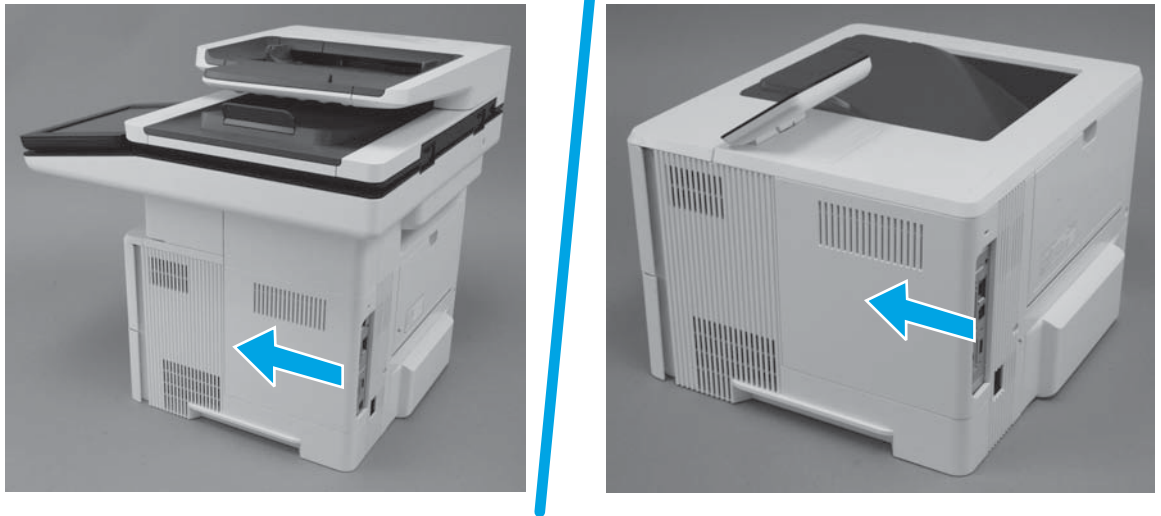


**Figure 1-1673** Install the formatter cover (M501)



2. **M506/M527:** Slide it toward the front of the printer to install it.

**Figure 1-1674** Install the formatter cover (M506/M527)



#### Step 40: Install the tray

1. With the tray at a slight angle, align the sides of the tray with the rails in the accessory, and then partially slide the tray into the printer.

**Figure 1-1675** Install the tray



2. Push the tray straight into the accessory to close it.

**Figure 1-1676** Close the tray



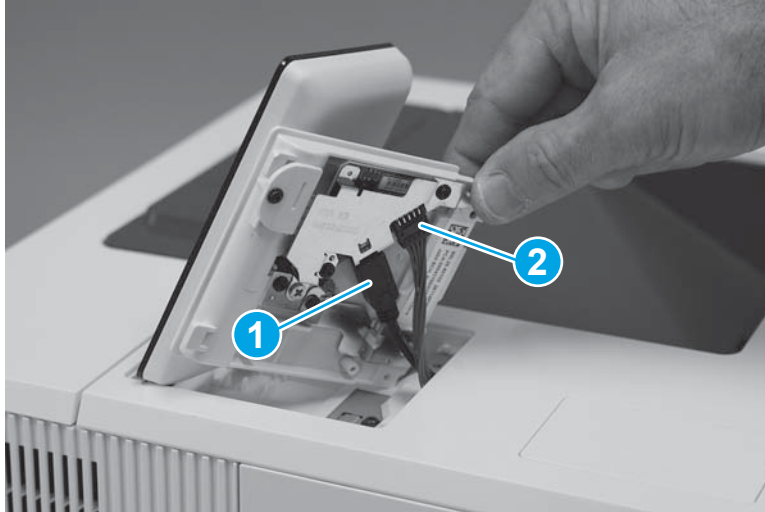
#### Step 41: Install the control panel (M506x)



**NOTE:** M506x model only.

1. Connect one HDMI cable (callout 1), one connector (callout 2).

**Figure 1-1677** Connect the cables



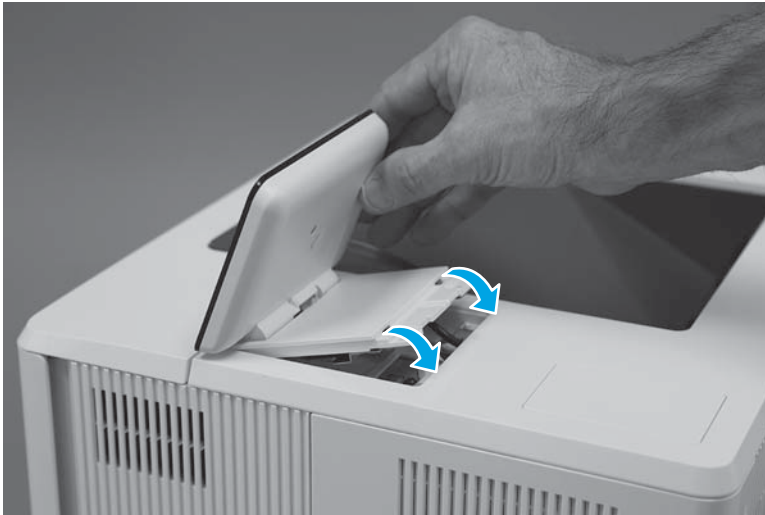
2. Install the tabs (callout 1) on the front of the control panel in the slots (callout 2) on the printer top cover.

**Figure 1-1678** Install the control panel



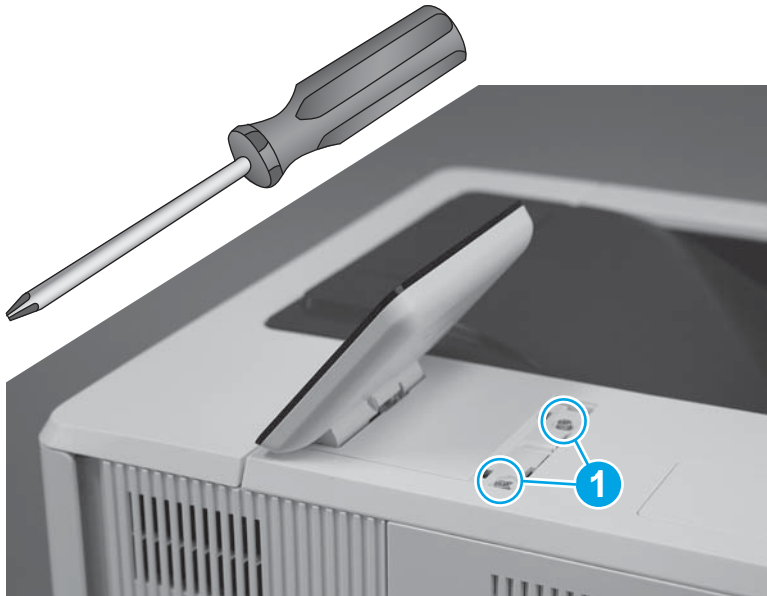
3. Rotate the control-panel base down onto the printer.

**Figure 1-1679** Rotate the control-panel base down




4. Use a small Phillips screwdriver to install two screws (callout 1).

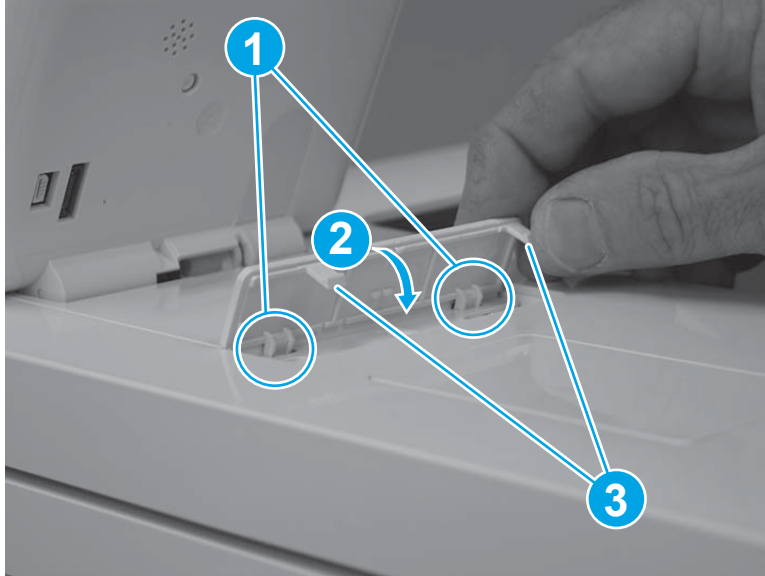
**Figure 1-1680** Install two screws




5. Position the screw cover mounting feet into the slots in the top cover (callout 1), and then rotate the cover down (callout 2) to install it.

 **NOTE:** Press down on the cover firmly to make sure that the tabs (callout 3) snap into place.

**Figure 1-1681** Install the cover



## Removal and replacement: DC controller

 **IMPORTANT:** Some figure might show assemblies removed or installed that have not yet been removed or installed at that specific step. However, the procedures are correct for this printer and the target assembly. Always thoroughly read the instructions that accompany each figure

---

- [Introduction](#)
- [Step 1: Remove the control panel \(M506x\)](#)
- [Step 2: Remove the tray](#)
- [Step 3: Remove the formatter cover](#)
- [Step 4: Remove the hard-disk drive \(HDD\)](#)
- [Step 5: Remove the fax PCA \(M527\)](#)
- [Step 6: Remove the formatter](#)
- [Step 7: Remove the stapler door or stapler blank cover \(M527\)](#)
- [Step 8: Remove the stapler stationary \(inner\) cover \(M527\)](#)
- [Step 9: Remove the top-left cover \(M527\)](#)
- [Step 10: Remove the top-rear cover \(M527\)](#)
- [Step 11: Remove the rear door assembly](#)
- [Step 12: Remove the cartridge door assembly](#)
- [Step 13: Remove the right cover](#)
- [Step 14: Remove the left cover](#)
- [Step 15: Remove the integrated scanner assembly \(M527\)](#)
- [Step 16: Remove the top cover \(M527\)](#)
- [Step 17: Remove the top cover \(M501/M506\)](#)
- [Step 18: Remove the paper delivery tray \(output bin\)](#)
- [Step 19: Remove the formatter case](#)
- [Step 20: Remove the DC controller \(DCC\)](#)
- [Step 21: Unpack the replacement DC controller \(DCC\)](#)
- [Step 22: Install the DC controller \(DCC\)](#)
- [Step 23: Install the formatter case](#)
- [Step 24: Install the paper delivery tray \(output bin\)](#)
- [Step 25: Install the top cover \(M501/M506\)](#)
- [Step 26: Install the top cover \(M527\)](#)
- [Step 27: Install the integrated scanner assembly \(M527\)](#)

- [Step 28: Install the left cover](#)
- [Step 29: Install the right cover](#)
- [Step 30: Install the cartridge door assembly](#)
- [Step 31: Install the rear door assembly](#)
- [Step 32: Install the top-rear cover \(M527\)](#)
- [Step 33: Install the top-left cover \(M527\)](#)
- [Step 34: Install the stapler stationary \(inner\) cover \(M527\)](#)
- [Step 35: Install the stapler door or stapler blank cover \(M527\)](#)
- [Step 36: Install the formatter](#)
- [Step 37: Install the fax PCA \(M527\)](#)
- [Step 38: Install the hard-disk drive \(HDD\)](#)
- [Step 39: Install the formatter cover](#)
- [Step 40: Install the tray](#)
- [Step 41: Install the control panel \(M506x\)](#)


## Introduction

This document provides the procedures to remove and replace the DC controller.

## Before performing service

### Turn the printer power off

- Disconnect the power cable.

 **WARNING!** To avoid damage to the printer, turn the printer off wait 30 seconds, and then remove the power cable before attempting to service the printer.

Use the table below to identify the correct part number for your printer. To order the part, go to [www.hp.com/buy/parts](http://www.hp.com/buy/parts).

DC controller part number	
RM2-8612-000CN	DC controller (M527)
RM2-8614-000CN	DC controller (simplex; M506)
RM2-8612-000CN	DC controller (duplex; M506)
RM2-8712-000CN	DC controller (simplex; M501)
RM2-8711-000CN	DC controller (duplex; M501)

## Required tools

- Small flat-blad screwdriver.
- #2 Phillips screwdriver with a magnetic tip.

## After performing service

### Turn the printer power on


- Connect the power cable.
- Use the power switch to turn the power on.

## Post service test

Make sure that the printer initializes to a **Ready** state.

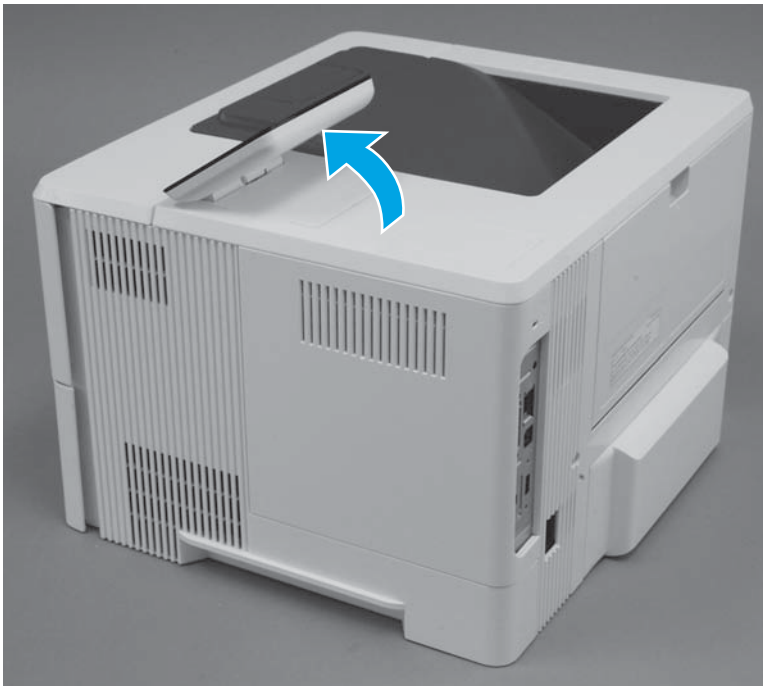
Print a configuration page to make sure that the printer is functioning correctly.

## Step 1: Remove the control panel (M506x)

 **NOTE:** This step is for the M506x printer. For all other printers, skip this step and proceed to [Step 2: Remove the tray on page 948](#).

1. Tilt the control panel to the fully raised position.

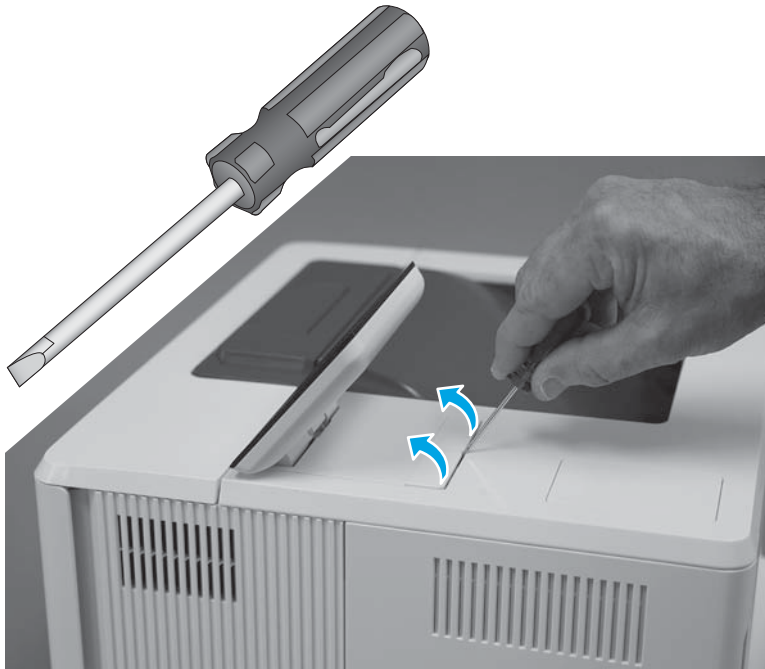
**Figure 1-1682** Tilt the control panel up






2. Use a small flat-blad screwdriver to release the control-panel screws cover, and then remove the cover.

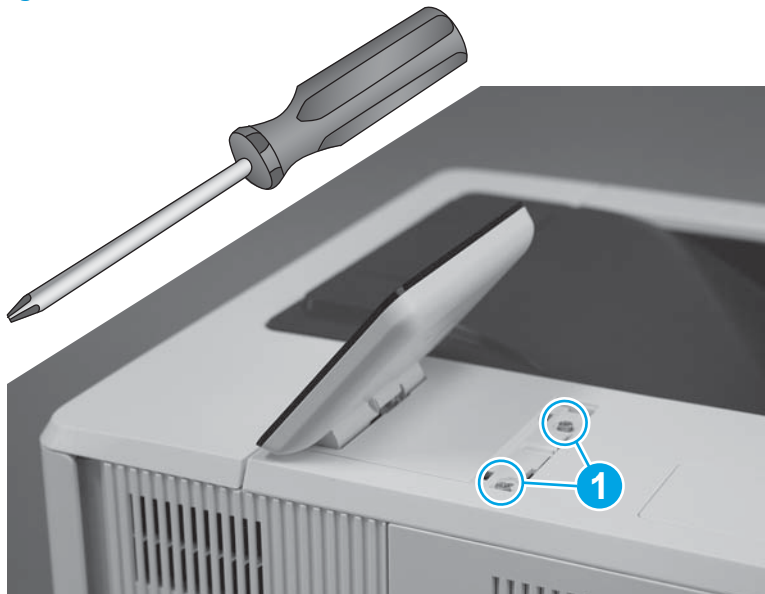
**Figure 1-1683** Remove the cover



3. Use a small Phillips screwdriver to remove two screws (callout 1).

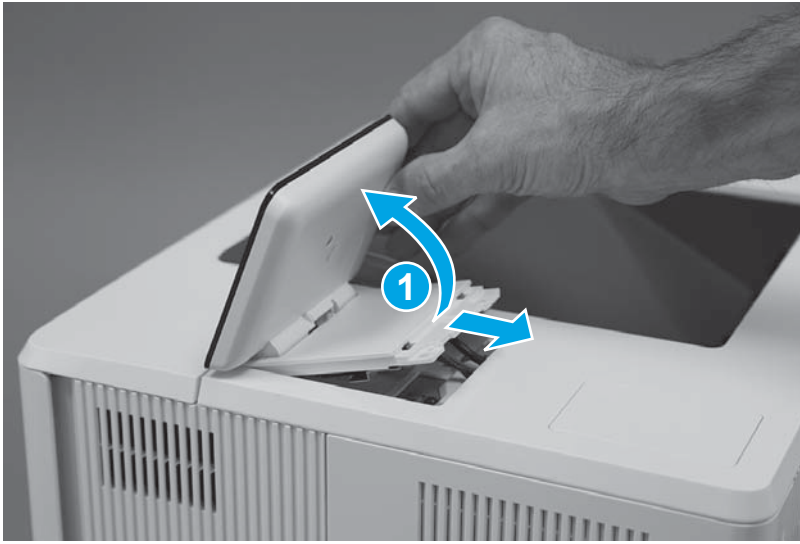
 **IMPORTANT:** Store the screws in a secure place where they cannot fall down into the printer.

**Figure 1-1684** Remove two screws



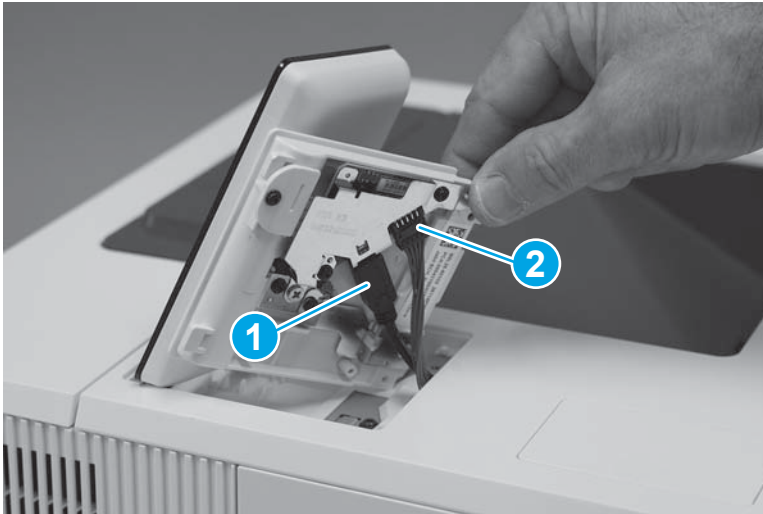
4. Turn the control panel over (callout 1), to gain access to the bottom side.

**Figure 1-1685** Turn the control panel over



5. Disconnect one HDMI cable (callout 1), one connector (callout 2), and then remove the control panel.

**Figure 1-1686** Remove the control panel



### Step 2: Remove the tray

1. Pull the tray straight out of the printer until it stops.

**Figure 1-1687** Pull the tray out until it stops



2. Lift the front of the tray, and then pull it out of the printer to remove it.

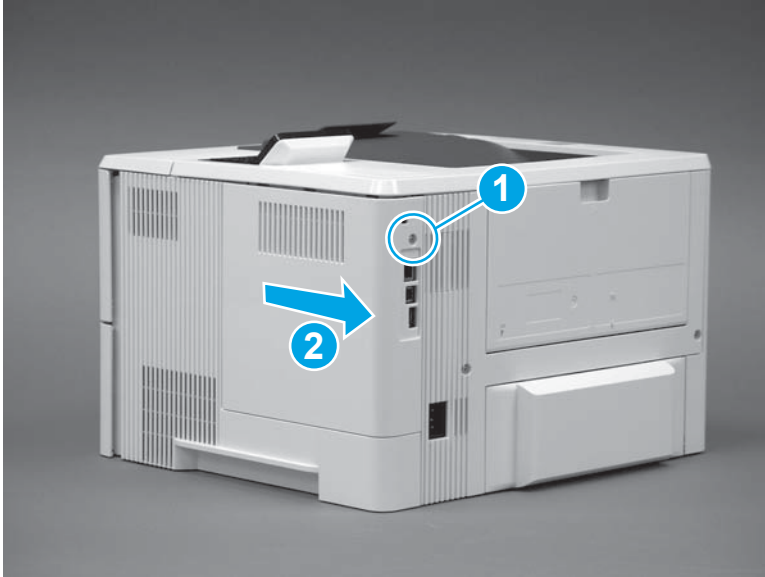
**Figure 1-1688** Release and remove the tray



### Step 3: Remove the formatter cover

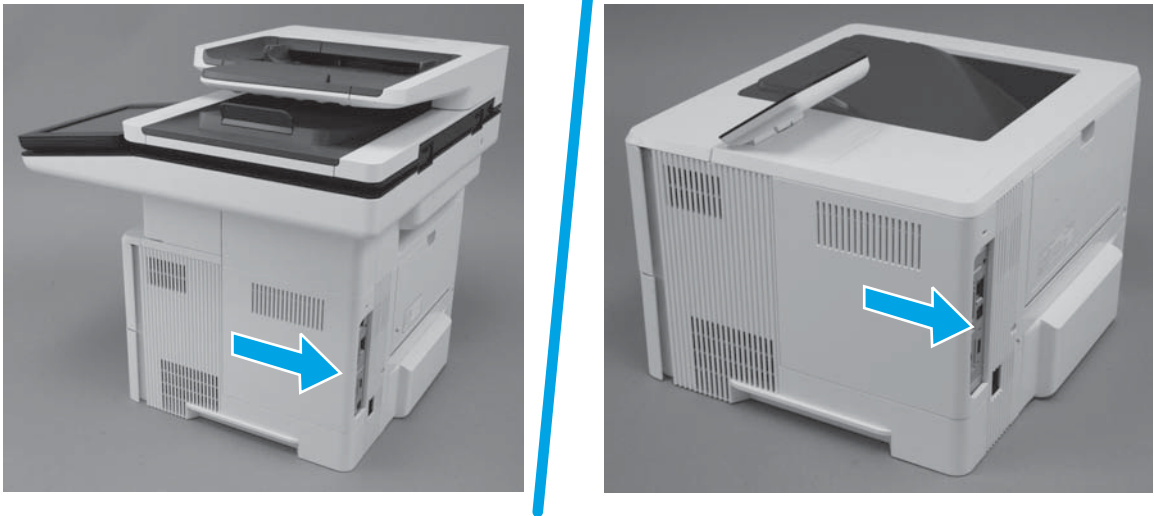
1. **M501:** Remove one screw (callout 1), and then slide the cover toward the rear of the printer to remove it (callout 2).

**Figure 1-1689** Remove the formatter cover (M501)




2. **M506/M527:** Slide the cover toward the rear of the printer to remove it.

**Figure 1-1690** Remove the formatter cover (M506/M527)



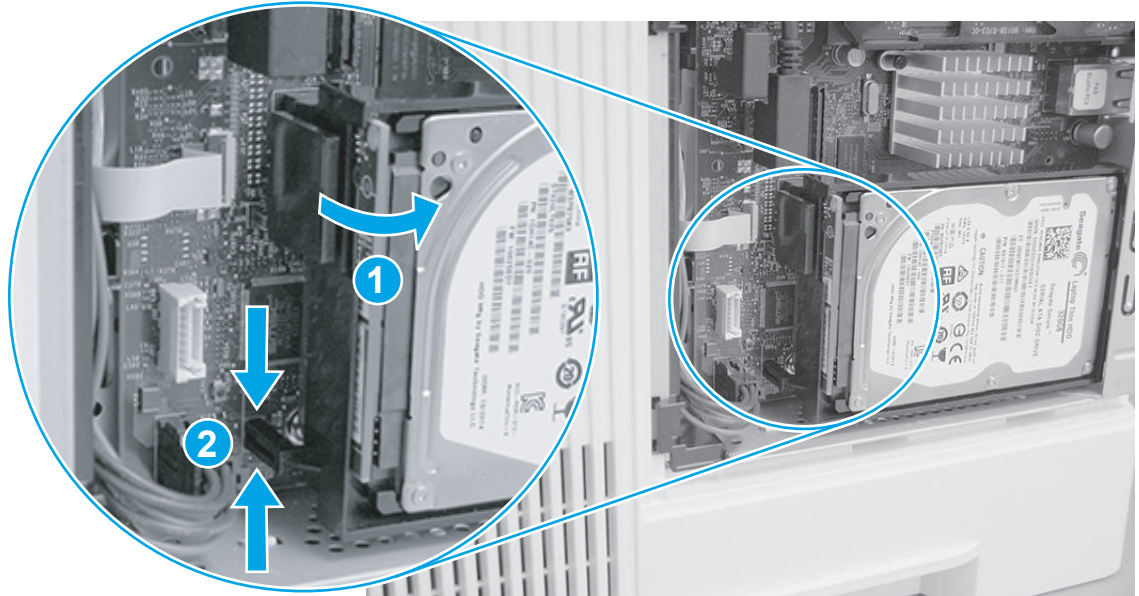
#### Step 4: Remove the hard-disk drive (HDD)

 **NOTE:** If the HDD is not installed, skip this step and go to [Step 5: Remove the fax PCA \(M527\) on page 951](#).

 **CAUTION:**  ESD-sensitive part.

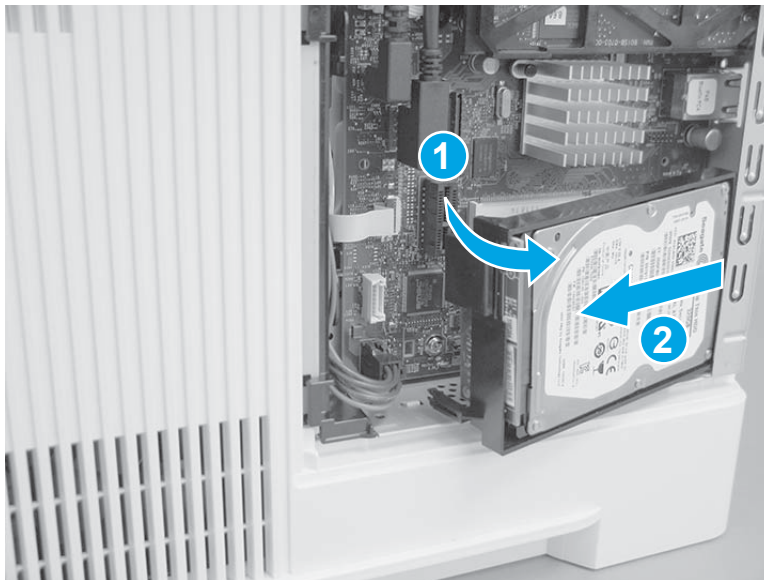
1. Release the locking connector (callout 1), and then pinch the retainer (callout 2) to release it.

**Figure 1-1691** Release the HDD



2. Rotate the connector end of the HDD out and away from the formatter (callout 1), and then slide it as shown (callout 2) to remove it.


**Figure 1-1692** Remove the HDD



### Step 5: Remove the fax PCA (M527)

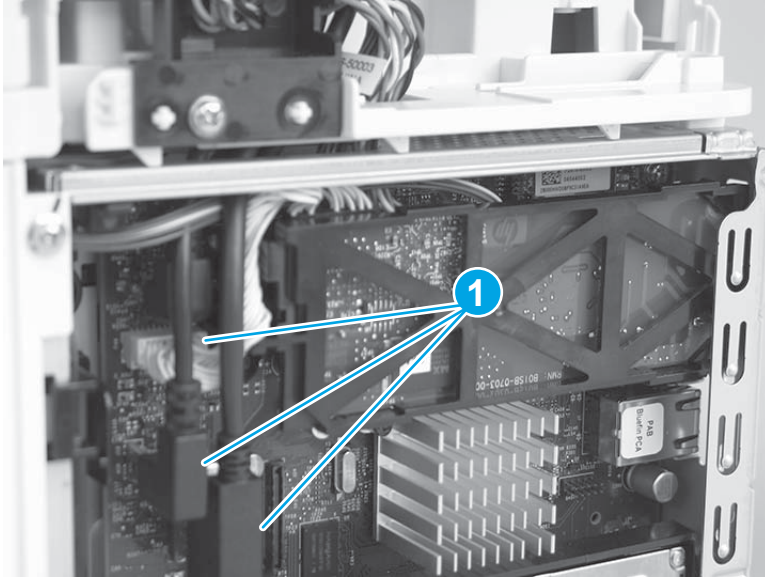
 **NOTE:** If the fax PCA is not installed, skip this step and go to [Step 6: Remove the formatter on page 953](#).

 **CAUTION:**  ESD-sensitive part.

 **NOTE:** M527c/f/z printers only (optional for the M527dn).

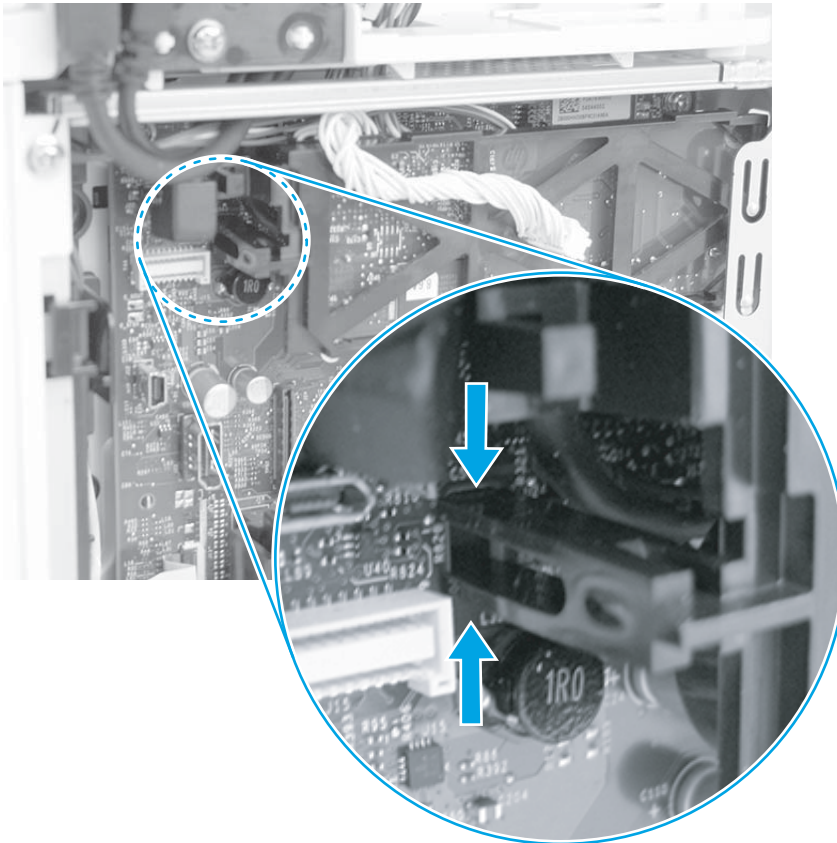
1. Disconnect three connectors (callout 1).

**Figure 1-1693** Disconnect three connectors



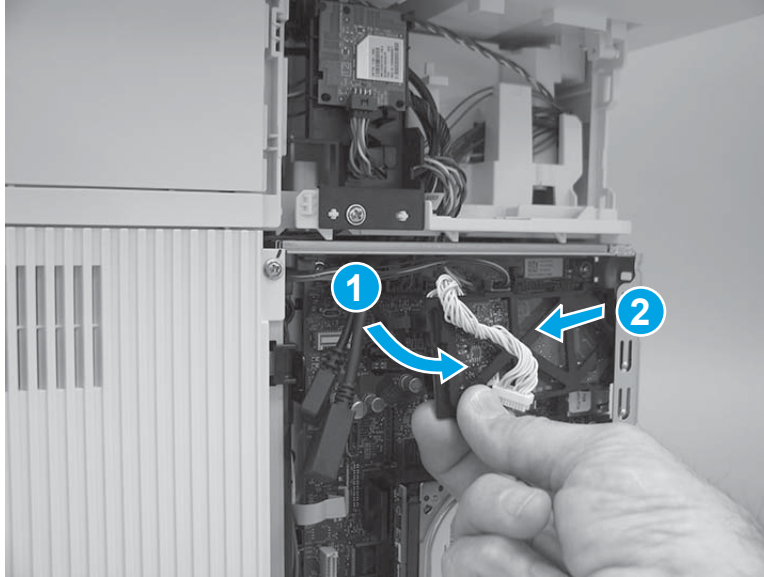
2. Pinch the retainer to release it.

**Figure 1-1694** Release the fax PCA




3. Rotate the connector end of the fax PCA out and away from the formatter (callout 1), and then slide it as shown (callout 2) to remove it.

**Figure 1-1695** Remove the fax PCA

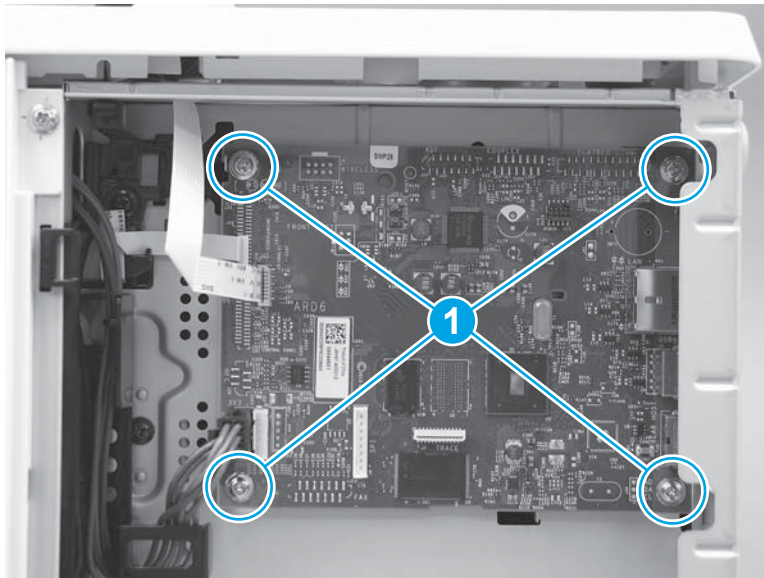


#### Step 6: Remove the formatter


 **IMPORTANT:** **M506/M527:** Take note of all empty connectors on the PCA before disconnecting any wire harnesses or flat-flexible cables (FFCs). Some empty connectors might not be visible until other items—like the hard-disk drive—are removed, so pay close attention while removing the formatter and accessory items.

1. **M501:** Disconnect all of the connectors and FFCs, remove four screws (callout 1), and then remove the formatter.

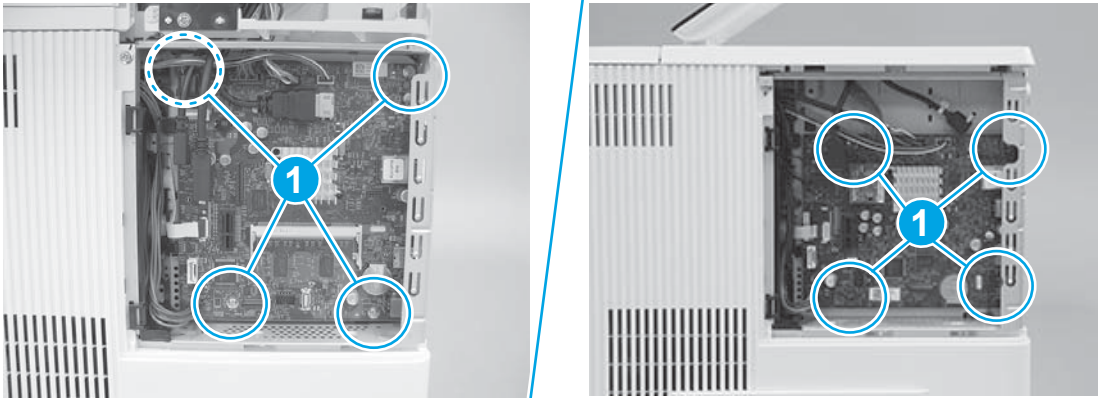
**Figure 1-1696** Remove the formatter (M501)




2. **M506/M527:** Disconnect all of the connectors and FFCs, remove four screws (callout 1), and then remove the formatter.

 **IMPORTANT:** Take note of all empty connectors on the formatter before disconnecting any wire harnesses or flat-flexible cables (FFCs). Some empty connectors might not be visible until other items—like the hard-disk drive—are removed, so pay close attention while removing the formatter and accessories items.

**Figure 1-1697** Remove the formatter (M506/M527)



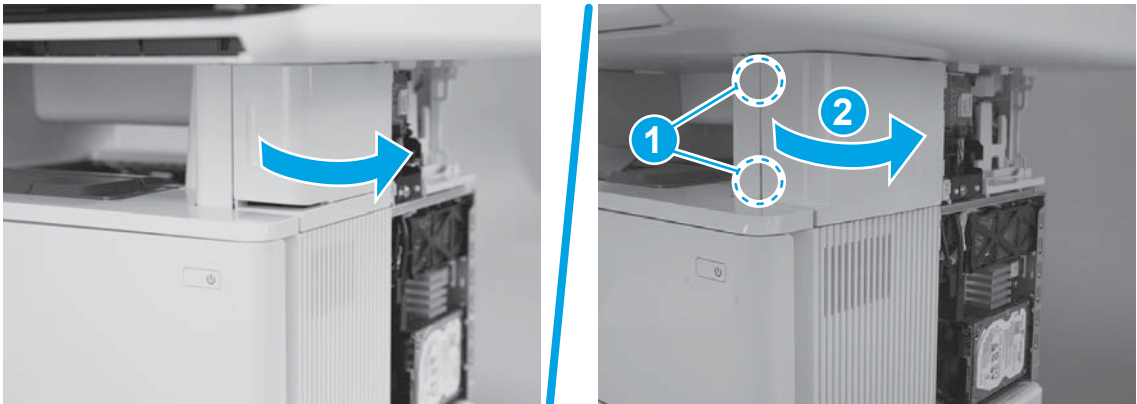
### Step 7: Remove the stapler door or stapler blank cover (M527)

 **NOTE:** This step is for the M527 printer. For the M501/M506, skip this step and go to [Step 11: Remove the rear door assembly on page 962](#).

The M527dn does not have a convenience stapler.

1. Do one of the following:
  - **M527c/f/z:** Open the stapler door.
  - **M527dn:** Use a small flat-blade screwdriver to release two tabs (callout 1), and then rotate the cover away from the printer (callout 2).

**Figure 1-1698** Open the door or release the cover



2. Do one of the following:
  - **M527c/f/z:** Use a small flat-blade screwdriver to release the upper hinge.
  - **M527dn:** Slide the cover toward the front of the printer to remove it.



**Figure 1-1699** Release the upper hinge or remove the cover



- 3. M527c/f/z:** Use a small flat-blad screwdriver to release the lower hinge.

**Figure 1-1700** Release the lower hinge





4. **M527c/f/z:** Remove the door.

**Figure 1-1701** Remove the door



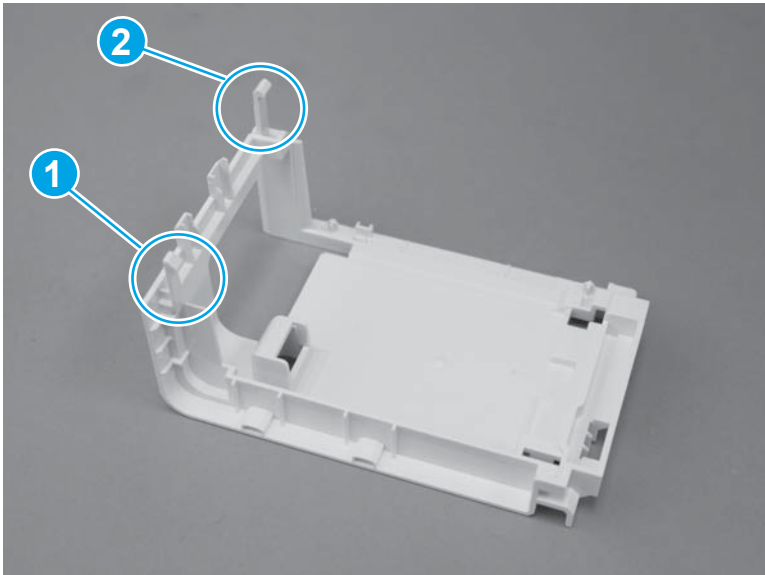
#### Step 8: Remove the stapler stationary (inner) cover (M527)

 **NOTE:** This step is for the M527c/f/z printers. For the M501/M506, skip this step and go to [Step 11: Remove the rear door assembly on page 962](#). For the M527dn, skip this step and go to [Step 9: Remove the top-left cover \(M527\) on page 958](#).

 **NOTE:** M527c/f/z printers only.

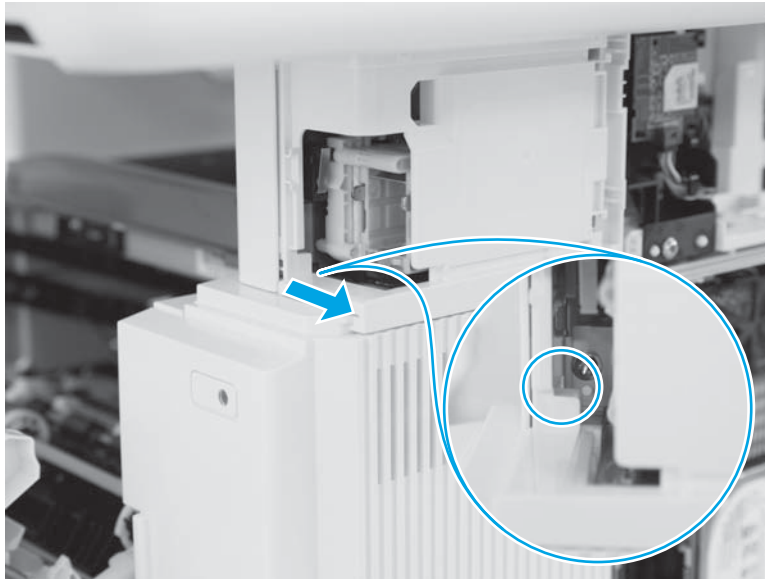
1. Before proceeding, take note of the locations of the upper tab (callout 1) and the lower tab (callout 2) on the stapler stationary (inner) cover.

**Figure 1-1702** Locate the tabs



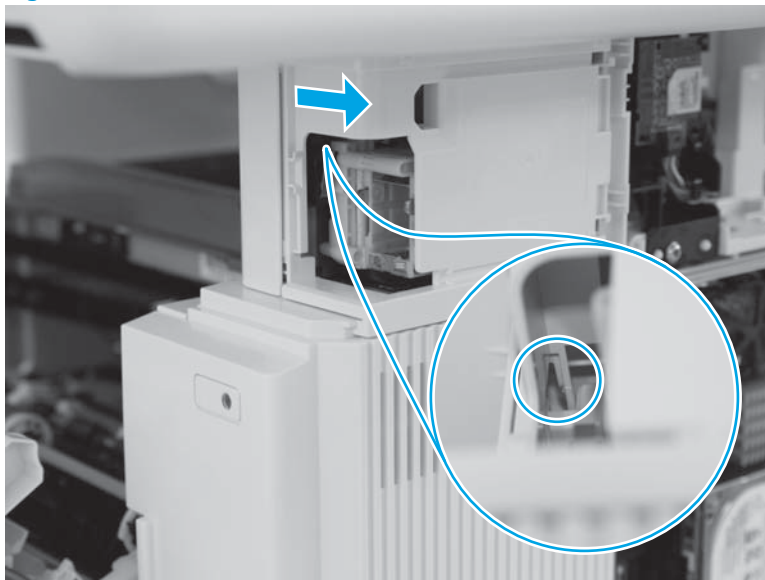
2. Use a long-shaft small flat-blad screwdriver to release the lower tab.

**Figure 1-1703** Release one tab



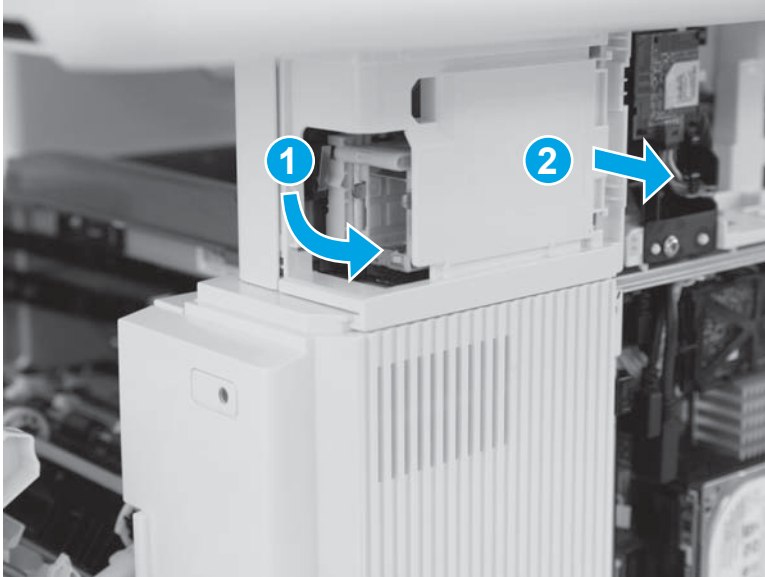
3. Use a long-shaft small flat-blad screwdriver to release the upper tab.

**Figure 1-1704** Release one tab



4. With the tabs disengaged the front of the cover is released. Rotate the front of the cover away from the printer (callout 1) to release the rear of the cover (callout 2), and then remove it.

**Figure 1-1705** Remove the cover



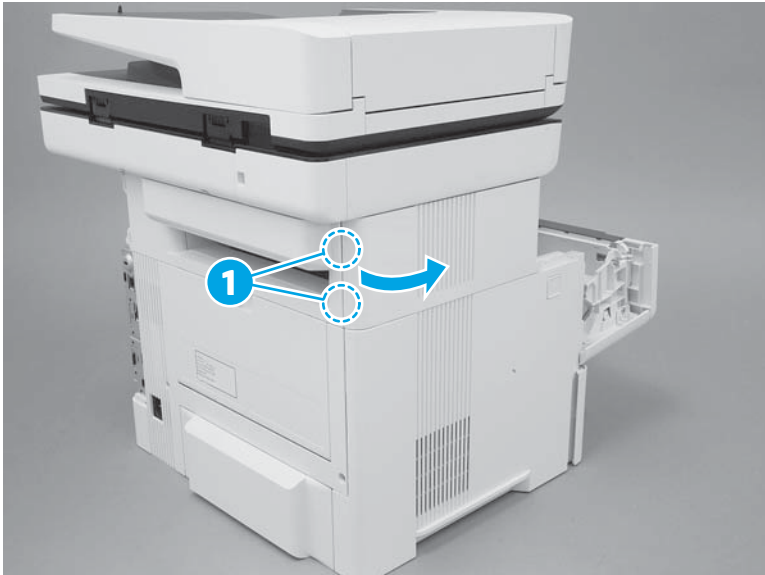
#### Step 9: Remove the top-left cover (M527)



**NOTE:** This step is for the M527 printer. For the M501/M506, skip this step and go to [Step 11: Remove the rear door assembly on page 962](#).

1. Open the toner-cartridge door, release two tabs (callout 1), and then rotate the rear edge of the cover away from the printer.

**Figure 1-1706** Release two tabs



2. Continue to rotate the cover away from the printer to release two more tabs at the middle of the cover.

**Figure 1-1707** Release two tabs



3. Slide the cover toward the rear of the printer to release two bosses at the front of the cover.

**Figure 1-1708** Slide the cover



4. Remove the cover.

**Figure 1-1709** Remove the cover



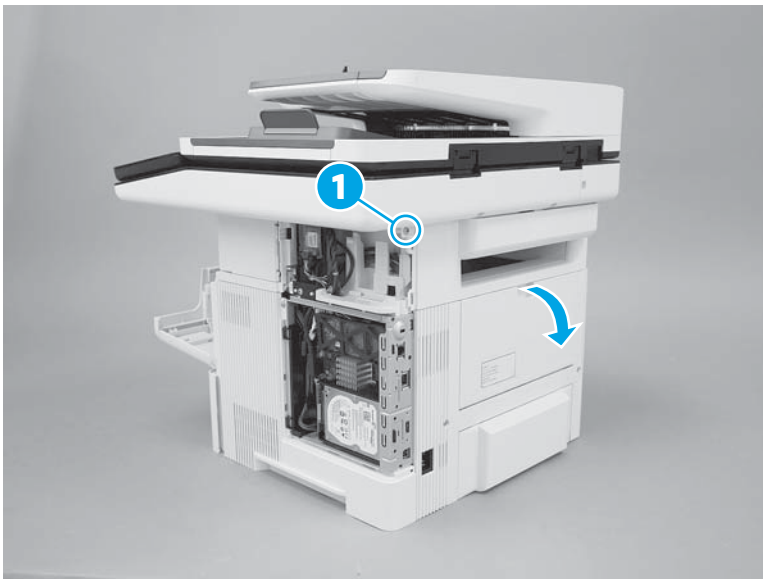
#### Step 10: Remove the top-rear cover (M527)



**NOTE:** This step is for the M527 printer. For the M501/M506, skip this step and go to [Step 11: Remove the rear door assembly on page 962](#).

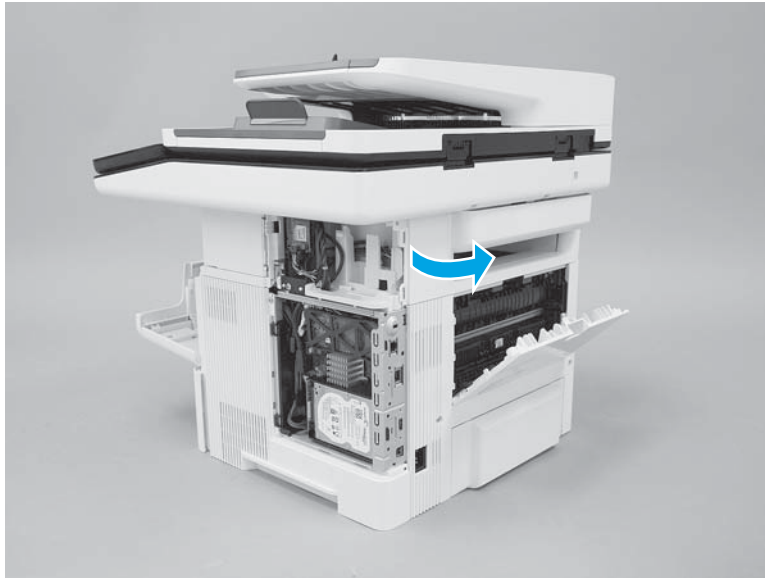
1. Remove one screw (callout 1), and then open the rear door.

**Figure 1-1710** Remove one screw



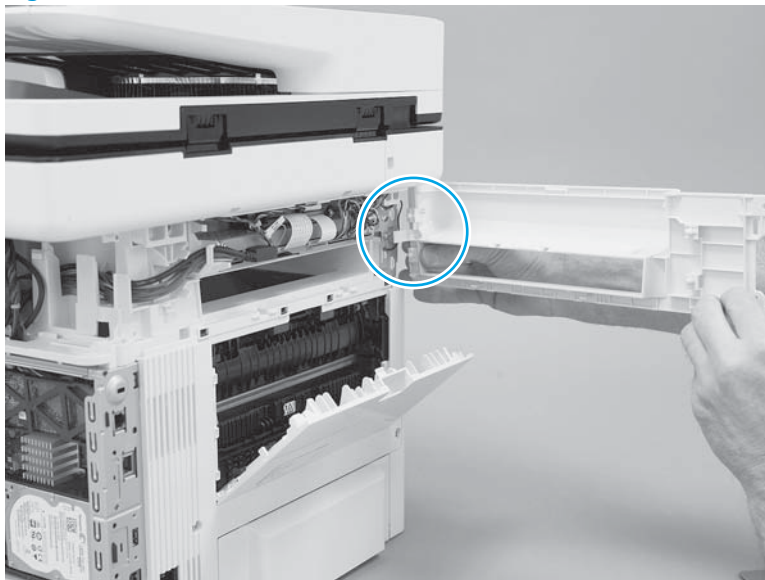
2. Rotate the exposed edge of the cover away from the printer (as shown).

**Figure 1-1711** Rotate the cover



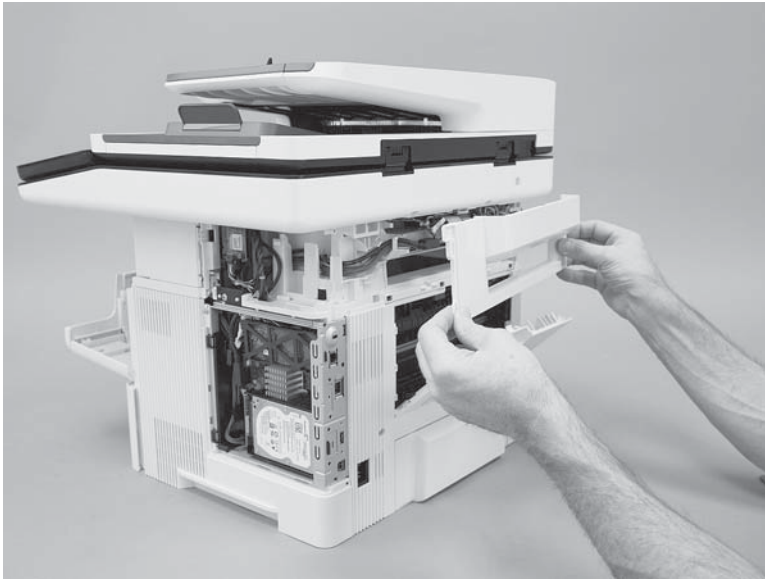
3. Continue to rotate the cover away from the printer to release one boss.

**Figure 1-1712** Release one boss



4. Remove the cover.

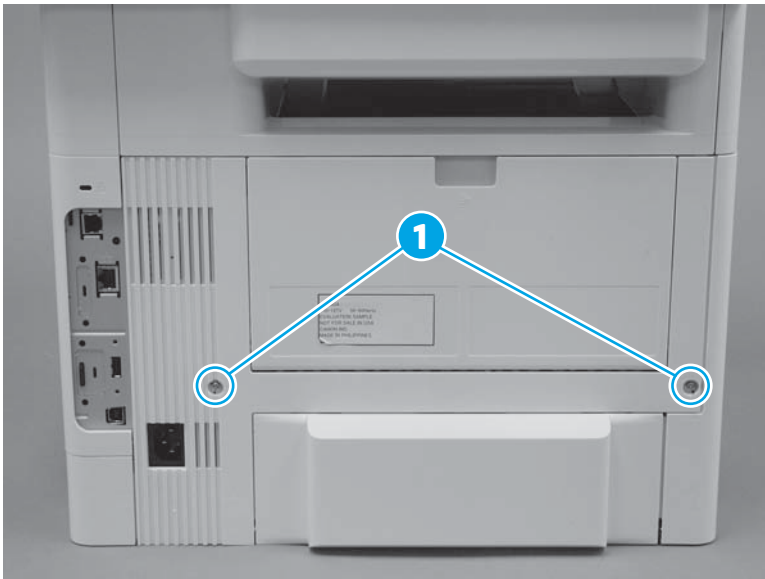
**Figure 1-1713** Remove the cover



#### Step 11: Remove the rear door assembly

1. At the rear of the printer, remove two screws (callout 1).

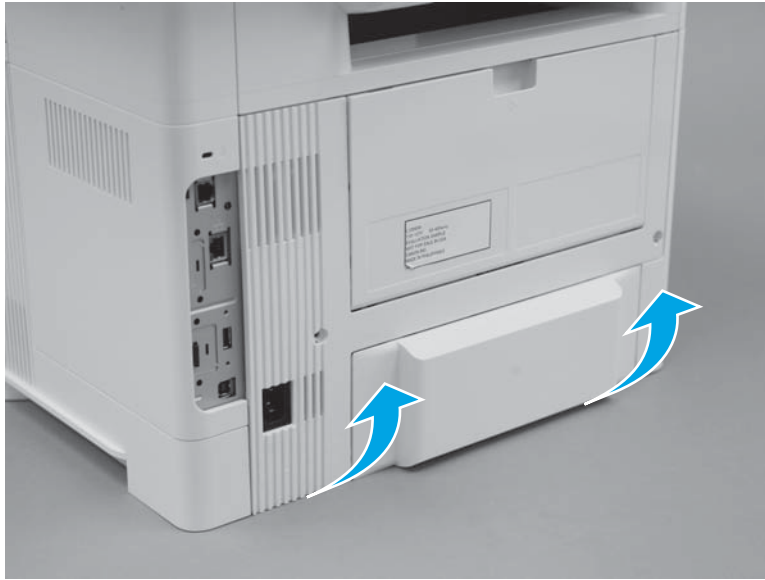
**Figure 1-1714** Remove two screws





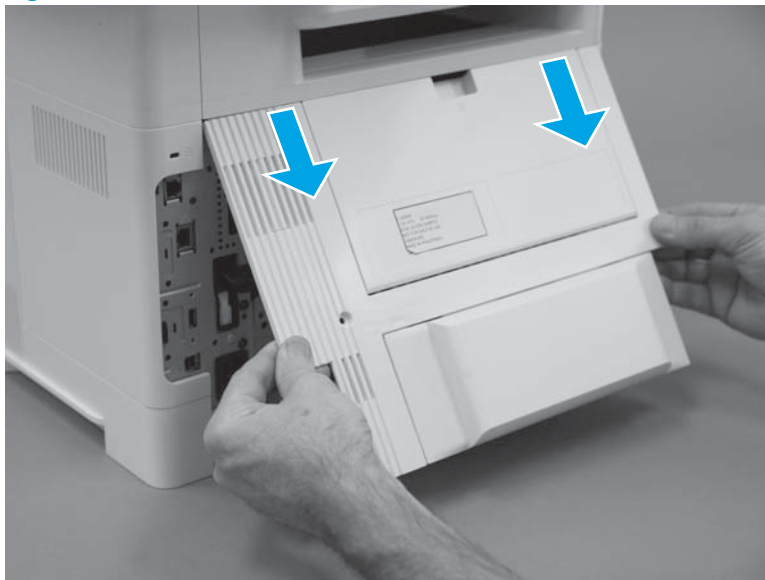
2. Rotate the bottom edge of the assembly away from the printer to release it.

**Figure 1-1715** Rotate the bottom of the cover



3. Pull down on the assembly to remove it.

**Figure 1-1716** Remove the cover



### Step 12: Remove the cartridge door assembly

---

 **NOTE:** If the toner cartridge was not removed prior to servicing the printer, remove it now.

---

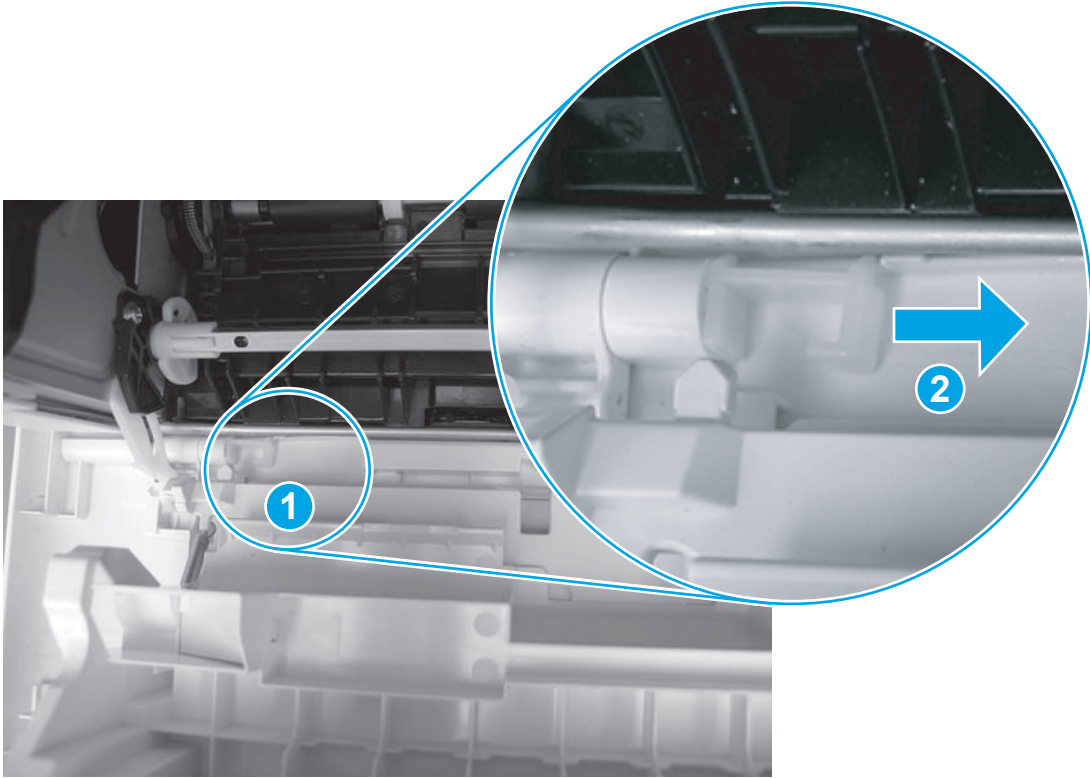
1. Release the support shaft (callout 1), and then slide it toward the center of the door (callout 2).

---

 **TIP:** It might be easier to release the support shaft by using a small flat-blad screwdriver.

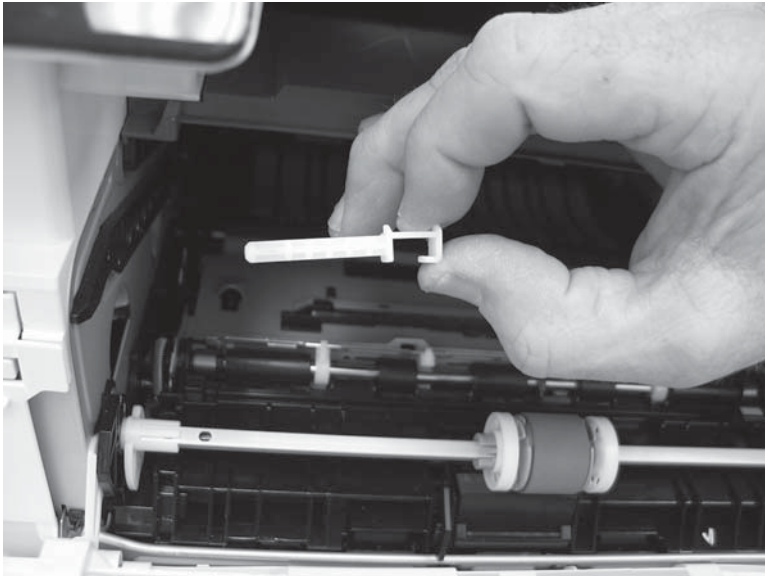
---

**Figure 1-1717** Release the support shaft



2. Remove the support shaft.

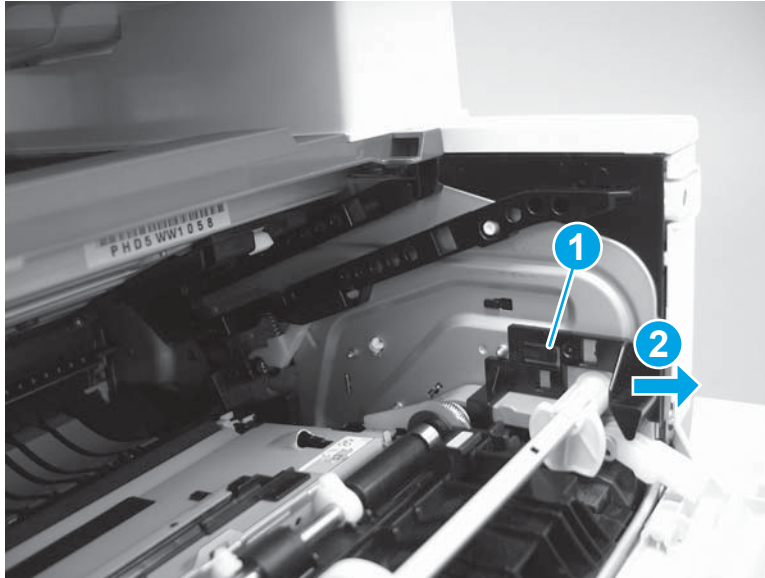
**Figure 1-1718** Remove the support shaft



3. Release one tab (callout 1), and then slide the guide out of the printer (callout 2).

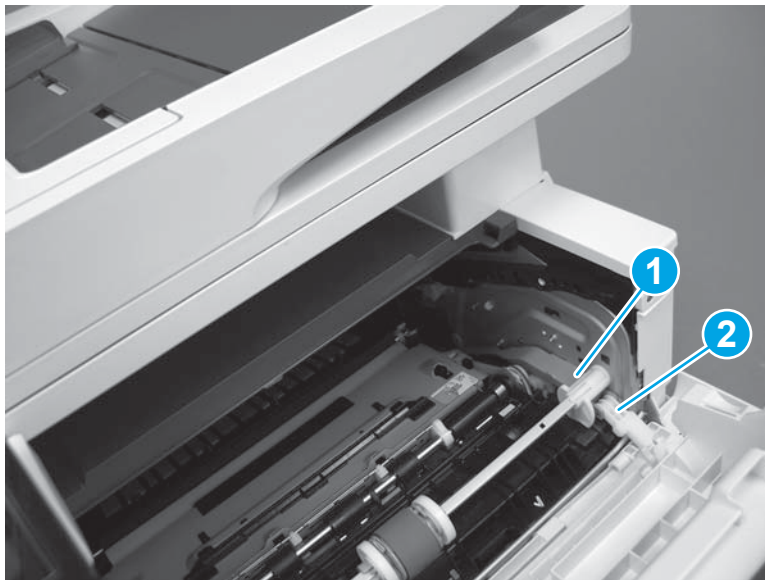
**CAUTION:** Be careful, the tab (callout 1) can be easily broken.

**Figure 1-1719** Remove the guide



4. Use a small flat-blade screwdriver to gently pry the white-plastic door arm (callout 1) off of the gray-plastic pressure-release link (callout 2) to release the door arm.

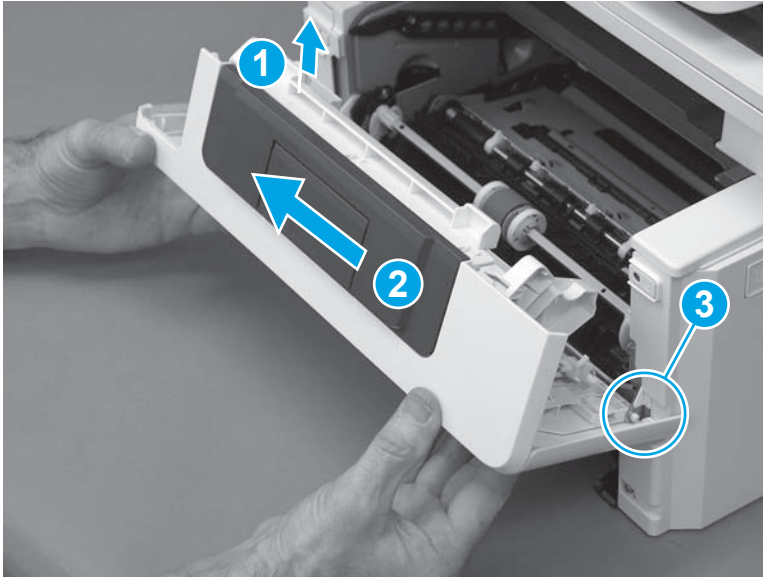
**Figure 1-1720** Release the pressure-release link



5. With the door in the partially closed position, slightly raise the left end (callout 1; raise it over the sheet-metal hinge boss), and then slide the door to the left (callout 2) to release the right hinge (callout 3).

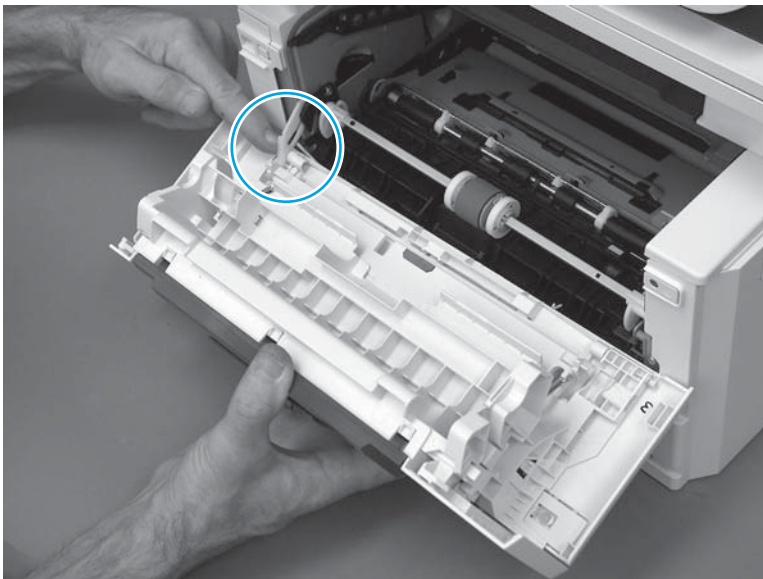
**⚠ CAUTION:** The door is still attached to the printer by the left-side retainer arm. Do not attempt to completely remove the door.

**Figure 1-1721** Release the door



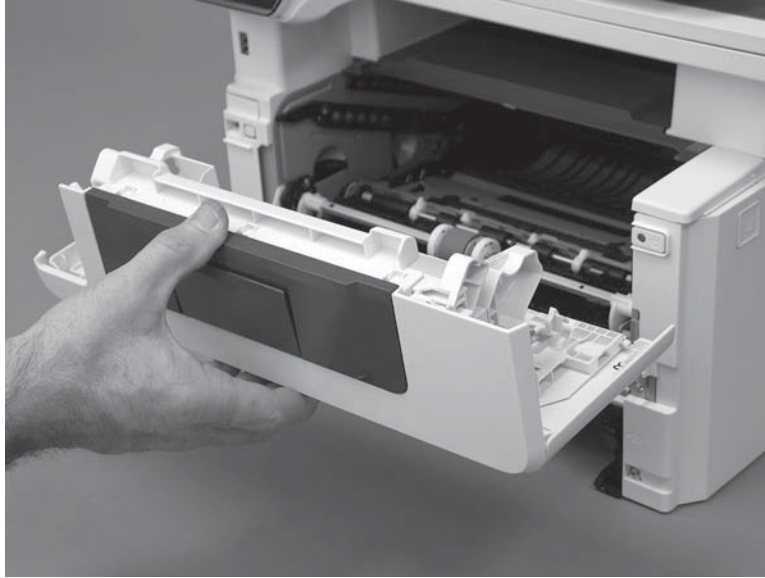
6. Rotate the door away from the printer until the keyed pin on the left-side retainer arm can disengage from the door.

**Figure 1-1722** Release the left-side retainer arm





7. Remove the door.

**Figure 1-1723** Remove the door



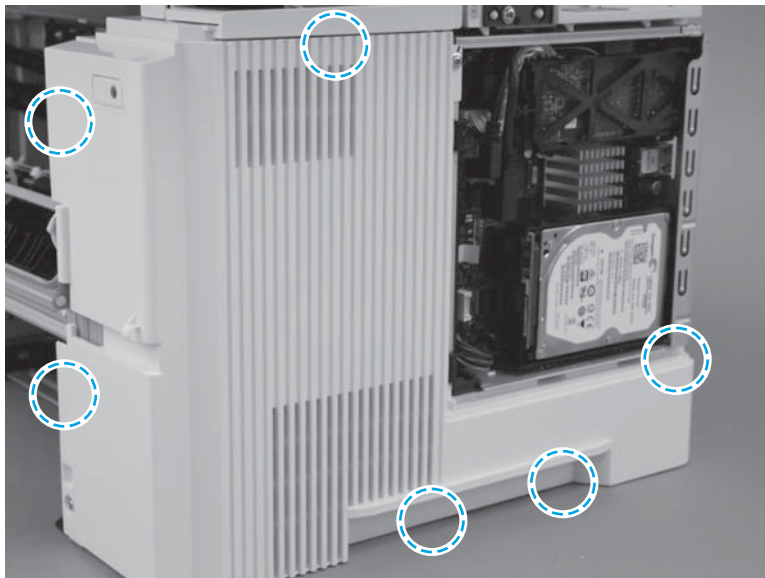
### Step 13: Remove the right cover

 **IMPORTANT:** The black-plastic cassette front and rear guides (located inside the tray cavity) can be easily dislodged. Do not lose the guides when the cover is removed or installed.

 **NOTE:** The M527 printer is shown in this procedure. However, this procedure is valid for the M501/M506 printers.

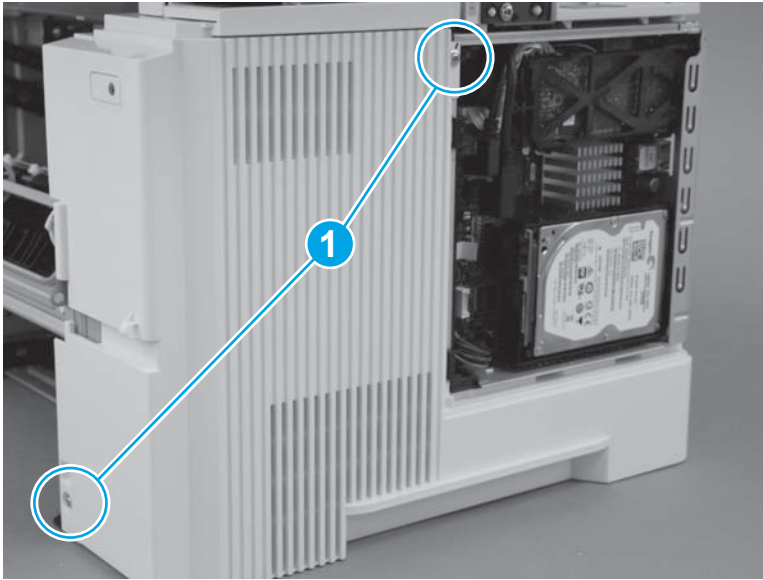
1. Before proceeding, take note of the location of the tabs and bosses on the inside of the cover.

**Figure 1-1724** Locate the tabs and bosses



2. Remove two screws (callout 1).

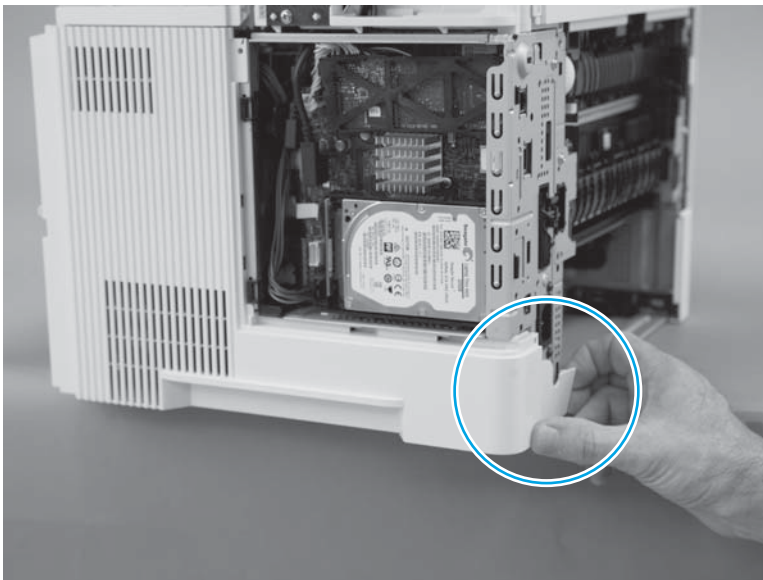
**Figure 1-1725** Remove two screws



3. At the rear of the printer, release one boss.

**CAUTION:** It might be easier to remove the cover with the printer slightly hanging over the edge of the workspace. Do not let the printer tip and fall off of the workspace when removing the cover.

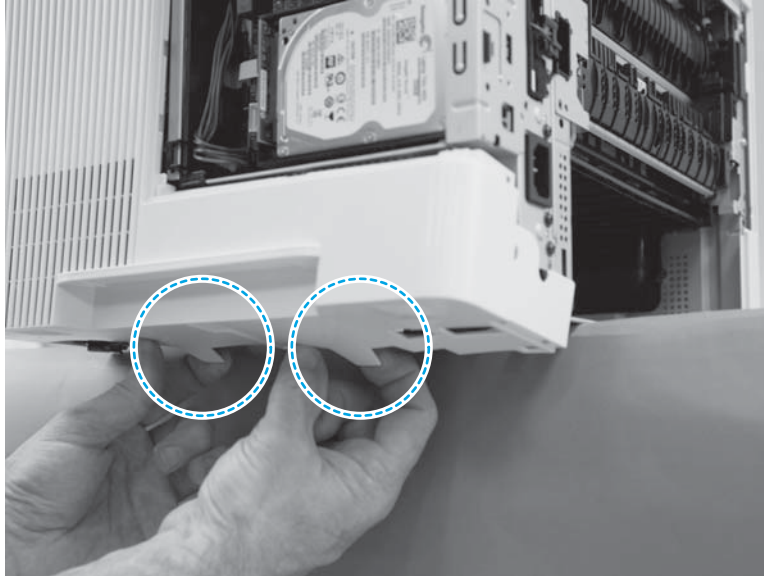
**Figure 1-1726** Release one boss



4. At the bottom edge of the cover, release two bosses.

**CAUTION:** It might be easier to remove the cover with the printer slightly hanging over the edge of the workspace. Do not let the printer tip and fall off of the workspace when removing the cover.

**Figure 1-1727** Release two bosses

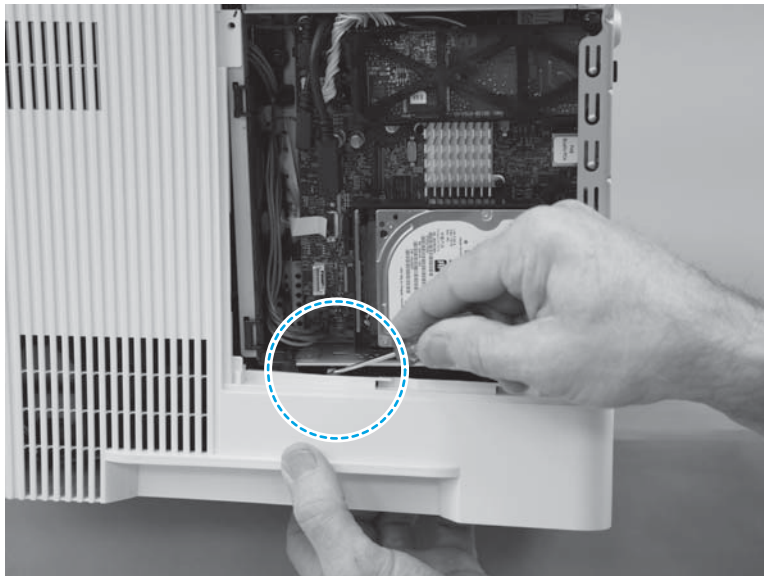


5. Near the formatter, release one tab.

**CAUTION:** It might be easier to remove the cover with the printer slightly hanging over the edge of the workspace. Do not let the printer tip and fall off of the workspace when removing the cover.

**TIP:** Hold the bottom of the cover away from the printer, and then use a small flat-blade screw driver to easily release this tab.

**Figure 1-1728** Release one tab

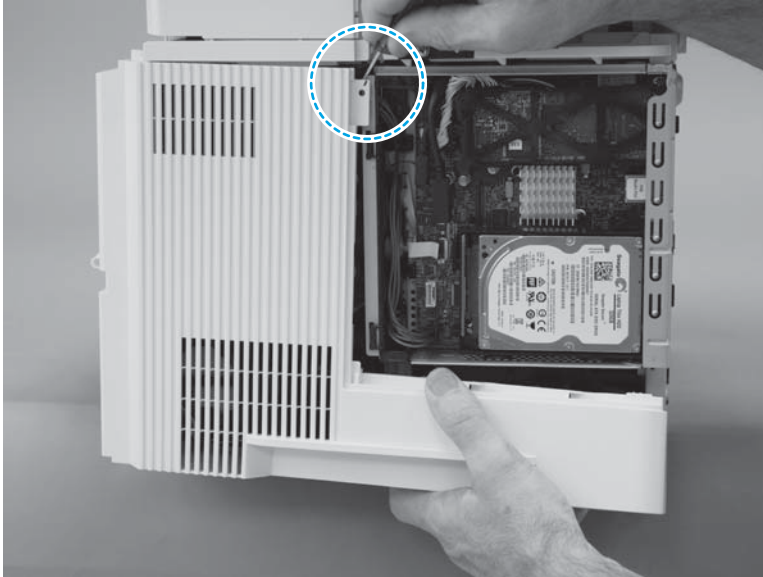


- At the top rear edge of the cover, release one tab.

**CAUTION:** It might be easier to remove the cover with the printer slightly hanging over the edge of the workspace. Do not let the printer tip and fall off of the workspace when removing the cover.

**TIP:** Use a small flat-blade screw driver to easily release this tab.

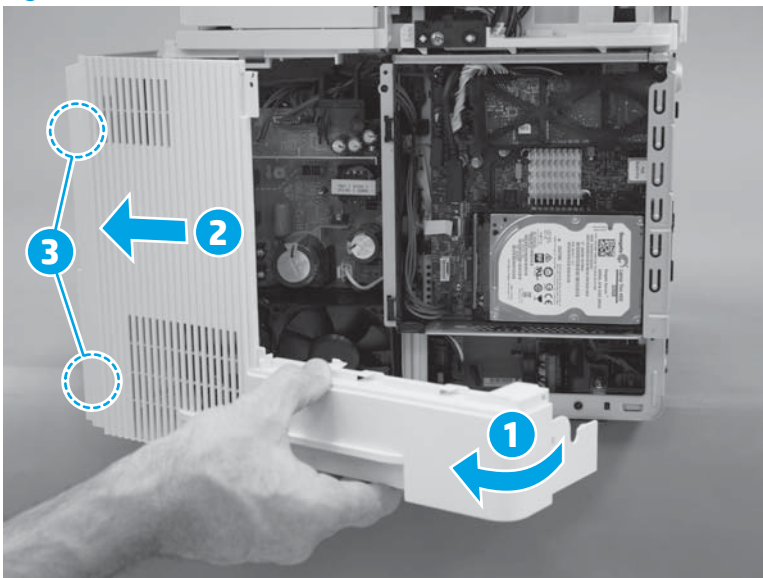
**Figure 1-1729** Release one tab



- Rotate the rear of the cover away from the printer (callout 1), slide the cover toward the front of the printer (callout 2) to release two bosses (callout 3), and then remove the cover.


**CAUTION:** It might be easier to remove the cover with the printer slightly hanging over the edge of the workspace. Do not let the printer tip and fall off of the workspace when removing the cover.


**Figure 1-1730** Remove the cover





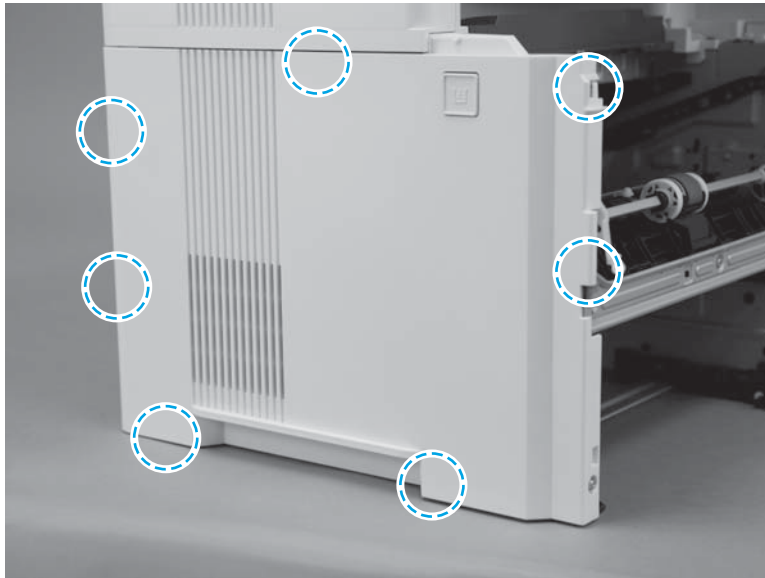
## Step 14: Remove the left cover

 **IMPORTANT:** The black-plastic cassette front and rear guides (located inside the tray cavity) can be easily dislodged. Do not lose the guides when the cover is removed or installed.

 **NOTE:** The M527 printer is shown in this procedure. However, this procedure is valid for the M501/M506 printers.

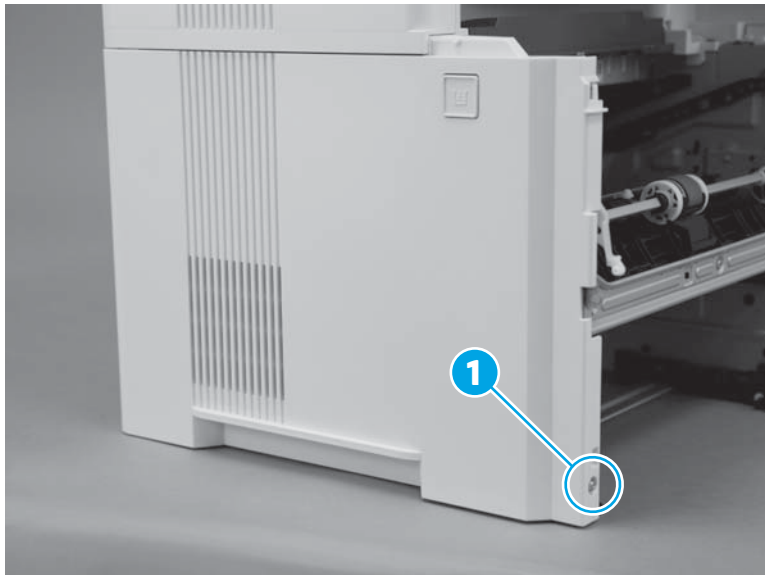
1. Before proceeding, take note of the location of the tabs and bosses on the inside of the cover.

**Figure 1-1731** Locate of the tabs and bosses



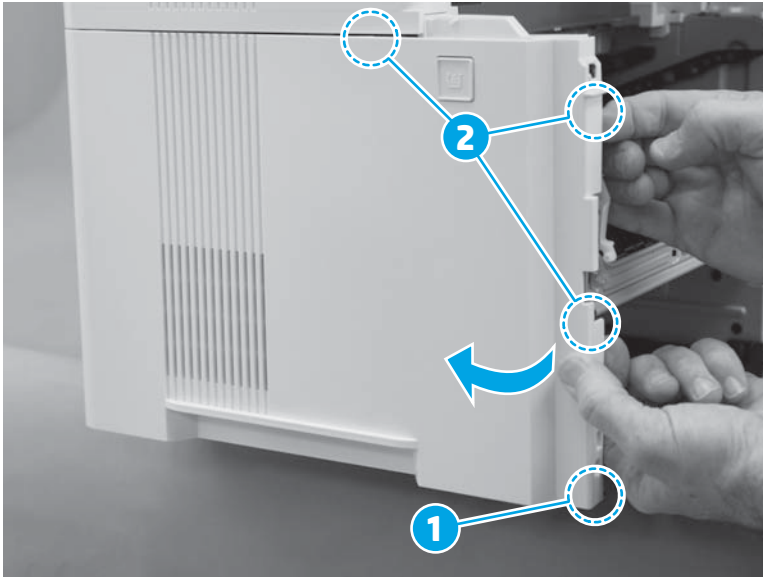
2. Remove one screw (callout 1).

**Figure 1-1732** Remove one screw



3. At the front of the printer, release one boss (callout 1), and then rotate the front edge of the cover away from the printer to release three tabs (callout 2).

**Figure 1-1733** Release one boss and three tabs




4. At the bottom edge of the cover, release two tabs.

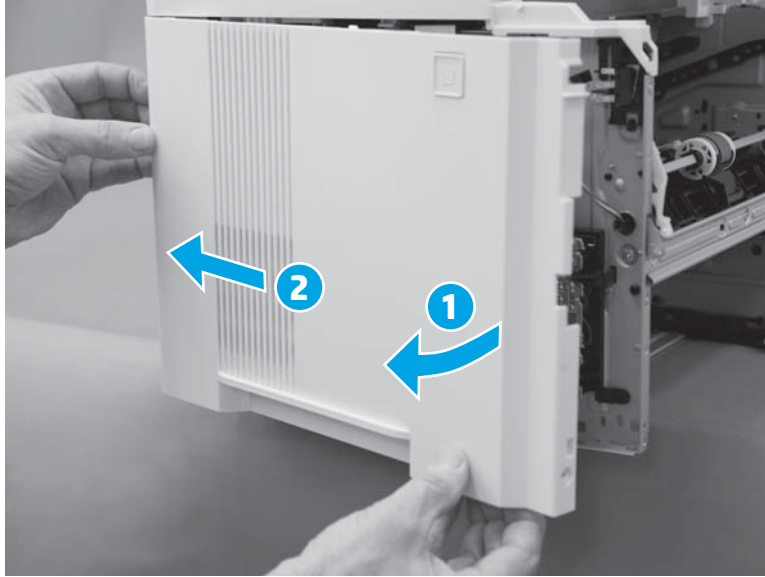
**Figure 1-1734** Release two tabs




5. Continue to rotate the front edge of the cover away from the printer (callout 1), and then slide the cover toward the rear of the printer (callout 2) to remove it.


 **NOTE:** If the cover is difficult to rotate or slide as shown below, make sure that the bottom tabs (released in the previous step) are completely disengaged from the chassis.


**Figure 1-1735** Remove the cover



### Step 15: Remove the integrated scanner assembly (M527)

 **IMPORTANT:** Some figure might show assemblies removed or installed that have not yet been removed or installed at that specific step. However, the procedures are correct for this printer and the target assembly. Always thoroughly read the instructions that accompany each figure.

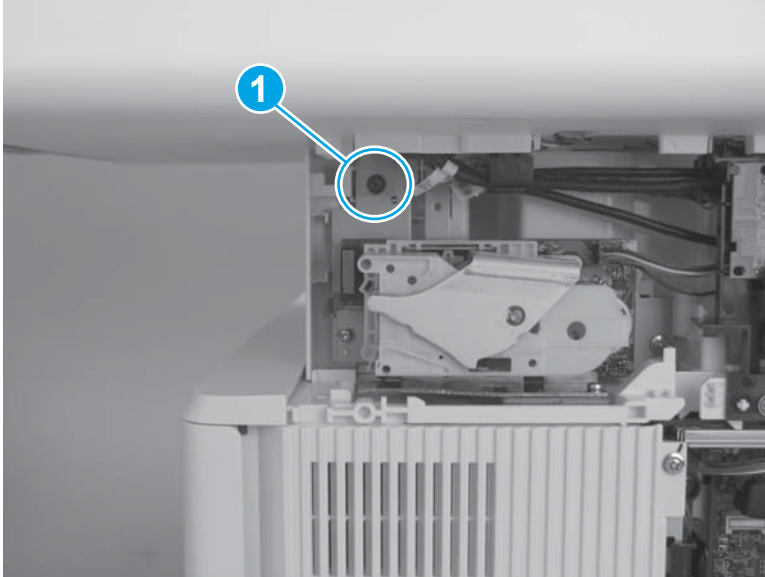
 **NOTE:** This step is for the M527 printer. For the M501/M506, skip this step and go to [Step 17: Remove the top cover \(M501/M506\) on page 979](#).

 **NOTE:** The ISA includes the document feeder, sub-scanner assembly (SSA), and the scanner control board (SCB).

1. Remove one screw (callout 1).


 **IMPORTANT:** This screw fastens the ISA ground plate to the printer chassis. Do not lose this screw.

**Figure 1-1736** Remove one screw

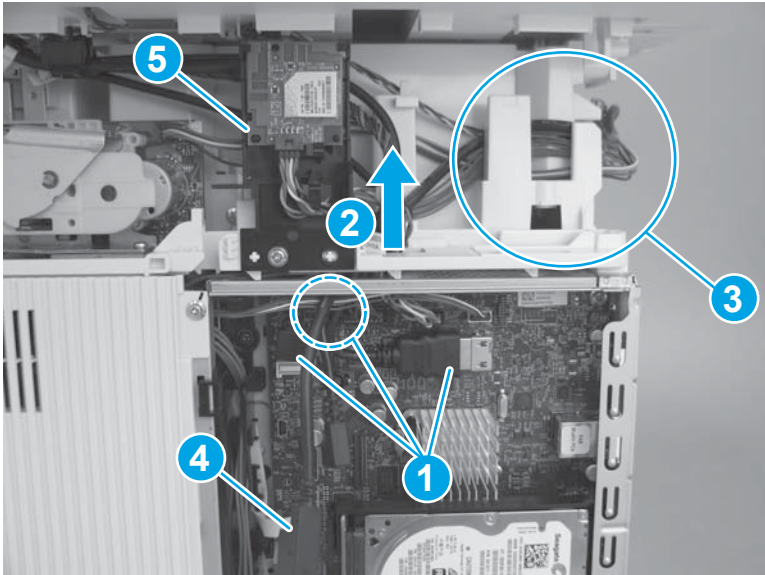


2. Disconnect three connectors (callout 1), pass the wire harnesses and cables through the opening in the cover (callout 2), and then release them from the retainers (callout 3).

 **NOTE:** One cable (callout 4) does not need to pass through the opening in the cover.

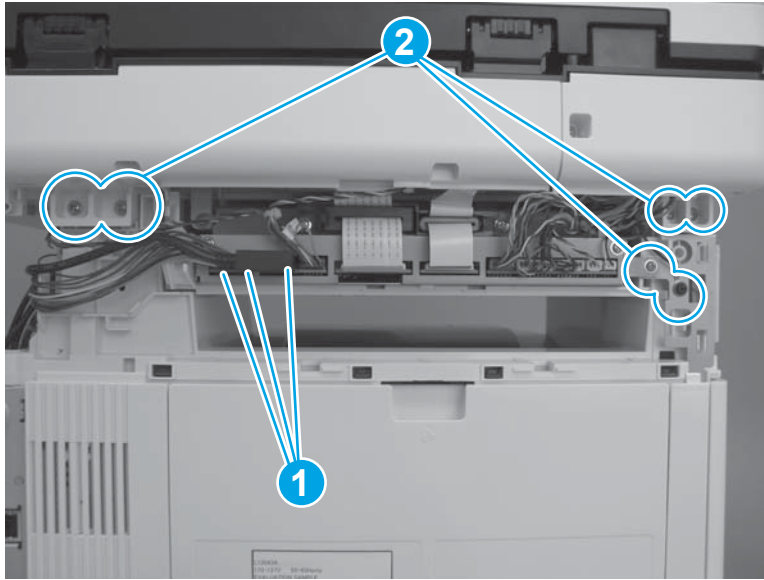
 **TIP:** It might be easier if the WiFi PCA and holder (callout 5) is detached from the printer, and then moved out of the way.

**Figure 1-1737** Disconnect cables and connectors



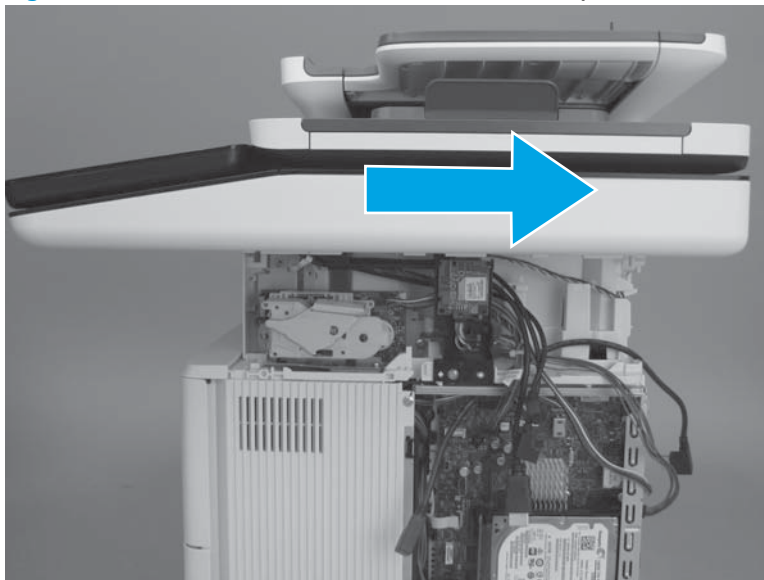
3. Disconnect three connectors (callout 1), and then remove six screws (callout 2).

**Figure 1-1738** Disconnect connectors and remove screws



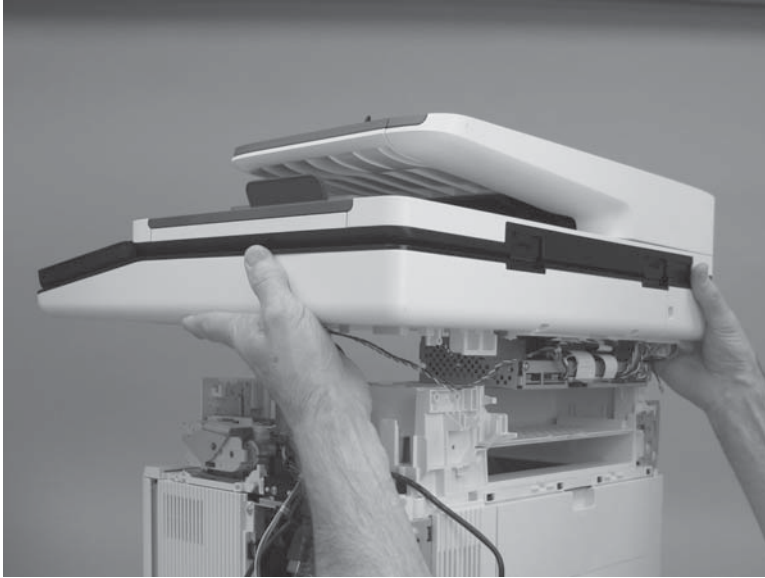
4. Slightly slide the ISA towards the back of the printer to release it.

**Figure 1-1739** Slide the ISA towards the back of the printer



5. Remove the ISA.

**Figure 1-1740** Remove the ISA



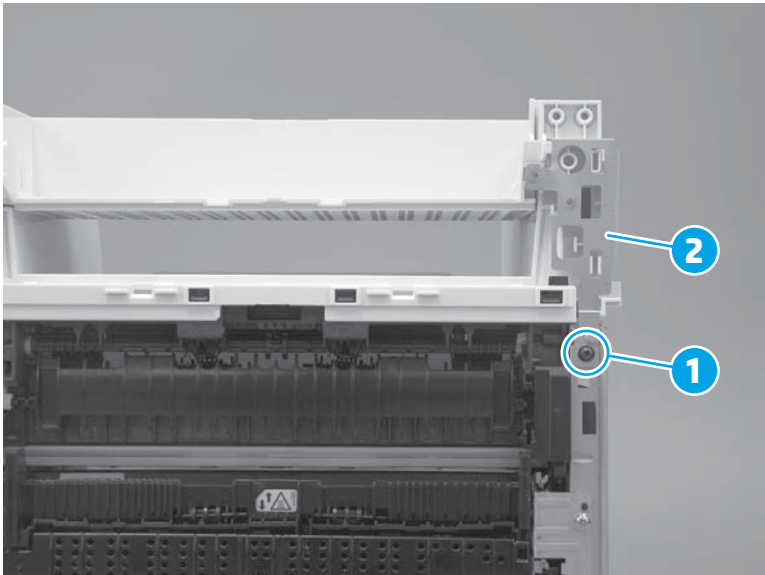
#### Step 16: Remove the top cover (M527)



**NOTE:** This step is for the M527 printer. For the M501/M506, skip this step and go to [Step 17: Remove the top cover \(M501/M506\) on page 979](#).

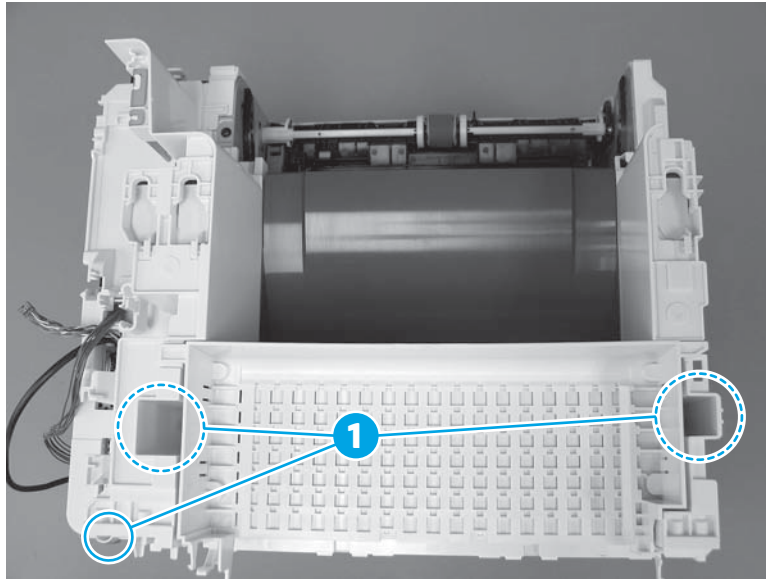
1. At the front right of the printer, remove one screw (callout 1), and then remove the sheet-metal plate (callout 2).

**Figure 1-1741** Remove one screw and the plate




2. At the top rear of the printer, remove three screws (callout 1).

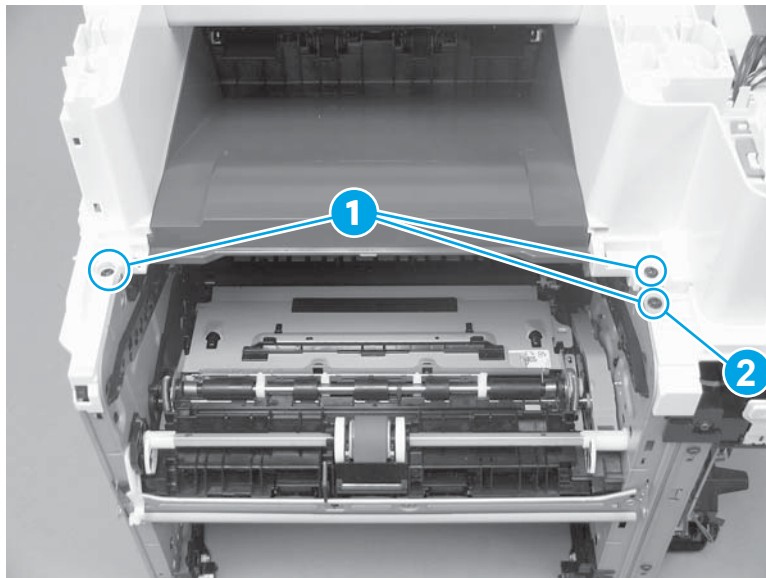
**Figure 1-1742** Remove three screws



3. At the top front of the printer, remove three screws (callout 1).

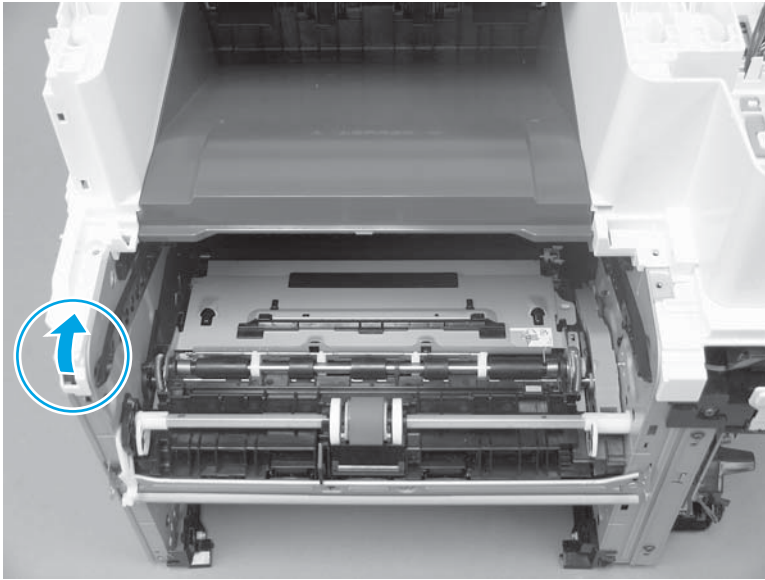
 **NOTE:** The screw (callout 2) on the lower-right portion of the cover is a different color than the other two screws, and is surrounded by sheet-metal. It might appear that this screw does not need to be removed. Remove this screw.

**Figure 1-1743** Remove three screws



4. At the front left of the printer, release one boss.

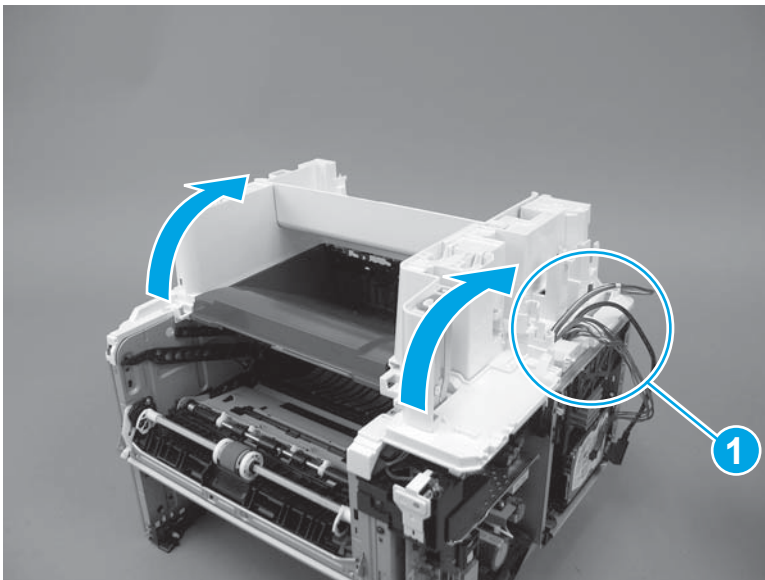
**Figure 1-1744** Release one boss



5. Rotate the front of the cover up and away from the printer.

**CAUTION:** As the cover is rotated up, carefully pass the cables and wire harnesses the hole in the cover (callout 1).

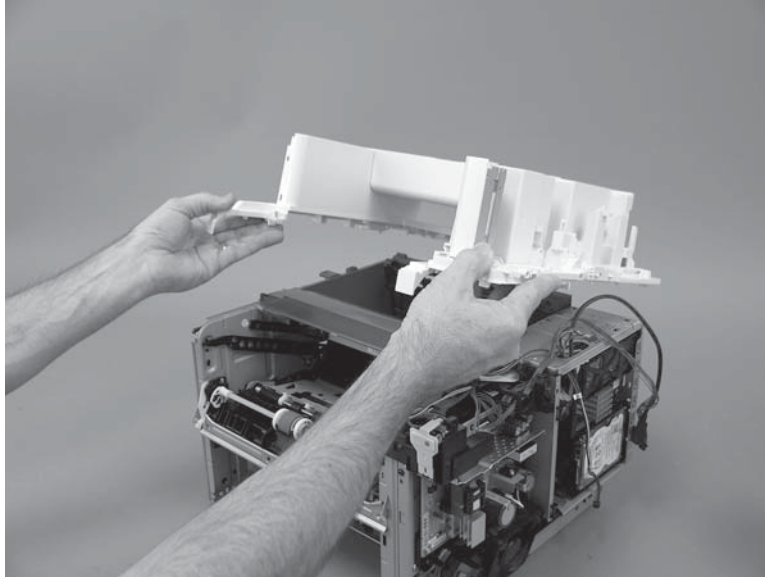
**Figure 1-1745** Rotate the front of the cover up






6. Remove the cover.

**Figure 1-1746** Remove the cover



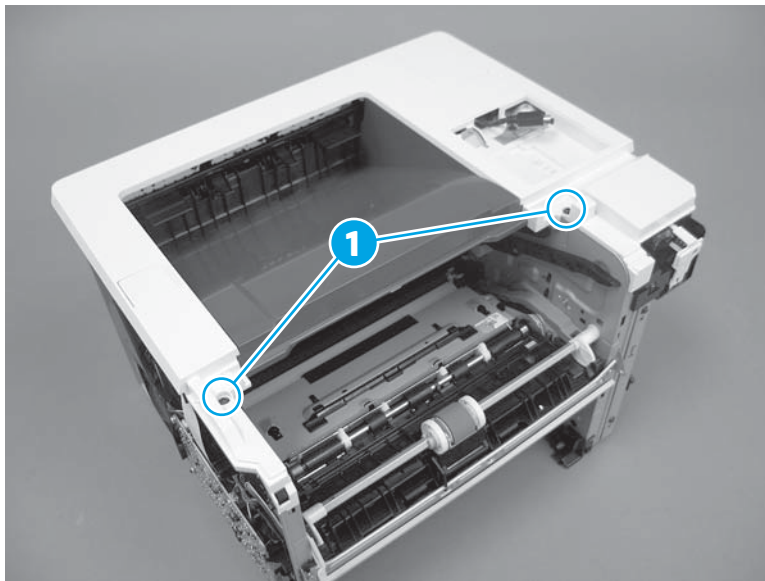
### Step 17: Remove the top cover (M501/M506)

 **NOTE:** This step is for the M501/M506 printers. For the M527, skip this step and go to [Step 19: Remove the formatter case on page 982](#).


The M506x is shown in this procedure. However, the steps are correct for all M506 models and the M501 printer.

1. Remove two screws (callout 1).

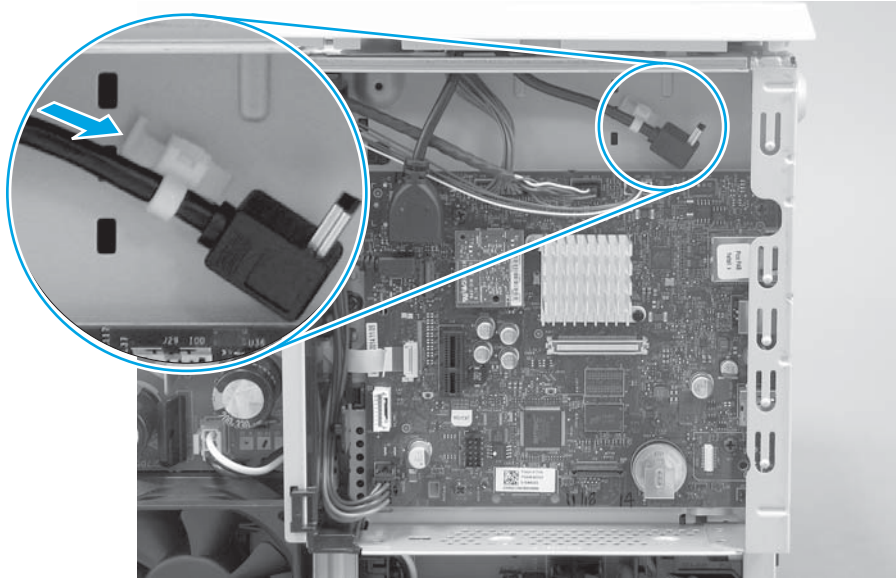
**Figure 1-1747** Remove two screws



2. **M506 only:** Release one cable retainer from the chassis.

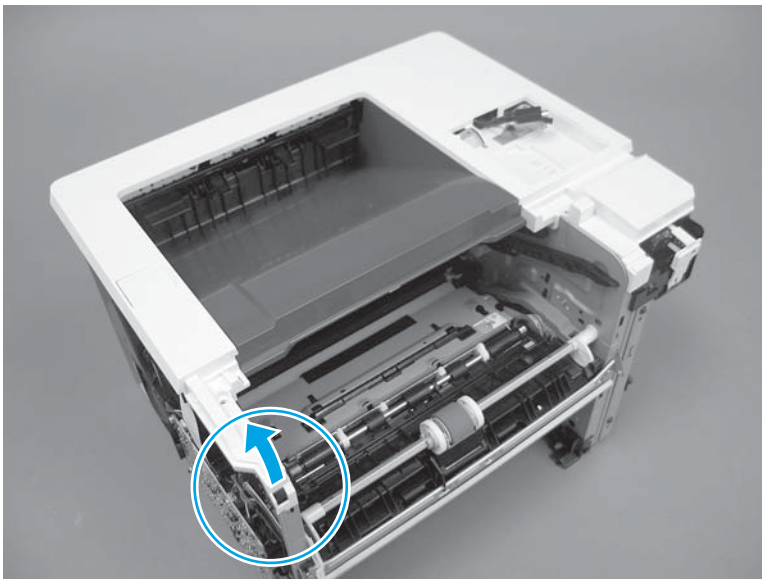
 **TIP:** Depress the tab on the retainer to release it.

**Figure 1-1748** Release one cable retainer



3. Release one boss.

**Figure 1-1749** Release one boss

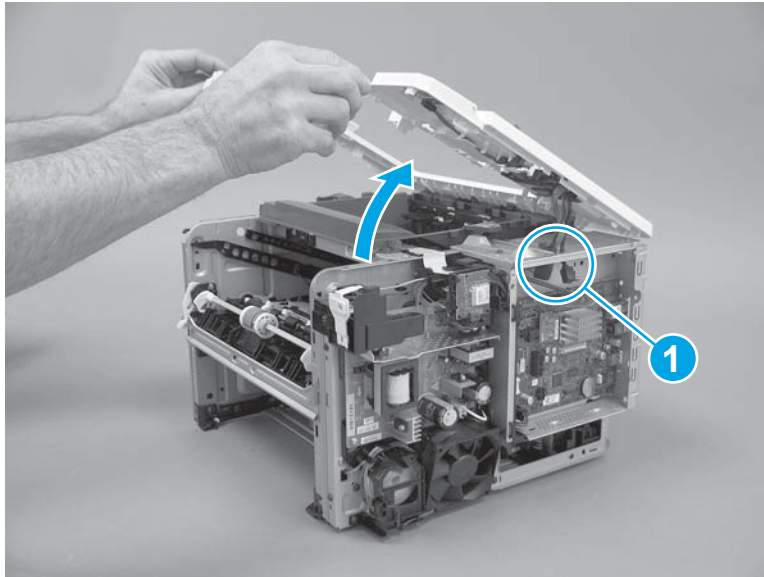


4. Rotate the front of the cover up and away from the printer, and then remove the cover.

**CAUTION:** **M506x only:** As the cover is rotated up, carefully pass the cables the hole in the chassis (callout 1).

**NOTE:** **LCD control panel models only:** Disconnect the control panel before removing the cover.

**Figure 1-1750** Remove the cover

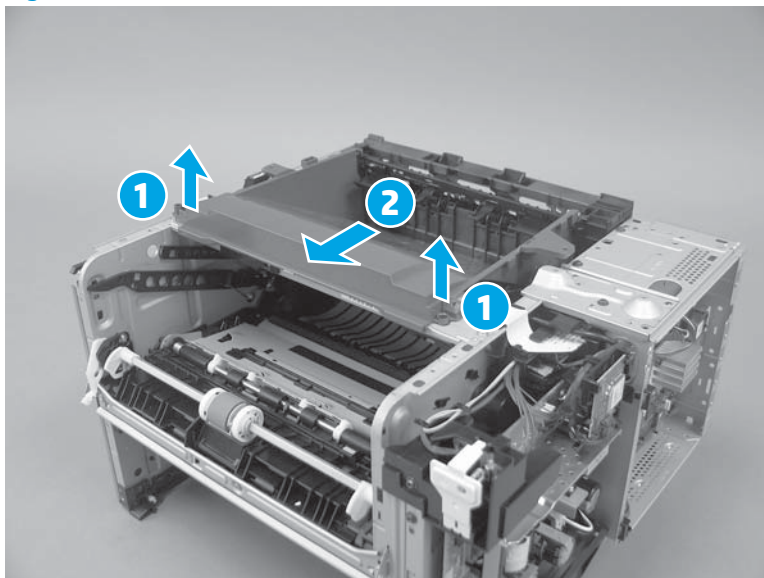


#### Step 18: Remove the paper delivery tray (output bin)

**NOTE:** This procedure shows the M506 printer. However, this procedure is valid for the M527 printer.

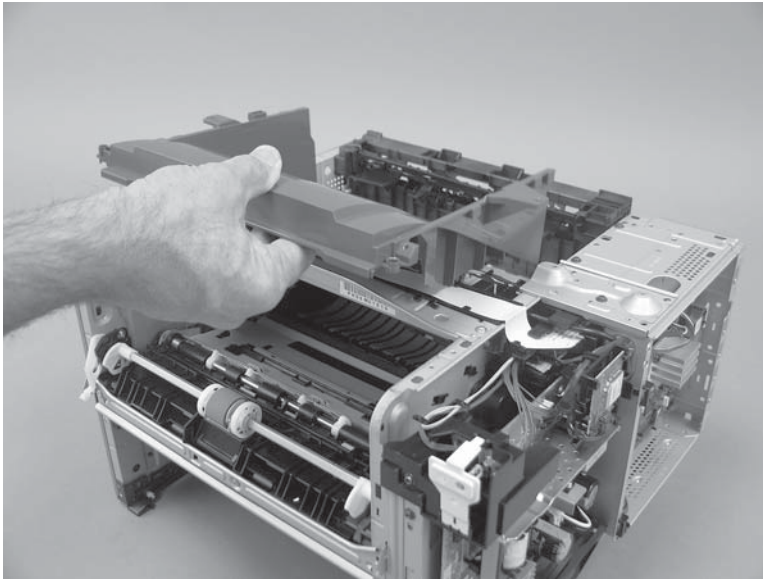
1. Release two tabs (callout 1), and then slide the cover toward the front of the printer (callout 2).

**Figure 1-1751** Release two tabs



2. Remove the bin.

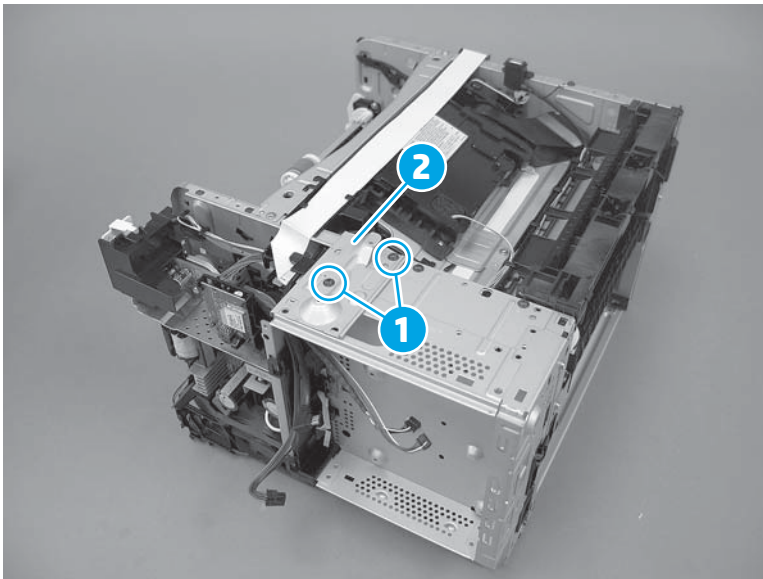
**Figure 1-1752** Remove the bin




#### Step 19: Remove the formatter case

1. **M506 only:** Remove two screws (callout 1), and then remove the sheet-metal plate (callout 2).

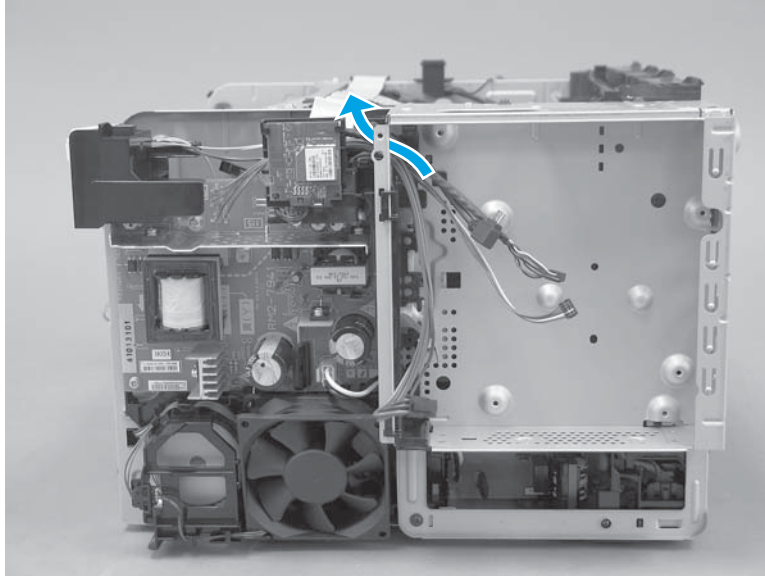
**Figure 1-1753** Remove the sheet-metal plate



- Carefully pass all cables and wire harnesses through the opening in the formatter case.

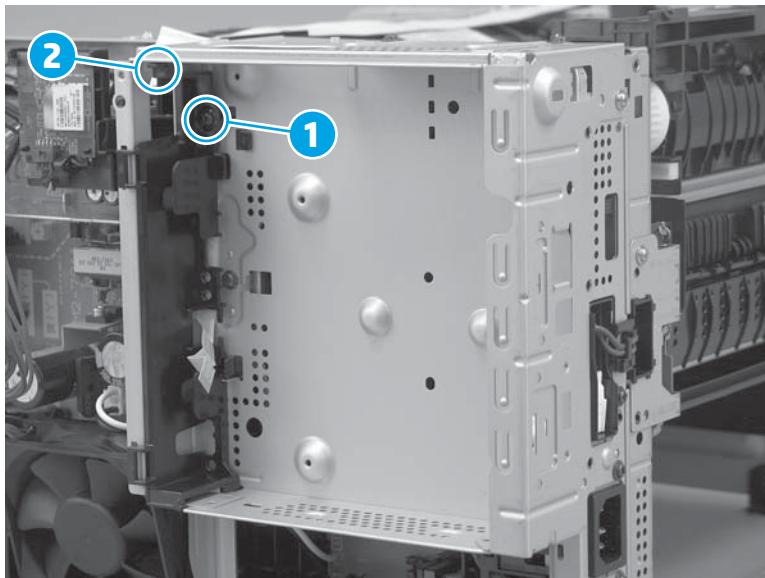
 **NOTE:** The figure below shows the M506 printer. However this step is valid for the M501/M527 printers—there will be a different number of cables and wire harnesses.

**Figure 1-1754** Pass all cables and wire harnesses through the opening



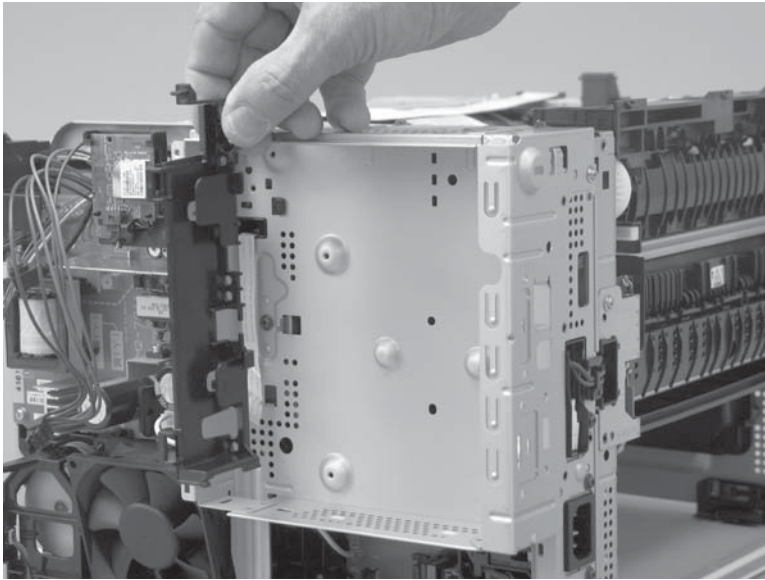
- Remove one screw (callout 1), and then push down on one tab (callout 2) to release it.

**Figure 1-1755** Remove one screw



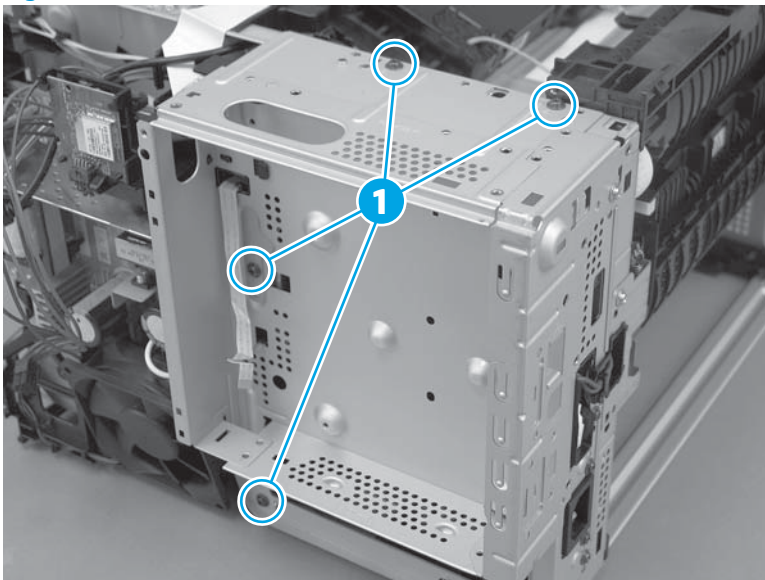
4. Remove the guide.

**Figure 1-1756** Remove the guide



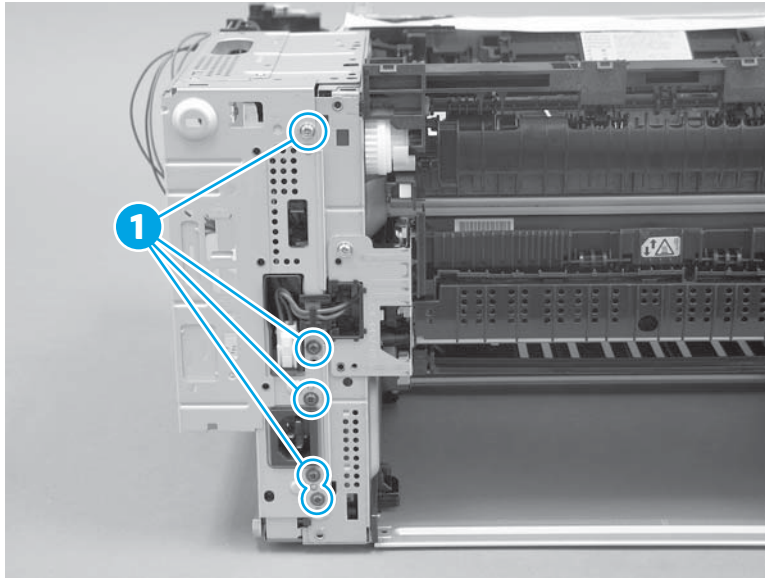
5. Remove four screws (callout 1).

**Figure 1-1757** Remove four screws



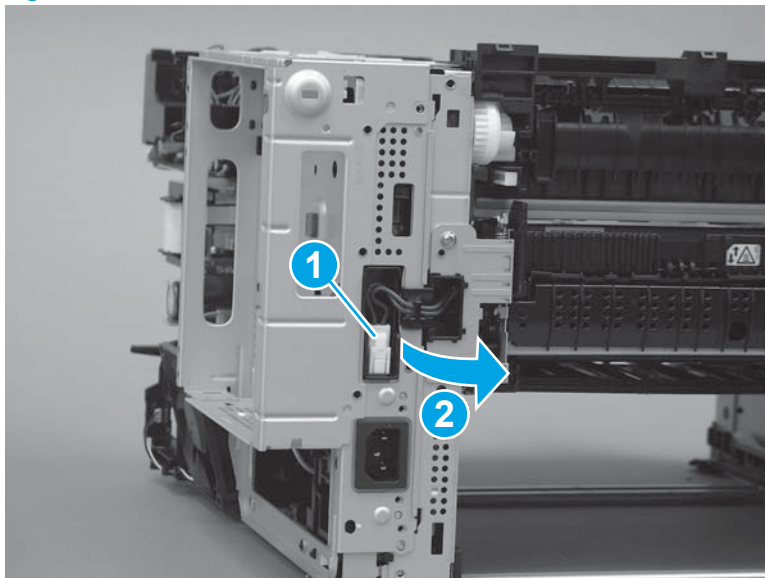
6. Remove five screws (callout 1).

**Figure 1-1758** Remove five screws



7. Disconnect one connector (callout 1), and then move the guide out of the way (callout 2).

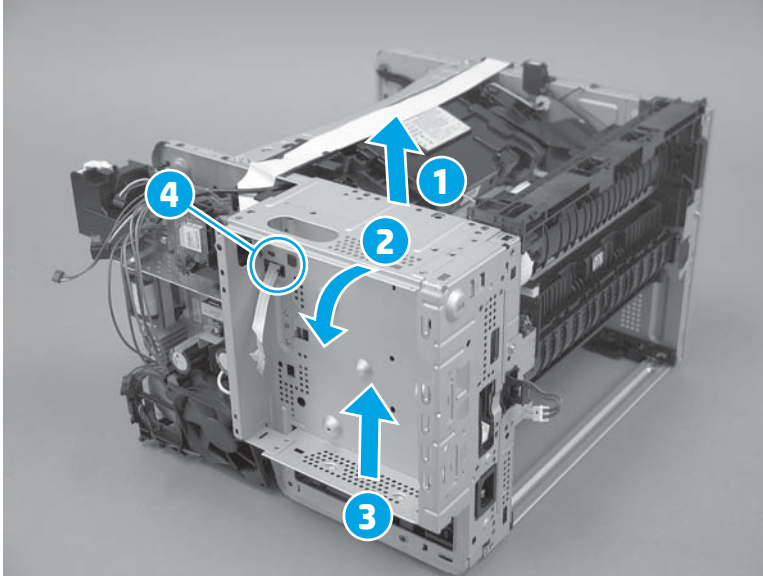
**Figure 1-1759** Disconnect one connector



8. Slightly lift up the formatter case (callout 1), rotate the top of the case away from the chassis (callout 2), and then lift up the case to release it (callout 3).

**CAUTION:** Pass the FFC through the opening (callout 4) in the formatter while removing the case.

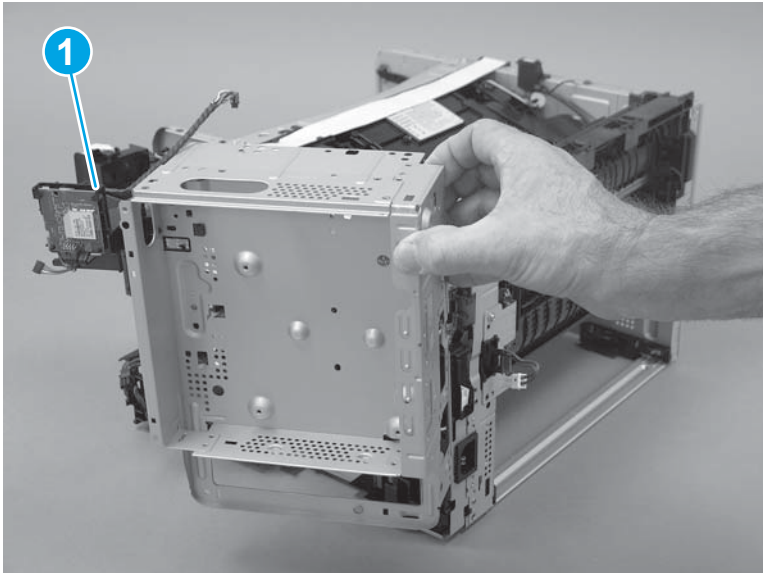
**Figure 1-1760** Release the formatter case



9. Remove the formatter case.

**NOTE:** **M506 only:** If the formatter case is being replaced, make sure that the WiFi PCA and bracket (callout 1) are transferred to the replacement case.

**Figure 1-1761** Remove the formatter case





## Step 20: Remove the DC controller (DCC)

**CAUTION:** Never remove and then install a replacement DCC and formatter at the same time. Doing so will cause the printer to become unstable or unusable.

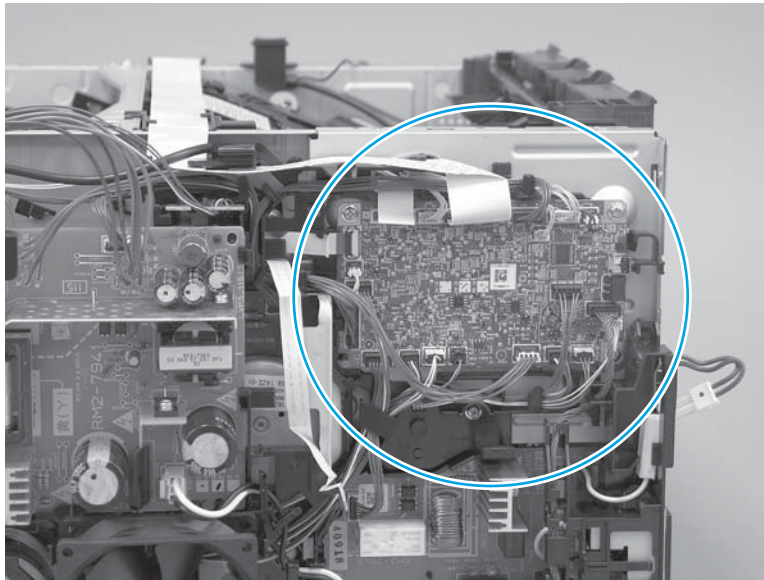
If a replacement DCC and formatter must be installed, first remove and install the formatter. Test operate the printer, and then if necessary install a replacement DCC.

1. Disconnect all of the connectors and flat-flexible cables (FFCs) on the DC controller (DCC).

**NOTE:** The number and type of connectors and FFCs depends on the printer model.

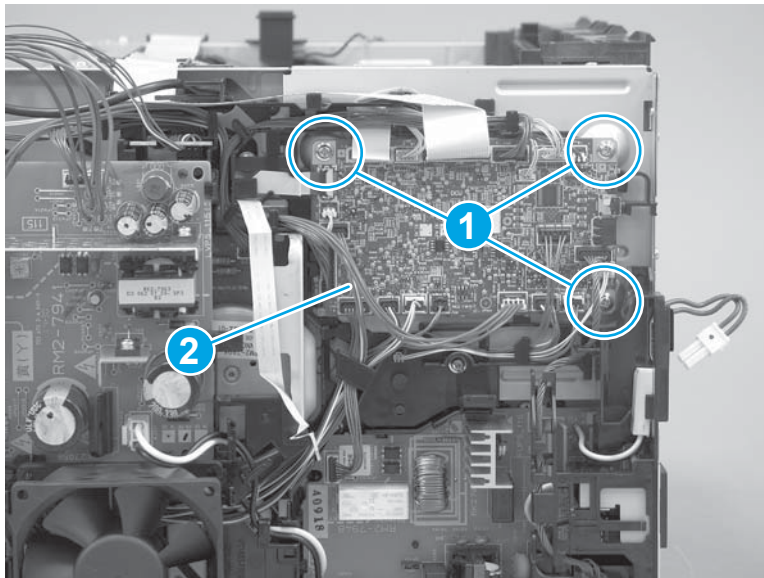
The M506 printer is shown in this procedure. However, the step is valid for the M527.

**Figure 1-1762** Disconnect all connectors and FFCs



2. Remove three screws (callout 1), and then remove the DCC (callout 2).

**Figure 1-1763** Remove the DCC



## Step 21: Unpack the replacement DC controller (DCC)

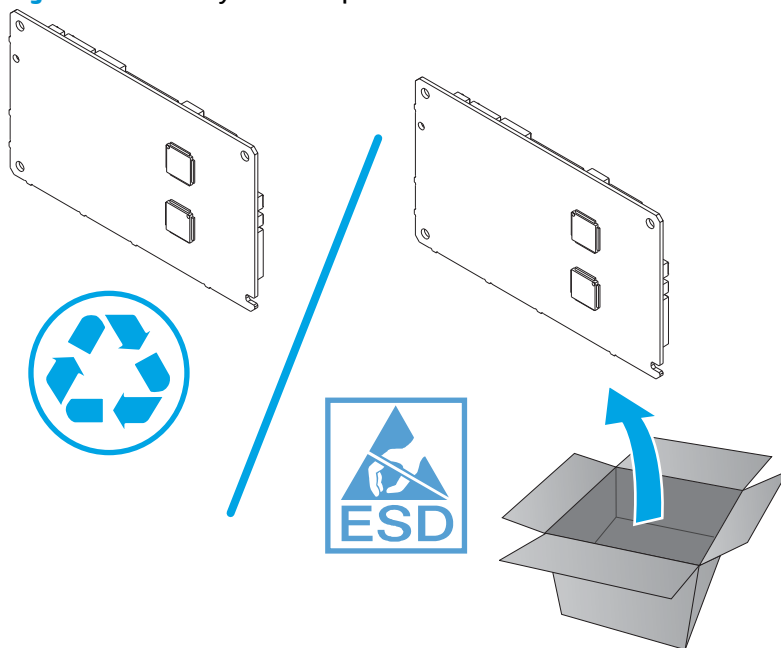
Unpack the replacement part from the packaging.

<http://www8.hp.com/us/en/hp-information/environment/product-recycling.html>

**CAUTION:** Never remove and then install a replacement DCC and formatter at the same time. Doing so will cause the printer to become unstable or unusable.

**NOTE:** HP recommends responsible disposal of the defective part.

**Figure 1-1764** Recycle and unpack



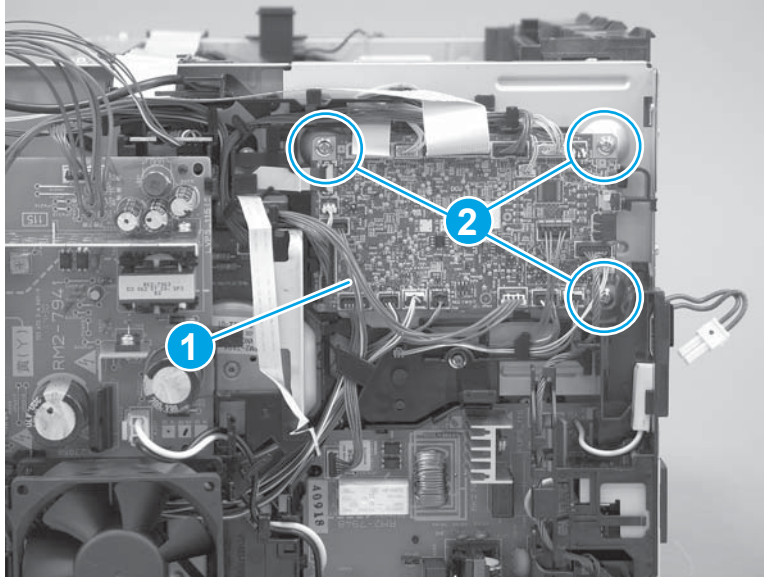
## Step 22: Install the DC controller (DCC)

**CAUTION:** Never remove and then install a replacement DCC and formatter at the same time. Doing so will cause the printer to become unstable or unusable.


If a replacement DCC and formatter must be installed, first remove and install the formatter. Test operate the printer, and then if necessary install a replacement DCC.

1. Install the DCC (callout 1) on the printer, and then install three screws (callout 2).

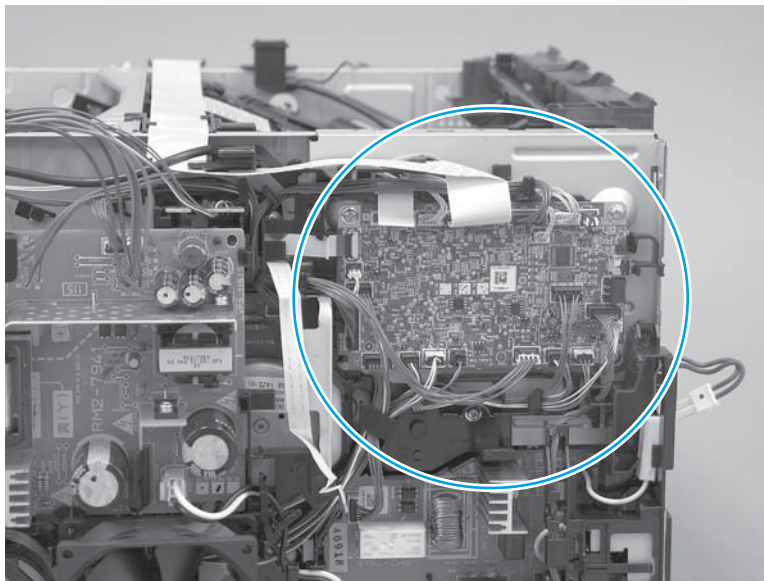
**Figure 1-1765** Install the DCC



2. Connect all of the connectors and flat-flexible cables (FFCs) on the DC controller (DCC).


 **NOTE:** The number and type of connectors and FFCs depends on the printer model. The M506 printer is shown in this procedure. However, the step is valid for the M527.

**Figure 1-1766** Connect all connectors and FFCs

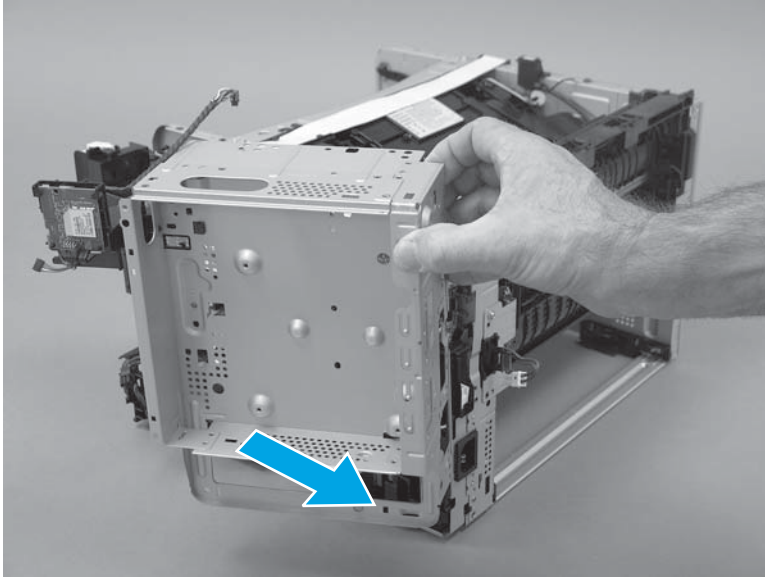


### Step 23: Install the formatter case

1. Position the bottom edge of the formatter case against the chassis.

 **NOTE: M506 only:** If the formatter case is being replaced, make sure that the WiFi PCA and bracket (callout 1) are transferred to the replacement case.

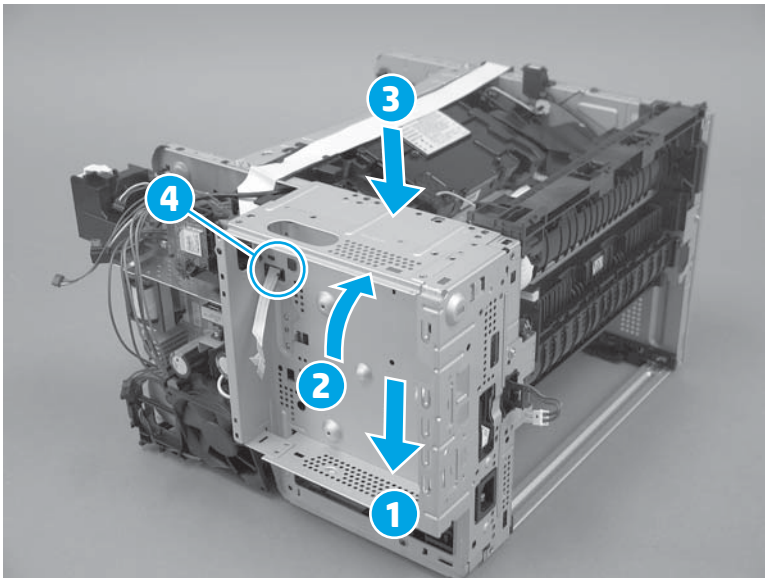
**Figure 1-1767** Position the formatter case against the chassis



2. With the bottom of the formatter case against the chassis (callout 1), rotate the top of the case toward the chassis (callout 2), and slide the case down into place to install it (callout 3).

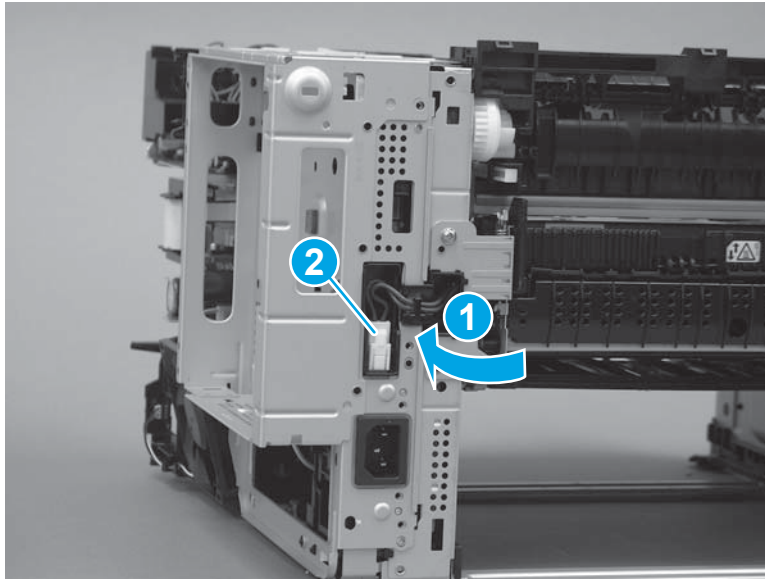
**CAUTION:** Pass the FFC through the opening (callout 4) in the formatter while installing the case.

**Figure 1-1768** Install the formatter case



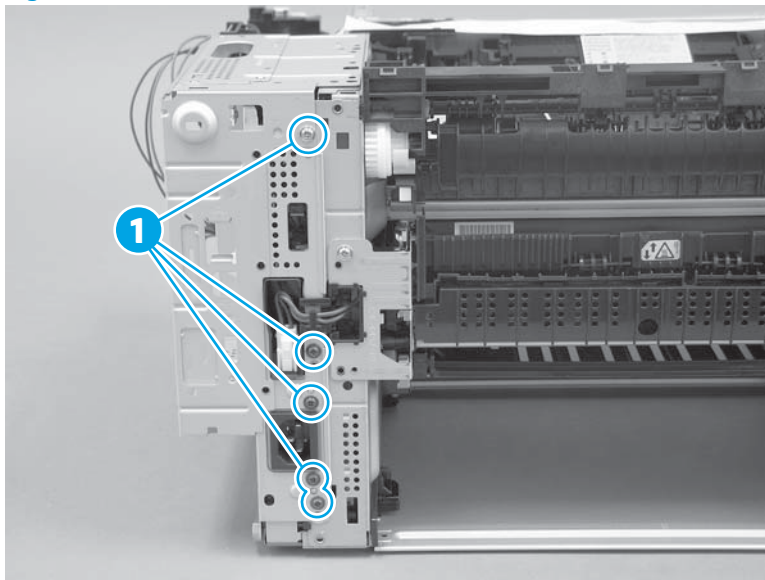
3. Reposition the guide (callout 1), and then connect one connector (callout 2).

**Figure 1-1769** Connect one connector



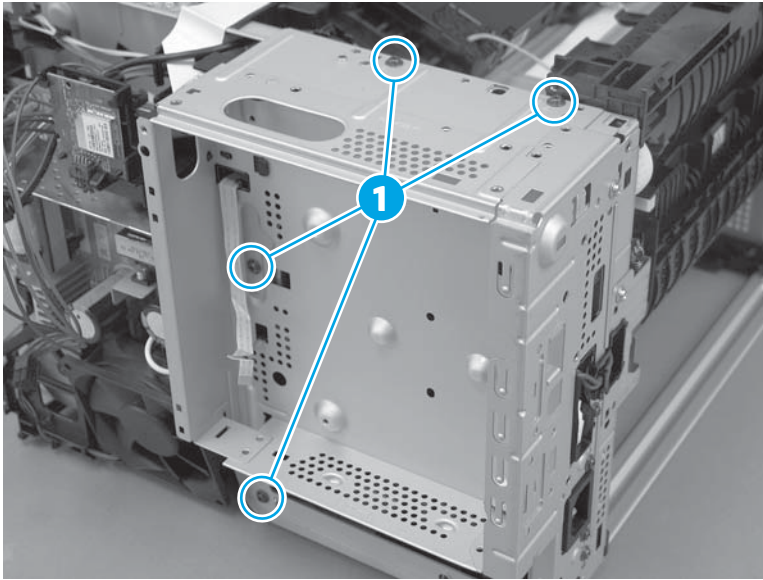
4. Install five screws (callout 1).

**Figure 1-1770** Install five screws



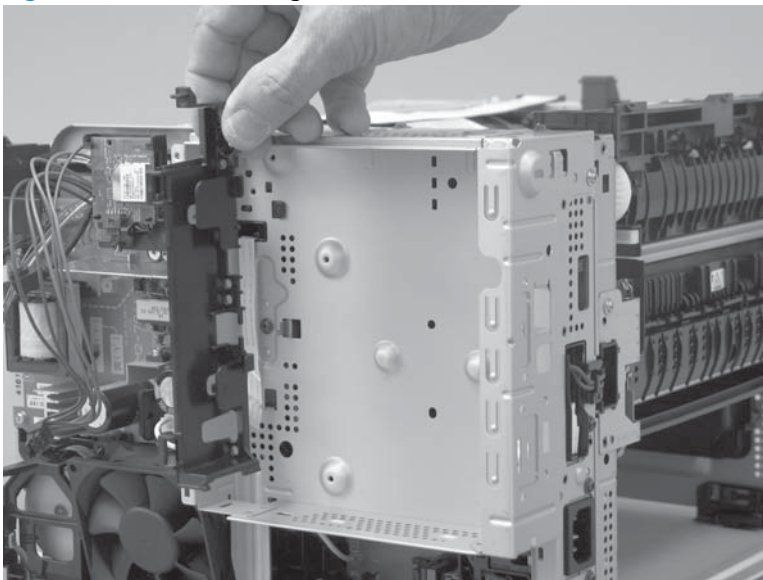
5. Install four screws (callout 1).

**Figure 1-1771** Install four screws



6. Install the guide.

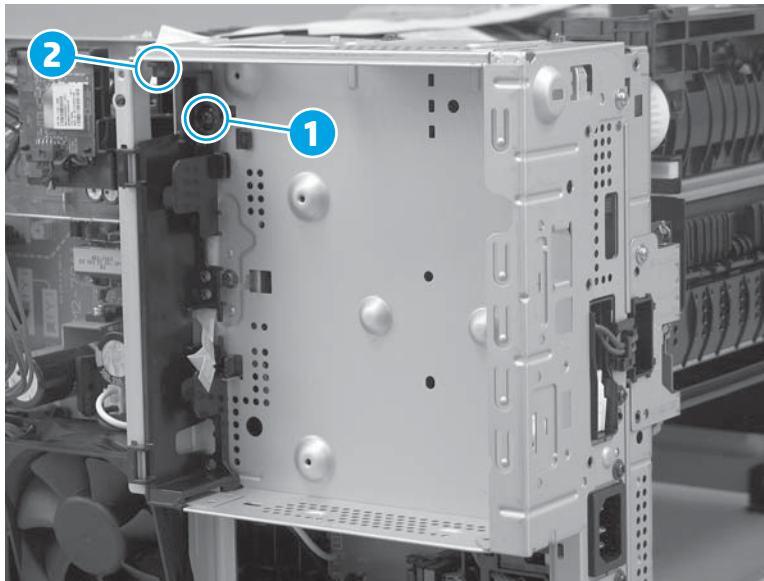
**Figure 1-1772** Install the guide




7. Install one screw (callout 1).

 **NOTE:** Make sure that the tab (callout 2) is engaged.

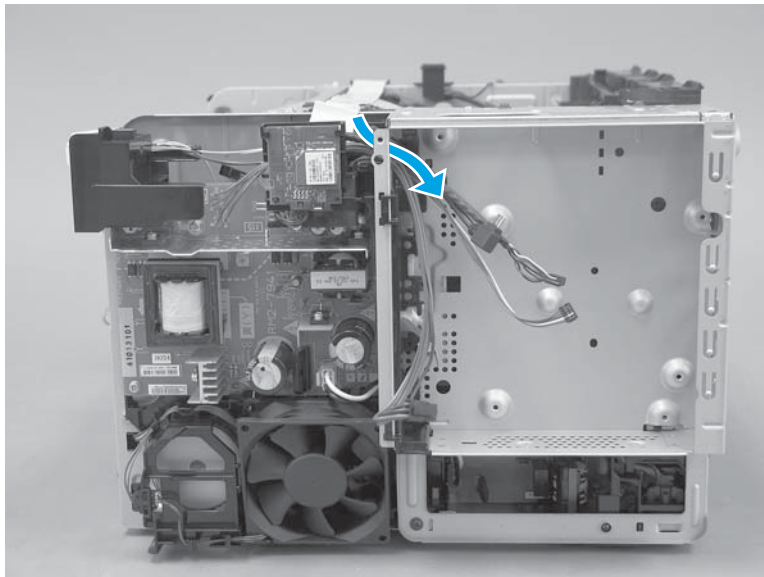
**Figure 1-1773** Install one screw



8. Carefully pass all cables and wire harnesses through the opening in the formatter case.

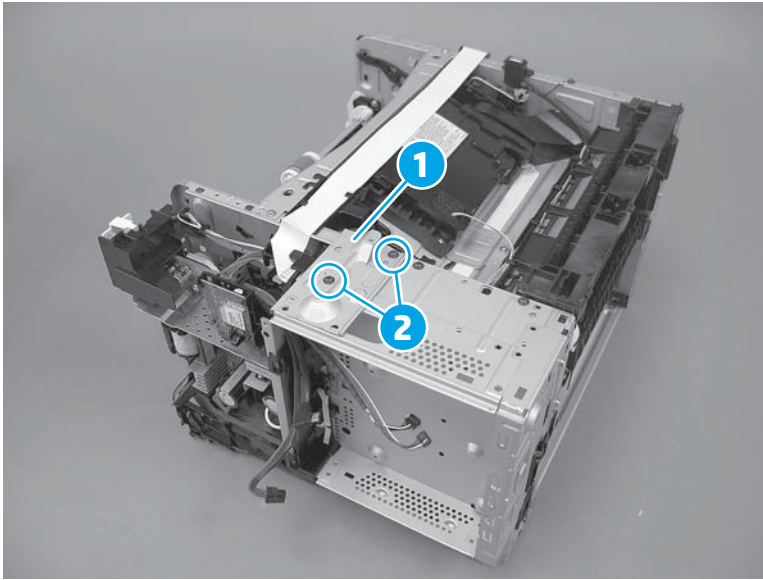
 **NOTE:** The figure below shows the M506 printer. However this step is valid for the M501/M527 printers—there will be a different number of cables and wire harnesses.

**Figure 1-1774** Pass all cables and wire harnesses through the opening




9. **M506 only:** Install the sheet-metal plate (callout 1), and then install two screws (callout 2).


**Figure 1-1775** Remove the sheet-metal plate



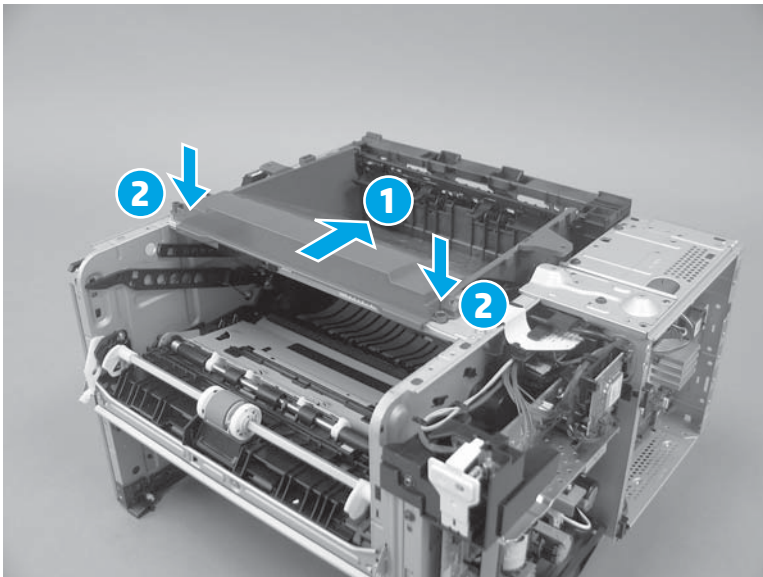
**Step 24: Install the paper delivery tray (output bin)**

 **NOTE:** This procedure shows the M506 printer. However, this procedure is valid for the M527 printer.


- ▲ Position the bin on the printer (callout 1), and then push down to engage two tabs (callout 2).

 **NOTE:** Position the tabs along the rear edge of the bin on the printer in the slots in the chassis.

**Figure 1-1776** Install the bin



**Step 25: Install the top cover (M501/M506)**

 **NOTE:** This step is for the M501/M506 printers. For the M527, skip this step and go to [Step 26: Install the top cover \(M527\) on page 996](#).



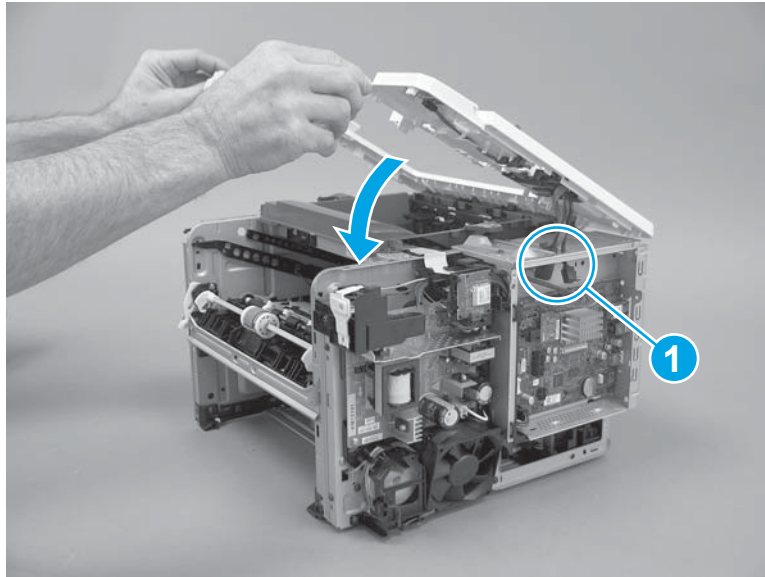
The M506x is shown in this procedure. However, the steps are correct for all M506 models and the M501 printer.

1. Position the rear edge of the cover on the printer, and then rotate the front of the cover down onto the printer.

**CAUTION:** **M506x only:** As the cover is rotated down, carefully pass the cables the hole in the chassis (callout 1).

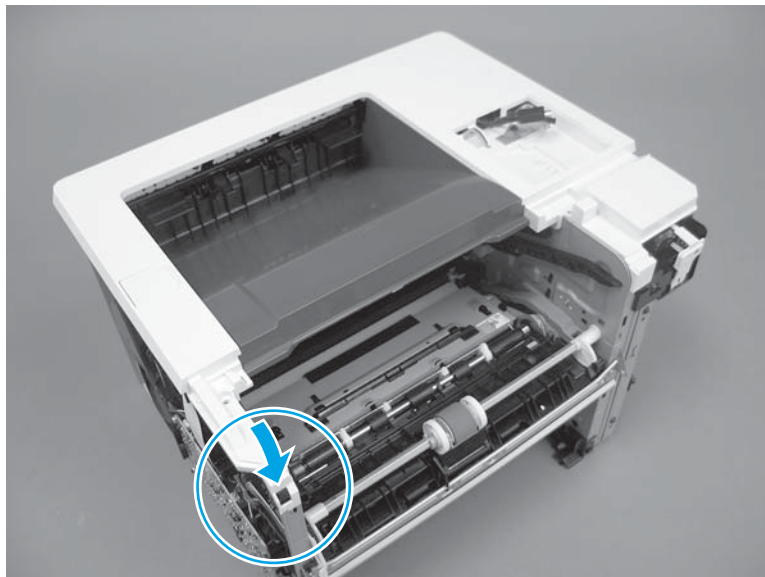
**NOTE:** **LCD control panel models only:** Pass the cables through the opening in the cover, and then connect the control panel after installing the cover.

**Figure 1-1777** Install the cover




2. Engage one boss.

**Figure 1-1778** Engage one boss



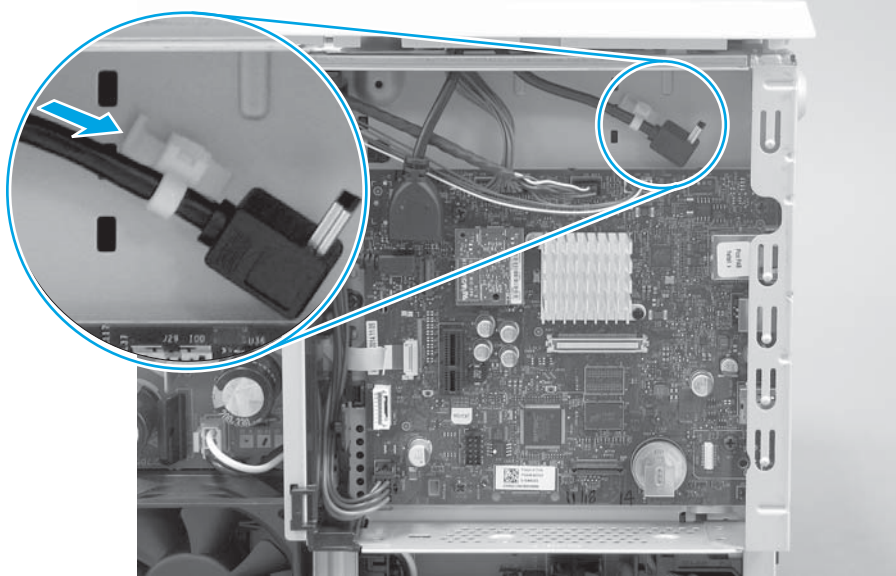
3. **M506 only:** Install one cable retainer on the chassis.

---

 **TIP:** Depress the tab on the retainer to install it.

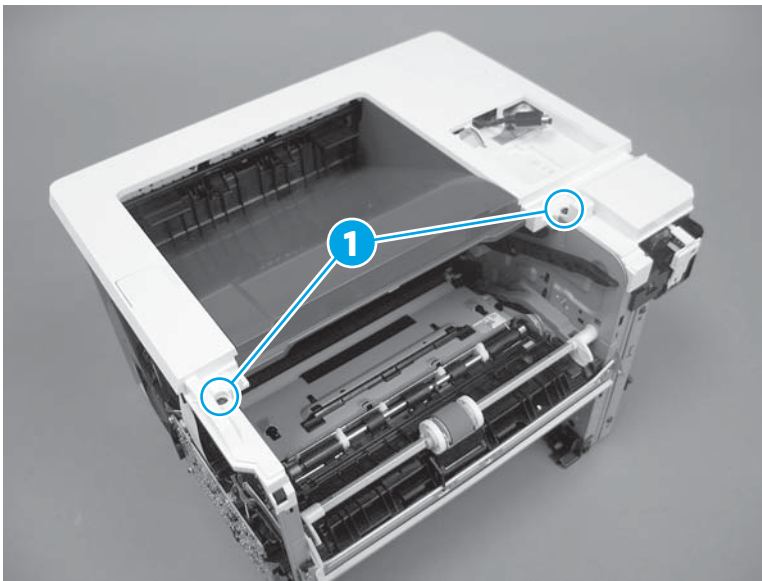
---

**Figure 1-1779** Install one cable retainer




4. Install two screws (callout 1).

**Figure 1-1780** Install two screws



### Step 26: Install the top cover (M527)

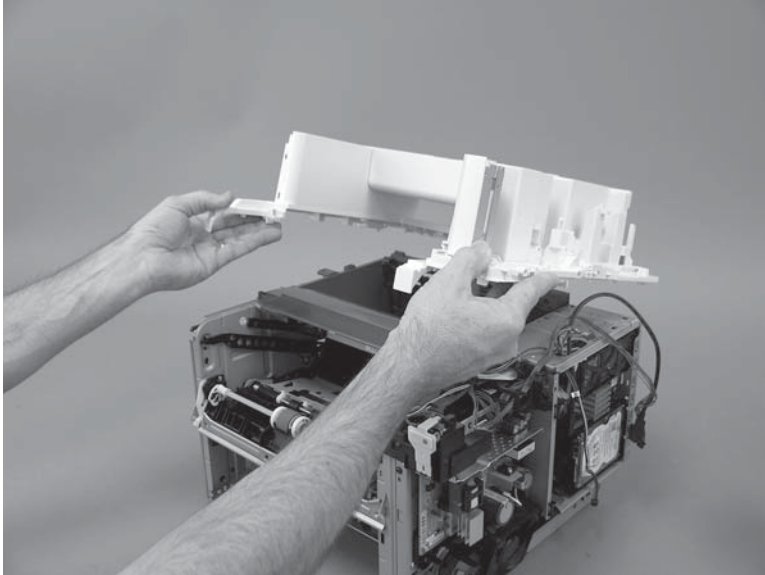
---

 **NOTE:** This step is for the M527 printer. For the M501/M506, skip this step and go to [Step 28: Install the left cover on page 1003](#).

---

1. Position the rear edge of the cover on the chassis.

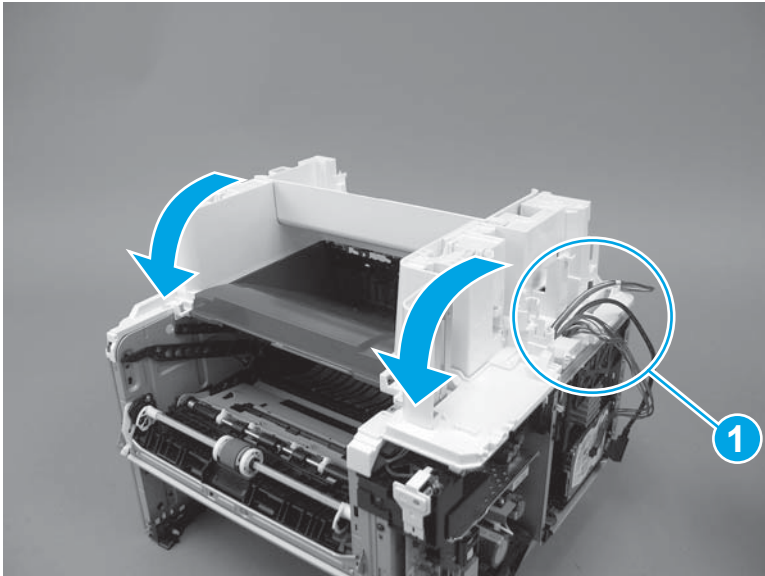
**Figure 1-1781** Install the cover



2. Rotate the front of the cover down onto the printer.

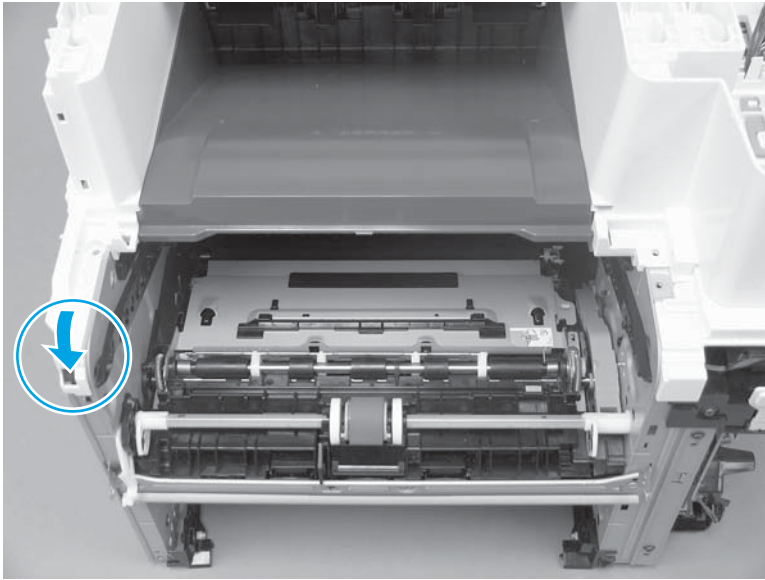
**CAUTION:** As the cover is rotated down, carefully pass the cables and wire harnesses the hole in the cover (callout 1).

**Figure 1-1782** Rotate the front of the cover down



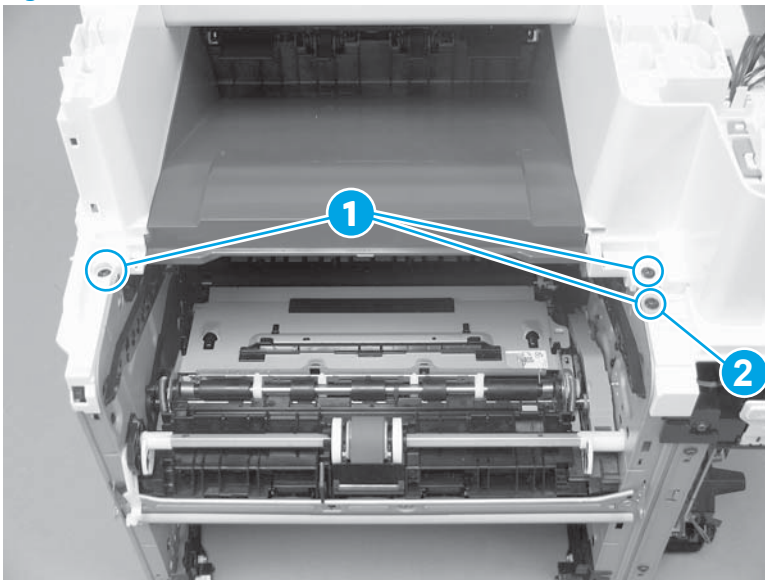
3. At the front left of the printer, engage one boss.

**Figure 1-1783** Engage one boss




4. At the top front of the printer, install three screws (callout 1).

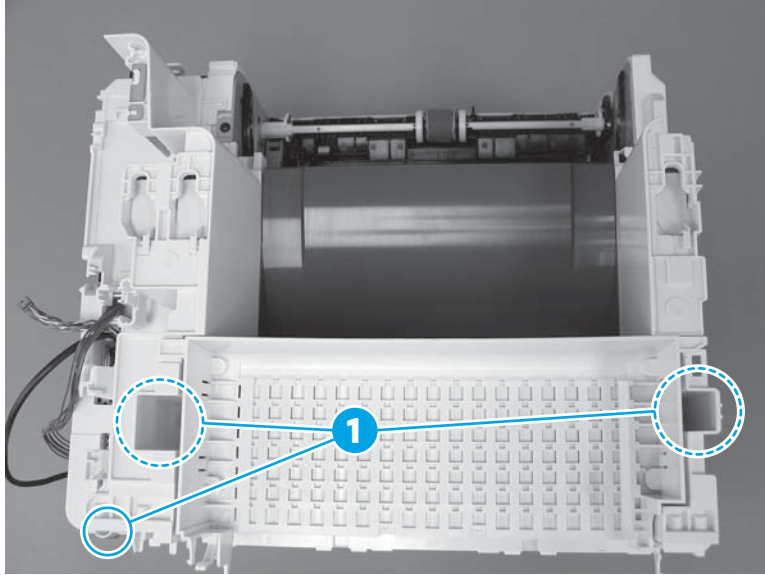
**Figure 1-1784** Install three screws



5. At the top rear of the printer, install three screws (callout 1).

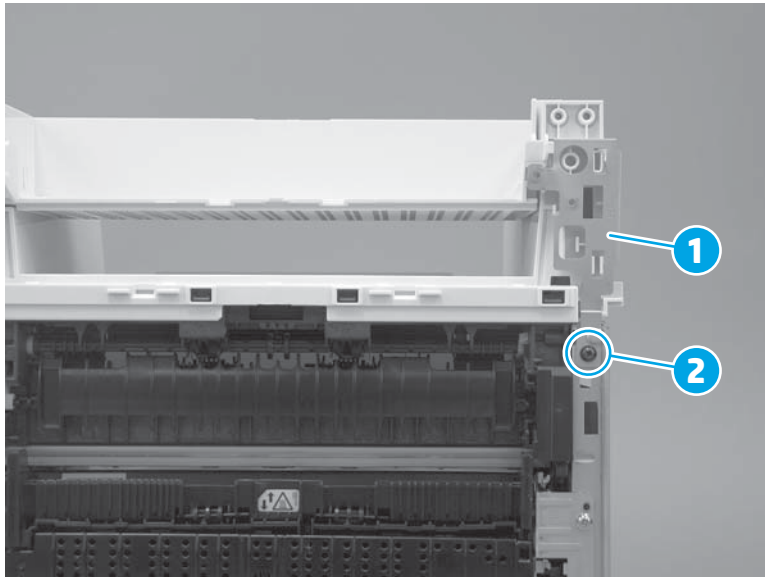
 **NOTE:** The screw (callout 2) on the lower-right portion of the cover is a different color than the other two screws, and is surrounded by sheet-metal. It might appear that this screw does not need to be removed. Remove this screw.

**Figure 1-1785** Install three screws





6. At the front right of the printer, install the sheet-metal plate (callout 1), and then install one screw (callout 2).

**Figure 1-1786** Install one screw and the plate




### Step 27: Install the integrated scanner assembly (M527)

 **IMPORTANT:** Some figure might show assemblies removed or installed that have not yet been removed or installed at that specific step. However, the procedures are correct for this printer and the target assembly. Always thoroughly read the instructions that accompany each figure

 **NOTE:** This step is for the M527 printer. For the M501/M506, skip this step and go to [Step 28: Install the left cover on page 1003](#).

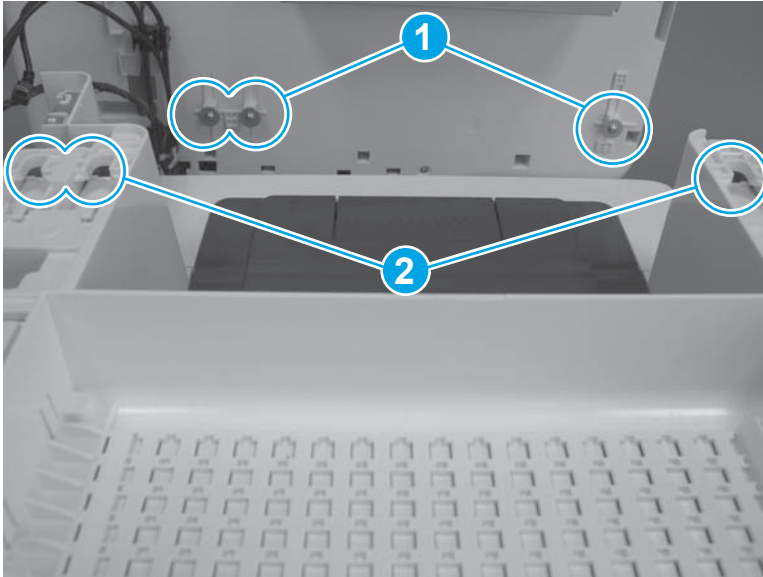
---

 **NOTE:** The ISA includes the document feeder, sub-scanner assembly (SSA), and the scanner control board (SCB)


---

1. Before proceeding, locate the ISA mounting pins (callout 1) on the bottom of the ISA and the slots (callout 2) on the printer base.

**Figure 1-1787** Locate the ISA mounting pins and slots

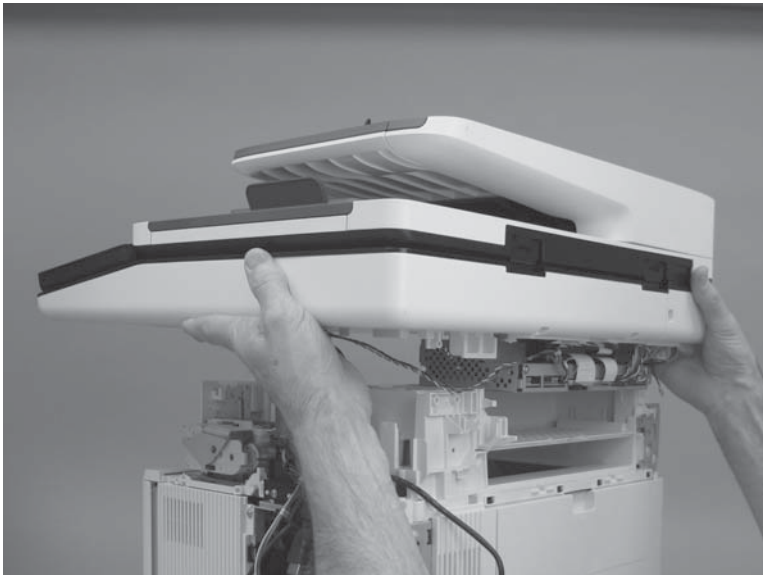


2. Position the ISA on the printer base with the pins in the slots.

 **NOTE:** To locate the pins and slots, see the previous step.

---

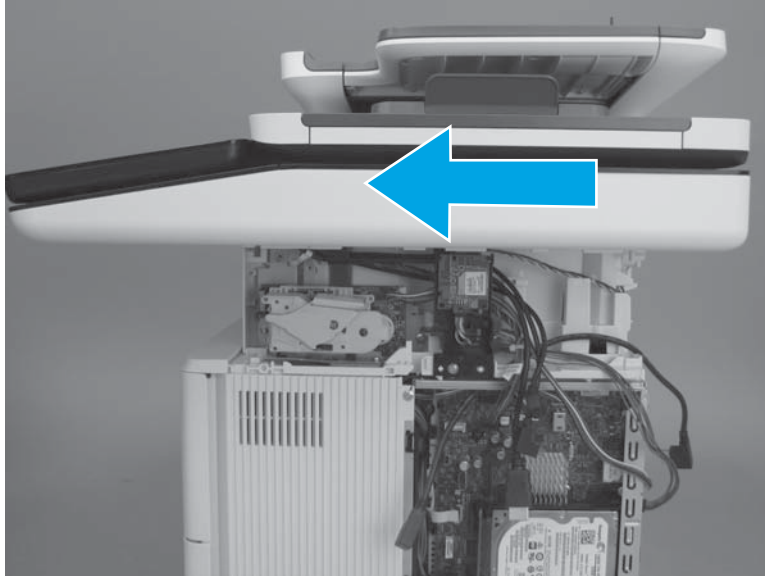
**Figure 1-1788** Install the ISA



3. Slightly slide the ISA towards the front of the printer to engage it.

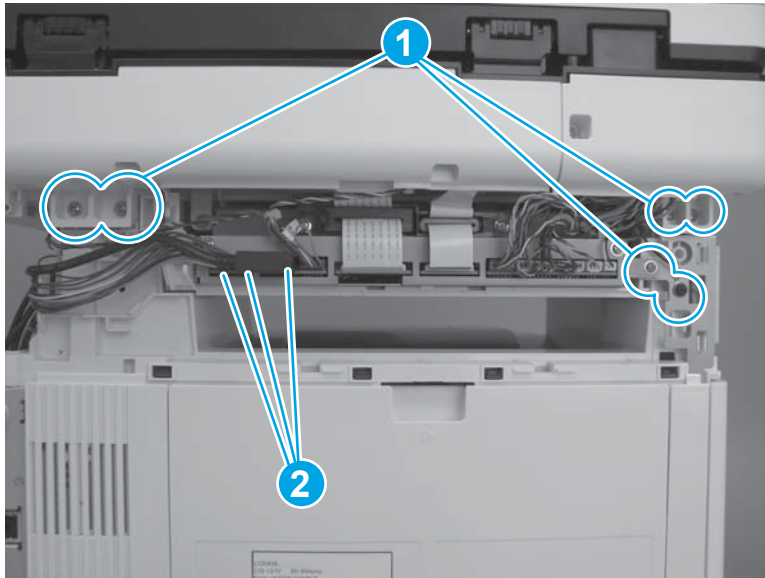
**CAUTION:** Make sure that none of the wire harnesses or cables are caught underneath the assembly when installing it.

**Figure 1-1789** Slide the ISA towards the front of the printer




4. Install six screws (callout 1), and then connect three connectors (callout 2).

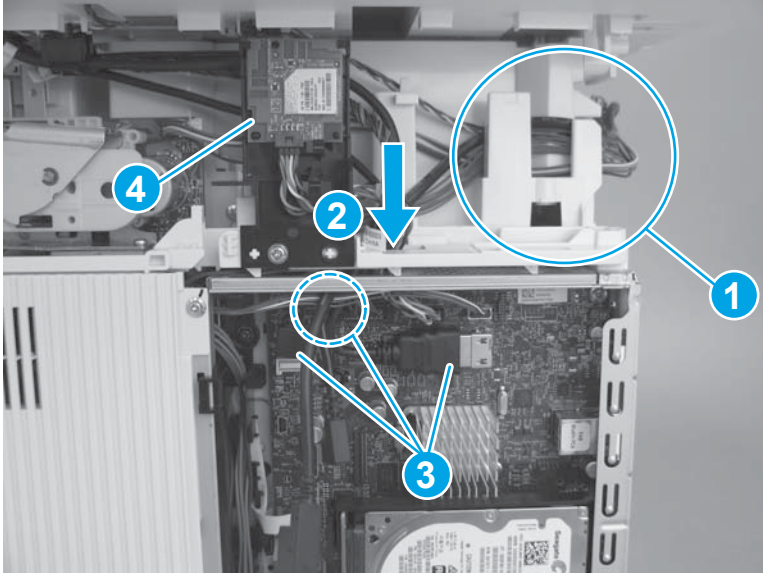
**Figure 1-1790** Install screws and connect connectors



5. Install the wire harnesses and cables in the retainers (callout 1), pass them through the opening in the cover (callout 2), and then connect three connectors (callout 3).

 **TIP:** If the WiFi PCA and holder (callout 4) was detached from the printer and then moved out of the way, reinstall it now.

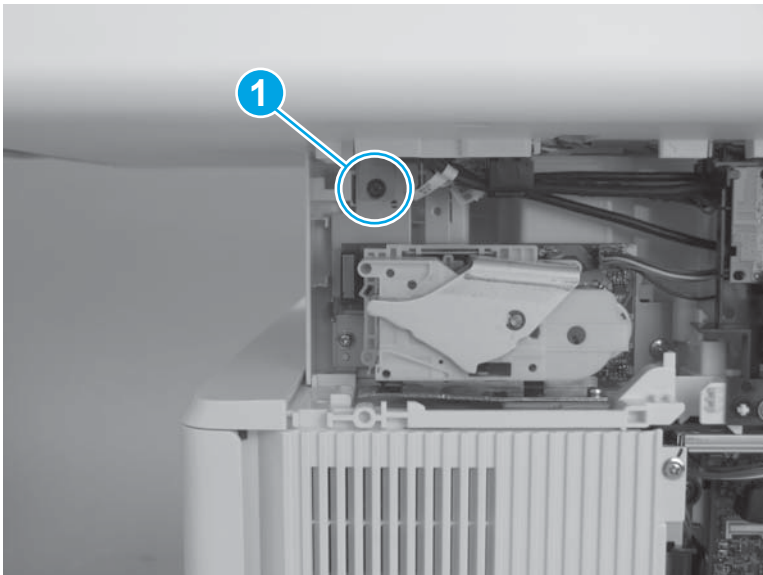
**Figure 1-1791** Connect cables and connectors



6. Install one screw (callout 1).


 **IMPORTANT:** This screw fastens the ISA ground plate to the printer chassis. This screw must be installed.


**Figure 1-1792** Install one screw





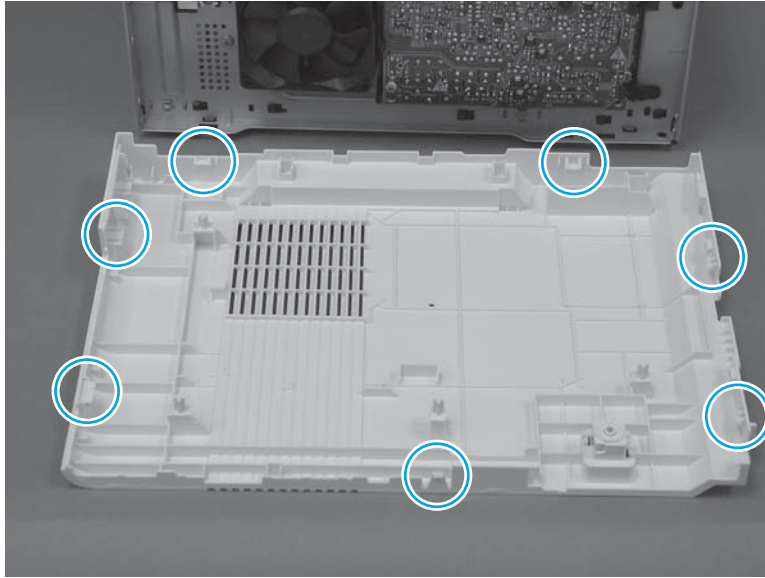
## Step 28: Install the left cover

 **IMPORTANT:** The black-plastic cassette front and rear guides (located inside the tray cavity) can be easily dislodged. Do not lose the guides when the cover is removed or installed.

 **NOTE:** The M527 printer is shown in this procedure. However, this procedure is valid for the M501/M506 printers.

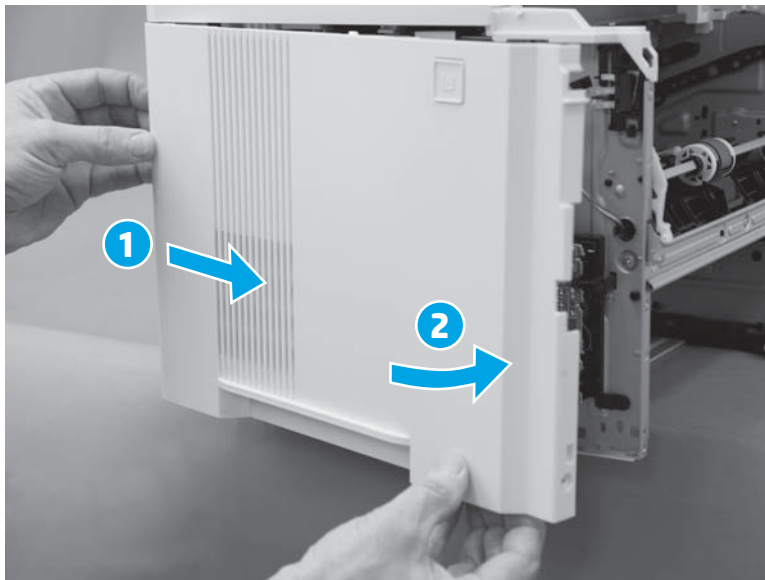
1. Before proceeding, take note of the location of the tabs and bosses on the inside of the cover.

**Figure 1-1793** Locate of the tabs and bosses



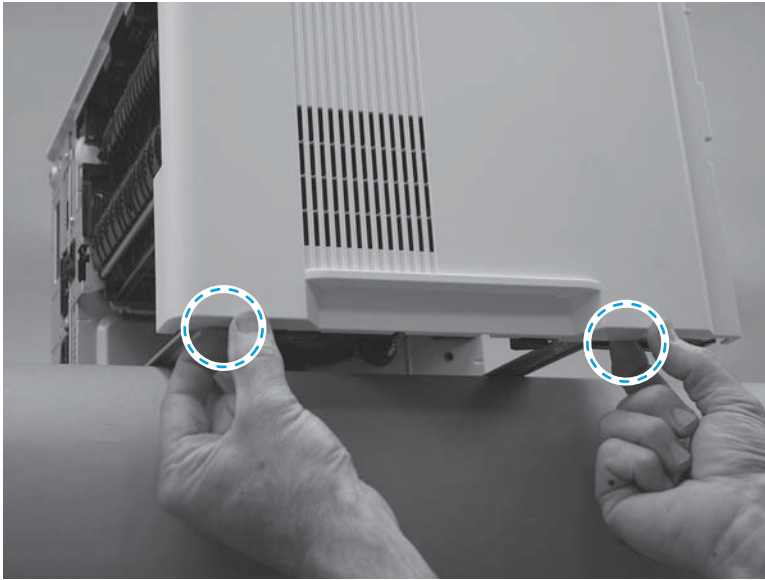
2. Engage the rear edge of the cover (callout 1), and then rotate the rear edge of the cover toward the printer (callout 2).

**Figure 1-1794** Install the cover



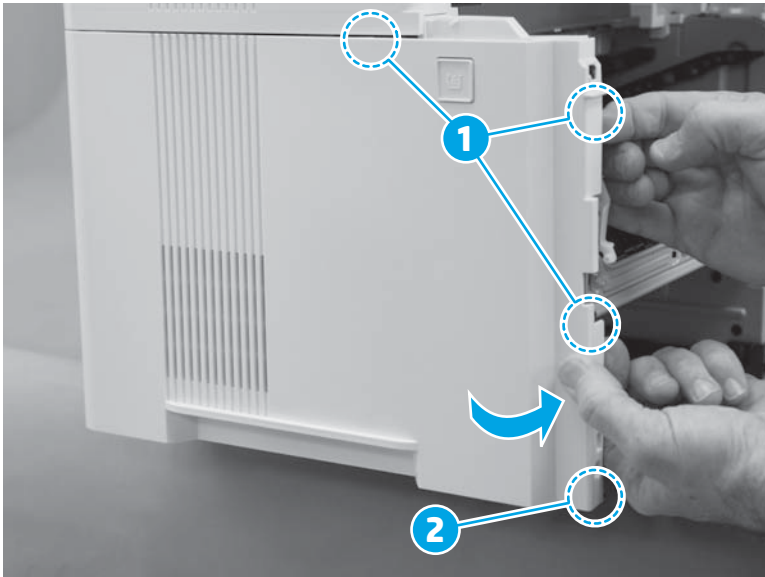
3. At the bottom edge of the cover, engage two tabs.

**Figure 1-1795** Engage two tabs



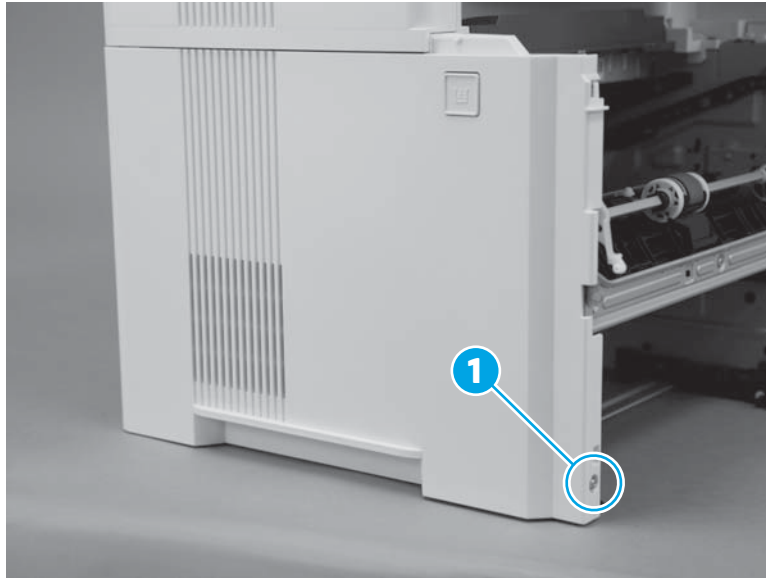
4. At the front of the printer, engage three tabs (callout 1), and then continue to rotate the front edge of the cover toward the printer to engage one boss (callout 2).

**Figure 1-1796** Engage three tabs and one boss





5. Install one screw (callout 1).

**Figure 1-1797** Install one screw



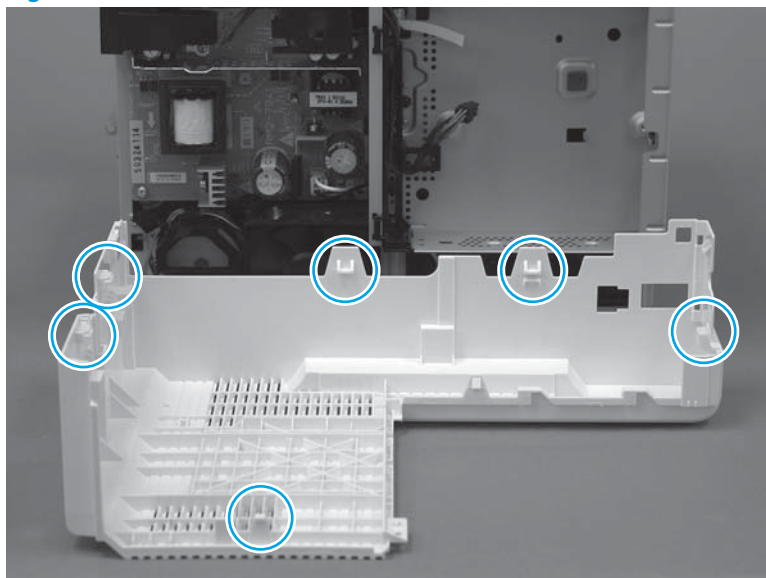
### Step 29: Install the right cover

 **IMPORTANT:** The black-plastic cassette front and rear guides (located inside the tray cavity) can be easily dislodged. Do not lose the guides when the cover is removed or installed.

 **NOTE:** The M527 printer is shown in this procedure. However, this procedure is valid for the M501/M506 printers.

1. Before proceeding, take note of the location of the tabs and bosses on the inside of the cover.

**Figure 1-1798** Locate the tabs and bosses

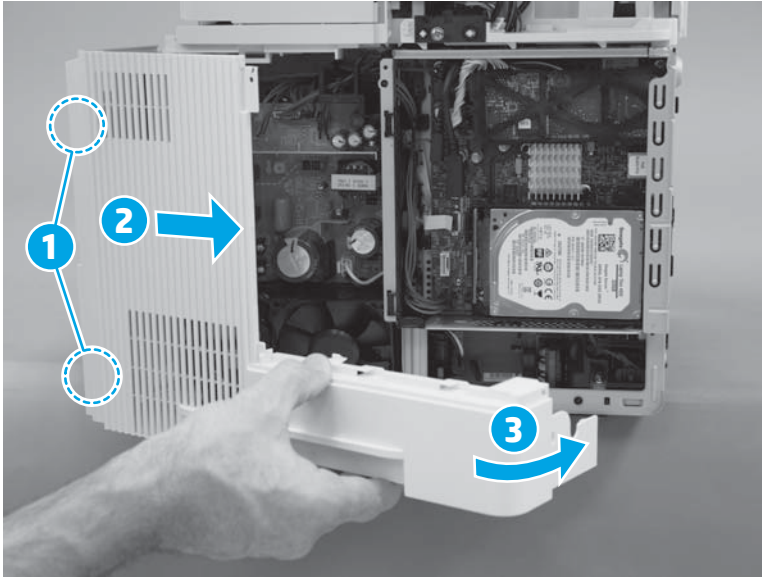


2. At the front of the cover engage two bosses (callout 1/2), and then rotate the rear of the cover toward the printer (callout 3).

**CAUTION:** It might be easier to install the cover with the printer slightly hanging over the edge of the workspace. Do not let the printer tip and fall off the workspace when removing the cover.

**TIP:** Make sure that the power switch at the front of the printer is positioned in the opening in the cover and that it does not interfere with the cover installation.

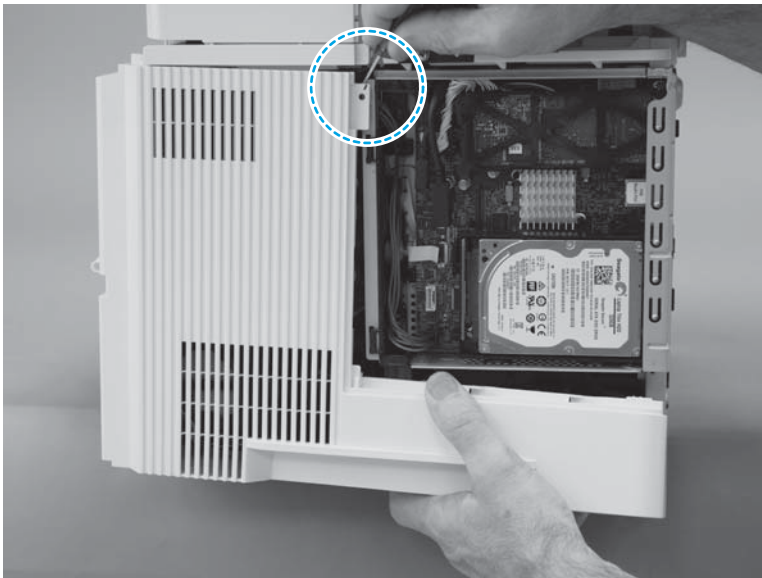
**Figure 1-1799** Install the cover



3. At the top rear edge of the cover, engage one tab.

**CAUTION:** It might be easier to install the cover with the printer slightly hanging over the edge of the workspace. Do not let the printer tip and fall off the workspace when removing the cover.

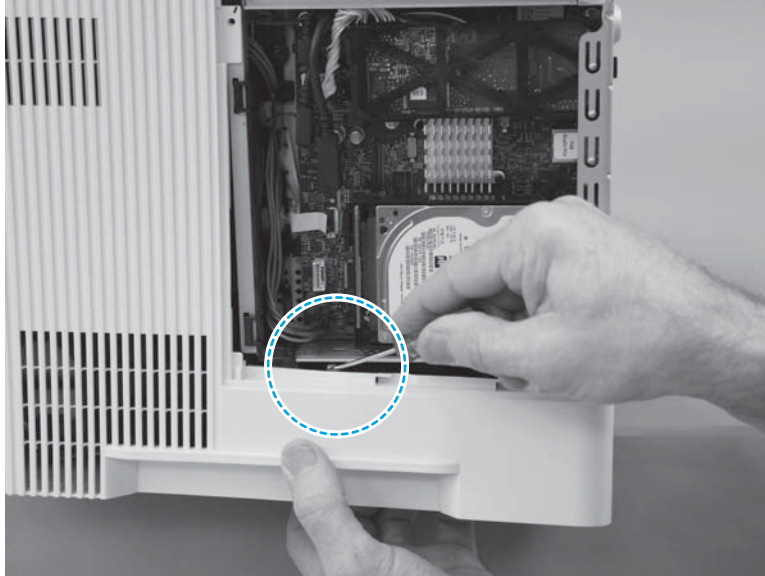
**Figure 1-1800** Engage one tab



4. Near the formatter, engage one tab.

**CAUTION:** It might be easier to install the cover with the printer slightly hanging over the edge of the workspace. Do not let the printer tip and fall off of the workspace when removing the cover.

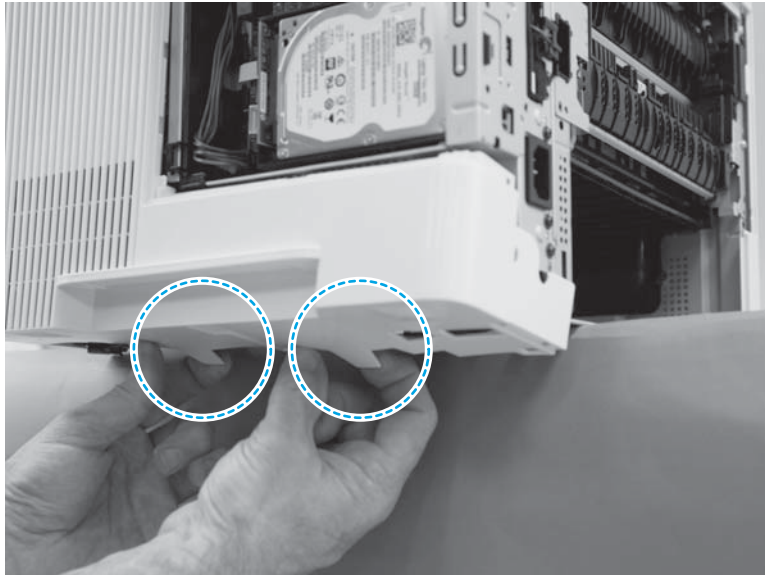
**Figure 1-1801** Engage one tab



5. At the bottom edge of the cover, engage two bosses.

**CAUTION:** It might be easier to install the cover with the printer slightly hanging over the edge of the workspace. Do not let the printer tip and fall off of the workspace when removing the cover.

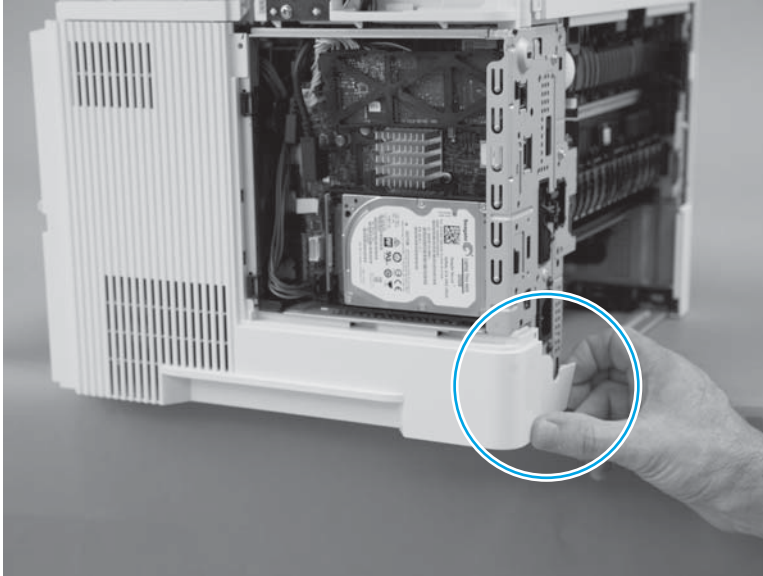
**Figure 1-1802** Engage two bosses



6. At the rear of the printer, engage one boss.

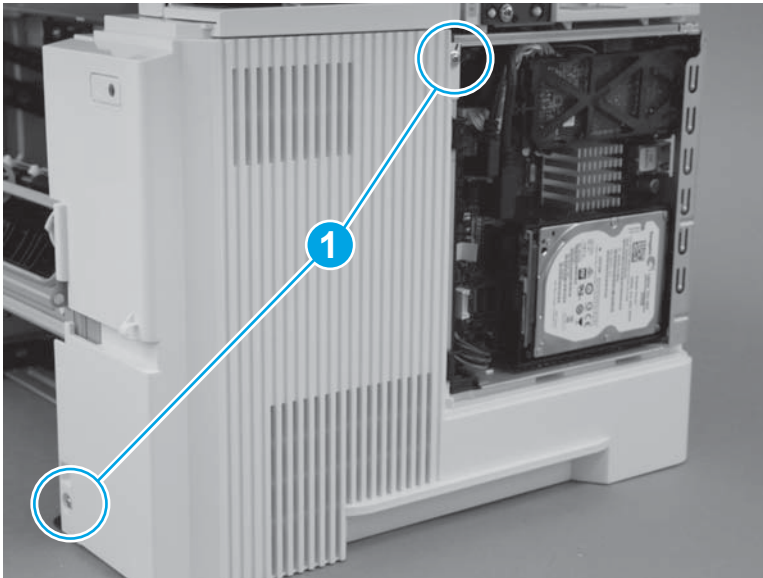
**⚠ CAUTION:** It might be easier to install the cover with the printer slightly hanging over the edge of the workspace. Do not let the printer tip and fall off of the workspace when removing the cover.

**Figure 1-1803** Engage one boss



7. Install two screws (callout 1).

**Figure 1-1804** Install two screws

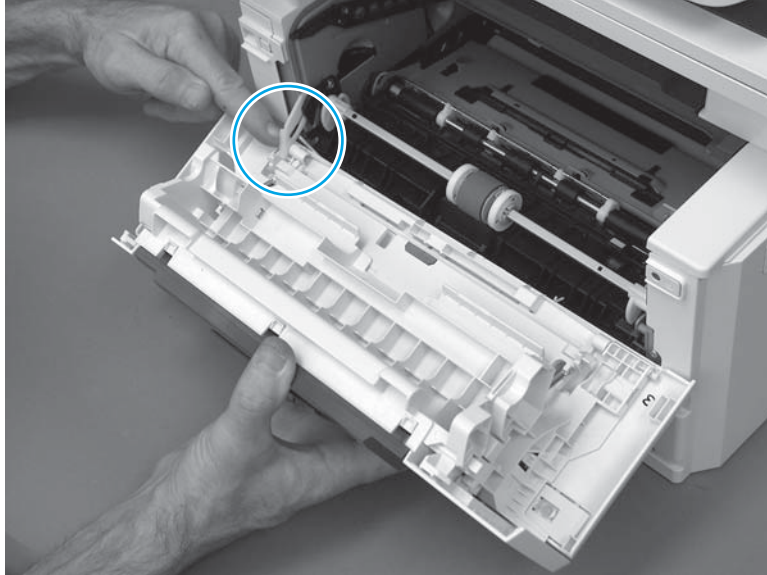


### Step 30: Install the cartridge door assembly

1. Position the door close to the printer, and then engage the keyed pin on the left-side retainer arm with the hole in the door.


**💡 TIP:** It might be easier to engage the keyed pin with the hole by using a small flat-blad screwdriver.

**Figure 1-1805** Engage the left-side retainer arm

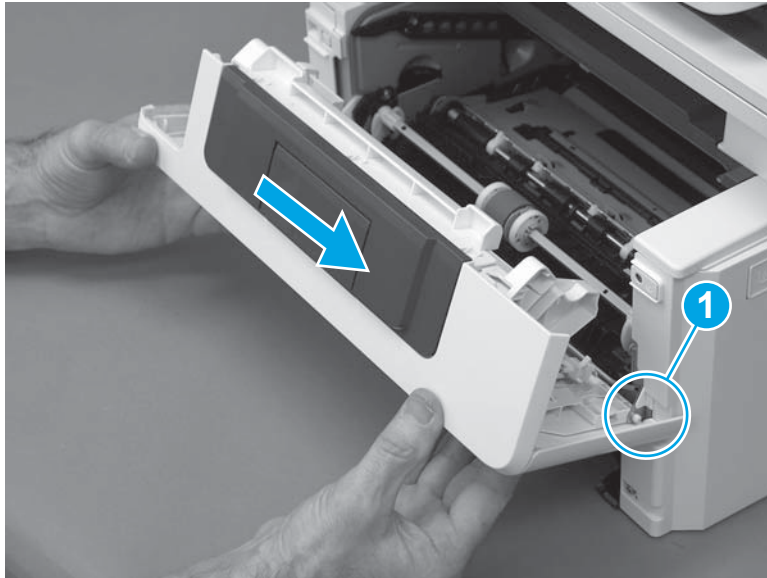


2. Engage the right-side door hinge pin with the hole in the chassis (callout 1).


 **NOTE:** There are two right-side hinge pins (not shown in callout 1).

 **TIP:** Keep a finger pressed on the left-side retainer arm so that it does not disengage from the door.

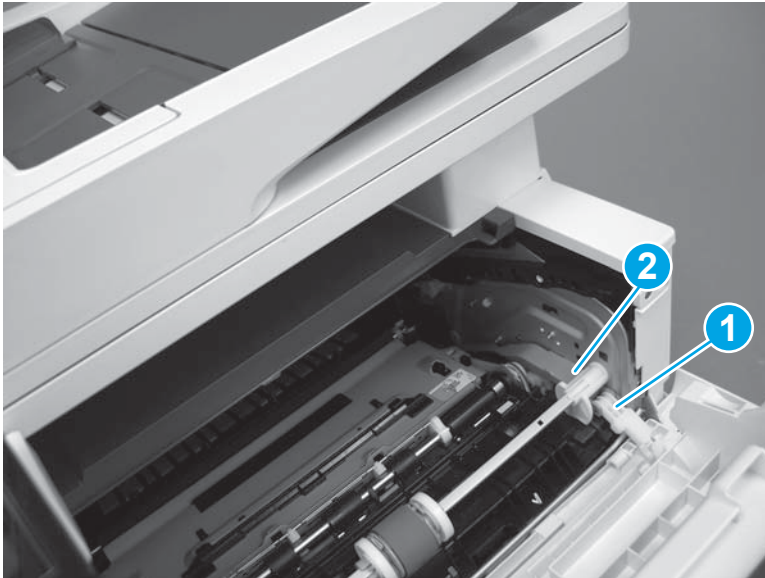
**Figure 1-1806** Install the door



3. Install the gray-plastic pressure-release link (callout 1) onto the white-plastic door arm (callout 2).

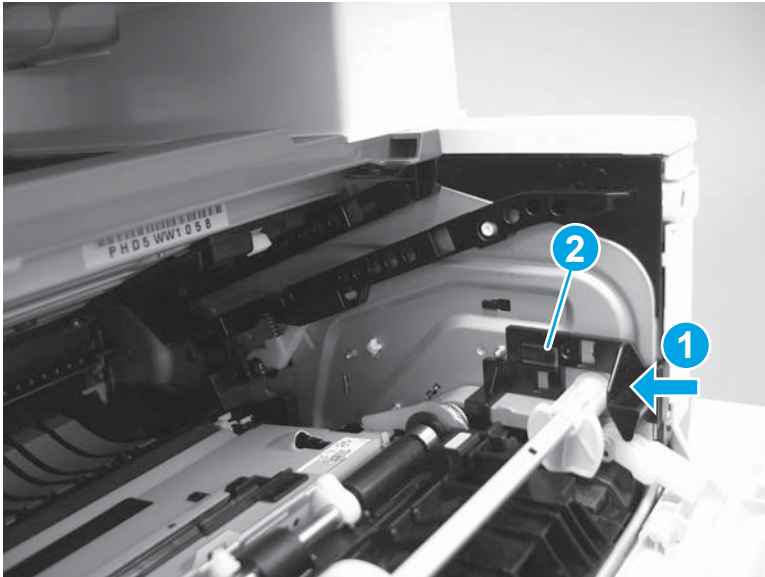
 **IMPORTANT:** Make sure that the arm snaps on to the link. Partially close and open the door to verify that the link (callout 2) moves in and out of the printer as the door closes/opens.

**Figure 1-1807** Install the pressure-release link



4. Slide the guide into the printer (callout 1), and then make sure that the tab (callout 2) snaps into place to secure the guide to the chassis.

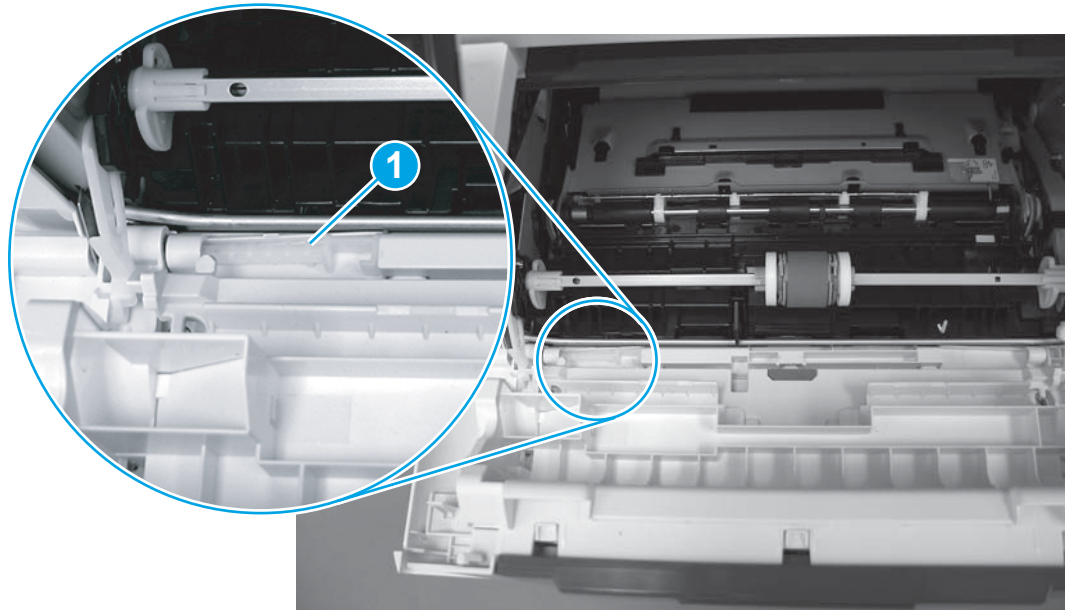
**Figure 1-1808** Install the guide







5. Position the support shaft on the door, and then align the left-side hinge on the door with the hole in the chassis (callout 1).

**Figure 1-1809** Align the hinge

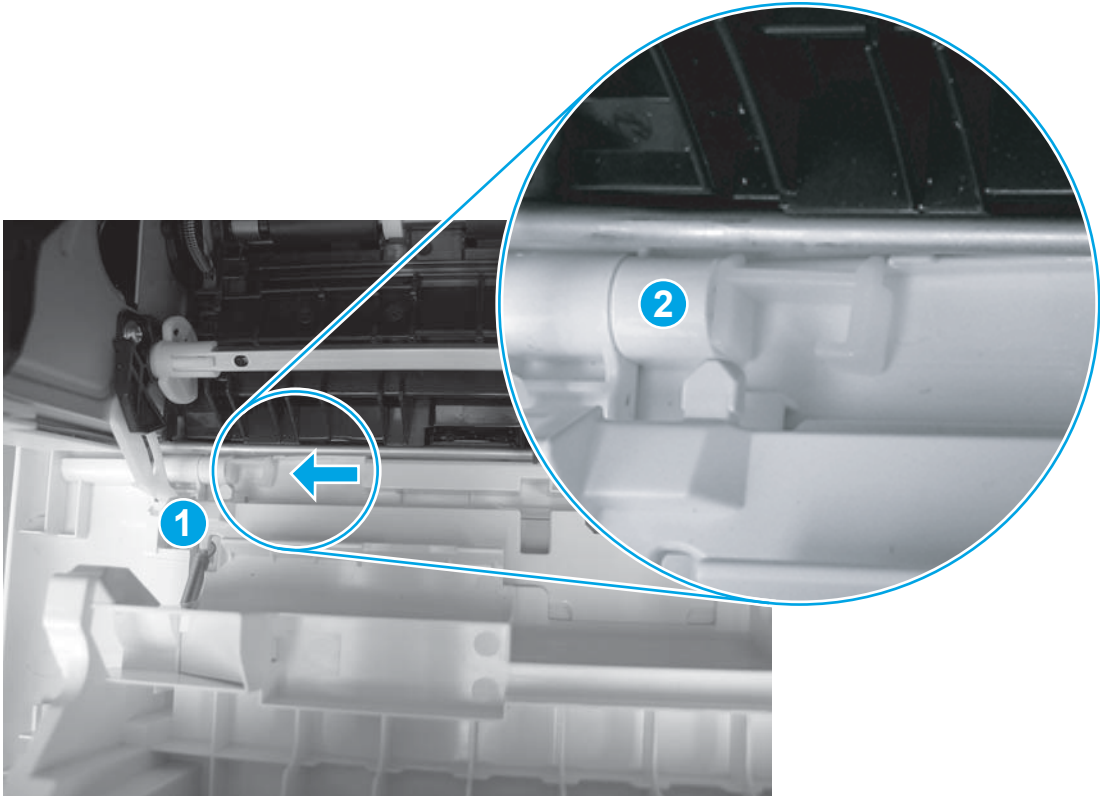


6. Push the shaft towards the left side of the printer to install it (callout 1).

 **NOTE:** Make sure that the support shaft is fully installed and correctly orientated (callout 2) so that it will not interfere with the door opening and closing.

 **Reinstallation tip:** If a replacement door was installed, make sure to install the nameplate (supplied in the kit) corresponding to the printer on the door.

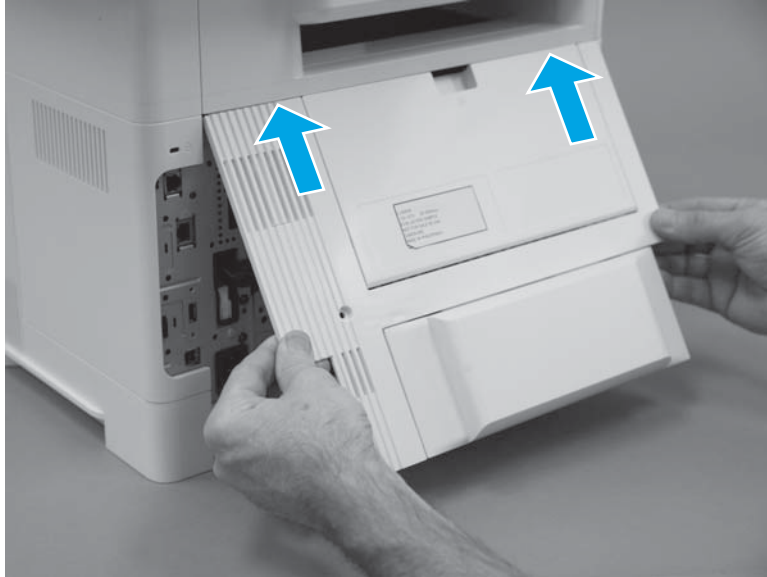
**Figure 1-1810** Install the support shaft



### Step 31: Install the rear door assembly

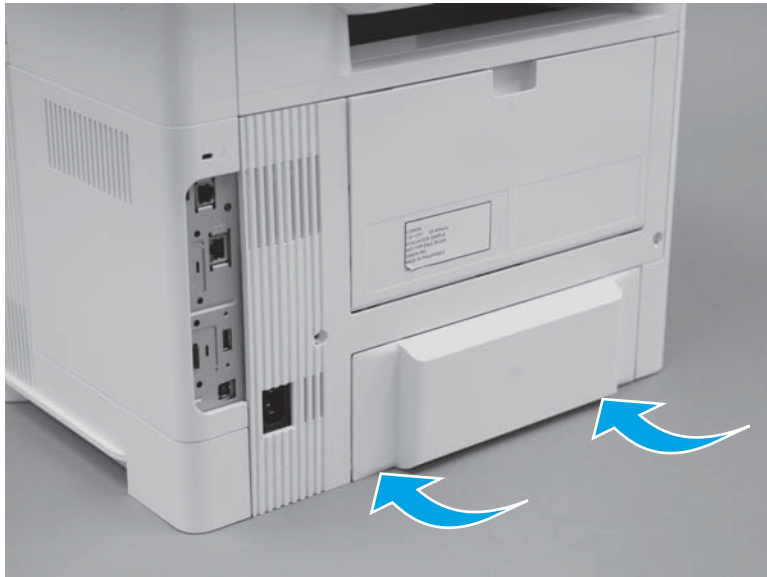
1. Engage the top edge of the assembly with the printer.

**Figure 1-1811** Install the cover



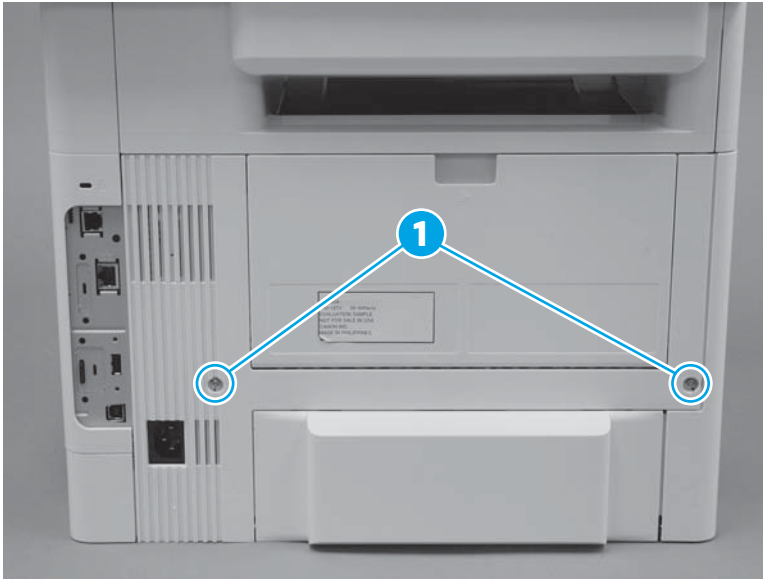
2. Rotate the bottom edge of the cover towards the printer.

**Figure 1-1812** Rotate the bottom of the cover



3. Install two screws (callout 1).

**Figure 1-1813** Install two screws



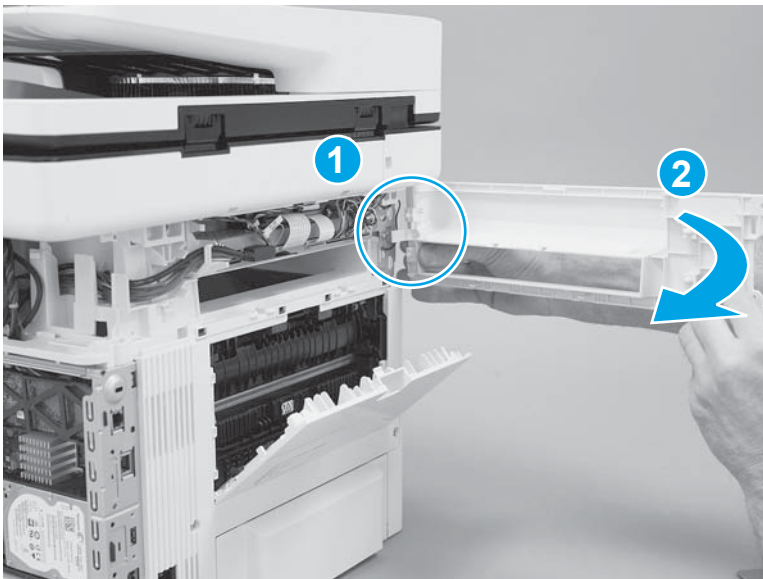
### Step 32: Install the top-rear cover (M527)



**NOTE:** This step is for the M527 printer. For the M501/M506, skip this step and go to [Step 36: Install the formatter on page 1021](#).

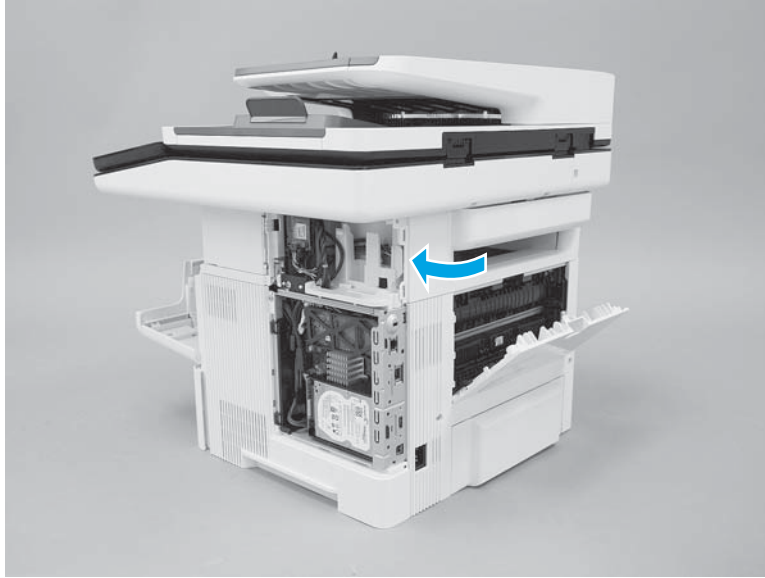
1. Engage one boss (callout 1), and then rotate the cover towards the printer (callout 2).

**Figure 1-1814** Engage one boss



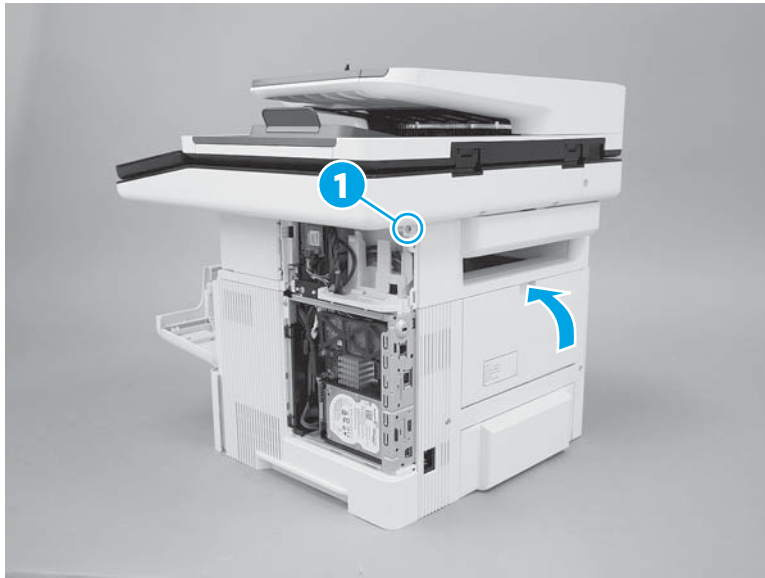
2. Continue to rotate the cover toward the printer to install it.

**Figure 1-1815** Install the cover




3. Install one screw (callout 1), and then close the rear door.

**Figure 1-1816** Install one screw



### Step 33: Install the top-left cover (M527)

 **NOTE:** This step is for the M527 printer. For the M501/M506, skip this step and go to [Step 36: Install the formatter on page 1021](#).

1. Position the front edge of the cover on the printer, and then slide the cover toward the front of the printer to engage two bosses at the front of the cover.

**Figure 1-1817** Slide the cover




2. Rotate the cover towards the printer to engage two tabs at the middle of the cover.

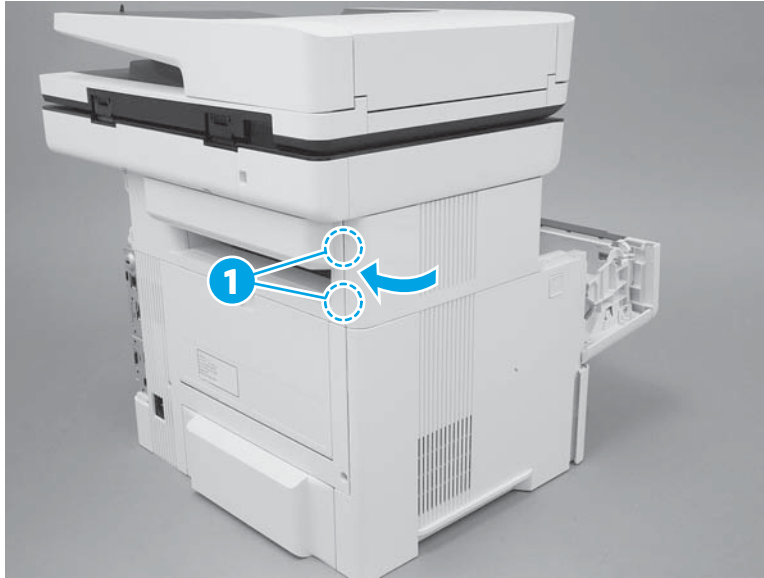
**Figure 1-1818** Engage two tabs




3. Continue to rotate the cover onto the printer to engage two tabs (callout 1) at the rear edge of the cover.


 **NOTE:** Close the toner-cartridge door.

**Figure 1-1819** Engage two tabs



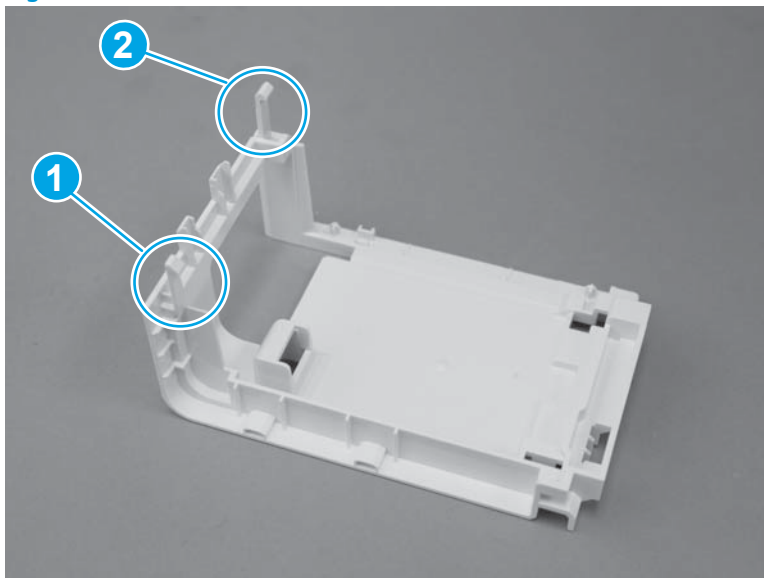
#### Step 34: Install the stapler stationary (inner) cover (M527)

 **NOTE:** This step is for the M527c/f/z printers. For the M501/M506, skip this step and go to [Step 36: Install the formatter on page 1021](#). For the M527dn, skip this step and go to [Step 35: Install the stapler door or stapler blank cover \(M527\) on page 1019](#).

 **NOTE:** M527c/f/z printers only.

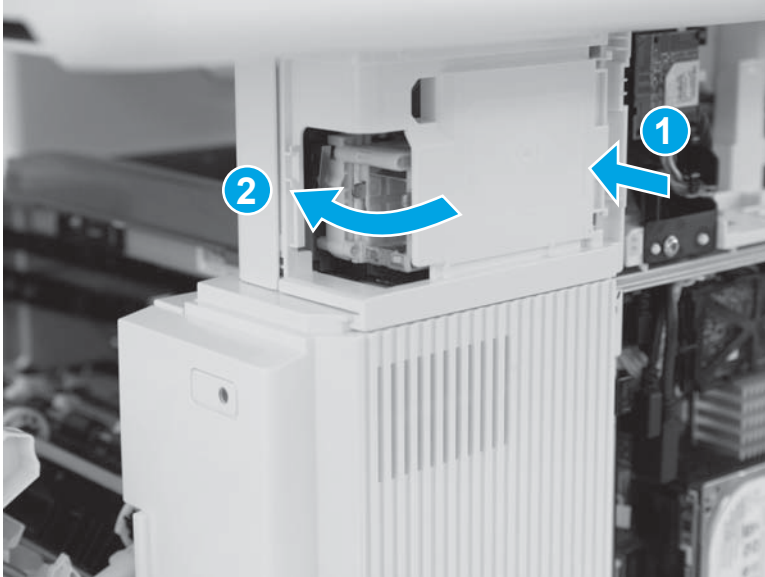
1. Before proceeding, take note of the locations of the upper tab (callout 1) and the lower tab (callout 2) on the stapler stationary (inner) cover.

**Figure 1-1820** Locate the tabs



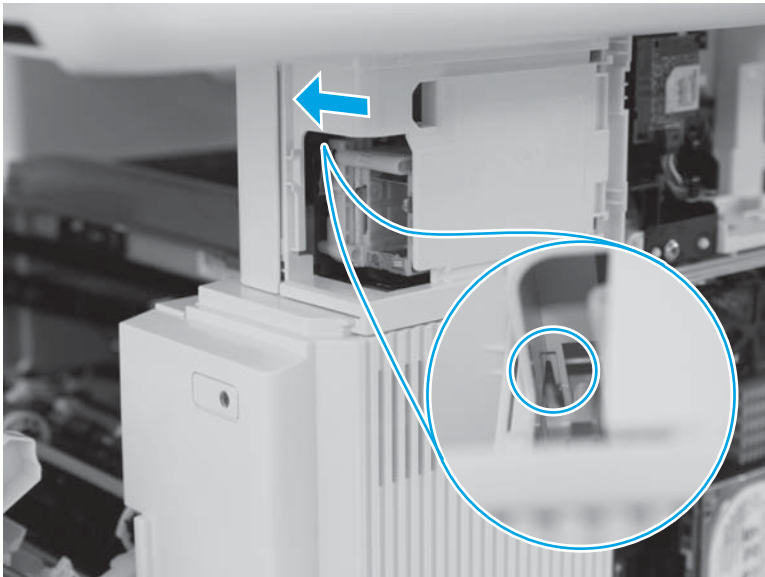
- Engage the rear edge of the cover with the printer (callout 1), and then rotate the front edge of the cover onto the printer (callout 2) to engage the two tabs.

**Figure 1-1821** Install the cover



- Verify that the upper tab is engaged.

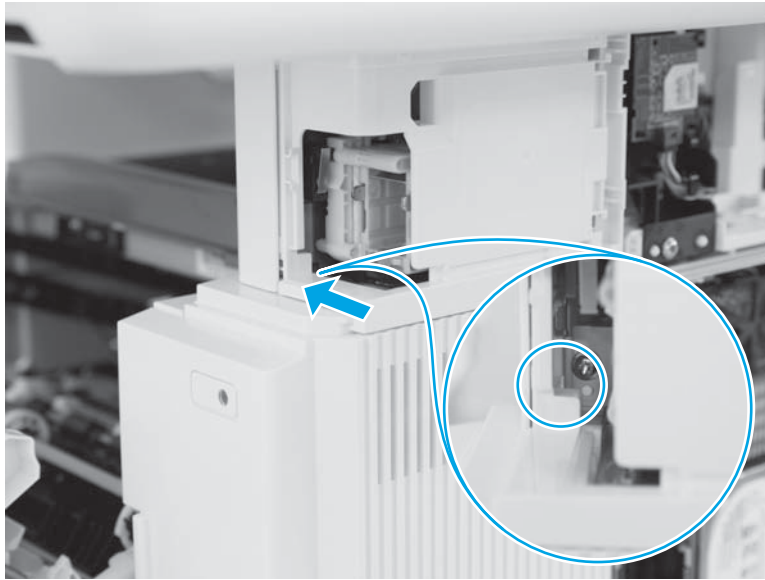
**Figure 1-1822** Engage one tab







4. Verify that the lower tab is engaged.

**Figure 1-1823** Engage one tab



### Step 35: Install the stapler door or stapler blank cover (M527)

 **NOTE:** This step is for the M527 printer. For the M501/M506, skip this step and go to [Step 36: Install the formatter on page 1021](#).

 **NOTE:** The M527dn does not have a convenience stapler.

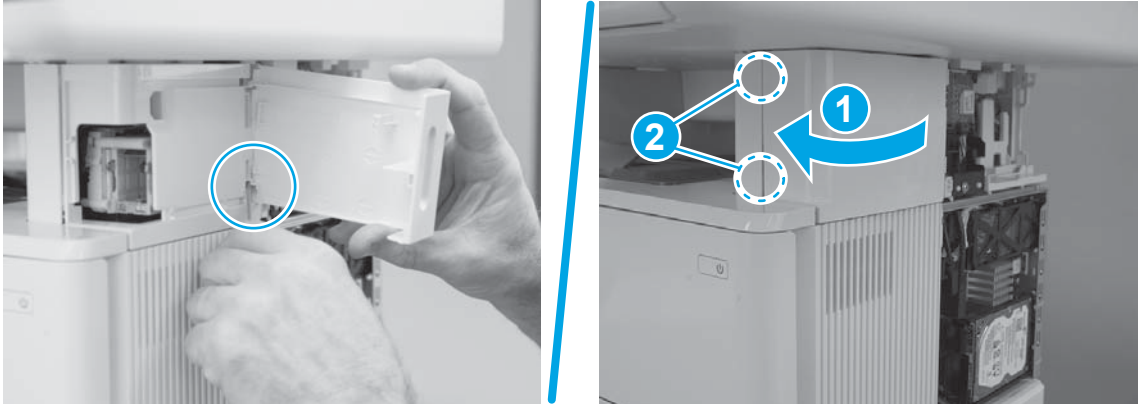
1. Do one of the following:
  - **M527c/f/z:** Position the door near the printer.
  - **M527dn:** Position the cover on the printer.

**Figure 1-1824** Install the door or cover



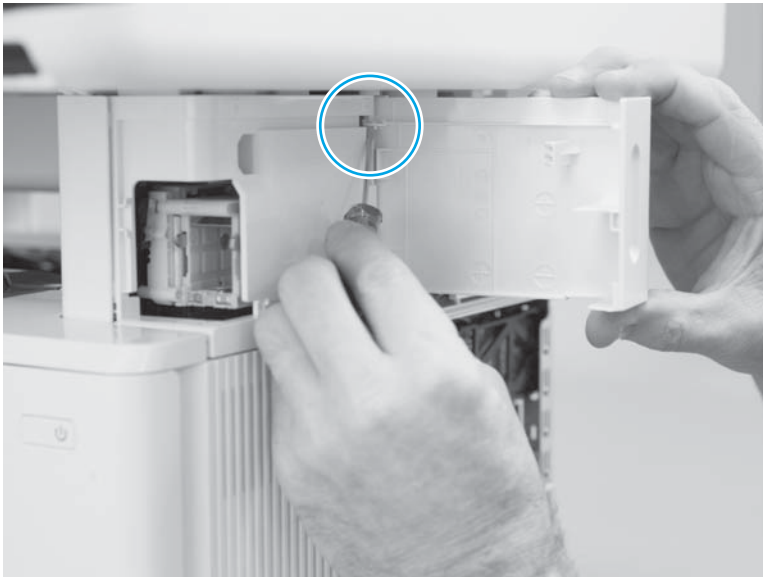
2.
  - **M527c/f/z:** Engage the lower hinge.
  - **M527dn:** Rotate the cover towards the printer (callout 1), and then make sure that the two tabs (callout 2) snap into place to install the cover.

**Figure 1-1825** Engage the lower hinge or engage the cover



3. **M527c/f/z:** Engage the upper hinge.

**Figure 1-1826** Engage the upper hinge



4. **M527c/f/z:** Close the stapler door.

**Figure 1-1827** Close the door

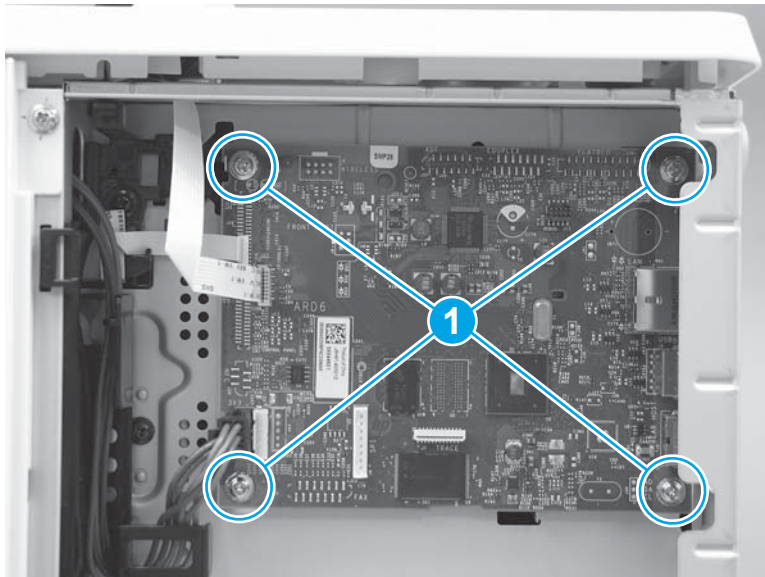


### Step 36: Install the formatter


**IMPORTANT:** **M506/M527:** Take note of all empty connectors on the PCA before disconnecting any wire harnesses or flat-flexible cables (FFCs). Some empty connectors might not be visible until other items—like the hard-disk drive—are removed, so pay close attention while removing the formatter and accessory items.

1. **M501:** Disconnect all of the connectors and FFCs, remove four screws (callout 1), and then remove the formatter.

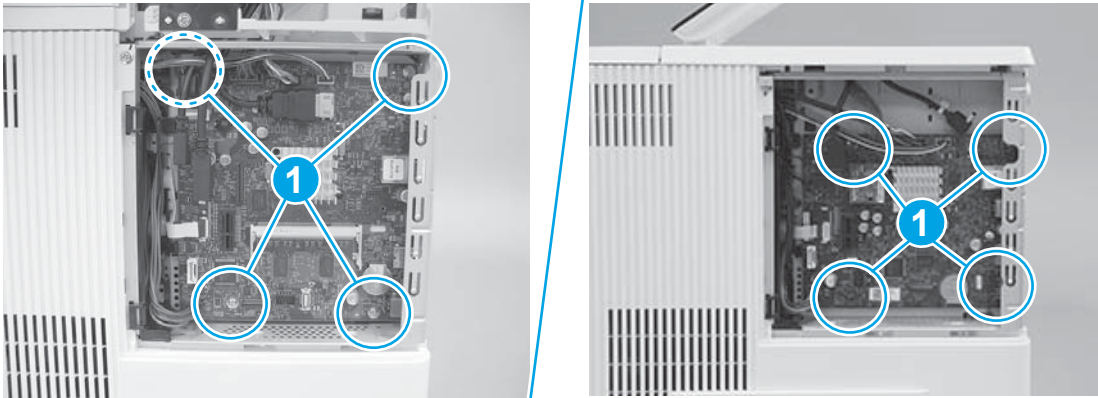
**Figure 1-1828** Remove the formatter (M501)



2. **M506/M527:** Disconnect all of the connectors and FFCs, remove four screws (callout 1), and then remove the formatter.

 **IMPORTANT:** Take note of all empty connectors on the formatter before disconnecting any wire harnesses or flat-flexible cables (FFCs). Some empty connectors might not be visible until other items—like the hard-disk drive—are removed, so pay close attention while removing the formatter and accessories items.


**Figure 1-1829** Remove the formatter (M506/M527)



### Step 37: Install the fax PCA (M527)

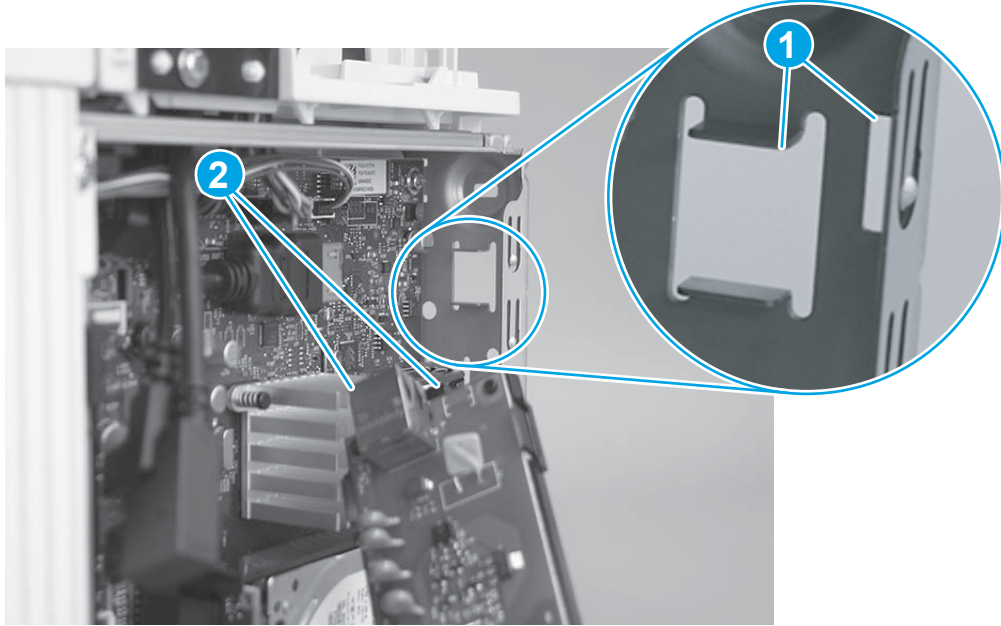
 **NOTE:** If the fax PCA is not installed, skip this step and go to [Step 38: Install the hard-disk drive \(HDD\) on page 1025](#).

 **CAUTION:**  ESD-sensitive part.

 **NOTE:** M527c/f/z printers only (optional for the M527dn).

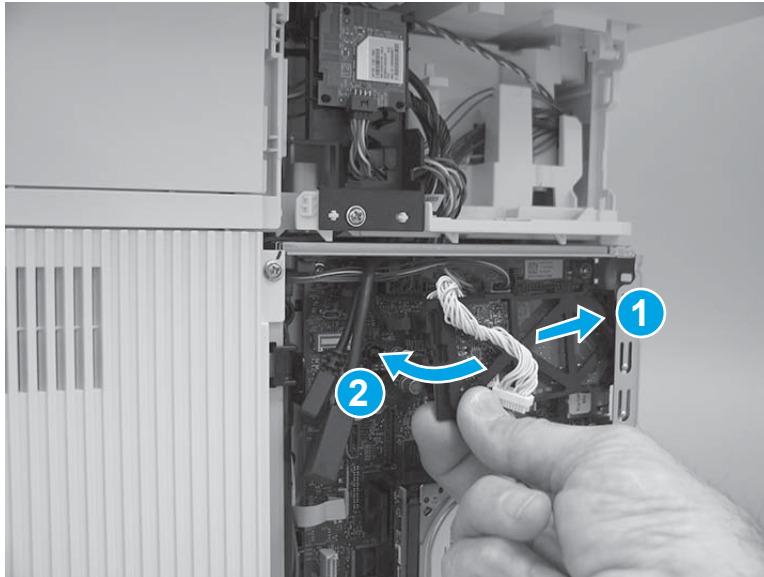
1. Before proceeding, take note of the location of the slots (callout 1) in the sheet-metal where the fax PCA cradle mounting tab and fax port (callout 2) must be installed.

**Figure 1-1830** Locate the slots in the sheet-metal



2. Insert the fax PCA cradle mounting tab and fax port in the slots in the sheet-metal plate (callout 1), and then rotate the connector end of the fax PCA toward the formatter (callout 2).

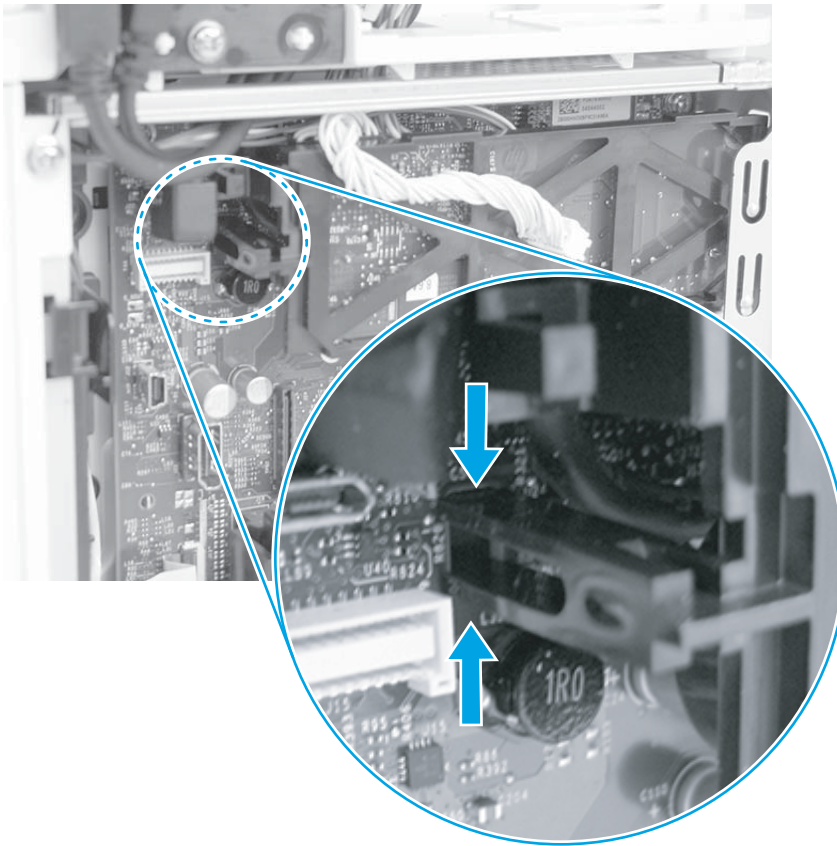
**Figure 1-1831** Install the fax PCA



- Engage the retainer with the slot in the formatter.

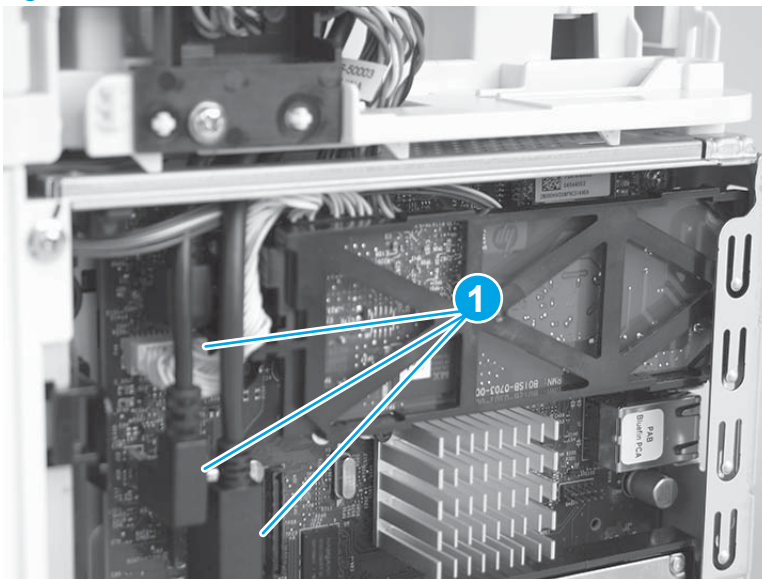
 **Reinstallation tip:** Pinch the retainer to easily engage it with the slot.

**Figure 1-1832** Engage the fax PCA




- Connect three connectors (callout 1).

**Figure 1-1833** Connect three connectors




### Step 38: Install the hard-disk drive (HDD)

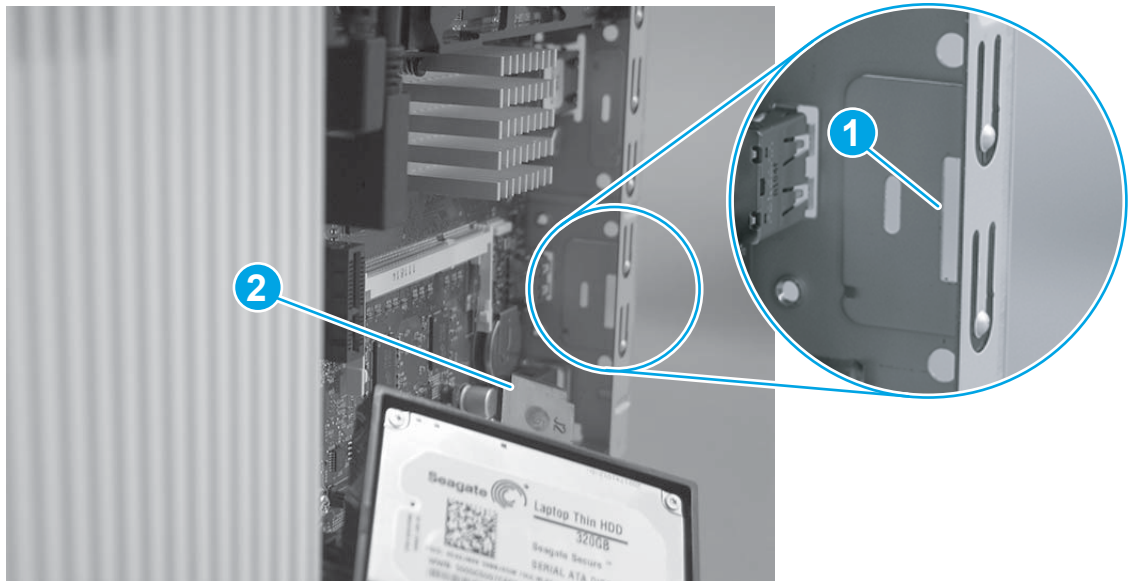
 **NOTE:** If the HDD is not installed, skip this step and go to [Step 39: Install the formatter cover on page 1026](#).

 **CAUTION:**  ESD-sensitive part.

1. Before proceeding, take note of the location of the slot (callout 1) in the sheet-metal where the HDD cradle mounting tab (callout 2) must be installed.

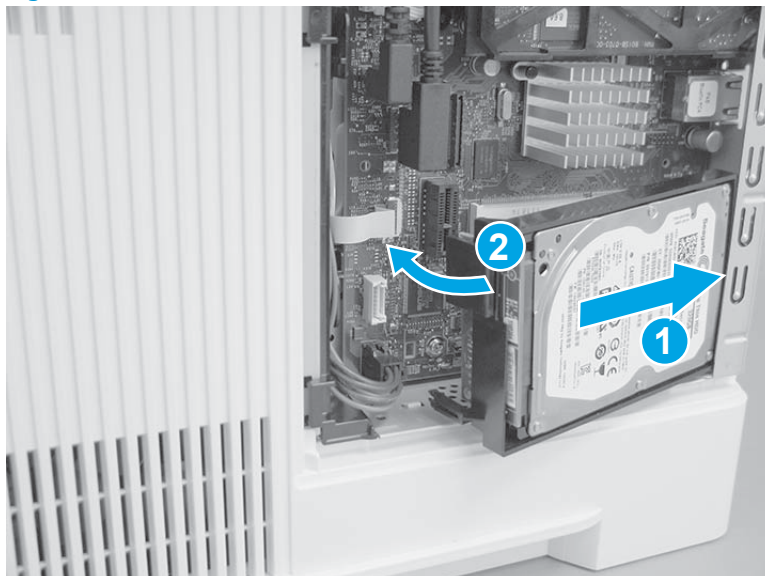
 **CAUTION:** This portion of the sheet-metal is a knock-out plate (callout 1). Do not push on it with sufficient force to detach it when installing the HDD.

**Figure 1-1834** Locate the slot in the sheet-metal



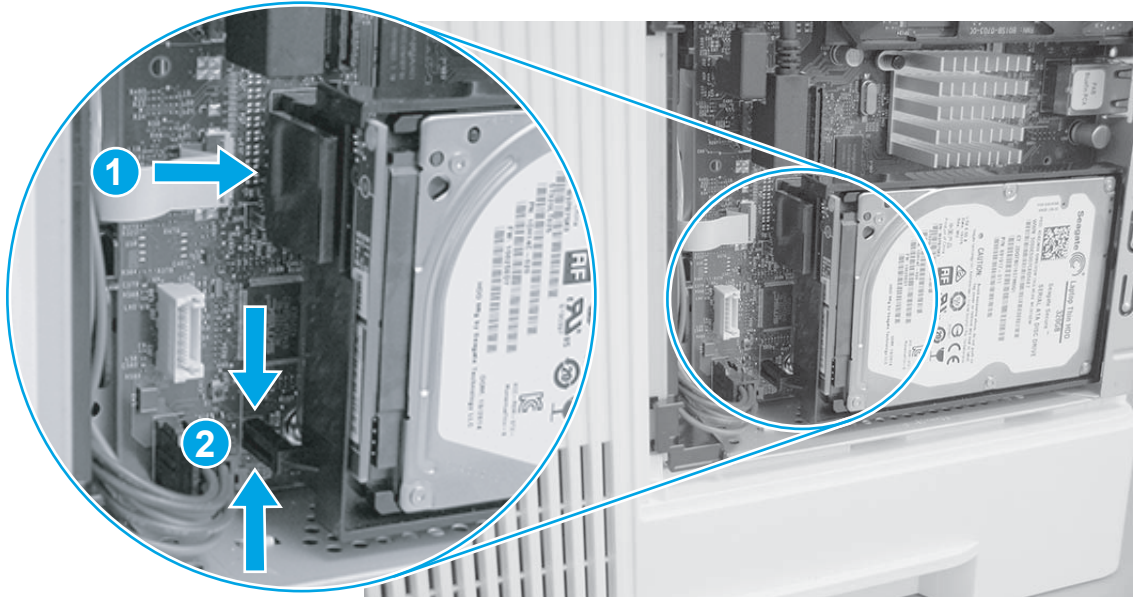
2. Insert the HDD cradle mounting tab in the slot in the sheet-metal (callout 1), and then rotate the connector end (callout 2) of the HDD toward the formatter.

**Figure 1-1835** Install the HDD



3. Make sure that the locking connector (callout 1) latches and that the stando (callout 2) engages with the slot in the formatter (it might be necessary to pinch the retainer to engage it with the slot).

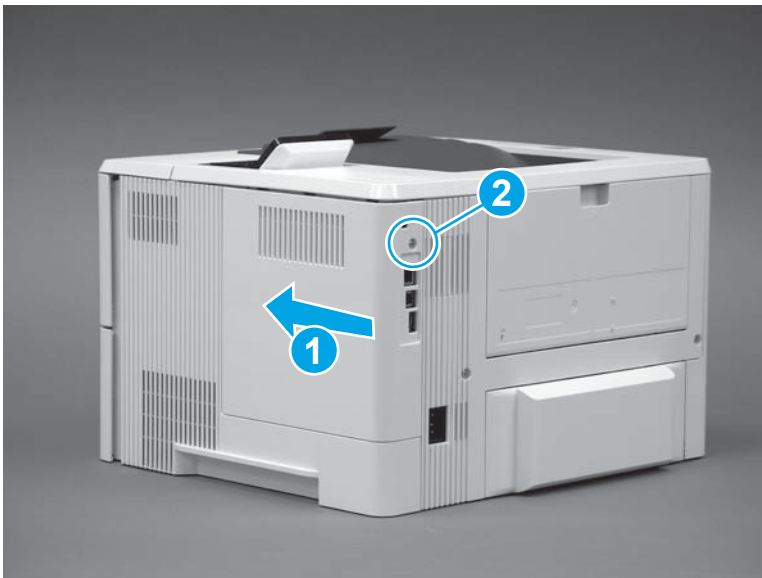
**Figure 1-1836** Install the HDD



### Step 39: Install the formatter cover

1. **M501**: Slide it toward the front of the printer to install it (callout 1), and then install one screw (callout 2).

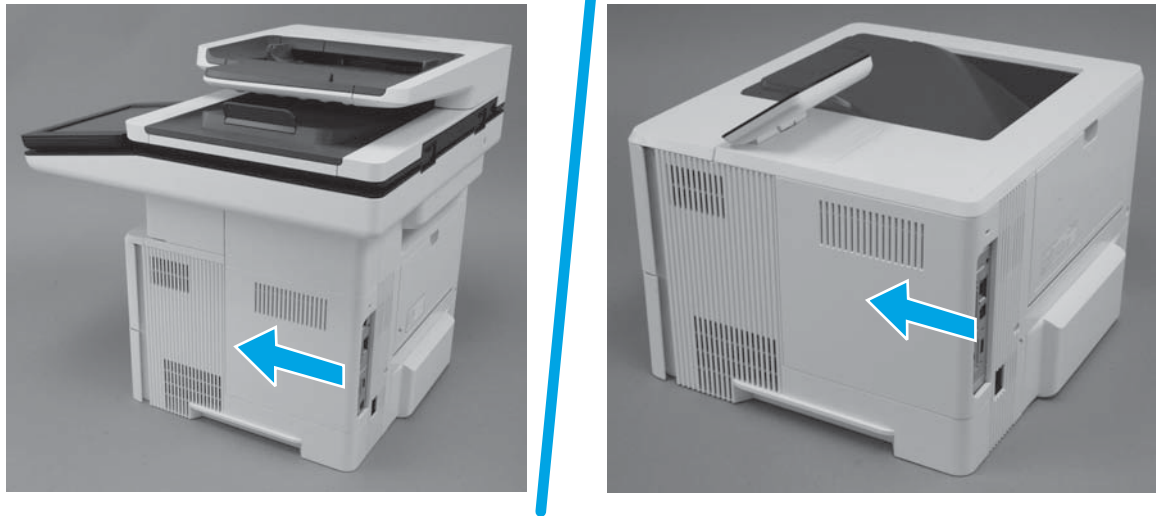
**Figure 1-1837** Install the formatter cover (M501)





2. **M506/M527:** Slide it toward the front of the printer to install it.

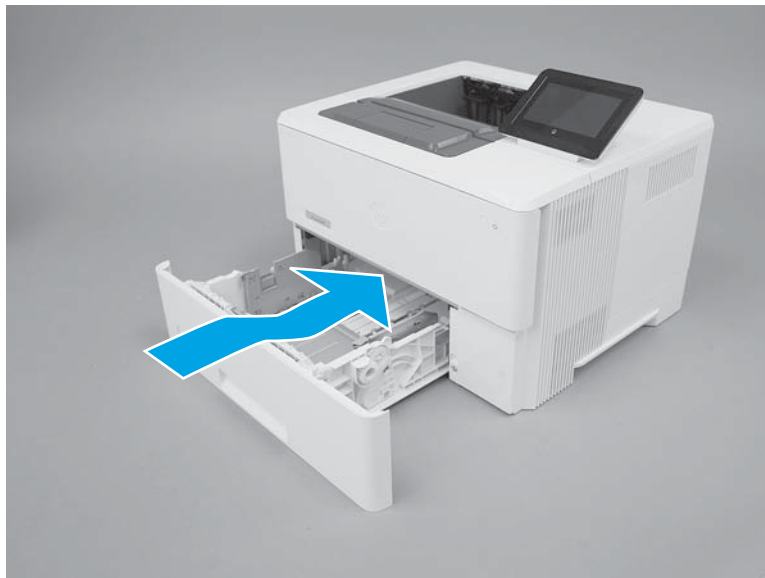
**Figure 1-1838** Install the formatter cover (M506/M527)



#### Step 40: Install the tray

1. With the tray at a slight angle, align the sides of the tray with the rails in the accessory, and then partially slide the tray into the printer.

**Figure 1-1839** Install the tray



2. Push the tray straight into the accessory to close it.

**Figure 1-1840** Close the tray



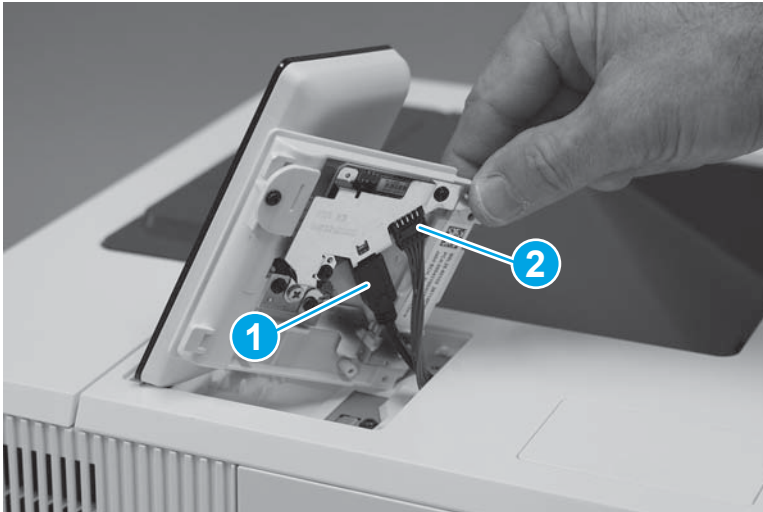
#### Step 41: Install the control panel (M506x)



**NOTE:** M506x model only.

1. Connect one HDMI cable (callout 1), one connector (callout 2).

**Figure 1-1841** Connect the cables



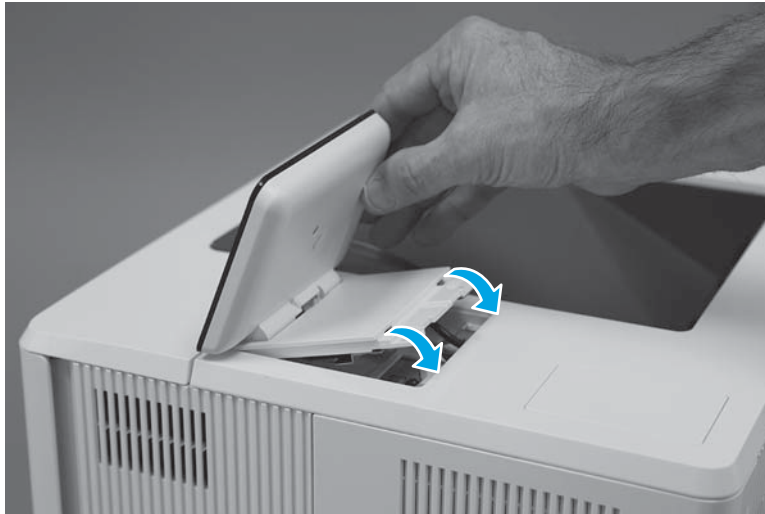
2. Install the tabs (callout 1) on the front of the control panel in the slots (callout 2) on the printer top cover.

**Figure 1-1842** Install the control panel



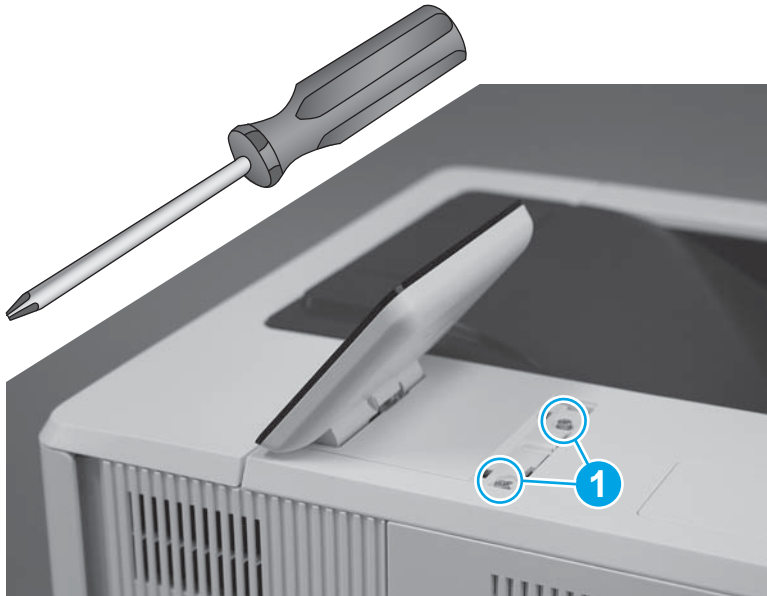
3. Rotate the control-panel base down onto the printer.

**Figure 1-1843** Rotate the control-panel base down



4. Use a small Phillips screwdriver to install two screws (callout 1).

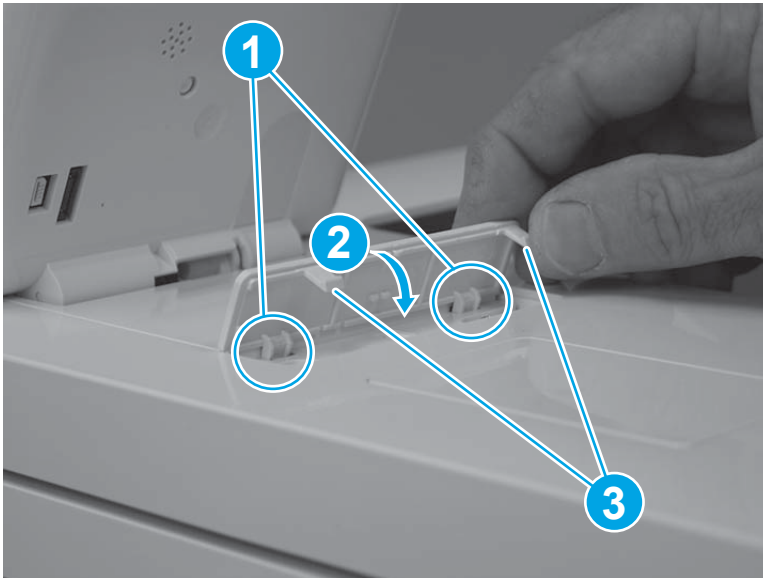
**Figure 1-1844** Install two screws




5. Position the screw cover mounting feet into the slots in the top cover (callout 1), and then rotate the cover down (callout 2) to install it.

 **NOTE:** Press down on the cover firmly to make sure that the tabs (callout 3) snap into place.

**Figure 1-1845** Install the cover



## Removal and replacement: High-voltage power supply

 **IMPORTANT:** Some figure might show assemblies removed or installed that have not yet been removed or installed at that specific step. However, the procedures are correct for this printer and the target assembly. Always thoroughly read the instructions that accompany each figure

- [Introduction](#)
- [Step 1: Remove the tray](#)
- [Step 2: Remove the cartridge door assembly](#)
- [Step 3: Remove the rear door assembly](#)
- [Step 4: Remove the left cover](#)
- [Step 10: Remove the HVPS](#)
- [Step 11: Unpack the replacement assembly](#)
- [Step 12: Install the HVPS](#)
- [Step 6: Install the left cover](#)
- [Step 7: Install the rear door assembly](#)
- [Step 8: Install the cartridge door assembly](#)
- [Step 9: Install the tray](#)


### Introduction

This document provides the procedures to remove and replace the high-voltage power supply (HVPS).

### Before performing service

#### Turn the printer power off

- Disconnect the power cable.

 **WARNING!** To avoid damage to the printer, turn the printer off wait 30 seconds, and then remove the power cable before attempting to service the printer.

Use the table below to identify the correct part number for your printer. To order the part, go to [www.hp.com/buy/parts](http://www.hp.com/buy/parts).

High-voltage power supply (HVPS) part number	
RM2-7945-000CN	High-voltage power supply (HVPS)

### Required tools

- Small flat-blade screwdriver.
- #2 Phillips screwdriver with a magnetic tip.

## After performing service

### Turn the printer power on

- Connect the power cable.
- Use the power switch to turn the power on.

### Post service test

Make sure that the printer initializes to a **Ready** state.

Print a configuration page to make sure that the printer is functioning correctly.

### Step 1: Remove the tray

1. Pull the tray straight out of the printer until it stops.

**Figure 1-1846** Pull the tray out until it stops



2. Lift the front of the tray, and then pull it out of the printer to remove it.

**Figure 1-1847** Release and remove the tray



### Step 2: Remove the cartridge door assembly



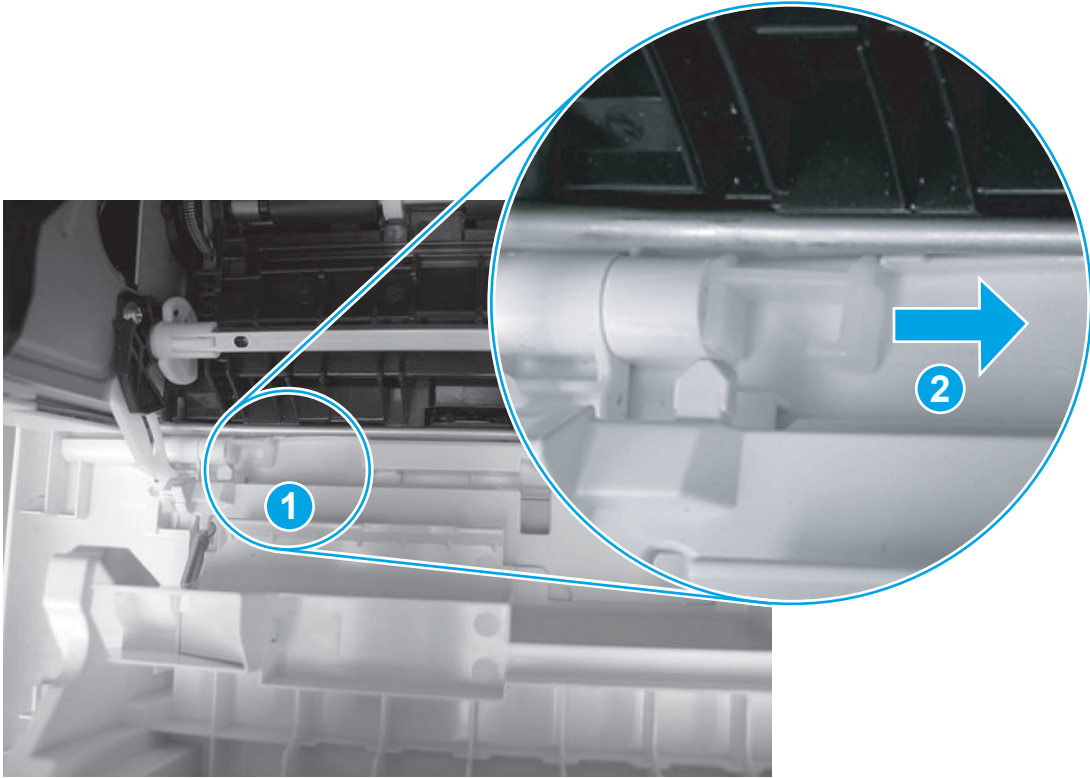
**NOTE:** If the toner cartridge was not removed prior to servicing the printer, remove it now.

1. Release the support shaft (callout 1), and then slide it toward the center of the door (callout 2).



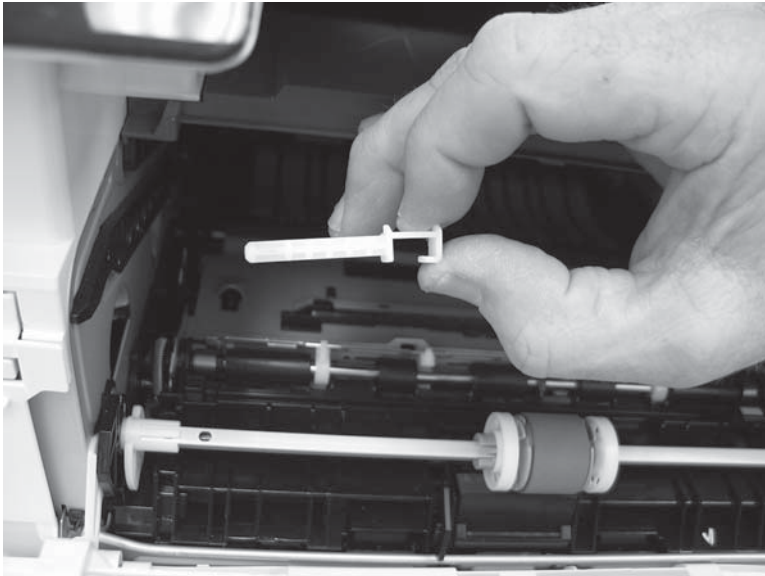
**TIP:** It might be easier to release the support shaft by using a small flat-blad screwdriver.

**Figure 1-1848** Release the support shaft



2. Remove the support shaft.

**Figure 1-1849** Remove the support shaft

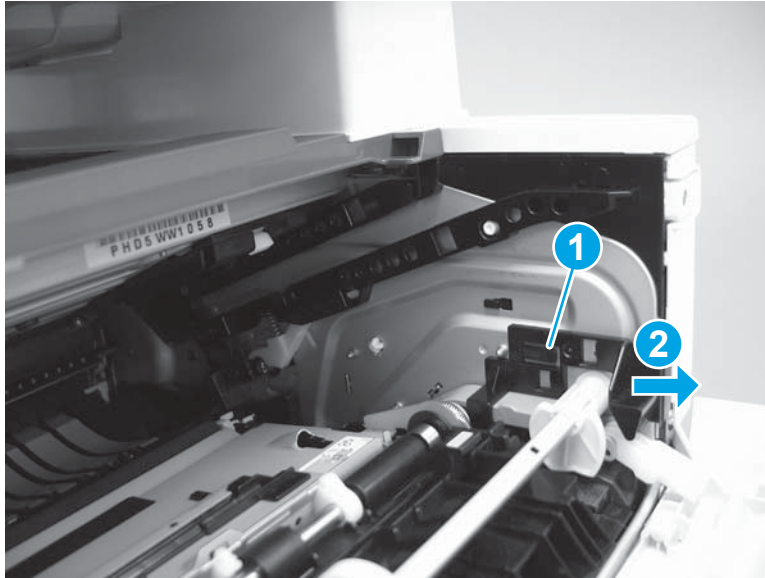




3. Release one tab (callout 1), and then slide the guide out of the printer (callout 2).

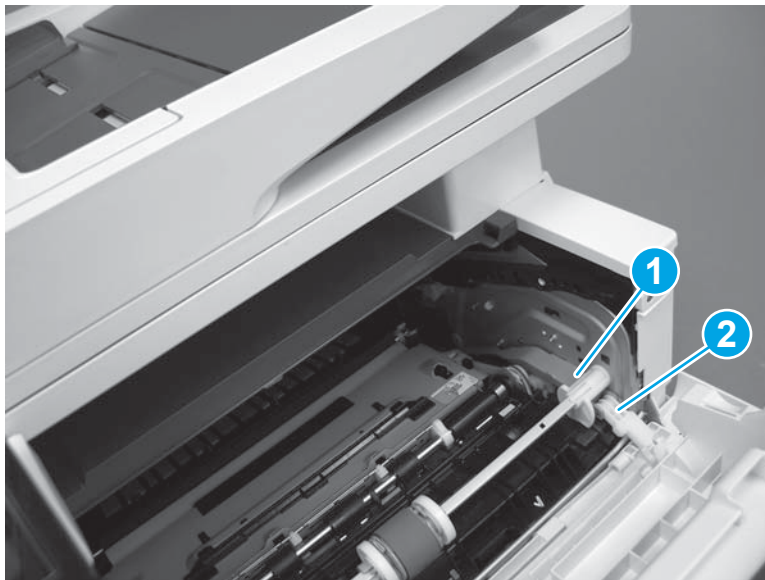
**CAUTION:** Be careful, the tab (callout 1) can be easily broken.

**Figure 1-1850** Remove the guide



4. Use a small flat-blade screwdriver to gently pry the white-plastic door arm (callout 1) off of the gray-plastic pressure-release link (callout 2) to release the door arm.

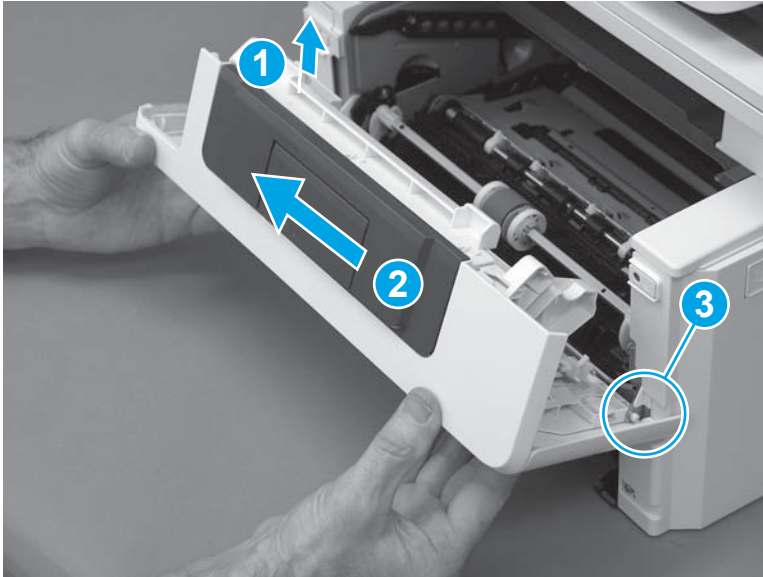
**Figure 1-1851** Release the pressure-release link



5. With the door in the partially closed position, slightly raise the left end (callout 1; raise it over the sheet-metal hinge boss), and then slide the door to the left (callout 2) to release the right hinge (callout 3).

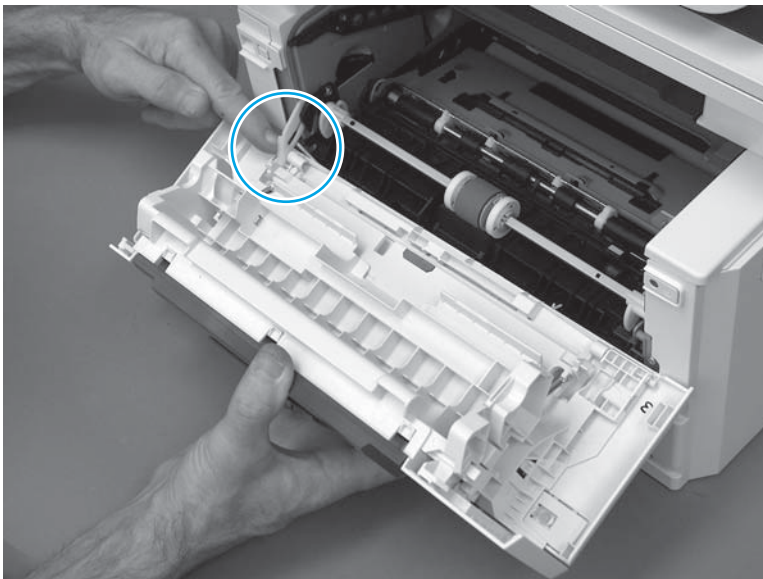
**⚠ CAUTION:** The door is still attached to the printer by the left-side retainer arm. Do not attempt to completely remove the door.

**Figure 1-1852** Release the door



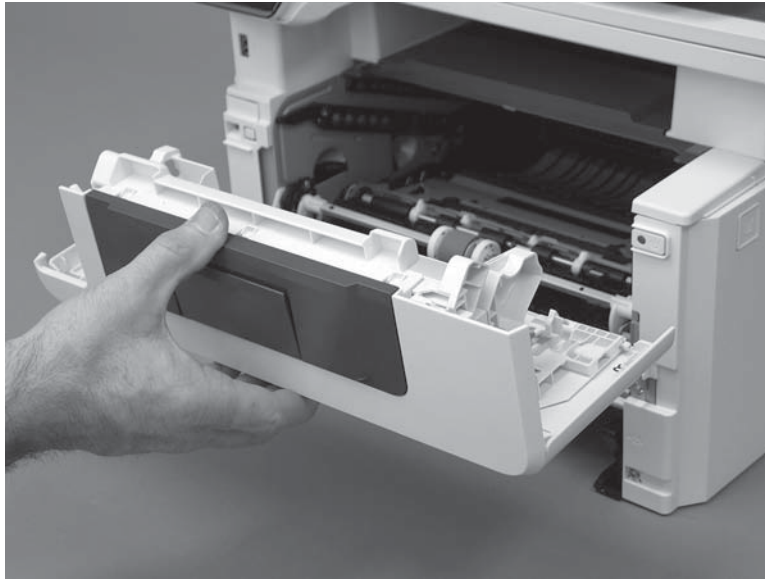
6. Rotate the door away from the printer until the keyed pin on the left-side retainer arm can disengage from the door.

**Figure 1-1853** Release the left-side retainer arm



7. Remove the door.

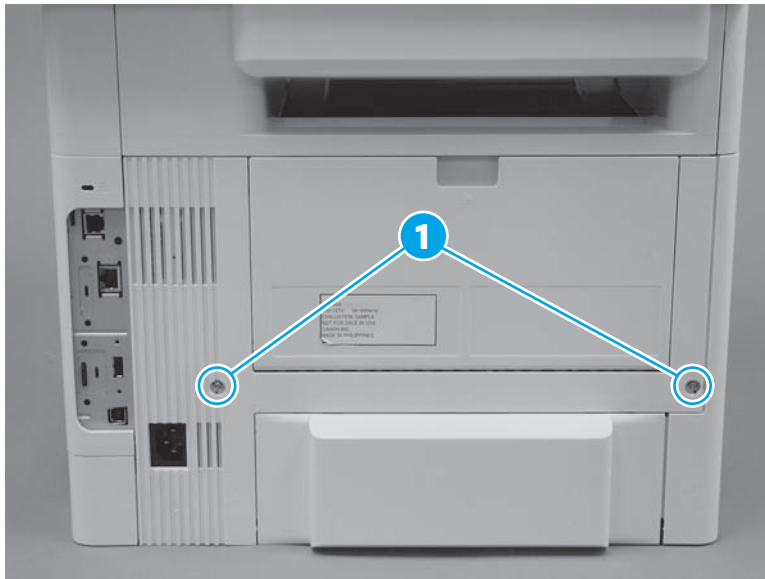
**Figure 1-1854** Remove the door



### Step 3: Remove the rear door assembly

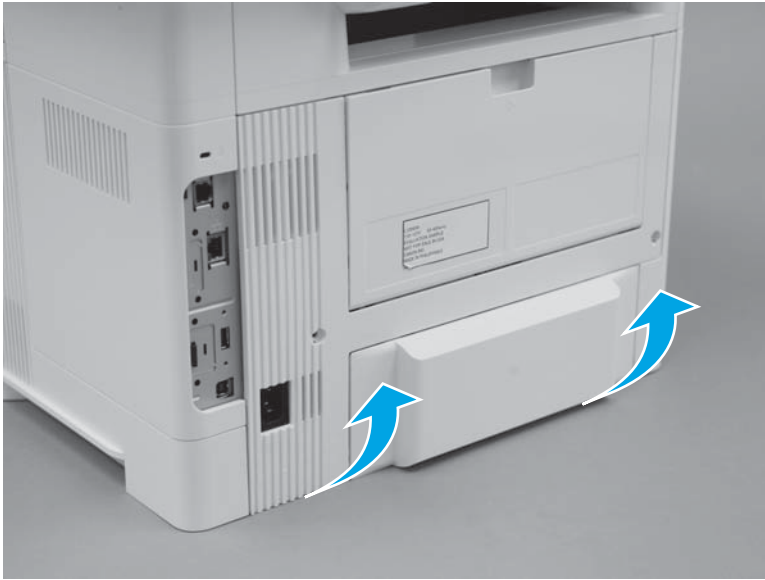
1. At the rear of the printer, remove two screws (callout 1).

**Figure 1-1855** Remove two screws



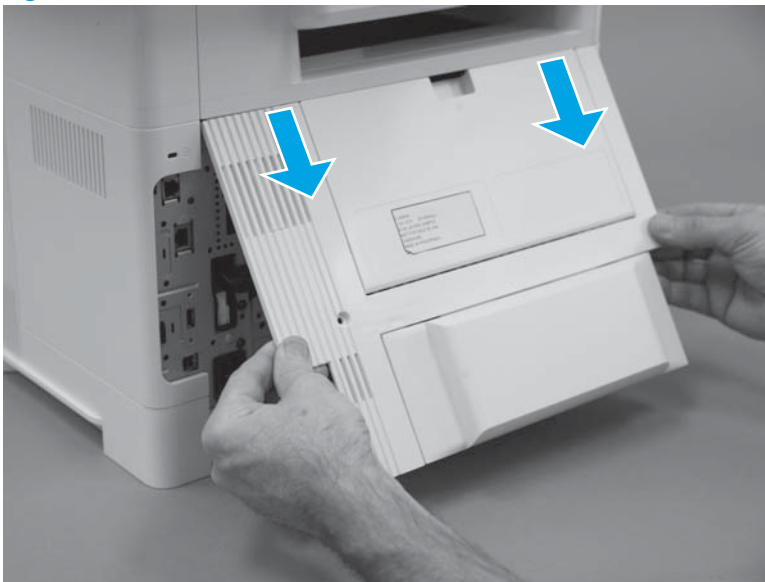
2. Rotate the bottom edge of the assembly away from the printer to release it.

**Figure 1-1856** Rotate the bottom of the cover





3. Pull down on the assembly to remove it.

**Figure 1-1857** Remove the cover

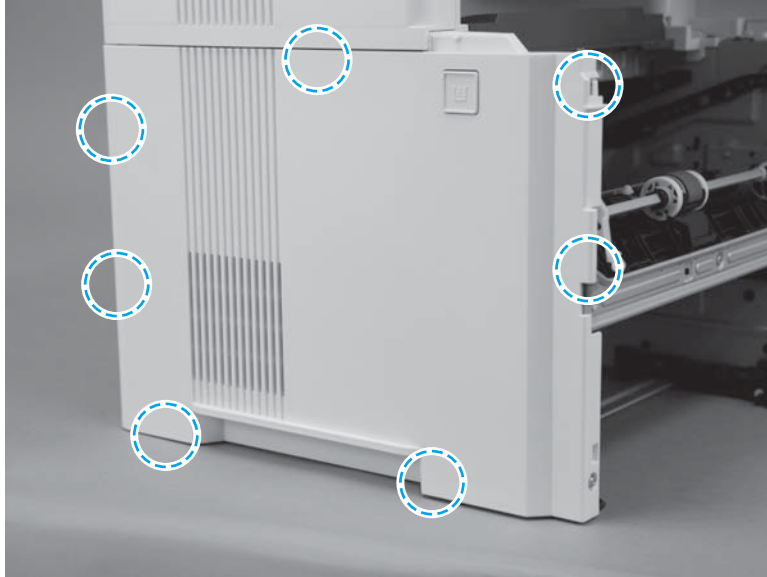


#### Step 4: Remove the left cover

- 
-  **IMPORTANT:** The black-plastic cassette front and rear guides (located inside the tray cavity) can be easily dislodged. Do not lose the guides when the cover is removed or installed.
-  **NOTE:** The M527 printer is shown in this procedure. However, this procedure is valid for the M501/M506 printers.
- 

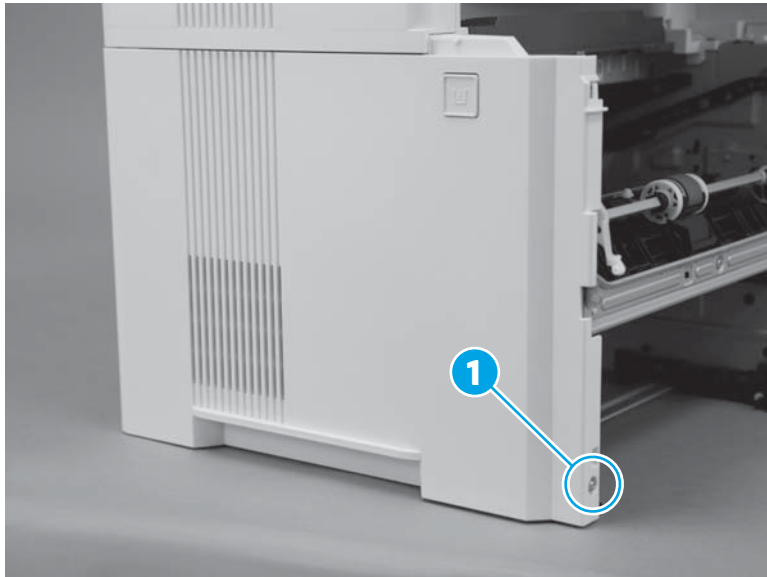
1. Before proceeding, take note of the location of the tabs and bosses on the inside of the cover.

**Figure 1-1858** Locate of the tabs and bosses



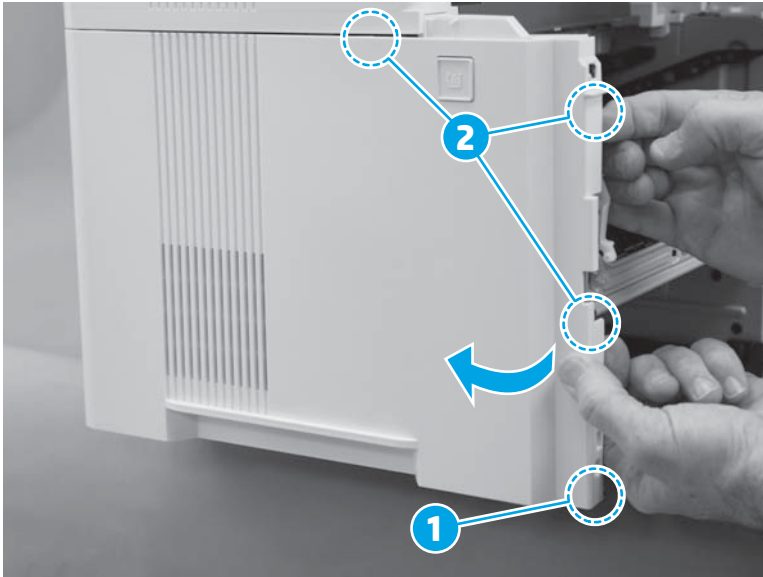
2. Remove one screw (callout 1).

**Figure 1-1859** Remove one screw



3. At the front of the printer, release one boss (callout 1), and then rotate the front edge of the cover away from the printer to release three tabs (callout 2).

**Figure 1-1860** Release one boss and three tabs




4. At the bottom edge of the cover, release two tabs.

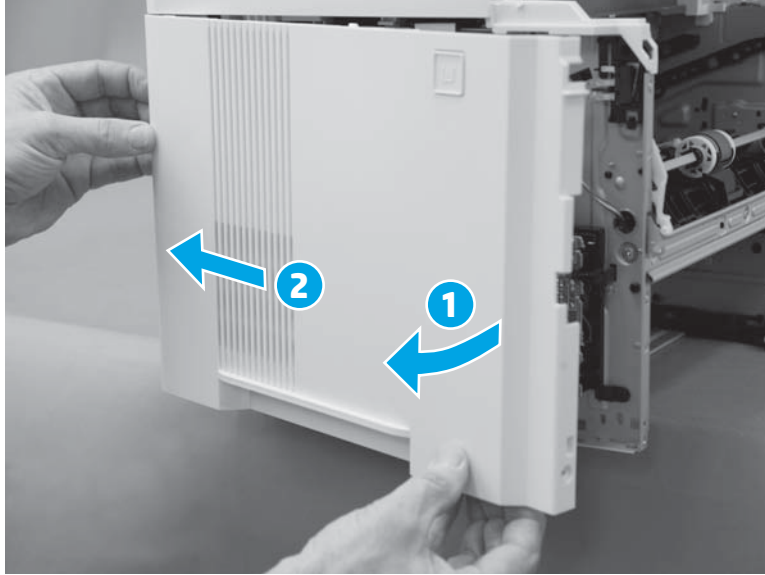
**Figure 1-1861** Release two tabs



5. Continue to rotate the front edge of the cover away from the printer (callout 1), and then slide the cover toward the rear of the printer (callout 2) to remove it.


 **NOTE:** If the cover is difficult to rotate or slide as shown below, make sure that the bottom tabs (released in the previous step) are completely disengaged from the chassis.

**Figure 1-1862** Remove the cover

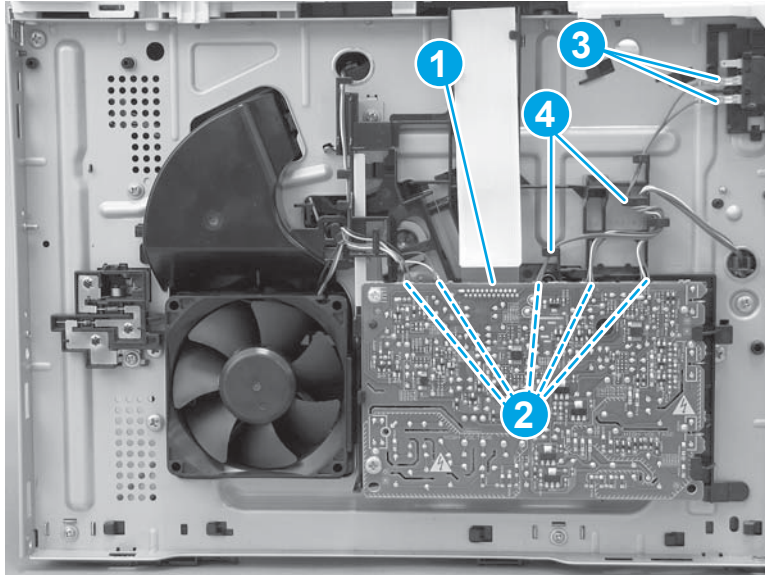


### Step 10: Remove the HVPS

1. Disconnect one FFC (callout 1), five connectors (callout 2), two wire-harness lugs (callout 3), and then release the wire harness from the retainers (callout 4).

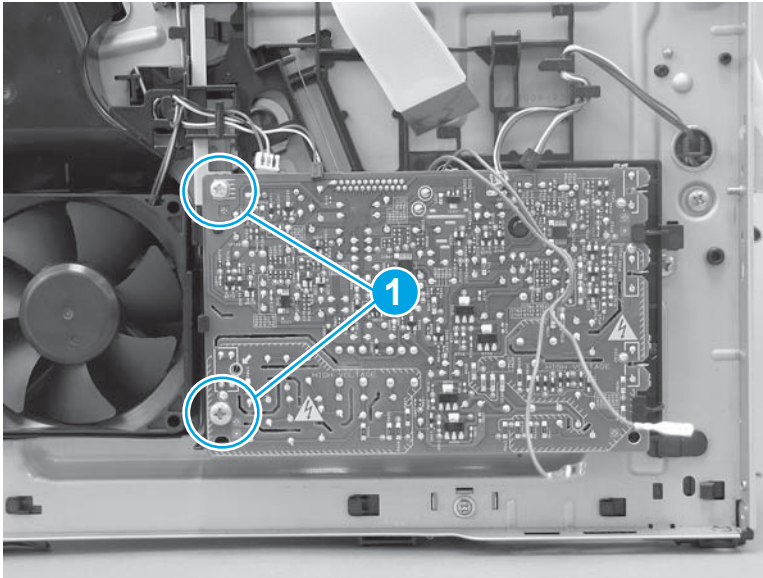
 **NOTE:** The M527 is shown in this step. However, the step is valid for the M506. The microswitch (callout 3) for the M506 only has two wire-harness terminals.

**Figure 1-1863** Disconnect the connectors



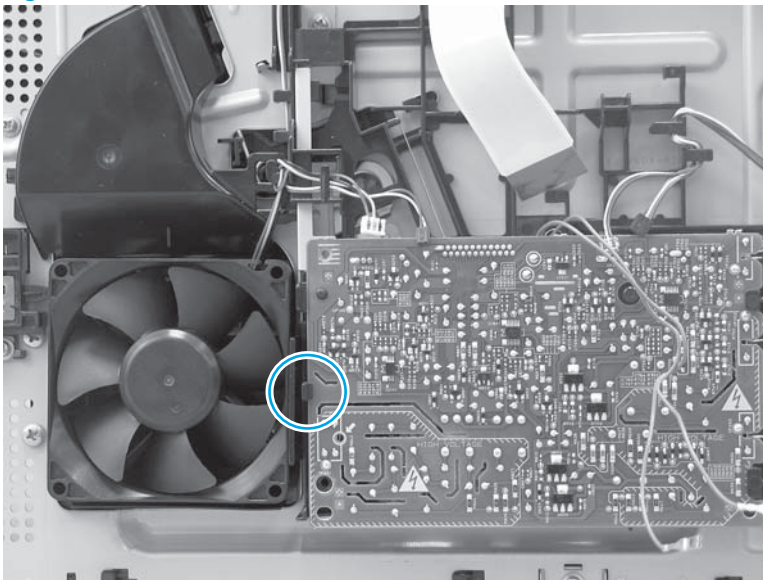
2. Remove two screws (callout 1).

**Figure 1-1864** Remove two screws



3. Release one tab.

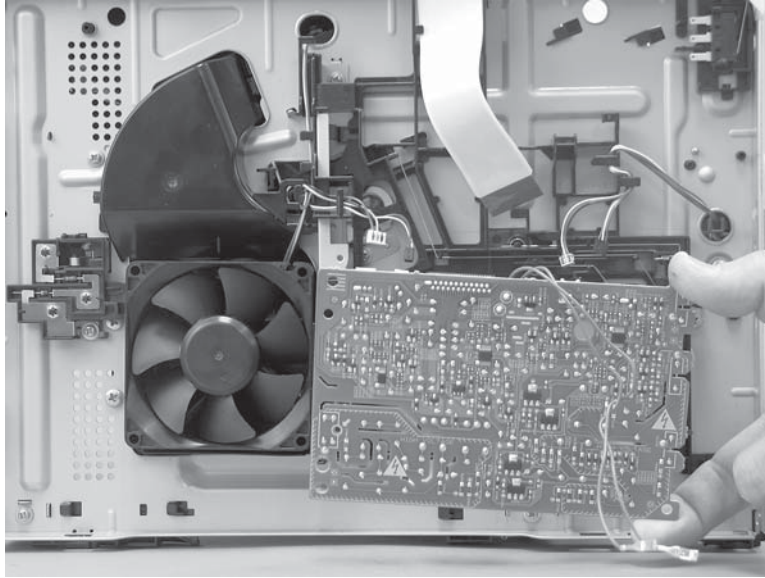
**Figure 1-1865** Release one tab





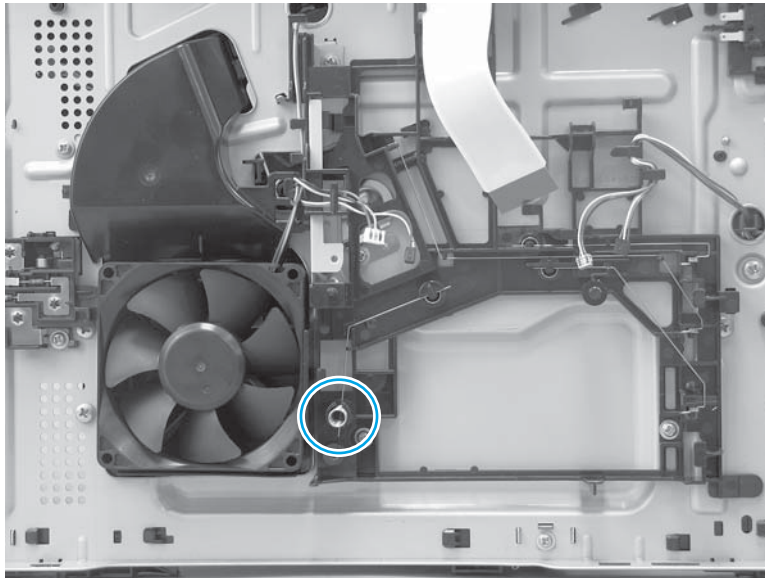
4. Remove the HVPS.

**Figure 1-1866** Remove the HVPS



5. One spring behind the HVPS is not captive. Do not lose the spring when removing the HVPS.

**Figure 1-1867** Check the spring



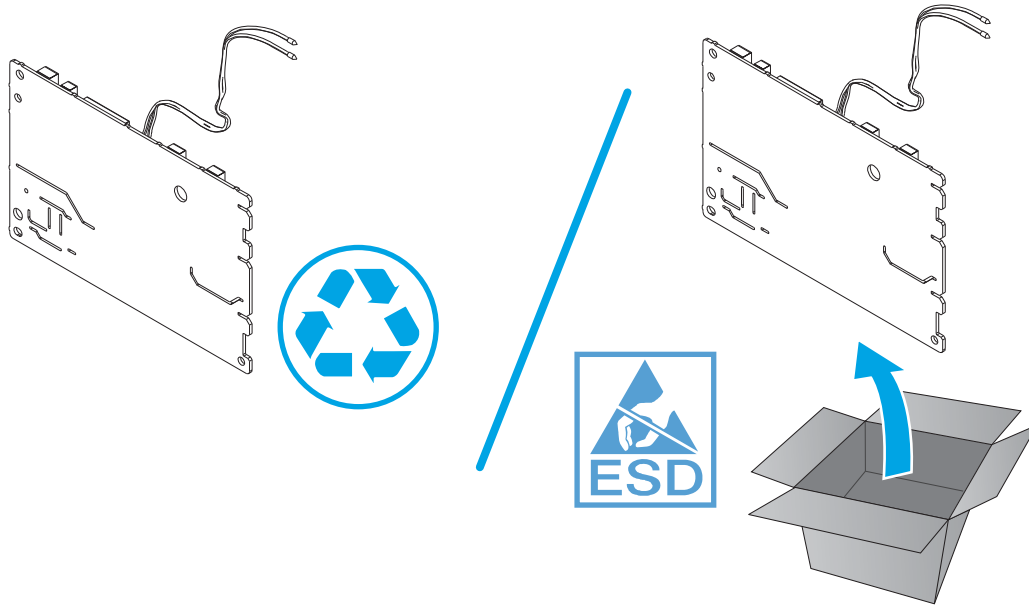
### Step 11: Unpack the replacement assembly

Unpack the replacement part from the packaging.

<http://www8.hp.com/us/en/hp-information/environment/product-recycling.html>

 **NOTE:** HP recommends responsible disposal of the defective part.

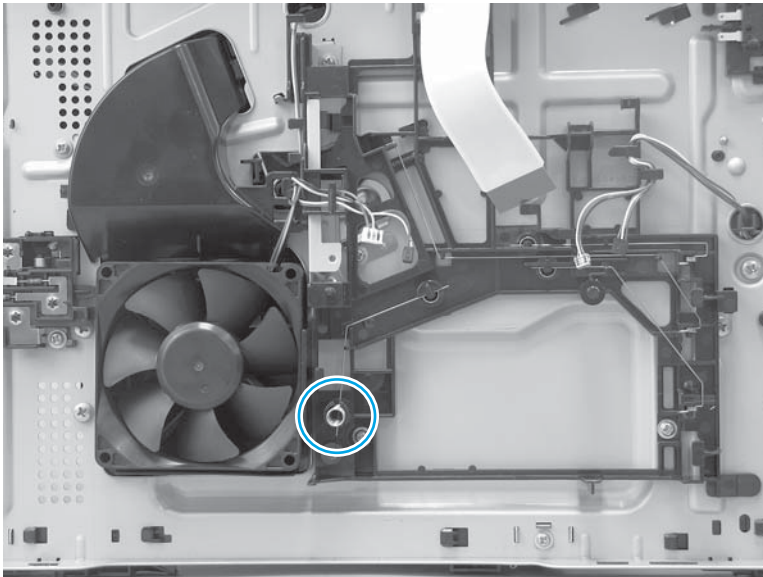
**Figure 1-1868** Recycle and unpack



**Step 12: Install the HVPS**

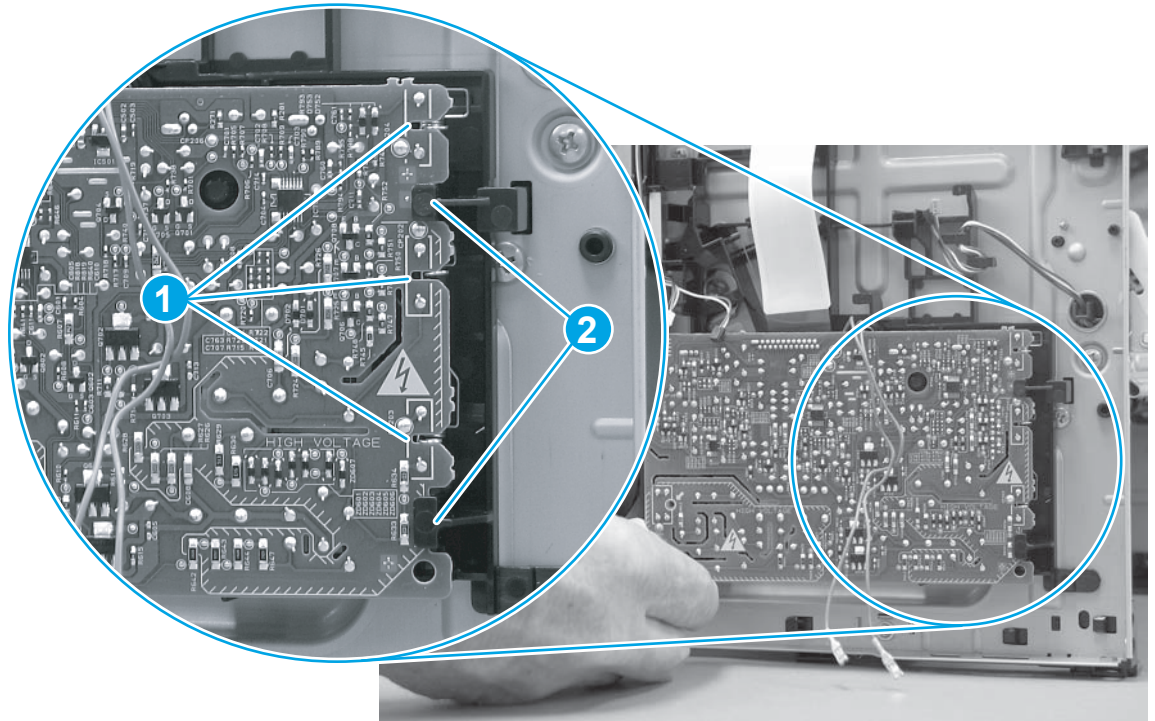
1. Make sure that the spring is installed in the holder.

**Figure 1-1869** Check the spring




2. Install the right edge of the HVPS in the holder. make sure that the springs on the holder are positioned in the slots on the PCA (callout 1), and that the PCA is behind the tabs of the holder (callout 2).

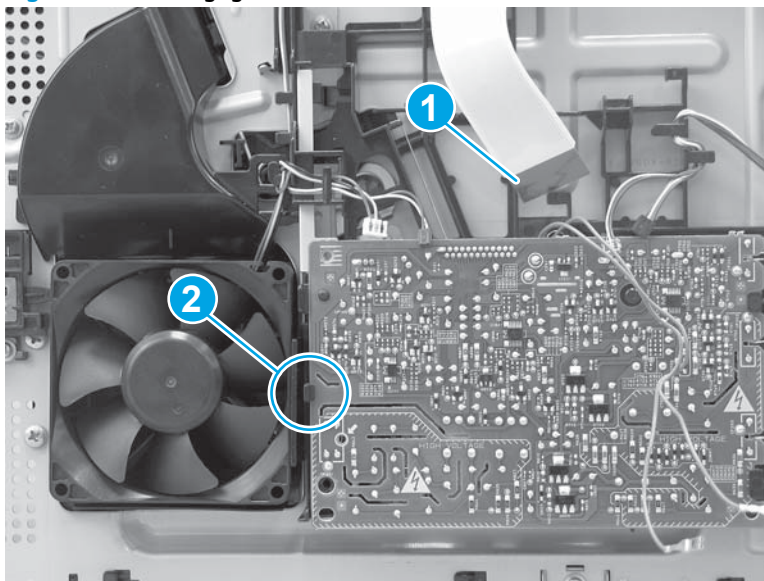
**Figure 1-1870** Install the HVPS



3. Rotate the left edge of the HVPS toward the printer to engage one tab (callout 1).

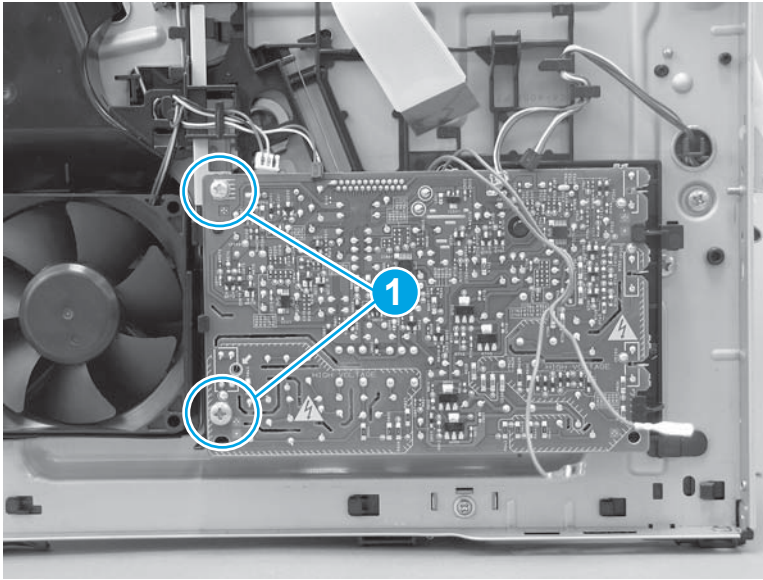
 **Reinstallation tip:** It might be easier to connect the FFC (callout 2) before installing the HVPS in the behind the tab.

**Figure 1-1871** Engage one tab




4. Install two screws (callout 1).

**Figure 1-1872** Install two screws

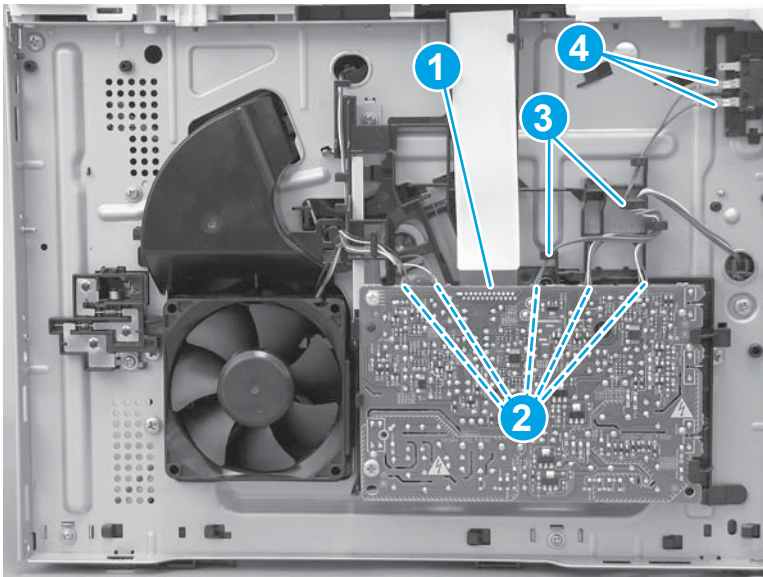


5. Connect one FFC (callout 1), five connectors (callout 2), install the wire harness in the retainers (callout 3), and then connect two wire-harness lugs to the switch terminals (callout 4).


 **NOTE:** The M527 is shown in this step. However, the step is valid for the M506. The microswitch for the M506 only has two wire-harness terminals.


For the M527, connect the wire-harness to the bottom two terminals (callout 4).

**Figure 1-1873** Connect the connectors



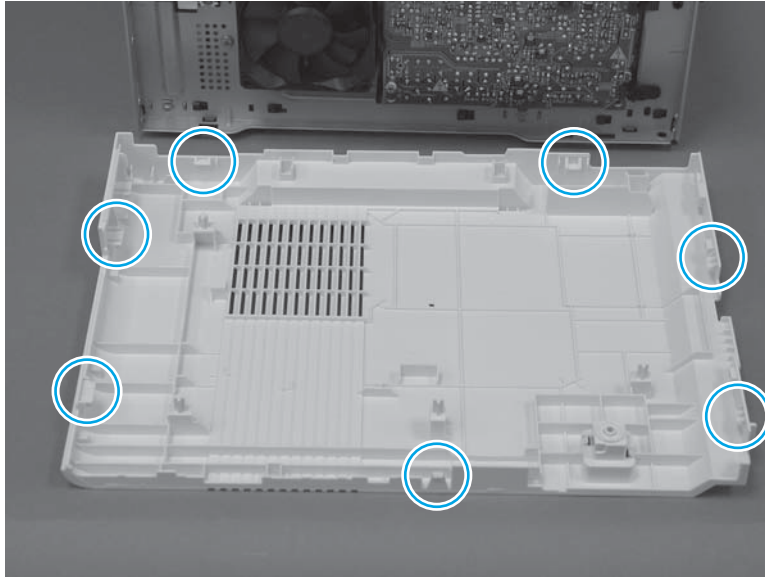
## Step 6: Install the left cover

 **IMPORTANT:** The black-plastic cassette front and rear guides (located inside the tray cavity) can be easily dislodged. Do not lose the guides when the cover is removed or installed.

 **NOTE:** The M527 printer is shown in this procedure. However, this procedure is valid for the M501/M506 printers.

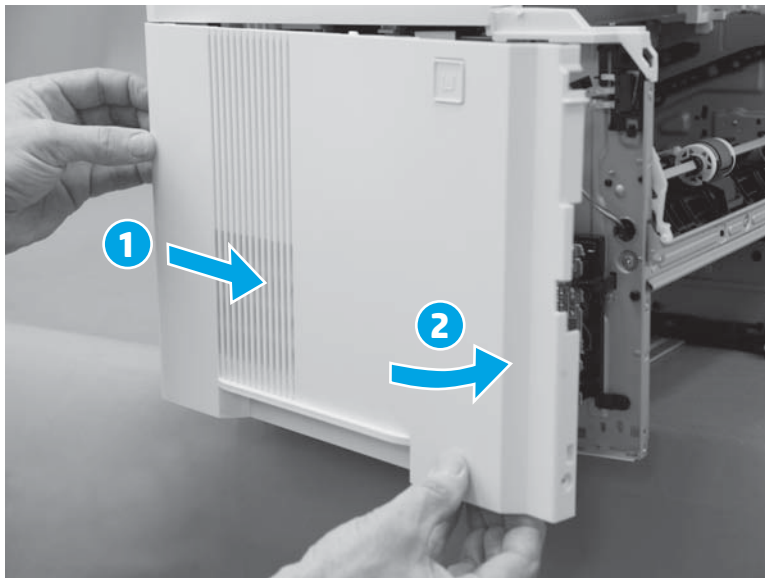
1. Before proceeding, take note of the location of the tabs and bosses on the inside of the cover.

**Figure 1-1874** Locate of the tabs and bosses



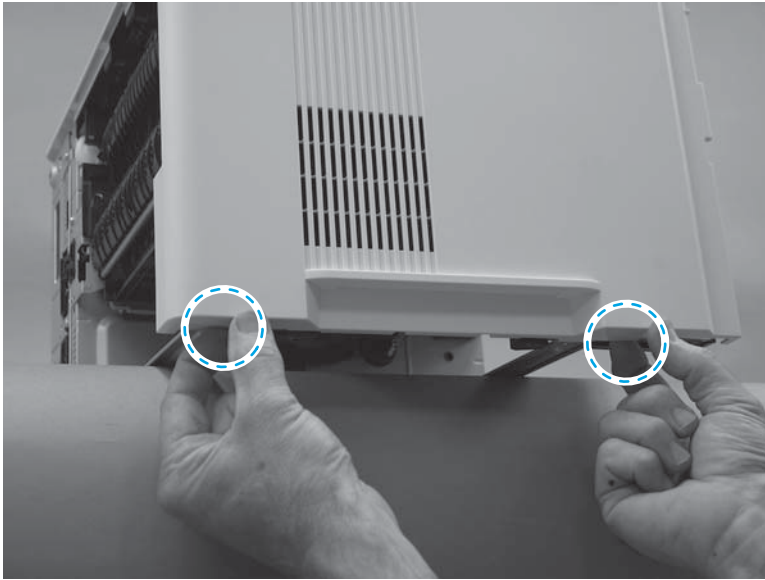
2. Engage the rear edge of the cover (callout 1), and then rotate the rear edge of the cover toward the printer (callout 2).

**Figure 1-1875** Install the cover



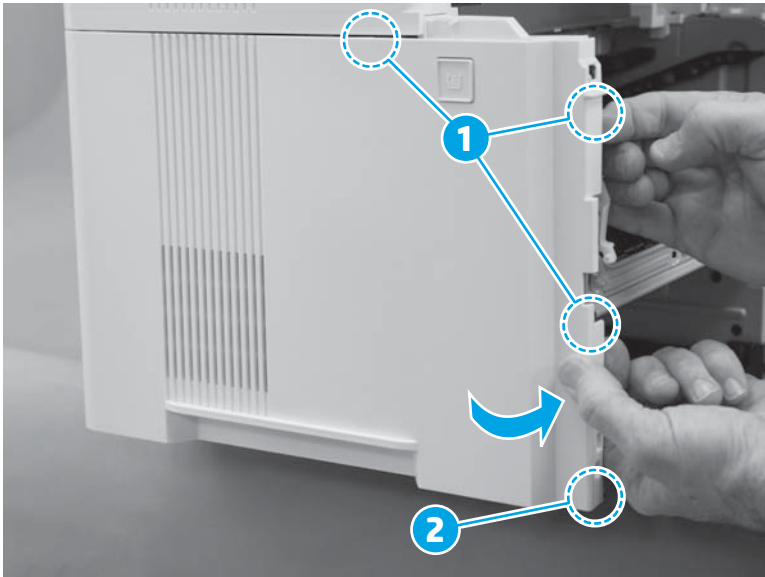
3. At the bottom edge of the cover, engage two tabs.

**Figure 1-1876** Engage two tabs



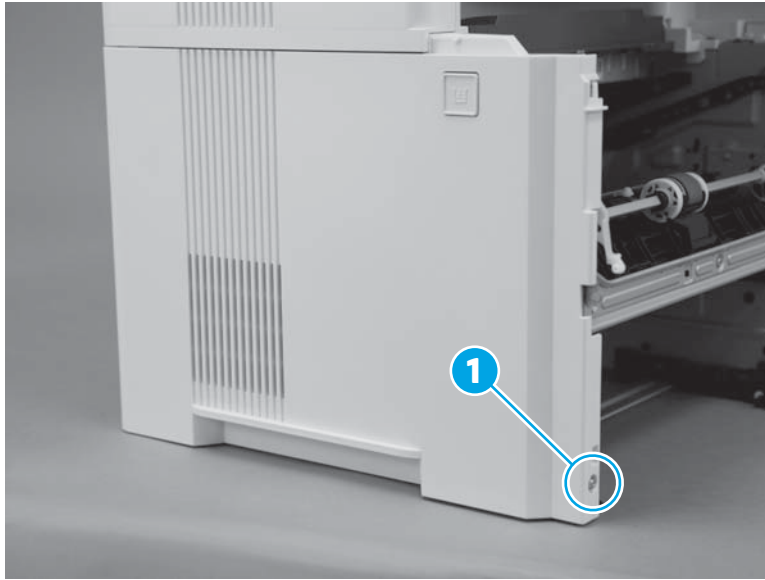
4. At the front of the printer, engage three tabs (callout 1), and then continue to rotate the front edge of the cover toward the printer to engage one boss (callout 2).

**Figure 1-1877** Engage three tabs and one boss



5. Install one screw (callout 1).

**Figure 1-1878** Install one screw



### Step 7: Install the rear door assembly

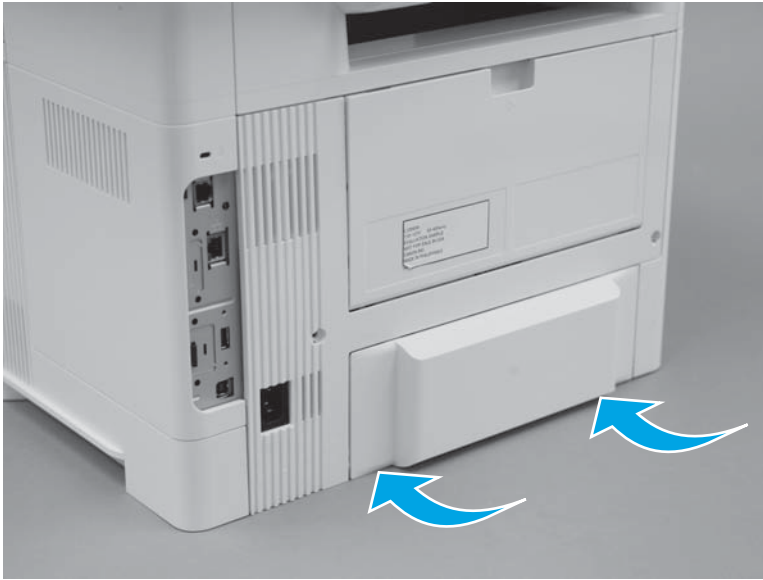
1. Engage the top edge of the assembly with the printer.

**Figure 1-1879** Install the cover



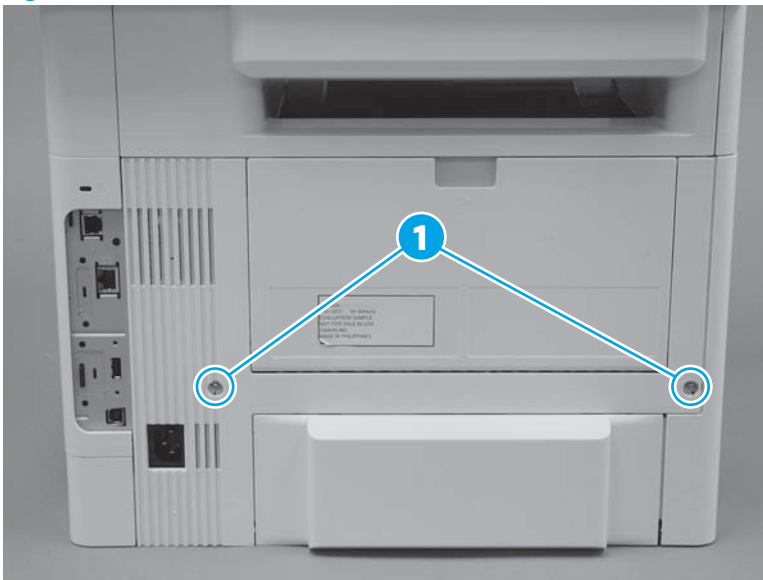
2. Rotate the bottom edge of the cover towards the printer.

**Figure 1-1880** Rotate the bottom of the cover




3. Install two screws (callout 1).

**Figure 1-1881** Install two screws



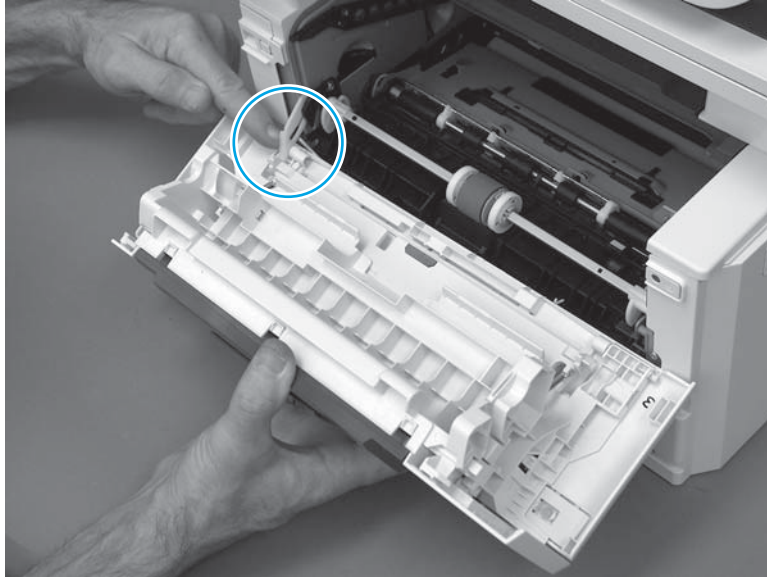
### Step 8: Install the cartridge door assembly

1. Position the door close to the printer, and then engage the keyed pin on the left-side retainer arm with the hole in the door.

 **TIP:** It might be easier to engage the keyed pin with the hole by using a small flat-blad screwdriver.





**Figure 1-1882** Engage the left-side retainer arm



2. Engage the right-side door hinge pin with the hole in the chassis (callout 1).

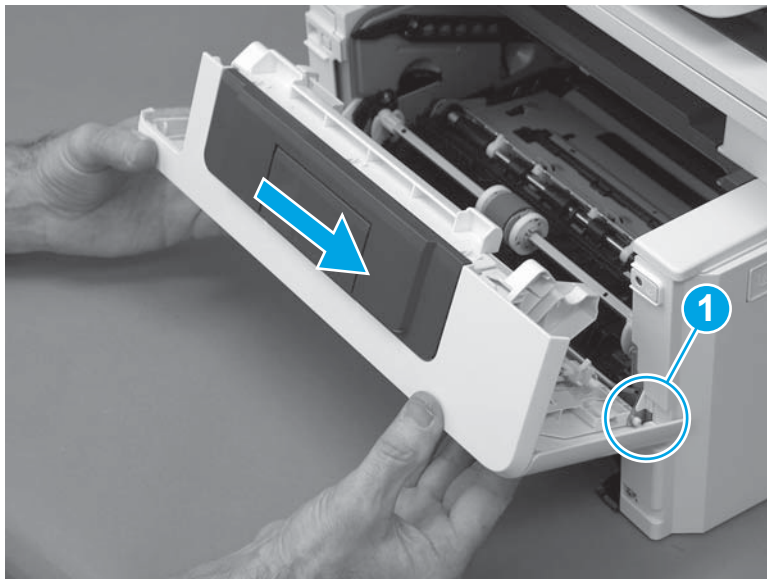
---

 **NOTE:** There are two right-side hinge pins (not shown in callout 1).


 **TIP:** Keep a finger pressed on the left-side retainer arm so that it does not disengage from the door.

---

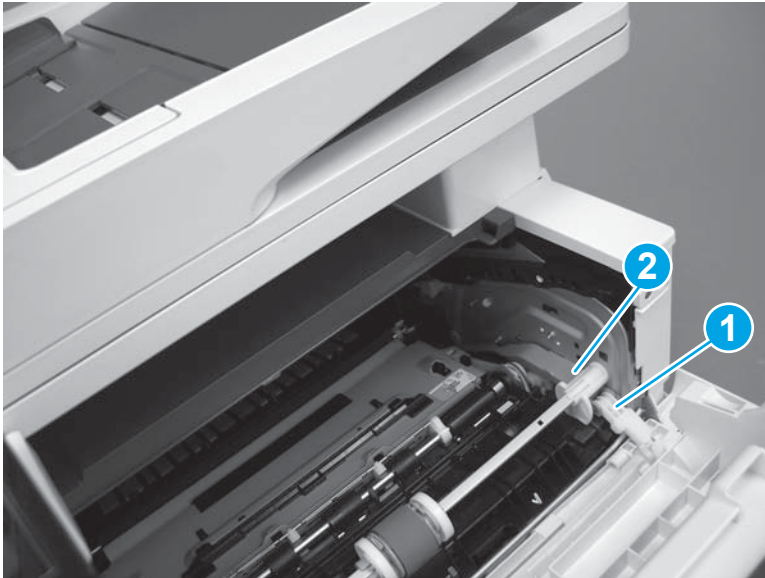
**Figure 1-1883** Install the door



3. Install the gray-plastic pressure-release link (callout 1) onto the white-plastic door arm (callout 2).

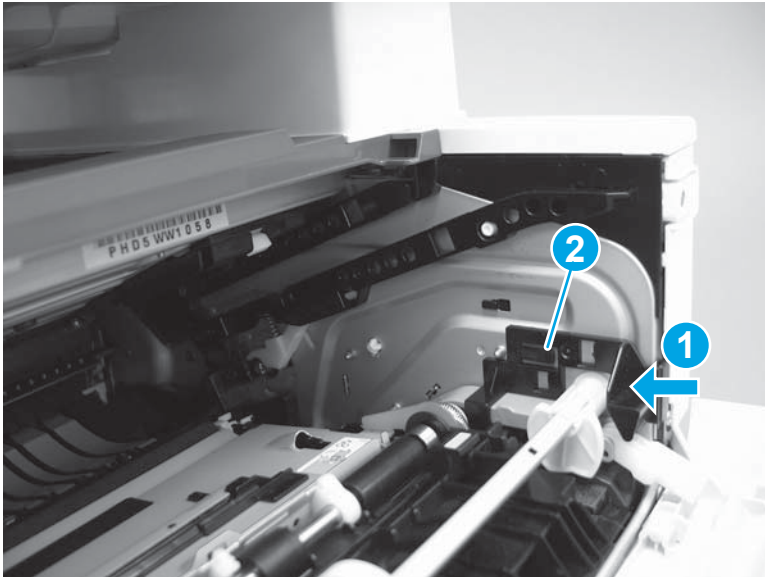
 **IMPORTANT:** Make sure that the arm snaps on to the link. Partially close and open the door to verify that the link (callout 2) moves in and out of the printer as the door closes/opens.

**Figure 1-1884** Install the pressure-release link



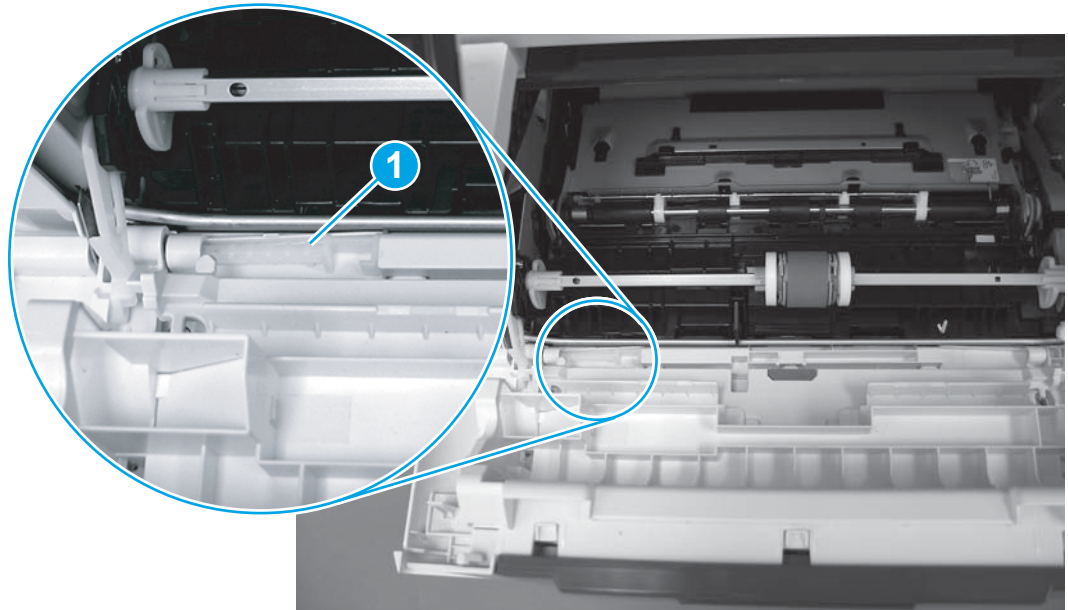
4. Slide the guide into the printer (callout 1), and then make sure that the tab (callout 2) snaps into place to secure the guide to the chassis.

**Figure 1-1885** Install the guide





5. Position the support shaft on the door, and then align the left-side hinge on the door with the hole in the chassis (callout 1).

**Figure 1-1886** Align the hinge

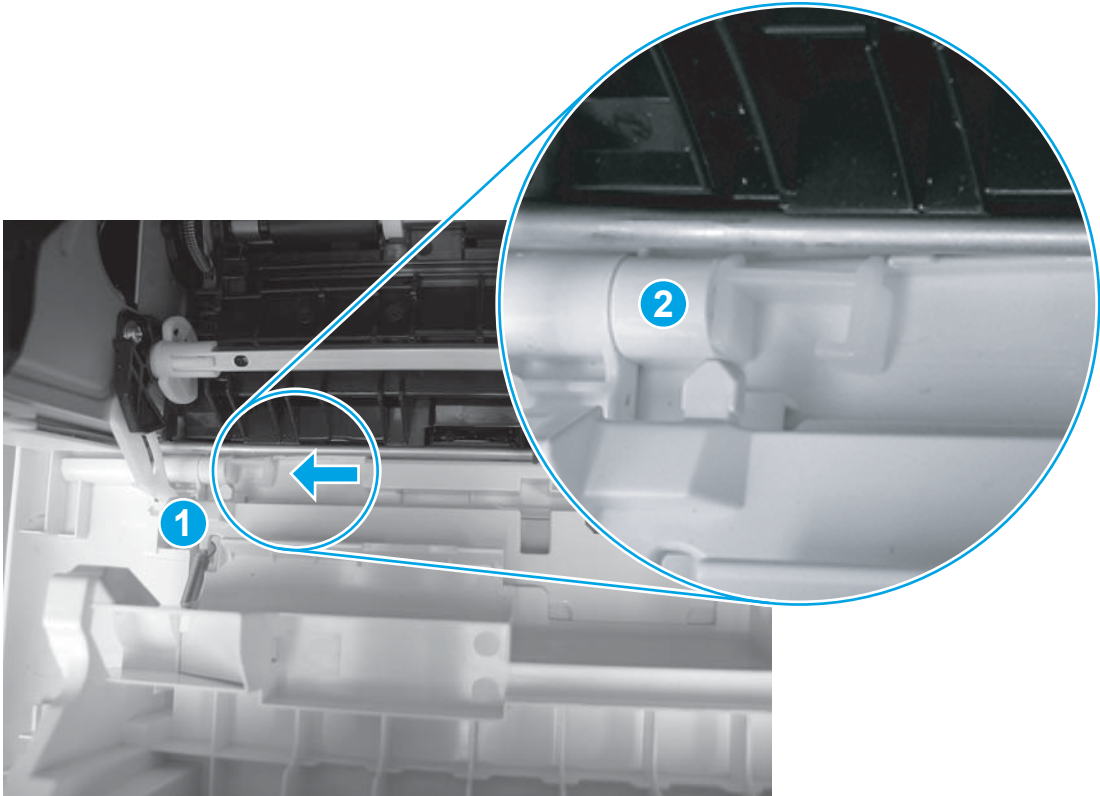


6. Push the shaft towards the left side of the printer to install it (callout 1).

 **NOTE:** Make sure that the support shaft is fully installed and correctly orientated (callout 2) so that it will not interfere with the door opening and closing.

 **Reinstallation tip:** If a replacement door was installed, make sure to install the nameplate (supplied in the kit) corresponding to the printer on the door.

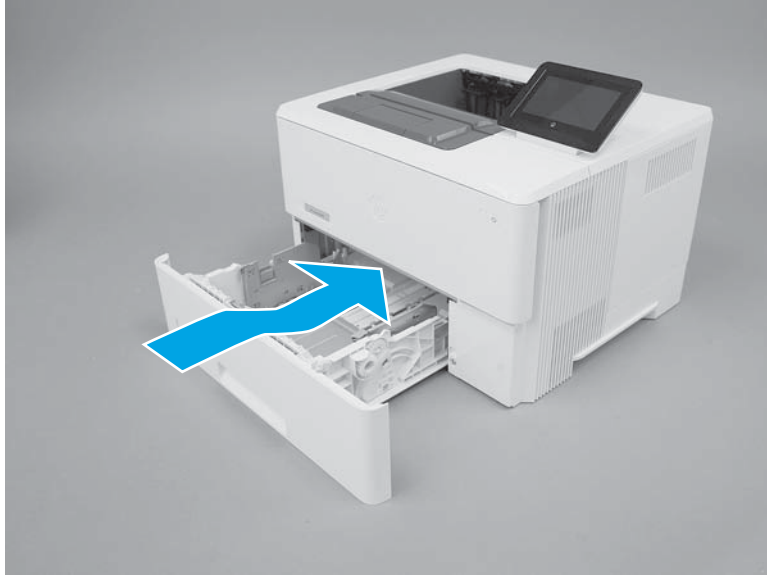
**Figure 1-1887** Install the support shaft



### Step 9: Install the tray

1. With the tray at a slight angle, align the sides of the tray with the rails in the accessory, and then partially slide the tray into the printer.

**Figure 1-1888** Install the tray




2. Push the tray straight into the accessory to close it.

**Figure 1-1889** Close the tray



## Removal and replacement: Low-voltage power supply

 **IMPORTANT:** Some figure might show assemblies removed or installed that have not yet been removed or installed at that specific step. However, the procedures are correct for this printer and the target assembly. Always thoroughly read the instructions that accompany each figure

---

- [Introduction](#)
- [Step 1: Remove the control panel \(M506x\)](#)
- [Step 2: Remove the tray](#)
- [Step 3: Remove the formatter cover](#)
- [Step 4: Remove the hard-disk drive \(HDD\)](#)
- [Step 5: Remove the fax PCA \(M527\)](#)
- [Step 6: Remove the formatter](#)
- [Step 7: Remove the stapler door or stapler blank cover \(M527\)](#)
- [Step 8: Remove the stapler stationary \(inner\) cover \(M527\)](#)
- [Step 9: Remove the top-left cover \(M527\)](#)
- [Step 10: Remove the top-rear cover \(M527\)](#)
- [Step 11: Remove the rear door assembly](#)
- [Step 12: Remove the cartridge door assembly](#)
- [Step 13: Remove the right cover](#)
- [Step 14: Remove the left cover](#)
- [Step 15: Remove the integrated scanner assembly \(M527\)](#)
- [Step 16: Remove the top cover \(M527\)](#)
- [Step 17: Remove the top cover \(M501/M506\)](#)
- [Step 18: Remove the paper delivery tray \(output bin\)](#)
- [Step 19: Remove the formatter case](#)
- [Step 20: Remove the LVPS](#)
- [Step 21: Unpack the replacement assembly](#)
- [Step 22: Install the LVPS](#)
- [Step 23: Install the formatter case](#)
- [Step 24: Install the paper delivery tray \(output bin\)](#)
- [Step 25: Install the top cover \(M501/M506\)](#)
- [Step 26: Install the top cover \(M527\)](#)
- [Step 27: Install the integrated scanner assembly \(M527\)](#)

- [Step 28: Install the left cover](#)
- [Step 29: Install the right cover](#)
- [Step 30: Install the cartridge door assembly](#)
- [Step 31: Install the rear door assembly](#)
- [Step 32: Install the top-rear cover \(M527\)](#)
- [Step 33: Install the top-left cover \(M527\)](#)
- [Step 34: Install the stapler stationary \(inner\) cover \(M527\)](#)
- [Step 35: Install the stapler door or stapler blank cover \(M527\)](#)
- [Step 36: Install the formatter](#)
- [Step 37: Install the fax PCA \(M527\)](#)
- [Step 38: Install the hard-disk drive \(HDD\)](#)
- [Step 39: Install the formatter cover](#)
- [Step 40: Install the tray](#)
- [Step 41: Install the control panel \(M506x\)](#)

## Introduction

This document provides the procedures to remove and replace the low-voltage power supply (LVPS).

## Before performing service

### Turn the printer power off

- Disconnect the power cable.

**⚠ WARNING!** To avoid damage to the printer, turn the printer off wait 30 seconds, and then remove the power cable before attempting to service the printer.

Use the table below to identify the correct part number for your printer. To order the part, go to [www.hp.com/buy/parts](http://www.hp.com/buy/parts).

Low-voltage power supply (LVPS) part number	
<b>RM2-7951-000CN</b>	Low-voltage power supply (M527; 110V-127V)
<b>RM2-7952-000CN</b>	Low-voltage power supply (M527; 220V-240V)
<b>RM2-7941-000CN</b>	Low-voltage power supply (M501/M506; 110V-127V)
<b>RM2-7942-000CN</b>	Low-voltage power supply (M501/M506; 220V-240V)

## Required tools

- Small flat-blade screwdriver.
- #2 Phillips screwdriver with a magnetic tip.

## After performing service

### Turn the printer power on


- Connect the power cable.
- Use the power switch to turn the power on.

### Post service test

Make sure that the printer initializes to a **Ready** state.

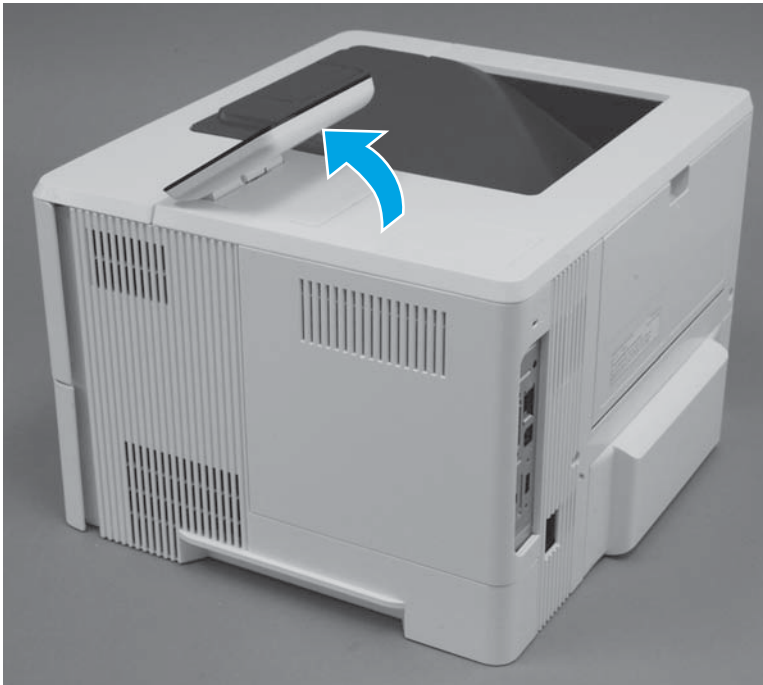
Print a configuration page to make sure that the printer is functioning correctly.

### Step 1: Remove the control panel (M506x)

 **NOTE:** This step is for the M506x printer. For all other printers, skip this step and proceed to [Step 2: Remove the tray on page 1060](#).

1. Tilt the control panel to the fully raised position.

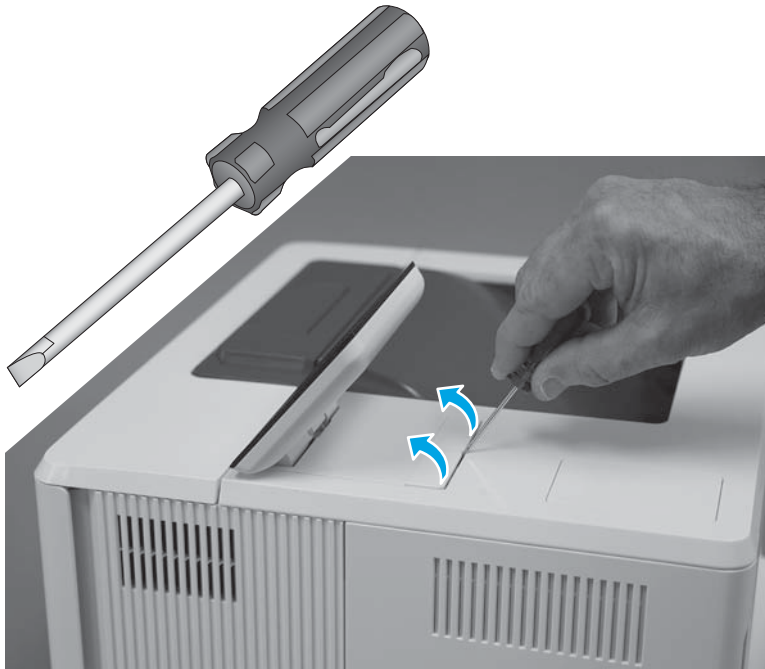
**Figure 1-1890** Tilt the control panel up






2. Use a small flat-blad screwdriver to release the control-panel screws cover, and then remove the cover.

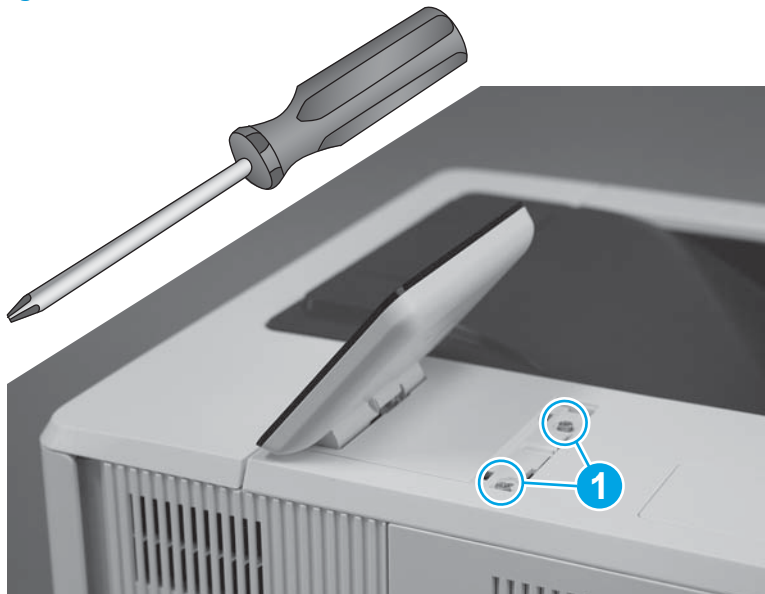
**Figure 1-1891** Remove the cover



3. Use a small Phillips screwdriver to remove two screws (callout 1).

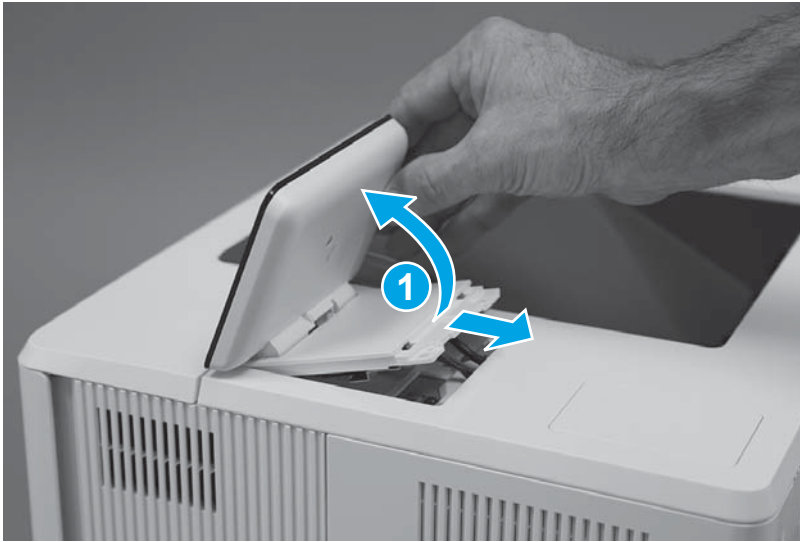
 **IMPORTANT:** Store the screws in a secure place where they cannot fall down into the printer.

**Figure 1-1892** Remove two screws



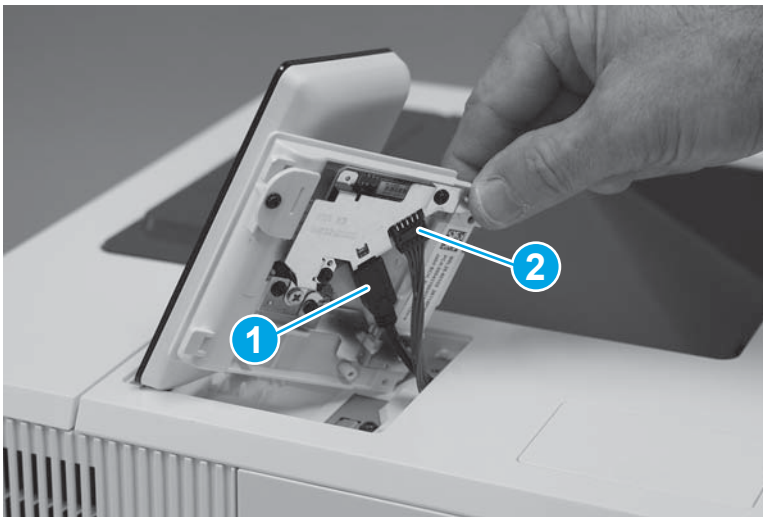
4. Turn the control panel over (callout 1), to gain access to the bottom side.

**Figure 1-1893** Turn the control panel over



5. Disconnect one HDMI cable (callout 1), one connector (callout 2), and then remove the control panel.

**Figure 1-1894** Remove the control panel



### Step 2: Remove the tray

1. Pull the tray straight out of the printer until it stops.

**Figure 1-1895** Pull the tray out until it stops



2. Lift the front of the tray, and then pull it out of the printer to remove it.

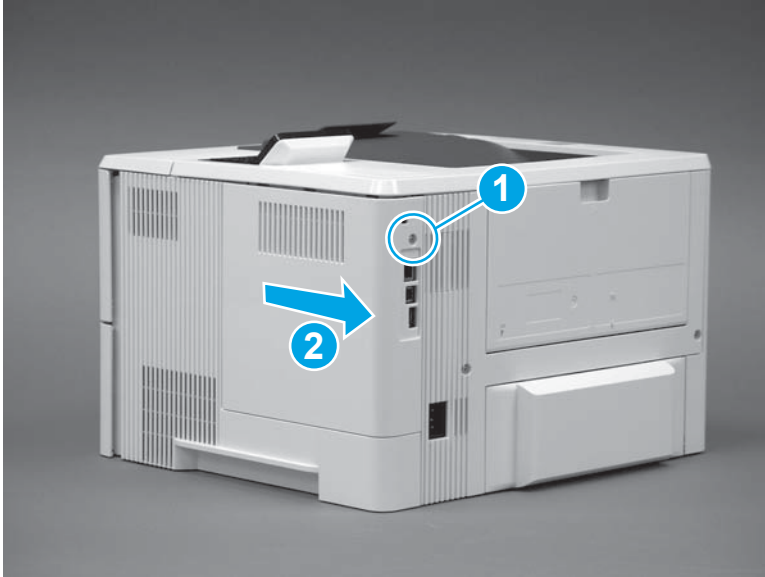
**Figure 1-1896** Release and remove the tray



### Step 3: Remove the formatter cover

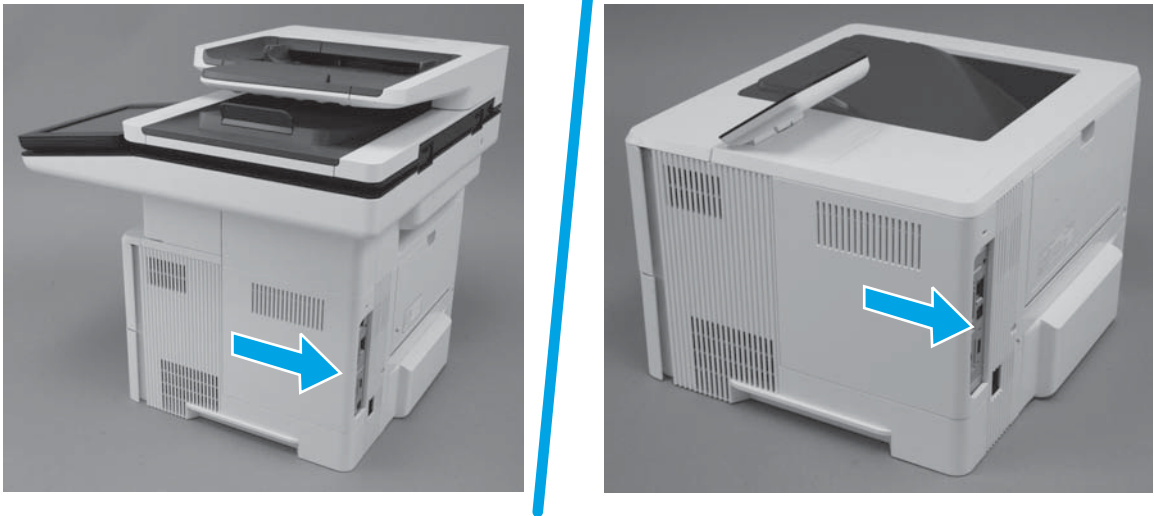
1. **M501:** Remove one screw (callout 1), and then slide the cover toward the rear of the printer to remove it (callout 2).

**Figure 1-1897** Remove the formatter cover (M501)



2. **M506/M527:** Slide the cover toward the rear of the printer to remove it.

**Figure 1-1898** Remove the formatter cover (M506/M527)



#### Step 4: Remove the hard-disk drive (HDD)



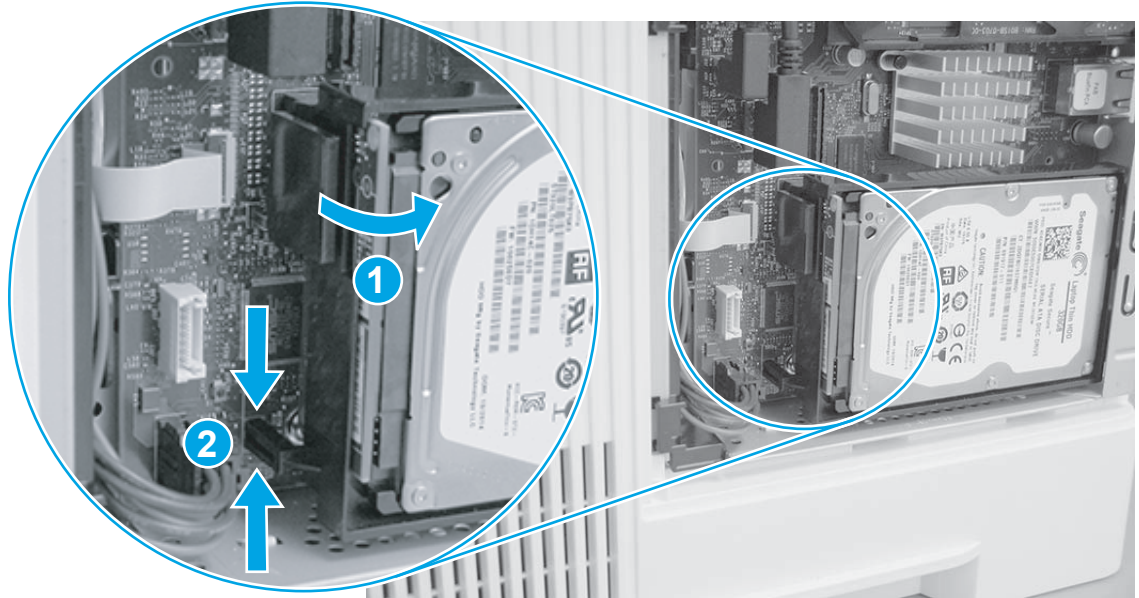
**NOTE:** If the HDD is not installed, skip this step and go to [Step 5: Remove the fax PCA \(M527\) on page 1063](#).



**CAUTION:**  ESD-sensitive part.

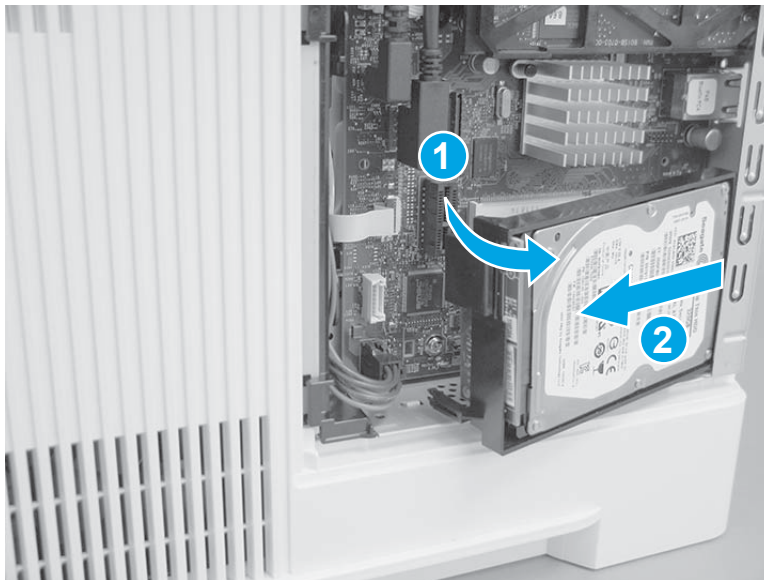
1. Release the locking connector (callout 1), and then pinch the retainer (callout 2) to release it.

**Figure 1-1899** Release the HDD




2. Rotate the connector end of the HDD out and away from the formatter (callout 1), and then slide it as shown (callout 2) to remove it.


**Figure 1-1900** Remove the HDD



### Step 5: Remove the fax PCA (M527)

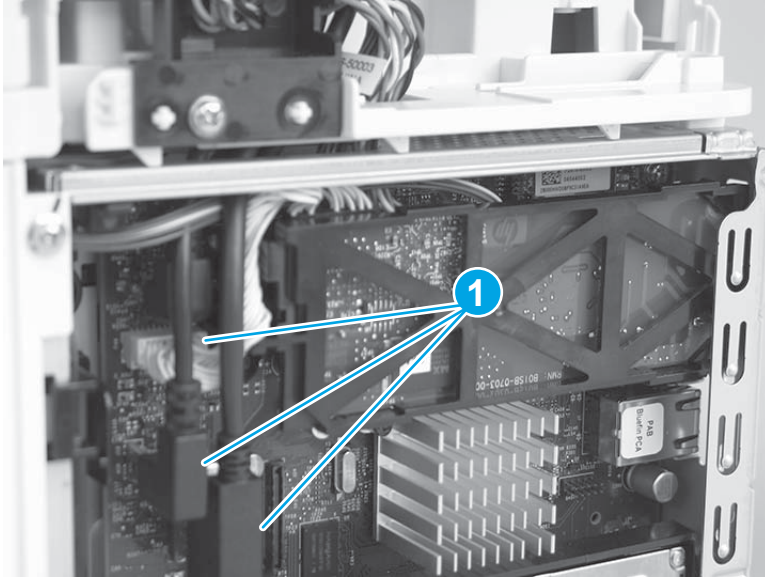
 **NOTE:** If the fax PCA is not installed, skip this step and go to [Step 6: Remove the formatter on page 1065](#).

 **CAUTION:**  ESD-sensitive part.

 **NOTE:** M527c/f/z printers only (optional for the M527dn).

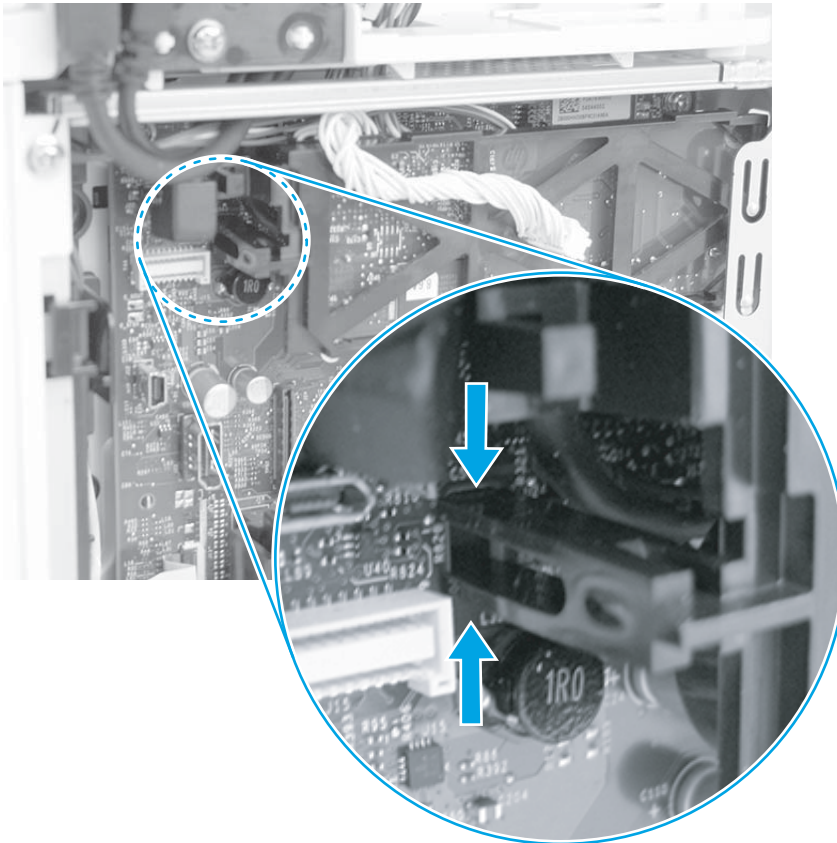
1. Disconnect three connectors (callout 1).

**Figure 1-1901** Disconnect three connectors



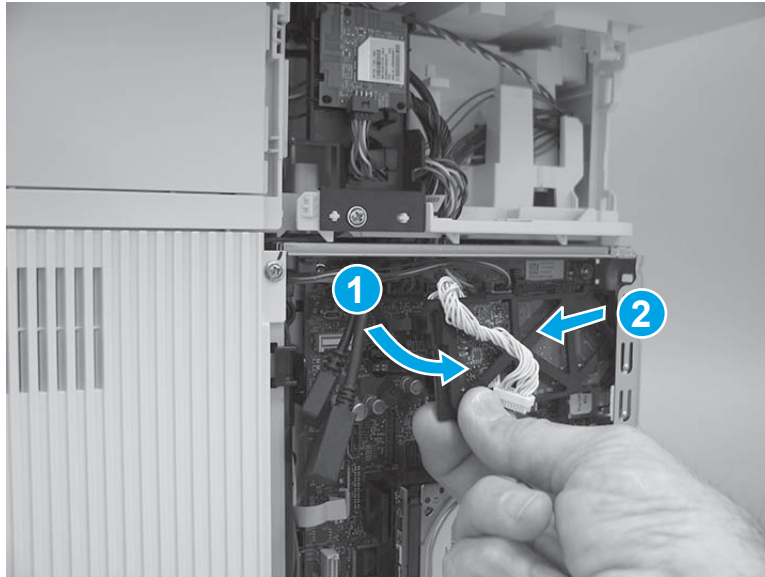
2. Pinch the retainer to release it.

**Figure 1-1902** Release the fax PCA




3. Rotate the connector end of the fax PCA out and away from the formatter (callout 1), and then slide it as shown (callout 2) to remove it.

**Figure 1-1903** Remove the fax PCA

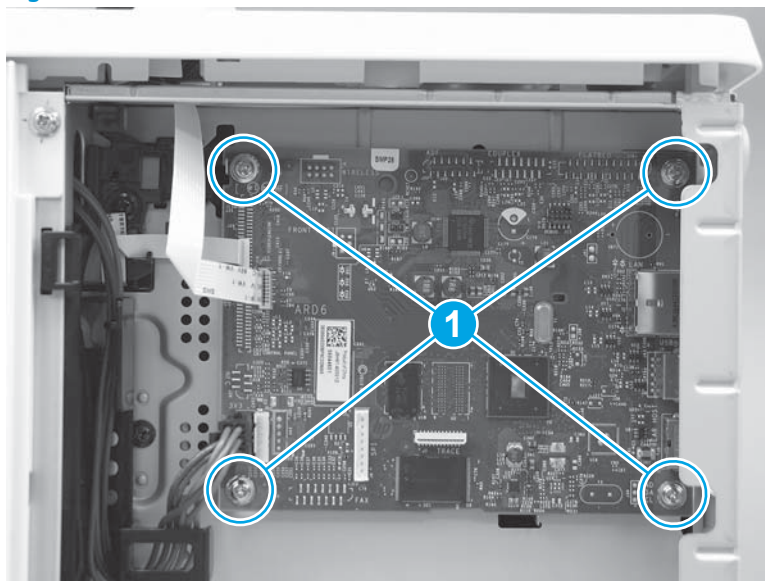


#### Step 6: Remove the formatter


 **IMPORTANT:** **M506/M527:** Take note of all empty connectors on the PCA before disconnecting any wire harnesses or flat-flexible cables (FFCs). Some empty connectors might not be visible until other items—like the hard-disk drive—are removed, so pay close attention while removing the formatter and accessory items.

1. **M501:** Disconnect all of the connectors and FFCs, remove four screws (callout 1), and then remove the formatter.

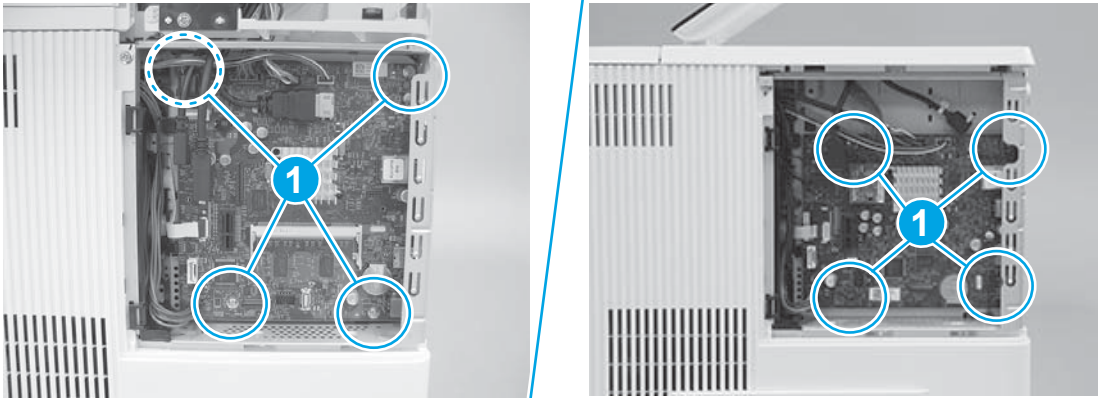
**Figure 1-1904** Remove the formatter (M501)




2. **M506/M527:** Disconnect all of the connectors and FFCs, remove four screws (callout 1), and then remove the formatter.

 **IMPORTANT:** Take note of all empty connectors on the formatter before disconnecting any wire harnesses or flat-flexible cables (FFCs). Some empty connectors might not be visible until other items—like the hard-disk drive—are removed, so pay close attention while removing the formatter and accessories items.

**Figure 1-1905** Remove the formatter (M506/M527)



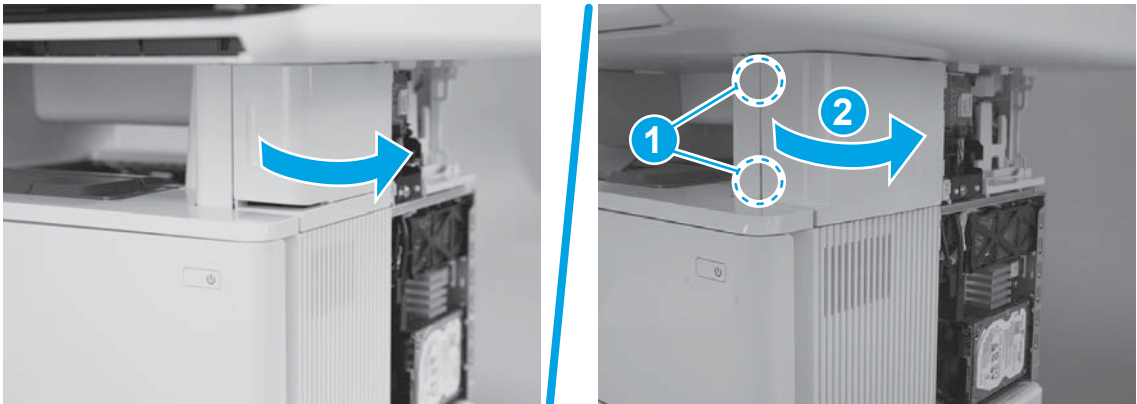
### Step 7: Remove the stapler door or stapler blank cover (M527)

 **NOTE:** This step is for the M527 printer. For the M501/M506, skip this step and go to [Step 11: Remove the rear door assembly on page 1074](#).

The M527dn does not have a convenience stapler.

1. Do one of the following:
  - **M527c/f/z:** Open the stapler door.
  - **M527dn:** Use a small flat-blade screwdriver to release two tabs (callout 1), and then rotate the cover away from the printer (callout 2).

**Figure 1-1906** Open the door or release the cover



2. Do one of the following:
  - **M527c/f/z:** Use a small flat-blade screwdriver to release the upper hinge.
  - **M527dn:** Slide the cover toward the front of the printer to remove it.

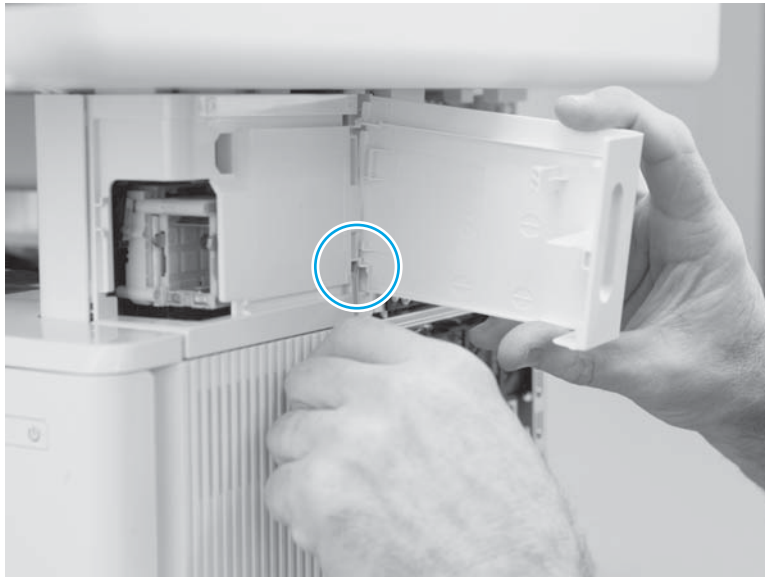


**Figure 1-1907** Release the upper hinge or remove the cover



3. **M527c/f/z:** Use a small flat-bladed screwdriver to release the lower hinge.

**Figure 1-1908** Release the lower hinge





4. **M527c/f/z:** Remove the door.

**Figure 1-1909** Remove the door



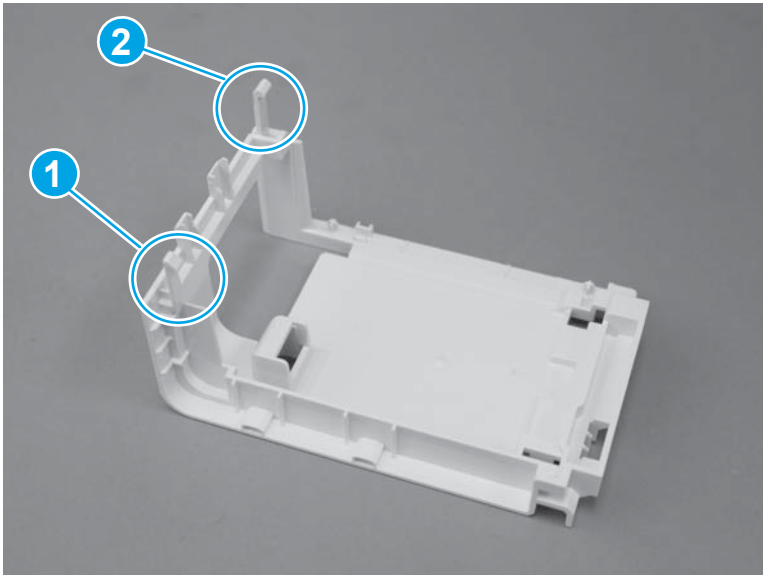
#### Step 8: Remove the stapler stationary (inner) cover (M527)

 **NOTE:** This step is for the M527c/f/z printers. For the M501/M506, skip this step and go to [Step 11: Remove the rear door assembly on page 1074](#). For the M527dn, skip this step and go to [Step 9: Remove the top-left cover \(M527\) on page 1070](#).

 **NOTE:** M527c/f/z printers only.

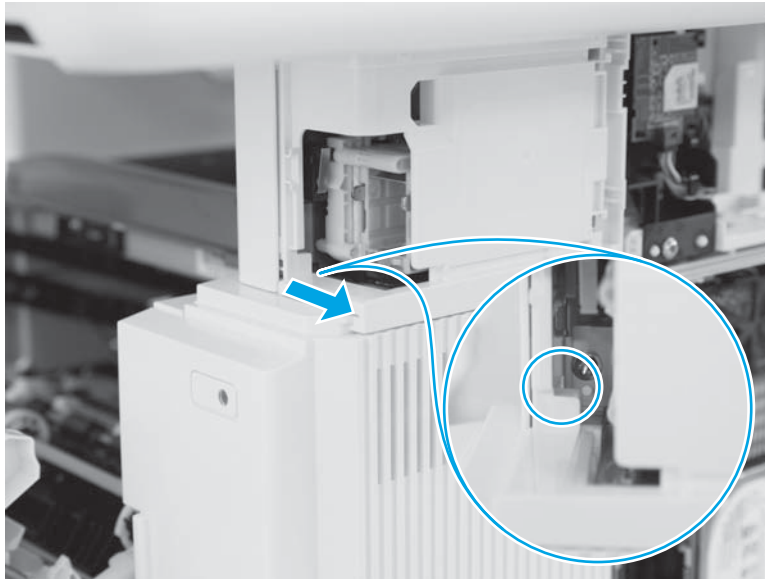
1. Before proceeding, take note of the locations of the upper tab (callout 1) and the lower tab (callout 2) on the stapler stationary (inner) cover.

**Figure 1-1910** Locate the tabs



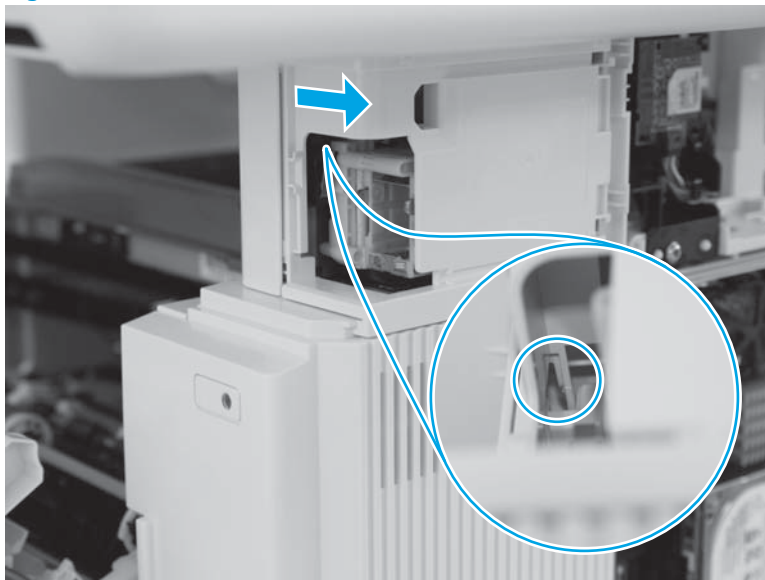
2. Use a long-shaft small flat-blad screwdriver to release the lower tab.

**Figure 1-1911** Release one tab



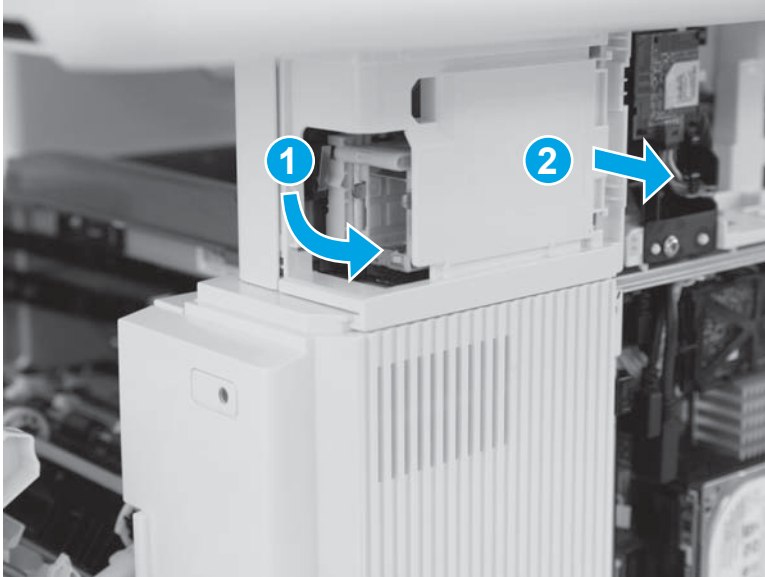
3. Use a long-shaft small flat-blad screwdriver to release the upper tab.

**Figure 1-1912** Release one tab



4. With the tabs disengaged the front of the cover is released. Rotate the front of the cover away from the printer (callout 1) to release the rear of the cover (callout 2), and then remove it.

**Figure 1-1913** Remove the cover



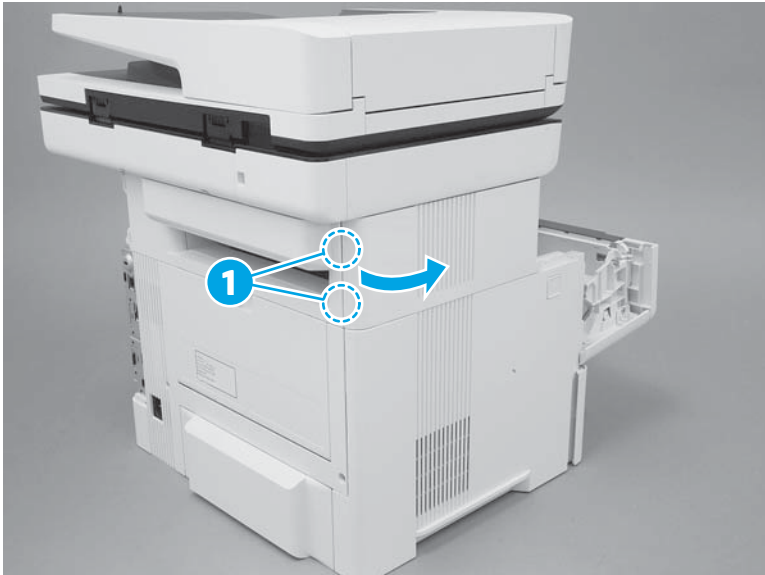
#### Step 9: Remove the top-left cover (M527)



**NOTE:** This step is for the M527 printer. For the M501M506, skip this step and go to [Step 11: Remove the rear door assembly on page 1074](#).

1. Open the toner-cartridge door, release two tabs (callout 1), and then rotate the rear edge of the cover away from the printer.

**Figure 1-1914** Release two tabs



2. Continue to rotate the cover away from the printer to release two more tabs at the middle of the cover.

**Figure 1-1915** Release two tabs



3. Slide the cover toward the rear of the printer to release two bosses at the front of the cover.

**Figure 1-1916** Slide the cover



4. Remove the cover.

**Figure 1-1917** Remove the cover



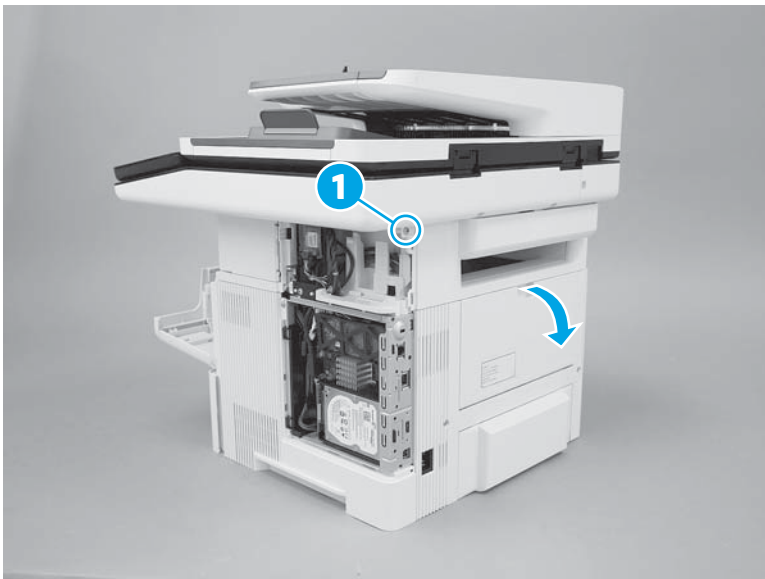
#### Step 10: Remove the top-rear cover (M527)



**NOTE:** This step is for the M527 printer. For the M501/M506, skip this step and go to [Step 11: Remove the rear door assembly on page 1074](#).

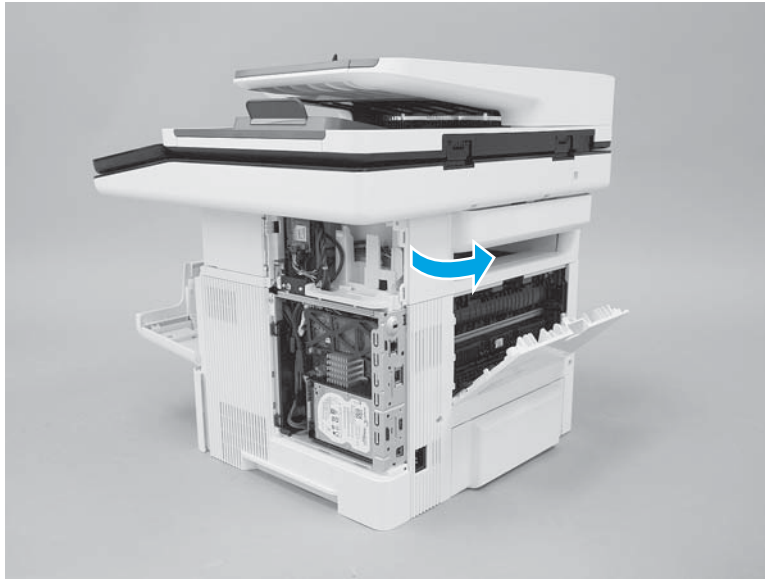
1. Remove one screw (callout 1), and then open the rear door.

**Figure 1-1918** Remove one screw



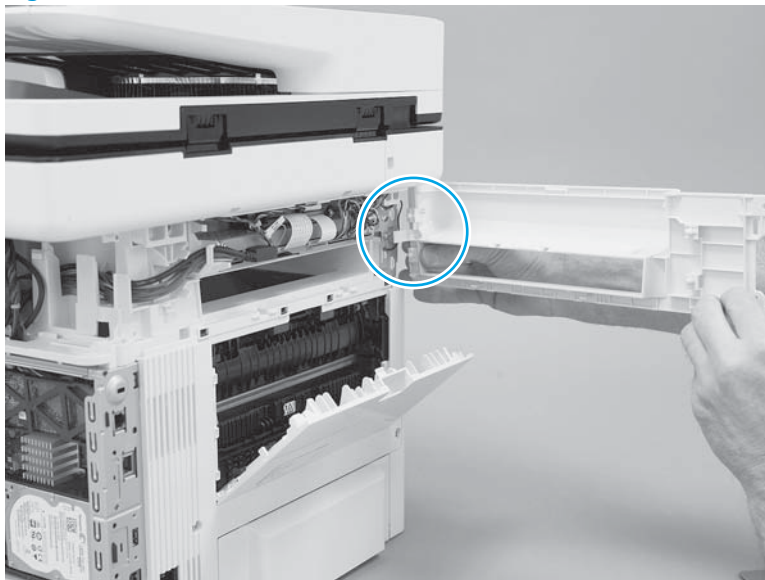
2. Rotate the exposed edge of the cover away from the printer (as shown).

**Figure 1-1919** Rotate the cover



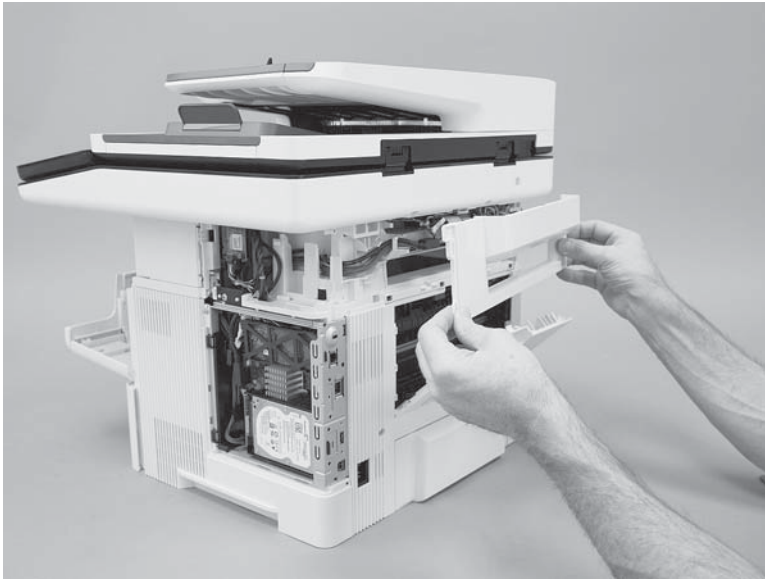
3. Continue to rotate the cover away from the printer to release one boss.

**Figure 1-1920** Release one boss



4. Remove the cover.

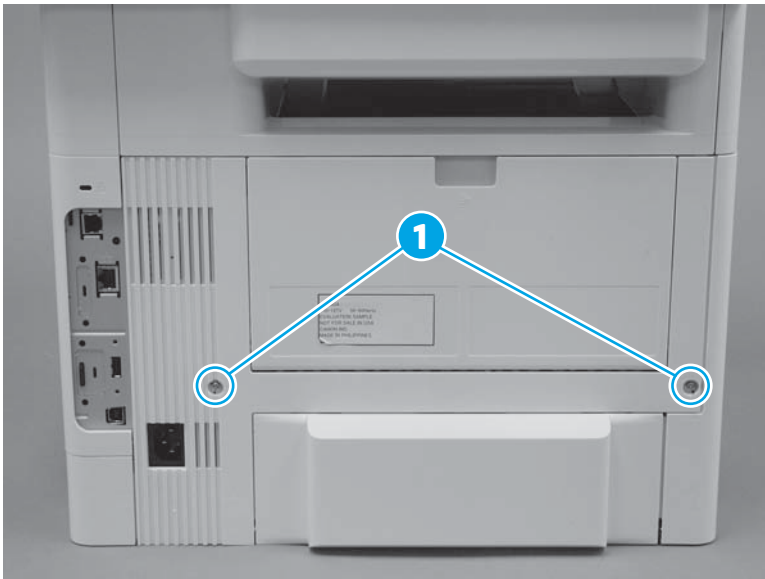
**Figure 1-1921** Remove the cover



### Step 11: Remove the rear door assembly

1. At the rear of the printer, remove two screws (callout 1).

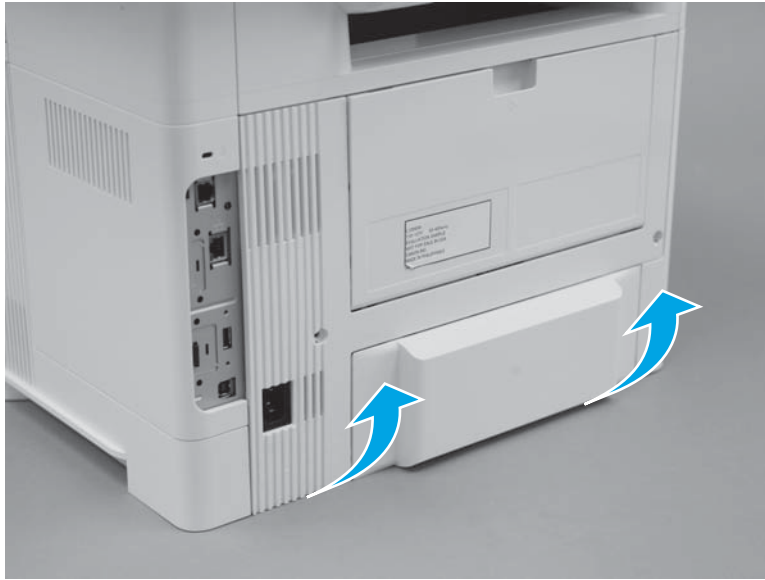
**Figure 1-1922** Remove two screws





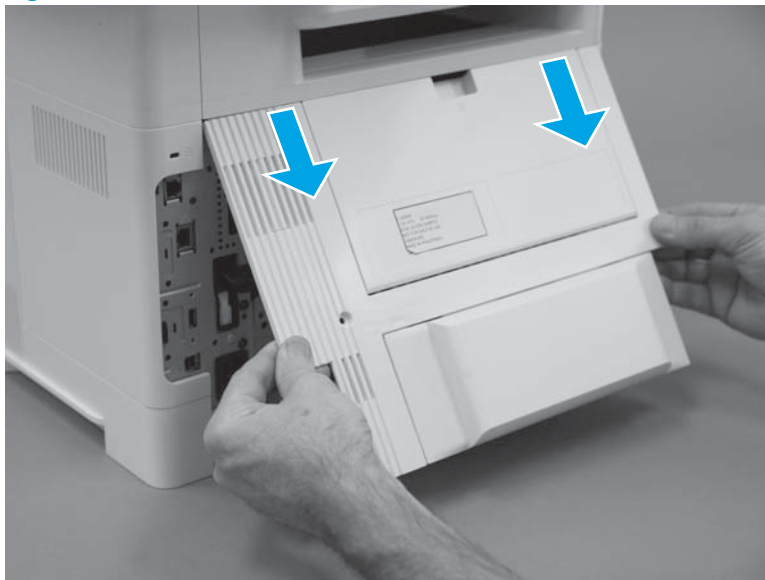
2. Rotate the bottom edge of the assembly away from the printer to release it.

**Figure 1-1923** Rotate the bottom of the cover




3. Pull down on the assembly to remove it.

**Figure 1-1924** Remove the cover



### Step 12: Remove the cartridge door assembly

---

 **NOTE:** If the toner cartridge was not removed prior to servicing the printer, remove it now.

---

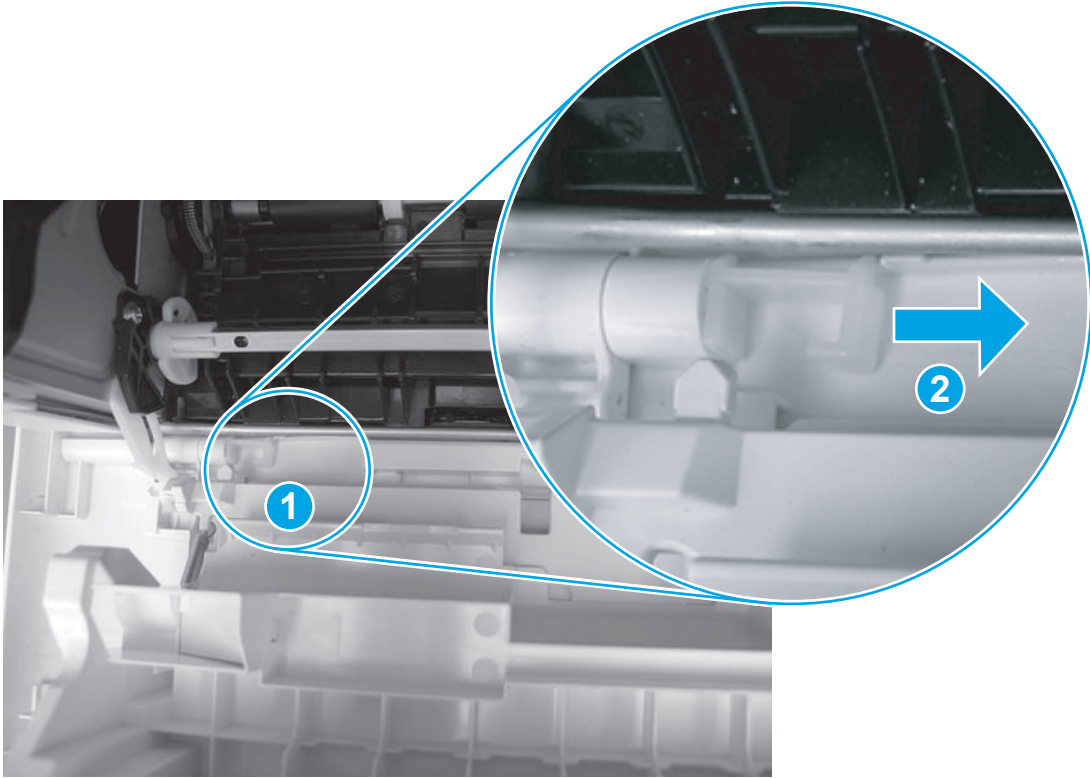
1. Release the support shaft (callout 1), and then slide it toward the center of the door (callout 2).

---

 **TIP:** It might be easier to release the support shaft by using a small flat-blad screwdriver.

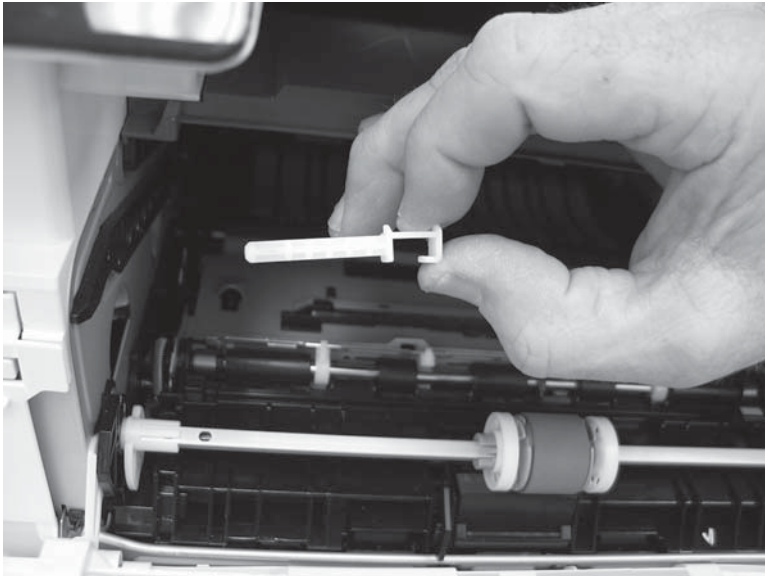
---

**Figure 1-1925** Release the support shaft



2. Remove the support shaft.

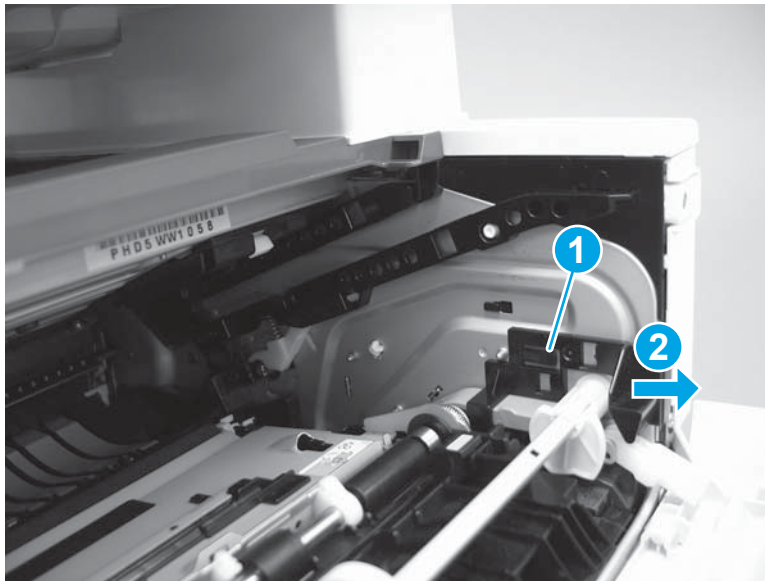
**Figure 1-1926** Remove the support shaft



3. Release one tab (callout 1), and then slide the guide out of the printer (callout 2).

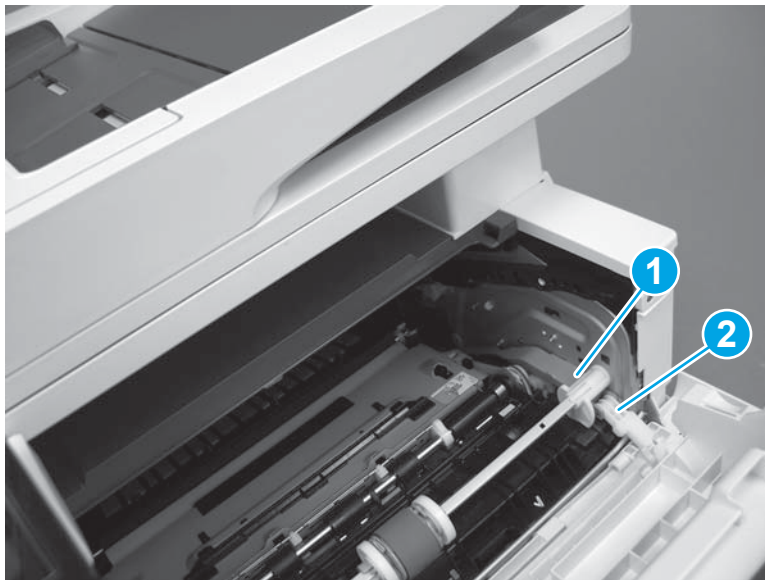
**CAUTION:** Be careful, the tab (callout 1) can be easily broken.

**Figure 1-1927** Remove the guide



4. Use a small flat-blade screwdriver to gently pry the white-plastic door arm (callout 1) off of the gray-plastic pressure-release link (callout 2) to release the door arm.

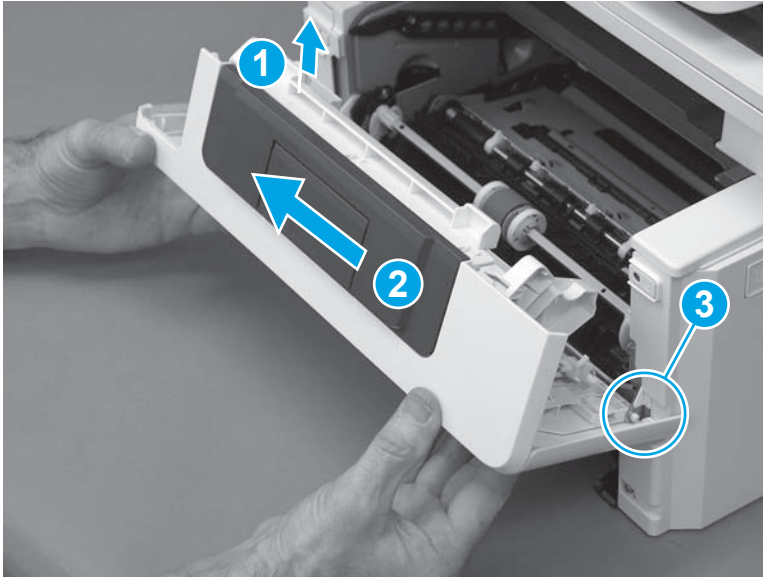
**Figure 1-1928** Release the pressure-release link



5. With the door in the partially closed position, slightly raise the left end (callout 1; raise it over the sheet-metal hinge boss), and then slide the door to the left (callout 2) to release the right hinge (callout 3).

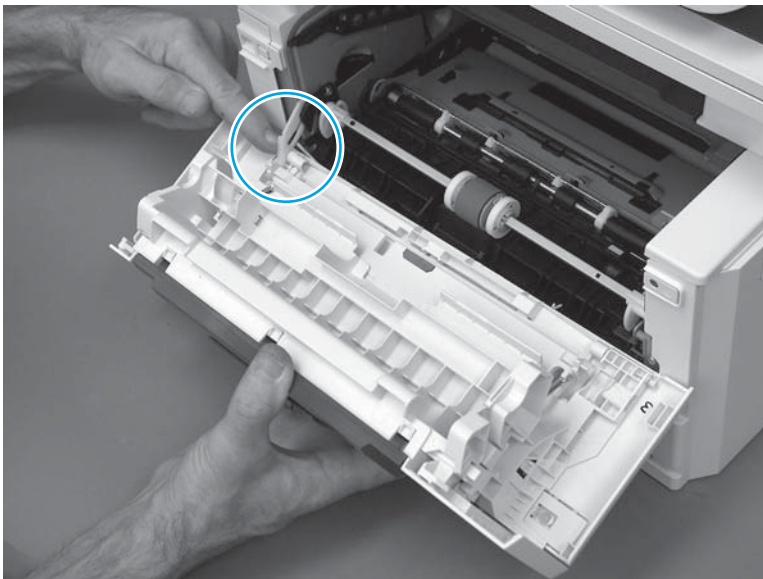
**⚠ CAUTION:** The door is still attached to the printer by the left-side retainer arm. Do not attempt to completely remove the door.

**Figure 1-1929** Release the door



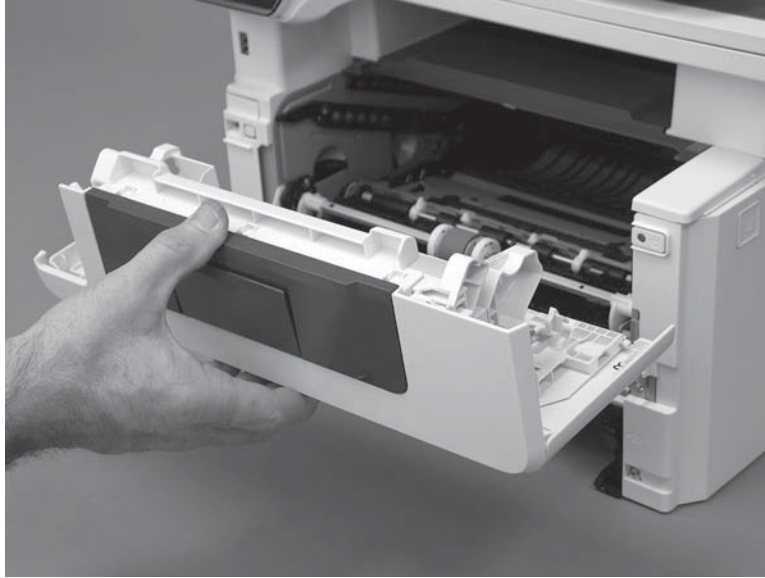
6. Rotate the door away from the printer until the keyed pin on the left-side retainer arm can disengage from the door.

**Figure 1-1930** Release the left-side retainer arm





7. Remove the door.

**Figure 1-1931** Remove the door



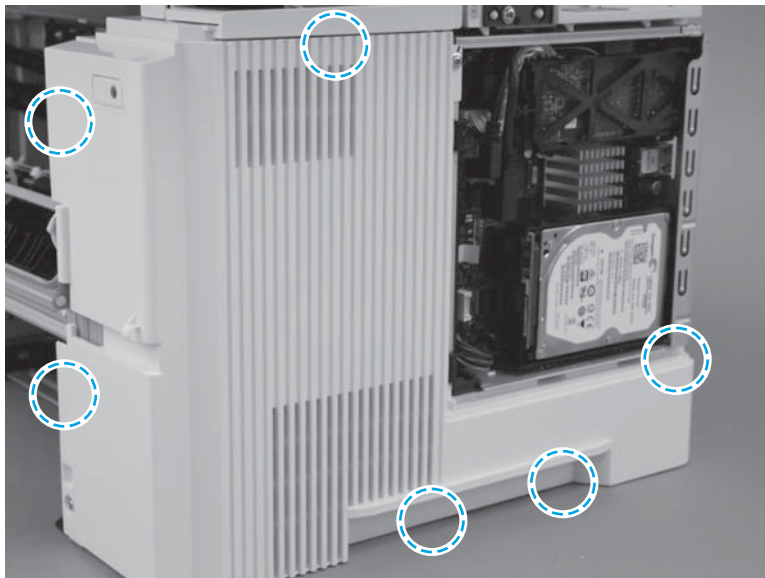
### Step 13: Remove the right cover

 **IMPORTANT:** The black-plastic cassette front and rear guides (located inside the tray cavity) can be easily dislodged. Do not lose the guides when the cover is removed or installed.

 **NOTE:** The M527 printer is shown in this procedure. However, this procedure is valid for the M501/M506 printers.

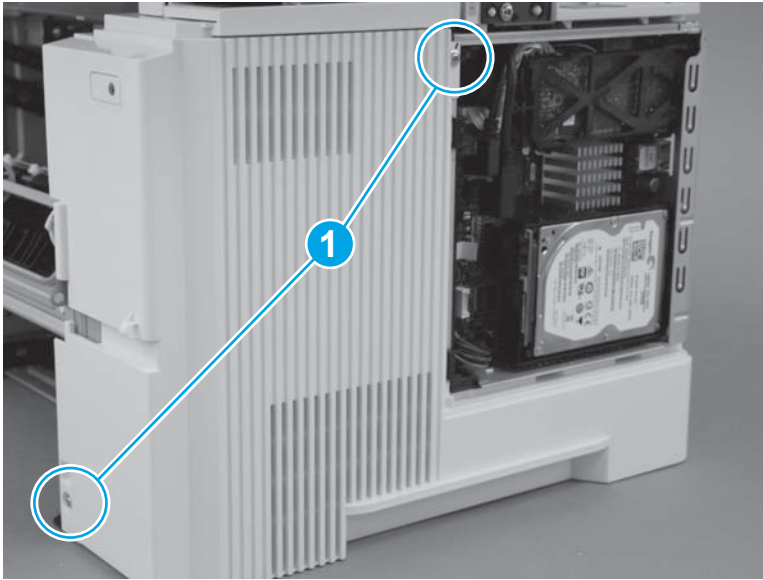
1. Before proceeding, take note of the location of the tabs and bosses on the inside of the cover.

**Figure 1-1932** Locate the tabs and bosses



2. Remove two screws (callout 1).

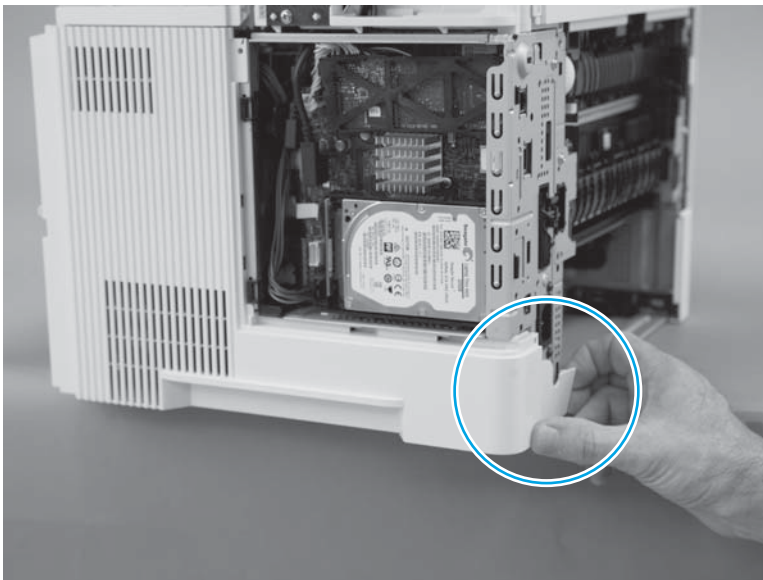
**Figure 1-1933** Remove two screws



3. At the rear of the printer, release one boss.

**CAUTION:** It might be easier to remove the cover with the printer slightly hanging over the edge of the workspace. Do not let the printer tip and fall off of the workspace when removing the cover.

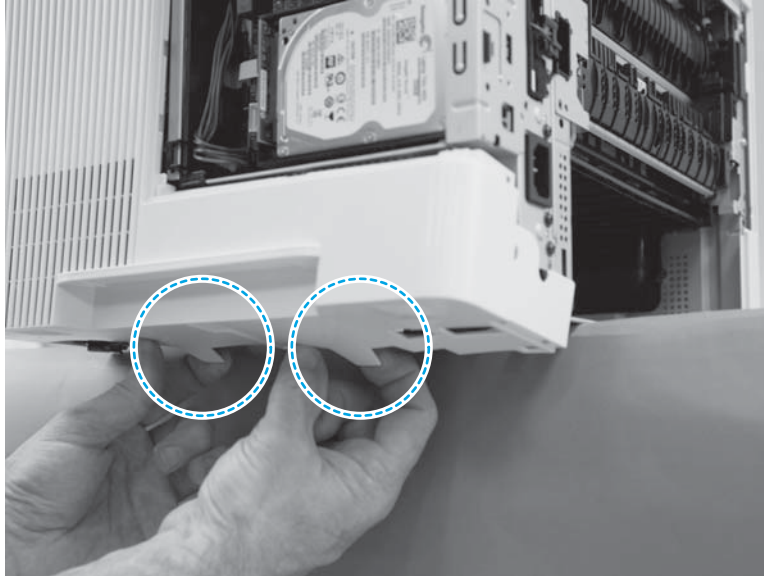
**Figure 1-1934** Release one boss



4. At the bottom edge of the cover, release two bosses.

**CAUTION:** It might be easier to remove the cover with the printer slightly hanging over the edge of the workspace. Do not let the printer tip and fall off of the workspace when removing the cover.

**Figure 1-1935** Release two bosses

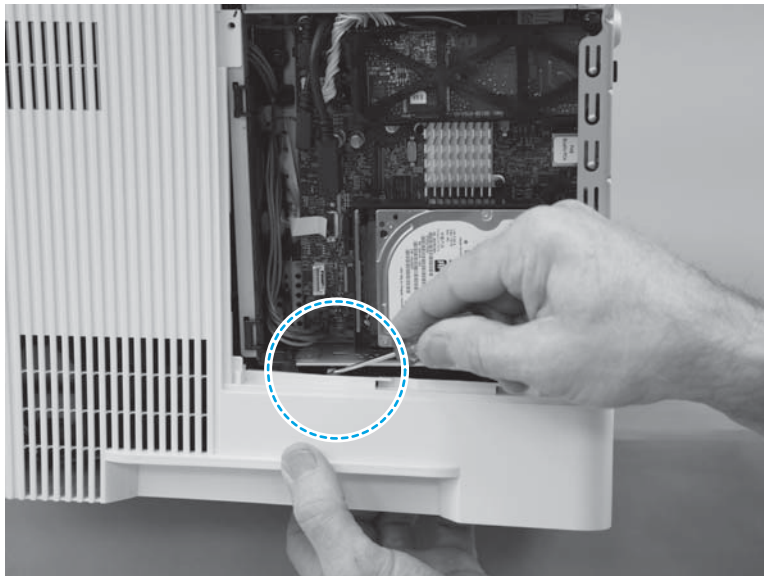


5. Near the formatter, release one tab.

**CAUTION:** It might be easier to remove the cover with the printer slightly hanging over the edge of the workspace. Do not let the printer tip and fall off of the workspace when removing the cover.

**TIP:** Hold the bottom of the cover away from the printer, and then use a small flat-blade screw driver to easily release this tab.

**Figure 1-1936** Release one tab

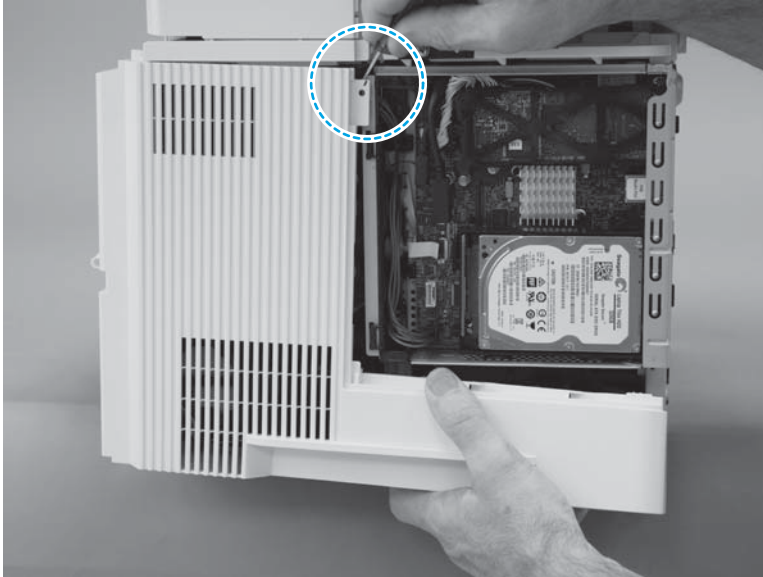


6. At the top rear edge of the cover, release one tab.

**CAUTION:** It might be easier to remove the cover with the printer slightly hanging over the edge of the workspace. Do not let the printer tip and fall off of the workspace when removing the cover.

**TIP:** Use a small flat-blade screw driver to easily release this tab.

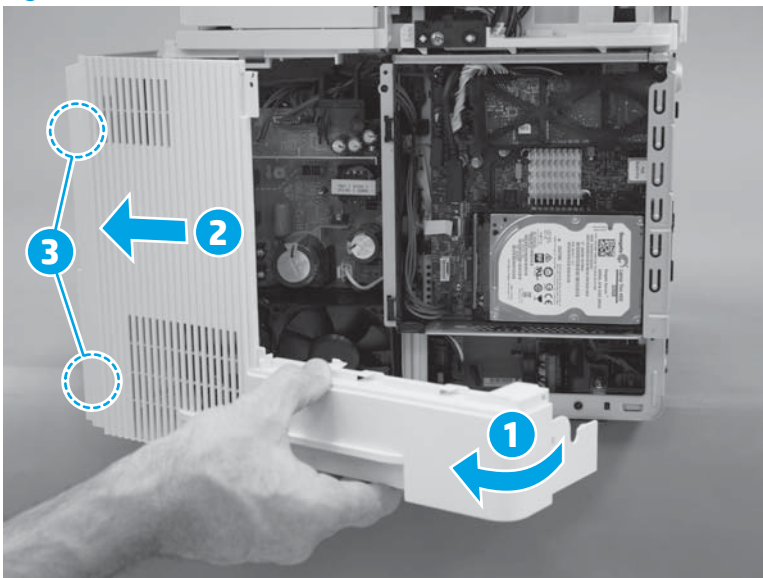
**Figure 1-1937** Release one tab



7. Rotate the rear of the cover away from the printer (callout 1), slide the cover toward the front of the printer (callout 2) to release two bosses (callout 3), and then remove the cover.


**CAUTION:** It might be easier to remove the cover with the printer slightly hanging over the edge of the workspace. Do not let the printer tip and fall off of the workspace when removing the cover.


**Figure 1-1938** Remove the cover





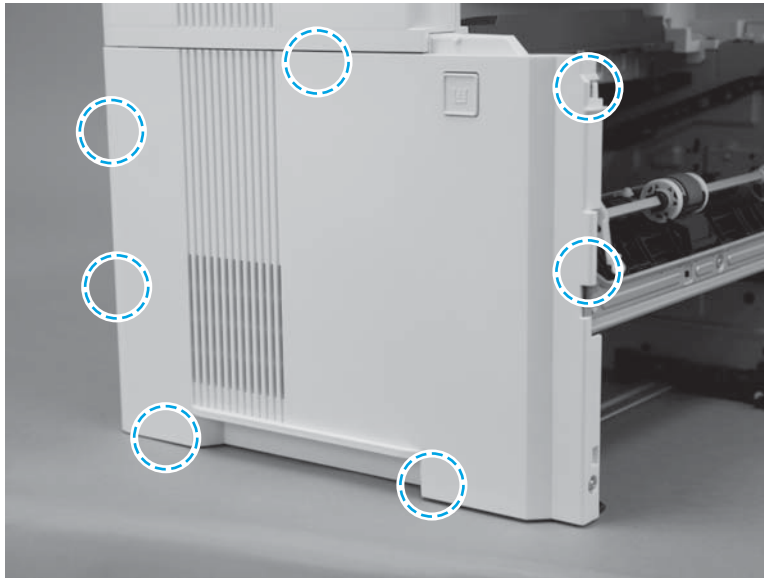
## Step 14: Remove the left cover

 **IMPORTANT:** The black-plastic cassette front and rear guides (located inside the tray cavity) can be easily dislodged. Do not lose the guides when the cover is removed or installed.

 **NOTE:** The M527 printer is shown in this procedure. However, this procedure is valid for the M501/M506 printers.

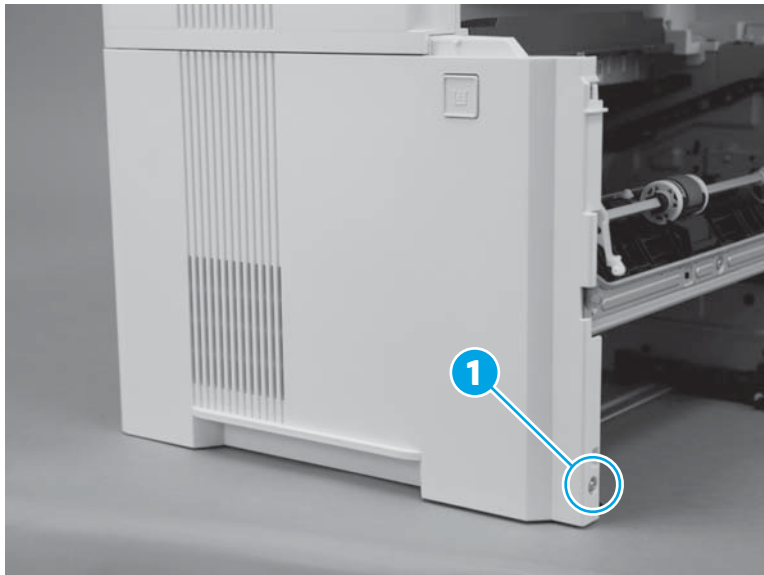
1. Before proceeding, take note of the location of the tabs and bosses on the inside of the cover.

**Figure 1-1939** Locate of the tabs and bosses



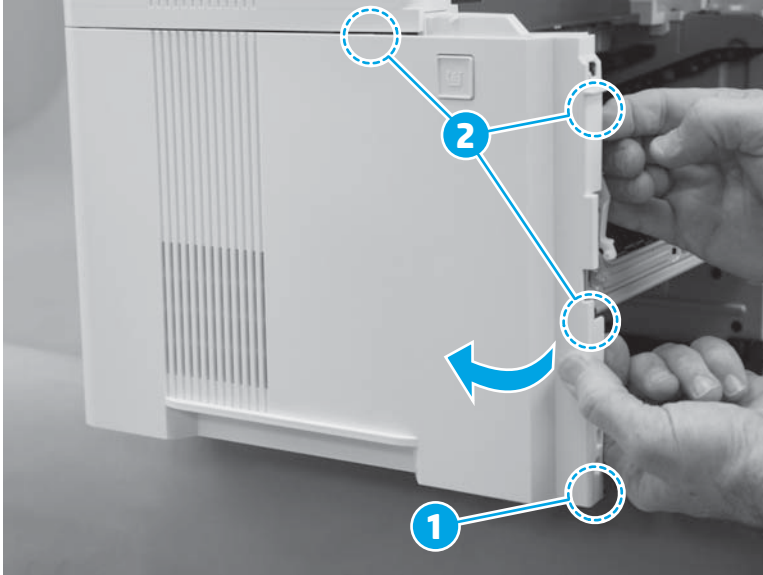
2. Remove one screw (callout 1).

**Figure 1-1940** Remove one screw



3. At the front of the printer, release one boss (callout 1), and then rotate the front edge of the cover away from the printer to release three tabs (callout 2).

**Figure 1-1941** Release one boss and three tabs




4. At the bottom edge of the cover, release two tabs.

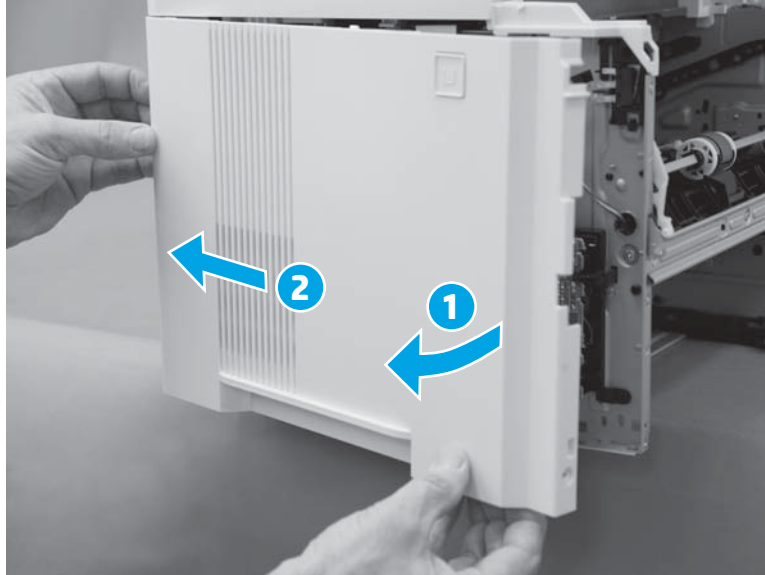
**Figure 1-1942** Release two tabs




5. Continue to rotate the front edge of the cover away from the printer (callout 1), and then slide the cover toward the rear of the printer (callout 2) to remove it.


 **NOTE:** If the cover is difficult to rotate or slide as shown below, make sure that the bottom tabs (released in the previous step) are completely disengaged from the chassis.


**Figure 1-1943** Remove the cover




### Step 15: Remove the integrated scanner assembly (M527)

 **IMPORTANT:** Some figure might show assemblies removed or installed that have not yet been removed or installed at that specific step. However, the procedures are correct for this printer and the target assembly. Always thoroughly read the instructions that accompany each figure

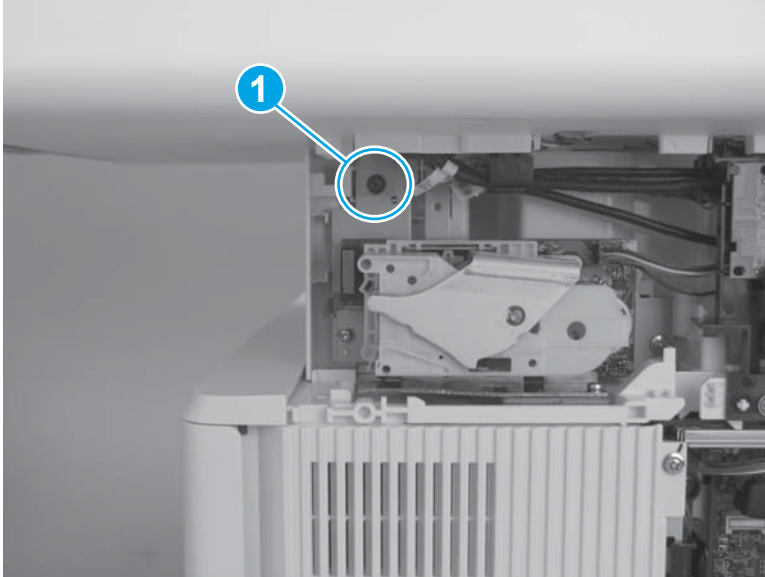
 **NOTE:** This step is for the M527 printer. For the M501/M506, skip this step and go to [Step 17: Remove the top cover \(M501/M506\) on page 1091](#).

 **NOTE:** The ISA includes the document feeder, sub-scanner assembly (SSA), and the scanner control board (SCB)

1. Remove one screw (callout 1).


 **IMPORTANT:** This screw fastens the ISA ground plate to the printer chassis. Do not lose this screw.

**Figure 1-1944** Remove one screw

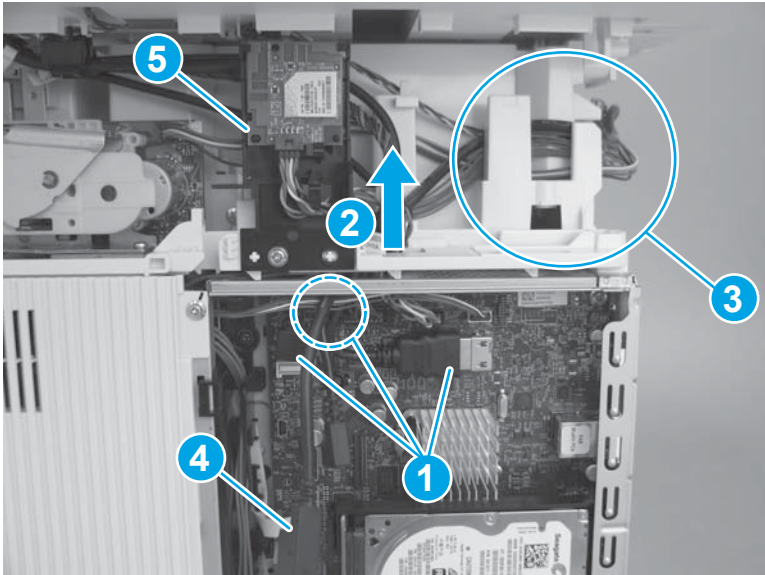


2. Disconnect three connectors (callout 1), pass the wire harnesses and cables through the opening in the cover (callout 2), and then release them from the retainers (callout 3).

 **NOTE:** One cable (callout 4) does not need to pass through the opening in the cover.

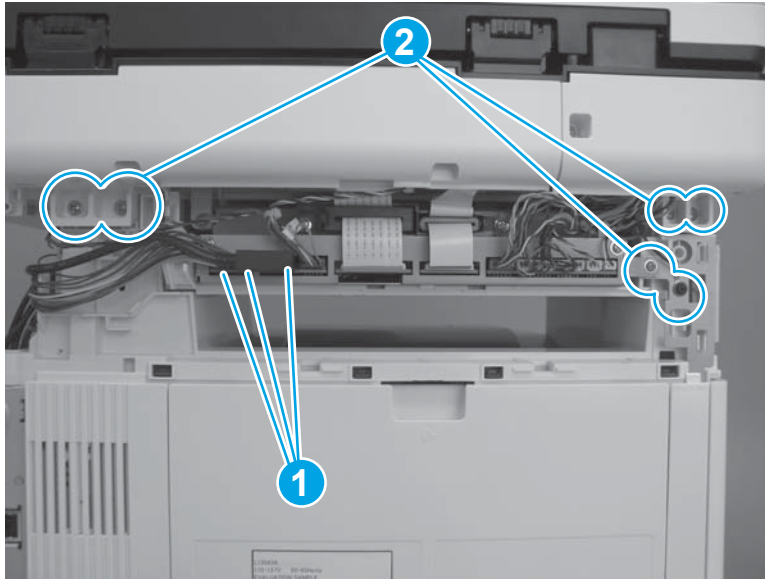
 **TIP:** It might be easier if the WiFi PCA and holder (callout 5) is detached from the printer, and then moved out of the way.

**Figure 1-1945** Disconnect cables and connectors



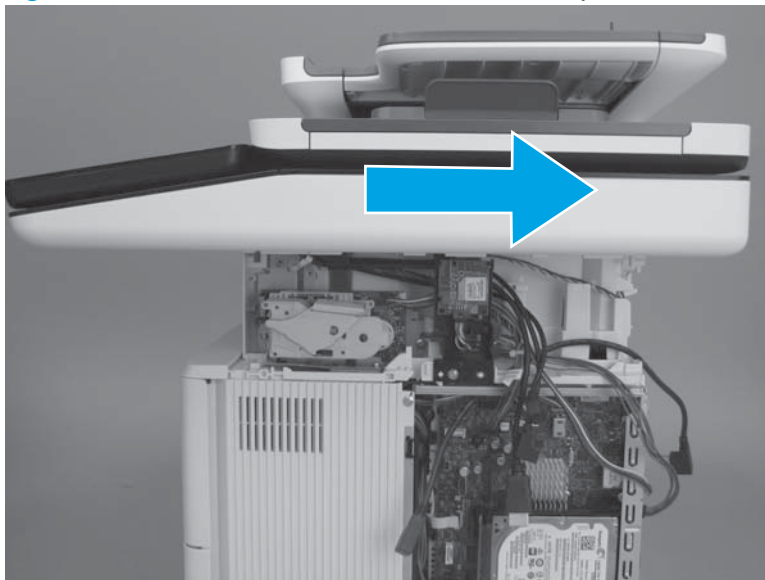
3. Disconnect three connectors (callout 1), and then remove six screws (callout 2).

**Figure 1-1946** Disconnect connectors and remove screws



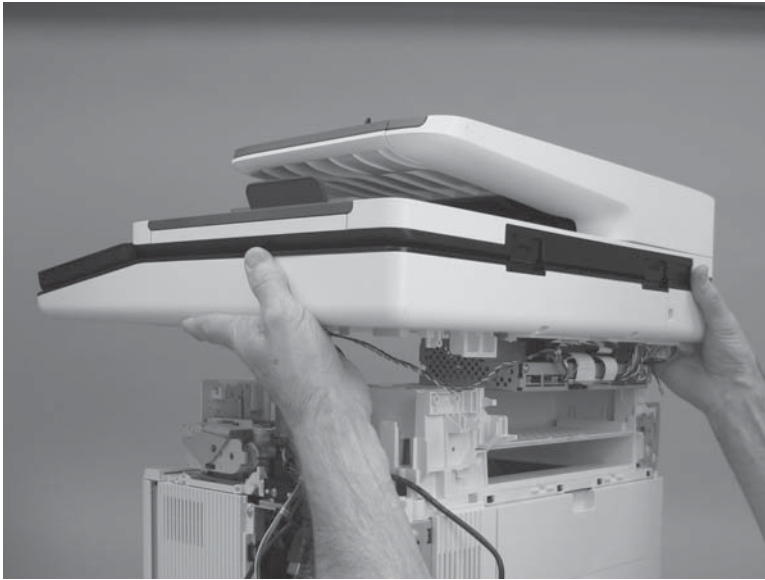
4. Slightly slide the ISA towards the back of the printer to release it.

**Figure 1-1947** Slide the ISA towards the back of the printer



5. Remove the ISA.

**Figure 1-1948** Remove the ISA



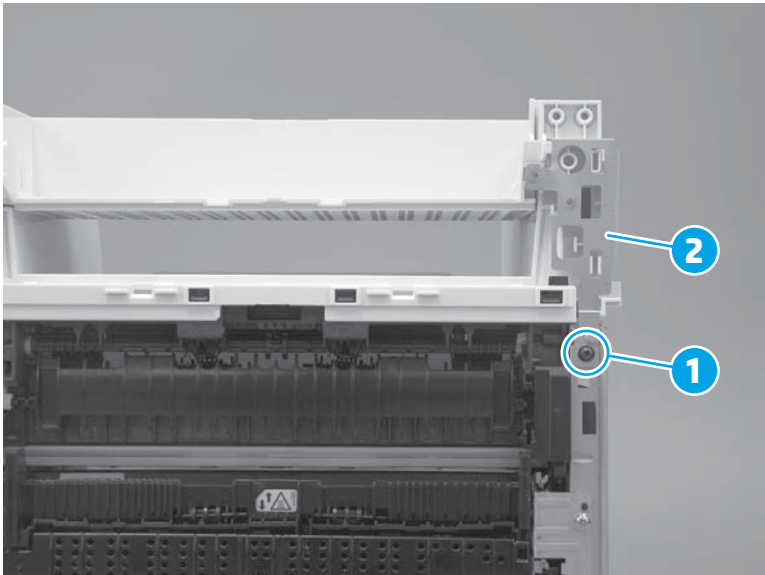
#### Step 16: Remove the top cover (M527)



**NOTE:** This step is for the M527 printer. For the M501/M506, skip this step and go to [Step 17: Remove the top cover \(M501/M506\) on page 1091](#).

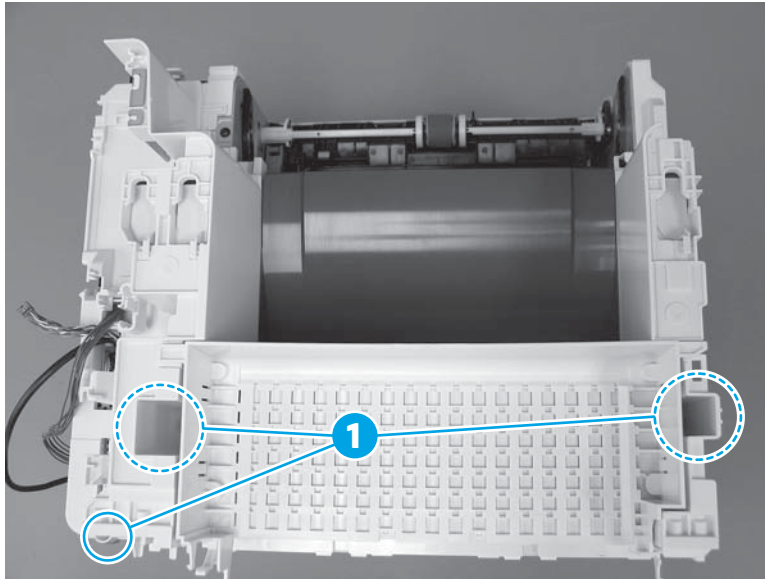
1. At the front right of the printer, remove one screw (callout 1), and then remove the sheet-metal plate (callout 2).

**Figure 1-1949** Remove one screw and the plate




2. At the top rear of the printer, remove three screws (callout 1).

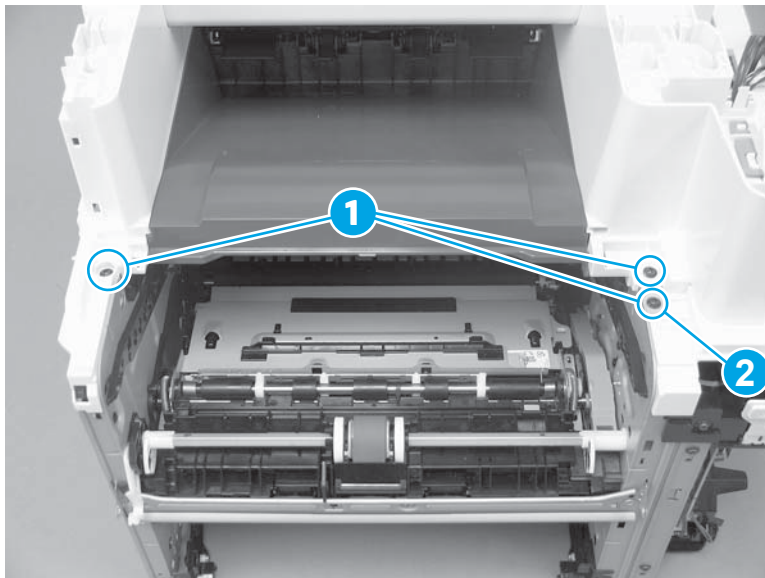
**Figure 1-1950** Remove three screws



3. At the top front of the printer, remove three screws (callout 1).

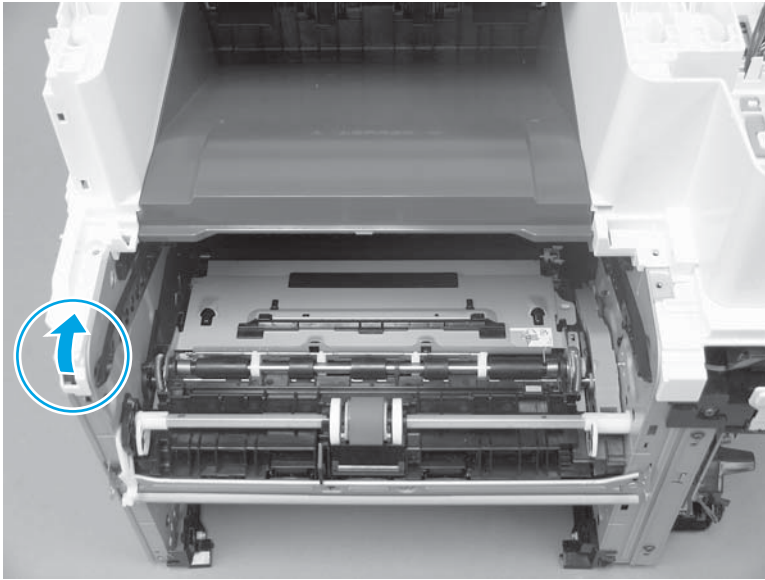
 **NOTE:** The screw (callout 2) on the lower-right portion of the cover is a different color than the other two screws, and is surrounded by sheet-metal. It might appear that this screw does not need to be removed. Remove this screw.

**Figure 1-1951** Remove three screws



4. At the front left of the printer, release one boss.

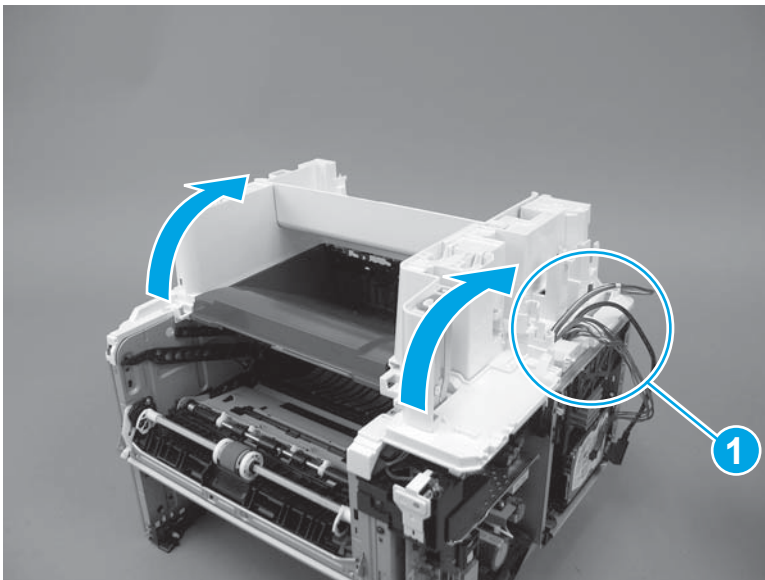
**Figure 1-1952** Release one boss



5. Rotate the front of the cover up and away from the printer.

**CAUTION:** As the cover is rotated up, carefully pass the cables and wire harnesses the hole in the cover (callout 1).

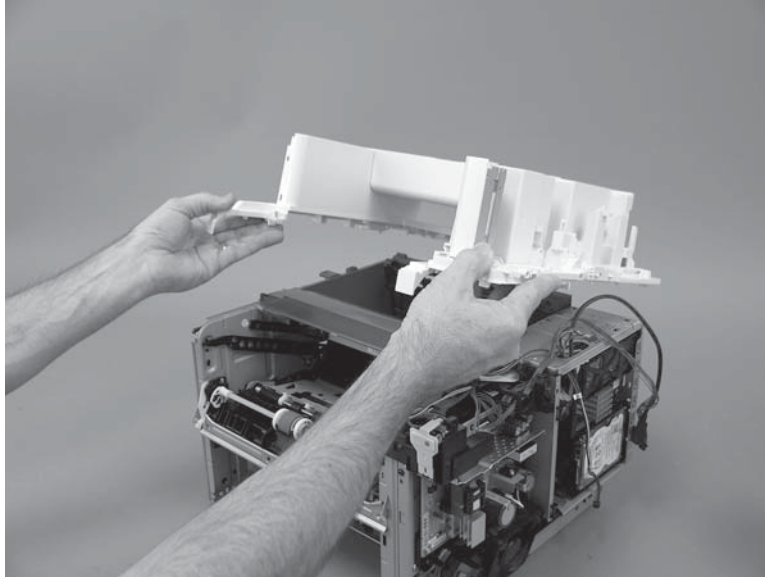
**Figure 1-1953** Rotate the front of the cover up






6. Remove the cover.

**Figure 1-1954** Remove the cover



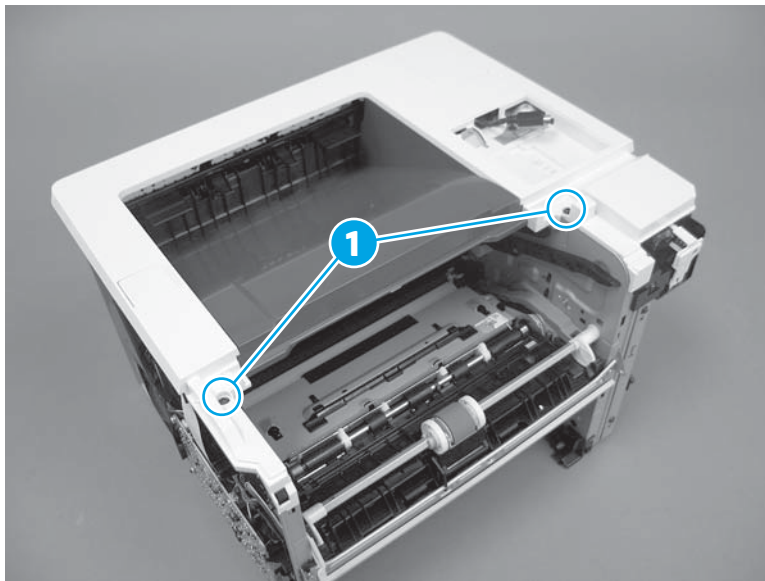
### Step 17: Remove the top cover (M501/M506)

 **NOTE:** This step is for the M501/M506 printers. For the M527, skip this step and go to [Step 19: Remove the formatter case on page 1094](#).


The M506x is shown in this procedure. However, the steps are correct for all M506 models and the M501 printer.

1. Remove two screws (callout 1).

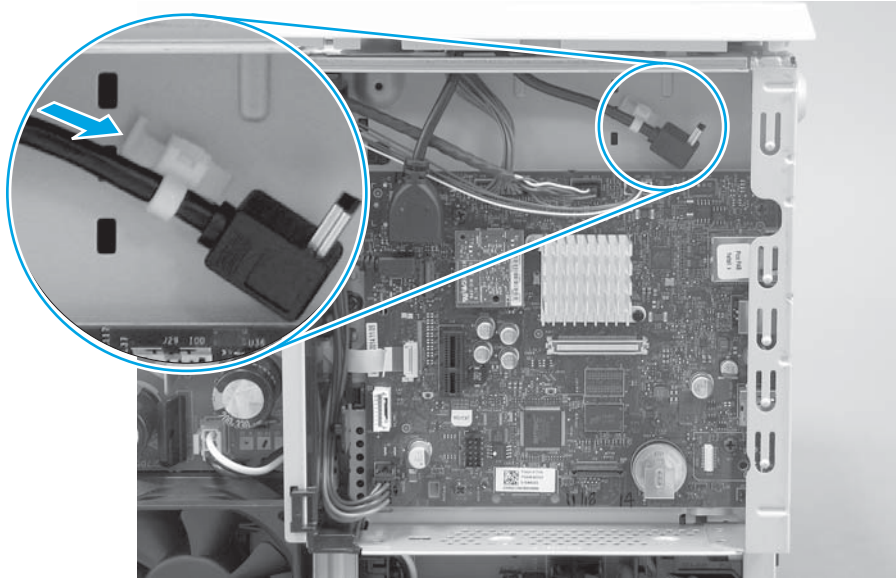
**Figure 1-1955** Remove two screws



- M506 only:** Release one cable retainer from the chassis.

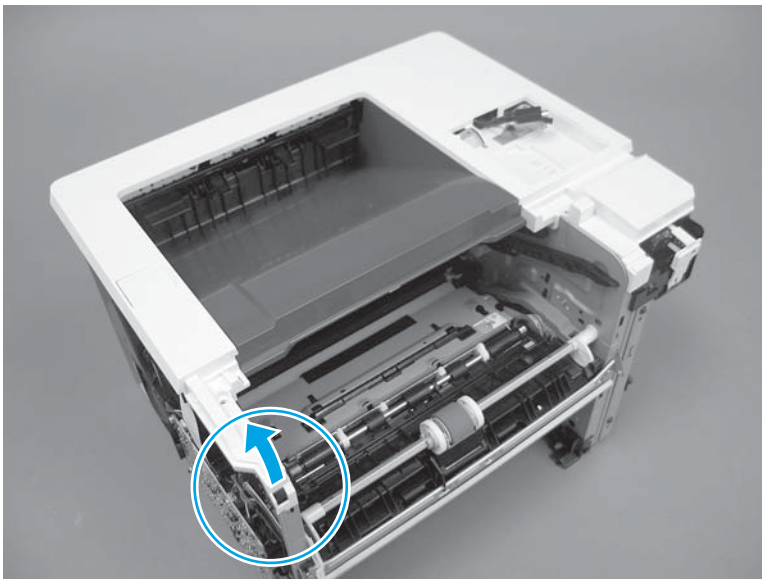
 **TIP:** Depress the tab on the retainer to release it.

**Figure 1-1956** Release one cable retainer



- Release one boss.

**Figure 1-1957** Release one boss

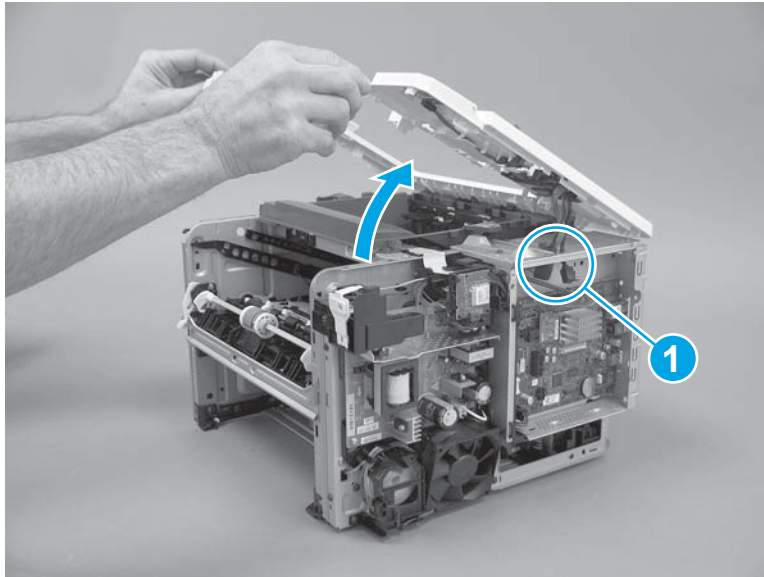


4. Rotate the front of the cover up and away from the printer, and then remove the cover.

**CAUTION:** **M506x only:** As the cover is rotated up, carefully pass the cables the hole in the chassis (callout 1).

**NOTE:** **LCD control panel models only:** Disconnect the control panel before removing the cover.

**Figure 1-1958** Remove the cover

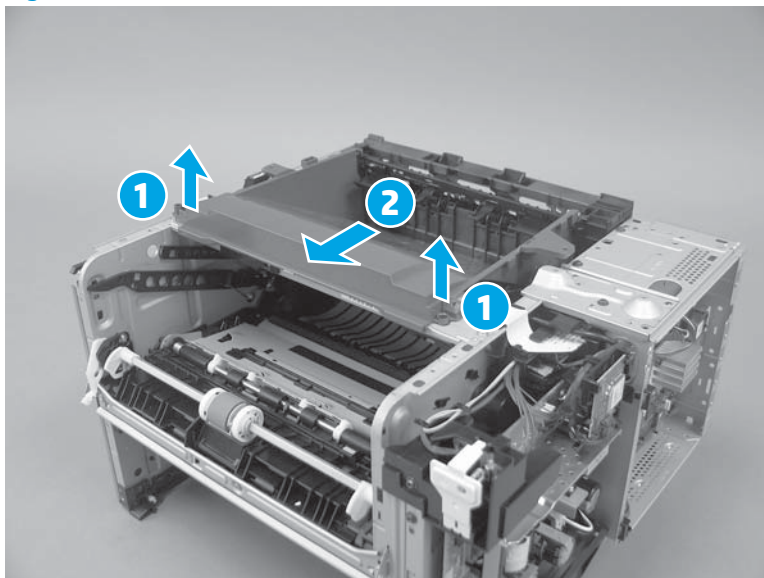


#### Step 18: Remove the paper delivery tray (output bin)

**NOTE:** This procedure shows the M506 printer. However, this procedure is valid for the M527 printer.

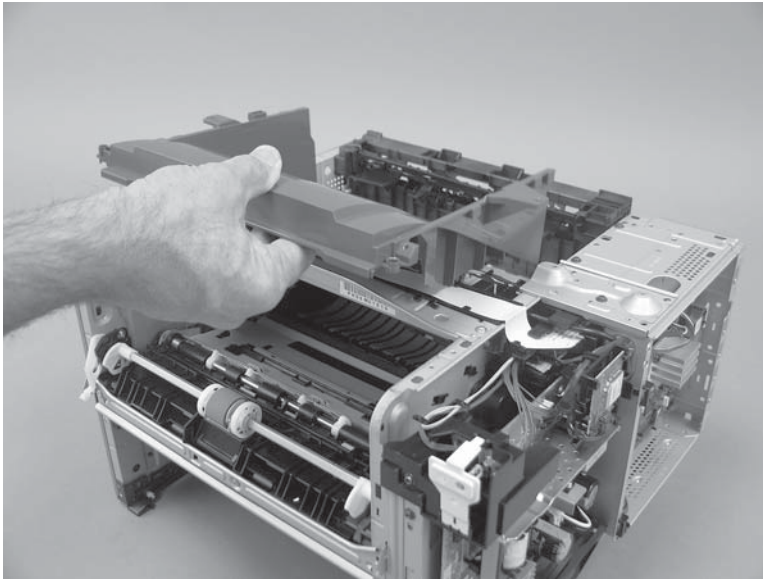
1. Release two tabs (callout 1), and then slide the cover toward the front of the printer (callout 2).

**Figure 1-1959** Release two tabs



2. Remove the bin.

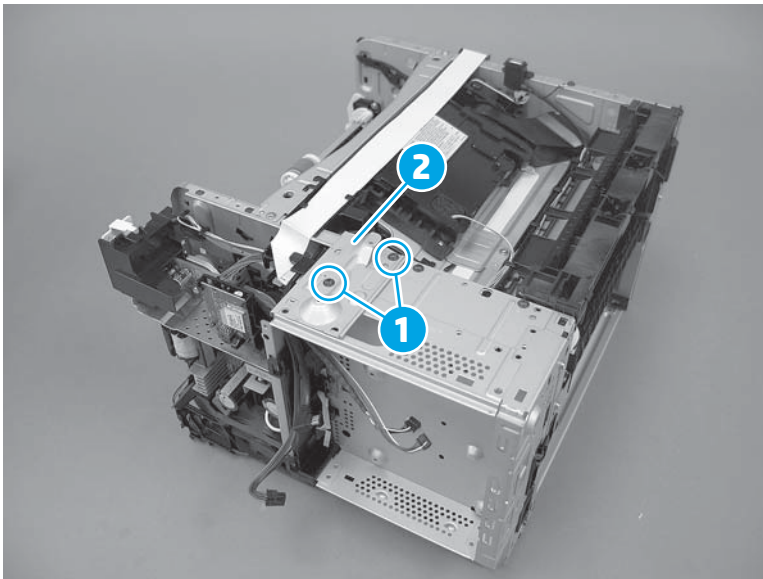
**Figure 1-1960** Remove the bin




#### Step 19: Remove the formatter case

1. **M506 only:** Remove two screws (callout 1), and then remove the sheet-metal plate (callout 2).

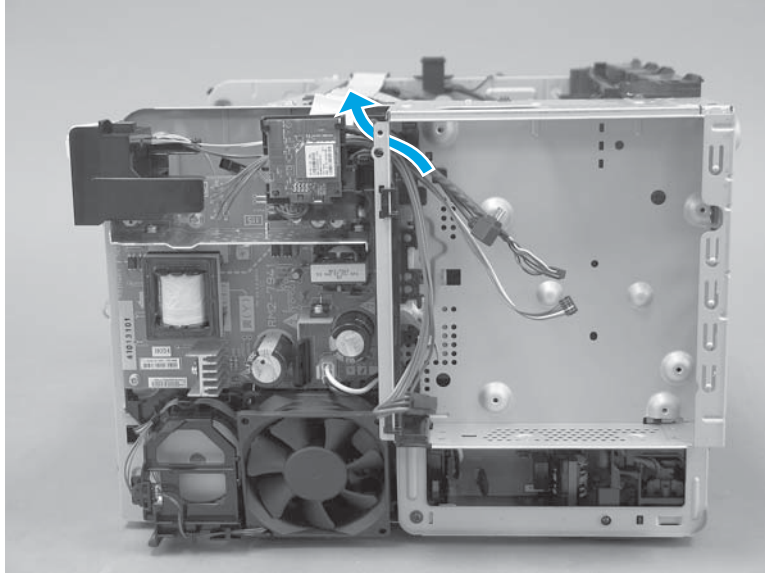
**Figure 1-1961** Remove the sheet-metal plate



- Carefully pass all cables and wire harnesses through the opening in the formatter case.

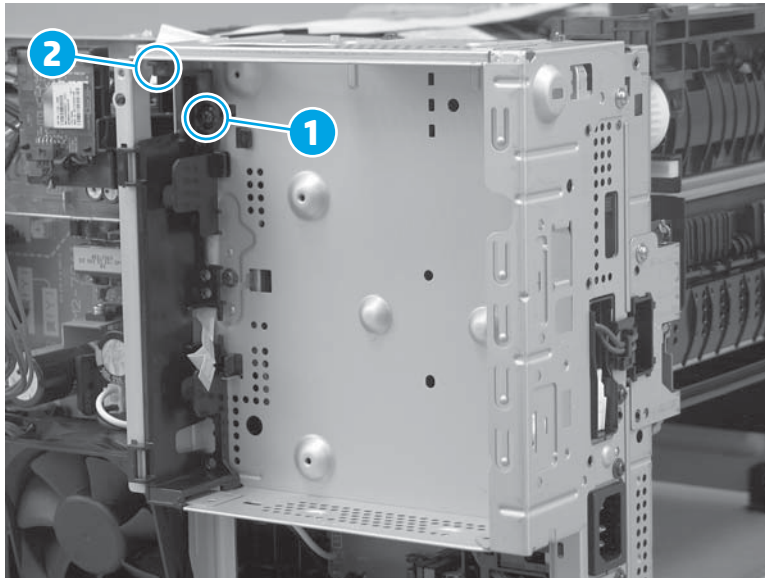
 **NOTE:** The figure below shows the M506 printer. However this step is valid for the M501/M527 printers—there will be a different number of cables and wire harnesses.

**Figure 1-1962** Pass all cables and wire harnesses through the opening



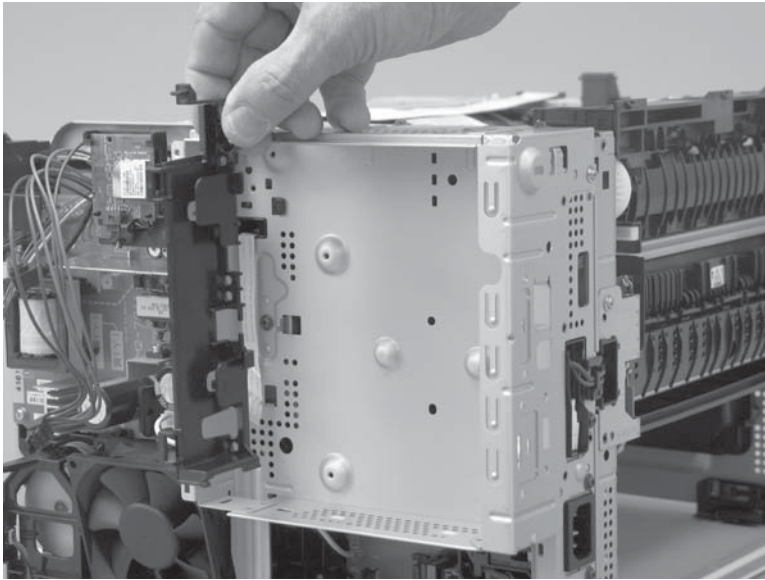
- Remove one screw (callout 1), and then push down on one tab (callout 2) to release it.

**Figure 1-1963** Remove one screw



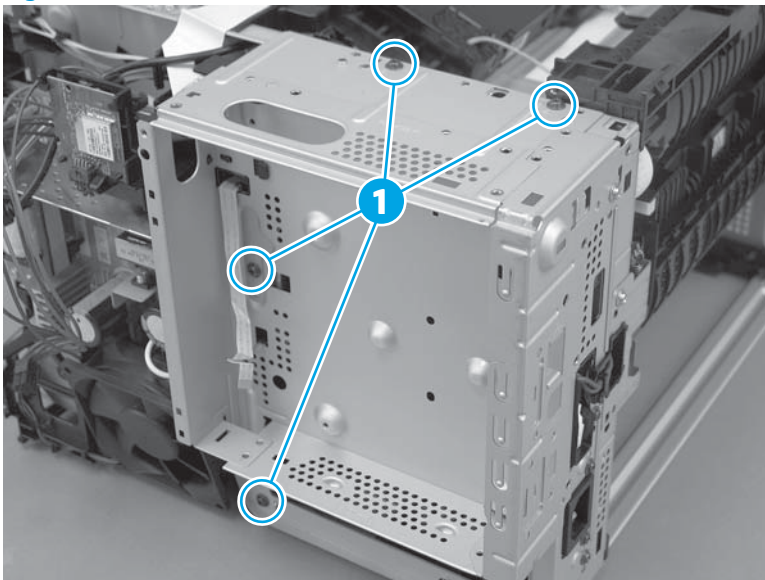
4. Remove the guide.

**Figure 1-1964** Remove the guide



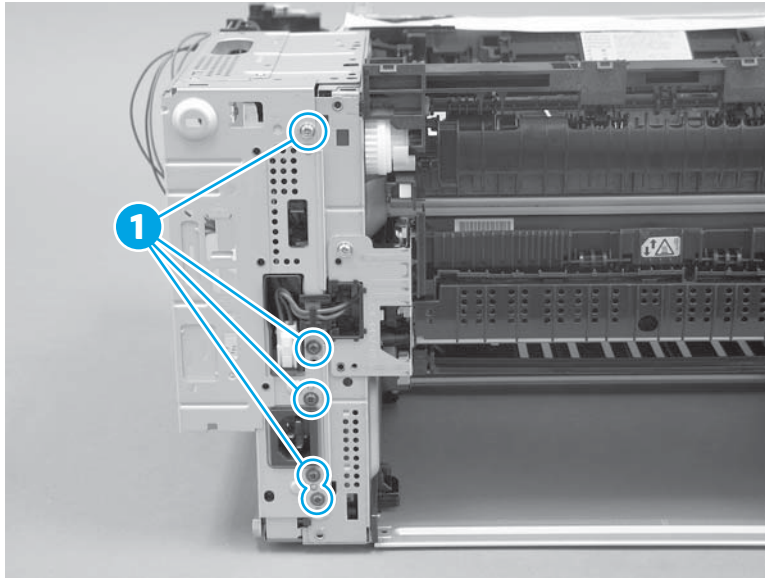
5. Remove four screws (callout 1).

**Figure 1-1965** Remove four screws



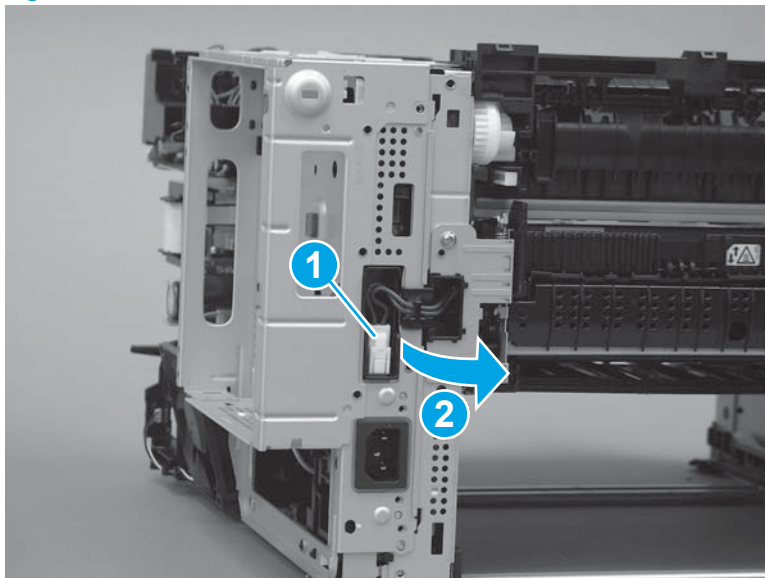
6. Remove five screws (callout 1).

**Figure 1-1966** Remove five screws



7. Disconnect one connector (callout 1), and then move the guide out of the way (callout 2).

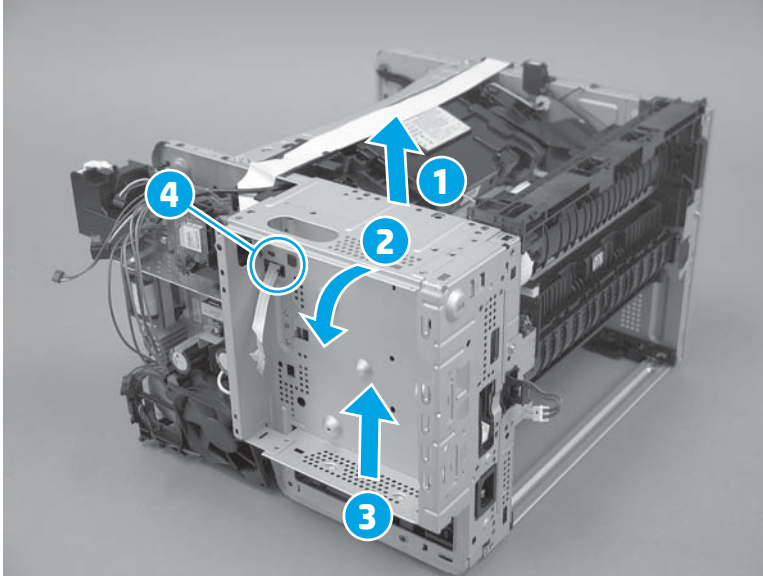
**Figure 1-1967** Disconnect one connector



8. Slightly lift up the formatter case (callout 1), rotate the top of the case away from the chassis (callout 2), and then lift up the case to release it (callout 3).

**CAUTION:** Pass the FFC through the opening (callout 4) in the formatter while removing the case.

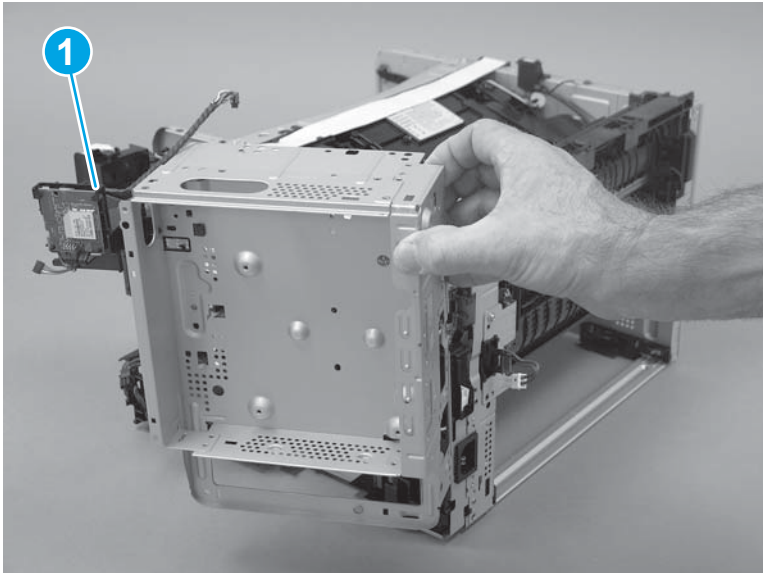
**Figure 1-1968** Release the formatter case



9. Remove the formatter case.

**NOTE:** **M506 only:** If the formatter case is being replaced, make sure that the WiFi PCA and bracket (callout 1) are transferred to the replacement case.

**Figure 1-1969** Remove the formatter case

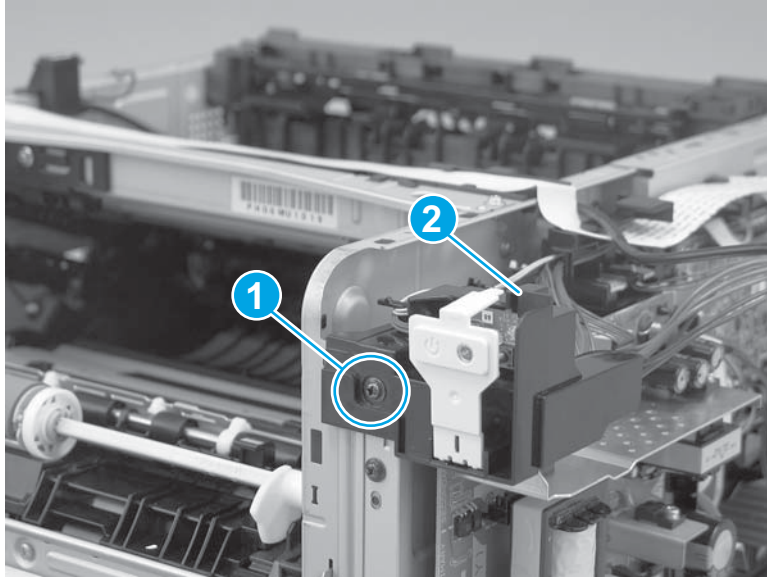


## Step 20: Remove the LVPS

1. Remove one screw (callout 1), and then move the power-switch assembly (callout 2) out of the way.

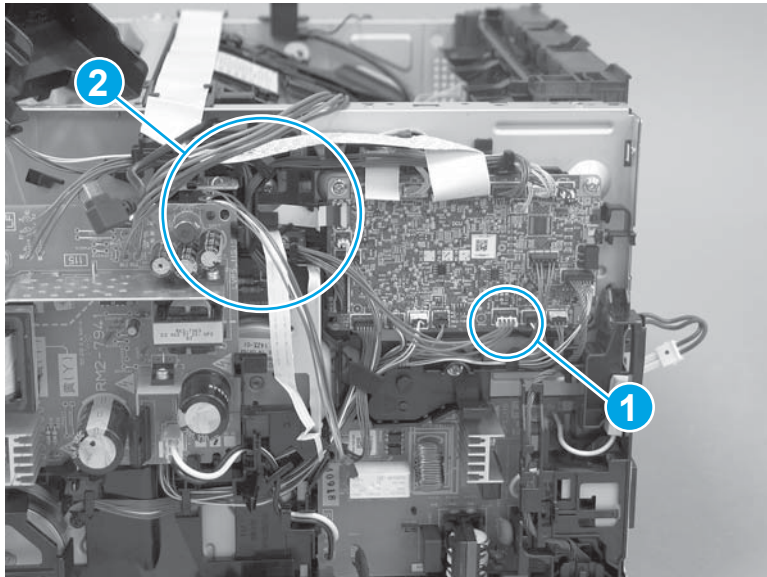


**Figure 1-1970** Move the power-switch assembly




2. Disconnect one connector (callout 1), and then release the wire harness from the guide (callout 2).

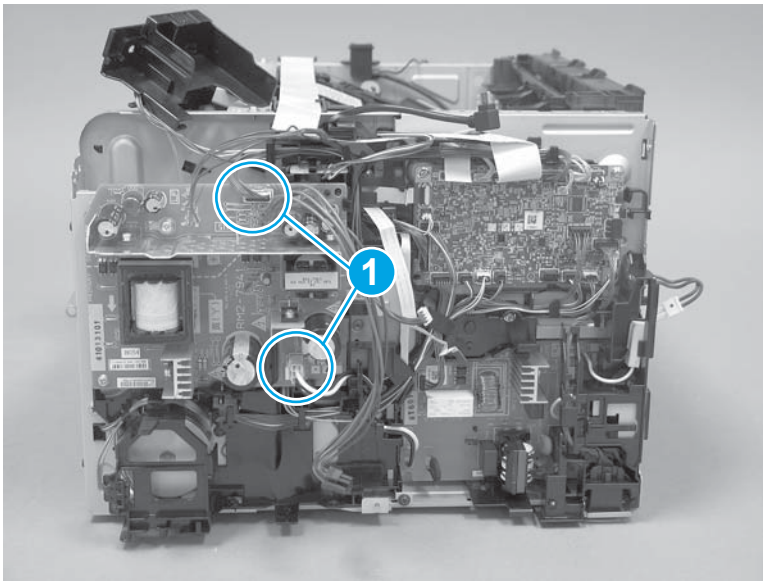
**Figure 1-1971** Disconnect one connector



3. Disconnect two connectors (callout 1).

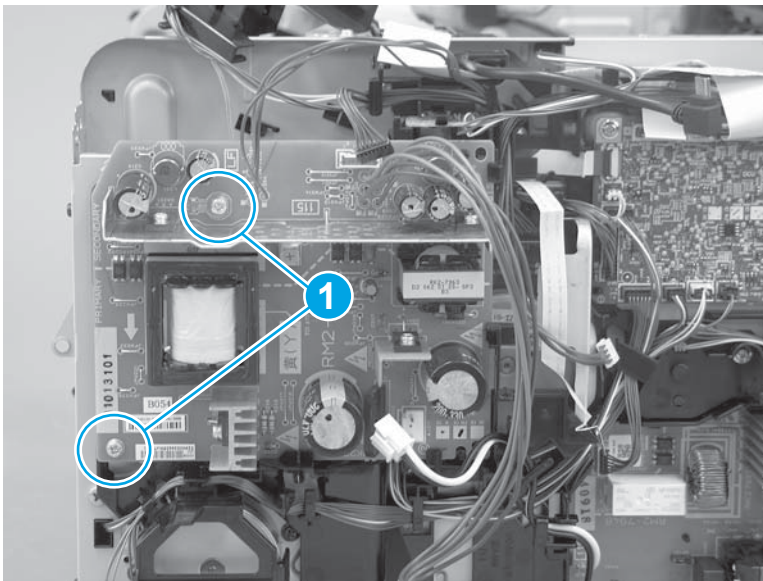
 **TIP:** Squeeze the locking lever on the lower connector to release it.

**Figure 1-1972** Disconnect two connectors



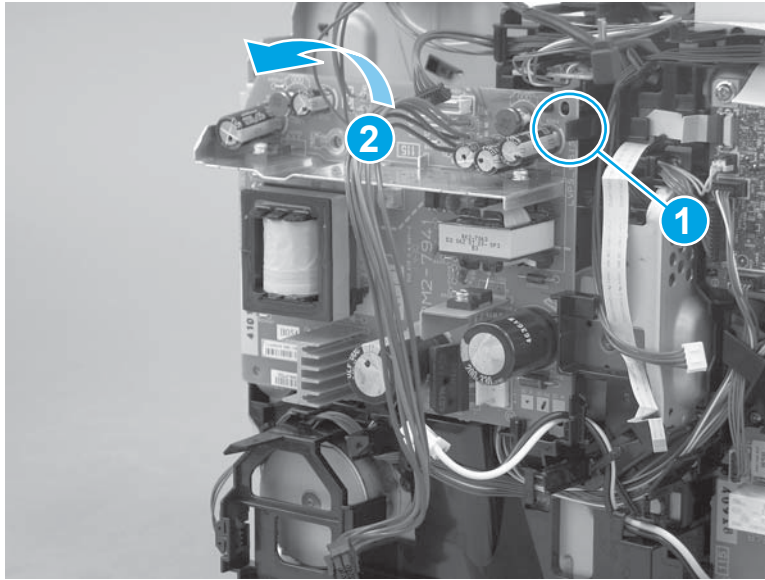
4. Remove two screws (callout 1).

**Figure 1-1973** Remove two screws



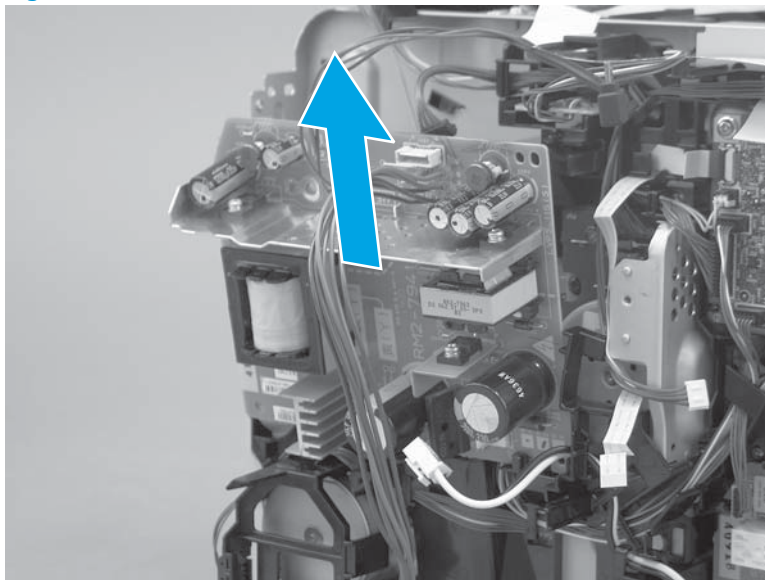
5. Release one tab (callout 1), and then rotate the top of the LVPS out and away from the printer (callout 2).

**Figure 1-1974** Release one tab



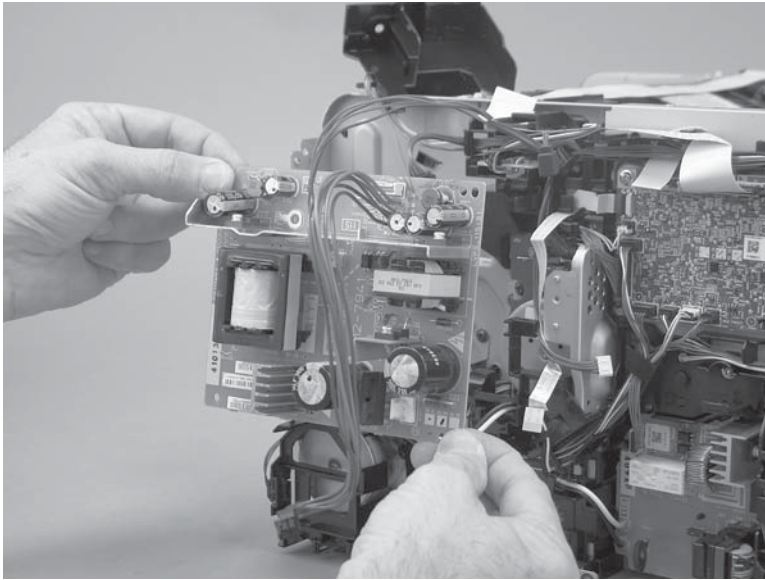
6. Slide the LVPS up and away from the printer to release it.

**Figure 1-1975** Release the LVPS



7. Remove the LVPS.

**Figure 1-1976** Remove the LVPS



### Step 21: Unpack the replacement assembly

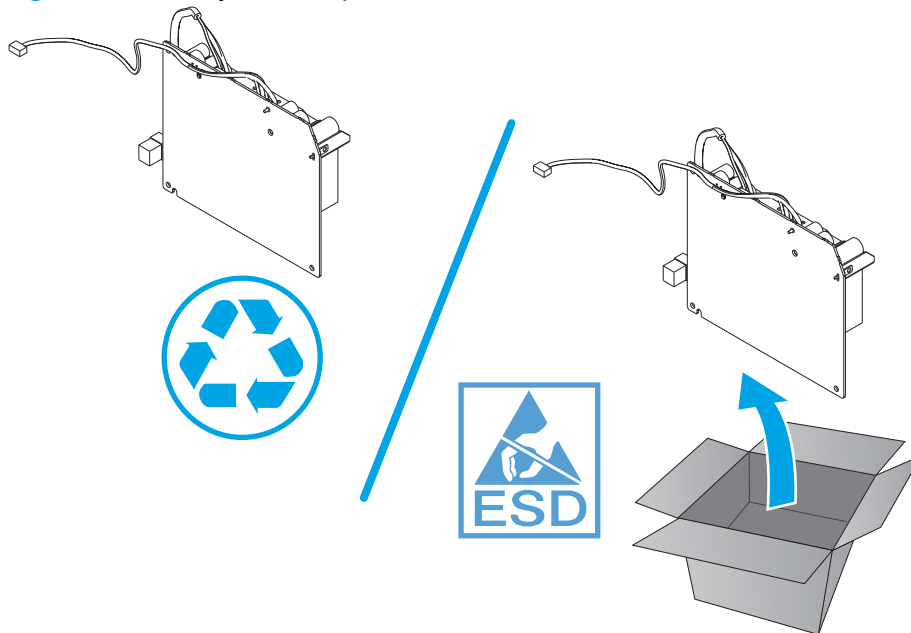
Unpack the replacement part from the packaging.

<http://www8.hp.com/us/en/hp-information/environment/product-recycling.html>




**NOTE:** HP recommends responsible disposal of the defective part.

**Figure 1-1977** Recycle and unpack

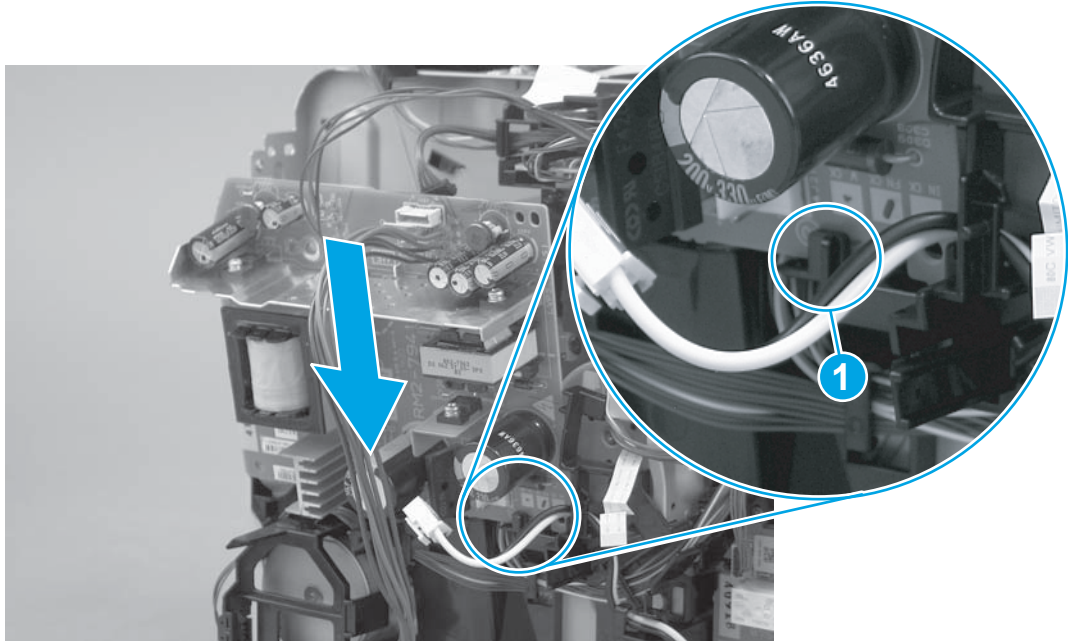


### Step 22: Install the LVPS

1. Position the bottom edge of the LVPS on the holder.

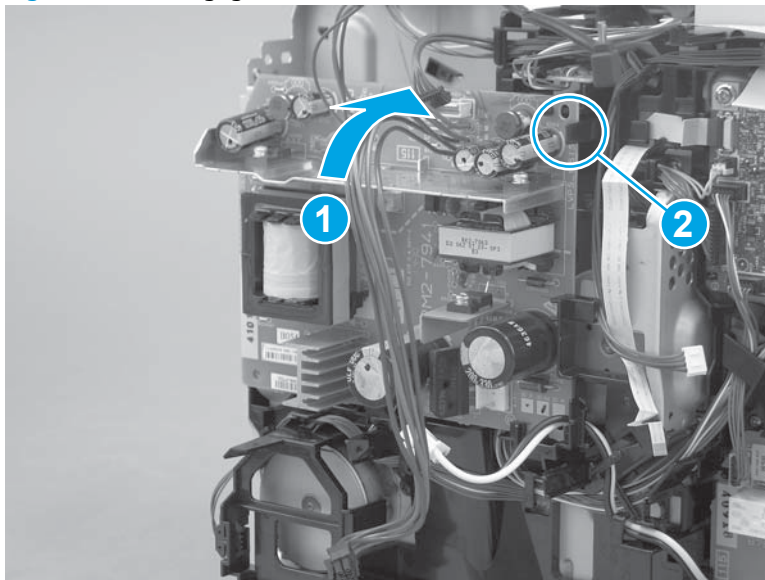
 **IMPORTANT:** Push down on the LVPS to make sure that it is fully seated on the holder (callout 1).

**Figure 1-1978** Install the LVPS



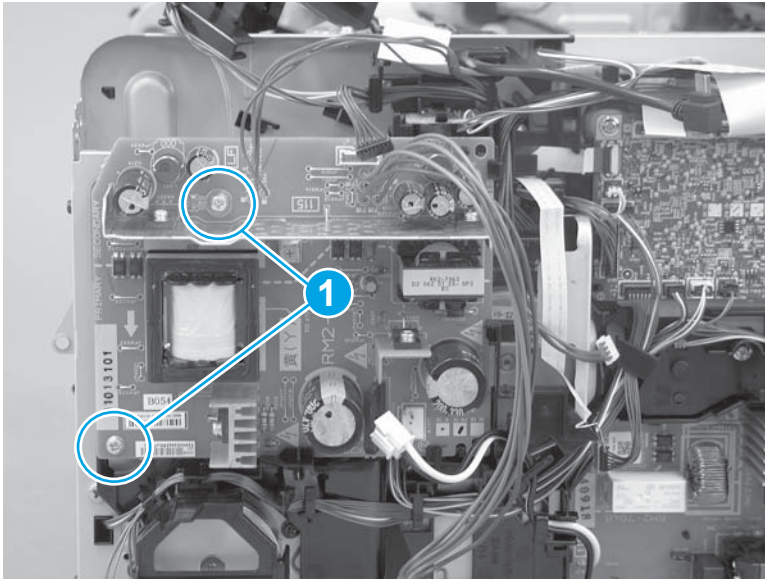
2. Rotate the top of the LVPS toward the printer (callout 1), and then engage one tab (callout 2).

**Figure 1-1979** Engage one tab



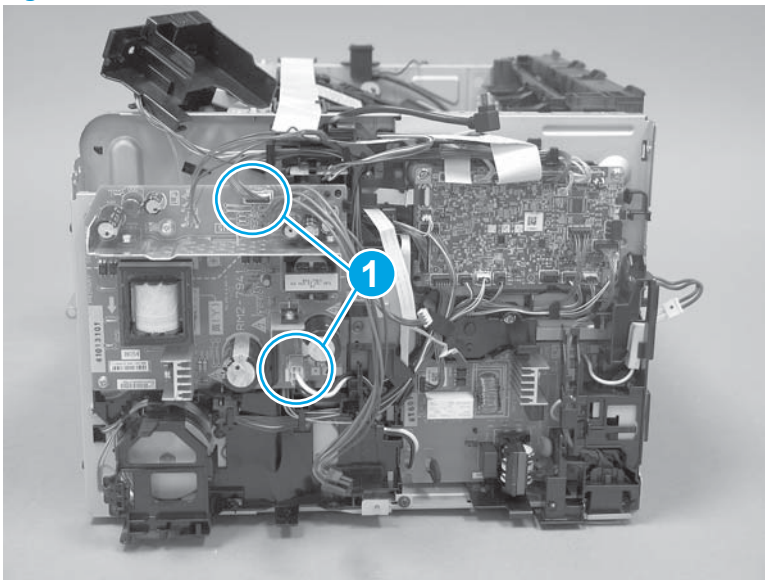
3. Install two screws (callout 1).

**Figure 1-1980** Install two screws



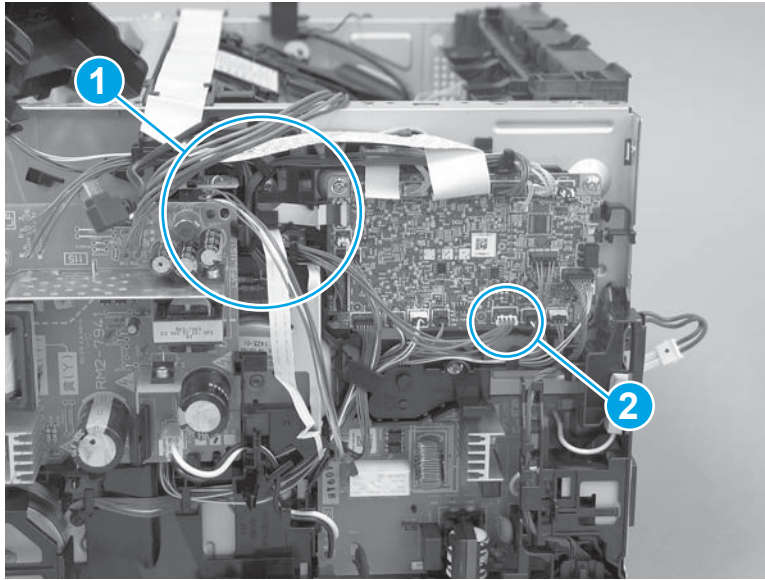
4. Connect two connectors (callout 1).

**Figure 1-1981** Connect two connectors



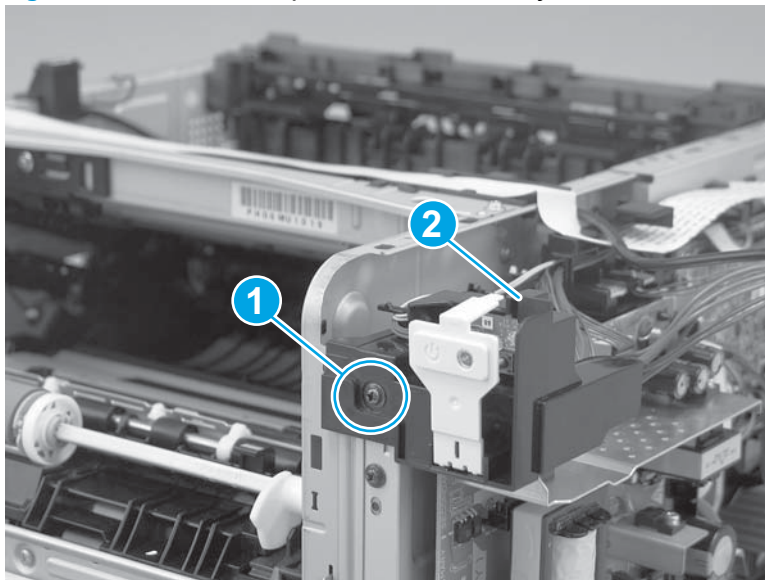
5. Install the wire harness in the guide (callout 1), and then connect one connector (callout 2).

**Figure 1-1982** Connect one connector



6. Position the power-switch assembly (callout 1) on the chassis, and then install one screw (callout 1).


**Figure 1-1983** Install the power-switch assembly



### Step 23: Install the formatter case

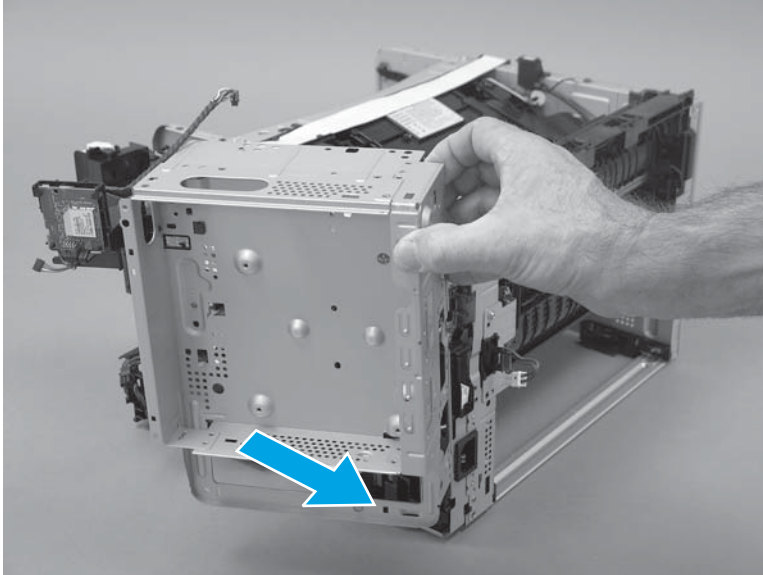
1. Position the bottom edge of the formatter case against the chassis.

---

 **NOTE: M506 only:** If the formatter case is being replaced, make sure that the WiFi PCA and bracket (callout 1) are transferred to the replacement case.

---

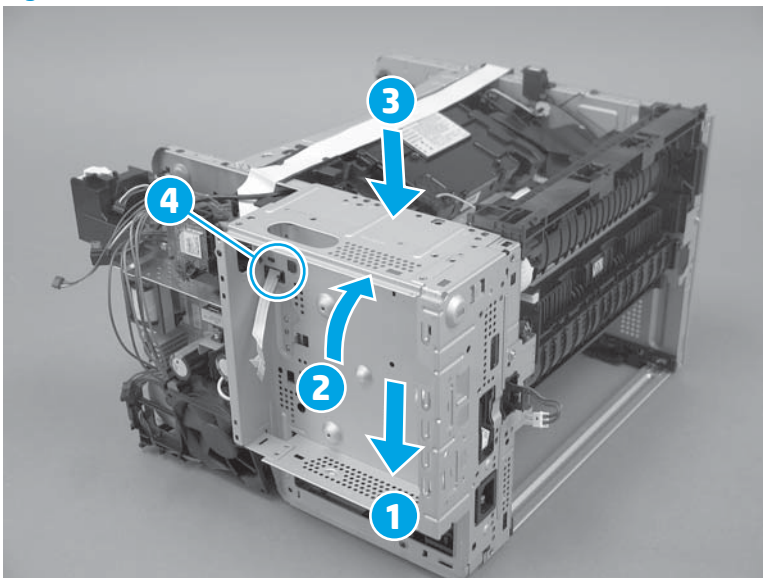
**Figure 1-1984** Position the formatter case against the chassis



2. With the bottom of the formatter case against the chassis (callout 1), rotate the top of the case toward the chassis (callout 2), and slide the case down into place to install it (callout 3).

**CAUTION:** Pass the FFC through the opening (callout 4) in the formatter while installing the case.

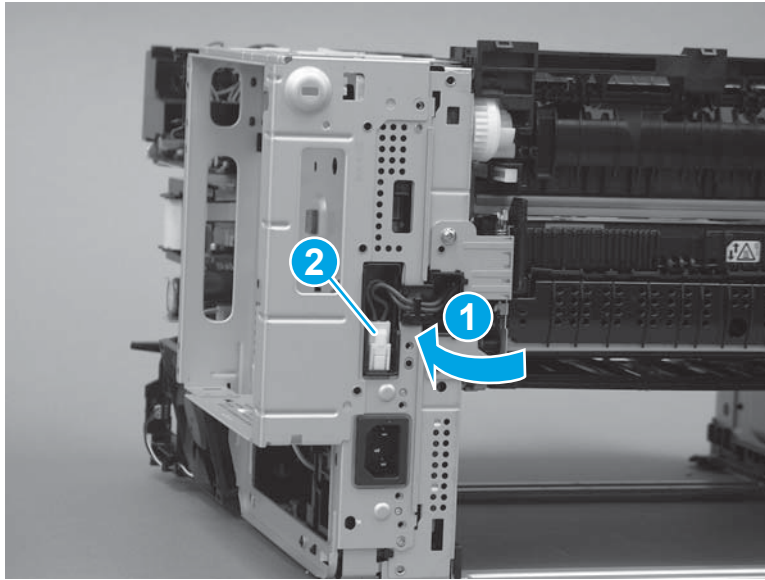
**Figure 1-1985** Install the formatter case





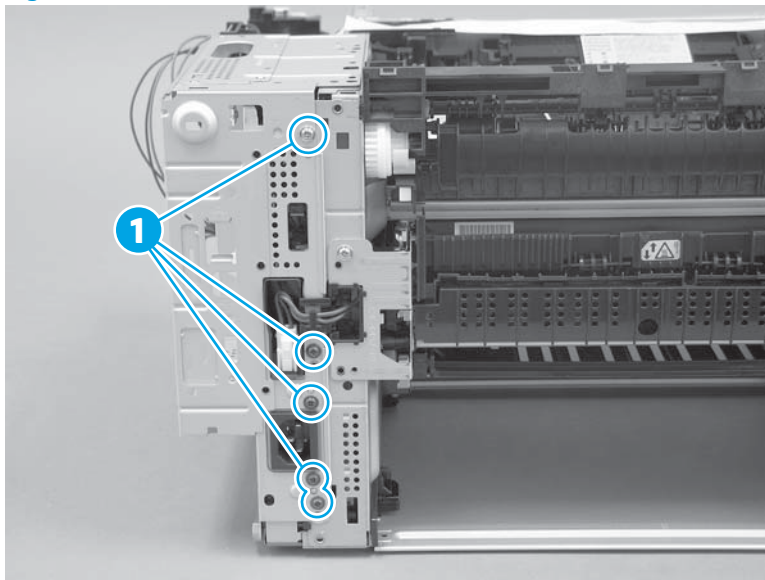
3. Reposition the guide (callout 1), and then connect one connector (callout 2).

**Figure 1-1986** Connect one connector



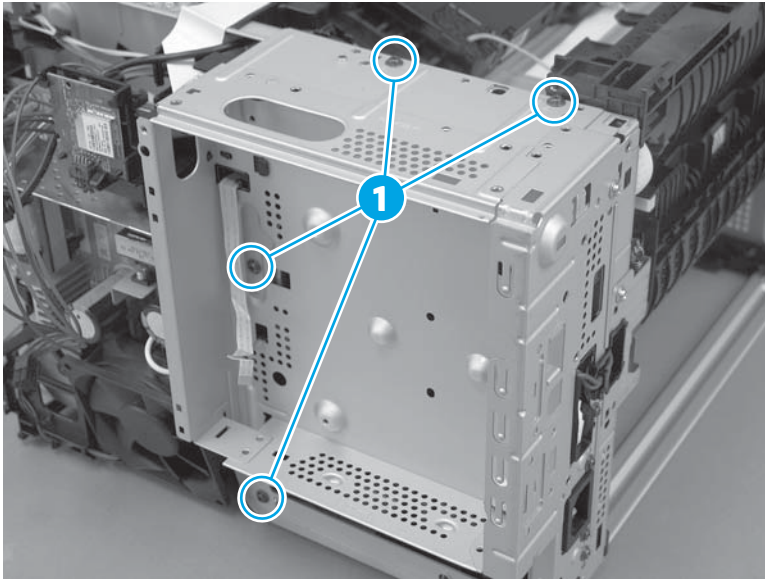
4. Install five screws (callout 1).

**Figure 1-1987** Install five screws



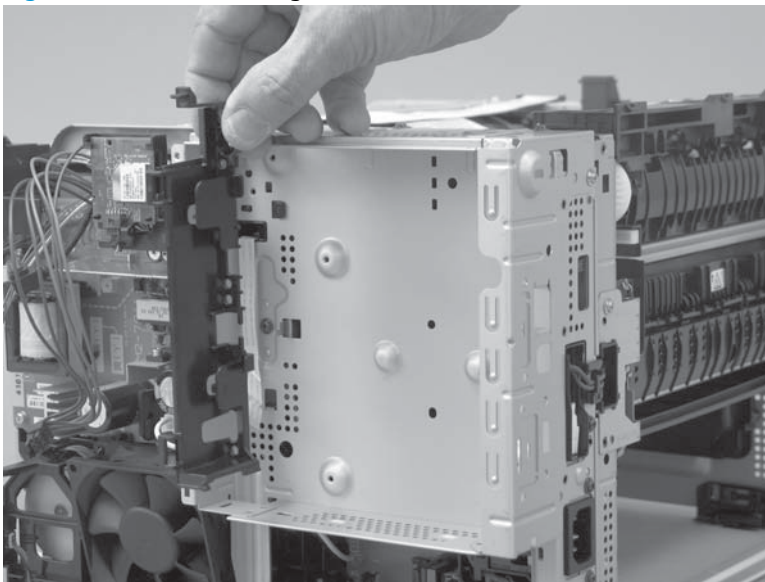
5. Install four screws (callout 1).

**Figure 1-1988** Install four screws




6. Install the guide.

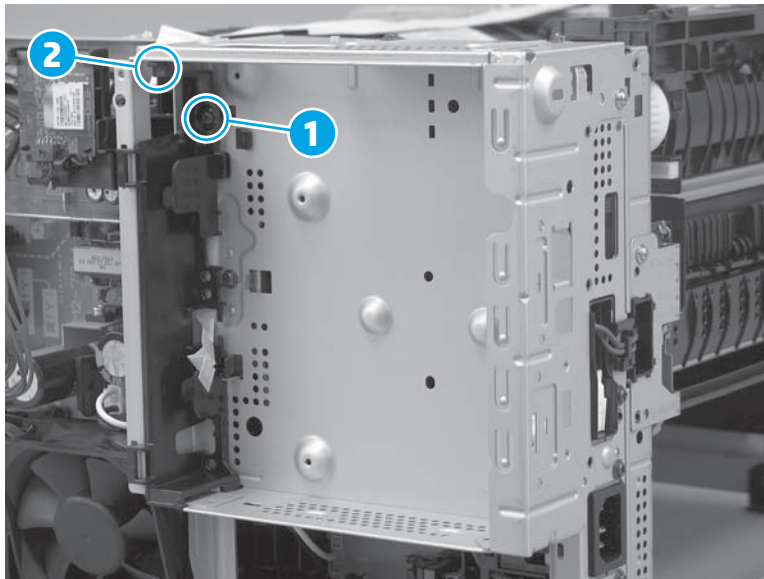
**Figure 1-1989** Install the guide




7. Install one screw (callout 1).

 **NOTE:** Make sure that the tab (callout 2) is engaged.

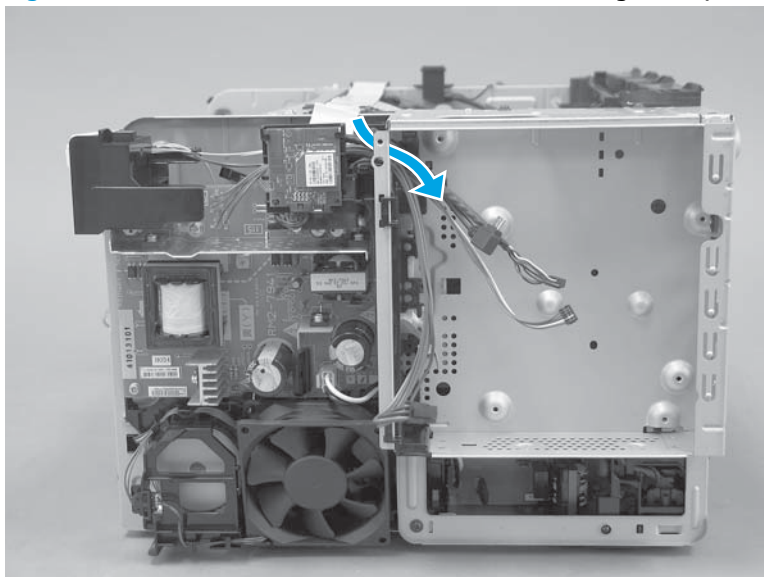
**Figure 1-1990** Install one screw



8. Carefully pass all cables and wire harnesses through the opening in the formatter case.

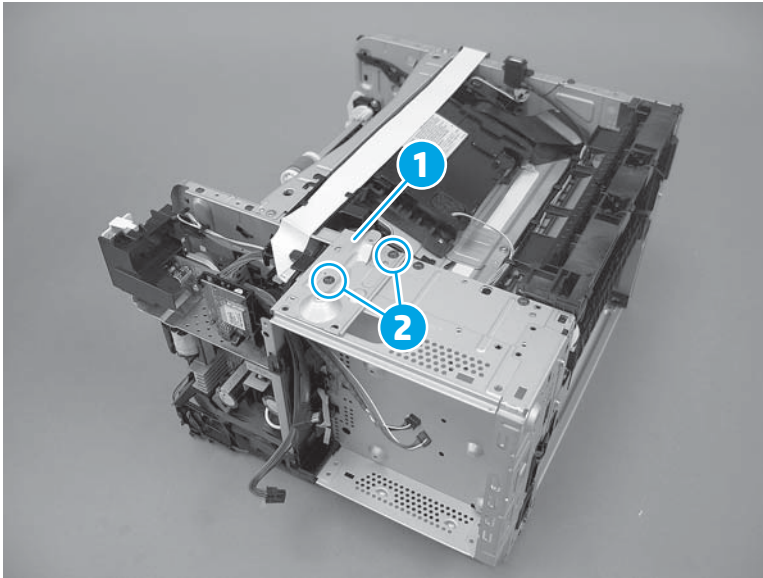
 **NOTE:** The figure below shows the M506 printer. However this step is valid for the M501/M527 printers—there will be a different number of cables and wire harnesses.

**Figure 1-1991** Pass all cables and wire harnesses through the opening




9. **M506 only:** Install the sheet-metal plate (callout 1), and then install two screws (callout 2).


**Figure 1-1992** Remove the sheet-metal plate



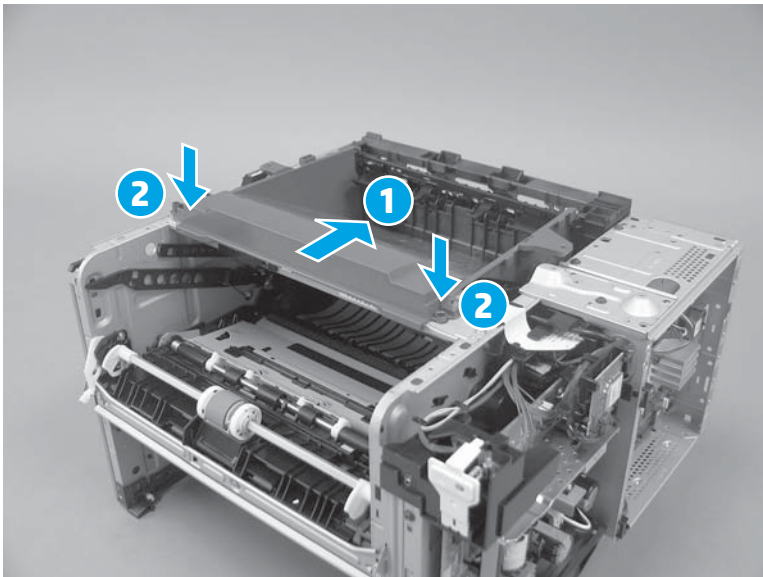
**Step 24: Install the paper delivery tray (output bin)**

 **NOTE:** This procedure shows the M506 printer. However, this procedure is valid for the M527 printer.


- ▲ Position the bin on the printer (callout 1), and then push down to engage two tabs (callout 2).

 **NOTE:** Position the tabs along the rear edge of the bin on the printer in the slots in the chassis.

**Figure 1-1993** Install the bin



**Step 25: Install the top cover (M501/M506)**

 **NOTE:** This step is for the M501/M506 printers. For the M527, skip this step and go to [Step 26: Install the top cover \(M527\) on page 1112](#).

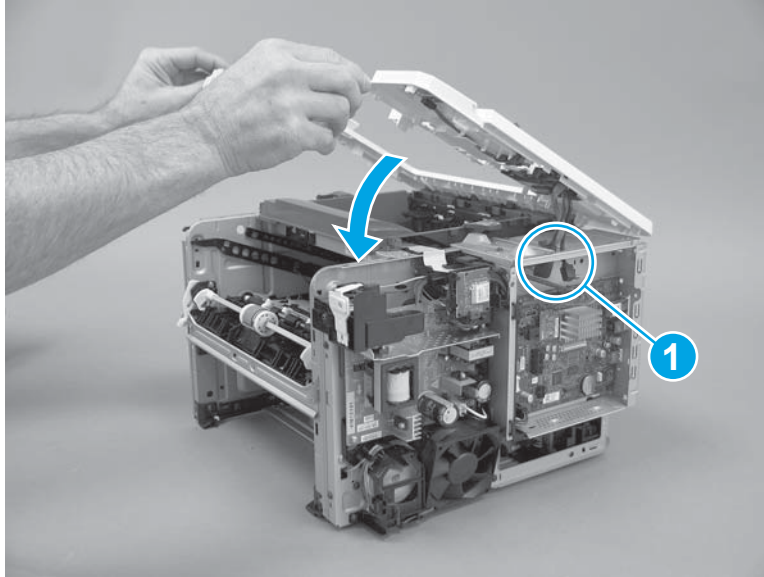
The M506x is shown in this procedure. However, the steps are correct for all M506 models and the M501 printer.

1. Position the rear edge of the cover on the printer, and then rotate the front of the cover down onto the printer.

**CAUTION:** **M506x only:** As the cover is rotated down, carefully pass the cables the hole in the chassis (callout 1).

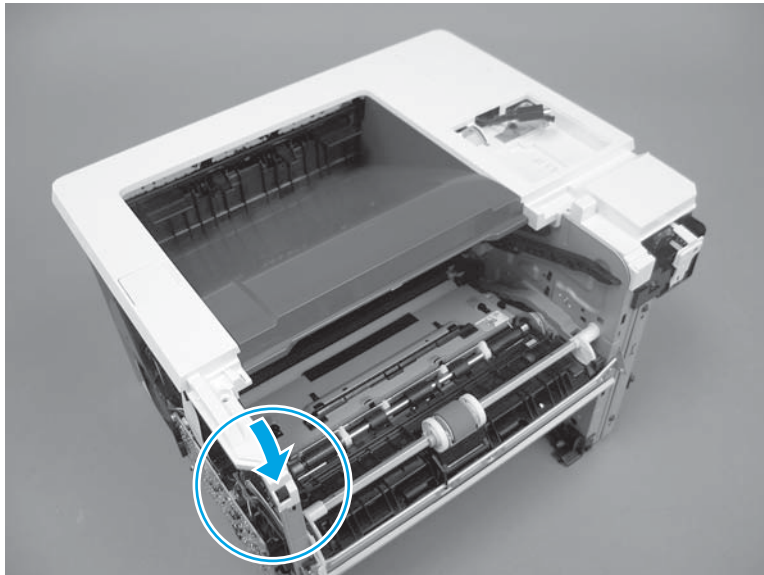
**NOTE:** **LCD control panel models only:** Pass the cables through the opening in the cover, and then connect the control panel after installing the cover.

**Figure 1-1994** Install the cover




2. Engage one boss.

**Figure 1-1995** Engage one boss



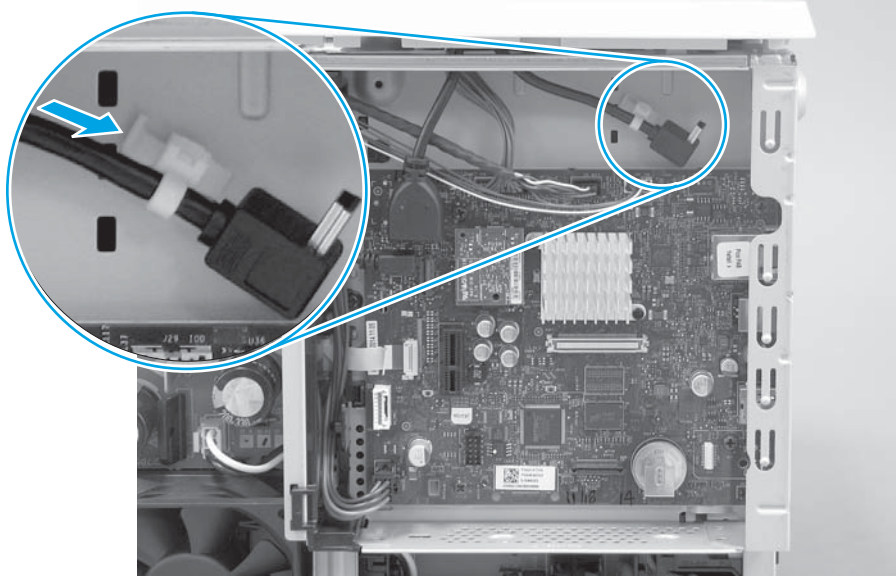
3. **M506 only:** Install one cable retainer on the chassis.

---

 **TIP:** Depress the tab on the retainer to install it.

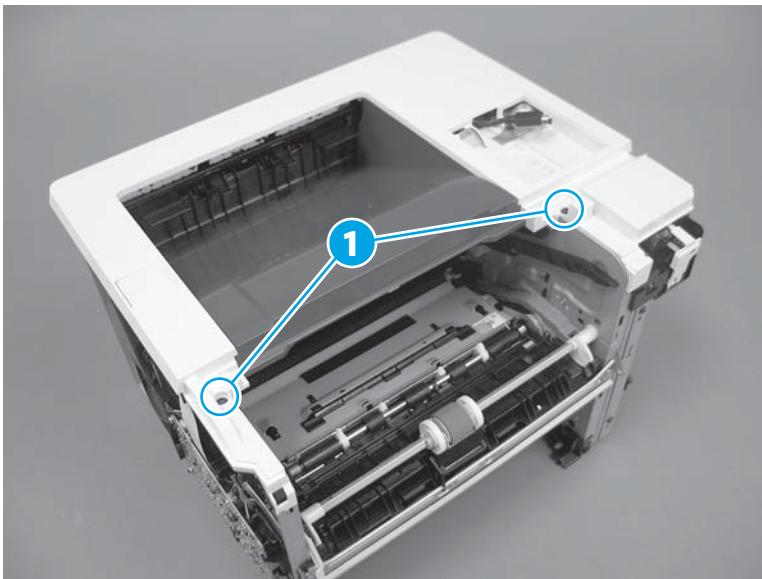
---

**Figure 1-1996** Install one cable retainer




4. Install two screws (callout 1).

**Figure 1-1997** Install two screws



### Step 26: Install the top cover (M527)

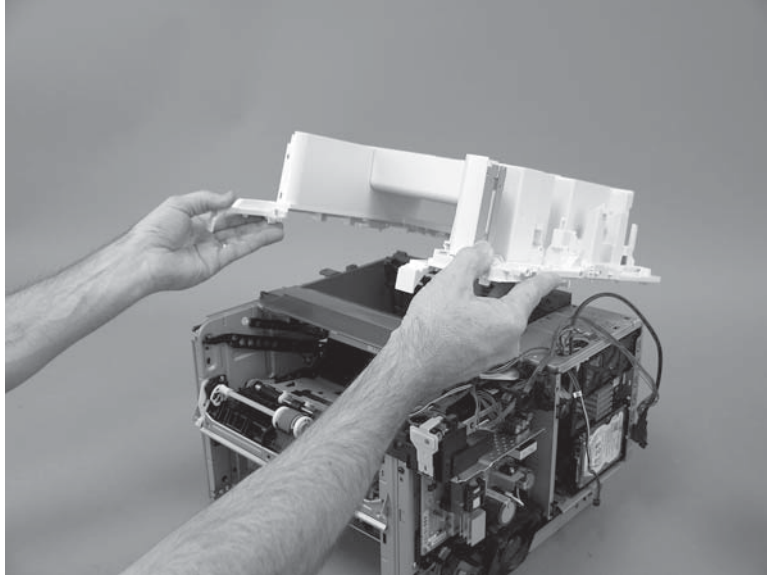
---

 **NOTE:** This step is for the M527 printer. For the M501/M506, skip this step and go to [Step 28: Install the left cover on page 1119](#).

---

1. Position the rear edge of the cover on the chassis.

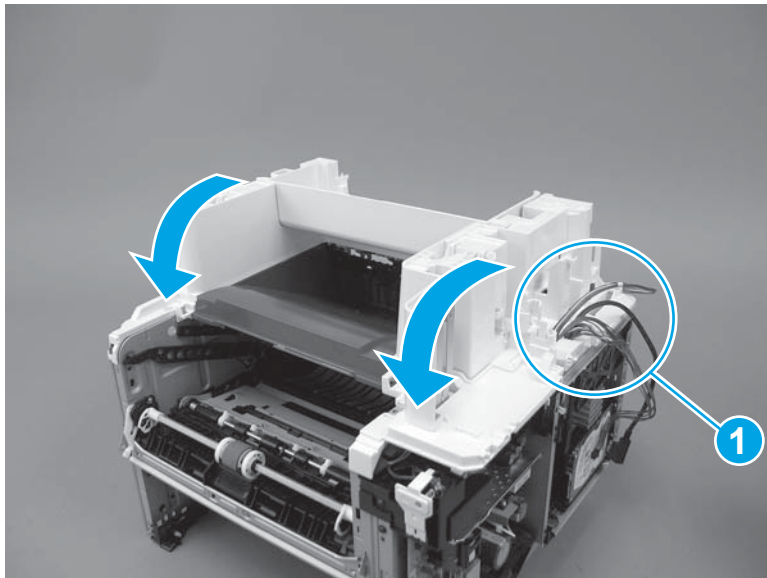
**Figure 1-1998** Install the cover



2. Rotate the front of the cover down onto the printer.

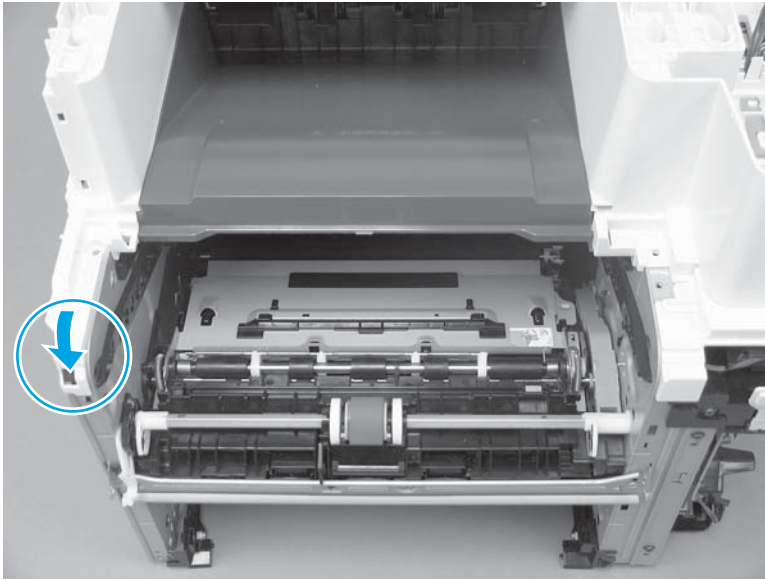
**CAUTION:** As the cover is rotated down, carefully pass the cables and wire harnesses the hole in the cover (callout 1).

**Figure 1-1999** Rotate the front of the cover down



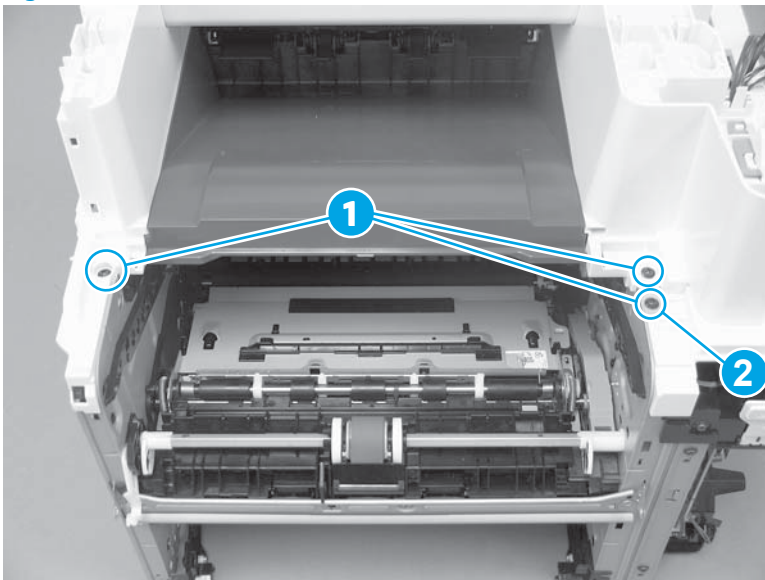
3. At the front left of the printer, engage one boss.

**Figure 1-2000** Engage one boss




4. At the top front of the printer, install three screws (callout 1).

**Figure 1-2001** Install three screws

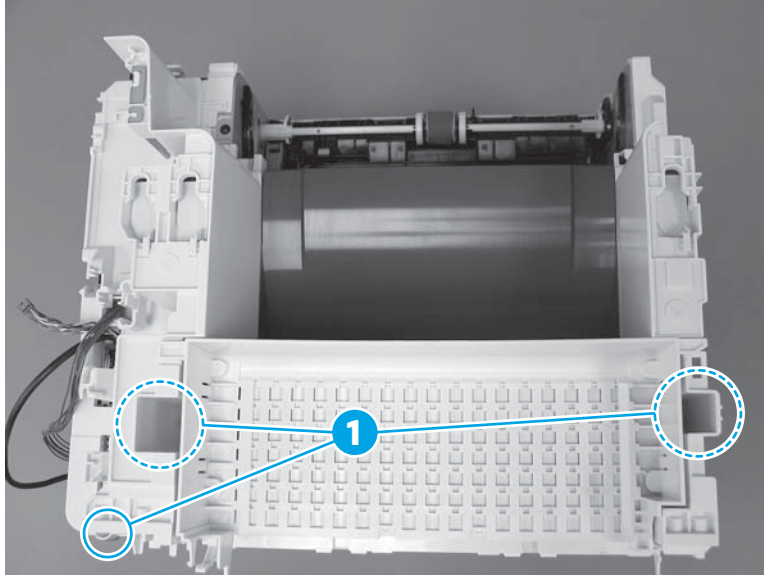




5. At the top rear of the printer, install three screws (callout 1).

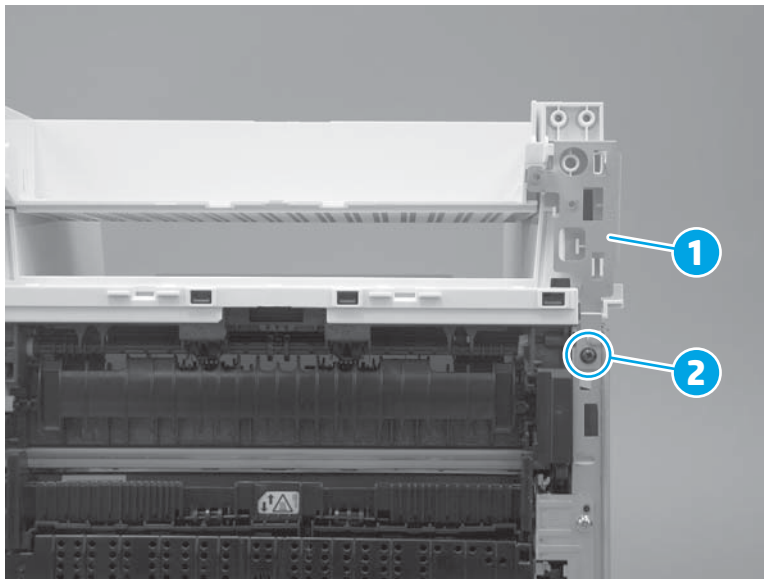
 **NOTE:** The screw (callout 2) on the lower-right portion of the cover is a different color than the other two screws, and is surrounded by sheet-metal. It might appear that this screw does not need to be removed. Remove this screw.

**Figure 1-2002** Install three screws





6. At the front right of the printer, install the sheet-metal plate (callout 1), and then install one screw (callout 2).

**Figure 1-2003** Install one screw and the plate




### Step 27: Install the integrated scanner assembly (M527)

 **IMPORTANT:** Some figure might show assemblies removed or installed that have not yet been removed or installed at that specific step. However, the procedures are correct for this printer and the target assembly. Always thoroughly read the instructions that accompany each figure

 **NOTE:** This step is for the M527 printer. For the M501/M506, skip this step and go to [Step 28: Install the left cover on page 1119](#).

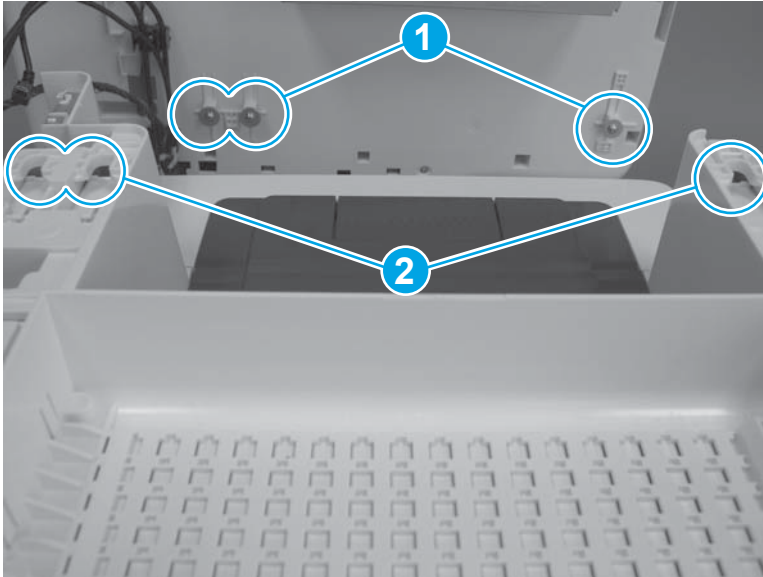
---

 **NOTE:** The ISA includes the document feeder, sub-scanner assembly (SSA), and the scanner control board (SCB)


---

1. Before proceeding, locate the ISA mounting pins (callout 1) on the bottom of the ISA and the slots (callout 2) on the printer base.

**Figure 1-2004** Locate the ISA mounting pins and slots

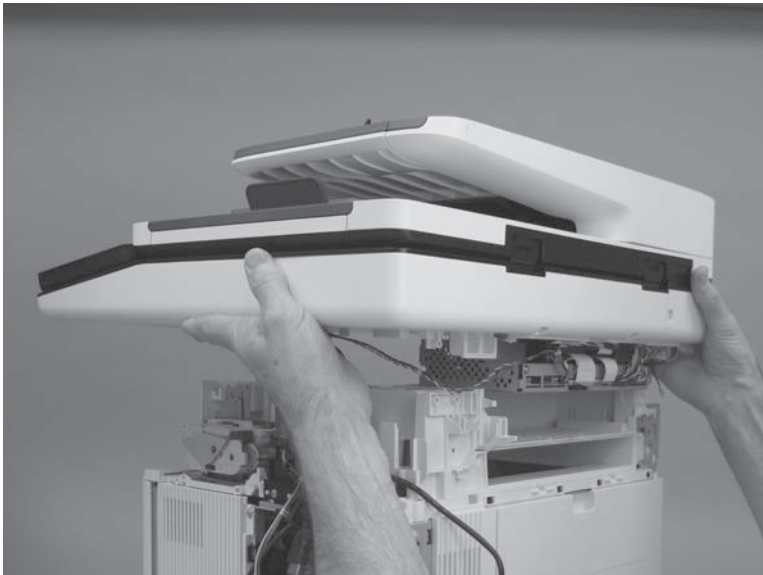


2. Position the ISA on the printer base with the pins in the slots.

 **NOTE:** To locate the pins and slots, see the previous step.

---

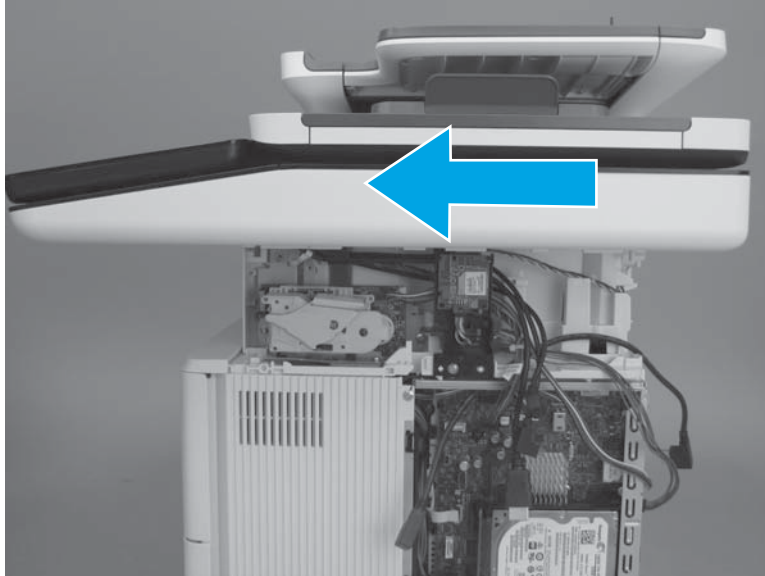
**Figure 1-2005** Install the ISA



3. Slightly slide the ISA towards the front of the printer to engage it.

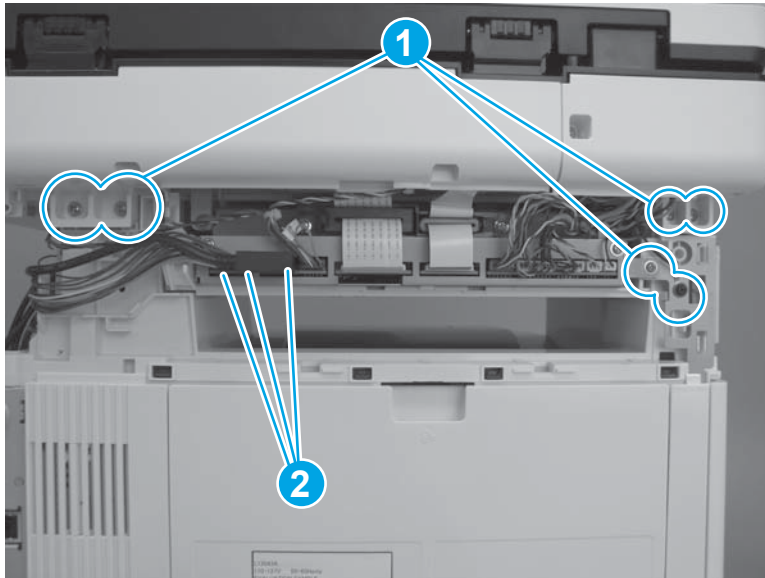
**⚠ CAUTION:** Make sure that none of the wire harnesses or cables are caught underneath the assembly when installing it.

**Figure 1-2006** Slide the ISA towards the front of the printer




4. Install six screws (callout 1), and then connect three connectors (callout 2).

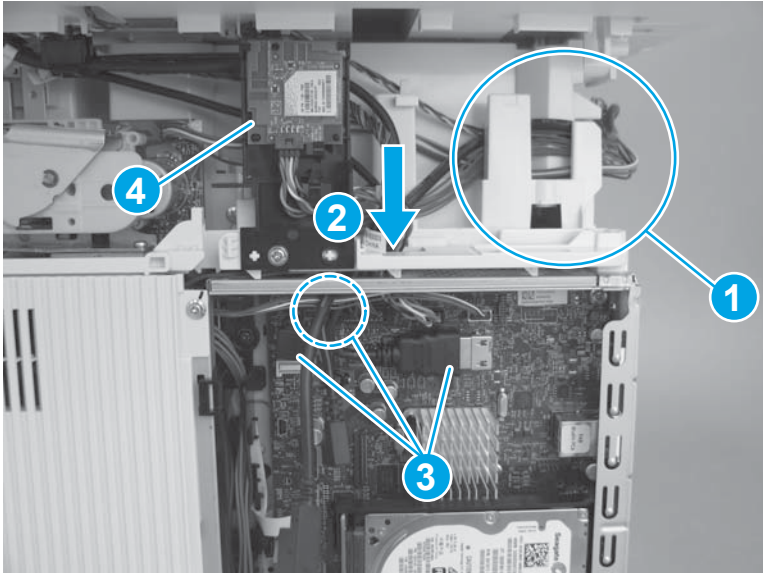
**Figure 1-2007** Install screws and connect connectors



5. Install the wire harnesses and cables in the retainers (callout 1), pass them through the opening in the cover (callout 2), and then connect three connectors (callout 3).

 **TIP:** If the WiFi PCA and holder (callout 4) was detached from the printer and then moved out of the way, reinstall it now.

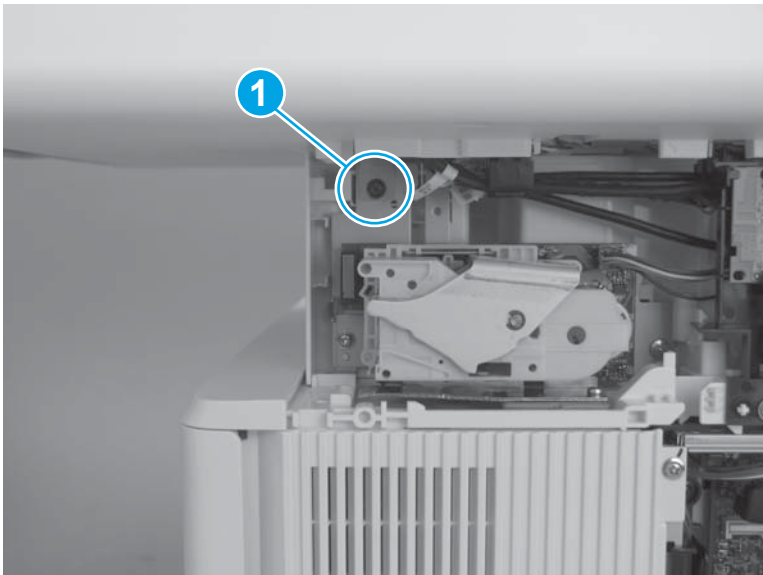
**Figure 1-2008** Connect cables and connectors




6. Install one screw (callout 1).


 **IMPORTANT:** This screw fastens the ISA ground plate to the printer chassis. This screw must be installed.

**Figure 1-2009** Install one screw



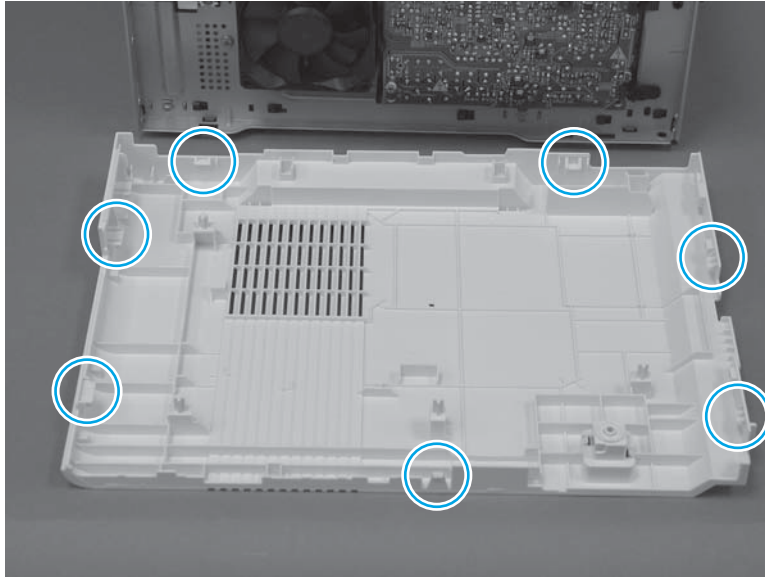
## Step 28: Install the left cover

 **IMPORTANT:** The black-plastic cassette front and rear guides (located inside the tray cavity) can be easily dislodged. Do not lose the guides when the cover is removed or installed.

 **NOTE:** The M527 printer is shown in this procedure. However, this procedure is valid for the M501/M506 printers.

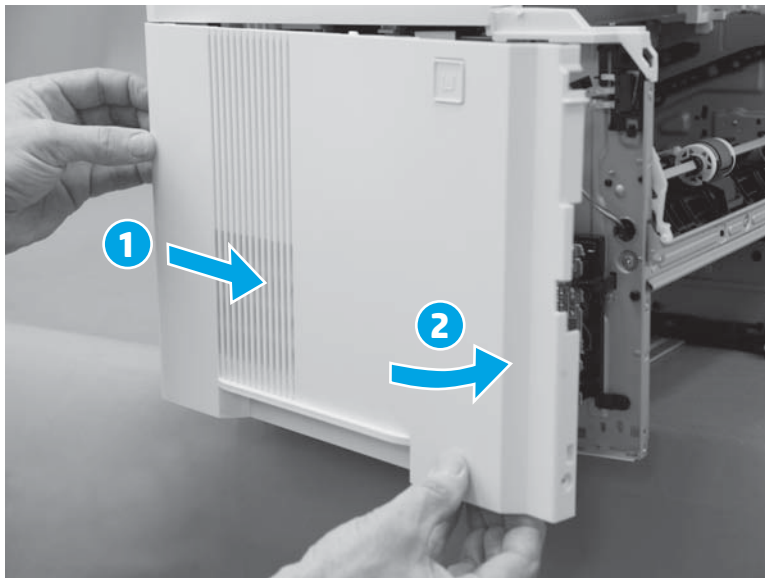
1. Before proceeding, take note of the location of the tabs and bosses on the inside of the cover.

**Figure 1-2010** Locate of the tabs and bosses



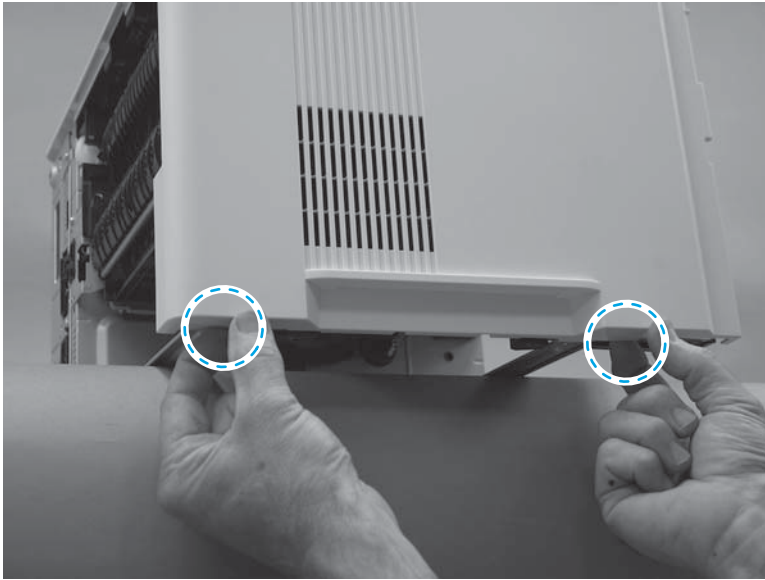
2. Engage the rear edge of the cover (callout 1), and then rotate the rear edge of the cover toward the printer (callout 2).

**Figure 1-2011** Install the cover



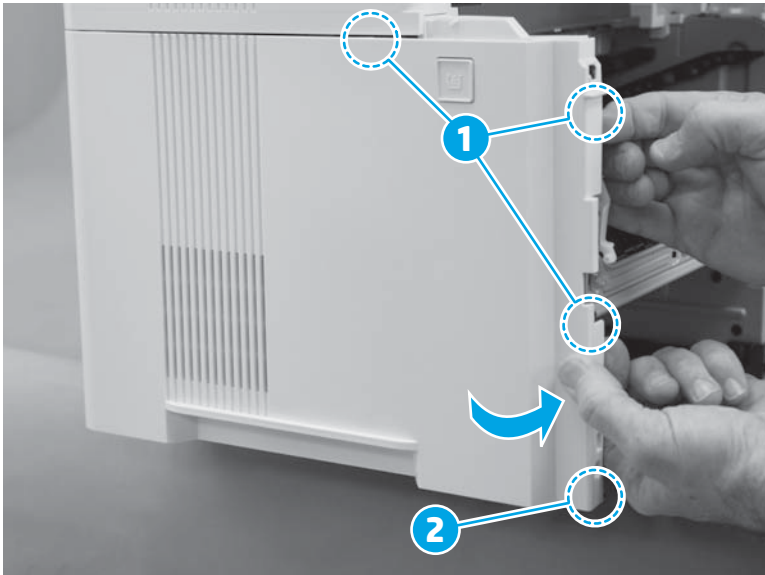
3. At the bottom edge of the cover, engage two tabs.

**Figure 1-2012** Engage two tabs



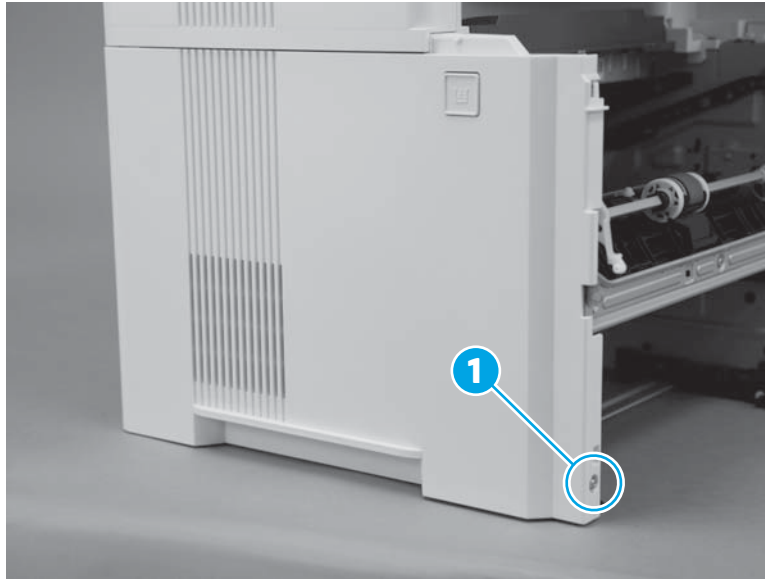
4. At the front of the printer, engage three tabs (callout 1), and then continue to rotate the front edge of the cover toward the printer to engage one boss (callout 2).

**Figure 1-2013** Engage three tabs and one boss





5. Install one screw (callout 1).

**Figure 1-2014** Install one screw



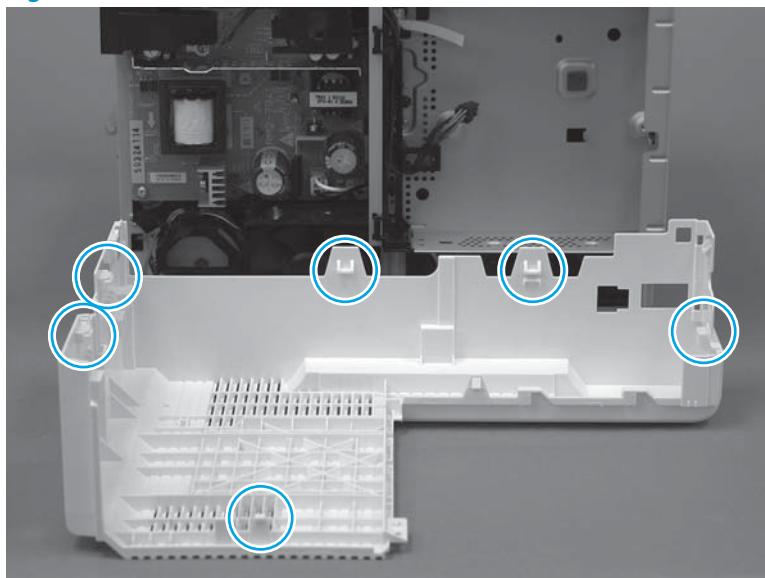
### Step 29: Install the right cover

 **IMPORTANT:** The black-plastic cassette front and rear guides (located inside the tray cavity) can be easily dislodged. Do not lose the guides when the cover is removed or installed.

 **NOTE:** The M527 printer is shown in this procedure. However, this procedure is valid for the M501/M506 printers.

1. Before proceeding, take note of the location of the tabs and bosses on the inside of the cover.

**Figure 1-2015** Locate the tabs and bosses

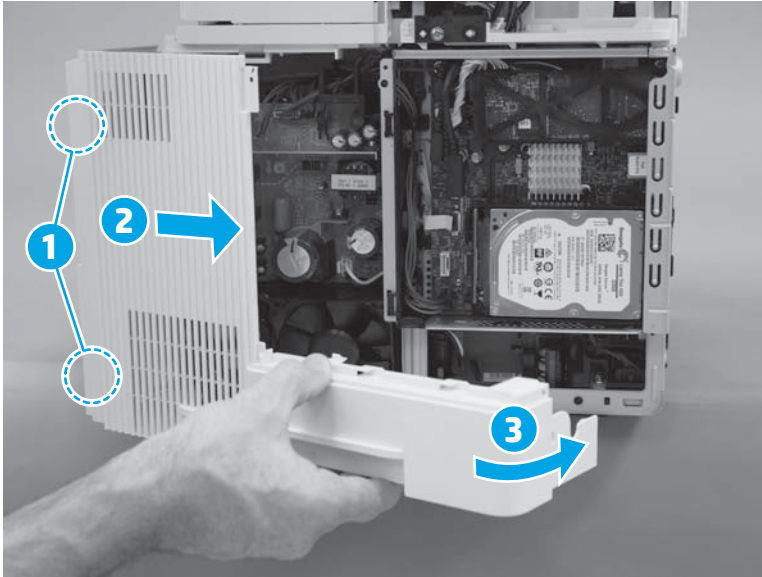


2. At the front of the cover engage two bosses (callout 1/2), and then rotate the rear of the cover toward the printer (callout 3).

**CAUTION:** It might be easier to install the cover with the printer slightly hanging over the edge of the workspace. Do not let the printer tip and fall off the workspace when removing the cover.

**TIP:** Make sure that the power switch at the front of the printer is positioned in the opening in the cover and that it does not interfere with the cover installation.

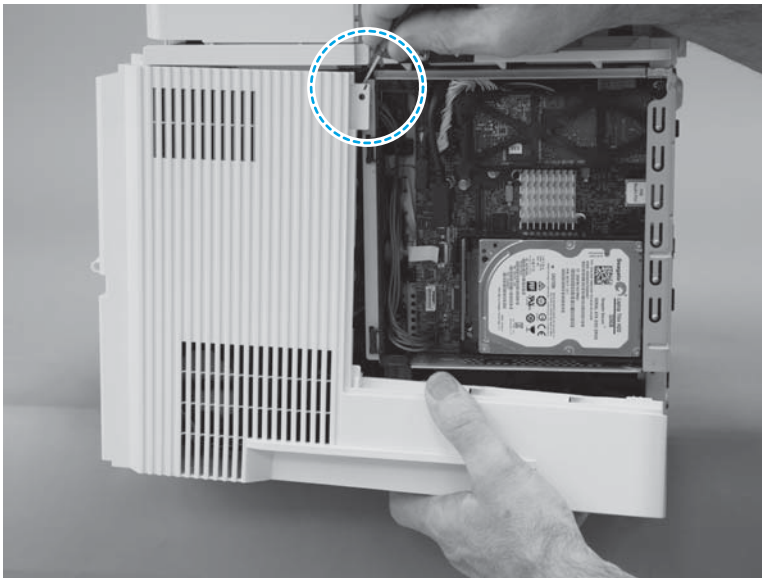
**Figure 1-2016** Install the cover



3. At the top rear edge of the cover, engage one tab.

**CAUTION:** It might be easier to install the cover with the printer slightly hanging over the edge of the workspace. Do not let the printer tip and fall off the workspace when removing the cover.

**Figure 1-2017** Engage one tab

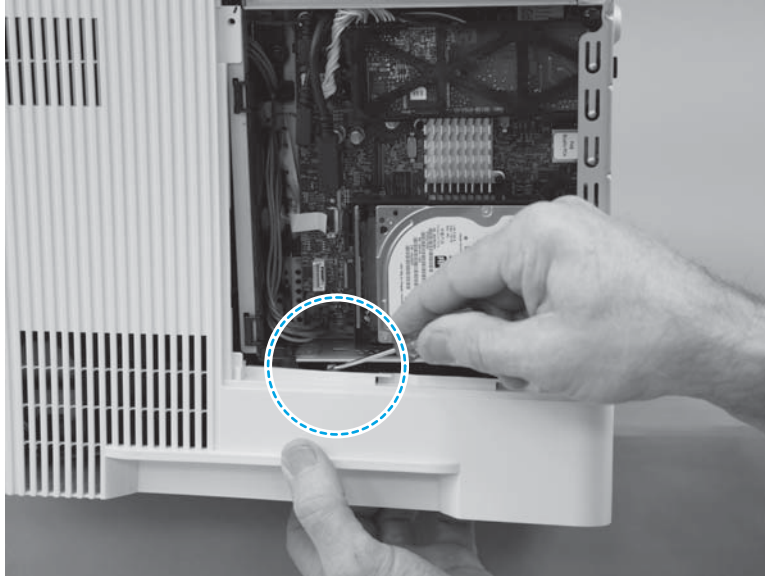




4. Near the formatter, engage one tab.

**CAUTION:** It might be easier to install the cover with the printer slightly hanging over the edge of the workspace. Do not let the printer tip and fall off of the workspace when removing the cover.

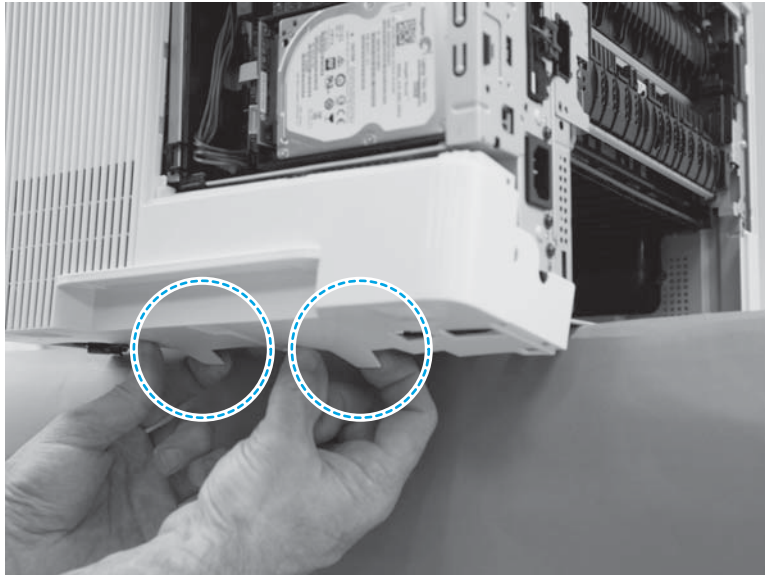
**Figure 1-2018** Engage one tab



5. At the bottom edge of the cover, engage two bosses.

**CAUTION:** It might be easier to install the cover with the printer slightly hanging over the edge of the workspace. Do not let the printer tip and fall off of the workspace when removing the cover.

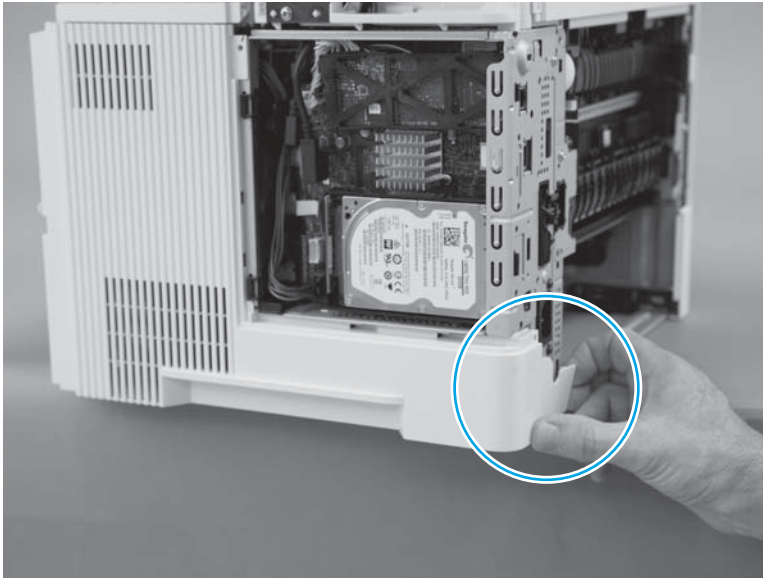
**Figure 1-2019** Engage two bosses



6. At the rear of the printer, engage one boss.

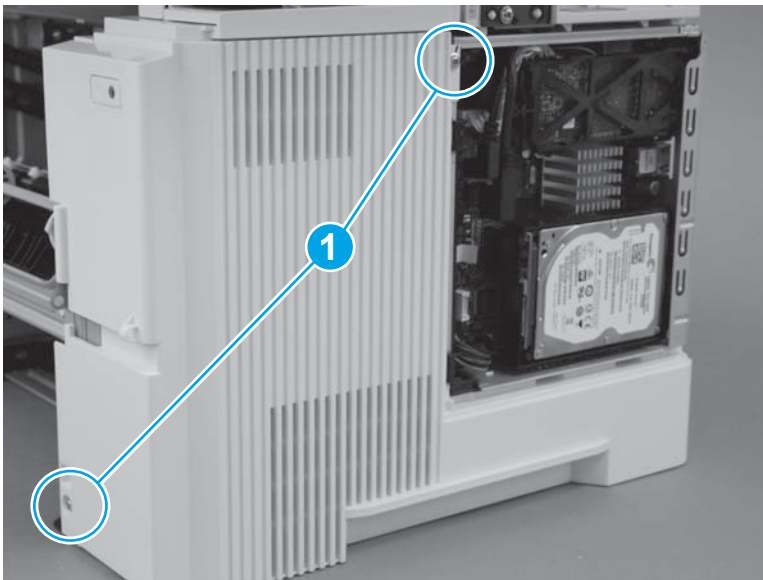
**⚠ CAUTION:** It might be easier to install the cover with the printer slightly hanging over the edge of the workspace. Do not let the printer tip and fall off of the workspace when removing the cover.

**Figure 1-2020** Engage one boss



7. Install two screws (callout 1).

**Figure 1-2021** Install two screws

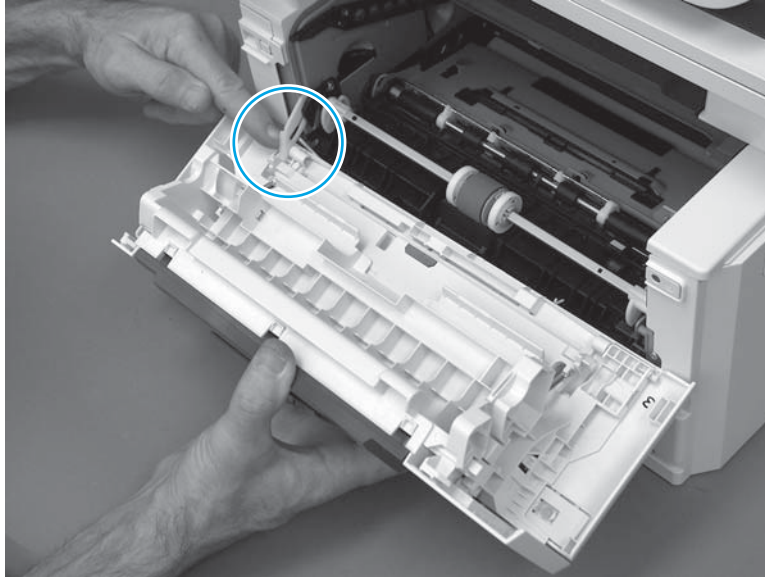


### Step 30: Install the cartridge door assembly

1. Position the door close to the printer, and then engage the keyed pin on the left-side retainer arm with the hole in the door.


**💡 TIP:** It might be easier to engage the keyed pin with the hole by using a small flat-blade screwdriver.


**Figure 1-2022** Engage the left-side retainer arm



2. Engage the right-side door hinge pin with the hole in the chassis (callout 1).

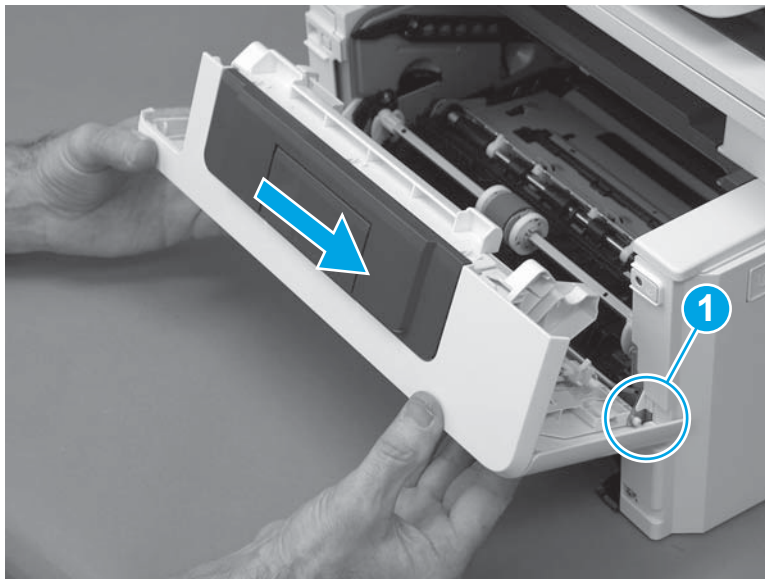
---

 **NOTE:** There are two right-side hinge pins (not shown in callout 1).


 **TIP:** Keep a finger pressed on the left-side retainer arm so that it does not disengage from the door.

---

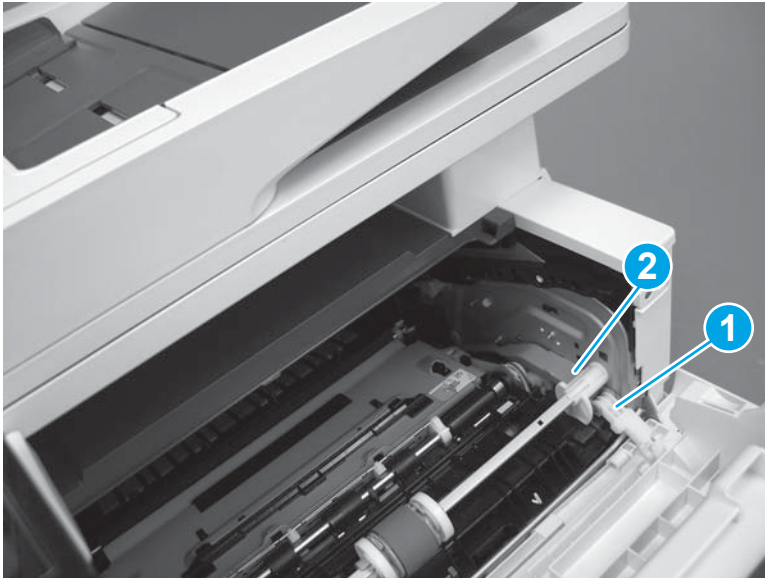
**Figure 1-2023** Install the door



3. Install the gray-plastic pressure-release link (callout 1) onto the white-plastic door arm (callout 2).

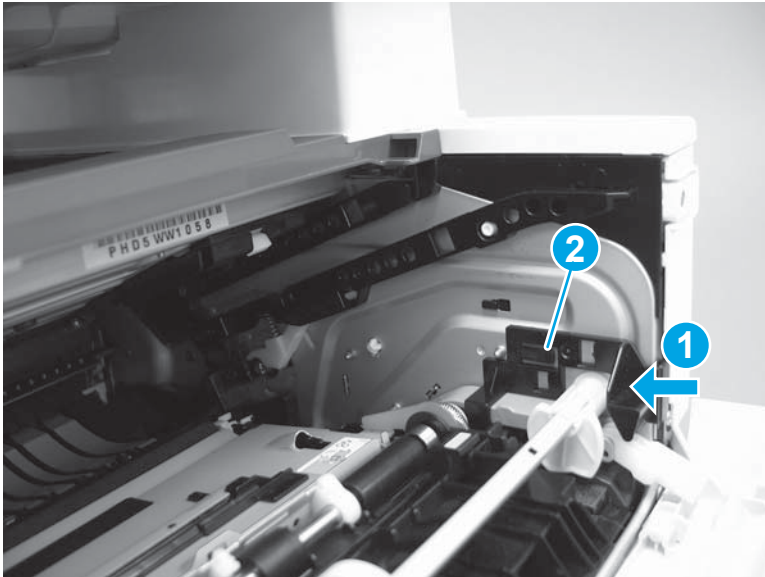
 **IMPORTANT:** Make sure that the arm snaps on to the link. Partially close and open the door to verify that the link (callout 2) moves in and out of the printer as the door closes/opens.

**Figure 1-2024** Install the pressure-release link



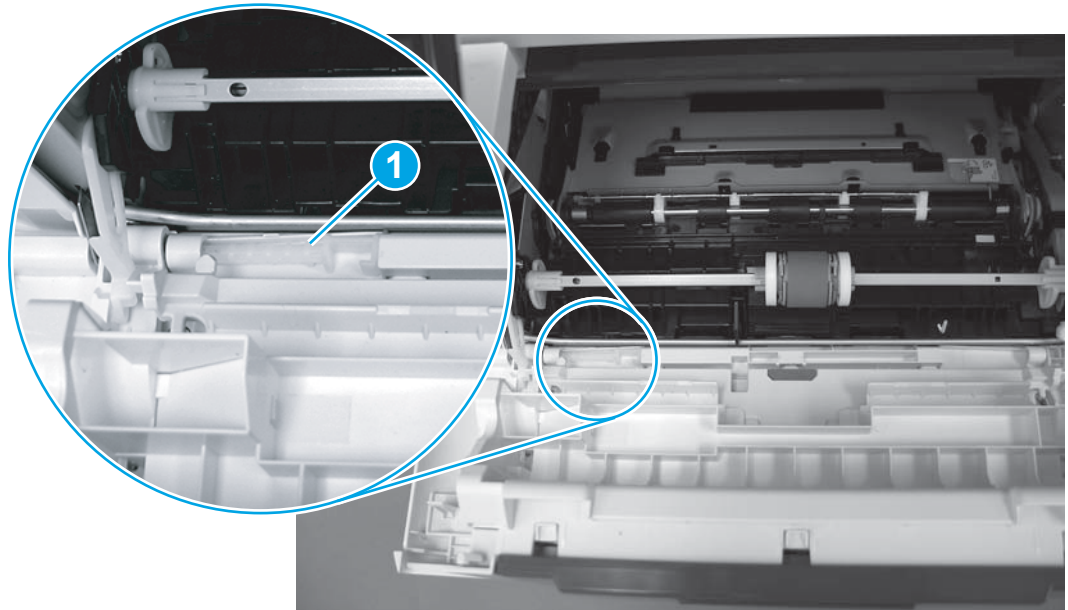
4. Slide the guide into the printer (callout 1), and then make sure that the tab (callout 2) snaps into place to secure the guide to the chassis.

**Figure 1-2025** Install the guide





5. Position the support shaft on the door, and then align the left-side hinge on the door with the hole in the chassis (callout 1).

**Figure 1-2026** Align the hinge

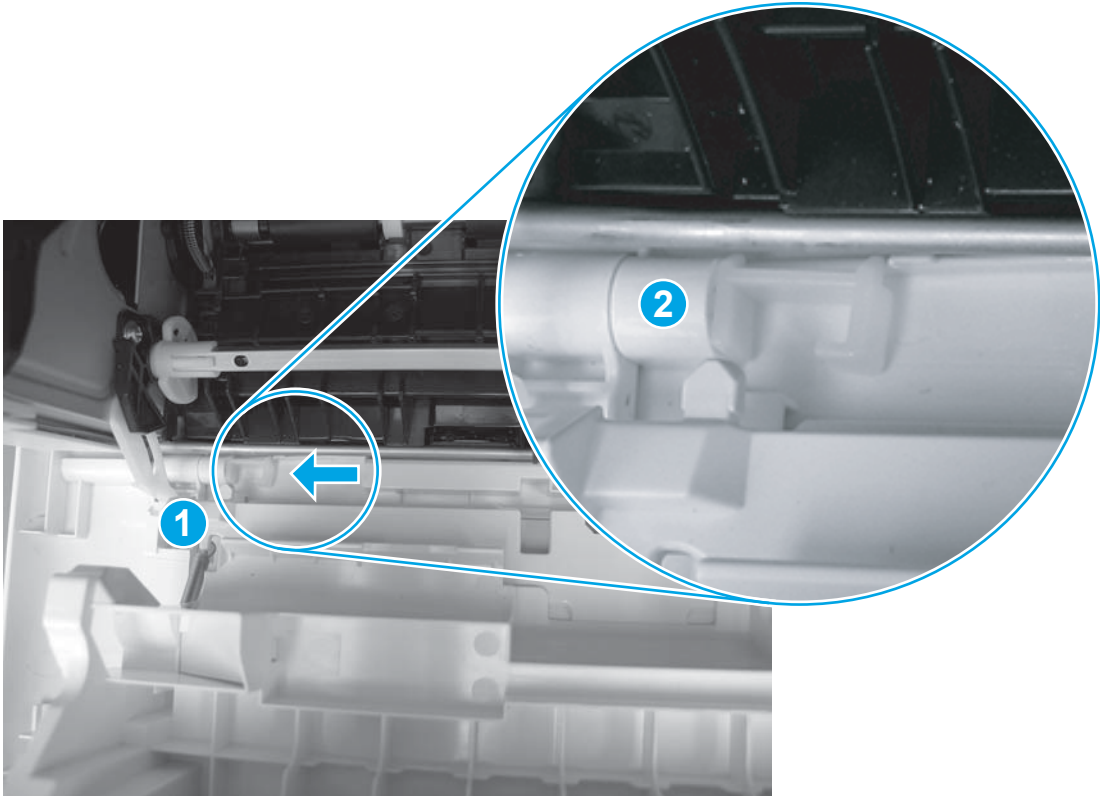


6. Push the shaft towards the left side of the printer to install it (callout 1).

 **NOTE:** Make sure that the support shaft is fully installed and correctly orientated (callout 2) so that it will not interfere with the door opening and closing.

 **Reinstallation tip:** If a replacement door was installed, make sure to install the nameplate (supplied in the kit) corresponding to the printer on the door.

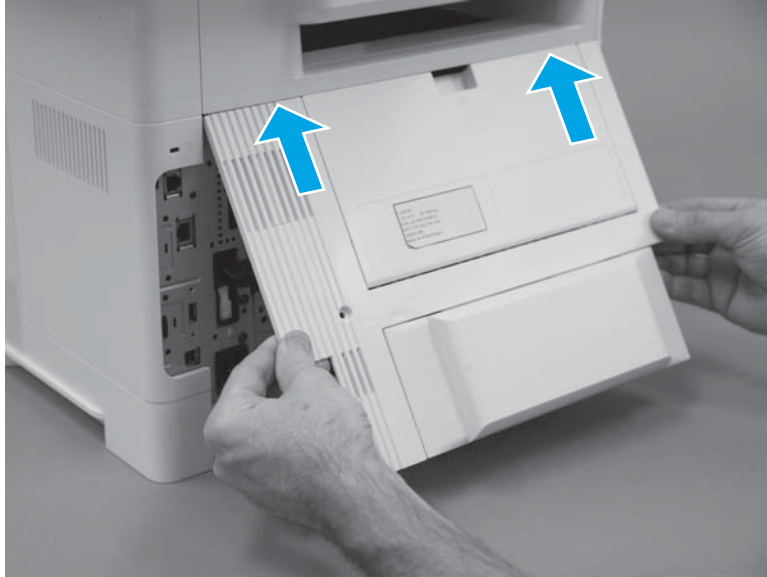
**Figure 1-2027** Install the support shaft



### Step 31: Install the rear door assembly

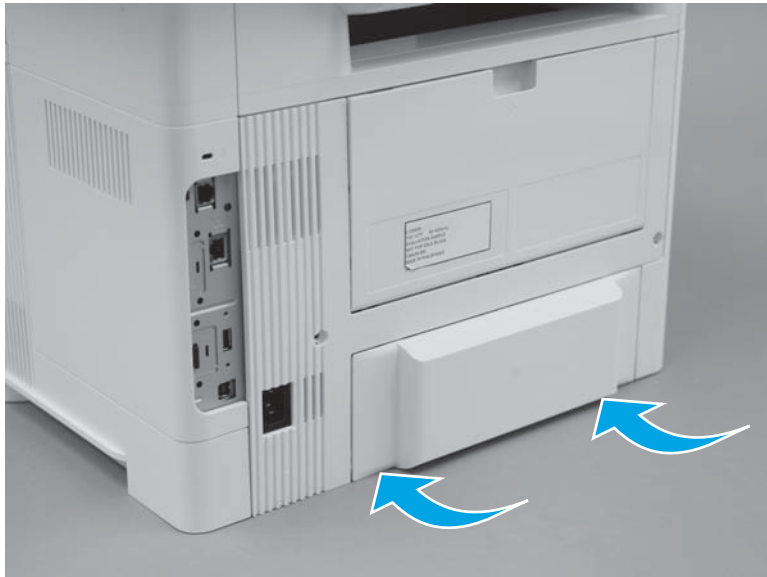
1. Engage the top edge of the assembly with the printer.

**Figure 1-2028** Install the cover



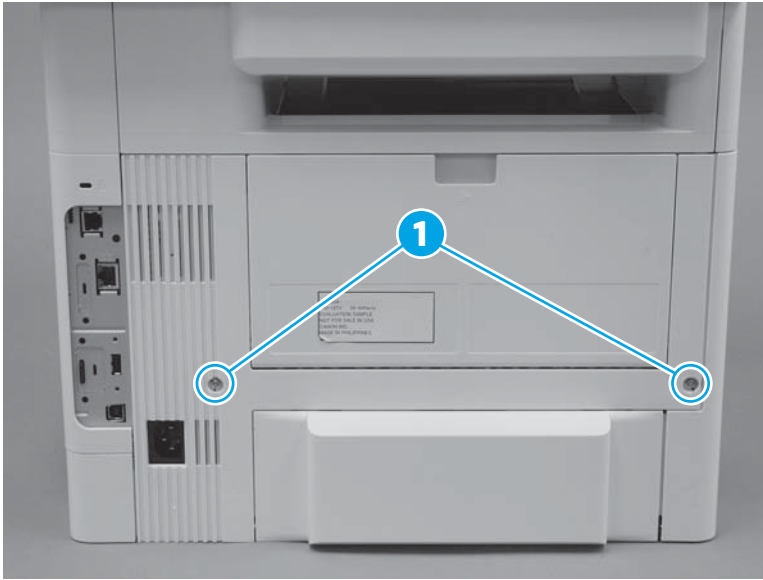
2. Rotate the bottom edge of the cover towards the printer.

**Figure 1-2029** Rotate the bottom of the cover



3. Install two screws (callout 1).

**Figure 1-2030** Install two screws



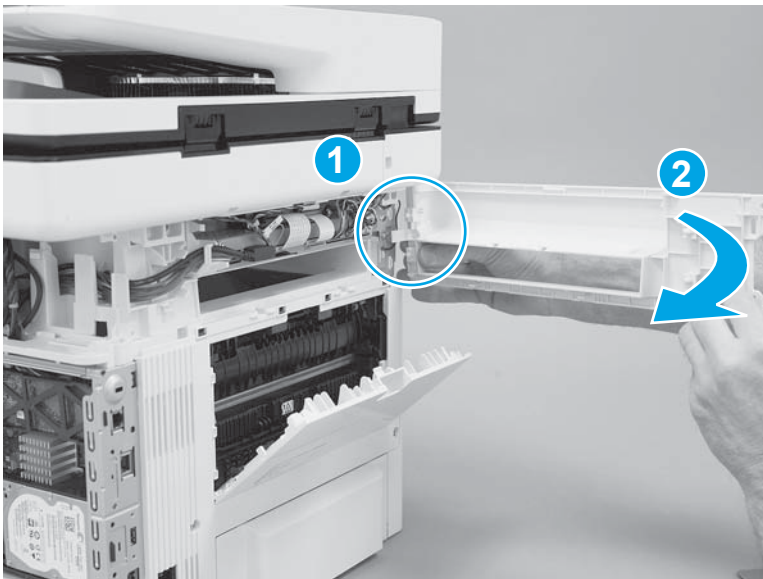
### Step 32: Install the top-rear cover (M527)



**NOTE:** This step is for the M527 printer. For the M501/M506, skip this step and go to [Step 36: Install the formatter on page 1137](#).

1. Engage one boss (callout 1), and then rotate the cover towards the printer (callout 2).

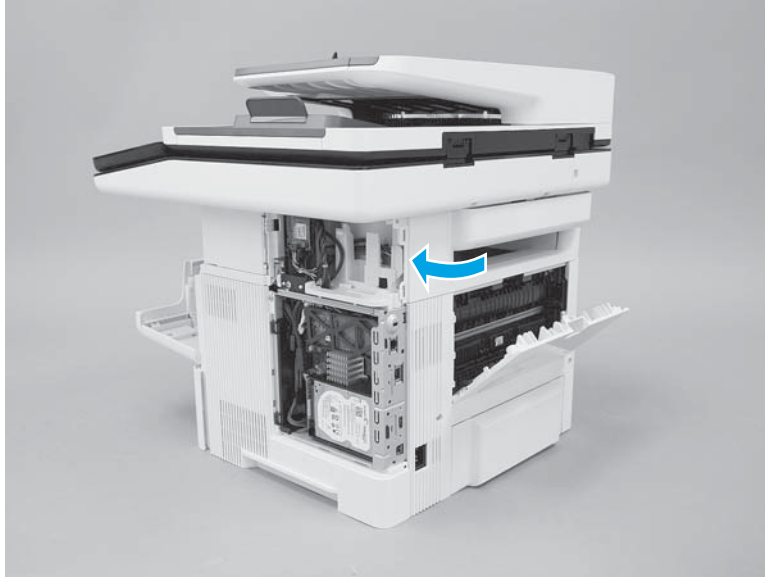
**Figure 1-2031** Engage one boss





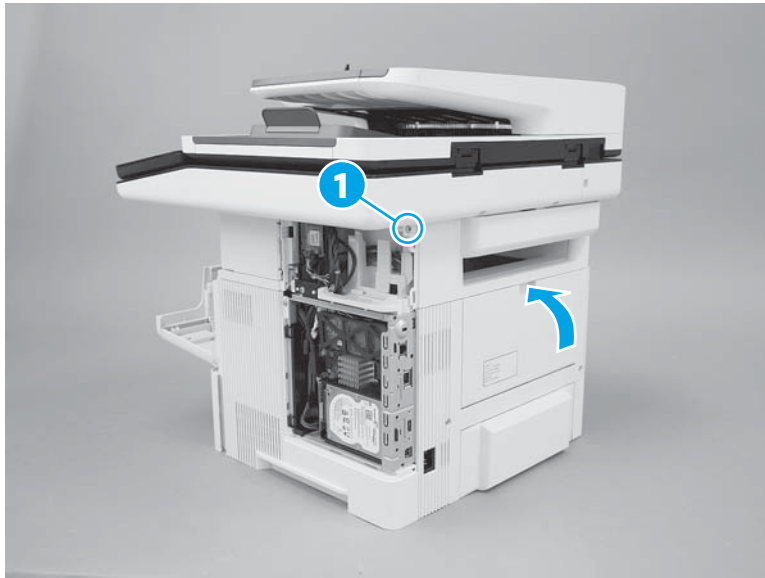
2. Continue to rotate the cover toward the printer to install it.

**Figure 1-2032** Install the cover




3. Install one screw (callout 1), and then close the rear door.

**Figure 1-2033** Install one screw



### Step 33: Install the top-left cover (M527)

 **NOTE:** This step is for the M527 printer. For the M501/M506, skip this step and go to [Step 36: Install the formatter on page 1137](#).

1. Position the front edge of the cover on the printer, and then slide the cover toward the front of the printer to engage two bosses at the front of the cover.

**Figure 1-2034** Slide the cover




2. Rotate the cover towards the printer to engage two tabs at the middle of the cover.

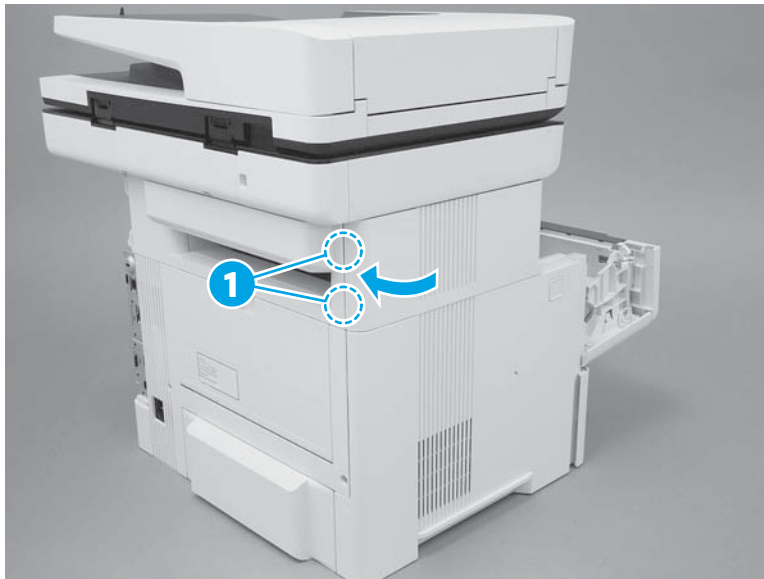
**Figure 1-2035** Engage two tabs




3. Continue to rotate the cover onto the printer to engage two tabs (callout 1) at the rear edge of the cover.


 **NOTE:** Close the toner-cartridge door.

**Figure 1-2036** Engage two tabs



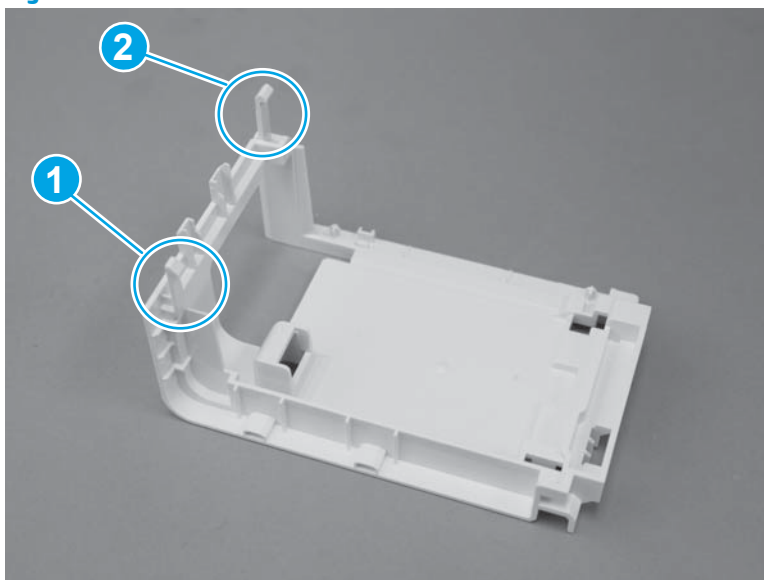
#### Step 34: Install the stapler stationary (inner) cover (M527)

 **NOTE:** This step is for the M527c/f/z printers. For the M501/M506, skip this step and go to [Step 36: Install the formatter on page 1137](#). For the M527dn, skip this step and go to [Step 35: Install the stapler door or stapler blank cover \(M527\) on page 1135](#).

 **NOTE:** M527c/f/z printers only.

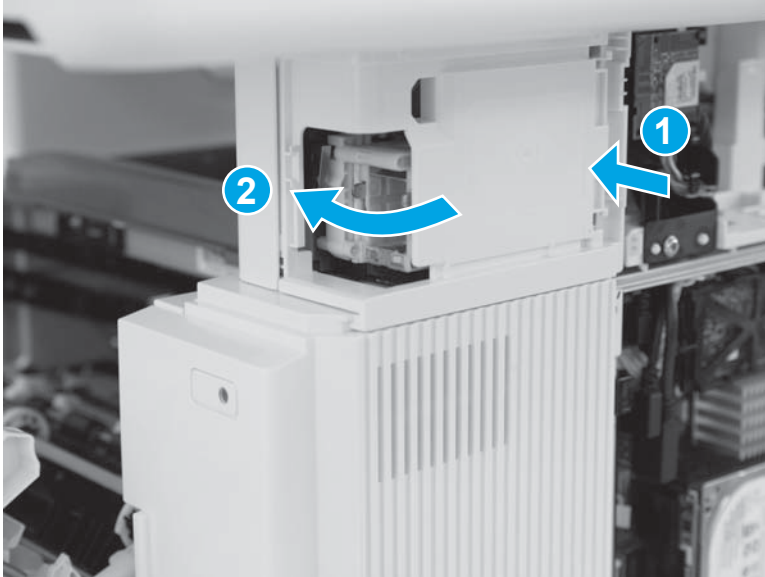
1. Before proceeding, take note of the locations of the upper tab (callout 1) and the lower tab (callout 2) on the stapler stationary (inner) cover.

**Figure 1-2037** Locate the tabs



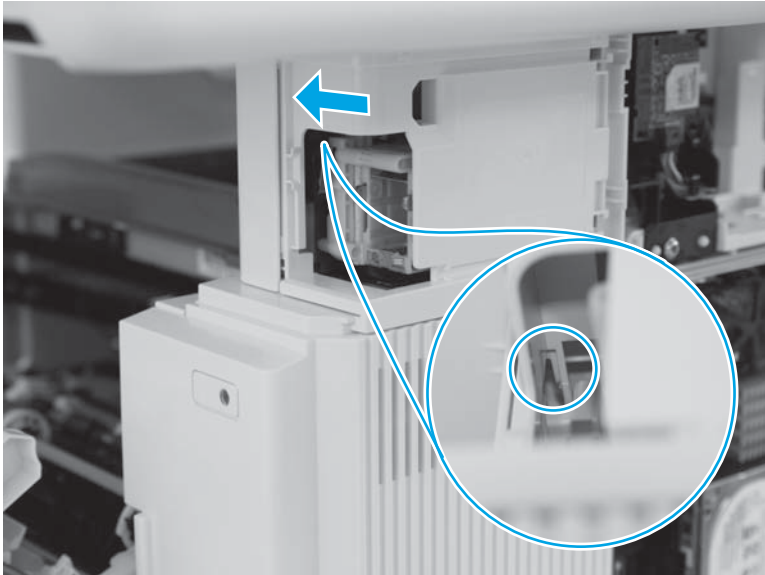
- Engage the rear edge of the cover with the printer (callout 1), and then rotate the front edge of the cover onto the printer (callout 2) to engage the two tabs.

**Figure 1-2038** Install the cover



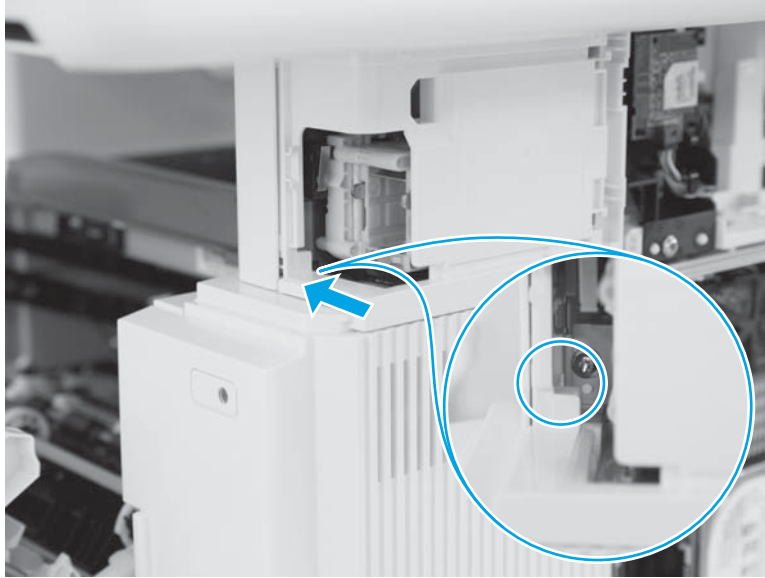
- Verify that the upper tab is engaged.

**Figure 1-2039** Engage one tab




4. Verify that the lower tab is engaged.

**Figure 1-2040** Engage one tab



### Step 35: Install the stapler door or stapler blank cover (M527)

 **NOTE:** This step is for the M527 printer. For the M501/M506, skip this step and go to [Step 39: Install the formatter cover on page 1141](#).

 **NOTE:** The M527dn does not have a convenience stapler.

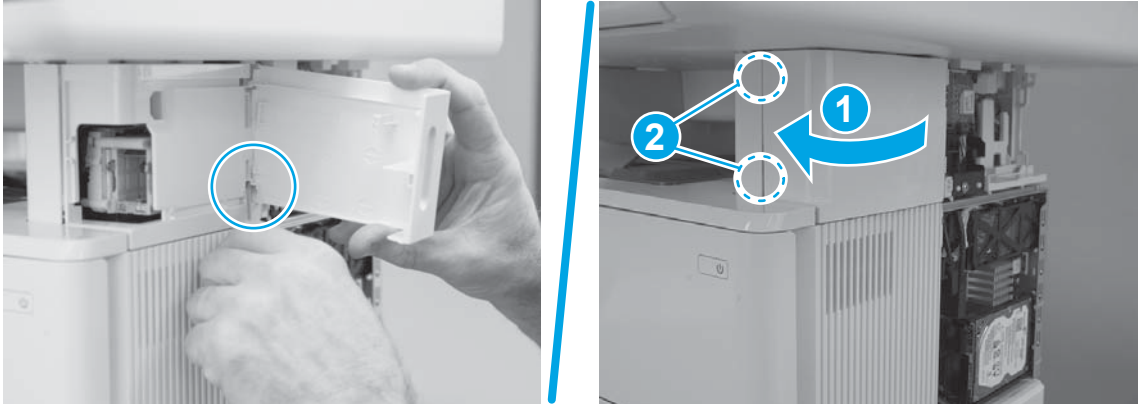
1. Do one of the following:
  - **M527c/f/z:** Position the door near the printer.
  - **M527dn:** Position the cover on the printer.

**Figure 1-2041** Install the door or cover



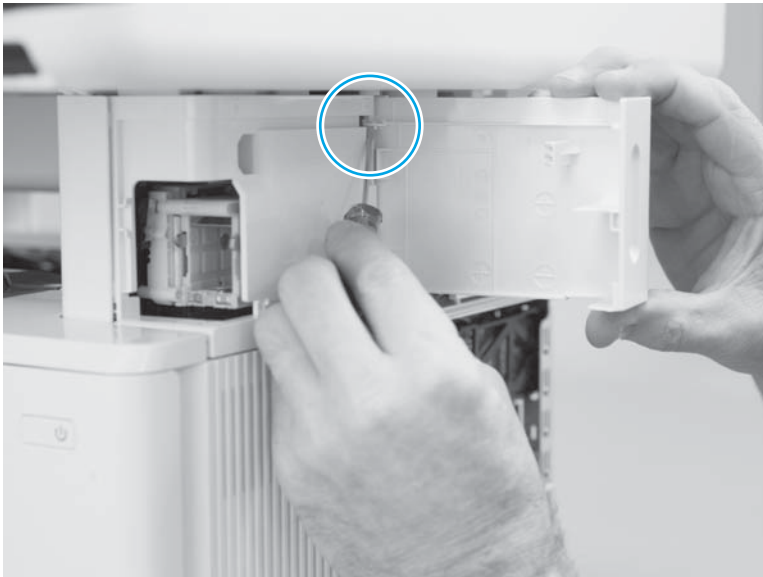
2.
  - **M527c/f/z:** Engage the lower hinge.
  - **M527dn:** Rotate the cover towards the printer (callout 1), and then make sure that the two tabs (callout 2) snap into place to install the cover.

**Figure 1-2042** Engage the lower hinge or engage the cover



- 3. **M527c/f/z:** Engage the upper hinge.

**Figure 1-2043** Engage the upper hinge



4. **M527c/f/z:** Close the stapler door.

**Figure 1-2044** Close the door

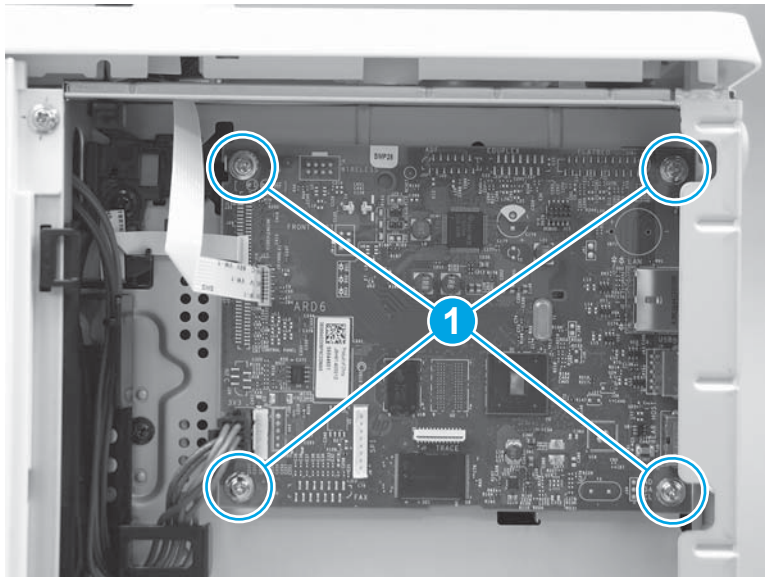


### Step 36: Install the formatter


**IMPORTANT:** **M506/M527:** Take note of all empty connectors on the PCA before disconnecting any wire harnesses or flat-flexible cables (FFCs). Some empty connectors might not be visible until other items—like the hard-disk drive—are removed, so pay close attention while removing the formatter and accessory items.

1. **M501:** Position the formatter on the chassis, install four screws (callout 1), and then connect all of the connectors and FFCs.

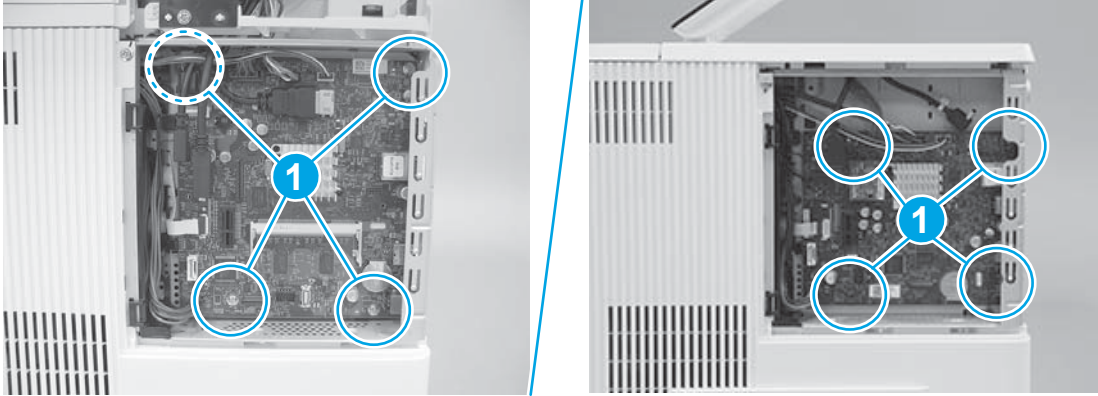
**Figure 1-2045** Install the formatter (M501)




2. **M506/M527:** Position the formatter on the chassis, install four screws (callout 1), and then connect all of the connectors and FFCs.

 **IMPORTANT:** Some connectors might need be empty if other items—for example a fax PCA—will be installed later.


**Figure 1-2046** Install the formatter (M506/M527)



### Step 37: Install the fax PCA (M527)

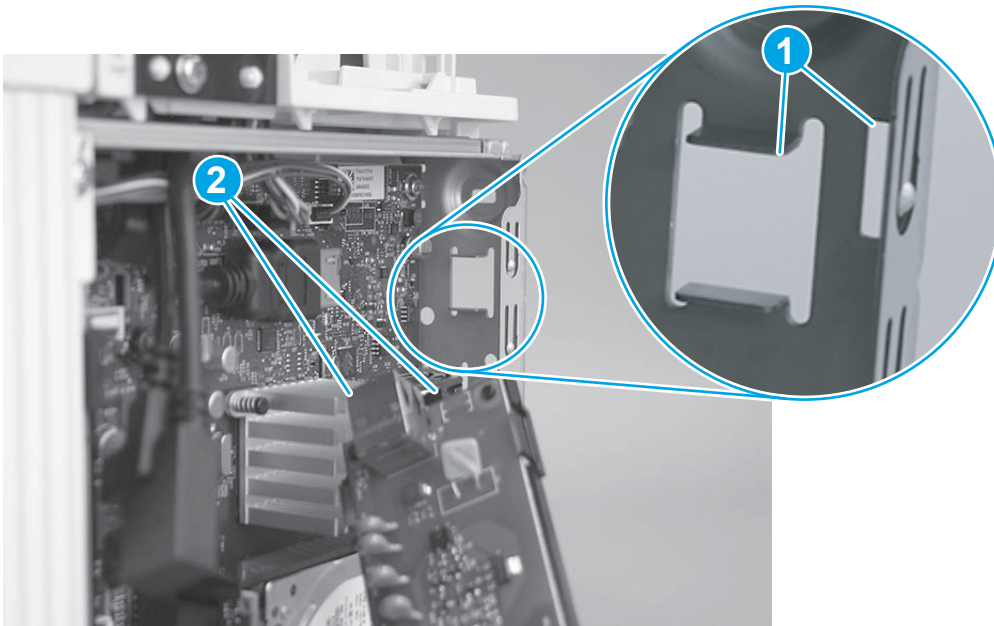
 **NOTE:** If the fax PCA is not installed, skip this step and go to [Step 38: Install the hard-disk drive \(HDD\)](#) on page 1140.

 **CAUTION:**  ESD-sensitive part.

 **NOTE:** M527c/f/z printers only (optional for the M527dn).

1. Before proceeding, take note of the location of the slots (callout 1) in the sheet-metal where the fax PCA cradle mounting tab and fax port (callout 2) must be installed.

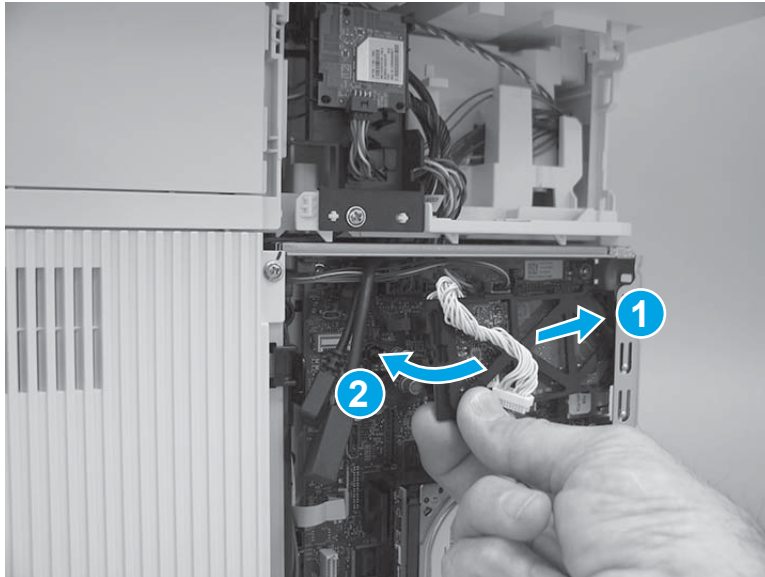
**Figure 1-2047** Locate the slots in the sheet-metal





2. Insert the fax PCA cradle mounting tab and fax port in the slots in the sheet-metal plate (callout 1), and then rotate the connector end of the fax PCA toward the formatter (callout 2).

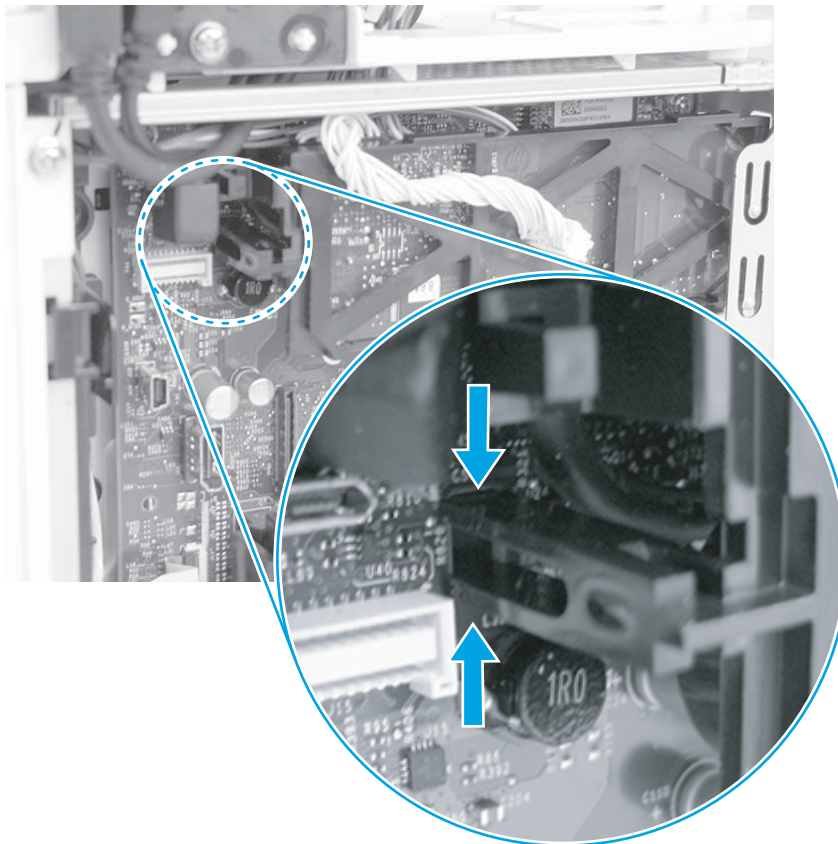
**Figure 1-2048** Install the fax PCA



3. Engage the retainer with the slot in the formatter.

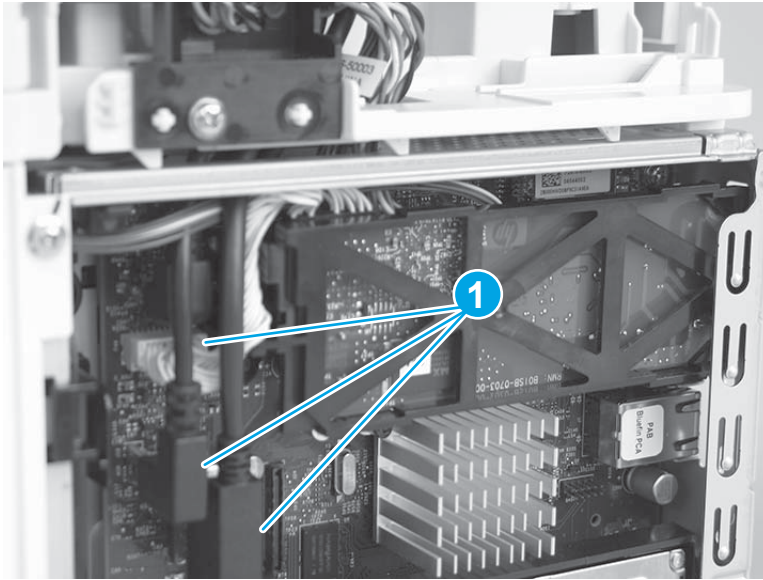
 **Reinstallation tip:** Pinch the retainer to easily engage it with the slot.

**Figure 1-2049** Engage the fax PCA



4. Connect three connectors (callout 1).

**Figure 1-2050** Connect three connectors



### Step 38: Install the hard-disk drive (HDD)



**NOTE:** If the HDD is not installed, skip this step and go to [Step 39: Install the formatter cover on page 1141](#).



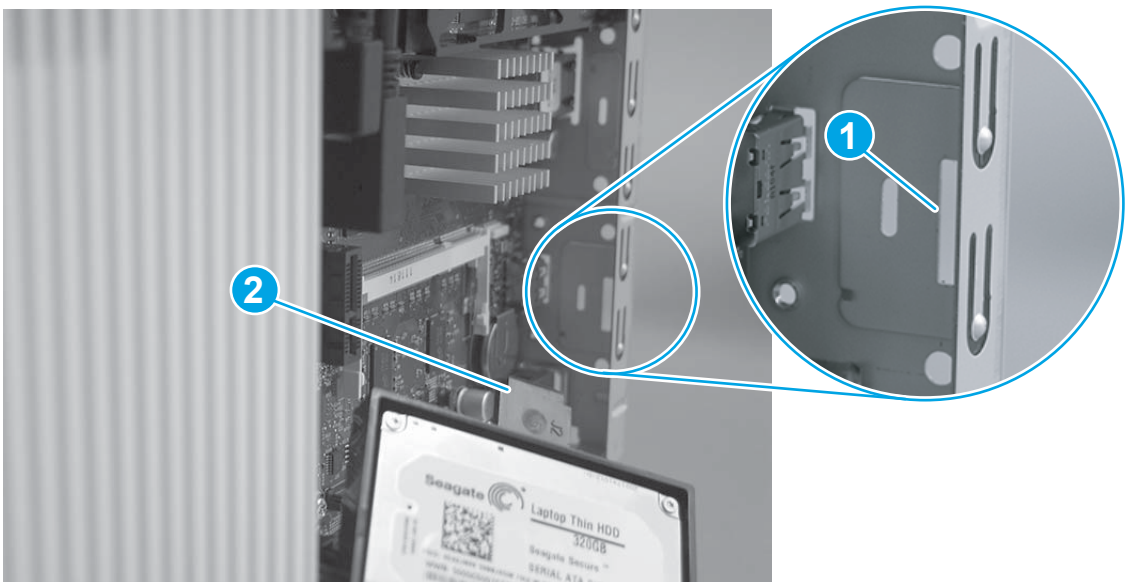
**CAUTION:**  ESD-sensitive part.

1. Before proceeding, take note of the location of the slot (callout 1) in the sheet-metal where the HDD cradle mounting tab (callout 2) must be installed.



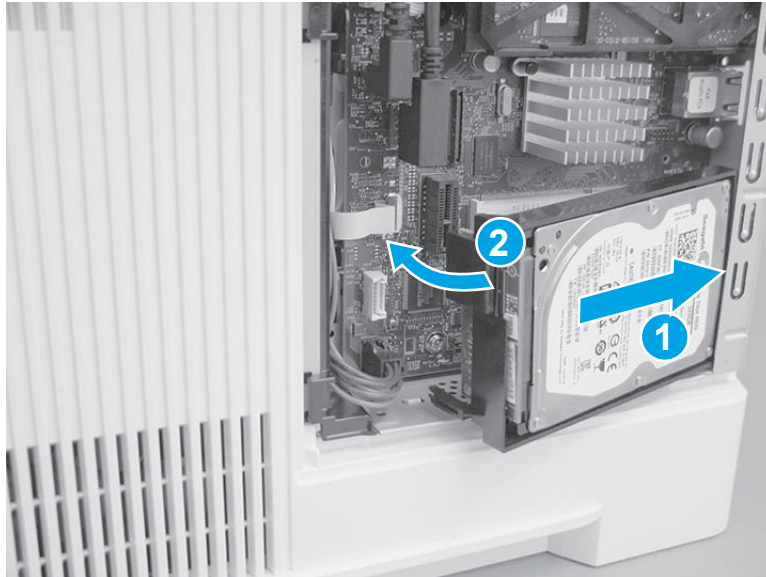
**CAUTION:** This portion of the sheet-metal is a knock-out plate (callout 1). Do not push on it with sufficient force to detach it when installing the HDD.

**Figure 1-2051** Locate the slot in the sheet-metal



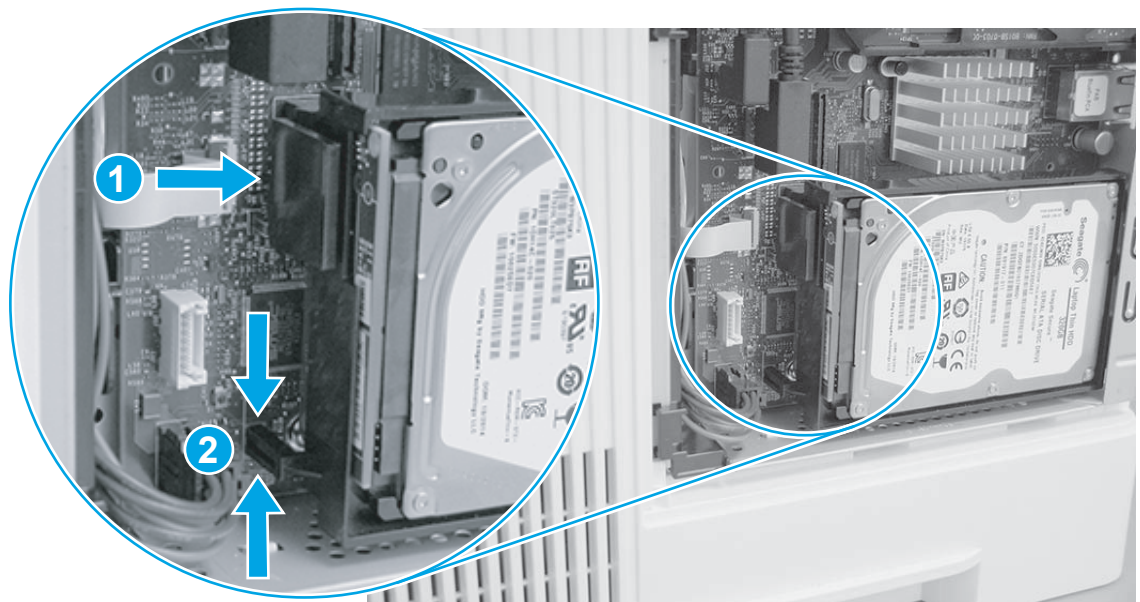
2. Insert the HDD cradle mounting tab in the slot in the sheet-metal (callout 1), and then rotate the connector end (callout 2) of the HDD toward the formatter.

**Figure 1-2052** Install the HDD



3. Make sure that the locking connector (callout 1) latches and that the stando (callout 2) engages with the slot in the formatter (it might be necessary to pinch the retainer to engage it with the slot).

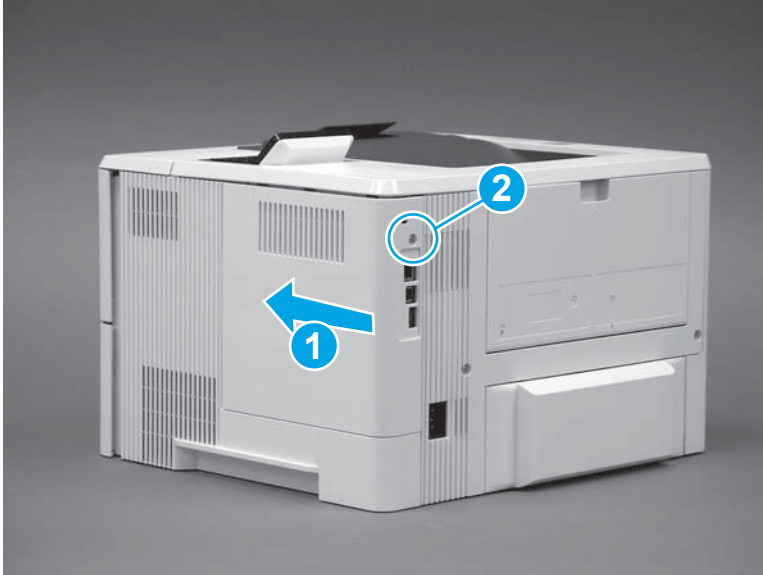
**Figure 1-2053** Install the HDD



### Step 39: Install the formatter cover

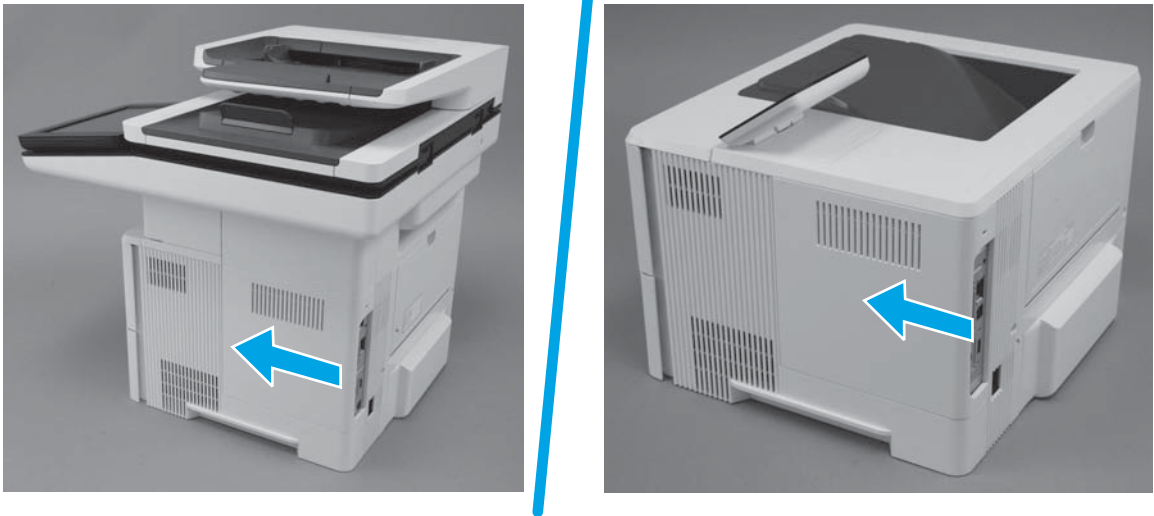
1. **M501**: Slide it toward the front of the printer to install it (callout 1), and then install one screw (callout 2).

**Figure 1-2054** Install the formatter cover (M501)



2. **M506/M527:** Slide it toward the front of the printer to install it.

**Figure 1-2055** Install the formatter cover (M506/M527)



#### Step 40: Install the tray

1. With the tray at a slight angle, align the sides of the tray with the rails in the accessory, and then partially slide the tray into the printer.

**Figure 1-2056** Install the tray




2. Push the tray straight into the accessory to close it.

**Figure 1-2057** Close the tray



#### Step 41: Install the control panel (M506x)

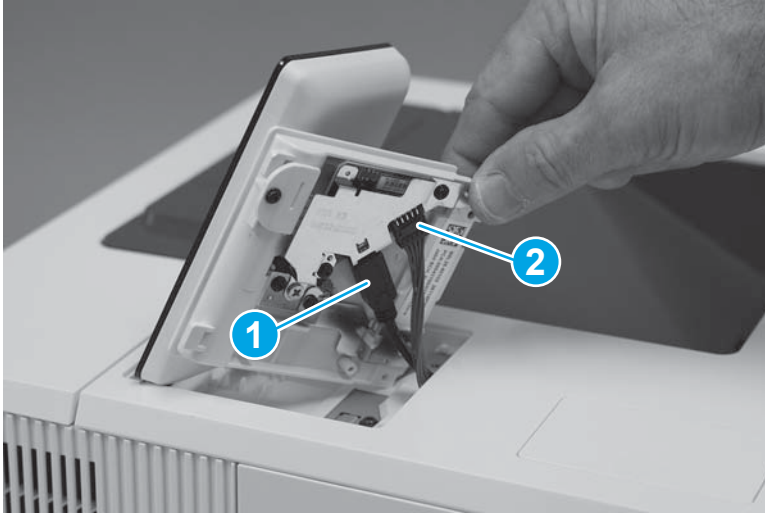
---

 **NOTE:** M506x model only.

---

1. Connect one HDMI cable (callout 1), one connector (callout 2).

**Figure 1-2058** Connect the cables



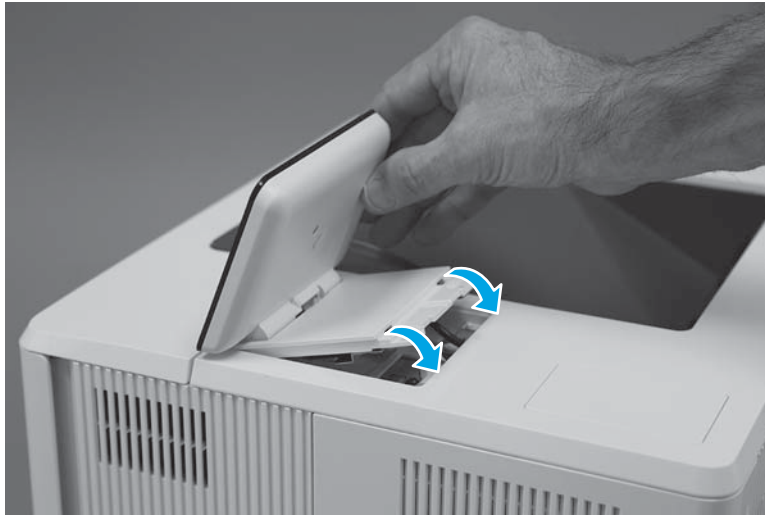
2. Install the tabs (callout 1) on the front of the control panel in the slots (callout 2) on the printer top cover.

**Figure 1-2059** Install the control panel



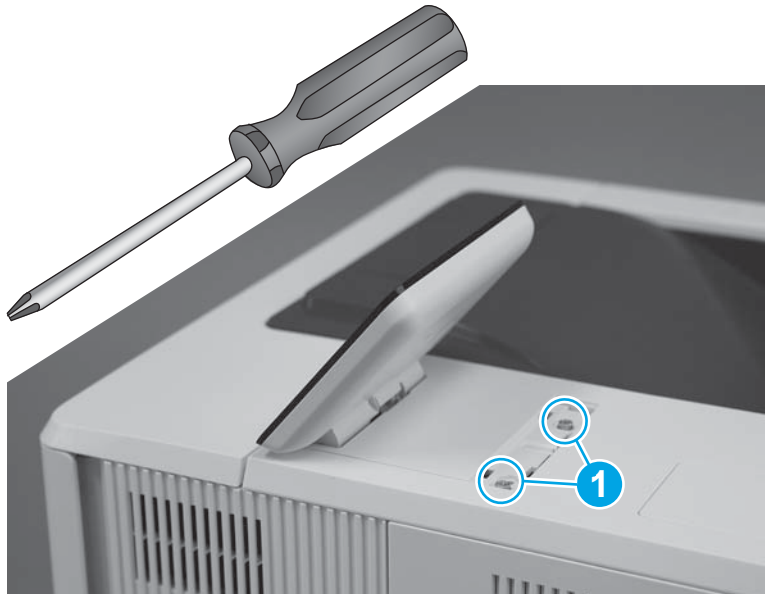
3. Rotate the control-panel base down onto the printer.

**Figure 1-2060** Rotate the control-panel base down



4. Use a small Phillips screwdriver to install two screws (callout 1).

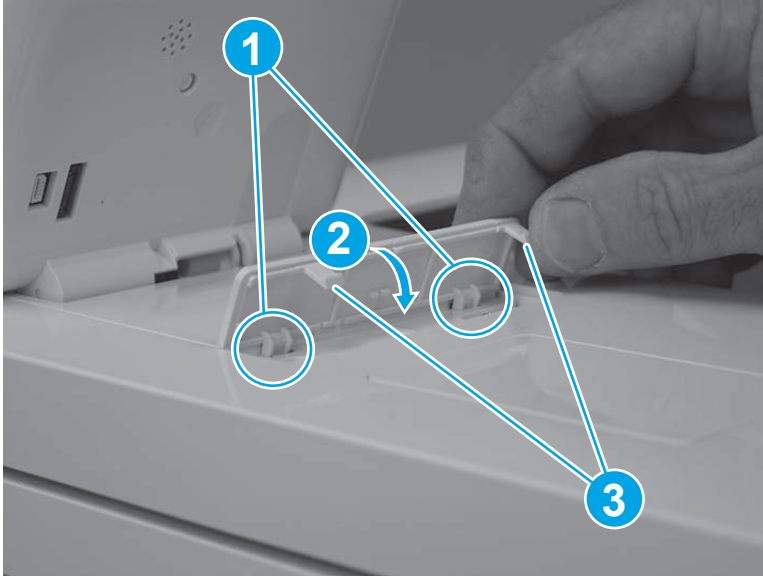
**Figure 1-2061** Install two screws



5. Position the screw cover mounting feet into the slots in the top cover (callout 1), and then rotate the cover down (callout 2) to install it.

 **NOTE:** Press down on the cover firmly to make sure that the tabs (callout 3) snap into place.

**Figure 1-2062** Install the cover





## Removal and replacement: Trays

- [Removal and replacement: Tray 2](#)
- [Removal and replacement: Tray 3](#)

### Removal and replacement: Tray 2

- [Introduction](#)
- [Step 1: Remove the tray](#)
- [Step 2: Unpack the replacement tray](#)
- [Step 3: Install the tray](#)

#### Introduction

This document provides the procedures to remove and replace Tray 2.

#### Before performing service

##### Turn the printer power off

- Disconnect the power cable.

**⚠ WARNING!** To avoid damage to the printer, turn the printer off, wait 30 seconds, and then remove the power cable before attempting to service the printer.

Use the table below to identify the correct part number for your printer. To order the part, go to [www.hp.com/buy/parts](http://www.hp.com/buy/parts).

Tray 2 part number	
RM2-5690-000CN	Cassette (Tray 2) assembly

#### Required tools

- No special tools are required to remove this part.

#### After performing service

##### Turn the printer power on

- Connect the power cable.
- Use the power switch to turn the power on.

#### Post service test

Make sure that the printer initializes to a **Ready** state.

Print a configuration page (from Tray 2) to make sure that the printer is functioning correctly.

#### Step 1: Remove the tray

1. Pull the tray straight out of the printer until it stops.

**Figure 1-2063** Pull the tray out until it stops



2. Lift the front of the tray, and then pull it out of the printer to remove it.

**Figure 1-2064** Release and remove the tray



### Step 2: Unpack the replacement tray

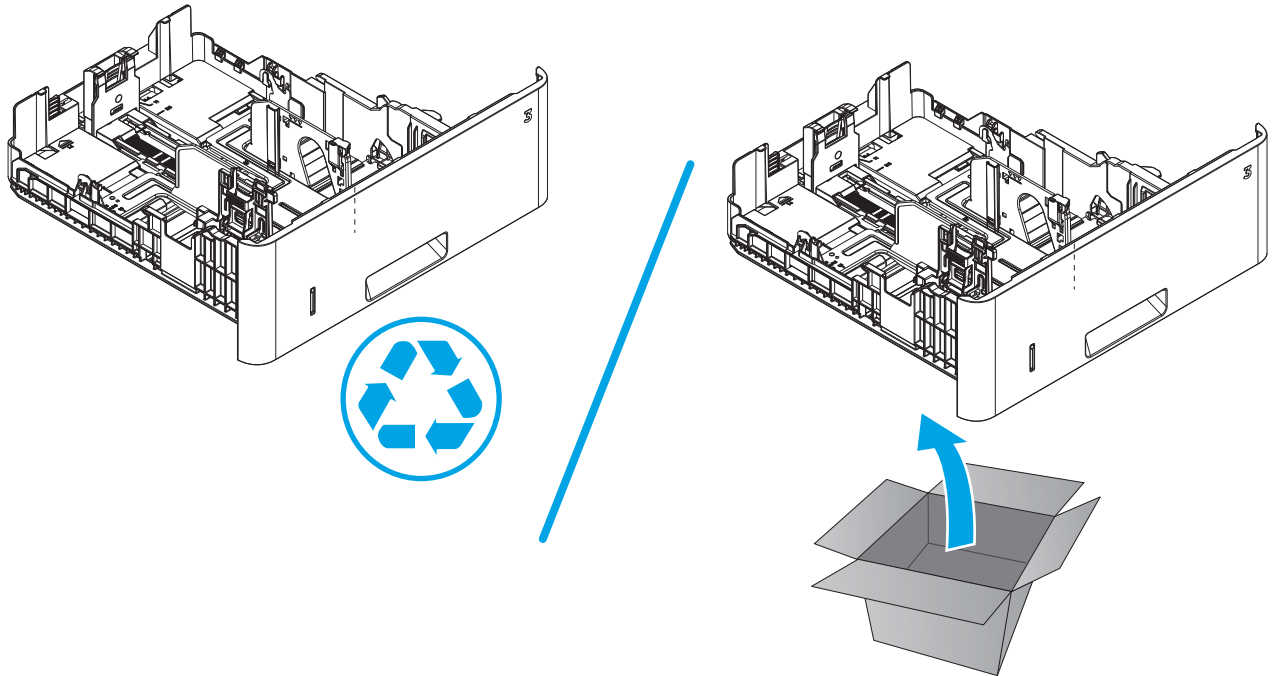
Unpack the replacement part from the packaging.

<http://www8.hp.com/us/en/hp-information/environment/product-recycling.html>



**NOTE:** HP recommends responsible disposal of the defective part.

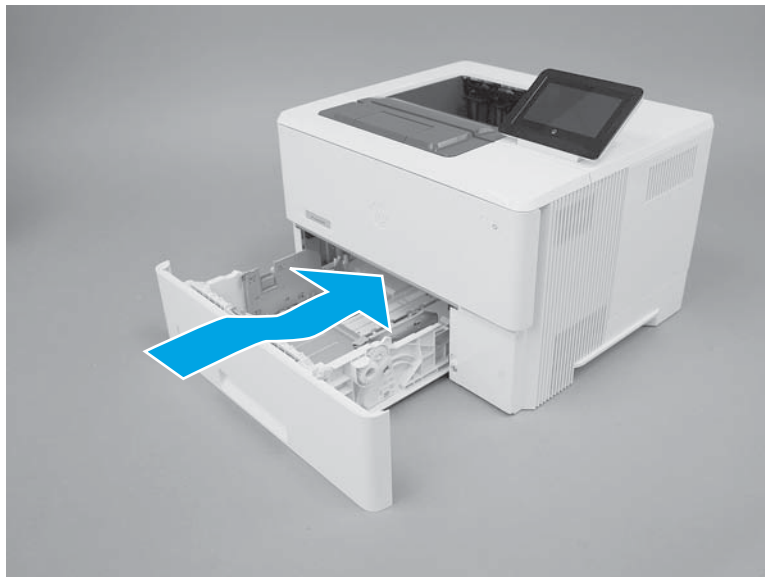
**Figure 1-2065** Recycle and unpack



### Step 3: Install the tray

1. With the tray at a slight angle, align the sides of the tray with the rails in the accessory, and then partially slide the tray into the printer.

**Figure 1-2066** Install the tray



2. Push the tray straight into the accessory to close it.

**Figure 1-2067** Close the tray



## Removal and replacement: Tray 3

- [Introduction](#)
- [Step 1: Remove the tray](#)
- [Step 2: Unpack the replacement tray](#)
- [Step 3: Install the tray](#)


### Introduction

This document provides the procedures to remove and replace Tray 3.

### Before performing service

#### Turn the printer power off

- Disconnect the power cable.

 **WARNING!** To avoid damage to the printer, turn the printer off wait 30 seconds, and then remove the power cable before attempting to service the printer.

Use the table below to identify the correct part number for your printer. To order the part, go to [www.hp.com/buy/parts](http://www.hp.com/buy/parts).

Tray 3 part number	
RM2-5758-000CN	Cassette (Tray 3) assembly

### Required tools

- No special tools are required to remove this part.

### After performing service

#### Turn the printer power on

- Connect the power cable.
- Use the power switch to turn the power on.

### Post service test

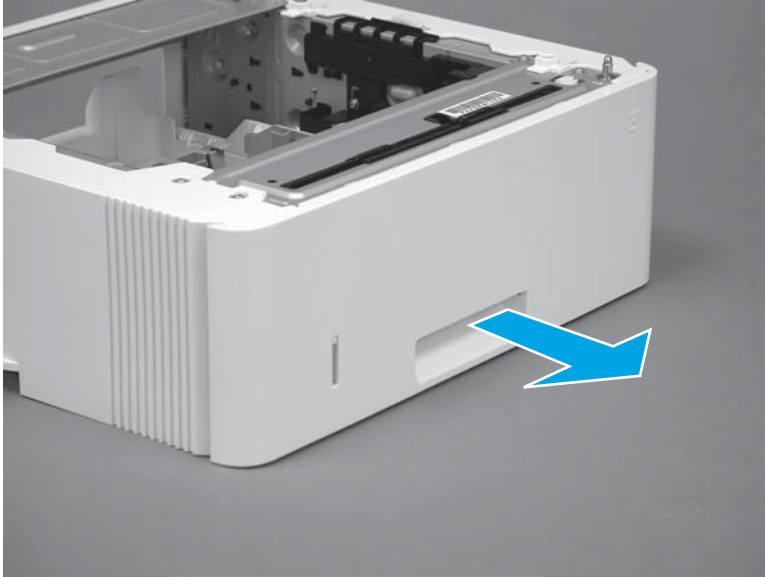
Make sure that the printer initializes to a **Ready** state.

Print a page from Tray 3 to make sure that the paper feeder is functioning correctly.

### Step 1: Remove the tray

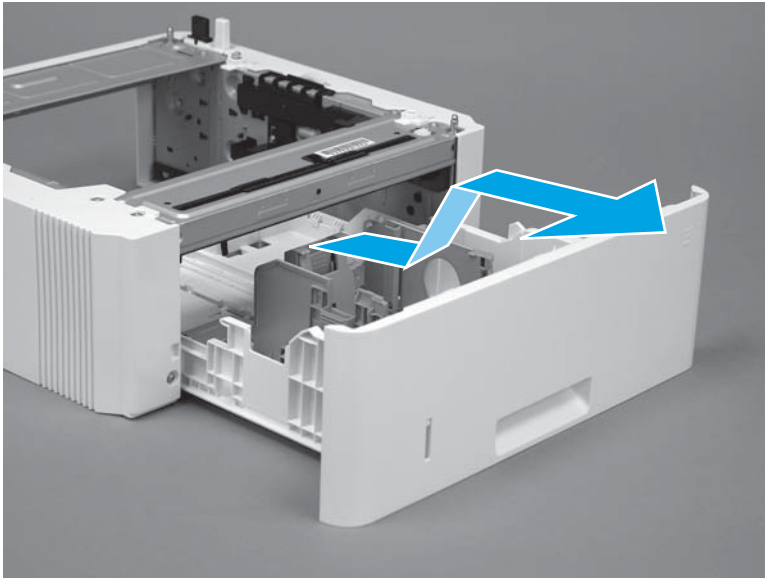
1. Pull the tray straight out of the printer until it stops.

**Figure 1-2068** Pull the tray out of the printer



2. Slightly lift up on the front of the tray to release it, and then continue to pull the tray out of the accessory to remove it.

**Figure 1-2069** Release and remove the tray



### Step 2: Unpack the replacement tray

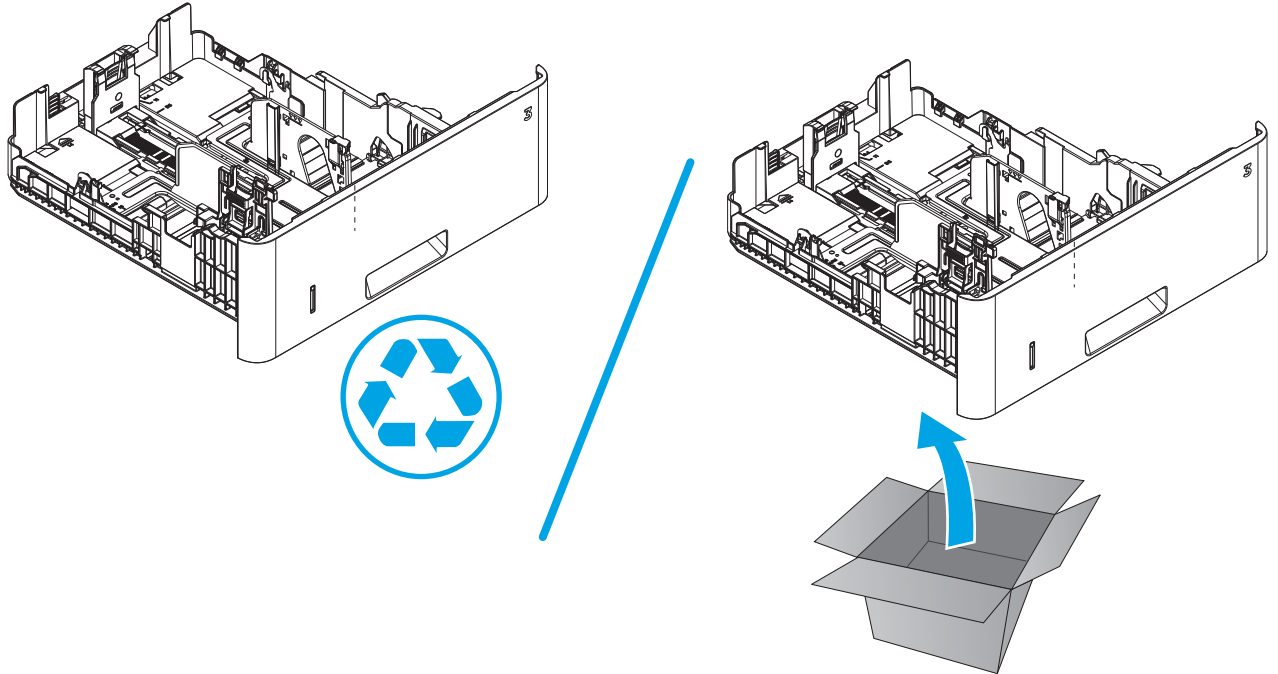
Unpack the replacement part from the packaging.

<http://www8.hp.com/us/en/hp-information/environment/product-recycling.html>



**NOTE:** HP recommends responsible disposal of the defective part.

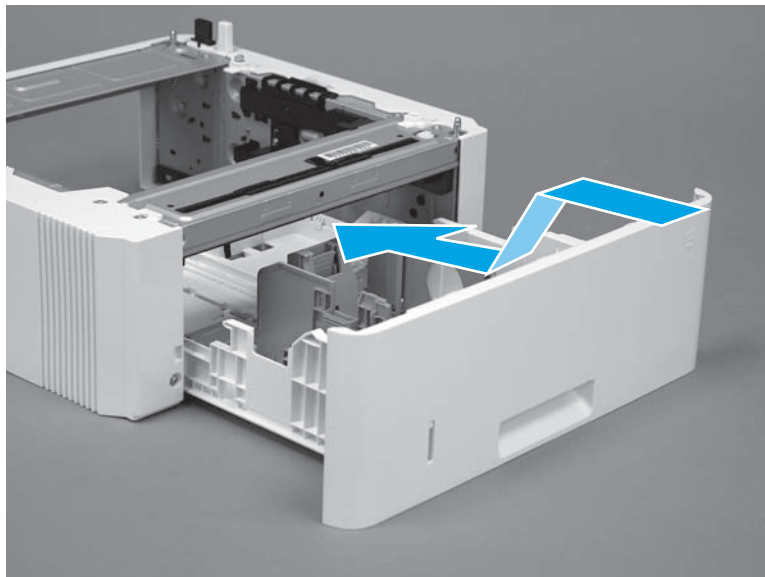
**Figure 1-2070** Recycle and unpack



**Step 3: Install the tray**

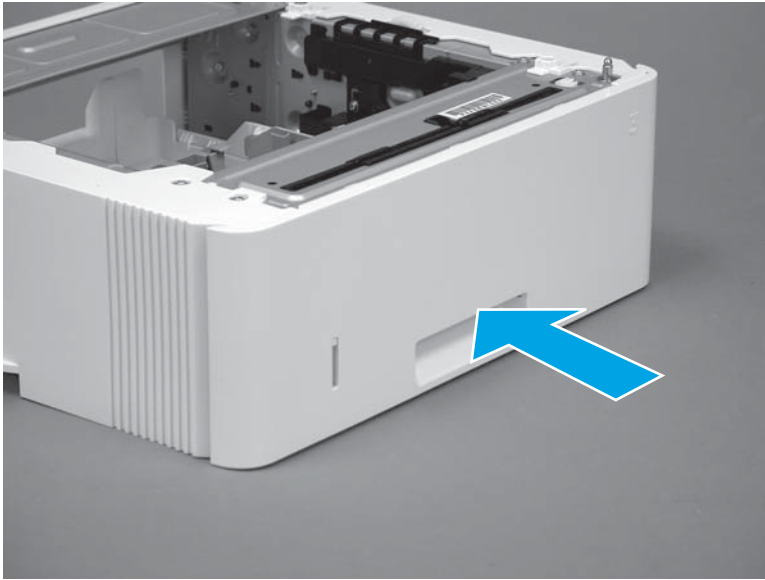
1. With the tray at a slight angle, align the sides of the tray with the rails in the accessory, and then partially slide the tray into the accessory.

**Figure 1-2071** Install the tray



2. Push the tray straight into the accessory to close it.

**Figure 1-2072** Close the tray





## Removal and replacement: Accessories

- [550-sheet paper feeder](#)
- [Removal and replacement: Document feeder rollers \(M527\)](#)
- [Removal and replacement: Fax printed-circuit board \(M527c/f/z\)](#)
- [Install accessory: Internal USB ports \(M527\)](#)
- [Install accessory: Internal USB ports \(M506\)](#)

## 550-sheet paper feeder



**NOTE:** HP recommends removing the accessory from the printer before servicing them.

- [Removal and replacement: Optional 550-sheet paper feeder](#)

### Removal and replacement: Optional 550-sheet paper feeder

- [Introduction](#)
- [Step 1: Remove the optional 550-sheet paper feeder](#)
- [Step 2: Unpack the replacement optional paper feeder](#)
- [Step 3: Install the optional 550-sheet paper feeder](#)

### Introduction

This document provides the procedures to remove and replace the optional 550-sheet paper feeder.



**NOTE:** The printer accepts up to three optional paper trays

### Before performing service

#### Turn the printer power off

- Disconnect the power cable.



**WARNING!** To avoid damage to the printer, turn the printer off wait 30 seconds, and then remove the power cable before attempting to service the printer.

Use the table below to identify the correct part number for your printer. To order the part, go to [www.hp.com/buy/parts](http://www.hp.com/buy/parts).

---

Optional 550-sheet paper feeder part number
---

---

<b>F2A72-67901</b>
--------------------

Optional 550-sheet paper feeder with instruction guide
--

---

### Required tools

- No special tools are required to remove this part.

### After performing service

#### Turn the printer power on

- Connect the power cable.
- Use the power switch to turn the power on.

### Post service test

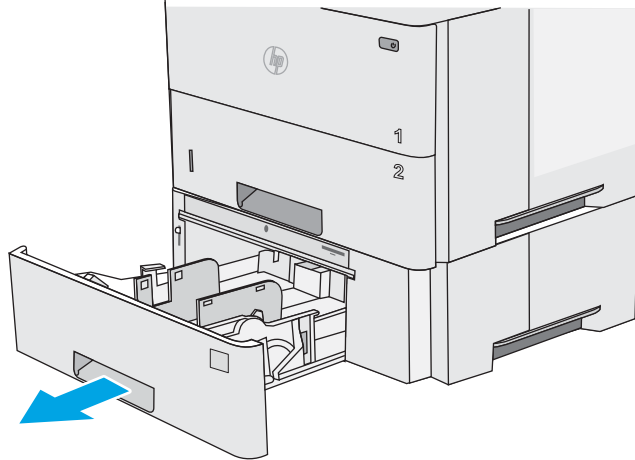
Make sure that the printer initializes to a **Ready** state.

Print a page from the optional Tray 3 (or trays) to make sure that the paper feeder is functioning correctly.

## Step 1: Remove the optional 550-sheet paper feeder

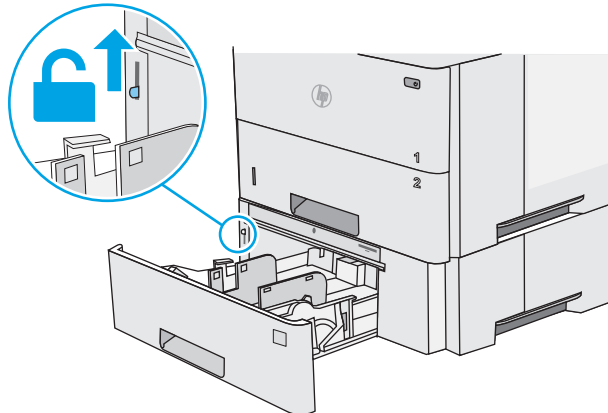
1. Slide the tray out of the printer.

**Figure 1-2073** Open the tray



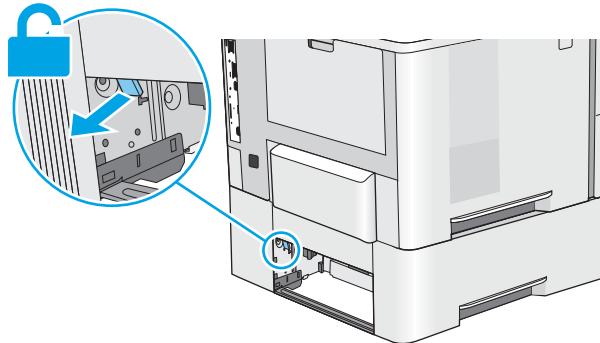
2. Pull up on the blue lever to unlock it.

**Figure 1-2074** Unlock the front accessory lock



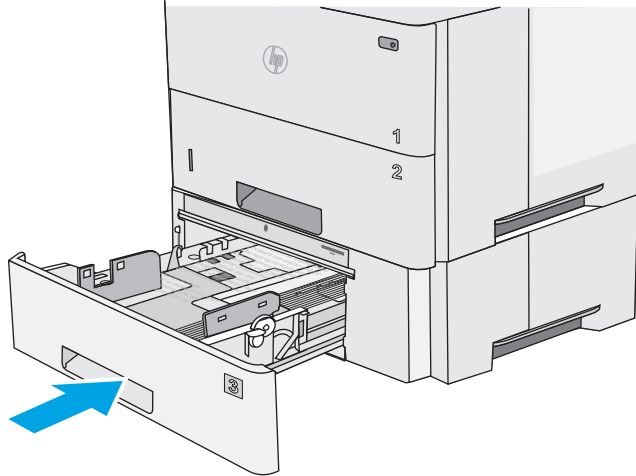
3. At the rear of the printer, pull out on the blue lever to unlock it.

**Figure 1-2075** Unlock the rear accessory lock



4. Close the tray.

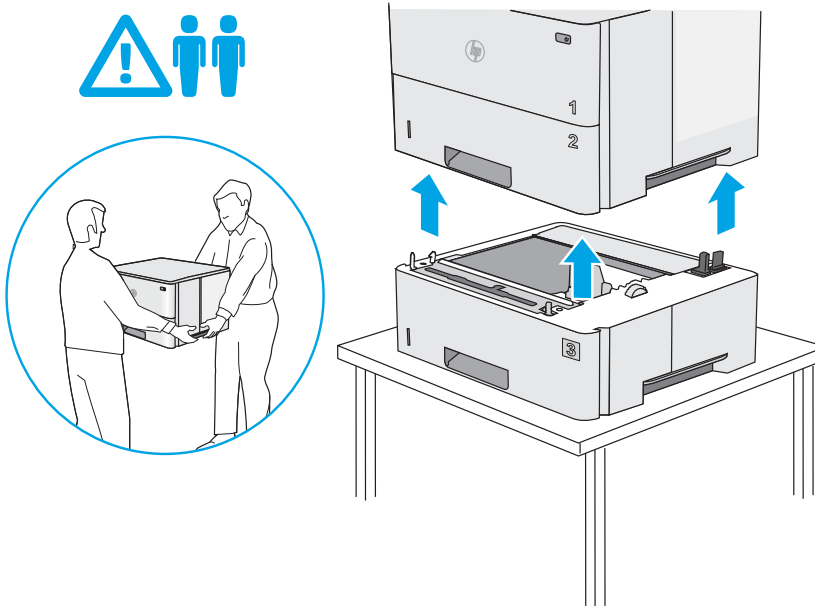
**Figure 1-2076** Close the tray



5. Lift the printer off of the accessory.

**CAUTION:** The printer is heavy. HP recommends two people lift the printer.

**Figure 1-2077** Lift the printer off of the accessory



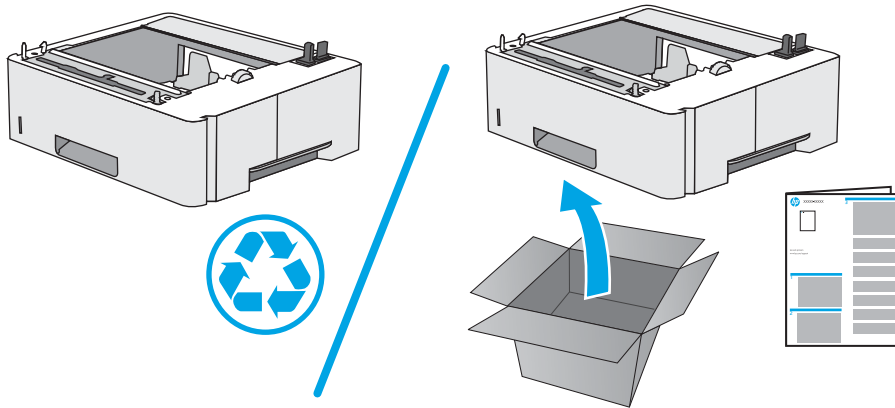
### Step 2: Unpack the replacement optional paper feeder

Unpack the replacement part from the packaging.

<http://www8.hp.com/us/en/hp-information/environment/product-recycling.html>

**NOTE:** HP recommends responsible disposal of the defective part.

**Figure 1-2078** Recycle and unpack



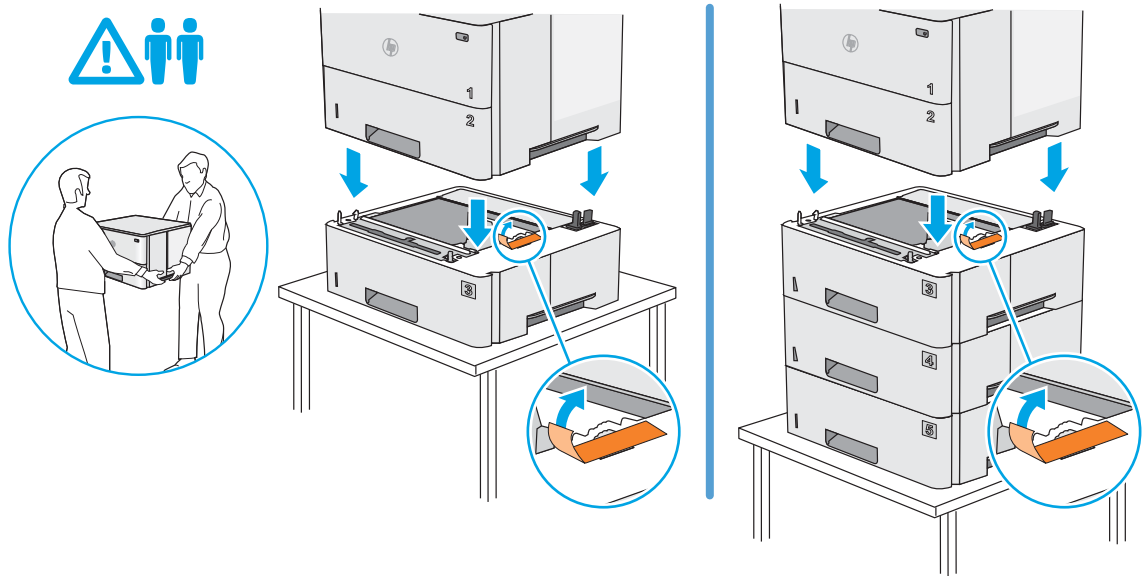
**Step 3: Install the optional 550-sheet paper feeder**

1. Remove the orange shipping tape, and then place the printer on the replacement accessory.

**CAUTION:** The printer is heavy. HP recommends two people lift the printer.

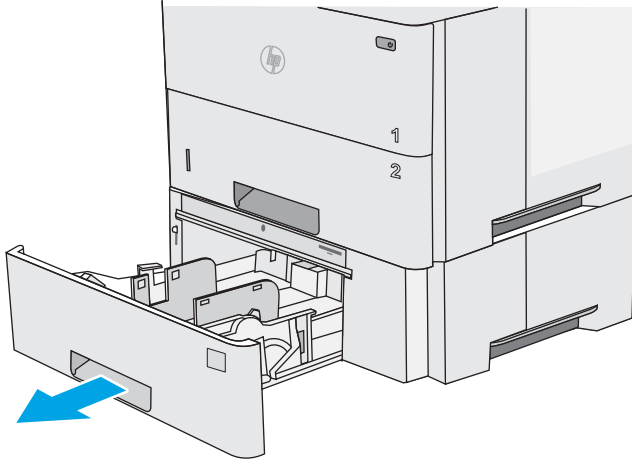
**NOTE:** The printer accepts up to three optional paper trays

**Figure 1-2079** Remove shipping tape



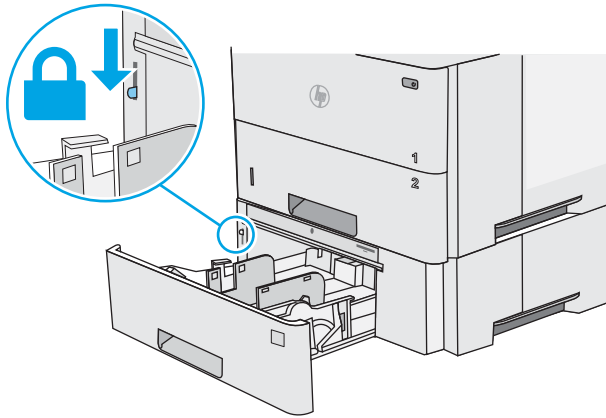
2. Slide the tray out of the printer.

**Figure 1-2080** Open the tray




3. Push down on the blue lever to lock it.

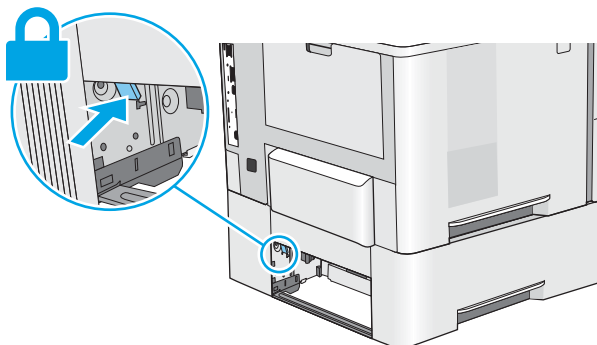
**Figure 1-2081** Lock the front accessory lock



4. At the rear of the printer, push out on the blue lever to lock it.

 **NOTE:** Repeat these steps to make sure all of the installed trays are locked together and to the printer base.

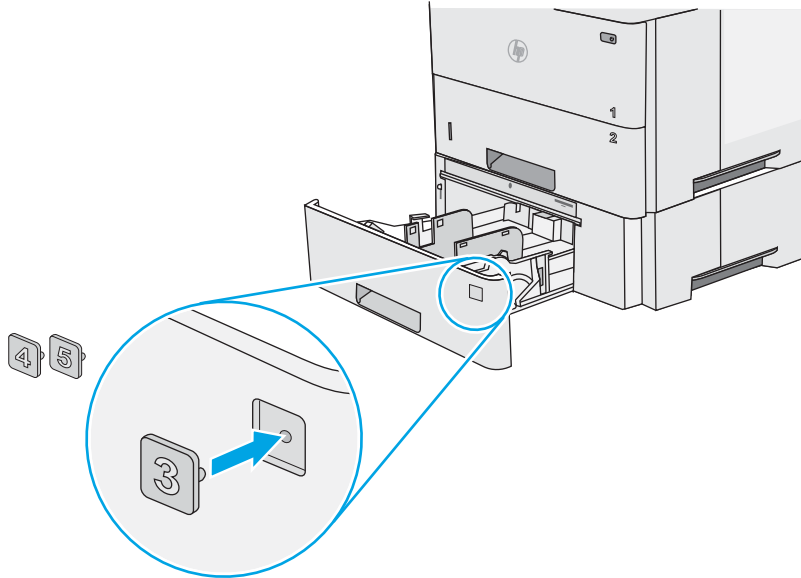
**Figure 1-2082** Lock the rear accessory lock



5. Position the appropriate tray number plate in the depression in the tray, and then push in to install it.

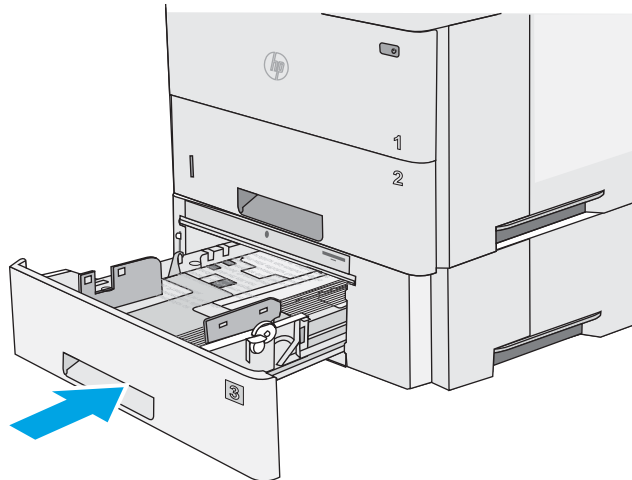
 **TIP:** Number plates are included with the accessory.

**Figure 1-2083** Install the tray number plate



6. Close the tray.

**Figure 1-2084** Close the tray



## Removal and replacement: Document feeder rollers (M527)

- [Introduction](#)
- [Step 1: Remove the document feeder pickup and feed roller assembly](#)
- [Step 2: Remove the document feeder separation roller assembly](#)
- [Step 3: Unpack the replacement assemblies](#)
- [Step 4: Install the document feeder separation roller assembly](#)
- [Step 5: Install the document feeder pickup and feed roller assembly](#)
- [Step 6: Reset the firmwar counter](#)


### Introduction


This document provides the procedures to remove and replace the document feeder pickup and feed roller assembly and the separation roller assembly (M527).

### Before performing service

#### Turn the printer power off

- Disconnect the power cable.

 **WARNING!** To avoid damage to the printer, turn the printer off wait 30 seconds, and then remove the power cable before attempting to service the printer.

 **IMPORTANT:** When replacement rollers are installed, reset the [New Document Feeder Kit](#) firmwar counter. See the last step in this guide.

Use the table below to identify the correct part number for your printer. To order the part, go to [www.hp.com/buy/parts](http://www.hp.com/buy/parts).

---

Document feeder maintenance kit (M527) part number	
--	--

---

<b>B5L52-67903</b>
--------------------

Document feeder maintenance kit (M527) accessory with instruction guide
---

---

### Required tools

- No special tools are required to remove this part.

### After performing service

#### Turn the printer power on

- Connect the power cable.
- Use the power switch to turn the power on.

### Post service test

Make sure that the printer initializes to a **Ready** state.

Use the document feeder to copy a page to make sure that it is functioning correctly.



### Step 1: Remove the document feeder pickup and feed roller assembly

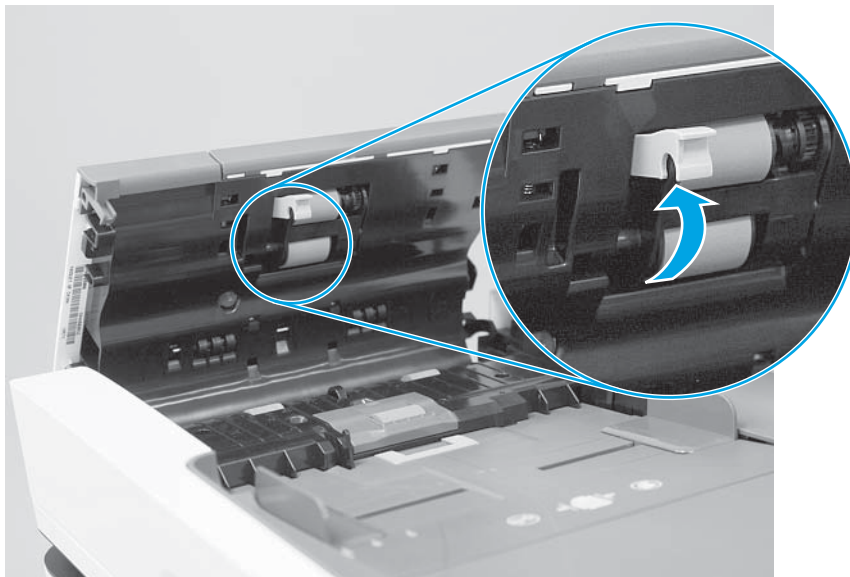
1. Open the document feeder jam access door.

**Figure 1-2085** Open the door



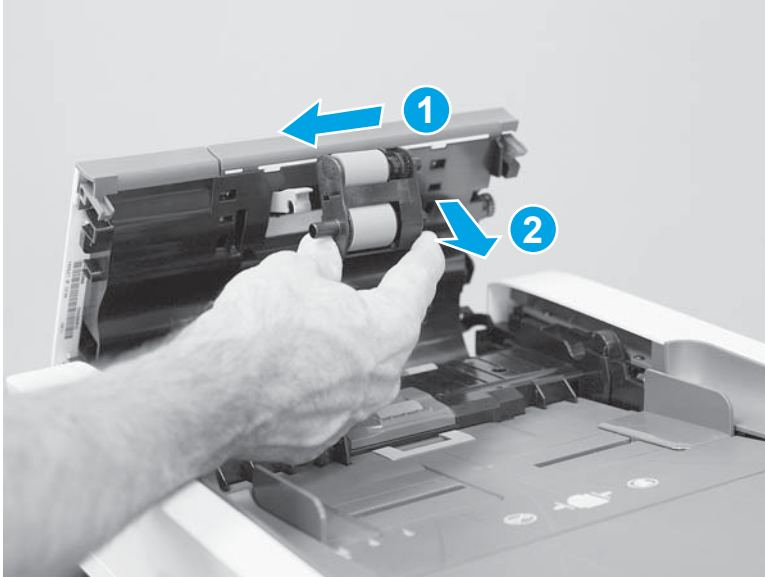
2. Raise the blue lever to release the document feeder pickup and feed roller assembly.

**Figure 1-2086** Raise the blue lever



3. Slide the roller assembly toward the front of the printer (callout 1), and then away from the document feeder (callout 2) to remove it.

**Figure 1-2087** Remove the roller assembly



### Step 2: Remove the document feeder separation roller assembly

1. Open the document feeder separation roller assembly cover.

**Figure 1-2088** Open the cover



2. Remove the cover.

**Figure 1-2089** Remove the cover



3. Slide the roller assembly toward the front of the printer, and then rotate it up and away from the document feeder to remove it.

**Figure 1-2090** Remove the roller assembly



### Step 3: Unpack the replacement assemblies

Unpack the replacement part from the packaging.

<http://www8.hp.com/us/en/hp-information/environment/product-recycling.html>

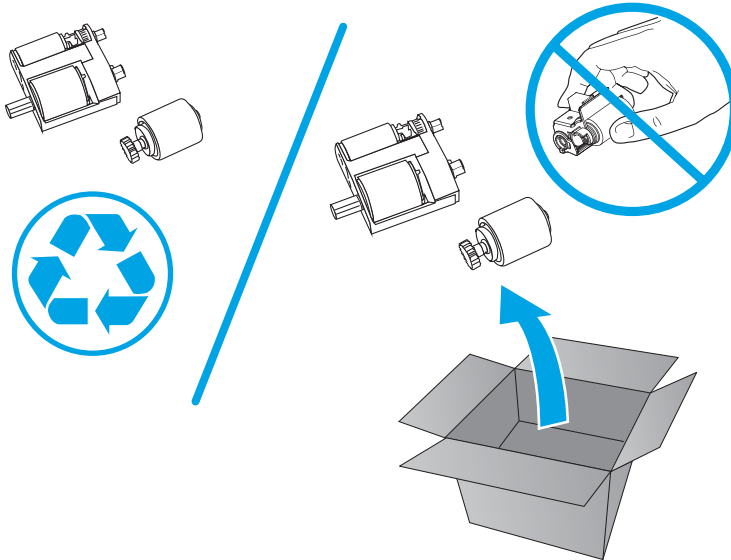
---

**CAUTION:** Do not touch the black spongy portion of the roller. Skin oils can cause image-quality problems.

**NOTE:** HP recommends responsible disposal of the defective part.

---

**Figure 1-2091** Recycle and unpack



**Step 4: Install the document feeder separation roller assembly**

**CAUTION:** Do not touch the gray spongy portion of the roller. Skin oils can cause image-quality problems.

1. Place the solid-shaft end of the assembly (the gear end will face the front of the printer) in the slot provided in the roller holder, and then rotate the gear end down and into the document feeder.

**NOTE:** The roller might seem loose until the cover is installed and snapped closed. The cover helps hold the roller in place.

**Figure 1-2092** Install the roller assembly



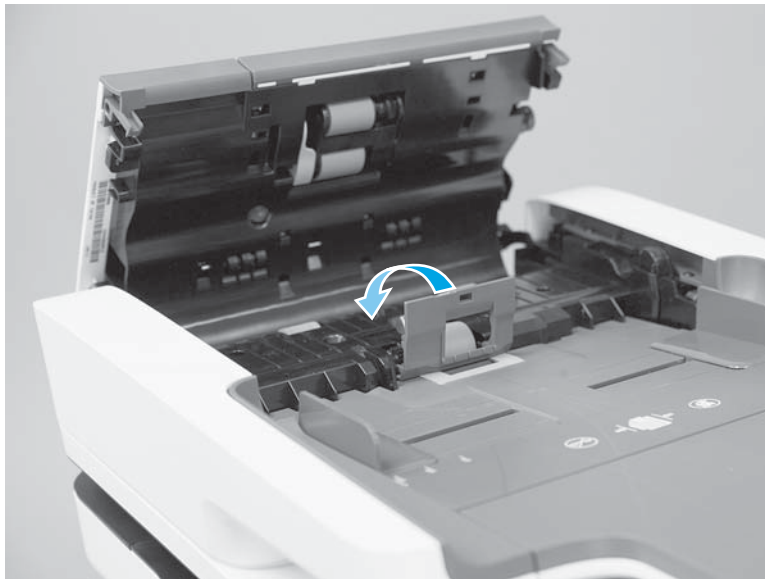
2. Position the roller cover on the document feeder.

**Figure 1-2093** Install the roller cover




3. Close the roller cover.

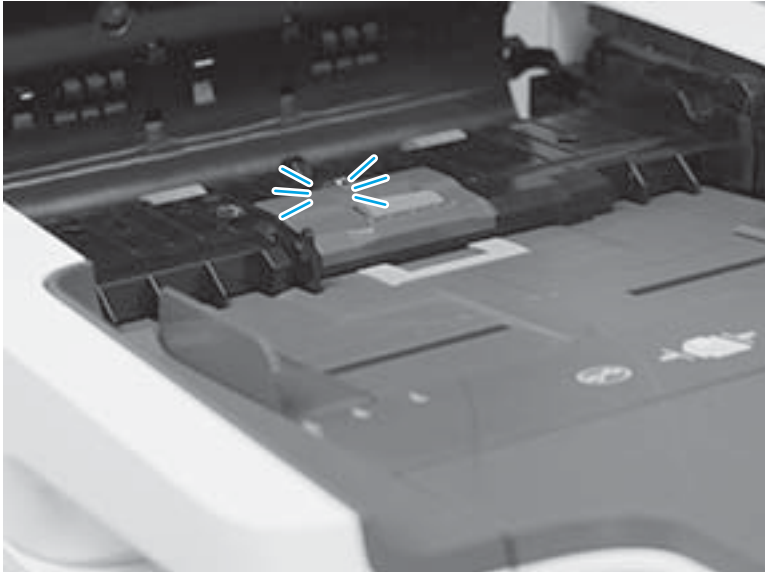
**Figure 1-2094** Close the roller cover




4. Push down to snap the cover into place.

 **NOTE:** When the cover is correctly installed, an audible click is heard when it snaps into place.

**Figure 1-2095** Push down on the roller cover



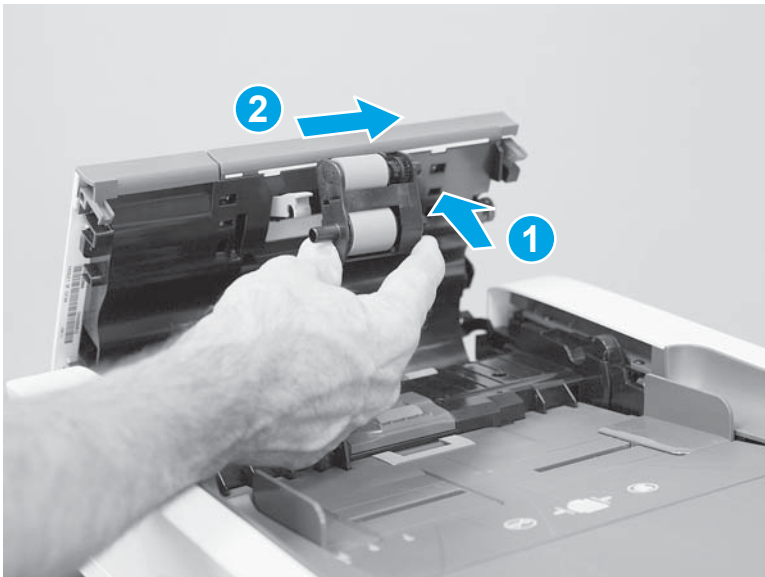
#### Step 5: Install the document feeder pickup and feed roller assembly

 **CAUTION:** Do not touch the gray spongy portion of the rollers. Skin oils can cause image-quality problems.

1. Position the roller assembly in the holder (callout 1) with the drive shaft end of the assembly facing toward the rear of the printer.

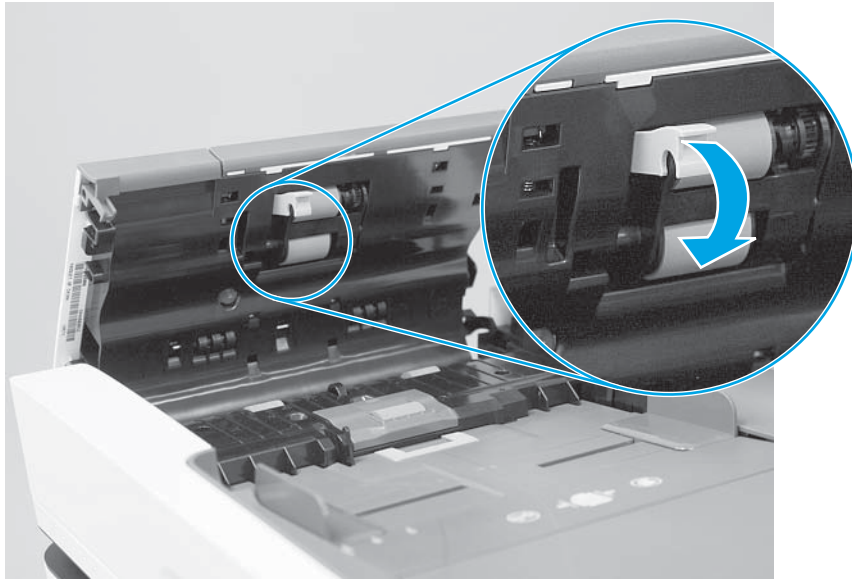
Slide the assembly toward the rear of the printer to engage the two keyed drive shafts with the two drive bushings (callout 2).

**Figure 1-2096** Install the roller assembly



2. Lower the blue lever until it snaps over the roller assembly solid shaft.

**Figure 1-2097** Close the blue lever



3. Close the document feeder jam access door.



**NOTE:** When the door is completely closed, an audible click is heard when it latches closed.

**Figure 1-2098** Close the door



### Step 6: Reset the firmware counter

1. From the Home screen on the control panel, scroll to and touch the **Administration** button.
2. Open the following menus:

- [Manage Supplies](#)
  - [Reset Supplies](#)
  - [New Document Feeder Kit](#)
3. Select the [Reset](#) item to reset the firmwar counter.



## Removal and replacement: Fax printed-circuit board (M527c/f/z)

 **NOTE:** M527c/f/z printers only (optional for the M527dn).

- [Introduction](#)
- [Step 1: Remove the formatter cover](#)
- [Step 2: Remove the fax printed-circuit board \(PCA\)](#)
- [Step 3: Unpack the replacement fax PCA](#)
- [Step 4: Install the fax PCA](#)
- [Step 5: Install the formatter cover](#)


### Introduction



This document provides the procedures to remove and replace the fax printed-circuit board (M527c/f/z).

### Before performing service

#### Turn the printer power off

- Disconnect the power cable.

 **WARNING!** To avoid damage to the printer, turn the printer off wait 30 seconds, and then remove the power cable before attempting to service the printer.

 **CAUTION:**  This part contains components that are electrostatic discharge (ESD) sensitive. To reduce the possibility of ESD damage, always touch the sheet-metal chassis to ground yourself before touching an ESD sensitive part.

Use the table below to identify the correct part number for your printer. To order the part, go to [www.hp.com/buy/parts](http://www.hp.com/buy/parts).

Fax printed-circuit board (M527c/f/z) kit part number	
<b>B5L53-67901</b>	Fax printed-circuit board (M527c/f/z) with instruction guide

### Required tools

No special tools are required to install this part.

### After performing service

#### Turn the printer power on

- Connect the power cable.
- Use the power switch to turn the power on.

### Post service test

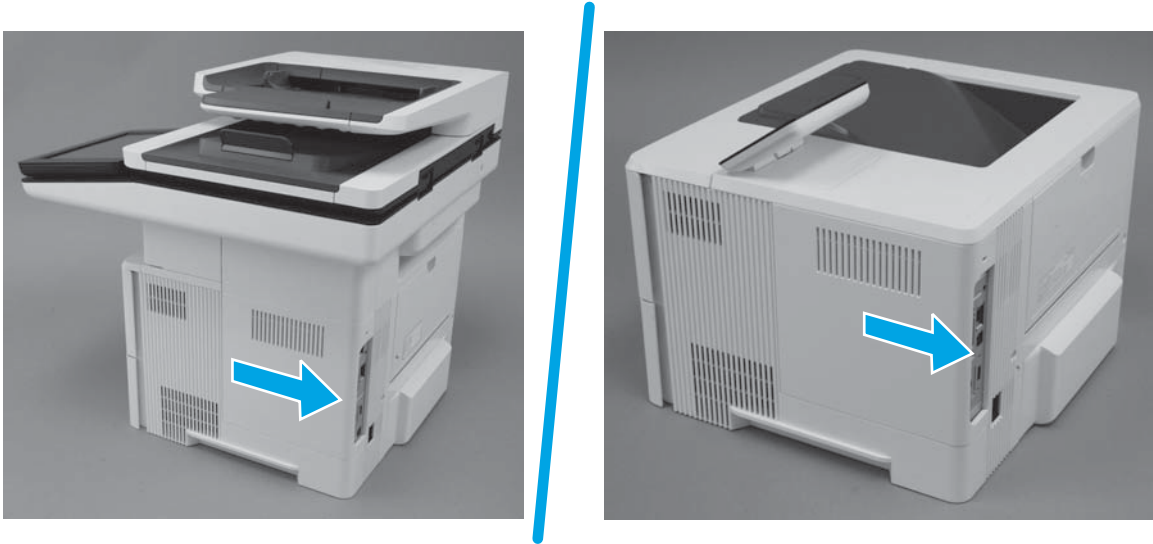
Make sure that the printer initializes to a **Ready** state.

Print a configuratio page to make sure that the printer is functioning correctly.

### Step 1: Remove the formatter cover

- ▲ Slide the cover toward the rear of the printer to remove it.

**Figure 1-2099** Remove the formatter cover



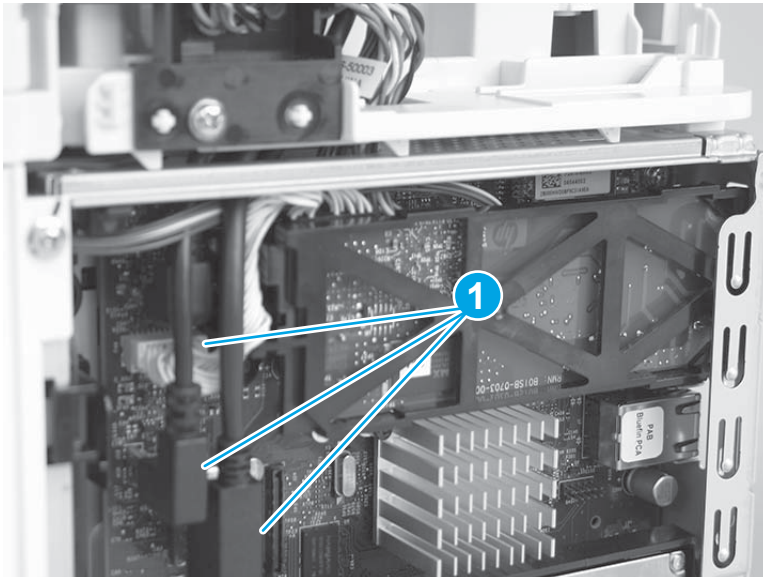
### Step 2: Remove the fax printed-circuit board (PCA)

**CAUTION:**  ESD-sensitive part.

**NOTE:** M527c/f/z printers only (optional for the M527dn).

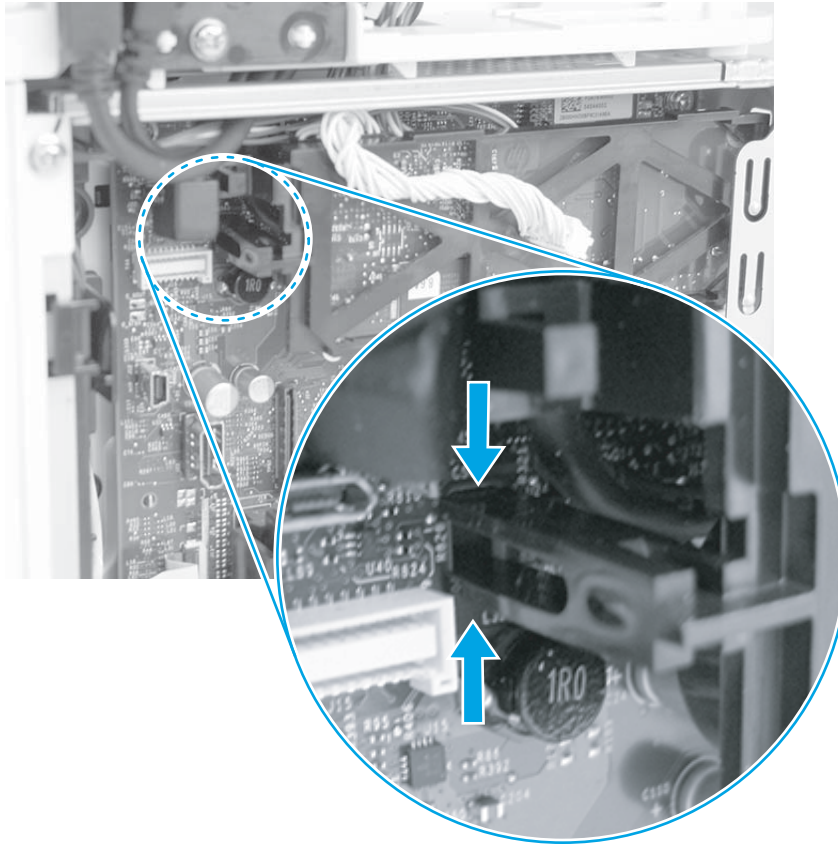
1. Disconnect three connectors (callout 1).

**Figure 1-2100** Disconnect three connectors



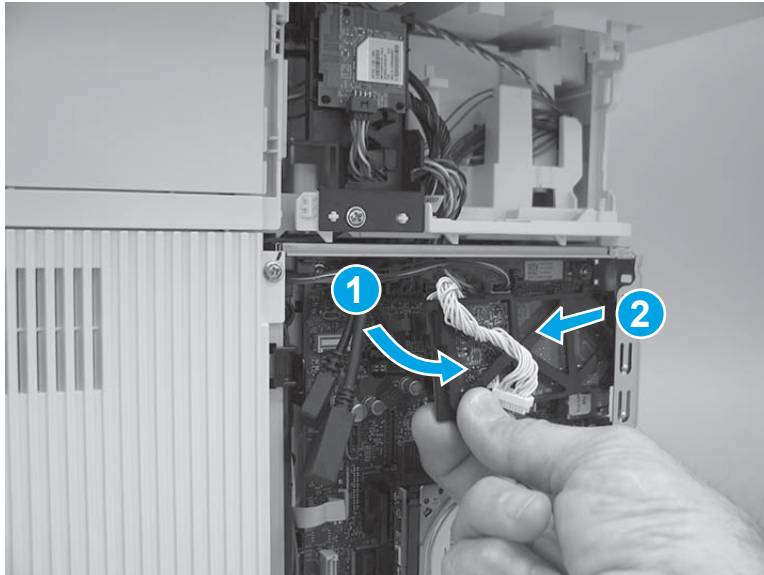
2. Pinch the retainer to release it.

**Figure 1-2101** Release the fax PCA



3. Rotate the connector end of the fax PCA out and away from the formatter (callout 1), and then slide it as shown (callout 2) to remove it.

**Figure 1-2102** Remove the fax PCA




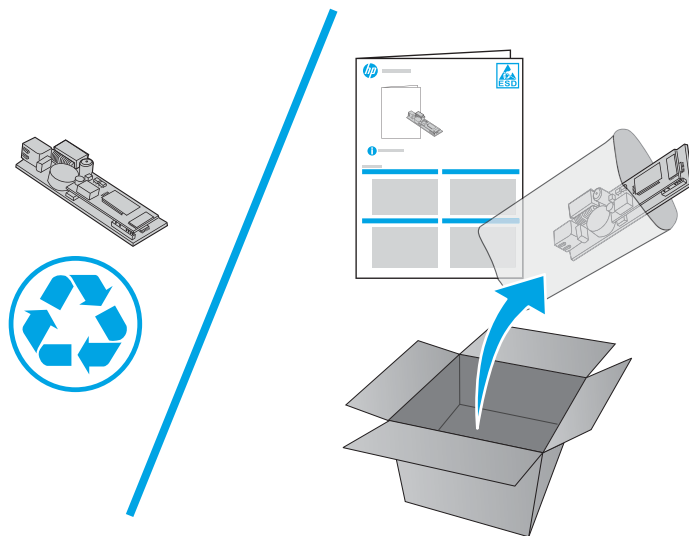
### Step 3: Unpack the replacement fax PCA

Unpack the replacement assembly from the packaging.

 **CAUTION:**  ESD-sensitive part.


<http://www8.hp.com/us/en/hp-information/environment/product-recycling.html>

 **NOTE:** HP recommends responsible disposal of the defective assembly.



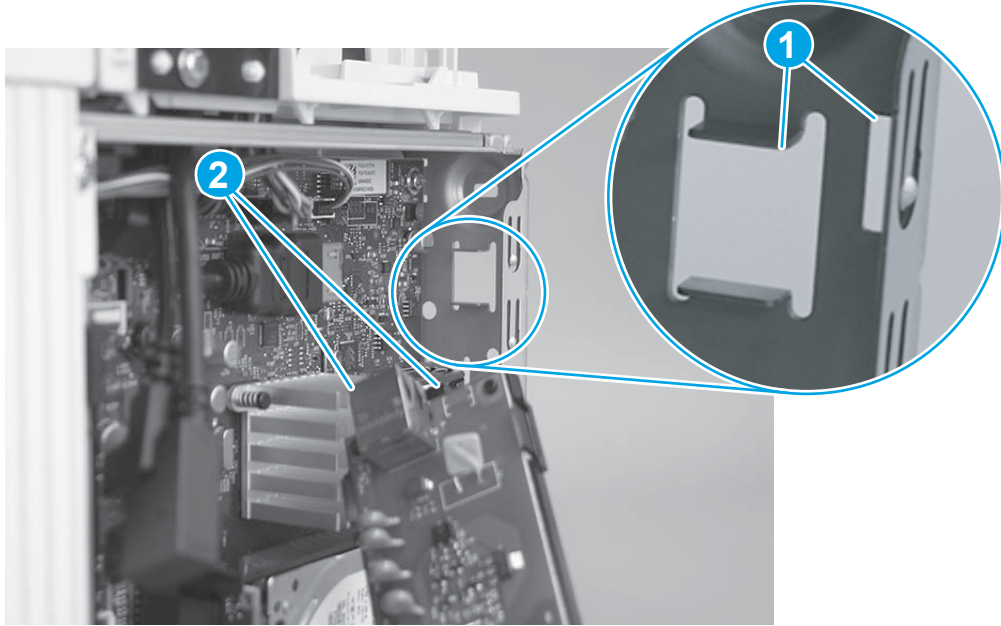
### Step 4: Install the fax PCA

 **CAUTION:**  ESD-sensitive part.

 **NOTE:** M527c/f/z printers only (optional for the M527dn).

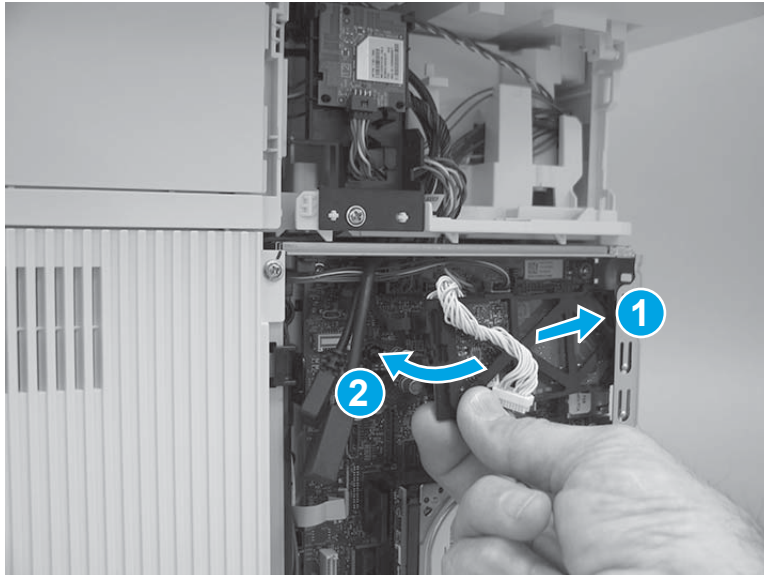
1. Before proceeding, take note of the location of the slots (callout 1) in the sheet-metal where the fax PCA cradle mounting tab and fax port (callout 2) must be installed.

**Figure 1-2103** Locate the slots in the sheet-metal



2. Insert the fax PCA cradle mounting tab and fax port in the slots in the sheet-metal plate (callout 1), and then rotate the connector end of the fax PCA toward the formatter (callout 2).

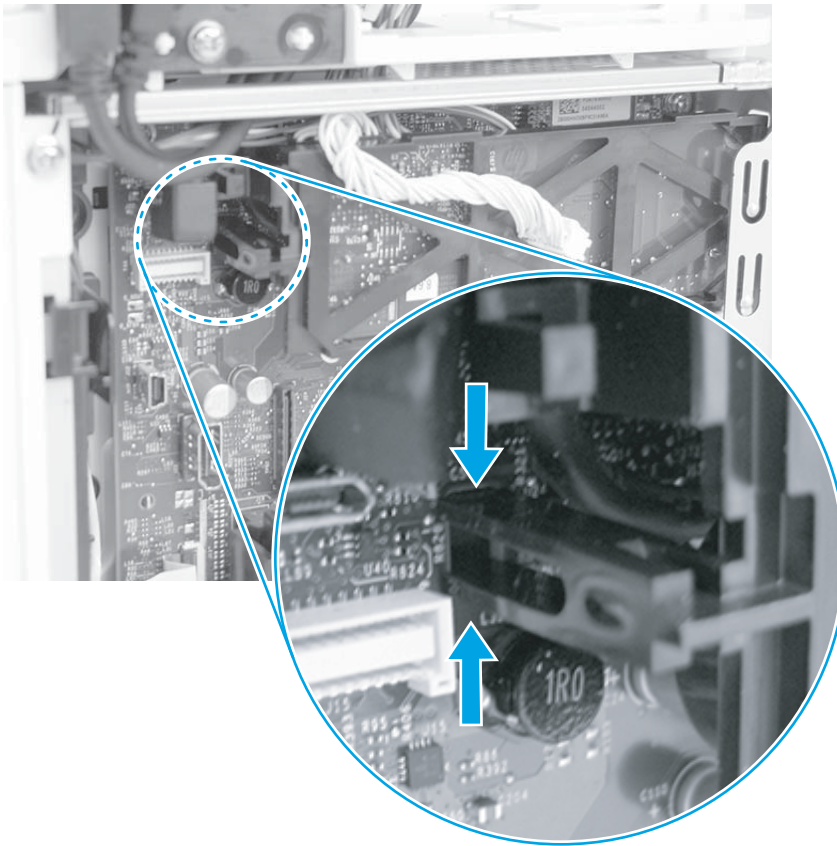
**Figure 1-2104** Install the fax PCA



- Engage the retainer with the slot in the formatter.

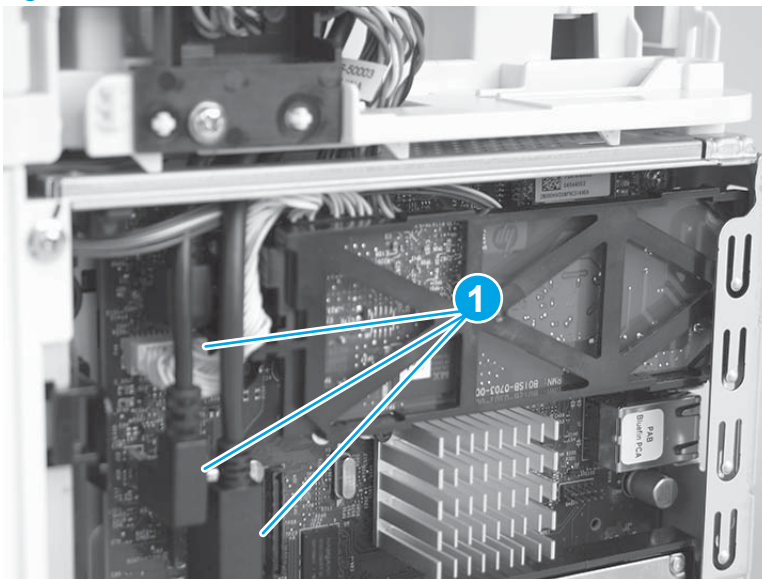
 **Reinstallation tip:** Pinch the retainer to easily engage it with the slot.

**Figure 1-2105** Engage the fax PCA



- Connect three connectors (callout 1).

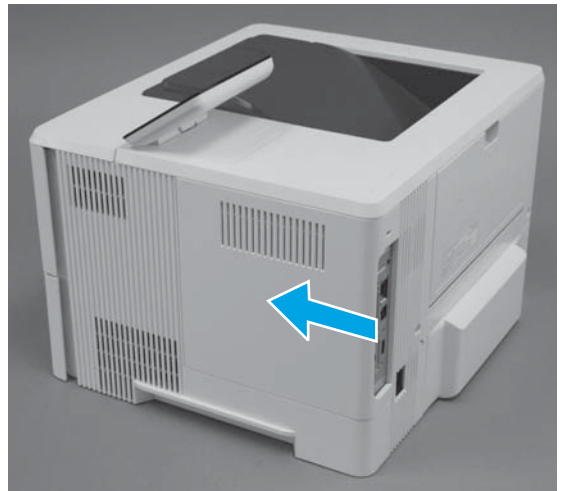
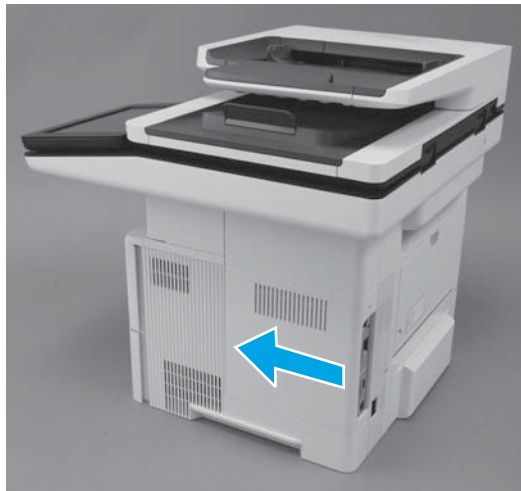
**Figure 1-2106** Connect three connectors



**Step 5: Install the formatter cover**

- ▲ Slide it toward the front of the printer to install it.

**Figure 1-2107** Install the formatter cover



## Install accessory: Internal USB ports (M527)

- [Introduction](#)
- [Step 1: Remove the formatter cover](#)
- [Step 2: Remove the fax \(M527c/f/z\)](#)
- [Step3: Unpack the accessory](#)
- [Step 4: Install the internal USB ports module](#)
- [Step 5: Install the fax \(M527c/f/z\)](#)
- [Step 6: Install the formatter cover](#)

### Introduction


This document provides the procedures to remove and replace the internal USB ports.

### Before performing service



#### Turn the printer power off

- Disconnect the power cable.

---

 **WARNING!** To avoid damage to the printer, turn the printer off wait 30 seconds, and then remove the power cord before attempting to service the printer.

---

 **CAUTION:**  This part contains components that are electrostatic discharge (ESD) sensitive. To reduce the possibility of ESD damage, always touch the sheet-metal chassis to ground yourself before touching an ESD sensitive part.

---

Use the table below to identify the correct part number for your printer. To order the part, go to [www.hp.com/buy/parts](http://www.hp.com/buy/parts).

---

Internal USB ports part number	
--------------------------------	--

---

<b>F2A87A</b>
---------------

Internal USB ports (M527)
---------------------------

---

### Required tools

No special tools are required to install this part.

### After performing service

#### Turn the printer power on

- Connect the power cable.
- Use the power switch to turn the power on.

### Post service test

Make sure that the printer initializes to a **Ready** state.



Print a configuration page to make sure that the printer is functioning correctly.

### Step 1: Remove the formatter cover


- ▲ Slide the cover toward the rear of the printer to remove it.

**Figure 1-2108** Remove the formatter cover




### Step 2: Remove the fax (M527c/f/z)

---

 **NOTE:** This step is for the M527c/f/z printers. For the N527dn model, skip this step and go to [Step3: Unpack the accessory on page 1181](#).

---

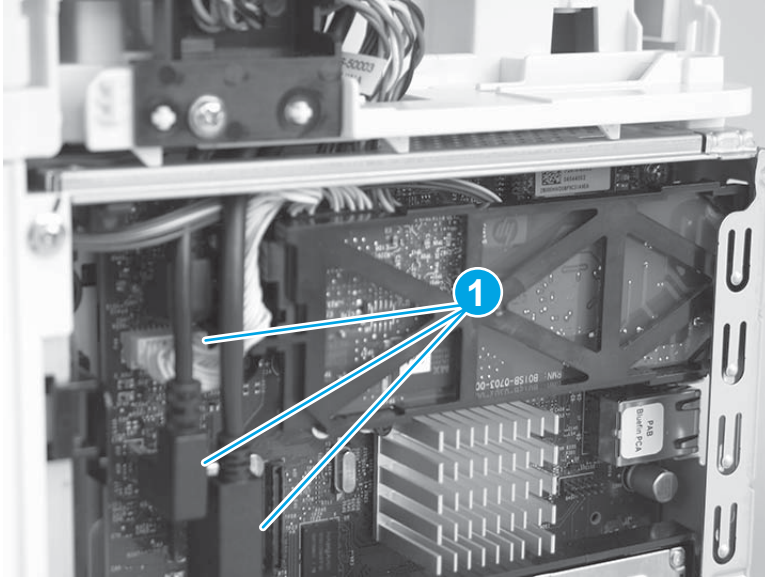
 **CAUTION:**  ESD-sensitive part.

 **NOTE:** M527c/f/z printers only (optional for the M527dn).

---

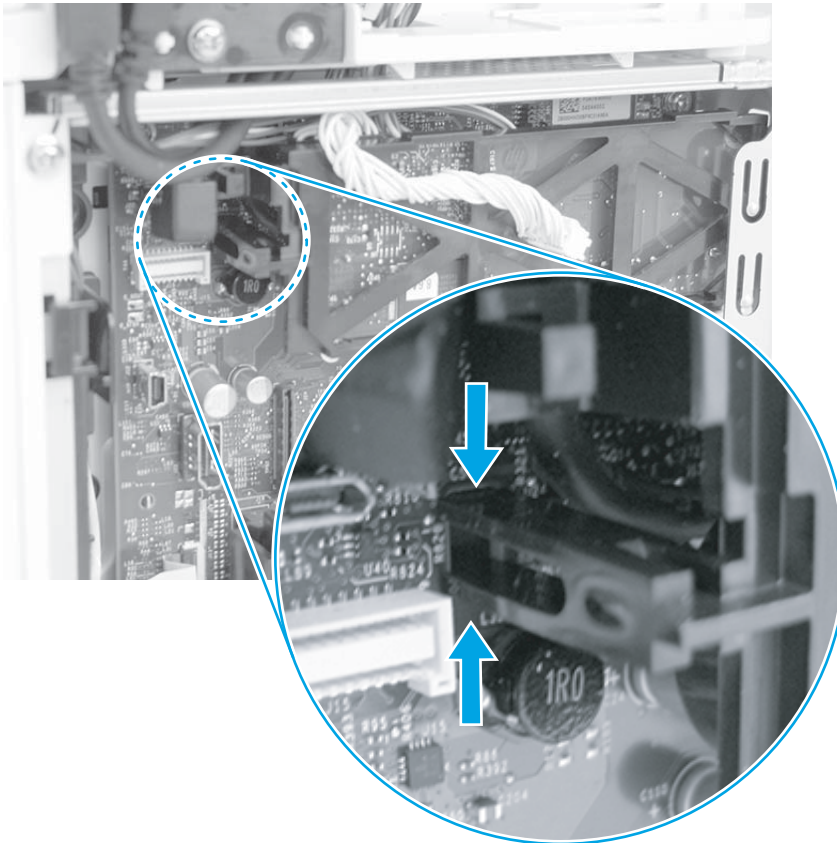
1. Disconnect three connectors (callout 1).

**Figure 1-2109** Disconnect three connectors



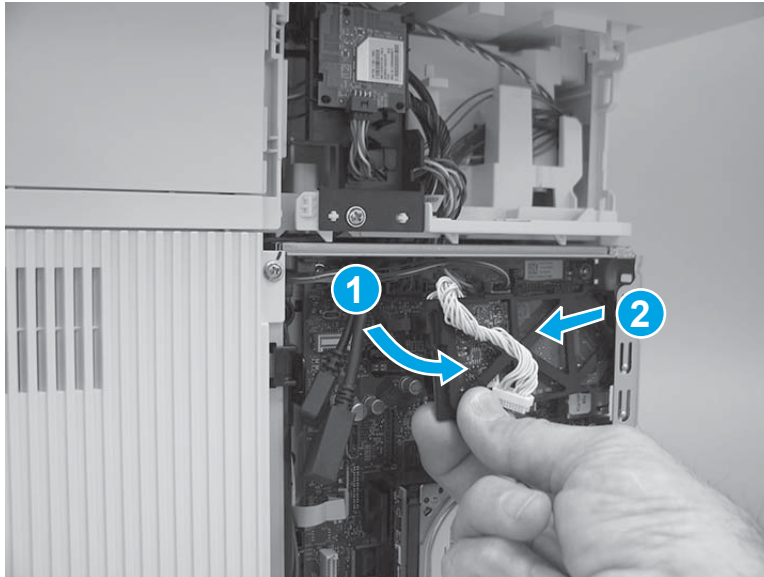
2. Pinch the retainer to release it.

**Figure 1-2110** Release the fax PCA



3. Rotate the connector end of the fax PCA out and away from the formatter (callout 1), and then slide it as shown (callout 2) to remove it.

**Figure 1-2111** Remove the fax PCA

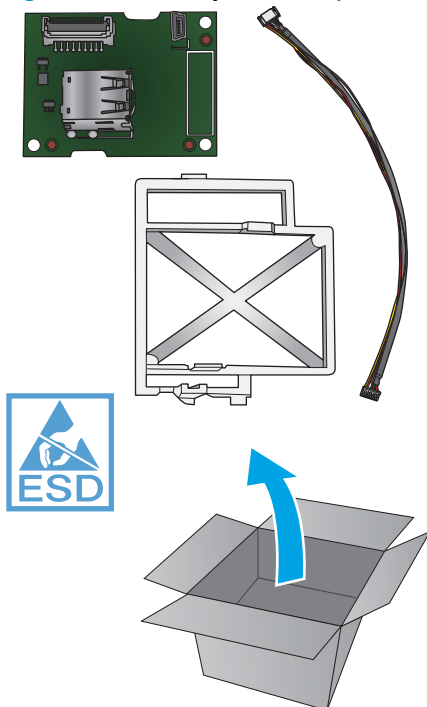


### Step3: Unpack the accessory

Remove the new part from its package. Save all packaging for recycling.

For complete information on HP's recycling programs, go to [Product return and recycling](#).

**Figure 1-2112** Recycle and unpack

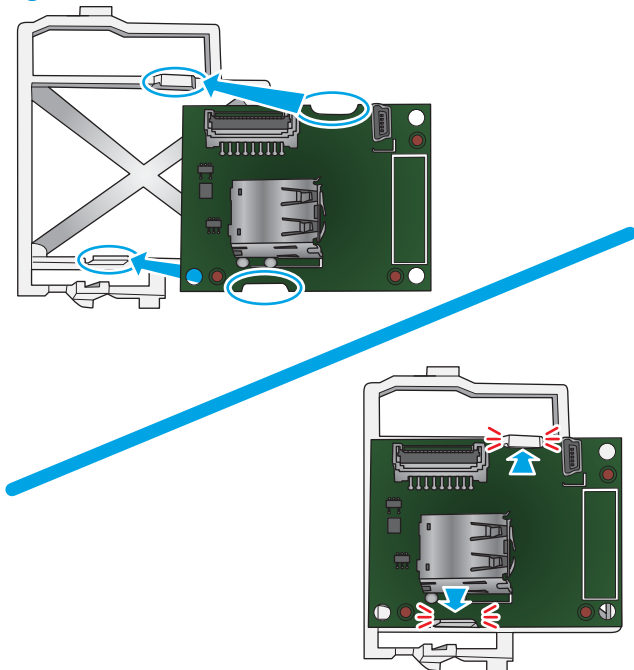


## Step 4: Install the internal USB ports module

 **CAUTION:**  ESD-sensitive part.

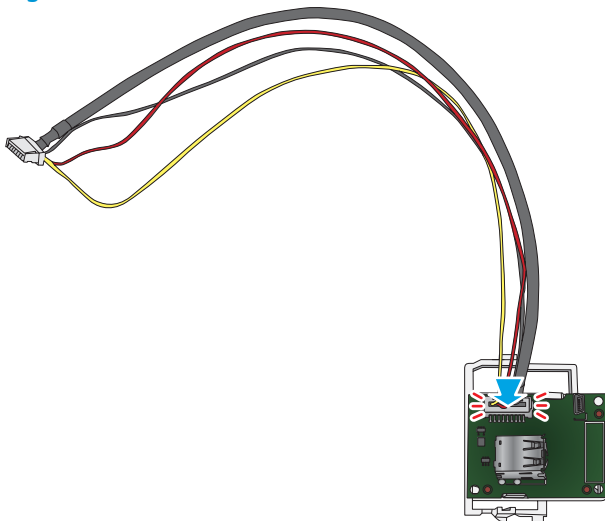
1. Position the notches on the internal USB ports PCA over the clips on the PCA holder and press down to attach the PCA to the holder. Make sure that the clips snap into place.

**Figure 1-2113** Install the PCA in the holder



2. Connect the wire harness to the PCA.

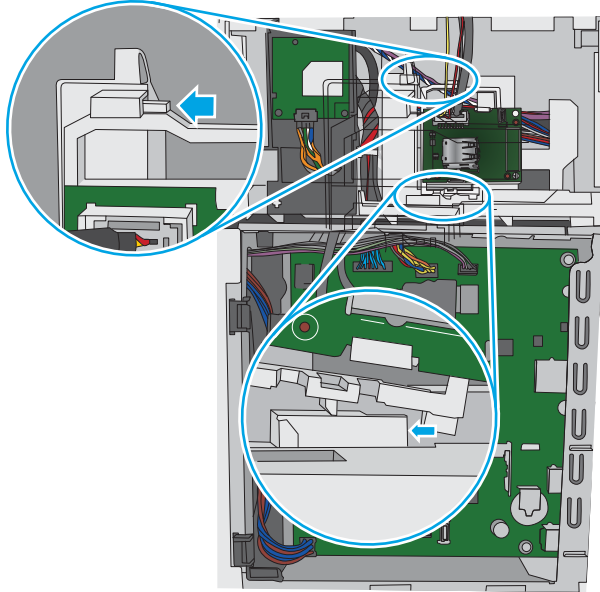
**Figure 1-2114** Connect one cable



3. Position the PCA and bracket in the printer with the top tab aligned with the top slot (callout 1), and bottom edge of the bracket aligned with the bottom slot (callout 2).

 **NOTE:** When correctly installed, the PCA and bracket are firmly held in place.

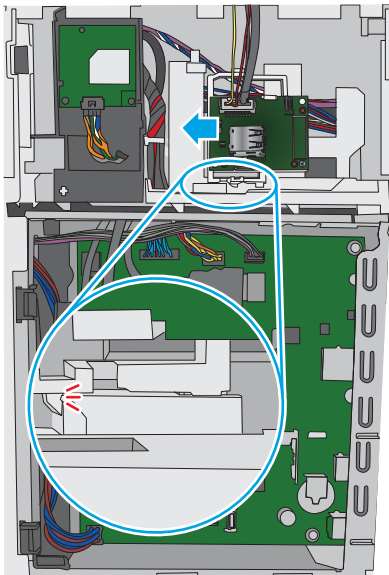
**Figure 1-2115** Position the internal USB ports module



4. Slide the PCA and bracket to the left until the tab on the bottom edge snaps into place.

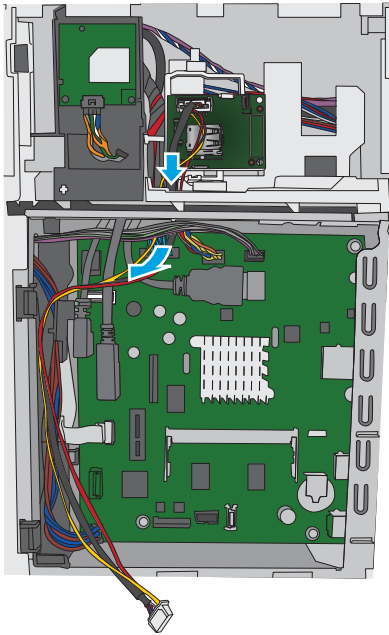
 **NOTE:** When correctly installed, the PCA and bracket are firmly held in place.

**Figure 1-2116** Install the internal USB ports module



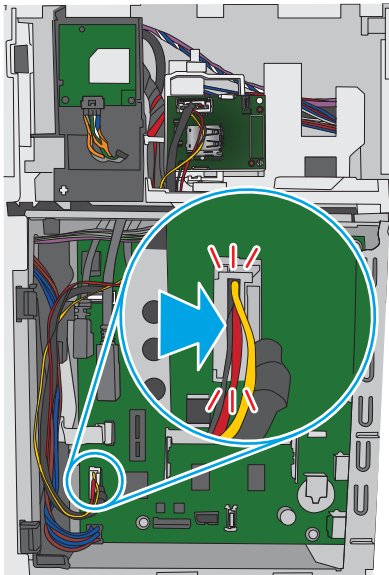
5. Pass the wire harness through the provided opening in the chassis.

**Figure 1-2117** Install the wire harness




6. Connect one connector on the formatter.


**Figure 1-2118** Connect one connector



### Step 5: Install the fax (M527c/f/z)

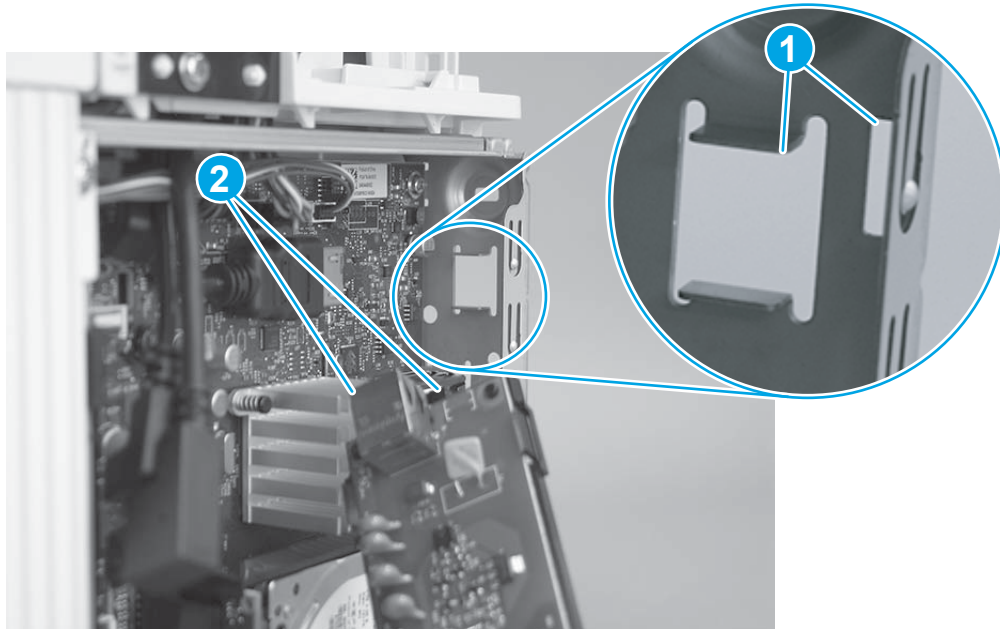
 **NOTE:** This step is for the M527c/f/z printers. For the N527dn model, skip this step and go to [Step 6: Install the formatter cover on page 1187](#).

 **CAUTION:**  ESD-sensitive part.

 **NOTE:** M527c/f/z printers only (optional for the M527dn).

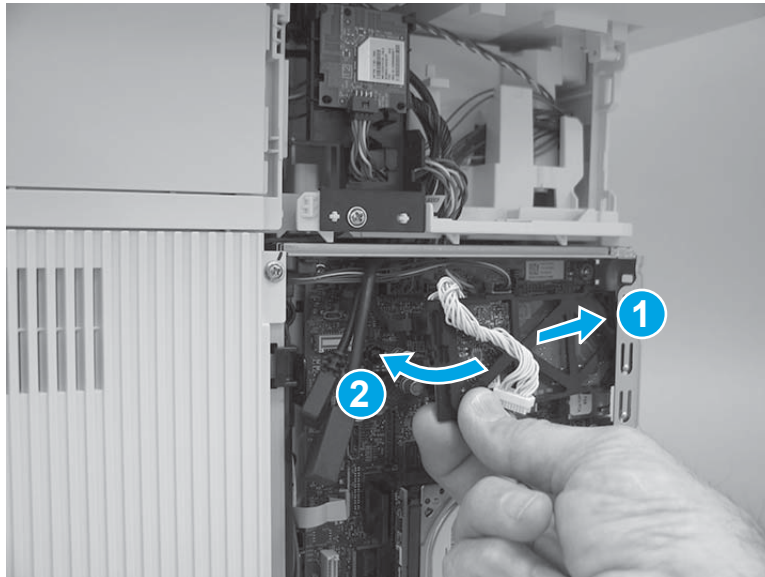
1. Before proceeding, take note of the location of the slots (callout 1) in the sheet-metal where the fax PCA cradle mounting tab and fax port (callout 2) must be installed.

**Figure 1-2119** Locate the slots in the sheet-metal



2. Insert the fax PCA cradle mounting tab and fax port in the slots in the sheet-metal plate (callout 1), and then rotate the connector end of the fax PCA toward the formatter (callout 2).

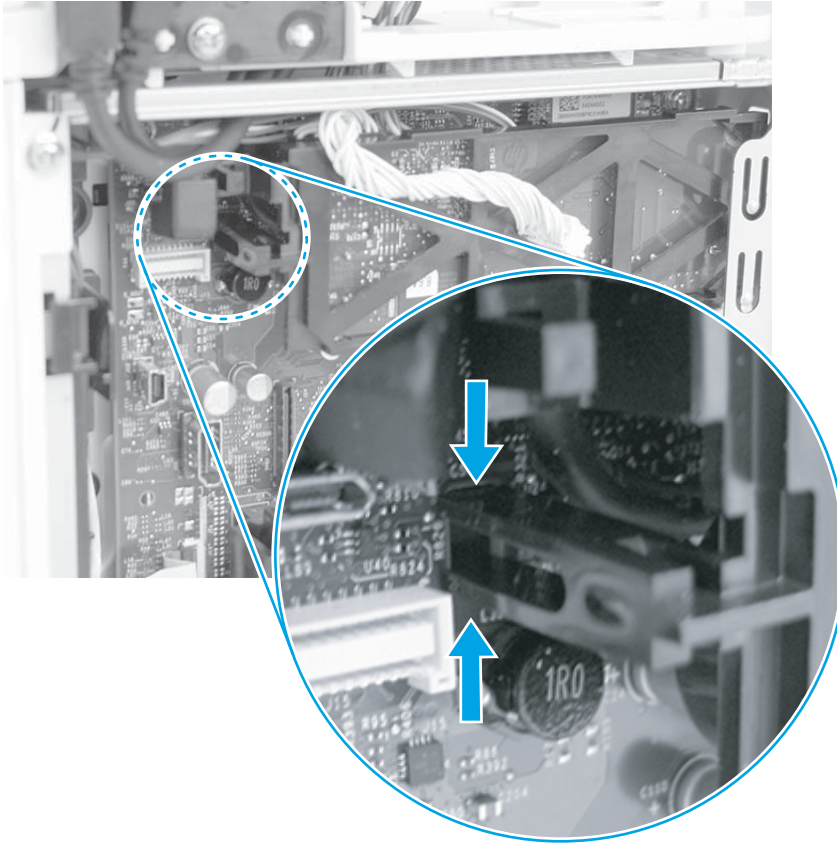
**Figure 1-2120** Install the fax PCA



- Engage the retainer with the slot in the formatter.

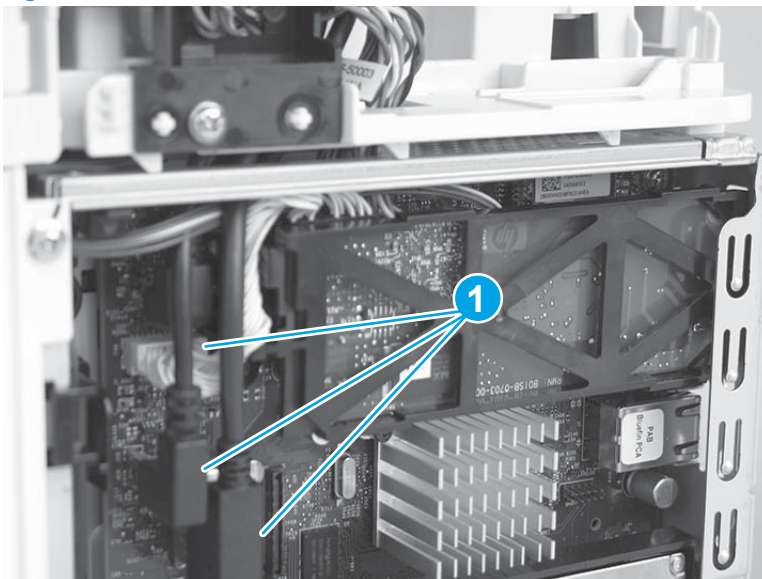
 **Reinstallation tip:** Pinch the retainer to easily engage it with the slot.

**Figure 1-2121** Engage the fax PCA



- Connect three connectors (callout 1).

**Figure 1-2122** Connect three connectors

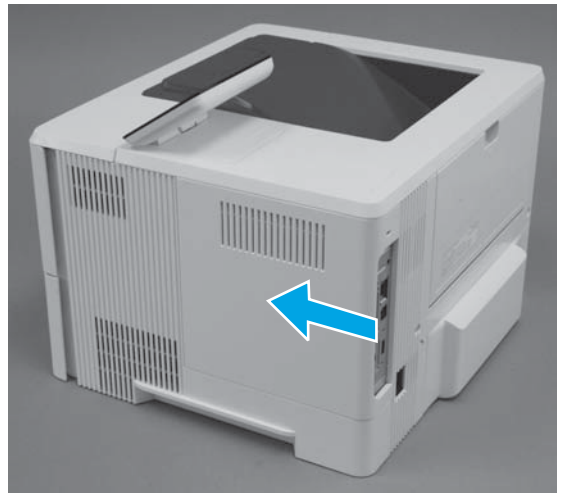




**Step 6: Install the formatter cover**

- ▲ Slide it toward the front of the printer to install it.

**Figure 1-2123** Install the formatter cover



## Install accessory: Internal USB ports (M506)

- [Introduction](#)
- [Step 1: Remove the formatter cover](#)
- [Step 2: Unpack the accessory](#)
- [Step 3: Install the internal USB ports module](#)
- [Step 4: Install the formatter cover](#)

### Introduction


This document provides the procedures to remove and replace the internal USB ports.

### Before performing service



#### Turn the printer power off

- Disconnect the power cable.

---

 **WARNING!** To avoid damage to the printer, turn the printer off wait 30 seconds, and then remove the power cord before attempting to service the printer.

---

 **CAUTION:**  This part contains components that are electrostatic discharge (ESD) sensitive. To reduce the possibility of ESD damage, always touch the sheet-metal chassis to ground yourself before touching an ESD sensitive part.

---

Use the table below to identify the correct part number for your printer. To order the part, go to [www.hp.com/buy/parts](http://www.hp.com/buy/parts).

---

Internal USB ports part number	
--------------------------------	--

---

<b>F2A87A</b>
---------------

Internal USB ports (M506)
---------------------------

---

### Required tools

No special tools are required to install this part.

### After performing service

#### Turn the printer power on

- Connect the power cable.
- Use the power switch to turn the power on.

### Post service test

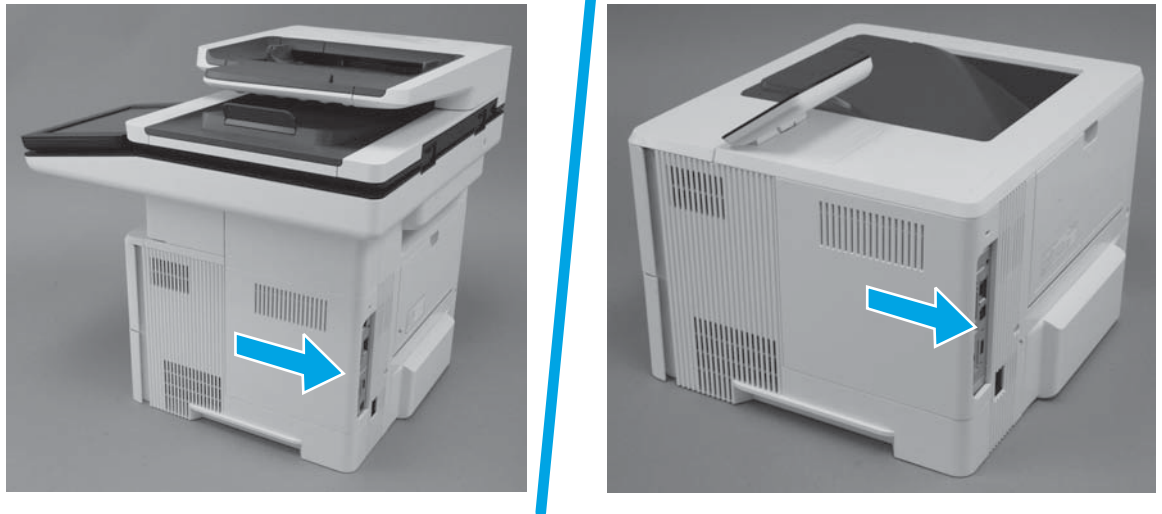
Make sure that the printer initializes to a **Ready** state.

Print a configuratio page to make sure that the printer is functioning correctly.

### Step 1: Remove the formatter cover

- ▲ Slide the cover toward the rear of the printer to remove it.

**Figure 1-2124** Remove the formatter cover

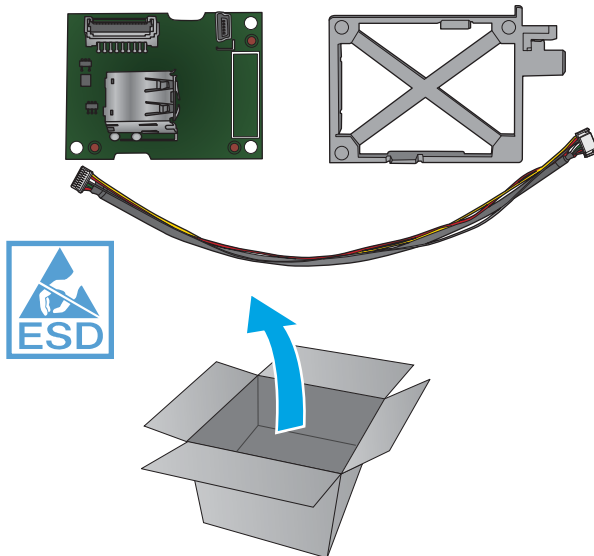


### Step 2: Unpack the accessory

Remove the new part from its package. Save all packaging for recycling.

For complete information on HP's recycling programs, go to [Product return and recycling](#).

**Figure 1-2125** Recycle and unpack

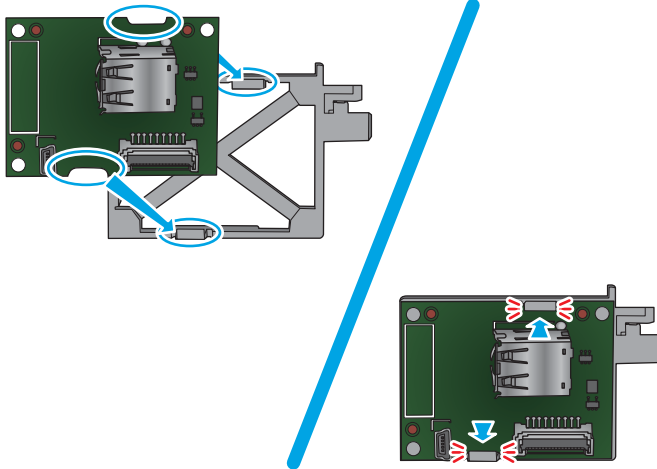


### Step 3: Install the internal USB ports module

**CAUTION:**  ESD-sensitive part.

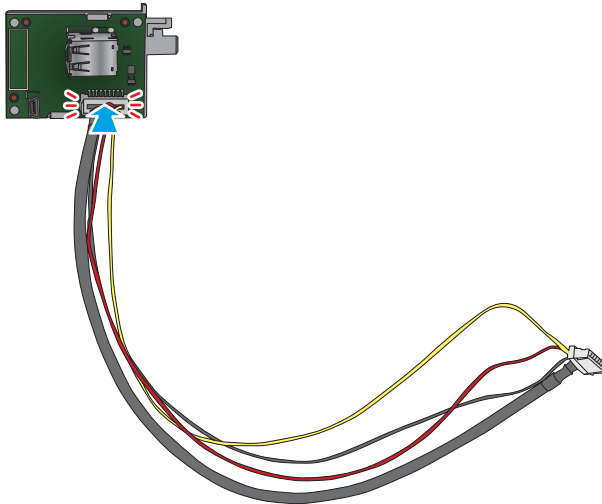
1. Position the notches on the internal USB ports PCA over the clips on the PCA holder and press down to attach the PCA to the holder. Make sure that the clips snap into place.

**Figure 1-2126** Install the PCA in the holder



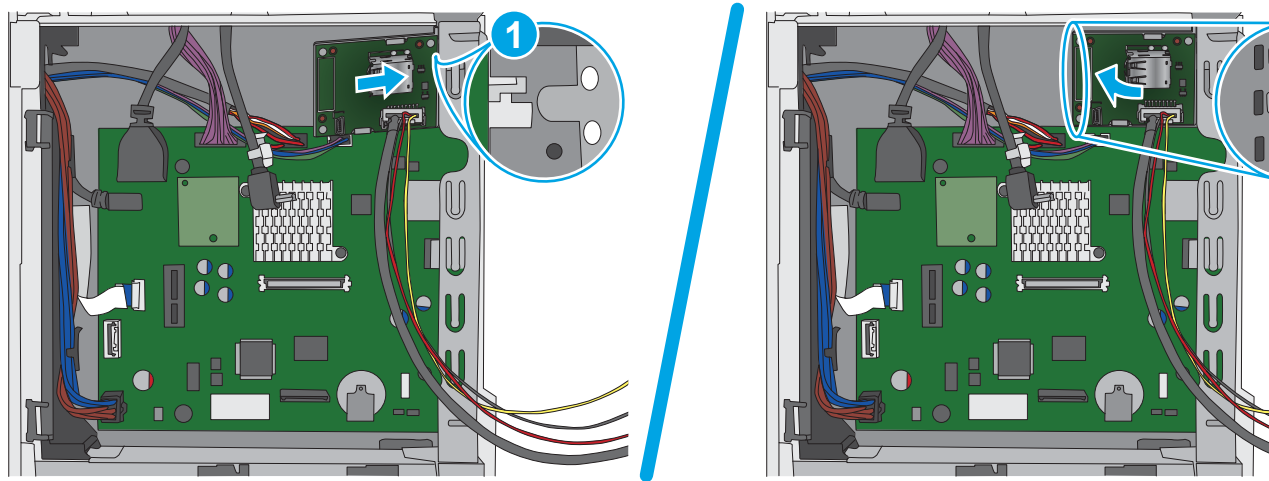
2. Connect the wire harness to the PCA.

**Figure 1-2127** Connect the wire harness



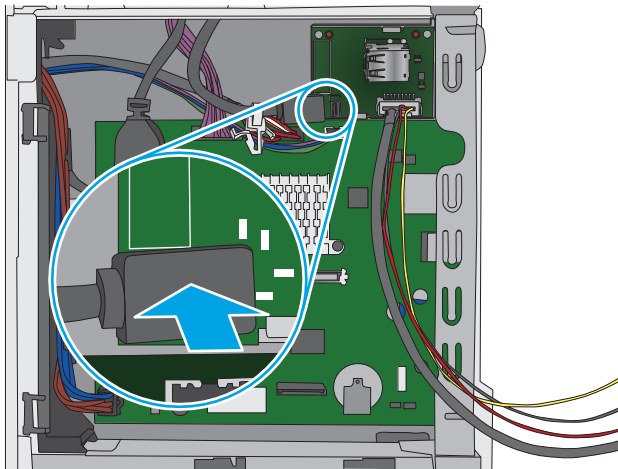
3. Position the tab on the PCA bracket in the slot on the formatter cage (callout 1), and then rotate the left end of the bracket toward the formatter to engage three tabs (callout 2).

**Figure 1-2128** Install the internal USB ports module



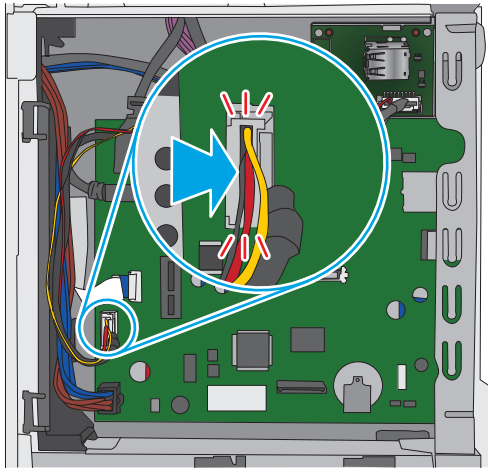
4. Connect one connector on the USB PCA.

**Figure 1-2129** Connect one connector



5. Connect one connector on the formatter.

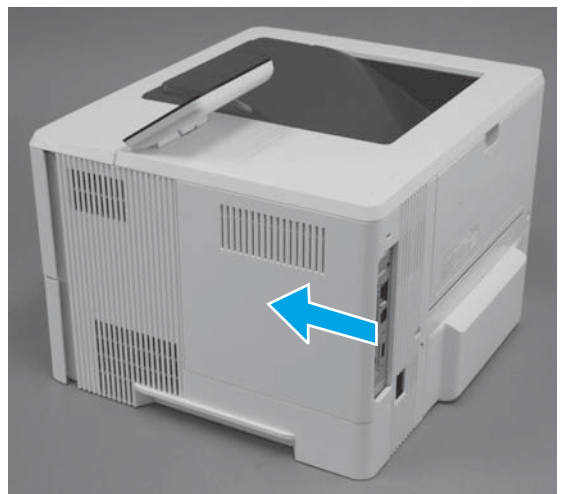
**Figure 1-2130** Connect one connector



#### Step 4: Install the formatter cover

- ▲ Slide it toward the front of the printer to install it.

**Figure 1-2131** Install the formatter cover



---

## 2 Parts and diagrams

- [For additional service and support information](#)
- [Assembly locations](#)
- [Order parts, accessories, and supplies](#)
- [How to use the parts lists and diagrams](#)
- [Parts and diagrams: Document feeder and scanner whole units](#)
- [Parts and diagrams Covers](#)
- [Parts and diagrams: Internal assemblies](#)
- [Parts and diagrams: Accessories](#)
- [Alphabetical parts list](#)
- [Numerical parts list](#)

## For additional service and support information

HP service personnel, go to the Service Access Work Bench (SAW) at <http://h41302.www4.hp.com/km/saw/home.do>.

Channel partners, go to HP Channel Services Network (CSN) at <https://h30125.www3.hp.com/hpcsn>.

- To access HP PartSurfer information from any mobile device, go to <http://partsurfermobile.hp.com/> or scan the Quick Response (QR) code below.



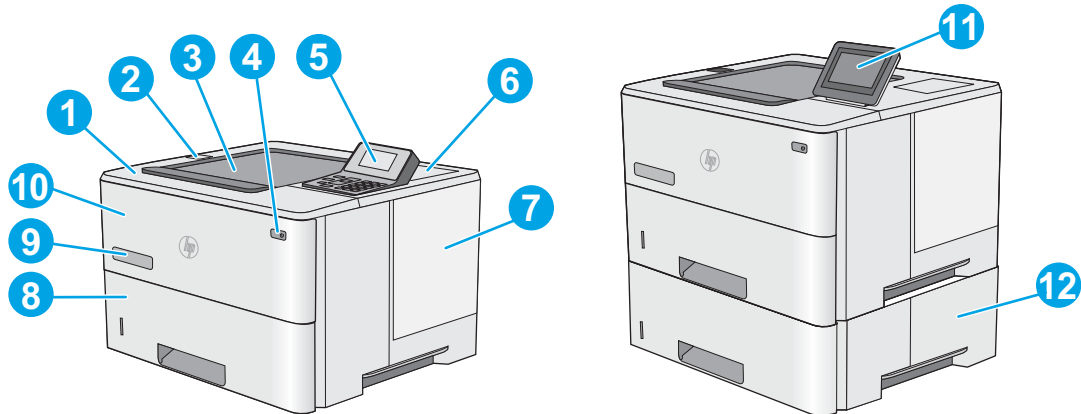
- Install and configur
- Printer specification
- Up-to-date control panel message (CPMD) troubleshooting
- Solutions for printer issues and emerging issues
- Remove and replace part instructions and videos
- Service advisories
- Warranty and regulatory information



# Assembly locations

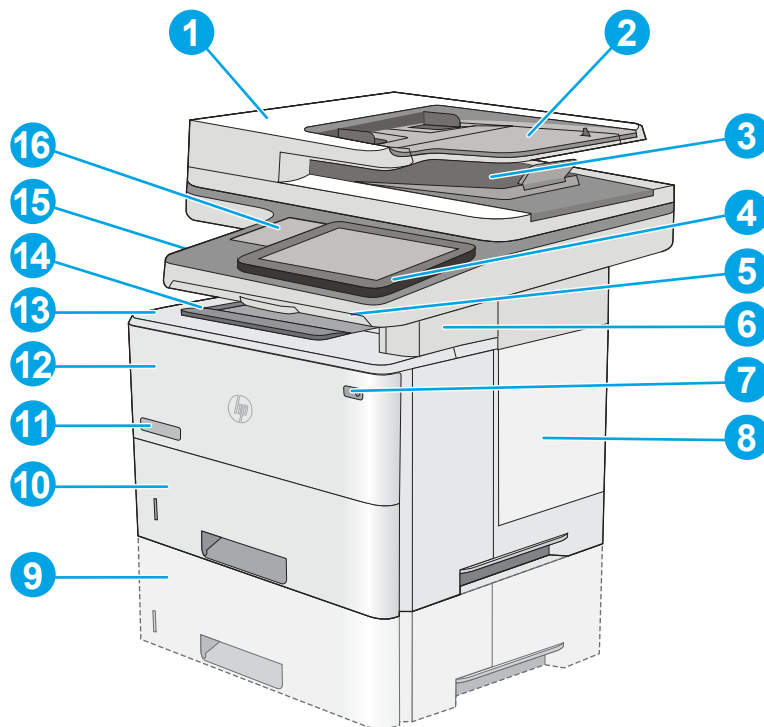
- [Printer front view \(M501/M506\)](#)
- [Printer front view \(M527\)](#)
- [Product back view \(M501/M506\)](#)
- [Product back view \(M527\)](#)

## Printer front view (M501/M506)



1	Top cover (access to the toner cartridge)
2	Easy-access USB port (M506 only)  Insert a USB flash drive for printing without a computer or to update the printer firmware  <b>NOTE:</b> An administrator must enable this port before use.
3	Standard output bin
4	On/off button
5	4-line LCD control panel with keypad (M506n and M506dn models only)  2-line LCD control panel with keypad (M501)
6	Hardware integration pocket for connecting accessory and third-party devices (M506dn and M506x models only)  <b>NOTE:</b> To use the hardware integration pocket (HIP), install the HP internal USB ports accessory (B5L28A). The USB port inside the HIP is not functional otherwise.
7	Formatter cover
8	Tray 2
9	Model name
10	Tray 1
11	Control panel with color touchscreen display (M506x models only)
12	1 x 550-sheet paper feeder, Tray 3 (included with the M506x model, optional for the other models)  <b>NOTE:</b> The M506 printer models accept up to three optional 1 x 550-sheet feeders (Trays 3, 4, and 5). Tray 3 is included with the M506 x model. The M501 printer accepts one optional 1 x 550-sheet feeder (Tray 3).

## Printer front view (M527)



1 Document-feeder cover (access for clearing jams)

2 Document-feeder input tray

3 Document-feeder output bin

**NOTE:** When feeding long paper through the document feeder, extend the paper stop at the right side of the output bin.

4 Control panel with color touchscreen display (tilts up for easier viewing)

5 Physical keyboard (z model only). Pull the keyboard straight out to use it.

6 Convenience stapler (f and z models only)

7 On/Off button

8 Formatter cover

9 Optional 1 x 550-sheet paper feeder (Tray 3)

**NOTE:** Each printer model accepts up to three optional 1 x 550-sheet feeders (Trays 3, 4, and 5).

10 Tray 2

11 Model name

12 Tray 1

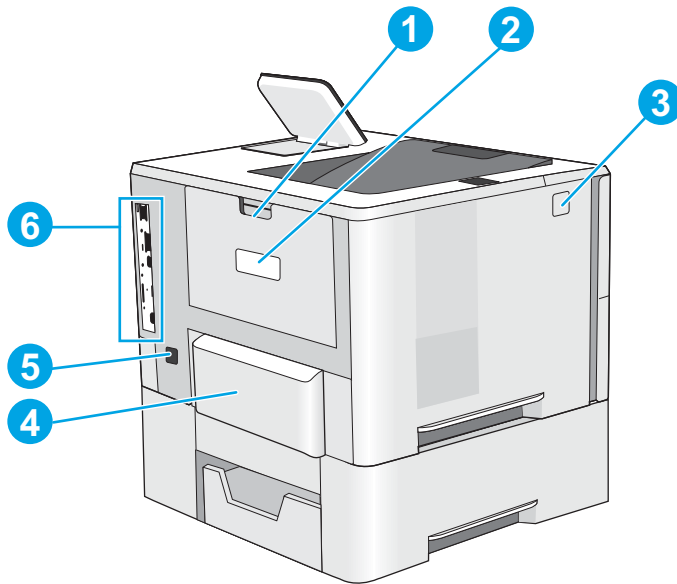
13 Top cover (access to the toner cartridge)

**NOTE:** The release button for the top cover is on the left side of the printer.

14 Standard output bin

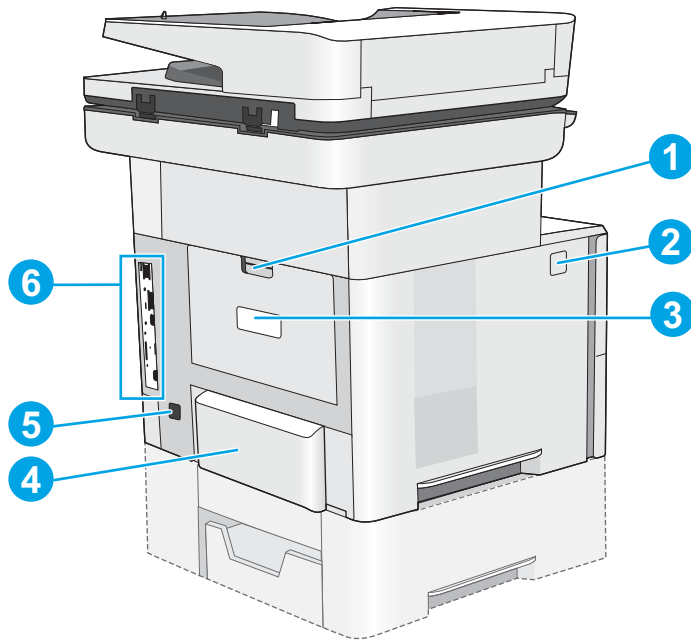
- 
- |    |   |
|----|---|
| 15 | Easy-access USB port (on the left side of the control panel support)<br>Insert a USB flash drive for printing or scanning without a computer or to update the printer firmware<br><b>NOTE:</b> An administrator must enable this port before use. |
|----|---|
- 
- |    |  |
|----|--|
| 16 | Hardware integration pocket (for connecting accessory and third-party devices) |
|----|--|
- 

## Product back view (M501/M506)



- 
- |   |                                      |
|---|--------------------------------------|
| 1 | Rear door (access for clearing jams) |
|---|--------------------------------------|
- 
- |   |  |
|---|--|
| 2 | Serial number and product number label |
|---|--|
- 
- |   |                          |
|---|--------------------------|
| 3 | Top-cover-release button |
|---|--------------------------|
- 
- |   |   |
|---|---|
| 4 | Dust cover for Tray 2 (flip up when legal-size paper is loaded) |
|---|---|
- 
- |   |                  |
|---|------------------|
| 5 | Power connection |
|---|------------------|
- 
- |   |  |
|---|--|
| 6 | Formatter (contains the interface ports) |
|---|--|
-

## Product back view (M527)



1	Rear door (access for clearing jams)
2	Top-cover-release button
3	Serial number and product number label
4	Dust cover for Tray 2 (flip up when legal-size paper is loaded)
5	Power connection
6	Formatter (contains the interface ports)

# Order parts, accessories, and supplies

## Ordering

Order supplies and paper	<a href="http://www.hp.com/go/suresupply">www.hp.com/go/suresupply</a>
Order genuine HP parts or accessories	<a href="http://www.hp.com/buy/parts">www.hp.com/buy/parts</a>
	or
	<a href="http://partsurfer.hp.com">partsurfer.hp.com</a>
Order through service or support providers	Contact an HP-authorized service or support provider.
Order using the HP Embedded Web Server (EWS)	To access, in a supported Web browser on your computer, enter the printer IP address or host name in the address/URL field. The EWS contains a link to the HP SureSupply Web site, which provides options for purchasing Original HP supplies.

## Orderable parts

Not all of the parts shown in the diagrams in this chapter can be ordered. Refer to the table following the diagram or the parts lists at the end of this chapter to determine if a part is orderable.

## Supplies and accessories

Following are the part numbers for the supplies and accessories available for the printers.

**Table 2-1 Supplies and Accessories (M501)**



Item	Description	Cartridge number	Part number
<b>Supplies</b>			
HP 508A Black Original LaserJet Toner Cartridge	Standard-capacity replacement black toner cartridge	872A	CF287A
HP 508X High Yield Black Original LaserJet Toner Cartridge	High-capacity replacement black toner cartridge	872X	CF287X
<b>Accessories</b>			
1 x 550-sheet paper feeder	Optional 550-sheet paper feeder	Not applicable	F2A72A
	<b>NOTE:</b> The M501 printer supports one 1 x 550-sheet paper feeder.		

**Table 2-2 Supplies and Accessories (M506)**

Item	Description	Cartridge number	Part number
<b>Supplies</b>			
HP 508A Black Original LaserJet Toner Cartridge	Standard-capacity replacement black toner cartridge	87A	CF287A Service: CF287-67901
HP 508X High Yield Black Original LaserJet Toner Cartridge	High-capacity replacement black toner cartridge	87X	CF287X Service: CF287-67902

**Table 2-2 Supplies and Accessories (M506) (continued)**

Item	Description	Cartridge number	Part number
<b>Accessories</b>			
1 x 550-sheet paper feeder	Optional 550-sheet paper feeder  <b>NOTE:</b> The printer supports up to three 1 x 550-sheet paper feeders.	Not applicable	F2A72A
Printer stand and cabinet	Optional stand with storage cabinet to support the printer  Recommended when using multiple optional paper feeders.	Not applicable	F2A73A
500 GB HP Secure High-Performance Hard Disk Drive	Accessory hard drive	Not applicable	B5L29A
1 GB DDR3 Slim Memory DIMM	Optional DIMM for expanding the memory (M527)	Not applicable	G6W84A
HP Internal USB ports	Two optional USB ports for connecting third-party devices	Not applicable	F2A87A
HP Trusted Platform Module	Automatically encrypts all data that passes through the printer	Not applicable	F5S62A
HP Jetdirect 2900nw Print Server	USB wireless print server accessory	Not applicable	J8031A
HP Jetdirect 3000w NFC/Wireless Accessory	Wi-Fi direct accessory for “touch” printing from mobile devices	Not applicable	J8030A

**Table 2-3 Supplies and Accessories (M527)**

Item	Description	Cartridge number	Part number
<b>Supplies</b>			
HP 508A Black Original LaserJet Toner Cartridge	Standard-capacity replacement black toner cartridge	872A	CF287A
HP 508X High Yield Black Original LaserJet Toner Cartridge	High-capacity replacement black toner cartridge	872X	CF287X
HP Staple Cartridge Pack	Replacement staple cartridges for the f and z models. Contains two staple cartridges of 1500 staples each.	Not applicable	Q7432A
HP LaserJet 200 ADF Roller Replacement Kit	Replacement feed rollers for the document feeder	Not applicable	B5L52A
<b>Accessories</b>			
1 x 550-sheet paper feeder	Optional 550-sheet paper feeder  <b>NOTE:</b> Each printer model accepts up to three optional 1 x 550-sheet feeders (Trays 3, 4, and 5).	Not applicable	F2A72A
Printer stand and cabinet	Optional stand with storage cabinet to support the printer  Recommended when using multiple optional paper feeders.	Not applicable	F2A73A

**Table 2-3 Supplies and Accessories (M527) (continued)**

Item	Description	Cartridge number	Part number
HP LaserJet Keyboard Overlay Kit for Simplified Chinese & Traditional Chinese  (z model only)	Language-specific adhesive overlay for the physical keyboard	Not applicable	A7W12A
HP LaserJet Keyboard Overlay Kit for Swedish  (z model only)	Language-specific adhesive overlay for the physical keyboard	Not applicable	A7W14A
320 GB HP Secure High-Performance Hard Disk Drive	Standard hard drive	Not applicable	5851-6712
500 GB HP Secure High-Performance Hard Disk Drive	Accessory hard drive	Not applicable	B5L29A
1GB DDR3 x32 144-pin 800MHz Memory SODIMM	Optional DIMM for expanding the memory	Not applicable	E5K49A
HP Internal USB ports	Two optional USB ports for connecting third-party devices	Not applicable	F2A87A
HP Trusted Platform Module	Automatically encrypts all data that passes through the printer	Not applicable	F5S62A
HP Foreign Interface Harness	Optional port for connecting third-party devices	Not applicable	B5L31A
HP LaserJet MFP Analog Fax Accessory 600	Optional fax accessory for the dn model	Not applicable	B5L53A
HP Jetdirect 2900nw Print Server	USB wireless print server accessory	Not applicable	J8031A
HP Jetdirect 3000w NFC/Wireless Accessory	Wi-Fi direct accessory for “touch” printing from mobile devices	Not applicable	J8030A

## Customer self-repair kits

Customer Self-Repair (CSR) parts are available for many HP LaserJet printers to reduce repair time. More information about the CSR program and benefit can be found at [www.hp.com/go/csr-support](http://www.hp.com/go/csr-support) and [www.hp.com/go/csr-faq](http://www.hp.com/go/csr-faq).

Genuine HP replacement parts can be ordered at [www.hp.com/buy/parts](http://www.hp.com/buy/parts) or by contacting an HP-authorized service or support provider. When ordering, one of the following will be needed: part number, serial number (found on back of printer), printer number, or printer name.

- Parts listed as **A**: Easy
- Parts listed as **B**: Difficult and/or requires tools

Kit	Description	CSR level	Part number
Control panel (M527 only)	<ul style="list-style-type: none"> <li>• Control panel</li> <li>• Screwdriver</li> </ul>	A	B5L47-67018

Kit	Description	CSR level	Part number
Control panel kit (M506x only)	<ul style="list-style-type: none"> <li>Control panel</li> <li>Screwdriver</li> </ul>	A	B5L24-67903
Control panel kit (M501)	<ul style="list-style-type: none"> <li>Control panel</li> </ul>	B	J8H60-67904
320 GB encrypted hard disk drive (M527)	<ul style="list-style-type: none"> <li>Hard-disk drive (HDD)</li> </ul>	A	5851-6712
White backing (M527 only)	<ul style="list-style-type: none"> <li>White backing (document feeder)</li> <li>Retention clip kit</li> </ul>	A	5851-6570
embedded MultiMedia Card (eMMC) kit (M527dn)	<ul style="list-style-type: none"> <li>eMMC module 16B</li> </ul>	A	B5L32-60002 (M525dn)
embedded MultiMedia Card (eMMC) kit (all M506)	<ul style="list-style-type: none"> <li>eMMC module 4GB</li> </ul>	A	B5L32-67901(M506)
Transfer roller	<ul style="list-style-type: none"> <li>Transfer roller</li> </ul>	A	F2A68-67910
Retention clip assembly (M527 only)	<ul style="list-style-type: none"> <li>Retention clips for the document feeder white backing</li> </ul>	A	5851-6573
Multipurpose tray (Tray 1) pickup roller and separation pad	<ul style="list-style-type: none"> <li>Roller and separation pad for Tray 1</li> </ul>	B	F2A68-67914
Tray 2-x roller kit (M506/M527)	<ul style="list-style-type: none"> <li>Rollers for Tray 2 and the optional 550-sheet paper feeders</li> </ul> <p><b>NOTE:</b> This kit includes roller assemblies for Tray 2 and up to three optional paper feeders.</p>	B	F2A68-67913
Tray 2-3 roller kit (M501)	<ul style="list-style-type: none"> <li>Rollers for Tray 2 and the optional 550-sheet paper feeder</li> </ul> <p><b>NOTE:</b> This kit includes roller assemblies for Tray 2 and one optional paper feeder.</p>	B	J8H60-67903
Document feeder maintenance kit (M527)	<ul style="list-style-type: none"> <li>Pickup, feed, and separation ADF roller kit</li> </ul>	A	B5L52-67903
Keyboard kit (M527c/z)	<ul style="list-style-type: none"> <li>Physical pull-out keyboard</li> </ul>	B	B5L47-67019 (US English) B5L47-67020 (UK English)

## Related documentation and software

HP service personnel, go to the Service Access Work Bench (SAW) at <http://h41302.www4.hp.com/km/saw/home.do>.

Channel partners, go to HP Channel Services Network (CSN) at <https://h30125.www3.hp.com/hpcsn>.


## How to use the parts lists and diagrams


The figure in this chapter show the major subassemblies in the printer and their component parts. A parts list table follows each exploded view assembly diagram. Each table lists the item number, the associated part



number, and the description of each part. If a part is not listed in the table, then it is not a field replacement unit (FRU) or bench repairable unit (BRU).

---

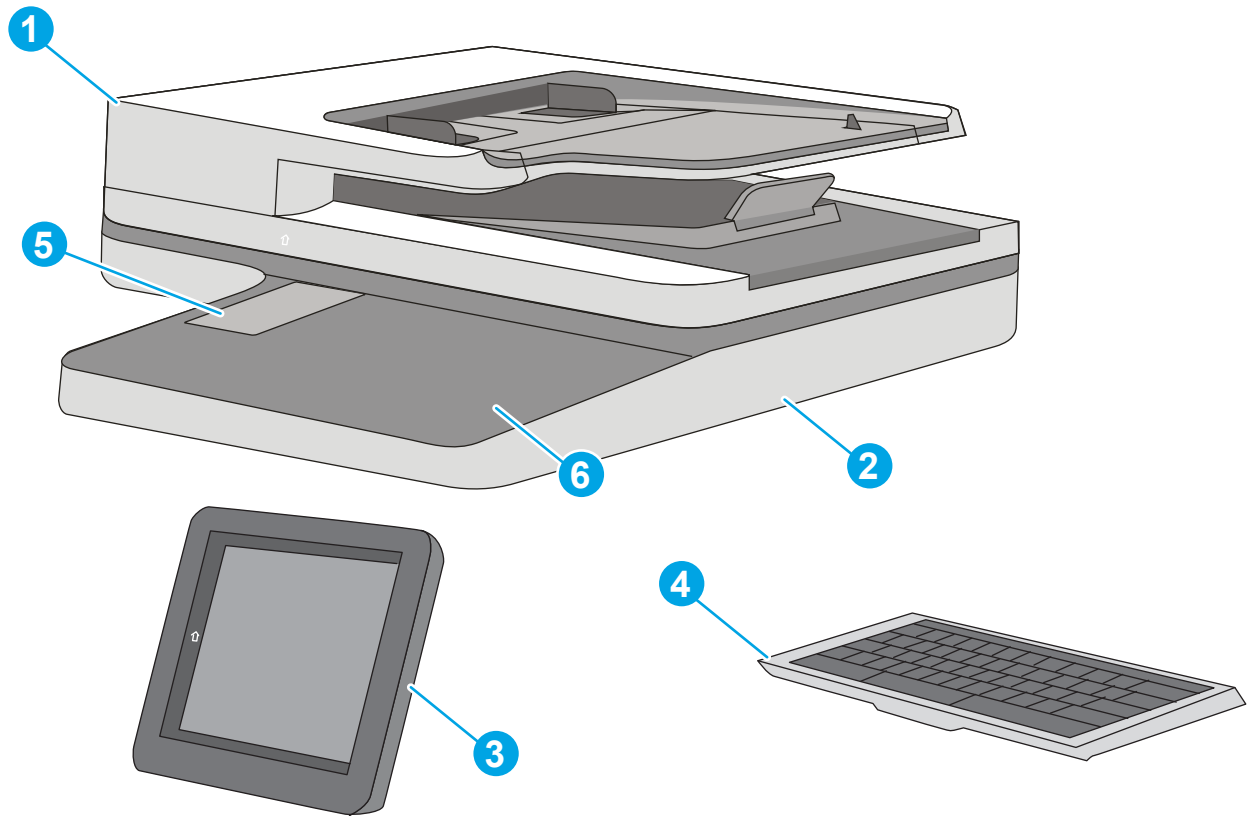
 **CAUTION:** Be sure to order the correct part. When looking for part numbers for electrical components, pay careful attention to the voltage that is listed in the description column. Doing so will ensure that the part number selected is for the correct model.

 **NOTE:** In this manual, the abbreviation “PCA” stands for “printed circuit-board assembly.” Components described as a PCA might consist of a single circuit board or a circuit board plus other parts, such as cables and sensors.


---

## Parts and diagrams: Document feeder and scanner whole units

Figure 2-1 Document feeder and image scanner assembly (M527 only)

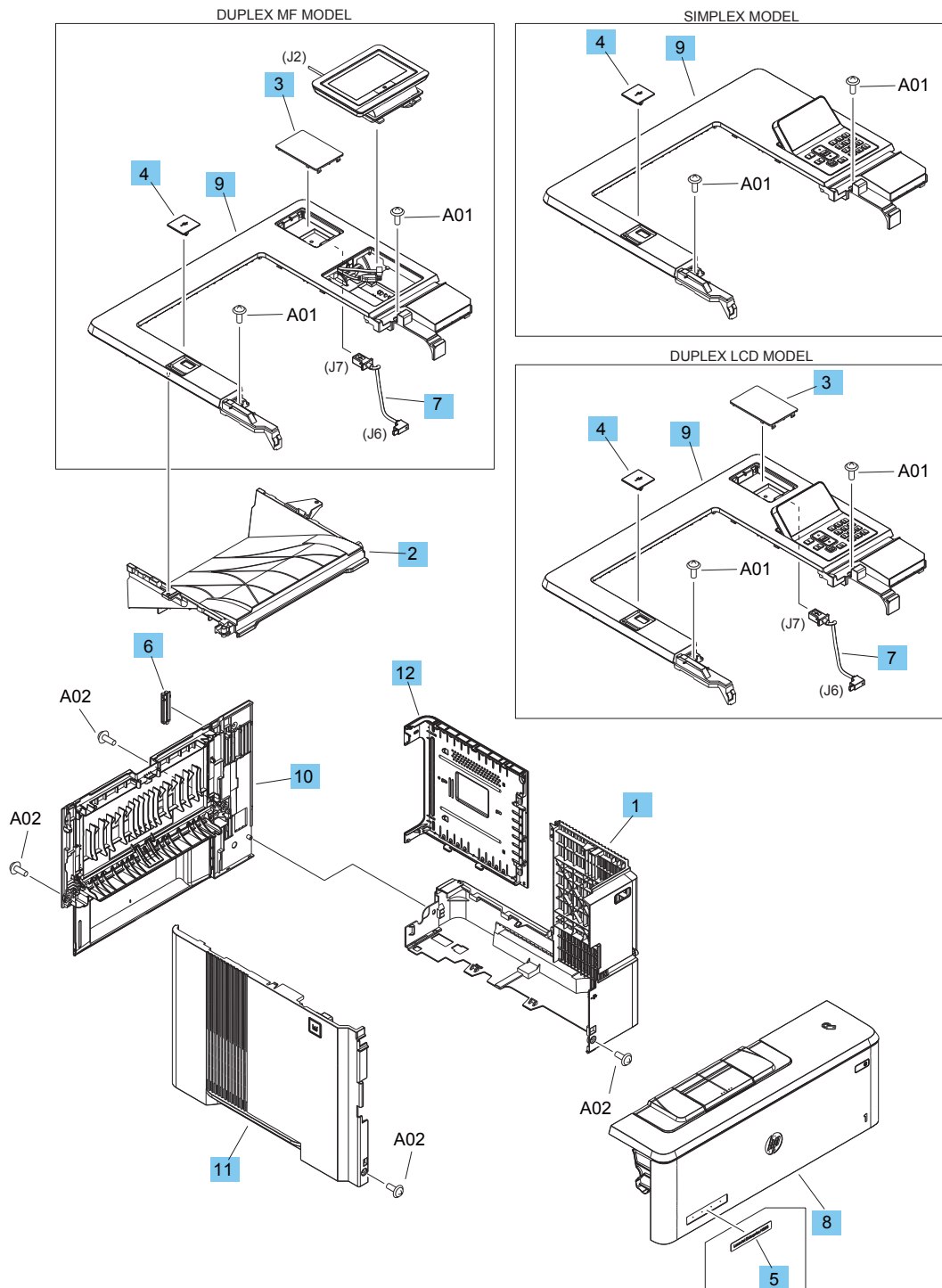


**Table 2-4 Document feeder and scanner whole units (M527 only)**

Ref	Description	Part number	Qty
1	Document feeder (M527 Enterprise) kit; includes white backing and retention clips	B5L47-67901	1
1	Document feeder (M527 Flow) kit; includes white backing and retention clips 	B5L47-67902	1
2	Image scanner assembly (M527) kit; includes white backing and retention clips	F2A76-67909	1
3	Control panel (M527) kit	B5L47-67018	1
4	Keyboard US (M527)	B5L47-67019	1
4	Keyboard UK (M527)	B5L47-67020	1
5	Cover, HIP (M527)	B5L46-40021	1
6	Bezel, control panel (M527)	B5L46-60117	1
Not shown	Cover, keyboard (M527)	B5L46-40002	1
Not shown	Cable, WU USB control panel (M527)	5851-5939	1
Not shown	Cable, HIP USB control panel (M527)	5851-5938	1
Not shown	Cable, HDMI control panel (M527)	5851-5936	1
Not shown	Cable, 18-pin control panel (M527)	5851-5935	1
Not shown	Cable, HDMI PAB to SCAM (M527)	B5L46-60114	1
Not shown	Hinge, left document feeder (M527)	COM39-60064	1
Not shown	Hinge, right document feeder (M527)	COM39-60065	1
Not shown	Cover, USB (M527)	B5L46-40028	1
Not shown	Cable, stapler (M527)	B5L46-60116	1
Not shown	Cover, rear image scanner (M527)	B5L46-40011	1
Not shown	Scan-control board (SCB) kit (M527)	B5L47-67903	1
Not shown	Keyboard overlay kit (FR, IT, RU, DE, ES: UK Kybd)	5851-6019	1
Not shown	Keyboard overlay kit (FR-CN, ES-LA, ES: US Kybd)	5851-6020	1
Not shown	Keyboard overlay kit (FR-SW, DE-SW, DA: UK Kybd)	5851-6021	1
Not shown	Keyboard overlay kit (ZHTW, ZHCN)	5851-6022	1
Not shown	Keyboard overlay kit (ES, PT)	5851-6023	1
Not shown	Keyboard overlay kit (JA-KG, JA-KT)	5851-6024	1

# Parts and diagrams Covers

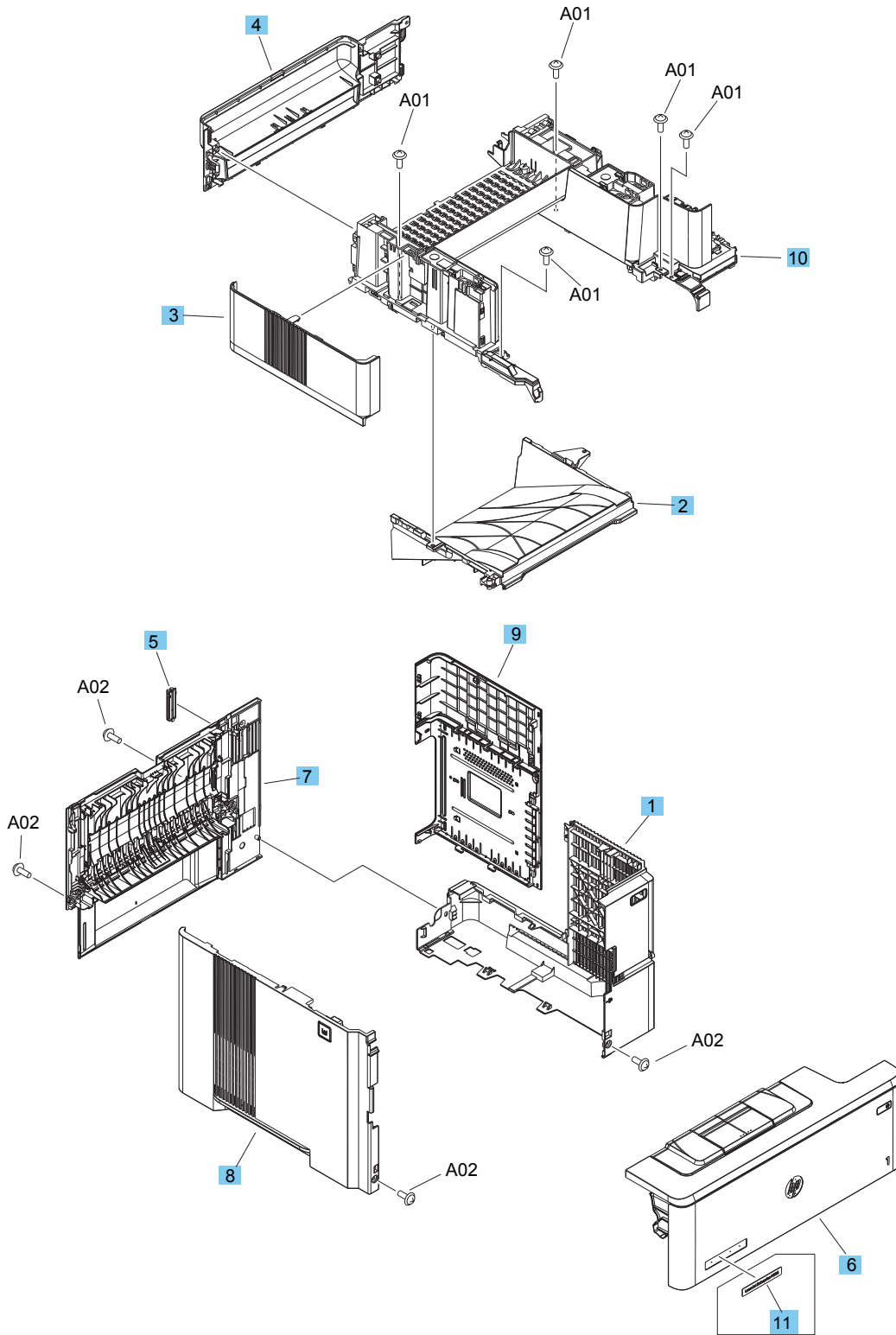
## Covers (M501/M506)



**Table 2-5 Covers (M501/M506)**

<b>Ref</b>	<b>Description</b>	<b>Part number</b>	<b>Qty</b>
1	Cover, right (M501/M506)	RC4-4437-000CN	1
2	Tray, paper delivery output bin (M501/M506)	RC4-4439-000CN	1
3	Cover, HIP (M506 duplex models)	RC4-4142-000CN	1
4	Cover, USB (M506)	RC4-4149-000CN	1
5	Plate, name (M506)	F2A68-40002	1
5	Plate, name (M501)	J8H60-40001	1
6	Cover, I/O (M506)	RC4-4433-000CN	1
7	Cable, HIP (M506 duplex models)	RK2-7104-000CN	1
8	Door, cartridge kit (M506n/dn)	F2A68-67919	1
8	Door, cartridge kit (M506x)	F2A68-67920	1
8	Door, cartridge (M501)	RM2-5677-000CN	1
Not shown	Cover, top (M501)	RM2-5735-000CN	1
9	Cover, top (M506 simplex models)	RM2-5687-000CN	1
9	Cover, top (M506 duplex LCD models)	RM2-5728-000CN	1
9	Cover, top (M506 duplex MF models)	RM2-5686-000CN	1
9	Cover, top (M501 duplex models)	RM2-5726-000CN	1
10	Door, rear (M501/M506 simplex models)	RM2-5712-000CN	1
10	Door, rear (M501/M506 duplex models)	RM2-5711-000CN	1
11	Cover, left (M501/M506)	RM2-5727-000CN	1
11	Cover, formatter (M501)	RC4-4200-000CN	1
11	Cover, formatter (M506)	RM2-5725-000CN	1
Not shown	Hinge, cartridge door left	RC4-3010-000CN	1
Not shown	Link, pressure release (cartridge door)	RC4-4479-000CN	1

# Covers (M527)

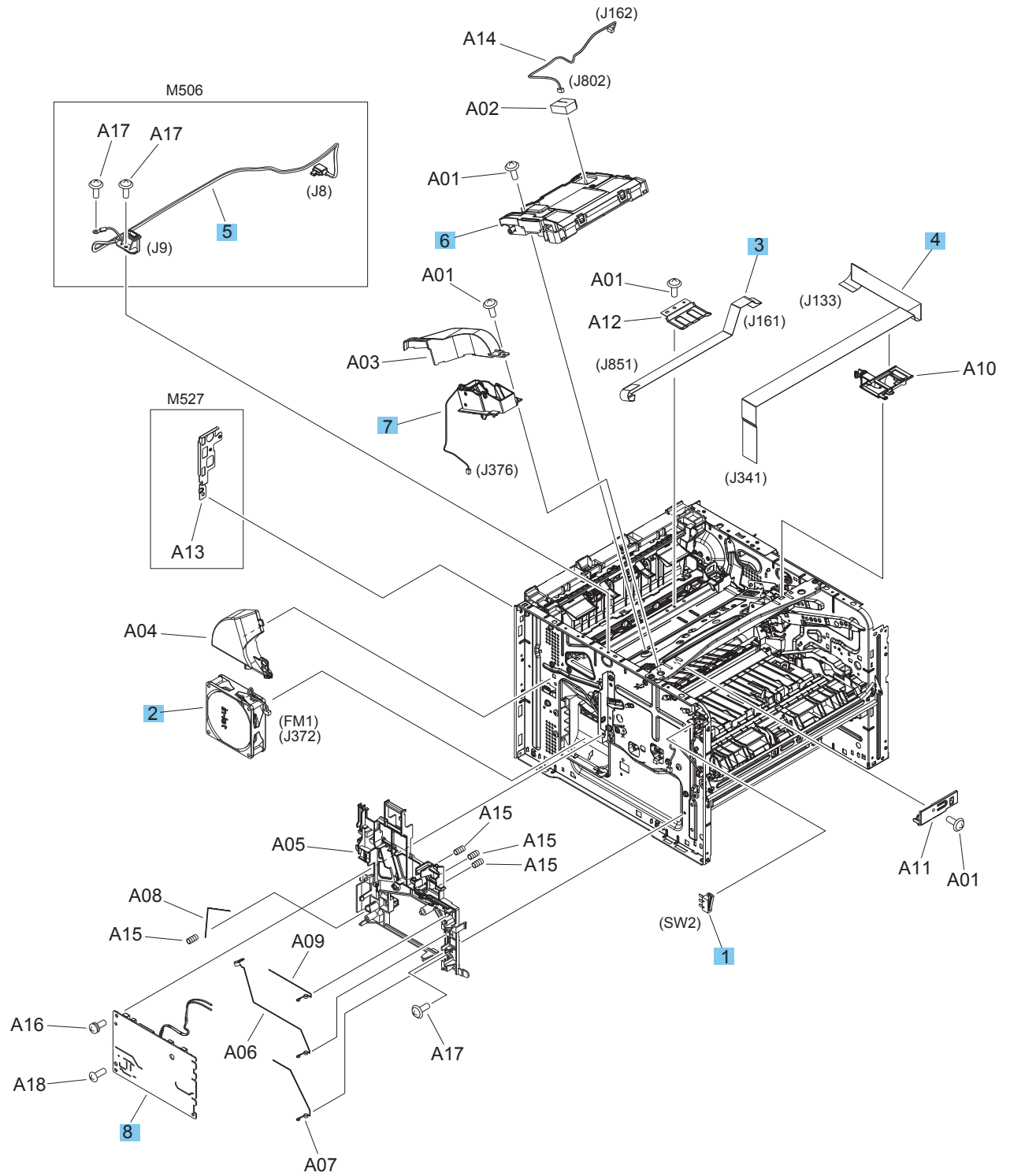


**Table 2-6 Covers (M527)**

<b>Ref</b>	<b>Description</b>	<b>Part number</b>	<b>Qty</b>
1	Cover, right (M527)	RC4-4437-000CN	1
2	Tray, paper delivery output bin (M527)	RC4-4141-000CN	1
3	Cover, top left (M527)	RC4-4147-000CN	1
4	Cover, top rear (M527)	RC4-4150-000CN	1
5	Cover, I/O (M527)	RC4-4433-000CN	1
6	Door, cartridge kit (M527)	F2A76-67912	1
7	Door, rear (M527)	RM2-5711-000CN	1
8	Cover, left (M527)	RM2-5727-000CN	1
9	Cover, formatter (M527)	RM2-5717-000CN	1
10	Cover, top (M527)	RM2-5718-000CN	1
11	Plate, name (M527)	F2A74-40001	1
Not shown	Cover, stationary stapler, inner (M527c/f/z)	F2A76-40003	1
Not shown	Door, stapler fla (M527c/f/z)	F2A76-40004	1
Not shown	Cover, stapler blank (M527dn)	F2A76-40005	1
Not shown	Sticker, stapler cartridge replacement (M527)	B5L24-00035	1
Not shown	Plug/cap, fax port (M527)	5851-1885	1
Not shown	Hinge, cartridge door left	RC4-3010-000CN	1
Not shown	Link, pressure release (cartridge door)	RC4-4479-000CN	1

# Parts and diagrams: Internal assemblies

## Internal assemblies (1 of 4)

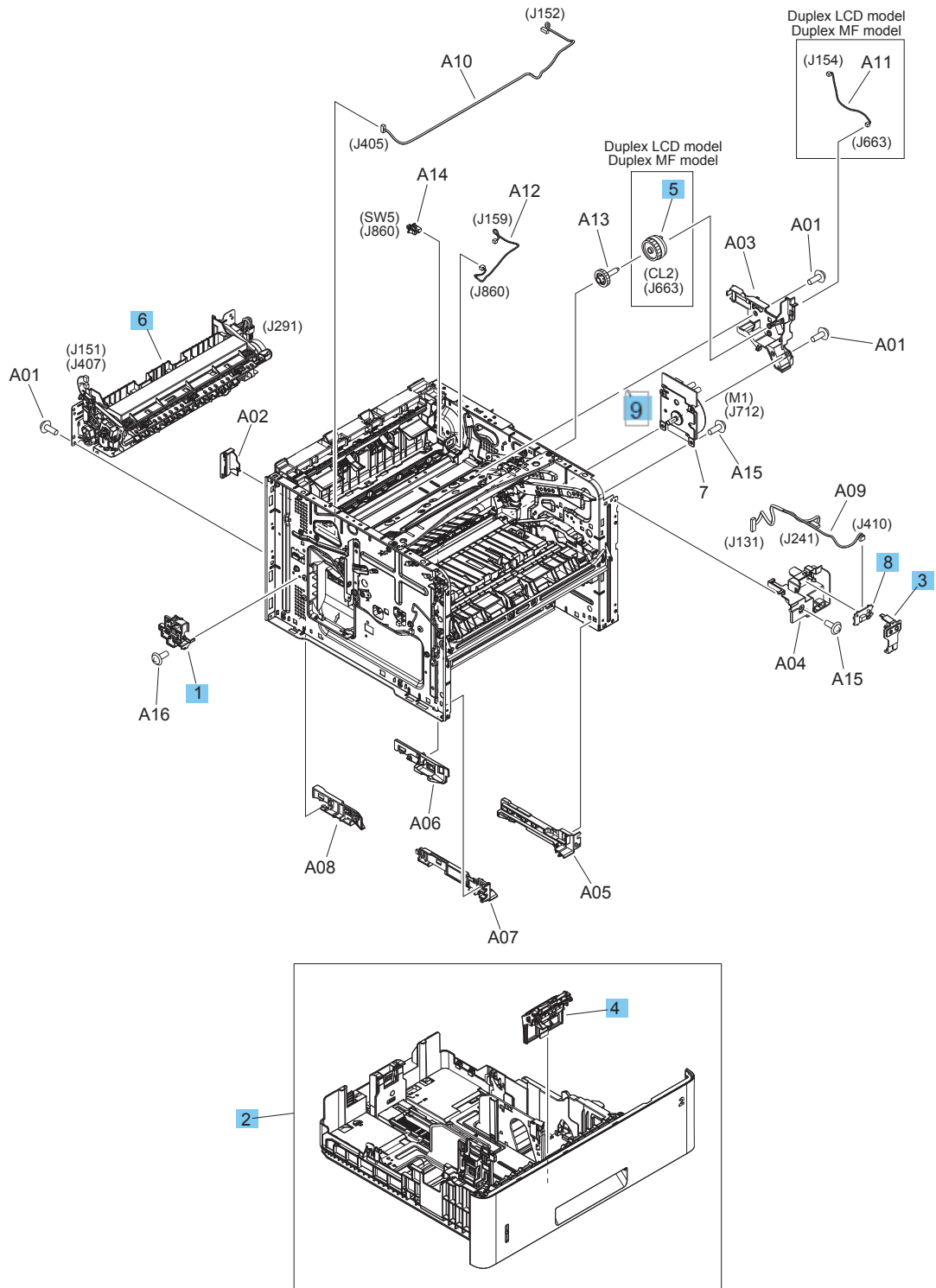




**Table 2-7 Internal assemblies (1 of 4)**

<b>Ref</b>	<b>Description</b>	<b>Part number</b>	<b>Qty</b>
1	Microswitch	RK2-0535-000CN	1
2	Fan (FM1)	RK2-8068-000CN	1
3	Cable, flat-flexib	RK2-6259-000CN	1
4	Cable, flat-flexib	RK2-6260-000CN	1
5	Cable, USB (M506)	RK2-7067-000CN	1
6	Laser/scanner assembly	RM2-5528-000CN	1
7	Cable, TAG assembly	RM2-5702-000CN	1
8	Power supply, high-voltage (HVPS)	RM2-7945-000CN	1

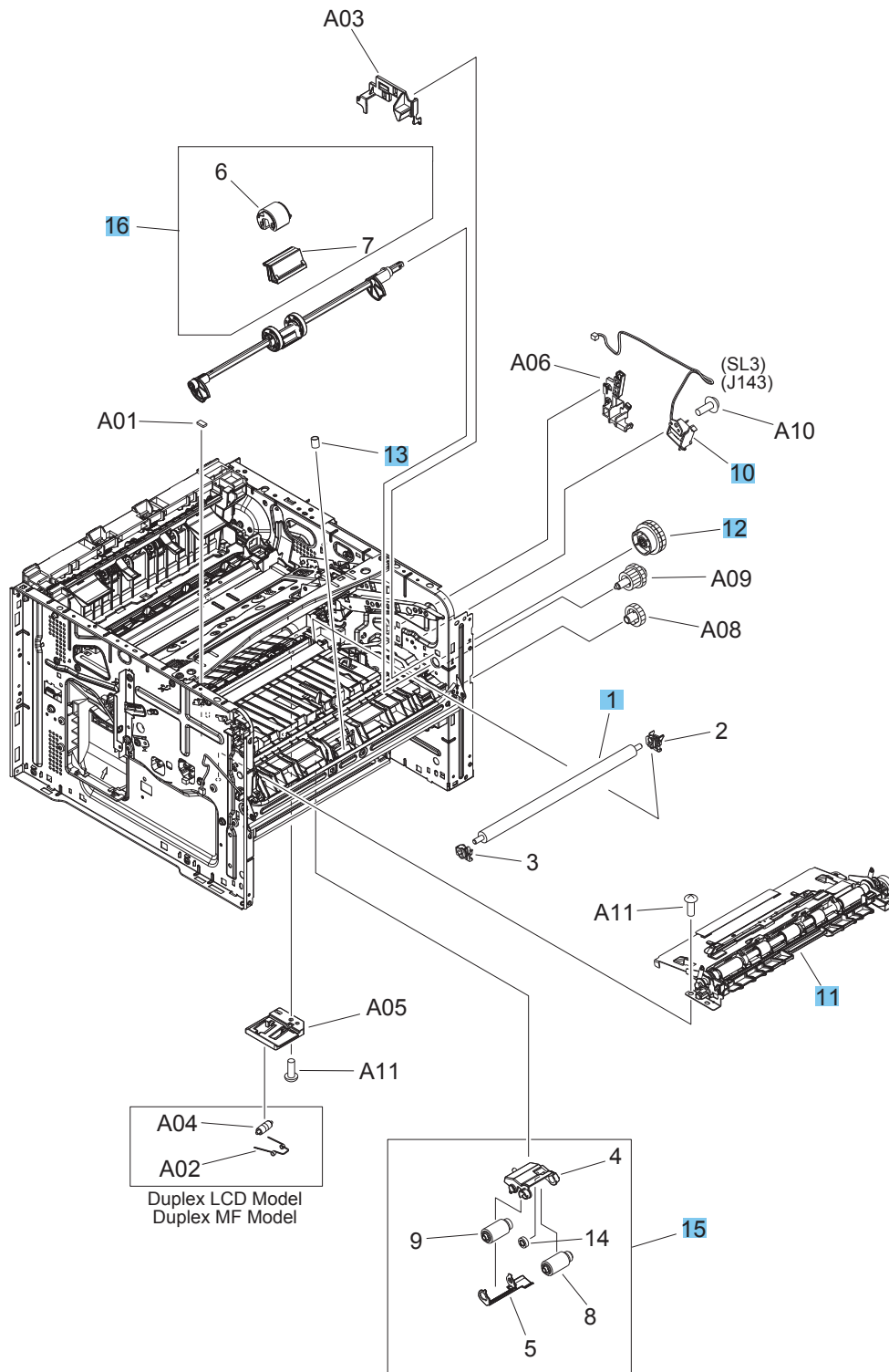
## Internal assemblies (2 of 4)



**Table 2-8 Internal assemblies (2 of 4)**

<b>Ref</b>	<b>Description</b>	<b>Part number</b>	<b>Qty</b>
1	Film bias assembly	RM2-5689-000CN	1
2	Cassette (Tray 2)	RM2-5690-000CN	1
3	Switch, lever assembly	RM2-5701-000CN	1
4	Roller, separation (Tray 2/3)	RM2-5745-000CN	1
5	Clutch, paper re-pickup assembly (M501/M506 duplex LCD and MF models)	RM2-8514-000CN	1
6	Fixing (fuser) assembly 110V-127V	RM2-5679-000CN	1
6	Fixing (fuser) assembly 220V-240V	RM2-5692-000CN	1
8	Switch, power PCA assembly	RM2-8597-000CN	1
9	Main motor M1 assembly	RM2-8684-000CN	1

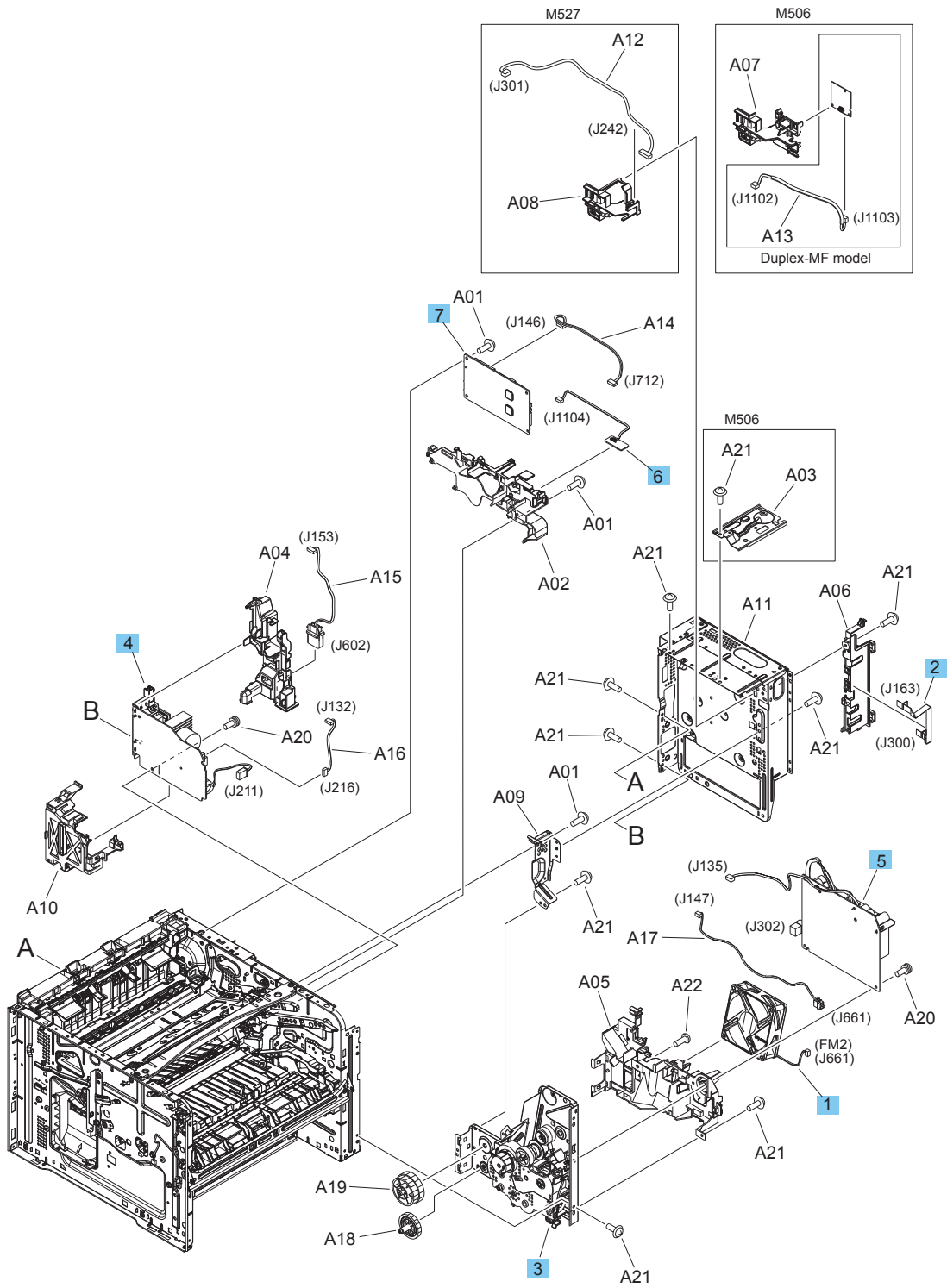
## Internal assemblies (3 of 4)




**Table 2-9 Internal assemblies (3 of 4)**

<b>Ref</b>	<b>Description</b>	<b>Part number</b>	<b>Qty</b>
1	Roller, transfer kit	F2A68-67910	1
10	Solenoid assembly (M501/M506)	RM1-5421-000CN	1
11	Registration assembly	RM2-5671-000CN	1
12	Gear, multi-purpose	RM2-5700-000CN	1
13	Spring, compression (included in the multipurpose tray roller and separation pad kit)	RU8-2935-000CN	1
15	Roller, Tray 2-3 kit (M501)	J8H60-67903	1
15	Roller, Tray 2-x kit (M506/M527)	F2A68-67913	1
16	Roller and pad, Tray 1 pickup and separation pad kit	F2A68-67914	1
Not shown	Stapler unit (M527)	B5L46-60102	1
Not shown	Cable, stapler 6-pin (M527)	F2A76-60113	1
Not shown	Near-field communications (NFC) PCA (M527)	B5L24-60001	1
Not shown	Bracket, WiFi PCA (M506z/M527)	F2A76-40007	1
Not shown	Cable, WiFi PCA (M506z/M527)	F2A76-60112	1
Not shown	Wireless embedded PCA (M506z/M527)	1150-7968	1

# Internal assemblies (4 of 4)



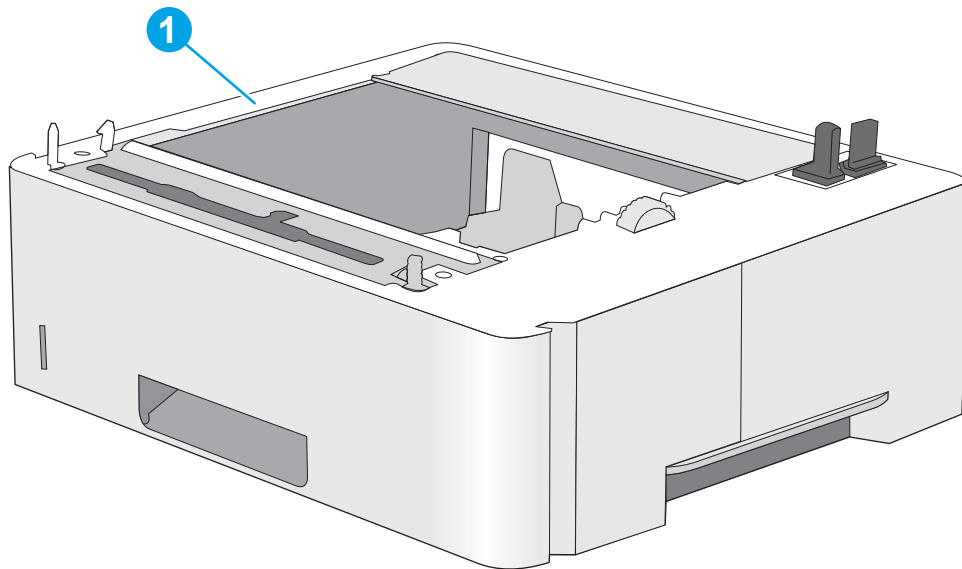
**Table 2-10 Internal assemblies (4 of 4)**

Ref	Description	Part number	Qty
1	Fan (FM2)	RK2-8068-000CN	1
2	Cable, fla flexibl (M506/M527)	RK2-6261-000CN	1
2	Cable, fla flexibl (M501)	RK2-6526-000CN	1
3	Paper feed drive assembly	RM2-5715-000CN	1
4	Fixing (fuser) power supply <sup>1</sup> (FPS) 110V-127V	RM2-7948-000CN	1
4	Fixing (fuser) power supply <sup>1</sup> (FPS) 220V-240V	RM2-7949-000CN	1
5	Low-voltage power supply (LVPS) 110V-127V (M527)	RM2-7951-000CN	1
5	Low-voltage power supply (LVPS) 220V-240V (M527)	RM2-7952-000CN	1
5	Low-voltage power supply (LVPS) 110V-127V (M501/M506)	RM2-7941-000CN	1
5	Low-voltage power supply (LVPS) 220V-240V (M501/M506)	RM2-7942-000CN	1
6	Memory PCA (M506/M527)	RM2-7955-000CN	1
7	DC controller PCA (M527)	RM2-8612-000CN	1
7	DC controller PCA, simplex (M506)	RM2-8614-000CN	1
7	DC controller PCA, duplex (M506)	RM2-8612-000CN	1
7	DC controller PCA, simplex (M501)	RM2-8712-000CN	1
7	DC controller PCA, duplex (M501)	RM2-8711-000CN	1
Not shown	Formatter PCA kit (M527)	F2A76-67910	1
Not shown	Case, formatter PCA (M527)	RL2-0895-000CN	1
Not shown	Formatter PCA kit (M506n/dn)	F2A68-67915	1
Not shown	Formatter PCA kit (M506x)	F2A68-67916	1
Not shown	Formatter PCA (M501n)	J8H60-67901	1
Not shown	Formatter PCA (M501n; China)	J8H60-67902	1
Not shown	Formatter PCA (M501 dn)	J8H61-67901	1
Not shown	Formatter PCA (M501 dn; China)	J8H61-67902	1
Not shown	Case, formatter (M501)	RL2-0888-000CN	1
Not shown	Case, formatter PCA (M506)	RL2-0885-000CN	1
Not shown	Case, formatter (M527)	RL2-0895-000CN	1
Not shown	Fax PCA (M527)	CC456-60002 	1
Not shown	Cradle, fax PCA (M527)	5851-5605	1
Not shown	Cable, fax PCA (M527)	5851-5997	1

<sup>1</sup> The FPS includes the optional paper feeder connector.

## Parts and diagrams: Accessories

### 1x550-sheet paper feeder





**Table 2-11 1x550-sheet paper feeder**

<b>Ref</b>	<b>Description</b>	<b>Part number</b>	<b>Qty</b>
1	1x550-sheet paper feeder (whole unit)	F2A72-67901	1

# Alphabetical parts list

**Table 2-12 Alphabetical parts list**

Description	Part number	Table and page
1x550-sheet paper feeder (whole unit)	F2A72-67901	<a href="#">1x550-sheet paper feeder on page 1219</a>
Bezel, control panel (M527)	B5L46-60117	<a href="#">Document feeder and scanner whole units (M527 only) on page 1205</a>
Bracket, WiFi PCA (M506z/M527)	F2A76-40007	<a href="#">Internal assemblies (3 of 4) on page 1215</a>
Cable, 18-pin control panel (M527)	5851-5935	<a href="#">Document feeder and scanner whole units (M527 only) on page 1205</a>
Cable, fax PCA (M527)	5851-5997	<a href="#">Internal assemblies (4 of 4) on page 1217</a>
Cable, fla flexibl (M501)	RK2-6526-000CN	<a href="#">Internal assemblies (4 of 4) on page 1217</a>
Cable, fla flexibl (M506/M527)	RK2-6261-000CN	<a href="#">Internal assemblies (4 of 4) on page 1217</a>
Cable, flat-flexib	RK2-6259-000CN	<a href="#">Internal assemblies (1 of 4) on page 1211</a>
Cable, flat-flexib	RK2-6260-000CN	<a href="#">Internal assemblies (1 of 4) on page 1211</a>
Cable, HDMI control panel (M527)	5851-5936	<a href="#">Document feeder and scanner whole units (M527 only) on page 1205</a>
Cable, HDMI PAB to SCAM (M527)	B5L46-60114	<a href="#">Document feeder and scanner whole units (M527 only) on page 1205</a>
Cable, HIP (M506 duplex models)	RK2-7104-000CN	<a href="#">Covers (M501/M506) on page 1207</a>
Cable, HIP USB control panel (M527)	5851-5938	<a href="#">Document feeder and scanner whole units (M527 only) on page 1205</a>
Cable, stapler (M527)	B5L46-60116	<a href="#">Document feeder and scanner whole units (M527 only) on page 1205</a>
Cable, stapler 6-pin (M527)	F2A76-60113	<a href="#">Internal assemblies (3 of 4) on page 1215</a>
Cable, TAG assembly	RM2-5702-000CN	<a href="#">Internal assemblies (1 of 4) on page 1211</a>
Cable, USB (M506)	RK2-7067-000CN	<a href="#">Internal assemblies (1 of 4) on page 1211</a>
Cable, WiFi PCA (M506z/M527)	F2A76-60112	<a href="#">Internal assemblies (3 of 4) on page 1215</a>

**Table 2-12 Alphabetical parts list (continued)**

<b>Description</b>	<b>Part number</b>	<b>Table and page</b>
Cable, WU USB control panel (M527)	5851-5939	<a href="#">Document feeder and scanner whole units (M527 only) on page 1205</a>
Case, formatter (M501)	RL2-0888-000CN	<a href="#">Internal assemblies (4 of 4) on page 1217</a>
Case, formatter (M527)	RL2-0895-000CN	<a href="#">Internal assemblies (4 of 4) on page 1217</a>
Case, formatter PCA (M506)	RL2-0885-000CN	<a href="#">Internal assemblies (4 of 4) on page 1217</a>
Case, formatter PCA (M527)	RL2-0895-000CN	<a href="#">Internal assemblies (4 of 4) on page 1217</a>
Cassette (Tray 2)	RM2-5690-000CN	<a href="#">Internal assemblies (2 of 4) on page 1213</a>
Clutch, paper re-pickup assembly (M501/M506 duplex LCD and MF models)	RM2-8514-000CN	<a href="#">Internal assemblies (2 of 4) on page 1213</a>
Control panel (M527) kit	B5L47-67018	<a href="#">Document feeder and scanner whole units (M527 only) on page 1205</a>
Cover, formatter (M501)	RC4-4200-000CN	<a href="#">Covers (M501/M506) on page 1207</a>
Cover, formatter (M506)	RM2-5725-000CN	<a href="#">Covers (M501/M506) on page 1207</a>
Cover, formatter (M527)	RM2-5717-000CN	<a href="#">Covers (M527) on page 1209</a>
Cover, HIP (M506 duplex models)	RC4-4142-000CN	<a href="#">Covers (M501/M506) on page 1207</a>
Cover, HIP (M527)	B5L46-40021	<a href="#">Document feeder and scanner whole units (M527 only) on page 1205</a>
Cover, I/O (M506)	RC4-4433-000CN	<a href="#">Covers (M501/M506) on page 1207</a>
Cover, I/O (M527)	RC4-4433-000CN	<a href="#">Covers (M527) on page 1209</a>
Cover, keyboard (M527)	B5L46-40002	<a href="#">Document feeder and scanner whole units (M527 only) on page 1205</a>
Cover, left (M501/M506)	RM2-5727-000CN	<a href="#">Covers (M501/M506) on page 1207</a>
Cover, left (M527)	RM2-5727-000CN	<a href="#">Covers (M527) on page 1209</a>
Cover, rear image scanner (M527)	B5L46-40011	<a href="#">Document feeder and scanner whole units (M527 only) on page 1205</a>
Cover, right (M501/M506)	RC4-4437-000CN	<a href="#">Covers (M501/M506) on page 1207</a>
Cover, right (M527)	RC4-4437-000CN	<a href="#">Covers (M527) on page 1209</a>

**Table 2-12 Alphabetical parts list (continued)**

<b>Description</b>	<b>Part number</b>	<b>Table and page</b>
Cover, stapler blank (M527dn)	F2A76-40005	<a href="#">Covers (M527) on page 1209</a>
Cover, stationary stapler, inner (M527c/f/z)	F2A76-40003	<a href="#">Covers (M527) on page 1209</a>
Cover, top (M501 duplex models)	RM2-5726-000CN	<a href="#">Covers (M501/M506) on page 1207</a>
Cover, top (M501)	RM2-5735-000CN	<a href="#">Covers (M501/M506) on page 1207</a>
Cover, top (M506 duplex LCD models)	RM2-5728-000CN	<a href="#">Covers (M501/M506) on page 1207</a>
Cover, top (M506 duplex MF models)	RM2-5686-000CN	<a href="#">Covers (M501/M506) on page 1207</a>
Cover, top (M506 simplex models)	RM2-5687-000CN	<a href="#">Covers (M501/M506) on page 1207</a>
Cover, top (M527)	RM2-5718-000CN	<a href="#">Covers (M527) on page 1209</a>
Cover, top left (M527)	RC4-4147-000CN	<a href="#">Covers (M527) on page 1209</a>
Cover, top rear (M527)	RC4-4150-000CN	<a href="#">Covers (M527) on page 1209</a>
Cover, USB (M506)	RC4-4149-000CN	<a href="#">Covers (M501/M506) on page 1207</a>
Cover, USB (M527)	B5L46-40028	<a href="#">Document feeder and scanner whole units (M527 only) on page 1205</a>
Cradle, fax PCA (M527)	5851-5605	<a href="#">Internal assemblies (4 of 4) on page 1217</a>
DC controller PCA (M527)	RM2-8612-000CN	<a href="#">Internal assemblies (4 of 4) on page 1217</a>
DC controller PCA, duplex (M501)	RM2-8711-000CN	<a href="#">Internal assemblies (4 of 4) on page 1217</a>
DC controller PCA, duplex (M506)	RM2-8612-000CN	<a href="#">Internal assemblies (4 of 4) on page 1217</a>
DC controller PCA, simplex (M501)	RM2-8712-000CN	<a href="#">Internal assemblies (4 of 4) on page 1217</a>
DC controller PCA, simplex (M506)	RM2-8614-000CN	<a href="#">Internal assemblies (4 of 4) on page 1217</a>
Document feeder (M527 Enterprise) kit; includes white backing and retention clips	B5L47-67901	<a href="#">Document feeder and scanner whole units (M527 only) on page 1205</a>
Document feeder (M527 Flow) kit; includes white backing and retention clips	B5L47-67902	<a href="#">Document feeder and scanner whole units (M527 only) on page 1205</a>
Door, cartridge (M501)	RM2-5677-000CN	<a href="#">Covers (M501/M506) on page 1207</a>
Door, cartridge kit (M506n/dn)	F2A68-67919	<a href="#">Covers (M501/M506) on page 1207</a>

**Table 2-12 Alphabetical parts list (continued)**

<b>Description</b>	<b>Part number</b>	<b>Table and page</b>
Door, cartridge kit (M506x)	F2A68-67920	<a href="#">Covers (M501/M506) on page 1207</a>
Door, cartridge kit (M527)	F2A76-67912	<a href="#">Covers (M527) on page 1209</a>
Door, rear (M501/M506 duplex models)	RM2-5711-000CN	<a href="#">Covers (M501/M506) on page 1207</a>
Door, rear (M501/M506 simplex models)	RM2-5712-000CN	<a href="#">Covers (M501/M506) on page 1207</a>
Door, rear (M527)	RM2-5711-000CN	<a href="#">Covers (M527) on page 1209</a>
Door, stapler fla (M527c/f/z)	F2A76-40004	<a href="#">Covers (M527) on page 1209</a>
Fan (FM1)	RK2-8068-000CN	<a href="#">Internal assemblies (1 of 4) on page 1211</a>
Fan (FM2)	RK2-8068-000CN	<a href="#">Internal assemblies (4 of 4) on page 1217</a>
Fax PCA (M527)	CC456-60002	<a href="#">Internal assemblies (4 of 4) on page 1217</a>
Film bias assembly	RM2-5689-000CN	<a href="#">Internal assemblies (2 of 4) on page 1213</a>
Fixing (fuser) assembly 110V-127V	RM2-5679-000CN	<a href="#">Internal assemblies (2 of 4) on page 1213</a>
Fixing (fuser) assembly 220V-240V	RM2-5692-000CN	<a href="#">Internal assemblies (2 of 4) on page 1213</a>
Fixing (fuser) power supply <sup>1</sup> (FPS) 110V-127V	RM2-7948-000CN	<a href="#">Internal assemblies (4 of 4) on page 1217</a>
Fixing (fuser) power supply <sup>1</sup> (FPS) 220V-240V	RM2-7949-000CN	<a href="#">Internal assemblies (4 of 4) on page 1217</a>
Formatter PCA (M501dn)	J8H61-67901	<a href="#">Internal assemblies (4 of 4) on page 1217</a>
Formatter PCA (M501dn; China)	J8H61-67902	<a href="#">Internal assemblies (4 of 4) on page 1217</a>
Formatter PCA (M501n)	J8H60-67901	<a href="#">Internal assemblies (4 of 4) on page 1217</a>
Formatter PCA (M501n; China)	J8H60-67902	<a href="#">Internal assemblies (4 of 4) on page 1217</a>
Formatter PCA kit (M506n/dn)	F2A68-67915	<a href="#">Internal assemblies (4 of 4) on page 1217</a>
Formatter PCA kit (M506x)	F2A68-67916	<a href="#">Internal assemblies (4 of 4) on page 1217</a>
Formatter PCA kit (M527)	F2A76-67910	<a href="#">Internal assemblies (4 of 4) on page 1217</a>
Gear, multi-purpose	RM2-5700-000CN	<a href="#">Internal assemblies (3 of 4) on page 1215</a>
Hinge, cartridge door left	RC4-3010-000CN	<a href="#">Covers (M501/M506) on page 1207</a>

**Table 2-12 Alphabetical parts list (continued)**

<b>Description</b>	<b>Part number</b>	<b>Table and page</b>
Hinge, cartridge door left	RC4-3010-000CN	<a href="#">Covers (M527) on page 1209</a>
Hinge, left document feeder (M527)	COM39-60064	<a href="#">Document feeder and scanner whole units (M527 only) on page 1205</a>
Hinge, right document feeder (M527)	COM39-60065	<a href="#">Document feeder and scanner whole units (M527 only) on page 1205</a>
Image scanner assembly (M527) kit; includes white backing and retention clips	F2A76-67909	<a href="#">Document feeder and scanner whole units (M527 only) on page 1205</a>
Keyboard overlay kit (ES, PT)	5851-6023	<a href="#">Document feeder and scanner whole units (M527 only) on page 1205</a>
Keyboard overlay kit (FR, IT, RU, DE, ES: UK Kybd)	5851-6019	<a href="#">Document feeder and scanner whole units (M527 only) on page 1205</a>
Keyboard overlay kit (FR-CN, ES-LA, ES: US Kybd)	5851-6020	<a href="#">Document feeder and scanner whole units (M527 only) on page 1205</a>
Keyboard overlay kit (FR-SW, DE-SW, DA: UK Kybd)	5851-6021	<a href="#">Document feeder and scanner whole units (M527 only) on page 1205</a>
Keyboard overlay kit (JA-KG, JA-KT)	5851-6024	<a href="#">Document feeder and scanner whole units (M527 only) on page 1205</a>
Keyboard overlay kit (ZHTW, ZHCN)	5851-6022	<a href="#">Document feeder and scanner whole units (M527 only) on page 1205</a>
Keyboard UK (M527)	B5L47-67020	<a href="#">Document feeder and scanner whole units (M527 only) on page 1205</a>
Keyboard US (M527)	B5L47-67019	<a href="#">Document feeder and scanner whole units (M527 only) on page 1205</a>
Laser/scanner assembly	RM2-5528-000CN	<a href="#">Internal assemblies (1 of 4) on page 1211</a>
Link, pressure release (cartridge door)	RC4-4479-000CN	<a href="#">Covers (M501/M506) on page 1207</a>
Link, pressure release (cartridge door)	RC4-4479-000CN	<a href="#">Covers (M527) on page 1209</a>
Low-voltage power supply (LVPS) 110V-127V (M501/M506)	RM2-7941-000CN	<a href="#">Internal assemblies (4 of 4) on page 1217</a>
Low-voltage power supply (LVPS) 110V-127V (M527)	RM2-7951-000CN	<a href="#">Internal assemblies (4 of 4) on page 1217</a>
Low-voltage power supply (LVPS) 220V-240V (M501/M506)	RM2-7942-000CN	<a href="#">Internal assemblies (4 of 4) on page 1217</a>

**Table 2-12 Alphabetical parts list (continued)**

<b>Description</b>	<b>Part number</b>	<b>Table and page</b>
Low-voltage power supply (LVPS) 220V-240V (M527)	RM2-7952-000CN	<a href="#">Internal assemblies (4 of 4) on page 1217</a>
Main motor (M1) assembly	RM2-8684-000CN	<a href="#">Internal assemblies (2 of 2)</a>
Memory PCA (M506/M527)	RM2-7955-000CN	<a href="#">Internal assemblies (4 of 4)</a>
Microswitch	RK2-0535-000CN	<a href="#">Internal assemblies (1 of 4) on page 1211</a>
Near-field communications (NFC) PCA (M527)	B5L24-60001	<a href="#">Internal assemblies (3 of 4) on page 1215</a>
Paper feed drive assembly	RM2-5715-000CN	<a href="#">Internal assemblies (4 of 4) on page 1217</a>
Plate, name (M501)	J8H60-40001	<a href="#">Covers (M501/M506) on page 1207</a>
Plate, name (M506)	F2A68-40002	<a href="#">Covers (M501/M506) on page 1207</a>
Plate, name (M527)	F2A74-40001	<a href="#">Covers (M527) on page 1209</a>
Plug/cap, fax port (M527)	5851-1885	<a href="#">Covers (M527) on page 1209</a>
Power supply, high-voltage (HVPS)	RM2-7945-000CN	<a href="#">Internal assemblies (1 of 4) on page 1211</a>
Registration assembly	RM2-5671-000CN	<a href="#">Internal assemblies (3 of 4) on page 1215</a>
Roller and pad, Tray 1 pickup and separation pad kit	F2A68-67914	<a href="#">Internal assemblies (3 of 4) on page 1215</a>
Roller, separation (Tray 2/3)	RM2-5745-000CN	<a href="#">Internal assemblies (2 of 4) on page 1213</a>
Roller, transfer kit	F2A68-67910	<a href="#">Internal assemblies (3 of 4) on page 1215</a>
Roller, Tray 2-3 kit (M501)	J8H60-67903	<a href="#">Internal assemblies (3 of 4) on page 1215</a>
Roller, Tray 2-x kit (M506/M527)	F2A68-67913	<a href="#">Internal assemblies (3 of 4) on page 1215</a>
Scan-control board (SCB) kit (M527)	5851-6571	<a href="#">Document feeder and scanner whole units (M527 only) on page 1205</a>
Solenoid assembly (M501/M506)	RM1-5421-000CN	<a href="#">Internal assemblies (3 of 4) on page 1215</a>
Spring, compression (included in the multipurpose tray roller and separation pad kit)	RU8-2935-000CN	<a href="#">Internal assemblies (3 of 4) on page 1215</a>
Stapler unit (M527)	B5L46-60102	<a href="#">Internal assemblies (3 of 4) on page 1215</a>
Sticker, stapler cartridge replacement (M527)	B5L24-00035	<a href="#">Covers (M527) on page 1209</a>
Switch, lever assembly	RM2-5701-000CN	<a href="#">Internal assemblies (2 of 4) on page 1213</a>

**Table 2-12 Alphabetical parts list (continued)**

<b>Description</b>	<b>Part number</b>	<b>Table and page</b>
Switch, power PCA assembly	RM2-8597-000CN	<a href="#">Internal assemblies (2 of 4) on page 1213</a>
Tray, paper delivery output bin (M501/M506)	RC4-4439-000CN	<a href="#">Covers (M501/M506) on page 1207</a>
Tray, paper delivery output bin (M527)	RC4-4141-000CN	<a href="#">Covers (M527) on page 1209</a>
Wireless embedded PCA (M506z/M527)	1150-7968	<a href="#">Internal assemblies (3 of 4) on page 1215</a>



# Numerical parts list

**Table 2-13 Numerical parts list**

Part number	Description	Table and page
1150-7968	Wireless embedded PCA (M506z/M527)	<a href="#">Internal assemblies (3 of 4) on page 1215</a>
5851-1885	Plug/cap, fax port (M527)	<a href="#">Covers (M527) on page 1209</a>
5851-5605	Cradle, fax PCA (M527)	<a href="#">Internal assemblies (4 of 4) on page 1217</a>
5851-5935	Cable, 18-pin control panel (M527)	<a href="#">Document feeder and scanner whole units (M527 only) on page 1205</a>
5851-5936	Cable, HDMI control panel (M527)	<a href="#">Document feeder and scanner whole units (M527 only) on page 1205</a>
5851-5938	Cable, HIP USB control panel (M527)	<a href="#">Document feeder and scanner whole units (M527 only) on page 1205</a>
5851-5939	Cable, WU USB control panel (M527)	<a href="#">Document feeder and scanner whole units (M527 only) on page 1205</a>
5851-5997	Cable, fax PCA (M527)	<a href="#">Internal assemblies (4 of 4) on page 1217</a>
5851-6019	Keyboard overlay kit (FR, IT, RU, DE, ES: UK Kybd)	<a href="#">Document feeder and scanner whole units (M527 only) on page 1205</a>
5851-6020	Keyboard overlay kit (FR-CN, ES-LA, ES: US Kybd)	<a href="#">Document feeder and scanner whole units (M527 only) on page 1205</a>
5851-6021	Keyboard overlay kit (FR-SW, DE-SW, DA: UK Kybd)	<a href="#">Document feeder and scanner whole units (M527 only) on page 1205</a>
5851-6022	Keyboard overlay kit (ZHTW, ZHCN)	<a href="#">Document feeder and scanner whole units (M527 only) on page 1205</a>
5851-6023	Keyboard overlay kit (ES, PT)	<a href="#">Document feeder and scanner whole units (M527 only) on page 1205</a>
5851-6024	Keyboard overlay kit (JA-KG, JA-KT)	<a href="#">Document feeder and scanner whole units (M527 only) on page 1205</a>
B5L47-67901	Document feeder (M527 Enterprise) kit; includes white backing and retention clips	<a href="#">Document feeder and scanner whole units (M527 only) on page 1205</a>
B5L47-67902	Document feeder (M527 Flow) kit; includes white backing and retention clips	<a href="#">Document feeder and scanner whole units (M527 only) on page 1205</a>

**Table 2-13 Numerical parts list (continued)**

<b>Part number</b>	<b>Description</b>	<b>Table and page</b>
B5L47-67903	Scan-control board (SCB) kit (M527)	<a href="#">Document feeder and scanner whole units (M527 only) on page 1205</a>
B5L24-00035	Sticker, stapler cartridge replacement (M527)	<a href="#">Covers (M527) on page 1209</a>
B5L24-60001	Near-field communications (NFC) PCA (M527)	<a href="#">Internal assemblies (3 of 4) on page 1215</a>
B5L46-40002	Cover, keyboard (M527)	<a href="#">Document feeder and scanner whole units (M527 only) on page 1205</a>
B5L46-40011	Cover, rear image scanner (M527)	<a href="#">Document feeder and scanner whole units (M527 only) on page 1205</a>
B5L46-40021	Cover, HIP (M527)	<a href="#">Document feeder and scanner whole units (M527 only) on page 1205</a>
B5L46-40028	Cover, USB (M527)	<a href="#">Document feeder and scanner whole units (M527 only) on page 1205</a>
B5L46-60102	Stapler unit (M527)	<a href="#">Internal assemblies (3 of 4) on page 1215</a>
B5L46-60114	Cable, HDMI PAB to SCAM (M527)	<a href="#">Document feeder and scanner whole units (M527 only) on page 1205</a>
B5L46-60116	Cable, stapler (M527)	<a href="#">Document feeder and scanner whole units (M527 only) on page 1205</a>
B5L46-60117	Bezel, control panel (M527)	<a href="#">Document feeder and scanner whole units (M527 only) on page 1205</a>
B5L47-67018	Control panel (M527) kit	<a href="#">Document feeder and scanner whole units (M527 only) on page 1205</a>
B5L47-67019	Keyboard US (M527)	<a href="#">Document feeder and scanner whole units (M527 only) on page 1205</a>
B5L47-67020	Keyboard UK (M527)	<a href="#">Document feeder and scanner whole units (M527 only) on page 1205</a>
CC456-60002	Fax PCA (M527)	<a href="#">Internal assemblies (4 of 4) on page 1217</a>
COM39-60064	Hinge, left document feeder (M527)	<a href="#">Document feeder and scanner whole units (M527 only) on page 1205</a>
COM39-60065	Hinge, right document feeder (M527)	<a href="#">Document feeder and scanner whole units (M527 only) on page 1205</a>

**Table 2-13 Numerical parts list (continued)**

<b>Part number</b>	<b>Description</b>	<b>Table and page</b>
F2A68-40002	Plate, name (M506)	<a href="#">Covers (M501/M506) on page 1207</a>
F2A68-67910	Roller, transfer kit	<a href="#">Internal assemblies (3 of 4) on page 1215</a>
F2A68-67913	Roller, Tray 2-x kit (M506/M527)	<a href="#">Internal assemblies (3 of 4) on page 1215</a>
F2A68-67914	Roller and pad, Tray 1 pickup and separation pad kit	<a href="#">Internal assemblies (3 of 4) on page 1215</a>
F2A68-67915	Formatter PCA kit (M506n/dn)	<a href="#">Internal assemblies (4 of 4) on page 1217</a>
F2A68-67916	Formatter PCA kit (M506x)	<a href="#">Internal assemblies (4 of 4) on page 1217</a>
F2A68-67919	Door, cartridge kit (M506n/dn)	<a href="#">Covers (M501/M506) on page 1207</a>
F2A68-67920	Door, cartridge kit (M506x)	<a href="#">Covers (M501/M506) on page 1207</a>
F2A72-67901	1x550-sheet paper feeder (whole unit)	<a href="#">1x550-sheet paper feeder on page 1219</a>
F2A74-40001	Plate, name (M527)	<a href="#">Covers (M527) on page 1209</a>
F2A76-40003	Cover, stationary stapler, inner (M527c/f/z)	<a href="#">Covers (M527) on page 1209</a>
F2A76-40004	Door, stapler fla (M527c/f/z)	<a href="#">Covers (M527) on page 1209</a>
F2A76-40005	Cover, stapler blank (M527dn)	<a href="#">Covers (M527) on page 1209</a>
F2A76-40007	Bracket, WiFi PCA (M506z/M527)	<a href="#">Internal assemblies (3 of 4) on page 1215</a>
F2A76-67912	Door, cartridge kit (M527)	<a href="#">Covers (M527) on page 1209</a>
F2A76-60112	Cable, WiFi PCA (M506z/M527)	<a href="#">Internal assemblies (3 of 4) on page 1215</a>
F2A76-60113	Cable, stapler 6-pin (M527)	<a href="#">Internal assemblies (3 of 4) on page 1215</a>
F2A76-67909	Image scanner assembly (M527) kit; includes white backing and retention clips	<a href="#">Document feeder and scanner whole units (M527 only) on page 1205</a>
F2A76-67910	Formatter PCA kit (M527)	<a href="#">Internal assemblies (4 of 4) on page 1217</a>
J8H60-40001	Plate, name (M501)	<a href="#">Covers (M501/M506) on page 1207</a>
J8H60-67901	Formatter PCA (M501n)	<a href="#">Internal assemblies (4 of 4) on page 1217</a>
J8H60-67902	Formatter PCA (M501n; China)	<a href="#">Internal assemblies (4 of 4) on page 1217</a>
J8H60-67903	Roller, Tray 2-3 kit (M501)	<a href="#">Internal assemblies (3 of 4) on page 1215</a>

**Table 2-13 Numerical parts list (continued)**

<b>Part number</b>	<b>Description</b>	<b>Table and page</b>
J8H61-67901	Formatter PCA (M501dn)	<a href="#">Internal assemblies (4 of 4) on page 1217</a>
J8H61-67902	Formatter PCA (M501dn; China)	<a href="#">Internal assemblies (4 of 4) on page 1217</a>
RC4-3010-000CN	Hinge, cartridge door left	<a href="#">Covers (M501/M506) on page 1207</a>
RC4-3010-000CN	Hinge, cartridge door left	<a href="#">Covers (M527) on page 1209</a>
RC4-4141-000CN	Tray, paper delivery output bin (M527)	<a href="#">Covers (M527) on page 1209</a>
RC4-4142-000CN	Cover, HIP (M506 duplex models)	<a href="#">Covers (M501/M506) on page 1207</a>
RC4-4147-000CN	Cover, top left (M527)	<a href="#">Covers (M527) on page 1209</a>
RC4-4149-000CN	Cover, USB (M506)	<a href="#">Covers (M501/M506) on page 1207</a>
RC4-4150-000CN	Cover, top rear (M527)	<a href="#">Covers (M527) on page 1209</a>
RC4-4200-000CN	Cover, formatter (M501)	<a href="#">Covers (M501/M506) on page 1207</a>
RC4-4433-000CN	Cover, I/O (M506)	<a href="#">Covers (M501/M506) on page 1207</a>
RC4-4433-000CN	Cover, I/O (M527)	<a href="#">Covers (M527) on page 1209</a>
RC4-4437-000CN	Cover, right (M501/M506)	<a href="#">Covers (M501/M506) on page 1207</a>
RC4-4437-000CN	Cover, right (M527)	<a href="#">Covers (M527) on page 1209</a>
RC4-4439-000CN	Tray, paper delivery output bin (M501/M506)	<a href="#">Covers (M501/M506) on page 1207</a>
RC4-4479-000CN	Link, pressure release (cartridge door)	<a href="#">Covers (M501/M506) on page 1207</a>
RC4-4479-000CN	Link, pressure release (cartridge door)	<a href="#">Covers (M527) on page 1209</a>
RK2-0535-000CN	Microswitch	<a href="#">Internal assemblies (1 of 4) on page 1211</a>
RK2-6259-000CN	Cable, flat-flexib	<a href="#">Internal assemblies (1 of 4) on page 1211</a>
RK2-6260-000CN	Cable, flat-flexib	<a href="#">Internal assemblies (1 of 4) on page 1211</a>
RK2-6261-000CN	Cable, fla flexibl (M506/M527)	<a href="#">Internal assemblies (4 of 4) on page 1217</a>
RK2-6526-000CN	Cable, fla flexibl (M501)	<a href="#">Internal assemblies (4 of 4) on page 1217</a>
RK2-7067-000CN	Cable, USB (M506)	<a href="#">Internal assemblies (1 of 4) on page 1211</a>
RK2-7104-000CN	Cable, HIP (M506 duplex models)	<a href="#">Covers (M501/M506) on page 1207</a>

**Table 2-13 Numerical parts list (continued)**

<b>Part number</b>	<b>Description</b>	<b>Table and page</b>
RK2-8068-000CN	Fan (FM1)	<a href="#">Internal assemblies (1 of 4) on page 1211</a>
RK2-8068-000CN	Fan (FM2)	<a href="#">Internal assemblies (4 of 4) on page 1217</a>
RL2-0885-000CN	Case, formatter PCA (M506)	<a href="#">Internal assemblies (4 of 4) on page 1217</a>
RL2-0888-000CN	Case, formatter (M501)	<a href="#">Internal assemblies (4 of 4) on page 1217</a>
RL2-0895-000CN	Case, formatter PCA (M527)	<a href="#">Internal assemblies (4 of 4) on page 1217</a>
RL2-0895-000CN	Case, formatter (M527)	<a href="#">Internal assemblies (4 of 4) on page 1217</a>
RM1-5421-000CN	Solenoid assembly (M501/M506)	<a href="#">Internal assemblies (3 of 4) on page 1215</a>
RM2-5528-000CN	Laser/scanner assembly	<a href="#">Internal assemblies (1 of 4) on page 1211</a>
RM2-5671-000CN	Registration assembly	<a href="#">Internal assemblies (3 of 4) on page 1215</a>
RM2-5677-000CN	Door, cartridge (M501)	<a href="#">Covers (M501/M506) on page 1207</a>
RM2-5679-000CN	Fixing (fuser) assembly 110V-127V	<a href="#">Internal assemblies (2 of 4) on page 1213</a>
RM2-5686-000CN	Cover, top (M506 duplex MF models)	<a href="#">Covers (M501/M506) on page 1207</a>
RM2-5687-000CN	Cover, top (M506 simplex models)	<a href="#">Covers (M501/M506) on page 1207</a>
RM2-5689-000CN	Film bias assembly	<a href="#">Internal assemblies (2 of 4) on page 1213</a>
RM2-5690-000CN	Cassette (Tray 2)	<a href="#">Internal assemblies (2 of 4) on page 1213</a>
RM2-5692-000CN	Fixing (fuser) assembly 220V-240V	<a href="#">Internal assemblies (2 of 4) on page 1213</a>
RM2-5728-000CN	Cover, top (M506 duplex LCD models)	<a href="#">Covers (M501/M506) on page 1207</a>
RM2-5700-000CN	Gear, multi-purpose	<a href="#">Internal assemblies (3 of 4) on page 1215</a>
RM2-5701-000CN	Switch, lever assembly	<a href="#">Internal assemblies (2 of 4) on page 1213</a>
RM2-5702-000CN	Cable, TAG assembly	<a href="#">Internal assemblies (1 of 4) on page 1211</a>
RM2-5711-000CN	Door, rear (M501/M506 duplex models)	<a href="#">Covers (M501/M506) on page 1207</a>
RM2-5711-000CN	Door, rear (M527)	<a href="#">Covers (M527) on page 1209</a>

**Table 2-13 Numerical parts list (continued)**

<b>Part number</b>	<b>Description</b>	<b>Table and page</b>
RM2-5712-000CN	Door, rear (M501/M506 simplex models)	<a href="#">Covers (M501/M506) on page 1207</a>
RM2-5715-000CN	Paper feed drive assembly	<a href="#">Internal assemblies (4 of 4) on page 1217</a>
RM2-5717-000CN	Cover, formatter (M527)	<a href="#">Covers (M527) on page 1209</a>
RM2-5718-000CN	Cover, top (M527)	<a href="#">Covers (M527) on page 1209</a>
RM2-5725-000CN	Cover, formatter (M506)	<a href="#">Covers (M501/M506) on page 1207</a>
RM2-5726-000CN	Cover, top (M501 duplex models)	<a href="#">Covers (M501/M506) on page 1207</a>
RM2-5727-000CN	Cover, left (M501/M506)	<a href="#">Covers (M501/M506) on page 1207</a>
RM2-5727-000CN	Cover, left (M527)	<a href="#">Covers (M527) on page 1209</a>
RM2-5735-000CN	Cover, top (M501)	<a href="#">Covers (M501/M506) on page 1207</a>
RM2-5745-000CN	Roller, separation (Tray 2/3)	<a href="#">Internal assemblies (2 of 4) on page 1213</a>
RM2-8612-000CN	DC controller PCA, duplex (M506)	<a href="#">Internal assemblies (4 of 4) on page 1217</a>
RM2-7941-000CN	Low-voltage power supply (LVPS) 110V-127V (M501/M506)	<a href="#">Internal assemblies (4 of 4) on page 1217</a>
RM2-7942-000CN	Low-voltage power supply (LVPS) 220V-240V (M501/M506)	<a href="#">Internal assemblies (4 of 4) on page 1217</a>
RM2-7945-000CN	Power supply, high-voltage (HVPS)	<a href="#">Internal assemblies (1 of 4) on page 1211</a>
RM2-7948-000CN	Fixing (fuser) power supply <sup>1</sup> (FPS) 110V-127V	<a href="#">Internal assemblies (4 of 4) on page 1217</a>
RM2-7949-000CN	Fixing (fuser) power supply <sup>1</sup> (FPS) 220V-240V	<a href="#">Internal assemblies (4 of 4) on page 1217</a>
RM2-8711-000CN	DC controller PCA, duplex (M501)	<a href="#">Internal assemblies (4 of 4) on page 1217</a>
RM2-7951-000CN	Low-voltage power supply (LVPS) 110V-127V (M527)	<a href="#">Internal assemblies (4 of 4) on page 1217</a>
RM2-7952-000CN	Low-voltage power supply (LVPS) 220V-240V (M527)	<a href="#">Internal assemblies (4 of 4) on page 1217</a>
RM2-7955-000CN	Memory PCA (M506/M527)	<a href="#">Internal assemblies (4 of 4) on page 1217</a>
RM2-8514-000CN	Clutch, paper re-pickup assembly (M501/M506 duplex LCD and MF models)	<a href="#">Internal assemblies (2 of 4) on page 1213</a>
RM2-8597-000CN	Switch, power PCA assembly	<a href="#">Internal assemblies (2 of 4) on page 1213</a>
RM2-8614-000CN	DC controller PCA, simplex (M506)	<a href="#">Internal assemblies (4 of 4) on page 1217</a>

**Table 2-13 Numerical parts list (continued)**

<b>Part number</b>	<b>Description</b>	<b>Table and page</b>
RM2-8612-000CN	DC controller PCA (M527)	<a href="#">Internal assemblies (4 of 4)</a>
RM2-8684-000CN	Main motor (M1) assembly	<a href="#">Internal assemblies (2 of 4)</a>
RM2-8712-000CN	DC controller PCA, simplex (M501)	<a href="#">Internal assemblies (4 of 4) on page 1217</a>
RU8-2935-000CN	Spring, compression (included in the multipurpose tray roller and separation pad kit)	<a href="#">Internal assemblies (3 of 4) on page 1215</a>





# Index

## Symbols/Numerics

- 1x550-sheet paper feeder
  - part number 1218
- 550-sheet paper feeder
  - removing and replacing 1156
- 550-sheet paper feeder, removing and replacing 1156

## A

- accessories
  - part numbers 1218
- after-service checklist 6

## B

- before-service checklist 6
- BRUs (bench repairable units units)
  - replacing 3

## C

- cartridge door assembly
  - removing and replacing 158
- cartridge door assembly, removing and replacing 158
- cautions iii
- control panel (M501)
  - removing and replacing 106
- control panel (M501), removing and replacing 106
- control panel (M506x)
  - removing and replacing 57
- control panel (M506x), removing and replacing 57
- control panel (M527)
  - removing and replacing 45
- control panel (M527), removing and replacing 45
- control-panel cover (M527)
  - removing and replacing 119

- control-panel cover (M527), removing and replacing 119
- conventions, document iii
- cover, top-rear (M527)
  - removing and replacing 124
- covers (M501/M506)
  - part numbers 1206
- covers (M527)
  - part numbers 1208

## D

- DC controller
  - removing and replacing 944
- DC controller, removing and replacing 944
- DIMM (M506/M527)
  - removing and replacing 29
- document conventions iii
- document feeder (M527)
  - removing and replacing 139
- document feeder (M527), removing and replacing 139
- document feeder and scanner whole units
  - parts lists and diagrams 1204
- document feeder maintenance kit (M527), removing and replacing 1162
- dual in-line memory module (DIMM) (M506/M527)
  - removing and replacing 29

## E

- electrostatic discharge (ESD) 4
- embedded MultiMedia Card (eMMC) (M506 and M527dn)
  - removing and replacing 18
- ESD electrostatic discharge (ESD) 4

## F

- fan (FM1)
    - removing and replacing 744
  - fan (FM1), removing and replacing 744
  - fan (FM2)
    - removing and replacing 768
  - fan (FM2), removing and replacing 768
  - fax printed-circuit board (M527c/f/z)
    - removing and replacing 1171
  - fiel replaceable units (FRUs)
    - replacing 3
  - fiel replaceable units (FRUs) and bench repairable units (BRUs)
    - replacing 3
  - formatter
    - removing and replacing 566
  - formatter case
    - removing and replacing 659
  - formatter case, removing and replacing 659
  - formatter cover
    - removing and replacing 115
  - formatter cover, removing and replacing 115
  - formatter, removing and replacing 566
- FRUs (fiel replaceable units) and BRUs (bench repairable units)
    - replacing 3
  - fuser
    - removing and replacing 542
  - fuser power supply (FPS)
    - removing and replacing 855
  - fuser power supply (FPS), removing and replacing 855
  - fuser, removing and replacing 542

- H**
- hard-disk drive (HDD) (M527c/f/z)
    - removing and replacing 23
  - high-voltage power supply
    - removing and replacing 1031
  - high-voltage power supply, removing and replacing 1031
  - HVPS
    - removing and replacing 1031
  - HVPS, removing and replacing 1031
- I**
- installation 5
    - screws 5
    - See also* replacing parts
  - installing
    - internal USB ports (M506) 1188
    - internal USB ports (M527) 1178
  - integrated scanner assembly (M527)
    - removing and replacing 408
  - integrated scanner assembly (M527), removing and replacing 408
  - internal assemblies (1 of 4)
    - part numbers 1210
  - internal assemblies (2 of 4)
    - part numbers 1212
  - internal assemblies (3 of 4)
    - part numbers 1214
  - internal assemblies (4 of 4)
    - part numbers 1216
  - internal USB ports (M506)
    - installing 1188
  - internal USB ports (M527)
    - installing 1178
- K**
- keyboard (M527c/z)
    - removing and replacing 78
  - keyboard (M527c/z), removing and replacing 78
  - kit
    - instructions, embedded
      - MultiMedia Card (eMMC) (M506 and M527dn) 18
- L**
- laser scanner
    - warnings for servicing 3
  - laser/scanner assembly
    - removing and replacing 584
  - laser/scanner assembly, removing and replacing 584
  - left cover
    - removing and replacing 197
  - left cover, removing and replacing 197
  - low-voltage power supply
    - removing and replacing 1056
  - low-voltage power supply, removing and replacing 1056
  - LVPS
    - removing and replacing 1056
  - LVPS, removing and replacing 1056
- M**
- maintenance kits
    - part numbers 1201
  - multipurpose tray (Tray 1) pickup roller and separation pad
    - removing and replacing 87
  - multipurpose tray (Tray 1) pickup roller and separation pad, removing and replacing 87
- N**
- near fiel communication PCA (M506x/M527z)
    - removing and replacing 507
  - near fiel communication PCA (M506x/M527z), removing and replacing 507
  - NFC (M506x/M527z)
    - removing and replacing 507
  - NFC (M506x/M527z), removing and replacing 507
  - notes iii
- O**
- output bin
    - removing and replacing 336
  - output bin, removing and replacing 336
- P**
- paper delivery tray (output bin)
    - removing and replacing 336
  - paper delivery tray (output bin), removing and replacing 336
  - paper pickup and feed rollers and separation roller (Tray 2-x)
    - removing and replacing 96
  - paper pickup and feed rollers and separation roller (Tray 2-x), removing and replacing 96
  - part numbers
    - 1x550-sheet paper feeder 1218
    - accessories 1218
    - covers (M501/M506) 1206
    - covers (M527) 1208
    - internal assemblies (1 of 4) 1210
    - internal assemblies (2 of 4) 1212
    - internal assemblies (3 of 4) 1214
    - internal assemblies (4 of 4) 1216
    - replacement parts 1201
    - staple cartridges 1201
    - supplies 1201
    - toner cartridge 1201
  - parts lists and diagrams 1193
    - document feeder and scanner whole units 1204
    - using 1202
- R**
- rear door assembly
    - removing and replacing 169
  - rear door assembly, removing and replacing 169
  - removal order
    - removing order 7
  - removal strategy
    - removing and replacing 3
  - removing and replacing
    - 550-sheet paper feeder 1156
    - cartridge door assembly 158
    - control panel (M501) 106
    - control panel (M506x) 57
    - control panel (M527) 45
    - control-panel cover (M527) 119
    - DC controller 944
    - document feeder (M527) 139
    - document feeder maintenance kit (M527) 1162
    - dual in-line memory module (DIMM) (M506/M527) 29
    - embedded MultiMedia Card (eMMC) (M506 and M527dn) 18

fan (FM1) 744  
 fan (FM2) 768  
 fax printed-circuit board (M527c/f/z) 1171  
 formatter 566  
 formatter case 659  
 formatter cover 115  
 fuser 542  
 fuser power supply (FPS) 855  
 hard-disk drive (HDD) (M527c/f/z) 23  
 high-voltage power supply 1031  
 HVPS 1031  
 integrated scanner assembly (M527) 408  
 keyboard (M527c/z) 78  
 laser/scanner assembly 584  
 left cover 197  
 low-voltage power supply 1056  
 LVPS 1056  
 multipurpose tray (Tray 1) pickup roller and separation pad 87  
 near field communication PCA (M506x/M527z) 507  
 NFC (M506x/M527z) 507  
 output bin 336  
 paper delivery tray (output bin) 336  
 paper pickup and feed rollers and separation roller (Tray 2-x) 96  
 rear door assembly 169  
 right cover 174  
 roller, pickup and separation pad MP tray (Tray 1) 87  
 rollers Tray 2-x 96  
 scanner control board (M527) 488  
 SCB (M527) 488  
 SSA (M527) 408  
 staple cartridge (M527) 14  
 stapler door or stapler blank cover (M527) 216  
 stapler stationary (inner) cover (M527) 223  
 stapler unit (M527c/f/z) 553  
 toner cartridge 9  
 top cover (M501/M506) 292  
 top cover (M527) 234  
 top-left cover (M527) 134  
 top-rear cover (M527) 124

transfer roller 38  
 Tray 1 pickup roller and separation pad 87  
 Tray 2 1147  
 Tray 2-x paper pickup and feed rollers and separation roller 96  
 Tray 3 1151  
 white backing (M527) 64, 71  
 wireless PCA (M506x) 514  
 wireless PCA (M527z) 538  
 removing parts  
 after-service checklist 6  
 before-service checklist 6  
 tools, required 4  
 replacement parts  
 part numbers 1201  
 replacing parts  
 about 3  
 after-service checklist 6  
 before-service checklist 6  
 screws 5  
 tools, required 4  
 right cover  
 removing and replacing 174  
 right cover, removing and replacing 174  
 roller, pickup and separation pad MP tray (Tray 1)  
 removing and replacing 87  
 roller, pickup and separation pad MP tray (Tray 1), removing and replacing 87  
 rollers  
 document feeder maintenance kit (M527), removing and replacing 1162  
 transfer roller, removing and replacing 38  
 rollers Tray 2-x2  
 removing and replacing 96  
 rollers, Tray 2-x, removing and replacing 96

**S**  
 scanner control board (M527)  
 removing and replacing 488  
 scanner control board (M527),  
 removing and replacing 488

SCB (M527)  
 removing and replacing 488  
 SCB (M527), removing and replacing 488  
 screwdrivers, required 4  
 screws  
 installing 5  
 types of 5  
 service and support information v, 2, 1194, 1202  
 service approach  
 removing and replacing 6  
 SSA  
 removing and replacing 408  
 SSA (M527), removing and replacing 408  
 staple cartridge (M527)  
 removing and replacing 14  
 staple cartridge (M527), removing and replacing 14  
 staple cartridges  
 part numbers 1201  
 stapler blank cover (M527)  
 removing and replacing 216  
 stapler door or stapler blank cover (M527), removing and replacing 216  
 stapler stationary (inner) cover (M527)  
 removing and replacing 223  
 stapler stationary (inner) cover (M527), removing and replacing 223  
 stapler unit (M527c/f/z)  
 removing and replacing 553  
 stapler unit (M527c/f/z), removing and replacing 553  
 static, precautions for 4  
 supplies  
 part numbers 1201

**T**  
 tips iii  
 toner cartridge  
 part numbers 1201  
 removing and replacing 9  
 toner cartridge, removing and replacing 9  
 tools, required 4

- top cover (M501/M506)
  - removing and replacing 292
- top cover (M501/M506), removing and replacing 292
- top cover (M527)
  - removing and replacing 234
- top cover (M527), removing and replacing 234
- top-left cover (M527)
  - removing and replacing 134
- top-left cover (M527), removing and replacing 134
- top-rear cover (M527), removing and replacing 124
- transfer roller, removing and replacing 38
- Tray 1 pickup roller and separation pad
  - removing and replacing 87
- Tray 1 pickup roller and separation pad, removing and replacing 87
- Tray 2
  - removing and replacing 1147
- Tray 2, removing and replacing 1147
- Tray 2-x paper pickup and feed rollers and separation roller
  - removing and replacing 96
- Tray 2-x paper pickup and feed rollers and separation roller, removing and replacing 96
- Tray 3
  - removing and replacing 1151
- Tray 3, removing and replacing 1151

## W

- warnings iii
- white backing (M527)
  - removing and replacing 64, 71
- white backing (M527), removing and replacing 64, 71
- wireless PCA (M506x)
  - removing and replacing 514
- wireless PCA (M506x), removing and replacing 514
- wireless PCA (M527z)
  - removing and replacing 538
- wireless PCA (WiFi) (M527z), removing and replacing 538