



HP PageWide MFP 377dw

User Guide

Copyright and License

© 2016 Copyright HP Development Company, L.P.

All rights reserved. Reproduction, adaptation, or translation of this material is prohibited without prior written permission of HP, except as allowed under copyright laws.

The information contained in this document is subject to change without notice.

The only warranties for HP products and services are set forth in the express warranty statements accompanying such products and services. Nothing herein should be construed as constituting an additional warranty. HP shall not be liable for technical or editorial errors or omissions contained herein.

Edition 1, 2/2016

Trademark Credits

Adobe®, Acrobat®, and PostScript® are trademarks of Adobe Systems Incorporated.

Intel® Core™ is a trademark of Intel Corporation in the U.S. and other countries.

Java™ is a US trademark of Sun Microsystems, Inc.

Microsoft®, Windows®, Windows® XP, and Windows Vista® are U.S. registered trademarks of Microsoft Corporation.

UNIX® is a registered trademark of The Open Group.

ENERGY STAR and the ENERGY STAR mark are registered trademarks owned by the U.S. Environmental Protection Agency.

Table of contents

1 Product basics	1
Product features	2
Environmental features	2
Accessibility features	3
Product views	4
Front left view	4
Front right view	5
Back view	5
Cartridge door view	6
Power on and off	7
Turn the product on	7
Manage power	7
Turn the product off	8
Use the control panel	9
Control panel buttons	9
Control panel home screen	10
Control panel dashboard	11
Control panel application folders	11
Control panel shortcuts	12
Help features	12
Printer information	13
Help animations	13
Quiet Mode	13
To turn Quiet Mode on or off from the control panel	13
To turn Quiet Mode on or off from the EWS	13
2 Connect the product	15
Connect the product to a computer or a network	16
To connect the product using a USB cable	16
To connect the product to a network	17
Supported network protocols	17
Connect the product using a wired network	17

Connect the product using a wireless network (wireless models only)	17
To connect the product to a wireless network using the Wireless Setup Wizard	18
To connect the product to a wireless network using WPS	18
To connect the product to a wireless network manually	19
Use Wi-Fi Direct to connect a computer or device to the product	20
To turn on Wi-Fi Direct	20
To print from a wireless-capable mobile device	20
To print from a wireless-capable computer (Windows)	20
To print from a wireless-capable computer (OS X)	20
Install HP printer software for a wireless product already on the network	22
Open the printer software (Windows)	22
Manage network settings	22
View or change network settings	22
Set or change the product password	23
Manually configure TCP/IP parameters from the control panel	23
Link speed and duplex settings	23

3 Printer management and services 25

HP Embedded Web Server	26
About the EWS	26
About cookies	26
Open the EWS	27
Features	27
Home tab	27
Scan tab	28
Fax tab	29
Web Services tab	29
Network tab	29
Tools tab	29
Settings tab	30
Web Services	31
What are Web Services?	31
HP ePrint	31
Print apps	31
Set Up Web Services	31
Use Web Services	32
HP ePrint	32
Print apps	33
Remove Web Services	34
Product security features	34

Security statements	34
Firewall	35
Security settings	35
Firmware updates	36
HP Printer Assistant in the printer software (Windows)	36
Open the HP Printer Assistant	36
Features	36
Connected tab	36
Print, Scan & Fax tab	36
Shop tab	37
Help tab	37
Tools tab	37
Estimated Levels tab	37
HP Utility (OS X)	37
AirPrint™ (OS X)	38

4 Paper and print media 39

Understand paper use	40
Supported media sizes	41
Supported paper and print media sizes	41
Supported envelope sizes	42
Supported card and label sizes	42
Supported photo media sizes	42
Supported paper types and tray capacity	43
Tray 1 (multipurpose) on left side of the product	43
Tray 2 (default tray) and Tray 3 (accessory tray)	44
Configure trays	44
Load media	45
Load Tray 1	45
Load Tray 2	46
Load optional Tray 3	48
Load envelopes	49
Load letterhead or preprinted forms	51
Load the automatic document feeder	52
Load the scanner	53
Tips for selecting and using paper	55

5 Cartridges 56

HP PageWide cartridges	57
HP policy on non-HP cartridges	57
Counterfeit HP cartridges	57

Manage cartridges	57
Store cartridges	58
Print with General Office mode	58
Print when a cartridge is at estimated end of life	58
Check the estimated cartridge levels	58
Order cartridges	59
Recycle cartridges	60
Replace cartridges	60
Tips for working with cartridges	62

6 Print **63**

Print from a computer	64
To print from a computer (Windows)	64
To print from a computer (OS X)	65
To set up printing shortcuts (Windows)	66
To set up printing presets (OS X)	66
To adjust or manage colors	67
Choose a preset color theme for a print job	67
Adjust the color options for a print job manually	67
Match colors to your computer screen	68
Control access to color printing	69
Print from the control panel	69
Print using job storage	69
To enable job storage	69
Disable or enable job storage (Windows)	69
Disable or enable job storage (OS X)	69
To apply job storage to one or all print jobs	70
Apply job storage to one or all print jobs (Windows)	70
Apply job storage to one or all print jobs (OS X)	71
To print a job stored on the printer	71
To delete a job stored on the printer	71
Print from a USB device	72
Print with NFC	72
Print with HP ePrint	72
Print off site by sending an email with the HP ePrint app	72
Print from an on-site computer or mobile device	73
Print with AirPrint (OS X)	73
Tips for print success	74
Cartridge tips	74
Paper loading tips	74
Printer settings tips (Windows)	75

Printer settings tips (OS X)	75
7 Copy and scan	76
Copy	77
Copy settings	77
Adjust lightness or darkness for copies	77
Select a paper tray and paper size for copies	77
Reduce or enlarge a copy	77
Load and copy identification cards	78
Copy photos	79
Load and copy mixed-size originals	80
Copy on both sides automatically	80
Cancel a copy job	80
Scan	81
Scan to a USB drive	81
Scan to a computer	81
To set up scan to computer	81
Set up scanning to a computer (Windows)	82
Set up scanning to a computer (OS X)	82
To scan to a computer from the control panel	82
Scan to email	82
To set up scan to email	82
Set up scan to email in the EWS	82
Set up scan to email in the HP Printer Assistant	83
Set up scan to email (OS X)	83
To scan a document or photo to email	83
To change account settings	83
Change account settings in the EWS	83
Change account settings (OS X)	84
Scan to a network folder	84
To set up scan to a network folder	84
Set up scan to a network folder in the EWS	84
Set up scan to a network folder in the HP Printer Assistant	84
To scan to a network folder	84
Scan to SharePoint	85
To set up scan to SharePoint	85
To scan to SharePoint	85
Scan using HP scanning software	85
Scan using other software	86
To scan from a TWAIN-compliant program	86
To scan from a WIA-compliant program	86

Scan using Webscan	87
Scan documents as editable text	87
Guidelines for scanning documents as editable text	87
To scan a document to editable text (Windows)	88
To scan documents as editable text (OS X)	89
Tips for copy and scan success	90

8 Fax 91

Set up fax	92
Connect fax to a telephone line	92
Configure fax settings	92
To configure fax settings from the control panel	92
To configure fax settings using the HP Digital Fax Setup Wizard (Windows)	93
Set up HP Digital Fax	93
HP Digital Fax requirements	93
To set up HP Digital Fax	94
Set up HP Digital Fax (Windows)	94
Set up HP Digital Fax (OS X)	94
Set up HP Digital Fax in the EWS	94
To modify HP Digital Fax settings	94
Modify HP Digital Fax settings (Windows)	94
Modify HP Digital Fax settings (OS X)	94
Modify HP Digital Fax settings in the EWS	94
To turn off HP Digital Fax	95
Fax programs, systems, and software	95
Supported fax programs	95
Supported phone services - analog	95
Alternate phone services - digital	95
DSL	95
PBX	95
ISDN	96
VoIP	96
Set fax settings	96
Send-fax settings	96
Set pauses or flash hooks	96
Set a dialing prefix	97
Set tone-dialing or pulse-dialing	97
Set autoredial and the time between redials	97
Set the light/dark setting	98
Set the default resolution	98
Use cover-page templates	99

Receive-fax settings	99
Set fax forwarding	99
Block or unblock fax numbers	100
Set the number of rings-to-answer	100
Set distinctive ring	101
Use autoreduction for incoming faxes	102
Set the fax sounds volume	102
Set stamp-received faxes	102
Send a fax	102
Send a fax from the control panel	103
Use speed dials and group-dial entries	103
Send a standard fax from the computer	103
Send a fax from the software	104
Send a fax using monitor dialing	105
Send a fax using printer memory	105
Receive a fax	106
Receive a fax manually	106
Fax memory	107
Reprint a fax	107
Delete faxes from memory	107
Use the phone book	107
Create and edit individual speed-dial entries	108
Create and edit group-dial entries	108
Delete speed-dial entries	108
Use reports	108
Print fax confirmation reports	109
Print fax error reports	110
Print and view the fax log	110
Clear the fax log	110
Print the details of the last fax transaction	111
Print a Caller ID Report	111
View the Call History	111
9 Solve problems	112
Problem-solving checklist	113
Check that the product power is on	113
Check the control panel for error messages	113
Test print functionality	113
Test copy functionality	114
Test the fax-sending functionality	114
Test the fax-receiving functionality	114

Try sending a print job from a computer	114
Test the plug-and-print USB functionality	114
Factors that affect product performance	114
Information pages	115
Factory-set defaults	116
Cleaning routines	116
Clean the printhead	117
Clean the scanner glass strip and platen	117
Clean the document feeder pick rollers and separation pad	118
Clean the touch screen	118
Jams and paper-feed issues	119
The product does not pick up paper	119
The product picks up multiple sheets of paper	119
Prevent paper jams	119
Clear jams	120
Jam locations	120
Clear jams from the document feeder	121
Clear jams in Tray 1 (multipurpose tray)	122
Clear jams in Tray 2	122
Clear jams in optional Tray 3	123
Clear jams in the left door	124
Clear jams in the output bin	125
Clear jams in the duplexer	126
Cartridge issues	127
Refilled or remanufactured cartridges	127
Interpret control panel messages for cartridges	127
Cartridge Depleted	127
Cartridge Low	128
Cartridge Very Low	128
Counterfeit or used [color] cartridge installed	128
Do not use SETUP cartridges	128
Genuine HP cartridge installed	128
Incompatible [color]	129
Incompatible cartridges	129
Install [color] cartridge	129
Non-HP cartridges installed	129
Printer Failure	130
Problem with Print System	130
Problem with Printer Preparation	130
Problem with SETUP cartridges	130
Use SETUP cartridges	130

Used [color] installed	131
Printing issues	131
The product does not print	131
The product prints slowly	132
Plug-and-print USB issues	132
The Memory Device Options menu does not open when you insert the USB accessory	132
The file does not print from the USB storage device	132
The file that you want to print is not listed in the Memory Device Options menu	133
Improve print quality	133
Check for genuine HP cartridges	133
Use paper that meets HP specifications	133
Use the correct paper type setting in the printer driver	134
Change the paper type and size setting (Windows)	134
Change the paper type and size setting (OS X)	134
Use the printer driver that best meets your printing needs	135
Align the printhead	135
Print a print-quality report	135
Scan issues	135
Fax issues	136
Fax troubleshooting checklist	136
Change error correction and fax speed	137
Set the fax-error-correction mode	137
Change the fax speed	137
Fax logs and reports	137
Print individual fax reports	138
Set the fax error report	138
Fax error messages	138
Communication error.	138
Document feeder door is open. Canceled fax.	139
Fax is busy. Canceled send.	139
Fax is busy. Redial pending.	139
Fax receive error.	140
Fax Send error.	140
Fax storage is full. Canceling the fax receive.	141
Fax storage is full. Canceling the fax send.	141
No dial tone.	141
No fax answer. Canceled send.	142
No fax answer. Redial pending.	142
No fax detected.	142
Solve problems sending faxes	143

An error message displays on the control panel	143
Document feeder paper jam	143
Scanner error	143
The control panel displays a Ready message with no attempt to send the fax.	143
The control panel displays the message "Receiving Page 1" and does not progress beyond that message	144
Faxes can be received, but not sent	144
Unable to use fax functions from the control panel	144
Unable to use speed dials	144
Unable to use group dials	144
Receive a recorded error message from the phone company when trying to send a fax	145
Unable to send a fax when a phone is connected to the product	145
Solve problems receiving faxes	145
An error message displays on the control panel	145
The fax does not respond	145
Voice mail is available on the fax line	145
The product is connected to a DSL phone service	146
The product uses a fax over IP or VoIP phone service	146
Sender receives a busy signal	146
A handset is connected to the product	146
A phone line splitter is being used	146
Cannot send or receive a fax on a PBX line	146
Solve general fax problems	146
Faxes are sending slowly	146
Fax quality is poor	147
Fax cuts off or prints on two pages	147
Connectivity issues	147
Solve USB direct-connect problems	147
Solve network problems	148
Poor physical connection	148
The computer is using the incorrect IP address for the product	148
The computer is unable to communicate with the product	148
The product is using incorrect link and duplex settings for the network	149
New software programs might be causing compatibility problems	149
The computer or workstation might be set up incorrectly	149
The product is disabled, or other network settings are incorrect	149
Wireless network issues	149
Wireless connectivity checklist	149
The product does not print, and the computer has a third-party firewall installed	150
The wireless connection does not work after moving the wireless router or product	150

Cannot connect more computers to the wireless product	150
The wireless product loses communication when connected to a VPN	151
The network does not appear in the wireless networks list	151
The wireless network is not functioning	151
Product software issues (Windows)	151
Product software issues (OS X)	153
The printer driver is not listed in the Print & Scan list	153
The product name does not appear in the product list in the Print & Scan list	153
The printer driver does not automatically set up the selected product in the Print & Scan list	153
A print job was not sent to the product that you wanted	153
When connected with a USB cable, the product does not appear in the Print & Scan list after the driver is selected.	153
You are using a generic printer driver when using a USB connection	154

10 Service and support 155

Customer support	156
HP limited warranty statement	157
UK, Ireland, and Malta	158
Austria, Belgium, Germany, and Luxemburg	158
Belgium, France, and Luxemburg	159
Italy	160
Spain	160
Denmark	161
Norway	161
Sweden	161
Portugal	162
Greece and Cyprus	162
Hungary	162
Czech Republic	163
Slovakia	163
Poland	163
Bulgaria	164
Romania	164
Belgium and the Netherlands	164
Finland	165
Slovenia	165
Croatia	165
Latvia	165
Lithuania	166
Estonia	166
Russia	166

Appendix A Technical information	167
Product specifications	168
Print specifications	168
Physical specifications	168
Power consumption and electrical specifications	168
Acoustic emission specifications	168
Environmental specifications	168
Environmental product stewardship program	170
Protecting the environment	171
Ozone production	171
Power consumption	171
European Union Commission Regulation 1275/2008	171
Paper	171
HP PageWide printing supplies	171
Plastics	171
Electronic hardware recycling	172
Material restrictions	172
General battery information	172
Battery disposal in Taiwan	172
California Perchlorate Material Notice	172
EU Battery Directive	172
Battery notice for Brazil	173
Chemical substances	173
EPEAT	173
Disposal of waste equipment by users	173
Toxic and hazardous substance table (China)	174
Restriction on hazardous substances statement (Turkey)	174
Restriction on hazardous substances statement (Ukraine)	174
Restriction of hazardous substance statement (India)	174
China energy label for printer, fax, and copier	175
China SEPA Eco Label user information	175
Regulatory information	176
Regulatory notices	176
Regulatory model identification number	176
FCC statement	176
VCCI statement (Japan)	177
Power cord instructions	177
Power cord statement (Japan)	177
EMC statement (Korea)	177
Visual display workplaces statement for Germany	177
European Union Regulatory Notice	178

European Union Regulatory Notice	178
Wireless models only	178
Models with fax capability only	178
Additional statements for telecom (fax) products	179
New Zealand telecom statements	179
Additional FCC statement for telecom products (US)	179
Industry Canada CS-03 requirements	180
Notice to users of the Canadian telephone network	181
Australia wired fax statement	181
Notice to users of the German telephone network	181
Additional statements for wireless products	182
Exposure to radio frequency radiation	182
Notice to users in Brazil	182
Canadian statements	182
Japan statement	183
Notice to users in Korea	183
Taiwan statement	183
Mexico statement	183

Index	184
--------------------	------------

1 Product basics

- [Product features](#)
- [Product views](#)
- [Power on and off](#)
- [Use the control panel](#)
- [Quiet Mode](#)

Product features

PageWide MFP 377dw

J9V80A, J9V80B, J9V80C, J9V80D



Tray capacity (75 GSM or 20-lb Bond paper)

- Tray 1: 50 sheets
- Tray 2: 500 sheets
- Optional Tray 3: 500 sheets
- Automatic Document Feeder (ADF): 50 sheets
- Standard output bin: 300 sheets

Print

- Simplex speeds up to 30 pages per minute (ppm) for both color and black with Professional quality
- Duplex speeds up to 21 ppm for both color and black with Professional quality
- Up to 45 ppm in General Office mode

Copy

- Simplex speeds up to 40 ppm in black and color
- Single-pass, two-sided copying for speeds up to 26 ppm in black and color
- 50-sheet ADF supports page sizes up to 356 mm (14.0 in) in length and 216 mm (8.5 in) in width

Scan

- Duplex speeds up to 26 ppm for both color and black
- Scan to walkup USB device, email address, network folder, or SharePoint site
- Glass supports page sizes up to 356 mm (14.0 in) in length and up to 216 mm (8.5 in) in width
- HP software enables scanning a document to a file that can be edited
- Compatible with TWAIN, WIA, and WS-Scan programs

Fax

- Fax to email address or network folder
- Fax from walkup control panel or from program on connected computer
- Fax archive, fax log, junk-fax blocking, non-volatile fax memory, fax redirect feature

Connectivity

- 802.3 LAN (10/100) Ethernet port
- Host USB Type A and Type B ports (back)
- USB 2.0 Device port (front)

Wireless

- Embedded wireless capability
- 802.11n 5GHz dual band support
- HP ePrint—send documents to the product email address for printing
- HP Wireless Direct support
- NFC-enabled (Near Field Communications); walkup printing from smart phones and tablets
- Scan to smart phone

Environmental features

Feature	Environmental benefit
Duplex printing	Automatic duplex printing is available on all models of HP PageWide MFP 377dw. Duplex printing saves the environment and saves you money.
Print multiple pages per sheet	Save paper by printing two or more pages of a document side-by-side on one sheet of paper. Access this feature through the printer driver.
Copies multiple pages per sheet	Save paper by copying two pages of an original document side-by-side on one sheet of paper.

Feature	Environmental benefit
Recycling	Reduce waste by using recycled paper. Recycle cartridges by using the HP Planet Partners return process.
Energy savings	Sleep modes and timer options enable this product to quickly go into reduced power states when not printing, thus saving energy.

Accessibility features

The product includes several features that aid users with limited vision, hearing, dexterity or strength.

- Online user guide that is compatible with text screen-readers.
- Cartridges can be installed and removed using one hand.
- All doors and covers can be opened using one hand.

Product views

- [Front left view](#)
- [Front right view](#)
- [Back view](#)
- [Cartridge door view](#)

Front left view

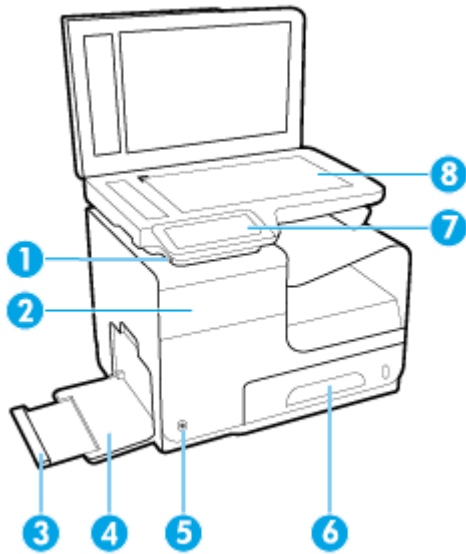

Label	Description
1	USB device connection port
2	Cartridge door
3	Tray 1 extension
4	Tray 1
5	Power button
6	Tray 2 – default paper tray
7	Control panel
8	Scanner glass

Front right view

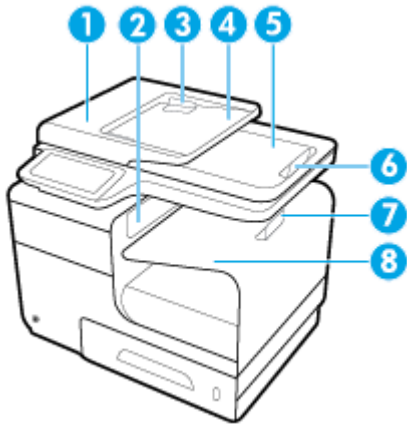

Label	Description
1	Automatic document feeder (ADF) cover
2	Main output door
3	ADF paper guides
4	ADF loading area
5	ADF output bin
6	ADF output bin stop
7	Main output bin stop
8	Main output bin

Back view

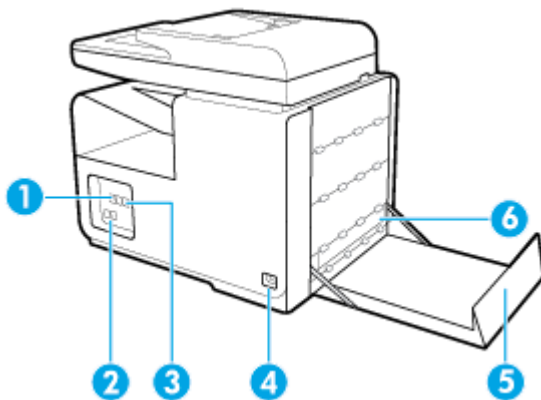

Label	Description
1	Ethernet connection port
2	Fax connection ports
3	USB Type A and USB Type B ports
4	Power cord connection

Label	Description
5	Left door
6	Duplexer

Cartridge door view

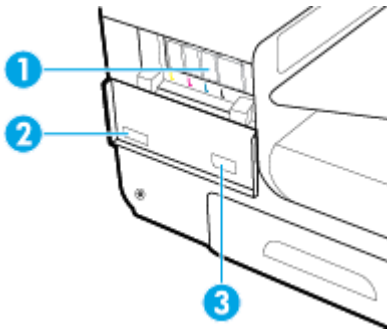

Label	Description
1	Cartridge slots
2	Product serial number and product number
3	Cartridge part numbers

Power on and off

NOTICE: To prevent damage to the product, use only the power cord that is provided with the product.

- [Turn the product on](#)
- [Manage power](#)
- [Turn the product off](#)

Turn the product on

1. Connect the power cord that is provided with the product to the connection port on the back of the product.
2. Connect the power cord to a wall outlet with an adequate voltage rating.

 **NOTE:** Make sure that your power source is adequate for the product voltage rating. The product uses either 100–240 Vac or 200–240 Vac and 50/60 Hz.

3. Press and release the power button on the front of the product.

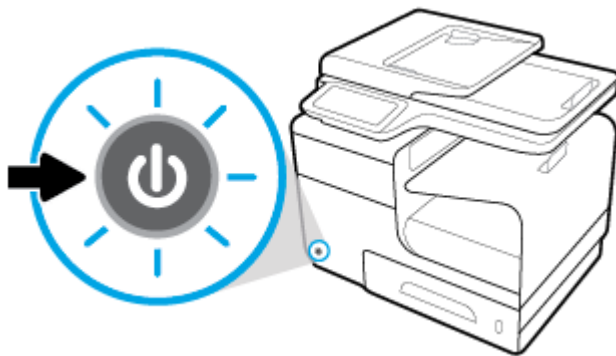

Manage power

HP PageWide MFP 377dw printers include power-management features that can help reduce power consumption and save energy.

- Sleep Mode puts the product in a reduced power-consumption state if it has been idle for a specific length of time. You can set the length of time before the product enters Sleep Mode from the control panel.
- Schedule On/Off enables you to turn the product on or off automatically at days and time that you set from the control panel. For example, you can set the product to turn off at 6 p.m. on Monday through Friday.

Set the Sleep Mode time

1. Open the control panel dashboard (swipe the dashboard tab at the top of any screen downward, or touch the dashboard area on the home screen).
2. On the control panel dashboard, touch .

3. Touch **Power Management**, and then touch **Sleep Mode**.
4. Select one of the time-interval options.

The product switches into a reduced power-consumption state when it has been idle for the amount of time that you select.

Schedule the product to turn on or off

1. Open the control panel dashboard (swipe the dashboard tab at the top of any screen downward, or touch the dashboard area on the home screen).
2. On the control panel dashboard, touch .
3. Touch **Power Management**, and then touch **Schedule Printer On/Off**.
4. Turn the **Schedule On** or **Schedule Off** option on.
5. Select the **Schedule On** or **Schedule Off** options, and then select the day and time that you want to schedule.

The product switches on or off at the time you select on the day you select.

 **NOTE:** The product cannot receive faxes when it is turned off. Faxes sent during a scheduled off interval will print when the product is turned on.

Turn the product off

NOTICE: Do not turn off the product if a cartridge is missing. Damage to the product can result.

- ▲ Press and release the power button on the front of the product to turn off your HP PageWide MFP 377dw printer.

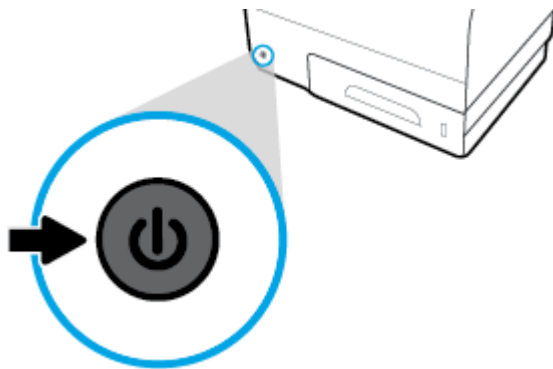

A warning message appears on the control panel if you attempt to turn the product off when one or more cartridges are missing.

NOTICE: To prevent print-quality problems, turn off the product by using the power button on the front only. Do not unplug the product, turn off the powerstrip, or use any other method.

Use the control panel





- [Control panel buttons](#)
- [Control panel home screen](#)
- [Control panel dashboard](#)
- [Control panel application folders](#)
- [Control panel shortcuts](#)
- [Help features](#)

 **NOTE:** The small text on the control panel is not designed for prolonged viewing.

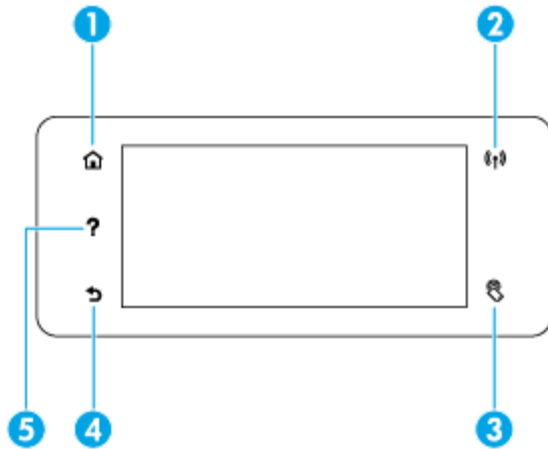
Control panel buttons

Buttons and indicator lights on the control panel of HP PageWide MFP 377dw printers appear lit when their function is available, and are darkened if their function is not available.



1		Home button. Touch to view the control panel home screen.
2		Wireless network indicator. Solid blue when the product is connected to a wireless network. Blinks when the product is searching for a wireless connection. Off when the product is connected to a wired network or by a USB cable.
3		NFC (Near Field Communications) indicator. The product can be enabled for walkup printing from tablets and smart phones.
4		Back or Cancel button. Touch to return to the previous screen, or to cancel the current process.
5		Help button. Touch to view the Help menu options.

Control panel home screen

The control panel home screen displays a dashboard, application folders, and user-defined shortcuts to screens for performing tasks.

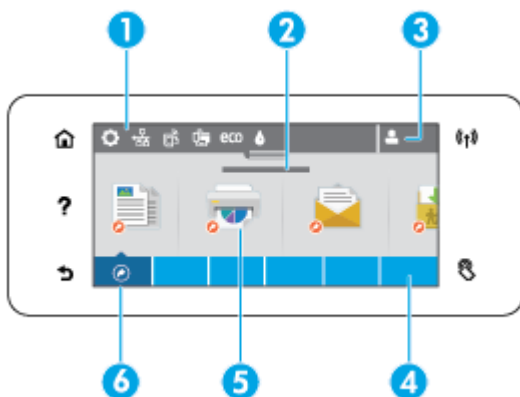

-
- 1 Dashboard.** Dashboard icons show current product status and provide access to screens for changing product settings (see [Control panel dashboard](#)).

To view the full dashboard, touch the strip at the top of the home screen, or press and drag the handle at the center of the dashboard strip.
 - 2 Time and date display.** This section also displays scheduled events, like scheduled off time (see [Manage power](#)).
 - 3 Sign in icon.** The product can be set up to require users to sign in before using some applications.

Touch here to sign in with a PIN (personal identification number) or user name and password.
 - 4 Application folders.** These folders contain icons for defined tasks (for example, [Print > Private Job](#)).

Touch a folder to view the application icons that it contains.
 - 5 Application or setup icons.** You can create shortcuts to icons contained within application folders and place them on the home screen (see [Control panel shortcuts](#)).

Press and drag to scroll horizontally through the available icons. Touch an icon to view an application or setup screen.
 - 6 Shortcuts.** You can create a shortcut to any application or setup icon contained within the application folders.

Touch to show all available shortcut icons (see [Control panel shortcuts](#)).
-

Control panel dashboard

To open the dashboard, touch the strip at the top of the home screen or swipe the dashboard tab downward.

To learn more about how to use the dashboard, touch **?** on the control panel, and then select [Control Panel Tips > Use the Dashboard](#).

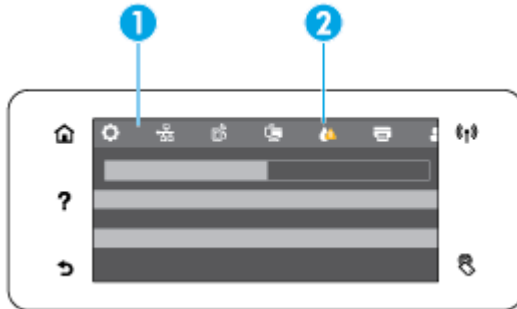

-
- 1 Larger icons appear across the top of the dashboard. These icons indicate the status of the product and enable you to change product settings.

Swipe to scroll horizontally through the available icons. Touch an icon to view a status screen or to change product settings.
 - 2 A yellow or red triangle appears on an icon to indicate that user attention is required.

In the example above, a yellow warning indicates that the contents of one or more cartridges are low.
-

Control panel application folders

Folder icons appear on a strip across the bottom of the control panel home screen. Touch a folder icon to view the application icons that it contains.

Application folders for HP PageWide MFP 377dw printers include:

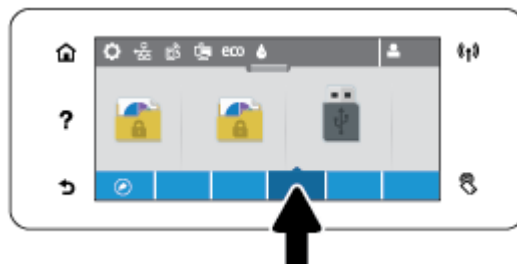

- [Copy](#)
- [Scan](#)
- [Print](#)
- [Fax](#)
- [Apps](#)

Control panel shortcuts

You can create a shortcut to any application or setup icon contained within the application folders, and then place that shortcut on the control panel home screen.

To learn more about how to use shortcuts, touch **?** and then select [Control Panel Tips](#).

Create a shortcut on the home screen

1. Open an application folder, and then navigate to the application or setup icon for which you want to create a shortcut.
2. Touch and hold the icon until the application folder strip turns green.
3. Drag the icon onto the green strip and then release it.

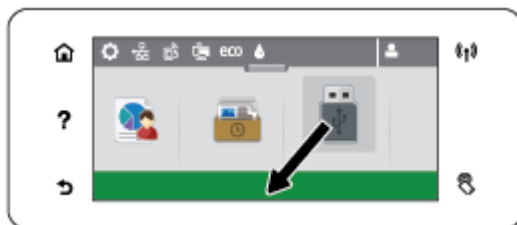

Remove a shortcut from the home screen

1. Touch the shortcuts icon at the lower left of the control panel home screen to display all available shortcuts.
2. If necessary, scroll to view the shortcut icon that you want to remove.
3. Touch and hold the shortcut icon until the application folder strip turns red.
4. Drag the icon onto the red strip and then release it.



Help features

HP PageWide MFP 377dw printers have built-in help that is accessible from the control panel. Help features include tips, important product information that you can view or print, and animations that show how to perform tasks or solve problems.

To view these help features, touch **?** on the printer control panel.

- [Printer information](#)
- [Help animations](#)

Printer information

The Printer Information page displays the following information about your HP PageWide MFP 377dw printer:

- Model name and number
- Product serial number
- Product Service ID
- Current firmware version number
- Usage, status, and settings information if you print the full product information and printer status report pages.

View or print a Printer Information page

1. On the printer control panel, touch .
2. Touch [Printer Information](#).
3. If you want to print the full product information and printer status report pages, touch [Print](#).

Help animations

The built-in help contains animations that show how to perform tasks or solve problems. To select and view an available help animation:

1. On the printer control panel, touch .
2. Touch [How To Videos](#).
3. Select the animation that you want to play in the printer control panel display.

Quiet Mode

To minimize printer noise, use Quiet Mode. You can enable this mode from either the control panel or the HP Embedded Web Server (EWS).



NOTE: Quiet Mode slows the printer speed. If it hinders productivity, you can turn the mode off.

To turn Quiet Mode on or off from the control panel

1. Open the control panel dashboard (swipe the dashboard tab at the top of any screen downward, or touch the dashboard area on the home screen).
2. On the control panel dashboard, touch .
3. Touch [Quiet Mode](#) and turn it on or off.

To turn Quiet Mode on or off from the EWS

1. Open the EWS. For more information, see [Open the EWS](#).
2. Click the **Settings** tab.

3. In the **Preferences** section, click **Quiet Mode** and turn it on or off.
4. Click **Apply**.

2 Connect the product

- [Connect the product to a computer or a network](#)
- [Use Wi-Fi Direct to connect a computer or device to the product](#)
- [Install HP printer software for a wireless product already on the network](#)
- [Open the printer software \(Windows\)](#)
- [Manage network settings](#)

Connect the product to a computer or a network

To connect the product using a USB cable

You can use a USB cable to connect the product to a computer.

This product supports a USB 2.0 connection. Use an A-to-B type USB cable. HP recommends using a cable that is no longer than 2 m (6.5 ft).

NOTICE: Do not connect the USB cable until the installation software prompts you to connect it.

1. Quit all open programs on the computer.
2. Install the printer software from 123.hp.com/pagewide (recommended) or from the HP software CD provided with the printer, and follow the onscreen instructions.

 **NOTE:** If you are installing on a Mac, click **About HP Easy Start** to install the software.

3. When prompted, select the **USB-Connect the printer to the computer using a USB cable** option, and then click the **Next** button.

 **NOTE:** A dialog box displays a warning that Web Services (HP ePrint and print Apps) are unavailable with a USB installation. Click **Yes** to proceed with the USB installation, or click **No** to cancel it.

4. When the software prompts you, connect the Type B end of the USB cable to the connection port (1) at the rear of the product.

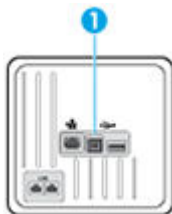

5. When the installation is complete, print a page from any program to make sure that the printing software is correctly installed.

To connect the product to a network

The product supports connection to either a wired or a wireless network.

Supported network protocols

HP PageWide MFP 377dw products support the following network protocols.

• TCP/IPv4	• gSOAP
• IPv6	• SAND box
• DHCP, AutoIP	• LPD
• DHCP v6	• Bootp, Bootp TCE improvement
• HTTP server, HTTP client	• Netbios
• SMTP client for alerts	• WINS
• SNMP v1	• LLNMR
• Open_ssl library	• CIFS v6
• Bonjour	

Connect the product using a wired network

Use this procedure to install the product on a wired network using Windows.

1. Connect the Ethernet cable to the product (1) and to the network. Turn the product on.

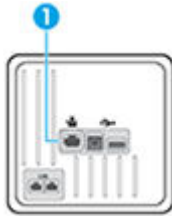

2. Wait for 60 seconds before continuing. During this time, the network recognizes the product and assigns an IP address or host name for the product.
3. Open the control panel dashboard (swipe the dashboard tab at the top of any screen downward, or touch the dashboard area on the home screen).
4. On the control panel dashboard, touch  to display the IP address. Touch [Print Details](#) to print a page with the IP address.

Connect the product using a wireless network (wireless models only)

You can connect the product to a wireless network using one of the following methods.

- [To connect the product to a wireless network using the Wireless Setup Wizard](#)
- [To connect the product to a wireless network using WPS](#)
- [To connect the product to a wireless network manually](#)

If your wireless router does not support Wi-Fi Protected Setup (WPS), obtain the wireless router network settings from your system administrator, or complete the following tasks.

- Obtain the wireless network name or service set identifier (SSID).
- Determine the security password or encryption key for the wireless network.



NOTE: Before installing the product software, make sure the product is not connected to the network using an Ethernet cable.

To connect the product to a wireless network using the Wireless Setup Wizard

The Wireless Setup Wizard is the best method for installing the product on a wireless network.

1. Open the control panel dashboard (swipe the dashboard tab at the top of any screen downward, or touch the dashboard area on the home screen).
2. On the control panel dashboard, touch .
3. Touch **Network Setup**, and then touch **Wireless Settings**.
4. Touch **Wireless Setup Wizard**.
5. The product scans for available wireless networks and returns a list of network names (SSIDs). Select the SSID for your wireless router from the list if it is available. If the SSID for your wireless router is not in the list, touch **Enter SSID**. When prompted for the type of network security, select the option that your wireless router uses. A keypad opens on the control panel display.
6. Do one of the following:
 - If your wireless router uses WPA security, type the passphrase on the keypad.
 - If your wireless router uses WEP security, type the key on the keypad.
7. Touch **OK**, and wait while the product establishes a connection with the wireless router. Establishing the wireless connection can take a few minutes.

To connect the product to a wireless network using WPS

Before you can connect your printer to a wireless network using WPS, make sure you have the following:

- A wireless 802.11b/g/n network that includes a WPS-enabled wireless router or access point.





NOTE: The printer supports only connections using 2.4GHz.



- A computer connected to the wireless network that you intend to connect the printer to. Be sure you have installed the HP printer software on the computer.

If you have a WPS router with a WPS push button, follow the **Push Button method**. If you are not certain your router has a push button, follow the **PIN method**.

Push Button method

1. On the control panel, press and hold  on the printer for more than three seconds to start WPS push mode. The  indicator starts blinking.
2. Press the WPS button on your router.
The product begins a timer for approximately two minutes while a wireless connection is established.

PIN method

1. Locate the WPS PIN.
 - a. Open the control panel dashboard (swipe the dashboard tab at the top of any screen downward, or touch the dashboard area on the home screen).
 - b. On the control panel dashboard, touch .
 - c. Touch [Network Setup](#), and then touch [Wireless Settings](#).
 - d. Touch [Wi-Fi Protected Setup](#), and then touch [PIN](#).
2. On the control panel, press and hold  on the printer for more than three seconds to start WPS push mode. The  indicator starts blinking.
3. Open the configuration utility or software for the wireless router or wireless access point, and then enter the WPS PIN.



NOTE: For more information about using the configuration utility, see the documentation provided with the router or wireless access point.

4. Wait for about two minutes. If the printer connects successfully, the  indicator stops blinking but remains lit.

To connect the product to a wireless network manually

During the first 120 minutes of product setup, or after resetting the product's network defaults (and without a network cable attached to the product), the product's wireless radio will broadcast a wireless setup network for the product.

The name of this network is “HP-Setup-xx-[product name]”.



NOTE: The “xx” in the network name is the last two characters of the product's MAC address. The product name is HP PageWide MFP 377dw .

1. From a wireless enabled product, connect to the setup network for the device.
2. Open a web browser while connected to this setup network, and open the HP Embedded Web Server (EWS) using the following IP address.
 - 192.168.223.1
3. Find the Wireless Setup Wizard in the EWS and follow the instructions to manually connect the product.



NOTE: The product uses Automatic DHCP by default.

Use Wi-Fi Direct to connect a computer or device to the product



With Wi-Fi Direct, you can print wirelessly from a computer, smart phone, tablet, or other wireless-capable device—without connecting to an existing wireless network.

Guidelines for using Wi-Fi Direct

- Make sure your computer or mobile device has the necessary software.
 - If you are using a computer, make sure you have installed the printer software from 123.hp.com/pagewide (recommended) or from the HP software CD provided with the printer.

If you have not installed the HP printer software on the computer, connect to Wi-Fi Direct first and then install the printer software. Select **Wireless** when prompted by the printer software for a connection type.
 - If you are using a mobile device, make sure you have installed a compatible printing app. For more information about mobile printing, visit the HP Mobile Printing website.
- Make sure Wi-Fi Direct for your printer is turned on.
- Up to five computers and mobile devices can use the same Wi-Fi Direct connection.
- Wi-Fi Direct can be used while the printer is also connected either to a computer using a USB cable or to a network using a wireless connection.
- Wi-Fi Direct cannot be used to connect a computer, mobile device, or printer to the Internet.

To turn on Wi-Fi Direct

1. Open the control panel dashboard (swipe the dashboard tab at the top of any screen downward, or touch the dashboard area on the home screen).
2. On the control panel dashboard, touch .
3. Touch .
4. If the display shows that Wi-Fi Direct is off, touch [Wi-Fi Direct](#) and switch it on.

 **TIP:** You can also turn on Wi-Fi Direct from the EWS. For more information about using the EWS, see [HP Embedded Web Server](#).

To print from a wireless-capable mobile device

Make sure you have installed a compatible printing app on your mobile device. For more information, visit the [HP Mobile Printing](#) website.

1. Make sure you have turned on Wi-Fi Direct on the printer.
2. Turn on the Wi-Fi connection on your mobile device. For more information, see the documentation provided with the mobile device.

 **NOTE:** If your mobile device does not support Wi-Fi, you are not able to use Wi-Fi Direct.

3. From the mobile device, connect to a new network. Use the process you normally use to connect to a new wireless network or hotspot. Choose the Wi-Fi Direct name from the list of wireless networks

shown such as **DIRECT-**-HP PageWide XXXX** (where ** are the unique characters to identify your printer and XXXX is the printer model located on the printer).

Enter the Wi-Fi Direct password when prompted.

4. Print your document.

To print from a wireless-capable computer (Windows)

1. Make sure Wi-Fi Direct for your printer is turned on.
2. Turn on the computer's Wi-Fi connection. For more information, see the documentation provided with the computer.

 **NOTE:** If your computer does not support Wi-Fi, you are not able to use Wi-Fi Direct.

3. From the computer, connect to a new network. Use the process you normally use to connect to a new wireless network or hotspot. Choose the Wi-Fi Direct name from the list of wireless networks shown such as **DIRECT-**-HP PageWide XXXX** (where ** are the unique characters to identify your printer and XXXX is the printer model located on the printer).

Enter the Wi-Fi Direct password when prompted.

 **NOTE:** To find the password, touch  (Wi-Fi Direct) on the home screen.

4. Proceed to step 5 if the printer has been installed and connected to the computer over a wireless network. If the printer has been installed and connected to your computer with a USB cable, follow the steps below to install the printer software using the HP Wi-Fi Direct connection.
 - a. Open the printer software. For more information, see [Open the printer software \(Windows\)](#).
 - b. Click **Printer Setup & Software**, and then select **Connect a new printer**.
 - c. When the **Connection Options** software screen appears, select **Wireless**.
Select your HP printer software from the list of detected printers.
 - d. Follow the onscreen instructions.
5. Print your document.

To print from a wireless-capable computer (OS X)

1. Make sure Wi-Fi Direct for your printer is turned on.
2. Turn on Wi-Fi on the computer.
For more information, see the documentation provided by Apple.
3. Click the Wi-Fi icon and choose the Wi-Fi Direct name, such as **DIRECT-**-HP PageWide XXXX** (where ** are the unique characters to identify your printer and XXXX is the printer model located on the printer).
If Wi-Fi Direct is turned on with security, enter the password when prompted.
4. Add the printer.
 - a. Open **System Preferences**.
 - b. Click **Printers & Scanners**.

- c. Click + below the list of printers at the left.
- d. Select the printer from the list of detected printers (the word “Bonjour” is listed in the right column beside the printer name), and click **Add**.

Install HP printer software for a wireless product already on the network

If the product already has an IP address on a wireless network and you want to install product software on a computer, complete the following steps.

1. Obtain the product IP (on the control panel dashboard, touch ).
2. Install the printer software from 123.hp.com/pagewide (recommended) or from the HP software CD provided with the printer.
3. Follow the onscreen instructions.
4. When prompted, select **Wireless - Connect the printer to your wireless network and internet**, and then click **Next**.
5. From the list of available printers, select the printer that has the correct IP address.

Open the printer software (Windows)

Depending on your operating system, you can open the printer software as follows:

- **Windows 10:** From the computer desktop, click **Start**, select **All apps**, click **HP**, click the folder for the printer, and then select the icon with the printer's name.
- **Windows 8.1:** Click the down arrow in lower left corner of the Start screen, and then select the printer name.
- **Windows 8:** Right-click an empty area on the Start screen, click **All Apps** on the app bar, and then select the printer name.
- **Windows 7, Windows Vista, and Windows XP:** From the computer desktop, click **Start**, select **All Programs**, click **HP**, click the folder for the printer, and then select the icon with the printer's name.

Manage network settings

- [View or change network settings](#)
- [Set or change the product password](#)
- [Manually configure TCP/IP parameters from the control panel](#)
- [Link speed and duplex settings](#)

View or change network settings

Use the HP Embedded Web Server to view or change IP configuration settings.

1. Obtain the product IP (on the control panel dashboard, touch .
2. Type the product IP address into the address bar of a web browser to open the HP Embedded Web Server.
3. Click the **Network** tab to obtain network information. You can change settings as needed.

Set or change the product password

Use the HP Embedded Web Server to set a password or change an existing password for a product on a network so unauthorized users cannot change the product settings.

1. Obtain the product IP (on the control panel dashboard, touch .
2. Type the product IP address into the address bar of a web browser. Click the **Settings** tab, click **Security**, and then click the **Password Settings** link.



NOTE: If a password has previously been set, you are prompted to type the password. Type “admin” for User Name along with the password, and then click **Apply**.

3. Type the new password in the **Password** field and in the **Confirm Password** field.
4. At the bottom of the window, click **Apply** to save the password.

Manually configure TCP/IP parameters from the control panel

Use the control panel menus to manually set an IPv4 address, subnet mask, and default gateway.

1. Open the control panel dashboard (swipe the dashboard tab at the top of any screen downward, or touch the dashboard area on the home screen).
2. On the control panel dashboard, touch .
3. Touch **Network Setup**, and then touch **Ethernet Settings**.
4. Touch **Advanced Settings**, and then touch **IP Settings**.
5. Touch **Manual**, and then touch **IP Address**.
6. Using the numeric keypad, do the following:
 - Enter the IP address, and touch **Done** .
 - Enter the subnet mask, and touch **Done** .
 - Enter the default gateway, and touch **Done** .
7. Touch **Apply**.

Link speed and duplex settings



NOTE: This information applies only to Ethernet (wired) networks. It does not apply to wireless networks.

The link speed and communication mode of the print server must match the network hub. For most situations, leave the product in automatic mode. Incorrect changes to the link speed and duplex settings might prevent the product from communicating with other network devices. If you need to make changes, use the printer control panel.

**NOTE:**

- The setting must match with the network product to which you are connecting (a network hub, switch, gateway, router, or computer).
- Making changes to these settings causes the product to turn off and then on. Make changes only when the product is idle.

1. Open the control panel dashboard (swipe the dashboard tab at the top of any screen downward, or touch the dashboard area on the home screen).
2. On the control panel dashboard, touch .
3. Touch [Network Setup](#), and then touch [Ethernet Settings](#).
4. Touch [Advanced Settings](#), and touch [Link Speed](#).
5. Select one of the following options.

Setting	Description
Automatic	The print server automatically configures itself for the highest link speed and communication mode allowed on the network.
10-Full	10 Mbps, full-duplex operation
10-Half	10 Mbps, half-duplex operation
100-Full	100 Mbps, full-duplex operation
100-Half	100 Mbps, half-duplex operation

3 Printer management and services

- [HP Embedded Web Server](#)
- [Web Services](#)
- [Product security features](#)
- [HP Printer Assistant in the printer software \(Windows\)](#)
- [HP Utility \(OS X\)](#)
- [AirPrint™ \(OS X\)](#)

HP Embedded Web Server

- [About the EWS](#)
- [About cookies](#)
- [Open the EWS](#)
- [Features](#)

About the EWS

This product is equipped with the HP Embedded Web Server (EWS), which provides access to information about product and network activities. EWS provides an environment in which Web programs may run, much in the same way that an operating system, such as Windows, provides an environment for programs to run on a computer. The output from these programs can then be displayed by a web browser.

The EWS resides on a hardware device (such as an HP printer) or in firmware, rather than as software that is loaded on a network server.

The advantage of the EWS is that it provides an interface to the product that anyone with a network-connected product and computer can use. There is no special software to install or configure, but you must have a supported web browser on the computer. To gain access to the EWS, type the IP address for the product in the address bar of the browser.

About cookies

The EWS places very small text files (cookies) on your hard drive when you are browsing. These files let the EWS recognize your computer the next time you visit. For example, if you have configured the EWS language, a cookie helps remember which language you have selected so that the next time you access the EWS, the pages are displayed in that language. Though some cookies are cleared at the end of each session (such as the cookie that stores the selected language), others (such as the cookie that stores customer-specific preferences) are stored on the computer until you clear them manually.



IMPORTANT: The cookies that the EWS stores on your computer are used only for saving settings on your computer or for sharing information between the printer and the computer. These cookies are not sent to any HP websites.

You can configure your browser to accept all cookies, or you can configure it to alert you every time a cookie is offered, which allows you to decide which cookies to accept or refuse. You can also use your browser to remove unwanted cookies.

Depending on your printer, if you disable cookies, you also disable one or more of the following features:

- Starting where you left the application (especially useful when using setup wizards).
- Remembering the EWS browser language setting.
- Personalizing the EWS home page.

For information about how to change your privacy and cookie settings and how to view or delete cookies, see the documentation available with your web browser.

Open the EWS

To open the EWS, do one of the following:

- In a supported web browser, type the product IP address into the address box. (To obtain the IP address, on the control panel dashboard, touch )
- In the printer software, open the HP Printer Assistant and on the **Print** tab, of the **Print, Scan & Fax** tab, click **Printer Home Page (EWS)**.

For more information, see [Open the HP Printer Assistant](#).

- In OS X, use HP Utility or click **System Preferences > Printers & Scanners > HP PageWide MFP 377dw > Options & Supplies > General > Show Printer Webpage**.

 **NOTE:** If an error occurs while opening the EWS, confirm that the proxy settings are correct for your network.

 **TIP:** After you open the URL, bookmark it so that you can return to it quickly in the future.

Features

- [Home tab](#)
- [Scan tab](#)
- [Fax tab](#)
- [Web Services tab](#)
- [Network tab](#)
- [Tools tab](#)
- [Settings tab](#)

 **NOTE:** Changing network settings in the EWS might disable some product or product software features.

Home tab

Use the **Home** tab to access frequently used items from the **Scan, Fax, Web Services, Network, Tools**, and **Settings** tabs. The **Home** tab includes the following items.

 **NOTE:** Not all of the following items are visible by default. Use the **Personalize** button to show or hide the items of your choice.

Item	Description
Scan to Email	Configure target email profiles for the scan-to-email feature
Scan to Network Folder	Configure a target network folder for the scan-to-network feature
HP Digital Fax	Configure the printer to save faxes to the network or forward them to email
Energy Save Settings	Configure energy-saving features that switch the printer to Sleep Mode or turn the printer on or off automatically
Web Services	Enable or disable HP ePrint or print apps that allow you to print from email

Item	Description
Printer Update	Check for new printer updates
Estimated Cartridge Levels	Review cartridge level status
Network Summary	View wired (802.3) status or wireless (802.11) status
Print Quality Toolbox	Run maintenance tools to improve print quality
Wireless Setup Wizard	Set up a wireless connection using the wizard
Wi-Fi Direct	Set up Wi-Fi Direct to print from a mobile device directly to the printer without connecting to a wireless network
AirPrint	Set up AirPrint™ for printing from Apple-supported products
Printer Information	View information about the printer, such as product serial number, service ID, firmware version, and total page count
Administrator	Set up administrator control of printer features
Backup	Back up the printer settings into a password-encrypted file
Fax Log	Display and manage all fax-related activities (including digital fax log)
Fax Setup Wizard	Run the wizard to set up fax features
Firewall	Configure the network firewall
Printer Reports	Print the information pages about your printer
Scan to SharePoint	Configure the target SharePoint folder for the scan-to-folder feature
Usage Report	Display usage counters for print, fax, and copy jobs
Webscan	Enable Webscan, which allows anyone with access to the printer to scan whatever is on the scanner glass



NOTE: Settings for this page are automatically saved in the web browser's cookies. If the web browser's cookies are deleted, these settings are lost.

Scan tab

Use the **Scan** tab to configure the product's scan features. The **Scan** tab includes the following items.

Item	Description
Scan to Computer	Use Webscan
	<p>IMPORTANT: For security purposes, Webscan is disabled by default. To enable Webscan, open the Settings tab, click Administrator Settings, select the Enable checkbox beside Webscan, and then click Apply.</p> <p>When Webscan is enabled, anyone with access to the printer can scan whatever is on the scanner glass.</p>

Item	Description
Scan to Email	<ul style="list-style-type: none"> • Scan to Email Setup: Use this to set up the Scan-to-Email function and to configure the sender of the scanned documents • Email Address Book: Configure the list of people to whom you can send the scanned documents • Email Options: Configure a default SUBJECT line and body text and configure the default scan settings
Scan to Network Folder	Network Folder Setup: Configure a network folder for saving scanned images or documents from the printer
Scan to SharePoint	SharePoint Setup: Configure a SharePoint destination for saving scanned documents from the printer

Fax tab

Use the **Fax** tab to configure the product's fax features. The **Fax** tab includes the following items.

Item	Description
Fax Setup Wizard	Configure the printer's fax feature
Basic Fax Settings	Change the header name/fax number and set other basic fax settings
Advanced Fax Settings	Set fax details such as Error Reporting, Confirmation, and so on
Fax Speed-dial	Enter and store speed dial numbers
Fax Forwarding	Automatically redirect incoming faxes to another fax number
Junk Fax Blocker	Block faxes from specific people or businesses
Information	Fax Log: View a list of the faxes that have been sent from or received by this product
HP Digital Fax	Digital Fax Profile: Save incoming black-and-white faxes to a designated folder on the network or forward them as email

Web Services tab

Use the **Web Services** tab to configure and enable HP Web Services for this product. You must enable HP Web Services to use the HP ePrint feature.

Network tab

Use the **Network** tab to configure and secure network settings for the product when it is connected to an IP-based network. The **Network** tab does not appear if the product is connected to other types of networks.

Tools tab

Use the **Tools** tab to view or manage product utilities. The **Tools** tab includes the following items.

Item	Description
Product Information	<ul style="list-style-type: none"> • Printer Information: View information about the printer, such as product serial number, service ID, firmware version, and total page count • Cartridge Level Gauge: Review cartridge level status • Cartridge Settings: Set the threshold at which the printer provides notifications that cartridges are running low
Reports	<ul style="list-style-type: none"> • Usage Report: View the number of pages processed for printing, scanning, copying, and faxing • Printer Reports: Print various reports, such as font lists • Event Log: View the printer's last 50 error messages • Job Log: View a list of the most recent jobs performed by the printer • Color Usage Job Log: View the number of pages printed in black-and-white/grayscale and color for all jobs and for individual jobs
Utilities	<ul style="list-style-type: none"> • Bookmarking: Bookmark pages in the EWS • Print Quality Toolbox: Run maintenance tools to improve the print quality of your printouts • Asset Tracking: Assign an asset number/location to this device
Backup and Restore	<ul style="list-style-type: none"> • Backup: Create a password-encrypted file that stores the printer's settings • Restore: Restore the printer's settings using a backup file created by the EWS
Printer Restart	Power Cycle: Turn off and restart the printer
Printer Updates	Firmware Updates: Set up the printer to alert you of updates or to automatically install updates

Settings tab

Use the **Settings** tab to set and maintain various options on your product including power management, date and time, printing and paper settings, email alerts, factory defaults, and firewall settings.

Item	Description
Power Management	Set up the Energy Save mode to minimize the amount of power that the product consumes when idle and to reduce wear on electronic components
Preferences	Configure the default settings for general printer features such as date and time, language, display, and anonymous usage information. You can also set the default values for specific features such as manual feed, tray and paper management, image registration, ColorLok, and Quiet Mode.
Security	Configure settings to prevent unauthorized use of the printer or specific printer features. For more information, see Security settings .
Email Alerts	Set the default values for the email server, alert destinations, and alert settings
Copy/Print Settings	Configure default settings for printing (such as font, print quality, duplexing, and black-and-white or color printing) and copying (such as tray selection and copy quality)
Restore Defaults	Restore the factory defaults or the network settings
Firewall	Configure firewall settings such as rules, addresses, services, and other options

Web Services

- [What are Web Services?](#)
- [Set Up Web Services](#)
- [Use Web Services](#)
- [Remove Web Services](#)

What are Web Services?

The printer offers innovative, web-enabled solutions that can help you quickly access the Internet, obtain documents, and print them faster and with less hassle—and all without using a computer.

 **NOTE:** To use these web features, the printer must be connected to the Internet (either using an Ethernet cable or wireless connection). You cannot use these web features if the printer is connected using a USB cable.

HP ePrint

HP ePrint is a free service from HP that allows you to print to your HP ePrint-enabled printer anytime, from any location. It's as simple as sending an email to the email address assigned to your printer when you enable Web Services on the printer. No special drivers or software are needed. If you can send an email, you can print from anywhere, using HP ePrint.

 **NOTE:**

- You can sign up for an account at the [HP Connected](#) website (might not be available in all countries/regions), and sign in to configure the ePrint settings.
 - After you sign up for an account at the HP Connected website, you can sign in to view your HP ePrint job status, manage your HP ePrint printer queue, control who can use your printer's HP ePrint email address to print, and get help for HP ePrint.
-

Print apps

- Print apps allow you to easily locate and print preformatted web content, directly from your printer. You can also store your documents digitally on the web.
- Preformatted content designed specifically for your printer means no cut-off text and pictures and no extra pages with only one line of text. On some printers, you can also choose paper and print quality settings on the print preview screen.

Set Up Web Services

Before you set up Web Services, make sure your printer is connected to the Internet using either an Ethernet or wireless connection.

To set up Web Services, use one of the following methods.

To set up Web Services using the control panel

1. Open the control panel dashboard (swipe the dashboard tab at the top of any screen downward, or touch the dashboard area on the home screen).
2. On the control panel dashboard, touch .

3. Touch [Web Services Setup](#).
4. Touch [Accept](#) to accept the Web Services terms of use and enable Web Services.
5. On the screen that appears, touch [OK](#) to allow the printer to automatically check for product updates.



NOTE: If prompted for proxy settings and if your network uses proxy settings, follow the onscreen instructions to set up a proxy server. If you do not have the proxy details, contact your network administrator or the person who set up the network.

6. If the [Printer Update Options](#) screen appears, touch [Install Automatically \(Recommended\)](#) or [Alert When Available](#).
7. When the printer is connected to the server, the printer prints an information page. Follow the instructions on the information page to finish the setup.

To set up Web Services using the EWS

1. Open the EWS. For more information, see [Open the EWS](#).
2. Click the **Web Services** tab.
3. In the **Web Services Settings** section, click **Setup**, click **Continue**, and follow the onscreen instructions to accept the terms of use.
4. If prompted, choose to allow the printer to check for and install printer updates.



NOTE: If prompted for proxy settings and if your network uses proxy settings, follow the onscreen instructions to set up a proxy server. If you do not have the proxy details, contact your network administrator or the person who set up the network.

5. When the printer is connected to the server, the printer prints an information page. Follow the instructions on the information page to finish the setup.

Use Web Services

- [HP ePrint](#)
- [Print apps](#)

HP ePrint

To use HP ePrint, do the following:

- Be sure you have an Internet- and email-capable computer or mobile device.
- Enable Web Services on the printer. For more information, see [Set Up Web Services](#).

For more information about managing and configuring HP ePrint settings and to learn about the latest features, visit [HP Connected](#). This site might not be available in all countries/regions.

To print documents using HP ePrint

1. On your computer or mobile device, open your email application.
2. Create a new email message, and then attach the file that you want to print.
3. Enter the HP ePrint email address in the "To" field, and then select the option to send the email message.



NOTE: Do not enter any additional email addresses in either the "To" or "Cc" fields. The HP ePrint server does not accept print jobs if there are multiple email addresses.

To find the HP ePrint email address

1. Open the control panel dashboard (swipe the dashboard tab at the top of any screen downward, or touch the dashboard area on the home screen).
2. On the control panel dashboard, touch .
3. Touch [Web Services Setup](#), and then touch [Print Info Page](#). The printer prints an information page that contains the printer code and instructions on how to customize the email address.

To turn off HP ePrint from the control panel

1. Open the control panel dashboard (swipe the dashboard tab at the top of any screen downward, or touch the dashboard area on the home screen).
2. On the control panel dashboard, touch .
3. Touch , and then touch [HP ePrint](#) and turn it off.

To turn off HP ePrint in the EWS

1. Open the EWS. For more information, see [Open the EWS](#).
2. Click the **Web Services** tab.
3. In the **Web Services Settings** section, for **HP ePrint**, click **Turn Off**.
4. In the confirmation dialog box that appears, click **Yes**.

Print apps

Print apps allow you to easily locate and print preformatted web content, directly from your printer.

To use print apps

1. On the control panel, touch the [Apps](#) application folder.
2. Touch the print app you want to use.

For more information about an individual print app, visit the [HP Connected](#) website. This site might not be available in all countries/regions.

To manage print apps

You can add, configure, or remove print apps, and set the order in which they appear on your printer control panel display.

1. On the control panel, touch the [Apps](#) application folder.
2. In the display, touch the [Manage](#) icon and follow the onscreen instructions.



NOTE: You can also manage your print apps at the [HP Connected](#) website.

Remove Web Services

Use the following instructions to remove Web Services.

To remove Web Services using the control panel

1. Open the control panel dashboard (swipe the dashboard tab at the top of any screen downward, or touch the dashboard area on the home screen).
2. On the control panel dashboard, touch .
3. Touch , and then touch [Remove Web Services](#) and touch [Yes](#).

To remove Web Services using the EWS

1. Open the EWS. For more information, see [Open the EWS](#).
2. Click the **Web Services** tab.
3. In the **Web Services Settings** section, click **Remove Web Services**.
4. Click **Remove Web Services** to confirm.
5. Click **Yes** to remove Web Services from your printer.

Product security features

- [Security statements](#)
- [Firewall](#)
- [Security settings](#)
- [Firmware updates](#)

Security statements

This product supports security standards and protocols that help secure the product, protect information on your network, and simplify monitoring and maintenance of the product.

For information about HP's secure imaging and printing solutions, visit the [HP secure printing](#) website. The site provides links to white papers and FAQ documents about security features and may include information about additional security features that are not contained in this document.

Firewall

The HP Embedded Web Server allows you to enable and configure product firewall rules, priorities, templates, services, and policies. The firewall feature provides a network layer of security on both IPv4 and IPv6 networks. The firewall configuration capability gives you control over IP addresses that are allowed to access the product. It also lets you set permissions and priorities for digital send, management, discovery, and print services. All of this helps provide a more secure way of controlling access to the product.

The firewall feature also allows you to disable unused protocols and services. These protocol and services settings can also be protected from being changed by setting the EWS admin password. These protocols and services include the following.

Protocol or service	Description
IPv4 and IPv6	<p>To operate properly on a TCP/IP network, the product must be configured with valid TCP/IP network configuration settings, such as an IP address that is valid for your network.</p> <p>This product supports two versions of this protocol: version 4 (IPv4) and version 6 (IPv6). IPv4 and IPv6 can be enabled/disabled individually or simultaneously enabled.</p>
Bonjour	Bonjour services are typically used on small networks for IP address and name resolution where a conventional DNS server is not used. The Bonjour service can be enabled or disabled.
SNMP	SNMP (Simple Network Management Protocol) is used by network management applications for product management. This product supports the SNMPv1 protocol on IP networks. This product allows the ability to enable/disable SNMPv1.
WINS	<p>If you have a Dynamic Host Configuration Protocol (DHCP) service on your network, the product automatically obtains its IP address from that server and registers its name with any RFC 1001 and 1002-compliant dynamic name services as long as the Windows Internet Name Service (WINS) server IP address has been specified.</p> <p>The WINS server IP address configuration can be enable or disabled. If enabled, then the primary and secondary WINS server can be specified.</p>
SLP	Service Location Protocol (SLP) is an Internet standard network protocol that provides a framework to allow network applications to discover the existence, location and configuration of networked services in enterprise networks. This protocol can be enabled or disabled.
LPD	Line Printer Daemon (LPD) refers to the protocol and programs associated with line-printer spooling services that may be installed on various TCP/IP systems. LPD can be enabled or disabled.
LLMNR	Link-Local Multicast Name Resolution (LLMNR) is a protocol based on the Domain Name System (DNS) packet format that allows both IPv4 and IPv6 hosts to perform name resolution for hosts on the same local link. LLMNR can be enabled or disabled.
Port 9100	The product supports raw IP printing through TCP Port 9100. This HP-propriety TCP/IP port on the product is the default port for printing and it is accessed by HP software. Port 9100 can be enabled or disabled.
Web Services	The product supports the ability to enable or disable Microsoft Web Services Dynamic Discovery (WS Discovery) protocols or Microsoft Web Services for Devices (WSD) Print services supported on the product. These web services can be enabled or disabled together or WS Discovery can be enabled separately.
Internet Printing Protocol (IPP)	Internet Printing Protocol (IPP) is an Internet-standard protocol that allows you to print documents and manage jobs over the internet. IPP can be disabled or enabled.

Security settings

On the **Settings** tab of the Embedded Web Server, under **Security**, you can find the following options.

Item	Description
Password Settings	Set a password to prevent unauthorized users from remotely configuring the printer or viewing printer settings from the EWS
Administrator Settings	Customize your printer by enabling or disabling features related to network connectivity, Web Services, printer functions (such as color printing), memory devices, and firmware updates
Control Panel Shortcuts	Select which shortcuts appear in the Shortcuts folder on the printer control panel
Access Control	Enable and configure sign-in methods to control user access to specific printer tasks
Protect Stored Data	Configure settings to protect jobs stored on the printer from unauthorized users

Firmware updates

The printer firmware can be automatically updated. On the **Tools** tab of the Embedded Web Server, click **Printer Updates**, **Firmware Updates**, and then **Install updates automatically**. HP recommends using this option.

HP Printer Assistant in the printer software (Windows)

The HP Printer Assistant provides access to HP printer features and resources from the Windows programs menu or the desktop icon on your computer.

Open the HP Printer Assistant

1. On your computer, click **Start**, and then click **All Programs**.
2. Click **HP**, click the name of the product, and then click your printer.

Features

- [Connected tab](#)
- [Print, Scan & Fax tab](#)
- [Shop tab](#)
- [Help tab](#)
- [Tools tab](#)
- [Estimated Levels tab](#)

Connected tab

Click the **Connected** tab to access the [HP Connected](#) website (might not be available in all countries/regions). HP Connected gives you a single login for select HP apps and cloud solutions plus access to the HP Connected platform from a smartphone, tablet, computer, or web-enabled HP printer. You can sign into HP Connected using your existing ePrintCenter account or sign up for a new HP Connected account.

Print, Scan & Fax tab

Use the **Print, Scan & Fax** tab to view or manage print, scan, and fax utilities. This tab includes the following items.

Item	Description
Print	<ul style="list-style-type: none"> • Connect Printer to the Web: Click to open the HP website and get new content and solutions for your HP web-connected printer • Set Preferences: Click to open your Printing Preferences dialog box to view and change defaults for paper size, print quality, and more • Maintain Your Printer: Click to open the Toolbox to align and clean cartridges or print a diagnostic page • Print From Your Mobile Devices: Click to open the HP Mobile Printing website to learn how to print from your smartphone or tablet. If a local version of this website is not available in your country/region, you might be directed to the HP Mobile Printing site in another country/region or language. • See What's Printing: Click to open the print monitor and view, pause, or cancel your print jobs • Customize Your Printer: Click to open your Printing Preferences dialog box to change the name, security settings, or other properties of your printer • Printer Home Page (EWS): Click to open the HP Embedded Web Server to configure, monitor, and maintain your printer
Scan	<ul style="list-style-type: none"> • Scan a Document or Photo: Open the scan dialog box • Scan to Network Folder Wizard: Scan from your printer to a network folder • Scan to E-mail Wizard: Send scans as email attachments from your printer • Manage Scan to Computer: Turn on scanning from your printer's control panel to this computer over a network
Fax	<ul style="list-style-type: none"> • Send a Fax: Send an individual or group fax • Digital Fax Setup Wizard: Save your upcoming faxes digitally • Manage Fax Settings: View fax history, block junk faxes, and manage fax settings

Shop tab

Use the **Shop** tab to shop for HP supplies and other products online.

Help tab

Use the **Help** tab to access resources such as online help and HP Eco Solutions.

Tools tab

Use the **Tools** tab to set and maintain the printer driver and software and to diagnose and resolve printing, scanning, and connectivity problems.

Estimated Levels tab

Use the **Estimated Levels** tab to review cartridge levels and to order new cartridges, if needed.

HP Utility (OS X)

HP Utility contains tools to configure print settings, calibrate the printer, order supplies online, and find website support information.



NOTE: The features available in HP Utility vary depending on the selected printer.

Cartridge level warnings and indicators provide estimates for planning purposes only. When you receive a low-cartridge warning message, consider having a replacement cartridge available to avoid possible printing delays. You do not need to replace cartridges until the print quality becomes unacceptable.

Open HP Utility

- ▲ Double-click **HP Utility** in the **HP** folder, in the **Applications** folder.

AirPrint™ (OS X)

Your product supports printing with Apple's AirPrint for iOS 4.2 and Mac OS X v10.9 or later. Use AirPrint to print wirelessly to the printer from an iPad (iOS 4.2), iPhone (3GS or later), or iPod touch (third generation or later).

For more information, see [Print with AirPrint \(OS X\)](#).

4 Paper and print media

- [Understand paper use](#)
- [Supported media sizes](#)
- [Supported paper types and tray capacity](#)
- [Configure trays](#)
- [Load media](#)
- [Tips for selecting and using paper](#)

Understand paper use

HP PageWide cartridges for business are specifically developed for use with HP printheads. Unique formulations help extend the life of the printheads and enhance reliability. When used with ColorLok® paper, these cartridges provide laser-like color output that dries quickly and is ready for distribution.

 **NOTE:** Based on HP internal testing using a range of plain papers, HP highly recommends using papers with the ColorLok® logo for this product. For details, visit the [HP print permanence](#) website.



This product supports a variety of paper and other print media. Paper or print media that does not meet the following guidelines might cause poor print quality, increased jams, and premature wear on the product.

It is possible for paper to meet all of these guidelines and still not produce satisfactory results. This might be the result of improper handling, unacceptable temperature and/or humidity levels, or other variables over which HP has no control.

NOTICE: Using paper or print media that does not meet HP specifications might cause problems for the product, requiring repair. This repair is not covered by the HP warranty or service agreements.

Use the following guidelines to obtain satisfactory results when using special paper or print media. Set the paper type and size in the printer driver to obtain the best results.

Media type	Do	Do not
Envelopes	<ul style="list-style-type: none">• Store envelopes flat.• Use envelopes where the seam extends all the way to the corner of the envelope.	<ul style="list-style-type: none">• Do not use envelopes that are wrinkled, nicked, stuck together, or otherwise damaged.• Do not use envelopes that have clasps, snaps, windows, or coated linings.
Labels	<ul style="list-style-type: none">• Use fresh labels. Old labels are more likely to delaminate during printing.• Use only labels that have no exposed backing between them.• Use labels that lie flat.• Use only full sheets of labels.	<ul style="list-style-type: none">• Do not use labels that have wrinkles or bubbles, or are damaged.• Do not print partial sheets of labels.
Letterhead or preprinted forms	<ul style="list-style-type: none">• Use only letterhead or forms approved for use in HP PageWide products.	<ul style="list-style-type: none">• Do not use raised or metallic letterhead.
Heavy paper	<ul style="list-style-type: none">• Use only heavy paper that is approved for use in HP PageWide products and meets the weight specifications for this product.	<ul style="list-style-type: none">• Do not use paper that is heavier than the recommended media specification for this product unless it is HP paper that has been approved for use in this product.
Glossy or coated paper	<ul style="list-style-type: none">• Use only glossy or coated paper that is approved for use in HP PageWide products.	<ul style="list-style-type: none">• Do not use glossy or coated paper designed for use in laser products.

NOTICE: Do not use any media that contains staples or paper clips.

Supported media sizes

For best results, use the appropriate paper and media sizes:

- [Supported paper and print media sizes](#)
- [Supported envelope sizes](#)
- [Supported card and label sizes](#)
- [Supported photo media sizes](#)

Supported paper and print media sizes

Size	Dimensions	Tray 1	Tray 2	Optional Tray 3	Electronic duplex printing
Letter	216 x 279 mm (8.5 x 11 inches)	✓	✓	✓	✓
Oficio 8.5 x 13	(8.5 x 13 inches)	✓		✓	✓
Oficio 216x340 mm	216 x 340 mm	✓		✓	✓
Legal	216 x 356 mm (8.5 x 14 inches)	✓		✓	✓
A4	210 x 297 mm (8.3 x 11.7 inches)	✓	✓	✓	✓
Executive	184 x 267 mm (7.25 x 10.5 inches)	✓	✓	✓	✓
Statement	140 by 216 mm (5.5 x 8.5 inches)	✓	✓	✓	
A5	148 x 210 mm (5.8 x 8.3 inches)	✓	✓	✓	
A6	105 x 148.5 mm (4.13 x 5.83 inches)	✓			
B5 (JIS)	182 x 257 mm (7.17 x 10.12 inches)	✓	✓	✓	✓
B6 (JIS)	128x182 mm (5 x 7 inches)	✓			
16k	184 x 260 mm (7.24 x 10.23 inches)	✓	✓	✓	
	195 x 270 mm (7.68 x 10.62 inches)	✓	✓	✓	
	197 x 273 mm (7.75 x 10.75 inches)	✓	✓	✓	
Custom	Minimum: 76 x 127 mm (3 x 5 inches) Maximum: 216 x 356 mm (8.5 x 14 inches)	Width: 76 to 216 mm (3 to 8.5 inches) Length: 127 to 356 mm (5 to 14 inches)	Width: 102 to 216 mm (4 to 8.5 inches) Length: 210.06 to 297.2 mm (8.27 to 11.7 inches)	Width: 102 to 216 mm (4 to 8.5 inches) Length: 210.06 to 356 mm (8.27 to 14 inches)	

Supported envelope sizes

Size	Dimensions	Tray 1	Tray 2
Envelope #10	105 x 241 mm (4.13 x 9.49 inches)	✓	✓
Envelope DL	110 x 220 mm (4.33 x 8.66 inches)	✓	✓
Envelope C5	162 x 229 mm (6.4 x 9 inches)	✓	✓
Envelope B5	176 x 250 mm (6.7 x 9.8 inches)	✓	✓
Envelope C6	114 x 162 mm (4.5 x 6.4 inches)	✓	
Monarch	98.4 x 190.5 mm (3.875 x 7.5 inches)	✓	
Japanese Envelope Chou #3	120 x 235 mm (4.7 x 9.3 inches)	✓	
Japanese Envelope Chou #4	90 x 205 mm (3.5 x 8.1 inches)	✓	

Supported card and label sizes

Size	Dimensions	Tray 1	Tray 2	Optional Tray 3
3x5	(76.2 x 127 mm) (3 x 5 inches)	✓		
4x6	(102 x 152 mm) (4 x 6 inches)	✓		
5x8	(127 x 203 mm) (5 x 8 inches)	✓		
A6	(105 x 148.5 mm) (4.13 x 5.83 inches)	✓		
Japanese Postcard	(100 x 148 mm) (3.9 x 5.8 inches)	✓		
Double Japan Postcard Rotated	(148 x 200 mm) (5.8 x 7.9 inches)	✓		
Labels (Letter and A4)		✓	✓	✓

Supported photo media sizes

Size	Dimensions	Tray 1	Tray 2	Optional Tray 3
4x6	(102 x 152 mm) (4 x 6 inches)	✓		
10x15cm	(100 x 150 mm) (3.9 x 5.9 inches)	✓		
L	(89 x 127 mm) (3.5 x 5 inches)	✓		
5x7 Photo Media (5 x 7 in no-tabs)	(127 x 178 mm) (5 x 7 inches)	✓		
Photo Media (Letter & A4)		✓	✓	✓
Japanese Postcard	(100 x 148 mm) (3.9 x 5.8 inches)	✓		
Custom	Minimum: 76 x 127 mm (3 x 5 inches) Maximum: 216 x 356 mm (8.5 to 14 inches)	Width: 76 to 216 mm (3 to 8.5 inches) Length: 127 to 356 mm (5 to 14 inches)	Width: 102 to 216 mm (4 to 8.5 inches) Length: 210.06 to 297.2 mm (8.27 to 11.7 inches)	Width: 102 to 216 mm (4 to 8.5 inches) Length: 210.06 to 356 mm (8.27 to 14 inches)

Supported paper types and tray capacity

For best results, use the appropriate paper types and tray capacities:

- [Tray 1 \(multipurpose\) on left side of the product](#)
- [Tray 2 \(default tray\) and Tray 3 \(accessory tray\)](#)

Tray 1 (multipurpose) on left side of the product

Paper type	Weight	Capacity ¹	Paper orientation
Every day: <ul style="list-style-type: none">• Unspecified and Plain• HP EcoFFICIENT• Letterhead• Preprinted• Prepunched• Light 60-74g• Intermediate 85-95g• Mid-Weight 96-110g• Heavy 111-130g• HP Premium Presentation Matte 120g• Extra Heavy 131-175g	60 to 175 g/m ² (16 to 47 lb)	Up to 50 sheets	Side to be printed on face-down, with the top edge toward the printer
<ul style="list-style-type: none">• HP Brochure Matte 180g• HP Brochure Glossy 180g• Cardstock 176-220g• HP Cover Matte 200g• HP Advanced Photo Papers	Up to 220 g/m ² (58 lb) ¹	Up to 25 sheets	Side to be printed on face-down
<ul style="list-style-type: none">• Envelope• Heavy Envelope• Labels		Up to 7 envelopes or labels	Side to be printed on face-down

¹ Capacity can vary depending on paper weight and thickness, and environmental conditions.

Tray 2 (default tray) and Tray 3 (accessory tray)

Paper type	Weight	Capacity ¹	Paper orientation
<ul style="list-style-type: none"> Unspecified and Plain HP EcoFFICIENT Letterhead Preprinted Prepunched Light 60-74g Intermediate 85-95g Mid-Weight 96-110g Heavy 111-130g HP Premium Presentation Matte 120g Extra Heavy 131-175g 	60 to 175 g/m ² (16 to 47 lb)	Up to 500 sheets	Side to be printed on face-up, with the top edge toward the left
<ul style="list-style-type: none"> HP Brochure Matte 180g HP Brochure Glossy 180g Cardstock 176-220g HP Cover Matte 200g HP Advanced Photo Papers 	Up to 220 g/m ² (58 lb)	Up to 100 sheets	Side to be printed on face-up
<ul style="list-style-type: none"> Envelope Heavy Envelope Labels 		Up to 30 envelopes or labels.	Side to be printed on face-up

¹ Capacity can vary depending on paper weight and thickness, and environmental conditions.

Configure trays

By default, the product pulls paper from Tray 2. If Tray 2 is empty, the product pulls paper from Tray 1, or from the optional Tray 3 if it is installed.



NOTE: If you change the default tray to Tray 1, be sure to configure the tray for the correct paper size and type.

If you use special paper for all or most print jobs on the product, change this default tray setting on the product.

The following table lists possible ways you can use the tray settings to meet your printing needs.

Paper use	Configure the product	Print
Load Tray 1 and one other tray with the same paper, and have the product pick paper from one tray if the other one is empty.	Load paper in Tray 1, and configure the tray for the correct paper and type. Do not use Any Size/Any Type .	From the software program, print the job.
Frequently use special paper, such as heavy paper or letterhead, from one tray.	Load special paper in Tray 1, and configure the tray for the paper type.	From the software program print dialog, choose the paper type that matches the special paper loaded in the tray before sending the print job. Select Tray 1 as the Paper Source from the Paper/Quality tab (Windows) or Paper Feed pop-up menu (OS X).

Load media

- [Load Tray 1](#)
- [Load Tray 2](#)
- [Load optional Tray 3](#)
- [Load envelopes](#)
- [Load letterhead or preprinted forms](#)
- [Load the automatic document feeder](#)
- [Load the scanner](#)

Load Tray 1

Tray 1 is the multipurpose tray at the left side of the product.

 **NOTE:** If you are not using Alternate Letterhead Mode (ALM), place the paper with the side to be printed on face-down, with the top edge toward the printer. For ALM orientation, see [Load letterhead or preprinted forms](#).

1. Open Tray 1.



2. Pull out the Tray 1 extension.



3. Open the paper guides completely, and then load the paper stack into Tray 1.



4. Close the paper guides against the loaded media.

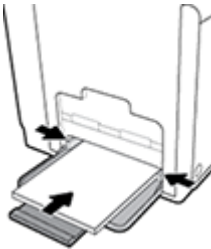

Load Tray 2

Tray 2 is the default (main) paper tray at the front of the product.



NOTE: If you are not using Alternate Letterhead Mode (ALM), place the paper with the side to be printed on face-up, with the top edge toward the left side of the tray. For ALM orientation, see [Load letterhead or preprinted forms](#).

1. Pull the tray out of the product.

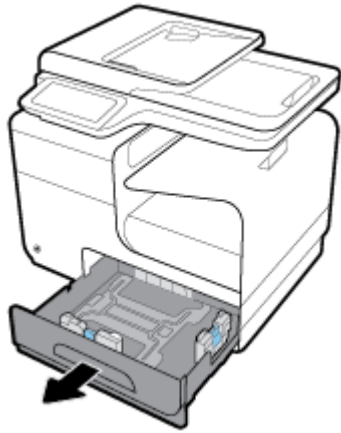

2. Open the paper length and width guides completely.

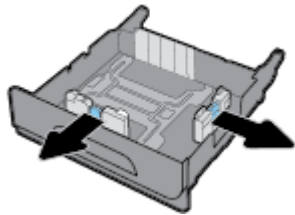

3. Place the paper in the tray and make sure that it is flat at all four corners. Close the length and width paper guides against the loaded media.

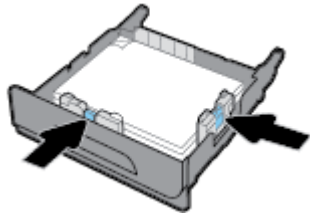

4. Push down on the paper to make sure that the stack is below the paper limit tabs on the side of the tray.

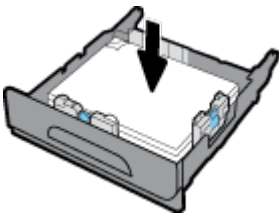

5. Put the tray into the product.

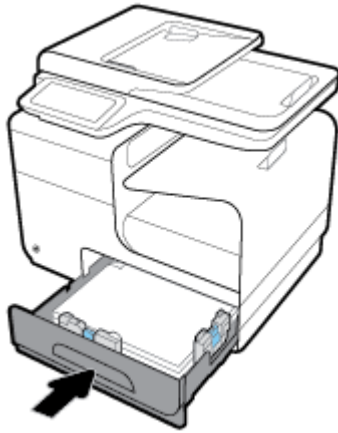

Load optional Tray 3

Tray 3 is an optional accessory tray that attaches to the bottom of the product. It can hold longer media, such as legal (216 x 356 mm, 8.5 x 14 inches) paper.



NOTE: If you are not using Alternate Letterhead Mode (ALM), place the paper with the side to be printed on face-up, with the top edge toward the left side of the tray. For ALM orientation, see [Load letterhead or preprinted forms](#).

1. Pull the tray out of the product.

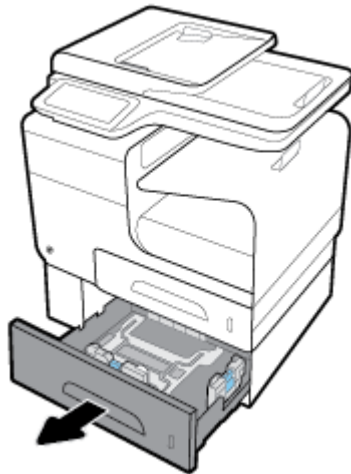

2. Open the paper length and width guides completely.

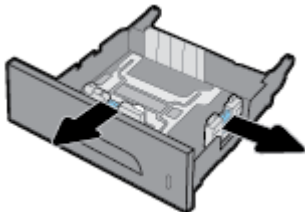

3. Place the paper in the tray and make sure that it is flat at all four corners. Close the length and width paper guides against the loaded media.

4. Push down on the paper to make sure that the stack is below the paper limit tabs on the front and the side of the tray.

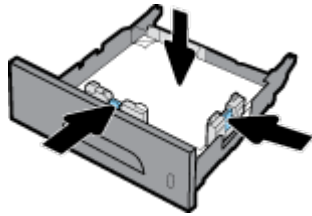

5. Put the tray into the product.

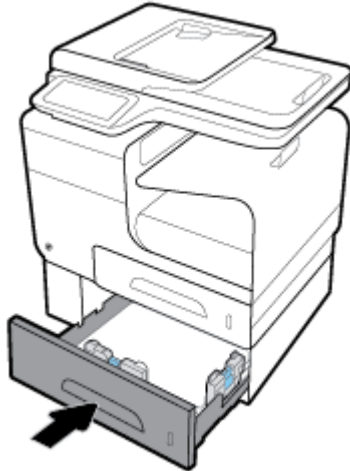

Load envelopes

You can load envelopes into Tray 1 or Tray 2.

To load envelopes into Tray 1

1. Open Tray 1.



2. Pull out the Tray 1 extension.



3. Place envelopes in Tray 1 face-down, with the top of the envelope oriented toward the front of the printer.

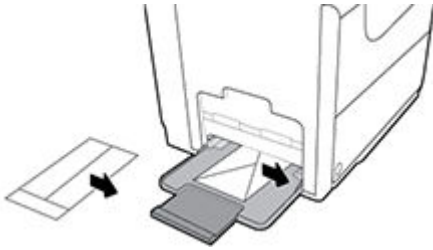

4. Close the paper guides.

To load envelopes into Tray 2

1. Pull the tray out of the product.



2. Stack envelopes face-up, with the top of the envelopes oriented toward the front of the tray.

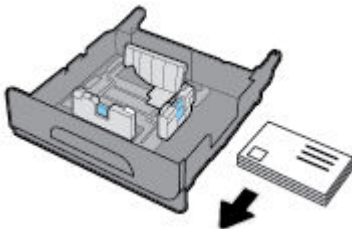

3. Place the envelopes in the tray and make sure that they are flat at all four corners. Close the length and width paper guides against the loaded media.

4. Push down on the envelopes to make sure that the envelopes are below the paper limit tabs on the side of the tray.

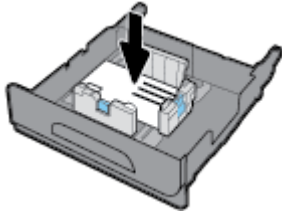

5. Put the tray into the product.

Load letterhead or preprinted forms

You can load letterhead, preprinted, or prepunched forms into any tray. Paper orientation depends on whether you are printing in simplex or duplex mode. If Alternative Letterhead Mode (ALM) is enabled, you can print in both simplex and duplex modes without reorienting the paper.



NOTE: With ALM enabled, you must select Letterhead, Preprinted, or Prepunched as the paper type in the Printer Properties dialog box.

To enable or disable ALM from the control panel

1. Open the control panel dashboard (swipe the dashboard tab at the top of any screen downward, or touch the dashboard area on the home screen).
2. On the control panel dashboard, touch .
3. Touch **Tray and Paper Management**, and then touch **Alternative Letterhead Mode** and turn it on or off.

To enable or disable ALM from the EWS

1. Type the product IP address into the address box of a web browser to open the EWS. (To obtain the product IP, on the control panel dashboard, touch .)
2. Click the **Settings** tab.
3. Click **Preferences**, and then click **Tray and Paper Management**.
4. In the **Alternative Letterhead Mode** section, select **Enabled** or **Disabled**.
5. Click **Apply**.

To load letterhead or preprinted forms with ALM enabled

1. Depending on the tray, orient the paper as follows.

Tray 1	Other tray(s)
Place the letterhead face-up, with the top of the page oriented toward the left.	Place the letterhead face-down, with the top of the page oriented toward the right.

2. Complete the steps in [Load Tray 1](#), [Load Tray 2](#), or [Load optional Tray 3](#).

To load letterhead or preprinted forms with ALM disabled

1. Depending on the tray, orient the paper as follows.

	Tray 1	Other tray(s)
Simplex	Place the letterhead face-down, with the top of the page oriented toward the right.	Place the letterhead face-up, with the top of the page oriented toward the left.
Duplex	Place the letterhead face-up, with the top of the page oriented toward the left.	Place the letterhead face-down, with the top of the page oriented toward the right.

2. Complete the steps in [Load Tray 1](#), [Load Tray 2](#), or [Load optional Tray 3](#).

Load the automatic document feeder

The automatic document feeder (ADF) holds up to 50 sheets of 75 g/m² (20 lb bond) paper.

NOTICE: When using the automatic document feeder (ADF), make sure that your documents contain no staples, paper clips, tape, or similar items that can damage the product.

1. Open the ADF paper guides.



2. For longer documents, pull the ADF loading area extension outward if necessary.
3. Place the documents to be copied in the ADF loading area face up.

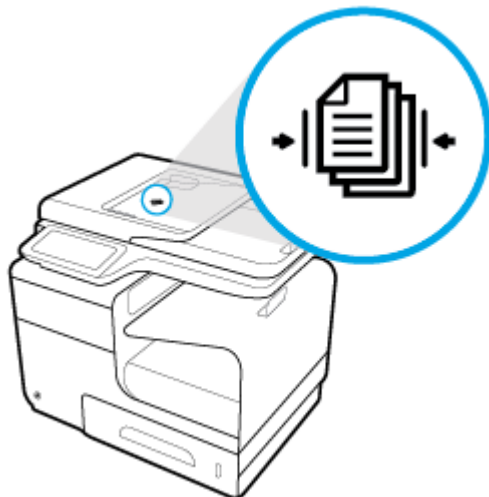

4. Push the documents to the left until they are stopped by the feeder mechanism under the ADF cover. A **Document Loaded** message appears on the printer control panel.
5. Close the paper guides securely against the loaded documents.



Load the scanner

1. Open the scanner lid.
2. Use the media mark at the back-left of the scanner glass to orient the original document.

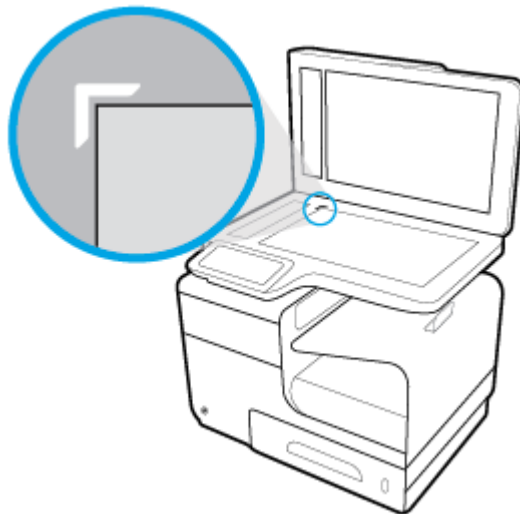

3. Place the original face down on the scanner glass.



4. Close the scanner lid.

Tips for selecting and using paper

For the best results, observe the following guidelines.

- Load only one type of paper at a time into a tray or document feeder.
- Make sure the paper is loaded correctly when loading from the input tray or document feeder.
- Do not overload the tray or document feeder.
- To prevent jams, poor print quality, and other printing problems, avoid loading the following paper in the tray or document feeder:
 - Multipart forms
 - Media that is damaged, curled, or wrinkled
 - Media with cutouts or perforations
 - Media that is heavily textured, embossed, or otherwise difficult to print on
 - Media that is too lightweight or stretches easily
 - Media that contains staples or clips

5 Cartridges

- [HP PageWide cartridges](#)
- [Manage cartridges](#)
- [Replace cartridges](#)
- [Tips for working with cartridges](#)

HP PageWide cartridges

HP policy on non-HP cartridges

IMPORTANT:

- HP does not guarantee the quality or reliability of non-HP contents in HP cartridges.
- HP's cartridge warranty does not cover non-HP cartridges or cartridges with non-HP contents.
- HP's printer warranty does not cover repairs or service due to use of non-HP cartridges or cartridges with non-HP contents.

NOTE:

- This printer is not designed to use continuous ink systems. To resume printing, remove the continuous ink system and install original HP (or compatible) cartridges.
 - This printer is designed for cartridges to be used until they are empty. Refilling cartridges before they are depleted might cause your printer to fail. If this happens, insert a new cartridge (either genuine HP or compatible) to continue printing.
-

Counterfeit HP cartridges

Your cartridge might not be a genuine HP cartridge if you notice the following:

- The control panel or printer status report indicates that a used or counterfeit cartridge is installed.
- You are experiencing a high number of problems with the cartridge.
- The cartridge does not look like it usually does (for example, the packaging differs from HP packaging).

Visit the [HP anticounterfeit](#) website when you install an HP print cartridge and the control panel message says the cartridge is used or counterfeit. HP will help resolve the problem.

Manage cartridges

Correctly storing, using, and monitoring cartridges can help ensure high-quality print output and extend the life of cartridges.

- [Store cartridges](#)
- [Print with General Office mode](#)
- [Print when a cartridge is at estimated end of life](#)
- [Check the estimated cartridge levels](#)
- [Order cartridges](#)
- [Recycle cartridges](#)

Store cartridges

- Do not remove the cartridge from its package until you are ready to use it.
- Store cartridges at room temperature (15-35° C or 59-95° F) for at least 12 hours before using them.
- Handle cartridges carefully. Dropping, jarring, or rough handling during installation can cause temporary printing problems.

Print with General Office mode

General Office mode produces slightly lighter printouts, which might extend the life of the cartridge.

1. On the **File** menu in the software program, click **Print**.
2. Make sure your printer is selected.
3. Click the link or button that opens the **Properties** dialog box.

Depending on your software application, this link or button might be called **Properties**, **Options**, **Printer Setup**, **Printer Properties**, **Printer**, or **Set Preferences**.

Do one of the following.

- **Windows:** Click **Print Options**, and then click **Properties**.
 - **OS X:** From the pop-up menu, select **Copies and Pages**.
4. Click the **Paper/Quality** tab.
 5. Select **General Office** from the **Print Quality** drop-down list (Windows) or pop-up menu (OS X).

Print when a cartridge is at estimated end of life

Supply-related notifications are communicated on the printer control panel.

- **Cartridge Low** message appears when a cartridge is nearing the estimated end of its useful life. Printing can continue, but consider having a replacement cartridge available.
- **Cartridge Very Low** message appears when the cartridge is near its estimated end of useful life. Have a replacement cartridge available.
- **Cartridge Depleted** message appears when the cartridge is empty.



NOTE: Although using the **Continue** setting allows printing beyond **Cartridge Very Low** without replacing the cartridge, the product will shut down before any print problems occur.

Check the estimated cartridge levels

You can check the estimated cartridge levels from the printer control panel or from the printer software.

To check the cartridge levels from the control panel

1. Open the control panel dashboard (swipe the dashboard tab at the top of any screen downward, or touch the dashboard area on the home screen).
2. On the control panel dashboard, touch  to display the estimated cartridge levels.

To check the cartridge levels from the EWS

1. Open the EWS. For more information, see [Open the EWS](#).
2. Click the **Tools** tab, and then click **Cartridge Level Gauge**.

To check the cartridge levels from the product software (Windows)

1. Open the HP Printer Assistant. For more information, see [Open the HP Printer Assistant](#).
2. On the **Print, Scan & Fax** tab, under **Print**, click **Maintain Your Printer**.
3. Click the **Estimated Cartridge Levels** tab.

To check the cartridge levels from the product software (OS X)

1. Open HP Utility. For more information, see [Open HP Utility](#).
2. Make sure your printer is selected.
3. Click **Supplies Status**.
The estimated cartridge levels appear.
4. Click **All Settings** to return to the **Information and Support** pane.



NOTE:

- If you have installed a refilled or remanufactured cartridge, or a cartridge that has been used in another printer, the cartridge level indicator might be inaccurate or unavailable.
- Cartridge-level alerts and indicators provide estimates for planning purposes only. When you receive a low-cartridge alert, consider having a replacement cartridge available to avoid possible printing delays. You do not need to replace the cartridges until you are prompted to.
- Ink from the cartridges is used in the printing process in a number of different ways, including in the initialization process, which prepares the printer and cartridges for printing, and in printhead servicing, which keeps the cartridges printing smoothly. Some residual ink is left in the cartridge after it is used. For more information, visit the [HP SureSupply](#) website.

Order cartridges

To order cartridges, visit the [HP website](#). (At this time, some portions of the HP website are available in English only.) Ordering cartridges online is not supported in all countries/regions. However, many countries have information on ordering by telephone, locating a local store, and printing a shopping list. In addition, you can visit the [HP SureSupply](#) website to obtain information about purchasing HP products in your country.

Use only the replacement cartridges that have the same cartridge number as the cartridge you are replacing. You can find the cartridge number in the following places:

- On the label of the cartridge you are replacing.
- On a sticker inside the printer. Open the cartridge access door to locate the sticker.
- In the printer software, open the HP Printer Assistant, click **Shop**, and then click **Shop For Supplies Online**.
- In the HP Embedded Web Server, click the **Tools** tab and then, under **Product Information**, click **Cartridge Level Gauge**. For more information, see [HP Embedded Web Server](#).



NOTE: The SETUP cartridge that comes with the printer is not available for separate purchase.

Recycle cartridges

Visit the [HP sustainability](#) website for full information on recycling and to order postage-paid labels, envelopes, and boxes for recycling.

Replace cartridges

The product uses four colors and has a different cartridge for each color: yellow (Y), magenta (M), cyan (C), and black (K).

NOTICE:

- To prevent print-quality problems, HP recommends replacing any missing cartridges with genuine HP cartridges as soon as possible. For more information, see [Order cartridges](#).
- Never turn off the printer if any cartridges are missing.

1. Open the cartridge door.



2. Push the old cartridge inward to unlock and release it.

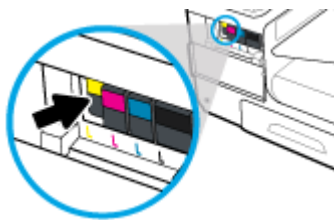

3. Grasp the edge of the old cartridge and then pull the cartridge straight out to remove it.

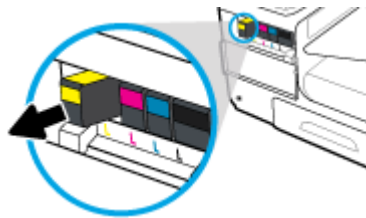

4. Do not touch the metal contacts on the cartridge. Fingerprints on the contacts can cause connection errors.



5. Insert the new cartridge into its slot.

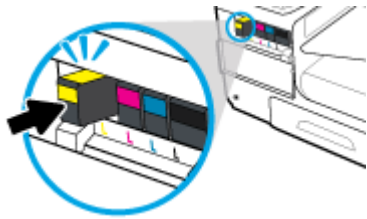

6. Close the cartridge door.



Tips for working with cartridges

Use the following tips to work with cartridges:

- To prevent print-quality problems, do the following:
 - Always turn the printer off using the power button on the front, and wait until the power button light goes out.

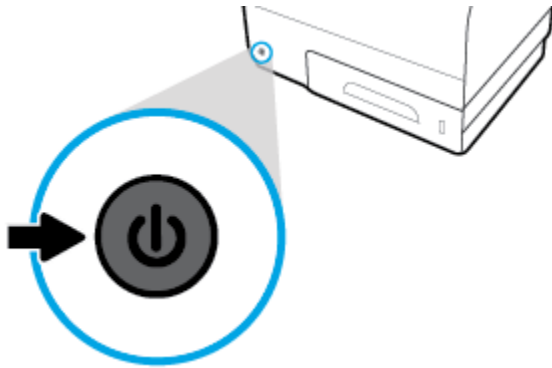

- Make sure that all the cartridge slots are filled.
- If you remove a cartridge from the printer for any reason, try to replace it again as soon as possible.
- Do not open or unpackage cartridges until you are ready to install them.
- Insert the cartridges into the correct slots. Match the color and icon of each cartridge to the color and icon for each slot. Make sure the cartridges snap into place.
- When the Estimated Cartridge Levels screen shows one or more cartridges in a low state, consider getting replacement cartridges to avoid possible printing delays. You do not need to replace the cartridges until prompted to. See [Replace cartridges](#) for more information.
- Do not clean the printhead unnecessarily. This shortens the life of the cartridges.
- If you are transporting the printer, do the following to prevent leaking from the printer or other damage from occurring.
 - Make sure you turn off the printer by pressing the power button in the front. Wait until all sounds of internal motion stop before unplugging the printer.
 - Make sure you leave the cartridges installed.
 - The printer must be transported sitting flat; it should not be placed on its side, back, front, or top.

6 Print

- [Print from a computer](#)
- [Print from the control panel](#)
- [Print with NFC](#)
- [Print with HP ePrint](#)
- [Print with AirPrint \(OS X\)](#)
- [Tips for print success](#)

Print from a computer

To print from a computer (Windows)

These instructions apply to printing on various media including the following.

-
- | | | |
|----------------------------------|-------------|-------------|
| • Plain paper | • Envelopes | • Brochures |
| • Letterhead or preprinted forms | • Photos | • Labels |
-

To print from a computer (Windows)

1. Load the supported media in the correct tray.
For more information, see [Supported media sizes](#).
2. On the **File** menu in the software program, click **Print**.
3. Make sure your printer is selected.
4. Click the link or button that opens the **Properties** dialog box.

Depending on your software application, this link or button might be called **Properties**, **Options**, **Printer Setup**, **Printer Properties**, **Printer**, or **Set Preferences**.

5. Set the correct print options for your type of media (plain paper, letterhead or preprinted, envelope, photo paper, label, and so forth).

The following table describes the tabs and options that might be available in your software program.

Tab	Description
Printing Shortcuts	<p>A printing shortcut stores the settings that are appropriate for a particular kind of job, so that you can set all the options with a single click.</p> <p>This tab displays the current printing shortcuts and their settings, such as paper type, paper source, and color or grayscale.</p>
Paper/Quality	<p>This tab contains settings that define the type of print job. For example, printing on envelopes requires different size, source, and type of paper than printing on plain paper.</p> <p>You can select from the following options:</p> <ul style="list-style-type: none">• Paper size: Includes Letter, Envelope #10, and Japanese Envelope Chou #3• Paper source: Includes Printer Auto Select, Manual Feed, Tray 1, and Tray 2• Paper type: Includes Plain, Letterhead, Preprinted, Envelope, HP Advanced Photo Papers, HP Brochure Matte 180g, and Labels <p>NOTE: If Alternative Letterhead Mode (ALM) is enabled, and you are printing on letterhead, preprinted, or prepunched forms, select Letterhead, Preprinted, or Prepunched as the paper type. For more information, see Load letterhead or preprinted forms.</p> <ul style="list-style-type: none">• Special pages: Includes front and back covers, blank sheets, and preprinted sheets• Print quality: Includes Professional (for high-quality jobs) and General Office (for everyday jobs) <p>NOTE: You cannot print envelopes in General Office mode.</p>

Tab	Description
Effects	<p>This tab contains settings that temporarily affect the presentation of the print job.</p> <p>You can select from the following options:</p> <ul style="list-style-type: none"> • Resizing options: Includes actual size, a percentage of actual, or scaled to a specific media size such as Letter or Envelope #10 • Watermarks: Includes Confidential and Draft
Finishing	<p>This tab contains settings that influence the output of the print job.</p> <p>You can select from the following options:</p> <ul style="list-style-type: none"> • Print on both sides: Includes the option to print with room for binding on the left, right, or neither side • Pages per sheet: Print more than one page per sheet, with the option to print borders around each page • Orientation: Includes Portrait and Landscape
Job Storage	<p>This tab contains settings for printing a stored job from the control panel. Only one setting is described here:</p> <ul style="list-style-type: none"> • Off (default): Prints a job without storing it on the printer <p>For information about the other settings, see Print using job storage.</p>
Color	<p>This tab contains settings for printing in color or grayscale.</p> <p>You can select from the following:</p> <ul style="list-style-type: none"> • Print in Grayscale: Print in black ink only, or high-quality grayscale (which uses the color cartridges in addition to the black cartridge) • Color Themes: These options determine how colors are rendered. They include various red-green-blue themes such as in Default, Photo, or Vivid. For more information, see To adjust or manage colors.
Advanced	<p>This tab contains settings that you may use or change infrequently.</p> <p>You can select from the following:</p> <ul style="list-style-type: none"> • Copies: Select the number of copies and whether to collate them • Reverse page order: Prints from the last page of the job to the first page • Print all text as black: Helps reduce color cartridge usage • Ink Settings: Use the sliders to select the dry time, saturation level, and black ink spread for the print job. For more information, see To adjust or manage colors.

6. Click **OK** to return to the **Properties** dialog box.
7. Click **OK**, and then click **Print** or click **OK** in the Print dialog box.

 **NOTE:** After printing, remove any special media, such as envelopes or photo paper, from the product.

To print from a computer (OS X)

These instructions apply to printing on various media including the following.

-
- | | | |
|----------------------------------|-------------|-------------|
| • Plain paper | • Envelopes | • Brochures |
| • Letterhead or preprinted forms | • Photos | • Labels |
-

To print from a computer (OS X)

1. Load the supported media in the correct tray.
For more information, see [Supported media sizes](#).
2. On the **File** menu in the software program, click **Print**.
3. Make sure your printer is selected.
4. In the **Presets** menu, select a printing preset if needed.
5. On the **Paper/Quality** tab, click the pop-up menu next to the media type.

Set the correct print options for your media (plain paper, letterhead, preprinted, prepunched, envelope, photo paper, label, and so forth). Print options can include size, type, tray, print resolution, and automatic adjustments.

If you do not see options on the Print dialog box, click **Show Details**.

6. Click **Print**.



NOTE: After printing, remove any special media, such as envelopes or photo paper, from the product.

To set up printing shortcuts (Windows)

1. On the **File** menu in the software program, click **Print**.
2. Click the link or button that opens the **Properties** dialog box.

Depending on your software application, this link or button might be called **Properties**, **Options**, **Printer Setup**, **Printer Properties**, **Printer**, or **Set Preferences**.

3. Click the **Printing Shortcuts** tab.
4. Select an existing shortcut as a base.



NOTE: Always select a shortcut before adjusting any of the settings on the right side of the screen. If you adjust the settings and then select a shortcut, all your adjustments are lost.

5. Select the print options for the new shortcut.
6. Click the **Save As** button.
7. Type a name for the shortcut, and click the **OK** button.

To set up printing presets (OS X)

1. On the **File** menu in the software program, click **Print**.
2. Make sure your printer is selected.
3. From the **Presets** pop-up menu, select **Default Settings**.

4. Click **Save Current Settings as Preset**.
5. Type a descriptive name for the preset, and save it for **Only this printer** or **All printers**.

To adjust or manage colors

Adjust the color of print output for the product by changing the settings in the printer driver software.

- [Choose a preset color theme for a print job](#)
- [Adjust the color options for a print job manually](#)
- [Match colors to your computer screen](#)
- [Control access to color printing](#)

Choose a preset color theme for a print job

1. On the **File** menu in the software program, click **Print**.
2. Make sure your printer is selected.
3. Click the link or button that opens the **Properties** dialog box.

Depending on your software application, this link or button might be called **Properties**, **Options**, **Printer Setup**, **Printer Properties**, **Printer**, or **Set Preferences**.
4. Click the **Color** tab, and select a color theme from the **Color Themes** drop-down list (Windows) or the **RGB Color** pop-up menu (OS X).
 - **Default (sRGB)**: This theme sets the product to print RGB data in raw device mode. When using this theme, manage color in the software program or in the operating system for correct rendering.
 - **Vivid**: The product increases the color saturation in the midtones. Use this theme when printing business graphics.
 - **Photo**: The product interprets RGB color as if it were printed as a photograph using a digital mini lab. The product renders deeper, more saturated colors differently than with the Default (sRGB) theme. Use this theme when printing photos.
 - **Photo (Adobe RGB 1998)**: Use this theme with printing digital photos that use the AdobeRGB color space rather than sRGB. Turn off color management in the software program when using this theme.
 - **None**: No color theme is used.

Adjust the color options for a print job manually

Use the printer driver software to clear default color settings and adjust settings manually. Use the built-in help in the driver software to understand how each setting affects print output.

1. On the **File** menu in the software program, click **Print**.
2. Make sure your printer is selected.
3. Do one of the following.
 - **Windows**: Click the link or button that opens the **Properties** dialog box.

Depending on your software application, this link or button might be called **Properties** , **Options**, **Printer Setup**, **Printer Properties**, **Printer**, or **Set Preferences**.

- **OS X:** From the **Copies & Pages** pop-up menu, select **Color**. Then, deselect **HP EasyColor**.
4. Continue to the **Advanced** tab or pane.
 - **Windows:** On the **Advanced** tab, click **Ink Settings**.
 - **OS X:** Click the disclosure triangle next to **Advanced**.
 5. Use the sliders to make the following adjustments.
 - **Dry Time:** Move the slider to the right to increase the amount of time that the printer takes to dry a printed page. Increasing the drying time works best for jobs printed on plain paper.
 - **Saturation:** Move the slider to the right to increase the amount of ink applied. Increasing the saturation works best for jobs printed on brochure or photo paper.
 - **Black Ink Spread:** Move the slider to the left to limit the spread of black ink onto adjacent areas of color on the printed page. Decreasing the spread works best for jobs printed on plain paper.
-
-  **NOTE:** Changing color settings manually can affect output. HP recommends that only color graphics experts change these settings.
6. Click **OK** to save your adjustments and close the window, or click **Reset** to return the settings to the factory defaults (Windows).

Match colors to your computer screen

For most users, the best method for matching colors is to print sRGB colors.

The process of matching printer output color to your computer screen is complex, because printers and computer monitors use different methods of producing color. Monitors display colors by using light pixels that use an RGB (red, green, blue) color process, but printers print colors by using a CMYK (cyan, magenta, yellow, and black) process.

Many factors can influence your ability to match printed colors to those on your monitor:

- Print media
- Printing process (cartridge, press, or laser technology, for example)
- Overhead lighting
- Personal differences in perception of color
- Software programs
- Printer drivers
- Computer operating systems
- Monitors
- Video cards and drivers
- Operating environment (humidity, for example)

Control access to color printing

HP's suite of color access control tools allows you to enable or disable color by individual users or groups and applications. For more information, visit the [HP Universal Print Driver](#) website.

The HP Embedded Web Server also allows you to disable color faxing, color copying, and color print from memory devices. For more information, see [HP Embedded Web Server](#).

Print from the control panel

Print using job storage

You can create and store jobs on the product, which you or others can print later. To save printer memory or to protect sensitive information, you can delete the stored jobs from the product.

- [To enable job storage](#)
- [To apply job storage to one or all print jobs](#)
- [To print a job stored on the printer](#)
- [To delete a job stored on the printer](#)

To enable job storage

Job storage is enabled, by default. You can disable or re-enable it, as needed.

Disable or enable job storage (Windows)

1. Click **Start**, and do one of the following, depending on your operating system.
 - **Windows 10:** Click **Settings**, click **Devices**, and then click **Printers and Scanners**.
 - **Windows 8, 8.1:** Click **Control Panel**, click **Hardware and Sound**, and then click **Devices and Printers**.
 - **Windows 7:** Click **Devices and Printers**.
2. Right-click your printer, and then click **Properties** or **Printer properties**.
3. In the Printer Properties window, click the **Device Settings** tab.
4. From the **Job Storage** drop-down list, select **Disable** to turn the feature off or select **Automatic** to turn it on.
5. Click **Apply**, and then click **OK**.

Disable or enable job storage (OS X)

1. Open HP Utility. For more information, see [Open HP Utility](#).
2. Make sure your printer is selected.
3. Click **Devices**.
4. Select **Allow Stored Jobs on this printer**, and set the storage job settings.

To apply job storage to one or all print jobs

You can apply the job storage feature to a single job or to all print jobs. When you do this, the single job or all jobs are stored in the printer memory so that you can print them later from the printer control panel.

Apply job storage to one or all print jobs (Windows)

1. Do one of the following.
 - For one print job: On the **File** menu in the software program, click **Print**.
 - For all print jobs: Click **Start**, and do one of the following, depending on your operating system.
 - **Windows 10**: Click **Settings**, click **Devices**, and then click **Printers and Scanners**.
 - **Windows 8, 8.1**: Click **Control Panel**, click **Hardware and Sound**, and then click **Devices and Printers**.
 - **Windows 7**: Click **Devices and Printers**.
2. Make sure your printer is selected.
3. Continue to the **Job Storage** tab.
 - For one print job: Click the link or button that opens the **Properties** dialog box. Then, click the **Job Storage** tab.
 - For all print jobs: Right-click your printer, click **Printing preferences**, and then click the **Job Storage** tab.
4. On the **Job Storage** tab, select one of the following options:
 - **Proof and Hold**: Prints the first copy of a multiple-copy job so you can verify the print quality and prints the remaining copies when you request them at the printer control panel
 - **Personal Job**: Does not print the job until you request it at the printer control panel
 - **Quick Copy**: Prints the requested number of copies of the job and stores a copy of it so you can print it again later
 - **Stored Job**: Prints the job on the printer and lets other users print it at any time
 - **Make Job Private/Secure**: Applies to Personal or Stored Jobs. You can require a personal identification number (PIN) or password to print the stored job from the control panel.
 - **None**: No PIN or password is required.
 - **PIN to print**: A four-digit PIN is required.
 - **Encrypt Job (with password)** (for Windows 7 or later): A password, consisting of 4-32 characters, is required.
5. To use a custom user name or job name, click **Custom** and then type the user name or the job name.

If you type a job name that is already in use, select one of the following:

 - **Use Job Name + (1-99)**: Append a unique number to the end of the job name
 - **Replace Existing File**: Overwrite the existing stored job with the new one
6. Click **OK**, and then click **Print** to store the job on the printer.

Apply job storage to one or all print jobs (OS X)

1. Do one of the following.
 - For one print job: On the **File** menu in the software program, click **Print**. Then, in the pop-up menu below **Presets**, select **Job Storage**.
 - For all print jobs: From the **Copies & Pages** pop-up menu, select **Job Storage**.
2. Make sure your printer is selected.
3. From the **Mode** pop-up menu, select one of the following options:
 - **Quick Copy**: Prints the requested number of copies of the job and stores a copy of it so you can print it again later
 - **Proof and Hold**: Prints the first copy of a multiple-copy job so you can verify the print quality and prints the remaining copies when you request them at the printer control panel
 - **Stored Job**: Prints the job on the printer and lets other users print it at any time
 - **Personal Job**: Does not print the job until you request it at the printer control panel
4. To use a custom user name or job name, click **Custom** and then type the user name or the job name.
 - If you type a job name that is already in use, select one of the following:
 - **Use Job Name + (1-99)**: Append a unique number to the end of the job name
 - **Replace Existing File**: Overwrite the existing stored job with the new one
5. For Personal or Stored Jobs, select **Use PIN to Print** if you want to require a four-digit personal identification number (PIN) to print the stored job from the control panel.
6. Click **Print** to store the job on the printer.

To print a job stored on the printer

1. On the control panel, touch the **Print** application folder.
2. In the display, touch the **Job Storage** icon.
3. Navigate to the stored job you want, and open it.



NOTE: If the job is private or encrypted, enter the PIN or password.

4. Select the number of copies, and touch **Print**.

To delete a job stored on the printer

1. On the control panel, touch the **Print** application folder.
2. In the display, touch the **Job Storage** icon.
3. Open the folder containing your stored job, and do one of the following.
 - To delete one job, touch the job you want to delete.
 - To delete all the jobs in the folder, touch the trash icon, and then touch **Delete**.



NOTE: If some jobs are protected with a PIN or password, touch [All jobs without a PIN or password](#) or [All jobs with the same PIN or password](#) and follow the onscreen instructions.



NOTE: If the job is private or encrypted, enter the PIN or password.

4. If needed, touch the trash icon, and then touch [Delete](#).

Print from a USB device

This product features printing directly from a USB storage device (Plug and Print), so you can quickly print files without sending them from a computer. The product accepts standard USB storage accessories in the USB port near the control panel.

You can print the following types of files.

-
- | | |
|---------|---------|
| • .JPEG | • .PNG |
| • .JPG | • .TIFF |
| • .PDF | |
-

1. Insert the USB device into the USB port on the front of the product. The [Memory Device Options](#) menu opens.
2. In the display, touch the [Print Documents](#) icon.
3. Navigate to the job you want on the USB device, and open it.
4. Select the number of copies, and touch [Start Black](#) or [Start Color](#) to start printing.

Print with NFC

With Near Field Communications (NFC), you can walk up to the product and print from your smart phone or tablet. To print using NFC, in the control panel touch  and follow the onscreen instructions.

Print with HP ePrint

With HP ePrint, you can print anywhere, anytime, from a mobile phone, laptop, or any other mobile device. HP ePrint works with any email-capable device. If you can email, you can print to an HP ePrint-enabled product. For more details, visit the [HP Connected](#) website.

To use HP ePrint, ensure the following:

- You have an Internet- and email-capable computer or mobile device.
- HP Embedded Web Server and HP ePrint are enabled on the printer. For more information, see [HP Embedded Web Server](#).

Print off site by sending an email with the HP ePrint app

If you are on the road, you can print a document by sending an email with the HP ePrint app to your HP ePrint-enabled printer. See [Web Services](#) for more information.



NOTE: Obtain your HP ePrint email address while in the office. For instructions, see [HP ePrint](#).

1. On your computer or mobile device, open your email application.
2. Create a new email message, and then attach the file that you want to print.
3. Enter the HP ePrint email address in the "To" field, and then select the option to send the email message.



NOTE: Do not enter any additional email addresses in either the "To" or "Cc" fields. The HP ePrint server does not accept print jobs if there are multiple email addresses.

Print from an on-site computer or mobile device

If you are at home or in the office, you can print from a smartphone or tablet to your printer easily.



NOTE: If you want to print without accessing the network, see [Use Wi-Fi Direct to connect a computer or device to the product](#) for more information.

1. Make sure your mobile device and printer are on the same network.
2. Select the photo or document you want to print and choose your printer.
3. Confirm print settings and print.

Print with AirPrint (OS X)

Printing using Apple's AirPrint is supported for iPad (iOS 4.2), iPhone (3GS or later), iPod touch (third generation or later), and Mac (OS X v10.9 or later).

To use AirPrint, ensure the following:

- The printer and the Apple device are connected to the same network as your AirPrint-enabled device. For more information, visit the [HP Mobile Printing](#) website. If a local version of this website is not available in your country/region, you might be directed to the HP Mobile Printing site in another country/region or language.
- Load paper that matches the paper settings of the printer.

To re-enable AirPrint

AirPrint is enabled, by default. If it becomes disabled, you can use the following instructions to enable it again.

1. Open the EWS. For more information, see [Open the EWS](#).
2. On the **Network** tab, click **AirPrint** and then click **Status**.
3. In the **AirPrint Status** row, click **Turn On AirPrint**.

Tips for print success

Software settings selected in the print driver apply only to printing. They do not apply to copying or scanning.

- [Cartridge tips](#)
- [Paper loading tips](#)
- [Printer settings tips \(Windows\)](#)
- [Printer settings tips \(OS X\)](#)

Cartridge tips

- If the print quality is unacceptable, see [Improve print quality](#) for more information.
- Use Original HP cartridges.

Original HP cartridges are designed and tested with HP printers and papers to help you easily produce great results, time after time.



NOTE: HP cannot guarantee the quality or reliability of non-HP cartridges. Product service or repairs required as a result of using a non-HP cartridge will not be covered under warranty.

If you believe you purchased Original HP cartridges, visit the [HP anticounterfeit](#) website.

- Install the black and color cartridges correctly.

For more information, see [Replace cartridges](#).

- Check the estimated cartridge levels to make sure there is sufficient ink.

Supply level warnings and indicators provide estimates for planning purposes only.

For more information, see [Check the estimated cartridge levels](#).



NOTE: When you receive a low-cartridge warning message, consider having a replacement cartridge available to avoid possible printing delays. You do not need to replace the cartridges until prompted to.

- To protect the product from damage, always turn off the printer by using the power button on the front.

Paper loading tips

For more information, see [Supported media sizes](#).

- Ensure the paper is loaded in the input tray properly, and set the correct media size and media type. Upon loading paper in input tray, you will be prompted to set the media size and media type.
- Load a stack of paper (not just one page). All the paper in the stack should be of the same size and type to avoid a paper jam.
- Ensure that paper loaded in the input tray lays flat and the edges are not bent or torn.
- Adjust the paper-width guides in the input tray to fit snugly against all paper. Make sure the guides do not bend the paper in the tray.

Printer settings tips (Windows)

- To change default print settings, do one of the following:
 - In the HP Printer Assistant, click **Print, Scan & Fax**, and then click **Set Preferences**.
 - On the **File** menu in the software program, click **Print**. Open the Printer Properties dialog box.
- On the **Color** or **Finishing** tab of the printer driver, set the following options as needed:
 - **Print in Grayscale:** Allows you to print a black-and-white document using only the black cartridge. Click **Black Ink Only**, and then click **OK**.
 - **Pages per sheet:** Helps you specify the order of the pages if you print document in more than two pages per sheet.
 - **Booklet Layout:** Allows you to print a multiple-page document as a booklet. It places two pages on each side of a sheet that can then be folded into a booklet in half size of the paper. Select a binding method from the drop-down list, and then click **OK**.
 - **Left binding:** The binding side after folded into a booklet appears at the left side. Select the option if your reading habit is from left to right.
 - **Right binding:** The binding side after folded into a booklet appears at the right side. Select the option if your reading habit is from right to left.
 - **Print page borders:** Allows you to add the borders to the pages if you print the document with two or more pages per sheet.
- You can use printing shortcuts to save time setting printing preferences.

Printer settings tips (OS X)

- In the software program, be sure to select the correct paper size loaded in the printer.
 - a. From the **File** menu, select **Page Setup**.
 - b. In **Format For**, make sure your printer is selected.
 - c. From the pop-up menu, select **Paper Size**.
- In the software program, be sure to select the correct paper type and quality loaded in the printer.
 - a. On the **File** menu in the software program, click **Print**.
 - b. From the **Copies & Pages** pop-up menu, select **Paper/Quality**, and select the correct paper type and quality.
- To print a black-and-white document using only the black cartridge, do the following.
 - a. On the **File** menu in the software program, click **Print**.
 - b. In the Print window, from the pop-up menu, select **Copies & Pages**, and then select **Color**.
 - c. Deselect **HP EasyColor**, and then select **Print Color as Gray**.
 - d. Select **Black Ink Only**.

7 Copy and scan

- [Copy](#)
- [Scan](#)
- [Tips for copy and scan success](#)

Copy

- [Copy settings](#)
- [Load and copy identification cards](#)
- [Copy photos](#)
- [Load and copy mixed-size originals](#)
- [Copy on both sides automatically](#)
- [Cancel a copy job](#)

Copy settings

Adjust lightness or darkness for copies

1. Load your original print-side down on the scanner glass or print-side up in the automatic document feeder.
For more information, see [Load the scanner](#) or [Load the automatic document feeder](#).
2. On the control panel, touch the **Copy** application folder.
3. In the display, touch the **Document** icon.
4. Touch  to view the **Copy Settings** menu.
5. Touch **Lighter/Darker**.
6. Use the slider to lighten or darken the printed copies.

Select a paper tray and paper size for copies

1. Load the paper onto which you want to copy into a tray.
For more information, see [Supported media sizes](#).
2. On the control panel, touch the **Copy** application folder.
3. In the display, touch the **Document** icon.
4. Touch  to view the **Copy Settings** menu.
5. Touch **Tray Selection**.
6. Select the tray into which you loaded the paper in step 1.

Reduce or enlarge a copy

1. Load your original print-side down on the scanner glass or print-side up in the automatic document feeder.
For more information, see [Load the scanner](#) or [Load the automatic document feeder](#).
2. On the control panel, touch the **Copy** application folder.

3. In the display, touch the [Document](#) icon.
4. Touch  to view the [Copy Settings](#) menu.
5. Touch [Resize](#), and select one of the resize menu options.

Load and copy identification cards

Use this feature to copy both sides of identification cards, or other small-sized documents, onto the same side of one sheet of paper. The product prompts you to copy the first side, and then to rotate the second side on the scanner glass and copy again. The product prints both images on a single page.

1. Load the ID card onto the scanner glass. Orient the card using the media mark at the back-left of the scanner glass.

For more information, see [Load the scanner](#).



2. Close the scanner lid.
3. On the control panel, touch the [Copy](#) application folder.
4. In the display, touch the [ID Card](#) icon.
5. Touch  to view the [Copy Settings](#) menu.
6. Select the tray, copy quality, and lightness/darkness settings.

7. Follow the prompts on the control panel to copy the first side of the ID card, rotate and orient the card on the scanner glass, and then complete copying and printing the ID card.





Copy photos

 **NOTE:** Copy photos from the scanner glass, not from the document feeder.

1. Place the photo on the scanner glass, picture-side down at the upper-left corner of the glass, and close the scanner lid.

For more information, see [Load the scanner](#).



2. On the control panel, touch the [Copy](#) application folder.
3. In the display, touch the [Document](#) icon.
4. Touch  to view the [Copy Settings](#) menu.
5. Touch [Enhancements](#), and then touch [Mixed](#).
6. Touch  to return to the home page, and then touch the [Copy Document](#) icon.
7. Touch [Start Black](#) or [Start Color](#) to start copying.

Load and copy mixed-size originals

Use the scanner glass to make copies of mixed-size originals.



NOTE: You can use the document feeder to copy mixed-size originals only if the pages share a common dimension. For example, you can combine Letter and Legal size pages because they have the same width. Stack the pages so the top edges are even with each other, and so that the pages have the same width but varying lengths.

1. Load paper that is large enough for the largest page in the original document into a tray.
2. Place one page of the original document face down on the scanner glass. Use the media mark at the back-left of the glass to orient the document.

For more information, see [Load the scanner](#).
3. On the control panel, touch the **Copy** application folder.
4. In the display, touch the **Document** icon.
5. Specify the number of copies, and select the tray containing the paper for this job.
6. Follow the prompts on the control panel to copy the document loaded on the glass. Repeat steps 2–6 for each original page.

Copy on both sides automatically

1. Load originals in the document feeder.

For more information, see [Load the automatic document feeder](#).
2. On the control panel, touch the **Copy** application folder.
3. In the display, touch the **Document** icon.
4. Touch  to view the **Copy Settings** menu.
5. Touch **2-sided**, and select a two-sided copying option.



Cancel a copy job

- If a copying job is in progress, touch  on the printer control panel at any time to cancel the job.
- If the originals for the job are loaded in the document feeder, wait until the product stops feeding originals, and then remove the originals from the ADF loading area and the ADF output tray.

Scan

- [Scan to a USB drive](#)
- [Scan to a computer](#)
- [Scan to email](#)
- [Scan to a network folder](#)
- [Scan to SharePoint](#)
- [Scan using HP scanning software](#)
- [Scan using other software](#)
- [Scan using Webscan](#)
- [Scan documents as editable text](#)

Scan to a USB drive

1. Load your original print-side down on the scanner glass or print-side up in the automatic document feeder.
For more information, see [Load the scanner](#) or [Load the automatic document feeder](#).
2. Insert a USB device into the USB port on the front of the product.
3. On the control panel, touch the **Scan** application folder. Then, touch the **USB** icon.
4. Touch  to select color, size, and resolution options from the **Settings** menu.
5. Touch  to return to the **Scan to USB** menu, and select a file type from the **Save As** list.
6. Touch **Filename**, and use the keypad to assign a name to the scanned file. Touch **Done**.
7. Touch **Start Scan**.

Scan to a computer

Before scanning to a computer, make sure you have already installed the HP recommended printer software. The printer and computer must be connected and turned on.

In addition, on Windows computers, the printer software must be running before you scan.



NOTE: You can use the HP printer software to scan documents into editable text. For more information, see [Scan documents as editable text](#).

To set up scan to computer

The scan to a computer feature is enabled by default from the factory. Follow these instructions if the feature has been disabled, and you want to enable it again.

Set up scanning to a computer (Windows)

1. Open the HP Printer Assistant. For more information, see [Open the HP Printer Assistant](#).
2. Go to the **Scan** section.
3. Select **Manage Scan to Computer**.
4. Click **Enable**.

Set up scanning to a computer (OS X)

1. Open HP Utility. For more information, see [Open HP Utility](#).
2. Select **Scan to Computer**.
3. Select **Enable Scan to Computer**.

To scan to a computer from the control panel

1. Load your original print-side down on the scanner glass or print-side up in the automatic document feeder.

For more information, see [Load the scanner](#) or [Load the automatic document feeder](#).
2. On the control panel, touch the **Scan** application folder.
3. In the display, touch the **Computer** icon and select the computer.
4. Touch **Scan Shortcut**, select a scan option, and then touch **Start Scan**.

Scan to email

The Scan-to-Email App is an application that allows you to quickly scan and email photos or documents to the specified recipients directly from your HP printer. You can set up your email addresses, log in to your accounts with the given PIN codes, and then scan and email your documents.

To set up scan to email

- [Set up scan to email in the EWS](#)
- [Set up scan to email in the HP Printer Assistant](#)
- [Set up scan to email \(OS X\)](#)

Set up scan to email in the EWS

1. Open the EWS. For more information, see [Open the EWS](#).
2. On the **Scan** tab, click **Scan to Email**, and then click **Scan to Email Setup**.
3. Do one of the following:
 - If your organization uses one email server for all its emails: In the **Outgoing Email Settings** section, set up your email addresses and the SMTP server information.
 - If your organization uses multiple email servers for its emails: In the **Outgoing Email Profiles** section, set up the email addresses, names, and security PINs for each email profile.
4. Under **Scan to Email**, click **Email Address Book**, and set up contacts in the address book.

5. Under **Scan to Email**, click **Email Options**, and configure the scan and file settings for email sent from the printer.
6. Click **Apply**.

Set up scan to email in the HP Printer Assistant

1. Open the HP Printer Assistant. For more information, see [Open the HP Printer Assistant](#).
2. On the **Scan** tab, click **Scan to E-mail Wizard** and follow the onscreen instructions.

Set up scan to email (OS X)

1. Open HP Utility. For more information, see [Open HP Utility](#).
2. Click **Scan to Email**.

The EWS opens. Follow the instructions in [Set up scan to email in the EWS](#).

To scan a document or photo to email

1. Load your original print-side down on the scanner glass or print-side up in the automatic document feeder.

For more information, see [Load the scanner](#) or [Load the automatic document feeder](#).

2. On the control panel, touch the **Scan** application folder.
3. In the display, touch the **Email** icon, and select the email account you want.



NOTE: If you do not have an account, set up the scan-to-email feature.

4. If prompted, enter the PIN.
5. Verify or change the information in the **To**, **Subject**, and **File Name** fields. To change the email recipients, touch .
6. Touch **Touch to Preview**, and then touch **Start Scan**.

To change account settings

- [Change account settings in the EWS](#)
- [Change account settings \(OS X\)](#)

Change account settings in the EWS

1. Open the EWS. For more information, see [Open the EWS](#).
2. On the **Scan** tab, click **Scan to Email**, and then click **Scan to Email Setup**.
3. In the setup page, do one of the following:
 - If your organization uses one email server for all its emails: In the **Outgoing Email Settings** section, change the email addresses and the SMTP server information, as needed.
 - If your organization uses multiple email servers for its emails: In the **Outgoing Email Profiles** section, change the email addresses, names, and security PINs for each email profile, as needed.

4. To verify the changes to the profile, click **Save and Test** and follow the onscreen instructions.
5. When done, click **Apply**.

Change account settings (OS X)

1. Open HP Utility. For more information, see [Open HP Utility](#).
2. Click **Scan to Email**.

The EWS opens. Follow the instructions in [Change account settings in the EWS](#).

Scan to a network folder

- [To set up scan to a network folder](#)
- [To scan to a network folder](#)

To set up scan to a network folder

Set up scan to a network folder in the EWS

1. Open the EWS. For more information, see [Open the EWS](#).
2. On the **Scan** tab, click **Scan to Network Folder**, and then click **Network Folder Setup**.
3. In the setup page, click , and follow the onscreen instructions for adding network folder profiles. When finished, click **Next**.
4. In the authentication page, follow the onscreen instructions to set up credentials for logging into the network folder. When finished, click **Next**.
5. In the settings page, follow the onscreen instructions for configuring scan settings, such as paper size and scan resolution. When finished, click **Save**.

Set up scan to a network folder in the HP Printer Assistant

1. Open the HP Printer Assistant. For more information, see [Open the HP Printer Assistant](#).
2. On the **Scan** tab, click **Scan to Network Folder Wizard** and follow the onscreen instructions.

To scan to a network folder

1. Load your original print-side down on the scanner glass or print-side up in the automatic document feeder.

For more information, see [Load the scanner](#) or [Load the automatic document feeder](#).

2. On the control panel, touch the **Scan** application folder.
3. Touch the **Network Folder** icon, and then navigate to the network folder.
4. If prompted, enter the PIN.
5. Verify or change the information in the **Save As** and **File Name** fields.
6. Touch **Touch to Preview**, and then touch **Start Scan**.

Scan to SharePoint

- [To set up scan to SharePoint](#)
- [To scan to SharePoint](#)

To set up scan to SharePoint

1. Open the EWS. For more information, see [Open the EWS](#).
2. On the **Scan** tab, click **Scan to SharePoint**, and then click **SharePoint Setup**.
3. In the setup page, click , and follow the onscreen instructions for adding SharePoint profiles. When finished, click **Next**.

To scan to SharePoint

1. Load your original print-side down on the scanner glass or print-side up in the automatic document feeder.

For more information, see [Load the scanner](#) or [Load the automatic document feeder](#).
2. On the control panel, touch the **Scan** application folder.
3. Touch the **SharePoint** icon, and then navigate to the SharePoint folder.
4. If prompted, enter the PIN.
5. Verify or change the information in the **Save As** and **File Name** fields.
6. Touch **Touch to Preview**, and then touch **Start Scan**.

Scan using HP scanning software

Follow the instructions for your operating system.



NOTE: Use the HP software to scan documents into editable text, a format that allows you to search, copy, paste, and edit within the scanned document. Use this format to edit letters, newspaper clippings, and many other documents. For more information, see [Scan documents as editable text](#).

To scan using HP scanning software (Windows)

1. Load your original print-side down on the scanner glass or print-side up in the automatic document feeder.

For more information, see [Load the scanner](#) or [Load the automatic document feeder](#).
2. On the computer, open the HP scanning software:
 - a. From the computer desktop, click **Start**.
 - b. Select **Programs** or **All Programs**.
 - c. Select the folder for your HP printer.
 - d. Select **HP Scan**.

3. Select a scan shortcut. Make changes to the scan settings, if needed.
4. To start the scan, click **Scan**.

**NOTE:**

- Click the **More** link in the top-right corner of the Scan dialog box to review and modify settings for any scan.
- If **Show Viewer After Scan** is selected, you can make adjustments to the scanned image in the preview screen.

To scan using HP scanning software (OS X)

1. Load your original print-side down on the scanner glass or print-side up in the automatic document feeder.
For more information, see [Load the scanner](#) or [Load the automatic document feeder](#).
2. Open HP Easy Scan. This is located in the **HP** folder of the **Applications** folder.
3. Follow the onscreen instructions to complete the scan.

Scan using other software

The product is TWAIN-compliant and Windows Imaging Application (WIA)-compliant. The product works with Windows-based programs that support TWAIN-compliant or WIA-compliant scanning devices and with Macintosh-based programs that support TWAIN-compliant scanning devices.

While you are in a TWAIN-compliant or WIA-compliant program, you can gain access to the scanning feature and scan an image directly into the open program. For more information, see the help file or the documentation that came with your TWAIN-compliant or WIA-compliant software program.

To scan from a TWAIN-compliant program

Generally, a software program is TWAIN-compliant if it has a command such as **Acquire**, **File Acquire**, **Scan**, **Import New Object**, **Insert from**, or **Scanner**. If you are unsure whether the program is compliant or you do not know what the command is called, see the software program help or documentation.

- ▲ Start the scan from within the TWAIN-compliant program. See the software program help or documentation for information about the commands and steps to use.



NOTE: When scanning from a TWAIN-compliant program, the HP Scan software program might start automatically. If the HP Scan program starts, you can make changes while previewing the image. If the program does not start automatically, the image goes to the TWAIN-compliant program immediately.

To scan from a WIA-compliant program

WIA is another way to scan an image directly into a software program. WIA uses Microsoft software to scan, instead of the HP Scan software.

Generally, a software program is WIA-compliant if it has a command such as **Picture/From Scanner or Camera** in the Insert or File menu. If you are unsure whether the program is WIA-compliant, see the software program help or documentation.

- ▲ To scan, do one of the following.

- Start the scan from within the WIA-compliant program. See the software program help or documentation for information about the commands and steps to use.
- **Windows Vista or XP:** In the control panel, open the **Hardware and Sound** folder, open the **Cameras and Scanner** folder, and double-click the product icon. This opens the standard Microsoft WIA Wizard, which enables you to scan to a file.
- **Windows 7, 8, 8.1, or 10:** In the control panel, open the **Devices and Printers** folder, and double-click the product icon. This opens the standard Microsoft WIA Wizard, which enables you to scan to a file.

Scan using Webscan

Webscan is a feature of the HP Embedded Web Server (EWS) that lets you scan photos and documents from your printer to your computer using a web browser.

This feature is available even if you did not install the printer software on your computer.



NOTE:

- By default, Webscan is off. You can enable this feature from the EWS.
- If you are unable to open Webscan in the EWS, your network administrator might have turned it off. For more information, contact your network administrator or the person who set up your network.

To enable Webscan

1. Open the EWS. For more information, see [Open the EWS](#).
2. Click the **Settings** tab.
3. In the **Security** section, click **Administrator Settings**.
4. Select **Webscan from EWS**, and click **Apply**.

To scan using Webscan

Scanning using Webscan offers basic scan options. For additional scan options or functionality, scan from the HP printer software.

1. Load the original onto the scanner glass. For more information, see [Load the scanner](#).
2. Open the EWS. For more information, see [Open the EWS](#).
3. Click the **Scan** tab.
4. Click **Webscan**, change any settings, and then click **Start Scan**.

Scan documents as editable text

When scanning documents, you can use the HP software to scan documents into a format that you can search, copy, paste, and edit. This allows you to edit letters, newspaper clippings, and many other documents.

Guidelines for scanning documents as editable text

- **Make sure the scanner glass or document feeder window is clean.**

Smudges or dust on the scanner glass or document feeder window can prevent the software from converting the document to editable text.

- **Make sure the document is loaded correctly.**

Make sure the original is properly loaded and that the document is not skewed.

- **Make sure the text on the document is clear.**

To successfully convert the document to editable text, the original must be clear and of high quality.

The following conditions can cause the software to not convert the document successfully:

- The text on the original is faint or wrinkled.
- The text is too small.
- The structure of the document is too complex.
- The text is tightly spaced. For example, if the text that the software converts has missing or combined characters, "rn" might appear as "m."
- The text is on a colored background. Colored backgrounds can cause images in the foreground to blend too much.

- **Choose the correct profile.**

Be sure to select a shortcut or preset that allows scanning as editable text. These options use scan settings designed to maximize the quality of your scan:

- **Windows:** Use the **Editable Text (OCR)** or **Save as PDF** shortcuts.
- **OS X:** Use the **Documents** preset.

- **Save your file in the correct format.**

- If you want to extract just the text from the document, without any of the formatting of the original, select a plain text format, such as **Text (.txt)** or **TXT**.
- If you want to extract the text, as well as some of the formatting of the original, select **RTF** or **PDF Searchable**.

To scan a document to editable text (Windows)

1. Load your original print-side down on the scanner glass or print-side up in the automatic document feeder.
For more information, see [Load the scanner](#) or [Load the automatic document feeder](#).
2. Open the printer software. For more information, see [Open the printer software \(Windows\)](#).
3. Select **Save as Editable Text (OCR)**, and click **Scan**.



NOTE:

- Click the **More** link in the top-right corner of the Scan dialog box to review and modify settings for any scan.
 - If **Show Viewer After Scan** is selected, you can make adjustments to the scanned image in the preview screen.
-

To scan documents as editable text (OS X)

1. Load your original print-side down on the scanner glass or print-side up in the automatic document feeder.

For more information, see [Load the scanner](#) or [Load the automatic document feeder](#).

2. Double-click the **HP Scan** icon. This icon is located in the **HP** folder in the **Applications** folder at the top level of the hard disk.
3. Click the **Scan** button and confirm your scanning device and settings.
4. Follow the onscreen instructions to complete the scan.
5. When all of the pages have been scanned, select **Save** from the **File** menu. The Save dialog box appears.
6. Select the type of editable text.

I want to...	Follow these steps
Extract just the text, without any of the formatting of the original.	Select TXT from the Format pop-up menu.
Extract the text, as well as some of the formatting of the original.	Select RTF from the Format pop-up menu.
Extract the text and make it searchable in PDF readers.	Select PDF Searchable from the Format pop-up menu.

7. Click **Save**.

Tips for copy and scan success

Use the following tips to copy and scan successfully.

- Keep the glass and the back of the lid clean. The scanner interprets anything it detects on the glass as part of the image.
- Load your original, print-side down, in the back-left corner of the glass.
- To make a large copy of a small original, scan the original into the computer, resize the image in the scanning software, and then print a copy of the enlarged image.
- If you want to adjust scan size, output type, scan resolution, or file type, and so on, start scan from the printer software.
- To avoid incorrect or missing scanned text, make sure the brightness is set appropriately in the software.
- If you want to scan a document with several pages into one file instead of multiple files, start the scan with the printer software instead of selecting [Scan](#) from the printer display.

8 Fax

- [Set up fax](#)
- [Set fax settings](#)
- [Send a fax](#)
- [Receive a fax](#)
- [Use the phone book](#)
- [Use reports](#)

Set up fax

- [Connect fax to a telephone line](#)
- [Configure fax settings](#)
- [Set up HP Digital Fax](#)
- [Fax programs, systems, and software](#)

Connect fax to a telephone line

- ▲ Connect the telephone cable to the fax port (1) on the product and to the telephone jack on the wall.

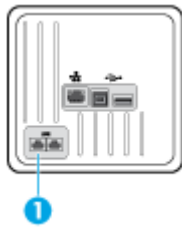

The product is an analog device. HP recommends using the product on a dedicated analog telephone line. If you are using a digital environment, such as DSL, PBX, ISDN, or VoIP, make sure to use the correct filters and configure the digital settings correctly. For more information, contact your digital service provider.

 **NOTE:** Some countries/regions might require an adapter to the phone cord that came with the product.



Configure fax settings

To configure fax settings from the control panel

You can configure the product fax settings from the control panel or from the HP Embedded Web Server.

In the United States and many other countries/regions, setting the time, date, and other fax header information is a legal requirement.

 **NOTE:** When using the control panel to enter text, or to enter a name for a one-touch key, speed-dial entry, or group-dial entry, touch the **123** button to open a keypad that contains special characters.

1. Open the control panel dashboard (swipe the dashboard tab at the top of any screen downward, or touch the dashboard area on the home screen).
2. On the control panel dashboard, touch .
3. Touch **Preferences**.
4. To set the time and date, touch **Date and Time**, and do the following:
 - Select the 12-hour clock or 24-hour clock. Then, use the keypad to enter the current time, and touch **Done**.
 - Select the date format. Then, use the keypad to enter the current date, and touch **Done**.
5. Touch  until you return to the **Setup** menu.

6. To set the default paper size, do the following:
 - Touch [Tray and Paper Management](#), and then touch [Paper Settings](#).
 - Touch the tray you want to use, and then touch [Paper Size](#) and select the size you want as the default.
7. Touch  until you return to the [Setup](#) menu.
8. Touch [Fax Setup](#), and then touch [Preferences](#).
9. Touch [Auto Answer](#), and turn it on.
10. Touch [Fax Header](#), and do the following:
 - a. Use the keypad to enter your company name or other identifying information (maximum of 25 characters), and touch [Done](#).
 - b. Use the keypad to enter your name and fax number (maximum of 20 characters) when prompted, and touch [Done](#).

To configure fax settings using the HP Digital Fax Setup Wizard (Windows)

If you did not complete the fax setup process at the time you installed the software, you can complete it at any time by using the HP Digital Fax Setup Wizard.

1. Open the HP Printer Assistant. For more information, see [Open the HP Printer Assistant](#).
2. Click the **Fax** tab, and then click **Digital Fax Setup Wizard**.
3. Follow the onscreen instructions to configure the fax settings.

Set up HP Digital Fax

You can use HP Digital Fax to automatically receive faxes and save them directly to your computer. This saves paper and cartridges.

Received faxes are saved as TIFF (Tagged Image File Format) or PDF (Portable Document Format).

The files are named in the following method: XXXX_YYYYYYYY_ZZZZZZ.tif, where X is the sender's information, Y is the date, and Z is the time that the fax was received.



NOTE: Fax to Computer is available for receiving black-and-white faxes only. Color faxes will be printed.

HP Digital Fax requirements

- The destination folder of the computer must be available at all times. Faxes will not be saved if the computer is asleep or in hibernate mode.
- Paper must be loaded in the input tray. For more information, see [Supported media sizes](#).

To set up HP Digital Fax

Set up HP Digital Fax (Windows)

1. Open the printer software. For more information, see [Open the printer software \(Windows\)](#).
2. Click **Print, Scan & Fax** and click **Digital Fax Setup Wizard**.
3. Follow the onscreen instructions.

Set up HP Digital Fax (OS X)

1. Open HP Utility. For more information, see [Open HP Utility](#).
2. Select the printer.
3. Click **Digital Fax Archive** in the Fax Settings section.

Set up HP Digital Fax in the EWS

1. Open the EWS. For more information, see [Open the EWS](#).
2. Click the **Fax** tab.
3. Click **HP Digital Fax**, and then click **Digital Fax Profile**.
4. In the **Digital Fax to Network Folder** or **Digital Fax to Email** section, click **Set Up** and follow the onscreen instructions.

To modify HP Digital Fax settings

Modify HP Digital Fax settings (Windows)

1. Open the printer software. For more information, see [Open the printer software \(Windows\)](#).
2. Click **Print, Scan & Fax** and click **Digital Fax Setup Wizard**.
3. Follow the onscreen instructions.

Modify HP Digital Fax settings (OS X)

1. Open HP Utility. For more information, see [Open HP Utility](#).
2. Select the printer.
3. Click **Digital Fax Archive** in the Fax Settings section.

Modify HP Digital Fax settings in the EWS

1. Open the EWS. For more information, see [Open the EWS](#).
2. Click the **Fax** tab.
3. If the **Redirecting to Secure Page** dialog box appears, follow the onscreen instructions and click **OK**.
4. Click **HP Digital Fax**, and then click **Digital Fax Profile**.
5. In the **Digital Fax to Network Folder** or **Digital Fax to Email** section, click **Set Up** and follow the onscreen instructions.

To turn off HP Digital Fax

1. Open the control panel dashboard (swipe the dashboard tab at the top of any screen downward, or touch the dashboard area on the home screen).
2. On the control panel dashboard, touch .
3. Touch [Fax Setup](#), and then touch [Preferences](#).
4. Touch [HP Digital Fax](#).
5. Touch [Turn Off HP Digital Fax](#), and then touch [Yes](#).

Fax programs, systems, and software

Supported fax programs

The PC fax program that came with the product is the only PC fax program that works with the product. To continue to use a PC fax program previously installed on the computer, use the modem that is already connected to the computer; it will not function through the product modem.

Supported phone services - analog

The HP PageWide Pro product is an analog device that is not compatible with all digital phone environments (unless a digital-to-analog converter is used). HP does not guarantee that the product will be compatible with digital environments or digital-to-analog converters.

Alternate phone services - digital

Although HP products are not designed to work on DSL, PBX, ISDN lines, or VoIP services, they will work with the proper setup and equipment.



NOTE: HP recommends discussing DSL, PBX, ISDN, and VoIP setup options with the service provider.

DSL

A digital subscriber line (DSL) uses digital technology over standard copper telephone wires. This product is not directly compatible with those digital signals. However, if the configuration is specified during DSL setup, the signal can be separated so that some of the bandwidth is used to transmit an analog signal (for voice and fax) while the remaining bandwidth is used to transmit digital data.



NOTE: Not all faxes are compatible with DSL services. HP does not guarantee that the product will be compatible with all DSL service lines or providers.

A typical DSL modem employs a filter to separate the higher frequency DSL modem communication from lower frequency analog phone and fax modem communication. It is often necessary to use a filter with analog phones and analog fax products that are connected to a telephone line used by a DSL modem. The DSL service provider usually provides this filter. Contact the DSL provider for more information or for assistance.

PBX

The product is an analog device that is not compatible in all digital phone environments. Digital-to-analog filters or converters may be needed for faxing functionality. If faxing issues occur in a PBX environment, it might be necessary to contact the PBX provider for assistance. HP does not guarantee that the product will be compatible with digital environments or digital-to-analog converters.

Contact the PBX provider for more information and for assistance.

ISDN

The product is an analog device that is not compatible in all digital phone environments. Digital-to-analog filters or converters may be needed for faxing functionality. If faxing issues occur in an ISDN environment, it might be necessary to contact the ISDN provider for assistance. HP does not guarantee that the product will be compatible with ISDN digital environments or digital-to-analog converters.

VoIP

Voice over internet protocol (VoIP) services are often not compatible with fax machines unless the provider explicitly states that it supports fax over IP services.

If the product experiences problems getting a fax to work on a VoIP network, verify that all cables and settings are correct. Decreasing the fax-speed setting might allow the product to send a fax over a VoIP network.

If the VoIP provider offers a "Pass through" mode for the connection, that will offer better fax performance on VoIP. Also if the provider has "comfort noise" added to the line, fax performance can be enhanced if this feature is not enabled.

If faxing problems continue, contact the VoIP provider.



Set fax settings

Send-fax settings

- [Set pauses or flash hooks](#)
- [Set a dialing prefix](#)
- [Set tone-dialing or pulse-dialing](#)
- [Set autore dial and the time between redials](#)
- [Set the light/dark setting](#)
- [Set the default resolution](#)
- [Use cover-page templates](#)

Set pauses or flash hooks

You can insert pauses into a fax number that you are dialing. Pauses are often needed when dialing internationally or connecting to an outside line. To access these symbols, touch the * character on the keypad.

Special symbol	Button	Description
Pause for dial tone		The W button is available on the control panel keypad for entering a fax number. This character causes the product to wait for a dial tone before dialing the remainder of the telephone number.
Hook flash		The R button is available on the control panel keypad for entering a fax number. This character causes the product to insert a hook flash.

Set a dialing prefix

A dial prefix is a number or group of numbers that are automatically added to the beginning of every fax number you enter at the control panel or from the software. The maximum number of characters for a dial prefix is 50.

The default setting is **Off**. You might want to turn this setting on and enter a prefix if, for example, you have to dial a number such as 9 to get a telephone line outside of your company telephone system. While this setting is active, you can dial a fax number without the dial prefix by using manual dial.

1. Open the control panel dashboard (swipe the dashboard tab at the top of any screen downward, or touch the dashboard area on the home screen).
2. On the control panel dashboard, touch .
3. Touch **Fax Setup**, and then touch **Preferences**.
4. Touch **Dialing Prefix**, and turn it on.
5. Use the keypad to enter the prefix, and then touch the **Done** button. You can use numbers, pauses, and dialing symbols.

Set tone-dialing or pulse-dialing

Use this procedure to set the product to tone-dialing or pulse-dialing mode. The factory-set default is Tone. Do not change this setting unless you know that the telephone line cannot use tone dialing.

 **NOTE:** The pulse-dialing option is not available in all countries/regions.

1. Open the control panel dashboard (swipe the dashboard tab at the top of any screen downward, or touch the dashboard area on the home screen).
2. On the control panel dashboard, touch .
3. Touch **Fax Setup**, and then touch **Preferences**.
4. Touch **Dial Type**, and then touch **Tone** or **Pulse**.

Set autoredial and the time between redials

If the product was unable to send a fax because the receiving fax machine did not answer or was busy, the product attempts to redial based on the redial-on-busy, redial-on-no-answer, and redial-on-communication-error options.

To set the redial-on-busy option

If this option is on, the product redials automatically if it receives a busy signal. The factory-set default for the redial-on-busy option is **On**.

1. Open the control panel dashboard (swipe the dashboard tab at the top of any screen downward, or touch the dashboard area on the home screen).
2. On the control panel dashboard, touch .
3. Touch **Fax Setup**, and then touch **Preferences**.
4. Touch **Auto Redial**, and then touch **Busy Redial** and turn it on.

To set the redial-on-no-answer option

If this option is on, the product redials automatically if the receiving machine does not answer. The factory-set default for the redial-on-no-answer option is Off.

1. Open the control panel dashboard (swipe the dashboard tab at the top of any screen downward, or touch the dashboard area on the home screen).
2. On the control panel dashboard, touch .
3. Touch **Fax Setup**, and then touch **Preferences**.
4. Touch **Auto Redial**, and then touch **No Answer Redial** and turn it on.

To set the redial-on-connection-problem option

If this option is on, the product redials automatically if some sort of connection problem occurs. The factory-set default for the redial-on-connection-problem option is On.

 **NOTE:** The redial-on-connection-problem functionality is available only with Scan and Fax, Send Fax Later, or Broadcast Fax methods.

1. Open the control panel dashboard (swipe the dashboard tab at the top of any screen downward, or touch the dashboard area on the home screen).
2. On the control panel dashboard, touch .
3. Touch **Fax Setup**, and then touch **Preferences**.
4. Touch **Auto Redial**, and then touch **Connection Problem Redial** and turn it on.

Set the light/dark setting

This setting affects the lightness and darkness of an outgoing fax as it is being sent.

The default light/dark setting is normally applied to items that are being faxed. The slider is set to the middle as the default setting.

1. On the control panel, touch the **Fax** application folder.
2. In the display, touch the **Send Now** icon, and follow the onscreen instructions.
3. On the keypad, touch .
4. Touch **Lighter/Darker**, and then drag the slider to increase or decrease the brightness.

Set the default resolution

 **NOTE:** Increasing the resolution increases the fax size. Larger faxes increase the send time and could exceed the available memory in the product.

Use this procedure to change the default resolution for all fax jobs to one of the following settings:

- **Standard:** This setting provides the lowest quality and the fastest transmission.
- **Fine:** This setting provides a higher resolution quality than **Standard**, which is usually appropriate for text documents.

- **Very Fine:** This setting is best used for documents that mix text and images. The transmission time is slower than the **Fine** setting.
- **Photo:** This setting is best for documents that contain images.

The factory-set default resolution setting is **Fine**.

To set the default resolution

1. On the control panel, touch the **Fax** application folder.
2. In the display, touch the **Send Now** icon, and follow the onscreen instructions.
3. On the keypad, touch .
4. Touch **Resolution**, and then touch one of the options.

Use cover-page templates

Several business and personal fax cover-page templates are available in the HP Digital Fax software program.

 **NOTE:** You cannot alter cover-sheet templates, but you can edit the fields within the templates.

Receive-fax settings

- [Set fax forwarding](#)
- [Block or unblock fax numbers](#)
- [Set the number of rings-to-answer](#)
- [Set distinctive ring](#)
- [Use autoreduction for incoming faxes](#)
- [Set the fax sounds volume](#)
- [Set stamp-received faxes](#)

Set fax forwarding

You can set your product to forward incoming faxes to another fax number. When the fax arrives at your product, it is stored in the memory. The product then dials the fax number that you have specified and sends the fax. If the product cannot forward a fax because of an error (for example, the number is busy) and repeated redial attempts are unsuccessful, your product prints the fax.

If the product runs out of memory while receiving a fax, it terminates the incoming fax and only forwards the pages and partial pages that have been stored in the memory.

When using the fax-forwarding feature, the product (rather than the computer) must be receiving the faxes, and the answer mode must be set to **Automatic**.

1. Open the control panel dashboard (swipe the dashboard tab at the top of any screen downward, or touch the dashboard area on the home screen).
2. On the control panel dashboard, touch .
3. Touch **Fax Setup**, and then touch **Preferences**.

4. Touch [Fax Forwarding](#), and then touch either [On \(Print and Forward\)](#) or [On \(Forward\)](#).
5. Use the keypad to enter the fax-forwarding number, and then touch [Done](#).

Block or unblock fax numbers





NOTE: Faxing blocking is only supported where the caller ID feature is supported.

If you do not want to receive faxes from specific people or businesses, you can block as many as 30 fax numbers by using the control panel. When you block a fax number and someone from that number sends you a fax, the control panel display indicates that the number is blocked, the fax does not print, and the fax is not saved in memory. Faxes from blocked fax numbers appear in the fax activity log with a “discarded” designation. You can unblock blocked fax numbers individually or all at one time.



NOTE: The sender of a blocked fax is not notified that the fax failed.

1. Open the control panel dashboard (swipe the dashboard tab at the top of any screen downward, or touch the dashboard area on the home screen).
2. On the control panel dashboard, touch .
3. Touch [Fax Setup](#), and then touch [Preferences](#).
4. Touch [Junk Fax Blocking](#), and then touch .
5. Use the keypad to enter the fax number that you want to block, and touch [Add](#).

Set the number of rings-to-answer

When the answer mode is set to [Automatic](#), the product rings-to-answer setting determines the number of times the telephone rings before the product answers an incoming call.

If the product is connected to a telephone line that receives both fax and voice calls (a shared line) and that also uses an answering machine, you might need to adjust the rings-to-answer setting. The number of rings-to-answer for the product must be greater than the rings-to-answer on the answering machine. This allows the answering machine to answer the incoming call and record a message if it is a voice call. When the answering machine answers the call, the product listens to the call and automatically answers it if it detects fax tones.

The default setting for rings-to-answer is five for all countries/regions.

Use the following table to determine the number of rings-to-answer to use.

Type of telephone line	Recommended rings-to-answer setting
Dedicated fax line (receiving only fax calls)	Set to a number of rings within the range shown in the control panel display. (The minimum and maximum number of rings allowed varies by country/region.)
One line with two separate numbers and a ring-pattern service	One or two rings. (If you have an answering machine or computer voicemail for the other telephone number, make sure that the product is set to a greater number of rings than the answering system. Also, use the distinctive-ring feature to differentiate between voice and fax calls.)

Type of telephone line	Recommended rings-to-answer setting
Shared line (receiving both fax and voice calls) with only an attached telephone	Five rings or more.
Shared line (receiving both fax and voice calls) with an attached answering machine or computer voicemail	Two rings more than the answering machine or computer voicemail.

To set the number of rings-to-answer

1. Open the control panel dashboard (swipe the dashboard tab at the top of any screen downward, or touch the dashboard area on the home screen).
2. On the control panel dashboard, touch .
3. Touch **Fax Setup**, and then touch **Preferences**.
4. Touch **Rings to Answer**.
5. Select the number of rings, and then touch **Done**.

Set distinctive ring

Ring-pattern or distinctive-ring service is available through some local telephone companies. The service allows you to have more than one telephone number on a single line. Each telephone number has a unique ring pattern, so that you can answer voice calls and the product can answer fax calls.

If you subscribe to a ring-pattern service with a telephone company, you must set the product to answer the correct ring pattern. Not all countries/regions support unique ring patterns. Contact the telephone company to determine if this service is available in your country/region.



NOTE: If you do not have ring-pattern service and you change the ring-pattern settings to something other than the default (All Standard Rings), the product might not be able to receive faxes.

The settings are as follows:

- **Ring Pattern Detection:** Turn off or on the product's ring pattern detection capability.
- **All Standard Rings:** The product answers any calls that come through the telephone line.
- **Single:** The product answers any calls that produce a single-ring pattern.
- **Double:** The product answers any calls that produce a double-ring pattern.
- **Triple:** The product answers any calls that produce a triple-ring pattern.
- **Double and Triple:** The product answers any calls that produce a double-ring or triple-ring pattern.

To set distinctive ring

1. Open the control panel dashboard (swipe the dashboard tab at the top of any screen downward, or touch the dashboard area on the home screen).
2. On the control panel dashboard, touch .
3. Touch **Fax Setup**, and then touch **Preferences**.
4. Touch **Distinctive Ring**, touch **Yes**, and then touch the name of the option.

Use autoreduction for incoming faxes

The factory-set default for incoming fax autoreduction is **On**.

If you have the Stamping option turned on, you might also want to turn on Autoreduction. This reduces the size of the incoming faxes slightly, and prevents the page-stamp from forcing a fax onto two pages.



NOTE: Make sure that the default paper size setting matches the size of the paper in the tray.

1. Open the control panel dashboard (swipe the dashboard tab at the top of any screen downward, or touch the dashboard area on the home screen).
2. On the control panel dashboard, touch .
3. Touch **Fax Setup**, and then touch **Preferences**.
4. Touch **Automatic Reduction**, and turn it on.

Set the fax sounds volume

Control the volume of the fax sounds from the control panel.

Set stamp-received faxes

The product prints the sender identification information at the top of each received fax. You can also stamp the incoming fax with your own header information to confirm the date and time that the fax was received. The factory-set default for stamp-received faxes is **Off**.



NOTE: This option applies only to received faxes that the product prints.

Turning on the stamp-received setting might increase the page size and cause the product to print a second page.

1. Open the control panel dashboard (swipe the dashboard tab at the top of any screen downward, or touch the dashboard area on the home screen).
2. On the control panel dashboard, touch .
3. Touch **Fax Setup**, and then touch **Preferences**.
4. Touch **Stamping**, and turn it on or off.

Send a fax



- [Send a fax from the control panel](#)
- [Use speed dials and group-dial entries](#)
- [Send a standard fax from the computer](#)
- [Send a fax from the software](#)
- [Send a fax using monitor dialing](#)
- [Send a fax using printer memory](#)

Send a fax from the control panel

1. Load your original print-side down on the scanner glass or print-side up in the automatic document feeder.
For more information, see [Load the scanner](#) or [Load the automatic document feeder](#).
2. On the control panel, touch the **Fax** application folder.
3. Do one of the following:
 - To send the fax now, touch the **Send Now** icon, and follow the onscreen instructions.
 - To send the fax later, touch the **Send Later** icon, follow the onscreen instructions, and set the fax time.
4. Use the keypad to enter the fax number.
5. Touch **Black** or **Color**.

Use speed dials and group-dial entries

For more information about speed dial, see [Use the phone book](#).

1. Load your original print-side down on the scanner glass or print-side up in the automatic document feeder.
For more information, see [Load the scanner](#) or [Load the automatic document feeder](#).
2. On the control panel, touch the **Fax** application folder.
3. Do one of the following:
 - To send the fax now, touch the **Send Now** icon, and follow the onscreen instructions.
 - To send the fax later, touch the **Send Later** icon, follow the onscreen instructions, and set the fax time.
4. On the keypad, touch , and do one of the following:
 - For an individual speed-dial entry, touch .
 - For a group speed-dial entry, touch .
5. Touch the name of the individual or group entry that you want to use, and touch **Select**.
6. Touch **Black** or **Color**.

Send a standard fax from the computer

You can send a document on your computer as a fax, without printing a copy and faxing it from the printer.



NOTE: Faxes sent from your computer by this method use the printer's fax connection, not your Internet connection or computer modem. Therefore, make sure the printer is connected to a working telephone line and that the fax function is set up and functioning correctly.

To use this feature, you must install the printer software using the installation program from 123.hp.com/pagewide (recommended) or from the HP software CD provided with the printer.

To send a standard fax from the computer (Windows)

1. Open the document on your computer that you want to fax.
2. On the **File** menu in the software program, click **Print**.
3. From the **Name** list, select the printer that has “**fax**” in the name.
4. To change settings (such as Orientation, Page Order, Pages Per Sheet), click the button or link that opens the **Properties** dialog box.

Depending on your software application, this link or button might be called **Properties**, **Options**, **Printer Setup**, **Printer Properties**, **Printer**, or **Set Preferences**.

5. After you have changed any settings, click **OK**.
6. Click **Print** or **OK**.
7. Enter the fax number and other information for the recipient, change any further settings for the fax (such as selecting to send the document as a black or color fax), and then click **Send Fax**. The printer begins dialing the fax number and faxing the document.

To send a standard fax from the computer (OS X)

1. Open the document on your computer that you want to fax.
2. On the **File** menu in the software program, click **Print**.
3. Select the printer that has “**(Fax)**” in the name.
4. Select **Fax Information** from the pop-up menu.



NOTE: If the pop-up menu does not appear, click the disclosure triangle next to **Printer selection**.

5. Enter the fax number and other information in the boxes provided.



TIP: To send a color fax, select **Fax Options** from the pop-up menu, and then click **Color**.

6. Select any other fax options you want, and then click **Fax** to begin dialing the fax number and faxing the document.

Send a fax from the software

The following information provides basic instructions for sending faxes by using the software that came with the product. All other software-related topics are covered in the software help, which can be opened from the software-program **Help** menu.

You can fax electronic documents from a computer if the following requirements are met:

- The product is connected directly to the computer or to a network to which the computer is connected.
- The product software is installed on the computer.
- The computer operating system is one that this product supports.

To send a fax from the software

1. Open the HP Printer Assistant. For more information, see [Open the HP Printer Assistant](#).
2. On the **Print, Scan & Fax** tab, click the **Fax** tab.
3. Click the **Send a Fax** icon to open the fax software.
4. Load your original print-side down on the scanner glass or print-side up in the automatic document feeder.

For more information, see [Load the scanner](#) or [Load the automatic document feeder](#).

5. Enter a recipient or add one from the address book.
6. Click the **Add Cover Page** button and then click the **Add Scan** button to scan the document on the scanner glass and add it to the fax job.
7. Click the **Send Fax** button to send the fax.

Send a fax using monitor dialing

When you send a fax using monitor dialing, you can hear the dial tones, telephone prompts, or other sounds through the speakers on the printer. This enables you to respond to prompts while dialing, as well as control the pace of your dialing.



NOTE: Make sure the volume is turned on to hear a dial tone.



TIP: If you are using a calling card and do not enter your PIN fast enough, the printer might start sending fax tones too soon and cause your PIN not to be recognized by the calling card service. If this is the case, create a phone book contact to store the PIN for your calling card.

1. Load your original print-side down on the scanner glass or print-side up in the automatic document feeder.

For more information, see [Load the scanner](#) or [Load the automatic document feeder](#).

2. On the control panel, touch the **Fax** application folder.
3. In the display, touch the **Send Now** icon, and follow the onscreen instructions.
4. Touch **Black** or **Color**.
5. When you hear the dial tone, enter the number by using the keypad on the printer control panel.
6. Follow any prompts that might occur.



TIP: If you are using a calling card to send a fax and you have your calling card PIN stored as a phone book contact, when prompted to enter your PIN, touch  to select the phone book contact where you have your PIN stored.

Your fax is sent when the receiving fax machine answers.

Send a fax using printer memory

You can scan a black-and-white fax into memory and then send the fax from memory. This feature is useful if the fax number you are trying to reach is busy or temporarily unavailable. The printer scans the originals into memory and sends them once it is able to connect to the receiving fax machine. After the printer scans the

pages into memory, you can immediately remove the originals from the document feeder tray or scanner glass.



NOTE: You can only send a black-and-white fax from memory.

To turn on the Scan and Fax method

1. Open the control panel dashboard (swipe the dashboard tab at the top of any screen downward, or touch the dashboard area on the home screen).
2. On the control panel dashboard, touch .
3. Touch [Fax Setup](#), and then touch [Preferences](#).
4. Touch [Scan and Fax Method](#), and turn it on.

To send a fax using printer memory

1. Make sure that the Scan and Fax method is turned on.
2. Load your original print-side down on the scanner glass or print-side up in the automatic document feeder.

For more information, see [Load the scanner](#) or [Load the automatic document feeder](#).

3. On the control panel, touch the [Fax](#) application folder.
4. In the display, touch the [Send Now](#) icon, and follow the onscreen instructions.
5. Use the keypad to enter the fax number or select it from the phone book.
6. Touch [Black](#) or [Color](#).

The printer scans the originals into memory and sends the fax when the receiving fax machine is available.

Receive a fax

- [Receive a fax manually](#)
- [Fax memory](#)

Receive a fax manually

When you are on the phone, the person you are speaking with can send you a fax while you are still connected. You can pick up the handset to talk or listen for fax tones.

You can receive faxes manually from a phone that is directly connected to the fax port on the back of the product.

1. Make sure the printer is turned on and you have paper loaded in the main tray.
2. Remove any originals from the document feeder tray.
3. Do one of the following:

- Set the [Rings to Answer](#) setting to a high number to allow you to answer the incoming call before the printer answers.
 - Turn off the [Auto Answer](#) setting so that the printer does not automatically answer incoming calls.
4. If you are currently on the phone with the sender, instruct the sender to press **Start** on their fax machine.
 5. When you hear fax tones from a sending fax machine, on the control panel, touch the [Fax](#) application folder.
 6. Touch [Send and Receive](#), and then touch [Receive Now](#).
 7. After the printer begins to receive the fax, you can hang up the phone or remain on the line. The phone line is silent during fax transmission.

Fax memory

NAND memory protects the product against data loss when a power failure occurs. NAND can maintain data for years without power applied.

The product stores about 10MB of memory. This is approximately 500 black-and-white A4 pages at standard resolution, based on standard ITU-T Test Image No. 1. More complicated pages or higher resolution takes longer and uses more memory.

Reprint a fax

1. On the control panel, touch the [Fax](#) application folder.
2. Touch [Reprint](#).
3. Touch the entry for the fax that you want to reprint.

Delete faxes from memory

Use this procedure if you are concerned that someone else has access to your product and might try to reprint faxes from the memory.



NOTICE: In addition to clearing the reprint memory, this procedure clears any fax that is currently being sent, unsent faxes that are pending redial, faxes that are scheduled to be sent at a future time, and faxes that are not printed or forwarded.

1. Open the control panel dashboard (swipe the dashboard tab at the top of any screen downward, or touch the dashboard area on the home screen).
2. On the control panel dashboard, touch .
3. Touch [Fax Setup](#), and then touch [Tools](#).
4. Touch [Clear Fax Logs/Memory](#).



Use the phone book

You can store frequently dialed fax numbers (up to 75 entries) either as individual fax numbers or as other phone book fax number entries.



Create and edit individual speed-dial entries

1. On the control panel, touch the **Fax** application folder.
2. In the display, touch the **Send Now** icon, and follow the onscreen instructions.
3. On the keypad, touch , and then touch .
4. Touch , enter the name of the contact, and touch **Done**.
5. Enter fax number of the contact, and touch **Done**.
6. Touch **Add**.

Create and edit group-dial entries

1. Create an individual entry for each fax number that you want in the group. (For more information, see [Create and edit individual speed-dial entries](#).)
2. On the control panel, touch the **Fax** application folder.
3. In the display, touch the **Send Now** icon, and follow the onscreen instructions.
4. On the keypad, touch , and then touch .
5. Touch , enter the name of the group, and touch **Done**.
6. Touch **Number of Members**, select each individual entry you want to add to the group, and touch **Select**.
7. Touch **Create**.

Delete speed-dial entries

1. On the control panel, touch the **Fax** application folder.
2. In the display, touch the **Send Now** icon, and follow the onscreen instructions.
3. On the keypad, touch , and then touch .
4. Touch , and touch the entry that you want to delete.
5. Touch **Delete**, and then touch **Yes**.

Use reports

You can set up the printer to print error reports and confirmation reports automatically for each fax you send and receive. You can also manually print system reports as required; these reports provide useful system information about the printer.

By default, the printer is set to print a report only if there is a problem sending or receiving a fax. A confirmation message that indicates whether a fax was successfully sent appears briefly on the control panel display after each transaction.



NOTE:

- If the reports are not legible, you can check the estimated cartridge levels from the control panel or the HP software. For more information, see [Check the estimated cartridge levels](#).
- Cartridge-level alerts and indicators provide estimates for planning purposes only. When you receive a low-cartridge alert, consider having a replacement cartridge available to avoid possible printing delays. You do not need to replace the cartridges until you are prompted to.
- Ensure that the printheads and cartridges are in good condition and installed properly.

This section contains the following topics:

- [Print fax confirmation reports](#)
- [Print fax error reports](#)
- [Print and view the fax log](#)
- [Clear the fax log](#)
- [Print the details of the last fax transaction](#)
- [Print a Caller ID Report](#)
- [View the Call History](#)

Print fax confirmation reports

You can print a confirmation report either when a fax is sent, or when any fax is sent or received. The default setting is **On (Fax Send)**. When turned off, a confirmation message appears briefly on the control panel after each fax is sent or received.

To enable fax confirmation

1. On the control panel, touch the **Fax** application folder.
2. In the display, touch the **Fax Setup** icon.
3. Touch **Reports**, and then touch **Fax Confirmation**.
4. Touch to select one of the following options.

Setting	Description
Off	Does not print a fax confirmation report when you send and receive faxes successfully. This is the default setting.
On (Fax Send)	Prints a fax confirmation report for every fax you send.
On (Fax Receive)	Prints a fax confirmation report for every fax you receive.
On (Fax Send and Fax Receive)	Prints a fax confirmation report for every fax you send and receive.

To include an image of the fax on the report

1. On the control panel, touch the **Fax** application folder.
2. In the display, touch the **Fax Setup** icon.

3. Touch [Reports](#) , and then touch [Fax Confirmation](#).
4. Touch [On \(Fax Send\)](#) to include images of only sent faxes on the report, or touch [On \(Fax Send and Fax Receive\)](#) to include images of both sent and received faxes.
5. Touch [Fax confirmation with image](#).

Print fax error reports

You can configure the printer so that it automatically prints a report when there is an error during transmission or reception.

1. On the control panel, touch the [Fax](#) application folder.
2. In the display, touch the [Fax Setup](#) icon.
3. Touch [Reports](#) , and then touch [Fax Error Reports](#).
4. Touch to select one of the following.

Setting	Description
On (Fax Send)	Prints whenever a transmission error occurs. This is the default setting.
On (Fax Receive)	Prints whenever a receiving error occurs.
On (Fax Send and Fax Receive)	Prints whenever a fax error occurs.
Off	Does not print any fax error reports.

Print and view the fax log

You can print a log of faxes that have been received and sent by the printer.

1. Open the control panel dashboard (swipe the dashboard tab at the top of any screen downward, or touch the dashboard area on the home screen).
2. On the control panel dashboard, touch .
3. Touch [Fax Logs](#), and do one of the following:
 - For sent faxes, touch [Logs for Sent Faxes](#).
 - For received faxes, touch [Logs for Received Faxes](#).
4. Touch [Print Log](#) to begin printing.

Clear the fax log

Clearing the fax log also deletes all faxes stored in memory.

1. On the control panel, touch the [Fax](#) application folder.
2. In the display, touch the [Fax Setup](#) icon.
3. Touch [Tools](#), and then touch [Logs/Memory](#).

Print the details of the last fax transaction

The Last Transaction Log prints the details of the last fax transaction to occur. Details include the fax number, number of pages, and the fax status.

1. On the control panel, touch the **Fax** application folder.
2. In the display, touch the **Fax Setup** icon.
3. Touch **Reports** , and then touch **Print Fax Reports**.
4. Touch **Last Transaction Log**.
5. Touch **Print** to begin printing.

Print a Caller ID Report

You can print a list of Caller ID fax numbers.



1. On the control panel, touch the **Fax** application folder.
2. In the display, touch the **Fax Setup** icon.
3. Touch **Reports** , and then touch **Print Fax Reports**.
4. Touch **Caller ID Report**, and then touch **Print**.

View the Call History

You can view a list of all the calls placed from the printer.



NOTE: You cannot print the call history.

1. On the control panel, touch the **Fax** application folder.
2. In the display, touch the **Fax Setup** icon.
3. On the keypad, touch  , and then touch .

9 Solve problems

- [Problem-solving checklist](#)
- [Information pages](#)
- [Factory-set defaults](#)
- [Cleaning routines](#)
- [Jams and paper-feed issues](#)
- [Cartridge issues](#)
- [Printing issues](#)
- [Scan issues](#)
- [Fax issues](#)
- [Connectivity issues](#)
- [Wireless network issues](#)
- [Product software issues \(Windows\)](#)
- [Product software issues \(OS X\)](#)

Problem-solving checklist

Follow these steps when trying to solve a problem with the product.

- [Check that the product power is on](#)
- [Check the control panel for error messages](#)
- [Test print functionality](#)
- [Test copy functionality](#)
- [Test the fax-sending functionality](#)
- [Test the fax-receiving functionality](#)
- [Try sending a print job from a computer](#)
- [Test the plug-and-print USB functionality](#)
- [Factors that affect product performance](#)

Check that the product power is on

1. If the power button is not lit, press it to turn the product on.
2. If the power button does not seem to work, ensure that the power cable is connected to both the product and the electrical or AC outlet.
3. If the product is still not powering up, check the power source by connecting the power cable to a different electrical or AC outlet.

Check the control panel for error messages

The control panel should indicate ready status. If an error message appears, resolve the error.

Test print functionality

1. Open the control panel dashboard (swipe the dashboard tab at the top of any screen downward, or touch the dashboard area on the home screen).
2. On the control panel dashboard, touch .
3. Touch [Reports](#), and then touch [Printer Status Report](#) to print a test page.
4. If the report does not print, make sure paper is loaded in the tray, and check the control panel to see if paper is jammed inside the product.



NOTE: Make sure the paper in the tray meets specifications for this product.

Test copy functionality

1. Place the Printer Status page into the document feeder and make a copy. If paper does not feed smoothly through the document feeder, you might need to clean the document feeder rollers and separation pad. Make sure the paper meets specifications for this product.
2. Place the Printer Status page onto the scanner glass and make a copy.
3. If the print quality on the copied pages is not acceptable, clean the scanner glass and the small glass strip.

Test the fax-sending functionality

1. On the control panel, touch the **Fax** application folder.
2. In the display, touch the **Fax Setup** icon.
3. Touch **Tools**, and then touch **Run Fax Test**.

Test the fax-receiving functionality

1. On the control panel, touch the **Fax** application folder.
2. In the display, touch the **Fax Setup** icon.
3. Touch **Tools**, and then touch **Run Fax Test**.
4. Use another fax machine to send a fax to the product.
5. Review and reset the product fax settings.

Try sending a print job from a computer

1. Use a word-processing program to send a print job to the product.
2. If the job does not print, make sure you selected the correct printer driver.
3. Uninstall and then reinstall the product software.

Test the plug-and-print USB functionality

1. Load a .PDF document or .JPEG photo onto a USB flash drive, and insert it in the slot on the front of the product.
2. The **Memory Device Options** menu opens. Try printing the document or photo.
3. If no documents are listed, try a different type of USB flash drive.

Factors that affect product performance

Several factors affect the time it takes to print a job:

- The software program that you are using and its settings
- The use of special paper (such as heavy paper and custom-size paper)
- Product processing and download time

- The complexity and size of graphics
- The speed of the computer you are using
- The USB or network connection
- Whether the product is printing in color or in monochrome
- The type of USB drive, if you are using one

Information pages

Information pages reside within the product memory. These pages help diagnose and solve problems with the product.



NOTE: If the product language was not correctly set during installation, you can set the language manually so the information pages print in one of the supported languages. Change the language by using the [Preferences](#) menu on the [Setup](#) menu in the control panel or by using the HP Embedded Web Server.

1. Open the control panel dashboard (swipe the dashboard tab at the top of any screen downward, or touch the dashboard area on the home screen).
2. On the control panel dashboard, touch .
3. Touch [Reports](#) to view the menu.
4. Touch the name of the report that you want to print.

Menu Item	Description
Printer Status Report	<p>Prints the cartridge status. Includes the following information:</p> <ul style="list-style-type: none"> • Estimated proportion of cartridge life remaining <p>NOTE: Cartridge-level alerts and indicators provide estimates for planning purposes only. When you receive a low-cartridge alert, consider having a replacement cartridge available to avoid possible printing delays. You do not need to replace the cartridges until you are prompted to.</p> <ul style="list-style-type: none"> • Approximate number of pages remaining • Part numbers for HP cartridges • Number of pages printed • Information about ordering new HP cartridges and recycling used HP cartridges
Print Quality Report	Prints a page that helps solve problems with print quality
Web Access Test Report	Shows the current configuration settings and diagnostic results for the local network, gateway, DNS, proxy, and test server. This report is useful for resolving problems accessing the web.
Usage Page	Shows a count of all paper sizes that have passed through the product; lists whether they were monochrome or color, simplex or duplex, and reports the page count. This report is useful for reconciling contractual billing statements.

Menu Item	Description
Network Configuration Page	Displays status for: <ul style="list-style-type: none"> • Network hardware configuration • Enabled features • TCP/IP and SNMP information • Network statistics • Wireless network configuration (wireless models only)
Event Log	Prints a log of errors and other events during product use.
Fax Reports	<ul style="list-style-type: none"> • Fax Confirmation: Sets whether the product prints a confirmation report after a successful fax job. • Fax Error Report: Sets whether the product prints a report after a failed fax job. • Last Transaction: Prints a detailed report of the last fax operation, either sent or received. • Fax Logs: The fax service log prints out the last 40 entries in the fax log. • Speed Dial List • Caller ID Report: Prints a list of all incoming fax phone numbers • Junk Fax Report: Prints a list of phone numbers that are blocked from sending faxes to this product.
PCL Font List	Prints a list of all installed PCL fonts
PCL6 Font List	Prints a list of all installed PCL6 fonts
PS Font List	Prints a list of all installed PS fonts

Factory-set defaults

NOTICE: Restoring the factory-set defaults returns all of the product and network settings to the factory defaults, and it also clears the fax header name, phone number, and any stored faxes in the product memory. This procedure also clears the fax phone book, and deletes any pages that are stored in the memory. The procedure then automatically restarts the product.

1. Open the control panel dashboard (swipe the dashboard tab at the top of any screen downward, or touch the dashboard area on the home screen).
2. On the control panel dashboard, touch .
3. Touch [Printer Maintenance](#), and then touch [Restore](#).
4. Touch [Restore Factory Defaults](#), and then touch [Continue](#).

The product automatically restarts.

Cleaning routines

- [Clean the printhead](#)
- [Clean the scanner glass strip and platen](#)

- [Clean the document feeder pick rollers and separation pad](#)
- [Clean the touch screen](#)

Clean the printhead

During the printing process, paper, ink, and dust particles can accumulate inside the product. Over time, this buildup can cause print-quality problems such as specks or smearing.

This product automatically services itself, running cleaning routines that can correct most of these problems.

For problems that the product cannot automatically solve, use the following routine to clean the printhead.



NOTE: This routine uses ink to clean the printhead. Use the routine only to correct print quality errors. Do not use it for periodic maintenance.



TIP: Turning the product off properly by pressing the power button on the front of the product helps keep the printhead from clogging and creating print-quality problems.

1. Open the control panel dashboard (swipe the dashboard tab at the top of any screen downward, or touch the dashboard area on the home screen).
2. On the control panel dashboard, touch .
3. Touch [Printer Maintenance](#) to view the list of cleaning and alignment routines.
4. Touch [Clean Printhead Level 1](#), and then follow the prompts on the control panel. If necessary, load paper in the requested tray.

A page feeds through the product slowly. Discard the page when the process is completed.

5. If the printhead is still not clean, touch [Clean Printhead Level 2](#), and follow the prompts on the control panel. If that does not work, continue with the next cleaning routine. Continue down the list of cleaning routines, if needed.

A page feeds through the product slowly. Discard the page when the process is completed.

Clean the scanner glass strip and platen

Over time, specks of debris collect on the scanner glass and white plastic backing, which can affect performance. Use the following procedure to clean the scanner glass and white plastic backing.

1. Turn off the product, and then disconnect the power cord from the product.
2. Open the scanner lid.
3. Clean the scanner glass and the white plastic backing with a soft cloth or sponge that has been moistened with nonabrasive glass cleaner.

NOTICE: Do not use abrasives, acetone, benzene, ammonia, ethyl alcohol, or carbon tetrachloride on any part of the product; these can damage the product. Do not place liquids directly on the glass or platen. They might seep and damage the product.

4. Dry the glass and white plastic backing with a chamois or a cellulose sponge to prevent spotting.
5. Reconnect the power cord to the product, and then power the product on.

Clean the document feeder pick rollers and separation pad

If the product document feeder experiences paper-handling problems, such as jams or multiple-page feeds, clean the document feeder rollers and separation pad.

1. Open the document feeder cover.

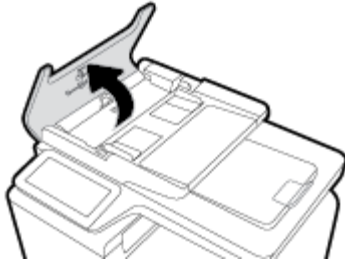

2. Use a moist, lint-free cloth to wipe both pick rollers and the separation pad to remove dirt.

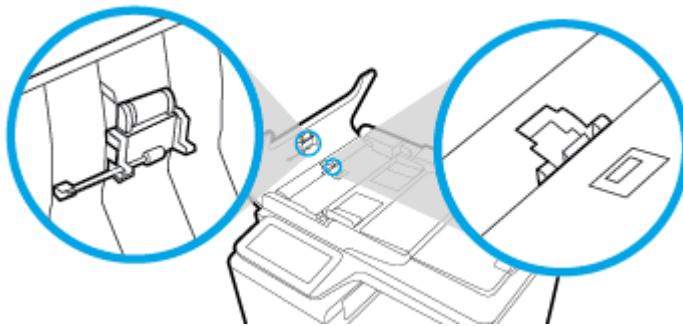

3. Close the document feeder cover.

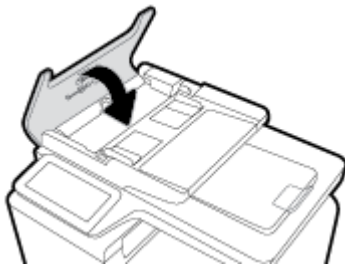

Clean the touch screen

Clean the touch screen whenever it is necessary to remove fingerprints or dust. Wipe the touch screen gently with a clean, water-dampened, lint-free cloth.

NOTICE: Use water only. Solvents or cleaners can damage the touch screen. Do not pour or spray water directly onto the touch screen.

Jams and paper-feed issues

Try these steps to solve paper-handling problems.

The product does not pick up paper

If the product does not pick up paper from the tray, try these solutions.

1. Open the product and remove any jammed sheets of paper.
2. Load the tray with the correct size of paper for your job.
3. Make sure the paper guides in the tray are adjusted correctly for the size of paper. Align the guides with the paper-size markings in the bottom of the tray.
4. Remove the stack of paper from the tray and flex it, rotate it 180 degrees, and flip it over. *Do not fan the paper.* Return the stack of paper to the tray.
5. Check the control panel to see if the product is waiting for you to acknowledge a prompt to feed the paper manually through Tray 1, the multipurpose tray on the left side of the product. Load paper, and continue.

The product picks up multiple sheets of paper

If the product picks up multiple sheets of paper from the tray, try these solutions.

1. Remove the stack of paper from the tray and flex it, rotate it 180 degrees, and flip it over. *Do not fan the paper.* Return the stack of paper to the tray.
2. Use only paper that meets HP specifications for this product.
3. Use paper that is not wrinkled, folded, or damaged. If necessary, use paper from a different package. Make sure all paper in the tray is the same type and size.
4. Make sure the tray is not overfilled. If it is, remove the entire stack of paper from the tray, straighten the stack, and then return less paper to the tray.

Even if the tray is not overfilled, try using a lower stack of media, such as half.

5. Make sure the paper guides in the tray are adjusted correctly for the size of paper. Align the guides with the paper-size markings in the bottom of the tray.
6. Print from another tray.

Prevent paper jams

To reduce the number of paper jams, try these solutions.

1. Use only paper that meets HP specifications for this product. Lightweight, short-grain paper is not recommended.
2. Use paper that is not wrinkled, folded, or damaged. If necessary, use paper from a different package.
3. Use paper that has not previously been printed or copied on.
4. Make sure the tray is not overfilled. If it is, remove the entire stack of paper from the tray, straighten the stack, and then return some of the paper to the tray.

5. Make sure the paper guides in the tray are adjusted correctly for the size of paper. Adjust the guides so they are touching the paper stack without bending it.
6. Make sure that the tray is fully inserted in the product.
7. If you are printing on heavy, embossed, or perforated paper, use Tray 1, the multipurpose tray on the left side of the printer, and then feed sheets manually one at a time.

Clear jams

- [Jam locations](#)
- [Clear jams from the document feeder](#)
- [Clear jams in Tray 1 \(multipurpose tray\)](#)
- [Clear jams in Tray 2](#)
- [Clear jams in optional Tray 3](#)
- [Clear jams in the left door](#)
- [Clear jams in the output bin](#)
- [Clear jams in the duplexer](#)



NOTE: For best results, do not turn off the product before clearing paper jams.

Jam locations

Jams can occur in these locations:

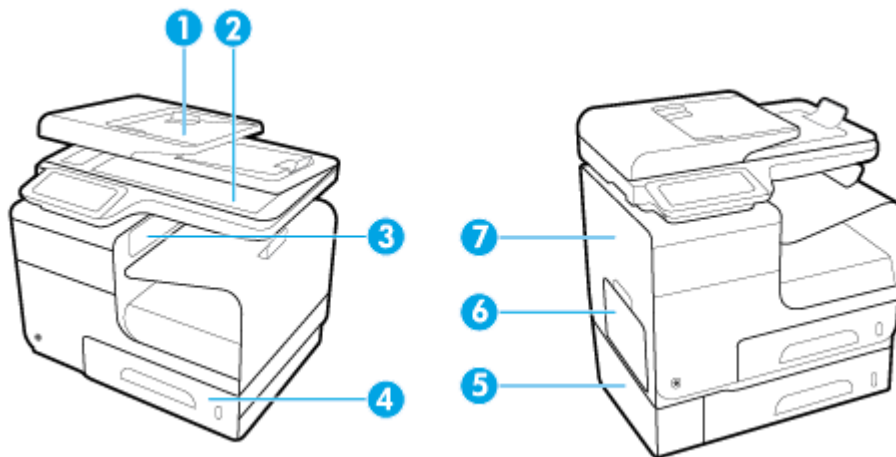

1	Automatic document feeder
2	Scanner
3	Output bin
4	Tray 2
5	Optional Tray 3 and left jam-access door

6	Tray 1
7	Left door

Traces of ink might remain in the product after a jam. This problem typically resolves itself after a few sheets have been printed.

Clear jams from the document feeder

1. Open the document feeder cover.

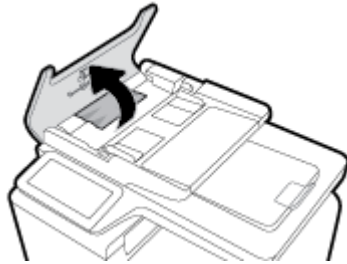

2. Lift the document feeder roller assembly, and gently pull the jammed paper out.

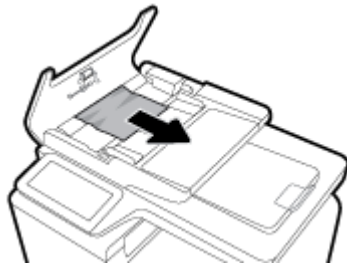

3. Close the document feeder cover.

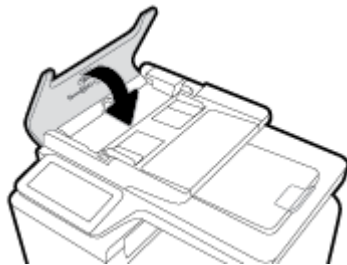

4. Open the scanner lid. If paper is jammed behind the white plastic backing, gently pull it out.

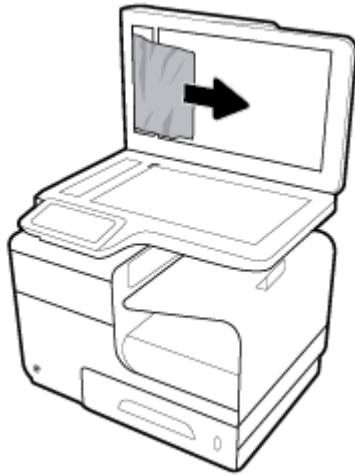

Clear jams in Tray 1 (multipurpose tray)

- ▲ If the jammed sheet is visible and easily accessible in Tray 1, pull it from Tray 1.

 **NOTE:** If the sheet tears, make sure that all of the fragments are removed before you resume printing.



Clear jams in Tray 2

1. Open Tray 2 by pulling it out and releasing the latch at the rear left of the tray.

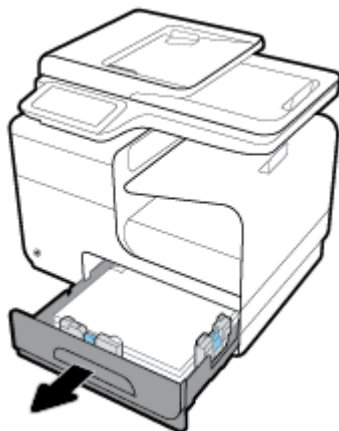

2. Remove the jammed sheet by pulling it to the right and then out of the product.

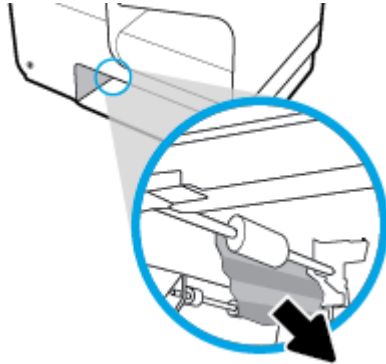

3. Close Tray 2.

 **NOTE:** To close the tray, push in the middle or with even pressure on both sides. Avoid pushing on one side only.



Clear jams in optional Tray 3

1. Open Tray 3.

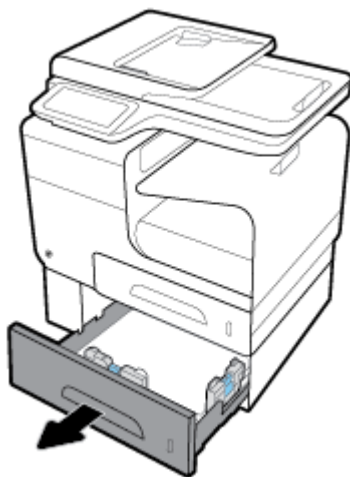

2. Remove the jammed sheet by pulling it to the right and then out of the product.

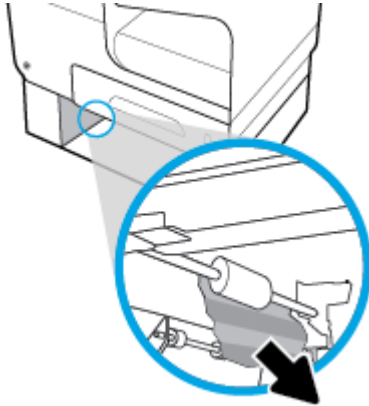

3. If the jam cannot be cleared at the tray, try clearing the jam from the Tray 3 left door.

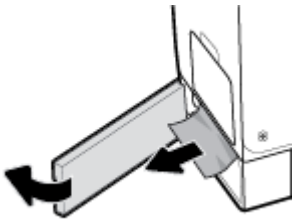

4. Close Tray 3.

 **NOTE:** To close the tray, push in the middle or with even pressure on both sides. Avoid pushing on one side only.

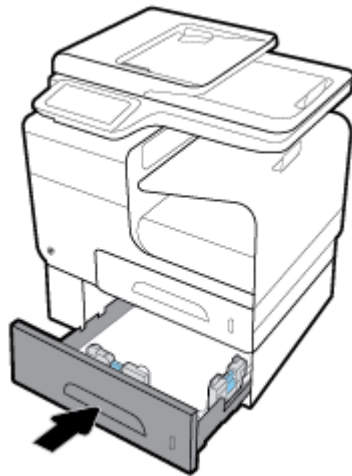

Clear jams in the left door

1. Open the left door.

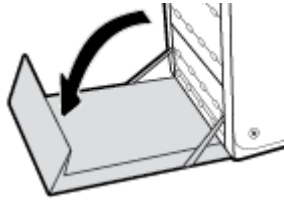

2. Gently remove any visible paper from the rollers and delivery area.



NOTE: If the sheet tears, make sure that all fragments are removed before you resume printing. Do not use sharp objects to remove fragments.

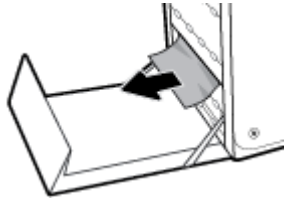

3. Close the left door.

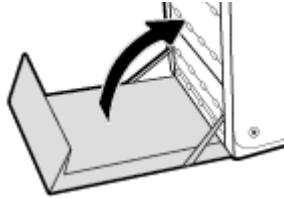

Clear jams in the output bin

1. Look for jammed paper in the output bin area.
2. Remove any visible media.



NOTE: If the sheet tears, remove all fragments before you resume printing.



3. Open and then close the left door to clear the message.

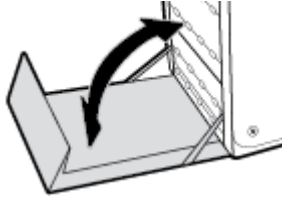

Clear jams in the duplexer

1. Open the left door.

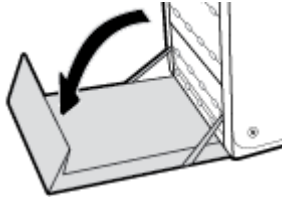

2. Remove the duplexer by pulling it out with both hands. Set the duplexer aside, upright, on a piece of paper to prevent spills.

NOTICE: When pulling out the duplexer, avoid making direct contact with the black cylinder to prevent ink smear on skin or clothes.

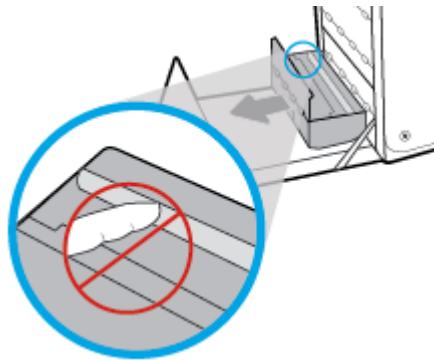

3. Lower the platen by pressing down on the green tab. This will cause the product to try to feed the sheet through the print zone. You may need to gently pull on the sheet if it does not feed. Remove the sheet.

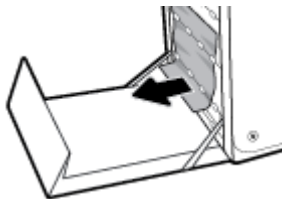

4. Lift the green tab to place the platen back into its operating position.

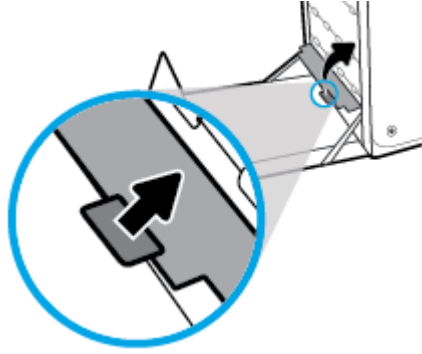

5. Reinstall the duplexer.

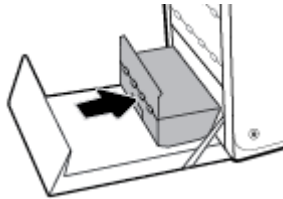

6. Close the left door.

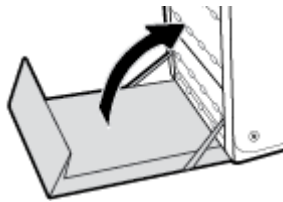

Cartridge issues

Refilled or remanufactured cartridges

HP cannot recommend the use of non-HP supplies, either new or remanufactured. Because they are not HP products, HP cannot influence their design or control their quality. If you are using a refilled or remanufactured cartridge and are not satisfied with the print quality, replace the cartridge with a genuine HP cartridge.

 **NOTE:** If you replace a non-HP cartridge with a genuine HP cartridge, the printhead may still contain non-HP ink until the printhead is depleted of that ink and is supplied with ink from the newly installed, genuine HP cartridge. Until the non-HP ink is depleted, print quality will be affected.

Interpret control panel messages for cartridges

Cartridge Depleted

Description

The cartridge is at the end of its useful life, and the product will no longer print.

Recommended action

Depleted cartridges must be replaced to resume printing.

Cartridge Low**Description**

The cartridge is nearing the end of its useful life.

Recommended action

Printing can continue, but consider having a replacement cartridge on hand. You do not need to replace the cartridges until prompted to.

Cartridge Very Low**Description**

The cartridge is near the end of its useful life.

Recommended action

Have a replacement cartridge on hand. You do not need to replace the cartridges until prompted to.

Counterfeit or used [color] cartridge installed**Description**

The original HP ink in this cartridge has been depleted.

Recommended action

Click OK to continue printing or replace with genuine HP cartridge.

Do not use SETUP cartridges**Description**

SETUP cartridges cannot be used after the device has been initialized.

Recommended action

Remove and install non-SETUP cartridges.

Genuine HP cartridge installed**Description**

A genuine HP cartridge was installed.

Recommended action

No action necessary.

Incompatible [color]

Description

You have installed a cartridge that is intended for use in a different HP product model. The product will NOT function with this print cartridge installed.

Recommended action

Install the correct cartridge for this product.

Incompatible cartridges

Description

- The contacts on the cartridge might not be making a connection to the printer.
- The cartridge is not compatible with your printer.

Recommended action

- Carefully clean the contacts on the cartridge by using a soft, lint-free cloth and insert the cartridge again.
- Remove this cartridge immediately and replace with a compatible cartridge.

Install [color] cartridge

Description

This message can appear during the initial set up of the product and may also appear after the initial set up of the product has been completed.

If this message appears during initial setup, it means one of the color cartridges is not installed with the door closed. The product will not print if a cartridge is missing.

If this message appears after the initial setup of the product, it means that the cartridge is missing or is installed but damaged.

Recommended action

Install or replace the indicated color cartridge.

Non-HP cartridges installed

Description

No action necessary, this is a notification only.

Recommended action

No action necessary, this is a notification only.

However, HP cannot recommend the use of non-HP supplies, either new or remanufactured. Touch **OK** to continue printing or replace the cartridge with a genuine HP cartridge.

Printer Failure

Description

The printer refuses to function.

Recommended action

Have a replacement cartridge on hand. You do not need to replace the cartridges until prompted to.

Problem with Print System

Description

The cartridge identified in the message is missing, damaged, incompatible, or inserted into the wrong slot in the printer.

Recommended action

Printing functionality is disabled. Visit the [HP Customer Support](#) website.

Problem with Printer Preparation

Description

The printer clock has failed and cartridge preparation may not be complete. The estimated Cartridge Level gauge might be inaccurate.

Recommended action

Check the print quality of your print job. If it is not satisfactory, running the printhead cleaning procedure from the toolbox might improve it.

Problem with SETUP cartridges

Description

There is a problem with the SETUP cartridges and the printer cannot complete system initialization.

Recommended action

Visit the [HP Customer Support](#) website.

Use SETUP cartridges

Description

The SETUP cartridges have been removed before the product has completed initialization.

Recommended action

Use the SETUP cartridges that came with your product for product initialization.

When you first set up the printer, you must install the SETUP cartridges that shipped in the box with the printer. These cartridges calibrate your printer before the first print job. Failure to install the SETUP cartridges during the initial product setup causes an error. If you installed a set of regular cartridges, remove them and install the SETUP cartridges to complete printer setup. After printer setup is complete, the printer can use regular cartridges.

If you still receive error messages and the printer cannot complete system initialization, visit the [HP Customer Support](#) website.

Used [color] installed

Description

A used, but still genuine, HP color cartridge has been installed or moved.

Recommended action

You have a used, but still genuine, HP cartridge installed. No action required.

Printing issues

The product does not print

If the product does not print at all, try the following solutions.

1. Make sure the product is turned on and that the control panel indicates it is ready.
 - If the control panel does not indicate the product is ready, turn the product off and then on again.
 - If the control panel indicates the product is ready, try sending the job again.
2. If the control panel indicates the product has an error, resolve the error and then try to print a test page from the control panel. If the test page prints, there may be a communication problem between the product and the computer you are trying to print from.
3. Make sure the cables are all connected correctly. If the product is connected to a network, check the following items:
 - Check the light next to the network connection on the product. If the network is active, the light is green.
 - Make sure that you are using a network cable and not a phone cord to connect to the network.
 - Make sure the network router, hub, or switch is turned on and that it is working correctly.
4. Install the HP software from 123.hp.com/pagewide (recommended) or from the HP software CD provided with the printer. Using generic printer drivers can cause delays clearing jobs from the print queue.
5. From the list of printers on your computer, right-click the name of this product, click **Properties** , and open the **Ports** tab.
 - If you are using a network cable to connect to the network, make sure the printer name listed on the **Ports** tab matches the product name on the product configuration page.
 - If you are using a USB cable and are connecting to a wireless network, make sure the box is checked next to **Virtual printer port for USB**.
6. If you are using a personal firewall system on the computer, it might be blocking communication with the product. Try temporarily disabling the firewall to see if it is the source of the problem.
7. If your computer or the product is connected to a wireless network, low signal quality or interference might be delaying print jobs.

The product prints slowly

If the product prints, but it seems slow, try the following solutions.

- Make sure the computer meets the minimum specifications for this product. For a list of specifications, visit [HP Customer Support](#).
- If the paper type setting is not correct for the type of paper you are using, change the setting to the correct paper type.
- If your computer or the product is connected to a wireless network, low signal quality or interference might be delaying print jobs.
- If Quiet Mode is on, turn it off. This mode slows down the print speed. For more information, see [Quiet Mode](#).

Plug-and-print USB issues

- [The Memory Device Options menu does not open when you insert the USB accessory](#)
- [The file does not print from the USB storage device](#)
- [The file that you want to print is not listed in the Memory Device Options menu](#)

The Memory Device Options menu does not open when you insert the USB accessory

1. You might be using a USB storage device or a file system that this product does not support. Save the files on a standard USB storage device that uses File Allocation Table (FAT) file systems. The product supports FAT12, FAT16, and FAT32 USB storage accessories.
2. If another menu is already open, close that menu and then reinsert the USB storage device.
3. The USB storage device might have multiple partitions. (Some USB storage device manufacturers install software on the accessory that creates partitions, similar to a CD.) Reformat the USB storage device to remove the partitions, or use a different USB storage device.
4. The USB storage device might require more power than the product can provide.
 - a. Remove the USB storage device.
 - b. Turn the product off and then on.
 - c. Use a USB storage device that has its own power supply or that requires less power.
5. The USB storage device might not be functioning correctly.
 - a. Remove the USB storage device.
 - b. Turn the product off and then on.
 - c. Try printing from another USB storage device.

The file does not print from the USB storage device

1. Make sure paper is in the tray.
2. Check the control panel for messages. If paper is jammed in the product, clear the jam.

The file that you want to print is not listed in the Memory Device Options menu

1. You might be trying to print a file type that the USB printing feature does not support.

You can print the following types of files.

-
- .JPEG
 - .PNG
 - .JPG
 - .TIFF
 - .PDF
-

2. You might have too many files in a single folder on the USB storage accessory. Reduce the number of files in the folder by moving them to subfolders.
3. You might be using a character set for the file name that the product does not support. In this case, the product replaces the file names with characters from a different character set. Rename the files using ASCII characters.

Improve print quality

You can prevent most print-quality problems by following these guidelines.

- [Check for genuine HP cartridges](#)
- [Use paper that meets HP specifications](#)
- [Use the correct paper type setting in the printer driver](#)
- [Use the printer driver that best meets your printing needs](#)
- [Align the printhead](#)
- [Print a print-quality report](#)

Check for genuine HP cartridges

Your cartridge may not be a genuine HP cartridge. For more information, see [Counterfeit HP cartridges](#). Replace it with a genuine HP cartridge.

Use paper that meets HP specifications

Use different paper if you are having any of the following problems:

- The printing is too light or seems faded in areas.
- Specks of ink are on the printed pages.
- Ink smears on the printed pages.
- Printed characters seem misformed.
- Printed pages are curled.

Always use a paper type and weight that this product supports. In addition, follow these guidelines when selecting paper:

- Use paper that is of good quality and free of cuts, nicks, tears, spots, loose particles, dust, wrinkles, voids, staples, and curled or bent edges.
- Use paper that has not been previously printed on.
- Use paper that is designed for use in PageWide printers.
- Use paper that is not too rough. Using smoother paper generally results in better print quality.



NOTE: Based on HP internal testing using a range of plain papers, HP highly recommends using papers with the ColorLok® logo for this product. For details, visit the [HP print permanence](#) website.



Use the correct paper type setting in the printer driver

Check the paper type setting if you are having any of the following problems:

- Ink smears on the printed pages.
- Repeated marks occur on the printed pages.
- Printed pages are curled.
- Printed pages have small unprinted areas.

Change the paper type and size setting (Windows)

1. On the **File** menu in the software program, click **Print**.
2. Select the product, and then click the **Properties** or **Preferences** button.
3. Click the **Paper/Quality** tab.
4. From the **Paper Type** drop-down list, click **More**.
5. Expand the list of **Type Is** options.
6. Expand each category of paper types until you find the paper type that you are using.
7. Select the option for the type of paper you are using, and click **OK**.

Change the paper type and size setting (OS X)

1. From the **File** menu, select **Page Setup**.
2. In **Format For:**, make sure your printer is selected.
3. From the **Paper Size** pop-up menu, select the correct size.
4. From the **Copies & Pages** pop-up menu, select **Paper/Quality**.
5. From the **Media type:** pop-up menu, select the correct media type.

Use the printer driver that best meets your printing needs

You might need to use a different printer driver if the printed page has unexpected lines in graphics, missing text, missing graphics, incorrect formatting, or substituted fonts.

HP PCL 6 driver	<ul style="list-style-type: none">• Provided as the default driver. This driver is automatically installed when installing the product from 123.hp.com/pagewide (recommended) or from the HP software CD provided with the printer.• Recommended for all Windows environments. For Windows 7 and later, this driver is XPS-based. For Windows 2003, XP, and Vista, a more basic PCL 6 print driver is provided.• Provides the overall best speed, print quality, and product-feature support for most users.
HP UPD PS driver	<ul style="list-style-type: none">• Recommended for printing with Adobe® software programs or with other highly graphics-intensive software programs.• Provides support for printing from postscript emulation needs, or for postscript flash font support.• This driver is available for download at HP Universal Print Driver.
HP UPD PCL 6	<ul style="list-style-type: none">• Recommended for printing in all Windows environments.• Provides the overall best speed, print quality, and printer feature support for users in managed environments.• Developed to align with Windows Graphic Device Interface (GDI) for best speed in Windows environments.• This driver is available for download at HP Universal Print Driver.



NOTE: Download additional printer drivers from the [HP Customer Support](#) website.

Align the printhead

1. Open the control panel dashboard (swipe the dashboard tab at the top of any screen downward, or touch the dashboard area on the home screen).
2. On the control panel dashboard, touch .
3. Touch [Printer Maintenance](#), and then touch [Align Printhead](#).

Print a print-quality report

Run a Print Quality report and follow the instructions. For more information, see [Information pages](#).

Scan issues

HP Print and Scan Doctor	The HP Print and Scan Doctor is a utility that will try to diagnose and fix the issue automatically.
	NOTE: HP Print and Scan Doctor



NOTE: The HP Print and Scan Doctor and the HP online troubleshooting wizards may not be available in all languages.

Fax issues

Fax troubleshooting checklist

Several possible fixes are available. After each recommended action, retry faxing to see if the problem is resolved.

For best results during fax problem solving, make sure the line from the product is plugged directly into the wall phone port. Disconnect all other devices that are connected to the product.

1. Verify that the telephone cord is plugged into the correct port on the back of the product.
2. Check the phone line by using the fax test. On the control panel, touch the **Fax** application folder, and in the display, touch the **Setup** icon. Then, touch **Tools** and touch **Run Fax Test**. This test verifies that the phone cord is connected to the correct port and that the phone line has a signal. The product prints a report with the results.

The report contains the following possible results:

- **Pass:** The report contains all of the current fax settings for review.
- **Fail:** The cord is in the wrong port. The report contains suggestions for how to resolve the issue.
- **Not run:** The phone line is not active. The report contains suggestions for how to resolve the issue.

3. Verify that the product firmware is current:
 - a. Print a configuration page from the control panel **Reports** menu to obtain the current firmware date code.
 - b. Go to the [HP website](#).
 1. Click the **Support** link.
 2. Click the **Software and Driver** link.
 3. In the **Enter my HP model number** field, type the product model number, and click the **Find my product** button.
 4. Click the link for your operating system.
 5. Scroll to the Firmware section of the table.
 - If the listed version matches the version on the configuration page, you have the most current version.
 - If the versions are different, download the firmware upgrade and update the firmware on the product following the onscreen instructions.
-
-  **NOTE:** The product must be connected to a computer with internet access to upgrade firmware.
-
- Resend the fax.
 4. Verify that the fax was set up when the product software was installed.

From the computer, in the HP program folder, run the Fax Setup Utility.

5. Verify that the telephone service supports analog fax.
 - If using ISDN or digital PBX, contact your service provider for information about configuring to an analog fax line.
 - If using a VoIP service, change the Fax Speed setting to **Slow (9600 bps)** or disable **Fast (33600 bps)** from the control panel. Ask if your service provider supports fax and for the recommended fax modem speed. Some companies might require an adapter.
 - If using a DSL service, ensure that a filter is included on the phone line connection to the product. Contact the DSL service provider or purchase a DSL filter if you do not have one. If a DSL filter is installed, try another since these filters can be defective.
6. If the error persists, find more detailed problem-solving solutions in the sections that follow this one.

Change error correction and fax speed

Set the fax-error-correction mode

Usually, the product monitors the signals on the telephone line while it is sending or receiving a fax. If the product detects an error during the transmission and the error-correction setting is **On**, the product can request that the portion of the fax be resent. The factory-set default for error correction is **On**.

You should turn off error correction only if you are having trouble sending or receiving a fax, and you are willing to accept the errors in the transmission. Turning off the setting might be useful when you are trying to send a fax overseas or receive one from overseas, or if you are using a satellite telephone connection.

1. On the control panel, touch the **Fax** application folder.
2. In the display, touch the **Fax Setup** icon.
3. Touch **Preferences**, and then touch **Error Correction Mode** and turn it on or off.

Change the fax speed

The fax-speed setting is the modem protocol that the product uses to send faxes. It is the worldwide standard for full-duplex modems that send and receive data across telephone lines at up to 33,600 bits per second (bps). The factory-set default for the fax-speed setting is 33,600 bps.

You should change the setting only if you are having trouble sending a fax to or receiving a fax from a particular device. Decreasing the fax speed might be useful when you are trying to send a fax overseas, or receive one from overseas, or if you are using a satellite telephone connection.

1. On the control panel, touch the **Fax** application folder.
2. In the display, touch the **Fax Setup** icon.
3. Touch **Preferences**, and then touch **Speed** to select the speed setting that you want to use.

Fax logs and reports

Use the following instructions to print fax logs and reports:

Print individual fax reports

1. Open the control panel dashboard (swipe the dashboard tab at the top of any screen downward, or touch the dashboard area on the home screen).
2. On the control panel dashboard, touch .
3. Touch **Reports** , and then touch **Fax Reports**.
4. Touch the name of the report that you want to print.

Set the fax error report

A fax error report is a brief report that indicates the product experienced a fax job error. You can set it to print after the following events:

- Every fax error (the factory-set default)
- Send fax error
- Receive fax error
- Never



NOTE: With this option, you will have no indication that a fax failed to be transmitted unless you print a fax activity log.

For instructions, see [Information pages](#).

1. On the control panel, touch the **Fax** application folder.
2. In the display, touch the **Fax Setup** icon.
3. Touch **Reports** , and then touch **Fax Error Reports**.
4. Touch to select one of the following.

On (Fax Send)	Prints whenever a transmission error occurs. This is the default setting.
On (Fax Receive)	Prints whenever a receiving error occurs.
On (Fax Send and Fax Receive)	Prints whenever a fax error occurs.
Off	Does not print any fax error reports.

Fax error messages

Alert and warning messages appear temporarily and might require you to acknowledge the message by touching the **OK** button to resume or by touching a cancel button to cancel the job. With certain warnings, the job might not complete or the print quality might be affected. If the alert or warning message is related to printing and the auto-continue feature is on, the product will attempt to resume printing the job after the warning has appeared for 10 seconds without acknowledgement.

Communication error.

Description

A fax communication error occurred between the product and the sender or receiver.

Recommended action

- Allow the product to retry sending the fax. Unplug the product telephone cord from the wall, plug in a telephone, and try making a call. Plug the product phone cord into a jack for another phone line.
- Try a different phone cord.
- Set the **Fax Speed** option to the **Slow (9600 bps)** setting or set the fax speed to a lower value.
- Turn off the **Error Correction Mode** feature to prevent automatic error correction.



NOTE: Turning off the **Error Correction Mode** feature can reduce image quality.

- Print the **Fax Activity Log** report from the control panel to determine if the error occurs with a specific fax number.

If the error persists, visit [HP Customer Support](#) or review the support flyer that came in the product box.

Document feeder door is open. Canceled fax.**Description**

The cover at the top of the document feeder is open, and the product cannot send the fax.

Recommended action

Close the cover, and send the fax again.

Fax is busy. Canceled send.**Description**

The fax line to which you were sending a fax was busy. The product has canceled sending the fax.

Recommended action

- Call the recipient to ensure that the fax machine is on and ready.
- Check that you are dialing the correct fax number.
- Check that the **Busy Redial** option is enabled.
- On the control panel, touch the **Fax** application folder, and in the display, touch the **Setup** icon. Then, touch **Tools** and touch **Run Fax Test**. This test verifies that the phone cord is connected to the correct port and that the phone line has a signal. The product prints a report with the results.

If the error persists, visit [HP Customer Support](#) or review the support flyer that came in the product box.

Fax is busy. Redial pending.**Description**

The fax line to which you were sending a fax was busy. The product automatically redials the busy number.

Recommended action

- Allow the product to retry sending the fax.
- Call the recipient to ensure that the fax machine is on and ready.

- Check that you are dialing the correct fax number.
- On the control panel, touch the **Fax** application folder, and in the display, touch the **Setup** icon. Then, touch **Tools** and touch **Run Fax Test**. This test verifies that the phone cord is connected to the correct port and that the phone line has a signal. The product prints a report with the results.

If the error persists, visit [HP Customer Support](#) or review the support flyer that came in the product box.

Fax receive error.

Description

An error occurred while trying to receive a fax.

Recommended action

- Ask the sender to resend the fax.
- Try faxing back to the sender or another fax machine.
- Check for a dial tone on the phone line by touching the **Start Fax** button.
- Check that the telephone cord is securely connected by unplugging and replugging the cord.
- Make sure that you are using the telephone cord that came with the product.
- On the control panel, touch the **Fax** application folder, and in the display, touch the **Setup** icon. Then, touch **Tools** and touch **Run Fax Test**. This test verifies that the phone cord is connected to the correct port and that the phone line has a signal. The product prints a report with the results.
- Decrease the fax speed. Ask the sender to resend the fax.
- Turn off error-correction mode. Ask the sender to resend the fax.



NOTE: Turning off error-correction mode can reduce the quality of the fax image.

- Connect the product to a different phone line.

If the error persists, visit [HP Customer Support](#) or review the support flyer that came in the product box.

Fax Send error.

Description

An error occurred while trying to send a fax.

Recommended action

- Try resending the fax.
- Try faxing to another fax number.
- Check for a dial tone on the phone line by touching the **Start Fax** button.
- Check that the telephone cord is securely connected by unplugging and replugging the cord.
- Make sure that you are using the telephone cord that came with the product.
- Make sure that the phone line is working by disconnecting the product, plugging in a telephone to the phone line, and making a voice call.

- Connect the product to a different phone line.
- Set the fax resolution to [Standard](#) instead of the default of [Fine](#).

If the error persists, visit [HP Customer Support](#) or review the support flyer that came in the product box.

Fax storage is full. Canceling the fax receive.

Description

The amount of available memory for storing faxes is insufficient to store an incoming fax.

Recommended action

Clear faxes from memory. On the control panel, touch the [Fax](#) application folder. In the display, touch the [Setup](#) icon. Then touch [Tools](#), and touch [Clear Fax Logs/Memory](#).

Fax storage is full. Canceling the fax send.

Description

During the fax job, the memory filled. All pages of the fax have to be in memory for a fax job to work correctly. Only the pages that fit into memory were sent.

Recommended action

- Cancel the current job. Turn the product off and then on. Try sending the job again.
- If the error reoccurs, cancel the job and turn the product off and then on a second time. The product might not have enough memory for some jobs.

No dial tone.

Description

The product could not detect a dial tone.

Recommended action

- Check for a dial tone on the phone line by touching the [Start Fax](#) button.
- Unplug the telephone cord from both the product and the wall and replug the cord.
- Make sure that you are using the telephone cord that came with the product.
- Unplug the product telephone cord from the wall, plug in a telephone, and try making a voice call.
- Make sure that the phone cord from the wall telephone jack is plugged into the line-in port.
- Plug the product phone cord into a port for another phone line.
- Check the phone line by printing the [Run Fax Test](#) . On the control panel, touch the [Fax](#) application folder, and in the display, touch the [Setup](#) icon. Then, touch [Tools](#) and touch [Run Fax Test](#). This test verifies that the phone cord is connected to the correct port and that the phone line has a signal. The product prints a report with the results.



NOTE: This product is not designed to be connected to a digital PBX or VOIP system. Disable Dial Tone Detection and try again.

If the error persists, visit [HP Customer Support](#) or review the support flyer that came in the product box.

No fax answer. Canceled send.

Description

Attempts to redial a fax number failed, or the [No Answer Redial](#) option was turned off.

Recommended action

- Call the recipient to ensure that the fax machine is on and ready.
- Check that you are dialing the correct fax number.
- Check that the redial option is enabled.
- Unplug the telephone cord from both the product and the wall and replug the cord.
- Unplug the product telephone cord from the wall, plug in a telephone, and try making a voice call.
- Make sure that the phone cord from the wall telephone jack is plugged into the line-in port.
- Plug the product phone cord into a jack for another phone line.

If the error persists, visit [HP Customer Support](#) or review the support flyer that came in the product box.

No fax answer. Redial pending.

Description

The receiving fax line did not answer. The product attempts to redial after a few minutes.

Recommended action

- Allow the product to retry sending the fax.
- Call the recipient to ensure that the fax machine is on and ready.
- Check that you are dialing the correct fax number.
- If the product continues to redial, unplug the product telephone cord from the wall, plug in a telephone, and try making a voice call.
- Make sure that the phone cord from the wall telephone jack is plugged into the line-in port.
- Plug the product phone cord into a jack for another phone line.
- Try a different phone cord.

If the error persists, visit [HP Customer Support](#) or review the support flyer that came in the product box.

No fax detected.

Description

The product answered the incoming call but did not detect that a fax machine was calling.

Recommended action

- Allow the product to retry receiving the fax.
- Try a different phone cord.
- Plug the product phone cord into a jack for another phone line.

If the error persists, visit [HP Customer Support](#) or review the support flyer that came in the product box.

Solve problems sending faxes

- [An error message displays on the control panel](#)
- [The control panel displays a Ready message with no attempt to send the fax.](#)
- [The control panel displays the message "Receiving Page 1" and does not progress beyond that message](#)
- [Faxes can be received, but not sent](#)
- [Unable to use fax functions from the control panel](#)
- [Unable to use speed dials](#)
- [Unable to use group dials](#)
- [Receive a recorded error message from the phone company when trying to send a fax](#)
- [Unable to send a fax when a phone is connected to the product](#)

An error message displays on the control panel

For fax error messages, see [Fax error messages](#).

Document feeder paper jam

- Verify that the paper meets product size requirements. The product does not support pages longer than 381 mm (15 in) for faxing.
- Copy or print the original to letter, A4, or legal size paper, and then resend the fax.

Scanner error

- Verify that the paper meets product size requirements. The product does not support pages longer than 381 mm (15 in) for faxing.
- Copy or print the original onto letter, A4, or legal size paper and then resend the fax.

The control panel displays a Ready message with no attempt to send the fax.

- Check the fax activity log for errors.
For more information, see [Information pages](#).
- If an extension phone is connected between the product and the wall, make sure that the phone is hung up.
- Connect the product directly into the wall telephone jack and resend the fax.

The control panel displays the message "Receiving Page 1" and does not progress beyond that message

Delete stored faxes from memory.

Faxes can be received, but not sent

Send fax and nothing happens.

1. Check for a dial tone on the phone line by using the [Start Fax](#) button.
2. Turn the product off and then on.
3. Use the control panel or the HP Fax Setup Wizard to configure the fax time, date, and fax header information.

For more information, see [Configure fax settings](#).

4. Verify that any extension phones on the line are hung up.
5. If the phone line also provides DSL service, make sure that the phone line connection to the product includes a high-pass filter.

Unable to use fax functions from the control panel

- The product might be password protected. Use the HP Embedded Web Server, HP Toolbox software, or the control panel to set a password.
- If you do not know the password for the product, contact your system administrator.
- Verify with the system administrator that the fax functionality has not been disabled.

Unable to use speed dials

- Make sure that the fax number is valid.
- If an outside line requires a prefix, turn on the [Dialing Prefix](#) option or include the prefix in the speed dial number.

For more information, see [Set a dialing prefix](#).

Unable to use group dials

- Make sure that the fax number is valid.
- If an outside line requires a prefix, turn on the [Dialing Prefix](#) option or include the prefix in the speed dial number.

For more information, see [Set a dialing prefix](#).

- Set up all entries in the group with speed dial entries.
 - a. Open an unused speed dial entry.
 - b. Enter the fax number for the speed dial.
 - c. Touch the [OK](#) button to save the speed dial.

Receive a recorded error message from the phone company when trying to send a fax

- Make sure you dial the fax number correctly, and make sure that the phone service is not blocked. For example, some phone services might prevent long distance calling.
- If an outside line requires a prefix, turn on the [Dialing Prefix](#) option or include the prefix in the speed dial number.

For more information, see [Set a dialing prefix](#).



NOTE: To send a fax without a prefix, when the [Dialing Prefix](#) option is turned on, send the fax manually.

- Send a fax to an international number.
 - a. If a prefix is required, manually dial the telephone number with the prefix.
 - b. Enter the country/region code before dialing the phone number.
 - c. Wait for pauses as you hear the tones on the phone.
 - d. Send the fax manually from the control panel.

Unable to send a fax when a phone is connected to the product

- Make sure that the telephone is hung up.
- Make sure that an extension telephone on the same line is not being used for a voice call when faxing.
- Unplug the phone from the line, and then try sending the fax.

Solve problems receiving faxes

- [An error message displays on the control panel](#)
- [The fax does not respond](#)
- [Sender receives a busy signal](#)
- [Cannot send or receive a fax on a PBX line](#)

An error message displays on the control panel

See [Fax error messages](#) .

The fax does not respond

Voice mail is available on the fax line

- Add a distinctive ring service to your telephone line and change the [Distinctive Ring](#) setting on the product to match the ring pattern supplied by the telephone company. Contact your telephone company for information.

For more information, see [Set a dialing prefix](#).

- Buy a dedicated line for faxing.

The product is connected to a DSL phone service

- Check the installation and features. A DSL modem requires a high-pass filter on the phone line connection to the product. Contact your DSL service provider for a filter or buy a filter.
- Verify that the filter is plugged in.
- Replace the existing filter to make sure that it is not defective.

The product uses a fax over IP or VoIP phone service

- Set the **Fax Speed** to the **Slow (9600 bps)** or **Medium (14400 bps)** setting, or disable the **Fast (33600 bps)** setting.

For more information, see [Change the fax speed](#).

- Contact your service provider to make sure that fax is supported and for a recommended fax speed settings. Some companies might require an adapter.

Sender receives a busy signal

A handset is connected to the product

- Make sure the phone is hung up.
- Turn on **Auto Answer** . For more information, see [Configure fax settings](#).

A phone line splitter is being used

- If you are using a phone line splitter, remove the splitter and set up the phone as a downstream phone.
- Make sure the phone is hung up.
- Make sure the phone is not being used for a voice call when faxing.

Cannot send or receive a fax on a PBX line

- If you are using a PBX phone line, contact your PBX administrator to configure an analog fax line for your product.

Solve general fax problems

- [Faxes are sending slowly](#)
- [Fax quality is poor](#)
- [Fax cuts off or prints on two pages](#)

Faxes are sending slowly

The product is experiencing poor phone line quality.

- Retry sending the fax when the line conditions have improved.
- Check with the phone service provider that the line supports fax.
- Turn off the **Error Correction Mode** setting.

For more information, see [Set the default resolution](#).

 **NOTE:** This can reduce image quality.

- Use white paper for the original. Do not use colors such as gray, yellow, or pink.
- Increase the fax speed.

For more information, see [Change the fax speed](#).

- Divide large fax jobs into smaller sections, and then fax them individually.
- Change the fax settings on the control panel to a lower resolution.

For more information, see [Set the default resolution](#).

Fax quality is poor

Fax is blurry or light.

- Increase fax resolution when sending faxes. Resolution does not affect received faxes.

For more information, see [Set the default resolution](#).

 **NOTE:** Increasing resolution slows transmission speed.

- Turn on the [Error Correction Mode](#) setting from the control panel.
- Check the cartridges and replace if necessary.
- Ask the sender to darken the contrast setting on the sending fax machine, and then resend the fax.

Fax cuts off or prints on two pages

- Set the [Default Paper Size](#) setting. Faxes print on a single size of paper based on the [Default Paper Size](#) settings.

For more information, see [Configure fax settings](#).

- Set the paper type and size for the tray used for faxes.

 **NOTE:** If the [Default Paper Size](#) setting is set to letter, a legal size original prints on two pages.

Connectivity issues

Solve USB direct-connect problems

If you have connected the product directly to a computer, check the USB cable.

- Verify that the cable is connected to the computer and to the product.
- Verify that the cable is not longer than 5 m (16.4 ft). Try using a shorter cable.
- Verify that the cable is working correctly by connecting it with another product. Replace the cable if necessary.

Solve network problems

Check the following items to verify that the product is communicating with the network. Before beginning, print a configuration page from the control panel and locate the product IP address that is listed on this page.

- [Poor physical connection](#)
- [The computer is using the incorrect IP address for the product](#)
- [The computer is unable to communicate with the product](#)
- [The product is using incorrect link and duplex settings for the network](#)
- [New software programs might be causing compatibility problems](#)
- [The computer or workstation might be set up incorrectly](#)
- [The product is disabled, or other network settings are incorrect](#)

Poor physical connection

1. Verify that the product is attached to the correct ethernet port using the proper cable.
2. Verify that cable connections are securely attached.
3. Look at the Ethernet port on the back of the product, and verify that the amber activity light and the green link-status light are active.
4. If the problem continues, try a different cable or port on the network router, switch, or hub.

The computer is using the incorrect IP address for the product

1. On the computer, open the printer properties and click the **Ports** tab. Verify that the current IP address for the product is selected. The product IP address is listed on the product configuration page or through the control panel.
2. If you installed the product using an HP standard TCP/IP port, select the box labeled **Always print to this printer, even if its IP address changes**.
3. If you installed the product using a Microsoft standard TCP/IP port, use the hostname instead of the IP address.

If you installed the product from 123.hp.com/pagewide (recommended) or from the HP software CD provided with the printer, you can view or change the product IP address using the following steps:

- a. Open the HP Printer Assistant. For more information, see [Open the HP Printer Assistant](#).
 - b. Click the **Tools** tab.
 - c. Click **Update IP Address** to open a utility that reports the known (“previous”) IP address for the product and allows you to change the IP address, if necessary.
4. If the IP address is correct, delete the product entry from the list of installed printers, and then add it again.

The computer is unable to communicate with the product

1. Test network communication by pinging the product.

- a. Open a command-line prompt on your computer. For Windows, click **Start** , click **Run**, and then type `cmd`.
 - b. Type `ping` followed by the IP address for your product.
 - c. If the window displays round-trip times, both the network and device are working.
2. If the ping command failed, verify that the network router, hubs, or switches are on, and then verify that the network settings, the product, and the computer are all configured for the same network.

The product is using incorrect link and duplex settings for the network

HP recommends leaving this setting in automatic mode (the default setting). If you change these settings, you must also change them for your network.

New software programs might be causing compatibility problems

Verify that any new software programs are correctly installed and that they use the correct printer driver.

The computer or workstation might be set up incorrectly

1. Check the network drivers, printer drivers, and the network redirection.
2. Verify that the operating system is configured correctly.

The product is disabled, or other network settings are incorrect

1. Review the configuration page to check the status of the network protocol. Enable it if necessary.
2. Reconfigure the network settings if necessary.

Wireless network issues

Wireless connectivity checklist

- The product and the wireless router are turned on and have power. Also make sure the wireless radio in the product is turned on.
- The service set identifier (SSID) is correct. Print a configuration page to determine the SSID. If you are not sure the SSID is correct, run the wireless setup again.
- With secured networks, make sure the security information is correct. If the security information is incorrect, run the wireless setup again.
- If the wireless network is working correctly, try accessing other computers on the wireless network. If the network has Internet access, try connecting to the Internet over another wireless connection.
- The encryption method (AES or TKIP) is the same for the product as it is for the wireless access point, such as a wireless router (on networks using WPA security).
- The product is within the range of the wireless network. For most networks, the product must be within 30 m (100 ft) of the wireless access point (wireless router).
- Obstacles do not block the wireless signal. Remove any large metal objects between the access point and the product. Make sure poles, walls, or support columns containing metal or concrete do not separate the product and wireless access point.

- The product is located away from electronic devices that might interfere with the wireless signal. Many devices can interfere with the wireless signal including motors, cordless phones, security system cameras, other wireless networks, and some Bluetooth devices.
- The printer driver is installed on the computer.
- You have selected the correct printer port.
- The computer and product connect to the same wireless network.

The product does not print, and the computer has a third-party firewall installed

1. Update the firewall with the most recent update available from the manufacturer.
2. If programs request firewall access when you install the product or try to print, make sure you allow the programs to run.
3. Temporarily turn off the firewall, and then install the wireless product on the computer. Enable the firewall when you have completed the wireless installation.

The wireless connection does not work after moving the wireless router or product

Make sure that the router or product connects to the same network that your computer connects to.

1. Open the control panel dashboard (swipe the dashboard tab at the top of any screen downward, or touch the dashboard area on the home screen).
2. On the control panel dashboard, touch .
3. Touch [Reports](#), and then touch [Network Configuration Page](#) to print the report.
4. Compare the service set identifier (SSID) on the configuration report to the SSID in the printer configuration for your computer.
5. If the SSIDs are not the same, the devices are not connecting to the same network. Reconfigure the wireless setup for your product.

Cannot connect more computers to the wireless product

1. Make sure that the other computers are within the wireless range and that no obstacles block the signal. For most networks, the wireless range is within 30 m (100 ft) of the wireless access point.
2. Make sure the product is turned on and in the ready state.
3. Turn off any third-party firewalls on your computer.
4. Make sure that the wireless network is working correctly.
 - a. Open the control panel dashboard (swipe the dashboard tab at the top of any screen downward, or touch the dashboard area on the home screen).
 - b. On the control panel dashboard, touch .
 - c. Touch [Reports](#), and then touch [Web Access Report](#) to print the report.
5. Make sure that the correct port or product is selected.
 - For printers installed *without* the fully featured installer:

- a. From the list of printers on your computer, right-click the name of this product, click **Printer Properties**, and then open the **Ports** tab.
- b. Make sure the box is checked next to **Virtual printer port for USB**.
- If you installed the printer software from 123.hp.com/pagewide (recommended) or from the HP software CD provided with the printer, you can view or change the product IP address using the following steps:
 - a. Click **Start**.
 - b. Click **All Programs**.
 - c. Click **HP**.
 - d. Click your product.
 - e. Click **Update IP Address** to open a utility that reports the known (“previous”) IP address for the product and allows you to change the IP address, if necessary.
- 6. Make sure that your computer is working correctly. If necessary, restart your computer.

The wireless product loses communication when connected to a VPN

- Typically, you cannot connect to a VPN and other networks at the same time.

The network does not appear in the wireless networks list

- Make sure the wireless router is turned on and has power.
- The network might be hidden. However, you can still connect to a hidden network.

The wireless network is not functioning

1. To verify if the network has lost communication, try connecting other devices to the network.
2. Test network communication by pinging the network.
 - a. Open a command-line prompt on your computer. For Windows, click **Start**, click **Run**, and then type `cmd`.
 - b. Type `ping` followed by the service set identifier (SSID) for your network.
 - c. If the window displays round-trip times, the network is working.
3. To make sure that the router or product connects to the same network that your computer connects to, print the Network Configuration Page. For instructions, see [Information pages](#).

Product software issues (Windows)

Problem	Solution
A printer driver for the product is not visible in the Printer folder	<ul style="list-style-type: none"> • Reinstall the product software.

Problem	Solution
	<p>NOTE: Close any applications that are running. To close an application that has an icon in the system tray, right-click the icon, and select Close or Disable.</p> <ul style="list-style-type: none"> • Try plugging the USB cable into a different USB port on the computer.
An error message was displayed during the software installation	<ul style="list-style-type: none"> • Reinstall the product software. <p>NOTE: Close any applications that are running. To close an application that has an icon in the task bar, right-click the icon, and select Close or Disable.</p> <ul style="list-style-type: none"> • Check the amount of free space on the drive where you are installing the product software. If necessary, free up as much space as you can, and reinstall the product software. • If necessary, run the Disk Defragmenter, and reinstall the product software.
The product is in Ready mode, but nothing prints	<ul style="list-style-type: none"> • Print a configuration page from the control panel, and verify the product functionality. • Verify that all of the cables are correctly seated and within specifications. This includes the USB and power cables. Try a new cable. • Verify the IP Address on the Configuration Page matches the IP address for the software port. Use one of the following procedures: <ul style="list-style-type: none"> — Windows XP, Windows Server 2003, Windows Server 2008, and Windows Vista, installed without using the fully featured installer (such as Add Printer Wizard in Windows): <ol style="list-style-type: none"> 1. Click Start. 2. Click Settings. 3. Click Printers and Faxes (using the default Start menu view) or click Printers (using the Classic Start menu view). 4. Right-click the product driver icon, and then select Properties. 5. Click the Ports tab, and then click Configure Port. 6. Verify the IP address, and then click OK or Cancel. 7. If the IP Addresses are not the same, delete the driver, and reinstall the driver using the correct IP address. — Windows 7, installed without using the fully featured installer (such as Add Printer Wizard in Windows): <ol style="list-style-type: none"> 1. Click Start. 2. Click Devices and Printers. 3. Right-click the product driver icon, and then select Printer properties. 4. Click the Ports tab, and then click Configure Port. 5. Verify the IP address, and then click OK or Cancel. 6. If the IP Addresses are not the same, delete the driver, and reinstall the driver using the correct IP address. — Windows XP, Windows Server 2003, Windows Server 2008, Windows Vista, and Windows 7, installed using the fully featured installer: <ol style="list-style-type: none"> 1. Click Start. 2. Click All Programs. 3. Click HP.

Problem	Solution
	<ol style="list-style-type: none">Click your product.Click Update IP Address to open a utility that reports the known (“previous”) IP address for the product and allows you to change the IP address, if necessary.

Product software issues (OS X)

The printer driver is not listed in the Print & Scan list

1. Make sure that the product .GZ file is in the following hard-drive folder: `Library/Printers/PPDs/Contents/Resources`. If necessary, reinstall the software.
2. If the .GZ file is in the folder, the PPD file might be corrupt. Delete the PPD file and then reinstall the software.

The product name does not appear in the product list in the Print & Scan list

1. Make sure that the cables are connected correctly and the product is on.
2. Print a configuration page to check the product name. Verify that the name on the configuration page matches the product name in the Print & Scan list.
3. Replace the USB or ethernet cable with a high-quality cable.

The printer driver does not automatically set up the selected product in the Print & Scan list

1. Make sure that the cables are connected correctly and the product is on.
2. Make sure that the product .GZ file is in the following hard-drive folder: `Library/Printers/PPDs/Contents/Resources`. If necessary, reinstall the software.
3. If the GZ file is in the folder, the PPD file might be corrupt. Delete the file and then reinstall the software.
4. Replace the USB or ethernet cable with a high-quality cable.

A print job was not sent to the product that you wanted

1. Open the print queue and restart the print job.
2. Another product with the same or similar name might have received your print job. Print a configuration page to check the product name. Verify that the name on the configuration page matches the product name in the Printers & Scanners list.

When connected with a USB cable, the product does not appear in the Print & Scan list after the driver is selected.

Software troubleshooting

- ▲ Make sure that your Mac operating system is OS X v10.9 or later.

Hardware troubleshooting

1. Make sure that the product is turned on.
2. Make sure that the USB cable is connected correctly.
3. Make sure that you are using the appropriate high-speed USB cable.
4. Make sure that you do not have too many USB devices drawing power from the chain. Disconnect all of the devices from the chain, and connect the cable directly to the USB port on the computer.
5. Check to see if more than two nonpowered USB hubs are connected in a row on the chain. Disconnect all of the devices from the chain, and then connect the cable directly to the USB port on the computer.



NOTE: The iMac keyboard is a nonpowered USB hub.

You are using a generic printer driver when using a USB connection

If you connected the USB cable before you installed the software, you might be using a generic printer driver instead of the driver for this product.

1. Delete the generic printer driver.
2. Reinstall the software from the product CD. Do not connect the USB cable until the software installation program prompts you.
3. If multiple printers are installed, make sure that you have selected the correct printer in the **Format For** pop-up menu in the **Print** dialog box.

10 Service and support

- [Customer support](#)
- [HP limited warranty statement](#)

Customer support

If you need help from an HP technical support representative to solve a problem, contact [HP Customer Support](#).

Register your product	www.register.hp.com
Download software utilities, drivers, and electronic documentation	HP Customer Support
Get 24-hour Internet product support and troubleshooting and download drivers and software, and electronic information	HP Customer Support
Get support for products used with a Mac computer	HP Customer Support
Get telephone support, free during your warranty period, for your country/region	Country/region phone numbers are on the flyer that was in the box with your product or at HP Customer Support .
Have the product name, serial number, date of purchase, and problem description ready.	
Order additional HP service or maintenance agreements	www.hp.com/go/carepack

HP limited warranty statement

HP PRODUCT	DURATION OF LIMITED WARRANTY
HP PageWide MFP 377dw	1 year

HP warrants to you, the end-user customer, that HP hardware and accessories will be free from defects in materials and workmanship after the date of purchase, for the period specified above. If HP receives notice of such defects during the warranty period, HP will, at its option, either repair or replace products which prove to be defective. Replacement products may be either new or equivalent in performance to new.

HP warrants to you that HP software will not fail to execute its programming instructions after the date of purchase, for the period specified above, due to defects in material and workmanship when properly installed and used. If HP receives notice of such defects during the warranty period, HP will replace software which does not execute its programming instructions due to such defects.

HP does not warrant that the operation of HP products will be uninterrupted or error free. If HP is unable, within a reasonable time, to repair or replace any product to a condition as warranted, you will be entitled to a refund of the purchase price upon prompt return of the product.

HP products may contain remanufactured parts equivalent to new in performance or may have been subject to incidental use.

Warranty does not apply to defects resulting from (a) improper or inadequate maintenance or calibration, (b) software, interfacing, parts or supplies not supplied by HP, (c) unauthorized modification or misuse, (d) operation outside of the published environmental specifications for the product, or (e) improper site preparation or maintenance.

HP's limited warranty is void in the event the printer is attached to an aftermarket apparatus or system that modifies the printer's functionality such as a continuous ink system.

TO THE EXTENT ALLOWED BY LOCAL LAW, THE ABOVE WARRANTIES ARE EXCLUSIVE AND NO OTHER WARRANTY OR CONDITION, WHETHER WRITTEN OR ORAL, IS EXPRESSED OR IMPLIED AND HP SPECIFICALLY DISCLAIMS ANY IMPLIED WARRANTIES OR CONDITIONS OF MERCHANTABILITY, SATISFACTORY QUALITY, AND FITNESS FOR A PARTICULAR PURPOSE. Some countries/regions, states or provinces do not allow limitations on the duration of an implied warranty, so the above limitation or exclusion might not apply to you. This warranty gives you specific legal rights and you might also have other rights that vary from country/region to country/region, state to state, or province to province.

HP's limited warranty is valid in any country/region or locality where HP has a support presence for this product and where HP has marketed this product. The level of warranty service you receive may vary according to local standards. HP will not alter form, fit or function of the product to make it operate in a country/region for which it was never intended to function for legal or regulatory reasons.

TO THE EXTENT ALLOWED BY LOCAL LAW, THE REMEDIES IN THIS WARRANTY STATEMENT ARE YOUR SOLE AND EXCLUSIVE REMEDIES. EXCEPT AS INDICATED ABOVE, IN NO EVENT WILL HP OR ITS SUPPLIERS BE LIABLE FOR LOSS OF DATA OR FOR DIRECT, SPECIAL, INCIDENTAL, CONSEQUENTIAL (INCLUDING LOST PROFIT OR DATA), OR OTHER DAMAGE, WHETHER BASED IN CONTRACT, TORT, OR OTHERWISE. Some countries/regions, states or provinces do not allow the exclusion or limitation of incidental or consequential damages, so the above limitation or exclusion may not apply to you.

THE WARRANTY TERMS CONTAINED IN THIS STATEMENT, EXCEPT TO THE EXTENT LAWFULLY PERMITTED, DO NOT EXCLUDE, RESTRICT OR MODIFY AND ARE IN ADDITION TO THE MANDATORY STATUTORY RIGHTS APPLICABLE TO THE SALE OF THIS PRODUCT TO YOU.

UK, Ireland, and Malta

The HP Limited Warranty is a commercial guarantee voluntarily provided by HP. The name and address of the HP entity responsible for the performance of the HP Limited Warranty in your country/region is as follows:

UK: HP Inc UK Limited, Cain Road, Amen Corner, Bracknell, Berkshire, RG12 1HN

Ireland: Hewlett-Packard Ireland Limited, Liffey Park Technology Campus, Barnhall Road, Leixlip, Co.Kildare

Malta: Hewlett-Packard Europe B.V., Amsterdam, Meyrin Branch, Route du Nant-d'Avril 150, 1217 Meyrin, Switzerland

United Kingdom: The HP Limited Warranty benefits apply in addition to any legal rights to a guarantee from seller of nonconformity of goods with the contract of sale. These rights expire six years from delivery of goods for products purchased in England or Wales and five years from delivery of goods for products purchased in Scotland. However various factors may impact your eligibility to receive these rights. For further information, please consult the following link: Consumer Legal Guarantee (www.hp.com/go/eu-legal) or you may visit the European Consumer Centers website (http://ec.europa.eu/consumers/solving_consumer_disputes/non-judicial_redress/ecc-net/index_en.htm). Consumers have the right to choose whether to claim service under the HP Limited Warranty or against the seller under the legal guarantee.

Ireland: The HP Limited Warranty benefits apply in addition to any statutory rights from seller in relation to nonconformity of goods with the contract of sale. However various factors may impact your eligibility to receive these rights. Consumer statutory rights are not limited or affected in any manner by HP Care Pack. For further information, please consult the following link: Consumer Legal Guarantee (www.hp.com/go/eu-legal) or you may visit the European Consumer Centers website (http://ec.europa.eu/consumers/solving_consumer_disputes/non-judicial_redress/ecc-net/index_en.htm). Consumers have the right to choose whether to claim service under the HP Limited Warranty or against the seller under the legal guarantee.

Malta: The HP Limited Warranty benefits apply in addition to any legal rights to a two-year guarantee from seller of nonconformity of goods with the contract of sale; however various factors may impact your eligibility to receive these rights. Consumer statutory rights are not limited or affected in any manner by the HP Limited Warranty. For further information, please consult the following link: Consumer Legal Guarantee (www.hp.com/go/eu-legal) or you may visit the European Consumer Centers website (http://ec.europa.eu/consumers/solving_consumer_disputes/non-judicial_redress/ecc-net/index_en.htm). Consumers have the right to choose whether to claim service under the HP Limited Warranty or against the seller under two-year legal guarantee.

Austria, Belgium, Germany, and Luxembourg

Die beschränkte HP Herstellergarantie ist eine von HP auf freiwilliger Basis angebotene kommerzielle Garantie. Der Name und die Adresse der HP Gesellschaft, die in Ihrem Land für die Gewährung der beschränkten HP Herstellergarantie verantwortlich ist, sind wie folgt:

Deutschland: HP Deutschland GmbH, Schickardstr. 32, D-71034 Böblingen

Österreich: HP Austria GmbH., Technologiestrasse 5, A-1120 Wien

Luxemburg: Hewlett-Packard Luxembourg S.C.A., 75, Parc d'Activités Capellen, Rue Pafebruc, L-8308 Capellen

Belgien: HP Belgium BVBA, Hermeslaan 1A, B-1831 Diegem

Die Rechte aus der beschränkten HP Herstellergarantie gelten zusätzlich zu den gesetzlichen Ansprüchen wegen Sachmängeln auf eine zweijährige Gewährleistung ab dem Lieferdatum. Ob Sie Anspruch auf diese Rechte haben, hängt von zahlreichen Faktoren ab. Die Rechte des Kunden sind in keiner Weise durch die

beschränkte HP Herstellergarantie eingeschränkt bzw. betroffen. Weitere Hinweise finden Sie auf der folgenden Website: Gewährleistungsansprüche für Verbraucher (www.hp.com/go/eu-legal) oder Sie können die Website des Europäischen Verbraucherzentrums (http://ec.europa.eu/consumers/solving_consumer_disputes/non-judicial_redress/ecc-net/index_en.htm) besuchen. Verbraucher haben das Recht zu wählen, ob sie eine Leistung von HP gemäß der beschränkten HP Herstellergarantie in Anspruch nehmen oder ob sie sich gemäß der gesetzlichen zweijährigen Haftung für Sachmängel (Gewährleistung) sich an den jeweiligen Verkäufer wenden.

Belgium, France, and Luxembourg

La garantie limitée HP est une garantie commerciale fournie volontairement par HP. Voici les coordonnées de l'entité HP responsable de l'exécution de la garantie limitée HP dans votre pays:

France: HP France SAS, société par actions simplifiée identifiée sous le numéro 448 694 133 RCS Evry, 1 Avenue du Canada, 91947, Les Ulis

G.D. Luxembourg: Hewlett-Packard Luxembourg S.C.A., 75, Parc d'Activités Capellen, Rue Pafebruc, L-8308 Capellen

Belgique: HP Belgium BVBA, Hermeslaan 1A, B-1831 Diegem

France: Les avantages de la garantie limitée HP s'appliquent en complément des droits dont vous disposez au titre des garanties légales applicables dont le bénéfice est soumis à des conditions spécifiques. Vos droits en tant que consommateur au titre de la garantie légale de conformité mentionnée aux articles L. 211-4 à L. 211-13 du Code de la Consommation et de celle relatives aux défauts de la chose vendue, dans les conditions prévues aux articles 1641 à 1648 et 2232 du Code de Commerce ne sont en aucune façon limités ou affectés par la garantie limitée HP. Pour de plus amples informations, veuillez consulter le lien suivant : Garanties légales accordées au consommateur (www.hp.com/go/eu-legal). Vous pouvez également consulter le site Web des Centres européens des consommateurs (http://ec.europa.eu/consumers/solving_consumer_disputes/non-judicial_redress/ecc-net/index_en.htm). Les consommateurs ont le droit de choisir d'exercer leurs droits au titre de la garantie limitée HP, ou auprès du vendeur au titre des garanties légales applicables mentionnées ci-dessus.

POUR RAPPEL:

Garantie Légale de Conformité:

« Le vendeur est tenu de livrer un bien conforme au contrat et répond des défauts de conformité existant lors de la délivrance.

Il répond également des défauts de conformité résultant de l'emballage, des instructions de montage ou de l'installation lorsque celle-ci a été mise à sa charge par le contrat ou a été réalisée sous sa responsabilité ».

Article L211-5 du Code de la Consommation:

« Pour être conforme au contrat, le bien doit:

1° Etre propre à l'usage habituellement attendu d'un bien semblable et, le cas échéant:

- correspondre à la description donnée par le vendeur et posséder les qualités que celui-ci a présentées à l'acheteur sous forme d'échantillon ou de modèle;

- présenter les qualités qu'un acheteur peut légitimement attendre eu égard aux déclarations publiques faites par le vendeur, par le producteur ou par son représentant, notamment dans la publicité ou l'étiquetage;

2° Ou présenter les caractéristiques définies d'un commun accord par les parties ou être propre à tout usage spécial recherché par l'acheteur, porté à la connaissance du vendeur et que ce dernier a accepté ».

Article L211-12 du Code de la Consommation:

« L'action résultant du défaut de conformité se prescrit par deux ans à compter de la délivrance du bien ».

Garantie des vices cachés

Article 1641 du Code Civil : *« Le vendeur est tenu de la garantie à raison des défauts cachés de la chose vendue qui la rendent impropre à l'usage auquel on la destine, ou qui diminuent tellement cet usage que l'acheteur ne l'aurait pas acquise, ou n'en aurait donné qu'un moindre prix, s'il les avait connus. »*

Article 1648 alinéa 1 du Code Civil:

« L'action résultant des vices rédhibitoires doit être intentée par l'acquéreur dans un délai de deux ans à compter de la découverte du vice. »

G.D. Luxembourg et Belgique: Les avantages de la garantie limitée HP s'appliquent en complément des droits dont vous disposez au titre de la garantie de non-conformité des biens avec le contrat de vente. Cependant, de nombreux facteurs peuvent avoir un impact sur le bénéfice de ces droits. Vos droits en tant que consommateur au titre de ces garanties ne sont en aucune façon limités ou affectés par la garantie limitée HP. Pour de plus amples informations, veuillez consulter le lien suivant : Garanties légales accordées au consommateur (www.hp.com/go/eu-legal) ou vous pouvez également consulter le site Web des Centres européens des consommateurs (http://ec.europa.eu/consumers/solving_consumer_disputes/non-judicial_redress/ecc-net/index_en.htm). Les consommateurs ont le droit de choisir de réclamer un service sous la garantie limitée HP ou auprès du vendeur au cours d'une garantie légale de deux ans.

Italy

La Garanzia limitata HP è una garanzia commerciale fornita volontariamente da HP. Di seguito sono indicati nome e indirizzo della società HP responsabile della fornitura dei servizi coperti dalla Garanzia limitata HP nel vostro Paese:

Italia: HP Italy S.r.l., Via G. Di Vittorio 9, 20063 Cernusco S/Naviglio

I vantaggi della Garanzia limitata HP vengono concessi ai consumatori in aggiunta ai diritti derivanti dalla garanzia di due anni fornita dal venditore in caso di non conformità dei beni rispetto al contratto di vendita. Tuttavia, diversi fattori possono avere un impatto sulla possibilità di beneficiare di tali diritti. I diritti spettanti ai consumatori in forza della garanzia legale non sono in alcun modo limitati, né modificati dalla Garanzia limitata HP. Per ulteriori informazioni, si prega di consultare il seguente link: Garanzia legale per i clienti (www.hp.com/go/eu-legal), oppure visitare il sito Web dei Centri europei per i consumatori (http://ec.europa.eu/consumers/solving_consumer_disputes/non-judicial_redress/ecc-net/index_en.htm). I consumatori hanno il diritto di scegliere se richiedere un servizio usufruendo della Garanzia limitata HP oppure rivolgendosi al venditore per far valere la garanzia legale di due anni.

Spain

Su Garantía limitada de HP es una garantía comercial voluntariamente proporcionada por HP. El nombre y dirección de las entidades HP que proporcionan la Garantía limitada de HP (garantía comercial adicional del fabricante) en su país es:

España: Hewlett-Packard Española S.L. Calle Vicente Aleixandre, 1 Parque Empresarial Madrid - Las Rozas, E-28232 Madrid

Los beneficios de la Garantía limitada de HP son adicionales a la garantía legal de 2 años a la que los consumidores tienen derecho a recibir del vendedor en virtud del contrato de compraventa; sin embargo, varios factores pueden afectar su derecho a recibir los beneficios bajo dicha garantía legal. A este respecto, la Garantía limitada de HP no limita o afecta en modo alguno los derechos legales del consumidor (www.hp.com/go/eu-legal). Para más información, consulte el siguiente enlace: Garantía legal del

consumidor o puede visitar el sitio web de los Centros europeos de los consumidores (http://ec.europa.eu/consumers/solving_consumer_disputes/non-judicial_redress/ecc-net/index_en.htm). Los clientes tienen derecho a elegir si reclaman un servicio acogiéndose a la Garantía limitada de HP o al vendedor de conformidad con la garantía legal de dos años.

Denmark

Den begrænsede HP-garanti er en garanti, der ydes frivilligt af HP. Navn og adresse på det HP-selskab, der er ansvarligt for HP's begrænsede garanti i dit land, er som følger:

Danmark: HP Inc Danmark ApS, Engholm Parkvej 8, 3450, Allerød

Den begrænsede HP-garanti gælder i tillæg til eventuelle juridiske rettigheder, for en toårig garanti fra sælgeren af varer, der ikke er i overensstemmelse med salgsaftalen, men forskellige faktorer kan dog påvirke din ret til at opnå disse rettigheder. Forbrugerens lovbestemte rettigheder begrænses eller påvirkes ikke på nogen måde af den begrænsede HP-garanti. Se nedenstående link for at få yderligere oplysninger: Forbrugerens juridiske garanti (www.hp.com/go/eu-legal) eller du kan besøge De Europæiske Forbrugercentres websted (http://ec.europa.eu/consumers/solving_consumer_disputes/non-judicial_redress/ecc-net/index_en.htm). Forbrugere har ret til at vælge, om de vil gøre krav på service i henhold til HP's begrænsede garanti eller hos sælger i henhold til en toårig juridisk garanti.

Norway

HPs garanti er en begrenset og kommersiell garanti som HP selv har valgt å tilby. Følgende lokale selskap innestår for garantien:

Norge: HP Norge AS, Rolfbuktveien 4b, 1364 Fornebu

HPs garanti kommer i tillegg til det mangelsansvar HP har i henhold til norsk forbrukerkjøpslovgivning, hvor reklamasjonsperioden kan være to eller fem år, avhengig av hvor lenge salgsgjenstanden var ment å vare. Ulike faktorer kan imidlertid ha betydning for om du kvalifiserer til å kreve avhjelp iht slikt mangelsansvar. Forbrukerens lovmessige rettigheter begrenses ikke av HPs garanti. Hvis du vil ha mer informasjon, kan du klikke på følgende kobling: Juridisk garanti for forbruker (www.hp.com/go/eu-legal) eller du kan besøke nettstedet til de europeiske forbrukersentrene (http://ec.europa.eu/consumers/solving_consumer_disputes/non-judicial_redress/ecc-net/index_en.htm). Forbrukere har retten til å velge å kreve service under HPs garanti eller iht selgerens lovpålagte mangelsansvar.

Sweden

HP:s begränsade garanti är en kommersiell garanti som tillhandahålls frivilligt av HP. Namn och adress till det HP-företag som ansvarar för HP:s begränsade garanti i ditt land är som följer:

Sverige: HP PPS Sverige AB, SE-169 73 Stockholm

Fördelarna som ingår i HP:s begränsade garanti gäller utöver de lagstadgade rättigheterna till tre års garanti från säljaren angående varans bristande överensstämmelse gentemot köpeavtalet, men olika faktorer kan påverka din rätt att utnyttja dessa rättigheter. Konsumentens lagstadgade rättigheter varken begränsas eller påverkas på något sätt av HP:s begränsade garanti. Mer information får du om du följer denna länk: Lagstadgad garanti för konsumenter (www.hp.com/go/eu-legal) eller så kan du gå till European Consumer Centers webbplats (http://ec.europa.eu/consumers/solving_consumer_disputes/non-judicial_redress/ecc-net/index_en.htm). Konsumenter har rätt att välja om de vill ställa krav enligt HP:s begränsade garanti eller på säljaren enligt den lagstadgade treåriga garantin.

Portugal

A Garantia Limitada HP é uma garantia comercial fornecida voluntariamente pela HP. O nome e a morada da entidade HP responsável pela prestação da Garantia Limitada HP no seu país são os seguintes:

Portugal: HPCP – Computing and Printing Portugal, Unipessoal, Lda., Edifício D. Sancho I, Quinta da Fonte, Porto Salvo, Lisboa, Oeiras, 2740 244

As vantagens da Garantia Limitada HP aplicam-se cumulativamente com quaisquer direitos decorrentes da legislação aplicável à garantia de dois anos do vendedor, relativa a defeitos do produto e constante do contrato de venda. Existem, contudo, vários fatores que poderão afetar a sua elegibilidade para beneficiar de tais direitos. Os direitos legalmente atribuídos aos consumidores não são limitados ou afetados de forma alguma pela Garantia Limitada HP. Para mais informações, consulte a ligação seguinte: Garantia legal do consumidor (www.hp.com/go/eu-legal) ou visite o Web site da Rede dos Centros Europeus do Consumidor (http://ec.europa.eu/consumers/solving_consumer_disputes/non-judicial_redress/ecc-net/index_en.htm). Os consumidores têm o direito de escolher se pretendem reclamar assistência ao abrigo da Garantia Limitada HP ou contra o vendedor ao abrigo de uma garantia jurídica de dois anos.

Greece and Cyprus

Η Περιορισμένη εγγύηση HP είναι μια εμπορική εγγύηση η οποία παρέχεται εθελοντικά από την HP. Η επωνυμία και η διεύθυνση του νομικού προσώπου HP που παρέχει την Περιορισμένη εγγύηση HP στη χώρα σας είναι η εξής:

Ελλάδα /Κύπρος: HP Printing and Personal Systems Hellas EPE, Tzavella 1-3, 15232 Chalandri, Attiki

Ελλάδα /Κύπρος: HP Συστήματα Εκτύπωσης και Προσωπικών Υπολογιστών Ελλάς Εταιρεία Περιορισμένης Ευθύνης, Tzavella 1-3, 15232 Chalandri, Attiki

Τα προνόμια της Περιορισμένης εγγύησης HP ισχύουν επιπλέον των νόμιμων δικαιωμάτων για διετή εγγύηση έναντι του Πωλητή για τη μη συμμόρφωση των προϊόντων με τις συνομολογημένες συμβατικά ιδιότητες, ωστόσο η άσκηση των δικαιωμάτων σας αυτών μπορεί να εξαρτάται από διάφορους παράγοντες. Τα νόμιμα δικαιώματα των καταναλωτών δεν περιορίζονται ούτε επηρεάζονται καθ' οιονδήποτε τρόπο από την Περιορισμένη εγγύηση HP. Για περισσότερες πληροφορίες, συμβουλευτείτε την ακόλουθη τοποθεσία web: Νόμιμη εγγύηση καταναλωτή (www.hp.com/go/eu-legal) ή μπορείτε να επισκεφτείτε την τοποθεσία web των Ευρωπαϊκών Κέντρων Καταναλωτή (http://ec.europa.eu/consumers/solving_consumer_disputes/non-judicial_redress/ecc-net/index_en.htm). Οι καταναλωτές έχουν το δικαίωμα να επιλέξουν αν θα αξιώσουν την υπηρεσία στα πλαίσια της Περιορισμένης εγγύησης HP ή από τον πωλητή στα πλαίσια της νόμιμης εγγύησης δύο ετών.

Hungary

A HP korlátozott jótállás egy olyan kereskedelmi jótállás, amelyet a HP a saját elhatározásából biztosít. Az egyes országokban a HP mint gyártó által vállalt korlátozott jótállást biztosító HP vállalatok neve és címe:

Magyarország: HP Inc Magyarország Kft., H-1117 Budapest, Alíz utca 1.

A HP korlátozott jótállásban biztosított jogok azokon a jogokon felül illetik meg Önt, amelyek a termékeknek az adásvételi szerződés szerinti minőségére vonatkozó kétéves, jogszabályban foglalt eladói szavatosságból, továbbá ha az Ön által vásárolt termékre alkalmazandó, a jogszabályban foglalt kötelező eladói jótállásból erednek, azonban számos körülmény hatással lehet arra, hogy ezek a jogok Önt megilletik-e. További információért kérjük, keresse fel a következő webhelyet: Jogi Tájékoztató Fogyasztóknak (www.hp.com/go/eu-legal) vagy látogassa meg az Európai Fogyasztói Központok webhelyét (http://ec.europa.eu/consumers/solving_consumer_disputes/non-judicial_redress/ecc-net/index_en.htm). A fogyasztóknak jogában áll, hogy megválasszák, hogy a jótállással kapcsolatos igényüket a HP korlátozott

jótállás alapján vagy a kétéves, jogszabályban foglalt eladói szavatosság, illetve, ha alkalmazandó, a jogszabályban foglalt kötelező eladói jótállás alapján érvényesítik.

Czech Republic

Omezená záruka HP je obchodní zárukou dobrovolně poskytovanou společností HP. Názvy a adresy společností skupiny HP, které odpovídají za plnění omezené záruky HP ve vaší zemi, jsou následující:

Česká republika: HP Inc Czech Republic s. r. o., Za Brumlovkou 5/1559, 140 00 Praha 4

Výhody, poskytované omezenou zárukou HP, se uplatňují jako doplněk k jakýmkoli právním nárokům na dvouletou záruku poskytnutou prodejcem v případě nesouladu zboží s kupní smlouvou. Váš nárok na uznání těchto práv však může záviset na mnohých faktorech. Omezená záruka HP žádným způsobem neomezuje ani neovlivňuje zákonná práva zákazníka. Další informace získáte kliknutím na následující odkaz: Zákonná záruka spotřebitele (www.hp.com/go/eu-legal) případně můžete navštívit webové stránky Evropského spotřebitelského centra (http://ec.europa.eu/consumers/solving_consumer_disputes/non-judicial_redress/ecc-net/index_en.htm). Spotřebitelé mají právo se rozhodnout, zda chtějí službu reklamovat v rámci omezené záruky HP nebo v rámci zákonem stanovené dvouleté záruky u prodejce.

Slovakia

Obmedzená záruka HP je obchodná záruka, ktorú spoločnosť HP poskytuje dobrovoľne. Meno a adresa subjektu HP, ktorý zabezpečuje plnenie vyplývajúce z Obmedzenej záruky HP vo vašej krajine:

Slovenská republika: HP Inc Slovakia, s.r.o., Galvaniho 7, 821 04 Bratislava

Výhody Obmedzenej záruky HP sa uplatnia vedľa prípadných zákazníkovoých zákonných nárokov voči predávajúcemu z väd, ktoré spočívajú v nesúlade vlastností tovaru s jeho popisom podľa predmetnej zmluvy. Možnosť uplatnenia takých prípadných nárokov však môže závisieť od rôznych faktorov. Služby Obmedzenej záruky HP žiadnym spôsobom neobmedzujú ani neovplyvňujú zákonné práva zákazníka, ktorý je spotrebiteľom. Ďalšie informácie nájdete na nasledujúcom prepojení: Zákonná záruka spotrebiteľa (www.hp.com/go/eu-legal), prípadne môžete navštíviť webovú lokalitu európskych zákazníckych stredísk (http://ec.europa.eu/consumers/solving_consumer_disputes/non-judicial_redress/ecc-net/index_en.htm). Spotrebiteľia majú právo zvoliť si, či chcú uplatniť servis v rámci Obmedzenej záruky HP alebo počas zákonnej dvojročnej záručnej lehoty u predajcu.

Poland

Ograniczona gwarancja HP to komercyjna gwarancja udzielona dobrowolnie przez HP. Nazwa i adres podmiotu HP odpowiedzialnego za realizację Ograniczonej gwarancji HP w Polsce:

Polska: HP Inc Polska sp. z o.o., Szturmowa 2a, 02-678 Warszawa, wpisana do rejestru przedsiębiorców prowadzonego przez Sąd Rejonowy dla m.st. Warszawy w Warszawie, XIII Wydział Gospodarczy Krajowego Rejestru Sądowego, pod numerem KRS 0000546115, NIP 5213690563, REGON 360916326, GIOŚ E0020757WZBW, kapitał zakładowy 480.000 PLN.

Świadczenia wynikające z Ograniczonej gwarancji HP stanowią dodatek do praw przysługujących nabywcy w związku z dwuletnią odpowiedzialnością sprzedawcy z tytułu niezgodności towaru z umową (rękojmia). Niemniej, na możliwość korzystania z tych praw mają wpływ różne czynniki. Ograniczona gwarancja HP w żaden sposób nie ogranicza praw konsumenta ani na nie nie wpływa. Więcej informacji można znaleźć pod następującym łączem: Gwarancja prawna konsumenta (www.hp.com/go/eu-legal), można także odwiedzić stronę internetową Europejskiego Centrum Konsumentckiego (http://ec.europa.eu/consumers/solving_consumer_disputes/non-judicial_redress/ecc-net/index_en.htm). Konsumenti mają prawo wyboru co do możliwości skorzystania albo z usług gwarancyjnych przysługujących w ramach Ograniczonej gwarancji HP albo z uprawnień wynikających z dwuletniej rękojmi w stosunku do sprzedawcy.

Bulgaria

Ограничената гаранция на HP представлява търговска гаранция, доброволно предоставяна от HP. Името и адресът на дружеството на HP за вашата страна, отговорно за предоставянето на гаранционната поддръжка в рамките на Ограничената гаранция на HP, са както следва:

HP Inc Bulgaria EOOD (Ейч Пи Инк България ЕООД), гр. София 1766, район р-н Младост, бул. Околовръстен Път No 258, Бизнес Център Камбаните

Предимствата на Ограничената гаранция на HP се прилагат в допълнение към всички законови права за двугодишна гаранция от продавача при несъответствие на стоката с договора за продажба. Въпреки това, различни фактори могат да окажат влияние върху условията за получаване на тези права. Законовите права на потребителите не са ограничени или засегнати по никакъв начин от Ограничената гаранция на HP. За допълнителна информация, моля вижте Правната гаранция на потребителя (www.hp.com/go/eu-legal) или посетете уебсайта на Европейския потребителски център (http://ec.europa.eu/consumers/solving_consumer_disputes/non-judicial_redress/ecc-net/index_en.htm). Потребителите имат правото да избират дали да претендират за извършване на услуга в рамките на Ограничената гаранция на HP или да потърсят такава от търговеца в рамките на двугодишната правна гаранция.

Romania

Garanția limitată HP este o garanție comercială furnizată în mod voluntar de către HP. Numele și adresa entității HP răspunzătoare de punerea în aplicare a Garanției limitate HP în țara dumneavoastră sunt următoarele:

România: HP Inc Romania SRL, 5 Fabrica de Glucoza Str., Building F, Ground Floor & Floor 8, 2nd District, București

Beneficiile Garanției limitate HP se aplică suplimentar față de orice drepturi privind garanția de doi ani oferită de vânzător pentru neconformitatea bunurilor cu contractul de vânzare; cu toate acestea, diverși фактори pot avea impact asupra eligibilității dvs. de a beneficia de aceste drepturi. Drepturile legale ale consumatorului nu sunt limitate sau afectate în vreun fel de Garanția limitată HP. Pentru informații suplimentare consultați următorul link: гаранцията acordată потребителю prin lege (www.hp.com/go/eu-legal) sau puteți accesa site-ul Centrul European al Consumatorilor (http://ec.europa.eu/consumers/solving_consumer_disputes/non-judicial_redress/ecc-net/index_en.htm). Consumatorii au dreptul să aleagă dacă să pretendă despăгубири în cadrul Garanției limitate HP sau de la vânзător, în cadrul гаранției legale de doi ani.

Belgium and the Netherlands

De Beperkte Garantie van HP is een commerciële garantie vrijwillig verstrekt door HP. De naam en het adres van de HP-entiteit die verantwoordelijk is voor het uitvoeren van de Beperkte Garantie van HP in uw land is als volgt:

Nederland: HP Nederland B.V., Startbaan 16, 1187 XR Amstelveen

België: HP Belgium BVBA, Hermeslaan 1A, B-1831 Diegem

De voordelen van de Beperkte Garantie van HP vormen een aanvulling op de wettelijke garantie voor consumenten gedurende twee jaren na de levering te verlenen door de verkoper bij een gebrek aan conformiteit van de goederen met de relevante verkoopovereenkomst. Niettemin kunnen diverse factoren een impact hebben op uw eventuele aanspraak op deze wettelijke rechten. De wettelijke rechten van de consument worden op geen enkele wijze beperkt of beïnvloed door de Beperkte Garantie van HP. Raadpleeg voor meer informatie de volgende webpagina: Wettelijke garantie van de consument (www.hp.com/go/eu-legal) of u kan de website van het Europees Consumenten Centrum bezoeken (http://ec.europa.eu/consumers/solving_consumer_disputes/non-judicial_redress/ecc-net/index_en.htm). Consumenten hebben

het recht om te kiezen tussen enerzijds de Beperkte Garantie van HP of anderzijds het aanspreken van de verkoper in toepassing van de wettelijke garantie.

Finland

HP:n rajoitettu takuu on HP:n vapaaehtoisesti antama kaupallinen takuu. HP:n myöntämästä takuusta maassanne vastaavan HP:n edustajan yhteystiedot ovat:

Suomi: HP Finland Oy, Piispankalliontie, FIN - 02200 Espoo

HP:n takuun edut ovat voimassa mahdollisten kuluttajansuojalakiin perustuvien oikeuksien lisäksi sen varalta, että tuote ei vastaa myyntisopimusta. Saat lisätietoja seuraavasta linkistä: Kuluttajansuoja (www.hp.com/go/eu-legal) tai voit käydä Euroopan kuluttajakeskuksen sivustolla (http://ec.europa.eu/consumers/solving_consumer_disputes/non-judicial_redress/ecc-net/index_en.htm). Kuluttajilla on oikeus vaatia virheen korjausta HP:n takuun ja kuluttajansuojan perusteella HP:lta tai myyjältä.

Slovenia

Omejena garancija HP je prostovoljna trgovska garancija, ki jo zagotavlja podjetje HP. Ime in naslov poslovne enote HP, ki je odgovorna za omejeno garancijo HP v vaši državi, sta naslednja:

Slovenija: Hewlett-Packard Europe B.V., Amsterdam, Meyrin Branch, Route du Nant-d'Avril 150, 1217 Meyrin, Switzerland

Ugodnosti omejene garancije HP veljajo poleg zakonskih pravic, ki ob sklenitvi kupoprodajne pogodbe izhajajo iz dveletne garancije prodajalca v primeru neskladnosti blaga, vendar lahko na izpolnjevanje pogojev za uveljavitev pravic vplivajo različni dejavniki. Omejena garancija HP nikakor ne omejuje strankinih z zakonom predpisanih pravic in ne vpliva nanje. Za dodatne informacije glejte naslednjo povezavo: Strankino pravno jamstvo (www.hp.com/go/eu-legal); ali pa obiščite spletno mesto evropskih središč za potrošnike (http://ec.europa.eu/consumers/solving_consumer_disputes/non-judicial_redress/ecc-net/index_en.htm). Potrošniki imajo pravico izbrati, ali bodo uveljavljali pravice do storitev v skladu z omejeno garancijo HP ali proti prodajalcu v skladu z dvoletno zakonsko garancijo.

Croatia

HP ograničeno jamstvo komercijalno je dobrovoljno jamstvo koje pruža HP. Ime i adresa HP subjekta odgovornog za HP ograničeno jamstvo u vašoj državi:

Hrvatska: HP Computing and Printing d.o.o. za računalne i srodne aktivnosti, Radnička cesta 41, 10000 Zagreb

Pogodnosti HP ograničenog jamstva vrijede zajedno uz sva zakonska prava na dvogodišnje jamstvo kod bilo kojeg prodavača s obzirom na nepodudaranje robe s ugovorom o kupnji. Međutim, razni faktori mogu utjecati na vašu mogućnost ostvarivanja tih prava. HP ograničeno jamstvo ni na koji način ne utječe niti ne ograničava zakonska prava potrošača. Dodatne informacije potražite na ovoj adresi: Zakonsko jamstvo za potrošače (www.hp.com/go/eu-legal) ili možete posjetiti web-mjesto Europskih potrošačkih centara (http://ec.europa.eu/consumers/solving_consumer_disputes/non-judicial_redress/ecc-net/index_en.htm). Potrošači imaju pravo odabrati žele li ostvariti svoja potraživanja u sklopu HP ograničenog jamstva ili pravnog jamstva prodavača u trajanju ispod dvije godine.

Latvia

HP ierobežotā garantija ir komercgarantija, kuru brīvprātīgi nodrošina HP. HP uzņēmums, kas sniedz HP ierobežotās garantijas servisa nodrošinājumu jūsu valstī:

Latvija: HP Finland Oy, PO Box 515, 02201 Espoo, Finland

HP ierobežotās garantijas priekšrocības tiek piedāvātas papildus jebkurām likumīgajām tiesībām uz pārdevēja un/vai ražotāju nodrošinātu divu gadu garantiju gadījumā, ja preces neatbilst pirkuma līgumam, tomēr šo tiesību saņemšanu var ietekmēt vairāki faktori. HP ierobežotā garantija nekādā veidā neierobežo un neietekmē patērētāju likumīgās tiesības. Lai iegūtu plašāku informāciju, izmantojiet šo saiti: Patērētāju likumīgā garantija (www.hp.com/go/eu-legal) vai arī Eiropas Patērētāju tiesību aizsardzības centra tīmekļa vietni (http://ec.europa.eu/consumers/solving_consumer_disputes/non-judicial_redress/ecc-net/index_en.htm). Patērētājiem ir tiesības izvēlēties, vai pieprasīt servisa nodrošinājumu saskaņā ar HP ierobežoto garantiju, vai arī pārdevēja sniegto divu gadu garantiju.

Lithuania

HP ribotoji garantija yra HP savanoriškai teikiama komercinė garantija. Toliau pateikiami HP bendrovių, teikiančių HP garantiją (gamintojo garantiją) jūsų šalyje, pavadinimai ir adresai:

Lietuva: HP Finland Oy, PO Box 515, 02201 Espoo, Finland

HP ribotoji garantija papildomai taikoma kartu su bet kokiais kitomis įstatymais nustatytais teisėmis į pardavėjo suteikiamą dviejų metų laikotarpio garantiją dėl prekių atitikties pardavimo sutarčiai, tačiau tai, ar jums ši teisė bus suteikiama, gali priklausyti nuo įvairių aplinkybių. HP ribotoji garantija niekaip neapriboja ir neįtakoja įstatymais nustatytų vartotojo teisių. Daugiau informacijos rasite paspaudę šią nuorodą: Teisinė vartotojo garantija (www.hp.com/go/eu-legal) arba apsilankę Europos vartotojų centro internetinėje svetainėje (http://ec.europa.eu/consumers/solving_consumer_disputes/non-judicial_redress/ecc-net/index_en.htm). Vartotojai turi teisę prašyti atlikti techninį aptarnavimą pagal HP ribotąją garantiją arba pardavėjo teikiamą dviejų metų įstatymais nustatytą garantiją.

Estonia

HP piiratud garantii on HP poolt vabatahtlikult pakutav kaubanduslik garantii. HP piiratud garantii eest vastutab HP üksus aadressil:

Eesti: HP Finland Oy, PO Box 515, 02201 Espoo, Finland

HP piiratud garantii rakendub lisaks seaduses ettenähtud müüjapoolsele kaheaastasele garantiile, juhul kui toode ei vasta müügilepingu tingimustele. Siiski võib esineda asjaolusid, mille puhul teie jaoks need õigused ei pruugi kehtida. HP piiratud garantii ei piira ega mõjuta mingil moel tarbija seadusjärgseid õigusi. Lisateavet leiate järgmiselt lingilt: tarbija õiguslik garantii (www.hp.com/go/eu-legal) või võite külastada Euroopa tarbijakeskuste veebisaiti (http://ec.europa.eu/consumers/solving_consumer_disputes/non-judicial_redress/ecc-net/index_en.htm). Tarbijal on õigus valida, kas ta soovib kasutada HP piiratud garantiid või seadusega ette nähtud müüjapoolset kaheaastast garantiid.

Russia

Срок службы принтера для России

Срок службы данного принтера HP составляет пять лет в нормальных условиях эксплуатации. Срок службы отсчитывается с момента ввода принтера в эксплуатацию. В конце срока службы HP рекомендует посетить веб-сайт нашей службы поддержки по адресу <http://www.hp.com/support> и/или связаться с авторизованным поставщиком услуг HP для получения рекомендаций в отношении дальнейшего безопасного использования принтера.

A Technical information

- [Product specifications](#)
- [Environmental product stewardship program](#)
- [Regulatory information](#)

Product specifications

- [Print specifications](#)
- [Physical specifications](#)
- [Power consumption and electrical specifications](#)
- [Acoustic emission specifications](#)
- [Environmental specifications](#)

Print specifications

For a list of supported print resolutions, visit the printer support website at [HP Customer Support](#).

Physical specifications

Product	Product dimensions (width x depth x height)	Operation dimensions (width x depth x height)	Weight
HP PageWide MFP 377dw	530 x 401 x 421 mm (20.87 x 15.79 x 16.57 inches)	806 x 681 x 452 mm (31.73 x 26.81 x 17.8 inches)	16.4 kg (35.1 lb)

Power consumption and electrical specifications

 **CAUTION:** Power requirements are based on the country/region where the product is sold. Do not convert operating voltages. This will damage the product and any such damage is not covered under the HP limited warranty and service agreements.

Acoustic emission specifications

Operation	LwAd-mono (B)	LwAd-color (B)	Notes
Print	6.9	6.8	
Copy	7.1	6.9	ADF models
Scan	6.9	6.7	ADF models

 **NOTE:** HP recommends that the printer be located in a room in which no employee has a regular workstation.

Environmental specifications

	Operating	Transporting
Temperature	15° to 30° C (59° to 86° F)	-40° to 60° C (-40° to 140° F)
Relative humidity	20 to 80%	90% or less (non-condensing)
Altitude	0 to 3048 m (0 to 10,000 ft)	

	Operating	Transporting
Tilt	IMPORTANT: Use caution when moving the product after you install the cartridges. Tilting the product at an angle greater than 3 degrees can result in ink leakage.	
Electrostatic discharge (ESD)	If an electrostatic discharge occurs when using the product to copy, a line can appear on the copied page. The ESD should clear if you copy the page again.	



NOTE: Values are subject to change.

Environmental product stewardship program

- [Protecting the environment](#)
- [Ozone production](#)
- [Power consumption](#)
- [European Union Commission Regulation 1275/2008](#)
- [Paper](#)
- [HP PageWide printing supplies](#)
- [Plastics](#)
- [Electronic hardware recycling](#)
- [Material restrictions](#)
 - [General battery information](#)
 - [Battery disposal in Taiwan](#)
 - [California Perchlorate Material Notice](#)
 - [EU Battery Directive](#)
 - [Battery notice for Brazil](#)
- [Chemical substances](#)
- [EPEAT](#)
- [Disposal of waste equipment by users](#)
- [Toxic and hazardous substance table \(China\)](#)
- [Restriction on hazardous substances statement \(Turkey\)](#)
- [Restriction on hazardous substances statement \(Ukraine\)](#)
- [Restriction of hazardous substance statement \(India\)](#)
- [China energy label for printer, fax, and copier](#)
- [China SEPA Eco Label user information](#)

Protecting the environment

HP is committed to providing quality products in an environmentally sound manner. This product has been designed with several attributes to minimize impacts on our environment.

Visit www.hp.com/go/environment or www.hp.com/hpinfo/globalcitizenship/environment to obtain more information about HP and the environment, including environmental profile sheets for these products, Material Data Safety Sheets, and HP return and recycling programs.

Ozone production

This product generates no appreciable ozone gas (O₃).

Power consumption

HP printing and imaging equipment marked with the ENERGY STAR® logo is certified by the U.S. Environmental Protection Agency. The following mark will appear on ENERGY STAR certified imaging products:



Additional ENERGY STAR certified imaging product model information is listed at: www.hp.com/go/energystar

European Union Commission Regulation 1275/2008

For product power data, including the power consumption of the product in networked standby if all wired network ports are connected and all wireless network ports are activated, please refer to section P14 'Additional Information' of the product IT ECO Declaration at www.hp.com/hpinfo/globalcitizenship/environment/productdata/itecodesktop-pc.html.

Paper

This product is capable of using recycled paper and lightweight paper (EcoFFICIENT™) when the paper meets the guidelines outlined in the product's Print Media Guide. This product is suitable for the use of recycled paper and lightweight paper (EcoFFICIENT™) according to EN12281:2002.

HP PageWide printing supplies

Original HP Supplies were designed with the environment in mind. HP makes it easy to conserve resources and paper when printing. And when you are done, we make it easy and free to recycle. Program availability varies. For more information, visit www.hp.com/recycle. To participate in HP Planet Partners return and recycling program, visit www.hp.com/recycle. Select your country/region for information on how to return your HP PageWide printing supplies.



NOTE: Visit the [HP sustainability](http://www.hp.com/sustainability) website for complete recycling information and to order postage-paid labels, envelopes, or boxes, for recycling.

Plastics

Plastic parts over 25 grams are marked according to international standards that enhance the ability to identify plastics for recycling purposes at the end of the product's life.

Electronic hardware recycling

HP encourages customers to recycle used electronic hardware. For more information about recycling programs, visit the [HP sustainability](#) website.

Material restrictions

- [General battery information](#)
- [Battery disposal in Taiwan](#)
- [California Perchlorate Material Notice](#)
- [EU Battery Directive](#)
- [Battery notice for Brazil](#)

General battery information

This HP product does not contain intentionally added mercury.

This HP product contains a battery that might require special handling at end-of-life. The batteries contained in or supplied by HP for this product include the following.

HP PageWide MFP 377dw	
Type	Lithium Manganese Dioxide
Weight	3.0 g
Location	On main board
User-removable	No

Battery disposal in Taiwan



廢電池請回收

Please recycle waste batteries.

California Perchlorate Material Notice

California Perchlorate Material Notice

Perchlorate material - special handling may apply. See:
<http://www.dtsc.ca.gov/hazardouswaste/perchlorate/>

This product's real-time clock battery or coin cell battery may contain perchlorate and may require special handling when recycled or disposed of in California.

EU Battery Directive

This product contains a battery that is used to maintain data integrity of real time clock or product settings and is designed to last the life of the product. Any attempt to service or replace this battery should be performed by a qualified service technician.



Battery notice for Brazil

A bateria deste equipamento não foi projetada para ser removida pelo cliente.

Chemical substances

HP is committed to providing our customers with information about the chemical substances in our products as needed to comply with legal requirements such as REACH (Regulation EC No 1907/2006 of the European Parliament and the Council). A chemical information report for this product can be found at <http://www.hp.com/go/reach>.

EPEAT

Most HP products are designed to meet EPEAT. EPEAT is a comprehensive environmental rating that helps identify greener electronics equipment. For more information on EPEAT go to www.epeat.net. For information on HP's EPEAT registered products go to www.hp.com/hpinfo/globalcitizenship/environment/pdf/epeat_printers.pdf.

Disposal of waste equipment by users



This symbol means do not dispose of your product with your other household waste. Instead, you should protect human health and the environment by handing over your waste equipment to a designated collection point for the recycling of waste electrical and electronic equipment. For more information, go to <http://www.hp.com/recycle>

Toxic and hazardous substance table (China)

产品中有毒物质或元素的名称及含量
根据中国《电子信息产品污染控制管理办法》



零件描述	有害物质					
	铅	汞	镉	六价铬	多溴联苯	多溴联苯醚
外壳和托盘*	0	0	0	0	0	0
电线*	0	0	0	0	0	0
印刷电路板*	X	0	0	0	0	0
打印系统*	X	0	0	0	0	0
显示器*	X	0	0	0	0	0
喷墨打印机墨盒*	0	0	0	0	0	0
驱动光盘*	X	0	0	0	0	0
扫描仪*	X	X	0	0	0	0
网络配件*	X	0	0	0	0	0
电池板*	X	0	0	0	0	0
自动双面打印系统*	0	0	0	0	0	0
外部电源*	X	0	0	0	0	0

本表格依据 SJ/T 11364 的规定编制。
 0: 表示该有害物质在该部件所有均质材料中的含量均在 GB/T 26572 规定的限量要求以下。
 X: 表示该有害物质至少在该部件的某一均质材料中的含量超出 GB/T 26572 规定的限量要求。
 此表中所有名称中含“X”的部件均符合欧盟 RoHS 立法。
 注: 环保使用期限的参考标识取决于产品正常工作的温度和湿度等条件

Restriction on hazardous substances statement (Turkey)

Türkiye Cumhuriyeti: EEE Yönetmeliğine Uygundur

Restriction on hazardous substances statement (Ukraine)

Обладнання відповідає вимогам Технічного регламенту щодо обмеження використання деяких небезпечних речовин в електричному та електронному обладнанні, затвердженого постановою Кабінету Міністрів України від 3 грудня 2008 № 1057

Restriction of hazardous substance statement (India)

Restriction of hazardous substances (India)

This product complies with the "India E-waste (Management and Handling) Rule 2011" and prohibits use of lead, mercury, hexavalent chromium, polybrominated biphenyls or polybrominated diphenyl ethers in concentrations exceeding 0.1 weight % and 0.01 weight % for cadmium, except for the exemptions set in Schedule 2 of the Rule.

复印机、打印机和传真机能源效率标识 实施规则

依据“复印机、打印机和传真机能源效率标识实施规则”，本打印机具有中国能效标签。根据“复印机、打印机和传真机能效限定值及能效等级”（“GB21521”）决定并计算得出该标签上所示的能效等级和 TEC（典型能耗）值。

1. 能效等级

能效等级分为三个等级，等级 1 级能效最高。根据产品类型和打印速度标准决定能效限定值。

2. 能效信息

2.1 LaserJet 打印机和高性能喷墨打印机

- 典型能耗

典型能耗是正常运行 GB21521 测试方法中指定的时间后的耗电量。此数据表示为每周千瓦时 (kWh)。

标签上所示的能效数字按涵盖根据“复印机、打印机和传真机能源效率标识实施规则”选择的登记装置中所有配置的代表性配置测定而得。因此，本特定产品型号的实际能耗可能与标签上所示的数据不同。

有关规范的详情信息，请参阅 GB21521 标准的当前版本。

China SEPA Eco Label user information

中国环境标识认证产品用户说明

噪声大于63.0Db(A)的办公设备不宜放置于办公室内，请在独立的隔离区域使用。

如需长时间使用本产品或打印大量文件，请确保在通风良好的房间内使用。

如您需要确认本产品处于零能耗状态，请按下电源关闭按钮，并将插头从电源插座断开。

您可以使用再生纸，以减少资源耗费。

Regulatory information

- [Regulatory notices](#)
- [VCCI statement \(Japan\)](#)
- [Power cord instructions](#)
- [Power cord statement \(Japan\)](#)
- [EMC statement \(Korea\)](#)
- [Visual display workplaces statement for Germany](#)
- [European Union Regulatory Notice](#)
- [Additional statements for telecom \(fax\) products](#)
- [Additional statements for wireless products](#)

Regulatory notices

Regulatory model identification number

For regulatory identification purposes, your product is assigned a Regulatory Model Number. This regulatory number should not be confused with the marketing name or product numbers.

Product model number	Regulatory Model Number
PageWide MFP 377dw	VCVRA-1502-01
PageWide MFP 377dw	VCVRA-1502-02

FCC statement

This equipment has been tested and found to comply with the limits for a Class B digital device, pursuant to Part 15 of the FCC Rules. These limits are designed to provide reasonable protection against harmful interference in a residential installation. This equipment generates, uses and can radiate radio frequency energy and, if not installed and used in accordance with the instructions, may cause harmful interference to radio communications. However, there is no guarantee that interference will not occur in a particular installation. If this equipment does cause harmful interference to radio or television reception, which can be determined by turning the equipment off and on, the user is encouraged to try to correct the interference by one or more of the following measures:

- Reorient or relocate the receiving antenna.
- Increase the separation between the equipment and receiver.
- Connect the equipment into an outlet on a circuit different from that to which the receiver is connected.
- Consult the dealer or an experienced radio/TV technician for help.



NOTE: Any changes or modifications made to this device that are not expressly approved by HP may void the user's authority to operate the equipment.

Use of a shielded interface cable is required to comply with the Class B limits of Part 15 of FCC rules.

For further information, contact: Manager of Corporate Product Regulations, HP Inc., 1501 Page Mill Road, Palo Alto, CA 94304, USA.

This device complies with Part 15 of the FCC Rules. Operation is subject to the following two conditions: (1) this device may not cause harmful interference, and (2) this device must accept any interference received, including interference that may cause undesired operation.

VCCI statement (Japan)

この装置は、情報処理装置等電波障害自主規制協議会（VCCI）の基準に基づくクラスB情報技術装置です。この装置は、家庭環境で使用することを目的としていますが、この装置がラジオやテレビジョン受信機に近接して使用されると、受信障害を引き起こすことがあります。
取扱説明書に従って正しい取り扱いをして下さい。

Power cord instructions

Make sure your power source is adequate for the product voltage rating. The voltage rating is on the product label. The product uses either 100-240 Vac or 200-240 Vac and 50/60 Hz.

⚠ CAUTION: To prevent damage to the product, use only the power cord that is provided with the product.

Power cord statement (Japan)

製品には、同梱された電源コードをお使い下さい。
同梱された電源コードは、他の製品では使用出来ません。

EMC statement (Korea)

B급 기기 (가정용 방송통신기기)	이 기기는 가정용(B급)으로 전자파적합등록을 한 기기로서 주로 가정에서 사용하는 것을 목적으로 하며, 모든 지역에서 사용할 수 있습니다.
-----------------------	--

Visual display workplaces statement for Germany

Das Gerät ist nicht für die Benutzung im unmittelbaren Gesichtsfeld am Bildschirmarbeitsplatz vorgesehen. Um störende Reflexionen am Bildschirmarbeitsplatz zu vermeiden, darf dieses Produkt nicht im unmittelbaren Gesichtsfeld platziert werden.

European Union Regulatory Notice

- [European Union Regulatory Notice](#)
- [Wireless models only](#)
- [Models with fax capability only](#)

European Union Regulatory Notice



Products bearing the CE marking comply with one or more of the following EU Directives as may be applicable: Low Voltage Directive 2006/95/EC, EMC Directive 2004/108/EC, Ecodesign Directive 2009/125/EC, R&TTE Directive 1999/5/EC, RoHS Directive 2011/65/EU. Compliance with these directives is assessed using applicable European Harmonised Standards. The full Declaration of Conformity can be found at the following website: www.hp.com/go/certificates (Search with the product model name or its Regulatory Model Number (RMN), which may be found on the regulatory label.)

The point of contact for regulatory matters is:

HP GmbH, Dept./MS: HQ-TRE, Herrenberger Strasse 140, 71034 Boeblingen, GERMANY

Wireless models only

EMF

- This product meets international guidelines (ICNIRP) for exposure to radio frequency radiation. If it incorporates a radio transmitting and receiving device that in normal use, a separation distance of 20 cm ensures that radio frequency exposure levels comply with EU requirements.

Wireless functionality in Europe

- This product is designed for use without restrictions in all EU countries plus Iceland, Liechtenstein, Norway and Switzerland.

Models with fax capability only

HP products with FAX capability comply with the requirements of the R&TTE Directive 1999/5/EC (Annex II) and carry the CE marking accordingly. However, due to differences between the individual PSTNs provided in different countries/regions, the approval does not, of itself, give an unconditional assurance of successful operation on every PSTN network termination point. In the event of problems, you should contact your equipment supplier in the first instance.

Additional statements for telecom (fax) products

- [New Zealand telecom statements](#)
- [Additional FCC statement for telecom products \(US\)](#)
- [Industry Canada CS-03 requirements](#)
- [Notice to users of the Canadian telephone network](#)
- [Australia wired fax statement](#)
- [Notice to users of the German telephone network](#)

New Zealand telecom statements

The grant of a Telepermit for any item of terminal equipment indicates only that Telecom has accepted that the item complies with minimum conditions for connection to its network. It indicates no endorsement of the product by Telecom, nor does it provide any sort of warranty. Above all, it provides no assurance that any item will work correctly in all respects with another item of Telepermitted equipment of a different make or model, nor does it imply that any product is compatible with all of Telecom's network services.

This equipment shall not be set up to make automatic calls to the Telecom "111" Emergency Service.

Additional FCC statement for telecom products (US)

This equipment complies with Part 68 of the FCC rules and the requirements adopted by the ACTA. On the rear (or bottom) of this equipment is a label that contains, among other information, a product identifier in the format US:AAAEQ##TXXXX. If requested, this number must be provided to the telephone company.

Applicable connector jack Universal Service Order Codes ("USOC") for the Equipment is: RJ-11C.

A plug and jack used to connect this equipment to the premises wiring and telephone network must comply with the applicable FCC Part 68 rules and requirements adopted by the ACTA. A compliant telephone cord and modular plug is provided with this product. It is designed to be connected to a compatible modular jack that is also compliant. See installation instructions for details.

The REN is used to determine the number of devices that may be connected to a telephone line. Excessive RENs on a telephone line may result in the devices not ringing in response to an incoming call. In most but not all areas, the sum of RENs should not exceed five (5.0). To be certain of the number of devices that may be connected to a line, as determined by the total RENs, contact the local telephone company. For products approved after July 23, 2001, the REN for this product is part of the product identifier that has the format US:AAAEQ##TXXXX. The digits represented by ## are the REN without a decimal point (e.g., 00 is a REN of 0.0).

If this equipment causes harm to the telephone network, the telephone company will notify you in advance that temporary discontinuance of service may be required. But if advance notice isn't practical, the telephone company will notify the customer as soon as possible. Also, you will be advised of your right to file a complaint with the FCC if you believe it is necessary.

The telephone company may make changes in its facilities, equipment, operations or procedures that could affect the operation of the equipment. If this happens the telephone company will provide advance notice in order for you to make necessary modifications to maintain uninterrupted service.

If trouble is experienced with this equipment, please contact the manufacturer, or look elsewhere in this manual, for repair or warranty information. If the equipment is causing harm to the telephone network, the telephone company may request that you disconnect the equipment until the problem is resolved.

Connection to party line service is subject to state tariffs. Contact the state public utility commission, public service commission or corporation commission for information.

⚠ CAUTION: If your home has specially wired alarm equipment connected to the telephone line, ensure the installation of this equipment does not disable your alarm equipment. If you have questions about what will disable alarm equipment, consult your telephone company or a qualified installer.

WHEN PROGRAMMING EMERGENCY NUMBERS AND(OR) MAKING TEST CALLS TO EMERGENCY NUMBERS:

- Remain on the line and briefly explain to the dispatcher the reason for the call.
- Perform such activities in the off-peak hours, such as early morning or late evening.

📝 NOTE: The FCC hearing aid compatibility rules for telephones are not applicable to this equipment.

The Telephone Consumer Protection Act of 1991 makes it unlawful for any person to use a computer or other electronic device, including FAX machines, to send any message unless such message clearly contains in a margin at the top or bottom of each transmitted page or on the first page of the transmission, the date and time it is sent and an identification of the business or other entity, or other individual sending the message and the telephone number of the sending machine or such business, other entity, or individual. (The telephone number provided may not be a 900 number or any other number for which charges exceed local or long-distance transmission charges.)

In order to program this information into your FAX machine, you should complete the steps described in the software.

Industry Canada CS-03 requirements

Notice: The Industry Canada label identifies certified equipment. This certification means the equipment meets certain telecommunications network protective, operational, and safety requirements as prescribed in the appropriate Terminal Equipment Technical Requirement document(s). The Department does not guarantee the equipment will operate to the user's satisfaction. Before installing this equipment, users should ensure that it is permissible for the equipment to be connected to the facilities of the local telecommunications company. The equipment must also be installed using an acceptable method of connection. The customer should be aware that compliance with the above conditions may not prevent degradation of service in some situations. Repairs to certified equipment should be coordinated by a representative designated by the supplier. Any repairs or alterations made by the user to this equipment, or equipment malfunctions, may give the telecommunications company cause to request the user to disconnect the equipment. Users should ensure for their own protection that the electrical ground connections of the power utility, telephone lines, and internal metallic water pipe system, if present, are connected together. This precaution can be particularly important in rural areas.

⚠ CAUTION: Users should not attempt to make such connections themselves, but should contact the appropriate electric inspection authority, or electrician, as appropriate. The Ringer Equivalence Number (REN) of this device is 0.1.

Notice: The Ringer Equivalence Number (REN) assigned to each terminal device provides an indication of the maximum number of terminals allowed to be connected to a telephone interface. The termination on an interface may consist of any combination of devices subject only to the requirement that the sum of the Ringer Equivalence Number of all the devices does not exceed five (5.0). The standard connecting arrangement code (telephone jack type) for equipment with direct connections to the telephone network is CA11A.

Notice to users of the Canadian telephone network

Note à l'attention des utilisateurs du réseau téléphonique Canadien/notice to users of the Canadian telephone network

Cet appareil est conforme aux spécifications techniques des équipements terminaux d'Industrie Canada. Le numéro d'enregistrement atteste de la conformité de l'appareil. L'abréviation IC qui précède le numéro d'enregistrement indique que l'enregistrement a été effectué dans le cadre d'une Déclaration de conformité stipulant que les spécifications techniques d'Industrie Canada ont été respectées. Néanmoins, cette abréviation ne signifie en aucun cas que l'appareil a été validé par Industrie Canada.

Pour leur propre sécurité, les utilisateurs doivent s'assurer que les prises électriques reliées à la terre de la source d'alimentation, des lignes téléphoniques et du circuit métallique d'alimentation en eau sont, le cas échéant, branchées les unes aux autres. Cette précaution est particulièrement importante dans les zones rurales.



Remarque Le numéro REN (Ringer Equivalence Number) attribué à chaque appareil terminal fournit une indication sur le nombre maximal de terminaux qui peuvent être connectés à une interface téléphonique. La terminaison d'une interface peut se composer de n'importe quelle combinaison d'appareils, à condition que le total des numéros REN ne dépasse pas 5.

Basé sur les résultats de tests FCC Partie 68, le numéro REN de ce produit est 0.1.

This equipment meets the applicable Industry Canada Terminal Equipment Technical Specifications. This is confirmed by the registration number. The abbreviation IC before the registration number signifies that registration was performed based on a Declaration of Conformity indicating that Industry Canada technical specifications were met. It does not imply that Industry Canada approved the equipment. Users should ensure for their own protection that the electrical ground connections of the power utility, telephone lines and internal metallic water pipe system, if present, are connected together. This precaution might be particularly important in rural areas.



Note The Ringer Equivalence Number (REN) assigned to each terminal device provides an indication of the maximum number of terminals allowed to be connected to a telephone interface. The termination on an interface might consist of any combination of devices subject only to the requirement that the sum of the Ringer Equivalence Numbers of all the devices does not exceed 5.

The REN for this product is 0.1, based on FCC Part 68 test results.

Australia wired fax statement

In Australia the HP device must be connected to the Telecommunications Network through a line cord which meets the requirements of the Technical Standard AS/ACIF S008.

Notice to users of the German telephone network

This HP fax product is designed to connect only to the analogue public-switched telephone network (PSTN). Please connect the TAE N telephone connector plug, provided with the HP All-in-One into the wall socket (TAE 6) code N. This HP fax product can be used as a single device and/or in combination (in serial connection) with other approved terminal equipment.

Additional statements for wireless products

- [Exposure to radio frequency radiation](#)
- [Notice to users in Brazil](#)
- [Canadian statements](#)
- [Japan statement](#)
- [Notice to users in Korea](#)
- [Taiwan statement](#)
- [Mexico statement](#)

Exposure to radio frequency radiation

Exposure to radio frequency radiation

 **Caution** The radiated output power of this device is far below the FCC radio frequency exposure limits. Nevertheless, the device shall be used in such a manner that the potential for human contact during normal operation is minimized. This product and any attached external antenna, if supported, shall be placed in such a manner to minimize the potential for human contact during normal operation. In order to avoid the possibility of exceeding the FCC radio frequency exposure limits, human proximity to the antenna shall not be less than 20 cm (8 inches) during normal operation.

Notice to users in Brazil

Aviso aos usuários no Brasil

Este equipamento opera em caráter secundário, isto é, não tem direito à proteção contra interferência prejudicial, mesmo de estações do mesmo tipo, e não pode causar interferência a sistemas operando em caráter primário.

Canadian statements

Under Industry Canada regulations, this radio transmitter may only operate using an antenna of a type and maximum (or lesser) gain approved for the transmitter by Industry Canada. To reduce potential radio interference to other users, the antenna type and its gain should be so chosen that the equivalent isotropically radiated power (e.i.r.p.) is not more than that necessary for successful communication.

This device complies with Industry Canada licence-exempt RSS standard(s). Operation is subject to the following two conditions: (1) this device may not cause interference, and (2) this device must accept any interference, including interference that may cause undesired operation of the device.

 **WARNING!** Exposure to Radio Frequency Radiation The radiated output power of this device is below the Industry Canada radio frequency exposure limits. Nevertheless, the device should be used in such a manner that the potential for human contact is minimized during normal operation.

To avoid the possibility of exceeding the Industry Canada radio frequency exposure limits, human proximity to the antennas should not be less than 20 cm (8 inches).

Japan statement

この機器は技術基準適合証明又は工事設計認証を受けた無線設備を搭載しています。

Notice to users in Korea

해당 무선설비는 전파혼신 가능성이 있으므로 인명안전과 관련된 서비스는 할 수 없음

Taiwan statement

低功率電波輻射性電機管理辦法

第十二條 經型式認證合格之低功率射頻電機，非經許可，公司、商號或使用者均不得擅自變更頻率、加大功率或變更原設計之特性及功能。

第十四條 低功率射頻電機之使用不得影響飛航安全及干擾合法通信；經發現有干擾現象時，應立即停用，並改善至無干擾時方得繼續使用。前項合法通信，指依電信法規定作業之無線電通信。低功率射頻電機須忍受合法通信或工業、科學及醫療用電波輻射性電機設備之干擾。

Mexico statement

Aviso para los usuarios de México

La operación de este equipo está sujeta a las siguientes dos condiciones: (1) es posible que este equipo o dispositivo no cause interferencia perjudicial y (2) este equipo o dispositivo debe aceptar cualquier interferencia, incluyendo la que pueda causar su operación no deseada. Para saber el modelo de la tarjeta inalámbrica utilizada, revise la etiqueta regulatoria de la impresora.

Index

- A**
 - acoustic specifications 168
 - Alternative Letterhead Mode
 - input tray 51
 - answering machines, connecting
 - fax settings 100
 - anticounterfeit supplies 57
 - autoreduction settings, fax 102
- B**
 - batteries included 172
 - bin, output
 - jams, clearing 125
 - blocking faxes 100
 - busy signals, redialing options 97
- C**
 - canceling
 - copy jobs 80
 - cartridge levels, check 58
 - cartridges 59
 - check cartridge levels 58
 - non-HP 57
 - recycling 60, 171
 - storage 58
 - checklist
 - fax troubleshooting 136
 - clean
 - touch screen 118
 - cleaning
 - glass 117
 - printhead 117
 - clear
 - fax logs 110
 - color
 - adjusting 67
 - matching 68
 - printed vs. monitor 68
 - colored text, and OCR 87
 - comparison, product models 1
 - confirmation reports, fax 109
 - connecting to a wireless network 17
 - connectivity
 - solving problems 147
 - USB 16
 - contrast settings
 - copy 77
 - control panel
 - clean touch screen 118
 - cleaning page, printing 117
 - copying
 - canceling 80
 - contrast, adjusting 77
 - double-sided 80
 - enlarging 77
 - light/dark settings 77
 - photos 79
 - reducing 77
 - counterfeit supplies 57
 - custom-size copies 77
 - customer support
 - online 156
- D**
 - darkness settings
 - fax 98
 - darkness, contrast settings
 - copy 77
 - default gateway, setting 23
 - defaults, restoring 116
 - deleting faxes from memory 107
 - dialing
 - pauses, inserting 96
 - prefixes, inserting 97
 - redialing automatically, settings 97
 - tone or pulse settings 97
 - disposal, end-of-life 172
 - distinctive-ring settings 101
 - document feeder
 - jams 121
 - loading 52
 - DSL
 - faxing 95
 - duplex settings, changing 23
- E**
 - edit
 - text in OCR program 87
 - electrical specifications 168
 - electronic faxes
 - sending 104
 - embedded Web server
 - features 26
 - embedded web server
 - Webscan 87
 - end-of-life disposal 172
 - enlarging documents
 - copying 77
 - environmental features 2
 - error messages, fax 138, 143, 145
 - error report, fax
 - printing 138
 - error reports, fax 110
 - error-correction setting, fax 137
 - errors
 - software 151
- F**
 - factory-set defaults, restoring 116
 - fax
 - autoreduction 102
 - blocking 100
 - confirmation reports 109
 - contrast setting 98
 - deleting from memory 107
 - dial prefixes 97

- dialing, tone or pulse 97
- error report, printing 138
- error reports 110
- error-correction 137
- forwarding 99
- log, clear 110
- log, print 110
- manual receive 106
- monitor dialing 105
- pauses, inserting 96
- print last transaction details 111
- redial settings 97
- reports 108
- reprinting from memory 107
- ring patterns 101
- rings-to-answer 100
- sending from software 104
- solve general problems 146
- speed dials 103
- stamp-received 102
- unable to receive 145
- unable to send 143
- using DSL, PBX, or ISDN 95
- using VoIP 96
- V.34 setting 137
- volume settings 102
- fax date, setup
 - use control panel 92
 - use HP Digital Fax Setup Wizard 93
- fax header, setup
 - use control panel 92
 - use HP Digital Fax Setup Wizard 93
- fax time, setup
 - use control panel 92
 - use HP Digital Fax Setup Wizard 93
- fax troubleshooting
 - checklist 136
- faxing
 - from a computer (OS X) 104
 - from a computer (Windows) 104
- features 2
- firewall 17
- Fit to Page setting, fax 102
- forwarding faxes 99
- fraud Web site 57

G

- gateway, setting default 23
- General Office setting 58
- glass, cleaning 117
- group-dial entries
 - creating 108
 - editing 108

H

- HP Customer Care 156
- HP fraud website 57
- HP Utility (OS X)
 - opening 37

I

- identification cards
 - copying 78
- input tray
 - loading 45, 49, 50, 51, 52
- installing
 - product on wired networks 17
- IPv4 address 23
- ISDN
 - faxing 95

J

- jams
 - causes of 119
 - document feeder, clearing 121
 - locating 120
 - output bin, clearing 125
 - paper path, clearing 124
 - paper to avoid 55
- Japanese VCCI statement 177

K

- Korean EMC statement 177

L

- left door
 - jams, clearing 124
- light/dark settings
 - fax 98
- lightness
 - copy contrast 77
 - fax light/dark 98
- link speed settings 23
- loading envelopes
 - input tray 49, 50
- loading letterhead 52
 - input tray 51

- loading paper
 - input tray 45
- loading preprinted forms 51
 - input tray 52
- log, fax
 - print 110
- logs, fax
 - error 138

M

- Mac
 - problems, troubleshooting 153
- Macintosh
 - support 156
- maintenance
 - check cartridge levels 58
- managing network 22
- manual faxing
 - receive 106
 - send 105
- matching colors 68
- material restrictions 172
- memory
 - deleting faxes 107
 - reprinting faxes 107
- mercury-free product 172
- model
 - comparison 1
- models, feature overview 2
- monitor dialing 105

N

- network
 - password, changing 23
 - password, setting 23
 - settings, changing 22
 - settings, viewing 22
- networks
 - default gateway 23
 - IPv4 address 23
 - subnet mask 23
- networks, wired
 - installing product 17
- non-HP supplies 57

O

- OCR
 - edit scanned documents 87
- online support 156

- OS X
 - HP Utility 37
 - scanning from TWAIN-compliant software 86
- output bin
 - jams, clearing 125
- outside lines
 - dial prefixes 97
 - pauses, inserting 96
- P**
- paper
 - default size for tray 44
 - fax autoreduction settings 102
 - jams 119
 - selecting 55, 133
- paper path
 - jams, clearing 124
- paper pickup problems
 - solving 119
- paper type
 - changing 134
- pauses, inserting 96
- PBX
 - faxing 95
- phone book, fax
 - adding entries 103
- phone, fax from
 - receive 106
- photos
 - copying 79
- Plug and Print USB Drive printing 72
- power
 - consumption 168
- prefixes, dial 97
- print
 - fax logs 110
 - fax reports 108
 - last fax details 111
- print cartridges
 - recycling 60, 171
- print quality
 - improving 133, 134
- printer driver
 - configuring wireless network 22
- printer drivers
 - choosing 135
- printer software (OS X)
 - opening 38
- printer software (Windows)
 - opening the printer software (Windows) 22
- printing
 - from USB storage accessories 72
- problem-solving
 - no response 131
 - slow response 132
- product
 - model comparison 1
- product overview 2
- protocol settings, fax 137
- pulse-dialing 97
- R**
- receive faxes
 - manually 106
- receiving faxes
 - autoreduction settings 102
 - blocking 100
 - error report, printing 138
 - reprinting 107
 - ring patterns, settings 101
 - rings-to-answer settings 100
 - stamp-received setting 102
- recycling 2, 171
- recycling supplies 60
- redialing
 - automatically, settings 97
- reducing documents
 - copying 77
- reports
 - confirmation, fax 109
 - error, fax 110
 - event log 116
 - network configuration page 116
 - PCL font list 116
 - PCL6 font list 116
 - printer status report 115
 - PS fonts list 116
 - quality report 115
- reports, fax
 - error 138
- reprinting faxes 107
- resizing documents
 - copying 77
- restoring factory-set defaults 116
- ring patterns 101
- ring tones
 - distinctive 101
- rings-to-answer setting 100
- S**
- scaling documents
 - copying 77
- scan
 - from Webscan 87
 - OCR 87
- scanner
 - glass cleaning 117
- scanning
 - TWAIN-compliant software 86
 - WIA-compliant software 86
- send faxes
 - memory, from 105
 - monitor dialing 105
- send scans
 - for OCR 87
- sending faxes
 - error report, printing 138
 - forwarding 99
 - from software 104
- settings
 - factory-set defaults, restoring 116
- size, copy
 - reducing or enlarging 77
- sizes, media
 - Fit to Page setting, faxing 102
- small documents
 - copying 78
- software
 - OCR 87
 - problems 151
 - scanning from TWAIN or WIA 86
 - sending faxes 104
 - Webscan 87
- solve
 - fax problems 143
- solve problems
 - fax 146
- solving
 - network problems 148
 - Plug and Print USB Drive printing problems 132
 - USB direct-connect problems 147

- specifications
 - electrical and acoustic 168
- speed dials
 - programming 103
- speed-dial entries
 - creating 108
 - editing 108
- storing
 - cartridges 58
- subnet mask 23
- supplies
 - counterfeit 57
 - non-HP 57
 - recycling 60, 171
- support
 - online 156

T

- TCP/IP
 - manually configuring IPv4 parameters 23
- technical support
 - online 156
- telephone, fax from
 - receive 106
- tone-dialing 97
- touch screen, clean 118
- Tray 1
 - jams, clearing 122
- Tray 2
 - jams, clearing 122
- Tray 3
 - jams, clearing 123
- trays
 - default paper size 44
 - jams, clearing 122, 123
- troubleshooting
 - checklist 113
 - fax error-correction setting 137
 - faxes 136
 - jams 119
 - Mac problems 153
 - network problems 148
 - paper feed problems 119
 - Plug and Print USB Drive printing problems 132
 - receive fax 145
 - send fax 143
 - USB direct-connect problems 147

- TWAIN-compliant software, scanning
 - from 86

U

- unblocking fax numbers 100
- USB configuration 16
- USB storage accessories
 - printing from 72

V

- V.34 setting 137
- VoIP
 - faxing 96
- volume, adjusting 102

W

- warranty
 - product 157
- Waste disposal 173
- Web sites
 - customer support 156
 - Macintosh customer support 156
- Webscan 87
- websites
 - fraud reports 57
- WIA-compliant software, scanning
 - from 86
- Windows
 - scanning from TWAIN or WIA software 86
- wireless network
 - configuring with the setup wizard 18
 - installing the driver 22
- wireless network connection 17
- Wireless Setup Wizard
 - configuring wireless network 18