



CS310 Series and CS317

User's Guide

November 2017

www.lexmark.com

Machine type(s):

5027

Model(s):

210, 230

Contents

- Safety information..... 5**
 - Conventions..... 5

- Learning about the printer..... 7**
 - Finding information about the printer..... 7
 - Selecting a location for the printer..... 8
 - Printer configurations..... 9
 - Using the printer control panel..... 10
 - Understanding the colors of the Sleep button and indicator lights..... 11
 - Using the Embedded Web Server..... 11

- Additional printer setup..... 12**
 - Installing internal options..... 12
 - Installing hardware options..... 16
 - Attaching cables..... 18
 - Setting up the printer software..... 19
 - Networking..... 20
 - Verifying printer setup..... 24

- Loading paper and specialty media..... 25**
 - Setting the paper size and type..... 25
 - Configuring Universal paper settings..... 25
 - Loading the 250-sheet tray..... 25
 - Loading the 650-sheet duo tray..... 28
 - Loading the multipurpose feeder..... 29
 - Loading the manual feeder..... 32
 - Linking and unlinking trays..... 33

- Paper and specialty media guide..... 36**
 - Using specialty media..... 36
 - Paper guidelines..... 39
 - Supported paper sizes, types, and weights..... 43

- Printing..... 46**
 - Printing a document..... 46

Printing information pages..... 47
Printing from a mobile device..... 48
Canceling a print job..... 49

Understanding the printer menus.....50

Menus list..... 50
Supplies menu..... 50
Paper menu.....51
Reports menu.....60
Network/Ports.....61
Security menu.....67
Settings menu..... 68
Help menu.....86

Saving money and the environment.....88

Saving paper and toner..... 88
Saving energy..... 88
Recycling..... 91

Securing the printer..... 93

Statement of Volatility..... 93
Erasing volatile memory..... 93
Erasing non-volatile memory.....93
Finding printer security information..... 94

Maintaining the printer..... 95

Cleaning the printer.....95
Checking the status of parts and supplies..... 95
Estimated number of remaining pages..... 96
Ordering supplies.....96
Storing supplies..... 98
Replacing supplies.....99
Moving the printer..... 116

Managing the printer.....118

Finding advanced networking and administrator information..... 118
Setting up Remote Operator Panel..... 118
Viewing reports..... 118

Configuring supply notifications from the Embedded Web Server..... 118
Copying printer settings to other printers..... 119
Restoring factory default settings.....120

Clearing jams.....121

Avoiding jams..... 121
Identifying jam locations..... 122
Paper jam in the standard bin.....123
Paper jam in the front door.....123
Paper jam in trays..... 125
Paper jam in the manual feeder.....126
Paper jam in the multipurpose feeder..... 127

Troubleshooting..... 128

Understanding the printer messages..... 128
Solving printer problems..... 137
Solving print problems..... 143
Embedded Web Server does not open..... 170
Contacting customer support..... 171

Notices..... 172

Product information..... 172
Edition notice..... 172
Power consumption..... 177

Index..... 183

Safety information

Conventions

Note: A *note* identifies information that could help you.

Warning: A *warning* identifies something that could damage the product hardware or software.

CAUTION: A *caution* indicates a potentially hazardous situation that could injure you.

Different types of caution statements include:



CAUTION—POTENTIAL INJURY: Indicates a risk of injury.



CAUTION—SHOCK HAZARD: Indicates a risk of electrical shock.



CAUTION—HOT SURFACE: Indicates a risk of burn if touched.



CAUTION—TIPPING HAZARD: Indicates a crush hazard.



CAUTION—PINCH HAZARD: Indicates a risk of being caught between moving parts.



CAUTION—POTENTIAL INJURY: To avoid the risk of fire or electrical shock, connect the power cord to an appropriately rated and properly grounded electrical outlet that is near the product and easily accessible.



CAUTION—POTENTIAL INJURY: Do not use this product with extension cords, multioutlet power strips, multioutlet extenders, or other types of surge or UPS devices. The power rating capacity of these types of accessories can be easily overloaded by a laser printer and may result in poor printer performance, property damage, or potential fire.



CAUTION—POTENTIAL INJURY: Only a Lexmark Inline Surge Protector that is properly connected between the printer and the power cord provided with the printer may be used with this product. The use of non-Lexmark surge protection devices may result in a risk of fire, property damage, or poor printer performance.

Do not place or use this product near water or wet locations.



CAUTION—POTENTIAL INJURY: This product uses a laser. Use of controls or adjustments or performance of procedures other than those specified herein may result in hazardous radiation exposure.





CAUTION—POTENTIAL INJURY: The lithium battery in this product is not intended to be replaced. There is a danger of explosion if a lithium battery is incorrectly replaced. Do not recharge, disassemble, or incinerate a lithium battery. Discard used lithium batteries according to the manufacturer's instructions and local regulations.

This product uses a printing process that heats the print media, and the heat may cause the media to release emissions. You must understand the section in your operating instructions that discusses the guidelines for selecting print media to avoid the possibility of harmful emissions.





CAUTION—HOT SURFACE: The inside of the printer might be hot. To reduce the risk of injury from a hot component, allow the surface to cool before touching.

 **CAUTION—POTENTIAL INJURY:** The printer weight is greater than 18 kg (40 lb) and requires two or more trained personnel to lift it safely.

 **CAUTION—POTENTIAL INJURY:** When moving the printer, follow these guidelines to avoid personal injury or printer damage:

- Make sure that all doors and trays are closed.
- Turn off the printer, and then unplug the power cord from the electrical outlet.
- Disconnect all cords and cables from the printer.
- If the printer has a caster base, then carefully roll it to the new location. Use caution when passing over thresholds and breaks in flooring.
- If the printer does not have a caster base but is configured with optional trays, then lift the printer off the trays. Do not try to lift the printer and the trays at the same time.
- Always use the handholds on the printer to lift it.
- Any cart used to move the printer must have a surface able to support the full footprint of the printer.
- Any cart used to move the hardware options must have a surface able to support the dimensions of the options.
- Keep the printer in an upright position.
- Avoid severe jarring movements.
- Make sure that your fingers are not under the printer when you set it down.
- Make sure that there is adequate clearance around the printer.

 **CAUTION—POTENTIAL INJURY:** To avoid the risk of fire or electrical shock, use only the power cord provided with this product or the manufacturer's authorized replacement.

 **CAUTION—SHOCK HAZARD:** If you are accessing the controller board or installing optional hardware or memory devices sometime after setting up the printer, then turn the printer off, and unplug the power cord from the electrical outlet before continuing. If you have any other devices attached to the printer, then turn them off as well, and unplug any cables going into the printer.

 **CAUTION—SHOCK HAZARD:** Make sure that all external connections (such as Ethernet and telephone system connections) are properly installed in their marked plug-in ports.

This product is designed, tested, and approved to meet strict global safety standards with the use of specific manufacturer's components. The safety features of some parts may not always be obvious. The manufacturer is not responsible for the use of other replacement parts.

 **CAUTION—POTENTIAL INJURY:** Do not cut, twist, bind, crush, or place heavy objects on the power cord. Do not subject the power cord to abrasion or stress. Do not pinch the power cord between objects such as furniture and walls. If any of these things happen, a risk of fire or electrical shock results. Inspect the power cord regularly for signs of such problems. Remove the power cord from the electrical outlet before inspecting it.

Refer service or repairs, other than those described in the user documentation, to a service representative.

 **CAUTION—SHOCK HAZARD:** To avoid the risk of electrical shock when cleaning the exterior of the printer, unplug the power cord from the electrical outlet and disconnect all cables from the printer before proceeding.

 **CAUTION—POTENTIAL INJURY:** To reduce the risk of equipment instability, load each tray separately. Keep all other trays closed until needed.

SAVE THESE INSTRUCTIONS.

Learning about the printer

Finding information about the printer

What are you looking for?	Find it here
Initial setup instructions: <ul style="list-style-type: none"> • Connecting the printer • Installing the printer software 	Setup documentation—The setup documentation came with the printer and is also available at http://support.lexmark.com .
Additional setup and instructions for using the printer: <ul style="list-style-type: none"> • Selecting and storing paper and specialty media • Loading paper • Configuring printer settings • Viewing and printing documents and photos • Setting up and using the printer software • Configuring the printer on a network • Caring for and maintaining the printer • Troubleshooting and solving problems 	<i>User's Guide</i> and <i>Quick Reference Guide</i> —The guides may be available on the <i>Software and Documentation</i> CD. For more information, visit http://support.lexmark.com .
Instructions for: <ul style="list-style-type: none"> • Connecting the printer to an Ethernet network • Troubleshooting printer connection problems 	<i>Networking Guide</i> —Open the <i>Software and Documentation</i> CD, and then navigate to: Documentation > User's Guide and other publications > Networking Guide
Help using the printer software	Windows or Mac Help—Open a printer software program or application, and then click Help . Click  to view context-sensitive information. Notes: <ul style="list-style-type: none"> • Help is automatically installed with the printer software. • The printer software is located in the printer program folder or on the desktop, depending on your operating system.

What are you looking for?	Find it here
<p>The latest supplemental information, updates, and customer support:</p> <ul style="list-style-type: none"> • Documentation • Driver downloads • Live chat support • E-mail support • Voice support 	<p>Lexmark support Web site— http://support.lexmark.com</p> <p>Note: Select your country or region, and then select your product to view the appropriate support site.</p> <p>Support telephone numbers and hours of operation for your country or region can be found on the support Web site or on the printed warranty that came with your printer.</p> <p>Record the following information (located on the store receipt and at the back of the printer), and have it ready when you contact customer support so that they may serve you faster:</p> <ul style="list-style-type: none"> • Machine Type number • Serial number • Date purchased • Store where purchased
<p>Warranty information</p>	<p>Warranty information varies by country or region:</p> <ul style="list-style-type: none"> • In the U.S.—See the Statement of Limited Warranty included with this printer, or at http://support.lexmark.com. • In other countries and regions—See the printed warranty that came with your printer.

Selecting a location for the printer

 **CAUTION—POTENTIAL INJURY:** The printer weight is greater than 18 kg (40 lb) and requires two or more trained personnel to lift it safely.

When selecting a location for the printer, leave enough room to open trays, covers, and doors. If you plan to install any options, then leave enough room for them also. It is important to:

- Set up the printer near a properly grounded and easily accessible electrical outlet.
- Make sure airflow in the room meets the latest revision of the ASHRAE 62 standard or the CEN Technical Committee 156 standard.
- Provide a flat, sturdy, and stable surface.
- Keep the printer:
 - Clean, dry, and free of dust.
 - Away from stray staples and paper clips.
 - Away from the direct airflow of air conditioners, heaters, or ventilators.
 - Free from direct sunlight and humidity extremes.
- Observe the recommended temperatures and avoid fluctuations:

Ambient temperature	15.6 to 32.2°C (60 to 90°F)
Storage temperature	1 to 35°C (34 to 95°F)

- Allow the following recommended amount of space around the printer for proper ventilation:

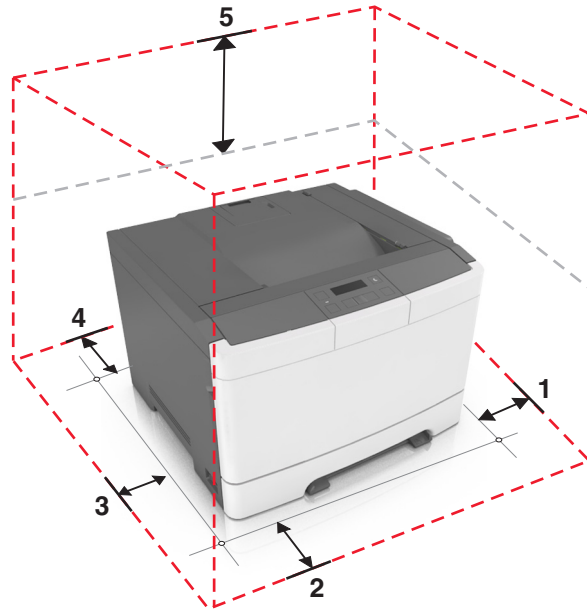

1	Right side	152.4 mm (6 in.)
2	Front	508 mm (20 in.)
3	Left side	76.2 mm (3 in.)
4	Rear	101.6 mm (4 in.)
5	Top	254 mm (10 in.)

Printer configurations

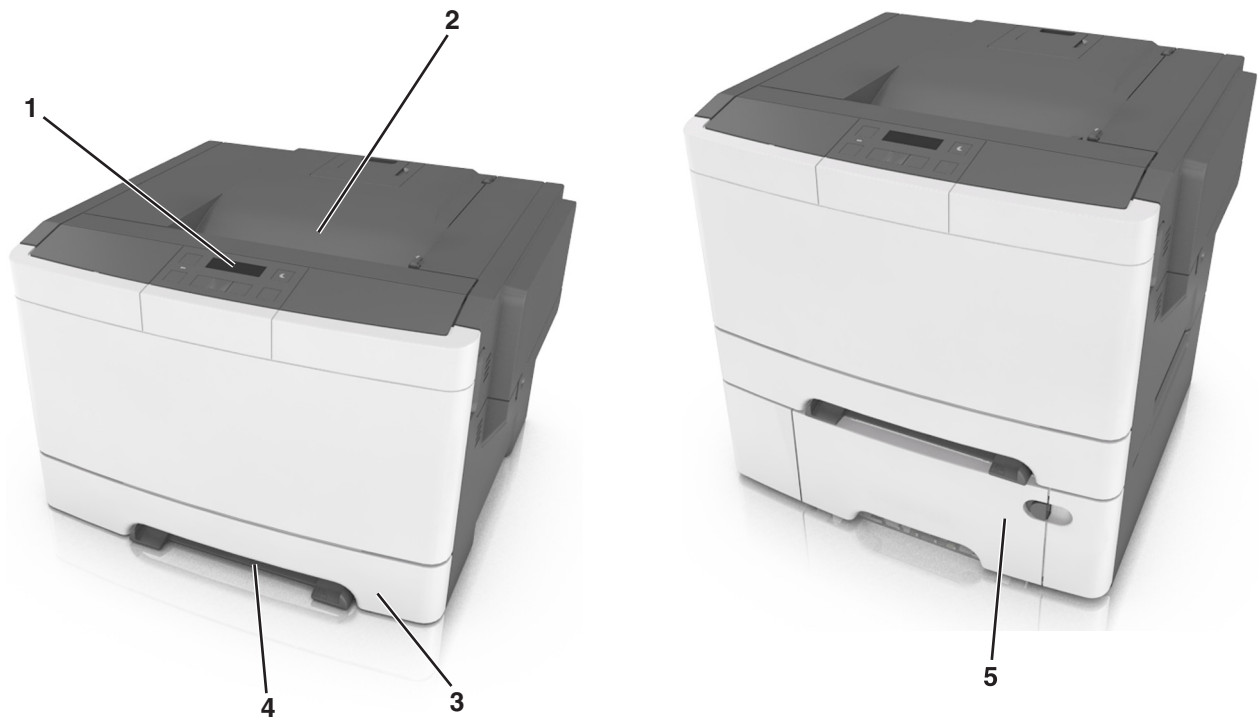

1	Printer control panel
2	Standard bin
3	250-sheet tray (Tray 1)
4	Manual feeder
5	Optional 650-sheet duo tray with integrated multipurpose feeder (Tray 2)

Using the printer control panel

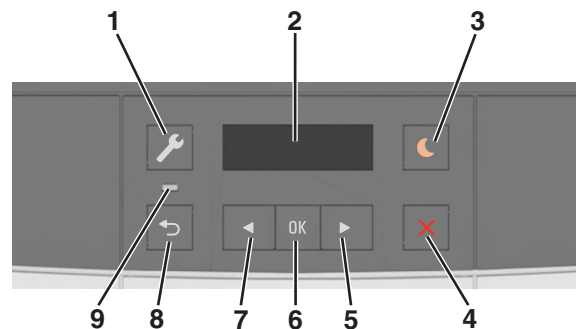

	Use the	To
1	Menu button	Open the menus. Notes: <ul style="list-style-type: none"> The menus are available only when the printer is in Ready state. Pressing the button while in a menu item lets you return to the top level menu screen.
2	Display	View printing options as well as status and error messages.
3	Sleep button	Enable Sleep mode or Hibernate mode. Notes: <ul style="list-style-type: none"> Pressing any hard button, sending a print job, or performing a power on reset with the main power switch wakes the printer from Sleep mode. Pressing the Sleep button or performing a power on reset with the main power switch wakes the printer from Hibernate mode.
4	Stop button	Stop printer activity.
5	Right arrow button	<ul style="list-style-type: none"> Scroll through menus or move between screens and menu options. Increase the numeric value of an option or setting being displayed.
6	Select button	<ul style="list-style-type: none"> Select menu options. Save settings.
7	Left arrow button	<ul style="list-style-type: none"> Scroll through menus or move between screens and menu options. Decrease the numeric value of an option or setting being displayed.
8	Back button	Return to the previous screen.
9	Indicator light	Determine the status of the printer.

Understanding the colors of the Sleep button and indicator lights

The colors of the Sleep button and indicator lights on the control panel signify a printer status or condition.

Indicator light	Printer status
Off	The printer is off or in Hibernate mode.
Blinking green	The printer is warming up, processing data, or printing.
Solid green	The printer is on, but idle.
Blinking red	The printer requires user intervention.

Sleep button light	Printer status
Off	The printer is off, idle, or in Ready state.
Solid amber	The printer is in Sleep mode.
Blinking amber	The printer is entering or waking from Hibernate mode.
Blinking amber for 0.1 second, then goes completely off for 1.9 seconds in a slow, pulsing pattern	The printer is in Hibernate mode.

Using the Embedded Web Server

Note: This feature is available only in network printers or printers connected to print servers.

If the printer is installed on a network, then you can use the Embedded Web Server to do the following:

- View the virtual display of the printer control panel.
- Check the status of the printer supplies.
- Configure supply notifications.
- Configure printer settings.
- Configure network settings.
- View reports.

To access the Embedded Web Server for your printer:

1 Obtain the printer IP address:

- From the TCP/IP section in the Network/Ports menu
- By printing a network setup page or menu settings page, and then finding the TCP/IP section

Notes:

- An IP address appears as four sets of numbers separated by periods, such as 123.123.123.123.
- If you are using a proxy server, then temporarily disable it to load the Web page correctly.

2 Open a Web browser, and then type the printer IP address in the address field.

3 Press **Enter**.

The Embedded Web Server page appears.

Additional printer setup

Installing internal options

 **CAUTION—SHOCK HAZARD:** If you are accessing the controller board or installing optional hardware or memory devices sometime after setting up the printer, then turn the printer off, and unplug the power cord from the electrical outlet before continuing. If you have any other devices attached to the printer, then turn them off as well, and unplug any cables going into the printer.

You can customize your printer connectivity and memory capacity by adding optional cards.

Available internal option

Memory card

DDR3 DIMM

Installing a memory card

 **CAUTION—SHOCK HAZARD:** If you are accessing the controller board or installing optional hardware or memory devices sometime after setting up the printer, then turn the printer off, and unplug the power cord from the electrical outlet before continuing. If you have any other devices attached to the printer, then turn them off as well, and unplug any cables going into the printer.

Warning—Potential Damage: Controller board electronic components are easily damaged by static electricity. Touch a metal surface on the printer before touching any controller board electronic components or connectors.

An optional memory card can be purchased separately and attached to the controller board.

1 Access the controller board at the back of the printer.

Note: This task requires a flat-head screwdriver.

2 Turn the screws counterclockwise to remove them.

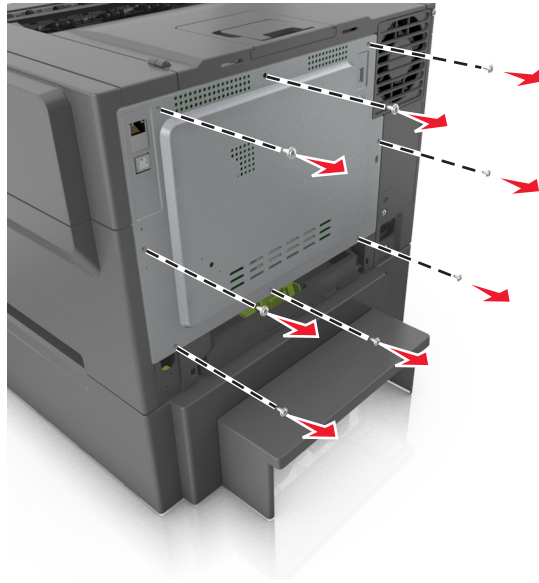

3 Slightly open the controller board access cover, and then shift to the right to remove it.

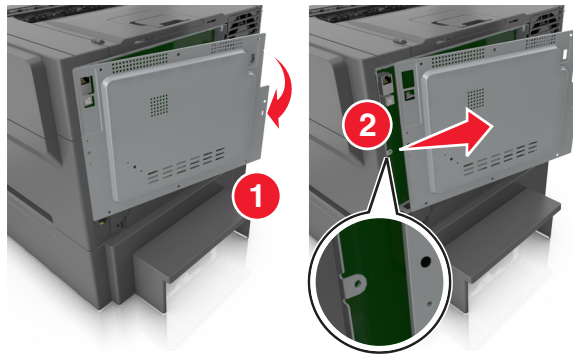

- 4 Locate the memory card connector on the controller board.

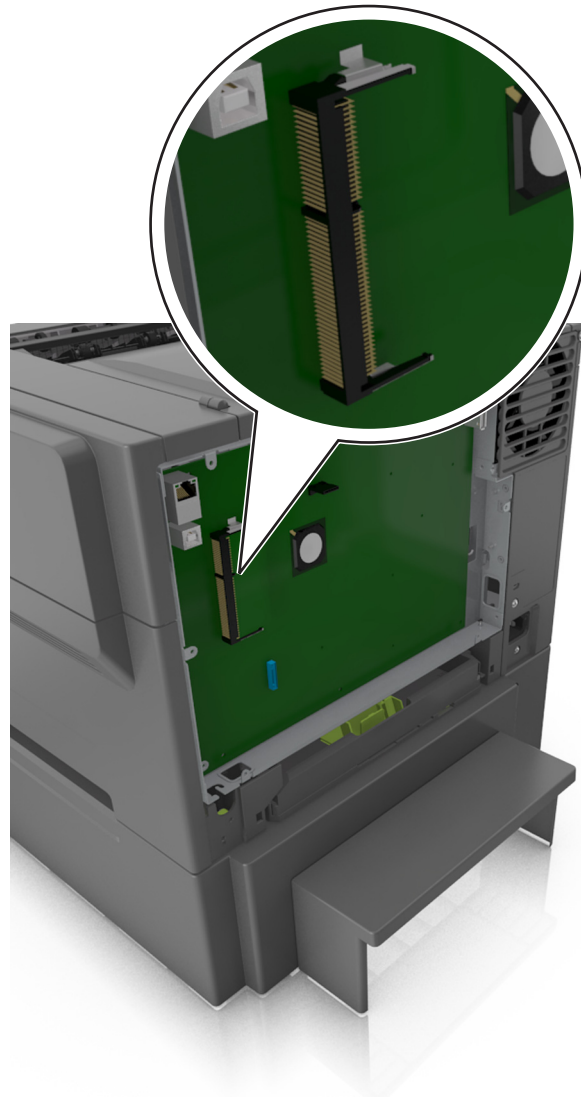

Warning—Potential Damage: Controller board electronic components are easily damaged by static electricity. Touch a metal surface on the printer before touching any controller board electronic components or connectors.

- 5 Unpack the memory card.

Warning—Potential Damage: Do not touch the connection points along the edge of the card. Doing so may damage the memory card.

6 Align the notch (1) on the memory card with the ridge (2) on the connector.

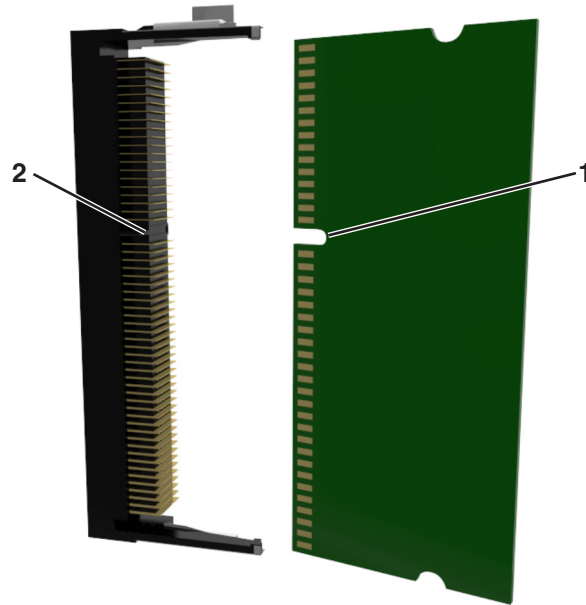

7 Push the memory card straight into the connector, and then push it into the controller board wall until it *clicks* into place.

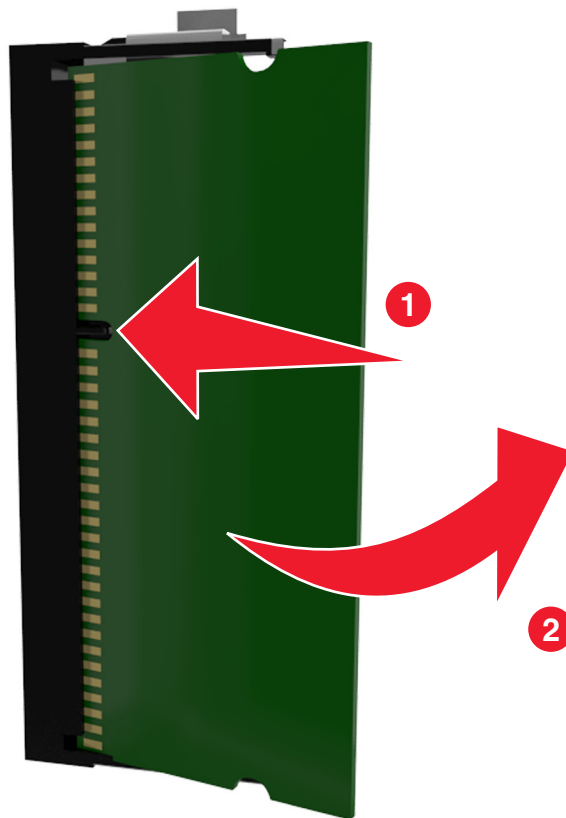

8 Reattach the cover.

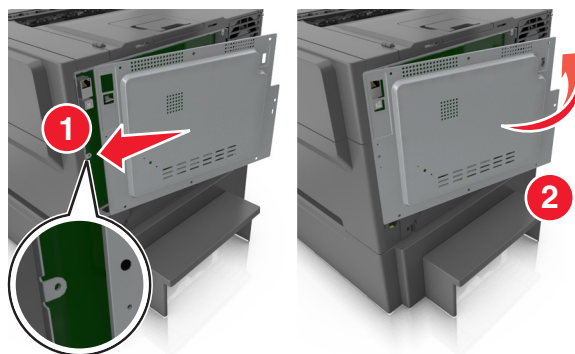

9 Turn the screws clockwise to lock the cover.

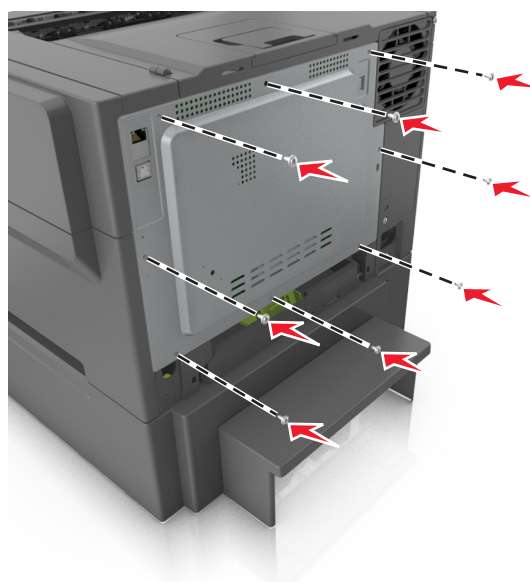

Installing hardware options

Order of installation

CAUTION—SHOCK HAZARD: If you are accessing the controller board or installing optional hardware or memory devices sometime after setting up the printer, then turn the printer off, and unplug the power cord from the electrical outlet before continuing. If you have any other devices attached to the printer, then turn them off as well, and unplug any cables going into the printer.

Install the printer and any optional tray in the following order:

- Optional 650-sheet duo tray with integrated multipurpose feeder
- Printer

Installing a 650-sheet duo tray

The printer supports an optional 650-sheet duo tray (Tray 2) with an integrated multipurpose feeder.

- ⚠ CAUTION—POTENTIAL INJURY:** The printer weight is greater than 18 kg (40 lb) and requires two or more trained personnel to lift it safely.
- ⚠ CAUTION—SHOCK HAZARD:** If you are accessing the controller board or installing optional hardware or memory devices sometime after setting up the printer, then turn the printer off, and unplug the power cord from the electrical outlet before continuing. If you have any other devices attached to the printer, then turn them off as well, and unplug any cables going into the printer.
- 1 Unpack the optional 650-sheet duo tray, and then remove all packing material and the dust cover.

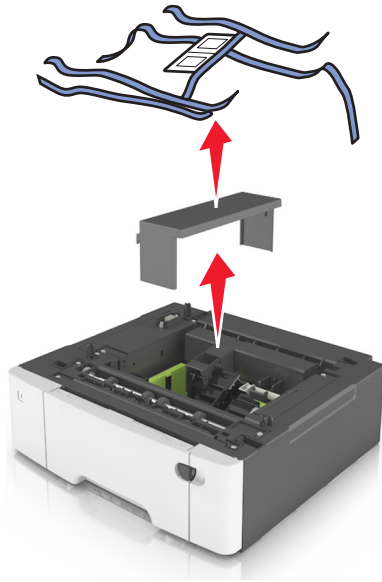

- 2 Place the tray in the location chosen for the printer.
- 3 Align the printer with the 650-sheet duo tray, and then lower the printer into place.

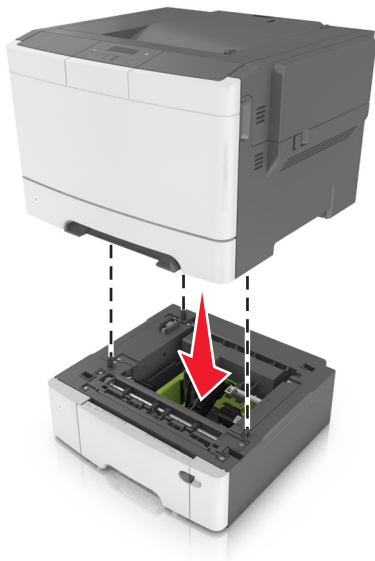

4 Install the dust cover.

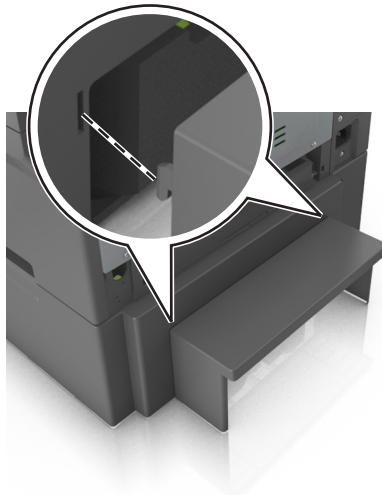

Note: When the printer software and any options are installed, it may be necessary to manually add the options in the printer driver to make them available for print jobs. For more information, see [“Adding available options in the print driver” on page 19](#).

Attaching cables

Connect the printer to the computer using a USB cable or to the network using an Ethernet cable.

Make sure to match the following:

- The USB symbol on the cable with the USB symbol on the printer
- The appropriate Ethernet cable to the Ethernet port

Warning—Potential Damage: Do not touch the USB cable, any wireless network adapter, or the printer in the area shown while actively printing. A loss of data or a malfunction can occur.



	Use the	To
1	USB printer port	Connect the printer to a computer.
2	Ethernet port	Connect the printer to a network.
3	USB port	Attach an optional wireless network adapter.
4	Printer power cord socket	Connect the printer to a properly grounded electrical outlet.

Setting up the printer software

Installing the printer software

- 1 Obtain a copy of the software installer package.
 - From the software CD that came with your printer.
 - Go to <http://support.lexmark.com>, and then select your printer and operating system.
- 2 Run the installer, and then follow the instructions on the computer screen.
- 3 For Macintosh users, add the printer.

Note: Obtain the printer IP address from the TCP/IP section in the Network/Ports menu.

Adding available options in the print driver

For Windows users

- 1 Open the printers folder.
- 2 Select the printer you want to update, and then do the following:
 - For Windows 7 or later, select **Printer properties**.
 - For earlier versions, select **Properties**.
- 3 Navigate to the Configuration tab, and then select **Update Now - Ask Printer**.
- 4 Apply the changes.

For Macintosh users

- 1 From System Preferences in the Apple menu, navigate to your printer, and then select **Options & Supplies**.
- 2 Navigate to the list of hardware options, and then add any installed options.
- 3 Apply the changes.

Networking

Notes:

- Purchase a MarkNet™ N8352 wireless network adapter before setting up the printer on a wireless network. For information on installing the wireless network adapter, see the instruction sheet that came with the adapter.
- A Service Set Identifier (SSID) is a name assigned to a wireless network. Wired Equivalent Privacy (WEP), Wi-Fi Protected Access (WPA), WPA2, and 802.1X - RADIUS are types of security used on a network.

Preparing to set up the printer on an Ethernet network

To configure your printer to connect to an Ethernet network, organize the following information before you begin:

Note: If your network automatically assigns IP addresses to computers and printers, continue on to installing the printer.

- A valid, unique IP address for the printer to use on the network
- The network gateway
- The network mask
- A nickname for the printer (optional)

Note: A printer nickname can make it easier for you to identify your printer on the network. You can choose to use the default printer nickname, or assign a name that is easier for you to remember.

You will need an Ethernet cable to connect the printer to the network and an available port where the printer can physically connect to the network. Use a new network cable when possible to avoid potential problems caused by a damaged cable.

Preparing to set up the printer on a wireless network

Notes:

- Make sure your wireless network adapter is installed in your printer and working properly. For more information, see the instruction sheet that came with the wireless network adapter.
- Make sure your access point (wireless router) is turned on and is working properly.

Make sure you have the following information before setting up the printer on a wireless network:

- **SSID**—The SSID is also referred to as the network name.
- **Wireless Mode (or Network Mode)**—The mode is either infrastructure or ad hoc.
- **Channel (for ad hoc networks)**—The channel defaults to automatic for infrastructure networks.

Some ad hoc networks will also require the automatic setting. Check with your system support person if you are not sure which channel to select.

- **Security Method**—There are four basic options for Security Method:
 - WEP key

If your network uses more than one WEP key, then enter up to four in the provided spaces. Select the key currently in use on the network by selecting the default WEP transmit key.
 - WPA or WPA2 preshared key or passphrase

WPA includes encryption as an additional layer of security. The choices are AES or TKIP. Encryption must be set for the same type on the router and on the printer, or the printer will not be able to communicate on the network.
 - 802.1X–RADIUS

If you are installing the printer on an 802.1X network, then you may need the following:

 - Authentication type
 - Inner authentication type
 - 802.1X user name and password
 - Certificates
 - No security

If your wireless network does not use any type of security, then you will not have any security information.

Note: We do not recommend using an unsecured wireless network.

Notes:

- If you do not know the SSID of the network that your computer is connected to, then launch the wireless utility of the computer network adapter, and then look for the network name. If you cannot find the SSID or the security information for your network, then see the documentation that came with the access point, or contact your system support person.
- To find the WPA/WPA2 preshared key or passphrase for the wireless network, see the documentation that came with the access point, see the Embedded Web Server associated with the access point, or consult your system support person.

Connecting the printer to a wireless network using Wi-Fi Protected Setup

Before connecting the printer to a wireless network, make sure that:

- The access point (wireless router) is Wi-Fi Protected Setup (WPS) certified or WPS-compatible. For more information, see the documentation that came with your access point.
- A wireless network adapter installed in your printer is attached and working properly. For more information, see the instruction sheet that came with the wireless network adapter.

Using the Push Button Configuration method

1 From the printer control panel, navigate to:

 > **Network/Ports** >  > **Network [x]** >  > **Network [x] Setup** >  > **Wireless** >  > **Wi-Fi Protected Setup** >  > **Start Push Button Method** > 

2 Follow the instructions on the printer display.

Using the Personal Identification Number (PIN) method

1 From the printer control panel, navigate to:

 > **Network/Ports** >  > **Network [x]** >  > **Network [x] Setup** >  > **Wireless** >  > **Wi-Fi Protected Setup** >  > **Start PIN Method** > 

2 Copy the eight-digit WPS PIN.

3 Open a Web browser, and then type the IP address of your access point in the address field.

Notes:

- The IP address appears as four sets of numbers separated by periods, such as 123.123.123.123.
- If you are using a proxy server, then temporarily disable it to load the Web page correctly.

4 Access the WPS settings. For more information, see the documentation that came with your access point.

5 Enter the eight-digit PIN, and then save the setting.

Connecting the printer to a wireless network using the printer software

Notes:

- Make sure that the printer is turned on.
- Make sure that a wireless network adapter is installed in your printer and working properly. For more information, see the instruction sheet that came with the adapter.

Using the Wireless Setup Utility (Windows only)

1 Check if the printer software is already installed.

2 Use the search command on the Start menu to locate Printer Home.

3 Open Printer Home, and then click **Settings > Wireless Setup Utility**.

4 Follow the steps on the computer screen.

Using the Wireless Setup Assistant (Macintosh only)

The Wireless Setup Assistant lets you:

- Configure the printer to join an existing wireless network.
- Add a printer to an existing ad hoc network.
- Change the wireless settings after installation.
- Install the printer on additional network computers.

Installing the Wireless Setup Assistant

1 Go to the Lexmark support Web site at <http://support.lexmark.com>.

2 Download the latest Wireless Setup Assistant application.

3 Double-click the downloaded software installer package.

4 Follow the instructions on the computer screen.

Launching the Wireless Setup Assistant

Notes:

- Make sure the printer is turned on.
- Make sure a wireless network adapter is installed in your printer and is working properly.

1 From the Finder, navigate to:

Applications > select your printer folder

2 Double-click **Wireless Setup Assistant**, and then follow the instructions on the computer screen.

Note: If you encounter problems while running the application, then click .

Connecting the printer to a wireless network using the Embedded Web Server

Before you begin, make sure that:

- Your printer is connected temporarily to an Ethernet network.
- A wireless network adapter is installed in your printer and working properly. For more information, see the instruction sheet that came with the wireless network adapter.

1 Open a Web browser, and then type the printer IP address in the address field.

Notes:

- View the printer IP address on the printer control panel. The IP address appears as four sets of numbers separated by periods, such as 123.123.123.123.
- If you are using a proxy server, then temporarily disable it to load the Web page correctly.

2 Click **Settings** > **Network/Ports** > **Wireless**.

3 Modify the settings to match the settings of your access point (wireless router).

Note: Make sure to enter the correct SSID, security method, preshared key or passphrase, network mode, and channel.

4 Click **Submit**.

5 Turn off the printer, and then disconnect the Ethernet cable. Then wait for at least five seconds, and then turn the printer back on.

6 To verify if your printer is connected to the network, print a network setup page. Then in the Network Card [x] section, see if the status is Connected.

Verifying printer setup

When all hardware and software options are installed and the printer is turned on, verify that the printer is set up correctly by printing the following:

- **Menu settings page**—Use this page to verify that all printer options are installed correctly. A list of installed options appears toward the bottom of the page. If an option you installed is not listed, then it is not installed correctly. Remove the option, and then install it again.
- **Network setup page**—If your printer is connected to a network or connected to a print server, print a network setup page to verify the network connection. This page also provides important information that aids network printing configuration.

Printing a menu settings page

Print a menu settings page to review the current menu settings and to verify if the printer options are installed correctly.

Note: If you have not changed any menu settings, then the menu settings page lists all the factory default settings. When you select and save other settings from the menus, they replace the factory default settings as *user default settings*. A user default setting remains in effect until you access the menu again, choose another value, and save it.

From the printer control panel, navigate to:

 > **Reports** >  > **Menu Settings Page** > 

Printing a network setup page

If the printer is connected to a network, then print a network setup page to verify the network connection. This page also provides important information that aids network printing configuration.

- 1 From the printer control panel, navigate to:

 > **Reports** >  > **Network Setup Page** > 

Note: If an optional print server is installed, then **Print Network [x] Setup Page** appears.

- 2 Check the first section of the network setup page and confirm that the status is Connected.

If the status is Not Connected, then the LAN drop may not be active, or the network cable may be malfunctioning. Consult your system support person for a solution, and then print another network setup page.

Loading paper and specialty media

The selection and handling of paper and specialty media can affect how reliably documents print. For more information, see [“Avoiding jams” on page 121](#) and [“Storing paper” on page 42](#).

Setting the paper size and type

- 1 From the printer control panel, navigate to:

 > **Paper Menu** >  > **Paper Size/Type** > 

- 2 Press the arrow buttons until **Tray [x] Size** or **Tray [x] Type** appears, and then press .

- 3 Select a setting, and then press .

Configuring Universal paper settings

The Universal paper size is a user-defined setting that lets you print on paper sizes that are not preset in the printer menus.

Notes:

- The smallest supported Universal size is 76 x 127 mm (3 x 5 inches) and is loaded only in the multipurpose feeder and manual feeder.
- The largest supported Universal size is 215.9 x 359.9 mm (8.5 x 14.17 inches) and is loaded only in the multipurpose feeder and manual feeder.

- 1 From the printer control panel, navigate to:

 > **Paper Menu** >  > **Universal Setup**

- 2 Press the arrow buttons until **Units of Measure**, **Portrait Height**, or **Portrait Width** appears, and then press .

- 3 Select a setting, and then press .

Loading the 250-sheet tray

The printer has one standard 250-sheet tray (Tray 1) with an integrated manual feeder. The 250-sheet tray and the optional 650-sheet duo tray with an integrated multipurpose feeder support the same paper sizes and types and are loaded in the same way.

- 1 Pull out the tray completely.

Note: Do not remove trays while a job is printing or while **Busy** appears on the display. Doing so may cause a jam.



2 Squeeze, and then slide the width guide tab to the correct position for the paper you are loading.

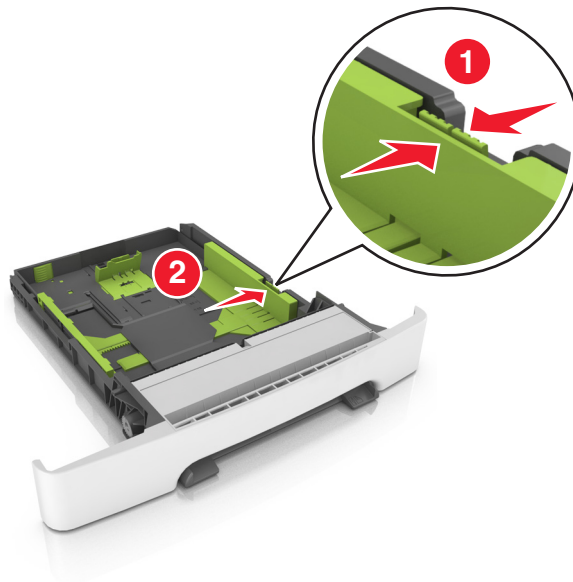

3 Squeeze, and then slide the length guide tab to the correct position for the paper you are loading.

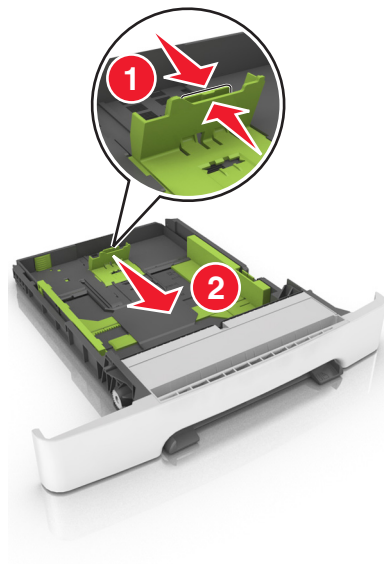

Notes:

- Use the paper size indicators on the bottom of the tray to help position the guides.
- If the paper is longer than letter-size paper, then push the length guide and the length guide tab to extend it.

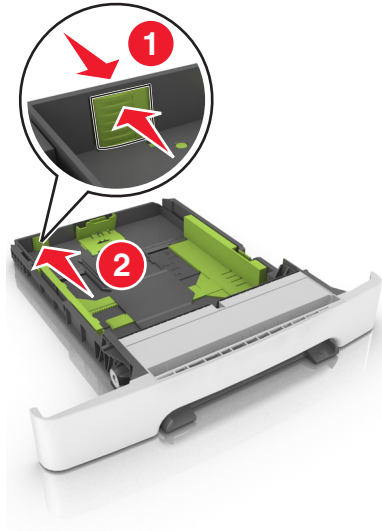

- 4** Flex the sheets back and forth to loosen them, and then fan them. Do not fold or crease the paper. Straighten the edges on a level surface.

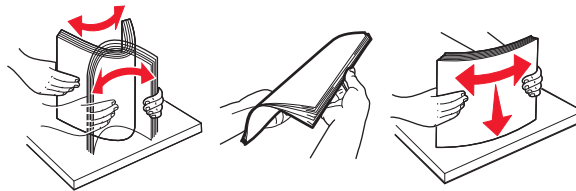

- 5 Load the paper stack with the recommended printable side faceup.

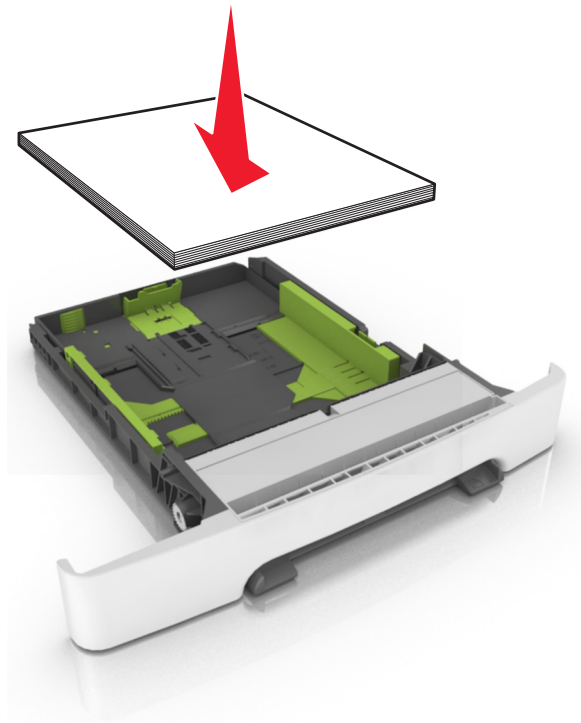

- 6 Insert the tray.



- 7 From the printer control panel, set the paper size and type in the Paper menu to match the paper loaded in the tray.

Note: Set the correct paper size and paper type to avoid paper jams and print quality problems.

Loading the 650-sheet duo tray

The 650-sheet duo tray (Tray 2) consists of a 550-sheet tray and an integrated 100-sheet multipurpose feeder. The tray is loaded in the same way as the 250-sheet tray and the optional 550-sheet tray, and supports the same paper types and sizes. The only differences are the look of the guide tabs and the location of the paper size indicators.

⚠ CAUTION—POTENTIAL INJURY: To reduce the risk of equipment instability, load each tray separately. Keep all other trays closed until needed.

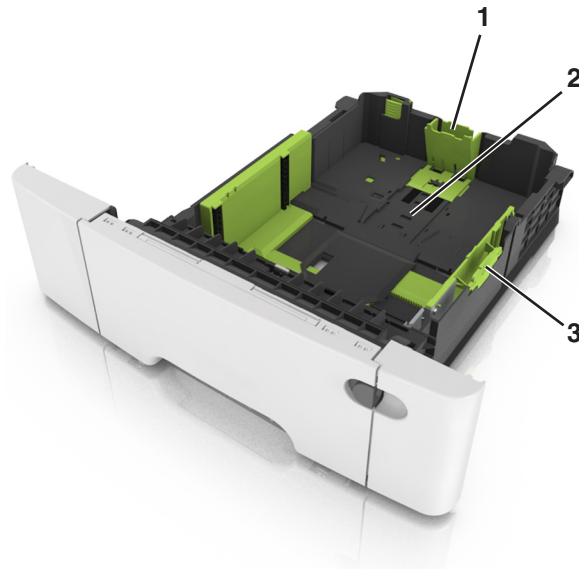

1	Length guide tab
2	Paper size indicator
3	Width guide tab

Loading the multipurpose feeder

1 Push the multipurpose feeder latch to the left.



2 Open the multipurpose feeder.



3 Pull the multipurpose feeder extender.

Note: Guide the extender gently so that the multipurpose feeder is fully extended and open.



4 Prepare the paper for loading.

- Flex the sheets of paper back and forth to loosen them, and then fan them. Do not fold or crease the paper. Straighten the edges on a level surface.

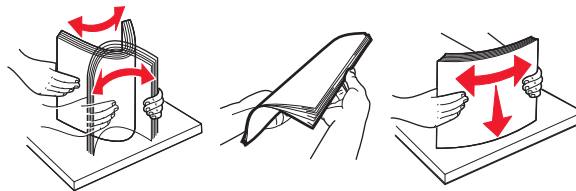

- Hold transparencies by the edges, and then fan them. Straighten the edges on a level surface.

Note: Avoid touching the printable side of transparencies. Be careful not to scratch them.

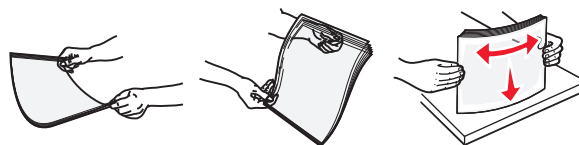

- Flex a stack of envelopes back and forth to loosen them, and then fan them. Straighten the edges on a level surface.

Warning—Potential Damage: Never use envelopes with stamps, clasps, snaps, windows, coated linings, or self-stick adhesives. These envelopes may severely damage the printer.

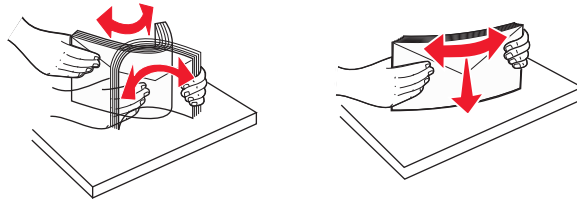

5 Locate the maximum paper fill indicator and tab.

Note: Make sure the paper or specialty media is below the maximum paper fill indicator located on the paper guides.

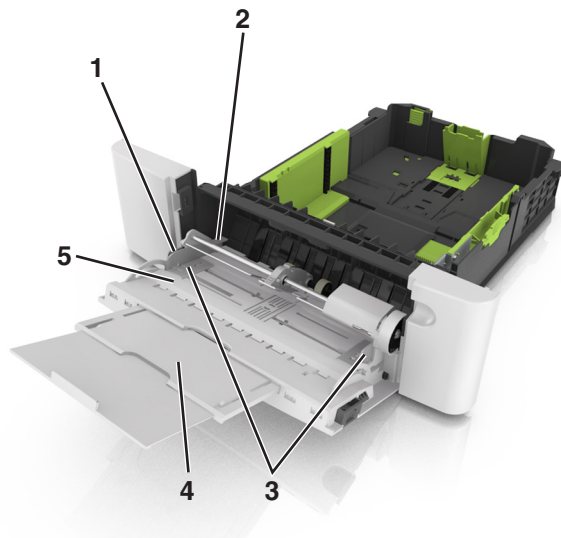

1	Width guide tab
2	Maximum paper fill indicator
3	Width guide
4	Feeder extender
5	Paper size indicator

6 Load the paper, and then adjust the width guide to lightly touch the edge of the paper stack.

- Load paper, card stock, and transparencies with the recommended printable side facedown and the top edge entering the printer first.

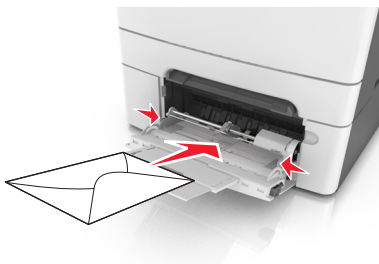

- Load envelopes with the flap side up and against the right side of the paper guide.

**Notes:**

- Do not load or close the multipurpose feeder while a job is printing.
- Load only one size and type of paper at a time.
- Paper should lie flat in the multipurpose feeder. Make sure the paper fits loosely in the multipurpose feeder and is not bent or wrinkled.

- 7 From the printer control panel, set the paper size and type in the Paper menu to match the paper loaded in the tray.

Loading the manual feeder

The standard 250-sheet tray has an integrated manual feeder that can be used to print on different types of paper one sheet at a time.

- 1 Load a sheet of paper into the manual feeder:

- Printable side facedown for one-sided printing
- Printable side faceup for two-sided (duplex) printing

Note: There are different ways for loading letterhead depending on the mode of printing.

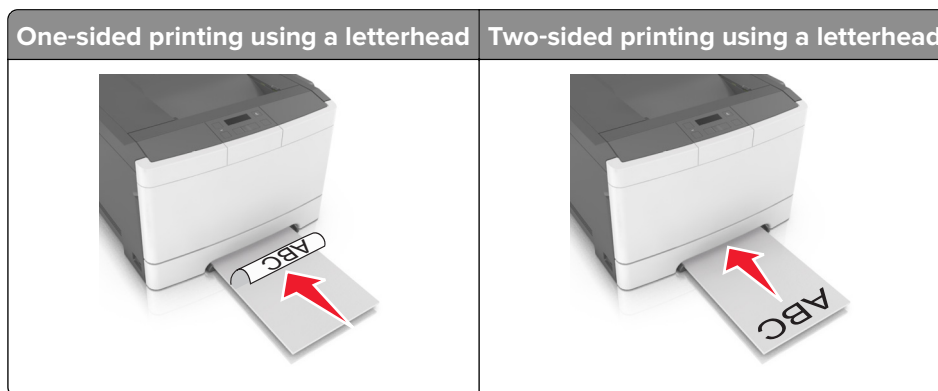

- Load envelope with the flap side up and against the right side of the paper guide.



- 2 Feed paper into the manual feeder only to the point where its leading edge can contact the paper guides.

Note: To achieve the best possible print quality, use only high-quality media designed for laser printers.

- 3 Adjust the paper guides to the width of the paper loaded.

Warning—Potential Damage: Do not force the paper into the feeder. Forcing the paper may cause jams.

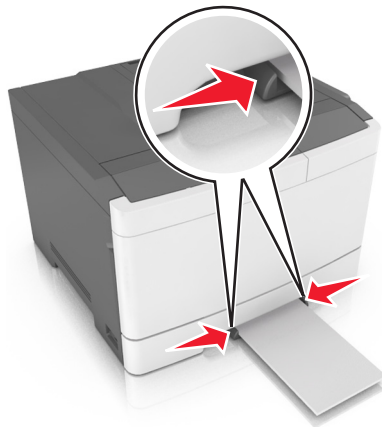

Linking and unlinking trays

Linking and unlinking trays

Note: This feature applies only in network printers.

- 1 Open a Web browser, and then type the printer IP address in the address field.

Notes:

- View the printer IP address in the TCP/IP section in the Network/Ports menu. The IP address appears as four sets of numbers separated by periods, such as 123.123.123.123.
- If you are using a proxy server, then temporarily disable it to load the Web page correctly.

- 2 Click **Settings > Paper Menu**.

- 3** Change the tray settings to specify the paper size and type for the tray.
 - To link trays, make sure the paper size and type for the tray match with that of the other tray.
 - To unlink trays, make sure the paper size or type for the tray *does not* match with that of the other tray.
- 4** Click **Submit**.

Warning—Potential Damage: Paper loaded in the tray should match the paper type name assigned in the printer. The temperature of the fuser varies according to the specified paper type. Printing issues may occur if settings are not properly configured.

Creating a custom name for a paper type

- 1** Open a Web browser, and then type the printer IP address in the address field.

Notes:

- View the printer IP address in the TCP/IP section in the Network/Ports menu. The IP address appears as four sets of numbers separated by periods, such as 123.123.123.123.
- If you are using a proxy server, then temporarily disable it to load the Web page correctly.

- 2** Click **Settings > Paper Menu > Custom Names**.
- 3** Select a custom name, and then type a new custom paper type name.
- 4** Click **Submit**.
- 5** Click **Custom Types**, and then verify if the new custom paper type name has replaced the custom name.

Assigning a custom paper type name

Assign a custom paper type name to a tray when linking or unlinking trays.

Using the Embedded Web Server

- 1** Open a Web browser, and then type the printer IP address in the address field.

Notes:

- View the printer IP address in the TCP/IP section in the Network/Ports menu. The IP address appears as four sets of numbers separated by periods, such as 123.123.123.123.
- If you are using a proxy server, then temporarily disable it to load the Web page correctly.

- 2** Click **Settings > Paper Menu > Custom Name**.
 - 3** Type a name for the paper type, and then click **Submit**.
 - 4** Select a custom type, and then verify that the correct paper type is associated with the custom name.
- Note:** Plain Paper is the factory default paper type for all user-defined custom names.

Configuring a custom name

- 1** Open a Web browser, and then type the printer IP address in the address field.

Notes:

- View the printer IP address in the TCP/IP section in the Network/Ports menu. The IP address appears as four sets of numbers separated by periods, such as 123.123.123.123.
- If you are using a proxy server, then temporarily disable it to load the Web page correctly.

2 Click **Settings > Paper Menu > Custom Types**.



3 Select the custom name you want to configure, then select a paper or specialty media type, and then click **Submit**.

Paper and specialty media guide



Using specialty media

Tips on using letterhead

- Use letterhead designed specifically for laser printers.
- Print a test page on the letterhead being considered for use before buying large quantities.
- Before loading letterhead, flex, fan, and straighten the stacks to prevent sheets from sticking together.
- Page orientation is important when printing on letterhead.

Source	Printing	Printable side	Paper orientation
Trays 	One-sided	Faceup	Load the sheet with the top edge entering the printer first.
Trays 	Two-sided	Facedown	Load the sheet with the bottom edge entering the printer first.

Note: Check with the manufacturer or vendor to determine whether or not the preprinted letterhead is acceptable for laser printers.

Source	Printing	Printable side	Paper orientation
<p>Manual feeder</p> 	One-sided	Facedown	Load the sheet with the top edge entering the printer first.
<p>Manual feeder</p> 	Two-sided	Faceup	Load the sheet with the bottom edge entering the printer first.
<p>Multipurpose feeder</p> 	One-sided	Facedown	Load the sheet with the top edge entering the printer first.
<p>Note: Check with the manufacturer or vendor to determine whether or not the preprinted letterhead is acceptable for laser printers.</p>			

Source	Printing	Printable side	Paper orientation
Multipurpose feeder 	Two-sided	Faceup	Load the sheet with the bottom edge entering the printer first.
Note: Check with the manufacturer or vendor to determine whether or not the preprinted letterhead is acceptable for laser printers.			

Tips on using transparencies

Print a test page on the transparencies being considered for use before buying large quantities.

- From the printer control panel, set the paper size, type, texture, and weight in the Paper menu to match the transparencies loaded in the tray.
- Print a test page on the transparencies being considered for use before buying large quantities.
- Feed transparencies from the 250-sheet tray, manual feeder, or multipurpose feeder.
- Use transparencies designed specifically for laser printers.
- Avoid getting fingerprints on the transparencies to prevent print quality problems.
- Before loading transparencies, flex, fan, and straighten the stacks to prevent sheets from sticking together.

Tips on using envelopes

- From the printer control panel, set the paper size, type, texture, and weight in the Paper menu to match the envelopes loaded in the tray.
- Print samples on the envelopes being considered for use before buying large quantities.
- Use envelopes designed specifically for laser printers.
- For best performance, use envelopes made from 90-g/m² (24-lb) paper or 25% cotton.
- Use only new envelopes from undamaged packages.
- To optimize performance and minimize jams, do not use envelopes that:
 - Have excessive curl or twist.
 - Are stuck together or damaged in any way.
 - Have windows, holes, perforations, cutouts, or embossing.
 - Have metal clasps, string ties, or folding bars.
 - Have an interlocking design.
 - Have postage stamps attached.
 - Have any exposed adhesive when the flap is in the sealed or closed position.

- Have bent corners.
- Have rough, cockle, or laid finishes.
- Adjust the width guides to fit the width of the envelopes.
- Before loading the envelopes on the tray, flex and fan the envelopes to loosen them. Straighten the edges on a level surface.

Note: A combination of high humidity (over 60%) and high printing temperature may wrinkle or seal envelopes.

Tips on using labels

- From the printer control panel, set the paper size, type, texture, and weight in the Paper menu to match the labels loaded in the tray.
- Print samples on labels being considered for use before buying large quantities.
- For more information on label printing, characteristics, and design, see the *Card Stock & Label Guide* at <http://support.lexmark.com>.
- Use labels designed specifically for laser printers.
- Do not use labels with slick backing material.
- Use full label sheets. Partial sheets may cause labels to peel off during printing, resulting in a jam. Partial sheets also contaminate the printer and the cartridge with adhesive, and could void the printer and toner cartridge warranties.
- Do not use labels with exposed adhesive.
- Before loading labels on the tray, flex and fan labels to loosen them. Straighten the edges on a level surface.

Tips on using card stock

Card stock is heavy, single-ply specialty media. Many of its variable characteristics, such as moisture content, thickness, and texture, can significantly affect print quality.

- From the printer control panel, set the paper size, type, texture, and weight in the Paper menu to match the card stock loaded in the tray.
- Print samples on the card stock being considered for use before buying large quantities.
- Specify the paper texture and weight from the tray settings to match the paper loaded in the tray.
- Preprinting, perforation, and creasing may significantly affect the print quality and cause jams or other paper feed problems.
- Before loading the card stock on the tray, flex and fan the card stock to loosen them. Straighten the edges on a level surface.

Paper guidelines

Selecting the correct paper or specialty media reduces printing problems. For the best print quality, try a sample of the paper or specialty media before buying large quantities.

Paper characteristics

The following paper characteristics affect print quality and reliability. Consider these characteristics when evaluating new paper stock.

Weight

The printer trays can automatically feed paper weights up to 176-g/m² (47-lb) bond grain long paper. The multipurpose feeder can automatically feed paper weights up to 176-g/m² (47-lb) bond grain long paper. Paper lighter than 60 g/m² (16 lb) might not be stiff enough to feed properly, causing jams. For best performance, use 75-g/m² (20-lb) bond grain long paper. For paper smaller than 182 x 257 mm (7.2 x 10.1 inches), we recommend 90 g/m² (24 lb) or heavier paper.

Note: Duplex printing is supported from 60–105-g/m² (16–28-lb) bond grain long paper.

Curl

Curl is the tendency for paper to curl at its edges. Excessive curl can cause paper feeding problems. Curl can occur after the paper passes through the printer, where it is exposed to high temperatures. Storing paper unwrapped in hot, humid, cold, or dry conditions, even in the trays, can contribute to paper curling prior to printing and can cause feeding problems.

Smoothness

Paper smoothness directly affects print quality. If paper is too rough, then toner cannot fuse to it properly. If paper is too smooth, then it can cause paper feeding or print quality issues. Always use paper between 100 and 300 Sheffield points; smoothness between 150 and 250 Sheffield points produces the best print quality.

Moisture content

The amount of moisture in paper affects both print quality and the ability of the printer to feed the paper correctly. Leave paper in its original wrapper until it is time to use it. This limits the exposure of paper to moisture changes that can degrade its performance.

Store paper in its original wrapper in the same environment as the printer for 24 to 48 hours before printing. Extend the time to several days if the storage or transportation environment is very different from the printer environment. Thick paper may also require a longer conditioning period.

Grain direction

Grain refers to the alignment of the paper fibers in a sheet of paper. Grain is either *grain long*, running the length of the paper, or *grain short*, running the width of the paper.

For 60–90-g/m² (16–24-lb) bond paper, grain long paper is recommended.

Fiber content

Most high-quality xerographic paper is made from 100% chemically treated pulped wood. This content provides the paper with a high degree of stability resulting in fewer paper feeding problems and better print quality. Paper containing fibers such as cotton can negatively affect paper handling.

Selecting paper

Using the appropriate paper prevents jams and helps ensure trouble-free printing.

To help avoid paper jams and poor print quality:

- *Always* use new, undamaged paper.
- Before loading paper, know the recommended printable side of the paper. This information is usually indicated on the paper package.

- *Do not* use paper that has been cut or trimmed by hand.
- *Do not* mix paper sizes, types, or weights in the same tray; mixing results in jams.
- *Do not* use coated papers unless they are specifically designed for electrophotographic printing.

Selecting preprinted forms and letterhead

Use these guidelines when selecting preprinted forms and letterhead:

- Use grain long for 60–90-g/m² (16–24-lb) paper.
- Use only forms and letterhead printed using an offset lithographic or engraved printing process.
- Avoid paper with rough or heavily textured surfaces.

Use inks that are not affected by the resin in toner. Inks that are oxidation-set or oil-based generally meet these requirements; latex inks might not.

When in doubt, contact your paper supplier.

Using recycled paper and other office papers

As an environmentally conscientious company, Lexmark supports the use of recycled paper produced specifically for use in laser (electrophotographic) printers.

While no blanket statement can be made that all recycled paper will feed well, Lexmark consistently tests papers that represent recycled cut size copier papers available on the global market. This scientific testing is conducted with rigor and discipline. Many factors are taken into consideration both separately and as a whole, including the following:

- Amount of post-consumer waste (Lexmark tests up to 100% post-consumer waste content.)
- Temperature and humidity conditions (Testing chambers simulate climates from all over the world.)
- Moisture content (Business papers should have low moisture: 4–5%.)
- Bending resistance and proper stiffness means optimum feeding through the printer.
- Thickness (impacts how much can be loaded into a tray)
- Surface roughness (measured in Sheffield units, impacts print clarity and how well toner fuses to the paper)
- Surface friction (determines how easily sheets can be separated)
- Grain and formation (impacts curling, which also influences the mechanics of how the paper behaves as it moves through the printer)
- Brightness and texture (look and feel)

Recycled papers are better than ever; however, the amount of recycled content in a paper affects the degree of control over foreign matter. And while recycled papers are one good path to printing in an environmentally responsible manner, they are not perfect. The energy required to de-ink and deal with additives such as colorants and “glue” often generates more carbon emissions than does normal paper production. However, using recycled papers enables better resource management overall.

Lexmark concerns itself with the responsible use of paper in general based on life cycle assessments of its products. To gain a better understanding of the impact of printers on the environment, the company commissioned a number of life cycle assessments and found that paper was identified as the primary contributor (up to 80%) of carbon emissions caused throughout the entire life of a device (from design to end-of-life). This is due to the energy-intensive manufacturing processes required to make paper.

Thus, Lexmark seeks to educate customers and partners on minimizing the impact of paper. Using recycled paper is one way. Eliminating excessive and unnecessary paper consumption is another. Lexmark is well-

equipped to help customers minimize printing and copying waste. In addition, the company encourages purchasing paper from suppliers who demonstrate their commitment to sustainable forestry practices.

Lexmark does not endorse specific suppliers, although a converter's product list for special applications is maintained. However, the following paper choice guidelines will help alleviate the environmental impact of printing:

- 1 Minimize paper consumption.
- 2 Be selective about the origin of wood fiber. Buy from suppliers who carry certifications such as the Forestry Stewardship Council (FSC) or The Program for the Endorsement of Forest Certification (PEFC). These certifications guarantee that the paper manufacturer uses wood pulp from forestry operators that employ environmentally and socially responsible forest management and restoration practices.
- 3 Choose the most appropriate paper for printing needs: normal 75 or 80 g/m² certified paper, lower weight paper, or recycled paper.

Unacceptable paper examples

Test results indicate that the following paper types are at risk for use with laser printers:

- Chemically treated papers used to make copies without carbon paper, also known as *carbonless papers*
- Preprinted papers with chemicals that may contaminate the printer
- Preprinted papers that can be affected by the temperature in the printer fuser
- Preprinted papers that require a registration (the precise location on the page) greater than ± 2.3 mm (± 0.9 in.), such as optical character recognition (OCR) forms. In some cases, registration can be adjusted with a software application to successfully print on these forms.)
- Coated papers (erasable bond), synthetic papers, thermal papers
- Rough-edged, rough or heavily textured surface papers or curled papers
- Recycled papers that fail EN12281:2002 (European testing)
- Paper weighing less than 60 g/m² (16 lb)
- Multiple part forms or documents

For more information about Lexmark, visit www.lexmark.com. General sustainability-related information can be found at the **Environmental Sustainability** link.

Storing paper

Use these paper storage guidelines to help avoid jams and uneven print quality:

- For best results, store paper where the temperature is 21°C (70°F) and the relative humidity is 40 percent. Most label manufacturers recommend printing in a temperature range of 18–24°C (65–75°F) with relative humidity between 40 and 60 percent.
- Store paper in cartons, on a pallet or shelf, rather than on the floor.
- Store individual packages on a flat surface.
- Do not store anything on top of individual paper packages.
- Take paper out of the carton or wrapper only when you are ready to load it in the printer. The carton and wrapper help keep the paper clean, dry, and flat.

Supported paper sizes, types, and weights

Supported paper sizes

Note: Your printer model may have a 650-sheet duo tray, which consists of a 550-sheet tray and an integrated 100-sheet multipurpose feeder. The 550-sheet tray of the 650-sheet duo tray supports the same paper sizes as the optional 550-sheet tray. The integrated multipurpose feeder supports different paper sizes, types, and weights.

Paper size and dimension	Standard 250-sheet tray	Optional 650-sheet duo tray		Manual feeder	Duplex mode
		550-sheet tray	Multipurpose feeder		
A4 210 x 297 mm (8.3 x 11.7 in.)	√ ¹	√ ¹	√ ¹	√	√
A5 148 x 210 mm (5.83 x 8.3 in.)	√ ¹	√ ²	√ ¹	√	X
A6 105 x 148 mm (4.1 x 5.8 in.)	X	X	√ ¹	√	X
JIS B5 182 x 257 mm (7.2 x 10.1 in.)	√ ¹	√ ¹	√ ¹	√	X
Letter 216 x 279 mm (8.5 x 11 in.)	√ ¹	√ ¹	√ ¹	√	√
Legal 216 x 356 mm (8.5 x 14 in.)	√ ¹	√ ¹	√ ¹	√	√
Executive 184 x 267 mm (7.3 x 10.5 in.)	√ ¹	√ ¹	√ ¹	√	X
Oficio (Mexico) 216 x 340 mm (8.5 x 13.4 in.)	√ ¹	√ ¹	√ ¹	√	√
Folio 216 x 330 mm (8.5 x 13 in.)	√ ¹	√ ¹	√ ¹	√	√

¹ Source supports paper size without *size sensing*.

² Universal is only supported in the standard 250- and optional 550-sheet tray if the paper size is from 148 x 215.9 mm (5.83 x 8.5 inches) to 215.9 x 355.6 mm (8.5 x 14 inches).

³ Universal is only supported in the multipurpose feeder and manual feeder if the paper size is from 76.2 x 127 mm (3 x 5 inches) to 215.9 x 359.9 mm (8.5 x 14.17 inches).

⁴ Universal is only supported in duplex mode if the width is between 210 mm (8.27 inches) and 215.9 mm (8.5 inches) and length is between 279.4 mm (11 inches) and 355.6 mm (14 inches).

Paper size and dimension	Standard 250-sheet tray	Optional 650-sheet duo tray		Manual feeder	Duplex mode
		550-sheet tray	Multipurpose feeder		
Statement 140 x 216 mm (5.5 x 8.5 in.)	X	X	√ ¹	√	X
Universal 76 x 127 mm (3 x 5 in.) to 216 x 356 mm (8.5 x 14 in.)	X	X	√ ^{1,3}	√ ^{1,3}	X
Universal 148 x 210 mm (5.8 x 8.3 in.) to 216 x 356 mm (8.5 x 14 in.)	√ ^{1,2}	√ ^{1,2}	√	√	√ ⁴
7 3/4 Envelope (Monarch) 98 x 191 mm (3.9 x 7.5 in.)	X	X	√ ¹	√	X
9 Envelope 98 x 225 mm (3.9 x 8.9 in.)	X	X	√ ¹	√	X
10 Envelope 105 x 241 mm (4.1 x 9.5 in.)	X	X	√ ¹	√	X
DL Envelope 110 x 220 mm (4.3 x 8.7 in.)	X	X	√ ¹	√	X
C5 Envelope 162 x 229 mm (6.4 x 9 in.)	X	X	√ ¹	√	X
B5 Envelope 176 x 250 mm (6.9 x 9.8 in.)	X	X	√ ¹	√	X
Other Envelope 98 x 162 mm (3.9 x 6.3 in.) up to 176 x 250 mm (6.9 x 9.8 in.)	X	X	√ ¹	√	X

¹ Source supports paper size without *size sensing*.

² Universal is only supported in the standard 250- and optional 550-sheet tray if the paper size is from 148 x 215.9 mm (5.83 x 8.5 inches) to 215.9 x 355.6 mm (8.5 x 14 inches).

³ Universal is only supported in the multipurpose feeder and manual feeder if the paper size is from 76.2 x 127 mm (3 x 5 inches) to 215.9 x 359.9 mm (8.5 x 14.17 inches).

⁴ Universal is only supported in duplex mode if the width is between 210 mm (8.27 inches) and 215.9 mm (8.5 inches) and length is between 279.4 mm (11 inches) and 355.6 mm (14 inches).

Supported paper types and weights

Notes:

- Your printer model may have a 650-sheet duo tray, which consists of a 550-sheet tray and an integrated 100-sheet multipurpose feeder. The 550-sheet tray of the 650-sheet duo tray supports the same paper as the 550-sheet tray. The integrated multipurpose feeder supports different paper sizes, types, and weights.
- Labels, transparencies, envelopes, and card stock always print at reduced speed.

Paper type	250-sheet tray	650-sheet duo tray		Manual feeder	Duplex mode
		550-sheet tray	Multipurpose feeder		
Plain Paper	✓	✓	✓	✓	✓
Card Stock	✓	✓	✓	✓	X
Transparency	✓	X	✓	✓	X
Recycled	✓	✓	✓	✓	✓
Glossy	✓	✓	✓	✓	✓
Labels	✓	✓	✓	✓	X
Bond	✓	✓	✓	✓	✓
Envelope	X	X	✓	✓	X
Letterhead	✓	✓	✓	✓	✓
Preprinted	✓	✓	✓	✓	✓
Colored Paper	✓	✓	✓	✓	✓
Light Paper	✓	✓	✓	✓	✓
Heavy Paper	✓	✓	✓	✓	✓
Rough/Cotton	✓	✓	✓	✓	X
Custom Type [x]	✓	✓	✓	✓	✓

Printing

Printing a document

Printing from a computer

Note: For labels, card stock, and envelopes, set the paper size and type in the printer before sending the print job.

- 1 From the document that you are trying to print, open the Print dialog.
- 2 If necessary, adjust the settings.
- 3 Send the print job.

Printing in black and white

From the printer control panel, navigate to:

 > **Settings** >  > **Print Settings** >  > **Quality menu** >  > **Print Mode** >  > **Black Only** > 

Adjusting toner darkness

Using the Embedded Web Server

- 1 Open a Web browser, and then type the printer IP address in the address field.

Notes:

- View the printer IP address in the TCP/IP section in the Network/Ports menu. The IP address appears as four sets of numbers separated by periods, such as 123.123.123.123.
- If you are using a proxy server, then temporarily disable it to load the Web page correctly.

- 2 Click **Settings > Print Settings > Quality Menu > Toner Darkness**.
- 3 Adjust the toner darkness, and then click **Submit**.

Using the printer control panel

- 1 From the printer control panel, navigate to:

 > **Settings** >  > **Print Settings** >  > **Quality Menu** >  > **Toner Darkness**

- 2 Set the toner darkness, and then press .

Using Max Speed and Max Yield

Max Speed and Max Yield let you choose between a faster print speed and a higher toner yield.

- **Max Speed**—This lets you print in either black or color depending on what is set in the printer driver. The printer prints in color unless Black Only is selected in the printer driver.
- **Max Yield**—This lets you switch from black to color based on the color content found on each page. This is the factory default setting. Frequent color mode switching can result to slower printing if the content of pages is mixed.

Using the Embedded Web Server

- 1 Open a Web browser, and then type the printer IP address in the address field.

Notes:

- View the printer IP address in the TCP/IP section in the Network/Ports menu. The IP address appears as four sets of numbers separated by periods, such as 123.123.123.123.
- If you are using a proxy server, then temporarily disable it to load the Web page correctly.

- 2 Click **Settings > Print Settings > Setup Menu**.
- 3 From the Printer Usage list, select **Max Speed** or **Max Yield**.
- 4 Click **Submit**.

Using the printer control panel

- 1 From the printer control panel, navigate to:

 > **Settings** >  > **Print Settings** >  > **Setup Menu** > 

- 2 From the Printer Usage list, select **Max Speed** or **Max Yield**.
- 3 Press .

Printing information pages

For more information on printing information pages, see [“Printing a menu settings page” on page 24](#) and [“Printing a network setup page” on page 24](#).

Printing a font sample list

From the printer control panel, navigate to either of the following:

 > **Reports** >  > **Print Fonts** >  > **PCL Fonts** > 

or

 > **Reports** >  > **Print Fonts** >  > **PostScript Fonts** > 

Printing from a mobile device

Note: Make sure that the printer and mobile device share the same wireless network. For information on configuring the wireless settings of your mobile device, see the documentation that came with the device.

Printing from a mobile device using Mopria Print Service

Mopria® Print Service is a mobile printing solution for mobile devices running on Android version 4.4 or later. It allows you to print directly to any Mopria-certified printer.

Note: Before printing, make sure that the Mopria Print Service is enabled.

- 1 From the home screen of your mobile device, launch a compatible application.
- 2 Tap **Print**, and then select the printer.
- 3 Send the print job.

Printing from a mobile device using Google Cloud Print

Google Cloud Print™ is a mobile printing service that allows enabled applications on mobile devices to print to any Google Cloud Print-ready printer.

- 1 From the home screen of your mobile device, launch an enabled application.
- 2 Tap **Print**, and then select the printer.
- 3 Send the print job.

Printing from a mobile device using AirPrint

AirPrint is a mobile printing solution that allows you to print directly from Apple devices to an AirPrint-certified printer.

Notes:

- This application is supported only in some Apple devices.
 - This application is supported only in some printer models.
- 1 From the home screen of your mobile device, launch a compatible application.
 - 2 Select an item to print, and then tap the share icon.
 - 3 Tap **Print**, and then select a printer.
 - 4 Print the document.

Printing from a mobile device using Lexmark Mobile Print

Lexmark™ Mobile Print allows you to send documents and images directly to a supported Lexmark printer.

- 1 Open the document, and then send or share the document to Lexmark Mobile Print.

Note: Some third-party applications may not support the send or share feature. For more information, see the documentation that came with the application.

- 2 Select a printer.
- 3 Print the document.

Canceling a print job

Canceling a print job from the printer control panel

From the printer control panel, press  > .

Canceling a print job from the computer

- 1 Depending on the operating system, do either of the following:
 - Open the printers folder, and then select your printer.
 - From the System Preferences in the Apple menu, navigate to your printer.
- 2 Select the print job to cancel.

Understanding the printer menus

Menus list

Supplies

- Cyan Cartridge
- Magenta Cartridge
- Yellow Cartridge
- Black Cartridge
- Waste Toner Bottle
- Black or Color Imaging Kit
- Maintenance Kit

Paper Menu

- Default Source
- Paper Size/Type
- Configure MP
- Substitute Size
- Paper Texture
- Paper Weight
- Paper Loading
- Custom Types
- Universal Setup

Reports

- Menu Settings Page
- Device Statistics
- Network Setup Page
- Network [x] Setup Page
- Profiles List
- Print Fonts
- Print Directory
- Print Demo
- Asset Report

Settings

- General Settings
- Print Settings

Security

- Set Date and Time

Network/Ports²

- Active NIC
- Standard Network¹
- Standard USB

¹ Depending on the printer setup, this menu item appears as Standard Network or Network [x].

² The menu items in this menu appear only in network printers or printers connected to print servers.

Supplies menu

Use	To
Cyan Cartridge	View the status of the toner cartridges, which can be any of the following: Early Warning Low Invalid Near End of Life Replace Missing Defective OK Unsupported
Magenta Cartridge	
Yellow Cartridge	
Black Cartridge	
Waste Toner Bottle Near Full Replace Missing OK	View the status of the waste toner bottle.

Use	To
Imaging Kit OK Replace Black Imaging Kit Replace Color Imaging Kit	View the status of the imaging kit.
Maintenance Kit OK Replace	View the status of the maintenance kit.

Paper menu

Default Source menu

Use	To
Default Source Tray [x] MP Feeder Manual Paper Manual Envelope	Set a default paper source for all print jobs. Notes: <ul style="list-style-type: none"> • Tray 1 (standard tray) is the factory default setting. • From the Paper menu, set Configure MP to "Cassette" for MP Feeder to appear as a menu setting. • If two trays contain paper of the same size and type, and the trays have the same settings, then the trays are automatically linked. When one tray is empty, the print job continues using the linked tray.

Paper Size/Type menu

Use	To
Tray [x] Size A4 A5 JIS-B5 Letter Legal Executive Oficio (Mexico) Folio Universal	Specify the size of the paper loaded in each tray. Note: Letter is the U.S. factory default setting. A4 is the international factory default setting.
Note: Only installed trays and feeders are listed in this menu.	

Use	To
<p>Tray [x] Type</p> <ul style="list-style-type: none"> Plain Paper Card Stock Transparency Recycled Glossy Labels Bond Letterhead Preprinted Colored Paper Light Paper Heavy Paper Rough/Cotton Custom Type [x] 	<p>Specify the type of the paper loaded in each tray.</p> <p>Notes:</p> <ul style="list-style-type: none"> • Plain Paper is the factory default setting for Tray 1. Custom Type [x] is the factory default setting for all other trays. • If available, a user-defined name will appear instead of Custom Type [x]. • Use this menu to configure automatic tray linking. • Only the 250-sheet tray supports transparency.
<p>Multipurpose Feeder Size</p> <ul style="list-style-type: none"> A4 A5 A6 JIS B5 Letter Legal Executive Oficio (Mexico) Folio Statement Universal 7 3/4 Envelope 9 Envelope 10 Envelope DL Envelope C5 Envelope B5 Envelope Other Envelope 	<p>Specify the size of the paper loaded in the multipurpose feeder.</p> <p>Notes:</p> <ul style="list-style-type: none"> • Letter is the U.S. factory default setting. A4 is the international factory default setting. • From the Paper menu, set Configure MP to Cassette in order for Multipurpose Feeder Size to appear as a menu. • The multipurpose feeder does not automatically detect the paper size. Make sure the paper size is set.
<p>Note: Only installed trays and feeders are listed in this menu.</p>	

Use	To
<p>Multipurpose Feeder Type</p> <ul style="list-style-type: none"> Plain Paper Card Stock Transparency Recycled Glossy Labels Bond Envelope Letterhead Preprinted Colored Paper Light Paper Heavy Paper Rough/Cotton Custom Type [x] 	<p>Specify the type of the paper loaded in the multipurpose feeder.</p> <p>Notes:</p> <ul style="list-style-type: none"> • Custom [x] is the factory default setting. • From the Paper menu, set Configure MP to Cassette in order for Multipurpose Feeder Type to appear as a menu.
<p>Manual Paper Size</p> <ul style="list-style-type: none"> A4 A5 A6 JIS B5 Letter Legal Executive Oficio (Mexico) Folio Statement Universal 	<p>Specify the size of the paper being manually loaded.</p> <p>Note: Letter is the U.S. factory default setting. A4 is the international factory default setting.</p>
<p>Manual Paper Type</p> <ul style="list-style-type: none"> Plain Paper Card Stock Transparency Recycled Glossy Labels Bond Letterhead Preprinted Colored Paper Light Paper Heavy Paper Rough/Cotton Custom Type [x] 	<p>Specify the type of the paper being manually loaded.</p> <p>Notes:</p> <ul style="list-style-type: none"> • Plain Paper is the factory default setting. • From the Paper menu, set Configure MP to Manual in order for Manual Paper Type to appear as a menu.
<p>Note: Only installed trays and feeders are listed in this menu.</p>	

Use	To
<p>Manual Envelope Size</p> <ul style="list-style-type: none"> 7 3/4 Envelope 9 Envelope 10 Envelope DL Envelope C5 Envelope B5 Envelope Other Envelope 	<p>Specify the size of the envelope being manually loaded.</p> <p>Note: 10 Envelope is the U.S. factory default setting. DL Envelope is the international factory default setting.</p>
<p>Manual Envelope Type</p> <ul style="list-style-type: none"> Envelope Custom Type [x] 	<p>Specify the type of the envelope being manually loaded.</p> <p>Note: Envelope is the factory default setting.</p>
<p>Note: Only installed trays and feeders are listed in this menu.</p>	

Configure MP menu

Use	To
<p>Configure MP</p> <ul style="list-style-type: none"> Cassette Manual First 	<p>Determine when the printer selects paper from the multipurpose feeder.</p> <p>Notes:</p> <ul style="list-style-type: none"> • Cassette is the factory default setting. Cassette configures the multipurpose feeder as the automatic paper source. • Manual sets the multipurpose feeder only for manual-feed print jobs. • First configures the multipurpose feeder as the primary paper source.

Substitute Size menu

Use	To
<p>Substitute Size</p> <ul style="list-style-type: none"> Off Statement/A5 Letter/A4 All Listed 	<p>Substitute a specified paper size if the requested paper size is not available.</p> <p>Notes:</p> <ul style="list-style-type: none"> • All Listed is the factory default setting. All available substitutions are allowed. • Off indicates that no size substitutions are allowed. • Setting a size substitution lets the print job continue without Change Paper appearing.

Paper Texture menu

Use	To
Plain Texture Smooth Normal Rough	Specify the relative texture of the plain paper loaded. Note: Normal is the factory default setting.
Card Stock Texture Smooth Normal Rough	Specify the relative texture of the card stock loaded. Notes: <ul style="list-style-type: none"> • Normal is the factory default setting. • The options appear only if card stock is supported.
Transparency Texture Smooth Normal Rough	Specify the relative texture of the transparencies loaded. Note: Normal is the factory default setting.
Recycled Texture Smooth Normal Rough	Specify the relative texture of the recycled paper loaded. Note: Normal is the factory default setting.
Glossy Texture Smooth Normal Rough	Specify the relative texture of the glossy paper loaded. Note: Normal is the factory default setting.
Labels Texture Smooth Normal Rough	Specify the relative texture of the labels loaded. Note: Normal is the factory default setting.
Bond Texture Smooth Normal Rough	Specify the relative texture of the bond paper loaded. Note: Rough is the factory default setting.
Envelope Texture Smooth Normal Rough	Specify the relative texture of the envelopes loaded. Note: Normal is the factory default setting.
Letterhead Texture Smooth Normal Rough	Specify the relative texture of the letterhead loaded. Note: Normal is the factory default setting.
Preprinted Texture Smooth Normal Rough	Specify the relative texture of the preprinted paper loaded. Note: Normal is the factory default setting.

Use	To
Colored Texture Smooth Normal Rough	Specify the relative texture of the colored paper loaded. Note: Normal is the factory default setting.
Light Texture Smooth Normal Rough	Specify the relative texture of the light paper loaded. Note: Normal is the factory default setting.
Heavy Texture Smooth Normal Rough	Specify the relative texture of the heavy paper loaded. Note: Normal is the factory default setting.
Rough/Cotton Texture Rough	Specify the relative texture of the cotton paper loaded.
Custom [x] Texture Smooth Normal Rough	Specify the relative texture of the custom paper loaded. Notes: <ul style="list-style-type: none"> • Normal is the factory default setting. • The options appear only if custom type is supported.

Paper Weight menu

Use	To
Plain Weight Light Normal Heavy	Specify the relative weight of the plain paper loaded. Note: Normal is the factory default setting.
Card Stock Weight Light Normal Heavy	Specify the relative weight of the card stock loaded. Note: Normal is the factory default setting.
Transparency Weight Light Normal Heavy	Specify the relative weight of the transparencies loaded. Note: Normal is the factory default setting.
Recycled Weight Light Normal Heavy	Specify the relative weight of the recycled paper loaded. Note: Normal is the factory default setting.

Use	To
Glossy Weight Light Normal Heavy	Specify the relative weight of the glossy paper loaded. Note: Normal is the factory default setting.
Labels Weight Light Normal Heavy	Specify the relative weight of the labels loaded. Note: Normal is the factory default setting.
Bond Weight Light Normal Heavy	Specify the relative weight of the bond paper loaded. Note: Normal is the factory default setting.
Envelope Weight Light Normal Heavy	Specify the relative weight of the envelope loaded. Note: Normal is the factory default setting.
Letterhead Weight Light Normal Heavy	Specify the relative weight of the letterhead loaded. Note: Normal is the factory default setting.
Preprinted Weight Light Normal Heavy	Specify the relative weight of the preprinted paper loaded. Note: Normal is the factory default setting.
Colored Weight Light Normal Heavy	Specify the relative weight of the colored paper loaded. Note: Normal is the factory default setting.
Light Weight Light	Specify that the relative weight of the paper loaded is light.
Heavy Weight Heavy	Specify that the relative weight of the paper loaded is heavy.
Rough/Cotton Weight Light Normal Heavy	Specify the relative weight of the rough or cotton paper loaded. Note: Normal is the factory default setting.
Custom [x] Weight Light Normal Heavy	Specify the relative weight of the custom paper loaded. Notes: <ul style="list-style-type: none"> • Normal is the factory default setting. • The options appear only when the custom type is supported.

Paper Loading menu

Use	To
Recycled Loading Duplex Off	Determine and set two-sided printing for all print jobs that specify Recycled as the paper type.
Glossy Loading Duplex Off	Determine and set two-sided printing for all print jobs that specify Glossy as the paper type.
Bond Loading Duplex Off	Determine and set two-sided printing for all print jobs that specify Bond as the paper type.
Letterhead Loading Duplex Off	Determine and set two-sided printing for all print jobs that specify Letterhead as the paper type.
Preprinted Loading Duplex Off	Determine and set two-sided printing for all print jobs that specify Preprinted as the paper type.
Colored Loading Duplex Off	Determine and set two-sided printing for all print jobs that specify Colored as the paper type.
Light Loading Duplex Off	Determine and set two-sided printing for all print jobs that specify Light as the paper type.
Heavy Loading Duplex Off	Determine and set two-sided printing for all print jobs that specify Heavy as the paper type.
Custom [x] Loading Duplex Off	Determine and set two-sided printing for all print jobs that specify Custom [x] as the paper type. Note: Custom [x] Loading is available only when the custom type is supported.
Notes: <ul style="list-style-type: none"> • Duplex sets the printer default to two-sided printing for every print job unless one-sided printing is selected from Printing Preferences or the Print dialog. • Off is the factory default setting for all the menus. 	

Custom Types menu

Use	To
<p>Custom Type [x] Paper Card Stock Transparency Glossy Rough/Cotton Labels Envelope</p>	<p>Associate a paper or specialty media type with a factory default Custom Type [x] name or a user-defined custom name created in the Embedded Web Server or MarkVision™ Professional.</p> <p>Notes:</p> <ul style="list-style-type: none"> • Paper is the factory default setting for Custom Type [x]. • The custom media type must be supported in the selected tray or feeder in order to print from that source.
<p>Recycled Paper Card Stock Transparency Glossy Rough/Cotton Labels Envelope</p>	<p>Specify a paper type when Recycled is selected.</p> <p>Notes:</p> <ul style="list-style-type: none"> • Paper is the factory default setting. • The Recycled paper type must be supported in the selected tray or feeder in order to print from that source.

Universal Setup menu

Use	To
<p>Units of Measure Inches Millimeters</p>	<p>Identify the units of measure.</p> <p>Notes:</p> <ul style="list-style-type: none"> • Inches is the U.S. factory default setting. • Millimeters is the international factory default setting.
<p>Portrait Width 3–14.17 inches 76–360 mm</p>	<p>Set the portrait width.</p> <p>Notes:</p> <ul style="list-style-type: none"> • If the width exceeds the maximum, then the printer uses the maximum width allowed. • 8.5 inches is the U.S. factory default setting. You can increase the width in 0.01-inch increments. • 216 mm is the international factory default setting. You can increase the width in 1-mm increments.
<p>Portrait Height 3–14.17 inches 76–360 mm</p>	<p>Set the portrait height.</p> <p>Notes:</p> <ul style="list-style-type: none"> • If the height exceeds the maximum, then the printer uses the maximum height allowed. • 14 inches is the U.S. factory default setting. You can increase the height in 0.01-inch increments. • 356 mm is the international factory default setting. You can increase the height in 1-mm increments.

Use	To
Feed Direction Short Edge Long Edge	Specify the feed direction if the paper can be loaded in either direction. Notes: <ul style="list-style-type: none"> • Short Edge is the factory default setting. • Long Edge appears only when the longest edge is shorter than the maximum width supported in the tray.

Reports menu

Reports menu

Use	To
Menu Settings Page	Print a report containing information about paper loaded in trays, installed memory, the total page count, alarms, timeouts, the printer control panel language, the TCP/IP address, the status of supplies, the status of the network connection, and other information.
Device Statistics	Print a report containing printer statistics such as supply information and details about printed pages.
Network Setup Page	Print a report containing information about the network printer settings, such as the TCP/IP address. Note: This menu appears only in network printers or printers connected to print servers.
Network [x] Setup Page	Print a report containing information on network printer settings, such as the TCP/IP address information. Notes: <ul style="list-style-type: none"> • This menu item is available only when more than one network option is installed. • This menu item appears only in network printers or in printers connected to print servers.
Profiles List	Print a list of profiles stored in the printer.
Print Fonts PCL Fonts PostScript Fonts	Print a report in English of all the fonts available for the printer language currently set in the printer. Note: A separate list is available for PCL and PostScript emulations. Each emulation report contains print samples and information about the available fonts for each language.
Print Defects Guide	Print a report containing information about repeating print defects.
Print Demo Demo Page [list of available demo pages]	Print demo files that are available in the RIP code, the flash option, and the disk option.

Use	To
Asset Report	Print a report containing asset information including the printer serial number and model name. The report contains text and UPC bar codes that can be scanned into an asset database.

Network/Ports

Active NIC menu

Use	To
Active NIC Auto [list of available network cards]	Allow the printer to connect to a network. Notes: <ul style="list-style-type: none"> • Auto is the factory default setting. • This menu item appears only if an optional network adapter is installed.

Standard Network or Network [x] menus

Note: Only active ports appear in this menu.

Use	To
Energy Efficient Ethernet Enable Disable	Set the printer Ethernet connection to a energy-saving mode. Note: Enable is the factory default setting.
PCL SmartSwitch On Off	Set the printer to automatically switch to PCL emulation when a print job requires it, regardless of the default printer language. Notes: <ul style="list-style-type: none"> • On is the factory default setting. • When Off is used, the printer does not examine incoming data. The printer uses PostScript emulation if PS SmartSwitch is set to On. It uses the default printer language specified in the Setup menu if PS SmartSwitch is set to Off.
PS SmartSwitch On Off	Set the printer to automatically switch to PS emulation when a print job requires it, regardless of the default printer language. Notes: <ul style="list-style-type: none"> • On is the factory default setting. • When Off is used, the printer does not examine incoming data. The printer uses PCL emulation if PCL SmartSwitch is set to On. It uses the default printer language specified in the Setup menu if PCL SmartSwitch is set to Off.

Use	To
NPA Mode Off Auto	Set the printer to perform the special processing required for bidirectional communication following the conventions defined by the NPA protocol. Notes: <ul style="list-style-type: none"> • Auto is the factory default setting. • Changing this setting from the control panel, and then exiting the menus causes the printer to restart. The menu selection is then updated.
Network Buffer Auto 3KB to [maximum size allowed]	Set the size of the network input buffer. Notes: <ul style="list-style-type: none"> • Auto is the factory default setting. • The value can be changed in 1-KB increments. • The maximum size allowed depends on the amount of memory in the printer, the size of the other link buffers, and whether Resource Save is set to On or Off. • To increase the maximum size range for the Network Buffer, disable or reduce the size of the parallel, serial, and USB buffers. • Changing this setting from the control panel and then exiting the menus causes the printer to restart. The menu selection is then updated.
Mac Binary PS On Off Auto	Set the printer to process Macintosh binary PostScript print jobs. Notes: <ul style="list-style-type: none"> • Auto is the factory default setting. • Off filters print jobs using the standard protocol. • On processes raw binary PostScript print jobs.
Standard Network Setup OR Network [x] Setup Reports Network Card TCP/IP IPv6 Wireless AppleTalk	Display and set the printer network settings. Note: The Wireless menu appears only when the printer is connected to a wireless network.

Network Card menu

To access the menu, navigate to either of the following:

- **Network/Ports > Standard Network > Standard Network Setup > Network Card**
- **Network/Ports > Network [x] > Network [x] Setup > Network Card**

Use	To
View Card Status Connected Disconnected	View the connection status of the wireless network adapter.
View Card Speed	View the speed of an active wireless network adapter.

Use	To
Network Address UAA LAA	View the network addresses.
Job Timeout 0, 10–225 seconds	Set the amount of time it takes for a network print job to be canceled. Notes: <ul style="list-style-type: none"> • “90 seconds” is the factory default setting. • A setting value of 0 disables the timeout. • If a value between 1 and 9 is selected, then Invalid appears on the display, and the value is not saved.
Banner Page Off On	Allow the printer to print a banner page. Note: Off is the factory default setting.

TCP/IP menu

To access the menu, navigate to either of the following:

- **Network/Ports > Standard Network > Standard Network Setup > TCP/IP**
- **Network/Ports > Network [x] > Network [x] Setup > TCP/IP**

Note: This menu is available only in network printers or printers that are attached to print servers.

Use	To
Set Hostname	Set the current TCP/IP hostname.
IP Address	View or change the current TCP/IP address. Note: Manually setting the IP address sets the Enable DHCP and Enable Auto IP settings to Off. It also sets Enable BOOTP and Enable RARP to Off on systems that support BOOTP and RARP.
Netmask	View or change the current TCP/IP netmask.
Gateway	View or change the current TCP/IP gateway.
Enable DHCP On Off	Specify the DHCP address and parameter assignment. Note: On is the factory default setting.
Enable RARP On Off	Specify the RARP address assignment setting. Note: Off is the factory default setting.
Enable BOOTP On Off	Specify the BOOTP address assignment setting. Note: On is the factory default setting.
Enable AutoIP Yes No	Specify the Zero Configuration Networking setting. Note: Yes is the factory default setting.

Use	To
Enable FTP/TFTP Yes No	Send files to the printer using the built-in FTP server. Note: Yes is the factory default setting.
Enable HTTP Server Yes No	Enable the built-in Web server (Embedded Web Server) which lets you monitor and manage the printer remotely using a Web browser. Note: Yes is the factory default setting.
WINS Server Address	View or change the current WINS server address.
Enable DDNS Yes No	View or change the current DDNS setting. Note: Yes is the factory default setting.
Enable mDNS Yes No	View or change the current mDNS setting. Note: Yes is the factory default setting.
DNS Server Address	View or change the current DNS server address.
Backup DNS Server Address [x]	View or change the current DNS server address.
Enable HTTPS Yes No	View or change the current HTTPS setting. Note: Yes is the factory default setting.

IPv6 menu

To access the menu, navigate to either of the following:

- **Network/Ports > Standard Network > Standard Network Setup > IPv6**
- **Network/Ports > Network [x] > Network [x] Setup > IPv6**

Note: This menu is available only in network printers or printers that are attached to print servers.

Use	To
Enable IPv6 On Off	Enable IPv6 in the printer. Note: On is the factory default setting.
Auto Configuration On Off	Specify whether or not the wireless network adapter accepts the automatic IPv6 address configuration entries provided by a router. Note: On is the factory default setting.
View Hostname	Set the host name.
View Address	Note: These settings can be changed only from the Embedded Web Server.
View Router Address	
Enable DHCPv6 On Off	Enable DHCPv6 in the printer. Note: On is the factory default setting.

Wireless menu

Note: This menu is available only in printers connected to a wireless network or printer models that have a wireless network adapter.

To access the menu, navigate to:

- **Network/Ports > Network [x] > Network [x] Setup > Wireless**

Use	To
Wi-Fi Protected Setup (WPS) Start Push Button Method Start PIN Method	Establish a wireless network and enable network security. Notes: <ul style="list-style-type: none"> • Start Push Button Method connects the printer to a wireless network when buttons on both the printer and the access point (wireless router) are pressed within a given period of time. • Start PIN Method connects the printer to a wireless network when a PIN on the printer is entered into the wireless settings of the access point.
Enable/Disable WPS Auto-detection Enable Disable	Automatically detect the connection method that an access point with WPS uses—Start Push Button Method or Start PIN Method. Note: Disable is the factory default setting.
Network Mode BSS Type Infrastructure Ad hoc	Specify the network mode. Notes: <ul style="list-style-type: none"> • Infrastructure is the factory default setting. This lets the printer access a network using an access point. • Ad hoc configures wireless connection directly between the printer and a computer.
Compatibility 802.11b/g 802.11b/g/n	Specify the wireless standard for the wireless network. Note: The 802.11b/g/n is the factory default setting.
Choose Network	Select an available network for the printer to use.
View Signal Quality	View the quality of the wireless connection.
View Security Mode	View the encryption method for the wireless network.

AppleTalk menu

To access the menu, navigate to either of the following:

- **Network/Ports > Standard Network > Standard Network Setup > AppleTalk**
- **Network/Ports > Network [x] > Network [x] Setup > AppleTalk**

Use	To
Activate Yes No	Enable or disable AppleTalk support. Note: No is the factory default setting.

Use	To
View Name	Show the assigned AppleTalk name. Note: The AppleTalk name can be changed only from the Embedded Web Server.
View Address	Show the assigned AppleTalk address. Note: The AppleTalk address can be changed only from the Embedded Web Server.
Set Zone [list of zones available on the network]	Provide a list of AppleTalk zones available on the network. Note: The default zone for the network is the factory default setting.

Standard USB menu

Use	To
PCL SmartSwitch On Off	Set the printer to automatically switch to PCL emulation when a print job received through a USB port requires it, regardless of the default printer language. Notes: <ul style="list-style-type: none"> • On is the factory default setting. • If PCL SmartSwitch is enabled, then the printer uses PostScript emulation. • If PCL SmartSwitch is disabled, then the printer does not examine incoming data and it uses the default printer language specified in the Setup menu.
PS SmartSwitch On Off	Set the printer to automatically switch to PS emulation when a print job received through a USB port requires it, regardless of the default printer language. Notes: <ul style="list-style-type: none"> • On is the factory default setting. • If PS SmartSwitch is enabled, then the printer uses PostScript emulation. • If PS SmartSwitch is disabled, then the printer does not examine incoming data and it uses the default printer language specified in the Setup menu.
NPA Mode On Off Auto	Set the printer to perform the special processing required for bidirectional communication following the conventions defined by the NPA protocol. Notes: <ul style="list-style-type: none"> • Auto is the factory default setting. Auto sets the printer to examine data, determine the format, and then process it appropriately. • The printer automatically restarts when changing the setting from the printer control panel. The menu selection is then updated.

Use	To
USB Buffer Disabled Auto 3K to [maximum size allowed]	Set the size of the USB input buffer. Notes: <ul style="list-style-type: none"> • Auto is the factory default setting. • Disabled turns off job buffering. Any jobs already buffered in the printer hard disk are printed before normal processing resumes. • The USB buffer size value can be changed in 1KB increments. • The maximum size allowed depends on the amount of memory in the printer, the size of the other link buffers, and whether Resource Save is enabled or disabled. • To increase the maximum size range for the USB Buffer, disable or reduce the size of the parallel, serial, and network buffers. • The printer automatically restarts when the setting is changed from the printer control panel. The menu selection is then updated.
Mac Binary PS On Off Auto	Set the printer to process Macintosh binary PostScript print jobs. Notes: <ul style="list-style-type: none"> • Auto is the factory default setting. • On processes raw binary PostScript print jobs. • Off filters print jobs using the standard protocol.
ENA Address yyy.yyy.yyy.yyy	Set the network address, netmask, and gateway information for an external print server. Note: This menu is available only when the printer is attached to an external print server through the USB port.
ENA Netmask yyy.yyy.yyy.yyy	
ENA Gateway yyy.yyy.yyy.yyy	

Security menu

Set Date and Time menu

Use	To
Current Date and Time	View the current date and time settings for the printer.
Manually Set Date and Time	Enter the date and time. Notes: <ul style="list-style-type: none"> • Date/Time is set in YYYY-MM-DD HH:MM:SS format. • Manually setting the date and time sets “Enable NTP” (Network Time Protocol) to On.
Time Zone	Select the time zone. Note: GMT is the factory default setting.

Use	To
Automatically Observe DST On Off	Set the printer to use the applicable daylight saving time (DST) start and end times associated with the printer Time Zone setting. Note: On is the factory default setting and uses the applicable Daylight Saving Time associated with the Time Zone setting.
Enable NTP On Off	Enable Network Time Protocol, which synchronizes the clocks of devices on a network. Note: On is the factory default setting.

Settings menu

General settings

General Settings menu

Use	To
Display Language English Francais Deutsch Italiano Espanol Dansk Norsk Nederlands Svenska Portugues Suomi Russian Polski Greek Magyar Turkce Cesky Simplified Chinese Traditional Chinese Korean Japanese	Set the language of the text appearing on the display. Note: Not all languages are available for all models. You may need to install special hardware for some languages.
Show Supply Estimates Show estimates Do not show estimates	View the estimates of the supplies on the control panel, Embedded Web Server, menu settings, and device statistics reports. Note: Show estimates is the factory default setting.

Use	To
Eco-Mode Off Energy Energy/Paper Paper	Minimize the use of energy, paper, or specialty media. Notes: <ul style="list-style-type: none"> • Off is the factory default setting. This resets the printer to its factory default settings. • When setting Eco Mode to Energy or Paper, performance may be affected, but print quality is not.
Quiet Mode Off On	Minimize the printer noise. Note: Off is the factory default setting.
Run Initial Setup Yes No	Run the setup wizard.
Keyboard Keyboard Type English Francais Francais Canadien Deutsch Italiano Espanol Greek Dansk Norsk Nederlands Svenska Suomi Portugues Russian Polski Swiss German Swiss French Korean Magyar Turkce Cesky Simplified Chinese Traditional Chinese Japanese Custom Key [x]	Specify a language and custom key information for the display keyboard.

Use	To
<p>Paper Sizes</p> <ul style="list-style-type: none"> U.S. Metric 	<p>Specify the unit of measurement for paper sizes.</p> <p>Notes:</p> <ul style="list-style-type: none"> • U.S. is the factory default setting. • The initial setting is determined by your country or region selection in the initial setup wizard.
<p>Displayed Information</p> <ul style="list-style-type: none"> Left Side Right Side Custom Text [x] 	<p>Specify what is displayed on the upper corners of the home screen.</p> <p>For Left side and Right side, select from the following options:</p> <ul style="list-style-type: none"> None IP Address Hostname Contact Name Location Date/Time mDNS/DDNS Service Name Zero Configuration Name Custom Text [x] Model Name <p>Notes:</p> <ul style="list-style-type: none"> • IP Address is the factory default setting for Left Side. • Date/Time is the factory default setting for Right Side.
<p>Displayed Information (continued)</p> <ul style="list-style-type: none"> Black Toner Cyan Toner Magenta Toner Yellow Toner Waste Toner Bottle Fuser Transfer Module 	<p>Customize the displayed information for the supplies.</p> <p>Select from the following options:</p> <ul style="list-style-type: none"> When to display <ul style="list-style-type: none"> Do not display Display Message to display <ul style="list-style-type: none"> Default Alternate Default <ul style="list-style-type: none"> [text entry] Alternate <ul style="list-style-type: none"> [text entry] <p>Notes:</p> <ul style="list-style-type: none"> • Do not display is the factory default setting for When to display. • Default is the factory default setting for Message to display.

Use	To
<p>Displayed Information (continued)</p> <ul style="list-style-type: none"> Paper Jam Load Paper Service Errors 	<p>Customize the displayed information for certain menus. Select from the following options:</p> <ul style="list-style-type: none"> Display <ul style="list-style-type: none"> Yes No Message to display <ul style="list-style-type: none"> Default Alternate Default <ul style="list-style-type: none"> [text entry] Alternate <ul style="list-style-type: none"> [text entry] <p>Notes:</p> <ul style="list-style-type: none"> • No is the factory default setting for Display. • Default is the factory default setting for Message to display.
<p>Home screen customization</p> <ul style="list-style-type: none"> Change Language Search Held Jobs Held Jobs USB Drive Profiles and Apps Bookmarks Jobs by User Forms and Favorites Background and Idle Screen Eco-Settings 	<p>Change the icons that appear on the home screen. For each icon, select from the following options:</p> <ul style="list-style-type: none"> Display Do Not display
<p>Date Format</p> <ul style="list-style-type: none"> MM-DD-YYYY DD-MM-YYYY YYYY-MM-DD 	<p>Format the date.</p> <p>Note: MM-DD-YYYY is the U.S. factory default setting. DD-MM-YYYY is the international factory default setting.</p>
<p>Time Format</p> <ul style="list-style-type: none"> 12 hour A.M./P.M. 24 hour clock 	<p>Format the time.</p> <p>Note: 12 hour A.M./P.M. is the factory default setting.</p>
<p>Screen Brightness</p> <ul style="list-style-type: none"> 20–100 	<p>Specify the brightness of the display.</p> <p>Note: 100 is the factory default setting.</p>
<p>Audio Feedback</p> <ul style="list-style-type: none"> Button Feedback <ul style="list-style-type: none"> On Off Volume <ul style="list-style-type: none"> 1–10 	<p>Set the audio volume for the buttons.</p> <p>Notes:</p> <ul style="list-style-type: none"> • On is the factory default setting for Button Feedback. • 5 is the factory default setting for Volume.

Use	To
<p>Show Bookmarks Yes No</p>	<p>Specify whether bookmarks are displayed from the Held Jobs area. Note: Yes is the factory default setting.</p>
<p>Web Page Refresh Rate 30–300</p>	<p>Specify the number of seconds between Embedded Web Server refreshes. Note: 120 is the factory default setting.</p>
<p>Contact Name</p>	<p>Specify a contact name. Note: The contact name is stored on the Embedded Web Server.</p>
<p>Location</p>	<p>Specify the location. Note: The location is stored on the Embedded Web Server.</p>
<p>Alarms Alarm Control Cartridge Alarm</p>	<p>Set an alarm when the printer requires user intervention. For each alarm type, select from the following options: Off Single Continuous Notes:</p> <ul style="list-style-type: none"> • Single is the factory default setting. This sounds three quick beeps. • Continuous repeats three beeps every 10 seconds.
<p>Timeouts Standby Mode Disabled 1–240</p>	<p>Set the amount of time in minutes before the printer enters a lower power state. Note: 15 is the factory default setting.</p>
<p>Timeouts Sleep Mode Disabled 1–120</p>	<p>Set the amount of time in minutes the printer waits after a job is printed before it goes into a reduced power state. Notes:</p> <ul style="list-style-type: none"> • 20 is the factory default setting. • Lower settings conserve more energy, but may require longer warm-up times. • Select the lowest setting if the printer shares an electrical circuit with room lighting or you notice lights flickering in the room. • Select a high setting if the printer is in constant use. Under most circumstances, this keeps the printer ready to print with minimum warm-up time. • Disabled appears only if Energy Conserve is set to Off.
<p>Timeouts Print with Display Off Allow printing with display off Display on when printing</p>	<p>Print a job with the display turned off. Note: Display on when printing is the factory default setting.</p>

Use	To
Timeouts Hibernate Timeout Disabled 20 minutes 1–3 hours 6 hours 1–3 days 1–2 weeks 1 month	Set the amount of time the printer waits before it enters Hibernate mode. Note: 3 days is the factory default setting.
Hibernate Timeout on Connection Hibernate Do Not Hibernate	Set the printer to Hibernate mode even if there is an active Ethernet connection. Notes: <ul style="list-style-type: none"> • Hibernate is the factory default setting. • The fax function is available only in some printer models.
Timeouts Screen Timeout 15–300	Set the amount of time in seconds before returning the control panel to a Ready state. Note: 30 is the factory default setting.
Timeouts Print Timeout Disabled 1–255	Set the amount of time in seconds the printer waits to receive an end-of-job message before canceling the rest of the print job. Notes: <ul style="list-style-type: none"> • 90 is the factory default setting. • When the timer expires, any partially printed page still in the printer is printed, and then the printer checks to see if any new print jobs are waiting. • Print Timeout is available only when using PCL emulation.
Timeouts Wait Timeout Disabled 15–65535	Set the amount of time in seconds the printer waits for additional data before canceling a print job. Notes: <ul style="list-style-type: none"> • 40 is the factory default setting. • Wait Timeout is available only when the printer is using PostScript emulation.
Timeouts Job Hold Timeout 5–255	Set the amount of time the printer waits for user intervention before it holds jobs that require unavailable resources and continues to print other jobs in the print queue. Notes: <ul style="list-style-type: none"> • 30 is the factory default setting. • This menu appears only when a hard disk is installed.

Use	To
<p>Error Recovery</p> <ul style="list-style-type: none"> Auto Reboot <ul style="list-style-type: none"> Reboot when idle Reboot always Reboot never 	<p>Set the printer to restart when an error occurs.</p> <p>Note: Reboot always is the factory default setting.</p>
<p>Error Recovery</p> <ul style="list-style-type: none"> Max Auto Reboots <ul style="list-style-type: none"> 1–20 	<p>Determine the number of automatic reboots the printer can perform.</p> <p>Notes:</p> <ul style="list-style-type: none"> • 2 is the factory default setting. • If the printer reaches the maximum number of reboots within a certain amount of time, the printer does not continue to reboot, and the error message appears on the display.
<p>Print Recovery</p> <ul style="list-style-type: none"> Auto Continue <ul style="list-style-type: none"> Disabled 5–255 	<p>Let the printer automatically continue printing from certain offline situations when these are not resolved within the specified time period.</p> <p>Note: Disabled is the factory default setting.</p>
<p>Print Recovery</p> <ul style="list-style-type: none"> Jam Recovery <ul style="list-style-type: none"> On Off Auto 	<p>Specify whether the printer reprints jammed pages.</p> <p>Notes:</p> <ul style="list-style-type: none"> • Auto is the factory default setting. The printer reprints jammed pages unless the memory required to hold the pages is needed for other printer tasks. • On sets the printer to always reprint jammed pages. • Off sets the printer to never reprint jammed pages.
<p>Print Recovery</p> <ul style="list-style-type: none"> Page Protect <ul style="list-style-type: none"> Off On 	<p>Successfully print a page that may not have printed otherwise.</p> <p>Notes:</p> <ul style="list-style-type: none"> • Off is the factory default setting. This prints a partial page when there is not enough memory to print the whole page. • On sets the printer to process the whole page so that the entire page prints.
<p>Accessibility</p> <ul style="list-style-type: none"> Prolong Screen Timeout <ul style="list-style-type: none"> On Off 	<p>Set the printer to continue a specified job without returning to the home screen when the screen timeout timer expires.</p> <p>Note: Off is the factory default setting.</p>
<p>Press Sleep Button</p> <ul style="list-style-type: none"> Do Nothing Sleep Hibernate 	<p>Determine how the printer, while in idle state, reacts to a short press of the Sleep button.</p> <p>Note: Sleep is the factory default setting.</p>

Use	To
Press and Hold Sleep Button Do Nothing Sleep Hibernate	Determine how the printer, while in idle state, reacts to a long press of the Sleep button. Note: Do Nothing is the factory default setting.
Factory Defaults Do Not Restore Restore Now	Use the printer factory default settings. Notes: <ul style="list-style-type: none"> • Do Not Restore is the factory default setting. • Restore Now sets all printer settings to the factory default settings except for the Network/Ports menu settings. All downloads stored in the RAM are deleted. Downloads stored in the flash memory or on a hard disk are not affected.
Export Configuration File Export	Export configuration files to a flash drive.

Print settings

Setup menu

Use	To
Printer Language PCL Emulation PS Emulation	Set the default printer language. Notes: <ul style="list-style-type: none"> • PS Emulation is the factory default setting. PS Emulation uses a PS interpreter for processing print jobs. • PCL Emulation uses a PCL interpreter for processing print jobs. • This does not prevent a software program from sending print jobs that use another printer language.
Print Area Normal Fit To Page Whole Page	Set the logical and physical printable area. Note: Normal is the factory default setting. When attempting to print data in the non-printable area defined by the Normal setting, the printer clips the image.
Printer Usage Max Yield Max Speed	Set color toner use in printing. Note: Max Yield is the factory default setting.
Black Only Mode On Off	Set the printer to print text and graphics using only the black toner cartridge. Notes: <ul style="list-style-type: none"> • Off is the factory default setting. • This does not affect the ability of the printer to generate color output from flash drive print jobs.

Use	To
Resource Save On Off	Specify how the printer handles temporary downloads, such as fonts and macros stored in the RAM, when the printer receives a job that requires more than the available memory. Note: Off is the factory default setting. This sets the printer to retain the downloads only until memory is needed. Downloads are deleted in order to process print jobs.
Print All Order Alphabetical Oldest First Newest First	Specify the order in which confidential and held jobs are printed when Print All is selected. Note: Alphabetical is the factory default setting.

Finishing menu

Use	To
Sides (Duplex) 1 sided 2 sided	Specify whether two-sided printing is set as the default for all print jobs. Notes: <ul style="list-style-type: none"> • 1 sided is the factory default setting. • You can set two-sided printing from the printer software.
Duplex Binding Long Edge Short Edge	Define the way two-sided pages are bound and printed. Note: Long Edge is the factory default setting.
Copies 1–999	Specify the default number of copies for each print job. Note: 1 is the factory default setting.
Blank Pages Do Not Print Print	Specify whether blank pages are inserted in a print job. Note: Do Not Print is the factory default setting.
Collate (1,1) (2,2,2) (1,2,3) (1,2,3)	Stack the pages of a print job in sequence when printing multiple copies. Note: (1,1) (2,2,2) is the factory default setting.
Separator Sheets Off Between Copies Between Jobs Between Pages	Specify whether blank separator sheets are inserted. Notes: <ul style="list-style-type: none"> • Off is the factory default setting. • Between Copies inserts a blank sheet between each copy of a print job if Collate is set to (1,2,3) (1,2,3). If Collate is set to (1,1) (2,2,2), then a blank page is inserted between each set of printed pages, such as after all page 1's and after all page 2's. • Between Jobs inserts a blank sheet between print jobs. • Between Pages inserts a blank sheet between each page of a print job. This setting is useful when printing transparencies or when inserting blank pages in a document.

Use	To
Separator Source Tray [x] MP Feeder	Specify the paper source for the separator sheet. Note: Tray 1 (standard tray) is the factory default setting.
Paper Saver Off 2-Up 3-Up 4-Up 6-Up 9-Up 12-Up 16-Up	Print multiple pages on a single sheet of paper. Notes: <ul style="list-style-type: none"> • Off is the factory default setting. • The number selected is the number of page images that are printed per side.
Paper Saver Ordering Horizontal Reverse Horizontal Reverse Vertical Vertical	Specify the order in which pages are printed on a single sheet when using Paper Saver. Notes: <ul style="list-style-type: none"> • Horizontal is the factory default setting. • Positioning depends on the number of page images and whether they are in portrait or in landscape orientation.
Paper Saver Orientation Auto Landscape Portrait	Specify the orientation in which pages are printed on a single sheet. Note: Auto is the factory default setting. The printer chooses between portrait and landscape.
Paper Saver Border None Solid	Print a border when using Paper Saver. Note: None is the factory default setting.

Quality menu

Use	To
Print Mode Color Black Only	Specify whether images are printed in black and white or in color. Notes: <ul style="list-style-type: none"> • Color is the factory default setting. • The printer driver is capable of overriding this setting.

Use	To
Color Correction Auto Off Manual	Adjust the color output on the printed page. Notes: <ul style="list-style-type: none"> • Auto is the factory default setting. This applies different color conversion tables to each object on the printed page. • Off turns off color correction. • Manual allows customization of the color tables using the settings available from the Manual Color menu. • Due to the differences in additive and subtractive colors, certain colors that appear on computer monitors are impossible to duplicate on the printed page.
Print Resolution 1200 dpi 4800 CQ	Specify the printed output resolution in dots per inch or in color quality (CQ). Note: 4800 CQ is the factory default setting.
Toner Darkness 1–5	Lighten or darken the printed output. Notes: <ul style="list-style-type: none"> • 4 is the factory default setting. • Selecting a smaller number can help conserve toner.
Enhance Fine Lines On Off	Enable a print mode preferable for files such as architectural drawings, maps, electrical circuit diagrams, and flow charts. Notes: <ul style="list-style-type: none"> • Off is the factory default setting. • To set this option using the Embedded Web Server, type the network printer IP address in the Web browser address field. • You can set this option from the software program. For Windows users: Click File > Print, and then click Properties, Preferences, Options, or Setup. For Macintosh users: Choose File > Print, and then adjust the settings from the Print dialog and pop-up menus.
Color Saver On Off	Reduce the amount of toner used for graphics and images. The amount of toner used for text is not reduced. Notes: <ul style="list-style-type: none"> • Off is the factory default setting. • On overrides Toner Darkness settings.
RGB Brightness -6 to 6	Adjust the printed output either by lightening or darkening it. You can conserve toner by lightening the output. Note: 0 is the factory default setting.
RGB Contrast 0–5	Adjust the contrast of printed objects. Note: 0 is the factory default setting.

Use	To
<p>RGB Saturation 0–5</p>	<p>Adjust saturation in color outputs. Note: 0 is the factory default setting.</p>
<p>Color Balance Cyan -5 to 5 Magenta -5 to 5 Yellow -5 to 5 Black -5 to 5 Reset Defaults</p>	<p>Adjust color in printed output by increasing or decreasing the amount of toner being used for each color. Note: 0 is the factory default setting.</p>
<p>Color Samples sRGB Display sRGB Vivid Display—True Black Vivid Off—RGB US CMYK Euro CMYK Vivid CMYK Off—CMYK</p>	<p>Print sample pages for each of the RGB and CMYK color conversion tables used in the printer. Notes:</p> <ul style="list-style-type: none"> • Selecting any setting prints the sample. • Color samples consist of a series of colored boxes along with the RGB or CMYK combination that creates the color observed. These pages can be used to help decide which combinations to use to get the printed output you want. • To access a complete list of color sample pages using the Embedded Web Server, type the network printer IP address in the Web browser address field.
<p>Manual Color RGB Image RGB Text RGB Graphics</p>	<p>Customize the RGB color conversions. Select from the following options: Vivid sRGB Display Display—True Black sRGB Vivid Off Notes:</p> <ul style="list-style-type: none"> • sRGB Display is the factory default setting for RGB Image. This applies a color conversion table to an output that matches the colors displayed on a computer monitor. • sRGB Vivid is the factory default setting for RGB Text and RGB Graphics. This applies a color table that increases saturation. This is preferred for business graphics and text. • Vivid applies a color conversion table that produces brighter, more saturated colors. • “Display—True Black” applies a color conversion table that uses only black toner for neutral gray colors. • Off turns off color conversion.

Use	To
<p>Manual Color (continued) CMYK Image CMYK Text CMYK Graphics</p>	<p>Customize the CMYK color conversions. Select from the following options: US CMYK Euro CMYK Vivid CMYK Off</p> <p>Notes:</p> <ul style="list-style-type: none"> • US CMYK is the factory default setting. This applies a color conversion table that tries to produce output that matches SWOP color output. • Euro CMYK is the international factory default setting. This applies a color conversion table that tries to produce output that matches Euroscale color output. • Vivid CMYK increases color saturation for the US conversion table. • Off turns off color conversion.
<p>Spot Color Replacement</p>	<p>Assign specific CMYK values to named spot colors. Note: This menu is available only in the Embedded Web Server.</p>
<p>Color Adjust</p>	<p>Initiate a recalibration of color conversion tables and allow the printer to make adjustments for color variations in output. Notes:</p> <ul style="list-style-type: none"> • Adjusting color starts when the menu is selected. Adjusting color appears on the display until the process is finished. • Color variations in output sometimes result from changeable conditions such as room temperature and humidity. Color adjustments are made on printer algorithms. Color alignment is also recalibrated in this process.

Utilities menu

Use	To
<p>Activate Hex Trace</p>	<p>Assist in isolating the source of a print job problem. Notes:</p> <ul style="list-style-type: none"> • When activated, all data sent to the printer is printed in hexadecimal and character representation, and control codes are not executed. • To exit or deactivate Hex Trace, turn off or reset the printer.
<p>Coverage Estimator Off On</p>	<p>Provide an estimate of the percentage coverage of toner on a page. The estimate is printed on a separate page at the end of each print job. Note: Off is the factory default setting.</p>

XPS menu

Use	To
Print Error Pages Off On	Print a page containing information on errors, including XML markup errors. Note: Off is the factory default setting.

PDF menu

Use	To
Scale to Fit Yes No	Scale page content to fit the selected paper size. Note: No is the factory default setting.
Annotations Do Not Print Print	Print annotations in a PDF. Note: Do Not Print is the factory default setting.

PostScript menu

Use	To
Print PS Error On Off	Print a page containing the PostScript error. Note: Off is the factory default setting.
Lock PS Startup Mode On Off	Allow users to disable the SysStart file. Note: Off is the factory default setting.
Image Smoothing On Off	Enhance the contrast and sharpness of low-resolution images and smoothen their color transitions. Notes: <ul style="list-style-type: none"> • Off is the factory default setting. • Image Smoothing has no effect on images that are 300 dpi or higher in resolution.

PCL Emul menu

Use	To
<p>Font Source</p> <ul style="list-style-type: none"> Resident Disk Download Flash All 	<p>Specify the set of fonts used by the Font Name menu.</p> <p>Notes:</p> <ul style="list-style-type: none"> • “Resident” is the factory default setting. Resident shows the factory default set of fonts downloaded in the RAM. • “Flash” and “Disk” settings show all fonts resident in that option. • The flash option must be properly formatted and cannot be read/write-, write-, or password-protected. • “Download” shows all the fonts downloaded in the RAM. • “All” shows all fonts available to any option.
<p>Font Name</p> <ul style="list-style-type: none"> Courier 10 	<p>Identify a specific font and the option where it is stored.</p> <p>Note: Courier 10 is the factory default setting. Courier 10 shows the font name, font ID, and the storage location in the printer. The font source abbreviation is R for Resident, F for Flash, K for Disk, and D for Download.</p>
<p>Symbol Set</p> <ul style="list-style-type: none"> 10U PC-8 12U PC-850 	<p>Specify the symbol set for each font name.</p> <p>Notes:</p> <ul style="list-style-type: none"> • 10U PC-8 is the US factory default setting. 12U PC-850 is the international factory default setting. • A symbol set is a set of alphabetic and numeric characters, punctuation, and special symbols. Symbol sets support the different languages or specific programs such as math symbols for scientific text. Only the supported symbol sets are shown.
<p>PCL Emulation Settings</p> <ul style="list-style-type: none"> Point Size 1.00–1008.00 	<p>Change the point size for scalable typographic fonts.</p> <p>Notes:</p> <ul style="list-style-type: none"> • 12 is the factory default setting. • Point size refers to the height of the characters in the font. One point equals approximately 0.014 inch. • Point sizes can be increased or decreased in 0.25-point increments.
<p>PCL Emulation Settings</p> <ul style="list-style-type: none"> Pitch 0.08–100 	<p>Specify the font pitch for scalable monospaced fonts.</p> <p>Notes:</p> <ul style="list-style-type: none"> • 10 is the factory default setting. • Pitch refers to the number of fixed-space characters per inch (cpi). • Pitch can be increased or decreased in 0.01-cpi increments. • For nonscalable monospaced fonts, the pitch appears on the display but it cannot be changed.

Use	To
PCL Emulation Settings Orientation Portrait Landscape	Specify the orientation of text and graphics on the page. Notes: <ul style="list-style-type: none"> • Portrait is the factory default setting. Portrait prints text and graphics parallel to the short edge of the page. • Landscape prints text and graphics parallel to the long edge of the page.
PCL Emulation Settings Lines per Page 1–255	Specify the number of lines that print on each page. Notes: <ul style="list-style-type: none"> • 60 is the US factory default setting. 64 is the international default setting. • The printer sets the amount of space between each line based on the Lines per Page, Paper Size, and Orientation settings. Select the Paper Size and Orientation you want before setting Lines per Page.
PCL Emulation Settings A4 Width 198 mm 203 mm	Set the printer to print on A4-size paper. Notes: <ul style="list-style-type: none"> • “198 mm” is the factory default setting. • The 203-mm setting sets the width of the page to allow printing of eighty 10-pitch characters.
PCL Emulation Settings Auto CR after LF On Off	Specify whether the printer automatically performs a carriage return (CR) after a line feed (LF) control command. Note: Off is the factory default setting.
PCL Emulation Settings Auto LF after CR On Off	Specify whether the printer automatically performs a line feed (LF) after a carriage return (CR) control command. Note: Off is the factory default setting.

Use	To
<p>Tray Renumber</p> <p>Assign MP Feeder</p> <ul style="list-style-type: none"> Off None 0–199 <p>Assign Tray [x]</p> <ul style="list-style-type: none"> Off None 0–199 <p>Assign Manual Paper</p> <ul style="list-style-type: none"> Off None 0–199 <p>Assign Manual Env</p> <ul style="list-style-type: none"> Off None 0–199 	<p>Configure the printer to work with printer software or programs that use different source assignments for trays and feeders.</p> <p>Notes:</p> <ul style="list-style-type: none"> • “Off” is the factory default setting. • “None” ignores the Select Paper Feed command. This option appears only when it is selected by the PCL 5 interpreter. • “0–199” allows a custom setting to be assigned.
<p>Tray Renumber</p> <p>View Factory Defaults</p> <ul style="list-style-type: none"> MPF Default = 8 T1 Default = 1 T1 Default = 4 T1 Default = 5 T1 Default = 20 T1 Default = 21 Env Default = 6 MPaper Default = 2 MEnv Default = 3 	<p>Display the factory default setting assigned to each tray or feeder.</p>
<p>Tray Renumber</p> <p>Restore Defaults</p> <ul style="list-style-type: none"> Yes No 	<p>Restore all tray and feeder assignments to the factory default settings.</p>

HTML menu

Use		To
Font Name Albertus MT Antique Olive Apple Chancery Arial MT Avant Garde Bodoni Bookman Chicago Clarendon Cooper Black Copperplate Coronet Courier Eurostile Garamond Geneva Gill Sans Goudy Helvetica Hoefler Text Intl CG Times Intl Courier Intl Univers	Joanna MT Letter Gothic Lubalin Graph Marigold MonaLisa Recut Monaco New CenturySbk New York Optima Oxford Palatino StempelGaramond Taffy Times TimesNewRoman Univers Zapf Chancery NewSansMTCS NewSansMTCT New SansMTJA NewSansMTKO	Set the default font for HTML documents. Note: The Times font is used in HTML documents that do not specify a font.

Use	To
Font Size 1–255 pt	Set the default font size for HTML documents. Notes: <ul style="list-style-type: none"> • 12 pt is the factory default setting. • Font size can be increased in 1-point increments.
Scale 1–400%	Scale the default font for HTML documents. Notes: <ul style="list-style-type: none"> • 100% is the factory default setting. • Scaling can be increased in 1% increments.
Orientation Portrait Landscape	Set the page orientation for HTML documents. Note: Portrait is the factory default setting.
Margin Size 8–255 mm	Set the page margin for HTML documents. Notes: <ul style="list-style-type: none"> • 19 mm is the factory default setting. • Margin size can be increased in 1-mm increments.

Use	To
Backgrounds Do Not Print Print	Specify whether to print backgrounds on HTML documents. Note: Print is the factory default setting.

Image menu

Use	To
Auto Fit On Off	Select the optimal paper size, scaling, and orientation. Note: On is the factory default setting. It overrides scaling and orientation settings for some images.
Invert On Off	Invert bitonal monochrome images. Notes: <ul style="list-style-type: none"> • Off is the factory default setting. • This setting does not apply to GIF or JPEG images.
Scaling Anchor Top Left Best Fit Anchor Center Fit Height/Width Fit Height Fit Width	Scale the image to fit the selected paper size. Notes: <ul style="list-style-type: none"> • Best Fit is the factory default setting. • When Auto Fit is set to On, Scaling is automatically set to Best Fit.
Orientation Portrait Landscape Reverse Portrait Reverse Landscape	Set the image orientation. Note: Portrait is the factory default setting.

Help menu

Menu item	Description
Print All Guides	Prints all the guides
Color Quality	Provides information about solving color quality issues
Print Quality	Provides information about solving print quality issues
Printing Guide	Provides information about loading paper and other specialty media
Media Guide	Provides a list of the paper sizes supported in trays and feeders
Print Defects Guide	Provides a template for determining the cause of repeating print quality defects, and lists settings that can be used to adjust print quality
Menu Map	Provides a list of the control panel menus and settings
Information Guide	Provides help in locating additional information

Menu item	Description
Connection Guide	Provides information about connecting the printer locally (USB) or to a network
Moving Guide	Provides instructions for safely moving the printer
Supplies Guide	Provides information about ordering supplies

Saving money and the environment

Lexmark is committed to environmental sustainability and is continually improving its printers to reduce their impact on the environment. We design with the environment in mind, engineer our packaging to reduce materials, and provide collection and recycling programs. For more information, see:

- The Notices chapter
- The Environmental Sustainability section of the Lexmark Web site at www.lexmark.com/environment
- The Lexmark recycling program at www.lexmark.com/recycle

By selecting certain printer settings or tasks, you may be able to reduce your printer's impact even further. This chapter outlines the settings and tasks that may yield a greater environmental benefit.

Saving paper and toner

Studies show that as much as 80% of the carbon footprint of a printer is related to paper usage. You can significantly reduce your carbon footprint by using recycled paper and the following printing suggestions, such as printing on both sides of the paper and printing multiple pages on one side of a single sheet of paper.

For information on how you can quickly save paper and energy using one printer setting, see [“Using Eco-Mode” on page 88](#).

Using recycled paper

As an environmentally conscious company, Lexmark supports the use of recycled office paper produced specifically for use in laser printers. For more information on recycled papers that work well with your printer, see [“Using recycled paper and other office papers” on page 41](#).

Conserving supplies

- Print on both sides of the paper.
Note: Two-sided printing is the default setting in the print driver.
- Print multiple pages on a single sheet of paper.
- Use the preview feature to see how the document looks like before printing it.
- Print one copy of the document to check its content and format for accuracy.

Saving energy

Using Eco-Mode

Use Eco-Mode to quickly select one or more ways to reduce your printer's environmental impact.

- 1 From the printer control panel, navigate to:

 > **Settings** >  > **General Settings** >  > **Eco-Mode** >  > select the setting you want

Use	To
Off	Use the factory default settings for all settings associated with Eco-Mode. This setting supports the performance specifications for your printer.
Energy	Reduce energy use, especially when the printer is idle. <ul style="list-style-type: none"> • Printer engine motors do not start until a document is ready to print. You may notice a short delay before the first page is printed. • The printer enters Sleep mode after one minute of inactivity.
Energy/Paper	Use all the settings associated with Energy and Paper modes.
Paper	<ul style="list-style-type: none"> • Enable the automatic two-sided (duplex) printing feature. • Turn off print log features.

2 Press .

Reducing printer noise

Use Quiet Mode to reduce the printer noise.

1 From the printer control panel, navigate to:

 > **Settings** >  > **General Settings** >  > **Quiet Mode** >  > select a setting you want

Use	To
On	Reduce printer noise. <ul style="list-style-type: none"> • Print jobs will process at a reduced speed. • Printer engine motors do not start until a document is ready to print. There is a short delay before the first page is printed. • The alarm control and cartridge alarm sounds are turned off. • The printer will ignore the Advance Start command.
Off	Use factory default settings. This setting supports the performance specifications of the printer. <p>Note: Selecting Photo from the printer driver may disable Quiet Mode and provide better print quality and full speed printing.</p>

2 Press .

Adjusting Sleep mode

To save energy, decrease the number of minutes before the printer enters Sleep mode. You can choose from 1 to 60 minutes. The factory default setting is 30 minutes.

Using the Embedded Web Server

1 Open a Web browser, and then type the printer IP address in the address field.

Notes:

- View the printer IP address in the TCP/IP section in the Network/Ports menu. The IP address appears as four sets of numbers separated by periods, such as 123.123.123.123.
- If you are using a proxy server, then temporarily disable it to load the Web page correctly.

2 Click **Settings > General Settings > Timeouts**.

3 In the Sleep Mode field, enter the number of minutes you want the printer to wait before it enters Sleep mode.

4 Click **Submit**.

Using the printer control panel

1 From the printer control panel, navigate to:

 > **Settings** >  > **General Settings** >  > **Timeouts** >  > **Sleep Mode** > 

2 In the Sleep Mode field, select the number of minutes you want the printer to wait before it enters Sleep mode.

3 Press .

Using Hibernate mode

Hibernate is an ultra-low-power saving mode.

Notes:

- Three days is the default amount of time before the printer enters Hibernate mode.
- Make sure to wake the printer from Hibernate mode before sending a print job. A hard reset or a long press of the Sleep button wakes the printer from Hibernate mode.
- If the printer is in Hibernate mode, then the Embedded Web Server is disabled.

1 From the control panel, navigate to:

 > **Settings** >  > **General Settings** > 

2 Press **Press Sleep Button** or **Press and Hold Sleep Button**, and then press .

3 Press **Hibernate** > .

Setting Hibernate Timeout

Hibernate Timeout lets you set the amount of time the printer waits after a print job is processed before it goes into a reduced power state.

Using the Embedded Web Server

1 Open a Web browser, and then type the printer IP address in the address field.

Notes:

- View the printer IP address in the TCP/IP section in the Network/Ports menu. The IP address appears as four sets of numbers separated by periods, such as 123.123.123.123.
- If you are using a proxy server, then temporarily disable it to load the Web page correctly.

2 Click **Settings > General Settings > Timeouts**.

3 From the Hibernate Timeout menu, select the number of hours, days, weeks, or months you want for the printer to wait before it goes into a reduced power state.

4 Click **Submit**.

Using the printer control panel

1 From the printer control panel, navigate to:

 > **Settings** >  **General Settings** >  **Timeouts** >  **Hibernate Timeout**

2 Select the number of hours, days, weeks, or month you want the printer to wait before it enters Hibernate Timeout, and then press .

Using Schedule Power Modes

Schedule Power Modes lets the user schedule when the printer goes into a reduced power state or into the Ready state.

1 Open a Web browser, and then type the printer IP address in the address field.

Notes:

- View the printer IP address in the TCP/IP section in the Network/Ports menu. The IP address appears as four sets of numbers separated by periods, such as 123.123.123.123.
- If you are using a proxy server, then temporarily disable it to load the Web page correctly.

2 Click **Settings > General Settings > Schedule Power Modes**.

3 From the Action menu, select the power mode.

4 From the Time menu, select the time.

5 From the Day(s) menu, select the day or days.

6 Click **Add**.

Recycling

Lexmark provides collection programs and environmentally progressive approaches to recycling. For more information, see:

- The Notices chapter
- The Environmental Sustainability section of the Lexmark Web site at www.lexmark.com/environment
- The Lexmark recycling program at www.lexmark.com/recycle

Recycling Lexmark products

To return Lexmark products for recycling:

- 1 Go to www.lexmark.com/recycle.
- 2 Find the product type you want to recycle, and then select your country or region from the list.
- 3 Follow the instructions on the computer screen.

Note: Printer supplies and hardware not listed in the Lexmark collection program may be recycled through your local recycling center. Contact your local recycling center to determine the items they accept.

Recycling Lexmark packaging

Lexmark continually strives to minimize packaging. Less packaging helps to ensure that Lexmark printers are transported in the most efficient and environmentally sensitive manner and that there is less packaging to dispose of. These efficiencies result in fewer greenhouse emissions, energy savings, and natural resource savings.

Lexmark cartons are 100% recyclable where corrugated recycling facilities exist. Facilities may not exist in your area.

The foam used in Lexmark packaging is recyclable where foam recycling facilities exist. Facilities may not exist in your area.

When you return a cartridge to Lexmark, you can reuse the box that the cartridge came in. Lexmark will recycle the box.

Returning Lexmark cartridges for reuse or recycling

The Lexmark Cartridge Collection Program allows you to return used cartridges for free to Lexmark for reuse or recycling. One hundred percent of the empty cartridges returned to Lexmark are either reused or demanufactured for recycling. The boxes used to return the cartridges are also recycled.

To return Lexmark cartridges for reuse or recycling, do the following:

- 1 Go to www.lexmark.com/recycle.
- 2 Select the product that you want to recycle.

Securing the printer

Statement of Volatility

Your printer contains various types of memory that can store device and network settings, and user data.

Type of memory	Description
Volatile memory	Your printer uses standard <i>random access memory</i> (RAM) to temporarily buffer user data during simple print jobs.
Non-volatile memory	Your printer may use two forms of non-volatile memory: EEPROM and NAND (flash memory). Both types are used to store operating system, device settings, and network information.

Erase the content of any installed printer memory in the following circumstances:

- The printer is being decommissioned.
- The printer is being moved to a different department or location.
- The printer is being serviced by someone from outside your organization.
- The printer is being removed from your premises for service.
- The printer is being sold to another organization.

Erasing volatile memory

The volatile memory (RAM) installed in your printer requires a power source to retain information. To erase the buffered data, simply turn off the printer.

Erasing non-volatile memory

- 1 Turn off the printer.
- 2 From the printer control panel, hold down **OK** and the right arrow button while turning the printer on. Release the buttons only when the Configuration menu appears.
- 3 Press the arrow buttons until **Wipe All Settings** appears, and then press **OK**.
The printer will restart several times during this process.
Note: Wipe All Settings securely removes device settings, solutions, jobs, and passwords from the printer memory.
- 4 Press the arrow buttons until **Exit Config Menu** appears, and then press **OK**.

The printer will perform a power-on reset, and then return to normal operating mode.

Finding printer security information

In high-security environments, it may be necessary to take additional steps to make sure that confidential data stored in the printer cannot be accessed by unauthorized persons. For more information, visit the [Lexmark security Web page](#).

You can also see the *Embedded Web Server — Security: Administrator's Guide* for additional information:

- 1 Go to www.lexmark.com, and then navigate to **Support & Downloads** > select your printer.
- 2 Click the **Manuals** tab, and then select *Embedded Web Server — Security: Administrator's Guide*.

Maintaining the printer

Warning—Potential Damage: Failure to maintain optimum printer performance periodically, or to replace parts and supplies, may cause damage to your printer.

Cleaning the printer

Cleaning the printer



CAUTION—SHOCK HAZARD: To avoid the risk of electrical shock when cleaning the exterior of the printer, unplug the power cord from the electrical outlet and disconnect all cables from the printer before proceeding.

Notes:

- Perform this task after every few months.
- Damage to the printer caused by improper handling is not covered by the printer warranty.

- 1 Turn off the printer, and then unplug the power cord from the electrical outlet.
- 2 Remove paper from the standard bin and multipurpose feeder.
- 3 Remove any dust, lint, and pieces of paper around the printer using a soft brush or vacuum.
- 4 Wipe the outside of the printer with a damp, soft, lint-free cloth.

Notes:

- Do not use household cleaners or detergents, as they may damage the finish of the printer.
- Make sure that all areas of the printer are dry after cleaning.

- 5 Connect the power cord, and then turn on the printer.

Checking the status of parts and supplies

A message appears on the display when a replacement supply item is needed or when maintenance is required.

Checking the status of parts and supplies

Using the Embedded Web Server

- 1 Open a Web browser, and then type the printer IP address in the address field.

Notes:

- View the printer IP address in the TCP/IP section in the Network/Ports menu. The IP address appears as four sets of numbers separated by periods, such as 123.123.123.123.
- If you are using a proxy server, then temporarily disable it to load the Web page correctly.

- 2 Click **Device Status > More Details**.

Using the printer control panel

From the printer control panel, navigate to:



Note: You can view the status of parts and supplies in the “Supply Information” section of the pages printed.

Estimated number of remaining pages

The estimated number of remaining pages is based on the recent printing history of the printer. Its accuracy may vary significantly and is dependent on many factors, such as actual document content, print quality settings, and other printer settings.

The accuracy of the estimated number of remaining pages may decrease when the actual printing consumption is different from the historical printing consumption. Consider the variable level of accuracy before purchasing or replacing supplies based on the estimate. Until an adequate print history is obtained on the printer, initial estimates assume future supplies consumption based on the International Organization for Standardization* test methods and page content.

* Average continuous black or composite CMY declared cartridge yield in accordance with ISO/IEC 19798.

Ordering supplies

To order parts and supplies in the U.S., contact Lexmark at 1-800-539-6275 for information about Lexmark authorized supplies dealers in your area. In other countries or regions, go to the Lexmark Web site at www.lexmark.com or contact the place where you purchased the printer.

Note: All life estimates for printer supplies assume printing on letter- or A4-size plain paper.

Using genuine Lexmark parts and supplies

Your Lexmark printer is designed to function best with genuine Lexmark supplies and parts. Use of third-party supplies or parts may affect the performance, reliability, or life of the printer and its imaging components. Use of third-party supplies or parts can affect warranty coverage. Damage caused by the use of third-party supplies or parts is not covered by the warranty. All life indicators are designed to function with Lexmark supplies and parts, and may deliver unpredictable results if third-party supplies or parts are used. Imaging component usage beyond the intended life may damage your Lexmark printer or its associated components.

Ordering toner cartridges

Notes:

- Estimated cartridge yield is based on the ISO/IEC 19798 standard.
- Extremely low print coverage for extended periods of time may negatively affect actual yield.

CS310 Return program cartridges

Item	United States and Canada	European Economic Area (EEA+)	Rest of Europe, Middle East, and Africa (RoEMEA)	Latin America Distribution (LAD)	Rest of Asia Pacific (RoAP)	Australia and New Zealand (ANZ)
Return program toner cartridges						
Black	70C10K0	70C20K0	70C80K0	70C80K0	70C80K0	70C80K0
Cyan	70C10C0	70C20C0	70C80C0	70C80C0	70C80C0	70C80C0
Magenta	70C10M0	70C20M0	70C80M0	70C80M0	70C80M0	70C80M0
Yellow	70C10Y0	70C20Y0	70C80Y0	70C80Y0	70C80Y0	70C80Y0
High yield return program toner cartridges						
Black	70C1HK0	70C2HK0	70C8HK0	70C8HK0	70C8HK0	70C8HK0
Cyan	70C1HC0	70C2HC0	70C8HC0	70C8HC0	70C8HC0	70C8HC0
Magenta	70C1HM0	70C2HM0	70C8HM0	70C8HM0	70C8HM0	70C8HM0
Yellow	70C1HY0	70C2HY0	70C8HY0	70C8HY0	70C8HY0	70C8HY0
For more information on countries located in each region, go to www.lexmark.com/regions .						

CS310 Regular cartridges

Item	Worldwide
High yield regular toner cartridges	
Black	70C0H10
Cyan	70C0H20
Magenta	70C0H30
Yellow	70C0H40
For more information on countries located in each region, go to www.lexmark.com/regions .	

CS317 Return program cartridges

Item	United States and Canada	European Economic Area (EEA+)	Rest of Europe, Middle East, and Africa (RoEMEA)	Latin America Distribution (LAD)	Rest of Asia Pacific (RoAP)	Australia and New Zealand (ANZ)
Return program toner cartridges						
Black	71B10K0	71B20K0	71B50K0	71B40K0	71B30K0	71B60K0
Cyan	71B10C0	71B20C0	71B50C0	71B40C0	71B30C0	71B60C0
Magenta	71B10M0	71B20M0	71B50M0	71B40M0	71B30M0	71B60M0
Yellow	71B10Y0	71B20Y0	71B50Y0	71B40Y0	71B30Y0	71B60Y0
For more information on countries located in each region, go to www.lexmark.com/regions .						

CS317 Regular cartridges

Item	Worldwide
Regular toner cartridges	
Black	71B0010
Cyan	71B0020
Magenta	71B0030
Yellow	71B0040
For more information on countries located in each region, go to www.lexmark.com/regions .	

Ordering imaging kits

Item	All countries and regions
Black imaging kit	700Z1
Color imaging kit	700Z5

Ordering a waste toner bottle

Item	All countries and regions
Waste toner bottle	C540X75G

Storing supplies

Choose a cool, clean storage area for the printer supplies. Store supplies right side up in their original packing until you are ready to use them.

Do not expose supplies to:

- Direct sunlight
- Temperatures above 35°C (95°F)
- High humidity above 80%
- Salty air
- Corrosive gases
- Heavy dust

Replacing supplies

Replacing the waste toner bottle

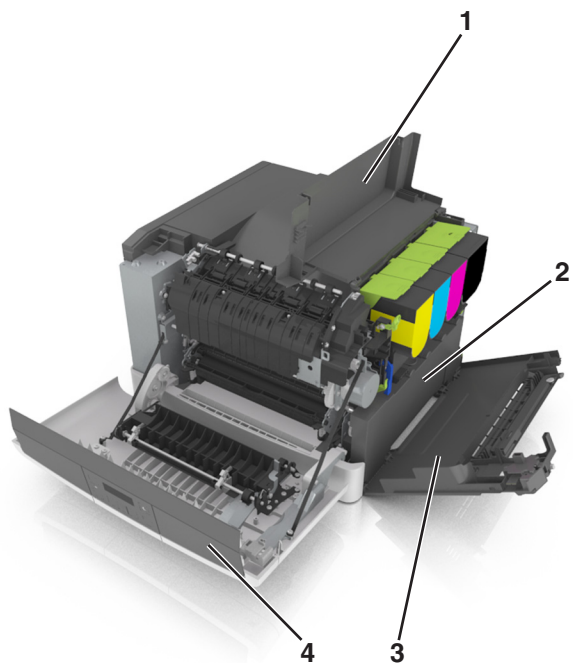

1	Top door
2	Waste toner bottle
3	Right side cover
4	Front door

1 Unpack the replacement waste toner bottle.

2 Open the front door.

 **CAUTION—HOT SURFACE:** The inside of the printer might be hot. To reduce the risk of injury from a hot component, allow the surface to cool before touching it.

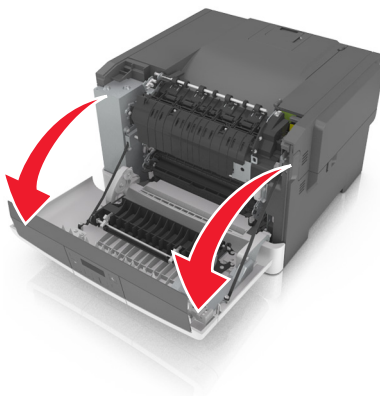

3 Open the top door.

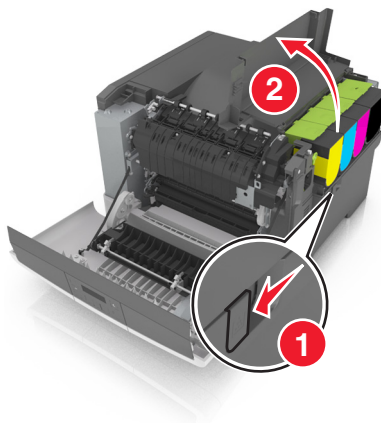

4 Remove the right side cover.

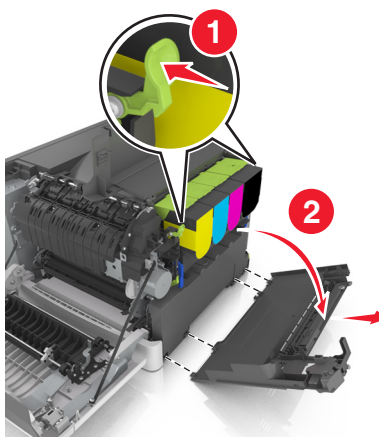

5 Remove the waste toner bottle.

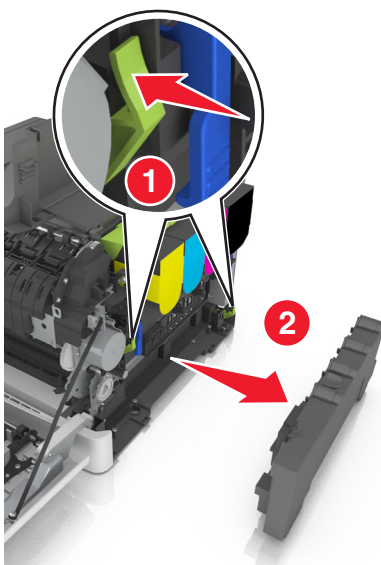

6 Pack the used waste toner bottle.

For more information, see [“Recycling Lexmark products” on page 92.](#)

- 7 Insert the replacement waste toner bottle.

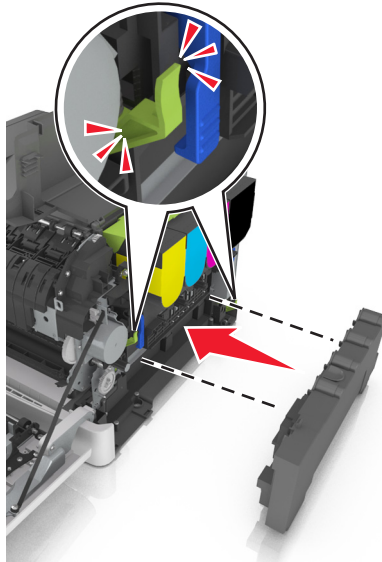

- 8 Insert the right side cover.

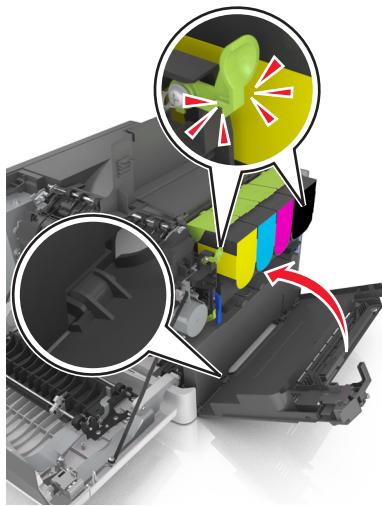

- 9 Close the top door.

- 10 Close the front door.

Replacing a black and color imaging kit

- 1 Open the front door.

 **CAUTION—HOT SURFACE:** The inside of the printer might be hot. To reduce the risk of injury from a hot component, allow the surface to cool before touching it.

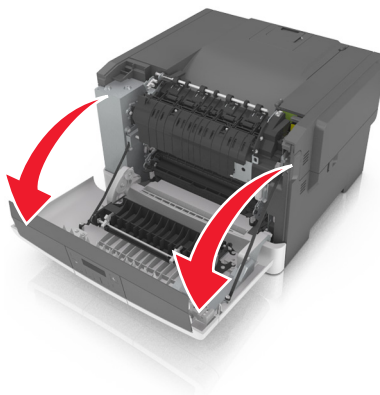

2 Open the top door.

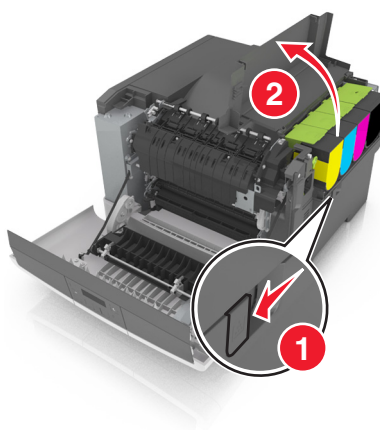

3 Remove the toner cartridges.

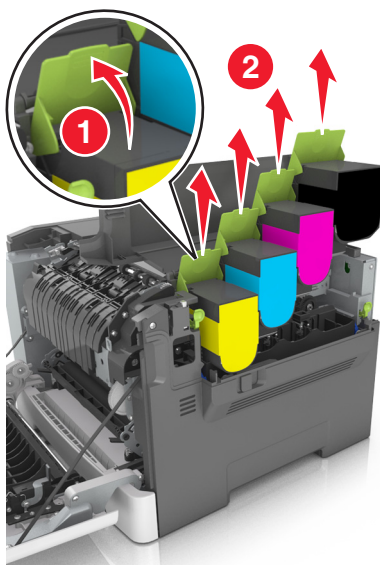

4 Remove the right side cover.

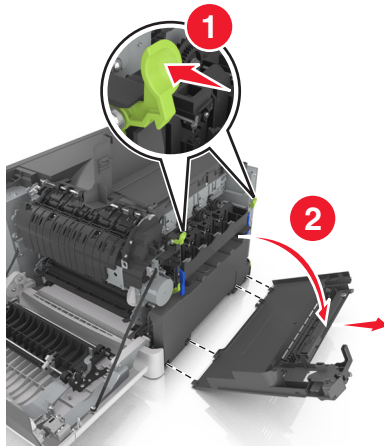

5 Remove the waste toner bottle.

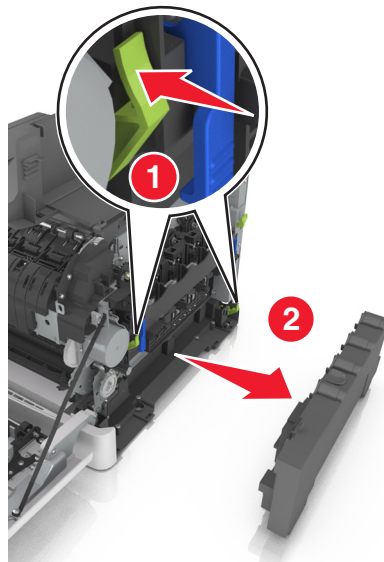

6 Lift the blue levers on the imaging kit, and then pull the imaging kit until it stops.

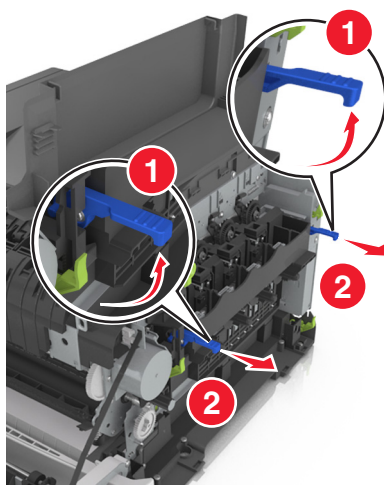

7 Press down the blue lever, and then grasp the green handles on the sides to pull out the imaging kit.

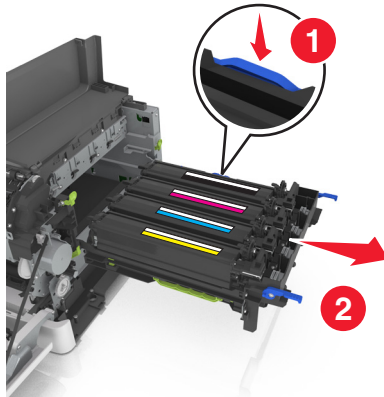

8 Unpack the replacement black and color imaging kit.

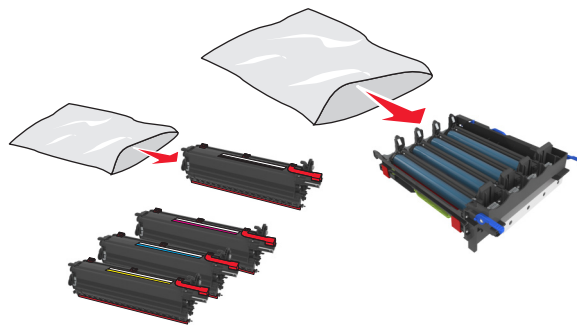

Notes:

- Color imaging kit includes the imaging kit and the cyan, magenta, yellow, and black developer units.
- Black imaging kit includes the imaging kit and the black developer unit.

9 Pack the used imaging kit.

For more information, see [“Recycling Lexmark products” on page 92](#).

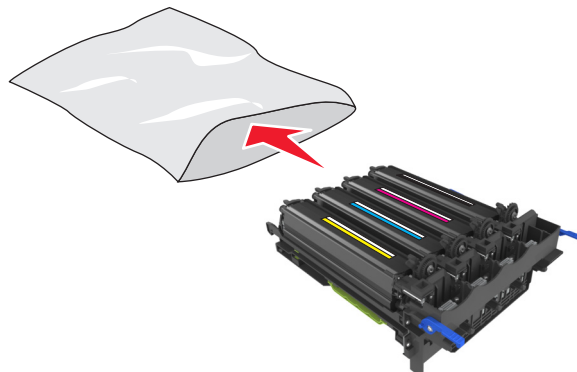

Note: When replacing the black imaging kit, save the cyan, magenta, and yellow developer units. Dispose only the black developer unit.

- 10** Gently shake the yellow, cyan, magenta, and black developer units side-to-side.

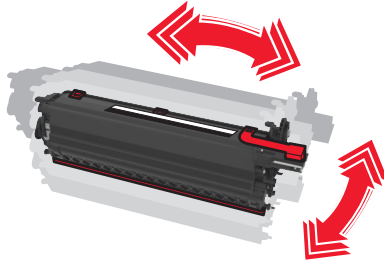

- 11** Remove the red packing strip and the attached fabric from the developer units.

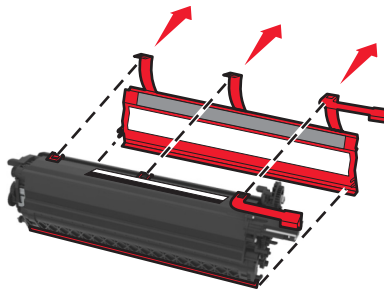

- 12** Insert the yellow, cyan, magenta, and black developer units into the matching color slots.

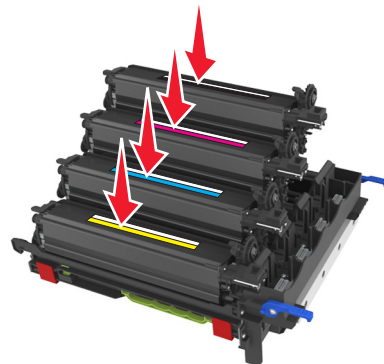

- 13** Remove the red packing strip from the imaging kit.

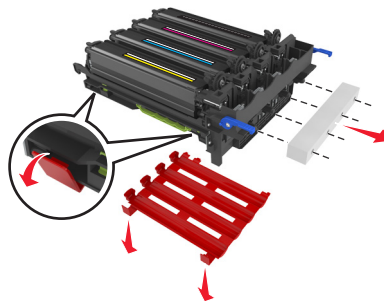

Warning—Potential Damage: Do not touch the shiny photoconductor drum under the imaging kit. Doing so may affect the quality of future print jobs.

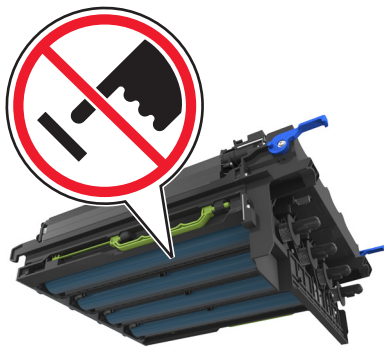

14 Align, and then insert the imaging kit.

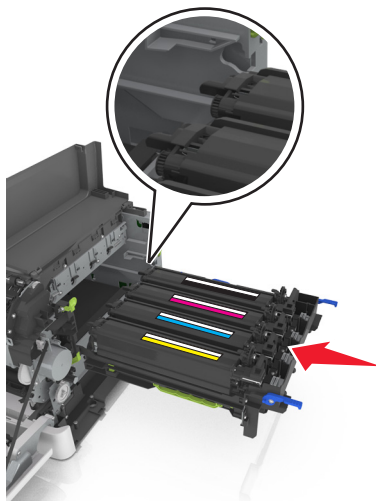

15 Push the blue levers down until the imaging kit is fully seated into place.

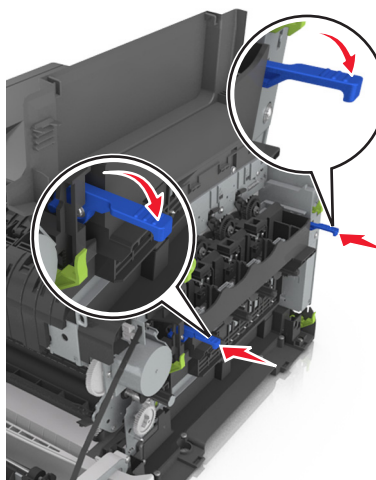

16 Insert the waste toner bottle.

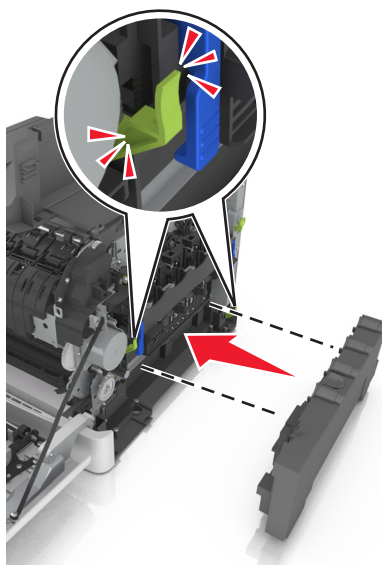

17 Insert the right side cover.

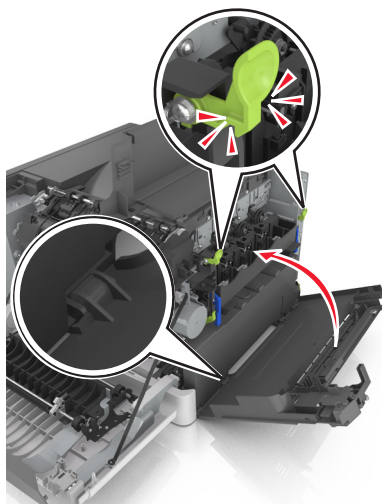

18 Insert the toner cartridges.

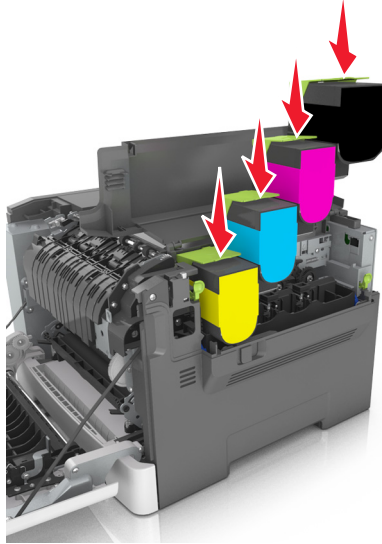

19 Close the top door.

20 Close the front door.

Replacing toner cartridges

Warning—Potential Damage: Damage caused by use of a non-Lexmark toner cartridge is not covered under warranty.

Note: Reduced print quality may result from using non-Lexmark toner cartridges.

1 Slide the release latch on the right side of the printer, and then open the top door.

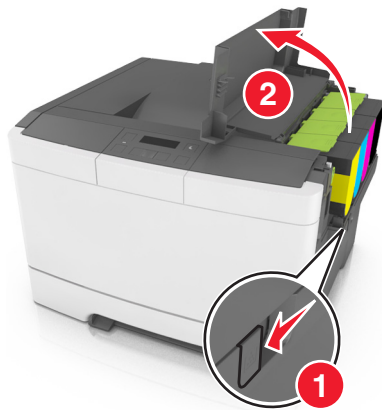

2 Remove the toner cartridge by lifting the handle, and then gently pulling it away from the imaging kit.

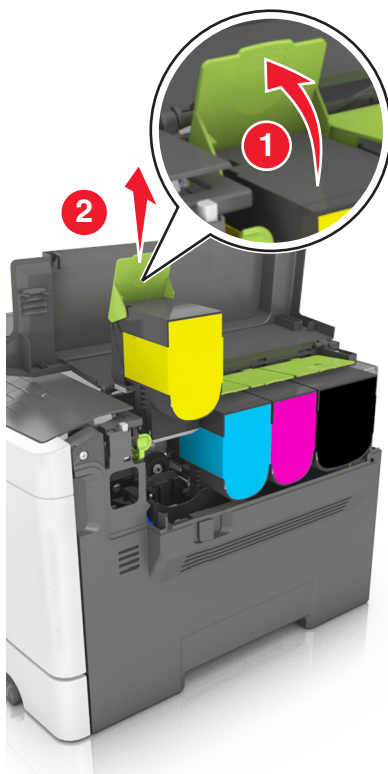

3 Unpack the new toner cartridge, and then remove its packaging.

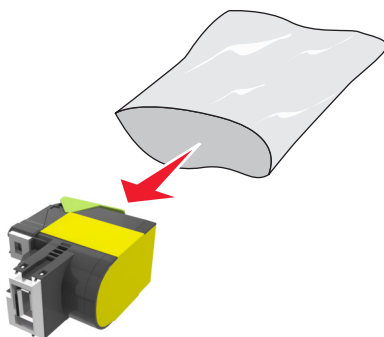

- 4 Align the new toner cartridge, and then press the cartridge down until it fits into place.

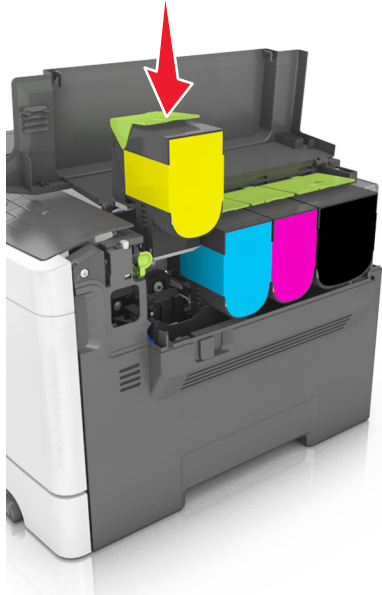

- 5 Close the top door.



- 6 Seal the used toner cartridge in the bag that the replacement toner cartridge came in before disposing. For more information, see [“Recycling Lexmark products” on page 92](#).

Replacing a developer unit

Replace the developer unit when a print quality defect occurs or when damage occurs to the printer.

- 1 Open the front door.



CAUTION—HOT SURFACE: The inside of the printer might be hot. To reduce the risk of injury from a hot component, allow the surface to cool before touching it.

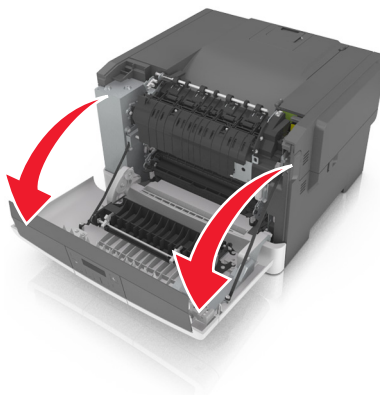

2 Open the top door.

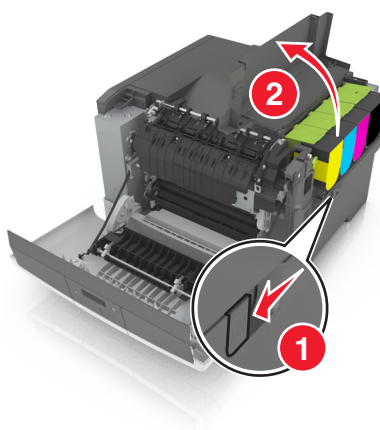

3 Remove the toner cartridges.

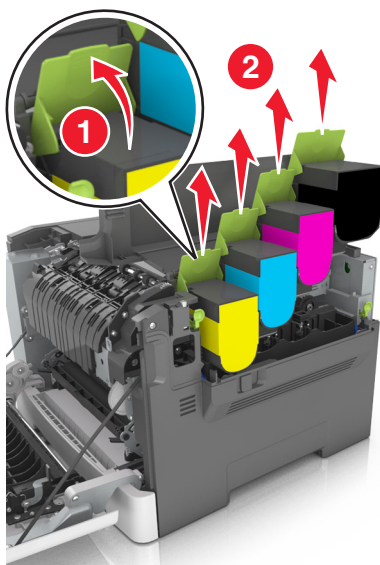

4 Remove the right side cover.

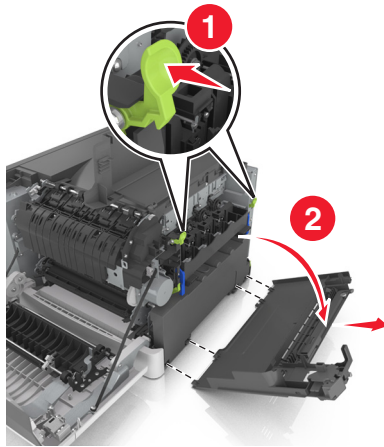

5 Remove the waste toner bottle.

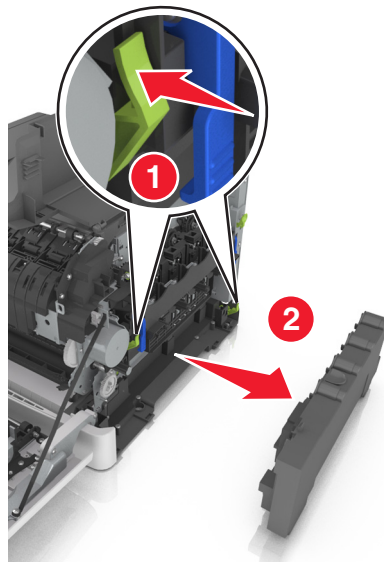

6 Lift the blue levers on the imaging kit, and then pull the imaging kit until it stops.

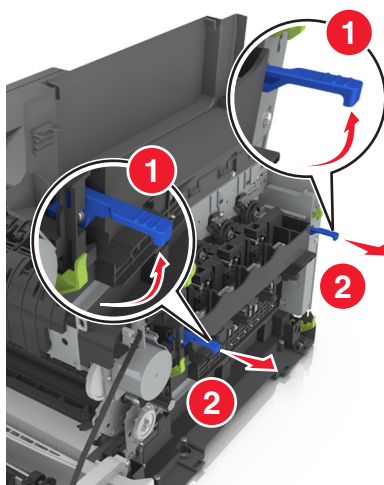

7 Press down the blue lever, and then grasp the green handles on the sides to pull out the imaging kit.

Warning—Potential Damage: Do not touch the underside of the imaging kit. This could damage the imaging kit.

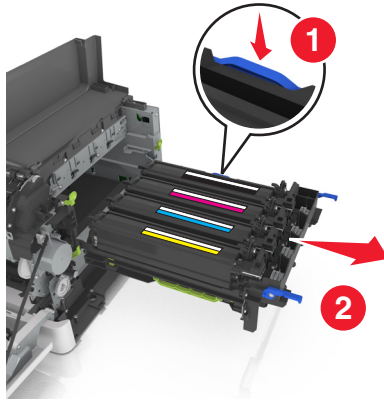

8 Remove the used developer unit.

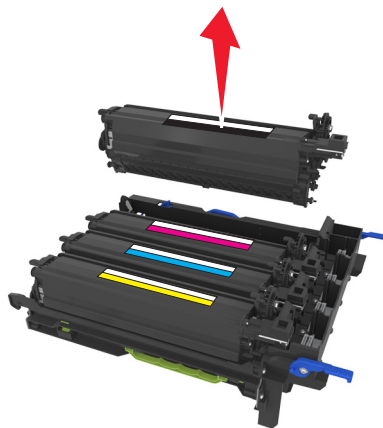

9 Gently shake the replacement developer unit side-to-side before removing it from its packaging.

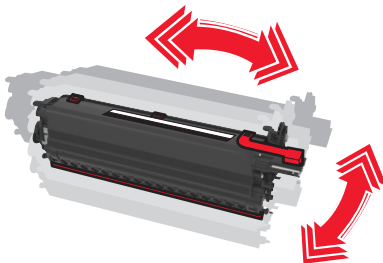

10 Remove the red shipping cover from the developer unit.

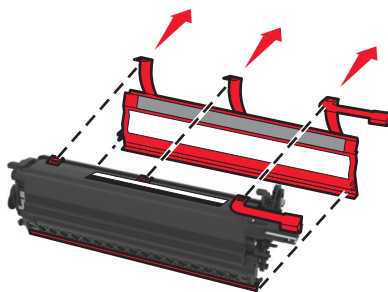

11 Insert the developer unit.

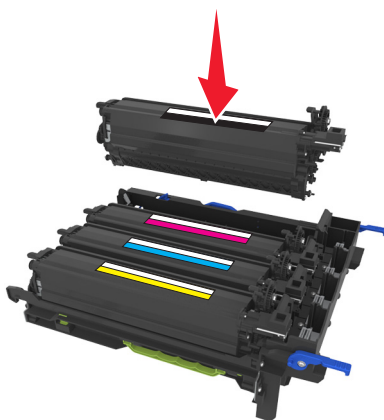

12 Align, and then insert the imaging kit.

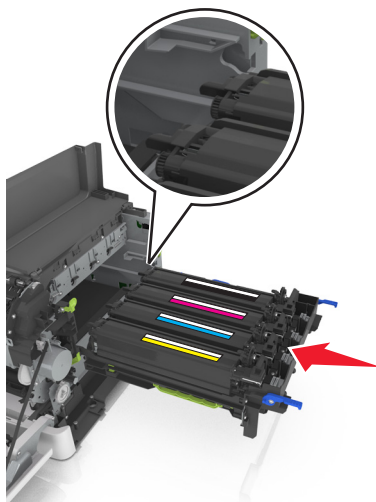

13 Push the blue levers down until the imaging kit is fully seated into place.

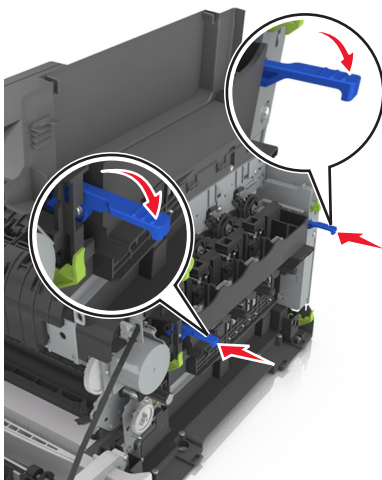

14 Insert the waste toner bottle.

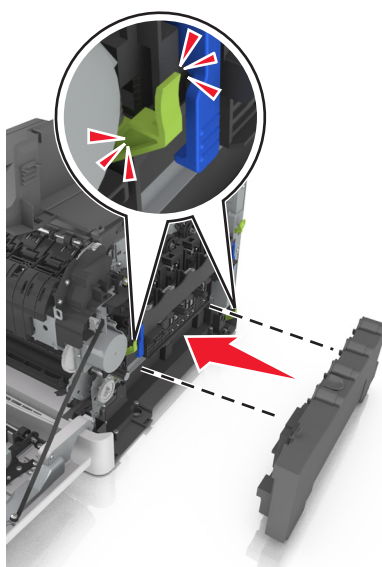

- 15** Insert the right side cover.

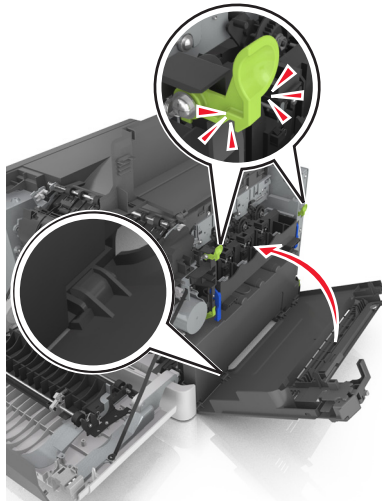

- 16** Insert the toner cartridges.

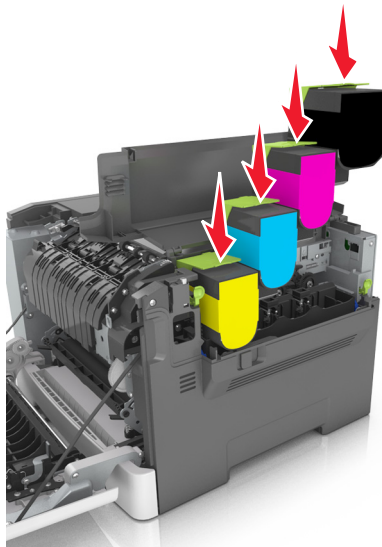

- 17** Close the top door.

- 18** Close the front door.

- 19** Pack the used developer unit in the bag that the replacement developer unit came in before disposing.
For more information, see [“Recycling Lexmark products” on page 92](#).

Moving the printer

Moving the printer to another location

- ⚠ CAUTION—POTENTIAL INJURY:** The printer weight is greater than 18 kg (40 lb) and requires two or more trained personnel to lift it safely.

 **CAUTION—POTENTIAL INJURY:** To avoid the risk of fire or electrical shock, use only the power cord provided with this product or the manufacturer's authorized replacement.

 **CAUTION—POTENTIAL INJURY:** When moving the printer, follow these guidelines to avoid personal injury or printer damage:

- Make sure that all doors and trays are closed.
- Turn off the printer, and then unplug the power cord from the electrical outlet.
- Disconnect all cords and cables from the printer.
- If the printer has a caster base, then carefully roll it to the new location. Use caution when passing over thresholds and breaks in flooring.
- If the printer does not have a caster base but is configured with optional trays, then lift the printer off the trays. Do not try to lift the printer and the trays at the same time.
- Always use the handholds on the printer to lift it.
- Any cart used to move the printer must have a surface able to support the full footprint of the printer.
- Any cart used to move the hardware options must have a surface able to support the dimensions of the options.
- Keep the printer in an upright position.
- Avoid severe jarring movements.
- Make sure that your fingers are not under the printer when you set it down.
- Make sure that there is adequate clearance around the printer.

Note: Damage to the printer caused by improper moving is not covered by the printer warranty.

Shipping the printer

When shipping the printer, use the original packaging.

Managing the printer

Finding advanced networking and administrator information

This chapter covers basic administrative support tasks using the Embedded Web Server. For more advanced system support tasks, see the *Networking Guide* on the *Software and Documentation CD* or the *Embedded Web Server — Security: Administrator's Guide* on the Lexmark support Web site at <http://support.lexmark.com>.

Setting up Remote Operator Panel

This application enables you to interact with the printer control panel even when you are not physically near the network printer. From your computer, you can view the printer status, release held print jobs, create bookmarks, and do other print-related tasks.

- 1 Open a Web browser, and then type the printer IP address in the address field.

Note: View the printer IP address on the printer home screen. The IP address appears as four sets of numbers separated by periods, such as 123.123.123.123.

- 2 Click **Settings > Remote Operator Panel Settings**.
- 3 Select the **Enable** check box, and then customize the settings.
- 4 Click **Submit**.

To use the application, click **Remote Operator Panel > Launch VNC Applet**.

Viewing reports

You can view some reports from the Embedded Web Server. These reports are useful for assessing the status of the printer, network, and supplies.

- 1 Open a Web browser, and then type the printer IP address in the address field.

Notes:

- View the printer IP address in the TCP/IP section in the Network/Ports menu. The IP address appears as four sets of numbers separated by periods, such as 123.123.123.123.
- If you are using a proxy server, then temporarily disable it to load the Web page correctly.

- 2 Click **Reports**, and then click the type of report you want to view.

Configuring supply notifications from the Embedded Web Server

You can determine how you would like to be notified when supplies run nearly low, low, very low, or reach their end-of-life by setting the selectable alerts.

Notes:

- You can select alerts for toner cartridges, imaging kit, maintenance kit, and waste toner bottle.
- All alerts can be set for nearly low, low, and very low supply conditions. Not all alerts can be set for the end-of-life supply condition. E-mail alert is available for all supply conditions.
- The percentage of estimated remaining supply that prompts the alert can be set on some supplies for some supply conditions.

1 Open a Web browser, and then type the printer IP address in the address field.

Notes:

- View the printer IP address in the TCP/IP section in the Network/Ports menu. The IP address appears as four sets of numbers separated by periods, such as 123.123.123.123.
- If you are using a proxy server, then temporarily disable it to load the Web page correctly.

2 Click **Settings > Print Settings > Supply Notifications**.

3 From the drop-down menu for each supply, select one of the following notification options:

Notification	Description
Off	The normal printer behavior for all supplies occurs.
E-mail Only	The printer generates an e-mail when the supply condition is reached. The status of the supply appears on the menus page and status page.
Warning	The printer shows the warning message and generates an email about the status of the supply. The printer does not stop when the supply condition is reached.
Continuable Stop ¹	The printer stops processing jobs when the supply condition is reached. The user needs to press a button to continue printing.
Non Continuable Stop ^{1,2}	The printer stops when the supply condition is reached. The supply must be replaced to continue printing.
¹ The printer generates an e-mail about the status of the supply when supply notification is enabled. ² The printer stops when some supplies become empty to prevent damage.	

4 Click **Submit**.

Copying printer settings to other printers

Note: This feature is available only in network printers.

1 Open a Web browser, and then type the printer IP address in the address field.

Notes:

- View the printer IP address in the TCP/IP section in the Network/Ports menu. The IP address appears as four sets of numbers separated by periods, such as 123.123.123.123.
- If you are using a proxy server, then temporarily disable it to load the Web page correctly.

2 Click the **Copy Printer Settings**.

3 To change the language, select a language from the drop-down menu, and then click **Click here to submit language**.

4 Click **Printer Settings**.

5 Type the IP addresses of the source and target printers in their appropriate fields.

Note: If you want to add or remove a target printer, then click **Add Target IP** or **Remove Target IP**.

6 Click **Copy Printer Settings**.

Restoring factory default settings

If you want to keep a list of the current menu settings for reference, then print a menu settings page before restoring the factory default settings. For more information, see [“Printing a menu settings page” on page 24](#).

If you want a more comprehensive method of restoring the printer factory default settings, then perform the Wipe All Settings option. For more information, see [“Erasing non-volatile memory” on page 93](#).

Warning—Potential Damage: Restoring factory defaults returns most printer settings to the original factory default settings. Exceptions include the display language, custom sizes and messages, and Network/Port menu settings. All downloads stored in the RAM are deleted.

From the printer control panel, navigate to:

 > **Settings** >  > **General Settings** >  > **Factory Defaults** >  > **Restore Now** > 

Clearing jams

Avoiding jams

Load paper properly

- Make sure that the paper lies flat in the tray.

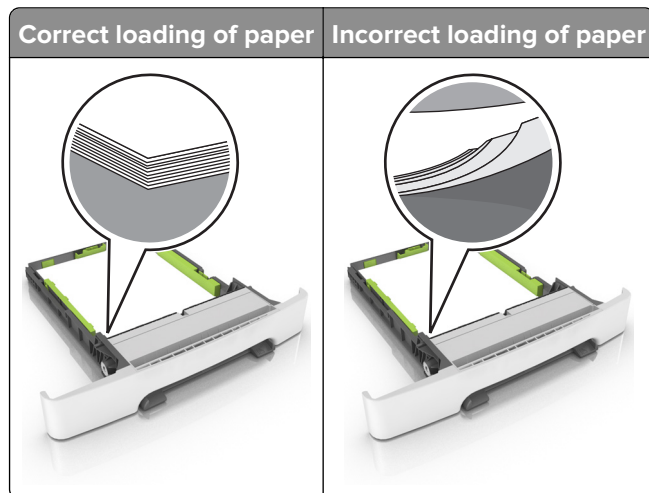

- Do not load or remove a tray while the printer is printing.
- Do not load too much paper. Make sure that the stack height is below the maximum paper fill indicator.
- Do not slide paper into the tray. Load paper as shown in the illustration.

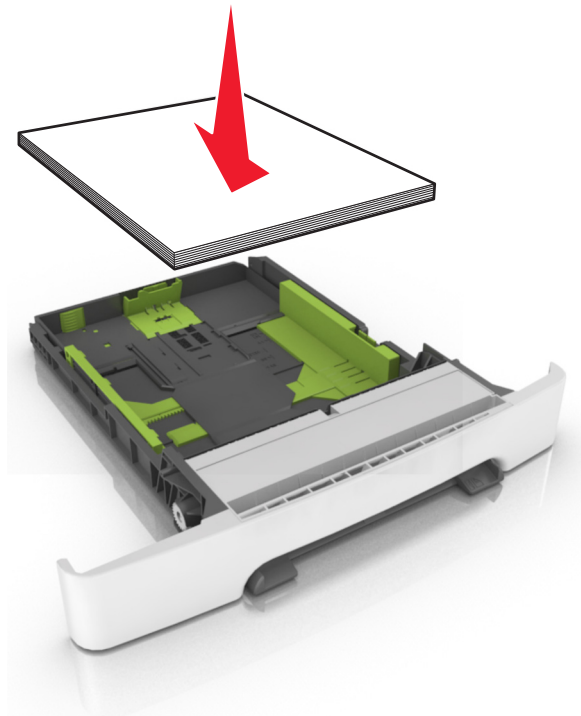

- Make sure that the paper guides are positioned correctly and are not pressing tightly against the paper or envelopes.
- Push the tray firmly into the printer after loading paper.

Use recommended paper

- Use only recommended paper or specialty media.
- Do not load paper that is wrinkled, creased, damp, bent, or curled.
- Flex, fan, and align the paper edges before loading.

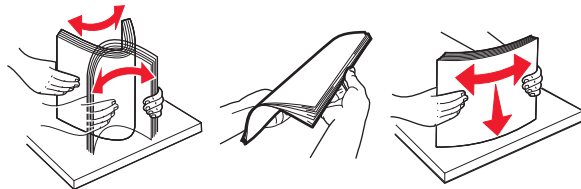

- Do not use paper that has been cut or trimmed by hand.
- Do not mix paper sizes, weights, or types in the same tray.
- Make sure that the paper size and type are set correctly on the computer or printer control panel.
- Store paper according to manufacturer recommendations.

Identifying jam locations

Notes:

- When Jam Assist is set to On, the printer flushes blank pages or pages with partial prints after a jammed page has been cleared. Check your printed output for blank pages.
- When Jam Recovery is set to On or Auto, the printer reprints jammed pages.

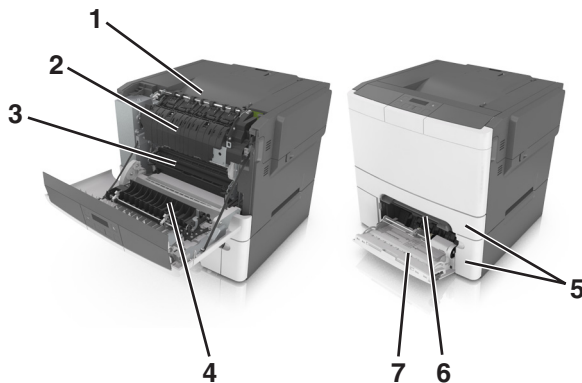

	Jam location
1	Standard bin
2	Fuser
3	Front door
4	Duplex unit
5	Trays

	Jam location
6	Manual feeder
7	Multipurpose feeder

Paper jam in the standard bin

Remove the jammed paper.

Note: Make sure that all paper fragments are removed.

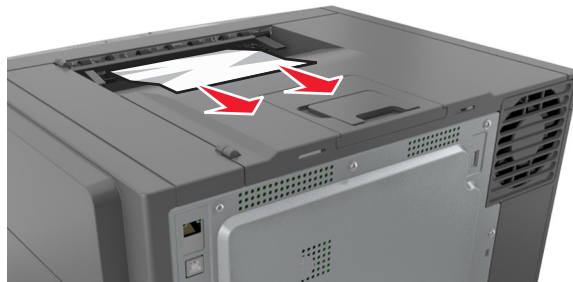

Paper jam in the front door

Paper jam in the fuser

- 1 Open the front door.

 **CAUTION—HOT SURFACE:** The inside of the printer might be hot. To reduce the risk of injury from a hot component, allow the surface to cool before touching it.

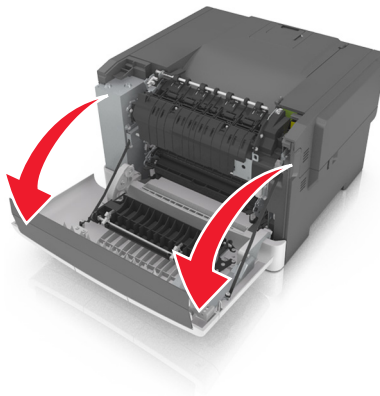

- 2 Remove the jammed paper.

Note: Make sure that all paper fragments are removed.

- Below the fuser

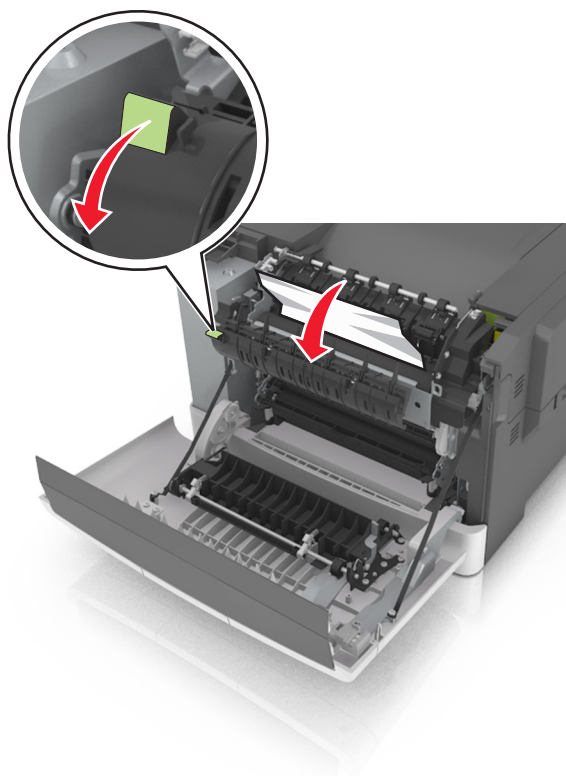

- In the fuser access door

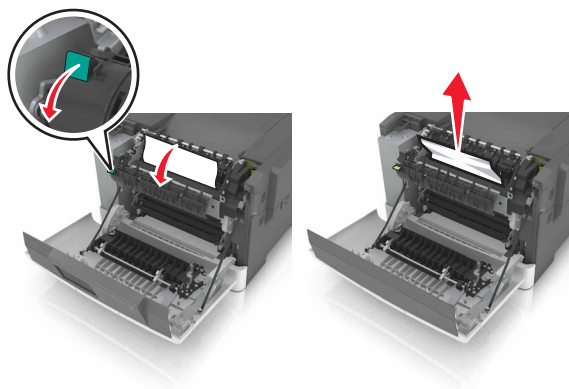

3 Close the front door.

Paper jam in the duplex unit

- 1 Open the front door.

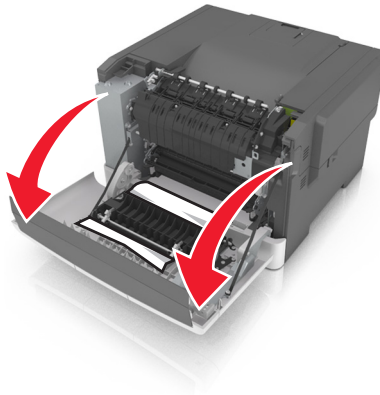

- 2 Remove the jammed paper.

Note: Make sure that all paper fragments are removed.

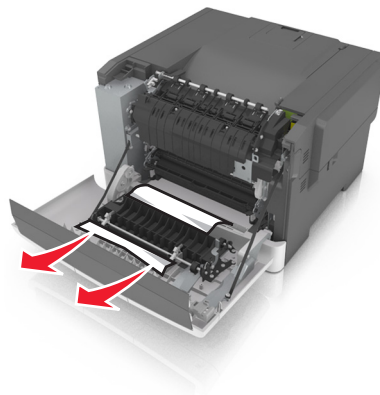

- 3 Close the front door.

Paper jam in trays

- 1 Pull out the tray.



- 2 Remove the jammed paper.

Note: Make sure that all paper fragments are removed.



- 3 Insert the tray.

Paper jam in the manual feeder

- 1 Remove the tray.



- 2 Remove the jammed paper.

Note: Make sure that all paper fragments are removed.



- 3 Insert the tray.

Paper jam in the multipurpose feeder

- 1 Remove paper from the multipurpose feeder.
- 2 Remove the jammed paper.
Note: Make sure that all paper fragments are removed.
- 3 Flex, fan, and align the paper edges before loading.

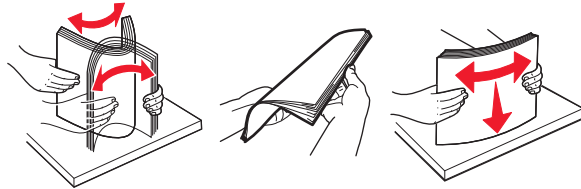

- 4 Reload paper.



Troubleshooting

Understanding the printer messages

Adjusting color

Wait for the process to complete.

Bin full. Remove paper.

Remove the paper stack from the standard bin.

Cannot collate large document [37]

Try one or more of the following:

- From the printer control panel, press **OK** to print the portion of the job already stored and begin collating the rest of the print job.
- Cancel the current print job.

Change [paper source] to [custom string]

Try one or more of the following:

- Load the correct size and type of paper in the tray, and then press **OK** on the printer control panel.
Note: Make sure the paper size and type are specified in the Paper menu on the printer control panel.
- Cancel the print job.

Change [paper source] to [custom type name]

Try one or more of the following:

- Load the correct size and type of paper in the tray, and then press **OK** on the printer control panel.
Note: Make sure the paper size and type are specified in the Paper menu on the printer control panel.
- Cancel the print job.

Change [paper source] to [paper type] [paper size]

Try one or more of the following:

- Load the correct size and type of paper in the tray, and then press **OK** on the printer control panel.
Note: Make sure the paper size and type are specified in the Paper menu on the printer control panel.
- Cancel the print job.

Close door

Make sure the right side cover is installed, and then close the front and top doors to clear the message.

[Color] cartridge low [88.xy]

You may need to order a toner cartridge. If necessary, press **OK** on the printer control panel to clear the message and continue printing.

[Color] cartridge nearly low [88.xy]

If necessary, press **OK** on the printer control panel to clear the message and continue printing.

[Color] cartridge very low, [x] estimated pages remain [88.xy]

You may need to replace the toner cartridge very soon. For more information, see the “Replacing supplies” section of the *User’s Guide*.

If necessary, press **OK** on the printer control panel to clear the message and continue printing.

Complex page may misprint [39]

Try one or more of the following:

- From the printer control panel, press **OK** to clear the message and continue printing.
- Reduce the number and size of fonts, the number and complexity of images, and the number of pages in the print job.
- Cancel the print job.
- Install additional printer memory.

Error reading USB drive. Remove USB.

An unsupported USB device is inserted. Remove the USB device, and then insert a supported one.

Incompatible tray [x] [59]

Remove, and then reinstall the indicated tray to clear the message.

Insert tray [x]

Insert the indicated tray into the printer.

Load [paper source] with [custom string]

Try one or more of the following:

- Load the indicated tray or feeder with the correct size and type of paper.
- From the printer control panel, press  to clear the message and continue printing.

Note: If the printer finds a tray or feeder that has the correct paper type and size, then it feeds from that tray or feeder. If the printer cannot find a tray or feeder that has the correct size and type of paper, then it prints from the default paper source.

- Cancel the current job.

Load [paper source] with [custom type name]

Try one or more of the following:

- Load the tray or feeder with the correct size and type of paper.
- From the printer control panel, press  to clear the message and continue printing.

Note: If the printer finds a tray or feeder that has the correct size and type of paper, then it feeds from that tray or feeder. If the printer cannot find a tray or feeder that has the correct size and type of paper, then it prints from the default paper source.

- Cancel the current job.

Load [paper source] with [paper size]

Try one or more of the following:

- Load the tray or feeder with the correct size of paper.
- From the printer control panel, press  to clear the message and continue printing.

Note: If the printer finds a tray or feeder that has the correct paper size, then it feeds from that tray or feeder. If the printer cannot find a tray or feeder that has the correct size of paper, then it prints from the default paper source.

- Cancel the current job.

Load [paper source] with [paper type] [paper size]

Try one or more of the following:

- Load the tray or feeder with the correct size and type of paper.
- From the printer control panel, press  to clear the message and continue printing.

Note: If the printer finds a tray or feeder that has the correct size and type of paper, then it feeds from that tray or feeder. If the printer cannot find a tray or feeder that has the correct size and type of paper, then it prints from the default paper source.

- Cancel the current job.

Load Manual Feeder with [custom string]

Try one or more of the following:

- Load the feeder with the correct size and type of paper.
- From the printer control panel, press  to clear the message and continue printing.

Note: If no paper is loaded in the feeder, then the printer manually overrides the request, and then prints from an automatically selected tray.

- Cancel the current job.

Load Manual Feeder with [custom type name]

Try one or more of the following:

- Load the feeder with the correct size and type of paper.
- From the printer control panel, press  to clear the message and continue printing.

Note: If no paper is loaded in the feeder, then the printer manually overrides the request, and then prints from an automatically selected tray.

- Cancel the current job.

Load Manual Feeder with [paper size]

Try one or more of the following:

- Load the feeder with the correct size of paper.
- From the printer control panel, press  to clear the message and continue printing.

Note: If no paper is loaded in the feeder, then the printer manually overrides the request, and then prints from an automatically selected tray.

- Cancel the current job.

Load Manual Feeder with [paper type] [paper size]

Try one or more of the following:

- Load the feeder with the correct size and type of paper.
- From the printer control panel, press  to clear the message and continue printing.

Note: If no paper is loaded in the feeder, then the printer manually overrides the request, and then prints from an automatically selected tray.

- Cancel the current job.

Maintenance kit low [80.xy]

You may need to order a maintenance kit. For more information, visit the Lexmark support Web site at <http://support.lexmark.com> or contact customer support, and then report the message.

If necessary, press  on the printer control panel to clear the message and continue printing.

Maintenance kit nearly low [80.xy]

For more information, visit the Lexmark support Web site at <http://support.lexmark.com> or contact customer support, and then report the message.

If necessary, press  on the printer control panel to clear the message and continue printing.

Maintenance kit very low [80.xy]

You may need to replace the maintenance kit very soon. For more information, go to <http://support.lexmark.com> or contact customer support.

If necessary, press  on the printer control panel to clear the message and continue printing.

Memory full [38]

Try one or more of the following:

- From the printer control panel, press  to clear the message.
- Decrease the resolution setting.
- Install additional printer memory.

Memory low, no Resource Save [35]

Try one or more of the following:

- From the printer control panel, press  to disable Resource Save, clear the message, and continue printing.
- Install additional printer memory.

Network error, port [x] [54]

Try one or more of the following:

- From the printer control panel, press  to clear the message and continue printing.
- Unplug the router, wait for 30 seconds, and then plug it back again.
- Turn off the printer, wait for about 10 seconds, and then turn the printer back on.
- Update the network firmware in the printer or the print server. For more information, visit the Lexmark Web site at <http://support.lexmark.com>.

Network error, standard port [54]

Try one or more of the following:

- From the printer control panel, press  to clear the message and continue printing.
- Unplug the router, wait for 30 seconds, and then plug it back again.
- Turn off the printer, wait for about 10 seconds, and then turn the printer back on.
- Update the network firmware in the printer or the print server. For more information, visit the Lexmark Web site at <http://support.lexmark.com>.

Non-Lexmark [supply type], see User's Guide [33.xy]



Note: The supply type can be a toner cartridge or the imaging kit.

The printer has detected a non-Lexmark supply or part installed in the printer.

Your Lexmark printer is designed to function best with genuine Lexmark supplies and parts. Use of third-party supplies or parts may affect the performance, reliability, or life of the printer and its imaging components. For more information, see [“Using genuine Lexmark parts and supplies” on page 96](#).

All life indicators are designed to function with Lexmark supplies and parts, and may deliver unpredictable results if third-party supplies or parts are used. Imaging component usage beyond the intended life may damage your Lexmark printer or its associated components.

Warning—Potential Damage: Use of third-party supplies or parts can affect warranty coverage. Damage caused by the use of third-party supplies or parts may not be covered by the warranty.

To accept any and all of these risks, and to proceed with the use of non-genuine supplies or parts in your printer, press  and  on the control panel simultaneously for 15 seconds to clear the message and continue printing.

If you do not want to accept these risks, then remove the third-party supply or part from your printer and install a genuine Lexmark supply or part.

Note: For the list of supported supplies, see the “Ordering supplies” section or go to www.lexmark.com.

Paper too short [34]

Try one or more of the following:

- Load the correct size of paper in the tray.
- From the printer control panel, press  to clear the message and print using a different tray.
- Check the tray length and width guides and make sure the paper is loaded properly in the tray.
- Make sure the correct paper size and type are specified in Print Properties or in the Print dialog.
- Make sure the paper size and type settings are specified in the Paper menu on the printer control panel.
- Make sure the paper size is correctly set. For example, if the Multipurpose Feeder Size is set to Universal, then make sure the paper is large enough for the data being printed.
- Cancel the print job.

Printer had to restart. Last job may be incomplete.

From the printer control panel, press  to clear the message and continue printing.

For more information, go to <http://support.lexmark.com> or contact customer support.

Rear USB port disabled [56]

Try one or more of the following:

- From the printer control panel, press  to clear the message and continue printing.

Note: The printer discards any data received through the USB port.

- From the printer control panel, set USB Buffer to Auto.

Reinstall missing or unresponsive [color] cartridge [31.xy]

Try one or more of the following:

- Install the missing toner cartridge. For more information, see the “Replacing supplies” section of the *User’s Guide*.
- Remove the unresponsive cartridge, and then reinstall it.

Note: If the message appears after reinstalling the supply, then the cartridge may be defective. Replace the cartridge.

Reinstall missing or unresponsive black and color imaging kit and all cartridges [31.xy]



Try one or more of the following:

- Check if the imaging kit is missing. If missing, then install the imaging kit.
For information on installing the imaging kit, see the “Replacing supplies” section.
- If the imaging kit is installed, then remove and reinstall the unresponsive imaging kit.

Note: If the message appears after reinstalling the supply, then replace the imaging kit. The imaging kit may be defective or a non-genuine Lexmark supply. For more information, see [“Using genuine Lexmark parts and supplies” on page 96](#).

Reload printed pages in Tray [x]

Try any of the following:

- From the printer control panel, press  to clear the message and continue printing the second side of the sheet.
- From the printer control panel, press  to cancel the print job.

Remove packaging material, check all

- 1 Remove any remaining packing material from the specified location.
- 2 From the printer control panel, press  to clear the message and continue printing.

Remove paper from standard output bin

Remove the paper stack from the standard bin.

Replace maintenance kit [80.xy]

The printer is scheduled for maintenance. For more information, go to <http://support.lexmark.com> or contact your service representative, and then report the message.

Replace missing [color] cartridge [31.xy]

Install the indicated toner cartridge to clear the message. For more information, see the “Replacing supplies” section of the *User’s Guide*.

Replace missing [type] imaging kit [31.xy]

Note: The type can be a black imaging kit, or a black and color imaging kit.

Install the indicated imaging kit to clear the message. For more information, see the “Replacing supplies” section of the *User’s Guide*.

Replace missing waste toner bottle [31.xyz]

Install the missing waste toner bottle to clear the message. For more information, see the instruction sheet that came with the supply.

Replace [type] imaging kit, 0 estimated pages remain [84.xy]

Note: The type can be a black imaging kit, or a black and color imaging kit.

Replace the indicated imaging kit to clear the message and continue printing. For more information, see the instruction sheet that came with the supply.

Note: If you do not have a replacement imaging kit, then see the “Ordering supplies” section of the *User’s Guide* or visit www.lexmark.com.

Replace unsupported [color] cartridge [32.xy]

Remove the toner cartridge, and then install a supported one to clear the message.

Note: If you do not have a replacement cartridge, then see the “Ordering supplies” section of the *User’s Guide* or visit www.lexmark.com.

Replace unsupported [type] imaging kit [32.xy]

Note: The type can be a black imaging kit, or a black and color imaging kit.

Remove the indicated imaging kit, and then install a supported one to clear the message.

Note: If you do not have a replacement imaging kit, then see the “Ordering supplies” section of the *User’s Guide* or visit www.lexmark.com.

Replace waste toner bottle [82.xy]

Replace the waste toner bottle to clear the message.

Supply needed to complete job

A supply needed to complete the job is missing. Cancel the current job.

Too many trays. Remove some. [58]

- 1 Turn off the printer.
- 2 Unplug the power cord from the electrical outlet.
- 3 Remove the extra trays.
- 4 Connect the power cord to the electrical outlet.
- 5 Turn the printer back on.

[Type] imaging kit low [84.xy]

Note: The type can be a black imaging kit, or a black and color imaging kit.

You may need to replace the imaging kit. If necessary, press  on the printer control panel to clear the message and continue printing.

[Type] imaging kit nearly low [84.xy]

Note: The type can be a black imaging kit, or a black and color imaging kit.

If necessary, press  on the printer control panel to clear the message and continue printing.

[Type] imaging kit very low, [x] estimated pages remain [84.xy]

Note: The type can be a black imaging kit, or a black and color imaging kit.

You may need to replace the imaging kit very soon. For more information, see the “Replacing supplies” section of the *User’s Guide*.

If necessary, press  on the printer control panel to clear the message and continue printing.

Waste toner bottle nearly full [82.xy]

You may need to order a waste toner bottle. If necessary, press  on the printer control panel to clear the message and continue printing.

Solving printer problems

Basic printer problems

The printer is not responding

Action	Yes	No
<p>Step 1 Make sure the printer is turned on.</p> <p>Is the printer turned on?</p>	Go to step 2.	Turn on the printer.
<p>Step 2 Check if the printer is in Sleep mode or Hibernate mode.</p> <p>Is the printer in Sleep mode or Hibernate mode?</p>	Press the Sleep button to wake the printer from Sleep mode or Hibernate mode.	Go to step 3.
<p>Step 3 Check if one end of the power cord is plugged into the printer and the other to a properly grounded electrical outlet.</p> <p>Is the power cord plugged into the printer and a properly grounded electrical outlet?</p>	Go to step 4.	Plug one end of the power cord into the printer and the other to a properly grounded electrical outlet.
<p>Step 4 Check other electrical equipment plugged into the electrical outlet.</p> <p>Does other electrical equipment work?</p>	Unplug the other electrical equipment, and then turn on the printer. If the printer does not work, then reconnect the other electrical equipment.	Go to step 5.
<p>Step 5 Check if the cables connecting the printer and the computer are inserted in the correct ports.</p> <p>Are the cables inserted in the correct ports?</p>	Go to step 6.	<p>Make sure to match the following:</p> <ul style="list-style-type: none"> • The USB symbol on the cable with the USB symbol on the printer • The appropriate Ethernet cable with the Ethernet port

Action	Yes	No
<p>Step 6 Make sure the electrical outlet is not turned off by a switch or breaker.</p> <p>Is the electrical outlet turned off by a switch or breaker?</p>	Turn on the switch or reset the breaker.	Go to step 7.
<p>Step 7 Check if the printer is plugged into any surge protectors, uninterruptible power supplies, or extension cords.</p> <p>Is the printer plugged into any surge protectors, uninterruptible power supplies, or extension cords?</p>	Connect the printer power cord directly to a properly grounded electrical outlet.	Go to step 8.
<p>Step 8 Check if one end of the printer cable is plugged into a port on the printer and the other to the computer, print server, option, or other network device.</p> <p>Is the printer cable securely attached to the printer and the computer, print server, option, or other network device?</p>	Go to step 9.	Connect the printer cable securely to the printer and the computer, print server, option, or other network device.
<p>Step 9 Make sure to install all hardware options properly and remove any packing material.</p> <p>Are all hardware options properly installed and all packing material removed?</p>	Go to step 10.	Turn off the printer, remove all packing materials, then reinstall the hardware options, and then turn on the printer.
<p>Step 10 Check if you have selected the correct port settings in the printer driver.</p> <p>Are the port settings correct?</p>	Go to step 11.	Use correct printer driver settings.
<p>Step 11 Check the installed printer driver.</p> <p>Is the correct printer driver installed?</p>	Go to step 12.	Install the correct printer driver.
<p>Step 12 Turn off the printer, then wait for about 10 seconds, and then turn the printer back on.</p> <p>Is the printer working?</p>	The problem is solved.	Contact customer support .

Printer display is blank

Action	Yes	No
<p>Step 1 Press the Sleep button on the printer control panel.</p> <p>Does Ready appear on the printer display?</p>	The problem is solved.	Go to step 2.
<p>Step 2 Turn off the printer, then wait for about 10 seconds, and then turn the printer back on.</p> <p>Do Please wait and Ready appear on the printer display?</p>	The problem is solved.	Turn off the printer, and then contact customer support .

Option problems

Cannot detect memory card

Action	Yes	No
<p>Make sure the memory card is installed.</p> <p>a Install the memory card. For more information, see “Installing a memory card” on page 12.</p> <p>Note: Check if the memory card is securely connected to the printer controller board.</p> <p>b Print a menu settings page, and then check if the card is listed in the Installed Options list.</p> <p>Is the card listed in the Installed Options list?</p>	The problem is solved.	Contact customer support .

Cannot detect internal option







Action	Yes	No
<p>Step 1 Turn off the printer, then wait for about 10 seconds, and then turn the printer back on.</p> <p>Does the internal option operate correctly?</p>	The problem is solved.	Go to step 2.
<p>Step 2 Check if the internal option is properly installed in the controller board.</p> <ul style="list-style-type: none"> a Turn off the printer. b Unplug the power cord from the electrical outlet. c Make sure the internal option is installed in the appropriate connector in the controller board. d Turn the printer back on. <p>Is the internal option properly installed in the controller board?</p>	Go to step 3.	Connect the internal option to the controller board.
<p>Step 3 Print a menu settings page, and then check to see if the internal option is listed in the Installed Options list.</p> <p>Is the internal option listed in the menu settings page?</p>	Go to step 4.	Reinstall the internal option.
<p>Step 4 Check if the option is available in the printer driver.</p> <p>It may be necessary to manually add the internal option in the printer driver to make it available for print jobs. For more information, see “Adding available options in the print driver” on page 19.</p> <p>Is the internal option available in the printer driver?</p>	Go to step 5.	Manually add the internal option in the printer driver.
<p>Step 5 a Check if the internal option is selected.</p> <p>Note: From the application you are using, select the internal option. For Mac OS X version 9 users, make sure the printer is set up in Chooser.</p> <p>b Resend the print job.</p> <p>Does the internal option operate correctly?</p>	The problem is solved.	Contact customer support .

Tray problems

Action	Yes	No
<p>Step 1</p> <p>a Open the tray and do one or more of the following:</p> <ul style="list-style-type: none"> • Check for paper jams or misfeeds. • Check if the paper size indicators on the paper guides are aligned with the paper size indicators on the tray. • If you are printing on custom-size paper, then make sure that the paper guides rest against the edges of the paper. • Make sure the paper is below the maximum paper fill indicator. • Make sure paper lies flat in the tray. <p>b Check if the tray closes properly.</p> <p>Is the tray working?</p>	The problem is solved.	Go to step 2.
<p>Step 2</p> <p>a Turn off the printer, then wait about 10 seconds, and then turn the printer back on.</p> <p>b Resend the print job.</p> <p>Is the tray working?</p>	The problem is solved.	Go to step 3.
<p>Step 3</p> <p>Check if the tray is installed.</p> <p>Print a menu settings page, and then check if the tray is listed in the Installed Options list.</p> <p>Is the tray listed in the menu settings page?</p>	Go to step 4.	Reinstall the tray. For more information, see the setup documentation that came with the tray.
<p>Step 4</p> <p>Check if the tray is available in the printer driver.</p> <p>Note: If necessary, manually add the tray in the printer driver to make it available for print jobs. For more information, see “Adding available options in the print driver” on page 19.</p> <p>Is the tray available in the printer driver?</p>	Go to step 5.	Manually add the tray in the printer driver.
<p>Step 5</p> <p>Check if the option is selected.</p> <p>a From the application you are using, select the option. For Mac OS X version 9 users, make sure the printer is set up in Chooser.</p> <p>b Resend the print job.</p> <p>Is the tray working?</p>	The problem is solved.	Contact customer support .

Paper feed problems

Jammed pages are not reprinted

Action	Yes	No
<p>a Turn on jam recovery.</p> <p>1 From the printer control panel, navigate to:</p> <p> > Settings >  > General Settings >  > Print Recovery >  > Jam Recovery > </p> <p>2 Press the arrow buttons until On or Auto appears, and then press .</p> <p>b Resend the pages that did not print.</p> <p>Were the jammed pages reprinted?</p>	<p>The problem is solved.</p>	<p>Contact customer support.</p>

Paper frequently jams

Action	Yes	No
<p>Step 1</p> <p>a Pull out the tray, and then do one or more of the following:</p> <ul style="list-style-type: none"> • Make sure paper lies flat in the tray. • Check if the paper size indicators on the paper guides are aligned with the paper size indicators on the tray. • Check if the paper guides are aligned against the edges of the paper. • Make sure the paper is below the maximum paper fill indicator. • Check if you are printing on a recommended paper size and type. <p>b Insert the tray properly.</p> <p>If jam recovery is enabled, then the print jobs will reprint automatically.</p> <p>Do paper jams still occur frequently?</p>	<p>Go to step 2.</p>	<p>The problem is solved.</p>
<p>Step 2</p> <p>a Load paper from a fresh package.</p> <p>Note: Paper absorbs moisture due to high humidity. Store paper in its original wrapper until you use it.</p> <p>b Resend the print job.</p> <p>Do paper jams still occur frequently?</p>	<p>Go to step 3.</p>	<p>The problem is solved.</p>

Action	Yes	No
<p>Step 3</p> <p>a Review the tips on avoiding jams. For more information, see “Avoiding jams” on page 121.</p> <p>b Follow the recommendations, and then resend the print job.</p> <p>Do paper jams still occur frequently?</p>	<p>Contact customer support.</p>	<p>The problem is solved.</p>

Paper jam message remains after jam is cleared

Action	Yes	No
<p>Open front door and remove all trays.</p> <p>a Clear any jammed pages.</p> <p>Note: Make sure all paper fragments are removed.</p> <p>b Press  to clear the message and continue printing.</p> <p>Does the paper jam message remain?</p>	<p>Contact customer support.</p>	<p>The problem is solved.</p>

Solving print problems

Printing problems

Incorrect characters print

Action	Yes	No
<p>Step 1</p> <p>Make sure the printer is not in Hex Trace mode.</p> <p>Note: If Ready Hex appears on the printer display, then turn off the printer, and then turn it back on to deactivate Hex Trace mode.</p> <p>Is the printer in Hex Trace mode?</p>	<p>Deactivate Hex Trace mode.</p>	<p>Go to step 2.</p>
<p>Step 2</p> <p>a From the printer control panel, select Standard Network or Network [x], and then set SmartSwitch to On.</p> <p>b Resend the print job.</p> <p>Do incorrect characters print?</p>	<p>Contact customer support.</p>	<p>The problem is solved.</p>

Job prints from the wrong tray or on the wrong paper

Action	Yes	No
<p>Step 1</p> <p>a Check if you are printing on paper that is supported by the tray.</p> <p>b Resend the print job.</p> <p>Did the job print from the correct tray or on the correct paper?</p>	The problem is solved.	Go to step 2.
<p>Step 2</p> <p>a From the Paper menu on the printer control panel, set the paper size and type to match the paper loaded in the tray.</p> <p>b Resend the print job.</p> <p>Did the job print from the correct tray or on the correct paper?</p>	The problem is solved.	Go to step 3.
<p>Step 3</p> <p>a Depending on your operating system, open Printing Preferences or the Print dialog, and then specify the paper type.</p> <p>b Resend the print job.</p> <p>Did the job print from the correct tray or on the correct paper?</p>	The problem is solved.	Go to step 4.
<p>Step 4</p> <p>a Check if the trays are not linked.</p> <p>b Resend the print job.</p> <p>Did the job print from the correct tray or on the correct paper?</p>	The problem is solved.	Contact customer support .

Large jobs do not collate

Action	Yes	No
<p>Step 1</p> <p>a From the Finishing menu on the printer control panel, set Collate to (1,2,3) (1,2,3).</p> <p>b Resend the print job.</p> <p>Did the job print and collate correctly?</p>	The problem is solved.	Go to step 2.
<p>Step 2</p> <p>a From the printer software, set Collate to (1,2,3) (1,2,3).</p> <p>Note: Setting Collate to (1,1,1) (2,2,2) in the software overrides the setting in the Finishing menu.</p> <p>b Resend the print job.</p> <p>Did the job print and collate correctly?</p>	The problem is solved.	Go to step 3.

Action	Yes	No
<p>Step 3 Reduce the complexity of the print job by eliminating the number and size of fonts, the number and complexity of images, and the number of pages in the job.</p> <p>Did the job print and collate correctly?</p>	The problem is solved.	Contact customer support .

Printing slows down

Notes:

- When printing using narrow paper, the printer prints at a reduced speed to prevent damage to the fuser.
- The printer speed may be reduced if printing for long periods of time, or printing at elevated temperatures.

Action	Yes	No
<p>Place letter- or A4-size paper in the tray, and then resend the print job.</p> <p>Does the print speed increase?</p>	The problem is solved.	Contact customer support .

Print jobs do not print

Action	Yes	No
<p>Step 1</p> <p>a From the document you are trying to print, open the Print dialog and check if you have selected the correct printer.</p> <p>Note: If the printer is not the default printer, then you must select the printer for each document that you want to print.</p> <p>b Resend the print job.</p> <p>Do the jobs print?</p>	The problem is solved.	Go to step 2.
<p>Step 2</p> <p>a Check if the printer is plugged in and turned on, and if Ready appears on the printer display.</p> <p>b Resend the print job.</p> <p>Do the jobs print?</p>	The problem is solved.	Go to step 3.
<p>Step 3</p> <p>If an error message appears on the printer display, then clear the message.</p> <p>Note: The printer continues to print after clearing the message.</p> <p>Do the jobs print?</p>	The problem is solved.	Go to step 4.

Action	Yes	No
<p>Step 4</p> <p>a Check if the ports (USB, serial, or Ethernet) are working and if the cables are securely connected to the computer and the printer.</p> <p>Note: For more information, see the setup documentation that came with the printer.</p> <p>b Resend the print job.</p> <p>Do the jobs print?</p>	The problem is solved.	Go to step 5.
<p>Step 5</p> <p>a Turn off the printer, then wait for about 10 seconds, and then turn the printer back on.</p> <p>b Resend the print job.</p> <p>Do the jobs print?</p>	The problem is solved.	Go to step 6.
<p>Step 6</p> <p>a Remove, and then reinstall the printer software. For more information, see “Installing the printer software” on page 19.</p> <p>Note: The printer software is available at http://support.lexmark.com.</p> <p>b Resend the print job.</p> <p>Do the jobs print?</p>	The problem is solved.	Contact customer support .

Print job takes longer than expected

Action	Yes	No
<p>Step 1</p> <p>Change the environmental settings of the printer.</p> <p>a From the printer control panel, navigate to:</p> <p>Settings > General Settings</p> <p>b Select Eco-Mode or Quiet Mode, and then select Off.</p> <p>Note: Disabling Eco-Mode or Quiet Mode may increase the consumption of energy or supplies, or both.</p> <p>Did the job print?</p>	The problem is solved.	Go to step 2.
<p>Step 2</p> <p>Reduce the number and size of fonts, the number and complexity of images, and the number of pages in the print job, and then resend the job</p> <p>Did the job print?</p>	The problem is solved.	Go to step 3.

Action	Yes	No
<p>Step 3</p> <p>a Remove held jobs stored in the printer memory.</p> <p>b Resend the print job.</p> <p>Did the job print?</p>	The problem is solved.	Go to step 4.
<p>Step 4</p> <p>a Disable the Page Protect feature.</p> <p>From the printer control panel, navigate to: Settings > General Settings > Print Recovery > Page Protect > Off</p> <p>b Resend the print job.</p> <p>Did the job print?</p>	The problem is solved.	Go to step 5.
<p>Step 5</p> <p>Install additional printer memory, and then resend the print job.</p> <p>Did the job print?</p>	The problem is solved.	Contact customer support .

Tray linking does not work

Notes:

- The trays can detect paper length.
- The multipurpose feeder does not automatically detect the paper size. You must set the size from the Paper Size/Type menu.

Action	Yes	No
<p>Step 1</p> <p>a Open the trays, and then check if they contain paper of the same size and type.</p> <ul style="list-style-type: none"> • Check if the paper guides are in the correct positions for the size of the paper loaded in each tray. • Check if the paper size indicators on the paper guides are aligned with the paper size indicators on the tray. <p>b Resend the print job.</p> <p>Do the trays link correctly?</p>	The problem is solved.	Go to step 2.

Action	Yes	No
<p>Step 2</p> <p>a From the printer control panel, set the paper size and type in the Paper menu to match the paper loaded in the trays to be linked.</p> <p>Note: The paper size and type must match for trays to be linked.</p> <p>b Resend the print job.</p> <p>Do the trays link correctly?</p>	<p>The problem is solved.</p>	<p>Contact customer support.</p>

Unexpected page breaks occur

Action	Yes	No
<p>Step 1</p> <p>Adjust the print timeout settings.</p> <p>a From the printer control panel, navigate to: Settings > General Settings > Timeouts > Print Timeout</p> <p>b Select a higher setting and then, depending on your printer model, select <input type="button" value="OK"/> or Submit.</p> <p>c Resend the print job.</p> <p>Did the file print correctly?</p>	<p>The problem is solved.</p>	<p>Go to step 2.</p>
<p>Step 2</p> <p>a Check the original file for manual page breaks.</p> <p>b Resend the print job.</p> <p>Did the file print correctly?</p>	<p>The problem is solved.</p>	<p>Contact customer support.</p>

Print quality problems

Characters have jagged or uneven edges

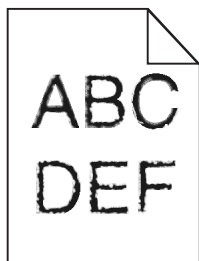

Action	Yes	No
<p>Step 1</p> <p>a Print a font sample list to check if the fonts you are using are supported by the printer.</p> <p>1 From the printer control panel, navigate to: Menus > Reports > Print Fonts</p> <p>2 Select PCL Fonts or PostScript Fonts.</p> <p>b Resend the print job.</p> <p>Are you using fonts that are supported by the printer?</p>	Go to step 2.	Select a font that is supported by the printer.
<p>Step 2</p> <p>Check if the fonts installed on the computer are supported by the printer.</p> <p>Are the fonts installed on the computer supported by the printer?</p>	The problem is solved.	Contact customer support .

Clipped pages or images

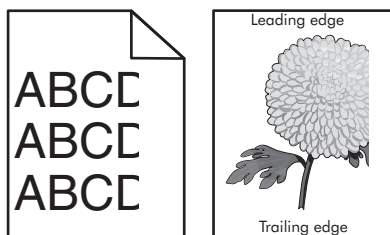

Action	Yes	No
<p>Step 1</p> <p>a Move the width and length guides in the tray to the correct positions for the paper loaded.</p> <p>b Resend the print job.</p> <p>Is the page or image clipped?</p>	Go to step 2.	The problem is solved.
<p>Step 2</p> <p>From the printer control panel, set the paper size and type in the Paper menu to match the paper loaded in the tray.</p> <p>Does the paper size match the paper loaded in the tray?</p>	Go to step 3.	<p>Do one or more of the following:</p> <ul style="list-style-type: none"> From the printer control panel, change the paper size to match the paper loaded in the tray. From the printer control panel, change the paper type to match the paper loaded in the tray.

Action	Yes	No
<p>Step 3</p> <p>a Depending on your operating system, specify the paper size from Printing Preferences or from the Print dialog.</p> <p>b Resend the print job.</p> <p>Is the page or image clipped?</p>	Go to step 4.	The problem is solved.
<p>Step 4</p> <p>a Remove, and then reinstall the imaging kit.</p> <p>Warning—Potential Damage: Do not expose the imaging kit to direct light for more than 10 minutes. Extended exposure to light may cause print quality problems.</p> <p>Warning—Potential Damage: Do not touch the underside of the imaging kit. This could damage the imaging kit.</p> <p>b Resend the print job.</p> <p>Is the page or image clipped?</p>	Contact customer support .	The problem is solved.

Gray background on prints

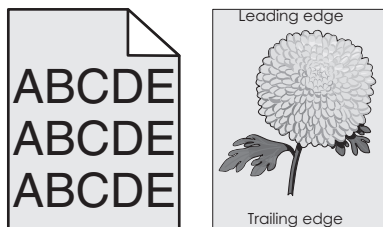

Action	Yes	No
<p>Step 1</p> <p>Reduce the toner darkness.</p> <p>a From the Quality menu on the printer control panel, reduce the toner density.</p> <p>Note: 4 is the factory default setting.</p> <p>b Resend the print job.</p> <p>Did the gray background disappear?</p>	The problem is solved.	Go to step 2.

Action	Yes	No
<p>Step 2</p> <p>a Remove, and then reinstall the imaging kit.</p> <p>Warning—Potential Damage: Do not expose the imaging kit to direct light for more than 10 minutes. Extended exposure to light may cause print quality problems.</p> <p>Warning—Potential Damage: Do not touch the underside of the imaging kit. This could damage the imaging kit.</p> <p>b Resend the print job.</p> <p>Did the gray background disappear?</p>	<p>The problem is solved.</p>	<p>Contact customer support.</p>

Horizontal voids appear on prints

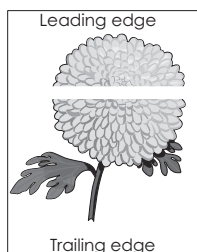

Action	Yes	No
<p>Step 1</p> <p>a Make sure your software program is using a correct fill pattern.</p> <p>b Resend the print job.</p> <p>Do horizontal voids appear on prints?</p>	<p>Go to step 2.</p>	<p>The problem is solved.</p>
<p>Step 2</p> <p>a Load the specified tray or feeder with a recommended type of paper.</p> <p>b Resend the print job.</p> <p>Do horizontal voids appear on prints?</p>	<p>Go to step 3.</p>	<p>The problem is solved.</p>
<p>Step 3</p> <p>a Remove, and then reinstall the imaging kit.</p> <p>Warning—Potential Damage: Do not expose the imaging kit to direct light for more than 10 minutes. Extended exposure to light may cause print quality problems.</p> <p>Warning—Potential Damage: Do not touch the underside of the imaging kit. This could damage the imaging kit.</p> <p>b Resend the print job.</p> <p>Do horizontal voids appear on prints?</p>	<p>Go to step 4.</p>	<p>The problem is solved.</p>

Action	Yes	No
<p>Step 4 Replace the imaging kit, and then resend the print job.</p> <p>Do horizontal voids appear on prints?</p>	Contact customer support .	The problem is solved.

Incorrect margins on prints

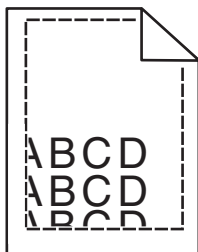

Action	Yes	No
<p>Step 1 a Move the width and length guides in the tray to the correct positions for the paper size loaded. b Resend the print job.</p> <p>Are the margins correct?</p>	The problem is solved.	Go to step 2.
<p>Step 2 From the printer control panel, set the paper size in the Paper menu to match the paper loaded in the tray.</p> <p>Does the paper size match the paper loaded in the tray?</p>	Go to step 3.	Do one or more of the following: <ul style="list-style-type: none"> Specify the paper size from the tray settings to match the paper loaded in the tray. Change the paper loaded in the tray to match the paper size specified in the tray settings.
<p>Step 3 a Depending on your operating system, specify the paper size from Printing Preferences or from the Print dialog. b Resend the print job.</p> <p>Are the margins correct?</p>	The problem is solved.	Contact customer support .

Paper curl

Action	Yes	No
<p>Step 1 Move the width and length guides in the tray to the correct positions for the size of the paper loaded.</p> <p>Are the width and length guides positioned correctly?</p>	Go to step 2.	Adjust the width and length guides.
<p>Step 2 From the printer control panel, set the paper type and weight in the Paper menu to match the paper loaded in the tray.</p> <p>Do the paper type and weight match the type and weight of the paper in the tray?</p>	Go to step 3.	Specify the paper type and weight from the tray settings to match the paper loaded in the tray.
<p>Step 3</p> <p>a Depending on your operating system, specify the paper type and weight from Printing Preferences or from the Print dialog.</p> <p>b Resend the print job.</p> <p>Is the paper still curled?</p>	Go to step 4.	The problem is solved.
<p>Step 4</p> <p>a Remove the paper from the tray, and then turn it over.</p> <p>b Resend the print job.</p> <p>Is the paper still curled?</p>	Go to step 5.	The problem is solved.
<p>Step 5</p> <p>a Load paper from a fresh package.</p> <p>Note: Paper absorbs moisture due to high humidity. Store paper in its original wrapper until you use it.</p> <p>b Resend the print job.</p> <p>Is the paper still curled?</p>	Contact customer support .	The problem is solved.

Print irregularities

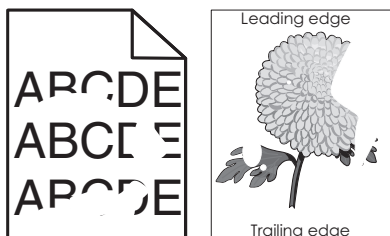

Action	Yes	No
<p>Step 1</p> <p>a Move the width and length guides in the tray to the correct positions for the size of the paper loaded in the tray.</p> <p>b Resend the print job.</p> <p>Do print irregularities still appear?</p>	Go to step 2.	The problem is solved.
<p>Step 2</p> <p>From the printer control panel, set the paper size and type in the Paper menu to match the paper loaded in the tray.</p> <p>Is the tray set to the size and type of the paper loaded in the tray?</p>	Go to step 3.	<p>Do one or more of the following:</p> <ul style="list-style-type: none"> • Specify the paper size from the tray settings to match the paper loaded in the tray. • Change the paper loaded in the tray to match the paper size specified in the tray settings.
<p>Step 3</p> <p>a Depending on your operating system, specify the paper type and weight from Printing Preferences or from the Print dialog.</p> <p>b Resend the print job.</p> <p>Do print irregularities still appear?</p>	Go to step 4.	The problem is solved.
<p>Step 4</p> <p>Check if the paper loaded in the tray has texture or rough finishes.</p> <p>Are you printing on textured or rough paper?</p>	From the printer control panel, set the paper texture in the Paper menu to match the paper loaded in the tray.	Go to step 5.
<p>Step 5</p> <p>a Load paper from a fresh package.</p> <p>Note: Paper absorbs moisture due to high humidity. Store paper in its original wrapper until you use it.</p> <p>b Resend the print job.</p> <p>Do print irregularities still appear?</p>	Go to step 6.	The problem is solved.
<p>Step 6</p> <p>Replace the imaging kit, and then resend the print job.</p> <p>Do print irregularities still appear?</p>	Contact customer support .	The problem is solved.

Print is too dark

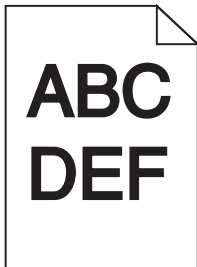

Action	Yes	No
<p>Step 1</p> <p>a From the Quality menu on the printer control panel, select Color Adjust.</p> <p>b Resend the print job.</p> <p>Is the print still too dark?</p>	Go to step 2.	The problem is solved.
<p>Step 2</p> <p>a From the Quality menu on the printer control panel, reduce the toner darkness.</p> <p>Note: 4 is the factory default setting.</p> <p>b Resend the print job.</p> <p>Is the print still too dark?</p>	Go to step 3.	The problem is solved.
<p>Step 3</p> <p>a From the printer control panel, set the paper type, texture, and weight in the Paper menu to match the paper loaded in the tray.</p> <p>b Resend the print job.</p> <p>Is the tray set to the type, texture, and weight of the paper loaded?</p>	Go to step 4.	Change the paper loaded in the tray to match the paper type, texture, and weight specified in the tray settings.
<p>Step 4</p> <p>a Depending on your operating system, specify the paper type, texture and weight from Printing Preferences or from the Print dialog.</p> <p>b Resend the print job.</p> <p>Is the print still too dark?</p>	Go to step 5.	The problem is solved.
<p>Step 5</p> <p>Check if the paper loaded in the tray has texture or rough finishes.</p> <p>Are you printing on textured or rough paper?</p>	From the printer control panel, set the paper texture in the Paper menu to match the paper loaded on the tray.	Go to step 6.

Action	Yes	No
<p>Step 6</p> <p>a Load paper from a fresh package.</p> <p>Note: Paper absorbs moisture due to high humidity. Store paper in its original wrapper until you use it.</p> <p>b Resend the print job.</p> <p>Is the print still too dark?</p>	Go to step 7.	The problem is solved.
<p>Step 7</p> <p>Replace the imaging kit, and then resend the print job.</p> <p>Is the print still too dark?</p>	Contact customer support .	The problem is solved.

Print is too light



Action	Yes	No
<p>Step 1</p> <p>a From the Quality menu on the printer control panel, select Color Adjust.</p> <p>b Resend the print job.</p> <p>Is the print still too light?</p>	Go to step 2.	The problem is solved.
<p>Step 2</p> <p>a From the Quality menu on the printer control panel, increase the toner darkness.</p> <p>Note: 4 is the factory default setting.</p> <p>b Resend the print job.</p> <p>Is the print still too light?</p>	Go to step 3.	The problem is solved.
<p>Step 3</p> <p>From the printer control panel, set the paper type, texture, and weight in the Paper menu to match the paper loaded in the tray.</p> <p>Is the tray set to the type, texture, and weight of the paper loaded?</p>	Go to step 4.	Specify the paper type, texture, and weight from the tray settings to match the paper loaded in the tray.

Action	Yes	No
<p>Step 4</p> <p>a Depending on your operating system, specify the paper type, texture, and weight from Printing Preferences or from the Print dialog.</p> <p>b Resend the print job.</p> <p>Is the print still too light?</p>	Go to step 5.	The problem is solved.
<p>Step 5</p> <p>Make sure that the paper has no texture or rough finishes.</p> <p>Are you printing on textured or rough paper?</p>	From the printer control panel, set the paper texture in the Paper menu to match the paper loaded in the tray	Go to step 5.
<p>Step 6</p> <p>a Load paper from a fresh package.</p> <p>Note: Paper absorbs moisture due to high humidity. Store paper in its original wrapper until you use it.</p> <p>b Resend the print job.</p> <p>Is the print still too light?</p>	Go to step 7.	The problem is solved.
<p>Step 7</p> <p>Replace the imaging kit, and then resend the print job.</p> <p>Is the print still too light?</p>	Contact customer support .	The problem is solved.

Printer is printing blank pages

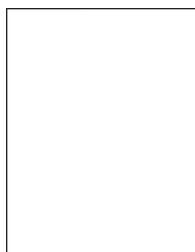

Action	Yes	No
<p>Step 1</p> <p>a Check if there is packing material left on the imaging kit.</p> <ol style="list-style-type: none"> 1 Remove the imaging kit. 2 Check if the packing material is properly removed from the imaging kit. <p>Warning—Potential Damage: Do not expose the imaging kit to direct light for more than 10 minutes. Extended exposure to light may cause print quality problems.</p> <p>Warning—Potential Damage: Do not touch the underside of the imaging kit. This could damage the imaging kit.</p> <ol style="list-style-type: none"> 3 Reinstall the imaging kit. <p>b Resend the print job.</p> <p>Is the printer still printing blank pages?</p>	Go to step 2.	The problem is solved.
<p>Step 2</p> <p>Replace the imaging kit, and then resend the print job.</p> <p>Is the printer still printing blank pages?</p>	Contact customer support .	The problem is solved.

Printer is printing solid black pages



Action	Yes	No
<p>Step 1</p> <p>a Remove, and then reinstall the imaging kit.</p> <p>Warning—Potential Damage: Do not expose the imaging kit to direct light for more than 10 minutes. Extended exposure to light may cause print quality problems.</p> <p>Warning—Potential Damage: Do not touch the underside of the imaging kit. This could damage the imaging kit.</p> <p>b Resend the print job.</p> <p>Is the printer printing solid black pages?</p>	Go to step 2.	The problem is solved.
<p>Step 2</p> <p>Replace the imaging kit, and then resend the print job.</p> <p>Is the printer printing solid black pages?</p>	Contact customer support .	The problem is solved.

Repeating defects appear on prints

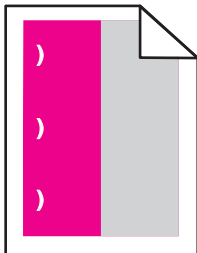

Action	Yes	No
<p>a Check if the distance between the defects is equal to one of the following:</p> <ul style="list-style-type: none"> • 25.1 mm (0.98 in.) • 29.8 mm (1.17 in.) • 43.9 mm (1.72 in.) • 45.5 mm (1.79 in.) • 94.2 mm (3.70 in.) <p>b If the distance between the defects equals 25.1 mm (0.98 in.), 29.8 mm (1.17 in.), or 94.2 mm (3.70 in.), then replace the photoconductor unit.</p> <p>c If the distance between the defects equals 43.9 mm (1.72 in.) or 45.5 mm (1.79 in.), then replace the developer unit.</p> <p>Do the repeating defects still appear?</p>	<p>1 Check if the distance between the defects is equal to one of the following:</p> <ul style="list-style-type: none"> • 37.7 mm (1.48 in.) • 78.5 mm (3.09 in.) • 95 mm (3.74 in.) <p>2 Take note of the distance, and then contact customer support or your service representative.</p>	<p>The problem is solved.</p>

Shadow images appear on prints

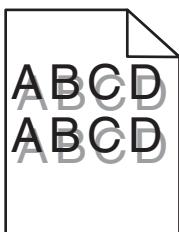

Action	Yes	No
<p>Step 1 Check if the paper loaded in the tray has the correct paper type and weight.</p> <p>Is paper with the correct paper type and weight loaded in the tray?</p>	Go to step 2.	Load paper with the correct paper type and weight in the tray.
<p>Step 2 From the printer control panel, set the paper type and weight in the Paper menu to match the paper loaded in the tray.</p> <p>Do the printer settings match the type and weight of the paper loaded?</p>	Go to step 3.	Change the paper type and weight to match the paper loaded in the tray.
<p>Step 3</p> <ul style="list-style-type: none"> a Depending on your operating system, specify the paper type and weight from Printing Preferences or from the Print dialog. b Resend the print job. <p>Do shadow images still appear on prints?</p>	Go to step 4.	The problem is solved.
<p>Step 4 Replace the imaging kit, and then resend the print job.</p> <p>Do shadow images still appear on prints?</p>	Contact customer support .	The problem is solved.

Skewed print

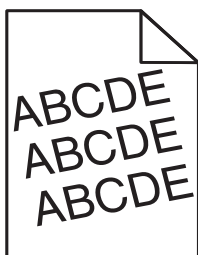

Action	Yes	No
<p>Step 1</p> <ul style="list-style-type: none"> a Move the width and length guides in the tray to the correct positions for the size of the paper loaded. b Resend the print job. <p>Is the print still skewed?</p>	Go to step 2.	The problem is solved.

Action	Yes	No
<p>Step 2</p> <p>a Check if you are printing on a paper that is supported by the tray.</p> <p>b Resend the print job.</p> <p>Is the print still skewed?</p>	<p>Contact customer support.</p>	<p>The problem is solved.</p>

Streaked horizontal lines appear on prints

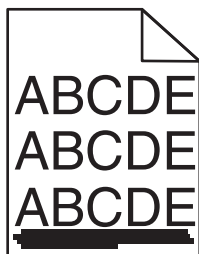

Action	Yes	No
<p>Step 1</p> <p>a Depending on your operating system, specify the tray or feeder from Printing Preferences or the Print dialog.</p> <p>b Resend the print job.</p> <p>Do streaked horizontal lines appear on prints?</p>	<p>Go to step 2.</p>	<p>The problem is solved.</p>
<p>Step 2</p> <p>From the printer control panel, set the paper type and weight in the Paper menu to match the paper loaded in the tray.</p> <p>Do the paper type and weight match the paper in the tray?</p>	<p>Go to step 3.</p>	<p>Do one or more of the following:</p> <ul style="list-style-type: none"> Specify the paper type and weight from the tray settings to match the paper loaded in the tray. Change the paper loaded in the tray to match the paper type and weight specified in the tray settings.
<p>Step 3</p> <p>a Load paper from a fresh package.</p> <p>Note: Paper absorbs moisture due to high humidity. Store paper in its original wrapper until you use it.</p> <p>b Resend the print job.</p> <p>Do streaked horizontal lines appear on prints?</p>	<p>Go to step 4.</p>	<p>The problem is solved.</p>

Action	Yes	No
<p>Step 4</p> <p>a Remove, and then reinstall the imaging kit.</p> <p>Warning—Potential Damage: Do not expose the imaging kit to direct light for more than 10 minutes. Extended exposure to light may cause print quality problems.</p> <p>Warning—Potential Damage: Do not touch the underside of the imaging kit. This could damage the imaging kit.</p> <p>b Resend the print job.</p> <p>Do streaked horizontal lines appear on prints?</p>	Go to step 5.	The problem is solved.
<p>Step 5</p> <p>Replace the imaging kit, and then resend the print job.</p> <p>Do streaked horizontal lines appear on prints?</p>	Contact customer support .	The problem is solved.

Streaked vertical lines appear on prints

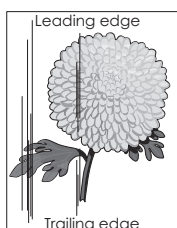
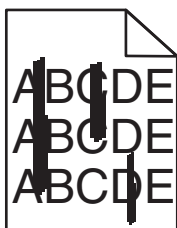

Action	Yes	No
<p>Step 1</p> <p>a Depending on your operating system, specify the paper type, texture, and weight from Printing Preferences or from the Print dialog.</p> <p>b Resend the print job.</p> <p>Do streaked vertical lines appear on prints?</p>	Go to step 2.	The problem is solved.
<p>Step 2</p> <p>From the printer control panel, set the paper texture, type, and weight in the Paper menu to match the paper loaded in the tray.</p> <p>Do the paper texture, type, and weight match the paper in the tray?</p>	Go to step 3.	<p>Do one or more of the following:</p> <ul style="list-style-type: none"> Specify the paper texture, type, and weight from the tray settings to match the paper loaded in the tray. Change the paper loaded in the tray to match the paper size specified in the tray settings.

Action	Yes	No
<p>Step 3</p> <p>a Load paper from a fresh package.</p> <p>Note: Paper absorbs moisture due to high humidity. Store paper in its original wrapper until you use it.</p> <p>b Resend the print job.</p> <p>Do streaked vertical lines appear on prints?</p>	Go to step 4.	The problem is solved.
<p>Step 4</p> <p>a Remove, and then reinstall the imaging kit.</p> <p>Warning—Potential Damage: Do not expose the imaging kit to direct light for more than 10 minutes. Extended exposure to light may cause print quality problems.</p> <p>Warning—Potential Damage: Do not touch the underside of the imaging kit. This could damage the imaging kit.</p> <p>b Resend the print job.</p> <p>Do streaked vertical lines appear on prints?</p>	Go to step 5.	The problem is solved.
<p>Step 5</p> <p>Replace the imaging kit, and then resend the print job.</p> <p>Do streaked vertical lines appear on prints?</p>	Contact customer support .	The problem is solved.

Toner fog or background shading appears on prints

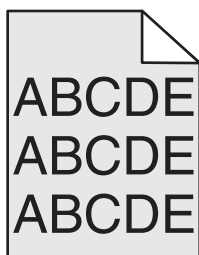

Action	Yes	No
<p>Step 1</p> <p>a Remove, and then reinstall the imaging kit.</p> <p>Warning—Potential Damage: Do not expose the imaging kit to direct light for more than 10 minutes. Extended exposure to light may cause print quality problems.</p> <p>Warning—Potential Damage: Do not touch the underside of the imaging kit. This could damage the imaging kit.</p> <p>b Resend the print job.</p> <p>Does fog or shading disappear from the prints?</p>	The problem is solved.	Go to step 2.

Action	Yes	No
<p>Step 2 Replace the imaging kit, and then resend the print job.</p> <p>Does fog or shading disappear from the prints?</p>	The problem is solved.	Contact customer support .

Toner rubs off

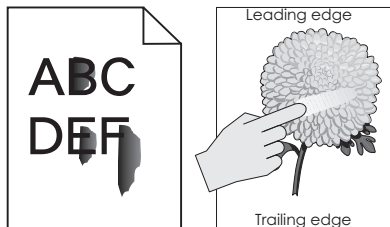

Action	Yes	No
<p>Step 1 From the Paper menu on the printer control panel, check the paper type, texture, and weight.</p> <p>Do the paper type, texture, and weight match the paper loaded in the tray?</p>	Go to step 2.	Specify the paper type, texture, and weight from the tray settings to match the paper loaded in the tray.
<p>Step 2 Resend the print job.</p> <p>Does the toner still rub off?</p>	Contact customer support .	The problem is solved.

Toner specks appear on prints

Action	Yes	No
<p>Replace the imaging kit, and then resend the print job.</p> <p>Do toner specks appear on prints?</p>	Contact customer support .	The problem is solved.

Transparency print quality is poor

Action	Yes	No
<p>Step 1 From the printer control panel, set the paper type in the Paper menu to match the paper loaded in the tray.</p> <p>Is the paper type for the tray set to Transparency?</p>	Go to step 2.	Set the paper type to Transparency.
<p>Step 2 a Check if you are using a recommended type of transparency. b Resend the print job.</p> <p>Is the print quality still poor?</p>	Contact customer support .	The problem is solved.

Uneven print density

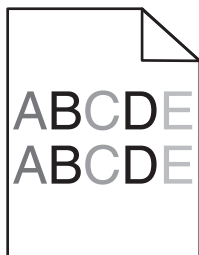

Action	Yes	No
<p>Replace the imaging kit, and then resend the print job.</p> <p>Is the print density uneven?</p>	Contact customer support .	The problem is solved.

Vertical voids appear on prints

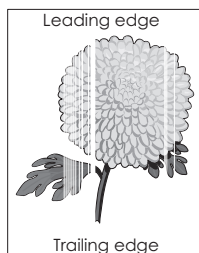

Action	Yes	No
<p>Step 1 a Check if your software program is using a correct fill pattern. b Resend the print job.</p> <p>Do vertical voids appear on prints?</p>	Go to step 2.	The problem is solved.

Action	Yes	No
<p>Step 2</p> <p>a From the Paper Menu on the printer control panel, check the paper type and paper weight.</p> <p>b Resend the print job.</p> <p>Do vertical voids appear on prints?</p>	Go to step 3.	The problem is solved.
<p>Step 3</p> <p>Check if you are using a recommended type of paper.</p> <p>a Load paper source with a recommended type of paper.</p> <p>b Resend the print job.</p> <p>Do vertical voids appear on prints?</p>	Go to step 4.	The problem is solved.
<p>Step 4</p> <p>a Remove, and then reinstall the imaging kit.</p> <p>Warning—Potential Damage: Do not expose the imaging kit to direct light for more than 10 minutes. Extended exposure to light may cause print quality problems.</p> <p>Warning—Potential Damage: Do not touch the underside of the imaging kit. This could damage the imaging kit.</p> <p>b Resend the print job.</p> <p>Do vertical voids appear on prints?</p>	Go to step 5.	The problem is solved.
<p>Step 5</p> <p>Replace the imaging kit, and then resend the print job.</p> <p>Do vertical voids appear on prints?</p>	Contact customer support .	The problem is solved.

Color quality problems

FAQ about color printing

What is RGB color?

Red, green, and blue light can be added together in various amounts to produce a large range of colors observed in nature. For example, red and green can be combined to create yellow. Televisions and computer monitors create colors in this manner. RGB color is a method of describing colors by indicating the amount of red, green, or blue needed to produce a certain color.

What is CMYK color?

Cyan, magenta, yellow, and black inks or toners can be printed in various amounts to produce a large range of colors observed in nature. For example, cyan and yellow can be combined to create green. Printing presses, inkjet printers, and color laser printers create colors in this manner. CMYK color is a method of describing colors by indicating the amount of cyan, magenta, yellow, and black needed to reproduce a particular color.

How is color specified in a document to be printed?

Software programs typically specify the document color using RGB or CMYK color combinations. Additionally, they let users modify the color of each object in a document. For more information, see the help information of your operating system.

How does the printer know what color to print?

When a user prints a document, information describing the type and color of each object is sent to the printer. The color information is passed through color conversion tables that translate the color into the appropriate amounts of cyan, magenta, yellow, and black toner needed to produce the color you want. The object information determines the application of color conversion tables. For example, it is possible to apply one type of color conversion table to text while applying a different color conversion table to photographic images.

What is manual color correction?

When manual color correction is enabled, the printer employs user-selected color conversion tables to process objects. However, Color Correction must be set to Manual, or no user-defined color conversion will be implemented. Manual color correction settings are specific to the type of object being printed (text, graphics, or images), and how the color of the object is specified in the software program (RGB or CMYK combinations).

Notes:

- Manual color correction is not useful if the software program does not specify colors with RGB or CMYK combinations. It is also not effective in situations in which the software program or the computer operating system controls the adjustment of colors.
- When **Auto Color Correction** is selected, the color conversion tables will generate preferred colors used for the majority of the documents.

To manually apply a different color conversion table, do the following:

- 1 From the Quality menu on the printer control panel, select **Color Correction**, and then select **Manual**.
- 2 From the Quality menu on the printer control panel, select **Manual Color**, and then select the appropriate color conversion table for the affected object type.

Object type	Color conversion tables
RGB Image RGB Text RGB Graphics	<ul style="list-style-type: none"> • Vivid—Produces brighter, more saturated colors and may be applied to all incoming color formats. • sRGB Display—Produces an output that approximates the colors displayed on a computer monitor. Note: Black toner usage is optimized for printing photographs. • Display—True Black—Produces an output that approximates the colors displayed on a computer monitor. This uses only black toner to create all levels of neutral gray. • sRGB Vivid—Provides an increased color saturation for the sRGB Display color correction. Note: Black toner usage is optimized for printing business graphics. • Off—No color correction is implemented.

Object type	Color conversion tables
CMYK Image CMYK Text CMYK Graphics	<ul style="list-style-type: none"> • US CMYK—Applies color correction to approximate the SWOP (Specifications for Web Offset Publishing) color output. • Euro CMYK—Applies color correction to approximate Euroscale color output. • Vivid CMYK—Increases the color saturation of the US CMYK color correction setting. • Off—No color correction is implemented.

How can I match a particular color (such as a corporate logo)?

Nine types of Color Samples sets are available from the Quality menu on the printer control panel. These are also available from the Color Samples page of the Embedded Web Server. Selecting any sample set generates a multiple-page printout consisting of hundreds of colored boxes. Either a CMYK or RGB combination is located on each box, depending on the table selected. The observed color of each box is obtained by passing the CMYK or RGB combination labeled on the box through the selected color conversion table.

By examining Color Samples sets, you can identify the box whose color is the closest to the color you want. The color combination labeled on the box can then be used for modifying the color of the object in a software program. For more information, see the help information of your operating system.

Note: Manual color correction may be necessary to utilize the selected color conversion table for the particular object.

Selecting which Color Samples set to use for a particular color-matching problem depends on the Color Correction setting being used, the type of object being printed, and how the color of the object is specified in the software program. When Color Correction is set to Off, the color is based on the print job information, and no color conversion is implemented.

Note: The Color Samples pages are not useful if the software program does not specify colors with RGB or CMYK combinations. Additionally, certain situations exist in which the software program or the computer operating system adjusts the RGB or CMYK combinations specified in the program through color management. The resulting printed color may not be an exact match of the Color Samples pages.

Prints on color transparencies appear dark when projected

Note: This problem occurs when projecting transparencies with reflective overhead projectors. To obtain the highest projected color quality, transmissive overhead projectors are recommended.

Action	Yes	No
<p>Step 1 From the printer control panel, make sure the paper type setting is set to Transparency.</p> <p>Is the paper type setting correct?</p>	<p>Go to step 2.</p>	<p>Set the paper type to Transparency.</p>
<p>Step 2 Reduce the toner darkness, and then resend the print job.</p> <p>Does the print on the color transparency look lighter?</p>	<p>The problem is solved.</p>	<p>Go to step 3.</p>

Action	Yes	No
<p>Step 3 Make sure you are using a recommended type of color transparency, and then resend the print job.</p> <p>Does the print on the color transparency look lighter?</p>	The problem is solved.	Contact customer support .

The color of the print does not match the color of the original file

Note: The color conversion tables used in Auto Color Correction mode generally approximate the colors of a standard computer monitor. However, because of technology differences that exist between printers and monitors, there are many colors that can also be affected by monitor variations and lighting conditions.

Action	Yes	No
<p>Step 1 a Set Color Correction to Off. Note: When the printer color correction is disabled, the color is based on the print job information, and no color conversion is implemented. b Resend the print job.</p> <p>Does the color of the print match the color of the file on the computer screen?</p>	The problem is solved.	Go to step 2.
<p>Step 2 From the Quality menu on the printer control panel, do the following: a Select Color Correction, and then select Manual. b Select Manual Color, and then select the appropriate color conversion table for the affected object type. c Resend the print job.</p> <p>Does the color of the print match the color of the file on the computer screen?</p>	The problem is solved.	Contact customer support .

The print appears tinted

Action	Yes	No
<p>Adjust the color balance. a From the Color Balance menu on the printer control panel, increase or decrease the values for cyan, magenta, yellow, and black. b Resend the print job.</p> <p>Does the print still appear tinted?</p>	The problem is solved.	Contact customer support .

Embedded Web Server does not open

Action	Yes	No
<p>Step 1</p> <p>a Turn on the printer.</p> <p>b Open a Web browser, and then type the printer IP address.</p> <p>c Press Enter.</p> <p>Does the Embedded Web Server open?</p>	The problem is solved.	Go to step 2.
<p>Step 2</p> <p>Make sure the printer IP address is correct.</p> <p>a View the printer IP address:</p> <ul style="list-style-type: none"> • From the TCP/IP section in the Network/Ports menu • By printing a network setup page or menu settings page, and then finding the TCP/IP section <p>Note: An IP address appears as four sets of numbers separated by periods, such as 123.123.123.123.</p> <p>b Open a Web browser, and then type the IP address.</p> <p>Note: Depending on the network settings, you may need to type “https://” instead of “http://” before the printer IP address to access the Embedded Web Server.</p> <p>c Press Enter.</p> <p>Does the Embedded Web Server open?</p>	The problem is solved.	Go to step 3.
<p>Step 3</p> <p>Check if the network is working.</p> <p>a Print a network setup page.</p> <p>b Check the first section of the network setup page and confirm that the status is Connected.</p> <p>Note: If the status is Not Connected, then the connection may be intermittent, or the network cable may be defective. Contact your system support person for a solution, and then print another network setup page.</p> <p>c Open a Web browser, and then type the printer IP address.</p> <p>d Press Enter.</p> <p>Does the Embedded Web Server open?</p>	The problem is solved.	Go to step 4.

Action	Yes	No
<p>Step 4 Check if the cable connections to the printer and print server are secure.</p> <ul style="list-style-type: none"> a Connect the cables properly. For more information, see the setup documentation that came with the printer. b Open a Web browser, and then type the printer IP address. c Press Enter. <p>Does the Embedded Web Server open?</p>	<p>The problem is solved.</p>	<p>Go to step 5.</p>
<p>Step 5 Temporarily disable the Web proxy servers. Proxy servers may block or restrict you from accessing certain Web sites including the Embedded Web Server.</p> <p>Does the Embedded Web Server open?</p>	<p>The problem is solved.</p>	<p>Contact your system support person.</p>

Contacting customer support

Before contacting customer support, make sure to have the following information:

- Printer problem
- Error message
- Printer model type and serial number

Go to <http://support.lexmark.com> to receive e-mail or chat support, or browse through the library of manuals, support documentation, drivers, and other downloads.

Technical support via telephone is also available. In the U.S. or Canada, call 1-800-539-6275. For other countries or regions, go to <http://support.lexmark.com>.

Notices

Product information

Product name:

Lexmark CS310n, CS310dn, CS317dn

Machine type:

5027

Model(s):

210, 230

Edition notice

November 2017

The following paragraph does not apply to any country where such provisions are inconsistent with local law: LEXMARK INTERNATIONAL, INC., PROVIDES THIS PUBLICATION "AS IS" WITHOUT WARRANTY OF ANY KIND, EITHER EXPRESS OR IMPLIED, INCLUDING, BUT NOT LIMITED TO, THE IMPLIED WARRANTIES OF MERCHANTABILITY OR FITNESS FOR A PARTICULAR PURPOSE. Some states do not allow disclaimer of express or implied warranties in certain transactions; therefore, this statement may not apply to you.

This publication could include technical inaccuracies or typographical errors. Changes are periodically made to the information herein; these changes will be incorporated in later editions. Improvements or changes in the products or the programs described may be made at any time.

References in this publication to products, programs, or services do not imply that the manufacturer intends to make these available in all countries in which it operates. Any reference to a product, program, or service is not intended to state or imply that only that product, program, or service may be used. Any functionally equivalent product, program, or service that does not infringe any existing intellectual property right may be used instead. Evaluation and verification of operation in conjunction with other products, programs, or services, except those expressly designated by the manufacturer, are the user's responsibility.

For Lexmark technical support, visit <http://support.lexmark.com>.

For information on supplies and downloads, visit www.lexmark.com.

© 2012 Lexmark International, Inc.

All rights reserved.

GOVERNMENT END USERS

The Software Program and any related documentation are "Commercial Items," as that term is defined in 48 C.F.R. 2.101, "Computer Software" and "Commercial Computer Software Documentation," as such terms are used in 48 C.F.R. 12.212 or 48 C.F.R. 227.7202, as applicable. Consistent with 48 C.F.R. 12.212 or 48 C.F.R. 227.7202-1 through 227.7207-4, as applicable, the Commercial Computer Software and Commercial Software Documentation are licensed to the U.S. Government end users (a) only as Commercial Items and (b) with only those rights as are granted to all other end users pursuant to the terms and conditions herein.

Trademarks

Lexmark, the Lexmark logo, MarkNet, and MarkVision are trademarks or registered trademarks of Lexmark International, Inc. in the United States and/or other countries.

Google Cloud Print is a trademark of Google Inc.

Mac and the Mac logo are trademarks of Apple Inc., registered in the U.S. and other countries.

Microsoft and Windows are either registered trademarks or trademarks of the Microsoft group of companies in the United States and other countries.

Mopria®, the Mopria® logo, and the Mopria® Alliance logo are registered trademarks and service marks of Mopria Alliance, Inc. in the United States and other countries. Unauthorized use is strictly prohibited.

PCL® is a registered trademark of the Hewlett-Packard Company. PCL is Hewlett-Packard Company’s designation of a set of printer commands (language) and functions included in its printer products. This printer is intended to be compatible with the PCL language. This means the printer recognizes PCL commands used in various application programs, and that the printer emulates the functions corresponding to the commands.

PostScript is a registered trademark of Adobe Systems Incorporated in the United States and/or other countries.

The following terms are trademarks or registered trademarks of these companies:

Albertus	The Monotype Corporation plc
Antique Olive	Monsieur Marcel OLIVE
Apple-Chancery	Apple Computer, Inc.
Arial	The Monotype Corporation plc
CG Times	Based on Times New Roman under license from The Monotype Corporation plc, is a product of Agfa Corporation
Chicago	Apple Computer, Inc.
Clarendon	Linotype-Hell AG and/or its subsidiaries
Eurostile	Nebiolo
Geneva	Apple Computer, Inc.
GillSans	The Monotype Corporation plc
Helvetica	Linotype-Hell AG and/or its subsidiaries
Hoefler	Jonathan Hoefler Type Foundry
ITC Avant Garde Gothic	International Typeface Corporation
ITC Bookman	International Typeface Corporation
ITC Mona Lisa	International Typeface Corporation
ITC Zapf Chancery	International Typeface Corporation
Joanna	The Monotype Corporation plc
Marigold	Arthur Baker
Monaco	Apple Computer, Inc.
New York	Apple Computer, Inc.
Oxford	Arthur Baker

Palatino	Linotype-Hell AG and/or its subsidiaries
Stempel Garamond	Linotype-Hell AG and/or its subsidiaries
Taffy	Agfa Corporation
Times New Roman	The Monotype Corporation plc
Univers	Linotype-Hell AG and/or its subsidiaries

All other trademarks are the property of their respective owners.

AirPrint and the AirPrint logo are trademarks of Apple, Inc.

Federal Communications Commission (FCC) compliance information statement

This product has been tested and found to comply with the limits for a Class B digital device, pursuant to Part 15 of the FCC Rules. Operation is subject to the following two conditions: (1) this device may not cause harmful interference, and (2) this device must accept any interference received, including interference that may cause undesired operation.

The FCC Class B limits are designed to provide reasonable protection against harmful interference when the equipment is operated in a residential installation. This equipment generates, uses, and can radiate radio frequency energy and, if not installed and used in accordance with the instructions, may cause harmful interference to radio communications. However, there is no guarantee that interference will not occur in a particular installation. If this equipment does cause harmful interference to radio or television reception, which can be determined by turning the equipment off and on, the user is encouraged to try to correct the interference by one or more of the following measures:

- Reorient or relocate the receiving antenna.
- Increase the separation between the equipment and receiver.
- Connect the equipment into an outlet on a circuit different from that to which the receiver is connected.
- Consult your point of purchase or service representative for additional suggestions.

The manufacturer is not responsible for radio or television interference caused by using other than recommended cables or by unauthorized changes or modifications to this equipment. Unauthorized changes or modifications could void the user's authority to operate this equipment.

Note: To assure compliance with FCC regulations on electromagnetic interference for a Class B computing device, use a properly shielded and grounded cable such as Lexmark part number 1021231 for parallel attach or 1021294 for USB attach. Use of a substitute cable not properly shielded and grounded may result in a violation of FCC regulations.

Any questions regarding this compliance information statement should be directed to:

Director of Lexmark Technology & Services
 Lexmark International, Inc.
 740 West New Circle Road
 Lexington, KY 40550
 (859) 232-3000

Licensing notices

All licensing notices associated with this product can be viewed from the root directory of the installation software CD.

Noise emission levels

The following measurements were made in accordance with ISO 7779 and reported in conformance with ISO 9296.

Note: Some modes may not apply to your product.

1-meter average sound pressure, dBA	
Printing	48
Ready	16

Values are subject to change. See www.lexmark.com for current values.

Waste from Electrical and Electronic Equipment (WEEE) directive



The WEEE logo signifies specific recycling programs and procedures for electronic products in countries of the European Union. We encourage the recycling of our products.

If you have further questions about recycling options, visit the Lexmark Web site at www.lexmark.com for your local sales office phone number.

India E-Waste notice

This product complies with the India E-Waste (Management and Handling) Rules, 2011, which prohibit use of lead, mercury, hexavalent chromium, polybrominated biphenyls, or polybrominated diphenyl ethers in concentrations exceeding 0.1% by weight and 0.01% by weight for cadmium, except for the exemption set in Schedule II of the Rules.

Product disposal

Do not dispose of the printer or supplies in the same manner as normal household waste. Consult your local authorities for disposal and recycling options.

Static sensitivity notice



This symbol identifies static-sensitive parts. Do not touch the areas near these symbols without first touching a metal surface in an area away from the symbol.

ENERGY STAR

Any Lexmark product bearing the ENERGY STAR emblem on the product or on a start-up screen is certified to comply with Environmental Protection Agency (EPA) ENERGY STAR requirements as configured when shipped by Lexmark.



Temperature information

Ambient operating temperature	15.6 to 32.2°C (60 to 90°F)
Shipping temperature	-40 to 43.3°C (-40 to 110°F)
Storage temperature and relative humidity	1 to 35°C (34 to 95°F) 8 to 80% RH

Información de la energía de México

Consumo de energía en operación:

540 Wh

Consumo de energía en modo de espera:

0.2 Wh

Cantidad de producto por unidad de energía consumida:

2.78 páginas / Wh

Laser notice

The printer is certified in the U.S. to conform to the requirements of DHHS 21 CFR, Chapter I, Subchapter J for Class I (1) laser products, and elsewhere is certified as a Class I laser product conforming to the requirements of IEC 60825-1: 2014.

Class I laser products are not considered to be hazardous. The printer contains internally a Class IIIb (3b) laser that is nominally a 12-milliwatt gallium arsenide laser operating in the wavelength of 655–675 nanometers. The laser system and printer are designed so there is never any human access to laser radiation above a Class I level during normal operation, user maintenance, or prescribed service condition.

Laser advisory label

A laser notice label may be affixed to this printer as shown:

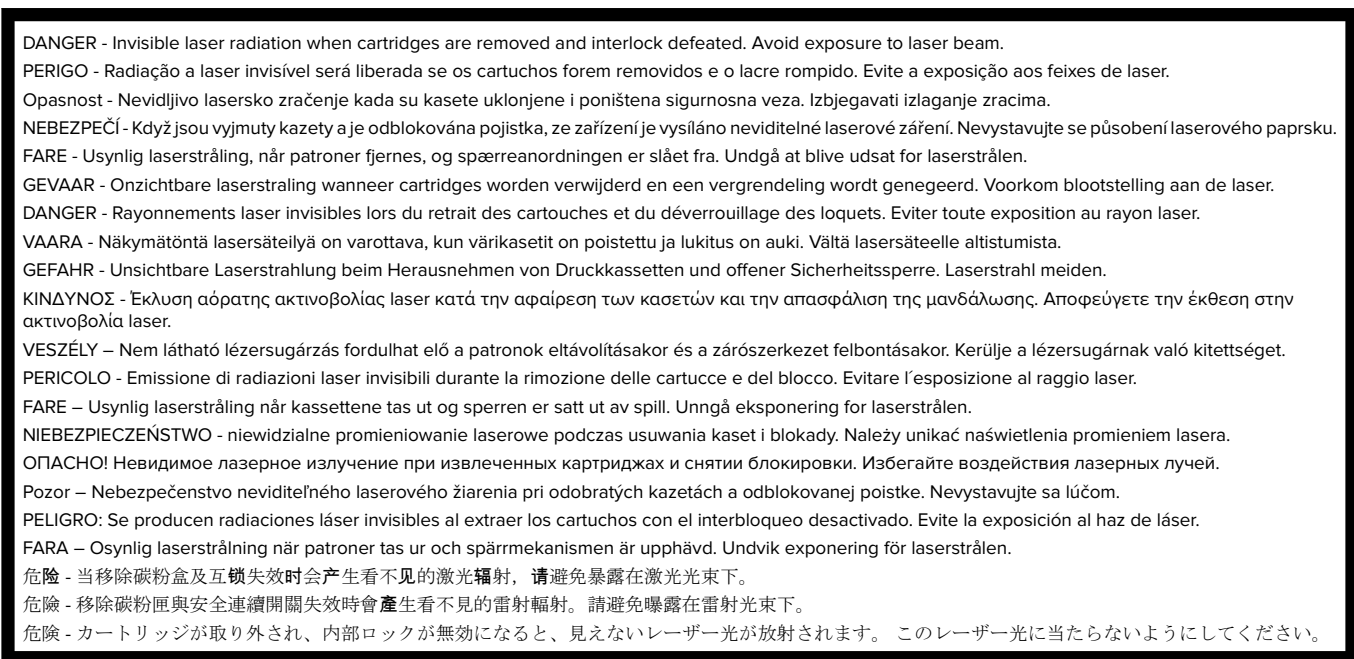

Power consumption

Product power consumption

The following table documents the power consumption characteristics of the product.

Note: Some modes may not apply to your product.

Mode	Description	Power consumption (Watts)
Printing	The product is generating hard-copy output from electronic inputs.	480
Copy	The product is generating hard-copy output from hard-copy original documents.	N/A

Mode	Description	Power consumption (Watts)
Scan	The product is scanning hard-copy documents.	N/A
Ready	The product is waiting for a print job.	30
Sleep Mode	The product is in a high-level energy-saving mode.	2.5
Hibernate	The product is in a low-level energy-saving mode.	0.5
Off	The product is plugged into an electrical outlet, but the power switch is turned off.	0.0

The power consumption levels listed in the previous table represent time-averaged measurements. Instantaneous power draws may be substantially higher than the average.

Values are subject to change. See www.lexmark.com for current values.

Sleep Mode

This product is designed with an energy-saving mode called *Sleep Mode*. The Sleep Mode saves energy by lowering power consumption during extended periods of inactivity. The Sleep Mode is automatically engaged after this product is not used for a specified period of time, called the *Sleep Mode Timeout*.

Factory default Sleep Mode Timeout for this product (in minutes):	20
---	----

By using the configuration menus, the Sleep Mode Timeout can be modified between 1 minute and 180 minutes. Setting the Sleep Mode Timeout to a low value reduces energy consumption, but may increase the response time of the product. Setting the Sleep Mode Timeout to a high value maintains a fast response, but uses more energy.

Hibernate Mode

This product is designed with an ultra-low power operating mode called *Hibernate mode*. When operating in Hibernate Mode, all other systems and devices are powered down safely.

The Hibernate mode can be entered in any of the following methods:

- Using the Hibernate Timeout
- Using the Schedule Power modes
- Using the Sleep/Hibernate button

Factory default Hibernate Timeout for this product in all countries or regions	3 days
--	--------

The amount of time the printer waits after a job is printed before it enters Hibernate mode can be modified between one hour and one month.

Off mode

If this product has an off mode which still consumes a small amount of power, then to completely stop product power consumption, disconnect the power supply cord from the electrical outlet.

Total energy usage

It is sometimes helpful to calculate the total product energy usage. Since power consumption claims are provided in power units of Watts, the power consumption should be multiplied by the time the product spends in each mode in order to calculate energy usage. The total product energy usage is the sum of each mode's energy usage.

Industry Canada compliance statement

This Class B digital apparatus meets all requirements of the Canadian Interference-Causing Equipment Standard ICES-003.

Avis de conformité aux normes de l'industrie du Canada

Cet appareil numérique de classe B est conforme aux exigences de la norme canadienne relative aux équipements pouvant causer des interférences NMB-003.

日本の VCCI 規定

製品にこのマークが表示されている場合、次の要件を満たしています。



この装置は、クラス B 情報技術装置です。この装置は、家庭環境で使用することを目的としていますが、この装置がラジオやテレビジョン受信機に近接して使用されると、受信障害を引き起こすことがあります。

取扱説明書に従って正しい取り扱いをしてください。

VCCI-B

European Community (EC) directives conformity

This product is in conformity with the protection requirements of EC Council directives 2014/30/EU, 2014/35/EU, 2009/125/EC, and 2011/65/EU on the approximation and harmonization of the laws of the Member States relating to electromagnetic compatibility, safety of electrical equipment designed for use within certain voltage limits, the ecodesign of energy-related products, and on the restrictions of use of certain hazardous substances in electrical and electronic equipment.

The manufacturer of this product is: Lexmark International, Inc., 740 West New Circle Road, Lexington, KY, 40550 USA. The authorized representative is: Lexmark International Technology Hungária Kft., 8 Lechner Ödön fasor, Millennium Tower III, 1095 Budapest HUNGARY. A declaration of conformity to the requirements of the Directives is available upon request from the Authorized Representative or may be obtained at www.lexmark.com/en_us/about/regulatory-compliance/european-union-declaration-of-conformity.html.

This product satisfies the Class B limits of EN 55022 and EN55032 and safety requirements of EN 60950-1 or EN 62368-1.

STATEMENT OF LIMITED WARRANTY FOR LEXMARK LASER PRINTERS, LEXMARK LED PRINTERS, AND LEXMARK MULTIFUNCTION LASER PRINTERS

Lexmark International, Inc., Lexington, KY

This limited warranty applies to the United States and Canada. For customers outside the U.S., refer to the country-specific warranty information that came with your product.

This limited warranty applies to this product only if it was originally purchased for your use, and not for resale, from Lexmark or a Lexmark Remarketer, referred to in this statement as “Remarketer.”

Limited warranty

Lexmark warrants that this product:

- Is manufactured from new parts, or new and serviceable used parts, which perform like new parts
- Is, during normal use, free from defects in material and workmanship

If this product does not function as warranted during the warranty period, contact a Remarketer or Lexmark for repair or replacement (at Lexmark's option).

If this product is a feature or option, this statement applies only when that feature or option is used with the product for which it was intended. To obtain warranty service, you may be required to present the feature or option with the product.

If you transfer this product to another user, warranty service under the terms of this statement is available to that user for the remainder of the warranty period. You should transfer proof of original purchase and this statement to that user.

Limited warranty service

The warranty period starts on the date of original purchase as shown on the purchase receipt and ends 12 months later provided that the warranty period for any supplies and for any maintenance items included with the printer shall end earlier if it, or its original contents, are substantially used up, depleted, or consumed. Fuser Units, Transfer/Transport Units, Paper Feed items, if any, and any other items for which a Maintenance Kit is available are substantially consumed when the printer displays a “Life Warning” or “Scheduled Maintenance” message for such item.

To obtain warranty service you may be required to present proof of original purchase. You may be required to deliver your product to the Remarketer or Lexmark, or ship it prepaid and suitably packaged to a Lexmark designated location. You are responsible for loss of, or damage to, a product in transit to the Remarketer or the Lexmark designated location.

When warranty service involves the exchange of a product or part, the item replaced becomes the property of the Remarketer or Lexmark. The replacement may be a new or repaired item.

The replacement item assumes the remaining warranty period of the original product.

Replacement is not available to you if the product you present for exchange is defaced, altered, in need of a repair not included in warranty service, damaged beyond repair, or if the product is not free of all legal obligations, restrictions, liens, and encumbrances.

As part of your warranty service and/or replacement, Lexmark may update the firmware in your printer to the latest version. Firmware updates may modify printer settings and cause counterfeit and/or unauthorized products, supplies, parts, materials (such as toners and inks), software, or interfaces to stop working. Authorized use of genuine Lexmark products will not be impacted.

Before you present this product for warranty service, remove all print cartridges, programs, data, and removable storage media (unless directed otherwise by Lexmark).

For further explanation of your warranty alternatives and the nearest Lexmark authorized servicer in your area contact Lexmark on the World Wide Web.

Remote technical support is provided for this product throughout its warranty period. For products no longer covered by a Lexmark warranty, technical support may not be available or only be available for a fee.

Extent of limited warranty

Lexmark does not warrant uninterrupted or error-free operation of any product or the durability or longevity of prints produced by any product.

Warranty service does not include repair of failures caused by:

- Modification or unauthorized attachments
- Accidents, misuse, abuse or use inconsistent with Lexmark user's guides, manuals, instructions or guidance
- Unsuitable physical or operating environment
- Maintenance by anyone other than Lexmark or a Lexmark authorized servicer
- Operation of a product beyond the limit of its duty cycle
- Use of printing media outside of Lexmark specifications
- Refurbishment, repair, refilling or remanufacture by a third party of products, supplies or parts
- Products, supplies, parts, materials (such as toners and inks), software, or interfaces not furnished by Lexmark

TO THE EXTENT PERMITTED BY APPLICABLE LAW, NEITHER LEXMARK NOR ITS THIRD PARTY SUPPLIERS OR REMARKETERS MAKE ANY OTHER WARRANTY OR CONDITION OF ANY KIND, WHETHER EXPRESS OR IMPLIED, WITH RESPECT TO THIS PRODUCT, AND SPECIFICALLY DISCLAIM THE IMPLIED WARRANTIES OR CONDITIONS OF MERCHANTABILITY, FITNESS FOR A PARTICULAR PURPOSE, AND SATISFACTORY QUALITY. ANY WARRANTIES THAT MAY NOT BE DISCLAIMED UNDER APPLICABLE LAW ARE LIMITED IN DURATION TO THE WARRANTY PERIOD. NO WARRANTIES, EXPRESS OR IMPLIED, WILL APPLY AFTER THIS PERIOD. ALL INFORMATION, SPECIFICATIONS, PRICES, AND SERVICES ARE SUBJECT TO CHANGE AT ANY TIME WITHOUT NOTICE.

Limitation of liability

Your sole remedy under this limited warranty is set forth in this document. For any claim concerning performance or nonperformance of Lexmark or a Remarketer for this product under this limited warranty, you may recover actual damages up to the limit set forth in the following paragraph.

Lexmark's liability for actual damages from any cause whatsoever will be limited to the amount you paid for the product that caused the damages. This limitation of liability will not apply to claims by you for bodily injury or damage to real property or tangible personal property for which Lexmark is legally liable. **IN NO EVENT WILL LEXMARK BE LIABLE FOR ANY LOST PROFITS, LOST SAVINGS, INCIDENTAL DAMAGE, OR OTHER ECONOMIC OR CONSEQUENTIAL DAMAGES.** This is true even if you advise Lexmark or a Remarketer of the possibility of such damages. Lexmark is not liable for any claim by you based on a third party claim.

This limitation of remedies also applies to claims against any Suppliers and Remarketers of Lexmark. Lexmark's and its Suppliers' and Remarketers' limitations of remedies are not cumulative. Such Suppliers and Remarketers are intended beneficiaries of this limitation.

Additional rights

Some states do not allow limitations on how long an implied warranty lasts, or do not allow the exclusion or limitation of incidental or consequential damages, so the limitations or exclusions contained above may not apply to you.

This limited warranty gives you specific legal rights. You may also have other rights that vary from state to state.

Index

Numerics

- 250-sheet tray
 - loading 25
- 650-sheet duo tray
 - installing 16
 - loading 28

Symbols

- [Color] cartridge low [88.xy] 129
- [Color] cartridge nearly low [88.xy] 129
- [Color] cartridge very low, [x] estimated pages remain [88.xy] 129
- [Type] imaging kit low [84.xy] 136
- [Type] imaging kit nearly low [84.xy] 136
- [Type] imaging kit very low, [x] estimated pages remain [84.xy] 136

A

- Active NIC menu 61
- adding hardware options
 - print driver 19
- adding internal options
 - print driver 19
- Adjusting color 128
- adjusting Sleep mode 89
- adjusting toner darkness 46
- administrator settings
 - Embedded Web Server 118
- AirPrint
 - using 48
- AppleTalk menu 65
- attaching cables 18
- available internal option 12
- avoiding jams 42
- avoiding paper jams 121

B

- Back button
 - printer control panel 10
- Bin full. Remove paper. 128
- black-and-white printing 46

C

- cables
 - Ethernet 18
 - USB 18
- canceling a print job
 - from the computer 49
 - from the printer control panel 49
- Cannot collate large document [37] 128
- cannot open Embedded Web Server 170
- card stock
 - loading 29
 - tips 39
- Change [paper source] to [custom string] 128
- Change [paper source] to [custom type name] 128
- Change [paper source] to [paper type][paper size] 129
- checking an unresponsive printer 137
- checking the status of parts and supplies 95
- cleaning
 - exterior of the printer 95
 - interior of the printer 95
- cleaning the printer 95
- Close door 129
- color quality troubleshooting
 - color of print and color on computer screen do not match 169
 - prints on color transparencies appear dark when projected 168
- color quality, troubleshooting
 - print appears tinted 169
- Complex page may misprint [39] 129
- confidential data
 - information on securing 94
- configuration information
 - wireless network 20
- configurations
 - printer 9
- Configure MP menu 54
- configuring
 - multiple printers 119
 - supply notifications, imaging kit 118
 - supply notifications, maintenance kit 118
 - supply notifications, toner cartridge 118
 - supply notifications, waste toner bottle 118
- configuring supply notifications from the Embedded Web Server 118
- connecting to a wireless network
 - using Personal Identification Number (PIN) method 21
 - using Push Button Configuration (PBC) method 21
 - using the Embedded Web Server 23
- conservation settings
 - Eco-Mode 88
 - Hibernate mode 90
 - Hibernate Timeout 90
 - Quiet Mode 89
 - Schedule Power Modes 91
 - Sleep mode 89
- conserving supplies 88
- contacting customer support 171
- control panel
 - indicator light 11
 - Sleep button light 11
- custom name
 - configuring 34
- custom paper type name
 - assigning 34
 - creating 34
- Custom Type [x] name
 - configuring 34
 - creating 34
- Custom Types menu 59
- customer support
 - contacting 171

D

- Default Source menu 51
- developer unit
 - replacing 101, 110

- display
 - printer control panel 10
- display troubleshooting
 - printer display is blank 139
- documents, printing
 - from a computer 46
 - from a mobile device 48, 49

E

- Eco-Mode setting 88
- Embedded Web Server 118
 - accessing 11
 - administrator settings 118
 - copying settings to other printers 119
 - functions 11
 - networking settings 118
 - problem accessing 170
 - using 11
- Embedded Web Server Administrator's Guide
 - where to find 94
- Embedded Web Server — Security: Administrator's Guide
 - where to find 118
- emission notices 174, 175, 179
- envelopes
 - loading 29, 32
 - tips on using 38
- environmental settings
 - Eco-Mode 88
 - Hibernate mode 90
 - Hibernate Timeout 90
 - Quiet Mode 89
 - Schedule Power Modes 91
 - Sleep mode 89
- erasing non-volatile memory 93
- erasing volatile memory 93
- Error reading USB drive. Remove USB. 129
- Ethernet network
 - preparing to set up for Ethernet printing 20
- Ethernet port 18
- Ethernet setup
 - preparing for an 20
- exterior of the printer
 - cleaning 95

F

- factory defaults, restoring 120

- FAQ about color printing 166
- FCC notices 174
- finding more information about the printer 7
- Finishing menu 76
- font sample list, printing 47

G

- General Settings menu 68
- Google Cloud Print
 - using 48
- green settings
 - Eco-Mode 88
 - Hibernate mode 90
 - Hibernate Timeout 90
 - Quiet Mode 89
 - Schedule Power Modes 91

H

- hardware options, adding
 - print driver 19
- Help menu 86
- Hibernate mode
 - using 90
- Hibernate Timeout
 - setting 90
- HTML menu 85

I

- Image menu 86
- imaging kit
 - replacing 101
- imaging kits
 - ordering 98
- Incompatible tray [x] [59] 129
- indicator light
 - printer control panel 10
- Insert tray [x] 130
- installing options
 - order of installation 16
- installing the printer software 19
- interior of the printer
 - cleaning 95
- internal options, adding
 - print driver 19
- IPv6 menu 64

J

- jams
 - avoiding 121
 - locating jam areas 122

- locations 122
- jams, clearing
 - below the fuser 123
 - in the duplex unit 123
 - in the front door 123
 - in the manual feeder 126
 - in the multipurpose feeder 127
 - in the standard bin 123
 - in trays 125

L

- labels, paper
 - tips 39
- left arrow button
 - printer control panel 10
- letterhead
 - loading, multipurpose feeder 36
 - loading, trays 36
- Lexmark Mobile Print
 - using 49
- linking trays 33, 34
- Load [paper source] with [custom string] 130
- Load [paper source] with [custom type name] 130
- Load [paper source] with [paper size] 130
- Load [paper source] with [paper type] [paper size] 130
- Load Manual Feeder with [custom string] 131
- Load Manual Feeder with [custom type name] 131
- Load Manual Feeder with [paper size] 131
- Load Manual Feeder with [paper type] [paper size] 131
- loading
 - 250-sheet tray 25
 - 650-sheet duo tray 28
 - card stock 29
 - envelopes 29, 32
 - manual feeder 32
 - multipurpose feeder 29
 - transparencies 29
- loading letterhead
 - paper orientation 36

M

- Maintenance kit low [80.xy] 131

- Maintenance kit nearly low [80.xy] 132
 - Maintenance kit very low [80.xy] 132
 - manual feeder
 - loading 32
 - Max Speed and Max Yield
 - using 47
 - memory
 - types installed on printer 93
 - memory card
 - installing 12
 - troubleshooting 139
 - Memory full [38] 132
 - Memory low, no Resource Save [35] 132
 - menu settings
 - loading on multiple printers 119
 - menu settings page
 - printing 24
 - menus
 - Active NIC 61
 - AppleTalk 65
 - Configure MP 54
 - Custom Types 59
 - Default Source 51
 - Finishing 76
 - General Settings 68
 - Help 86
 - HTML 85
 - Image 86
 - IPv6 64
 - list 50
 - Network [x] 61
 - Network Card 62
 - Paper Loading 58
 - Paper Size/Type 51
 - Paper Texture 55
 - Paper Weight 56
 - PCL Emul 82
 - PDF 81
 - PostScript 81
 - Quality 77
 - Reports 60
 - Set Date/Time 67
 - Setup 75
 - Standard Network 61
 - Standard USB 66
 - Substitute Size 54
 - Supplies 50
 - TCP/IP 63
 - Universal Setup 59
 - Utilities 80
 - Wireless 65
 - XPS 81
 - Menu button
 - printer control panel 10
 - menus list 50
 - mobile device
 - printing from 48, 49
 - Mopria Print Service
 - using 48
 - moving the printer 8, 116
 - multipurpose feeder
 - loading 29
- N**
- Network [x] menu 61
 - Network Card menu 62
 - Network error, port [x] [54] 132
 - Network error, standard port [54] 133
 - network settings
 - Embedded Web Server 118
 - network setup page
 - printing 24
 - Networking Guide
 - where to find 118
 - noise emission levels 175
 - Non-Lexmark [supply type], see User's Guide [33.xy] 133
 - non-volatile memory 93
 - erasing 93
 - notices 174, 175, 176, 177, 178, 179
 - number of remaining pages
 - estimate 96
- O**
- option
 - memory card 12
 - options
 - 650-sheet duo tray 16
 - memory card 12
 - order of installation 16
 - ordering
 - imaging kits 98
 - toner cartridges 96
 - waste toner bottle 98
- P**
- paper
 - characteristics 39
 - letterhead 41
 - preprinted forms 41
 - recycled 41, 88
 - selecting 40
 - storing 42
 - unacceptable 41
 - Universal size setting 25
 - paper feed troubleshooting
 - message remains after jam is cleared 143
 - paper jams
 - avoiding 121
 - paper jams, clearing
 - below the fuser 123
 - in the duplex unit 123
 - in the front door 123
 - in the manual feeder 126
 - in the multipurpose feeder 127
 - in the standard bin 123
 - in trays 125
 - Paper Loading menu 58
 - paper size
 - setting 25
 - Paper Size/Type menu 51
 - paper sizes
 - supported by the printer 43
 - Paper Texture menu 55
 - Paper too short [34] 133
 - paper type
 - setting 25
 - paper types
 - supported by printer 45
 - where to load 45
 - Paper Weight menu 56
 - paper weights
 - supported by printer 45
 - parts
 - checking status 95
 - using genuine Lexmark 96
 - PCL Emul menu 82
 - PDF menu 81
 - Personal Identification Number
 - method
 - using 21
 - PostScript menu 81
 - power cord socket 18
 - preparing to set up the printer on an Ethernet network 20
 - print driver
 - hardware options, adding 19
 - print irregularities 153

- print job
 - canceling from the computer 49
 - canceling from the printer control panel 49
- print quality
 - replacing a developer unit 110
 - replacing imaging kit 101
 - replacing the waste toner bottle 99
- print quality troubleshooting
 - blank pages 157
 - characters have jagged edges 148
 - clipped pages or images 149
 - gray background on prints 150
 - horizontal voids appear on prints 151
 - print irregularities 153
 - print is too dark 155
 - print is too light 156
 - printer is printing solid black pages 158
 - repeating print defects 159
 - shadow images appear on prints 159
 - skewed print 160
 - streaked horizontal lines appear on prints 161
 - streaked vertical lines appear on prints 162
 - toner fog or background shading appears on prints 163
 - toner rubs off 164
 - toner specks appear on prints 164
 - transparency print quality is poor 165
 - uneven print density 165
 - vertical voids appear on prints 165
- print troubleshooting
 - incorrect characters print 143
 - incorrect margins on prints 152
 - jammed pages are not reprinted 142
 - job prints from wrong tray 144
 - job prints on wrong paper 144
 - jobs do not print 145
 - Large jobs do not collate 144
 - paper curl 153
 - paper frequently jams 142
 - print job takes longer than expected 146
 - printing slows down 145
 - tray linking does not work 147
 - unexpected page breaks occur 148
- printer
 - configurations 9
 - minimum clearances 8
 - models 9
 - moving 8, 116
 - selecting a location 8
 - shipping 117
- printer control panel
 - factory defaults, restoring 120
 - using 10
- Printer had to restart. Last job may be incomplete. 134
- printer information
 - where to find 7
- printer is printing blank pages 157
- printer messages
 - [Color] cartridge low [88.xy] 129
 - [Color] cartridge nearly low [88.xy] 129
 - [Color] cartridge very low, [x] estimated pages remain [88.xy] 129
 - [Type] imaging kit low [84.xy] 136
 - [Type] imaging kit nearly low [84.xy] 136
 - [Type] imaging kit very low, [x] estimated pages remain [84.xy] 136
 - Adjusting color 128
 - Bin full. Remove paper. 128
 - Cannot collate large document [37] 128
 - Change [paper source] to [custom string] 128
 - Change [paper source] to [custom type name] 128
 - Change [paper source] to [paper type] [paper size] 129
 - Close door 129
 - Complex page may misprint [39] 129
 - Error reading USB drive. Remove USB. 129
 - Incompatible tray [x] [59] 129
 - Insert tray [x] 130
 - Load [paper source] with [custom string] 130
 - Load [paper source] with [custom type name] 130
 - Load [paper source] with [paper size] 130
 - Load [paper source] with [paper type] [paper size] 130
 - Load Manual Feeder with [custom string] 131
 - Load Manual Feeder with [custom type name] 131
 - Load Manual Feeder with [paper size] 131
 - Load Manual Feeder with [paper type] [paper size] 131
 - Maintenance kit low [80.xy] 131
 - Maintenance kit nearly low [80.xy] 132
 - Maintenance kit very low [80.xy] 132
 - Memory full [38] 132
 - Memory low, no Resource Save [35] 132
 - Network error, port [x] [54] 132
 - Network error, standard port [54] 133
 - Non-Lexmark [supply type], see User's Guide [33.xy] 133
 - Paper too short [34] 133
 - Printer had to restart. Last job may be incomplete. 134
 - Rear USB port disabled [56] 134
 - Reinstall missing or unresponsive [color] cartridge [31.xy] 134
 - Reload printed pages in Tray [x] 134
 - Remove packaging material, check all 135
 - Remove paper from standard output bin 135
 - Replace [type] imaging kit, 0 estimated pages remain [84.xy] 135
 - Replace maintenance kit [80.xy] 135
 - Replace missing [color] cartridge [31.xy] 135
 - Replace missing [type] imaging kit [31.xy] 135

Replace missing or unresponsive black and color imaging kit and all cartridges [31.xy] 134

Replace missing waste toner bottle [31.xyz] 135

Replace unsupported [color] cartridge [32.xy] 135

Replace unsupported [type] imaging kit [32.xy] 136

Replace waste toner bottle [82.xy] 136

Supply needed to complete job 136

Too many trays. Remove some. [58] 136

Waste toner bottle nearly full [82.xy] 137

printer options troubleshooting

- internal option is not detected 140
- memory card 139
- tray problems 141

printer problems, solving

- basic 137

printer security

- information on 94

printer software, installing 19

printing

- black-and-white 46
- font sample list 47
- from a computer 46
- from a mobile device 48
- Max Speed and Max Yield 47
- menu settings page 24
- network setup page 24

printing in black and white 46

publications

- where to find 7

Push Button Configuration

- method
- using 21

Q

Quality menu 77

Quiet Mode 89

R

Rear USB port disabled [56] 134

recycled paper

- using 41, 88

recycling

- Lexmark packaging 92
- Lexmark products 92
- toner cartridges 92

reducing noise 89

Reinstall missing or unresponsive [color] cartridge [31.xy] 134

Reload printed pages in Tray [x] 134

remaining pages, number of estimate 96

Remote Operator Panel

- setting up 118

Remove packaging material, check all 135

Remove paper from standard output bin 135

repeating print defects 159

Replace [type] imaging kit, 0 estimated pages remain [84.xy] 135

Replace maintenance kit [80.xy] 135

Replace missing [color] cartridge [31.xy] 135

Replace missing [type] imaging kit [31.xy] 135

Replace missing or unresponsive black and color imaging kit and all cartridges [31.xy] 134

Replace missing waste toner bottle [31.xyz] 135

Replace unsupported [color] cartridge [32.xy] 135

Replace unsupported [type] imaging kit [32.xy] 136

Replace waste toner bottle [82.xy] 136

reports

- viewing 118

Reports menu 60

restoring factory default settings 120

right arrow button

- printer control panel 10

S

safety information 5, 6

Schedule Power Modes

- using 91

security Web page

- where to find 94

Select button

- printer control panel 10

selecting a location for the printer 8

selecting paper 40

Set Date/Time menu 67

setting

- paper size 25
- paper type 25
- TCP/IP address 63
- Universal paper size 25

setting Hibernate Timeout 90

Setup menu 75

shipping the printer 117

Sleep button

- printer control panel 10

Sleep mode

- adjusting 89

Standard Network menu 61

Standard USB menu 66

statement of volatility 93

Stop button

- printer control panel 10

storing

- paper 42
- supplies 98

streaked horizontal lines appear on prints 161

streaked vertical lines appear on prints 162

Substitute Size menu 54

supplies

- checking status 95
- conserving 88
- storing 98
- using genuine Lexmark 96
- using recycled paper 88

Supplies menu 50

supplies, ordering

- imaging kits 98
- toner cartridges 96
- waste toner bottle 98

Supply needed to complete job 136

supply notifications

- configuring 118

T

TCP/IP menu 63

tips

- card stock 39
- labels, paper 39

- on using envelopes 38
 - on using letterhead 36
 - transparencies 38
 - tips on using envelopes 38
 - tips on using letterhead 36
 - toner cartridges
 - ordering 96
 - recycling 92
 - replacing 108
 - toner darkness
 - adjusting 46
 - Too many trays. Remove some. [58] 136
 - transparencies
 - loading 29
 - tips on using 38
 - tray
 - loading 25
 - trays
 - linking 33, 34
 - unlinking 33, 34
 - troubleshooting
 - cannot open Embedded Web Server 170
 - checking an unresponsive printer 137
 - FAQ about color printing 166
 - solving basic printer problems 137
 - troubleshooting, color quality
 - color of print and color on computer screen do not match 169
 - print appears tinted 169
 - prints on color transparencies appear dark when projected 168
 - troubleshooting, display
 - printer display is blank 139
 - troubleshooting, paper feed
 - message remains after jam is cleared 143
 - troubleshooting, print
 - incorrect characters print 143
 - incorrect margins on prints 152
 - jammed pages are not reprinted 142
 - job prints from wrong tray 144
 - job prints on wrong paper 144
 - jobs do not print 145
 - Large jobs do not collate 144
 - paper curl 153
 - paper frequently jams 142
 - print job takes longer than expected 146
 - printing slows down 145
 - tray linking does not work 147
 - unexpected page breaks occur 148
 - troubleshooting, print quality
 - blank pages 157
 - characters have jagged edges 148
 - clipped pages or images 149
 - gray background on prints 150
 - horizontal voids appear on prints 151
 - print irregularities 153
 - print is too dark 155
 - print is too light 156
 - printer is printing solid black pages 158
 - repeating print defects 159
 - shadow images appear on prints 159
 - skewed print 160
 - streaked horizontal lines appear on prints 161
 - streaked vertical lines appear on prints 162
 - toner fog or background shading appears on prints 163
 - toner rubs off 164
 - toner specks appear on prints 164
 - transparency print quality is poor 165
 - uneven print density 165
 - vertical voids appear on prints 165
 - troubleshooting, printer options
 - internal option is not detected 140
 - memory card 139
 - tray problems 141
 - U**
 - uneven print density 165
 - Universal paper size
 - setting 25
 - Universal Setup menu 59
 - unlinking trays 33, 34
 - USB port 18
 - using
 - Wireless Setup Assistant 22
 - using Hibernate mode 90
 - using Max Speed and Max Yield 47
 - using Schedule Power Modes 91
 - using the Embedded Web Server 11
 - using Wireless Setup Utility 22
- Utilities menu 80
- V**
- vertical voids appear on prints 165
 - viewing
 - reports 118
 - volatile memory 93
 - erasing 93
 - volatility
 - statement of 93
- W**
- waste toner bottle
 - ordering 98
 - replacing 99
 - Waste toner bottle nearly full [82.xy] 137
 - Wireless menu 65
 - wireless network
 - configuration information 20
 - wireless network setup
 - using the Embedded Web Server 23
 - Wireless Setup Assistant
 - using 22
 - Wireless Setup Utility
 - using 22
- X**
- XPS menu 81