

Quick Reference

Learning about the printer

Using the printer control panel

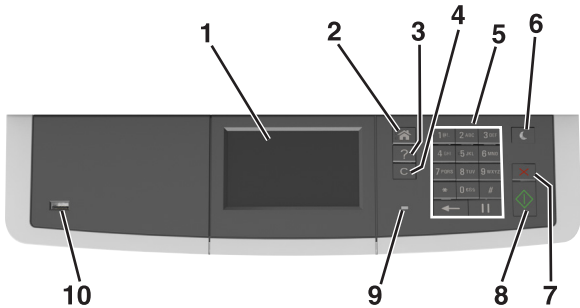

	Use the	To
1	Display	<ul style="list-style-type: none"> View the printer status and messages. Set up and operate the printer.
2	Home button	Go to the home screen.
3	Help button	Go to the Help menus.
4	Clear all / Reset button	Reset the default settings of a function, such as printing, copying, or e-mailing.
5	Keypad	Enter numbers, letters, or symbols.
6	Sleep button	Enable Sleep mode or Hibernate mode.
7	Cancel button	Cancel all printer activity.
8	Start button	Start a job, depending on which mode is selected.
9	Indicator light	Check the status of the printer.
10	USB port	Connect a flash drive to the printer. Note: Only the front USB port supports flash drives.

Understanding the home screen

When the printer is turned on, the display shows a basic screen, referred to as the home screen. Use the home screen buttons and icons to initiate an action such as copying, faxing, or scanning; to open the menu screen; or respond to messages.

Note: Your home screen may vary depending on your home screen customization settings, administrative setup, and active embedded solutions.

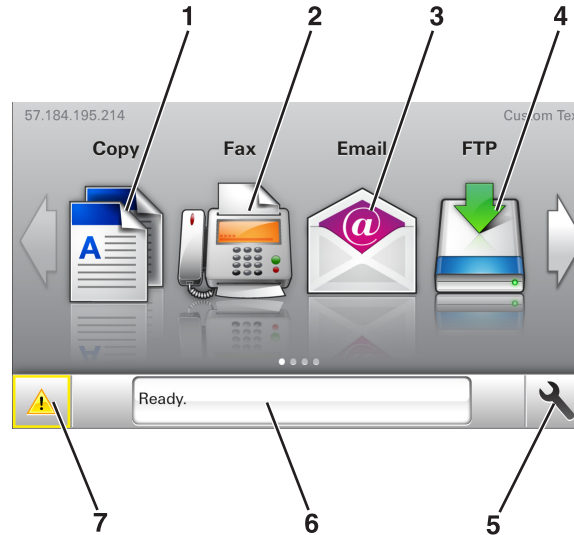



Touch	To
1	Copy Access the Copy menus and make copies.
2	Fax Access the Fax menus and send fax.
3	E-mail Access the E-mail menus and send e-mails.
4	FTP Access the File Transfer Protocol (FTP) menus and scan documents directly to an FTP server.
5	Menu icon Access printer menus. Note: The menus are available only when the printer is in ready state.

Touch	To
6	Status message bar <ul style="list-style-type: none"> Show the current printer status such as Ready or Busy. Show printer supply conditions such as Imaging unit low or Cartridge Low. Show intervention messages and the instructions on how to clear them.
7	Status/Supplies <ul style="list-style-type: none"> Show a printer warning or error message whenever the printer requires intervention to continue processing. View more information on the printer warning or message, and on how to clear it.

This may also appear on the home screen:

Touch	To
Search Held Jobs	Search current held jobs.
Jobs by user	Access print jobs saved by user.
Profiles and Apps	Access profiles and applications.

Features

Feature	Description
Attendance message alert 	If an attendance message affects a function, then this icon appears and the red indicator light blinks.
Warning 	If an error condition occurs, then this icon appears.
Printer IP address Example: 123 . 123 . 123 . 123	The IP address of your printer is located at the top left corner of the home screen and appears as four sets of numbers separated by periods. You can use the IP address when accessing the Embedded Web Server to view and remotely configure printer settings even when you are not physically near the printer.

Using the touch-screen buttons

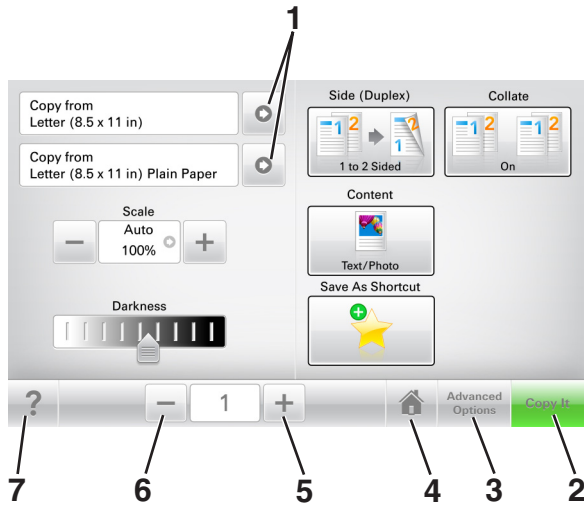

Note: Your home screen, icons, and buttons may vary, depending on your home screen customization settings, administrative setup, and active embedded solutions.



	Touch	To
1	Arrows	View a list of options.
2	Copy It	Print a copy.
3	Advanced Options	Select a copy option.
4	Home	Go to the home screen.
5	Increase	Select a higher value.
6	Decrease	Select a lower value.
7	Tips	Open a context-sensitive Help dialog.

Other touch-screen buttons

Touch	To
Accept 	Save a setting.

Touch	To
Cancel 	<ul style="list-style-type: none"> Cancel an action or a selection. Exit a screen and return to the previous screen without saving changes.
Reset 	Reset values on the screen.

Setting up and using the home screen applications

Finding the IP address of the computer

For Windows users

- 1 In the Run dialog box, type `cmd` to open the command prompt.
- 2 Type `ipconfig`, and then look for the IP address.

For Macintosh users

- 1 From System Preferences in the Apple menu, select **Network**.
- 2 Select your connection type, and then click **Advanced > TCP/IP**.
- 3 Look for the IP address.

Finding the IP address of the printer

Note: Make sure your printer is connected to a network or to a print server.

You can find the printer IP address:

- From the top left corner of the printer home screen.
- From the TCP/IP section in the Network/Ports menu.
- By printing a network setup page or menu settings page, and then finding the TCP/IP section.

Note: An IP address appears as four sets of numbers separated by periods, such as 123.123.123.123.

Accessing the Embedded Web Server

The Embedded Web Server is the printer Web page that lets you view and remotely configure printer settings even when you are not physically near the printer.

1 Obtain the printer IP address:

- From the printer control panel home screen
- From the TCP/IP section in the Network/Ports menu
- By printing a network setup page or menu settings page, and then finding the TCP/IP section

Note: An IP address appears as four sets of numbers separated by periods, such as 123 . 123 . 123 . 123.

2 Open a Web browser, and then type the printer IP address in the address field.

3 Press Enter.

Note: If you are using a proxy server, then temporarily disable it to load the Web page correctly.

Customizing the home screen

1 Open a Web browser, and then type the printer IP address in the address field.

Note: View the printer IP address on the printer home screen. The IP address appears as four sets of numbers separated by periods, such as 123.123.123.123.

2 Do one or more of the following:

- Show or hide the icons of basic printer functions.
 - a Click **Settings > General Settings > Home screen customization**.
 - b Select the check boxes to specify which icons appear on the home screen.

Note: If you clear a check box beside an icon, then the icon does not appear on the home screen.

c Click **Submit**.

- Customize the icon for an application. For more information, see ["Finding information about the home screen applications" on page 3](#) or see the documentation that came with the application.

Understanding the different applications

Use	To
Card Copy	Scan and print both sides of a card on a single page. For more information, see “Setting up Card Copy” on page 3.
Fax	Scan a document, and then send it to a fax number. For more information, see “Faxing” on page 13.
Forms and Favorites	Quickly find and print frequently used online forms directly from the printer home screen. For more information, see “Setting up Forms and Favorites” on page 3.
Multi Send	Scan a document, and then send it to multiple destinations. For more information, see “Setting up Multi Send” on page 4.
MyShortcut	Create shortcuts directly on the printer home screen. For more information, see “Using MyShortcut” on page 4.
Scan to E-mail	Scan a document, and then send it to an e-mail address. For more information, see “E-mailing” on page 12.
Scan to Computer	Scan a document, and then save it to a predefined folder on a host computer. For more information, see “Setting up Scan to Computer” on page 15.
Scan to FTP	Scan documents directly to a File Transfer Protocol (FTP) server. For more information, see “Scanning to an FTP address” on page 14.
Scan to Network	Scan a document, and then send it to a network shared folder. For more information, see “Setting up Scan to Network” on page 4.

Activating the home screen applications

Finding information about the home screen applications

Your printer comes with preinstalled home screen applications. Before you can use these applications, you must first activate and set up these applications using the Embedded Web Server. For more information on accessing the Embedded Web Server, see [“Accessing the Embedded Web Server” on page 2.](#)

For detailed information on configuring and using the home screen applications, contact the place where you purchased the printer.

Setting up Forms and Favorites

Use	To
	Streamline work processes by letting you quickly find and print frequently used online forms directly from the printer home screen. Note: The printer must have permission to access the network folder, FTP site, or Web site where the bookmark is stored. From the computer where the bookmark is stored, use sharing, security, and firewall settings to allow the printer at least a <i>read</i> access. For help, see the documentation that came with your operating system.

- 1 Open a Web browser, and then type the printer IP address in the address field.

Note: View the printer IP address on the printer home screen. The IP address appears as four sets of numbers separated by periods, such as 123.123.123.123.

- 2 Click **Settings > Apps > Apps Management > Forms and Favorites.**
- 3 Click **Add**, and then customize the settings.

Notes:

- See the mouse-over help beside each field for a description of the setting.
- To make sure the location settings of the bookmark are correct, type the correct IP address of the host computer where the bookmark is located. For more information on obtaining the IP address of the host computer, see [“Finding the IP address of the computer” on page 2.](#)
- Make sure the printer has access rights to the folder where the bookmark is located.

- 4 Click **Apply.**

To use the application, touch **Forms and Favorites** on the printer home screen, and then navigate through form categories, or search for forms based on a form number, name, or description.

Setting up Card Copy

Use	To
	Quickly and easily copy insurance, identification, and other wallet-size cards. You can scan and print both sides of a card on a single page, saving paper and showing the information on the card in a more convenient manner.

- 1 Open a Web browser, and then type the printer IP address in the address field.

Note: View the printer IP address on the printer home screen. The IP address appears as four sets of numbers separated by periods, such as 123.123.123.123.

- 2 Click **Settings > Apps > Apps Management > Card Copy.**

- 3 Change the default scanning options, if necessary.

- **Default tray**—Select the default tray to be used for printing scan images.
- **Default number of copies**—Specify the number of copies that should automatically print when the application is used.
- **Default contrast setting**—Specify a setting to increase or decrease the level of contrast when a copy of the scanned card is printed. Select **Best for Content** if you want the printer to adjust the contrast automatically.
- **Default scale setting**—Set the size of the scanned card when printed. The default setting is 100% (full size).
- **Color Output**—Select the check box to print the scanned card in color, or clear it to scan in black and white.
- **Resolution setting**—Adjust the quality of the scanned card.

Notes:

- When scanning a card, make sure the scan resolution is not more than 200 dpi for color, and 400 dpi for black and white.
- When scanning multiple cards, make sure the scan resolution is not more than 150 dpi for color, and 300 dpi for black and white.
- **Print Borders**—Select the check box to print the scan image with a border around it.

- 4 Click **Apply.**

To use the application, touch **Card Copy** on the printer home screen, and then follow the instructions.

Using MyShortcut

Use	To
	Create shortcuts on the printer home screen, with settings for up to 25 frequently used copy, fax, or e-mail jobs.

To use the application, touch **MyShortcut**, and then follow the instructions on the printer display.

Setting up Multi Send

Use	To
	Scan a document, and then send the scanned document to multiple destinations. Note: Make sure there is enough space in the printer hard disk.

- 1 Open a Web browser, and then type the printer IP address in the address field.

Note: View the printer IP address on the printer home screen. The printer IP address appears as four sets of numbers separated by periods, such as 123.123.123.123.

- 2 Click **Settings > Apps > Apps Management > Multi Send**.
- 3 From the Profiles section, click **Add**, and then customize the settings.

Notes:

- See the mouse-over help beside each field for a description of the setting.
- If you select **FTP** or **Share Folder** as a destination, then make sure the location settings of the destination are correct. Type the correct IP address of the host computer where the specified destination is located. For more information on obtaining the IP address of the host computer, see "[Finding the IP address of the computer](#)" on [page 2](#).

- 4 Click **Apply**.

To use the application, touch **Multi Send** on the printer home screen, and then follow the instructions on the printer display.

Setting up Scan to Network

Use	To
	Scan a document and send it to a shared network folder. You can define up to 30 unique folder destinations. Notes: <ul style="list-style-type: none"> • The printer must have permission to write to the destinations. From the computer where the destination is specified, use sharing, security, and firewall settings to allow the printer at least a <i>write</i> access. For help, see the documentation that came with your operating system. • The Scan to Network icon appears only when one or more destinations are defined.

- 1 Open a Web browser, and then type the printer IP address in the address field.

Note: View the printer IP address on the printer home screen. The IP address appears as four sets of numbers separated by periods, such as 123.123.123.123.

- 2 Do either of the following:
 - Click **Set up Scan to Network > Click here**.
 - Click **Settings > Apps > Apps Management > Scan to Network**.
- 3 Specify the destinations, and then customize the settings.

Notes:

- See the mouse-over help beside some of the fields for a description of the setting.
- To make sure the location settings of the destination are correct, type the correct IP address of the host computer where the specified destination is located. For more information on obtaining the IP address of the host computer, see "[Finding the IP address of the computer](#)" on [page 2](#).
- Make sure the printer has access rights to the folder where the specified destination is located.

- 4 Click **Apply**.

To use the application, touch **Scan to Network** on the printer home screen, and then follow the instructions on the printer display.

Setting up Remote Operator Panel

This application enables you to interact with the printer control panel even when you are not physically near the network printer. From your computer, you can view the printer status, release held print jobs, create bookmarks, and do other print-related tasks.

- 1 Open a Web browser, and then type the printer IP address in the address field.

Note: View the printer IP address on the printer home screen. The IP address appears as four sets of numbers separated by periods, such as 123.123.123.123.

- 2 Click **Settings > Remote Operator Panel Settings**.
- 3 Select the **Enable** check box, and then customize the settings.
- 4 Click **Submit**.

To use the application, click **Remote Operator Panel > Launch VNC Applet**.

Exporting and importing a configuration

You can export configuration settings into a text file, and then import the file to apply the settings to other printers.

- 1 Open a Web browser, and then type the printer IP address in the address field.

Note: View the IP address on the printer home screen. The IP address appears as four sets of numbers separated by periods, such as 123.123.123.123.

- 2 Export or import a configuration file for one or multiple applications.

For one application

- a Navigate to:
 - Settings > Apps > Apps Management > select an application > Configure**
- b Export or import the configuration file.

Notes:

- If a **JVM Out of Memory** error occurs, then repeat the export process until the configuration file is saved.
- If a timeout occurs and a blank screen appears, then refresh the Web browser, and then click **Apply**.

For multiple applications



- a Click **Settings > Import/Export**.
- b Export or import a configuration file.

Note: When importing a configuration file, click **Submit** to complete the process.

Loading paper and specialty media

Setting the paper size and type

From the home screen navigate to:

 > **Paper Menu > Paper Size/Type** > select a tray > select the paper size or type > 

Configuring Universal paper settings

The Universal paper size is a user-defined setting that lets you print on paper sizes that are not preset in the printer menus.

Notes:

- The smallest supported Universal size is 76 x 127 mm (3 x 5 inches) and is loaded only in the multipurpose feeder and manual feeder.
- The largest supported Universal size is 215.9 x 359.9 mm (8.5 x 14.17 inches) and is loaded only in the multipurpose feeder and manual feeder.

- 1 From the home screen, navigate to:

 > **Paper Menu > Universal Setup > Units of Measure** > select a unit of measure

- 2 Touch **Portrait Width** or **Portrait Height**.

- 3 Select the width or height, and then touch .

Loading the 250- and 550-sheet tray

The printer has one 250-sheet tray (Tray 1) with an integrated manual feeder. The 250-sheet tray, the 650-sheet duo tray, and the 550-sheet

tray support the same paper sizes and types and are loaded in the same way.

 **CAUTION—POTENTIAL INJURY:** To reduce the risk of equipment instability, load each tray separately. Keep all other trays closed until needed.

- 1 Pull out the tray completely.

Note: Do not remove trays while a job is printing or while **Busy** appears on the display. Doing so may cause a jam.

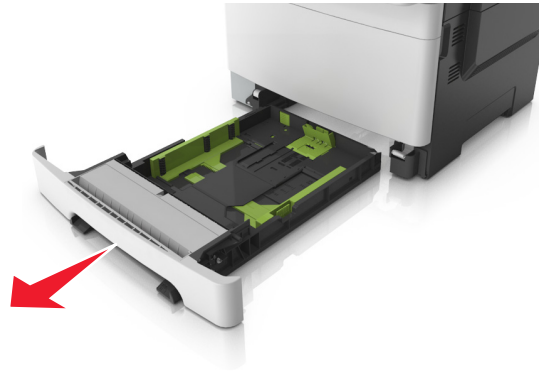

- 2 If the paper is longer than letter-size paper, then squeeze and then slide the length guide at the back of the tray to extend it.

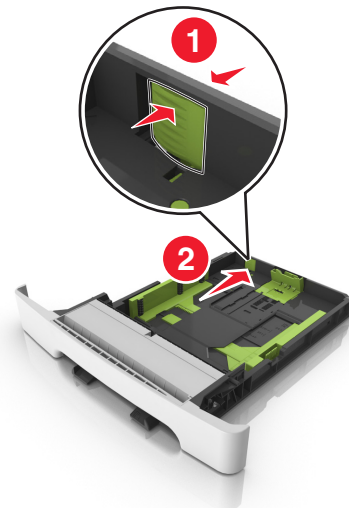

- 3 Squeeze, and then slide the length guide tab to the correct position for the size of the paper being loaded.

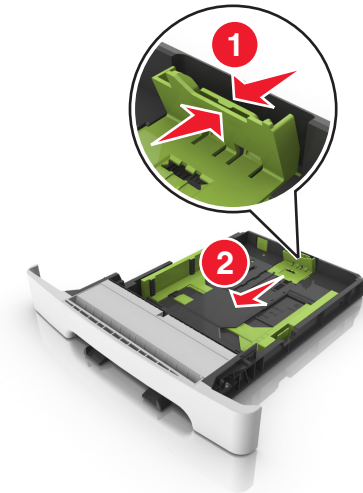

Note: Use the paper size indicators on the bottom of the tray to help position the guide.

- 4 Squeeze, and then slide the width guide tab to the correct position for the size of the paper being loaded.

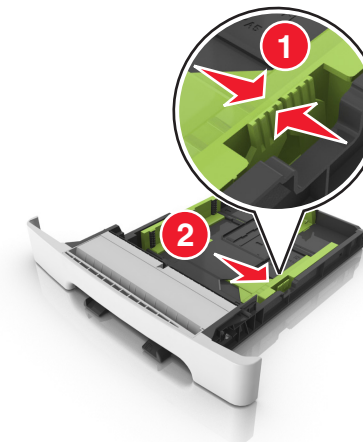

Note: Use the paper size indicators on the bottom of the tray to help position the guides.

5 Flex the sheets back and forth to loosen them, and then fan them. Do not fold or crease the paper. Straighten the edges on a level surface.

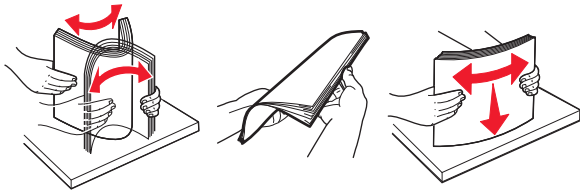

6 Load the paper stack with the recommended printable side faceup.

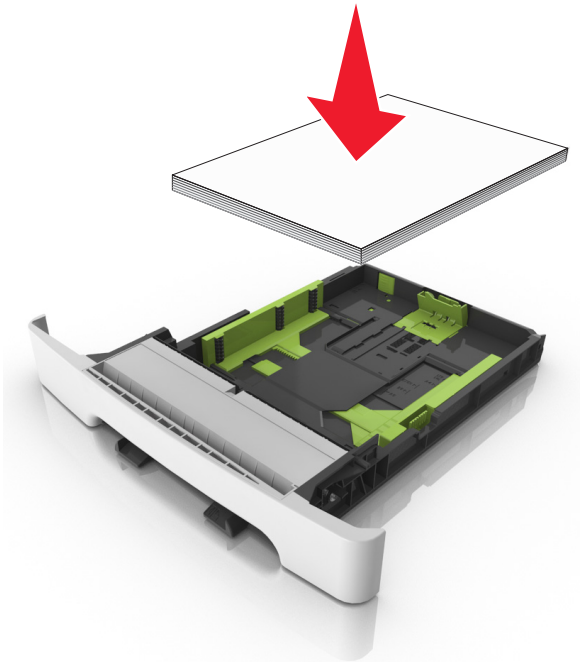

7 Place the paper guides securely against the edges of the paper.

8 Insert the tray.



9 From the printer control panel, set the paper size and paper type in the Paper menu to match the paper loaded in the tray.

Note: Mixing paper sizes or paper types in a tray may cause jams.

Loading the manual feeder

The standard 250-sheet tray has an integrated manual feeder that can be used to print on different types of paper one sheet at a time.

- 1 Load a sheet of paper into the manual feeder:
 - Printable side facedown for one-sided printing
 - Printable side faceup for two-sided (duplex) printing

Note: There are different ways for loading letterhead depending on the mode of printing.

One-sided printing using a letterhead	Two-sided printing using a letterhead

- Load envelope with the flap side up and against the right side of the paper guide.



2 Feed paper into the manual feeder only to the point where its leading edge can contact the paper guides.

Note: To achieve the best possible print quality, use only high-quality media designed for laser printers.

3 Adjust the paper guides to the width of the paper loaded.

Warning—Potential Damage: Do not force the paper into the feeder. Forcing the paper may cause jams.

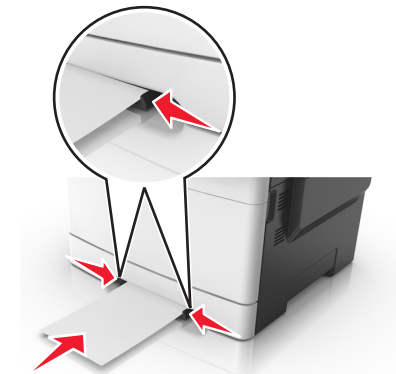

Loading the 650-sheet duo tray

The 650-sheet duo tray (Tray 2) consists of a 550-sheet tray and an integrated 100-sheet multipurpose feeder. The tray is loaded in the same way as the 250-sheet tray and the optional 550-sheet tray, and supports the same paper types and sizes. The only differences are the look of the guide tabs and the location of the paper size indicators.

CAUTION—POTENTIAL INJURY: To reduce the risk of equipment instability, load each tray separately. Keep all other trays closed until needed.

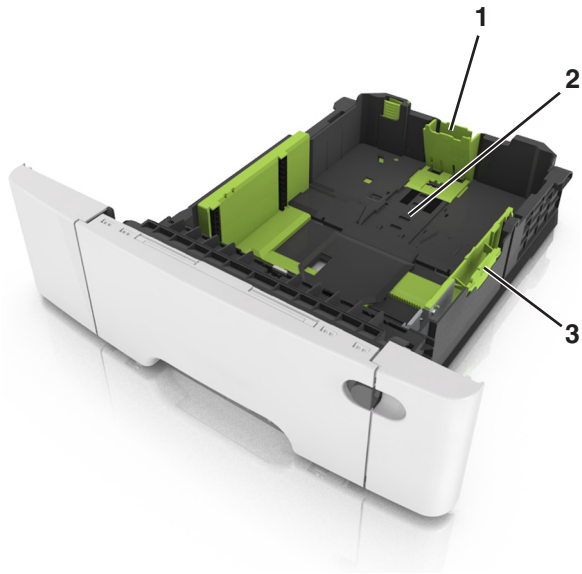

1	Length guide tab
2	Paper size indicator
3	Width guide tab

Loading the multipurpose feeder

1 Push the multipurpose feeder latch to the left.



2 Open the multipurpose feeder.



3 Pull the multipurpose feeder extender.

Note: Guide the extender gently so that the multipurpose feeder is fully extended and open.



4 Prepare the paper for loading.

- Flex the sheets of paper back and forth to loosen them, and then fan them. Do not fold or crease the paper. Straighten the edges on a level surface.

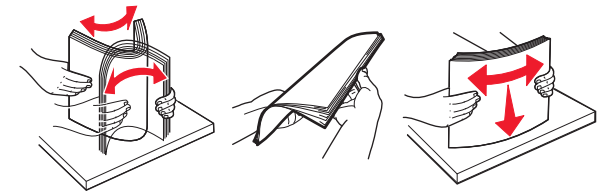

- Hold transparencies by the edges, and then fan them. Straighten the edges on a level surface.

Note: Avoid touching the printable side of transparencies. Be careful not to scratch them.

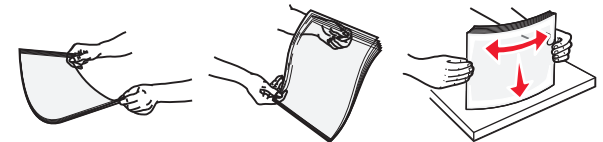

- Flex a stack of envelopes back and forth to loosen them, and then fan them. Straighten the edges on a level surface.

Warning—Potential Damage: Never use envelopes with stamps, clasps, snaps, windows, coated linings, or self-stick adhesives. These envelopes may severely damage the printer.



5 Locate the maximum paper fill indicator and tab.

Note: Make sure the paper or specialty media is below the maximum paper fill indicator located on the paper guides.

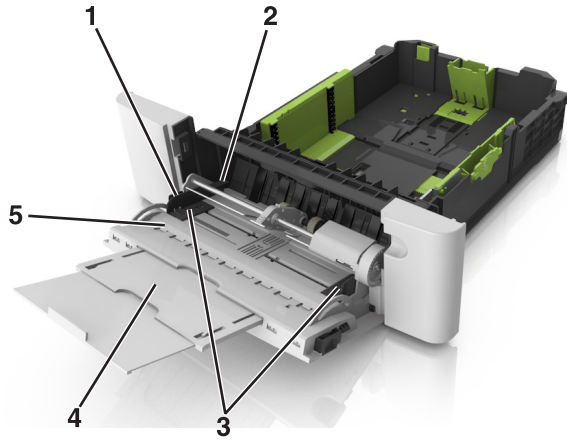

1	Width guide tab
2	Maximum paper fill indicator
3	Width guide
4	Feeder extender
5	Paper size indicator

6 Load the paper, and then adjust the width guide to lightly touch the edge of the paper stack.

- Load paper, card stock, and transparencies with the recommended printable side facedown and the top edge entering the printer first.



- Load envelopes with the flap side up and against the right side of the paper guide.

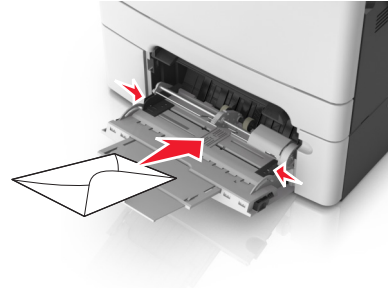

Notes:

- Do not load or close the multipurpose feeder while a job is printing.
- Load only one size and type of paper at a time.
- Paper should lie flat in the multipurpose feeder. Make sure the paper fits loosely in the multipurpose feeder and is not bent or wrinkled.

7 From the printer control panel, set the paper size and type in the Paper menu to match the paper loaded in the tray.

Linking and unlinking trays

Linking and unlinking trays

1 Open a Web browser, and then type the printer IP address in the address field.

Notes:

- View the printer IP address on the printer home screen. The IP address appears as four sets of numbers separated by periods, such as 123.123.123.123.
- If you are using a proxy server, then temporarily disable it to load the Web page correctly.

2 Click **Settings > Paper Menu**.

3 Change the paper size and type settings for the trays you are linking.

- To link trays, make sure the paper size and type for the tray match that of the other tray.
- To unlink trays, make sure the paper size or type for the tray does *not* match that of the other tray.

4 Click **Submit**.

Note: You can also change the paper size and type settings using the printer control panel. For more information, see ["Setting the paper size and type" on page 5](#).

Warning—Potential Damage: Paper loaded in the tray should match the paper type name assigned in the printer. The temperature of the fuser varies according to the specified paper type. Printing issues may occur if settings are not properly configured.

Creating a custom name for a paper type

Using the Embedded Web Server

1 Open a Web browser, and then type the printer IP address in the address field.

Notes:

- View the printer IP address on the printer home screen. The IP address appears as four sets of numbers separated by periods, such as 123.123.123.123.
- If you are using a proxy server, then temporarily disable it to load the Web page correctly.

2 Click **Settings > Paper Menu > Custom Names**.

3 Select a custom name, and then type a custom paper type name.

4 Click **Submit**.

5 Click **Custom Types**, and then verify if the new custom paper type name has replaced the custom name.

Using the printer control panel

1 From the home screen, navigate to:



> **Paper Menu > Custom Names**

2 Select a custom name, and then type a custom paper type name.

3 Touch .

4 Touch **Custom Types**, and then verify that the new custom paper type name has replaced the custom name.

Assigning a custom paper type

Using the Embedded Web Server

Assign a custom paper type name to a tray when linking or unlinking trays.

- 1 Open a Web browser, and then type the printer IP address in the address field.

Notes:

- View the printer IP address on the printer home screen. The IP address appears as four sets of numbers separated by periods, such as 123.123.123.123.
- If you are using a proxy server, then temporarily disable it to load the Web page correctly.

- 2 Click **Settings > Paper Menu > Custom Types**.

- 3 Select a custom paper type name, and then select a paper type

Note: Paper is the factory default paper type for all user-defined custom names.

- 4 Click **Submit**.

Using the printer control panel

- 1 From the home screen, navigate to:



- 2 Select a custom paper type name, and then select a paper type

Note: Paper is the factory default paper type for all user-defined custom names.

- 3 Touch .

Configuring a custom name

Using the Embedded Web Server

- 1 Open a Web browser, and then type the printer IP address in the address field.

Notes:

- View the printer IP address on the printer home screen. The IP address appears as four sets of numbers separated by periods, such as 123.123.123.123.
- If you are using a proxy server, then temporarily disable it to load the Web page correctly.

- 2 Click **Settings > Paper Menu > Custom Types**.

- 3 Select a custom name you want to configure, then select a paper or specialty media type, and then click **Submit**.

Using the printer control panel

- 1 From the home screen, navigate to:



- 2 Select a custom name you want to configure, and then touch



Printing

Printing forms

Use Forms and Favorites to quickly and easily access frequently used forms or other information that is regularly printed. Before you can use this application, first set it up on the printer. For more information, see [“Setting up Forms and Favorites” on page 3](#).

- 1 From the home screen, navigate to:

Forms and Favorites > select the form from the list > enter the number of copies > adjust other settings

- 2 Apply the changes.

Printing a document

Printing a document

- 1 From the printer control panel, set the paper type and size to match the paper loaded.

- 2 Send the print job:

For Windows users

- a With a document open, click **File > Print**.
- b Click **Properties, Preferences, Options, or Setup**.
- c Adjust the settings, if necessary.
- d Click **OK > Print**.

For Macintosh users

- a Customize the settings in the Page Setup dialog:

- 1 With a document open, choose **File > Page Setup**.
- 2 Choose a paper size or create a custom size to match the paper loaded.
- 3 Click **OK**.

- b Customize the settings in the Print dialog:

- 1 With a document open, choose **File > Print**.
If necessary, click the disclosure triangle to see more options.
- 2 From the print options pop-up menus, adjust the settings, if necessary.

Note: To print on a specific paper type, adjust the paper type setting to match the paper loaded, or select the appropriate tray or feeder.

- 3 Click **Print**.

Printing in black and white

From the home screen, navigate to:



Adjusting toner darkness

Using the Embedded Web Server

- 1 Open a Web browser, and then type the printer IP address in the address field.

Notes:

- View the printer IP address on the printer home screen. The IP address appears as four sets of numbers separated by periods, such as 123.123.123.123.
- If you are using a proxy server, then temporarily disable it to load the Web page correctly.

- 2 Click **Settings > Print Settings > Quality Menu > Toner Darkness**.

- 3 Adjust the setting, and then click **Submit**.

Using the printer control panel

- 1 From the home screen, navigate to:



- 2 Adjust the setting, and then touch .

Using Max Speed and Max Yield

Max Speed and Max Yield let you choose between a faster print speed or a higher toner yield. Max Yield is the factory default setting.

- **Max Speed**—This lets you print in either black or color depending on what is set in the printer driver. The printer prints in color unless Black Only is selected in the printer driver.
- **Max Yield**—This lets you switch from black to color based on the color content found on each page. Frequent color mode switching can result to slower printing if the content of pages is mixed.

Using the Embedded Web Server

- 1 Open a Web browser, and then type the printer IP address in the address field.

Notes:

- View the printer IP address on the printer home screen. The IP address appears as four sets of numbers separated by periods, such as 123.123.123.123.
- If you are using a proxy server, then temporarily disable it to load the Web page correctly.

- 2 Click **Settings** > **Print Settings** > **Setup Menu**.

- 3 From the Printer Usage list, select **Max Speed** or **Max Yield**.

- 4 Click **Submit**.

Using the printer control panel

- 1 From the home screen, navigate to:



> **Settings** > **Print Settings** > **Setup Menu**

- 2 From the Printer Usage list, select **Max Speed** or **Max Yield**.

- 3 Touch **Submit**.

Printing from a flash drive or mobile device

Printing from a flash drive

Notes:

- Before printing an encrypted PDF file, you will be prompted to type the file password from the printer control panel.
- You cannot print files for which you do not have printing permissions.

- 1 Insert a flash drive into the USB port.

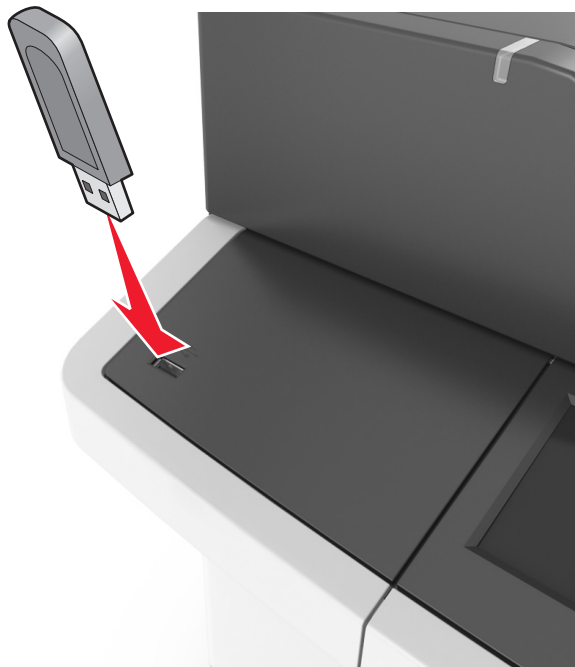

Notes:

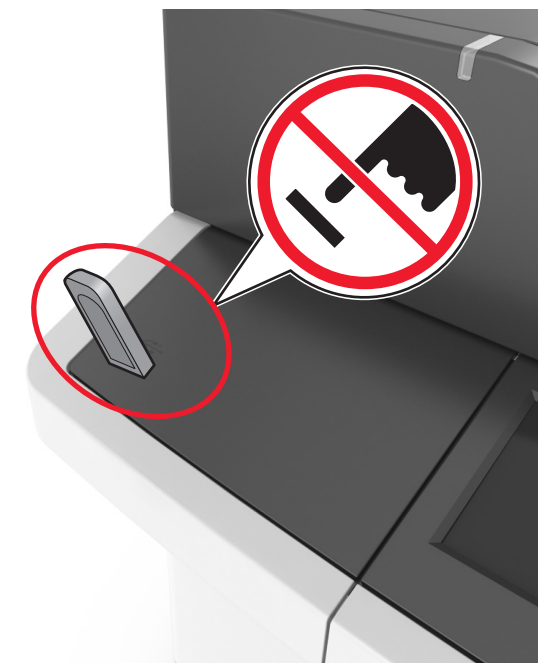

- A flash drive icon appears on the printer home screen when a flash drive is inserted.
- If you insert the flash drive when the printer requires attention, such as when a jam has occurred, then the printer ignores the flash drive.
- If you insert the flash drive while the printer is processing other print jobs, then **Busy** appears on the printer display. After these print jobs are processed, you may need to view the held jobs list to print documents from the flash drive.

Warning—Potential Damage: Do not touch the USB cable, any wireless network adapter, any connector, the memory device, or the printer in the areas shown while actively printing, reading, or writing from the memory device. Loss of data can occur.



- 2 From the printer control panel, touch the document you want to print.

- 3 Touch the arrows to get a preview of the document.

- 4 Use  or  to specify the number of copies to be printed, and then touch **Print**.

Notes:

- Do not remove the flash drive from the USB port until the document has finished printing.
- If you leave the flash drive in the printer after leaving the initial USB menu screen, then touch **Held Jobs** on the home screen to print files from the flash drive.

Supported flash drives and file types

Notes:

- High-speed USB flash drives must support the full-speed standard. Low-speed USB devices are not supported.
- USB flash drives must support the File Allocation Table (FAT) system. Devices formatted with New Technology File System (NTFS) or any other file system are not supported.

Recommended flash drives	File type
Many flash drives are tested and approved for use with the printer. For more information, contact the place where you purchased the printer.	Documents: <ul style="list-style-type: none"> • .pdf • .xps Images: <ul style="list-style-type: none"> • .dcm • .gif • .jpeg or .jpg • .bmp • .pcx • .tiff or .tif • .png • .fls



Printing from a mobile device

To download a compatible mobile printing application, visit our Web site or contact the place where you purchased the printer.

Note: Mobile printing applications may also be available from your mobile device manufacturer.

Canceling a print job

Canceling a print job from the printer control panel

- 1 From the home screen, touch **Cancel Jobs**, or press  on the keypad.
- 2 Touch the job you want to cancel, and then touch .
- 3 Press  on the keypad to return to the home screen.

Canceling a print job from the computer

For Windows users

- 1 Open the printers folder, and then select your printer.
- 2 From the print queue, select the print job you want to cancel, and then delete it.

For Macintosh users

- 1 From System Preferences in the Apple menu, navigate to your printer.
- 2 From the print queue, select the print job you want to cancel, and then delete it.

Copying

Making copies

Making a quick copy

- 1 Load an original document faceup, short edge first into the ADF tray or facedown on the scanner glass.

Notes:

- Do not load postcards, photos, small items, transparencies, photo paper, or thin media (such as magazine clippings) into the ADF tray. Place these items on the scanner glass.
 - The ADF indicator light comes on when the paper is loaded properly.
- 2 If you are loading a document into the ADF tray, then adjust the paper guides.

Note: To avoid a cropped image, make sure the size of the original document and the size of the copy paper are the same.

- 3 From the printer control panel, press .

Copying using the ADF

- 1 Load an original document faceup, short edge first into the ADF tray.

Notes:



- Do not load postcards, photos, small items, transparencies, photo paper, or thin media (such as magazine clippings) into the ADF tray. Place these items on the scanner glass.
 - The ADF indicator light comes on when the paper is loaded properly.
- 2 Adjust the paper guides.

- 3 From the home screen, navigate to:
Copy > specify the copy settings > **Copy It**

Copying using the scanner glass

- 1 Place an original document facedown on the scanner glass in the upper left corner.
- 2 From the home screen, navigate to:
Copy > specify the copy settings > **Copy It**
If you have more pages to scan, then place the next document on the scanner glass, and then touch **Scan the next page**.
- 3 Touch **Finish the Job**.

Copying photos

- 1 Place a photo facedown on the scanner glass in the upper left corner.
- 2 From the home screen, navigate to:
Copy > **Content** > **Photo** > 
- 3 From the Content Source menu, select the appropriate setting that best matches the original photo.
- 4 Touch  > **Copy It**
Note: If you have more photos to copy, then place the next photo on the scanner glass, and then touch **Scan the next page**.
- 5 Touch **Finish the Job**.

Canceling a copy job

Canceling a copy job while the original document is in the ADF



When the ADF begins processing a document, touch **Cancel Job** on the printer control panel.

Canceling a copy job while copying pages using the scanner glass

From the home screen, touch **Cancel Job**.

Canceling appears on the display. When the job is canceled, the Copy screen appears.

Canceling a copy job while pages are being printed

- 1 From the printer control panel, press .
- 2 Touch the job you want to cancel, and then touch .
- 3 Press  to return to the home screen.

E-mailing

Setting up the printer to e-mail

Setting up the e-mail function

- 1 Open a Web browser, and then type the printer IP address in the address field.

Notes:

- View the printer IP address on the printer home screen. The IP address appears as four sets of numbers separated by periods, such as 123.123.123.123.
- If you are using a proxy server, then temporarily disable it to load the Web page correctly.

- 2 Click **Settings** > **E-mail/FTP Settings** > **E-mail Settings**.
- 3 Enter the appropriate information, and then click **Submit**.

Creating an e-mail shortcut

Creating an e-mail shortcut using the Embedded Web Server

- 1 Open a Web browser, and then type the printer IP address in the address field.

Notes:

- View the printer IP address on the printer home screen. The IP address appears as four sets of numbers separated by periods, such as 123.123.123.123.
- If you are using a proxy server, then temporarily disable it to load the Web page correctly.



- 2 Click **Settings**.
- 3 From the Other Settings column, click **Manage Shortcuts** > **E-mail Shortcut Setup**.
- 4 Type a unique name for the e-mail recipient, and then type the e-mail address. If you are entering multiple addresses, then separate each address with a comma.
- 5 Click **Add**.

Creating an e-mail shortcut using the printer control panel

- 1 From the home screen, navigate to:

E-mail > **Recipient(s)** > type the recipient's e-mail address > 

Note: To create a group of recipients, touch  and then type the next recipient's e-mail address.

- 2 Touch **Subject** > type the e-mail subject > .
- 3 Touch **Message** > type your message > .
- 4 Adjust the e-mail settings.

Note: If you change the settings after the e-mail shortcut has been created, then the settings are not saved.

- 5 Touch **Save As Shortcut**.

- 6 Type a unique name for the shortcut, and then touch .

- 7 Verify that the shortcut name is correct, and then touch **OK**.
If the shortcut name is incorrect, then touch **Cancel**, and then reenter the information.

Notes:

- The shortcut name appears in the E-mail Shortcuts icon on the printer home screen.
- You can use the shortcut when e-mailing another document using the same settings.

E-mailing a document

Sending an e-mail using the printer control panel

- 1 Load an original document faceup, short edge first into the ADF tray or facedown on the scanner glass.

Notes:

- Do not load postcards, photos, small items, transparencies, photo paper, or thin media (such as magazine clippings) into the ADF tray. Place these items on the scanner glass.
- The ADF indicator light comes on when the paper is loaded properly.

- 2 If you are loading a document into the ADF tray, then adjust the paper guides.

Note: To avoid a cropped image, make sure that the size of the original document and the copy paper size are the same.

- 3 From the home screen, navigate to:

E-mail > **Recipient(s)**

- 4 Type the e-mail address, or press # and then enter the shortcut number.

To enter additional recipients, touch  and then enter the e-mail address or shortcut number that you want to add.

Note: You can also enter an e-mail address using the address book.

- 5 Touch  > **E-mail It**.

Sending an e-mail using a shortcut number

- 1 Load an original document faceup, short edge first into the ADF tray or facedown on the scanner glass.

Notes:

- Do not load postcards, photos, small items, transparencies, photo paper, or thin media (such as magazine clippings) into the ADF tray. Place these items on the scanner glass.
- The ADF indicator light comes on when the paper is loaded properly.

- 2 If you are loading a document into the ADF tray, then adjust the paper guides.

- 3 Press #, then enter the shortcut number using the keypad, and then touch .

To enter additional recipients, touch  and then enter the e-mail address or shortcut number that you want to add.

- 4 Touch  > E-mail It.



Sending an e-mail using the address book

- 1 Load an original document faceup, short edge first into the ADF tray or facedown on the scanner glass.

Notes:

- Do not load postcards, photos, small items, transparencies, photo paper, or thin media (such as magazine clippings) into the ADF tray. Place these items on the scanner glass.
- The ADF indicator light comes on when the paper is loaded properly.

- 2 If you are loading a document into the ADF tray, then adjust the paper guides.
- 3 From the home screen, navigate to:

E-mail > Recipient(s) >  > type the name of the recipient > 

- 4 Touch the name of the recipient.

To search for additional recipients, touch **New Search**, and then type the name of the next recipient.

- 5 Touch  > E-mail It.

Canceling an e-mail

- When using the ADF, touch **Cancel Job** while **Scanning** appears.
- When using the scanner glass, touch **Cancel Job** while **Scanning** appears, or while **Scan the Next Page/Finish the Job** appears.

Faxing

Sending a fax

Sending a fax using the printer control panel

- 1 Load an original document faceup, short edge first into the ADF tray or facedown on the scanner glass.

Notes:

- Do not load postcards, photos, small items, transparencies, photo paper, or thin media (such as magazine clippings) into the ADF tray. Place these items on the scanner glass.
- The ADF indicator light comes on when the paper is loaded properly.

- 2 If you are loading a document into the ADF tray, then adjust the paper guides.
- 3 From the home screen, touch **Fax**.
- 4 From the printer control panel keypad, enter the fax number or the shortcut number.

Note: To add recipients, touch  and then enter the recipient's telephone number or shortcut number, or search the address book.

- 5 Touch **Fax It**.

Sending a fax using the computer

For Windows users

- 1 With a document open, click **File > Print**.
- 2 Select the printer, and then click **Properties, Preferences, Options, or Setup**.
- 3 Click **Fax > Enable fax**, and then enter the recipient fax number or numbers.
- 4 If necessary, configure other fax settings.
- 5 Apply the changes, and then send the fax job.

Notes:

- The fax option is available only with the PostScript driver or the Universal Fax Driver. For more information, contact the place where you purchased the printer.

- To use the fax option with the PostScript driver, configure and enable it in the Configuration tab.

For Macintosh users

- 1 With a document open, choose **File > Print**.
- 2 Select the printer.
- 3 Enter the recipient fax number, and then configure other fax settings, if necessary.
- 4 Send the fax job.

Sending a fax using a shortcut number

Fax shortcuts are like the speed dial numbers on a telephone or a fax machine. A shortcut number (1–999) can contain a single recipient or multiple recipients.

- 1 Load an original document faceup, short edge first into the ADF tray or facedown on the scanner glass.

Notes:

- Do not load postcards, photos, small items, transparencies, photo paper, or thin media (such as magazine clippings) into the ADF tray. Place these items on the scanner glass.
- The ADF indicator light comes on when the paper is loaded properly.

- 2 If you are loading a document into the ADF tray, then adjust the paper guides.
- 3 From the printer control panel, press #, and then enter the shortcut number using the keypad.
- 4 Touch **Fax It**.

Sending a fax using the address book

The address book feature lets you search for bookmarks and network directory servers.

Note: If the address book feature is not enabled, then contact your system support person.



- 1 Load an original document faceup, short edge first into the ADF tray or facedown on the scanner glass.

Notes:

- Do not load postcards, photos, small items, transparencies, photo paper, or thin media (such as magazine clippings) into the ADF tray. Place these items on the scanner glass.

- The ADF indicator light comes on when the paper is loaded properly.
- 2 If you are loading a document into the ADF tray, then adjust the paper guides.

3 From the home screen, navigate to:

Fax >  > type the name of the recipient > 

Note: You can only search for one name at a time.

4 Touch the name of the recipient, and then touch **Fax It**.

Sending a fax at a scheduled time

1 Load an original document faceup, short edge first into the ADF tray or facedown on the scanner glass.

Notes:

- Do not load postcards, photos, small items, transparencies, photo paper, or thin media (such as magazine clippings) into the ADF tray. Place these items on the scanner glass.
- The ADF indicator light comes on when the paper is loaded properly.

2 If you are loading a document into the ADF tray, then adjust the paper guides.

3 From the home screen, navigate to:

Fax > enter the fax number > **Delayed Send**

Note: If Fax Mode is set to Fax Server, then the Delayed Send button will not appear. Faxes waiting for transmission are listed in the fax queue.

4 Specify the time the fax will be transmitted, and then touch



The time is increased or decreased in 30-minute increments.

5 Touch **Fax It**.

Note: The document is scanned and then faxed at the scheduled time.

Creating shortcuts

Creating a fax destination shortcut using the Embedded Web Server

Assign a shortcut number to a single fax number or a group of fax numbers.

1 Open a Web browser, and then type the printer IP address in the address field.

Notes:

- View the printer IP address in the TCP/IP section in the Network/Ports menu. The IP address appears as four sets of numbers separated by periods, such as 123.123.123.123.
- If you are using a proxy server, then temporarily disable it to load the Web page correctly.

2 Click **Settings** > **Manage Shortcuts** > **Fax Shortcut Setup**.

Note: A password may be required. If you do not have an ID and password, then contact your system support person.

3 Type a name for the shortcut, and then enter the fax number.

Notes:

- To create a multiple-number shortcut, enter the fax numbers for the group.
- Separate each fax number in the group with a semicolon (;).

4 Assign a shortcut number.

Note: If you enter a number that is already in use, then you are prompted to select another number.

5 Click **Add**.

Creating a fax destination shortcut using the printer control panel

1 From the home screen, touch **Fax**, and then enter the fax number.

To create a group of fax numbers, touch , and then enter the other fax number.

2 Touch .

3 Type a unique name for the shortcut, and then touch .

4 Verify that the shortcut name and number are correct, and then touch **OK**.

If the name or number is incorrect, then touch **Cancel**, and then reenter the information.

Scanning

Using Scan to Network

Scan to Network lets you scan your documents to network destinations specified by your system support person. After the destinations (shared network folders) have been established on the network, the setup process for the application involves installing and configuring the application on the appropriate printer using its Embedded Web Server. For more information, see [“Setting up Scan to Network” on page 4](#).

Scanning to an FTP address

Scanning to an FTP address using the printer control panel

1 Load an original document faceup, short edge first into the ADF tray or facedown on the scanner glass.

Notes:

- Do not load postcards, photos, small items, transparencies, photo paper, or thin media (such as magazine clippings) into the ADF tray. Place these items on the scanner glass.
- The ADF indicator light comes on when the paper is loaded properly.

2 If you are loading a document into the ADF tray, then adjust the paper guides.

3 From the home screen, navigate to:

FTP > FTP Address > type the FTP address >  > **Scan It**

Scanning to an FTP address using a shortcut number

1 Load an original document faceup, short edge first into the ADF tray or facedown on the scanner glass.

Notes:

- Do not load postcards, photos, small items, transparencies, photo paper, or thin media (such as magazine clippings) into the ADF tray. Place these items on the scanner glass.

- The ADF indicator light comes on when the paper is loaded properly.
- 2 If you are loading a document into the ADF tray, then adjust the paper guides.
 - 3 From the printer control panel, press # on the keypad, and then enter the FTP shortcut number.
 - 4 Touch **Scan It**.

Scanning to a computer or flash drive

Scanning to a computer using the Embedded Web Server

- 1 Open a Web browser, and then type the printer IP address in the address field.

Notes:

- View the printer IP address on the printer home screen. The IP address appears as four sets of numbers separated by periods, such as 123.123.123.123.
- If you are using a proxy server, then temporarily disable it to load the Web page correctly.

- 2 Click **Scan Profile > Create Scan Profile**.
- 3 Select your scan settings, and then click **Next**.
- 4 Select a location on your computer where you want to save the scan image.
- 5 Type a scan name, and then a user name.

Note: The scan name is the name that appears in the Scan Profile list on the display.

- 6 Click **Submit**.

Note: Clicking **Submit** automatically assigns a shortcut number. You can use this shortcut number when you are ready to scan your documents.

- 7 Review the instructions on the Scan Profile screen.
 - a Load an original document faceup, short edge first into the ADF tray or facedown on the scanner glass.

Notes:

- Do not load postcards, photos, small items, transparencies, photo paper, or thin media (such as magazine clippings) into the ADF tray. Place these items on the scanner glass.

- The ADF indicator light comes on when the paper is loaded properly.
- b If you are loading a document into the ADF tray, then adjust the paper guides.
 - c Do either of the following:
 - Press #, and then enter the shortcut number using the keypad.
 - From the home screen, navigate to: **Held Jobs > Profiles >** select your shortcut on the list

Note: The scanner scans and sends the document to the directory you specified.

- 8 View the file from the computer.

Note: The output file is saved in the location or launched in the program you specified.

Setting up Scan to Computer

Notes:

- This feature is supported only in Windows Vista or later.
- Make sure your computer and printer are connected to the same network.

- 1 Open the printers folder, and then select your printer.

Note: If your printer is not in the list, then add your printer.
- 2 Open the printer properties, and then adjust the settings as necessary.
- 3 From the control panel, touch **Scan to Computer >** select the appropriate scan setting **> Send It**.

Scanning to a flash drive

- 1 Load an original document faceup, short edge first into the ADF tray or facedown on the scanner glass.

Notes:

- Do not load postcards, photos, small items, transparencies, photo paper, or thin media (such as magazine clippings) into the ADF tray. Place these items on the scanner glass.
 - The ADF indicator light comes on when the paper is loaded properly.
- 2 If you are loading a document into the ADF tray, then adjust the paper guides.
 - 3 Insert the flash drive into the USB port on the front of the printer.

Note: The USB Drive home screen appears.

- 4 Select the destination folder, and then touch **Scan to USB drive**.

Note: The printer goes back to the home screen after 30 seconds of inactivity.

- 5 Adjust the scan settings, and then touch **Scan It**.

Clearing jams

[x]-page jam, clear standard bin [203.xx]

- 1 Open the top door.



- 2 Firmly grasp the jammed paper on each side, and then gently pull it out.

Note: Make sure all paper fragments are removed.



3 Open the front door.

 **CAUTION—HOT SURFACE:** The inside of the printer might be hot. To reduce the risk of injury from a hot component, allow the surface to cool before touching.

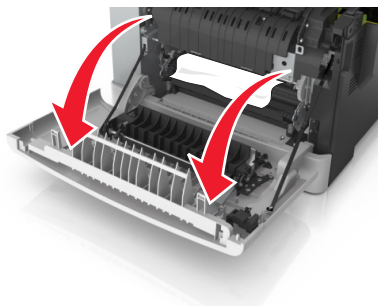

a If there is a jammed paper under the fuser, then firmly grasp the paper on each side, and then gently pull it out.

Note: Make sure all paper fragments are removed.

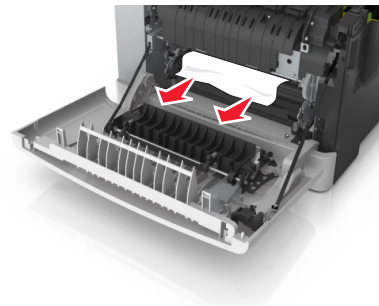

b Pull the green lever to open the fuser cover.

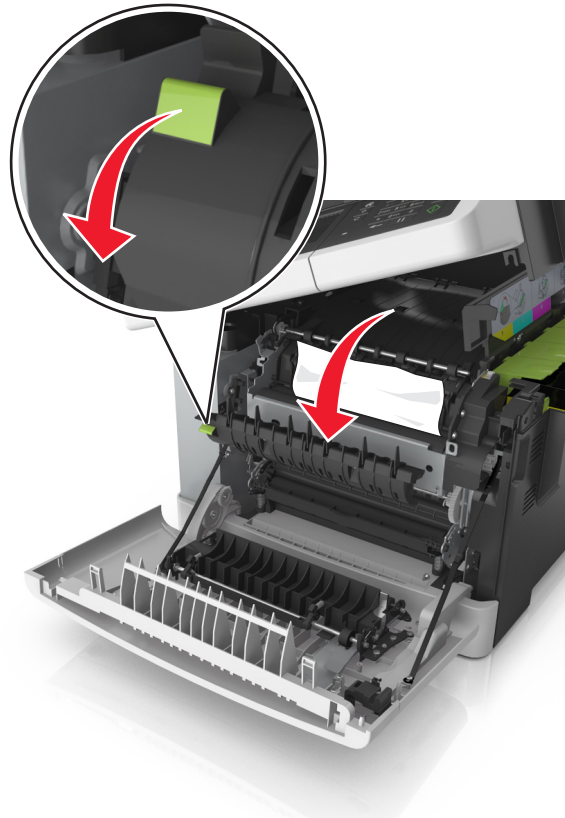

c If there is a jammed paper in the fuser, then hold down the fuser cover, and then remove the paper.

Note: Make sure all paper fragments are removed.

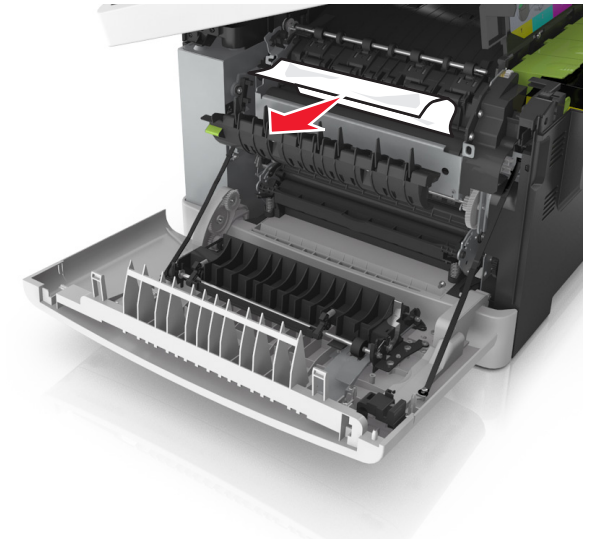



4 Slide and hold the release latch on the right side of the printer, and then slowly close the top door.

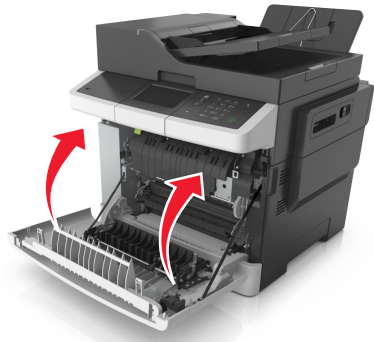

5 Close the front door.



6 From the printer control panel, touch  to clear the message and continue printing. For non-touch-screen printer models, select **Next > Clear the jam, press OK**, and then press  to confirm.

[x]-page jam, open front door to clear fuser [202.xx]

1 Open the front door.

 **CAUTION—HOT SURFACE:** The inside of the printer might be hot. To reduce the risk of injury from a hot component, allow the surface to cool before touching.

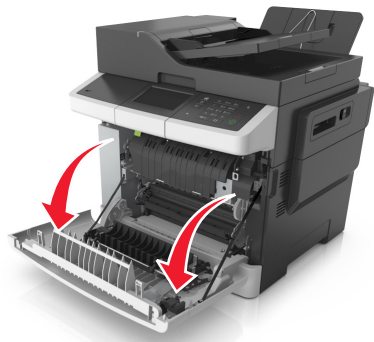

2 Open the top door.



3 Pull the green lever to open the fuser cover.

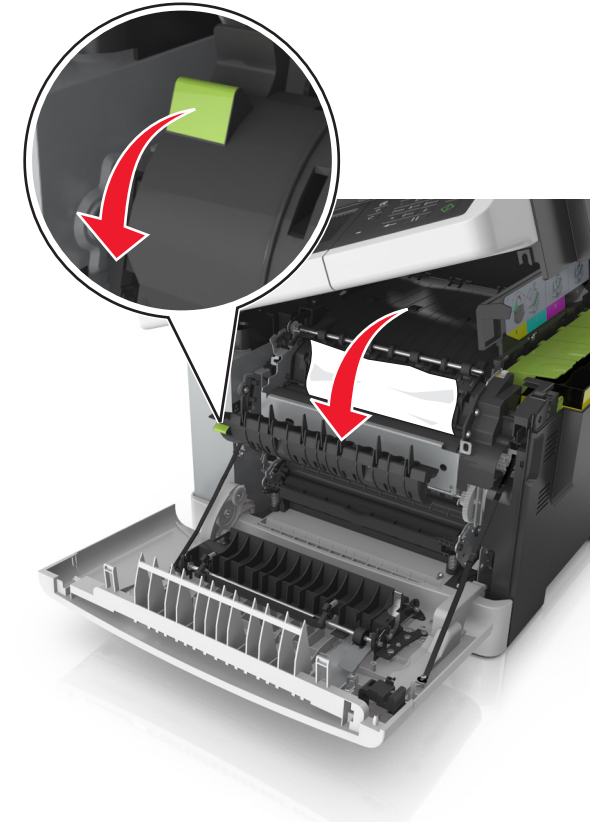

4 Hold down the fuser cover, and then remove the jammed paper.

Note: Make sure all paper fragments are removed.

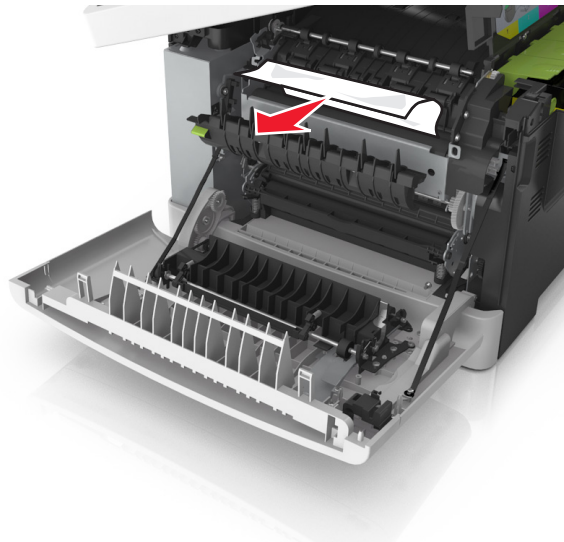



5 Slide and hold the release latch on the right side of the printer, and then slowly close the top door.



6 Close the front door.



7 From the printer control panel, touch  to clear the message and continue printing. For non-touch-screen printer models, select

Next > Clear the jam, press OK, and then press  to confirm.

[x]-page jam, open front door [20y.xx]

1 Open the front door.

 **CAUTION—HOT SURFACE:** The inside of the printer might be hot. To reduce the risk of injury from a hot component, allow the surface to cool before touching.

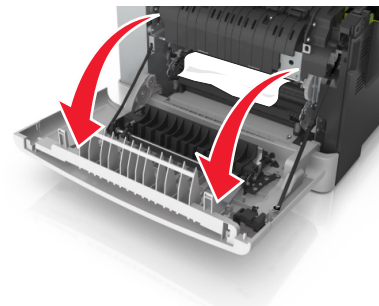

2 Firmly grasp the jammed paper on each side, and then gently pull it out.

Note: Make sure all paper fragments are removed.

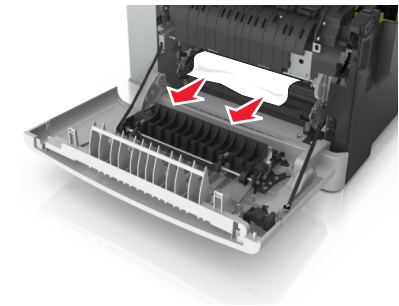

3 Close the front door.



4 From the printer control panel, touch  to clear the message and continue printing. For non-touch-screen printer models, select

Next > Clear the jam, press OK, and then press  to confirm.

[x]-page jam, open front door to clear duplex [23y.xx]

1 Open the front door.

 **CAUTION—HOT SURFACE:** The inside of the printer might be hot. To reduce the risk of injury from a hot component, allow the surface to cool before touching.

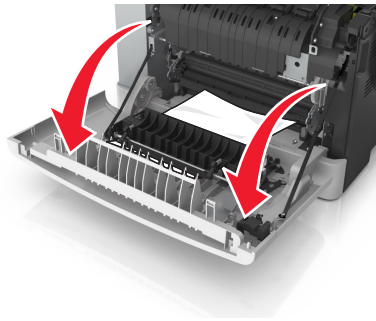

2 Firmly grasp the jammed paper on each side, and then gently pull it out.

Note: Make sure all paper fragments are removed.

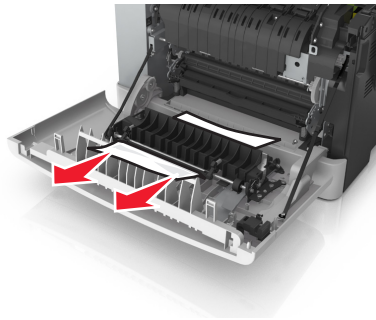

3 Close the front door.



4 From the printer control panel, touch  to clear the message and continue printing. For non-touch-screen printer models, select

Next > Clear the jam, press OK, and then press  to confirm.

[x]-page jam, open tray [x] [24y.xx]

1 Pull out the tray completely.

Note: The message on the printer display indicates the tray where the jammed paper is located.

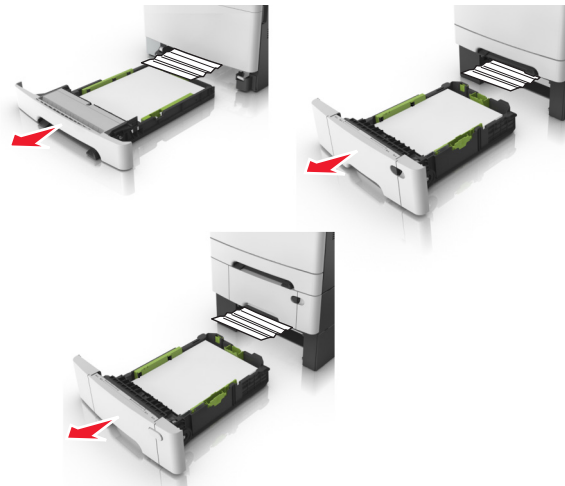



2 Firmly grasp the jammed paper on each side, and then gently pull it out.

Note: Make sure all paper fragments are removed.



3 Insert the tray.

4 From the printer control panel, touch  to clear the message and continue printing. For non-touch-screen printer models, select

Next > Clear the jam, press OK, and then press  to confirm.

[x]-page jam, clear manual feeder [251.xx]

1 Pull out the standard 250-sheet tray (Tray 1) and manual feeder.

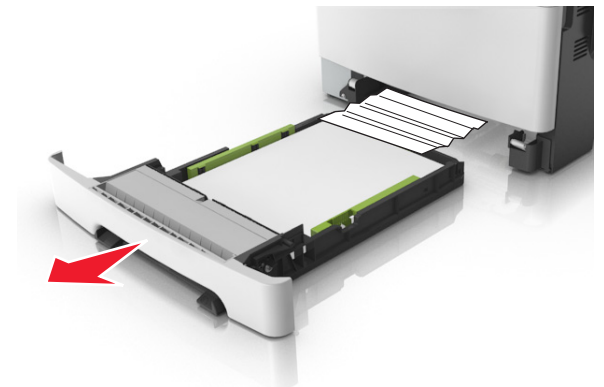

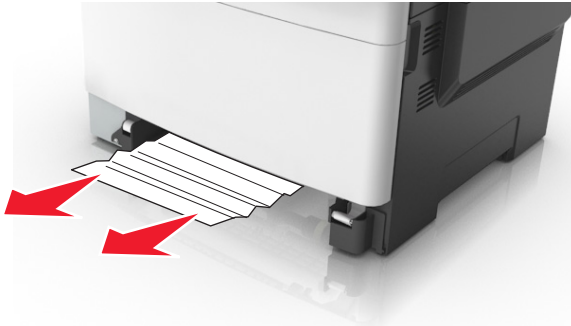

2 Firmly grasp the jammed paper on each side, and then gently pull it out.

Note: Make sure all paper fragments are removed.



3 Insert the tray.

4 From the printer control panel, touch  to clear the message and continue printing. For non-touch-screen printer models, select

Next > Clear the jam, press OK, and then press  to confirm.

[x]-page jam, clear multipurpose feeder [250.xx]

1 Push the paper release lever in the multipurpose feeder to access the jammed paper, and then gently pull out the paper.

Note: Make sure all paper fragments are removed.

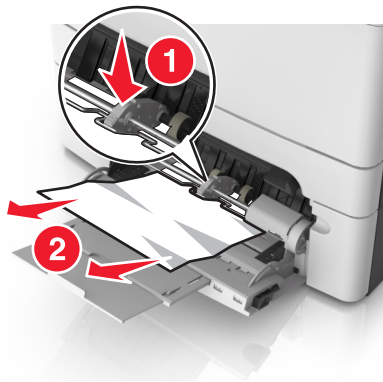

2 Flex the sheets back and forth to loosen them, and then fan them. Do not fold or crease the paper. Straighten the edges on a level surface.

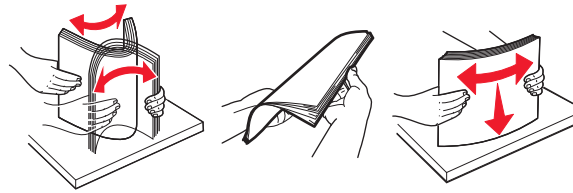



3 Reload paper into the multipurpose feeder.

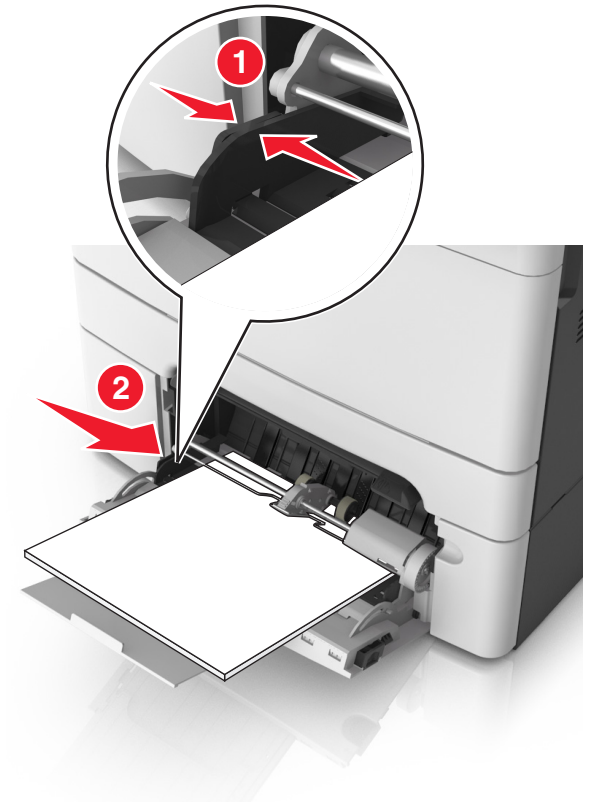

4 Slide the paper guide until it rests lightly against the edge of the paper stack.



5 From the printer control panel, touch  to clear the message and continue printing. For non-touch-screen printer models, select

Next >  > Clear the jam, press OK > .

[x]-page jam, open automatic feeder top cover. [28y.xx]

1 Remove all original documents from the ADF tray.

Note: The message is cleared when the pages are removed from the ADF tray.

2 Open the ADF cover.

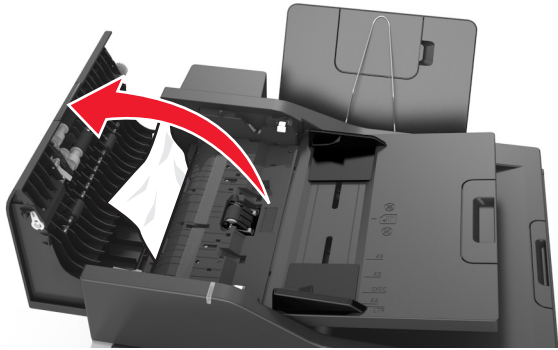

3 Firmly grasp the jammed paper on each side, and then gently pull it out.

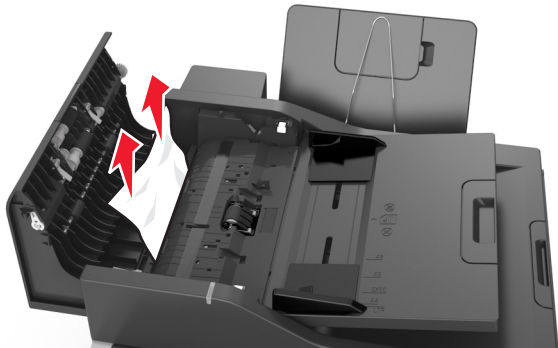

Note: Make sure all paper fragments are removed.



4 Close the ADF cover.

5 Straighten the edges of the original documents, then load the documents into the ADF, and then adjust the paper guide.

6 From the printer control panel, touch  to clear the message and continue printing. For non-touch-screen printer models, select

Next >  > Clear the jam, press OK > .