

Revised: September 5, 2006



Service Manual

**Lexmark™ E238, E240,
E240n, E340, and E342n**

4511-000

4511-100

4511-410

4511-600

4511-610

- ***Table of contents***
- ***Start diagnostics***
- ***Safety and notices***
- ***Trademarks***
- ***Index***

LEXMARK™

Lexmark and Lexmark with diamond design are trademarks of Lexmark International, Inc., registered in the United States and/or other countries.

Edition: September 5, 2006

The following paragraph does not apply to any country where such provisions are inconsistent with local law: LEXMARK INTERNATIONAL, INC. PROVIDES THIS PUBLICATION "AS IS" WITHOUT WARRANTY OF ANY KIND, EITHER EXPRESS OR IMPLIED, INCLUDING, BUT NOT LIMITED TO, THE IMPLIED WARRANTIES OF MERCHANTABILITY OR FITNESS FOR A PARTICULAR PURPOSE. Some *states* do not allow disclaimer of express or implied warranties in certain transactions; therefore, this statement may not apply to you.

This publication could include technical inaccuracies or typographical errors. Changes are periodically made to the information herein; these changes will be incorporated in later editions. Improvements or changes in the products or the programs described may be made at any time.

Comments may be addressed to Lexmark International, Inc., Department D22A/032-2, 740 West New Circle Road, Lexington, Kentucky 40550, U.S.A or e-mail at ServiceInfoAndTraining@Lexmark.com. Lexmark may use or distribute any of the information you supply in any way it believes appropriate without incurring any obligation to you..

References in this publication to products, programs, or services do not imply that the manufacturer intends to make these available in all countries in which it operates. Any reference to a product, program, or service is not intended to state or imply that only that product, program, or service may be used. Any functionally equivalent product, program, or service that does not infringe any existing intellectual property right may be used instead. Evaluation and verification of operation in conjunction with other products, programs, or services, except those expressly designated by the manufacturer, are the user's responsibility.

Lexmark, Lexmark with diamond design, MarkNet, and MarkVision are trademarks of Lexmark International, Inc., registered in the United States and/or other countries.

Opra Forms and PictureGrade are trademarks of Lexmark International, Inc.

PCL® is a registered trademark of the Hewlett-Packard Company.

PostScript® is a registered trademark of Adobe Systems Incorporated.

All other trademarks are the property of their respective owners.

© 2006 Lexmark International, Inc.

All rights reserved.

UNITED STATES GOVERNMENT RIGHTS

This software and any accompanying documentation provided under this agreement are commercial computer software and documentation developed exclusively at private expense.

U.S.A. P/N 12G9615

Table of contents

Laser notices	vii
Safety information	xvii
Preface	xxii
Definitions	xxii
General information	1-1
Models	1-1
Maintenance approach	1-1
Overview of the operator panels	1-2
Models E238, E240, and E240n	1-2
Models E340 and E342n	1-3
Overview of the operator panel	1-3
Specifications	1-4
Memory	1-4
Print speed	1-4
Connectivity and compatibility	1-5
Media trays and supply capacity	1-6
Types of print media	1-7
Tips on preventing jams	1-8
Tools	1-8
Acronyms	1-9
Diagnostic information	2-1
Start	2-1
Diagnostics—E238, E240, and E240n	2-2
Power-On Self Test (POST) sequence	2-2
Light patterns and error messages	2-3
Common primary light patterns	2-4
Common secondary light patterns	2-8
Secondary errors—paper jams	2-12
Additional information—primary codes	2-13
Additional information—secondary error codes	2-24
Service codes	2-36
Diagnostics—E340 and E342n	2-50
Power-On Self Test (POST) sequence	2-50
Overview of the operator panel and menus	2-51
Indicator light	2-51
Buttons	2-52
Diagram of the printer menus	2-54
Messages and error codes	2-55
User attendance messages	2-55
Paper jam messages	2-64

Service error codes	2-65
Sub error codes	2-68
Diagnostics—all models 79	2-79
Symptom tables	2-79
POST symptom table	2-79
Printer symptom table	2-79
Service checks	2-81
Cooling fan service check	2-81
Controller card service check	2-82
Cover interlock switch service check	2-85
Dead machine service check	2-86
Fuser service check	2-87
Cold fuser service check	2-89
Hot fuser service check	2-89
LVPS/HVPS service check	2-90
Main motor service check	2-91
Operator panel service check (models E238, E240, and E240n)	2-92
Operator panel service check (models E340 and E342n)	2-93
Paper feed service checks	2-94
Parallel port service check (models E238, E240, and E240n)	2-97
Parallel port service check (models E340 and E342n)	2-97
Print quality service checks	2-98
Printhead service check	2-111
Transfer roll service check	2-111
Diagnostic aids	3-1
Diagnostic aids—E238, E240, and E240n	3-2
Accessing service menus	3-2
Printing menus	3-2
Moving around the menu	3-5
Configuration menu selections	3-6
Utilities	3-6
Setup	3-7
Parallel	3-8
USB	3-9
Network	3-10
Diagnostics mode selections	3-11
Development	3-11
Parallel	3-12
Network	3-13
Diagnostic aids—E340 and E342n	3-14
Accessing service menus	3-14
Printing menus	3-14
Configuration menu (CONFIG MENU)	3-15
Entering Configuration Menu	3-15
Available menus	3-15
Reset PC Cnt.	3-16

Print quality pages (Prt Quality Pgs)	3-16
Panel Menus	3-16
PPDS Emulation	3-16
Download Emuls	3-17
Demo Mode	3-17
Factory Defaults	3-17
Energy Conserve	3-17
Error log	3-18
Paper Prompts	3-18
Env Prompts	3-18
Exit Config Menu	3-18
Diagnostics mode	3-19
Available tests	3-19
Registration	3-21
Print tests	3-22
Hardware tests	3-23
Input tray tests	3-26
Base sensor test	3-28
Device tests	3-28
Printer setup	3-29
EP setup	3-31
Error log	3-32
Exit Diagnostics mode	3-33
Repair information	4-1
Handling ESD-sensitive parts	4-1
Removal procedures	4-2
Covers	4-2
Controller card removal	4-15
Cover open sensor removal	4-18
Developer drive coupling assembly removal	4-20
Door latch assembly removal	4-21
Exit sensor removal (on the fuser)	4-22
Fan removal	4-26
Front access cover logo removal (E238, E240, and E240n)	4-27
Fuser removal	4-28
Fuser idle gear links removal	4-30
Fuser power cable removal	4-32
Input roller clutch and lever removal (autocompensator clutch)	4-34
Input sensor #1 removal	4-35
Input sensor #2 (manual feed) removal	4-36
LCD bezel removal	4-37
LCD operator panel removal	4-39
LED operator panel removal (E238, E240, and E240n)	4-40
LVPS/HVPS card assembly removal	4-41
LVPS/HVPS-to-controller card cable removal	4-43
Manual feed clutch assembly removal	4-44

- Paper exit guide assembly removal 4-46
- Paper feed rollers (autocompensator tires) removal 4-47
- Printhead removal 4-48
- Toner level sensor cable removal (E340 and E342n) 4-49
- Toner level sensor removal (E340 and E342n) 4-49
- Transfer roll removal 4-50
- Transport motor cable removal 4-51
- Locations and connections 5-1**
 - Locations 5-1
 - Front view 5-1
 - Rear view 5-2
 - Connectors 5-3
 - Controller card 5-3
 - Controller card connector pin values 5-4
- Preventive maintenance 6-1**
- Parts catalog 7-1**
 - How to use this parts catalog 7-1
 - Assembly 1: Covers 7-2
 - Assembly 2: Electronics 7-4
 - Assembly 3: Frame 7-6
 - Assembly 4: Options 7-8
 - Assembly 5: Miscellaneous 7-9
- Index I-1**
- Part number index I-7**

Laser notices

The following laser notice labels may be affixed to this MFP as shown:

Laser advisory label

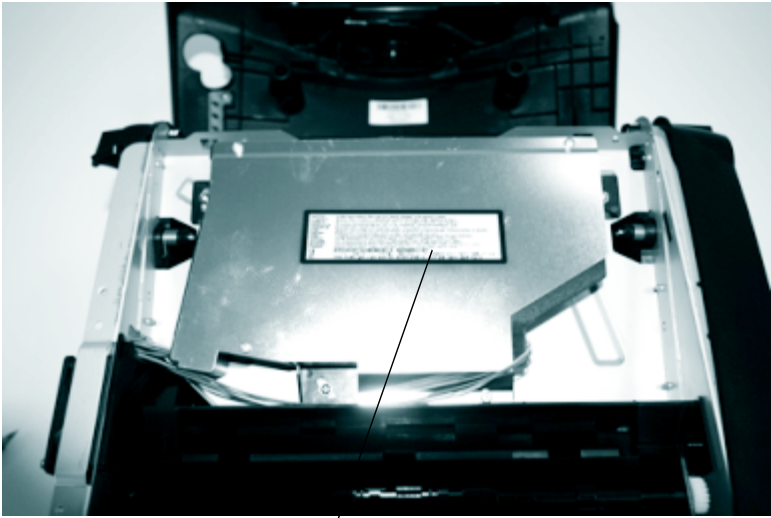

CAUTION -	Invisible laser radiation when open and interlock defeated. Avoid exposure to beam.
ATTENTION -	Radiation laser invisible si le dispositif est ouvert et non bloqué. Évitez l'exposition au rayon.
VORSICHT -	Unsichtbare Laserstrahlung wenn drucker offen und sperre gelöst. Nicht dem strahl aussetzen.
VOORZICHTIG -	Onzichtbare laserstraling wanneer open en niet vergrendeld. Vermijd blootstelling aan straal.
ATTENZIONE -	Radiatione laser invisibile se il dispositivo è aperto e non bloccato. Evitare l'esposizione diretta.
AVISO -	Radiación laser invisible si la puerta está abierta y el dispositivo no está bloqueado. Evite exponerse a la radiación.
CUIDADO -	Radiación laser invisible quando a tampa é aberta. Evite exposição aos raios.
VAROIT -	Aviettäminen ja suojauskeuhkujen ohittaminen voi aiheuttaa näkövaurioita laser säteilyllä. Älä katso säteeseen.
WARNING -	Öpprig laserstrålning när dörarna öppnas och spärrar är urkopplade. Strålen är färglös.
ADVARSEL -	Usynlig laserstrålning når dørene åpnes og sikkerhetslås brytes. Unngå eksponering for strålen.
ATENCIÓN -	Usynlig laserstrålning ved åbning, når sikkerhedsafbrydere er ude af funktion. Undgå udsættelse for stråling.
ATENCIÓN -	Radiación laser invisible si el dispositivo está abierto y no está conectado. Evite la exposición a la radiación.
注意：	開閉時蓋有無不到防輻射輻射外洩，構成危險於光線下。
注意 -	トップカバーを開閉するとスイッチが作動し、視認できないレーザーが放射されるので、必ずよく注意してください。
주의 -	개방 및 닫힐 때 스위치가 작동하는 동안 레이저가 방사됩니다. 확인 후 주의하십시오.

Laser notice

The printer is certified in the U.S. to conform to the requirements of DHHS 21 CFR Subchapter J for Class I (1) laser products, and elsewhere is certified as a Class I laser product conforming to the requirements of IEC 60825-1.

Class I laser products are not considered to be hazardous. The printer contains internally a Class IIIb (3b) laser that is nominally a 5 milliwatt gallium arsenide laser operating in the wavelength region of 770-795 nanometers. The laser system and printer are designed so there is never any human access to laser radiation above a Class I level during normal operation, user maintenance, or prescribed service condition.

Laser

Der Drucker erfüllt gemäß amtlicher Bestätigung der USA die Anforderungen der Bestimmung DHHS (Department of Health and Human Services) 21 CFR Teil J für Laserprodukte der Klasse I (1). In anderen Ländern gilt der Drucker als Laserprodukt der Klasse I, der die Anforderungen der IEC (International Electrotechnical Commission) 60825-1 gemäß amtlicher Bestätigung erfüllt.

Laserprodukte der Klasse I gelten als unschädlich. Im Inneren des Druckers befindet sich ein Laser der Klasse IIIb (3b), bei dem es sich um einen Galliumarsenlaser mit 5 Milliwatt handelt, der Wellen der Länge 770-795 Nanometer ausstrahlt. Das Lasersystem und der Drucker sind so konzipiert, daß im Normalbetrieb, bei der Wartung durch den Benutzer oder bei ordnungsgemäßer Wartung durch den Kundendienst Laserbestrahlung, die die Klasse I übersteigen würde, Menschen keinesfalls erreicht.

Avis relatif à l'utilisation de laser

Pour les Etats-Unis : cette imprimante est certifiée conforme aux provisions DHHS 21 CFR alinéa J concernant les produits laser de Classe I (1). Pour les autres pays : cette imprimante répond aux normes IEC 60825-1 relatives aux produits laser de Classe I.

Les produits laser de Classe I sont considérés comme des produits non dangereux. Cette imprimante est équipée d'un laser de Classe IIIb (3b) (arséniure de gallium d'une puissance nominale de 5 milliwatts) émettant sur des longueurs d'onde comprises entre 770 et 795 nanomètres. L'imprimante et son système laser sont conçus pour impossible, dans des conditions normales d'utilisation, d'entretien par l'utilisateur ou de révision, l'exposition à des rayonnements laser supérieurs à des rayonnements de Classe I.

Avvertenze sui prodotti laser

Questa stampante è certificata negli Stati Uniti per essere conforme ai requisiti del DHHS 21 CFR Sottocapitolo J per i prodotti laser di classe 1 ed è certificata negli altri Paesi come prodotto laser di classe 1 conforme ai requisiti della norma CEI 60825-1.

I prodotti laser di classe non sono considerati pericolosi. La stampante contiene al suo interno un laser di classe IIIb (3b) all'arseniuro di gallio della potenza di 5mW che opera sulla lunghezza d'onda compresa tra 770 e 795 nanometri. Il sistema laser e la stampante sono stati progettati in modo tale che le persone a contatto con la stampante, durante il normale funzionamento, le operazioni di servizio o quelle di assistenza tecnica, non ricevano radiazioni laser superiori al livello della classe 1.

Avisos sobre el láser

Se certifica que, en los EE.UU., esta impresora cumple los requisitos para los productos láser de Clase I (1) establecidos en el subcapítulo J de la norma CFR 21 del DHHS (Departamento de Sanidad y Servicios) y, en los demás países, reúne todas las condiciones expuestas en la norma IEC 60825-1 para productos láser de Clase I (1).

Los productos láser de Clase I no se consideran peligrosos. La impresora contiene en su interior un láser de Clase IIIb (3b) de arseniuro de galio de funcionamiento nominal a 5 milivatios en una longitud de onda de 770 a 795 nanómetros. El sistema láser y la impresora están diseñados de forma que ninguna persona pueda verse afectada por ningún tipo de radiación láser superior al nivel de la Clase I durante su uso normal, el mantenimiento realizado por el usuario o cualquier otra situación de servicio técnico.

Declaração sobre Laser

A impressora está certificada nos E.U.A. em conformidade com os requisitos da regulamentação DHHS 21 CFR Subcapítulo J para a Classe I (1) de produtos laser. Em outros locais, está certificada como um produto laser da Classe I, em conformidade com os requisitos da norma IEC 60825-1.

Os produtos laser da Classe I não são considerados perigosos. Internamente, a impressora contém um produto laser da Classe IIIb (3b), designado laser de arseneto de potássio, de 5 milliwatts, operando numa faixa de comprimento de onda entre 770 e 795 nanómetros. O sistema e a impressora laser foram concebidos de forma a nunca existir qualquer possibilidade de acesso humano a radiação laser superior a um nível de Classe I durante a operação normal, a manutenção feita pelo utilizador ou condições de assistência prescritas.

Laserinformatie

De printer voldoet aan de eisen die gesteld worden aan een laserprodukt van klasse I. Voor de Verenigde Staten zijn deze eisen vastgelegd in DHHS 21 CFR Subchapter J, voor andere landen in IEC 60825-1.

Laserprodukten van klasse I worden niet als ongevaarlijk aangemerkt. De printer is voorzien van een laser van klasse IIIb (3b), dat wil zeggen een gallium arsenide-laser van 5 milliwatt met een golflengte van 770-795 nanometer. Het lasergedeelte en de printer zijn zo ontworpen dat bij normaal gebruik, bij onderhoud of reparatie conform de voorschriften, nooit blootstelling mogelijk is aan laserstraling boven een niveau zoals voorgeschreven is voor klasse 1.

Lasermeddelelse

Printeren er godkendt som et Klasse I-laserprodukt, i overensstemmelse med kravene i IEC 60825-1.

Klasse I-laserprodukter betragtes ikke som farlige. Printerene indeholder internt en Klasse IIIB (3b)-laser, der nominelt er en 5 milliwatt galliumarsenid laser, som arbejder på bølgelængdeområdet 770-795 nanometer. Lasersystemet og printerene er udformet således, at mennesker aldrig udsættes for en laserstråling over Klasse I-niveau ved normal drift, brugervedligeholdelse eller obligatoriske servicebetingelser.

Huomautus laserlaitteesta

Tämä kirjoitin on Yhdysvalloissa luokan I (1) laserlaitteiden DHHS 21 CFR Subchapter J -määrityksen mukainen ja muualla luokan I laserlaitteiden IEC 60825-1 -määrityksen mukainen.

Luokan I laserlaitteiden ei katsota olevan vaarallisia käyttäjälle. Kirjoittimessa on sisäinen luokan IIIb (3b) 5 milliwatin galliumarsenidilaser, joka toimii aaltoalueella 770 - 795 nanometriä. Laserjärjestelmä ja kirjoitin on suunniteltu siten, että käyttäjä ei altistu luokan I määräyksiä voimakkaammalle säteilylle kirjoittimen normaalin toiminnan, käyttäjän tekemien huoltotoimien tai muiden huoltotoimien yhteydessä.

VARO! Avattaessa ja suojalukitus ohitettaessa olet alttiina näkymättömälle lasersäteilylle. Älä katso säteeseen.

WARNING! Osynlig laserstrålning när denna del är öppnad och spärren är urkopplad. Betrakta ej strålen.

Laser-notis

Denna skrivare är i USA certifierad att motsvara kraven i DHHS 21 CFR, underparagraf J för laserprodukter av Klass I (1). I andra länder uppfyller skrivaren kraven för laserprodukter av Klass I enligt kraven i IEC 60825-1.

Laserprodukter i Klass I anses ej hälsovådliga. Skrivaren har en inbyggd laser av Klass IIIb (3b) som består av en laserenhet av gallium-arsenid på 5 milliwatt som arbetar i våglängdsområdet 770-795 nanometer. Lasersystemet och skrivaren är utformade så att det aldrig finns risk för att någon person utsätts för laserstrålning över Klass I-nivå vid normal användning, underhåll som utförs av användaren eller annan föreskriven serviceåtgärd.

Laser-melding

Skriveren er godkjent i USA etter kravene i DHHS 21 CFR, underkapittel J, for klasse I (1) laserprodukter, og er i andre land godkjent som et Klasse I-laserprodukt i samsvar med kravene i IEC 60825-1.

Klasse I-laserprodukter er ikke å betrakte som farlige. Skriveren inneholder internt en klasse IIIb (3b)-laser, som består av en gallium-arsenlaserenhet som avgir stråling i bølgelengdeområdet 770-795 nanometer.

Lasersystemet og skriveren er utformet slik at personer aldri utsettes for laserstråling ut over klasse I-nivå under vanlig bruk, vedlikehold som utføres av brukeren, eller foreskrevne serviceoperasjoner.

Avís sobre el Làser

Segons ha estat certificat als Estats Units, aquesta impressora compleix els requisits de DHHS 21 CFR, apartat J, pels productes làser de classe I (1), i segons ha estat certificat en altres llocs, és un producte làser de classe I que compleix els requisits d'IEC 60825-1.

Els productes làser de classe I no es consideren perillous. Aquesta impressora conté un làser de classe IIIb (3b) d'arseniür de gal.li, nominalment de 5 mil.liwats, i funciona a la regió de longitud d'ona de 770-795 nanòmetres. El sistema làser i la impressora han sigut concebuts de manera que mai hi hagi exposició a la radiació làser per sobre d'un nivell de classe I durant una operació normal, durant les tasques de manteniment d'usuari ni durant els serveis que satisfacin les condicions prescrites.

Japanese Laser Notice

レーザーに関するお知らせ

このプリンターは、米国ではDHHS 21 CFRサブチャプターJのクラスI（1）の基準を満たしたレーザー製品であることが証明されています。また米国以外ではIEC 825の基準を満たしたクラスIのレーザー製品であることが証明されています。

クラスIのレーザー製品には危険性はないと考えられています。このプリンターはクラスIII b（3 b）のレーザーを内蔵しています。このレーザーは、波長が770 ～ 795ナノメートルの範囲で、通常5ミリワットのガリウム砒化物を放射するレーザーです。このレーザーシステムとプリンターは、通常の操作、ユーザのメンテナンス、規定された修理においては、人体がクラスIのレベル以上のレーザー放射に晒されることのないよう設計されています。

Chinese Laser Notice

注意：

本打印机被美国认证合乎 DHHS 21 CFR Subchapter I 对分类 I (1) 激光产品的标准，而在其他地区则被认证合乎 IEC 825 的标准。

分类 I 激光产品一般认为不具危险性，本打印机内部含有分类 IIIb (3b) 的激光，在操作过程中会产生 5 毫瓦含镓及砷的微量激光，其波长范围在 770-795 nm 之间。本激光系统及打印机的设计，在一般操作、使用者维护或规定内的维修情况下，不会使人体接触分类 I 以上等级的辐射。

Korean Laser Notice

본프린터는 1등급 레이저 제품들에 대한 DHHS 21 CFR Subchapter 3의 규정을 준수하고 있음을 미국에서 인증받았으며, 그외의 나라에서도 IEC 825 규정을 준수하는 1등급 레이저 제품으로서 인증을 받았습니다.

1등급 레이저 제품들은 안전한 것으로 간주됩니다. 본 프린터는 5 밀리와트 가렘 아르세나이드 레이저로서 770-795 나노미터의 파장대에서 활동하는 Class III (3b) 레이저를 내부에 갖고 있습니다. 본 레이저 시스템과 프린터는 정상 작동 중이나 유지 보수 중 또는 규정된 서비스 상태에서 상기의 Class I 수준의 레이저 방출에 사람이 절대 접근할 수 없도록 설계되어 있습니다.

4511-xxx

Safety information

- The safety of this product is based on testing and approvals of the original design and specific components. The manufacturer is not responsible for safety in the event of use of unauthorized replacement parts.
- The maintenance information for this product has been prepared for use by a professional service person and is not intended to be used by others.
- There may be an increased risk of electric shock and personal injury during disassembly and servicing of this product. Professional service personnel should understand this and take necessary precautions.
-  **CAUTION:** When you see this symbol, there is a danger from hazardous voltage in the area of the product where you are working. Unplug the product before you begin, or use caution if the product must receive power in order to perform the task.

Consignes de sécurité

- La sécurité de ce produit repose sur des tests et des agréments portant sur sa conception d'origine et sur des composants particuliers. Le fabricant n'assume aucune responsabilité concernant la sécurité en cas d'utilisation de pièces de rechange non agréées.
- Les consignes d'entretien et de réparation de ce produit s'adressent uniquement à un personnel de maintenance qualifié.
- Le démontage et l'entretien de ce produit pouvant présenter certains risques électriques, le personnel d'entretien qualifié devra prendre toutes les précautions nécessaires.
-  **ATTENTION :** Ce symbole indique la présence d'une tension dangereuse dans la partie du produit sur laquelle vous travaillez. Débranchez le produit avant de commencer ou faites preuve de vigilance si l'exécution de la tâche exige que le produit reste sous tension.

Norme di sicurezza

- La sicurezza del prodotto si basa sui test e sull'approvazione del progetto originale e dei componenti specifici. Il produttore non è responsabile per la sicurezza in caso di sostituzione non autorizzata delle parti.
- Le informazioni riguardanti la manutenzione di questo prodotto sono indirizzate soltanto al personale di assistenza autorizzato.
- Durante lo smontaggio e la manutenzione di questo prodotto, il rischio di subire scosse elettriche e danni alla persona è più elevato. Il personale di assistenza autorizzato deve, quindi, adottare le precauzioni necessarie.
-  **ATTENZIONE:** Questo simbolo indica la presenza di tensione pericolosa nell'area del prodotto. Scollegare il prodotto prima di iniziare o usare cautela se il prodotto deve essere alimentato per eseguire l'intervento.

Sicherheitshinweise

- Die Sicherheit dieses Produkts basiert auf Tests und Zulassungen des ursprünglichen Modells und bestimmter Bauteile. Bei Verwendung nicht genehmigter Ersatzteile wird vom Hersteller keine Verantwortung oder Haftung für die Sicherheit übernommen.
- Die Wartungsinformationen für dieses Produkt sind ausschließlich für die Verwendung durch einen Wartungsfachmann bestimmt.
- Während des Auseinandernehmens und der Wartung des Geräts besteht ein zusätzliches Risiko eines elektrischen Schlags und körperlicher Verletzung. Das zuständige Fachpersonal sollte entsprechende Vorsichtsmaßnahmen treffen.
-  **ACHTUNG:** Dieses Symbol weist auf eine gefährliche elektrische Spannung hin, die in diesem Bereich des Produkts auftreten kann. Ziehen Sie vor den Arbeiten am Gerät den Netzstecker des Geräts, bzw. arbeiten Sie mit großer Vorsicht, wenn das Produkt für die Ausführung der Arbeiten an den Strom angeschlossen sein muß.

Pautas de Seguridad

- La seguridad de este producto se basa en pruebas y aprobaciones del diseño original y componentes específicos. El fabricante no es responsable de la seguridad en caso de uso de piezas de repuesto no autorizadas.
- La información sobre el mantenimiento de este producto está dirigida exclusivamente al personal cualificado de mantenimiento.
- Existe mayor riesgo de descarga eléctrica y de daños personales durante el desmontaje y la reparación de la máquina. El personal cualificado debe ser consciente de este peligro y tomar las precauciones necesarias.
-  **PRECAUCIÓN:** este símbolo indica que el voltaje de la parte del equipo con la que está trabajando es peligroso. Antes de empezar, desenchufe el equipo o tenga cuidado si, para trabajar con él, debe conectarlo.

Informações de Segurança

- A segurança deste produto baseia-se em testes e aprovações do modelo original e de componentes específicos. O fabricante não é responsável pela segurança, no caso de uso de peças de substituição não autorizadas.
- As informações de segurança relativas a este produto destinam-se a profissionais destes serviços e não devem ser utilizadas por outras pessoas.
- Risco de choques eléctricos e ferimentos graves durante a desmontagem e manutenção deste produto. Os profissionais destes serviços devem estar avisados deste facto e tomar os cuidados necessários.
-  **CUIDADO:** Quando vir este símbolo, existe a possível presença de uma potencial tensão perigosa na zona do produto em que está a trabalhar. Antes de começar, desligue o produto da tomada eléctrica ou seja cuidadoso caso o produto tenha de estar ligado à corrente eléctrica para realizar a tarefa necessária.

Informació de Seguretat

- La seguretat d'aquest producte es basa en l'avaluació i aprovació del disseny original i els components específics. El fabricant no es fa responsable de les qüestions de seguretat si s'utilitzen peces de recanvi no autoritzades.
- La informació pel manteniment d'aquest producte està orientada exclusivament a professionals i no està destinada a ningú que no ho sigui.
- El risc de xoc elèctric i de danys personals pot augmentar durant el procés de desmuntatge i de servei d'aquest producte. El personal professional ha d'estar-ne assabentat i prendre les mesures convenients.
-  **PRECAUCIÓ:** aquest símbol indica que el voltatge de la part de l'equip amb la qual esteu treballant és perillós. Abans de començar, desendolleu l'equip o extremeu les precaucions si, per treballar amb l'equip, l'heu de connectar.

안전 사항

- 본 제품은 원래 설계 및 특정 구성품에 대한 테스트 결과로 안정성이 입증된 것입니다. 따라서 무허가 교체부품을 사용하는 경우에는 제조업체에서 안전에 대한 책임을 지지 않습니다.
- 본 제품에 관한 유지 보수 설명서는 전문 서비스 기술자 용으로 작성된 것이므로, 비전문가는 사용할 수 없습니다.
- 본 제품을 해체하거나 정비할 경우, 전기적인 충격을 받거나 상처를 입을 위험이 커집니다. 전문 서비스 기술자는 이 사실을 숙지하고, 필요한 예방 조치를 취하도록 하십시오.
-  **주의:** 이 표시는 해당영역에서 고압전류가 흐른다는 위험 표시입니다. 시작전에 플러그를 뽑으시거나, 주의를 기울여 주시기 바랍니다.

安全信息

- 本产品的安全性以原来设计和特定产品的测试结果和认证为基础。万一使用未经许可的替换部件，制造商不对安全性负责。
- 本产品的维护信息仅供专业服务人员使用，并不打算让其他人使用。
- 本产品在拆卸、维修时，遭受电击或人员受伤的危险性会增高，专业服务人员对这点必须有所了解，并采取必要的预防措施。
-  **切记：**当您看到此符号时，说明在您工作的产品区域有危险电压的存在。请在开始操作前拔掉产品的电源线，或者在产品必须使用电源来执行任务时，小心从事。

Preface

This manual contains maintenance procedures for service personnel. It is divided into the following chapters:

1. **General information** contains a general description of the MFP and the maintenance approach used to repair it. Special tools and test equipment are listed, as well as general environmental and safety instructions.
2. **Diagnostic information** contains an error indicator table, symptom tables, and service checks used to isolate failing field replaceable units (FRUs).
3. **Diagnostic aids** contains tests and checks used to locate or repeat symptoms of MFP problems.
4. **Repair information** provides instructions for making MFP adjustments and removing and installing FRUs.
5. **Connector locations** uses illustrations to identify the connector locations and test points on the printer.
6. **Preventive maintenance** contains the lubrication specifications and recommendations to prevent problems.
7. **Parts catalog** contains illustrations and part numbers for individual FRUs.

Definitions

Note: A note provides additional information.

Warning: A warning identifies something that might damage the product hardware or software.

CAUTION: A caution identifies something that might cause a service harm.



CAUTION: When you see this symbol, there is a danger from hazardous voltage in the area of the product where you are working. Unplug the product before you begin, or use caution if the product must receive power in order to perform the task.

1. General information

The Lexmark™ E238, E240, E240n, E340, and E342n printers are monochrome laser printers designed for single users or small workgroups.

Models

There are five models:

- E238—16MB memory standard, a USB (universal serial bus) port, a parallel port, and prints 25 pages per minute on letter-size paper (24 ppm on A4).
Note: The optional 550-sheet tray is not supported.
- E240—16MB of memory standard, a parallel port, a USB port, and prints 27 ppm on letter-size paper (26 ppm on A4).
- E240n—32MB of memory standard, an integrated Ethernet adapter, a parallel port, a USB port, and prints 27 ppm on letter-size paper (26 ppm on A4).
- E340, 32MB of memory standard, a parallel port, a USB port, and prints 30 ppm on letter-size paper (28 ppm on A4).
- E342n, 32MB of memory standard, an integrated Ethernet adapter, a parallel port, a USB port, and prints 30 ppm on letter-size paper (28 ppm on A4).

Maintenance approach

The diagnostic information in this manual leads you to the correct field replaceable unit (FRU) or part. Use the error code charts, symptom index, and service checks to determine the symptom and repair the failure. See **“Diagnostic information” on page 2-1** for more information. See **“Repair information” on page 4-1** to help identify parts. After completing the repair, perform tests as needed to verify the repair.





Overview of the operator panels

There are two available operator panels.

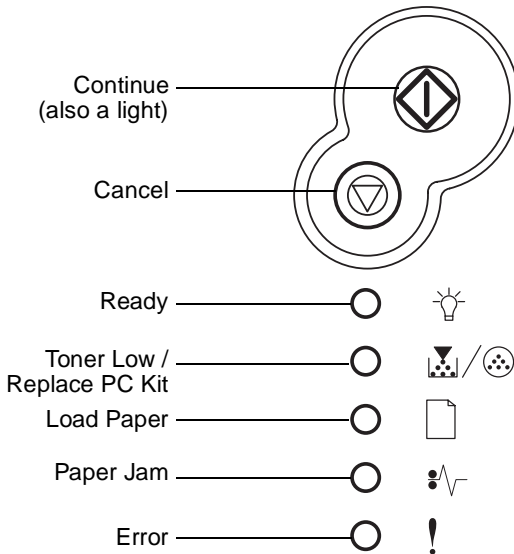
Models E238, E240, and E240n

These models have six lights and two buttons. See **“Diagnostics—E238, E240, and E240n” on page 2-2** for more information.



- Press and hold  until lights flash to print the setting sheet.
- Press and release  to resume printing.
- Press and release  twice quickly to display a secondary error code following an error.
- Press and release  to cancel the job currently printing.
- Press and hold  until all of the lights come on to reset the printer.

Models E340 and E342n

These models have LCD operator panel. See page “**Diagnostics—E340 and E342n**” on page 2-50.

Overview of the operator panel

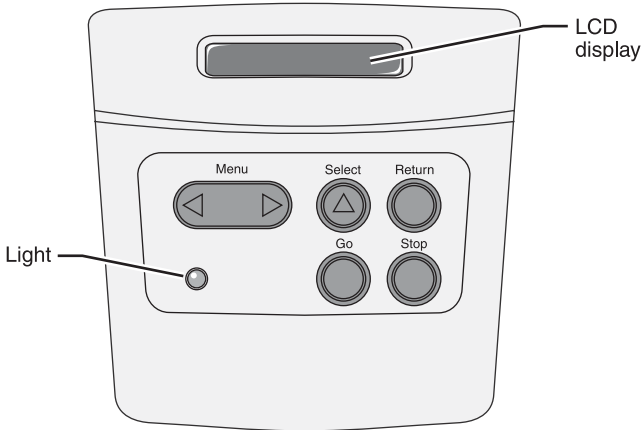

- Press **Go** to resume printing.
- Press **Menu** to move forward and backward through the menu selections.
- Press **Return** to go one level back in the menu.
- Press **Select** to indicate the menu or selection you choose.
- Press **Stop** to cancel the job currently printing.
- Light indicates **Busy** (flashing) or **Ready** (on steadily).

Specifications

Memory

Item	4511-000 Lexmark E238	4511-100 Lexmark E240	4511-410 Lexmark E240n	4511-600 Lexmark E340	4511-610 Lexmark E342n
Base memory	16MB	16MB	32MB	32MB	32MB
Maximum memory	80MB	80MB	160MB	160MB	160MB
Flash support				✓	✓

Print speed

Media Size	4511-000 Lexmark E238	4511-100 Lexmark E240	4511-410 Lexmark E240n	4511-600 Lexmark E340	4511-610 Lexmark E342n
Letter—8.5 x 11 in.	25 ppm	27 ppm	27 ppm	30 ppm	30 ppm
A4—210 x 297 mm	24 ppm	26 ppm	26 ppm	28 ppm	28 ppm
Speed measured on media from tray 1, simplex, and at 600 x 600 dpi.					

Connectivity and compatibility

Item	4511-000 Lexmark E238	4511-100 Lexmark E240	4511-410 Lexmark E240n	4511-600 Lexmark E340	4511-610 Lexmark E342n
Data stream emulations					
PCL 6	✓	✓	✓	✓	✓
PostScript 3	Mac OS only	Mac OS only	✓	✓	✓
PPDS				✓	✓
Compatibility	Windows/Macintosh/Linux*				
Connectivity					
USB ^a	✓	✓	✓	✓	✓
Parallel ^b	✓	✓	✓	✓	✓
Ethernet ^c			✓		✓
ENA option	✓	✓	✓	✓	✓
* Linux support for E238/E240/E240n models utilizing the PCL data stream.					
Wireless ^d	✓	✓	✓	✓	✓
<p>^a These products are USB 2.0 Certified and support full-speed (12MB/sec) data transfer. They are also compatible with Hi-Speed USB systems, peripherals, and cables.</p> <p>^b IEEE 1284 Bi-directional.</p> <p>^c 10/100 BaseTx Ethernet.</p> <p>^d 802.11g wireless print adapter.</p>					

Media trays and supply capacity

Item	4511-000 Lexmark E238	4511-100 Lexmark E240	4511-410 Lexmark E240n	4511-600 Lexmark E340	4511-610 Lexmark E342n
Available input trays					
250-sheet tray	✓	✓	✓	✓	✓
Single-sheet manual feeder	✓	✓	✓	✓	✓
550-sheet option drawer		✓	✓	✓	✓
Toner and photoconductor					
Toner cartridge yield	1,500 pages* (starter toner cartridge)				2,500 pages
PC kit yield	30,000 pages*				
*Photoconductor yield based on approximately 5% coverage of pages.					

Types of print media

Ensure trays are properly loaded. Never mix media types within a tray.

Source	Sizes	Types	Weight	Input capacity (sheets)
Tray 1 (250-sheet tray)	A4, A5, JIS B5, letter, legal, executive, folio, statement, Universal ^a	Plain paper, transparencies, paper labels ^b	60–90 g/m ² (16–24 lb)	250 paper, 50 labels ^b , 50 transparencies
Tray 2 (550-sheet — E240(n)/E340/E340n only)	A4, A5, JIS B5, letter, legal, executive, folio, statement, Universal ^a	Plain paper, transparencies, paper labels ^b	60–163 g/m ² (16–43 lb)	550 paper, 50 labels ^b , 50 transparencies, card stock ^c
Manual feeder	A4, A5, JIS B5, letter, legal, executive, folio, statement, Universal ^a	Plain paper, transparencies, paper labels ^b , card stock ^c	60–163 g/m ² (16–43 lb)	1 sheet
	7¼, 9, 10, DL, C5, B5, other ^d	Envelopes		
<p>^a Universal size range: 76–216 x 127–356 mm (3.0–8.5 x 5.0–14.0 in.) (includes 3 x 5 in. cards).</p> <p>^b Dual web, integrated, or vinyl labels are not supported.</p> <p>^c Card stock up to 90# Index. Grain short is recommended.</p> <p>^d Maximum and minimum sizes for other envelopes are 98.4 x 162 mm to 176 x 250 mm (3.87 x 6.38 in. to 6.93 x 9.84 in.).</p>				

Tips on preventing jams

You can avoid most paper jams by correctly loading paper and specialty media.

The following hints can help you avoid paper jams:

- Do not load wrinkled, creased, or damp paper.
- Never mix media types within a tray.
- Flex, fan, and straighten paper before you load it.
- Do not exceed the maximum stack height.
- Push all trays *firmly* into the printer after loading them.
- Make sure the guides in the trays are positioned snugly against the paper or specialty media.
- Do not remove paper trays while a job is printing. Wait for a Load Paper or Ready light sequence or message before you remove the tray.
- Before loading transparencies, fan the stack to prevent sheets from sticking together.
- Do not use envelopes that:
 - Have excessive curl
 - Are stuck together
 - Are damaged in any way
 - Contain windows, holes, perforations, cutouts, or embossing
 - Have metal clasps, string ties, or metal folding bars
 - Have postage stamps attached
 - Have any exposed adhesive when the flap is in the sealed position
- Use only recommended paper. Refer to the *Card Stock & Label Guide* available on the Lexmark Web site at www.lexmark.com for more information about which paper provides optimum results for the current printing environment.

Tools

The removal and adjustment procedures require the following tools and equipment:

- Magnetic tip Phillips screwdrivers, large and small
- Volt-ohmmeter

Acronyms

ACM	Autocompensator Mechanism (or paper feed)
ASIC	Application Specific Integrated Circuit
CBM	Complete Bill Of Material
CRC	Cyclic Redundancy Check
DEV	Development Roll (of print cartridge/photoconductor system)
DIMM	Dual In-Line Memory Module
ECC	Error Correction Code
EEPROM	Erasable Electrically Programmable Read-Only Memory
ENA	External Network Adapter
ESD	Electrostatic Discharge
FRU	Field Replaceable Unit
HBP	Host Based Printing
HVPS	High Voltage Power Supply
LCD	Liquid Crystal Diode
LED	Light Emitting Diode
LVPS	Low Voltage Power Supply
NVRAM	Nonvolatile Random Access Memory
PC	Photoconductor
PCL	Printer Control Language
POR	Power-On Reset
POST	Power-On Self Test
PPDS	Personal Printer Data Stream
PRC	Peoples' Republic of China
PSO	Participating Standards Organization
RIP	Raster Image Processor
TAR	Toner Add Roll
SDR	Synchronous Dynamic RAM
USB	Universal Serial Bus
V ac	Volts alternating current
V dc	Volts direct current

4511-xxx

2. Diagnostic information

Start



CAUTION: Unplug power from the printer before connecting or disconnecting any cable, assembly, or electronic card. This is a precaution for personal safety and to prevent damage to the printer.

This chapter contains the codes and diagnostic tools to aid in providing corrective action for a malfunctioning printer. To determine the corrective action to repair a printer, look for the following information:

- A description of a problem, see **“Symptom tables” on page 2-79.**
- Information from the operator panel of the printer.
 - **Models E238, E240, and E240n** have an operator panel containing lights and buttons. For diagnostic information specific to these modes, see **“Diagnostics—E238, E240, and E240n” on page 2-2.**



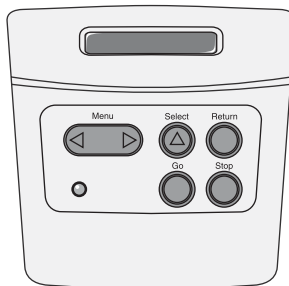

- **Models E340 and E342n** have an operator panel with messages. For diagnostic information specific to these models, see **“Diagnostics—E340 and E342n” on page 2-50.**





Diagnostics—E238, E240, and E240n

Power-On Self Test (POST) sequence

When you turn the printer on, it performs a POST. Check for correct POST functioning of the base printer by observing the following process:

1. All operator panel lights on momentarily
2. Lights then flash on and off sequentially.
3. After the lights quit flashing, the  light flashes until the fuser comes up to temperature (5–20 additional seconds, depending on the initial temperature of the fuser) and then stays on.
4. If there is a problem in the printer such as a paper jam, the panel lights indicate the problem. See **“Common primary light patterns” on page 2-4** for more information.
5. The printer cycles down into standby mode, and  lights solid.

Light patterns and error messages

User attendance messages, paper jam errors, and service errors display a light pattern. This may be all the information you need. However, if you double-click  on the panel, a second pattern may appear with more detailed information. If you double-click  a third time, you usually return to the first pattern. Not all initial level light patterns have secondary patterns; when you double-click, the pattern does not change.

All service errors are indicated by all lights flashing as the primary notification or code. The secondary code indicates an area or function which has the error. Additional tertiary codes used for service (see **“Service tertiary error codes” on page 2-40**) indicate specific errors. See **“Service codes” on page 2-36**.

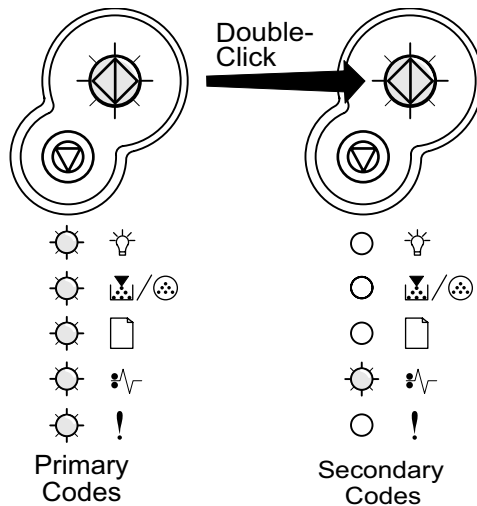







Note: If you send data to the printer and all lights flash immediately, and double-clicking does not change the display, there may be a code problem. Contact the next level of support.

Common primary light patterns







See **“Overview of the operator panels”** on **page 1-2** for icon information.

●	Light on
	Light off
*	Light blinking
x	Light blinking slowly







Primary light patterns

Lights	Ready/Power Saver (See page 2-13)	Busy (See page 2-14)	2xx Paper Jam (see secondary errors on page 2-24)	Hex Trace Ready (See page 2-15)	Waiting (See page 2-15)	Flushing / Resolution reduced (See page 2-16)
 Continue			●		●	
 Ready	●	*		x	●	*
 Toner Low/ Replace PC Kit						
 Load Paper						
 Paper Jam			●			
 Error						*







Primary light patterns (continued)

Lights	Not ready (printer offline) (See page 2-16)	Close door / Insert cartridge (See page 2-17)	Load media (See page 2-17)	Load manual feeder (See page 2-18)	Print side two of duplex job (See page 2-18)	Toner low (See page 2-19)
 Continue	●		●	●	*	
 Ready						
 Toner Low/ Replace PC Kit						●
 Load Paper			●	*	●	
 Paper Jam						
 Error		●				

Primary light patterns (continued)

Lights	Replace photoconductor kit (See page 2-19)	Replace photoconductor kit (printer hard stop) (See page 2-20)	Cartridge errors (See page 2-28)	Invalid engine code / Invalid network code (See page 2-21)	Programming engine code / Programming system code (See page 2-21)	Cancel job / Reset printer (See page 2-22)
 Continue	●	●				●
 Ready				●	●	●
 Toner Low/ Replace PC Kit	*	*	●		●	●
 Load Paper					●	●
 Paper Jam						●
 Error		*	●	●		●

Primary light patterns (continued)

Lights	Printer error (see "Secondary error codes" on page 2-24.)	Service error (see Service secondary codes on page 2-38 or Service tertiary codes on page 2-40.)
 Continue	*	*
 Ready		*
 Toner Low/ Replace PC Kit		*
 Load Paper		*
 Paper Jam		*
 Error	●	*







Common secondary light patterns

When the ! and ◇ lights are both on, a secondary error has occurred. Press and release ◇ twice quickly to display the secondary error code light pattern. The following table shows what these light patterns mean.







Secondary error codes

Lights	Primary code	Secondary error codes				
		Standard network software error manual feeder (See page 2-32)	Unsupported flash in slot	Too many options attached	Complex page (See page 2-27)	Insufficient printer memory (See page 2-29)
◇ Continue	●	●	●	●	●	●
💡 Ready					●	*
🖨️/🔄 Toner Low/ Replace PC Kit			●	●		
📄 Load Paper			●	●		
🚫 Paper Jam		●	●			
! Error	●	●	●	●	●	●







Secondary errors (continued)

Lights	Secondary codes					
	Insufficient collation area (See page 2-30)	PPDS font error (See page 2-30)	Defective flash (See page 2-31)	Insufficient defrag memory (See page 2-31)	Network interface errors (See page 2-32)	ENA connection lost (See page 2-32)
 Continue	●	●	●	●	●	●
 Ready						
 Toner Low/ Replace PC Kit	●	*				
 Load Paper			●	*		
 Paper Jam					●	*
 Error	●	●	●	●	●	●

Secondary errors (continued)







Lights	Secondary error codes					
	Memory full (See page 2-33)	Short paper (See page 2-33)	Unformatted flash (See page 2-34)	Flash full (See page 2-34)	Invalid engine code (See page 2-35)	Invalid network code (See page 2-35)
 Continue	●	●	●	●		
 Ready	●	●		●	●	●
 Toner Low/ Replace PC Kit	●		●			
 Load Paper		●			●	*
 Paper Jam			●	●		
 Error	●	●	●	●	●	●

Secondary errors (continued)

Lights	Secondary error codes			
	Print cartridge mismatch (See page 2-28)	Print cartridge has invalid refill (See page 2-28)	Missing or defective print cartridge (See page 2-28)	Unsupported print cartridge (See page 2-29)
 Continue	●	●	●	●
 Ready	●	●		●
 Toner Low/ Replace PC Kit	●		●	
 Load Paper		●		
 Paper Jam			●	●
 Error	●	●	●	●

Secondary errors—paper jams



Secondary errors—paper jams

Lights	Secondary error codes					
	200 Paper jam input sensor (See page 2-24)	201 Paper jam between input and exit sensors (See page 2-25)	202 Paper jam exit sensor (See page 2-25)	241 Paper jam Tray 1 jam (See page 2-26)	242 Paper Jam Tray 2 jam (See page 2-26)	251 Paper jam manual feeder (See page 2-27)
 Continue	●	●	●	●	●	●
 Ready	●				●	*
 Toner Low/ Replace PC Kit		●		●		
 Load Paper			●	●	●	
 Paper Jam	●	●	●	●	●	●
 Error						









Additional information—primary codes

The following tables explain the primary light patterns, or codes, and secondary error codes, what they mean and how to clear them. User attendance and status information is included. For service information, see **“Service codes” on page 2-36.**



Ready / Power Saver

Light pattern	Meaning	Action
	<ul style="list-style-type: none"> • Printer ready to receive and process data. • Printer is in Power Saver mode. 	<ul style="list-style-type: none"> • Send a print job. • Press  to print the menu settings pages for a list of current printer settings. • Press and hold  to reset the printer. <p>Note: To change the Power Saver setting, use the Local Printer Setup Utility. See the <i>User's Reference</i> for more information.</p>





Busy

Light pattern	Meaning	Action
	<ul style="list-style-type: none"> • Printer is busy receiving and processing data or printing. • Printer is defragmenting the flash memory to reclaim storage space occupied by deleted resources. • Printer is formatting the flash memory. • Printer is storing resources, such as fonts or macros, in flash memory. • Printer is printing a directory, font list, menu settings pages, or Print Quality Test Pages. 	<ul style="list-style-type: none"> • Busy: <ul style="list-style-type: none"> – Wait for message to clear. – Press and release  to cancel print job. – Press and hold  to reset printer. • Defragmenting flash, formatting flash, or programming flash: <ul style="list-style-type: none"> – Wait for message to clear. – Warning: Do not turn the printer off while this message is displayed. • Printing a directory, a font list, menu settings pages, or Print Quality Test Pages: <ul style="list-style-type: none"> – Wait for the pages to print. The Busy message is displayed as the pages print. The  light is on when printing stops. – Press and release  to cancel printing. – Press and hold  to reset printer. • Receiving/processing data from a host interface: <ul style="list-style-type: none"> – Wait for message to clear. – Press and release  to stop processing. – Press and hold  to reset printer.





Hex Trace Ready

Light pattern	Meaning	Action
	<p>Printer is in the Ready mode and Hex Trace is active.</p>	<ul style="list-style-type: none"> Hex Trace helps troubleshoot printing problems. After resolving the problem, turn off the printer to exit Hex Trace. Or, press and hold  to reset the printer.





Waiting

Light pattern	Meaning	Action
	<p>Printer is waiting until a print timeout occurs, or until it receives additional data.</p>	<ul style="list-style-type: none"> Press and release  to print contents of the print buffer. Press and release  to cancel the print job. Press and hold  to reset the printer.

Flushing / Resolution reduced

Light pattern	Meaning	Action
	<ul style="list-style-type: none"> • Printer is flushing corrupted print data. • Printer is processing data or printing pages, but the resolution of a page in the current print job is reduced from 600 dots per inch (dpi) to 300 dpi to prevent a memory full error. 	<ul style="list-style-type: none"> • Wait until  is on to print other jobs. • Press and release  to cancel print job. • Press and hold  to reset printer.



Not ready

Light pattern	Meaning	Action
	<p>Printer is not ready to receive or process data, or the printer ports are offline.</p>	<ul style="list-style-type: none"> • Press  to return to Ready or Busy state. • Press and release  to cancel print job. • Press and hold  to reset printer.



Close door / Insert cartridge

Light pattern	Meaning	Action
	<p>The printer door is open.</p>	<p>Close the door.</p>



Load media

Light pattern	Meaning	Action
	<p>The printer is out of media, or the media did not feed properly, thereby not making the input sensor in the allotted time.</p>	<ul style="list-style-type: none"> • Load media into tray 1 or the optional 550-sheet tray, and press  to resume printing. • Check that the media is loaded correctly in tray 1 or the optional 550-sheet tray. • Press  to cancel the print job.





Load manual feeder

Light pattern	Meaning	Action
	<p>Printer prompts to load a single sheet of media in the manual feeder.</p>	<ul style="list-style-type: none"> • Load media in the manual feeder with the side to be printed facing up. • Press  to resume printing. • Press and hold  to reset printer.



Print side two of duplex job

Light pattern	Meaning	Action
	<p>Print the other side of duplex print job.</p>	<ul style="list-style-type: none"> • Reinsert print job in tray 1 using the instructions in the driver pop-up menu to orient the pages correctly (printed side up, loading edge to front of the printer). • Press  to resume printing. • Press and hold  to reset printer.

Toner low

Light pattern	Meaning	Action
	<p>The toner in the print cartridge is getting low.</p>	<ul style="list-style-type: none"> • Send a print job. • Press  to print the menu settings page for a list of current settings. • Remove the print cartridge, and shake it to extend the life of the cartridge. • Replace the print cartridge. • Press and hold  to reset printer. <p>Note: The /  light may not come on if the starter print cartridge is installed in a base model.</p>

Replace photoconductor kit (an early warning)

Light pattern	Meaning	Action
	<p>The photoconductor kit drum is full and needs replacing.</p>	<ul style="list-style-type: none"> • Press  to resume printing. • Replace the photoconductor kit.

Replace photoconductor kit (printer hard stop)

Light pattern	Meaning	Action
	<p>The photoconductor kit drum is full and needs replacing. No pages print until the photoconductor kit is replaced.</p>	<p>Replace the photoconductor kit.</p>

Print cartridge error / Print cartridge is not installed

Light pattern	Meaning	Action
	<p>The print cartridge is not installed, or the printer detects a print cartridge error.</p> <p>The error is caused by a defective cartridge, an unsupported cartridge, an invalid refill, or a cartridge meant to be used in another geographic region.</p>	<ul style="list-style-type: none"> • If the print cartridge is not installed, install it. • If the print cartridge is installed, remove it and install a new print cartridge. <p>See secondary codes “Print cartridge errors” on page 2-28.</p>

Invalid engine code / Invalid network code

Light pattern	Meaning	Action
	<p>The code in an internal print server has not been programmed, or the programmed code is not valid.</p>	<ul style="list-style-type: none"> • Download valid network code to the internal print server. • Press \diamond twice quickly to see the secondary error code.



Programming engine code / Programming system code

Light pattern	Meaning	Action
	<p>New code is being loaded into the engine or firmware code flash.</p>	<p>Wait for the message to clear. When the printer has finished loading the code, it performs a soft reset.</p>

Cancel job / Reset printer

Light pattern	Meaning	Action
	<ul style="list-style-type: none"> • The current print job is canceled. • The printer is resetting to the user default settings. <ul style="list-style-type: none"> – Any active print jobs are canceled. – A user default setting remains in effect until changed or until restored to factory default settings. 	<p>Wait for the message to clear.</p>







Service error

Light pattern	Meaning	Action
	<p>The printer has a service error, and printing has stopped.</p>	<p>Turn the printer off and back on.</p> <p>If the lights are still blinking, contact the place where printer was purchased.</p> <p>Press and release  twice quickly to view the secondary message. See page “Service primary code” on page 2-37.</p>

Printer error

Light pattern	Meaning	Action
	<p>The printer has one of the following errors:</p> <ul style="list-style-type: none"> • Memory is full, insufficient to save what is in the buffer, or insufficient to defragment flash memory. • A page is too complex to print or is shorter than the set page margins. • Resolution of a formatted page is reduced to 300 dpi. • A font error occurred. • Communication with the host computer is lost. 	<ul style="list-style-type: none"> • Press \diamond twice quickly to see the secondary error code. See “Additional information—secondary error codes” on page 2-24 for more information. • Press \diamond to clear the secondary message.

Additional information—secondary error codes

- When the  light is flashing and  light is on, a secondary printer error has occurred.
- When the  and  lights are both on, a paper jam secondary error has occurred.
- When the  and the  lights are both on, a print cartridge error has occurred.

Press and release  twice to display the secondary error code light pattern.

The following tables show what these light patterns mean and what to do.

Paper jam at the input sensor (200 error)

Light pattern	Meaning	Action
	<p>Media has stopped over the input sensor.</p>	<p>Remove the print cartridge to access the area. Check for obstructions and remove them.</p>

Paper jams between input sensor and exit sensor (201 error)

Light pattern	Meaning	Action
	<p>Paper has cleared the input sensor but not made the exit sensor.</p>	<p>Check the paper path for obstacles. The fuser should be inspected.</p>

Paper jams as a printed job exits the printer (202 error)

Light pattern	Meaning	Action
	<p>A paper jam has occurred as the paper is exiting the printer.</p>	<p>Clear the paper jam.</p>

Paper jams as it exits tray 2 into the printer (241 error)

Light pattern	Meaning	Action
	<p>A paper jam has occurred as the paper is exiting the paper tray and entering the printer.</p>	<p>Clear the paper jam.</p>

Paper Jams as it exits tray 2 (242 error)

Light pattern	Meaning	Action
	<p>Paper jams in Tray 2 between time of picking and the input sensor.</p>	<p>Clear the paper jam. Check the pick tires and for any obstructions.</p>



Paper jam in the manual feeder (251 error)

Light pattern	Meaning	Action
	<p>A paper jam has occurred in the manual feeder.</p>	<p>Clear the paper jam.</p>

Complex page

Light pattern	Meaning	Action
	<p>The page may not print correctly because the print information on the page is too complex (that is, too large for the printer memory).</p>	<ul style="list-style-type: none"> • Press \diamond to clear the message and continue processing the print job (some of the print data may be lost). • To avoid this error in the future: <ul style="list-style-type: none"> – Reduce the complexity of the page by reducing the amount of text or graphics on the page and deleting unnecessary downloaded fonts or macros. – Set Page Protect to on in the Local Printer Setup Utility. • Install additional printer memory.





Print cartridge errors

Light pattern	Meaning	Action
	<p>31 Error—Print cartridge is either missing or defective.</p>	<p>Install the correct cartridge.</p>
	<p>32 Error—The print cartridge is unsupported.</p>	<p>Replace the cartridge.</p>
	<p>33 Error—The print cartridge has an invalid refill.</p>	<p>Replace the cartridge.</p>

Print cartridge errors (continued)

Light pattern	Meaning	Action
	<p>42 Error—The print cartridge was manufactured for a different geographic region than the printer.</p>	<p>Replace the cartridge with a cartridge from the same region as the printer.</p>

Insufficient printer memory

Light pattern	Meaning	Action
	<p>The printer does not have enough memory to save the data in the buffer.</p>	<ul style="list-style-type: none"> • Press  to continue printing the job. • Press  to cancel the print job. • Press  to cancel the print job, turn off the printer and install additional memory.



Insufficient collation area

Light pattern	Meaning	Action
	<p>The printer memory does not have the free space necessary to collate the print job. This may happen due to one of these errors:</p> <ul style="list-style-type: none"> • Memory is full. • A page is too complex to print. • A page is shorter than the set page margins. • Memory is insufficient to save what is in the buffer. 	<ul style="list-style-type: none"> • Press \blacktriangleleft to clear the message and continue printing the job (the job may not print correctly). • Press and release ∇ to cancel the print job. • Press and hold ∇ to reset the printer. • To avoid this error in the future: <ul style="list-style-type: none"> – Simplify the print job. Reduce the complexity of the page by reducing the amount of text or graphics on the page and deleting unnecessary downloaded fonts or macros. – Install additional printer memory.

Font error

Light pattern	Meaning	Action
	<p>The printer has received a request for a PPDS font which is not installed.</p>	<ul style="list-style-type: none"> • Press and release ∇ to cancel the print job. • Press and hold ∇ to reset the printer. • Press and release \blacktriangleleft to clear the message and continue printing.



Defective flash

Light pattern	Meaning	Action
	<p>The printer detects defective flash memory.</p>	<ul style="list-style-type: none"> • Press  to clear the message and continue printing. – Downloaded fonts and macros not previously stored in flash memory are deleted. – Install flash memory.



Insufficient defrag memory

Light pattern	Meaning	Action
	<p>The printer has insufficient memory to free unused space in flash memory.</p>	<ul style="list-style-type: none"> • Delete fonts, macros, and other data in RAM. • Install additional printer memory.





Network interface errors

Light pattern	Meaning	Action
 	<p>The printer cannot establish communication with the network.</p>	<p>Press  to clear the message and continue printing (the job may not print correctly).</p>



Network or ENA connection lost

Light pattern	Meaning	Action
 	<p>The printer has lost the connection to an external print server (also called an external network adapter or ENA).</p> <p>This light pattern is displayed if your printer is connected to the network, but it cannot detect the print server when you turn on the printer.</p>	<ul style="list-style-type: none"> • Make sure the cable connecting the ENA and the printer is securely attached. • Turn the printer off and then on to reset the printer. • Press and hold  to reset the printer.

Memory full

Light pattern	Meaning	Action
	<p>The printer is processing data, but the memory used to store pages is full.</p>	<ul style="list-style-type: none"> • Press  to clear the message and continue printing the job (the job may not print correctly). • Press and release  to cancel the print job. • Press and hold  to reset the printer. • To avoid this error in the future: <ul style="list-style-type: none"> – Simplify the print job. Reduce the complexity of the page by reducing the amount of text or graphics on the page and deleting unnecessary downloaded fonts or macros. – Install additional printer memory.

Short paper

Light pattern	Meaning	Action
	<p>The paper length is too short to print the formatted data. This occurs when the printer does not know the media size loaded in the tray, or there is a problem feeding the media.</p>	<ul style="list-style-type: none"> • Make sure the print media you loaded is large enough. • Open the front cover, clear the paper path, and close the cover to resume printing. • Press  to clear the message and continue printing the job. • Press  to cancel the print job.

Flash full

Light pattern	Meaning	Action
	<p>There is not enough free space in the flash memory to store the data you are trying to download.</p>	<ul style="list-style-type: none"> • Delete fonts, macros, and other data stored on the flash memory to free up space. • Press \blacklozenge to clear the message and continue printing. <ul style="list-style-type: none"> – Downloaded fonts and macros not previously stored in flash memory are deleted. – Install flash memory with more storage capacity. • Press and release \blacktriangledown to cancel the print job. • Press and hold \blacktriangledown to reset the printer.

Unformatted flash

Light pattern	Meaning	Action
	<p>The printer detects unformatted flash memory.</p>	<ul style="list-style-type: none"> • Press \blacklozenge to clear the message and continue printing. The job may not print correctly. • Reformat the flash memory. Refer to the <i>Technical Reference</i> on the Lexmark Web site for more information. • If the error message remains, the flash memory may be defective and should be replaced.

Invalid engine code

Light pattern	Meaning	Action
	<p>The code in an internal print server has not been programmed, or the programmed code is not valid.</p>	<p>Download valid engine code to the internal print server.</p>

Invalid network code

Light pattern	Meaning	Action
	<p>The code in an internal print server has not been programmed, or the programmed code is not valid.</p>	<p>Download valid network code to the internal print server.</p>

Service codes

All service errors are indicated by all lights flashing as the primary notification or code. The secondary light pattern indicates an area or function which has the error. Tertiary codes (shown on the following pages) indicate specific device errors. When all lights flash, double-click \diamond to see the secondary code. Double-click \diamond again to see the tertiary code. If you double-click again, you return to the primary light pattern again.

In the following example:

- The primary light pattern indicates a service error (all flashing). Double-click \diamond for more information.
- The secondary light pattern indicates a fuser or toner sensor error. Double-click \diamond for more information.
- The tertiary light pattern indicates the fan has stalled. If you double-click again, the original primary light pattern will appear.

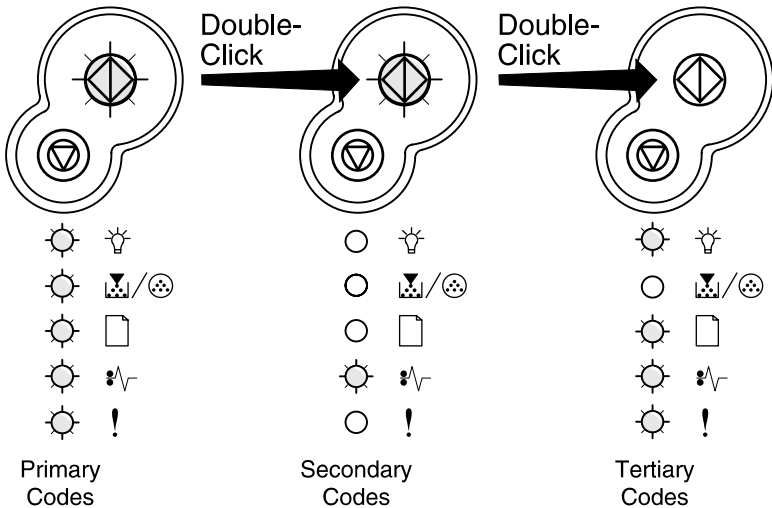







Note: If you send data to the printer and all lights flash simultaneously, and double-clicking \diamond does not produce a secondary code, you may have a code problem. Contact the next level of support.

Service primary code

*	Light blinking
---	----------------







When this code appears, double-click  to reveal the secondary codes.

Service primary code





Lights	Primary code for service errors See secondary codes
 Continue	*
 Ready	*
 Toner Low/ Replace PC Kit	*
 Load Paper	*
 Paper Jam	*
 Error	*

Service secondary error codes

Service secondary error codes

Lights	Service secondary error codes					
	90x—Software	91x—DC motor or transfer roll	92x—Fuser or toner sensor	93x—Printhead, drive motor, RIP to engine	94x—RIP to engine communications, engine electronics	95x—Controller card (NVRAM, ROM, or NAND)
 Continue	*	*	*	*	*	*
 Ready						
 Toner Low/ Replace PC Kit						
 Load Paper					*	*
 Paper Jam			*	*		
 Error		*		*		*

Service secondary error codes (continued)

Lights	Service secondary error codes		
	96x—RAM memory	97x—Network	98x—Paper port communications
 Continue	*	*	*
 Ready			
 Toner Low/ Replace PC Kit			*
 Load Paper	*	*	
 Paper Jam	*	*	
 Error		*	

Service tertiary error codes







Service error codes are generally non-recoverable except in an intermittent condition when you can POR (power-on reset) the printer to temporarily recover from the error.

Note: All service errors are initially communicated by all lights flashing which is the primary indication or code. For brevity, this indication is not repeated in the following codes.

Controller software

Controller software error/illegal trap (90x). For the other errors, which indicate a faulty programming process or faulty component on the controller card, replace the controller card. See **“Controller card removal” on page 4-15.**

Service tertiary error codes—controller software

Lights	Service secondary codes—90x	Service tertiary codes	
		902—General engine software error	905—Interface violation by paperport device
 Continue	*		
 Ready		*	*
 Toner Low/ Replace PC Kit			
 Load Paper			*
 Paper Jam		*	
 Error			*

Transfer roll or tray 2









CAUTION: When you see this symbol, there is a danger from hazardous voltage in the area of the product where you are working. Unplug the product before you begin, or use caution if the product must receive power in order to perform the task.

Code 914 indicates an error in tray 2 motor. Replace the drawer.

Code 917 indicates a problem in the transfer roll circuitry. Check the continuity from the cable connection on the HVPS (high voltage power supply) to the right side of the transfer roll.







Service tertiary error codes—transfer roll

	Service secondary codes—91x	Service tertiary codes	
		914—Tray 2 motor	917—Transfer roll circuitry
Lights			
 Continue	*		
 Ready		*	*
 Toner Low/ Replace PC Kit			
 Load Paper		*	*
 Paper Jam			*
 Error	*		*







Fuser, fan, or toner sensor error

Codes 920 through 929 indicate a problem in the fuser (see **“Fuser service check” on page 2-87** for more information), a stalled fan motor, or a faulty toner sensor or toner cartridge.

Service tertiary error codes—fuser, fan, or toner sensor

Lights	Service secondary codes—92x	Service tertiary codes—fuser, fan, or toner sensor				
		920—Fuser below temperature when printing	921—Fuser below standby temperature at idle	922—Fuser failed to reach standby temperature	923—Fuser too hot during printing or idle	924—Open circuit in thermistor path
 Continue	*					
 Ready		*	*	*	*	*
 Toner Low/ Replace PC Kit						
 Load Paper						*
 Paper Jam	*			*	*	
 Error			*		*	

Service tertiary error codes—fuser, fan, or toner sensor (continued)

Lights	Service tertiary codes—fuser, fan, or toner sensor			
	925—Incorrect fuser lamp installed	926—Fuser thermistor open circuit	927—Fan stalled	929—Toner sensor or toner cartridge
 Continue				
 Ready	*	*	*	*
 Toner Low/ Replace PC Kit				*
 Load Paper	*	*	*	
 Paper Jam		*	*	
 Error	*		*	*





Printhead, transport motor or RIP/engine communication error

Codes 930 through 935 indicate a problem with the printhead. Check cables to the printhead. Replace the printhead as necessary.







Codes 936 and 937 indicate a problem in the drive system.

Code 939 indicates a communication failure between the RIP and engine processors.

Service tertiary error codes—printhead, transport motor, or RIP engine communication error

Lights	Service secondary codes—93x	Service tertiary codes—printhead, transport motor, or RIP engine communication				
		930—Wrong printhead	931—No first HYSNC. Verify interlock switch at J13.	932—Printhead lost HYSNC	933—Mirror motor locked	934—Mirror motor lost lock
 Continue	*					
 Ready		*	*	*	*	*
 Toner Low/Replace PC Kit						
 Load Paper						*
 Paper Jam	*			*	*	
Error	*		*		*	







Service tertiary error codes—printhead, transport motor, or RIP/engine communication error (continued)

Lights	Service tertiary error codes			
	935—Mirror motor not at opening speed. Verify +24 V dc at J11-5	936—Transport motor initial lock failure	937—Transport motor lost lock	939—RIP/engine communication error
 Continue				
 Ready	*	*	*	*
 Toner Low/ Replace PC Kit				*
 Load Paper	*	*	*	
 Paper Jam		*	*	
 Error	*		*	*

NVRAM failure







Error codes 950–954 indicate a problem in the NVRAM (nonvolatile random access memory). Replace the operator panel assembly. Codes 955–959 indicate a failed controller card assembly. Replace the controller card.

Service tertiary error codes—NVRAM failure

Lights	Service secondary codes—95x	Service tertiary codes—NVRAM failure				
		950—Secure EEPROM data does not match NVRAM	951—Secure EEPROM failure	952—NVRAM CRC failure	954—NVRAM chip failure	955—Code ROM or NAND failed CRC
 Continue	*					
 Ready		*	*	*	*	*
 Toner Low/ Replace PC Kit						
 Load Paper	*				*	*
 Paper Jam				*		
 Error	*		*			*

Note: NVRAM is on the operator panel printed circuit board while secure NVRAM is on the controller card. Check margin alignments after replacing the operator panel assembly. See **“Printhead service check” on page 2-111** for more information. If margin errors are unacceptable, corrections can only be made through software. Contact the next level of support.







Service tertiary error codes—NVRAM failure (continued)

Lights	Service tertiary codes—NVRAM failure			
	956—Processor failure	957—ASIC failure	958—NAND failure	959—SRAM failure
 Continue				
 Ready	*	*	*	*
 Toner Low/ Replace PC Kit			*	*
 Load Paper	*	*		
 Paper Jam	*	*		
 Error		*		*

RAM memory error

This error indicates RAM failure. Remove DIMM(s), and POR the printer. If the error persists, replace the card. If the error subsides, check the DIMM. Replace faulty DIMM.







Service tertiary error codes—RAM memory error

Lights	Service secondary codes—96x	Service tertiary codes—RAM	
		960—RAM soldered on the board is bad	961—RAM in slot 1 is bad
 Continue	*		
 Ready		*	*
 Toner Low/ Replace PC Kit			
 Load Paper	*		
 Paper Jam	*		
 Error			*

Network error

Indicates an error in the network circuitry. Replace the controller card assembly.

Service tertiary error codes—network error

Lights	Service secondary codes—97x	Service tertiary codes - network			
		975—Unrecognizable network port	976—Unrecoverable software error in network port	978—Bad checksum while programming port	979—Flash parts failed while programming port
 Continue	*				
 Ready		*	*	*	*
 Toner Low/ Replace PC Kit				*	*
 Load Paper	*	*	*		
 Paper Jam	*		*		
 Error	*	*			*

Diagnostics—E340 and E342n

Power-On Self Test (POST) sequence

The following is an example of the events that occur during the POR sequence when the printer is turned on.

1. Diamonds are displayed on the operator panel.
2. While code is being loaded into DRAM, dots scroll across the operator panel.
3. A screen is displayed with the memory and processor speed. A typical example of this message is:

* 32 Mb 366 Mhz

4. Performing Self Test is displayed.
5. Busy is displayed.
6. Close Door will be displayed if the cover is open.
7. Any cartridge errors, such as Defective Cartridge, are displayed.
8. Applicable maintenance messages are displayed.
9. Applicable toner low messages are displayed.
10. The printer displays Ready.

Overview of the operator panel and menus

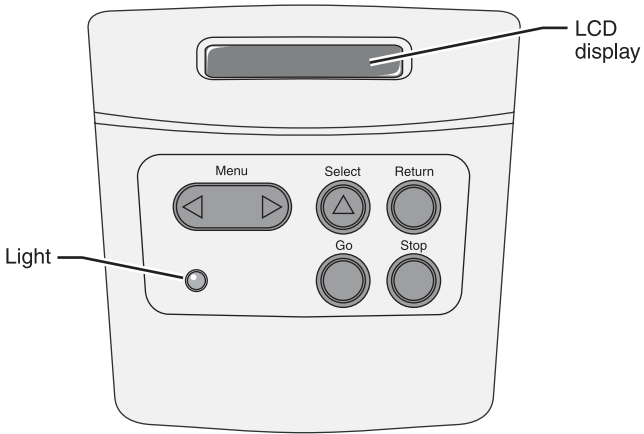

Indicator light

The indicator light gives information about the status of your printer.

If the light is	The printer is
Off	Off
On	On, but idle
Blinking	On and busy

Buttons

Use the five operator panel buttons to open a menu, scroll through a list of values, change printer settings, and respond to printer messages.

Note: Buttons act on the information displayed on the second line of the operator panel.

The following information describes the functions of each button.

Button	Function
Go	<p>Press Go to:</p> <ul style="list-style-type: none"> • Return to the Ready state if the printer is offline (the Ready message does not appear on the display). • Exit printer menus and return to the Ready state. • Clear some operator panel messages. • Resume printing after loading media and clearing paper jams. • Exit Power Saver. <p>If you have changed printer settings from the operator panel menus, press Go before sending a job to print. The printer must display Ready for jobs to print.</p>
Menu	<p>Each end of the button has a function. Press Menu>:</p> <ul style="list-style-type: none"> • When Ready is displayed, to take the printer offline (out of the Ready state) and enter the menus. • When Busy is displayed, to take the printer to the Job Menu. • When the printer is offline, to scroll through the menus. <p>Press <Menu to go to the previous item in the menus. However, menus are circular, and using either side of the button will eventually get to the same point.</p> <p>For menu items with numeric values, such as Copies, press and hold Menu> to scroll quickly through the values. Release the button when the number you want appears.</p>

Button	Function
Select	Press Select to: <ul style="list-style-type: none"> • Open the menu shown on the second line of the operator panel. Depending on the type of menu, this action: <ul style="list-style-type: none"> – Opens the menu and displays the first item in the menu. – Opens the menu item and displays the default setting. • Save the displayed menu item as the new user default setting. The printer displays the <i>Saved</i> message and returns to the menu item. • Clear certain messages from the operator panel.
Return	Press Return to return to the previous menu level or menu item.
Stop	Press Stop at the <i>Ready, Busy, or Waiting</i> message to temporarily take the printer offline. The message changes to <i>Not Ready</i> . No data is lost. Press Go to return the printer to the <i>Ready, Busy, or Waiting</i> state.

Diagram of the printer menus

Not all menus or selections will be available on all models or in all situations.

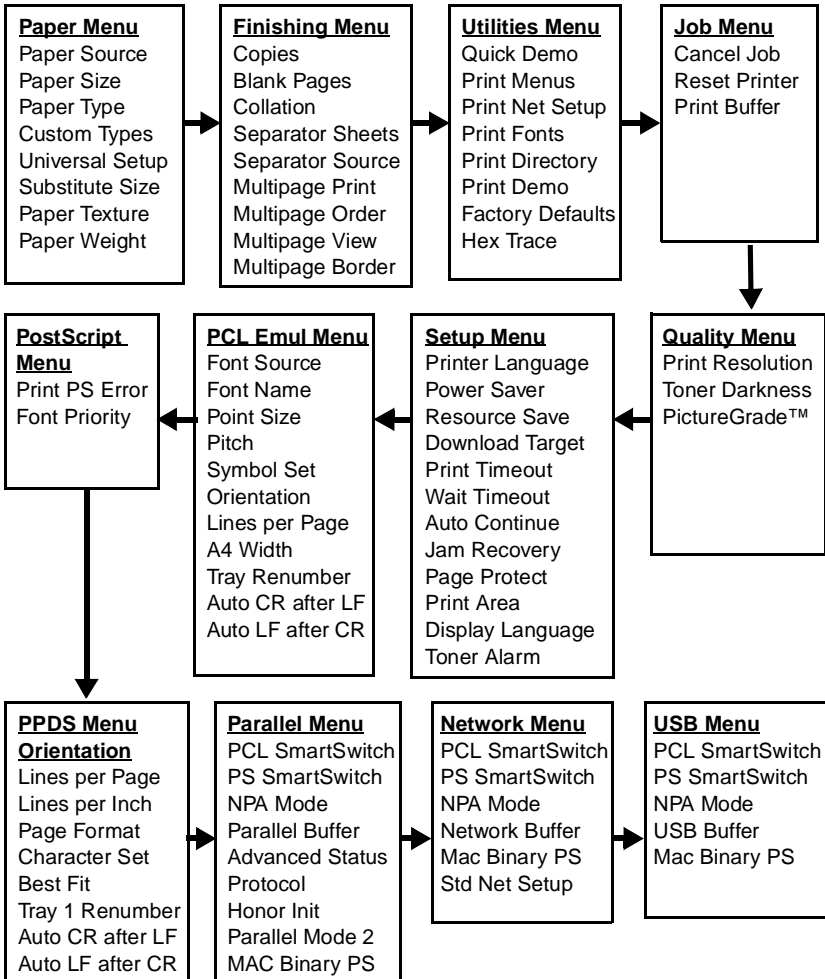

Messages and error codes

User attendance messages

User attendance messages

Message	Explanation
Change Cartridge Invalid Refill	Remove the print cartridge, and install a new cartridge.
Change <input source> <custom type name>	<p>This message displays when the user should change the media installed in one of the input options.</p> <ul style="list-style-type: none"> • <input source>=Tray 1, Tray 2, Tray 3, or Manual feeder. • <Custom Type name>=Custom 1 through Custom 6 using the MarkVision™ utility. When the printer is prompting for one of the custom types which has been named by the user, then only the custom type name is displayed on line 2. The name may be truncated to fit the display.
Change <input source> <custom string>	<p>This message displays when the user should change the media installed in one of the input options.</p> <ul style="list-style-type: none"> • <input source>=Tray 1, Tray 2, Tray 3, or Manual feeder. • <custom string>= a user-definable name.
Change <input source> <size>	<p>This message displays when the user should change the media installed in one of the input options:</p> <ul style="list-style-type: none"> • <input source>=Tray 1, Tray 2, Tray 3, or Manual feeder. • <size>=letter, legal, B5, A4, Executive, Universal, A5, Folio, or Statement. For envelopes, <size>=7¾ Envelope, 9 Envelope, 10 Envelope, DL Envelope, C5 Envelope, B5 Envelope, or other Envelope.

User attendance messages (continued)

Message	Explanation
Change <input source> <type><size>	<p>This message displays when the user should change the media installed in one of the input options.</p> <ul style="list-style-type: none"> • <input source>=Tray 1, Tray 2, Tray 3, or Manual feeder. • <type>=Bond, Card stock, Colored, Envelope, Labels, Ltrhead, Plain, Preprint, or Transparency. • <size>=letter, legal, B5, A4, Executive, Universal, A5, Folio, or Statement. For envelopes, <size>=7¼ Envelope, 9 Envelope, 10 Envelope, DL Envelope, C5 Envelope, B5 Envelope, or other Envelope.
Close Door	Close the front access door.
Delete All Jobs Go/Stop?	<p>When the user has selected Print and Hold Delete All Jobs, this message is displayed. The following actions may be taken:</p> <ul style="list-style-type: none"> • Press Go to confirm the selection. All jobs are deleted. • Press Return or Stop to cancel the delete operation.

User attendance messages (continued)

Message	Explanation
Insert <tray>	<p><i>Tray</i>=Tray 1 or Tray 2.</p> <p>The printer does not detect the presence or absence of a tray, but that paper was not picked. Replace the tray, and press Go.</p> <p>Note: This situation usually occurs when the tray is refilled during a job. To refill a tray during a printing session, press Stop, and wait for pages to reach the output bin before refilling the tray.</p> <p>The following actions may be taken:</p> <ul style="list-style-type: none"> • Insert the requested tray. • Press Menu until Job Menu displays. The following selections are available: <ul style="list-style-type: none"> – Cancel Job – Reset Printer <p>If the message cannot be cleared, verify whether the paper is being picked. If so, and the paper advances to activate the input sensor, this message would indicate a sensor problem. Otherwise, check the pick tires and pick mechanism.</p>
Install Tray x or Cancel Job	<p>Tray x=Tray 2 or Tray 3.</p> <p>This message is displayed when a paper handling option has been hot unplugged. The printer requires the reinstallation of the option to print a page which has been formatted by the interpreter before the option was removed.</p> <p>The following actions may be taken:</p> <ul style="list-style-type: none"> • Install the option. • Press Menu until Job Menu displays. Select one of the following: <ul style="list-style-type: none"> – Cancel Job – Reset Printer <p>If the message cannot be cleared, check connections and then POR the printer with the option attached. If the message persists, check the cables, starting at the controller card.</p>

User attendance messages (continued)

Message	Explanation
Load <input source> <custom type name>	<p><i>Input source</i>=Tray 1, Tray 2, or Manual Feeder. <i>Custom type name</i> is a user defined media type.</p> <p>The following actions may be taken:</p> <ul style="list-style-type: none"> • Load media in the indicated source. • Press Menu until Job Menu displays. Select one of the following: <ul style="list-style-type: none"> – Cancel Job – Reset Printer <p>If the message cannot be cleared, go to “Input tray(s) service check” on page 2-64.</p>
Load <input source> <size>	<p><i>Input source</i>=Tray 1, Tray 2, or Manual Feeder. <i>Size</i>=Letter, Legal, B5, A4, A5, Exec, Univ., Folio, or Stmt.</p> <p>The following actions may be taken:</p> <ul style="list-style-type: none"> • Load media in the indicated source. • Press Menu until Job Menu displays. Select one of the following: <ul style="list-style-type: none"> – Cancel Job – Reset Printer <p>If the message cannot be cleared, go to “Input tray(s) service check” on page 2-64.</p>
31 Missing or Defective Cart.	<p>The cartridge may be missing and the front access door closed. Return the cartridge. The cartridge may also be defective. Replace the cartridge.</p>
32 Unsupported Print Cartridge	<p>Error 32 displays when the top cover is closed and an unsupported print cartridge is detected. It may take the printer 10–20 seconds to determine if the print cartridge is supported. Depending on the setting of the Machine Class ID, the printer may be allowed to print pages during this 10–20 second interval. If pages are allowed to print, then they are not reprinted once a good print cartridge is inserted. Replace the cartridge.</p>
33 Change Cartridge	<p>The toner cartridge has an invalid refill.</p>

User attendance messages (continued)

Message	Explanation
35 Res Save Off Deficient Memory	<p>The printer lacks sufficient memory to enable Resource Save. The following actions may be taken:</p> <ul style="list-style-type: none"> • Press Go to clear the message. The printer disables Resource Save. • Install additional memory. • Set link buffers to Auto, return to Ready, enable Resource Save, and reset the link buffers.
37 Insufficient Defrag Memory	<p>This message displays prior to the actual start of the defragmentation process. If there is not enough free memory available to complete the process, the process will not proceed, and no data already in memory will be lost.</p> <p>While this message is displayed, the following actions may be taken:</p> <ul style="list-style-type: none"> • Press Go to clear the message. To perform defragmentation operation, you can: <ul style="list-style-type: none"> – Delete fonts, macros, and other data from RAM. – Install additional printer memory. • Press Menu until Job Menu appears. The following functions may be available: <ul style="list-style-type: none"> – Cancel Job – Reset Printer
37 Insufficient Memory Held Jobs may be lost	<p>This message displays when there is not enough memory available to continue processing a job, and Print and Hold feature is in use. The printer frees memory by deleting the oldest Reserve Print and Verify Print jobs. It deletes only the amount needed to continue the incoming job. Some or all of the jobs may not be restored. If, while printing the current job, it runs out of memory again, another message is not posted.</p> <ul style="list-style-type: none"> • Press Go to clear the message. Some of the Print and Hold jobs on the disk will not be restored. They remain on the disk, but cannot be accessed. • Press Menu until Job Menu appears. The function, Reset Printer, may be available.

User attendance messages (continued)

Message	Explanation
38 Memory Full	<p>This message displays when the printer is processing an incoming job, and there is insufficient memory available to continue processing the job. The following actions may be taken:</p> <ul style="list-style-type: none"> • Press Go to clear the message. Perform the defragment operation: <ul style="list-style-type: none"> – Simplify the print job. – Delete fonts, macros, and other data in RAM. – Install additional memory. • Press Menu to display Job Menu. The following functions may be available: <ul style="list-style-type: none"> – Cancel Job – Reset Printer
39 Complex Page	<p>This message displays when the page is too complex to print. The following actions may be taken:</p> <ul style="list-style-type: none"> • Press Go to clear the message and continue the job. Some data loss may occur. Simplify the print job and reprint, if necessary. • Press Menu until Job Menu appears. The following selections are possible: <ul style="list-style-type: none"> – Cancel Job – Reset Printer
42 Cartridge Region Mismatch	<p>Toner cartridges are manufactured for specific geographic regions. This message indicates this cartridge does not match the region for the printer. Change the cartridge.</p>

User attendance messages (continued)

Message	Explanation
50 PPDS Font Error	<p>This message displays when the PPDS interpreter has encountered a font error.</p> <p>Note: This error may only occur when the PPDS compiler requests a font which is not present or is not installed.</p> <p>The following actions may be taken:</p> <ul style="list-style-type: none"> • Press Go to clear the message and continue processing the job. • Press Menu until Job Menu appears. The following are available: <ul style="list-style-type: none"> – Cancel Job – Reset Printer
51 Defective Flash	<p>This message displays when the printer detects a defective flash. This error may occur at power on, or during flash format and write operations. Press Go to clear the message. The flash is marked as bad, and normal operation continues. Flash operations are not allowed until the problem is resolved.</p>
52 Flash Full	<p>This message displays when there is not enough free space in the flash memory to hold the resources that have been requested to be written to flash.</p> <p>The following actions may be taken:</p> <ul style="list-style-type: none"> • Press Go to clear the message and continue processing the job. • Press Menu until Job Menu appears. The following are available: <ul style="list-style-type: none"> – Cancel Job – Reset Printer
53 Unformatted Flash	<p>This message displays when the printer detects an unformatted flash at power on. Press Go to clear the message. The flash is marked as bad, and normal operation continues. Flash operations are not allowed until the flash is formatted.</p>

User attendance messages (continued)

Message	Explanation
54 Std Network Software Error	<p>This error displays when a network port is detected, but the printer cannot establish communications with it.</p> <p>Press Go to clear the message. The printer disables all communications to the network interface.</p>
55 Unsupported Flash	<p>An unsupported flash option is installed in the DIMM slot. Turn off the printer, and remove the unsupported flash option in the specified slot.</p>
56 Std Parallel Port Disabled	<p>This error is displayed when data is sent to the printer across the parallel port, but the parallel port has been disabled. Once this message is displayed, reporting of further errors is suppressed until the menus are entered, or the printer is reset. The following actions may be taken:</p> <ul style="list-style-type: none"> • Press Go to clear the message. The printer discards any data received on the parallel port. • Press Menu until Job Menu appears, and select Reset Printer.
56 Standard USB Port Disabled	<p>Displayed when status is requested over the USB port, but the port has been disabled. Once the error has been displayed for the first time, reporting of further errors is suppressed until the menus are entered or the printer is reset.</p> <p>The following actions may be taken:</p> <ul style="list-style-type: none"> • Press Go to clear the message. The printer discards any data received on the USB port. • Press Menu until Job Menu appears, and select Reset Printer.
58 Too Many Trays Attached	<p>This error displays when too many input trays are attached to the printer.</p>

User attendance messages (continued)

Message	Explanation
58 Too Many Flash Options	<p>This error displays when too many flash options are installed in the printer.</p> <p>The following options may be taken:</p> <ul style="list-style-type: none"> • Turn off the printer, and remove the extra flash options. • Press Go to clear the message. The extra flash options are ignored.
84 Photoconductor Life Warning	<p>This message displays when the photoconductor unit is near end of life. Press Go to clear the message.</p>
84 Replace Photoconductor	<p>This message displays when the photoconductor is exhausted. The printer is disabled until the photoconductor is replaced.</p> <p>Replace the photoconductor:</p> <ol style="list-style-type: none"> 1. Turn the printer off, and replace the photoconductor unit. 2. Reset the page count. <ul style="list-style-type: none"> • Press and hold Select and Return while turning the printer on. • Release the button when Performing Self Test displays. • Select Reset Maint Cnt, and press Select. The counter is reset to zero.
88 Toner Low	<p>This message displays when toner low occurs and the toner low alarm is activated. Press Go to clear this message.</p>

Paper jam messages

Repeating jams or jam messages can be caused by any of the following:

- Faulty pick solenoids or worn cams of the solenoids.
- Faulty flags or springs.
- Worn backup rollers at the reference guide.
- Improperly adjusted reference guide.
- Debris in the paper path.
- Paper not of the specified length.

Paper jam messages

Message	Explanation
200 Paper Jam Remove Cartridge	The input sensor under print cartridge is covered too long, is covered during POR, or is covered when Go is pressed after clearing a different jam or problem. The exit sensor could also be covered. Remove the print cartridge and open the rear door to remove the media.
201 Paper Jam Remove Cartridge	Paper is jammed between the printer input and exit sensor. Remove the print cartridge to clear the paper path.
202 Paper Jam Open Rear Door	The exit sensor is either covered during POR or covered too long. Open the rear door to access the jam area.
241 Paper Jam Check Tray 1	Paper is jammed between Tray 1 and the input sensor.
242 Paper Jam Check Tray 2	Tray 2 pass thru sensor is covered during warm-up. Try opening Tray 2. If the tray is difficult to remove, then you may have to remove the tray above.
251 Paper Jam Check Manual Feeder	Sensor at the manual feeder indicates paper is stuck in the path. Remove the paper, and check the flag/sensor.

Service error codes

Service error codes are generally non-recoverable except in an intermittent condition when you can POR the printer to temporarily recover from the error condition.

Service error codes (9xx)

Error	Description	Action
900	Service RIP software	Server firmware problem. Contact the next level of support.
902	General engine software failure	An unrecoverable engine software error. Reset the printer (POR). If the problem continues, replace the controller card.
905	Interface violation by the Paperport device	
917	Transfer roll	The likely cause is a faulty HVPS. It may also indicate a problem in the transfer roll area. Go to “Transfer roll service check” on page 2-111 .
920	Fuser error Indicates that the fuser is below temperature when printing.	Go to “Fuser service check” on page 2-87 .
921	Fuser error Indicates that the fuser is below proper temperature during standby or idle time.	Go to “Fuser service check” on page 2-87 .
922	Fuser error Fuser failed to reach standby temperature.	Verify line voltage to the fuser. Go to “Fuser service check” on page 2-87 .
923	Fuser is too hot during printing or when printer is idle.	Go to “Fuser service check” on page 2-87 .
924	An open circuit has been detected in the fuser thermistor circuit.	Check cabling and connectors. Go to “Fuser service check” on page 2-87 for the thermistor.

Service error codes (9xx) (continued)

Error	Description	Action
925	Fuser Error (Incorrect fuser lamp.)	Replace fuser with correct one. See “Fuser removal” on page 4-28.
927	Fan Error Fan is stalling.	Replace the fan. See “Fan removal” on page 4-26.
929	Toner sensor	The toner sensor is not operating properly, the developer drive assembly is not operating properly, or the print cartridge is defective. Go to “Sensor Test (input tray)” on page 3-27.
931	Printhead—no first HSYNC	Check for unplugged printhead, faulty cabling, or faulty printhead.
932	Printhead—lost HSYNC	Replace the printhead.
934	Mirror motor lost lock	Replace the printhead.
935	Mirror motor unable to reach operating speed.	Faulty printhead, cabling or connector.
936	Transport motor initial lock failure	Indicates a problem with the main drive motor or a jam occurred during the motor ramp-up to speed.
937	Transport motor lost lock	Faulty motor or a jam occurred after motor ramp-up to speed. Possible problem with the main drive or motor cable.
950	Controller card	There is a mismatch between the variables in the EPROM on the operator panel card and those in the secure NVRAM on the controller card. This can only occur after a replacement of one of the two parts, and the replaced part is faulty. Replace the controller card or the operator panel. Warning: Always replace only one at a time with a POR between.
951	Controller card	The secure NVRAM was not detected on the controller card. Replace the controller card.

Service error codes (9xx) (continued)

Error	Description	Action
952	NV failure: <i>n</i>	Recoverable error. Reset (POR) the printer. Where <i>n</i> =offset where error occurred.
954	NVRAM CRC failure	Indicates the NVRAM experienced a CRC failure. Replace the controller card.
955	Code CRC <loc>	Replace the controller card. Where <loc> = CRC Failure or ECC Failure on the controller card.
956	Controller card	Perform a power on reset (POR). If this does not fix the problem, replace the controller card.
957	ASIC failure	Perform a power on reset (POR). If this does not fix the problem, replace the controller card.
958	NAND failure	Before proceeding, perform a power on reset (POR) to see if the ECC (error correction code) can reflash NAND. If this does not fix the problem, replace the controller card.
959	SRAM failure	Perform a power on reset (POR). If this does not fix the problem, replace the controller card.
960	RAM soldered on the card is bad	Indicates a DRAM Memory Error on the controller card. Replace the controller card.
961	RAM in slot 1 is bad	If another SDRAM memory DIMM is available, turn the power off, and switch the DIMM. If the memory card now works correctly, replace the failing DIMM. If this does not fix the problem, replace the controller card. If another DIMM is not available, replace the memory option first and then the controller card if necessary.

Service error codes (9xx) (continued)

Error	Description	Action
975	Unrecognizable network port	A failure with the network port. If the printer is a network model, replace the controller card. See “Controller card removal” on page 4-15.
976	Software error in network port	
978	Bad checksum while programming network port.	
979	Flash parts failed while programming network port.	

Sub error codes

The sub error codes are helpful troubleshooting a paper path problem. Each status byte has a different level of troubleshooting value for each area of the printer. The following table displays up to 8 status bytes of data. Some or all of these bytes may be used to help diagnose a printer problem. These status bytes are designed to help isolate paper jams and paper feed problems in the base printer.

DU	xx	xx	xx	xx
DU	xx	xx	xx	xx

To identify the bytes:

	Byte 1	Byte 2	Byte 3	Byte 4
DU	xx	xx	xx	xx
DU	xx	xx	xx	xx
	Byte 5	Byte 6	Byte 7	Byte 8

Displayed error codes

When a 9xx or 2xx error displays:

1. Press and hold **Return**, and press **Select** to view sub error codes.
The first screen of information displays. Write down the information.
2. Continue pressing **Return** and **Select** until each screen of information is obtained.

When the last screen displays, the original message displays.

Printed error codes

Additional information is available by printing the error log. See **“Print Log” on page 3-33**.

Values

In the table below, the values for common variables are listed below:

- *media source*
10=Manual feeder
11=Tray 1
12=Tray 2
- *media size*
1=Letter
2=Legal
3=B5
4=A4
5=Executive
6=A5
7=Custom size
9=7¼ in. envelope
A=#9 Envelope
B=#10 Envelope
C=8.661 in. Envelope
D=C5 Envelope
E=B5 Envelope
F=Legal envelope

Sub error codes

First 6 bytes sub error code data (xx can be any value)	Explanation	Possible error message
84 00 22 x1 x2 00	Indicates the media reached the image point before EP leading edge state machine was ready. (x1=leading edge of media state, x2=trailing edge of media state)	200
84 01 22 x1 x2 00	Media reached the image point before EP trailing edge state printer was ready. (x1=EP leading edge state, x2=EP trailing edge state.)	200
84 x1 30 x2 x3 x4	Motor head transport motor error. (x1=motore type, x2=error code, x3=TimWatchingHallCount, x4=TimeWatchingHallPeriod.)	
84 1x 2D x2 x3 x4	Misidentified no gap jam. Engine detected no gap at the manual feeder sensor, attempted to open the gap by stopping the feed rolls, trailing edge was seen at the input sensor, manual feeder sensor is no longer covered. (x1+x2=page ahead's expected length, x3+x4=Page ahead's measured length)	
84 xx 00 x1 x2 x3	This code indicates that the input sensor is still actuated from the first sheet, and the second sheet is ready to arrive at the sensor. (x1=FsyncFall flag for Page Ahead, x2=media source, x3=last measured gap at input sensor). <ul style="list-style-type: none"> • Check the printer input sensor and flag for correct operation. The flag should operate freely. • Check for debris in the area of the input sensor. • Check the area of the transfer roll and input to the fuser for anything that might cause the paper to remain over the input sensor. 	200

Sub error codes (continued)

First 6 bytes sub error code data (xx can be any value)	Explanation	Possible error message
84 xx 01 x1 x2 00	The video signal did not start within two inches after actuating the input sensor. Check input sensor and flag. (x1=media size, x2=irqcnt)	200
84 xx 02 x1 x2 x3	Paper is over the input sensor too long. (x1=media size, x2=source, x3=LastDetectedSize.) Possible causes are: <ul style="list-style-type: none"> • Multi sheet feeding. • Paper size is not the same as expected. • The media feeding from the source is slipping or media is slipping before exiting the input sensor. 	200
84 xx 03 x1 00 00	The measured gap between sheets of media at the input sensor is too small to meet video requirements. x1=time by which the gap was too small.	200
84 xx 04 x1 x2 x3	The input sensor was covered when not expected (media in paper path during warmup.) (x1+x2=fuser heating time, x3=fuser wattage detection result) <ul style="list-style-type: none"> • Clear the media or debris from the printer. • Run the base sensor test (input sensor) from the diagnostic tests menu to test the input sensor and flag for correct operation. 	

Sub error codes (continued)

First 6 bytes sub error code data (xx can be any value)	Explanation	Possible error message
84 xx 05 x1 x2 00	<p>There was media at the input sensor too early. There was not enough time between printhead start and the printhead mirror motor to lock. (x1=input sensor state, x2=0 is normal printhead lock expectation; 1 is lock assumption that proved to be wrong.)</p> <p>Possible causes for this error are:</p> <ul style="list-style-type: none"> • Paper might be pre-staged in the paper source tray. • Paper is picking too fast due to faulty paper feed assembly. • A defective input sensor. 	200
84 xx 20 x1 x2 00	<p>The imaged page is not the expected page. (x1=media size, x2=media source)</p> <p>Check the pass thru sensor to make sure it is operating properly. If no problem is found, it may still be necessary to try a new pass thru sensor.</p>	200
84 xx 23 x1 x2 x3	<p>Transfer servo never started. (x1=media size, x2=EP leading edge state, x3=EP trailing edge state.)</p> <p>Possible causes include:</p> <ul style="list-style-type: none"> • Slow or missing transport motor positional feedback. • Media too fast to input sensor. • Gap too small on interpage servo. 	200
84 xx 26 x1 x2 x3	<p>The media has activated the input sensor; however, the printhead fell out of lock condition or expected a stable lock too soon. The media may have also reached the input sensor early. (x1=HSYNC state, x2=0 is normal PH lock expectation; 1 is lock assumption that proved to be wrong.)</p>	200

Sub error codes (continued)

First 6 bytes sub error code data (xx can be any value)	Explanation	Possible error message
84 xx 27 x1 x2 x3	Manual feeder sensor never became uncovered from the sheet ahead. (x1=media size, x2=media source, x3=last measured gap at input sensor (gap ahead of PageAhead.))	
84 xx 28 x1	Media never reached the input sensor, but was detected at manual feeder sensor. (x1=last measured gap at input sensor (gap ahead of PageAhead.))	
84 xx 29 x1 x2 x3	Media too long over manual feeder sensor. x1=media size, x2=source, x3=LastDetectedSize Possible causes include: <ul style="list-style-type: none"> • Multiple sheet feed. • Media too long. • Media was prestaged. 	
84 xx 2A 00 00 00	Media detected in manual feeder sensor when not expected. Possible causes include: <ul style="list-style-type: none"> • Insertion of paper when motor is running. • Prestaged media in tray. 	
84 xx 2B 00 00 00	Could not detect the end of a sheet at the manual feeder sensor. Possible causes include: <ul style="list-style-type: none"> • Very small interpage gap. • Excessive bounce of manual feeder sensor. 	

Sub error codes (continued)

First 6 bytes sub error code data (xx can be any value)	Explanation	Possible error message
84 xx 2C x1 x2 x3	Unrecoverable no gap jam. Engine detected no gap at the manual feeder sensor, attempted to open the gap by stopping the feed rolls, but no trailing edge was ever seen at the input sensor. (x1=media size, x2=media source, x3=LastdetectedSize)	
84 xx 2D x1 x2 x3	Misidentified no gap jam. Engine detected no gap at the manual feeder sensor, attempted to open the gap by stopping the feed rolls, trailing edge was seen at the input sensor, manual feeder sensor is no longer covered. (x1=media size, x2=source, x3=LastDectedSize)	
84 xx 2E x1 x2 00	Failed no gap jam recovery. Engine detected no gap at the manual feeder sensor, opened the gap by stopping the feed rolls, but never saw the leading edge of the second page at the input sensor. (x1=RecoveryStatus, x2-source)	
84 xx 2F x1 x2 x3	Laser servo never started due to potential conflict with the transfer servo. (x1=bit 0: transfer servo started, bit 1: transport started; x2+x3=transfer servo count value.) Possible causes are: <ul style="list-style-type: none"> • Slow or missing transport motor positional feedback. • Media arrives too early at the input sensor. 	200

Sub error codes (continued)

First 6 bytes sub error code data (xx can be any value)	Explanation	Possible error message
84 xx 30 00 00 00	<p>Input sensor never became uncovered from page ahead while trying to feed media out of path during warm-up. Paper originally detected at option tray pass thru sensor.</p> <ul style="list-style-type: none"> • Clear the media or debris from the printer. • Enter Diagnostics, and perform the Base Sensor test to verify the proper function of the input sensor. See “Accessing service menus” on page 3-2 for models E238, E240, or E240n or “Accessing service menus” on page 3-14 for models E340 or E342n. See “Base sensor test” on page 3-28. 	200
84 xx 3B x1 x2 x3	Media picked from the manual source failed to reach the input sensor.	251
89 00 01 00 00 00 	<p>The exit sensor at the fuser is activated by a piece of media indicating there is a piece of media in the paper path during warmup.</p> <p>Check for media in the exit of the fuser assembly or redrive assembly. Feed a sheet of paper, and if the same error occurs after clearing the fuser, or the same error occurs when no media is present, check the exit sensor assembly.</p> <p>Turn the printer off, enter the diagnostic tests menu, and select the base sensor test. Select output sensor, and check the sensor for correct operation.</p>	202

Sub error codes (continued)

First 6 bytes sub error code data (xx can be any value)	Explanation	Possible error message
89 xx 03 x1 x2 x3	<p>The exit sensor did not detect the trailing edge of the media. (x1=bit7:filtered exit sensor state; bits 6–0:H1(time exit sensor covered), x2=suspect gap measurement at input sensor, x3=Low(time exit sensor covered).)</p> <ul style="list-style-type: none"> • This failure can be caused by a broken fuser exit sensor flag. • This may also be caused by erratic operation of exit sensor flag or exit sensor or a defective piece of media. 	202
89 xx 04 x1 x2 00	<p>The exit sensor never actuated from the sheet going through the fuser before the next page entering the sensor. (x1=media size, x2=GeneralFlags1.)</p>	202
89 xx 0D 00 x2 x3	<p>The fuser exit sensor bounced. (x2 + x3=paper path location.)</p> <p>Check the exit sensor for correct operation. Check the sensor cable to J16 on the controller card. Also, the controller card may be failing.</p>	202
8A 39 x1 x2 x3 x4	<p>Printhead driver IR: LE at image point based on lock assumption that proved to be wrong. (x1=printhead type, x2=1 if lock, x3, x4=time since printhead start.)</p>	

Sub error codes (continued)

First 6 bytes sub error code data (xx can be any value)	Explanation	Possible error message
8D 00 00 00 00 00	<p>The fuser exit sensor was never activated by the leading edge of the media fed through the printer.</p> <ul style="list-style-type: none"> This error can be displayed after a 201 paper jam. This can be caused by a defective fuser exit sensor assembly. <p>Note: Enter the diagnostic tests menu, select Base Sensor Tests, select Output Sensor Test and check the fuser exit sensor for correct operation. If the test fails, check the cable connection to J17 on the controller card.</p>	201
8D 00 01 00 00 00	<p>User pressed Go or Continue after an 8D xx 00 jam, but never opened the front access cover. Need to open cover and clear any media under cartridge before continuing.</p>	201
8E xx 00 x1 x2 x3	<p>Sheet being duplexed never made it to the input sensor. (x1=source, x2+x3=time since pick)</p>	
8E xx 08 00 00 00	<p>Page in output hopper flushed; page ahead of it in the paper path never made it out of the tray.</p>	
8E xx 09 x1	<p>The second pick from Tray 1 failed when other sheets were committed to the paper path. (x1=media source)</p>	250
8E x1 10 x2 x3 x4	<p>Received lots of dc feed interrupts before losing them. Tray 2 motor stall. (x1=DCFeedMSCounter, x2=IntegralPWM, x3+x4=DCFeedRQCount.)</p>	

Sub error codes (continued)

First 6 bytes sub error code data (xx can be any value)	Explanation	Possible error message
8E x1 11 x2 x3 x4	Took too long to ramp up Tray 2 motor. (x1=DCFeedMSCounter, x2=Low(DCFeedIRQCount), x3=RampTableLengthCache, x4=DCFeedClosedLoopState.)	

Diagnostics—all models

Symptom tables

POST symptom table

Symptom	Action
The main motor, cooling fan, and fuser do not come on.	See “Cover interlock switch service check” on page 2-85.
POST completes, except one or more lights do not come on.	See “Operator panel service check (models E238, E240, and E240n)” on page 2-92.
None of the lights come on.	See “Operator panel service check (models E238, E240, and E240n)” on page 2-92.
Main motor does not come on.	See “Main motor service check” on page 2-91.
Fan does not come on.	See “Cooling fan service check” on page 2-81.
Fuser lamp does not come on.	See “Cooling fan service check” on page 2-81.
Fuser lamp never turns off.	See “Hot fuser service check” on page 2-89.
The paper feed picks and tries to feed paper.	See “Paper feed service checks” on page 2-94.

Printer symptom table

Symptom	Action
Dead machine (no power).	See “Dead machine service check” on page 2-86.
Fan noisy or not working.	See “Cooling fan service check” on page 2-81.

Symptom	Action
Fuser parts melted.	See “Hot fuser service check” on page 2-89.
Fuser lamp does not light.	See “Cooling fan service check” on page 2-81.
Toner not fused to the paper.	See “Cooling fan service check” on page 2-81.
Paper jams.	See “Paper feed service checks” on page 2-94.
Main motor noisy or not moving.	See “Main motor service check” on page 2-91.
Paper skew.	See “Paper feed service checks” on page 2-94.
Printer not communicating with host.	See “Parallel port service check (models E238, E240, and E240n)” on page 2-97.
Front access cover will not close.	See “Cover interlock switch service check” on page 2-85.
Operator panel button not responding.	See “Operator panel service check (models E238, E240, and E240n)” on page 2-92, “Operator panel service check (models E340 and E342n)” on page 2-93, or “Controller card service check” on page 2-82.
Operator panel lights are off or very dim.	See “Controller card service check” on page 2-82.
Blank page.	See “Blank page” on page 2-99.
Black page.	See “Black page” on page 2-100.
Heavy background.	See “Heavy background” on page 2-101.
Light print.	See “Light print” on page 2-103.
White or black lines or bands.	See “White or black lines or bands” on page 2-103.
Toner on back of page.	See “Toner on back of page” on page 2-104.

Symptom	Action
Paper never picks.	See “Paper never picks” on page 2-95.
Paper feeds continuously.	See “Paper picks during POST and/or continuously” on page 2-94.
Paper wrinkled or bent.	See “Paper “trees,” wrinkles, stacks poorly, or curls” on page 2-96.

Service checks



Service checks which involve measuring voltages on the LVPS/HVPS (low voltage power supply/high voltage power supply board) should be performed with the printer positioned on its back side.

Note: When you make voltage readings, always use frame ground unless another ground is specified. See the wiring diagram in the back of the book for more information.

Cooling fan service check

FRU	Action
Cooling fan	<p>Make sure the fan cable plug is properly seated at J18 (controller card).</p> <p>Turn the printer off, and disconnect the cooling fan cable from the controller card.</p> <p>Turn the printer on. Within a few seconds, the controller card assembly should apply between +24 V dc to pin 2.</p> <ul style="list-style-type: none"> • If voltage is present and the fan is not turning, replace the cooling fan. If the fan still doesn't function, replace the controller card. <p>Note: The fan speed is controlled by a module on the printed circuit board. Between +8 V and +24 V dc are constantly supplied at pin 2 (J18). Pin 1 is ground while pin 3 receives feedback from the fan motor.</p> <ul style="list-style-type: none"> • If voltage is not present, check the cables and all connections.

Controller card service check

Controller card service check

FRU	Action
Controller card assembly	<p>POST (Power-On Self Test)</p> <p>Note: With all cables connected, the printer should complete POST within approximately 30 seconds in the following sequence:</p> <ul style="list-style-type: none"> • For models E238, E240, and E240n, see “Power-On Self Test (POST) sequence” on page 2-2. If some lights are on or flashing see “Common primary light patterns” on page 2-4 to determine action required. • For models E340 and E342n, see “Power-On Self Test (POST) sequence” on page 2-50. If error messages are posted, see “Messages and error codes” on page 2-55. <p>If the printer fails to complete POST without displaying an error message, replace the controller card assembly.</p> <p>Note: Settings for U.S. versus non-U.S. and the printer configuration ID can be changed. For models E238, E240, and E240n, see “Defaults” on page 3-12 and “Configuration ID” on page 3-12. For models E340 and E342n see “Defaults” on page 3-29 and “Configuration ID” on page 3-30.</p>

Controller card service check (continued)

FRU	Action
Controller card assembly (continued)	<p>Verify +24 V dc input from the LVPS/HVPS.</p> <ul style="list-style-type: none"> • Turn the printer off. • Disconnect the LVPS/HVPS cable from the controller card at J4. • Turn the printer on. • Verify +24 V dc from the cable connector of J4, pins 8 and 9. <p>If voltage is correct, check the continuity in the cable. If the cable is good, check the connectors to the controller board.</p> <p>Verify that pins 7 and 14 on both the cable and the card connector are ground.</p> <ul style="list-style-type: none"> • If grounds are not correct on the cable, first check it for continuity and then the LVPS/HVPS. • If the grounds are not correct on the controller card, replace the controller card. (Check with one probe on the connector pin and the other on the card's ground plane found at each screw head.)

Controller card service check (continued)

FRU	Action																
LVPS/HVPS	<p>Verify main power to controller card</p> <p>With the printer off, unplug the LPS/HVPS cable at J4 on the controller card. Verify grounds on pins 7, 12, and 14 for both the cable and the controller card. If any of these grounds are incorrect, check the cable for continuity. Replace the cable or the respective card as necessary.</p> <p>Turn the printer on with the cable still unplugged, and verify the following on the cable (controller card will not be powered):</p> <table border="1" data-bbox="474 553 855 891"> <thead> <tr> <th>Pins</th> <th>Voltage</th> </tr> </thead> <tbody> <tr> <td>J4-1</td> <td>+5 V dc</td> </tr> <tr> <td>J4-2</td> <td>+5 V dc</td> </tr> <tr> <td>J4-3</td> <td>+5 V dc</td> </tr> <tr> <td>J4-4</td> <td>+5 V dc</td> </tr> <tr> <td>J4-8</td> <td>+24 V dc</td> </tr> <tr> <td>J4-9</td> <td>+24 V dc</td> </tr> <tr> <td>J4-13</td> <td>+5 V dc</td> </tr> </tbody> </table> <p>If any of the voltages are incorrect, check or replace the LVPS/HVPS. See “Dead machine service check” on page 2-86.</p>	Pins	Voltage	J4-1	+5 V dc	J4-2	+5 V dc	J4-3	+5 V dc	J4-4	+5 V dc	J4-8	+24 V dc	J4-9	+24 V dc	J4-13	+5 V dc
Pins	Voltage																
J4-1	+5 V dc																
J4-2	+5 V dc																
J4-3	+5 V dc																
J4-4	+5 V dc																
J4-8	+24 V dc																
J4-9	+24 V dc																
J4-13	+5 V dc																
Controller card assembly	<p>Controller card voltage outputs</p> <p>Turn the printer off, and plug the LVPS/HVPS cable into J4 of the controller card. See the table, “Controller card connector pin values” on page 5-4, which identifies the voltages and grounds for a good controller card.</p> <p>Note: Turn the printer off before plugging or unplugging any connectors.</p>																

Cover interlock switch service check

Note: Make sure a print cartridge assembly is installed and the cover closes all the way, engaging the cover open switch lever.

FRU	Action
Cover interlock switch	<p>Disconnect the cover interlock cable from the controller card at J15.</p> <p>With the printer turned off, verify continuity between cable pin 1 and pin 2 with the door closed and discontinuity with the door open.</p> <p>Verify continuity between cable pin 1 and pin 3 with the door open and discontinuity with the door closed.</p> <p>Verify discontinuity between cable pins 2 and 3 whether the door is open or closed.</p> <ul style="list-style-type: none"> • If either fails, replace the cover interlock switch. • If both pass continuity, turn the printer on, and measure +5 V dc on pin 2 at J15 on the controller card. • Verify pins 1 and 3 at J15 are ground. • If voltage or ground is not present, see “Controller card service check” on page 2-82 for more information.

Dead machine service check



CAUTION: Check the AC line voltage. The voltage should be within the following limits:

- 100 V ac (volts alternating current) – 127 V ac for the 110 V printer
- 200 V ac – 240 V ac for the 220 V printer

FRU	Action
 <p>LVPS/HVPS</p>	<p>Unplug the printer and check the fuses on the LVPS/HVPS board for continuity.</p> <ul style="list-style-type: none"> • If open, replace the LVPS/HVPS board. If fuse opens again, see “LVPS/HVPS service check” on page 2-90 for more information. • If not open, unplug the cables at CN102 and CN201 (fuser and controller card respectively). <p>Plug LVPS/HVPS board to source and turn switch on.</p> <p>Verify 24 V dc on pin 8 at connector CN201 (or pin 8 at J4 on the controller card).</p> <p>Verify line voltage (100 V, 110 V, or 220 V ac) across pins 1 and 2 of CN102.</p> <ul style="list-style-type: none"> • If voltages are not correct for the geography, replace the LVPS/HVPS board. • If voltages are correct, check the controller card. See “Controller card” on page 5-3. <p>Verify grounds. See the wiring diagram at the end of the book.</p>

Fuser service check

When toner is partially fused to the paper, it is usually caused by low fuser temperature.

Warning: Avoid handling the lamp as much as possible, as it is easily broken. Be careful not to touch the glass housing with bare hands, because skin acids can weaken the glass.

Note: The lamp is not a service part.

The line voltage to the printer must be within the following limits:

- 100 V ac–127 V ac for the 110 V model printer
- 200 V ac–240 V ac for the 220 V model printer

Turn the printer off, and wait a few minutes for the fuser lamp to cool. Turn the printer on, and observe the lamp turning on during POST.



You can see the light from the lamp by opening the left side cover and observing the upper opening through which the fuser power cables pass.

Fuser service check

FRU	Action
 <p>Fuser power cable LVPS/HVPS Fuser</p>	<p>Unplug the printer, and disconnect the fuser lamp cable plug from the LVPS/HVPS board connector at CN102.</p> <p>Check for continuity across the fuser lamp by checking across the connector pins.</p> <ul style="list-style-type: none"> • If there is continuity, go to Step 1: Continuity. • If there is no continuity, go to Step 2: No continuity. <p>Step 1: Continuity</p> <p>Turn the printer on with only the fuser power disconnected. Measure the voltage at connector CN102 on the LVPS/HVPS. It should match the line voltage. If line voltage is not present, see “LVPS/HVPS service check” on page 2-90 for more information.</p> <p>Make sure the fuser thermistor is correctly connected to the controller board. If the problem persists, disconnect the thermistor cable at J16, and check for less than +5 V dc on pin 1. Pin 2 should be ground. If line voltage is incorrect on pin 1, see “Controller card service check” on page 2-82 for more information.</p>

Fuser service check

FRU	Action
Fuser power cable LVPS/HVPS Fuser (continued)	<p>Step 2: No continuity Check the lamp cable for continuity.</p> <ul style="list-style-type: none"> • If correct, replace the fuser. • If incorrect, replace the lamp cable.
 <p>Fuser</p>	<p>Disconnect the thermistor cable from J16 on the controller card.</p> <p>Measure the resistance across the ends of the thermistor cable.</p> <p>Replace the fuser assembly if the resistance is lower than 1K ohm or shorted.</p> <p>Note: Resistance measures approximately 240K ohms when cool and 1K ohms hot.</p>

Cold fuser service check

Make sure the correct voltage lamp is installed. The voltage rating is stamped on one of the lamp contacts.

FRU	Action
 <p>Fuser AC cables LVPS/HVPS Fuser</p>	<p>If the fuser lamp comes on and a fuser failure light error code displays, be sure the thermistor is contacting the hot roll, and the thermistor cable is firmly seated in connector J6 on the controller card.</p> <p>Check for excessive toner buildup on the surface of the thermistor. Clean as necessary.</p> <p>With the printer unplugged, disconnect the thermistor cable from J16 on the controller card.</p> <p>Measure the resistance of the thermistor. The resistance measures from approximately 1K ohms immediately after printing or POR to approximately 240K ohms when the thermistor reaches room temperature. (It may take 30 minutes to cool.)</p> <p>Replace the fuser assembly as necessary.</p>

Hot fuser service check

Note: Ensure correct lamp is installed.

FRU	Action
 <p>Fuser AC cables LVPS/HVPS Fuser</p>	<p>Measure the resistance of the thermistor. The resistance measures from approximately 1K ohms immediately after printing or POR to approximately 240K ohms when thermistor reaches room temperature. (It may take 30 minutes to cool.)</p> <p>Replace the fuser assembly as necessary.</p>

LVPS/HVPS service check

FRU	Action
 <p>LVPS/HVPS</p>	<p>LVPS portion of board</p> <p>Fuses that open typically indicate a faulty LVPS/HVPS.</p> <p>Use the voltage meter to verify the appropriate voltage at the printer end of the power cable.</p> <p>Remove the LVPS/HVPS assembly from the printer. Check continuity on the fuses. If either fuse has opened, replace the card.</p> <p>Ensure the switch is off, and plug the power cord into the card. Turn the switch on.</p> <p>CAUTION: The card has several points where AC voltage is exposed.</p> <p>Carefully verify the AC voltage between pins 1 and 2 of CN102 matches the power cable (wall) voltage. If voltage is incorrect, replace the card assembly.</p> <p>Verify +24 V dc from pin 8 at CN201. If voltage is incorrect, replace the card assembly.</p> <p>HVPS portion of board</p> <p>Problems with the HVPS are exhibited in the print quality. See “Print quality service checks” on page 2-98 for more information.</p>

Main motor service check



FRU	Action								
<div data-bbox="136 315 235 402" data-label="Image"> </div> <p data-bbox="139 418 327 495">Main motor cable LVPS/HVPS Controller card</p> <p data-bbox="139 509 384 885">Warning: <i>Do not</i> replace the operator panel and controller card at the same time. Each card contains the printer settings. When either of these cards is new, it obtains the settings from the other card. Settings are lost when both are new and replaced at the same time.</p>	<p data-bbox="430 277 932 354">Turn off the printer, and unplug the main motor cable at J8. Turn on the printer, and check for the following voltages at J8:</p> <table border="1" data-bbox="476 370 896 537"> <thead> <tr> <th>J8 pins</th> <th>Voltages</th> </tr> </thead> <tbody> <tr> <td>Pins 1–4</td> <td>Approx. +3.3 V dc</td> </tr> <tr> <td>Pin 6</td> <td>Approx. +5 V dc</td> </tr> <tr> <td>Pins 7–9</td> <td>10 V dc–24 V dc</td> </tr> </tbody> </table> <p data-bbox="430 561 889 610">Verify ground at pin 5 for both the card and cable.</p> <ul data-bbox="438 626 944 950" style="list-style-type: none"> • If these voltages are correct, check the main motor cable for continuity. <ul data-bbox="458 688 939 841" style="list-style-type: none"> – Remove rear cover to access connector on motor. – If continuity exists on each wire, call next level of service. – If continuity does not exist on one or more of the wires, replace the motor cable. • If these voltages are not correct, see “Controller card connector pin values” on page 5-4, or replace the controller card. See “Controller card removal” on page 4-15. <p data-bbox="430 956 892 980">Note: The main motor is not a service part.</p>	J8 pins	Voltages	Pins 1–4	Approx. +3.3 V dc	Pin 6	Approx. +5 V dc	Pins 7–9	10 V dc–24 V dc
J8 pins	Voltages								
Pins 1–4	Approx. +3.3 V dc								
Pin 6	Approx. +5 V dc								
Pins 7–9	10 V dc–24 V dc								

Operator panel service check (models E238, E240, and E240n)

Inspect the operator panel cable for damage. Make sure the cable is plugged in securely.

Run POST, and check each light for proper operation. See **“Power-On Self Test (POST) sequence” on page 2-2.**

LED Operator panel service check

FRU	Action
Operator panel (LED)	<p>Buttons</p> <p>Open controller card cage and locate the operator panel connector at J19.</p> <p>Check for continuity between pins 1 and 2 of the cable as you press the Continue  button.</p> <p>Similarly, check the continuity between pins 1 and 6 of the cable while pressing Cancel  .</p> <p>If continuity is not present, replace the operator panel.</p> <p>Note: Check margin alignments after replacing the operator panel assembly. If margin errors are unacceptable, corrections can only be made through software. Contact the next level of support.</p>

LED Operator panel service check (continued)

FRU	Action
<p>Operator panel (LED) Controller card</p> <p>Warning: <i>Do not</i> replace the operator panel and controller card at the same time. Each card contains the printer settings. When either of these cards is new, it obtains the settings from the other card. Settings are lost when both are new and replaced at the same time.</p>	<p>Lights</p> <p>If none of the lights come on, make sure the cable is properly connected to the controller card and the controller card has input voltage to it.</p> <p>Verify +24 V dc on cable pin 8 at J4.</p> <ul style="list-style-type: none"> • Check for +5 V dc at J19, pin 5. See “Controller card service check” on page 2-82. • If these voltages are not correct, replace the controller card. • If these voltages are correct, replace the operator panel. <p>If more than one light does not turn on, or an individual light stays on solid during POST, replace the operator panel.</p> <p>If all lights are dim and operate erratically during POST, or all lights come on and stay on solid during POST, replace the FRUs in the following order one at a time:</p> <ul style="list-style-type: none"> • Controller card • Operator panel

Operator panel service check (models E340 and E342n)

Inspect the operator panel cable for damage. Make sure the cable is plugged in securely. Run POST, and check for proper operation. See **“Power-On Self Test (POST) sequence” on page 2-50.**

LCD operator panel service check

FRU	Action
<p>Operator panel (LCD)</p>	<p>Enter Diagnostics mode (turn off the printer, restart while holding Return and Go), and press Menu until HARDWARE TESTS display. The first two items, LCD Test and Button Test interactively test the screen and buttons. The LED below the Menu button is not tested, but can otherwise be checked during POR. Also, it flashes when the printer is working and stays on steady at Ready.</p>

Paper feed service checks

Paper jam error indication during POST

FRU	Action
Exit sensor	If the exit sensor flag is not resting within the paper exit sensor during POST, the printer displays a paper jam message. Make sure the flag is operating freely and is correctly installed.
Input sensor #1 (under print cartridge assembly) and Input sensor #2 (manual)	Make sure the input paper feed sensors are working properly. A stuck or incorrectly installed sensor causes this error.

Paper picks during POST and/or continuously

FRU	Action
ACM (autocompensator mechanism or paper feed) clutch Manual feed clutch	<p>Check the ACM clutch for wear. The solenoid interacts with the clutch to control the motion of the pick tires.</p> <p>If the ratchet teeth of the ACM clutch assembly are worn or broken, the solenoid may not stop the ACM from rotating. Replace the ACM clutch assembly if necessary.</p> <p>Check the manual feed clutch for the same damage.</p>

Paper picks but stops halfway through the printer

FRU	Action
Input sensor #1 (under print cartridge assembly) and Input sensor #2 (manual)	<p>Make sure the input sensors are working properly.</p> <p>Check for a broken or stuck flag on the input sensors.</p> <p>Make sure the cables are seated on the controller card at J9 (Tray 1 input) and J20 (manual input).</p> <p>Check for about +5 V dc on pin 1 at J9 (Input sensor #1) and pin 1 at J20 (Input sensor #2).</p> <ul style="list-style-type: none"> • If correct, replace the input paper feed sensor. • If these voltages are not correct, replace the controller card.

Paper never picks

FRU	Action
Paper feed (pick tires)	<p>Open the left cover, and verify the solenoid and clutch are functioning when an attempt is made to feed the paper.</p> <p>Make sure the rubber tires are installed and clean.</p> <p>Replace if necessary.</p>



Paper occasionally mispicks or picks multiple sheets at once

FRU	Action
Tray 1 Tray 2 (option)	<p>Check tray for paper catch points.</p> <p>If the sheet being fed stops momentarily, the ACM applies additional vertical force, causing additional sheets to feed.</p> <p>Do not mix paper types in one tray.</p>
Paper pick tires	<p>Check the tires in the ACM assembly for signs of wear or damage.</p> <p>Replace the tires as necessary.</p>
ACM clutch complete bill of material (CBM) Manual feed clutch CBM	<p>Open left cover, and observe the solenoid and clutch actions at the ACM and manual feed shafts as a print job is attempted.</p> <p>Replace the faulty part.</p>
Controller card	<p>Disconnect the solenoid cable at J3 on the controller card.</p> <p>Measure the resistance across cable pins 1 and 2 and then pins 3 and 4.</p> <ul style="list-style-type: none"> • The resistance should be 180–250 ohms. • If it is not, call the next level of service. • If the resistance is 180–250 ohms, check the controller card. See “Controller card service check” on page 2-82 for more information. <p>Replace controller card as necessary.</p>

Paper “trees,” wrinkles, stacks poorly, or curls

FRU	Action
Fuser	<p>This problem is most likely due to a worn backup roll. It causes the printer to run hotter than required for the media being printed. Excessive heat can cause paper treeing problems, poor stacking, or curl.</p>

Parallel port service check (models E238, E240, and E240n)

1. Perform a print test to make sure the printer prints correctly. Verify  is on, then press  to print menu settings.
2. Be sure the printer cable is designed for bidirectional printing.
3. Be sure the user's application is set up correctly.
4. If the internal print test page prints correctly, the user's application/printer driver is set up correctly, and the correct bidirectional parallel cable is installed, but the printer still fails to print on command from the host computer, replace the controller card.

Parallel port service check (models E340 and E342n)

1. Perform a print test to make sure the printer prints correctly. See **“Print quality pages (Prt Quality Pgs)” on page 3-23.**
2. Be sure the printer cable is designed for bidirectional printing.
3. Be sure the user's application is set up correctly.
4. Using an extra long parallel cable may require some adjustment in the Par S strobe. See **“Parallel strobe adjustment (Par S Strobe Adj)” on page 3-30.**
5. Some computers assume the printer samples data on the trailing edge of the strobe. This printer samples data on the leading edge by default. This process can be switched by turning Parallel Mode 2 off. To change this setting:
 - a. Select **PARALLEL MENU** from the Ready Menu.
 - b. Select **Parallel Mode 2**.
Selections are **On** and **Off**.
6. If the printer fails to print on command from the host, verify the following:
 - a. Internal print test page prints correctly.
 - b. The user application/printer driver is set up correctly.
 - c. The host computer has been restarted.
 - d. The bidirectional parallel cable is connected correctly and is functional.

If the printer still fails to print correctly, replace the controller card assembly.

Note: Always check printhead alignment after replacing the controller card assembly.

Print quality service checks







Note: Ensure cover closes tightly. A gap in the opening may allow light to expose the photoconductor resulting in a 'dirty' print. Extreme environmental conditions, temperatures, and humidity will affect the print quality.

Using print quality test pages

To help isolate print quality problems, like streaking, print test pages using the print quality test pages.

Models E238, E240, and E240n

To print the print quality test pages:

1. Enter Configuration Menu.
 - a. Turn off the printer.
 - b. Open the front access cover.
 - c. Turn on the printer while pressing and holding  .
 - d. When  light stays on, close cover.
 - e. Wait (approximately 10 seconds) until the printer drive activates.
2. Slowly press and release  three times until the  and  lights come on.
3. Press and hold  until all the lights flash to initiate printing the quality test pages.

Four pages print to help you evaluate print quality. The first page has various fonts and a graphic, the second page is gray with graphics, the third page is black, and the last page is blank. Once the paper exits into the output bin, the printer returns to the home state (four top lights on).

4. Use the test pages to isolate problems such as light or toner streaks. See **“POST symptom table” on page 2-79** for solutions to these problems.

To exit print quality test pages, turn the printer off.

Models E340 and E342n

To print the print quality test pages:

1. Enter Configuration Menu.
 - a. Turn the printer off.
 - b. Press and hold **Select** and **Return**.
 - c. Turn the printer on.
 - d. Release the buttons when `Performing Self Test` displays.
2. Select **Prt Quality Pgs**.

3. Press **Go**.

Four pages print to help you evaluate print quality. The first page has various fonts and a graphic, the second page is gray with graphics, the third page is black, and the last page is blank.

4. Use the test pages to isolate problems such as light or toner streaks. See **“POST symptom table” on page 2-79** for solutions to these problems.

To exit, press **Menu** until **Exit Config Menu** appears, and press **Select**.

Blank page

FRU	Action
Toner cartridge (not a FRU)	Remove the toner cartridge, and gently shake it to evenly distribute the toner. Check for cartridge damage.
 Printhead LVPS/HVPS Controller card Toner electrodes (cable assembly)	Blank pages can be caused by a defective printhead assembly, LVPS/HVPS, or controller card. <ul style="list-style-type: none"> • Printhead errors typically result in printer service errors. • Blank pages typically are caused by the PC roll not being properly charged. Try a different PC kit. Unplug the printer, and check the cable continuity between the LVPS/HVPS connector marked OPC and the corresponding wire form (spring) found about 14 mm above and to the right of the transfer roll gear. <ul style="list-style-type: none"> • If there is not continuity, call the next level of service. Try a different toner cartridge and PC kit. <ul style="list-style-type: none"> • If those fail, replace the LVPS/HVPS.

Black page

Note: Incorrect laser exposure or incorrect charging of the photoconductor causes an all black page. Always verify the same results from a different print cartridge assembly and developer before proceeding.

FRU	Action
Toner electrodes (not a FRU)	<p>Check the three rearward electrodes below the print cartridge assembly for contamination or damage. Correct as necessary.</p> <p>Check continuity between the cable (DEV, TAR, and doctor blade) connection CN203 and on the contact tips below the print cartridge assembly.</p> <ul style="list-style-type: none"> • If continuity fails, call the next level of service.
 <p>LVPS/HVPS board Controller card</p>	<p>With the printer off, disconnect the LVPS/HVPS cable from J4 on the controller card.</p> <p>Turn the printer on, and verify +24 V dc on pin 8 of the cable.</p> <p>Verify ground on pin 7.</p> <ul style="list-style-type: none"> • If the voltage is incorrect, replace LVPS/ HVPS board. • If voltage is correct and the toner electrodes are good, replace the controller card. • See the “LVPS/HVPS service check” on page 2-90 and the “Controller card service check” on page 2-82, if necessary.

Heavy background

Poor development or poorly charged toner particles cause excessive background. This is more noticeable as the toner cartridge nears end-of-life.

FRU	Action
Toner cartridge (not a FRU) PC Kit (not a FRU)	<p>Make sure the toner cartridge and PC Kit are correctly installed and the high voltage contacts are clean.</p> <p>If the toner cartridge and PC Kit are installed correctly, try a new PC Kit first and then toner cartridge.</p>
 LVPS/HVPS Controller card	<p>Check the contacts for correct installation and contamination where contact is made between the print cartridge assembly and LVPS/HVPS board. Clean as necessary.</p> <p>If this does not correct the problem, replace the following FRUs one at a time in the order shown:</p> <ul style="list-style-type: none"> • LVPS/HVPS board • Controller card

Partial blank image/white spots (no repeating pattern)

FRU	Action
Toner cartridge (not a FRU)	<p>Remove the toner cartridge assembly, and gently shake the assembly to evenly distribute the toner.</p> <p>If toner cartridge is low, try a new one.</p>
Paper (not a FRU)	<p>Make sure recommended paper is being used.</p>

Variation in image density horizontally across page

FRU	Action
PC Kit (not a FRU)	<p>The charge roll may have an unbalanced pressure against the PC (photoconductor) drum.</p> <p>Try a new PC Kit.</p>
Transfer roll	<p>Check the springs in the left and right transfer roll bearings. The bearing assemblies should support the transfer roll, applying even pressure to the PC drum.</p> <p>Replace the transfer roll assembly if the springs or bearing show signs of damage or fatigue.</p> <p>Inspect the transfer roll for signs of wear, damage or contamination.</p> <p>Replace as necessary.</p>

Poor fusing of image

FRU	Action
Fuser	<p>The fuser may not be operating at the proper temperature to fuse the toner to the paper.</p> <p>See “Hot fuser service check” on page 2-89 for more information.</p>
Paper (not a FRU)	<p>Make sure recommended paper is being used.</p>

Light print

FRU	Action
Toner cartridge (not a FRU)	<p>Make sure the toner cartridge and PC Kit are installed correctly and that the toner cartridge is not low on toner.</p> <p>If the problem continues, install a new toner cartridge.</p> <p>Recheck condition before replacing PC Kit, if necessary.</p>
 <p>Transfer roll LVPS/HVPS board</p>	<p>Check the transfer roll for signs of toner buildup and contamination.</p> <p>Inspect the HVPS contact (transfer roll) for contamination.</p> <p>Verify the high voltage cable is plugged into the LVPS/HVPS.</p> <p>If all components appear free of contamination, replace the following FRUs one at a time in the order shown:</p> <ul style="list-style-type: none"> • Transfer roll • LVPS/HVPS board

White or black lines or bands

FRU	Action
Print cartridge assembly (not a FRU) Developer drive coupling assembly	<p>Banding appears as light or dark horizontal lines on a uniformly gray page or on a page with a large area of graphics. Banding is primarily due to a variation in the speed of the paper as it feeds through the printer, especially in the developer and transfer process.</p> <p>Inspect the toner cartridge and paper feed components, especially the drive coupler and drive gears for debris, binds, or damage.</p>

Toner on back of page



FRU	Action
PC Kit (not a FRU)	Inspect the overall paper path for signs of spilled toner. Gently clean the contaminated areas with a soft cloth or compressed air.
Fuser	The fuser hot roll can cause toner deposits on the back of the paper if toner is building up on the hot roll. This buildup may transfer to the backup roll, later transferring to the back of the paper. Inspect the hot roll and backup roller for signs of contamination. Replace the fuser as necessary.
Transfer roll	A transfer roll contaminated with toner can cause toner to transfer to the back of printed pages. Inspect the transfer roll for contamination, and replace as necessary.

Solving print quality problems

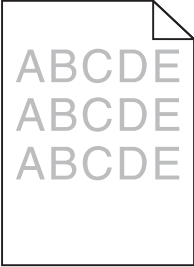
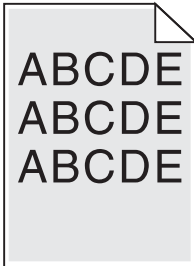
Print quality problems

Problem	Action
<p>Light or blurred characters.</p> 	<p>Light print</p> <p>The toner cartridge may be getting low on toner:</p> <ul style="list-style-type: none"> • Remove the toner cartridge and print cartridge assembly. • Shake it from side to side to redistribute the toner. • Reinstall it and recheck for condition. • Make sure you are using recommended print media (see media types and sizes in the <i>User's Reference</i>). • Use MarkVision to define the custom type setting for media type, media texture, or media weight. • The toner cartridge or PC Kit may be defective. Replace the PC Kit first and recheck. <p>Blurred characters</p> <p>Blurred images, including characters, are usually caused by a defective printhead. See “Light print” on page 2-103.</p>
<p>Toner smudges appear on the front or back of the page.</p> 	<ul style="list-style-type: none"> • Make sure the paper is straight and unwrinkled. • Replace the PC Kit and recheck before replacing the toner cartridge. See “Toner on back of page” on page 2-104 for more information.

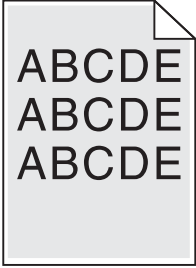
Print quality problems (continued)

Problem	Action
<p>Vertical or horizontal streaks appear on the page.</p> 	<p>Replace the toner cartridge for vertical black streaks.</p> <p>Wipe the glass lens clean with a soft tissue for vertical “white” streaks.</p> <p>For horizontal streaks, see “White or black lines or bands” on page 2-103 for more information.</p>
<p>Toner smears or rubs off the page.</p> 	<ul style="list-style-type: none"> • Replace the fuser. The toner is not being fused. See “Cooling fan service check” on page 2-81 for more information. • Try a different kind of paper. Paper designed for copiers gives the best quality fusing. • If you are printing on special media, such as card stock or labels, be sure you select the correct paper type in the printer driver. • Change the media texture setting. If the setting is not in your driver, you can download the correct Lexmark setup utility from the Lexmark Web site at www.lexmark.com.
<p>The print is getting light but the printer has not indicated it is low on toner.</p>	<ul style="list-style-type: none"> • The  light nor Toner Low message do not display if the standard 1,500 page toner cartridge is installed. • Remove the toner cartridge and gently shake it from side to side to redistribute the toner. • Replace the toner cartridge.
<p>The  light is on (E238, E240, and E240n) or Toner Low displays (E240 and E242n).</p>	<ul style="list-style-type: none"> • Remove the toner cartridge and gently shake it from side to side to redistribute the toner. • Replace the toner cartridge.

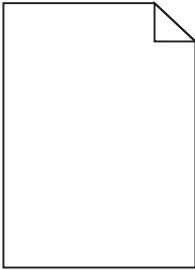

Print quality problems (continued)

Problem	Action
<p>Solid black areas on transparencies or white streaks on paper.</p>	<ul style="list-style-type: none"> • Choose a different fill pattern in your software program. • Try a different type of paper. Paper designed for copiers gives the best quality. • Remove the toner cartridge, and gently shake it from side to side to redistribute the toner. • Replace the toner cartridge.
<p>Faint images or repetitive spots appear on the page.</p>	<ul style="list-style-type: none"> • Select a different media type or form type setting from your printer driver. • Try a different type of paper. Paper designed for copiers gives the best quality. • Replace the toner cartridge.
<p>Pages are blank.</p> 	<ul style="list-style-type: none"> • The print cartridge may be out of toner or defective. Replace the cartridge. • You may have a software error. Try turning the printer off and back on. • Check the printhead. See “Paper feed service checks” on page 2-94 for more information.



Print quality problems (continued)

Problem	Action
The printer is on, but nothing prints.	<ul style="list-style-type: none"> • Make sure the toner cartridge assembly is installed properly. • Make sure the parallel or USB cable is not damaged and is firmly plugged into the connector on the back of the printer. • Press and release  to print a menu settings page (E238, E240, E240n), or press Menu to select Utilities Menu, and then select Print Menus (E340, E342n). <ul style="list-style-type: none"> – If you cannot print a menu settings page, contact the next level of support. – If you can print a menu settings page, the problem is one of the following: <ul style="list-style-type: none"> • Computer • Software program • Cable • (USB only) failed ASIC or controller card. Replace card. <p>Note: Test by unplugging USB and replugging it with the printer on. If the computer indicates “unknown device,” replace the card.</p>
Toner Low light is on and printing stops.	<p>If you are using a 3,000 or 6,000 page toner cartridge and the Toner Low alarm is set to on, the printer stops printing until you replace the toner cartridge.</p> <p>Download the correct Lexmark setup utility from the Lexmark Web site at www.lexmark.com to change the Toner Low alarm.</p>
The Error light is on (E238, E240, E240n).	Make sure the printer cover is closed.
The Toner Low light is blinking, and the Error light is on (E238, E240, E240n).	<ul style="list-style-type: none"> • Make sure the toner cartridge is installed correctly. • Install a new toner cartridge.
The media skews or buckles.	<ul style="list-style-type: none"> • Don't overfill Tray 1 or the optional Tray 2 (see media capacities in the media types and sizes table in the <i>User's Reference</i>). • Make sure the paper guides are flush against the edges of the media.

Print quality problems (continued)

Problem	Action
The paper sticks together, resulting in the printer feeding multiple sheets of paper.	<ul style="list-style-type: none"> • Remove the paper from Tray 1 or the optional Tray 2, and fan it. • Don't overfill Tray 1 or the optional Tray 2 (see media capacities in the media types and sizes chart in the <i>User's Reference</i>).
The paper fails to feed from Tray 1.	<ul style="list-style-type: none"> • Remove the paper from Tray 1, and fan the paper. • Make sure Tray 1 is selected from the printer driver. For E340/E342n, make sure the proper tray and paper type is selected from the printer. • Do not overfill the tray. • Check the condition of the rubber on the paper feed rolls. • Verify clutch for ACM is functioning correctly.
The paper fails to feed from the optional Tray 2.	<ul style="list-style-type: none"> • Make sure the correct tray and paper type are selected from the driver. For E340/E342n, make sure the correct tray and paper type is selected from the printer. • Make sure the tray is pushed all the way in. • Remove the paper from the optional Tray 2, and fan it. • Check the rubber on the paper feed tires. • Check the paper path in the tray for burrs or debris that may hinder paper movement. • Make sure the paper does not exceed the stack height indicator.
The Load Paper light is on even though there is paper loaded in the optional Tray 2.	<ul style="list-style-type: none"> • Make sure the tray is pushed all the way in. • Press  or Go.
The printer does not print after a paper jam has been cleared.	<ul style="list-style-type: none"> • Clear all jams. • Press and release  (E238, E240, E240n) or Go (E340, E342n), or open and close the printer cover to restart the printer. • Make sure the print cartridge assembly is installed properly.

Print quality problems (continued)

Problem	Action
Unexpected characters print or characters are missing.	<ul style="list-style-type: none"> • Ensure correct printer driver is being used. • Select hex trace mode to determine what the problem is. • Restore factory defaults. • Make sure the parallel cable or USB cable is firmly plugged in at the back of the printer.
Jobs are not printing, and the error light is on solid.	<ul style="list-style-type: none"> • Make sure the print cartridge assembly is installed properly. • Make sure the printer top cover is closed.
While in PostScript 3 emulation, the printer is flushing data (Ready/Data and Error lights are blinking).	<ul style="list-style-type: none"> • Ensure the correct PostScript driver is being used. • The printer doesn't have enough memory to print the job. Install more memory.
While using manual duplex, the printer gets a paper jam.	<p>A paper jam interrupts the duplex process. As a result, the information on the page that jammed is lost.</p> <ul style="list-style-type: none"> • Press and release  to cancel the print job (E238, E240, E240n) or press Menu and select Cancel (E340, E342n). • Press and hold  (approximately 3 seconds) to reset the printer. • Resend the print job.

Printhead service check

FRU	Action
 <p>Printhead</p>	<p>Unplug the printer.</p> <p>Disconnect the printhead cables from J13 and J14 on the controller card.</p> <p>Turn the printer on.</p> <p>On the controller card, verify +24 V dc on pin 5 at J13 and +5 V dc on pin 7 at J14.</p> <p>Verify grounds on pin 4 at J13 and on pins 2, 6, and 8 at J14.</p> <ul style="list-style-type: none"> • If voltages or grounds are incorrect, check the controller card. See “Controller card service check” on page 2-82 for more information. • If voltages are correct, replace the printhead (comes with cables).

Transfer roll service check

FRU	Action
 <p>Transfer roll</p>	<p>Check transfer roll area for debris, and clean area as necessary.</p> <p>Verify continuity between the spring below the left side bearing and the transfer roll shaft.</p> <p>Verify continuity in the spring and the cable connection on the LVPS/HVPS.</p> <p>Inspect the roll for signs of wear or damage and replace if necessary.</p>

4511-xxx







3. Diagnostic aids

Since the operator panels differ, you need to determine which model you are servicing, and begin in the section below:

- Model E240 and E240n—go to **“Accessing service menus” on page 3-2.**
- Model E340 and E342n—go to **“Accessing service menus” on page 3-14.**

Diagnostic aids—E238, E240, and E240n

Accessing service menus

Diagnostics mode	<ol style="list-style-type: none"> 1. Turn off the printer. 2. Open the front access cover. 3. Press and hold  while turning on the printer. 4. Close cover once the  light is displayed. 	<p>The diagnostic group contains menu settings and operations that are useful in the manufacturing of the printer. It also features other aids in diagnosing problems.</p> <p>See “Diagnostics mode printout sample” on page 3-4 or “Diagnostics mode selections” on page 3-11 for details on the available settings.</p>
Enter Configuration Menu	<ol style="list-style-type: none"> 1. Turn off the printer. 2. Open the front access cover. 3. Turn on the printer while pressing and holding  . 4. Close cover once the  light is displayed. 	<p>The configuration group contains a set of menus, configuration settings, and other operations.</p> <p>See “Configuration Menu printout sample” on page 3-3 or “Configuration menu selections” on page 3-6 for details on the available settings.</p>
Reset NVRAM and enter normal mode	<ol style="list-style-type: none"> 1. Turn off the printer. 2. Open the front cover. 3. Press and hold both  and  buttons pressed. 4. Close cover once the  light is displayed. 	

Printing menus

Print menus by pressing and holding  until the lights flash (see menu samples on **page 3-3** and **page 3-4**).

Configuration Menu printout sample

Printer Settings Configuration

This page explains how to access the printer menus and change values. Menus are represented by Continue, Ready/Data, Toner Low, and Load/Remove Paper Light sequences. Menu items and their values are indicated by Paper Jam and Error Light sequences.

Use the illustration to help you find the menu and value you want to change. The Paper Jam and Error Lights show the current value of the menu item.

- 1 Press and release Cancel to advance through the menus and menu items to the one you need.
- 2 Press and release Continue to advance to the value you need.
- 3 Press and hold Continue until all of the lights cycle to perform the function or to save the value.
- 4 Press and hold Cancel until all of the lights cycle to return to the Home menu.
- 5 Turn the printer off to exit the menus.

Menus, menu items, and values

	Press Continue	Ready/Data	Toner Low	Load Paper	Paper Jam	Error	
Print Configuration Mode Instructions	●	●	●	●	●	●	Utilities
Reset Factory Defaults	○	○	○	○	○	○	Setup
Hex Trace = Off	○	○	○	○	○	○	
Off	○	○	○	○	○	○	
On	○	○	○	○	○	○	
Print Quality Test Pages	○	○	○	○	○	○	
Reset Photoconductor Counter	○	○	○	○	○	○	
PPDS Emulation = Deactivate	○	○	○	○	○	○	
Deactivate	○	○	○	○	○	○	
Activate	○	○	○	○	○	○	
Demo Mode = Deactivate	○	○	○	○	○	○	
Deactivate	○	○	○	○	○	○	
Activate	○	○	○	○	○	○	
Auto CR after LF = Off	○	○	○	○	○	○	
Off	○	○	○	○	○	○	
On	○	○	○	○	○	○	
Auto LF after CR = Off	○	○	○	○	○	○	
Off	○	○	○	○	○	○	
On	○	○	○	○	○	○	
NPA Mode = Auto	○	○	○	○	○	○	Parallel
On	○	○	○	○	○	○	
Off	○	○	○	○	○	○	
Auto	○	○	○	○	○	○	
Protocol = Fastbytes	○	○	○	○	○	○	
Standard	○	○	○	○	○	○	
Fastbytes	○	○	○	○	○	○	
Parallel Mode 2 = On	○	○	○	○	○	○	
Off	○	○	○	○	○	○	
On	○	○	○	○	○	○	
MAC Binary PS = Auto	○	○	○	○	○	○	
On	○	○	○	○	○	○	
Off	○	○	○	○	○	○	
Auto	○	○	○	○	○	○	
NPA Mode = Auto	○	○	○	○	○	○	USB
On	○	○	○	○	○	○	
Off	○	○	○	○	○	○	
Auto	○	○	○	○	○	○	
MAC Binary PS = Auto	○	○	○	○	○	○	
On	○	○	○	○	○	○	
Off	○	○	○	○	○	○	
Auto	○	○	○	○	○	○	
NPA Mode = Auto	○	○	○	○	○	○	Network
Off	○	○	○	○	○	○	
Auto	○	○	○	○	○	○	
MAC Binary PS = Auto	○	○	○	○	○	○	
On	○	○	○	○	○	○	
Off	○	○	○	○	○	○	
Auto	○	○	○	○	○	○	
Set Card Speed = Auto	○	○	○	○	○	○	
Auto	○	○	○	○	○	○	
10 Mbps, Half Duplex	○	○	○	○	○	○	
10 Mbps, Full Duplex	○	○	○	○	○	○	
100 Mbps, Half Duplex	○	○	○	○	○	○	
100 Mbps, Full Duplex	○	○	○	○	○	○	

● Light On
○ Light Off
◐ Light Blinking
□ Value

Diagnostics mode printout sample

Printer Diagnostics

This page explains how to access the printer menus and change values. Menus are represented by Continue, Ready/Data, Toner Low, and Load/Remove Paper Light sequences. Menu items and their values are indicated by Paper Jam and Error Light sequences.

Use the illustration to help you find the menu and value you want to change. The Paper Jam and Error Lights show the current value of the menu item.



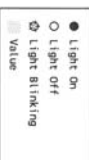

- 1 Press and release Cancel to advance through the menus and menu items to the one you need.
 - 2 Press and release Continue to advance to the value you need.
 - 3 Press and hold Continue until all of the lights cycle to perform the function or to save the value.
 - 4 Press and hold Cancel until all of the lights cycle to return to the Home menu.
 - 5 Turn the printer off to exit the menus.
- Menus, menu items, and values

	Development	Parallel	Network
Press Continue	●	●	●
Ready/Data	○	○	○
Toner Low	○	○	○
Load Paper	○	○	○
Paper Jam	○	○	○
Error	○	○	○
Print Diag Inst	○	○	○
Edge to Edge = Off	○	○	○
Off	○	○	○
On	○	○	○
Prt Quality Pgs	○	○	○
Cont Prt Simplex Tray 1	○	○	○
Print History	○	○	○
Defaults = U.S.	○	○	○
U.S.	○	○	○
Non-U.S.	○	○	○
Configuration ID = 000112	○	○	○
000112	○	○	○
00019A	○	○	○
Par S Strobe Adj = 0	○	○	○
-1	○	○	○
0	○	○	○
1	○	○	○
2	○	○	○
3	○	○	○
History	○	○	○
Mark History = Do Not Mark	○	○	○
Mark	○	○	○
Do Not Mark	○	○	○
History Mode = Modified	○	○	○
Modified	○	○	○
Every Time	○	○	○
Dump NVRAM	○	○	○
Reinit NVRAM	○	○	○
Optra Forms Mode = Off	○	○	○
On	○	○	○
Off	○	○	○
Meditech Mode = No	○	○	○
Yes	○	○	○
No	○	○	○





Moving around the menu

“Configuration Menu printout sample” on page 3-3 and **“Diagnostics mode printout sample” on page 3-4** are similar to the instructions printed by following steps 1–6 on **page 3-2**. These menu items are designated by the non-indented items listed along the left edge of the page (Bottom as printed from printer). These items are also un-shaded.

- Press and release  to move sequentially from one menu item to another.
- Press and hold  to jump to home state (top four lights on).
- Press and release  to move through the menu settings (indicated by  and  lights).

This action rotates only through the possible settings of the selected menu item.

Configuration menu selections

To enter Configuration menu, turn off the printer, open the front access cover, turn on the printer while pressing and holding , and close the cover once the  light displays.

Print menus by pressing and holding  until the lights flash.

Utilities

Use the Utilities menu to troubleshoot printer problems.

Setting	Use setting to	Values
Reset Factory Defaults	<p>Return the printer settings to factory default values.</p> <p>Sometimes resetting the printer to the original settings solves formatting problems.</p> <p>All menu items are reset to the factory default values except:</p> <ul style="list-style-type: none"> • Display Language. • All settings in the Parallel menu, Network menu, LocalTalk menu, and USB menu. • All downloaded resources (fonts, macros, and symbol sets) in printer memory (RAM) are deleted. <p>Resources in flash memory are unaffected.</p>	
Hex Trace	<p>Help isolate printing problems when unexpected characters print or characters are missing.</p> <p>Hex Trace helps determine if there is a problem with the language interpreter or the cable by providing information about what the printer is receiving.</p> <p>To exit Hex Trace, turn off the printer.</p>	<p>Off (default)</p> <p>On</p>

Setting	Use setting to	Values
Print Quality Test Pages	Help isolate print quality problems, such as streaking. Four pages print to help evaluate print quality: <ul style="list-style-type: none"> • A text page with printer information, cartridge information, current margin settings, and a graphic. • One page is gray with graphics, one is black, and one is blank. 	
Reset Photoconductor Counter	Return the photoconductor counter to zero. The replace photoconductor message should be cleared <i>only</i> when the photoconductor kit has been replaced.	

Setup

Use the Setup menu to configure how the printer formats the end of a line depending on the computer system being used.

Menu item	Use setting to	Values
Demo Mode	Put printer into demo mode where internal sheets print with each press of \diamond . To deactivate, turn the printer off, and re-enter configuration group. Set to deactivate.	Deactivate (default) Activate
Auto CR After LF	Specify whether the printer automatically performs a carriage return after a line feed control command.	Off (default) On
Auto LF after CR	Specify whether the printer automatically performs a line feed after a carriage return control command.	Off (default) On

Parallel

Use the Parallel menu to change printer settings on jobs sent through a parallel port.

Menu item	Use setting to	Values
NPA Mode	Send print jobs to the printer and query printer status information simultaneously.	Off On Auto (default)
Protocol	Receive information at a much higher transmission rate if your printer is set to Fastbytes (if your computer supports Fastbytes) or receive information at a normal transmission rate if your printer is set to Standard.	Standard Fastbytes (default)
Parallel Mode 2	Determine whether the parallel port data is sampled on the leading (On) or trailing (Off) edge of strobe.	Off On (default)
MAC Binary PS	Configure the printer to process Macintosh binary PostScript print jobs.	Off—The printer filters PostScript print jobs using Standard protocol. On—The printer processes raw binary PostScript print jobs from computers using the Macintosh operating system. This setting often causes Windows print jobs to fail. Auto (default)—The printer processes print jobs from computers using either Windows or Macintosh operating systems.

USB

Use the USB menu to change printer settings on jobs sent through a USB port.



Menu item	Use setting to	Values
NPA Mode	Send print jobs to the printer and query printer status information simultaneously.	Off On Auto (default)
MAC Binary PS	Configure the printer to process Macintosh binary PostScript print jobs.	Off—The printer filters PostScript print jobs using Standard protocol. On—The printer processes raw binary PostScript print jobs from computers using the Macintosh operating system. This setting often causes Windows print jobs to fail. Auto (default)—The printer processes print jobs from computers using either Windows or Macintosh operating systems.

Network

Use the network menu to change printer settings on jobs sent through a network port (either standard network or network opt <x>).



Menu item	Use setting to	Values
NPA Mode	Send print jobs to the printer and query printer status information simultaneously.	Off Auto (default)
MAC Binary PS	Configure the printer to process Macintosh binary PostScript print jobs.	Off—The printer filters PostScript print jobs using Standard protocol. On—The printer processes raw binary PostScript print jobs from computers using the Macintosh operating system. This setting often causes Windows print jobs to fail. Auto (default)—The printer processes print jobs from computers using either Windows or Macintosh operating systems.
Set Card Speed	Automatically detect the connection speed of your network. This setting can be disabled to set the speed manually.	Auto (default)—the printer detects current network speed. 10Mbps, half duplex—forces the printer to try to connect to the network only at 10Mbps, half duplex. 10Mbps, full duplex—forces the printer to try to connect to the network only at 10Mbps, full duplex. 100Mbps, half duplex—forces the printer to try to connect to the network only at 100Mbps, half duplex. 100Mbps, full duple—forces the printer to try to connect to the network only at 100Mbps, full duplex.

Diagnostics mode selections



To enter Diagnostics mode, turn off the printer, open the front access cover, press and hold  while turning on the printer, and close the cover when the  light displays.

Print menus by pressing and holding  until the lights flash.

Development

Menu item	Use setting to	Value
Edge to Edge	Allow a shift of all four margins (top, bottom, right, and left) to the physical edge of the page (printable area of supported paper). Setting is ignored by PPDS interpreter.	Off (default) On
Print quality pages	Print test pages by pressing and holding  until the lights flash. Help isolate print quality problems, such as streaking. Four pages print: <ul style="list-style-type: none"> • A text page with printer information, cartridge information, current margin settings, and a graphic. • Three pages all gray, all black, and the last one blank. Note: Cartridge lockout function is disabled.	
Continuous print—simplex Tray 1	Continuously print pages containing cross lines, printer information, and margin settings. Press and hold  until the lights flash to begin. Press  to stop.	



Development (continued)

Menu item	Use setting to	Value
Continuous print— simplex Tray 2	Continuously print pages containing cross lines, printer information, and margin settings. This menu item does not appear if Tray 2 is not installed. Press and hold  until the lights flash to begin. Press  to stop.	
Print History	Print history of errors. Press and hold  until the lights flash to print.	
Defaults	Change sizes and designations to metric.	U.S. (default) Non-U.S.
Configuration ID	Allow the printer ID to match the label ID after the controller card is replaced.	000101 (default) 000189

Parallel

Menu item	Use setting to	Value
Par S Strobe Adjustment	Adjust for an unusually long parallel cable. (Parallel mode 2 only is supported and can be turned off in the configuration group.)	Range from -1 to 3, 0 is default.

Network

Menu item	Use setting to	Value
History	Print history of errors. Press and hold  until the lights flash to print.	
Mark History	Append a tag to the history report to indicate the most recent crashes.	Mark Do not mark (default)
History Mode	Post the 976 error code to the user each time it occurs. The default (modified) internally resets the posting but records it in the crash history. A substantial number of consecutive errors result in posting 976.	Modified (default) Every time
Dump NVRAM	Print a hex dump if the network NVRAM partition. Press and hold  until the lights flash to initiate this action.	
Reinit NVRAM	Rest the network NVRAM to factory defaults. Press and hold  until the lights flash to initiate this action.	
Meditech Mode	Prevent the network card from accepting more than one 9100 mode connection at a time.	Yes No (default)

Diagnostic aids—E340 and E342n

Accessing service menus

There are different test menus that can be accessed during POR to identify problems with the printer.

Configuration Menu	<ol style="list-style-type: none"> 1. Turn off the printer. 2. Press and hold Select and Return. 3. Turn on the printer. 4. Release the buttons when Performing Self Test displays. 	<p>The Configuration Menu group contains a set of menus, settings, and operations which are infrequently required by a user. Generally, the options made available in this menu group are used to configure a printer for operation.</p> <p>See “Available menus” on page 3-15.</p>
Diagnostics Mode	<ol style="list-style-type: none"> 1. Turn off the printer. 2. Press and hold Go and Return. 3. Turn on the printer. 4. Release the buttons when Performing Self Test displays. 	<p>The Diagnostics Mode group contains the settings and operations used while manufacturing and servicing the printer.</p> <p>See “Available tests” on page 3-19.</p>

Printing menus

To print a listing of the menus:

1. At the Ready prompt, press **Menu** until Utilities appears.
2. Press **Select**.
3. Press **Menu** until Print Menus appears.
4. Press **Select**.

Configuration menu (CONFIG MENU)

Entering Configuration Menu

1. Turn off the printer.
2. Press and hold **Select** and **Return**.
3. Turn on the printer.
4. Release the buttons when Performing Self Test displays.

The message CONFIG MENU displays on the top line of the operator panel.

Available menus

Reset PC Cnt	See “Reset PC Cnt” on page 3-16.
Prt Quality Pgs	See “Print quality pages (Prt Quality Pgs)” on page 3-16.
Panel Menus	See “Panel Menus” on page 3-16.
PPDS Emulation	See “PPDS Emulation” on page 3-16.
Download Emuls	See “Download Emuls” on page 3-17.
Demo Mode	See “Demo Mode” on page 3-17.
Factory Defaults	See “Factory Defaults” on page 3-17.
Energy Conserve	See “Energy Conserve” on page 3-17.
ERROR LOG (print log only)	See “Error log” on page 3-18.
Paper Prompts	See “Paper Prompts” on page 3-18.
Env Prompts	See “Env Prompts” on page 3-18.
Exit Config Menu	

Some menus are not available, depending on the configuration of the printer.

Reset PC Cnt

When you install a new photoconductor, this number should be reset.

To reset the counter:

1. Select **Reset PC Cnt** from the CONFIG MENU.
2. Press **Select** to reset the counter to zero.

Note: Permanent page count is not affected by this operation.

Print quality pages (Prt Quality Pgs)

To print the Print Quality Pages:

1. Select **Prt Quality Pgs** from CONFIG MENU.
2. Press **Select**.

Four pages print. Additional button presses are ignored until the pages have printed. If duplex is selected, the pages print front and back.

The first page is a mix of graphics and text. The second two pages are graphics, and the last page is blank.

The Print Quality Pages can also be printed from the Diagnostics Mode.

Panel Menus

If no password is set, Panel Menus lets you restrict access to the Ready Menu Group. When a password is set by an administrator, this menu item does not appear.

1. Select **Panel Menus** from the Diagnostics Mode.
2. Select **Disable** to make menus in the Ready Menu Group inaccessible.

To change the setting, select **Panel Menus**, and select **Enable** to make the menus available.

PPDS Emulation

This menu lets you turn on PPDS emulation, if desired.

1. Select **PPDS Emulation** from CONFIG MENU.
2. Select **Activate** to enable PPDS emulation and **Deactivate** to turn it off.

Download Emuls

This menu item only displays if a downloaded emulator is installed.

To disable downloaded emulations:

1. Select **Download Emuls** from CONFIG MENU.
2. Select **Disable**.

The printer performs a POR and starts as if the downloaded emulations were not loaded.

To reactivate downloaded emulations, restart the printer.

Demo Mode

This menu item lets you turn demo mode on or off.

1. Select **Demo Mode** from CONFIG MENU.
2. Select **Activate** to turn the demo mode on or **Deactivate** to turn demo mode off.

Factory Defaults

This menu lets you restore the printer settings to their factory default values.

1. Select **Factory Defaults** from the Configuration Menu.
2. Select either **Restore Base** or **Restore Network**. Restore Network is only available if an integrated network adapter is installed.

Energy Conserve

Select **On** to allow access to the Power Saver menu. If you select **Off**, an additional item appears in the Power Saver menu. **Disable** lets you enable or disable Power Saver from the customer menu.

Error log

See **“Error log” on page 3-32** for a more detailed description. The error log printed from the Diagnostics Mode contains additional debug information for 9xx errors than the error log printed from the Configuration Menu. You can also view or clear the log from the Diagnostics Mode.

Print Log

Additional diagnostic information is available when you print the error log. This report can also be printed from the Diagnostics Mode. See **“Print Log” on page 3-33**. Also, the error log printed from the Diagnostics Mode contains additional debug information for 9xx errors than the error log printed from the Configuration Menu. Because you can clear error logs you can view, the contents of this log may not match the contents when you view the error log.

To print the error log:

1. Select **Print Log** from the Error Log menu.
2. Press **Return** to exit the Error Log menu.

Paper Prompts

Setting **Paper Prompts** controls which tray a change prompt is directed to when paper is sensed to be the wrong size. Selections include **Auto and Manual Paper**.

Env Prompts

Setting **Env Prompts** controls which tray a change prompt is directed to when envelopes are sensed to be the wrong size. Selections include **Auto and Manual Env**.

Exit Config Menu

Select **Exit Config Menu** to exit the Configuration Menu and return to normal mode.

Diagnostics mode

Available tests

The tests display on the operator panel in the order shown:

Diagnostics mode tests

REGISTRATION	See “Registration” on page 3-21.
Bottom Margin	
Top Margin	
Left Margin	
Right Margin	
Quick Test	See “Quick Test” on page 3-22.
PRINT TESTS	
Tray 1	See “Input source tests” on page 3-22.
Tray 2 (if installed)	
Manual Feeder	
Prt Quality Pgs	See “Print quality pages (Prt Quality Pgs)” on page 3-23.
HARDWARE TESTS	
LCD Test	See “LCD Test” on page 3-23.
Button Test	See “Button Test” on page 3-23.
DRAM Test	See “DRAM Test” on page 3-24.
Parallel Wrap	See “Parallel Wrap” on page 3-25.
INPUT TRAY TESTS	
Feed Tests	See “Feed Tests (input tray)” on page 3-26.
Sensor Test	See “Sensor Test (input tray)” on page 3-27.
BASE SENSOR TEST	
Front Door	
Toner	
Input	
Output	
Standard Bin	
DEVICE TESTS	
Flash Test (if installed)	See “Flash Test” on page 3-28.

Diagnostics mode tests (continued)

PRINTER SETUP	
Defaults	See “Defaults” on page 3-29.
Page Count	See “Page Count” on page 3-29.
Perm Page Count	See “Perm Page Count (permanent page count)” on page 3-29.
Serial Number	See “Serial Number” on page 3-30.
Engine Setting 1 through 4	See “Engine Setting 1 through 4” on page 3-30.
Model Name	See “Model Name” on page 3-30.
Configuration ID	See “Configuration ID” on page 3-30.
Edge to Edge	See “Edge to Edge” on page 3-30.
Par S Strobe Adj	See “Parallel strobe adjustment (Par S Strobe Adj)” on page 3-30.
EP SETUP	
EP Defaults	See “EP Defaults” on page 3-31.
Fuser Temp	See “Fuser Temperature (Fuser Temp)” on page 3-31.
Transfer	See “Transfer” on page 3-31.
Print Contrast	See “Print Contrast” on page 3-31.
Charge Roll	See “Charge Roll” on page 3-31.
Gap Adjust	See “Gap Adjust” on page 3-31.
ERROR LOG	
Display Log	See “Display Log” on page 3-32.
Print Log	See “Print Log” on page 3-33.
Clear Log	See “Clear Log” on page 3-33.
EXIT DIAGNOSTICS	

Registration

To set print registration:

1. Select **REGISTRATION** from the Diagnostics menu.
The Top margin sign/value pair *blinks*. This indicates it is the margin value being changed.

T=SXX*	B=SXX*
L=SXX*	R=SXX*

2. To select the margin value to be changed, press **Select** until the margin value pair you want to change is blinking.

The print registration range is:

Variable	Description	Value
s	sign	blank for positive values, "-" for negative values
B=	Bottom margin	-20 to +20—Each increment causes approximately 0.55 mm shift in the bottom margin.
T=	Top margin	-16 to +16
L=	Left margin	-25 to +25
R=	Right margin	-10 to +10

3. To change the margin value, press **Menu**. When the value you want displays, press **Select** to save the value.

To verify the margin values are correct, you must print the Quick Test page. Press **Go** to print the test page. While printing, *Quick Test Printing* displays. Once the Quick Test page completes printing, the registration screen displays again.

4. To exit, press **Return**.
5. To Test the setting by printing the Quick Test page for all the source, see "**Quick Test**" on page 3-22. Select all the available sources.

Print the Quick Test Page on letter or A4 paper.

Quick Test

The Quick Test contains the following information:

- Print registration settings
- Alignment diamonds at the top and bottom
- Horizontal lines to check for skew
- General printer information, including current page count, installed memory, serial number, and code level.

To print the Quick Test page:

Note: Print the Quick Test Page on letter or A4 paper.

1. Select **REGISTRATION** from **DIAGNOSTICS**.
2. Press **Go**.

Once the Quick Test Page completes printing, the Registration screen displays again.

Print tests

Input source tests

Input source print tests can verify that the printer can print on media from the installed input sources. Only installed sources appear in the menu.

To run the input source test:

1. Select **PRINT TESTS** from Diagnostics Mode.
2. Select the input source from the sources displayed on the **Feed Test** menu. All installed sources are listed.

Menu selections	Description
Tray 1	Standard tray
Tray 2*	Optional tray
* If installed	

3. Select either **Single** (feeds one sheet of blank media from the selected source) or **Continuous** (continues feeding blank media from the selected source until **Return** or **Stop** is pressed).

Press **Return** or **Stop** to exit the test.

Print quality pages (Prt Quality Pgs)

To print the Print Quality pages:

1. Select **PRINT TESTS** from Diagnostics Mode.
2. Select **Prt Quality Pgs**.
3. Press **Select**.

Four pages print. Additional button presses are ignored until the pages have printed.

The first page is a mix of graphics and text. The second two pages are graphics, and the last page is blank.

The Print Quality pages can also be printed from the Configuration Menu.

Hardware tests

Select the following selections from **HARDWARE TESTS**:

- LCD Panel
- Buttons
- Op Panel
- DRAM
- Parallel Port

LCD Test

This test continuously executes a pattern.

1. Select **LCD Test** from Diagnostics Mode. The test continually executes.
2. Press **Return** or **Stop** to cancel the test.

Button Test

1. Select **Button Test** from Diagnostics Mode.

With no buttons pressed, several occurrences of **OP** (Open) appear on the display.

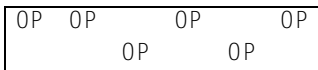

2. To test the proper operation of each button, press each button on the operator panel one at a time, and a **CL** (Closed) displays in place of an **OP**.
3. Press **Return** or **Stop** to cancel the test.

DRAM Test

The purpose of this test is to check the validity of DRAM, both standard and optional. The test writes patterns of data to SDRAM to verify that each bit in memory can be set and read correctly.

To run the SDRAM Memory Test:

1. Select **DRAM Test** from the menu. The power indicator *blinks* indicating the test is in progress.

DRAM Test	xxxMb
P:#####	F:#####

xxxMB represents the amount of installed DRAM memory in MB.

P:##### represents the number of times the memory test has passed and finished successfully. Initially 000000 displays with the maximum pass count being 999,999.

F:##### represents the number of times the memory test has failed and finished with errors. Initially 00000 displays with the maximum fail count being 99,999.

2. Once the maximum pass count or fail count is reached, the test stops, the power indicator is turned on solid, and the final results display. If the test fails, the message **DRAM Error** displays for approximately three seconds and the failure count increases by 1.

Turn the power off if you want to stop the test before it completes.

Parallel Wrap

This test is used with a wrap plug to check operation of the parallel port hardware. Each parallel signal is tested.

To run the Parallel Wrap Test:

1. Disconnect the parallel interface cable, and install the wrap plug (P/N 1319128).
2. Select HARDWARE TESTS from Diagnostics Mode.
3. Select **Parallel Wrap**.
4. Select **Parallel Wrap**, **Parallel 1 Wrap**, **Parallel 2 Wrap**, or **Parallel 3 Wrap**.

The power indicator *blinks*, indicating the test is in progress. The test runs continuously until canceled.

Parallel Wrap P: ##### F: #####

P: ##### represents the number of times the memory test has passed and finished successfully. Initially 000000 displays with the maximum pass count being 999,999.

F: ##### represents the number of times the memory test has failed and finished with errors. Initially 00000 displays with the maximum fail count being 99,999.

5. Each time the test finishes, the screen updates. If the test passes, the pass count increases by 1, however if the test fails, a message displays for approximately three seconds. One of the following failure messages may display:

```

Sync Busy Error
Byte Interrupt Request Error
Strobe Interrupt Request Error
Init Fail Error
Init Busy Error
Host Busy Error
RAM Data FF Error
RAM Data AA Error
RAM Data 00 Error
RAM Data 55 Error
DMA Count Error
DMA Address Error
DMA Interrupt Error
DMA Memory Error
  
```

DMA Background Error
Clear Init Rise Error
False Init Rise Error
False Init Fail Error
Autofeed Rising Interrupt Error
Clear Autofeed Rise Error
False Autofeed Rise Error
Autofeed Failing Interrupt Error
Clear Autofeed Fail Error

6. Once the maximum count is reached, the test stops. The power indicator goes on solid, and the final results display.

Press **Return** or **Stop** to exit the test.

Input tray tests

Feed Tests (input tray)

These tests are used to determine if the input tray sensors are working correctly. Observe the paper path as blank media is being fed through the printer. The front access door cannot be opened during the feed test. To observe the paper path, open the door cover to access the manual feeder. Any media that meets the specifications for the printer can be used for this test.

To run the Input Tray Feed Test:

1. Open the manual feeder door.
Note: Do not open the front cover.
2. Select the **Feed Test** from the INPUT TRAY TESTS menu.
3. Select the input source. Only installed sources display, but may include **Tray 1**, **Tray 2**, and **Manual Feeder**.
4. Select **Single** to feed a single blank sheet or **Continuous** to feed blank sheets until you press **Return** or **Stop**.

The selected input source appears on the display:

```
<input source>  
Feeding...
```

Sensor Test (input tray)

This test is used to determine if the input tray sensors are working correctly.

1. Select the **Sensor Test** from the Input Tray Test menu.
2. Select the input source. Only installed sources display, but may include **Tray 1**, **Tray 2**, and **Manual Feeder**.

```
<input source>
Testing...
```

3. A list of sensors appears, depending upon the input source selected. For example, if tray 2 were selected:

```
Tray 2
TP=OP          P=OP
```

TP refers to tray present sensor.

P refers to pass thru sensor.

OP indicates the sensor is open.

CL indicates the sensor is closed.

Not all sources have the same set of sensors. The table below indicates which sources should display which sensors.

Source	Tray present (TP)	Pass thru sensor (P)
Tray 1	No	No
Tray 2	No	No*
Manual feeder	Yes	No
* Only available if tray is a 550-sheet drawer.		

4. Press **Return** or **Stop** to exit the test.

Base sensor test

Base sensor test is used to determine if the sensors inside the printer are working correctly.

To run the Base Sensor Test:

1. Select **BASE SENSOR TEST** from the Diagnostics Mode.
2. Select the sensor to test. The following sensors may be tested:

Input (input sensor)

Output (exit sensor)

Front Door (front access door sensor)

The selected sensor is displayed with **OP** for open or **CL** for closed. You can actuate the sensors to toggle between open and closed.

Device tests

This menu is only displayed if flash memory is installed.

Flash Test

This test causes the file system to write and read data on the flash to test the flash.

Warning: This test destroys all data on the flash. The flash will be unformatted at the end of the test. **Format Flash** is available from the Utilities menu.

To run the Flash Test:

1. Select **Flash Test** from the DEVICE TESTS menu.
The power indicator *blinks* while the test is running.

Files will be Lost. Go/Stop?
--

2. Select **Go** to continue. Select **Stop** or **Return** to exit.

Flash Test Testing...

The results are displayed, and the power indicator turns on solid:

Flash Test Test Passed

Flash Test Test Failed

3. Press **Go**, **Return**, or **Stop** to return to the DEVICE TESTS menu.

Printer setup

Defaults

Selections are **U.S.** or **Non-U.S.** This selection affects the following defaults:

Printer setting	U.S. value	Non-U.S. value
Default paper size*	Letter	A4
Envelope size*	10 Envelope	DL Envelope
Fax paper size	Letter	A4
PCL Symbol Set	PC-8	PC-850
PPDS code page	437	850
Units of measure	Inches	Millimeters
* Where input sources do not have size sensing capabilities.		

Warning: Changing this setting resets the printer to factory defaults and data may be lost. It cannot be undone.

Page Count

Reset the page count when an engine card is replaced.

To reset the page count:

1. Select **Page Count** from the PRINTER SETUP menu.

Page Count =1234567*

2. The leftmost number *blinks*. Use **Menu** to increase or decrease the number, and press **Select** to move to the next digit to the right. Continue until the correct number displays. To skip a number without changing it, press **Select**.

When **Select** is pressed after the last digit, the number is saved.

Perm Page Count (permanent page count)

The permanent page count can only be viewed and cannot be changed.

To view the permanent page count:

1. Select **Perm Page Count** from PRINTER SETUP.
2. Press **Return** to return to PRINTER SETUP.

Serial Number

The serial number can only be viewed and cannot be changed.

To view the serial number:

1. Select **Serial number** from PRINTER SETUP.
2. Press **Return** to return to PRINTER SETUP.

Engine Setting 1 through 4

Warning: Do not change these settings unless requested to do so by your next level of support.

Model Name

The serial number can only be viewed and cannot be changed.

Configuration ID

The configuration ID is used to communicate characteristics of certain areas of the printer that cannot be determined by hardware sensors. The configuration ID was originally set when the printer was manufactured and is located on the printer label.

Edge to Edge

When Edge to Edge is set to **On**, text and graphics are printed with all margins set to the physical edges of the page. This feature does not work in PPDS emulation.

Parallel strobe adjustment (Par S Strobe Adj)

This setting adjusts the factory setting for the amount of time the strobe is sampled to determine that valid data is available on the parallel port. Incrementing this value by one means the strobe is sampled 50 nanoseconds longer. The range of values are between -4 and +6, in increments of one. A value of zero indicates no change is made from the factory setting.

EP setup

EP Defaults

Restores all EP settings to factory default values. Selections are **Restore** and **Do Not Restore**.

Fuser Temperature (Fuser Temp)

Changing this setting can reduce paper curl or melting of some letterhead images. Selections are **Normal** (default), **Lower**, and **Lowest**.

Transfer

The transfer can be adjusted to **Low**, **Medium**, or **High**. The default setting is Medium.

Print Contrast

The print contrast can be adjusted to **Low**, **Medium**, or **High**. The default setting is Medium.

Charge Roll

The charge roll can be adjusted to **Low**, **Medium**, or **High**. The default setting is Medium.

Gap Adjust

Adjusts the minimum gap between sheets during printing. This setting reduces speed (pages per minute), but can be used to reduce curl of printed media and improve stacking in the output bin.

Range is 0 (default) to 255. Adjusting by one results in 9 mm of increased gap.

Error log

Display Log

Selecting ERROR LOG provides a history of printer errors. It contains the 12 most recent errors that have occurred on the printer. The most recent error displays in position 1 and the oldest error displays in position 12 (if 12 errors have occurred). If an error occurs after the log is full, the oldest error is discarded. Identical errors in consecutive positions in the log are entered. All 2xx and 9xx error messages are stored in the error log.

To view the error log:

1. Select **Display Log** from the Error Log menu.

The error log is displayed on three screens, but only four entries are shown at a time. To move to the next screen, press **Menu**. For example:

1-200	2-920
3-928	4-922

5-250	6-990
7-230	8-230

9-953	10-000
11-000	12-000

In this example, the last error was a 200 error. In positions 10, 11, and 12, no codes were recorded.

2. Press **Return** to exit the error log.

Print Log

Additional diagnostic information is available when you print the error log. Some of the additional information includes:

- Detailed printer information, including model and serial number
- Time and date stamps
- Page counts for each error

The printed error log can be faxed to Lexmark or your next level of support for verification or diagnosis. This report can also be printed from the Configuration Menu. Because you can clear error logs, the contents of this log may not match the contents when you view the error log.

To print the error log:

1. Select **Print Log** from the Error Log menu.
2. Press **Return** to exit the Error Log menu.

Clear Log

1. Select **Clear Log** from the Error Log menu.

Clear Log =Yes

2. Press **Yes** to confirm. Select **No** to exit without clearing the log.

1-000	2-000
3-000	4-000

3. Press **Return** to exit the Clear Log menu after clearing the log.

Exit Diagnostics mode

Selecting EXIT DIAGNOSTICS exits the Diagnostics mode, and Resetting the Printer displays. The printer performs a POR, and the printer returns to normal mode.

4511-xxx

4. Repair information

Warning: Read the following before handling electronic parts.

Handling ESD-sensitive parts

Many electronic products use parts that are known to be sensitive to electrostatic discharge (ESD). To prevent damage to ESD-sensitive parts, follow the instructions below in addition to all the usual precautions, such as turning off power before removing logic cards:

- Keep the ESD-sensitive part in its original shipping container (a special “ESD bag”) until you are ready to install the part into the printer.
- Make the least-possible movements with your body to prevent an increase of static electricity from clothing fibers, carpets, and furniture.
- Put the ESD wrist strap on your wrist. Connect the wrist band to the system ground point. This discharges any static electricity in your body to the printer.
- Hold the ESD-sensitive part by its edge connector shroud (cover); do not touch its pins. If you are removing a pluggable module, use the correct tool.
- Do not place the ESD-sensitive part on the MFP cover or on a metal table; if you need to put down the ESD-sensitive part for any reason, first put it into its special bag.
- Machine covers and metal tables are electrical grounds. They increase the risk of damage because they make a discharge path from your body through the ESD-sensitive part. (Large metal objects can be discharge paths without being grounded.)
- Prevent ESD-sensitive parts from being accidentally touched by other personnel. Install machine covers when you are not working on the machine, and do not put unprotected ESD-sensitive parts on a table.
- If possible, keep all ESD-sensitive parts in a grounded metal cabinet (case).
- Be extra careful in working with ESD-sensitive parts when cold-weather heating is used because low humidity increases static electricity.

Removal procedures

Note:

1. Remove the toner cartridge and paper tray before removing other printer parts. The toner cartridge should be protected from light while out of the printer.
2. We recommend disconnecting all external cables from the printer to prevent damage during service.
3. Unless otherwise stated, reinstall the parts in reverse order of removal.
4. When reinstalling a part held with several screws, start all screws before final tightening.

Covers

Extender cover removal

1. Locate the latches on the left and right sides of the extender cover.
2. Push the latches, and pull the cover away from the rear of the printer.

Front access cover removal (E238, E240, and E240n)

1. Open the front access cover.
2. Place thumbs on the inside of the respective hinge.



3. Force the left hinge out of its socket, and relax it above the socket.
4. Force the right hinge out of its socket, and lift it above the socket.

Warning: Do not pull the fuser link out of the printer any farther than when the door is fully open. Otherwise, the link extension may dislodge the cartridge coupler.



5. Carefully lift the cover free from the printer frame.

6. Use your left hand to hold the fuser link at the cover joint while rotating the right side of the cover slightly away from the printer to disengage the link.



7. Remove the front access cover.

Reinstallation note: If the front access cover is being replaced, remove the logo plate, and install it on the new cover. See **“Front access cover logo removal (E238, E240, and E240n)”** on page 4-27.

Front access cover removal (E340 and E342n)

1. Open the front access cover.
2. Remove the screw (A) securing the LCD cable cover.
3. Remove the left and right screws (B) that hold the LCD bezel.

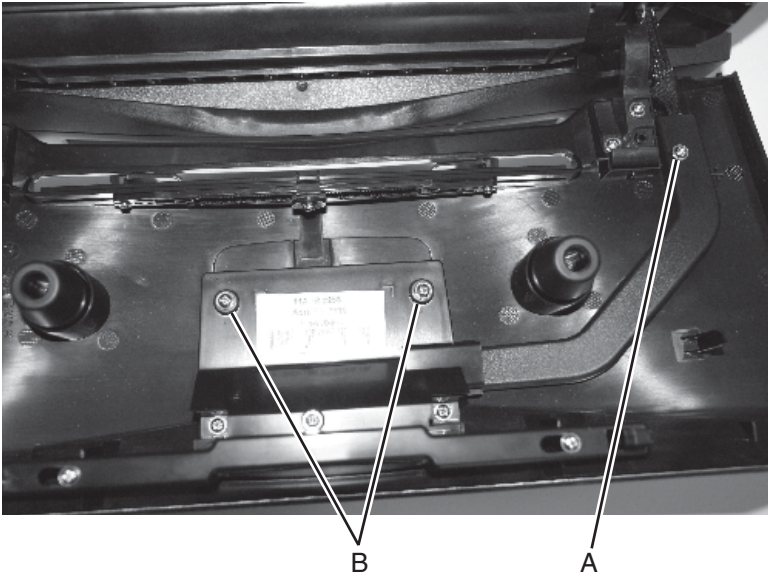

4. Close the front access cover.

4511-xxx

5. Place a piece of tape (C) across the LCD lens and the bezel.
Use about three inches and fold one end under to form a tab to allow easy removal after reinstallation.
6. Using fingernails, pull the top of the bezel away from the front access cover. Carefully work the bezel away from the buttons and front access cover.

Push down on the top edge of the bezel to deflect it away from the buttons.

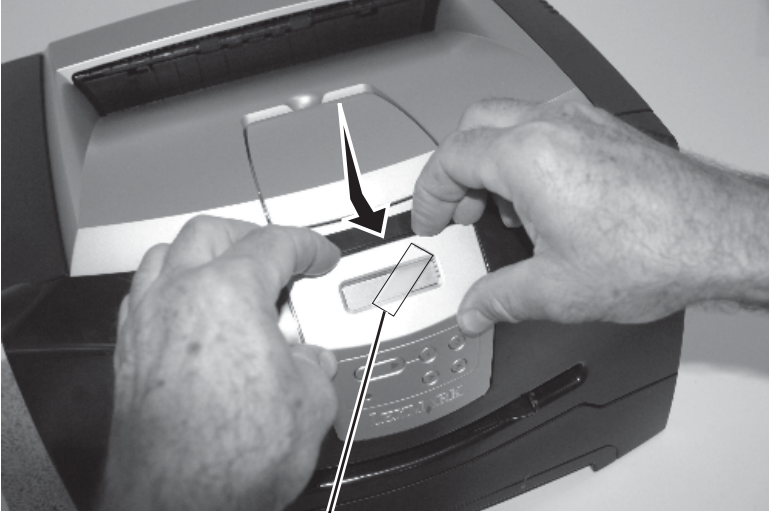

C

7. Remove the screws (D) holding the button card assembly to the front access cover.
8. Unlatch the LCD display (right and left sides).

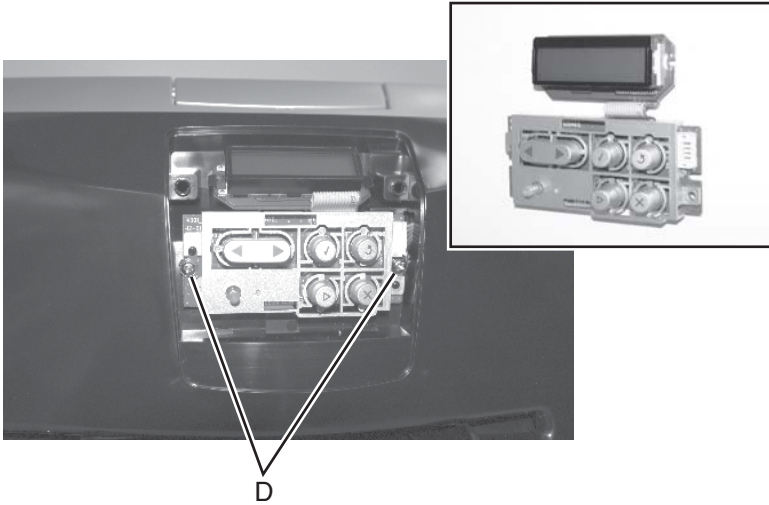

9. Carefully pull the LCD assembly away from the front access cover.
10. Disconnect the LCD panel and controller card.
11. Open the front access cover, and position the cable outside the cover.
12. Place thumbs on the inside of the respective hinge.

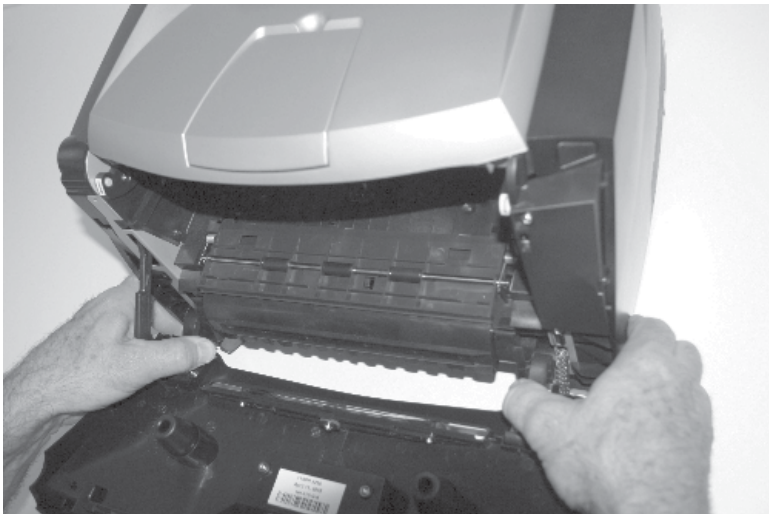

13. Force the left hinge out of its socket, and relax it above the socket.
14. Force the right hinge out of its socket, and lift it above the socket.

Warning: Do not pull the fuser link out of the printer any farther than when the door is fully open. Otherwise, extending the link may dislodge the cartridge coupler.

15. Carefully lift the cover free from the printer frame.
16. Use your left hand to hold the fuser link at the cover joint while rotating the right side of the cover slightly away from the printer to disengage the link.

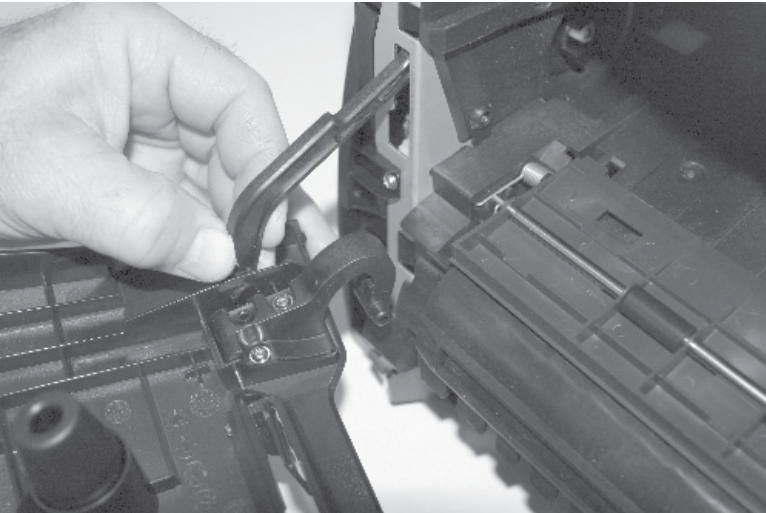

17. Remove the front access cover.

Left side cover removal

1. Open the rear door (output tray).
2. Open the front access cover.
3. Remove the screw (A).
4. Press the two latches (B) to release the left side cover.

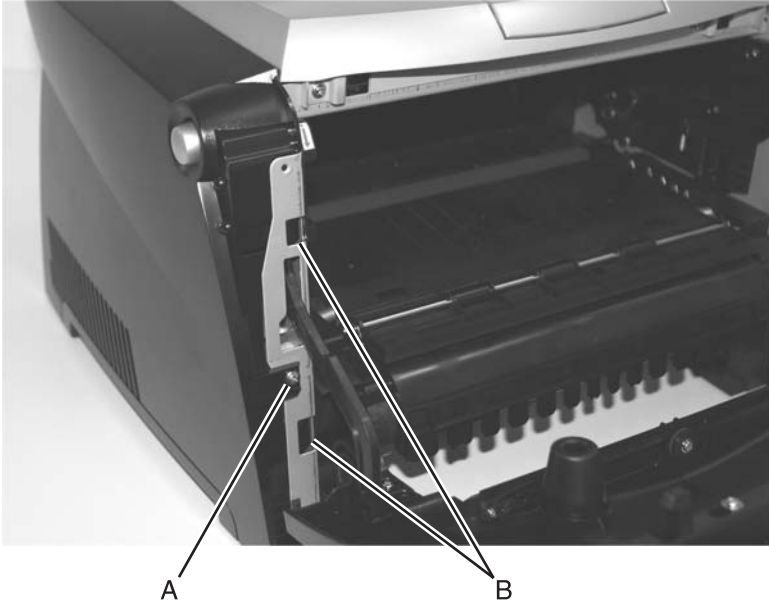

5. Swing the cover open.

6. To remove the cover, position the printer with the left rear corner hanging over the edge of the table.
7. Lift the top rear of the cover over the pivot point, and drop the cover away from the printer.



Rear cover removal

1. Remove the right side cover. See **“Right side cover removal” on page 4-12** for more information.
2. Remove the left side cover. See **“Left side cover removal” on page 4-9** for more information.

3. Remove the two screws (A) holding the cover.

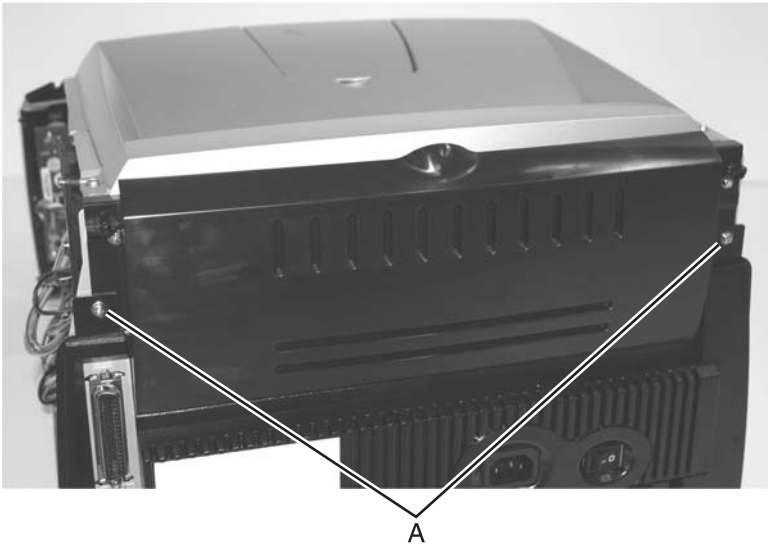

4. Open the rear door (rear exit tray).
5. Lift the rear cover, unhooking it from the frame at the bottom and remove.

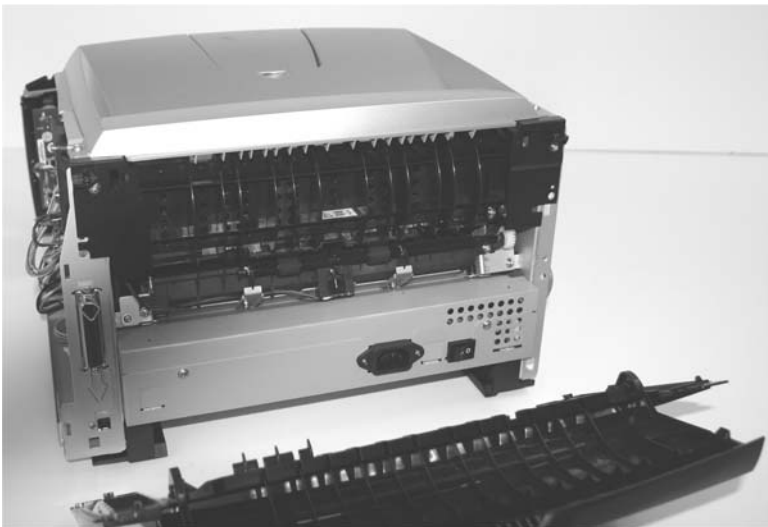

Right side cover removal

1. Open the front access cover.
2. Open the rear door (output tray).
3. Release the latches (A) while applying opening force with the right hand.
4. Swing the cover open.



5. To remove the cover, position the printer with the right rear corner hanging over the edge of the table.
6. Lift the top rear of the cover over the pivot point, and drop the cover away from the printer.



Top cover removal

1. Open the front access cover.
2. Open the left cover.
3. Open the right cover.
4. Open the rear door.
5. Remove two screws (A) at the top rear corners of the top cover.
6. Remove two screws (B) at the front of the top cover just behind the access door.
7. Release the top cover latch (C) which holds the top cover to the metal side frame.

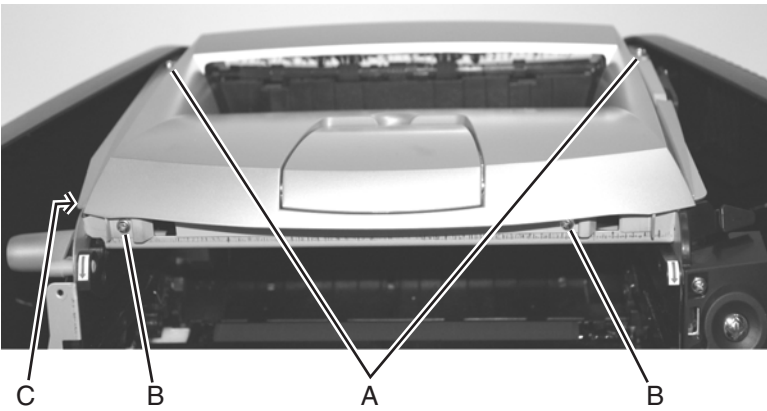

8. Lift and remove the top cover.

Controller card removal

Warning:

- Always touch a ground before touching the card.
- Handle the card carefully by the edges.

1. Remove the right side cover. **“Right side cover removal” on page 4-12.**
2. Remove the screw (A) securing the metal controller card cover.

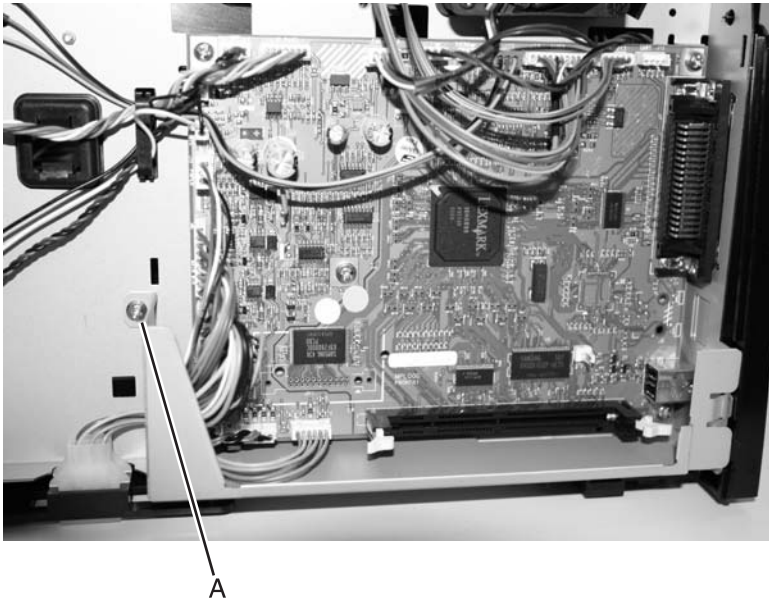

3. Disconnect all the cables from the controller card.

4. Remove two screws (B) securing the parallel port and the screw (C) securing the USB port to the frame at the back of the printer.

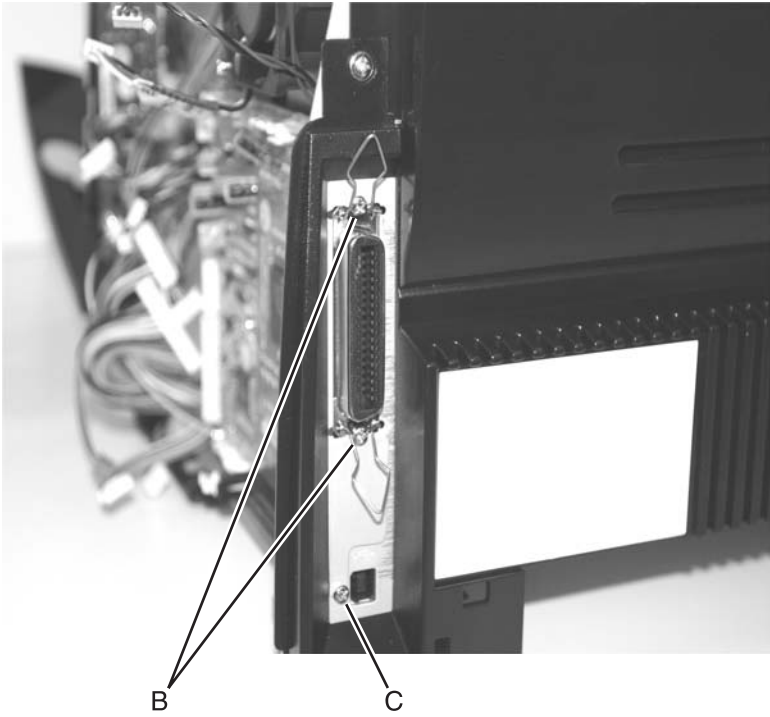

5. Remove five screws (D) holding the card to the metal side frame.

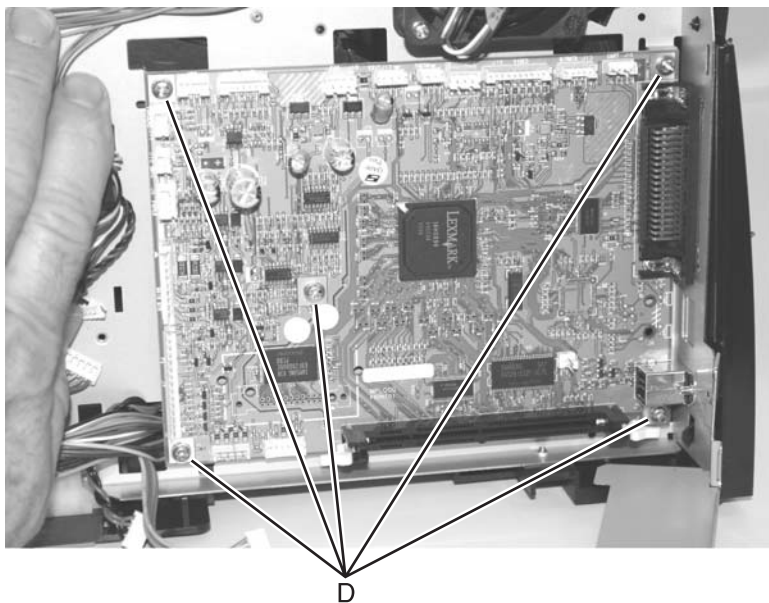

6. Carefully lift the card, and remove.

Cover open sensor removal

1. Open the right side cover.
2. Disconnect the cover open switch at J15 on the controller card, and extract the cable.
3. For E340 and E342n models, remove the two screws (A) securing the inner cover to gain access to the sensor.

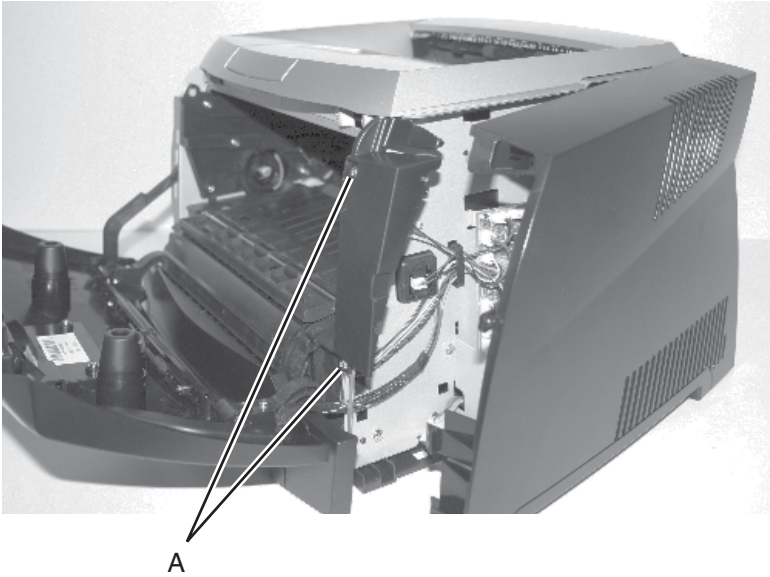

4. Use a smaller Phillips screwdriver to remove the screw (B) holding the sensor.

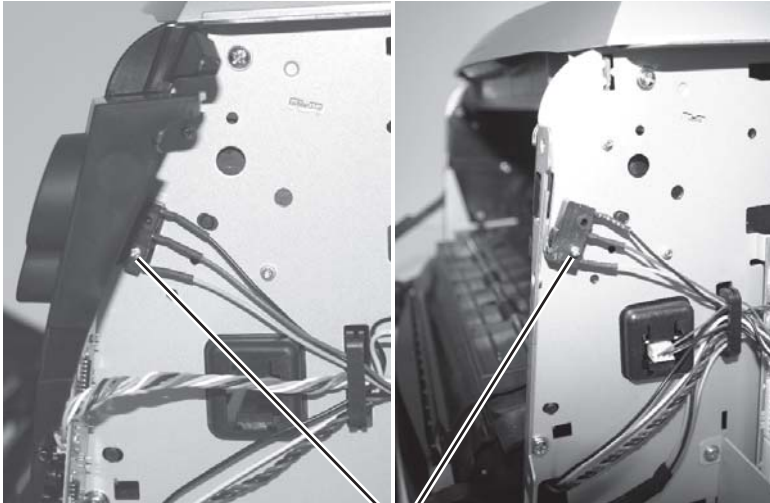

B

5. Slide the sensor from the positioning post.

Installation note: Be sure to reroute the cable through the cable clip.

Developer drive coupling assembly removal

1. Remove the left side cover. See **“Left side cover removal”** on page 4-9.
2. Carefully place the printer on its right side.
Use a clean cloth to protect the cover from marring.
3. Remove four screws (A) in the gear train metal cover.

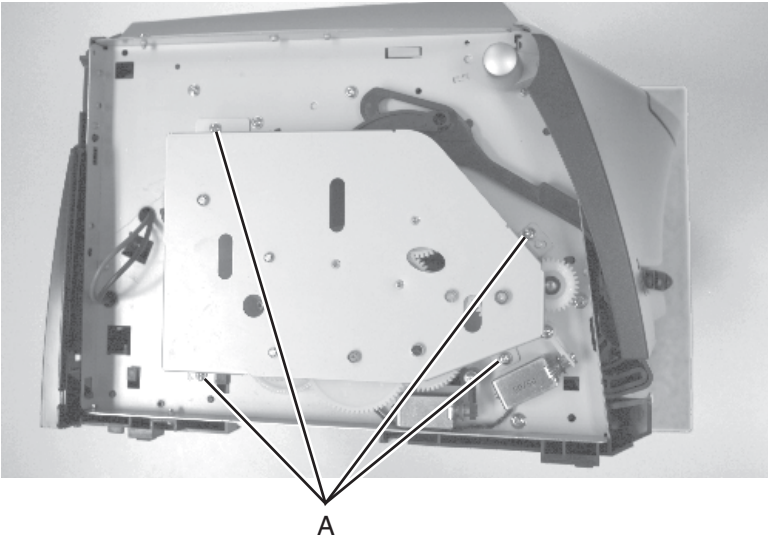

4. Lift the metal cover from the printer.
5. Remove the developer drive coupler (B) and the conical spring (C).

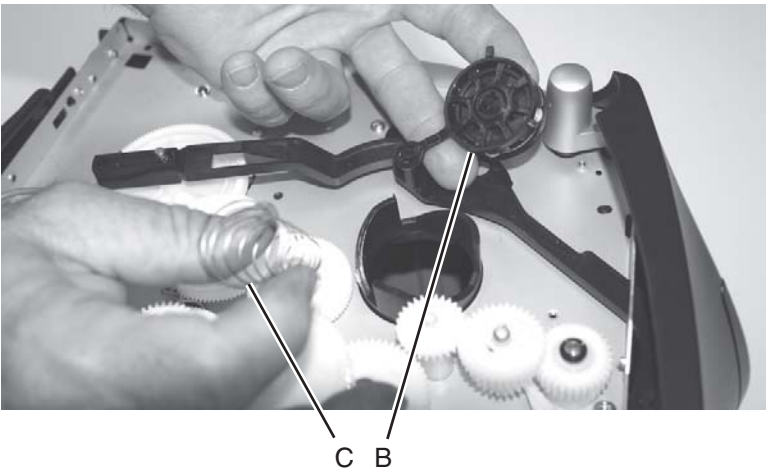

Door latch assembly removal

1. Open the front access cover.
2. Open the left side cover.
3. Locate the opening on the inside of the button.

The opening is partially covered by the front left edge of the printhead metal frame.

4. Use a small shank Phillips screwdriver to remove the screw.



5. Restrain the spring as the latch is removed.

Exit sensor removal (on the fuser)

1. Remove the paper exit guide assembly. See **“Paper exit guide assembly removal”** on page 4-46 for more information.
2. Unplug the exit sensor at J17 on the controller card.
3. Push the shaft (A) to the right using your right thumb against the inside gear surface and your left index finger against the opposite end of the shaft.

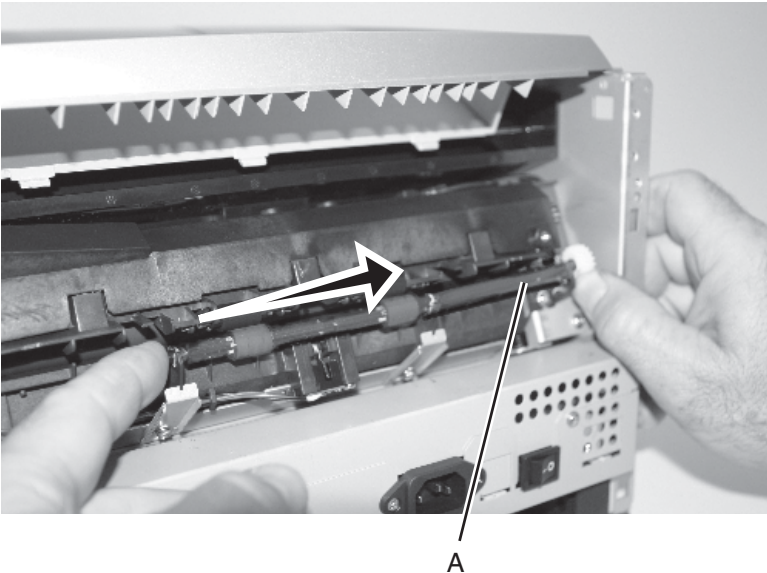

Warning: There will be some lubricant on the gear and shaft. Be sure to wipe hands clean with each contact to prevent spreading lubricant to other areas.

4. Align the flat portion on the right end of the shaft with the opening of the bearing support, and lift the right end of the shaft through the support.
5. Swing the shaft away from the printer to expose the sensor flag.

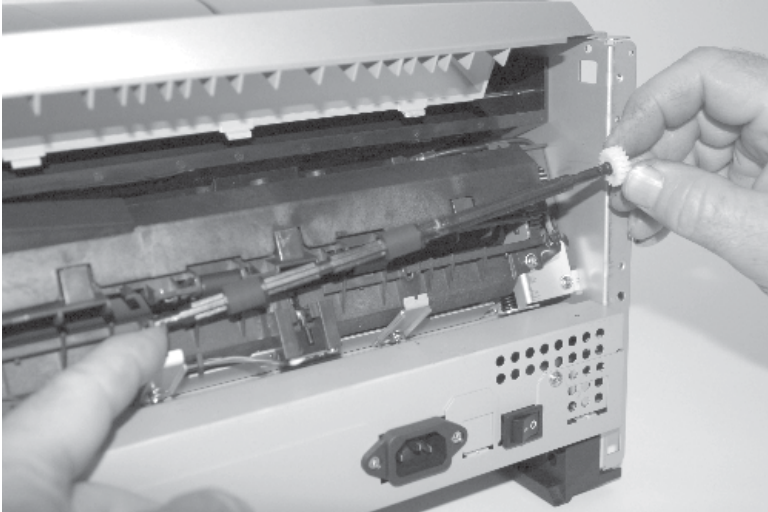

6. Remove the two screws (B) securing the fuser.

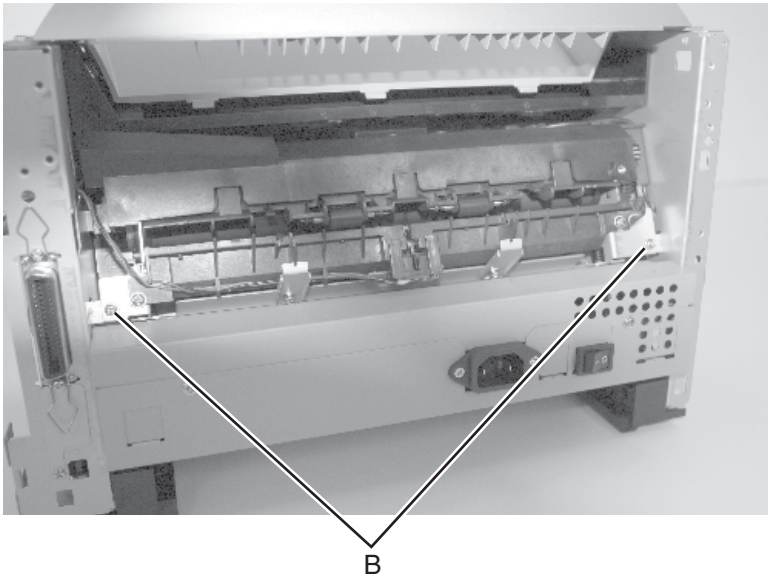

7. Slide the fuser out just enough to access the screw holding the sensor.
8. *Unsnap* the sensor from the bracket.



9. Observe the orientation of the flag (C) and spring (D) before replacing units.

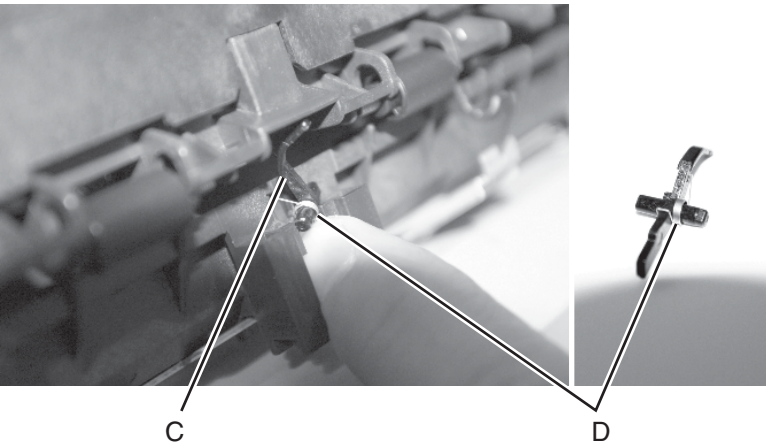

10. Remove the sensor and its attached cable.

11. Loosen the screw (E) that secures the bracket to remove the cable.

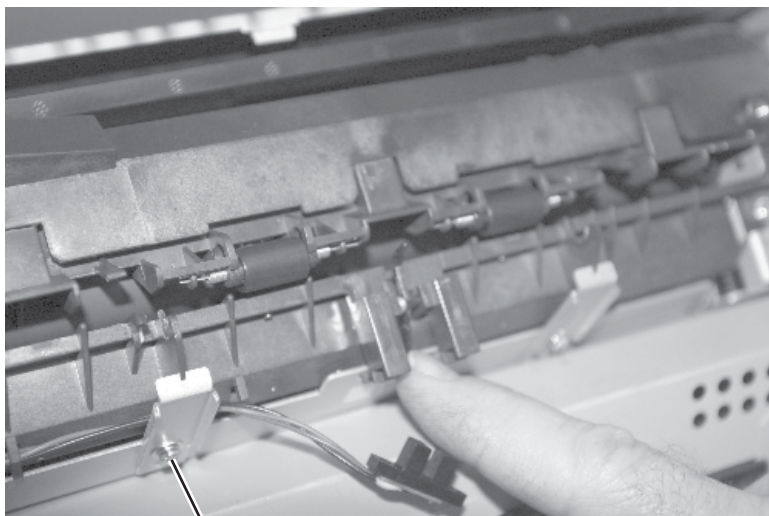

E

Fan removal

1. Open the right side cover.
2. Unplug the fan from the controller card at J18.
3. Remove two screws (A) holding the fan to the metal side frame.

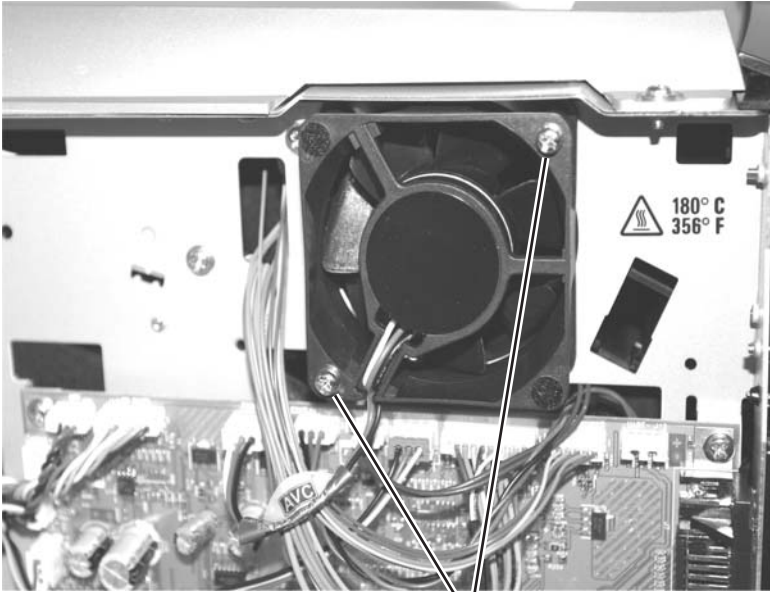

A

Front access cover logo removal (E238, E240, and E240n)

1. Open the front access cover.
2. Remove the screw (A) holding the logo cover in place.

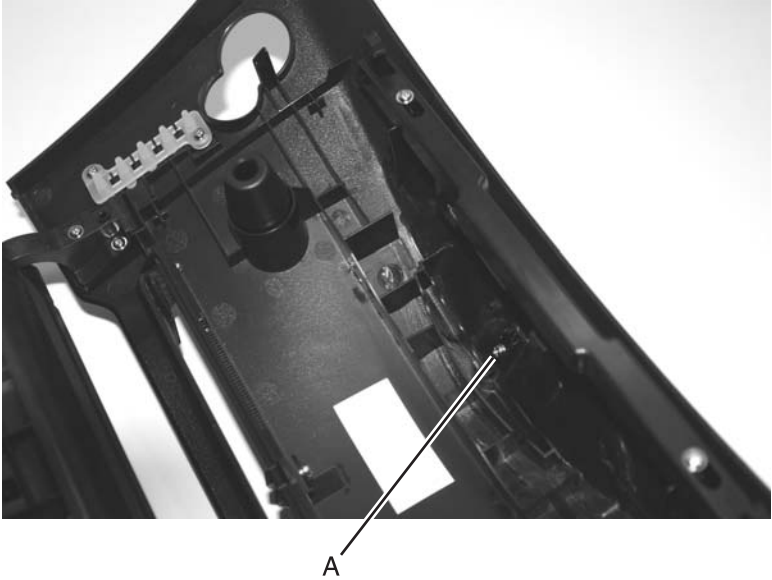

3. Remove the logo cover from the front access cover.

Fuser removal



1. Remove the paper exit guide assembly. See **“Paper exit guide assembly removal”** on page 4-46 for more information.

2. Remove the two screws (A) securing the fuser.

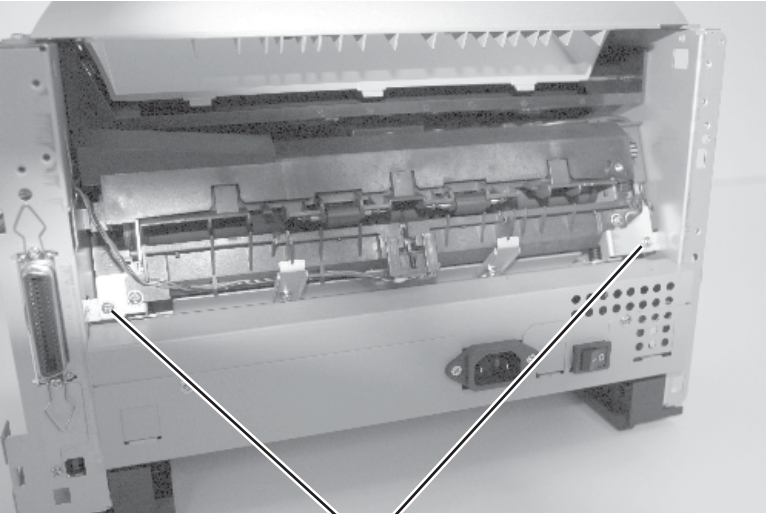

A

3. Disconnect the thermistor at J16 and exit sensor at J17 on the controller card.

4. Slide the fuser out far enough to access the power cables on the right side.
5. To disconnect the fuser power cables, slide the insulation (B) back to expose the connectors. Press the tang (C) on the connector to disconnect the cable connector.

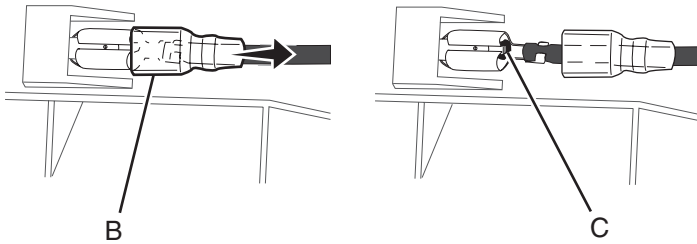

6. Slide the fuser out while carefully directing the thermistor and exit sensor cables through the frame openings.

Note: Be sure to slide the insulation back in place after reconnecting the cables.

Fuser idle gear links removal

1. Remove the front access cover. For models E238, E240, and E240n, see **“Front access cover removal (E238, E240, and E240n)” on page 4-2.**

For models E340 and E342n, first perform steps 1 and 2 of **“Front access cover removal (E340 and E342n)” on page 4-5.** Gently pull enough slack in the cable to remove the cover without disconnecting the cable, then follow the instructions for E238, E240, and E240n models.

2. Remove the left side cover. See **“Left side cover removal” on page 4-9.**
3. Place printer on its right side. Protect the cover from being marred.
4. Remove the screws (A) securing the metal plate covering the gear train.

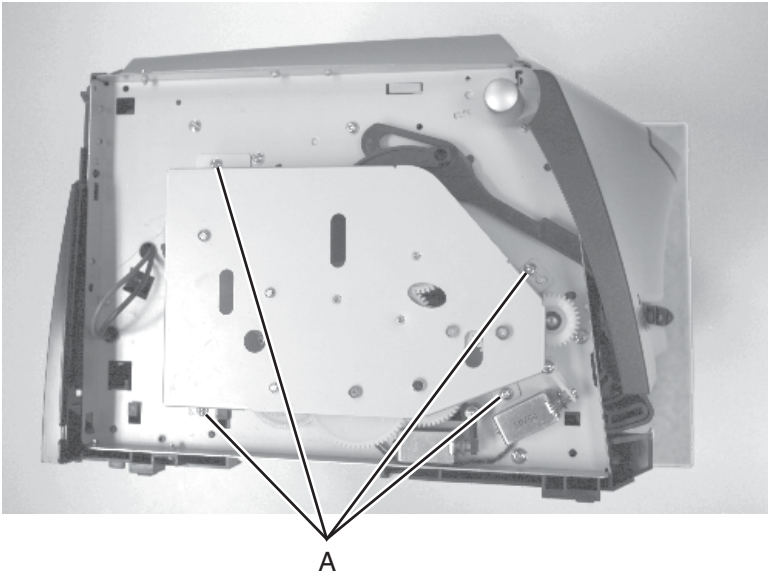

5. Remove the metal cover and *unsnap* the link (A) from the shaft.
6. Disconnect the coupler from the front link, and remove the links.

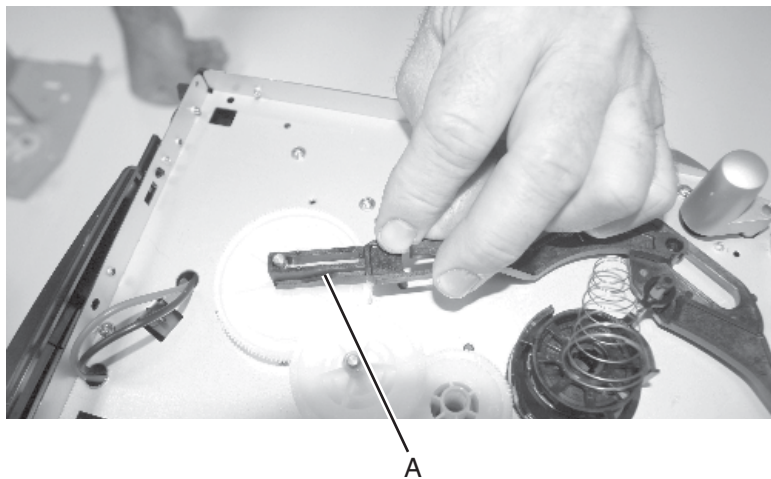

Fuser power cable removal



1. Remove the LVPS/HVPS card. See **“LVPS/HVPS card assembly removal” on page 4-41** for more information.

Note: The cable can be reached and disconnected without fully removing the card.

2. Remove the rear cover. See **“Rear cover removal” on page 4-10** for more information.
3. Remove the exit guide assembly. See **“Paper exit guide assembly removal” on page 4-46** for more information.
4. Remove the two screws (A) from the lower corners of the fuser.

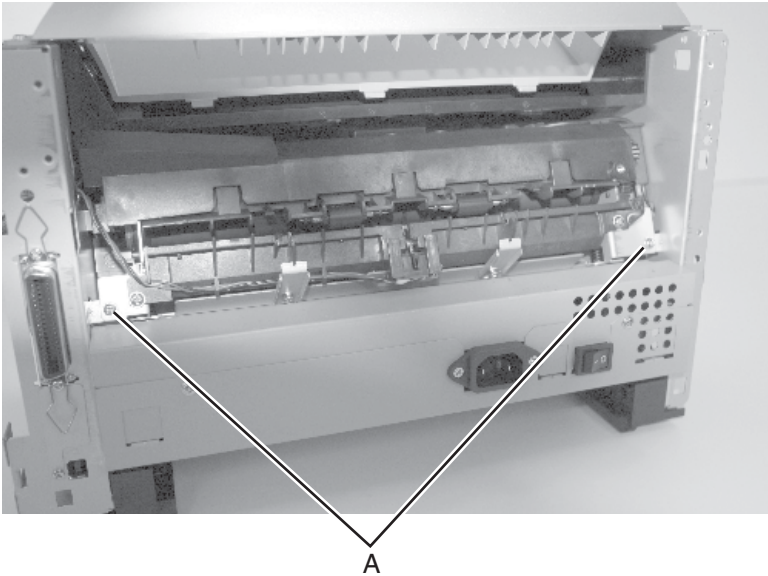

- Slide the fuser out far enough to expose and disconnect the AC cable connections.

You may have to remove the fuser to disconnect the cables. See **“Fuser removal” on page 4-28.**

- To disconnect the fuser power cables, slide the insulation (A) back to expose the connectors. Press the tang (B) on the connector to disconnect the cable connector.

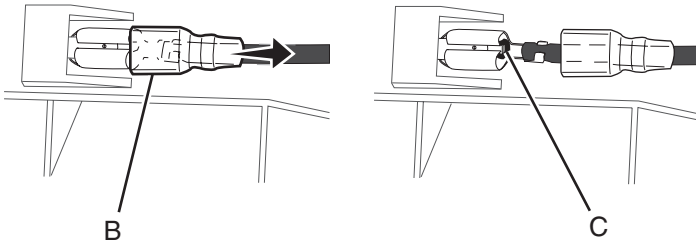

- Extract the fuser power cable from the LVPS/HVPS side.

Note: Be sure to slide the insulation back in place after reconnecting the cables.

Input roller clutch and lever removal (autocompensator clutch)

1. Remove the left side cover. See **“Left side cover removal” on page 4-9.**
2. Place the printer on its right side. Protect the cover from being marred.
3. Remove four screws in the gear train metal cover.

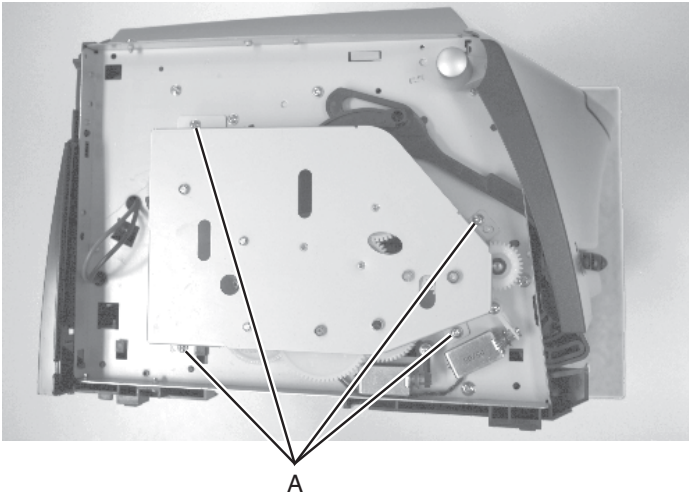

4. Remove the screws (B) from the shaft of the input roller clutch assembly and the lever (pawl).

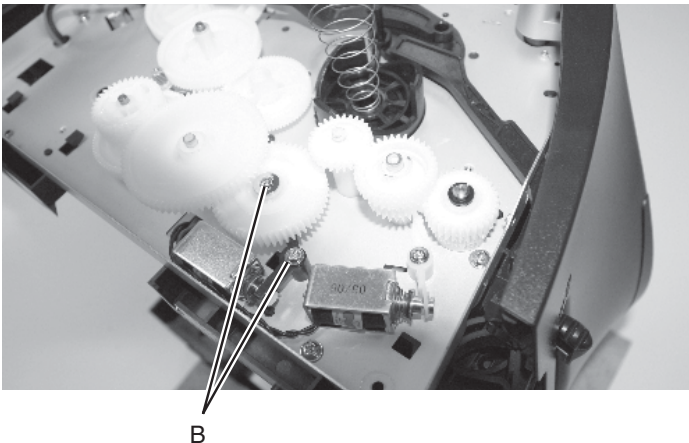

5. Remove the clutch assembly and the lever. If the pieces come apart, they can be easily reassembled if necessary.

Input sensor #1 removal

1. Open the right side cover.
2. Disconnect the sensor cable at J9 on the controller card (front, near top of card).
3. Carefully place the printer on its top.
4. Using a small shank screwdriver, remove the screw (A) behind the ACM (autocompensator) pivot which holds the paper sensor in place.

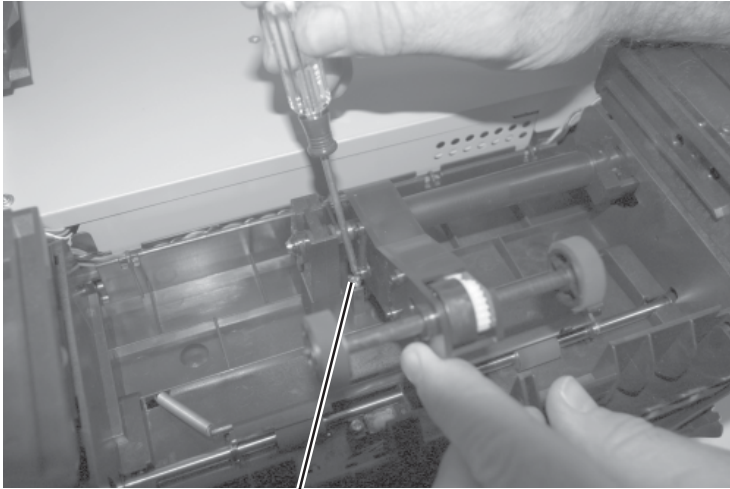

A

5. Remove the sensor assembly.
6. Reinstall the sensor so that the flag is spring loaded against the page as it advances in its path.
7. Verify the cable is captured and out of the paper path.

Input sensor #2 (manual feed) removal

1. Open the right side cover. See **“Right side cover removal”** on **page 4-12** for more information.
2. Disconnect the sensor cable at J20 on the controller card.
3. Carefully place the printer on its top, with the front facing you.
4. Remove the screw (A) beside and under the left pick tire.

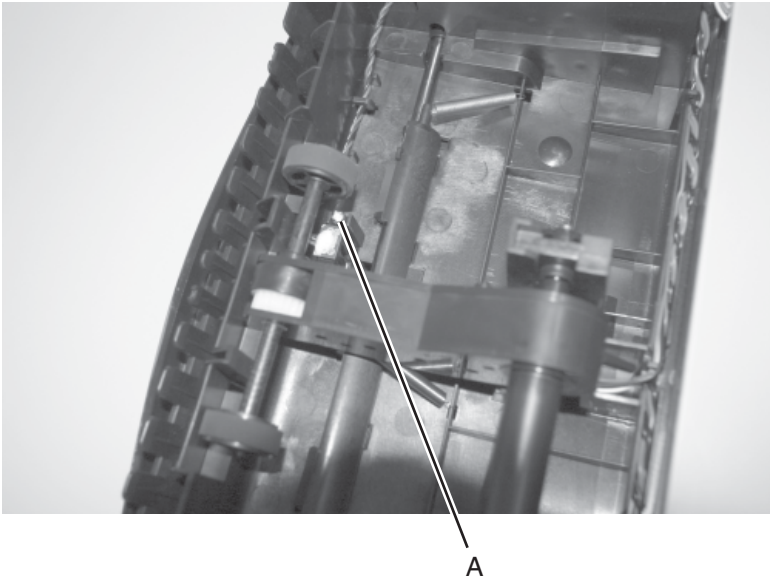

5. Remove the sensor assembly.
6. Reinstall the new sensor in the same orientation as the old. The flag should be spring loaded against the leading edge of an advancing sheet.
7. Verify the cable is captured and away from the paper path.

LCD bezel removal

1. Open the front access cover.
2. Remove the two screws (A) that hold the LCD bezel.

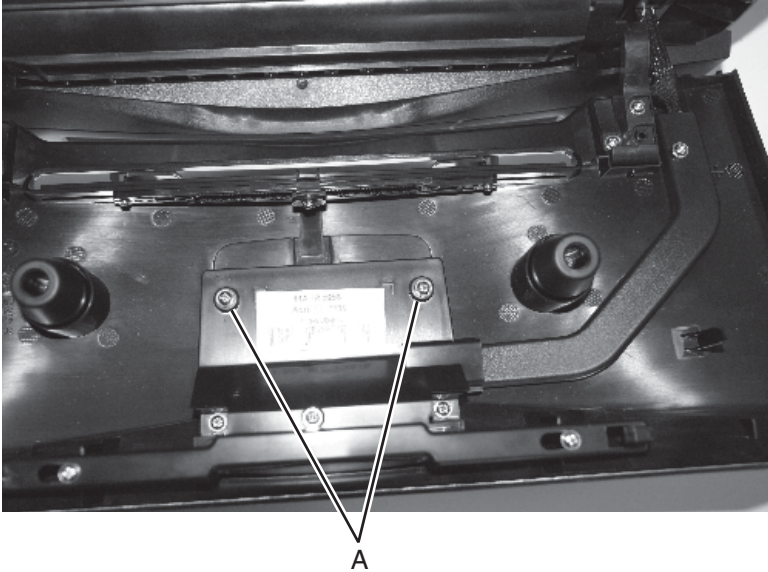

3. Close the front access cover.

4. If the bezel will be reused, stick a piece of tape (B) across the LCD lens and bezel.

Use about three inches of tape and fold the end under to form a tab to allow easy removal after reinstallation.

5. Using your fingernail or sharp, non-marring object, pull the top of the bezel away from the front access cover. Carefully work the bezel away from the buttons and front access cover.

Note: Push down on the top edge of the bezel to deflect it away from the buttons. If the bezel does not easily come out, open the front access cover, remove the three screws holding the shield cover behind the LCD panel, and release the bezel latch.

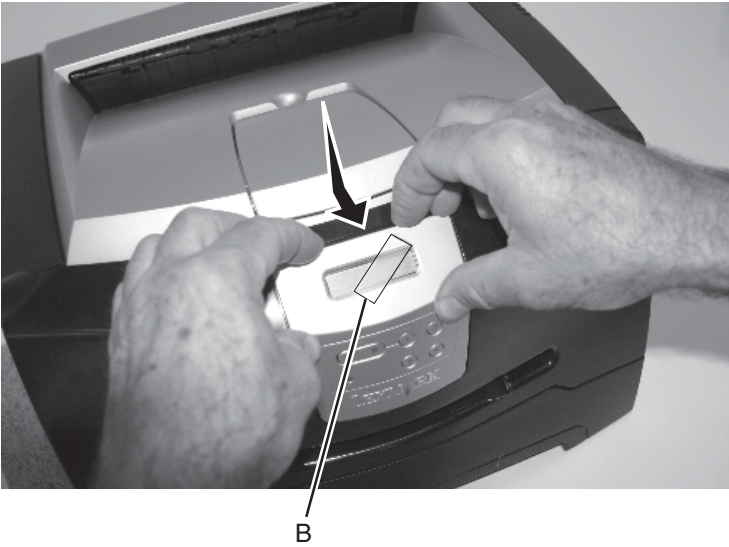

Installation note: The clear lens has a molded-in triangle (C). Install the lens so the triangle is positioned toward the LCD buttons. Be sure the lens is free of debris and fingerprints before installing.

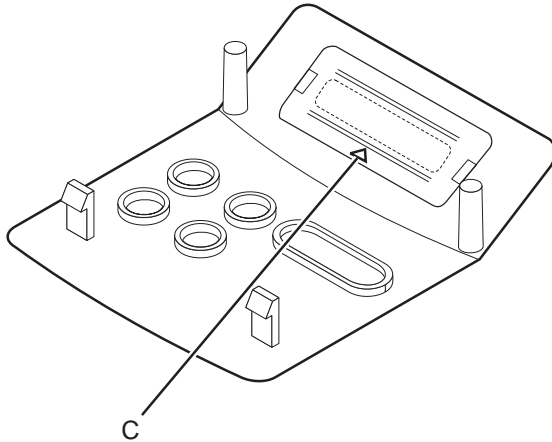

LCD operator panel removal

1. Remove the LCD bezel. See **“LCD bezel removal”** on page 4-37.
2. Remove the two screws (A) holding the LCD assembly to the front access cover.
3. Unlatch the LCD display (left and right side of the LCD).

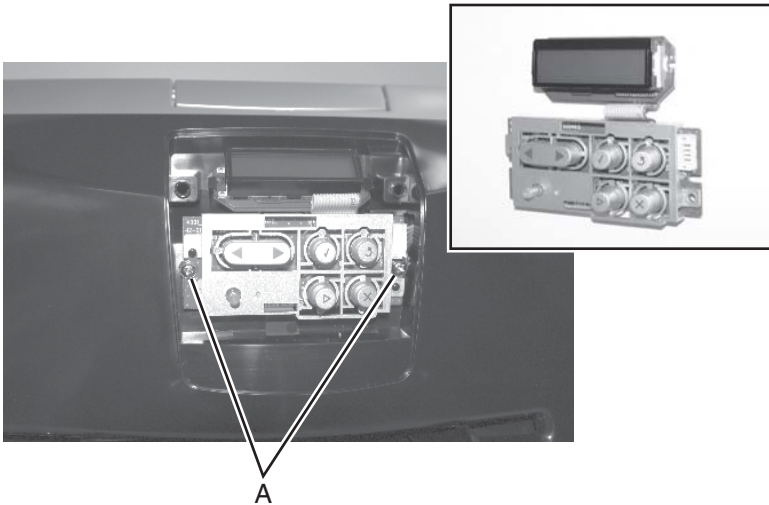

4. Carefully pull the LCD assembly away from the front access cover.
5. Disconnect the LCD cable.

LED operator panel removal (E238, E240, and E240n)

1. Open the access door.
2. Remove the right side cover. See **“Right side cover removal” on page 4-12.**
3. Unplug the operator panel from the controller card at J19.
4. Remove two screws (A) holding the operator panel.



A

5. Remove the operator panel.

LVPS/HVPS card assembly removal



1. Remove the cover extender (if installed).
2. Remove the rear cover. See **“Rear cover removal”** on page 4-10 for more information.
3. Place the printer onto its top, with the back and bottom in view.
4. Remove two screws (A), one left of the power switch and the other at the opposite side of the panel.
5. Remove the screws (B) securing the two foot brackets.

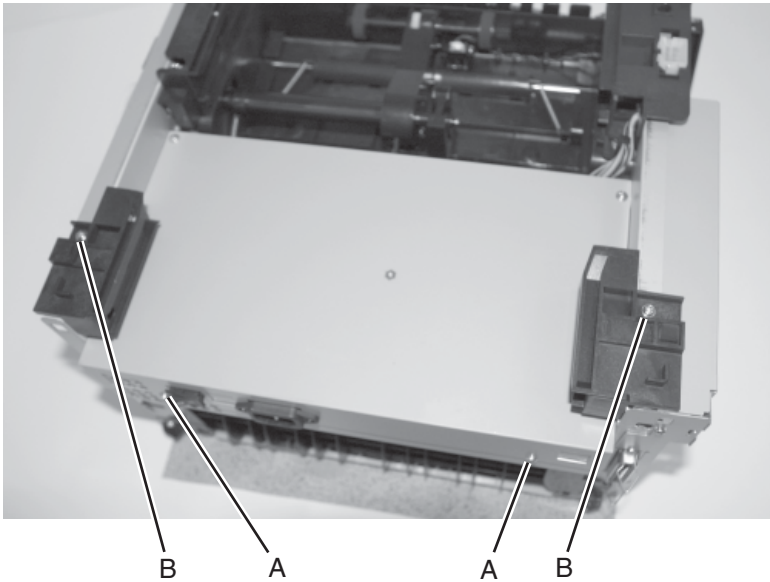

6. Remove four screws (C) in the bottom of the metal cover.

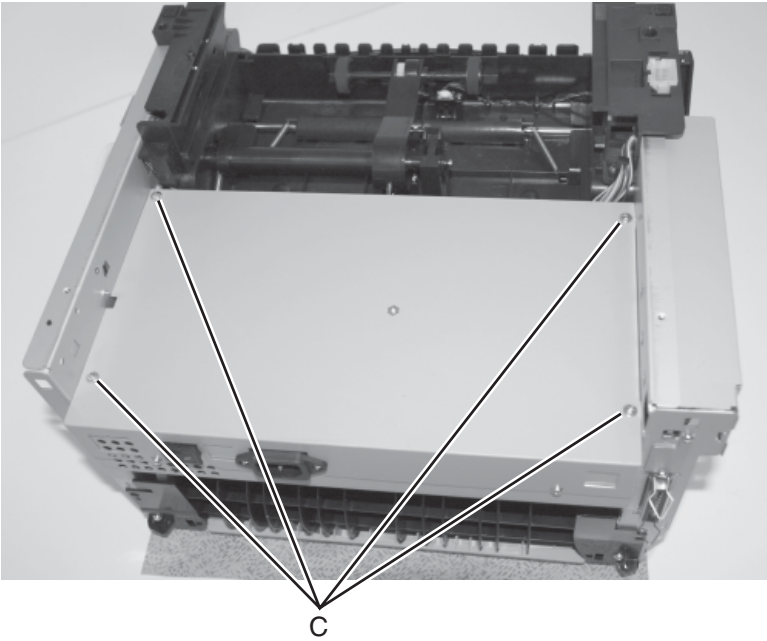

7. Lift the metal cover so the connecting cables can be unplugged on the side shown.

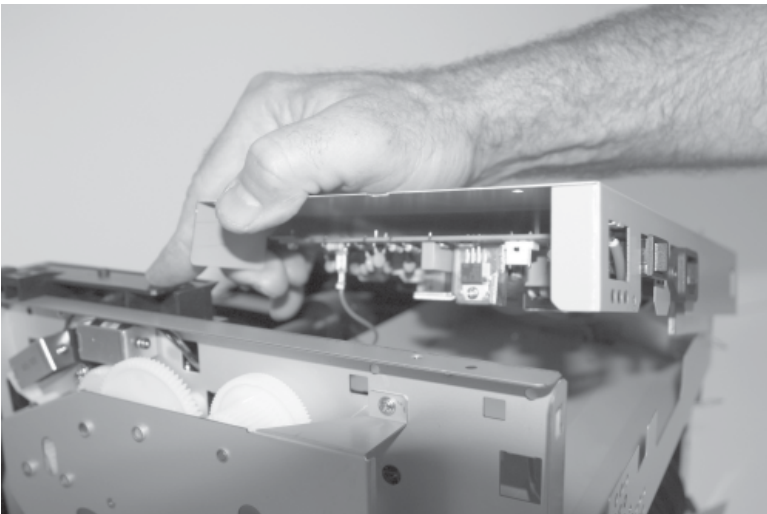

8. Rotate the assembly, and unplug the remaining cables.



9. Remove the assembly.

LVPS/HVPS-to-controller card cable removal

1. Remove the LVPS/HVPS card. See **“LVPS/HVPS card assembly removal”** on page 4-41 for more information.
2. Unplug the cable at J4 on the controller card and at CN201 on the LVPS/HVPS card, and extract the cable.

Manual feed clutch assembly removal

1. Remove the left side cover.
2. Place the printer on its right side. Protect the cover from being marred.
3. Remove the four screws (A) in the gear train metal cover.

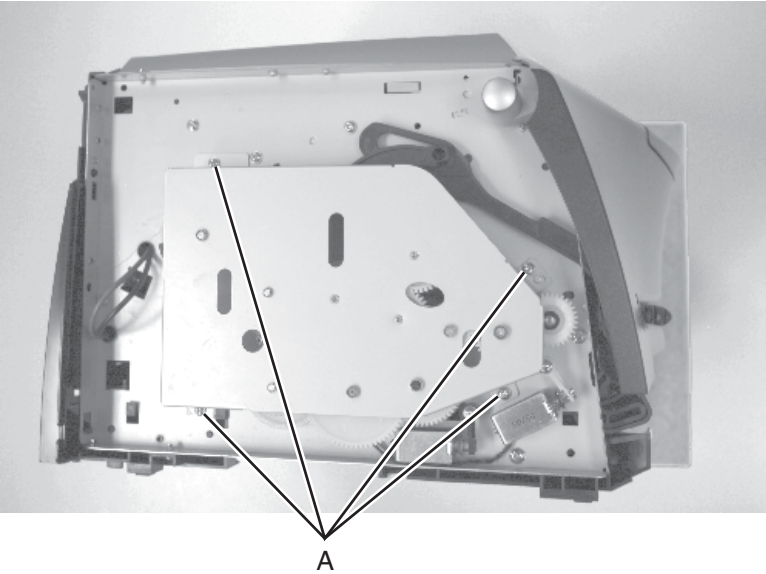

4. Remove the clip (B) from the shaft of the pick up clutch assembly.
5. Remove the screw (C) and lever (pawl).

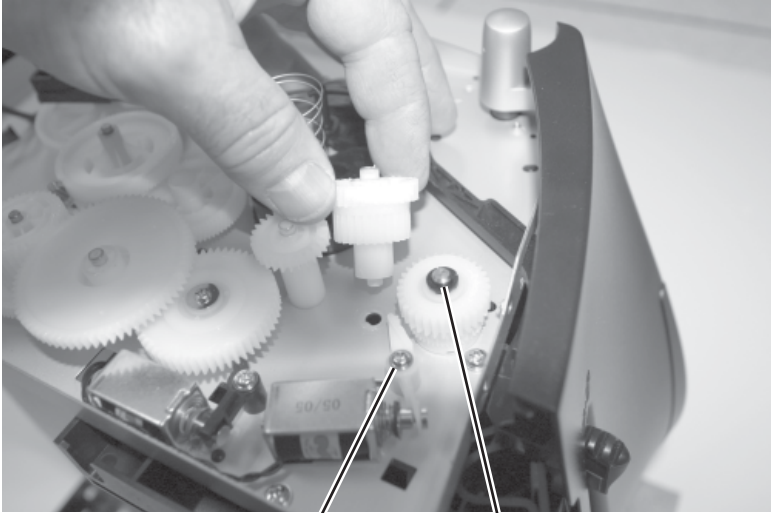

C

B

6. Remove the clutch assembly. If the pieces come apart, they can be easily reassembled.

Paper exit guide assembly removal

1. Remove the rear cover. See **“Rear cover removal”** on page 4-10 for more information.
2. Remove the two screws (A) and the longer screw (B) holding the exit guide.

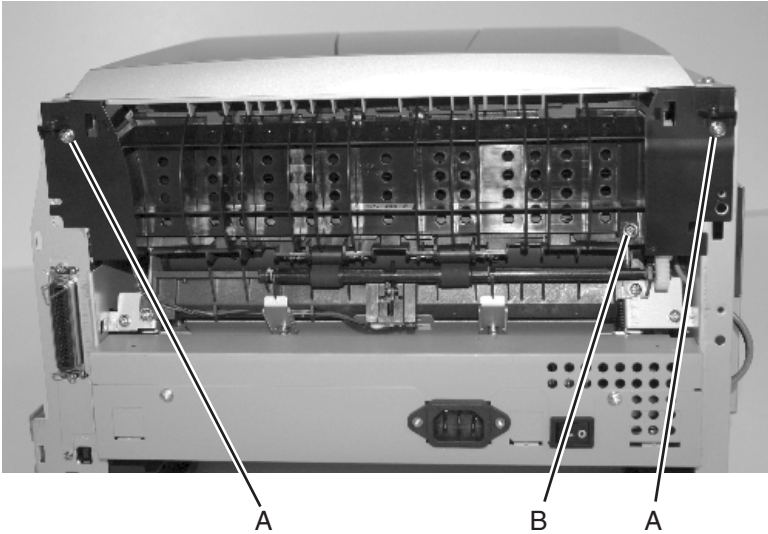

3. Remove the paper exit guide assembly.

Reinstallation note: It may be necessary to rotate the gears to mesh with the fuser and drive gear.

Paper feed rollers (autocompensator tires) removal

1. Be sure you have removed the paper tray and the toner cartridge.
2. Turn the printer onto its back.

Note: Be careful not to mar the finish of the printer.

3. Remove the rubber paper feed rollers.

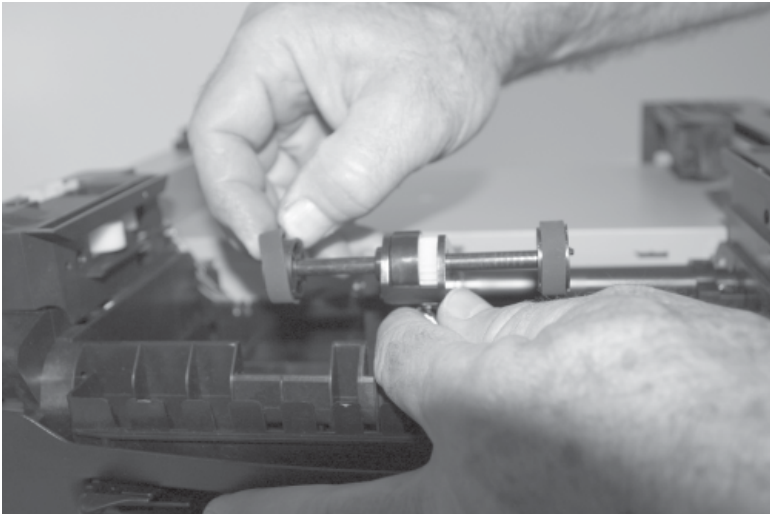

4. Make sure the new paper feed rollers are captured between the rims of the plastic hub.

Printhead removal

1. Remove the top cover. See **“Top cover removal” on page 4-14** for more information.
2. Remove the right side cover. See **“Right side cover removal” on page 4-12.**
3. Notice the alignment of the printhead at each screw.
4. Unplug the printhead cables at locations J13 and J14.
5. Remove three screws (A) securing the printhead to the cross brace.

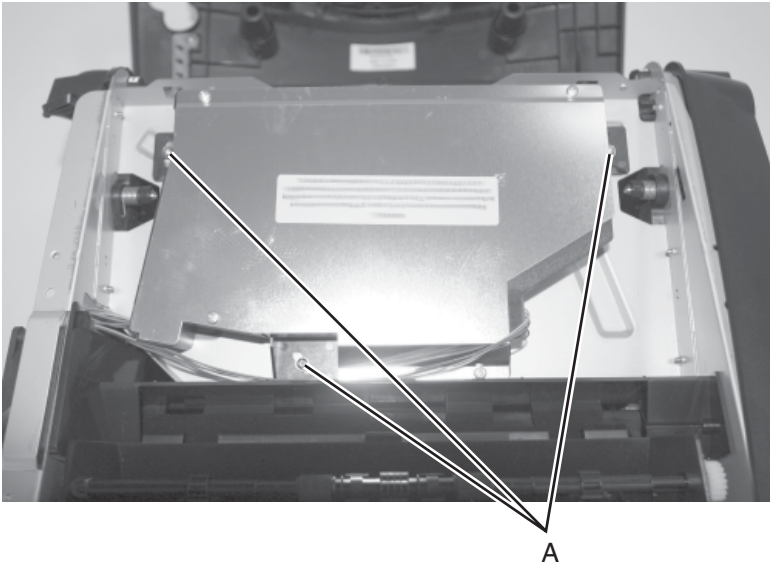

6. Remove the printhead.

Install the new printhead in the same position as the old one. Always run the registration test following replacement, and adjust as needed. See **“Registration” on page 3-21.**

Check skew caused by the printhead by printing the Quick Test. For E340 and E342n, see **“Quick Test” on page 3-22.** For the E238, E240, and E240n, enter Diagnostic mode (see **“Diagnostics mode selections” on page 3-11**), and select **Continuous print—simplex Tray 1.**

The printed test sheets have horizontal lines and two vertical lines. Printhead misalignment causes skewed horizontal lines, but not vertical lines (that is, the vertical lines will be parallel to the vertical edges). If the ends of the horizontal lines on the right side drop down from the left side to the right side, adjust the printhead clockwise to the printer. Adjust the printhead counterclockwise if the horizontal lines rise from left to right.

Toner level sensor cable removal (E340 and E342n)

1. Open the right side cover. See **“Right side cover removal” on page 4-12** for more information.
2. Unplug the sensor at J11, and extract the cable.
3. Unplug the cable from the sensor.

Toner level sensor removal (E340 and E342n)

1. Open the right side cover. See **“Right side cover removal” on page 4-12** for more information.
2. Unplug the cable (A) from the sensor.
3. *Unsnap* the toner level sensor from the frame, and remove it through the inside of the printer.

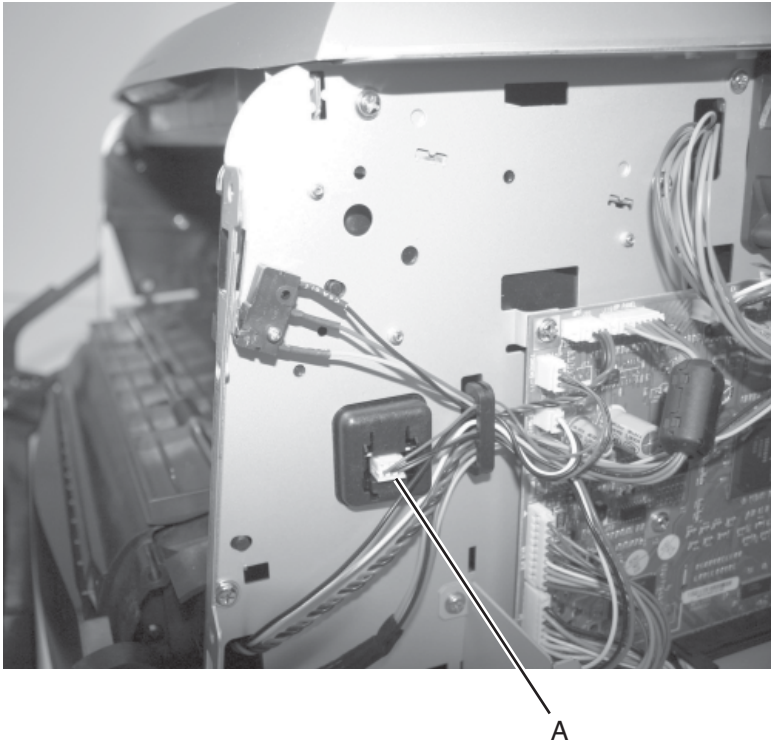

Transfer roll removal

Note: Handle or touch the transfer roll as little as possible.

1. Open the front access cover.
2. Place a sheet of clean paper around the transfer roll to protect it.
3. At the right side of the transfer roll, squeeze the holder arms with the left hand while lifting. Stop when the holder is unlatched.

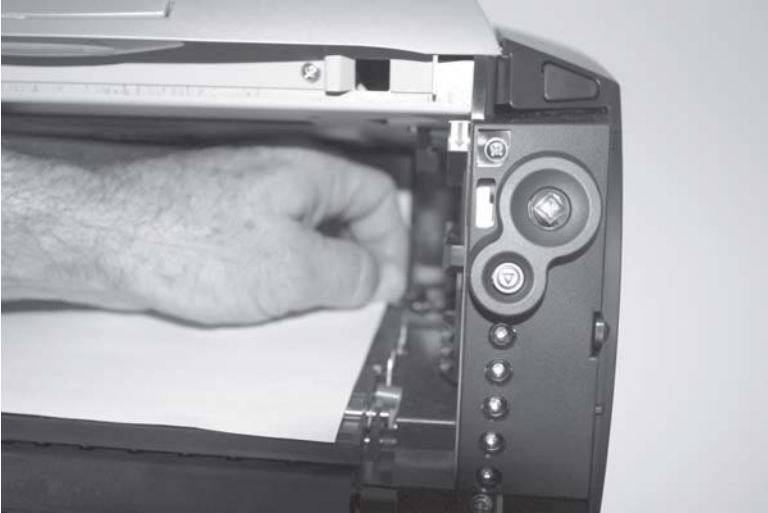

4. At the left side of the transfer roll, squeeze the holder arms with the right hand while lifting with the left hand. Stop when the left holder is unlatched.
5. With a hand at each end, lift the transfer roll out. The springs should remain in place. Replace the right spring with the transfer roller FRU.

Reinstallation note: Verify the springs are inserted into the bearings when re-installing.

Transport motor cable removal



1. Remove the right cover. See **“Right side cover removal” on page 4-12** for more information.
2. Remove the controller card cover. See **“Controller card removal” on page 4-15** for more information.
3. Unplug the transport motor cable at J8 on the controller card.
4. Remove the LVPS/HVPS card assembly. See **“LVPS/HVPS card assembly removal” on page 4-41** for more information.
5. Extract the cable (A) through the side frame, leaving it free at the opening above the LVPS/HVPS (B).

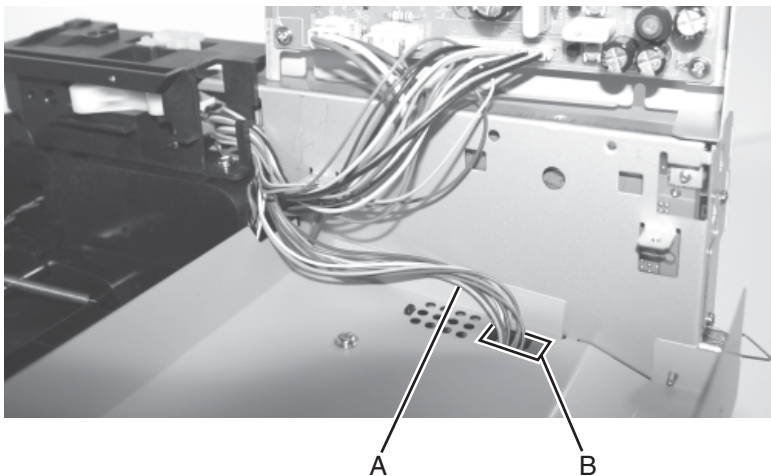

6. Turn the printer over.
7. Remove the fuser. See **“Fuser removal” on page 4-28**.
8. Extract the cable through the hole and from its retainers behind the fuser.
9. Unplug the cable at the motor. 30

4511-xxx

5. Locations and connections

Locations

Front view

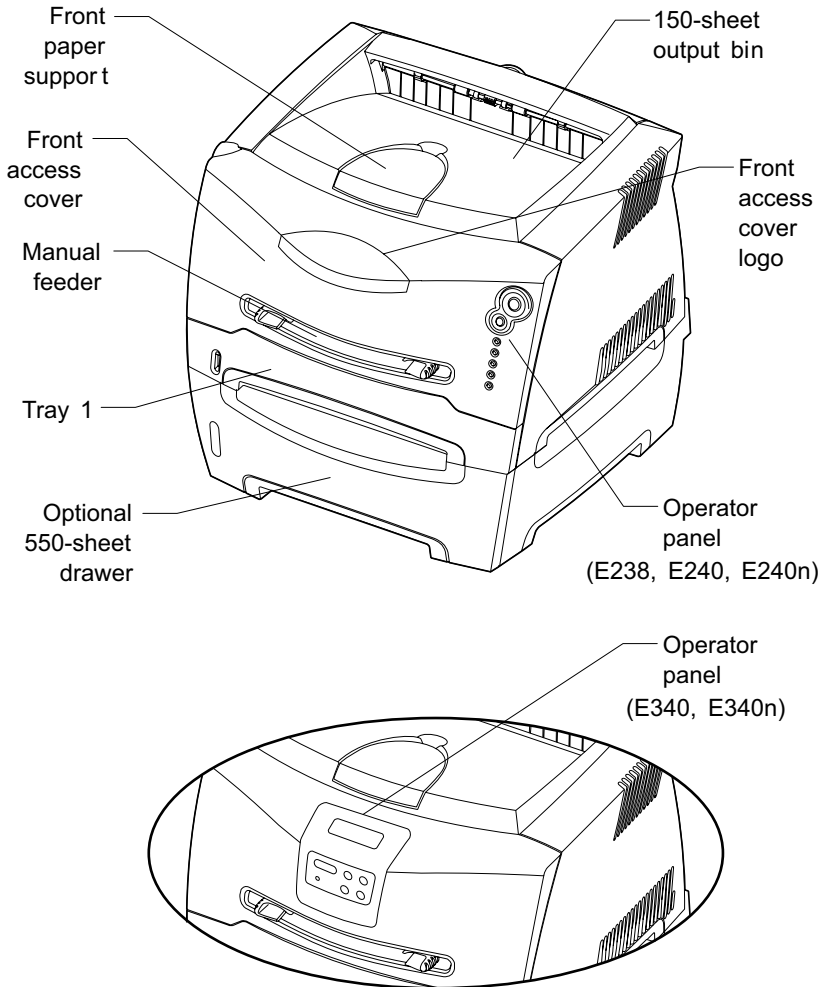

4511-xxx

Rear view

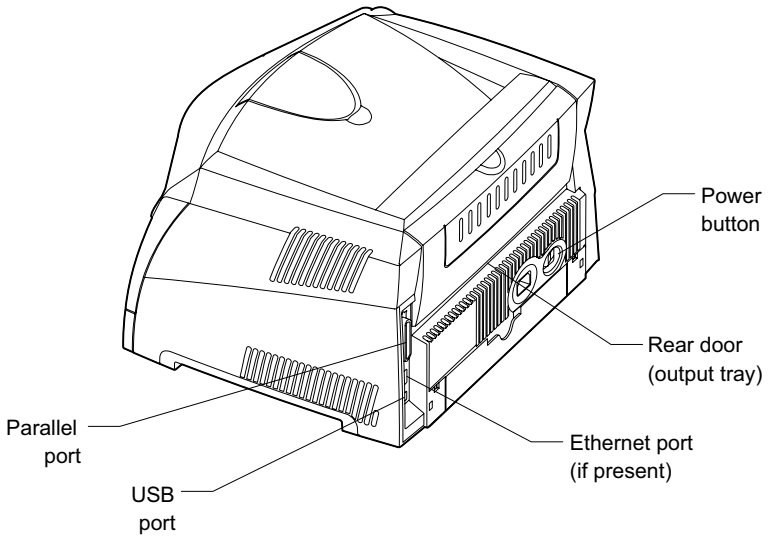

Connectors

Controller card

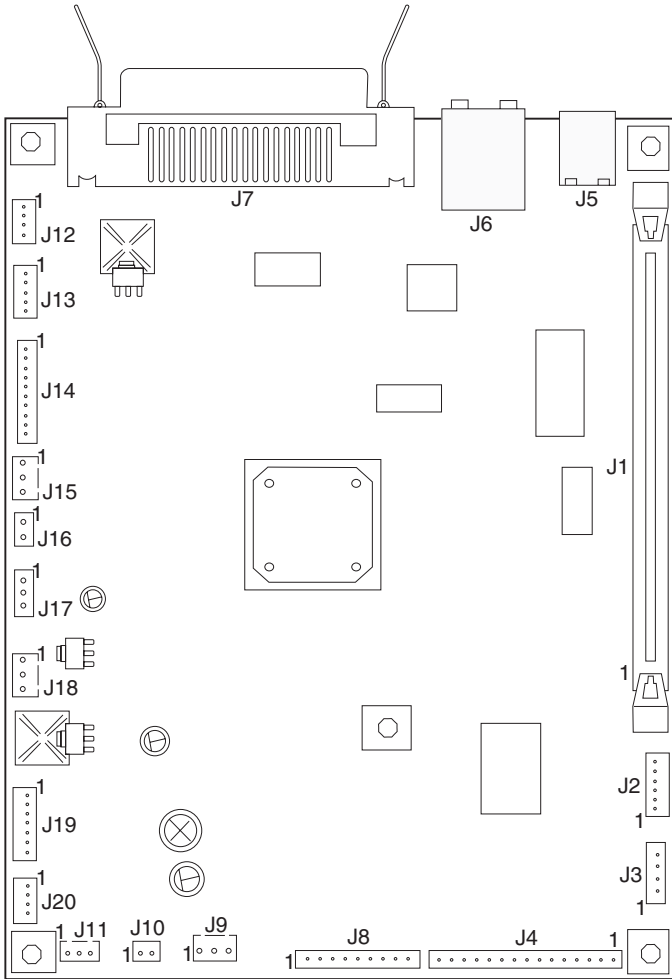

Controller card connector pin values

(Also, see the wiring diagram at back of book.)

These values were measured with all connections made (plugged) or with only one connector at a time unplugged to expose the pins. Always disconnect and connect with the printer power off. Otherwise, the values below may not match.

Connector	Pin #	Value (plugged)	Value (unplugged)	Comments
J2	1, 4	+5 V dc	+5 V dc	Without tray 2 attached; Ready mode
	2	+24 V dc	+24 V dc	
	6	Ground	Ground	
	3, 5	Signal	Signal	
J3	1, 3	+24 V dc	+24 V dc	Manual and paper feed solenoids; Ready mode
	2, 4	+24 V dc	0 V dc	
J4	1, 2	0 V dc	Main power source to controller card	LVPS/HVPS; Ready mode
	3, 4	+5 V dc		
	5, 6	Signal		
	7	Ground		
	8, 9	+24 V dc		
	10	Signal		
	11	+5		
	12, 14	Ground		
	13	Signal		
J5	–	–	–	USB port
J6	–	–	–	Network port (Ethernet)
J7	–	–	–	Parallel port

Connector	Pin #	Value (plugged)	Value (unplugged)	Comments
J8	1	–	+3.3 V dc	Ready mode, main motor drive.
	2	–	+3.3 V dc	
	3	–	+3.3 V dc	
	4	–	+3.3 V dc	
	5	Ground	Ground	
	6	+5 V dc	+5 V dc	
	7, 8, 9	+24 V dc	<+24 V dc	
J9	1	+1.1 V dc	+5 V dc	Input sensor, Ready mode
	2	+5 V dc	+5 V dc	
	3	Ground	Ground	
J10	1, 2	Signal	Signal	Smart chip
J11	1	Signal	Signal	Toner low sensor
	2	Ground	Ground	
	3	Signal	Signal	
J13	1			Mirror motor, Ready mode
	2, 3	+5 V dc	+5 V dc	
	4	Ground	Ground	
	5	+24 V dc	+24 V dc	
J14	1		–	LSU, Ready mode
	2	Ground	Ground	
	3	+3.3 V dc	–	
	4	Signal	–	
	5	+3.3 V dc	–	
	6	Ground	Ground	
	7	+5 V dc	+5 V dc	
	8	Ground	Ground	
	9	+5 V dc	–	
J15	1	+5 V dc	0 V dc	Door open sensor, Ready mode (door closed)
	2	+5 V dc	+5 V dc	
	3	Ground	Ground	

Connector	Pin #	Value (plugged)	Value (unplugged)	Comments
J16	1	Approx. +2 V dc	Approx. +5 V dc	Thermistor
	2	Ground	Ground	
J17	1	+1.1 V dc	+5 V dc	Exit sensor, Ready mode
	2	+5 V dc	+5 V dc	
	3	Ground	Ground	
J18	1	Ground	Ground	Fan, Ready mode (fan running)
	2	+11–12 V dc	+24 V dc	
	3	Approx. +1.5 V dc	+3.2 V dc	
J19	1	Ground	Ground	Operator panel, Ready mode. LED and LCD panels use the same common connector.
	2	+5 V dc	+5 V dc	
	3	0 V dc	0 V dc	
	4	+5 V dc	+5 V dc	
	5	+5 V dc	+5 V dc	
	6	LED ONLY	+5 V dc	
	7	+5 V dc	+5 V dc	
J20	1	+1.1 V dc	+5 V dc	Manual feed sensor
	2	+5 V dc	+5 V dc	
	3	Ground	Ground	
	4	–	–	

6. Preventive maintenance

The Lexmark E238, E240, E240n, E340, and E342n do not require preventive maintenance.

4511-xxx

7. Parts catalog

How to use this parts catalog

The following legend is used in the parts catalog:

Asm-Index	Part number	Units/mach	Units/FRU	Description
-----------	-------------	------------	-----------	-------------

- **Asm-index:** identifies the assembly and the item in the diagram. For example 3-1 indicates assembly 3 and the item number 1.
- **Part number:** identifies the unique number that identifies this FRU.
- **Units/mach:** refers to the number of units actually used in the machine or product.
- **Units/FRU:** refers to the number of units packaged together and identified by the part number.
- **NS:** (Not shown) in the Asm-Index column indicates that the part is procurable but is not pictured in the illustration.
- **PP:** (Parts Packet) in the parts description column indicates the part is contained in a parts packet.
- Model information used in the parts catalog.

Machine type and model	Description
4511-000	Lexmark E238
4511-100	Lexmark E240
4511-410	Lexmark E240n (network)
4511-600	Lexmark E340
4511-610	Lexmark E342n (network)

Assembly 1: Covers

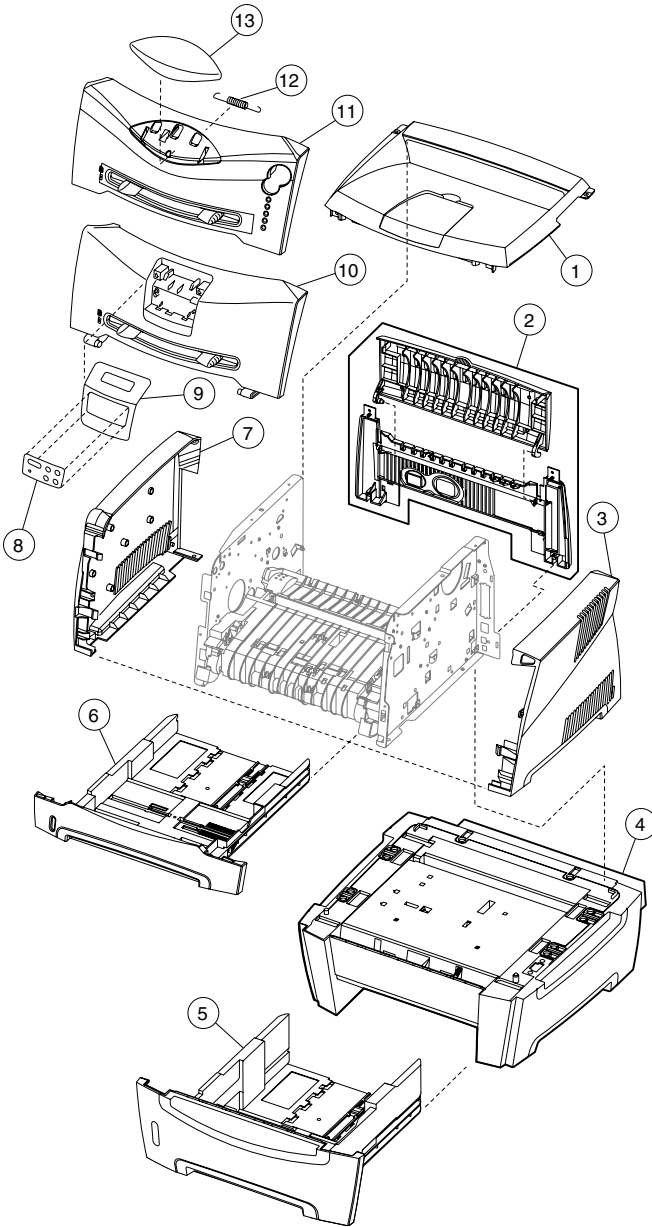

Assembly 1: Covers

Asm-Index	Part number	Units/mach	Units/FRU	Description
1—1	40X1335	1		Top cover assembly
2	40X1339	1		Rear cover assembly
3	40X1320	1		Right side cover
4	40X1341	1		Optional media drawer assembly (no tray)
5	40X1342	1		Optional tray 2
6	40X1340	1		Main tray
7	40X1336	1		Left side cover
8	40X1356	1	15	Language overlays
9	40X1357	1	1	LCD bezel, E340 cover
9	40X1327	1	1	LCD bezel, E342n cover
10	40X1309	1		Front access cover assembly, E340, E342n
11	40X1310	1		Front access cover assembly, no logo, E238, E240, E240n
12	40X1354	1		Springs, ACM and front access door
13	40X1359	1		Logo plate cover, E238
13	40X1311	1		Logo plate cover, E240
13	40X1312	1		Logo plate cover, E240n

Assembly 2: Electronics

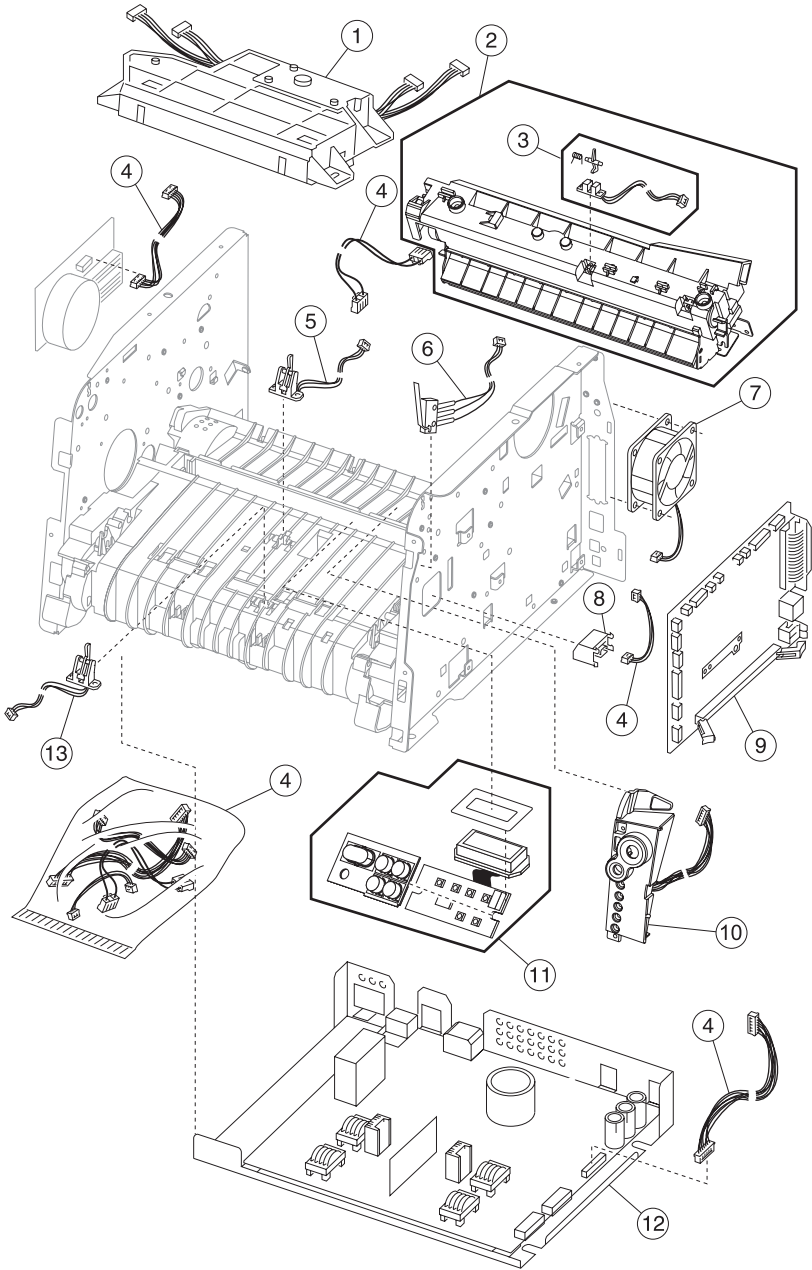







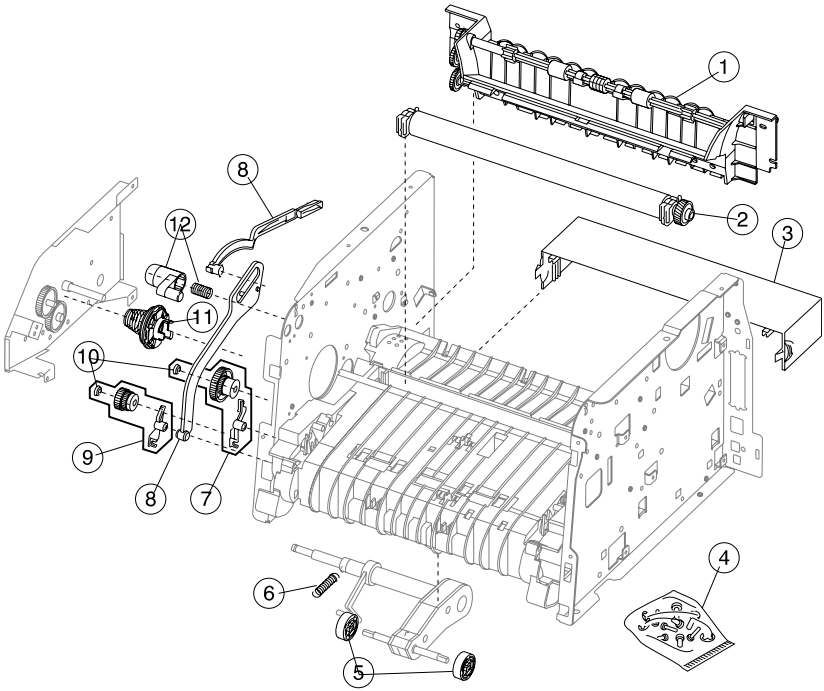

Assembly 2: Electronics

Asm-Index	Part number	Units/mach	Units/FRU	Description
2-1	40X1303	1		Laser/mirror printhead assembly, E238/E240/E240n
1	40X1304	1		Laser/mirror printhead assembly, E340/E342n
2	40X1300	1		Fuser assembly, 110 V
2	40X1301	1		Fuser assembly, 220 V
2	40X1302	1		Fuser assembly, 100 V
3	40X1325	1		Exit sensor assembly
4	40X1333	1		Miscellaneous cable assemblies <ul style="list-style-type: none"> • Fuser power • Toner sensor • LVPS/HVPS to controller • Main drive motor
5	40X1323	1		Input #1 sensor assembly
6	40X1326	1		Cover open sensor assembly
7	40X1328	1		Cooling fan
8	56P2076	1		Toner level sensor (RO)
9	40X1305	1		Controller card, E238/E240
9	40X1306	1		Controller card, E240n
9	40X1307	1		Controller card, E340
9	40X1308	1		Controller card, E342n
10	40X1316	1		LED operator panel assembly, E238/E240/E240n
11	40X1315	1		LCD operator panel assembly, E340/E342n
11	40X1358	1		LCD operator panel assembly, Katakana
12	40X1317	1		LVPS/HVPS card assembly, 110 V
12	40X1318	1		LVPS/HVPS card assembly, 220 V
13	40X1324	1		Input #2 sensor assembly (manual)

Assembly 3: Frame



Assembly 3: Frame

Asm-Index	Part number	Units/mach	Units/FRU	Description
3-1	40X1334	1		Paper exit guide assembly
2	40X1322	1		Transfer roll, bearings, gear, spring
3	40X1321	1		Legal-size paper extender cover
4	40X1353	N/A		Screws, miscellaneous (actual size) TP2NC-3.0+6P-Ni (2)  
				M3.0*0.5+6P-Ni,2 Washer (2)  
				MT3.0*0.5+6PF-Ni (5)  
				TP2NC-3.0+6PF-Ni (4)  
5	40X1319	2		Paper feed, rubber tires
6	40X1354	1		Front access door and ACM springs
7	40X1331	1		ACM clutch CBM
8	40X1338	1		Door-fuser idle gear link CBM
9	40X1330	1		Manual feed clutch CBM
10	40X1355	2		Plastic snap rings
11	40X1329	1		Developer drive coupling assembly
12	40X1337	1		Front access cover latch CBM

Assembly 4: Options

Asm-Index	Part number	Units/mach	Units/FRU	Description
NS	40X1564	1		32MB flash card assembly
NS	40X1513	1		Simplified Chinese font card assembly
NS	40X1514	1		Traditional Chinese font card assembly
NS	40X1512	1		Japanese font card assembly
NS	40X1515	1		Korean font card assembly
NS	40X1364	1		32MB SDR DIMM
NS	40X1365	1		64MB SDR DIMM
NS	40X1366	1		128MB SDR DIMM

Assembly 5: Miscellaneous

Asm-Index	Part number	Units/mach	Units/FRU	Description
NS	40X1368	1		USB cable, packaged (2 m)
NS	40X1367	1		Parallel cable, packaged (3 m)
NS	7372839	1		Field location package assembly
NS	40X0289	1		Power cord, 1.8M (straight)—USA, Canada
NS	40X0278	1		Power cord, 6 foot (straight)—Europe and others
NS	40X0288	1		Power cord, 8 foot (straight)—Argentina
NS	40X0271	1		Power cord, 8 foot (straight)—United Kingdom
NS	40X0275	1		Power cord, 6 foot (straight)—Israel
NS	40X0274	1		Power cord, 6 foot (straight)—Switzerland
NS	40X0276	1		Power cord, 6 foot (straight)—South Africa
NS	40X0287	1		Power cord, 6 foot (straight)—Traditional Italy
NS	40X0279	1		Power cord, 6 foot (straight)—Danish
NS	40X0277	1		Power cord, 6 foot (straight)—Brazil
NS	40X0282	1		Power cord, 1.8M (straight)—PRC
NS	40X0270	1		Power cord, 2.5M (straight)—Japan
NS	40X0280	1		Power cord, 1.8M (straight)—Korea
NS	40X0281	1		Power cord, 1.8M (straight)—Taiwan
NS	40X0296	1		Power cord, 1.8M (straight)—Australia

4511-xxx

Index

Numerics

- 3x—9x attendance messages 2-4, 2-58
- 2xx paper jams 2-24, 2-64
- 9xx service errors 2-36, 2-65

A

- abbreviations 1-9
- acronyms 1-9
- Auto CR After LF, E238/E240(n) 3-7
- Auto LF After CR, E238/E240(n) 3-7
- autocompensator clutch
 - parts catalog 7-7
 - removal 4-34
- autocompensator tires 4-47

B

- Button Test, E340/E342n 3-23
- buttons
 - E238/240(n) 1-2
 - E340/E342n 1-3, 2-52
 - numeric values 2-52

C

- cables
 - fuser power cable 4-32
 - LVPS/HVPS to controller card cable 4-43
- Charge Roll, diagnostics mode 3-31
- compatibility 1-5
- configuration ID
 - E238/E240(n) 3-12
 - E340/E342n 3-30
- configuration menu—E238/E240(n)
 - accessing 3-2
 - navigating menu 3-5
 - Network
 - Mac Binary PS 3-10
 - NPA Mode 3-10
 - Set Card Speed 3-10

- Parallel
 - MAC Binary PS 3-8
 - NPA Mode 3-8
 - Parallel Mode 2 3-8
 - Protocol 3-8
- printing menu 3-3
- Setup
 - Auto CR After LF 3-7
 - Auto LF After CR 3-7
 - Demo Mode 3-7
- table of light patterns 3-3
- USB
 - Mac Binary PS 3-9
 - NPA Mode 3-9
- Utilities
 - Hex Trace 3-6
 - Print Quality Pages 3-7
 - Reset Factory Defaults 3-6
 - Reset Photoconductor Counter 3-7
- configuration menu—E340/E342n
 - accessing 3-14
 - Demo Mode 3-17
 - Download Emuls 3-17
 - Energy Conserve 3-17
 - entering 3-15
 - Env Prompts 3-18
 - ERROR LOG 3-18
 - Exit Config Menu 3-18
 - Factory Defaults 3-17
 - menus 3-15
 - Panel Menus 3-16
 - Paper Prompts 3-18
 - PPDS Emulation 3-16
 - Prt Quality Pgs 3-16
 - Reset PC Cnt 3-16
- controller card
 - removal 4-15
 - service check 2-82

D

Defaults

- E238/E240(n) 3-12
- E340/E342n
 - US/Non-US defaults 3-29

Demo Mode

- E238/E240(n) 3-7
- E340/E342n 3-17

diagnostic information 2-1

diagnostics mode—E238/E240(n)

Development

- Configuration ID 3-12
- Continuous Print
 - Simplex Tray 1 3-11
 - Simplex Tray 2 3-12
- Defaults 3-12
- Edge to Edge 3-11
- Print History 3-12
- Print Quality Pages 3-11

entering 3-2

Network

- Dump NVRAM 3-13
- History 3-13
- History Mode 3-13
- Mark History 3-13
- Reinit NVRAM 3-13

Parallel

- Par S Strobe Adjustment 3-12
- printout sample 3-4

diagnostics mode—E340/E342n 3-14

- available tests 3-19
- Base Sensor Test 3-28

Device Tests

- Flash Test 3-28

EP Setup

- Charge Roll 3-31
- EP Defaults 3-31
- Fuser Temp 3-31
- Gap Adjust 3-31
- Print Contrast 3-31
- Transfer 3-31

Error Log

- Clear Log 3-33
- Display Log 3-32
- Print Log 3-33

Exit Diagnostics 3-33

exiting 3-20

Hardware Tests

- Button Test 3-23
- DRAM Test 3-24
- LCD Test 3-23
- Parallel Wrap 3-25

Input Tray Tests

- Feed Tests 3-26
- Sensor Test 3-27

menu list 3-19

Print Tests

- input source 3-22
- input source tests 3-22
- Prt Quality Pgs 3-23

Printer Setup

- Configuration ID 3-30
- Defaults 3-29
- Edge to Edge 3-30
- Engine Settings 3-30
- Model Name 3-30
- Page Count 3-29
- Par S Strobe Adj 3-30
- Perm Page Count 3-29
- Serial Number 3-30
- Registration 3-21
- Quick Test 3-22

door latch assembly 4-21

Download Emuls, E340/E342n 3-17

DRAM Test, E340/E342n 3-24

dump NVRAM, E238/E240(n) 3-13

E

Edge to Edge

- E238/E240(n) 3-11
- E340/E342n 3-30
- Energy Conserve, E340/E342n 3-17

Env Prompts, E340/E342n 3-18

EP Defaults, E340/E342n 3-31

error log, E238/E240(n)

see History 3-13, 3-18

error log, E340/E342n

- clear log (diagnostics mode) 3-33
- display log (diagnostics mode) 3-32
- Print Log 3-33
- print log (configuration menu) 3-18

- error messages
 - E238/E240(n)
 - additional information 2-13, 2-24
 - primary light patterns 2-3
 - secondary light patterns 2-8
 - secondary paper jams 2-12
 - service error codes 2-36
 - user attendance messages 2-3
 - E340/E342n
 - paper jams 2-64
 - service error codes 2-65
 - sub error codes 2-68
 - user attendance messages 2-55
- ESD-sensitive parts 4-1
- F**
 - Factory Defaults, E340/E342n 3-17
 - fan
 - parts catalog 7-5
 - removal 4-26
 - service check 2-81
 - Flash Test, E340/E342n 3-28
 - frame, parts catalog 7-6
 - fuser
 - parts catalog 7-5
 - removal 4-28
 - service check 2-87
 - Fuser Temp, E340/E342n 3-31
- G**
 - Gap Adjust, E340/E342n 3-31
- H**
 - handling ESD-sensitive parts 4-1
 - Hex Trace
 - E238/E240(n) 3-6
 - E340/E342n 2-54
 - History
 - E238/E240(n) 3-13
 - E340/E342n, *see error log* 3-33
- I**
 - input feed tests, E340/E342n 3-26
 - input sensor tray tests, E340/E342n 3-27
 - input source tests 3-22
 - input source tests, E340/E342n 3-22
- L**
 - laser notices iv-vii
 - LCD operator panel 4-39
 - LCD Test, E340/E342n 3-23
 - LED operator panel 4-40
 - light patterns—E238/E240(n)
 - additional information 2-13
 - description 2-3
 - primary 2-4
 - secondary 2-8
 - service codes 2-36
 - lights 1-2
 - locations
 - front views 5-1
 - rear views 5-2
 - logo removal 4-27
 - LVPS/HVPS
 - cable removal 4-43
 - parts catalog 7-5
 - removal 4-41
 - service check 2-90
- M**
 - maintenance approach 1-1
 - manual feed
 - clutch assembly 4-44
 - input sensor #2 4-36
 - print media types and sizes 1-7
 - mark history, E238/E240(n) 3-13
 - menus
 - E238/E240(n)
 - accessing service menus 3-2
 - configuration menu 3-3
 - diagnostics mode 3-4
 - printing 3-2
 - E340/E342n
 - accessing service menus 3-14
 - configuration menu 3-15
 - diagnostic mode 3-19
 - numerical values 2-52
 - printing 3-14

4511-xxx

messages

- E238/E240(n)
 - paper jams 2-24
 - service error codes 2-36
 - user attendance messages 2-4
- E340/E342n
 - paper jam 2-64
 - service error codes 2-65
 - user attendance messages 2-55

Model Name, E340/E342n 3-30

models

- comparison 1-1
- diagnostic aids 3-1
- diagnostics 2-2, 2-50
- diagrams 5-1, 5-2
- operator panels 1-2, 1-3
- service menus 3-2, 3-14
- trays available 1-6

N

NPA Mode, E238/E240(n) 3-8

O

operator panel

- LCD—E340/E342n
 - buttons 1-3
 - overview 1-3, 2-51
 - removal 4-39
 - service check 2-93
- LED—E238/E240(n) 4-40
 - buttons 1-2
 - lights 1-2
 - overview 1-2
 - primary light patterns 2-13
 - removal 4-40
 - secondary light patterns 2-8, 2-24
 - service check 2-92

operator panel test, E340/E342n 3-23

P

- Page Count, E340/E342n 3-29
- Panel Menus, E340/E342n 3-16
- paper exit guide, removal 4-46

paper jams

- E238/E240(n) 2-24
- paper feed service check 2-94
- tips on preventing 1-8

Paper Prompts, E340/E342n 3-18

parallel port service check

- E238/E240(n) 2-97
- E340/E342n 2-97

parallel wrap test, E340/E342n 3-25

part number index 2-7

parts catalog

- covers 7-2
- electronics 7-4
- frame 7-6
- how to use 7-1
- options 7-8

permanent page count, E340/E342n 3-29

power-on self test (POST)

- E238/E240(n) 2-2
- E340/E342n 2-50
- symptoms 2-79

PPDS emulation, E340/E342n 3-16

Print Contrast, E340/E342n 3-31

print history, E238/E240(n) 3-12

print media

- preventing jams 1-8
- trays by model 1-6
- types and sizes 1-7

print quality pages

- E238/E240(n) 3-7, 3-11
- E340/E342n 3-16, 3-23
- using 2-98

print quality problems

- print media 1-8
- service check 2-98
- solving 2-105

printer symptom table 2-79

printhead

- parts catalog 7-5
- removal 4-48
- service check 2-111

Protocol, E238/E240(n) 3-8

Q

Quick Test

- E238/E240(n) 3-11
- E340/E342n 3-21, 3-22

R

registration, E340/E342n 3-21

Reinit NVRAM, E238/E240(n) 3-13

removals

- autocompensator clutch 4-34
- controller card 4-15
- cover open sensor 4-18

covers

- extender 4-2
- front access cover
 - 238/E240(n) 4-2
 - E340/E342n 4-5
- front access cover logo—E238/
E240(n) 4-27

- left side cover 4-9
- rear cover 4-10
- right side cover 4-12
- top cover 4-14

developer drive coupling assembly 4-20

door latch assembly 4-21

exit sensor 4-22

fan 4-26

fuser 4-28

fuser idle gear links 4-30

fuser power cable 4-32

input roller clutch and lever 4-34

input sensor #1 4-35

input sensor #2 (manual feed) 4-36

LCD bezel—E340/E342n 4-37

LVPS/HVPS card assembly 4-41

LVPS/HVPS to controller card cable 4-43

manual feed clutch assembly 4-44

operator panel—E238/E240(n) 4-40

operator panel—LCD—E340/E342n 4-39

paper exit guide assembly 4-46

paper feed rollers 4-47

printhead 4-48

procedures 4-2

toner level sensor cable—E340/
E342n 4-49

toner level sensor—E340/E342n 4-49

transfer roll 4-50

transport motor cable 4-51

Reset Factory Defaults

E238/E240(n) 3-6

E340/E342n 3-29

reset maintenance page counter,
E238/E240(n) 3-7

reset NVRAM, E238/E240(n) 3-2

Reset PC Counter

E238/E240(n) 3-7

E340/E342n 3-16

S

safety information xvii

secondary error codes

complex page 2-27

defective flash 2-31

error communicating with the host
computer 2-32

flash full 2-34

font error 2-30

insufficient collation area 2-30

insufficient defrag memory 2-31

insufficient printer memory 2-29

invalid engine code 2-35

invalid network code 2-35

memory full 2-33

network interface errors 2-32

PPDS font error 2-30

short paper 2-33

unformatted flash 2-34

sensors

cover open 4-18

exit 4-22

input sensor #1 4-35

input sensor #2 (manual feed) 4-36

Serial Number, E340/E342n 3-30

service checks 2-81

controller card 2-82

cooling fan 2-81

cover interlock switch 2-85

dead machine 2-86

4511-xxx

- fuser 2-87
 - cold 2-89
 - hot 2-89
 - LVPS/HVPS 2-90
 - main motor 2-91
 - operator panel E238/E240(n) 2-92
 - operator panel E340/E342n 2-93
 - paper feed 2-94
 - paper jam during POST 2-94
 - paper never picks 2-95
 - paper picks but stops 2-95
 - paper picks during POST 2-94
 - paper picks sheets 2-96
 - paper trees, curls 2-96
 - parallel port E238/E240(n) 2-97
 - parallel port E340/E342n 2-97
 - print quality 2-98
 - black page 2-100
 - blank page 2-99
 - heavy background 2-101
 - image density 2-102
 - light print 2-103
 - partial blank image 2-101
 - poor fusing of image 2-102
 - toner on back of page 2-104
 - white or black lines 2-103
 - printhead 2-111
 - transfer roll 2-111
 - service error codes
 - E238/E240(n)
 - accessing 2-36
 - primary light pattern 2-37
 - secondary light patterns 2-38
 - tertiary light patterns 2-40
 - E340/E342n 2-65
 - service menus
 - E238/E240(n) 3-2
 - E340/E342n 3-14
 - special tools 1-8
 - specifications
 - connectivity 1-5
 - input trays 1-6
 - memory 1-4
 - operating systems 1-5
 - photoconductor capacity 1-6
 - print media 1-7
 - print speed 1-4
 - toner capacity 1-6
 - start 2-1
 - strobe adjustment, E340/E342n 3-30
 - sub error codes 2-68
 - symptom tables 2-79
 - POST 2-79
 - printer 2-79
- ## T
- test pages
 - Print Quality Pages 3-7, 3-23
 - Quick Test 3-11, 3-21
 - tires, removal 4-47
 - tools 1-8
 - Top Margin, E340/E342n 3-21
 - transfer roll
 - parts catalog 7-7
 - removal 4-50
 - service check 2-111
 - Transfer, E340/E342n 3-31
 - transport motor cable, removal 4-51
- ## U
- user attendance messages
 - E238/E240n 2-4
 - E340/E342n 2-55

Part number index

P/N	Description	Page
40X0270	Power cord, 1.77M (straight)—Japan	7-9
40X0271	Power cord, 6 foot—United Kingdom	7-9
40X0274	Power cord, 6 foot—Switzerland	7-9
40X0275	Power cord, 6 foot (straight)—Israel	7-9
40X0276	Power cord, 6 foot—South Africa	7-9
40X0277	Power cord, 6 foot (straight)—Brazil	7-9
40X0278	Power cord, 6 foot (straight)—Europe and others	7-9
40X0279	Power cord, 6 foot (straight)—Danish	7-9
40X0280	Power cord, 1.77M (straight)—Korea	7-9
40X0281	Power cord, 1.77M (straight)—Taiwan	7-9
40X0282	Power cord, 1.77M (straight)—PRC	7-9
40X0287	Power cord, 6 foot (straight)—Traditional Italy	7-9
40X0288	Power cord, 6 foot—Argentina	7-9
40X0289	Power cord, 1.77M (straight)—USA, Canada	7-9
40X0296	Power cord, 1.8M (straight)—Australia	7-9
40X1300	Fuser assembly, 110 V	7-5
40X1301	Fuser assembly, 220 V	7-5
40X1302	Fuser assembly, 100 V	7-5
40X1303	Laser/mirror printhead assembly, E238/ E240/E240n	7-5
40X1304	Laser/mirror printhead assembly, E340/E342n	7-5
40X1305	Controller card, E240	7-5
40X1306	Controller card, E240n	7-5
40X1307	Controller card, E340	7-5
40X1308	Controller card, E342n	7-5
40X1309	Front access cover assembly	7-3
40X1310	Front access cover assembly, no logo	7-3
40X1311	Logo plate cover, E240	7-3
40X1312	Logo plate cover, E240n	7-3
40X1315	LCD operator panel assembly, E340/E342n	7-5
40X1316	LED operator panel assembly, E238/E240/E240n	7-5
40X1317	LVPS/HVPS card assembly, 110 V	7-5
40X1318	LVPS/HVPS card assembly, 220 V	7-5
40X1319	Paper feed, rubber tires	7-7
40X1320	Right side cover	7-3
40X1321	Legal-size paper extender cover	7-7
40X1322	Transfer, roll, bearings, gear, spring	7-7
40X1323	Input #1 sensor assembly	7-5
40X1324	Input #2 sensor assembly (manual)	7-5
40X1325	Exit sensor assembly	7-5
40X1326	Cover open sensor assembly	7-5
40X1327	LCD bezel, E342n cover	7-3

4511-xxx

40X1328	Cooling fan	7-5
40X1329	Developer drive coupling assembly	7-7
40X1330	Manual feed clutch CBM	7-7
40X1331	ACM clutch CBM	7-7
40X1333	Cable assembly, misc - fuser power	7-5
40X1333	Cable assembly, misc - main drive motor	7-5
40X1333	Cable assembly, misc.- LVPS/HVPS to controller	7-5
40X1333	Cable assembly, misc.- toner sensor	7-5
40X1333	Miscellaneous cable assemblies	7-5
40X1334	Paper exit guide assembly	7-7
40X1335	Top cover assembly	7-3
40X1336	Left side cover	7-3
40X1337	Front access cover latch CBM	7-7
40X1338	Door-fuser idle gear link CBM	7-7
40X1339	Rear cover assembly	7-3
40X1340	Main tray	7-3
40X1341	Optional media drawer assembly (no tray)	7-3
40X1342	Optional tray 2	7-3
40X1353	Screws	7-7
40X1354	Front access door and ACM springs	7-7
40X1354	Springs, ACM and front access door	7-3
40X1355	Plastic snap rings	7-7
40X1356	Language overlays	7-3
40X1357	LCD bezel, E340 cover	7-3
40X1358	LCD operator panel assembly, Katakana	7-5
40X1359	Logo plate cover, E238	7-3
40X1364	32MB SDR DIMM	7-8
40X1365	64MB SDR DIMM	7-8
40X1366	128MB SDR DIMM	7-8
40X1367	Parallel cable, packaged (3 m)	7-9
40X1368	USB cable, packaged (2 m)	7-9
40X1512	Japanese font card assembly	7-8
40X1513	Simplified Chinese font card assembly	7-8
40X1514	Traditional Chinese font card assembly	7-8
40X1515	Korean font card assembly	7-8
40X1564	32MB flash card assembly	7-8
56P2076	Toner level sensor	7-5
7372839	Field location package assembly	7-9

