



Lexmark™

MB2650, MX622, XM3250 MFPs

User's Guide

February 2020

www.lexmark.com

Machine type(s):

7018

Models:

676, 678, 679, 686

Contents

- Safety information.....7**
 - Conventions.....7
 - Product statements.....7

- Learning about the printer..... 10**
 - Finding information about the printer..... 10
 - Selecting a location for the printer..... 11
 - Printer configurations..... 13
 - Attaching cables..... 14
 - Using the control panel..... 15
 - Understanding the status of the power button and indicator light..... 15

- Setting up and using the home screen applications..... 17**
 - Using the home screen.....17
 - Customizing the home screen..... 18
 - Setting up Card Copy.....18
 - Creating a shortcut..... 18
 - Using Display Customization..... 19
 - Configuring Eco-Settings..... 19
 - Using Customer Support.....20
 - Using QR Code Generator.....20
 - Setting up Scan Center.....20
 - Setting up Device Quotas.....20
 - Managing bookmarks.....21
 - Managing contacts.....22

- Setting up and using the accessibility features..... 24**
 - Enabling Magnification mode.....24
 - Activating Voice Guidance.....24
 - Navigating the screen using gestures.....24
 - Adjusting the Voice Guidance speech rate.....25
 - Using the keyboard on the display.....25
 - Enabling spoken passwords or personal identification numbers..... 25

Loading paper and specialty media..... 26

- Setting the paper size and type..... 26
- Configuring Universal paper settings..... 26
- Loading trays..... 26
- Loading the multipurpose feeder..... 28
- Linking trays.....29

Paper support.....30

- Supported paper sizes.....30
- Supported paper types..... 32
- Supported paper weights..... 32

Printing..... 33

- Printing from a computer..... 33
- Printing from a mobile device..... 33
- Printing from a flash drive..... 35
- Supported flash drives and file types..... 36
- Configuring confidential jobs..... 37
- Printing confidential and other held jobs..... 37
- Printing a font sample list..... 38
- Printing a directory list.....38
- Canceling a print job.....38

Copying..... 40

- Using the automatic document feeder and scanner glass..... 40
- Making copies..... 40
- Copying photos..... 40
- Copying on letterhead..... 41
- Copying on both sides of the paper.....41
- Reducing or enlarging copies..... 41
- Collating copies..... 41
- Placing separator sheets between copies..... 41
- Copying multiple pages onto a single sheet..... 42
- Creating a copy shortcut..... 42

E-mailing..... 43

- Using the automatic document feeder and scanner glass..... 43

Configuring the SMTP server for e-mail..... 43
Sending an e-mail.....44
Creating an e-mail shortcut.....44

Faxing.....45

Setting up the printer to fax..... 45
Sending a fax.....52
Scheduling a fax..... 52
Creating a fax destination shortcut.....53
Changing the fax resolution..... 53
Adjusting the fax darkness..... 53
Printing a fax log..... 53
Blocking junk faxes..... 53
Holding faxes.....53
Forwarding a fax..... 54

Scanning..... 55

Using the automatic document feeder and scanner glass..... 55
Scanning to an FTP server.....55
Creating an FTP shortcut..... 55
Scanning to a flash drive.....56
Scanning to a fax server..... 57
Sending scanned documents to a computer.....57

Understanding the printer menus.....58

Menu map..... 58
Device..... 59
Print..... 72
Paper.....81
Copy.....83
Fax..... 87
E-mail..... 91
FTP..... 97
USB Drive.....101
Network/Ports.....106
Security.....118
Reports..... 126

Help.....	127
Troubleshooting.....	128
Printing the Menu Settings Page.....	128
Securing the printer.....	129
Locating the security slot.....	129
Erasing printer memory.....	129
Erasing printer hard disk memory.....	129
Encrypting the printer hard disk.....	130
Restoring factory default settings.....	130
Statement of Volatility.....	130
Maintaining the printer.....	132
Adjusting the speaker volume.....	132
Networking.....	133
Cleaning printer parts.....	136
Ordering parts and supplies.....	139
Replacing parts and supplies.....	143
Moving the printer.....	158
Saving energy and paper.....	158
Recycling.....	159
Clearing jams.....	161
Avoiding jams.....	161
Identifying jam locations.....	162
Paper jam in door A.....	163
Paper jam in the rear door.....	167
Paper jam in the standard bin.....	168
Paper jam in the duplex unit.....	169
Paper jam in trays.....	170
Paper jam in the multipurpose feeder.....	170
Paper jam in the automatic document feeder.....	171
Paper jam in the finisher.....	172
Staple jam in the finisher.....	174
Troubleshooting.....	176
Network connection problems.....	176

Hardware options problems.....178
Issues with supplies..... 180
Paper feed problems..... 181
Printing problems.....184
Faxing problems.....213
Scanning problems..... 216
Contacting customer support.....220

Upgrading and migrating.....221

Hardware..... 221
Software..... 235
Firmware..... 235

Notices..... 237

Index..... 251

Safety information

Conventions

Note: A *note* identifies information that could help you.

Warning: A *warning* identifies something that could damage the product hardware or software.

CAUTION: A *caution* indicates a potentially hazardous situation that could injure you.

Different types of caution statements include:



CAUTION—POTENTIAL INJURY: Indicates a risk of injury.



CAUTION—SHOCK HAZARD: Indicates a risk of electrical shock.



CAUTION—HOT SURFACE: Indicates a risk of burn if touched.



CAUTION—TIPPING HAZARD: Indicates a crush hazard.



CAUTION—PINCH HAZARD: Indicates a risk of being caught between moving parts.

Product statements



CAUTION—POTENTIAL INJURY: To avoid the risk of fire or electrical shock, connect the power cord to an appropriately rated and properly grounded electrical outlet that is near the product and easily accessible.



CAUTION—POTENTIAL INJURY: To avoid the risk of fire or electrical shock, use only the power cord provided with this product or the manufacturer's authorized replacement.



CAUTION—POTENTIAL INJURY: Do not use this product with extension cords, multioutlet power strips, multioutlet extenders, or UPS devices. The power capacity of these types of accessories can be easily overloaded by a laser printer and may result in a risk of fire, property damage, or poor printer performance.



CAUTION—POTENTIAL INJURY: Only a Lexmark Inline Surge Protector that is properly connected between the printer and the power cord provided with the printer may be used with this product. The use of non-Lexmark surge protection devices may result in a risk of fire, property damage, or poor printer performance.



CAUTION—POTENTIAL INJURY: To reduce the risk of fire, use only a 26 AWG or larger telecommunications (RJ-11) cord when connecting this product to the public switched telephone network. For users in Australia, the cord must be approved by the Australian Communications and Media Authority.





CAUTION—SHOCK HAZARD: To avoid the risk of electrical shock, do not place or use this product near water or wet locations.





CAUTION—SHOCK HAZARD: To avoid the risk of electrical shock, do not set up this product or make any electrical or cabling connections, such as the power cord, fax feature, or telephone, during a lightning storm.

 **CAUTION—POTENTIAL INJURY:** Do not cut, twist, bind, crush, or place heavy objects on the power cord. Do not subject the power cord to abrasion or stress. Do not pinch the power cord between objects such as furniture and walls. If any of these things happen, a risk of fire or electrical shock results. Inspect the power cord regularly for signs of such problems. Remove the power cord from the electrical outlet before inspecting it.

 **CAUTION—SHOCK HAZARD:** To avoid the risk of electrical shock, make sure that all external connections (such as Ethernet and telephone system connections) are properly installed in their marked plug-in ports.

 **CAUTION—SHOCK HAZARD:** To avoid the risk of electrical shock, if you are accessing the controller board or installing optional hardware or memory devices sometime after setting up the printer, then turn the printer off, and unplug the power cord from the electrical outlet before continuing. If you have any other devices attached to the printer, then turn them off as well, and unplug any cables going into the printer.

 **CAUTION—SHOCK HAZARD:** To avoid the risk of electrical shock, do not use the fax feature during a lightning storm.





 **CAUTION—SHOCK HAZARD:** To avoid the risk of electrical shock when cleaning the exterior of the printer, unplug the power cord from the electrical outlet and disconnect all cables from the printer before proceeding.

 **CAUTION—POTENTIAL INJURY:** If the printer weight is greater than 20 kg (44 lb), then it may require two or more people to lift it safely.

 **CAUTION—POTENTIAL INJURY:** When moving the printer, follow these guidelines to avoid personal injury or printer damage:

- Make sure that all doors and trays are closed.
- Turn off the printer, and then unplug the power cord from the electrical outlet.
- Disconnect all cords and cables from the printer.
- If the printer has separate floor-standing optional trays or output options attached to it, then disconnect them before moving the printer.
- If the printer has a caster base, then carefully roll it to the new location. Use caution when passing over thresholds and breaks in flooring.
- If the printer does not have a caster base but is configured with optional trays or output options, then remove the output options and lift the printer off the trays. Do not try to lift the printer and any options at the same time.
- Always use the handholds on the printer to lift it.
- Any cart used to move the printer must have a surface able to support the full footprint of the printer.
- Any cart used to move the hardware options must have a surface able to support the dimensions of the options.
- Keep the printer in an upright position.
- Avoid severe jarring movements.
- Make sure that your fingers are not under the printer when you set it down.
- Make sure that there is adequate clearance around the printer.

 **CAUTION—TIPPING HAZARD:** Installing one or more options on your printer or MFP may require a caster base, furniture, or other feature to prevent instability causing possible injury. For more information on supported configurations, see www.lexmark.com/multifunctionprinters.

-  **CAUTION—TIPPING HAZARD:** To reduce the risk of equipment instability, load each tray separately. Keep all other trays closed until needed.
-  **CAUTION—HOT SURFACE:** The inside of the printer might be hot. To reduce the risk of injury from a hot component, allow the surface to cool before touching it.
-  **CAUTION—PINCH HAZARD:** To avoid the risk of a pinch injury, use caution in areas marked with this label. Pinch injuries may occur around moving parts, such as gears, doors, trays, and covers.
-  **CAUTION—POTENTIAL INJURY:** This product uses a laser. Use of controls or adjustments or performance of procedures other than those specified in the *User's Guide* may result in hazardous radiation exposure.
-  **CAUTION—POTENTIAL INJURY:** The lithium battery in this product is not intended to be replaced. There is a danger of explosion if a lithium battery is incorrectly replaced. Do not recharge, disassemble, or incinerate a lithium battery. Discard used lithium batteries according to the manufacturer's instructions and local regulations.

This product is designed, tested, and approved to meet strict global safety standards with the use of specific manufacturer's components. The safety features of some parts may not always be obvious. The manufacturer is not responsible for the use of other replacement parts.

Refer service or repairs, other than those described in the user documentation, to a service representative.

This product uses a printing process that heats the print media, and the heat may cause the media to release emissions. You must understand the section in your operating instructions that discusses the guidelines for selecting print media to avoid the possibility of harmful emissions.

This product may produce small amounts of ozone during normal operation, and may be equipped with a filter designed to limit ozone concentrations to levels well below the recommended exposure limits. To avoid high ozone concentration levels during extensive usage, install this product in a well-ventilated area and replace the ozone and exhaust filters if instructed to do so in the product maintenance instructions. If there are no references to filters in the product maintenance instructions, then there are no filters requiring replacement for this product.

SAVE THESE INSTRUCTIONS.

Learning about the printer

Finding information about the printer

What are you looking for?	Find it here
Initial setup instructions: <ul style="list-style-type: none"> • Connecting the printer • Installing the printer software 	See the setup documentation that came with the printer or go to http://support.lexmark.com .
More setup and instructions for using the printer: <ul style="list-style-type: none"> • Selecting and storing paper and specialty media • Loading paper • Configuring printer settings • Viewing and printing documents and photos • Setting up and using the printer software • Configuring the printer on a network • Caring for and maintaining the printer • Troubleshooting and solving problems 	<i>Information Center</i> —Go to http://infoserve.lexmark.com . <i>Help Menu Pages</i> —Access the guides on the printer firmware or go to http://support.lexmark.com . <i>Touch Screen Guide</i> —Go to http://support.lexmark.com . Product videos—Go to http://infoserve.lexmark.com/idv/ .
Information on setting up and configuring the accessibility features of your printer	<i>Lexmark Accessibility Guide</i> —Go to http://support.lexmark.com .
Help using the printer software	Help for Microsoft® Windows® or Macintosh operating systems—Open a printer software program or application, and then click Help . Click  to view context-sensitive information. Notes: <ul style="list-style-type: none"> • Help is automatically installed with the printer software. • Depending on the operating system, the printer software is located in the printer program folder or on the desktop.

What are you looking for?	Find it here
<p>The latest supplemental information, updates, and customer support:</p> <ul style="list-style-type: none"> • Documentation • Driver downloads • Live chat support • E-mail support • Voice support 	<p>Go to http://support.lexmark.com.</p> <p>Note: Select your country or region, and then select your product to view the appropriate support site.</p> <p>Support contact information for your country or region can be found on the website or on the printed warranty that came with the printer.</p> <p>Have the following information ready when you contact customer support:</p> <ul style="list-style-type: none"> • Place and date of purchase • Machine type and serial number 
<ul style="list-style-type: none"> • Safety information • Regulatory information • Warranty information • Environmental information 	<p>Warranty information varies by country or region:</p> <ul style="list-style-type: none"> • In the U.S.—See the Statement of Limited Warranty included with the printer, or go to http://support.lexmark.com. • In other countries and regions—See the printed warranty that came with the printer. <p><i>Product Information Guide</i>—See the documentation that came with the printer or go to http://support.lexmark.com.</p>

Selecting a location for the printer

- Leave enough room to open trays, covers, and doors and to install hardware options.
- Set up the printer near an electrical outlet.

 **CAUTION—POTENTIAL INJURY:** To avoid the risk of fire or electrical shock, connect the power cord to an appropriately rated and properly grounded electrical outlet that is near the product and easily accessible.

 **CAUTION—SHOCK HAZARD:** To avoid the risk of electrical shock, do not place or use this product near water or wet locations.

- Make sure that airflow in the room meets the latest revision of the ASHRAE 62 standard or the CEN Technical Committee 156 standard.
- Provide a flat, sturdy, and stable surface.
- Keep the printer:
 - Clean, dry, and free of dust
 - Away from stray staples and paper clips
 - Away from the direct airflow of air conditioners, heaters, or ventilators
 - Free from direct sunlight and humidity extremes
- Observe the recommended temperatures and avoid fluctuations.

Ambient temperature	10 to 32°C (50 to 90°F)
Storage temperature	0 to 40°C (32 to 104°F)

- Allow the following recommended amount of space around the printer for proper ventilation:

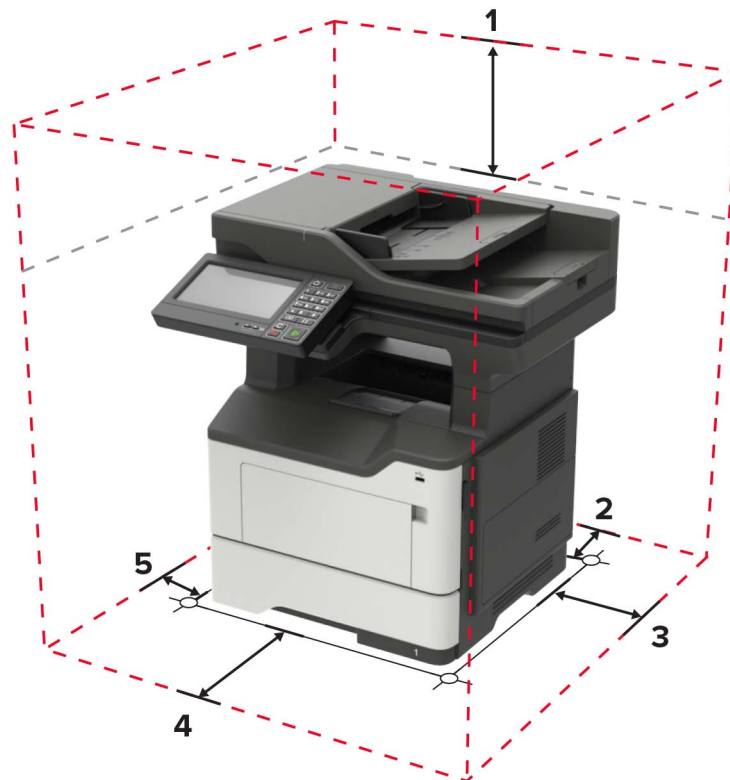

1	Top	800 mm (32 in.)
2	Rear	203 mm (8 in.)
3	Right side	305 mm (12 in.)
4	Front	510 mm (20 in.) Note: The minimum space needed in front of the printer is 76 mm (3 in.).
5	Left side	203 mm (8 in.)

Printer configurations

CAUTION—TIPPING HAZARD: Installing one or more options on your printer or MFP may require a caster base, furniture, or other feature to prevent instability causing possible injury. For more information on supported configurations, see www.lexmark.com/multifunctionprinters.

CAUTION—TIPPING HAZARD: To reduce the risk of equipment instability, load each tray separately. Keep all other trays closed until needed.

You can configure your printer by adding optional 250- or 550-sheet trays. For more information, see [“Installing optional trays” on page 234](#).

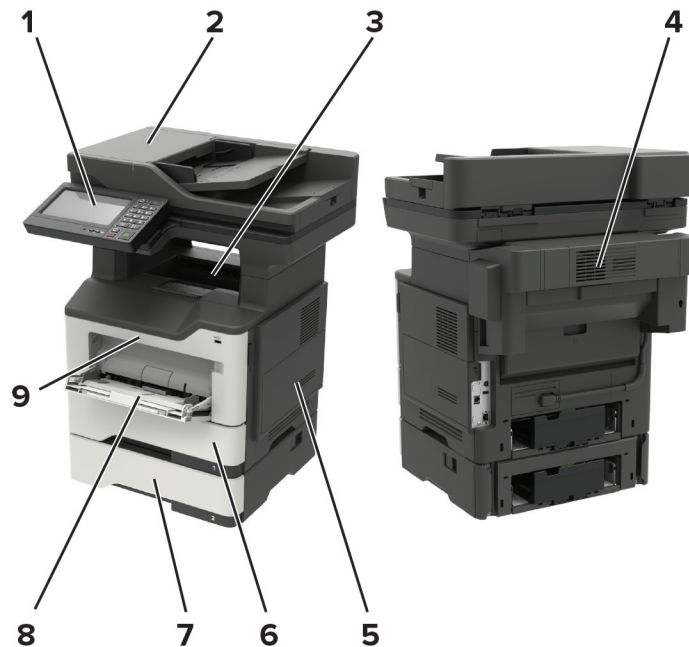

1	Control panel
2	Automatic document feeder (ADF)
3	Standard bin
4	Optional staple finisher Note: Only a technical service representative can install this option.
5	Controller board access cover
6	Standard 550-sheet tray
7	Optional 250- or 550-sheet tray
8	Multipurpose feeder
9	Door A

Attaching cables

- ⚠ CAUTION—SHOCK HAZARD:** To avoid the risk of electrical shock, do not set up this product or make any electrical or cabling connections, such as the power cord, fax feature, or telephone, during a lightning storm.
- ⚠ CAUTION—POTENTIAL INJURY:** To avoid the risk of fire or electrical shock, connect the power cord to an appropriately rated and properly grounded electrical outlet that is near the product and easily accessible.
- ⚠ CAUTION—POTENTIAL INJURY:** To avoid the risk of fire or electrical shock, use only the power cord provided with this product or the manufacturer's authorized replacement.
- ⚠ CAUTION—POTENTIAL INJURY:** To reduce the risk of fire, use only a 26 AWG or larger telecommunications (RJ-11) cord when connecting this product to the public switched telephone network. For users in Australia, the cord must be approved by the Australian Communications and Media Authority.

Warning—Potential Damage: To avoid loss of data or printer malfunction, do not touch the USB cable, any wireless network adapter, or the printer in the areas shown while actively printing.



	Use the	To
1	Power cord socket	Connect the printer to an electrical outlet.
2	Ethernet port	Connect the printer to an Ethernet network.
3	LINE port	Connect the printer to an active telephone line through a standard wall jack (RJ-11), DSL filter, or VoIP adapter, or any other adapter that allows you to access the telephone line to send and receive faxes.
4	USB port	Attach a keyboard or any compatible option.
5	USB printer port	Connect the printer to a computer.

Using the control panel

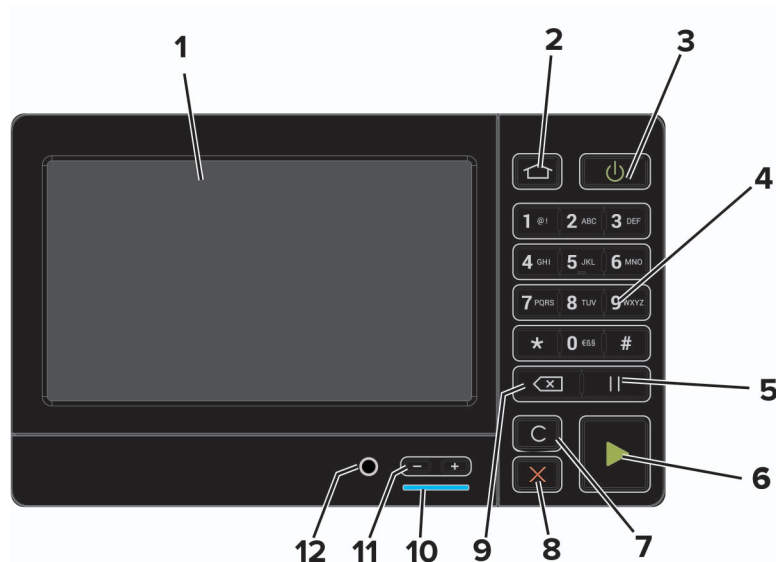

	Use the	To
1	Display	<ul style="list-style-type: none"> View printer messages and supply status. Set up and operate the printer.
2	Home button	Go to the home screen.
3	Power button	Turn on or turn off the printer. Note: To turn off the printer, press and hold the power button for five seconds.
4	Numeric keypad	Enter numbers or symbols in an input field.
5	Pause button	Place a dial pause in a fax number.
6	Start button	Start a job, depending on which mode is selected.
7	Clear all or Reset button	Reset the default settings of a function such as copying, faxing, or scanning.
8	Stop or Cancel button	Stop the current printer task.
9	Backspace button	Move the cursor backward and delete a character in an input field.
10	Indicator light	Check the status of the printer.
11	Volume buttons	Adjust the speaker volume.
12	Speaker port	Attach a speaker.

Understanding the status of the power button and indicator light

Indicator light	Printer status
Off	The printer is off or in Hibernate mode.
Blue	The printer is ready or processing data.

Indicator light	Printer status
Red	The printer requires user intervention.

Power button light	Printer status
Off	The printer is off, ready, or processing data.
Solid amber	The printer is in Sleep mode.
Blinking amber	The printer is in Hibernate mode.

Setting up and using the home screen applications

Note: These applications are supported only in some printer models.

Using the home screen

Note: Your home screen may vary depending on your home screen customization settings, administrative setup, and active embedded solutions.



Touch		To
1	Copy	Make copies.
2	E-mail	Send e-mails.
3	Settings	Access the printer menus.
4	Fax	Send fax.
5	Address Book	Manage a contact list that other applications on the printer can access.
6	Status/Supplies	<ul style="list-style-type: none"> Show a printer warning or error message whenever the printer requires intervention to continue processing. View more information on the printer warning or message, and on how to clear it. <p>Note: You can also access this setting by touching the top section of the home screen.</p>
7	USB Drive	<ul style="list-style-type: none"> Print photos and documents from a flash drive. Scan photos and documents to a flash drive
8	Job Queue	Show all the current print jobs. Note: You can also access this setting by touching the top section of the home screen.
9	Held Jobs	Show the print jobs that are held in the printer memory.

Touch		To
10	Shortcut Center	Organize all shortcuts.
11	App Profiles	Access application profiles.
12	Scan Profiles	Scan and save documents directly to the computer.
13	FTP	Scan and save documents directly to an FTP server.
14	Bookmarks	Organize all bookmarks.
15	Change Language	Change the language on the display.

Customizing the home screen

- 1 From the control panel, touch **Settings > Device > Visible Home Screen Icons**.
- 2 Select the icons that you want to appear on the home screen.
- 3 Apply the changes.

Setting up Card Copy

- 1 Open a web browser, and then type the printer IP address in the address field.

Notes:

- View the printer IP address on the printer home screen. The IP address appears as four sets of numbers separated by periods, such as 123.123.123.123.
- If you are using a proxy server, then temporarily disable it to load the web page correctly.

- 2 Click **Apps > Card Copy > Configure**.

Notes:

- Make sure that Display Icon is enabled.
- Make sure that E-mail Settings and Network Share Settings are configured.
- When scanning a card, make sure that the scan resolution does not exceed 200 dpi for color and 400 dpi for black and white.
- When scanning multiple cards, make sure that the scan resolution does not exceed 150 dpi for color and 300 dpi for black and white.

- 3 Apply the changes.

Note: You need a printer hard disk to scan multiple cards.

Creating a shortcut

- 1 From the home screen, touch **Shortcut Center**.

Note: The icon and name may have been changed. For more information, contact your administrator.

- 2 Select a printer function, and then touch **Create Shortcut**.

Note: The Secure E-mail function is not supported.

3 Configure the settings, and then touch **Save**.

4 Type a unique shortcut name.

Note: To avoid clipped names on the home screen, type only up to 25 characters.

5 Touch **OK**.

The application automatically generates a unique shortcut number. To launch the shortcut, press **#** and then the shortcut number.

Using Display Customization

Before using the application, make sure to do the following:

- From the Embedded Web Server, click **Apps > Display Customization > Configure**.
- Enable and configure the screen saver, slideshow, and wallpaper settings.

Managing screen saver and slide show images

1 From the Screen Saver and Slideshow Images section, add, edit, or delete an image.

Notes:

- You can add up to 10 images.
- When enabled, the status icons appear on the screen saver only when there are errors, warnings, or cloud-based notifications.

2 Apply the changes.

Changing the wallpaper image

1 From the home screen, touch **Change Wallpaper**.

2 Select an image to use.

3 Apply the changes.

Running a slide show from a flash drive

1 Insert a flash drive into the USB port.

2 From the home screen, touch **Slideshow**.

Images appear in alphabetical order.

Note: You can remove the flash drive after the slide show starts, but the images are not stored in the printer. If the slide show stops, then insert the flash drive again to view the images.

Configuring Eco-Settings

1 From the home screen, touch **Eco-Settings**.

2 Configure Eco-Mode or Schedule Power Modes.

3 Apply the changes.

Using Customer Support

- 1 From the home screen, touch **Customer Support**.
- 2 Print or e-mail the information.

Note: For information on configuring the application settings, see the *Customer Support Administrator's Guide*.

Using QR Code Generator

You may need administrative rights to access the application.

- 1 Open a Web browser, and then type the printer IP address in the address field.

Notes:

- View the printer IP address on the printer home screen. The IP address appears as four sets of numbers separated by periods, such as 123.123.123.123.
- If you are using a proxy server, then temporarily disable it to load the Web page correctly.

- 2 Click **Apps > QR Code Generator > Configure**.

- 3 Do either of the following:

- Select a default QR code value.
- Type a QR code value.

- 4 Apply the changes.

Setting up Scan Center

- 1 From the home screen, touch **Scan Center**.
- 2 Select and create a destination, and then configure the settings.

Notes:

- When creating a network destination, make sure to validate and adjust the settings until no errors occur.
- Only destinations created from the Embedded Web Server are saved. For more information, see the documentation that came with the solution.

- 3 Apply the changes.

Setting up Device Quotas

You may need administrative rights to access the application.

- 1 Open a Web browser, and then type the printer IP address in the address field.

Notes:

- View the printer IP address on the printer home screen. The IP address appears as four sets of numbers separated by periods, such as 123.123.123.123.

- If you are using a proxy server, then temporarily disable it to load the Web page correctly.

2 Click **Apps > Device Quotas > Configure**.

3 From the User Accounts section, add or edit a user, and then set the user quota.

4 Apply the changes.

Note: For information on how to configure the application and its security settings, see the *Device Quotas Administrator's Guide*.

Managing bookmarks

Creating bookmarks

Use bookmarks to print frequently accessed documents that are stored in servers or on the web.

1 Open a web browser, and then type the printer IP address in the address field.

Notes:

- View the printer IP address on the printer home screen. The IP address appears as four sets of numbers separated by periods, such as 123.123.123.123.
- If you are using a proxy server, then temporarily disable it to load the web page correctly.

2 Click **Bookmarks > Add Bookmark**, and then type a bookmark name.

3 Select an Address protocol type, and then do one of the following:

- For HTTP and HTTPS, type the URL that you want to bookmark.
- For HTTPS, make sure to use the host name instead of the IP address. For example, type **myWebsite.com/sample.pdf** instead of typing **123.123.123.123/sample.pdf**. Make sure that the host name also matches the Common Name (CN) value in the server certificate. For more information on obtaining the CN value in the server certificate, see the help information for your web browser.
- For FTP, type the FTP address. For example, **myServer/myDirectory**. Enter the FTP port. Port 21 is the default port for sending commands.
- For SMB, type the network folder address. For example, **myServer/myShare/myFile.pdf**. Type the network domain name.
- If necessary, select the Authentication type for FTP and SMB.

To limit access to the bookmark, enter a PIN.

Note: The application supports the following file types: PDF, JPEG, TIFF, and HTML-based web pages. Other file types such as DOCX and XLXS are supported in some printer models.

4 Click **Save**.

Creating folders

1 Open a web browser, and then type the printer IP address in the address field.

Notes:

- View the printer IP address on the printer home screen. The IP address appears as four sets of numbers separated by periods, such as 123.123.123.123.

- If you are using a proxy server, then temporarily disable it to load the web page correctly.

2 Click **Bookmarks > Add Folder**, and then type a folder name.

Note: To limit access to the folder, enter a PIN.

3 Click **Save**.

Note: You can create folders or bookmarks inside a folder. To create a bookmark, see [“Creating bookmarks” on page 21](#).

Managing contacts

Adding contacts

1 Open a web browser, and then type the printer IP address in the address field.

Notes:

- View the printer IP address on the printer home screen. The IP address appears as four sets of numbers separated by periods, such as 123.123.123.123.
- If you are using a proxy server, then temporarily disable it to load the web page correctly.

2 Click **Address Book**.

3 From the Contacts section, add a contact.

Note: You can assign the contact to one or more groups.

4 If necessary, specify a login method to allow application access.

5 Apply the changes.

Adding groups

1 Open a web browser, and then type the printer IP address in the address field.

Notes:

- View the printer IP address on the printer home screen. The IP address appears as four sets of numbers separated by periods, such as 123.123.123.123.
- If you are using a proxy server, then temporarily disable it to load the web page correctly.

2 Click **Address Book**.

3 From the Contact Groups section, add a group name.

Note: You can assign one or more contacts to the group.

4 Apply the changes.

Editing contacts or groups

1 Open a web browser, and then type the printer IP address in the address field.

Notes:

- View the printer IP address on the printer home screen. The IP address appears as four sets of numbers separated by periods, such as 123.123.123.123.
- If you are using a proxy server, then temporarily disable it to load the web page correctly.

2 Click **Address Book**.

3 Do either of the following:

- From the Contacts section, click a contact name, and then edit the information.
- From the Contact Groups section, click a group name, and then edit the information.

4 Apply the changes.

Deleting contacts or groups

1 Open a web browser, and then type the printer IP address in the address field.

Notes:

- View the printer IP address on the printer home screen. The IP address appears as four sets of numbers separated by periods, such as 123.123.123.123.
- If you are using a proxy server, then temporarily disable it to load the web page correctly.

2 Click **Address Book**.

3 Do either of the following:

- From the Contacts section, select a contact that you want to delete.
- From the Contact Groups section, select a group name that you want to delete.

Setting up and using the accessibility features

Note: For more information on the accessibility features of your printer model, see the Accessibility Guide at <http://support.lexmark.com>.

Enabling Magnification mode

- 1 From the control panel, press and hold the **5** key until you hear a voice message.
- 2 Select **Magnification mode**.
- 3 Select **OK**.

For more information on navigating a magnified screen, see [“Navigating the screen using gestures” on page 24](#).

Activating Voice Guidance

From the control panel

- 1 Press and hold the **5** key until you hear a voice message.
- 2 Select **OK**.

From the keyboard

- 1 Press and hold the **5** key until you hear a voice message.
- 2 Press **Tab** to navigate the focus cursor to the OK button, and then press **Enter**.

Notes:

- Voice Guidance is also activated when you insert headphones into the headphone jack.
- To adjust the volume, use the volume buttons at the bottom part of the control panel.

Navigating the screen using gestures

Notes:

- The gestures are applicable only when Voice Guidance is activated.
- Enable Magnification to use the zoom and pan gestures.
- Use a physical keyboard to type characters and adjust certain settings.

Gesture	Function
Double-tap	Select an option or item on the screen.
Triple-tap	Zoom in or zoom out text and images.
Swipe right or swipe down	Move to the next item on the screen.
Swipe left or swipe up	Move to the previous item on the screen.

Gesture	Function
Pan	Access parts of the zoomed image that are beyond the limits of the screen. Note: This gesture requires the use of two fingers to drag across a zoomed image.
Swipe up then left	Exit an application and return to the home screen.
Swipe down then left	<ul style="list-style-type: none"> • Cancel a job. • Go back to the previous setting. • Exit the screen that appears without changing any setting or value.
Swipe up then down	Repeat a spoken prompt.

Adjusting the Voice Guidance speech rate

- 1 From the home screen, select **Settings > Device > Accessibility > Speech Rate**.
- 2 Select the speech rate.

Using the keyboard on the display

Do one or more of the following:

- Drag a finger over the key to announce the character.
- Lift the finger to enter or type the character in the field.
- Select **Backspace** to delete characters.
- To hear the content in the input field, select **Tab**, and then select **Shift + Tab**.

Enabling spoken passwords or personal identification numbers

- 1 From the home screen, select **Settings > Device > Accessibility > Speak Passwords/PINs**.
- 2 Enable the setting.

Loading paper and specialty media

Setting the paper size and type

- 1 From the home screen, navigate to:
Settings > Paper > Tray Configuration > Paper Size/Type > select a paper source
- 2 Set the paper size and type.

Configuring Universal paper settings

- 1 From the home screen, touch **Settings > Paper > Media Configuration > Universal Setup**.
- 2 Configure the settings.

Loading trays

 **CAUTION—TIPPING HAZARD:** To reduce the risk of equipment instability, load each tray separately. Keep all other trays closed until needed.

- 1 Remove the tray.

Note: To avoid paper jams, do not remove trays while the printer is busy.

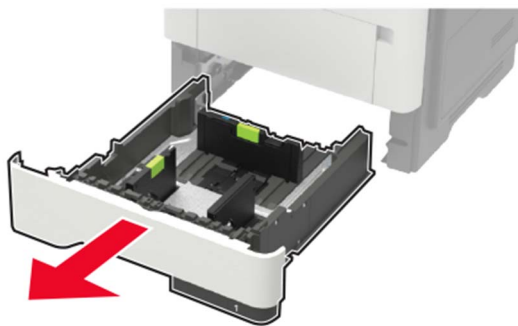

- 2** Adjust the paper guides to match the size of the paper that you are loading.

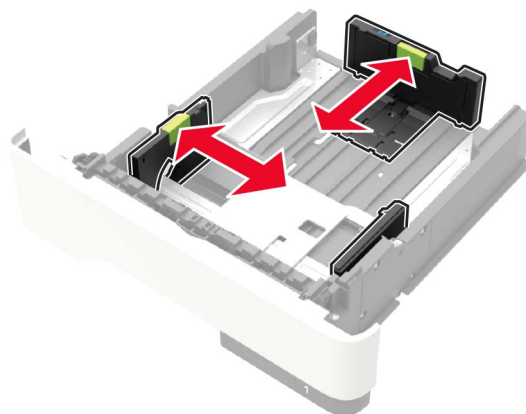

- 3** Flex, fan, and align the paper edges before loading.

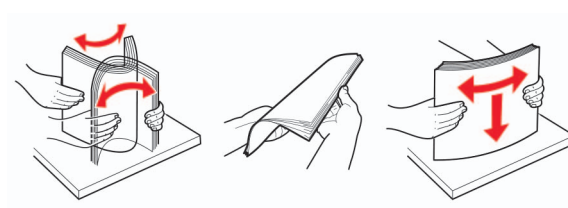

- 4** Load the paper stack with the printable side facedown, and then make sure that the side guides fit snugly against the paper.

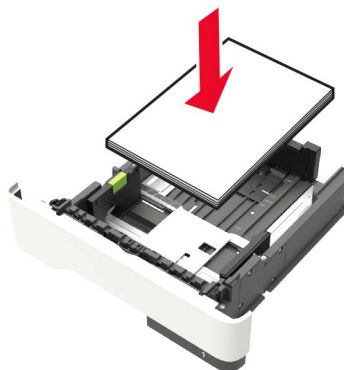

Notes:

- Load letterhead facedown with the top edge of the sheet toward the front of the tray for one-sided printing.
- Load letterhead faceup with the bottom edge of the sheet toward the front of the tray for two-sided printing.
- Do not slide paper into the tray.
- To avoid paper jams, make sure that the stack height is below the maximum paper fill indicator.

- 5** Insert the tray.

If necessary, set the paper size and paper type from the control panel to match the paper loaded.

Loading the multipurpose feeder

- 1 Open the multipurpose feeder.

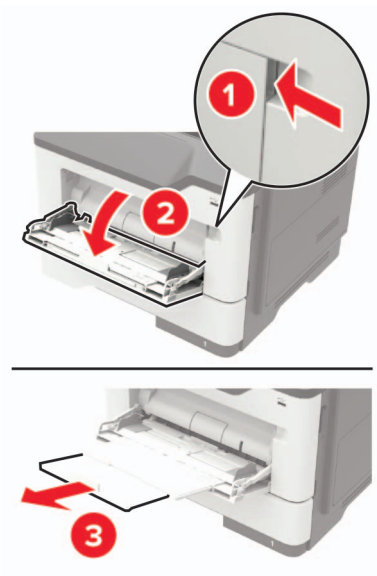

- 2 Adjust the guide to match the size of the paper that you are loading.

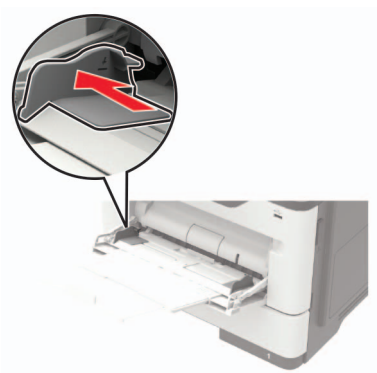

- 3 Flex, fan, and align the paper edges before loading.

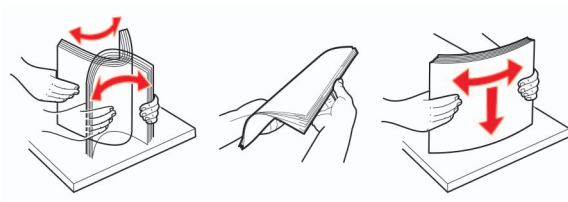

- 4 Load paper with the printable side faceup.

Notes:

- Load letterhead faceup with the top edge of the sheet toward the front of the tray for one-sided printing.
- Load letterhead facedown with the bottom edge of the sheet toward the front of the tray for two-sided printing.

- Load envelopes with the flap facedown on the left side.
- Load European envelopes with the flap facedown and entering the printer first.

Warning—Potential Damage: Do not use envelopes with stamps, clasps, snaps, windows, coated linings, or self-stick adhesives.

5 From the control panel, set the paper size and paper type to match the paper loaded.

Linking trays

- 1** From the home screen, touch **Settings > Paper > Tray Configuration** > select a paper source.
- 2** Set the same paper size and paper type for the trays that you are linking.
- 3** From the home screen, touch **Settings > Device > Maintenance > Config Menu > Tray Configuration > Tray Linking**.
- 4** Touch **Automatic**.

To unlink trays, make sure that no trays have the same paper size and paper type settings.

Warning—Potential Damage: The temperature of the fuser varies according to the specified paper type. To avoid printing issues, match the paper type setting in the printer with the paper loaded in the tray.

Paper support

Supported paper sizes

Paper size	Standard 550-sheet tray	Optional 250- or 550-sheet tray	Multipurpose feeder	Two-sided printing	ADF	Scanner glass
A4 210 x 297 mm (8.3 x 11.7 in.)	✓	✓	✓	✓	✓	✓
A5 210 x 148 mm (8.3 x 5.8 in.)	✓	✓	✓	✗	✓	✓
A5 LEF 148 x 210 mm (5.8 x 8.3 in.)	✓	✗	✓	✗	✓	✓
A6 105 x 148 mm (4.1 x 5.8 in.)	✓	✗	✓	✗	✓	✓
JIS B5 182 x 257 mm (7.2 x 10.1 in.)	✓	✓	✓	✗	✓	✓
Oficio (Mexico) 216 x 340 mm (8.5 x 13.4 in.)	✓	✓	✓	✓	✓	✓
Hagaki 100 x 148 mm (3.9 x 5.8 in.)	✗	✗	✓	✗	✗	✓
Business card 50.8 x 88.9 mm (2 x 3.5 in.)	✗	✗	✗	✗	✗	✓
Statement 140 x 216 mm (5.5 x 8.5 in.)	✓	✓	✓	✗	✓	✓
Executive 184 x 267 mm (7.3 x 10.5 in.)	✓	✓	✓	✗	✓	✓

* Supports paper only with sizes ranging from 105 x 139 mm to 217 x 356 mm (4.13 x 5.47 in. to 8.5 x 14 in.).

Paper size	Standard 550-sheet tray	Optional 250- or 550-sheet tray	Multipurpose feeder	Two-sided printing	ADF	Scanner glass
Letter 216 x 279 mm (8.5 x 11 in.)	✓	✓	✓	✓	✓	✓
Legal 216 x 356 mm (8.5 x 14 in.)	✓	✓	✓	✓	✓	✓
Folio 216 x 330 mm (8.5 x 13 in.)	✓	✓	✓	✓	✓	✓
Universal 76.2 x 127 mm to 216 x 356 mm (3 x 5 in. to 8.5 x 14 in.)	✓	✓	✓	X	✓*	✓
7 3/4 Envelope (Monarch) 98 x 191 mm (3.9 x 7.5 in.)	X	X	✓	X	X	✓
9 Envelope 98 x 225 mm (3.9 x 8.9 in.)	X	X	✓	X	X	✓
10 Envelope 105 x 241 mm (4.1 x 9.5 in.)	X	X	✓	X	X	✓
DL Envelope 110 x 220 mm (4.3 x 8.7 in.)	X	X	✓	X	X	✓
C5 Envelope 162 x 229 mm (6.4 x 9 in.)	X	X	✓	X	X	✓
B5 Envelope 176 x 250 mm (6.9 x 9.8 in.)	X	X	✓	X	X	✓
Other Envelope 76.2 x 127 mm to 216 x 356 mm (3 x 5 in. to 8.5 x 14 in.)	X	X	✓	X	X	✓

* Supports paper only with sizes ranging from 105 x 139 mm to 217 x 356 mm (4.13 x 5.47 in. to 8.5 x 14 in.).

Supported paper types

Paper type	Tray	Multipurpose feeder	Two-sided printing	ADF	Scanner glass
Plain paper	✓	✓	✓	✓	✓
Card stock	X	✓	X	X	✓
Transparency	✓	✓	X	X	✓
Recycled	✓	✓	✓	✓	✓
Paper labels ¹	✓	✓	X	X	✓
Bond ²	✓	✓	✓	✓	✓
Letterhead	✓	✓	✓	✓	✓
Preprinted	✓	✓	✓	✓	✓
Colored Paper	✓	✓	✓	✓	✓
Light Paper	✓	✓	✓	✓	✓
Heavy Paper ²	✓	✓	✓	✓	✓
Rough/Cotton	✓	✓	✓	✓	✓
Envelope	X	✓	X	X	✓
Rough envelope	X	✓	X	X	✓

¹ One-sided paper labels designed for laser printers are supported for occasional use. It is recommended to print 20 or fewer pages of paper labels per month. Vinyl, pharmacy, and two-sided labels are not supported.

² Bond and Heavy Paper are supported in two-sided printing up to 90-g/m² (24-lb) paper weight.

Supported paper weights

	Tray	Multipurpose feeder	Two-sided printing	ADF
Paper weight	60–120 g/m ² (16–32 lb)	60–216 g/m ² (16–58 lb)	60–90 g/m ² (16–24 lb)	52–120 g/m ² (14–32 lb)

Printing

Printing from a computer

Note: For labels, card stock, and envelopes, set the paper size and type in the printer before printing the document.

- 1 From the document that you are trying to print, open the Print dialog.
- 2 If necessary, adjust the settings.
- 3 Print the document.

Printing from a mobile device

Printing from a mobile device using Lexmark Mobile Print

Lexmark™ Mobile Print allows you to send documents and images directly to a supported Lexmark printer.

- 1 Open the document, and then send or share the document to Lexmark Mobile Print.

Note: Some third-party applications may not support the send or share feature. For more information, see the documentation that came with the application.



- 2 Select a printer.
- 3 Print the document.

Printing from a mobile device using Google Cloud Print

Google Cloud Print™ is a printing service that allows you to print to any Google Cloud Print-ready printer.

Before you begin, make sure that:



- The printer is registered to the Google Cloud Print server.
- The Cloud Print plugin is downloaded from the Google Play™ store and is enabled in the mobile device.

- 1 From your Android™ mobile device, open a document or select a document from your file manager.
- 2 Tap  > **Print**.
- 3 Select a printer, and then tap .

Printing from a mobile device using Mopria Print Service

Mopria® Print Service is a mobile printing solution for mobile devices running on Android version 5.0 or later. It allows you to print directly to any Mopria-certified printer.

Note: Make sure that you download the Mopria Print Service application from the Google Play store and enable it in the mobile device.

- 1 From your Android mobile device, launch a compatible application or select a document from your file manager.
- 2 Tap  > **Print**.
- 3 Select a printer, and then adjust the settings, if necessary.
- 4 Tap .

Printing from a mobile device using AirPrint

The AirPrint software feature is a mobile printing solution that allows you to print directly from Apple devices to an AirPrint-certified printer.

Notes:



- Make sure that the Apple device and the printer are connected to the same network. If the network has multiple wireless hubs, then make sure that both devices are connected to the same subnet.
- This application is supported only in some Apple devices.

- 1 From your mobile device, select a document from your file manager or launch a compatible application.
- 2 Tap  > **Print**.
- 3 Select a printer, and then adjust the settings, if necessary.
- 4 Print the document.

Printing from a mobile device using Wi-Fi Direct®

Wi-Fi Direct® is a printing service that lets you print to any Wi-Fi Direct-ready printer.

Note: Make sure that the mobile device is connected to the printer wireless network. For more information, see [“Connecting a mobile device to the printer wireless network” on page 134](#).

- 1 From your mobile device, launch a compatible application or select a document from your file manager.
- 2 Depending on your mobile device, do one of the following:
 - Tap  > **Print**.
 - Tap  > **Print**.
 - Tap  > **Print**.
- 3 Select a printer, and then adjust the settings, if necessary.
- 4 Print the document.

Printing from a flash drive

- 1 Insert the flash drive.



Notes:

- If you insert the flash drive when an error message appears, then the printer ignores the flash drive.
- If you insert the flash drive while the printer is processing other print jobs, then **Busy** appears on the display.

- 2 From the display, touch the document that you want to print.

If necessary, configure other print settings.

- 3 Send the print job.

To print another document, touch **USB Drive**.

Warning—Potential Damage: To avoid loss of data or printer malfunction, do not touch the flash drive or the printer in the area shown while actively printing, reading, or writing from the memory device.



Supported flash drives and file types

Flash drives

- Lexar JumpDrive S70 (16GB and 32GB)
- SanDisk Cruzer (16GB and 32GB)
- PNY Attache (16GB and 32GB)

Notes:

- The printer supports high-speed USB flash drives with full-speed standard.
- USB flash drives must support the File Allocation Table (FAT) system.

File types

Documents

- PDF (version 1.7 or earlier)
- XPS
- Microsoft file formats (.doc, .docx, .xls, .xlsx, .ppt, .pptx)

Images

- .dcx
- .gif
- .JPEG or .jpg
- .bmp
- .pcx
- .TIFF or .tif
- .png

Configuring confidential jobs

- 1 From the control panel, navigate to:
Settings > Security > Confidential Print Setup
- 2 Configure the settings.

Use	To
Max Invalid PIN	Set the number of times an invalid PIN can be entered. Note: When the limit is reached, the print jobs for that user name are deleted.
Confidential Job Expiration	Set the expiration time for confidential print jobs. Note: Confidential held jobs are stored in the printer until they are released or deleted manually.
Repeat Job Expiration	Set the expiration time for a repeat print job. Note: Repeat held jobs are stored in the printer memory for reprinting.
Verify Job Expiration	Set the expiration time that the printer prints a copy before printing the remaining copies. Note: Verify jobs print one copy to check if it is satisfactory before printing the remaining copies.
Reserve Job Expiration	Set the expiration time that the printer stores print jobs. Note: Reserve held jobs are automatically deleted after printing.
Require All Jobs to be Held	Set the printer to hold all print jobs.
Keep duplicate documents	Set the printer to print all documents with the same file name.

Printing confidential and other held jobs

For Windows users

- 1 With a document open, click **File > Print**.
- 2 Click **Properties, Preferences, Options, or Setup**.
- 3 Click **Print and Hold**.
- 4 Select **Use Print and Hold**, and then assign a user name.
- 5 Select the print job type (Confidential, Repeat, Reserve, or Verify).
If the print job is confidential, then enter a four-digit PIN.
- 6 Click **OK** or **Print**.

7 From the printer home screen, release the print job.

- For confidential print jobs, navigate to:
Held jobs > select your user name > **Confidential** > enter the PIN > select the print job > configure the settings > **Print**
- For other print jobs, navigate to:
Held jobs > select your user name > select the print job > configure the settings > **Print**

For Macintosh users

1 With a document open, choose **File** > **Print**.

If necessary, click the disclosure triangle to see more options.

2 From the print options or Copies & Pages menu, choose **Job Routing**.

3 Select the print job type (Confidential, Repeat, Reserve, or Verify).

If the print job is confidential, then assign a user name and a four-digit PIN.

4 Click **OK** or **Print**.

5 From the printer home screen, release the print job.

- For confidential print jobs, navigate to:
Held jobs > select your user name > **Confidential** > enter the PIN > select the print job > configure the settings > **Print**
- For other print jobs, navigate to:
Held jobs > select your user name > select the print job > configure the settings > **Print**

Printing a font sample list

1 From the home screen, touch **Settings** > **Reports** > **Print** > **Print Fonts**.

2 Touch **PCL Fonts** or **PS Fonts**.

Printing a directory list

From the home screen, touch **Settings** > **Reports** > **Print** > **Print Directory**.

Canceling a print job

From the printer control panel

1 From the home screen, touch **Job Queue**.

Note: You can also access this setting by touching the top section of the home screen.



2 Select the job to cancel.

From the computer

- 1** Depending on the operating system, do either of the following:
 - Open the printers folder, and then select your printer.
 - From the System Preferences in the Apple menu, navigate to your printer.
- 2** Select the job to cancel.

Copying

Using the automatic document feeder and scanner glass

Automatic document feeder (ADF)	Scanner glass
 <ul style="list-style-type: none"> • Use the ADF for multiple-page or two-sided documents. • Load an original document faceup. For multiple-page documents, make sure to align the leading edge before loading. • Make sure to adjust the ADF guides to match the width of the paper that you are loading. 	 <ul style="list-style-type: none"> • Use the scanner glass for single-page documents, book pages, small items (such as postcards or photos), transparencies, photo paper, or thin media (such as magazine clippings). • Place the document facedown in the corner with the arrow.

Making copies

- 1 Load an original document into the ADF tray or on the scanner glass.

Note: To avoid a cropped image, make sure that the original document and output have the same paper size.

- 2 From the home screen, touch **Copy**, and then specify the number of copies.
If necessary, adjust the copy settings.

- 3 Copy the document.

Note: To make a quick copy, from the control panel, press .

Copying photos

- 1 Place a photo on the scanner glass.
- 2 From the home screen, touch **Copy** > **Content** > **Content Type** > **Photo**.
- 3 Touch **Content Source**, and then select the setting that best matches the original photo.
- 4 Copy the photo.

Copying on letterhead

- 1 Load an original document into the ADF tray or on the scanner glass.
- 2 From the home screen, touch **Copy** > **Copy From** > select the size of the original document.
- 3 Touch **Copy To**, and then select the paper source that contains the letterhead.
If you loaded the letterhead into the multipurpose feeder, then navigate to:
Copy To > **Multipurpose Feeder** > select a paper size > **Letterhead**
- 4 Copy the document.

Copying on both sides of the paper

- 1 Load an original document into the ADF tray or on the scanner glass.
- 2 From the home screen, touch **Copy** > **Paper Setup**.
- 3 Adjust the settings.
- 4 Copy the document.

Reducing or enlarging copies

- 1 Load an original document into the ADF tray or on the scanner glass.
- 2 From the home screen, navigate to:
Copy > **Scale** > specify a scale value
Note: Changing the size of the original document or output after setting Scale restores the scale value to Auto.
- 3 Copy the document.

Collating copies

- 1 Load an original document into the ADF tray or on the scanner glass.
- 2 From the home screen, touch **Copy** > **Collate** > **On** [1,2,1,2,1,2].
- 3 Copy the document.

Placing separator sheets between copies

- 1 Load an original document into the ADF tray or on the scanner glass.
- 2 From the home screen, touch **Copy** > **Separator Sheets**.
- 3 Adjust the settings.
- 4 Send the copy job.

Copying multiple pages onto a single sheet



- 1 Load an original document into the ADF tray or on the scanner glass.
- 2 From the home screen, touch **Copy** > **Pages per Side**.
- 3 Adjust the settings.
- 4 Copy the document.

Creating a copy shortcut

- 1 From the home screen, touch **Copy**.
- 2 Configure the settings, and then touch .
- 3 Create a shortcut.

E-mailing

Using the automatic document feeder and scanner glass

Automatic document feeder (ADF)	Scanner glass
 <ul style="list-style-type: none"> • Use the ADF for multiple-page or two-sided documents. • Load an original document faceup. For multiple-page documents, make sure to align the leading edge before loading. • Make sure to adjust the ADF guides to match the width of the paper that you are loading. 	 <ul style="list-style-type: none"> • Use the scanner glass for single-page documents, book pages, small items (such as postcards or photos), transparencies, photo paper, or thin media (such as magazine clippings). • Place the document facedown in the corner with the arrow.

Configuring the SMTP server for e-mail

From the control panel

- 1 From the control panel, touch **Settings** > **E-mail** > **E-mail Setup**.
- 2 Configure the settings.

From the Embedded Web Server

- 1 Open a web browser, and then type the printer IP address in the address field.

Notes:

- View the printer IP address on the printer home screen. The IP address appears as four sets of numbers separated by periods, such as 123.123.123.123.
- If you are using a proxy server, then temporarily disable it to load the web page correctly.

- 2 Click **Settings** > **E-mail**.
- 3 From the E-mail Setup section, configure the settings.
- 4 Click **Save**.

Sending an e-mail

Using the control panel

- 1 Load an original document into the ADF tray or on the scanner glass.
- 2 From the home screen, touch **E-mail**, and then enter the needed information.
Note: You can also enter the recipient using the address book or shortcut number.
- 3 If necessary, configure the output file type settings.
- 4 Send the e-mail.

Using the shortcut number

- 1 From the control panel, press #, and then enter the shortcut number using the keypad.
- 2 Send the e-mail.

Creating an e-mail shortcut

- 1 From the home screen, touch **E-mail**.
- 2 Configure the settings, and then touch .
- 3 Create a shortcut.

Faxing

Setting up the printer to fax



Notes:

- The following connection methods are applicable only in some countries or regions.
- During the initial printer setup, clear the fax function check box and any other function you plan to set up later, and then touch **Continue**.
- If the fax function is enabled and not fully set up, then the indicator light may blink red.

Warning—Potential Damage: Do not touch cables or the printer in the area shown while actively sending or receiving a fax.



Using the automatic document feeder and scanner glass

Automatic document feeder (ADF)	Scanner glass
 <ul style="list-style-type: none"> • Use the ADF for multiple-page or two-sided documents. • Load an original document faceup. For multiple-page documents, make sure to align the leading edge before loading. • Make sure to adjust the ADF guides to match the width of the paper that you are loading. 	 <ul style="list-style-type: none"> • Use the scanner glass for single-page documents, book pages, small items (such as postcards or photos), transparencies, photo paper, or thin media (such as magazine clippings). • Place the document facedown in the corner with the arrow.

Configuring the SMTP server for fax

From the control panel

- 1 From the control panel, touch **Settings** > **Fax** > **Fax Server Setup** > **Fax Server E-mail Settings**.
- 2 Configure the settings.

Note: To use the SMTP server setting for e-mail, enable **Use E-mail SMTP Server**.

From the Embedded Web Server

- 1 Open a web browser, and then type the printer IP address in the address field.

Notes:



- View the printer IP address on the printer home screen. The IP address appears as four sets of numbers separated by periods, such as 123.123.123.123.
- If you are using a proxy server, then temporarily disable it to load the web page correctly.

- 2 Click **Settings** > **Fax** > **Fax Server Setup**.
- 3 From the Fax Server E-mail Settings section, configure the settings.

Note: To use the SMTP server setting for e-mail, enable **Use E-mail SMTP Server**.

- 4 Click **Save**.

Setting up fax using a standard telephone line

-  **CAUTION—SHOCK HAZARD:** To avoid the risk of electrical shock, do not set up this product or make any electrical or cabling connections, such as the power cord, fax feature, or telephone, during a lightning storm.
-  **CAUTION—SHOCK HAZARD:** To avoid the risk of electrical shock, do not use the fax feature during a lightning storm.
-  **CAUTION—POTENTIAL INJURY:** To reduce the risk of fire, use only a 26 AWG or larger telecommunications (RJ-11) cord when connecting this product to the public switched telephone network. For users in Australia, the cord must be approved by the Australian Communications and Media Authority.

Setup 1: Printer is connected to a dedicated fax line

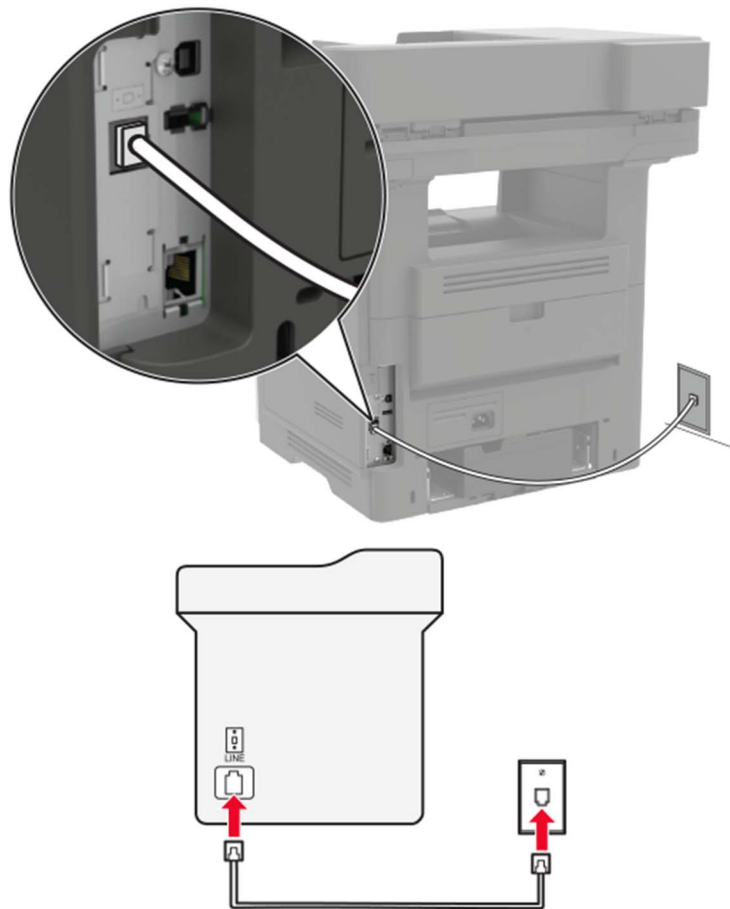

- 1 Connect one end of the telephone cable to the line port of the printer.
- 2 Connect the other end of the cable to an active analog wall jack.

Notes:

- You can set the printer to receive faxes automatically (Auto Answer On) or manually (Auto Answer Off).
- If you want to receive faxes automatically, then set the printer to pick up on a specified number of rings.

Setup 2: Printer is sharing the line with an answering machine

Note: If you subscribe to a distinctive ring service, then make sure that you set the correct ring pattern for the printer. Otherwise, the printer does not receive faxes even if you have set it to receive faxes automatically.

Connected to different wall jacks

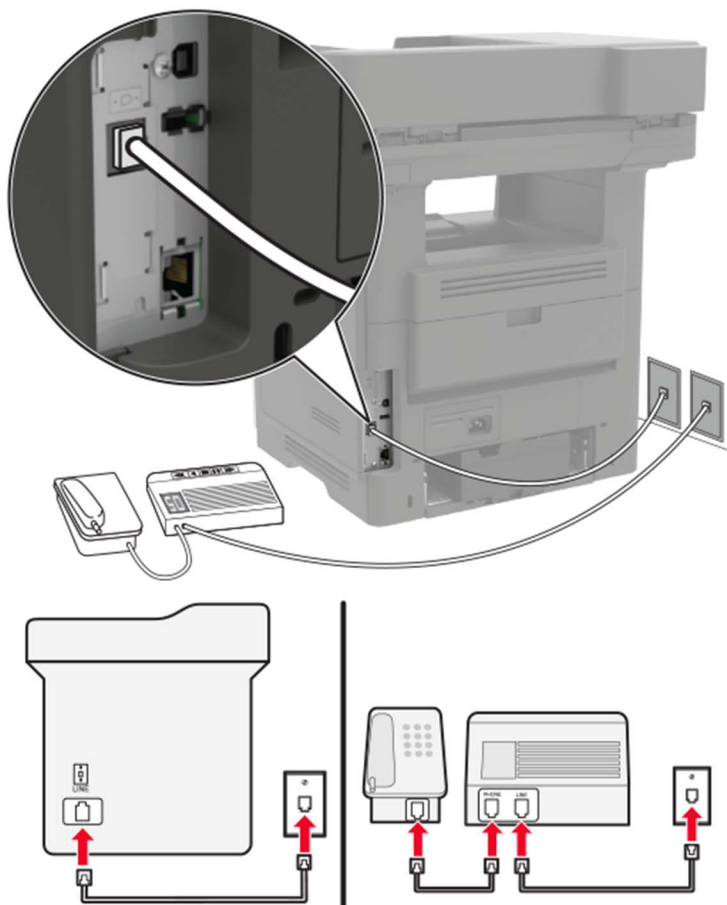



- 1 Connect one end of the telephone cable to the line port of the printer.
- 2 Connect the other end of the cable to an active analog wall jack.

Notes:

- If you have only one telephone number on your line, then set the printer to receive faxes automatically.
- Set the printer to pick up calls two rings after the answering machine. For example, if the answering machine picks up calls after four rings, then set the printer Rings to Answer setting to six.

Setting up fax in countries or regions with different telephone wall jacks and plugs

-  **CAUTION—SHOCK HAZARD:** To avoid the risk of electrical shock, do not set up this product or make any electrical or cabling connections, such as the power cord, fax feature, or telephone, during a lightning storm.
-  **CAUTION—SHOCK HAZARD:** To avoid the risk of electrical shock, do not use the fax feature during a lightning storm.
-  **CAUTION—POTENTIAL INJURY:** To reduce the risk of fire, use only a 26 AWG or larger telecommunications (RJ-11) cord when connecting this product to the public switched telephone network. For users in Australia, the cord must be approved by the Australian Communications and Media Authority.

The standard wall jack adopted by most countries or regions is RJ11. If the wall jack or equipment in your facility is not compatible with this type of connection, then use a telephone adapter. An adapter for your country or region may not come with your printer, and you may need to purchase it separately.

There may be an adapter plug installed in the telephone port of the printer. Do not remove the adapter plug from the telephone port of the printer if you are connecting to a serial or cascaded telephone system.

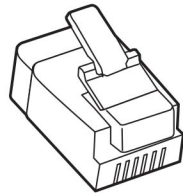

Part name	Part number
Lexmark adapter plug	40X8519

Connecting the printer to a non-RJ11 wall jack

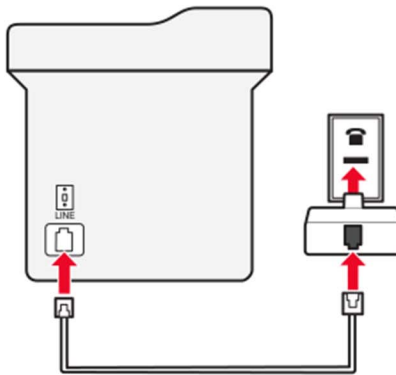
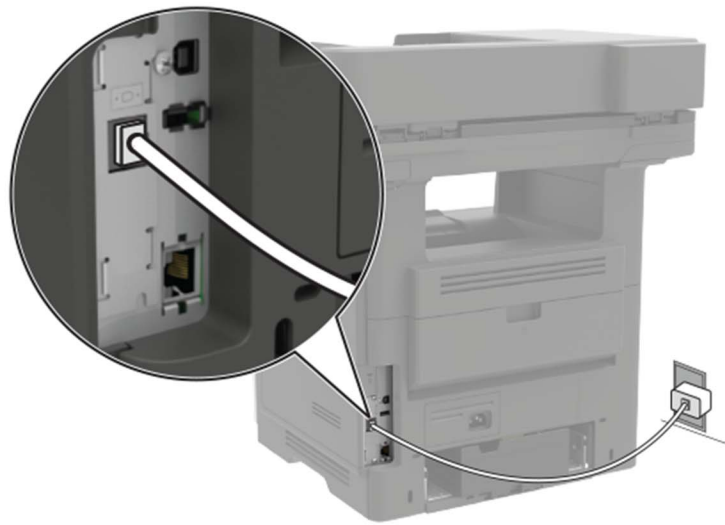

- 1** Connect one end of the telephone cable to the line port of the printer.
- 2** Connect the other end of the cable to the RJ11 adapter, and then connect the adapter to the wall jack.
- 3** If you want to connect another device with a non-RJ11 connector to the same wall jack, then connect it directly to the telephone adapter.

Connecting the printer to a wall jack in Germany

The German wall jack has two kinds of ports. The N ports are for fax machines, modems, and answering machines. The F port is for telephones. Connect the printer to any of the N ports.

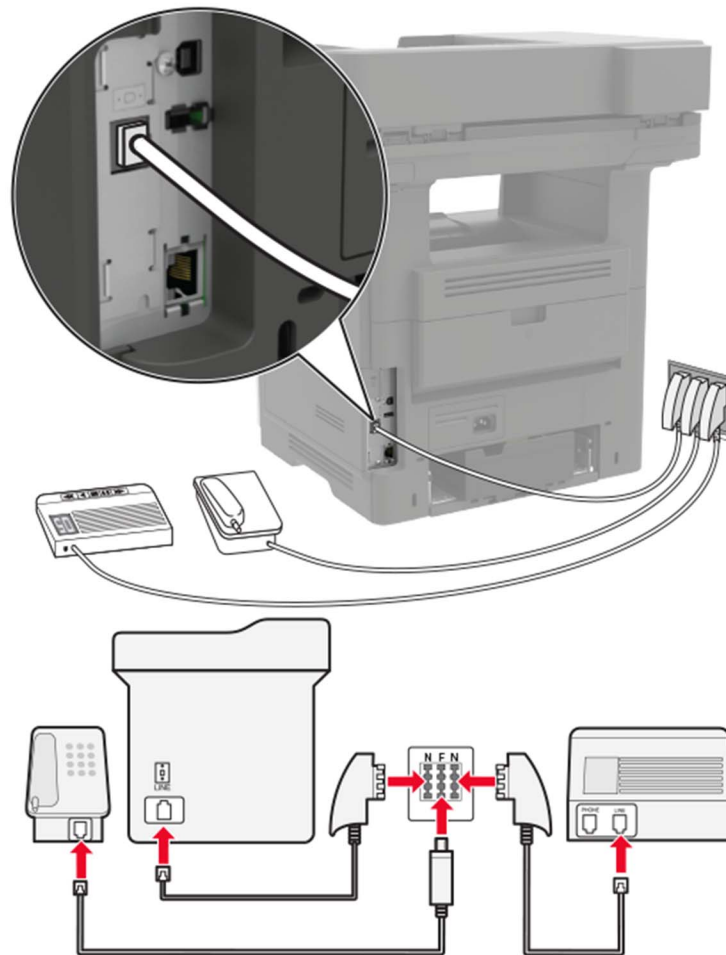

- 1 Connect one end of the telephone cable to the line port of the printer.
- 2 Connect the other end of the cable to the RJ11 adapter, and then connect the adapter to an N port.
- 3 If you want to connect a telephone and answering machine to the same wall jack, then connect the devices as shown.

Connecting to a distinctive ring service

A distinctive ring service lets you have multiple telephone numbers on one telephone line. Each telephone number is assigned a different ring pattern.

- 1 From the home screen, touch **Settings** > **Fax** > **Fax Setup** > **Fax Receive Settings** > **Admin Controls** > **Answer On**.
- 2 Select a ring pattern.

Setting the fax date and time

- 1 From the home screen, touch **Settings** > **Device** > **Preferences** > **Date and Time** > **Configure**.
- 2 Configure the settings.

Sending a fax

Using the control panel

- 1 Load the original document into the ADF tray or on the scanner glass.
- 2 From the home screen, touch **Fax**, and then enter the needed information.
- 3 If necessary, configure other fax settings.
- 4 Send the fax job.

Using the computer

Note: Make sure that the Universal Fax driver is installed.

For Windows users

- 1 With a document open, click **File** > **Print**.
- 2 Select the printer, and then click **Properties**, **Preferences**, **Options**, or **Setup**.
- 3 Click **Fax** > **Enable fax**, and then enter the recipient number.
- 4 If necessary, configure other fax settings.
- 5 Send the fax job.

For Macintosh users

- 1 With a document open, choose **File** > **Print**.
- 2 Select the printer and enter the recipient number.
- 3 If necessary, configure other fax settings.
- 4 Send the fax job.

Scheduling a fax

- 1 Load the original document into the ADF tray or on the scanner glass.
- 2 From the home screen, navigate to:
Fax > **To** > enter the fax number > **Done**
- 3 Touch **Send Time**, configure the settings, and then touch **Done**.
- 4 Send the fax.

Creating a fax destination shortcut

- 1 From the home screen, touch **Fax > To**.
- 2 Enter the recipient number, and then touch **Done**.
- 3 Touch .
- 4 Create a shortcut.

Changing the fax resolution

- 1 Load an original document into the ADF tray or on the scanner glass.
- 2 From the home screen, touch **Fax**, and then enter the needed information.
- 3 Touch **Resolution**, and then adjust the setting.
- 4 Send the fax.

Adjusting the fax darkness

- 1 Load an original document into the ADF tray or on the scanner glass.
- 2 From the home screen, touch **Fax**, and then enter the needed information.
- 3 Touch **Darkness**, and then adjust the setting.
- 4 Send the fax.

Printing a fax log

- 1 From the home screen, touch **Settings > Reports > Fax**.
- 2 Touch **Fax Job Log** or **Fax Call Log**.

Blocking junk faxes

- 1 From the home screen, touch **Settings > Fax > Fax Setup > Fax Receive Settings > Admin Controls**.
- 2 Set Block No Name Fax to **On**.

Holding faxes



- 1 From the home screen, touch **Settings > Fax > Fax Setup > Fax Receive Settings > Holding Faxes**.
- 2 Select a mode.

Forwarding a fax

- 1 From the home screen, touch **Settings** > **Fax** > **Fax Setup** > **Fax Receive Settings** > **Admin Controls**.
- 2 Touch **Fax Forwarding** > **Forward**.
- 3 Configure the Forward to and Confirmation E-mail settings.

Scanning

Using the automatic document feeder and scanner glass

Automatic document feeder (ADF)	Scanner glass
 <ul style="list-style-type: none"> • Use the ADF for multiple-page or two-sided documents. • Load an original document faceup. For multiple-page documents, make sure to align the leading edge before loading. • Make sure to adjust the ADF guides to match the width of the paper that you are loading. 	 <ul style="list-style-type: none"> • Use the scanner glass for single-page documents, book pages, small items (such as postcards or photos), transparencies, photo paper, or thin media (such as magazine clippings). • Place the document facedown in the corner with the arrow.

Scanning to an FTP server

- 1 Load the original document into the ADF tray or on the scanner glass.
- 2 From the home screen, touch **FTP**, and then enter the needed information.
- 3 If necessary, configure other FTP settings.
- 4 Send the FTP job.

Creating an FTP shortcut

- 1 From the home screen, touch **FTP**.
- 2 Enter the FTP server address, and then touch ★.
- 3 Create a shortcut.

Scanning to a flash drive

- 1 Load an original document into the ADF tray or on the scanner glass.
- 2 Insert the flash drive.



- 3 Touch **Scan to USB** and adjust the settings if necessary.

Note: If the USB Drive screen does not appear, then touch **USB Drive** on the home screen.

- 4 Scan the document.

Warning—Potential Damage: To avoid loss of data or printer malfunction, do not touch the flash drive or the printer in the area shown while actively printing, reading, or writing from the memory device.



Scanning to a fax server

- 1 Load an original document into the ADF tray or on the scanner glass.
- 2 From the home screen, touch **Scan Center**, and then from the list of destinations, select **Fax**.
- 3 Select a fax destination.
Note: To create a fax destination, touch **Create Fax**.
- 4 Scan the document.

Sending scanned documents to a computer

- 1 Load an original document into the ADF tray or on the scanner glass.
- 2 From the home screen, touch **Scan Profiles > Scan To Computer**.
- 3 Select the scan profile where you want to save the document.

Understanding the printer menus

Menu map

Device	<ul style="list-style-type: none"> • Preferences • Eco-Mode • Remote Operator Panel • Notifications • Power Management • Information Sent to Lexmark 	<ul style="list-style-type: none"> • Accessibility • Restore Factory Defaults • Maintenance • Visible Home Screen Icons • About this Printer
Print	<ul style="list-style-type: none"> • Layout • Finishing • Setup • Quality • Job Accounting • XPS 	<ul style="list-style-type: none"> • PDF • PostScript • PCL • HTML • Image
Paper	<ul style="list-style-type: none"> • Tray Configuration 	<ul style="list-style-type: none"> • Media Configuration
Copy	Copy Defaults	
Fax	<ul style="list-style-type: none"> • Fax Defaults 	
E-mail	<ul style="list-style-type: none"> • E-mail Setup • E-mail Defaults 	<ul style="list-style-type: none"> • Web Link Setup
FTP	FTP Defaults	
USB Drive	<ul style="list-style-type: none"> • Flash Drive Scan 	<ul style="list-style-type: none"> • Flash Drive Print
Network/Ports	<ul style="list-style-type: none"> • Network Overview • Wireless • Ethernet • TCP/IP • SNMP • IPSec • 802.1x 	<ul style="list-style-type: none"> • LPD Configuration • HTTP/FTP Settings • ThinPrint • USB • Restrict external network access • Google Cloud Print • Wi-Fi Direct
Security	<ul style="list-style-type: none"> • Login Methods • Schedule USB Devices • Security Audit Log • Login Restrictions • Confidential Print Setup 	<ul style="list-style-type: none"> • Disk Encryption • Erase Temporary Data Files • Solutions LDAP Settings • Miscellaneous
Reports	<ul style="list-style-type: none"> • Menu Settings Page • Device • Print 	<ul style="list-style-type: none"> • Shortcuts • Fax • Network

Help	<ul style="list-style-type: none"> • Print All Guides • Connection Guide • Copy Guide • E-mail Guide • Fax Guide • FTP Guide 	<ul style="list-style-type: none"> • Information Guide • Media Guide • Mono Quality Guide • Moving Guide • Print Quality Guide • Supplies Guide
Troubleshooting	Print Quality Test Pages	Cleaning the scanner

Device

Preferences

Menu item	Description
Display Language [List of languages]	Set the language of the text that appears on the display.
Country/Region [List of countries or regions]	Identify the country or region where the printer is configured to operate.
Run initial setup On Off*	Run the setup wizard.
Keyboard Keyboard Type [List of languages]	Select a language as a keyboard type. Notes: <ul style="list-style-type: none"> • All the Keyboard Type values may not appear or may require special hardware to appear. • This menu item appears only in some printer models.
Displayed information Display Text 1 [IP Address*] Display Text 2 [Date/Time*] Custom Text 1 Custom Text 2	Specify the information to appear on the home screen. Note: Custom Text 1 and Custom Text 2 appear only in some printer models.
Date and Time Configure Current Date and Time Manually Set Date and Time Date Format [MM-DD-YYYY*] Time Format [12 hour A.M./P.M.*] Time Zone [GMT*]	Configure the printer date and time.
Note: An asterisk (*) next to a value indicates the factory default setting.	

Menu item	Description
Date and Time Network Time Protocol Enable NTP [On*] NTP Server Enable Authentication	Configure the settings for Network Time Protocol (NTP). Notes: <ul style="list-style-type: none"> • Enable Authentication appears only in some printer models. • When Enable Authentication is set to MD5 key, Key ID and Password appear.
Paper Sizes U.S.* Metric	Specify the unit of measurement for paper sizes. Note: The country or region selected in the initial setup wizard determines the initial paper size setting.
Screen Brightness 20–100% (100*)	Adjust the brightness of the display. Note: This menu item appears only in some printer models.
Flash Drive Access Enabled* Disabled	Enable access to the flash drive.
Allow Background Removal On* Off	Specify whether background removal is allowed.
Allow Custom Job scans On* Off	Scan multiple jobs to one file.
One Page Flatbed Scanning On Off*	Set copies from the scanner glass to only one page at a time.
Audio Feedback Button Feedback On* Off	Enable audio feedback for button presses, panel interactions, paper loaded prompts, and error notifications. Note: This menu item appears only in some printer models.
Audio Feedback Volume 1–10 (5*)	Adjust the volume of the printer speakers. Notes: <ul style="list-style-type: none"> • Changes to the volume are applied after the current user session ends. • This menu item appears only in some printer models.
Screen Timeout 10–300 (60*)	Set the idle time in seconds before the display shows the home screen, or before the printer logs off a user account automatically.
Note: An asterisk (*) next to a value indicates the factory default setting.	

Eco-Mode

Menu item	Description
Print Sides 1-Sided* 2-Sided	Specify whether to print on one side or two sides of the paper.
Print Pages per Side Off* 2 pages per side 3 pages per side 4 pages per side 6 pages per side 9 pages per side 12 pages per side 16 pages per side	Print multiple page images on one side of a sheet of paper.
Print Toner Darkness 1–10 (8*)	Determine the lightness or darkness of text images.
Copy Sides 1 sided to 1 sided* 1 sided to 2 sided 2 sided to 1 sided 2 sided to 2 sided	Specify the scanning behavior based on the original document.
Copy Pages per Side Off* 2 Portrait pages 4 Portrait pages 2 Landscape pages 4 Landscape pages	Specify the scanning behavior based on the original document.
Copy Darkness 1–9 (5*)	Determine the darkness of the scanned text images.
Note: An asterisk (*) next to a value indicates the factory default setting.	

Remote Operator Panel

Menu item	Description
External VNC Connection Don't Allow* Allow	Connect an external Virtual Network Computing (VNC) client to the remote control panel.
Authentication Type None* Standard Authentication	Set the authentication type when accessing the VNC client server. Note: When set to Standard Authentication, VNC Password appears.
Note: An asterisk (*) next to a value indicates the factory default setting.	

Notifications

Menu item	Description
ADF Loaded Beep Off On*	Enable a sound when loading paper into the ADF.
Alarm Control Off Single* Continuous	Set the number of times that the alarm sounds when the printer requires user intervention.
Supplies Show Supply Estimates Show estimates* Do not show estimates	Show the estimated status of the supplies.
Supplies Display Estimates Pages* Percent	Determine the unit that the printer uses to estimate supply usage and trigger custom notifications when user intervention is required. Note: This menu item appears only in the Embedded Web Server.
Supplies Cartridge Alarm Off Single* Continuous	Set the number of times that the alarm sounds when the toner cartridge is low.
Supplies Custom Supply Estimates Show Estimates Do Not Show Estimates*	Configure notification settings when the printer requires user intervention. Note: This menu item appears only in the Embedded Web Server.
Note: An asterisk (*) next to a value indicates the factory default setting.	

Menu item	Description
<p>E-mail Alerts Setup</p> <ul style="list-style-type: none"> E-mail Setup <ul style="list-style-type: none"> Primary SMTP Gateway Primary SMTP Gateway Port (25*) Secondary SMTP Gateway Secondary SMTP Gateway Port (25*) SMTP Timeout (30 seconds*) Reply Address <ul style="list-style-type: none"> Always use SMTP default Reply Address(Off*) Use SSL/TLS(Disabled*) Require Trusted Certificate(On*) SMTP Server Authentication (No authentication required*) Device-Initiated E-mail(None*) User-Initiated E-mail(None*) Use Active Directory Device Credentials(Off*) Device Userid Device Password Kerberos 5 REALM NTLM Domain Disable "SMTP server not set up" error(Off*) 	<p>Configure the e-mail settings of the printer.</p>
<p>E-mail Alerts Setup</p> <ul style="list-style-type: none"> Setup E-mail Lists and Alerts <ul style="list-style-type: none"> E-mail List 1 E-mail List 2 E-mail Events 	<p>Specify the e-mail addresses and enable the e-mail alert events.</p> <p>Note: This menu item appears only in the Embedded Web Server.</p>
<p>Error Prevention</p> <ul style="list-style-type: none"> Jam Assist <ul style="list-style-type: none"> Off On* 	<p>Set the printer to flush blank pages or pages with partial prints automatically after a jammed page has been cleared.</p>
<p>Error Prevention</p> <ul style="list-style-type: none"> Auto Continue <ul style="list-style-type: none"> Off On* (5 seconds) 	<p>Let the printer continue processing or printing a job automatically after clearing certain printer conditions that require user intervention.</p>
<p>Error Prevention</p> <ul style="list-style-type: none"> Auto Reboot <ul style="list-style-type: none"> Auto Reboot <ul style="list-style-type: none"> Reboot when idle Reboot always* Reboot never 	<p>Set the printer to restart when an error occurs.</p>
<p>Note: An asterisk (*) next to a value indicates the factory default setting.</p>	

Menu item	Description
Error Prevention Auto Reboot Max Auto Reboots 1–20 (2*)	Set the number of automatic reboots that the printer can perform.
Error Prevention Auto Reboot Auto Reboot Window 1–525600 seconds (720*)	Set the time before the printer performs an automatic reboot.
Error Prevention Auto Reboot Auto Reboot Counter	Show a read-only information of the reboot counter.
Error Prevention Auto Reboot Reset Auto Reboot Counter Cancel Continue	Reset Auto Reboot Counter.
Error Prevention Display Short Paper Error On Auto-clear*	Set the printer to show a message when a short paper error occurs. Note: Short paper refers to the size of the paper loaded.
Error Prevention Page Protect Off* On	Set the printer to process the entire page into the memory before printing it.
Jam Content Recovery Jam Recovery Off On Auto*	Set the printer to reprint jammed pages.
Jam Content Recovery Scanner Jam Recovery Job level Page level*	Specify how to restart a scan job after resolving a paper jam.

Note: An asterisk (*) next to a value indicates the factory default setting.

Power Management

Menu item	Description
Sleep Mode Profile Print from Sleep Mode Stay awake after printing Enter Sleep Mode after printing*	Set the printer to stay in Ready mode or return to Sleep mode after printing.
Timeouts Sleep Mode 1–120 minutes (15*)	Set the idle time before the printer begins operating in Sleep mode.
Timeouts Hibernate Timeout Disabled 1 hour 2 hours 3 hours 6 hours 1 day 2 days 3 days* 1 week 2 weeks 1 month	Set the time before the printer turns off.
Timeouts Hibernate Timeout on Connection Hibernate Do Not Hibernate*	Set Hibernate Timeout to turn off the printer while an active Ethernet connection exists.
Schedule Power Modes Schedules Add New Schedule	Schedule the printer when to enter Sleep or Hibernate mode.
Note: An asterisk (*) next to a value indicates the factory default setting.	

Information Sent to Lexmark

Menu item	Description
Information Sent to Lexmark Supplies and Page Usage Device Performance None*	Send printer usage and performance information to Lexmark. Note: Information Send Time appears only when you select any of the settings in Information Sent to Lexmark, except None.
Information Send Time Start Time Stop Time	
Note: An asterisk (*) next to a value indicates the factory default setting.	

Accessibility

Note: This menu appears only in some printer models.

Menu item	Description
Duplicate Key Strike Interval 0–5 (0*)	Set the interval in seconds during which the printer ignores duplicate key presses on an attached keyboard.
Key Repeat Initial Delay 0.25–5 (1*)	Set the initial length of delay in seconds before a repeating key starts repeating. Note: This menu item appears only when a keyboard is attached to the printer.
Key Repeat Rate 0.5–30 (30*)	Set the number of presses per second for a repeating key. Note: This menu item appears only when a keyboard is attached to the printer.
Prolong Screen Timeout Off* On	Let the user remain in the same location and reset the Screen Timeout timer when it expires instead of returning to the home screen.
Headphone Volume 1–10 (5*)	Adjust the headphone volume. Note: This menu item appears only when a headphone is attached to the printer.
Enable Voice Guidance When Headphone Is Attached Off* On	Enable Voice Guidance when a headphone is attached to the printer.
Speak Passwords/PINs Off* On	Set the printer to read out loud passwords or personal identification numbers. Note: This menu item appears only when a headphone or a speaker is attached to the printer.
Speech Rate Very Slow Slow Normal* Fast Faster Very Fast Rapid Very Rapid Fastest	Set the Voice Guidance speech rate. Note: This menu item appears only when a headphone or a speaker is attached to the printer.
Note: An asterisk (*) next to a value indicates the factory default setting.	

Restore Factory Defaults

Menu item	Description
Restore Settings Restore all settings Restore printer settings Restore network settings Restore fax settings Restore app settings	Restore the printer factory default settings. Note: The default value is the value selected during the initial setup.

Maintenance

Configuration Menu

Menu item	Description
USB Configuration USB PnP 1* 2	Change the USB driver mode of the printer to improve its compatibility with a personal computer.
USB Configuration USB Scan to Local On* Off	Set whether the USB device driver enumerates as a USB Simple device (single interface) or as a USB Composite device (multiple interfaces).
USB Configuration USB Speed Full Auto*	Set the USB port to run at full speed and disable its high-speed capabilities.
Tray Configuration Tray Linking Automatic* Off	Set the printer to link the trays that have the same paper type and paper size settings.
Tray Configuration Show Tray Insert Message Off Only for unknown sizes* Always	Show the Tray Insert message.
Tray Configuration A5 Loading Short Edge* Long Edge	Specify the page orientation when loading A5 paper size.
Note: An asterisk (*) next to a value indicates the factory default setting.	

Menu item	Description
Tray Configuration Paper Prompts Auto* Multipurpose Feeder Manual Paper	Set the paper source that the user fills when a prompt to load paper appears.
Tray Configuration Envelope Prompts Auto* Multipurpose Feeder Manual Envelope	Set the paper source that the user fills when a prompt to load envelope appears.
Tray Configuration Action for Prompts Prompt user Continue* Use current	Set the printer to resolve paper- or envelope-related change prompts.
Reports Menu Settings Page Event Log Event Log Summary HealthCheck Statistics	Print reports about printer menu settings, status, and event logs.
Supply Usage And Counters Clear Supply Usage History Reset Black Cartridge Counter Reset Maintenance Counter	Reset the supply page counter or view the total printed pages.
Printer Emulations PPDS Emulation Off* On	Set the printer to recognize and use the PPDS data stream.
Printer Emulations PS Emulation Off On*	Set the printer to recognize and use the PS data stream.
Printer Emulations Emulator Security Page Timeout 0–60 (60*)	Set the page timeout during emulation.
Printer Emulations Emulator Security Reset Emulator After Job Off* On	Reset the emulator after a print job.
Note: An asterisk (*) next to a value indicates the factory default setting.	

Menu item	Description
Printer Emulations Emulator Security Disable Printer Message Access On* Off	Disable access to the printer message during emulation.
Print Configuration Font Sharpening 0–150 (24*)	Set a text point-size value below which the high-frequency screens are used when printing font data.
Fax Configuration Fax Low Power Support Disable Sleep Permit Sleep Auto*	Set fax to enter Sleep mode whenever the printer determines that it should.
Fax Configuration Fax Storage Location Disk* NAND	Set the storage location for all faxes.
Print Configuration Print Density Disabled* 1–5 Copy Density Disabled* 1–5	Adjust the toner density when printing or copying documents.
Device Operations Quiet Mode Off* On	Set the printer to reduce the amount of noise that it makes when printing. Note: Enabling this setting slows down the overall performance of the printer.
Device Operations Panel Menus Enable* Disable	Set the printer to show the control panel menus. Note: This menu item appears only in the Embedded Web Server.
Device Operations Safe Mode Off* On	Set the printer to operate in a special mode, in which it attempts to continue offering as much functionality as possible, despite known issues. For example, when set to On, and the duplex motor is nonfunctional, the printer performs one-sided printing of the documents even if the job is two-sided printing.
Device Operations Clear Custom Status	Erase all custom messages.

Note: An asterisk (*) next to a value indicates the factory default setting.

Menu item	Description
Device Operations Clear all remotely-installed messages	Erase all remotely-installed messages.
Device Operations Automatically Display Error Screens On* Off	Show existing error messages on the display after the printer remains inactive on the home screen for a length of time equal to the Screen Timeout setting.
App Configuration LES Applications On* Off	Enable the Lexmark Embedded Solutions (LES) applications.
Scanner Configuration Scanner Manual Registration Print Quick Test	Print a Quick Test target page. Note: Make sure that the margin spacing on the target page is uniform all the way around the target. If it is not, then the printer margins must be reset.
Scanner Configuration Scanner Manual Registration Front ADF Registration Rear ADF Registration Flatbed Registration	Manually register the flatbed and ADF after replacing the ADF, scanner glass, or controller board.
Scanner Configuration Edge Erase Flatbed Edge Erase 0–6 (3*) ADF Edge Erase 0–6 (3*)	Set the size, in millimeters, of the no-print area around an ADF or flatbed scan job.
Scanner Configuration ADF Deskew ADF Mechanical Deskew Off On Auto*	Set the printer to perform ADF mechanical skew adjustment.
Scanner Configuration Disable Scanner Enabled* Disabled ADF Disabled	Disable the scanner if it is not working properly.
Scanner Configuration Tiff Byte Order CPU Endianness* Little Endian Big Endian	Set the byte order of a TIFF-formatted scan output.
Note: An asterisk (*) next to a value indicates the factory default setting.	

Menu item	Description
Scanner Configuration Exact Tiff Rows Per Strip On* Off	Set the RowsPerStrip tag value of a TIFF-formatted scan output.
Note: An asterisk (*) next to a value indicates the factory default setting.	

Out of Service Erase

Menu item	Description
Out of Service Erase Memory Last Sanitized Hard Disk Last Sanitized	Show information on when the printer memory or hard disk was last sanitized. Note: Hard Disk Last Sanitized appears only in printers with a hard disk installed.
Out of Service Erase Sanitize all information on nonvolatile memory Sanitize all information on hard disk Erase all printer and network settings	Clear all settings and applications that are stored in the printer memory or hard disk. Note: Sanitize all information on hard disk appears only in printers with a hard disk installed.

Visible Home Screen Icons

Menu	Description
Visible Home Screen Icons Copy E-mail Fax Status/Supplies Job Queue Change Language Shortcut Center Address Book Bookmarks Held Jobs USB FTP Scan Profiles App Profiles Display Customization Scan Center Card Copy	Specify which icons to show on the home screen.

About this Printer

Menu item	Description
Asset Tag	Describe the printer. The maximum length is 32 characters.
Printer's Location	Identify the printer location. The maximum length is 63 characters.
Contact	Personalize the printer name. The maximum length is 63 characters.
Export Configuration File to USB*	Export configuration files to a flash drive.
Export Compressed Logs to USB*	Export compressed log files to a flash drive.
Send Logs Cancel Send	Send diagnostic information to Lexmark.
* This menu item appears only in some printer models.	

Print

Layout

Menu item	Description
Sides 1-Sided* 2-Sided	Specify whether to print on one side or both sides of the paper.
Flip Style Long Edge* Short Edge	Determine which side of the paper is bound when performing two-sided printing.
Blank Pages Print Do Not Print*	Print blank pages that are included in a print job.
Collate Off (1,1,2,2,2) On (1,2,1,2,1,2)*	Keep the pages of a print job stacked in sequence, particularly when printing multiple copies of the job.
Separator Sheets None* Between Copies Between Jobs Between Pages	Insert blank separator sheets when printing.
Separator Sheet Source Tray [x] (1*) Multipurpose Feeder	Specify the paper source for the separator sheet.
Note: An asterisk (*) next to a value indicates the factory default setting.	

Menu item	Description
Pages per Side Off* 2 pages per side 3 pages per side 4 pages per side 6 pages per side 9 pages per side 12 pages per side 16 pages per side	Print multiple page images on one side of a sheet of paper.
Pages per Side Ordering Horizontal* Reverse Horizontal Vertical Reverse Vertical	Specify the positioning of multiple page images when using the Pages per Side menu.
Pages per Side Orientation Auto* Landscape Portrait	Specify the orientation of multiple page images when using the Pages per Side menu.
Pages per Side Border None* Solid	Print a border around each page image when using the Pages per Side menu.
Copies 1–9999 (1*)	Specify the number of copies for each print job.
Print Area Normal* Whole Page	Set the printable area on a sheet of paper.
Note: An asterisk (*) next to a value indicates the factory default setting.	

Finishing

Menu item	Description
Staple Job Off* 1 staple, top left corner 2 staples, left 1 staple, top right corner 2 staples, top 1 staple, bottom left corner 2 staples, bottom 1 staple, bottom right corner 2 staples, right	Specify the staple position for all print jobs. Note: This menu item appears only when a staple finisher is installed.
Note: An asterisk (*) next to a value indicates the factory default setting.	

Menu item	Description
Staple Test Start	Determine whether the staple finisher is functioning properly. Note: This menu item appears only when a staple finisher is installed.
Offset Pages None* Between Copies Between Jobs	Offset the output of each print job or each copy of a print job. Notes: <ul style="list-style-type: none"> Between Copies offsets each copy of a print job if Collate is set to On [1,2,1,2,1,2]. If Collate is set to Off [1,1,1,2,2,2], then each set of printed pages are offset, such as all page 1s and all page 2s. Between Jobs sets the same offset position for the entire print job regardless of the number of copies printed. This menu item appears only when a staple finisher is installed.
Note: An asterisk (*) next to a value indicates the factory default setting.	

Setup

Menu item	Description
Printer Language PCL Emulation PS Emulation*	Set the printer language. Note: Setting a printer language default does not prevent a software program from sending print jobs that use another printer language.
Job Waiting Off* On	Preserve print jobs requiring supplies so that jobs not requiring the missing supplies can print. Note: This menu item appears only when a printer hard disk is installed.
Job Hold Timeout 0–255 (30*)	Set the time in seconds that the printer waits for user intervention before it holds jobs that require unavailable resources and continues to print other jobs in the print queue. Note: This menu item appears only when a printer hard disk is installed.
Download Target RAM* Disk	Specify where to save all permanent resources, such as fonts and macros, that have been downloaded to the printer. Note: This menu item appears only when a printer hard disk is installed.
Resource Save Off* On	Determine what the printer does with downloaded resources, such as fonts and macros, when it receives a job that requires more than the available memory. Notes: <ul style="list-style-type: none"> When set to Off, the printer retains downloaded resources only until memory is needed. Resources associated with the inactive printer language are deleted. When set to On, the printer preserves all the permanent downloaded resources across all language switches. When necessary, the printer shows memory full messages instead of deleting permanent resources.
Note: An asterisk (*) next to a value indicates the factory default setting.	

Menu item	Description
Print All Order Alphabetical* Newest First Oldest First	Specify the order in which held and confidential jobs are printed when Print All is selected. Note: This menu item appears only when a printer hard disk is installed.
Note: An asterisk (*) next to a value indicates the factory default setting.	

Quality

Menu item	Description
Print Resolution 600 dpi* 1200 Image Q 2400 Image Q 1200 dpi 300 dpi	Set the resolution for the text and images on the printed output. Note: Resolution is determined in dots per inch or image quality.
Pixel Boost Off* Fonts Horizontally Vertically Both directions	Enable more pixels to print in clusters for clarity, in order to enhance text and images.
Toner Darkness 1–10 (8*)	Determine the lightness or darkness of text images.
Halftone Normal* Detail	Enhance the printed output to have smoother lines with sharper edges.
Brightness -6 to 6 (0*)	Adjust the brightness of the printed output.
Contrast 0 to 5 (0*)	Adjust the contrast of the printed output.
Gray Correction Off Auto*	Adjust the contrast enhancement applied to images.
Note: An asterisk (*) next to a value indicates the factory default setting.	

Job Accounting

Note: This menu appears only when a printer hard disk is installed.

Menu item	Description
Job Accounting Off* On	Set the printer to create a log of the print jobs that it receives.
Accounting Log Frequency Daily Weekly Monthly*	Specify how often the printer creates a log file.
Log Action at End of Frequency None* E-mail Current Log E-mail & Delete Current Log Post Current Log Post & Delete Current Log	Specify how the printer responds when the frequency threshold expires. Note: The value defined in Accounting Log Frequency determines when this action is triggered.
Log Near Full Level Off* On	Specify the maximum size of the log file before the printer executes the Log Action at Near Full.
Log Action at Near Full None* E-mail Current Log E-mail & Delete Current Log E-mail & Delete Oldest Log Post Current Log Post & Delete Current Log Post & Delete Oldest Log Delete Current Log Delete Oldest Log Delete All But Current Delete All Logs	Specify how the printer responds when the hard disk is nearly full. Note: The value defined in Log Near Full Level determines when this action is triggered.
Log Action at Full None* E-mail & Delete Current Log E-mail & Delete Oldest Log Post & Delete Current Log Post & Delete Oldest Log Delete Current Log Delete Oldest Log Delete All But Current Delete All Logs	Specify how the printer responds when disk usage reaches the maximum limit (100MB).
URL to Post Log	Specify where the printer posts job accounting logs.
E-mail Address to Send Logs	Specify the e-mail address to which the printer sends job accounting logs.
Note: An asterisk (*) next to a value indicates the factory default setting.	

Menu item	Description
Log File Prefix	Specify the prefix for the log file name. Note: The current host name defined in the TCP/IP menu is used as the default log file prefix.
Note: An asterisk (*) next to a value indicates the factory default setting.	

XPS

Menu item	Description
Print Error Pages Off* On	Print a test page that contains information on errors, including XML markup errors.
Minimum Line Width 1–30 (2*)	Set the minimum stroke width of any job printed in 1200 dpi.
Note: An asterisk (*) next to a value indicates the factory default setting.	

PDF

Menu item	Description
Scale To Fit Off* On	Scale the page content to fit the selected paper size.
Annotations Print Do Not Print*	Specify whether to print annotations in the PDF.
Print PDF Error Off On*	Enable the printing of PDF error.
Note: An asterisk (*) next to a value indicates the factory default setting.	

PostScript

Menu item	Description
Print PS Error Off* On	Print a page that describes the PostScript® error. Note: When an error occurs, processing of the job stops, the printer prints an error message, and the rest of the print job is flushed.
Minimum Line Width 1–30 (2*)	Set the minimum stroke width of any job printed in 1200 dpi.
Note: An asterisk (*) next to a value indicates the factory default setting.	

Menu item	Description
Lock PS Startup Mode Off On*	Disable the SysStart file.
Font Priority Resident* Flash/Disk	Establish the font search order. Notes: <ul style="list-style-type: none"> Resident sets the printer to search its memory for the requested font before searching the flash memory or printer hard disk. Flash/Disk sets the printer to search the flash memory or printer hard disk for the requested font before searching the printer memory. This menu item appears only when a flash memory or hard disk is installed.
Wait Timeout Off On*	Enable the printer to wait for more data before canceling a print job. Note: When enabled, the factory default setting is 40 seconds.
Note: An asterisk (*) next to a value indicates the factory default setting.	

PCL

Menu item	Description
Font Source Resident* Disk Flash All	Choose the source which contains the default font selection. Notes: <ul style="list-style-type: none"> Flash and Disk appear only when a flash memory or hard disk is installed. For Flash and Disk to appear, make sure that they are not read- or write-protected.
Font Name Courier*	Select a font from the specified font source.
Symbol Set 10U PC-8*	Specify the symbol set for each font name. Note: A symbol set is a set of alphabetic and numeric characters, punctuation, and special symbols. Symbol sets support the different languages or specific programs such as math symbols for scientific text.
Pitch 0.08–100 (10*)	Specify the pitch for fixed or monospaced fonts. Note: Pitch refers to the number of fixed-space characters in a horizontal inch of type.
Orientation Portrait* Landscape	Specify the orientation of text and graphics on the page.
Note: An asterisk (*) next to a value indicates the factory default setting.	

Menu item	Description
Lines per Page 1–255	Specify the number of lines of text for each page printed through the PCL® data stream. Notes: <ul style="list-style-type: none"> This menu item activates vertical escapement that causes the selected number of requested lines to print between the default margins of the page. 60 is the U.S. factory default setting. 64 is the international factory default setting.
PCL5 Minimum Line Width 1–30 (2*)	Set the initial minimum stroke width of any job printed in 1200 dpi.
PCLXL Minimum Line Width 1–30 (2*)	
A4 Width 198 mm* 203 mm	Set the width of the logical page on A4-size paper. Note: Logical page is the space on the physical page where data is printed.
Auto CR after LF Off* On	Set the printer to perform a carriage return after a line feed control command. Note: Carriage return is a mechanism that commands the printer to move the position of the cursor to the first position on the same line.
Auto LF after CR Off* On	Set the printer to perform a line feed after a carriage return control command.
Tray Renumber Assign MP Feeder Assign Tray [x] Assign Manual Paper Assign Manual Envelope View Factory Defaults Restore Defaults	<ul style="list-style-type: none"> Configure the printer to work with a different print driver or custom application that uses a different set of source assignments to request a given paper source. Show the factory default value assigned for each paper source. Restore the tray renumber values to their factory defaults.
Print Timeout Off On* (90 seconds)	Set the printer to end a print job after it has been idle for the specified amount of time.
Note: An asterisk (*) next to a value indicates the factory default setting.	

HTML

Menu item	Description
Font Name [List of fonts] (Times*)	Set the font to use for HTML documents.
Note: An asterisk (*) next to a value indicates the factory default setting.	

Menu item	Description
Font Size 1–255 (12*)	Set the font size to use for HTML documents.
Scale 1–400% (100*)	Scale HTML documents.
Orientation Portrait* Landscape	Set the page orientation for HTML documents.
Margin Size 8–255 mm (19*)	Set the page margin for HTML documents.
Backgrounds Do Not Print Print*	Print background information or graphics for HTML documents.

Note: An asterisk (*) next to a value indicates the factory default setting.

Image

Menu item	Description
Auto Fit On Off*	Select the best available paper size and orientation setting for an image. Note: When set to On, this menu item overrides the scaling and orientation settings for the image.
Invert Off* On	Invert bitonal monochrome images. Note: This menu item does not apply to GIF or JPEG image formats.
Scaling Anchor Top Left Best Fit* Anchor Center Fit Height/Width Fit Height Fit Width	Adjust the image to fit the printable area. Note: When Auto Fit is set to On, Scaling is automatically set to Best Fit.
Orientation Portrait* Landscape Reverse Portrait Reverse Landscape	Specify the orientation of text and graphics on the page.

Note: An asterisk (*) next to a value indicates the factory default setting.

Paper

Tray Configuration

Menu item	Description
Default Source Tray [x] (1*) Multipurpose Feeder Manual Paper Manual Envelope	Set the paper source for all print jobs.
Paper Size/Type Tray [x] Multipurpose Feeder Manual Paper Manual Envelope	Specify the paper size or paper type loaded in each paper source.
Substitute Size Off Letter/A4 All Listed*	Set the printer to substitute a specified paper size if the requested size is not loaded in any paper source. Notes: <ul style="list-style-type: none"> • Off prompts the user to load the required paper size. • All Listed allows all available substitutions.
Configure MP Cassette* Manual First	Determine the behavior of the multipurpose feeder. Notes: <ul style="list-style-type: none"> • Cassette configures the multipurpose feeder as the automatic paper source. • Manual sets the multipurpose feeder only for manual-feed print jobs. • First configures the multipurpose feeder as the primary paper source.
Note: An asterisk (*) next to a value indicates the factory default setting.	

Media Configuration

Universal Setup

Menu item	Description
Units of Measure Inches Millimeters	Specify the unit of measurement for the universal paper. Note: Inches is the U.S. factory default setting. Millimeters is the international factory default setting.
Portrait Width 3–14.17 inches (8.50*) 76–359.91 mm (216*)	Set the portrait width of the universal paper.
Note: An asterisk (*) next to a value indicates the factory default setting.	

Menu item	Description
Portrait Height 3–14.17 inches (14*) 76–359.91 mm (356*)	Set the portrait height of the universal paper.
Feed Direction Short Edge* Long Edge	Set the printer to pick paper from the short edge or long edge direction. Note: Long Edge appears only when the longest edge is shorter than the maximum width supported.
Note: An asterisk (*) next to a value indicates the factory default setting.	

Custom Scan Sizes

Menu item	Description
Custom Scan Size [x] Scan Size Name Width 1–8.50 inches (8.50*) 25–216 mm (216*) Height 1–14 inches (14*) 25–356 mm (297*) Orientation Portrait* Landscape 2 scans per side Off* On	Assign a scan size name and configure the scan settings.

Media Types

Menu item	Description
Plain	Specify the texture and weight of the paper loaded.
Card Stock	Select from the following options: Paper Texture Smooth Normal* Rough Paper Weight Light Normal* Heavy
Transparency	
Recycled	
Labels	
Bond	
Envelope	
Rough Envelope	
Letterhead	
Preprinted	
Colored Paper	
Light	
Heavy	
Rough/Cotton	
Custom Type [x]	

Note: An asterisk (*) next to a value indicates the factory default setting.

Copy

Copy Defaults

Menu item	Description
Content Type Text Text/Photo* Photo Graphics	Improve the output result based on the content of the original document.
Content Source Black and White Laser* Color Laser Inkjet Photo/Film Magazine Newspaper Press Other	Improve the output result based on the source of the original document.

Note: An asterisk (*) next to a value indicates the factory default setting.

Menu item	Description
Sides 1 sided to 1 sided* 1 sided to 2 sided 2 sided to 1 sided 2 sided to 2 sided	Specify the scanning behavior based on the original document.
Separator Sheets None* Between Copies Between Jobs Between Pages	Specify whether to insert blank separator sheets when printing.
Separator Sheet Source Tray [x] (1*) Multipurpose Feeder	Specify the paper source for the separator sheet.
Pages per Side Off* 2 Portrait pages 4 Portrait pages 2 Landscape pages 4 Landscape pages	Specify the number of page images to print on one side of a sheet of paper.
Print Page Borders Off* On	Place a border around each image when printing multiple pages on a single page.
Collate Off [1,1,1,2,2,2] On [1,2,1,2,1,2]*	Print multiple copies in sequence.
“Copy from” Size	Set the paper size of the original document. Note: Letter is the U.S. factory default setting. A4 is the international factory default setting.
“Copy to” Source Tray [x] (1*) Multipurpose Feeder Auto Size Match	Specify the paper source for the copy job.
Darkness 1 to 9 (5*)	Adjust the darkness of the scanned image.
Number of Copies 1–9999 (1*)	Specify the number of copies.
Note: An asterisk (*) next to a value indicates the factory default setting.	

Menu item	Description
Header/Footer Left Header Middle Header Right Header Left Footer Middle Footer Right Footer	Specify the header or footer information on the scanned image.
Overlay Confidential Copy Draft Urgent Custom Off*	Specify the overlay text to print on each copy.
Custom overlay	Type the text for the Custom choice in Overlay menu.
Note: An asterisk (*) next to a value indicates the factory default setting.	

Advanced Imaging

Menu item	Description
Color Dropout Color Dropout (None*) Default Red Threshold (128*) Default Green Threshold (128*) Default Blue Threshold (128*)	Specify which color to drop during scanning, and adjust the dropout setting for that color.
Contrast Best for content* 0–5	Specify the contrast for the scanned image.
Background Removal Background Detection (Content-based*) Level (0*)	Remove the background color or image noise from the original document. Notes: <ul style="list-style-type: none"> • Content-based removes the background color from the original document . • Fixed removes image noise from a photo.
Auto Center Off* On	Align the content at the center of the page.
Mirror Image Off* On	Create a mirror image of the original document.
Note: An asterisk (*) next to a value indicates the factory default setting.	

Menu item	Description
Negative Image Off* On	Create a negative image of the original document.
Shadow Detail -4 to 4 (0*)	Adjust the shadow detail in the original document.
Scan Edge to Edge Off* On	Scan the original document from edge to edge.
Sharpness 1–5 (3*)	Adjust the sharpness of the scanned image.
Note: An asterisk (*) next to a value indicates the factory default setting.	

Admin Controls

Menu item	Description
Transparency Separators Off On*	Insert a blank sheet between transparencies.
Allow Priority Copies Off On*	Interrupt a print job to make copies.
Custom Job Scanning Off* On	Set the printer to scan the first set of original documents using the specified settings, and then scan the next set with the same or different settings. Note: This menu item appears only when a hard disk is installed.
Allow Save as Shortcut Off On*	Save copy settings as a shortcut.
Sample copy	Print a sample copy to check the quality before printing the remaining copies.
Note: An asterisk (*) next to a value indicates the factory default setting.	

Fax

Fax Defaults

Fax Mode

Menu item	Description
Fax Mode Fax* Fax Server Disabled	Select a fax mode.
Note: An asterisk (*) next to a value indicates the factory default setting.	

Fax Setup

Menu item	Description
General Fax Settings Fax Name Fax Number Fax ID (Fax Number*) Enable Manual Fax (Off*) Memory Use (Equal*) Cancel Faxes (Allow*) Fax Number Masking (Off*) Digits to Mask Enable Line Connected Detection (On*) Enable Line In Wrong Jack Detection (On*) Enable Extension In Use Support (On*) Optimize Fax Compatibility Fax Transport (Analog*)	Configure the general fax settings.
Note: An asterisk (*) next to a value indicates the factory default setting.	

Menu item	Description
<p>Fax Send Settings</p> <ul style="list-style-type: none"> Resolution (Standard*) Original Size (Mixed Sizes*) Orientation (Portrait*) Sides (Off*) Content Type (Text*) Content Source (Color Laser*) Darkness (5*) Behind a PABX (Off*) Dial Mode (Tone*) Advanced Imaging <ul style="list-style-type: none"> Color Balance Color Dropout Contrast (Best for Content*) Background Removal <ul style="list-style-type: none"> Background Detection (Content-based*) Level (0*) Mirror Image (Off*) Negative Image (Off*) Shadow Detail (0*) Scan Edge to Edge (Off*) Sharpness (3*) Temperature (0*) Admin Controls <ul style="list-style-type: none"> Automatic Redial (5*) Redial Frequency (3 minutes*) Enable ECM (On*) Enable Fax Scans (On*) Driver to Fax (Off*) Allow Save as Shortcut (On*) Max Speed (33600*) Custom Job Scanning (Off*) Scan Preview (Off*) Enable Color Fax Scans (Off by Default*) Auto Convert Color Faxes to Mono Faxes (On*) Confirm Fax Number (Off*) Dial Prefix Dialing Prefix Rules 	<p>Configure the fax send settings.</p> <p>Note: Custom Job Scanning and Scan Preview appear only when a hard disk is installed.</p>
<p>Note: An asterisk (*) next to a value indicates the factory default setting.</p>	

Menu item	Description
<p>Fax Receive Settings</p> <ul style="list-style-type: none"> Rings to Answer (3*) Auto Reduction (Off*) Paper Source (Auto*) Sides (Off*) Separator Sheets (None*) Separator Sheet Source(Tray 1*) Output Bin(Standard Bin*) Fax Footer (Off*) Fax Footer Time Stamp (Receive*) Holding Faxes <ul style="list-style-type: none"> Held Fax Mode (Off*) Admin Controls <ul style="list-style-type: none"> Enable Fax Receive (On*) Enable Color Fax Receive (On*) Enable Caller ID (On*) Block No Name Fax (Off*) Banned Fax List Answer On (All Rings*) Auto Answer (On*) Manual Answer Code (*9*) Fax Forwarding (Print*) Forward to Confirmation E-mail Max Speed (33600*) 	<p>Configure the fax receive settings.</p>
<p>Fax Cover Page</p> <ul style="list-style-type: none"> Fax Cover Page (Off by Default*) Include To field (Off*) Include From field (Off*) Include Message field (Off*) Include Logo (Off*) Include Footer [x] 	<p>Configure the fax cover page settings.</p>
<p>Note: An asterisk (*) next to a value indicates the factory default setting.</p>	

Menu item	Description
Fax Log Settings Transmission Log Frequency (Always*) Transmission Log Action Print (On*) E-mail (Off*) Receive Error Log (Print Never*) Auto Print Logs (On*) Log Paper Source (Tray 1*) Logs Display (Remote Fax Name*) Enable Job Log (On*) Enable Call Log (On*) Log Output Bin (Standard Bin*)	Configure the fax log settings.
Speaker Settings Speaker Mode (Always Off*) Speaker Volume (Low*) Ringer Volume (Off*)	Set the speaker mode and volume for incoming or outgoing fax.
Note: An asterisk (*) next to a value indicates the factory default setting.	

Fax Server Setup

Menu item	Description
General Fax Settings To Format Reply Address Subject: Message: Enable analog receive (Off*)	Configure the general fax settings.
Note: An asterisk (*) next to a value indicates the factory default setting.	

Menu item	Description
<p>Fax Server E-mail Settings</p> <ul style="list-style-type: none"> Use E-mail SMTP Server (Off*) Primary SMTP Gateway Primary SMTP Gateway Port Secondary SMTP Gateway Secondary SMTP Gateway Port SMTP Timeout (30 seconds*) Reply Address Use SSL/TLS (Disabled*) Required Trusted Certificate (On*) SMTP Server Authentication (No authentication required*) Device-Initiated E-mail (None*) User-Initiated E-mail (None*) Use Active Directory Device Credentials (Off*) Device Userid Device Password Kerberos 5 REALM NTLM Domain Disable "SMTP server not set up" error (Off*) 	<p>Configure the fax server e-mail settings.</p>
<p>Fax Server Scan Settings</p> <ul style="list-style-type: none"> Image Format (PDF (.pdf)*) Content Type (Text*) Content Source (Color Laser*) Fax Resolution (Standard*) Sides (Off*) Darkness (5*) Orientation (Portrait*) Original Size (Mixed Sizes*) Use Multi-Page TIFF (On*) 	<p>Configure the fax server scan settings.</p>

Note: An asterisk (*) next to a value indicates the factory default setting.

E-mail

E-mail Setup

Menu item	Description
<p>Primary SMTP Gateway</p>	<p>Type the IP address or host name of the primary SMTP server for sending e-mail.</p>
<p>Primary SMTP Gateway Port 1–65535 (25*)</p>	<p>Enter the port number of the primary SMTP server.</p>

Note: An asterisk (*) next to a value indicates the factory default setting.

Menu item	Description
Secondary SMTP Gateway	Type the server IP address or host name of your secondary or backup SMTP server.
Secondary SMTP Gateway Port 1–65535 (25*)	Enter the server port number of your secondary or backup SMTP server.
SMTP Timeout 5–30 seconds (30*)	Set the time before the printer times out if the SMTP server does not respond.
Reply Address	Specify a reply address in the e-mail.
Always use SMTP default Reply Address On Off*	Always use the default reply address in the SMTP server.
Use SSL/TLS Disabled* Negotiate Required	Specify whether to send e-mail using an encrypted link.
Require Trusted Certificate Off On*	Require a trusted certificate when accessing the SMTP server.
SMTP Server Authentication No authentication required* Login / Plain NTLM CRAM-MD5 Digest-MD5	Set the authentication type for the SMTP server.
Device-Initiated E-mail None* Use Device SMTP Credentials	Specify whether credentials are required for device-initiated e-mail.
Device Userid	Specify the user ID and password to connect to the SMTP server.
Device Password	
NTLM Domain	Specify the domain name for the NTLM security protocol.
Disable "SMTP server not set up" error Off* On	Hide the SMTP server not set up error message.
Note: An asterisk (*) next to a value indicates the factory default setting.	

E-mail Defaults

Menu item	Description
Subject:	Specify the e-mail subject and message.
Message:	
File Name	Specify the filename for the scanned document.
Format JPEG (.jpg) PDF (.pdf)* TIFF (.tif) XPS (.xps)	Specify the file format of the scanned document.
PDF Settings PDF Version (1.5*) Archival Version (A-1a*) Highly Compressed (Off*) Secure (Off*) Archival (PDF/A) (Off*)	Configure the PDF settings of the scanned document. Notes: <ul style="list-style-type: none"> Archival Version and Archival (PDF/A) are supported only when PDF Version is set to 1.4. Highly Compressed appears only when a hard disk is installed.
Content Type Text Text/Photo* Photo Graphics	Improve the output result based on the content type of the original document.
Content Source Black and White Laser Color Laser* Inkjet Photo/Film Magazine Newspaper Press Other	Improve the output result based on the content source of the original document.
Color Black and White Gray Color* Auto	Set the printer to capture file content in color or in mono.
Resolution 75 dpi 150 dpi* 200 dpi 300 dpi 400 dpi 600 dpi	Set the resolution of the scanned image.
Note: An asterisk (*) next to a value indicates the factory default setting.	

Menu item	Description
Darkness 1–9 (5*)	Adjust the darkness of the scanned image.
Orientation Portrait* Landscape	Specify the orientation of the original document.
Original Size Mixed Sizes*	Set the paper size of the original document.
Sides Off* Short Edge Long Edge	Specify the orientation of the original document when scanning on both sides of the document.
Note: An asterisk (*) next to a value indicates the factory default setting.	

Advanced Imaging

Menu item	Description
Color Balance Cyan (0*) Magenta (0*) Yellow (0*)	Adjust the color intensity for cyan, magenta, and yellow.
Color Dropout Color Dropout (None*) Default Red Threshold (128*) Default Green Threshold (128*) Default Blue Threshold (128*)	Specify which color to drop during scanning, and adjust the dropout setting for that color.
Auto Color Detect Color Sensitivity (5*) Area Sensitivity (5*) E-mail Bit Depth (1 bit*)	Configure the auto color detection setting.
JPEG Quality Best for content* 5–95	Set the JPEG quality of the scanned image.
Contrast Best for content* 0–5	Specify the contrast for the scanned image.
Background Removal Background Detection (Content-based*) Level (0*)	Remove the background color or image noise from the original document. Notes: <ul style="list-style-type: none"> • Content-based removes the background color from the original document. • Fixed removes image noise from a photo.
Note: An asterisk (*) next to a value indicates the factory default setting.	

Menu item	Description
Mirror Image Off* On	Create a mirror image of the original document.
Negative Image Off* On	Create a negative image of the original document.
Shadow Detail -4 to 4 (0*)	Adjust the shadow detail in the scanned image.
Scan Edge to Edge Off* On	Scan the original document from edge to edge.
Sharpness 1–5 (3*)	Adjust the sharpness in the scanned image.
Temperature -4 to 4 (0*)	Generate a bluer or redder output of the original document.
Blank Pages Blank Page Removal (Remove*) Blank Page Sensitivity (5*)	Set the sensitivity of scans in relation to blank pages in the original document.
Note: An asterisk (*) next to a value indicates the factory default setting.	

Admin Controls

Menu item	Description
Max E-mail Size 0–65535 (0*)	Set the allowable file size for each e-mail.
Size Error Message	Specify an error message that the printer sends when an e-mail exceeds its allowable file size. Note: You can type up to 1024 characters.
Limit Destinations	Limit sending of e-mail only to the specified list of domain name. Note: Use a comma to separate each domain.
Send Me a Copy Never appears* On by Default Off by Default Always On	Send a copy of the e-mail to yourself.
Allow self e-mails only Off* On	Set the printer to send e-mails to yourself only.
Note: An asterisk (*) next to a value indicates the factory default setting.	

Menu item	Description
Use cc:/bcc: Off* On	Enable carbon copy and blind carbon copy in e-mail.
Use Multi-Page TIFF Off On*	Enable scanning of multiple TIFF images in one TIFF file.
TIFF Compression JPEG LZW*	Specify the compression type for TIFF files.
Text Default 5–95 (75*)	Set the text quality in the content being scanned.
Text/Photo Default 5–95 (75*)	Set the text and photo quality in the content being scanned.
Photo Default 5–95 (50*)	Set the photo quality of the content being scanned.
Transmission Log Print log* Do Not Print Log Print Only For Error	Print a transmission log for e-mail scans.
Log Paper Source Tray [x] (1*) Multipurpose Feeder	Specify the paper source for printing e-mail logs.
Custom Job Scanning Off* On	Set the printer to scan the first set of original documents using the specified settings, and then scan the next set with the same or different settings. Note: This menu item appears only when a hard disk is installed.
Scan Preview Off On*	Show a scan preview of the original document. Note: This menu item appears only when a hard disk is installed.
Allow Save as Shortcut Off On*	Save an e-mail address as a shortcut.
E-mail Images Sent As Attachment* Web Link	Specify how to send the images that are included in the e-mail.
Reset E-mail Information After Sending Off On*	Reset the To, Subject, Message, and Filename fields to their default values after sending an e-mail.
Note: An asterisk (*) next to a value indicates the factory default setting.	

Web Link Setup

Menu item	Description
Server	Set the printer to send e-mail as a web link.
Login	
Password	
Path	
File Name	
Web Link	

FTP

FTP Defaults

Menu item	Description
Format JPEG (.jpg) PDF (.pdf)* TIFF (.tif) XPS (.xps)	Specify the file format for the scanned image.
Global OCR Settings Recognized Languages Auto Rotate* Despeckle Auto Contrast Enhance	Configure the settings for optical character recognition (OCR). Note: This menu appears only if you have purchased and installed an OCR solution.
PDF Settings PDF Version (1.5*) Archival Version (A-1a*) Highly Compressed (Off*) Secure (Off*) Archival (PDF/A) (Off*)	Configure the PDF settings for the scanned image. Note: Highly Compressed appears only when a hard disk is installed.
Content Type Text Text/Photo* Graphics Photo	Improve the output result based on the content type of the original document.
Note: An asterisk (*) next to a value indicates the factory default setting.	

Menu item	Description
Content Source Black and White Laser Color Laser* Inkjet Photo/Film Magazine Newspaper Press Other	Improve the output result based on the content source of the original document.
Color Black and White Gray Color* Auto	Set the printer to capture file content in color or in mono.
Resolution 75 dpi 150 dpi* 200 dpi 300 dpi 400 dpi 600 dpi	Set the resolution of the scanned image.
Darkness 1–9 (5*)	Adjust the darkness of the scanned image.
Orientation Portrait* Landscape	Specify the orientation of the original document.
Original Size Mixed Sizes*	Set the paper size of the original document.
Sides Off* Long Edge Short Edge	Specify the orientation when scanning on both sides of the document.
File Name	Specify the file name of the scanned image.
Note: An asterisk (*) next to a value indicates the factory default setting.	

Advanced Imaging

Menu item	Description
Color Balance Cyan (0*) Magenta (0*) Yellow (0*)	Adjust the color intensity for cyan, magenta, and yellow.
Color Dropout Color Dropout (None*) Default Red Threshold (128*) Default Green Threshold (128*) Default Blue Threshold (128*)	Specify which color to drop during scanning, and adjust the dropout setting for that color.
Auto Color Detect Color Sensitivity (5*) Area Sensitivity (5*) FTP Bit Depth (1 bit*) Minimum Scan Resolution (300 dpi*)	Configure the auto color detection setting.
JPEG Quality Best for content* 5–95	Set the JPEG quality of the scanned image.
Contrast Best for content* 0 1 2 3 4 5	Specify the contrast for the scanned image.
Background Removal Background Detection (Content-based*) Level (0*)	Remove the background color or image noise from the original document. Notes: <ul style="list-style-type: none"> • Content-based removes the background color from the original document . • Fixed removes image noise from a photo.
Mirror Image Off* On	Create a mirror image of the original document.
Negative Image Off* On	Create a negative image of the original document.
Shadow Detail -4 to 4 (0*)	Adjust the shadow detail in the scanned image.
Note: An asterisk (*) next to a value indicates the factory default setting.	

Menu item	Description
Scan Edge to Edge Off* On	Allow edge-to-edge scanning of the original document.
Sharpness 1–5 (3*)	Adjust the sharpness in the scanned image.
Temperature -4 to 4 (0*)	Generate a bluer or redder output of the original document.
Blank Pages Blank Page Removal (Remove*) Blank Page Sensitivity (5*)	Set the sensitivity of scans in relation to blank pages in the original document.
Note: An asterisk (*) next to a value indicates the factory default setting.	

Admin Controls

Menu item	Description
Text Default 5–95 (75*)	Set the quality of text on the scanned image.
Text/Photo Default 5–95 (75*)	Set the quality of text and photo on the scanned image.
Photo Default 5–95 (50*)	Set the quality of photo on the scanned image.
Use Multi-Page TIFF On* Off	Enable scanning of multiple TIFF images in one TIFF file.
TIFF Compression LZW* JPEG	Specify the compression type for TIFF files.
Transmission Log Print Log* Do Not Print Log Print Only For Error	Print a transmission log for FTP scans.
Log Paper Source Tray [x] (1*) Multipurpose Feeder	Specify the paper source for printing FTP logs.
Custom Job Scanning Off* On	Set the printer to scan the first set of original documents using the specified settings, and then scan the next set with the same or different settings. Note: This menu item appears only when a hard disk is installed.
Scan Preview Off On*	Show a preview of the original document. Note: This menu item appears only when a hard disk is installed.
Note: An asterisk (*) next to a value indicates the factory default setting.	

Menu item	Description
Allow Save as Shortcut Off On*	Save an FTP address as a shortcut.
Note: An asterisk (*) next to a value indicates the factory default setting.	

USB Drive

Flash Drive Scan

Menu item	Description
Format JPEG (.jpg) PDF (.pdf)* TIFF (.tif) XPS (.xps)	Specify the file format for the scanned image.
Global OCR Settings Recognized Languages Auto Rotate Despeckle Auto Contrast Enhance	Configure the settings for optical character recognition (OCR). Note: This menu appears only if you have purchased and installed an OCR solution.
PDF Settings PDF Version (1.5*) Archival Version (A-1a*) Highly Compressed (Off*) Secure (Off*) Archival (PDF/A) (Off*)	Configure the PDF settings of the scanned image. Notes: <ul style="list-style-type: none"> • Archival Version and Archival (PDF/A) are supported only when PDF Version is set to 1.4. • Highly Compressed appears only when a hard disk is installed.
Content Type Text Text/Photo* Graphics Photo	Improve the output result based on the content type of the original document.
Content Source Black and White Laser Color Laser* Inkjet Photo/Film Magazine Newspaper Press Other	Improve the output result based on the content source of the original document.
Note: An asterisk (*) next to a value indicates the factory default setting.	

Menu item	Description
Color Black and White Gray Color* Auto	Set the printer to capture file content in color or in mono.
Resolution 75 dpi 150 dpi* 200 dpi 300 dpi 400 dpi 600 dpi	Set the resolution of the scanned image.
Darkness 1–9 (5*)	Adjust the darkness of the scanned image.
Orientation Portrait* Landscape	Specify the orientation of the original document.
Original Size Mixed Sizes*	Set the paper size of the original document.
Sides Off* Long edge Short edge	Specify the orientation of the original document when scanning on both sides of the document.
File Name	Specify the file name of the scanned image.
Note: An asterisk (*) next to a value indicates the factory default setting.	

Advanced Imaging

Menu item	Description
Color Balance Cyan (0*) Magenta (0*) Yellow (0*)	Adjust the color intensity for cyan, magenta, and yellow.
Color Dropout Color Dropout (None*) Default Red Threshold (128*) Default Green Threshold (128*) Default Blue Threshold (128*)	Specify which color to drop during scanning, and adjust the dropout setting for that color.
Note: An asterisk (*) next to a value indicates the factory default setting.	

Menu item	Description
Auto Color Detect Color Sensitivity (5*) Area Sensitivity (5*) Scan Bit Depth (1 bit*) Minimum Scan Resolution (300 dpi*)	Configure the auto color detection setting.
JPEG Quality Best for content* 5–95	Set the JPEG quality of the scanned image.
Contrast Best for content* 0–5	Specify the contrast for the scanned image.
Background Removal Background Detection (Content-based*) Level (0*)	Remove the background color or image noise from the original document. Notes: <ul style="list-style-type: none"> • Content-based removes the background color from the original document. • Fixed removes image noise from a photo.
Mirror Image Off* On	Create a mirror image of the original document.
Negative Image Off* On	Create a negative image of the original document.
Shadow Detail -4 to 4 (0*)	Adjust the shadow detail in the scanned image.
Scan Edge to Edge Off* On	Scan the original document from edge to edge.
Sharpness 1–5 (3*)	Adjust the sharpness in the scanned image.
Temperature -4 to 4 (0*)	Generate a bluer or redder output of the original document.
Blank Pages Blank Page Removal (Remove*) Blank Page Sensitivity (5*)	Set the sensitivity of scans in relation to blank pages in the original document.
Note: An asterisk (*) next to a value indicates the factory default setting.	

Admin Controls

Menu item	Description
Text Default 5–95 (75*)	Set the quality of text on the scanned image.
Text/Photo Default 5–95 (75*)	Set the quality of text and photo on the scanned image.
Photo Default 5–95 (50*)	Set the quality of a photo on the scanned image.
Use Multi-Page TIFF Off On*	Enable scanning of multiple TIFF images in one TIFF file.
TIFF Compression LZW* JPEG	Specify the compression type for TIFF files.
Custom Job Scanning Off* On	Set the printer to scan the first set of original documents using the specified settings, and then scan the next set with the same or different settings. Note: This menu item appears only when a hard disk is installed.
Scan Preview Off On*	Show a scan preview of the original document. Note: This menu item appears only when a hard disk is installed.
Adjust ADF Skew Off On*	Set the printer to adjust the skewed images from documents that are scanned from the ADF.
Note: An asterisk (*) next to a value indicates the factory default setting.	

Flash Drive Print

Menu item	Description
Number of Copies 1–9999 (1*)	Set the number of copies.
Paper Source Tray [x] (1*) Multipurpose Feeder Manual Paper Manual Envelope	Set the paper source for the print job.
Color Off On*	Print a flash drive file in color.
Note: An asterisk (*) next to a value indicates the factory default setting.	

Menu item	Description
Collate (1,1,1) (2,2,2) (1,2,3) (1,2,3)*	Keep the pages of a print job stacked in sequence, particularly when printing multiple copies of the job.
Sides 1-Sided* 2-Sided	Specify whether to print on one side or both sides of the paper.
Flip Style Long Edge* Short Edge	Determine which side of the paper is bound when performing two-sided printing.
Pages per Side Off* 2 pages per side 3 pages per side 4 pages per side 6 pages per side 9 pages per side 12 pages per side 16 pages per side	Print multiple page images on one side of a sheet of paper.
Pages per Side Ordering Horizontal* Reverse Horizontal Reverse Vertical Vertical	Specify the positioning of multiple page images when using Pages per Side menu.
Pages per Side Orientation Auto* Landscape Portrait	Specify the orientation of multiple page images when using Pages per Side menu.
Pages per Side Border None* Solid	Print a border around each page image when using Pages per Side menu.
Separator Sheets Off* Between Copies Between Jobs Between Pages	Insert blank separator sheets when printing.
Separator Sheet Source Tray [x] (1*) Multipurpose Feeder	Specify the paper source for the separator sheet.
Blank Pages Do Not Print* Print	Print blank pages in a print job.
Note: An asterisk (*) next to a value indicates the factory default setting.	

Network/Ports

Network Overview

Menu item	Description
Active Adapter Auto* Standard Network Wireless	Specify the type of the network connection. Note: Wireless is available only in printers connected to a wireless network.
Network Status	Show the connectivity status of the printer network.
Display Network Status on Printer Off On*	Show the network status on the display.
Speed, Duplex	Show the speed of the currently active network card.
IPv4	Show the IPv4 address.
All IPv6 Addresses	Show all IPv6 addresses.
Reset Print Server	Reset all active network connections to the printer. Note: This setting removes all network configuration settings.
Network Job Timeout Off On* (90 seconds)	Set the time before the printer cancels a network print job.
Banner Page Off* On	Print a banner page.
Scan to PC Port Range	Specify a valid port range for printers that are behind a port blocking firewall.
Enable Network Connections Off On*	Enable the printer to connect to a network.
Enable LLDP Off* On	Enable Link Layer Discovery Protocol (LLDP) in the printer.
Note: An asterisk (*) next to a value indicates the factory default setting.	

Wireless

Note: This menu is available only in printers connected to a Wi-Fi network or printers that have a wireless network adapter.

Menu item	Description
Setup Using Mobile App	Configure the Wi-Fi connection using Lexmark Mobile Assistant.

Menu item	Description
Setup On Printer Panel Choose Network Add Wi-Fi Network Network Name Network Mode Infrastructure Wireless Security Mode Disabled* WEP WPA2/WPA - Personal WPA2 - Personal 802.1x - RADIUS	Configure the Wi-Fi connection using the control panel. Note: 802.1x - RADIUS can be configured only from the Embedded Web Server.
Wi-Fi Protected Setup WPS Auto Detect Off On* Start Push Button Method Start PIN Method	Establish a Wi-Fi network and enable network security. Notes: <ul style="list-style-type: none"> • WPS Auto Detect appears only when the Wireless Security Mode is set to WEP. • Start Push-Button Method connects the printer to a Wi-Fi network when buttons on both the printer and the access point (wireless router) are pressed within a given time. • Start PIN Method connects the printer to a Wi-Fi network when a PIN on the printer is entered into the wireless settings of the access point.
Network Mode BSS Type Infrastructure*	Specify the network mode.
Enable Wi-Fi Direct On Off*	Enable Wi-Fi Direct-capable devices to connect directly to the printer.
Compatibility 802.11b/g/n (2.4GHz)* 802.11a/b/g/n/ac (2.4GHz/5GHz) 802.11a/n/ac (5GHz)	Specify the standard for the Wi-Fi network. Note: 802.11a/b/g/n/ac (2.4GHz/5GHz) and 802.11a/n/ac (5GHz) only appear when a Wi-Fi option is installed.
Wireless Security Mode Disabled* WEP WPA2/WPA-Personal WPA2-Personal 802.1x - RADIUS	Set the security mode for connecting the printer to Wi-Fi devices. Note: 802.1x - RADIUS can be configured only from the Embedded Web Server.
WEP Authentication Mode Auto* Open Shared	Set the type of Wireless Encryption Protocol (WEP) for the printer. Note: This menu item appears only when the Wireless Security Mode is set to WEP.
Set WEP Key	Specify a WEP password for secure Wi-Fi connection.

Menu item	Description
WPA2/WPA Personal AES	Enable Wi-Fi security through Wi-Fi Protected Access (WPA). Note: This menu item appears only when the Wireless Security Mode is set to WPA2/WPA-Personal.
Set Pre-Shared Key	Set the password for secure Wi-Fi connection.
WPA2-Personal AES	Enable Wi-Fi security through WPA2. Note: This menu item appears only when the Wireless Security Mode is set to WPA2-Personal.
802.1x Encryption Mode WPA+ WPA2*	Enable Wi-Fi security through 802.1x standard. Notes: <ul style="list-style-type: none"> • This menu item appears only when the Wireless Security Mode is set to 802.1x - RADIUS. • 802.1x - RADIUS can be configured only from the Embedded Web Server.
IPv4 Enable DHCP On* Off Set Static IP Address IP Address Netmask Gateway	Enable and configure IPv4 settings in the printer.
IPv6 Enable IPv6 On* Off Enable DHCPv6 On Off* Stateless Address Autoconfiguration On* Off DNS Server Address Manually Assigned IPv6 Address Manually Assigned IPv6 Router Address Prefix All IPv6 Addresses All IPv6 Router Addresses	Enable and configure IPv6 settings in the printer.
Network Address UAA LAA	View the network addresses.

Menu item	Description
PCL SmartSwitch Off On*	Set the printer to switch automatically to PCL emulation when a print job requires it, regardless of the default printer language. Note: If PCL SmartSwitch is off, then the printer does not examine incoming data and uses the default printer language specified in the Setup menu.
PS SmartSwitch Off On*	Set the printer to switch automatically to PS emulation when a print job requires it, regardless of the default printer language. Note: If PS SmartSwitch is off, then the printer does not examine incoming data and uses the default printer language specified in the Setup menu.
Job Buffering On Off*	Temporarily store print jobs in the printer hard disk before printing. Note: This menu item appears only when a hard disk is installed.
Mac Binary PS Auto* On Off	Set the printer to process Macintosh binary PostScript print jobs. Notes: <ul style="list-style-type: none"> • On processes raw binary PostScript print jobs. • Off filters print jobs using the standard protocol.

Ethernet

Menu item	Description
Network Speed	Show the speed of the active network adapter.
IPv4 Enable DHCP (On*) Set Static IP Address	Configure the IPv4 settings.
IPv6 Enable IPv6 (On*) Enable DHCPv6 (Off*) Stateless Address Autoconfiguration (On*) DNS Server Address Manually Assigned IPv6 Address Manually Assigned IPv6 Router Address Prefix (64*) All IPv6 Addresses All IPv6 Router Addresses	Configure the IPv6 settings.
Network Address UAA LAA	Specify the network address.
Note: An asterisk (*) next to a value indicates the factory default setting.	

Menu item	Description
PCL SmartSwitch Off On*	Set the printer to switch automatically to PCL emulation when a print job requires it, regardless of the default printer language. Note: When this setting is disabled, the printer does not examine incoming data and uses the default printer language specified in the Setup menu.
PS SmartSwitch Off On*	Set the printer to switch automatically to PostScript emulation when a print job requires it, regardless of the default printer language. Note: When this setting is disabled, the printer does not examine incoming data and uses the default printer language specified in the Setup menu.
Job Buffering Off* On	Temporarily store jobs on the hard disk before printing. Note: This menu item appears only when a hard disk is installed.
Mac Binary PS Auto* On Off	Set the printer to process Macintosh binary PostScript print jobs. Notes: <ul style="list-style-type: none"> • Auto processes print jobs from computers using either Windows or Macintosh operating systems. • Off filters PostScript print jobs using the standard protocol.
Energy Efficient Ethernet On Off Auto*	Reduce power consumption when the printer does not receive data from the Ethernet network.
Note: An asterisk (*) next to a value indicates the factory default setting.	

TCP/IP

Note: This menu appears only in network printers or printers attached to print servers.

Menu item	Description
Set Hostname	Set the current TCP/IP host name.
Domain Name	Set the domain name.
Allow DHCP/BOOTP to update NTP server On* Off	Allow the DHCP and BOOTP clients to update the NTP settings of the printer.
Zero Configuration Name	Specify a service name for the zero configuration network.
Enable Auto IP Off* On	Assign an IP address automatically.
DNS Server Address	Specify the current Domain Name System (DNS) server address.
Note: An asterisk (*) next to a value indicates the factory default setting.	

Menu item	Description
Backup DNS Address	Specify the backup DNS server addresses.
Backup DNS Address 2	
Backup DNS Address 3	
Domain Search Order	Specify a list of domain names to locate the printer and its resources that reside in different domains on the network.
Enable DDNS Off* On	Update the Dynamic DNS settings.
DDNS TTL	Specify the current DDNS settings.
Default TTL	
DDNS Refresh Time	
Enable mDNS Off On*	Update the multicast DNS settings.
WINS Server Address	Specify a server address for Windows Internet Name Service (WINS).
Enable BOOTP Off* On	Allow the BOOTP to assign a printer IP address.
Restricted Server List	Specify the IP addresses that are allowed to communicate with the printer over TCP/IP. Notes: <ul style="list-style-type: none"> • Use a comma to separate each IP address. • You can add up to 50 IP addresses.
Restricted Server List Options Block All Ports* Block Printing Only Block Printing and HTTP Only	Specify the access option for IP addresses that are not in the list.
MTU 256–1500 Ethernet (1500*)	Specify a maximum transmission unit (MTU) parameter for the TCP connections.
Raw Print Port 1–65535 (9100*)	Specify a raw port number for printers connected on a network.
Outbound Traffic Maximum Speed Off* On	Set the maximum transfer rate of the printer. Note: When enabled, the option for this setting is 100–1000000 Kilobits/second.
Enable TLSv1.0 Off On*	Enable the TLSv1.0 protocol.
Note: An asterisk (*) next to a value indicates the factory default setting.	

Menu item	Description
Enable TLSv1.1 Off On*	Enable the TLSv1.1 protocol.
SSL Cipher List	Specify the cipher algorithms to use for the SSL or the TLS connections.
Note: An asterisk (*) next to a value indicates the factory default setting.	

SNMP

Note: This menu appears only in network printers or printers that are attached to print servers.

Menu item	Description
SNMP Versions 1 and 2c Enabled Off On* Allow SNMP Set Off On* Enable PPM MIB Off On* SNMP Community	Configure Simple Network Management Protocol (SNMP) versions 1 and 2c to install print drivers and applications.
SNMP Version 3 Enabled Off On* Set Read/Write Credentials User Name Password Set Read-only Credentials User Name Password Authentication Hash MD5 SHA1* Minimum Authentication Level No Authentication, No Privacy Authentication, No Privacy Authentication, Privacy* Privacy Algorithm DES AES-128*	Configure SNMP version 3 to install and update the printer security.
Note: An asterisk (*) next to a value indicates the factory default setting.	

IPSec

Note: This menu appears only in network printers or printers that are attached to print servers.

Menu item	Description
Enable IPSec Off* On	Enable Internet Protocol Security (IPSec).
Base Configuration Default* Compatibility Secure	Set the IPSec base configuration. Note: This menu item appears only when Enable IPSec is set to On.
DH (Diffie-Hellman) Group Proposal modp2048 (14)* modp3072 (15) modp4069 (16) modp6144 (17) modp8192 (18)	Set the IPSec encryption. Note: This menu item appears only when Base Configuration is set to Compatibility.
IKE SA Lifetime (Hours) 1 2 4 8 24*	Set the amount of time before a new authentication key is generated. Note: These menu items appear only when Base Configuration is set to Secure.
IPSec SA Lifetime (Hours) 1 2 4 8 24*	
Proposed Encryption Method 3DES AES*	Specify the encryption and authentication methods to connect to a network securely. Note: These menu items appear only when Base Configuration is set to Compatibility.
Proposed Authentication Method SHA1 SHA256* SHA512	
IPSec Device Certificate	Specify an IPSec certificate. Note: This menu item appears only when Base Configuration is set to Compatibility.
Note: An asterisk (*) next to a value indicates the factory default setting.	

Menu item	Description
Pre-Shared Key Authenticated Connections Host [x] Address Key	Configure the authenticated connections of the printer. Note: These menu items appear only when Enable IPsec is set to On.
Certificate Authenticated Connections Host [x] Address[/subnet] Address[/subnet]	
Note: An asterisk (*) next to a value indicates the factory default setting.	

802.1x

Note: This menu appears only in network printers or printers that are attached to print servers.

Menu item	Description
Active Off* On	Let the printer join networks that require authentication before allowing access. Note: To configure the settings of this menu item, access the Embedded Web Server.
Note: An asterisk (*) next to a value indicates the factory default setting.	

LPD Configuration

Note: This menu appears only in network printers or printers that are attached to print servers.

Menu item	Description
LPD Timeout 0–65535 seconds (90*)	Set the time-out value to stop the Line Printer Daemon (LPD) server from waiting indefinitely for hung or invalid print jobs.
LPD Banner Page Off* On	Print a banner page for all LPD print jobs. Note: A banner page is the first page of a print job used as a separator of print jobs and to identify the originator of the print job request.
LPD Trailer Page Off* On	Print a trailer page for all LPD print jobs. Note: A trailer page is the last page of a print job.
LPD Carriage Return Conversion Off* On	Enable carriage return conversion. Note: Carriage return is a mechanism that commands the printer to move the position of the cursor to the first position on the same line.
Note: An asterisk (*) next to a value indicates the factory default setting.	

HTTP/FTP Settings

Menu item	Description
Enable HTTP Server Off On*	Access the Embedded Web Server to monitor and manage the printer.
Enable HTTPS Off On*	Enable Hypertext Transfer Protocol Secure (HTTPS) to encrypt data transferring to and from the print server.
Force HTTPS Connections On Off*	Force the printer to use HTTPS connections.
Enable FTP/TFTP Off On*	Send files using FTP/TFTP.
Local Domains	Specify domain names for HTTP and FTP servers.
HTTP Proxy IP Address	Configure the HTTP and FTP server settings.
FTP Proxy IP Address	
HTTP Default IP Port	
HTTPS Device Certificate	
FTP Default IP Port	
Timeout for HTTP/FTP Requests 1–299 (30*)	Specify the amount of time before the server connection stops.
Retries for HTTP/FTP Requests 1–299 (3*)	Set the number of retries to connect to the HTTP/FTP server.
Note: An asterisk (*) next to a value indicates the factory default setting.	

ThinPrint

Menu item	Description
Enable ThinPrint Off On*	Print using ThinPrint.
Port Number 4000–4999 (4000*)	Set the port number for the ThinPrint server.
Bandwidth (bits/sec) 0* 100–1000000	Set the speed to transmit data in a ThinPrint environment.
Note: An asterisk (*) next to a value indicates the factory default setting.	

Menu item	Description
Packet Size (kbytes) 0–64000 (0*)	Set the packet size for data transmission.
Note: An asterisk (*) next to a value indicates the factory default setting.	

USB

Menu item	Description
PCL SmartSwitch Off On*	Set the printer to switch to PCL emulation when a print job received through a USB port requires it, regardless of the default printer language. Note: When this setting is disabled, the printer does not examine incoming data and uses the default printer language specified in the Setup menu.
PS SmartSwitch Off On*	Set the printer to switch to PostScript emulation when a print job received through a USB port requires it, regardless of the default printer language. Note: When this setting is disabled, the printer does not examine incoming data and uses the default printer language specified in the Setup menu.
Job Buffering Off* On	Temporarily store jobs on the hard disk before printing. Note: This menu item appears only when a hard disk is installed.
Mac Binary PS Auto* On Off	Set the printer to process Macintosh binary PostScript print jobs. Notes: <ul style="list-style-type: none"> • Auto processes print jobs from computers using either Windows or Macintosh operating systems. • Off filters PostScript print jobs using the standard protocol.
Enable USB Port Off On*	Enable the front USB drive port.
Note: An asterisk (*) next to a value indicates the factory default setting.	

Restrict external network access

Menu item	Description
Restrict external network access Off* On	Restrict access to network sites.
External network address	Specify the network addresses with restricted access.
E-mail address for notification	Specify an e-mail address to send a notification of logged events.
Ping frequency 1–300 (10*)	Specify the network query interval in seconds.
Note: An asterisk (*) next to a value indicates the factory default setting.	

Menu item	Description
Subject	Specify the subject and message of the notification e-mail.
Message	
Note: An asterisk (*) next to a value indicates the factory default setting.	

Google Cloud Print

Menu item	Description
Registration Register	Register the printer to the Google Cloud server.
Options Enable Google Cloud Print Off On*	Print directly from your Google account.
Options Enable Local Discovery Off On*	Allow higher bandwidth for data transmission.
Options Enable SSL Peer Verification Off On*	Verify authenticity of the peer certificate to connect to your Google account.
Options Always Print As Image Off* On	Enable the Always Print As Image feature.
Note: An asterisk (*) next to a value indicates the factory default setting.	

Wi-Fi Direct

Note: This menu appears only when a direct Wi-Fi network is the active network.

Menu item	Description
SSID	Specify the service set identifier (SSID) of the Wi-Fi network.
Preferred Channel Number Auto 1–11 (6*)	Show the PSK on the Network Setup Page.
Set PSK	Set the preshared key (PSK) to authenticate and validate users on a Wi-Fi connection.
Note: An asterisk (*) next to a value indicates the factory default setting.	

Menu item	Description
Show PSK on Setup Page Off On*	Show the PSK on the Network Setup Page.
Group Owner IP Address	Specify the IP address of the group owner.
Auto-Accept Push Button Requests Off* On	Accept requests to connect to the network automatically. Note: Accepting clients automatically is not secure.
Note: An asterisk (*) next to a value indicates the factory default setting.	

Security

Login Methods

Manage Permissions

Menu item	Description
Function Access Access Address Book in Apps Modify Address Book Manage Shortcuts Create Profiles Manage Bookmarks Flash Drive Print Flash Drive Scan Copy Function Color Dropout E-mail Function Fax Function FTP Function Release Held Faxes Held Jobs Access User Profiles Cancel Jobs at the Device Change Language Internet Printing Protocol (IPP) Initiate Scans Remotely B/W Print Network Folder - Scan	Control access to the printer functions.

Menu item	Description
<p>Administrative Menus</p> <ul style="list-style-type: none"> Security Menu Network/Ports Menu Paper Menu Reports Menu Function Configuration Menus Supplies Menu Option Card Menu SE Menu Device Menu 	<p>Control access to the printer menu settings.</p>
<p>Device Management</p> <ul style="list-style-type: none"> Remote Management Firmware Updates Apps Configuration Operator Panel Lock Import/Export All Settings Out of Service Erase Embedded Web Server Access 	<p>Control access to the printer management options.</p>
<p>Apps</p> <ul style="list-style-type: none"> New Apps Slideshow Change Wallpaper Screen Saver Card Copy Scan Center Scan Center Custom 1 Scan Center Custom 2 Scan Center Custom 3 Scan Center Custom 4 Scan Center Custom 5 Scan Center Custom 6 Scan Center Custom 7 Scan Center Custom 8 Scan Center Custom 9 Scan Center Custom 10 Forms and Favorites 	<p>Control access to printer applications.</p>

Local Accounts

Menu item	Description
Manage Groups/Permissions Add Group Import Access Controls Function Access Administrative Menus Device Management Apps All Users Import Access Controls Function Access Administrative Menus Device Management Apps Admin	Control group or user access to the printer functions, applications, and security settings.
Add User User Name/Password User Name Password PIN	Create local accounts to manage access to the printer functions.
User Name/Password Accounts Add User	
User Name Accounts Add User	
Password Accounts Add User	
PIN Accounts Add User	

Schedule USB Devices

Menu item	Description
Schedules Add New Schedule	Schedule access to the USB ports.

Security Audit Log

Menu item	Description
Enable Audit Off* On	Record the events in the secure audit log and remote syslog.
Enable Remote Syslog Off* On	Send audit logs to a remote server.
Remote Syslog Server	Specify the remote syslog server.
Remote Syslog Port 1–65535 (514*)	Specify the remote syslog port.
Remote Syslog Method Normal UDP* Stunnel	Specify a syslog method to transmit logged events to a remote server.
Remote Syslog Facility 0 - Kernel Messages 1 - User-Level Messages 2 - Mail System 3 - System Daemons 4 - Security/Authorization Messages* 5 - Messages Generated Internally by Syslogs 6 - Line Printer Subsystem 7 - Network News Subsystem 8 - UUCP Subsystem 9 - Clock Daemon 10 - Security/Authorization Messages 11 - FTP Daemon 12 - NTP Subsystem 13 - Log Audit 14 - Log Alert 15 - Clock Daemon 16 - Local Use 0 (local0) 17 - Local Use 1 (local1) 18 - Local Use 2 (local2) 19 - Local Use 3 (local3) 20 - Local Use 4 (local4) 21 - Local Use 5 (local5) 22 - Local Use 6 (local6) 23 - Local Use 7 (local7)	Specify a facility code that the printer uses when sending log events to a remote server.
Note: An asterisk (*) next to a value indicates the factory default setting.	

Menu item	Description
Severity of Events to Log 0 - Emergency 1 - Alert 2 - Critical 3 - Error 4 - Warning* 5 - Notice 6 - Informational 7 - Debug	Specify the priority level cutoff for logging messages and events.
Remote Syslog Non-Logged Events Off* On	Send all events, regardless of severity level, to the remote server.
Admin's E-mail Address	Send e-mail notification of logged events to the administrator.
E-mail Log Cleared Alert Off* On	Send e-mail notification to the administrator when a log entry is deleted.
E-mail Log Wrapped Alert Off* On	Send e-mail notification to the administrator when the log becomes full and begins to overwrite the oldest entries.
Log Full Behavior Wrap Over Older Entries* E-mail Log Then Delete All Entries	Resolve log storage issues when the log fills its allotted memory.
E-mail % Full Alert Off* On	Send e-mail notification to the administrator when the log fills its allotted memory.
% Full Alert Level 1–99 (90*)	
E-mail Log Exported Alert Off* On	Send e-mail notification to the administrator when a log is exported.
E-mail Log Settings Changed Alert Off* On	Send e-mail notification to the administrator when Enable Audit is set.
Log Line Endings LF (\n)* CR (\r) CRLF (\r\n)	Specify how the log file terminates the end of each line.
Note: An asterisk (*) next to a value indicates the factory default setting.	

Menu item	Description
Digitally Sign Exports Off* On	Add a digital signature to each exported log file.
Clear Log	Delete all audit logs.
Export Log Syslog (RFC 5424) Syslog (RFC 3164) CSV	Export a security log to a flash drive.
Note: An asterisk (*) next to a value indicates the factory default setting.	

Login Restrictions

Menu item	Description
Login failures 1–10 (3*)	Specify the number of failed login attempts before the user gets locked out.
Failure time frame 1–60 minutes (5*)	Specify the time frame between failed login attempts before the user gets locked out.
Lockout time 1–60 minutes (5*)	Specify the lockout duration.
Web Login Timeout 1–120 minutes (10*)	Specify the delay for a remote login before the user is logged off automatically.
Note: An asterisk (*) next to a value indicates the factory default setting.	

Confidential Print Setup

Menu item	Description
Max Invalid PIN 2–10	Set the number of times an invalid PIN can be entered. Notes: <ul style="list-style-type: none"> • A value of zero turns off this setting. • When the limit is reached, the print jobs for that user name and PIN are deleted. • This menu item appears only when a hard disk is installed.
Confidential Job Expiration Off* 1 Hour 4 Hours 24 Hours 1 Week	Set the expiration time for confidential print jobs. Notes: <ul style="list-style-type: none"> • If this menu item is changed while confidential print jobs reside in the printer memory or hard disk, then the expiration time for those print jobs does not change to the new default value. • If the printer is turned off, then all confidential jobs held in the printer memory are deleted.
Note: An asterisk (*) next to a value indicates the factory default setting.	

Menu item	Description
Repeat Job Expiration Off* 1 Hour 4 Hours 24 Hours 1 Week	Set the expiration time for a print job that you want to repeat.
Verify Job Expiration Off* 1 Hour 4 Hours 24 Hours 1 Week	Set the expiration time that the printer prints a copy for the user to examine its quality, before printing the remaining copies.
Reserve Job Expiration Off* 1 Hour 4 Hours 24 Hours 1 Week	Set the expiration time that the printer stores print jobs for printing later.
Require All Jobs to be Held Off* On	Set the printer to hold all print jobs.
Keep duplicate documents Off* On	Set the printer to print other documents with the same file name without overwriting any of the print jobs.
Note: An asterisk (*) next to a value indicates the factory default setting.	

Disk Encryption

Note: This menu appears only when a printer hard disk is installed.

Menu item	Description
Status Enabled Disabled	Determine whether Disk Encryption is enabled.
Start encryption	Prevent the loss of sensitive data in case the printer or its hard disk is stolen. Note: Enabling disk encryption erases all contents in the hard disk. If necessary, back up important data from the printer before starting the encryption.

Erase Temporary Data Files

Menu item	Description
Stored in onboard memory Off* On	Delete all files stored on the printer memory.
Stored on hard disk 1 Pass Erase* 3 Pass Erase 7 Pass Erase	Delete all files stored on the printer hard disk.
Note: An asterisk (*) next to a value indicates the factory default setting.	

Solutions LDAP Settings

Use	To
Follow LDAP Referrals Off* On	Search the different servers in the domain for the logged-in user account.
LDAP Certificate Verification No* Yes	Enable verification of LDAP certificates.

Mobile Services Management

Use	To
AirPrint Print Scan Fax	Enable functions in the AirPrint software feature.

Miscellaneous

Menu item	Description
Protected Features Show* Hide	Show all the features that Function Access Control (FAC) protects regardless of the security permission that the user has. Note: FAC manages access to specific menus and functions or disables them entirely.
Print Permission Off* On	Let the user log in before printing.
Default Print Permission Login	Set the default login for Print Permission.
Note: An asterisk (*) next to a value indicates the factory default setting.	

Menu item	Description
Security Reset Jumper Enable “Guest” access* No Effect	Specify the effect of using the security reset jumper. Notes: <ul style="list-style-type: none"> • The jumper is located beside a lock icon on the controller board. • Enable “Guest” access provides full access control to users who are not logged in. • No Effect means that the reset has no effect on the printer security configuration.
Minimum Password Length 0–32 (0*)	Specify the minimum characters that are allowed for a password.
Note: An asterisk (*) next to a value indicates the factory default setting.	

Reports

Menu Settings Page

Menu item	Description
Menu Settings Page	Print a report that contains the printer preferences, settings, and configurations.

Device

Menu item	Description
Device Information	Print a report that contains information about the printer.
Device Statistics	Print a report about printer usage and supply status.
Profile List	Print a list of profiles that are stored in the printer.
Asset Report	Print a report that contains the printer serial number and model name.

Print

Menu item	Description
Print Fonts PCL Fonts PS Fonts	Print samples and information about the fonts that are available in each printer language.
Print Demo	Print sample pages.
Print Directory	Print the resources that are stored in the flash drive or hard disk. Note: This menu item appears only when a flash drive or hard disk is installed.

Shortcuts

Menu item	Description
All Shortcuts	Print a report that lists the shortcuts that are stored in the printer.
Fax Shortcuts	
Copy Shortcuts	
E-mail Shortcuts	
FTP Shortcuts	
Network Folder Shortcuts	

Fax

Menu item	Description
Fax Job Log	Print a report about the last 200 completed fax jobs. Note: This menu item appears only when Enable Job Log is set to On.
Fax Call Log	Print a report about the last 100 attempted, received, and blocked calls. Note: This menu item appears only when Enable Job Log is set to On.

Network

Menu item	Description
Network Setup Page	Print a page that shows the configured network and wireless settings on the printer. Note: This menu item appears only in network printers or printers connected to print servers.
Wi-Fi Direct Connected Clients	Print a page that shows the list of devices that are connected to the printer using Wi-Fi Direct. Note: This menu item appears only when Enable Wi-Fi Direct is set to On.

Help

Menu item	Description
Print All Guides	Prints all the guides
Connection Guide	Provides information about connecting the printer locally (USB) or to a network
Copy Guide	Provides information about making copies and configuring the settings
E-mail Guide	Provides information about sending e-mails and configuring the settings
Fax Guide	Provides information about sending faxes and configuring the settings
FTP Guide	Provides information about scanning documents and configuring the settings
Information Guide	Provides more information sources about the printer

Menu item	Description
Media Guide	Provides information about loading paper and specialty media
Mono Quality Guide	Provides information about mono print quality settings
Moving Guide	Provides information about moving, locating, or shipping the printer
Print Quality Guide	Provides information about solving print quality issues
Supplies Guide	Provides information about ordering supplies

Troubleshooting

Menu item	Description
Print Quality Test Pages	Print sample pages to identify and correct print quality defects.
Cleaning the Scanner	Print instructions on how to clean the scanner.

Printing the Menu Settings Page

From the home screen, touch **Settings > Reports > Menu Settings Page**.

Securing the printer

Locating the security slot

The printer is equipped with a security lock feature. Attach a security lock compatible with most laptop computers in the location shown to secure the printer in place.

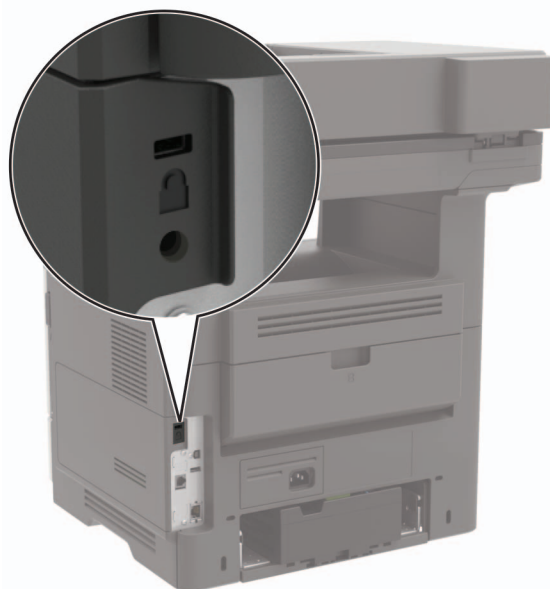

Erasing printer memory

To erase volatile memory or buffered data in your printer, turn off the printer.

To erase non-volatile memory or individual settings, device and network settings, security settings, and embedded solutions, do the following:

- 1 From the home screen, touch **Settings > Device > Maintenance > Out of Service Erase**.
- 2 Select the **Sanitize all information on nonvolatile memory** check box, and then touch **ERASE**.
- 3 Follow the instructions on the display.

Erasing printer hard disk memory

- 1 From the home screen, touch **Settings > Device > Maintenance > Out of Service Erase**.
- 2 Select the **Sanitize all information on hard disk** check box, and then touch **ERASE**.
- 3 Follow the instructions on the display.

Note: This process can take from several minutes to more than an hour, making the printer unavailable for other tasks.

Encrypting the printer hard disk

This process erases all contents in the hard disk. If necessary, back up important data from the printer before starting the encryption.

- 1 From the home screen, touch **Settings** > **Security** > **Disk Encryption** > **Start encryption**.
- 2 Follow the instructions on the display.

Notes:

- To avoid loss of data, do not turn off the printer during the encryption process.
- This process can take from several minutes to more than an hour, making the printer unavailable for other tasks.
- After encryption, the printer automatically restarts.

Restoring factory default settings

- 1 From the home screen, touch **Settings** > **Device** > **Restore Factory Defaults**.
- 2 Touch **Restore Settings** > select the settings that you want to restore > **RESTORE**.
- 3 Start the operation.

Statement of Volatility

Type of memory	Description
Volatile memory	The printer uses standard random access memory (RAM) to buffer temporarily user data during simple print and copy jobs.
Non-volatile memory	The printer may use two forms of non-volatile memory: EEPROM and NAND (flash memory). Both types are used to store the operating system, printer settings, network information, scanner and bookmark settings, and embedded solutions.
Hard disk memory	Some printers may have a hard disk drive installed. The printer hard disk is designed for printer-specific functionality. The hard disk lets the printer retain buffered user data from complex print jobs, form data, and font data.

Erase the content of any installed printer memory in the following circumstances:

- The printer is decommissioned.
- The printer hard disk is replaced.
- The printer is moved to a different department or location.
- The printer is serviced by someone from outside your organization.
- The printer is removed from your premises for service.
- The printer is sold to another organization.

Disposing of a printer hard disk

- **Degaussing**—Flushes the hard disk with a magnetic field that erases stored data
- **Crushing**—Physically compresses the hard disk to break component parts and render them unreadable
- **Milling**—Physically shreds the hard disk into small metal bits

Note: To guarantee that all data are completely erased, destroy physically each hard disk where data is stored.

Maintaining the printer

Warning—Potential Damage: Failure to maintain optimum printer performance, or to replace parts and supplies, may cause damage to your printer.

Adjusting the speaker volume

Adjusting the default internal speaker volume

- 1 From the control panel, navigate to:
Settings > Device > Preferences > Audio Feedback
- 2 Adjust the volume.

Notes:

- If Quiet Mode is enabled, then audible alerts are turned off. This setting also slows the printer performance.
- The volume resets to the default value after the session is logged out or when the printer wakes from Sleep or Hibernate mode.

Adjusting the default headphone volume

- 1 From the control panel, navigate to:
Settings > Device > Accessibility
- 2 Adjust the headphone volume.

Note: The volume resets to the default value after the session is logged out or when the printer wakes from Sleep or Hibernate mode.

Configuring the fax speaker settings

- 1 From the home screen, touch **Settings > Fax > Fax Setup > Speaker Settings**.
- 2 Do the following:
 - Set the Speaker Mode to **Always On**.
 - Set the Speaker Volume to **High**.
 - Activate the Ringer Volume.

Networking

Connecting the printer to a Wi-Fi network

Make sure that Active Adapter is set to Auto. From the home screen, touch **Settings > Network/Ports > Network Overview > Active Adapter**.

Using the control panel

- 1 From the home screen, touch **Settings > Network/Ports > Wireless > Setup On Printer Panel > Choose Network**.
- 2 Select a Wi-Fi network, and then type the network password.

Note: For Wi-Fi-network-ready printer models, a prompt for Wi-Fi network setup appears during initial setup.

Using Lexmark Mobile Assistant

- 1 Depending on your mobile device, download the Lexmark Mobile Assistant application from either the Google Play store or App Store online store.
- 2 From the printer home screen, touch **Settings > Network/Ports > Wireless > Setup Using Mobile App > Printer ID**.
- 3 From your mobile device, launch the application, and then accept the Terms of Use.
Note: If necessary, grant permissions.
- 4 Tap **Connect to Printer > Go to Wi-Fi Settings**.
- 5 Connect your mobile device to the printer wireless network.
- 6 Return to the application, and then tap **Setup Wi-Fi Connection**
- 7 Select a Wi-Fi network, and then type the network password.
- 8 Tap **Done**.

Connecting the printer to a wireless network using Wi-Fi Protected Setup (WPS)

Before you begin, make sure that:

- The access point (wireless router) is WPS-certified or WPS-compatible. For more information, see the documentation that came with your access point.
- A wireless network adapter is installed in your printer. For more information, see the instructions that came with the adapter.
- Active Adapter is set to Auto. From the home screen, touch **Settings > Network/Ports > Network Overview > Active Adapter**.

Using the Push Button method

- 1 From the home screen, touch **Settings > Network/Ports > Wireless > Wi-Fi Protected Setup > Start Push Button Method**.
- 2 Follow the instructions on the display.

Using the personal identification number (PIN) method

- 1 From the home screen, touch **Settings > Network/Ports > Wireless > Wi-Fi Protected Setup > Start PIN Method**.
- 2 Copy the eight-digit WPS PIN.
- 3 Open a web browser, and then type the IP address of your access point in the address field.

Notes:

- To know the IP address, see the documentation that came with your access point.
 - If you are using a proxy server, then temporarily disable it to load the web page correctly.
- 4 Access the WPS settings. For more information, see the documentation that came with your access point.
 - 5 Enter the eight-digit PIN, and then save the changes.

Connecting a mobile device to the printer wireless network

- 1 Enable Wi-Fi Direct in the printer. From the home screen, touch **Settings > Network/Ports > Wireless > Enable Wi-Fi Direct**.

Notes:

- The Wi-Fi Direct SSID and password are generated automatically. To view the Wi-Fi Direct SSID and password, go to the Wi-Fi Direct menu.
 - You can also change the SSID and password, if necessary.
- 2 Connect your mobile device to the printer wireless network.

Deactivating the Wi-Fi network

- 1 From the home screen, touch **Settings > Network/Ports > Network Overview > Active Adapter > Standard Network**.
- 2 Follow the instructions on the display.

Changing the printer port settings after installing an internal solutions port

Notes:

- If the printer has a static IP address, then do not change the configuration.
- If the computers are configured to use the network name instead of an IP address, then do not change the configuration.
- If you are adding a wireless internal solutions port (ISP) to a printer previously configured for an Ethernet connection, then disconnect the printer from the Ethernet network.

For Windows users

- 1 Open the printers folder.
- 2 From the shortcut menu of the printer with the new ISP, open the printer properties.
- 3 Configure the port from the list.
- 4 Update the IP address.
- 5 Apply the changes.

For Macintosh users

- 1 From System Preferences in the Apple menu, navigate to the list of printers, and then select + > **IP**.
- 2 Type the IP address in the address field.
- 3 Apply the changes.

Setting up serial printing (Windows only)

- 1 Set the parameters in the printer.
 - a From the control panel, navigate to the menu for the port settings.
 - b Locate the menu for the serial port settings, and then adjust the settings, if necessary.
 - c Apply the changes.
- 2 From your computer, open the printers folder, and then select your printer.
- 3 Open the printer properties, and then select the COM port from the list.
- 4 Set the COM port parameters in Device Manager.

Notes:

- Serial printing reduces printing speed.
- Make sure that the serial cable is connected to the serial port on your printer.

Cleaning printer parts

Cleaning the printer

⚠ CAUTION—SHOCK HAZARD: To avoid the risk of electrical shock when cleaning the exterior of the printer, unplug the power cord from the electrical outlet and disconnect all cables from the printer before proceeding.

Notes:

- Perform this task after every few months.
- Damage to the printer caused by improper handling is not covered by the printer warranty.

- 1 Turn off the printer, and then unplug the power cord from the electrical outlet.
- 2 Remove paper from the standard bin and multipurpose feeder.
- 3 Remove any dust, lint, and pieces of paper around the printer using a soft brush or vacuum.
- 4 Wipe the outside of the printer with a damp, soft, lint-free cloth.

Notes:

- Do not use household cleaners or detergents, as they may damage the finish of the printer.
- Make sure that all areas of the printer are dry after cleaning.

- 5 Connect the power cord to the electrical outlet, and then turn on the printer.

⚠ CAUTION—POTENTIAL INJURY: To avoid the risk of fire or electrical shock, connect the power cord to an appropriately rated and properly grounded electrical outlet that is near the product and easily accessible.

Cleaning the scanner

- 1 Open the scanner cover.



2 Using a damp, soft, lint-free cloth, wipe the following areas:

- ADF glass



- ADF glass pad



- Scanner glass



- Scanner glass pad



3 Close the scanner cover.

4 Open the ADF cover.

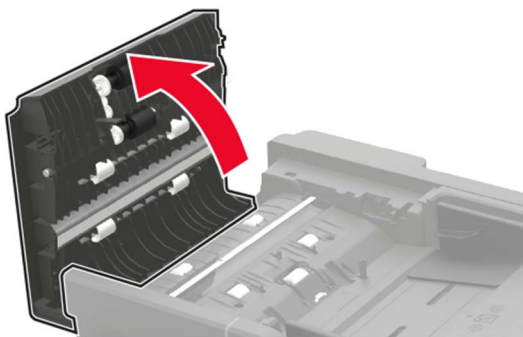

5 Using a damp, soft, lint-free cloth, wipe the following areas:

- ADF glass pad in the ADF cover

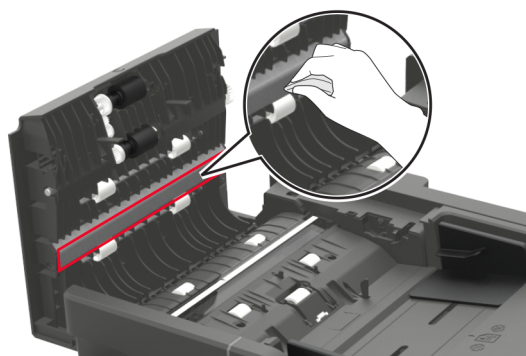

- ADF glass in the ADF cover

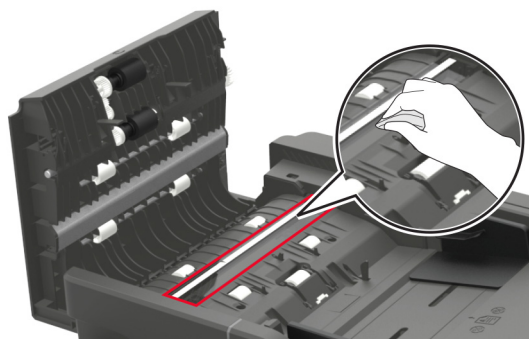

- 6 Close the ADF cover.

Ordering parts and supplies

To order parts and supplies in the U.S., contact 1-800-539-6275 for information about Lexmark authorized dealers in your area. In other countries or regions, go to www.lexmark.com or contact the place where you purchased the printer.

Note: All life estimates for printer supplies assume printing on letter- or A4-size plain paper.

Using genuine Lexmark parts and supplies

Your Lexmark printer is designed to function best with genuine Lexmark parts and supplies. Use of third-party supplies or parts may affect the performance, reliability, or life of the printer and its imaging components. It can also affect warranty coverage. Damage caused by the use of third-party parts and supplies is not covered by the warranty. All life indicators are designed to function with Lexmark parts and supplies, and may deliver unpredictable results if third-party parts and supplies are used. Imaging component usage beyond the intended life may damage your Lexmark printer or its associated components.

Warning—Potential Damage: Supplies and parts without Return Program agreement terms may be reset and remanufactured. However, the manufacturer's warranty does not cover any damage caused by non-genuine supplies or parts. Resetting counters on the supply or part without proper remanufacturing can cause damage to your printer. After resetting the supply or part counter, your printer may display an error indicating the presence of the reset item.

Checking the status of parts and supplies

- 1 From the home screen, touch **Status/Supplies**.
- 2 Select the parts or supplies that you want to check.

Note: You can also access this setting by touching the top section of the home screen.

Ordering a toner cartridge

Notes:

- The estimated cartridge yield is based on the ISO/IEC 19752 standard.
- Extremely low print coverage for extended periods of time may negatively affect actual yield.

Lexmark MX622 Return Program toner cartridges

Item	United States and Canada	European Economic Area	Rest of Asia Pacific	Latin America	Rest of Europe, Middle East, and Africa	Australia and New Zealand
Return Program toner cartridge	56F1000	56F2000	56F3000	56F4000	56F5000	56F6000
High yield Return Program toner cartridge	56F1H00	56F2H00	56F3H00	56F4H00	56F5H00	56F6H00
Extra high yield Return Program toner cartridge	56F1X00	56F2X00	56F3X00	56F4X00	56F5X00	56F6X00
Ultra high yield Return Program toner cartridge	56F1U00	56F2U00	56F3U00	56F4U00	56F5U00	56F6U00
High yield Corporate Return Program toner cartridge*	56F1H0E	56F2H0E	56F3H0E	56F4H0E	56F5H0E	56F6H0E
Extra high yield Corporate Return Program toner cartridge*	56F1X0E	56F2X0E	56F3X0E	56F4X0E	56F5X0E	56F6X0E
Ultra high yield Corporate Return Program toner cartridge*	56F1U0E	56F2U0E	56F3U0E	56F4U0E	56F5U0E	56F6U0E

* Available only for contract-managed printers. For more information, contact your Lexmark representative or system administrator.

Lexmark MX622 regular toner cartridge

Item	Worldwide
Regular toner cartridge	56FOUA0

Lexmark XM3250 Return Program toner cartridge

Item	United States, Canada, Australia, and New Zealand	European Economic Area	Rest of Asia Pacific	Latin America
Return Program toner cartridge	24B6887	24B6890	24B6893	24B6896

Lexmark MB2650 Return Program toner cartridges

Item	United States and Canada	European Economic Area	Rest of Asia Pacific	Latin America	Rest of Europe, Middle East, and Africa	Australia and New Zealand
Return Program toner cartridge	B231000	B232000	B233000	B234000	B235000	B236000
High yield Return Program toner cartridge	B241H00	B242H00	B243H00	B244H00	B245H00	B246H00
Extra high yield Return Program toner cartridge	B251X00	B252X00	B253X00	B254X00	B255X00	B256X00
Ultra high yield Return Program toner cartridge	B261U00	B262U00	B263U00	B264U00	B265U00	B266U00

Lexmark MB2650 Regular toner cartridge

Item	Worldwide
Regular toner cartridge	B260UA0

Ordering an imaging unit

Extremely low print coverage for extended periods of time may cause imaging unit parts to fail before the toner is exhausted.

Item	Part Number
Return Program imaging unit	56FOZ00
Regular imaging unit	56FOZA0
Corporate Return Program imaging unit*	56FOZ0E

* This imaging unit is available only for contract-managed printers. For more information, contact your Lexmark representative or system administrator.

Ordering a maintenance kit

Match the maintenance kit to the printer voltage.

Notes:

- Using certain types of paper may require more frequent replacement of the maintenance kit.
- The maintenance kit includes a fuser, MPF pick roller and separator pad, pick tires, separator roller assembly, and transfer roller. These parts may be individually ordered and replaced if necessary.

Item	Part number
200K maintenance kit, 100 V	41X1227
200K maintenance kit, 110 V	41X1225
200K maintenance kit, 220 V	41X1226

Note: Only an authorized service technician can replace the maintenance kit. Contact your service provider.

Ordering staple cartridges

Part name	Part number
Staple cartridges	35S8500

Configuring supply notifications

- 1 Open a web browser, and then type the printer IP address in the address field.

Notes:

- View the printer IP address on the printer home screen. The IP address appears as four sets of numbers separated by periods, such as 123.123.123.123.
- If you are using a proxy server, then temporarily disable it to load the web page correctly.

- 2 Click **Settings > Device > Notifications**.
- 3 From the Supplies menu, click **Custom Supply Notifications**.
- 4 Select a notification for each supply item.
- 5 Apply the changes.

Replacing parts and supplies

Replacing the toner cartridge

- 1 Open door A.

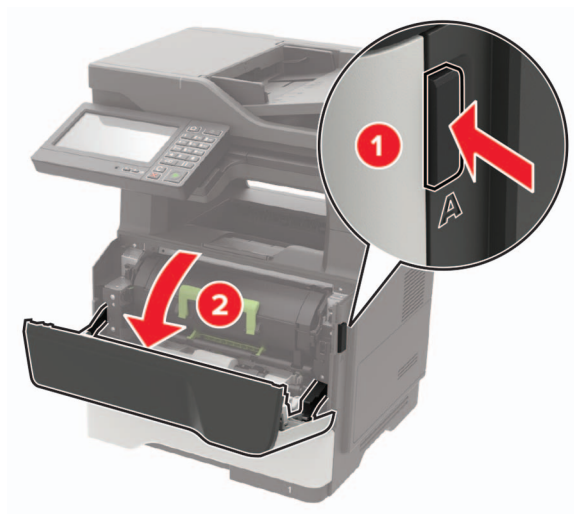

- 2 Remove the used toner cartridge.



- 3** Unpack the new toner cartridge, and then shake it three times to redistribute the toner.

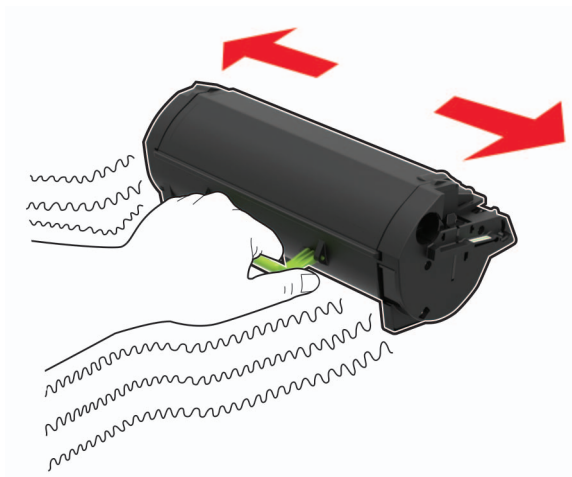

- 4** Insert the new toner cartridge.

Note: Use the arrows inside the printer as guides.



- 5** Close door A.

Replacing the imaging unit

1 Open door A.

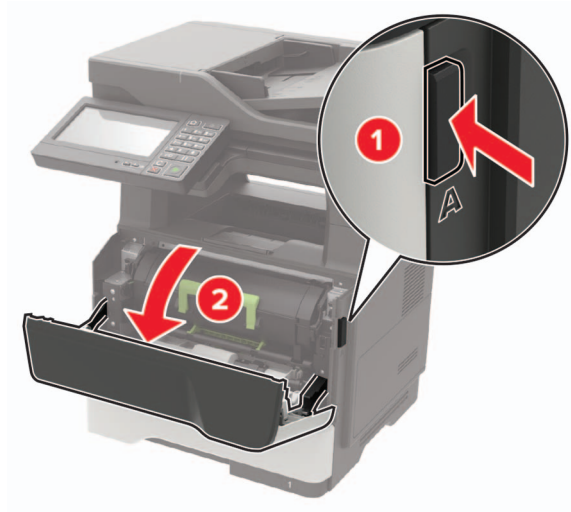

2 Remove the toner cartridge.



3 Remove the used imaging unit.



- 4 Unpack the new imaging unit, and then shake it three times to redistribute the toner.

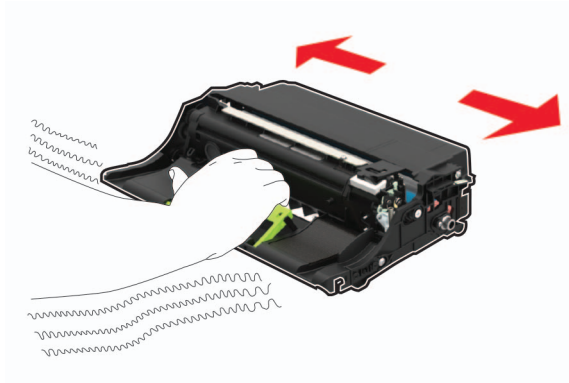

Warning—Potential Damage: Do not expose the imaging unit to direct light for more than 10 minutes. Extended exposure to light may cause print quality problems.

Warning—Potential Damage: Do not touch the photoconductor drum. Doing so may affect the quality of future print jobs.



- 5 Insert the new imaging unit.

Note: Use the arrows inside the printer as guides.



- 6 Insert the toner cartridge.

Note: Use the arrows inside the printer as guides.



7 Close door A.

Replacing the staple cartridge

1 Open the stapler access door.

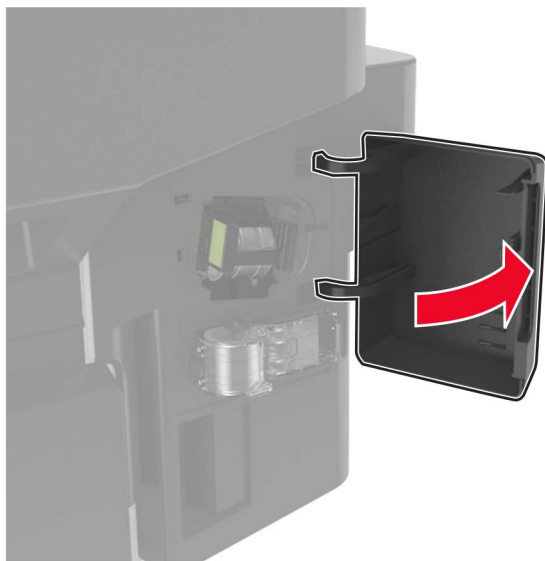

2 Remove the staple cartridge.

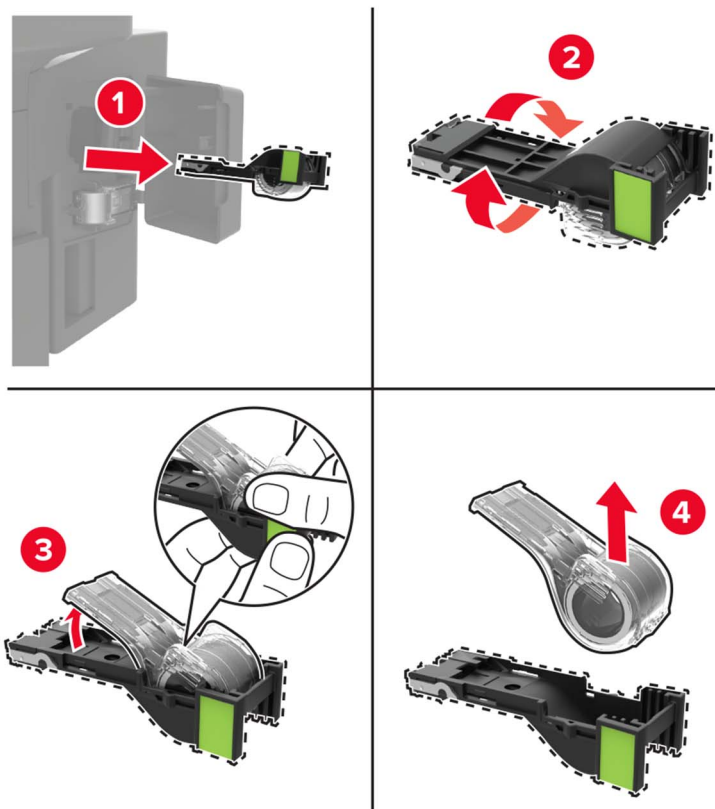

3 Remove the spare staple cartridge.

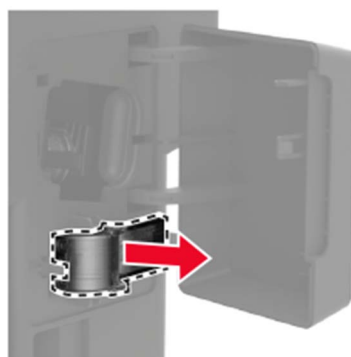

4 Insert the spare staple cartridge.

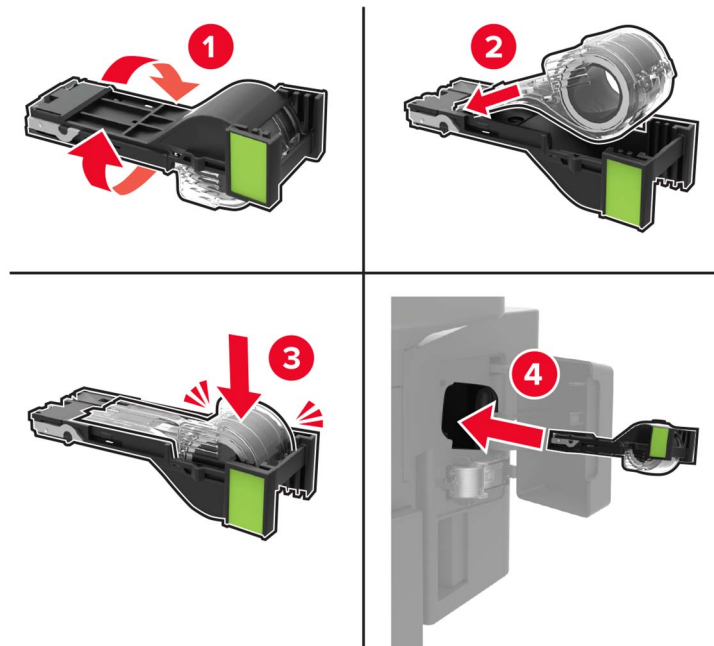

Note: Replace the spare staple cartridge for future use.

5 Close the stapler access door.

Replacing the pick tires

- 1 Turn off the printer.
- 2 Unplug the power cord from the electrical outlet, and then from the printer.
- 3 Remove the tray.

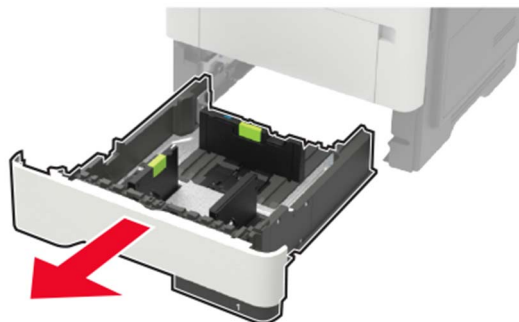

4 Remove the used pick tires one after the other.

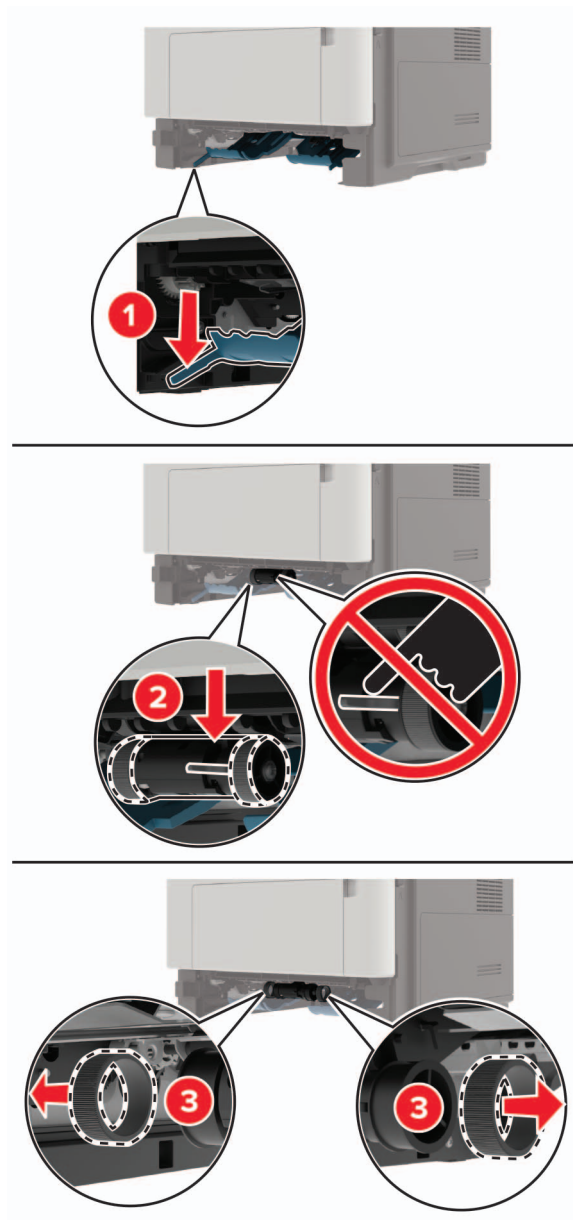

5 Unpack the new pick tires.

- 6 Insert the new pick tires.

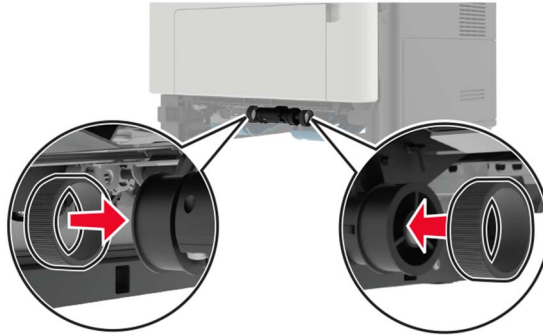

- 7 Insert the tray.
- 8 Connect the power cord to the printer, and then to the electrical outlet.

⚠ CAUTION—POTENTIAL INJURY: To avoid the risk of fire or electrical shock, connect the power cord to an appropriately rated and properly grounded electrical outlet that is near the product and easily accessible.

- 9 Turn on the printer.

Replacing the pick roller assembly

- 1 Turn off the printer.
- 2 Unplug the power cord from the electrical outlet, and then from the printer.
- 3 Remove the optional tray.

⚠ CAUTION—POTENTIAL INJURY: If the printer weight is greater than 20 kg (44 lb), then it may require two or more people to lift it safely.

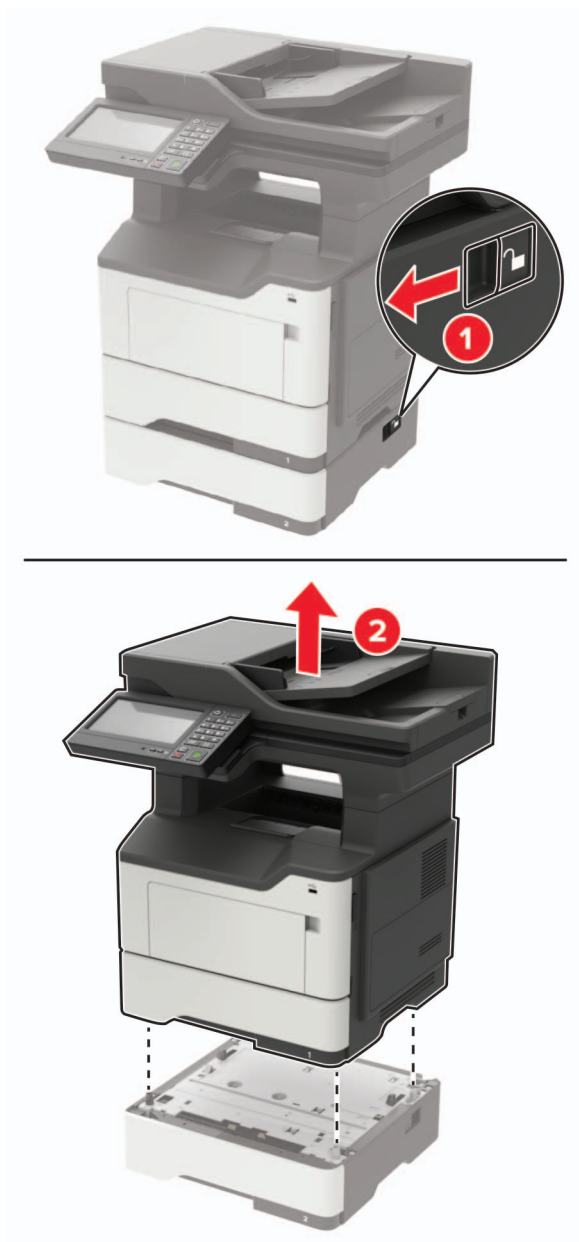

4 Remove the tray insert, and then flip the tray base.

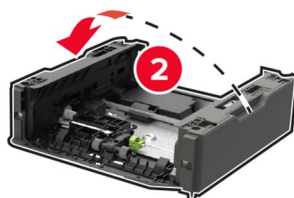
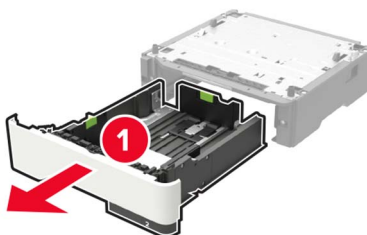

5 Remove the used pick roller assembly.

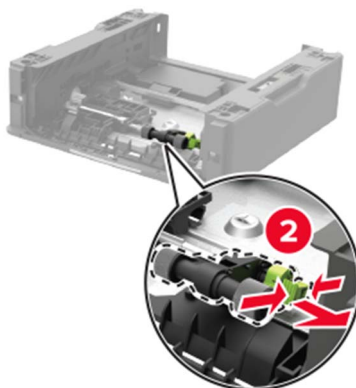
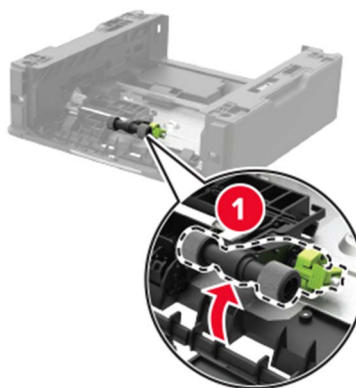

6 Unpack the new pick roller assembly.

7 Insert the new pick roller assembly.

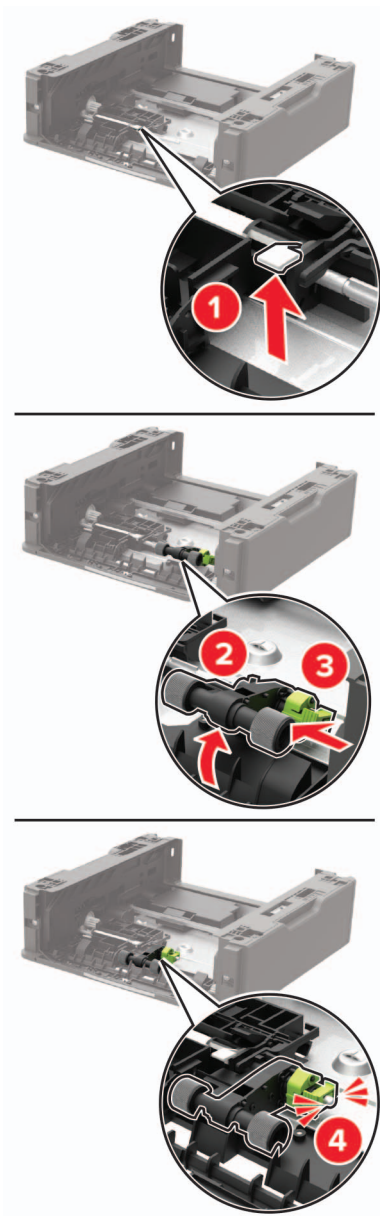

8 Flip the tray base, and then insert the tray insert.

- 9 Align the printer with the optional tray, and then lower the printer until it *clicks* into place.



- 10 Connect the power cord to the printer, and then to the electrical outlet.

 **CAUTION—POTENTIAL INJURY:** To avoid the risk of fire or electrical shock, connect the power cord to an appropriately rated and properly grounded electrical outlet that is near the product and easily accessible.

- 11 Turn on the printer.

Replacing the ADF separator roller

- 1 Open the ADF cover.

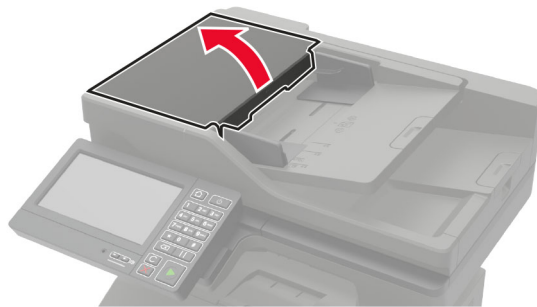

- 2 Remove the used ADF separator roller.

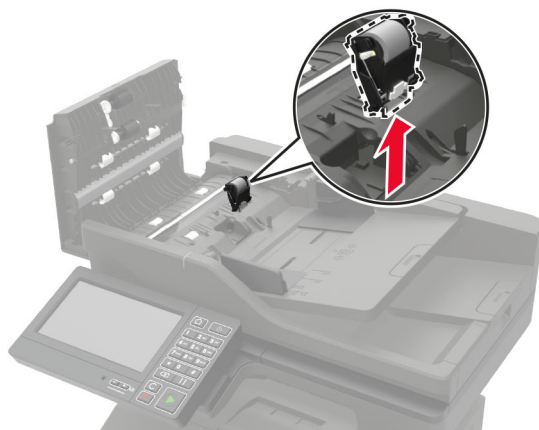
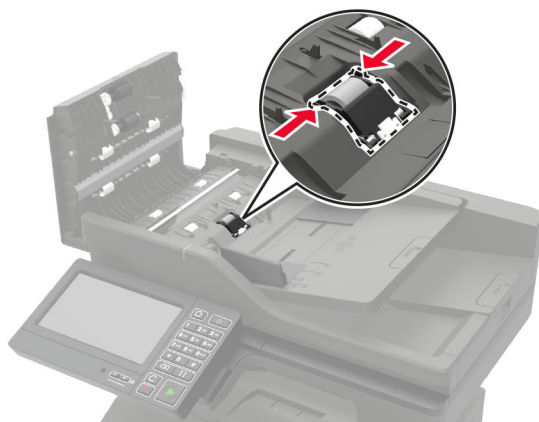

- 3 Unpack the new ADF separator roller.

Warning—Potential Damage: To avoid damage and poor printer performance, handle this part with clean hands.

4 Insert the new ADF separator roller until it *clicks* into place.

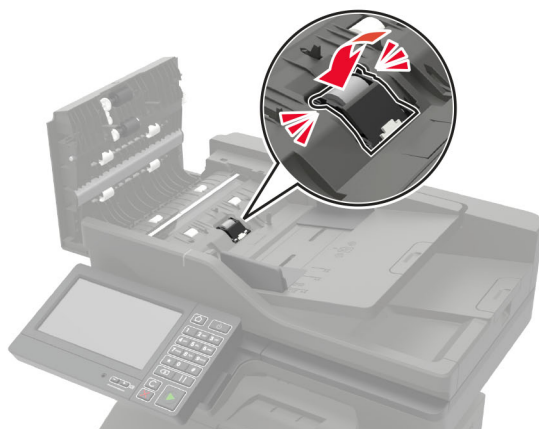
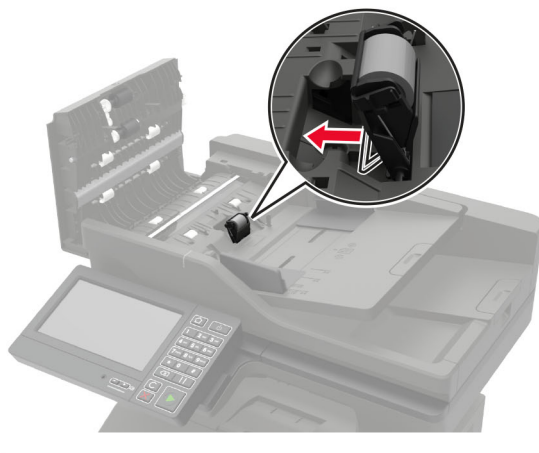
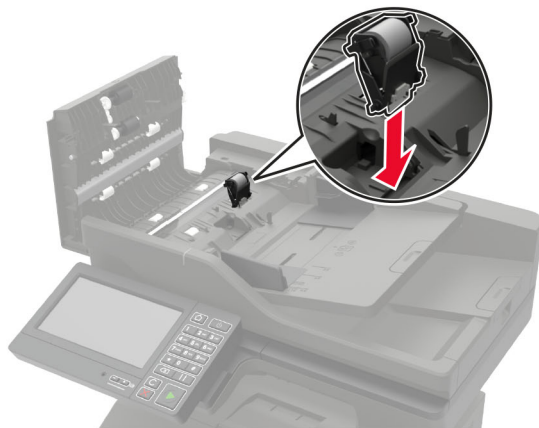



5 Close the ADF cover.

Moving the printer

Moving the printer to another location

 **CAUTION—POTENTIAL INJURY:** If the printer weight is greater than 20 kg (44 lb), then it may require two or more people to lift it safely.

 **CAUTION—POTENTIAL INJURY:** To avoid the risk of fire or electrical shock, use only the power cord provided with this product or the manufacturer's authorized replacement.

 **CAUTION—POTENTIAL INJURY:** When moving the printer, follow these guidelines to avoid personal injury or printer damage:

- Make sure that all doors and trays are closed.
- Turn off the printer, and then unplug the power cord from the electrical outlet.
- Disconnect all cords and cables from the printer.
- If the printer has separate floor-standing optional trays or output options attached to it, then disconnect them before moving the printer.
- If the printer has a caster base, then carefully roll it to the new location. Use caution when passing over thresholds and breaks in flooring.
- If the printer does not have a caster base but is configured with optional trays or output options, then remove the output options and lift the printer off the trays. Do not try to lift the printer and any options at the same time.
- Always use the handholds on the printer to lift it.
- Any cart used to move the printer must have a surface able to support the full footprint of the printer.
- Any cart used to move the hardware options must have a surface able to support the dimensions of the options.
- Keep the printer in an upright position.
- Avoid severe jarring movements.
- Make sure that your fingers are not under the printer when you set it down.
- Make sure that there is adequate clearance around the printer.

Note: Damage to the printer caused by improper moving is not covered by the printer warranty.

Shipping the printer

For shipping instructions, go to <http://support.lexmark.com> or contact customer support.

Saving energy and paper

Configuring the power save mode settings

Sleep mode

- 1 From the home screen, touch **Settings** > **Device** > **Power Management** > **Timeouts** > **Sleep Mode**.
- 2 Specify the amount of time that the printer stays idle before it enters Sleep Mode.

Hibernate mode

- 1 From the home screen, touch **Settings > Device > Power Management > Timeouts > Hibernate Timeout**.
- 2 Select the amount of time that the printer stays idle before it enters Hibernate mode.

Notes:

- For Hibernate Timeout to work, set Hibernate Timeout on Connection to Hibernate.
- The Embedded Web Server is disabled when the printer is in Hibernate mode.

Adjusting the brightness of the printer display

- 1 From the home screen, touch **Settings > Device > Preferences > Screen Brightness**.
- 2 Adjust the setting.

Conserving supplies

- Print on both sides of the paper.
Note: Two-sided printing is the default setting in the print driver.
- Print multiple pages on a single sheet of paper.
- Use the preview feature to see how the document looks like before printing it.
- Print one copy of the document to check its content and format for accuracy.

Recycling

Recycling Lexmark products

To return Lexmark products for recycling:

- 1 Go to www.lexmark.com/recycle.
- 2 Select the product you want to recycle.

Note: Printer supplies and hardware not listed in the Lexmark Collection and Recycling Program may be recycled through your local recycling center.

Recycling Lexmark packaging

Lexmark continually strives to minimize packaging. Less packaging helps to ensure that Lexmark printers are transported in the most efficient and environmentally sensitive manner and that there is less packaging to dispose of. These efficiencies result in fewer greenhouse emissions, energy savings, and natural resource savings. Lexmark also offers recycling of packaging components in some countries or regions. For more information, go to www.lexmark.com/recycle, and then choose your country or region. Information on available packaging recycling programs is included with the information on product recycling.

Lexmark cartons are 100% recyclable where corrugated recycling facilities exist. Facilities may not exist in your area.

The foam used in Lexmark packaging is recyclable where foam recycling facilities exist. Facilities may not exist in your area.

When you return a cartridge to Lexmark, you can reuse the box that the cartridge came in. Lexmark recycles the box.

Clearing jams

Avoiding jams

Load paper properly

- Make sure that the paper lies flat in the tray.

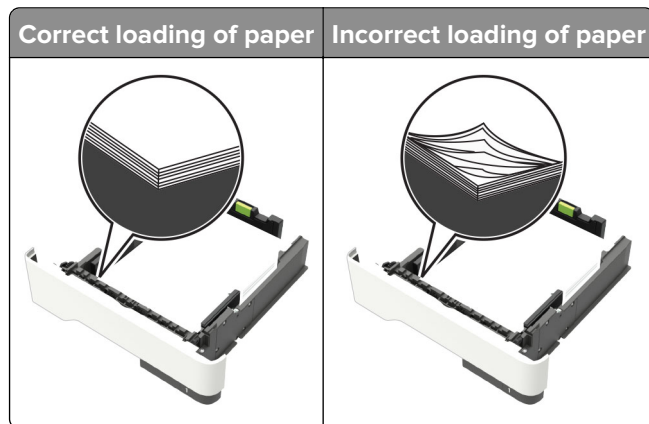

- Do not load or remove a tray while the printer is printing.
- Do not load too much paper. Make sure that the stack height is below the maximum paper fill indicator.
- Do not slide paper into the tray. Load paper as shown in the illustration.

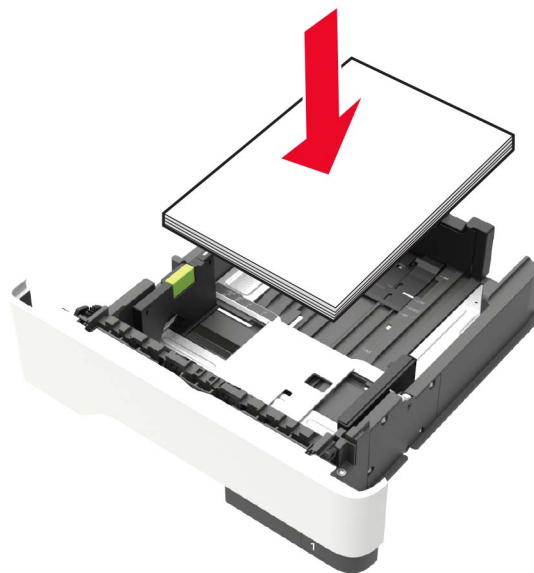

- Make sure that the paper guides are positioned correctly and are not pressing tightly against the paper or envelopes.
- Push the tray firmly into the printer after loading paper.

Use recommended paper

- Use only recommended paper or specialty media.
- Do not load paper that is wrinkled, creased, damp, bent, or curled.
- Flex, fan, and align the paper edges before loading.

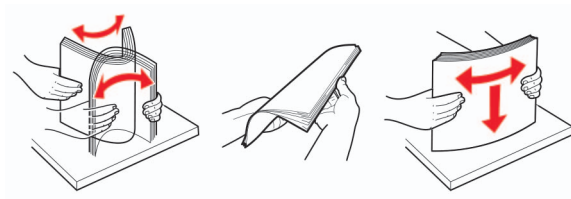

- Do not use paper that has been cut or trimmed by hand.
- Do not mix paper sizes, weights, or types in the same tray.
- Make sure that the paper size and type are set correctly on the computer or printer control panel.
- Store paper according to manufacturer recommendations.

Identifying jam locations

Notes:

- When Jam Assist is set to On, the printer automatically flushes blank pages or partially printed pages with after a jammed page is cleared. Check your printed output for blank pages.
- When Jam Recovery is set to On or Auto, the printer reprints jammed pages.

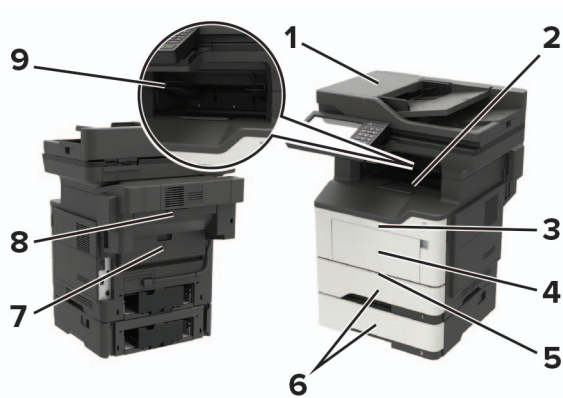

	Jam location
1	Automatic document feeder
2	Standard bin
3	Door A
4	Multipurpose feeder
5	Duplex unit
6	Trays
7	Door B

	Jam location
8	Optional staple finisher
9	Finisher bin

Paper jam in door A

1 Remove the tray.

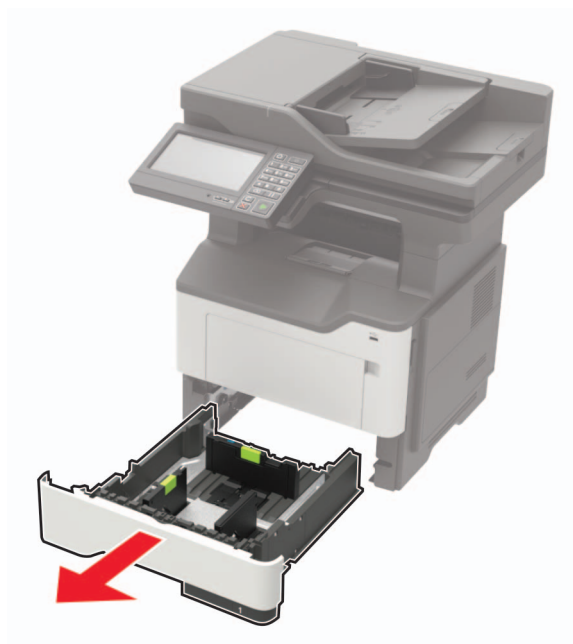

2 Open door A.

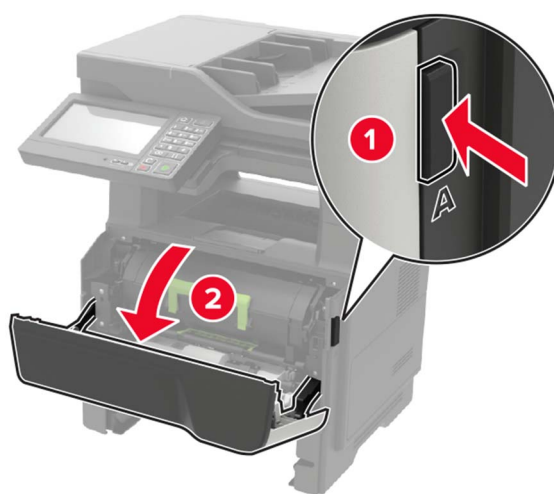

- 3 Remove the toner cartridge.



- 4 Remove the imaging unit.



Warning—Potential Damage: Do not expose the imaging unit to direct light for more than 10 minutes. Extended exposure to light may cause print quality problems.

Warning—Potential Damage: Do not touch the photoconductor drum. Doing so may affect the quality of future print jobs.



5 Remove the jammed paper.

 **CAUTION—HOT SURFACE:** The inside of the printer might be hot. To reduce the risk of injury from a hot component, allow the surface to cool before touching it.

Note: Make sure that all paper fragments are removed.

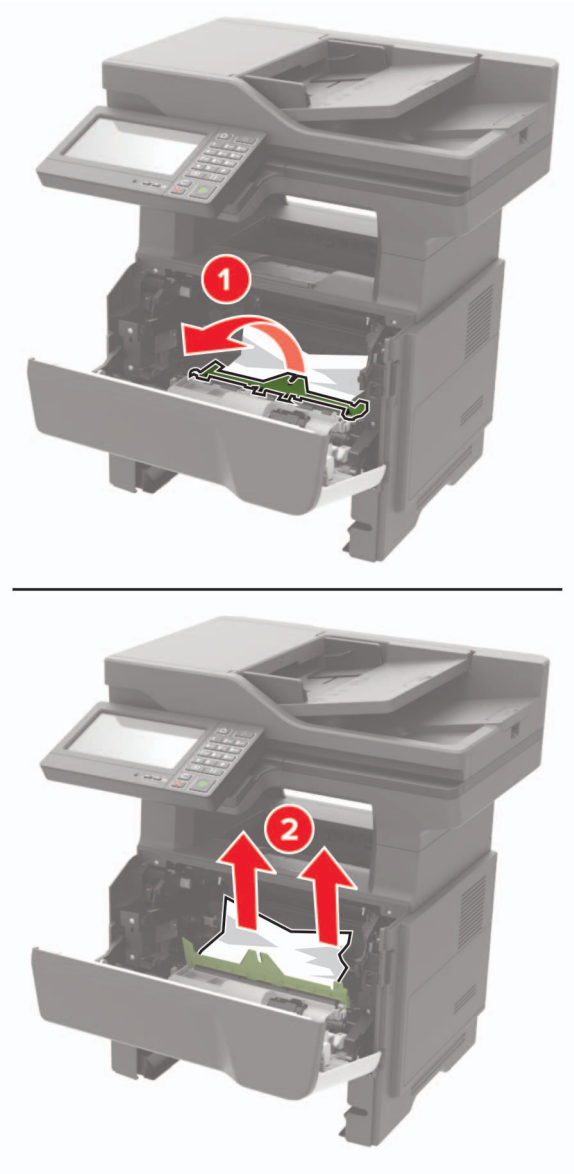

6 Insert the imaging unit.

Note: Use the arrows inside the printer as guides.

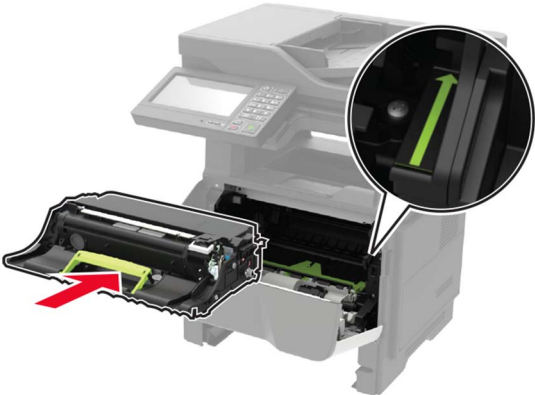

- 7 Insert the toner cartridge.

Note: Use the arrows inside the printer as guides.



- 8 Close door A.
- 9 Insert the tray.

Paper jam in the rear door

- 1 Open the rear door.

 **CAUTION—HOT SURFACE:** The inside of the printer might be hot. To reduce the risk of injury from a hot component, allow the surface to cool before touching it.

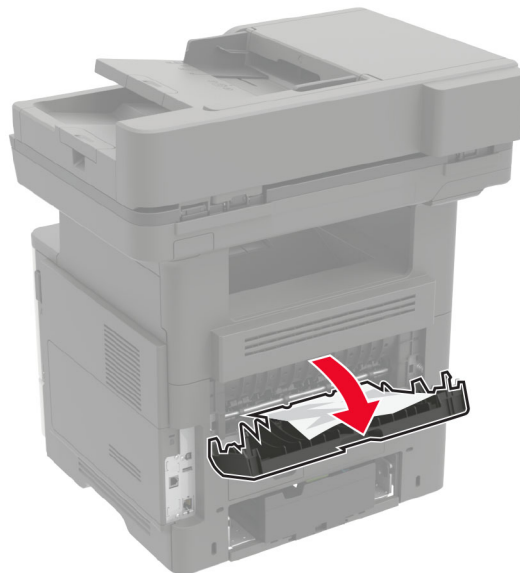

- 2 Remove the jammed paper.

Note: Make sure that all paper fragments are removed.

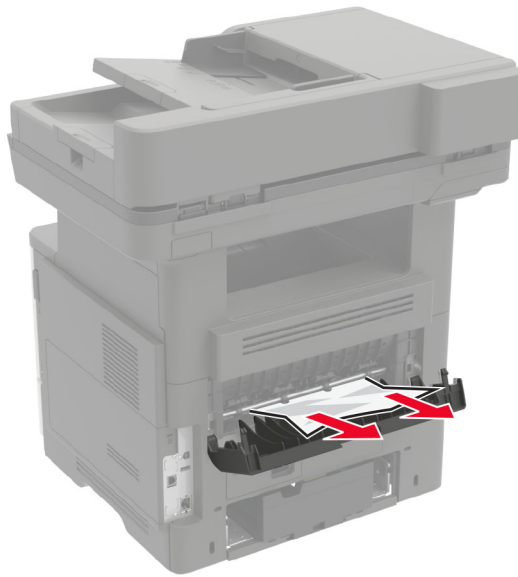

3 Close the rear door.

Paper jam in the standard bin

Remove the jammed paper.

Note: Make sure that all paper fragments are removed.



Paper jam in the duplex unit

- 1 Remove the tray.

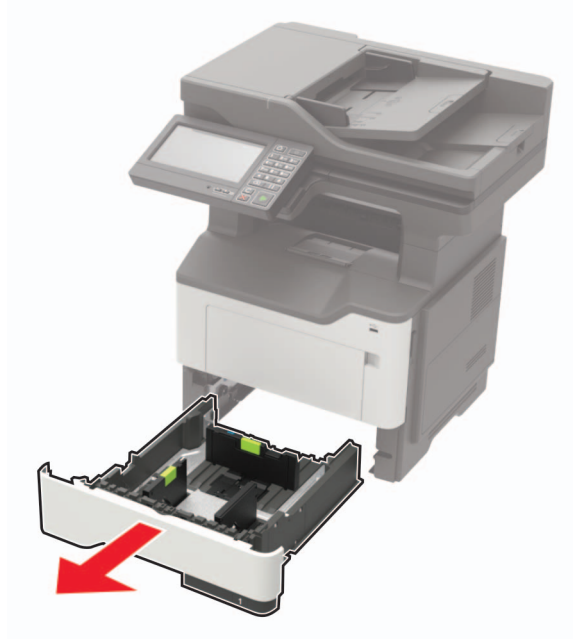

- 2 Remove the jammed paper.

Note: Make sure that all paper fragments are removed.



- 3 Insert the tray.

Paper jam in trays

- 1 Remove the tray.

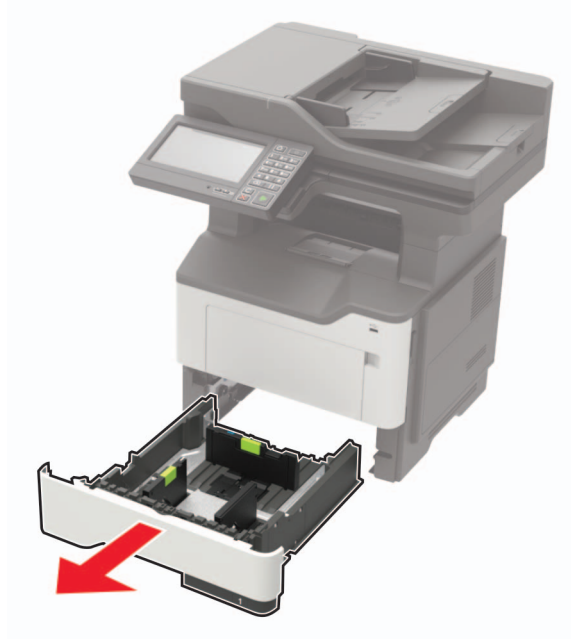

- 2 Remove the jammed paper.

Note: Make sure that all paper fragments are removed.

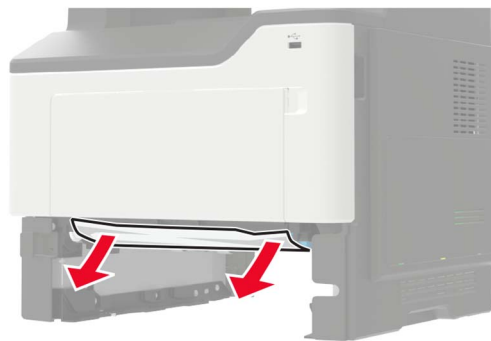

- 3 Insert the tray.

Paper jam in the multipurpose feeder

- 1 Remove paper from the multipurpose feeder.
- 2 Remove the jammed paper.

Note: Make sure that all paper fragments are removed.



3 Flex, fan, and align the paper edges before loading.

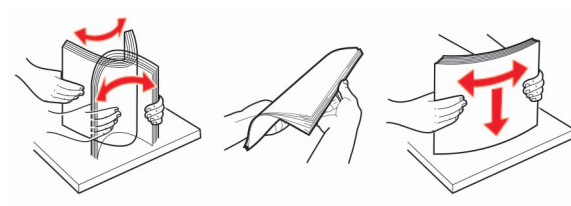

4 Reload paper, and then adjust the paper guide.



Paper jam in the automatic document feeder

- 1** Remove all original documents from the ADF tray.
- 2** Open the ADF cover.

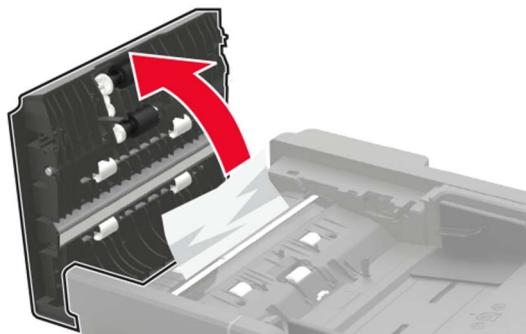

3 Remove the jammed paper.

Note: Make sure that all paper fragments are removed.

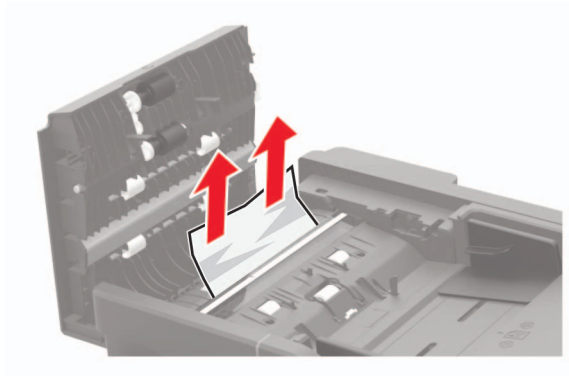

4 Close the ADF cover.

Paper jam in the finisher

Paper jam in the finisher bin

1 Remove paper from the finisher bin.



2 Remove the jammed paper.

Note: Make sure that all paper fragments are removed.



Paper jam in the finisher rear door

- 1 Open the finisher rear door.

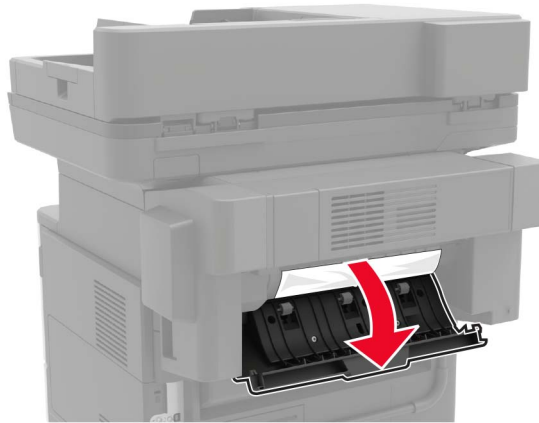

- 2 Remove the jammed paper.

Note: Make sure that all paper fragments are removed.

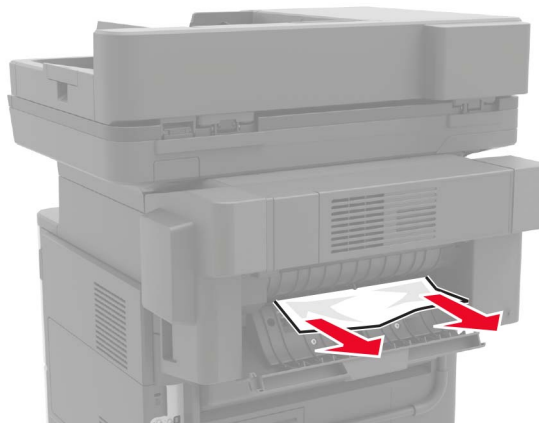

- 3 Open the finisher narrow door, and then remove any paper fragments.

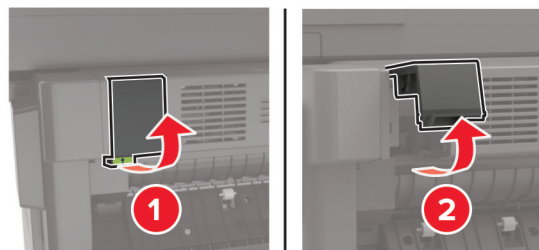

- 4 Close the doors.

Staple jam in the finisher

- 1 Open the staple access door.

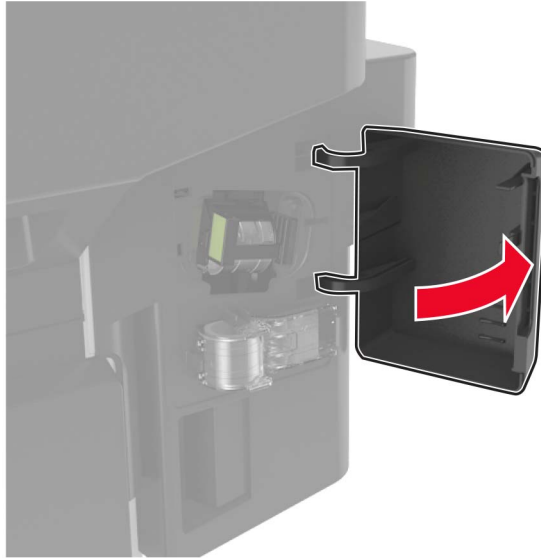

- 2 Remove the staple cartridge holder.



- 3 Lift the staple guard, and then remove the loose staples.

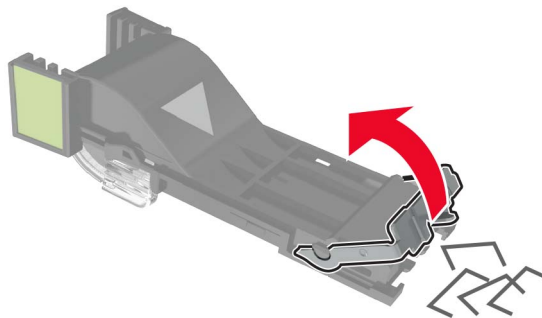

4 Close the staple guard.

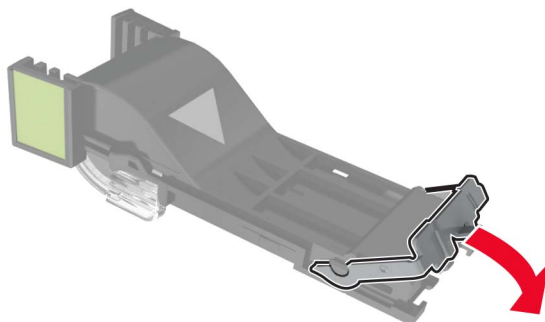

5 Insert the staple cartridge holder.

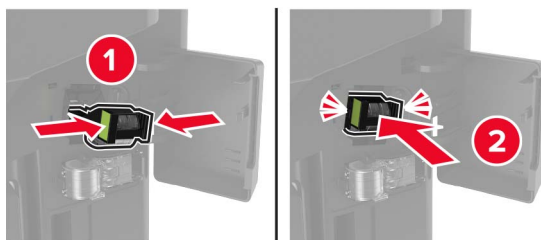

6 Close the staple access door.

Troubleshooting

Network connection problems

Cannot open Embedded Web Server

Action	Yes	No
<p>Step 1 Check if the printer is on.</p> <p>Is the printer on?</p>	Go to step 2.	Turn on the printer.
<p>Step 2 Make sure that the printer IP address is correct.</p> <p>Notes:</p> <ul style="list-style-type: none"> • View the IP address on the home screen. • An IP address appears as four sets of numbers separated by periods, such as 123.123.123.123. <p>Is the printer IP address correct?</p>	Go to step 3.	Type the correct printer IP address in the address field.
<p>Step 3 Check if you are using a supported browser:</p> <ul style="list-style-type: none"> • Internet Explorer version 11 or later • Microsoft Edge • Safari version 6 or later • Google Chrome™ version 32 or later • Mozilla Firefox version 24 or later <p>Is your browser supported?</p>	Go to step 4.	Install a supported browser.
<p>Step 4 Check if the network connection is working.</p> <p>Is the network connection working?</p>	Go to step 5.	Contact your administrator.
<p>Step 5 Make sure that the cable connections to the printer and print server are secure. For more information, see the documentation that came with the printer.</p> <p>Are the cable connections secure?</p>	Go to step 6.	Secure the cable connections.
<p>Step 6 Check if the web proxy servers are disabled.</p> <p>Are the web proxy servers disabled?</p>	Go to step 7.	Contact your administrator.

Action	Yes	No
<p>Step 7 Access the Embedded Web Server.</p> <p>Did the Embedded Web Server open?</p>	The problem is solved.	Contact customer support .

Unable to read flash drive

Action	Yes	No
<p>Step 1 Check if the printer is not busy processing another print, copy, scan, or fax job.</p> <p>Is the printer ready?</p>	Go to step 2.	Wait for the printer to finish processing the other job.
<p>Step 2 Check if the flash drive is supported. For more information, see “Supported flash drives and file types” on page 36.</p> <p>Is the flash drive supported?</p>	Go to step 3.	Insert a supported flash drive.
<p>Step 3 Remove, and then insert the flash drive.</p> <p>Does the printer recognize the flash drive?</p>	The problem is solved.	Contact customer support .

Enabling the USB port

From the home screen, touch **Settings > Network/Ports > USB > Enable USB Port**.

Checking the printer connectivity

- 1 From the home screen, touch **Settings > Reports > Network > Network Setup Page**.
- 2 Check the first section of the network setup page, and confirm that the status is connected.
If the status is not connected, then the LAN drop may be inactive, or the network cable may be malfunctioning. Contact your administrator for assistance.

Hardware options problems

Cannot detect internal option

Action	Yes	No
<p>Step 1 Turn off the printer, wait for about 10 seconds, and then turn on the printer.</p> <p>Does the internal option operate correctly?</p>	The problem is solved.	Go to step 2.
<p>Step 2 Print the Menu Settings Page, and then check if the internal option appears in the Installed Features list.</p> <p>Is the internal option listed in the menu settings page?</p>	Go to step 4.	Go to step 3.
<p>Step 3 Check if the internal option is installed properly into the controller board.</p> <ul style="list-style-type: none"> a Turn off the printer, and then unplug the power cord from the electrical outlet. b Make sure that the internal option is installed in the appropriate connector in the controller board. c Connect the power cord to the electrical outlet, and then turn on the printer. <p> CAUTION—POTENTIAL INJURY: To avoid the risk of fire or electrical shock, connect the power cord to an appropriately rated and properly grounded electrical outlet that is near the product and easily accessible.</p> <p>Does the internal option operate correctly?</p>	The problem is solved.	Go to step 4.
<p>Step 4</p> <ul style="list-style-type: none"> a Check if the internal option is available in the print driver. Note: If necessary, manually add the internal option in the print driver to make it available for print jobs. For more information, see “Adding available options in the print driver” on page 235. b Resend the print job. <p>Does the internal option operate correctly?</p>	The problem is solved.	Contact customer support .

Internal solutions port does not operate correctly

Action	Yes	No
<p>Step 1 Print a menu settings page, and then check if the internal solutions port (ISP) appears in the Installed Features list.</p> <p>Is the ISP listed in the Installed Features list?</p>	Go to step 3.	Go to step 2.
<p>Step 2 Remove, and then install the ISP. For more information, see “Installing an internal solutions port” on page 228.</p> <p>Note: Use a supported ISP.</p> <p>Does the ISP operate correctly?</p>	The problem is solved.	Go to step 3.
<p>Step 3 Check the cable and the ISP connection.</p> <p>a Use the correct cable, and then make sure that it is securely connected to the ISP.</p> <p>b Check if the ISP solution interface cable is securely connected into the receptacle of the controller board.</p> <p>Does the ISP operate correctly?</p>	The problem is solved.	Contact customer support .

Defective flash detected

Try one or more of the following:

- Replace the defective flash memory.
- From the printer control panel, select **Continue** to ignore the message and continue printing.
- Cancel the current print job.

Not enough free space in flash memory for resources

Try one or more of the following:

- From the printer control panel, select **Continue** to clear the message and continue printing.
- Delete fonts, macros, and other data stored in the flash memory.
- Install flash memory with larger capacity.

Note: Downloaded fonts and macros that are not previously stored in the flash memory are deleted.

Unformatted flash detected

Try one or more of the following:

- From the control panel, select **Continue** to stop the defragmentation and continue printing.
- Format the flash memory.

Note: If the error message remains, then the flash memory may be defective and needs to be replaced.

Issues with supplies

Replace cartridge, printer region mismatch

To correct this problem, purchase a cartridge with the correct region that matches the printer region, or purchase a worldwide cartridge.

- The first number in the message after 42 indicates the region of the printer.
- The second number in the message after 42 indicates the region of the cartridge.

Printer and toner cartridge regions

Region	Numeric code
Worldwide or Undefined region	0
North America (United States, Canada)	1
European Economic Area, Western Europe, Nordic countries, Switzerland	2
Asia Pacific	3
Latin America	4
Rest of Europe, Middle East, Africa	5
Australia, New Zealand	6
Invalid region	9

Note: To find the region settings of the printer and toner cartridge, print the print quality test pages. From the control panel, navigate to: **Settings > Troubleshooting > Print Quality Test Pages.**

Non-Lexmark supply

The printer has detected a non-Lexmark supply or part installed in the printer.

Your Lexmark printer is designed to function best with genuine Lexmark supplies and parts. Use of third-party supplies or parts may affect the performance, reliability, or life of the printer and its imaging components.

All life indicators are designed to function with Lexmark supplies and parts and may deliver unpredictable results if third-party supplies or parts are used. Imaging component usage beyond the intended life may damage your Lexmark printer or associated components.

Warning—Potential Damage: Use of third-party supplies or parts can affect warranty coverage. Damage caused by the use of third-party supplies or parts may not be covered by the warranty.

To accept any and all of these risks and to proceed with the use of non-genuine supplies or parts in your printer, from the control panel, press and hold **X** and **#** simultaneously for 15 seconds.

If you do not want to accept these risks, then remove the third-party supply or part from your printer and install a genuine Lexmark supply or part. For more information, see [“Using genuine Lexmark parts and supplies” on page 139](#).

If the printer does not print after pressing and holding **X** and **#** simultaneously for 15 seconds, then reset the supply usage counter.

- 1 From the control panel, navigate to:
Settings > Device > Maintenance > Configuration Menu > Supply Usage And Counters
- 2 Select the part or supply that you want to reset, and then select **Start**.
- 3 Read the warning message, and then select **Continue**.
- 4 Press and hold **X** and **#** simultaneously for 15 seconds to clear the message.

Note: If you are unable to reset the supply usage counters, then return the item to the place of purchase.

Paper feed problems

Envelope seals when printing

Action	Yes	No
<p>Step 1</p> <p>a Use an envelope that has been stored in a dry environment. Note: Printing on envelopes with high moisture content can seal the flaps.</p> <p>b Send the print job.</p> <p>Does the envelope seal when printing?</p>	Go to step 2.	The problem is solved.
<p>Step 2</p> <p>a Make sure that paper type is set to Envelope. From the control panel, navigate to: Settings > Paper > Tray Configuration > Paper Size/Type</p> <p>b Send the print job.</p> <p>Does the envelope seal when printing?</p>	Contact customer support .	The problem is solved.

Collated printing does not work

Action	Yes	No
<p>Step 1</p> <p>a From the control panel, navigate to: Settings > Print > Layout > Collate</p> <p>b Touch On [1,2,1,2,1,2].</p> <p>c Print the document.</p> <p>Is the document collated correctly?</p>	The problem is solved.	Go to step 2.
<p>Step 2</p> <p>a From the document that you are trying to print, open the Print dialog, and then select Collate.</p> <p>b Print the document.</p> <p>Is the document collated correctly?</p>	The problem is solved.	Go to step 3.
<p>Step 3</p> <p>a Reduce the number of pages to print.</p> <p>b Print the document.</p> <p>Are the pages collated correctly?</p>	The problem is solved.	Contact customer support .

Tray linking does not work

Action	Yes	No
<p>Step 1</p> <p>a Check if the trays contain the same paper size and paper type.</p> <p>b Check if the paper guides are positioned correctly.</p> <p>c Print the document.</p> <p>Do the trays link correctly?</p>	The problem is solved.	Go to step 2.
<p>Step 2</p> <p>a From the home screen, touch Settings > Paper > Tray Configuration > Paper Size/Type.</p> <p>b Set the paper size and paper type to match the paper loaded in the linked trays.</p> <p>c Print the document.</p> <p>Do the trays link correctly?</p>	The problem is solved.	Go to step 3.

Action	Yes	No
<p>Step 3</p> <p>a Make sure that Tray Linking is set to Automatic. For more information, see “Linking trays” on page 29.</p> <p>b Print the document.</p> <p>Do the trays link correctly?</p>	<p>The problem is solved.</p>	<p>Contact customer support.</p>

Paper frequently jams

Action	Yes	No
<p>Step 1</p> <p>a Remove the tray.</p> <p>b Check if paper is loaded correctly.</p> <p>Notes:</p> <ul style="list-style-type: none"> • Make sure that the paper guides are positioned correctly. • Make sure that the stack height is below the maximum paper fill indicator. • Make sure to print on recommended paper size and type. <p>c Insert the tray.</p> <p>d Print the document.</p> <p>Do paper jams occur frequently?</p>	<p>Go to step 2.</p>	<p>The problem is solved.</p>
<p>Step 2</p> <p>a From the control panel, navigate to: Settings > Paper > Tray Configuration > Paper Size/Type</p> <p>b Set the correct paper size and type.</p> <p>c Print the document.</p> <p>Do paper jams occur frequently?</p>	<p>Go to step 3.</p>	<p>The problem is solved.</p>
<p>Step 3</p> <p>a Load paper from a fresh package.</p> <p>Note: Paper absorbs moisture due to high humidity. Store paper in its original wrapper until you are ready to use it.</p> <p>b Print the document.</p> <p>Do paper jams occur frequently?</p>	<p>Contact customer support.</p>	<p>The problem is solved.</p>

Jammed pages are not reprinted

Action	Yes	No
<p>a From the control panel, navigate to: Settings > Device > Notifications > Jam Content Recovery</p> <p>b In the Jam Recovery menu, select On or Auto.</p> <p>c Print the document.</p> <p>Are the jammed pages reprinted?</p>	<p>The problem is solved.</p>	<p>Contact customer support.</p>

Printing problems

Print quality is poor

Blank or white pages



Note: Before solving the problem, print the Print Quality Test Pages. From the control panel, navigate to **Settings > Troubleshooting > Print Quality Test Pages**. For non-touch-screen printer models, press  to navigate through the settings.

Action	Yes	No
<p>Step 1</p> <p>a Check if the printer is using a genuine and supported Lexmark toner cartridge.</p> <p>Note: If the cartridge is not supported, then install a supported one.</p> <p>b Print the document.</p> <p>Is the printer printing blank or white pages?</p>	<p>Go to step 2.</p>	<p>The problem is solved.</p>

Action	Yes	No
<p>Step 2</p> <p>a Remove any packing material that is left on the imaging unit.</p> <p>1 Remove the toner cartridge, and then remove the imaging unit.</p> <p>Warning—Potential Damage: Do not expose the imaging unit to direct light for more than 10 minutes. Extended exposure to light may cause print quality problems.</p> <p>Warning—Potential Damage: Do not touch the photoconductor drum under the imaging unit. Doing so may affect the quality of future print jobs.</p> <p>2 Check the imaging unit for signs of damage, and replace if necessary.</p> <p>Note: Make sure that the photoconductor drum contact is not bent or out of place.</p> <p>3 Firmly shake the imaging unit to redistribute the toner.</p> <p>4 Insert the imaging unit, and then insert the toner cartridge.</p> <p>b Print the document.</p> <p>Is the printer printing blank or white pages?</p>	<p>Go to step 3.</p>	<p>The problem is solved.</p>
<p>Step 3</p> <p>Check the status of the toner cartridge, and replace if necessary.</p> <p>a From the control panel, navigate to:</p> <p>Status/Supplies > Supplies</p> <p>b Print the document.</p> <p>Is the printer printing blank or white pages?</p>	<p>Contact customer support.</p>	<p>The problem is solved.</p>

Dark print



Note: Before solving the problem, print the Print Quality Test Pages. From the control panel, navigate to **Settings > Troubleshooting > Print Quality Test Pages**. For non-touch-screen printer models, press  to navigate through the settings.

Action	Yes	No
<p>Step 1</p> <p>a Check if the printer is using a genuine and supported Lexmark toner cartridge.</p> <p>Note: If the cartridge is not supported, then install a supported one.</p> <p>b Print the document.</p> <p>Is the print dark?</p>	Go to step 2.	The problem is solved.
<p>Step 2</p> <p>a Turn off the printer, wait for about 10 seconds, and then turn on the printer.</p> <p>b Reduce toner darkness. From the control panel, navigate to: Settings > Print > Quality</p> <p>c Print the document.</p> <p>Is the print dark?</p>	Go to step 3.	The problem is solved.
<p>Step 3</p> <p>a Depending on your operating system, specify the paper type from the Printing Preferences or Print dialog.</p> <p>Notes:</p> <ul style="list-style-type: none"> • Make sure that the setting matches the paper loaded. • You can also change the setting on the printer control panel. <p>b Print the document.</p> <p>Is the print dark?</p>	Go to step 4.	The problem is solved.
<p>Step 4</p> <p>Check if the paper has texture or rough finishes.</p> <p>Are you printing on textured or rough paper?</p>	Go to step 5.	Go to step 6.
<p>Step 5</p> <p>a Replace textured paper with plain paper.</p> <p>b Print the document.</p> <p>Is the print dark?</p>	Go to step 6.	The problem is solved.
<p>Step 6</p> <p>a Load paper from a fresh package.</p> <p>Note: Paper absorbs moisture due to high humidity. Store paper in its original wrapper until you are ready to use it.</p> <p>b Print the document.</p> <p>Is the print dark?</p>	Go to step 7.	The problem is solved.

Action	Yes	No
<p>Step 7</p> <p>a Remove, and then insert the imaging unit.</p> <p>Warning—Potential Damage: Do not expose the imaging unit to direct light for more than 10 minutes. Extended exposure to light may cause print quality problems.</p> <p>Warning—Potential Damage: Do not touch the photoconductor drum under the imaging unit. Doing so may affect the quality of future print jobs.</p> <p>b Print the document.</p> <p>Is the print dark?</p>	Go to step 8.	The problem is solved.
<p>Step 8</p> <p>a Replace the imaging unit.</p> <p>b Print the document.</p> <p>Is the print dark?</p>	Contact customer support .	The problem is solved.

Fine lines are not printed correctly



Note: Before solving the problem, print the Print Quality Test Pages. From the control panel, navigate to **Settings > Troubleshooting > Print Quality Test Pages**. For non-touch-screen printer models, press  to navigate through the settings.

Action	Yes	No
<p>Step 1</p> <p>a Check if the printer is using a genuine and supported Lexmark toner cartridge.</p> <p>Note: If the cartridge is not supported, then install a supported one.</p> <p>b Print the document.</p> <p>Are fine lines not printed correctly?</p>	Go to step 2.	The problem is solved.

Action	Yes	No
<p>Step 2</p> <p>a Adjust the print quality settings.</p> <ol style="list-style-type: none"> From the control panel, navigate to: Settings > Print > Quality > Pixel Boost > Fonts Adjust Toner Darkness to 7. From the control panel, navigate to: Settings > Print > Quality <p>b Print the document.</p> <p>Are fine lines not printed correctly?</p>	<p>Contact customer support.</p>	<p>The problem is solved.</p>

Folded or wrinkled paper



Note: Before solving the problem, print the Print Quality Test Pages. From the control panel, navigate to **Settings > Troubleshooting > Print Quality Test Pages**. For non-touch-screen printer models, press  to navigate through the settings.

Action	Yes	No
<p>Step 1</p> <p>a Check if the printer is using a genuine and supported Lexmark toner cartridge.</p> <p>Note: If the cartridge is not supported, then install a supported one.</p> <p>b Print the document.</p> <p>Is the paper folded or wrinkled?</p>	<p>Go to step 2.</p>	<p>The problem is solved.</p>
<p>Step 2</p> <p>a Load paper from a fresh package.</p> <p>Note: Paper absorbs moisture due to high humidity. Store paper in its original wrapper until you are ready to use it.</p> <p>b Print the document.</p> <p>Is the paper folded or wrinkled?</p>	<p>Go to step 3.</p>	<p>The problem is solved.</p>

Action	Yes	No
<p>Step 3</p> <p>a Depending on your operating system, specify the paper type from the Printing Preferences or Print dialog.</p> <p>Notes:</p> <ul style="list-style-type: none"> • Make sure that the setting matches the paper loaded. • You can also change the setting from the printer control panel. <p>b Print the document.</p> <p>Is the paper folded or wrinkled?</p>	<p>Contact customer support.</p>	<p>The problem is solved.</p>

Gray background

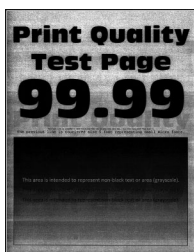

Note: Before solving the problem, print the Print Quality Test Pages. From the control panel, navigate to **Settings > Troubleshooting > Print Quality Test Pages**. For non-touch-screen printer models, press **OK** to navigate through the settings.

Action	Yes	No
<p>Step 1</p> <p>a Turn off the printer, wait for 10 seconds, and then turn on the printer.</p> <p>b Increase toner darkness. From the control panel, navigate to: Settings > Print > Quality</p> <p>c Print the document.</p> <p>Does gray background appear on prints?</p>	<p>Go to step 2.</p>	<p>The problem is solved.</p>
<p>Step 2</p> <p>a Check if the printer is using a genuine and supported Lexmark toner cartridge. Note: If the toner cartridge is not supported, then install a supported one.</p> <p>b Print the document.</p> <p>Does gray background appear on prints?</p>	<p>Go to step 3.</p>	<p>The problem is solved.</p>

Action	Yes	No
<p>Step 3</p> <p>a Depending on your operating system, specify the paper type from the Printing Preferences or Print dialog.</p> <p>Notes:</p> <ul style="list-style-type: none"> • Make sure that the setting matches the paper loaded. • You can also change the setting from the printer control panel. <p>b Print the document.</p> <p>Does gray background appear on prints?</p>	<p>Go to step 4.</p>	<p>The problem is solved.</p>
<p>Step 4</p> <p>Check the status of the toner cartridge, and replace if necessary.</p> <p>a From the control panel, navigate to: Status/Supplies > Supplies</p> <p>b Print the document.</p> <p>Does gray background appear on prints?</p>	<p>Go to step 5.</p>	<p>The problem is solved.</p>
<p>Step 5</p> <p>a Remove the imaging unit.</p> <p>Warning—Potential Damage: Do not expose the imaging unit to direct light for more than 10 minutes. Extended exposure to light may cause print quality problems.</p> <p>Warning—Potential Damage: Do not touch the photoconductor drum under the imaging unit. Doing so may affect the quality of future print jobs.</p> <p>b Remove any packing material that is stuck on the imaging unit.</p> <div data-bbox="402 1312 779 1480" data-label="Image"> </div> <p>Note: Make sure to remove any obstruction between the charge roller and photoconductor drum.</p> <p>c Insert the imaging unit.</p> <p>d Print the document.</p> <p>Does gray background appear on prints?</p>	<p>Go to step 6.</p>	<p>The problem is solved.</p>
<p>Step 6</p> <p>a Replace the imaging unit.</p> <p>b Print the document.</p> <p>Does gray background appear on prints?</p>	<p>Contact customer support.</p>	<p>The problem is solved.</p>

Horizontal light bands



Note: Before solving the problem, print the Print Quality Test Pages. From the control panel, navigate to **Settings > Troubleshooting > Print Quality Test Pages**. For non-touch-screen printer models, press **OK** to navigate through the settings.

Action	Yes	No
<p>a Check if the printer is using a genuine and supported Lexmark toner cartridge.</p> <p>Note: If the cartridge is not supported, then install a supported one.</p> <p>b Print the document.</p> <p>Do horizontal light bands appear on prints?</p>	<p>Contact customer support.</p>	<p>The problem is solved.</p>

Incorrect margins



Action	Yes	No
<p>Step 1</p> <p>a Adjust the paper guides to the correct position for the paper loaded.</p> <p>b Print the document.</p> <p>Are the margins correct?</p>	<p>The problem is solved.</p>	<p>Go to step 2.</p>

Action	Yes	No
<p>Step 2</p> <p>a Depending on your operating system, specify the paper size from the Printing Preferences or Print dialog.</p> <p>Notes:</p> <ul style="list-style-type: none"> • Make sure that the setting matches the paper loaded. • You can also change the setting from the printer control panel. <p>b Print the document.</p> <p>Are the margins correct?</p>	<p>The problem is solved.</p>	<p>Contact customer support.</p>

Light print

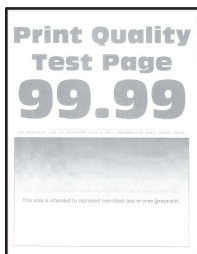

Note: Before solving the problem, print the Print Quality Test Pages. From the control panel, navigate to **Settings > Troubleshooting > Print Quality Test Pages**. For non-touch-screen printer models, press  to navigate through the settings.

Action	Yes	No
<p>Step 1</p> <p>a Check if the printer is using a genuine and supported Lexmark toner cartridge.</p> <p>Note: If the cartridge is not supported, then install a supported one.</p> <p>b Print the document.</p> <p>Is the print light?</p>	<p>Go to step 2.</p>	<p>The problem is solved.</p>
<p>Step 2</p> <p>a Turn off the printer, wait for about 10 seconds, and then turn on the printer.</p> <p>b Increase toner darkness. From the control panel, navigate to: Settings > Print > Quality</p> <p>c Print the document.</p> <p>Is the print light?</p>	<p>Go to step 3.</p>	<p>The problem is solved.</p>

Action	Yes	No
<p>Step 3</p> <p>a Depending on your operating system, specify the paper type from the Printing Preferences or Print dialog.</p> <p>Notes:</p> <ul style="list-style-type: none"> • Make sure that the setting matches the paper loaded. • You can also change the setting on the printer control panel. <p>b Print the document.</p> <p>Is the print light?</p>	<p>Go to step 4.</p>	<p>The problem is solved.</p>
<p>Step 4</p> <p>Check the status of the toner cartridge, and replace if necessary.</p> <p>a From the control panel, navigate to: Status/Supplies > Supplies</p> <p>b Print the document.</p> <p>Is the print light?</p>	<p>Go to step 5.</p>	<p>The problem is solved.</p>
<p>Step 5</p> <p>a Remove the toner cartridge, and then remove the imaging unit.</p> <p>Warning—Potential Damage: Do not expose the imaging unit to direct light for more than 10 minutes. Extended exposure to light can cause print quality problems.</p> <p>Warning—Potential Damage: Do not touch the photoconductor drum under the imaging unit. Doing so may affect the quality of future print jobs.</p> <p>b Push either side of the transfer roller, located below the imaging unit, to check if it depresses and bounces back into place.</p> <p> CAUTION—HOT SURFACE: The inside of the printer might be hot. To reduce the risk of injury from a hot component, allow the surface to cool before touching it.</p> <p>c If the transfer roller does not depress and bounce back into place, then remove and insert it.</p> <ol style="list-style-type: none"> 1 Pull up one end of the transfer roller and push it down until it <i>clicks</i> into place. 2 If necessary, repeat the step on the other end. <p>d Firmly shake the imaging unit to redistribute the toner, and then insert it.</p> <p>e Insert the toner cartridge.</p> <p>f Turn off the printer, wait for 10 seconds, and then turn on the printer.</p> <p>g Print the document.</p> <p>Is the print light?</p>	<p>Go to step 6.</p>	<p>The problem is solved.</p>

Action	Yes	No
<p>Step 6</p> <p>a If the issue happens after installing a new maintenance kit, then check whether the transfer roller included with the kit is installed.</p> <p>Note: If necessary, replace the transfer roller.</p> <p>b Print the document.</p> <p>Is the print light?</p>	Go to step 7.	The problem is solved.
<p>Step 7</p> <p>Check the status of the imaging unit. From the control panel, navigate to:</p> <p>Status/Supplies > Supplies</p> <p>Is the imaging unit near End of Life?</p>	Go to step 8.	Contact customer support .
<p>Step 8</p> <p>a Replace the imaging unit.</p> <p>b Print the document.</p> <p>Is the print light?</p>	Contact customer support .	The problem is solved.

Mottled print and dots



Note: Before solving the problem, print the Print Quality Test Pages. From the control panel, navigate to **Settings > Troubleshooting > Print Quality Test Pages**. For non-touch-screen printer models, press  to navigate through the settings.

Action	Yes	No
<p>Step 1</p> <p>a Check if the printer is using a genuine and supported Lexmark toner cartridge.</p> <p>Note: If the toner cartridge is not supported, then install a supported one.</p> <p>b Print the document.</p> <p>Is the print mottled?</p>	Go to step 2.	The problem is solved.

Action	Yes	No
<p>Step 2 Check the printer for leaked toner contamination.</p> <p>Is the printer free of leaked toner?</p>	Go to step 4.	Go to step 3.
<p>Step 3 a Replace the toner cartridge. b Print the document.</p> <p>Is the print mottled?</p>	Go to step 4.	The problem is solved.
<p>Step 4 Check the status of the imaging unit. From the control panel, navigate to: Status/Supplies > Supplies</p> <p>Is the imaging unit near end of life?</p>	Go to step 5.	Contact customer support .
<p>Step 5 a Replace the imaging unit. b Print the document.</p> <p>Is the print mottled?</p>	Contact customer support .	The problem is solved.

Paper curl



Note: Before solving the problem, print the Print Quality Test Pages. From the control panel, navigate to **Settings > Troubleshooting > Print Quality Test Pages**. For non-touch-screen printer models, press  to navigate through the settings.

Action	Yes	No
<p>Step 1 a Check if the printer is using a genuine and supported Lexmark toner cartridge. Note: If the cartridge is not supported, then install a supported one. b Print the document.</p> <p>Is the paper curled?</p>	Go to step 2.	The problem is solved.

Action	Yes	No
<p>Step 2</p> <p>a Adjust the guides in the tray to the correct position for the paper loaded.</p> <p>b Print the document.</p> <p>Is the paper curled?</p>	<p>Go to step 3.</p>	<p>The problem is solved.</p>
<p>Step 3</p> <p>a Depending on your operating system, specify the paper size and paper type from the Printing Preferences or Print dialog.</p> <p>Notes:</p> <ul style="list-style-type: none"> • Make sure that the settings match the paper loaded. • You can also change the settings from the printer control panel. <p>b Print the document.</p> <p>Is the paper curled?</p>	<p>Go to step 4.</p>	<p>The problem is solved.</p>
<p>Step 4</p> <p>a Remove paper from the tray, and then turn over the paper.</p> <p>b Print the document.</p> <p>Is the paper curled?</p>	<p>Go to step 5.</p>	<p>The problem is solved.</p>
<p>Step 5</p> <p>a Load paper from a fresh package.</p> <p>Note: Paper absorbs moisture due to high humidity. Store paper in its original wrapper until you are ready to use it.</p> <p>b Print the document.</p> <p>Is the paper curled?</p>	<p>Go to step 6.</p>	<p>The problem is solved.</p>
<p>Step 6</p> <p>a Check if the paper loaded is supported.</p> <p>Note: If paper is not supported, then load a supported paper.</p> <p>b Print the document.</p> <p>Is the paper curled?</p>	<p>Contact customer support.</p>	<p>The problem is solved.</p>

Print crooked or skewed



Note: Before solving the problem, print the Print Quality Test Pages. From the control panel, navigate to **Settings > Troubleshooting > Print Quality Test Pages**. For non-touch-screen printer models, press **OK** to navigate through the settings.

Action	Yes	No
<p>Step 1</p> <p>a Adjust the guides in the tray to the correct position for the paper loaded.</p> <p>b Print the document.</p> <p>Is the print crooked or skewed?</p>	Go to step 2.	The problem is solved.
<p>Step 2</p> <p>a Check if the paper loaded is supported.</p> <p>Note: If paper is not supported, then load a supported paper.</p> <p>b Print the document.</p> <p>Is the print crooked or skewed?</p>	Go to step 3.	The problem is solved.
<p>Step 3</p> <p>a Check the pick tire in the tray for signs of damage and contamination, and replace if necessary.</p> <p>b Print the document.</p> <p>Is the print crooked or skewed?</p>	Contact customer support .	The problem is solved.

Repeating defects



Note: Before solving the problem, print the Print Quality Test Pages. From the control panel, navigate to **Settings > Troubleshooting > Print Quality Test Pages**. For non-touch-screen printer models, press **OK** to navigate through the settings.

Action	Yes	No
<p>Step 1</p> <p>Using the Print Quality Test Pages, check if the distance between the repeating defects is equal to any of the following:</p> <ul style="list-style-type: none"> • 97 mm (3.82 in.) • 47 mm (1.85 in.) • 38 mm (1.5 in.) <p>Does the distance between the repeating defects match any of the measurements?</p>	Go to step 2.	Take note of the distance, and then contact customer support .
<p>Step 2</p> <p>a Replace the imaging unit.</p> <p>b Print the document.</p> <p>Do the repeating defects appear?</p>	Contact customer support .	The problem is solved.

Solid black pages

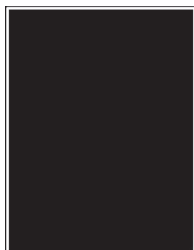

Note: Before solving the problem, print the Print Quality Test Pages. From the control panel, navigate to **Settings > Troubleshooting > Print Quality Test Pages**. For non-touch-screen printer models, press **OK** to navigate through the settings.

Action	Yes	No
<p>Step 1</p> <p>a Check if the printer is using a genuine and supported Lexmark toner cartridge.</p> <p>Note: If the toner cartridge is not supported, then install a supported one.</p> <p>b Print the document.</p> <p>Is the printer printing solid black pages?</p>	Go to step 2.	The problem is solved.

Action	Yes	No
<p>Step 2</p> <p>a Remove, and then insert the imaging unit.</p> <p>Warning—Potential Damage: Do not expose the imaging unit to direct light for more than 10 minutes. Extended exposure to light may cause print quality problems.</p> <p>Warning—Potential Damage: Do not touch the photoconductor drum under the imaging unit. Doing so may affect the quality of future print jobs.</p> <p>b Print the document.</p> <p>Is the printer printing solid black pages?</p>	<p>Go to step 3.</p>	<p>The problem is solved.</p>
<p>Step 3</p> <p>a Remove the imaging unit.</p> <p>Warning—Potential Damage: Do not expose the imaging unit to direct light for more than 10 minutes. Extended exposure to light may cause print quality problems.</p> <p>Warning—Potential Damage: Do not touch the photoconductor drum under the imaging unit. Doing so may affect the quality of future print jobs.</p> <p>b Remove any packing material that is stuck on the imaging unit.</p> <div data-bbox="402 1052 776 1192" style="text-align: center;">  </div> <p>Note: Make sure to remove any obstruction between the charge roller and photoconductor drum.</p> <p>c Insert the imaging unit.</p> <p>d Print the document.</p> <p>Is the printer printing solid black pages?</p>	<p>Go to step 4.</p>	<p>The problem is solved.</p>
<p>Step 4</p> <p>Check the imaging unit for signs of damage.</p> <p>Is the imaging unit free from damage?</p>	<p>Contact customer support.</p>	<p>Go to step 5.</p>
<p>Step 5</p> <p>a Replace the imaging unit.</p> <p>b Print the document.</p> <p>Is the printer printing solid black pages?</p>	<p>Contact customer support.</p>	<p>The problem is solved.</p>

Text or images cut off





Note: Before solving the problem, print the Print Quality Test Pages. From the control panel, navigate to **Settings > Troubleshooting > Print Quality Test Pages**. For non-touch-screen printer models, press **OK** to navigate through the settings.

Action	Yes	No
<p>Step 1</p> <p>a Check if the printer is using a genuine and supported Lexmark toner cartridge.</p> <p>Note: If the toner cartridge is not supported, then install a supported one.</p> <p>b Print the document.</p> <p>Are text or images cut off?</p>	Go to step 2.	The problem is solved.
<p>Step 2</p> <p>a Remove, and then insert the imaging unit.</p> <p>Warning—Potential Damage: Do not expose the imaging unit to direct light for more than 10 minutes. Extended exposure to light may cause print quality problems.</p> <p>Warning—Potential Damage: Do not touch the photoconductor drum under the imaging unit. Doing so may affect the quality of future print jobs.</p> <p>b Print the document.</p> <p>Are text or images cut off?</p>	Go to step 3.	The problem is solved.

Action	Yes	No
<p>Step 3</p> <p>a Remove the imaging unit.</p> <p>Warning—Potential Damage: Do not expose the imaging unit to direct light for more than 10 minutes. Extended exposure to light may cause print quality problems.</p> <p>Warning—Potential Damage: Do not touch the photoconductor drum under the imaging unit. Doing so may affect the quality of future print jobs.</p> <p>b Remove any packing material that is stuck on the imaging unit.</p> <div data-bbox="402 638 776 779" style="text-align: center;">  </div> <p>Note: Make sure to remove any obstruction between the charge roller and photoconductor drum.</p> <p>c Insert the imaging unit.</p> <p>d Print the document.</p> <p>Are text or images cut off?</p>	<p>Go to step 4.</p>	<p>The problem is solved.</p>
<p>Step 4</p> <p>a Replace the imaging unit.</p> <p>b Print the document.</p> <p>Are text or images cut off?</p>	<p>Contact customer support.</p>	<p>The problem is solved.</p>

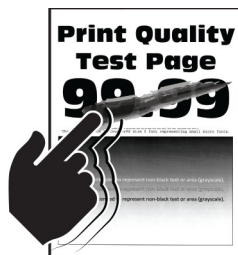
Toner easily rubs off



Note: Before solving the problem, print the Print Quality Test Pages. From the control panel, navigate to **Settings > Troubleshooting > Print Quality Test Pages**. For non-touch-screen printer models, press  to navigate through the settings.

Action	Yes	No
<p>Step 1</p> <p>a Check if the printer is using a genuine and supported Lexmark toner cartridge.</p> <p>Note: If the toner cartridge is not supported, then install a supported one.</p> <p>b Print the document.</p> <p>Does the toner easily rub off?</p>	Go to step 2.	The problem is solved.
<p>Step 2</p> <p>a Depending on your operating system, specify the paper type from the Printing Preferences or Print dialog.</p> <p>Notes:</p> <ul style="list-style-type: none"> • Make sure that the setting matches the paper loaded. • You can also change the setting on the printer control panel. <p>b Print the document.</p> <p>Does the toner easily rub off?</p>	Contact customer support .	The problem is solved.

Vertical dark bands

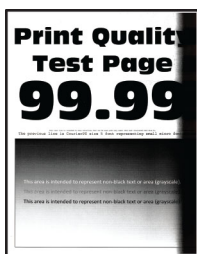

Note: Before solving the problem, print the Print Quality Test Pages. From the control panel, navigate to **Settings > Troubleshooting > Print Quality Test Pages**. For non-touch-screen printer models, press **OK** to navigate through the settings.

Action	Yes	No
<p>Step 1</p> <p>a Check if the printer is using a genuine and supported Lexmark toner cartridge.</p> <p>Note: If the toner cartridge is not supported, then install a supported one.</p> <p>b Print the document.</p> <p>Do vertical dark bands appear on prints?</p>	Go to step 2.	The problem is solved.

Action	Yes	No
<p>Step 2</p> <p>a Remove the toner cartridge, and then remove the imaging unit.</p> <p>Warning—Potential Damage: Do not expose the imaging unit to direct light for more than 10 minutes. Extended exposure to light may cause print quality problems.</p> <p>Warning—Potential Damage: Do not touch the photoconductor drum under the imaging unit. Doing so may affect the quality of future print jobs.</p> <p>b Insert the imaging unit, and then insert the cartridge.</p> <p>c Print the document.</p> <p>Do vertical dark bands appear on prints?</p>	<p>Go to step 3.</p>	<p>The problem is solved.</p>
<p>Step 3</p> <p>a Remove the imaging unit.</p> <p>Warning—Potential Damage: Do not expose the imaging unit to direct light for more than 10 minutes. Extended exposure to light may cause print quality problems.</p> <p>Warning—Potential Damage: Do not touch the photoconductor drum under the imaging unit. Doing so may affect the quality of future print jobs.</p> <p>b Remove any packing material that is stuck on the imaging unit.</p> <div data-bbox="404 1094 776 1230" data-label="Image"> </div> <p>Note: Make sure to remove any obstruction between the charge roller and photoconductor drum.</p> <p>c Insert the imaging unit.</p> <p>d Print the document.</p> <p>Do vertical dark bands appear on prints?</p>	<p>Go to step 4.</p>	<p>The problem is solved.</p>
<p>Step 4</p> <p>a Check if a bright light enters the right side of the printer, and move the printer if necessary.</p> <p>b Print the document.</p> <p>Do vertical dark bands appear on prints?</p>	<p>Contact customer support.</p>	<p>The problem is solved.</p>

Vertical dark lines or streaks



Action	Yes	No
<p>Step 1</p> <p>a From the control panel, navigate to: Settings > Troubleshooting > Cleaning the scanner</p> <p>b Print the document.</p> <p>Do vertical dark lines or streaks appear on prints?</p>	Go to step 3.	Go to step 2.
<p>Step 2</p> <p>a Using a damp, soft, lint-free cloth, clean the scanner. For more information, see “Cleaning the scanner” on page 136.</p> <p>b Copy the document using the ADF.</p> <p>Do vertical dark lines or streaks appear on prints?</p>	Contact customer support .	The problem is solved.
<p>Step 3</p> <p>a Check if the printer is using a genuine and supported Lexmark toner cartridge.</p> <p>Note: If the toner cartridge is not supported, then install a supported one.</p> <p>b Print the document.</p> <p>Do vertical dark lines or streaks appear on prints?</p>	Go to step 4.	The problem is solved.
<p>Step 4</p> <p>a Remove, and then insert the imaging unit.</p> <p>Warning—Potential Damage: Do not expose the imaging unit to direct light for more than 10 minutes. Extended exposure to light can cause print quality problems.</p> <p>Warning—Potential Damage: Do not touch the photoconductor drum under the imaging unit. Doing so may affect the quality of future print jobs.</p> <p>b Print the document.</p> <p>Do vertical dark lines or streaks appear on prints?</p>	Go to step 5.	The problem is solved.

Action	Yes	No
<p>Step 5</p> <p>a Replace the imaging unit.</p> <p>b Print the document.</p> <p>Do vertical dark lines or streaks appear on prints?</p>	<p>Contact customer support.</p>	<p>The problem is solved.</p>

Vertical dark streaks with print missing

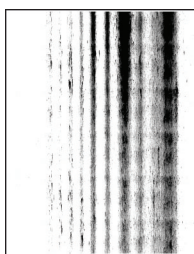

Note: Before solving the problem, print the Print Quality Test Pages. From the control panel, navigate to **Settings > Troubleshooting > Print Quality Test Pages**. For non-touch-screen printer models, press  to navigate through the settings.

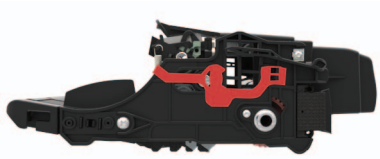
Action	Yes	No
<p>Step 1</p> <p>a Remove the imaging unit.</p> <p>Warning—Potential Damage: Do not expose the imaging unit to direct light for more than 10 minutes. Extended exposure to light may cause print quality problems.</p> <p>Warning—Potential Damage: Do not touch the photoconductor drum under the imaging unit. Doing so may affect the quality of future print jobs.</p> <p>b Remove any packing material that is stuck on the imaging unit.</p> <div style="text-align: center;">  </div> <p>Note: Make sure to remove any obstruction between the charge roller and photoconductor drum.</p> <p>c Insert the imaging unit.</p> <p>d Print the document.</p> <p>Do vertical dark streaks with missing images appear on prints?</p>	<p>Go to step 2.</p>	<p>The problem is solved.</p>

Action	Yes	No
<p>Step 2</p> <p>a Check if the printer is using a genuine and supported Lexmark toner cartridge.</p> <p>Note: If the toner cartridge is not supported, then install a supported one.</p> <p>b Print the document.</p> <p>Do vertical dark streaks with missing images appear on prints?</p>	<p>Contact customer support.</p>	<p>The problem is solved.</p>

Vertical light bands



Note: Before solving the problem, print the Print Quality Test Pages. From the control panel, navigate to **Settings > Troubleshooting > Print Quality Test Pages**. For non-touch-screen printer models, press **OK** to navigate through the settings.

Action	Yes	No
<p>a Check if the printer is using a genuine and supported Lexmark toner cartridge.</p> <p>Note: If the cartridge is not supported, then install a supported one.</p> <p>b Print the document.</p> <p>Do vertical light bands appear on prints?</p>	<p>Contact customer support.</p>	<p>The problem is solved.</p>

Vertical white lines



Note: Before solving the problem, print the Print Quality Test Pages. From the control panel, navigate to **Settings > Troubleshooting > Print Quality Test Pages**. For non-touch-screen printer models, press **OK** to navigate through the settings.

Action	Yes	No
<p>Step 1</p> <p>a Check if the printer is using a genuine and supported Lexmark toner cartridge.</p> <p>Note: If the cartridge is not supported, then install a supported one.</p> <p>b Print the document.</p> <p>Do vertical white lines appear on prints?</p>	Go to step 2.	The problem is solved.
<p>Step 2</p> <p>a Depending on your operating system, specify the paper type from the Printing Preferences or Print dialog.</p> <p>Notes:</p> <ul style="list-style-type: none"> • Make sure that the setting matches the paper loaded. • You can also change the setting on the printer control panel. <p>b Print the document.</p> <p>Do vertical white lines appear on prints?</p>	Contact customer support .	The problem is solved.

Confidential and other held documents do not print

Action	Yes	No
<p>Step 1</p> <p>a From the control panel, check if the documents appear in the Held Jobs list.</p> <p>Note: If the documents are not listed, then print the documents using the Print and Hold options.</p> <p>b Print the documents.</p> <p>Are the documents printed?</p>	The problem is solved.	Go to step 2.
<p>Step 2</p> <p>The print job may contain a formatting error or invalid data.</p> <ul style="list-style-type: none"> • Delete the print job, and then send it again. • For PDF files, generate a new file, and then print the documents. <p>Are the documents printed?</p>	The problem is solved.	Go to step 3.

Action	Yes	No
<p>Step 3</p> <p>If you are printing from the Internet, then the printer may be reading the multiple job titles as duplicates.</p> <p>For Windows users</p> <ul style="list-style-type: none"> a Open the Printing Preferences dialog. b From the Print and Hold section, select Keep duplicate documents. c Enter a PIN. d Resend the print job. <p>For Macintosh users</p> <ul style="list-style-type: none"> a Save and name each job differently. b Send the job individually. <p>Are the documents printed?</p>	<p>The problem is solved.</p>	<p>Go to step 4.</p>
<p>Step 4</p> <ul style="list-style-type: none"> a Delete some held jobs to free up printer memory. b Resend the print job. <p>Are the documents printed?</p>	<p>The problem is solved.</p>	<p>Go to step 5.</p>
<p>Step 5</p> <ul style="list-style-type: none"> a Add printer memory. b Resend the print job. <p>Are the documents printed?</p>	<p>The problem is solved.</p>	<p>Contact customer support.</p>

Slow printing

Action	Yes	No
<p>Step 1</p> <p>Make sure that the printer cable is securely connected to the printer and to the computer, print server, option, or other network device.</p> <p>Is the printer printing slow?</p>	<p>Go to step 2.</p>	<p>The problem is solved.</p>
<p>Step 2</p> <ul style="list-style-type: none"> a Make sure that the printer is not in Quiet Mode. From the home screen, touch Settings > Device > Maintenance > Config Menu > Device Operations > Quiet Mode. b Print the document. <p>Is the printer printing slow?</p>	<p>Go to step 3.</p>	<p>The problem is solved.</p>

Action	Yes	No
<p>Step 3</p> <p>a Depending on your operating system, specify the print resolution from the Printing Preferences or Print dialog.</p> <p>b Set the resolution to 600 dpi.</p> <p>c Print the document.</p> <p>Is the printer printing slow?</p>	Go to step 4.	The problem is solved.
<p>Step 4</p> <p>a From the home screen, touch Settings > Print > Quality > Print Resolution.</p> <p>b Set the resolution to 600 dpi.</p> <p>c Print the document.</p> <p>Is the printer printing slow?</p>	Go to step 5.	The problem is solved.
<p>Step 5</p> <p>a Depending on your operating system, specify the paper type from the Printing Preferences or Print dialog.</p> <p>Notes:</p> <ul style="list-style-type: none"> • Make sure that the setting matches the paper loaded. • You can also change the setting on the printer control panel. • Heavier paper prints more slowly. • Paper narrower than letter, A4, and legal may print more slowly. <p>b Print the document.</p> <p>Is the printer printing slow?</p>	Go to step 6.	The problem is solved.
<p>Step 6</p> <p>a Make sure that the printer settings for texture and weight match the paper being loaded.</p> <p>From the home screen, touch Settings > Paper > Media Configuration > Media Types.</p> <p>Note: Rough paper textures and heavy paper weights may print more slowly.</p> <p>b Print the document.</p> <p>Is the printer printing slow?</p>	Go to step 7.	The problem is solved.
<p>Step 7</p> <p>Remove held jobs.</p> <p>Is the printer printing slow?</p>	Go to step 8.	The problem is solved.

Action	Yes	No
<p>Step 8</p> <p>a Make sure that the printer is not overheating.</p> <p>Notes:</p> <ul style="list-style-type: none"> • Allow the printer to cool down after a long print job. • Observe the recommended ambient temperature for the printer. For more information, see “Selecting a location for the printer” on page 11. <p>b Print the document.</p> <p>Is the printer printing slow?</p>	<p>Contact customer support.</p>	<p>The problem is solved.</p>

Print jobs do not print

Action	Yes	No
<p>Step 1</p> <p>a From the document you are trying to print, open the Print dialog, and then check if you have selected the correct printer.</p> <p>b Print the document.</p> <p>Is the document printed?</p>	<p>The problem is solved.</p>	<p>Go to step 2.</p>
<p>Step 2</p> <p>a Check if the printer is on.</p> <p>b Resolve any error messages that appear on the display.</p> <p>c Print the document.</p> <p>Is the document printed?</p>	<p>The problem is solved.</p>	<p>Go to step 3.</p>
<p>Step 3</p> <p>a Check if the ports are working and if the cables are securely connected to the computer and the printer.</p> <p>For more information, see the setup documentation that came with the printer.</p> <p>b Print the document.</p> <p>Is the document printed?</p>	<p>The problem is solved.</p>	<p>Go to step 4.</p>
<p>Step 4</p> <p>a Turn off the printer, wait for about 10 seconds, and then turn on the printer.</p> <p>b Print the document.</p> <p>Is the document printed?</p>	<p>The problem is solved.</p>	<p>Go to step 5.</p>

Action	Yes	No
<p>Step 5</p> <p>a Remove, and then reinstall the print driver.</p> <p>b Print the document.</p> <p>Is the document printed?</p>	<p>The problem is solved.</p>	<p>Contact customer support.</p>

Adjusting toner darkness

- 1 From the home screen, touch **Settings > Print > Quality**.
- 2 Adjust the toner darkness.
- 3 Apply the changes.

The printer is not responding

Action	Yes	No
<p>Step 1</p> <p>Check if the power cord is connected to the electrical outlet.</p> <p> CAUTION—POTENTIAL INJURY: To avoid the risk of fire or electrical shock, connect the power cord to an appropriately rated and properly grounded electrical outlet that is near the product and easily accessible.</p> <p>Is the printer responding?</p>	<p>The problem is solved.</p>	<p>Go to step 2.</p>
<p>Step 2</p> <p>Check if the electrical outlet is turned off by a switch or breaker.</p> <p>Is the electrical outlet turned off by a switch or breaker?</p>	<p>Turn on the switch or reset the breaker.</p>	<p>Go to step 3.</p>
<p>Step 3</p> <p>Check if the printer is on.</p> <p>Is the printer on?</p>	<p>Go to step 4.</p>	<p>Turn on the printer.</p>
<p>Step 4</p> <p>Check if the printer is in Sleep or Hibernate mode.</p> <p>Is the printer in Sleep or Hibernate mode?</p>	<p>Press the power button to wake the printer.</p>	<p>Go to step 5.</p>
<p>Step 5</p> <p>Check if the cables connecting the printer and the computer are inserted to the correct ports.</p> <p>Are the cables inserted to the correct ports?</p>	<p>Go to step 6.</p>	<p>Insert the cables to the correct ports.</p>

Action	Yes	No
<p>Step 6</p> <p>Turn off the printer, install the hardware options, and then turn on the printer.</p> <p>For more information, see the documentation that came with the option.</p> <p>Is the printer responding?</p>	The problem is solved.	Go to step 7.
<p>Step 7</p> <p>Install the correct print driver.</p> <p>Is the printer responding?</p>	The problem is solved.	Go to step 8.
<p>Step 8</p> <p>Turn off the printer, wait for about 10 seconds, and then turn on the printer.</p> <p>Is the printer responding?</p>	The problem is solved.	Contact customer support .

Job prints from the wrong tray or on the wrong paper

Action	Yes	No
<p>Step 1</p> <p>a Check if you are printing on the correct paper.</p> <p>b Print the document.</p> <p>Is the document printed on the correct paper?</p>	Go to step 2.	Load the correct paper size and paper type.
<p>Step 2</p> <p>a Depending on your operating system, specify the paper size and paper type from the Printing Preferences or Print dialog.</p> <p>Note: You can also change the settings on the printer control panel. Navigate to:</p> <p>Settings > Paper > Tray Configuration > Paper Size/Type</p> <p>b Make sure that the settings match the paper loaded.</p> <p>c Print the document.</p> <p>Is the document printed on the correct paper?</p>	The problem is solved.	Go to step 3.
<p>Step 3</p> <p>a Check if the trays are linked.</p> <p>For more information, see “Linking trays” on page 29.</p> <p>b Print the document.</p> <p>Is the document printed from the correct tray?</p>	The problem is solved.	Contact customer support .

Faxing problems

Cannot send or receive faxes

Action	Yes	No
<p>Step 1 Resolve any error messages that appear on the display.</p> <p>Can you send or receive a fax?</p>	The problem is solved.	Go to step 2.
<p>Step 2 Make sure that the cable connections for the following equipment are secure:</p> <ul style="list-style-type: none"> • Telephone • Handset • Answering machine <p>Can you send or receive a fax?</p>	The problem is solved.	Go to step 3.
<p>Step 3 Check for a dial tone.</p> <ul style="list-style-type: none"> • Call the fax number to check if it is working properly. • If you are using the On Hook Dial feature, then turn up the volume to check if you hear a dial tone. <p>Can you hear a dial tone?</p>	Go to step 5.	Go to step 4.
<p>Step 4 Check the telephone wall jack.</p> <ul style="list-style-type: none"> a Connect the analog telephone directly to the wall jack. b Listen for a dial tone. c If you do not hear a dial tone, then use a different telephone cable. d If you still do not hear a dial tone, then connect the analog telephone to a different wall jack. e If you hear a dial tone, then connect the printer to that wall jack. <p>Can you send or receive a fax?</p>	The problem is solved.	Go to step 5.

Action	Yes	No
<p>Step 5</p> <p>Check if the printer is connected to an analog phone service or to the correct digital connector.</p> <ul style="list-style-type: none"> • If you are using an Integrated Services for Digital Network (ISDN) telephone service, then connect to an analog telephone port of an ISDN terminal adapter. For more information, contact your ISDN provider. • If you are using DSL, then connect to a DSL filter or router that supports analog use. For more information, contact your DSL provider. • If you are using a private branch exchange (PBX) telephone service, then make sure that you are connecting to an analog connection on the PBX. If none exists, then consider installing an analog telephone line for the fax machine. <p>Can you send or receive a fax?</p>	<p>The problem is solved.</p>	<p>Go to step 6.</p>
<p>Step 6</p> <p>Temporarily disconnect other equipment and disable other telephone services.</p> <ol style="list-style-type: none"> a Disconnect other equipment (such as answering machines, computers, modems, or telephone line splitters) between the printer and the telephone line. b Disable call waiting and voice mail. For more information, contact your telephone company. <p>Can you send or receive a fax?</p>	<p>The problem is solved.</p>	<p>Go to step 7.</p>
<p>Step 7</p> <p>Scan the original document one page at a time.</p> <ol style="list-style-type: none"> a Dial the fax number. b Scan the document. <p>Can you send or receive a fax?</p>	<p>The problem is solved.</p>	<p>Contact customer support.</p>

Can receive but not send faxes

Action	Yes	No
<p>Step 1 Load the original document properly into the ADF tray or on the scanner glass.</p> <p>Can you send faxes?</p>	The problem is solved.	Go to step 2.
<p>Step 2 Set up the shortcut number properly.</p> <ul style="list-style-type: none"> • Check if the shortcut number is set for the telephone number that you want to dial. • Dial the telephone number manually. <p>Can you send faxes?</p>	The problem is solved.	Contact customer support .

Can send but not receive faxes

Action	Yes	No
<p>Step 1 Make sure that the paper source is not empty.</p> <p>Can you receive faxes?</p>	The problem is solved.	Go to step 2.
<p>Step 2 Check the ring count delay settings. From the control panel, touch Settings > Fax > Fax Setup > Fax Receive Settings > Rings to Answer.</p> <p>Can you receive faxes?</p>	The problem is solved.	Go to step 3.
<p>Step 3 If the printer is printing blank pages, then see “Blank or white pages” on page 184.</p> <p>Can you receive faxes?</p>	The problem is solved.	Contact customer support .

Poor fax print quality

Action	Yes	No
<p>Step 1 Make sure that there are no print quality defects.</p> <p>a From the control panel, touch Settings > Troubleshooting > Print Quality Test Pages.</p> <p>b Correct any print quality defects. For more information, see “Print quality is poor” on page 184.</p> <p>Is the fax print quality satisfactory?</p>	<p>The problem is solved.</p>	<p>Go to step 2.</p>
<p>Step 2 Decrease the incoming fax transmission speed.</p> <p>a From the control panel, touch Settings > Fax > Fax Setup > Fax Receive Settings > Admin Controls.</p> <p>b In the Max Speed menu, select a lower transmission speed.</p> <p>Is the fax print quality satisfactory?</p>	<p>The problem is solved.</p>	<p>Contact customer support.</p>

Scanning problems

Cannot scan from a computer

Action	Yes	No
<p>Step 1</p> <p>a Turn off the printer, wait for about 10 seconds, and then turn it back on.</p> <p>b Resend the scan job.</p> <p>Can you send the scan job?</p>	<p>The problem is solved.</p>	<p>Go to step 2.</p>
<p>Step 2</p> <p>a Make sure that the cables between the printer and the print server are secure. For more information, see the setup documentation that came with the printer.</p> <p>b Resend the scan job.</p> <p>Can you send the scan job?</p>	<p>The problem is solved.</p>	<p>Contact customer support.</p>

Partial copies of document or photo

Action	Yes	No
<p>Step 1</p> <p>a Make sure that the document or photo is loaded facedown on the upper left corner of the scanner glass.</p> <p>b Copy the document or photo.</p> <p>Is the document or photo copied correctly?</p>	The problem is solved.	Go to step 2.
<p>Step 2</p> <p>a Match the paper size setting and the paper loaded in the tray.</p> <p>b Copy the document or photo.</p> <p>Is the document or photo copied correctly?</p>	The problem is solved.	Contact customer support .

Poor copy quality

Action	Yes	No
<p>Step 1</p> <p>a Clean the scanner glass and the ADF glass with a damp, soft, lint-free cloth. If your printer has a second ADF glass inside the ADF, then also clean that glass.</p> <p>For more information, see “Cleaning the scanner” on page 136.</p> <p>b Make sure that the document or photo is loaded facedown on the upper left corner of the scanner glass.</p> <p>c Copy the document or photo.</p> <p>Is the copy quality satisfactory?</p>	The problem is solved.	Go to step 2.
<p>Step 2</p> <p>a Check the quality of the original document or photo.</p> <p>b Adjust the scan quality settings.</p> <p>c Copy the document or photo.</p> <p>Is the copy quality satisfactory?</p>	The problem is solved.	Contact customer support .

Vertical dark streaks on output when scanning from the ADF

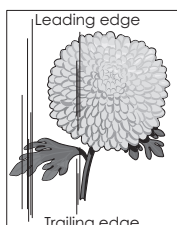
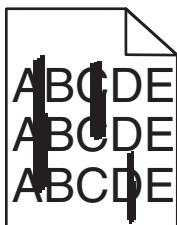

Action	Yes	No
<p>Step 1</p> <ul style="list-style-type: none"> a Open the scanner cover. b Using a damp, soft, lint-free cloth, wipe the ADF glass and the white underside of the ADF cover. c Close the scanner cover. <p>Do vertical streaks still appear on scanned documents?</p>	Go to step 2.	The problem is solved.
<p>Step 2</p> <ul style="list-style-type: none"> a Open door C. b Using a damp, soft, lint-free cloth, wipe the ADF glass and the white underside of the ADF cover. c Close the door. <p>Do vertical streaks still appear on scanned documents?</p>	Contact customer support .	The problem is solved.

Scan job was not successful

Action	Yes	No
<p>Step 1</p> <p>Check the cable connections.</p> <ul style="list-style-type: none"> a Make sure that the Ethernet or USB cable is securely connected to the computer and the printer. b Resend the scan job. <p>Is the scan job successful?</p>	The problem is solved.	Go to step 2.
<p>Step 2</p> <p>Check the file you want to scan.</p> <ul style="list-style-type: none"> a Make sure that the file name is not already used in the destination folder. b Make sure that the document or photo you want to scan is not open in another application. c Resend the scan job. <p>Is the scan job successful?</p>	The problem is solved.	Go to step 3.
<p>Step 3</p> <ul style="list-style-type: none"> a Make sure that the Append time stamp or the Overwrite existing file check box is selected in the destination configuration settings. b Resend the scan job. <p>Is the scan job successful?</p>	The problem is solved.	Contact customer support .

Scanner does not close

Action	Yes	No
Remove obstructions that keep the scanner unit open. Did the scanner unit close correctly?	The problem is solved.	Contact customer support .

Scanning takes too long or freezes the computer

Action	Yes	No
Close all applications that are interfering with the scan. Does scanning take too long or freeze the computer?	Contact customer support .	The problem is solved.

Scanner does not respond

Action	Yes	No
<p>Step 1</p> <p>a Check if the power cord is connected properly to the printer and the electrical outlet.</p> <p> CAUTION—POTENTIAL INJURY: To avoid the risk of fire or electrical shock, connect the power cord to an appropriately rated and properly grounded electrical outlet that is near the product and easily accessible.</p> <p>b Copy or scan the document.</p> <p>Is the scanner responding?</p>	The problem is solved.	Go to step 2.
<p>Step 2</p> <p>a Check if the printer is turned on.</p> <p>b Resolve any error messages that appear on the display.</p> <p>c Copy or scan the document.</p> <p>Is the scanner responding?</p>	The problem is solved.	Go to step 3.
<p>Step 3</p> <p>a Turn off the printer, wait for about 10 seconds, and then turn the printer on.</p> <p>b Copy or scan the document.</p> <p>Is the scanner responding?</p>	The problem is solved.	Contact customer support .

Adjusting scanner registration

- 1 From the home screen, touch **Settings > Device > Maintenance > Configuration Menu > Scanner Configuration > Scanner Manual Registration**.
- 2 In the Print Quick Test menu, touch **Start**.
- 3 Place the Print Quick Test page on the scanner glass, and then touch **Flatbed Registration**.
- 4 In the Copy Quick Test menu, touch **Start**.
- 5 Compare the Copy Quick Test page with the original document.
Note: If the margins of the test page are different from the original document, then adjust Left Margin and Top Margin.
- 6 Repeat [step 4](#) and [step 5](#) until the margins of the Copy Quick Test page closely match the original document.

Adjusting ADF registration

- 1 From the home screen, touch **Settings > Device > Maintenance > Configuration Menu > Scanner Configuration > Scanner Manual Registration**.
- 2 In the Print Quick Test menu, touch **Start**.
- 3 Place the Print Quick Test page on the ADF tray.
- 4 Touch **Front ADF Registration** or **Rear ADF Registration**.
Notes:
 - To align Front ADF Registration, place the test page faceup, short edge first into the ADF.
 - To align Rear ADF Registration, place the test page facedown, short edge first into the ADF.
- 5 In the Copy Quick Test menu, touch **Start**.
- 6 Compare the Copy Quick Test page with the original document.
Note: If the margins of the test page are different from the original document, then adjust Horizontal Adjust and Top Margin.
- 7 Repeat [step 5](#) and [step 6](#) until the margins of the Copy Quick Test page closely match the original document.

Contacting customer support

Before contacting customer support, make sure to have the following information:

- Printer problem
- Error message
- Printer model type and serial number

Go to <http://support.lexmark.com> to receive e-mail or chat support, or browse through the library of manuals, support documentation, drivers, and other downloads.

Technical support via telephone is also available. In the U.S. or Canada, call 1-800-539-6275. For other countries or regions, go to <http://support.lexmark.com>.

Upgrading and migrating

Hardware

Available internal options

- Flash memory
- Font cards
- Firmware cards
 - Forms and Bar Code
 - IPDS
 - PRESCRIBE
- Internal solutions port
 - RS-232C Serial Interface Card
 - Parallel 1284-B Interface Card
 - MarkNet™ N8230 Fiber Ethernet

Accessing the controller board

 **CAUTION—SHOCK HAZARD:** To avoid the risk of electrical shock, if you are accessing the controller board or installing optional hardware or memory devices sometime after setting up the printer, then turn the printer off, and unplug the power cord from the electrical outlet before continuing. If you have any other devices attached to the printer, then turn them off as well, and unplug any cables going into the printer.

- 1 Turn off the printer.
- 2 Unplug the power cord from the electrical outlet, and then from the printer.
- 3 Using a flat-head screwdriver, open the controller board access cover.

Warning—Potential Damage: Controller board electronic components are easily damaged by static electricity. Touch a metal surface on the printer before touching any controller board components or connectors.

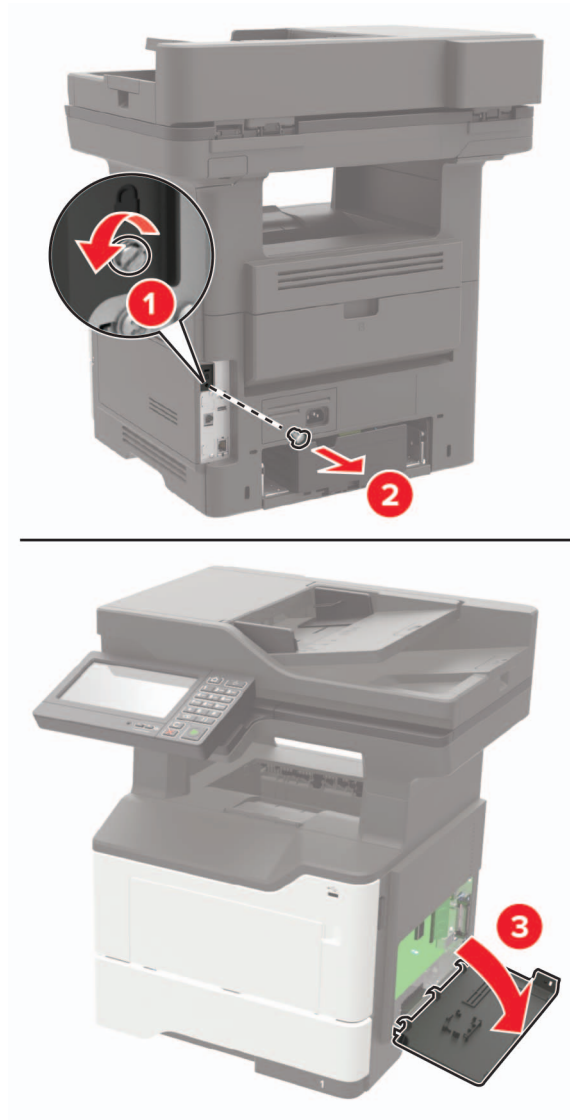

4 Close the access cover.

5 Connect the power cord to the printer, and then to the electrical outlet.

⚠ CAUTION—POTENTIAL INJURY: To avoid the risk of fire or electrical shock, connect the power cord to an appropriately rated and properly grounded electrical outlet that is near the product and easily accessible.

6 Turn on the printer.

Installing a memory card

⚠ CAUTION—SHOCK HAZARD: To avoid the risk of electrical shock, if you are accessing the controller board or installing optional hardware or memory devices sometime after setting up the printer, then turn the printer off, and unplug the power cord from the electrical outlet before continuing. If you have any other devices attached to the printer, then turn them off as well, and unplug any cables going into the printer.

- 1 Turn off the printer.
- 2 Unplug the power cord from the electrical outlet, and then from the printer.
- 3 Open the controller board access cover.

Warning—Potential Damage: Controller board electronic components are easily damaged by static electricity. Touch a metal surface on the printer before touching any controller board components or connectors.

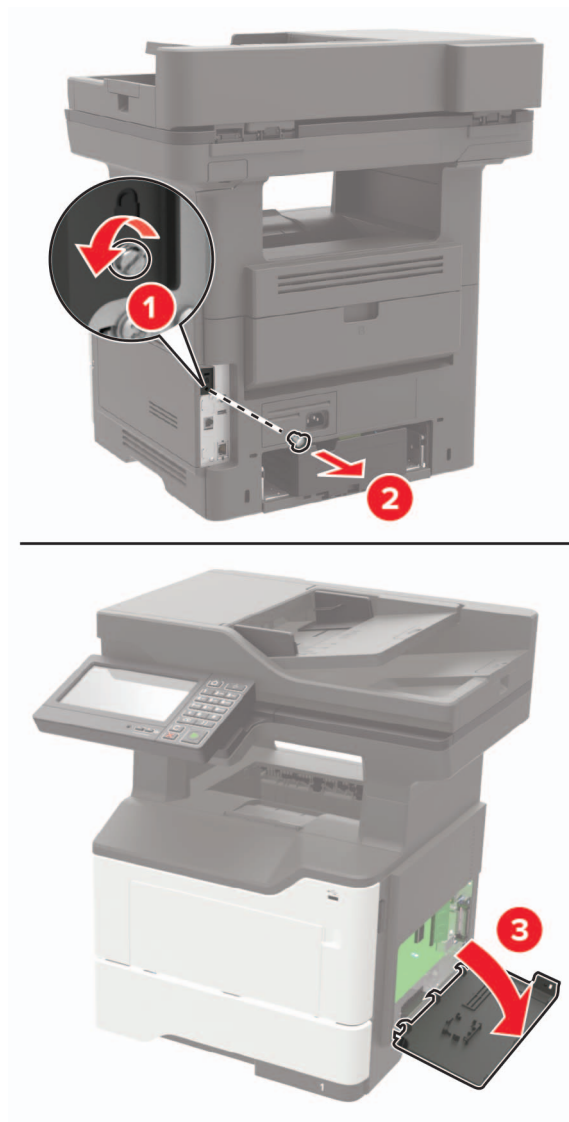

4 Unpack the memory card.

Warning—Potential Damage: Do not touch the connection points along the edge of the card.

5 Insert the memory card until it *clicks* into place.

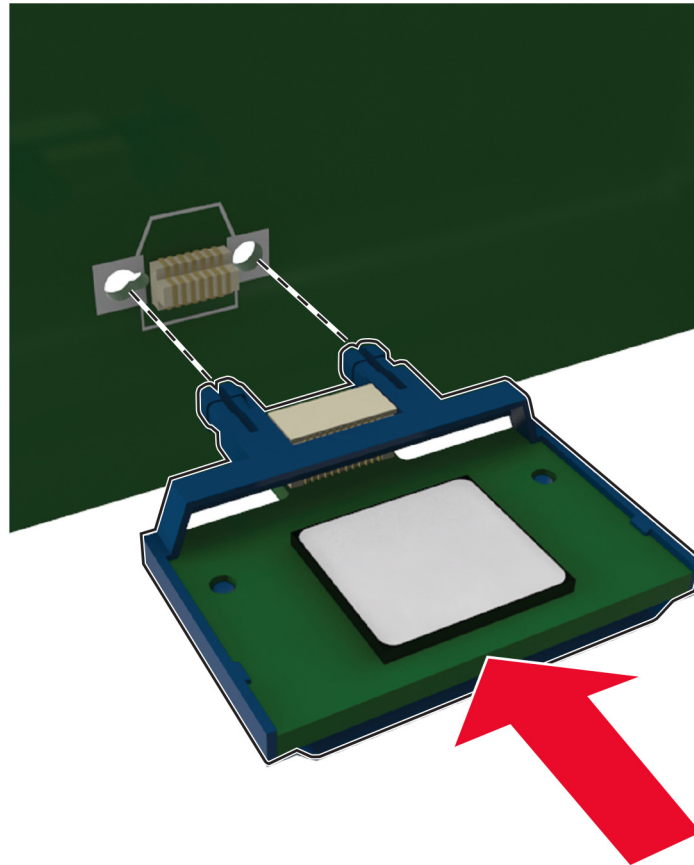

6 Close the controller board access cover.

7 Connect the power cord to the printer, and then to the electrical outlet.

⚠ CAUTION—POTENTIAL INJURY: To avoid the risk of fire or electrical shock, connect the power cord to an appropriately rated and properly grounded electrical outlet that is near the product and easily accessible.

8 Turn on the printer.

Installing an optional card

⚠ CAUTION—SHOCK HAZARD: To avoid the risk of electrical shock, if you are accessing the controller board or installing optional hardware or memory devices sometime after setting up the printer, then turn the printer off, and unplug the power cord from the electrical outlet before continuing. If you have any other devices attached to the printer, then turn them off as well, and unplug any cables going into the printer.

- 1 Turn off the printer.
- 2 Unplug the power cord from the electrical outlet, and then from the printer.
- 3 Open the controller board access cover.

Warning—Potential Damage: Controller board electronic components are easily damaged by static electricity. Touch a metal surface on the printer before touching any components or connectors.

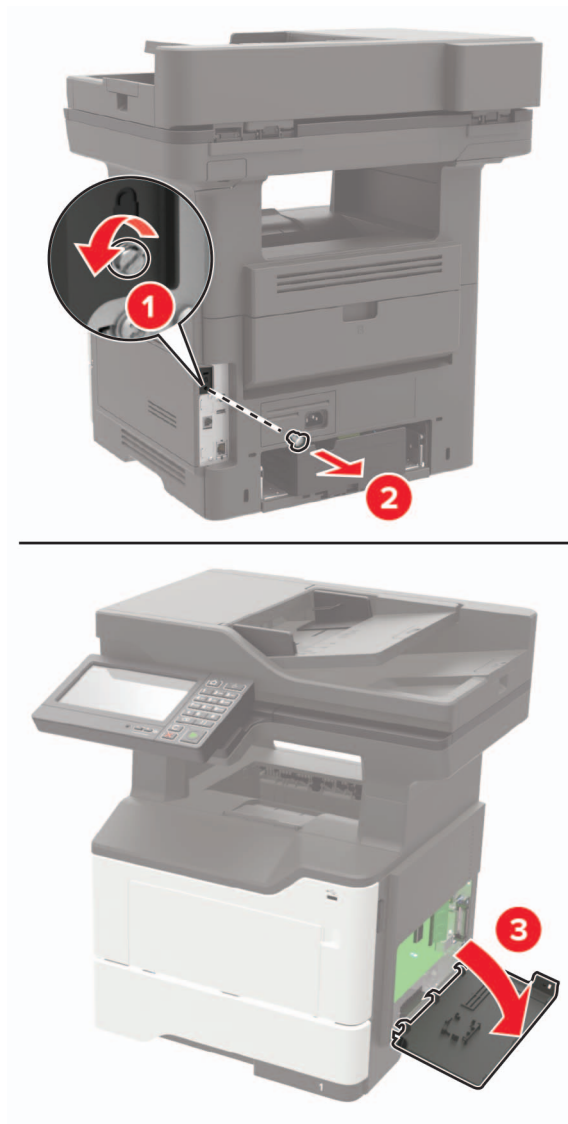

- 4 Unpack the optional card.

Warning—Potential Damage: Do not touch the connection points along the edge of the card.

- 5 Push the card firmly into place.

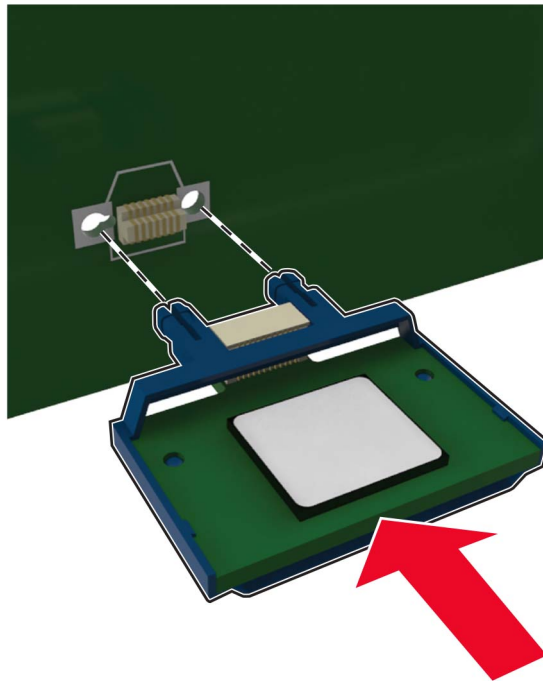

Note: The entire length of the connector on the card must touch and be flush against the controller board.

Warning—Potential Damage: Improper installation of the card may cause damage to the card and the controller board.

- 6 Close the access cover.
- 7 Connect the power cord to the printer, and then to the electrical outlet.

CAUTION—POTENTIAL INJURY: To avoid the risk of fire or electrical shock, connect the power cord to an appropriately rated and properly grounded electrical outlet that is near the product and easily accessible.

- 8 Turn on the printer.

Installing a printer hard disk

CAUTION—SHOCK HAZARD: To avoid the risk of electrical shock, if you are accessing the controller board or installing optional hardware or memory devices sometime after setting up the printer, then turn the printer off, and unplug the power cord from the electrical outlet before continuing. If you have any other devices attached to the printer, then turn them off as well, and unplug any cables going into the printer.

- 1 Turn off the printer.
- 2 Unplug the power cord from the electrical outlet, and then from the printer.
- 3 Open the controller board access cover.

Warning—Potential Damage: Controller board electronic components are easily damaged by static electricity. Touch a metal surface on the printer before touching any controller board components or connectors.

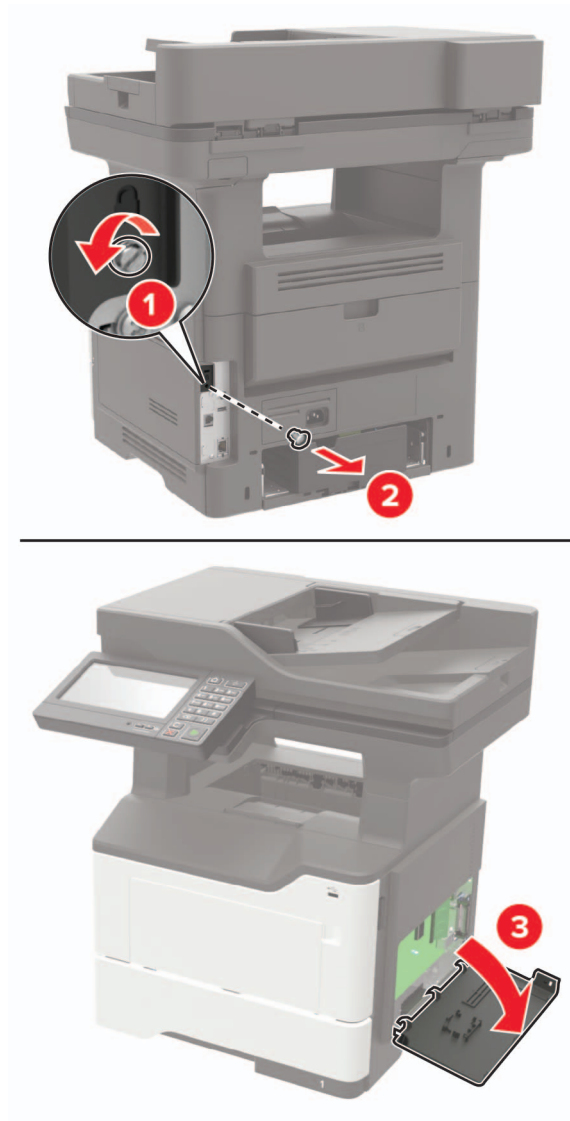

4 Unpack the hard disk.

5 Attach the hard disk to the controller board.

Warning—Potential Damage: Do not touch or press the center of the hard disk.

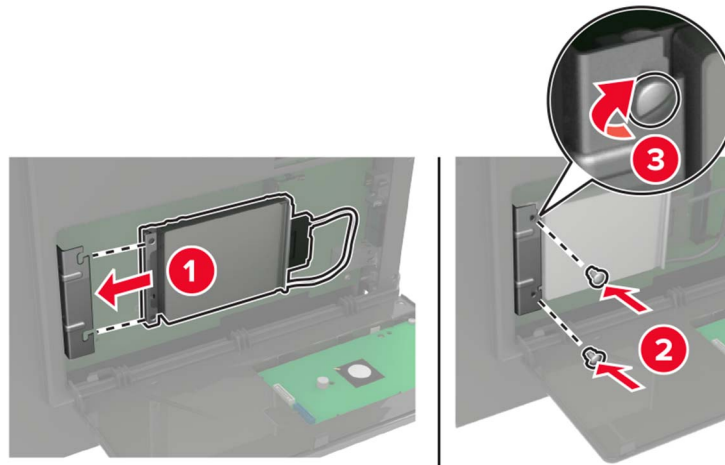

- 6 Attach the hard disk interface cable to the controller board.

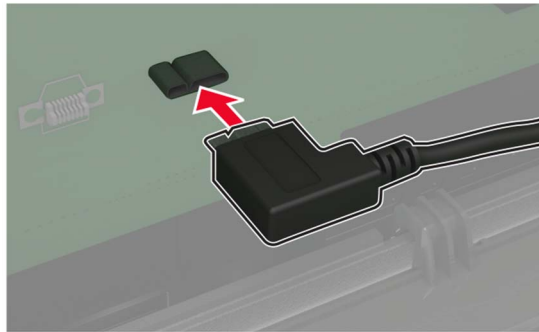

- 7 Close the access cover.
8 Connect the power cord to the printer, and then to the electrical outlet.

⚠ CAUTION—POTENTIAL INJURY: To avoid the risk of fire or electrical shock, connect the power cord to an appropriately rated and properly grounded electrical outlet that is near the product and easily accessible.

- 9 Turn on the printer.

Installing an internal solutions port

⚠ CAUTION—SHOCK HAZARD: To avoid the risk of electrical shock, if you are accessing the controller board or installing optional hardware or memory devices sometime after setting up the printer, then turn the printer off, and unplug the power cord from the electrical outlet before continuing. If you have any other devices attached to the printer, then turn them off as well, and unplug any cables going into the printer.

- 1 Turn off the printer.
- 2 Unplug the power cord from the electrical outlet, and then from the printer.
- 3 Unpack the internal solutions port (ISP) kit.

Note: Remove the preinstalled interface cable from the ISP.

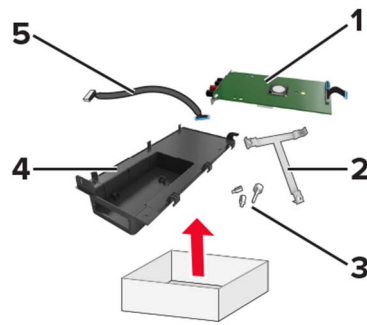

1	ISP
2	Mounting bracket
3	Thumbscrews
4	Housing
5	Interface cable

4 Install the ISP into its housing.

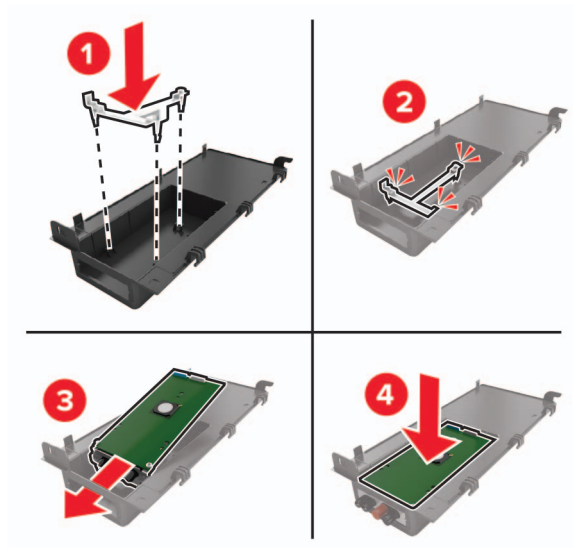

5 Secure the ISP in place and attach the ISP extended cable.

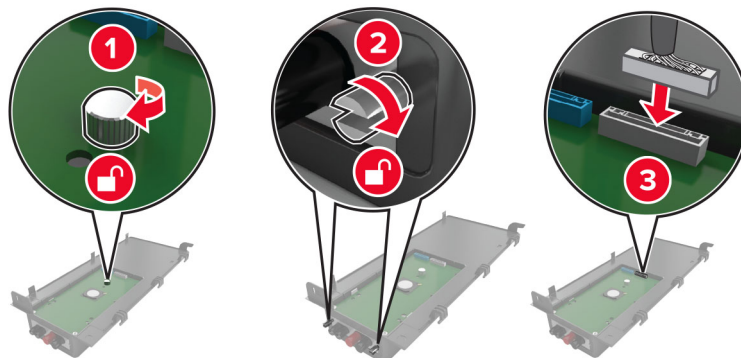

6 Open, and then remove the controller board access cover.

Warning—Potential Damage: Controller board electronic components are easily damaged by static electricity. Touch a metal surface on the printer before touching any controller board electronic components or connectors.

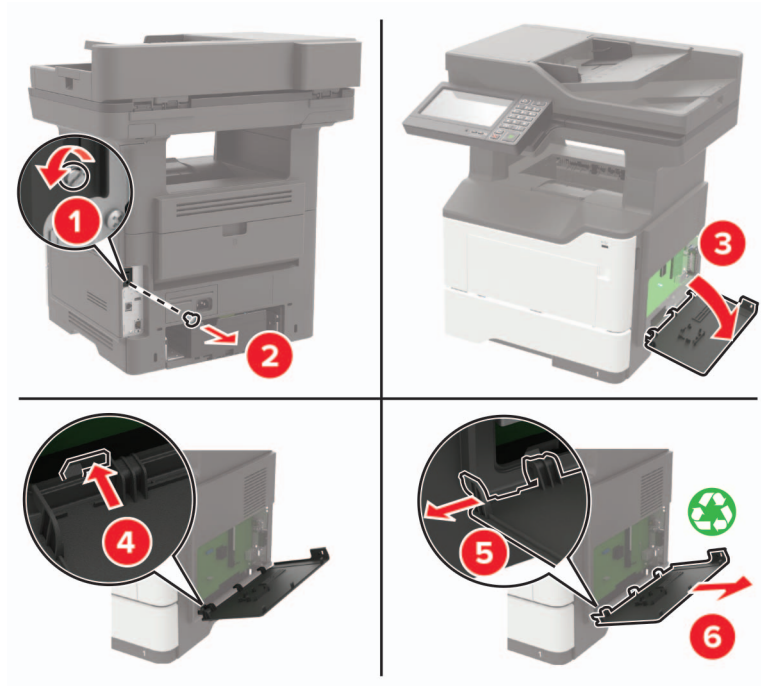
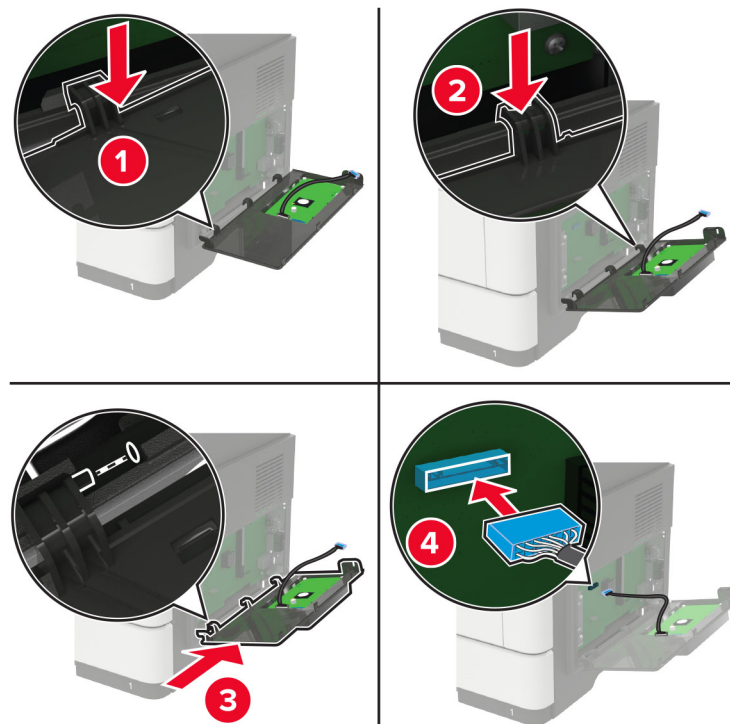
**7** Attach the ISP kit to the printer.

If a printer hard disk is installed, then remove the hard disk before installing the ISP.

- a** Unplug the hard disk interface cable from the controller board.

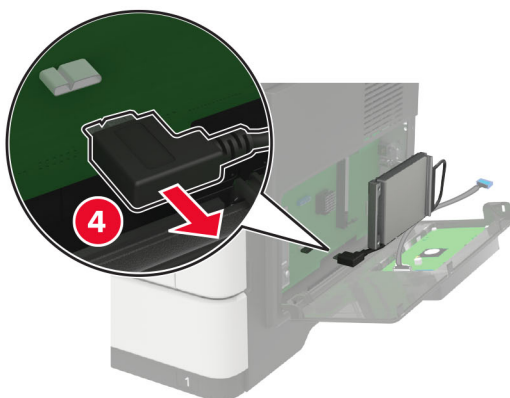
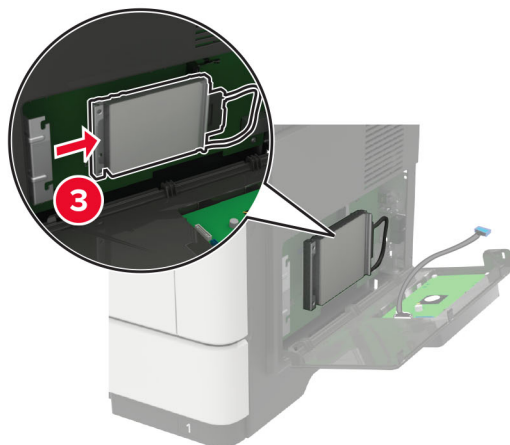
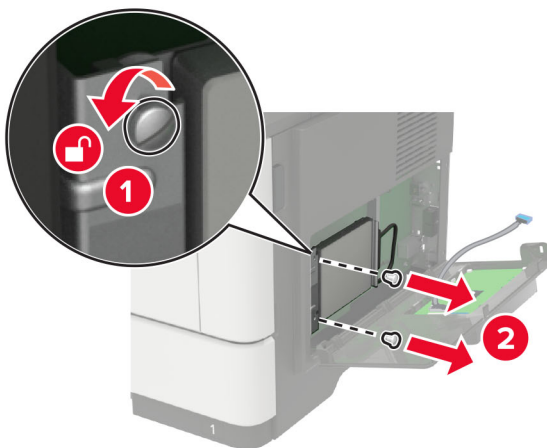

- b** Connect the ISP extended cable to the ISP connector.

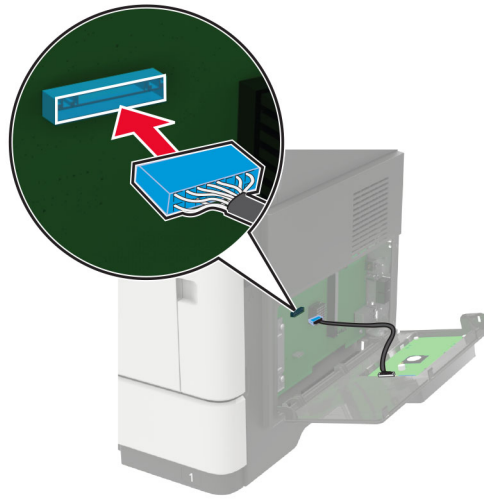

c Install the hard disk.

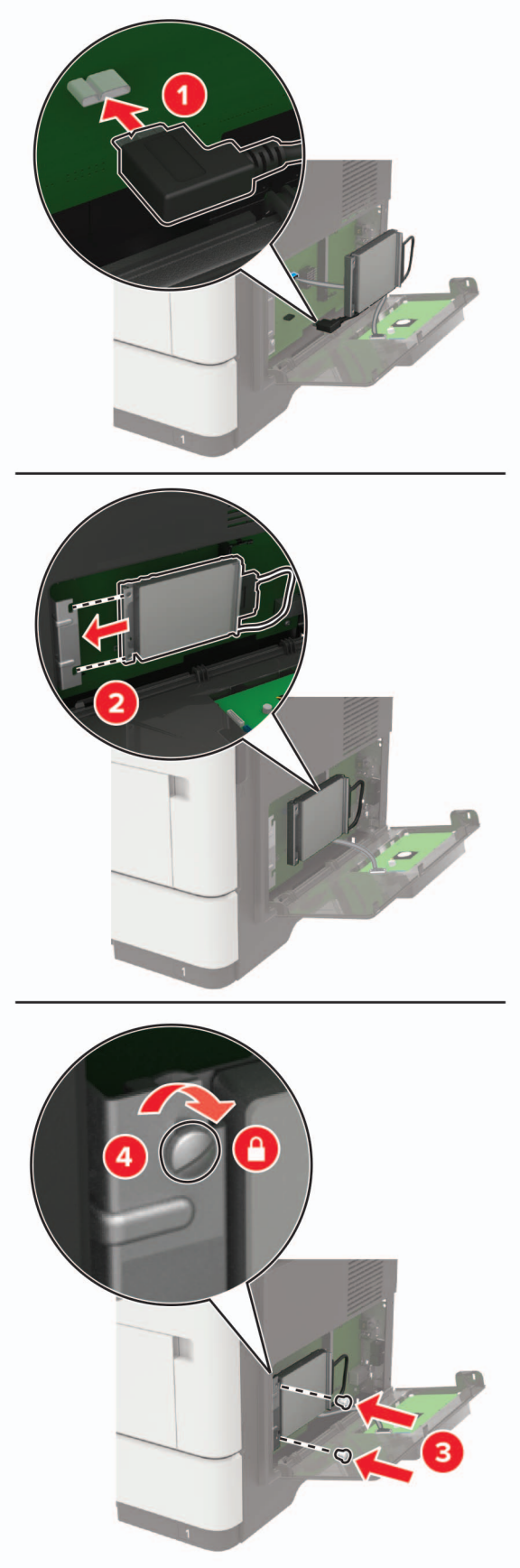

- 8 Close the access cover.
- 9 Connect the power cord to the printer, and then to the electrical outlet.

⚠ CAUTION—POTENTIAL INJURY: To avoid the risk of fire or electrical shock, connect the power cord to an appropriately rated and properly grounded electrical outlet that is near the product and easily accessible.

- 10 Turn on the printer.

Installing optional trays

⚠ CAUTION—SHOCK HAZARD: To avoid the risk of electrical shock, if you are accessing the controller board or installing optional hardware or memory devices sometime after setting up the printer, then turn the printer off, and unplug the power cord from the electrical outlet before continuing. If you have any other devices attached to the printer, then turn them off as well, and unplug any cables going into the printer.

- 1 Turn off the printer.
- 2 Unplug the power cord from the electrical outlet, and then from the printer.
- 3 Unpack the optional tray, and then remove all packing material.
- 4 Align the printer with the optional tray, and then lower the printer into place.

⚠ CAUTION—POTENTIAL INJURY: If the printer weight is greater than 20 kg (44 lb), then it may require two or more people to lift it safely.



- 5 Connect the power cord to the printer, and then to the electrical outlet.

⚠ CAUTION—POTENTIAL INJURY: To avoid the risk of fire or electrical shock, connect the power cord to an appropriately rated and properly grounded electrical outlet that is near the product and easily accessible.

- 6 Turn on the printer.

Add the tray in the print driver to make it available for print jobs. For more information, see [“Adding available options in the print driver” on page 235](#).

Software

Installing the printer software

Notes:

- The print driver is included in the software installer package.
 - For Macintosh computers with macOS version 10.7 or later, you do not need to install the driver to print on an AirPrint-certified printer.
- 1 Obtain a copy of the software installer package.
 - From the software CD that came with your printer.
 - Go to <http://support.lexmark.com>, and then select your printer and operating system.
 - 2 Run the installer, and then follow the instructions on the computer screen.

Adding available options in the print driver

For Windows users

- 1 Open the printers folder.
- 2 Select the printer you want to update, and then do either of the following:
 - For Windows 7 or later, select **Printer properties**.
 - For earlier versions, select **Properties**.
- 3 Navigate to the Configuration tab, and then select **Update Now - Ask Printer**.
- 4 Apply the changes.

For Macintosh users

- 1 From System Preferences in the Apple menu, navigate to your printer, and then select **Options & Supplies**.
- 2 Navigate to the list of hardware options, and then add any installed options.
- 3 Apply the changes.

Firmware

Exporting or importing a configuration file

You can export the configuration settings of your printer into a text file, and then import the file to apply the settings to other printers.

- 1 Open a web browser, and then type the printer IP address in the address field.

Notes:

- View the printer IP address on the printer home screen. The IP address appears as four sets of numbers separated by periods, such as 123.123.123.123.

- If you are using a proxy server, then temporarily disable it to load the web page correctly.
- 2** From the Embedded Web Server, click **Export Configuration** or **Import Configuration**.
 - 3** Follow the instructions on the screen.
 - 4** If the printer supports applications, then do the following:
 - a** Click **Apps** > select the application > **Configure**.
 - b** Click **Export** or **Import**.

Updating firmware

Some applications require a minimum device firmware level to operate correctly.

For more information on updating the device firmware, contact your Lexmark representative.

- 1** Open a web browser, and then type the printer IP address in the address field.

Notes:

- View the printer IP address on the printer home screen. The IP address appears as four sets of numbers separated by periods, such as 123.123.123.123.
 - If you are using a proxy server, then temporarily disable it to load the web page correctly.
- 2** Click **Settings** > **Device** > **Update Firmware**.
 - 3** Browse to the flash file.
 - 4** Click **Upload**.

Notices

Product information

Product name:

Lexmark MB2650ade, Lexmark MB2650adwe; Lexmark MX622ade, Lexmark MX622adhe; Lexmark XM3250 MFPs

Machine type:

7018

Model(s):

676, 678, 679, 686

Edition notice

February 2020

The following paragraph does not apply to any country where such provisions are inconsistent with local law: LEXMARK INTERNATIONAL, INC., PROVIDES THIS PUBLICATION "AS IS" WITHOUT WARRANTY OF ANY KIND, EITHER EXPRESS OR IMPLIED, INCLUDING, BUT NOT LIMITED TO, THE IMPLIED WARRANTIES OF MERCHANTABILITY OR FITNESS FOR A PARTICULAR PURPOSE. Some states do not allow disclaimer of express or implied warranties in certain transactions; therefore, this statement may not apply to you.

This publication could include technical inaccuracies or typographical errors. Changes are periodically made to the information herein; these changes will be incorporated in later editions. Improvements or changes in the products or the programs described may be made at any time.

References in this publication to products, programs, or services do not imply that the manufacturer intends to make these available in all countries in which it operates. Any reference to a product, program, or service is not intended to state or imply that only that product, program, or service may be used. Any functionally equivalent product, program, or service that does not infringe any existing intellectual property right may be used instead. Evaluation and verification of operation in conjunction with other products, programs, or services, except those expressly designated by the manufacturer, are the user's responsibility.

For Lexmark technical support, go to <http://support.lexmark.com>.

For information on Lexmark's privacy policy governing the use of this product, go to www.lexmark.com/privacy.

For information on supplies and downloads, go to www.lexmark.com.

© 2018 Lexmark International, Inc.

All rights reserved.

GOVERNMENT END USERS

The Software Program and any related documentation are "Commercial Items," as that term is defined in 48 C.F.R. 2.101, "Computer Software" and "Commercial Computer Software Documentation," as such terms are used in 48 C.F.R. 12.212 or 48 C.F.R. 227.7202, as applicable. Consistent with 48 C.F.R. 12.212 or 48 C.F.R. 227.7202-1 through 227.7207-4, as applicable, the Commercial Computer Software and Commercial Software

Documentation are licensed to the U.S. Government end users (a) only as Commercial Items and (b) with only those rights as are granted to all other end users pursuant to the terms and conditions herein.

Trademarks

Lexmark, the Lexmark logo, and MarkNet are trademarks or registered trademarks of Lexmark International, Inc. in the United States and/or other countries.

Google Cloud Print, Google Chrome, Android, and Google Play are trademarks of Google LLC.

Macintosh, macOS, App Store, Safari, and AirPrint are trademarks of Apple Inc., registered in the U.S. and other countries. Use of the Works with Apple badge means that an accessory has been designed to work specifically with the technology identified in the badge and has been certified by the developer to meet Apple performance standards.

Mopria®, the Mopria® logo, and the Mopria® Alliance logo are registered trademarks and service marks of Mopria Alliance, Inc. in the United States and other countries. Unauthorized use is strictly prohibited.

PCL® is a registered trademark of the Hewlett-Packard Company. PCL is Hewlett-Packard Company’s designation of a set of printer commands (language) and functions included in its printer products. This printer is intended to be compatible with the PCL language. This means the printer recognizes PCL commands used in various application programs, and that the printer emulates the functions corresponding to the commands.

PostScript is a registered trademark of Adobe Systems Incorporated in the United States and/or other countries.

Wi-Fi® and Wi-Fi Direct® are registered trademarks of Wi-Fi Alliance®.

All other trademarks are the property of their respective owners.

Licensing notices

All licensing notices associated with this product can be viewed from the CD:\NOTICES directory of the installation software CD.

Noise emission levels

The following measurements were made in accordance with ISO 7779 and reported in conformance with ISO 9296.

Note: Some modes may not apply to your product.

1-meter average sound pressure, dBA	
Printing	One-sided: 55; Two-sided: 54
Scanning	56
Copying	56
Ready	14

Values are subject to change. See www.lexmark.com for current values.

Waste from Electrical and Electronic Equipment (WEEE) directive



The WEEE logo signifies specific recycling programs and procedures for electronic products in countries of the European Union. We encourage the recycling of our products.

If you have further questions about recycling options, visit the Lexmark Web site at www.lexmark.com for your local sales office phone number.

India E-Waste notice



This product complies with the India E-Waste (Management and Handling) Rules, 2011, which prohibit use of lead, mercury, hexavalent chromium, polybrominated biphenyls, or polybrominated diphenyl ethers in concentrations exceeding 0.1% by weight and 0.01% by weight for cadmium, except for the exemption set in Schedule II of the Rules.

Product disposal

Do not dispose of the printer or supplies in the same manner as normal household waste. Consult your local authorities for disposal and recycling options.

Returning Lexmark cartridges for reuse or recycling

The Lexmark Cartridge Collection Program allows you to return used cartridges for free to Lexmark for reuse or recycling. One hundred percent of the empty cartridges returned to Lexmark are either reused or demanufactured for recycling. The boxes used to return the cartridges are also recycled.

To return Lexmark cartridges for reuse or recycling, do the following:

- 1 Go to www.lexmark.com/recycle.
- 2 Select the product that you want to recycle.

Static sensitivity notice

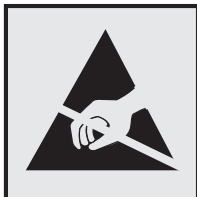

This symbol identifies static-sensitive parts. Do not touch the areas near these symbols without first touching a metal surface in an area away from the symbol.

To prevent damage from electrostatic discharge when performing maintenance tasks such as clearing paper jams or replacing supplies, touch any exposed metal frame of the printer before accessing or touching interior areas of the printer even if the symbol is not present.

ENERGY STAR

Any Lexmark product bearing the ENERGY STAR® emblem on the product or on a start-up screen is certified to comply with Environmental Protection Agency (EPA) ENERGY STAR requirements as of the date of manufacture.



Temperature information

Ambient operating temperature	10 to 32°C (50 to 90°F)
Shipping temperature	-20 to 40°C (-4 to 104°F)
Storage temperature and relative humidity	0 to 40°C (32 to 104°F) 8 to 80% RH

Laser notice

The printer is certified in the U.S. to conform to the requirements of DHHS 21 CFR, Chapter I, Subchapter J for Class I (1) laser products, and elsewhere is certified as a Class I laser product conforming to the requirements of IEC 60825-1: 2014.

Class I laser products are not considered to be hazardous. The laser system and printer are designed so there is never any human access to laser radiation above a Class I level during normal operation, user maintenance, or prescribed service conditions. The printer has a non-serviceable printhead assembly that contains a laser with the following specifications:

Class: IIIb (3b) AlGaInP

Nominal output power (milliwatts): 15

Wavelength (nanometers): 650–670

Power consumption

Product power consumption

The following table documents the power consumption characteristics of the product.

Note: Some modes may not apply to your product.

Mode	Description	Power consumption (Watts)
Printing	The product is generating hard-copy output from electronic inputs.	670 (one-sided); 410 (two-sided)
Copy	The product is generating hard-copy output from hard-copy original documents.	680
Scan	The product is scanning hard-copy documents.	23.5
Ready	The product is waiting for a print job.	16.5
Sleep Mode	The product is in a high-level energy-saving mode.	1.8
Hibernate	The product is in a low-level energy-saving mode.	0.1
Off	The product is plugged into an electrical outlet, but the power switch is turned off.	0.1

The power consumption levels listed in the previous table represent time-averaged measurements. Instantaneous power draws may be substantially higher than the average.

Values are subject to change. See www.lexmark.com for current values.

Sleep Mode

This product is designed with an energy-saving mode called *Sleep Mode*. The Sleep Mode saves energy by lowering power consumption during extended periods of inactivity. The Sleep Mode is automatically engaged after this product is not used for a specified period of time, called the *Sleep Mode Timeout*.

Factory default Sleep Mode Timeout for this product (in minutes):	15
---	----

By using the configuration menus, the Sleep Mode Timeout can be modified between 1 minute and 120 minutes. If the print speed is less than or equal to 30 pages per minute, then you can set the timeout only up to 60 minutes. Setting the Sleep Mode Timeout to a low value reduces energy consumption, but may increase the response time of the product. Setting the Sleep Mode Timeout to a high value maintains a fast response, but uses more energy.

Hibernate Mode

This product is designed with an ultra-low power operating mode called *Hibernate mode*. When operating in Hibernate Mode, all other systems and devices are powered down safely.

The Hibernate mode can be entered in any of the following methods:

- Using the Hibernate Timeout
- Using the Schedule Power modes

Factory default Hibernate Timeout for this product in all countries or regions	3 days
--	--------

The amount of time the printer waits after a job is printed before it enters Hibernate mode can be modified between one hour and one month.

Off mode

If this product has an off mode which still consumes a small amount of power, then to completely stop product power consumption, disconnect the power supply cord from the electrical outlet.

Total energy usage

It is sometimes helpful to estimate the total product energy usage. Since power consumption claims are provided in power units of Watts, the power consumption should be multiplied by the time the product spends in each mode in order to calculate energy usage. The total product energy usage is the sum of each mode's energy usage.

Regulatory notices for telecommunication terminal equipment

This section contains regulatory information pertaining to products that contain the analog facsimile card:

Lexmark Regulatory Type/Model Number:

LEX-M14-002

Notice to users of the US telephone network: FCC requirements

This equipment complies with Part 68 of the FCC rules and the requirements adopted by the Administrative Council for Terminal Attachments (ACTA). On the back of this equipment is a label that contains, among other information, a product identifier in the format US:AAAEQ##TXXXX. If requested, this number must be provided to your telephone company.

This equipment uses the RJ-11C Universal Service Order Code (USOC) jack.

A plug and jack used to connect this equipment to the premises' wiring and telephone network must comply with the applicable FCC Part 68 rules and requirements adopted by the ACTA. Use a compliant telephone cord (RJ-11) that is 26 AWG or larger when connecting this product to the public switched telephone network. See your setup documentation for more information.

The Ringer Equivalence Number (REN) is used to determine the number of devices that may be connected to a telephone line. Excessive RENs on a telephone line may result in the devices not ringing in response to an incoming call. In most but not all areas, the sum of RENs should not exceed five (5.0). To be certain of the number of devices that may be connected to a line, as determined by the total RENs, contact your local telephone company. For products approved after July 23, 2001, the REN for this product is part of the product identifier that has the format US:AAAEQ##TXXXX. The digits represented by ## are the REN without a decimal point (for example, 03 is a REN of 0.3). For earlier products, the REN is shown separately on the label.

If this equipment causes harm to the telephone network, the telephone company will notify you in advance that temporary discontinuance of service may be required. If advance notice is not practical, the telephone company will notify the customer as soon as possible. You will also be advised of your right to file a complaint with the FCC.

The telephone company may make changes in its facilities, equipment, operations or procedures that could affect the operation of this equipment. If this happens, the telephone company will provide advance notice in order for you to make necessary modifications to maintain uninterrupted service.

If you experience trouble with this equipment, for repair or warranty information, contact Lexmark International, Inc. at www.lexmark.com or your Lexmark representative. If the equipment is causing harm to the telephone network, the telephone company may request that you disconnect the equipment until the problem is resolved.

This equipment contains no user serviceable parts. For repair and warranty information, contact Lexmark International, Inc. See the previous paragraph for contact information.

Connection to party line service is subject to state tariffs. Contact the state public utility commission, public service commission, or corporation commission for information.

If your home has specially wired alarm equipment connected to the telephone line, ensure the installation of this equipment does not disable your alarm equipment. If you have questions about what will disable alarm equipment, consult your telephone company or a qualified installer.

The Telephone Consumer Protection Act of 1991 makes it unlawful for any person to use a computer or other electronic device, including fax machines, to send any message unless said message clearly contains in a margin at the top or bottom of each transmitted page or on the first page of the transmission, the date and time it is sent and an identification of the business or other entity, or other individual sending the message, and the telephone number of the sending machine or such business, other entity, or individual. (The telephone number provided may not be a 900 number or any other number for which charges exceed local or long-distance transmission charges.)

See your user documentation in order to program this information into your fax machine.

Notice to users of the Canadian telephone network

This product meets the applicable Industry Canada technical specifications.

The Ringer Equivalence Number (REN) indicates the maximum number of devices allowed to be connected to a telephone interface. The termination of an interface may consist of any combination of devices subject only to the requirement that the sum of the RENs of all the devices not exceed five. The REN is located on the product label.

This equipment uses CA11A telephone jacks.

Avis réservé aux utilisateurs du réseau téléphonique du Canada

Ce produit est conforme aux spécifications techniques d'Industrie Canada.

Le numéro REN (ringer equivalence number : numéro d'équivalence de sonnerie) indique le nombre maximum d'appareils pouvant être connectés à l'interface téléphonique. En bout de ligne, le nombre d'appareils qui peuvent être connectés n'est pas directement limité, mais la somme des REN de ces appareils ne doit pas dépasser cinq. Le numéro REN est indiqué sur l'étiquette produit.

Cet équipement utilise des prises de téléphone CA11A.

Notice to users of the New Zealand telephone network

The following are special conditions for the Facsimile User Instructions. The grant of a telepermit for any item of terminal equipment indicates only that Telecom has accepted that the item complies with minimum conditions for connection to its network. It indicates no endorsement of the product by Telecom, nor does it provide any sort of warranty. Above all, it provides no assurance that any item will work correctly in all respects with another item of telepermitted equipment of a different make or model, nor does it imply that any product is compatible with all of Telecom's network services.

This equipment shall not be set up to make automatic calls to the Telecom "111" Emergency Service.

This equipment may not provide for the effective hand-over of a call to another device connected to the same line.

This equipment should not be used under any circumstances that may constitute a nuisance to other Telecom customers.

This equipment is not capable, under all operating conditions, of correct operation at the higher speeds for which it is designed. Telecom will accept no responsibility should difficulties arise in such circumstances.

The decadic (or pulse) dialing on this device is unsuitable for use on the Telecom network in New Zealand.

For correct operation, the total of all the Ringer Equivalence Numbers (RENs) of all parallel devices connected to the same telephone line may not exceed 5. The REN of this device is located on the label.

This device uses an RJ-11C modular connector. Contact your point of purchase if a BT adapter is required. The Lexmark part number is 80D1873.

Some parameters required for compliance with Telecom's telepermit requirements are dependent on the equipment associated with this device. The associated equipment shall be set to operate within the following limits for compliance to Telecom's specifications:

- There shall be no more than 10 call attempts to the same number within any 30 minute period for any single manual call initiation, and
- The equipment shall go on-hook for a period of not less than 30 seconds between the end of one attempt and the beginning of the next call attempt.
- The equipment shall be set to ensure that automatic calls to different numbers are spaced such that there is not less than 5 seconds between the end of one call attempt and the beginning of another.

Japanese telecom notice

The installed optional modem is in compliance with Japanese Telecommunication Law and has been Certified by JATE, with the following Certification Number:

A18-0046001

	Lexmark International, Inc.
	LEX-M14-002
	A18-0046001

Using this product in Switzerland

This product requires a Swiss billing tone filter (Lexmark part number 80D1877) to be installed on any line which receives metering pulses in Switzerland.

Utilisation de ce produit en Suisse

Cet appareil nécessite l'utilisation d'un filtre de tonalité de facturation suisse (n° de référence Lexmark : 80D1877) devant être installé sur toute ligne recevant des impulsions de comptage en Suisse.

Verwendung dieses Produkts in der Schweiz

Für dieses Produkt muss ein schweizerischer Billing Tone Filter zur Zählzeichenübertragung (Lexmark Teilenummer 80D1877) für jede Leitung installiert werden, über die in der Schweiz Zeitsteuertakte übertragen werden.

Uso del prodotto in Svizzera

Questo prodotto richiede un filtro toni Billing svizzero, (codice Lexmark 80D1877) da installare su tutte le linee che ricevono impulsi remoti in Svizzera.

Regulatory notices for wireless products

This section contains regulatory information that applies only to wireless models.

If in doubt as to whether your model is a wireless model, go to <http://support.lexmark.com>.

Modular component notice

Wireless models contain one of the following modular components:

Lexmark Regulatory Type/Model Number LEX-M07-001; FCC ID:IYLLEXM07001; Industry Canada IC:2376A-LEXM07001

Lexmark Regulatory Type/Model Number LEX-M08-001; FCC ID:IYLLEXM08001; IC:2376A-LEXM08001

To determine which modular components are installed in your particular product, refer to the labeling on your actual product.

Exposure to radio frequency radiation

The radiated output power of this device is far below the radio frequency exposure limits of the FCC and other regulatory agencies. A minimum separation of 20 cm (8 inches) must be maintained between the antenna and any persons for this device to satisfy the RF exposure requirements of the FCC and other regulatory agencies.

Industry Canada (Canada)

This device complies with Industry Canada license-exempt RSS standards. Operation is subject to the following two conditions: (1) this device may not cause interference, and (2) this device must accept any interference, including interference that may cause undesired operation of the device.

Industrie Canada (Canada)

Cet appareil est conforme aux normes RSS exemptes de licence d'Industrie Canada. Son fonctionnement est soumis aux deux conditions suivantes : (1) cet appareil ne doit pas causer d'interférences et (2) il doit accepter toutes les interférences, y compris les celles qui peuvent entraîner un fonctionnement indésirable.

European Community (EC) directives conformity

This product is in conformity with the protection requirements of EC Council directive 2014/53/EU on the approximation and harmonization of the laws of the Member States relating to radio equipment.

The manufacturer of this product is: Lexmark International, Inc., 740 West New Circle Road, Lexington, KY, 40550 USA. The authorized representative is: Lexmark International Technology Hungária Kft., 8 Lechner Ödön fasor, Millennium Tower III, 1095 Budapest HUNGARY. A declaration of conformity to the requirements of the Directives is available upon request from the Authorized Representative or may be obtained at www.lexmark.com/en_us/about/regulatory-compliance/european-union-declaration-of-conformity.html.

Compliance is indicated by the CE marking:



EU statement of radio transmitter operational frequency bands and maximum RF power

This radio product transmits in the 2.4GHz (2.412–2.472GHz) band in the EU. The maximum transmitter EIRP power output, including antenna gain, is ≤ 20 dBm.

Federal Communications Commission (FCC) compliance information statement

This product has been tested and found to comply with the limits for a Class A digital device, pursuant to Part 15 of the FCC Rules. Operation is subject to the following two conditions: (1) this device may not cause harmful interference, and (2) this device must accept any interference received, including interference that may cause undesired operation.

The FCC Class A limits are designed to provide reasonable protection against harmful interference when the equipment is operated in a commercial environment. This equipment generates, uses, and can radiate radio frequency energy and, if not installed and used in accordance with the instruction manual, may cause harmful interference to radio communications. Operation of this equipment in a residential area is likely to cause harmful interference, in which case the user will be required to correct the interference at his own expense.

The manufacturer is not responsible for any radio or television interference caused by using other than recommended cables or by unauthorized changes or modifications to this equipment. Unauthorized changes or modifications could void the user's authority to operate this equipment.

Note: To assure compliance with FCC regulations on electromagnetic interference for a Class A computing device, use a properly shielded and grounded cable such as Lexmark part number 1021231 for parallel attach or 1021294 for USB attach. Use of a substitute cable not properly shielded and grounded may result in a violation of FCC regulations.

Any questions regarding this compliance information statement should be directed to:

Director of Lexmark Technology & Services
Lexmark International, Inc.
740 West New Circle Road
Lexington, KY 40550
Telephone: (859) 232-2000
E-mail: regulatory@lexmark.com

Industry Canada compliance statement

This Class A digital apparatus meets all requirements of the Canadian Interference-Causing Equipment Standard ICES-003.

Avis de conformité aux normes de l'industrie du Canada

Cet appareil numérique de classe A est conforme aux exigences de la norme canadienne relative aux équipements pouvant causer des interférences NMB-003.

Notice to users of Class A products in Brazil

Este produto não é apropriado para uso em ambientes domésticos, pois poderá causar interferências eletromagnéticas que obrigam o usuário a tomar medidas necessárias para minimizar estas interferências.

European Community (EC) directives conformity

This product is in conformity with the protection requirements of EC Council directives 2014/30/EU, 2014/35/EU, and 2011/65/EU on the approximation and harmonization of the laws of the Member States relating to electromagnetic compatibility, safety of electrical equipment designed for use within certain voltage limits, and on the restrictions of use of certain hazardous substances in electrical and electronic equipment.

The manufacturer of this product is: Lexmark International, Inc., 740 West New Circle Road, Lexington, KY, 40550 USA. The authorized representative is: Lexmark International Technology Hungária Kft., 8 Lechner Ödön fasor, Millennium Tower III, 1095 Budapest HUNGARY. A declaration of conformity to the requirements of the Directives is available upon request from the Authorized Representative or may be obtained at www.lexmark.com/en_us/about/regulatory-compliance/european-union-declaration-of-conformity.html.

This product satisfies the Class A limits of EN 55022 and EN55032 and safety requirements of EN 60950-1 or EN 62368-1.

Radio interference notice

Warning

This is a product that complies with the emission requirements of EN55022 and EN55032 Class A limits and immunity requirements of EN55024. This product is not intended to be used in residential/domestic environments.

This is a Class A product. In a domestic environment, this product may cause radio interference, in which case the user may be required to take adequate measures.

STATEMENT OF LIMITED WARRANTY FOR LEXMARK LASER PRINTERS, LEXMARK LED PRINTERS, AND LEXMARK MULTIFUNCTION LASER PRINTERS

Lexmark International, Inc., Lexington, KY

This limited warranty applies to the United States and Canada. For customers outside the U.S., refer to the country-specific warranty information that came with your product.

This limited warranty applies to this product only if it was originally purchased for your use, and not for resale, from Lexmark or a Lexmark Remarketer, referred to in this statement as “Remarketer.”

Limited warranty

Lexmark warrants that this product:

- Is manufactured from new parts, or new and serviceable used parts, which perform like new parts
- Is, during normal use, free from defects in material and workmanship

If this product does not function as warranted during the warranty period, contact a Remarketer or Lexmark for repair or replacement (at Lexmark's option).

If this product is a feature or option, this statement applies only when that feature or option is used with the product for which it was intended. To obtain warranty service, you may be required to present the feature or option with the product.

If you transfer this product to another user, warranty service under the terms of this statement is available to that user for the remainder of the warranty period. You should transfer proof of original purchase and this statement to that user.

Limited warranty service

The warranty period starts on the date of original purchase as shown on the purchase receipt and ends 12 months later provided that the warranty period for any supplies and for any maintenance items included with the printer shall end earlier if it, or its original contents, are substantially used up, depleted, or consumed. Fuser Units, Transfer/Transport Units, Paper Feed items, if any, and any other items for which a Maintenance Kit is available are substantially consumed when the printer displays a “Life Warning” or “Scheduled Maintenance” message for such item.

To obtain warranty service you may be required to present proof of original purchase. You may be required to deliver your product to the Remarketer or Lexmark, or ship it prepaid and suitably packaged to a Lexmark

designated location. You are responsible for loss of, or damage to, a product in transit to the Remarketer or the Lexmark designated location.

When warranty service involves the exchange of a product or part, the item replaced becomes the property of the Remarketer or Lexmark. The replacement may be a new or repaired item.

The replacement item assumes the remaining warranty period of the original product.

Replacement is not available to you if the product you present for exchange is defaced, altered, in need of a repair not included in warranty service, damaged beyond repair, or if the product is not free of all legal obligations, restrictions, liens, and encumbrances.

As part of your warranty service and/or replacement, Lexmark may update the firmware in your printer to the latest version. Firmware updates may modify printer settings and cause counterfeit and/or unauthorized products, supplies, parts, materials (such as toners and inks), software, or interfaces to stop working. Authorized use of genuine Lexmark products will not be impacted.

Before you present this product for warranty service, remove all print cartridges, programs, data, and removable storage media (unless directed otherwise by Lexmark).

For further explanation of your warranty alternatives and the nearest Lexmark authorized servicer in your area contact Lexmark on the World Wide Web.

Remote technical support is provided for this product throughout its warranty period. For products no longer covered by a Lexmark warranty, technical support may not be available or only be available for a fee.

Extent of limited warranty

Lexmark does not warrant uninterrupted or error-free operation of any product or the durability or longevity of prints produced by any product.

Warranty service does not include repair of failures caused by:

- Modification or unauthorized attachments
- Accidents, misuse, abuse or use inconsistent with Lexmark user's guides, manuals, instructions or guidance
- Unsuitable physical or operating environment
- Maintenance by anyone other than Lexmark or a Lexmark authorized servicer
- Operation of a product beyond the limit of its duty cycle
- Use of printing media outside of Lexmark specifications
- Refurbishment, repair, refilling or remanufacture by a third party of products, supplies or parts
- Products, supplies, parts, materials (such as toners and inks), software, or interfaces not furnished by Lexmark

TO THE EXTENT PERMITTED BY APPLICABLE LAW, NEITHER LEXMARK NOR ITS THIRD PARTY SUPPLIERS OR REMARKETERS MAKE ANY OTHER WARRANTY OR CONDITION OF ANY KIND, WHETHER EXPRESS OR IMPLIED, WITH RESPECT TO THIS PRODUCT, AND SPECIFICALLY DISCLAIM THE IMPLIED WARRANTIES OR CONDITIONS OF MERCHANTABILITY, FITNESS FOR A PARTICULAR PURPOSE, AND SATISFACTORY QUALITY. ANY WARRANTIES THAT MAY NOT BE DISCLAIMED UNDER APPLICABLE LAW ARE LIMITED IN DURATION TO THE WARRANTY PERIOD. NO WARRANTIES, EXPRESS OR IMPLIED, WILL APPLY AFTER THIS PERIOD. ALL INFORMATION, SPECIFICATIONS, PRICES, AND SERVICES ARE SUBJECT TO CHANGE AT ANY TIME WITHOUT NOTICE.

Limitation of liability

Your sole remedy under this limited warranty is set forth in this document. For any claim concerning performance or nonperformance of Lexmark or a Remarketer for this product under this limited warranty, you may recover actual damages up to the limit set forth in the following paragraph.

Lexmark's liability for actual damages from any cause whatsoever will be limited to the amount you paid for the product that caused the damages. This limitation of liability will not apply to claims by you for bodily injury or damage to real property or tangible personal property for which Lexmark is legally liable. **IN NO EVENT WILL LEXMARK BE LIABLE FOR ANY LOST PROFITS, LOST SAVINGS, INCIDENTAL DAMAGE, OR OTHER ECONOMIC OR CONSEQUENTIAL DAMAGES.** This is true even if you advise Lexmark or a Remarketer of the possibility of such damages. Lexmark is not liable for any claim by you based on a third party claim.

This limitation of remedies also applies to claims against any Suppliers and Remarketers of Lexmark. Lexmark's and its Suppliers' and Remarketers' limitations of remedies are not cumulative. Such Suppliers and Remarketers are intended beneficiaries of this limitation.

Additional rights

Some states do not allow limitations on how long an implied warranty lasts, or do not allow the exclusion or limitation of incidental or consequential damages, so the limitations or exclusions contained above may not apply to you.

This limited warranty gives you specific legal rights. You may also have other rights that vary from state to state.

Index

A

- accessing the controller board 221
- activating Voice Guidance 24
- adapter plug 49
- adding a shortcut
 - copy 42
- adding contacts 22
- adding groups 22
- adding hardware options
 - print driver 235
- adding internal options
 - print driver 235
- adding shortcut
 - e-mail 44
 - fax destination 53
 - FTP address 55
- ADF registration
 - adjusting 220
- ADF separator roller
 - replacing 155
- adjusting
 - scanner registration 220
- adjusting ADF registration 220
- adjusting darkness
 - fax 53
- adjusting default volume
 - headphone 132
 - speaker 132
- adjusting speech rate
 - Voice Guidance 25
- adjusting the brightness
 - printer display 159
- adjusting the brightness of the printer display 159
- adjusting toner darkness 211
- AirPrint
 - using 34
- Android device
 - printing from 33
- answering machine
 - setting up 47
- assigning printer to a ring pattern 51
- attaching cables 14
- automatic document feeder (ADF)
 - using 40, 43, 46, 55

- avoiding paper jams 161

B

- blank pages 184
- blocking junk faxes 53
- bookmarks
 - creating 21
 - creating folders for 21

C

- cable
 - Ethernet 14
 - USB 14
- can send but not receive faxes 215
- canceling a print job
 - from the computer 38
 - from the printer control panel 38
- cannot open Embedded Web Server 176
- cannot receive faxes 215
- Card Copy
 - setting up 18
- changing resolution
 - fax 53
- changing the printer port settings after installing ISP 135
- changing the wallpaper 19
- checking the status of parts and supplies 139
- cleaning
 - exterior of the printer 136
 - interior of the printer 136
- cleaning the printer 136
- cleaning the scanner 128, 136
- clearing jam
 - in door A 163
- clearing jams
 - in the finisher 172
- collated printing does not work 182
- collating copies 41
- confidential print jobs 37
 - printing from a Macintosh computer 37
 - printing from Windows 37
- configuring Eco-Mode setting 19
- configuring Eco-Settings 19
- configuring supply notifications 142
- configuring the settings
 - fax speaker 132
- configuring the SMTP server 43
- configuring the SMTP server for fax 46
- connecting printer to distinctive ring service 51
- connecting the mobile device to the printer wireless
 - network 134
- connecting the printer to a wireless network 133
- connecting to a wireless network
 - using PIN method 133
 - using Push Button method 133
- conserving supplies 159
- contacting customer support 220
- contacts
 - adding 22
 - deleting 23
 - editing 22
- control panel
 - using 15
- controller board
 - accessing 221
- copy troubleshooting
 - partial copies of documents or photos 217
 - poor copy quality 217
 - scanner does not respond 219
 - scanner unit does not close 219
- copying
 - on both sides of the paper 41
 - on letterhead 41
 - photos 40
 - using the automatic document feeder (ADF) 40
 - using the scanner glass 40
- copying different paper sizes 40
- copying from
 - selected tray 40
- copying multiple pages onto a single sheet 42

- creating a shortcut
 - copy 42
- creating bookmarks 21
- creating folders
 - for bookmarks 21
- creating shortcut
 - e-mail 44
 - fax destination 53
 - FTP address 55
- creating shortcuts 18
- crooked print 197
- Customer Support
 - using 20
- customer support
 - contacting 220
- customizing the display 19

D

- date and time
 - fax settings 52
- deactivating the Wi-Fi network 134
- default headphone volume
 - adjusting 132
- default speaker volume
 - adjusting 132
- Defective flash detected 179
- deleting contacts 23
- deleting groups 23
- Device Quotas
 - setting up 20
- different paper sizes, copying 40
- directory list
 - printing 38
- Display Customization
 - using 19
- distinctive ring service, fax
 - enabling 51
- documents
 - scanning to a fax server 57
- documents, printing
 - from a computer 33
 - from a mobile device 33
- dots on print 194

E

- Eco-Settings
 - configuring 19
- editing contacts 22
- editing groups 22
- emission notices 238, 245, 247

- enabling Magnification mode 24
- enabling personal identification numbers 25
- enabling spoken passwords 25
- enabling the USB port 177
- enabling Wi-Fi Direct 134
- encrypting
 - printer hard disk 130
- enlarging copies 41
- environmental settings 158
- erasing printer hard disk memory 129
- erasing printer memory 130
- Ethernet port 14
- exporting a configuration file
 - using the Embedded Web Server 235
- e-mail server
 - setting up 43
- e-mail shortcut
 - creating 44
- e-mailing
 - using a shortcut number 44
 - using the address book 44
 - using the automatic document feeder (ADF) 43
 - using the printer 44
 - using the scanner glass 43

F

- factory default settings
 - restoring 130
- fax
 - configuring the SMTP server 46
 - forwarding 54
 - holding 53
 - setting the schedule to send 52
- fax darkness
 - adjusting 53
- fax destination shortcut
 - creating 53
- fax log
 - viewing 53
- fax port 14
- fax resolution
 - changing 53
- fax setup
 - country- or region-specific 49
 - standard telephone line connection 47
- fax speaker
 - configuring the settings 132

- fax troubleshooting
 - cannot receive faxes 215
 - cannot send faxes 215
 - cannot send or receive faxes 213
 - poor print quality 216
- faxing
 - setting the date and time 52
 - using the automatic document feeder (ADF) 46
 - using the scanner glass 46
- FCC notices 245
- finding more information about the printer 10
- firmware, updating 236
- flash drive
 - printing from 35
 - scanning to 56
- folder paper 188
- font sample list
 - printing 38
- FTP address
 - creating shortcut 55
- FTP server, scanning to
 - using the control panel 55

G

- genuine Lexmark parts and supplies 139
- Google Cloud Print
 - using 33
- groups
 - adding 22
 - deleting 23
 - editing 22

H

- hardware options
 - trays 234
- hardware options, adding print driver 235
- held jobs 37
 - printing from a Macintosh computer 37
 - printing from Windows 37
- Help menu 127
- Hibernate mode
 - configuring 158
- holding faxes 53
- home screen
 - customizing 18

home screen icons
 displaying 18
 using 17

I

icons on the home screen
 showing 18
identifying jam locations 162
imaging unit
 ordering 141
 replacing 145
importing a configuration file
 using the Embedded Web
 Server 235
indicator light
 understanding the status 15
installing a memory card 223
installing a printer hard disk 226
installing an internal solutions
port 228
installing an optional card 225
installing options
 printer hard disk 226
installing the print driver 235
installing the printer
software 235
installing trays 234
internal option is not
detected 178
internal options
 firmware cards 221
 flash memory 221
 font cards 221
 installing 225
 internal solutions port 221
 memory card 223
 printer hard disk 226
internal options, adding
 print driver 235
internal solutions port
 installing 228
 troubleshooting 179
IPSec menu 113

J

jam, clearing
 finisher 174
jams
 avoiding 161

jams, clearing
 in the automatic document
 feeder 171
 in the duplex unit 169
 in the multipurpose feeder 170
 in the standard bin 168
 trays 170
junk faxes
 blocking 53

K

keyboard on the display
 using 25

L

letterhead
 copying on 41
Lexmark Mobile Print
 using 33
LINE port 14
linking trays 29
loading
 multipurpose feeder 28
loading envelopes
 in the multipurpose feeder 28
loading trays 26
locating paper jams 162
locating the security slot 129

M

Magnification mode
 enabling 24
maintenance kit
 ordering 142
making copies 40
managing screen saver 19
Media Types menu 83
memory card
 installing 223
menu
 802.1x 114
 About this Printer 72
 Accessibility 66
 Confidential Print Setup 123
 Configuration Menu 67
 Copy Defaults 83
 Custom Scan Sizes 82
 Device 126
 Eco-Mode 61
 Erase Temporary Data Files 125
 Ethernet 109

E-mail Defaults 93
E-mail Setup 91
Fax 127
Fax Mode 87
Fax Server Setup 90
Fax Setup 87
Finishing 73
Flash Drive Print 104
Flash Drive Scan 101
FTP Defaults 97
Google Cloud Print 117
HTML 79
HTTP/FTP Settings 115
Image 80
Information Sent to Lexmark 65
IPSec 113
Job Accounting 75
Layout 72
Local Accounts 120
Login Restrictions 123
LPD Configuration 114
Manage Permissions 118
Media Types 83
Menu Settings Page 126
Miscellaneous 125
Mobile Services
 Management 125
 Network 127
Network Overview 106
Notifications 62
Out of Service Erase 71
PCL 78
PDF 77
PostScript 77
Power Management 65
Preferences 59
Print 126
Quality 75
Remote Operator Panel 62
Restrict external network
 access 116
Security Audit Log 121
Setup 74
Shortcuts 127
SNMP 112
Solutions LDAP Settings 125
TCP/IP 110
ThinPrint 115
Tray Configuration 81
Troubleshooting 128
Universal Setup 81
USB 116

- Visible Home Screen Icons 71
- Web Link Setup 97
- Wi-Fi Direct 117
- XPS 77
- Menu Settings Page
 - printing 128
- menus
 - Disk Encryption 124
 - Restore Factory Defaults 67
 - Schedule USB Devices 120
 - Wireless 106
- mobile device
 - printing from 33, 34
- Mopria Print Service 33
- mottled print 194
- moving the printer 11, 158
- multipurpose feeder
 - loading 28

N

- navigating the screen
 - using gestures 24
- navigating the screen using gestures 24
- network setup page
 - printing 177
- noise emission levels 238
- Non-Lexmark supply 180
- non-volatile memory 130
 - erasing 129
- Not enough free space in flash memory for resources 179
- notices 238, 239, 240, 241, 242, 245, 247

O

- optional card
 - installing 225
- options
 - internal solutions port 228
- ordering
 - imaging unit 141
 - maintenance kit 142
 - staple cartridges 142
- ordering supplies
 - toner cartridge 140

P

- paper
 - Universal size setting 26
 - paper jam in door A 163

- paper jam in the automatic document feeder 171
- paper jam in the duplex unit 169
- paper jam in the finisher 172
- paper jam in the multipurpose feeder 170
- paper jam in the rear door 167
- paper jam in trays 170
- paper jam, clearing
 - in the automatic document feeder 171
 - in the duplex unit 169
 - in the multipurpose feeder 170
 - in the rear door 167
 - trays 170
- paper jams
 - avoiding 161
- paper jams, clearing
 - in the standard bin 168
- parts status
 - checking 139
- personal identification number method 133
- personal identification numbers
 - enabling 25
- photos, copying 40
- pick roller assembly
 - replacing 151
- pick tires
 - replacing 149
- placing separator sheets
 - between copies
 - copying 41
- poor fax print quality 216
- power button light
 - understanding the status 15
- power save modes
 - configuring 158
- print driver
 - hardware options, adding 235
 - installing 235
- print job
 - canceling from the computer 38
 - canceling from the printer control panel 38
- print jobs not printed 210
- print quality troubleshooting
 - blank or white pages 184
 - crooked or skewed print 197
 - dark print 185

- fine lines are not printed
 - correctly 187
- folded or wrinkled paper 188
- gray background on prints 189
- horizontal light bands 191
- light print 192
- mottled print and dots 194
- paper curl 195
- repeating defects 197
- solid black pages 198
- text or images cut off 200
- toner easily rubs off 201
- vertical dark bands 202
- vertical dark lines or streaks 204
- vertical dark streaks with print missing 205
- vertical light bands 206
- vertical white lines 206
- print troubleshooting
 - collated printing does not work 182
 - confidential and other held documents do not print 207
 - envelope seals when printing 181
 - incorrect margins 191
 - jammed pages are not reprinted 184
 - job prints from the wrong tray 212
 - job prints on the wrong paper 212
 - paper frequently jams 183
 - print jobs do not print 210
 - slow printing 208
 - tray linking does not work 182
 - unable to read flash drive 177
- printer
 - minimum clearances 11
 - selecting a location 11
 - shipping 158
- printer display
 - adjusting the brightness 159
- printer hard disk
 - encrypting 130
- printer hard disk memory 130
 - erasing 129
- printer information
 - finding 10
- printer is not responding 211
- printer menus 58

printer messages
Defective flash detected 179
Non-Lexmark supply 180
Not enough free space in flash memory for resources 179
Replace cartridge, printer region mismatch 180
Unformatted flash detected 180
printer options troubleshooting
cannot detect internal option 178
internal solutions port 179
printer port settings
changing 135
printer ports 14
printer settings
restoring factory default 130
printer software
installing 235
printer status 15
printer wireless network
connecting the mobile device to 134
printing
directory list 38
font sample list 38
from a computer 33
from a flash drive 35
from a mobile device 33, 34
from an Android device 33
Menu Settings Page 128
network setup page 177
quality test pages 128
using Google Cloud Print 33
using Mopria Print Service 33
using Wi-Fi Direct 34
printing a directory list 38
printing a font sample list 38
printing a network setup page 177
printing confidential and other held jobs
from a Macintosh computer 37
from Windows 37
printing from a computer 33
printing from a flash drive 35
Push Button method 133

Q

QR codes
adding 20

R

received fax
forwarding 54
received faxes
holding 53
recycling
Lexmark packaging 159
Lexmark products 159
reducing copies 41
removing paper jam
in door A 163
repeat print jobs 37
printing from a Macintosh computer 37
printing from Windows 37
Replace cartridge, printer region mismatch 180
replacing parts
ADF separator roller 155
replacing supplies
imaging unit 145
staple cartridge 147
toner cartridge 143
replacing the pick roller assembly 151
replacing the pick tires 149
replacing the staple cartridge 147
reserve print jobs
printing from a Macintosh computer 37
printing from Windows 37
resetting
supply usage counters 180
resetting the supply usage counters 180
RJ11 adapter 49
running a slideshow 19

S

safety information 8, 9
saving paper 42
saving toner 42
Scan Center
setting up 20
Scan to Computer
setting up 57
scan troubleshooting
cannot scan from a computer 216

partial copies of documents or photos 217
poor copy quality 217
scan job was not successful 218
scanner does not respond 219
scanner unit does not close 219
scanning freezes the computer 219
scanning takes too long 219
vertical dark streaks on output when scanning from the ADF 217
scanner
cleaning 136
scanner glass
using 40, 43, 46, 55
scanning
to an FTP server 55
using the automatic document feeder (ADF) 55
using the scanner glass 55
scanning quality problem 217
scanning to a computer 57
scanning to a fax server 57
scanning to a flash drive 56
scanning to an FTP server
using the control panel 55
scheduling a fax 52
scheduling power modes 19
securing printer memory 130
security slot
locating 129
selecting a location for the printer 11
sending a fax
using the computer 52
using the control panel 52
sending an e-mail 44
serial printing
setting up 135
setting the paper size 26
setting the paper type 26
setting the Universal paper size 26
setting up Device Quotas 20
setting up fax
country- or region-specific 49
standard telephone line connection 47
setting up serial printing 135
shipping the printer 158

- shortcut
 - Copy 18
 - Email 18
 - Fax 18
 - FTP 18
- shortcut, creating
 - e-mail 44
 - fax destination 53
 - FTP address 55
- shortcut, creating a
 - copy 42
- shortcuts
 - creating 18
- skewed print 197
- Sleep mode
 - configuring 158
- slow printing 208
- SMTP server for e-mail
 - configuring 43
- SMTP server for fax
 - configuring 46
- sorting multiple copies 41
- spoken passwords
 - enabling 25
- staple cartridge
 - replacing 147
- staple cartridges
 - ordering 142
- staple jam in the finisher 174
- staple jam, clearing
 - finisher 174
- statement of volatility 130
- storing print jobs 37
- supplies
 - conserving 159
- supplies status
 - checking 139
- supplies, ordering
 - maintenance kit 142
 - staple cartridges 142
- supply notifications
 - configuring 142
- supply usage counters
 - resetting 180
- supported file types 36
- supported flash drives 36
- supported paper sizes 30
- supported paper types 32
- supported paper weights 32

T

- toner cartridge
 - ordering 140
 - replacing 143
- toner darkness
 - adjusting 211
- trays
 - installing 234
 - linking 29
 - loading 26
 - unlinking 29
- troubleshooting
 - cannot open Embedded Web Server 176
 - printer is not responding 211
- troubleshooting, copy
 - partial copies of documents or photos 217
 - poor copy quality 217
 - scanner does not respond 219
 - scanner unit does not close 219
- troubleshooting, fax
 - cannot send faxes 215
 - cannot send or receive faxes 213
 - poor print quality 216
- troubleshooting, print
 - collated printing does not work 182
 - confidential and other held documents do not print 207
 - envelope seals when printing 181
 - incorrect margins 191
 - jammed pages are not reprinted 184
 - job prints from the wrong tray 212
 - job prints on the wrong paper 212
 - paper frequently jams 183
 - print jobs do not print 210
 - slow printing 208
 - tray linking does not work 182
- troubleshooting, print quality
 - blank or white pages 184
 - crooked or skewed print 197
 - dark print 185
 - fine lines are not printed correctly 187
 - folded or wrinkled paper 188
 - gray background on prints 189
 - horizontal light bands 191
 - light print 192
 - mottled print and dots 194
 - paper curl 195
 - repeating defects 197
 - solid black pages 198
 - text or images cut off 200
 - toner easily rubs off 201
 - vertical dark bands 202
 - vertical dark lines or streaks 204
 - vertical dark streaks with print missing 205
 - vertical light bands 206
 - vertical white lines 206
- troubleshooting, printer options
 - cannot detect internal option 178
 - internal solutions port 179
- troubleshooting, scan
 - cannot scan from a computer 216
 - partial copies of documents or photos 217
 - poor copy quality 217
 - scan job was not successful 218
 - scanner does not respond 219
 - scanner unit does not close 219
 - vertical dark streaks on output when scanning from the ADF 217
- two-sided copying 41

U

- unable to read flash drive
 - troubleshooting, print 177
- Unformatted flash detected 180
- Universal paper size
 - setting 26
- unlinking trays 29
- updating firmware 236
- USB port 14
 - enabling 177
- using Customer Support 20
- using Display Customization 19
- using genuine Lexmark parts and supplies 139
- using QR Code Generator 20
- using the ADF
 - copying 40

using the automatic document feeder (ADF) 40, 43, 46, 55
using the control panel 15
using the home screen 17
using the scanner
glass 40, 43, 46, 55
copying 40

V

verify print jobs 37
printing from a Macintosh computer 37
printing from Windows 37
vertical dark lines on prints 204
vertical dark streaks on output when scanning from the ADF 217
vertical streaks on prints 204
viewing a fax log 53
virtual keyboard
using 25
Voice Guidance
activating 24
speech rate 25
Voice Guidance speech rate
adjusting 25
volatile memory 130
erasing 129

W

white lines 206
white pages 184
Wireless menu 106
wireless network
connecting the printer to 133
Wi-Fi Protected Setup 133
wireless networking 133
Wi-Fi Direct 134
printing from a mobile device 34
Wi-Fi network
deactivating 134
Wi-Fi Protected Setup
wireless network 133
wrinkled paper 188