

# Quick Reference

## Using the 2.4-inch display printer model

### Learning about the printer

#### Using the printer control panel

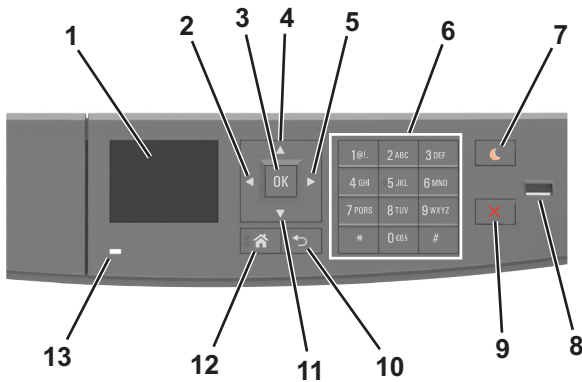

	Use the	To
1	Display	<ul style="list-style-type: none"> <li>View the printer status and messages.</li> <li>Set up and operate the printer.</li> </ul>
2	Left arrow button	Scroll to the left.
3	Select button	<ul style="list-style-type: none"> <li>Select menu options.</li> <li>Save settings.</li> </ul>
4	Up arrow button	Scroll up.
5	Right arrow button	Scroll to the right.
6	Keypad	Enter numbers, letters, or symbols.

	Use the	To
7	Sleep button	Enable Sleep mode or Hibernate mode. The following actions wake the printer from Sleep mode: <ul style="list-style-type: none"> <li>Pressing any hard button</li> <li>Opening a tray or the front door</li> <li>Sending a print job from the computer</li> <li>Performing a power-on reset using the main power switch</li> <li>Attaching a device to the USB port</li> </ul>
8	USB port	Connect a flash drive to the printer. <b>Notes:</b> <ul style="list-style-type: none"> <li>Only the front USB port supports flash drives.</li> <li>This feature is available only in select printer models.</li> </ul>
9	Stop or cancel button	Stop all printer activity.
10	Back button	Return to the previous screen.
11	Down arrow button	Scroll down.
12	Home button	Go to the home screen.
13	Indicator light	Check the status of the printer.

### Understanding the colors of the Sleep button and indicator lights

The colors of the Sleep button and indicator lights on the printer control panel signify a certain printer status or condition.

Indicator light	Printer status
Off	The printer is off or in Hibernate mode.
Blinking green	The printer is warming up, processing data, or printing.
Solid green	The printer is on, but idle.
Blinking red	The printer requires user intervention.

Sleep button light	Printer status
Off	The printer is off, idle or in Ready state.
Solid amber	The printer is in Sleep mode.

Sleep button light	Printer status
Blinking amber	The printer is entering or waking from Hibernate mode.
Blinking amber for 0.1 second, then goes completely off for 1.9 seconds in a slow, pulsing pattern	The printer is in Hibernate mode.

### Setting the paper size and type

1 From the printer control panel, navigate to:



- Press the up or down arrow button to select the tray or feeder, and then press **OK**.
- Press the up or down arrow button to select the paper size, and then press **OK**.
- Press the up or down arrow button to select the paper type, and then press **OK** to change the settings.

### Configuring Universal paper settings



The Universal paper size is a user-defined setting that lets you print on paper sizes that are not preset in the printer menus.

**Notes:**

- The smallest Universal paper size is 6 x 127 mm (3 x 5 inches), and is supported only from the multipurpose feeder.
- The largest Universal paper size is 216 x 355.6 mm (8.5 x 14 inches), and is supported from all paper sources.

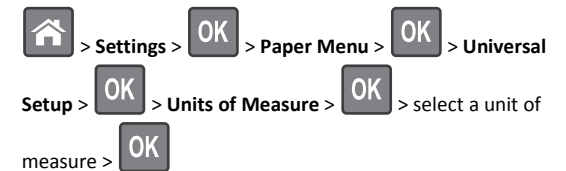
1 From the printer control panel, navigate to:



- 2 Select **Portrait Width** or **Portrait Height**, and then press .
- 3 Press the left or right arrow button to change the setting, and then press .

## Adjusting toner darkness

### Using the Embedded Web Server

- 1 Open a Web browser, and then type the IP address of the printer in the address field.

#### Notes:

- View the printer IP address in the TCP/IP section in the Network/Ports menu. The IP address appears as four sets of numbers separated by periods, such as 123.123.123.123.
- If you are using a proxy server, then temporarily disable it to load the Web page correctly.

- 2 Click **Settings > Print Settings > Quality Menu > Toner Darkness**.
- 3 Adjust the toner darkness, and then click **Submit**.

### Using the printer control panel

- 1 From the printer control panel, navigate to:

 > **Settings** >  > **Print Settings** >  > **Quality Menu** >  > **Toner Darkness**

- 2 Adjust the toner darkness, and then press .

## Printing from a flash drive

### Notes:

- Before printing an encrypted PDF file, you will be prompted to enter the file password from the printer control panel.
- You cannot print files for which you do not have printing permissions.

- 1 Insert a flash drive into the USB port.



### Notes:

- A flash drive icon appears on the printer control panel and in the held jobs icon when a flash drive is installed.
- If you insert the flash drive when the printer requires attention, such as when a jam has occurred, then the printer ignores the flash drive.
- If you insert the flash drive while the printer is processing other print jobs, then **Busy** appears. After these print jobs are processed, you may need to view the held jobs list to print documents from the flash drive.

**Warning—Potential Damage:** Do not touch the printer or the flash drive in the area shown while actively printing, reading, or writing from the memory device. Loss of data can occur.

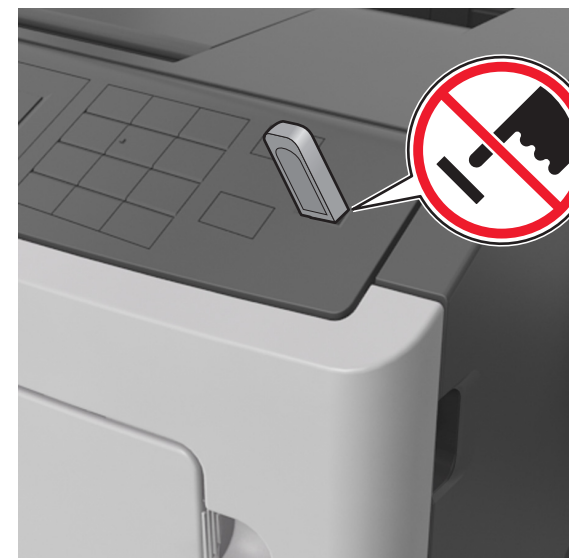

- 2 From the printer control panel, select the document you want to print.
- 3 Press the left or right arrow button to specify the number of copies for printing, and then press .



### Notes:

- Do not remove the flash drive from the USB port until the document has finished printing.
- If you leave the flash drive in the printer after leaving the initial USB menu screen, then access held jobs from the printer control panel to print files from the flash drive.

## Supported flash drives and file types

Flash drive	File type
<p>Many flash drives are tested and approved for use with the printer. For more information, contact the place where you purchased the printer.</p> <p><b>Notes:</b></p> <ul style="list-style-type: none"> <li>Hi-speed USB flash drives must support the full-speed standard. Low-speed USB devices are not supported.</li> <li>USB flash drives must support the File Allocation Table (FAT) system. Devices formatted with New Technology File System (NTFS) or any other file system are not supported.</li> </ul>	<p>Documents:</p> <ul style="list-style-type: none"> <li>.pdf</li> <li>.xps</li> </ul> <p>Images:</p> <ul style="list-style-type: none"> <li>.dcx</li> <li>.gif</li> <li>.JPEG or .jpg</li> <li>.bmp</li> <li>.pcx</li> <li>.TIFF or .tif</li> <li>.png</li> </ul>

## Canceling a print job from the printer control panel

From the printer control panel, press  > .

## Linking and unlinking trays

- 1 Open a Web browser, and then type the printer IP address in the address field.

### Notes:

- View the printer IP address on the printer control panel in the TCP/IP section under the Network/Ports menu. The IP address appears as four sets of numbers separated by periods, such as 123.123.123.123.
- If you are using a proxy server, then temporarily disable it to load the Web page correctly.

- 2 Click **Settings > Paper Menu**.

- 3 Change the paper size and type settings for the trays you are linking.

- To link trays, make sure the paper size and type for the tray match that of the other tray.
- To unlink trays, make sure the paper size or type for the tray does *not* match that of the other tray.

- 4 Click **Submit**.

**Note:** You can also change the paper size and type settings using the printer control panel. For more information, see [“Setting the paper size and type” on page 1](#).

**Warning—Potential Damage:** Paper loaded in the tray should match the paper type name assigned in the printer. The temperature of the fuser varies according to the specified paper type. Printing issues may occur if settings are not properly configured.

## Using the 4.3-inch display printer model

### Learning about the printer

### Using the printer control panel

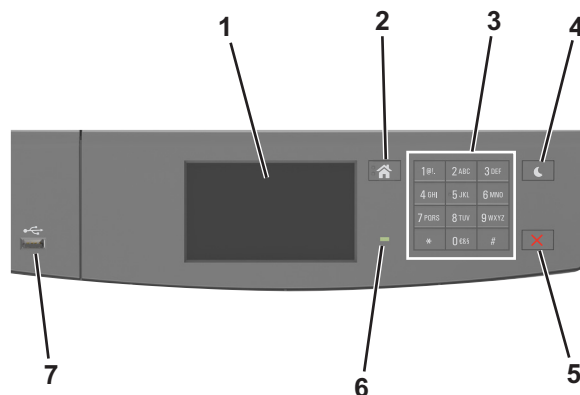

	Use the	To
1	Display	<ul style="list-style-type: none"> <li>View the printer status and messages.</li> <li>Set up and operate the printer.</li> </ul>
2	Home button	Go to the home screen.
3	Keypad	Enter numbers, letters, or symbols.

	Use the	To
4	Sleep button	<p>Enable Sleep mode or Hibernate mode.</p> <p>The following actions wake the printer from Sleep mode:</p> <ul style="list-style-type: none"> <li>Touching the screen</li> <li>Pressing any hard button</li> <li>Opening a tray or the front door</li> <li>Sending a print job from the computer</li> <li>Performing a power-on reset using the main power switch</li> <li>Attaching a device to the USB port</li> </ul>
5	Stop or cancel button	Stop all printer activity.
6	Indicator light	Check the status of the printer.
7	USB port	<p>Connect a flash drive to the printer.</p> <p><b>Note:</b> Only the front USB port supports flash drives.</p>

## Understanding the colors of the Sleep button and indicator lights

The colors of the Sleep button and indicator lights on the printer control panel signify a certain printer status or condition.

Indicator light	Printer status
Off	The printer is off or in Hibernate mode.
Blinking green	The printer is warming up, processing data, or printing.
Solid green	The printer is on, but idle.
Blinking red	The printer requires user intervention.

Sleep button light	Printer status
Off	The printer is off, idle or in Ready state.
Solid amber	The printer is in Sleep mode.
Blinking amber	The printer is entering or waking from Hibernate mode.
Blinking amber for 0.1 second, then goes completely off for 1.9 seconds in a slow, pulsing pattern	The printer is in Hibernate mode.

## Understanding the home screen

When the printer is turned on, the display shows a basic screen, referred to as the home screen. Use the home screen buttons and icons to initiate an action.

**Note:** Your home screen may vary depending on your home screen customization settings, administrative setup, and active embedded solutions.

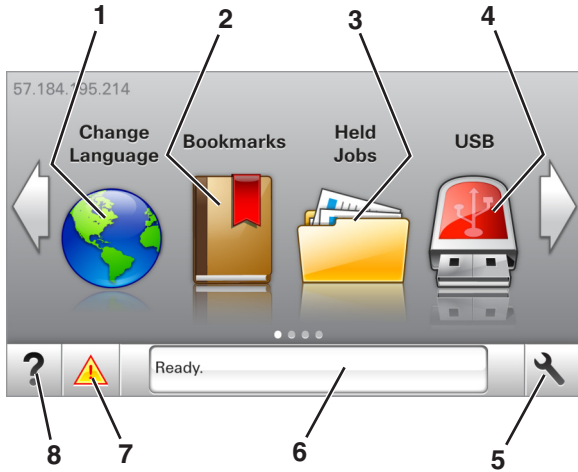



Touch	To
1	Change Language Change the primary language of the printer.
2	Bookmarks Create, organize, and save a set of bookmarks (URLs) into a tree view of folders and file links. <b>Note:</b> The tree view does not include bookmarks created within Forms and Favorites, and the ones in the tree are not usable in Forms and Favorites.
3	Held Jobs Display all current held jobs.
4	USB View, select, or print photos and documents from a flash drive. <b>Note:</b> This icon appears only when you return to the home screen while a memory card or flash drive is connected to the printer.
5	Menus Access printer menus. <b>Note:</b> These menus are available only when the printer is in ready state.

Touch	To
6	Status message bar <ul style="list-style-type: none"> <li>Show the current printer status such as <b>Ready</b> or <b>Busy</b>.</li> <li>Show printer conditions such as <b>Imaging unit low</b> or <b>Cartridge Low</b>.</li> <li>Show intervention messages and the instructions on how to clear them.</li> </ul>
7	Status/Supplies <ul style="list-style-type: none"> <li>Show a printer warning or error message whenever the printer requires intervention to continue processing.</li> <li>View more information on the printer warning or message, and on how to clear it.</li> </ul>
8	Tips View a context-sensitive help information.

This may also appear on the home screen:

Touch	To
Search Held Jobs	Search current held jobs.
Jobs by user	Access print jobs saved by user.
Profiles and Solutions	Access profiles and solutions.

## Features

Feature	Description
Attendance message alert 	If an attendance message affects a function, then this icon appears and the red indicator light blinks.
Warning 	If an error condition occurs, then this icon appears.



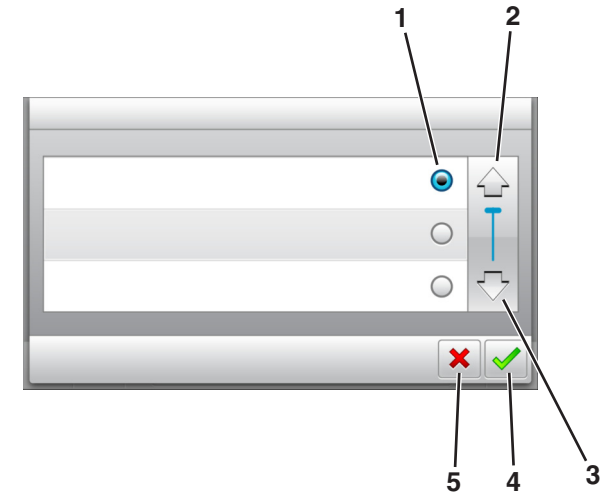

Feature	Description
Printer IP address Example: 123 . 123 . 123 . 123	The IP address of your printer is located at the top left corner of the home screen and appears as four sets of numbers separated by periods. You can use the IP address when accessing the Embedded Web Server to view and remotely configure printer settings even when you are not physically near the printer.

## Using the touch-screen buttons

**Note:** Your home screen may vary, depending on your home screen customization settings, administrative setup, and active embedded solutions.





	Touch the	To
1	Radio button	Select or clear an item.
2	Up arrow	Scroll up.
3	Down arrow	Scroll down.
4	Accept button	Save a setting.
5	Cancel button	<ul style="list-style-type: none"> <li>Cancel an action or a selection.</li> <li>Return to the previous screen.</li> </ul>

Touch	To
	Return to the home screen.
	Open a context-sensitive Help dialog on the printer control panel.
	Scroll to the left.
	Scroll to the right.

## Setting the paper size and type

From the home screen navigate to:

 > **Paper Menu** > **Paper Size/Type** > select a tray > select the paper size or type > 

## Configuring Universal paper settings

The Universal paper size is a user-defined setting that lets you print on paper sizes that are not preset in the printer menus.

### Notes:

- The smallest Universal paper size is 6 x 127 mm (3 x 5 inches), and is supported only from the multipurpose feeder.
- The largest Universal paper size is 216 x 355.6 mm (8.5 x 14 inches), and is supported from all paper sources.

1 From the printer control panel, navigate to:

 > **Paper Menu** > **Universal Setup** > **Units of Measure** > select a unit of measure > 

2 Touch **Portrait Width** or **Portrait Height**.

3 Select the width or height, and then touch .

## Printing from a flash drive

### Notes:

- Before printing an encrypted PDF file, you will be prompted to type the file password from the printer control panel.
- You cannot print files for which you do not have printing permissions.

1 Insert a flash drive into the USB port.



### Notes:

- A flash drive icon appears on the printer home screen when a flash drive is inserted.
- If you insert the flash drive when the printer requires attention, such as when a jam has occurred, then the printer ignores the flash drive.
- If you insert the flash drive while the printer is processing other print jobs, then **Busy** appears. After these print jobs are processed, you may need to view the held jobs list to print documents from the flash drive.

**Warning—Potential Damage:** Do not touch the printer or the flash drive in the area shown while actively printing, reading, or writing from the memory device. Loss of data can occur.



2 From the printer control panel, touch the document you want to print.

3 Touch the arrows to specify the number of copies for printing, and then touch **Print**.

### Notes:

- Do not remove the flash drive from the USB port until the document has finished printing.
- If you leave the flash drive in the printer after leaving the initial USB menu screen, then touch **Held Jobs** on the home screen to print files from the flash drive.

## Supported flash drives and file types

Flash drive	File type
Many flash drives are tested and approved for use with the printer. For more information, contact the place where you purchased the printer.	Documents:
<b>Notes:</b>	<ul style="list-style-type: none"><li>• .pdf</li><li>• .xps</li></ul>
<ul style="list-style-type: none"><li>• High-speed USB flash drives must support the fullspeed standard. Low-speed USB devices are not supported.</li><li>• USB flash drives must support the File Allocation Table (FAT) system. Devices formatted with New Technology File System (NTFS) or any other file system are not supported.</li></ul>	Images:
	<ul style="list-style-type: none"><li>• .dcx</li><li>• .gif</li><li>• .jpeg or .jpg</li><li>• .bmp</li><li>• .pcx</li><li>• .tiff or .tif</li><li>• .png</li><li>• .fls</li></ul>

## Canceling a print job from the printer control panel

- 1 From the printer control panel, touch **Cancel Job** or press  on the keypad.
- 2 Touch the print job you want to cancel, and then touch **Delete Selected Jobs**.

**Note:** If you press  on the keypad, then touch **Resume** to return to the home screen.

## Adjusting toner darkness

### Using the Embedded Web Server

- 1 Open a Web browser, and then type the printer IP address in the address field.

#### Notes:

- View the printer IP address on the printer home screen. The IP address appears as four sets of numbers separated by periods, such as 123.123.123.123.
  - If you are using a proxy server, then temporarily disable it to load the Web page correctly.
- 2 Click **Settings > Print Settings > Quality Menu > Toner Darkness**.
  - 3 Adjust the setting, and then click **Submit**.

### Using the printer control panel

- 1 From the home screen, navigate to:



> **Settings > Print Settings > Quality Menu > Toner Darkness**

- 2 Adjust the setting, and then touch .

## Linking and unlinking trays

- 1 Open a Web browser, and then type the printer IP address in the address field.

#### Notes:

- View the printer IP address on the printer home screen. The IP address appears as four sets of numbers separated by periods, such as 123.123.123.123.
- If you are using a proxy server, then temporarily disable it to load the Web page correctly.

- 2 Click **Settings > Paper Menu**.
- 3 Change the paper size and type settings for the trays you are linking.
  - To link trays, make sure the paper size and type for the tray match that of the other tray.
  - To unlink trays, make sure the paper size or type for the tray does *not* match that of the other tray.
- 4 Click **Submit**.

**Note:** You can also change the paper size and type settings using the printer control panel. For more information, see [“Setting the paper size and type” on page 5](#).

**Warning—Potential Damage:** Paper loaded in the tray should match the paper type name assigned in the printer. The temperature of the fuser varies according to the specified paper type. Printing issues may occur if settings are not properly configured.

## Setting up and using the home screen applications

### Finding the IP address of the computer

#### For Windows users

- 1 In the Run dialog box, type **cmd** to open the command prompt.
- 2 Type **ipconfig**, and then look for the IP address.

#### For Macintosh users

- 1 From System Preferences in the Apple menu, select **Network**.
- 2 Select your connection type, and then click **Advanced > TCP/IP**.
- 3 Look for the IP address.

## Accessing the Embedded Web Server

The Embedded Web Server is the printer Web page that lets you view and remotely configure printer settings even when you are not physically near the printer.

- 1 Obtain the printer IP address:
  - From the printer control panel home screen
  - From the TCP/IP section in the Network/Ports menu
  - By printing a network setup page or menu settings page, and then finding the TCP/IP section

**Note:** An IP address appears as four sets of numbers separated by periods, such as 123.123.123.123.

- 2 Open a Web browser, and then type the printer IP address in the address field.
- 3 Press **Enter**.

**Note:** If you are using a proxy server, then temporarily disable it to load the Web page correctly.

## Customizing the home screen

- 1 Open a Web browser, and then type the printer IP address in the address field.

**Note:** View the printer IP address on the printer home screen. The IP address appears as four sets of numbers separated by periods, such as 123.123.123.123.

- 2 Do one or more of the following:
  - Show or hide the icons of basic printer functions.
    - a Click **Settings > General Settings > Home screen customization**.
    - b Select the check boxes to specify which icons appear on the home screen.

**Note:** If you clear a check box beside an icon, then the icon does not appear on the home screen.
    - c Click **Submit**.
  - Customize the icon for an application. For more information, see [“Finding information about the home screen applications”](#)

[on page 7](#) or see the documentation that came with the application.

## Activating the home screen applications

### Finding information about the home screen applications

Your printer comes with preinstalled home screen applications. Before you can use these applications, you must first activate and set up these applications using the Embedded Web Server. For more information on accessing the Embedded Web Server, see [“Accessing the Embedded Web Server” on page 6](#).

For detailed information on configuring and using the home screen applications, contact the place where you purchased the printer.

### Using Background and Idle Screen

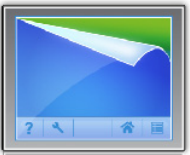
Icon	Description
	The application lets you customize the background and idle screen of your printer home screen.

- 1 From the home screen, navigate to:  
**Change Background** > select background to use
- 2 Touch .

### Setting up Forms and Favorites

Use	To
	Streamline work processes by letting you quickly find and print frequently used online forms directly from the printer home screen. <b>Note:</b> The printer must have permission to access the network folder, FTP site, or Web site where the bookmark is stored. From the computer where the bookmark is stored, use sharing, security, and firewall settings to allow the printer at least a <i>read</i> access. For help, see the documentation that came with your operating system.

- 1 Open a Web browser, and then type the printer IP address in the address field.

**Note:** View the printer IP address on the printer home screen. The IP address appears as four sets of numbers separated by periods, such as 123.123.123.123.

- 2 Click **Settings** > **Apps** > **Apps Management** > **Forms and Favorites**.
- 3 Click **Add**, and then customize the settings.

#### Notes:

- See the mouse-over help beside each field for a description of the setting.
- To make sure the location settings of the bookmark are correct, type the correct IP address of the host computer where the bookmark is located. For more information on obtaining the IP address of the host computer, see [“Finding the IP address of the computer” on page 6](#).
- Make sure the printer has access rights to the folder where the bookmark is located.

- 4 Click **Apply**.

To use the application, touch **Forms and Favorites** on the printer home screen, and then navigate through form categories, or search for forms based on a form number, name, or description.

### Understanding Eco-Settings

Icon	Description
	The application lets you easily manage energy consumption, noise, toner, and paper usage settings to help reduce the environmental impact of your printer.

### Setting up Remote Operator Panel

This application enables you to interact with the printer control panel even when you are not physically near the network printer. From your computer, you can view the printer status, release held print jobs, create bookmarks, and do other print-related tasks.

- 1 Open a Web browser, and then type the printer IP address in the address field.

**Note:** View the printer IP address on the printer home screen. The IP address appears as four sets of numbers separated by periods, such as 123.123.123.123.

- 2 Click **Settings** > **Remote Operator Panel Settings**.
- 3 Select the **Enable** check box, and then customize the settings.
- 4 Click **Submit**.

To use the application, click **Remote Operator Panel** > **Launch VNC Applet**.

### Exporting and importing a configuration

You can export configuration settings into a text file, and then import the file to apply the settings to other printers.

- 1 Open a Web browser, and then type the printer IP address in the address field.

**Note:** View the printer IP address on the printer home screen. The IP address appears as four sets of numbers separated by periods, such as 123.123.123.123.

- 2 To export or import a configuration for one application, do the following:
    - a Click **Settings** > **Apps** > **Apps Management**.
    - b From the list of installed applications, click the name of the application you want to configure.
    - c Click **Configure**, and then do either of the following:
      - To export a configuration to a file, click **Export**, and then follow the instructions on the computer screen to save the configuration file.
- Notes:**
- When saving the configuration file, you can type a unique file name or use the default name.
  - If a "JVM Out of Memory" error occurs, then repeat the export process until the configuration file is saved.
  - To import a configuration from a file, click **Import**, and then browse to the saved configuration file that was exported from a previously configured printer.
- Notes:**
- Before importing the configuration file, you can choose to preview it first or load it directly.

- If a timeout occurs and a blank screen appears, then refresh the Web browser, and then click **Apply**.
- 3 To export or import a configuration for multiple applications, do the following:
    - a Click **Settings > Import/Export**.
    - b Do either of the following:
      - To export a configuration file, click **Export Embedded Solutions Settings File**, and then follow the instructions on the computer screen to save the configuration file.
      - To import a configuration file, do the following:
        - 1 Click **Import Embedded Solutions Settings File > Choose File**, and then browse to the saved configuration file that was exported from a previously configured printer.
        - 2 Click **Submit**.

## Printing

### Printing a document

- 1 From the Paper menu on the printer control panel, set the paper type and size to match the paper loaded.
- 2 Send the print job:

#### For Windows users

- a With a document open, click **File > Print**.
- b Click **Properties, Preferences, Options, or Setup**.
- c Adjust the settings, if necessary.
- d Click **OK > Print**.

#### For Macintosh users

- a Customize the settings in the Page Setup dialog if necessary:
  - 1 With a document open, choose **File > Page Setup**.
  - 2 Choose a paper size or create a custom size to match the paper loaded.
  - 3 Click **OK**.
- b Customize the settings in the Page Setup dialog if necessary:
  - 1 With a document open, choose **File > Print**. If necessary, click the disclosure triangle to see more options.
  - 2 From the Print dialog and pop-up menus adjust the settings if necessary.

**Note:** To print on a specific paper type, adjust the paper type setting to match the paper loaded, or select the appropriate tray or feeder.

- 3 Click **Print**.

### Canceling a print job from the computer

#### For Windows users

- 1 Open the printers folder, and then select your printer.
- 2 From the print queue, select the print job you want to cancel, and then delete it.

#### For Macintosh users

- 1 From System Preferences in the Apple menu, navigate to your printer.
- 2 From the print queue, select the print job you want to cancel, and then delete it.

## Loading paper and specialty media

### Loading trays

**CAUTION—POTENTIAL INJURY:** To reduce the risk of equipment instability, load each tray separately. Keep all other trays closed until needed.

- 1 Pull out the tray completely.

**Note:** Do not remove trays while a job prints or while **Busy** appears on the printer display. Doing so may cause a jam.



- 2 Squeeze and then slide the width guide tab to the correct position for the size of the paper you are loading.

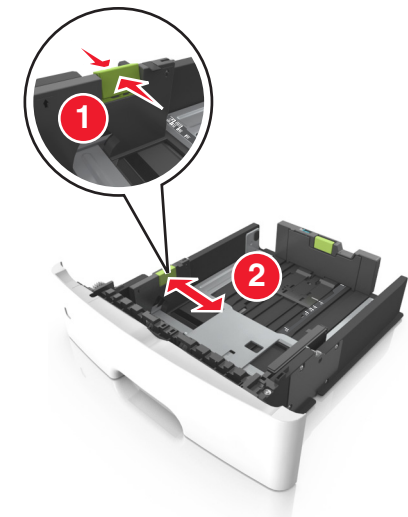



- 3 Squeeze and then slide the length guide tab to the correct position for the size of the paper you are loading.

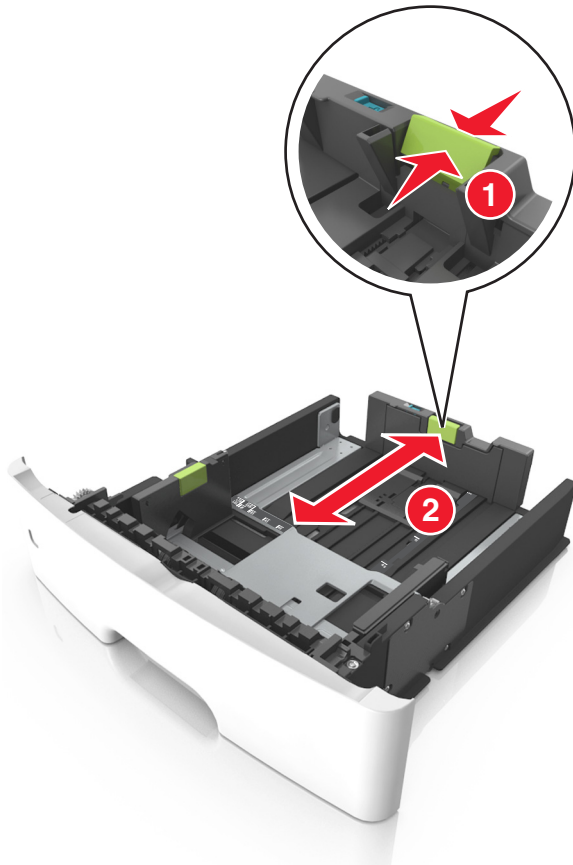

**Notes:**

- For some paper sizes like letter, legal, and A4, squeeze and slide the length guide tab backward to accommodate their length.
- When loading legal-size paper, the length guide extends beyond the base leaving the paper exposed to dust. To protect the paper from dust, you can purchase a dust cover separately. For more information, contact customer support.
- If you are loading A6-size paper in the standard tray, then squeeze and then slide the length guide tab toward the center of the tray to the A6-size position.
- Make sure the width and length guides are aligned with the paper size indicators on the bottom of the tray.

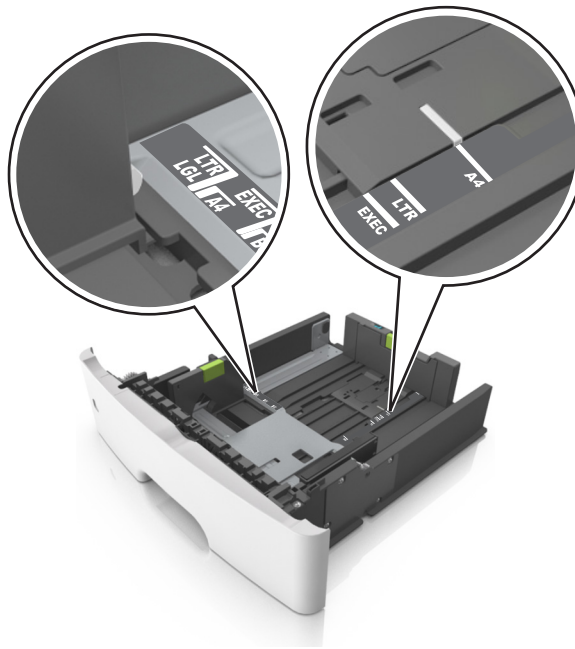

- 4 Flex the sheets back and forth to loosen them, and then fan them. Do not fold or crease the paper. Straighten the edges on a level surface.

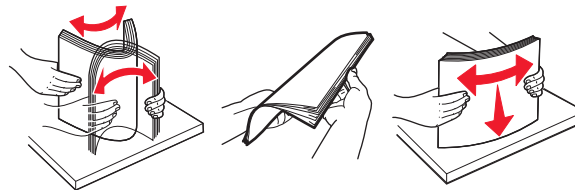

- 5 Load the paper stack.

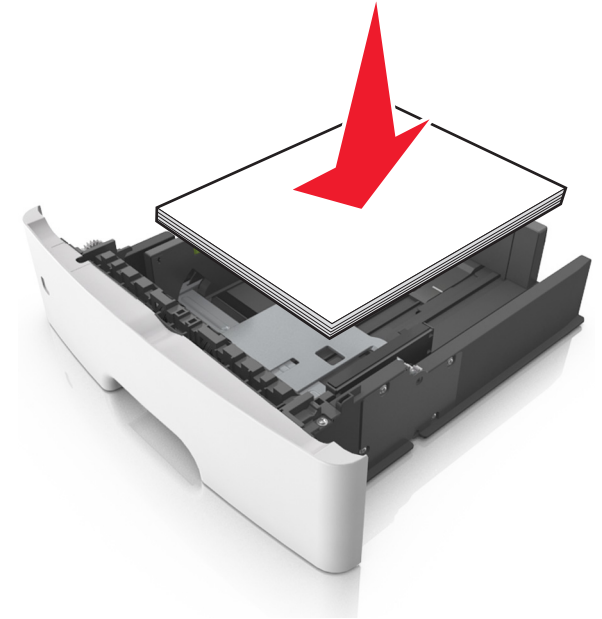

**Notes:**

- Load with the printable side facedown when using recycled or preprinted paper.
- Load prepunched paper with the holes on the top edge toward the front of the tray.
- Load letterhead facedown, with the top edge of the sheet toward the front of the tray. For two-sided printing, load letterhead faceup with the bottom edge of the sheet toward the front of the tray.
- Make sure the paper is below the maximum paper fill indicator located on the side of the width guide.

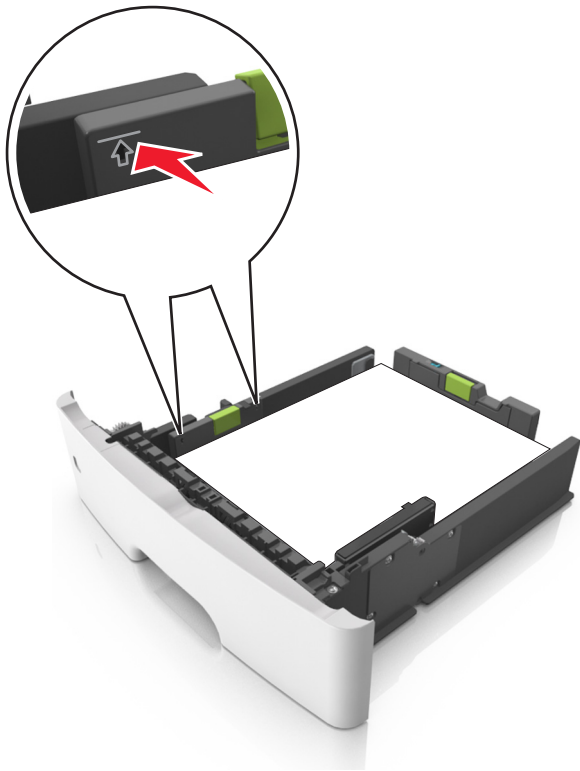

6 Insert the tray.

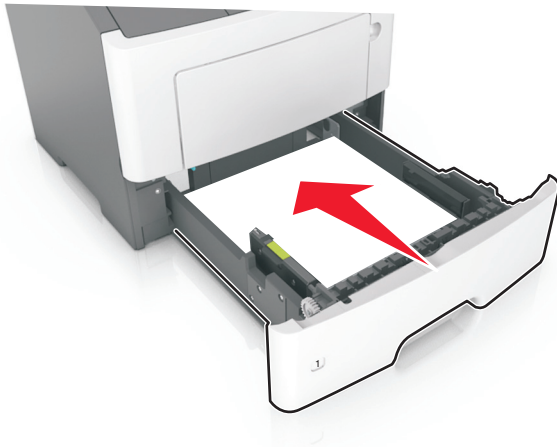

7 From the printer control panel, set the paper size and paper type in the Paper menu to match the paper loaded in the tray.

**Note:** Set the correct paper size and paper type to avoid paper jams and print quality problems.

### Loading the multipurpose feeder

Use the multipurpose feeder when printing on different paper sizes and types or specialty media, such as card stock, transparencies, and envelopes. You can also use it for single-page print jobs on letterhead.

1 Open the multipurpose feeder.

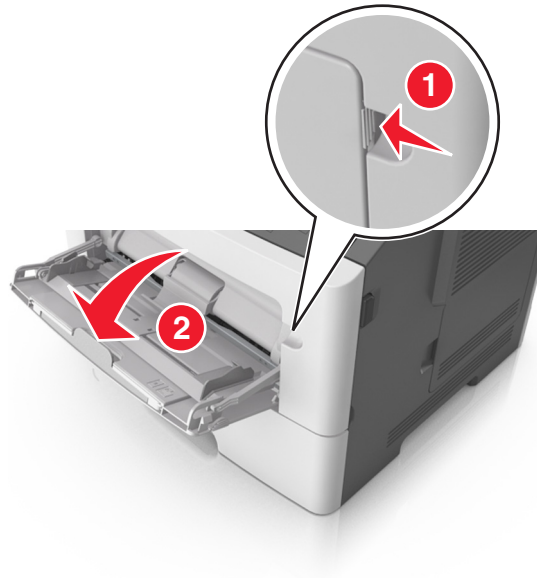

a Pull the multipurpose feeder extender.



b Pull the extender gently so that the multipurpose feeder is fully extended and open.



- 2 Squeeze the tab on the left width guide, and then move the guides for the paper you are loading.

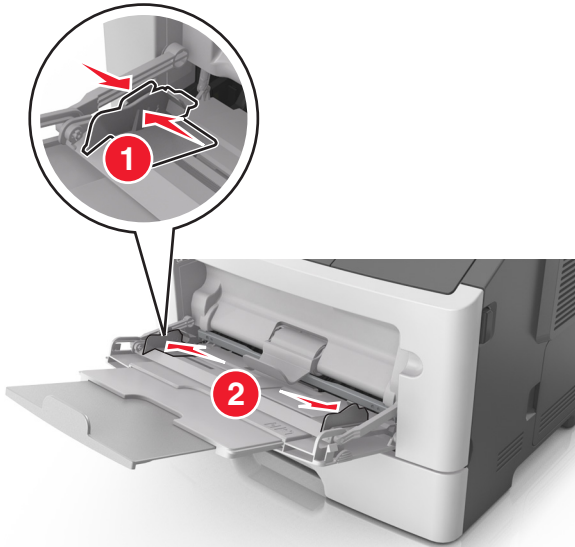

- 3 Prepare the paper or specialty media for loading.

- Flex sheets of paper back and forth to loosen them, and then fan them. Do not fold or crease the paper. Straighten the edges on a level surface.

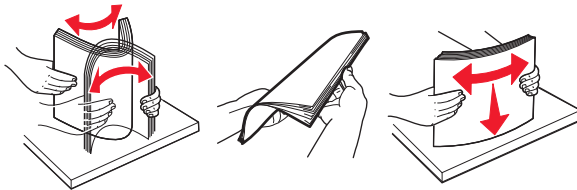

- Hold transparencies by the edges. Flex the stack of transparencies back and forth to loosen them, and then fan them. Straighten the edges on a level surface.

**Note:** Avoid touching the printable side of the transparencies. Be careful not to scratch them.

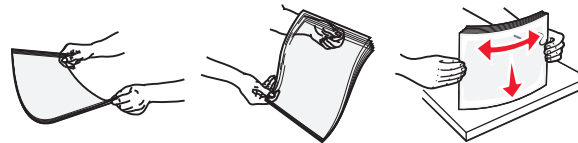

- Flex the stack of envelopes back and forth to loosen them, and then fan them. Straighten the edges on a level surface.



- 4 Load the paper or specialty media.

**Notes:**

- Do not force paper or specialty media into the multipurpose feeder.
- Make sure the paper or specialty media is below the maximum paper fill indicator located on the paper guides. Overfilling may cause paper jams.

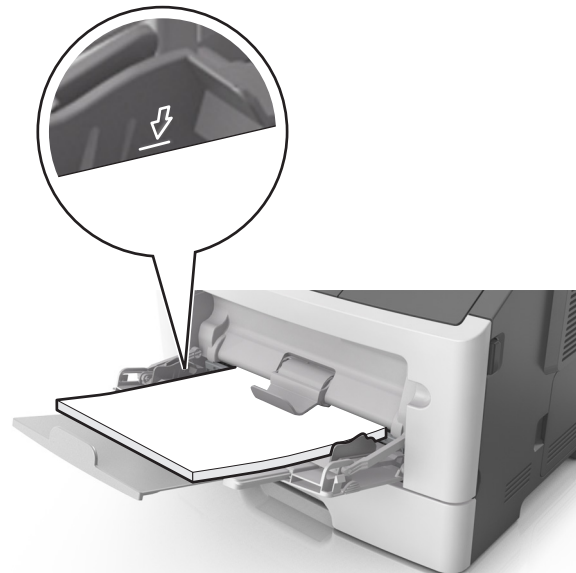

- Load paper, transparencies, and card stock with the recommended printable side faceup and the top edge entering

the printer first. For more information on loading transparencies, see the packaging that the transparencies came in.



**Note:** When loading A6-size paper, make sure the multipurpose feeder extender rests lightly against the edge of the paper so that the last few sheets of paper remain in place.

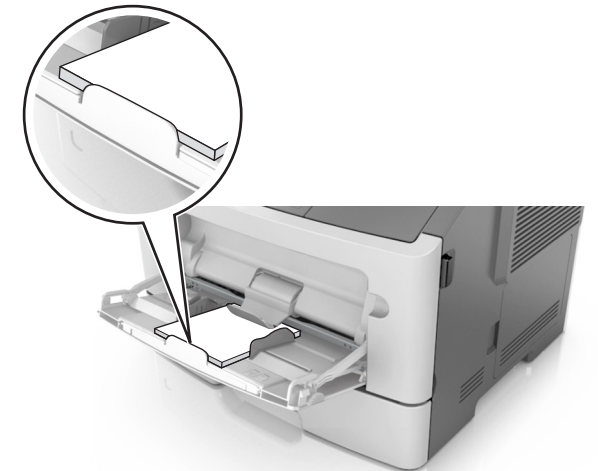

- Load letterhead faceup with the top edge entering the printer first. For two-sided (duplex) printing, load letterhead facedown with the bottom edge entering the printer first.



- Load envelopes with the flap on the left side facedown.

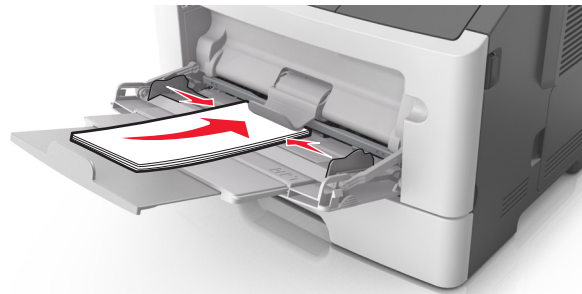

**Warning—Potential Damage:** Never use envelopes with stamps, clasps, snaps, windows, coated linings, or self-stick adhesives. These envelopes may severely damage the printer.

- 5 From the printer control panel, set the paper size and paper type in the Paper menu to match the paper or specialty media loaded in the multipurpose feeder.

## Clearing jams

### [x]-page jam, open front door. [20y.xx]

**CAUTION—HOT SURFACE:** The inside of the printer might be hot. To reduce the risk of injury from a hot component, allow the surface to cool before touching it.

- 1 Press the button on the right side of the printer, and then open the front door.

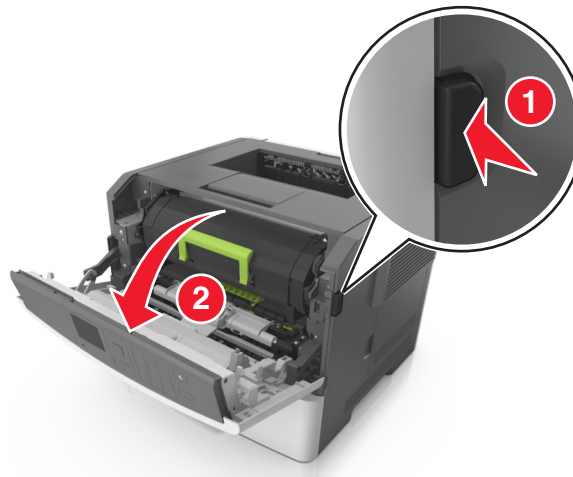

- 2 Pull out the toner cartridge using the handle.



- 3 Lift the green handle, and then pull out the imaging unit from the printer.

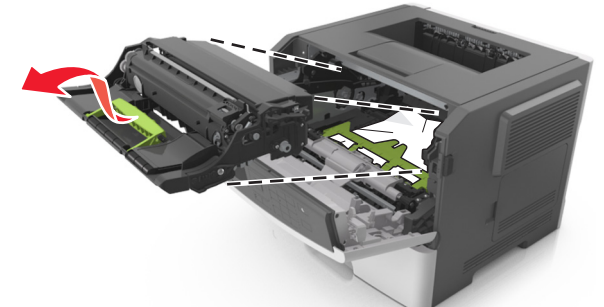

**Warning—Potential Damage:** Do not touch the shiny blue photoconductor drum under the imaging unit. Doing so may affect the quality of future print jobs.

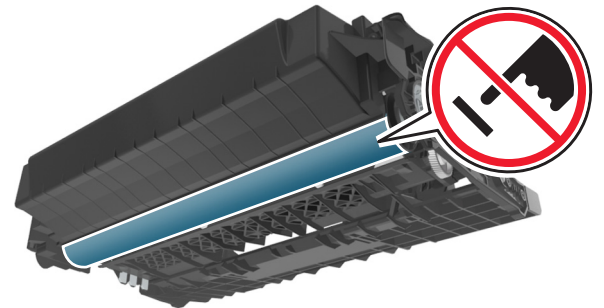

- 4 Place the imaging unit aside on a flat, smooth surface.

**Warning—Potential Damage:** Do not expose the imaging unit to direct light for more than 10 minutes. Extended exposure to light may cause print quality problems.

5 Lift the green flap in front of the printer.

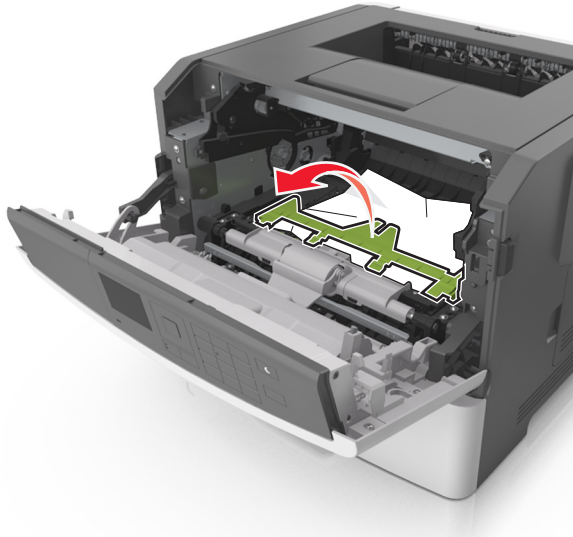

6 Firmly grasp the jammed paper on each side, and then gently pull it out.

**Note:** Make sure all paper fragments are removed.

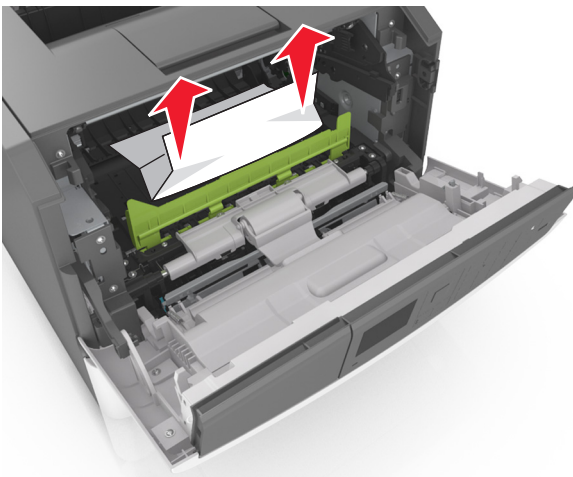

7 Insert the imaging unit by aligning the arrows on the side rails of the unit with the arrows on the side rails inside the printer, and then insert the imaging unit into the printer.

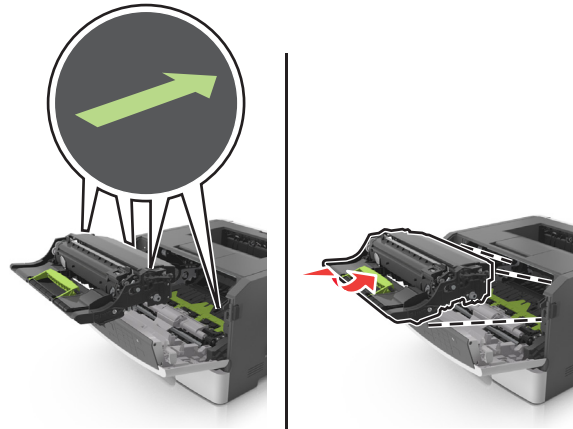

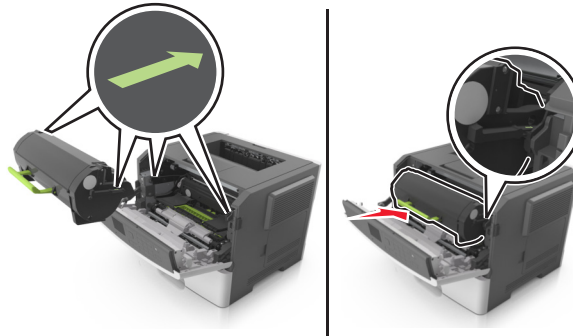

8 Insert the toner cartridge by aligning the side rails of the cartridge with the arrows on the side rails inside the printer, and then insert the cartridge into the printer.



9 Close the front door.

10 From the printer control panel, touch  to clear the message and continue printing. For non-touch-screen printer models, select

Next >  > Clear the jam, press OK > .

## [x]-page jam, open rear door. [20y.xx]

1 Open the front door.

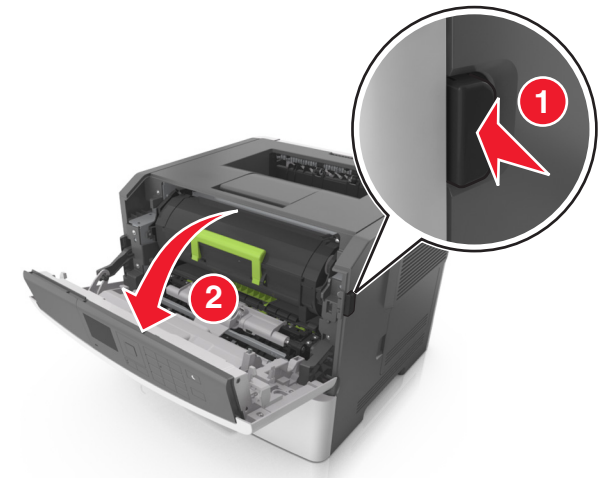

2 Gently pull down the rear door.

 **CAUTION—HOT SURFACE:** The inside of the printer might be hot. To reduce the risk of injury from a hot component, allow the surface to cool before touching it.

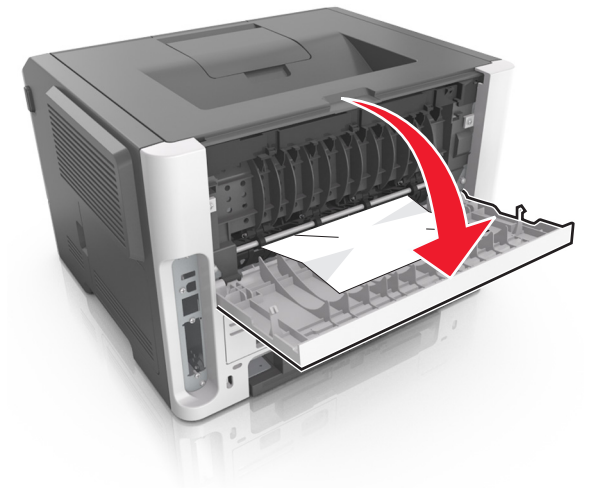

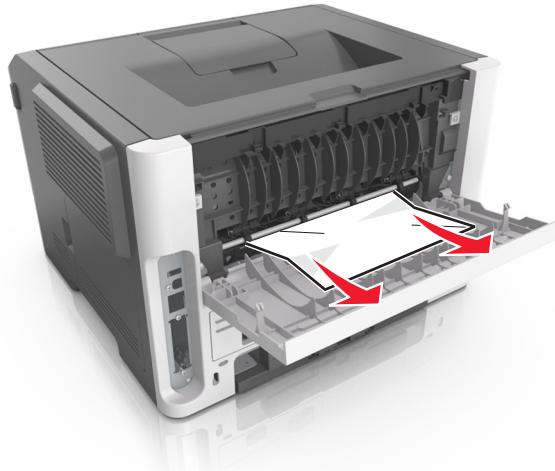

3 Firmly grasp the jammed paper on each side, and then gently pull it out.

**Note:** Make sure all paper fragments are removed.



4 Close the rear door.

5 From the printer control panel, touch  to clear the message and continue printing. For non-touch-screen printer models, select

Next >  > Clear the jam, press OK > .



### [x]-page jam, clear standard bin. [20y.xx]

1 Firmly grasp the jammed paper on each side, and then gently pull it out.

**Note:** Make sure all paper fragments are removed.



2 From the printer control panel, touch  to clear the message and continue printing. For non-touch-screen printer models, select

Next >  > Clear the jam, press OK > .

### [x]-page jam, remove tray 1 to clear duplex. [23y.xx]

 **CAUTION—HOT SURFACE:** The inside of the printer might be hot. To reduce the risk of injury from a hot component, allow the surface to cool before touching it.

1 Pull the tray completely out of the printer.

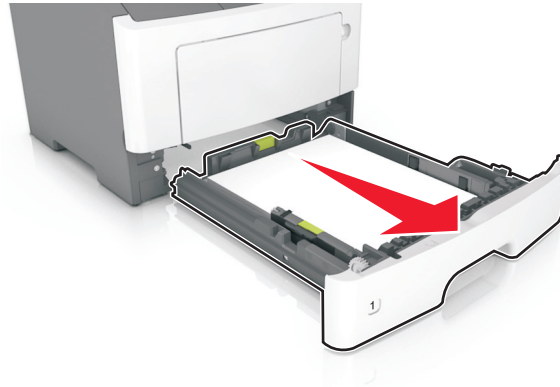

2 Locate the blue lever, and then pull it down to release the jam.

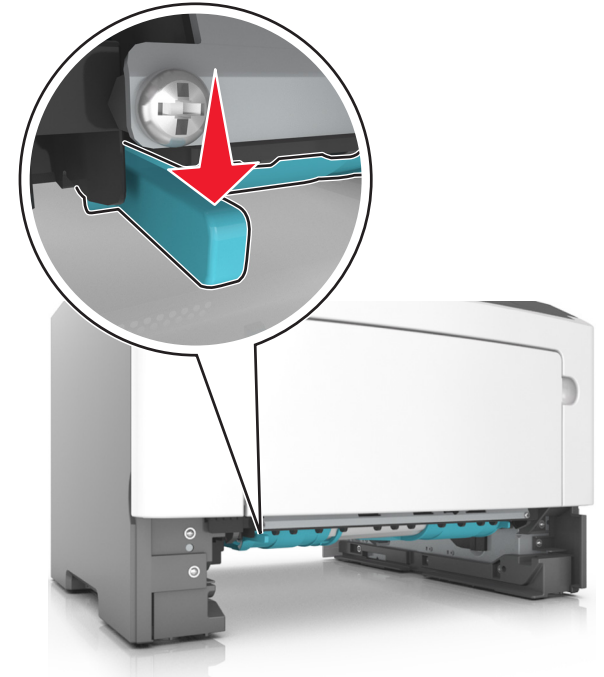

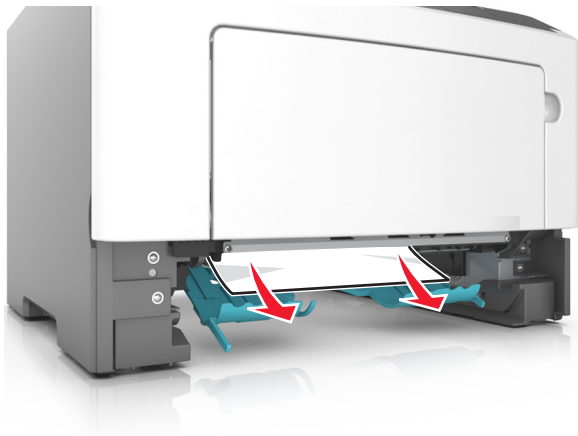

3 Firmly grasp the jammed paper on each side, and then gently pull it out.

**Note:** Make sure all paper fragments are removed.



4 Insert the tray.

5 From the printer control panel, touch  to clear the message and continue printing. For non-touch-screen printer models, select

Next >  > Clear the jam, press OK > .

### [x]-page jam, open tray [x]. [24y.xx]

1 Pull the tray completely out of the printer.

**Note:** The message on the printer display indicates the tray where the jammed paper is located.

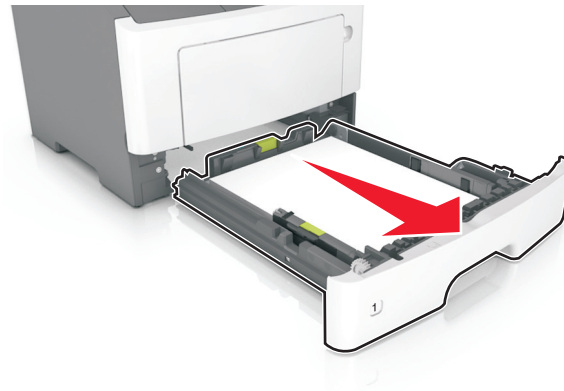

2 Firmly grasp the jammed paper on each side, and then gently pull it out.

**Note:** Make sure all paper fragments are removed.

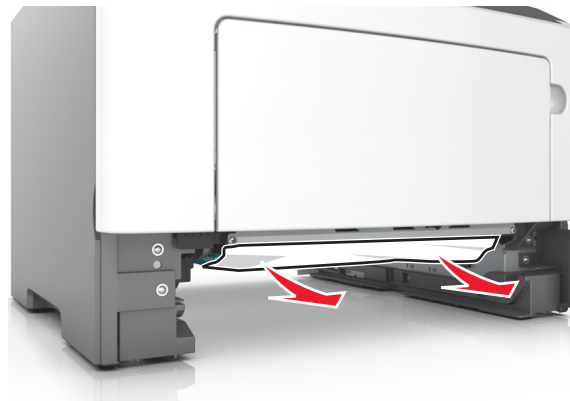

3 Insert the tray.

4 From the printer control panel, touch  to clear the message and continue printing. For non-touch-screen printer models, select

Next >  > Clear the jam, press OK > .

### [x]-page jam, clear manual feeder. [25y.xx]

1 From the multipurpose feeder, firmly grasp the jammed paper on each side, and then gently pull it out.

**Note:** Make sure all paper fragments are removed.



2 Flex the sheets of paper back and forth to loosen them, and then fan them. Do not fold or crease the paper. Straighten the edges on a level surface.

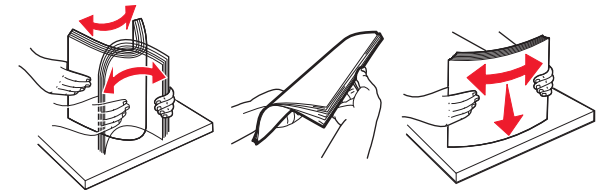



3 Reload paper into the multipurpose feeder.



**Note:** Make sure the paper guide lightly rests against the edge of the paper.

4 From the printer control panel, touch  to clear the message and continue printing. For non-touch-screen printer models, select

Next >  > Clear the jam, press OK > .