



Lexmark™

# **MX410, MX417, MX510, MX511, MX517**

---

## **User's Guide**

**November 2017**

**[www.lexmark.com](http://www.lexmark.com)**

---

Machine type(s):

7015

Model(s):

470, 630, 670, 675

# Contents

- Safety information.....7**
  - Conventions.....7
  
- Learning about the printer..... 10**
  - Finding information about the printer..... 10
  - Selecting a location for the printer..... 11
  - Printer configurations..... 12
  - Understanding the basic functions of the scanner.....13
  - Using the ADF and scanner glass.....14
  
- Understanding the printer control panel..... 15**
  - Using the printer control panel..... 15
  - Understanding the colors of the Sleep button and indicator lights.....15
  - Understanding the home screen..... 16
  - Using the touch-screen buttons..... 17
  
- Setting up and using the home screen applications.....19**
  - Finding the IP address of the computer.....19
  - Finding the IP address of the printer.....19
  - Accessing the Embedded Web Server.....19
  - Customizing the home screen.....20
  - Understanding the different applications..... 20
  - Activating the home screen applications.....21
  - Setting up Remote Operator Panel..... 24
  - Exporting and importing a configuration..... 25
  
- Additional printer setup.....26**
  - Installing internal options..... 26
  - Installing hardware options.....42
  - Attaching cables..... 45
  - Setting up the printer software..... 46
  - Networking..... 47
  - Verifying printer setup.....51

---

<b>Loading paper and specialty media.....</b>	<b>53</b>
Setting the paper size and type.....	53
Configuring Universal paper settings.....	53
Loading trays.....	53
Loading the multipurpose feeder.....	58
Linking and unlinking trays.....	62
<b>Paper and specialty media guide.....</b>	<b>65</b>
Using specialty media.....	65
Paper guidelines.....	67
Supported paper sizes, types, and weights.....	70
<b>Printing.....</b>	<b>74</b>
Printing a document.....	74
Printing from a mobile device.....	75
Printing from a flash drive.....	76
Printing confidential and other held jobs.....	78
Printing information pages.....	80
Canceling a print job.....	80
<b>Copying.....</b>	<b>81</b>
Making copies.....	81
Copying photos.....	82
Copying on specialty media.....	82
Customizing copy settings.....	83
Placing information on copies.....	88
Canceling a copy job.....	88
Understanding the copy options.....	89
<b>E-mailing.....</b>	<b>93</b>
Setting up the e-mail function.....	93
Creating an e-mail shortcut.....	93
E-mailing a document.....	94
Customizing e-mail settings.....	96
Canceling an e-mail.....	96
Understanding the e-mail options.....	97

---

<b>Faxing.....</b>	<b>100</b>
Setting up the printer to fax.....	100
Sending a fax.....	113
Creating shortcuts.....	115
Customizing fax settings.....	116
Canceling an outgoing fax.....	117
Holding and forwarding faxes.....	118
Understanding the fax options.....	119
<b>Scanning.....</b>	<b>121</b>
Using Scan to Network.....	121
Scanning to an FTP address.....	121
Scanning to a computer or flash drive.....	123
Understanding the scan options.....	124
<b>Understanding the printer menus.....</b>	<b>128</b>
Menu list.....	128
Paper menu.....	129
Reports Menu.....	139
Network/Ports menu.....	140
Security menu.....	149
Settings menu.....	152
Help menu.....	198
<b>Saving money and the environment.....</b>	<b>199</b>
Saving paper and toner.....	199
Saving energy.....	199
Recycling.....	202
<b>Securing the printer.....</b>	<b>203</b>
Statement of Volatility.....	203
Erasing volatile memory.....	203
Erasing non-volatile memory.....	204
Erasing printer hard disk memory.....	204
Configuring printer hard disk encryption.....	205
Finding printer security information.....	206

<b>Maintaining the printer.....</b>	<b>207</b>
Cleaning printer parts.....	207
Checking the status of parts and supplies.....	209
Estimated number of remaining pages.....	209
Ordering supplies.....	209
Storing supplies.....	212
Replacing supplies.....	212
Moving the printer.....	216
 <b>Managing the printer.....</b>	 <b>218</b>
Finding advanced networking and administrator information.....	218
Checking the virtual display.....	218
Setting up e-mail alerts.....	218
Viewing reports.....	219
Configuring supply notifications from the Embedded Web Server.....	219
Restoring factory default settings.....	220
 <b>Clearing jams.....</b>	 <b>221</b>
Avoiding jams.....	221
Identifying jam locations.....	222
Paper jam in the front door.....	223
Paper jam in the rear door.....	225
Paper jam in the standard bin.....	226
Paper jam in the duplex unit.....	227
Paper jam in trays.....	228
Paper jam in the multipurpose feeder.....	228
Paper jam in the automatic document feeder.....	230
 <b>Troubleshooting.....</b>	 <b>231</b>
Understanding the printer messages.....	231
Solving printer problems.....	246
Solving print problems.....	253
Solving copy problems.....	279
Solving fax problems.....	282
Solving scanner problems.....	288
Solving home screen applications problems.....	293

Embedded Web Server does not open..... 293

Contacting customer support.....295

**Notices..... 296**

Product information.....296

Edition notice..... 296

Power consumption..... 301

**Index..... 310**

# Safety information











## Conventions

**Note:** A *note* identifies information that could help you.

**Warning:** A *warning* identifies something that could damage the product hardware or software.

**CAUTION:** A *caution* indicates a potentially hazardous situation that could injure you.

Different types of caution statements include:

-  **CAUTION—POTENTIAL INJURY:** Indicates a risk of injury.
-  **CAUTION—SHOCK HAZARD:** Indicates a risk of electrical shock.
-  **CAUTION—HOT SURFACE:** Indicates a risk of burn if touched.
-  **CAUTION—TIPPING HAZARD:** Indicates a crush hazard.
-  **CAUTION—PINCH HAZARD:** Indicates a risk of being caught between moving parts.
-  **CAUTION—POTENTIAL INJURY:** To avoid the risk of fire or electrical shock, connect the power cord to an appropriately rated and properly grounded electrical outlet that is near the product and easily accessible.
-  **CAUTION—POTENTIAL INJURY:** Do not use this product with extension cords, multioutlet power strips, multioutlet extenders, or UPS devices. The power capacity of these types of accessories can be easily overloaded by a laser printer and may result in a risk of fire, property damage, or poor printer performance.
-  **CAUTION—POTENTIAL INJURY:** Only a Lexmark Inline Surge Protector that is properly connected between the printer and the power cord provided with the printer may be used with this product. The use of non-Lexmark surge protection devices may result in a risk of fire, property damage, or poor printer performance.
-  **CAUTION—SHOCK HAZARD:** To avoid the risk of electrical shock, do not place or use this product near water or wet locations.
-  **CAUTION—SHOCK HAZARD:** To avoid the risk of electrical shock, do not set up this product or make any electrical or cabling connections, such as the power cord, fax feature, or telephone, during a lightning storm.
-  **CAUTION—SHOCK HAZARD:** To avoid the risk of electrical shock, do not use the fax feature during a lightning storm.

Refer service or repairs, other than those described in the user documentation, to a service representative.

-  **CAUTION—TIPPING HAZARD:** Floor-mounted configurations require additional furniture for stability. You must use either a printer stand or printer base if you are using multiple input options. If you purchased a multifunction printer (MFP) that scans, copies, and faxes, then you may need additional furniture. For more information, see [www.lexmark.com/multifunctionprinters](http://www.lexmark.com/multifunctionprinters).

This product is designed, tested, and approved to meet strict global safety standards with the use of specific manufacturer's components. The safety features of some parts may not always be obvious. The manufacturer is not responsible for the use of other replacement parts.

 **CAUTION—SHOCK HAZARD:** To avoid the risk of electrical shock, make sure that all external connections (such as Ethernet and telephone system connections) are properly installed in their marked plug-in ports.

 **CAUTION—POTENTIAL INJURY:** This product uses a laser. Use of controls or adjustments or performance of procedures other than those specified in the *User's Guide* may result in hazardous radiation exposure.

This product uses a printing process that heats the print media, and the heat may cause the media to release emissions. You must understand the section in your operating instructions that discusses the guidelines for selecting print media to avoid the possibility of harmful emissions.

 **CAUTION—HOT SURFACE:** The inside of the printer might be hot. To reduce the risk of injury from a hot component, allow the surface to cool before touching it.

 **CAUTION—POTENTIAL INJURY:** The lithium battery in this product is not intended to be replaced. There is a danger of explosion if a lithium battery is incorrectly replaced. Do not recharge, disassemble, or incinerate a lithium battery. Discard used lithium batteries according to the manufacturer's instructions and local regulations.

 **CAUTION—POTENTIAL INJURY:** To reduce the risk of fire, use only a 26 AWG or larger telecommunications (RJ-11) cord when connecting this product to the public switched telephone network. For users in Australia, the cord must be approved by the Australian Communications and Media Authority.

 **CAUTION—POTENTIAL INJURY:** Do not cut, twist, bind, crush, or place heavy objects on the power cord. Do not subject the power cord to abrasion or stress. Do not pinch the power cord between objects such as furniture and walls. If any of these things happen, a risk of fire or electrical shock results. Inspect the power cord regularly for signs of such problems. Remove the power cord from the electrical outlet before inspecting it.

 **CAUTION—POTENTIAL INJURY:** To reduce the risk of equipment instability, load each tray separately. Keep all other trays closed until needed.

 **CAUTION—SHOCK HAZARD:** To avoid the risk of electrical shock when cleaning the exterior of the printer, unplug the power cord from the electrical outlet and disconnect all cables from the printer before proceeding.

 **CAUTION—SHOCK HAZARD:** If you are accessing the controller board or installing optional hardware or memory devices sometime after setting up the printer, then turn the printer off, and unplug the power cord from the electrical outlet before continuing. If you have any other devices attached to the printer, then turn them off as well, and unplug any cables going into the printer.

 **CAUTION—POTENTIAL INJURY:** The printer weight is greater than 18 kg (40 lb) and requires two or more trained personnel to lift it safely.

 **CAUTION—POTENTIAL INJURY:** When moving the printer, follow these guidelines to avoid personal injury or printer damage:

- Make sure that all doors and trays are closed.
- Turn off the printer, and then unplug the power cord from the electrical outlet.
- Disconnect all cords and cables from the printer.



- If the printer has a caster base, then carefully roll it to the new location. Use caution when passing over thresholds and breaks in flooring.
- If the printer does not have a caster base but is configured with optional trays, then lift the printer off the trays. Do not try to lift the printer and the trays at the same time.
- Always use the handholds on the printer to lift it.
- Any cart used to move the printer must have a surface able to support the full footprint of the printer.
- Any cart used to move the hardware options must have a surface able to support the dimensions of the options.
- Keep the printer in an upright position.
- Avoid severe jarring movements.
- Make sure that your fingers are not under the printer when you set it down.
- Make sure that there is adequate clearance around the printer.



**CAUTION—POTENTIAL INJURY:** To avoid the risk of fire or electrical shock, use only the power cord provided with this product or the manufacturer's authorized replacement.

**SAVE THESE INSTRUCTIONS.**

# Learning about the printer

## Finding information about the printer

What are you looking for?	Find it here
Initial setup instructions: <ul style="list-style-type: none"> <li>• Connecting the printer</li> <li>• Installing the printer software</li> </ul>	Setup documentation—The setup documentation came with the printer and is also available at <a href="http://support.lexmark.com">http://support.lexmark.com</a> .
Additional setup and instructions for using the printer: <ul style="list-style-type: none"> <li>• Selecting and storing paper and specialty media</li> <li>• Loading paper</li> <li>• Configuring printer settings</li> <li>• Viewing and printing documents and photos</li> <li>• Setting up and using the printer software</li> <li>• Configuring the printer on a network</li> <li>• Caring for and maintaining the printer</li> <li>• Troubleshooting and solving problems</li> </ul>	<i>User's Guide</i> and <i>Quick Reference Guide</i> —The guides are available at <a href="http://support.lexmark.com">http://support.lexmark.com</a> . <b>Note:</b> These guides are also available in other languages.
Information on setting up and configuring the accessibility features of your printer	<i>Lexmark Accessibility Guide</i> —This guide is available at <a href="http://support.lexmark.com">http://support.lexmark.com</a> .
Help using the printer software	Windows or Mac Help—Open a printer software program or application, and then click <b>Help</b> . Click  to view context-sensitive information. <b>Notes:</b> <ul style="list-style-type: none"> <li>• Help is automatically installed with the printer software.</li> <li>• The printer software is located in the printer program folder or on the desktop, depending on your operating system.</li> </ul>

What are you looking for?	Find it here
<p>The latest supplemental information, updates, and customer support:</p> <ul style="list-style-type: none"> <li>• Documentation</li> <li>• Driver downloads</li> <li>• Live chat support</li> <li>• E-mail support</li> <li>• Voice support</li> </ul>	<p>Lexmark support Web site—  <a href="http://support.lexmark.com">http://support.lexmark.com</a></p> <p><b>Note:</b> Select your country or region, and then select your product to view the appropriate support site.</p> <p>Support telephone numbers and hours of operation for your country or region can be found on the support Web site or on the printed warranty that came with your printer.</p> <p>Record the following information (located on the store receipt and at the back of the printer), and have it ready when you contact customer support so that they may serve you faster:</p> <ul style="list-style-type: none"> <li>• Machine Type number</li> <li>• Serial number</li> <li>• Date purchased</li> <li>• Store where purchased</li> </ul>
<p>Warranty information</p>	<p>Warranty information varies by country or region:</p> <ul style="list-style-type: none"> <li>• <b>In the U.S.</b>—See the Statement of Limited Warranty included with this printer, or go to <a href="http://support.lexmark.com">http://support.lexmark.com</a>.</li> <li>• <b>In other countries and regions</b>—See the printed warranty that came with this printer.</li> </ul>

## Selecting a location for the printer

 **CAUTION—POTENTIAL INJURY:** The printer weight is greater than 18 kg (40 lb) and requires two or more trained personnel to lift it safely.

When selecting a location for the printer, leave enough room to open trays, covers, and doors. If you plan to install any options, then leave enough room for them also. It is important to:

- Set up the printer near a properly grounded and easily accessible electrical outlet.
- Make sure airflow in the room meets the latest revision of the ASHRAE 62 standard or the CEN Technical Committee 156 standard.
- Provide a flat, sturdy, and stable surface.
- Keep the printer:
  - Clean, dry, and free of dust.
  - Away from stray staples and paper clips.
  - Away from the direct airflow of air conditioners, heaters, or ventilators.
  - Free from direct sunlight and humidity extremes.
- Observe the recommended temperatures and avoid fluctuations:

Ambient temperature	15.6 to 32.2°C (60 to 90°F)
Storage temperature	-40 to 60°C (-40 to 140°F)

- Allow the following recommended amount of space around the printer for proper ventilation:

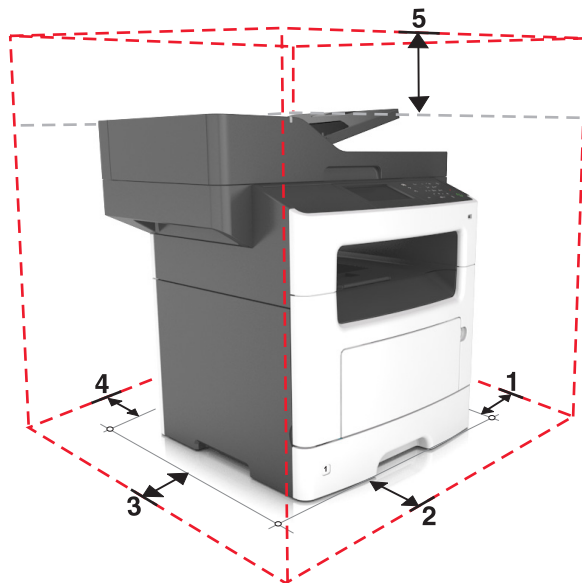

1	Right side	304.8 mm (12 in.)
2	Front	508 mm (20 in.)
3	Left side	203.2 mm (8 in.)
4	Rear	203.2 mm (8 in.)
5	Top	736.6 mm (29 in.)

## Printer configurations

**CAUTION—TIPPING HAZARD:** Floor-mounted configurations require additional furniture for stability. You must use either a printer stand or printer base if you are using multiple input options. If you purchased a multifunction printer (MFP) that scans, copies, and faxes, then you may need additional furniture. For more information, see [www.lexmark.com/multifunctionprinters](http://www.lexmark.com/multifunctionprinters).

**CAUTION—POTENTIAL INJURY:** To reduce the risk of equipment instability, load each tray separately. Keep all other trays closed until needed.

You can configure your printer by adding an optional 250- or 550-sheet tray. For instructions on installing the optional tray, see [“Installing optional trays” on page 42](#).

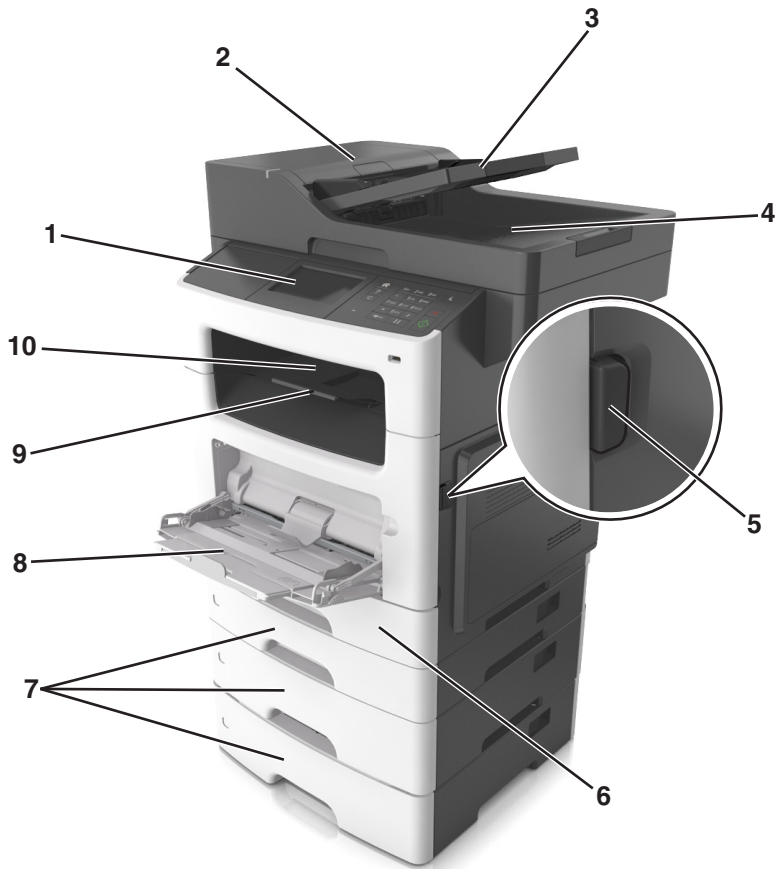



1	Printer control panel
2	Automatic document feeder (ADF)
3	ADF tray
4	ADF bin
5	Front door release button
6	Standard 250-sheet tray
7	Optional 250- or 550-sheet tray
8	100-sheet multipurpose feeder
9	Paper stop
10	Standard bin

## Understanding the basic functions of the scanner

- Make quick copies or set the printer to perform specific copy jobs.
- Send a fax using the printer control panel.
- Send a fax to multiple fax destinations at the same time.
- Scan documents and send them to your computer, an e-mail address, or an FTP destination.
- Scan documents and send them to another printer (PDF through an FTP).

## Using the ADF and scanner glass

Automatic document feeder (ADF)	Scanner glass
 <p data-bbox="149 688 643 751">Use the ADF for multiple-page documents including two-sided (duplex) pages.</p>	 <p data-bbox="750 772 1471 865">Use the scanner glass for single-page documents, book pages, small items (such as postcards or photos), transparencies, photo paper, or thin media (such as magazine clippings).</p>

### Using the ADF

When using the ADF:

- Load the document into the ADF tray faceup, short edge first.
- Load up to 50 sheets of plain paper into the ADF tray.
- Scan sizes from 105 x 148 mm (4.1 x 5.8 inches) wide to 216 x 368 mm (8.5 x 14.5 inches) long.
- Scan media weights from 52 to 120 g/m<sup>2</sup> (14–32 lb).
- Do not load postcards, photos, small items, transparencies, photo paper, or thin media (such as magazine clippings) into the ADF tray. Place these items on the scanner glass.

### Using the scanner glass

When using the scanner glass:

- Place a document facedown on the scanner glass in the corner with the green arrow.
- Scan or copy documents up to 216 x 355.6 mm (8.5 x 14 inches) long.
- Copy books up to 25.3 mm (1 inch) thick.

# Understanding the printer control panel

## Using the printer control panel

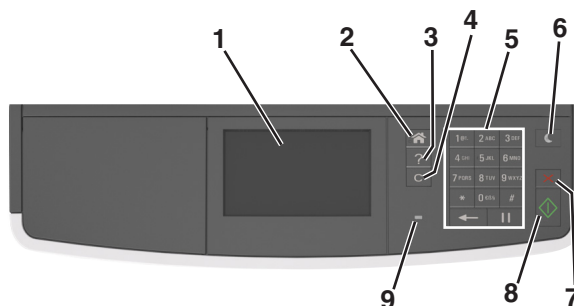

	Use the	To
1	Display	<ul style="list-style-type: none"> <li>View the printer status and messages.</li> <li>Set up and operate the printer.</li> </ul>
2	Home button	Go to the home screen.
3	Tips	Open a context-sensitive Help dialog.
4	Clear all / Reset button	Reset the default settings of a function, such as copying, faxing, or scanning.
5	Keypad	Enter numbers, letters, or symbols.
6	Sleep button	Enable Sleep mode or Hibernate mode. Do one of the following to wake the printer from Sleep mode: <ul style="list-style-type: none"> <li>Press any hard button.</li> <li>Open a door or cover.</li> <li>Send a print job from the computer.</li> <li>Perform a power-on reset with the main power switch.</li> </ul>
7	Stop or Cancel button	Stop all printer activity.
8	Submit button	Submit changes made in the printer settings.
9	Indicator light	Check the status of the printer.

## Understanding the colors of the Sleep button and indicator lights

The colors of the Sleep button and indicator lights on the control panel signify a printer status or condition.

Indicator light	Printer status
Off	The printer is off or in Hibernate mode.
Blinking green	The printer is warming up, processing data, or printing.
Solid green	The printer is on, but idle.
Blinking red	The printer requires user intervention.

Sleep button light	Printer status
Off	The printer is off, idle, or in Ready state.
Solid amber	The printer is in Sleep mode.
Blinking amber	The printer is entering or waking from Hibernate mode.
Blinking amber for 0.1 second, then goes completely off for 1.9 seconds in a slow, pulsing pattern	The printer is in Hibernate mode.

## Understanding the home screen

When the printer is turned on, the display shows a basic screen, referred to as the home screen. Use the home screen buttons and icons to initiate an action such as copying, faxing, or scanning; to open the menu screen; or respond to messages.

**Note:** Your home screen may vary depending on your home screen customization settings, administrative setup, and active embedded solutions.

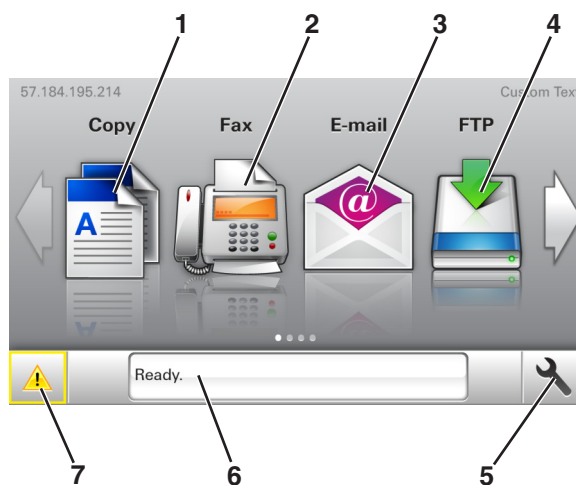

Touch	To
<b>1</b> Copy	Access the Copy menus and make copies.
<b>2</b> Fax	Access the Fax menus and send fax.
<b>3</b> E-mail	Access the E-mail menus and send e-mails.
<b>4</b> FTP	Access the File Transfer Protocol (FTP) menus and scan documents directly to an FTP server.
<b>5</b> Menu icon	Access printer menus. <b>Note:</b> The menus are available only when the printer is in ready state.
<b>6</b> Status message bar	<ul style="list-style-type: none"> <li>Show the current printer status such as <b>Ready</b> or <b>Busy</b>.</li> <li>Show printer supply conditions such as <b>Imaging unit low</b> or <b>Cartridge Low</b>.</li> <li>Show intervention messages and the instructions on how to clear them.</li> </ul>





Touch		To
7	Status/Supplies	<ul style="list-style-type: none"> <li>• Show a printer warning or error message whenever the printer requires intervention to continue processing.</li> <li>• View more information on the printer warning or message, and on how to clear it.</li> </ul>

This may also appear on the home screen:

Touch	To
Search Held Jobs	Search current held jobs.
Jobs by user	Access print jobs saved by user.
Profiles and Apps	Access profiles and applications.

## Features



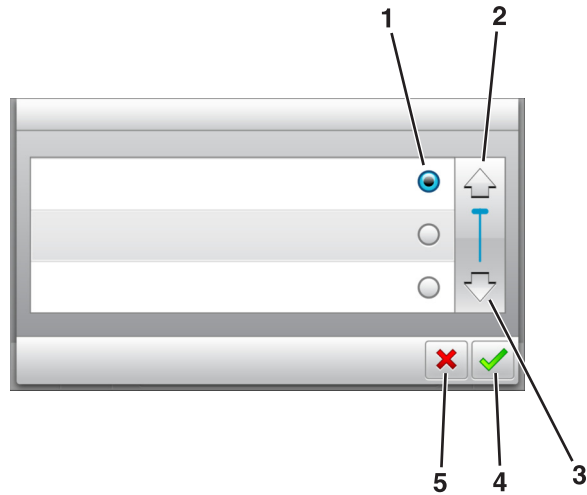

Feature	Description
Attendance message alert 	If an attendance message affects a function, then this icon appears and the red indicator light blinks.
Warning 	If an error condition occurs, then this icon appears.
Printer IP address Example: <b>123 . 123 . 123 . 123</b>	The IP address of your printer is located at the top left corner of the home screen and appears as four sets of numbers separated by periods. You can use the IP address when accessing the Embedded Web Server to view and remotely configure printer settings even when you are not physically near the printer.

## Using the touch-screen buttons

**Note:** Your home screen may vary, depending on your home screen customization settings, administrative setup, and active embedded solutions.



	Touch the	To
<b>1</b>	Radio button	Select or clear an item.
<b>2</b>	Up arrow	Scroll up.
<b>3</b>	Down arrow	Scroll down.
<b>4</b>	Accept button	Save a setting.
<b>5</b>	Cancel button	<ul style="list-style-type: none"> <li>• Cancel an action or a selection.</li> <li>• Return to the previous screen.</li> </ul>

Touch	To
	Return to the home screen.
	Open a context-sensitive Help dialog on the printer control panel.
	Scroll to the left.
	Scroll to the right.

# Setting up and using the home screen applications

## Notes:

- Your home screen, icons, and buttons may vary depending on your home screen customization settings, administrative setup, and active embedded applications.
- There may be additional solutions and applications available for purchase. For more information, go to <http://support.lexmark.com> or contact the place where you purchased the printer.

## Finding the IP address of the computer

### For Windows users

- 1 In the Run dialog box, type **cmd** to open the command prompt.
- 2 Type **ipconfig**, and then look for the IP address.

### For Macintosh users

- 1 From System Preferences in the Apple menu, select **Network**.
- 2 Select your connection type, and then click **Advanced** > **TCP/IP**.
- 3 Look for the IP address.

## Finding the IP address of the printer

**Note:** Make sure your printer is connected to a network or to a print server.

You can find the printer IP address:

- From the top left corner of the printer home screen.
- From the TCP/IP section in the Network/Ports menu.
- By printing a network setup page or menu settings page, and then finding the TCP/IP section.

**Note:** An IP address appears as four sets of numbers separated by periods, such as 123.123.123.123.

## Accessing the Embedded Web Server

The Embedded Web Server is the printer Web page that lets you view and remotely configure printer settings even when you are not physically near the printer.

- 1 Obtain the printer IP address:
  - From the printer control panel home screen
  - From the TCP/IP section in the Network/Ports menu
  - By printing a network setup page or menu settings page, and then finding the TCP/IP section

**Note:** An IP address appears as four sets of numbers separated by periods, such as **123 . 123 . 123 . 123**.

- 2 Open a Web browser, and then type the printer IP address in the address field.
- 3 Press **Enter**.

**Note:** If you are using a proxy server, then temporarily disable it to load the Web page correctly.

## Customizing the home screen

- 1 Open a Web browser, and then type the printer IP address in the address field.

**Note:** View the printer IP address on the printer home screen. The IP address appears as four sets of numbers separated by periods, such as 123.123.123.123.

- 2 Do one or more of the following:

- Show or hide the icons of basic printer functions.
  - a Click **Settings** > **General Settings** > **Home screen customization**.
  - b Select the check boxes to specify which icons appear on the home screen.

**Note:** If you clear a check box beside an icon, then the icon does not appear on the home screen.

- Click **Submit**.
- Customize the icon for an application. For more information, see [“Finding information about the home screen applications” on page 21](#) or see the documentation that came with the application.

## Understanding the different applications

Use	To
<b>Card Copy</b>	Scan and print both sides of a card on a single page. For more information, see <a href="#">“Setting up Card Copy” on page 22</a> .
<b>Fax</b>	Scan a document, and then send it to a fax number. For more information, see <a href="#">“Faxing” on page 100</a> .
<b>Forms and Favorites</b>	Quickly find and print frequently used online forms directly from the printer home screen. For more information, see <a href="#">“Setting up Forms and Favorites” on page 21</a> .
<b>Multi Send</b>	Scan a document, and then send it to multiple destinations. For more information, see <a href="#">“Setting up Multi Send” on page 23</a> .
<b>MyShortcut</b>	Create shortcuts directly on the printer home screen. For more information, see <a href="#">“Using MyShortcut” on page 22</a> .
<b>Scan to E-mail</b>	Scan a document, and then send it to an e-mail address. For more information, see <a href="#">“E-mailing” on page 93</a> .
<b>Scan to Computer</b>	Scan a document, and then save it to a predefined folder on a host computer. For more information, see <a href="#">“Setting up Scan to Computer” on page 124</a> .
<b>Scan to FTP</b>	Scan documents directly to a File Transfer Protocol (FTP) server. For more information, see <a href="#">“Scanning to an FTP address” on page 122</a> .
<b>Scan to Network</b>	Scan a document, and then send it to a network shared folder. For more information, see <a href="#">“Setting up Scan to Network” on page 23</a> .

## Activating the home screen applications

### Finding information about the home screen applications

Your printer comes with preinstalled home screen applications. Before you can use these applications, you must first activate and set up these applications using the Embedded Web Server. For more information on accessing the Embedded Web Server, see [“Accessing the Embedded Web Server” on page 19](#).

For more information on configuring and using the home screen applications, do the following:

- 1 Go to <http://support.lexmark.com>.
- 2 Click **Software Solutions**, and then select either of the following:
  - **Scan to Network**—This lets you find information about the Scan to Network application.
  - **Other Applications**—This lets you find information about the other applications.
- 3 Click the **Manuals** tab, and then select the document for the home screen application.

### Setting up Forms and Favorites

**Note:** A later version of this *User's Guide* may contain a direct link to the *Administrator's Guide* of this application. To check for updates of this *User's Guide*, go to <http://support.lexmark.com>.

Use	To
	<p>Streamline work processes by letting you quickly find and print frequently used online forms directly from the printer home screen.</p> <p><b>Note:</b> The printer must have permission to access the network folder, FTP site, or Web site where the bookmark is stored. From the computer where the bookmark is stored, use sharing, security, and firewall settings to allow the printer at least a <i>read</i> access. For help, see the documentation that came with your operating system.</p>

- 1 Open a Web browser, and then type the printer IP address in the address field.

**Note:** View the printer IP address on the printer home screen. The IP address appears as four sets of numbers separated by periods, such as 123.123.123.123.

- 2 Click **Settings > Apps > Apps Management > Forms and Favorites**.
- 3 Click **Add**, and then customize the settings.

**Notes:**

- See the mouse-over help beside each field for a description of the setting.
- To make sure the location settings of the bookmark are correct, type the correct IP address of the host computer where the bookmark is located. For more information on obtaining the IP address of the host computer, see [“Finding the IP address of the computer” on page 19](#).
- Make sure the printer has access rights to the folder where the bookmark is located.

- 4 Click **Apply**.

To use the application, touch **Forms and Favorites** on the printer home screen, and then navigate through form categories, or search for forms based on a form number, name, or description.

## Setting up Card Copy

**Note:** A later version of this *User's Guide* may contain a direct link to the *Administrator's Guide* of this application. To check for updates of this *User's Guide*, go to <http://support.lexmark.com>.

Use	To
	<p>Quickly and easily copy insurance, identification, and other wallet-size cards. You can scan and print both sides of a card on a single page, saving paper and showing the information on the card in a more convenient manner.</p>

**1** Open a Web browser, and then type the printer IP address in the address field.

**Note:** View the printer IP address on the printer home screen. The IP address appears as four sets of numbers separated by periods, such as 123.123.123.123.

**2** Click **Settings > Apps > Apps Management > Card Copy**.

**3** Change the default scanning options, if necessary.

- **Default tray**—Select the default tray to be used for printing scan images.
- **Default number of copies**—Specify the number of copies that should automatically print when the application is used.
- **Default contrast setting**—Specify a setting to increase or decrease the level of contrast when a copy of the scanned card is printed. Select **Best for Content** if you want the printer to adjust the contrast automatically.
- **Default scale setting**—Set the size of the scanned card when printed. The default setting is 100% (full size).
- **Resolution setting**—Adjust the quality of the scanned card.

**Notes:**

- When scanning a card, make sure the scan resolution is not more than 200 dpi for color, and 400 dpi for black and white.
- When scanning multiple cards, make sure the scan resolution is not more than 150 dpi for color, and 300 dpi for black and white.

- **Print Borders**—Select the check box to print the scan image with a border around it.

**4** Click **Apply**.

To use the application, touch **Card Copy** on the printer home screen, and then follow the instructions.

## Using MyShortcut

**Note:** A later version of this *User's Guide* may contain a direct link to the *Administrator's Guide* of this application. To check for updates of this *User's Guide*, go to <http://support.lexmark.com>.

Use	To
	Create shortcuts on the printer home screen, with settings for up to 25 frequently used copy, fax, or e-mail jobs.

To use the application, touch **MyShortcut**, and then follow the instructions on the printer display.

## Setting up Multi Send

**Note:** A later version of this *User's Guide* may contain a direct link to the *Administrator's Guide* of this application. To check for updates of this *User's Guide*, go to <http://support.lexmark.com>.

Use	To
	Scan a document, and then send the scanned document to multiple destinations. <b>Note:</b> Make sure there is enough space in the printer hard disk.

**1** Open a Web browser, and then type the printer IP address in the address field.

**Note:** View the printer IP address on the printer home screen. The printer IP address appears as four sets of numbers separated by periods, such as 123.123.123.123.

**2** Click **Settings > Apps > Apps Management > Multi Send**.

**3** From the Profiles section, click **Add**, and then customize the settings.

**Notes:**

- See the mouse-over help beside each field for a description of the setting.
- If you select **FTP** or **Share Folder** as a destination, then make sure the location settings of the destination are correct. Type the correct IP address of the host computer where the specified destination is located. For more information on obtaining the IP address of the host computer, see [“Finding the IP address of the computer” on page 19](#).

**4** Click **Apply**.

To use the application, touch **Multi Send** on the printer home screen, and then follow the instructions on the printer display.

## Setting up Scan to Network

**Note:** A later version of this *User's Guide* may contain a direct link to the *Administrator's Guide* of this application. To check for updates of this *User's Guide*, go to <http://support.lexmark.com>.

Use	To
	<p>Scan a document and send it to a shared network folder. You can define up to 30 unique folder destinations.</p> <p><b>Notes:</b></p> <ul style="list-style-type: none"> <li>• The printer must have permission to write to the destinations. From the computer where the destination is specified, use sharing, security, and firewall settings to allow the printer at least a <i>write</i> access. For help, see the documentation that came with your operating system.</li> <li>• The Scan to Network icon appears only when one or more destinations are defined.</li> </ul>

**1** Open a Web browser, and then type the printer IP address in the address field.

**Note:** View the printer IP address on the printer home screen. The IP address appears as four sets of numbers separated by periods, such as 123.123.123.123.

**2** Do either of the following:

- Click **Set up Scan to Network** > **Click here**.
- Click **Settings** > **Apps** > **Apps Management** > **Scan to Network**.

**3** Specify the destinations, and then customize the settings.

**Notes:**

- See the mouse-over help beside some of the fields for a description of the setting.
- To make sure the location settings of the destination are correct, type the correct IP address of the host computer where the specified destination is located. For more information on obtaining the IP address of the host computer, see [“Finding the IP address of the computer” on page 19](#).
- Make sure the printer has access rights to the folder where the specified destination is located.

**4** Click **Apply**.

To use the application, touch **Scan to Network** on the printer home screen, and then follow the instructions on the printer display.

## Setting up Remote Operator Panel

This application enables you to interact with the printer control panel even when you are not physically near the network printer. From your computer, you can view the printer status, release held print jobs, create bookmarks, and do other print-related tasks.

**1** Open a Web browser, and then type the printer IP address in the address field.

**Note:** View the printer IP address on the printer home screen. The IP address appears as four sets of numbers separated by periods, such as 123.123.123.123.

**2** Click **Settings** > **Remote Operator Panel Settings**.

**3** Select the **Enable** check box, and then customize the settings.

**4** Click **Submit**.

To use the application, click **Remote Operator Panel** > **Launch VNC Applet**.



## Exporting and importing a configuration

You can export configuration settings into a text file, and then import the file to apply the settings to other printers.

- 1 Open a Web browser, and then type the printer IP address in the address field.

**Note:** View the IP address on the printer home screen. The IP address appears as four sets of numbers separated by periods, such as 123.123.123.123.

- 2 Export or import a configuration file for one or multiple applications.

### For one application

- a Navigate to:

**Settings > Apps > Apps Management > select an application > Configure**

- b Export or import the configuration file.

#### Notes:

- If a **JVM Out of Memory** error occurs, then repeat the export process until the configuration file is saved.
- If a timeout occurs and a blank screen appears, then refresh the Web browser, and then click **Apply**.

### For multiple applications

- a Click **Settings > Import/Export**.

- b Export or import a configuration file.

**Note:** When importing a configuration file, click **Submit** to complete the process.

# Additional printer setup

## Installing internal options

 **CAUTION—SHOCK HAZARD:** If you are accessing the controller board or installing optional hardware or memory devices sometime after setting up the printer, then turn the printer off, and unplug the power cord from the electrical outlet before continuing. If you have any other devices attached to the printer, then turn them off as well, and unplug any cables going into the printer.

## Available internal options

- Memory card
  - DDR3 DIMM
  - Flash memory
    - Fonts
    - Firmware cards
      - Forms Barcode
      - Prescribe
      - IPDS
      - Printcrypton
- Printer hard disk<sup>1</sup>
- Lexmark™ Internal Solutions Ports (ISPs)
  - Parallel 1284-B interface
  - MarkNet™ N8350 802.11 b/g/n wireless printer server<sup>1</sup>
  - MarkNet N8352 802.11 b/g/n wireless printer server<sup>2</sup>
  - MarkNet N8130 10/100 fiber interface
  - RS-232-C serial interface

<sup>1</sup> This internal option is available only in MX510, MX511, and MX517 printer models.

<sup>2</sup> This internal option is available only in MX410 and MX417 printer models.

## Accessing the controller board

**⚠ CAUTION—SHOCK HAZARD:** If you are accessing the controller board or installing optional hardware or memory devices sometime after setting up the printer, then turn the printer off, and unplug the power cord from the electrical outlet before continuing. If you have any other devices attached to the printer, then turn them off as well, and unplug any cables going into the printer.

- 1 Open the controller board access door.



- 2 Open the controller board shield using the green handle.

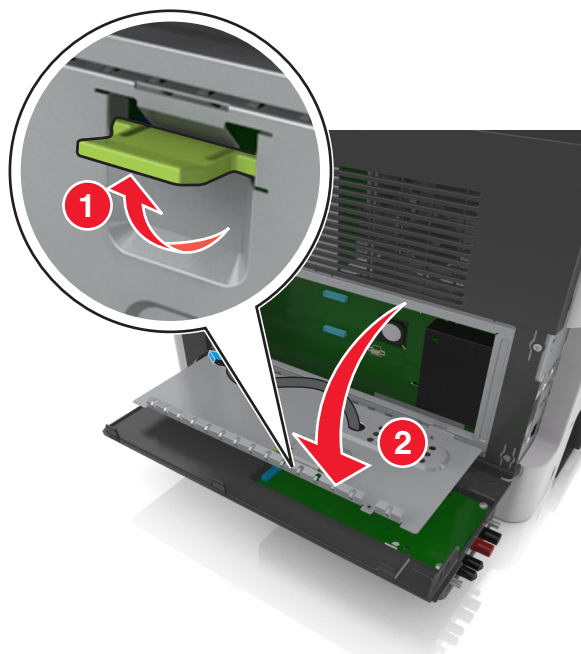

- 3 Use the following illustration to locate the appropriate connector.

**Warning—Potential Damage:** Controller board electronic components are easily damaged by static electricity. Touch something metal on the printer before touching any controller board electronic components or connectors.

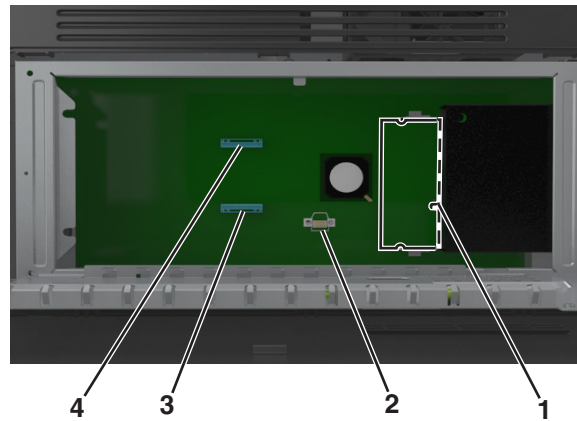

1	Memory card connector
2	Option card connector
3	Printer hard disk connector
4	Lexmark Internal Solutions Port connector

4 Close the shield, and then the access door.

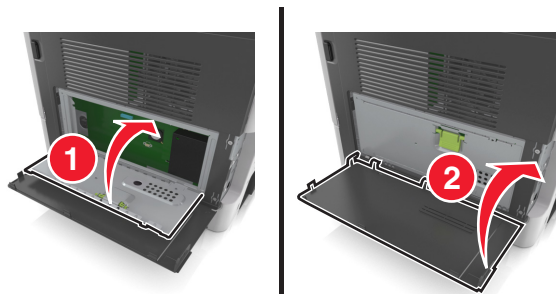

## Installing a memory card

**⚠ CAUTION—SHOCK HAZARD:** If you are accessing the controller board or installing optional hardware or memory devices sometime after setting up the printer, then turn the printer off, and unplug the power cord from the electrical outlet before continuing. If you have any other devices attached to the printer, then turn them off as well, and unplug any cables going into the printer.

**Warning—Potential Damage:** Controller board electronic components are easily damaged by static electricity. Touch something metal on the printer before touching any controller board electronic components or connectors.

**Note:** An optional memory card can be purchased separately and attached to the controller board.

1 Access the controller board.

For more information, see [“Accessing the controller board” on page 27.](#)

2 Unpack the memory card.

**Warning—Potential Damage:** Do not touch the connection points along the edge of the card. Doing so may cause damage.

**3** Align the notch (1) on the memory card with the ridge (2) on the connector.

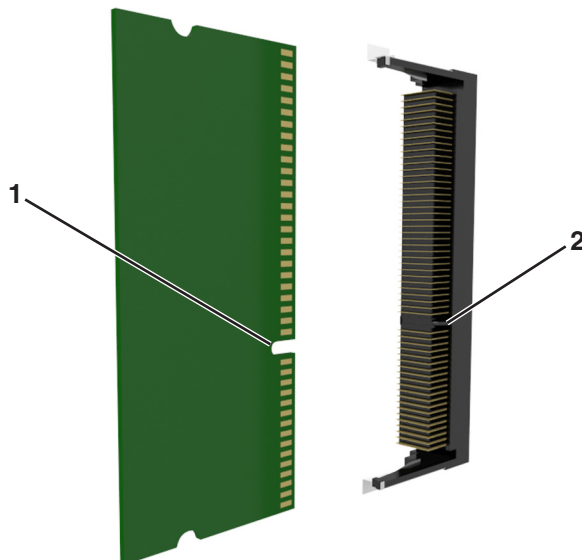

**4** Push the memory card straight into the connector, and then push the card toward the controller board wall until it *clicks* into place.

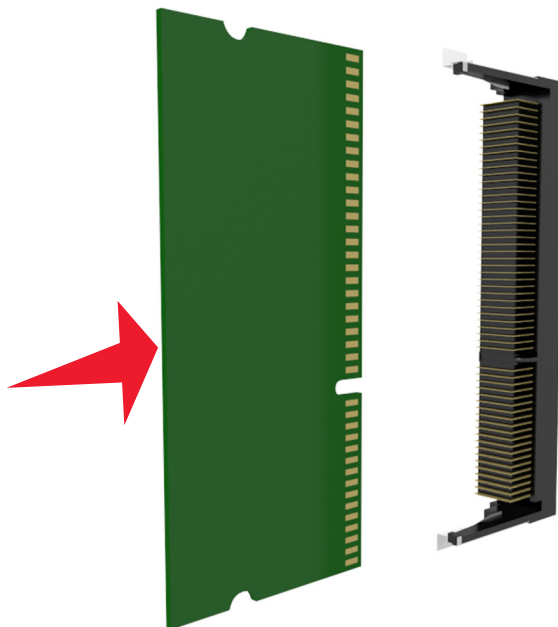

**5** Close the controller board shield, and then the controller board access door.

**Note:** When the printer software and any hardware options are installed, you may need to manually add the options in the printer driver to make them available for print jobs. For more information, see [“Adding available options in the print driver” on page 46.](#)

## Installing an optional card

**⚠ CAUTION—SHOCK HAZARD:** If you are accessing the controller board or installing optional hardware or memory devices sometime after setting up the printer, then turn the printer off, and unplug the power cord from the electrical outlet before continuing. If you have any other devices attached to the printer, then turn them off as well, and unplug any cables going into the printer.

**Warning—Potential Damage:** Controller board electronic components are easily damaged by static electricity. Touch a metal surface on the printer before touching any controller board electronic components or connectors.

**1** Access the controller board.

For more information, see [“Accessing the controller board” on page 27.](#)

**2** Unpack the optional card.

**Warning—Potential Damage:** Avoid touching the connection points along the edge of the card. Doing so may cause damage.

**3** Holding the card by its sides, align the plastic pins (1) on the card with the holes (2) on the controller board.

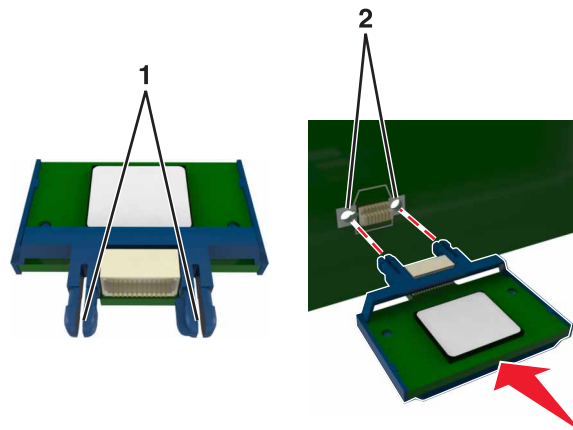

- 4 Push the card firmly into place.

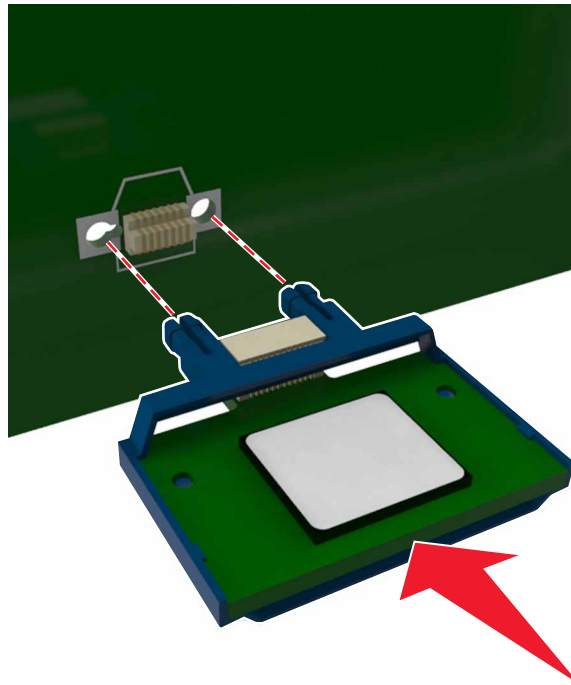

**Warning—Potential Damage:** Improper installation of the card may cause damage to the card and the controller board.

**Note:** The entire length of the connector on the card must touch and be flush with the controller board.

## Installing an Internal Solutions Port

The controller board supports one optional Lexmark Internal Solutions Port (ISP).

**Note:** This task requires a flat-head screwdriver.

**⚠ CAUTION—SHOCK HAZARD:** If you are accessing the controller board or installing optional hardware or memory devices sometime after setting up the printer, then turn the printer off, and unplug the power cord from the electrical outlet before continuing. If you have any other devices attached to the printer, then turn them off as well, and unplug any cables going into the printer.

**Warning—Potential Damage:** Controller board electronic components are easily damaged by static electricity. Touch a metal surface on the printer before touching any controller board electronic components or connectors.

- 1 Open the controller board access door.



- 2 Lightly press the stop on the left side of the access door, and then slide the access door to remove it.

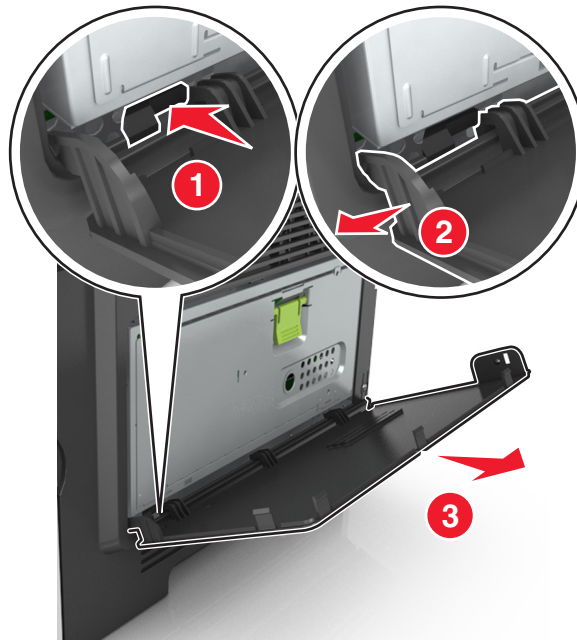

- 3 Unpack the ISP kit.

**Note:** Make sure to remove and discard the small cable attached to the white connector.



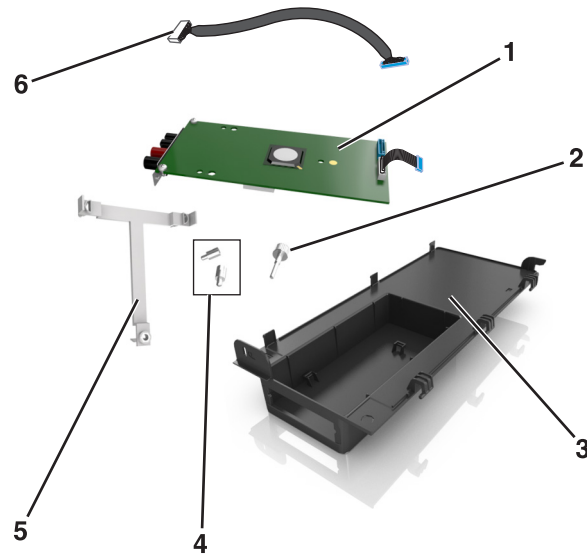

1	ISP solution
2	Screw to attach the ISP to the bracket
3	ISP exterior cover
4	Screws to attach the ISP metal bracket to the printer cage
5	Plastic bracket
6	Long ISP cable

**4** Place the plastic bracket inside the ISP exterior cover until it *clicks* into place.

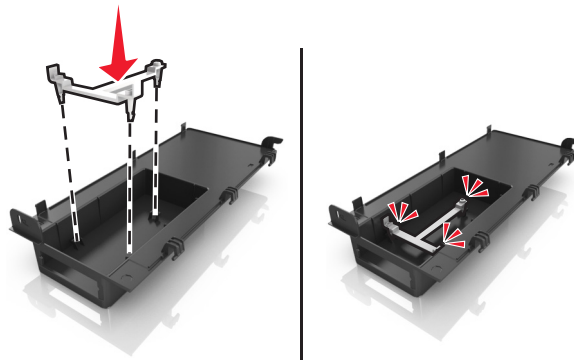

**5** Slide and push the ISP solution into the plastic bracket.

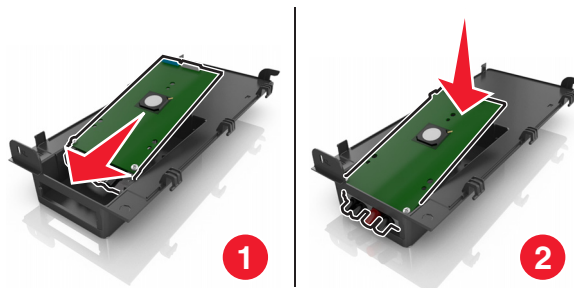

**6** Secure the ISP solution to the plastic bracket using the long screw.

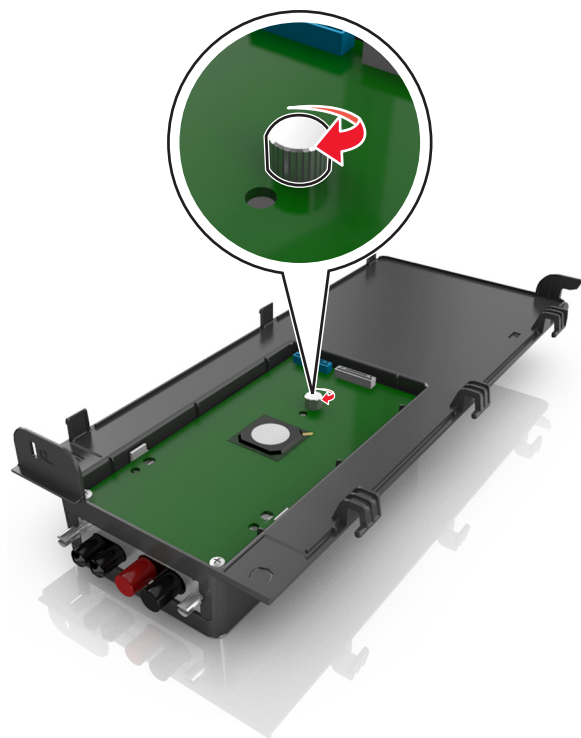

**7** Tighten the two screws on the end of the ISP solution.

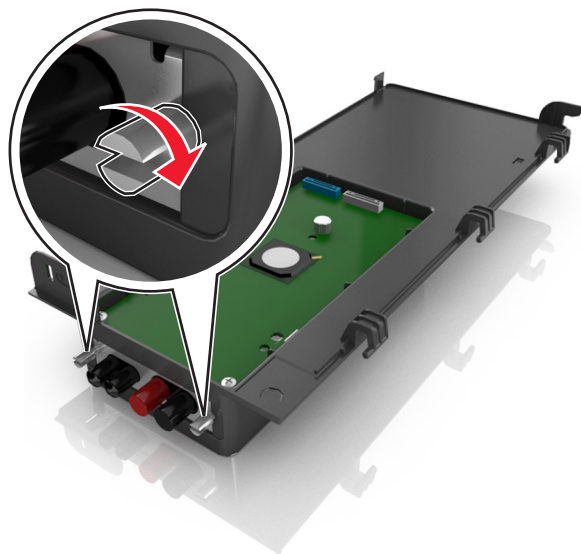

**8** Attach the white plug of the ISP solution interface cable into the white receptacle on the ISP.

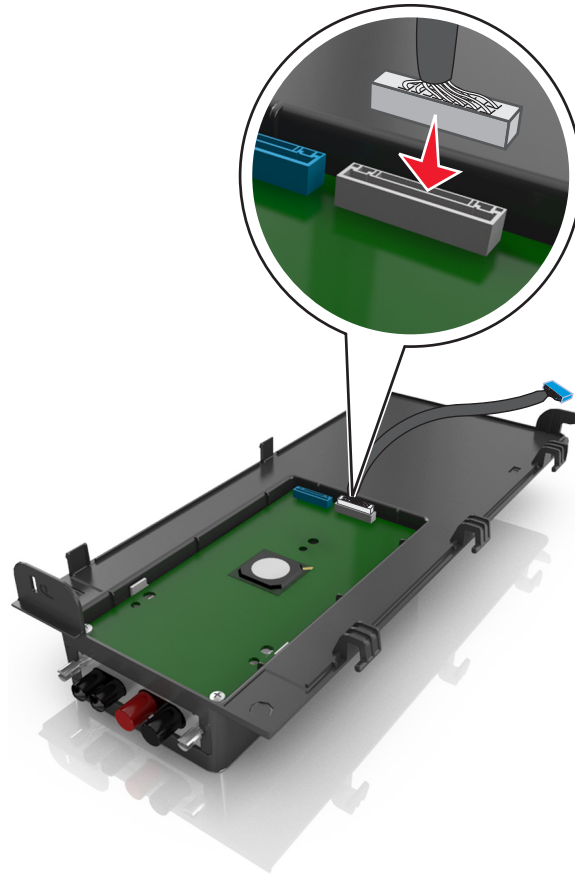

**9** Attach the ISP exterior cover at an angle by inserting the left hinges first.

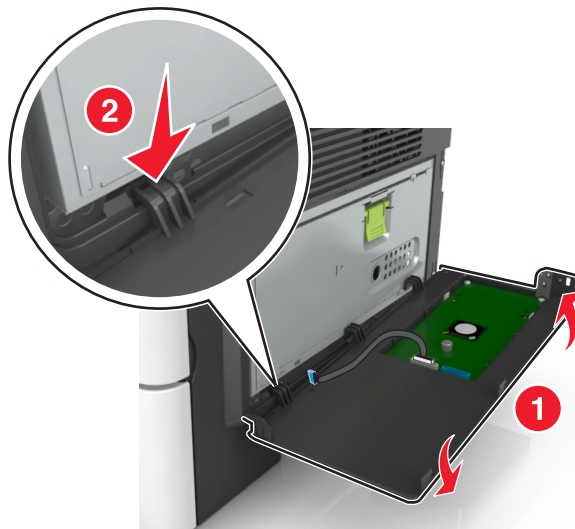

**10** Lower the rest of the cover, and then slide the cover to the right.

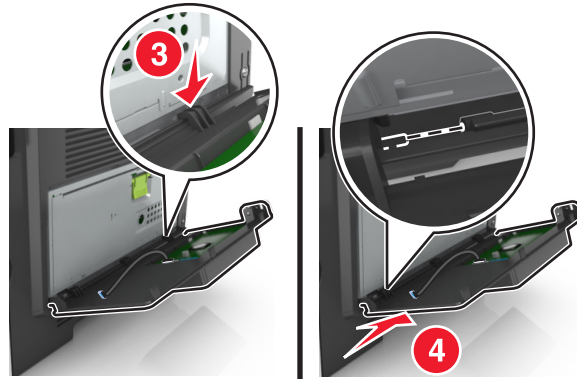

**11** Run the ISP cable through the controller board shield.

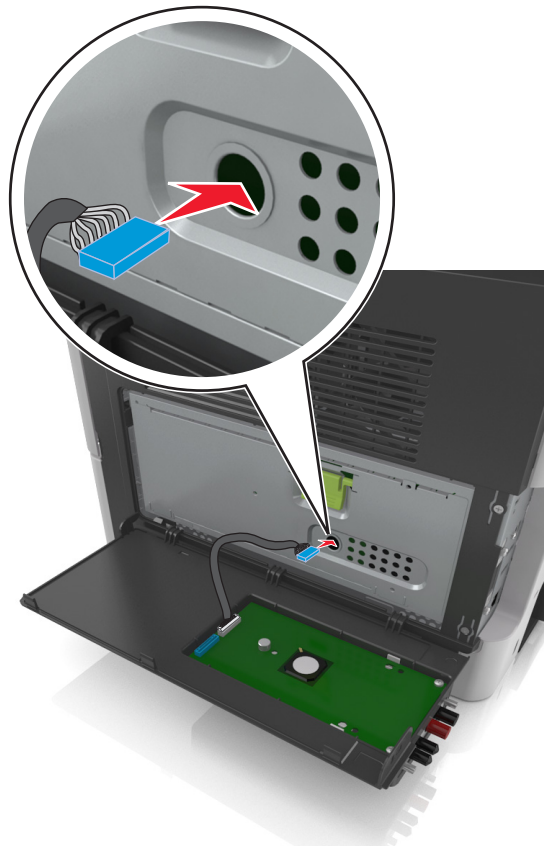

- 12 Open the shield using the green handle.

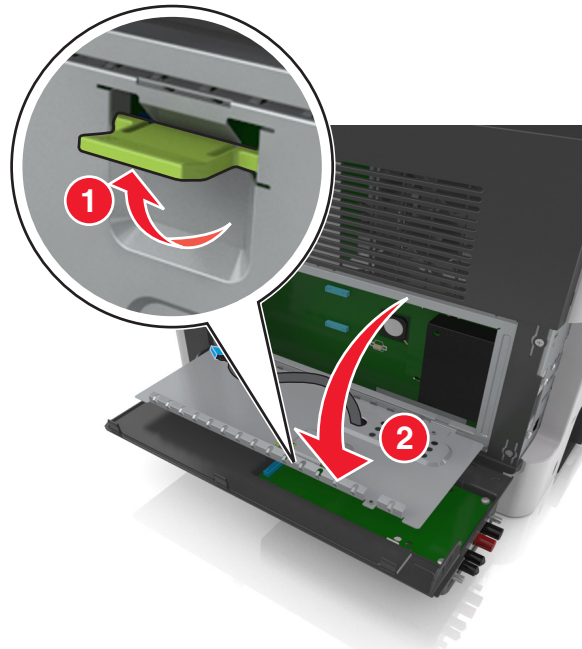

- 13 Attach the blue plug of the ISP solution interface cable into the blue receptacle on the controller board.

**Note:** If you have installed a printer hard disk, then you need to remove it. For more information, see [“Removing a printer hard disk” on page 41](#). To reinstall the printer hard disk, see [“Installing a printer hard disk” on page 38](#).

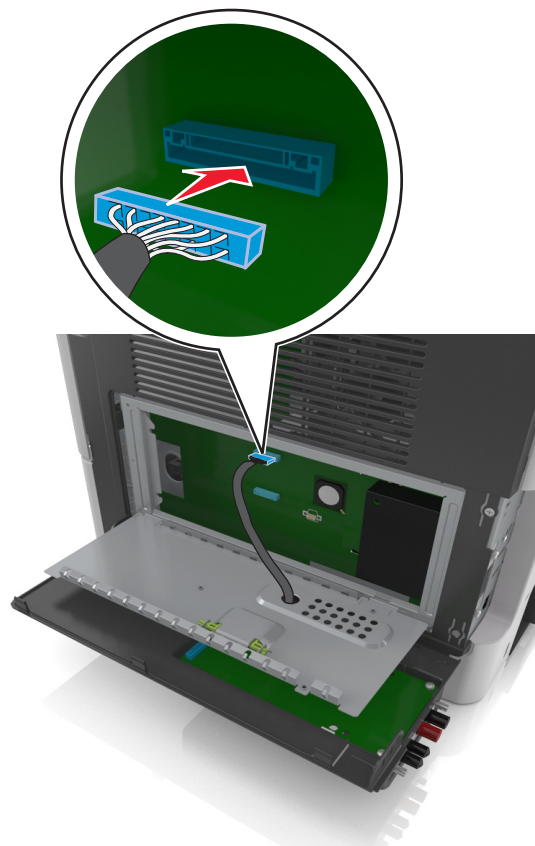

- 14 Close the shield.

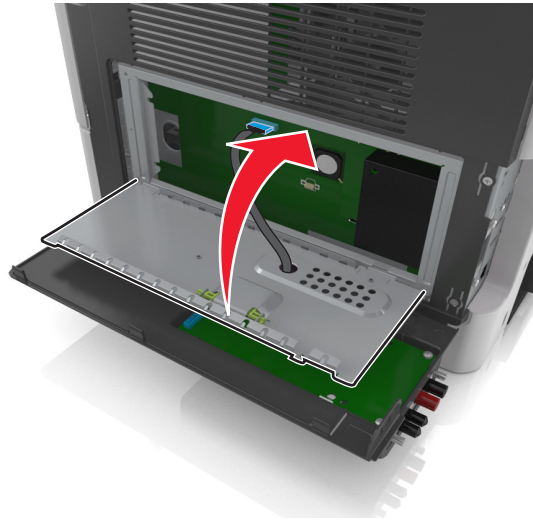

- 15 Close the ISP exterior cover.

**Note:** When the printer software and any hardware options are installed, it may be necessary to manually add the options in the printer driver to make them available for print jobs. For more information, see [“Adding available options in the print driver” on page 46](#).

## Installing a printer hard disk

**⚠ CAUTION—SHOCK HAZARD:** If you are accessing the controller board or installing optional hardware or memory devices sometime after setting up the printer, then turn the printer off, and unplug the power cord from the electrical outlet before continuing. If you have any other devices attached to the printer, then turn them off as well, and unplug any cables going into the printer.

**Warning—Potential Damage:** Controller board electronic components are easily damaged by static electricity. Touch a metal surface on the printer before touching any controller board electronic components or connectors.

- 1 Access the controller board.  
For more information, see [“Accessing the controller board” on page 27](#).
- 2 Unpack the printer hard disk.
- 3 Install the printer hard disk on the controller board.

**Warning—Potential Damage:** Hold only the edges of the printed circuit board assembly. Do not touch or press on the center of the printer hard disk. Doing so may cause damage.

- a** Using a flat-head screwdriver, loosen the screws.

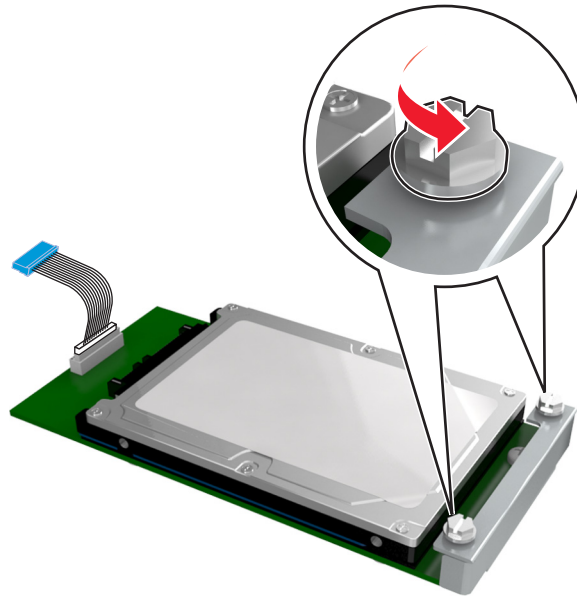

- b** Insert the plug of the printer hard disk interface cable into the receptacle of the controller board.

**Note:** The plug and the receptacle are color-coded blue.

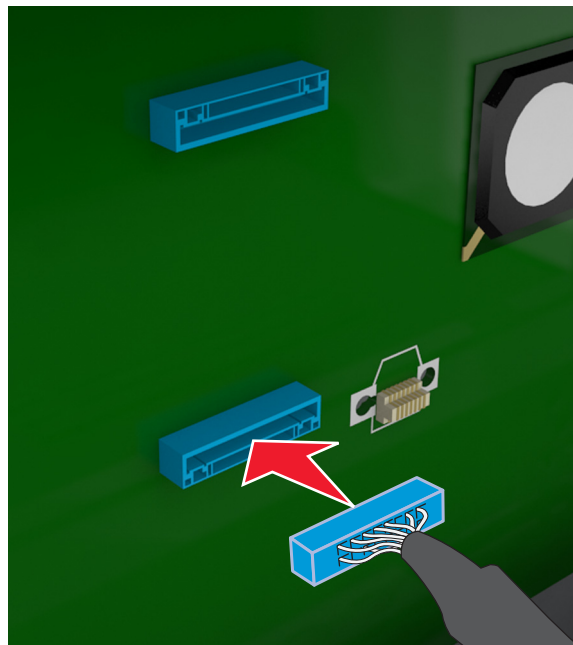

- c Align the screws on the printer hard disk to the slots on the controller board bracket, and then slide the printer hard disk onto the brackets.

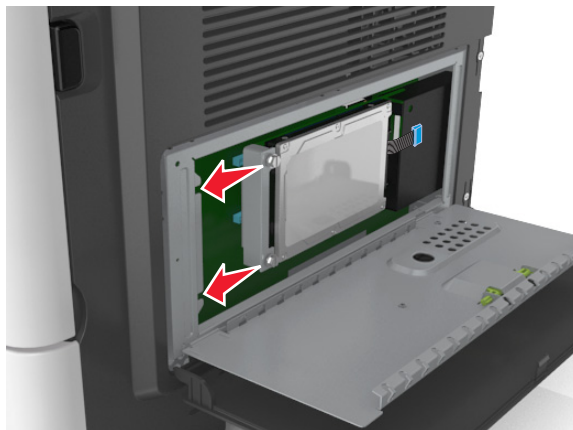

- d Tighten the two screws.

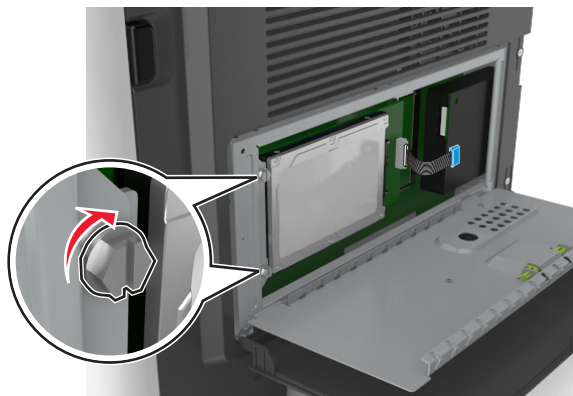

- 4 Close the controller board shield, and then close the controller board access door.

**Note:** When the printer software and any hardware options are installed, you may need to manually add the options in the printer driver to make them available for print jobs. For more information, see [“Adding available options in the print driver” on page 46](#).



## Removing a printer hard disk

**Warning—Potential Damage:** Controller board electronic components are easily damaged by static electricity. Touch a metal surface on the printer before touching any controller board electronic components or connectors.

- 1 Access the controller board.

For more information, see [“Accessing the controller board” on page 27](#).

**Note:** This task requires a flat-head screwdriver.

- 2 Loosen the screws that connect the printer hard disk to the controller board bracket.

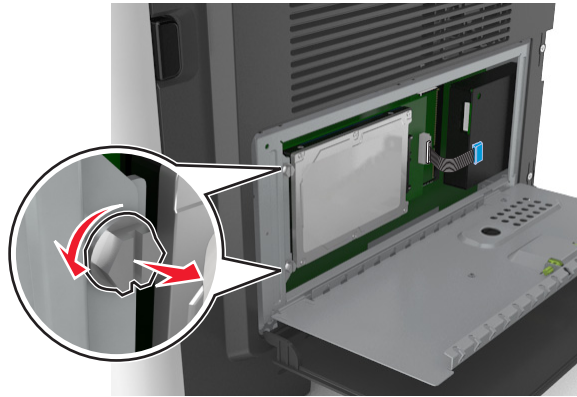

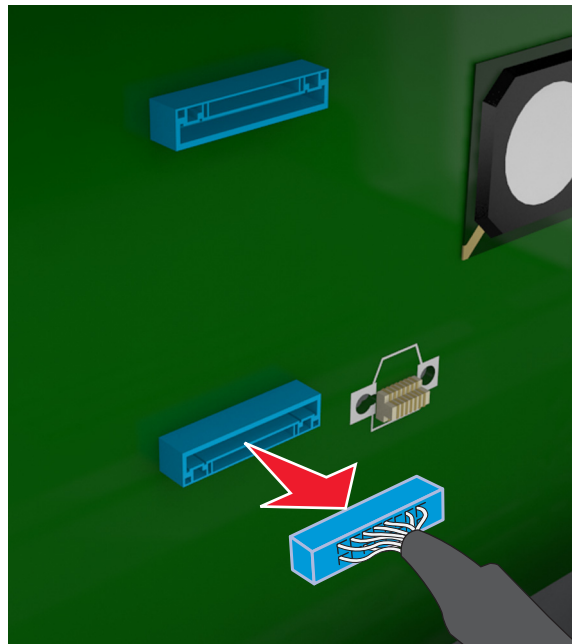

- 3 Unplug the printer hard disk interface cable from the receptacle in the controller board, leaving the cable attached to the printer hard disk. To unplug the cable, squeeze the paddle at the plug of the interface cable to disengage the latch before pulling the cable out.



- 4 Hold the printer hard disk by the edges, and then remove it from the printer.
- 5 Close the controller board shield, and then close the access door.

## Installing hardware options

### Order of installation



-  **CAUTION—POTENTIAL INJURY:** The printer weight is greater than 18 kg (40 lb) and requires two or more trained personnel to lift it safely.
-  **CAUTION—SHOCK HAZARD:** If you are accessing the controller board or installing optional hardware or memory devices sometime after setting up the printer, then turn the printer off, and unplug the power cord from the electrical outlet before continuing. If you have any other devices attached to the printer, then turn them off as well, and unplug any cables going into the printer.
-  **CAUTION—TIPPING HAZARD:** Floor-mounted configurations require additional furniture for stability. You must use either a printer stand or printer base if you are using multiple input options. If you purchased a multifunction printer (MFP) that scans, copies, and faxes, then you may need additional furniture. For more information, see [www.lexmark.com/multifunctionprinters](http://www.lexmark.com/multifunctionprinters).

Install the printer and any hardware options you have purchased in the following order:

- Printer stand
- Optional 250- or 550-sheet tray
- Printer

For more information on installing a printer stand, optional 250- or 550-sheet tray, or spacer, see the setup sheet that came with the option.

### Installing optional trays

-  **CAUTION—POTENTIAL INJURY:** The printer weight is greater than 18 kg (40 lb) and requires two or more trained personnel to lift it safely.
-  **CAUTION—SHOCK HAZARD:** If you are accessing the controller board or installing optional hardware or memory devices sometime after setting up the printer, then turn the printer off, and unplug the power cord from the electrical outlet before continuing. If you have any other devices attached to the printer, then turn them off as well, and unplug any cables going into the printer.
-  **CAUTION—TIPPING HAZARD:** Floor-mounted configurations require additional furniture for stability. You must use either a printer stand or printer base if you are using multiple input options. If you purchased a multifunction printer (MFP) that scans, copies, and faxes, then you may need additional furniture. For more information, see [www.lexmark.com/multifunctionprinters](http://www.lexmark.com/multifunctionprinters).

- 1 Turn off the printer using the power switch, and then unplug the power cord from the electrical outlet.



- 2 Unpack the tray, and then remove all packing material.
- 3 Pull out the tray from the base.

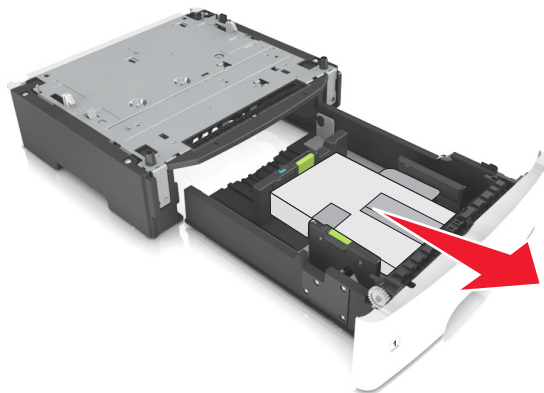

- 4 Remove any packing material from inside the tray.
- 5 Insert the tray into the base.
- 6 Place the tray near the printer.
- 7 Align the printer with the tray, and then slowly lower the printer into place.

**Note:** Optional trays lock together when stacked.

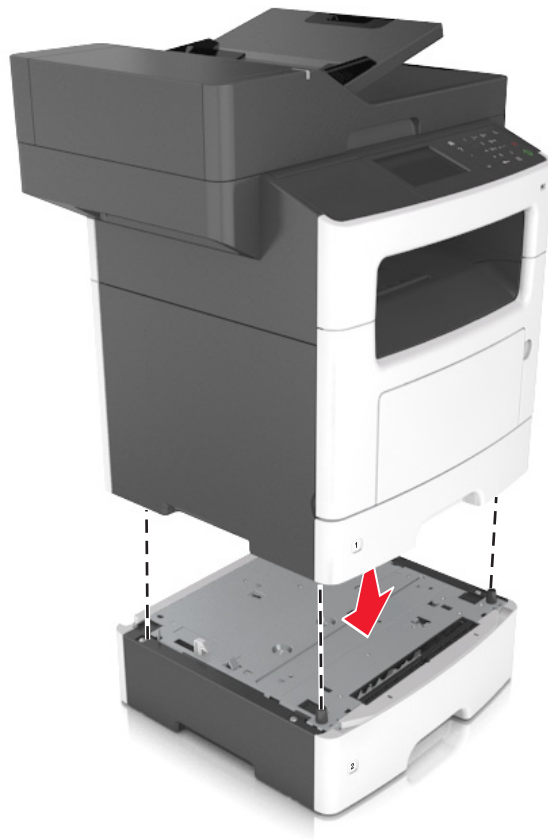

- 8** Connect the power cord to the printer, then to a properly grounded electrical outlet, and then turn on the printer.



**Notes:**

- When the printer software and any hardware options are installed, you may need to manually add the options in the printer driver to make them available for print jobs. For more information, see [“Adding available options in the print driver” on page 46](#).
- To uninstall the optional trays, slide the latch on the right side of the printer toward the front of the printer until it *clicks* into place, and then remove stacked trays one at a time from the top to the bottom.

## Attaching cables

- ⚠ CAUTION—SHOCK HAZARD:** To avoid the risk of electrical shock, do not set up this product or make any electrical or cabling connections, such as the power cord, fax feature, or telephone, during a lightning storm.
- ⚠ CAUTION—POTENTIAL INJURY:** To avoid the risk of fire or electrical shock, connect the power cord to an appropriately rated and properly grounded electrical outlet that is near the product and easily accessible.
- ⚠ CAUTION—POTENTIAL INJURY:** To avoid the risk of fire or electrical shock, use only the power cord provided with this product or the manufacturer's authorized replacement.
- ⚠ CAUTION—POTENTIAL INJURY:** To reduce the risk of fire, use only a 26 AWG or larger telecommunications (RJ-11) cord when connecting this product to the public switched telephone network. For users in Australia, the cord must be approved by the Australian Communications and Media Authority.

**Warning—Potential Damage:** To avoid loss of data or printer malfunction, do not touch the USB cable, any wireless network adapter, or the printer in the areas shown while actively printing.

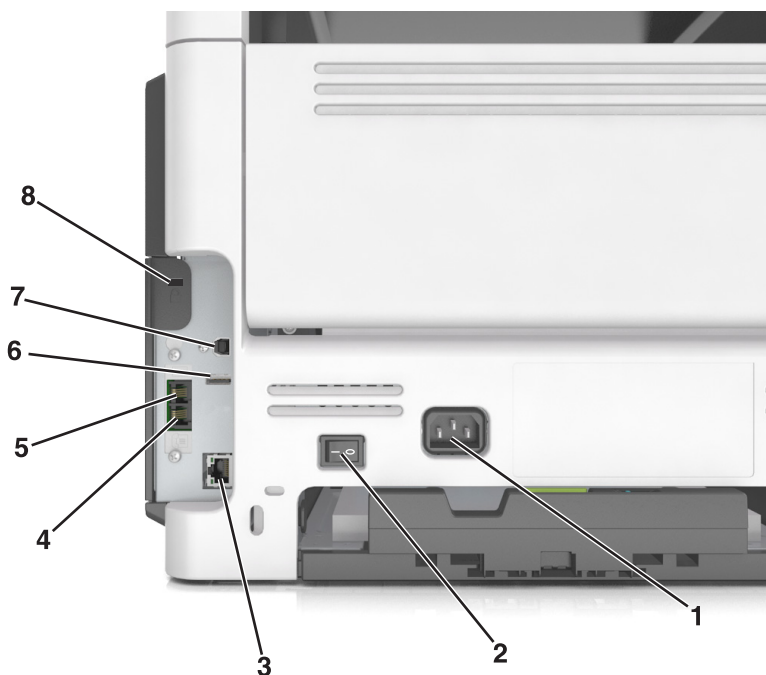

	Use the	To
1	Power cord socket	Connect the printer to a properly grounded electrical outlet.
2	Power switch	Turn on or turn off the printer.
3	Ethernet port	Connect the printer to an Ethernet network.
4	EXT port	<p>Connect additional devices (telephone or answering machine) to the printer and the telephone line. Use this port if you do not have a dedicated fax line for the printer and if this connection method is supported in your country or region.</p> <p><b>Note:</b> Remove the adapter plug to access the port.</p>

	Use the	To
<b>5</b>	LINE port	Connect the printer to an active telephone line through a standard wall jack (RJ-11), DSL filter, or VoIP adapter, or any other adapter that allows you to access the telephone line to send and receive faxes.
<b>6</b>	USB port	Attach a keyboard or any compatible option.
<b>7</b>	USB printer port	Connect the printer to a computer.
<b>8</b>	Security slot	Attach a lock to secure the printer in place.

## Setting up the printer software

### Installing the printer software

- Obtain a copy of the software installer package.
  - From the software CD that came with your printer.
  - Go to <http://support.lexmark.com>, and then select your printer and operating system.
- Run the installer, and then follow the instructions on the computer screen.
- For Macintosh users, add the printer.
 

**Note:** Obtain the printer IP address from the TCP/IP section in the Network/Ports menu.

### Adding available options in the print driver

#### For Windows users

- Open the printers folder.
- Select the printer you want to update, and then do the following:
  - For Windows 7 or later, select **Printer properties**.
  - For earlier versions, select **Properties**.
- Navigate to the Configuration tab, and then select **Update Now - Ask Printer**.
- Apply the changes.

#### For Macintosh users

- From System Preferences in the Apple menu, navigate to your printer, and then select **Options & Supplies**.
- Navigate to the list of hardware options, and then add any installed options.
- Apply the changes.

# Networking

## Notes:

- Purchase a MarkNet N8350 wireless network adapter for MX510, MX511, and MX517 printer models or MarkNet N8352 wireless network adapter for MX410 and MX417 printer models before setting up the printer on a wireless network. For information on installing the wireless network adapter, see the setup sheet that came with the adapter.
- A Service Set Identifier (SSID) is a name assigned to a wireless network. Wired Equivalent Privacy (WEP), Wi-Fi Protected Access (WPA), and WPA2 are types of security used on a network.

## Preparing to set up the printer on an Ethernet network

To configure your printer to connect to an Ethernet network, organize the following information before you begin:

**Note:** If your network automatically assigns IP addresses to computers and printers, continue on to installing the printer.

- A valid, unique IP address for the printer to use on the network
- The network gateway
- The network mask
- A nickname for the printer (optional)

**Note:** A printer nickname can make it easier for you to identify your printer on the network. You can choose to use the default printer nickname, or assign a name that is easier for you to remember.

You will need an Ethernet cable to connect the printer to the network and an available port where the printer can physically connect to the network. Use a new network cable when possible to avoid potential problems caused by a damaged cable.

## Preparing to set up the printer on a wireless network

### Notes:

- Make sure your wireless network adapter is installed in your printer and working properly. For more information, see the instruction sheet that came with the wireless network adapter.
- Make sure your access point (wireless router) is turned on and is working properly.

Make sure you have the following information before setting up the printer on a wireless network:

- **SSID**—The SSID is also referred to as the network name.
- **Wireless Mode (or Network Mode)**—The mode is either infrastructure or ad hoc.
- **Channel (for ad hoc networks)**—The channel defaults to automatic for infrastructure networks.

Some ad hoc networks will also require the automatic setting. Check with your system support person if you are not sure which channel to select.

- **Security Method**—There are four basic options for Security Method:
  - WEP key  
If your network uses more than one WEP key, then enter up to four in the provided spaces. Select the key currently in use on the network by selecting the default WEP transmit key.
  - WPA or WPA2 preshared key or passphrase  
WPA includes encryption as an additional layer of security. The choices are AES or TKIP. Encryption must be set for the same type on the router and on the printer, or the printer will not be able to communicate on the network.
  - 802.1X–RADIUS  
If you are installing the printer on an 802.1X network, then you may need the following:
    - Authentication type
    - Inner authentication type
    - 802.1X user name and password
    - Certificates
  - No security  
If your wireless network does not use any type of security, then you will not have any security information.  
**Note:** We do not recommend using an unsecured wireless network.



**Notes:**

- If you do not know the SSID of the network that your computer is connected to, then launch the wireless utility of the computer network adapter, and then look for the network name. If you cannot find the SSID or the security information for your network, then see the documentation that came with the access point, or contact your system support person.
- To find the WPA/WPA2 preshared key or passphrase for the wireless network, see the documentation that came with the access point, see the Embedded Web Server associated with the access point, or consult your system support person.

## Connecting the printer using the Wireless Setup Wizard

Before you begin, make sure that:

- A wireless network adapter is installed in the printer and is working properly. For more information, see the instruction sheet that came with the wireless network adapter.
- An Ethernet cable is disconnected from the printer.
- Active NIC is set to Auto. To set this to Auto, navigate to:

 > **Network/Ports** > **Active NIC** > **Auto** > 

**Note:** Make sure to turn off the printer, then wait for at least five seconds, and then turn the printer back on.

- 1 From the printer control panel, navigate to:

 > **Network/Ports** > **Network [x]** > **Network [x] Setup** > **Wireless** > **Wireless Connection Setup**

- 2 Select a wireless connection setup.



Use	To
<b>Search for networks</b>	Show available wireless connections. <b>Note:</b> This menu shows all broadcast secured or unsecured SSIDs.
<b>Enter a network name</b>	Manually type the SSID. <b>Note:</b> Make sure to type the correct SSID.
<b>Wi-Fi Protected Setup</b>	Connect the printer to a wireless network using Wi-Fi Protected Setup.

3 Follow the instructions on the printer display.

## Connecting the printer to a wireless network using Wi-Fi Protected Setup

Before you begin, make sure that:

- The access point (wireless router) is Wi-Fi Protected Setup (WPS) certified or WPS-compatible. For more information, see the documentation that came with your access point.
- A wireless network adapter installed in your printer is attached and working properly. For more information, see the instruction sheet that came with the wireless network adapter.

### Using the Push Button Configuration method

1 From the printer control panel, navigate to:



> **Network/Ports** > **Network [x]** > **Network [x] Setup** > **Wireless** > **Wireless Connection Setup** > **Wi-Fi Protected Setup** > **Start Push Button Method**

2 Follow the instructions on the printer display.

### Using the Personal Identification Number (PIN) method

1 From the printer control panel, navigate to:



> **Network/Ports** > **Network [x]** > **Network [x] Setup** > **Wireless** > **Wireless Connection Setup** > **Wi-Fi Protected Setup** > **Start PIN Method**

2 Copy the eight-digit WPS PIN.

3 Open a Web browser, and then type the IP address of your access point in the address field.

#### Notes:

- The IP address appears as four sets of numbers separated by periods, such as 123.123.123.123.
- If you are using a proxy server, then temporarily disable it to load the Web page correctly.

4 Access the WPS settings. For more information, see the documentation that came with your access point.

5 Enter the eight-digit PIN, and then save the setting.

## Connecting the printer to a wireless network using the Embedded Web Server

Before you begin, make sure that:

- Your printer is connected temporarily to an Ethernet network.
- A wireless network adapter is installed in your printer and working properly. For more information, see the instruction sheet that came with the wireless network adapter.

**1** Open a Web browser, and then type the printer IP address in the address field.

**Notes:**

- View the printer IP address on the printer control panel. The IP address appears as four sets of numbers separated by periods, such as 123.123.123.123.
- If you are using a proxy server, then temporarily disable it to load the Web page correctly.

**2** Click **Settings > Network/Ports > Wireless**.

**3** Modify the settings to match the settings of your access point (wireless router).

**Note:** Make sure to enter the correct SSID, security method, preshared key or passphrase, network mode, and channel.

**4** Click **Submit**.

**5** Turn off the printer, and then disconnect the Ethernet cable. Then wait for at least five seconds, and then turn the printer back on.

**6** To verify if your printer is connected to the network, print a network setup page. Then in the Network Card [x] section, see if the status is Connected.

## Changing port settings after installing an internal solutions port

**Notes:**

- If the printer has a static IP address, then do not change the configuration.
- If the computers are configured to use the network name instead of an IP address, then do not change the configuration.
- If you are adding a wireless internal solutions port (ISP) to a printer previously configured for an Ethernet connection, then disconnect the printer from the Ethernet network.

### For Windows users

**1** Open the printers folder.

**2** From the shortcut menu of the printer with the new ISP, open the printer properties.

**3** Configure the port from the list.

**4** Update the IP address.

**5** Apply the changes.

### For Macintosh users

- 1 From System Preferences in the Apple menu, navigate to the list of printers, and then select + > **IP**.
- 2 Type the IP address in the address field.
- 3 Apply the changes.

### Setting up serial printing (Windows only)

- 1 Set the parameters in the printer.
  - a From the control panel, navigate to the menu for the port settings.
  - b Locate the menu for the serial port settings, and then adjust the settings, if necessary.
  - c Apply the changes.
- 2 From your computer, open the printers folder, and then select your printer.
- 3 Open the printer properties, and then select the COM port from the list.
- 4 Set the COM port parameters in Device Manager.

#### Notes:

- Serial printing reduces printing speed.
- Make sure that the serial cable is connected to the serial port on your printer.

## Verifying printer setup

When all hardware and software options are installed and the printer is turned on, verify that the printer is set up correctly by printing the following:

- **Menu settings page**—Use this page to verify that all printer options are installed correctly. If an option you installed is not listed, then it is not installed correctly. Remove the option, and then install it again.
- **Network setup page**—If your printer has networking support, then use this page to verify that the network connection is working. This page also provides important information that aids network printing configuration.

### Printing a menu settings page

From the home screen, navigate to:



> **Reports** > **Menu Settings Page**

## Printing a network setup page

If the printer is attached to a network, then print a network setup page to verify the network connection. This page also provides important information that aids network printing configuration.

- 1 From the home screen, navigate to:



> **Reports** > **Network Setup Page**

- 2 Check the first section of the network setup page, and confirm that the status is **Connected**.

If the status is **Not Connected**, then the LAN drop may not be active, or the network cable may be malfunctioning. Consult a system support person for a solution, and then print another network setup page.

## Loading paper and specialty media

The selection and handling of paper and specialty media can affect how reliably documents print. For more information, see [“Avoiding jams” on page 221](#) and [“Storing paper” on page 70](#).

### Setting the paper size and type

From the home screen navigate to:

 > **Paper Menu** > **Paper Size/Type** > select a tray > select the paper size or type > 

### Configuring Universal paper settings

The Universal paper size is a user-defined setting that lets you print on paper sizes that are not preset in the printer menus.

#### Notes:

- The smallest supported Universal size is 76.2 x 76.2 mm (3 x 3 inches).
- The largest supported Universal size is 215.9 x 359.92 mm (8.5 x 14.17 inches).

1 From the home screen, navigate to:

 > **Paper Menu** > **Universal Setup** > **Units of Measure** > select the unit of measure > 

2 Touch **Portrait Width** or **Portrait Height**.

3 Select the width or height, and then touch .

### Loading trays

 **CAUTION—POTENTIAL INJURY:** To reduce the risk of equipment instability, load each tray separately. Keep all other trays closed until needed.

1 Pull out the tray completely.

**Note:** Do not remove trays while a job prints or while **Busy** appears on the printer display. Doing so may cause a jam.

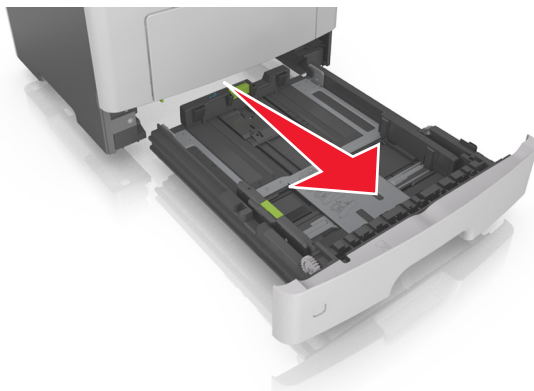

**2** Squeeze and then slide the width guide tab to the correct position for the size of the paper you are loading.

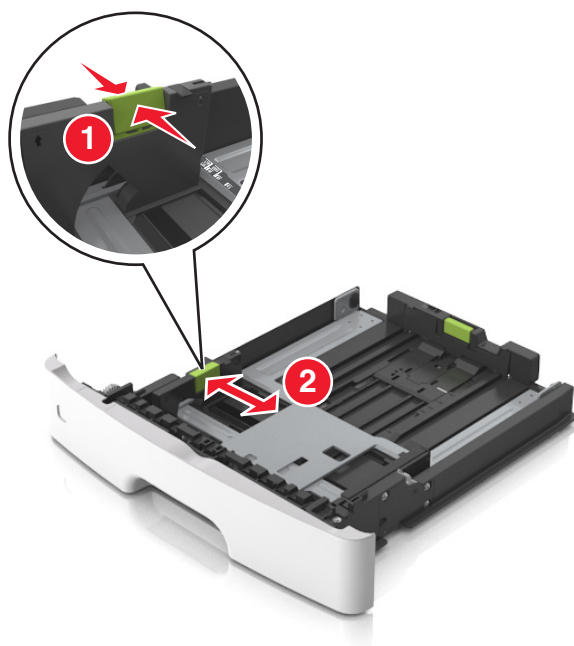

- 3** Squeeze and then slide the length guide tab to the correct position for the size of the paper you are loading.

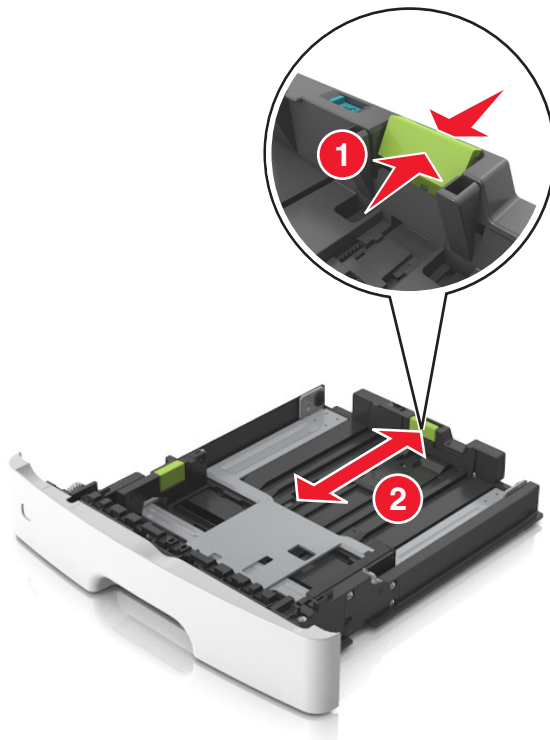

**Notes:**

- For some paper sizes like letter, legal, and A4, squeeze and slide the length guide tab backward to accommodate their length.
- When loading legal-size paper, the length guide extends beyond the base leaving the paper exposed to dust. To protect the paper from dust, you can purchase a dust cover separately. For more information, contact customer support.
- If you are loading A6-size paper in the standard tray, then squeeze and then slide the length guide tab toward the center of the tray to the A6-size position.
- Make sure the width and length guides are aligned with the paper size indicators on the bottom of the tray.

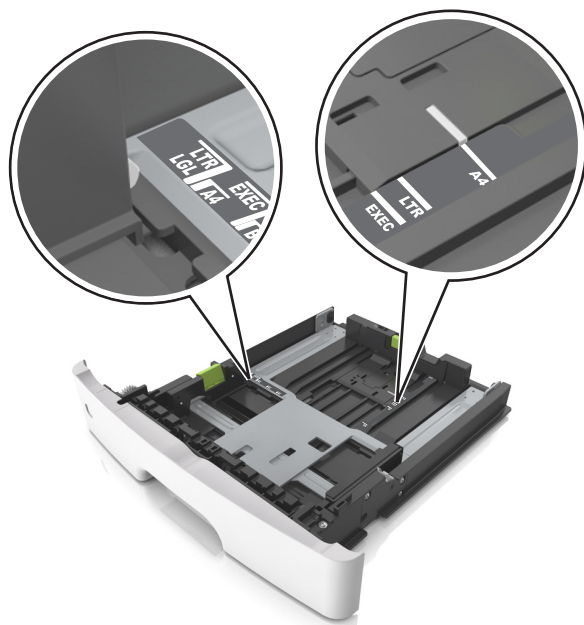

**4** Flex the sheets back and forth to loosen them, and then fan them. Do not fold or crease the paper. Straighten the edges on a level surface.

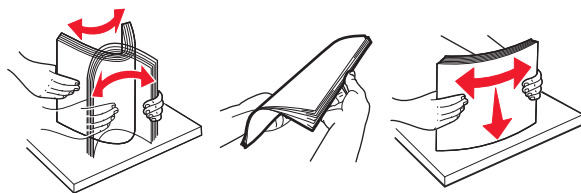

**5** Load the paper stack.

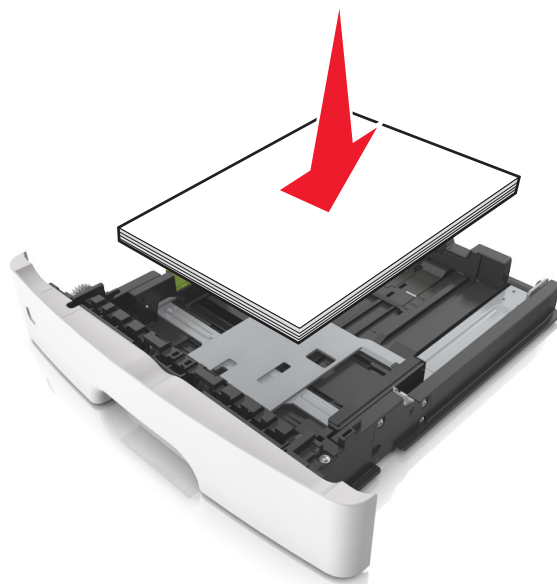



**Notes:**

- Load with the printable side facedown when using recycled or preprinted paper.
- Load prepunched paper with the holes on the top edge toward the front of the tray.
- Load letterhead facedown, with the top edge of the sheet toward the front of the tray. For two-sided printing, load letterhead faceup with the bottom edge of the sheet toward the front of the tray.
- Make sure the paper is below the maximum paper fill indicator located on the side of the width guide.

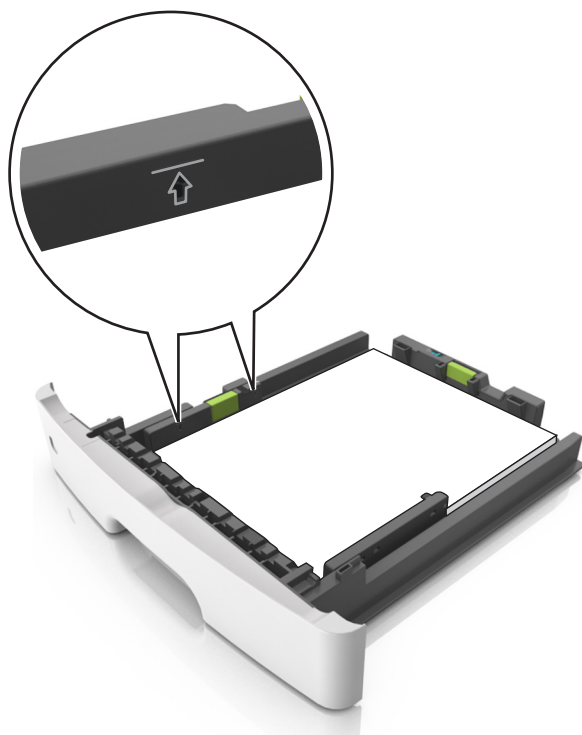
**6** Insert the tray.**7** From the printer control panel, set the paper size and paper type in the Paper menu to match the paper loaded in the tray.

**Note:** Set the correct paper size and type to avoid paper jams and print quality problems.

## Loading the multipurpose feeder

Use the multipurpose feeder when printing on different paper sizes and types or specialty media, such as card stock, transparencies, paper labels, and envelopes. You can also use it for single-page print jobs on letterhead.

- 1 Open the multipurpose feeder.

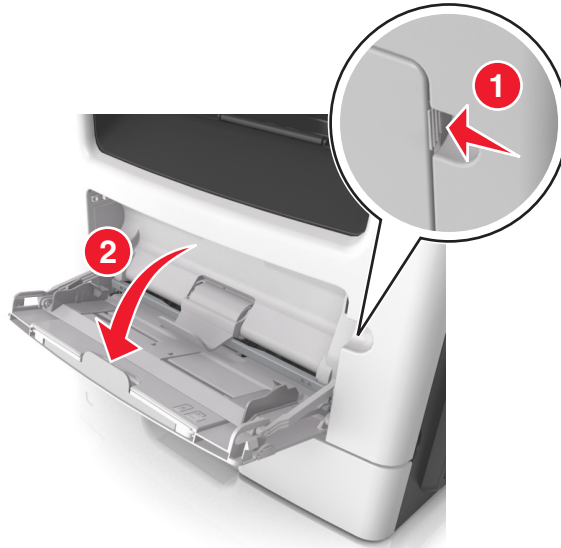

- a Pull the multipurpose feeder extender.



- b** Pull the extender gently so that the multipurpose feeder is fully extended and open.



- 2** Squeeze the tab on the left width guide, and then move the guides for the paper you are loading.

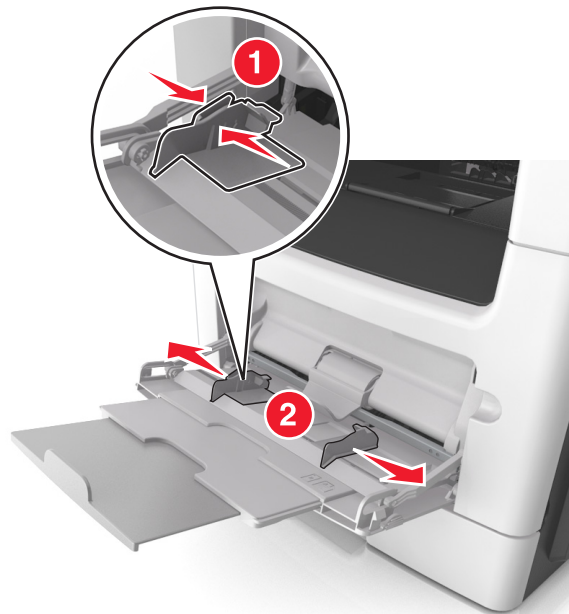

- 3** Prepare the paper or specialty media for loading.

- Flex sheets of paper back and forth to loosen them, and then fan them. Do not fold or crease the paper. Straighten the edges on a level surface.

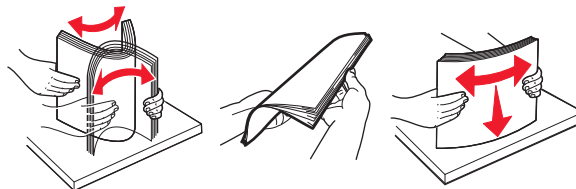

- Hold transparencies by the edges. Flex the stack of transparencies back and forth to loosen them, and then fan them. Straighten the edges on a level surface.

**Note:** Avoid touching the printable side of the transparencies. Be careful not to scratch them.

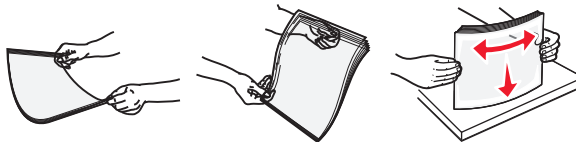

- Flex the stack of envelopes back and forth to loosen them, and then fan them. Straighten the edges on a level surface.



#### 4 Load the paper or specialty media.

##### Notes:

- Do not force paper or specialty media into the multipurpose feeder.
- Make sure the paper or specialty media is below the maximum paper fill indicator located on the paper guides. Overfilling may cause paper jams.



- Load paper, transparencies, and card stock with the recommended printable side faceup and the top edge entering the printer first. For more information on loading transparencies, see the packaging that the transparencies came in.



**Note:** When loading A6-size paper, make sure the multipurpose feeder extender rests lightly against the edge of the paper so that the last few sheets of paper remain in place.

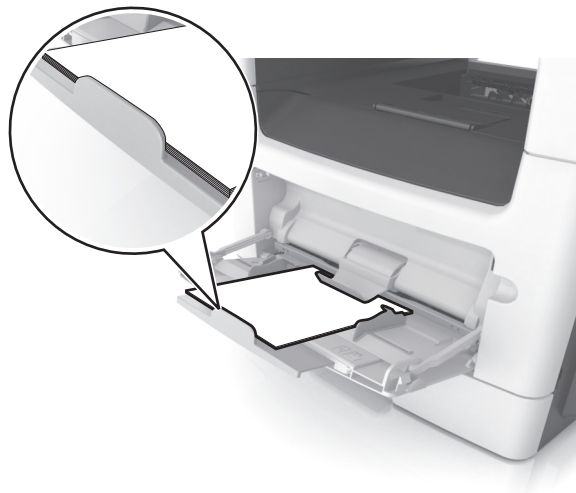

- Load letterhead faceup with the top edge entering the printer first. For two-sided (duplex) printing, load letterhead facedown with the bottom edge entering the printer first.



- Load envelopes with the flap on the left side facedown.



**Warning—Potential Damage:** Never use envelopes with stamps, clasps, snaps, windows, coated linings, or self-stick adhesives. These envelopes may severely damage the printer.

- 5 From the printer control panel, set the paper size and paper type in the Paper menu to match the paper or specialty media loaded in the multipurpose feeder.

## Linking and unlinking trays

The printer links trays when the specified paper size and type are the same. When a linked tray becomes empty, paper feeds from the next linked tray. To prevent trays from linking, assign a unique custom paper type name.

### Linking and unlinking trays

- 1 Open a Web browser, and then type the printer IP address in the address field.

**Notes:**

- View the printer IP address on the printer home screen. The IP address appears as four sets of numbers separated by periods, such as 123.123.123.123.
- If you are using a proxy server, then temporarily disable it to load the Web page correctly.

- 2 Click **Settings > Paper Menu**.

- 3 Change the paper size and type settings for the trays you are linking.

- To link trays, make sure the paper size and type for the tray match that of the other tray.
- To unlink trays, make sure the paper size or type for the tray does *not* match that of the other tray.

- 4 Click **Submit**.

**Note:** You can also change the paper size and type settings using the printer control panel. For more information, see [“Setting the paper size and type” on page 53](#).

**Warning—Potential Damage:** Paper loaded in the tray should match the paper type name assigned in the printer. The temperature of the fuser varies according to the specified paper type. Printing issues may occur if settings are not properly configured.

## Creating a custom name for a paper type

### Using the Embedded Web Server

- 1 Open a Web browser, and then type the printer IP address in the address field.

**Notes:**

- View the printer IP address on the printer home screen. The IP address appears as four sets of numbers separated by periods, such as 123.123.123.123.
- If you are using a proxy server, then temporarily disable it to load the Web page correctly.

- 2 Click **Settings** > **Paper Menu** > **Custom Names**.

- 3 Select a custom name, and then type a custom paper type name.

- 4 Click **Submit**.

- 5 Click **Custom Types**, and then verify if the new custom paper type name has replaced the custom name.

### Using the printer control panel

- 1 From the home screen, navigate to:



> **Paper Menu** > **Custom Names**

- 2 Select a custom name, and then type a custom paper type name.

- 3 Touch

- 4 Touch **Custom Types**, and then verify that the new custom paper type name has replaced the custom name.

## Assigning a custom paper type

### Using the Embedded Web Server

Assign a custom paper type name to a tray when linking or unlinking trays.

- 1 Open a Web browser, and then type the printer IP address in the address field.

**Notes:**

- View the printer IP address on the printer home screen. The IP address appears as four sets of numbers separated by periods, such as 123.123.123.123.
- If you are using a proxy server, then temporarily disable it to load the Web page correctly.

- 2 Click **Settings** > **Paper Menu** > **Custom Types**.

- 3 Select a custom paper type name, and then select a paper type

**Note:** Paper is the factory default paper type for all user-defined custom names.

- 4 Click **Submit**.

## Using the printer control panel

1 From the home screen, navigate to:



> **Paper Menu** > **Custom Types**

2 Select a custom paper type name, and then select a paper type

**Note:** Paper is the factory default paper type for all user-defined custom names.

3 Touch

## Configuring a custom name

### Using the Embedded Web Server

1 Open a Web browser, and then type the printer IP address in the address field.

**Notes:**

- View the printer IP address on the printer home screen. The IP address appears as four sets of numbers separated by periods, such as 123.123.123.123.
- If you are using a proxy server, then temporarily disable it to load the Web page correctly.

2 Click **Settings** > **Paper Menu** > **Custom Types**.

3 Select a custom name you want to configure, then select a paper or specialty media type, and then click **Submit**.

### Using the printer control panel

1 From the home screen, navigate to:



> **Paper Menu** > **Custom Types**

2 Select a custom name you want to configure, and then touch



# Paper and specialty media guide

## Using specialty media

### Tips on using letterhead

- Use letterhead designed specifically for laser printers.
- Print samples on the letterhead being considered for use before buying large quantities.
- Before loading letterhead, flex, fan, and straighten the stack to prevent sheets from sticking together.
- Page orientation is important when printing on letterhead. For information on how to load letterhead, see:
  - [“Loading trays” on page 53](#)
  - [“Loading the multipurpose feeder” on page 58](#)

### Tips on using transparencies

- Print a test page on the transparencies being considered for use before buying large quantities.
- Feed transparencies from the standard tray, or the multipurpose feeder.
- Use transparencies designed specifically for laser printers. Transparencies must be able to withstand temperatures up to 185°C (365°F) without melting, discoloring, offsetting, or releasing hazardous emissions.  
**Note:** If the transparency weight is set to Heavy and the transparency texture is set to Rough in the Paper menu, then transparencies can be printed at a temperature up to 195°C (383°F).
- Avoid getting fingerprints on the transparencies to prevent print quality problems.
- Before loading transparencies, flex, fan, and straighten the stack to prevent sheets from sticking together.

### Tips on using envelopes

Print samples on the envelopes being considered for use before buying large quantities.

- Use envelopes designed specifically for laser printers. Check with the manufacturer or vendor to ensure that the envelopes can withstand temperatures up to 230°C (446°F) without sealing, wrinkling, curling excessively, or releasing hazardous emissions.
- For best performance, use envelopes made from 90-g/m<sup>2</sup> (24-lb bond) paper or 25% cotton. All-cotton envelopes must not exceed 75-g/m<sup>2</sup> (20-lb bond) weight.
- Use only new envelopes from undamaged packages.
- To optimize performance and minimize jams, do not use envelopes that:
  - Have excessive curl or twist
  - Are stuck together or damaged in any way
  - Have windows, holes, perforations, cutouts, or embossing
  - Have metal clasps, string ties, or folding bars
  - Have an interlocking design
  - Have postage stamps attached
  - Have any exposed adhesive when the flap is in the sealed or closed position

- Have bent corners
- Have rough, cockle, or laid finishes
- Adjust the width guides to fit the width of the envelopes.

**Note:** A combination of high humidity (over 60%) and high printing temperature may wrinkle or seal envelopes.

## Tips on using labels

Print samples on the labels being considered for use before buying large quantities.

**Note:** Use only paper label sheets. Vinyl, pharmacy, and two-sided labels are not supported.

For more information on label printing, characteristics, and design, see the *Card Stock & Label Guide* available at <http://support.lexmark.com>.

When printing on labels:

- Use labels designed specifically for laser printers. Check with the manufacturer or vendor to verify that:
  - The labels can withstand temperatures up to 240°C (464°F) without sealing, excessive curling, wrinkling, or releasing hazardous emissions.
  - Label adhesives, face sheet (printable stock), and topcoats can withstand up to 172-kPa (25-psi) pressure without delaminating, oozing around the edges, or releasing hazardous fumes.
- Do not use labels with slick backing material.
- Use full label sheets. Partial sheets may cause labels to peel off during printing, resulting in a jam. Partial sheets also contaminate the printer and the cartridge with adhesive, and could void the printer and toner cartridge warranties.
- Do not use labels with exposed adhesive.
- Do not print within 1 mm (0.04 inch) of the edge of the label, of the perforations, or between die-cuts of the label.
- Make sure the adhesive backing does not reach to the edge of the sheet. Zone coating of the adhesive should be at least 1 mm (0.04 inch) away from edges. Adhesive material contaminates the printer and could void the warranty.
- If zone coating of the adhesive is not possible, then remove a 2-mm (0.08-inch) strip on the leading and driver edge, and then use a non-oozing adhesive.
- Portrait orientation is recommended, especially when printing bar codes.

## Tips on using card stock

Card stock is heavy, single-ply specialty media. Many of its variable characteristics, such as moisture content, thickness, and texture, can significantly impact print quality. Print samples on the card stock being considered for use before buying large quantities.

When printing on card stock:

- Make sure the Paper Type is Card Stock.
- Select the appropriate Paper Texture setting.
- Be aware that preprinting, perforation, and creasing may significantly affect the print quality and cause jams or other paper handling problems.
- Check with the manufacturer or vendor to ensure that the card stock can withstand temperatures up to 240°C (464°F) without releasing hazardous emissions.

- Do not use preprinted card stock manufactured with chemicals that may contaminate the printer. Preprinting introduces semi-liquid and volatile components into the printer.
- Use grain short card stock when possible.

## Paper guidelines

Selecting the correct paper or specialty media reduces printing problems. For the best print quality, try a sample of the paper or specialty media before buying large quantities.

### Paper characteristics

The following paper characteristics affect print quality and reliability. Consider these characteristics when evaluating new paper stock.

#### Weight

The printer trays can automatically feed paper weights up to 120-g/m<sup>2</sup> (32-lb) bond grain long paper. The multipurpose feeder can automatically feed paper weights up to 163-g/m<sup>2</sup> (43-lb) bond grain long paper. Paper lighter than 60 g/m<sup>2</sup> (16 lb) might not be stiff enough to feed properly, causing jams. For best performance, use 75-g/m<sup>2</sup> (20-lb) bond grain long paper. For paper smaller than 182 x 257 mm (7.2 x 10.1 inches), we recommended to use 90 g/m<sup>2</sup> (24 lb) or heavier paper.

**Note:** Two-sided printing is supported only for 60–90-g/m<sup>2</sup> (16–24-lb) bond paper.

#### Curl

Curl is the tendency for paper to curl at its edges. Excessive curl can cause paper feeding problems. Curl can occur after the paper passes through the printer, where it is exposed to high temperatures. Storing paper unwrapped in hot, humid, cold, or dry conditions, even in the trays, can contribute to paper curling prior to printing and can cause feeding problems.

#### Smoothness

Paper smoothness directly affects print quality. If paper is too rough, then toner cannot fuse to it properly. If paper is too smooth, then it can cause paper feeding or print quality issues. Always use paper between 100 and 300 Sheffield points; however, smoothness between 150 and 250 Sheffield points produces the best print quality.

#### Moisture content

The amount of moisture in paper affects both print quality and the ability of the printer to feed the paper correctly. Leave paper in its original wrapper until it is time to use it. This limits the exposure of paper to moisture changes that can degrade its performance.

Store paper in its original wrapper in the same environment as the printer for 24 to 48 hours before printing. Extend the time to several days if the storage or transportation environment is very different from the printer environment. Thick paper may also require a longer conditioning period.

#### Grain direction

Grain refers to the alignment of the paper fibers in a sheet of paper. Grain is either *grain long*, running the length of the paper, or *grain short*, running the width of the paper.

For 60–90-g/m<sup>2</sup> (16–24-lb) bond paper, grain long paper is recommended.

## Fiber content

Most high-quality xerographic paper is made from 100% chemically treated pulped wood. This content provides the paper with a high degree of stability resulting in fewer paper feeding problems and better print quality. Paper containing fibers such as cotton can negatively affect paper handling.

## Selecting paper

Using the appropriate paper prevents jams and helps ensure trouble-free printing.

To help avoid paper jams and poor print quality:

- *Always* use new, undamaged paper.
- Before loading paper, know the recommended printable side of the paper. This information is usually indicated on the paper package.
- *Do not* use paper that has been cut or trimmed by hand.
- *Do not* mix paper sizes, types, or weights in the same tray; mixing results in jams.
- *Do not* use coated papers unless they are specifically designed for electrophotographic printing.

## Selecting preprinted forms and letterhead

Use these guidelines when selecting preprinted forms and letterhead:

- Use grain long for 60 to 90 g/m<sup>2</sup> (16 to 24 lb) weight paper.
- Use only forms and letterhead printed using an offset lithographic or engraved printing process.
- Avoid papers with rough or heavily textured surfaces.

Use papers printed with heat-resistant inks designed for use in xerographic copiers. The ink must be able to withstand temperatures up to 230°C (446°F) without melting or releasing hazardous emissions. Use inks that are not affected by the resin in toner. Inks that are oxidation-set or oil-based generally meet these requirements; latex inks might not. When in doubt, contact the paper supplier.

Preprinted papers such as letterhead must be able to withstand temperatures up to 230°C (446°F) without melting or releasing hazardous emissions.

## Using recycled paper and other office papers

As an environmentally conscientious company, Lexmark supports the use of recycled paper produced specifically for use in laser (electrophotographic) printers.

While no blanket statement can be made that all recycled paper will feed well, Lexmark consistently tests papers that represent recycled cut size copier papers available on the global market. This scientific testing is conducted with rigor and discipline. Many factors are taken into consideration both separately and as a whole, including the following:

- Amount of post-consumer waste (Lexmark tests up to 100% post-consumer waste content.)
- Temperature and humidity conditions (Testing chambers simulate climates from all over the world.)
- Moisture content (Business papers should have low moisture: 4–5%.)
- Bending resistance and proper stiffness means optimum feeding through the printer.
- Thickness (impacts how much can be loaded into a tray)

- Surface roughness (measured in Sheffield units, impacts print clarity and how well toner fuses to the paper)
- Surface friction (determines how easily sheets can be separated)
- Grain and formation (impacts curling, which also influences the mechanics of how the paper behaves as it moves through the printer)
- Brightness and texture (look and feel)

Recycled papers are better than ever; however, the amount of recycled content in a paper affects the degree of control over foreign matter. And while recycled papers are one good path to printing in an environmentally responsible manner, they are not perfect. The energy required to de-ink and deal with additives such as colorants and “glue” often generates more carbon emissions than does normal paper production. However, using recycled papers enables better resource management overall.

Lexmark concerns itself with the responsible use of paper in general based on life cycle assessments of its products. To gain a better understanding of the impact of printers on the environment, the company commissioned a number of life cycle assessments and found that paper was identified as the primary contributor (up to 80%) of carbon emissions caused throughout the entire life of a device (from design to end-of-life). This is due to the energy-intensive manufacturing processes required to make paper.

Thus, Lexmark seeks to educate customers and partners on minimizing the impact of paper. Using recycled paper is one way. Eliminating excessive and unnecessary paper consumption is another. Lexmark is well-equipped to help customers minimize printing and copying waste. In addition, the company encourages purchasing paper from suppliers who demonstrate their commitment to sustainable forestry practices.

Lexmark does not endorse specific suppliers, although a converter’s product list for special applications is maintained. However, the following paper choice guidelines will help alleviate the environmental impact of printing:

- 1** Minimize paper consumption.
- 2** Be selective about the origin of wood fiber. Buy from suppliers who carry certifications such as the Forestry Stewardship Council (FSC) or the Program for the Endorsement of Forest Certification (PEFC). These certifications guarantee that the paper manufacturer uses wood pulp from forestry operators that employ environmentally and socially responsible forest management and restoration practices.
- 3** Choose the most appropriate paper for printing needs: normal 75 or 80 g/m<sup>2</sup> certified paper, lower weight paper, or recycled paper.

## Unacceptable paper examples

Test results indicate that the following paper types are at risk for use with laser printers:

- Chemically treated papers used to make copies without carbon paper, also known as *carbonless papers*
- Preprinted papers with chemicals that may contaminate the printer
- Preprinted papers that can be affected by the temperature in the printer fuser
- Preprinted papers that require a registration (the precise location on the page) greater than  $\pm 2.3$  mm ( $\pm 0.9$  in.), such as optical character recognition (OCR) forms. In some cases, registration can be adjusted with a software application to successfully print on these forms.)
- Coated papers (erasable bond), synthetic papers, thermal papers
- Rough-edged, rough or heavily textured surface papers or curled papers
- Recycled papers that fail EN12281:2002 (European testing)
- Paper weighing less than 60 g/m<sup>2</sup> (16 lb)
- Multiple part forms or documents

For more information about Lexmark, visit [www.lexmark.com](http://www.lexmark.com). General sustainability-related information can be found at the **Environmental Sustainability** link.

## Storing paper

Use these paper storage guidelines to help avoid jams and uneven print quality:

- For best results, store paper where the temperature is 21°C (70°F) and the relative humidity is 40 percent. Most label manufacturers recommend printing in a temperature range of 18–24°C (65–75°F) with relative humidity between 40 and 60 percent.
- Store paper in cartons, on a pallet or shelf, rather than on the floor.
- Store individual packages on a flat surface.
- Do not store anything on top of individual paper packages.
- Take paper out of the carton or wrapper only when you are ready to load it in the printer. The carton and wrapper help keep the paper clean, dry, and flat.

## Supported paper sizes, types, and weights

### Supported paper sizes

Paper size and dimension	Standard 250-sheet tray	Optional 250- or 550-sheet tray	Multipurpose feeder	ADF	Scanner glass	Two-sided printing
<b>Business card</b>	X	X	X	X	✓	X
<b>3 x 5 in.</b>	X	X	✓ <sup>1</sup>	X	✓	X
<b>4 x 6 in.</b>	X	X	✓ <sup>1</sup>	X	✓	X
<b>A4</b> 210 x 297 mm (8.27 x 11.7 in.)	✓	✓	✓	✓	✓	✓
<b>A5</b> 148 x 210 mm (5.83 x 8.27 in.)	✓	✓	✓	✓	✓	X
<b>A6</b> 105 x 148 mm (4.13 x 5.83 in.)	✓	X	✓	✓	✓	X

<sup>1</sup> Paper is supported only if the paper size setting is set to Universal.

<sup>2</sup> Paper is supported only in MX510, MX511, and MX517 printer models.

<sup>3</sup> Paper is supported in two-sided printing only if the width is at least 210 mm (8.27 in.) and the length is at least 279.4 mm (11 in.). The smallest supported Universal paper size is supported only in the multipurpose feeder.

<sup>4</sup> Paper is supported in MX410 and MX417 printer models only if the width is at least 215.9 mm (8.5 in.) and the length is at least 296.9 mm (11.7 in.).

<sup>5</sup> Paper is supported in MX410 and MX417 printer models only if the length is at least 296.9 mm (11.7 in.).

Paper size and dimension	Standard 250-sheet tray	Optional 250- or 550-sheet tray	Multipurpose feeder	ADF	Scanner glass	Two-sided printing
<b>JIS B5</b> 182 x 257 mm (7.17 x 10.1 in.)	✓	✓	✓	✓	✓	✗
<b>Letter</b> 215.9 x 279.4 mm (8.5 x 11 in.)	✓	✓	✓	✓	✓	✓
<b>Legal</b> 215.9 x 355.6 mm (8.5 x 14 in.)	✓	✓	✓	✓	✓ <sup>2</sup>	✓
<b>Executive</b> 184.2 x 266.7 mm (7.25 x 10.5 in.)	✓	✓	✓	✓	✓	✗
<b>Oficio (México)</b> 215.9 x 340.4 mm (8.5 x 13.4 in.)	✓	✓	✓	✓	✓ <sup>2</sup>	✓
<b>Folio</b> 215.9 x 330.2 mm (8.5 x 13 in.)	✓	✓	✓	✓	✓ <sup>2</sup>	✓
<b>Statement</b> 139.7 x 215.9 mm (5.5 x 8.5 in.)	✓	✓	✓	✓	✓	✗
<b>Universal<sup>3</sup></b> 76.2 x 127 mm (3 x 5 in.) to 215.9 x 359.92 mm (8.5 x 14.17 in.)	✓	✓	✓	✓	✓ <sup>4</sup>	✓
<b>7 3/4 Envelope (Monarch)</b> 98.4 x 190.5 mm (3.875 x 7.5 in.)	✗	✗	✓	✗	✓	✗
<b>9 Envelope</b> 98.4 x 226.1 mm (3.875 x 8.9 in.)	✗	✗	✓	✗	✓	✗

<sup>1</sup> Paper is supported only if the paper size setting is set to Universal.

<sup>2</sup> Paper is supported only in MX510, MX511, and MX517 printer models.

<sup>3</sup> Paper is supported in two-sided printing only if the width is at least 210 mm (8.27 in.) and the length is at least 279.4 mm (11 in.). The smallest supported Universal paper size is supported only in the multipurpose feeder.

<sup>4</sup> Paper is supported in MX410 and MX417 printer models only if the width is at least 215.9 mm (8.5 in.) and the length is at least 296.9 mm (11.7 in.).

<sup>5</sup> Paper is supported in MX410 and MX417 printer models only if the length is at least 296.9 mm (11.7 in.).

Paper size and dimension	Standard 250-sheet tray	Optional 250- or 550-sheet tray	Multipurpose feeder	ADF	Scanner glass	Two-sided printing
<b>10 Envelope</b> 104.8 x 241.3 mm (4.12 x 9.5 in.)	X	X	✓	X	✓	X
<b>DL Envelope</b> 110 x 220 mm (4.33 x 8.66 in.)	X	X	✓	X	✓	X
<b>C5 Envelope</b> 162 x 229 mm (6.38 x 9.01 in.)	X	X	✓	X	✓	X
<b>B5 Envelope</b> 176 x 250 mm (6.93 x 9.84 in.)	X	X	✓	X	✓	X
<b>Other Envelope</b> 85.7 x 165 mm to 215.9 x 355.6 mm (3.375 x 6.50 in. to 8.5 x 14 in.)	X	X	✓	X	✓ <sup>5</sup>	X

<sup>1</sup> Paper is supported only if the paper size setting is set to Universal.

<sup>2</sup> Paper is supported only in MX510, MX511, and MX517 printer models.

<sup>3</sup> Paper is supported in two-sided printing only if the width is at least 210 mm (8.27 in.) and the length is at least 279.4 mm (11 in.). The smallest supported Universal paper size is supported only in the multipurpose feeder.

<sup>4</sup> Paper is supported in MX410 and MX417 printer models only if the width is at least 215.9 mm (8.5 in.) and the length is at least 296.9 mm (11.7 in.).

<sup>5</sup> Paper is supported in MX410 and MX417 printer models only if the length is at least 296.9 mm (11.7 in.).

## Supported paper types and weights

The standard tray supports 60–90-g/m<sup>2</sup> (16–24-lb) paper weights. The optional tray supports 60–120-g/m<sup>2</sup> (16–32-lb) paper weights. The multipurpose feeder supports 60–163-g/m<sup>2</sup> (16–43-lb) paper weights.

Paper type	250- or 550-sheet tray	Multipurpose feeder	Duplex mode	ADF	Scanner glass
<b>Plain paper</b>	✓	✓	✓	✓	✓
<b>Card stock</b>	X	✓	X	✓	✓
<b>Transparencies</b>	✓	✓	X	✓	✓
<b>Recycled</b>	✓	✓	✓	✓	✓

<sup>1</sup> One-sided paper labels designed for laser printers are supported for occasional use. We recommend printing only up to 20 pages of paper labels per month. Vinyl, pharmacy, and two-sided labels are not supported.

<sup>2</sup> Use envelopes that lie flat when individually placed on a table facedown.



Paper type	250- or 550-sheet tray	Multipurpose feeder	Duplex mode	ADF	Scanner glass
Paper labels <sup>1</sup>	✓	✓	X	✓	✓
Bond	✓	✓	✓	✓	✓
Envelope <sup>2</sup>	X	✓	X	X	✓
Rough envelope	X	✓	X	X	✓
Letterhead	✓	✓	✓	✓	✓
Preprinted	✓	✓	✓	✓	✓
Colored paper	✓	✓	✓	✓	✓
Light paper	✓	✓	✓	✓	✓
Heavy paper	✓	✓	✓	✓	✓
Rough/Cotton	✓	✓	X	✓	✓
Custom Type [x]	✓	✓	✓	✓	✓

<sup>1</sup> One-sided paper labels designed for laser printers are supported for occasional use. We recommend printing only up to 20 pages of paper labels per month. Vinyl, pharmacy, and two-sided labels are not supported.

<sup>2</sup> Use envelopes that lie flat when individually placed on a table facedown.

# Printing

## Printing a document

### Printing forms

Use Forms and Favorites to quickly and easily access frequently used forms or other information that is regularly printed. Before you can use this application, first set it up on the printer. For more information, see [“Setting up Forms and Favorites” on page 21](#).

- 1 From the home screen, navigate to:  
**Forms and Favorites** > select the form from the list > enter the number of copies > adjust other settings
- 2 Apply the changes.

### Printing from a computer

**Note:** For labels, card stock, and envelopes, set the paper size and type in the printer before sending the print job.

- 1 From the document that you are trying to print, open the Print dialog.
- 2 If necessary, adjust the settings.
- 3 Send the print job.

### Adjusting toner darkness

#### Using the Embedded Web Server

- 1 Open a Web browser, and then type the printer IP address in the address field.

**Notes:**

- View the printer IP address on the printer home screen. The IP address appears as four sets of numbers separated by periods, such as 123.123.123.123.
- If you are using a proxy server, then temporarily disable it to load the Web page correctly.

- 2 Click **Settings** > **Print Settings** > **Quality Menu** > **Toner Darkness**.
- 3 Adjust the setting, and then click **Submit**.

#### Using the printer control panel

- 1 From the home screen, navigate to:



> **Settings** > **Print Settings** > **Quality Menu** > **Toner Darkness**

- 2 Adjust the setting, and then touch .

## Printing from a mobile device

### Notes:

- Make sure that the printer and mobile device share the same wireless network. For more information on configuring the wireless settings of your mobile device, see the documentation that came with the device.
- Mobile printing is available only in some printer models.

### Printing from a mobile device using Mopria Print Service

Mopria® Print Service is a mobile printing solution for mobile devices running on Android version 4.4 or later. It allows you to print directly to any Mopria-certified printer.

**Note:** Before printing, make sure that the Mopria Print Service is enabled.

- 1 From the home screen of your mobile device, launch a compatible application.
- 2 Tap **Print**, and then select the printer.
- 3 Send the print job.

### Printing from a mobile device using Google Cloud Print

Google Cloud Print™ is a mobile printing service that allows enabled applications on mobile devices to print to any Google Cloud Print-ready printer.

- 1 From the home screen of your mobile device, launch an enabled application.
- 2 Tap **Print**, and then select the printer.
- 3 Send the print job.

### Printing from a mobile device using AirPrint

AirPrint is a mobile printing solution that allows you to print directly from Apple devices to an AirPrint-certified printer.

### Notes:

- This application is supported only in some Apple devices.
  - This application is supported only in some printer models.
- 1 From the home screen of your mobile device, launch a compatible application.
  - 2 Select an item to print, and then tap the share icon.
  - 3 Tap **Print**, and then select a printer.
  - 4 Print the document.

## Printing from a mobile device using Lexmark Mobile Print

Lexmark Mobile Print allows you to send documents and images directly to a supported Lexmark printer.

- 1 Open the document, and then send or share the document to Lexmark Mobile Print.

**Note:** Some third-party applications may not support the send or share feature. For more information, see the documentation that came with the application.

- 2 Select a printer.
- 3 Print the document.

## Printing from a flash drive

### Printing from a flash drive

#### Notes:

- Before printing an encrypted PDF file, you will be prompted to type the file password from the printer control panel.
- You cannot print files for which you do not have printing permissions.

- 1 Insert a flash drive into the USB port.



#### Notes:

- A flash drive icon appears on the printer home screen when a flash drive is inserted.
- If you insert the flash drive when the printer requires attention, such as when a jam has occurred, then the printer ignores the flash drive.
- If you insert the flash drive while the printer is processing other print jobs, then **Busy** appears on the printer display. After these print jobs are processed, you may need to view the held jobs list to print documents from the flash drive.

**Warning—Potential Damage:** Do not touch the USB cable, any wireless network adapter, any connector, the memory device, or the printer in the areas shown while actively printing, reading, or writing from the memory device. Loss of data can occur.



- 2 From the printer control panel, touch the document you want to print.
- 3 Touch the arrows to get a preview of the document.
- 4 Use **+** or **-** to specify the number of copies to be printed, and then touch **Print**.

**Notes:**

- Do not remove the flash drive from the USB port until the document has finished printing.
- If you leave the flash drive in the printer after leaving the initial USB menu screen, then touch **Held Jobs** on the home screen to print files from the flash drive.

## Supported flash drives and file types

**Notes:**

- High-speed USB flash drives must support the full-speed standard. Low-speed USB devices are not supported.
- USB flash drives must support the File Allocation Table (FAT) system. Devices formatted with New Technology File System (NTFS) or any other file system are not supported.

Recommended flash drives	File type
<ul style="list-style-type: none"> <li>• Lexar JumpDrive FireFly (512MB and 1GB)</li> <li>• SanDisk Cruzer Micro (512MB and 1GB)</li> <li>• Sony Micro Vault Classic (512MB and 1GB)</li> </ul>	<p>Documents:</p> <ul style="list-style-type: none"> <li>• .pdf</li> <li>• .xps</li> </ul> <p>Images:</p> <ul style="list-style-type: none"> <li>• .dcx</li> <li>• .gif</li> <li>• .jpeg or .jpg</li> <li>• .bmp</li> <li>• .pcx</li> <li>• .tiff or .tif</li> <li>• .png</li> <li>• .fls</li> </ul>

## Printing confidential and other held jobs

### Storing print jobs in the printer

1 From the home screen, navigate to:

 > **Security** > **Confidential Print** > select a print job type

Use	To
Max Invalid PIN	Limit the number of times an invalid PIN can be entered. <b>Note:</b> When the limit is reached, the print jobs for that user name and PIN are deleted.
Confidential Job Expiration	Hold print jobs in the computer until you enter the PIN from the printer control panel. <b>Note:</b> The PIN is set from the computer. It must be four digits, using the numbers 0–9.
Repeat Job Expiration	Print and store print jobs in the printer memory.
Verify Job Expiration	Print one copy of a print job and hold the remaining copies. It lets you examine if the first copy is satisfactory or not. The print job is automatically deleted from the printer memory when all copies are printed.

**Notes:**

- Confidential, Verify, Reserve, and Repeat print jobs may be deleted if the printer requires extra memory to process additional held jobs.
- You can set the printer to store print jobs in the printer memory until you start the print job from the printer control panel.
- All print jobs that can be initiated by the user at the printer are called *held jobs*.

Use	To
Reserve Job Expiration	Store print jobs for printing at a later time. <b>Note:</b> The print jobs are held until deleted from the Held Jobs menu.
<b>Notes:</b>	
<ul style="list-style-type: none"> <li>• Confidential, Verify, Reserve, and Repeat print jobs may be deleted if the printer requires extra memory to process additional held jobs.</li> <li>• You can set the printer to store print jobs in the printer memory until you start the print job from the printer control panel.</li> <li>• All print jobs that can be initiated by the user at the printer are called <i>held jobs</i>.</li> </ul>	

2 Touch .

## Printing held jobs

- 1 From the document you are trying to print, open the Print dialog.
- 2 Select the printer, and then do the following:
  - For Windows users, click **Properties** or **Preferences**, and then click **Print and Hold**.
  - For Macintosh users, select **Print and Hold**.
- 3 Select the print job type.
- 4 If necessary, assign a user name.
- 5 Send the print job.
- 6 From the printer home screen, touch **Held Jobs**.
- 7 Send the print job.

## Modifying confidential print settings

- 1 Open a Web browser, and then type the printer IP address in the address field.
 

**Notes:**

  - View the printer IP address on the printer home screen. The IP address appears as four sets of numbers separated by periods, such as 123.123.123.123.
  - If you are using a proxy server, then temporarily disable it to load the Web page correctly.
- 2 Click **Settings** > **Security** > **Confidential Print Setup**.
- 3 Modify the settings:
  - Set a maximum number of PIN entry attempts. When a user exceeds that number, all of the jobs for that user are deleted.
  - Set an expiration time for confidential print jobs. When a user has not printed the jobs within that time, all of the jobs for that user are deleted.
- 4 Click **Submit** to save the modified settings.

## Printing information pages

### Printing a font sample list

- 1 From the home screen, navigate to:



> **Reports** > **Print Fonts**

- 2 Touch **PCL Fonts** or **PostScript Fonts**.

### Printing a directory list

A directory list shows the resources stored in a flash memory or in the printer hard disk.



From the home screen, navigate to:



> **Reports** > **Print Directory**

## Canceling a print job

### Canceling a print job from the printer control panel



- 1 From the printer control panel, touch **Cancel Job** or press  on the keypad.
  - 2 Touch the print job you want to cancel, and then touch **Delete Selected Jobs**.
- Note:** If you press  on the keypad, then touch **Resume** to return to the home screen.

### Canceling a print job from the computer

- 1 Depending on the operating system, do either of the following:
  - Open the printers folder, and then select your printer.
  - From the System Preferences in the Apple menu, navigate to your printer.
- 2 Select the print job to cancel.



# Copying

Automatic document feeder (ADF)	Scanner glass
 <p data-bbox="147 747 643 810">Use the ADF for multiple-page documents including two-sided pages.</p>	 <p data-bbox="743 831 1469 921">Use the scanner glass for single-page documents, book pages, small items (such as postcards or photos), transparencies, photo paper, or thin media (such as magazine clippings).</p>

## Making copies

### Making a quick copy

- 1 Load an original document faceup, short edge first into the ADF tray or facedown on the scanner glass.

**Notes:**

- Do not load postcards, photos, small items, transparencies, photo paper, or thin media (such as magazine clippings) into the ADF tray. Place these items on the scanner glass.
- The ADF indicator light comes on when the paper is loaded properly.

- 2 If you are loading a document into the ADF tray, then adjust the paper guides.

**Note:** To avoid a cropped image, make sure the size of the original document and the size of the copy paper are the same.

- 3 From the printer control panel, press .

### Copying using the ADF

- 1 Load an original document faceup, short edge first into the ADF tray.

**Notes:**

- Do not load postcards, photos, small items, transparencies, photo paper, or thin media (such as magazine clippings) into the ADF tray. Place these items on the scanner glass.

- The ADF indicator light comes on when the paper is loaded properly.

2 Adjust the paper guides.

3 From the home screen, navigate to:

**Copy** > specify the copy settings > **Copy It**

## Copying using the scanner glass

1 Place an original document facedown on the scanner glass in the upper left corner.

2 From the home screen, navigate to:

**Copy** > specify the copy settings > **Copy It**

If you have more pages to scan, then place the next document on the scanner glass, and then touch **Scan the next page**.

3 Touch **Finish the Job**.

## Copying photos

1 Place a photo facedown on the scanner glass in the upper left corner.

2 From the home screen, navigate to:

**Copy** > **Content** > **Photo** > 

3 From the Content Source menu, select the appropriate setting that best matches the original photo.

4 Touch  > **Copy It**

**Note:** If you have more photos to copy, then place the next photo on the scanner glass, and then touch **Scan the next page**.

5 Touch **Finish the Job**.

## Copying on specialty media

### Copying on transparencies

1 Load an original document faceup, short edge first into the ADF tray or facedown on the scanner glass.

**Notes:**

- Do not load postcards, photos, small items, transparencies, photo paper, or thin media (such as magazine clippings) into the ADF tray. Place these items on the scanner glass.
- The ADF indicator light comes on when the paper is loaded properly.

2 From the home screen, navigate to:

**Copy** > **Copy from** > select the size of the original document

**3** Navigate to:

**Copy to** > select the tray that contains transparencies > **Copy It**

If there are no trays that support transparencies, then navigate to:

**Manual Feeder** > select the size of the transparencies > **Transparency**

**4** Load transparencies into the multipurpose feeder, and then touch **Copy It**.

## Copying on letterhead

**1** Load an original document faceup, short edge first into the ADF tray or facedown on the scanner glass.

### Notes:

- Do not load postcards, photos, small items, transparencies, photo paper, or thin media (such as magazine clippings) into the ADF tray. Place these items on the scanner glass.
- The ADF indicator light comes on when the paper is loaded properly.

**2** From the home screen, navigate to:

**Copy** > **Copy from** > select the size of the original document

**3** Touch **Copy to** > **Manual Feeder**.

**4** Place the letterhead faceup, top edge first into the multipurpose feeder.

**5** Select the size of the letterhead, and then touch **Letterhead** > **Copy It**.

## Customizing copy settings

### Copying to a different size

**1** Load an original document faceup, short edge first into the ADF tray or facedown on the scanner glass.

### Notes:

- Do not load postcards, photos, small items, transparencies, photo paper, or thin media (such as magazine clippings) into the ADF tray. Place these items on the scanner glass.
- The ADF indicator light comes on when the paper is loaded properly.

**2** If you are loading a document into the ADF tray, then adjust the paper guides.

**3** From the home screen, navigate to:

**Copy** > **Copy from** > select the size of the original document

**4** Navigate to:

**Copy to** > select a new size for the copy > **Copy It**

**Note:** If the selected paper size is different from the “Copy from” size, then the printer scales the size automatically.

### Making copies using paper from a selected tray

**1** Load an original document faceup, short edge first into the ADF tray or facedown on the scanner glass.

**Notes:**

- Do not load postcards, photos, small items, transparencies, photo paper, or thin media (such as magazine clippings) into the ADF tray. Place these items on the scanner glass.
- The ADF indicator light comes on when the paper is loaded properly.

**2** If you are loading a document into the ADF tray, then adjust the paper guides.

**3** From the home screen, navigate to:

**Copy > Copy from** > select the size of the original document

**4** Touch **Copy to**, and then select the tray that contains the paper type you want to use.

**5** Touch **Copy It**.

## Copying different paper sizes

Use the ADF to copy original documents with different paper sizes. Depending on the paper sizes loaded and the “Copy to” and “Copy from” settings, each copy is either printed on mixed paper sizes (Example 1) or scaled to fit a single paper size (Example 2).

### Example 1: Copying on mixed paper sizes

**1** Load an original document faceup, short edge first into the ADF tray or facedown on the scanner glass.

**Notes:**

- Do not load postcards, photos, small items, transparencies, photo paper, or thin media (such as magazine clippings) into the ADF tray. Place these items on the scanner glass.
- The ADF indicator light comes on when the paper is loaded properly.

**2** If you are loading a document into the ADF tray, then adjust the paper guides.

**3** From the home screen, navigate to:

**Copy > Copy from > Mixed Sizes > Copy to > Auto Size Match > Copy It**

The scanner identifies the different paper sizes as they are scanned. Copies are printed on mixed paper sizes corresponding to the paper sizes of the original document.

### Example 2: Copying on a single paper size

**1** Load an original document faceup, short edge first into the ADF tray or facedown on the scanner glass.

**Notes:**

- Do not load postcards, photos, small items, transparencies, photo paper, or thin media (such as magazine clippings) into the ADF tray. Place these items on the scanner glass.
- The ADF indicator light comes on when the paper is loaded properly.

**2** If you are loading a document into the ADF tray, then adjust the paper guides.

**3** From the home screen, navigate to:

**Copy > Copy from > Mixed Sizes > Copy to > Letter > Copy It**

The scanner identifies the different paper sizes as they are scanned, and then scales the mixed paper sizes to fit on the paper size selected.

## Copying on both sides of the paper (duplexing)

1 Load an original document faceup, short edge first into the ADF tray or facedown on the scanner glass.

**Notes:**

- Do not load postcards, photos, small items, transparencies, photo paper, or thin media (such as magazine clippings) into the ADF tray. Place these items on the scanner glass.
- The ADF indicator light comes on when the paper is loaded properly.

2 If you are loading a document into the ADF tray, then adjust the paper guides.

3 From the home screen, navigate to:

**Copy > Sides (Duplex)** > select the preferred duplexing method

**Note:** For the preferred duplexing method, the first number represents sides of the original documents while the second number represents sides of the copy. For example, select “2 sided to 2 sided” if you have two-sided original documents and you want two-sided copies.

4 Touch  > **Copy It.**

## Reducing or enlarging copies

Copies can be scaled from 25% to 400% of the original document size.

1 Load an original document faceup, short edge first into the ADF tray or facedown on the scanner glass.

**Notes:**

- Do not load postcards, photos, small items, transparencies, photo paper, or thin media (such as magazine clippings) into the ADF tray. Place these items on the scanner glass.
- The ADF indicator light comes on when the paper is loaded properly.

2 If you are loading a document into the ADF tray, then adjust the paper guides.

3 From the home screen, touch **Copy**.

4 From the Scale area, touch  or  to enlarge or reduce your copies.

**Notes:**

- The factory default setting for Scale is Auto.
- If you leave Scale set to Auto, then the content of your original document will be scaled to fit the size of the paper onto which you are copying.
- Touching **Copy to** or **Copy from** after setting Scale manually changes the scale value back to Auto.



5 Touch **Copy It.**

## Adjusting copy quality

1 Load an original document faceup, short edge first into the ADF tray or facedown on the scanner glass.



**Notes:**

- Do not load postcards, photos, small items, transparencies, photo paper, or thin media (such as magazine clippings) into the ADF tray. Place these items on the scanner glass.

- The ADF indicator light comes on when the paper is loaded properly.
- 2 If you are loading a document into the ADF tray, then adjust the paper guides.
  - 3 From the home screen, navigate to:  
**Copy > Content**
  - 4 Touch the button that best represents the content type of the document you are copying.
    - **Text**—The content of the original document is mostly text or line art.
    - **Text/Photo**—The original document is a mixture of text, graphics, and photos.
    - **Photo**—The original document is mostly a photo or an image.
    - **Graphics**—The original document is mostly business-type graphics, such as pie charts, bar charts, and animations.
  - 5 Touch .
  - 6 Touch the button that best represents the content source of the document you are copying.
    - **Color Laser**—The original document was printed using a color laser printer.
    - **Inkjet**—The original document was printed using an inkjet printer.
    - **Magazine**—The original document is from a magazine.
    - **Press**—The original document was printed using a printing press.
    - **Black/White Laser**—The original document was printed using a mono laser printer.
    - **Photo/Film**—The original document is a photo from a film.
    - **Newspaper**—The original document is from a newspaper.
    - **Other**—The original document was printed using an alternate or unknown printer.
  - 7 Touch  > **Copy It**.

## Collating copies

If you print multiple copies of a document, then you can choose to print the copies as a set (collated) or to print the copies as groups of pages (not collated).

Collated	Not collated
	

- 1 Load an original document faceup, short edge first into the ADF tray or facedown on the scanner glass.

### Notes:

- Do not load postcards, photos, small items, transparencies, photo paper, or thin media (such as magazine clippings) into the ADF tray. Place these items on the scanner glass.
  - The ADF indicator light comes on when the paper is loaded properly.
- 2 If you are loading a document into the ADF tray, then adjust the paper guides.
  - 3 From the home screen, navigate to:  
**Copy > enter the number of copies > Collate > select the preferred order of pages >  > Copy It**

## Placing separator sheets between copies

1 Load an original document faceup, short edge first into the ADF tray or facedown on the scanner glass.

**Notes:**

- Do not load postcards, photos, small items, transparencies, photo paper, or thin media (such as magazine clippings) into the ADF tray. Place these items on the scanner glass.
- The ADF indicator light comes on when the paper is loaded properly.

2 If you are loading a document into the ADF tray, then adjust the paper guides.

3 From the home screen, navigate to:

**Copy > Separator Sheets**

**Note:** Set Collate to “1,2,3 - 1,2,3” to place separator sheets between copies. If Collate is set to “1,1,1 - 2,2,2,” then the separator sheets are added to the end of the copy job. For more information, see [“Collating copies” on page 86](#).

4 Select one of the following:

- **Between Copies**
- **Between Jobs**
- **Between Pages**
- **Off**

5 Touch  > **Copy It**.

## Copying multiple pages onto a single sheet

In order to save paper, you can copy either two or four consecutive pages of a multiple-page document onto a single sheet of paper.

**Notes:**

- Make sure to set the paper size to letter, legal, A4, or JIS B5.
- Make sure to set the copy size to 100%.

1 Load an original document faceup, short edge first into the ADF tray or facedown on the scanner glass.

**Notes:**

- Do not load postcards, photos, small items, transparencies, photo paper, or thin media (such as magazine clippings) into the ADF tray. Place these items on the scanner glass.
- The ADF indicator light comes on when the paper is loaded properly.

2 If you are loading a document into the ADF tray, then adjust the paper guides.

3 From the home screen, navigate to:

**Copy > Paper Saver** > select the output you want >  > **Copy It**

**Note:** If Paper Saver is set to Off, then the Print Page Borders option is unavailable.

## Placing information on copies

### Placing a header or footer on pages

1 Load an original document faceup, short edge first into the ADF tray or facedown on the scanner glass.

**Notes:**

- Do not load postcards, photos, small items, transparencies, photo paper, or thin media (such as magazine clippings) into the ADF tray. Place these items on the scanner glass.
- The ADF indicator light comes on when the paper is loaded properly.

2 If you are loading a document into the ADF tray, then adjust the paper guides.

3 From the home screen, navigate to:

**Copy > Header/Footer**

4 Select **Header** or **Footer**, and then touch .

5 Select where you want to insert the header or footer, then select a text option, and then touch .

6 Select where you want to print the header or footer, and then touch .

7 From the Header/Footer menu, touch  > **Copy It**.

### Placing an overlay message on each page

1 Load an original document faceup, short edge first into the ADF tray or facedown on the scanner glass.

**Notes:**

- Do not load postcards, photos, small items, transparencies, photo paper, or thin media (such as magazine clippings) into the ADF tray. Place these items on the scanner glass.
- The ADF indicator light comes on when the paper is loaded properly.

2 If you are loading a document into the ADF tray, then adjust the paper guides.

3 From the home screen, navigate to:

**Copy > Overlay** > select an overlay message > .

**Note:** The message choices are Urgent, Confidential, Copy, Custom, and Draft.

4 Touch **Copy It**.

## Canceling a copy job

### Canceling a copy job while the original document is in the ADF

When the ADF begins processing a document, touch **Cancel Job** on the printer control panel.



## Canceling a copy job while copying pages using the scanner glass

From the home screen, touch **Cancel Job**.

**Canceling** appears on the display. When the job is canceled, the Copy screen appears.

## Canceling a copy job while pages are being printed

1 From the printer control panel, touch **Cancel Job** or press  on the keypad.

2 Touch the job you want to cancel, and then touch **Delete Selected Jobs**.

**Note:** If you press  on the keypad, then touch **Resume** to return to the home screen.

## Understanding the copy options

### Copy from

This option opens a screen where you can select the paper size of the original document.

- Touch the paper size that matches the original document.
- To copy an original document that contains mixed paper sizes with the same width, touch **Mixed Sizes**.
- To set the printer to automatically detect the size of the original document, touch **Auto Size Sense**.



### Copy to

This option opens a screen where you can enter the paper size and type on which your copies will be printed.

- Touch the paper size and type that matches the paper loaded.
- If the settings for “Copy from” and “Copy to” are different, then the printer automatically adjusts the Scale setting to accommodate the difference.
- If the paper type or size that you want to copy onto is not loaded in one of the trays, then touch **Manual Feeder**, and manually load the paper in the multipurpose feeder.
- When “Copy to” is set to Auto Size Match, each copy matches the paper size of the original document. If a matching paper size is not in one of the trays, then **Paper size not found** appears and prompts to load a paper in a tray or multipurpose feeder.

### Scale

This option lets you scale the document from 25% to 400% of the original document size. You can also set automatic scaling.

- When copying to a different paper size, such as from legal-size to letter-size paper, set the “Copy from” and “Copy to” paper sizes automatically to scale the scan image to fit the size of the paper onto which you are copying.
- To decrease or increase the value by 1%, touch  or  on the printer control panel. To make a continuous decrease or increase in value, hold the button for two seconds or more.

## Darkness

This option lets you adjust how light or dark the copies are in relation to the original document.

## Sides (Duplex)

This option lets you make one- or two-sided copies from one- or two-sided original documents.

## Collate

This option keeps the pages of a print job stacked in sequence when printing multiple copies of the document.

## Copies

This option lets you set the number of copies to be printed.

## Content

This option lets you set the original document type and source.

Select from the following content types:

- **Graphics**—The original document is mostly business-type graphics such as pie charts, bar charts, and animations.
- **Photo**—The original document is mostly a photo or an image.
- **Text**—The content of the original document is mostly text or line art.
- **Text/Photo**—The original document is a mixture of text, graphics, and photos.

Select from the following content sources:

- **Black/White Laser**—The original document was printed using a mono laser printer.
- **Color Laser**—The original document was printed using a color laser printer.
- **Inkjet**—The original document was printed using an inkjet printer.
- **Magazine**—The original document is from a magazine.
- **Newspaper**—The original document is from a newspaper.
- **Other**—The original document was printed using an alternate or unknown printer.
- **Photo/Film**—The original document is a photo from film.
- **Press**—The original document was printed using a printing press.

## Advanced Duplex

This option lets you specify the document orientation, whether documents are one-sided or two-sided, and how documents are bound.

## Save As Shortcut

This option lets you save the current settings by assigning a shortcut name.

**Note:** Selecting this option automatically assigns the next available shortcut number.

## Margin Shift

This option lets you increase or reduce the size of the margin of a page by shifting the scanned image.

Touch  or  to set the margin you want. If the additional margin is too large, then the copy will be cropped.

## Edge Erase

This option lets you remove smudges or marks around the edges of a document. You can choose to remove an equal area around all four sides of the paper, or pick a particular edge. Edge Erase also removes whatever is within the area selected, leaving nothing on that portion of the scan.

## Overlay

This option lets you create a watermark (or message) that overlays the content of your copy. You can choose from Confidential, Copy, Draft, Urgent, and Custom. You can type a custom message in the "Enter the Custom Text Overlay and press OK" field. The message will appear, faintly, in large print across each page.

## Cover Page Setup

This option lets you set up the cover page of copies and booklets.

## Separator Sheets

This option lets you place a blank sheet of paper between copies, prints, pages, print jobs or copy jobs. The separator sheets can be drawn from a tray that contains a type or color of paper that is different from the paper your copies are printed on.

## Header/Footer

This option lets you insert a header or footer and specify its location on a page.

Select one of the following:

- **Bates number**
- **Custom text**
- **Date/Time**
- **Page number**

## Paper Saver

This option lets you print two or more pages of an original document on the same page. Paper Saver is also called *N-up* printing where *N* stands for the number of pages. For example, 2-up would print two pages of your document on a single page, and 4-up would print four pages of your document on a single page.

## **Advanced Imaging**

This option lets you adjust the Auto Center, Background Removal, Color Dropout, Contrast, Mirror Image, Negative Image, Scan Edge to Edge, Shadow Detail, Sharpness, and Temperature settings before you copy the document.

## **Create Booklet**

This option lets you create a sequence of printed and collated pages that, when folded, forms a booklet half the page size of the original document and with all the pages in order. You can choose between one-sided and two-sided.

**Note:** This option appears only when a printer hard disk is installed.



## **Custom Job**

This option lets you combine multiple scan jobs into a single job and appears only when a working printer hard disk is installed.

## **Adjust ADF Skew**

This option lets you straighten scanned images that are slightly skewed when received from the ADF tray.

## E-mailing

Automatic document feeder (ADF)	Scanner glass
 <p data-bbox="149 745 649 777">Use the ADF for multiple-page documents.</p>	 <p data-bbox="665 829 1469 913">Use the scanner glass for single pages, small items (such as postcards or photos), transparencies, photo paper, or thin media (such as magazine clippings).</p>

## Setting up the e-mail function

- 1 Open a Web browser, and then type the printer IP address in the address field.

**Notes:**

- View the printer IP address on the printer home screen. The IP address appears as four sets of numbers separated by periods, such as 123.123.123.123.
- If you are using a proxy server, then temporarily disable it to load the Web page correctly.

- 2 Click **Settings > E-mail/FTP Settings > E-mail Settings**.

- 3 Enter the appropriate information, and then click **Submit**.

## Creating an e-mail shortcut

### Creating an e-mail shortcut using the Embedded Web Server

- 1 Open a Web browser, and then type the printer IP address in the address field.

**Notes:**

- View the printer IP address on the printer home screen. The IP address appears as four sets of numbers separated by periods, such as 123.123.123.123.
- If you are using a proxy server, then temporarily disable it to load the Web page correctly.

- 2 Click **Settings**.

- 3 From the Other Settings column, click **Manage Shortcuts > E-mail Shortcut Setup**.

- 4 Type a unique name for the e-mail recipient, and then type the e-mail address. If you are entering multiple addresses, then separate each address with a comma.
- 5 Click **Add**.

## Creating an e-mail shortcut using the printer control panel

- 1 From the home screen, navigate to:

**E-mail** > **Recipient(s)** > type the recipient's e-mail address > 

**Note:** To create a group of recipients, touch , and then type the next recipient's e-mail address.

- 2 Touch **Subject** > type the e-mail subject > .

- 3 Touch **Message** > type your message > .

- 4 Adjust the e-mail settings.

**Note:** If you change the settings after the e-mail shortcut has been created, then the settings are not saved.

- 5 Touch **Save As Shortcut**.

- 6 Type a unique name for the shortcut, and then touch .

- 7 Verify that the shortcut name is correct, and then touch **OK**.

If the shortcut name is incorrect, then touch **Cancel**, and then reenter the information.

**Notes:**

- The shortcut name appears in the E-mail Shortcuts icon on the printer home screen.
- You can use the shortcut when e-mailing another document using the same settings.

## E-mailing a document



You can use the printer to e-mail scanned documents to one or more recipients in a number of ways. You can type the e-mail address, use a shortcut number, or use the address book. You can also use the Multi Send or MyShortcut application from the printer home screen. For more information, see [“Activating the home screen applications” on page 21](#).

## Sending an e-mail using the printer control panel



- 1 Load an original document faceup, short edge first into the ADF tray or facedown on the scanner glass.

**Notes:**



- Do not load postcards, photos, small items, transparencies, photo paper, or thin media (such as magazine clippings) into the ADF tray. Place these items on the scanner glass.

- The ADF indicator light comes on when the paper is loaded properly.
- 2 If you are loading a document into the ADF tray, then adjust the paper guides.  
**Note:** To avoid a cropped image, make sure that the size of the original document and the copy paper size are the same.
  - 3 From the home screen, navigate to:  
**E-mail > Recipient(s)**
  - 4 Type the e-mail address, or press # and then enter the shortcut number.  
To enter additional recipients, touch , and then enter the e-mail address or shortcut number that you want to add.  
**Note:** You can also enter an e-mail address using the address book.
  - 5 Touch  > **E-mail It.**

## Sending an e-mail using a shortcut number

- 1 Load an original document faceup, short edge first into the ADF tray or facedown on the scanner glass.  
**Notes:**
  - Do not load postcards, photos, small items, transparencies, photo paper, or thin media (such as magazine clippings) into the ADF tray. Place these items on the scanner glass.
  - The ADF indicator light comes on when the paper is loaded properly.
- 2 If you are loading a document into the ADF tray, then adjust the paper guides.
- 3 Press #, then enter the shortcut number using the keypad, and then touch .  
To enter additional recipients, touch , and then enter the e-mail address or shortcut number that you want to add.
- 4 Touch  > **E-mail It.**

## Sending an e-mail using the address book

- 1 Load an original document faceup, short edge first into the ADF tray or facedown on the scanner glass.  
**Notes:**
  - Do not load postcards, photos, small items, transparencies, photo paper, or thin media (such as magazine clippings) into the ADF tray. Place these items on the scanner glass.
  - The ADF indicator light comes on when the paper is loaded properly.
- 2 If you are loading a document into the ADF tray, then adjust the paper guides.
- 3 From the home screen, navigate to:  
**E-mail > Recipient(s) >  > type the name of the recipient > **

4 Touch the name of the recipient.

To search for additional recipients, touch **New Search**, and then type the name of the next recipient.

5 Touch  > **E-mail It**.

## Customizing e-mail settings

### Adding e-mail subject and message information

1 Load an original document faceup, short edge first into the ADF tray or facedown on the scanner glass.

**Notes:**

- Do not load postcards, photos, small items, transparencies, photo paper, or thin media (such as magazine clippings) into the ADF tray. Place these items on the scanner glass.
- The ADF indicator light comes on when the paper is loaded properly.

2 If you are loading a document into the ADF tray, then adjust the paper guides.

3 From the home screen, navigate to:

**E-mail** > **Recipient(s)** > type the e-mail address > 

4 Touch **Subject** > type the e-mail subject > .

5 Touch **Message** > type your message > .

### Changing the output file type

1 Load an original document into the ADF tray or on the scanner glass.

2 From the home screen, navigate to:

**E-mail** > **Recipient(s)** > type the e-mail address >  > **Send as**

3 Select the file type you want to send.

4 Touch  > **Send It**.

## Canceling an e-mail

- When using the ADF, touch **Cancel Job** while **Scanning** appears.
- When using the scanner glass, touch **Cancel Job** while **Scanning** appears, or while **Scan the Next Page** / **Finish the Job** appears.



## Understanding the e-mail options

### Recipient(s)

This option lets you enter the recipient of your e-mail. You may enter multiple e-mail addresses.

### Subject

This option lets you type a subject line for your e-mail.

### Message

This option lets you type a message that will be sent with your scanned attachment.

### File Name

This option lets you customize the attachment file name.

### Save As Shortcut

This option lets you save the current settings as a shortcut by assigning a shortcut name.

**Note:** Selecting this option automatically assigns the next available shortcut number.

### Original Size

This option lets you set the paper size of the documents you are going to e-mail. When Original Size is set to Mixed Sizes, you can scan an original document that contains mixed paper sizes (letter- and legal-size pages).

### Darkness

This option lets you adjust how light or dark your scanned documents are in relation to the original document.

### Resolution

This option lets you adjust the output quality of your e-mail. Increasing the image resolution increases the e-mail file size and the time needed to scan your original document. Decreasing the image resolution reduces the file size.

### Send As

This option lets you set the output type for the scan image.

Select one of the following:

- **PDF**—Use this to create a single file with multiple pages. This can be sent as a secured or compressed file.
- **TIFF**—Use this to create multiple files or a single file. If Multi-page TIFF is turned off in the Settings menu of the Embedded Web Server, then TIFF saves one page in each file. The file size is usually larger than an equivalent JPEG.
- **JPEG**—Use this to create and attach a separate file for each page of your original document.
- **XPS**—Use this to create a single XPS file with multiple pages.
- **RTF**—Use this to create a file in editable format.
- **TXT**—Use this to create an ASCII text file with no formatting.

**Note:** To use the RTF or TXT option, purchase and install the AccuRead™ OCR solution.

## Content

This option lets you set the original document type and source.

Select from the following content types:

- **Graphics**—The original document is mostly business-type graphics, such as pie charts, bar charts, and animations.
- **Photo**—The original document is mostly a photo or an image.
- **Text**—The content of the original document is mostly text or line art.
- **Text/Photo**—The original document is a mixture of text, graphics, and photos.

Select from the following content sources:

- **Black/White Laser**—The original document was printed using a mono laser printer.
- **Color Laser**—The original document was printed using a color laser printer.
- **Inkjet**—The original document was printed using an inkjet printer.
- **Magazine**—The original document is from a magazine.
- **Newspaper**—The original document is from a newspaper.
- **Other**—The original document was printed using an alternate or unknown printer.
- **Photo/Film**—The original document is a photo from film.
- **Press**—The original document was printed using a printing press.

## Page Setup

This option lets you change the following settings:

- **Sides (Duplex)**—This specifies if the original document is printed on only one side or on both sides of the paper. This also identifies what needs to be scanned for inclusion in the e-mail.
- **Orientation**—This specifies the orientation of the original document, and then changes the Sides (Duplex) and Binding settings to match the orientation.
- **Binding**—This specifies if the original document is bound on the long-edge or short-edge side.

## Custom Job

This option lets you combine multiple scan jobs into a single job and appears only when a working printer hard disk is installed.

## Scan Preview

This option lets you view the first page of the image before it is included in the e-mail. When the first page is scanned, the scanning is paused and a preview image appears.

**Note:** This option appears only when a working printer hard disk is installed.

## Transmission Log

This option lets you print the transmission log or transmission error log.

## Edge Erase

This option lets you remove smudges or any mark around the edges of a document. You can remove an equal area around all four sides of the paper, or you can pick a particular edge. Edge Erase also removes whatever is within the area selected, leaving nothing on that portion of the scan.

## Advanced Imaging



This option lets you adjust the Background Removal, Color Balance, Color Dropout, Contrast, JPEG Quality, Mirror Image, Negative Image, Scan Edge to Edge, Shadow Detail, Sharpness, and Temperature settings before you e-mail the document.

## Adjust ADF Skew

This option lets you straighten scanned images that are slightly skewed when received from the ADF tray.

# Faxing

**Note:** The fax function is available only in some printer models.

Automatic document feeder (ADF)	Scanner glass
 <p data-bbox="149 800 646 863">Use the ADF for multiple-page documents including two-sided pages.</p>	 <p data-bbox="743 884 1474 970">Use the scanner glass for single-page documents, book pages, small items (such as postcards or photos), transparencies, photo paper, or thin media (such as magazine clippings).</p>

## Setting up the printer to fax

### Notes:

- The following connection methods are applicable only in some countries or regions.
- During the initial printer setup, clear the fax function check box and any other function you plan to set up later, and then touch **Continue**.
- The indicator light may blink red if the fax function is enabled but not fully set up.

**Warning—Potential Damage:** Do not touch the cables or the printer in the area shown while actively sending or receiving a fax.



## Initial fax setup

Many countries and regions require outgoing faxes to contain the following information in a margin at the top or bottom of each transmitted page, or on the first page of the transmission: fax name (identification of the business, other entity, or individual sending the message) and fax number (telephone number of the sending fax machine, business, other entity, or individual). For more information, see [“Regulatory notices for telecommunication terminal equipment” on page 303](#).

To enter your fax setup information, use the printer control panel, or use your browser to access the Embedded Web Server and then enter the Settings menu.

**Note:** If you do not have a TCP/IP environment, then you must use the printer control panel to enter your fax setup information.

### Using the printer control panel for fax setup

When the printer is turned on for the first time, a series of start-up screens appear. If the printer has fax capabilities, then the Fax Name and Fax Number screens appear.

- 1 When the Fax Name screen appears, do the following:
  - a Enter the name to be printed on all outgoing faxes.
  - b Enter the fax name, and then touch **Submit**.
- 2 When the Fax Number screen appears, enter the fax number, and then touch **Submit**.

### Using the Embedded Web Server for fax setup

- 1 Open a Web browser, and then type the printer IP address in the address field.

**Notes:**

- View the printer IP address on the printer home screen. The IP address appears as four sets of numbers separated by periods, such as 123.123.123.123.
- If you are using a proxy server, then temporarily disable it to load the Web page correctly.

- 2 Click **Settings > Fax Settings > Analog Fax Setup**.
- 3 In the Fax Name field, type the name to be printed on all outgoing faxes.
- 4 In the Fax Number field, enter the printer fax number.
- 5 Click **Submit**.

## Choosing a fax connection

### Setting up fax using a standard telephone line



**CAUTION—SHOCK HAZARD:** To avoid the risk of electrical shock, do not set up this product or make any electrical or cabling connections, such as the power cord, fax feature, or telephone, during a lightning storm.



**CAUTION—SHOCK HAZARD:** To avoid the risk of electrical shock, do not use the fax feature during a lightning storm.

**⚠ CAUTION—POTENTIAL INJURY:** To reduce the risk of fire, use only a 26 AWG or larger telecommunications (RJ-11) cord when connecting this product to the public switched telephone network. For users in Australia, the cord must be approved by the Australian Communications and Media Authority.

### Setup 1: Printer is connected to a dedicated fax line

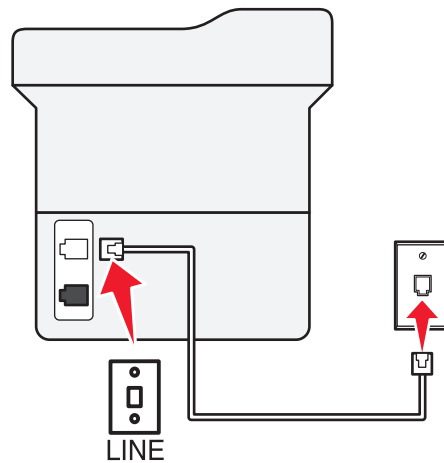

- 1 Connect one end of the telephone cable to the line port of the printer.
- 2 Connect the other end of the cable to an active analog wall jack.

#### Notes:

- You can set the printer to receive faxes automatically (Auto Answer On) or manually (Auto Answer Off).
- If you want to receive faxes automatically, then set the printer to pick up on a specified number of rings.

## Setup 2: Printer is sharing the line with an answering machine

**Note:** If you subscribe to a distinctive ring service, then make sure that you set the correct ring pattern for the printer. Otherwise, the printer does not receive faxes even if you have set it to receive faxes automatically.

### Connected to the same telephone wall jack

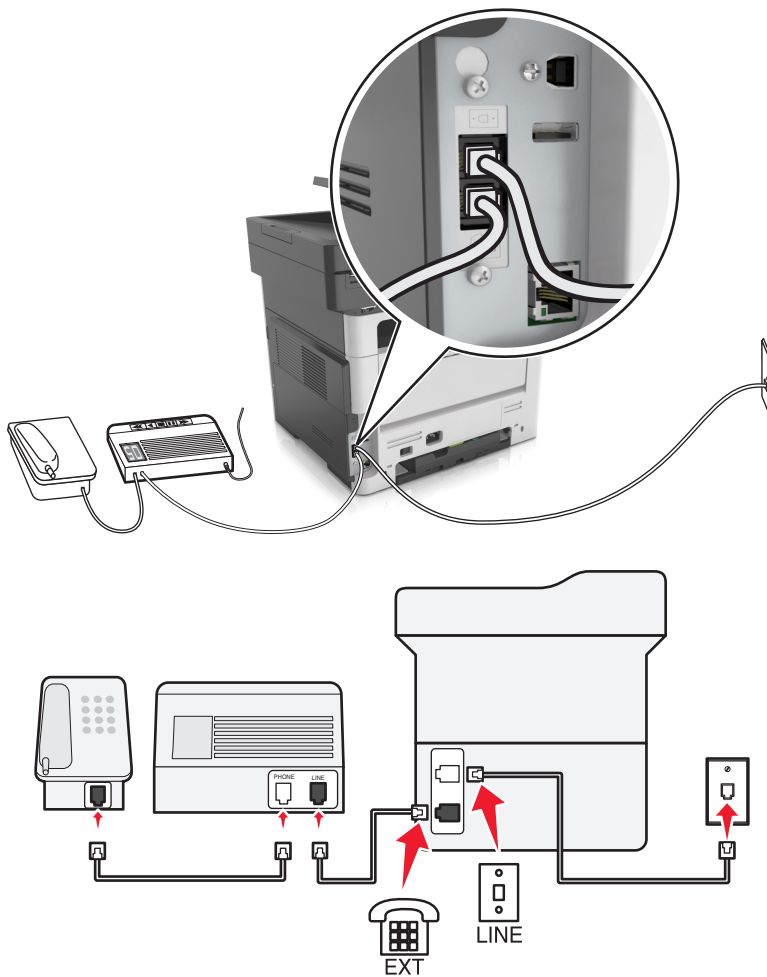

- 1 Connect one end of the telephone cable to the line port of the printer.
- 2 Connect the other end of the cable to an active analog wall jack.
- 3 Connect the answering machine to the telephone port of the printer.

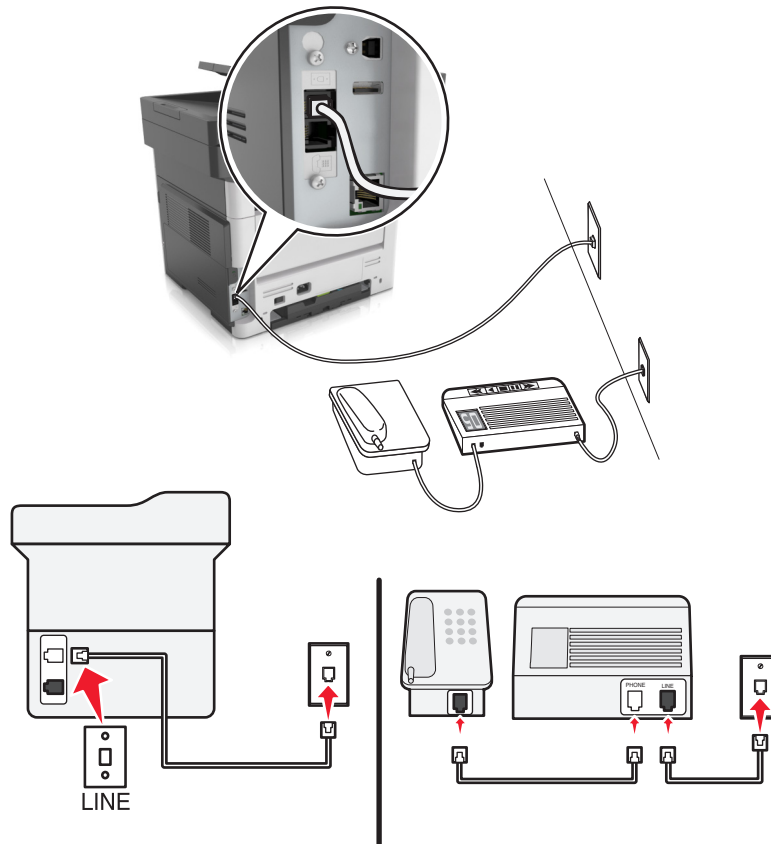
**Connected to different wall jacks**

- 1 Connect one end of the telephone cable to the line port of the printer.
- 2 Connect the other end of the cable to an active analog wall jack.

**Notes:**

- If you have only one telephone number on your line, then set the printer to receive faxes automatically.
- Set the printer to pick up calls two rings after the answering machine. For example, if the answering machine picks up calls after four rings, then set the printer Rings to Answer setting to six.



### Setup 3: Printer is sharing the line with a telephone subscribed to voice mail service

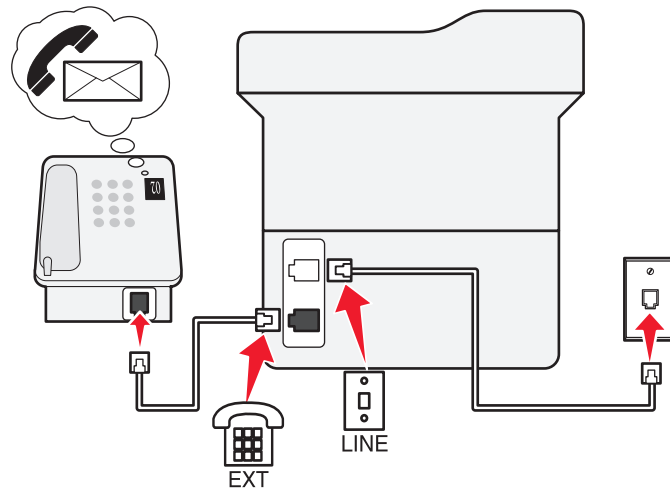
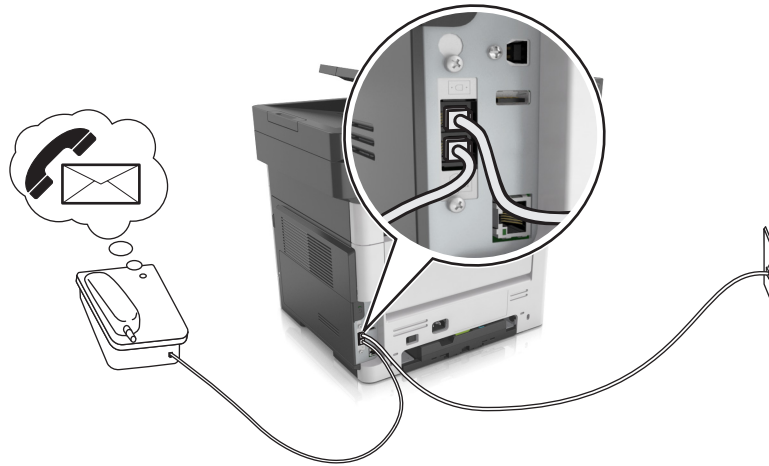

- 1 Connect one end of the telephone cable to the line port of the printer.
- 2 Connect the other end of the cable to an active analog wall jack.
- 3 Connect the telephone to the telephone port of the printer.

#### Notes:

- This setup works best if you are using voice mail more often than fax, and if you subscribe to a distinctive ring service.
- When you answer the telephone and you hear fax tones, press **\*9\*** or the manual answer code on the telephone to receive the fax.
- You can also set the printer to receive faxes automatically, but turn off the voice mail service when you are expecting a fax.

### Setting up fax using digital subscriber line

**⚡ CAUTION—SHOCK HAZARD:** To avoid the risk of electrical shock, do not set up this product or make any electrical or cabling connections, such as the power cord, fax feature, or telephone, during a lightning storm.

**⚠ CAUTION—SHOCK HAZARD:** To avoid the risk of electrical shock, do not use the fax feature during a lightning storm.

**⚠ CAUTION—POTENTIAL INJURY:** To reduce the risk of fire, use only a 26 AWG or larger telecommunications (RJ-11) cord when connecting this product to the public switched telephone network. For users in Australia, the cord must be approved by the Australian Communications and Media Authority.

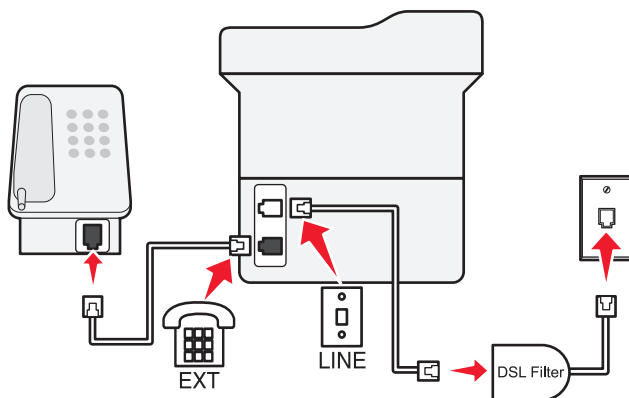

Digital subscriber line (DSL) splits your regular telephone line into two channels: voice and Internet. Telephone and fax signals travel through the voice channel, and Internet signals pass through the other channel.

To minimize interference between the two channels, ask for a DSL filter from your DSL provider.

- 1 Connect the line port of the DSL filter to the wall jack.
- 2 Connect one end of the telephone cable to the line port of the printer.
- 3 Connect the other end of the cable to the telephone port on the DSL filter.

**Note:** To connect a telephone to the printer, remove any installed adapter plug from the telephone port of the printer, and then connect the telephone.

### Setting up fax using VoIP telephone service

**⚠ CAUTION—SHOCK HAZARD:** To avoid the risk of electrical shock, do not set up this product or make any electrical or cabling connections, such as the power cord, fax feature, or telephone, during a lightning storm.

**CAUTION—SHOCK HAZARD:** To avoid the risk of electrical shock, do not use the fax feature during a lightning storm.

**CAUTION—POTENTIAL INJURY:** To reduce the risk of fire, use only a 26 AWG or larger telecommunications (RJ-11) cord when connecting this product to the public switched telephone network. For users in Australia, the cord must be approved by the Australian Communications and Media Authority.

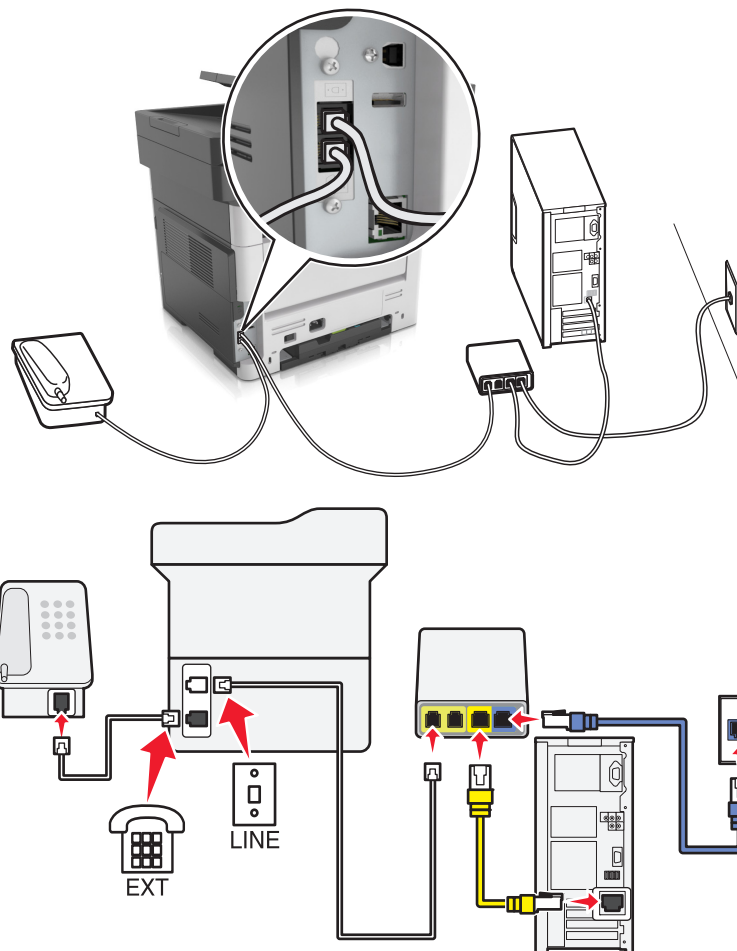

- 1 Connect one end of the telephone cable to the line port of the printer.
- 2 Connect the other end of the cable to the port labeled **Phone Line 1** or **Phone Port** on the VoIP adapter.  
**Note:** The port labeled **Phone Line 2** or **Fax Port** is not always active. VoIP providers may charge extra cost for the activation of the second telephone port.
- 3 Connect the telephone to the telephone port of the printer.

**Notes:**

- To check if the telephone port on the VoIP adapter is active, plug an analog telephone into the port, and then listen for a dial tone.
- If you need two telephone ports for your devices, but do not want to pay extra cost, then use a phone splitter. Plug the phone splitter into the port labeled **Phone Line 1** or **Phone Port**, and then plug the printer and telephone into the splitter.
- To check the splitter, plug an analog telephone into the splitter, and then listen for a dial tone.

## Setting up fax using cable modem connection

- ⚠ CAUTION—SHOCK HAZARD:** To avoid the risk of electrical shock, do not set up this product or make any electrical or cabling connections, such as the power cord, fax feature, or telephone, during a lightning storm.
- ⚠ CAUTION—SHOCK HAZARD:** To avoid the risk of electrical shock, do not use the fax feature during a lightning storm.
- ⚠ CAUTION—POTENTIAL INJURY:** To reduce the risk of fire, use only a 26 AWG or larger telecommunications (RJ-11) cord when connecting this product to the public switched telephone network. For users in Australia, the cord must be approved by the Australian Communications and Media Authority.

### Setup 1: Printer is connected directly to a cable modem

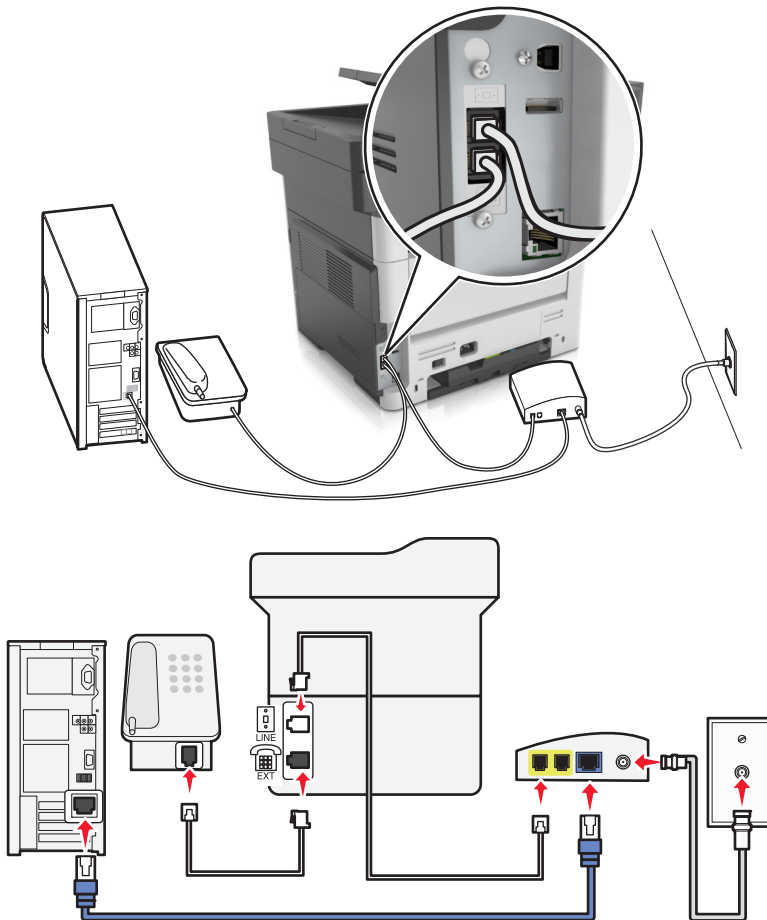

- 1** Connect one end of the telephone cable to the line port of the printer.
- 2** Connect the other end of the cable to the port labeled **Phone Line 1** or **Phone Port** on the cable modem.
- 3** Connect your analog telephone to the telephone port of the printer.

**Note:** To check if the telephone port on the cable modem is active, connect an analog telephone, and then listen for a dial tone.

## Setup 2: Printer is connected to a wall jack; cable modem is installed elsewhere in the facility

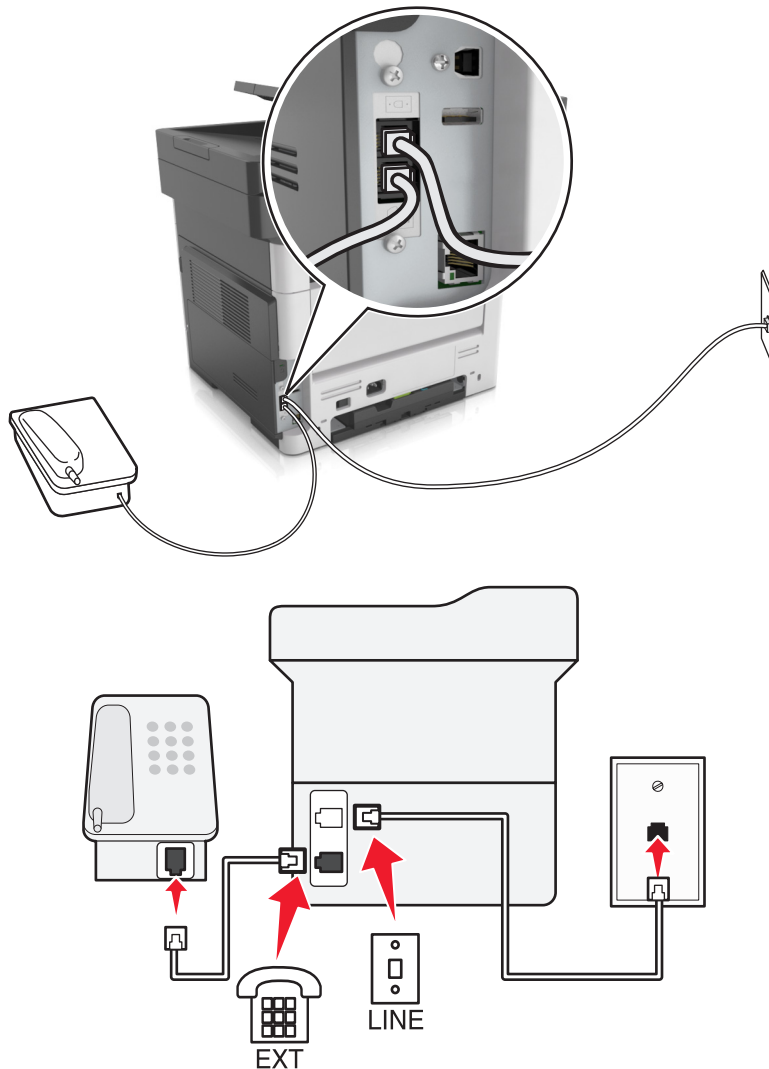

- 1 Connect one end of the telephone cable to the line port of the printer.
- 2 Connect the other end of the cable to an active analog telephone wall jack.
- 3 Connect your analog telephone to the telephone port of the printer.

### Setting up fax in countries or regions with different telephone wall jacks and plugs

- ⚡ CAUTION—SHOCK HAZARD:** To avoid the risk of electrical shock, do not set up this product or make any electrical or cabling connections, such as the power cord, fax feature, or telephone, during a lightning storm.
- ⚡ CAUTION—SHOCK HAZARD:** To avoid the risk of electrical shock, do not use the fax feature during a lightning storm.
- ⚠ CAUTION—POTENTIAL INJURY:** To reduce the risk of fire, use only a 26 AWG or larger telecommunications (RJ-11) cord when connecting this product to the public switched telephone network. For users in Australia, the cord must be approved by the Australian Communications and Media Authority.

The standard wall jack adopted by most countries or regions is RJ11. If the wall jack or equipment in your facility is not compatible with this type of connection, then use a telephone adapter. An adapter for your country or region may not come with your printer, and you may need to purchase it separately.

There may be an adapter plug installed in the telephone port of the printer. Do not remove the adapter plug from the telephone port of the printer if you are connecting to a serial or cascaded telephone system.

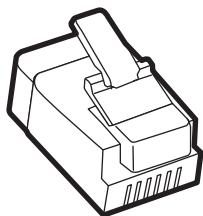

Part name	Part number
Lexmark adapter plug	40X8519

### Connecting the printer to a non-RJ11 wall jack

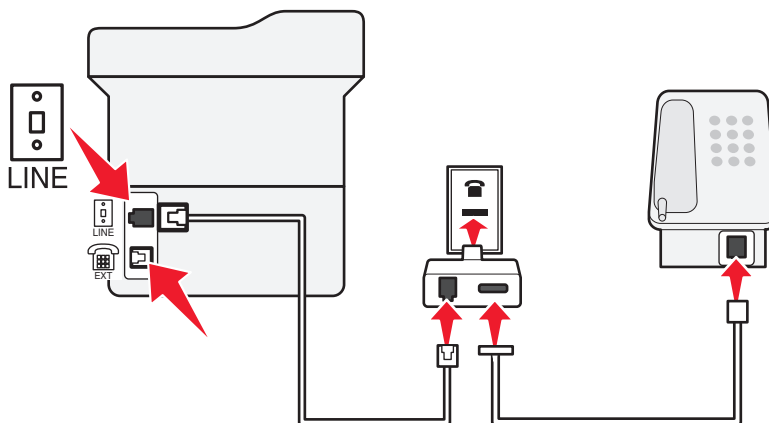
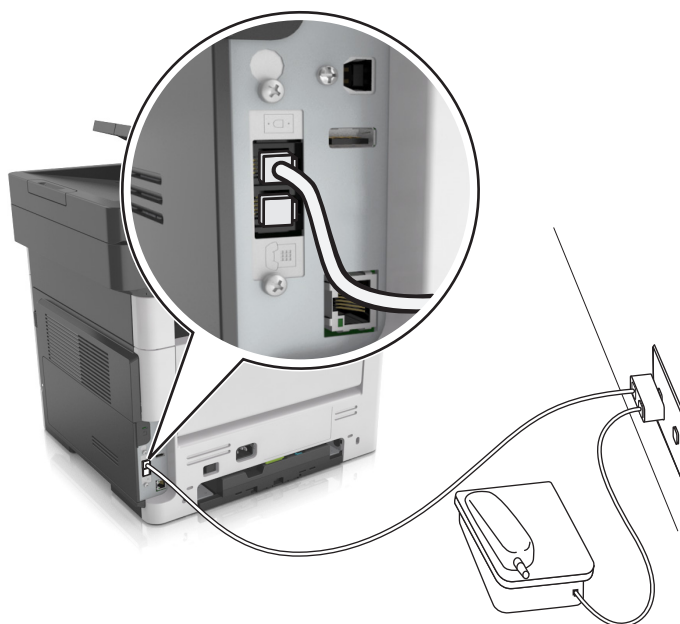

- 1 Connect one end of the telephone cable to the line port of the printer.
- 2 Connect the other end of the cable to the RJ11 adapter, and then connect the adapter to the wall jack.
- 3 If you want to connect another device with a non-RJ11 connector to the same wall jack, then connect it directly to the telephone adapter.

### Connecting the printer to a wall jack in Germany

The German wall jack has two kinds of ports. The N ports are for fax machines, modems, and answering machines. The F port is for telephones. Connect the printer to any of the N ports.

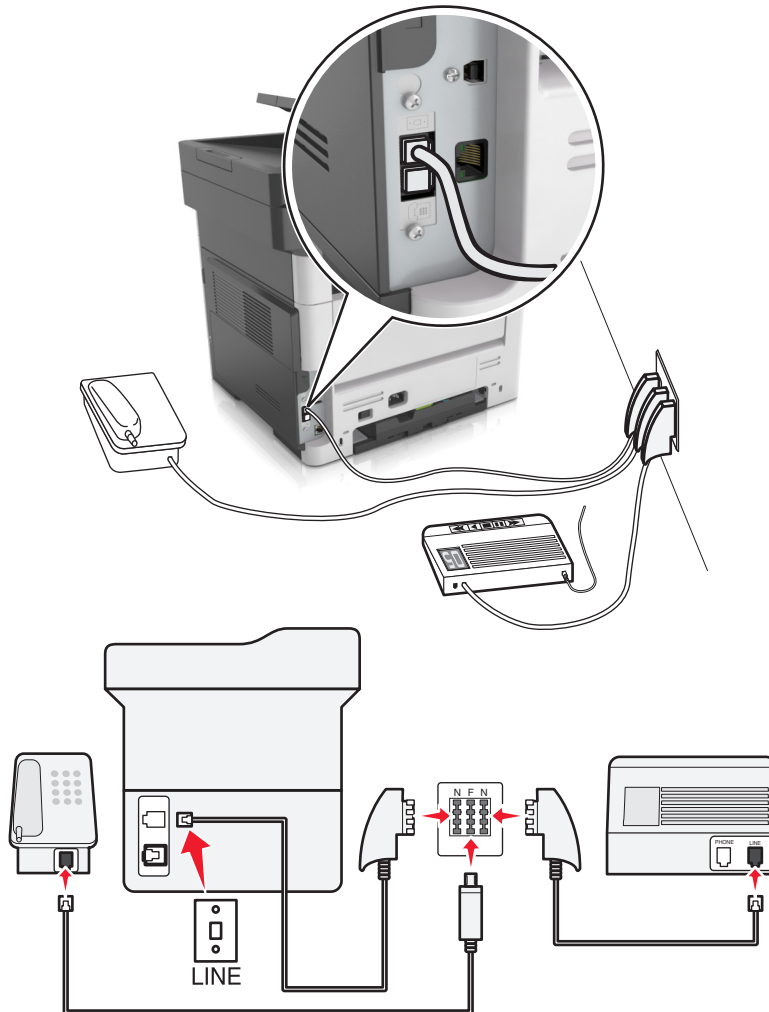

- 1 Connect one end of the telephone cable to the line port of the printer.
- 2 Connect the other end of the cable to the RJ11 adapter, and then connect the adapter to an N port.
- 3 If you want to connect a telephone and answering machine to the same wall jack, then connect the devices as shown.

## Connecting to a distinctive ring service

A distinctive ring service lets you have multiple telephone numbers on one telephone line. Each telephone number is assigned a different ring pattern.

- 1 From the home screen, touch **Settings > Fax > Analog Fax Setup > Fax Receive Settings > Admin Controls > Answer On**.
- 2 Select the ring pattern.
- 3 Apply the changes.

## Setting the outgoing fax name and number

- 1 Open a Web browser, and then type the printer IP address in the address field.

**Notes:**

- View the printer IP address on the printer home screen. The IP address appears as four sets of numbers separated by periods, such as 123.123.123.123.
- If you are using a proxy server, then temporarily disable it to load the Web page correctly.

- 2 Click **Settings > Fax Settings > Analog Fax Setup**.
- 3 In the Fax Name field, type the name to be printed on all outgoing faxes.
- 4 In the Fax Number field, enter the printer fax number.
- 5 Click **Submit**.

## Setting the date and time

You can set the date and time so that they are printed on every fax you send.

- 1 Open a Web browser, and then type the printer IP address in the address field.

**Notes:**

- View the printer IP address on the printer home screen. The IP address appears as four sets of numbers separated by periods, such as 123.123.123.123.
- If you are using a proxy server, then temporarily disable it to load the Web page correctly.

- 2 Click **Security > Set Date and Time**.
- 3 In the Manually Set Date & Time field, enter the current date and time.
- 4 Click **Submit**.

**Note:** It is recommended to use the network time.

## Configuring the printer to observe daylight saving time

The printer can be set to automatically adjust for daylight saving time:

- 1 Open a Web browser, and then type the printer IP address in the address field.



**Notes:**

- View the printer IP address on the printer home screen. The IP address appears as four sets of numbers separated by periods, such as 123.123.123.123.
- If you are using a proxy server, then temporarily disable it to load the Web page correctly.

**2** Click **Security > Set Date and Time**.

**3** Select the **Automatically Observe DST** check box, and then enter the DST start and end dates in the Custom Time Zone Setup section.

**4** Click **Submit**.

## Sending a fax

You can use the printer to send a fax to one or more recipients in a number of ways. You can type the e-mail address, use a shortcut number, or use the address book. You can also use the Multi Send or MyShortcut application from the printer home screen. For more information, see [“Activating the home screen applications” on page 21](#).

### Sending a fax using the printer control panel

**1** Load an original document faceup, short edge first into the ADF tray or facedown on the scanner glass.

**Notes:**

- Do not load postcards, photos, small items, transparencies, photo paper, or thin media (such as magazine clippings) into the ADF tray. Place these items on the scanner glass.
- The ADF indicator light comes on when the paper is loaded properly.

**2** If you are loading a document into the ADF tray, then adjust the paper guides.

**3** From the home screen, touch **Fax**.

**4** From the printer control panel keypad, enter the fax number or the shortcut number.

**Note:** To add recipients, touch , and then enter the recipient's telephone number or shortcut number, or search the address book.

**5** Touch **Fax It**.

### Sending a fax using the computer

#### For Windows users

**1** From the document that you are trying to fax, open the Print dialog.

**2** Select the printer, and then click **Properties, Preferences, Options**, or **Setup**.

**3** Click **Fax > Enable fax**, and then enter the recipient fax number or numbers.

**4** If necessary, configure other fax settings.

**5** Apply the changes, and then send the fax job.

**Notes:**

- The fax option is available only with the PostScript® driver or the Universal Fax Driver. For more information, go to <http://support.lexmark.com>.
- To use the fax option with the PostScript driver, configure and enable it in the Configuration tab.

**For Macintosh users**

- 1 With a document open, choose **File > Print**.
- 2 Select the printer.
- 3 Enter the recipient fax number, and then configure other fax settings, if necessary.
- 4 Send the fax job.

**Sending a fax using a shortcut number**

Fax shortcuts are like the speed dial numbers on a telephone or a fax machine. A shortcut number (1–999) can contain a single recipient or multiple recipients.

- 1 Load an original document faceup, short edge first into the ADF tray or facedown on the scanner glass.

**Notes:**

- Do not load postcards, photos, small items, transparencies, photo paper, or thin media (such as magazine clippings) into the ADF tray. Place these items on the scanner glass.
- The ADF indicator light comes on when the paper is loaded properly.

- 2 If you are loading a document into the ADF tray, then adjust the paper guides.
- 3 From the printer control panel, press **#**, and then enter the shortcut number using the keypad.
- 4 Touch **Fax It**.

**Sending a fax using the address book**

The address book feature lets you search for bookmarks and network directory servers.

**Note:** If the address book feature is not enabled, then contact your system support person.

- 1 Load an original document faceup, short edge first into the ADF tray or facedown on the scanner glass.

**Notes:**

- Do not load postcards, photos, small items, transparencies, photo paper, or thin media (such as magazine clippings) into the ADF tray. Place these items on the scanner glass.
- The ADF indicator light comes on when the paper is loaded properly.

- 2 If you are loading a document into the ADF tray, then adjust the paper guides.
- 3 From the home screen, navigate to:

**Fax** >  > type the name of the recipient > 

**Note:** You can only search for one name at a time.

- 4 Touch the name of the recipient, and then touch **Fax It**.

## Sending a fax at a scheduled time

- 1 Load an original document faceup, short edge first into the ADF tray or facedown on the scanner glass.

**Notes:**

- Do not load postcards, photos, small items, transparencies, photo paper, or thin media (such as magazine clippings) into the ADF tray. Place these items on the scanner glass.
- The ADF indicator light comes on when the paper is loaded properly.

- 2 If you are loading a document into the ADF tray, then adjust the paper guides.

- 3 From the home screen, navigate to:

**Fax** > enter the fax number > **Options** > **Delayed Send**

**Note:** If Fax Mode is set to Fax Server, then the Delayed Send button does not appear. Faxes waiting for transmission are listed in the fax queue.

- 4 Specify the time the fax will be transmitted, and then touch .

- 5 Touch **Fax It**.

**Note:** The document is scanned, and then faxed at the scheduled time.

## Creating shortcuts

### Creating a fax destination shortcut using the Embedded Web Server

Assign a shortcut number to a single fax number or a group of fax numbers.

- 1 Open a Web browser, and then type the printer IP address in the address field.

**Notes:**

- View the printer IP address on the printer home screen. The IP address appears as four sets of numbers separated by periods, such as 123.123.123.123.
- If you are using a proxy server, then temporarily disable it to load the Web page correctly.

- 2 Click **Settings** > **Manage Shortcuts** > **Fax Shortcut Setup**.

**Note:** A password may be required. If you do not have an ID and password, then contact your system support person.

- 3 Type a name for the shortcut, and then enter the fax number.

**Notes:**

- To create a multiple-number shortcut, enter the fax numbers for the group.
- Separate each fax number in the group with a semicolon (;).

- 4 Assign a shortcut number.

**Note:** If you enter a number that is already in use, then you are prompted to select another number.

- 5 Click **Add**.

## Creating a fax destination shortcut using the printer control panel

1 From the home screen, touch **Fax**, and then enter the fax number.

To create a group of fax numbers, touch , and then enter the other fax number.

2 Touch .

3 Type a unique name for the shortcut, and then touch .

4 Verify that the shortcut name and number are correct, and then touch **OK**.

If the name or number is incorrect, then touch **Cancel**, and then reenter the information.

## Customizing fax settings

### Changing the fax resolution



1 Load an original document faceup, short edge first into the ADF tray or facedown on the scanner glass.

**Notes:**

- Do not load postcards, photos, small items, transparencies, photo paper, or thin media (such as magazine clippings) into the ADF tray. Place these items on the scanner glass.
- The ADF indicator light comes on when the paper is loaded properly.

2 If you are loading a document into the ADF tray, then adjust the paper guides.

3 From the home screen, touch **Fax**, and then enter the fax number.

4 From the Resolution area, touch  or  to change to the resolution you want.

**Note:** Settings range from Standard (fastest speed) to Ultra Fine (best quality at a reduced speed).

5 Touch **Fax It**.

### Making a fax lighter or darker

1 Load an original document faceup, short edge first into the ADF tray or facedown on the scanner glass.

**Notes:**

- Do not load postcards, photos, small items, transparencies, photo paper, or thin media (such as magazine clippings) into the ADF tray. Place these items on the scanner glass.
- The ADF indicator light comes on when the paper is loaded properly.

2 If you are loading a document into the ADF tray, then adjust the paper guides.

3 From the home screen, touch **Fax**, and then enter the fax number.

4 From the Darkness area, touch  or  to adjust the darkness setting of the fax.

5 Touch **Fax It**.

## Viewing a fax log

1 Open a Web browser, and then type the printer IP address in the address field.

**Notes:**

- View the printer IP address on the printer home screen. The IP address appears as four sets of numbers separated by periods, such as 123.123.123.123.
- If you are using a proxy server, then temporarily disable it to load the Web page correctly.

2 Click **Settings > Reports**.

3 Click **Fax Job Log** or **Fax Call Log**.

## Blocking junk faxes

1 Open a Web browser, and then type the printer IP address in the address field.

**Notes:**

- View the printer IP address on the printer home screen. The IP address appears as four sets of numbers separated by periods, such as 123.123.123.123.
- If you are using a proxy server, then temporarily disable it to load the Web page correctly.

2 Click **Settings > Fax Settings > Analog Fax Setup > Block No Name Fax**.

**Notes:**

- This option blocks all incoming faxes that have a private caller ID or have no fax name.
- In the Banned Fax List field, enter the phone numbers or type the fax names of specific fax callers you want to block.

## Canceling an outgoing fax

### Canceling a fax while the original documents are still scanning

- When using the ADF, touch **Cancel Job** on the printer control panel while **Scanning** appears.
- When using the scanner glass, touch **Cancel Job** on the printer control panel while **Scanning** appears or while **Scan the Next Page** and **Finish the Job** appear.

### Canceling a fax after the original documents have been scanned to memory

1 On the home screen, touch **Cancel Jobs**.

The Cancel Jobs screen appears.

2 Touch the job or jobs you want to cancel.

Only three jobs appear on the screen; touch the down arrow until the job you want appears, and then touch the job you want to cancel.

### 3 Touch **Delete Selected Jobs**.

The Deleting Selected Jobs screen appears, the selected jobs are deleted, and then the home screen appears.

## Holding and forwarding faxes

### Holding faxes

This option lets you hold received faxes from printing until they are released. Held faxes can be released manually or at a scheduled day or time.

#### 1 Open a Web browser, and then type the printer IP address in the address field.

##### Notes:

- View the printer IP address on the printer home screen. The IP address appears as four sets of numbers separated by periods, such as 123.123.123.123.
- If you are using a proxy server, then temporarily disable it to load the Web page correctly.

#### 2 Click **Settings > Fax Settings > Analog Fax Setup > Holding Faxes**.

#### 3 From the Held Fax Mode menu, select one of the following:

- **Off**
- **Always On**
- **Manual**
- **Scheduled**

#### 4 If you selected Scheduled, then continue with the following steps:

- a Click **Fax Holding Schedule**.
- b From the Action menu, select **Hold faxes**.
- c From the Time menu, select the time you want the held faxes released.
- d From the Day(s) menu, select the day you want the held faxes released.

#### 5 Click **Add**.

### Forwarding a fax

This option lets you print and forward received faxes to a fax number, e-mail address, FTP site, or LDSS.

#### 1 Open a Web browser, and then type the printer IP address in the address field.

##### Notes:

- View the printer IP address on the printer home screen. The IP address appears as four sets of numbers separated by periods, such as 123.123.123.123.
- If you are using a proxy server, then temporarily disable it to load the Web page correctly.

#### 2 Click **Settings > Fax Settings**.

#### 3 From the Fax Forwarding menu, select **Print, Print and Forward**, or **Forward**.

#### 4 From the "Forward to" menu, select **Fax, E-mail, FTP, LDSS**, or **eSF**.

**5** In the “Forward to Shortcut” field, enter the shortcut number where you want the fax forwarded.

**Note:** The shortcut number must be valid for the setting selected in the “Forward to” menu.

**6** Click **Submit**.

## Understanding the fax options

### Content

This option lets you specify the content type and source of the original document.

Select from the following content types:

- **Graphics**—The original document is mostly business-type graphics, such as pie charts, bar charts, and animations.
- **Photo**—The original document is mostly a photo or an image.
- **Text**—The content of the original document is mostly text or line art.
- **Text/Photo**—The original document is a mixture of text, graphics, and photos.

Select from the following content sources:

- **Black/White Laser**—The original document was printed using a mono laser printer.
- **Color Laser**—The original document was printed using a color laser printer.
- **Inkjet**—The original document was printed using an inkjet printer.
- **Magazine**—The original document is from a magazine.
- **Newspaper**—The original document is from a newspaper.
- **Other**—The original document was printed using an alternate or unknown printer.
- **Photo/Film**—The original document is a photo from film.
- **Press**—The original document was printed using a printing press.

### Resolution

This option lets you adjust the quality of the fax output. Increasing the image resolution increases the file size and the time needed to scan your original document. Decreasing the image resolution reduces the file size.

Select one of the following:

- **Standard**—Use this when faxing most documents.
- **Fine 200 dpi**—Use this when faxing documents with small prints.
- **Super fine 300 dpi**—Use this when faxing documents with fine details.
- **Ultra fine 600 dpi**—Use this when faxing documents with pictures or photos.

### Darkness

This option lets you adjust how light or dark the faxes are in relation to the original document.

## Page Setup

This option lets you change the following settings:

- **Sides (Duplex)**—This specifies if the original document is printed on one side or on both sides of the page (duplex). This also identifies what needs to be scanned for inclusion in the fax.
- **Orientation**—This specifies the orientation of the original document, and then changes the Sides (Duplex) and Binding settings to match the orientation.
- **Binding**—This specifies if the original document is bound on the long-edge or short-edge side.

## Custom Job

This option lets you combine multiple scan jobs into a single job and appears only when a working printer hard disk is installed.

## Scan Preview

This option lets you view the first page of the image before it is included in the fax. When the first page is scanned, the scanning is paused and a preview image appears.

**Note:** This option appears only when a working printer hard disk is installed.

## Delayed Send

This option lets you send a fax at a later time or date.

## Advanced Imaging

This option lets you adjust the Background Removal, Color Balance, Color Dropout, Contrast, Mirror Image, Negative Image, Scan Edge to Edge, Shadow Detail, Sharpness, and Temperature settings before you fax the document.

## Edge Erase

This option lets you remove smudges or any mark around the edges of a document. You can remove an equal area around all four sides of the paper, or you can pick a particular edge. Edge Erase also removes whatever is within the area selected, leaving nothing on that portion of the scan.

## Transmission Log



This option lets you print the transmission log or transmission error log.

## Adjust ADF Skew

This option lets you straighten scanned images that are slightly skewed when received from the ADF tray.



## Scanning

Automatic document feeder (ADF)	Scanner glass
	
<p>Use the ADF for multiple-page documents.</p>	<p>Use the scanner glass for single pages, small items (such as postcards or photos), transparencies, photo paper, or thin media (such as magazine clippings).</p>

The scanner lets you scan documents directly to a computer or a flash drive. The computer does not have to be directly connected to the printer for you to receive Scan to PC images. You can scan the document back to the computer over the network by creating a scan profile on the computer and then downloading the profile to the printer.

## Using Scan to Network

Scan to Network lets you scan your documents to network destinations specified by your system support person. After the destinations (shared network folders) have been established on the network, the setup process for the application involves installing and configuring the application on the appropriate printer using its Embedded Web Server. For more information, see [“Setting up Scan to Network” on page 23](#).

## Scanning to an FTP address

### Creating shortcuts

Instead of entering the entire FTP site address on the printer control panel each time you want to send a document to an FTP server, you can create a permanent FTP destination and assign a shortcut number. There are two methods for creating shortcut numbers: using the Embedded Web Server and using the printer control panel.

### Creating an FTP shortcut using the Embedded Web Server

- 1 Open a Web browser, and then type the printer IP address in the address field.

**Notes:**

- View the printer IP address on the printer home screen. The IP address appears as four sets of numbers separated by periods, such as 123.123.123.123.
- If you are using a proxy server, then temporarily disable it to load the Web page correctly.

2 Navigate to:

**Settings** > Other Settings area > **Manage Shortcuts** > **FTP Shortcut Setup**

3 Enter the appropriate information.

**Note:** A password may be required. If you do not have an ID and password, then contact your system support person.

4 Enter a shortcut number.

**Note:** If you enter a number that is already in use, then you are prompted to select another number.

5 Click **Add**.

## Creating an FTP shortcut using the printer control panel

1 From the home screen, navigate to:

**FTP** > **FTP Address** > type the FTP address >  >  > type a name for the shortcut > 

2 Verify that the shortcut name and number are correct, and then touch **OK**.

If the name or number is incorrect, then touch **Cancel**, and then reenter the information. If you enter a number that is already in use, then you will be prompted to select another number.

## Scanning to an FTP address

You can use the printer to send scanned documents to an FTP address in a number of ways. You can type the FTP address, use a shortcut number, or use the address book. You can also use the Multi Send, Scan to Network, or MyShortcut application from the printer home screen. For more information, see [“Activating the home screen applications” on page 21](#).

## Scanning to an FTP address using the printer control panel

1 Load an original document faceup, short edge first into the ADF tray or facedown on the scanner glass.

**Notes:**

- Do not load postcards, photos, small items, transparencies, photo paper, or thin media (such as magazine clippings) into the ADF tray. Place these items on the scanner glass.
- The ADF indicator light comes on when the paper is loaded properly.

2 If you are loading a document into the ADF tray, then adjust the paper guides.

3 From the home screen, navigate to:

**FTP** > **FTP Address** > type the FTP address >  > **Scan It**

## Scanning to an FTP address using a shortcut number

- 1 Load an original document faceup, short edge first into the ADF tray or facedown on the scanner glass.

### Notes:

- Do not load postcards, photos, small items, transparencies, photo paper, or thin media (such as magazine clippings) into the ADF tray. Place these items on the scanner glass.
- The ADF indicator light comes on when the paper is loaded properly.

- 2 If you are loading a document into the ADF tray, then adjust the paper guides.
- 3 From the printer control panel, press **#** on the keypad, and then enter the FTP shortcut number.
- 4 Touch **Scan It**.

## Scanning to a computer or flash drive

### Scanning to a computer using the Embedded Web Server

- 1 Open a Web browser, and then type the printer IP address in the address field.

### Notes:

- View the printer IP address on the printer home screen. The IP address appears as four sets of numbers separated by periods, such as 123.123.123.123.
- If you are using a proxy server, then temporarily disable it to load the Web page correctly.

- 2 Click **Scan Profile > Create Scan Profile**.
- 3 Select your scan settings, and then click **Next**.
- 4 Select a location on your computer where you want to save the scan image.
- 5 Type a scan name, and then a user name.

**Note:** The scan name is the name that appears in the Scan Profile list on the display.

- 6 Click **Submit**.

**Note:** Clicking **Submit** automatically assigns a shortcut number. You can use this shortcut number when you are ready to scan your documents.

- 7 Review the instructions on the Scan Profile screen.
  - a Load an original document faceup, short edge first into the ADF tray or facedown on the scanner glass.

### Notes:

- Do not load postcards, photos, small items, transparencies, photo paper, or thin media (such as magazine clippings) into the ADF tray. Place these items on the scanner glass.
- The ADF indicator light comes on when the paper is loaded properly.

- b If you are loading a document into the ADF tray, then adjust the paper guides.

- c Do either of the following:
  - Press #, and then enter the shortcut number using the keypad.
  - From the home screen, navigate to:  
**Held Jobs > Profiles >** select your shortcut on the list

**Note:** The scanner scans and sends the document to the directory you specified.

- 8 View the file from the computer.

**Note:** The output file is saved in the location or launched in the program you specified.

## Setting up Scan to Computer

### Notes:

- This feature is supported only in Windows Vista or later.
- Make sure your computer and printer are connected to the same network.

- 1 Open the printers folder, and then select your printer.

**Note:** If your printer is not in the list, then add your printer.

- 2 Open the printer properties, and then adjust the settings as necessary.

- 3 From the control panel, touch **Scan to Computer >** select the appropriate scan setting > **Send It.**

## Scanning to a flash drive

- 1 Load an original document faceup, short edge first into the ADF tray or facedown on the scanner glass.

### Notes:

- Do not load postcards, photos, small items, transparencies, photo paper, or thin media (such as magazine clippings) into the ADF tray. Place these items on the scanner glass.
- The ADF indicator light comes on when the paper is loaded properly.

- 2 If you are loading a document into the ADF tray, then adjust the paper guides.

- 3 Insert the flash drive into the USB port on the front of the printer.

**Note:** The USB Drive home screen appears.

- 4 Select the destination folder, and then touch **Scan to USB drive.**

**Note:** The printer goes back to the home screen after 30 seconds of inactivity.

- 5 Adjust the scan settings, and then touch **Scan It.**

## Understanding the scan options

### FTP Address

This option lets you enter the IP address for the FTP destination.

**Note:** An IP address appears as four sets of numbers separated by periods, such as 123.123.123.123.

## File Name

This option lets you type a file name for the scan image.

## Save As Shortcut

This option lets you save the current settings as a shortcut by assigning a shortcut name.

**Note:** Selecting this option automatically assigns the next available shortcut number.

## Original Size

This option lets you set the paper size of the documents you are going to scan. When Original Size is set to Mixed Sizes, you can scan an original document that contains mixed paper sizes (letter- and legal-size pages).

## Darkness

This option lets you adjust how light or dark the scanned documents are in relation to the original document.

## Resolution

This option lets you adjust the output quality of your file. Increasing the image resolution increases the file size and the time needed to scan your original document. Decreasing the image resolution reduces the file size.

## Send As

This option lets you set the output type for the scan image.

Select one of the following:

- **PDF**—Use to create a single file with multiple pages. The PDF can be sent as a secured or compressed file.
- **TIFF**—Use to create multiple files or a single file. If Multi-page TIFF is turned off in the Settings menu, then TIFF saves one page in each file. The file size is usually larger than an equivalent JPEG.
- **JPEG**—Use to create and attach a separate file for each page of the original document.
- **XPS**—Use to create a single XPS file with multiple pages.
- **RTF**—Use to create a file in editable format.
- **TXT**—Use to create ASCII text file with no formatting.

**Note:** To use the RTF or TXT option, purchase and install the AccuRead OCR solution.

## Content

This option lets you set the original document type and source.

Select from the following content types:

- **Graphics**—The original document is mostly business-type graphics, such as pie charts, bar charts, and animations.
- **Photo**—The original document is mostly a photo or an image.

- **Text**—The content of the original document is mostly text or line art.
- **Text/Photo**—The original document is a mixture of text, graphics, and photos.

Select from the following content sources:

- **Black/White Laser**—The original document was printed using a mono laser printer.
- **Color Laser**—The original document was printed using a color laser printer.
- **Inkjet**—The original document was printed using an inkjet printer.
- **Magazine**—The original document is from a magazine.
- **Newspaper**—The original document is from a newspaper.
- **Other**—The original document was printed using an alternate or unknown printer.
- **Photo/Film**—The original document is a photo from film.
- **Press**—The original document was printed using a printing press.

## Page Setup

This option lets you change the following settings:

- **Sides (Duplex)**—This specifies if the original document is printed on only one side or on both sides of the paper.
- **Orientation**—This specifies the orientation of the original document, and then changes the Sides (Duplex) and Binding settings to match the orientation.
- **Binding**—This specifies if the original document is bound on the long-edge or short-edge side.

## Transmission Log

This option lets you print the transmission log or transmission error log.

## Scan Preview

This option lets you view the first page of the image before it is included in the file. When the first page is scanned, the scanning is paused and a preview image appears.

**Note:** This option appears only when a formatted, working printer hard disk is installed.

## Edge Erase

This option lets you remove smudges or any mark around the edges of a document. You can remove an equal area around all four sides of the paper, or you can pick a particular edge. Edge Erase also removes whatever is within the area selected, leaving nothing on that portion of the scan.

## Advanced Imaging

This option lets you adjust the Background Removal, Color Balance, Color Dropout, Contrast, JPEG Quality, Mirror Image, Negative Image, Scan Edge to Edge, Shadow Detail, Sharpness, and Temperature settings before you scan the document.

## **Custom Job**

This option lets you combine multiple scan jobs into a single job and appears only when a working printer hard disk is installed.

## **Adjust ADF Skew**

This option lets you straighten scanned images that are slightly skewed when received from the ADF tray.

# Understanding the printer menus

## Menus list

### Paper Menu

Default Source  
Paper Size/Type  
Configure MP  
Substitute Size  
Paper Texture  
Paper Weight  
Paper Loading  
Custom Types  
Custom Names<sup>1</sup>  
Custom Scan Sizes  
Universal Setup

### Reports

Menu Settings Page  
Device Statistics  
Stapler Test  
Network Setup Page<sup>1</sup>  
Network [x] Setup Page  
Shortcut List  
Fax Job Log  
Fax Call Log  
Copy Shortcuts  
E-mail Shortcuts  
Fax Shortcuts  
FTP Shortcuts  
Profiles List  
Print Fonts  
Print Directory  
Print Demo  
Asset Report

### Network/Ports

Active NIC  
Standard Network<sup>2</sup>  
Standard USB  
Parallel [x]  
Serial [x]  
SMTP Setup

### Security

Miscellaneous Security  
Settings  
Confidential Print  
Erase Temporary Data  
Files  
Security Audit Log  
Set Date and Time

### Settings

General Settings  
Copy Settings  
Fax Settings  
E-mail Settings  
FTP Settings  
Flash Drive Menu  
Print Settings

### Help

Print All Guides  
Copy Guide  
E-mail Guide  
Fax Guide  
FTP Guide  
Print Defects Guide  
Information Guide  
Supplies Guide

### Manage Shortcuts

Fax Shortcuts  
E-mail Shortcuts  
FTP Shortcuts  
Copy Shortcuts  
Profile Shortcuts

### Option Card Menu<sup>3</sup>

A list of installed DLEs (Download Emulators) appears.

<sup>1</sup> Depending on the printer setup, this menu appears as Network Setup Page or Network [x] Setup Page.

<sup>2</sup> Depending on the printer setup, this menu appears as Standard Network or Network [x].

<sup>3</sup> This menu appears only when one or more DLEs are installed.



# Paper menu

## Default Source menu

Use	To
<p><b>Default Source</b></p> <ul style="list-style-type: none"> <li>Tray [x]</li> <li>Multipurpose Feeder</li> <li>Manual Paper</li> <li>Manual Envelope</li> </ul>	<p>Set a default paper source for all print jobs.</p> <p><b>Notes:</b></p> <ul style="list-style-type: none"> <li>• Tray 1 (standard tray) is the factory default setting.</li> <li>• From the Paper menu, set Configure MP to "Cassette" for Multipurpose Feeder to appear as a menu setting.</li> <li>• If two trays contain paper of the same size and type, and the trays have the same settings, then the trays are automatically linked. When one tray is empty, the print job continues using the linked tray.</li> </ul>

## Paper Size/Type menu

Use	To
<p><b>Tray [x] Size</b></p> <ul style="list-style-type: none"> <li>A4</li> <li>A5</li> <li>A6</li> <li>JIS-B5</li> <li>Letter</li> <li>Legal</li> <li>Executive</li> <li>Oficio (Mexico)</li> <li>Folio</li> <li>Statement</li> <li>Universal</li> <li>7 3/4 Envelope</li> <li>9 Envelope</li> <li>10 Envelope</li> <li>DL Envelope</li> <li>C5 Envelope</li> <li>B5 Envelope</li> <li>Other Envelope</li> </ul>	<p>Specify the paper size loaded in each tray.</p> <p><b>Notes:</b></p> <ul style="list-style-type: none"> <li>• Letter is the U.S. factory default setting. A4 is the international factory default setting.</li> <li>• If two trays contain paper of the same size and type, and the trays have the same settings, then the trays are automatically linked. The multipurpose feeder may also be linked. When one tray is empty, the print job continues using the linked tray.</li> <li>• The A6 paper size is supported only in Tray 1 and the multipurpose feeder.</li> </ul>
<p><b>Note:</b> Only installed trays and feeders are listed in this menu.</p>	

Use	To
<p><b>Tray [x] Type</b></p> <ul style="list-style-type: none"> <li>Plain Paper</li> <li>Card Stock</li> <li>Transparency</li> <li>Recycled</li> <li>Labels</li> <li>Vinyl Labels</li> <li>Bond</li> <li>Envelope</li> <li>Rough Envelope</li> <li>Letterhead</li> <li>Preprinted</li> <li>Colored Paper</li> <li>Light Paper</li> <li>Heavy Paper</li> <li>Rough/Cotton</li> <li>Custom Type [x]</li> </ul>	<p>Specify the type of paper loaded in each tray.</p> <p><b>Notes:</b></p> <ul style="list-style-type: none"> <li>• Plain Paper is the factory default setting for Tray 1. Custom Type [x] is the factory default setting for all other trays.</li> <li>• If available, a user-defined name will appear instead of Custom Type [x].</li> <li>• Use this menu to configure automatic tray linking.</li> </ul>
<p><b>Multipurpose Feeder Size</b></p> <ul style="list-style-type: none"> <li>A4</li> <li>A5</li> <li>A6</li> <li>JIS B5</li> <li>Letter</li> <li>Legal</li> <li>Executive</li> <li>Oficio (Mexico)</li> <li>Folio</li> <li>Statement</li> <li>Universal</li> <li>7 3/4 Envelope</li> <li>9 Envelope</li> <li>10 Envelope</li> <li>DL Envelope</li> <li>C5 Envelope</li> <li>B5 Envelope</li> <li>Other Envelope</li> </ul>	<p>Specify the paper size loaded in the multipurpose feeder.</p> <p><b>Notes:</b></p> <ul style="list-style-type: none"> <li>• Letter is the U.S. factory default setting. A4 is the international factory default setting.</li> <li>• From the Paper menu, set Configure MP to “Cassette” for Multipurpose Feeder Size to appear as a menu.</li> <li>• The multipurpose feeder does not automatically detect paper size. Make sure to set the paper size value.</li> </ul>
<p><b>Note:</b> Only installed trays and feeders are listed in this menu.</p>	

Use	To
<p><b>Multipurpose Feeder Type</b></p> <ul style="list-style-type: none"> <li>Plain Paper</li> <li>Card Stock</li> <li>Transparency</li> <li>Recycled</li> <li>Labels</li> <li>Vinyl Labels</li> <li>Bond</li> <li>Envelope</li> <li>Rough Envelope</li> <li>Letterhead</li> <li>Preprinted</li> <li>Colored Paper</li> <li>Light Paper</li> <li>Heavy Paper</li> <li>Rough/Cotton</li> <li>Custom Type [x]</li> </ul>	<p>Specify the paper type loaded in the multipurpose feeder.</p> <p><b>Notes:</b></p> <ul style="list-style-type: none"> <li>• Plain Paper is the factory default setting.</li> <li>• From the Paper menu, set Configure to “Cassette” for Multipurpose Feeder Type to appear as a menu.</li> </ul>
<p><b>Manual Paper Size</b></p> <ul style="list-style-type: none"> <li>A4</li> <li>A5</li> <li>A6</li> <li>JIS B5</li> <li>Letter</li> <li>Legal</li> <li>Executive</li> <li>Oficio (Mexico)</li> <li>Folio</li> <li>Statement</li> <li>Universal</li> </ul>	<p>Specify the size of the paper being manually loaded.</p> <p><b>Note:</b> Letter is the U.S. factory default setting. A4 is the international factory default setting.</p>
<p><b>Note:</b> Only installed trays and feeders are listed in this menu.</p>	

Use	To
<p><b>Manual Paper Type</b></p> <ul style="list-style-type: none"> <li>Plain Paper</li> <li>Card Stock</li> <li>Transparency</li> <li>Recycled</li> <li>Labels</li> <li>Vinyl Labels</li> <li>Bond</li> <li>Letterhead</li> <li>Preprinted</li> <li>Colored Paper</li> <li>Light Paper</li> <li>Heavy Paper</li> <li>Rough/Cotton</li> <li>Custom Type [x]</li> </ul>	<p>Specify the paper type being manually loaded.</p> <p><b>Notes:</b></p> <ul style="list-style-type: none"> <li>• Plain Paper is the factory default setting.</li> <li>• From the Paper menu, set Configure MP to “Manual” for Manual Paper Type to appear as a menu.</li> </ul>
<p><b>Manual Envelope Size</b></p> <ul style="list-style-type: none"> <li>7 3/4 Envelope</li> <li>9 Envelope</li> <li>10 Envelope</li> <li>DL Envelope</li> <li>C5 Envelope</li> <li>B5 Envelope</li> <li>Other Envelope</li> </ul>	<p>Specify the envelope size being manually loaded.</p> <p><b>Note:</b> 10 Envelope is the U.S. factory default setting. DL Envelope is the international factory default setting.</p>
<p><b>Manual Envelope Type</b></p> <ul style="list-style-type: none"> <li>Envelope</li> <li>Rough Envelope</li> <li>Custom Type [x]</li> </ul>	<p>Specify the envelope type being manually loaded.</p> <p><b>Note:</b> Envelope is the factory default setting.</p>
<p><b>Note:</b> Only installed trays and feeders are listed in this menu.</p>	

## Configure MP menu

Use	To
<p><b>Configure MP</b></p> <ul style="list-style-type: none"> <li>Cassette</li> <li>Manual</li> <li>First</li> </ul>	<p>Determine when the printer selects paper from the multipurpose feeder.</p> <p><b>Notes:</b></p> <ul style="list-style-type: none"> <li>• Cassette is the factory default setting. Cassette configures the multipurpose feeder as the automatic paper source.</li> <li>• Manual sets the multipurpose feeder only for manual-feed print jobs.</li> <li>• First configures the multipurpose feeder as the primary paper source.</li> </ul>

## Substitute Size menu

Use	To
<p><b>Substitute Size</b>                      Off                      Statement/A5                      Letter/A4                      All Listed</p>	<p>Substitute a specified paper size if the requested paper size is not available.</p> <p><b>Notes:</b></p> <ul style="list-style-type: none"> <li>• All Listed is the factory default setting. All available substitutions are allowed.</li> <li>• Off indicates that no size substitutions are allowed.</li> <li>• Setting a size substitution lets the print job continue without <b>Change Paper</b> appearing.</li> </ul>

## Paper Texture menu

Use	To
<p><b>Plain Texture</b>                      Smooth                      Normal                      Rough</p>	<p>Specify the relative texture of the plain paper loaded.</p> <p><b>Note:</b> Normal is the factory default setting.</p>
<p><b>Card Stock Texture</b>                      Smooth                      Normal                      Rough</p>	<p>Specify the relative texture of the card stock loaded.</p> <p><b>Notes:</b></p> <ul style="list-style-type: none"> <li>• Normal is the factory default setting.</li> <li>• The options appear only if card stock is supported.</li> </ul>
<p><b>Transparency Texture</b>                      Smooth                      Normal                      Rough</p>	<p>Specify the relative texture of the transparencies loaded.</p> <p><b>Note:</b> Normal is the factory default setting.</p>
<p><b>Recycled Texture</b>                      Smooth                      Normal                      Rough</p>	<p>Specify the relative texture of the recycled paper loaded.</p> <p><b>Note:</b> Normal is the factory default setting.</p>
<p><b>Labels Texture</b>                      Smooth                      Normal                      Rough</p>	<p>Specify the relative texture of the labels loaded.</p> <p><b>Note:</b> Normal is the factory default setting.</p>
<p><b>Bond Texture</b>                      Smooth                      Normal                      Rough</p>	<p>Specify the relative texture of the bond paper loaded.</p> <p><b>Note:</b> Rough is the factory default setting.</p>
<p><b>Envelope Texture</b>                      Smooth                      Normal                      Rough</p>	<p>Specify the relative texture of the envelopes loaded.</p> <p><b>Note:</b> Normal is the factory default setting.</p>

Use	To
<b>Rough Envelope Texture</b> Rough	Specify the relative texture of the rough envelopes loaded.
<b>Letterhead Texture</b> Smooth Normal Rough	Specify the relative texture of the letterhead loaded. <b>Note:</b> Normal is the factory default setting.
<b>Preprinted Texture</b> Smooth Normal Rough	Specify the relative texture of the preprinted paper loaded. <b>Note:</b> Normal is the factory default setting.
<b>Colored Texture</b> Smooth Normal Rough	Specify the relative texture of the colored paper loaded. <b>Note:</b> Normal is the factory default setting.
<b>Light Texture</b> Smooth Normal Rough	Specify the relative texture of the paper loaded. <b>Note:</b> Normal is the factory default setting.
<b>Heavy Texture</b> Smooth Normal Rough	Specify the relative texture of the paper loaded. <b>Note:</b> Normal is the factory default setting.
<b>Rough/Cotton Texture</b> Rough	Specify the relative texture of the cotton paper loaded.
<b>Custom [x] Texture</b> Smooth Normal Rough	Specify the relative texture of the custom paper loaded. <b>Notes:</b> <ul style="list-style-type: none"> <li>• Normal is the factory default setting.</li> <li>• The options appear only if the custom type is supported.</li> </ul>

### Paper Weight menu

Use	To
<b>Plain Weight</b> Light Normal Heavy	Specify the relative weight of the plain paper loaded. <b>Note:</b> Normal is the factory default setting.
<b>Card Stock Weight</b> Light Normal Heavy	Specify the relative weight of the card stock loaded. <b>Note:</b> Normal is the factory default setting.

Use	To
<b>Transparency Weight</b> Light Normal Heavy	Specify the relative weight of the transparencies loaded. <b>Note:</b> Normal is the factory default setting.
<b>Recycled Weight</b> Light Normal Heavy	Specify the relative weight of the recycled paper loaded. <b>Note:</b> Normal is the factory default setting.
<b>Labels Weight</b> Light Normal Heavy	Specify the relative weight of the labels loaded. <b>Note:</b> Normal is the factory default setting.
<b>Bond Weight</b> Light Normal Heavy	Specify the relative weight of the bond paper loaded. <b>Note:</b> Normal is the factory default setting.
<b>Envelope Weight</b> Light Normal Heavy	Specify the relative weight of the envelope loaded. <b>Note:</b> Normal is the factory default setting.
<b>Rough Envelope Weight</b> Light Normal Heavy	Specify the relative weight of the rough envelope loaded. <b>Note:</b> Normal is the factory default setting.
<b>Letterhead Weight</b> Light Normal Heavy	Specify the relative weight of the letterhead loaded. <b>Note:</b> Normal is the factory default setting.
<b>Preprinted Weight</b> Light Normal Heavy	Specify the relative weight of the preprinted paper loaded. <b>Note:</b> Normal is the factory default setting.
<b>Colored Weight</b> Light Normal Heavy	Specify the relative weight of the colored paper loaded. <b>Note:</b> Normal is the factory default setting.
<b>Light Weight</b> Light	Specify that the relative weight of the paper loaded is light.
<b>Heavy Weight</b> Heavy	Specify the relative weight of the paper loaded is heavy.

Use	To
<b>Rough/Cotton Weight</b> Light Normal Heavy	Specify the relative weight of the cotton or rough paper loaded. <b>Note:</b> Normal is the factory default setting.
<b>Custom [x] Weight</b> Light Normal Heavy	Specify the relative weight of the custom paper loaded. <b>Notes:</b> <ul style="list-style-type: none"> <li>• Normal is the factory default setting.</li> <li>• The options appear only when the custom type is supported.</li> </ul>

## Paper Loading menu

Use	To
<b>Recycled Loading</b> Duplex Off	Determine and set two-sided printing for all print jobs that specify Recycled as the paper type.
<b>Bond Loading</b> Duplex Off	Determine and set two-sided printing for all print jobs that specify Bond as the paper type.
<b>Letterhead Loading</b> Duplex Off	Determine and set two-sided printing for all print jobs that specify Letterhead as the paper type.
<b>Preprinted Loading</b> Duplex Off	Determine and set two-sided printing for all print jobs that specify Preprinted as the paper type.
<b>Colored Loading</b> Duplex Off	Determine and set two-sided printing for all print jobs that specify Colored as the paper type.
<b>Light Loading</b> Duplex Off	Determine and set two-sided printing for all print jobs that specify Light as the paper type.
<b>Heavy Loading</b> Duplex Off	Determine and set two-sided printing for all print jobs that specify Heavy as the paper type.
<b>Notes:</b> <ul style="list-style-type: none"> <li>• Duplex sets two-sided printing as the default for all print jobs unless one-sided printing is set from Printing Preferences or Print dialog.</li> <li>• If Duplex is selected, then all print jobs are sent through the duplex unit, including one-sided jobs.</li> <li>• Off is the factory default setting for all the menus.</li> </ul>	



Use	To
<p><b>Custom [x] Loading</b></p> <ul style="list-style-type: none"> <li>Duplex</li> <li>Off</li> </ul>	<p>Determine and set two-sided printing for all print jobs that specify Custom [x] as the paper type.</p> <p><b>Note:</b> Custom [x] Loading is available only if the custom type is supported.</p>
<p><b>Notes:</b></p> <ul style="list-style-type: none"> <li>• Duplex sets two-sided printing as the default for all print jobs unless one-sided printing is set from Printing Preferences or Print dialog.</li> <li>• If Duplex is selected, then all print jobs are sent through the duplex unit, including one-sided jobs.</li> <li>• Off is the factory default setting for all the menus.</li> </ul>	

### Custom Types menu

Use	To
<p><b>Custom Type [x]</b></p> <ul style="list-style-type: none"> <li>Paper</li> <li>Card Stock</li> <li>Transparency</li> <li>Rough/Cotton</li> <li>Labels</li> <li>Envelope</li> </ul>	<p>Associate a paper or specialty media type with a factory default Custom Type [x] name or a user-defined custom name created in the Embedded Web Server or MarkVision™ Professional. The user-defined name appears instead of Custom Type [x].</p> <p><b>Notes:</b></p> <ul style="list-style-type: none"> <li>• Paper is the factory default setting for Custom Type [x].</li> <li>• The custom media type must be supported in the selected tray or feeder in order to print from that source.</li> </ul>
<p><b>Recycled</b></p> <ul style="list-style-type: none"> <li>Paper</li> <li>Card Stock</li> <li>Transparency</li> <li>Rough/Cotton</li> <li>Labels</li> <li>Envelope</li> <li>Cotton</li> </ul>	<p>Specify a paper type when the Recycled setting is selected in other menus.</p> <p><b>Notes:</b></p> <ul style="list-style-type: none"> <li>• Paper is the factory default setting.</li> <li>• The Recycled paper type must be supported in the selected tray or feeder in order to print from that source.</li> </ul>

### Custom Names menu

Use	To
<p><b>Custom Name [x]</b></p>	<p>Specify a custom name for a paper type. This name replaces Custom Type [x] in the printer menus.</p>

## Custom Scan Sizes menu

Use	To
<b>Custom Scan Size [x]</b> Scan Size Name Width Height Orientation 2 scans per side Off On	Specify a custom scan size name, size, and page orientation.  <b>Notes:</b> <ul style="list-style-type: none"> <li>• 8.5 inches is the U.S. factory default setting for Width. 216 mm is the international factory default setting for Width.</li> <li>• 14 inches is the U.S. factory default setting for Height. 356 mm is the international factory default setting for Height.</li> <li>• Portrait is the factory default setting for Orientation.</li> <li>• Off is the factory default setting for 2 scans per side.</li> </ul>

## Universal Setup menu

Use	To
<b>Units of Measure</b> Inches Millimeters	Identify the units of measure.  <b>Notes:</b> <ul style="list-style-type: none"> <li>• Inches is the US factory default setting.</li> <li>• Millimeters is the international factory default setting.</li> </ul>
<b>Portrait Width</b> 3–8.5 inches 76–216 mm	Set the portrait width.  <b>Notes:</b> <ul style="list-style-type: none"> <li>• If the width exceeds the maximum, then the printer uses the maximum width allowed.</li> <li>• 8.5 inches is the US factory default setting. You can increase the width in 0.01-inch increments.</li> <li>• 216 mm is the international factory default setting. You can increase the width in 1-mm increments.</li> </ul>
<b>Portrait Height</b> 3–14.17 inches 76–360 mm	Set the portrait height.  <b>Notes:</b> <ul style="list-style-type: none"> <li>• If the height exceeds the maximum, then the printer uses the maximum height allowed.</li> <li>• 14 inches is the US factory default setting. You can increase the height in 0.01-inch increments.</li> <li>• 356 mm is the international factory default setting. You can increase the height in 1-mm increments.</li> </ul>
<b>Feed Direction</b> Short Edge Long Edge	Specify the feed direction if the paper can be loaded in either direction.  <b>Notes:</b> <ul style="list-style-type: none"> <li>• Short Edge is the factory default setting.</li> <li>• Long Edge appears only when the longest edge is shorter than the maximum width supported in the tray.</li> </ul>

# Reports Menu

## Reports menu

Use	To
<b>Menu Settings Page</b>	Print a report on the current printer menu settings. The report also contains information about the status of the supplies and a list of hardware options that are successfully installed.
<b>Device Statistics</b>	Print a report containing printer statistics, such as supply information and number of printed pages.
<b>Network Setup Page</b>	Print a report containing information about the network settings of the printer. <b>Note:</b> This menu item appears only in network printers or printers connected to print servers.
<b>Network [x] Setup Page</b>	Print a report containing information about the network settings of the printer. <b>Note:</b> This menu item appears only in network printers or printers connected to print servers, and when there is more than one network option installed.
<b>Shortcut List</b>	Print a report containing information about configured shortcuts.
<b>Fax Job Log</b>	Print a report containing information about the last 200 completed faxes. <b>Notes:</b> <ul style="list-style-type: none"> <li>• This menu item appears only when Enable Job Log is set to On in the Fax Settings menu.</li> <li>• This menu is supported only in some printer models.</li> </ul>
<b>Fax Call Log</b>	Print a report containing information about the last 100 attempted, received, and blocked calls. <b>Notes:</b> <ul style="list-style-type: none"> <li>• This menu item appears only when Enable Job Log is set to On in the Fax Settings menu.</li> <li>• This menu is supported only in some printer models.</li> </ul>
<b>Copy Shortcuts</b>	Print a report containing information about copy shortcuts.
<b>E-mail Shortcuts</b>	Print a report containing information about e-mail shortcuts.
<b>Fax Shortcuts</b>	Print a report containing information about fax shortcuts.
<b>FTP Shortcuts</b>	Print a report containing information about FTP shortcuts.
<b>Profiles List</b>	Print a list of profiles stored in the printer.
<b>Print Fonts</b>	Print a report of all the fonts available for the printer language currently set in the printer.

Use	To
<b>Print Directory</b>	Print a list of all the resources stored in an optional flash memory card or printer hard disk.  <b>Notes:</b> <ul style="list-style-type: none"> <li>• Job Buffer Size must be set to 100%.</li> <li>• Make sure that the memory card or hard disk is installed and working properly.</li> </ul>
<b>Print Demo</b> Demo Page [list of available demo pages]	Print demo files that are available in the firmware, the flash option, and the disk option.
<b>Asset Report</b>	Print a report containing printer asset information, such as serial number and model name.
<b>Event Log Summary</b>	Print a summary of logged events.

## Network/Ports menu

### Active NIC menu

Use	To
<b>Active NIC</b> Auto [list of available network cards]	<b>Notes:</b> <ul style="list-style-type: none"> <li>• Auto is the factory default setting.</li> <li>• This menu item appears only when an optional network card is installed.</li> </ul>

### Standard Network or Network [x] menu

**Note:** Only active ports appear in this menu.

Use	To
<b>Energy Efficient Ethernet</b> Enable Disable	Reduce power consumption when the printer receives no data from the Ethernet network.  <b>Note:</b> Enable is the factory default setting.
<b>PCL SmartSwitch</b> On Off	Set the printer to automatically switch to PCL emulation when a print job requires it, regardless of the default printer language.  <b>Notes:</b> <ul style="list-style-type: none"> <li>• On is the factory default setting.</li> <li>• If PCL SmartSwitch is disabled, then the printer does not examine incoming data and it uses the default printer language specified in the Setup menu.</li> </ul>

Use	To
<p><b>PS SmartSwitch</b> On Off</p>	<p>Set the printer to automatically switch to PS emulation when a print job requires it, regardless of the default printer language.</p> <p><b>Notes:</b></p> <ul style="list-style-type: none"> <li>• On is the factory default setting.</li> <li>• If PS SmartSwitch is disabled, then the printer does not examine incoming data and it uses the default printer language specified in the Setup menu.</li> </ul>
<p><b>NPA Mode</b> Off Auto</p>	<p>Set the printer to perform the special processing required for bidirectional communication following the conventions defined by the NPA protocol.</p> <p><b>Notes:</b></p> <ul style="list-style-type: none"> <li>• Auto is the factory default setting.</li> <li>• The printer automatically restarts when the setting is changed from the control panel.</li> </ul>
<p><b>Network Buffer</b> Auto 3KB to [maximum size allowed]</p>	<p>Set the size of the network input buffer.</p> <p><b>Notes:</b></p> <ul style="list-style-type: none"> <li>• Auto is the factory default setting.</li> <li>• The maximum size allowed depends on the amount of memory in the printer, the size of the other link buffers, and whether Resource Save is set to On or Off.</li> <li>• To increase the maximum size range for the Network Buffer, disable or reduce the size of the parallel, serial, and USB buffers.</li> <li>• The printer automatically restarts when the setting is changed from the control panel.</li> </ul>
<p><b>Job Buffering</b> Off On Auto</p>	<p>Temporarily store print jobs in the printer hard disk before printing. This menu only appears when a formatted disk is installed.</p> <p><b>Notes:</b></p> <ul style="list-style-type: none"> <li>• Off is the factory default setting.</li> <li>• The printer automatically restarts when the setting is changed from the control panel. The menu selection is then updated.</li> </ul>
<p><b>Mac Binary PS</b> On Off Auto</p>	<p>Set the printer to process Macintosh binary PostScript print jobs.</p> <p><b>Note:</b> Auto is the factory default setting.</p>
<p><b>Standard Network Setup OR Network [x] Setup</b> Reports Network Card TCP/IP IPv6 Wireless AppleTalk</p>	<p>Show and set the printer network settings.</p> <p><b>Note:</b> The Wireless menu appears only when the printer is connected to a wireless network.</p>

## Reports menu

To access the menu, navigate to either of the following:

- **Network/Ports > Standard Network > Standard Network Setup > Reports**
- **Network/Ports > Network [x] > Network [x] Setup > Reports**

Use	To
<b>Print Setup Page</b>	Print a report containing information about the network printer settings, such as the TCP/IP address.

## Network Card menu

To access the menu, navigate to either of the following:

- **Network/Ports > Standard Network > Standard Network Setup > Network Card**
- **Network/Ports > Network [x] > Network [x] Setup > Network Card**

Use	To
<b>View Card Status</b> Connected Disconnected	View the connection status of the wireless network adapter.
<b>View Card Speed</b>	View the speed of an active wireless network adapter.
<b>Network Address</b> UAA LAA	View the network addresses.
<b>Job Timeout</b> 0, 10–225 seconds	Set the amount of time it takes for a network print job to be canceled. <b>Notes:</b> <ul style="list-style-type: none"> <li>• “90 seconds” is the factory default setting.</li> <li>• A setting value of 0 disables the timeout.</li> <li>• If a value between 1 and 9 is selected, then <b>Invalid</b> appears on the display, and the value is not saved.</li> </ul>
<b>Banner Page</b> Off On	Allow the printer to print a banner page. <b>Note:</b> Off is the factory default setting.

## TCP/IP menu

To access the menu, navigate to either of the following:

- **Network/Ports > Standard Network > Standard Network Setup > TCP/IP**
- **Network/Ports > Network [x] > Network [x] Setup > TCP/IP**

**Note:** This menu is available only in network printers or printers attached to print servers.

Use	To
<b>Set Hostname</b>	Set the current TCP/IP host name. <b>Note:</b> This can be changed only from the Embedded Web Server.
<b>IP Address</b>	View or change the current TCP/IP address. <b>Note:</b> Manually setting the IP address sets the Enable DHCP and Enable Auto IP settings to Off. It also sets Enable BOOTP and Enable RARP to Off on systems that support BOOTP and RARP.
<b>Netmask</b>	View or change the current TCP/IP netmask.
<b>Gateway</b>	View or change the current TCP/IP gateway.
<b>Enable DHCP</b> On Off	Specify the DHCP address and parameter assignment. <b>Note:</b> On is the factory default setting.
<b>Enable RARP</b> On Off	Specify the RARP address assignment setting. <b>Note:</b> Off is the factory default setting.
<b>Enable BOOTP</b> On Off	Specify the BOOTP address assignment setting. <b>Note:</b> On is the factory default setting.
<b>Enable AutoIP</b> Yes No	Specify the Zero Configuration Networking setting. <b>Note:</b> Yes is the factory default setting.
<b>Enable FTP/TFTP</b> Yes No	Enable the built-in FTP server, which lets you send files to the printer using File Transfer Protocol. <b>Note:</b> Yes is the factory default setting.
<b>Enable HTTP Server</b> Yes No	Enable the built-in Web server (Embedded Web Server). When enabled, the printer can be monitored and managed remotely using a Web browser. <b>Note:</b> Yes is the factory default setting.
<b>WINS Server Address</b>	View or change the current WINS server address.
<b>Enable DDNS</b> Yes No	View or change the current DDNS setting. <b>Note:</b> Yes is the factory default setting.
<b>Enable mDNS</b> Yes No	View or change the current mDNS setting. <b>Note:</b> Yes is the factory default setting.
<b>DNS Server Address</b>	View or change the current DNS server address.
<b>Backup DNS Server Address</b>	View or change the backup DNS server addresses.
<b>Backup DNS Server Address 2</b>	
<b>Backup DNS Server Address 3</b>	

Use	To
<b>Enable HTTPS</b> Yes No	View or change the current HTTPS setting. <b>Note:</b> Yes is the factory default setting.

## IPv6 menu

To access the menu, navigate to either of the following:

- **Network/Ports > Standard Network > Standard Network Setup > IPv6**
- **Network/Ports > Network [x] > Network [x] Setup > IPv6**

**Note:** This menu is available only in network printers or printers that are attached to print servers.

Use	To
<b>Enable IPv6</b> On Off	Enable IPv6 in the printer. <b>Note:</b> On is the factory default setting.
<b>Auto Configuration</b> On Off	Specify whether or not the wireless network adapter accepts the automatic IPv6 address configuration entries provided by a router. <b>Note:</b> On is the factory default setting.
<b>View Hostname</b>	Set the host name.
<b>View Address</b>	<b>Note:</b> These settings can be changed only from the Embedded Web Server.
<b>View Router Address</b>	
<b>Enable DHCPv6</b> On Off	Enable DHCPv6 in the printer. <b>Note:</b> On is the factory default setting.

## Wireless menu

**Note:** This menu is available only in printers connected to an Ethernet network and printers with a wireless network adapter attached.

To access the menu, navigate to either of the following:

- **Network/Ports > Standard Network > Standard Network Setup > Wireless**
- **Network/Ports > Network [x] > Network [x] Setup > Wireless**



Use	To
<b>Wi-Fi Protected Setup (WPS)</b> Start Push Button Method Start PIN Method	Establish a wireless network connection and enable network security.  <b>Notes:</b> <ul style="list-style-type: none"> <li>• Start Push Button Method connects the printer to a wireless network when buttons on both the printer and the access point (wireless router) are pressed within a given period of time.</li> <li>• Start PIN Method connects the printer to a wireless network when a PIN on the printer is entered into the wireless settings of the access point.</li> </ul>
<b>Enable/Disable WPS Auto-detection</b> Enable Disable	Automatically detect the connection method that an access point with WPS uses—Start Push Button Method or Start PIN Method.  <b>Note:</b> Disable is the factory default setting.
<b>Network Mode</b> BSS Type Infrastructure Ad hoc	Specify the network mode.  <b>Notes:</b> <ul style="list-style-type: none"> <li>• Infrastructure is the factory default setting. This lets the printer access a network using an access point.</li> <li>• Ad hoc configures a wireless connection directly between the printer and a computer.</li> </ul>
<b>Compatibility</b> 802.11b/g 802.11b/g/n	Specify the wireless standard for the wireless network.  <b>Note:</b> The 802.11b/g/n is the factory default setting.
<b>Choose Network</b>	Select an available network for the printer to use.
<b>View Signal Quality</b>	View the quality of the wireless connection.
<b>View Security Mode</b>	View the encryption method for the wireless network.

## AppleTalk menu

To access the menu, navigate to either of the following:

- **Network/Ports > Standard Network > Standard Network Setup > AppleTalk**
- **Network/Ports > Network [x] > Network [x] Setup > AppleTalk**

Use	To
<b>Activate</b> Yes No	Enable or disable AppleTalk support.  <b>Note:</b> No is the factory default setting.
<b>View Name</b>	Show the assigned AppleTalk name.  <b>Note:</b> The AppleTalk name can be changed only from the Embedded Web Server.
<b>View Address</b>	Show the assigned AppleTalk address.  <b>Note:</b> The AppleTalk address can be changed only from the Embedded Web Server.

Use	To
<p><b>Set Zone</b> [list of zones available on the network]</p>	<p>Provide a list of AppleTalk zones available on the network. <b>Note:</b> The default zone for the network is the factory default setting.</p>

## Standard USB menu

Use	To
<p><b>PCL SmartSwitch</b> On Off</p>	<p>Set the printer to automatically switch to PCL emulation when a print job received through a USB port requires it, regardless of the default printer language.</p> <p><b>Notes:</b></p> <ul style="list-style-type: none"> <li>• On is the factory default setting.</li> <li>• When set to Off, the printer does not examine incoming data. The printer uses PostScript emulation if the PS SmartSwitch is set to On. It uses the default printer language specified in the Setup menu if the PS SmartSwitch is set to Off.</li> </ul>
<p><b>PS SmartSwitch</b> On Off</p>	<p>Set the printer to automatically switch to PS emulation when a print job received through a USB port requires it, regardless of the default printer language.</p> <p><b>Notes:</b></p> <ul style="list-style-type: none"> <li>• On is the factory default setting.</li> <li>• When set to Off, the printer does not examine incoming data. The printer uses PCL emulation if the PCL SmartSwitch is set to On. It uses the default printer language specified in the Setup menu if the PCL SmartSwitch is set to Off.</li> </ul>
<p><b>NPA Mode</b> On Off Auto</p>	<p>Set the printer to perform the special processing required for bidirectional communication following the conventions defined by the NPA protocol.</p> <p><b>Notes:</b></p> <ul style="list-style-type: none"> <li>• Auto is the factory default setting. Auto sets the printer to examine data, determine the format, and then process it appropriately.</li> <li>• The printer automatically restarts when changing the setting from the printer control panel. The menu selection is then updated.</li> </ul>

Use	To
<p><b>USB Buffer</b></p> <p>Disabled Auto 3K to [maximum size allowed]</p>	<p>Set the size of the USB input buffer.</p> <p><b>Notes:</b></p> <ul style="list-style-type: none"> <li>• Auto is the factory default setting.</li> <li>• Disabled turns off job buffering. Any jobs already buffered on the printer hard disk are printed before normal processing resumes.</li> <li>• The USB buffer size value can be changed in 1-K increments.</li> <li>• The maximum size allowed depends on the amount of memory in the printer, the size of the other link buffers, and whether Resource Save is set to On or Off.</li> <li>• To increase the maximum size range for the USB Buffer, disable or reduce the size of the parallel, serial, and network buffers.</li> <li>• The printer automatically restarts when the setting is changed from the printer control panel. The menu selection is then updated.</li> </ul>
<p><b>Job Buffering</b></p> <p>Off On Auto</p>	<p>Temporarily store print jobs in the printer hard disk before printing.</p> <p><b>Notes:</b></p> <ul style="list-style-type: none"> <li>• Off is the factory default setting.</li> <li>• On buffers jobs on the printer hard disk.</li> <li>• Auto buffers print jobs only if the printer is busy processing data from another input port.</li> <li>• Changing this setting from the printer control panel and then exiting the menus causes the printer to restart. The menu selection is then updated.</li> </ul>
<p><b>Mac Binary PS</b></p> <p>On Off Auto</p>	<p>Set the printer to process Macintosh binary PostScript print jobs.</p> <p><b>Notes:</b></p> <ul style="list-style-type: none"> <li>• Auto is the factory default setting.</li> <li>• On processes raw binary PostScript print jobs.</li> <li>• Off filters print jobs using the standard protocol.</li> </ul>
<p><b>ENA Address</b></p> <p>yyy.yyy.yyy.yyy</p>	<p>Set the network address information for an external print server.</p> <p><b>Note:</b> This menu is available only when the printer is attached to an external print server through the USB port.</p>
<p><b>ENA Netmask</b></p> <p>yyy.yyy.yyy.yyy</p>	<p>Set the netmask information for an external print server.</p> <p><b>Note:</b> This menu is available only when the printer is attached to an external print server through the USB port.</p>
<p><b>ENA Gateway</b></p> <p>yyy.yyy.yyy.yyy</p>	<p>Set the gateway information for an external print server.</p> <p><b>Note:</b> This menu is available only when the printer is attached to an external print server through the USB port.</p>

## SMTP Setup menu

Use	To
<b>Primary SMTP Gateway</b>	Specify SMTP server gateway and port information. <b>Note:</b> 25 is the default SMTP gateway port.
<b>Primary SMTP Gateway Port</b>	
<b>Secondary SMTP Gateway</b>	
<b>Secondary SMTP Gateway Port</b>	
<b>SMTP Timeout</b> 5–30	Specify the amount of time in seconds before the server stops trying to send an e-mail. <b>Note:</b> 30 is the factory default setting.
<b>Reply Address</b>	Specify a reply address of up to 128 characters in the e-mail sent by the printer.
<b>Use SSL</b> Disabled Negotiate Required	Set the printer to use SSL for increased security when connecting to the SMTP server. <b>Notes:</b> <ul style="list-style-type: none"> <li>• Disabled is the factory default setting.</li> <li>• When the Negotiate setting is used, the SMTP server determines if SSL will be used.</li> </ul>
<b>SMTP Server Authentication</b> No authentication required Login/Plain CRAM-MD5 Digest-MD5 NTLM Kerberos 5	Specify the type of user authentication required for scan to e-mail privileges. <b>Note:</b> “No authentication required” is the factory default setting.
<b>Device-Initiated E-mail</b> None Use Device SMTP Credentials	Specify what credentials will be used when communicating to the SMTP server. <b>Notes:</b> <ul style="list-style-type: none"> <li>• None is the factory default setting for Device-Initiated E-mail and User-Initiated E-mail.</li> <li>• “Device Userid” and “Device password” are used to log in to the SMTP server when Use Device SMTP Credentials is selected.</li> </ul>
<b>User-Initiated E-mail</b> None Use Device SMTP Credentials Use Session User ID and Password Use Session E-mail address and Password Prompt user	
<b>Device Userid</b>	
<b>Device password</b>	
<b>Kerberos 5 Realm</b>	
<b>NTLM Domain</b>	

## Security menu

### Miscellaneous Security Settings menu

Use	To
<b>Login Restrictions</b> Login Failures Failure Time Frame Lockout Time Panel Login Timeout Remote Login Timeout	Limit the number and time frames of failed login attempts from the printer control panel before <i>all</i> users are locked out.  <b>Notes:</b> <ul style="list-style-type: none"> <li>• Login Failures specifies the number of failed login attempts before users are locked out. Settings range from 1–10. 3 attempts is the factory default setting.</li> <li>• Failure Time Frame specifies the time frame during which failed login attempts can be made before users are locked out. Settings range from 1–60 minutes. 5 minutes is the factory default setting.</li> <li>• Lockout Time specifies how long users are locked out after exceeding the login failures limit. Settings range from 1–60 minutes. 5 minutes is the factory default setting. 1 indicates the scanner does not impose a lockout time.</li> <li>• Panel Login Timeout specifies how long the scanner remains idle on the home screen before automatically logging the user off. Settings range from 1–900 seconds. 30 seconds is the factory default setting.</li> <li>• Remote Login Timeout specifies how long a remote interface remains idle before automatically logging the user off. Settings range from 1–120 minutes. 10 minutes is the factory default setting.</li> </ul>
<b>Minimum PIN Length</b> 1–16	Limit the digit length of the PIN.  <b>Note:</b> 4 is the factory default setting.

### Confidential Print menu

Use	To
<b>Max Invalid PIN</b> Off 2–10	Limit the number of times an invalid PIN can be entered.  <b>Notes:</b> <ul style="list-style-type: none"> <li>• This menu appears only when a formatted, non-defective printer hard disk is installed.</li> <li>• Once the limit is reached, the print jobs for that user name and PIN are deleted.</li> </ul>
<b>Confidential Job Expiration</b> Off 1 hour 4 hours 24 hours 1 week	Limit the amount of time a confidential print job stays in the printer before it is deleted.  <b>Notes:</b> <ul style="list-style-type: none"> <li>• If the “Confidential Job Expiration” setting is changed while confidential print jobs reside in the printer RAM or printer hard disk, then the expiration time for those print jobs does not change to the new default value.</li> <li>• If the printer is turned off, then all confidential jobs held in the printer RAM are deleted.</li> </ul>
<b>Note:</b> Off is the factory default setting.	

Use	To
<b>Repeat Job Expiration</b> Off 1 hour 4 hours 24 hours 1 week	Set a time limit on how long the printer stores print jobs.
<b>Verify Job Expiration</b> Off 1 hour 4 hours 24 hours 1 week	Set a time limit on how long the printer stores print jobs needing verification.
<b>Reserve Job Expiration</b> Off 1 hour 4 hours 24 hours 1 week	Set a time limit on how long the printer stores print jobs for printing at a later time.
<b>Note:</b> Off is the factory default setting.	

## Erase Temporary Data Files menu

Erase Temporary Data Files deletes *only* print job data on the printer hard disk that *are not* currently in use by the file system. All permanent data on the printer hard disk are preserved, such as downloaded fonts, macros, and held jobs.

**Note:** This menu appears only when a formatted, working printer hard disk is installed.

Use	To
<b>Wiping Mode</b> Auto	Specify the mode for erasing temporary data files.
<b>Automatic Method</b> Single pass Multiple pass	Mark all disk space used by a previous print job. This method does not permit the file system to reuse this space until it has been cleared.  <b>Notes:</b> <ul style="list-style-type: none"> <li>• “Single pass” is the factory default setting.</li> <li>• Only automatic wiping enables users to erase temporary data files without having to turn off the printer for an extended amount of time.</li> <li>• Highly confidential information should be erased using <i>only</i> the Multiple pass method.</li> </ul>

## Security Audit Log menu

Use	To
<b>Export Log</b>	Let an authorized user export the audit log. <b>Notes:</b> <ul style="list-style-type: none"> <li>To export the audit log from the printer control panel, a flash drive must be attached to the printer.</li> <li>The audit log can be downloaded from the Embedded Web Server and saved on a computer.</li> </ul>
<b>Delete Log</b> Yes No	Specify whether or not audit logs are deleted. <b>Note:</b> Yes is the factory default setting.
<b>Configure Log</b> Enable Audit Yes No Enable Remote Syslog No Yes Remote Syslog Facility 0–23 Severity of events to log 0–7	Specify how and whether or not audit logs are created. <b>Notes:</b> <ul style="list-style-type: none"> <li>Enable Audit determines if events are recorded in the secure audit log and remote syslog. No is the factory default setting.</li> <li>Enable Remote Syslog determines if logs are sent to a remote server. No is the factory default setting.</li> <li>Remote Syslog Facility determines the value used to send logs to the remote syslog server. 4 is the factory default setting.</li> <li>If the security audit log is activated, then the severity value of each event is recorded. 4 is the factory default setting.</li> </ul>

## Set Date and Time menu

Use	To
<b>Current Date and Time</b>	View the current date and time settings for the printer.
<b>Manually Set Date and Time</b> [input date/time]	Enter the date and time. <b>Notes:</b> <ul style="list-style-type: none"> <li>Manually setting the date and time sets Enable NTP to No.</li> <li>The wizard lets you set the date and time in YYYY-MM-DD-HH:MM format.</li> </ul>
<b>Time Zone</b> [list of time zones]	Select the time zone. <b>Note:</b> GMT is the factory default settings.
<b>Automatically observe DST</b> On Off	Set the printer to use the applicable daylight saving time (DST) start and end times associated with the printer Time Zone setting. <b>Note:</b> On is the factory default setting.

Use	To
<b>Enable NTP</b> On Off	Enable Network Time Protocol, which synchronizes the clocks of devices on a network.  <b>Notes:</b> <ul style="list-style-type: none"> <li>• On is the factory default setting.</li> <li>• This setting is turned off if you manually set the date and time.</li> </ul>

## Settings menu

### General Settings menu

Use	To
<b>Display Language</b> English Francais Deutsch Italiano Espanol Dansk Norsk Nederlands Svenska Portuguese Suomi Russian Polski Greek Magyar Turkce Cesky Simplified Chinese Traditional Chinese Korean Japanese	Set the language of the text that appears on the display.  <b>Note:</b> Not all languages are available for all models. You may need to install special hardware for some languages.
<b>Show Supply Estimates</b> Show estimates Do not show estimates	View the supply estimates on the control panel, Embedded Web Server, menu settings, and device statistics reports.  <b>Note:</b> Show estimates is the factory default setting.
<b>Eco-Mode</b> Off Energy Energy/Paper Paper	Minimize the use of energy, paper, or specialty media.  <b>Notes:</b> <ul style="list-style-type: none"> <li>• Off is the factory default setting.</li> <li>• Setting Eco-Mode to Energy or Paper may affect printer performance, but not print quality.</li> </ul>



Use	To
<b>ADF Loaded Beep</b> Enabled Disabled	Enable an ADF beep sound when loading paper. <b>Note:</b> Enabled is the factory default setting.
<b>Quiet Mode</b> Off On	Reduce printer noise. <b>Note:</b> Off is the factory default setting.
<b>Run Initial setup</b> Yes No	Run the setup wizard.
<b>Keyboard</b> Keyboard Type English Francais Francais Canadien Deutsch Italiano Espanol Greek Dansk Norsk Nederlands Svenska Suomi Portuguese Russian Polski Swiss German Swiss French Korean Magyar Turkce Cesky Simplified Chinese Traditional Chinese Japanese Custom Key [x]	Specify a language and custom key information for the keyboard on the display.
<b>Paper Sizes</b> US Metric	Specify the unit of measurement for paper sizes. <b>Notes:</b> <ul style="list-style-type: none"> <li>• US is the factory default setting.</li> <li>• The country or region selected in the initial setup wizard determines the initial paper size setting.</li> </ul>

Use	To
<p><b>Scan to PC Port Range</b> [port range]</p>	<p>Specify a valid port range for printers behind a port blocking firewall. <b>Note:</b> 9751:12000 is the factory default setting.</p>
<p><b>Displayed Information</b> Left side Right side</p>	<p>Specify the display information on the upper corners of the home screen. Select from the following options: None IP Address Hostname Contact Name Location Date/Time mDNS/DDNS Service Name Zero Configuration Name Custom Text [x] Model Name</p> <p><b>Notes:</b></p> <ul style="list-style-type: none"> <li>• IP Address is the factory default setting for Left side.</li> <li>• Date/Time is the factory default setting for Right side.</li> </ul>
<p><b>Displayed Information (continued)</b> Custom Text [x]</p>	<p>Customize the text to display in the upper corners of the home screen.</p>
<p><b>Displayed Information (continued)</b> Black Toner</p>	<p>Specify the display information for Black Toner. Select from the following options: When to display Do not display Display Message to display Default Alternate Default [text entry] Alternate [text entry]</p> <p><b>Notes:</b></p> <ul style="list-style-type: none"> <li>• Do not display is the factory default setting for When to display.</li> <li>• Default is the factory default setting for Message to display.</li> </ul>

Use	To
<p><b>Displayed Information (continued)</b></p> <ul style="list-style-type: none"> <li>Paper Jam</li> <li>Load Paper</li> <li>Service Errors</li> </ul>	<p>Customize the displayed information for certain menus.                      Select from the following options:</p> <ul style="list-style-type: none"> <li>Display                             <ul style="list-style-type: none"> <li>Yes</li> <li>No</li> </ul> </li> <li>Message to display                             <ul style="list-style-type: none"> <li>Default</li> <li>Alternate</li> </ul> </li> <li>Default                             <ul style="list-style-type: none"> <li>[text entry]</li> </ul> </li> <li>Alternate                             <ul style="list-style-type: none"> <li>[text entry]</li> </ul> </li> </ul> <p><b>Notes:</b></p> <ul style="list-style-type: none"> <li>• No is the factory default setting for Display.</li> <li>• Default is the factory default setting for Message to display.</li> </ul>
<p><b>Home screen customization</b></p> <ul style="list-style-type: none"> <li>Change Language</li> <li>Copy</li> <li>Copy Shortcuts</li> <li>Fax</li> <li>Fax Shortcuts</li> <li>E-mail</li> <li>E-mail Shortcuts</li> <li>FTP</li> <li>FTP Shortcuts</li> <li>Search Held Jobs</li> <li>Held Jobs</li> <li>USB Drive</li> <li>Profiles and Apps</li> <li>Bookmarks</li> <li>Jobs by User</li> <li>Forms and Favorites</li> <li>Card Copy</li> <li>Scan to Network</li> <li>MyShortcut</li> </ul>	<p>Change the icons that appear on the home screen.                      Select from the following options:</p> <ul style="list-style-type: none"> <li>Display</li> <li>Do not display</li> </ul>
<p><b>Date Format</b></p> <ul style="list-style-type: none"> <li>MM-DD-YYYY</li> <li>DD-MM-YYYY</li> <li>YYYY-MM-DD</li> </ul>	<p>Format the printer date.</p> <p><b>Note:</b> MM-DD-YYYY is the U.S. factory default setting. DD-MM-YYYY is the international factory default setting.</p>
<p><b>Time Format</b></p> <ul style="list-style-type: none"> <li>12 hour A.M./P.M.</li> <li>24 hour clock</li> </ul>	<p>Format the printer time.</p> <p><b>Note:</b> 12 hour A.M./P.M. is the factory default setting.</p>

Use	To
<b>Screen Brightness</b> 20–100	Specify the brightness of the display. <b>Note:</b> 100 is the factory default setting.
<b>One Page Copy</b> Off On	Set copies from the scanner glass to only one page at a time. <b>Note:</b> Off is the factory default setting.
<b>Audio Feedback</b> Button Feedback On Off Volume 1–10	Set the button volume and feedback. <b>Notes:</b> <ul style="list-style-type: none"> <li>• On is the factory default setting for Button Feedback.</li> <li>• 5 is the factory default setting for Volume.</li> </ul>
<b>Show Bookmarks</b> Yes No	Specify whether to display bookmarks from the Held Jobs area. <b>Note:</b> Yes is the factory default setting.
<b>Allow Background Removal</b> On Off	Specify whether to allow image background removal. <b>Note:</b> On is the factory default setting.
<b>Allow Custom Job Scans</b> On Off	Scan multiple jobs to one file. <b>Note:</b> On is the factory default setting.
<b>Scanner Jam Recovery</b> Job Level Page Level	Specify how to reload a scanned job when a paper jam occurs in the ADF. <b>Note:</b> Job Level is the factory default setting.
<b>Web Page Refresh Rate</b> 30–300	Specify the time between Embedded Web Server refreshes. <b>Note:</b> 120 seconds is the factory default setting.
<b>Contact Name</b>	Specify a contact name for the printer. <b>Note:</b> The contact name is stored on the Embedded Web Server.
<b>Location</b>	Specify the printer location. <b>Note:</b> The location is stored on the Embedded Web Server.
<b>Alarms</b> Alarm Control Cartridge Alarm	Set an alarm when the printer requires user intervention. Select from the following options: Off Single Continuous <b>Notes:</b> <ul style="list-style-type: none"> <li>• Single is the factory default setting for Alarm Control.</li> <li>• Off is the factory default setting for Cartridge Alarm.</li> </ul>

Use	To
<p><b>Timeouts</b>                      Standby Mode                      Disabled                      1–240</p>	<p>Set the idle time before the printer enters a lower power state.  <b>Note:</b> 15 minutes is the factory default setting.</p>
<p><b>Timeouts</b>                      Sleep Mode                      Disabled                      1–120</p>	<p>Set the idle time before the printer begins operating in Sleep mode.  <b>Notes:</b></p> <ul style="list-style-type: none"> <li>• 20 minutes is the factory default setting.</li> <li>• Disabled appears only when Energy Conserve is set to Off.</li> </ul>
<p><b>Timeouts</b>                      Print with Display Off                      Allow printing with display off                      Display on when printing</p>	<p>Print a job with the display turned off.  <b>Note:</b> Display on when printing is the factory default setting.</p>
<p><b>Timeouts</b>                      Hibernate Timeout                      Disabled                      20 minutes                      1 hour                      2 hours                      3 hours                      6 hours                      1 day                      2 days                      3 days                      1 week                      2 weeks                      1 month</p>	<p>Set the time before the printer enters Hibernate mode.  <b>Note:</b> 3 days is the factory default setting.</p>
<p><b>Hibernate Timeout on Connection</b>                      Hibernate                      Do Not Hibernate</p>	<p>Set the printer to Hibernate mode even if there is an active Ethernet connection.  <b>Note:</b> Do Not Hibernate is the factory default setting.</p>
<p><b>Timeouts</b>                      Screen Timeout                      15–300</p>	<p>Set the idle time before the display automatically returns to Ready state.  <b>Note:</b> 30 seconds is the factory default setting.</p>
<p><b>Timeouts</b>                      Print Timeout                      Disabled                      1–255</p>	<p>Set the printer to end a print job after it has been idle for the specified amount of time.  <b>Notes:</b></p> <ul style="list-style-type: none"> <li>• 90 seconds is the factory default setting.</li> <li>• Print Timeout is available only when using PCL emulation.</li> </ul>

Use	To
<b>Timeouts</b> Wait Timeout Disabled 15–65535	Set the time the printer waits for more data before canceling a print job.  <b>Notes:</b> <ul style="list-style-type: none"> <li>• 40 seconds is the factory default setting.</li> <li>• Wait Timeout is available only when the printer is using PostScript emulation.</li> </ul>
<b>Timeouts</b> Job Hold Timeout 5–255	Set the time the printer waits for user intervention before it holds jobs that require unavailable resources.  <b>Notes:</b> <ul style="list-style-type: none"> <li>• 30 seconds is the factory default setting.</li> <li>• This menu item appears only when a hard disk is installed.</li> </ul>
<b>Error Recovery</b> Auto Reboot Reboot when idle Reboot always Reboot never	Set the printer to restart when an error occurs. <b>Note:</b> Reboot always is the factory default setting.
<b>Error Recovery</b> Max Auto Reboots 1–20	Determine the number of automatic reboots the printer can perform. <b>Note:</b> 2 is the factory default setting.
<b>Print Recovery</b> Auto Continue Disabled 5–255	Let the printer automatically continue printing from certain offline situations when these are not resolved within the specified time period. <b>Note:</b> Disabled is the factory default setting.
<b>Print Recovery</b> Jam Recovery On Off Auto	Specify whether the printer reprints jammed pages. <b>Note:</b> Auto is the factory default setting.
<b>Print Recovery</b> Jam Assist On Off	Set the printer to check for jammed paper automatically. <b>Note:</b> On is the factory default setting.
<b>Print Recovery</b> Page Protect Off On	Set the printer to print the correct output for a page. <b>Note:</b> Off is the factory default setting.
<b>Accessibility Settings</b> Prolong Screen Timeout On Off	Remain in the same location and reset the Screen Timeout timer instead of returning to the home screen. <b>Note:</b> Off is the factory default setting.

Use	To
<b>Accessibility Settings</b> Speech Rate Very Slow Slow Normal Fast Faster Very Fast Rapid Very Rapid Fastest	Adjust the Voice Guidance speaking rate. <b>Note:</b> Normal is the factory default setting.
<b>Accessibility Settings</b> Headphone Volume 1–10	Set the headphones volume. <b>Note:</b> 5 is the factory default setting.
<b>Press Sleep Button</b> Do Nothing Sleep Hibernate	Determine how the printer, while in idle state, reacts to a short press of the Sleep button. <b>Note:</b> Sleep is the factory default setting.
<b>Press and Hold Sleep Button</b> Do Nothing Sleep Hibernate	Determine how the printer, while in idle state, reacts to a long press of the Sleep button. <b>Note:</b> Do Nothing is the factory default setting.
<b>Factory Defaults</b> Do Not Restore Restore Now	Restore the printer factory default settings. <b>Notes:</b> <ul style="list-style-type: none"> <li>• Do Not Restore is the factory default setting.</li> <li>• All downloads stored in the RAM are deleted. Downloads stored in the flash memory or on a hard disk are not affected.</li> </ul>
<b>Export Configuration File</b> Export	Export configuration files to a flash drive.

## Copy Settings menu

Use	To
<b>Content Type</b> Text Graphics Text/Photo Photo	Specify the content of the original document. <b>Note:</b> Text/Photo is the factory default setting.

Use	To
<b>Content Source</b> Black/White Laser Color Laser Inkjet Photo/Film Magazine Newspaper Press Other	Specify how the original document was produced. <b>Note:</b> Black/White Laser is the factory default setting.
<b>Sides (Duplex)</b> 1 sided to 1 sided 1 sided to 2 sided 2 sided to 1 sided 2 sided to 2 sided	Specify whether an original document is two-sided or one-sided, and then specify whether the copy should be two-sided or one-sided. <b>Note:</b> 1 sided to 1 sided is the factory default setting. This setting is selected when using a one-sided original document for a one-sided copy job.
<b>Paper Saver</b> Off 2-up Portrait 4-up Portrait 2-up Landscape 4-up Landscape	Copy two or four sheets of a document on one page. <b>Note:</b> Off is the factory default setting.
<b>Print Page Borders</b> On Off	Specify whether a border is printed. <b>Note:</b> Off is the factory default setting.
<b>Collate</b> (1,1) (2,2) (1,2,3) (1,2,3)	Stack the pages of a print job in sequence when printing multiple copies. <b>Note:</b> (1,2,3) (1,2,3) is the factory default setting.
<b>Staple</b> Off On	Enable the staple finisher. <b>Notes:</b> <ul style="list-style-type: none"> <li>• Off is the factory default setting.</li> <li>• This menu item appears only when a staple finisher is installed.</li> </ul>



Use	To
<p><b>Original Size</b></p> <ul style="list-style-type: none"> <li>Letter</li> <li>Legal</li> <li>Executive</li> <li>Folio</li> <li>Statement</li> <li>Oficio (Mexico)</li> <li>Universal</li> <li>Auto Size Sense</li> <li>Mixed Sizes</li> <li>A4</li> <li>A5</li> <li>A6</li> <li>JIS B5</li> <li>Custom Scan Size [x]</li> <li>Book Original</li> <li>Business Card</li> <li>3 x 5 in.</li> <li>4 x 6 in.</li> <li>ID Card</li> </ul>	<p>Specify the size of the original document.</p> <p><b>Note:</b> Letter is the U.S. factory default setting. A4 is the international factory default setting.</p>
<p><b>Copy To Source</b></p> <ul style="list-style-type: none"> <li>Tray [x]</li> <li>Auto Size Match</li> <li>Multipurpose Feeder</li> </ul>	<p>Specify the paper source for copy jobs.</p> <p><b>Note:</b> Tray 1 is the factory default setting.</p>
<p><b>Transparency Separators</b></p> <ul style="list-style-type: none"> <li>On</li> <li>Off</li> </ul>	<p>Place a sheet of paper between transparencies.</p> <p><b>Note:</b> On is the factory default setting.</p>
<p><b>Separator Sheets</b></p> <ul style="list-style-type: none"> <li>Off</li> <li>Between Copies</li> <li>Between Jobs</li> <li>Between Pages</li> </ul>	<p>Place a sheet of paper between pages, copies, or jobs.</p> <p><b>Note:</b> Off is the factory default setting.</p>
<p><b>Separator Sheet Source</b></p> <ul style="list-style-type: none"> <li>Tray [x]</li> <li>Multipurpose Feeder</li> </ul>	<p>Specify the paper source for the separator sheet.</p> <p><b>Note:</b> Tray 1 is the factory default setting.</p>
<p><b>Darkness</b></p> <ul style="list-style-type: none"> <li>1–9</li> </ul>	<p>Lighten or darken the output.</p> <p><b>Note:</b> 5 is the factory default setting.</p>
<p><b>Number of Copies</b></p> <ul style="list-style-type: none"> <li>1–9999</li> </ul>	<p>Specify the number of copies for the copy job.</p> <p><b>Note:</b> 1 is the factory default setting.</p>

Use	To
<p><b>Header/Footer</b>                      [Location]                      Off                      Date/Time                      Page number                      Custom text                      Print on                      All pages                      First page only                      All but first page                      Custom text</p>	<p>Specify the header or footer information and its location on the page.                      For the location, select from the following options:</p> <ul style="list-style-type: none"> <li>• Top left</li> <li>• Top middle</li> <li>• Top right</li> <li>• Bottom left</li> <li>• Bottom middle</li> <li>• Bottom right</li> </ul> <p><b>Notes:</b></p> <ul style="list-style-type: none"> <li>• Off is the factory default setting for the location.</li> <li>• All pages is the factory default setting for Print on.</li> </ul>
<p><b>Overlay</b>                      Confidential                      Copy                      Draft                      Urgent                      Custom                      Off</p>	<p>Specify the overlay text printed on each page of the copy job.  <b>Note:</b> Off is the factory default setting.</p>
<p><b>Custom Overlay</b></p>	<p>Specify the custom overlay text.</p>
<p><b>Allow priority copies</b>                      On                      Off</p>	<p>Allow interruption of a print job to copy a page or document.  <b>Note:</b> On is the factory default setting.</p>
<p><b>Custom Job scanning</b>                      On                      Off</p>	<p>Scan a document that contains mixed paper sizes into a single copy job.  <b>Notes:</b></p> <ul style="list-style-type: none"> <li>• Off is the factory default setting.</li> <li>• This menu item appears only when a formatted, working printer hard disk is installed.</li> </ul>
<p><b>Allow Save as Shortcut</b>                      On                      Off</p>	<p>Save custom copy settings as shortcuts.  <b>Note:</b> On is the factory default setting.</p>
<p><b>Background Removal</b>                      -4 to 4</p>	<p>Adjust the amount of background visible on a copy.  <b>Note:</b> 0 is the factory default setting.</p>
<p><b>Auto Center</b>                      Off                      On</p>	<p>Automatically align the content at the center of the page.  <b>Note:</b> Off is the factory default setting.</p>

Use	To
<b>Color Dropout</b> Color Dropout None Red Green Blue Default Red Threshold 0–255 Default Green Threshold 0–255 Default Blue Threshold 0–255	Specify which color to drop and to adjust the dropout setting for each color threshold.  <b>Notes:</b> <ul style="list-style-type: none"> <li>• None is the factory default setting for Color Dropout.</li> <li>• 128 is the factory default setting for each color threshold.</li> </ul>
<b>Contrast</b> 0–5 Best for content	Specify the contrast used for the copy job.  <b>Note:</b> Best for content is the factory default setting.
<b>Mirror Image</b> Off On	Create a mirror image of the original document.  <b>Note:</b> Off is the factory default setting.
<b>Negative Image</b> Off On	Create a negative image of the original document.  <b>Note:</b> Off is the factory default setting.
<b>Shadow Detail</b> -4 to 4	Adjust the amount of shadow detail visible on a copy.  <b>Note:</b> 0 is the factory default setting.
<b>Adjust ADF Skew</b> Auto Off On	Correct slight skew in the scanned image.  <b>Note:</b> Auto is the factory default setting.
<b>Scan edge to edge</b> Off On	Specify if the original document is scanned edge-to-edge.  <b>Note:</b> Off is the factory default setting.
<b>Sharpness</b> 1–5	Adjust the amount of sharpness of a copy.  <b>Note:</b> 3 is the factory default setting.
<b>Sample Copy</b> Off On	Create a sample copy of the original document.  <b>Note:</b> Off is the factory default setting.

## Fax Settings menu

### Fax Mode (Analog Fax Setup) menu

Analog Fax Setup mode sends the fax job through a telephone line.

**Note:** The fax function is available only in some printer models.

## General Fax Settings

Use	To
<b>Restore Factory Defaults</b>	Restore the factory defaults of all fax settings.
<b>Optimize Fax Compatibility</b>	Optimize fax compatibility with other fax machines.
<b>Fax Name</b>	Specify the name of the fax in the printer.
<b>Fax Number</b>	Specify the number assigned to the fax.
<b>Fax ID</b> Fax Name Fax Number	Specify how the fax is identified. <b>Note:</b> Fax Number is the factory default setting.
<b>Enable Manual Fax</b> On Off	Set the printer to fax manually, which requires a line splitter and a telephone handset. <b>Notes:</b> <ul style="list-style-type: none"> <li>• Off is the factory default setting.</li> <li>• Use a regular telephone to answer an incoming fax job and to dial a fax number.</li> <li>• Press <b># 0</b> on the numeric keypad to go directly to this setting.</li> </ul>
<b>Memory Use</b> All receive Mostly receive Equal Mostly send All send	Define the allocation of non-volatile memory between sending and receiving fax jobs. <b>Note:</b> Equal is the factory default setting.
<b>Cancel Faxes</b> Allow Don't Allow	Specify whether canceling of fax jobs is allowed. <b>Note:</b> Allow is the factory default setting.
<b>Caller ID</b> Off Primary Alternate	Specify the type of caller ID being used.
<b>Fax number masking</b> Off From left From right	Specify the direction from where digits are masked in an outgoing fax number. <b>Notes:</b> <ul style="list-style-type: none"> <li>• Off is the factory default setting.</li> <li>• The number of characters masked is determined by the Digits to Mask setting.</li> </ul>
<b>Digits to Mask</b> 0–58	Specify the number of digits to mask in an outgoing fax number. <b>Note:</b> 0 is the factory default setting.

Use	To
<p><b>Fax Cover Page</b></p> <ul style="list-style-type: none"> <li>Fax Cover Page                             <ul style="list-style-type: none"> <li>Off by default</li> <li>On by default</li> <li>Never use</li> <li>Always use</li> </ul> </li> <li>Include to Field                             <ul style="list-style-type: none"> <li>On</li> <li>Off</li> </ul> </li> <li>Include from Field                             <ul style="list-style-type: none"> <li>On</li> <li>Off</li> </ul> </li> <li>From                             <ul style="list-style-type: none"> <li>Include Message Field                                     <ul style="list-style-type: none"> <li>On</li> <li>Off</li> </ul> </li> </ul> </li> <li>Message                             <ul style="list-style-type: none"> <li>Include Logo                                     <ul style="list-style-type: none"> <li>On</li> <li>Off</li> </ul> </li> </ul> </li> <li>Include Footer [x]                             <ul style="list-style-type: none"> <li>On</li> <li>Off</li> </ul> </li> <li>Footer [x]</li> </ul>	<p>Configure the fax cover page.</p> <p><b>Notes:</b></p> <ul style="list-style-type: none"> <li>• Off by default is the factory default setting for Fax Cover Page.</li> <li>• Off is the factory default setting for all other menu items.</li> </ul>

**Fax Send Settings**

Use	To
<p><b>Resolution</b></p> <ul style="list-style-type: none"> <li>Standard</li> <li>Fine 200 dpi</li> <li>Super Fine 300 dpi</li> <li>Ultra Fine 600 dpi</li> </ul>	<p>Specify quality in dots per inch (dpi). A higher resolution gives better print quality, but increases the fax transmission time for outgoing faxes.</p> <p><b>Note:</b> Standard is the factory default setting.</p>

Use	To
<p><b>Original Size</b></p> <ul style="list-style-type: none"> <li>Letter</li> <li>Legal</li> <li>Executive</li> <li>Folio</li> <li>Statement</li> <li>Oficio (Mexico)</li> <li>Universal</li> <li>Auto Size Sense</li> <li>Mixed Sizes</li> <li>A4</li> <li>A5</li> <li>A6</li> <li>JIS B5</li> <li>Custom Scan Size [x]</li> <li>Book Original</li> <li>Business Card</li> <li>3 x 5 in.</li> <li>4 x 6 in.</li> </ul>	<p>Specify the size of the original document.</p> <p><b>Note:</b> Mixed Sizes is the U.S. factory default setting. A4 is the international factory default setting.</p>
<p><b>Sides (Duplex)</b></p> <ul style="list-style-type: none"> <li>Off</li> <li>Long edge</li> <li>Short edge</li> </ul>	<p>Specify the orientation of the original documents loaded in the ADF for two-sided scanning.</p> <p><b>Note:</b> Off is the factory default setting.</p>
<p><b>Content Type</b></p> <ul style="list-style-type: none"> <li>Text</li> <li>Graphics</li> <li>Text/Photo</li> <li>Photo</li> </ul>	<p>Specify the content of the original document.</p> <p><b>Note:</b> Text is the factory default setting.</p>
<p><b>Content Source</b></p> <ul style="list-style-type: none"> <li>Black/White Laser</li> <li>Color Laser</li> <li>Inkjet</li> <li>Photo/Film</li> <li>Magazine</li> <li>Newspaper</li> <li>Press</li> <li>Other</li> </ul>	<p>Specify how the original document was produced.</p> <p><b>Note:</b> Black/White Laser is the factory default setting.</p>
<p><b>Darkness</b></p> <ul style="list-style-type: none"> <li>1–9</li> </ul>	<p>Lighten or darken the output.</p> <p><b>Note:</b> 5 is the factory default setting.</p>
<p><b>Dial Prefix</b></p>	<p>Enter a dialing prefix, such as 99. A numeric entry field is provided.</p>
<p><b>Dialing Prefix Rules</b></p> <ul style="list-style-type: none"> <li>Prefix Rule [x]</li> </ul>	<p>Establish a dialing prefix rule.</p>

Use	To
<b>Automatic Redial</b> 0–9	Specify the number of times the printer tries to send the fax to a specified number. <b>Note:</b> 5 is the factory default setting.
<b>Redial frequency</b> 1–200	Specify the number of minutes between redials. <b>Note:</b> 3 is the factory default setting.
<b>Behind a PABX</b> Yes No	Enable or disable switchboard blind dialing without a dial tone. <b>Note:</b> No is the factory default setting.
<b>Enable ECM</b> Yes No	Enable or disable Error Correction Mode for fax jobs. <b>Note:</b> Yes is the factory default setting.
<b>Enable Fax Scans</b> On Off	Fax files that are scanned at the printer. <b>Note:</b> On is the factory default setting.
<b>Driver to fax</b> Yes No	Allow the print driver to send fax jobs. <b>Note:</b> Yes is the factory default setting.
<b>Allow Save as Shortcut</b> On Off	Save fax numbers as shortcuts in the printer. <b>Note:</b> On is the factory default setting.
<b>Dial Mode</b> Tone Pulse	Specify the dialing sound. <b>Note:</b> Tone is the factory default setting.
<b>Max Speed</b> 2400 4800 9600 14400 33600	Specify the maximum speed in baud at which faxes are sent. <b>Note:</b> 33600 is the factory default setting.
<b>Custom Job scanning</b> On Off	Scan a document that contains mixed paper sizes into a single file. <b>Notes:</b> <ul style="list-style-type: none"> <li>• Off is the factory default setting.</li> <li>• This menu item appears only when a formatted, working printer hard disk is installed.</li> </ul>
<b>Scan Preview</b> On Off	Specify whether a preview appears on the display for scan jobs. <b>Notes:</b> <ul style="list-style-type: none"> <li>• Off is the factory default setting.</li> <li>• This menu item appears only when a formatted, working printer hard disk is installed.</li> </ul>

Use	To
<b>Background Removal</b> -4 to 4	Adjust the amount of background visible on a scanned image. <b>Note:</b> 0 is the factory default setting.
<b>Color Balance</b> Cyan - Red Magenta - Green Yellow - Blue	Enable an equal balance of colors in the scanned image.
<b>Color Dropout</b> Color Dropout None Red Green Blue Default Red Threshold 0–255 Default Green Threshold 0–255 Default Blue Threshold 0–255	Specify which color to drop and to adjust the dropout setting for each color threshold. <b>Notes:</b> <ul style="list-style-type: none"> <li>• None is the factory default setting for Color Dropout.</li> <li>• 128 is the factory default setting for each color threshold.</li> </ul>
<b>Contrast</b> 0–5 Best for content	Specify the contrast in the scanned image. <b>Note:</b> Best for content is the factory default setting.
<b>Mirror Image</b> Off On	Create a mirror image of the original document. <b>Note:</b> Off is the factory default setting.
<b>Negative Image</b> Off On	Create a negative image of the original document. <b>Note:</b> Off is the factory default setting.
<b>Shadow Detail</b> -4 to 4	Adjust the amount of shadow detail visible. <b>Note:</b> 0 is the factory default setting.
<b>Adjust ADF Skew</b> Auto Off On	Correct the slight skew in the scanned image. <b>Notes:</b> <ul style="list-style-type: none"> <li>• Auto is the factory default setting.</li> <li>• This menu item is supported only in select printer models.</li> </ul>
<b>Scan edge to edge</b> Off On	Specify whether the original document is scanned edge-to-edge. <b>Note:</b> Off is the factory default setting.
<b>Sharpness</b> 1–5	Adjust the sharpness of a fax. <b>Note:</b> 3 is the factory default setting.
<b>Temperature</b> -4 to 4	Specify warm or cool outputs. Cool values generate a bluer output than the default while warm values generate a redder output than the default. <b>Note:</b> 0 is the factory default setting.



Use	To
<b>Enable Color Fax Scans</b> Off by default On by default Never use Always use	Enable color faxing. <b>Note:</b> Off by default is the factory default setting.
<b>Auto Convert Color Faxes to Mono Faxes</b> On Off	Convert all outgoing faxes to black and white. <b>Note:</b> On is the factory default setting.

### Fax Receive Settings

Use	To
<b>Enable Fax Receive</b> On Off	Allow the printer to receive fax jobs. <b>Note:</b> On is the factory default setting.
<b>Enable Caller ID</b> On Off	Display the caller ID information of an incoming fax. <b>Note:</b> On is the factory default setting.
<b>Fax Job Waiting</b> None Toner Toner and Supplies	Remove fax jobs from the print queue when the job requires specific unavailable resources. <b>Note:</b> None is the factory default setting.
<b>Rings to Answer</b> 1–25	Specify the number of rings before answering an incoming fax job. <b>Note:</b> 3 is the factory default setting.
<b>Auto Answer</b> Yes No	Set the printer to receive faxes automatically. <b>Note:</b> Yes is the factory default setting.
<b>Manual Answer Code</b> 0–9	Manually enter a code on the telephone number pad to begin receiving a fax. <b>Notes:</b> <ul style="list-style-type: none"> <li>• *9* is the factory default setting.</li> <li>• This menu item is used when the printer shares a line with a telephone.</li> </ul>
<b>Auto Reduction</b> On Off	Scale an incoming fax job so that it fits the size of the paper loaded in the designated fax source. <b>Note:</b> On is the factory default setting.
<b>Paper Source</b> Auto Tray [x] Multipurpose Feeder	Specify the paper source for printing incoming fax jobs. <b>Note:</b> Auto is the factory default setting.

Use	To
<b>Sides (Duplex)</b> Off On	Enable two-sided printing for incoming fax jobs. <b>Notes:</b> <ul style="list-style-type: none"> <li>• Off is the factory default setting.</li> <li>• This menu item appears only when a duplex unit is installed.</li> </ul>
<b>Separator Sheets</b> Off Before Job After Job	Enable the printer to include separator sheets for incoming fax jobs. <b>Note:</b> Off is the factory default setting.
<b>Separator Sheet Source</b> Tray [x] Multipurpose Feeder	Specify the paper source for the separator sheet. <b>Note:</b> Tray 1 is the factory default setting.
<b>Fax Footer</b> On Off	Print the transmission information at the bottom of each page from a received fax. <b>Note:</b> Off is the factory default setting.
<b>Max Speed</b> 2400 4800 9600 14400 33600	Specify the maximum speed in baud at which faxes are received. <b>Note:</b> 33600 is the factory default setting.
<b>Fax Forwarding</b> Print Print and Forward Forward	Enable forwarding of received faxes to another recipient. <b>Note:</b> Print is the factory default setting.
<b>Forward to</b> Fax E-mail FTP LDSS eSF	Specify the type of recipient to which faxes are forwarded. <b>Notes:</b> <ul style="list-style-type: none"> <li>• Fax is the factory default setting.</li> <li>• This menu item is available only from the Embedded Web Server.</li> </ul>
<b>Forward to Shortcut</b>	Enter the shortcut number that matches the recipient type (Fax, E-mail, FTP, LDSS, or eSF).
<b>Block No Name Fax</b> Off On	Enable blocking of incoming faxes sent from devices with no station ID or fax ID specified. <b>Note:</b> Off is the factory default setting.
<b>Banned Fax List</b>	Enable the list of blocked fax numbers stored in the printer.

Use	To
<b>Holding Faxes</b> Held Fax Mode Off Always On Manual Scheduled Fax Holding Schedule	Enable the printer to hold received faxes from printing until they are released. Held faxes can be released manually or at a scheduled day or time. <b>Note:</b> Off is the factory default setting.
<b>Enable Color Fax Receive</b> On Off	Enable the printer to receive fax in color and print it in grayscale. <b>Note:</b> On is the factory default setting.

**Fax Log Settings**

Use	To
<b>Transmission Log</b> Print log Do not print log Print only for error	Enable printing of a transmission log after each fax job. <b>Note:</b> Print log is the factory default setting.
<b>Receive Error Log</b> Print Never Print on Error	Enable printing of a received error log. <b>Note:</b> Print Never is the factory default setting.
<b>Auto Print Logs</b> On Off	Enable automatic printing of fax logs. <b>Notes:</b> <ul style="list-style-type: none"> <li>• On is the factory default setting.</li> <li>• Logs print after every 200 fax jobs.</li> </ul>
<b>Log Paper Source</b> Tray [x] Multipurpose Feeder	Specify the source of the paper used for printing logs. <b>Note:</b> Tray 1 is the factory default setting.
<b>Logs Display</b> Remote Station Name Dialed Number	Specify whether printed logs display the dialed number or the station name or fax name returned. <b>Note:</b> Remote Station Name is the factory default setting.
<b>Enable Job Log</b> On Off	Enable access to the Fax Job log. <b>Note:</b> On is the factory default setting.
<b>Enable Call Log</b> On Off	Enable access to the Fax Call log. <b>Note:</b> On is the factory default setting.

### Speaker Settings

Use	To
<b>Speaker Mode</b> Always Off On until Connected Always On	Specify the mode of the speaker. <b>Note:</b> On until Connected is the factory default setting. A sound is issued until the fax connection is made.
<b>Speaker Volume</b> High Low	Set the speaker volume to high or low. <b>Note:</b> High is the factory default setting.
<b>Ringer Volume</b> Off On	Enable or disable the ringer volume. <b>Note:</b> On is the factory default setting.

### Answer On

Use	To
All Rings Single Ring Only Double Ring Only Triple Ring Only Single or Double Rings Only Single or Triple Rings Only Double or Triple Rings Only	Specify ring patterns when the printer is answering calls. <b>Note:</b> All Rings is the factory default setting.

### E-mail Settings menu

Use	To
<b>E-mail Server Setup</b> Subject Message File Name	Specify e-mail server information.
<b>E-mail Server Setup</b> Send me a copy Never appears On by default Off by default Always On	Send a copy of the e-mail to the sender. <b>Note:</b> Never appears is the factory default setting.
<b>E-mail Server Setup</b> Max E-mail size 0–65535 KB	Specify the maximum e-mail size. <b>Note:</b> E-mails above the specified size are not sent.
<b>E-mail Server Setup</b> Size Error Message	Send a message when an e-mail is greater than the configured size limit.

Use	To
<p><b>E-mail Server Setup</b> Limit destinations</p>	<p>Specify a domain name, such as a company domain name, and then limit e-mail destinations only to that domain name. <b>Note:</b> You can only specify one domain.</p>
<p><b>E-mail Server Setup</b> Web Link Setup Server Login Password Path File Name Web Link</p>	<p>Define the e-mail server Web link settings. <b>Note:</b> The characters * : ? &lt; &gt;   are invalid entries for a path name.</p>
<p><b>Format</b> PDF (.pdf) TIFF (.tif) JPEG (.jpg) XPS (.xps) RTF (.rtf) TXT (.txt)</p>	<p>Specify the file format. <b>Notes:</b></p> <ul style="list-style-type: none"> <li>• PDF (.pdf) is the factory default setting.</li> <li>• To use the RTF (.rtf) or TXT (.txt) option, purchase and install the AccuRead OCR solution.</li> </ul>
<p><b>PDF Settings</b> PDF Version 1.2–1.7 A–1a A–1b PDF Compression Normal High Secure PDF Off On Searchable PDF Off On</p>	<p>Configure the PDF settings. <b>Notes:</b></p> <ul style="list-style-type: none"> <li>• 1.5 is the factory default setting for PDF Version.</li> <li>• Normal is the factory default setting for PDF Compression. This menu item appears only when a hard disk is installed.</li> <li>• Off is the factory default setting for Secure PDF and Searchable PDF. Secure PDF requires you to enter your password twice.</li> <li>• To use the Searchable PDF option, purchase and install the AccuRead OCR solution.</li> </ul>
<p><b>Content Type</b> Text Graphics Text/Photo Photo</p>	<p>Specify the content of the original document. <b>Note:</b> Text/Photo is the factory default setting.</p>

Use	To
<b>Content Source</b> Black/White Laser Color Laser Inkjet Photo/Film Magazine Newspaper Press Other	Specify how the original document was produced. <b>Note:</b> Black/White Laser is the factory default setting.
<b>Color</b> Off On	Specify whether the printer captures and transmits content in color. <b>Note:</b> On is the factory default setting.
<b>Resolution</b> 75 dpi 150 dpi 200 dpi 300 dpi 400 dpi 600 dpi	Specify the resolution of the scan in dots per inch. <b>Note:</b> 150 dpi is the factory default setting.
<b>Darkness</b> 1–9	Lighten or darken the output. <b>Note:</b> 5 is the factory default setting.
<b>Orientation</b> Portrait Landscape	Specify the orientation of the scanned image. <b>Note:</b> Portrait is the factory default setting.
<b>Original Size</b> Letter Legal Executive Folio Statement Oficio (Mexico) Universal Auto Size Sense Mixed Sizes A4 A5 A6 JIS B5 Custom Scan Size [x] Book Original Business Card 3 x 5 in. 4 x 6 in.	Specify the size of the original document. <b>Note:</b> Letter is the U.S. factory default setting. A4 is the international factory default setting.

Use	To
<b>Sides (Duplex)</b> Off Long edge Short edge	Specify the orientation of the original documents loaded in the ADF for two-sided scanning. <b>Note:</b> Off is the factory default setting.
<b>JPEG Quality</b> Best for content 5–90	Set the quality of a JPEG photo image in relation to file size and quality of the image. <b>Notes:</b> <ul style="list-style-type: none"> <li>• Best for content is the factory default setting.</li> <li>• 5 reduces the file size and quality of the image.</li> <li>• 90 provides the best image quality, but the file size is very large.</li> </ul>
<b>Text Default</b> 5–90	Set the quality of a text image in relation to file size and quality of the image. <b>Note:</b> 75 is the factory default setting.
<b>Text/Photo Default</b> 5–90	Set the quality of a text or photo image in relation to file size and the quality of the image. <b>Note:</b> 75 is the factory default setting.
<b>Photo Default</b> 5–90	Set the quality of a photo image in relation to file size and the quality of the image. <b>Note:</b> 50 is the factory default setting.
<b>E-mail images sent as</b> Attachment Web Link	Specify how the images are sent. <b>Note:</b> Attachment is the factory default setting.
<b>Use Multi-Page Tiff</b> On Off	Provide a choice between single-page TIFF files and multiple-page TIFF files. For a multiple-page scan-to-e-mail job, either one TIFF file is created containing all the pages, or multiple TIFF files are created with one file for each page of the job. <b>Note:</b> On is the factory default setting.
<b>TIFF Compression</b> LZW JPEG	Specify the format used in compressing TIFF files. <b>Note:</b> LZW is the factory default setting.
<b>Transmission Log</b> Print log Do not print log Print only for error	Enable printing of a transmission log after each e-mail job. <b>Note:</b> Print log is the factory default setting.
<b>Log Paper Source</b> Tray [x] Multipurpose Feeder	Specify the paper source for printing e-mail logs. <b>Note:</b> Tray 1 is the factory default setting.
<b>E-mail Bit Depth</b> 1 bit 8 bit	Enable the Text/Photo mode to produce smaller file sizes by using 1-bit images when Color is set to Off. <b>Note:</b> 8 bit is the factory default setting.

Use	To
<b>Custom Job scanning</b> On Off	Copy a document that contains mixed paper sizes. <b>Notes:</b> <ul style="list-style-type: none"> <li>• Off is the factory default setting.</li> <li>• This menu item appears only when a formatted, working hard disk is installed.</li> </ul>
<b>Scan Preview</b> On Off	Specify whether a preview appears on the display for scan jobs. <b>Notes:</b> <ul style="list-style-type: none"> <li>• Off is the factory default setting.</li> <li>• This menu item appears only when a formatted, working hard disk is installed.</li> </ul>
<b>Allow Save as Shortcut</b> On Off	Save e-mail addresses as shortcuts. <b>Notes:</b> <ul style="list-style-type: none"> <li>• On is the factory default setting.</li> <li>• When set to Off, the Save as Shortcut button does not appear on the e-mail destination screen.</li> </ul>
<b>Background Removal</b> -4 to 4	Adjust the amount of background visible on a scanned image. <b>Note:</b> 0 is the factory default setting.
<b>Color Balance</b> Cyan-Red Magenta-Green Yellow-Blue	Enable an equal balance of colors in the output.
<b>Color Dropout</b> Color Dropout None Red Green Blue Default Red Threshold 0–255 Default Green Threshold 0–255 Default Blue Threshold 0–255	Specify which color to drop and to adjust the dropout setting for each color threshold. <b>Notes:</b> <ul style="list-style-type: none"> <li>• None is the factory default setting for Color Dropout.</li> <li>• 128 is the factory default setting for each color threshold.</li> </ul>
<b>Contrast</b> 0–5 Best for content	Specify the contrast of the output. <b>Note:</b> Best for content is the factory default setting.
<b>Mirror Image</b> Off On	Create a mirror image of the original document. <b>Note:</b> Off is the factory default setting.



Use	To
<b>Negative Image</b> Off On	Create a negative image of the original document. <b>Note:</b> Off is the factory default setting.
<b>Shadow Detail</b> -4 to 4	Adjust the amount of shadow detail visible on a scanned image. <b>Note:</b> 0 is the factory default setting.
<b>Adjust ADF Skew</b> Auto Off On	Correct the slight skew in the scanned image. <b>Notes:</b> <ul style="list-style-type: none"> <li>• Auto is the factory default setting.</li> <li>• This menu item appears only in some printer models.</li> </ul>
<b>Scan edge to edge</b> Off On	Specify whether the original document is scanned edge-to-edge. <b>Note:</b> Off is the factory default setting.
<b>Sharpness</b> 1–5	Adjust the amount of sharpness on a scanned image. <b>Note:</b> 3 is the factory default setting.
<b>Temperature</b> -4 to 4	Specify warm or cool outputs. Cool values generate a bluer output than the default while warm values generate a redder output than the default. <b>Note:</b> 0 is the factory default setting.
<b>Use cc:/bcc:</b> Off On	Enable the use of the cc and bcc fields. <b>Note:</b> Off is the factory default setting.

## FTP Settings menu

Use	To
<b>Format</b> PDF (.pdf) TIFF (.tif) JPEG (.jpg) XPS (.xps) RTF (.rtf) TXT (.txt)	Specify the file format. <b>Notes:</b> <ul style="list-style-type: none"> <li>• PDF (.pdf) is the factory default setting.</li> <li>• To use the RTF (.rtf) or TXT (.txt) option, purchase and install the AccuRead OCR solution.</li> </ul>

Use	To
<p><b>PDF Settings</b></p> <ul style="list-style-type: none"> <li>PDF Version                             <ul style="list-style-type: none"> <li>1.2–1.7</li> <li>A–1a</li> <li>A–1b</li> </ul> </li> <li>PDF Compression                             <ul style="list-style-type: none"> <li>Normal</li> <li>High</li> </ul> </li> <li>Secure PDF                             <ul style="list-style-type: none"> <li>Off</li> <li>On</li> </ul> </li> <li>Searchable PDF                             <ul style="list-style-type: none"> <li>Off</li> <li>On</li> </ul> </li> </ul>	<p>Configure the PDF settings.</p> <p><b>Notes:</b></p> <ul style="list-style-type: none"> <li>• 1.5 is the factory default setting for PDF Version.</li> <li>• Normal is the factory default setting for PDF Compression. This setting appears only when a formatted, working hard disk is installed.</li> <li>• Off is the factory default setting for Secure PDF and Searchable PDF. Secure PDF requires you to enter your password twice.</li> <li>• To use the Searchable PDF option, purchase and install the AccuRead OCR solution.</li> </ul>
<p><b>Content Type</b></p> <ul style="list-style-type: none"> <li>Text</li> <li>Graphics</li> <li>Text/Photo</li> <li>Photo</li> </ul>	<p>Specify the content of the original document.</p> <p><b>Note:</b> Text/Photo is the factory default setting.</p>
<p><b>Content Source</b></p> <ul style="list-style-type: none"> <li>Black/White Laser</li> <li>Color Laser</li> <li>Inkjet</li> <li>Photo/Film</li> <li>Magazine</li> <li>Newspaper</li> <li>Press</li> <li>Other</li> </ul>	<p>Specify how the original document was produced.</p> <p><b>Note:</b> Black/White Laser is the factory default setting.</p>
<p><b>Color</b></p> <ul style="list-style-type: none"> <li>Off</li> <li>On</li> </ul>	<p>Specify whether the printer captures and transmits content in color.</p> <p><b>Note:</b> On is the factory default setting.</p>
<p><b>Resolution</b></p> <ul style="list-style-type: none"> <li>75 dpi</li> <li>150 dpi</li> <li>200 dpi</li> <li>300 dpi</li> <li>400 dpi</li> <li>600 dpi</li> </ul>	<p>Specify the quality of the scan in dots per inch (dpi).</p> <p><b>Note:</b> 150 dpi is the factory default setting.</p>
<p><b>Darkness</b></p> <ul style="list-style-type: none"> <li>1–9</li> </ul>	<p>Lighten or darken the output.</p> <p><b>Note:</b> 5 is the factory default setting.</p>
<p><b>Orientation</b></p> <ul style="list-style-type: none"> <li>Portrait</li> <li>Landscape</li> </ul>	<p>Specify the orientation of the scanned image.</p> <p><b>Note:</b> Portrait is the factory default setting.</p>

Use	To
<p><b>Original Size</b></p> <ul style="list-style-type: none"> <li>Letter</li> <li>Legal</li> <li>Executive</li> <li>Folio</li> <li>Statement</li> <li>Oficio (Mexico)</li> <li>Universal</li> <li>Auto Size Sense</li> <li>Mixed Sizes</li> <li>A4</li> <li>A5</li> <li>A6</li> <li>JIS B5</li> <li>Custom Scan Size [x]</li> <li>Book Original</li> <li>Business Card</li> <li>3 x 5 in.</li> <li>4 x 6 in.</li> </ul>	<p>Specify the size of the original document.</p> <p><b>Note:</b> Letter is the U.S. factory default setting. A4 is the international factory default setting.</p>
<p><b>Sides (Duplex)</b></p> <ul style="list-style-type: none"> <li>Off</li> <li>Long edge</li> <li>Short edge</li> </ul>	<p>Specify the orientation of the original documents loaded in the ADF for two-sided scanning.</p> <p><b>Note:</b> Off is the factory default setting.</p>
<p><b>JPEG Quality</b></p> <ul style="list-style-type: none"> <li>Best for content</li> <li>5–90</li> </ul>	<p>Set the quality of a JPEG photo image in relation to the file size and quality of the image.</p> <p><b>Notes:</b></p> <ul style="list-style-type: none"> <li>• Best for content is the factory default setting.</li> <li>• 5 reduces the file size, but the quality of the image is lessened.</li> <li>• 90 provides the best image quality, but the file size is very large.</li> </ul>
<p><b>Text Default</b></p> <ul style="list-style-type: none"> <li>5–90</li> </ul>	<p>Set the quality of the text in relation to the file size and quality of the image.</p> <p><b>Note:</b> 75 is the factory default setting.</p>
<p><b>Text/Photo Default</b></p> <ul style="list-style-type: none"> <li>5–90</li> </ul>	<p>Set the quality of a text/photo image in relation to the file size and quality of the image.</p> <p><b>Note:</b> 75 is the factory default setting.</p>
<p><b>Photo Default</b></p> <ul style="list-style-type: none"> <li>5–90</li> </ul>	<p>Set the quality of a photo image in relation to the file size and quality of the image.</p> <p><b>Note:</b> 50 is the factory default setting.</p>
<p><b>Use Multi-Page TIFF</b></p> <ul style="list-style-type: none"> <li>On</li> <li>Off</li> </ul>	<p>Provide a choice between single-page TIFF files and multiple-page TIFF files. For a multiple-page scan-to-FTP job, either one TIFF file is created containing all the pages, or multiple TIFF files are created with one file for each page of the job.</p> <p><b>Note:</b> On is the factory default setting.</p>

Use	To
<b>TIFF Compression</b> LZW JPEG	Specify the format used in compressing TIFF files. <b>Note:</b> LZW is the factory default setting.
<b>Transmission Log</b> Print log Do not print log Print only for error	Specify whether to print the transmission log. <b>Note:</b> Print log is the factory default setting.
<b>Log Paper Source</b> Tray [x] Multipurpose Feeder	Specify a paper source when printing FTP logs. <b>Note:</b> Tray 1 is the factory default setting.
<b>FTP bit Depth</b> 1 bit 8 bit	Enable the Text/Photo mode to have smaller file sizes by using 1-bit images. <b>Note:</b> 8 bit is the factory default setting.
<b>File Name</b>	Type a base file name.
<b>Custom Job Scanning</b> On Off	Copy a document that contains mixed paper sizes into a single scan job. <b>Note:</b> Off is the factory default setting.
<b>Scan Preview</b> On Off	Specify whether a preview appears on the display for scan jobs. <b>Notes:</b> <ul style="list-style-type: none"> <li>• Off is the factory default setting.</li> <li>• This menu item appears only when a formatted, working printer hard disk is installed.</li> </ul>
<b>Allow Save as Shortcut</b> On Off	Enable shortcut creation for FTP addresses. <b>Note:</b> On is the factory default setting.
<b>Background Removal</b> -4 to 4	Adjust the amount of background visible on a copy. <b>Note:</b> 0 is the factory default setting.
<b>Color Balance</b> Cyan-Red Magenta-Green Yellow-Blue	Enable an equal balance of colors in the output.

Use	To
<p><b>Color Dropout</b></p> <ul style="list-style-type: none"> <li>Color Dropout                             <ul style="list-style-type: none"> <li>None</li> <li>Red</li> <li>Green</li> <li>Blue</li> </ul> </li> <li>Default Red Threshold                             <ul style="list-style-type: none"> <li>0–255</li> </ul> </li> <li>Default Green Threshold                             <ul style="list-style-type: none"> <li>0–255</li> </ul> </li> <li>Default Blue Threshold                             <ul style="list-style-type: none"> <li>0–255</li> </ul> </li> </ul>	<p>Specify which color to drop and to adjust the dropout setting for each color threshold.</p> <p><b>Notes:</b></p> <ul style="list-style-type: none"> <li>None is the factory default setting for Color Dropout.</li> <li>128 is the factory default setting for each color threshold.</li> </ul>
<p><b>Contrast</b></p> <ul style="list-style-type: none"> <li>0–5</li> <li>Best for content</li> </ul>	<p>Specify the contrast of the output.</p> <p><b>Note:</b> Best for content is the factory default setting.</p>
<p><b>Mirror Image</b></p> <ul style="list-style-type: none"> <li>Off</li> <li>On</li> </ul>	<p>Create a mirror image of the original document.</p> <p><b>Note:</b> Off is the factory default setting.</p>
<p><b>Negative Image</b></p> <ul style="list-style-type: none"> <li>Off</li> <li>On</li> </ul>	<p>Create a negative image of the original document.</p> <p><b>Note:</b> Off is the factory default setting.</p>
<p><b>Shadow Detail</b></p> <ul style="list-style-type: none"> <li>-4 to 4</li> </ul>	<p>Adjust the amount of shadow detail visible on a scanned image.</p> <p><b>Note:</b> 0 is the factory default setting.</p>
<p><b>Adjust ADF Skew</b></p> <ul style="list-style-type: none"> <li>Auto</li> <li>Off</li> <li>On</li> </ul>	<p>Correct slight skew in the scanned image.</p> <p><b>Notes:</b></p> <ul style="list-style-type: none"> <li>Auto is the factory default setting.</li> <li>This menu item is supported only in some printer models.</li> </ul>
<p><b>Scan edge to edge</b></p> <ul style="list-style-type: none"> <li>Off</li> <li>On</li> </ul>	<p>Specify whether the original document is scanned edge-to-edge.</p> <p><b>Note:</b> Off is the factory default setting.</p>
<p><b>Sharpness</b></p> <ul style="list-style-type: none"> <li>1–5</li> </ul>	<p>Adjust the amount of sharpness of the scanned image.</p> <p><b>Note:</b> 3 is the factory default setting.</p>
<p><b>Temperature</b></p> <ul style="list-style-type: none"> <li>-4 to 4</li> </ul>	<p>Enable the user to specify warm or cool outputs. Cool values generate a bluer output than the default while warm values generate a redder output than the default.</p> <p><b>Note:</b> 0 is the factory default setting.</p>

## Flash Drive menu

### Scan Settings

Use	To
<p><b>Format</b></p> <ul style="list-style-type: none"> <li>PDF (.pdf)</li> <li>TIFF (.tif)</li> <li>JPEG (.jpg)</li> <li>XPS (.xps)</li> <li>RTF (.rtf)</li> <li>TXT (.txt)</li> </ul>	<p>Specify the file format.</p> <p><b>Notes:</b></p> <ul style="list-style-type: none"> <li>• PDF (.pdf) is the factory default setting.</li> <li>• To use the RTF (.rtf) or TXT (.txt) option, purchase and install the AccuRead OCR solution.</li> </ul>
<p><b>PDF Settings</b></p> <ul style="list-style-type: none"> <li>PDF Version                             <ul style="list-style-type: none"> <li>1.2–1.7</li> <li>A–1a</li> </ul> </li> <li>PDF Compression                             <ul style="list-style-type: none"> <li>Normal</li> <li>High</li> </ul> </li> <li>Secure PDF                             <ul style="list-style-type: none"> <li>Off</li> <li>On</li> </ul> </li> <li>Searchable PDF                             <ul style="list-style-type: none"> <li>Off</li> <li>On</li> </ul> </li> </ul>	<p>Configure the PDF settings.</p> <p><b>Notes:</b></p> <ul style="list-style-type: none"> <li>• 1.5 is the factory default setting for PDF Version.</li> <li>• Normal is the factory default setting for PDF Compression.</li> <li>• Off is the factory default setting for Secure PDF, and Searchable PDF. Secure PDF requires you to enter your password twice.</li> <li>• To use the Searchable PDF option, purchase and install the AccuRead OCR solution.</li> </ul>
<p><b>Content Type</b></p> <ul style="list-style-type: none"> <li>Text</li> <li>Graphics</li> <li>Text/Photo</li> <li>Photo</li> </ul>	<p>Specify the content of the original document.</p> <p><b>Note:</b> Text/Photo is the factory default setting.</p>
<p><b>Content Source</b></p> <ul style="list-style-type: none"> <li>Black/White Laser</li> <li>Color Laser</li> <li>Inkjet</li> <li>Photo/Film</li> <li>Magazine</li> <li>Newspaper</li> <li>Press</li> <li>Other</li> </ul>	<p>Specify how the original document was produced.</p> <p><b>Note:</b> Black/White Laser is the factory default setting.</p>
<p><b>Color</b></p> <ul style="list-style-type: none"> <li>On</li> <li>Off</li> </ul>	<p>Specify whether the printer captures and transmits content in color.</p> <p><b>Note:</b> On is the factory default setting.</p>

Use	To
<b>Resolution</b> 75 dpi 150 dpi 200 dpi 300 dpi 400 dpi 600 dpi	Specify the resolution of the scan in dots per inch (dpi). <b>Note:</b> 150 dpi is the factory default setting.
<b>Darkness</b> 1–9	Lighten or darken the output. <b>Note:</b> 5 is the factory default setting.
<b>Orientation</b> Portrait Landscape	Specify the orientation of the scanned image. <b>Note:</b> Portrait is the factory default setting.
<b>Original Size</b> Letter Legal Executive Folio Statement Oficio (Mexico) Universal Auto Size Sense Mixed Sizes A4 A5 A6 JIS B5 Custom Scan Size [x] Book Original Business Card 3 x 5 in. 4 x 6 in.	Specify the size of the original document. <b>Note:</b> Letter is the U.S. factory default setting. A4 is the international factory default setting.
<b>Sides (Duplex)</b> Off Long edge Short edge	Specify the orientation of the original documents loaded in the ADF for two-sided scanning. <b>Note:</b> Off is the factory default setting.
<b>JPEG Quality</b> Best for content 5–90	Set the quality of a JPEG photo image in relation to file size and quality. <b>Notes:</b> <ul style="list-style-type: none"> <li>• Best for content is the factory default setting.</li> <li>• 5 reduces the file size, but the quality of the image is lessened.</li> <li>• 90 provides the best image quality, but the file size is very large.</li> </ul>
<b>Text Default</b> 5–90	Set the quality of the text in relation to file size and the quality of the image. <b>Note:</b> 75 is the factory default setting.

Use	To
<b>Text/Photo Default</b> 5–90	Set the quality of a text/photo image in relation to file size and quality. <b>Note:</b> 75 is the factory default setting.
<b>Photo Default</b> 5–90	Set the quality of a photo image in relation to file size and quality. <b>Note:</b> 50 is the factory default setting.
<b>Use Multi-Page TIFF</b> On Off	Provide a choice between single-page TIFF files and multiple-page TIFF files. For a multiple-page scan-to-FTP job, either one TIFF file is created containing all the pages, or multiple TIFF files are created with one file for each page. <b>Note:</b> On is the factory default setting.
<b>Scan Bit Depth</b> 1 bit 8 bit	Enable the Text/Photo mode to produce smaller file sizes by using 1-bit images. <b>Note:</b> 8 bit is the factory default setting.
<b>File Name</b>	Type a base file name.
<b>Custom Job Scanning</b> On Off	Copy a document that contains mixed paper sizes. <b>Note:</b> Off is the factory default setting.
<b>Scan Preview</b> On Off	Specify whether a preview appears on the display for scan jobs. <b>Notes:</b> <ul style="list-style-type: none"> <li>• Off is the factory default setting.</li> <li>• This menu item appears only when a formatted, working printer hard disk is installed.</li> </ul>
<b>Background Removal</b> -4 to 4	Adjust the amount of background visible on a copy. <b>Note:</b> 0 is the factory default setting.
<b>Color Balance</b> Cyan - Red Magenta - Green Yellow - Blue	Enable an equal balance of colors in the output.
<b>Color Dropout</b> Color Dropout None Red Green Blue Default Red Threshold 0–255 Default Green Threshold 0–255 Default Blue Threshold 0–255	Specify which color to drop and to adjust the dropout setting for each color threshold. <b>Notes:</b> <ul style="list-style-type: none"> <li>• None is the factory default setting for Color Dropout.</li> <li>• 128 is the factory default setting for each color threshold.</li> </ul>
<b>Contrast</b> 0–5 Best for content	Specify the contrast of the scanned image. <b>Note:</b> Best for content is the factory default setting.



Use	To
<b>Mirror Image</b> Off On	Create a mirror image of the original document. <b>Note:</b> Off is the factory default setting.
<b>Negative Image</b> Off On	Create a negative image of the original document. <b>Note:</b> Off is the factory default setting.
<b>Shadow Detail</b> -4 to 4	Adjust the amount of shadow detail visible on a scanned image. <b>Note:</b> 0 is the factory default setting.
<b>Adjust ADF Skew</b> Auto Off On	Correct slight skew in the scanned image. <b>Notes:</b> <ul style="list-style-type: none"> <li>• Auto is the factory default setting.</li> <li>• This menu item appears only in some printer models.</li> </ul>
<b>Scan edge to edge</b> Off On	Specify whether the original document is scanned edge-to-edge. <b>Note:</b> Off is the factory default setting.
<b>Sharpness</b> 1–5	Adjust the amount of sharpness on a scanned image. <b>Note:</b> 3 is the factory default setting.
<b>Temperature</b> -4 to 4	Specify warm or cool outputs. Cool values generate a bluer output than the default while warm values generate a redder output than the default. <b>Note:</b> 0 is the factory default setting.

## Print Settings

<b>Copies</b> 1–999	Specify a default number of copies for each print job. <b>Note:</b> 1 is the factory default setting.
<b>Paper Source</b> Tray [x] Multipurpose Feeder Manual Paper Manual Envelope	Set a default paper source for all print jobs. <b>Note:</b> Tray 1 is the factory default setting.
<b>Collate</b> (1,1) (2,2,2) (1,2,3) (1,2,3)	Stack the pages of a print job in sequence when printing multiple copies. <b>Note:</b> (1,2,3) (1,2,3) is the factory default setting.
<b>Sides (Duplex)</b> 1 sided 2 sided	Enable two-sided printing for incoming print jobs. <b>Note:</b> 1 sided is the factory default setting.

<p><b>Duplex Binding</b> Long Edge Short Edge</p>	<p>Define binding for two-sided pages in relation to page orientation.</p> <p><b>Notes:</b></p> <ul style="list-style-type: none"> <li>• Long Edge is the factory default setting. This assumes binding along the long edge of the page (left edge for portrait and top edge for landscape).</li> <li>• Short Edge assumes binding along the short edge of the page (top edge for portrait and left edge for landscape).</li> </ul>
<p><b>Paper Saver Orientation</b> Auto Landscape Portrait</p>	<p>Specify the orientation of a multiple-page document.</p> <p><b>Note:</b> Auto is the factory default setting.</p>
<p><b>Paper Saver</b> Off 2-Up 3-Up 4-Up 6-Up 9-Up 12-Up 16-Up</p>	<p>Print multiple-page images on one side of the paper.</p> <p><b>Note:</b> Off is the factory default setting.</p>
<p><b>Paper Saver Border</b> None Solid</p>	<p>Print a border on each page image.</p> <p><b>Note:</b> None is the factory default setting.</p>
<p><b>Paper Saver Ordering</b> Horizontal Reverse Horizontal Reverse Vertical Vertical</p>	<p>Specify the positioning of multiple-page images.</p> <p><b>Notes:</b></p> <ul style="list-style-type: none"> <li>• Horizontal is the factory default setting.</li> <li>• Positioning depends on the number of page images and whether they are in portrait or in landscape orientation.</li> </ul>
<p><b>Separator Sheets</b> Off Between Copies Between Jobs Between Pages</p>	<p>Specify whether to insert blank separator sheets.</p> <p><b>Notes:</b></p> <ul style="list-style-type: none"> <li>• Off is the factory default setting.</li> <li>• Between Copies inserts a blank sheet between each copy of a print job if Collate is set to (1,2,3) (1,2,3). If Collate is set to (1,1,1) (2,2,2), then a blank page is inserted between each set of printed pages.</li> <li>• Between Jobs inserts a blank sheet between print jobs.</li> <li>• Between Pages inserts a blank sheet between each page of the print job. This setting is useful when printing transparencies or when inserting blank pages in a document.</li> </ul>
<p><b>Separator Sheet Source</b> Tray [x] Multipurpose Feeder</p>	<p>Specify the paper source for separator sheets.</p> <p><b>Note:</b> Tray 1 is the factory default setting.</p>
<p><b>Blank Pages</b> Do Not Print Print</p>	<p>Specify whether to insert blank pages in a print job.</p> <p><b>Note:</b> Do Not Print is the factory default setting.</p>

## OCR Settings menu

**Note:** This menu appears only if you have purchased and installed the AccuRead OCR solution.

Use	To
<b>Auto Rotate</b> On Off	Automatically rotate scanned documents for proper orientation. <b>Note:</b> On is the factory default setting.
<b>Despeckle</b> Off On	Remove specks from a scanned image. <b>Note:</b> Off is the factory default setting.
<b>Inverse Detection</b> On Off	Recognize and make the white text on a black background editable. <b>Note:</b> On is the factory default setting.
<b>Auto Contrast Enhance</b> Off On	Automatically adjust the contrast to improve OCR quality. <b>Note:</b> Off is the factory default setting.
<b>Recognized Languages</b> English French German Spanish Italian Portugues Danish Dutch Norwegian Swedish Finnish Hungarian Polish	Set the language or languages that the OCR can recognize. For each language, select from the following options: Off On <b>Note:</b> The language is enabled by default. If it is set to a value that is not in the list of recognized languages, English is enabled by default.

## Print Settings

### Setup menu

Use	To
<b>Printer Language</b> PCL Emulation PS Emulation	Set the printer language. <b>Notes:</b> <ul style="list-style-type: none"> <li>• PCL Emulation is the factory default setting.</li> <li>• Setting a printer language as the default does not prevent a software program from sending print jobs that use another printer language.</li> </ul>

Use	To
<p><b>Job Waiting</b></p> <p>On</p> <p>Off</p>	<p>Specify that print jobs be removed from the print queue if they require unavailable printer options or custom settings.</p> <p>Print jobs removed from the print queue are stored in a separate print queue, so other jobs print normally. When the missing information or options are obtained, the stored jobs print.</p> <p><b>Notes:</b></p> <ul style="list-style-type: none"> <li>• Off is the factory default setting.</li> <li>• This menu setting appears only when a formatted, working printer hard disk is installed. This requirement ensures that stored jobs are not deleted if the printer loses power.</li> </ul>
<p><b>Print Area</b></p> <p>Normal</p> <p>Whole Page</p>	<p>Set the logical and physical printable area.</p> <p><b>Notes:</b></p> <ul style="list-style-type: none"> <li>• Normal is the factory default setting. When attempting to print data in the non-printable area defined by the Normal setting, the printer clips the image at the boundary.</li> <li>• Whole Page allows the image to be moved into the non-printable area defined by the Normal setting, but the printer will clip the image at the Normal setting boundary. This affects only pages printed using a PCL 5e interpreter. This has no effect on pages printed using the PCL XL or PostScript interpreter.</li> </ul>
<p><b>Download Target</b></p> <p>RAM</p> <p>Flash</p> <p>Disk</p>	<p>Set the storage location for downloads.</p> <p><b>Notes:</b></p> <ul style="list-style-type: none"> <li>• RAM is the factory default setting. Storing downloads in the RAM is temporary.</li> <li>• Storing downloads in flash memory or on a printer hard disk places them in permanent storage. Downloads remain in flash memory or on the printer hard disk even when the printer is turned off.</li> <li>• This menu setting appears only when a formatted, working flash drive or printer hard disk is installed.</li> </ul>
<p><b>Resource Save</b></p> <p>On</p> <p>Off</p>	<p>Specify how the printer handles temporary downloads, such as fonts and macros stored in the RAM, when the printer receives a job that requires more memory than is available.</p> <p><b>Notes:</b></p> <ul style="list-style-type: none"> <li>• Off is the factory default setting. This sets the printer to retain the downloads only until memory is needed. Downloads are deleted in order to process print jobs.</li> <li>• On retains the downloads during language changes and printer resets. If the printer runs out of memory, then <b>Memory Full [38]</b> appears, and downloads are not deleted.</li> </ul>

Use	To
<b>Print All Order</b> Alphabetical Oldest First Newest First	Specify the order in which held and confidential jobs are printed when Print All is selected.  <b>Note:</b> Alphabetical is the factory default setting. Print jobs always appear in alphabetical order on the printer control panel.

## Finishing menu

Use	To
<b>Sides (Duplex)</b> 1 sided 2 sided	Specify whether two-sided printing is set as the default for all print jobs.  <b>Notes:</b> <ul style="list-style-type: none"> <li>• 1 sided is the factory default setting.</li> <li>• You can set two-sided printing from the printer software.</li> </ul>
<b>Duplex Binding</b> Long Edge Short Edge	Define binding for two-sided pages in relation to page orientation.  <b>Note:</b> Long Edge is the factory default setting.
<b>Copies</b> 1–999	Specify a default number of copies for each print job.  <b>Note:</b> 1 is the factory default setting.
<b>Blank Pages</b> Do Not Print Print	Specify whether to insert blank pages in a print job.  <b>Note:</b> Do Not Print is the factory default setting.
<b>Collate</b> (1,1,1) (2,2,2) (1,2,3) (1,2,3)	Stack the pages of a print job in sequence when printing multiple copies.  <b>Note:</b> (1,2,3) (1,2,3) is the factory default setting.
<b>Separator Sheets</b> Off Between Copies Between Jobs Between Pages	Specify whether to insert blank separator sheets.  <b>Notes:</b> <ul style="list-style-type: none"> <li>• Off is the factory default setting.</li> <li>• Between Copies inserts a blank sheet between each copy of a print job if Collate is set to (1,2,3) (1,2,3). If Collate is set to (1,1,1) (2,2,2), then a blank page is inserted between each set of printed pages, such as after all page 1's and after all page 2's.</li> <li>• Between Jobs inserts a blank sheet between print jobs.</li> <li>• Between Pages inserts a blank sheet between each page of a print job. This setting is useful when printing transparencies or when inserting blank pages in a document.</li> </ul>
<b>Separator Source</b> Tray [x] Multipurpose Feeder	Specify the paper source for separator sheets.  <b>Notes:</b> <ul style="list-style-type: none"> <li>• Tray 1 (standard tray) is the factory default setting.</li> <li>• From the Paper menu, set Configure MP to “Cassette” for Multipurpose Feeder to appear as a menu setting.</li> </ul>

Use	To
<b>Paper Saver</b> Off 2-Up 3-Up 4-Up 6-Up 9-Up 12-Up 16-Up	Print multiple-page images on one side of a paper. <b>Notes:</b> <ul style="list-style-type: none"> <li>• Off is the factory default setting.</li> <li>• The number selected is the number of page images that are printed per side.</li> </ul>
<b>Paper Saver Ordering</b> Horizontal Reverse Horizontal Reverse Vertical Vertical	Specify the positioning of multiple-page images. <b>Notes:</b> <ul style="list-style-type: none"> <li>• Horizontal is the factory default setting.</li> <li>• Positioning depends on the number of pages and whether they are in portrait or landscape orientation.</li> </ul>
<b>Paper Saver Orientation</b> Auto Landscape Portrait	Specify the orientation of a multiple-page document. <b>Note:</b> Auto is the factory default setting.
<b>Paper Saver Border</b> None Solid	Print a border on each page image. <b>Note:</b> None is the factory default setting.

## Quality menu

Use	To
<b>Print Resolution</b> 300 dpi 600 dpi 1200 dpi 1200 Image Q 2400 Image Q	Specify the printed output resolution in dots per inch. <b>Note:</b> 600 dpi is the factory default setting.
<b>Pixel Boost</b> Off Fonts Horizontally Vertically Both directions	Enable more pixels to print in clusters for clarity, in order to enhance images horizontally or vertically, or to enhance fonts. <b>Note:</b> Off is the factory default setting.
<b>Toner Darkness</b> 1–10	Lighten or darken the printed output. <b>Notes:</b> <ul style="list-style-type: none"> <li>• 8 is the factory default setting.</li> <li>• Selecting a smaller number can help conserve toner.</li> </ul>

Use	To
<b>Enhance Fine Lines</b> On Off	Enable a print mode preferable for files such as architectural drawings, maps, electrical circuit diagrams, and flow charts. <b>Notes:</b> <ul style="list-style-type: none"> <li>• Off is the factory default setting.</li> <li>• To set this option using the Embedded Web Server, type the network printer IP address in the Web browser address field.</li> </ul>
<b>Gray Correction</b> Auto Off	Automatically adjust the contrast enhancement applied to images. <b>Note:</b> Auto is the factory default setting.
<b>Brightness</b> -6 to 6	Adjust the printed output either by lightening or darkening it. You can conserve toner by lightening the output. <b>Note:</b> 0 is the factory default setting.
<b>Contrast</b> 0–5	Adjust the contrast of printed objects. <b>Note:</b> 0 is the factory default setting.

## Job Accounting menu

**Note:** This menu item appears only when a printer hard disk is installed. Make sure that the hard disk is not read/write- or write-protected.

Use	To
<b>Job Accounting Log</b> Off On	Set if the printer creates a log of the print jobs it receives. <b>Note:</b> Off is the factory default setting.
<b>Job Accounting Utilities</b>	Print and delete log files or export them to a flash drive.
<b>Accounting Log Frequency</b> Daily Weekly Monthly	Set how often a log file is created. <b>Note:</b> Monthly is the factory default setting.
<b>Log Action at End of Frequency</b> None E-mail Current Log E-mail & Delete Current Log Post Current Log Post & Delete Current Log	Set how the printer responds when the frequency threshold expires. <b>Note:</b> None is the factory default setting.
<b>Log Near Full Level</b> Off 1–99	Specify the maximum size of the log file before the printer executes the Log Action at Near Full. <b>Note:</b> 5 is the factory default setting.

Use	To
<p><b>Log Action at Near Full</b></p> <ul style="list-style-type: none"> <li>None</li> <li>E-mail Current Log</li> <li>E-mail &amp; Delete Current Log</li> <li>E-mail &amp; Delete Oldest Log</li> <li>Post Current Log</li> <li>Post &amp; Delete Current Log</li> <li>Post &amp; Delete Oldest Log</li> <li>Delete Current Log</li> <li>Delete Oldest Log</li> <li>Delete All Logs</li> <li>Delete All But Current</li> </ul>	<p>Set how the printer responds when the hard disk is nearly full.</p> <p><b>Notes:</b></p> <ul style="list-style-type: none"> <li>• None is the factory default setting.</li> <li>• The value defined in Log Near Full Level determines when this action is triggered.</li> </ul>
<p><b>Log Action at Full</b></p> <ul style="list-style-type: none"> <li>None</li> <li>E-mail &amp; Delete Current Log</li> <li>E-mail &amp; Delete Oldest Log</li> <li>Post &amp; Delete Current Log</li> <li>Post &amp; Delete Oldest Log</li> <li>Delete Current Log</li> <li>Delete Oldest Log</li> <li>Delete All Logs</li> <li>Delete All But Current</li> </ul>	<p>Set how the printer responds when disk usage reaches the maximum limit (100MB).</p> <p><b>Note:</b> None is the factory default setting.</p>
<p><b>URL to Post Logs</b></p>	<p>Set where the printer posts job accounting logs.</p>
<p><b>E-mail to Send Logs</b></p>	<p>Specify the e-mail address to which the device sends job accounting logs.</p>
<p><b>Log File Prefix</b></p>	<p>Specify the prefix you want for the log file name.</p> <p><b>Note:</b> The current host name defined in the TCP/IP menu is used as the default log file prefix.</p>

**Utilities menu**

Use	To
<p><b>Remove Held Jobs</b></p> <ul style="list-style-type: none"> <li>Confidential</li> <li>Held</li> <li>Not Restored</li> <li>All</li> </ul>	<p>Delete confidential and held jobs from the printer hard disk.</p> <p><b>Notes:</b></p> <ul style="list-style-type: none"> <li>• Selecting a setting affects only print jobs that are resident in the printer. Bookmarks, print jobs on flash drives, and other types of held jobs are not affected.</li> <li>• Not Restored removes all Print and Hold jobs that are <i>not</i> restored from the printer hard disk or memory.</li> </ul>



Use	To
<b>Format Flash</b> Yes No	Format the flash memory. <b>Warning—Potential Damage:</b> Do not turn off the printer while the flash memory is being formatted. <b>Notes:</b> <ul style="list-style-type: none"> <li>• Yes deletes all data stored in flash memory.</li> <li>• No cancels the format request.</li> <li>• Flash memory refers to the memory added by installing a flash memory card in the printer.</li> <li>• The flash memory option card must not be read/write- or write-protected.</li> <li>• This menu item appears only when a non-defective flash memory card is installed.</li> </ul>
<b>Delete Downloads on Disk</b> Delete Now Do Not Delete	Delete downloads from the printer hard disk, including all held jobs, buffered jobs, and parked jobs. <b>Notes:</b> <ul style="list-style-type: none"> <li>• Delete Now sets the printer to delete the downloads and allows the display to return to the originating screen after the deletion.</li> <li>• Do Not Delete sets the printer display to return to the main Utilities menu for touch-screen printer models. When selected in non-touch-screen printer models, Do Not Delete sets the printer to return to the originating screen after the deletion.</li> </ul>
<b>Activate Hex Trace</b>	Assist in isolating the source of a print job problem. <b>Notes:</b> <ul style="list-style-type: none"> <li>• When activated, all data sent to the printer is printed in hexadecimal and character representation, and control codes are not executed.</li> <li>• To exit or deactivate Hex Trace, turn off or reset the printer.</li> </ul>
<b>Coverage Estimator</b> Off On	Provide an estimate of the percentage coverage of toner on a page. The estimate is printed on a separate page at the end of each print job. <b>Note:</b> Off is the factory default setting.

**XPS menu**

Use	To
<b>Print Error Pages</b> Off On	Print a page containing information on errors, including XML markup errors. <b>Note:</b> Off is the factory default setting.

**PDF menu**

Use	To
<b>Scale to Fit</b> Yes No	Scale page content to fit the selected paper size. <b>Note:</b> No is the factory default setting.

Use	To
<b>Annotations</b> Do Not Print Print	Print annotations in a PDF. <b>Note:</b> Do Not Print is the factory default setting.

### PostScript menu

Use	To
<b>Print PS Error</b> On Off	Print a page containing the PostScript error. <b>Note:</b> Off is the factory default setting.
<b>Lock PS Startup Mode</b> On Off	Disable the SysStart file. <b>Note:</b> Off is the factory default setting.
<b>Font Priority</b> Resident Flash/Disk	Establish the font search order. <b>Notes:</b> <ul style="list-style-type: none"> <li>• Resident is the factory default setting.</li> <li>• This menu item is available only when a formatted flash memory option card or printer hard disk is installed and operating properly.</li> <li>• Make sure the flash memory option or printer hard disk is not read/write-, write-, or password-protected.</li> <li>• Job Buffer Size must not be set to 100%.</li> </ul>

### PCL Emul menu

Use	To
<b>Font Source</b> Resident Disk Download Flash All	Specify the set of fonts used in the Font Name menu. <b>Notes:</b> <ul style="list-style-type: none"> <li>• Resident is the factory default setting. It shows the factory default set of fonts downloaded in the RAM.</li> <li>• Flash and Disk settings show all fonts resident in that option. Make sure the flash option is properly formatted and is not read/write-, or password-protected.</li> <li>• Download shows all the fonts downloaded in the RAM.</li> <li>• All shows all fonts available to any option.</li> </ul>
<b>Font Name</b> Courier 10	Identify a specific font and where it is stored. <b>Note:</b> Courier 10 is the factory default setting.

Use	To
<b>Symbol Set</b> 10U PC-8 12U PC-850	Specify the symbol set for each font name.  <b>Notes:</b> <ul style="list-style-type: none"> <li>• 10U PC-8 is the US factory default setting. 12U PC-850 is the international factory default setting.</li> <li>• A symbol set is a set of alphabetical and numeric characters, punctuation, and special symbols. Symbol sets support the different languages or specific programs such as math symbols for scientific text. Only the supported symbol sets are shown.</li> </ul>
<b>PCL Emulation Settings</b> Point Size 1.00–1008.00	Change the point size for scalable typographic fonts.  <b>Notes:</b> <ul style="list-style-type: none"> <li>• 12 is the factory default setting.</li> <li>• Point size refers to the height of the characters in the font. One point equals approximately 0.014 of an inch. This can be increased or decreased in 0.25-point increments.</li> </ul>
<b>PCL Emulation Settings</b> Pitch 0.08–100.00	Specify the font pitch for scalable monospaced fonts.  <b>Notes:</b> <ul style="list-style-type: none"> <li>• 10 is the factory default setting.</li> <li>• Pitch refers to the number of fixed-space characters per inch (cpi). This can be increased or decreased in 0.01-cpi increments.</li> <li>• For non-scalable monospaced fonts, the pitch appears on the display but cannot be changed.</li> </ul>
<b>PCL Emulation Settings</b> Orientation Portrait Landscape	Specify the orientation of text and graphics on a page.  <b>Notes:</b> <ul style="list-style-type: none"> <li>• Portrait is the factory default setting. It prints text and graphics parallel to the short edge of the page.</li> <li>• Landscape prints text and graphics parallel to the long edge of the page.</li> </ul>
<b>PCL Emulation Settings</b> Lines per Page 1–255	Specify the number of lines that print on each page.  <b>Notes:</b> <ul style="list-style-type: none"> <li>• 60 is the US factory default setting. 64 is the international default setting.</li> <li>• The printer sets the amount of space between each line based on the Lines per Page, Paper Size, and Orientation settings. Select the paper size and orientation before setting Lines per Page.</li> </ul>
<b>PCL Emulation Settings</b> A4 Width 198 mm 203 mm	Set the printer to print on A4-size paper.  <b>Notes:</b> <ul style="list-style-type: none"> <li>• 198 mm is the factory default setting.</li> <li>• The 203-mm setting sets the width of the page to allow the printing of eighty 10-pitch characters.</li> </ul>

Use	To
<p><b>PCL Emulation Settings</b>                      Auto CR after LF                          On                          Off</p>	<p>Specify whether the printer automatically performs a carriage return (CR) after a line feed (LF) control command.  <b>Note:</b> Off is the factory default setting.</p>
<p><b>PCL Emulation Settings</b>                      Auto LF after CR                          On                          Off</p>	<p>Specify whether the printer automatically performs a line feed (LF) after a carriage return (CR) control command.  <b>Note:</b> Off is the factory default setting.</p>
<p><b>Tray Renumber</b>                      Assign MP Feeder                          Off                          None                          0–199                      Assign Tray [x]                          Off                          None                          0–199                      Assign Manual Paper                          Off                          None                          0–199                      Assign Manual Envelope                          Off                          None                          0–199</p>	<p>Configure the printer to work with printer software or programs that use different source assignments for trays, drawers, and feeders.  <b>Notes:</b></p> <ul style="list-style-type: none"> <li>• Off is the factory default setting.</li> <li>• None ignores the Select Paper Feed command. This selection appears only when it is selected by the PCL 5e interpreter.</li> <li>• 0–199 allows a custom setting to be assigned.</li> </ul>
<p><b>Tray Renumber</b>                      View Factory Defaults                          MPF Default = 8                          T1 Default = 1                          T2 Default = 4                          T3 Default = 5                          T4 Default = 20                          T5 Default = 21                          Env Default = 6                          MPaper Default = 2                          MEnv Default = 3</p>	<p>Display the factory default setting assigned to each tray, drawer, or feeder.</p>
<p><b>Tray Renumber</b>                      Restore Defaults                          Yes                          No</p>	<p>Return all tray, drawer, and feeder assignments to the factory default settings.</p>

### HTML menu

Use		To
<b>Font Name</b> Albertus MT Antique Olive Apple Chancery Arial MT Avant Garde Bodoni Bookman Chicago Clarendon Cooper Black Copperplate Coronet Courier Eurostile Garamond Geneva Gill Sans Goudy Helvetica Hoefler Text Intl CG Times Intl Courier Intl Univers	Joanna MT Letter Gothic Lubalin Graph Marigold MonaLisa Recut Monaco New CenturySbk New York Optima Oxford Palatino StempelGaramond Taffy Times TimesNewRoman Univers Zapf Chancery NewSansMTCS NewSansMTCT New SansMTJA NewSansMTKO	Set the default font for HTML documents.  <b>Note:</b> The Times font is used in HTML documents that do not specify a font.

Use	To
<b>Font Size</b> 1–255 pt	Set the default font size for HTML documents.  <b>Notes:</b> <ul style="list-style-type: none"> <li>• 12 pt is the factory default setting.</li> <li>• Font size can be increased in 1-point increments.</li> </ul>
<b>Scale</b> 1–400%	Scale the default font for HTML documents.  <b>Notes:</b> <ul style="list-style-type: none"> <li>• 100% is the factory default setting.</li> <li>• Scaling can be increased in 1% increments.</li> </ul>
<b>Orientation</b> Portrait Landscape	Set the page orientation for HTML documents.  <b>Note:</b> Portrait is the factory default setting.
<b>Margin Size</b> 8–255 mm	Set the page margin for HTML documents.  <b>Notes:</b> <ul style="list-style-type: none"> <li>• 19 mm is the factory default setting.</li> <li>• Margin size can be increased in 1-mm increments.</li> </ul>

Use	To
<b>Backgrounds</b> Do Not Print Print	Specify whether to print backgrounds on HTML documents. <b>Note:</b> Print is the factory default setting.

## Image menu

Use	To
<b>Auto Fit</b> On Off	Select the optimal paper size, scaling, and orientation. <b>Note:</b> On is the factory default setting. It overrides scaling and orientation settings for some images.
<b>Invert</b> On Off	Invert bitonal monochrome images. <b>Notes:</b> <ul style="list-style-type: none"> <li>Off is the factory default setting.</li> <li>This setting does not apply to GIF or JPEG images.</li> </ul>
<b>Scaling</b> Anchor Top Left Best Fit Anchor Center Fit Height/Width Fit Height Fit Width	Scale the image to fit the selected paper size. <b>Notes:</b> <ul style="list-style-type: none"> <li>Best Fit is the factory default setting.</li> <li>When Auto Fit is set to On, Scaling is automatically set to Best Fit.</li> </ul>
<b>Orientation</b> Portrait Landscape Reverse Portrait Reverse Landscape	Set the image orientation. <b>Note:</b> Portrait is the factory default setting.

## Help menu

Menu item	Description
Print All Guides	Prints all the guides
Copy Guide	Provides information about making copies and configuring the settings
E-mail Guide	Provides information about sending e-mails and configuring the settings
Fax Guide	Provides information about sending faxes and configuring the settings
FTP Guide	Provides information about scanning documents and configuring the settings
Print Defects Guide	Provides a template for determining the cause of repeating print quality defects, and lists settings that can be used to adjust print quality
Information Guide	Provides help in locating additional information
Supplies Guide	Provides information about ordering supplies

# Saving money and the environment

Lexmark is committed to environmental sustainability and is continually improving its printers to reduce their impact on the environment. We design with the environment in mind, engineer our packaging to reduce materials, and provide collection and recycling programs. For more information, see:

- The Notices chapter
- The Environmental Sustainability section of the Lexmark Web site at [www.lexmark.com/environment](http://www.lexmark.com/environment)
- The Lexmark recycling program at [www.lexmark.com/recycle](http://www.lexmark.com/recycle)

By selecting certain printer settings or tasks, you may be able to reduce your printer's impact even further. This chapter outlines the settings and tasks that may yield a greater environmental benefit.

## Saving paper and toner

Studies show that as much as 80% of the carbon footprint of a printer is related to paper usage. You can significantly reduce your carbon footprint by using recycled paper and the following printing suggestions, such as printing on both sides of the paper and printing multiple pages on one side of a single sheet of paper.

For information on how you can quickly save paper and energy using one printer setting, see [“Using Eco-Mode” on page 199](#).

### Using recycled paper

As an environmentally conscious company, Lexmark supports the use of recycled office paper produced specifically for use in laser/LED printers. For more information on recycled papers that work well with your printer, see [“Using recycled paper and other office papers” on page 68](#).

### Conserving supplies

- Print on both sides of the paper.  
**Note:** Two-sided printing is the default setting in the print driver.
- Print multiple pages on a single sheet of paper.
- Use the preview feature to see how the document looks like before printing it.
- Print one copy of the document to check its content and format for accuracy.

## Saving energy

### Using Eco-Mode

- 1 Open a Web browser, and then type the printer IP address in the address field.

**Notes:**

- View the printer IP address on the printer home screen. The IP address appears as four sets of numbers separated by periods, such as 123.123.123.123.

- If you are using a proxy server, then temporarily disable it to load the Web page correctly.

**2** Click **Settings > General Settings > Eco-Mode >** select a setting

Use	To
Off	Use the factory default settings for all settings associated with Eco-Mode. Off supports the performance specifications of the printer.
Energy	Reduce energy use, especially when the printer is idle. <ul style="list-style-type: none"> <li>• Printer engine motors do not start until it is ready to print. You may notice a short delay before the first page is printed.</li> <li>• The printer enters Sleep mode after one minute of inactivity.</li> </ul>
Energy/Paper	Use all the settings associated with Energy and Paper modes.
Plain Paper	<ul style="list-style-type: none"> <li>• Enable the automatic two-sided (duplex) feature.</li> <li>• Turn off print log features.</li> </ul>

**3** Click **Submit**.

## Reducing printer noise

Enable Quiet Mode to reduce printer noise.

**1** Open a Web browser, and then type the printer IP address in the address field.

**Notes:**

- View the printer IP address on the printer home screen. The IP address appears as four sets of numbers separated by periods, such as 123.123.123.123.
- If you are using a proxy server, then temporarily disable it to load the Web page correctly.

**2** Click **Settings > General Settings > Quiet Mode >** select a setting

Use	To
On	Reduce printer noise. <p><b>Notes:</b></p> <ul style="list-style-type: none"> <li>• Print jobs are processed at a reduced speed.</li> <li>• Printer engine motors do not start until a document is ready to print. There will be a short delay before the first page is printed.</li> </ul>
Off	Use factory default settings. <p><b>Note:</b> This setting supports the performance specifications of the printer.</p>

**3** Click **Submit**.



## Adjusting Sleep mode

1 From the home screen, navigate to:



> **Settings** > **General Settings** > **Timeouts** > **Sleep Mode**

2 In the Sleep Mode field, select the number of minutes the printer is idle before it enters Sleep mode.

3 Apply the changes.

## Using Hibernate mode

Hibernate is an ultra-low-power saving mode.

### Notes:

- Three days is the default amount of time before the printer enters Hibernate mode.
- Make sure to wake the printer from Hibernate mode before sending a print job. A hard reset or a long press of the Sleep button wakes the printer from Hibernate mode.
- If the printer is in Hibernate mode, then the Embedded Web Server is disabled.

1 From the home screen, navigate to:



> **Settings** > **General Settings**

2 Touch **Press Sleep Button** or **Press and Hold Sleep Button**.

3 Touch **Hibernate** > .

## Adjusting the brightness of the printer display

To save energy, or if you have trouble reading the display, adjust its brightness settings.

### Using the Embedded Web Server

1 Open a Web browser, and then type the printer IP address in the address field.

#### Notes:

- View the printer IP address in the TCP/IP section in the Network/Ports menu. The IP address appears as four sets of numbers separated by periods, such as 123.123.123.123.
- If you are using a proxy server, then temporarily disable it to load the Web page correctly.

2 Click **Settings** > **General Settings**.

3 In the Screen Brightness field, enter the brightness percentage you want for the display.

4 Click **Submit**.

## Recycling

Lexmark provides collection programs and environmentally progressive approaches to recycling. For more information, see:

- The Notices chapter
- The Environmental Sustainability section of the Lexmark Web site at [www.lexmark.com/environment](http://www.lexmark.com/environment)
- The Lexmark recycling program at [www.lexmark.com/recycle](http://www.lexmark.com/recycle)

### Recycling Lexmark products

To return Lexmark products for recycling:

- 1 Go to [www.lexmark.com/recycle](http://www.lexmark.com/recycle).
- 2 Find the product type you want to recycle, and then select your country or region from the list.
- 3 Follow the instructions on the computer screen.

**Note:** Printer supplies and hardware not listed in the Lexmark collection program may be recycled through your local recycling center. Contact your local recycling center to determine the items they accept.

### Recycling Lexmark packaging

Lexmark continually strives to minimize packaging. Less packaging helps to ensure that Lexmark printers are transported in the most efficient and environmentally sensitive manner and that there is less packaging to dispose of. These efficiencies result in fewer greenhouse emissions, energy savings, and natural resource savings.

Lexmark cartons are 100% recyclable where corrugated recycling facilities exist. Facilities may not exist in your area.

The foam used in Lexmark packaging is recyclable where foam recycling facilities exist. Facilities may not exist in your area.

When you return a cartridge to Lexmark, you can reuse the box that the cartridge came in. Lexmark will recycle the box.

### Returning Lexmark cartridges for reuse or recycling

The Lexmark Cartridge Collection Program allows you to return used cartridges for free to Lexmark for reuse or recycling. One hundred percent of the empty cartridges returned to Lexmark are either reused or demanufactured for recycling. The boxes used to return the cartridges are also recycled.

To return Lexmark cartridges for reuse or recycling, do the following:

- 1 Go to [www.lexmark.com/recycle](http://www.lexmark.com/recycle).
- 2 Select the product that you want to recycle.

# Securing the printer

## Statement of Volatility

Your printer contains various types of memory that can store device and network settings, and user data.

Types of memory	Description
Volatile memory	Your printer uses standard <i>Random Access Memory</i> (RAM) to temporarily buffer user data during simple print and copy jobs.
Non-volatile memory	Your printer may use two forms of non-volatile memory: EEPROM and NAND (flash memory). Both types are used to store the operating system, device settings, network information, scanner and bookmark settings, and embedded solutions.
Hard disk memory	Some printers have a hard disk drive installed. The printer hard disk is designed for device-specific functionality. This lets the device retain buffered user data from complex scan, print, copy, and fax jobs, as well as form data, and font data.

Erase the content of any installed printer memory in the following circumstances:

- The printer is being decommissioned.
- The printer hard disk is being replaced.
- The printer is being moved to a different department or location.
- The printer is being serviced by someone from outside your organization.
- The printer is being removed from your premises for service.
- The printer is being sold to another organization.

### Disposing of a printer hard disk

**Note:** Some printer models may not have a printer hard disk installed.

In high-security environments, it may be necessary to take additional steps to make sure that confidential data stored in the printer hard disk cannot be accessed when the printer—or its hard disk—is removed from your premises.

- **Degaussing**—Flushes the hard disk with a magnetic field that erases stored data
- **Crushing**—Physically compresses the hard disk to break component parts and render them unreadable
- **Milling**—Physically shreds the hard disk into small metal bits

**Note:** Most data can be erased electronically, but the only way to guarantee that all data is completely erased is to physically destroy each hard disk where data is stored.

## Erasing volatile memory

The volatile memory (RAM) installed in your printer requires a power source to retain information. To erase the buffered data, simply turn off the printer.

## Erasing non-volatile memory

- **Individual settings, device and network settings, security settings, and embedded solutions**—Erase information and settings by selecting **Wipe All Settings** in the Configuration menu.
- **Fax data**—Erase fax settings and data by selecting **Wipe All Settings** in the Configuration menu.

**1** Turn off the printer.

**2** Hold down **2** and **6** while turning the printer on. Release the buttons only when the screen with the progress bar appears.

The printer performs a power-on sequence, and then the Configuration menu appears. When the printer is fully powered up, the touch screen displays a list of functions, instead of the standard home screen icons.

**3** Touch **Wipe All Settings**.

The printer will restart several times during this process.

**Note:** Wipe All Settings securely removes device settings, solutions, jobs, faxes, and passwords from the printer memory.

**4** Touch **Back > Exit Config Menu**.

The printer will perform a power-on reset, and then return to normal operating mode.

## Erasing printer hard disk memory

### Notes:

- Some printer models may not have a printer hard disk installed.
- Configuring Erase Temporary Data Files in the printer menus lets you remove residual confidential material left by print jobs by securely overwriting files that have been marked for deletion.

### Using the printer control panel

**1** Turn off the printer.

**2** Hold down **2** and **6** while turning the printer on. Release the buttons only when the screen with the progress bar appears.

The printer performs a power-on sequence, and then the Configuration menu appears. When the printer is fully turned on, the touch screen displays a list of functions.

**3** Touch **Wipe Disk**, and then touch one of the following:

- **Wipe disk (fast)**—This lets you overwrite the disk with all zeroes in a single pass.
- **Wipe disk (secure)**—This lets you overwrite the disk with random bit patterns several times, followed by a verification pass. A secure overwrite is compliant with the DoD 5220.22-M standard for securely erasing data from a hard disk. Highly confidential information should be wiped using this method.

**4** Touch **Yes** to proceed with disk wiping.

### Notes:

- A status bar will indicate the progress of the disk wiping task.

- Disk wiping can take from several minutes to more than an hour, during which the printer will be unavailable for other user tasks.

**5** Touch **Back** > **Exit Config Menu**.

The printer will perform a power-on reset, and then return to normal operating mode.

## Configuring printer hard disk encryption

Enable hard disk encryption to prevent loss of sensitive data in the event the printer or its hard disk is stolen.

**Note:** Some printer models may not have a printer hard disk installed.

### Using the Embedded Web Server

- 1 Open a Web browser, and then type the printer IP address in the address field.

**Notes:**

- View the printer IP address on the printer home screen. The IP address appears as four sets of numbers separated by periods, such as 123.123.123.123.
- If you are using a proxy server, then temporarily disable it to load the Web page correctly.

- 2 Click **Settings** > **Security** > **Disk Encryption**.

**Note:** Disk Encryption appears in the Security Menu only when a formatted, non-defective printer hard disk is installed.

- 3 From the Disk encryption menu, select **Enable**.

**Notes:**

- Enabling disk encryption will erase the contents of the printer hard disk.
- Disk encryption can take from several minutes to more than an hour, during which the printer will be unavailable for other user tasks.

- 4 Click **Submit**.

### Using the printer control panel

- 1 Turn off the printer.
- 2 Hold down **2** and **6** while turning the printer on. Release the buttons only when the screen with the progress bar appears.

The printer performs a power-on sequence, and then the Configuration menu appears. When the printer is fully turned on, a list of functions appears on the printer display.

- 3 Touch **Disk Encryption** > **Enable**.

**Note:** Enabling disk encryption will erase the contents of the printer hard disk.

- 4 Touch **Yes** to proceed with disk wiping.

**Notes:**

- Do not turn off the printer during the encryption process. Doing so may result in loss of data.
- Disk encryption can take from several minutes to more than an hour, during which the printer will be unavailable for other user tasks.

- A status bar will indicate the progress of the disk wiping task. After the disk has been encrypted, the printer will return to the Enable/Disable screen.

**5** Touch **Back** > **Exit Config Menu**.

The printer will perform a power-on reset, and then return to normal operating mode.

## Finding printer security information

In high-security environments, it may be necessary to take additional steps to make sure that confidential data stored in the printer cannot be accessed by unauthorized persons. For more information, visit the [Lexmark security Web page](#).

You can also see the *Embedded Web Server — Security: Administrator's Guide* for additional information:

- 1** Go to [www.lexmark.com](http://www.lexmark.com), and then navigate to **Support & Downloads** > select your printer.
- 2** Click the **Manuals** tab, and then select *Embedded Web Server — Security: Administrator's Guide*.

# Maintaining the printer

**Warning—Potential Damage:** Failure to maintain optimum printer performance, or to replace parts and supplies, may cause damage to your printer.

## Cleaning printer parts

### Cleaning the printer

 **CAUTION—SHOCK HAZARD:** To avoid the risk of electrical shock when cleaning the exterior of the printer, unplug the power cord from the electrical outlet and disconnect all cables from the printer before proceeding.

**Notes:**

- Perform this task after every few months.
- Damage to the printer caused by improper handling is not covered by the printer warranty.

- 1** Turn off the printer, and then unplug the power cord from the electrical outlet.
- 2** Remove paper from the standard bin and multipurpose feeder.
- 3** Remove any dust, lint, and pieces of paper around the printer using a soft brush or vacuum.
- 4** Wipe the outside of the printer with a damp, soft, lint-free cloth.

**Notes:**

- Do not use household cleaners or detergents, as they may damage the finish of the printer.
- Make sure that all areas of the printer are dry after cleaning.

- 5** Connect the power cord to the electrical outlet, and then turn on the printer.

 **CAUTION—POTENTIAL INJURY:** To avoid the risk of fire or electrical shock, connect the power cord to an appropriately rated and properly grounded electrical outlet that is near the product and easily accessible.

## Cleaning the scanner glass

Clean the scanner glass if you encounter print quality problems, such as streaks on copied or scanned images.

- 1 Slightly dampen a soft, lint-free cloth or paper towel with water.
- 2 Open the scanner cover.



- 3 Clean all the areas shown, and then let them dry.



1	White underside of the scanner cover
2	Scanner glass
3	ADF glass
4	White underside of the ADF cover

- 4 Close the scanner cover.



## Checking the status of parts and supplies

### Checking the status of parts and supplies on the printer control panel

From the home screen, touch **Status/Supplies** > **View Supplies**.

### Checking the status of parts and supplies from the Embedded Web Server

**Note:** Make sure the computer and the printer are connected to the same network.

**1** Open a Web browser, and then type the printer IP address in the address field.

**Notes:**

- View the printer IP address on the home screen. The IP address appears as four sets of numbers separated by periods, such as 123.123.123.123.
- If you are using a proxy server, then temporarily disable it to load the Web page correctly.

**2** Click **Device Status** > **More Details**.

## Estimated number of remaining pages

The estimated number of remaining pages is based on the recent printing history of the printer. Its accuracy may vary significantly and is dependent on many factors, such as actual document content, print quality settings, and other printer settings.

The accuracy of the estimated number of remaining pages may decrease when the actual printing consumption is different from the historical printing consumption. Consider the variable level of accuracy before purchasing or replacing supplies based on the estimate. Until an adequate print history is obtained on the printer, initial estimates assume future supplies consumption based on the International Organization for Standardization\* test methods and page content.

\* Average continuous black declared cartridge yield in accordance with ISO/IEC 19752.

## Ordering supplies

To order supplies in the U.S., contact Lexmark at 1-800-539-6275 for information about Lexmark authorized supplies dealers in your area. In other countries or regions, go to [www.lexmark.com](http://www.lexmark.com) or contact the place where you purchased the printer.

**Note:** All life estimates for printer supplies assume printing on letter- or A4-size plain paper.

## Using genuine Lexmark parts and supplies

Your Lexmark printer is designed to function best with genuine Lexmark supplies and parts. Use of third-party supplies or parts may affect the performance, reliability, or life of the printer and its imaging components. Use of third-party supplies or parts can affect warranty coverage. Damage caused by the use of third-party supplies or parts is not covered by the warranty. All life indicators are designed to function with Lexmark supplies and parts, and may deliver unpredictable results if third-party supplies or parts are used. Imaging component usage beyond the intended life may damage your Lexmark printer or its associated components.

## Ordering toner cartridges

### Notes:

- Estimated cartridge yield is based on the ISO/IEC 19752 standard.
- Extremely low print coverage for extended periods of time may negatively affect actual yield.

### MX410, MX510, and MX511 Return program cartridges

Item	United States and Canada	European Economic Area (EEA+)	Rest of Europe, Middle East, and Africa (RoEMEA)	Latin America Distribution (LAD)	Rest of Asia Pacific (RoAP)	Australia and New Zealand (ANZ)
Toner cartridge	60F1000	60F2000	60F5000	60F4000	60F3000	60F3000
High yield toner cartridge	60F1H00	60F2H00	60F5H00	60F4H00	60F3H00	60F3H00
Extra high yield toner cartridge*	60F1X00	60F2X00	60F5X00	60F4X00	60F3X00	60F3X00

\* This supply item is supported only in MX510 and MX511 printer models.

For more information on countries located in each region, go to [www.lexmark.com/regions](http://www.lexmark.com/regions).

### MX410, MX510, and MX511 Regular cartridges

Item	Worldwide
High yield toner cartridge	60F0HA0 <sup>1</sup>
Extra high yield toner cartridge	60F0XA0 <sup>2</sup>

<sup>1</sup> This supply item is supported only in MX410 printer model.

<sup>2</sup> This supply item is supported only in MX510 and MX511 printer models.

For more information on countries located in each region, go to [www.lexmark.com/regions](http://www.lexmark.com/regions).

### MX417 and MX517 Return program cartridges

Item	United States and Canada	European Economic Area (EEA+)	Rest of Europe, Middle East, and Africa (RoEMEA)	Latin America Distribution (LAD)	Rest of Asia Pacific (RoAP)	Australia and New Zealand (ANZ)
Toner cartridge	51B1000	51B2000	51B5000	51B4000	51B3000	51B6000
High yield toner cartridge	51B1H00	51B2H00	51B5H00	51B4H00	51B3H00	51B6H00

\* This supply item is supported only in MX517 printer model.

For more information on countries located in each region, go to [www.lexmark.com/regions](http://www.lexmark.com/regions).

Item	United States and Canada	European Economic Area (EEA+)	Rest of Europe, Middle East, and Africa (RoEMEA)	Latin America Distribution (LAD)	Rest of Asia Pacific (RoAP)	Australia and New Zealand (ANZ)
Extra high yield toner cartridge*	51B1X00	51B2X00	51B5X00	51B4X00	51B3X00	51B6X00
* This supply item is supported only in MX517 printer model. For more information on countries located in each region, go to <a href="http://www.lexmark.com/regions">www.lexmark.com/regions</a> .						

### MX417 and MX517 Regular cartridges

Item	Worldwide
High yield toner cartridge	51B0HA0 <sup>1</sup>
Extra high yield toner cartridge	51B0XA0 <sup>2</sup>
<sup>1</sup> This supply item is supported only in MX417 printer model. <sup>2</sup> This supply item is supported only in MX517 printer model. For more information on countries located in each region, go to <a href="http://www.lexmark.com/regions">www.lexmark.com/regions</a> .	

### Ordering an imaging unit

Extremely low print coverage for extended periods of time may cause imaging unit parts to fail prior to exhaustion of toner from toner cartridge.

For more information on replacing the imaging unit, see the instruction sheet that came with the supply.

Part name	Lexmark Return Program	Regular
Imaging unit	500Z	500ZA

### Ordering a maintenance kit

**Notes:**

- Using certain types of paper may require more frequent replacement of the maintenance kit.
- The separator roller, fuser, pick rollers, transfer roller, and redrive assembly are all included in the maintenance kit and can be individually ordered and replaced if necessary.
- Contact your service representative to replace the maintenance kit.

Maintenance kit	Part number
100-V maintenance kit*	40X9146
110-V maintenance kit	40X9135
220-V maintenance kit	40X9136
* This is available only in Japan.	

## Ordering an ADF separator roller

Order an ADF separator roller when the ADF fails to pick paper or picks more than one sheet of paper at a time. For information on replacing the ADF separator roller, see the instruction sheet that came with the part.

Part name	Part number
Separator roller	40X9108

## Storing supplies

Choose a cool, clean storage area for the printer supplies. Store supplies right side up in their original packing until you are ready to use them.

Do not expose supplies to:

- Direct sunlight
- Temperatures above 35°C (95°F)
- High humidity above 80%
- Salty air
- Corrosive gases
- Heavy dust

## Replacing supplies

### Replacing the toner cartridge

- 1 Press the button on the right side of the printer, and then open the front door.

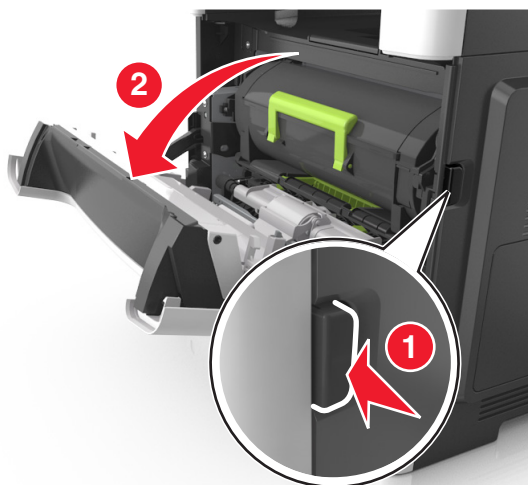

- 2 Pull the toner cartridge out using the handle.

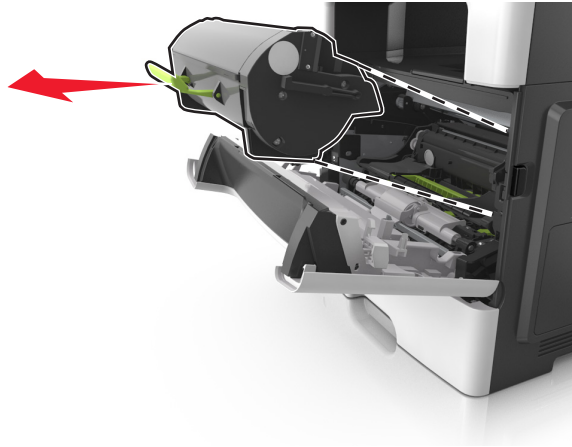

- 3 Unpack the toner cartridge, and then remove all packing materials.
- 4 Shake the new cartridge to redistribute the toner.

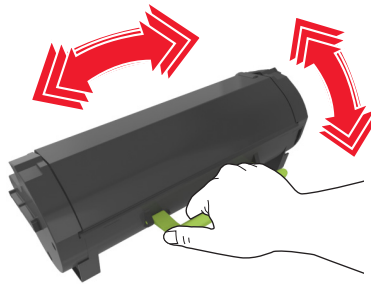

- 5 Insert the toner cartridge into the printer by aligning the side rails of the cartridge with the arrows on the side rails inside the printer.

**Warning—Potential Damage:** Do not expose the imaging unit to direct light for more than 10 minutes. Extended exposure to light may cause print quality problems.

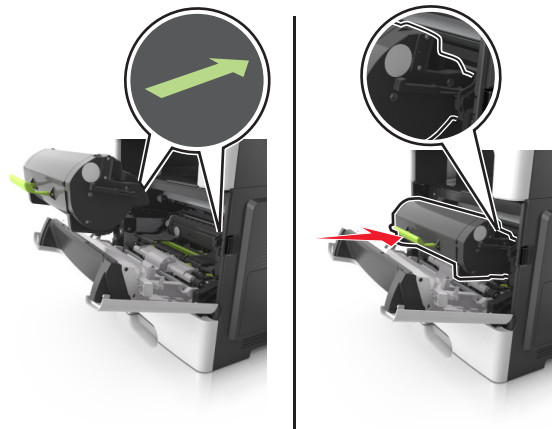

- 6 Close the front door.

## Replacing the imaging unit

- 1 Press the button on the right side of the printer, and then open the front door.

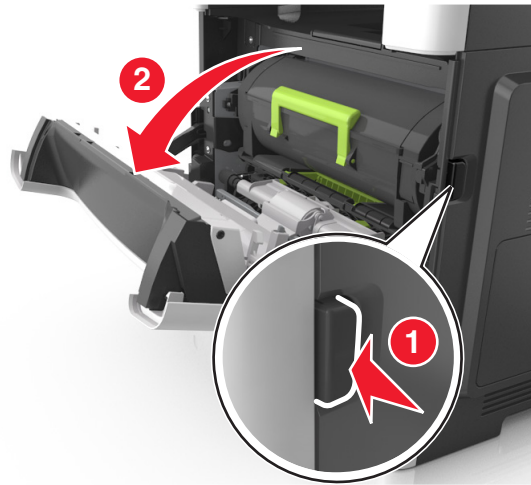

- 2 Pull the toner cartridge out using the handle.

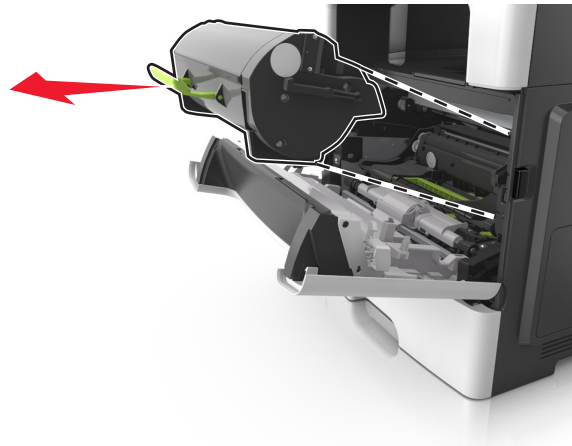

- 3 Lift the green handle, and then pull the imaging unit out of the printer.

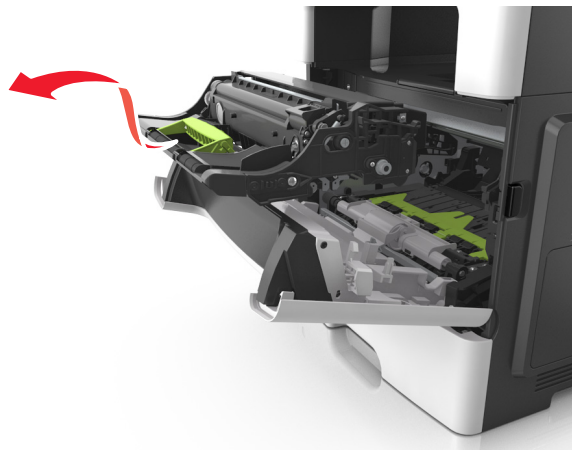

- 4 Unpack the new imaging unit, and then shake it.

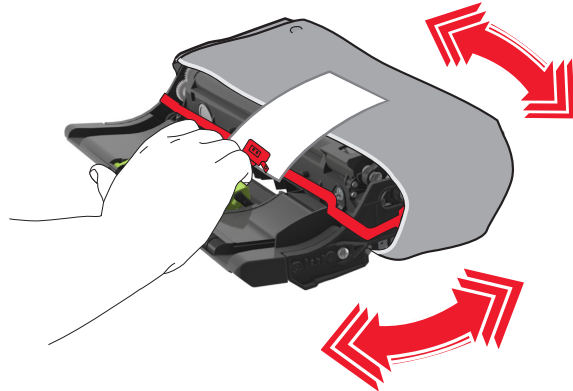

- 5 Remove all packing materials from the imaging unit.

**Warning—Potential Damage:** Do not expose the imaging unit to direct light for more than 10 minutes. Extended exposure to light may cause print quality problems.

**Warning—Potential Damage:** Do not touch the photoconductor drum. Doing so may affect the print quality of future print jobs.

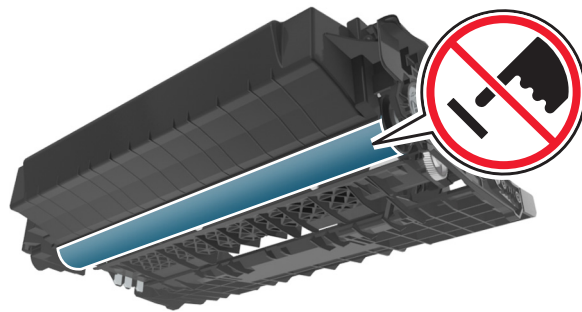

- 6 Insert the imaging unit into the printer by aligning the arrows on the side rails of the imaging unit with the arrows on the side rails inside the printer.

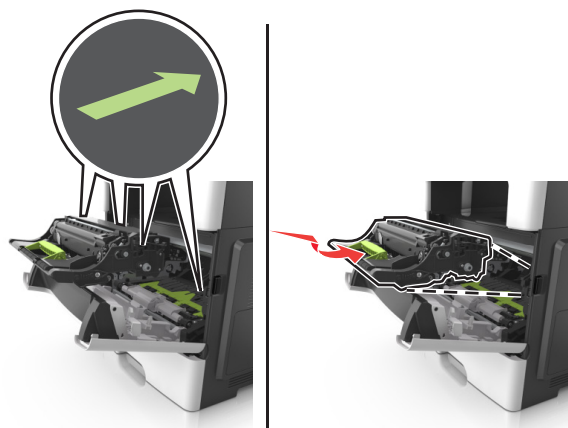

- 7 Insert the toner cartridge into the printer by aligning the side rails of the cartridge with the arrows on the side rails inside the printer.

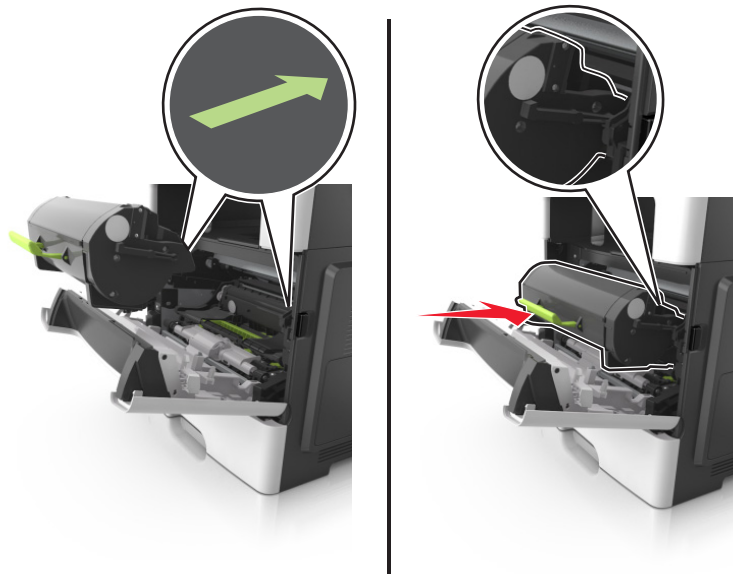

- 8 Close the front door.

## Moving the printer

### Moving the printer to another location

- ⚠ CAUTION—POTENTIAL INJURY:** The printer weight is greater than 18 kg (40 lb) and requires two or more trained personnel to lift it safely.
- ⚠ CAUTION—POTENTIAL INJURY:** To avoid the risk of fire or electrical shock, use only the power cord provided with this product or the manufacturer's authorized replacement.
- ⚠ CAUTION—POTENTIAL INJURY:** When moving the printer, follow these guidelines to avoid personal injury or printer damage:
  - Make sure that all doors and trays are closed.
  - Turn off the printer, and then unplug the power cord from the electrical outlet.
  - Disconnect all cords and cables from the printer.
  - If the printer has a caster base, then carefully roll it to the new location. Use caution when passing over thresholds and breaks in flooring.
  - If the printer does not have a caster base but is configured with optional trays, then lift the printer off the trays. Do not try to lift the printer and the trays at the same time.
  - Always use the handholds on the printer to lift it.
  - Any cart used to move the printer must have a surface able to support the full footprint of the printer.
  - Any cart used to move the hardware options must have a surface able to support the dimensions of the options.
  - Keep the printer in an upright position.
  - Avoid severe jarring movements.



- Make sure that your fingers are not under the printer when you set it down.
- Make sure that there is adequate clearance around the printer.

**Note:** Damage to the printer caused by improper moving is not covered by the printer warranty.

## **Shipping the printer**

When shipping the printer, use the original packaging or call the place of purchase for a relocation kit.

# Managing the printer

## Finding advanced networking and administrator information

This chapter covers basic administrative support tasks using the Embedded Web Server. For more advanced system support tasks, see the *Networking Guide* on the *Software and Documentation CD* or the *Embedded Web Server — Security: Administrator's Guide* on the Lexmark support Web site at <http://support.lexmark.com>.

## Checking the virtual display

- 1 Open a Web browser, and then type the printer IP address in the address field.

**Notes:**

- View the printer IP address on the printer home screen. The IP address appears as four sets of numbers separated by periods, such as 123.123.123.123.
- If you are using a proxy server, then temporarily disable it to load the Web page correctly.

- 2 Check the virtual display that appears at the top left corner of the screen.

The virtual display works as an actual display would work on a printer control panel.

## Setting up e-mail alerts

Configure the printer to send you e-mail alerts when the supplies are getting low or when the paper needs to be changed or added, or when there is a paper jam.

- 1 Open a Web browser, and then type the printer IP address in the address field.

**Notes:**

- View the printer IP address on the printer home screen. The IP address appears as four sets of numbers separated by periods, such as 123.123.123.123.
- If you are using a proxy server, then temporarily disable it to load the Web page correctly.

- 2 Click **Settings**.

- 3 From the Other Settings menu, click **E-mail Alert Setup**.

- 4 Select the items you want to be notified on, and then type the e-mail addresses.

- 5 Click **Submit**.

**Note:** For information on setting up the e-mail server, contact your system support person.

## Viewing reports

You can view some reports from the Embedded Web Server. These reports are useful for assessing the status of the printer, network, and supplies.

- 1 Open a Web browser, and then type the printer IP address in the address field.

**Notes:**

- View the printer IP address on the printer home screen. The IP address appears as four sets of numbers separated by periods, such as 123.123.123.123.
- If you are using a proxy server, then temporarily disable it to load the Web page correctly.

- 2 Click **Reports**, and then click the type of report you want to view.

## Configuring supply notifications from the Embedded Web Server

You can determine how you would like to be notified when supplies run nearly low, low, very low, or reach their end-of-life by setting the selectable alerts.

**Notes:**

- Selectable alerts can be set on the toner cartridge, imaging unit, and maintenance kit.
- All selectable alerts can be set for nearly low, low, and very low supply conditions. Not all selectable alerts can be set for the end-of-life supply condition. E-mail selectable alert is available for all supply conditions.
- The percentage of estimated remaining supply that prompts the alert can be set on some supplies for some supply conditions.

- 1 Open a Web browser, and then type the printer IP address in the address field.

**Notes:**

- View the printer IP address on the printer home screen. The IP address appears as four sets of numbers separated by periods, such as 123.123.123.123.
- If you are using a proxy server, then temporarily disable it to load the Web page correctly.

- 2 Click **Settings > Print Settings > Supply Notifications**.

- 3 From the drop-down menu for each supply, select one of the following notification options:

Notification	Description
Off	The normal printer behavior for all supplies occurs.
E-mail Only	The printer generates an e-mail when the supply condition is reached. The status of the supply appears on the menus page and status page.
Warning	The printer displays the warning message and generates an e-mail about the status of the supply. The printer does not stop when the supply condition is reached.
Continuable Stop <sup>1</sup>	The printer stops processing jobs when the supply condition is reached, and the user needs to press a button to continue printing.
Non Continuable Stop <sup>1,2</sup>	The printer stops processing jobs when the supply condition is reached. The supply must be replaced to continue printing.

Notification	Description
<sup>1</sup>	The printer generates an e-mail about the status of the supply when supply notification is enabled.
<sup>2</sup>	The printer stops when some supplies become empty to prevent damage.

4 Click **Submit**.

## Restoring factory default settings

If you want to keep a list of the current menu settings for reference, then print a menu settings page before restoring the factory default settings. For more information, see [“Printing a menu settings page” on page 51](#).

If you want a more comprehensive method of restoring the printer factory default settings, then perform the Wipe All Settings option. For more information, see [“Erasing non-volatile memory” on page 204](#).

**Warning—Potential Damage:** Restoring factory defaults returns most printer settings to the original factory default settings. Exceptions include the display language, custom sizes and messages, and network/port menu settings. All downloads stored in the RAM are deleted. Downloads stored in the flash memory or in a printer hard disk are not affected.

From the home screen, navigate to:

 > **Settings** > **General Settings** > **Factory Defaults** > **Restore Now** > 

## Clearing jams

Carefully select paper and specialty media and load them properly to avoid paper jams. If jams occur, then follow the steps outlined in this chapter.

**Warning—Potential Damage:** Never use any tool to remove a jam. Doing so could permanently damage the fuser.

## Avoiding jams

### Load paper properly

- Make sure that the paper lies flat in the tray.

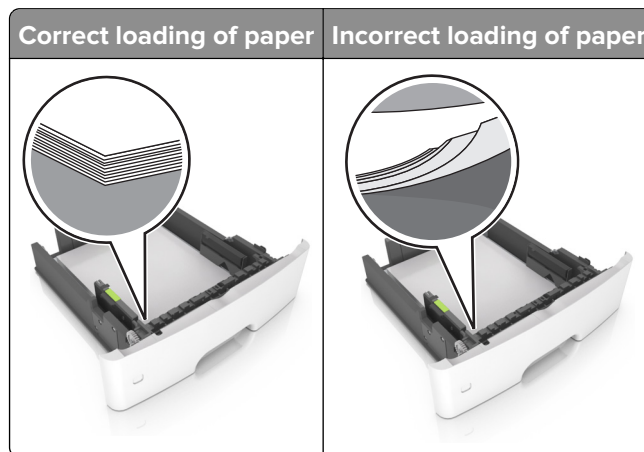

- Do not load or remove a tray while the printer is printing.
- Do not load too much paper. Make sure that the stack height is below the maximum paper fill indicator.
- Do not slide paper into the tray. Load paper as shown in the illustration.

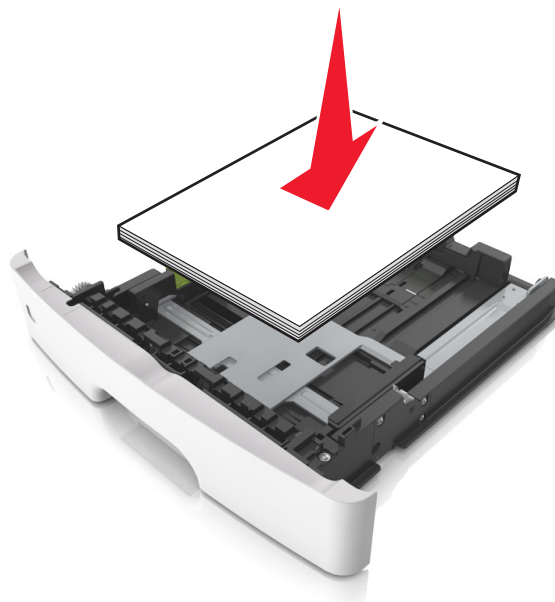

- Make sure that the paper guides are positioned correctly and are not pressing tightly against the paper or envelopes.
- Push the tray firmly into the printer after loading paper.

**Use recommended paper**

- Use only recommended paper or specialty media.
- Do not load paper that is wrinkled, creased, damp, bent, or curled.
- Flex, fan, and align the paper edges before loading.

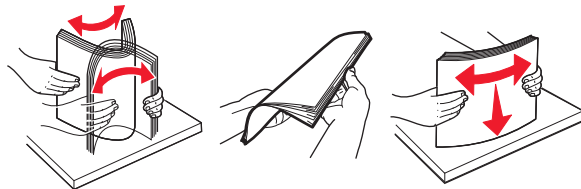

- Do not use paper that has been cut or trimmed by hand.
- Do not mix paper sizes, weights, or types in the same tray.
- Make sure that the paper size and type are set correctly on the computer or printer control panel.
- Store paper according to manufacturer recommendations.

**Identifying jam locations**

**Notes:**

- When Jam Assist is set to On, the printer flushes blank pages or pages with partial prints after a jammed page is cleared. Check your printed output stack for discarded pages.
- When Jam Recovery is set to On or Auto, the printer reprints jammed pages.

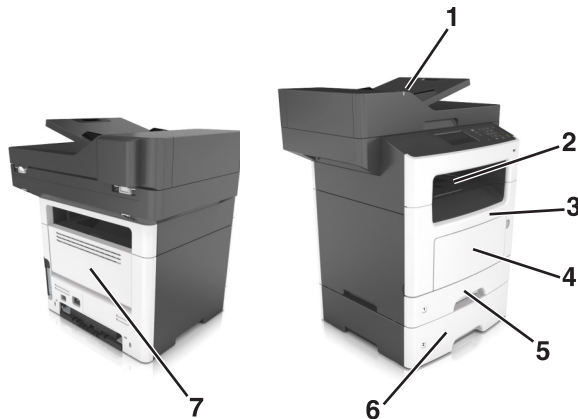

	Jam location
1	Automatic document feeder (ADF)
2	Standard bin
3	Front door
4	Multipurpose feeder

	Jam location
5	Duplex unit
6	Trays
7	Rear door

## Paper jam in the front door

 **CAUTION—HOT SURFACE:** The inside of the printer might be hot. To reduce the risk of injury from a hot component, allow the surface to cool before touching it.

- 1 Open the front door.

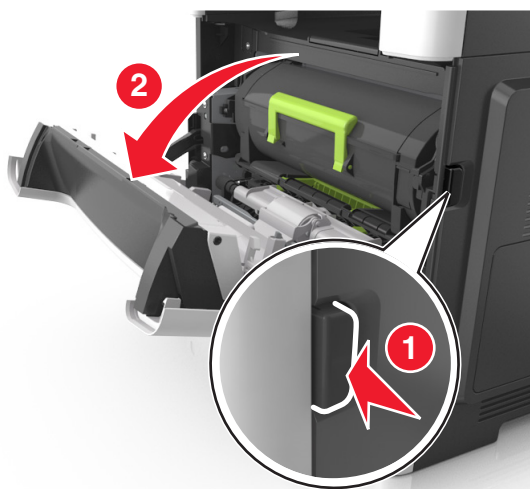

- 2 Remove the toner cartridge.

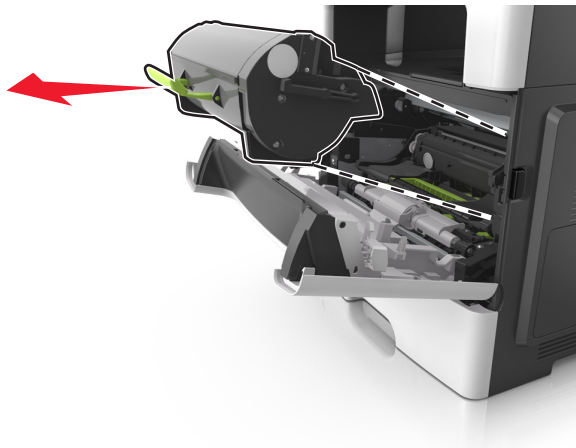

3 Remove the imaging unit.

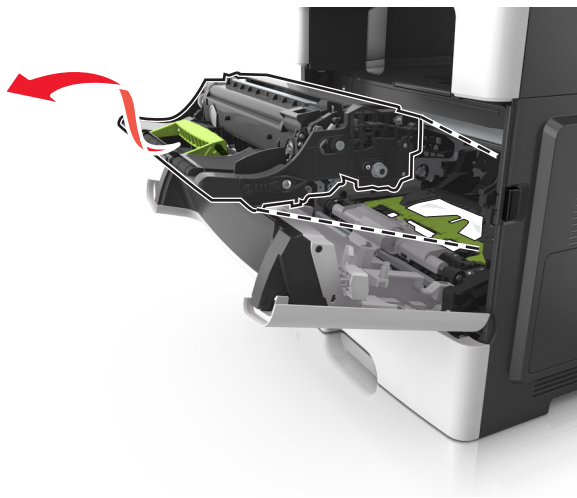

**Warning—Potential Damage:** Do not expose the imaging unit to direct light for more than 10 minutes. Extended exposure to light may cause print quality problems.

**Warning—Potential Damage:** Do not touch the shiny photoconductor drum under the imaging unit. Doing so may affect the quality of future print jobs.

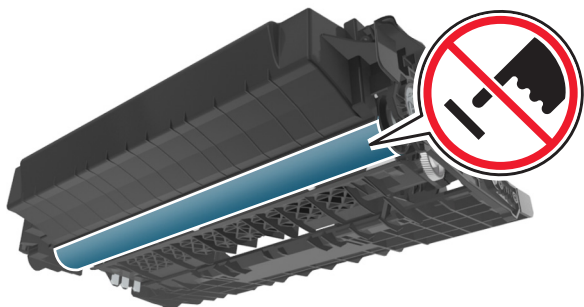

4 Remove the jammed paper.

**Note:** Make sure that all paper fragments are removed.

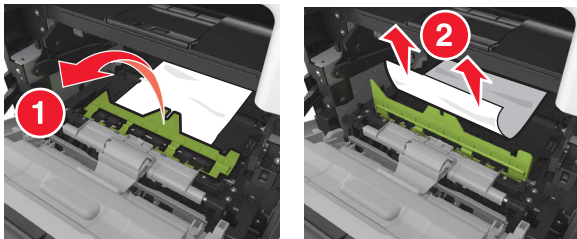

5 Insert the imaging unit.

**Note:** Use the arrows inside the printer as guides.



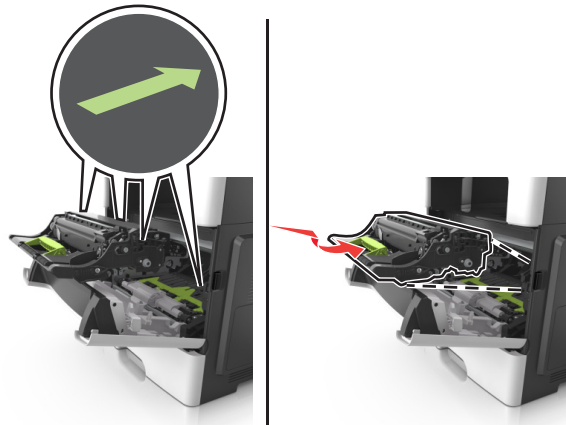

6 Insert the toner cartridge.

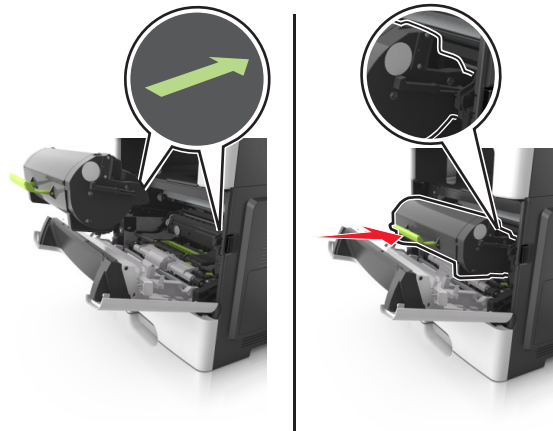

7 Close the front door.

8 If necessary, press **OK** on the control panel.

## Paper jam in the rear door

1 Open the rear door.

 **CAUTION—HOT SURFACE:** The inside of the printer might be hot. To reduce the risk of injury from a hot component, allow the surface to cool before touching it.

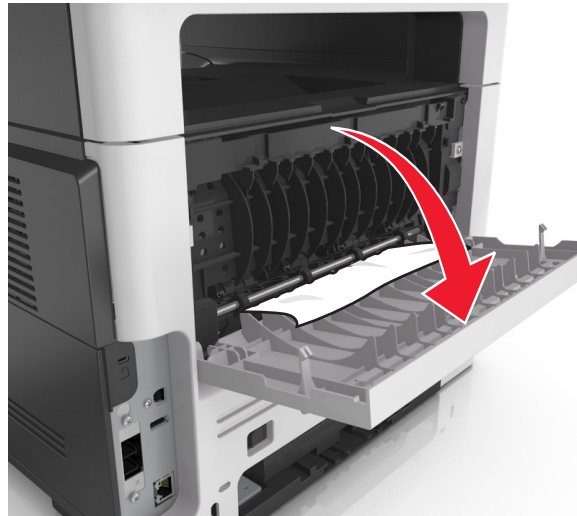

2 Remove the jammed paper.

**Note:** Make sure that all paper fragments are removed.



3 Close the rear door.

4 If necessary, press  on the control panel.

## Paper jam in the standard bin

1 Remove the jammed paper.

**Note:** Make sure that all paper fragments are removed.



2 If necessary, press **OK** on the control panel.

## Paper jam in the duplex unit

1 Remove the tray.



2 Remove the jammed paper.

**Note:** Make sure that all paper fragments are removed.

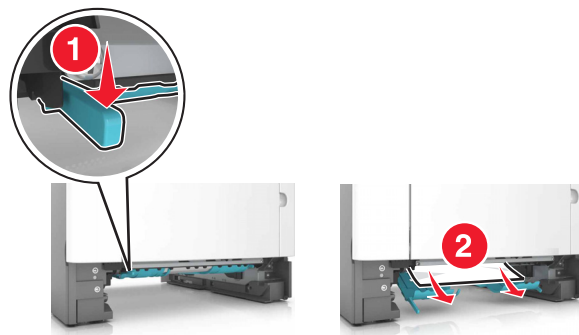

3 Insert the tray.

## Paper jam in trays

- 1 Remove the tray.



- 2 Remove the jammed paper.

**Note:** Make sure that all paper fragments are removed.

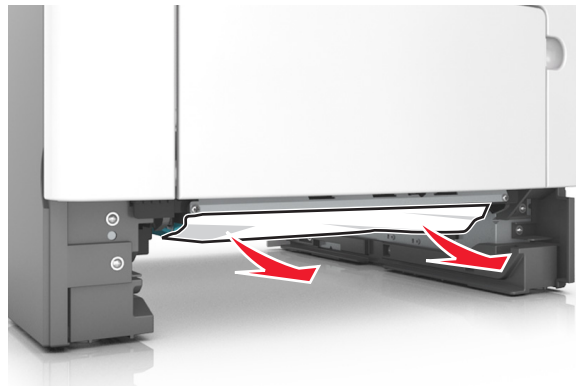

- 3 Insert the tray.

- 4 If necessary, press **OK** on the control panel.

## Paper jam in the multipurpose feeder

- 1 Remove paper from the multipurpose feeder.
- 2 Remove the jammed paper.

**Note:** Make sure that all paper fragments are removed.

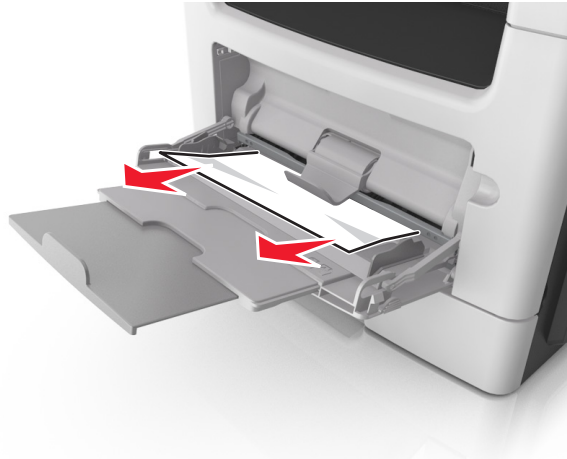

**3** Flex, fan, and align the paper edges before loading.

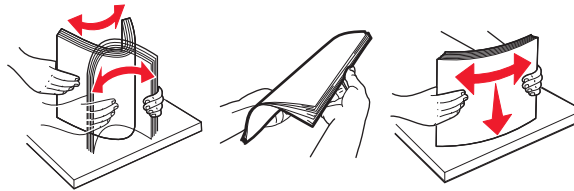

**4** Reload paper, and then adjust the paper guide.



**5** If necessary, press **OK** on the control panel.

## Paper jam in the automatic document feeder

- 1 Remove all original documents from the ADF tray.
- 2 Open the ADF cover.

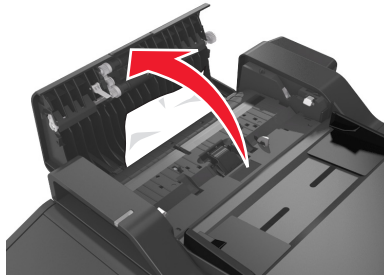

- 3 Remove the jammed paper.  
**Note:** Make sure that all paper fragments are removed.
- 4 Close the ADF cover.
- 5 If necessary, press **OK** from the control panel.

# Troubleshooting

## Understanding the printer messages

### Cartridge low [88.xy]

You may need to order a toner cartridge. If necessary, select **Continue** on the printer control panel to clear the message and continue printing. For non-touch-screen printer models, press  to confirm.

### Cartridge, imaging unit mismatch [41.xy]

Use only a supported toner cartridge and imaging unit.

**Note:** For a list of supported supplies, go to [www.lexmark.com](http://www.lexmark.com).

### Cartridge nearly low [88.xy]

If necessary, select **Continue** on the printer control panel to clear the message and continue printing. For non-touch-screen printer models, press  to confirm.

### Cartridge very low, [x] estimated pages remain [88.xy]

You may need to replace the toner cartridge very soon. For more information, see the “Replacing supplies” section of the *User’s Guide*.

If necessary, select **Continue** on the printer control panel to clear the message and continue printing. For non-touch-screen printer models, press  to confirm.

### Change [paper source] to [custom string] load [paper orientation]

Try one or more of the following:

- Load the correct size and type of paper in the tray, then verify that the paper size and type settings are specified in the Paper menu on the printer control panel, and then select **Finished changing paper**.

For non-touch-screen printer models, press  to confirm.

- Cancel the print job.

## Change [paper source] to [custom type name] load [orientation]

Try one or more of the following

- Load the correct paper size and type in the tray, verify the paper size and type settings are specified in the Paper menu on the printer control panel, and then select **Finished changing paper**. For non-touch-screen printer models, press  to confirm.
- Cancel the print job.

## Change [paper source] to [paper size] load [orientation]

Try one or more of the following:

- Load the correct paper size and type in the tray, verify the paper size and type settings are specified in the Paper menu on the printer control panel, and then select **Finished changing paper**. For non-touch-screen printer models, press  to confirm.
- Cancel the print job.

## Change [paper source] to [paper type] [paper size] load [orientation]

Try one or more of the following:

- Load the correct paper size and type in the tray, verify the paper size and type settings are specified in the Paper menu on the printer control panel, and then select **Finished changing paper**. For non-touch-screen printer models, press  to confirm.
- Cancel the print job.

## Close flatbed cover and load originals if restarting job [2yy.xx]

From the printer control panel, try one or more of the following:

- Select **Scan from automatic feeder** to continue scanning from the ADF immediately after the last successful scan job.
- Select **Scan from flatbed** to continue scanning from the scanner glass immediately after the last successful scan job.
- Select **Finish job without further scanning** to end the last successful scan job.  
**Note:** This does not cancel the scan job. All successfully scanned pages will be processed further for copying, faxing, or e-mailing.
- Select **Cancel job** to clear the message and cancel the scan job.
- For non-touch-screen printer models, press  to confirm.

## Close front door

Close the front door of the printer.



## Configuration change, some held jobs were not restored [57]

Held jobs are invalidated because of any of the following possible changes in the printer:

- The printer firmware has been updated.
- The tray for the print job is removed.
- The print job is sent from a flash drive that is no longer attached to the USB port.
- The printer hard disk contains print jobs that were stored when the hard disk was installed in a different printer model.

From the printer control panel, select **Continue** to clear the message. For non-touch-screen printer models, press  to confirm.

## Complex page, some data may not have printed [39]

Try one or more of the following:

- From the control panel, select **Continue** to ignore the message and continue printing. For non-touch-screen printer models, press  to confirm.
- Cancel the current print job.
- Add printer memory.

## Defective flash detected [51]

Try one or more of the following:

- Replace the defective flash memory card.
- From the printer control panel, select **Continue** to ignore the message and continue printing. For non-touch-screen printer models, press  to confirm.
- Cancel the current print job.

## Disk full [62]

Try one or more of the following:

- Select **Continue** to clear the message and continue printing. For non-touch-screen printer models, press  to confirm.
- Delete fonts, macros, and other data stored in the printer hard disk.
- Install a printer hard disk with larger capacity.

## Disk must be formatted for use in this device

From the printer control panel, select **Format disk** to format the printer hard disk and clear the message.

For non-touch-screen printer models, press  to confirm.

**Note:** Formatting deletes all the files stored in the printer hard disk.

## Error reading USB drive. Remove USB.

An unsupported USB device is inserted. Remove the USB device, and then insert a supported one.

## Error reading USB hub. Remove hub.

An unsupported USB hub has been inserted. Remove the USB hub, and then install a supported one.

## Fax memory full

- 1 From the control panel, touch **Continue** to clear the message and cancel the fax job.
- 2 Do the following:
  - Reduce the fax resolution.
  - Reduce the number of pages.
- 3 Send the fax job.

## Fax partition inoperative. Contact system administrator.

Try either of the following:

- From the printer control panel, select **Continue** to clear the message. For non-touch-screen printer models, press  to confirm.
- Turn the printer off, and then turn it back on. If the message appears again, then contact your system support person or see the “Setting up the printer to fax” section of the *User’s Guide*.

## Fax server 'To Format' not set up. Contact system administrator.

Try either of the following:

- From the printer control panel, select **Continue** to clear the message. For non-touch-screen printer models, press  to confirm.
- Complete the Fax Server setup. If the message appears again, then contact your system support person.

## Fax Station Name not set up. Contact system administrator.

Try either of the following:

- From the printer control panel, select **Continue** to clear the message. For non-touch-screen printer models, press  to confirm.
- Complete the Analog Fax Setup. If the message appears again after completing the setup, then contact your system support person.

## Fax Station Number not set up. Contact system administrator.

Try either of the following:

- From the printer control panel, select **Continue** to clear the message. For non-touch-screen printer models, press  to confirm.
- Complete the Analog Fax Setup. If the message appears again after completing the setup, then contact your system support person.

## Imaging unit low [84.xy]

You may need to order an imaging unit. If necessary, select **Continue** on the printer control panel to clear the message and continue printing. For non-touch-screen printer models, press  to confirm.

## Imaging unit nearly low [84.xy]

If necessary, select **Continue** on the printer control panel to clear the message and continue printing. For non-touch-screen printer models, press  to confirm.

## Imaging unit very low, [x] estimated pages remain [84.xy]

You may need to replace the imaging unit very soon. For more information, see the "Replacing supplies" section of the *User's Guide*.

If necessary, select **Continue** on the printer control panel to clear the message and continue printing. For non-touch-screen printer models, press  to confirm.

## Incorrect paper size, open [paper source] [34]

**Note:** The paper source can be a tray or a feeder.

Try one or more of the following:

- Load the correct size of paper in the paper source.
- From the printer control panel, select **Continue** to clear the message and print using a different paper source. For non-touch-screen printer models, press  to confirm.
- Check the length and width guides of the paper source and make sure the paper is loaded properly.
- Make sure the correct paper size and type are specified in the Printing Preferences or in the Print dialog.
- Make sure the paper size and type are specified in the Paper menu on the printer control panel.
- Make sure that the paper size is correctly set. For example, if Multipurpose Feeder Size is set to Universal, then make sure the paper is large enough for the data being printed.
- Cancel the print job.

## Insert Tray [x]

Insert the indicated tray into the printer.

## Insufficient memory, some Held Jobs were deleted [37]

The printer deleted some held jobs in order to process current jobs.

Select **Continue** to clear the message. For non-touch-screen printer models, press  to confirm.

## Insufficient memory, some held jobs will not be restored [37]

Try one or more of the following:

- From the printer control panel, select **Continue** to clear the message. For non-touch-screen printer models, press  to confirm.
- Delete other held jobs to free up additional printer memory.

## Insufficient memory to collate job [37]

Try one or more of the following:

- From the printer control panel, select **Continue** to print the part of the job already stored and begin collating the rest of the print job. For non-touch-screen printer models, press  to confirm.
- Cancel the current print job.

## Insufficient memory to support Resource Save feature [35]

Install additional printer memory or select **Continue** on the printer control panel to disable Resource Save, clear the message, and continue printing. For non-touch-screen printer models, press  to confirm.

## Load multipurpose feeder with [custom string] [orientation]

Try one or more of the following:

- Load the feeder with the correct paper size and type.
- Depending on your printer model, touch **Continue** or press  to clear the message and continue printing.

**Note:** If no paper is loaded in the feeder, the printer manually overrides the request, and then prints from an automatically selected tray.

- Cancel the current job.

## Load multipurpose feeder with [custom type name] [orientation]

Try one or more of the following:

- Load the multipurpose feeder with the correct paper size and type.
- Depending on your printer model, touch **Continue** or press  to clear the message and continue printing.

**Note:** If no paper is loaded in the feeder, the printer manually overrides the request, and then prints from an automatically selected tray.

- Cancel the current job.

## Load multipurpose feeder with [paper size] [orientation]

Try one or more of the following:

- Load the multipurpose feeder with the correct paper size.
- Depending on your printer model, touch **Continue** or press  to clear the message and continue printing.

**Note:** If no paper is loaded in the feeder, the printer manually overrides the request, and then prints from an automatically selected tray.

- Cancel the current job.

## Load multipurpose feeder with [paper type] [paper size] [orientation]

Try one or more of the following:

- Load the multipurpose feeder with the correct paper size and type.
- Depending on your printer model, touch **Continue** or press  to clear the message and continue printing.

**Note:** If no paper is loaded in the feeder, the printer manually overrides the request, and then prints from an automatically selected tray.

- Cancel the current job.

## Load [paper source] with [custom string] [paper orientation]

Try one or more of the following:

- Load the tray or feeder with the correct size and type of paper.
- To use the tray that has the correct size or type of paper, select **Finished loading paper** on the printer control panel. For non-touch-screen printer models, press  to confirm.

**Note:** If the printer finds a tray that has the correct size and type of paper, then it feeds from that tray. If the printer cannot find a tray that has the correct size and type of paper, then it prints from the default paper source.

- Cancel the current job.

## Load [paper source] with [custom type name] [paper orientation]

Try one or more of the following:

- Load the tray or feeder with the correct size and type of paper.
- To use the tray that has the correct size or type of paper, select **Finished loading paper** on the printer control panel. For non-touch-screen printer models, press  to confirm.

**Note:** If the printer finds a tray that has the correct size and type of paper, then it feeds from that tray. If the printer cannot find a tray that has the correct size and type of paper, then it prints from the default paper source.

- Cancel the current job.

## Load [paper source] with [paper size] [paper orientation]

Try one or more of the following:

- Load the tray or feeder with the correct size of paper.
- To use the tray or feeder that has the correct size of paper, select **Finished loading paper** on the printer control panel. For non-touch-screen printer models, press  to confirm.

**Note:** If the printer finds a tray that has the correct size and type of paper, then it feeds from that tray. If the printer cannot find a tray that has the correct size and type of paper, then it prints from the default paper source.

- Cancel the current job.

## Load [paper source] with [paper type] [paper size] [paper orientation]

Try one or more of the following:

- Load the tray or feeder with the correct size and type of paper.
- To use the tray or feeder that has the correct size and type of paper, select **Finished loading paper** on the printer control panel. For non-touch-screen printer models, press  to confirm.

**Note:** If the printer finds a tray that has the correct size and type of paper, then it feeds from that tray. If the printer cannot find a tray that has the correct size and type of paper, then it prints from the default paper source.

- Cancel the current job.

## Maintenance kit low [80.xy]

You may need to order a maintenance kit. For more information, visit the Lexmark support Web site at <http://support.lexmark.com> or contact customer support, and then report the message.

If necessary, select **Continue** to clear the message and continue printing. For non-touch-screen printer models, press  to confirm.

## Maintenance kit nearly low [80.xy]

For more information, visit the Lexmark support Web site at <http://support.lexmark.com> or contact customer support, and then report the message.

If necessary, select **Continue** to clear the message and continue printing. For non-touch-screen printer models, press  to confirm.

## Maintenance kit very low [80.xy]

You may need to replace the maintenance kit very soon. For more information, contact customer support at <http://support.lexmark.com> or your service representative.

If necessary, select **Continue** on the printer control panel to clear the message and continue printing. For non-touch-screen printer models, press  to confirm.

## Memory full [38]

Try one or more of the following:

- From the printer control panel, select **Cancel job** to clear the message. For non-touch-screen printer models, press  to confirm.
- Install additional printer memory.

## Memory full, cannot print faxes

From the control panel, do either of the following:

- Touch **Continue holding faxes without printing** to clear the message.
- Touch **Attempt to print** to restart the printer and continue printing.

## Network [x] software error [54]

Try one or more of the following:

- From the printer control panel, select **Continue** to continue printing. For non-touch-screen printer models, press  to confirm.
- Turn off the printer, wait for about 10 seconds, and then turn the printer back on.
- Update the network firmware in the printer or print server. For more information, visit the Lexmark support Web site at <http://support.lexmark.com>.

## No analog phone line connected to modem, fax is disabled.

Connect the printer to an analog phone line.

## Non-Lexmark [supply type], see User's Guide [33.xy]

**Note:** The supply type can be toner cartridge or imaging unit.

The printer has detected a non-Lexmark supply or part installed in the printer.

Your Lexmark printer is designed to function best with genuine Lexmark supplies and parts. Use of third-party supplies or parts may affect the performance, reliability, or life of the printer and its imaging components. For more information, see [“Using genuine Lexmark parts and supplies” on page 209](#).

All life indicators are designed to function with Lexmark supplies and parts and may deliver unpredictable results if third-party supplies or parts are used. Imaging component usage beyond the intended life may damage your Lexmark printer or associated components.

**Warning—Potential Damage:** Use of third-party supplies or parts can affect warranty coverage. Damage caused by the use of third-party supplies or parts may not be covered by the warranty.

To accept any and all of these risks and to proceed with the use of non-genuine supplies or parts in your printer, press and hold  and the # button on the control panel simultaneously for 15 seconds.

For non-touch-screen printer models, press  and  on the control panel simultaneously for 15 seconds to clear the message and continue printing.

If you do not want to accept these risks, then remove the third-party supply or part from your printer and install a genuine Lexmark supply or part.

**Note:** For a list of supported supplies, see the “Ordering supplies” section or go to [www.lexmark.com](http://www.lexmark.com).

## Not enough free space in flash memory for resources [52]

Try one or more of the following:

- From the printer control panel, select **Continue** to clear the message and continue printing. For non-touch-screen printer models, press  to confirm.
- Delete fonts, macros, and other data stored in the flash memory.
- Upgrade to a larger capacity flash memory card.

**Note:** Downloaded fonts and macros that are not previously stored in the flash memory are deleted.

## Printer had to restart. Last job may be incomplete.

Select **Continue** on the control panel to clear the message and continue printing. For non-touch-screen printer models, press  to confirm.

For more information, go to <http://support.lexmark.com> or contact customer support.



## Reinstall missing or unresponsive cartridge [31.xy]

Try one or more of the following:

- Check if the toner cartridge is missing. If missing, then install the toner cartridge.  
For information on installing the toner cartridge, see the “Replacing supplies” section.
- If the toner cartridge is installed, then remove and reinstall the unresponsive toner cartridge.

**Note:** If the message appears after reinstalling the supply, then replace the toner cartridge. The cartridge may be defective or a non-genuine Lexmark supply. For more information, see [“Using genuine Lexmark parts and supplies” on page 209](#).

## Remove paper from standard output bin

Remove the paper stack from the standard bin. The printer automatically detects paper removal and resumes printing.

If removing the paper does not clear the message, then select **Continue** on the printer control panel. For non-touch-screen printer models, press  to confirm.

## Replace all originals if restarting job.

From the printer control panel, try one or more of the following:

- Select **Cancel job** to clear the message and cancel the scan job.
- Select **Scan from automatic feeder** to continue scanning from the ADF immediately after the last successful scan job.
- Select **Scan from flatbed** to continue scanning from the scanner immediately after the last successful scan job.
- Select **Finish job without further scanning** to end the last successful scan job.
- Select **Restart job** to restart the scan job with the same settings from the previous scan job.
- For non-touch-screen printer models, press  to confirm.

## Replace cartridge, 0 estimated pages remain [88.xy]

Replace the toner cartridge to clear the message and continue printing. For more information, see the instruction sheet that came with the supply or see the “Replacing supplies” section of the *User’s Guide*.

**Note:** If you do not have a replacement cartridge, then see the “Ordering supplies” section of the *User’s Guide* or visit [www.lexmark.com](http://www.lexmark.com).

## Replace defective imaging unit [31.xy]

Replace the defective imaging unit to clear the message. For more information, see the instruction sheet that came with the supply or see the “Replacing supplies” section of the *User’s Guide*.

**Note:** If you do not have a replacement imaging unit, then see the “Ordering supplies” section of the *User’s Guide* or visit [www.lexmark.com](http://www.lexmark.com).





## Replace imaging unit, 0 estimated pages remain [84.xy]

Replace the imaging unit to clear the message and continue printing. For more information, see the instruction sheet that came with the supply or see the “Replacing supplies” section of the *User’s Guide*.

**Note:** If you do not have a replacement imaging unit, then see the “Ordering supplies” section of the *User’s Guide* or visit [www.lexmark.com](http://www.lexmark.com).

## Replace jammed originals if restarting job.

From the printer control panel, try one or more of the following:

- Select **Cancel job** to clear the message and cancel the scan job. For non-touch-screen printer models, press  to confirm.
- Select **Scan from automatic feeder** to continue scanning from the ADF immediately after the last successful scan job. For non-touch-screen printer models, press  to confirm.
- Select **Scan from flatbed** to continue scanning from the scanner immediately after the last successful scan job. For non-touch-screen printer models, press  to confirm.
- Select **Finish job without further scanning** to end the last successful scan job. For non-touch-screen printer models, press  to confirm.
- Select **Restart job** to restart the scan job with the same settings from the previous scan job. For non-touch-screen printer models, press  to confirm.

## Replace maintenance kit [80.xy]

The printer is scheduled for maintenance. For more information, go to <http://support.lexmark.com> or contact your service representative, and then report the message.

## Replace missing imaging unit [31.xy]

Install the missing imaging unit. For more information, see the instruction sheet that came with the supply.

## Replace unsupported cartridge [32.xy]

Remove the toner cartridge, and then install a supported one to clear the message and continue printing. For more information, see the instruction sheet that came with the supply.

This error can also be caused by installing a genuine Lexmark cartridge, such as a high yield cartridge, that is not intended to be used in this product.

The following error codes indicate that a non-genuine Lexmark toner cartridge is installed:

32.13  
32.16  
32.19  
32.22  
32.25

32.28

32.31

32.34

32.37

For more information, see [“Using genuine Lexmark parts and supplies” on page 209](#).

**Note:** If you do not have a replacement cartridge, then see the “Ordering supplies” section or go to [www.lexmark.com](http://www.lexmark.com).

## Replace unsupported imaging unit [32.xy]

Remove the imaging unit, and then install a supported one to clear the message and continue printing. For more information, see the instruction sheet that came with the supply.

This error can also be caused by installing a genuine Lexmark imaging unit, such as a MICR unit, that is not intended to be used in this product.

The following error codes indicate that a non-genuine Lexmark imaging unit is installed:

32.14

32.17

32.20

32.23

32.26

32.29

32.32

32.35



32.38

For more information, see [“Using genuine Lexmark parts and supplies” on page 209](#).

**Note:** If you do not have a replacement imaging unit, then see the “Ordering supplies” section or go to [www.lexmark.com](http://www.lexmark.com).

## Restore held jobs?

Try one or more of the following:

- From the printer control panel, select **Restore** to restore all held jobs stored in the printer hard disk.  
For non-touch-screen printer models, press  to confirm.
- From the printer control panel, select **Do not restore** if you do not want any print jobs to be restored.  
For non-touch-screen printer models, press  to confirm.

## Scanner automatic feeder cover open

Close the ADF cover.

## Scanner disabled by admin [840.01]

Print without the scanner, or contact your system support person.

## Scanner disabled. Contact system administrator if problem persists. [840.02]

From the printer control panel, try one or more of the following:

- Select **Continue with scanner disabled** to return to the home screen, and then contact your system support person.
- Select **Reboot and automatically enable scanner** to cancel the job.

**Note:** This attempts to enable the scanner.

- For non-touch-screen printer models, press  to confirm.

## Scanner jam, remove all originals from the scanner [2yy.xx]

Remove the jammed paper from the scanner.

## Scanner jam, remove jammed originals from the scanner [2yy.xx]

Remove the jammed paper from the scanner.

## SMTP server not set up. Contact system administrator.

From the printer control panel, select **Continue** to clear the message. For non-touch-screen printer models, press  to confirm.

**Note:** If the message appears again, then contact your system support person.

## Some held jobs were not restored

From the printer control panel, select **Continue** to delete the specified job. For non-touch-screen printer models, press  to confirm.

**Note:** Held jobs that are not restored stay in the printer hard disk and are inaccessible.

## Standard network software error [54]

Try one or more of the following:

- From the printer control panel, select **Continue** to continue printing. For non-touch-screen printer models, press  to confirm.
- Turn off the printer and then turn it back on.
- Update the network firmware in the printer or print server. For more information, visit the Lexmark support Web site at <http://support.lexmark.com>.

## Standard USB port disabled [56]

From the printer control panel, select **Continue** to clear the message. For non-touch-screen printer models, press  to confirm.

### Notes:

- The printer discards any data received through the USB port.
- Make sure the USB Buffer menu is not set to Disabled.

## Supply needed to complete job

Do either of the following:

- Install the missing supply to complete the job.
- Cancel the current job.

## The device is operating in Safe Mode. Some print options may be disabled or provide unexpected results.

Select **Continue** to clear the message. For non-touch-screen printer models, press  to confirm.

## Too many flash options installed [58]

- 1 Turn off the printer.
- 2 Unplug the power cord from the electrical outlet.
- 3 Remove the extra flash memory.
- 4 Connect the power cord to a properly grounded electrical outlet.
- 5 Turn the printer back on.

## Too many trays attached [58]

- 1 Turn off the printer.
- 2 Unplug the power cord from the electrical outlet.
- 3 Remove the extra trays.
- 4 Connect the power cord to a properly grounded electrical outlet.
- 5 Turn the printer back on.

## Unformatted flash detected [53]

Try one or more of the following:

- From the printer control, select **Continue** to stop the defragmentation and continue printing. For non-touch-screen printer models, press  to confirm.
- Format the flash memory.

**Note:** If the error message remains, then the flash memory may be defective and need to be replaced.

## Weblink server not set up. Contact system administrator.

Select **Continue** to clear the message. For non-touch-screen printer models, press  to confirm.

**Note:** If the message appears again, then contact your system support person.

## Solving printer problems

- “Basic printer problems” on page 246
- “Hardware and internal option problems” on page 248
- “Paper feed problems” on page 251

### Basic printer problems

#### The printer is not responding

Action	Yes	No
<p><b>Step 1</b> Make sure the printer is turned on.</p> <p>Is the printer turned on?</p>	Go to step 2.	Turn on the printer.
<p><b>Step 2</b> Check if the printer is in Sleep mode or Hibernate mode.</p> <p>Is the printer in Sleep mode or Hibernate mode?</p>	Press the Sleep button to wake the printer from Sleep mode or Hibernate mode.	Go to step 3.
<p><b>Step 3</b> Check if one end of the power cord is plugged into the printer and the other to a properly grounded electrical outlet.</p> <p>Is the power cord plugged into the printer and a properly grounded electrical outlet?</p>	Go to step 4.	Plug one end of the power cord into the printer and the other to a properly grounded electrical outlet.

Action	Yes	No
<p><b>Step 4</b> Check other electrical equipment plugged into the electrical outlet.</p> <p>Does other electrical equipment work?</p>	Unplug the other electrical equipment, and then turn on the printer. If the printer does not work, then reconnect the other electrical equipment.	Go to step 5.
<p><b>Step 5</b> Check if the cables connecting the printer and the computer are inserted in the correct ports.</p> <p>Are the cables inserted in the correct ports?</p>	Go to step 6.	<p>Make sure to match the following:</p> <ul style="list-style-type: none"> <li>• The USB symbol on the cable with the USB symbol on the printer</li> <li>• The appropriate Ethernet cable with the Ethernet port</li> </ul>
<p><b>Step 6</b> Make sure the electrical outlet is not turned off by a switch or breaker.</p> <p>Is the electrical outlet turned off by a switch or breaker?</p>	Turn on the switch or reset the breaker.	Go to step 7.
<p><b>Step 7</b> Check if the printer is plugged into any surge protectors, uninterruptible power supplies, or extension cords.</p> <p>Is the printer plugged into any surge protectors, uninterruptible power supplies, or extension cords?</p>	Connect the printer power cord directly to a properly grounded electrical outlet.	Go to step 8.
<p><b>Step 8</b> Check if one end of the printer cable is plugged into a port on the printer and the other to the computer, print server, option, or other network device.</p> <p>Is the printer cable securely attached to the printer and the computer, print server, option, or other network device?</p>	Go to step 9.	Connect the printer cable securely to the printer and the computer, print server, option, or other network device.
<p><b>Step 9</b> Make sure to install all hardware options properly and remove any packing material.</p> <p>Are all hardware options properly installed and all packing material removed?</p>	Go to step 10.	Turn off the printer, remove all packing materials, then reinstall the hardware options, and then turn on the printer.
<p><b>Step 10</b> Check if you have selected the correct port settings in the printer driver.</p> <p>Are the port settings correct?</p>	Go to step 11.	Use correct printer driver settings.

Action	Yes	No
<p><b>Step 11</b> Check the installed printer driver.</p> <p>Is the correct printer driver installed?</p>	Go to step 12.	Install the correct printer driver.
<p><b>Step 12</b> Turn off the printer, then wait for about 10 seconds, and then turn the printer back on.</p> <p>Is the printer working?</p>	The problem is solved.	Contact <a href="#">customer support</a> .

### Printer display is blank

Action	Yes	No
<p><b>Step 1</b> Press the Sleep button on the printer control panel.</p> <p>Does <b>Ready</b> appear on the printer display?</p>	The problem is solved.	Go to step 2.
<p><b>Step 2</b> Turn off the printer, then wait for about 10 seconds, and then turn the printer back on.</p> <p>Do <b>Please wait</b> and <b>Ready</b> appear on the printer display?</p>	The problem is solved.	Turn off the printer, and then contact <a href="#">customer support</a> .

### Hardware and internal option problems

#### Cannot detect internal option

Action	Yes	No
<p><b>Step 1</b> Turn off the printer, then wait for about 10 seconds, and then turn on the printer.</p> <p>Does the internal option operate correctly?</p>	The problem is solved.	Go to step 2.
<p><b>Step 2</b> Check if the internal option is properly installed in the controller board.</p> <ul style="list-style-type: none"> <li><b>a</b> Turn off the printer using the power switch, and then unplug the power cord from the electrical outlet.</li> <li><b>b</b> Make sure the internal option is installed in the appropriate connector in the controller board.</li> <li><b>c</b> Connect the power cord to the printer, then to a properly grounded electrical outlet, and then turn on the printer.</li> </ul> <p>Is the internal option properly installed in the controller board?</p>	Go to step 3.	Connect the internal option to the controller board.



Action	Yes	No
<p><b>Step 3</b></p> <p>Print a menu settings page, and then check to see if the internal option is listed in the Installed Features list.</p> <p>Is the internal option listed in the menu settings page?</p>	Go to step 4.	Reinstall the internal option.
<p><b>Step 4</b></p> <p><b>a</b> Check if the internal option is selected.</p> <p>It may be necessary to manually add the internal option in the printer driver to make it available for print jobs. For more information, see <a href="#">“Adding available options in the print driver” on page 46.</a></p> <p><b>b</b> Resend the print job.</p> <p>Does the internal option operate correctly?</p>	The problem is solved.	Contact <a href="#">customer support.</a>

**Internal Solutions Port does not operate correctly**

Action	Yes	No
<p><b>Step 1</b></p> <p>Make sure the Internal Solutions Port (ISP) is installed.</p> <p><b>a</b> Install the ISP. For more information, see <a href="#">“Installing an Internal Solutions Port” on page 31.</a></p> <p><b>b</b> Print a menu settings page, and then check if the ISP is listed in the Installed Options list.</p> <p>Is the ISP listed in the Installed Options list?</p>	Go to step 2.	<p>Check if you have a supported ISP.</p> <p><b>Note:</b> An ISP from another printer may not work on this printer.</p>
<p><b>Step 2</b></p> <p>Check the cable and the ISP connection.</p> <p><b>a</b> Use the correct cable, and then make sure it is securely connected to the ISP.</p> <p><b>b</b> Check if the ISP solution interface cable is securely connected into the receptacle of the controller board.</p> <p><b>Note:</b> The ISP solution interface cable and the receptacle on the controller board are color-coded.</p> <p>Does the Internal Solutions Port operate correctly?</p>	The problem is solved.	Contact <a href="#">customer support.</a>

### Tray problems

Action	Yes	No
<p><b>Step 1</b></p> <p><b>a</b> Pull out the tray, and then do one or more of the following:</p> <ul style="list-style-type: none"> <li>• Check for paper jams or misfeeds.</li> <li>• Check if the paper size indicators on the paper guides are aligned with the paper size indicators on the tray.</li> <li>• If you are printing on custom-size paper, then make sure that the paper guides rest against the edges of the paper.</li> <li>• Make sure the paper is below the maximum paper fill indicator.</li> <li>• Make sure paper lies flat in the tray.</li> </ul> <p><b>b</b> Check if the tray closes properly.</p> <p>Is the tray working?</p>	The problem is solved.	Go to step 2.
<p><b>Step 2</b></p> <p><b>a</b> Turn off the printer, then wait about 10 seconds, and then turn the printer back on.</p> <p><b>b</b> Resend the print job.</p> <p>Is the tray working?</p>	The problem is solved.	Go to step 3.
<p><b>Step 3</b></p> <p>Check if the tray is installed and recognized by the printer.</p> <p>Print a menu settings page, and then check if the tray is listed in the Installed Features list.</p> <p>Is the tray listed in the menu settings page?</p>	Go to step 4.	Reinstall the tray. For more information, see the setup documentation that came with the tray.
<p><b>Step 4</b></p> <p>Check if the tray is available in the printer driver.</p> <p><b>Note:</b> If necessary, manually add the tray in the printer driver to make it available for print jobs. For more information, see <a href="#">“Adding available options in the print driver” on page 46.</a></p> <p>Is the tray available in the printer driver?</p>	The problem is solved.	Contact <a href="#">customer support</a> .

### USB/parallel interface card does not operate correctly

Action	Yes	No
<p><b>Step 1</b>                      Make sure the USB or parallel interface card is installed.</p> <p><b>a</b> Install the USB or parallel interface card. For more information, see <a href="#">“Installing an Internal Solutions Port” on page 31.</a></p> <p><b>b</b> Print a menu settings page, and then check if the USB or parallel interface card is listed in the Installed Options list.</p> <p>Is the USB or parallel interface card listed in the Installed Options list?</p>	<p>Go to step 2.</p>	<p>Check if you have a supported USB or parallel interface card.</p> <p><b>Note:</b> A USB or parallel interface card from another printer may not work on this printer.</p>
<p><b>Step 2</b>                      Check if you are using the correct cable and if it is connected securely to the USB or parallel interface card.</p> <p>Is the correct cable securely connected to the USB or parallel interface card?</p>	<p>Contact <a href="#">customer support.</a></p>	<p>Connect the cable to the USB or parallel interface card connector.</p>

### Paper feed problems

#### Jammed pages are not reprinted

Action	Yes	No
<p>Turn on Jam Recovery.</p> <p><b>a</b> From the home screen, navigate to:</p> <p> &gt; <b>Settings</b> &gt; <b>General Settings</b> &gt; <b>Print Recovery</b></p> <p><b>b</b> From the Jam Recovery menu, touch the arrows to scroll to <b>On</b> or <b>Auto</b>.</p> <p><b>c</b> Touch <b>Submit</b>.</p> <p>Do pages reprint after a jam?</p>	<p>The problem is solved.</p>	<p>Contact <a href="#">customer support.</a></p>

### Paper frequently jams

Action	Yes	No
<p><b>Step 1</b></p> <p><b>a</b> Pull out the tray, and then do one or more of the following:</p> <ul style="list-style-type: none"> <li>• Make sure paper lies flat in the tray.</li> <li>• Check if the paper size indicators on the paper guides are aligned with the paper size indicators on the tray.</li> <li>• Check if the paper guides are aligned against the edges of the paper.</li> <li>• Make sure the paper is below the maximum paper fill indicator.</li> <li>• Check if you are printing on a recommended paper size and type.</li> </ul> <p><b>b</b> Insert the tray properly.</p> <p>If jam recovery is enabled, then the print jobs will reprint automatically.</p> <p>Do paper jams still occur frequently?</p>	Go to step 2.	The problem is solved.
<p><b>Step 2</b></p> <p><b>a</b> Load paper from a fresh package.</p> <p><b>Note:</b> Paper absorbs moisture due to high humidity. Store paper in its original wrapper until you use it.</p> <p><b>b</b> Resend the print job.</p> <p>Do paper jams still occur frequently?</p>	Go to step 3.	The problem is solved.
<p><b>Step 3</b></p> <p><b>a</b> Review the tips on avoiding jams. For more information, see <a href="#">“Avoiding jams” on page 221</a>.</p> <p><b>b</b> Follow the recommendations, and then resend the print job.</p> <p>Do paper jams still occur frequently?</p>	Contact <a href="#">customer support</a> .	The problem is solved.

### Paper jam message remains after jam is cleared

Action	Yes	No
<p>Check the entire paper path for jammed paper.</p> <p><b>a</b> Remove any jammed paper.</p> <p><b>b</b> From the printer control panel, touch <b>Continue</b> to clear the message.</p> <p>Does the paper jam message remain?</p>	Contact <a href="#">customer support</a> .	The problem is solved.

# Solving print problems

## Printing problems

### Confidential and other held documents do not print

Action	Yes	No
<p><b>Step 1</b></p> <p><b>a</b> From the control panel, check if the documents appear in the Held Jobs list.</p> <p><b>Note:</b> If the documents are not listed, then print the documents using the Print and Hold options.</p> <p><b>b</b> Print the documents.</p> <p>Are the documents printed?</p>	The problem is solved.	Go to step 2.
<p><b>Step 2</b></p> <p>The print job may contain a formatting error or invalid data.</p> <ul style="list-style-type: none"> <li>• Delete the print job, and then send it again.</li> <li>• For PDF files, generate a new file, and then print the documents.</li> </ul> <p>Are the documents printed?</p>	The problem is solved.	Go to step 3.
<p><b>Step 3</b></p> <p>If you are printing from the Internet, then the printer may be reading the multiple job titles as duplicates.</p> <p><b>For Windows users</b></p> <p><b>a</b> Open the Printing Preferences dialog.</p> <p><b>b</b> From the Print and Hold section, select <b>Keep duplicate documents</b>.</p> <p><b>c</b> Enter a PIN.</p> <p><b>d</b> Resend the print job.</p> <p><b>For Macintosh users</b></p> <p><b>a</b> Save and name each job differently.</p> <p><b>b</b> Send the job individually.</p> <p>Are the documents printed?</p>	The problem is solved.	Go to step 4.
<p><b>Step 4</b></p> <p><b>a</b> Delete some held jobs to free up printer memory.</p> <p><b>b</b> Resend the print job.</p> <p>Are the documents printed?</p>	The problem is solved.	Go to step 5.

Action	Yes	No
<p><b>Step 5</b></p> <p><b>a</b> Add printer memory.</p> <p><b>b</b> Resend the print job.</p> <p>Are the documents printed?</p>	The problem is solved.	Contact <a href="#">customer support</a> .

**Error message about reading the flash drive appears**

Action	Yes	No
<p><b>Step 1</b></p> <p>Check if the flash drive is inserted into the front USB port.</p> <p><b>Note:</b> The flash drive will not work if it is inserted into the rear USB port.</p> <p>Is the flash drive inserted into the front USB port?</p>	Go to step 2.	Insert the flash drive into the front USB port.
<p><b>Step 2</b></p> <p>Check if the indicator light on the printer control panel is blinking green.</p> <p><b>Note:</b> A green blinking light indicates that the printer is busy.</p> <p>Is the indicator light blinking green?</p>	Wait until the printer is ready, then view the held jobs list, and then print the documents.	Go to step 3.
<p><b>Step 3</b></p> <p><b>a</b> Check for an error message on the display.</p> <p><b>b</b> Clear the message.</p> <p>Does the error message still appear?</p>	Go to step 4.	The problem is solved.
<p><b>Step 4</b></p> <p>Check if the flash drive is supported.</p> <p>For more information on tested and approved USB flash drives, see <a href="#">“Supported flash drives and file types” on page 77</a>.</p> <p>Does the error message still appear?</p>	Go to step 5.	The problem is solved.
<p><b>Step 5</b></p> <p>Check if the USB port is disabled by the system support person.</p> <p>Does the error message still appear?</p>	Contact <a href="#">customer support</a> .	The problem is solved.

### Incorrect characters print

Action	Yes	No
<p><b>Step 1</b> Make sure the printer is not in Hex Trace mode.</p> <p><b>Note:</b> If <b>Ready Hex</b> appears on the printer display, then turn off the printer, and then turn it back on to deactivate Hex Trace mode.</p> <p>Is the printer in Hex Trace mode?</p>	Deactivate Hex Trace mode.	Go to step 2.
<p><b>Step 2</b></p> <p><b>a</b> From the printer control panel, select <b>Standard Network</b> or <b>Network [x]</b>, and then set SmartSwitch to On.</p> <p><b>b</b> Resend the print job.</p> <p>Do incorrect characters print?</p>	Contact <a href="#">customer support</a> .	The problem is solved.

### Job prints from the wrong tray or on the wrong paper

Action	Yes	No
<p><b>Step 1</b></p> <p><b>a</b> Check if you are printing on paper that is supported by the tray.</p> <p><b>b</b> Resend the print job.</p> <p>Did the job print from the correct tray or on the correct paper?</p>	The problem is solved.	Go to step 2.
<p><b>Step 2</b></p> <p><b>a</b> From the Paper menu on the printer control panel, set the paper size and type to match the paper loaded in the tray.</p> <p><b>b</b> Resend the print job.</p> <p>Did the job print from the correct tray or on the correct paper?</p>	The problem is solved.	Go to step 3.
<p><b>Step 3</b></p> <p><b>a</b> Depending on your operating system, open Printing Preferences or the Print dialog, and then specify the paper type.</p> <p><b>b</b> Resend the print job.</p> <p>Did the job print from the correct tray or on the correct paper?</p>	The problem is solved.	Go to step 4.
<p><b>Step 4</b></p> <p><b>a</b> Check if the trays are not linked.</p> <p><b>b</b> Resend the print job.</p> <p>Did the job print from the correct tray or on the correct paper?</p>	The problem is solved.	Contact <a href="#">customer support</a> .

### Large jobs do not collate

Action	Yes	No
<p><b>Step 1</b></p> <p><b>a</b> From the Finishing menu on the printer control panel, set Collate to “(1,2,3) (1,2,3).”</p> <p><b>b</b> Resend the print job.</p> <p>Did the job print and collate correctly?</p>	The problem is solved.	Go to step 2.
<p><b>Step 2</b></p> <p><b>a</b> From the printer software, set Collate to “(1,2,3) (1,2,3).”</p> <p><b>Note:</b> Setting Collate to “(1,1,1) (2,2,2)” in the software overrides the setting in the Finishing menu.</p> <p><b>b</b> Resend the print job.</p> <p>Did the job print and collate correctly?</p>	The problem is solved.	Go to step 3.
<p><b>Step 3</b></p> <p>Reduce the complexity of the print job by eliminating the number and size of fonts, the number and complexity of images, and the number of pages in the job.</p> <p>Did the job print and collate correctly?</p>	The problem is solved.	Contact <a href="#">customer support</a> .

### Multiple-language PDF files do not print

Action	Yes	No
<p><b>Step 1</b></p> <p><b>a</b> Check if the print options for the PDF output are set to embed all fonts.</p> <p>For more information, see the documentation that came with Adobe Acrobat.</p> <p><b>b</b> Generate a new PDF file, and then resend the print job.</p> <p>Do the files print?</p>	The problem is solved.	Go to step 2.
<p><b>Step 2</b></p> <p><b>a</b> Open the document you want to print in Adobe Acrobat.</p> <p><b>b</b> Click <b>File &gt; Print &gt; Advanced &gt; Print As Image &gt; OK &gt; OK</b>.</p> <p>Do the files print?</p>	The problem is solved.	Contact <a href="#">customer support</a> .

### Printing slows down

**Notes:**

- When printing using narrow paper, the printer prints at a reduced speed to prevent damage to the fuser.



- The printer speed may be reduced when printing for long periods of time, or printing at elevated temperatures.

Action	Yes	No
<p><b>Step 1</b></p> <p><b>a</b> Make sure the size of the paper loaded in the tray matches the fuser type.</p> <p><b>Note:</b> Use a 110-volt fuser for printing on letter-size paper and a 220-volt fuser for printing on A4-size paper.</p> <p><b>b</b> Resend the print job.</p> <p>Does the print speed increase?</p>	The problem is solved.	Go to step 2.
<p><b>Step 2</b></p> <p><b>a</b> Replace the fuser. For more information on installing the fuser, see the instruction sheet that came with the part.</p> <p><b>b</b> Resend the print job.</p> <p>Does the print speed increase?</p>	The problem is solved.	Contact <a href="#">customer support</a> .

**Print jobs do not print**

Action	Yes	No
<p><b>Step 1</b></p> <p><b>a</b> From the document you are trying to print, open the Print dialog and check if you have selected the correct printer.</p> <p><b>Note:</b> If the printer is not the default printer, then you must select the printer for each document that you want to print.</p> <p><b>b</b> Resend the print job.</p> <p>Do the jobs print?</p>	The problem is solved.	Go to step 2.
<p><b>Step 2</b></p> <p><b>a</b> Check if the printer is plugged in and turned on, and if <b>Ready</b> appears on the printer display.</p> <p><b>b</b> Resend the print job.</p> <p>Do the jobs print?</p>	The problem is solved.	Go to step 3.
<p><b>Step 3</b></p> <p>If an error message appears on the printer display, then clear the message.</p> <p><b>Note:</b> The printer continues to print after clearing the message.</p> <p>Do the jobs print?</p>	The problem is solved.	Go to step 4.

Action	Yes	No
<p><b>Step 4</b></p> <p><b>a</b> Check if the ports (USB, serial, or Ethernet) are working and if the cables are securely connected to the computer and the printer.</p> <p><b>Note:</b> For more information, see the setup documentation that came with the printer.</p> <p><b>b</b> Resend the print job.</p> <p>Do the jobs print?</p>	<p>The problem is solved.</p>	<p>Go to step 5.</p>
<p><b>Step 5</b></p> <p><b>a</b> Turn off the printer, then wait for about 10 seconds, and then turn the printer back on.</p> <p><b>b</b> Resend the print job.</p> <p>Do the jobs print?</p>	<p>The problem is solved.</p>	<p>Go to step 6.</p>
<p><b>Step 6</b></p> <p><b>a</b> Remove, and then reinstall the printer software. For more information, see <a href="#">“Installing the printer software” on page 46.</a></p> <p><b>Note:</b> The printer software is available at <a href="http://support.lexmark.com">http://support.lexmark.com</a>.</p> <p><b>b</b> Resend the print job.</p> <p>Do the jobs print?</p>	<p>The problem is solved.</p>	<p>Contact <a href="#">customer support</a>.</p>

**Print job takes longer than expected**

Action	Yes	No
<p><b>Step 1</b></p> <p>Change the environmental settings of the printer.</p> <p><b>a</b> From the printer control panel, navigate to:</p> <p><b>Settings &gt; General Settings</b></p> <p><b>b</b> Select <b>Eco-Mode</b> or <b>Quiet Mode</b>, and then select <b>Off</b>.</p> <p><b>Note:</b> Disabling Eco-Mode or Quiet Mode may increase the consumption of energy or supplies, or both.</p> <p>Did the job print?</p>	<p>The problem is solved.</p>	<p>Go to step 2.</p>
<p><b>Step 2</b></p> <p>Reduce the number and size of fonts, the number and complexity of images, and the number of pages in the print job, and then resend the job</p> <p>Did the job print?</p>	<p>The problem is solved.</p>	<p>Go to step 3.</p>

Action	Yes	No
<p><b>Step 3</b></p> <p><b>a</b> Remove held jobs stored in the printer memory.</p> <p><b>b</b> Resend the print job.</p> <p>Did the job print?</p>	The problem is solved.	Go to step 4.
<p><b>Step 4</b></p> <p><b>a</b> Disable the Page Protect feature.</p> <p>From the printer control panel, navigate to:  <b>Settings &gt; General Settings &gt; Print Recovery &gt; Page Protect &gt; Off</b></p> <p><b>b</b> Resend the print job.</p> <p>Did the job print?</p>	The problem is solved.	Go to step 5.
<p><b>Step 5</b></p> <p><b>a</b> Check if the cable connections to the printer and print server are secure. For more information, see the setup documentation that came with the printer.</p> <p><b>b</b> Resend the print job.</p> <p>Did the job print?</p>	The problem is solved.	Go to step 6.
<p><b>Step 6</b></p> <p>Install additional printer memory, and then resend the print job.</p> <p>Did the job print?</p>	The problem is solved.	Contact <a href="#">customer support</a> .

### Tray linking does not work

**Notes:**

- The trays can detect paper length.
- The multipurpose feeder does not automatically detect the paper size. You must set the size from the Paper Size/Type menu.

Action	Yes	No
<p><b>Step 1</b></p> <p><b>a</b> Open the trays, and then check if they contain paper of the same size and type.</p> <ul style="list-style-type: none"> <li>• Check if the paper guides are in the correct positions for the size of the paper loaded in each tray.</li> <li>• Check if the paper size indicators on the paper guides are aligned with the paper size indicators on the tray.</li> </ul> <p><b>b</b> Resend the print job.</p> <p>Do the trays link correctly?</p>	The problem is solved.	Go to step 2.

Action	Yes	No
<p><b>Step 2</b></p> <p><b>a</b> From the printer control panel, set the paper size and type in the Paper menu to match the paper loaded in the trays to be linked.</p> <p><b>Note:</b> The paper size and type must match for trays to be linked.</p> <p><b>b</b> Resend the print job.</p> <p>Do the trays link correctly?</p>	<p>The problem is solved.</p>	<p>Contact <a href="#">customer support</a>.</p>

### Unexpected page breaks occur

Action	Yes	No
<p>Increase the printing timeout.</p> <p><b>a</b> From the home screen, navigate to:</p> <p> &gt; <b>Settings</b> &gt; <b>General Settings</b> &gt; <b>Timeouts</b></p> <p><b>b</b> Increase the Print Timeout setting, and then touch <b>Submit</b>.</p> <p><b>c</b> Resend the print job.</p> <p>Did the file print correctly?</p>	<p>The problem is solved.</p>	<p>Check the original file for manual page breaks.</p>

### Print quality problems

#### Characters have jagged or uneven edges

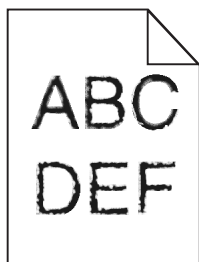

Action	Yes	No
<p><b>Step 1</b></p> <p><b>a</b> Print a font sample list to check if the fonts you are using are supported by the printer.</p> <p><b>1</b> From the printer control panel, navigate to:</p> <p> &gt; <b>Reports</b> &gt; <b>Print Fonts</b></p> <p><b>2</b> Touch <b>PCL Fonts</b> or <b>PostScript Fonts</b>.</p> <p><b>b</b> Use a font that is supported by the printer or install the font that you want to use. For more information, contact your system support person.</p> <p><b>c</b> Resend the print job.</p> <p>Do prints still contain characters that have jagged or uneven edges?</p>	Go to step 2.	The problem is solved.
<p><b>Step 2</b></p> <p><b>a</b> Use a font that is supported by the printer or install the font that you want to use on your computer. For more information, contact your system support person.</p> <p><b>b</b> Resend the print job.</p> <p>Do prints still contain characters that have jagged or uneven edges?</p>	Contact <a href="#">customer support</a> .	The problem is solved.

**Clipped pages or images**

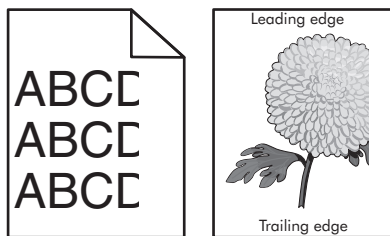

Action	Yes	No
<p><b>Step 1</b></p> <p><b>a</b> Move the width and length guides in the tray to the correct positions for the paper loaded.</p> <p><b>b</b> Resend the print job.</p> <p>Is the page or image clipped?</p>	Go to step 2.	The problem is solved.

Action	Yes	No
<p><b>Step 2</b></p> <p>From the printer control panel, set the paper size and type in the Paper menu to match the paper loaded in the tray.</p> <p>Do the paper size and type match the paper loaded in the tray?</p>	Go to step 3.	<p>Do one or more of the following:</p> <ul style="list-style-type: none"> <li>Specify the paper size from the tray settings to match the paper loaded in the tray.</li> <li>Change the paper loaded in the tray to match the paper size specified in the tray settings.</li> </ul>
<p><b>Step 3</b></p> <p><b>a</b> Depending on your operating system, specify the paper size from Printing Preferences or from the Print dialog.</p> <p><b>b</b> Resend the print job.</p> <p>Is the page or image clipped?</p>	Go to step 4.	The problem is solved.
<p><b>Step 4</b></p> <p><b>a</b> Reinstall the imaging unit.</p> <ol style="list-style-type: none"> <li>Remove the toner cartridge.</li> <li>Remove the imaging unit.</li> </ol> <p><b>Warning—Potential Damage:</b> Do not expose the imaging unit to direct light for more than 10 minutes. Extended exposure to light may cause print quality problems.</p> <ol style="list-style-type: none"> <li>Install the imaging unit, and then the cartridge.</li> </ol> <p><b>b</b> Resend the print job.</p> <p>Is the page or image clipped?</p>	Contact <a href="#">customer support</a> .	The problem is solved.

### Compressed images appear on prints

**Note:** Printing on letter-size paper using a 220-volt fuser compresses images.

Action	Yes	No
<p><b>Step 1</b></p> <p><b>a</b> Make sure the size of the paper loaded in the tray matches the fuser type.</p> <p><b>Note:</b> Use a 110-volt fuser for printing on letter-size paper and a 220-volt fuser for printing on A4-size paper.</p> <p><b>b</b> Resend the print job.</p> <p>Do compressed images still appear?</p>	The problem is solved.	Go to step 2.

Action	Yes	No
<p><b>Step 2</b></p> <p><b>a</b> Replace the fuser. For more information on installing the fuser, see the instruction sheet that came with the part.</p> <p><b>b</b> Resend the print job.</p> <p>Do compressed images still appear?</p>	<p>The problem is solved.</p>	<p>Contact <a href="#">customer support</a>.</p>

**Gray background on prints**

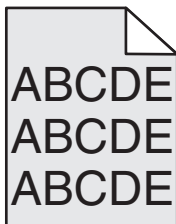

Action	Yes	No
<p><b>Step 1</b></p> <p>Check if Allow Background Removal is set to Off.</p> <p><b>a</b> From the General Settings menu, set Allow Background Removal to On.</p> <p><b>b</b> Resend the print job.</p> <p>Did the background disappear from the prints?</p>	<p>The problem is solved.</p>	<p>Go to step 2.</p>
<p><b>Step 2</b></p> <p>Adjust the toner darkness to a lighter setting.</p> <p><b>a</b> From the Quality Menu, select a lower value to reduce toner density.</p> <ul style="list-style-type: none"> <li>• 4 is the factory default setting.</li> <li>• If Print Mode is set to Black Only, then a setting of 5 increases toner density and darkness for all print jobs.</li> </ul> <p><b>b</b> Resend the print job.</p> <p>Did the background disappear from the prints?</p>	<p>The problem is solved.</p>	<p>Go to step 3.</p>
<p><b>Step 3</b></p> <p>Reinstall the toner cartridge.</p> <p><b>a</b> Remove the cartridge.</p> <p><b>b</b> Install the cartridge.</p> <p><b>c</b> Resend the print job.</p> <p>Did the background disappear from the prints?</p>	<p>The problem is solved.</p>	<p>Go to step 4.</p>

Action	Yes	No
<p><b>Step 4</b>                      Check if off-white background is selected.</p> <ul style="list-style-type: none"> <li><b>a</b> Depending on your operating system, set off-white background from Print Properties or the Print dialog.</li> <li><b>b</b> Resend the print job.</li> </ul> <p>Did the background disappear from the prints?</p>	<p>The problem is solved.</p>	<p>Contact <a href="#">customer support</a>.</p>

### Horizontal voids appear on prints

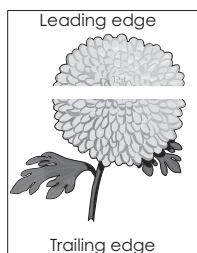

Action	Yes	No
<p><b>Step 1</b>  <b>a</b> Make sure your software program is using a correct fill pattern.  <b>b</b> Resend the print job.</p> <p>Do horizontal voids appear on prints?</p>	<p>Go to step 2.</p>	<p>The problem is solved.</p>
<p><b>Step 2</b>  <b>a</b> Load the specified tray or feeder with a recommended type of paper.  <b>b</b> Resend the print job.</p> <p>Do horizontal voids appear on prints?</p>	<p>Go to step 3.</p>	<p>The problem is solved.</p>
<p><b>Step 3</b>  <b>a</b> Redistribute the toner in the imaging unit.</p> <ol style="list-style-type: none"> <li><b>1</b> Remove the toner cartridge, and then the imaging unit.</li> <li><b>2</b> Firmly shake the imaging unit.</li> </ol> <p><b>Warning—Potential Damage:</b> Do not expose the imaging unit to direct light for more than 10 minutes. Extended exposure to light may cause print quality problems.</p> <ol style="list-style-type: none"> <li><b>3</b> Reinstall the imaging unit, and then the cartridge.</li> </ol> <p><b>b</b> Resend the print job.</p> <p>Do horizontal voids appear on prints?</p>	<p>Go to step 4.</p>	<p>The problem is solved.</p>



Action	Yes	No
<p><b>Step 4</b>                      Replace the imaging unit, and then resend the print job.</p> <p>Do horizontal voids appear on prints?</p>	Contact <a href="#">customer support</a> .	The problem is solved.

### Incorrect margins on prints

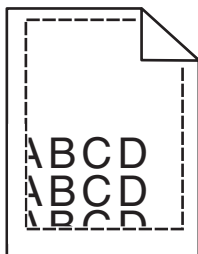

Action	Yes	No
<p><b>Step 1</b>                      a Move the width and length guides in the tray to the correct positions for the paper size loaded.                      b Resend the print job.</p> <p>Are the margins correct?</p>	The problem is solved.	Go to step 2.
<p><b>Step 2</b>                      From the printer control panel, set the paper size in the Paper menu to match the paper loaded in the tray.</p> <p>Does the paper size match the paper loaded in the tray?</p>	Go to step 3.	Do one or more of the following: <ul style="list-style-type: none"> <li>Specify the paper size from the tray settings to match the paper loaded in the tray.</li> <li>Change the paper loaded in the tray to match the paper size specified in the tray settings.</li> </ul>
<p><b>Step 3</b>                      a Depending on your operating system, specify the paper size from Printing Preferences or from the Print dialog.                      b Resend the print job.</p> <p>Are the margins correct?</p>	The problem is solved.	Contact <a href="#">customer support</a> .

### Paper curl

Action	Yes	No
<p><b>Step 1</b> Move the width and length guides in the tray to the correct positions for the size of the paper loaded.</p> <p>Are the width and length guides positioned correctly?</p>	Go to step 2.	Adjust the width and length guides.
<p><b>Step 2</b> From the printer control panel, set the paper type and weight in the Paper menu to match the paper loaded in the tray.</p> <p>Do the paper type and weight match the type and weight of the paper in the tray?</p>	Go to step 3.	Specify the paper type and weight from the tray settings to match the paper loaded in the tray.
<p><b>Step 3</b></p> <p><b>a</b> Depending on your operating system, specify the paper type and weight from Printing Preferences or from the Print dialog.</p> <p><b>b</b> Resend the print job.</p> <p>Is the paper still curled?</p>	Go to step 4.	The problem is solved.
<p><b>Step 4</b></p> <p><b>a</b> Remove the paper from the tray, and then turn it over.</p> <p><b>b</b> Resend the print job.</p> <p>Is the paper still curled?</p>	Go to step 5.	The problem is solved.
<p><b>Step 5</b></p> <p><b>a</b> Load paper from a fresh package.</p> <p><b>Note:</b> Paper absorbs moisture due to high humidity. Store paper in its original wrapper until you use it.</p> <p><b>b</b> Resend the print job.</p> <p>Is the paper still curled?</p>	Contact <a href="#">customer support</a> .	The problem is solved.

### Print irregularities

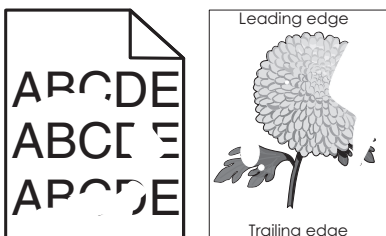

Action	Yes	No
<p><b>Step 1</b></p> <p><b>a</b> Move the width and length guides in the tray to the correct positions for the size of the paper loaded in the tray.</p> <p><b>b</b> Resend the print job.</p> <p>Do print irregularities still appear?</p>	<p>Go to step 2.</p>	<p>The problem is solved.</p>
<p><b>Step 2</b></p> <p>From the printer control panel, set the paper size and type in the Paper menu to match the paper loaded in the tray.</p> <p>Do the printer settings match the type and weight of the paper loaded in the tray?</p>	<p>Go to step 3.</p>	<p>Specify the paper size and type from the tray settings to match the paper loaded in the tray.</p>
<p><b>Step 3</b></p> <p><b>a</b> Depending on your operating system, specify the paper type and weight from Printing Preferences or from the Print dialog.</p> <p><b>b</b> Resend the print job.</p> <p>Do print irregularities still appear?</p>	<p>Go to step 4.</p>	<p>The problem is solved.</p>
<p><b>Step 4</b></p> <p>Check if the paper loaded in the tray has texture or rough finishes.</p> <p>Are you printing on textured or rough paper?</p>	<p>From the printer control panel, set the paper texture in the Paper menu to match the paper loaded in the tray.</p>	<p>Go to step 5.</p>
<p><b>Step 5</b></p> <p><b>a</b> Load paper from a fresh package.</p> <p><b>Note:</b> Paper absorbs moisture due to high humidity. Store paper in its original wrapper until you use it.</p> <p><b>b</b> Resend the print job.</p> <p>Do print irregularities still appear?</p>	<p>Go to step 6.</p>	<p>The problem is solved.</p>
<p><b>Step 6</b></p> <p>Replace the imaging unit, and then resend the print job.</p> <p>Do print irregularities still appear?</p>	<p>Contact <a href="#">customer support</a> at <a href="http://support.lexmark.com">http://support.lexmark.com</a> or your service representative.</p>	<p>The problem is solved.</p>

**Print is too dark**

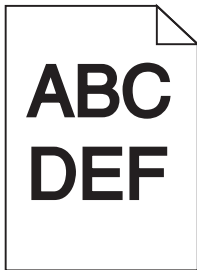

Action	Yes	No
<p><b>Step 1</b></p> <p><b>a</b> From the Quality menu on the printer control panel, reduce the toner darkness.</p> <p><b>Note:</b> 8 is the factory default setting.</p> <p><b>b</b> Resend the print job.</p> <p>Is the print still too dark?</p>	Go to step 2.	The problem is solved.
<p><b>Step 2</b></p> <p><b>a</b> From the printer control panel, set the paper type, texture and weight in the Paper menu to match the paper loaded in the tray.</p> <p><b>b</b> Resend the print job.</p> <p>Is the tray set to the type, texture, and weight of the paper loaded?</p>	Go to step 3.	<p>Do one or more of the following:</p> <ul style="list-style-type: none"> <li>Specify the paper type, texture, and weight from the tray settings to match the paper loaded in the tray.</li> <li>Change the paper loaded in the tray to match the paper type, texture and weight specified in the tray settings.</li> </ul>
<p><b>Step 3</b></p> <p><b>a</b> Depending on your operating system, specify the paper type, texture and weight from Printing Preferences or from the Print dialog.</p> <p><b>b</b> Resend the print job.</p> <p>Is the print still too dark?</p>	Go to step 4.	The problem is solved.
<p><b>Step 4</b></p> <p>Check if the paper loaded in the tray has texture or rough finishes.</p> <p>Are you printing on textured or rough paper?</p>	From the printer control panel, change the texture settings in the Paper Texture menu to match the paper you are printing on.	Go to step 5.

Action	Yes	No
<p><b>Step 5</b></p> <p><b>a</b> Load paper from a fresh package.</p> <p><b>Note:</b> Paper absorbs moisture due to high humidity. Store paper in its original wrapper until you use it.</p> <p><b>b</b> Resend the print job.</p> <p>Is the print still too dark?</p>	Go to step 6.	The problem is solved.
<p><b>Step 6</b></p> <p>Replace the imaging unit, and then resend the print job.</p> <p>Is the print still too dark?</p>	Contact <a href="#">customer support</a> .	The problem is solved.

**Print is too light**

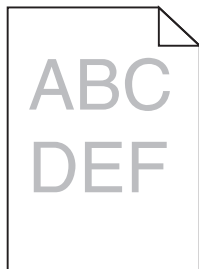

Action	Yes	No
<p><b>Step 1</b></p> <p><b>a</b> From the Quality menu on the printer control panel, increase the toner darkness.</p> <p><b>Note:</b> 8 is the factory default setting.</p> <p><b>b</b> Resend the print job.</p> <p>Is the print still too light?</p>	Go to step 2.	The problem is solved.
<p><b>Step 2</b></p> <p>From the printer control panel, set the paper type, texture, and weight in the Paper menu to match the paper loaded in the tray.</p> <p>Is the tray set to the type, texture, and weight of the paper loaded?</p>	Go to step 3.	Change the paper type, texture, and weight to match the paper loaded in the tray.
<p><b>Step 3</b></p> <p><b>a</b> Depending on your operating system, specify the paper type, texture, and weight from Printing Preferences or from the Print dialog.</p> <p><b>b</b> Resend the print job.</p> <p>Is the print still too light?</p>	Go to step 4.	The problem is solved.

Action	Yes	No
<p><b>Step 4</b>                      Make sure that the paper has no texture or rough finishes.</p> <p>Are you printing on textured or rough paper?</p>	<p>From the printer control panel, change the texture settings in the Paper Texture menu to match the paper you are printing on.</p>	<p>Go to step 5.</p>
<p><b>Step 5</b>  <b>a</b> Load paper from a fresh package.  <b>Note:</b> Paper absorbs moisture due to high humidity. Store paper in its original wrapper until you use it.  <b>b</b> Resend the print job.</p> <p>Is the print still too light?</p>	<p>Go to step 6.</p>	<p>The problem is solved.</p>
<p><b>Step 6</b>  <b>a</b> Redistribute the toner in the imaging unit.  <b>1</b> Remove the toner cartridge, and then the imaging unit.  <b>2</b> Firmly shake the imaging unit.  <b>Warning—Potential Damage:</b> Do not expose the imaging unit to direct light for more than 10 minutes. Extended exposure to light may cause print quality problems.  <b>3</b> Install the imaging unit, and then the cartridge.  <b>b</b> Resend the print job.</p> <p>Is the print still too light?</p>	<p>Go to step 7.</p>	<p>The problem is solved.</p>
<p><b>Step 7</b>                      Replace the imaging unit, and then resend the print job.</p> <p>Is the print still too light?</p>	<p>Contact <a href="#">customer support</a>.</p>	<p>The problem is solved.</p>

**Printer is printing blank pages**



Action	Yes	No
<p><b>Step 1</b></p> <p><b>a</b> Check if there is packing material left on the imaging unit.</p> <ol style="list-style-type: none"> <li><b>1</b> Remove the toner cartridge, and then the imaging unit.</li> <li><b>2</b> Check if the packing material is properly removed from the imaging unit.</li> </ol> <p><b>Warning—Potential Damage:</b> Do not expose the imaging unit to direct light for more than 10 minutes. Extended exposure to light may cause print quality problems.</p> <ol style="list-style-type: none"> <li><b>3</b> Reinstall the imaging unit, and then the cartridge.</li> </ol> <p><b>b</b> Resend the print job.</p> <p>Is the printer still printing blank pages?</p>	Go to step 2.	The problem is solved.
<p><b>Step 2</b></p> <p><b>a</b> Redistribute the toner in the imaging unit.</p> <ol style="list-style-type: none"> <li><b>1</b> Remove the toner cartridge, and then the imaging unit.</li> <li><b>2</b> Firmly shake the imaging unit.</li> </ol> <p><b>Warning—Potential Damage:</b> Do not expose the imaging unit to direct light for more than 10 minutes. Extended exposure to light may cause print quality problems.</p> <ol style="list-style-type: none"> <li><b>3</b> Reinstall the imaging unit, and then the cartridge.</li> </ol> <p><b>b</b> Resend the print job.</p> <p>Is the printer still printing blank pages?</p>	Go to step 3.	The problem is solved.
<p><b>Step 3</b></p> <p>Replace the imaging unit, and then resend the print job.</p> <p>Is the printer still printing blank pages?</p>	Contact <a href="#">customer support</a> .	The problem is solved.

**Printer is printing solid black pages**

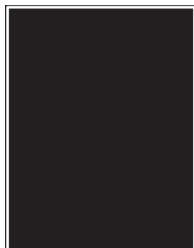

Action	Yes	No
<p><b>Step 1</b>  <b>a</b> Reinstall the imaging unit.</p> <ol style="list-style-type: none"> <li>1 Remove the toner cartridge, and then the imaging unit.  <b>Warning—Potential Damage:</b> Do not expose the imaging unit to direct light for more than 10 minutes. Extended exposure to light may cause print quality problems.</li> <li>2 Install the imaging unit, and then the cartridge.</li> </ol> <p><b>b</b> Resend the print job.</p> <p>Is the printer printing solid black pages?</p>	Go to step 2.	The problem is solved.
<p><b>Step 2</b>                      Replace the imaging unit, and then resend the print job.</p> <p>Is the printer printing solid black pages?</p>	Contact <a href="#">customer support</a> .	The problem is solved.

**Repeating defects appear on prints**

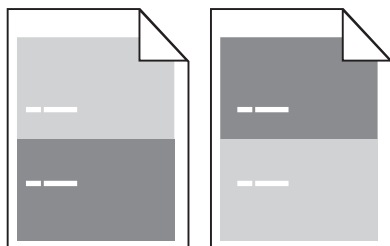

Action	Yes	No
<p><b>Step 1</b>                      Measure the distance between the defects.                      Check for a distance between the defects that equals:</p> <ul style="list-style-type: none"> <li>• 97 mm (3.82 in.)</li> <li>• 47 mm (1.85 in.)</li> <li>• 38 mm (1.5 in.)</li> </ul> <p>Is the distance between defects equal to one of the listed measurements?</p>	Go to step 2.	<ol style="list-style-type: none"> <li>1 Check if the distance between the defects equal to 80 mm (3.15 in.)</li> <li>2 Take note of the distance, and then contact <a href="#">customer support</a> at <a href="http://support.lexmark.com">http://support.lexmark.com</a> or your service representative.</li> </ol>
<p><b>Step 2</b>                      Replace the imaging unit, and then resend the print job.</p> <p>Do the repeating defects still appear?</p>	Contact <a href="#">customer support</a> at <a href="http://support.lexmark.com">http://support.lexmark.com</a> or your service representative.	The problem is solved.



### Shadow images appear on prints

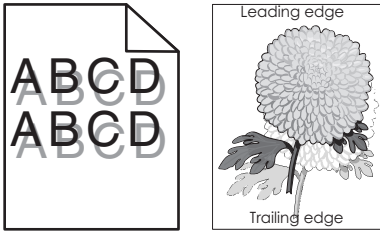

Action	Yes	No
<p><b>Step 1</b> Load paper with the correct paper type and weight in the tray.</p> <p>Is paper with the correct paper type and weight loaded in the tray?</p>	Go to step 2.	Load paper with the correct paper type and weight in the tray.
<p><b>Step 2</b> From the printer control panel, set the paper type and weight in the Paper menu to match the paper loaded in the tray.</p> <p>Is the tray set to the type and weight of the paper loaded?</p>	Go to step 3.	Change the paper loaded in the tray to match the paper type and weight specified in the tray settings.
<p><b>Step 3</b></p> <ul style="list-style-type: none"> <li>a Depending on your operating system, specify the paper type and weight from Printing Preferences or from the Print dialog.</li> <li>b Resend the print job.</li> </ul> <p>Do shadow images still appear on prints?</p>	Go to step 4.	The problem is solved.
<p><b>Step 4</b> Replace the imaging unit, and then resend the print job.</p> <p>Do shadow images still appear on prints?</p>	Contact <a href="#">customer support</a> .	The problem is solved.

### Skewed print

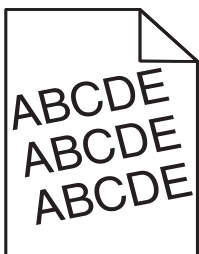

Action	Yes	No
<p><b>Step 1</b></p> <p><b>a</b> Move the width and length guides in the tray to the correct positions for the size of the paper loaded.</p> <p><b>b</b> Resend the print job.</p> <p>Is the print still skewed?</p>	Go to step 2.	The problem is solved.
<p><b>Step 2</b></p> <p><b>a</b> Check if you are printing on a paper that is supported by the tray.</p> <p><b>b</b> Resend the print job.</p> <p>Is the print still skewed?</p>	Contact <a href="#">customer support</a> .	The problem is solved.

**Streaked horizontal lines appear on prints**

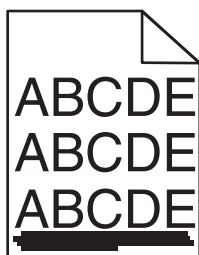

Action	Yes	No
<p><b>Step 1</b></p> <p><b>a</b> Depending on your operating system, specify the tray or feeder from Printing Preferences or the Print dialog.</p> <p><b>b</b> Resend the print job.</p> <p>Do streaked horizontal lines appear on prints?</p>	Go to step 2.	The problem is solved.
<p><b>Step 2</b></p> <p>From the printer control panel, set the paper type and weight in the Paper menu to match the paper loaded in the tray.</p> <p>Do the paper type and weight match the type and weight of the paper in the tray?</p>	Go to step 3.	Change the paper type and weight to match the paper loaded in the tray.
<p><b>Step 3</b></p> <p><b>a</b> Load paper from a fresh package.</p> <p><b>Note:</b> Paper absorbs moisture due to high humidity. Store paper in its original wrapper until you use it.</p> <p><b>b</b> Resend the print job.</p> <p>Do streaked horizontal lines appear on prints?</p>	Go to step 4.	The problem is solved.

Action	Yes	No
<p><b>Step 4</b></p> <p><b>a</b> Reinstall the imaging unit.</p> <p><b>1</b> Remove the toner cartridge, and then the imaging unit.</p> <p><b>Warning—Potential Damage:</b> Do not expose the imaging unit to direct light for more than 10 minutes. Extended exposure to light may cause print quality problems.</p> <p><b>2</b> Install the imaging unit, and then the cartridge.</p> <p><b>b</b> Resend the print job.</p> <p>Do streaked horizontal lines appear on prints?</p>	Go to step 5.	The problem is solved.
<p><b>Step 5</b></p> <p>Replace the imaging unit, and then resend the print job.</p> <p>Do streaked horizontal lines appear on prints?</p>	Contact <a href="#">customer support</a> .	The problem is solved.

**Streaked vertical lines appear on prints**

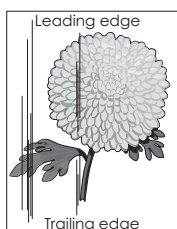
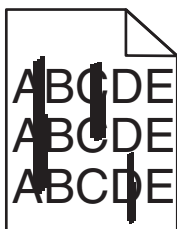

Action	Yes	No
<p><b>Step 1</b></p> <p><b>a</b> Depending on your operating system, specify the paper type, texture, and weight from Printing Preferences or from the Print dialog.</p> <p><b>b</b> Resend the print job.</p> <p>Do streaked vertical lines appear on prints?</p>	Go to step 2.	The problem is solved.

Action	Yes	No
<p><b>Step 2</b></p> <p>From the printer control panel, set the paper texture, type, and weight in the Paper menu to match the paper loaded in the tray.</p> <p>Do the paper texture, type, and weight match the paper in the tray?</p>	<p>Go to step 3.</p>	<p>Do one or more of the following:</p> <ul style="list-style-type: none"> <li>• Specify the paper texture, type, and weight from the tray settings to match the paper loaded in the tray.</li> <li>• Change the paper loaded in the tray to match the paper texture, type, and weight specified in the tray settings.</li> </ul>
<p><b>Step 3</b></p> <p><b>a</b> Load paper from a fresh package.</p> <p><b>Note:</b> Paper absorbs moisture due to high humidity. Store paper in its original wrapper until you use it.</p> <p><b>b</b> Resend the print job.</p> <p>Do streaked vertical lines appear on prints?</p>	<p>Go to step 4.</p>	<p>The problem is solved.</p>
<p><b>Step 4</b></p> <p><b>a</b> Reinstall the imaging unit.</p> <ol style="list-style-type: none"> <li><b>1</b> Remove the toner cartridge, and then the imaging unit.</li> </ol> <p><b>Warning—Potential Damage:</b> Do not expose the imaging unit to direct light for more than 10 minutes. Extended exposure to light may cause print quality problems.</p> <ol style="list-style-type: none"> <li><b>2</b> Install the imaging unit, and then the cartridge.</li> </ol> <p><b>b</b> Resend the print job.</p> <p>Do streaked vertical lines appear on prints?</p>	<p>Go to step 5.</p>	<p>The problem is solved.</p>
<p><b>Step 5</b></p> <p>Replace the imaging unit, and then resend the print job.</p> <p>Do streaked vertical lines appear on prints?</p>	<p>Contact <a href="#">customer support</a> at <a href="http://support.lexmark.com">http://support.lexmark.com</a> or your service representative.</p>	<p>The problem is solved.</p>

### Toner fog or background shading appears on prints

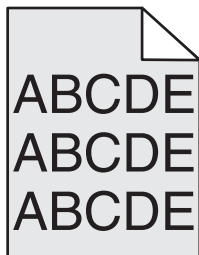

Action	Yes	No
<p><b>Step 1</b> Reinstall the imaging unit.</p> <ul style="list-style-type: none"> <li><b>a</b> Remove, and then install the imaging unit.</li> <li><b>b</b> Resend the print job.</li> </ul> <p>Does fog or shading appear on prints?</p>	Go to step 2.	The problem is solved.
<p><b>Step 2</b> Replace the imaging unit, and then resend the print job.</p> <p>Does fog or shading appear on prints?</p>	Contact <a href="#">customer support</a> at <a href="http://support.lexmark.com">http://support.lexmark.com</a> or your service representative.	The problem is solved.

### Toner rubs off

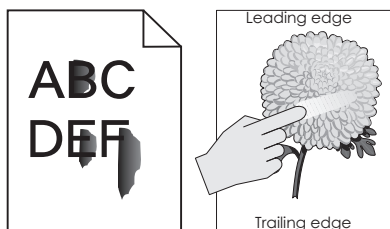

Action	Yes	No
<p><b>Step 1</b> From the Paper menu on the printer control panel, check the paper type, texture, and weight.</p> <p>Do the paper type, texture, and weight match the paper loaded in the tray?</p>	Go to step 2.	Specify the paper type, texture, and weight from the tray settings to match the paper loaded in the tray.
<p><b>Step 2</b> Resend the print job.</p> <p>Does the toner still rub off?</p>	Contact <a href="#">customer support</a> .	The problem is solved.

### Toner specks appear on prints

Action	Yes	No
Replace the imaging unit, and then resend the print job.  Do toner specks appear on prints?	Contact <a href="#">customer support</a> .	The problem is solved.

### Transparency print quality is poor

Action	Yes	No
<b>Step 1</b> From the printer control panel, set the paper type in the Paper menu to match the paper loaded in the tray.  Is the paper type for the tray set to Transparency?	Go to step 2.	Set the paper type to Transparency.
<b>Step 2</b> a Check if you are using a recommended type of transparency. b Resend the print job.  Is the print quality still poor?	Contact <a href="#">customer support</a> .	The problem is solved.

### Uneven print density

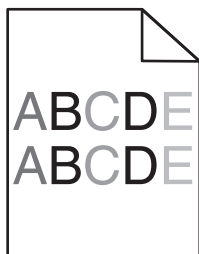

Action	Yes	No
Replace the imaging unit, and then resend the print job.  Is the print density uneven?	Contact <a href="#">customer support</a> .	The problem is solved.

### Vertical voids appear on prints

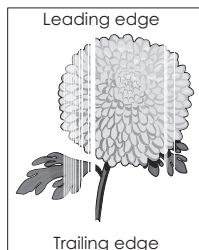

Action	Yes	No
<p><b>Step 1</b></p> <p><b>a</b> Make sure your software program is using a correct fill pattern.</p> <p><b>b</b> Resend the print job.</p> <p>Do vertical voids appear on prints?</p>	Go to step 2.	The problem is solved.
<p><b>Step 2</b></p> <p><b>a</b> From the printer control panel, set the paper type and weight in the Paper menu to match the paper loaded in the tray.</p> <p><b>b</b> Resend the print job.</p> <p>Do vertical voids appear on prints?</p>	Go to step 3.	The problem is solved.
<p><b>Step 3</b></p> <p>Check if you are using a recommended type of paper.</p> <p><b>a</b> Load the specified tray or feeder with a recommended type of paper.</p> <p><b>b</b> Resend the print job.</p> <p>Do vertical voids appear on prints?</p>	Go to step 4.	The problem is solved.
<p><b>Step 4</b></p> <p><b>a</b> Redistribute the toner in the imaging unit.</p> <ol style="list-style-type: none"> <li><b>1</b> Remove the toner cartridge, and then the imaging unit.</li> <li><b>2</b> Firmly shake the imaging unit.</li> </ol> <p><b>Warning—Potential Damage:</b> Do not expose the imaging unit to direct light for more than 10 minutes. Extended exposure to light may cause print quality problems.</p> <ol style="list-style-type: none"> <li><b>3</b> Reinstall the imaging unit, and then the cartridge.</li> </ol> <p><b>b</b> Resend the print job.</p> <p>Do vertical voids appear on prints?</p>	Go to step 5.	The problem is solved.
<p><b>Step 5</b></p> <p>Replace the imaging unit, and then resend the print job.</p> <p>Do vertical voids appear on prints?</p>	Contact <a href="#">customer support</a> .	The problem is solved.

## Solving copy problems

- “Copier does not respond” on page 280
- “Partial document or photo copies” on page 280
- “Poor copy quality” on page 281
- “Scanner unit does not close” on page 282

## Copier does not respond

Action	Yes	No
<p><b>Step 1</b> Check if an error or status message appears on the display.</p> <p>Does an error or status message appear?</p>	Clear the error or status message.	Go to step 2.
<p><b>Step 2</b> Check if the power cord is plugged into the printer and a properly grounded electrical outlet.</p> <p>Is the power cord plugged into the printer and a properly grounded electrical outlet?</p>	Go to step 3.	Connect the power cord to the printer and a properly grounded electrical outlet.
<p><b>Step 3</b> Turn off the printer, then wait for about 10 seconds, and then turn it back on.</p> <p>Did <b>Performing Self Test</b> and <b>Ready</b> appear?</p>	The problem is solved.	Contact <a href="#">customer support</a> .

## Partial document or photo copies

Action	Yes	No
<p><b>Step 1</b> Check the placement of the document or photo. Make sure the document or photo is loaded facedown on the scanner glass in the upper left corner.</p> <p>Is the document or photo loaded correctly?</p>	Go to step 2.	Place the document or photo facedown on the scanner glass in the upper left corner.
<p><b>Step 2</b> Check if the paper size setting matches the size of the paper loaded in the tray. From the Paper menu on the printer control panel, check the Paper Size setting.</p> <p>Does the paper size setting match the size of the paper loaded in the tray.</p>	Go to step 3.	Change the paper size setting to match the paper loaded in the tray, or load the tray with paper that matches the paper size setting.
<p><b>Step 3</b></p> <p><b>a</b> Specify the paper size. Depending on your operating system, specify the paper size in Printing Preferences or the Print dialog.</p> <p><b>b</b> Resend the print job.</p> <p>Do copies print properly?</p>	The problem is solved.	Contact <a href="#">customer support</a> .



## Poor copy quality

Action	Yes	No
<p><b>Step 1</b> Check if an error or status message appears on the display.</p> <p>Does an error or status message appear?</p>	Clear the error or status message.	Go to step 2.
<p><b>Step 2</b> Check the quality of the original document.</p> <p>Is the quality of the original document satisfactory?</p>	Go to step 3.	Increase the scan resolution setting for a higher-quality output.
<p><b>Step 3</b> If dark marks appear on prints, then clean the scanner glass and the ADF glass using a clean, lint-free cloth dampened with water.</p> <p>Is the scanner glass clean?</p>	Go to step 4.	See <a href="#">“Cleaning the scanner glass” on page 208.</a>
<p><b>Step 4</b> Send a print job, and then check for print quality problems.</p> <ul style="list-style-type: none"> <li><b>a</b> From the General Settings menu, adjust the Eco-Mode settings.</li> <li><b>b</b> From the Copy menu, adjust the Darkness setting.</li> <li><b>c</b> If the print remains faded, then replace the toner cartridge.</li> </ul> <p>Is the print quality satisfactory?</p>	Go to step 5.	See <a href="#">“Print quality problems” on page 260.</a>
<p><b>Step 5</b> Check the placement of the document or photo.</p> <p>Make sure the document or photo is loaded facedown on the scanner glass in the upper left corner.</p> <p>Is the document or photo loaded correctly?</p>	Go to step 6.	Place the document or photo facedown on the scanner glass in the upper left corner.
<p><b>Step 6</b> Check the copy settings.</p> <p>From the Copy screen, check if the Content Type and Content Source settings are correct for the document being scanned.</p> <p>Are the Content Type and Content Source settings correct for the document being scanned?</p>	Go to step 7.	Change the Content Type and Content Source settings to match the document being scanned.
<p><b>Step 7</b> Check for patterns on print.</p> <ul style="list-style-type: none"> <li><b>a</b> From the printer control panel, navigate to: <b>Copy &gt; Sharpness</b> &gt; select a lower setting <b>Note:</b> Make sure no scaling is being selected.</li> <li><b>b</b> Resend the copy job.</li> </ul> <p>Do patterns appear on prints?</p>	Go to step 8.	The problem is solved.

Action	Yes	No
<p><b>Step 8</b>                      Check for missing or faded text on prints.</p> <p><b>a</b> From the Copy screen, adjust the settings of the following:</p> <ul style="list-style-type: none"> <li>• <b>Sharpness</b>—Increase the sharpness setting.</li> <li>• <b>Contrast</b>—Increase the contrast setting.</li> </ul> <p><b>b</b> Resend the copy job.</p> <p>Do prints have missing or faded text?</p>	<p>Go to step 9.</p>	<p>The problem is solved.</p>
<p><b>Step 9</b>                      Check for washed-out or overexposed output.</p> <p><b>a</b> From the Copy screen, adjust the settings of the following:</p> <ul style="list-style-type: none"> <li>• <b>Background Removal</b>—Reduce the current setting.</li> <li>• <b>Darkness</b>—Increase the current setting.</li> </ul> <p><b>b</b> Resend the copy job.</p> <p>Do pages show washed-out or overexposed prints?</p>	<p>Contact <a href="#">customer support</a>.</p>	<p>The problem is solved.</p>

### Scanner unit does not close

Action	Yes	No
<p>Check if there are no obstructions between the scanner unit and the printer.</p> <p><b>a</b> Lift the scanner unit.</p> <p><b>b</b> Remove any obstruction that keeps the scanner unit open.</p> <p><b>c</b> Lower the scanner unit.</p> <p>Did the scanner unit close properly?</p>	<p>The problem is solved.</p>	<p>Contact <a href="#">customer support</a>.</p>

### Solving fax problems

- “Caller ID is not shown” on page 283
- “Cannot send or receive a fax” on page 283
- “Can receive but not send faxes” on page 286
- “Can send but not receive faxes” on page 286
- “Fax and e-mail functions are not set up” on page 287
- “Received fax has poor print quality” on page 288

### Caller ID is not shown

Action	Yes	No
<p>Contact your telephone company to check if your telephone line is subscribed to the caller ID service.</p> <p><b>Notes:</b></p> <ul style="list-style-type: none"> <li>• If your region supports multiple caller ID patterns, then you may have to change the default setting. There are two settings available: FSK (pattern 1) and DTMF (pattern 2).</li> <li>• The availability of these settings in the Fax menu depends on whether your country or region supports multiple caller ID patterns.</li> <li>• Contact your telephone company to determine which pattern or switch setting to use.</li> </ul> <p>Does the caller ID appear?</p>	<p>The problem is solved.</p>	<p>Contact <a href="#">customer support</a>.</p>

### Cannot send or receive a fax

Action	Yes	No
<p><b>Step 1</b></p> <p>Check if an error or status message appears on the display.</p> <p>Is there an error or status message on the display?</p>	<p>Clear the error or status message.</p>	<p>Go to step 2.</p>
<p><b>Step 2</b></p> <p>Check if the power cord is plugged into the printer and a properly grounded electrical outlet.</p> <p>Is the power cord plugged into the printer and a properly grounded electrical outlet?</p>	<p>Go to step 3.</p>	<p>Connect the power cord to the printer and a properly grounded electrical outlet.</p>
<p><b>Step 3</b></p> <p>Check the power.</p> <p>Check if the printer is plugged in and turned on, and if <b>Ready</b> appears on the display.</p> <p>Is the printer turned on, and does <b>Ready</b> appear on the display?</p>	<p>Go to step 4.</p>	<p>Turn on the printer, and then wait until <b>Ready</b> appears on the display.</p>
<p><b>Step 4</b></p> <p>Check the printer connections.</p> <p>If applicable, check if the cable connections for the following equipment are secure:</p> <ul style="list-style-type: none"> <li>• Telephone</li> <li>• Handset</li> <li>• Answering machine</li> </ul> <p>Are the cable connections secure?</p>	<p>Go to step 5.</p>	<p>Securely connect the cables.</p>

Action	Yes	No
<p><b>Step 5</b></p> <p><b>a</b> Check the telephone wall jack.</p> <ol style="list-style-type: none"> <li><b>1</b> Plug the telephone cable into the wall jack.</li> <li><b>2</b> Listen for a dial tone.</li> <li><b>3</b> If you do not hear a dial tone, then plug a different telephone cable into the wall jack.</li> <li><b>4</b> If you still do not hear a dial tone, then plug the telephone cable into a different wall jack.</li> <li><b>5</b> If you hear a dial tone, then connect the printer to that wall jack.</li> </ol> <p><b>b</b> Try sending or receiving a fax.</p> <p>Can you send or receive a fax?</p>	<p>The problem is solved.</p>	<p>Go to step 6.</p>
<p><b>Step 6</b></p> <p>Check if the printer is connected to an analog phone service or the correct digital connector.</p> <p>The fax modem is an analog device. Certain devices can be connected to the printer so that digital telephone services can be used.</p> <ul style="list-style-type: none"> <li>• If you are using an ISDN telephone service, then connect the printer to an analog telephone port (an R-interface port) on an ISDN terminal adapter. For more information and to request an R-interface port, contact your ISDN provider.</li> <li>• If you are using DSL, then connect to a DSL filter or router that will support analog use. For more information, contact your DSL provider.</li> <li>• If you are using a PBX telephone service, then make sure you are connecting to an analog connection on the PBX. If none exists, then consider installing an analog telephone line for the fax machine.</li> </ul> <p>Is the printer connected to an analog phone service or the correct digital connector?</p>	<p>Go to step 7.</p>	<p>Connect the printer to an analog phone service or the correct digital connector.</p>

Action	Yes	No
<p><b>Step 7</b> Check for a dial tone.</p> <p>Did you hear a dial tone?</p>	<p>Go to step 8.</p>	<ul style="list-style-type: none"> <li>• Try calling the fax number to make sure that it is working properly.</li> <li>• If the telephone line is being used by another device, then wait until the other device is finished before sending a fax.</li> <li>• If you are using the On Hook Dial feature, then turn up the volume to check if you hear a dial tone.</li> </ul>
<p><b>Step 8</b> Temporarily disconnect other equipment (such as answering machines, computers with modems, or telephone line splitters) between the printer and the telephone line, and then try sending or receiving a fax.</p> <p>Can you send or receive a fax?</p>	<p>The problem is solved.</p>	<p>Go to step 9.</p>
<p><b>Step 9</b></p> <p><b>a</b> Temporarily disable call waiting. Contact your telephone company to obtain the keypad sequence for temporarily disabling call waiting.</p> <p><b>b</b> Try sending or receiving a fax.</p> <p>Can you send or receive a fax?</p>	<p>The problem is solved.</p>	<p>Go to step 10.</p>
<p><b>Step 10</b></p> <p><b>a</b> Temporarily disable voice mail service. For more information, contact your telephone company.</p> <p><b>Note:</b> If you want to use both voice mail and the printer, then consider adding a second telephone line for the printer.</p> <p><b>b</b> Try sending or receiving a fax.</p> <p>Can you send or receive a fax?</p>	<p>The problem is solved.</p>	<p>Go to step 11.</p>
<p><b>Step 11</b> Scan the original document one page at a time.</p> <p><b>a</b> Dial the fax number.</p> <p><b>b</b> Scan the document one page at a time.</p> <p>Can you send or receive a fax?</p>	<p>The problem is solved.</p>	<p>Contact <a href="#">customer support</a>.</p>

### Can receive but not send faxes

Action	Yes	No
<p><b>Step 1</b></p> <p>Check if the printer is in Fax mode.</p> <p>From the home screen, touch <b>Fax</b> to put the printer in Fax mode, and then send the fax.</p> <p><b>Note:</b> The Multi Send application does not support the XPS output type. To use XPS, use the regular faxing method.</p> <p>Can you send faxes?</p>	<p>The problem is solved.</p>	<p>Go to step 2.</p>
<p><b>Step 2</b></p> <p>Load the original document properly.</p> <p>Load the original document faceup, short edge first into the ADF tray or facedown on the scanner glass in the upper left corner.</p> <p><b>Note:</b> Do not load postcards, photos, small items, transparencies, photo paper, or thin media (such as magazine clippings) into the ADF tray. Place these items on the scanner glass.</p> <p>Can you send faxes?</p>	<p>The problem is solved.</p>	<p>Go to step 3.</p>
<p><b>Step 3</b></p> <p>Set up the shortcut number properly.</p> <ul style="list-style-type: none"> <li>• Check if the shortcut number has been set for the telephone number that you want to dial.</li> <li>• Dial the telephone number manually.</li> </ul> <p>Can you send faxes?</p>	<p>The problem is solved.</p>	<p>Contact <a href="#">customer support</a>.</p>

### Can send but not receive faxes



Action	Yes	No
<p><b>Step 1</b></p> <p>Check the tray or feeder.</p> <p>If empty, then load paper in the tray or feeder.</p> <p>Can you receive faxes?</p>	<p>The problem is solved.</p>	<p>Go to step 2.</p>

Action	Yes	No
<p><b>Step 2</b> Check the ring count delay settings.</p> <p><b>a</b> Open a Web browser, and then type the printer IP address in the address field.</p> <p><b>Notes:</b></p> <ul style="list-style-type: none"> <li>View the printer IP address on the printer home screen. The IP address appears as four sets of numbers separated by periods, such as 123.123.123.123.</li> <li>If you are using a proxy server, then temporarily disable it to load the Web page correctly.</li> </ul> <p><b>b</b> Click <b>Settings</b> &gt; <b>Fax Settings</b> &gt; <b>Analog Fax Setup</b>.</p> <p><b>c</b> In the “Rings to Answer” field, enter the number of times you want the phone to ring before the printer answers.</p> <p><b>d</b> Click <b>Submit</b>.</p> <p>Can you receive faxes?</p>	<p>The problem is solved.</p>	<p>Go to step 3.</p>
<p><b>Step 3</b> Replace the toner cartridge. For more information, see the instruction sheet that came with the supply.</p> <p>Can you receive faxes?</p>	<p>The problem is solved.</p>	<p>Contact <a href="#">customer support</a>.</p>

## Fax and e-mail functions are not set up

**Notes:**

- Before you troubleshoot, check if the fax cables are connected.
- The indicator light is blinking red until you set up fax and e-mail.

Action	Yes	No
<p><b>a</b> From the home screen, navigate to:</p> <p> &gt; <b>Settings</b> &gt; <b>General Settings</b> &gt; <b>Run initial setup</b> &gt; <b>Yes</b> &gt; <b>Submit</b></p> <p><b>b</b> Turn off the printer, and then turn it back on. The “Select your language” screen appears on the printer display.</p> <p><b>c</b> Select a language, and then touch .</p> <p><b>d</b> Select a country or region, and then touch <b>Next</b>.</p> <p><b>e</b> Select a time zone, and then touch <b>Next</b>.</p> <p><b>f</b> Select <b>Fax</b> and <b>E-mail</b>, and then touch <b>Next</b>.</p> <p>Are fax and e-mail functions set up?</p>	<p>The problem is solved.</p>	<p>Contact <a href="#">customer support</a>.</p>

## Received fax has poor print quality

Action	Yes	No
<p><b>Step 1</b> Ask the person who sent you the fax to:</p> <ul style="list-style-type: none"> <li><b>a</b> Check if the quality of the original document is satisfactory.</li> <li><b>b</b> Increase the fax scan resolution, if possible.</li> <li><b>c</b> Resend the fax.</li> </ul> <p>Is the fax print quality satisfactory?</p>	The problem is solved.	Go to step 2.
<p><b>Step 2</b> Decrease the incoming fax transmission speed.</p> <ul style="list-style-type: none"> <li><b>a</b> Open a Web browser, and then type the printer IP address in the address field.</li> </ul> <p><b>Notes:</b></p> <ul style="list-style-type: none"> <li>• View the printer IP address on the printer home screen. The IP address appears as four sets of numbers separated by periods, such as 123.123.123.123.</li> <li>• If you are using a proxy server, then temporarily disable it to load the Web page correctly.</li> <li>• Print a network setup page or menu settings page, and then locate the IP address in the TCP/IP section.</li> </ul> <ul style="list-style-type: none"> <li><b>b</b> Click <b>Settings &gt; Fax Settings &gt; Analog Fax Setup</b>.</li> <li><b>c</b> In the Max Speed menu, click one of the following:                             <ul style="list-style-type: none"> <li>• 2400</li> <li>• 4800</li> <li>• 9600</li> <li>• 14400</li> <li>• 33600</li> </ul> </li> <li><b>d</b> Click <b>Submit</b>, and then resend the fax.</li> </ul> <p>Is the fax print quality satisfactory?</p>	The problem is solved.	Go to step 3.
<p><b>Step 3</b> Replace the toner cartridge. When <b>Cartridge low [88.xy]</b> appears, replace the cartridge, and then resend the fax.</p> <p>Is the fax print quality satisfactory?</p>	The problem is solved.	Contact <a href="#">customer support</a> .

## Solving scanner problems

- “Cannot scan from a computer” on page 289
- “Partial document or photo scans” on page 289
- “Poor scanned image quality” on page 290



- “Scan job was not successful” on page 291
- “Scanner unit does not close” on page 291
- “Scanning takes too long or freezes the computer” on page 291
- “The scanner does not respond” on page 292

### Cannot scan from a computer

Action	Yes	No
<p><b>Step 1</b></p> <p>Make sure the printer is turned on and that <b>Ready</b> appears on the printer display before scanning a job.</p> <p>Does <b>Ready</b> appear before scanning the job?</p>	Go to step 3.	Go to step 2.
<p><b>Step 2</b></p> <p>Turn off the printer, then wait for about 10 seconds, and then turn the printer back on.</p> <p>Is there an error message on the printer display?</p>	Clear the error message.	Go to step 3.
<p><b>Step 3</b></p> <p>Check the cable connections between the printer and the print server to make sure they are secure.</p> <p>For more information, see the setup documentation that came with the printer.</p> <p>Are the cable connections between the printer and the print server secure?</p>	Contact <a href="#">customer support</a> .	Tighten the cable connections.

### Partial document or photo scans

Action	Yes	No
<p>Check the placement of the document or photo.</p> <p>Make sure the document or photo is loaded facedown on the scanner glass in the upper left corner.</p> <p>Is the document or photo loaded correctly?</p>	Contact <a href="#">customer support</a> .	Load the document or photo facedown on the scanner glass in the upper left corner.

## Poor scanned image quality

Action	Yes	No
<p><b>Step 1</b> Check if an error message appears on the display.</p> <p>Is there an error message on the printer display?</p>	Clear the error message.	Go to step 2.
<p><b>Step 2</b> Check the quality of the original document.</p> <p>Is the quality of the original document satisfactory?</p>	Go to step 3.	Increase the scan resolution settings for a higher-quality output.
<p><b>Step 3</b> Clean the scanner glass and the ADF glass using a clean, lint-free cloth dampened with water.</p> <p>Is the scanner glass clean?</p>	Go to step 4.	See <a href="#">“Cleaning the scanner glass” on page 208.</a>
<p><b>Step 4</b> Check the placement of the document or photo. Make sure the document or photo is loaded facedown on the scanner glass in the upper left corner.</p> <p>Is the document or photo loaded correctly?</p>	Go to step 5.	Place the document or photo facedown on the scanner glass in the upper left corner.
<p><b>Step 5</b> Send a print job, and then check for print quality problems.</p> <ul style="list-style-type: none"> <li>• From the General Settings menu, adjust the Eco-Mode settings.</li> <li>• From the Copy menu, adjust the Darkness setting.</li> <li>• When the print becomes faded, replace the toner cartridge.</li> </ul> <p>Is the print quality satisfactory?</p>	Go to step 6.	See <a href="#">“Print quality problems” on page 260.</a>
<p><b>Step 6</b> Check the scan settings. From the Scan screen, make sure the Content Type and Content Source settings are correct for the document being scanned.</p> <p>Are the Content Type and Content Source settings correct for the document being scanned?</p>	Go to step 7.	Change the Content Type and Content Source settings to match the document being scanned.
<p><b>Step 7</b> Increase the scan resolution settings for a higher-quality output.</p> <p>Did the increased resolution produce a higher-quality output?</p>	Problem solved.	Contact <a href="#">customer support.</a>

### Scan job was not successful

Action	Yes	No
<p><b>Step 1</b> Check the cable connections. Make sure the Ethernet or USB cable is securely connected to the computer and the printer.</p> <p>Are the cables securely connected?</p>	Go to step 2.	Connect the cables properly.
<p><b>Step 2</b> Check if the file name is already in use.</p> <p>Is the file name already in use?</p>	Change the file name.	Go to step 3.
<p><b>Step 3</b> Check if the document or photo you want to scan is open in another application or being used by another user.</p> <p>Is the file you want to scan open by another application or user?</p>	Close the file you are scanning.	Go to step 4.
<p><b>Step 4</b> Check if either the <b>Append time stamp</b> or the <b>Overwrite existing file</b> check box is selected in the destination configuration settings.</p> <p>Is the <b>Append time stamp</b> or <b>Overwrite existing file</b> check box selected in the destination configuration settings?</p>	Contact <a href="#">customer support</a> .	Select the <b>Append time stamp</b> or <b>Overwrite existing file</b> check box in the destination configuration settings.

### Scanner unit does not close

Action	Yes	No
<p>Check if there are obstructions in the scanner unit.</p> <ul style="list-style-type: none"> <li><b>a</b> Lift the scanner unit.</li> <li><b>b</b> Remove any obstruction keeping the scanner unit open.</li> <li><b>c</b> Lower the scanner unit.</li> </ul> <p>Did the scanner unit close correctly?</p>	The problem is solved.	Contact <a href="#">customer support</a> .

### Scanning takes too long or freezes the computer

Action	Yes	No
<p><b>Step 1</b> Check if other applications are interfering with the scan. Close all applications that are not being used.</p> <p>Does scanning still take too long or freeze the computer?</p>	Go to step 2.	The problem is solved.

Action	Yes	No
<p><b>Step 2</b> Select a lower scan resolution.</p> <p>Does scanning still take too long or freeze the computer?</p>	Contact <a href="#">customer support</a> .	The problem is solved.

## The scanner does not respond

Action	Yes	No
<p><b>Step 1</b> Check if the printer is turned on.</p> <p>Is the printer turned on?</p>	Go to step 2.	Turn on the printer.
<p><b>Step 2</b> Check if the printer cable is securely attached to the printer and the computer, print server, option, or other network device.</p> <p>Is the printer cable securely attached to the printer and the computer, print server, option, or other network device?</p>	Go to step 3.	Connect the printer cable securely to the printer and the computer, print server, option, or other network device.
<p><b>Step 3</b> Check if the power cord is plugged into the printer and a properly grounded electrical outlet.</p> <p>Is the power cord plugged into the printer and a properly grounded electrical outlet?</p>	Go to step 4.	Connect the power cord to the printer and a properly grounded electrical outlet.
<p><b>Step 4</b> Check if the electrical outlet is turned off by a switch or breaker.</p> <p>Is the electrical outlet turned off by a switch or breaker?</p>	Turn on the switch or reset the breaker.	Go to step 5.
<p><b>Step 5</b> Check if the printer is plugged into any surge protectors, uninterruptible power supplies, or extension cords.</p> <p>Is the printer plugged into any surge protectors, uninterruptible power supplies, or extension cords?</p>	Connect the printer power cord directly to a properly grounded electrical outlet.	Go to step 6.
<p><b>Step 6</b> Check other electrical equipment plugged into the outlet.</p> <p>Are the other electrical equipment working?</p>	Unplug the other electrical equipment and turn on the printer. If the printer does not work, then reconnect the other electrical equipment and then go to step 6.	Go to step 7.

Action	Yes	No
<p><b>Step 7</b> Turn off the printer, then wait for about 10 seconds, and then turn the printer back on.</p> <p>Are the printer and scanner working?</p>	The problem is solved.	Contact <a href="#">customer support</a> .

## Solving home screen applications problems

### An application error has occurred

Action	Yes	No
<p><b>Step 1</b> Check the system log for relevant details.</p> <p><b>a</b> Open a Web browser, and then type the printer IP address in the address field.</p> <p>If you do not know the IP address of the printer, then you can:</p> <ul style="list-style-type: none"> <li>• View the IP address on the printer home screen.</li> <li>• Print a network setup page or the menu settings pages, and then locate the IP address in the TCP/IP section.</li> </ul> <p><b>Note:</b> An IP address appears as four sets of numbers separated by periods, such as 123.123.123.123.</p> <p><b>b</b> Click <b>Settings &gt; Apps &gt; Apps Management &gt; System</b> tab &gt; <b>Log</b>.</p> <p><b>c</b> From the Filter menu, select an application status.</p> <p><b>d</b> From the Application menu, select an application, and then click <b>Submit</b>.</p> <p>Does an error message appear in the log?</p>	Go to step 2.	Contact <a href="#">customer support</a> .
<p><b>Step 2</b> Resolve the error.</p> <p>Is the application working now?</p>	The problem is solved.	Contact <a href="#">customer support</a> .

## Embedded Web Server does not open

Action	Yes	No
<p><b>Step 1</b></p> <p><b>a</b> Turn on the printer.</p> <p><b>b</b> Open a Web browser, and then type the printer IP address.</p> <p><b>c</b> Press <b>Enter</b>.</p> <p>Does the Embedded Web Server open?</p>	The problem is solved.	Go to step 2.

Action	Yes	No
<p><b>Step 2</b>                      Make sure the printer IP address is correct.</p> <p><b>a</b> View the printer IP address:</p> <ul style="list-style-type: none"> <li>• From the TCP/IP section in the Network/Ports menu</li> <li>• By printing a network setup page or menu settings page, and then finding the TCP/IP section</li> </ul> <p><b>Note:</b> An IP address appears as four sets of numbers separated by periods, such as 123.123.123.123.</p> <p><b>b</b> Open a Web browser, and then type the IP address.</p> <p><b>Note:</b> Depending on the network settings, you may need to type “<b>https://</b>” instead of “<b>http://</b>” before the printer IP address to access the Embedded Web Server.</p> <p><b>c</b> Press <b>Enter</b>.</p> <p>Does the Embedded Web Server open?</p>	<p>The problem is solved.</p>	<p>Go to step 3.</p>
<p><b>Step 3</b>                      Check if the network is working.</p> <p><b>a</b> Print a network setup page.</p> <p><b>b</b> Check the first section of the network setup page and confirm that the status is Connected.</p> <p><b>Note:</b> If the status is Not Connected, then the connection may be intermittent, or the network cable may be defective. Contact your system support person for a solution, and then print another network setup page.</p> <p><b>c</b> Open a Web browser, and then type the printer IP address.</p> <p><b>d</b> Press <b>Enter</b>.</p> <p>Does the Embedded Web Server open?</p>	<p>The problem is solved.</p>	<p>Go to step 4.</p>
<p><b>Step 4</b>                      Check if the cable connections to the printer and print server are secure.</p> <p><b>a</b> Connect the cables properly. For more information, see the setup documentation that came with the printer.</p> <p><b>b</b> Open a Web browser, and then type the printer IP address.</p> <p><b>c</b> Press <b>Enter</b>.</p> <p>Does the Embedded Web Server open?</p>	<p>The problem is solved.</p>	<p>Go to step 5.</p>
<p><b>Step 5</b>                      Temporarily disable the Web proxy servers.                      Proxy servers may block or restrict you from accessing certain Web sites including the Embedded Web Server.</p> <p>Does the Embedded Web Server open?</p>	<p>The problem is solved.</p>	<p>Contact your system support person.</p>

## Contacting customer support

Before contacting customer support, make sure to have the following information:

- Printer problem
- Error message
- Printer model type and serial number

Go to <http://support.lexmark.com> to receive e-mail or chat support, or browse through the library of manuals, support documentation, drivers, and other downloads.

Technical support via telephone is also available. In the U.S. or Canada, call 1-800-539-6275. For other countries or regions, go to <http://support.lexmark.com>.

# Notices

## Product information

Product name:

Lexmark MX410de, MX417de, MX510de, MX511de, MX511dhe, MX517de

Machine type:

7015

Model(s):

470, 630, 670, 675

## Edition notice

November 2017

**The following paragraph does not apply to any country where such provisions are inconsistent with local law:** LEXMARK INTERNATIONAL, INC., PROVIDES THIS PUBLICATION "AS IS" WITHOUT WARRANTY OF ANY KIND, EITHER EXPRESS OR IMPLIED, INCLUDING, BUT NOT LIMITED TO, THE IMPLIED WARRANTIES OF MERCHANTABILITY OR FITNESS FOR A PARTICULAR PURPOSE. Some states do not allow disclaimer of express or implied warranties in certain transactions; therefore, this statement may not apply to you.

This publication could include technical inaccuracies or typographical errors. Changes are periodically made to the information herein; these changes will be incorporated in later editions. Improvements or changes in the products or the programs described may be made at any time.

References in this publication to products, programs, or services do not imply that the manufacturer intends to make these available in all countries in which it operates. Any reference to a product, program, or service is not intended to state or imply that only that product, program, or service may be used. Any functionally equivalent product, program, or service that does not infringe any existing intellectual property right may be used instead. Evaluation and verification of operation in conjunction with other products, programs, or services, except those expressly designated by the manufacturer, are the user's responsibility.

For Lexmark technical support, visit <http://support.lexmark.com>.

For information on supplies and downloads, visit [www.lexmark.com](http://www.lexmark.com).

© 2017 Lexmark International, Inc.

All rights reserved.

## GOVERNMENT END USERS

The Software Program and any related documentation are "Commercial Items," as that term is defined in 48 C.F.R. 2.101, "Computer Software" and "Commercial Computer Software Documentation," as such terms are used in 48 C.F.R. 12.212 or 48 C.F.R. 227.7202, as applicable. Consistent with 48 C.F.R. 12.212 or 48 C.F.R. 227.7202-1 through 227.7207-4, as applicable, the Commercial Computer Software and Commercial Software Documentation are licensed to the U.S. Government end users (a) only as Commercial Items and (b) with only those rights as are granted to all other end users pursuant to the terms and conditions herein.



## Trademarks

Lexmark, the Lexmark logo, MarkNet, AccuRead, and MarkVision are trademarks or registered trademarks of Lexmark International, Inc. in the United States and/or other countries.

Google Cloud Print is a trademark of Google Inc.

Mac and the Mac logo are trademarks of Apple Inc., registered in the U.S. and other countries.

Microsoft and Windows are either registered trademarks or trademarks of the Microsoft group of companies in the United States and other countries.

Mopria®, the Mopria® logo, and the Mopria® Alliance logo are registered trademarks and service marks of Mopria Alliance, Inc. in the United States and other countries. Unauthorized use is strictly prohibited.

PCL® is a registered trademark of the Hewlett-Packard Company. PCL is Hewlett-Packard Company’s designation of a set of printer commands (language) and functions included in its printer products. This printer is intended to be compatible with the PCL language. This means the printer recognizes PCL commands used in various application programs, and that the printer emulates the functions corresponding to the commands.

PostScript is a registered trademark of Adobe Systems Incorporated in the United States and/or other countries.

The following terms are trademarks or registered trademarks of these companies:

Albertus	The Monotype Corporation plc
Antique Olive	Monsieur Marcel OLIVE
Apple-Chancery	Apple Computer, Inc.
Arial	The Monotype Corporation plc
CG Times	Based on Times New Roman under license from The Monotype Corporation plc, is a product of Agfa Corporation
Chicago	Apple Computer, Inc.
Clarendon	Linotype-Hell AG and/or its subsidiaries
Eurostile	Nebiolo
Geneva	Apple Computer, Inc.
GillSans	The Monotype Corporation plc
Helvetica	Linotype-Hell AG and/or its subsidiaries
Hoefler	Jonathan Hoefler Type Foundry
ITC Avant Garde Gothic	International Typeface Corporation
ITC Bookman	International Typeface Corporation
ITC Mona Lisa	International Typeface Corporation
ITC Zapf Chancery	International Typeface Corporation
Joanna	The Monotype Corporation plc
Marigold	Arthur Baker
Monaco	Apple Computer, Inc.
New York	Apple Computer, Inc.
Oxford	Arthur Baker

Palatino	Linotype-Hell AG and/or its subsidiaries
Stempel Garamond	Linotype-Hell AG and/or its subsidiaries
Taffy	Agfa Corporation
Times New Roman	The Monotype Corporation plc
Univers	Linotype-Hell AG and/or its subsidiaries

All other trademarks are the property of their respective owners.

AirPrint and the AirPrint logo are trademarks of Apple, Inc.

## Federal Communications Commission (FCC) compliance information statement

This product has been tested and found to comply with the limits for a Class B digital device, pursuant to Part 15 of the FCC Rules. Operation is subject to the following two conditions: (1) this device may not cause harmful interference, and (2) this device must accept any interference received, including interference that may cause undesired operation.

The FCC Class B limits are designed to provide reasonable protection against harmful interference when the equipment is operated in a residential installation. This equipment generates, uses, and can radiate radio frequency energy and, if not installed and used in accordance with the instructions, may cause harmful interference to radio communications. However, there is no guarantee that interference will not occur in a particular installation. If this equipment does cause harmful interference to radio or television reception, which can be determined by turning the equipment off and on, the user is encouraged to try to correct the interference by one or more of the following measures:

- Reorient or relocate the receiving antenna.
- Increase the separation between the equipment and receiver.
- Connect the equipment into an outlet on a circuit different from that to which the receiver is connected.
- Consult your point of purchase or service representative for additional suggestions.

The manufacturer is not responsible for radio or television interference caused by using other than recommended cables or by unauthorized changes or modifications to this equipment. Unauthorized changes or modifications could void the user's authority to operate this equipment.

**Note:** To assure compliance with FCC regulations on electromagnetic interference for a Class B computing device, use a properly shielded and grounded cable such as Lexmark part number 1021231 for parallel attach or 1021294 for USB attach. Use of a substitute cable not properly shielded and grounded may result in a violation of FCC regulations.

Any questions regarding this compliance information statement should be directed to:

Director of Lexmark Technology & Services  
 Lexmark International, Inc.  
 740 West New Circle Road  
 Lexington, KY 40550  
 (859) 232-3000

## Noise emission levels

The following measurements were made in accordance with ISO 7779 and reported in conformance with ISO 9296.

**Note:** Some modes may not apply to your product.

1-meter average sound pressure, dBA	
Printing	One-sided: 55 (MX410, MX417), 56 (MX510, MX511, MX517); Two-sided: 53 (MX410, MX417), 54 (MX510, MX511, MX517)
Scanning	55
Copying	55
Ready	N/A

Values are subject to change. See [www.lexmark.com](http://www.lexmark.com) for current values.

## Temperature information

Ambient operating temperature	15.6 to 32.2°C (60 to 90°F)
Shipping temperature	-40 to 43.3°C (-40 to 110°F)
Storage temperature and relative humidity	1 to 35°C (34 to 95°F) 8 to 80% RH

## Waste from Electrical and Electronic Equipment (WEEE) directive



The WEEE logo signifies specific recycling programs and procedures for electronic products in countries of the European Union. We encourage the recycling of our products.

If you have further questions about recycling options, visit the Lexmark Web site at [www.lexmark.com](http://www.lexmark.com) for your local sales office phone number.

## India E-Waste notice

This product complies with the India E-Waste (Management and Handling) Rules, 2011, which prohibit use of lead, mercury, hexavalent chromium, polybrominated biphenyls, or polybrominated diphenyl ethers in

concentrations exceeding 0.1% by weight and 0.01% by weight for cadmium, except for the exemption set in Schedule II of the Rules.

## Product disposal

Do not dispose of the printer or supplies in the same manner as normal household waste. Consult your local authorities for disposal and recycling options.

## Static sensitivity notice



This symbol identifies static-sensitive parts. Do not touch the areas near these symbols without first touching a metal surface in an area away from the symbol.

## ENERGY STAR

Any Lexmark product bearing the ENERGY STAR emblem on the product or on a start-up screen is certified to comply with Environmental Protection Agency (EPA) ENERGY STAR requirements as configured when shipped by Lexmark.



## Laser notice

The printer is certified in the U.S. to conform to the requirements of DHHS 21 CFR, Chapter I, Subchapter J for Class I (1) laser products, and elsewhere is certified as a Class I laser product conforming to the requirements of IEC 60825-1: 2014.

Class I laser products are not considered to be hazardous. The printer contains internally a Class IIIb (3b) laser that is nominally a 12-milliwatt gallium arsenide laser operating in the wavelength of 655–675 nanometers. The laser system and printer are designed so there is never any human access to laser radiation above a Class I level during normal operation, user maintenance, or prescribed service condition.

## Laser advisory label

A laser notice label may be affixed to this printer as shown:

DANGER - Invisible laser radiation when cartridges are removed and interlock defeated. Avoid exposure to laser beam.

PERIGO - Radiação a laser invisível será liberada se os cartuchos forem removidos e o lacre rompido. Evite a exposição aos feixes de laser.

Opasnost - Nevidljivo lasersko zračenje kada su kasete uklonjene i poništena sigurnosna veza. Izbjegavati izlaganje zracima.

NEBEZPEČÍ - Když jsou vyjmuty kazety a je odblokována pojistka, ze zařízení je vysíláno neviditelné laserové záření. Nevystavujte se působení laserového paprsku.

FARE - Usynlig laserstråling når patroner fjernes, og spærreanordningen er slået fra. Undgå at blive udsat for laserstrålen.

GEVAAR - Onzichtbare laserstraling wanneer cartridges worden verwijderd en een vergrendeling wordt genegeerd. Voorkom blootstelling aan de laser.

DANGER - Rayonnements laser invisibles lors du retrait des cartouches et du déverrouillage des loquets. Éviter toute exposition au rayon laser.

VAARA - Näkymätöntä lasersäteilyä on varottava, kun värikasetit on poistettu ja lukitus on auki. Vältä lasersäteelle altistumista.

GEFAHR - Unsichtbare Laserstrahlung beim Herausnehmen von Druckkassetten und offener Sicherheitssperre. Laserstrahl meiden.

ΚΙΝΔΥΝΟΣ - Εκκλυση αόρατης ακτινοβολίας laser κατά την αφαίρεση των κασετών και την απασφάλιση της μανδάλωσης. Αποφεύγετε την έκθεση στην ακτινοβολία laser.

VESZÉLY – Nem látható lézersugárzás fordulhat elő a patronok eltávolításakor és a zárószervezet felbontásakor. Kerülje a lézersugárnak való kitettséget.

PERICOLO - Emissione di radiazioni laser invisibili durante la rimozione delle cartucce e del blocco. Evitare l'esposizione al raggio laser.

FARE – Usynlig laserstråling når kassetene tas ut og sperren er satt ut av spill. Unngå eksponering for laserstrålen.

NIEBEZPIECZEŃSTWO - niewidzialne promieniowanie laserowe podczas usuwania kaset i blokady. Należy unikać naświetlenia promieniem lasera.

ОПАСНО! Невидимое лазерное излучение при извлеченных картриджах и снятии блокировки. Избегайте воздействия лазерных лучей.

Pozor – Nebezpečnostvo neviditeľného laserového žiarenia pri odobratých kazetách a odblokovanej poistke. Nevystavujte sa lúčom.

PELIGRO: Se producen radiaciones láser invisibles al extraer los cartuchos con el interbloqueo desactivado. Evite la exposición al haz de láser.

FARA – Osynlig laserstråling när patroner tas ur och spärrmekanismen är upphävd. Undvik exponering för laserstrålen.

危険 - 当移除碳粉盒及互锁失效时会产生看不见的激光辐射, 请避免暴露在激光光束下。

危険 - 移除碳粉匣與安全連續開關失效時會產生看不見的雷射輻射。請避免暴露在雷射光束下。

危険 - カートリッジが取り外され、内部ロックが無効になると、見えないレーザー光が放射されます。このレーザー光に当たらないようにしてください。

## Power consumption

### Product power consumption

The following table documents the power consumption characteristics of the product.

**Note:** Some modes may not apply to your product.

Mode	Description	Power consumption (Watts)
Printing	The product is generating hard-copy output from electronic inputs.	560 (MX410, MX417); 600 (MX510, MX511, MX517)
Copy	The product is generating hard-copy output from hard-copy original documents.	580 (MX410, MX417); 620 (MX510, MX511, MX517)
Scan	The product is scanning hard-copy documents.	25 (MX410, MX417); 30 (MX510, MX511, MX517)
Ready	The product is waiting for a print job.	12 (MX410, MX417); 14 (MX510, MX511, MX517)
Sleep Mode	The product is in a high-level energy-saving mode.	3.2 (MX410, MX417); 3.5 (MX510, MX511, MX517)
Hibernate	The product is in a low-level energy-saving mode.	0.4
Off	The product is plugged into an electrical outlet, but the power switch is turned off.	0

The power consumption levels listed in the previous table represent time-averaged measurements. Instantaneous power draws may be substantially higher than the average.

Values are subject to change. See [www.lexmark.com](http://www.lexmark.com) for current values.

## Sleep Mode

This product is designed with an energy-saving mode called *Sleep Mode*. The Sleep Mode saves energy by lowering power consumption during extended periods of inactivity. The Sleep Mode is automatically engaged after this product is not used for a specified period of time, called the *Sleep Mode Timeout*.

Factory default Sleep Mode Timeout for this product (in minutes):	20
---	----

By using the configuration menus, the Sleep Mode Timeout can be modified between 1 minute and 120 minutes. Setting the Sleep Mode Timeout to a low value reduces energy consumption, but may increase the response time of the product. Setting the Sleep Mode Timeout to a high value maintains a fast response, but uses more energy.

## Hibernate Mode

This product is designed with an ultra-low power operating mode called *Hibernate mode*. When operating in Hibernate Mode, all other systems and devices are powered down safely.

The Hibernate mode can be entered in any of the following methods:

- Using the Hibernate Timeout
- Using the Schedule Power modes
- Using the Sleep/Hibernate button

Factory default Hibernate Timeout for this product in all countries or regions	3 days
--	--------

The amount of time the printer waits after a job is printed before it enters Hibernate mode can be modified between one hour and one month.

## Off mode

If this product has an off mode which still consumes a small amount of power, then to completely stop product power consumption, disconnect the power supply cord from the electrical outlet.

## Total energy usage

It is sometimes helpful to calculate the total product energy usage. Since power consumption claims are provided in power units of Watts, the power consumption should be multiplied by the time the product spends in each mode in order to calculate energy usage. The total product energy usage is the sum of each mode's energy usage.

## Industry Canada compliance statement

This Class B digital apparatus meets all requirements of the Canadian Interference-Causing Equipment Standard ICES-003.

## Avis de conformité aux normes de l'industrie du Canada

Cet appareil numérique de classe B est conforme aux exigences de la norme canadienne relative aux équipements pouvant causer des interférences NMB-003.

## Licensing notices

All licensing notices associated with this product can be viewed from the root directory of the installation software CD.

## 日本の VCCI 規定

製品にこのマークが表示されている場合、次の要件を満たしています。



この装置は、クラス B 情報技術装置です。この装置は、家庭環境で使用することを目的としていますが、この装置がラジオやテレビジョン受信機に近接して使用されると、受信障害を引き起こすことがあります。

取扱説明書に従って正しい取り扱いをしてください。

VCCI-B

## European Community (EC) directives conformity

This product is in conformity with the protection requirements of EC Council directives 2014/30/EU, 2014/35/EU, 2009/125/EC, and 2011/65/EU on the approximation and harmonization of the laws of the Member States relating to electromagnetic compatibility, safety of electrical equipment designed for use within certain voltage limits, the ecodesign of energy-related products, and on the restrictions of use of certain hazardous substances in electrical and electronic equipment.

The manufacturer of this product is: Lexmark International, Inc., 740 West New Circle Road, Lexington, KY, 40550 USA. The authorized representative is: Lexmark International Technology Hungária Kft., 8 Lechner Ödön fasor, Millennium Tower III, 1095 Budapest HUNGARY. A declaration of conformity to the requirements of the Directives is available upon request from the Authorized Representative or may be obtained at [www.lexmark.com/en\\_us/about/regulatory-compliance/european-union-declaration-of-conformity.html](http://www.lexmark.com/en_us/about/regulatory-compliance/european-union-declaration-of-conformity.html).

This product satisfies the Class B limits of EN 55022 and EN55032 and safety requirements of EN 60950-1 or EN 62368-1.

## Regulatory notices for telecommunication terminal equipment

This section contains regulatory information pertaining to products that contain telecommunication terminal equipment such as facsimile.

## Notice to users of the US telephone network: FCC requirements

This equipment complies with Part 68 of the FCC rules and the requirements adopted by the Administrative Council for Terminal Attachments (ACTA). On the back of this equipment is a label that contains, among other information, a product identifier in the format US:AAAEQ##TXXXX. If requested, this number must be provided to your telephone company.

This equipment uses the RJ-11C Universal Service Order Code (USOC) jack.

A plug and jack used to connect this equipment to the premises' wiring and telephone network must comply with the applicable FCC Part 68 rules and requirements adopted by the ACTA. A compliant telephone cord and modular plug is provided with this product. It is designed to be connected to a compatible modular jack that is also compliant. See your setup documentation for more information.

The Ringer Equivalence Number (REN) is used to determine the number of devices that may be connected to a telephone line. Excessive RENs on a telephone line may result in the devices not ringing in response to an incoming call. In most but not all areas, the sum of RENs should not exceed five (5.0). To be certain of the number of devices that may be connected to a line, as determined by the total RENs, contact your local telephone company. For products approved after July 23, 2001, the REN for this product is part of the product identifier that has the format US:AAAEQ##TXXXX. The digits represented by ## are the REN without a decimal point (for example, 03 is a REN of 0.3). For earlier products, the REN is shown separately on the label.

If this equipment causes harm to the telephone network, the telephone company will notify you in advance that temporary discontinuance of service may be required. If advance notice is not practical, the telephone company will notify the customer as soon as possible. You will also be advised of your right to file a complaint with the FCC.

The telephone company may make changes in its facilities, equipment, operations or procedures that could affect the operation of this equipment. If this happens, the telephone company will provide advance notice in order for you to make necessary modifications to maintain uninterrupted service.

If you experience trouble with this equipment, for repair or warranty information, contact Lexmark International, Inc. at [www.lexmark.com](http://www.lexmark.com) or your Lexmark representative. If the equipment is causing harm to the telephone network, the telephone company may request that you disconnect the equipment until the problem is resolved.

This equipment contains no user serviceable parts. For repair and warranty information, contact Lexmark International, Inc. See the previous paragraph for contact information.

Connection to party line service is subject to state tariffs. Contact the state public utility commission, public service commission, or corporation commission for information.

If your home has specially wired alarm equipment connected to the telephone line, ensure the installation of this equipment does not disable your alarm equipment. If you have questions about what will disable alarm equipment, consult your telephone company or a qualified installer.

Telephone companies report that electrical surges, typically lightning transients, are very destructive to customer terminal equipment connected to AC power sources. This has been identified as a major nationwide problem. It is recommended that the customer install an appropriate AC surge arrester in the AC outlet to which this device is connected. An appropriate AC surge arrester is defined as one that is suitably rated, and certified by UL (Underwriter's Laboratories), another NRTL (Nationally Recognized Testing Laboratory), or a recognized safety certification body in the country/region of use. This is to avoid damage to the equipment caused by local lightning strikes and other electrical surges.

The Telephone Consumer Protection Act of 1991 makes it unlawful for any person to use a computer or other electronic device, including fax machines, to send any message unless said message clearly contains in a margin at the top or bottom of each transmitted page or on the first page of the transmission, the date and time it is sent and an identification of the business or other entity, or other individual sending the message, and the telephone number of the sending machine or such business, other entity, or individual. (The telephone number provided may not be a 900 number or any other number for which charges exceed local or long-distance transmission charges.)

See your user documentation in order to program this information into your fax machine.



## Notice to users of the Canadian telephone network

This product meets the applicable Industry Canada technical specifications. The Ringer Equivalence Number (REN) is an indication of the maximum number of terminals allowed to be connected to a telephone interface. The terminus of an interface may consist of any combination of devices, subject only to the requirement that the sum of the RENs of all the devices does not exceed five. The modem REN is located on the rear of the equipment on the product labeling.

Telephone companies report that electrical surges, typically lightning transients, are very destructive to customer terminal equipment connected to AC power sources. This has been identified as a major nationwide problem. It is recommended that the customer install an appropriate AC surge arrestor in the AC outlet to which this device is connected. An appropriate AC surge arrestor is defined as one that is suitably rated, and certified by UL (Underwriter's Laboratories), another NRTL (Nationally Recognized Testing Laboratory), or a recognized safety certification body in the country/region of use. This is to avoid damage to the equipment caused by local lightning strikes and other electrical surges.

This equipment uses CA11A telephone jacks.

### Avis réservé aux utilisateurs du réseau téléphonique du Canada

Ce produit est conforme aux spécifications techniques d'Industrie Canada. Le numéro REN (ringer equivalence number : numéro d'équivalence de sonnerie) fournit une indication du nombre maximum de terminaux pouvant être connectés à l'interface téléphonique. En bout de ligne, le nombre d'appareils qui peuvent être connectés n'est pas directement limité, mais la somme des REN de ces appareils ne doit pas dépasser cinq. Le numéro REN du modem est indiqué sur l'étiquette produit située à l'arrière de l'équipement.

Les compagnies de téléphone constatent que les surtensions électriques, en particulier celles dues à la foudre, entraînent d'importants dégâts sur les terminaux privés connectés à des sources d'alimentation CA. Il s'agit-là d'un problème majeur d'échelle nationale. En conséquence, il vous est recommandé de brancher un parasurtenseur dans la prise de courant à laquelle l'équipement est connecté. Utilisez un parasurtenseur répondant à des caractéristiques nominales satisfaisantes et certifié par le laboratoire d'assureurs UL (Underwriter's Laboratories), un autre laboratoire agréé de type NRTL (Nationally Recognized Testing Laboratory) ou un organisme de certification agréé dans votre région ou pays. Ceci prévient tout endommagement de l'équipement causé par les orages et autres surtensions électriques.

Cet équipement utilise des prises de téléphone CA11A.

## Notice to users of the New Zealand telephone network

The following are special conditions for the Facsimile User Instructions. The grant of a telepermit for any item of terminal equipment indicates only that Telecom has accepted that the item complies with minimum conditions for connection to its network. It indicates no endorsement of the product by Telecom, nor does it provide any sort of warranty. Above all, it provides no assurance that any item will work correctly in all respects with another item of telepermitted equipment of a different make or model, nor does it imply that any product is compatible with all of Telecom's network services.

This equipment shall not be set up to make automatic calls to the Telecom "111" Emergency Service.

This equipment may not provide for the effective hand-over of a call to another device connected to the same line.

This equipment should not be used under any circumstances that may constitute a nuisance to other Telecom customers.

This equipment is not capable, under all operating conditions, of correct operation at the higher speeds for which it is designed. Telecom will accept no responsibility should difficulties arise in such circumstances.

The decadic (or pulse) dialing on this device is unsuitable for use on the Telecom network in New Zealand.

For correct operation, the total of all the Ringer Equivalence Numbers (RENs) of all parallel devices connected to the same telephone line may not exceed 5. The REN of this device is located on the label.

This device uses an RJ-11C modular connector. Contact your point of purchase if a BT adapter is required. The Lexmark part number is 80D1873.

Some parameters required for compliance with Telecom's telepermit requirements are dependent on the equipment associated with this device. The associated equipment shall be set to operate within the following limits for compliance to Telecom's specifications:

- There shall be no more than 10 call attempts to the same number within any 30 minute period for any single manual call initiation, and
- The equipment shall go on-hook for a period of not less than 30 seconds between the end of one attempt and the beginning of the next call attempt.
- The equipment shall be set to ensure that automatic calls to different numbers are spaced such that there is not less than 5 seconds between the end of one call attempt and the beginning of another.

### Japanese telecom notice

The installed optional modem is in compliance with Japanese Telecommunication Law and has been Certified by JATE, with Certification Number A11-0160001.

	Lexmark International, Inc.
	LEX-M03-002
	A11-0160001JP

### Using this product in Switzerland

This product requires a Swiss billing tone filter (Lexmark part number 80D1877) to be installed on any line which receives metering pulses in Switzerland. The filter must be used, as metering pulses are present on all analog telephone lines in Switzerland.

### Utilisation de ce produit en Suisse

Cet appareil nécessite l'utilisation d'un filtre de tonalité de facturation suisse (n° de référence Lexmark : 80D1877) devant être installé sur toute ligne recevant des impulsions de comptage en Suisse. Ce filtre doit être utilisé pour toute installation car ces impulsions existent sur toutes les lignes téléphoniques suisses.

## Verwendung dieses Produkts in der Schweiz

Für dieses Produkt muss ein schweizerischer Billing Tone Filter zur Zählzeichenübertragung (Lexmark Teilenummer 80D1877) für jede Leitung installiert werden, über die in der Schweiz Zeitsteuertakte übertragen werden. Die Verwendung des Filters ist obligatorisch, da in allen analogen Telefonleitungen in der Schweiz Zeitsteuertakte vorhanden sind.

## Uso del prodotto in Svizzera

Questo prodotto richiede un filtro toni Billing svizzero, (codice Lexmark 80D1877) da installare su tutte le linee che ricevono impulsi remoti in Svizzera. È necessario utilizzare il filtro poiché gli impulsi remoti sono presenti su tutte le linee analogiche in Svizzera.

## STATEMENT OF LIMITED WARRANTY FOR LEXMARK LASER PRINTERS, LEXMARK LED PRINTERS, AND LEXMARK MULTIFUNCTION LASER PRINTERS

### Lexmark International, Inc., Lexington, KY

This limited warranty applies to the United States and Canada. For customers outside the U.S., refer to the country-specific warranty information that came with your product.

This limited warranty applies to this product only if it was originally purchased for your use, and not for resale, from Lexmark or a Lexmark Remarketer, referred to in this statement as "Remarketer."

### Limited warranty

Lexmark warrants that this product:

- Is manufactured from new parts, or new and serviceable used parts, which perform like new parts
- Is, during normal use, free from defects in material and workmanship

If this product does not function as warranted during the warranty period, contact a Remarketer or Lexmark for repair or replacement (at Lexmark's option).

If this product is a feature or option, this statement applies only when that feature or option is used with the product for which it was intended. To obtain warranty service, you may be required to present the feature or option with the product.

If you transfer this product to another user, warranty service under the terms of this statement is available to that user for the remainder of the warranty period. You should transfer proof of original purchase and this statement to that user.

### Limited warranty service

The warranty period starts on the date of original purchase as shown on the purchase receipt and ends 12 months later provided that the warranty period for any supplies and for any maintenance items included with the printer shall end earlier if it, or its original contents, are substantially used up, depleted, or consumed. Fuser Units, Transfer/Transport Units, Paper Feed items, if any, and any other items for which a Maintenance Kit is

available are substantially consumed when the printer displays a “Life Warning” or “Scheduled Maintenance” message for such item.

To obtain warranty service you may be required to present proof of original purchase. You may be required to deliver your product to the Remarketer or Lexmark, or ship it prepaid and suitably packaged to a Lexmark designated location. You are responsible for loss of, or damage to, a product in transit to the Remarketer or the Lexmark designated location.

When warranty service involves the exchange of a product or part, the item replaced becomes the property of the Remarketer or Lexmark. The replacement may be a new or repaired item.

The replacement item assumes the remaining warranty period of the original product.

Replacement is not available to you if the product you present for exchange is defaced, altered, in need of a repair not included in warranty service, damaged beyond repair, or if the product is not free of all legal obligations, restrictions, liens, and encumbrances.

As part of your warranty service and/or replacement, Lexmark may update the firmware in your printer to the latest version. Firmware updates may modify printer settings and cause counterfeit and/or unauthorized products, supplies, parts, materials (such as toners and inks), software, or interfaces to stop working. Authorized use of genuine Lexmark products will not be impacted.

Before you present this product for warranty service, remove all print cartridges, programs, data, and removable storage media (unless directed otherwise by Lexmark).

For further explanation of your warranty alternatives and the nearest Lexmark authorized servicer in your area contact Lexmark on the World Wide Web.

Remote technical support is provided for this product throughout its warranty period. For products no longer covered by a Lexmark warranty, technical support may not be available or only be available for a fee.

### **Extent of limited warranty**

Lexmark does not warrant uninterrupted or error-free operation of any product or the durability or longevity of prints produced by any product.

Warranty service does not include repair of failures caused by:

- Modification or unauthorized attachments
- Accidents, misuse, abuse or use inconsistent with Lexmark user’s guides, manuals, instructions or guidance
- Unsuitable physical or operating environment
- Maintenance by anyone other than Lexmark or a Lexmark authorized servicer
- Operation of a product beyond the limit of its duty cycle
- Use of printing media outside of Lexmark specifications
- Refurbishment, repair, refilling or remanufacture by a third party of products, supplies or parts
- Products, supplies, parts, materials (such as toners and inks), software, or interfaces not furnished by Lexmark

**TO THE EXTENT PERMITTED BY APPLICABLE LAW, NEITHER LEXMARK NOR ITS THIRD PARTY SUPPLIERS OR REMARKETERS MAKE ANY OTHER WARRANTY OR CONDITION OF ANY KIND, WHETHER EXPRESS OR IMPLIED, WITH RESPECT TO THIS PRODUCT, AND SPECIFICALLY DISCLAIM THE IMPLIED WARRANTIES OR CONDITIONS OF MERCHANTABILITY, FITNESS FOR A PARTICULAR PURPOSE, AND SATISFACTORY QUALITY. ANY WARRANTIES THAT MAY NOT BE DISCLAIMED UNDER APPLICABLE LAW ARE LIMITED IN DURATION TO THE WARRANTY PERIOD. NO WARRANTIES, EXPRESS OR IMPLIED, WILL**

**APPLY AFTER THIS PERIOD. ALL INFORMATION, SPECIFICATIONS, PRICES, AND SERVICES ARE SUBJECT TO CHANGE AT ANY TIME WITHOUT NOTICE.**

### **Limitation of liability**

Your sole remedy under this limited warranty is set forth in this document. For any claim concerning performance or nonperformance of Lexmark or a Remarketer for this product under this limited warranty, you may recover actual damages up to the limit set forth in the following paragraph.

Lexmark's liability for actual damages from any cause whatsoever will be limited to the amount you paid for the product that caused the damages. This limitation of liability will not apply to claims by you for bodily injury or damage to real property or tangible personal property for which Lexmark is legally liable. **IN NO EVENT WILL LEXMARK BE LIABLE FOR ANY LOST PROFITS, LOST SAVINGS, INCIDENTAL DAMAGE, OR OTHER ECONOMIC OR CONSEQUENTIAL DAMAGES.** This is true even if you advise Lexmark or a Remarketer of the possibility of such damages. Lexmark is not liable for any claim by you based on a third party claim.

This limitation of remedies also applies to claims against any Suppliers and Remarketers of Lexmark. Lexmark's and its Suppliers' and Remarketers' limitations of remedies are not cumulative. Such Suppliers and Remarketers are intended beneficiaries of this limitation.

### **Additional rights**

Some states do not allow limitations on how long an implied warranty lasts, or do not allow the exclusion or limitation of incidental or consequential damages, so the limitations or exclusions contained above may not apply to you.

This limited warranty gives you specific legal rights. You may also have other rights that vary from state to state.

# Index

## Numerics

- 250-sheet tray
  - installing 42
- 550-sheet tray
  - installing 42

## A

- accessing the Embedded Web Server 19
- Active NIC menu 140
- adapter plug 109
- adding hardware options
  - print driver 46
- adding internal options
  - print driver 46
- ADF
  - copying using 81
- ADF separator roller
  - ordering 212
- Adjust ADF Skew
  - copy options 92
  - e-mail options 99
  - fax options 120
  - scan options 127
- adjusting copy quality 85
- adjusting printer display
  - brightness 201
- adjusting Sleep mode 201
- adjusting toner darkness 74
- administrator settings
  - Embedded Web Server 218
- advanced duplex
  - copy options 90
- advanced imaging
  - copy options 92
  - e-mail options 99
  - fax options 120
  - scan options 126
- AirPrint
  - using 75
- answering machine
  - setting up 101
- AppleTalk menu 145
- applications
  - home screen 21
  - understanding 20
- attaching cables 45
- available internal options 26

- avoiding jams 70
- avoiding paper jams 221

## B

- back button
  - printer control panel 15
- blocking junk faxes 117
- buttons, touch screen
  - using 17

## C

- cables
  - Ethernet 45
  - USB 45
- canceling a print job
  - from the computer 80
  - from the printer control panel 80
- canceling an e-mail 96
- cannot open Embedded Web Server 293
- Card Copy
  - setting up 22
- card stock
  - loading, multipurpose feeder 58
  - tips 66
- Cartridge low [88.xy] 231
- Cartridge nearly low [88.xy] 231
- Cartridge very low, [x] estimated pages remain [88.xy] 231
- Cartridge, imaging unit mismatch [41.xy] 231
- Change [paper source] to [custom string] load [paper orientation] 231
- Change [paper source] to [custom type name] load [orientation] 232
- Change [paper source] to [paper size] load [orientation] 232
- Change [paper source] to [paper type] [paper size] load [orientation] 232
- changing output file type
  - e-mailing 96
- changing port settings
  - internal solutions port 50
- checking an unresponsive printer 246
- checking status of parts and supplies 209
- checking the status of parts and supplies 209
- checking the virtual display
  - using the Embedded Web Server 218
- cleaning
  - exterior of the printer 207
  - interior of the printer 207
  - scanner glass 208
- cleaning the printer 207
- Close flatbed cover and load originals if restarting job [2yy.xx] 232
- Close front door 232
- collate
  - copy options 90
- collating copies 86
- Complex page, some data may not have printed [39] 233
- compressed images appear on prints 262
- confidential data
  - information on securing 206
- confidential jobs
  - modifying print settings 79
- confidential print jobs 78
- Confidential Print menu 149
- Configuration change, some held jobs were not restored [57] 233
- configuration information
  - wireless network 47
- Configure MP menu 132
- configuring
  - supply notifications, imaging unit 219
  - supply notifications, maintenance kit 219
  - supply notifications, toner cartridge 219
- configuring port settings 50
- configuring supply
  - notifications 219
- connecting printer to distinctive ring service 112

- connecting to a wireless network
    - using PIN (Personal Identification Number) method 49
    - using Push Button Configuration method 49
    - using the Embedded Web Server 50
    - using wireless setup wizard 48
  - conservation settings
    - brightness, adjusting 201
    - Eco-Mode 199
    - Hibernate mode 201
    - Quiet Mode 200
    - Sleep Mode 201
  - conserving supplies 199
  - contacting customer support 295
  - content
    - e-mail settings 98
  - content source
    - e-mail settings 98
    - fax options 119
  - content type
    - e-mail settings 98
    - fax options 119
  - control panel
    - indicator light 15
    - Sleep button light 15
  - controller board
    - accessing 27
  - copies
    - copy options 90
  - copy job, canceling
    - using the ADF 88
    - using the scanner glass 89
  - copy options
    - Adjust ADF Skew 92
    - advanced duplex 90
    - advanced imaging 92
    - collate 90
    - copies 90
    - cover page setup 91
    - create booklet 92
    - custom job 92
    - darkness 90
    - header/footer 91
    - overlay 91
    - paper saver 91
    - Save As Shortcut 90
    - separator sheets 91
    - sides (duplex) 90
  - copy quality
    - adjusting 85
  - copy screen
    - content source 90
    - content type 90
    - options 89, 91
  - Copy Settings menu 159
  - copy troubleshooting
    - copier does not respond 280
    - partial document or photo copies 280
    - poor copy quality 281
    - poor scanned image quality 290
    - scanner unit does not close 282, 291
  - copying
    - adding an overlay message 88
    - adjusting quality 85
    - canceling a copy job 88, 89
    - collating copies 86
    - different paper sizes 84
    - enlarging 85
    - inserting a header or footer 88
    - multiple pages on one sheet 87
    - on both sides of the paper (duplexing) 85
    - on letterhead 83
    - on transparencies 82
    - photos 82
    - placing separator sheets between copies 87
    - quick copy 81
    - reducing 85
    - selecting a tray 83
    - to a different size 83
    - using the ADF 81
    - using the scanner glass 82
  - copying different paper sizes 84
  - copying multiple pages on one sheet 87
  - copying on both sides of the paper (duplexing) 85
  - copying on letterhead 83
  - copying on transparencies 82
  - cover page setup
    - copy options 91
  - create booklet
    - copy options 92
  - creating a fax destination shortcut
    - using the Embedded Web Server 115
  - creating an FTP shortcut
    - using the Embedded Web Server 121
  - creating custom name
    - paper type 63
  - custom job
    - copy options 92
    - e-mail options 98
    - fax options 120
    - scan options 127
  - custom name
    - configuring 64
  - Custom Names menu 137
  - custom paper type name
    - assigning 63
  - Custom Scan Sizes menu 138
  - Custom Type [x]
    - changing paper type 64
    - creating custom name 63
  - Custom Types menu 137
  - customer support
    - contacting 295
- D**
- darkness
    - copy options 90
    - e-mail options 97
    - fax options 119
    - scan options 125
  - date and time, fax setting 112
  - daylight saving time, setting 112
  - Default Source menu 129
  - Defective flash detected [51] 233
  - delayed send
    - fax options 120
  - different paper sizes, copying 84
  - digital subscriber line (DSL)
    - fax setup 105
  - digital telephone service
    - fax setup 108
  - directory list
    - printing 80
  - Disk full [62] 233
  - Disk must be formatted for use in this device 233
  - disk wiping 204

- display troubleshooting
  - printer display is blank 248
- display, printer control panel
  - adjusting brightness 201
- disposing of printer hard disk 203
- distinctive ring service, fax
  - connecting to 112
- documents, printing
  - from a computer 74
  - from a mobile device 75, 76
- DSL filter 105
- duplexing 85

## E

- Eco-Mode setting 199
- edge erase
  - e-mail options 99
  - fax options 120
  - scan options 126
- Embedded Web Server
  - accessing 19
  - adjusting brightness 201
  - administrator settings 218
  - checking the status of parts 209
  - checking the status of supplies 209
  - creating a fax destination shortcut 115
  - creating an FTP shortcut 121
  - creating e-mail shortcuts 93
  - initial fax setup 101
  - modifying confidential print settings 79
  - networking settings 218
  - problem accessing 293
  - scanning to a computer using 123
  - setting up e-mail alerts 218
- Embedded Web Server Administrator's Guide
  - where to find 206
- Embedded Web Server — Security: Administrator's Guide
  - where to find 218
- emission
  - notices 298, 299, 302, 303
- encrypting the printer hard disk 205
- enlarging a copy 85

- envelopes
  - loading, multipurpose feeder 58
  - tips on using 65
- environmental settings
  - Eco-Mode 199
  - Hibernate mode 201
  - printer display brightness, adjusting 201
  - Quiet Mode 200
  - Sleep Mode 201
- Erase Temporary Data Files menu 150
- erasing hard disk memory 204
- erasing non-volatile memory 204
- erasing volatile memory 203
- Error reading USB drive. Remove USB. 234
- Error reading USB hub. Remove hub. 234
- Ethernet network
  - preparing to set up for Ethernet printing 47
- Ethernet port 45
- Ethernet setup
  - preparing for an 47
- exporting a configuration using the Embedded Web Server 25
- e-mail
  - canceling 96
- e-mail alerts
  - low supply levels 218
  - paper jam 218
  - setting up 218
- e-mail function
  - setting up 93
- e-mail options
  - Adjust ADF Skew 99
  - advanced imaging 99
  - custom job 98
  - darkness 97
  - edge erase 99
  - message 97
  - original size 97
  - page setup 98
  - recipient(s) 97
  - resolution 97
  - Save As Shortcut 97
  - Send As 97
  - subject 97
  - transmission log 99

- e-mail screen
  - options 97, 99
- E-mail Settings menu 172
- e-mail shortcuts, creating
  - using the Embedded Web Server 93
- e-mail, sending
  - using a shortcut number 95
  - using the address book 95
- e-mailing
  - adding message line 96
  - adding subject line 96
  - creating shortcuts using the Embedded Web Server 93
  - creating shortcuts using the printer control panel 94
  - setting up e-mail function 93
  - using a shortcut number 95
  - using the address book 95
  - using the printer control panel 94

## F

- factory defaults
  - restoring 220
- fax
  - sending at a scheduled time 115
  - sending using the printer control panel 113
- fax and e-mail functions
  - setting up 287
- fax and e-mail functions are not set up 287
- fax log
  - viewing 117
- Fax memory full 234
- Fax Mode (Analog Fax Setup) menu 163
- fax name, setting 112
- fax number, setting 112
- fax options
  - Adjust ADF Skew 120
  - advanced imaging 120
  - content source 119
  - content type 119
  - custom job 120
  - darkness 119
  - delayed send 120
  - edge erase 120
  - page setup 120
  - resolution 119
  - scan preview 120



- transmission log 120
- Fax partition inoperative. Contact system administrator. 234
- Fax server 'To Format' not set up. Contact system administrator. 234
- fax setup
  - country- or region-specific 109
  - digital telephone service 108
  - DSL connection 105
  - standard telephone line connection 101
  - VoIP 106
- Fax Station Name not set up. Contact system administrator. 234
- Fax Station Number not set up. Contact system administrator. 235
- fax troubleshooting
  - caller ID is not shown 283
  - can receive but not send faxes 286
  - can send but not receive faxes 286
  - cannot send or receive a fax 283
  - received fax has poor print quality 288
- faxing
  - blocking junk faxes 117
  - canceling a fax job 117
  - changing resolution 116
  - configuring the printer to observe daylight saving time 112
  - creating shortcuts using the Embedded Web Server 115
  - creating shortcuts using the printer control panel 116
  - fax setup 101
  - forwarding faxes 118
  - holding faxes 118
  - making a fax lighter or darker 116
  - sending a fax at a scheduled time 115
  - setting the date and time 112
  - setting the fax number 112
  - setting the outgoing fax name 112
  - viewing a fax log 117

- FCC notices 298, 303
- file name
  - scan options 125
- finding more information about the printer 10
- finding printer IP address 19
- Finishing menu 189
- firmware card 26
- flash drive
  - printing from 76
- Flash Drive menu 182
- flash drives
  - supported file types 77
- font sample list
  - printing 80
- footer
  - inserting 88
- Forms and Favorites
  - setting up 21
- forwarding faxes 118
- FTP address
  - creating shortcuts using the printer control panel 122
  - FTP options 124
- FTP address, scanning to
  - using a shortcut number 123
  - using the printer control panel 122
- FTP options
  - FTP address 124
- FTP Settings menu 177

## G

- General Settings menu 152
- Google Cloud Print
  - using 75
- green settings
  - Eco-Mode 199
  - Hibernate mode 201
  - Quiet Mode 200

## H

- hardware options, adding print driver 46
- header
  - inserting 88
- header/footer
  - copy options 91
- held jobs 78
  - printing from a Macintosh computer 79

- printing from Windows 79
- held print jobs
  - printing from a Macintosh computer 79
  - printing from Windows 79
- Help menu 198
- Hibernate mode
  - using 201
- hiding icons on the home screen 20
- holding faxes 118
- home button
  - printer control panel 15
- home screen
  - buttons, understanding 16
  - customizing 20
  - hiding icons 20
  - showing icons 20
- home screen applications
  - configuring 21
  - finding information 21
- home screen buttons
  - understanding 16
- HTML menu 197

## I

- icons on the home screen
  - hiding 20
  - showing 20
- identifying jam locations 222
- Image menu 198
- imaging unit
  - ordering 211
  - replacing 214
- Imaging unit low [84.xy] 235
- Imaging unit nearly low [84.xy] 235
- Imaging unit very low, [x] estimated pages remain [84.xy] 235
- importing a configuration
  - using the Embedded Web Server 25
- Incorrect paper size, open [paper source][34] 235
- indicator light
  - printer control panel 15
- initial fax setup 101
  - using the Embedded Web Server 101
- Insert Tray [x] 235
- inserting a header or footer 88

- installing an Internal Solutions Port 31
- installing an optional card 30
- installing options
  - order of installation 42
- installing printer hard disk 38
- installing the 250-sheet tray 42
- installing the 550-sheet tray 42
- installing the printer software 46
- Insufficient memory to collate job [37] 236
- Insufficient memory to support Resource Save feature [35] 236
- Insufficient memory, some Held Jobs were deleted [37] 236
- Insufficient memory, some held jobs will not be restored [37] 236
- internal options 26
- internal options, adding
  - print driver 46
- Internal Solutions Port
  - installing 31
  - troubleshooting 249
- IP address of computer
  - finding 19
- IP address, printer
  - finding 19
- IPv6 menu 144

## J

- jams
  - avoiding 221
- jams, clearing
  - in automatic document feeder 230
  - multipurpose feeder 228
  - standard bin 226
  - trays 228
- Job Accounting menu 191

## K

- keypad
  - printer control panel 15

## L

- labels, paper
  - tips on using 66
- letterhead
  - copying on 83
  - loading, multipurpose feeder 58

- tips on using 65
- Lexmark Mobile Print
  - using 76
- line filter 105
- linking trays 62, 63
- Load [paper source] with [custom string] [paper orientation] 237
- Load [paper source] with [custom type name] [paper orientation] 238
- Load [paper source] with [paper size] [paper orientation] 238
- Load [paper source] with [paper type] [paper size] [paper orientation] 238
- Load multipurpose feeder with [custom string] [orientation] 236
- Load multipurpose feeder with [custom type name] [orientation] 237
- Load multipurpose feeder with [paper size] orientation] 237
- Load multipurpose feeder with [paper type] [paper size] [orientation] 237
- loading
  - multipurpose feeder 58
  - trays 53
- loading the optional tray 53
- loading the standard tray 53

## M

- maintenance kit
  - ordering 211
- Maintenance kit low [80.xy] 238
- Maintenance kit nearly low [80.xy] 239
- Maintenance kit very low [80.xy] 239
- making copies using paper from selected tray 83
- memory
  - types installed on printer 203
- memory card 26
  - installing 28
- Memory full [38] 239
- Memory full, cannot print faxes 239
- menu settings page
  - printing 51
- menus
  - Active NIC 140

- AppleTalk 145
- Confidential Print 149
- Configure MP 132
- Copy Settings 159
- Custom Names 137
- Custom Scan Sizes 138
- Custom Types 137
- Default Source 129
- Erase Temporary Data Files 150
- E-mail Settings 172
- Fax Mode (Analog Fax Setup) 163
- Finishing 189
- Flash Drive 182
- FTP Settings 177
- General Settings 152
- Help 198
- HTML 197
- Image 198
- IPv6 144
- Job Accounting 191
  - list of 128
- Miscellaneous 149
- Network [x] 140
- Network Card 142
- Network Reports 142
- OCR Settings 187
- Paper Loading 136
- Paper Size/Type 129
- Paper Texture 133
- Paper Weight 134
- PCL Emul 194
- PDF 193
- PostScript 194
- Quality 190
- Reports 139
- Security Audit Log 151
- Set Date and Time 151
- Settings 187
- SMTP Setup menu 148
- Standard Network 140
- Standard USB 146
- Substitute Size 133
- TCP/IP 142
- Universal Setup 138
- Utilities 192
- Wireless 144
- XPS 193
- message
  - e-mail options 97
- Miscellaneous menu 149

mobile device  
 printing from 75, 76

Mopria Print Service  
 using 75

moving the printer 11, 216

Multi Send  
 adding a profile 23  
 setting up 23

multipurpose feeder  
 loading 58

MyShortcut  
 about 22

**N**

Network [x] menu 140

Network [x] software error  
 [54] 239

Network Card menu 142

Network Reports menu 142

network settings  
 Embedded Web Server 218

network setup page  
 printing 52

Networking Guide  
 where to find 218

No analog phone line connected  
 to modem, fax is disabled. 239

noise emission levels 299

Non-Lexmark [supply type], see  
 User's Guide [33.xy] 239

non-volatile memory 203  
 erasing 204

Not enough free space in flash  
 memory for resources [52] 240

notices 298, 299, 300, 301, 302,  
 303, 305, 306

number of remaining pages  
 estimate 209

**O**

OCR Settings menu 187

optional card  
 installing 30

optional tray  
 loading 53

options  
 250-sheet tray, installing 42  
 550-sheet tray, installing 42  
 firmware cards 26  
 Internal Solutions Port,  
 installing 31

memory card 28

memory cards 26

printer hard disk, installing 38

printer hard disk, removing 41

options, copy screen  
 copy from 89  
 edge erase 91  
 margin shift 91  
 scale 89

options, touch-screen  
 copy 89  
 e-mail 97, 99

ordering  
 imaging unit 211  
 maintenance kit 211

ordering supplies  
 toner cartridges 210

original size  
 e-mail options 97  
 scan options 125

output file type  
 changing 96  
 scan image 125

overlay  
 copy options 91

**P**

page setup  
 e-mail options 98  
 fax options 120  
 scan options 126

paper  
 characteristics 67  
 different sizes, copying 84  
 letterhead 68  
 loading, multipurpose  
 feeder 58  
 preprinted forms 68  
 recycled 68  
 saving 87  
 selecting 68  
 storing 70  
 unacceptable 68  
 Universal size setting 53  
 using recycled 199

paper feed troubleshooting  
 message remains after jam is  
 cleared 252

paper jam in front door 223

paper jam in the automatic  
 document feeder 230

paper jam in the duplex unit 227

paper jam in the multipurpose  
 feeder 228

paper jam in the rear door 225

paper jam in the standard  
 bin 226

paper jam in trays 228

paper jam, clearing  
 in automatic document  
 feeder 230  
 in front door 223  
 in the duplex unit 227  
 in the rear door 225  
 multipurpose feeder 228  
 standard bin 226  
 trays 228

paper jams  
 avoiding 221

paper labels  
 loading, multipurpose  
 feeder 58

Paper Loading menu 136

paper saver  
 copy options 91

paper size  
 setting 53

Paper Size/Type menu 129

paper sizes  
 supported 70

Paper Texture menu 133

paper type  
 setting 53

paper types  
 supported by printer 72  
 where to load 72

Paper Weight menu 134

paper weights  
 supported by printer 72

parts  
 checking status 209  
 checking, from printer control  
 panel 209  
 checking, using the Embedded  
 Web Server 209  
 using genuine Lexmark 209

PCL Emul menu 194

PDF menu 193

Personal Identification Number  
 method  
 using 49

phone splitter 106

photos  
 copying 82

- placing separator sheets between copies 87
- port settings
  - configuring 50
- PostScript menu 194
- preparing to set up the printer on an Ethernet network 47
- print driver
  - hardware options, adding 46
- print irregularities 266
- print job
  - canceling from the computer 80
- print quality
  - cleaning the scanner glass 208
- print quality troubleshooting
  - blank pages 270
  - characters have jagged edges 260
  - clipped pages or images 261
  - compressed images appear on prints 262
  - gray background on prints 263
  - horizontal voids appear on prints 264
  - print irregularities 266
  - print is too dark 268
  - print is too light 269
  - printer is printing solid black pages 271
  - repeating print defects appear on prints 272
  - shadow images appear on prints 273
  - skewed print 273
  - streaked horizontal lines appear on prints 274
  - streaked vertical lines 275
  - toner fog or background shading 277
  - toner rubs off 277
  - toner specks appear on prints 278
  - transparency print quality is poor 278
  - uneven print density 278
  - white streaks 278
- print troubleshooting
  - confidential and other held documents do not print 253
  - error reading flash drive 254
  - incorrect characters print 255
  - incorrect margins on prints 265
  - jammed pages are not reprinted 251
  - job prints from wrong tray 255
  - job prints on wrong paper 255
  - jobs do not print 257
  - Large jobs do not collate 256
  - multiple-language PDF files do not print 256
  - paper curl 266
  - paper frequently jams 252
  - print job takes longer than expected 258
  - tray linking does not work 259
  - unexpected page breaks occur 260
- printer
  - basic model 12
  - fully configured 12
  - minimum clearances 11
  - moving 11, 216
  - selecting a location 11
  - shipping 217
- printer configurations 12
- printer control panel
  - adjusting brightness 201
  - factory defaults, restoring 220
  - using 15
- printer control panel, virtual display
  - using the Embedded Web Server 218
- Printer had to restart. Last job may be incomplete. 240
- printer hard disk
  - disposing of 203
  - encrypting 205
  - installing 38
  - removing 41
  - wiping 204
- printer hard disk encryption 205
- printer hard disk memory erasing 204
- printer information
  - where to find 10
- printer IP address
  - finding 19
- printer is printing blank pages 270
- printer messages
  - Cartridge low [88.xy] 231
  - Cartridge nearly low [88.xy] 231
  - Cartridge very low, [x] estimated pages remain [88.xy] 231
- Cartridge, imaging unit mismatch [41.xy] 231
- Change [paper source] to [custom string] load [paper orientation] 231
- Change [paper source] to [custom type name] load [orientation] 232
- Change [paper source] to [paper size] load [orientation] 232
- Change [paper source] to [paper type] [paper size] load [orientation] 232
- Close flatbed cover and load originals if restarting job [2yy.xx] 232
- Close front door 232
- Complex page, some data may not have printed [39] 233
- Configuration change, some held jobs were not restored [57] 233
- Defective flash detected [51] 233
- Disk full [62] 233
- Disk must be formatted for use in this device 233
- Error reading USB drive. Remove USB. 234
- Error reading USB hub. Remove hub. 234
- Fax memory full 234
- Fax partition inoperative. Contact system administrator. 234
- Fax server 'To Format' not set up. Contact system administrator. 234
- Fax Station Name not set up. Contact system administrator. 234
- Fax Station Number not set up. Contact system administrator. 235
- Imaging unit low [84.xy] 235
- Imaging unit nearly low [84.xy] 235

- Imaging unit very low, [x] estimated pages remain [84.xy] 235
- Incorrect paper size, open [paper source] [34] 235
- Insert Tray [x] 235
- Insufficient memory to collate job [37] 236
- Insufficient memory to support Resource Save feature [35] 236
- Insufficient memory, some Held Jobs were deleted [37] 236
- Insufficient memory, some held jobs will not be restored [37] 236
- Load [paper source] with [custom string] [paper orientation] 237
- Load [paper source] with [custom type name] [paper orientation] 238
- Load [paper source] with [paper size] [paper orientation] 238
- Load [paper source] with [paper type] [paper size] [paper orientation] 238
- Load multipurpose feeder with [custom type name] [orientation] 237
- Load multipurpose feeder with [paper size] [orientation] 237
- Load multipurpose feeder with [paper type] [paper size] [orientation] 237
- Load multipurpose feeder with custom string [orientation] 236
- Maintenance kit low [80.xy] 238
- Maintenance kit nearly low [80.xy] 239
- Maintenance kit very low [80.xy] 239
- Memory full [38] 239
- Memory full, cannot print faxes 239
- Network [x] software error [54] 239
- No analog phone line connected to modem, fax is disabled. 239
- Non-Lexmark [supply type], see User's Guide [33.xy] 239
- Not enough free space in flash memory for resources [52] 240
- Printer had to restart. Last job may be incomplete. 240
- Reinstall missing or unresponsive cartridge [31.xy] 241
- Remove paper from standard output bin 241
- Replace all originals if restarting job. 241
- Replace cartridge, 0 estimated pages remain [88.xy] 241
- Replace defective imaging unit [31.xy] 241
- Replace imaging unit, 0 estimated pages remain [84.xy] 242
- Replace jammed originals if restarting job. 242
- Replace maintenance kit [80.xy] 242
- Replace missing imaging unit [31.xy] 242
- Replace unsupported cartridge [32.xy] 242
- Replace unsupported imaging unit [32.xy] 243
- Restore held jobs? 243
- Scanner automatic feeder cover open 243
- Scanner disabled by admin [840.01] 244
- Scanner disabled. Contact system administrator if problem persists. [840.02] 244
- Scanner jam, remove all originals from the scanner [2yy.xx] 244
- Scanner jam, remove jammed originals from the scanner [2yy.xx] 244
- SMTP server not set up. Contact system administrator. 244, 246
- Some held jobs were not restored 244
- Standard network software error [54] 244
- Standard USB port disabled [56] 245
- Supply needed to complete job 245
- The device is operating in safe mode. Some print options may be disabled or provide unexpected results. 245
- Too many flash options installed [58] 245
- Too many trays attached [58] 245
- Unformatted flash detected [53] 246
- Unsupported USB hub, please remove 234
- printer options troubleshooting
  - internal option is not detected 248
  - Internal Solutions Port 249
  - tray problems 250
  - USB/parallel interface card 251
- printer problems, solving
  - basic 246
- printer security
  - information on 206
- printer software, installing 46
- printing
  - canceling, from the printer control panel 80
  - directory list 80
  - font sample list 80
  - forms 74
  - from a computer 74
  - from a mobile device 75
  - from flash drive 76
  - menu settings page 51
  - network setup page 52
  - printing a directory list 80
  - printing a font sample list 80
  - printing a menu settings page 51
  - printing a network setup page 52
  - printing forms 74
  - printing from a flash drive 76
  - printing held jobs
    - from a Macintosh computer 79
    - from Windows 79
  - printing slows down 256

publications  
 where to find 10  
 Push Button Configuration  
 method  
 using 49

## Q

Quality menu 190  
 Quiet Mode 200

## R

recipient(s)  
 e-mail options 97  
 recycled paper  
 using 68, 199  
 recycling  
 Lexmark packaging 202  
 Lexmark products 202  
 toner cartridges 202  
 reducing a copy 85  
 reducing noise 200  
 Reinstall missing or unresponsive  
 cartridge [31.xy] 241  
 Remote Operator Panel  
 setting up 24  
 Remove paper from standard  
 output bin 241  
 removing printer hard disk 41  
 repeat print jobs 78  
 printing from a Macintosh  
 computer 79  
 printing from Windows 79  
 repeating print defects appear on  
 prints 272  
 Replace all originals if restarting  
 job. 241  
 Replace cartridge, 0 estimated  
 pages remain [88.xy] 241  
 Replace defective imaging unit  
 [31.xy] 241  
 Replace imaging unit, 0  
 estimated pages remain  
 [84.xy] 242  
 Replace jammed originals if  
 restarting job. 242  
 Replace maintenance kit  
 [80.xy] 242  
 Replace missing imaging unit  
 [31.xy] 242  
 Replace unsupported cartridge  
 [32.xy] 242

Replace unsupported imaging  
 unit [32.xy] 243  
 replacing  
 imaging unit 214  
 toner cartridge 212  
 reports  
 viewing 219  
 Reports menu 139  
 reserve print jobs  
 printing from a Macintosh  
 computer 79  
 printing from Windows 79  
 resolution  
 e-mail options 97  
 fax options 119  
 scan options 125  
 resolution, fax  
 changing 116  
 Restore held jobs? 243  
 restoring factory default  
 settings 220  
 RJ11 adapter 109

## S

safety information 7, 8, 9  
 Save As Shortcut  
 copy options 90  
 e-mail options 97  
 scan options 125  
 saving paper 87  
 scan image  
 output file type 125  
 scan options  
 Adjust ADF Skew 127  
 advanced imaging 126  
 custom job 127  
 darkness 125  
 edge erase 126  
 file name 125  
 original size 125  
 page setup 126  
 resolution 125  
 Save As Shortcut 125  
 Scan Preview 126  
 Send As 125  
 transmission log 126  
 Scan Preview  
 scan options 126  
 scan preview  
 fax options 120  
 scan screen  
 content source 125  
 content type 125  
 Scan to Computer  
 setting up 124  
 Scan to Network  
 setting up 23  
 using 121  
 scan troubleshooting  
 cannot scan from a  
 computer 289  
 partial document or photo  
 scans 289  
 scan job was not  
 successful 291  
 scanner unit does not  
 close 282, 291  
 scanning takes too long or  
 freezes the computer 291  
 scanner  
 automatic document feeder  
 (ADF) 14  
 functions 13  
 scanner glass 14  
 Scanner automatic feeder cover  
 open 243  
 Scanner disabled by admin  
 [840.01] 244  
 Scanner disabled. Contact  
 system administrator if problem  
 persists. [840.02] 244  
 scanner glass  
 cleaning 208  
 copying using 82  
 Scanner jam, remove all originals  
 from the scanner [2yy.xx] 244  
 Scanner jam, remove jammed  
 originals from the scanner  
 [2yy.xx] 244  
 scanning  
 from a flash drive 124  
 quick copy 81  
 to a computer using the  
 Embedded Web Server 123  
 scanning to a computer 124  
 using the Embedded Web  
 Server 123  
 scanning to a flash drive 124  
 scanning to an FTP address  
 creating shortcuts using the  
 computer 121  
 using a shortcut number 123  
 using the printer control  
 panel 122

- scanning to network destinations 121
  - security
    - modifying confidential print settings 79
  - Security Audit Log menu 151
  - security slot 45
  - security Web page
    - where to find 206
  - selecting a location for the printer 11
  - selecting paper 68
  - Send As
    - e-mail options 97
    - scan options 125
  - sending a fax using the computer 113
  - sending a fax using the printer control panel 113
  - sending an e-mail using the printer control panel 94
  - sending fax
    - using shortcuts 114
    - using the address book 114
  - sending fax at a scheduled time 115
  - separator sheets
    - copy options 91
  - serial printing
    - setting up 51
  - Set Date and Time menu 151
  - setting
    - paper size 53
    - paper type 53
    - TCP/IP address 142
  - setting the fax number 112
  - setting the outgoing fax name 112
  - setting the Universal paper size 53
  - setting up e-mail alerts 218
  - setting up fax
    - country- or region-specific 109
    - digital telephone service 108
    - DSL connection 105
    - standard telephone line connection 101
    - VoIP connection 106
  - setting up fax and e-mail functions 287
  - setting up serial printing 51
  - Settings menu 187
  - shipping the printer 217
  - shortcuts, creating
    - e-mail 93
    - e-mail screen 94
    - fax destination 115, 116
    - FTP address 122
    - FTP destination 121
  - showing icons on the home screen 20
  - sides (duplex)
    - copy options 90
  - sleep button
    - printer control panel 15
  - Sleep Mode
    - adjusting 201
  - SMTP server not set up. Contact system administrator. 244, 246
  - SMTP Setup menu 148
  - Some held jobs were not restored 244
  - Standard Network menu 140
  - Standard network software error [54] 244
  - standard tray
    - loading 53
  - Standard USB menu 146
  - Standard USB port disabled [56] 245
  - statement of volatility 203
  - status of parts
    - checking 209
  - status of supplies
    - checking 209
  - stop or cancel button
    - printer control panel 15
  - storing
    - paper 70
    - supplies 212
  - storing print jobs 78
  - streaked horizontal lines appear on prints 274
  - streaked vertical lines appear on prints 275
  - streaks appear 278
  - subject and message information
    - adding to e-mail 96
  - submit button
    - printer control panel 15
  - Substitute Size menu 133
  - supplies
    - checking status 209
    - checking, from printer control panel 209
    - checking, using the Embedded Web Server 209
    - conserving 199
    - storing 212
    - using genuine Lexmark 209
    - using recycled paper 199
  - supplies, ordering
    - ADF separator roller 212
    - imaging unit 211
    - maintenance kit 211
    - toner cartridges 210
  - Supply needed to complete job 245
  - supply notifications
    - configuring 219
  - supported flash drives 77
  - supported paper sizes 70
- T**
- TCP/IP menu 142
  - telecommunication notices 303, 305, 306
  - The device is operating in safe mode. Some print options may be disabled or provide unexpected results. 245
  - the scanner does not respond 292
  - tips
    - card stock 66
    - letterhead 65
    - on using envelopes 65
    - on using labels 66
    - printer control panel 15
    - transparencies 65
  - tips on using envelopes 65
  - toner cartridge
    - replacing 212
  - toner cartridges
    - ordering 210
    - recycling 202
  - toner darkness
    - adjusting 74
  - Too many flash options installed [58] 245
  - Too many trays attached [58] 245
  - touch screen
    - buttons, using 17

- transmission log
    - e-mail options 99
    - fax options 120
    - scan options 126
  - transparencies
    - copying on 82
    - loading, multipurpose feeder 58
    - tips 65
  - trays
    - linking 62, 63
    - loading 53
    - unlinking 62, 63
  - troubleshooting
    - an application error has occurred 293
    - cannot open Embedded Web Server 293
    - checking an unresponsive printer 246
    - fax and e-mail functions are not set up 287
    - solving basic printer problems 246
    - the scanner does not respond 292
  - troubleshooting, copy
    - copier does not respond 280
    - partial document or photo copies 280
    - poor copy quality 281
    - poor scanned image quality 290
    - scanner unit does not close 282, 291
  - troubleshooting, display
    - printer display is blank 248
  - troubleshooting, fax
    - caller ID is not shown 283
    - can receive but not send faxes 286
    - can send but not receive faxes 286
    - cannot send or receive a fax 283
    - received fax has poor print quality 288
  - troubleshooting, paper feed
    - message remains after jam is cleared 252
  - troubleshooting, print
    - confidential and other held documents do not print 253
    - error reading flash drive 254
    - incorrect characters print 255
    - incorrect margins on prints 265
    - jammed pages are not reprinted 251
    - job prints from wrong tray 255
    - job prints on wrong paper 255
    - jobs do not print 257
    - Large jobs do not collate 256
    - multiple-language PDF files do not print 256
    - paper curl 266
    - paper frequently jams 252
    - print job takes longer than expected 258
    - tray linking does not work 259
    - unexpected page breaks occur 260
  - troubleshooting, print quality
    - blank pages 270
    - characters have jagged edges 260
    - clipped pages or images 261
    - compressed images appear on prints 262
    - gray background on prints 263
    - horizontal voids appear on prints 264
    - print irregularities 266
    - print is too dark 268
    - print is too light 269
    - printer is printing solid black pages 271
    - repeating print defects appear on prints 272
    - shadow images appear on prints 273
    - skewed print 273
    - streaked horizontal lines appear on prints 274
    - streaked vertical lines 275
    - toner fog or background shading 277
    - toner rubs off 277
    - toner specks appear on prints 278
    - transparency print quality is poor 278
    - uneven print density 278
    - white streaks on a page 278
  - troubleshooting, printer options
    - internal option is not detected 248
    - Internal Solutions Port 249
    - tray problems 250
    - USB/parallel interface card 251
  - troubleshooting, printing
    - printing slows down 256
  - troubleshooting, scan
    - cannot scan from a computer 289
    - partial document or photo scans 289
    - scan job was not successful 291
    - scanner unit does not close 282, 291
    - scanning takes too long or freezes the computer 291
- ## U
- understanding the home screen 16
  - uneven print density 278
  - Unformatted flash detected [53] 246
  - Universal Paper Size setting 53
  - Universal paper size setting 53
  - Universal Setup menu 138
  - unlinking trays 62, 63
  - Unsupported USB hub, please remove 234
  - USB port 45
  - USB/parallel interface card
    - troubleshooting 251
  - using a shortcut number
    - scanning to an FTP address 123
  - using Forms and Favorites 74
  - using Hibernate mode 201
  - using recycled paper 199
  - using shortcuts
    - sending fax 114
  - using the address book
    - sending fax 114
  - using the touch-screen buttons 17
  - Utilities menu 192



**V**

- verify print jobs 78
  - printing from a Macintosh computer 79
  - printing from Windows 79
- vertical voids appear 278
- viewing
  - reports 219
- viewing a fax log 117
- virtual display
  - checking, using Embedded Web Server 218
- voice mail
  - setting up 101
- voice over Internet Protocol (VoIP)
  - fax setup 106
- voids appear 278
- VoIP adapter 106
- volatile memory 203
  - erasing 203
- volatility
  - statement of 203

**W**

- wiping the printer hard disk 204
- Wireless menu 144
- wireless network
  - configuration information 47
- wireless network setup
  - using the Embedded Web Server 50
- wireless setup wizard
  - using 48

**X**

- XPS menu 193