



MS312, MS315, MS317, MS415, and MS417

User's Guide

November 2017

www.lexmark.com

Machine type(s):

4514

Model(s):

330, 335, 530

Contents

- Safety information..... 6**
 - Conventions..... 6

- Learning about the printer..... 9**
 - Using this guide..... 9
 - Finding information about the printer..... 9
 - Selecting a location for the printer..... 10
 - Printer configurations..... 11

- Additional printer setup..... 14**
 - Installing internal options..... 14
 - Available internal options..... 14
 - Accessing the controller board 14
 - Installing an optional card 15
 - Installing hardware options..... 17
 - Installing optional trays 17
 - Attaching cables 18
 - Setting up the printer software..... 19
 - Installing the printer software..... 19
 - Adding available options in the print driver 20
 - Networking..... 20
 - Preparing to set up the printer on an Ethernet network 20
 - Preparing to set up the printer on a wireless network 21
 - MS315 and MS415 Wireless Setup Wizard 22
 - MS312 Wi-Fi Protected Setup..... 22
 - MS315 and MS415 Wi-Fi Protected Setup..... 23
 - Connecting MS312 to a wireless network using the printer software 24
 - Connecting the printer to a wireless network using the Embedded Web Server..... 25
 - Verifying printer setup..... 25
 - MS312 and MS317 printing menu settings and network setup pages..... 25
 - MS315, MS415, and MS417 printing menu settings and network setup pages..... 26

- Using MS312 and MS317..... 28**
 - Using the printer control panel..... 28
 - Understanding the colors of the Sleep button and indicator lights..... 29
 - Installing the Local Printer Settings Utility..... 29
 - Using the Local Printer Settings Utility..... 30

- Using MS315, MS415, and MS417..... 31**
 - Using the control panel.....31
 - Understanding the colors of the Sleep button and indicator lights.....32
 - Accessing the Embedded Web Server.....32

- Loading paper and specialty media..... 33**
 - MS312 and MS317 paper size and type setup..... 33
 - MS315, MS415, and MS417 paper size and type setup.....34
 - Using the standard bin and paper stop..... 34
 - Loading trays..... 35
 - Loading the multipurpose feeder.....39
 - Linking and unlinking trays..... 42

- Paper and specialty media guide..... 46**
 - Paper guidelines..... 46
 - Using specialty media..... 49
 - Supported paper sizes, types, and weights..... 52

- Printing.....55**
 - Printing a document..... 55
 - Printing from a mobile device..... 56
 - MS315, MS415, and MS417 printing confidential and other held jobs..... 57
 - Printing information pages.....58
 - Canceling a print job..... 59

- Saving money and the environment.....60**
 - Saving paper and toner..... 60
 - Recycling..... 60

- Managing the printer..... 62**
 - Finding advanced networking and administrator information..... 62
 - Copying printer settings to other printers..... 62
 - Configuring supply notifications from the Embedded Web Server..... 62
 - MS312 and MS317 printer management..... 63
 - MS315, MS415, and MS417 printer management..... 67
 - Adjusting Sleep mode..... 71

Securing the printer.....72

Using the security lock feature..... 72
Statement of Volatility.....72
Erasing volatile memory.....73
Erasing non-volatile memory..... 73
Finding printer security information.....74

Understanding the printer menus..... 75

MS312 and MS317 menus list..... 75
MS315, MS415, and MS417 menus list.....75
Paper menu.....76
Reports menu..... 88
Network/Ports menu.....89
Security menu.....101
Settings menu.....103
MS315, MS415, and MS417 help menu.....125

Clearing jams..... 126

Avoiding jams..... 126
Identifying jam locations..... 127
Paper jam in the front door..... 128
Paper jam in the rear door.....130
Paper jam in the standard bin.....131
Paper jam in the duplex unit..... 131
Paper jam in trays..... 132
Paper jam in the multipurpose feeder.....132

Maintaining the printer.....134

Cleaning the printer.....134
Checking the status of parts and supplies..... 134
Estimated number of remaining pages.....135
Ordering parts and supplies..... 135
Storing supplies.....137
Replacing supplies.....138
Moving the printer.....141

Troubleshooting..... 143

- Understanding the printer messages..... 143
- Solving printer problems.....159
- Solving print problems..... 165
- Embedded Web Server does not open..... 192
- Contacting customer support..... 193

Notices.....194

- Product information..... 194
- Edition notice..... 194
- Power consumption..... 199

Index..... 204

Safety information

Conventions

Note: A *note* identifies information that could help you.

Warning: A *warning* identifies something that could damage the product hardware or software.

CAUTION: A *caution* indicates a potentially hazardous situation that could injure you.

Different types of caution statements include:

-  **CAUTION—POTENTIAL INJURY:** Indicates a risk of injury.
-  **CAUTION—SHOCK HAZARD:** Indicates a risk of electrical shock.
-  **CAUTION—HOT SURFACE:** Indicates a risk of burn if touched.
-  **CAUTION—TIPPING HAZARD:** Indicates a crush hazard.
-  **CAUTION—PINCH HAZARD:** Indicates a risk of being caught between moving parts.
-  **CAUTION—POTENTIAL INJURY:** To avoid the risk of fire or electrical shock, connect the power cord to an appropriately rated and properly grounded electrical outlet that is near the product and easily accessible.
-  **CAUTION—POTENTIAL INJURY:** Do not use this product with extension cords, multioutlet power strips, multioutlet extenders, or UPS devices. The power capacity of these types of accessories can be easily overloaded by a laser printer and may result in a risk of fire, property damage, or poor printer performance.
-  **CAUTION—POTENTIAL INJURY:** Only a Lexmark Inline Surge Protector that is properly connected between the printer and the power cord provided with the printer may be used with this product. The use of non-Lexmark surge protection devices may result in a risk of fire, property damage, or poor printer performance.
-  **CAUTION—SHOCK HAZARD:** To avoid the risk of electrical shock, do not place or use this product near water or wet locations.
-  **CAUTION—POTENTIAL INJURY:** This product uses a laser. Use of controls or adjustments or performance of procedures other than those specified in the *User's Guide* may result in hazardous radiation exposure.

This product uses a printing process that heats the print media, and the heat may cause the media to release emissions. You must understand the section in your operating instructions that discusses the guidelines for selecting print media to avoid the possibility of harmful emissions.

-  **CAUTION—POTENTIAL INJURY:** The lithium battery in this product is not intended to be replaced. There is a danger of explosion if a lithium battery is incorrectly replaced. Do not recharge, disassemble, or incinerate a lithium battery. Discard used lithium batteries according to the manufacturer's instructions and local regulations.

 **CAUTION—POTENTIAL INJURY:** When moving the printer, follow these guidelines to avoid personal injury or printer damage:

- Make sure that all doors and trays are closed.
- Turn off the printer, and then unplug the power cord from the electrical outlet.
- Disconnect all cords and cables from the printer.
- If the printer has a caster base, then carefully roll it to the new location. Use caution when passing over thresholds and breaks in flooring.
- If the printer does not have a caster base but is configured with optional trays, then lift the printer off the trays. Do not try to lift the printer and the trays at the same time.
- Always use the handholds on the printer to lift it.
- Any cart used to move the printer must have a surface able to support the full footprint of the printer.
- Any cart used to move the hardware options must have a surface able to support the dimensions of the options.
- Keep the printer in an upright position.
- Avoid severe jarring movements.
- Make sure that your fingers are not under the printer when you set it down.
- Make sure that there is adequate clearance around the printer.

 **CAUTION—POTENTIAL INJURY:** To avoid the risk of fire or electrical shock, use only the power cord provided with this product or the manufacturer's authorized replacement.

 **CAUTION—HOT SURFACE:** The inside of the printer might be hot. To reduce the risk of injury from a hot component, allow the surface to cool before touching it.

 **CAUTION—SHOCK HAZARD:** If you are accessing the controller board or installing optional hardware or memory devices sometime after setting up the printer, then turn the printer off, and unplug the power cord from the electrical outlet before continuing. If you have any other devices attached to the printer, then turn them off as well, and unplug any cables going into the printer.

 **CAUTION—SHOCK HAZARD:** To avoid the risk of electrical shock, make sure that all external connections (such as Ethernet and telephone system connections) are properly installed in their marked plug-in ports.

This product is designed, tested, and approved to meet strict global safety standards with the use of specific manufacturer's components. The safety features of some parts may not always be obvious. The manufacturer is not responsible for the use of other replacement parts.

 **CAUTION—POTENTIAL INJURY:** Do not cut, twist, bind, crush, or place heavy objects on the power cord. Do not subject the power cord to abrasion or stress. Do not pinch the power cord between objects such as furniture and walls. If any of these things happen, a risk of fire or electrical shock results. Inspect the power cord regularly for signs of such problems. Remove the power cord from the electrical outlet before inspecting it.

Refer service or repairs, other than those described in the user documentation, to a service representative.

 **CAUTION—SHOCK HAZARD:** To avoid the risk of electrical shock when cleaning the exterior of the printer, unplug the power cord from the electrical outlet and disconnect all cables from the printer before proceeding.

 **CAUTION—POTENTIAL INJURY:** To reduce the risk of equipment instability, load each tray separately. Keep all other trays closed until needed.



CAUTION—SHOCK HAZARD: Do not set up this product or make any electrical or cabling connections, such as the fax feature, power cord, or telephone, during a lightning storm.

SAVE THESE INSTRUCTIONS.

Learning about the printer

Using this guide

This *User's Guide* provides general and specific information on using the printer models that are listed on the cover page.

The following chapters contain information applicable to all printer models:

- [Safety information](#)
- [Learning about the printer](#)
- [Additional printer setup](#)
- [Loading paper and specialty media](#)
- [Paper and specialty media guide](#)
- [Printing](#)
- [Saving money and the environment](#)
- [Managing the printer](#)
- [Securing the printer](#)
- [Understanding printer menus](#)
- [Clearing jams](#)
- [Maintaining the printer](#)
- [Troubleshooting](#)

To find instructions for your printer:

- Use the table of contents.
- Use the Search function or the Find toolbar of your application.

Finding information about the printer

What are you looking for?	Find it here
Initial setup instructions: <ul style="list-style-type: none"> • Connecting the printer • Installing the printer software 	Setup documentation—The setup documentation came with the printer and is also available at http://support.lexmark.com .
Additional setup and instructions for using the printer: <ul style="list-style-type: none"> • Selecting and storing paper and specialty media • Loading paper • Configuring printer settings • Viewing and printing documents and photos • Setting up and using the printer software • Configuring the printer on a network • Caring for and maintaining the printer • Troubleshooting and solving problems 	<i>User's Guide</i> and <i>Quick Reference Guide</i> —The guides are available at http://support.lexmark.com . Note: These guides are also available in other languages.

What are you looking for?	Find it here
Information on setting up and configuring the accessibility features of your printer	<i>Lexmark Accessibility Guide</i> —This guide is available at http://support.lexmark.com .
Help using the printer software	<p>Windows or Mac Help—Open a printer software program or application, and then click Help.</p> <p>Click  to view context-sensitive information.</p> <p>Notes:</p> <ul style="list-style-type: none"> • Help is automatically installed with the printer software. • The printer software is located in the printer program folder or on the desktop, depending on your operating system.
<p>The latest supplemental information, updates, and customer support:</p> <ul style="list-style-type: none"> • Documentation • Driver downloads • Live chat support • E-mail support • Voice support 	<p>Lexmark support Web site— http://support.lexmark.com</p> <p>Note: Select your country or region, and then select your product to view the appropriate support site.</p> <p>Support telephone numbers and hours of operation for your country or region can be found on the support Web site or on the printed warranty that came with your printer.</p> <p>Record the following information (located on the store receipt and at the back of the printer), and have it ready when you contact customer support so that they may serve you faster:</p> <ul style="list-style-type: none"> • Machine Type number • Serial number • Date purchased • Store where purchased
Warranty information	<p>Warranty information varies by country or region:</p> <ul style="list-style-type: none"> • In the U.S.—See the Statement of Limited Warranty included with this printer, or go to http://support.lexmark.com. • In other countries and regions—See the printed warranty that came with this printer.

Selecting a location for the printer

When selecting a location for the printer, leave enough room to open trays, covers, and doors. If you plan to install any hardware options, then leave enough room for them also. It is important to:

- Set up the printer near a properly grounded and easily accessible electrical outlet.
- Make sure airflow in the room meets the latest revision of the ASHRAE 62 standard or the CEN Technical Committee 156 standard.
- Provide a flat, sturdy, and stable surface.

- Keep the printer:
 - Clean, dry, and free of dust.
 - Away from stray staples and paper clips.
 - Away from the direct airflow of air conditioners, heaters, or ventilators.
 - Free from direct sunlight and humidity extremes.
- Observe the recommended temperatures and avoid fluctuations.

Ambient temperature	16 to 32°C (60 to 90°F)
Storage temperature	-20 to 40°C (-4 to 104°F)

- Allow the following recommended amount of space around the printer for proper ventilation:

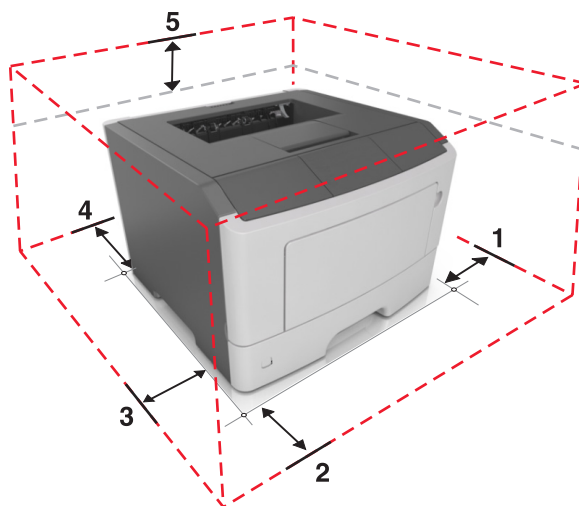

1	Right side	110 mm (4.33 in.)
2	Front	305 mm (12 in.)
3	Left side	65 mm (2.56 in.)
4	Rear	100 mm (3.94 in.)
5	Top	305 mm (12 in.)

Printer configurations

⚠ CAUTION—POTENTIAL INJURY: To reduce the risk of equipment instability, load each tray separately. Keep all other trays closed until needed.

You can configure your printer by adding one optional 250- or 550-sheet tray. For instructions on installing the optional tray, see [“Installing optional trays” on page 17](#).

MS312 printer model

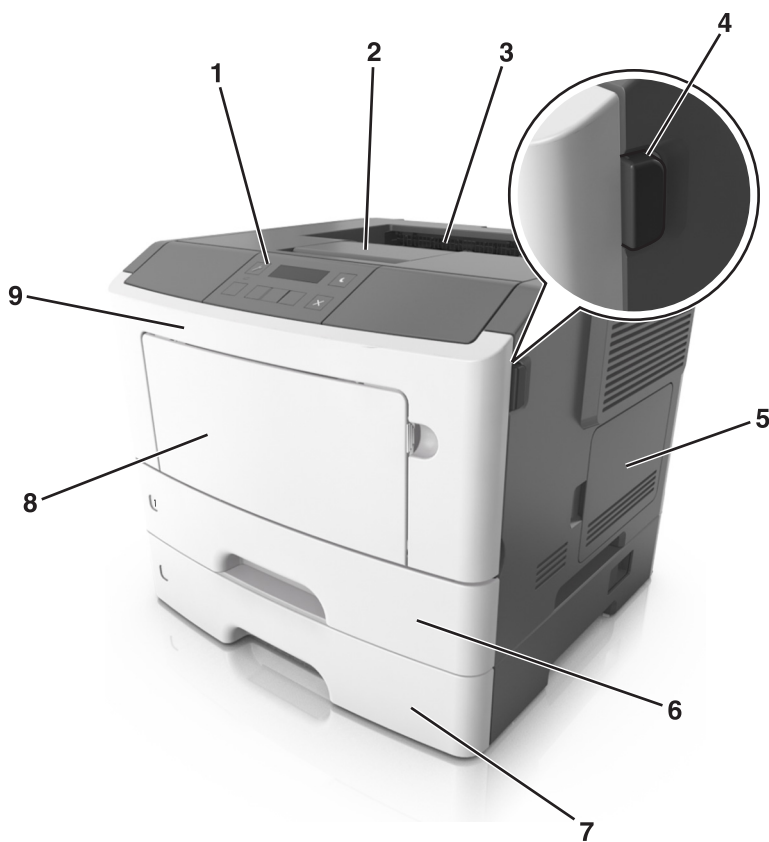

1	Control panel
2	Paper stop
3	Standard bin
4	Front door release button
5	Controller board access cover
6	Standard 250-sheet tray
7	Optional 250- or 550-sheet tray
8	50-sheet multipurpose feeder
9	Front door

MS315 and MS415 printer models

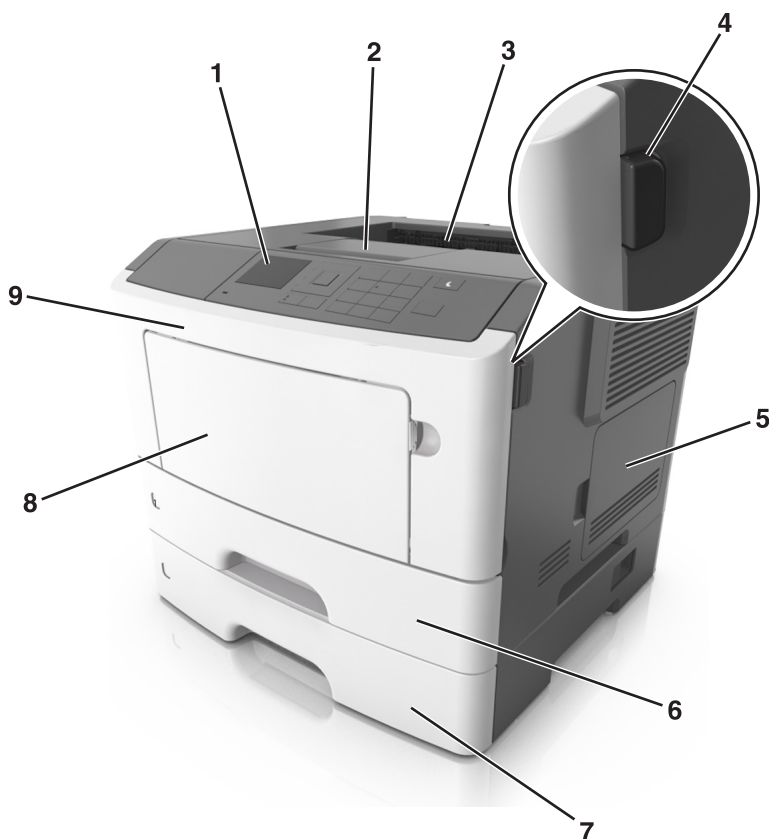

1	Control panel
2	Paper stop
3	Standard bin
4	Front door release button
5	Controller board access cover
6	Standard 250-sheet tray
7	Optional 250- or 550-sheet tray
8	50-sheet multipurpose feeder
9	Front door

Additional printer setup

Installing internal options

CAUTION—SHOCK HAZARD: If you are accessing the controller board or installing optional hardware or memory devices sometime after setting up the printer, then turn the printer off, and unplug the power cord from the electrical outlet before continuing. If you have any other devices attached to the printer, then turn them off as well, and unplug any cables going into the printer.

Warning—Potential Damage: Controller board electronic components are easily damaged by static electricity. Touch a metal surface on the printer before touching any controller board electronic components or connectors.

Available internal options

- Flash memory
 - Fonts

Accessing the controller board

CAUTION—SHOCK HAZARD: If you are accessing the controller board or installing optional hardware or memory devices sometime after setting up the printer, then turn the printer off, and unplug the power cord from the electrical outlet before continuing. If you have any other devices attached to the printer, then turn them off as well, and unplug any cables going into the printer.

- 1 Open the controller board access door.

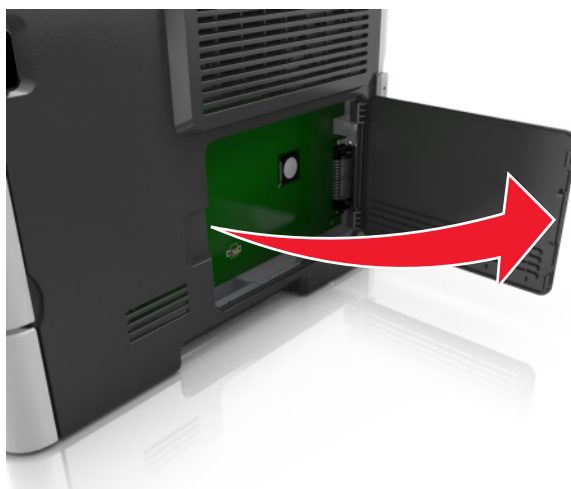

- 2 Locate the memory card connector.

Warning—Potential Damage: Controller board electronic components are easily damaged by static electricity. Touch a metal surface on the printer before touching any controller board electronic components or connectors.

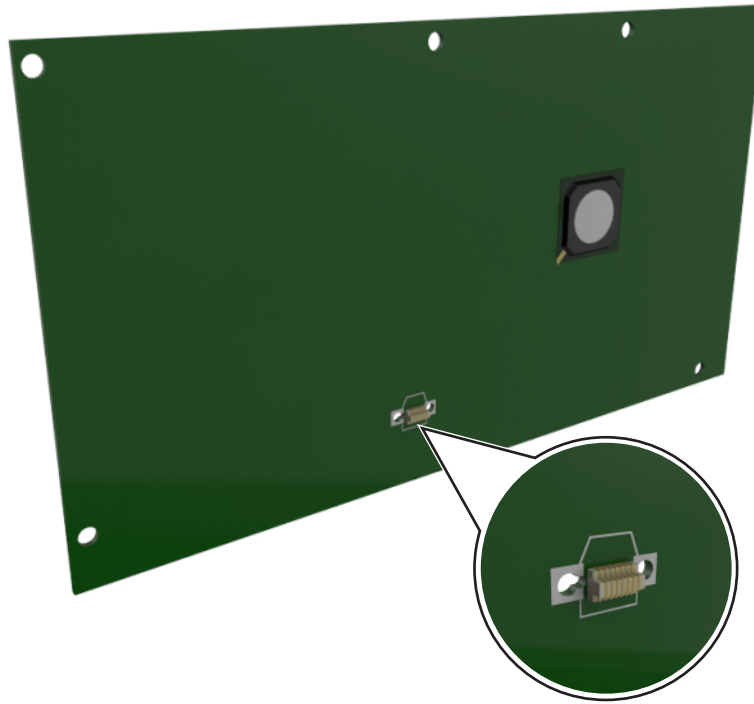

Installing an optional card

⚠ CAUTION—SHOCK HAZARD: If you are accessing the controller board or installing optional hardware or memory devices sometime after setting up the printer, then turn the printer off, and unplug the power cord from the electrical outlet before continuing. If you have any other devices attached to the printer, then turn them off as well, and unplug any cables going into the printer.

Warning—Potential Damage: Controller board electronic components are easily damaged by static electricity. Touch a metal surface on the printer before touching any controller board electronic components or connectors.

- 1 Access the controller board.

For more information, see [“Accessing the controller board” on page 14.](#)

- 2 Unpack the optional card.

Warning—Potential Damage: Avoid touching the connection points along the edge of the card.

3 Holding the card by its sides, align the plastic pins (1) on the card with the holes (2) on the controller board.

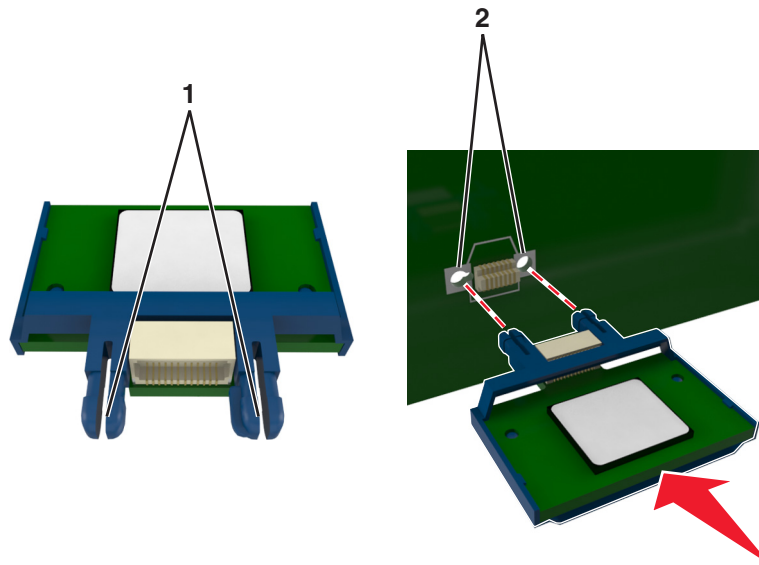

4 Push the card firmly into place as shown in the illustration.

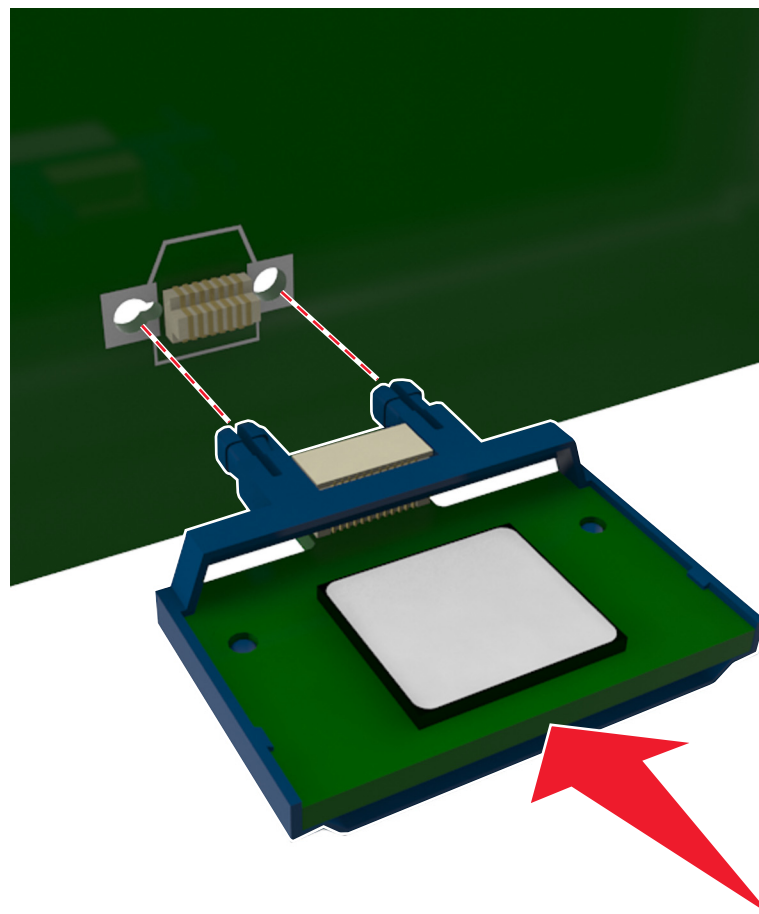

Warning—Potential Damage: Improper installation of the card may cause damage to the card and the controller board.

Note: The entire length of the connector on the card must touch and be flush against the controller board.

- 5 Close the controller board access door.

Note: When the printer software and any hardware options are installed, it may be necessary to manually add the options in the printer driver to make them available for print jobs. For more information, see [“Adding available options in the print driver” on page 20](#).

Installing hardware options

Installing optional trays

CAUTION—SHOCK HAZARD: If you are accessing the controller board or installing optional hardware or memory devices sometime after setting up the printer, then turn the printer off, and unplug the power cord from the electrical outlet before continuing. If you have any other devices attached to the printer, then turn them off as well, and unplug any cables going into the printer.

- 1 Turn off the printer using the power switch, and then unplug the power cord from the electrical outlet.



- 2 Unpack the tray, and then remove any packing material.
- 3 Remove the tray from the base.

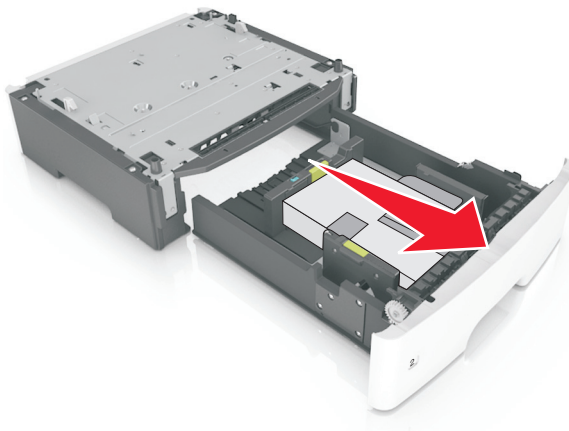

- 4 Remove any packing material from inside the tray.

- 5 Insert the tray into the base.
- 6 Place the tray near the printer.
- 7 Align the printer with the tray, and then slowly lower the printer into place.



- 8 Connect the power cord to the printer, then to a properly grounded electrical outlet, and then turn on the printer.



Note: When the printer software and any hardware options are installed, it may be necessary to manually add the options in the printer driver to make them available for print jobs. For more information, see [“Adding available options in the print driver” on page 20](#).

Attaching cables

Connect the printer to the computer using a USB or parallel cable, or to the network using an Ethernet cable.

Make sure to match the following:

- The USB symbol on the cable with the USB symbol on the printer
- The appropriate parallel cable with the parallel port
- The appropriate Ethernet cable with the Ethernet port

Warning—Potential Damage: Do not touch the USB cable, any network adapter, or the printer in the area shown while actively printing. Loss of data or a malfunction can occur.

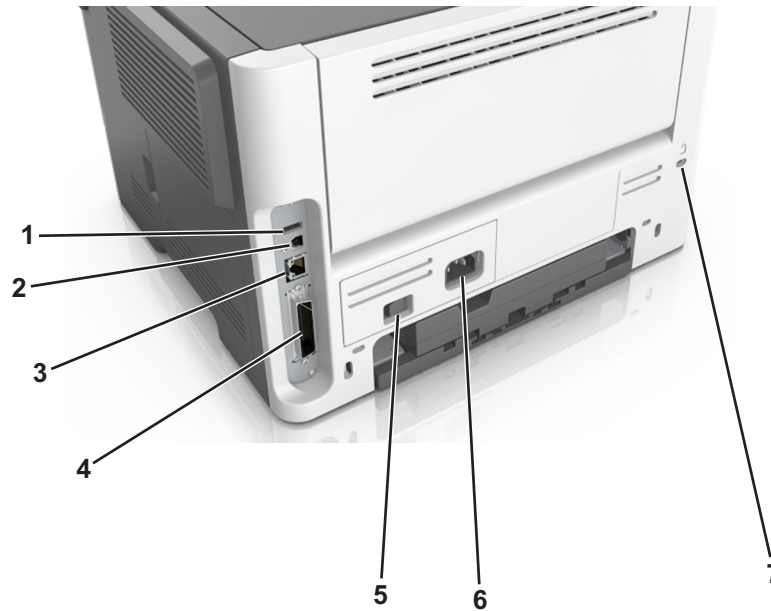

	Use the	To
1	USB port	Attach an optional wireless network adapter.
2	USB printer port	Connect the printer to a computer.
3	Ethernet port	Connect the printer to a network.
4	Parallel port	Connect the printer to a computer.
5	Power switch	Turn on or turn off the printer.
6	Printer power cord socket	Connect the printer to an electrical outlet.
7	Security slot	Attach a lock that will secure the printer in place.

Setting up the printer software

Installing the printer software

- 1 Obtain a copy of the software installer package.
 - From the software CD that came with your printer.
 - Go to <http://support.lexmark.com>, and then select your printer and operating system.
- 2 Run the installer, and then follow the instructions on the computer screen.
- 3 For Macintosh users, add the printer.

Note: Obtain the printer IP address from the TCP/IP section in the Network/Ports menu.

Adding available options in the print driver

For Windows users

- 1 Open the printers folder.
- 2 Select the printer you want to update, and then do the following:
 - For Windows 7 or later, select **Printer properties**.
 - For earlier versions, select **Properties**.
- 3 Navigate to the Configuration tab, and then select **Update Now - Ask Printer**.
- 4 Apply the changes.

For Macintosh users

- 1 From System Preferences in the Apple menu, navigate to your printer, and then select **Options & Supplies**.
- 2 Navigate to the list of hardware options, and then add any installed options.
- 3 Apply the changes.

Networking

Notes:

- Purchase a MarkNet™ N8352 wireless network adapter before setting up the printer on a wireless network. For information on the compatible adapter, go to www.lexmark.com.
- A Service Set Identifier (SSID) is a name assigned to a wireless network. Wired Equivalent Privacy (WEP), Wi-Fi Protected Access (WPA), WPA2, and 802.1X - RADIUS are types of security used on a network.

Preparing to set up the printer on an Ethernet network

To configure your printer to connect to an Ethernet network, organize the following information before you begin:

Note: If your network automatically assigns IP addresses to computers and printers, continue on to installing the printer.

- A valid, unique IP address for the printer to use on the network
- The network gateway
- The network mask
- A nickname for the printer (optional)

Note: A printer nickname can make it easier for you to identify your printer on the network. You can choose to use the default printer nickname, or assign a name that is easier for you to remember.

You will need an Ethernet cable to connect the printer to the network and an available port where the printer can physically connect to the network. Use a new network cable when possible to avoid potential problems caused by a damaged cable.

Preparing to set up the printer on a wireless network

Notes:

- Make sure your wireless network adapter is installed in your printer and working properly. For more information, see the instruction sheet that came with the wireless network adapter.
- Make sure your access point (wireless router) is turned on and is working properly.

Make sure you have the following information before setting up the printer on a wireless network:

- **SSID**—The SSID is also referred to as the network name.
- **Wireless Mode (or Network Mode)**—The mode is either infrastructure or ad hoc.
- **Channel (for ad hoc networks)**—The channel defaults to automatic for infrastructure networks.

Some ad hoc networks will also require the automatic setting. Check with your system support person if you are not sure which channel to select.

- **Security Method**—There are four basic options for Security Method:

- WEP key

If your network uses more than one WEP key, then enter up to four in the provided spaces. Select the key currently in use on the network by selecting the default WEP transmit key.

- WPA or WPA2 preshared key or passphrase

WPA includes encryption as an additional layer of security. The choices are AES or TKIP. Encryption must be set for the same type on the router and on the printer, or the printer will not be able to communicate on the network.

- 802.1X–RADIUS

If you are installing the printer on an 802.1X network, then you may need the following:

- Authentication type
- Inner authentication type
- 802.1X user name and password
- Certificates

- No security

If your wireless network does not use any type of security, then you will not have any security information.

Note: We do not recommend using an unsecured wireless network.

Notes:

- If you do not know the SSID of the network that your computer is connected to, then launch the wireless utility of the computer network adapter, and then look for the network name. If you cannot find the SSID or the security information for your network, then see the documentation that came with the access point, or contact your system support person.
- To find the WPA/WPA2 preshared key or passphrase for the wireless network, see the documentation that came with the access point, see the Embedded Web Server associated with the access point, or consult your system support person.

MS315 and MS415 Wireless Setup Wizard

Connecting the printer using the Wireless Setup Wizard

Before you begin, make sure that:

- A wireless network adapter is installed in the printer and is working properly. For more information, see the instruction sheet that came with the adapter.
- The Ethernet cable is disconnected from the printer.
- Active NIC is set to Auto. To set this to Auto, from the control panel, navigate to:

 > **Settings** >  > **Network/Ports** >  > **Active NIC** >  > **Auto** > 

Note: Turn off the printer, wait for at least five seconds, and then turn on the printer.

1 From the control panel, navigate to:

 > **Settings** >  > **Network/Ports** >  > **Network [x]** >  > **Network [x] Setup** >  > **Wireless** >  > **Wireless Connection Setup** > 

2 Select a wireless connection setup.

Use	To
Search for networks	Show available wireless connections. Note: This menu item shows all broadcast secured or unsecured SSIDs.
Enter a network name	Manually type the SSID.
Wi-Fi Protected Setup	Connect the printer to a wireless network using Wi-Fi Protected Setup.

3 Follow the instructions on the printer display.

MS312 Wi-Fi Protected Setup

Connecting the printer to a wireless network using Wi-Fi Protected Setup

Before connecting the printer to a wireless network, make sure that:

- The access point (wireless router) is Wi-Fi Protected Setup (WPS) certified or WPS-compatible. For more information, see the documentation that came with your access point.
- A wireless network adapter installed in your printer is attached and working properly. For more information, see the instruction sheet that came with the wireless network adapter.

Using the Push Button Configuration method







1 From the printer control panel, navigate to:

 > **Network/Ports** >  > **Network [x]** >  > **Network [x] Setup** >  > **Wireless** >  > **Wi-Fi Protected Setup** >  > **Start Push Button Method** > 

2 Follow the instructions on the printer display.

Using the Personal Identification Number (PIN) method

1 From the printer control panel, navigate to:

 > **Network/Ports** >  > **Network [x]** >  > **Network [x] Setup** >  > **Wireless** >  > **Wi-Fi Protected Setup** >  > **Start PIN Method** > 

2 Copy the eight-digit WPS PIN.

3 Open a Web browser, and then type the IP address of your access point in the address field.

Notes:

- The IP address appears as four sets of numbers separated by periods, such as 123.123.123.123.
- If you are using a proxy server, then temporarily disable it to load the Web page correctly.

4 Access the WPS settings. For more information, see the documentation that came with your access point.

5 Enter the eight-digit PIN, and then save the setting.

MS315 and MS415 Wi-Fi Protected Setup









Connecting the printer to a wireless network using Wi-Fi Protected Setup

Before connecting the printer to a wireless network, make sure that:

- The access point (wireless router) is Wi-Fi Protected Setup (WPS) certified or WPS-compatible. For more information, see the documentation that came with your access point.
- A wireless network adapter is installed on your printer and is working properly. For more information, see the instruction sheet that came with the adapter.

Using the Push Button Configuration Method









1 From the control panel, navigate to:

 > **Settings** >  > **Networks/Ports** >  > **Network [x]** >  > **Network [x] Setup** >  > **Wireless** >  > **Wireless Connection Setup** >  > **Wi-Fi Protected Setup** >  > **Start Push Button Method** > 

2 Follow the instructions on the printer display.

Using the Personal Identification Number (PIN) Method

1 From the control panel, navigate to:

 > **Settings** >  > **Networks/Ports** >  > **Network [x]** >  > **Network [x] Setup** >  > **Wireless** >  > **Wireless Connection Setup** >  > **Wi-Fi Protected Setup** >  > **Start PIN Method** > 

2 Copy the eight-digit WPS PIN.

3 Open a Web browser, and then type the IP address of your access point in the address field.

Notes:

- The IP address appears as four sets of numbers separated by periods, such as 123.123.123.123.
 - If you are accessing a proxy server, then temporarily disable it to load the Web page correctly.
- 4** Access the WPS settings. For more information, see the documentation that came with your access point.
 - 5** Enter the eight-digit PIN, and then save the setting.

Connecting MS312 to a wireless network using the printer software

Notes:

- Make sure that the printer is turned on.
- Make sure that a wireless network adapter is installed in your printer and working properly. For information, see the instruction sheet that came with the adapter.

Using the Wireless Setup Utility (Windows only)

- 1** Check if the printer software is already installed.
- 2** Use the search command on the Start menu to locate Printer Home.
- 3** Open Printer Home, and then click **Settings > Wireless Setup Utility**.
- 4** Follow the steps on the computer screen.

Using the Wireless Setup Assistant (Macintosh only)

The Wireless Setup Assistant lets you:

- Configure the printer to join an existing wireless network.
- Add a printer to an existing ad hoc network.
- Change the wireless settings after installation.
- Install the printer on additional network computers.

Installing the Wireless Setup Assistant

- 1** Go to the Lexmark support Web site at <http://support.lexmark.com>.
- 2** Download the latest Wireless Setup Assistant application.
- 3** Double-click the downloaded software installer package.
- 4** Follow the instructions on the computer screen.

Launching the Wireless Setup Assistant

Notes:

- Make sure the printer is turned on.

- Make sure a wireless network adapter is installed in your printer and is working properly.

1 From the Finder, navigate to:

Applications > select your printer folder

2 Double-click **Wireless Setup Assistant**, and then follow the instructions on the computer screen.

Note: If you encounter problems while running the application, then click .

Connecting the printer to a wireless network using the Embedded Web Server

Before you begin, make sure that:

- Your printer is connected temporarily to an Ethernet network.
- A wireless network adapter is installed in your printer and working properly. For more information, see the instruction sheet that came with your wireless network adapter.

1 Open a Web browser, and then type the printer IP address in the address field.

Notes:

- View the printer IP address on the printer control panel. The IP address appears as four sets of numbers separated by periods, such as 123.123.123.123.
- If you are using a proxy server, then temporarily disable it to load the Web page correctly.

2 Click **Settings** > **Network/Ports** > **Wireless**.

3 Modify the settings to match the settings of your access point (wireless router).

Note: Make sure to enter the correct SSID.

4 Click **Submit**.

5 Turn off the printer, and then disconnect the Ethernet cable. Then wait for at least five seconds, and then turn the printer back on.

6 To verify if your printer is connected to the network, print a network setup page. Then in the Network Card [x] section, see if the status is Connected.

Verifying printer setup

MS312 and MS317 printing menu settings and network setup pages

Printing a menu settings page

Print a menu settings page to review the current menu settings and to verify if the printer options are installed correctly.

Note: If you have not changed any menu settings, then the menu settings page lists all the factory default settings. When you select and save other settings from the menus, they replace the factory default settings as *user default settings*. A user default setting remains in effect until you access the menu again, choose another value, and save it.

From the printer control panel, navigate to:

 > **Reports** >  > **Menu Settings Page** > 

Printing a network setup page

If the printer is connected to a network, then print a network setup page to verify the network connection. This page also provides important information that aids network printing configuration.

- 1 From the printer control panel, navigate to:

 > **Reports** >  > **Network Setup Page** > 

Note: If an optional print server is installed, then **Print Network [x] Setup Page** appears.

- 2 Check the first section of the network setup page and confirm that the status is Connected.

If the status is Not Connected, then the LAN drop may not be active, or the network cable may be malfunctioning. Consult your system support person for a solution, and then print another network setup page.

MS315, MS415, and MS417 printing menu settings and network setup pages

Printing a menu settings page

Print a menu settings page to view the current menu settings and to verify if the printer options are installed correctly.

From the printer control panel, navigate to:

 > **Settings** > **Reports** >  > **Menu Settings Page** > 

Note: If you have not changed any menu settings, then the menu settings page lists all the factory default settings. Settings saved from the menus replace the factory default settings as *user default settings*. A user default setting remains in effect until you access the menu again, select another value, and save it.

Printing a network setup page

If the printer is attached to a network, then print a network setup page to verify the network connection. This page also provides important information that aids network printing configuration.

- 1 From the printer control panel, navigate to:

 > **Settings** > **Reports** >  > **Network Setup Page** > 

Note: If an optional internal print server is installed, then **Print Network [x] Setup Page** appears.

- 2 Check the first section of the network setup page, and confirm that the status is **Connected**.

If the status is **Not Connected**, then the LAN drop may not be active, or the network cable may be malfunctioning. Consult your system support person for a solution, and then print another network setup page.

Using MS312 and MS317

Using the printer control panel

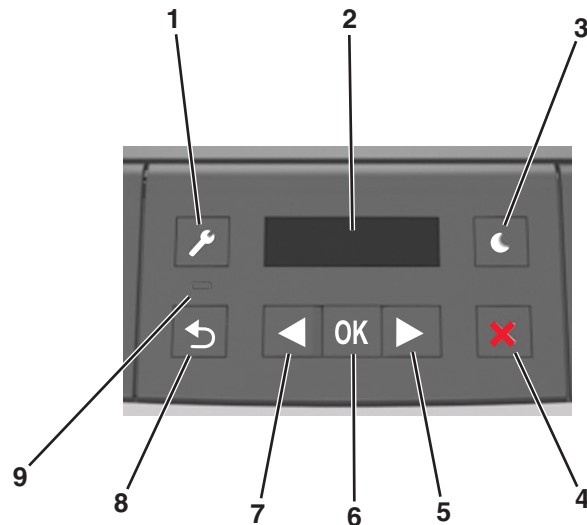

	Use the	To
1	Menu button	<p>Open the menus.</p> <p>Notes:</p> <ul style="list-style-type: none"> The menus are available only when the printer is in the Ready state. Pressing the button while navigating within the menus returns the printer control panel to the top-level menu screen.
2	Display	View printing options as well as status and error messages.
3	Sleep button	<p>Enable Sleep mode or Hibernate mode.</p> <p>Notes:</p> <ul style="list-style-type: none"> Pressing any hard button will cause the printer to wake from Sleep mode. Pressing the Sleep button or the power switch will cause the printer to wake from Hibernate mode.
4	Stop button	<ul style="list-style-type: none"> Exit the menus and return to the Ready state. Stop printer activities, such as printing or downloading fonts.
5	Right arrow button	<ul style="list-style-type: none"> Scroll through menus or to move between screens and menu options. Scroll through settings or text. For menus with numeric values, press and hold an arrow button to scroll through the settings. Release the button when the value you want appears.
6	Select button	<ul style="list-style-type: none"> Open a menu. Display available values or settings for a menu. The current default setting is indicated by an asterisk (*). Save the displayed value as the new user default setting.

	Use the	To
7	Left arrow button	<ul style="list-style-type: none"> • Scroll through menus or to move between screens and menu options. • Scroll through settings or text. For menus with numeric values, press and hold an arrow button to scroll through the settings. Release the button when the value you want appears.
8	Back button	Return to the previous screen.
9	Indicator light	Determine the status of the printer.

Understanding the colors of the Sleep button and indicator lights

The colors of the Sleep button and indicator lights on the control panel signify a printer status or condition.

Indicator light	Printer status
Off	The printer is off or in Hibernate mode.
Blinking green	The printer is warming up, processing data, or printing.
Solid green	The printer is on, but idle.
Blinking red	The printer requires user intervention.

Sleep button light	Printer status
Off	The printer is off, idle, or in Ready state.
Solid amber	The printer is in Sleep mode.
Blinking amber	The printer is entering or waking from Hibernate mode.
Blinking amber for 0.1 second, then goes completely off for 1.9 seconds in a slow, pulsing pattern	The printer is in Hibernate mode.

Installing the Local Printer Settings Utility

- 1 Visit <http://support.lexmark.com>, and then download the software.
- 2 Double-click the software installer package.
- 3 Select an installation type, and then click **Install**.
- 4 Click **Install** to start the installation.
- 5 Click **Agree** to accept the license agreement.
- 6 Click **Continue**, and then follow the instructions on the computer screen.

Notes:

- Use the Local Printer Settings Utility to change the toner darkness, power saver, and paper size settings for all print jobs. Use the printer software to change these settings for individual print jobs.
- This utility is supported only in select printer models.

Using the Local Printer Settings Utility

- 1 Access the Local Printer Settings Utility from the list of applications or the Start menu to adjust the printer settings.
- 2 Save the changes using the Actions menu.

Note: To distribute the settings to other printers, save the settings in a command file.

Using MS315, MS415, and MS417

Using the control panel

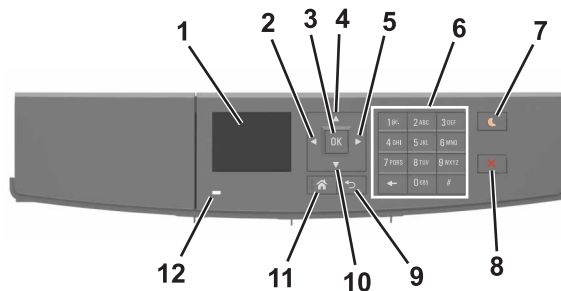

	Use the	To
1	Display	View the printer status and messages. Set up and operate the printer.
2	Left arrow button	Scroll to the left.
3	Select button	Select menu options. Save settings.
4	Up arrow button	Scroll up.
5	Right arrow button	Scroll to the right.
6	Keypad	Enter numbers, letters, or symbols.
7	Sleep button	Enable Sleep mode or Hibernate mode. The following actions wake the printer from Sleep mode: <ul style="list-style-type: none"> • Pressing any hard button • Sending a print job from the computer • Performing a power-on reset using the main power switch The following actions wake the printer from Hibernate mode: <ul style="list-style-type: none"> • Pressing the Sleep button until the printer wakes • Performing a power-on reset using the main power switch
8	Stop or cancel button	Stop all printer activities.
9	Back button	Return to the previous screen.
10	Down arrow button	Scroll down.
11	Home button	Go to the home screen.
12	Indicator light	Check the status of the printer.

Understanding the colors of the Sleep button and indicator lights

The colors of the Sleep button and indicator lights on the printer control panel signify a certain printer status or condition.

Indicator light	Printer status
Off	The printer is off or in Hibernate mode.
Blinking green	The printer is warming up, processing data, or printing.
Solid green	The printer is on, but idle.
Blinking red	The printer requires user intervention.
Sleep button light	Printer status
Off	The printer is off, idle or in Ready state.
Solid amber	The printer is in Sleep mode.
Blinking amber	The printer is entering or waking from Hibernate mode.
Blinking amber for 0.1 second, then goes completely off for 1.9 seconds in a slow, pulsing pattern	The printer is in Hibernate mode.

Accessing the Embedded Web Server

The Embedded Web Server is the printer Web page that lets you view and remotely configure printer settings even when you are not physically near the printer.

1 Obtain the printer IP address:

- From the printer control panel home screen
- From the TCP/IP section in the Network/Ports menu
- By printing a network setup page or menu settings page, and then finding the TCP/IP section

Note: An IP address appears as four sets of numbers separated by periods, such as **123 . 123 . 123 . 123**.

2 Open a Web browser, and then type the printer IP address in the address field.

3 Press **Enter**.

Note: If you are using a proxy server, then temporarily disable it to load the Web page correctly.

Loading paper and specialty media

MS312 and MS317 paper size and type setup

Setting the paper size and type

1 From the printer control panel, navigate to:

 > **Paper Menu** >  > **Paper Size/Type** > 

2 Select **Tray [x] Size** or **Tray [x] Type**, and then press .

3 Change the paper size or type setting, and then press .

Notes:

- The paper size setting for the standard 250-sheet tray (Tray 1), optional 250- or 550-sheet tray (Tray 2), and the multipurpose feeder must be set manually in the Paper Size menu.
- The factory default paper type for Tray 1 is Plain Paper.
- The factory default paper type for the multipurpose feeder is Custom Type 6.
- The paper type setting must be manually set for all trays.

Configuring Universal paper settings

The Universal paper size is a user-defined setting that lets you print on paper sizes that are not preset in the printer menus.

Notes:

- The smallest Universal paper size is 76 x 127 mm (3 x 5 inches), and is supported only from the multipurpose feeder.
- The largest Universal paper size is 216 x 355.6 mm (8.5 x 14 inches), and is supported from all paper sources.

From the control panel, navigate to:

 > **Paper Menu** >  > **Universal Setup** >  > **Units of Measure** >  > select the unit of measure > 

Specify the paper height and width

1 From the control panel, navigate to:

 > **Paper Menu** >  > **Universal Setup** >  > **Units of Measure** >  > select the unit of measure > 

2 Press the arrow buttons until **Portrait Height** or **Portrait Width** appears, and then press .



- 3 Change the settings, and then press .

MS315, MS415, and MS417 paper size and type setup

Setting the paper size and type

- 1 From the printer control panel, navigate to:

 > **Settings** >  > **Paper Menu** >  > **Paper Size/Type** > 

- 2 Press the up or down arrow button to select the tray or feeder, and then press .
- 3 Press the up or down arrow button to select the paper size, and then press .
- 4 Press the up or down arrow button to select the paper type, and then press  to change the settings.

Configuring Universal paper settings



The Universal paper size is a user-defined setting that lets you print on paper sizes that are not preset in the printer menus.

Notes:

- The smallest Universal paper size is 76 x 127 mm (3 x 5 inches), and is supported only from the multipurpose feeder.
- The largest Universal paper size is 216 x 355.6 mm (8.5 x 14 inches), and is supported from all paper sources.

- 1 From the control panel, navigate to:

 > **Settings** >  > **Paper Menu** >  > **Universal Setup** >  > **Units of Measure** >  > select a unit of measure > 

- 2 Select **Portrait Width** or **Portrait Height**, and then press .
- 3 Press the left or right arrow button to change the setting, and then press .

Using the standard bin and paper stop

The standard bin holds up to 150 sheets of 75-g/m² (20-lb) paper. It collects prints facedown. The standard bin includes a paper stop that keeps paper from sliding out the front of the bin as it stacks.

To open the paper stop, pull it so that it flips forward.

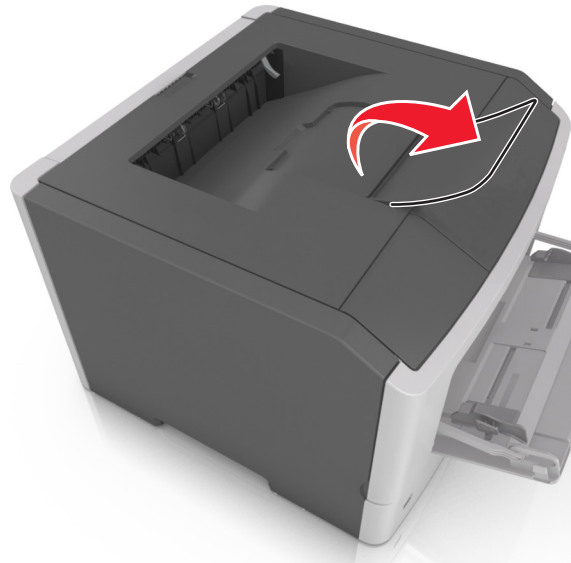

Note: Close the paper stop when moving the printer to another location.

Loading trays

⚠ CAUTION—POTENTIAL INJURY: To reduce the risk of equipment instability, load each tray separately. Keep all other trays closed until needed.

- 1 Pull out the tray completely.

Note: Do not remove trays while a job prints or while **Busy** appears on the printer display. Doing so may cause a jam.



- 2 Squeeze and then slide the width guide tab to the correct position for the size of the paper you are loading.

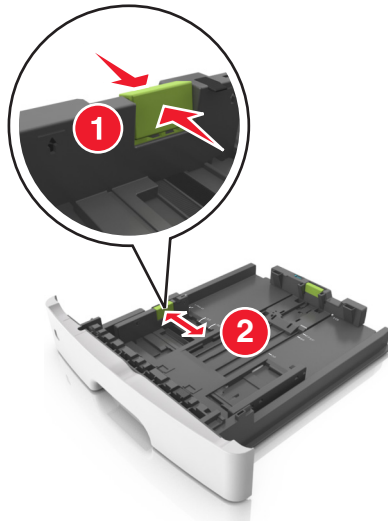

- 3 Squeeze and then slide the length guide tab to the correct position for the size of the paper you are loading.

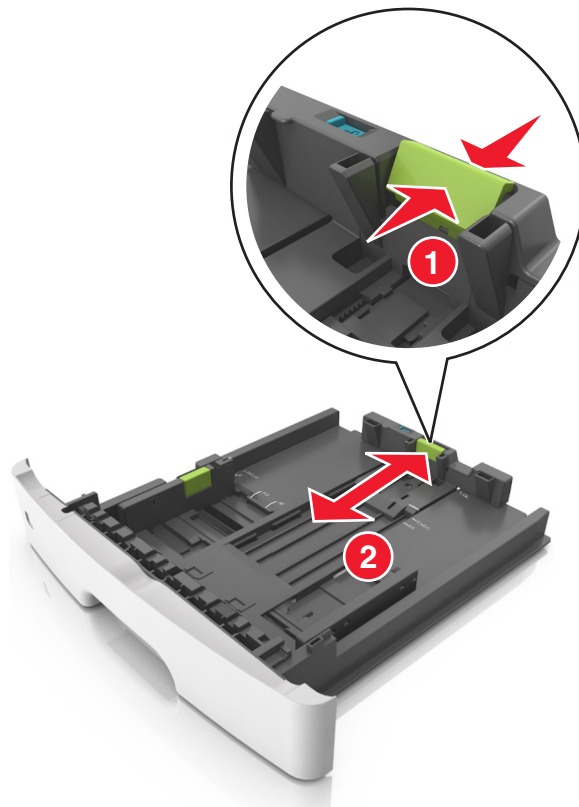

Notes:

- For some paper sizes like letter, legal, and A4, squeeze and slide the length guide tab backward to accommodate their length.
- When loading legal-size paper, the length guide extends beyond the base leaving the paper exposed to dust. To protect the paper from dust, you can purchase a dust cover separately. For more information, contact customer support.

- If you are loading A6-size paper in the standard tray, then squeeze and then slide the length guide tab toward the center of the tray to the A6-size position.
- Make sure the width and length guides are aligned with the paper size indicators on the bottom of the tray.

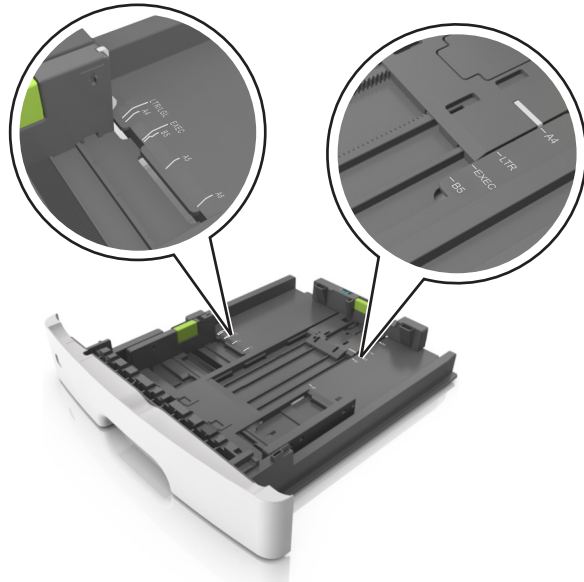

- 4** Flex the sheets back and forth to loosen them, and then fan them. Do not fold or crease the paper. Straighten the edges on a level surface.

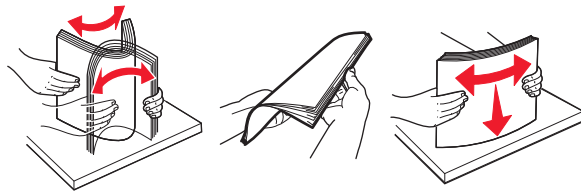

- 5** Load the paper stack.

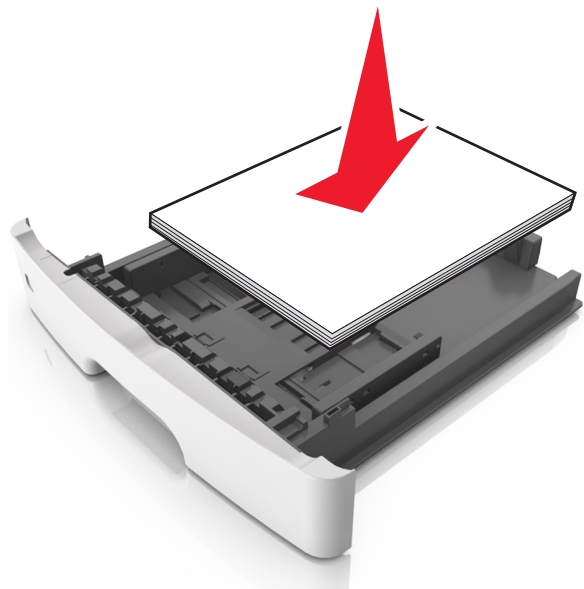

Notes:

- Load with the printable side facedown when using recycled or preprinted paper.
- Load prepunched paper with the holes on the top edge toward the front of the tray.
- Load letterhead facedown, with the top edge of the sheet toward the front of the tray. For two-sided printing, load letterhead faceup with the bottom edge of the sheet toward the front of the tray.
- Make sure the paper is below the maximum paper fill indicator located on the side of the width guide.

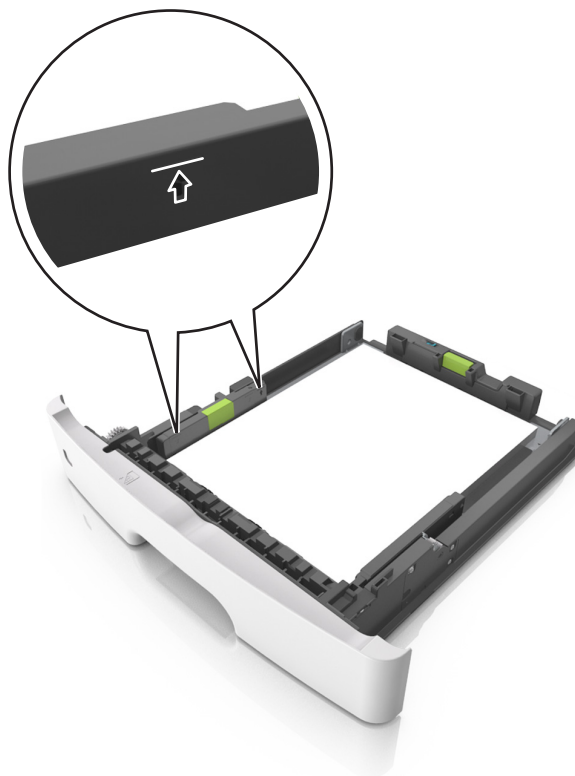
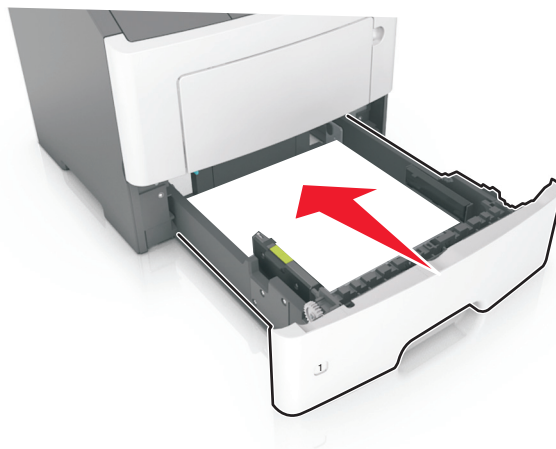
**6** Insert the tray.**7** From the printer control panel, set the paper size and paper type in the Paper menu to match the paper loaded in the tray.

Note: Set the correct paper size and type to avoid paper jams and print quality problems.

Loading the multipurpose feeder

Use the multipurpose feeder when printing on different paper sizes and types or specialty media, such as card stock, transparencies, paper labels, and envelopes. You can also use it for single-page print jobs on letterhead.

- 1 Open the multipurpose feeder.

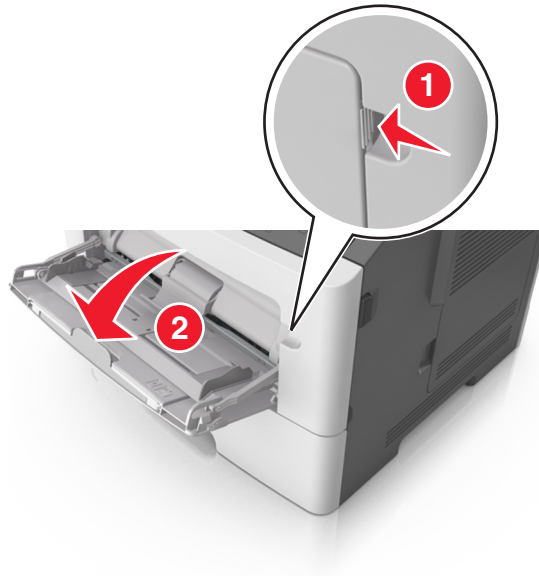

- a Pull the multipurpose feeder extender.



- b Pull the extender gently so that the multipurpose feeder is fully extended and open.



- 2 Squeeze the tab on the left width guide, and then move the guides for the paper you are loading.

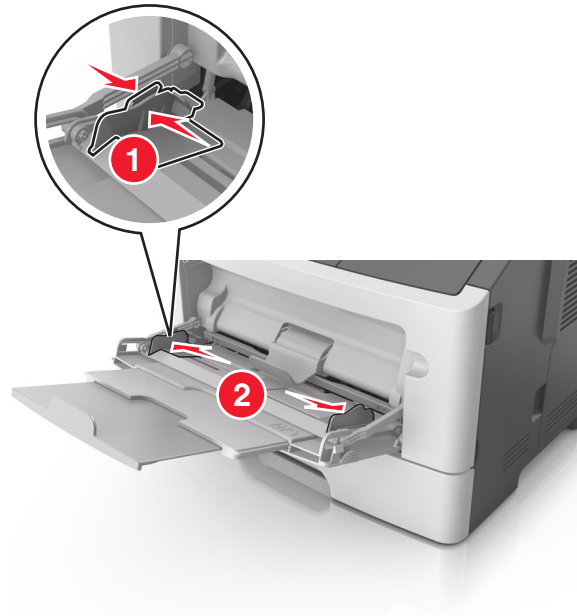

- 3 Prepare the paper or specialty media for loading.

- Flex sheets of paper back and forth to loosen them, and then fan them. Do not fold or crease the paper. Straighten the edges on a level surface.

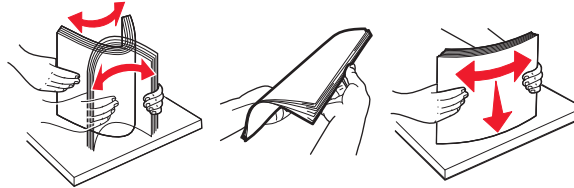

- Hold transparencies by the edges. Flex the stack of transparencies back and forth to loosen them, and then fan them. Straighten the edges on a level surface.

Note: Avoid touching the printable side of the transparencies. Be careful not to scratch them.

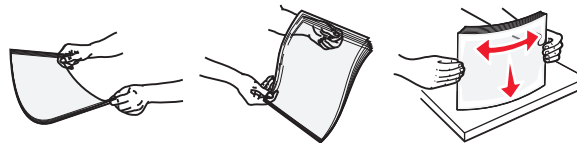

- Flex the stack of envelopes back and forth to loosen them, and then fan them. Straighten the edges on a level surface.



- 4 Load the paper or specialty media.

Notes:

- Do not force paper or specialty media into the multipurpose feeder.

- Make sure the paper or specialty media is below the maximum paper fill indicator located on the paper guides. Overfilling may cause paper jams.

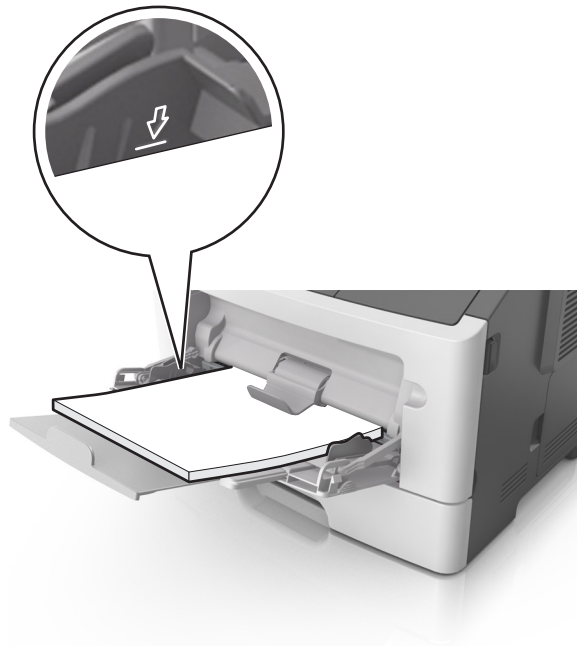

- Load paper, transparencies, and card stock with the recommended printable side faceup and the top edge entering the printer first. For more information on loading transparencies, see the packaging that the transparencies came in.



Note: When loading A6-size paper, make sure the multipurpose feeder extender rests lightly against the edge of the paper so that the last few sheets of paper remain in place.

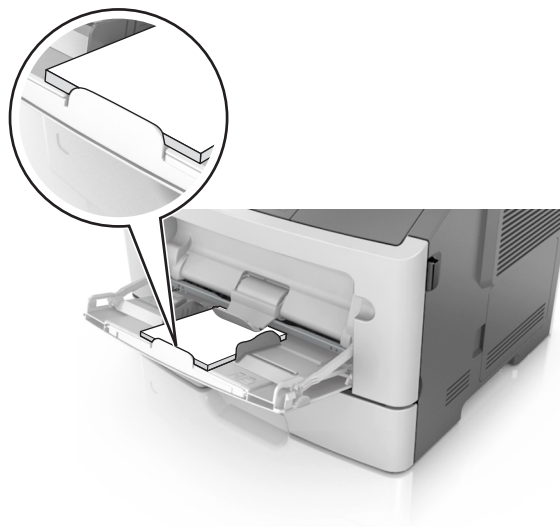

- Load letterhead faceup with the top edge entering the printer first. For two-sided (duplex) printing, load letterhead facedown with the bottom edge entering the printer first.



- Load envelopes with the flap on the left side facedown.



Warning—Potential Damage: Never use envelopes with stamps, clasps, snaps, windows, coated linings, or self-stick adhesives. These envelopes may severely damage the printer.

- 5 From the printer control panel, set the paper size and paper type in the Paper menu to match the paper or specialty media loaded in the multipurpose feeder.

Linking and unlinking trays

The printer links trays when the specified paper size and type are the same. When a linked tray becomes empty, paper feeds from the next linked tray. To prevent trays from linking, assign a unique custom paper type name.

MS312 and MS317 tray linking

Linking and unlinking trays

Using the Embedded Web Server

- 1 Open a Web browser, and then type the printer IP address in the address field.

Notes:

- View the printer IP address in the TCP/IP section in the Network/Ports menu. The IP address appears as four sets of numbers separated by periods, such as 123.123.123.123.

- If you are using a proxy server, then temporarily disable it to load the Web page correctly.

2 Click **Settings > Paper Menu**.

3 Change the tray settings to specify the paper size and type for the tray.

- To link trays, make sure the paper size and type for the tray match with that of the other tray.
- To unlink trays, make sure the paper size or type for the tray does *not* match with that of the other tray.

4 Click **Submit**.

Using the printer settings on the computer

Depending on your operating system, access the Paper menu using the Local Printer Settings Utility or Printer Settings.

Note: You can also specify the paper size and type for the tray using the printer control panel. For more information, see [“Setting the paper size and type” on page 33](#).

Warning—Potential Damage: Paper loaded in the tray should match the paper type name assigned in the printer. The temperature of the fuser varies according to the specified paper type. Printing issues may occur if settings are not properly configured.

Configuring a custom paper type

Using the Embedded Web Server

1 Open a Web browser, and then type the printer IP address in the address field.

Notes:

- Print a network setup page or menu settings page, and then locate the IP address in TCP/IP section. The IP address appears as four sets of numbers separated by periods, such as 123.123.123.123.
- If you are using a proxy server, then temporarily disable it to load the Web page correctly.

2 Click **Settings > Paper Menu > Custom Types**.

3 Select a custom paper type name, and then select a custom paper type.

Note: Plain Paper is the factory default paper type for all user-defined custom names.

4 Click **Submit**.

Using the printer settings on the computer

Depending on your operating system, access the Custom menu using the Local Printer Settings Utility or Printer Settings.

Assigning a custom paper type

Using the Embedded Web Server

1 Open a Web browser, and then type the printer IP address in the address field.

Notes:

- Print a network setup page or menu settings page, and then locate the IP address in the TCP/IP section. The IP address appears as four sets of numbers separated by periods, such as 123.123.123.123.

- If you are using a proxy server, then temporarily disable it to load the Web page correctly.

2 Click **Settings > Paper Menu**.

3 From the Tray Configuration section, select a paper source, and then select a custom paper type under the paper type column.

4 Click **Submit**.

Using the printer settings on the computer

Depending on your operating system, access the Paper menu using the Local Printer Settings Utility or Printer Settings.

MS315, MS415, and MS417 tray linking

Linking and unlinking trays

1 Open a Web browser, and then type the printer IP address in the address field.

Notes:

- View the printer IP address on the control panel in the TCP/IP section under the Network/Ports menu. The IP address appears as four sets of numbers separated by periods, such as 123.123.123.123.
- If you are using a proxy server, then temporarily disable it to load the Web page correctly.

2 Click **Settings > Paper Menu**.

3 Change the paper size and type settings for the trays you are linking.

- To link trays, make sure the paper size and type for the tray match that of the other tray.
- To unlink trays, make sure the paper size or type for the tray does not match that of the other tray.

4 Click **Submit**.

Note: You can also change the paper size and type settings using the control panel. For more information, see [“Setting the paper size and type” on page 34](#).

Warning—Potential Damage: Paper loaded in the tray should match the paper type name assigned in the printer. The temperature of the fuser varies according to the specified paper type. Printing issues may occur if settings are not properly configured.

Creating a custom name for a paper type

Using the Embedded Web Server

1 Open a Web browser, and then type the printer IP address in the address field.

Notes:

- View the printer IP address in the TCP/IP section in the Network/Ports menu. The IP address appears as four sets of numbers separated by periods, such as 123.123.123.123.
- If you are using a proxy server, then temporarily disable it to load the Web page correctly.

2 Click **Settings > Paper Menu > Custom Names**.

3 Select a custom name, and then type a new custom paper type name.

4 Click **Submit**.

5 Click **Custom Types**, and then verify if the new custom paper type name has replaced the custom name.

Using the printer control panel

1 From the printer control panel, navigate to:

 > **Settings** >  > **Paper Menu** >  > **Custom Names**

2 Select a custom name, and then type a new custom paper type name.

3 Press .

4 Press **Custom Types**, and then verify if the new custom paper type name has replaced the custom name.

Assigning a custom paper type

Using the Embedded Web Server

1 Open a Web browser, and then type the printer IP address in the address field.

Notes:

- View the printer IP address in the TCP/IP section in the Network/Ports menu. The IP address appears as four sets of numbers separated by periods, such as 123.123.123.123.
- If you are using a proxy server, then temporarily disable it to load the Web page correctly.

2 Click **Settings** > **Paper Menu** > **Custom Types**.

3 Select a custom paper type name, and then select a paper type.

Note: Paper is the factory default paper type for all user-defined custom names.

4 Click **Submit**.

Using the printer control panel

1 From the printer control panel, navigate to:

 > **Settings** >  > **Paper Menu** >  > **Custom Types**

2 Select a custom paper type name, and then select a paper type.

Note: Paper is the factory default paper type for all user-defined custom names.

3 Press .

Paper and specialty media guide

Paper guidelines

Paper characteristics

The following paper characteristics affect print quality and reliability. Consider these characteristics when evaluating new paper stock.

Weight

The printer trays can automatically feed paper weights up to 90-g/m² (24-lb) bond grain long paper. The multipurpose feeder can automatically feed paper weights up to 163-g/m² (43-lb) bond grain long paper. Paper lighter than 60 g/m² (16 lb) might not be stiff enough to feed properly, causing jams. For best performance, use 75-g/m² (20-lb) bond grain long paper. For paper smaller than 182 x 257 mm (7.2 x 10.1 inches), we recommended to use 90 g/m² (24 lb) or heavier paper.

Note: Two-sided printing is supported only for 60–90-g/m² (16–24-lb) bond paper.

Curl

Curl is the tendency for paper to curl at its edges. Excessive curl can cause paper feeding problems. Curl can occur after the paper passes through the printer, where it is exposed to high temperatures. Storing paper unwrapped in hot, humid, cold, or dry conditions, even in the trays, can contribute to paper curling prior to printing and can cause feeding problems.

Smoothness

Paper smoothness directly affects print quality. If paper is too rough, then toner cannot fuse to it properly. If paper is too smooth, then it can cause paper feeding or print quality issues. Always use paper between 100 and 300 Sheffield points; however, smoothness between 150 and 250 Sheffield points produces the best print quality.

Moisture content

The amount of moisture in paper affects both print quality and the ability of the printer to feed the paper correctly. Leave paper in its original wrapper until it is time to use it. This limits the exposure of paper to moisture changes that can degrade its performance.

Store paper in its original wrapper in the same environment as the printer for 24 to 48 hours before printing. Extend the time to several days if the storage or transportation environment is very different from the printer environment. Thick paper may also require a longer conditioning period.

Grain direction

Grain refers to the alignment of the paper fibers in a sheet of paper. Grain is either *grain long*, running the length of the paper, or *grain short*, running the width of the paper.

For 60–90-g/m² (16–24-lb) bond paper, grain long paper is recommended.

Fiber content

Most high-quality xerographic paper is made from 100% chemically treated pulped wood. This content provides the paper with a high degree of stability resulting in fewer paper feeding problems and better print quality. Paper containing fibers such as cotton can negatively affect paper handling.

Unacceptable paper

The following paper types are not recommended for use with the printer:

- Chemically treated papers used to make copies without carbon paper, also known as carbonless papers, carbonless copy paper (CCP), or no carbon required (NCR) paper
- Preprinted papers with chemicals that may contaminate the printer
- Preprinted papers that can be affected by the temperature in the printer fuser
- Preprinted papers that require a registration (the precise print location on the page) less than ± 2.5 mm (± 0.10 inch), such as optical character recognition (OCR) forms

In some cases, registration can be adjusted with a software application to successfully print on these forms:

- Coated papers (erasable bond), synthetic papers, thermal papers
- Rough-edged, rough or heavily textured surface papers, or curled papers
- Recycled papers that fail EN12281:2002 (European)
- Paper weighing less than 60 g/m^2 (16 lb)
- Multiple-part forms or documents

Selecting paper

Using the appropriate paper prevents jams and helps ensure trouble-free printing.

To help avoid paper jams and poor print quality:

- *Always* use new, undamaged paper.
- Before loading paper, know the recommended printable side of the paper. This information is usually indicated on the paper package.
- *Do not* use paper that has been cut or trimmed by hand.
- *Do not* mix paper sizes, types, or weights in the same tray; mixing results in jams.
- *Do not* use coated papers unless they are specifically designed for electrophotographic printing.

Selecting preprinted forms and letterhead

Use these guidelines when selecting preprinted forms and letterhead:

- Use grain long for 60 to 90 g/m^2 (16 to 24 lb) weight paper.
- Use only forms and letterhead printed using an offset lithographic or engraved printing process.
- Avoid papers with rough or heavily textured surfaces.

Use papers printed with heat-resistant inks designed for use in xerographic copiers. The ink must be able to withstand temperatures up to 230°C (446°F) without melting or releasing hazardous emissions. Use inks that are not affected by the resin in toner. Inks that are oxidation-set or oil-based generally meet these requirements; latex inks might not. When in doubt, contact the paper supplier.

Preprinted papers such as letterhead must be able to withstand temperatures up to 230°C (446°F) without melting or releasing hazardous emissions.

Using recycled paper and other office papers

As an environmentally conscientious company, Lexmark supports the use of recycled paper produced specifically for use in laser (electrophotographic) printers.

While no blanket statement can be made that all recycled paper will feed well, Lexmark consistently tests papers that represent recycled cut size copier papers available on the global market. This scientific testing is conducted with rigor and discipline. Many factors are taken into consideration both separately and as a whole, including the following:

- Amount of post-consumer waste (Lexmark tests up to 100% post-consumer waste content.)
- Temperature and humidity conditions (Testing chambers simulate climates from all over the world.)
- Moisture content (Business papers should have low moisture: 4–5%.)
- Bending resistance and proper stiffness means optimum feeding through the printer.
- Thickness (impacts how much can be loaded into a tray)
- Surface roughness (measured in Sheffield units, impacts print clarity and how well toner fuses to the paper)
- Surface friction (determines how easily sheets can be separated)
- Grain and formation (impacts curling, which also influences the mechanics of how the paper behaves as it moves through the printer)
- Brightness and texture (look and feel)

Recycled papers are better than ever; however, the amount of recycled content in a paper affects the degree of control over foreign matter. And while recycled papers are one good path to printing in an environmentally responsible manner, they are not perfect. The energy required to de-ink and deal with additives such as colorants and “glue” often generates more carbon emissions than does normal paper production. However, using recycled papers enables better resource management overall.

Lexmark concerns itself with the responsible use of paper in general based on life cycle assessments of its products. To gain a better understanding of the impact of printers on the environment, the company commissioned a number of life cycle assessments and found that paper was identified as the primary contributor (up to 80%) of carbon emissions caused throughout the entire life of a device (from design to end-of-life). This is due to the energy-intensive manufacturing processes required to make paper.

Thus, Lexmark seeks to educate customers and partners on minimizing the impact of paper. Using recycled paper is one way. Eliminating excessive and unnecessary paper consumption is another. Lexmark is well-equipped to help customers minimize printing and copying waste. In addition, the company encourages purchasing paper from suppliers who demonstrate their commitment to sustainable forestry practices.

Lexmark does not endorse specific suppliers, although a converter’s product list for special applications is maintained. However, the following paper choice guidelines will help alleviate the environmental impact of printing:

- 1** Minimize paper consumption.
- 2** Be selective about the origin of wood fiber. Buy from suppliers who carry certifications such as the Forestry Stewardship Council (FSC) or the Program for the Endorsement of Forest Certification (PEFC). These certifications guarantee that the paper manufacturer uses wood pulp from forestry operators that employ environmentally and socially responsible forest management and restoration practices.
- 3** Choose the most appropriate paper for printing needs: normal 75 or 80 g/m² certified paper, lower weight paper, or recycled paper.

Unacceptable paper examples

Test results indicate that the following paper types are at risk for use with laser printers:

- Chemically treated papers used to make copies without carbon paper, also known as *carbonless papers*
- Preprinted papers with chemicals that may contaminate the printer
- Preprinted papers that can be affected by the temperature in the printer fuser
- Preprinted papers that require a registration (the precise location on the page) greater than ± 2.3 mm (± 0.9 in.), such as optical character recognition (OCR) forms. In some cases, registration can be adjusted with a software application to successfully print on these forms.)
- Coated papers (erasable bond), synthetic papers, thermal papers
- Rough-edged, rough or heavily textured surface papers or curled papers
- Recycled papers that fail EN12281:2002 (European testing)
- Paper weighing less than 60 g/m² (16 lb)
- Multiple part forms or documents

For more information about Lexmark, visit www.lexmark.com. General sustainability-related information can be found at the **Environmental Sustainability** link.

Storing paper

Use these paper storage guidelines to help avoid jams and uneven print quality:

- For best results, store paper where the temperature is 21°C (70°F) and the relative humidity is 40 percent. Most label manufacturers recommend printing in a temperature range of 18–24°C (65–75°F) with relative humidity between 40 and 60 percent.
- Store paper in cartons, on a pallet or shelf, rather than on the floor.
- Store individual packages on a flat surface.
- Do not store anything on top of individual paper packages.
- Take paper out of the carton or wrapper only when you are ready to load it in the printer. The carton and wrapper help keep the paper clean, dry, and flat.

Using specialty media

Tips on using card stock

Card stock is heavy, single-ply specialty media. Many of its variable characteristics, such as moisture content, thickness, and texture, can significantly impact print quality. Print samples on the card stock being considered for use before buying large quantities.

When printing on card stock:

- Make sure the Paper Type is Card Stock.
- Select the appropriate Paper Texture setting.
- Be aware that preprinting, perforation, and creasing may significantly affect the print quality and cause jams or other paper handling problems.
- Check with the manufacturer or vendor to ensure that the card stock can withstand temperatures up to 240°C (464°F) without releasing hazardous emissions.

- Do not use preprinted card stock manufactured with chemicals that may contaminate the printer. Preprinting introduces semi-liquid and volatile components into the printer.
- Use grain short card stock when possible.

Tips on using envelopes

Print samples on the envelopes being considered for use before buying large quantities.

- Use envelopes designed specifically for laser printers. Check with the manufacturer or vendor to ensure that the envelopes can withstand temperatures up to 230°C (446°F) without sealing, wrinkling, curling excessively, or releasing hazardous emissions.
- For best performance, use envelopes made from 90-g/m² (24-lb bond) paper or 25% cotton. All-cotton envelopes must not exceed 70-g/m² (20-lb bond) weight.
- Use only new envelopes from undamaged packages.
- To optimize performance and minimize jams, do not use envelopes that:
 - Have excessive curl or twist
 - Are stuck together or damaged in any way
 - Have windows, holes, perforations, cutouts, or embossing
 - Have metal clasps, string ties, or folding bars
 - Have an interlocking design
 - Have postage stamps attached
 - Have any exposed adhesive when the flap is in the sealed or closed position
 - Have bent corners
 - Have rough, cockle, or laid finishes
- Adjust the width guides to fit the width of the envelopes.

Note: A combination of high humidity (over 60%) and high printing temperature may wrinkle or seal envelopes.

Tips on using labels

Print samples on the labels being considered for use before buying large quantities.

Note: Use only paper label sheets. Vinyl, pharmacy, and two-sided labels are not supported.

For more information on label printing, characteristics, and design, see the *Card Stock & Label Guide* available at <http://support.lexmark.com>.

When printing on labels:

- Use labels designed specifically for laser printers. Check with the manufacturer or vendor to verify that:
 - The labels can withstand temperatures up to 240°C (464°F) without sealing, excessive curling, wrinkling, or releasing hazardous emissions.
 - Label adhesives, face sheet (printable stock), and topcoats can withstand up to 172-kPa (25-psi) pressure without delaminating, oozing around the edges, or releasing hazardous fumes.
- Do not use labels with slick backing material.
- Use full label sheets. Partial sheets may cause labels to peel off during printing, resulting in a jam. Partial sheets also contaminate the printer and the cartridge with adhesive, and could void the printer and toner cartridge warranties.

- Do not use labels with exposed adhesive.
- Do not print within 1 mm (0.04 inch) of the edge of the label, of the perforations, or between die-cuts of the label.
- Make sure the adhesive backing does not reach to the edge of the sheet. Zone coating of the adhesive should be at least 1 mm (0.04 inch) away from edges. Adhesive material contaminates the printer and could void the warranty.
- If zone coating of the adhesive is not possible, then remove a 2-mm (0.08-inch) strip on the leading and driver edge, and then use a non-oozing adhesive.
- Portrait orientation is recommended, especially when printing bar codes.

Tips on using letterhead

- Use letterhead designed specifically for laser printers.
- Print samples on the letterhead being considered for use before buying large quantities.
- Before loading letterhead, flex, fan, and straighten the stack to prevent sheets from sticking together.
- Page orientation is important when printing on letterhead. For information on how to load letterhead, see:
 - [“Loading trays” on page 35](#)
 - [“Loading the multipurpose feeder” on page 39](#)

Tips on using transparencies

- Print a test page on the transparencies being considered for use before buying large quantities.
- Feed transparencies from the standard tray, or the multipurpose feeder.
- Use transparencies designed specifically for laser printers. Transparencies must be able to withstand temperatures up to 185°C (365°F) without melting, discoloring, offsetting, or releasing hazardous emissions.
Note: If the transparency weight is set to Heavy and the transparency texture is set to Rough in the Paper menu, then transparencies can be printed at a temperature up to 195°C (383°F).
- Avoid getting fingerprints on the transparencies to prevent print quality problems.
- Before loading transparencies, flex, fan, and straighten the stack to prevent sheets from sticking together.

Supported paper sizes, types, and weights

For information on card stock and labels, see the *Card Stock & Label Guide* available at <http://support.lexmark.com>.

Supported paper sizes

Paper size	Standard tray	Optional 250- or 550-sheet tray	Multipurpose feeder	Duplex mode
A4 210 x 297 mm (8.3 x 11.7 in.)	✓	✓	✓	✓
A5 148 x 210 mm (5.8 x 8.3 in.)	✓	✓	✓	X
A6 105 x 148 mm (4.1 x 5.8 in.)	✓	X	✓	X
JIS B5 182 x 257 mm (7.2 x 10.1 in.)	✓	✓	✓	X
Letter 216 x 279 mm (8.5 x 11 in.)	✓	✓	✓	✓
Legal 216 x 356 mm (8.5 x 14 in.)	✓	✓	✓	✓
Executive 184 x 267 mm (7.3 x 10.5 in.)	✓	✓	✓	X
Oficio (Mexico) 216 x 340 mm (8.5 x 13.4 in.)	✓	✓	✓	✓
Folio 216 x 330 mm (8.5 x 13 in.)	✓	✓	✓	✓
Statement 140 x 216 mm (5.5 x 8.5 in.)	✓	✓	✓	X
Universal^{1, 2} 76.2 x 127 mm (3 x 5 in.) up to 216 x 356 mm (8.5 x 14 in.)	✓	✓	✓	✓
7 3/4 Envelope (Monarch) 98 x 191 mm (3.9 x 7.5 in.)	X	X	✓	X
9 Envelope 98 x 225 mm (3.9 x 8.9 in.)	X	X	✓	X

¹ This size setting formats the page for 216 x 356 mm (8.5 x 14 in.) unless the size is specified by the software application.

² Universal is supported in the standard tray only if the paper size is at least 105 x 148 mm (4.1 x 5.8 in.). Universal is supported in the optional 250- or 550-sheet tray only if the paper size is at least 148 x 210 mm (5.8 x 8.3 in.). Universal is supported in duplex mode only if the width is at least 210 mm (8.3 in.) and the length is at least 279 mm (11 in.). The smallest supported Universal size is supported only in the multipurpose feeder.

Paper size	Standard tray	Optional 250- or 550-sheet tray	Multipurpose feeder	Duplex mode
10 Envelope 105 x 241 mm (4.1 x 9.5 in.)	X	X	✓	X
DL Envelope 110 x 220 mm (4.3 x 8.7 in.)	X	X	✓	X
C5 Envelope 162 x 229 mm (6.4 x 9 in.)	X	X	✓	X
B5 Envelope 176 x 250 mm (6.9 x 9.8 in.)	X	X	✓	X
Other Envelope 229 x 356 mm (9 x 14 in.)	X	X	✓	X

¹ This size setting formats the page for 216 x 356 mm (8.5 x 14 in.) unless the size is specified by the software application.

² Universal is supported in the standard tray only if the paper size is at least 105 x 148 mm (4.1 x 5.8 in.). Universal is supported in the optional 250- or 550-sheet tray only if the paper size is at least 148 x 210 mm (5.8 x 8.3 in.). Universal is supported in duplex mode only if the width is at least 210 mm (8.3 in.) and the length is at least 279 mm (11 in.). The smallest supported Universal size is supported only in the multipurpose feeder.

Supported paper types and weights

The standard tray supports 60–90-g/m² (16–24-lb) paper weights. The optional tray supports 60–120-g/m² (16–32-lb) paper weights. The multipurpose feeder supports 60–163-g/m² (16–43-lb) paper weights.

Paper type	250- or 550-sheet tray	Multipurpose feeder	Duplex mode
Plain paper	✓	✓	✓
Card stock	X	✓	X
Transparencies	✓	✓	X
Recycled	✓	✓	✓
Glossy paper	X	X	X
Paper labels¹	✓	✓	X
Vinyl labels	X	X	X
Bond²	✓	✓	✓
Envelope	X	✓	X
Rough envelope	X	✓	X
Letterhead	✓	✓	✓

Paper type	250- or 550-sheet tray	Multipurpose feeder	Duplex mode
Preprinted	✓	✓	✓
Colored Paper	✓	✓	✓
Light Paper	✓	✓	✓
Heavy Paper²	✓	✓	✓
Rough/Cotton	✓	✓	x

¹ One-sided paper labels designed for laser printers are supported for occasional use. It is recommended to print 20 or fewer pages of paper labels per month. Vinyl, pharmacy, and two-sided labels are not supported.

² Bond and Heavy Paper are supported in duplex mode up to 90-g/m² (24-lb) paper weight.

Printing

Printing a document

Printing from a computer

Note: For labels, card stock, and envelopes, set the paper size and type in the printer before sending the print job.

- 1 From the document that you are trying to print, open the Print dialog.
- 2 If necessary, adjust the settings.
- 3 Send the print job.

MS312 and MS317 toner darkness adjustment

Adjusting toner darkness

Using the Embedded Web Server

- 1 Open a Web browser, and then type the printer IP address in the address field.

Notes:

- View the printer IP address in the TCP/IP section in the Network/Ports menu. The IP address appears as four sets of numbers separated by periods, such as 123.123.123.123.
- If you are using a proxy server, then temporarily disable it to load the Web page correctly.

- 2 Click **Settings > Print Settings > Quality Menu > Toner Darkness**.
- 3 Adjust the toner darkness setting.
- 4 Click **Submit**.

Using the printer settings on the computer

Depending on your operating system, adjust the toner darkness settings using the Local Printer Settings Utility or Printer Settings.

Using the printer control panel

- 1 From the printer control panel, navigate to:

 > **Settings** >  > **Print Settings** >  > **Quality Menu** >  > **Toner Darkness** > 

- 2 Adjust the toner darkness.
- 3 Press .

MS315, MS415, and MS417 toner darkness adjustment

Adjusting toner darkness

Using the Embedded Web Server

- 1 Open a Web browser, and then type the IP address of the printer in the address field.

Notes:

- View the printer IP address in the TCP/IP section in the Network/Ports menu. The IP address appears as four sets of numbers separated by periods, such as 123.123.123.123.
- If you are using a proxy server, then temporarily disable it to load the Web page correctly.

- 2 Click **Settings** > **Print Settings** > **Quality Menu** > **Toner Darkness**.

- 3 Adjust the toner darkness, and then click **Submit**.

Using the printer control panel

- 1 From the printer control panel, navigate to:

 > **Settings** >  > **Print Settings** >  > **Quality Menu** >  > **Toner Darkness**

- 2 Adjust the toner darkness, and then press .

Printing from a mobile device

Note: Make sure that the printer and mobile device share the same wireless network. For information on configuring the wireless settings of your mobile device, see the documentation that came with the device.

Printing from a mobile device using Mopria Print Service

Mopria® Print Service is a mobile printing solution for mobile devices running on Android version 4.4 or later. It allows you to print directly to any Mopria-certified printer.

Note: Before printing, make sure that the Mopria Print Service is enabled.

- 1 From the home screen of your mobile device, launch a compatible application.
- 2 Tap **Print**, and then select the printer.
- 3 Send the print job.

Printing from a mobile device using Google Cloud Print

Google Cloud Print™ is a mobile printing service that allows enabled applications on mobile devices to print to any Google Cloud Print-ready printer.

- 1 From the home screen of your mobile device, launch an enabled application.
- 2 Tap **Print**, and then select the printer.
- 3 Send the print job.

Printing from a mobile device using AirPrint

AirPrint is a mobile printing solution that allows you to print directly from Apple devices to an AirPrint-certified printer.

Notes:

- This application is supported only in some Apple devices.
- This application is supported only in some printer models.

- 1 From the home screen of your mobile device, launch a compatible application.
- 2 Select an item to print, and then tap the share icon.
- 3 Tap **Print**, and then select a printer.
- 4 Print the document.

Printing from a mobile device using Lexmark Mobile Print

Lexmark™ Mobile Print allows you to send documents and images directly to a supported Lexmark printer.

- 1 Open the document, and then send or share the document to Lexmark Mobile Print.

Note: Some third-party applications may not support the send or share feature. For more information, see the documentation that came with the application.

- 2 Select a printer.
- 3 Print the document.

MS315, MS415, and MS417 printing confidential and other held jobs

Storing print jobs in the printer

- 1 From the printer control panel, navigate to:



> **Security** > **Confidential Print**

- 2 Select a print job type.

Use	To
Confidential Job Expiration	Hold print jobs in the computer until you enter the PIN from the printer control panel. Note: The PIN is set from the computer. It must be four digits, using the numbers 0–9.
Max Invalid PIN	Limit the number of times an invalid PIN can be entered. Note: When the limit is reached, the print jobs for that user name and PIN are deleted.
Repeat Job Expiration	Print and store print jobs in the printer memory.
Reserve Job Expiration	Store print jobs for printing at a later time. Note: The print jobs are held until deleted from the Held Jobs menu.
Verify Job Expiration	Print one copy of a print job and hold the remaining copies. It lets you examine if the first copy is satisfactory. Note: The print job is automatically deleted from the printer memory once all copies are printed.
Notes: <ul style="list-style-type: none"> • Confidential, Verify, Reserve, and Repeat print jobs may be deleted if the printer requires extra memory to process additional held jobs. • You can set the printer to store print jobs in the printer memory until you start the print job from the printer control panel. • All print jobs that can be initiated by the user at the printer are called <i>held jobs</i>. 	

3 Press .

Printing information pages

For information on printing a menu settings page or a network setup page, see:

- [“Printing a menu settings page” on page 25](#) and [“Printing a network setup page” on page 26](#) for MS312
- [“Printing a menu settings page” on page 26](#) and [“Printing a network setup page” on page 27](#) for MS315 and MS415

MS312 and MS317 information pages

Printing a font sample list

From the printer control panel, navigate to either of the following:

 > Reports >  > Print Fonts >  > PCL Fonts > 

or

 > Reports >  > Print Fonts >  > PostScript Fonts > 

MS315, MS415, and MS417 information pages

Printing a font sample list

1 From the printer control panel, navigate to:

 > **Settings** >  > **Reports** >  > **Print Fonts**

2 Press the up or down arrow button to select the font setting.

3 Press .

Note: The PPDS fonts appear only when the PPDS data stream is activated.

Printing a directory list



From the control panel, navigate to:

 > **Settings** > **Reports** >  > **Print Directory** > 

Note: The Print Directory menu item appears only when an optional flash memory card is installed.

Canceling a print job

Canceling a print job from the printer control panel

From the printer control panel, press  > .

Canceling a print job from the computer

1 Depending on the operating system, do either of the following:

- Open the printers folder, and then select your printer.
- From the System Preferences in the Apple menu, navigate to your printer.

2 Select the print job to cancel.

Saving money and the environment

Lexmark is committed to environmental sustainability and is continually improving its printers to reduce their impact on the environment. We design with the environment in mind, engineer our packaging to reduce materials, and provide collection and recycling programs. For more information, see:

- The Notices chapter
- The Environmental Sustainability section of the Lexmark Web site at www.lexmark.com/environment
- The Lexmark recycling program at www.lexmark.com/recycle

By selecting certain printer settings or tasks, you may be able to reduce your printer's impact even further. This chapter outlines the settings and tasks that may yield a greater environmental benefit.

Saving paper and toner

Studies show that as much as eighty percent of the carbon footprint of a printer is related to paper usage. You can significantly reduce your carbon footprint by using recycled paper and the following printing suggestions, such as printing on both sides of the paper and printing multiple pages on one side of a single sheet of paper.

For information on how you can quickly save paper and energy using one printer setting, see [“Using Eco-Mode” on page 65](#) for MS312 or [“Using Eco-mode” on page 67](#) for MS315 and MS415.

Using recycled paper

As an environmentally conscious company, Lexmark supports the use of recycled office paper produced specifically for use in laser printers. For more information on recycled papers that work well with your printer, see [“Using recycled paper and other office papers” on page 48](#).

Conserving supplies

- Print on both sides of the paper.
Note: Two-sided printing is the default setting in the print driver.
- Print multiple pages on a single sheet of paper.
- Use the preview feature to see how the document looks like before printing it.
- Print one copy of the document to check its content and format for accuracy.

Recycling

Lexmark provides collection programs and environmentally progressive approaches to recycling. For more information, see:

- The Notices chapter
- The Environmental Sustainability section of the Lexmark Web site at www.lexmark.com/environment
- The Lexmark recycling program at www.lexmark.com/recycle

Recycling Lexmark products

To return Lexmark products for recycling:

- 1 Go to www.lexmark.com/recycle.
- 2 Select the product you want to recycle.

Note: Printer supplies and hardware not listed in the Lexmark Collection and Recycling Program may be recycled through your local recycling center.

Recycling Lexmark packaging

Lexmark continually strives to minimize packaging. Less packaging helps to ensure that Lexmark printers are transported in the most efficient and environmentally sensitive manner and that there is less packaging to dispose of. These efficiencies result in fewer greenhouse emissions, energy savings, and natural resource savings.

Lexmark cartons are 100% recyclable where corrugated recycling facilities exist. Facilities may not exist in your area.

The foam used in Lexmark packaging is recyclable where foam recycling facilities exist. Facilities may not exist in your area.

When you return a cartridge to Lexmark, you can reuse the box that the cartridge came in. Lexmark will recycle the box.

Returning Lexmark cartridges for reuse or recycling

The Lexmark Cartridge Collection Program allows you to return used cartridges for free to Lexmark for reuse or recycling. One hundred percent of the empty cartridges returned to Lexmark are either reused or demanufactured for recycling. The boxes used to return the cartridges are also recycled.

To return Lexmark cartridges for reuse or recycling, do the following:

- 1 Go to www.lexmark.com/recycle.
- 2 Select the product that you want to recycle.

Managing the printer

Finding advanced networking and administrator information

This chapter covers basic administrative support tasks using the Embedded Web Server. For more advanced system support tasks, see the *Networking Guide* on the *Software and Documentation CD* or the *Embedded Web Server — Security: Administrator's Guide* on the Lexmark support Web site at <http://support.lexmark.com>.

Copying printer settings to other printers

Note: This feature is available only in network printers.

- 1 Open a Web browser, and then type the printer IP address in the address field.

Notes:

- View the printer IP address in the TCP/IP section in the Network/Ports menu. The IP address appears as four sets of numbers separated by periods, such as 123.123.123.123.
- If you are using a proxy server, then temporarily disable it to load the Web page correctly.

- 2 Click the **Copy Printer Settings**.

- 3 To change the language, select a language from the drop-down menu, and then click **Click here to submit language**.

- 4 Click **Printer Settings**.

- 5 Type the IP addresses of the source and target printers in their appropriate fields.

Note: If you want to add or remove a target printer, then click **Add Target IP** or **Remove Target IP**.

- 6 Click **Copy Printer Settings**.

Configuring supply notifications from the Embedded Web Server

You can determine how you would like to be notified when supplies run nearly low, low, very low, or reach their end-of-life by setting the selectable alerts.

Notes:

- Selectable alerts can be set on the toner cartridge and imaging unit.
- All selectable alerts can be set for nearly low, low, and very low supply conditions. Not all selectable alerts can be set for the end-of-life supply condition. E-mail selectable alert is available for all supply conditions.
- The percentage of estimated remaining supply that prompts the alert can be set on some supplies for some supply conditions.

- 1 Open a Web browser, and then type the printer IP address in the address field.

Notes:

- View the printer IP address in the TCP/IP section in the Network/Ports menu. The IP address appears as four sets of numbers separated by periods, such as 123.123.123.123.
- If you are using a proxy server, then temporarily disable it to load the Web page correctly.

2 Click **Settings > Print Settings > Supply Notifications**.

3 From the drop-down menu for each supply, select one of the following notification options:

Notification	Description
Off	The normal printer behavior for all supplies occurs.
SNMP Only	The printer generates a simple network management protocol (SNMP) alert when the supply condition is reached. The status of the supply will appear on the menus page and status page.
E-mail Only	The printer generates an e-mail when the supply condition is reached. The status of the supply will appear on the menus page and status page.
Warning	The printer displays the warning message and generates an e-mail about the status of the supply. The printer does not stop when the supply condition is reached.
Continuable Stop ¹	The printer stops processing jobs when the supply condition is reached, and the user needs to press a button to continue printing.
Non Continuable Stop ^{1,2}	The printer stops when the supply condition is reached. The supply must be replaced to continue printing.
¹ The printer generates an e-mail about the status of the supply when supply notification is enabled.	
² The printer stops when some supplies become empty to prevent damage.	

4 Click **Submit**.

MS312 and MS317 printer management

Accessing the remote control panel

The remote control panel on your computer screen lets you interact with the printer control panel, even when you are not physically near the network printer. From your screen, you can view the printer status and do print-related tasks.

1 Open a Web browser, and then type the printer IP address in the address field.

Notes:

- Print a network setup page or menu settings page, and then locate the IP address in the TCP/IP section. The IP address appears as four sets of numbers separated by periods, such as 123.123.123.123.
- If you are using a proxy server, then temporarily disable it to load the Web page correctly.

2 Press **Enter** to open the Web page of your printer.

3 Click **Remote Operator Panel > Run Remote Panel**.

Note: The remote control panel requires a Java plug-in to launch.

Viewing reports

You can view some reports from the Embedded Web Server. These reports are useful for assessing the status of the printer, network, and supplies.

- 1 Open a Web browser, and then type the printer IP address in the address field.

Notes:

- View the printer IP address in the TCP/IP section in the Network/Ports menu. The IP address appears as four sets of numbers separated by periods, such as 123.123.123.123.
- If you are using a proxy server, then temporarily disable it to load the Web page correctly.

- 2 Click **Reports**, and then click the type of report you want to view.

Restoring factory default settings

If you want to keep a list of the current menu settings for reference, then print a menu settings page before restoring the factory default settings. For more information, see [“Printing a menu settings page” on page 25](#).

If you want a more comprehensive method of restoring the printer factory default settings, then perform the Wipe All Settings option. For more information, see [“Erasing non-volatile memory” on page 73](#).

Warning—Potential Damage: Restoring factory defaults returns most printer settings to the original factory default settings. Exceptions include the display language, custom sizes and messages, and Network/Port menu settings. All downloads stored in the RAM are deleted.

From the printer control panel, navigate to:



Creating a printer control panel PIN

The Panel PIN Protect menu lets you restrict access to the menus from the printer control panel. To restrict access to the menus, create a Personal Identification Number (PIN), and then assign the PIN to each menu.

- 1 Open a Web browser, and then type the printer IP address in the address field.

Notes:

- View the printer IP address in the TCP/IP section in the Network/Ports menu. The IP address appears as four sets of numbers separated by periods, such as 123.123.123.123.
- If you are using a proxy server, then temporarily disable it to load the Web page correctly.

- 2 Click **Settings > Security > Panel PIN Protect**.

- 3 From the Create User PIN or Create Admin PIN sections, enter your PIN.

Note: You can enter up to 16 digits for your PIN.

- 4 Click **Modify**.

- 5 From any menu in the Administrative Menus, Management, or Function Access sections, select **User PIN Protected** or **Admin PIN Protected** or **Admin PIN and User PIN Protected**.

Note: Using an Admin PIN, you can still access a menu assigned with a User PIN.

- 6 Click **Submit**.

If you try to access a PIN-protected menu from the printer control panel, the printer will require you to enter the PIN.

Note: After you enter the last digit of the PIN, make sure to press  on the printer control panel for more than three seconds.

Saving energy

Using Eco-Mode

Use Eco-Mode to quickly select one or more ways to reduce your printer's environmental impact.

1 From the printer control panel, navigate to:

 > **Settings** >  > **General Settings** >  > **Eco-Mode** >  > select the setting you want

Use	To
Off	Use the factory default settings for all settings associated with Eco-Mode. This setting supports the performance specifications for your printer.
Energy	Reduce energy use, especially when the printer is idle. <ul style="list-style-type: none"> • Printer engine motors do not start until a document is ready to print. You may notice a short delay before the first page is printed. • The printer enters Sleep mode after one minute of inactivity.
Energy/Paper	Use all the settings associated with Energy and Paper modes.
Paper	<ul style="list-style-type: none"> • Enable the automatic two-sided (duplex) printing feature. • Turn off print log features.

2 Press .

Using Hibernate mode

Hibernate is an ultra-low-power saving mode.

Notes:

- Three days is the default amount of time before the printer enters Hibernate mode.
- Make sure to wake the printer from Hibernate mode before sending a print job. A hard reset or a long press of the Sleep button wakes the printer from Hibernate mode.
- If the printer is in Hibernate mode, then the Embedded Web Server is disabled.

1 From the control panel, navigate to:

 > **Settings** >  > **General Settings** > 

2 Press **Press Sleep Button** or **Press and Hold Sleep Button**, and then press .

3 Press **Hibernate** > .

Setting Hibernate Timeout

Hibernate Timeout lets you set the amount of time the printer waits after a print job is processed before it goes into a reduced power state.

Using the Embedded Web Server

- 1 Open a Web browser, and then type the printer IP address in the address field.

Notes:

- Print a network setup page or menu settings page, and then locate the IP address in the TCP/IP section. The IP address appears as four sets of numbers separated by periods, such as 123.123.123.123.
- If you are using a proxy server, then temporarily disable it to load the Web page correctly.

- 2 Click **Settings > General Settings > Timeouts**.

- 3 From the Hibernate Timeout menu, select the number of hours, days, weeks, or months you want for the printer to wait before it goes into a reduced power state.

- 4 Click **Submit**.

Using the printer settings on the computer

Depending on your operating system, access the Hibernate Timeout menu using the Local Printer Settings Utility or Print Settings.

Using Schedule Power Modes

Schedule Power Modes lets the user schedule when the printer goes into a reduced power state or into the Ready state.

Using the Embedded Web Server

- 1 Open a Web browser, and then type the printer IP address in the address field.

Notes:

- Print a network setup page or menu settings page, and then locate the IP address in the TCP/IP section. The IP address appears as four sets of numbers separated by periods, such as 123.123.123.123.
- If you are using a proxy server, then temporarily disable it to load the Web page correctly.

- 2 Click **Settings > General Settings > Schedule Power Modes**.

- 3 From the Action menu, select the power mode.

- 4 From the Time menu, select the time.

- 5 From the Day(s) menu, select the day or days.

- 6 Click **Add**.

Using the printer settings on the computer (Windows only)

- Access the Schedule Power Modes menu using the Local Printer Settings Utility.

MS315, MS415, and MS417 printer management

Checking the virtual display

- 1 Open a Web browser, and then type the printer IP address in the address field.

Notes:

- View the printer IP address in the TCP/IP section in the Network/Ports menu. The IP address appears as four sets of numbers separated by periods, such as 123.123.123.123.
- If you are using a proxy server, then temporarily disable it to load the Web page correctly.

- 2 Check the virtual display that appears at the top left corner of the screen.

The virtual display works as an actual display would work on a printer control panel.

Modifying confidential print settings

Note: This feature is available only in network printers or printers connected to print servers.

- 1 Open a Web browser, and then type the printer IP address in the address field.

Notes:

- View the printer IP address in the TCP/IP section in the Network/Ports menu. The IP address appears as four sets of numbers separated by periods, such as 123.123.123.123.
- If you are using a proxy server, then temporarily disable it to load the Web page correctly.

- 2 Click **Settings** tab > **Security** > **Confidential Print Setup**.

- 3 Modify the settings:

- Set a maximum number of PIN entry attempts. When a user exceeds a specific number of PIN entry attempts, all of the jobs for that user are deleted.
- Set an expiration time for confidential print jobs. When a user has not printed the jobs within the specified time, all of the jobs for that user are deleted.

- 4 Save the modified settings.

Saving energy

Using Eco-mode

Use Eco-Mode to quickly select one or more ways to reduce your printer's environmental impact.

- 1 From the printer control panel, navigate to:

 > **Settings** > **Settings** >  > **General Settings** >  > **Eco-Mode** >  > select the setting you want

Use	To
Off	Use the factory default settings for all settings associated with Eco-Mode. This setting supports the performance specifications for your printer.
Energy	Reduce energy use, especially when the printer is idle. <ul style="list-style-type: none"> • Printer engine motors do not start until a job is ready to print. You may notice a short delay before the first page is printed. • The printer enters Sleep mode after one minute of inactivity.
Energy/Paper	Use all the settings associated with Energy and Paper modes.
Plain Paper	<ul style="list-style-type: none"> • Enable the automatic two-sided (duplex) feature. • Turn off print log features.

2 Press .

Reducing printer noise

Use Quiet mode to reduce the printer noise.

1 From the printer control panel, navigate to:

 > **Settings** > **Settings** >  > **General Settings** >  > **Quiet Mode** > 

2 Select a setting you want.

Use	To
On	Reduce printer noise. <p>Notes:</p> <ul style="list-style-type: none"> • Print jobs will process at a reduced speed. • Printer engine motors do not start until a document is ready to print. There is a short delay before the first page is printed.
Off	Use factory default settings. <p>Note: This setting supports the performance specifications of the printer.</p>

3 Press .

Using Hibernate mode

Hibernate is an ultra-low-power saving mode.

Notes:

- Three days is the default amount of time before the printer enters Hibernate mode.
- Make sure to wake the printer from Hibernate mode before sending a print job. A hard reset or a long press of the Sleep button wakes the printer from Hibernate mode.
- If the printer is in Hibernate mode, then the Embedded Web Server is disabled.

1 From the control panel, navigate to:

 > **Settings** >  > **Settings** >  > **General Settings** > 

2 Select **Press Sleep Button** or **Press and Hold Sleep Button**, and then press .

3 Press **Hibernate** > .

Setting Hibernate Timeout

Hibernate Timeout lets you set the amount of time the printer waits after a print job is processed before it goes into a reduced power state.

Using the Embedded Web Server

1 Open a Web browser, and then type the printer IP address in the address field.

Notes:

- View the printer IP address in the TCP/IP section in the Network/Ports menu. The IP address appears as four sets of numbers separated by periods, such as 123.123.123.123.
- If you are using a proxy server, then temporarily disable it to load the Web page correctly.

2 Click **Settings** > **General Settings** > **Timeouts**.

3 From the Hibernate Timeout menu, select the number of hours, days, weeks, or months you want for the printer to wait before it goes into a reduced power state.

4 Click **Submit**.

Using the control panel

1 From the control panel, navigate to:

 > **Settings** >  > **Settings** >  > **General Settings** >  > **Timeouts** >  > **Hibernate Timeout**
> 

2 Select the amount of time the printer waits after a print job is processed before it enters Hibernate mode.

3 Press .

Using Schedule Power Modes

Schedule Power Modes lets you schedule when the printer goes into a reduced power state or into the Ready state.

Note: This feature is available only in network printers or printers connected to print servers.

Using the Embedded Web Server

- 1 Open a Web browser, and then type the printer IP address in the address field.

Notes:

- View the printer IP address in the TCP/IP section in the Network/Ports menu. The IP address appears as four sets of numbers separated by periods, such as 123.123.123.123.
- If you are using a proxy server, then temporarily disable it to load the Web page correctly.

- 2 Click **Settings > General Settings > Schedule Power Modes**.

- 3 From the Action menu, select the power mode.

- 4 From the Time menu, select the time.

- 5 From the Day(s) menu, select the day or days.

- 6 Click **Add**.

Adjusting the brightness of the printer display

To save energy, or if you have trouble reading the display, adjust its brightness settings.

Using the Embedded Web Server

- 1 Open a Web browser, and then type the printer IP address in the address field.

Notes:

- View the printer IP address in the TCP/IP section in the Network/Ports menu. The IP address appears as four sets of numbers separated by periods, such as 123.123.123.123.
- If you are using a proxy server, then temporarily disable it to load the Web page correctly.

- 2 Click **Settings > General Settings**.

- 3 In the Screen Brightness field, enter the brightness percentage you want for the display.

- 4 Click **Submit**.

Restoring factory default settings

If you want to keep a list of the current menu settings for reference, then print a menu settings page before restoring the factory default settings. For more information, see [“Printing a menu settings page” on page 26](#).

If you want a more comprehensive method of restoring the printer factory default settings, then perform the Wipe All Settings option. For more information, see [“Erasing non-volatile memory” on page 73](#).

Warning—Potential Damage: Restoring factory defaults returns most printer settings to the original factory default settings. Exceptions include the display language, custom sizes and messages, and network/port menu settings. All downloads stored in the RAM are deleted. Downloads stored in the flash memory card are not affected.

From the control panel, navigate to:

 > **Settings** > **Settings** >  > **General Settings** >  > **Factory Defaults** >  > **Restore Now** > 

Adjusting Sleep mode

To save energy, decrease the number of minutes before the printer enters Sleep mode.

Note: Sleep mode can be scheduled. For more information, see [“Using Schedule Power Modes” on page 66](#).

1 From the control panel, navigate to:

 > **Settings** >  > **General Settings** >  > **Timeouts** >  > **Sleep Mode** > 

2 Select the number of minutes before the printer enters Sleep mode.

3 Apply the changes.

Securing the printer

Using the security lock feature

The printer is equipped with a security lock feature. Attach a security lock compatible with most laptop computers in the location shown to secure the printer in place.



Statement of Volatility

Your printer contains various types of memory that can store device and network settings, and user data.

Type of memory	Description
Volatile memory	Your printer uses standard <i>random access memory</i> (RAM) to temporarily buffer user data during simple print jobs.
Non-volatile memory	Your printer may use two forms of non-volatile memory: EEPROM and NAND (flash memory). Both types are used to store operating system, device settings, and network information.

Erase the content of any installed printer memory in the following circumstances:

- The printer is being decommissioned.
- The printer is being moved to a different department or location.
- The printer is being serviced by someone from outside your organization.
- The printer is being removed from your premises for service.
- The printer is being sold to another organization.

Erasing volatile memory

The volatile memory (RAM) installed in your printer requires a power source to retain information. To erase the buffered data, simply turn off the printer.

Erasing non-volatile memory

MS312 and MS317 non-volatile memory erase

Erasing non-volatile memory

- 1 Turn off the printer.
- 2 From the printer control panel, hold down  and the right arrow button while turning the printer on. Release the buttons only when the Configuration menu appears.

- 3 Press the arrow buttons until **Wipe All Settings** appears, and then press .
The printer will restart several times during this process.

Note: Wipe All Settings securely removes device settings, solutions, jobs, and passwords from the printer memory.

- 4 Press the arrow buttons until **Exit Config Menu** appears, and then press .

The printer will perform a power-on reset, and then return to normal operating mode.

MS315, MS415, and MS417 non-volatile memory erase

Erasing non-volatile memory

Erase individual settings, device and network settings, security settings, and embedded solutions by following these steps:

- 1 Turn off the printer.
- 2 Hold down **2** and **6** on the keypad while turning the printer on. Release the buttons only when the screen with the progress bar appears.

The printer performs a power-on sequence, and then the Configuration menu appears. When the printer is fully turned on, a list of functions appears on the printer display.

- 3 Press the up or down arrow button until **Wipe All Settings** appears.
The printer will restart several times during this process.

Note: Wipe All Settings securely removes device settings, solutions, jobs, and passwords from the printer memory.

- 4 Navigate to:

Back > Exit Config Menu

The printer will perform a power-on reset, and then return to normal operating mode.

Finding printer security information

In high-security environments, it may be necessary to take additional steps to make sure that confidential data stored in the printer cannot be accessed by unauthorized persons. For more information, go to the [Lexmark security Web page](#) or see the *Embedded Web Server—Security: Administrator's Guide* at <http://support.lexmark.com>.

Understanding the printer menus

MS312 and MS317 menu list

Menu list

Paper Menu

Default Source
 Paper Size/Type
 Configure MP
 Substitute Size
 Paper Texture
 Paper Weight
 Paper Loading
 Custom Types
 Universal Setup

Reports

Menu Settings Page
 Device Statistics
 Network Setup Page¹
 Print Fonts
 Print Directory
 Print Demo
 Asset Report
 Print Demo

Network/Ports

Active NIC
 Standard Network²
 Standard USB
 Standard Parallel
 SMTP Setup

Security

Set Date and Time

Settings

General Settings
 Print Settings

¹ Depending on the printer setup, this menu item appears as Network Setup Page or Network [x] Setup Page.

² Depending on the printer setup, this menu item appears as Standard Network or Network [x].

MS315, MS415, and MS417 menu list

Menu list

Paper Menu

Default Source
 Paper Size/Type
 Configure MP
 Substitute Size
 Paper Texture
 Paper Weight
 Paper Loading
 Custom Types
 Universal Setup

Reports

Menu Settings Page
 Device Statistics
 Network Setup Page¹
 Print Fonts
 Print Directory
 Print Demo
 Asset Report
 Event Log Summary

Network/Ports

Active NIC
 Standard Network²
 Standard USB
 Standard Parallel
 SMTP Setup

Security

- Confidential Print
- Security Audit Log
- Set Date and Time

Settings

- General Settings
- Print Settings

Help

- Print All Guides
- Print Quality
- Printing Guide
- Media Guide
- Print Defects Guide
- Menu Map
- Information Guide
- Connection Guide
- Moving Guide
- Supplies Guide

¹ Depending on the printer setup, this menu item appears as Network Setup Page or Network [x] Setup Page.

² Depending on the printer setup, this menu item appears as Standard Network or Network [x].

Paper menu

MS312 and MS317 paper menu

Default Source menu

Use	To
<p>Default Source</p> <ul style="list-style-type: none"> Tray [x] MP Feeder Manual Paper Manual Envelope 	<p>Set a default paper source for all print jobs.</p> <p>Notes:</p> <ul style="list-style-type: none"> • Tray 1 (standard tray) is the factory default setting. • From the Paper menu, set Configure MP to "Cassette" for MP Feeder to appear as a menu setting. • If two trays contain paper of the same size and type, and the trays have the same settings, then the trays are automatically linked. When one tray is empty, the print job continues using the linked tray.

Paper Size/Type menu

Use	To
<p>Tray [x] Size</p> <ul style="list-style-type: none"> A4 A5 A6 JIS-B5 Letter Legal Executive Oficio (Mexico) Folio Statement Universal 	<p>Specify the paper size loaded in each tray.</p> <p>Notes:</p> <ul style="list-style-type: none"> • Letter is the U.S. factory default setting. A4 is the international factory default setting. • If two trays contain paper of the same size and type, and the trays have the same settings, then the trays are automatically linked. When one tray is empty, the print job continues using the linked tray. • The A6 paper size is supported only in Tray 1 and the multipurpose feeder.
<p>Tray [x] Type</p> <ul style="list-style-type: none"> Plain Paper Transparency Recycled Labels Bond Letterhead Preprinted Colored Paper Light Paper Heavy Paper Rough/Cotton Custom Type [x] 	<p>Specify the type of paper loaded in each tray.</p> <p>Notes:</p> <ul style="list-style-type: none"> • Plain Paper is the factory default setting for Tray 1. Custom Type [x] is the factory default setting for all other trays. • If available, a user-defined name will appear instead of Custom Type [x]. • Use this menu to configure automatic tray linking.
<p>Note: Only installed trays and feeders are listed in this menu.</p>	

Use	To
<p>MP Feeder Size</p> <ul style="list-style-type: none"> A4 A5 A6 JIS B5 Letter Legal Executive Oficio (Mexico) Folio Statement Universal 7 3/4 Envelope 9 Envelope 10 Envelope DL Envelope C5 Envelope B5 Envelope Other Envelope 	<p>Specify the paper size loaded in the multipurpose feeder.</p> <p>Notes:</p> <ul style="list-style-type: none"> • Letter is the U.S. factory default setting. A4 is the international factory default setting. • From the Paper menu, set Configure MP to “Cassette” for MP Feeder Size to appear as a menu. • The multipurpose feeder does not automatically detect paper size. Make sure to set the paper size value.
<p>MP Feeder Type</p> <ul style="list-style-type: none"> Plain Paper Card Stock Transparency Recycled Labels Bond Envelope Rough Envelope Letterhead Preprinted Colored Paper Light Paper Heavy Paper Rough/Cotton Custom Type [x] 	<p>Specify the type of paper loaded in the multipurpose feeder.</p> <p>Notes:</p> <ul style="list-style-type: none"> • Custom Type [x] is the factory default setting. • From the Paper menu, set Configure MP to “Cassette” for MP Feeder Type to appear as a menu.
<p>Note: Only installed trays and feeders are listed in this menu.</p>	

Use	To
<p>Manual Paper Size</p> <ul style="list-style-type: none"> A4 A5 A6 JIS B5 Letter Legal Executive Oficio (Mexico) Folio Statement Universal 	<p>Specify the paper size being manually loaded.</p> <p>Note: Letter is the U.S. factory default setting. A4 is the international factory default setting.</p>
<p>Manual Paper Type</p> <ul style="list-style-type: none"> Plain Paper Card Stock Transparency Recycled Labels Bond Letterhead Preprinted Colored Paper Light Paper Heavy Paper Rough/Cotton Custom Type [x] 	<p>Specify the paper type being manually loaded.</p> <p>Notes:</p> <ul style="list-style-type: none"> • Plain Paper is the factory default setting. • From the Paper menu, set Configure MP to “Manual” for Manual Paper Type to appear as a menu.
<p>Manual Envelope Size</p> <ul style="list-style-type: none"> 7 3/4 Envelope 9 Envelope 10 Envelope DL Envelope C5 Envelope B5 Envelope Other Envelope 	<p>Specify the envelope size being manually loaded.</p> <p>Note: 10 Envelope is the U.S. factory default setting. DL Envelope is the international factory default setting.</p>
<p>Manual Envelope Type</p> <ul style="list-style-type: none"> Envelope Rough Envelope Custom Type [x] 	<p>Specify the envelope type being manually loaded.</p> <p>Note: Envelope is the factory default setting.</p>
<p>Note: Only installed trays and feeders are listed in this menu.</p>	

MS315, MS415, and MS417 paper menus

Default Source menu

Use	To
<p>Default Source</p> <ul style="list-style-type: none"> Tray [x] Multipurpose Feeder Manual Paper Manual Envelope 	<p>Set a default paper source for all print jobs.</p> <p>Notes:</p> <ul style="list-style-type: none"> • Tray 1 (standard tray) is the factory default setting. • From the Paper menu, set Configure MP to Cassette for Multipurpose Feeder to appear as a menu setting.

Paper Size/Type menu

Use	To
<p>Tray [x] Size</p> <ul style="list-style-type: none"> A4 A5 A6 JIS B5 Letter Legal Executive Oficio (Mexico) Folio Statement Universal 	<p>Specify the paper size loaded in each tray.</p> <p>Notes:</p> <ul style="list-style-type: none"> • Letter is the U.S. factory default setting. A4 is the international factory default setting. • The A6 paper size is supported only in Tray 1 and the multipurpose feeder.
<p>Tray [x] Type</p> <ul style="list-style-type: none"> Plain Paper Transparency Recycled Labels Bond Letterhead Preprinted Colored Paper Light Paper Heavy Paper Rough/Cotton Custom Type [x] 	<p>Specify the type of paper loaded in each tray.</p> <p>Notes:</p> <ul style="list-style-type: none"> • Plain Paper is the factory default setting for Tray 1. Custom Type [x] is the factory default setting for all other trays. • If available, a user-defined name will appear instead of Custom Type [x]. • Use this menu to configure automatic tray linking.
<p>Note: Only installed trays and feeders are listed in this menu.</p>	

Use	To
<p>Multipurpose Feeder Size</p> <ul style="list-style-type: none"> A4 A5 A6 JIS B5 Letter Legal Executive Oficio (Mexico) Folio Statement Universal 7 3/4 Envelope 9 Envelope 10 Envelope DL Envelope C5 Envelope B5 Envelope Other Envelope 	<p>Specify the paper size loaded in the multipurpose feeder.</p> <p>Notes:</p> <ul style="list-style-type: none"> • Letter is the U.S. factory default setting. A4 is the international factory default setting. • From the Paper menu, set Configure MP to Cassette for Multipurpose Feeder Size to appear as a menu. • The multipurpose feeder does not automatically detect paper size. Make sure to set the paper size value.
<p>Multipurpose Feeder Type</p> <ul style="list-style-type: none"> Plain Paper Card Stock Transparency Recycled Labels Bond Envelope Rough Envelope Letterhead Preprinted Colored Paper Light Paper Heavy Paper Rough/Cotton Custom Type [x] 	<p>Specify the type of paper loaded in the multipurpose feeder.</p> <p>Notes:</p> <ul style="list-style-type: none"> • Plain Paper is the factory default setting. • From the Paper menu, set Configure MP to Cassette for Multipurpose Feeder Type to appear as a menu.
<p>Note: Only installed trays and feeders are listed in this menu.</p>	

Use	To
<p>Manual Paper Size</p> <ul style="list-style-type: none"> A4 A5 A6 JIS B5 Letter Legal Executive Oficio (Mexico) Folio Statement Universal 	<p>Specify the paper size being manually loaded.</p> <p>Note: Letter is the U.S. factory default setting. A4 is the international factory default setting.</p>
<p>Manual Paper Type</p> <ul style="list-style-type: none"> Plain Paper Card Stock Transparency Recycled Labels Bond Letterhead Preprinted Colored Paper Light Paper Heavy Paper Rough/Cotton Custom Type [x] 	<p>Specify the paper type being manually loaded.</p> <p>Notes:</p> <ul style="list-style-type: none"> • Plain Paper is the factory default setting. • From the Paper menu, set Configure MP to Manual for Manual Paper Type to appear as a menu.
<p>Manual Envelope Size</p> <ul style="list-style-type: none"> 7 3/4 Envelope 9 Envelope 10 Envelope DL Envelope C5 Envelope B5 Envelope Other Envelope 	<p>Specify the envelope size being manually loaded.</p> <p>Note: 10 Envelope is the U.S. factory default setting. DL Envelope is the international factory default setting.</p>
<p>Manual Envelope Type</p> <ul style="list-style-type: none"> Envelope Rough Envelope Custom Type [x] 	<p>Specify the envelope type being manually loaded.</p> <p>Note: Envelope is the factory default setting.</p>
<p>Note: Only installed trays and feeders are listed in this menu.</p>	

Configure MP menu

Use	To
Configure MP Cassette Manual First	Determine when the printer selects paper from the multipurpose feeder. Notes: <ul style="list-style-type: none"> • Cassette is the factory default setting. Cassette configures the multipurpose feeder as the default paper source. • Manual sets the multipurpose feeder only for manual-feed print jobs. • First sets the multipurpose feeder as the primary paper source regardless of settings.

Substitute Size menu

Use	To
Substitute Size Off Statement/A5 Letter/A4 All Listed	Substitute a specified paper size if the requested paper size is not available. Notes: <ul style="list-style-type: none"> • All Listed is the factory default setting. All available substitutions are allowed. • Off indicates that no size substitutions are allowed. • Setting a size substitution lets the print job continue without Change Paper appearing.

Paper Texture menu

Use	To
Plain Texture Smooth Normal Rough	Specify the relative texture of the plain paper loaded. Note: Normal is the factory default setting.
Card Stock Texture Smooth Normal Rough	Specify the relative texture of the card stock loaded. Notes: <ul style="list-style-type: none"> • Normal is the factory default setting. • The options appear only if card stock is supported.
Transparency Texture Smooth Normal Rough	Specify the relative texture of the transparencies loaded. Note: Normal is the factory default setting.
Recycled Texture Smooth Normal Rough	Specify the relative texture of the recycled paper loaded. Note: Normal is the factory default setting.

Use	To
Labels Texture Smooth Normal Rough	Specify the relative texture of the labels loaded. Note: Normal is the factory default setting.
Bond Texture Smooth Normal Rough	Specify the relative texture of the bond paper loaded. Note: Rough is the factory default setting.
Envelope Texture Smooth Normal Rough	Specify the relative texture of the envelopes loaded. Note: Normal is the factory default setting.
Rough Envelope Texture Rough	Specify the relative texture of the rough envelopes loaded.
Letterhead Texture Smooth Normal Rough	Specify the relative texture of the letterhead loaded. Note: Normal is the factory default setting.
Preprinted Texture Smooth Normal Rough	Specify the relative texture of the preprinted paper loaded. Note: Normal is the factory default setting.
Colored Texture Smooth Normal Rough	Specify the relative texture of the colored paper loaded. Note: Normal is the factory default setting.
Light Texture Smooth Normal Rough	Specify the relative texture of the paper loaded. Note: Normal is the factory default setting.
Heavy Texture Smooth Normal Rough	Specify the relative texture of the paper loaded. Note: Normal is the factory default setting.
Rough/Cotton Texture Rough	Specify the relative texture of the cotton paper loaded.
Custom [x] Texture Smooth Normal Rough	Specify the relative texture of the custom paper loaded. Notes: <ul style="list-style-type: none"> • Normal is the factory default setting. • The options appear only if the custom type is supported.

Paper Weight menu

Use	To
Plain Weight Light Normal Heavy	Specify the relative weight of the plain paper loaded. Note: Normal is the factory default setting.
Card Stock Weight Light Normal Heavy	Specify the relative weight of the card stock loaded. Note: Normal is the factory default setting.
Transparency Weight Light Normal Heavy	Specify the relative weight of the transparencies loaded. Note: Normal is the factory default setting.
Recycled Weight Light Normal Heavy	Specify the relative weight of the recycled paper loaded. Note: Normal is the factory default setting.
Labels Weight Light Normal Heavy	Specify the relative weight of the labels loaded. Note: Normal is the factory default setting.
Bond Weight Light Normal Heavy	Specify the relative weight of the bond paper loaded. Note: Normal is the factory default setting.
Envelope Weight Light Normal Heavy	Specify the relative weight of the envelope loaded. Note: Normal is the factory default setting.
Rough Envelope Weight Light Normal Heavy	Specify the relative weight of the rough envelope loaded. Note: Normal is the factory default setting.
Letterhead Weight Light Normal Heavy	Specify the relative weight of the letterhead loaded. Note: Normal is the factory default setting.
Preprinted Weight Light Normal Heavy	Specify the relative weight of the preprinted paper loaded. Note: Normal is the factory default setting.

Use	To
Colored Weight Light Normal Heavy	Specify the relative weight of the colored paper loaded. Note: Normal is the factory default setting.
Light Weight Light	Specify that the weight of the paper loaded is light.
Heavy Weight Heavy	Specify that the weight of the paper loaded is heavy.
Rough/Cotton Weight Light Normal Heavy	Specify the relative weight of the cotton or rough paper loaded. Note: Heavy is the factory default setting.
Custom [x] Weight Light Normal Heavy	Specify the relative weight of the custom paper loaded. Notes: <ul style="list-style-type: none"> • Normal is the factory default setting. • The options appear only when the custom type is supported.

Paper Loading menu

Use	To
Recycled Loading Duplex Off	Determine and set two-sided printing for all print jobs that specify Recycled as the paper type.
Bond Loading Duplex Off	Determine and set two-sided printing for all print jobs that specify Bond as the paper type.
Letterhead Loading Duplex Off	Determine and set two-sided printing for all print jobs that specify Letterhead as the paper type.
Preprinted Loading Duplex Off	Determine and set two-sided printing for all print jobs that specify Preprinted as the paper type.
Colored Loading Duplex Off	Determine and set two-sided printing for all print jobs that specify Colored as the paper type.
Notes: <ul style="list-style-type: none"> • Duplex sets two-sided printing as the default for all print jobs unless one-sided printing is set from Printing Preferences or Print dialog. • If Duplex is selected, then all print jobs are sent through the duplex unit, including one-sided jobs. • Off is the factory default setting for all the menus. 	

Use	To
Light Loading Duplex Off	Determine and set two-sided printing for all print jobs that specify Light as the paper type.
Heavy Loading Duplex Off	Determine and set two-sided printing for all print jobs that specify Heavy as the paper type.
Custom [x] Loading Duplex Off	Determine and set two-sided printing for all print jobs that specify Custom [x] as the paper type. Note: Custom [x] Loading is available only if the custom type is supported.
Notes: <ul style="list-style-type: none"> • Duplex sets two-sided printing as the default for all print jobs unless one-sided printing is set from Printing Preferences or Print dialog. • If Duplex is selected, then all print jobs are sent through the duplex unit, including one-sided jobs. • Off is the factory default setting for all the menus. 	

Custom Types menu

Use	To
Custom Type [x] Paper Card Stock Transparency Rough/Cotton Labels Envelope	Associate a paper or specialty media type with a Custom Type [x] name. Notes: <ul style="list-style-type: none"> • Paper is the factory default setting for Custom Type [x]. • The specialty media type must be supported in the selected tray or feeder in order to print from that source.
Recycled Paper Card Stock Transparency Rough/Cotton Labels Envelope Cotton	Specify a paper type when the Recycled setting is selected in other menus. Notes: <ul style="list-style-type: none"> • Paper is the factory default setting. • The Recycled paper type must be supported in the selected tray or feeder in order to print from that source.

Universal Setup menu

Use	To
Units of Measure Inches Millimeters	Identify the units of measure. Notes: <ul style="list-style-type: none"> • Inches is the US factory default setting. • Millimeters is the international factory default setting.
Portrait Width 3–8.5 inches 76–216 mm	Set the portrait width. Notes: <ul style="list-style-type: none"> • If the width exceeds the maximum, then the printer uses the maximum width allowed. • 8.5 inches is the US factory default setting. You can increase the width in 0.01-inch increments. • 216 mm is the international factory default setting. You can increase the width in 1-mm increments.
Portrait Height 3–14.17 inches 76–360 mm	Set the portrait height. Notes: <ul style="list-style-type: none"> • If the height exceeds the maximum, then the printer uses the maximum height allowed. • 14 inches is the US factory default setting. You can increase the height in 0.01-inch increments. • 356 mm is the international factory default setting. You can increase the height in 1-mm increments.
Feed Direction Short Edge Long Edge	Specify the feed direction if the paper can be loaded in either direction. Notes: <ul style="list-style-type: none"> • Short Edge is the factory default setting. • Long Edge appears only when the longest edge is shorter than the maximum width supported in the tray.

Reports menu

Reports menu

Use	To
Menu Settings Page	Print a report containing information about the paper loaded in trays, installed memory, total page count, alarms, timeouts, control panel language, TCP/IP address, status of supplies, status of the network connection, and other information.
Device Statistics	Print a report containing printer statistics, such as supply information and details about printed pages.

Use	To
Network Setup Page	Print a report containing information about the network printer settings, such as the TCP/IP address information. Note: This menu item appears only in network printers or in printers connected to print servers.
Profiles List	Print a list of profiles stored in the printer. Note: This menu item appears only when LDSS is enabled.
Print Fonts PCL Fonts PostScript Fonts	Print a report of all the fonts available for the printer language currently set in the printer. Note: A separate list is available for PCL and PostScript emulations.
Print Directory	Print a list of all the resources stored in an optional flash memory card. Notes: <ul style="list-style-type: none"> • Job Buffer Size must be set to 100%. • Make sure the optional flash memory card is installed correctly and working properly. • This menu item appears only when an optional flash memory card is installed.
Asset Report	Print a report containing printer asset information, such as serial number and model name.
Event Log Summary	Print a report containing a summary of all logged events.

Network/Ports menu

The menus in this section only appear in network printers or printers connected to print servers.

Active NIC menu

Use	To
Active NIC Auto [list of available network cards]	Notes: <ul style="list-style-type: none"> • Auto is the factory default setting. • This menu item appears only when an optional network card is installed.

MS312 and MS317 network/ports menu

Standard Network or Network [x] menu

Note: Only active ports appear in this menu. All inactive ports are omitted.

Use	To
PCL SmartSwitch On Off	Set the printer to automatically switch to PCL emulation when a print job requires it, regardless of the default printer language. Notes: <ul style="list-style-type: none"> • On is the factory default setting. • If PCL SmartSwitch is disabled, then the printer does not examine incoming data and it uses the default printer language specified in the Setup menu.
PS SmartSwitch On Off	Set the printer to automatically switch to PS emulation when a print job requires it, regardless of the default printer language. Notes: <ul style="list-style-type: none"> • On is the factory default setting. • If PS SmartSwitch is disabled, then the printer does not examine incoming data and it uses the default printer language specified in the Setup menu.
NPA Mode Off Auto	Set the printer to perform the special processing required for bidirectional communication following the conventions defined by the NPA protocol. Notes: <ul style="list-style-type: none"> • Auto is the factory default setting. • Changing this setting from the control panel and then exiting the menus causes the printer to restart. The menu selection is then updated.
Network Buffer Disabled Auto 3KB to [maximum size allowed]	Set the size of the network input buffer. Notes: <ul style="list-style-type: none"> • Auto is the factory default setting. • The value can be changed in 1-KB increments. • The maximum size allowed depends on the amount of memory in the printer, the size of the other link buffers, and whether Resource Save is set to On or Off. • To increase the maximum size range for the Network Buffer, disable or reduce the size of the parallel, serial, and USB buffers. • Changing this setting from the control panel and then exiting the menus causes the printer to restart. The menu selection is then updated.
Mac Binary PS On Off Auto	Set the printer to process Macintosh binary PostScript print jobs. Notes: <ul style="list-style-type: none"> • Auto is the factory default setting. • Off filters print jobs using the standard protocol. • On processes raw binary PostScript print jobs.

Use	To
Standard Network Setup OR Network [x] Setup Reports Network Card TCP/IP IPv6 Wireless AppleTalk	Display and set the printer network settings. Note: The Wireless menu appears only when the printer is connected to a wireless network.

Reports menu

To access the menu, navigate to either of the following:

- **Network/Ports > Standard Network > Standard Network Setup > Reports**
- **Network/Ports > Network [x] > Network [x] Setup > Reports**

Use	To
Print Setup Page	Print a report containing information about the network printer settings, such as the TCP/IP address.

Wireless menu

Note: This menu is available only in printers connected to a wireless network or printer models that have a wireless network adapter.

To access the menu, navigate to any of the following:

- **Network/Ports > Network [x] > Network [x] Setup > Wireless**

Use	To
Network Mode Infrastructure Ad hoc	Specify the network mode. Notes: <ul style="list-style-type: none"> • Ad hoc is the factory default setting. This configures wireless connection directly between the printer and a computer. • Infrastructure lets the printer access a network using an access point.
Compatibility 802.11b/g 802.11b/g/n	Specify the wireless standard for the wireless network. Note: The 802.11b/g/n is the factory default setting.
Choose Network	Select an available network for the printer to use.
View Signal Quality	View the quality of the wireless connection.
View Security Mode	View the encryption method for the wireless network.

MS315, MS415, and MS417 network/ports menus

Standard Network or Network [x] menus

Note: Only active ports appear in this menu.

Use	To
Energy Efficient Ethernet Enable Disable	Set the printer Ethernet connection to a energy-saving mode. Note: Enable is the factory default setting.
PCL SmartSwitch On Off	Set the printer to automatically switch to PCL emulation when a print job requires it, regardless of the default printer language. Notes: <ul style="list-style-type: none"> • On is the factory default setting. • When Off is used, the printer does not examine incoming data. The printer uses PostScript emulation if PS SmartSwitch is set to On. It uses the default printer language specified in the Setup menu if PS SmartSwitch is set to Off.
PS SmartSwitch On Off	Set the printer to automatically switch to PS emulation when a print job requires it, regardless of the default printer language. Notes: <ul style="list-style-type: none"> • On is the factory default setting. • When Off is used, the printer does not examine incoming data. The printer uses PCL emulation if PCL SmartSwitch is set to On. It uses the default printer language specified in the Setup menu if PCL SmartSwitch is set to Off.
NPA Mode Off Auto	Set the printer to perform the special processing required for bidirectional communication following the conventions defined by the NPA protocol. Notes: <ul style="list-style-type: none"> • Auto is the factory default setting. • Changing this setting from the control panel, and then exiting the menus causes the printer to restart. The menu selection is then updated.
Network Buffer Auto 3KB to [maximum size allowed]	Set the size of the network input buffer. Notes: <ul style="list-style-type: none"> • Auto is the factory default setting. • The value can be changed in 1-KB increments. • The maximum size allowed depends on the amount of memory in the printer, the size of the other link buffers, and whether Resource Save is set to On or Off. • To increase the maximum size range for the Network Buffer, disable or reduce the size of the parallel, serial, and USB buffers. • Changing this setting from the control panel and then exiting the menus causes the printer to restart. The menu selection is then updated.

Use	To
Mac Binary PS On Off Auto	Set the printer to process Macintosh binary PostScript print jobs. Notes: <ul style="list-style-type: none"> • Auto is the factory default setting. • Off filters print jobs using the standard protocol. • On processes raw binary PostScript print jobs.
Standard Network Setup OR Network [x] Setup Reports Network Card TCP/IP IPv6 Wireless AppleTalk	Display and set the printer network settings. Note: The Wireless menu appears only when the printer is connected to a wireless network.

Reports menu

Use	To
Print Setup Page	Print a report containing information about the network printer settings, such as the TCP/IP address.

Wireless menu

Note: This menu is available only in printer models connected to a wireless network.

Use	To
Wi-Fi Protected Setup (WPS) Start Push Button Method Start PIN Method	Establish a wireless network and enable network security. Notes: <ul style="list-style-type: none"> • Start Push Button Method connects the printer to a wireless network by pressing buttons on both the printer and the access point (wireless router) within a given period of time. • Start PIN Method connects the printer to a wireless network by using a PIN on the printer and entering it into the wireless settings of the access point.
Enable/Disable WPS Auto-detection Enable Disable	Automatically detect the connection method that an access point with WPS uses—Start Push Button Method or Start PIN Method. Note: Disable is the factory default setting.
Network Mode Infrastructure Ad hoc	Specify the network mode. Notes: <ul style="list-style-type: none"> • Ad hoc is the factory default setting. This configures wireless connection directly between the printer and a computer. • Infrastructure lets the printer access a network using an access point.

Use	To
Compatibility 802.11b/g 802.11 b/g/n	Specify the wireless standard for the wireless network. Note: The 802.11b/g/n is the factory default setting.
Choose Network	Select an available network for the printer to use.
View Signal Quality	View the quality of the wireless connection.
View Security Mode	View the encryption method for the wireless network.

Network Card menu

Use	To
View Card Status Connected Disconnected	View the connection status of the network card.
View Card Speed	View the speed of an active network card.
Network Address UAA LAA	View the network addresses.
Job Timeout 0–255 seconds	Set the amount of time it takes for a network print job to be canceled. Notes: <ul style="list-style-type: none"> • 90 seconds is the factory default setting. • A setting value of 0 disables the timeout. • If a value of 1–9 is selected, then the setting is saved as 10.
Banner Page Off On	Enable banner pages. Note: Off is the factory default setting

TCP/IP menu

Note: This menu is available only in network printers or printers connected to print servers.

Use	To
Set Hostname	Set the host name. Notes: <ul style="list-style-type: none"> • This setting can be changed only from the Embedded Web Server. • The host name can be up to 15 characters and can be a US-ASCII or alphanumeric character, or hyphen.
IP Address	View or change the current TCP/IP address. Note: Manually setting the IP address sets the Enable DHCP and Enable Auto IP settings to Off. It also sets Enable BOOTP and Enable RARP to Off on systems that support BOOTP and RARP.

Use	To
Netmask	View or change the current TCP/IP netmask.
Gateway	View or change the current TCP/IP gateway.
Enable DHCP On Off	Specify the DHCP address and parameter assignment. Note: On is the factory default setting.
Enable AutoIP Yes No	Specify the Zero Configuration Networking setting. Note: Yes is the factory default setting.
Enable FTP/TFTP Yes No	Enable the built-in FTP server, which lets you send files to the printer using File Transfer Protocol. Note: Yes is the factory default setting.
Enable HTTP Server Yes No	Enable the built-in Web server (Embedded Web Server). When enabled, the printer can be monitored and managed remotely using a Web browser. Note: Yes is the factory default setting.
WINS Server Address	View or change the current WINS server address.
Enable DDNS Yes No	View or change the current DDNS setting. Note: Yes is the factory default setting.
Enable mDNS Yes No	View or change the current mDNS setting. Note: Yes is the factory default setting.
DNS Server Address	View or change the current DNS server address.
Backup DNS Server Address	View or change the backup DNS server addresses.
Backup DNS Server Address 2	
Backup DNS Server Address 3	
Enable HTTPS Yes No	View or change the current HTTPS setting. Note: Yes is the factory default setting.

IPv6 menu

To access the menu, navigate to any of the following:

- **Network/Ports > Standard Network > Standard Network Setup > IPv6**
- **Network/Ports > Network [x] > Network [x] Setup > IPv6**

Note: This menu is available only in network printers or printers connected to print servers.

Use	To
Enable IPv6 On Off	Enable Internet Protocol Version Six (IPv6) in the printer. IPv6 uses bigger numbers to create IP addresses. Note: On is the factory default setting.
Auto Configuration On Off	Specify whether or not the network adapter accepts the automatic IPv6 address configuration entries provided by a router. Note: On is the factory default setting.
Set Hostname*	Set the host name. Note: The host name is limited to 15 characters, and accepts US-ASCII, alphanumeric characters and hyphen only.
View Address*	View the current IPv6 addresses.
View Router Address*	View the current router address.
Enable DHCPv6 On Off	Enable DHCPv6 in the printer. Note: On is the factory default setting.
* These settings can be changed only from the Embedded Web Server.	

Standard USB menu

Use	To
PCL SmartSwitch On Off	Set the printer to automatically switch to PCL emulation when a print job received through a USB port requires it, regardless of the default printer language. Notes: <ul style="list-style-type: none"> • On is the factory default setting. • When set to Off, the printer does not examine incoming data. The printer uses PostScript emulation if the PS SmartSwitch is set to On. It uses the default printer language specified in the Setup menu if the PS SmartSwitch is set to Off.
PS SmartSwitch On Off	Set the printer to automatically switch to PS emulation when a print job received through a USB port requires it, regardless of the default printer language. Notes: <ul style="list-style-type: none"> • On is the factory default setting. • When set to Off, the printer does not examine incoming data. The printer uses PCL emulation if the PCL SmartSwitch is set to On. It uses the default printer language specified in the Setup menu if the PCL SmartSwitch is set to Off.

Use	To
<p>NPA Mode</p> <p>On Off Auto</p>	<p>Set the printer to perform the special processing required for bidirectional communication following the conventions defined by the NPA protocol.</p> <p>Notes:</p> <ul style="list-style-type: none"> • Auto is the factory default setting. Auto sets the printer to examine data, determine the format, and then process it appropriately. • The printer automatically restarts when changing the setting from the printer control panel. The menu selection is then updated.
<p>USB Buffer</p> <p>Disabled Auto 3K to [maximum size allowed]</p>	<p>Set the size of the USB input buffer.</p> <p>Notes:</p> <ul style="list-style-type: none"> • Auto is the factory default setting. • Disabled turns off job buffering. • The USB buffer size value can be changed in 1-KB increments. • The maximum size allowed depends on the amount of memory in the printer, the size of the other link buffers, and whether Resource Save is set to On or Off. • To increase the maximum size range for USB Buffer, disable or reduce the size of the parallel, serial, and network buffers. • The printer automatically restarts when the setting is changed from the printer control panel. The menu selection is then updated.
<p>Mac Binary PS</p> <p>On Off Auto</p>	<p>Set the printer to process Macintosh binary PostScript print jobs.</p> <p>Notes:</p> <ul style="list-style-type: none"> • Auto is the factory default setting. • On processes raw binary PostScript print jobs. • Off filters print jobs using the standard protocol.
<p>ENA Address</p> <p>yyy.yyy.yyy.yyy</p>	<p>Set the network address information for an external print server.</p> <p>Note: This menu is available only when the printer is attached to an external print server through the USB port.</p>
<p>ENA Netmask</p> <p>yyy.yyy.yyy.yyy</p>	<p>Set the netmask information for an external print server.</p> <p>Note: This menu is available only when the printer is attached to an external print server through the USB port.</p>
<p>ENA Gateway</p> <p>yyy.yyy.yyy.yyy</p>	<p>Set the gateway information for an external print server.</p> <p>Note: This menu is available only when the printer is attached to an external print server through the USB port.</p>

Standard Parallel menu

Use	To
PCL SmartSwitch On Off	Set the printer to automatically switch to PCL emulation when a print job received through a serial port requires it, regardless of the default printer language. Notes: <ul style="list-style-type: none"> • On is the factory default setting. • When set to Off, the printer does not examine incoming data. The printer uses PostScript emulation if PS SmartSwitch is set to On. It uses the default printer language specified in the Setup menu if PS SmartSwitch is set to Off.
PS SmartSwitch On Off	Set the printer to automatically switch to PS emulation when a print job received through a serial port requires it, regardless of the default printer language. Notes: <ul style="list-style-type: none"> • On is the factory default setting. • When set to Off, the printer does not examine incoming data. The printer uses PCL emulation if PCL SmartSwitch is set to On. It uses the default printer language specified in the Setup menu if PCL SmartSwitch is set to Off.
NPA Mode On Off Auto	Set the printer to perform the special processing required for bidirectional communication following the conventions defined by the NPA protocol. Notes: <ul style="list-style-type: none"> • Auto is the factory default setting. • Changing this setting from the control panel and then exiting the menus causes the printer to restart. The menu selection is then updated.
Parallel Buffer Disabled Auto 3K to [maximum size allowed]	Set the size of the parallel input buffer. Notes: <ul style="list-style-type: none"> • Auto is the factory default setting. • Disabled turns off job buffering. Any print jobs already buffered on the printer hard disk are printed before normal processing resumes. • The parallel buffer size setting can be changed in 1-KB increments. • The maximum size allowed depends on the amount of memory in the printer, the size of the other link buffers, and whether Resource Save is set to On or Off. • To increase the maximum size range for the Parallel Buffer, disable or reduce the size of the USB, serial, and network buffers. • Changing this setting from the control panel and then exiting the menus causes the printer to restart. The menu selection is then updated.
Advanced Status On Off	Enable bidirectional communication through the parallel port. Notes: <ul style="list-style-type: none"> • On is the factory default setting. • Off disables parallel port negotiation.

Use	To
Protocol Standard Fastbytes	Specify the parallel port protocol. Notes: <ul style="list-style-type: none"> Fastbytes is the factory default setting. It provides compatibility with most existing parallel ports and is the recommended setting. Standard tries to resolve parallel port communication problems.
Honor Init On Off	Determine if the printer honors printer hardware initialization requests from the computer. Notes: <ul style="list-style-type: none"> Off is the factory default setting. The computer requests initialization by activating the Init signal from the parallel port. Many personal computers activate the Init signal each time the computer is turned on.
Parallel Mode 2 On Off	Determine if the parallel port data is sampled on the leading or trailing edge of a strobe. Note: On is the factory default setting.
Mac Binary PS On Off Auto	Set the printer to process Macintosh binary PostScript print jobs. Notes: <ul style="list-style-type: none"> Auto is the factory default setting. Off filters print jobs using the standard protocol. On processes raw binary PostScript print jobs.
ENA Address yyy.yyy.yyy.yyy	Set the network address information for an external print server. Note: This menu item is available only if the printer is attached to an external print server through the USB port.
ENA Netmask yyy.yyy.yyy.yyy	Set the netmask information for an external print server. Note: This menu item is available only if the printer is attached to an external print server through the USB port.
ENA Gateway yyy.yyy.yyy.yyy	Set the gateway information for an external print server. Note: This menu item is available only if the printer is attached to an external print server through the USB port.

AppleTalk menu

To access the menu, navigate to either of the following:

- **Network/Ports > Standard Network > Standard Network Setup > AppleTalk**
- **Network/Ports > Network [x] > Network [x] Setup > AppleTalk**

Use	To
Activate Yes No	Enable or disable AppleTalk support. Note: No is the factory default setting.

Use	To
View Name	Show the assigned AppleTalk name. Note: The AppleTalk name can be changed only from the Embedded Web Server.
View Address	Show the assigned AppleTalk address. Note: The AppleTalk address can be changed only from the Embedded Web Server.
Set Zone [list of zones available on the network]	Provide a list of AppleTalk zones available on the network. Note: The default zone for the network is the factory default setting.

SMTP Setup menu

Use	To
Primary SMTP Gateway	Specify SMTP server gateway and port information. Note: 25 is the default SMTP gateway port.
Primary SMTP Gateway Port	
Secondary SMTP Gateway	
Secondary SMTP Gateway Port	
SMTP Timeout 5–30	Specify the amount of time in seconds before the server stops trying to send an e-mail. Note: 30 seconds is the factory default setting.
Reply Address	Specify a reply address of up to 128 characters in the e-mail sent by the printer.
Use SSL Disabled Negotiate Required	Set the printer to use SSL for increased security when connecting to the SMTP server. Notes: <ul style="list-style-type: none"> • Disabled is the factory default setting. • When the Negotiate setting is used, the SMTP server determines if SSL will be used.
SMTP Server Authentication No authentication required Login/Plain CRAM-MD5 Digest-MD5 NTLM Kerberos 5	Specify the type of user authentication required for printing privileges. Note: “No authentication required” is the factory default setting.

Use	To
Device-Initiated E-mail None Use Device SMTP Credentials	Specify what credentials will be used when communicating to the SMTP server. Some SMTP servers require credentials to send an e-mail. Notes: <ul style="list-style-type: none"> • None is the factory default setting for Device-Initiated E-mail. • Device Userid and Device Password are used to log in to the SMTP server when Use Device SMTP Credentials is selected.
Device Userid	
Device Password	

Security menu

MS315, MS415, and MS417 security menu

Confidential Print menu

Use	To
Max Invalid PIN Off 2–10	Limit the number of times an invalid PIN can be entered. Note: Once the limit is reached, the print jobs for that user name and PIN are deleted.
Confidential Job Expiration Off 1 hour 4 hours 24 hours 1 week	Limit the amount of time a confidential print job stays in the printer before it is deleted. Notes: <ul style="list-style-type: none"> • If the Confidential Job Expiration setting is changed while confidential print jobs reside in the printer RAM, then the expiration time for those print jobs does not change to the new default value. • If the printer is turned off, then all confidential jobs held in the printer RAM are deleted.
Repeat Job Expiration Off 1 hour 4 hours 24 hours 1 week	Set a time limit on how long the printer stores print jobs.
Verify Job Expiration Off 1 hour 4 hours 24 hours 1 week	Set a time limit on how long the printer stores print jobs needing verification.
Note: Off is the factory default setting.	

Use	To
Reserve Job Expiration Off 1 hour 4 hours 24 hours 1 week	Set a time limit on how long the printer stores print jobs for printing at a later time.
Note: Off is the factory default setting.	

Security Audit Log menu

Use	To
Delete Log Delete now Do not delete	Specify whether or not audit logs are deleted. Note: Delete now is the factory default setting.
Configure Log Enable Audit Yes No Enable Remote Syslog No Yes Remote Syslog Facility 0–23 Severity of events to log 0–7	Specify how and whether or not audit logs are created. Notes: <ul style="list-style-type: none"> • Enable Audit determines if events are recorded in the secure audit log and remote syslog. No is the factory default setting. • Enable Remote Syslog determines if logs are sent to a remote server. No is the factory default setting. • Remote Syslog Facility determines the value used to send logs to the remote syslog server. 4 is the factory default setting. • If the security audit log is activated, then the severity value of each event is recorded. 4 is the factory default setting.

Set Date and Time menu

Use	To
Current Date and Time	View the current date and time settings for the printer. Note: The date and time are set in YYYY-MM-DD HH:MM format.
Manually Set Date and Time [input date/time]	Enter the date and time. Note: Setting the date and time using this menu automatically sets Enable NTP to Off.
Time Zone [list of time zones]	Select the time zone. Note: GMT is the factory default setting.
Automatically observe DST On Off	Set the printer to use the applicable daylight saving time (DST) start and end times associated with the printer Time Zone setting. Note: On is the factory default setting.

Use	To
Enable NTP On Off	Enable Network Time Protocol, which synchronizes the clocks of devices on a network. Notes: <ul style="list-style-type: none"> • On is the factory default setting. • Enable NTP is automatically set to Off if you manually set the date and time.

Settings menu

MS312 and MS317 general settings

General Settings menu

Use	To
Display Language English Francais Deutsch Italiano Espanol Dansk Norsk Nederlands Svenska Portuguese Suomi Russian Polski Greek Magyar Turkce Cesky Simplified Chinese Traditional Chinese Korean Japanese	Set the language of the text appearing on the display.
Show Supply Estimates Show estimates Do not show estimates	View the estimates of the supplies on the control panel, Embedded Web Server, menu settings, and device statistics reports.

Use	To
<p>Eco-Mode Off Energy Energy/Paper Paper</p>	<p>Minimize the use of energy, paper, or specialty media. Note: Off is the factory default setting. This resets the printer to its factory default settings.</p>
<p>Quiet Mode Off On</p>	<p>Minimize the printer noise. Note: Off is the factory default setting.</p>
<p>Run Initial setup Yes No</p>	<p>Run the setup wizard.</p>
<p>Paper Sizes US Metric</p>	<p>Specify the unit of measurement for paper sizes. Notes:</p> <ul style="list-style-type: none"> • US is the factory default setting. • The initial setting is determined by your country or region selection in the initial setup wizard.
<p>Timeouts Sleep Mode Disabled 1–120</p>	<p>Set the amount of time in minutes the printer waits after a job is printed before it goes into a reduced power state. Notes:</p> <ul style="list-style-type: none"> • 20 is the factory default setting. • Disabled appears only when Energy Conserve is set to Off. • The maximum amount of time is increased to 240 minutes when Energy Conserve is set to Off. • Lower settings conserve more energy, but may require longer warm-up times. • Select a high setting if the printer is in constant use. Under most circumstances, this keeps the printer ready to print with minimum warm-up time.
<p>Timeouts Print with Display Off Allow printing with display off Display on when printing</p>	<p>Print a job with the display turned off. Note: Display on when printing is the factory default setting.</p>
<p>Timeouts Hibernate Timeout Disabled 1–3 hours 6 hours 1–3 days 1–2 weeks 1 month</p>	<p>Set the amount of time the printer waits before it enters Hibernate mode. Note: 3 days is the factory default setting.</p>

Use	To
Timeouts Hibernate Timeout on Connection Hibernate Do Not Hibernate	Set the printer to Hibernate mode even if there is an active Ethernet connection. Note: Do Not Hibernate is the factory default setting.
Timeouts Screen Timeout 15–300	Set the amount of time in seconds before returning the control panel to a Ready state. Note: 30 is the factory default setting.
Timeouts Print Timeout Disabled 1–255	Set the amount of time in seconds the printer waits to receive an end-of-job message before canceling the rest of the job. Notes: <ul style="list-style-type: none"> • 90 is the factory default setting. • When the timer expires, any partially printed page still in the printer is printed, and then the printer checks to see if any new print jobs are waiting. • Print Timeout is available only when using PCL emulation. This setting has no effect on PostScript emulation print jobs.
Timeouts Wait Timeout Disabled 15–65535	Set the amount of time in seconds the printer waits for additional data before canceling a print job. Note: 40 is the factory default setting.
Error Recovery Auto Reboot Reboot when idle Reboot always Reboot never Max Auto Reboots 1–20	Set the printer to restart when an error occurs. Notes: <ul style="list-style-type: none"> • Reboot always is the factory default setting for Auto Reboot. • 2 is the factory default setting for Max Auto Reboots.
Print Recovery Auto Continue Disabled 5–255	Let the printer automatically continue printing from certain offline situations when these are not resolved within the specified time period. Note: Disabled is the factory default setting.
Print Recovery Jam Recovery On Off Auto	Specify whether the printer reprints jammed pages. Note: Auto is the factory default setting. The printer reprints jammed pages unless the memory required to hold the pages is needed for other printer tasks.

Use	To
<p>Print Recovery</p> <p>Jam Assist</p> <p>On</p> <p>Off</p>	<p>Set the printer to automatically check for jammed paper.</p> <p>Notes:</p> <ul style="list-style-type: none"> On is the factory default setting. This sets the printer to automatically dump blank pages or partially printed pages to the standard bin after a jammed page has been cleared. Off requires the user to remove all pages from all possible jam locations.
<p>Print Recovery</p> <p>Page Protect</p> <p>Off</p> <p>On</p>	<p>Successfully print a page that may not have printed otherwise.</p> <p>Notes:</p> <ul style="list-style-type: none"> Off is the factory default setting. This prints a partial page when there is not enough memory to print the whole page. On sets the printer to process the whole page so that the entire page prints.
<p>Press Sleep Button</p> <p>Do nothing</p> <p>Sleep</p> <p>Hibernate</p>	<p>Determine how the printer, while in idle state, reacts to a short press of the Sleep button.</p> <p>Note: Sleep is the factory default setting.</p>
<p>Press and Hold Sleep Button</p> <p>Do nothing</p> <p>Sleep</p> <p>Hibernate</p>	<p>Determine how the printer, while in idle state, reacts to a long press of the Sleep button.</p> <p>Note: Do nothing is the factory default setting.</p>
<p>Factory Defaults</p> <p>Do Not Restore</p> <p>Restore Now</p>	<p>Use the printer factory default settings except the Network/Ports menu settings.</p> <p>Notes:</p> <ul style="list-style-type: none"> Do Not Restore is the factory default setting. Restore Now deletes all downloads stored in RAM. Downloads stored in the flash memory are not affected.
<p>Custom Home Message</p> <p>Off</p> <p>IP Address</p> <p>Hostname</p> <p>Contact Name</p> <p>Location</p> <p>Zero Configuration Name</p> <p>Custom Text 1</p>	<p>Select a custom home message that appears as an alternating display of the printer status.</p> <p>Note: Off is the factory default setting.</p>

MS315, MS415, and MS417 general settings

General Settings menu

Use	To
Display Language English Francais Deutsch Italiano Espanol Dansk Norsk Nederlands Svenska Portuguese Suomi Russian Polski Greek Magyar Turkce Cesky Simplified Chinese Traditional Chinese Korean Japanese	Set the language of the text appearing on the display. Note: Not all languages are available for all models. You may need to install special hardware for some languages.
Show Supply Estimates Show estimates Do not show estimates	View the estimates of the supplies on the control panel, Embedded Web Server, menu settings, and device statistics reports.
Eco-Mode Off Energy Energy/Paper Paper	Minimize the use of energy, paper, or specialty media. Notes: <ul style="list-style-type: none"> • Off is the factory default setting. This setting resets the printer to its factory default settings. • When setting Eco-Mode to Energy or Paper, performance may be affected, but print quality is not.
Quiet Mode Off On	Minimize the printer noise. Note: Off is the factory default setting.
Run Initial setup Yes No	Run the setup wizard.

Use	To
<p>Paper Sizes</p> <ul style="list-style-type: none"> US Metric 	<p>Specify the unit of measurement for paper sizes.</p> <p>Notes:</p> <ul style="list-style-type: none"> • US is the factory default setting. • The initial setting is determined by your country or region selection in the initial setup wizard.
<p>Home screen customization</p> <ul style="list-style-type: none"> Change Language Search Held Jobs Held Jobs USB Drive 	<p>Change the icons that appear on the home screen.</p> <p>For each icon, select from the following options:</p> <ul style="list-style-type: none"> Display Do not display
<p>Alarms¹</p> <ul style="list-style-type: none"> Alarm Control Cartridge Alarm 	<p>Set an alarm when the printer requires user intervention.</p> <p>For each alarm type, select from the following options:</p> <ul style="list-style-type: none"> Off Single Continuous <p>Notes:</p> <ul style="list-style-type: none"> • Single is the factory default setting for Alarm Control. • Off is the factory default setting for Cartridge Alarm. • Continuous repeats three beeps every 10 seconds.
<p>Timeouts</p> <ul style="list-style-type: none"> Sleep Mode Disabled 1–120 	<p>Set the amount of time in minutes the printer waits after a job is printed before it goes into a reduced power state.</p> <p>Notes:</p> <ul style="list-style-type: none"> • 20 is the factory default setting. • Disabled appears only when Energy Conserve is set to Off. • Lower settings conserve more energy, but may require longer warm-up times. • Select a high setting if the printer is in constant use. Under most circumstances, this keeps the printer ready to print with minimum warm-up time.
<p>Timeouts</p> <ul style="list-style-type: none"> Print with Display Off Allow printing with display off Display on when printing 	<p>Print a job with the display turned off.</p> <p>Note: Display on when printing is the factory default setting.</p>

Use	To
<p>Timeouts</p> <p>Hibernate Timeout</p> <ul style="list-style-type: none"> Disabled 20 minutes 1–3 hours 6 hours 1–3 days 1–2 weeks 1 month 	<p>Set the amount of time the printer waits before it enters Hibernate mode.</p> <p>Note: 3 days is the factory default setting.</p>
<p>Timeouts</p> <p>Hibernate Timeout on Connection</p> <ul style="list-style-type: none"> Hibernate Do Not Hibernate 	<p>Set the printer to Hibernate mode even if there is an active Ethernet or fax connection.</p> <p>Note: Hibernate is the factory default setting.</p>
<p>Timeouts</p> <p>Screen Timeout</p> <ul style="list-style-type: none"> 15–300 	<p>Set the amount of time in seconds before returning the control panel to a Ready state.</p> <p>Note: 30 is the factory default setting.</p>
<p>Timeouts</p> <p>Print Timeout</p> <ul style="list-style-type: none"> Disabled 1–255 	<p>Set the amount of time in seconds the printer waits to receive an end-of-job message before canceling the rest of the print job.</p> <p>Notes:</p> <ul style="list-style-type: none"> • 90 is the factory default setting. • When the timer expires, any partially printed page still in the printer is printed, and then the printer checks for new print jobs in the print queue. • Print Timeout is available only when using PCL emulation. This has no effect on PostScript emulation print jobs.
<p>Timeouts</p> <p>Wait Timeout</p> <ul style="list-style-type: none"> Disabled 15–65535 	<p>Set the amount of time in seconds the printer waits for more data before canceling a print job.</p> <p>Notes:</p> <ul style="list-style-type: none"> • 40 is the factory default setting. • Wait Timeout is available only when the printer is using PostScript emulation. This setting has no effect on PCL emulation print jobs.
<p>Error Recovery</p> <p>Auto Reboot</p> <ul style="list-style-type: none"> Reboot when idle Reboot always Reboot never 	<p>Set the printer to restart when an error occurs.</p> <p>Note: Reboot always is the factory default setting.</p>
<p>Error Recovery</p> <p>Max Auto Reboots</p> <ul style="list-style-type: none"> 1–20 	<p>Determine the number of automatic reboots the printer can perform.</p> <p>Note: 2 is the factory default setting.</p>

Use	To
Print Recovery Auto Continue Disabled 5–255 sec	Let the printer automatically continue printing from certain offline situations when these are not resolved within the specified time period. Note: Disabled is the factory default setting.
Print Recovery Jam Recovery On Off Auto	Specify whether the printer reprints jammed pages. Note: Auto is the factory default setting. The printer reprints jammed pages unless the memory required to hold the pages is needed for other printer tasks.
Print Recovery Jam Assist On Off	Set the printer to check for jammed paper automatically. Note: On is the factory default setting.
Print Recovery Page Protect Off On	Successfully print a page that may not have printed otherwise. Notes: <ul style="list-style-type: none"> • Off is the factory default setting. This prints a partial page when there is not enough memory to print the whole page. • On sets the printer to print the entire page.
Information Sent to Lexmark Supplies and Page Usage (Anonymous) On Off	Send anonymous device usage information to Lexmark. Note: The default value depends on the selection made during initial setup.
Information Sent to Lexmark Device Performance (Anonymous) On Off	Send anonymous device function and error information to Lexmark. Note: The default value depends on the selection made during initial setup.
Information Sent to Lexmark Start Send Stop Send	Set the time for sending anonymous information to Lexmark.
Press Sleep Button Do nothing Sleep Hibernate	Determine how the printer, while in idle state, reacts to a short press of the Sleep button. Note: Sleep is the factory default setting.
Press and Hold Sleep Button Do nothing Sleep Hibernate	Determine how the printer, while in idle state, reacts to a long press of the Sleep button. Note: Do nothing is the factory default setting.

Use	To
<p>Factory Defaults Do Not Restore Restore Now</p>	<p>Restore the printer factory default settings.</p> <p>Notes:</p> <ul style="list-style-type: none"> • Do Not Restore is the factory default setting. • Restore Now returns all printer settings to the factory default settings except Network/Ports menu settings. All downloads stored in the RAM are deleted. Downloads stored in the flash memory or on a hard disk are not affected.
<p>Export Configuration File¹ Export</p>	<p>Export configuration files to a flash drive.</p>

Print Settings

Setup menu

Use	To
<p>Printer Language PCL Emulation PS Emulation</p>	<p>Set the default printer language.</p> <p>Notes:</p> <ul style="list-style-type: none"> • PCL Emulation is the factory default setting. • PostScript emulation uses a PostScript interpreter for processing print jobs. • PCL Emulation uses a PCL interpreter for processing print jobs. • Setting a printer language default does not prevent a software program from sending print jobs that use another printer language.
<p>Print Area Normal Whole Page</p>	<p>Set the logical and physical printable area.</p> <p>Notes:</p> <ul style="list-style-type: none"> • Normal is the factory default setting. When attempting to print data on the non-printable area defined by the Normal setting, the printer clips the image at the boundary. • Whole Page allows the image to be moved into the non-printable area defined by the Normal setting. This setting affects only pages printed using a PCL 5 interpreter and has no effect on pages printed using the PCL XL or PostScript interpreter.

Use	To
<p>Download Target</p> <p>RAM</p> <p>Flash</p>	<p>Set the storage location for downloads.</p> <p>Notes:</p> <ul style="list-style-type: none"> • RAM is the factory default setting. Storing downloads in the RAM is temporary. • Storing downloads in a flash memory places them in permanent storage. Downloads remain in the flash memory even when the printer is turned off. • This menu item appears only when an optional flash memory is installed.
<p>Resource Save</p> <p>On</p> <p>Off</p>	<p>Specify how the printer handles temporary downloads, such as fonts and macros stored in the RAM, when the printer receives a print job that requires more than the available memory.</p> <p>Notes:</p> <ul style="list-style-type: none"> • Off is the factory default setting. Off sets the printer to retain downloads only until memory is needed. Downloads are deleted in order to process print jobs. • On sets the printer to retain downloads during language changes and printer resets. If the printer runs out of memory, then Memory Full [38] appears on the printer display, but downloads are not deleted.

Finishing menu

Use	To
<p>Sides (Duplex)</p> <p>1 sided</p> <p>2 sided</p>	<p>Specify whether two-sided (duplex) printing is set as the default for all print jobs.</p> <p>Notes:</p> <ul style="list-style-type: none"> • “1 sided” is the factory default setting. • You can set two-sided printing from the software program. <p>For Windows users:</p> <ol style="list-style-type: none"> 1 Click File > Print. 2 Click Properties, Preferences, Options, or Setup. <p>For Macintosh users:</p> <ol style="list-style-type: none"> 1 Choose File > Print. 2 Adjust the settings from the print dialog and pop-up menus.
<p>Duplex Binding</p> <p>Long Edge</p> <p>Short Edge</p>	<p>Define the way two-sided pages are bound and printed.</p> <p>Notes:</p> <ul style="list-style-type: none"> • Long Edge is the factory default setting. Long Edge binds pages along their long edge (left edge for portrait and top edge for landscape). • Short Edge binds pages along their short edge (top edge for portrait and left edge for landscape).

Use	To
Copies 1–999	Specify the default number of copies for each print job. Note: 1 is the factory default setting.
Blank Pages Do Not Print Print	Specify whether to insert blank pages in a print job. Note: Do Not Print is the factory default setting.
Collate (1,1,1) (2,2,2) (1,2,3) (1,2,3)	Stack the pages of a print job in sequence when printing multiple copies. Note: “(1,2,3) (1,2,3)” is the factory default setting.
Separator Sheets Off Between Copies Between Jobs Between Pages	Specify whether to insert blank separator sheets. Notes: <ul style="list-style-type: none"> • Off is the factory default setting. • Between Copies inserts a blank sheet between each copy of a print job if Collate is set to (1,1,1) (2,2,2). If Collate is set to (1,2,3) (1,2,3), then a blank page is inserted between each set of printed pages, such as after all page 2's and after all page 3's. • Between Jobs inserts a blank sheet between print jobs. • Between Pages inserts a blank sheet between each page of a print job. This setting is useful when printing transparencies or when inserting blank pages in a document.
Separator Source Tray [x] Multi-Purpose Feeder	Specify the paper source for separator sheets. Note: Tray 1 (standard tray) is the factory default setting.
Paper Saver Off 2-Up 3-Up 4-Up 6-Up 9-Up 12-Up 16-Up	Print multiple-page images on one side of a paper. Notes: <ul style="list-style-type: none"> • Off is the factory default setting. • The number selected is the number of page images that will print per side.
Paper Saver Ordering Horizontal Reverse Horizontal Reverse Vertical Vertical	Specify the positioning of multiple-page images when using Paper Saver. Notes: <ul style="list-style-type: none"> • Horizontal is the factory default setting. • Positioning depends on the number of page images and whether they are in portrait or landscape orientation.
Paper Saver Orientation Auto Landscape Portrait	Specify the orientation of a multiple-page document. Note: Auto is the factory default setting. The printer chooses between portrait and landscape.

Use	To
Paper Saver Border None Solid	Print a border when using Paper Saver. Note: None is the factory default setting.

Quality menu

Use	To
Print Resolution 300 dpi 600 dpi 1200 dpi 1200 Image Q 2400 Image Q	Specify the printed output resolution in dots per inch. Note: 600 dpi is the factory default setting.
Pixel Boost Off Fonts Horizontally Vertically Both directions	Enable more pixels to print in clusters for clarity, in order to enhance images horizontally or vertically, or to enhance fonts. Note: Off is the factory default setting.
Toner Darkness 1–10	Lighten or darken the printed output. Notes: <ul style="list-style-type: none"> • 8 is the factory default setting. • Selecting a smaller number can help conserve toner.
Enhance Fine Lines On Off	Enable a print mode preferable for files such as architectural drawings, maps, electrical circuit diagrams, and flow charts. Notes: <ul style="list-style-type: none"> • Off is the factory default setting. • You can set this option from the printer software. For Windows users, click File > Print, and then click Properties, Preferences, Options, or Setup. For Macintosh users, choose File > Print, and then adjust the settings from the Print dialog and context menus. • To set this option using the Embedded Web Server, type the network printer IP address in the Web browser address field.
Gray Correction Auto Off	Automatically adjust the contrast enhancement applied to images. Note: Auto is the factory default setting.
Brightness -6 to 6	Adjust the printed output either by lightening or darkening it. You can conserve toner by lightening the output. Note: 0 is the factory default setting.
Contrast 0–5	Adjust the contrast of printed objects. Note: 0 is the factory default setting.

XPS menu

Use	To
Print Error Pages Off On	Print a page containing information on errors, including XML markup errors. Note: Off is the factory default setting.

PostScript menu

Use	To
Print PS Error On Off	Print a page containing the PostScript error. Note: Off is the factory default setting.
Lock PS Startup Mode On Off	Disable the SysStart file. Note: Off is the factory default setting.
Font Priority Resident Flash	Establish the font search order. Notes: <ul style="list-style-type: none"> • Resident is the factory default setting. • This menu item is available only when a formatted flash memory card is installed and operating properly. • Make sure the flash memory card is not read/write-, write-, or password-protected. • Job Buffer Size must not be set to 100%.

MS312 and MS317 print settings

Utilities menu

Use	To
Format Flash Yes No	Format the flash memory. Warning—Potential Damage: Do not turn off the printer while the flash memory is being formatted. Notes: <ul style="list-style-type: none"> • Flash memory refers to the memory added by installing a flash memory card in the printer. • Yes deletes all data stored in the flash memory. • No cancels the format request. • The flash memory option card must not be read/write- or write-protected. • This menu item appears only when a non-defective flash memory card is installed.

Use	To
Activate Hex Trace	Isolate the source of a print job problem. Notes: <ul style="list-style-type: none"> • When activated, all data sent to the printer is printed in hexadecimal and character representation, and control codes are not executed. • To exit or deactivate Hex Trace, restart the printer.
Coverage Estimator Off On	Provide an estimate of the percentage coverage of toner on a page. The estimate is printed on a separate page at the end of each print job. Note: Off is the factory default setting.

PCL Emul menu

Use	To
Font Source Resident Download Flash All	Specify the set of fonts used by the Font Name menu. Notes: <ul style="list-style-type: none"> • Resident is the factory default setting. This shows the factory default set of fonts downloaded in the RAM. • Download shows all the fonts downloaded in the RAM. • Flash shows all fonts resident in that option. The optional flash memory card must be properly formatted and cannot be read/write-, write-, or password-protected. • All shows the fonts available to any option.
Font Name Courier 10	Identify a specific font and the option where it is stored. Note: Courier 10 is the factory default setting. This shows the font name, font ID, and the storage location in the printer. The font source abbreviation is R for Resident, F for Flash, and D for Download.
Symbol Set 10U PC-8 12U PC-850	Specify the symbol set for each font name. Notes: <ul style="list-style-type: none"> • 10U PC-8 is the U.S. factory default setting. 12U PC-850 is the international factory default setting. • A symbol set is a set of alphabetic and numeric characters, punctuation, and special symbols. Symbol sets support the different languages or specific program, such as math symbols for scientific text. Only the supported symbol sets are shown.
PCL Emulation Settings Point Size 1.00–1008.00	Change the point size for scalable typographic fonts. Notes: <ul style="list-style-type: none"> • 12 is the factory default setting. • Point size refers to the height of the characters in the font. One point equals approximately 0.014 inch. • Point sizes can be increased or decreased in 0.25-point increments.

Use	To
<p>PCL Emulation Settings</p> <p>Pitch</p> <p>0.08–100</p>	<p>Specify the font pitch for scalable monospaced fonts.</p> <p>Notes:</p> <ul style="list-style-type: none"> • 10 is the factory default setting. • Pitch refers to the number of fixed-space characters per inch (cpi). • Pitch can be increased or decreased in 0.01-cpi increments. • For nonscalable monospaced fonts, the pitch appears on the display but it cannot be changed.
<p>PCL Emulation Settings</p> <p>Orientation</p> <p>Portrait</p> <p>Landscape</p>	<p>Specify the orientation of text and graphics on the page.</p> <p>Notes:</p> <ul style="list-style-type: none"> • Portrait is the factory default setting. Portrait prints text and graphics parallel to the short edge of the page. • Landscape prints text and graphics parallel to the long edge of the page.
<p>PCL Emulation Settings</p> <p>Lines per Page</p> <p>1–255</p>	<p>Specify the number of lines that print on each page.</p> <p>Notes:</p> <ul style="list-style-type: none"> • 60 is the US factory default setting. 64 is the international default setting. • The printer sets the amount of space between each line based on the Lines per Page, Paper Size, and Orientation settings. Select the Paper Size and Orientation you want before setting Lines per Page.
<p>PCL Emulation Settings</p> <p>A4 Width</p> <p>198 mm</p> <p>203 mm</p>	<p>Set the printer to print on A4-size paper.</p> <p>Notes:</p> <ul style="list-style-type: none"> • 198 mm is the factory default setting. • The 203-mm setting sets the width of the page to allow printing of eighty 10-pitch characters.
<p>PCL Emulation Settings</p> <p>Auto CR after LF</p> <p>On</p> <p>Off</p>	<p>Specify whether the printer automatically performs a carriage return (CR) after a line feed (LF) control command.</p> <p>Note: Off is the factory default setting.</p>
<p>PCL Emulation Settings</p> <p>Auto LF after CR</p> <p>On</p> <p>Off</p>	<p>Specify whether the printer automatically performs a line feed (LF) after a carriage return (CR) control command.</p> <p>Note: Off is the factory default setting.</p>

Use	To
<p>Tray Renumber</p> <p>Assign MP Feeder</p> <ul style="list-style-type: none"> Off None 0–199 <p>Assign Tray [x]</p> <ul style="list-style-type: none"> Off None 0–199 <p>Assign Manual Paper</p> <ul style="list-style-type: none"> Off None 0–199 <p>Assign Manual Envelope</p> <ul style="list-style-type: none"> Off None 0–199 	<p>Configure the printer to work with printer software or programs that use different source assignments for trays and feeders.</p> <p>Notes:</p> <ul style="list-style-type: none"> • Off is the factory default setting. • None cannot be selected. It is only displayed when it is selected by the PCL 5 interpreter. It also ignores the Select Paper Feed command. • 0–199 allows a custom setting to be assigned.
<p>Tray Renumber</p> <p>View Factory Defaults</p> <ul style="list-style-type: none"> MPF Default = 8 T1 Default = 1 T1 Default = 4 T1 Default = 5 T1 Default = 20 T1 Default = 21 Env Default = 6 MPaper Default = 2 MEnv Default = 3 	<p>Display the factory default setting assigned to each tray or feeder.</p>
<p>Tray Renumber</p> <p>Restore Defaults</p> <ul style="list-style-type: none"> Yes No 	<p>Restore all tray and feeder assignments to their factory default settings.</p>

MS315, MS415, MS417 print settings

Job Accounting menu

Note: This menu item appears only when an optional flash memory card is installed.

Use	To
<p>Job Accounting Log</p> <ul style="list-style-type: none"> Off On 	<p>Determine and set if the printer creates a log of the print jobs it receives.</p> <p>Note: Off is the factory default setting.</p>

Use	To
Job Accounting Utilities	Print and delete log files or export them to a flash drive.
Accounting Log Frequency Daily Weekly Monthly	Determine and set how often a log file is created. Note: Monthly is the factory default setting.
Log Action at End of Frequency None E-mail Current Log E-mail & Delete Current Log Post Current Log Post & Delete Current Log	Determine and set how the printer responds when the frequency threshold expires. Note: None is the factory default setting.
Log Near Full Level Off 1–49 for optional flash memory cards	Specify the maximum size of the log file before the printer executes the Log Action at Near Full. Note: 5 is the factory default setting.
Log Action at Near Full None E-mail Current Log E-mail & Delete Current Log E-mail & Delete Oldest Log Post Current Log Post & Delete Current Log Post & Delete Oldest Log Delete Current Log Delete Oldest Log Delete All Logs Delete All But Current	Determine and set how the printer responds when the flash memory is nearly full. Notes: <ul style="list-style-type: none"> • None is the factory default setting. • The value defined in Log Near Full Level determines when this action is triggered.
Log Action at Full None E-mail & Delete Current Log E-mail & Delete Oldest Log Post & Delete Current Log Post & Delete Oldest Log Delete Current Log Delete Oldest Log Delete All Logs Delete All But Current	Determine and set how the printer responds when flash memory usage reaches the maximum limit (100MB). Note: None is the factory default setting.
URL to Post Logs	Determine and set where the printer posts job accounting logs.
E-mail Address to Send Logs	Specify the e-mail address to which the device sends job accounting logs.
Log File Prefix	Specify the prefix you want for the log file name. Note: The current host name defined in the TCP/IP menu is used as the default log file prefix.

Utilities menu

Use	To
Format Flash Yes No	Format the flash memory. Warning—Potential Damage: Do not turn off the printer while the flash memory is being formatted. Notes: <ul style="list-style-type: none"> • Yes deletes all data stored in flash memory. • No cancels the format request. • Flash memory refers to the memory added by installing a flash memory card in the printer. • The flash memory option card must not be read/write- or write-protected. • This menu item appears only when a non-defective flash memory card is installed.
Activate Hex Trace	Isolate the source of a print job problem. Notes: <ul style="list-style-type: none"> • When activated, all data sent to the printer is printed in hexadecimal and character representation, and control codes are not executed. • To exit or deactivate Hex Trace, restart the printer.
Coverage Estimator Off On	Provide an estimate of the percentage coverage of toner on a page. The estimate is printed on a separate page at the end of each print job. Note: Off is the factory default setting.

PDF menu

Use	To
Scale to Fit Yes No	Scale page content to fit the selected paper size. Note: No is the factory default setting.
Annotations Do Not Print Print	Print annotations in a PDF. Note: Do Not Print is the factory default setting.

PCL Emul menu

Use	To
<p>Font Source Resident Download Flash All</p>	<p>Specify the set of fonts used by the Font Name menu.</p> <p>Notes:</p> <ul style="list-style-type: none"> • Resident is the factory default setting. This shows the factory default set of fonts downloaded in the RAM. • Download shows all the fonts downloaded in the RAM. • Flash shows all fonts resident in that option. The optional flash memory card must be properly formatted and cannot be read/write-, write-, or password-protected. • All shows the fonts available to any option.
<p>Font Name Courier 10</p>	<p>Identify a specific font and the option where it is stored.</p> <p>Note: Courier 10 is the factory default setting. Courier 10 shows the font name, font ID, and the storage location in the printer. The font source abbreviation is R for Resident, F for Flash, and D for Download.</p>
<p>Symbol Set 10U PC-8 12U PC-850</p>	<p>Specify the symbol set for each font name.</p> <p>Notes:</p> <ul style="list-style-type: none"> • 10U PC-8 is the U.S. factory default setting. 12U PC-850 is the international factory default setting. • A symbol set is a set of alphabetic and numeric characters, punctuation, and special symbols. Symbol sets support the different languages or specific program, such as math symbols for scientific text. Only the supported symbol sets are shown.
<p>PCL Emulation Settings Point Size 1.00–1008.00</p>	<p>Change the point size for scalable typographic fonts.</p> <p>Notes:</p> <ul style="list-style-type: none"> • 12 is the factory default setting. • Point size refers to the height of the characters in the font. One point equals approximately 0.014 inch. • Point sizes can be increased or decreased in 0.25-point increments.
<p>PCL Emulation Settings Pitch 0.08–100</p>	<p>Specify the font pitch for scalable monospaced fonts.</p> <p>Notes:</p> <ul style="list-style-type: none"> • 10 is the factory default setting. • Pitch refers to the number of fixed-space characters per inch (cpi). • Pitch can be increased or decreased in 0.01-cpi increments. • For non-scalable monospaced fonts, the pitch appears on the display but it cannot be changed.
<p>PCL Emulation Settings Orientation Portrait Landscape</p>	<p>Specify the orientation of text and graphics on the page.</p> <p>Notes:</p> <ul style="list-style-type: none"> • Portrait is the factory default setting. Portrait prints text and graphics parallel to the short edge of the page. • Landscape prints text and graphics parallel to the long edge of the page.

Use	To
<p>PCL Emulation Settings Lines per Page 1–255</p>	<p>Specify the number of lines that print on each page.</p> <p>Notes:</p> <ul style="list-style-type: none"> • 60 is the U.S. factory default setting. 64 is the international default setting. • The printer sets the amount of space between each line based on the Lines per Page, Paper Size, and Orientation settings. Select the Paper Size and Orientation you want before setting Lines per Page.
<p>PCL Emulation Settings A4 Width 198 mm 203 mm</p>	<p>Set the printer to print on A4-size paper.</p> <p>Notes:</p> <ul style="list-style-type: none"> • 198 mm is the factory default setting. • The 203-mm setting sets the width of the page to allow printing of eighty 10-pitch characters.
<p>PCL Emulation Settings Auto CR after LF On Off</p>	<p>Specify whether the printer automatically performs a carriage return (CR) after a line feed (LF) control command.</p> <p>Note: Off is the factory default setting.</p>
<p>PCL Emulation Settings Auto LF after CR On Off</p>	<p>Specify whether the printer automatically performs a line feed (LF) after a carriage return (CR) control command.</p> <p>Note: Off is the factory default setting.</p>
<p>Tray Renumber Assign Multipurpose Feeder Off None 0–199 Assign Tray [x] Off None 0–199 Assign Manual Paper Off None 0–199 Assign Manual Envelope Off None 0–199</p>	<p>Configure the printer to work with printer software or programs that use different source assignments for trays and feeders.</p> <p>Notes:</p> <ul style="list-style-type: none"> • Off is the factory default setting. • None cannot be selected. It is only displayed when it is selected by the PCL 5 interpreter. It also ignores the Select Paper Feed command. • 0–199 allows a custom setting to be assigned.

Use	To
<p>Tray Renumber</p> <p>View Factory Defaults</p> <ul style="list-style-type: none"> MPF Default = 8 T1 Default = 1 T2 Default = 4 T3 Default = 5 T4 Default = 20 T5 Default = 21 Env Default = 6 MPaper Default = 2 MEnv Default = 3 	<p>Display the factory default setting assigned to each tray or feeder.</p>
<p>Tray Renumber</p> <p>Restore Defaults</p> <ul style="list-style-type: none"> Yes No 	<p>Restore all tray and feeder assignments to their factory default settings.</p>

HTML menu

Use	To
<p>Font Name</p> <ul style="list-style-type: none"> Albertus MT Antique Olive Apple Chancery Arial MT Avant Garde Bodoni Bookman Chicago Clarendon Cooper Black Copperplate Coronet Courier Eurostile Garamond Geneva Gill Sans Goudy Helvetica Hoefler Text Intl CG Times Intl Courier Intl Univers 	<ul style="list-style-type: none"> Joanna MT Letter Gothic Lubalin Graph Marigold MonaLisa Recut Monaco New CenturySbk New York Optima Oxford Palatino StempelGaramond Taffy Times TimesNewRoman Univers Zapf Chancery NewSansMTCS NewSansMTCT New SansMTJA NewSansMTKO <p>Set the default font for HTML documents.</p> <p>Note: The Times font is used in HTML documents that do not specify a font.</p>

Use	To
Font Size 1–255 pt	Set the default font size for HTML documents. Notes: <ul style="list-style-type: none"> • 12 pt is the factory default setting. • Font size can be increased in 1-point increments.
Scale 1–400%	Scale the default font for HTML documents. Notes: <ul style="list-style-type: none"> • 100% is the factory default setting. • Scaling can be increased in 1% increments.
Orientation Portrait Landscape	Set the page orientation for HTML documents. Note: Portrait is the factory default setting.
Margin Size 8–255 mm	Set the page margin for HTML documents. Notes: <ul style="list-style-type: none"> • 19 mm is the factory default setting. • Margin size can be increased in 1-mm increments.
Backgrounds Do Not Print Print	Specify whether to print backgrounds on HTML documents. Note: Print is the factory default setting.

Image menu

Use	To
Auto Fit On Off	Select the optimal paper size, scaling, and orientation. Note: On is the factory default setting. It overrides scaling and orientation settings for some images.
Invert On Off	Invert bitonal monochrome images. Notes: <ul style="list-style-type: none"> • Off is the factory default setting. • This setting does not apply to GIF or JPEG images.
Scaling Anchor Top Left Best Fit Anchor Center Fit Height/Width Fit Height Fit Width	Scale the image to fit the selected paper size. Notes: <ul style="list-style-type: none"> • Best Fit is the factory default setting. • When Auto Fit is set to On, Scaling is automatically set to Best Fit.

Use	To
Orientation Portrait Landscape Reverse Portrait Reverse Landscape	Set the image orientation. Note: Portrait is the factory default setting.

MS315, MS415, and MS417 help menu

Help menu

The Help menu consists of a series of Help pages that are stored in the printer as PDFs. They contain information about using the printer and performing printing tasks.

English, French, German, and Spanish translations are stored in the printer. Other translations are available at <http://support.lexmark.com>.

Use	To
Print All Guides	Print all the guides.
Print Quality	Print information about solving print quality issues.
Printing Guide	Print information about loading paper and other specialty media.
Media Guide	Print a list of the paper sizes supported in trays and feeders.
Print Defects Guide	Print information about resolving print defects.
Menu Map	Print a list of the printer control panel menus and settings.
Information Guide	Print a guide in locating additional information.
Connection Guide	Print information about connecting the printer locally (USB) or to a network.
Moving Guide	Print instructions for safely moving the printer.
Supplies Guide	Print part numbers for ordering supplies.

Clearing jams

Avoiding jams

Load paper properly

- Make sure that the paper lies flat in the tray.

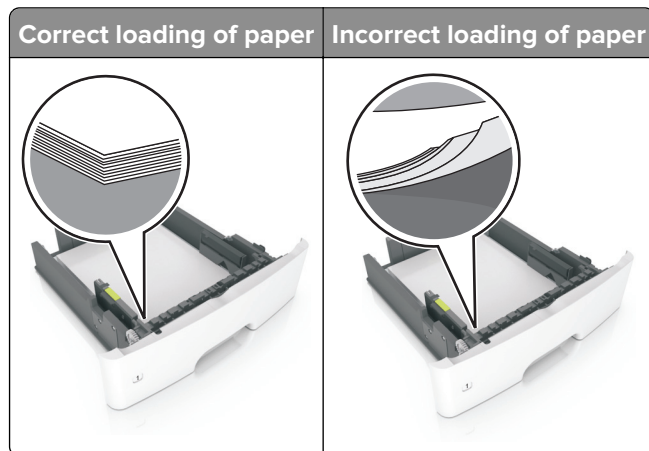

- Do not load or remove a tray while the printer is printing.
- Do not load too much paper. Make sure that the stack height is below the maximum paper fill indicator.
- Do not slide paper into the tray. Load paper as shown in the illustration.



- Make sure that the paper guides are positioned correctly and are not pressing tightly against the paper or envelopes.
- Push the tray firmly into the printer after loading paper.

Use recommended paper

- Use only recommended paper or specialty media.
- Do not load paper that is wrinkled, creased, damp, bent, or curled.
- Flex, fan, and align the paper edges before loading.

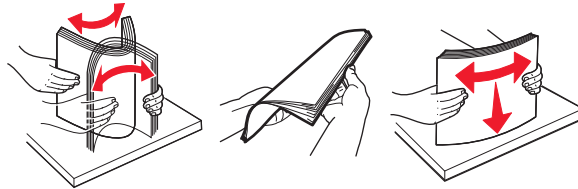

- Do not use paper that has been cut or trimmed by hand.
- Do not mix paper sizes, weights, or types in the same tray.
- Make sure that the paper size and type are set correctly on the computer or printer control panel.
- Store paper according to manufacturer recommendations.

Identifying jam locations

Notes:

- When Jam Assist is set to On, the printer automatically flushes blank pages or pages with partial prints after a jammed page has been cleared. Check your printed output for blank pages.
- When Jam Recovery is set to On or Auto, the printer reprints jammed pages.

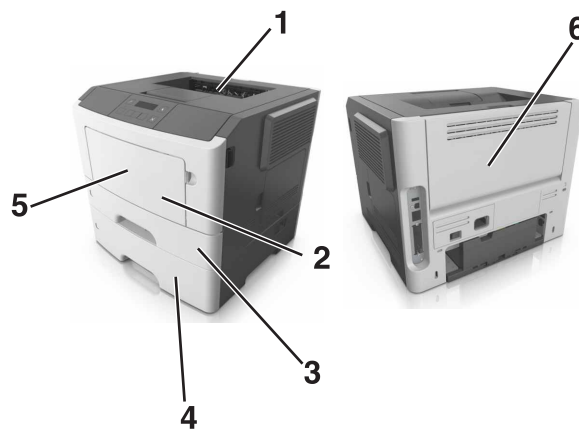

	Jam location
1	Standard bin
2	Multipurpose feeder
3	Tray 1
4	Tray [x]
5	Front door
6	Rear door

Paper jam in the front door

 **CAUTION—HOT SURFACE:** The inside of the printer might be hot. To reduce the risk of injury from a hot component, allow the surface to cool before touching it.

- 1 Open the front door.

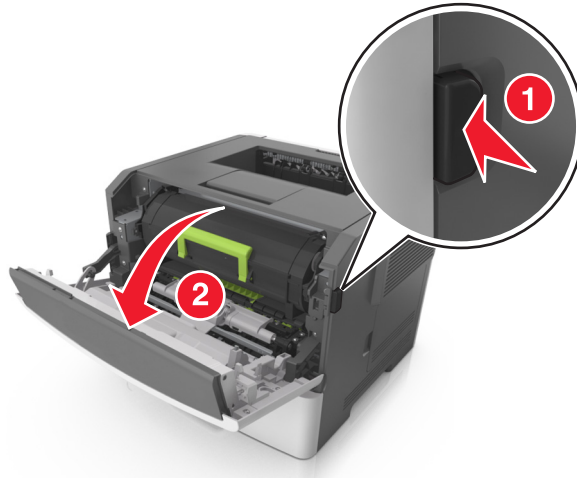

- 2 Remove the toner cartridge.

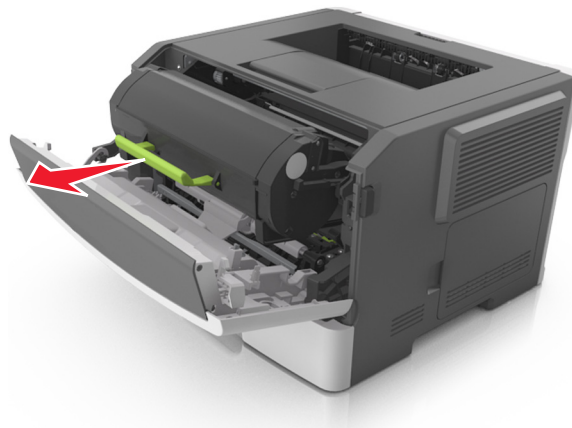

- 3 Remove the imaging unit.

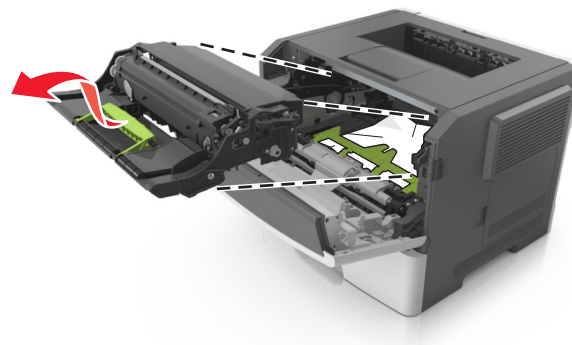

Warning—Potential Damage: Do not expose the imaging unit to direct light for more than 10 minutes. Extended exposure to light may cause print quality problems.

Warning—Potential Damage: Do not touch the shiny photoconductor drum under the imaging unit. Doing so may affect the quality of future print jobs.

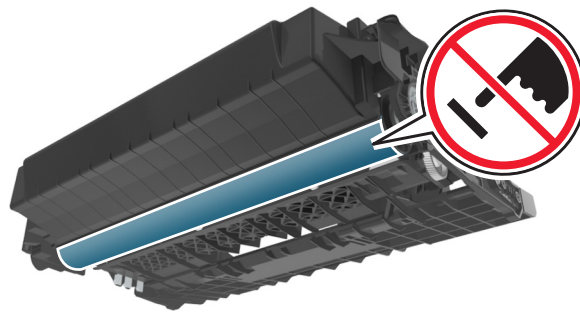

4 Remove the jammed paper.

Note: Make sure that all paper fragments are removed.

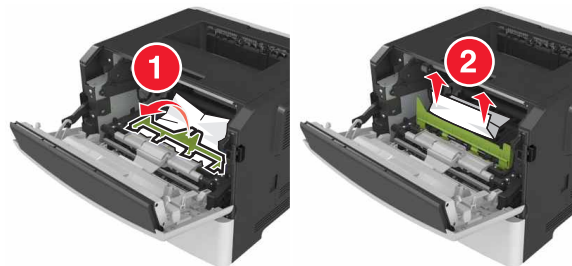

5 Insert the imaging unit.

Note: Use the arrows inside the printer as guides.

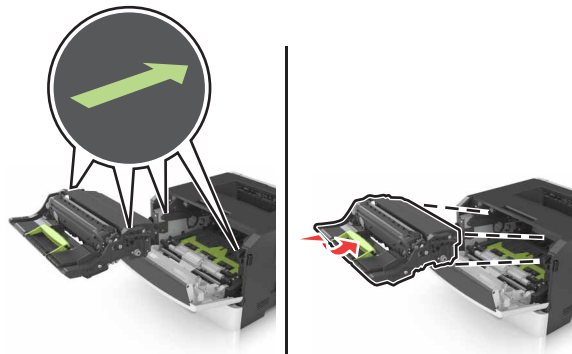

6 Insert the toner cartridge.

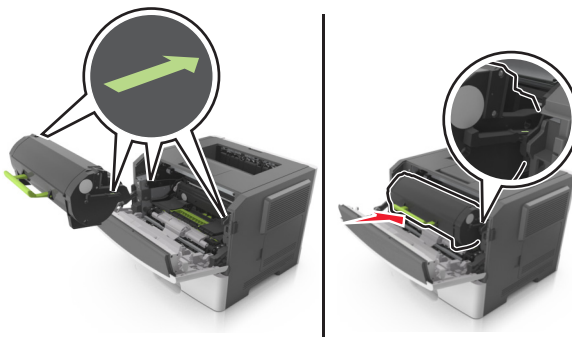

7 Close the front door.

8 From the control panel, press **OK**.

Paper jam in the rear door

1 Open the rear door.

 **CAUTION—HOT SURFACE:** The inside of the printer might be hot. To reduce the risk of injury from a hot component, allow the surface to cool before touching it.

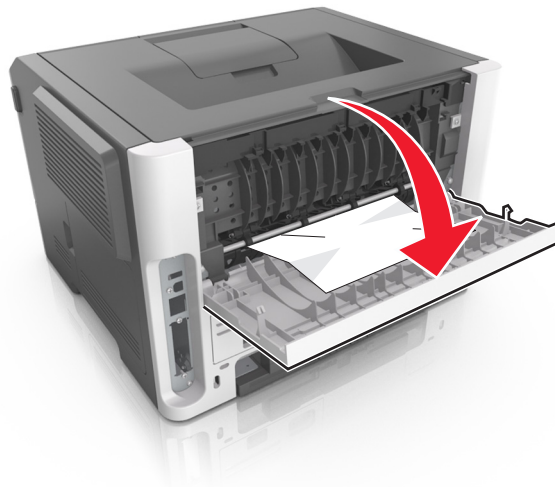

2 Remove the jammed paper.

Note: Make sure that all paper fragments are removed.

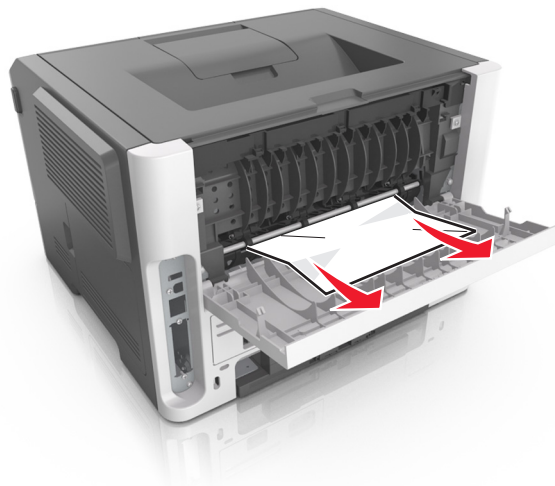

3 Close the rear door.

4 From the control panel, press **OK**.

Paper jam in the standard bin

- 1 Remove the jammed paper.

Note: Make sure that all paper fragments are removed.

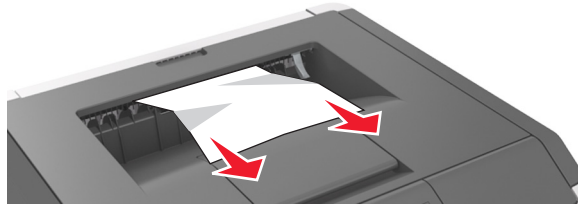

- 2 From the control panel, press **OK**.

Paper jam in the duplex unit

- 1 Remove the tray.

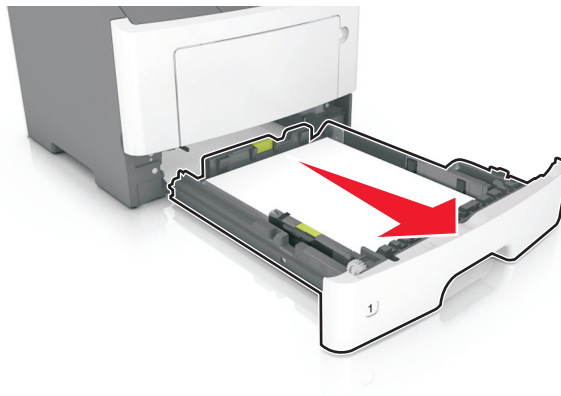

- 2 Remove the jammed paper.

Note: Make sure that all paper fragments are removed.



- 3 Insert the tray.

Paper jam in trays

- 1 Remove the tray.

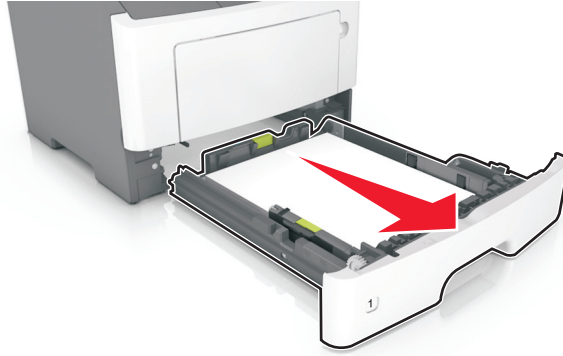

- 2 Remove the jammed paper.

Note: Make sure that all paper fragments are removed.

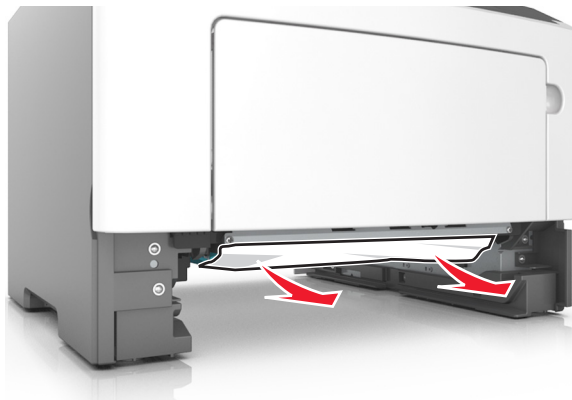

- 3 Insert the tray.

- 4 From the control panel, press .

Paper jam in the multipurpose feeder

- 1 Remove the jammed paper.

Note: Make sure that all paper fragments are removed.

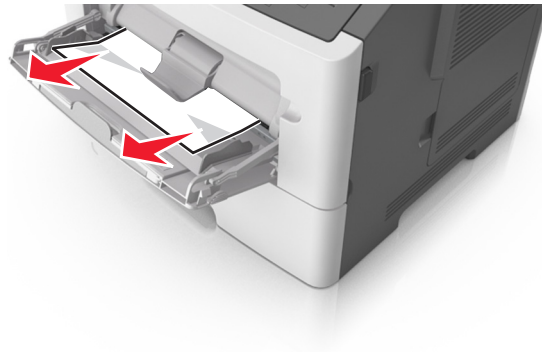

2 From the control panel, press .

Maintaining the printer

Warning—Potential Damage: Failure to maintain optimum printer performance, or to replace parts and supplies, may cause damage to your printer.

Cleaning the printer

 **CAUTION—SHOCK HAZARD:** To avoid the risk of electrical shock when cleaning the exterior of the printer, unplug the power cord from the electrical outlet and disconnect all cables from the printer before proceeding.

Notes:

- Perform this task after every few months.
- Damage to the printer caused by improper handling is not covered by the printer warranty.

- 1 Turn off the printer, and then unplug the power cord from the electrical outlet.
- 2 Remove paper from the standard bin and multipurpose feeder.
- 3 Remove any dust, lint, and pieces of paper around the printer using a soft brush or vacuum.
- 4 Wipe the outside of the printer with a damp, soft, lint-free cloth.

Notes:

- Do not use household cleaners or detergents, as they may damage the finish of the printer.
- Make sure that all areas of the printer are dry after cleaning.

- 5 Connect the power cord to the electrical outlet, and then turn on the printer.

 **CAUTION—POTENTIAL INJURY:** To avoid the risk of fire or electrical shock, connect the power cord to an appropriately rated and properly grounded electrical outlet that is near the product and easily accessible.

Checking the status of parts and supplies

Using the Embedded Web Server

- 1 Open a Web browser, and then type the printer IP address in the address field.

Notes:

- View the printer IP address in the TCP/IP section in the Network/Ports menu. The IP address appears as four sets of numbers separated by periods, such as 123.123.123.123.
- If you are using a proxy server, then temporarily disable it to load the Web page correctly.

- 2 Click **Device Status**.

Using the control panel

Depending on your printer model, navigate to either of the following:

-  > **Reports** >  > **Device Statistics** > 

Note: You can view the status of parts and supplies in the “Supply Information” section of the pages printed.

-  > **Status/Supplies** >  > **View Supplies** > 

Estimated number of remaining pages

The estimated number of remaining pages is based on the recent printing history of the printer. Its accuracy may vary significantly and is dependent on many factors, such as actual document content, print quality settings, and other printer settings.

The accuracy of the estimated number of remaining pages may decrease when the actual printing consumption is different from the historical printing consumption. Consider the variable level of accuracy before purchasing or replacing supplies based on the estimate. Until an adequate print history is obtained on the printer, initial estimates assume future supplies consumption based on the International Organization for Standardization* test methods and page content.

* Average continuous black declared cartridge yield in accordance with ISO/IEC 19752.

Ordering parts and supplies

To order supplies in the U.S., contact Lexmark at 1-800-539-6275 for information about Lexmark authorized supplies dealers in your area. In other countries or regions, go to www.lexmark.com or contact the place where you purchased the printer.

Note: All life estimates for printer supplies assume printing on letter- or A4-size plain paper.

Using genuine Lexmark parts and supplies

Your Lexmark printer is designed to function best with genuine Lexmark supplies and parts. Use of third-party supplies or parts may affect the performance, reliability, or life of the printer and its imaging components. Use of third-party supplies or parts can affect warranty coverage. Damage caused by the use of third-party supplies or parts is not covered by the warranty. All life indicators are designed to function with Lexmark supplies and parts, and may deliver unpredictable results if third-party supplies or parts are used. Imaging component usage beyond the intended life may damage your Lexmark printer or its associated components.

Ordering toner cartridges

Notes:

- The estimated cartridge yield is based on the ISO/IEC 19752 standard.
- Extremely low print coverage for extended periods of time may reduce the actual yield.

MS312, MS315, and MS415 Return program cartridges

Item	United States and Canada	European Economic Area (EEA+)	Rest of Europe, Middle East, and Africa (RoEMEA)	Latin America Distribution (LAD)	Rest of Asia Pacific (RoAP)	Australia and New Zealand (ANZ)
Toner cartridge	50F1000	50F2000	50F5000	50F4000	50F3000	50F3000
High yield toner cartridge	50F1H00	51F2H00	51F5H00	50F4H00	50F3H00	50F3H00
Extra high yield toner cartridge*	50F1X00	50F2X00	50F5X00	50F4X00	50F3X00	50F3X00

* This supply is supported only in MS415 printer model.

For more information on countries located in each region, go to www.lexmark.com/regions.

MS312, MS315, and MS415 Regular cartridges

Item	Worldwide
High yield toner cartridge	51F0HA0
Extra high yield toner cartridge*	50F0XA0

* This supply is supported only in MS415 printer model.

For more information on countries located in each region, go to www.lexmark.com/regions.

MS317 and MS417 Return program cartridges

Item	United States and Canada	European Economic Area (EEA+)	Rest of Europe, Middle East, and Africa (RoEMEA)	Latin America Distribution (LAD)	Rest of Asia Pacific (RoAP)	Australia and New Zealand (ANZ)
Toner cartridge	51B1000	51B2000	51B5000	51B4000	51B3000	51B6000
High yield toner cartridge*	51B1H00	51B2H00	51B5H00	51B4H00	51B3H00	51B6H00

* This supply is supported only in MS417 printer model.

For more information on countries located in each region, go to www.lexmark.com/regions.

MS317 and MS417 Regular cartridges

Item	Worldwide
Toner cartridge	51B00A0 ¹
High yield toner cartridge	51B0HA0 ²
¹ This supply is supported only in MS317 printer model. ² This supply is supported only in MS417 printer model. For more information on countries located in each region, go to www.lexmark.com/regions .	

Ordering an imaging unit

Extremely low print coverage for extended periods of time may cause imaging unit parts to fail prior to exhaustion of toner from toner cartridge.

For more information on replacing the imaging unit, see the instruction sheet that came with the supply.

Part name	Lexmark Return Program	Regular
Imaging unit	500Z	500ZA

Storing supplies

Choose a cool, clean storage area for the printer supplies. Store supplies right side up in their original packing until you are ready to use them.

Do not expose supplies to:

- Direct sunlight
- Temperatures above 35°C (95°F)
- High humidity above 80%
- Salty air
- Corrosive gases
- Heavy dust

Replacing supplies

Replacing the toner cartridge

- 1 Press the button on the right side of the printer, and then open the front door.

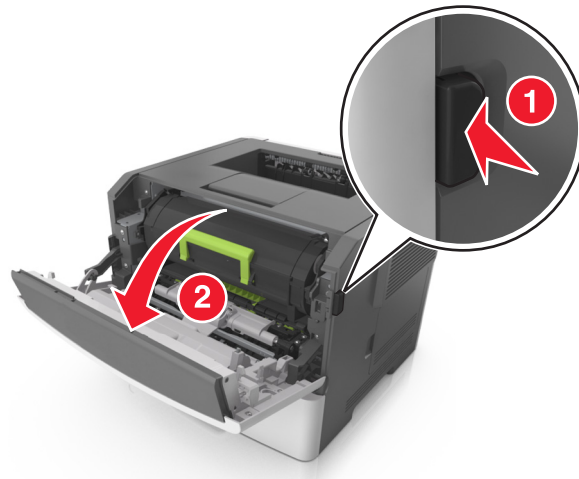

- 2 Pull the toner cartridge out using the handle.



- 3 Unpack the toner cartridge, and then remove all packing materials.

- 4 Shake the new cartridge to redistribute the toner.

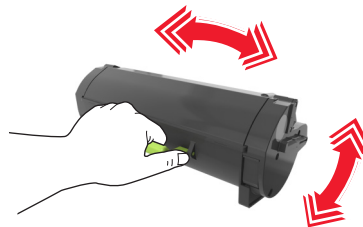

- 5 Insert the toner cartridge into the printer by aligning the side rails of the cartridge with the arrows on the side rails inside the printer.

Warning—Potential Damage: Do not expose the imaging unit to direct light for more than 10 minutes. Extended exposure to light may cause print quality problems.

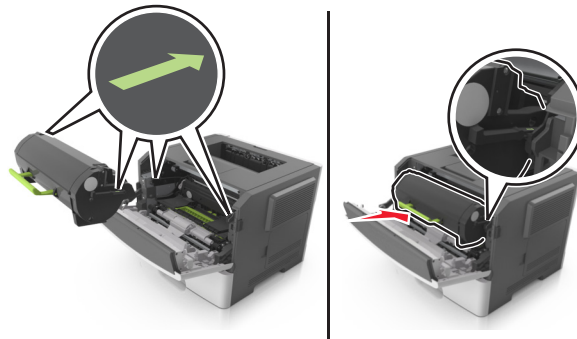

6 Close the front door.

Replacing the imaging unit

1 Press the button on the right side of the printer, and then open the front door.

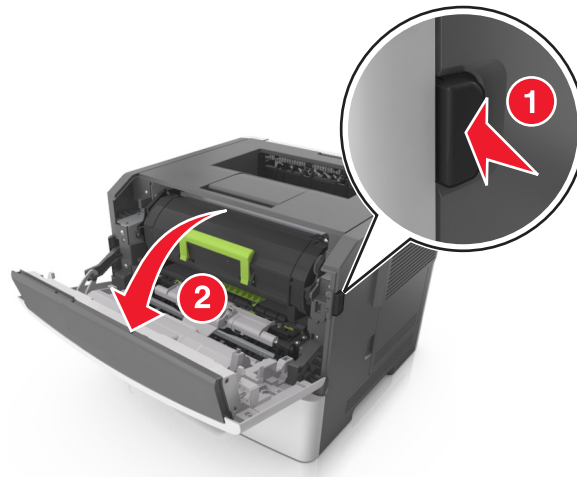

2 Pull the toner cartridge out using the handle.



- 3 Lift the green handle, and then pull the imaging unit out of the printer.

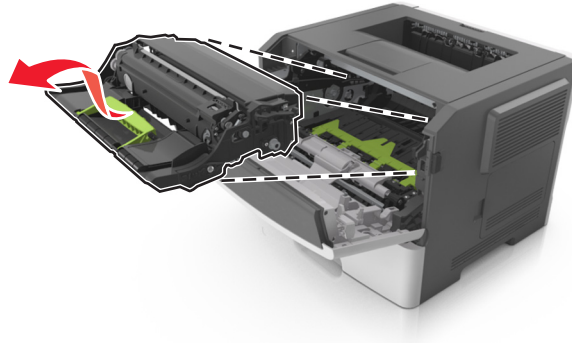

- 4 Unpack the new imaging unit, and then shake it.

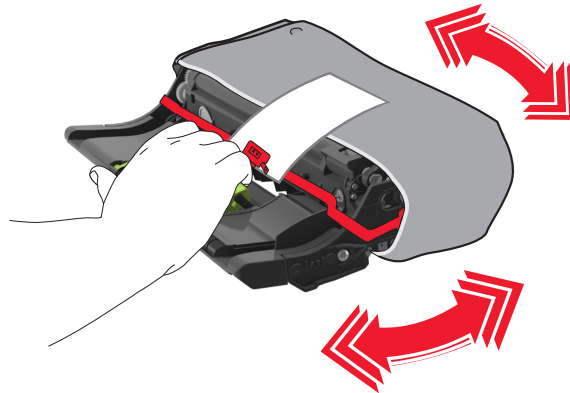

- 5 Remove all packing materials from the imaging unit.

Warning—Potential Damage: Do not expose the imaging unit to direct light for more than 10 minutes. Extended exposure to light may cause print quality problems.

Warning—Potential Damage: Do not touch the photoconductor drum. Doing so may affect the print quality of future print jobs.

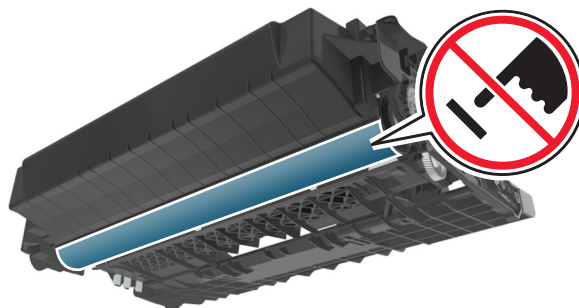

- 6 Insert the imaging unit into the printer by aligning the arrows on the side rails of the imaging unit with the arrows on the side rails inside the printer.

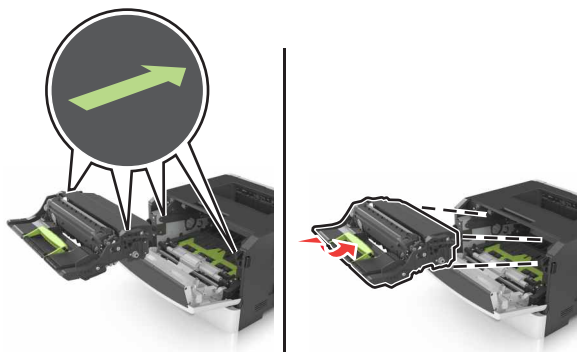

- 7 Insert the toner cartridge into the printer by aligning the side rails of the cartridge with the arrows on the side rails inside the printer.

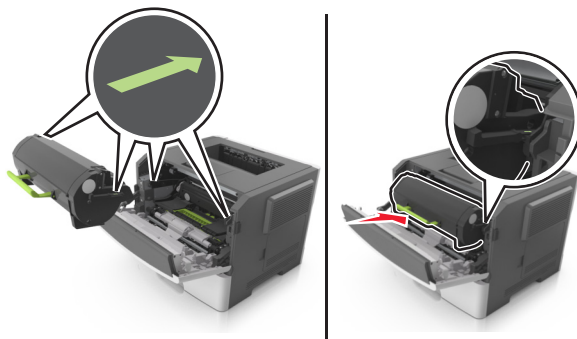

- 8 Close the front door.

Moving the printer

Moving the printer to another location

- ⚠ CAUTION—POTENTIAL INJURY:** The printer weight is greater than 18 kg (40 lb) and requires two or more trained personnel to lift it safely.
- ⚠ CAUTION—POTENTIAL INJURY:** To avoid the risk of fire or electrical shock, use only the power cord provided with this product or the manufacturer's authorized replacement.
- ⚠ CAUTION—POTENTIAL INJURY:** When moving the printer, follow these guidelines to avoid personal injury or printer damage:
 - Make sure that all doors and trays are closed.
 - Turn off the printer, and then unplug the power cord from the electrical outlet.
 - Disconnect all cords and cables from the printer.
 - If the printer has a caster base, then carefully roll it to the new location. Use caution when passing over thresholds and breaks in flooring.
 - If the printer does not have a caster base but is configured with optional trays, then lift the printer off the trays. Do not try to lift the printer and the trays at the same time.

- Always use the handholds on the printer to lift it.
- Any cart used to move the printer must have a surface able to support the full footprint of the printer.
- Any cart used to move the hardware options must have a surface able to support the dimensions of the options.
- Keep the printer in an upright position.
- Avoid severe jarring movements.
- Make sure that your fingers are not under the printer when you set it down.
- Make sure that there is adequate clearance around the printer.

Note: Damage to the printer caused by improper moving is not covered by the printer warranty.

Shipping the printer

When shipping the printer, use the original packaging or call the place of purchase for a relocation kit.

Troubleshooting

Understanding the printer messages

MS312 and MS317 printer messages

Bin full. Remove paper.

Remove the paper stack from the standard bin.

Cannot collate large document [37]







Try one or more of the following:

- From the printer control panel, press  to print the portion of the job already stored and begin collating the rest of the print job.
- Cancel the current print job.

Cannot defrag flash memory [37]

Try one or more of the following:

- From the printer control panel, press  to stop the defragmentation and continue printing.
- Delete fonts, macros, and other data in the printer memory. From the printer control panel, navigate to:

 > **Settings** >  > **Print Settings** >  > **Utilities Menu** >  > **Format Flash** >  > **Yes** > 
- Install additional printer memory.

Change [paper source] to [custom string] load [orientation]

Try one or more of the following:

- Load the correct size and type of paper in the tray or feeder, specify the paper size and type in the Paper menu on the control panel, and then press .
- Select **Ignore** to use the available paper size and type in the tray or feeder.
- Cancel the print job.

Change [paper source] to [custom type name] load [orientation]

Try one or more of the following:

- Load the correct size and type of paper in the tray or feeder, specify the paper size and type in the Paper menu on the control panel, and then press .
- Select **Ignore** to use the available paper size and type in the tray or feeder.

- Cancel the print job.

Change [paper source] to [paper size] load [orientation]

Try one or more of the following:

- Load the correct size and type of paper in the tray or feeder, specify the paper size and type in the Paper menu on the control panel, and then press .
- Select **Ignore** to use the available paper size and type in the tray or feeder.
- Cancel the print job.

Change [paper source] to [paper type] [paper size] load [orientation]

Try one or more of the following:

- Load the correct size and type of paper in the tray or feeder, specify the paper size and type in the Paper menu on the control panel, and then press .
- Select **Ignore** to use the available paper size and type in the tray or feeder.
- Cancel the print job.

Complex page may misprint [39]

Try one or more of the following:

- From the printer control panel, press  to clear the message and continue printing.
- Reduce the number and size of fonts, the number and complexity of images, and the number of pages in the print job.
- Cancel the print job.
- Install additional printer memory.

Defective flash memory [51]

Try one or more of the following:

- Replace the defective flash memory card.
- From the printer control panel, press  to ignore the message and continue printing.
- Cancel the current print job.

Flash memory full [52]

Try one or more of the following:

- From the printer control panel, press  to clear the message and continue printing.
- Delete fonts, macros, and other data stored in the flash memory. From the printer control panel, navigate to:

 > **Settings** >  > **Print Settings** >  > **Utilities Menu** >  > **Format Flash** >  > **Yes** > 

- Use a larger-capacity flash memory card.

Note: Downloaded fonts and macros that are not stored in the flash memory are deleted when the printer is powered off or restarted.

Flash memory unformatted [53]

Try one or more of the following:

- From the printer control panel, press  to stop the defragmentation and continue printing.
- Format the flash memory device.

Note: If the error message remains, then the flash memory device may be defective and need to be replaced.

Memory low, no Resource Save [35]

Try one or more of the following:

- From the printer control panel, press  to disable Resource Save, clear the message, and continue printing.
- Install additional printer memory.

Network error, port [x] [54]

Try one or more of the following:

- From the printer control panel, press  to clear the message and continue printing.
- Unplug the router, wait for 30 seconds, and then plug it back again.
- Turn off the printer, wait for about 10 seconds, and then turn the printer back on.
- Update the network firmware in the printer or the print server. For more information, visit the Lexmark Web site at <http://support.lexmark.com>.

Network error, standard port [54]

Try one or more of the following:

- From the printer control panel, press  to clear the message and continue printing.
- Unplug the router, wait for 30 seconds, and then plug it back again.

- Turn off the printer, wait for about 10 seconds, and then turn the printer back on.
- Update the network firmware in the printer or the print server. For more information, visit the Lexmark Web site at <http://support.lexmark.com>.

Paper too short [34]

Try one or more of the following:

- Load the correct size of paper in the tray.
- From the printer control panel, press  to clear the message and print using a different tray.
- Check the tray length and width guides and make sure the paper is loaded properly in the tray.
- Make sure the correct paper size and type are specified in Print Properties or in the Print dialog.
- Make sure the paper size and type settings are specified in the Paper menu on the printer control panel.
- Make sure the paper size is correctly set. For example, if the MP Feeder Size is set to Universal, then make sure the paper is large enough for the data being printed.
- Cancel the print job.

Printer restart. Check last job.

Press  on the printer control panel to clear the message and continue printing.

For more information, visit <http://support.lexmark.com> or contact customer support.

Rear USB port disabled [56]

Try one or more of the following:

- From the printer control panel, press  to clear the message and continue printing.
Note: The printer discards any data received through the USB port.
- From the printer control panel, set USB Buffer to Auto.

Too many trays. Remove some. [58]

- 1 Turn off the printer.
- 2 Unplug the power cord from the electrical outlet.
- 3 Remove the extra trays.
- 4 Connect the power cord to the electrical outlet.
- 5 Turn the printer back on.

MS315, MS415, and MS417 printer messages

Change [paper source] to [custom string] load [orientation]

Try one or more of the following:

- Load the correct size and type of paper in the tray, and then press  on the control panel.
Note: Make sure the paper size and type settings are specified in the Paper menu on the control panel.
- Select **Use current [paper source]** on the control panel to clear the message and continue printing using the current size and type of paper in the tray.
- Cancel the print job.

Change [paper source] to [custom type name] load [orientation]

Try one or more of the following:

- Load the correct size and type of paper in the tray, and then press  on the control panel.
Note: Make sure the paper size and type settings are specified in the Paper menu on the control panel.
- Select **Use current [paper source]** on the control panel to clear the message and continue printing using the current size and type of paper in the tray.
- Cancel the print job.

Change [paper source] to [paper size] load [orientation]

Try one or more of the following:

- Load the correct size and type of paper in the tray, and then press  on the control panel.
Note: Make sure the paper size and type settings are specified in the Paper menu on the control panel.
- Select **Use current [paper source]** on the control panel to clear the message and continue printing using the current size and type of paper in the tray.
- Cancel the print job.

Change [paper source] to [paper type] [paper size] load [orientation]

Try one or more of the following:

- Load the correct size and type of paper in the tray, and then press  on the control panel.
Note: Make sure the paper size and type settings are specified in the Paper menu on the control panel.
- Select **Use current [paper source]** on the control panel to clear the message and continue printing using the current size and type of paper in the tray.
- Cancel the print job.

Complex page, some data may not have printed [39]

Try one or more of the following:

- From the printer control panel, press  to clear the message and continue printing.
- Reduce the number and size of fonts, the number and complexity of images, and the number of pages in the print job.
- Cancel the print job.
- Install additional printer memory.

Configuration change, some held jobs were not restored [57]

From the control panel, press  to clear the message and continue printing.

Defective flash detected [51]

Try one or more of the following:

- Replace the defective flash memory card.
- From the printer control panel, press  to ignore the message and continue printing.
- Cancel the current print job.

Incorrect paper size, open [paper source] [34]

Note: The paper source can be a tray or a feeder.

Try one or more of the following:

- Load the correct size of paper in the paper source.
- From the control panel, press  to clear the message and print using a different paper source.
- Check the length and width guides of the paper source and make sure the paper is loaded properly.
- Make sure the correct paper size and type are specified in the Printing Preferences or in the Print dialog.
- Make sure the paper size and type are specified in the Paper menu on the control panel.
- Make sure that the paper size is correctly set. For example, if Multipurpose Feeder Size is set to Universal, then make sure the paper is large enough for the data being printed.
- Cancel the print job.

Insufficient memory to support Resource Save feature [35]

Try one or more of the following:

- From the printer control panel, press  to disable Resource Save, clear the message, and continue printing.
- Install additional printer memory.









Insufficient memory to collate job [37]

Try one or more of the following:

- From the printer control panel, press  to print the portion of the job already stored and begin collating the rest of the print job.
- Cancel the current print job.

Insufficient memory for Flash Memory Defragment operation [37]

Try one or more of the following:

- From the printer control panel, press  to stop the defragmentation and continue printing.
- Delete fonts, macros, and other data in the printer memory. From the printer control panel, navigate to:
 > **Settings** >  > **Settings** >  > **Print Settings** >  > **Utilities Menu** >  > **Format Flash**
>  > **Yes** > 
- Install additional printer memory.

Insufficient memory, some Held Jobs were deleted [37]

From the printer control panel, press  to clear the message.

Insufficient memory, some held jobs will not be restored [37]

Do either of the following:

- From the printer control panel, press  to clear the message.
- Delete other held jobs to free up additional printer memory.

Network [x] software error [54]

Try one or more of the following:







- From the control panel, press  to continue printing.
- Turn off the printer, wait for about 10 seconds, and then turn the printer back on.
- Update the network firmware in the printer or print server. For more information, go to <http://support.lexmark.com>.

Not enough free space in flash memory for resources [52]

Try one or more of the following:

- From the printer control panel, press  to clear the message and continue printing.
- Delete fonts, macros, and other data stored in the flash memory.

From the printer control panel, navigate to:

 > **Settings** >  > **Settings** >  > **Print Settings** >  > **Utilities Menu** >  > **Format Flash**
>  > **Yes** > 

- Use a larger-capacity flash memory card.

Note: Downloaded fonts and macros that are not stored in the flash memory are deleted when the printer is turned off or restarted.

Printer had to restart. Last job may be incomplete.

From the printer control panel, select **Continue** to clear the message and continue printing.

For more information, visit <http://support.lexmark.com> or contact customer support.

Remove paper from standard output bin

Remove the paper stack from the standard bin.

Serial option [x] error [54]

Try one or more of the following:

- Make sure that the serial cable is properly connected and is the correct one for the serial port.
- Make sure that the serial interface parameters (protocol, baud, parity, and data bits) are set correctly on the printer and computer.
- From the printer control panel, press  to continue printing.
- Turn off the printer, and then turn it back on.

SMTP server not set up. Contact system administrator.

From the printer control panel, press  to clear the message.

Note: If the message appears again, then contact your system support person.

Standard network software error [54]

Try one or more of the following:

- From the printer control panel, press  to confirm.
- Unplug the router, then wait for 30 seconds, and then plug it back again.

- Turn off the printer, and then turn it back on.
- Update the network firmware in the printer or the print server. For more information, visit the Lexmark Web site at <http://support.lexmark.com>.

Standard parallel port disabled [56]

- From the printer control panel, press  to clear the message.

Notes:

- The printer discards any data received through the parallel port.
- Make sure the Parallel Buffer menu is not set to Disabled.

Standard USB port disabled [56]

Try one or more of the following:

- From the printer control panel, press  to clear the message and continue printing.

Note: The printer discards any data received through the USB port.

- From the printer control panel, set USB Buffer to Auto.

Too many flash options installed [58]

- 1 Turn off the printer.
- 2 Unplug the power cord from the electrical outlet.
- 3 Remove the extra flash memory.
- 4 Connect the power cord to a properly grounded electrical outlet.
- 5 Turn the printer back on.

Too many trays attached [58]

- 1 Turn off the printer.
- 2 Unplug the power cord from the electrical outlet.
- 3 Remove the extra trays.
- 4 Connect the power cord to a properly grounded electrical outlet.
- 5 Turn the printer back on.

Unformatted flash detected [53]

Try one or more of the following:

- From the printer control panel, press  to stop the defragmentation and continue printing.
- Format the flash memory device.

Note: If the error message remains, then the flash memory device may be defective and need to be replaced.

Unsupported option in slot [x] [55]

- 1 Turn off the printer.
- 2 Unplug the power cord from the electrical outlet.
- 3 Remove the unsupported option card from the printer controller board, and then replace it with a supported card.
- 4 Connect the power cord to a properly grounded electrical outlet.
- 5 Turn the printer back on.

Weblink server not set up. Contact system administrator.

From the printer control panel, press  to clear the message.

Note: If the message appears again, then contact your system support person.

Cartridge, imaging unit mismatch [41.xy]

- 1 Check if both the toner cartridge and imaging unit are Lexmark-authorized *MICR* (magnetic ink character recognition) supplies or non-MICR supplies.
- 2 Change the toner cartridge or imaging unit so that both are Lexmark-authorized MICR supplies or non-MICR supplies.

Notes:

- For a list of supported supplies, see the “Ordering supplies” section of the *User's Guide* or go to www.lexmark.com.
- For more information on MICR, go to www.lexmark.com.

Cartridge nearly low [88.xy]

If necessary, press  on the printer control panel to clear the message and continue printing.

Cartridge low [88.xy]

You may need to order a toner cartridge. If necessary, press  on the printer control panel to clear the message and continue printing.

Cartridge very low, [x] estimated pages remain [88.xy]

You may need to replace a toner cartridge very soon. For more information, see the “Replacing supplies” section of the *User's Guide*.

If necessary, press  on the printer control panel to clear the message and continue printing.

Close front door

Close the front door of the printer.

Credentials invalid. Print job canceled.

Enter the correct credentials or contact your system support person.

Imaging unit nearly low [84.xy]

If necessary, press  on the printer control panel to clear the message and continue printing.

Imaging unit low [84.xy]

You may need to order an imaging unit. If necessary, press  on the printer control panel to clear the message and continue printing.

Imaging unit very low, [x] estimated pages remain [84.xy]

You may need to replace the imaging unit very soon. For more information, see the “Replacing supplies” section of the *User's Guide*.

If necessary, press  on the printer control panel to clear the message and continue printing.

Insert tray [x]

Insert the indicated tray into the printer.

Load [paper source] with [custom string] [orientation]

Try one or more of the following:

- Load the indicated tray or feeder with the correct size and type of paper.
- From the printer control panel, press  to clear the message and continue printing.

Note: If the printer finds a tray that has the correct paper type and size, then it feeds from that tray. If the printer cannot find a tray that has the correct size and type of paper, then it prints from the default paper source.

- Cancel the current job.

Load [paper source] with [custom type name] [orientation]

Try one or more of the following:

- Load the tray or feeder with the correct size and type of paper.
- From the printer control panel, press  to clear the message and continue printing.

Note: If the printer finds a tray that has the correct size and type of paper, then it feeds from that tray. If the printer cannot find a tray that has the correct size and type of paper, then it prints from the default paper source.

- Cancel the current job.

Load [paper source] with [paper size] [orientation]

Try one or more of the following:

- Load the tray or feeder with the correct size of paper.
- From the printer control panel, press  to clear the message and continue printing.

Note: If the printer finds a tray that has the correct paper size, then it feeds from that tray. If the printer cannot find a tray that has the correct size of paper, then it prints from the default paper source.

- Cancel the current job.

Load [paper source] with [paper type] [paper size] [orientation]

Try one or more of the following:

- Load the tray or feeder with the correct size and type of paper.
- From the printer control panel, press  to clear the message and continue printing.

Note: If the printer finds a tray that has the correct size and type of paper, then it feeds from that tray. If the printer cannot find a tray that has the correct size and type of paper, then it prints from the default paper source.

- Cancel the current job.

Load multipurpose feeder with [custom type name] [orientation]

Try one or more of the following:

- Load the multipurpose feeder with the correct paper size and type.
- Depending on your printer model, touch **Continue** or press  to clear the message and continue printing.

Note: If no paper is loaded in the feeder, the printer manually overrides the request, and then prints from an automatically selected tray.

- Cancel the current job.

Load multipurpose feeder with [custom string] [orientation]

Try one or more of the following:

- Load the feeder with the correct paper size and type.
- Depending on your printer model, touch **Continue** or press  to clear the message and continue printing.

Note: If no paper is loaded in the feeder, the printer manually overrides the request, and then prints from an automatically selected tray.

- Cancel the current job.

Load multipurpose feeder with [paper size] [orientation]

Try one or more of the following:

- Load the multipurpose feeder with the correct paper size.
- Depending on your printer model, touch **Continue** or press  to clear the message and continue printing.

Note: If no paper is loaded in the feeder, the printer manually overrides the request, and then prints from an automatically selected tray.

- Cancel the current job.

Load multipurpose feeder with [paper type] [paper size] [orientation]

Try one or more of the following:

- Load the multipurpose feeder with the correct paper size and type.
- Depending on your printer model, touch **Continue** or press  to clear the message and continue printing.

Note: If no paper is loaded in the feeder, the printer manually overrides the request, and then prints from an automatically selected tray.

- Cancel the current job.

Memory full [38]

Try one or more of the following:

- From the printer control panel, press  to clear the message.
- Decrease the resolution setting.
- Install additional printer memory.

Non-Lexmark [supply type], see User's Guide [33.xy]

Note: The supply type can be toner cartridge or imaging unit.

The printer has detected a non-Lexmark supply or part installed in the printer.

Your Lexmark printer is designed to function best with genuine Lexmark supplies and parts. Use of third-party supplies or parts may affect the performance, reliability, or life of the printer and its imaging components. For more information, see [“Using genuine Lexmark parts and supplies” on page 135](#).

All life indicators are designed to function with Lexmark supplies and parts and may deliver unpredictable results if third-party supplies or parts are used. Imaging component usage beyond the intended life may damage your Lexmark printer or associated components.

Warning—Potential Damage: Use of third-party supplies or parts can affect warranty coverage. Damage caused by the use of third-party supplies or parts may not be covered by the warranty.

To accept any and all of these risks and to proceed with the use of non-genuine supplies or parts in your printer, press and hold  and the # button on the control panel simultaneously for 15 seconds.

For non-touch-screen printer models, press  and  on the control panel simultaneously for 15 seconds to clear the message and continue printing.

If you do not want to accept these risks, then remove the third-party supply or part from your printer and install a genuine Lexmark supply or part.

Note: For a list of supported supplies, see the “Ordering supplies” section or go to www.lexmark.com.

Parallel port disabled [56]

- Depending on your printer model, touch **Continue** or press  to clear the message and continue printing.

Notes:

- The printer discards data received through the parallel port.
- Make sure that the Parallel Buffer menu is not disabled.

Print quota exceeded. Print job canceled.

Contact your system support person.

Print quota exceeded. Print job incomplete.

Contact your system support person.

Reinstall missing or unresponsive cartridge [31.xy]

Try one or more of the following:

- Check if the toner cartridge is missing. If missing, then install the toner cartridge.
For information on installing the toner cartridge, see the “Replacing supplies” section.
- If the toner cartridge is installed, then remove and reinstall the unresponsive toner cartridge.

Note: If the message appears after reinstalling the supply, then replace the toner cartridge. The cartridge may be defective or a non-genuine Lexmark supply. For more information, see [“Using genuine Lexmark parts and supplies” on page 135](#).

Reinstall missing or unresponsive imaging unit [31.xy]

Try one or more of the following:

- Check if the imaging unit is missing. If missing, then install the imaging unit.
For information on installing the imaging unit, see the “Replacing supplies” section.
- If the imaging unit is installed, then remove and reinstall the unresponsive imaging unit.

Note: If the message appears after reinstalling the supply, then replace the imaging unit. The imaging unit may be defective or a non-genuine Lexmark supply. For more information, see [“Using genuine Lexmark parts and supplies” on page 135](#).

Replace cartridge, 0 estimated pages remain [88.xy]

Replace the toner cartridge to clear the message and continue printing. For more information, see the instruction sheet that came with the supply or see the “Replacing supplies” section of the *User’s Guide*.

Note: If you do not have a replacement cartridge, then see the “Ordering supplies” section of the *User’s Guide* or visit www.lexmark.com.

Replace cartridge, printer region mismatch [42.xy]

Install a toner cartridge that matches the region number of the printer. x indicates the value of the printer region. y indicates the value of the cartridge region. x and y can have the following values:

Printer and toner cartridge regions

Region number	Region
0	Global
1	United States, Canada
2	European Economic Area (EEA), Switzerland
3	Asia Pacific, Australia, New Zealand
4	Latin America
5	Africa, Middle East, rest of Europe
9	Invalid

Notes:

- The x and y values represent **.xy** in the code that appears on the printer control panel.
- The x and y values must match for printing to continue.

Replace imaging unit, 0 estimated pages remain [84.xy]

Replace the imaging unit to clear the message and continue printing. For more information, see the instruction sheet that came with the supply or see the “Replacing supplies” section of the *User’s Guide*.

Note: If you do not have a replacement imaging unit, then see the “Ordering supplies” section of the *User’s Guide* or visit www.lexmark.com.

Replace maintenance kit [80.xy]

The printer is scheduled for maintenance. For more information, go to <http://support.lexmark.com> or contact your service representative, and then report the message.

Replace unsupported cartridge [32.xy]

Remove the toner cartridge, and then install a supported one to clear the message and continue printing. For more information, see the instruction sheet that came with the supply.

This error can also be caused by installing a genuine Lexmark cartridge, such as a high yield cartridge, that is not intended to be used in this product.

The following error codes indicate that a non-genuine Lexmark toner cartridge is installed:

32.13
32.16
32.19
32.22
32.25
32.28
32.31
32.34
32.37

For more information, see [“Using genuine Lexmark parts and supplies” on page 135](#).

Note: If you do not have a replacement cartridge, then see the “Ordering supplies” section or go to www.lexmark.com.

Replace unsupported imaging unit [32.xy]

Remove the imaging unit, and then install a supported one to clear the message and continue printing. For more information, see the instruction sheet that came with the supply.

This error can also be caused by installing a genuine Lexmark imaging unit, such as a MICR unit, that is not intended to be used in this product.

The following error codes indicate that a non-genuine Lexmark imaging unit is installed:

32.14
32.17
32.20
32.23
32.26
32.29
32.32
32.35
32.38

For more information, see [“Using genuine Lexmark parts and supplies” on page 135](#).

Note: If you do not have a replacement imaging unit, then see the “Ordering supplies” section or go to www.lexmark.com.

Solving printer problems

- “Basic printer problems” on page 159
- “Option problems” on page 161
- “MS312 and MS317 paper feed problems” on page 163
- “MS315, MS415, and MS417 paper feed problems” on page 164

Basic printer problems

The printer is not responding

Action	Yes	No
<p>Step 1 Make sure the printer is turned on.</p> <p>Is the printer turned on?</p>	Go to step 2.	Turn on the printer.
<p>Step 2 Check if the printer is in Sleep mode or Hibernate mode.</p> <p>Is the printer in Sleep mode or Hibernate mode?</p>	Press the Sleep button to wake the printer from Sleep mode or Hibernate mode.	Go to step 3.
<p>Step 3 Check if one end of the power cord is plugged into the printer and the other to a properly grounded electrical outlet.</p> <p>Is the power cord plugged into the printer and a properly grounded electrical outlet?</p>	Go to step 4.	Plug one end of the power cord into the printer and the other to a properly grounded electrical outlet.
<p>Step 4 Check other electrical equipment plugged into the electrical outlet.</p> <p>Does other electrical equipment work?</p>	Unplug the other electrical equipment, and then turn on the printer. If the printer does not work, then reconnect the other electrical equipment.	Go to step 5.
<p>Step 5 Check if the cables connecting the printer and the computer are inserted in the correct ports.</p> <p>Are the cables inserted in the correct ports?</p>	Go to step 6.	<p>Make sure to match the following:</p> <ul style="list-style-type: none"> • The USB symbol on the cable with the USB symbol on the printer • The appropriate Ethernet cable with the Ethernet port

Action	Yes	No
<p>Step 6 Make sure the electrical outlet is not turned off by a switch or breaker.</p> <p>Is the electrical outlet turned off by a switch or breaker?</p>	Turn on the switch or reset the breaker.	Go to step 7.
<p>Step 7 Check if the printer is plugged into any surge protectors, uninterruptible power supplies, or extension cords.</p> <p>Is the printer plugged into any surge protectors, uninterruptible power supplies, or extension cords?</p>	Connect the printer power cord directly to a properly grounded electrical outlet.	Go to step 8.
<p>Step 8 Check if one end of the printer cable is plugged into a port on the printer and the other to the computer, print server, option, or other network device.</p> <p>Is the printer cable securely attached to the printer and the computer, print server, option, or other network device?</p>	Go to step 9.	Connect the printer cable securely to the printer and the computer, print server, option, or other network device.
<p>Step 9 Make sure to install all hardware options properly and remove any packing material.</p> <p>Are all hardware options properly installed and all packing material removed?</p>	Go to step 10.	Turn off the printer, remove all packing materials, then reinstall the hardware options, and then turn on the printer.
<p>Step 10 Check if you have selected the correct port settings in the printer driver.</p> <p>Are the port settings correct?</p>	Go to step 11.	Use correct printer driver settings.
<p>Step 11 Check the installed printer driver.</p> <p>Is the correct printer driver installed?</p>	Go to step 12.	Install the correct printer driver.
<p>Step 12 Turn off the printer, then wait for about 10 seconds, and then turn the printer back on.</p> <p>Is the printer working?</p>	The problem is solved.	Contact customer support .

Printer display is blank

Action	Yes	No
<p>Step 1 Press the Sleep button on the printer control panel.</p> <p>Does Ready appear on the printer display?</p>	The problem is solved.	Go to step 2.
<p>Step 2 Turn off the printer, then wait for about 10 seconds, and then turn the printer back on.</p> <p>Do Please wait and Ready appear on the printer display?</p>	The problem is solved.	Turn off the printer, and then contact customer support .

Option problems

Cannot detect internal option

Action	Yes	No
<p>Step 1 Turn off the printer, then wait for about 10 seconds, and then turn on the printer.</p> <p>Does the internal option operate correctly?</p>	The problem is solved.	Go to step 2.
<p>Step 2 Check if the internal option is properly installed in the controller board.</p> <ul style="list-style-type: none"> a Turn off the printer using the power switch, and then unplug the power cord from the electrical outlet. b Make sure the internal option is installed in the appropriate connector in the controller board. c Connect the power cord to the printer, then to a properly grounded electrical outlet, and then turn on the printer. <p>Is the internal option properly installed in the controller board?</p>	Go to step 3.	Connect the internal option to the controller board.
<p>Step 3 Print a menu settings page, and then check to see if the internal option is listed in the Installed Features list.</p> <p>Is the internal option listed in the menu settings page?</p>	Go to step 4.	Reinstall the internal option.

Action	Yes	No
<p>Step 4</p> <p>a Check if the internal option is selected. It may be necessary to manually add the internal option in the printer driver to make it available for print jobs. For more information, see “Adding available options in the print driver” on page 20.</p> <p>b Resend the print job.</p> <p>Does the internal option operate correctly?</p>	<p>The problem is solved.</p>	<p>Contact customer support.</p>

Tray problems

Action	Yes	No
<p>Step 1</p> <p>a Open the tray and do one or more of the following:</p> <ul style="list-style-type: none"> • Check for paper jams or misfeeds. • Check if the paper size indicators on the paper guides are aligned with the paper size indicators on the tray. • If you are printing on custom-size paper, then make sure that the paper guides rest against the edges of the paper. • Make sure the paper is below the maximum paper fill indicator. • Make sure paper lies flat in the tray. <p>b Check if the tray closes properly.</p> <p>Is the tray working?</p>	<p>The problem is solved.</p>	<p>Go to step 2.</p>
<p>Step 2</p> <p>a Turn off the printer, then wait about 10 seconds, and then turn the printer back on.</p> <p>b Resend the print job.</p> <p>Is the tray working?</p>	<p>The problem is solved.</p>	<p>Go to step 3.</p>
<p>Step 3</p> <p>Check if the tray is installed and recognized by the printer. Print a menu settings page, and then check if the tray is listed in the Installed Features list.</p> <p>Is the tray listed in the menu settings page?</p>	<p>Go to step 4.</p>	<p>Reinstall the tray. For more information, see the setup documentation that came with the tray.</p>







Action	Yes	No
<p>Step 4 Check if the tray is available in the printer driver.</p> <p>Note: If necessary, manually add the tray in the printer driver to make it available for print jobs. For more information, see “Adding available options in the print driver” on page 20.</p> <p>Is the tray available in the printer driver?</p>	Go to step 5.	Manually add the tray in the printer driver.
<p>Step 5 Check if the option is selected.</p> <p>a From the application you are using, select the option. For Mac OS X version 9 users, make sure the printer is set up in Chooser.</p> <p>b Resend the print job.</p> <p>Is the tray working?</p>	The problem is solved.	Contact customer support.

MS312 and MS317 paper feed problems

Paper jam message remains after jam is cleared

Action	Yes	No
<p>Open front door and remove all trays.</p> <p>a Clear any jammed pages.</p> <p>Note: Make sure all paper fragments are removed.</p> <p>b Press  to clear the message and continue printing.</p> <p>Does the paper jam message remain?</p>	Contact customer support.	The problem is solved.

Jammed pages are not reprinted

Action	Yes	No
<p>a Turn on jam recovery.</p> <p>1 From the printer control panel, navigate to:</p> <p> > Settings >  > General Settings >  > Print Recovery >  > Jam Recovery > </p> <p>2 Press the arrow buttons until On or Auto appears, and then press .</p> <p>b Resend the pages that did not print.</p> <p>Were the jammed pages reprinted?</p>	The problem is solved.	Contact customer support.

MS315, MS415, and MS417 paper feed problems

Paper frequently jams

Action	Yes	No
<p>Step 1</p> <p>a Pull out the tray, and then do one or more of the following:</p> <ul style="list-style-type: none"> • Make sure paper lies flat in the tray. • Check if the paper size indicators on the paper guides are aligned with the paper size indicators on the tray. • Check if the paper guides are aligned against the edges of the paper. • Make sure the paper is below the maximum paper fill indicator. • Check if you are printing on a recommended paper size and type. <p>b Insert the tray properly. If jam recovery is enabled, then the print jobs will reprint automatically.</p> <p>Do paper jams still occur frequently?</p>	Go to step 2.	The problem is solved.
<p>Step 2</p> <p>a Load paper from a fresh package. Note: Paper absorbs moisture due to high humidity. Store paper in its original wrapper until you use it.</p> <p>b Resend the print job.</p> <p>Do paper jams still occur frequently?</p>	Go to step 3.	The problem is solved.
<p>Step 3</p> <p>a Review the tips on avoiding jams. For more information, see “Avoiding jams” on page 126.</p> <p>b Follow the recommendations, and then resend the print job.</p> <p>Do paper jams still occur frequently?</p>	Contact customer support .	The problem is solved.

Paper jam message remains after jam is cleared

Action	Yes	No
<p>a From the printer control panel, navigate to:</p> <p>Next >  > Clear the jam, press OK > </p> <p>b Follow the instructions on the printer display.</p> <p>Does the paper jam message remain?</p>	Contact customer support .	The problem is solved.

Jammed pages are not reprinted

Action	Yes	No
<p>a Turn on jam recovery.</p> <p>1 From the control panel, navigate to: Settings > General Settings > Print Recovery > Jam Recovery</p> <p>2 Select On or Auto.</p> <p>3 Depending on your printer model, press .</p> <p>b Resend the pages that did not print.</p> <p>Were the jammed pages reprinted?</p>	<p>The problem is solved.</p>	<p>Contact customer support.</p>

Solving print problems

Printing problems

Print jobs do not print

Action	Yes	No
<p>Step 1</p> <p>a From the document you are trying to print, open the Print dialog and check if you have selected the correct printer.</p> <p>Note: If the printer is not the default printer, then you must select the printer for each document that you want to print.</p> <p>b Resend the print job.</p> <p>Do the jobs print?</p>	<p>The problem is solved.</p>	<p>Go to step 2.</p>
<p>Step 2</p> <p>a Check if the printer is plugged in and turned on, and if Ready appears on the printer display.</p> <p>b Resend the print job.</p> <p>Do the jobs print?</p>	<p>The problem is solved.</p>	<p>Go to step 3.</p>
<p>Step 3</p> <p>If an error message appears on the printer display, then clear the message.</p> <p>Note: The printer continues to print after clearing the message.</p> <p>Do the jobs print?</p>	<p>The problem is solved.</p>	<p>Go to step 4.</p>

Action	Yes	No
<p>Step 4</p> <p>a Check if the ports (USB, serial, or Ethernet) are working and if the cables are securely connected to the computer and the printer.</p> <p>Note: For more information, see the setup documentation that came with the printer.</p> <p>b Resend the print job.</p> <p>Do the jobs print?</p>	The problem is solved.	Go to step 5.
<p>Step 5</p> <p>a Turn off the printer, then wait for about 10 seconds, and then turn the printer back on.</p> <p>b Resend the print job.</p> <p>Do the jobs print?</p>	The problem is solved.	Go to step 6.
<p>Step 6</p> <p>a Remove, and then reinstall the printer software. For more information, see “Installing the printer software” on page 19.</p> <p>Note: The printer software is available at http://support.lexmark.com.</p> <p>b Resend the print job.</p> <p>Do the jobs print?</p>	The problem is solved.	Contact customer support .

Printing slows down

Notes:

- When printing using narrow paper, the printer prints at a reduced speed to prevent damage to the fuser.
- The printer speed may be reduced when printing for long periods of time, or printing at elevated temperatures.
- The printer speed may also be reduced when the printed output resolution is set to 1,200 dpi.

Action	Yes	No
<p>Place letter- or A4-size paper in the tray, and then resend the print job.</p> <p>Does the print speed increase?</p>	The problem is solved.	Contact customer support .

Job prints from the wrong tray or on the wrong paper

Action	Yes	No
<p>Step 1</p> <p>a Check if you are printing on paper that is supported by the tray.</p> <p>b Resend the print job.</p> <p>Did the job print from the correct tray or on the correct paper?</p>	The problem is solved.	Go to step 2.
<p>Step 2</p> <p>a From the Paper menu on the printer control panel, set the paper size and type to match the paper loaded in the tray.</p> <p>b Resend the print job.</p> <p>Did the job print from the correct tray or on the correct paper?</p>	The problem is solved.	Go to step 3.
<p>Step 3</p> <p>a Depending on your operating system, open Printing Preferences or the Print dialog, and then specify the paper type.</p> <p>b Resend the print job.</p> <p>Did the job print from the correct tray or on the correct paper?</p>	The problem is solved.	Go to step 4.
<p>Step 4</p> <p>a Check if the trays are not linked.</p> <p>b Resend the print job.</p> <p>Did the job print from the correct tray or on the correct paper?</p>	The problem is solved.	Contact customer support .

Incorrect characters print

Action	Yes	No
<p>Step 1</p> <p>Make sure the printer is not in Hex Trace mode.</p> <p>Note: If Ready Hex appears on the printer display, then turn off the printer, and then turn it back on to deactivate Hex Trace mode.</p> <p>Is the printer in Hex Trace mode?</p>	Deactivate Hex Trace mode.	Go to step 2.
<p>Step 2</p> <p>a From the printer control panel, select Standard Network or Network [x], and then set SmartSwitch to On.</p> <p>b Resend the print job.</p> <p>Do incorrect characters print?</p>	Contact customer support .	The problem is solved.

Tray linking does not work

Note: The trays and the multipurpose feeder do not automatically detect the paper size. You must set the size from the Paper Size/Type menu.

Action	Yes	No
<p>a From the printer control panel, set the paper size and type in the Paper menu to match the paper loaded in the trays to be linked.</p> <p>Note: The paper size and type must match for trays to be linked.</p> <p>b Resend the print job.</p> <p>Do the trays link correctly?</p>	The problem is solved.	Contact customer support .

Large jobs do not collate







Action	Yes	No
<p>Step 1</p> <p>a From the Finishing menu on the printer control panel, set Collate to (1,2,3) (1,2,3).</p> <p>b Resend the print job.</p> <p>Did the job print and collate correctly?</p>	The problem is solved.	Go to step 2.
<p>Step 2</p> <p>a From the printer software, set Collate to (1,2,3) (1,2,3).</p> <p>Note: Setting Collate to (1,1,1) (2,2,2) in the software overrides the setting in the Finishing menu.</p> <p>b Resend the print job.</p> <p>Did the job print and collate correctly?</p>	The problem is solved.	Go to step 3.
<p>Step 3</p> <p>Reduce the complexity of the print job by eliminating the number and size of fonts, the number and complexity of images, and the number of pages in the job.</p> <p>Did the job print and collate correctly?</p>	The problem is solved.	Contact customer support .





Unexpected page breaks occur

Action	Yes	No
<p>Step 1 Adjust the print timeout settings.</p> <p>a From the printer control panel, navigate to: Settings > General Settings > Timeouts > Print Timeout</p> <p>b Select a higher setting and then, depending on your printer model, select  or Submit.</p> <p>c Resend the print job.</p> <p>Did the file print correctly?</p>	The problem is solved.	Go to step 2.
<p>Step 2</p> <p>a Check the original file for manual page breaks.</p> <p>b Resend the print job.</p> <p>Did the file print correctly?</p>	The problem is solved.	Contact customer support .

MS312 and MS317 printing problems

Print job takes longer than expected

Action	Yes	No
<p>Step 1 Reduce the number and size of fonts, the number and complexity of images, and the number of pages in the print job, and then resend the print job.</p> <p>Does the print job still take long?</p>	Go to step 2.	The problem is solved.
<p>Step 2 Disable the Page Protect feature.</p> <p>From the printer control panel, navigate to:</p> <p> > Settings >  > General Settings >  > Print Recovery >  > Page Protect >  > Off > </p> <p>Does the print job still take long?</p>	Go to step 3.	The problem is solved.

Action	Yes	No
<p>Step 3 Change the environmental settings. From the printer control panel, navigate to:</p> <p> > Settings >  > General Settings >  > Eco-Mode</p> <p>> select a setting > </p> <p>Note: When using the Eco-Mode setting, you may notice a reduction in performance.</p> <p>Does the print job still take long?</p>	<p>Install additional printer memory. For more information, contact customer support.</p>	<p>The problem is solved.</p>

MS315, MS415, and MS417 printing problems

Multiple-language PDF files do not print

Action	Yes	No
<p>Step 1</p> <p>a Check if the print options for the PDF output are set to embed all fonts.</p> <p>b Generate a new PDF file, and then resend the print job.</p> <p>Do the files print?</p>	<p>The problem is solved.</p>	<p>Go to step 2.</p>
<p>Step 2</p> <p>a Open the document you want to print in Adobe Acrobat.</p> <p>b Click File > Print > Advanced > Print As Image > OK > OK .</p> <p>Do the files print?</p>	<p>The problem is solved.</p>	<p>Contact customer support.</p>

Confidential and other held jobs do not print

Note: Confidential, Verify, Reserve, and Repeat print jobs may be deleted if the printer requires extra memory to process additional held jobs.

Action	Yes	No
<p>Step 1</p> <p>Open the held jobs folder on the display, and then verify that your print job is listed.</p> <p>Is your print job listed in the held jobs folder?</p>	Go to step 2.	Select one of the Print and Hold options, and then resend the print job. For more information, see “Storing print jobs in the printer” on page 57.
<p>Step 2</p> <p>The print job may contain a formatting error or invalid data.</p> <ul style="list-style-type: none"> • Delete the print job, and then send it again. • For PDF files, generate a new PDF, and then print it again. <p>If you are printing from the Internet, then the printer may be reading multiple job titles as duplicates and deleting all jobs except the first one.</p> <p>For Macintosh users</p> <p>Save each print job, name each job differently, and then send the individual jobs to the printer.</p> <p>Does the job print?</p>	The problem is solved.	Go to step 3.
<p>Step 3</p> <p>Free up additional printer memory by deleting some of the held jobs.</p> <p>Does the job print?</p>	The problem is solved.	Add additional printer memory.

Print job takes longer than expected

Action	Yes	No
<p>Step 1</p> <p>Change the environmental settings of the printer.</p> <p>a From the control panel, navigate to: Settings > General Settings</p> <p>b Select Eco-Mode or Quiet Mode, and then select Off.</p> <p>Note: Disabling Eco-Mode or Quiet Mode may increase the consumption of energy or supplies, or both.</p> <p>Did the job print?</p>	The problem is solved.	Go to step 2.

Action	Yes	No
<p>Step 2 Reduce the font size, the number and complexity of images, and the number of pages in the print job, and then resend the job</p> <p>Did the job print?</p>	The problem is solved.	Go to step 3.
<p>Step 3 a Remove held jobs stored in the printer memory. b Resend the print job.</p> <p>Did the job print?</p>	The problem is solved.	Go to step 4.
<p>Step 4 a Disable the Page Protect feature. From the control panel, navigate to: Settings > General Settings > Print Recovery > Page Protect > Off b Resend the print job.</p> <p>Did the job print?</p>	The problem is solved.	Go to step 5.
<p>Step 5 Install additional printer memory, and then resend the print job.</p> <p>Did the job print?</p>	The problem is solved.	Contact customer support .

Print quality problems

Clipped pages or images

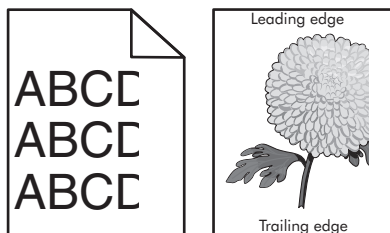

Action	Yes	No
<p>Step 1 a Move the width and length guides in the tray to the correct positions for the paper loaded. b Resend the print job.</p> <p>Is the page or image clipped?</p>	Go to step 2.	The problem is solved.

Action	Yes	No
<p>Step 2</p> <p>From the printer control panel, set the paper size and type in the Paper menu to match the paper loaded in the tray.</p> <p>Do the paper size and type match the paper loaded in the tray?</p>	Go to step 3.	<p>Do one or more of the following:</p> <ul style="list-style-type: none"> Specify the paper size from the tray settings to match the paper loaded in the tray. Change the paper loaded in the tray to match the paper size specified in the tray settings.
<p>Step 3</p> <p>a Depending on your operating system, specify the paper size from Printing Preferences or from the Print dialog.</p> <p>b Resend the print job.</p> <p>Is the page or image clipped?</p>	Go to step 4.	The problem is solved.
<p>Step 4</p> <p>a Reinstall the imaging unit.</p> <ol style="list-style-type: none"> Remove the toner cartridge. Remove the imaging unit. <p>Warning—Potential Damage: Do not expose the imaging unit to direct light for more than 10 minutes. Extended exposure to light may cause print quality problems.</p> <ol style="list-style-type: none"> Install the imaging unit, and then the cartridge. <p>b Resend the print job.</p> <p>Is the page or image clipped?</p>	Contact customer support .	The problem is solved.

Shadow images appear on prints

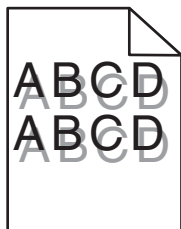

Action	Yes	No
<p>Step 1 Load paper with the correct paper type and weight in the tray.</p> <p>Is paper with the correct paper type and weight loaded in the tray?</p>	Go to step 2.	Load paper with the correct paper type and weight in the tray.
<p>Step 2 From the printer control panel, set the paper type and weight in the Paper menu to match the paper loaded in the tray.</p> <p>Is the tray set to the type and weight of the paper loaded?</p>	Go to step 3.	Change the paper loaded in the tray to match the paper type and weight specified in the tray settings.
<p>Step 3</p> <p>a Depending on your operating system, specify the paper type and weight from Printing Preferences or from the Print dialog.</p> <p>b Resend the print job.</p> <p>Do shadow images still appear on prints?</p>	Go to step 4.	The problem is solved.
<p>Step 4 Replace the imaging unit, and then resend the print job.</p> <p>Do shadow images still appear on prints?</p>	Contact customer support .	The problem is solved.

Gray background on prints

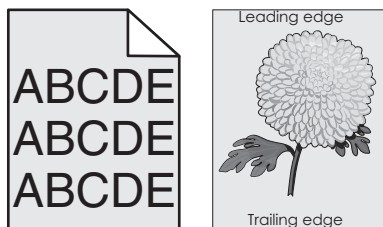

Action	Yes	No
<p>Step 1</p> <p>a From the Quality Menu on the printer control panel, decrease the toner darkness.</p> <p>Note: 8 is the factory default setting.</p> <p>b Resend the print job.</p> <p>Did the gray background disappear from the prints?</p>	The problem is solved.	Go to step 2.

Action	Yes	No
<p>Step 2 Reinstall the imaging unit and the toner cartridge.</p> <ul style="list-style-type: none"> a Remove the toner cartridge. b Remove the imaging unit. <p>Warning—Potential Damage: Do not expose the imaging unit to direct light for more than 10 minutes. Extended exposure to light can cause print quality problems.</p> <ul style="list-style-type: none"> c Install the imaging unit, and then the cartridge. d Resend the print job. <p>Did the gray background disappear from the prints?</p>	The problem is solved.	Go to step 3.
<p>Step 3 Replace the imaging unit, and then resend the print job.</p> <p>Did the gray background disappear from the prints?</p>	The problem is solved.	Contact customer support .

Incorrect margins on prints

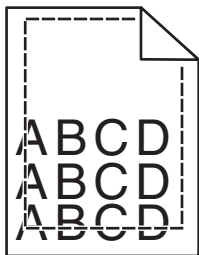

Action	Yes	No
<p>Step 1</p> <ul style="list-style-type: none"> a Move the width and length guides in the tray to the correct positions for the paper size loaded. b Resend the print job. <p>Are the margins correct?</p>	The problem is solved.	Go to step 2.

Action	Yes	No
<p>Step 2</p> <p>From the printer control panel, set the paper size in the Paper menu to match the paper loaded in the tray.</p> <p>Does the paper size match the paper loaded in the tray?</p>	Go to step 3.	<p>Do one or more of the following:</p> <ul style="list-style-type: none"> Specify the paper size from the tray settings to match the paper loaded in the tray. Change the paper loaded in the tray to match the paper size specified in the tray settings.
<p>Step 3</p> <p>a Depending on your operating system, specify the paper size from Printing Preferences or from the Print dialog.</p> <p>b Resend the print job.</p> <p>Are the margins correct?</p>	The problem is solved.	Contact customer support .

Paper curl

Action	Yes	No
<p>Step 1</p> <p>Move the width and length guides in the tray to the correct positions for the size of the paper loaded.</p> <p>Are the width and length guides positioned correctly?</p>	Go to step 2.	Adjust the width and length guides.
<p>Step 2</p> <p>From the printer control panel, set the paper type and weight in the Paper menu to match the paper loaded in the tray.</p> <p>Do the paper type and weight match the type and weight of the paper in the tray?</p>	Go to step 3.	Specify the paper type and weight from the tray settings to match the paper loaded in the tray.
<p>Step 3</p> <p>a Depending on your operating system, specify the paper type and weight from Printing Preferences or from the Print dialog.</p> <p>b Resend the print job.</p> <p>Is the paper still curled?</p>	Go to step 4.	The problem is solved.
<p>Step 4</p> <p>a Remove the paper from the tray, and then turn it over.</p> <p>b Resend the print job.</p> <p>Is the paper still curled?</p>	Go to step 5.	The problem is solved.

Action	Yes	No
<p>Step 5</p> <p>a Load paper from a fresh package.</p> <p>Note: Paper absorbs moisture due to high humidity. Store paper in its original wrapper until you use it.</p> <p>b Resend the print job.</p> <p>Is the paper still curled?</p>	<p>Contact customer support.</p>	<p>The problem is solved.</p>

Print irregularities

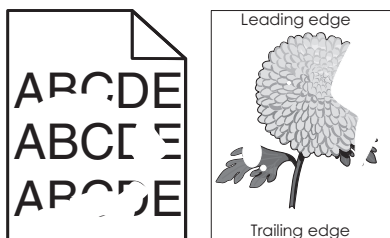

Action	Yes	No
<p>Step 1</p> <p>a Move the width and length guides in the tray to the correct positions for the size of the paper loaded in the tray.</p> <p>b Resend the print job.</p> <p>Do print irregularities still appear?</p>	<p>Go to step 2.</p>	<p>The problem is solved.</p>
<p>Step 2</p> <p>From the printer control panel, set the paper size and type in the Paper menu to match the paper loaded in the tray.</p> <p>Do the printer settings match the type and weight of the paper loaded in the tray?</p>	<p>Go to step 3.</p>	<p>Specify the paper size and type from the tray settings to match the paper loaded in the tray.</p>
<p>Step 3</p> <p>a Depending on your operating system, specify the paper type and weight from Printing Preferences or from the Print dialog.</p> <p>b Resend the print job.</p> <p>Do print irregularities still appear?</p>	<p>Go to step 4.</p>	<p>The problem is solved.</p>
<p>Step 4</p> <p>Check if the paper loaded in the tray has texture or rough finishes.</p> <p>Are you printing on textured or rough paper?</p>	<p>From the printer control panel, set the paper texture in the Paper menu to match the paper loaded in the tray.</p>	<p>Go to step 5.</p>

Action	Yes	No
<p>Step 5</p> <p>a Load paper from a fresh package.</p> <p>Note: Paper absorbs moisture due to high humidity. Store paper in its original wrapper until you use it.</p> <p>b Resend the print job.</p> <p>Do print irregularities still appear?</p>	Go to step 6.	The problem is solved.
<p>Step 6</p> <p>Replace the imaging unit, and then resend the print job.</p> <p>Do print irregularities still appear?</p>	Contact customer support at http://support.lexmark.com or your service representative.	The problem is solved.

Repeating defects appear on prints

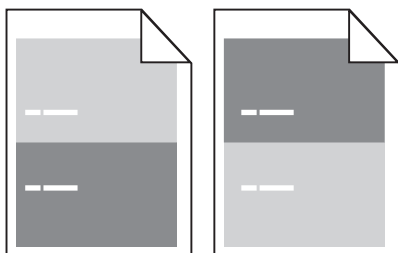

Action	Yes	No
<p>Step 1</p> <p>Measure the distance between the defects.</p> <p>Check for a distance between the defects that equals:</p> <ul style="list-style-type: none"> • 97 mm (3.82 in.) • 47 mm (1.85 in.) • 38 mm (1.5 in.) <p>Is the distance between defects equal to one of the listed measurements?</p>	Go to step 2.	<p>1 Check if the distance between the defects equal to 80 mm (3.15 in.)</p> <p>2 Take note of the distance, and then contact customer support at http://support.lexmark.com or your service representative.</p>
<p>Step 2</p> <p>Replace the imaging unit, and then resend the print job.</p> <p>Do the repeating defects still appear?</p>	Contact customer support at http://support.lexmark.com or your service representative.	The problem is solved.

Print is too dark

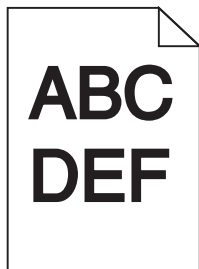

Action	Yes	No
<p>Step 1</p> <p>a From the Quality menu on the printer control panel, reduce the toner darkness.</p> <p>Note: 8 is the factory default setting.</p> <p>b Resend the print job.</p> <p>Is the print still too dark?</p>	Go to step 2.	The problem is solved.
<p>Step 2</p> <p>a From the printer control panel, set the paper type, texture and weight in the Paper menu to match the paper loaded in the tray.</p> <p>b Resend the print job.</p> <p>Is the tray set to the type, texture, and weight of the paper loaded?</p>	Go to step 3.	<p>Do one or more of the following:</p> <ul style="list-style-type: none"> Specify the paper type, texture, and weight from the tray settings to match the paper loaded in the tray. Change the paper loaded in the tray to match the paper type, texture and weight specified in the tray settings.
<p>Step 3</p> <p>a Depending on your operating system, specify the paper type, texture and weight from Printing Preferences or from the Print dialog.</p> <p>b Resend the print job.</p> <p>Is the print still too dark?</p>	Go to step 4.	The problem is solved.
<p>Step 4</p> <p>Check if the paper loaded in the tray has texture or rough finishes.</p> <p>Are you printing on textured or rough paper?</p>	From the printer control panel, change the texture settings in the Paper Texture menu to match the paper you are printing on.	Go to step 5.

Action	Yes	No
<p>Step 5</p> <p>a Load paper from a fresh package.</p> <p>Note: Paper absorbs moisture due to high humidity. Store paper in its original wrapper until you use it.</p> <p>b Resend the print job.</p> <p>Is the print still too dark?</p>	Go to step 6.	The problem is solved.
<p>Step 6</p> <p>Replace the imaging unit, and then resend the print job.</p> <p>Is the print still too dark?</p>	Contact customer support .	The problem is solved.

Print is too light



Action	Yes	No
<p>Step 1</p> <p>a From the Quality menu on the printer control panel, increase the toner darkness.</p> <p>Note: 8 is the factory default setting.</p> <p>b Resend the print job.</p> <p>Is the print still too light?</p>	Go to step 2.	The problem is solved.
<p>Step 2</p> <p>From the printer control panel, set the paper type, texture, and weight in the Paper menu to match the paper loaded in the tray.</p> <p>Is the tray set to the type, texture, and weight of the paper loaded?</p>	Go to step 3.	Change the paper type, texture, and weight to match the paper loaded in the tray.
<p>Step 3</p> <p>a Depending on your operating system, specify the paper type, texture, and weight from Printing Preferences or from the Print dialog.</p> <p>b Resend the print job.</p> <p>Is the print still too light?</p>	Go to step 4.	The problem is solved.

Action	Yes	No
<p>Step 4 Make sure that the paper has no texture or rough finishes.</p> <p>Are you printing on textured or rough paper?</p>	<p>From the printer control panel, change the texture settings in the Paper Texture menu to match the paper you are printing on.</p>	<p>Go to step 5.</p>
<p>Step 5 a Load paper from a fresh package. Note: Paper absorbs moisture due to high humidity. Store paper in its original wrapper until you use it. b Resend the print job.</p> <p>Is the print still too light?</p>	<p>Go to step 6.</p>	<p>The problem is solved.</p>
<p>Step 6 a Redistribute the toner in the imaging unit. 1 Remove the toner cartridge, and then the imaging unit. 2 Firmly shake the imaging unit. Warning—Potential Damage: Do not expose the imaging unit to direct light for more than 10 minutes. Extended exposure to light may cause print quality problems. 3 Install the imaging unit, and then the cartridge. b Resend the print job.</p> <p>Is the print still too light?</p>	<p>Go to step 7.</p>	<p>The problem is solved.</p>
<p>Step 7 Replace the imaging unit, and then resend the print job.</p> <p>Is the print still too light?</p>	<p>Contact customer support.</p>	<p>The problem is solved.</p>

Printer is printing blank pages

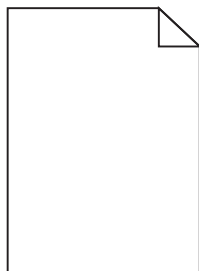

Action	Yes	No
<p>Step 1</p> <p>a Check if there is packing material left on the imaging unit.</p> <ol style="list-style-type: none"> 1 Remove the toner cartridge, and then the imaging unit. 2 Check if the packing material is properly removed from the imaging unit. <p>Warning—Potential Damage: Do not expose the imaging unit to direct light for more than 10 minutes. Extended exposure to light may cause print quality problems.</p> <ol style="list-style-type: none"> 3 Reinstall the imaging unit, and then the cartridge. <p>b Resend the print job.</p> <p>Is the printer still printing blank pages?</p>	Go to step 2.	The problem is solved.
<p>Step 2</p> <p>a Redistribute the toner in the imaging unit.</p> <ol style="list-style-type: none"> 1 Remove the toner cartridge, and then the imaging unit. 2 Firmly shake the imaging unit. <p>Warning—Potential Damage: Do not expose the imaging unit to direct light for more than 10 minutes. Extended exposure to light may cause print quality problems.</p> <ol style="list-style-type: none"> 3 Reinstall the imaging unit, and then the cartridge. <p>b Resend the print job.</p> <p>Is the printer still printing blank pages?</p>	Go to step 3.	The problem is solved.
<p>Step 3</p> <p>Replace the imaging unit, and then resend the print job.</p> <p>Is the printer still printing blank pages?</p>	Contact customer support .	The problem is solved.

Skewed print

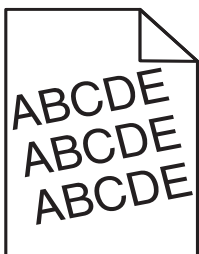

Action	Yes	No
<p>Step 1</p> <p>a Move the width and length guides in the tray to the correct positions for the size of the paper loaded.</p> <p>b Resend the print job.</p> <p>Is the print still skewed?</p>	Go to step 2.	The problem is solved.
<p>Step 2</p> <p>a Check if you are printing on a paper that is supported by the tray.</p> <p>b Resend the print job.</p> <p>Is the print still skewed?</p>	Contact customer support .	The problem is solved.

Printer is printing solid black pages



Action	Yes	No
<p>Step 1</p> <p>a Reinstall the imaging unit.</p> <p>1 Remove the toner cartridge, and then the imaging unit.</p> <p>Warning—Potential Damage: Do not expose the imaging unit to direct light for more than 10 minutes. Extended exposure to light may cause print quality problems.</p> <p>2 Install the imaging unit, and then the cartridge.</p> <p>b Resend the print job.</p> <p>Is the printer printing solid black pages?</p>	Go to step 2.	The problem is solved.
<p>Step 2</p> <p>Replace the imaging unit, and then resend the print job.</p> <p>Is the printer printing solid black pages?</p>	Contact customer support .	The problem is solved.

Transparency print quality is poor

Action	Yes	No
<p>Step 1 From the printer control panel, set the paper type in the Paper menu to match the paper loaded in the tray.</p> <p>Is the paper type for the tray set to Transparency?</p>	Go to step 2.	Set the paper type to Transparency.
<p>Step 2 a Check if you are using a recommended type of transparency. b Resend the print job.</p> <p>Is the print quality still poor?</p>	Contact customer support .	The problem is solved.

Streaked horizontal lines appear on prints

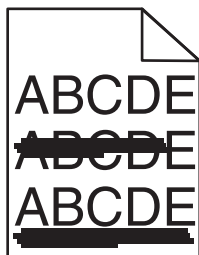

Action	Yes	No
<p>Step 1 a Depending on your operating system, specify the tray or feeder from Printing Preferences or the Print dialog. b Resend the print job.</p> <p>Do streaked horizontal lines appear on prints?</p>	Go to step 2.	The problem is solved.
<p>Step 2 From the printer control panel, set the paper type and weight in the Paper menu to match the paper loaded in the tray.</p> <p>Do the paper type and weight match the type and weight of the paper in the tray?</p>	Go to step 3.	Change the paper type and weight to match the paper loaded in the tray.
<p>Step 3 a Load paper from a fresh package. Note: Paper absorbs moisture due to high humidity. Store paper in its original wrapper until you use it. b Resend the print job.</p> <p>Do streaked horizontal lines appear on prints?</p>	Go to step 4.	The problem is solved.

Action	Yes	No
<p>Step 4</p> <p>a Reinstall the imaging unit.</p> <p>1 Remove the toner cartridge, and then the imaging unit.</p> <p>Warning—Potential Damage: Do not expose the imaging unit to direct light for more than 10 minutes. Extended exposure to light may cause print quality problems.</p> <p>2 Install the imaging unit, and then the cartridge.</p> <p>b Resend the print job.</p> <p>Do streaked horizontal lines appear on prints?</p>	Go to step 5.	The problem is solved.
<p>Step 5</p> <p>Replace the imaging unit, and then resend the print job.</p> <p>Do streaked horizontal lines appear on prints?</p>	Contact customer support .	The problem is solved.

Streaked vertical lines appear on prints

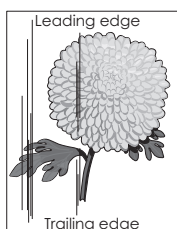
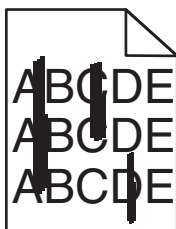

Action	Yes	No
<p>Step 1</p> <p>a Depending on your operating system, specify the paper type, texture, and weight from Printing Preferences or from the Print dialog.</p> <p>b Resend the print job.</p> <p>Do streaked vertical lines appear on prints?</p>	Go to step 2.	The problem is solved.

Action	Yes	No
<p>Step 2 From the printer control panel, set the paper texture, type, and weight in the Paper menu to match the paper loaded in the tray.</p> <p>Do the paper texture, type, and weight match the paper in the tray?</p>	<p>Go to step 3.</p>	<p>Do one or more of the following:</p> <ul style="list-style-type: none"> • Specify the paper texture, type, and weight from the tray settings to match the paper loaded in the tray. • Change the paper loaded in the tray to match the paper texture, type, and weight specified in the tray settings.
<p>Step 3 a Load paper from a fresh package. Note: Paper absorbs moisture due to high humidity. Store paper in its original wrapper until you use it. b Resend the print job.</p> <p>Do streaked vertical lines appear on prints?</p>	<p>Go to step 4.</p>	<p>The problem is solved.</p>
<p>Step 4 a Reinstall the imaging unit. 1 Remove the toner cartridge, and then the imaging unit. Warning—Potential Damage: Do not expose the imaging unit to direct light for more than 10 minutes. Extended exposure to light may cause print quality problems. 2 Install the imaging unit, and then the cartridge. b Resend the print job.</p> <p>Do streaked vertical lines appear on prints?</p>	<p>Go to step 5.</p>	<p>The problem is solved.</p>
<p>Step 5 Replace the imaging unit, and then resend the print job.</p> <p>Do streaked vertical lines appear on prints?</p>	<p>Contact customer support at http://support.lexmark.com or your service representative.</p>	<p>The problem is solved.</p>

Horizontal voids appear on prints

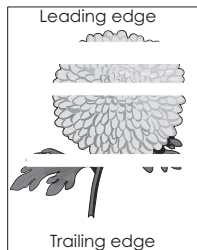

Action	Yes	No
<p>Step 1</p> <ul style="list-style-type: none"> a Make sure your software program is using a correct fill pattern. b Resend the print job. <p>Do horizontal voids appear on prints?</p>	Go to step 2.	The problem is solved.
<p>Step 2</p> <ul style="list-style-type: none"> a Load the specified tray or feeder with a recommended type of paper. b Resend the print job. <p>Do horizontal voids appear on prints?</p>	Go to step 3.	The problem is solved.
<p>Step 3</p> <ul style="list-style-type: none"> a Redistribute the toner in the imaging unit. <ul style="list-style-type: none"> 1 Remove the toner cartridge, and then the imaging unit. 2 Firmly shake the imaging unit. <p>Warning—Potential Damage: Do not expose the imaging unit to direct light for more than 10 minutes. Extended exposure to light may cause print quality problems.</p> 3 Reinstall the imaging unit, and then the cartridge. b Resend the print job. <p>Do horizontal voids appear on prints?</p>	Go to step 4.	The problem is solved.
<p>Step 4</p> <p>Replace the imaging unit, and then resend the print job.</p> <p>Do horizontal voids appear on prints?</p>	Contact customer support .	The problem is solved.

Vertical voids appear on prints

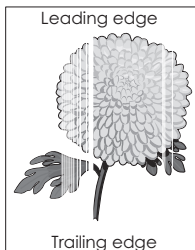

Action	Yes	No
<p>Step 1</p> <p>a Make sure your software program is using a correct fill pattern.</p> <p>b Resend the print job.</p> <p>Do vertical voids appear on prints?</p>	Go to step 2.	The problem is solved.
<p>Step 2</p> <p>a From the printer control panel, set the paper type and weight in the Paper menu to match the paper loaded in the tray.</p> <p>b Resend the print job.</p> <p>Do vertical voids appear on prints?</p>	Go to step 3.	The problem is solved.
<p>Step 3</p> <p>Check if you are using a recommended type of paper.</p> <p>a Load the indicated tray or feeder with a recommended type of paper.</p> <p>b Resend the print job.</p> <p>Do vertical voids appear on prints?</p>	Go to step 4.	The problem is solved.
<p>Step 4</p> <p>a Redistribute the toner in the imaging unit.</p> <ol style="list-style-type: none"> 1 Remove the toner cartridge, and then the imaging unit. 2 Firmly shake the imaging unit. <p>Warning—Potential Damage: Do not expose the imaging unit to direct light for more than 10 minutes. Extended exposure to light may cause print quality problems.</p> <ol style="list-style-type: none"> 3 Reinstall the imaging unit, and then the cartridge. <p>b Resend the print job.</p> <p>Do vertical voids appear on prints?</p>	<p>Contact customer support.</p> <p>Note: The laser scanning unit may be defective.</p>	The problem is solved.

Toner specks appear on prints

Action	Yes	No
Replace the imaging unit, and then resend the print job. Do toner specks appear on prints?	Contact customer support .	The problem is solved.

Toner fog or background shading appears on prints

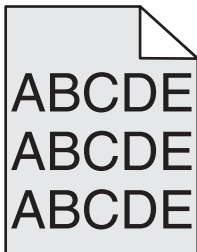

Action	Yes	No
Step 1 Reinstall the imaging unit. a Remove, and then install the imaging unit. b Resend the print job. Does fog or shading appear on prints?	Go to step 2.	The problem is solved.
Step 2 Replace the imaging unit, and then resend the print job. Does fog or shading appear on prints?	Contact customer support at http://support.lexmark.com or your service representative.	The problem is solved.

Toner rubs off

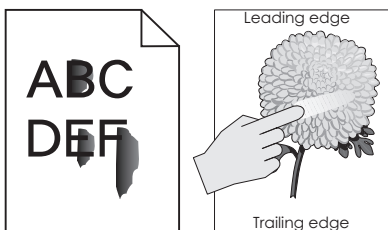

Action	Yes	No
<p>Step 1 From the Paper menu on the printer control panel, check the paper type, texture, and weight.</p> <p>Do the paper type, texture, and weight match the paper loaded in the tray?</p>	Go to step 2.	Specify the paper type, texture, and weight from the tray settings to match the paper loaded in the tray.
<p>Step 2 Resend the print job.</p> <p>Does the toner still rub off?</p>	Contact customer support .	The problem is solved.

Uneven print density

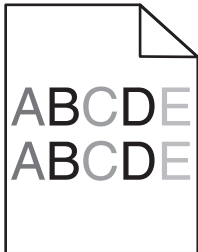



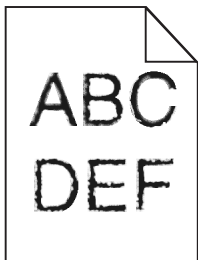

Action	Yes	No
<p>Replace the imaging unit, and then resend the print job.</p> <p>Is the print density uneven?</p>	Contact customer support .	The problem is solved.

MS312 and MS317 print quality problem

Characters have jagged or uneven edges



Action	Yes	No
<p>Step 1</p> <p>a Print a font sample list to check if the fonts you are using are supported by the printer.</p> <p>1 From the printer control panel, navigate to:</p> <p> > Reports >  > Print Fonts > </p> <p>2 Press the arrow buttons until PCL Fonts or PostScript Fonts appears, and then press .</p> <p>b Use a font that is supported by the printer or install the font that you want to use. For more information, contact your system support person.</p> <p>c Resend the print job.</p> <p>Do prints still contain characters that have jagged or uneven edges?</p>	<p>Go to step 2.</p>	<p>The problem is solved.</p>
<p>Step 2</p> <p>a Use a font that is supported by the printer or install the font that you want to use in your computer. For more information, contact your system support person.</p> <p>b Resend the print job.</p> <p>Do prints still contain characters that have jagged or uneven edges?</p>	<p>Contact customer support.</p>	<p>The problem is solved.</p>

MS315, MS415, and MS417 print quality problem

Characters have jagged or uneven edges

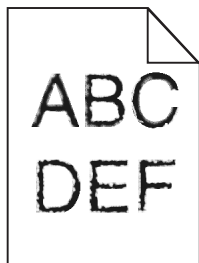

Action	Yes	No
<p>Step 1</p> <p>a Print a font sample list to check if the fonts you are using are supported by the printer.</p> <p>1 From the control panel, navigate to: Menus > Reports > Print Fonts</p> <p>2 Select PCL Fonts or PostScript Fonts.</p> <p>b Resend the print job.</p> <p>Are you using fonts that are supported by the printer?</p>	Go to step 2.	Select a font that is supported by the printer.
<p>Step 2</p> <p>Check if the fonts installed on the computer are supported by the printer.</p> <p>Are the fonts installed on the computer supported by the printer?</p>	The problem is solved.	Contact customer support .

Embedded Web Server does not open

Action	Yes	No
<p>Step 1</p> <p>a Turn on the printer.</p> <p>b Open a Web browser, and then type the printer IP address.</p> <p>c Press Enter.</p> <p>Does the Embedded Web Server open?</p>	The problem is solved.	Go to step 2.
<p>Step 2</p> <p>Make sure the printer IP address is correct.</p> <p>a View the printer IP address:</p> <ul style="list-style-type: none"> From the TCP/IP section in the Network/Ports menu By printing a network setup page or menu settings page, and then finding the TCP/IP section <p>Note: An IP address appears as four sets of numbers separated by periods, such as 123.123.123.123.</p> <p>b Open a Web browser, and then type the IP address.</p> <p>Note: Depending on the network settings, you may need to type “https://” instead of “http://” before the printer IP address to access the Embedded Web Server.</p> <p>c Press Enter.</p> <p>Does the Embedded Web Server open?</p>	The problem is solved.	Go to step 3.

Action	Yes	No
<p>Step 3</p> <p>Check if the network is working.</p> <p>a Print a network setup page.</p> <p>b Check the first section of the network setup page and confirm that the status is Connected.</p> <p>Note: If the status is Not Connected, then the connection may be intermittent, or the network cable may be defective. Contact your system support person for a solution, and then print another network setup page.</p> <p>c Open a Web browser, and then type the printer IP address.</p> <p>d Press Enter.</p> <p>Does the Embedded Web Server open?</p>	<p>The problem is solved.</p>	<p>Go to step 4.</p>
<p>Step 4</p> <p>Check if the cable connections to the printer and print server are secure.</p> <p>a Connect the cables properly. For more information, see the setup documentation that came with the printer.</p> <p>b Open a Web browser, and then type the printer IP address.</p> <p>c Press Enter.</p> <p>Does the Embedded Web Server open?</p>	<p>The problem is solved.</p>	<p>Go to step 5.</p>
<p>Step 5</p> <p>Temporarily disable the Web proxy servers.</p> <p>Proxy servers may block or restrict you from accessing certain Web sites including the Embedded Web Server.</p> <p>Does the Embedded Web Server open?</p>	<p>The problem is solved.</p>	<p>Contact your system support person.</p>

Contacting customer support

Before contacting customer support, make sure to have the following information:

- Printer problem
- Error message
- Printer model type and serial number

Go to <http://support.lexmark.com> to receive e-mail or chat support, or browse through the library of manuals, support documentation, drivers, and other downloads.

Technical support via telephone is also available. In the U.S. or Canada, call 1-800-539-6275. For other countries or regions, go to <http://support.lexmark.com>.

Notices

Product information

Product name:

Lexmark MS312dn, MS315dn, MS317dn, MS415dn, MS417dn

Machine type:

4514

Model(s):

330, 335, 530

Edition notice

November 2017

The following paragraph does not apply to any country where such provisions are inconsistent with local law: LEXMARK INTERNATIONAL, INC., PROVIDES THIS PUBLICATION "AS IS" WITHOUT WARRANTY OF ANY KIND, EITHER EXPRESS OR IMPLIED, INCLUDING, BUT NOT LIMITED TO, THE IMPLIED WARRANTIES OF MERCHANTABILITY OR FITNESS FOR A PARTICULAR PURPOSE. Some states do not allow disclaimer of express or implied warranties in certain transactions; therefore, this statement may not apply to you.

This publication could include technical inaccuracies or typographical errors. Changes are periodically made to the information herein; these changes will be incorporated in later editions. Improvements or changes in the products or the programs described may be made at any time.

References in this publication to products, programs, or services do not imply that the manufacturer intends to make these available in all countries in which it operates. Any reference to a product, program, or service is not intended to state or imply that only that product, program, or service may be used. Any functionally equivalent product, program, or service that does not infringe any existing intellectual property right may be used instead. Evaluation and verification of operation in conjunction with other products, programs, or services, except those expressly designated by the manufacturer, are the user's responsibility.

For Lexmark technical support, visit <http://support.lexmark.com>.

For information on supplies and downloads, visit www.lexmark.com.

© 2012 Lexmark International, Inc.

All rights reserved.

GOVERNMENT END USERS

The Software Program and any related documentation are "Commercial Items," as that term is defined in 48 C.F.R. 2.101, "Computer Software" and "Commercial Computer Software Documentation," as such terms are used in 48 C.F.R. 12.212 or 48 C.F.R. 227.7202, as applicable. Consistent with 48 C.F.R. 12.212 or 48 C.F.R. 227.7202-1 through 227.7207-4, as applicable, the Commercial Computer Software and Commercial Software Documentation are licensed to the U.S. Government end users (a) only as Commercial Items and (b) with only those rights as are granted to all other end users pursuant to the terms and conditions herein.

Trademarks

Lexmark, the Lexmark logo, MarkNet, and MarkVision are trademarks or registered trademarks of Lexmark International, Inc. in the United States and/or other countries.

Google Cloud Print is a trademark of Google Inc.

Mac and the Mac logo are trademarks of Apple Inc., registered in the U.S. and other countries.

Microsoft and Windows are either registered trademarks or trademarks of the Microsoft group of companies in the United States and other countries.

Mopria®, the Mopria® logo, and the Mopria® Alliance logo are registered trademarks and service marks of Mopria Alliance, Inc. in the United States and other countries. Unauthorized use is strictly prohibited.

PCL® is a registered trademark of the Hewlett-Packard Company. PCL is Hewlett-Packard Company’s designation of a set of printer commands (language) and functions included in its printer products. This printer is intended to be compatible with the PCL language. This means the printer recognizes PCL commands used in various application programs, and that the printer emulates the functions corresponding to the commands.

PostScript is a registered trademark of Adobe Systems Incorporated in the United States and/or other countries.

The following terms are trademarks or registered trademarks of these companies:

Albertus	The Monotype Corporation plc
Antique Olive	Monsieur Marcel OLIVE
Apple-Chancery	Apple Computer, Inc.
Arial	The Monotype Corporation plc
CG Times	Based on Times New Roman under license from The Monotype Corporation plc, is a product of Agfa Corporation
Chicago	Apple Computer, Inc.
Clarendon	Linotype-Hell AG and/or its subsidiaries
Eurostile	Nebiolo
Geneva	Apple Computer, Inc.
GillSans	The Monotype Corporation plc
Helvetica	Linotype-Hell AG and/or its subsidiaries
Hoefler	Jonathan Hoefler Type Foundry
ITC Avant Garde Gothic	International Typeface Corporation
ITC Bookman	International Typeface Corporation
ITC Mona Lisa	International Typeface Corporation
ITC Zapf Chancery	International Typeface Corporation
Joanna	The Monotype Corporation plc
Marigold	Arthur Baker
Monaco	Apple Computer, Inc.
New York	Apple Computer, Inc.
Oxford	Arthur Baker

Palatino	Linotype-Hell AG and/or its subsidiaries
Stempel Garamond	Linotype-Hell AG and/or its subsidiaries
Taffy	Agfa Corporation
Times New Roman	The Monotype Corporation plc
Univers	Linotype-Hell AG and/or its subsidiaries

All other trademarks are the property of their respective owners.

AirPrint and the AirPrint logo are trademarks of Apple, Inc.

Federal Communications Commission (FCC) compliance information statement

This product has been tested and found to comply with the limits for a Class B digital device, pursuant to Part 15 of the FCC Rules. Operation is subject to the following two conditions: (1) this device may not cause harmful interference, and (2) this device must accept any interference received, including interference that may cause undesired operation.

The FCC Class B limits are designed to provide reasonable protection against harmful interference when the equipment is operated in a residential installation. This equipment generates, uses, and can radiate radio frequency energy and, if not installed and used in accordance with the instructions, may cause harmful interference to radio communications. However, there is no guarantee that interference will not occur in a particular installation. If this equipment does cause harmful interference to radio or television reception, which can be determined by turning the equipment off and on, the user is encouraged to try to correct the interference by one or more of the following measures:

- Reorient or relocate the receiving antenna.
- Increase the separation between the equipment and receiver.
- Connect the equipment into an outlet on a circuit different from that to which the receiver is connected.
- Consult your point of purchase or service representative for additional suggestions.

The manufacturer is not responsible for radio or television interference caused by using other than recommended cables or by unauthorized changes or modifications to this equipment. Unauthorized changes or modifications could void the user's authority to operate this equipment.

Note: To assure compliance with FCC regulations on electromagnetic interference for a Class B computing device, use a properly shielded and grounded cable such as Lexmark part number 1021231 for parallel attach or 1021294 for USB attach. Use of a substitute cable not properly shielded and grounded may result in a violation of FCC regulations.

Any questions regarding this compliance information statement should be directed to:

Director of Lexmark Technology & Services
 Lexmark International, Inc.
 740 West New Circle Road
 Lexington, KY 40550
 (859) 232-3000

Licensing notices

All licensing notices associated with this product can be viewed from the root directory of the documentation CD.

Noise emission levels

The following measurements were made in accordance with ISO 7779 and reported in conformance with ISO 9296.

Note: Some modes may not apply to your product.

1-meter average sound pressure, dBA	
Printing	One-sided: 53 (MS312, MS315, MS317), 54 (MS415, MS417); Two-sided: 52 (MS312, MS317), 53 (MS315), 54 (MS415, MS417)
Ready	15

Values are subject to change. See www.lexmark.com for current values.

Waste from Electrical and Electronic Equipment (WEEE) directive



The WEEE logo signifies specific recycling programs and procedures for electronic products in countries of the European Union. We encourage the recycling of our products.

If you have further questions about recycling options, visit the Lexmark Web site at www.lexmark.com for your local sales office phone number.

India E-Waste notice

This product complies with the India E-Waste (Management and Handling) Rules, 2011, which prohibit use of lead, mercury, hexavalent chromium, polybrominated biphenyls, or polybrominated diphenyl ethers in concentrations exceeding 0.1% by weight and 0.01% by weight for cadmium, except for the exemption set in Schedule II of the Rules.

Product disposal

Do not dispose of the printer or supplies in the same manner as normal household waste. Consult your local authorities for disposal and recycling options.

Static sensitivity notice



This symbol identifies static-sensitive parts. Do not touch the areas near these symbols without first touching a metal surface in an area away from the symbol.

ENERGY STAR

Any Lexmark product bearing the ENERGY STAR emblem on the product or on a start-up screen is certified to comply with Environmental Protection Agency (EPA) ENERGY STAR requirements as configured when shipped by Lexmark.



Temperature information

Ambient operating temperature	16 to 32°C (60 to 90°F)
Shipping temperature	-40 to 43.3°C (-40 to 110°F)
Storage temperature and relative humidity	2 to 35°C (34 to 95°F) 8 to 80% RH

Laser notice

The printer is certified in the U.S. to conform to the requirements of DHHS 21 CFR, Chapter I, Subchapter J for Class I (1) laser products, and elsewhere is certified as a Class I laser product conforming to the requirements of IEC 60825-1: 2014.

Class I laser products are not considered to be hazardous. The printer contains internally a Class IIIb (3b) laser that is nominally a 12-milliwatt gallium arsenide laser operating in the wavelength of 655–675 nanometers. The laser system and printer are designed so there is never any human access to laser radiation above a Class I level during normal operation, user maintenance, or prescribed service condition.

Laser advisory label

A laser notice label may be affixed to this printer as shown:

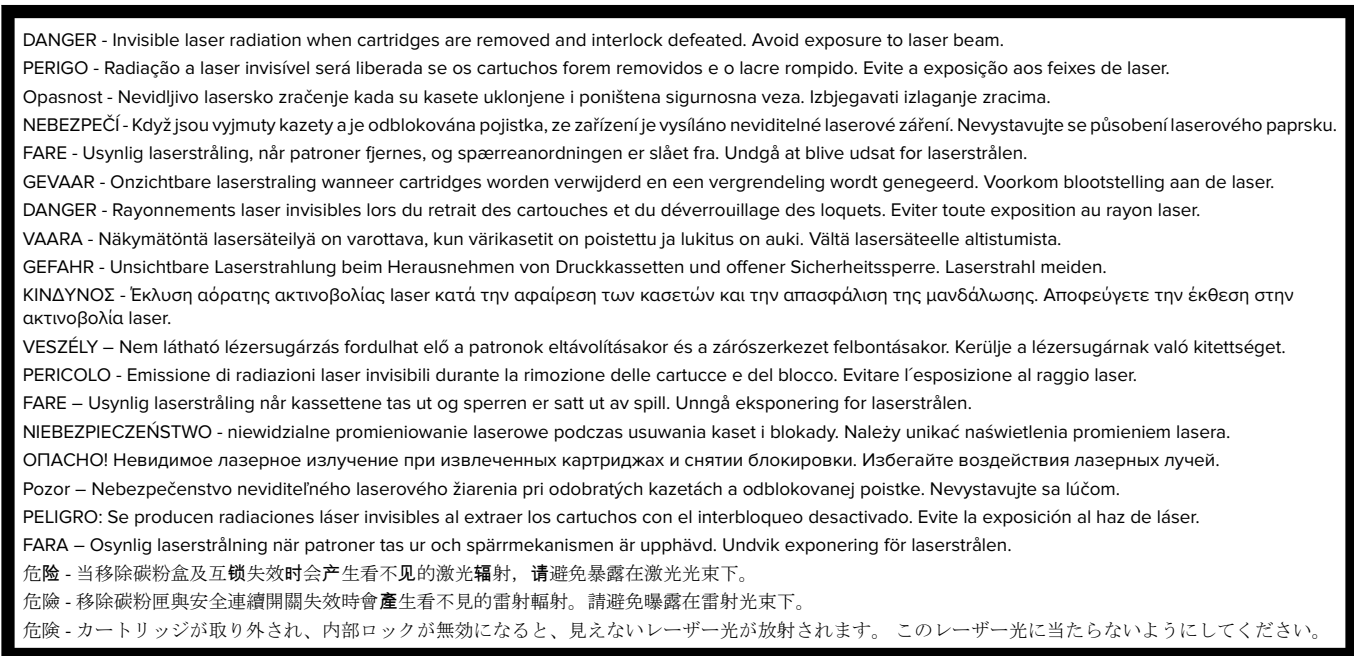

Power consumption

Product power consumption

The following table documents the power consumption characteristics of the product.

Note: Some modes may not apply to your product.

Mode	Description	Power consumption (Watts)
Printing	The product is generating hard-copy output from electronic inputs.	MS312, MS317: 520 (one-sided), 340 (two-sided); MS315, MS415, MS417: 560 (one-sided); 380 (two-sided)
Copy	The product is generating hard-copy output from hard-copy original documents.	NA
Scan	The product is scanning hard-copy documents.	NA
Ready	The product is waiting for a print job.	7
Sleep Mode	The product is in a high-level energy-saving mode.	3
Hibernate	The product is in a low-level energy-saving mode.	0.5
Off	The product is plugged into an electrical outlet, but the power switch is turned off.	0.0

The power consumption levels listed in the previous table represent time-averaged measurements. Instantaneous power draws may be substantially higher than the average.

Values are subject to change. See www.lexmark.com for current values.

Sleep Mode

This product is designed with an energy-saving mode called *Sleep Mode*. The Sleep Mode saves energy by lowering power consumption during extended periods of inactivity. The Sleep Mode is automatically engaged after this product is not used for a specified period of time, called the *Sleep Mode Timeout*.

Factory default Sleep Mode Timeout for this product (in minutes):	20
---	----

By using the configuration menus, the Sleep Mode Timeout can be modified between 1 minute and 120 minutes. Setting the Sleep Mode Timeout to a low value reduces energy consumption, but may increase the response time of the product. Setting the Sleep Mode Timeout to a high value maintains a fast response, but uses more energy.

Hibernate Mode

This product is designed with an ultra-low power operating mode called *Hibernate mode*. When operating in Hibernate Mode, all other systems and devices are powered down safely.

The Hibernate mode can be entered in any of the following methods:

- Using the Hibernate Timeout
- Using the Schedule Power modes
- Using the Sleep/Hibernate button

Factory default Hibernate Timeout for this product in all countries or regions	3 days
--	--------

The amount of time the printer waits after a job is printed before it enters Hibernate mode can be modified between one hour and one month.

Off mode

If this product has an off mode which still consumes a small amount of power, then to completely stop product power consumption, disconnect the power supply cord from the electrical outlet.

Total energy usage

It is sometimes helpful to calculate the total product energy usage. Since power consumption claims are provided in power units of Watts, the power consumption should be multiplied by the time the product spends in each mode in order to calculate energy usage. The total product energy usage is the sum of each mode's energy usage.

Industry Canada compliance statement

This Class B digital apparatus meets all requirements of the Canadian Interference-Causing Equipment Standard ICES-003.

Avis de conformité aux normes de l'industrie du Canada

Cet appareil numérique de classe B est conforme aux exigences de la norme canadienne relative aux équipements pouvant causer des interférences NMB-003.

European Community (EC) directives conformity

This product is in conformity with the protection requirements of EC Council directives 2014/30/EU, 2014/35/EU, 2009/125/EC, and 2011/65/EU on the approximation and harmonization of the laws of the Member States relating to electromagnetic compatibility, safety of electrical equipment designed for use within certain voltage limits, the ecodesign of energy-related products, and on the restrictions of use of certain hazardous substances in electrical and electronic equipment.

The manufacturer of this product is: Lexmark International, Inc., 740 West New Circle Road, Lexington, KY, 40550 USA. The authorized representative is: Lexmark International Technology Hungária Kft., 8 Lechner Ödön fasor, Millennium Tower III, 1095 Budapest HUNGARY. A declaration of conformity to the requirements of the Directives is available upon request from the Authorized Representative or may be obtained at www.lexmark.com/en_us/about/regulatory-compliance/european-union-declaration-of-conformity.html.

This product satisfies the Class B limits of EN 55022 and EN55032 and safety requirements of EN 60950-1 or EN 62368-1.

STATEMENT OF LIMITED WARRANTY FOR LEXMARK LASER PRINTERS, LEXMARK LED PRINTERS, AND LEXMARK MULTIFUNCTION LASER PRINTERS

Lexmark International, Inc., Lexington, KY

This limited warranty applies to the United States and Canada. For customers outside the U.S., refer to the country-specific warranty information that came with your product.

This limited warranty applies to this product only if it was originally purchased for your use, and not for resale, from Lexmark or a Lexmark Remarketer, referred to in this statement as "Remarketer."

Limited warranty

Lexmark warrants that this product:

- Is manufactured from new parts, or new and serviceable used parts, which perform like new parts
- Is, during normal use, free from defects in material and workmanship

If this product does not function as warranted during the warranty period, contact a Remarketer or Lexmark for repair or replacement (at Lexmark's option).

If this product is a feature or option, this statement applies only when that feature or option is used with the product for which it was intended. To obtain warranty service, you may be required to present the feature or option with the product.

If you transfer this product to another user, warranty service under the terms of this statement is available to that user for the remainder of the warranty period. You should transfer proof of original purchase and this statement to that user.

Limited warranty service

The warranty period starts on the date of original purchase as shown on the purchase receipt and ends 12 months later provided that the warranty period for any supplies and for any maintenance items included with the printer shall end earlier if it, or its original contents, are substantially used up, depleted, or consumed. Fuser Units, Transfer/Transport Units, Paper Feed items, if any, and any other items for which a Maintenance Kit is available are substantially consumed when the printer displays a “Life Warning” or “Scheduled Maintenance” message for such item.

To obtain warranty service you may be required to present proof of original purchase. You may be required to deliver your product to the Remarketer or Lexmark, or ship it prepaid and suitably packaged to a Lexmark designated location. You are responsible for loss of, or damage to, a product in transit to the Remarketer or the Lexmark designated location.

When warranty service involves the exchange of a product or part, the item replaced becomes the property of the Remarketer or Lexmark. The replacement may be a new or repaired item.

The replacement item assumes the remaining warranty period of the original product.

Replacement is not available to you if the product you present for exchange is defaced, altered, in need of a repair not included in warranty service, damaged beyond repair, or if the product is not free of all legal obligations, restrictions, liens, and encumbrances.

As part of your warranty service and/or replacement, Lexmark may update the firmware in your printer to the latest version. Firmware updates may modify printer settings and cause counterfeit and/or unauthorized products, supplies, parts, materials (such as toners and inks), software, or interfaces to stop working. Authorized use of genuine Lexmark products will not be impacted.

Before you present this product for warranty service, remove all print cartridges, programs, data, and removable storage media (unless directed otherwise by Lexmark).

For further explanation of your warranty alternatives and the nearest Lexmark authorized servicer in your area contact Lexmark on the World Wide Web.

Remote technical support is provided for this product throughout its warranty period. For products no longer covered by a Lexmark warranty, technical support may not be available or only be available for a fee.

Extent of limited warranty

Lexmark does not warrant uninterrupted or error-free operation of any product or the durability or longevity of prints produced by any product.

Warranty service does not include repair of failures caused by:

- Modification or unauthorized attachments
- Accidents, misuse, abuse or use inconsistent with Lexmark user’s guides, manuals, instructions or guidance
- Unsuitable physical or operating environment
- Maintenance by anyone other than Lexmark or a Lexmark authorized servicer
- Operation of a product beyond the limit of its duty cycle
- Use of printing media outside of Lexmark specifications
- Refurbishment, repair, refilling or remanufacture by a third party of products, supplies or parts
- Products, supplies, parts, materials (such as toners and inks), software, or interfaces not furnished by Lexmark

TO THE EXTENT PERMITTED BY APPLICABLE LAW, NEITHER LEXMARK NOR ITS THIRD PARTY SUPPLIERS OR REMARKETERS MAKE ANY OTHER WARRANTY OR CONDITION OF ANY KIND, WHETHER EXPRESS OR IMPLIED, WITH RESPECT TO THIS PRODUCT, AND SPECIFICALLY DISCLAIM THE IMPLIED WARRANTIES OR CONDITIONS OF MERCHANTABILITY, FITNESS FOR A PARTICULAR PURPOSE, AND SATISFACTORY QUALITY. ANY WARRANTIES THAT MAY NOT BE DISCLAIMED UNDER APPLICABLE LAW ARE LIMITED IN DURATION TO THE WARRANTY PERIOD. NO WARRANTIES, EXPRESS OR IMPLIED, WILL APPLY AFTER THIS PERIOD. ALL INFORMATION, SPECIFICATIONS, PRICES, AND SERVICES ARE SUBJECT TO CHANGE AT ANY TIME WITHOUT NOTICE.

Limitation of liability

Your sole remedy under this limited warranty is set forth in this document. For any claim concerning performance or nonperformance of Lexmark or a Remarketer for this product under this limited warranty, you may recover actual damages up to the limit set forth in the following paragraph.

Lexmark's liability for actual damages from any cause whatsoever will be limited to the amount you paid for the product that caused the damages. This limitation of liability will not apply to claims by you for bodily injury or damage to real property or tangible personal property for which Lexmark is legally liable. **IN NO EVENT WILL LEXMARK BE LIABLE FOR ANY LOST PROFITS, LOST SAVINGS, INCIDENTAL DAMAGE, OR OTHER ECONOMIC OR CONSEQUENTIAL DAMAGES.** This is true even if you advise Lexmark or a Remarketer of the possibility of such damages. Lexmark is not liable for any claim by you based on a third party claim.

This limitation of remedies also applies to claims against any Suppliers and Remarketers of Lexmark. Lexmark's and its Suppliers' and Remarketers' limitations of remedies are not cumulative. Such Suppliers and Remarketers are intended beneficiaries of this limitation.

Additional rights

Some states do not allow limitations on how long an implied warranty lasts, or do not allow the exclusion or limitation of incidental or consequential damages, so the limitations or exclusions contained above may not apply to you.

This limited warranty gives you specific legal rights. You may also have other rights that vary from state to state.

Index

A

- accessing the controller board 14
- accessing the Embedded Web Server 32
- accessing the remote control panel
 - Embedded Web Server 63
- Active NIC menu 89
- adding hardware options
 - print driver 20
- adding internal options
 - print driver 20
- adjusting printer display brightness 70
- adjusting Sleep mode 71
- adjusting toner darkness 55, 56
- administrator settings
 - Embedded Web Server 62
- AirPrint
 - using 57
- AppleTalk menu 99
- assigning custom paper types 43
- attaching cables 18
- available internal options 14
- avoiding jams 49
- avoiding paper jams 126

B

- Bin full. Remove paper. 143

C

- cables
 - Ethernet 18
 - parallel 18
 - USB 18
- canceling a print job
 - from the computer 59
 - from the printer control panel 59
- Cannot collate large document [37] 143
- Cannot defrag flash memory [37] 143
- cannot open Embedded Web Server 192
- card stock
 - loading, multipurpose feeder 39
 - tips 49
- Cartridge low [88.xy] 152
- Cartridge nearly low [88.xy] 152
- Cartridge very low, [x] estimated pages remain [88.xy] 152
- Cartridge, imaging unit mismatch [41.xy] 152
- Change [paper source] to [custom string] load [orientation] 143, 147
- Change [paper source] to [custom type name] load [orientation] 143, 147
- Change [paper source] to [paper size] load [orientation] 144, 147
- Change [paper source] to [paper type] [paper size] load [orientation] 144, 147
- checking an unresponsive printer 159
- checking the status of parts and supplies 134
- checking the virtual display
 - using the Embedded Web Server 67
- cleaning
 - exterior of the printer 134
 - interior of the printer 134
- cleaning the printer 134
- Close front door 153
- Complex page may misprint [39] 144
- Complex page, some data may not have printed [39] 148
- confidential data
 - information on securing 74
- confidential jobs
 - modifying print settings 67
- confidential print jobs 57
- Confidential Print menu 101
- Configuration change, some held jobs were not restored [57] 148
- configuration information
 - wireless network 21

- configurations
 - printer 11
- Configure MP menu 83
- configuring
 - multiple printers 62
 - supply notifications, imaging unit 62
 - supply notifications, toner cartridge 62
- configuring custom paper types 43
- configuring supply notifications 62
- configuring the Universal paper size settings 34
- connecting to a wireless network
 - using Personal Identification Number (PIN) method 22, 23
 - using Push Button Configuration (PBC) method 22, 23
 - using the Embedded Web Server 25
 - using wireless setup wizard 22
- conservation settings
 - brightness, adjusting 70
 - Eco-Mode 65, 67
 - Hibernate mode 65, 69
 - Hibernate Timeout 66, 69
 - Quiet mode 68
 - Schedule Power Modes 66, 70
 - Sleep mode 71
- conserving supplies 60
- contacting customer support 193
- control panel 31
 - factory defaults, restoring 70
 - indicator light 29
 - Sleep button light 29
 - using 31
- control panel, printer buttons 28
 - indicator light 28, 32
 - Sleep button light 32
 - using 28
- controller board
 - accessing 14
 - creating the printer control panel PIN 64

Credentials invalid. Print job canceled. 153
custom paper type
 assigning 43, 45
 configuring 43
custom paper type name
 creating 44
Custom Type [x]
 assigning a paper type 45
Custom Type [x] name
 creating 44
Custom Types menu 87
customer support
 contacting 193

D

Default Source menu 76, 80
Defective flash detected [51] 148
Defective flash memory [51] 144
device and network settings
 erasing 73
directory list
 printing 59
display troubleshooting
 printer display is blank 161
display, printer control panel
 adjusting brightness 70
documents, printing
 from a computer 55
 from a mobile device 57

E

Eco-Mode setting 65, 67
embedded solutions
 erasing 73
Embedded Web Server
 accessing 32
 accessing the remote control panel 63
 adjusting brightness 70
 administrator settings 62
 copying settings to other printers 62
 modifying confidential print settings 67
 networking settings 62
 problem accessing 192
Embedded Web Server —
Security: Administrator's Guide
 where to find 62

Embedded Web Server—
Security: Administrator's Guide
 where to find 74
emission notices 196, 197, 200
envelopes
 loading, multipurpose feeder 39
 tips on using 50
environmental settings
 Eco-Mode 65, 67
 Hibernate mode 65, 69
 Hibernate Timeout 66, 69
 printer display brightness, adjusting 70
 Quiet mode 68
 Schedule Power Modes 66, 70
 Sleep mode 71
erasing non-volatile memory 73
erasing volatile memory 73
Ethernet network
 preparing to set up for Ethernet printing 20
Ethernet port 18
Ethernet setup
 preparing for an 20

F

factory defaults, restoring 64, 70
FCC notices 196
finding more information about the printer 9
Finishing menu 112
firmware card 14
Flash memory full [52] 145
Flash memory unformatted [53] 145
font sample list
 printing 59
font sample list, printing 58

G

General Settings menu 103, 107
Google Cloud Print
 using 56
green settings
 Eco-Mode 65, 67
 Hibernate mode 65, 69
 Hibernate Timeout 66, 69
 Quiet mode 68
 Schedule Power Modes 66, 70

H

hardware options, adding
 print driver 20
held jobs 57
Help menu 125
Hibernate mode
 using 65, 69
Hibernate Timeout
 setting 66, 69
HTML menu 123

I

identifying jam locations 127
Image menu 124
imaging unit
 ordering 137
 replacing 139
Imaging unit low [84.xy] 153
Imaging unit nearly low [84.xy] 153
Imaging unit very low, [x]
 estimated pages remain [84.xy] 153
Incorrect paper size, open [paper source] [34] 148
individual settings
 erasing 73
Insert tray [x] 153
installing
 optional tray 17
installing an optional card 15
installing optional tray 17
installing software
 Local Printer Settings Utility 29
installing the printer software 19
Insufficient memory for Flash Memory Defragment operation [37] 149
Insufficient memory to collate job [37] 149
Insufficient memory to support Resource Save feature [35] 148
Insufficient memory, some Held Jobs were deleted [37] 149
Insufficient memory, some held jobs will not be restored [37] 149
internal options 14
internal options, adding
 print driver 20
IPv6 menu 95

J

jams
 avoiding 126
 Job Accounting menu 118

L

labels, paper
 tips on using 50
 letterhead
 loading, multipurpose
 feeder 39
 tips on using 51
 Lexmark Mobile Print
 using 57
 linking trays 42, 44
 list of menus 75
 Load [paper source] with [custom
 string] [orientation] 153
 Load [paper source] with [custom
 type name] [orientation] 154
 Load [paper source] with [paper
 size] [orientation] 154
 Load [paper source] with [paper
 type] [paper size]
 [orientation] 154
 Load multipurpose feeder with
 [custom string] [orientation] 155
 Load multipurpose feeder with
 [custom type name]
 [orientation] 154
 Load multipurpose feeder with
 [paper size] orientation] 155
 Load multipurpose feeder with
 [paper type] [paper size]
 [orientation] 155
 loading
 multipurpose feeder 39
 trays 35
 loading the optional tray 35
 loading the standard tray 35
 Local Printer Settings Utility
 installing 29
 using 30
 locating paper jam 127
 lock, security 72

M

memory
 types installed on printer 72
 memory card 14
 Memory full [38] 155

Memory low, no Resource Save
 [35] 145
 menu settings
 loading on multiple printers 62
 menu settings page
 printing 25, 26
 menus
 Active NIC 89
 AppleTalk 99
 Confidential Print 101
 Configure MP 83
 Custom Types 87
 Default Source 76, 80
 Finishing 112
 General Settings 103, 107
 Help 125
 HTML 123
 Image 124
 in Local Printer Settings
 Utility 30
 IPv6 95
 Job Accounting 118
 list of 75
 Network [x] 89, 92
 Network Card 94
 Network Reports 91
 Paper Loading 86
 Paper Size/Type 77, 80
 Paper Texture 83
 Paper Weight 85
 PCL Emul 116, 121
 PDF 120
 PostScript 115
 Quality 114
 Reports 88, 93
 Security Audit Log 102
 Set Date and Time 102
 Setup 111
 SMTP Setup menu 100
 Standard Network 89, 92
 Standard Parallel 98
 Standard USB 96
 Substitute Size 83
 TCP/IP 94
 Universal Setup 88
 Utilities 115, 120
 Wireless 91
 wireless 93
 XPS 115
 menus list 75
 mobile device
 printing from 56, 57

Mopria Print Service
 using 56
 moving the printer 10, 141
 multipurpose feeder
 loading 39

N

Network [x] menu 89, 92
 Network [x] software error
 [54] 149
 Network Card menu 94
 Network error, port [x] [54] 145
 Network error, standard port
 [54] 145
 Network Reports menu 91
 network settings
 Embedded Web Server 62
 network setup page
 printing 26, 27
 Networking Guide
 where to find 62
 noise emission levels 197
 Non-Lexmark [supply type], see
 User's Guide [33.xy] 155
 non-volatile memory 72
 erasing 73
 Not enough free space in flash
 memory for resources [52] 150
 notices 196, 197, 198, 199, 200
 number of remaining pages
 estimate 135

O

optional card
 installing 15
 optional tray
 installing 17
 loading 35
 options
 firmware cards 14
 memory cards 14
 ordering
 imaging unit 137
 ordering supplies
 toner cartridges 135

P

paper
 characteristics 46
 letterhead 47

- loading, multipurpose feeder 39
- preprinted forms 47
- recycled 48
- selecting 47
- setting size 34
- setting type 34
- storing 49
- unacceptable 47, 48
- Universal size setting 33, 34
- using recycled 60
- paper feed troubleshooting
 - message remains after jam is cleared 163, 164
- paper jam in front door 128
- paper jam in the duplex unit 131
- paper jam in the multipurpose feeder 132
- paper jam in the rear door 130
- paper jam in the standard bin 131
- paper jam in trays 132
- paper jam, clearing
 - in front door 128
 - in the duplex unit 131
 - in the multipurpose feeder 132
 - in the rear door 130
 - in the standard bin 131
 - in trays 132
- paper jams
 - avoiding 126
- paper labels
 - loading, multipurpose feeder 39
- Paper Loading menu 86
- paper size
 - setting 33
- Paper Size/Type menu 77, 80
- paper sizes
 - supported by the printer 52
- paper stop, using 34
- Paper Texture menu 83
- Paper too short [34] 146
- paper type
 - setting 33
- paper types
 - duplex support 53
 - supported by printer 53
 - where to load 53
- Paper Weight menu 85
- parallel port 18
- Parallel port disabled [56] 156
- parts
 - checking status 134
 - using genuine Lexmark 135
- PCL Emul menu 116, 121
- PDF menu 120
- Personal Identification Number method
 - using 22, 23
- PostScript menu 115
- preparing to set up the printer on an Ethernet network 20
- print driver
 - hardware options, adding 20
- print irregularities 177
- print job
 - canceling from the computer 59
 - canceling from the printer control panel 59
- print quality troubleshooting
 - blank pages 181
 - characters have jagged edges 190, 191
 - clipped pages or images 172
 - gray background on prints 174
 - horizontal voids appear on prints 187
 - print irregularities 177
 - print is too dark 179
 - print is too light 180
 - printer is printing solid black pages 183
 - repeating print defects appear on prints 178
 - shadow images appear on prints 173
 - skewed print 182
 - streaked horizontal lines appear on prints 184
 - streaked vertical lines 185
 - toner fog or background shading 189
 - toner rubs off 189
 - toner specks appear on prints 189
 - transparency print quality is poor 184
 - uneven print density 190
 - white streaks 188
- Print quota exceeded. Print job canceled. 156
- Print quota exceeded. Print job incomplete. 156
- print troubleshooting
 - held jobs do not print 171
 - incorrect characters print 167
 - incorrect margins on prints 175
 - jammed pages are not reprinted 163, 165
 - job prints from wrong tray 167
 - job prints on wrong paper 167
 - jobs do not print 165
 - Large jobs do not collate 168
 - multiple-language PDF files do not print 170
 - paper curl 176
 - paper frequently jams 164
 - print job takes longer than expected 169, 171
 - printing slows down 166
 - tray linking does not work 168
 - unexpected page breaks occur 169
- printer
 - basic model 11
 - minimum clearances 10
 - moving 10, 141
 - selecting a location 10
 - shipping 142
- printer configurations 11
- printer control panel
 - adjusting brightness 70
 - buttons 28
 - factory defaults, restoring 64
 - indicator light 28, 32
 - Sleep button light 32
 - using 28
- printer control panel PIN
 - creating 64
- printer control panel, virtual display
 - using the Embedded Web Server 67
- Printer had to restart. Last job may be incomplete. 150
- printer information
 - where to find 9
- printer is printing blank pages 181
- printer messages
 - Bin full. Remove paper. 143
 - Cannot collate large document [37] 143

- Cannot defrag flash memory [37] 143
- Cartridge low [88.xy] 152
- Cartridge nearly low [88.xy] 152
- Cartridge very low, [x] estimated pages remain [88.xy] 152
- Cartridge, imaging unit mismatch [41.xy] 152
- Change [paper source] to [custom string] load [orientation] 143, 147
- Change [paper source] to [custom type name] load [orientation] 143, 147
- Change [paper source] to [paper size] load [orientation] 144, 147
- Change [paper source] to [paper type] [paper size] load [orientation] 144, 147
- Close front door 153
- Complex page may misprint [39] 144
- Complex page, some data may not have printed [39] 148
- Configuration change, some held jobs were not restored [57] 148
- Credentials invalid. Print job canceled. 153
- Defective flash detected [51] 148
- Defective flash memory [51] 144
- Flash memory full [52] 145
- Flash memory unformatted [53] 145
- Imaging unit low [84.xy] 153
- Imaging unit nearly low [84.xy] 153
- Imaging unit very low, [x] estimated pages remain [84.xy] 153
- Incorrect paper size, open [paper source] [34] 148
- Insert tray [x] 153
- Insufficient memory for Flash Memory Defragment operation [37] 149
- Insufficient memory to collate job [37] 149
- Insufficient memory to support Resource Save feature [35] 148
- Insufficient memory, some Held Jobs were deleted [37] 149
- Insufficient memory, some held jobs will not be restored [37] 149
- Load [paper source] with [custom string] [orientation] 153
- Load [paper source] with [custom type name] [orientation] 154
- Load [paper source] with [paper size] [orientation] 154
- Load [paper source] with [paper type] [paper size] [orientation] 154
- Load multipurpose feeder with [custom type name] [orientation] 154
- Load multipurpose feeder with [paper size] [orientation] 155
- Load multipurpose feeder with [paper type] [paper size] [orientation] 155
- Load multipurpose feeder with custom string [orientation] 155
- Memory full [38] 155
- Memory low, no Resource Save [35] 145
- Network [x] software error [54] 149
- Network error, port [x] [54] 145
- Network error, standard port [54] 145
- Non-Lexmark [supply type], see User's Guide [33.xy] 155
- Not enough free space in flash memory for resources [52] 150
- Paper too short [34] 146
- Parallel port disabled [56] 156
- Print quota exceeded. Print job canceled. 156
- Print quota exceeded. Print job incomplete. 156
- Printer had to restart. Last job may be incomplete. 150
- Printer restart. Check last job. 146
- Insufficient memory to support Resource Save feature [35] 148
- Rear USB port disabled [56] 146
- Reinstall missing or unresponsive cartridge [31.xy] 156
- Reinstall missing or unresponsive imaging unit [31.xy] 157
- Remove paper from standard output bin 150
- Replace cartridge, 0 estimated pages remain [88.xy] 157
- Replace cartridge, printer region mismatch [42.xy] 157
- Replace imaging unit, 0 estimated pages remain [84.xy] 157
- Replace maintenance kit [80.xy] 158
- Replace unsupported cartridge [32.xy] 158
- Replace unsupported imaging unit [32.xy] 158
- Serial option [x] error [54] 150
- SMTP server not set up. Contact system administrator. 150, 152
- Standard network software error [54] 150
- Standard parallel port disabled [56] 151
- Standard USB port disabled [56] 151
- Too many flash options installed [58] 151
- Too many trays attached [58] 151
- Too many trays. Remove some. [58] 146
- Unformatted flash detected [53] 151
- Unsupported option in slot [x] [55] 152
- printer options troubleshooting
 - internal option is not detected 161
 - tray problems 162
- printer problems, solving basic 159
- Printer restart. Check last job. 146
- printer security information on 74
- printer software, installing 19

printing
 directory list 59
 font sample list 58, 59
 from a computer 55
 from a mobile device 56
 menu settings page 25, 26
 network setup page 26, 27
printing a network setup page 27
publications
 where to find 9
Push Button Configuration method
 using 22, 23

Q

Quality menu 114
Quiet mode 68

R

Rear USB port disabled [56] 146
recycled paper
 using 48, 60
recycling
 Lexmark packaging 61
 Lexmark products 61
 toner cartridges 61
reducing noise 68
Reinstall missing or unresponsive cartridge [31.xy] 156
Reinstall missing or unresponsive imaging unit [31.xy] 157
remote control panel
 using Embedded Web Server 63
Remove paper from standard output bin 150
repeat print jobs 57
repeating print defects appear on prints 178
Replace cartridge, 0 estimated pages remain [88.xy] 157
Replace cartridge, printer region mismatch [42.xy] 157
Replace imaging unit, 0 estimated pages remain [84.xy] 157
Replace maintenance kit [80.xy] 158
Replace unsupported cartridge [32.xy] 158

Replace unsupported imaging unit [32.xy] 158
replacing
 imaging unit 139
 toner cartridge 138
reports
 viewing 64
Reports menu 88, 93
restoring factory default settings 64

S

safety information 6, 7, 8
Schedule Power Modes
 using 66, 70
security
 modifying confidential print settings 67
Security Audit Log menu 102
security lock 72
security settings
 erasing 73
security Web page
 printer security information 74
selecting a location for the printer 10
selecting paper 47
Serial option [x] error [54] 150
Set Date and Time menu 102
setting
 paper size 33, 34
 paper type 33, 34
 TCP/IP address 94
 Universal paper size 33
setting Hibernate
Timeout 66, 69
Setup menu 111
shipping the printer 142
Sleep mode
 adjusting 71
SMTP server not set up. Contact system administrator. 150, 152
SMTP Setup menu 100
standard bin, using 34
Standard Network menu 89, 92
Standard network software error [54] 150
Standard Parallel menu 98
Standard parallel port disabled [56] 151
standard tray
 loading 35

Standard USB menu 96
Standard USB port disabled [56] 151
statement of volatility 72
storing
 paper 49
 supplies 137
storing print jobs 57
streaked horizontal lines appear on prints 184
streaked vertical lines appear on prints 185
streaks appear 188
Substitute Size menu 83
supplies
 checking status 134
 conserving 60
 storing 137
 using genuine Lexmark 135
 using recycled paper 60
supplies, ordering
 imaging unit 137
 toner cartridges 135
supply notifications
 configuring 62
supported paper sizes 52
supported paper types and weights 53

T

TCP/IP menu 94
tips
 card stock 49
 letterhead 51
 on using envelopes 50
 on using labels 50
 transparencies 51
tips on using envelopes 50
toner cartridge
 replacing 138
toner cartridges
 ordering 135
 recycling 61
toner darkness
 adjusting 55, 56
Too many flash options installed [58] 151
Too many trays attached [58] 151
Too many trays. Remove some. [58] 146

- transparencies
 - loading, multipurpose feeder 39
 - tips 51
- trays
 - linking 42, 44
 - loading 35
 - unlinking 42, 44
- troubleshooting
 - cannot open Embedded Web Server 192
 - checking an unresponsive printer 159
 - solving basic printer problems 159
- troubleshooting, display
 - printer display is blank 161
- troubleshooting, paper feed
 - message remains after jam is cleared 163, 164
- troubleshooting, print
 - held jobs do not print 171
 - incorrect characters print 167
 - incorrect margins on prints 175
 - jammed pages are not reprinted 163, 165
 - job prints from wrong tray 167
 - job prints on wrong paper 167
 - jobs do not print 165
 - Large jobs do not collate 168
 - multiple-language PDF files do not print 170
 - paper curl 176
 - paper frequently jams 164
 - print job takes longer than expected 169, 171
 - printing slows down 166
 - tray linking does not work 168
 - unexpected page breaks occur 169
- troubleshooting, print quality
 - blank pages 181
 - characters have jagged edges 190, 191
 - clipped pages or images 172
 - gray background on prints 174
 - horizontal voids appear on prints 187
 - print irregularities 177
 - print is too dark 179
 - print is too light 180

- printer is printing solid black pages 183
- repeating print defects appear on prints 178
- shadow images appear on prints 173
- skewed print 182
- streaked horizontal lines appear on prints 184
- streaked vertical lines 185
- toner fog or background shading 189
- toner rubs off 189
- toner specks appear on prints 189
- transparency print quality is poor 184
- uneven print density 190
- white streaks on a page 188

troubleshooting, printer options

- internal option is not detected 161

tray problems 162

U

- unacceptable paper 47
- uneven print density 190
- Unformatted flash detected [53] 151
- Universal paper size
 - setting 33
- Universal paper size settings
 - configuring 34
- Universal Setup menu 88
- unlinking trays 42, 44
- Unsupported option in slot [x] [55] 152
- USB port 18
- User's Guide
 - using 9
- using
 - Wireless Setup Assistant 24
 - using Hibernate mode 65, 69
 - using recycled paper 60
 - using Schedule Power Modes 66, 70
 - using the control panel 31
 - using Wireless Setup Utility 24
- Utilities menu 115, 120

V

- verify print jobs 57
- vertical voids appear 188
- viewing
 - reports 64
- virtual display
 - checking, using Embedded Web Server 67
- voids appear 188
- volatile memory 72
 - erasing 73
- volatility
 - statement of 72

W

- Wireless menu 91, 93
- wireless network
 - configuration information 21
- wireless network setup
 - using the Embedded Web Server 25
- Wireless Setup Assistant
 - using 24
- Wireless Setup Utility
 - using 24
- wireless setup wizard
 - using 22

X

- XPS menu 115