

Revised: February 2005



## *Service Manual*

**Lexmark™ T430**

**4048-1xx**

- ***Table of contents***
- ***Start diagnostics***
- ***Safety and notices***
- ***Trademarks***
- ***Index***

**LEXMARK™**

*Lexmark and Lexmark with diamond design are trademarks of Lexmark International, Inc., registered in the United States and/or other countries.*

**Edition: February 2005**

**The following paragraph does not apply to any country where such provisions are inconsistent with local law:** LEXMARK INTERNATIONAL, INC. PROVIDES THIS PUBLICATION "AS IS" WITHOUT WARRANTY OF ANY KIND, EITHER EXPRESS OR IMPLIED, INCLUDING, BUT NOT LIMITED TO, THE IMPLIED WARRANTIES OF MERCHANTABILITY OR FITNESS FOR A PARTICULAR PURPOSE. Some states do not allow disclaimer of express or implied warranties in certain transactions; therefore, this statement may not apply to you.

This publication could include technical inaccuracies or typographical errors. Changes are periodically made to the information herein; these changes will be incorporated in later editions. Improvements or changes in the products or the programs described may be made at any time.

Comments may be addressed to Lexmark International, Inc., Department D22A/032-2, 740 West New Circle Road, Lexington, Kentucky 40550, U.S.A or e-mail at [ServiceInfoAndTraining@Lexmark.com](mailto:ServiceInfoAndTraining@Lexmark.com). Lexmark may use or distribute any of the information you supply in any way it believes appropriate without incurring any obligation to you. You can purchase additional copies of publications related to this product by calling 1-800-553-9727. In other countries, contact your point of purchase.

References in this publication to products, programs, or services do not imply that the manufacturer intends to make these available in all countries in which it operates. Any reference to a product, program, or service is not intended to state or imply that only that product, program, or service may be used. Any functionally equivalent product, program, or service that does not infringe any existing intellectual property right may be used instead. Evaluation and verification of operation in conjunction with other products, programs, or services, except those expressly designated by the manufacturer, are the user's responsibility.

Lexmark, Lexmark with diamond design, MarkNet, and MarkVision are trademarks of Lexmark International, Inc., registered in the United States and/or other countries.

ImageQuick, Opra Forms, and PrictureGrade are trademarks of Lemark International, Inc.

PCL<sup>®</sup> is a registered trademark of the Hewlett-Packard Company.

PostScript<sup>®</sup> is a registered trademark of Adobe Systems Incorporated.

Other trademarks are the property of their respective owners.

© 2004 Lexmark International, Inc.

**All rights reserved.**

**UNITED STATES GOVERNMENT RESTRICTED RIGHTS**

This software and documentation are provided with RESTRICTED RIGHTS. Use, duplication or disclosure by the Government is subject to restrictions as set forth in subparagraph (c)(1)(ii) of the Rights in Technical Data and Computer Software clause at DFARS 252.227-7013 and in applicable FAR provisions: Lexmark International, Inc., Lexington, KY 40550.

# Table of Contents

<b>Laser notices</b> .....	<b>vii</b>
<b>Safety information</b> .....	<b>xvii</b>
<b>Preface</b> .....	<b>xxii</b>
Definitions .....	<b>xxii</b>
<b>General information</b> .....	<b>1-1</b>
Models .....	<b>1-1</b>
Maintenance approach .....	<b>1-1</b>
Special tools .....	<b>1-2</b>
Printer identification .....	<b>1-2</b>
Printer features and specifications .....	<b>1-3</b>
Operator panel .....	<b>1-3</b>
Resolution and print quality .....	<b>1-4</b>
Memory and user flash memory .....	<b>1-5</b>
Printer data streams .....	<b>1-5</b>
Print area .....	<b>1-6</b>
Supplies .....	<b>1-6</b>
Fonts .....	<b>1-6</b>
Media and paper handling .....	<b>1-7</b>
Media .....	<b>1-7</b>
Standard and optional paper sources .....	<b>1-8</b>
Input media sources .....	<b>1-9</b>
Output media .....	<b>1-10</b>
Acronyms .....	<b>1-11</b>
<b>Diagnostic information</b> .....	<b>2-1</b>
Start .....	<b>2-1</b>
Power-On Reset (POR) sequence .....	<b>2-2</b>
Symptom tables .....	<b>2-3</b>
POST symptom table .....	<b>2-3</b>
Printer symptom table .....	<b>2-4</b>
Messages and error codes .....	<b>2-6</b>
Service error codes .....	<b>2-6</b>
User attendance messages .....	<b>2-11</b>
Paper jam messages .....	<b>2-22</b>
Sub error codes .....	<b>2-24</b>
Disconnects on the controller card .....	<b>2-34</b>

- Service checks .....2-36
  - Cooling fan service check .....2-36
  - Cover interlock switch service check.....2-37
  - Controller card service check .....2-38
  - Dead machine service check.....2-39
  - Low voltage power supply (LVPS) service check .....2-39
  - High voltage power supply (HVPS) service check.....2-40
  - Fuser service check.....2-40
  - Main motor service check .....2-42
  - Operator panel service check .....2-43
  - Transfer roll service check .....2-44
  - Paper feed service checks.....2-45
  - Parallel port service check.....2-49
  - Print quality service checks.....2-50
- Solving print quality problems .....2-56
- Diagnostic aids .....3-1**
  - Additional service menus .....3-1
  - Diagnostics Mode .....3-2
    - Entering Diagnostic Mode .....3-2
    - REGISTRATION .....3-4
    - PRINT TESTS .....3-5
    - HARDWARE TESTS.....3-6
    - DUPLEX TESTS .....3-9
    - INPUT TRAY TESTS.....3-12
    - BASE SENSOR TEST.....3-14
    - DEVICE TESTS.....3-14
    - PRINTER SETUP .....3-15
    - EP SETUP.....3-17
    - ERROR LOG.....3-18
  - Configuration Menu .....3-21
    - Entering CONFIG MENU.....3-21
    - Maint Cnt Value .....3-22
    - Reset Maint Cnt.....3-22
    - Prt Quality Pgs.....3-23
    - Panel Menus .....3-23
    - PPDS Emulation .....3-23
    - Download Emuls .....3-24
    - Demo Mode.....3-24
    - Factory Defaults.....3-24
    - Energy Conserve.....3-25
    - ERROR LOG.....3-25
    - Paper Prompts.....3-26
    - Env Prompts .....3-26
    - Reduced Curl.....3-26
    - Exit Config Menu .....3-26
  - Paper jams .....3-27

<b>Repair information</b> .....	<b>4-1</b>
Handling ESD-sensitive parts .....	4-1
Adjustments .....	4-2
Printhead assembly adjustment .....	4-2
Adjusting paper feed alignment (skew) .....	4-5
Lubrication .....	4-6
Reassembly .....	4-7
Removal procedures .....	4-8
MPF door cover removal .....	4-8
Front cover removal .....	4-9
Top cover assembly removal .....	4-11
Right side cover removal .....	4-12
Left side cover removal .....	4-14
Rear cover removal .....	4-15
Rear exit door removal .....	4-17
Output tray full flag removal .....	4-18
Operator panel cable removal .....	4-20
Operator panel assembly removal .....	4-22
Duplex tray assembly removal .....	4-24
Bottom pan removal .....	4-25
Fuser assembly removal .....	4-26
Fuser paper exit guide assembly removal .....	4-29
Fuser exit sensor removal .....	4-33
Cartridge contact assembly removal .....	4-34
Tray damper and spring removal .....	4-35
Door latch removal .....	4-36
Paper guide roller removal .....	4-37
Charge roll removal .....	4-38
Right guide removal .....	4-39
Left guide removal .....	4-40
Cartridge signature button sensor removal .....	4-42
Transfer roll assembly .....	4-43
Bracket, paper detect (input sensor) removal .....	4-44
D-roll feed removal, tray 1 .....	4-44
D-roll shaft assembly removal, tray 1 .....	4-45
3-pin and 2-pin connectors removal .....	4-46
Printhead removal .....	4-46
Controller card cage (with card in place) removal .....	4-48
Controller card assembly removal .....	4-50
MPF gear removal .....	4-52
Main drive motor assembly removal .....	4-53
Main drive assembly removal .....	4-55
Exit drive motor removal .....	4-58
Exit drive assembly removal .....	4-59
Ratchet drive removal .....	4-60
Reference feed assembly removal .....	4-62

Cartridge coupling assembly removal . . . . .	4-65
Upper MPF housing assembly (with paper flag) removal . . . . .	4-66
MPF paper sensor removal . . . . .	4-67
Lower MPF housing assembly removal. . . . .	4-70
Backup feed roller assembly removal . . . . .	4-72
MPF pick roller assembly removal. . . . .	4-73
HVPS card removal. . . . .	4-75
LVPS fan removal . . . . .	4-76
LVPS card removal . . . . .	4-77
Inner link and outer link assembly removal . . . . .	4-78
Cooling fan removal. . . . .	4-82
<b>Locations and connections . . . . .</b>	<b>5-1</b>
Exterior locations . . . . .	5-1
Connectors . . . . .	5-2
Controller card assembly. . . . .	5-2
Low voltage power supply (LVPS) . . . . .	5-7
High voltage power supply (HVPS) . . . . .	5-8
<b>Preventive maintenance . . . . .</b>	<b>6-1</b>
Safety inspection guide . . . . .	6-1
Lubrication specifications . . . . .	6-1
Scheduled maintenance . . . . .	6-2
Maintenance kits . . . . .	6-2
Maintenance kit parts group . . . . .	6-3
<b>Parts catalog . . . . .</b>	<b>7-1</b>
How to use this parts catalog . . . . .	7-1
Assembly 1: Covers . . . . .	7-2
Assembly 2: Paper feed . . . . .	7-4
Assembly 3: Frame . . . . .	7-6
Assembly 4: Multipurpose feeder (MPF) . . . . .	7-8
Assembly 5: Fuser. . . . .	7-9
Assembly 6: Charging . . . . .	7-10
Assembly 7: Electronics and cables 1 . . . . .	7-12
Assembly 8: Electronics and cables 2 . . . . .	7-14
Assembly 9: Sensors . . . . .	7-18
Assembly 10: Options . . . . .	7-20
<b>Index . . . . .</b>	<b>I-1</b>
<b>Part number index . . . . .</b>	<b>I-7</b>

## Laser notices

The following laser notice labels may be affixed to this printer as shown:

### Laser advisory label



5mW  
780nm-800nm

**DANGER** – INVISIBLE LASER RADIATION WHEN OPEN.  
AVOID DIRECT EXPOSURE TO BEAM.

**VORSICHT**–UNSICHTBARE LASERSTRAHLUNG. WENN ABDECKUNG  
GEÖFFNET UND SICHERHEITSVERRIEGELUNG  
ÜBERBRÜCKT. NICHT DEM STRAHL AUSSETZEN.

**DANGER** – RAYON LASER INVISIBLE LORS DE LOUVER TURE  
EVITER L'EXPOSITION DIRECTE.

**PELIGRO** – RADIACION LASER INVISIBLE AL ABRIR. EVITAR  
LA EXPOSICION DIRECTA AL HAZ.

**危険**

開けたときレーザー放射の危険有り。

ビームに直接当たらないように注意して下さい。 **MAS**

---

## Laser notice

The printer is certified in the U.S. to conform to the requirements of DHHS 21 CFR Subchapter J for Class I (1) laser products, and elsewhere is certified as a Class I laser product conforming to the requirements of IEC 60825-1.

Class I laser products are not considered to be hazardous. The printer contains internally a Class IIIb (3b) laser that is nominally a 5 milliwatt gallium arsenide laser operating in the wavelength region of 770-795 nanometers. The laser system and printer are designed so there is never any human access to laser radiation above a Class I level during normal operation, user maintenance, or prescribed service condition.

---

## Laser

Der Drucker erfüllt gemäß amtlicher Bestätigung der USA die Anforderungen der Bestimmung DHHS (Department of Health and Human Services) 21 CFR Teil J für Laserprodukte der Klasse I (1). In anderen Ländern gilt der Drucker als Laserprodukt der Klasse I, der die Anforderungen der IEC (International Electrotechnical Commission) 60825-1 gemäß amtlicher Bestätigung erfüllt.

Laserprodukte der Klasse I gelten als unschädlich. Im Inneren des Druckers befindet sich ein Laser der Klasse IIIb (3b), bei dem es sich um einen Galliumarsenlaser mit 5 Milliwatt handelt, der Wellen der Länge 770-795 Nanometer ausstrahlt. Das Lasersystem und der Drucker sind so konzipiert, daß im Normalbetrieb, bei der Wartung durch den Benutzer oder bei ordnungsgemäßer Wartung durch den Kundendienst Laserbestrahlung, die die Klasse I übersteigen würde, Menschen keinesfalls erreicht.



---

## Avis relatif à l'utilisation de laser

Pour les Etats-Unis : cette imprimante est certifiée conforme aux provisions DHHS 21 CFR alinéa J concernant les produits laser de Classe I (1). Pour les autres pays : cette imprimante répond aux normes IEC 60825-1 relatives aux produits laser de Classe I.

Les produits laser de Classe I sont considérés comme des produits non dangereux. Cette imprimante est équipée d'un laser de Classe IIIb (3b) (arséniure de gallium d'une puissance nominale de 5 milliwatts) émettant sur des longueurs d'onde comprises entre 770 et 795 nanomètres. L'imprimante et son système laser sont conçus pour impossible, dans des conditions normales d'utilisation, d'entretien par l'utilisateur ou de révision, l'exposition à des rayonnements laser supérieurs à des rayonnements de Classe I .

---

## Avvertenze sui prodotti laser

Questa stampante è certificata negli Stati Uniti per essere conforme ai requisiti del DHHS 21 CFR Sottocapitolo J per i prodotti laser di classe 1 ed è certificata negli altri Paesi come prodotto laser di classe 1 conforme ai requisiti della norma CEI 60825-1.

I prodotti laser di classe non sono considerati pericolosi. La stampante contiene al suo interno un laser di classe IIIb (3b) all'arseniuro di gallio della potenza di 5mW che opera sulla lunghezza d'onda compresa tra 770 e 795 nanometri. Il sistema laser e la stampante sono stati progettati in modo tale che le persone a contatto con la stampante, durante il normale funzionamento, le operazioni di servizio o quelle di assistenza tecnica, non ricevano radiazioni laser superiori al livello della classe 1.

---

## Avisos sobre el láser

Se certifica que, en los EE.UU., esta impresora cumple los requisitos para los productos láser de Clase I (1) establecidos en el subcapítulo J de la norma CFR 21 del DHHS (Departamento de Sanidad y Servicios) y, en los demás países, reúne todas las condiciones expuestas en la norma IEC 60825-1 para productos láser de Clase I (1).

Los productos láser de Clase I no se consideran peligrosos. La impresora contiene en su interior un láser de Clase IIIb (3b) de arseniuro de galio de funcionamiento nominal a 5 milivatios en una longitud de onda de 770 a 795 nanómetros. El sistema láser y la impresora están diseñados de forma que ninguna persona pueda verse afectada por ningún tipo de radiación láser superior al nivel de la Clase I durante su uso normal, el mantenimiento realizado por el usuario o cualquier otra situación de servicio técnico.

---

## Declaração sobre Laser

A impressora está certificada nos E.U.A. em conformidade com os requisitos da regulamentação DHHS 21 CFR Subcapítulo J para a Classe I (1) de produtos laser. Em outros locais, está certificada como um produto laser da Classe I, em conformidade com os requisitos da norma IEC 60825-1.

Os produtos laser da Classe I não são considerados perigosos. Internamente, a impressora contém um produto laser da Classe IIIb (3b), designado laser de arseneto de potássio, de 5 milliwatts, operando numa faixa de comprimento de onda entre 770 e 795 nanómetros. O sistema e a impressora laser foram concebidos de forma a nunca existir qualquer possibilidade de acesso humano a radiação laser superior a um nível de Classe I durante a operação normal, a manutenção feita pelo utilizador ou condições de assistência prescritas.

---

## Laserinformatie

De printer voldoet aan de eisen die gesteld worden aan een laserprodukt van klasse I. Voor de Verenigde Staten zijn deze eisen vastgelegd in DHHS 21 CFR Subchapter J, voor andere landen in IEC 60825-1.

Laserprodukten van klasse I worden niet als ongevaarlijk aangemerkt. De printer is voorzien van een laser van klasse IIIb (3b), dat wil zeggen een gallium arsenide-laser van 5 milliwatt met een golflengte van 770-795 nanometer. Het lasergedeelte en de printer zijn zo ontworpen dat bij normaal gebruik, bij onderhoud of reparatie conform de voorschriften, nooit blootstelling mogelijk is aan laserstraling boven een niveau zoals voorgeschreven is voor klasse 1.

---

## Lasermeddelelse

Printeren er godkendt som et Klasse I-laserprodukt, i overensstemmelse med kravene i IEC 60825-1.

Klasse I-laserprodukter betragtes ikke som farlige. Printeren indeholder internt en Klasse IIIB (3b)-laser, der nominelt er en 5 milliwatt galliumarsenid laser, som arbejder på bølgelængdeområdet 770-795 nanometer. Lasersystemet og printeren er udformet således, at mennesker aldrig udsættes for en laserstråling over Klasse I-niveau ved normal drift, brugervedligeholdelse eller obligatoriske servicebetingelser.

---

## Huomautus laserlaitteesta

Tämä kirjoitin on Yhdysvalloissa luokan I (1) laserlaitteiden DHHS 21 CFR Subchapter J -määrityksen mukainen ja muualla luokan I laserlaitteiden IEC 60825-1 -määrityksen mukainen.

Luokan I laserlaitteiden ei katsota olevan vaarallisia käyttäjälle. Kirjoittimessa on sisäinen luokan IIIb (3b) 5 milliwatin galliumarsenidilaser, joka toimii aaltoalueella 770 - 795 nanometriä. Laserjärjestelmä ja kirjoitin on suunniteltu siten, että käyttäjä ei altistu luokan I määrityksiä voimakkaammalle säteilylle kirjoittimen normaalin toiminnan, käyttäjän tekemien huoltotoimien tai muiden huoltotoimien yhteydessä.

**VARO!** Avattaessa ja suojalukitus ohitettaessa olet alttiina näkymättömälle lasersäteilylle. Älä katso säteeseen.

**WARNING!** Osynlig laserstrålning när denna del är öppnad och spärren är urkopplad. Betrakta ej strålen.

---

## Laser-notis

Denna skrivare är i USA certifierad att motsvara kraven i DHHS 21 CFR, underparagraf J för laserprodukter av Klass I (1). I andra länder uppfyller skrivaren kraven för laserprodukter av Klass I enligt kraven i IEC 60825-1.

Laserprodukter i Klass I anses ej hälsovådliga. Skrivaren har en inbyggd laser av Klass IIIb (3b) som består av en laserenhet av gallium-arsenid på 5 milliwatt som arbetar i våglängdsområdet 770-795 nanometer. Lasersystemet och skrivaren är utformade så att det aldrig finns risk för att någon person utsätts för laserstrålning över Klass I-nivå vid normal användning, underhåll som utförs av användaren eller annan föreskriven serviceåtgärd.

---

## Laser-melding

Skriveren er godkjent i USA etter kravene i DHHS 21 CFR, underkapittel J, for klasse I (1) laserprodukter, og er i andre land godkjent som et Klasse I-laserprodukt i samsvar med kravene i IEC 60825-1.

Klasse I-laserprodukter er ikke å betrakte som farlige. Skriveren inneholder internt en klasse IIIb (3b)-laser, som består av en gallium-arsenlaserenhet som avgir stråling i bølgelengdeområdet 770-795 nanometer. Lasersystemet og skriveren er utformet slik at personer aldri utsettes for laserstråling ut over klasse I-nivå under vanlig bruk, vedlikehold som utføres av brukeren, eller foreskrevne serviceoperasjoner.

---

## Avís sobre el Làser

Segons ha estat certificat als Estats Units, aquesta impressora compleix els requisits de DHHS 21 CFR, apartat J, pels productes làser de classe I (1), i segons ha estat certificat en altres llocs, és un producte làser de classe I que compleix els requisits d'IEC 60825-1.

Els productes làser de classe I no es consideren perillosos. Aquesta impressora conté un làser de classe IIIb (3b) d'arseniür de gal.li, nominalment de 5 mil.liwats, i funciona a la regió de longitud d'ona de 770-795 nanòmetres. El sistema làser i la impressora han sigut concebuts de manera que mai hi hagi exposició a la radiació làser per sobre d'un nivell de classe I durant una operació normal, durant les tasques de manteniment d'usuari ni durant els serveis que satisfacin les condicions prescrites.

---

## Japanese Laser Notice

### レーザーに関するお知らせ

このプリンターは、米国ではDHHS 21 CFRサブチャプターJのクラスI (1)の基準を満たしたレーザー製品であることが証明されています。また米国以外ではIEC 825の基準を満たしたクラスIのレーザー製品であることが証明されています。

クラスIのレーザー製品には危険性はないと考えられています。このプリンターはクラスIII b (3 b)のレーザーを内蔵しています。このレーザーは、波長が770 ~ 795ナノメートルの範囲で、通常5ミリワットのガリウム砒化物を放射するレーザーです。このレーザーシステムとプリンターは、通常の操作、ユーザのメンテナンス、規定された修理においては、人体がクラスIのレベル以上のレーザー放射に晒されることのないよう設計されています。

---

## Chinese Laser Notice

### 注意：

本打印机被美国认证合乎 DHHS 21 CFR Subchapter I 对分类 I (1) 激光产品的标准，而在其他地区则被认证合乎 IEC 825 的标准。

分类 I 激光产品一般认为不具危险性，本打印机内部含有分类 IIIb (3b) 的激光，在操作过程中会产生 5 毫瓦含镓及砷的微量激光，其波长范围在 770-795 nm 之间。本激光系统及打印机的设计，在一般操作、使用者维护或规定内的维修情况下，不会使人体接触分类 I 以上等级的辐射。

---

## Korean Laser Notice

본프린터는 1등급 레이저 제품들에 대한 DHHS 21 CFR Subchapter 3의 규정을 준수하고 있음을 미국에서 인증받았으며, 그외의 나라에서도 IEC 825 규정을 준수하는 1등급 레이저 제품으로서 인증을 받았습니다.

1등급 레이저 제품들은 안전한 것으로 간주됩니다. 본 프린터는 5 밀리와트 가솔륨 아르세나이드 레이저로서 770-795 나노미터의 파장대에서 활동하는 Class III (3b) 레이저를 내부에 갖고 있습니다. 본 레이저 시스템과 프린터는 정상 작동 중이나 유지 보수 중 또는 규정된 서비스 상태에서 상기의 Class I 수준의 레이저 방출에 사람이 절대 접근할 수 없도록 설계되어 있습니다.

**4048-1xx**



---

## Safety information

- The safety of this product is based on testing and approvals of the original design and specific components. The manufacturer is not responsible for safety in the event of use of unauthorized replacement parts.
- The maintenance information for this product has been prepared for use by a professional service person and is not intended to be used by others.
- There may be an increased risk of electric shock and personal injury during disassembly and servicing of this product. Professional service personnel should understand this and take necessary precautions.
-  **CAUTION:** When you see this symbol, there is a danger from hazardous voltage in the area of the product where you are working. Unplug the product before you begin, or use caution if the product must receive power in order to perform the task.

---

## Consignes de sécurité

- La sécurité de ce produit repose sur des tests et des agréments portant sur sa conception d'origine et sur des composants particuliers. Le fabricant n'assume aucune responsabilité concernant la sécurité en cas d'utilisation de pièces de rechange non agréées.
- Les consignes d'entretien et de réparation de ce produit s'adressent uniquement à un personnel de maintenance qualifié.
- Le démontage et l'entretien de ce produit pouvant présenter certains risques électriques, le personnel d'entretien qualifié devra prendre toutes les précautions nécessaires.
-  **ATTENTION :** Ce symbole indique la présence d'une tension dangereuse dans la partie du produit sur laquelle vous travaillez. Débranchez le produit avant de commencer ou faites preuve de vigilance si l'exécution de la tâche exige que le produit reste sous tension.

---

## Norme di sicurezza

- La sicurezza del prodotto si basa sui test e sull'approvazione del progetto originale e dei componenti specifici. Il produttore non è responsabile per la sicurezza in caso di sostituzione non autorizzata delle parti.
- Le informazioni riguardanti la manutenzione di questo prodotto sono indirizzate soltanto al personale di assistenza autorizzato.
- Durante lo smontaggio e la manutenzione di questo prodotto, il rischio di subire scosse elettriche e danni alla persona è più elevato. Il personale di assistenza autorizzato deve, quindi, adottare le precauzioni necessarie.
-  **ATTENZIONE:** Questo simbolo indica la presenza di tensione pericolosa nell'area del prodotto. Scollegare il prodotto prima di iniziare o usare cautela se il prodotto deve essere alimentato per eseguire l'intervento.

---

## Sicherheitshinweise

- Die Sicherheit dieses Produkts basiert auf Tests und Zulassungen des ursprünglichen Modells und bestimmter Bauteile. Bei Verwendung nicht genehmigter Ersatzteile wird vom Hersteller keine Verantwortung oder Haftung für die Sicherheit übernommen.
- Die Wartungsinformationen für dieses Produkt sind ausschließlich für die Verwendung durch einen Wartungsfachmann bestimmt.
- Während des Auseinandernehmens und der Wartung des Geräts besteht ein zusätzliches Risiko eines elektrischen Schlags und körperlicher Verletzung. Das zuständige Fachpersonal sollte entsprechende Vorsichtsmaßnahmen treffen.
-  **ACHTUNG:** Dieses Symbol weist auf eine gefährliche elektrische Spannung hin, die in diesem Bereich des Produkts auftreten kann. Ziehen Sie vor den Arbeiten am Gerät den Netzstecker des Geräts, bzw. arbeiten Sie mit großer Vorsicht, wenn das Produkt für die Ausführung der Arbeiten an den Strom angeschlossen sein muß.

---

## Pautas de Seguridad

- La seguridad de este producto se basa en pruebas y aprobaciones del diseño original y componentes específicos. El fabricante no es responsable de la seguridad en caso de uso de piezas de repuesto no autorizadas.
- La información sobre el mantenimiento de este producto está dirigida exclusivamente al personal cualificado de mantenimiento.
- Existe mayor riesgo de descarga eléctrica y de daños personales durante el desmontaje y la reparación de la máquina. El personal cualificado debe ser consciente de este peligro y tomar las precauciones necesarias.
-  **PRECAUCIÓN:** este símbolo indica que el voltaje de la parte del equipo con la que está trabajando es peligroso. Antes de empezar, desenchufe el equipo o tenga cuidado si, para trabajar con él, debe conectarlo.

---

## Informações de Segurança

- A segurança deste produto baseia-se em testes e aprovações do modelo original e de componentes específicos. O fabricante não é responsável pela segurança, no caso de uso de peças de substituição não autorizadas.
- As informações de segurança relativas a este produto destinam-se a profissionais destes serviços e não devem ser utilizadas por outras pessoas.
- Risco de choques eléctricos e ferimentos graves durante a desmontagem e manutenção deste produto. Os profissionais destes serviços devem estar avisados deste facto e tomar os cuidados necessários.
-  **CUIDADO:** Quando vir este símbolo, existe a possível presença de uma potencial tensão perigosa na zona do produto em que está a trabalhar. Antes de começar, desligue o produto da tomada eléctrica ou seja cuidadoso caso o produto tenha de estar ligado à corrente eléctrica para realizar a tarefa necessária.

## Informació de Seguretat

- La seguretat d'aquest producte es basa en l'avaluació i aprovació del disseny original i els components específics. El fabricant no es fa responsable de les qüestions de seguretat si s'utilitzen peces de recanvi no autoritzades.
- La informació pel manteniment d'aquest producte està orientada exclusivament a professionals i no està destinada a ningú que no ho sigui.
- El risc de xoc elèctric i de danys personals pot augmentar durant el procés de desmuntatge i de servei d'aquest producte. El personal professional ha d'estar-ne assabentat i prendre les mesures convenients.
-  **PRECAUCIÓ:** aquest símbol indica que el voltatge de la part de l'equip amb la qual esteu treballant és perillós. Abans de començar, desendolleu l'equip o extremeu les precaucions si, per treballar amb l'equip, l'heu de connectar.

### 안전 사항

- 본 제품은 원래 설계 및 특정 구성품에 대한 테스트 결과로 안정성이 입증된 것입니다. 따라서 무허가 교체부품을 사용하는 경우에는 제조업체에서 안전에 대한 책임을 지지 않습니다.
- 본 제품에 관한 유지 보수 설명서는 전문 서비스 기술자 용으로 작성된 것이므로, 비전문가는 사용할 수 없습니다.
- 본 제품을 해체하거나 정비할 경우, 전기적인 충격을 받거나 상처를 입을 위험이 커집니다. 전문 서비스 기술자는 이 사실을 숙지하고, 필요한 예방 조치를 취하도록 하십시오.
-  **주의:** 이 표시는 해당영역에서 고압전류가 흐른다는 위험 표시입니다. 시작전에 플러그를 뽑으시거나, 주의를 기울여 주시기 바랍니다.

---

## 安全信息

本产品的安全性以原来设计和特定产品的测试结果和认证为基础。万一使用未经许可的替换部件，制造商不对安全性负责。

本产品的维护信息仅供专业服务人员使用，并不打算让其他人使用。

本产品在拆卸、维修时，遭受电击或人员受伤的危险性会增高，专业服务人员对这点必须有所了解，并采取必要的预防措施。



**切记：**当您看到此符号时，说明在您工作的产品区域有危险电压的存在。请在开始操作前拔掉产品的电源线，或者在产品必须使用电源来执行任务时，小心从事。

---

# Preface

This manual contains maintenance procedures for service personnel. It is divided into the following chapters:

1. **General information** contains a general description of the printer and the maintenance approach used to repair it. Special tools and test equipment are listed, as well as general environmental and safety instructions.
2. **Diagnostic information** contains an error indicator table, symptom tables, and service checks used to isolate failing field replaceable units (FRUs).
3. **Diagnostic aids** contains tests and checks used to locate or repeat symptoms of printer problems.
4. **Repair information** provides instructions for making printer adjustments and removing and installing FRUs.
5. **Locations and connections** uses illustrations to identify the connector locations and test points on the printer.
6. **Preventive maintenance** contains the lubrication specifications and recommendations to prevent problems.
7. **Parts catalog** contains illustrations and part numbers for individual FRUs.

---

## Definitions

**Note:** A note provides additional information.

**Warning:** A warning identifies something that might damage the product hardware or software.

**CAUTION:** A caution identifies something that might cause a servicer harm.



**CAUTION:** When you see this symbol, there is a danger from hazardous voltage in the area of the product where you are working. Unplug the product before you begin, or use caution if the product must receive power in order to perform the task.

# 1. General information

The Lexmark™ T430 (4048-1xx) laser printer is a monochrome laser printer designed for individual users or small workgroups.

## Models

There are three models, differing on standard features, including standard memory. For information on standard and optional memory, see **“Memory and user flash memory” on page 1-5.**

Standard features	Models		
	101	102	111
Duplex	✓	✓	✗
Parallel interface connector (1284–B connector.)	✓	✓	✓
Parallel mode 2	✓	✓	✓
USB port	✓	✓	✓
Ethernet adapter, integrated	✗	✓	✗
✓ Indicates attachment is part of the factory shipped configuration. ✗ Indicates attachment is not part of the factory shipped configuration.			

## Maintenance approach

The diagnostic information leads you to the correct field replaceable unit (FRU) or part. Use the error code charts, symptom index, and service checks to determine the symptom and repair the failure. See **“Diagnostic information” on page 2-1**, for the location of each section. See the **“Repair information” on page 4-1** to help identify parts. After completing the repair, perform tests as needed to verify the repair.

---

## Special tools

- Long Phillips screwdriver (approximately 6-inch shank)
- Slotted screwdriver
- Small Phillips screwdriver
- Spring hook

When taking voltage readings, always use the printer frame as ground unless another ground is specified.

---

## Printer identification

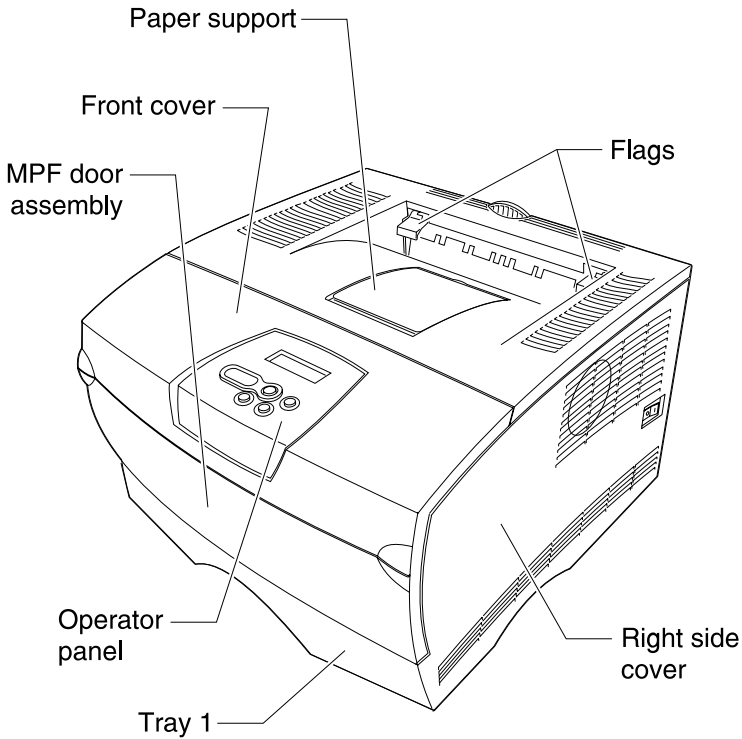

## Serial number

Look for the serial number label on the inside front cover of the printer.



---

## Printer features and specifications

### *Operator panel*

The operator panel consists of a two-line display and six buttons (Menu is two buttons).

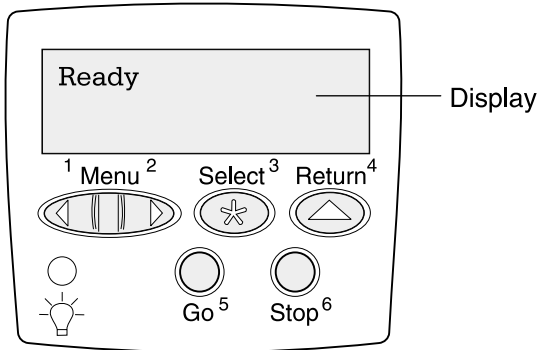

## ***Resolution and print quality***

- IET, PictureGrade™, print resolution, print darkness, and toner saver can all be set independently of each other through the data stream.
- Control panel menus let a user independently set PictureGrade and print resolution.
- The IET setting is selected when a print resolution is selected using the Quality Menu.
- Toner saver and print darkness settings are set when a toner darkness is selected using the Quality Menu.

<b>Print Quality setting</b>	<b>All models</b>
Print resolution: <ul style="list-style-type: none"> <li>• 300 dpi</li> <li>• 600 dpi</li> <li>• 1200 Image Quality</li> <li>• 2400 Image Quality</li> <li>• 1200 dpi</li> </ul>	✓ ✓ ✓ ✓ ✓
Image Enhancement Technology (IET): <ul style="list-style-type: none"> <li>• 2 bits/pel</li> <li>• 4 bits/pel</li> </ul>	✓ ✓
Toner saver	✓
Print darkness	✓
PictureGrade	✓
✓ Indicates print quality setting is supported.	

## Memory and user flash memory

Each model has a standard amount of memory (RAM) soldered on the controller card, and a certain number of 100-pin DIMM slots available for installing additional memory or user flash memory options.

Memory	Models	
	101 and 111	102
Standard memory	32MB	64MB
Standard flash memory	None	None
Memory options		
8MB DIMM	✓	✓
16MB DIMM	✓	✓
32MB DIMM	✓	✓
64MB DIMM	✓	✓
128MB DIMM	✓	✓
256MB DIMM	✓	✓
Maximum # of memory DIMM	1	1
Maximum possible memory	288MB	320MB
Flash memory options		
16MB	✓	✓
32MB	✓	✓
Maximum # of flash memory options	1	1
Maximum possible flash memory	32MB	32MB
✓ Indicates option is supported.		

## Printer data streams

Data streams	All models
PCL 6 emulation	✓
PostScript 3 emulation	✓
PPDS	✓
PDF (version 1.3)	✓

**Print area**

The following print area settings are available.

Print area option	All models
Normal	✓
Fit to page	✗
Edge to edge	✓

**Supplies**

Print cartridge	Average yield	Approximate coverage
Lexmark Return Program print cartridges	6,000	5%
	12,000	5%
Regular cartridges (without Lexmark Return Program terms and conditions)	6,000	5%
	12,000	5%

**Fonts**

Fonts/options	All models
PCL bitmapped	2
PCL scalable	89
PostScript scalable	91
PPDS bitmapped	5
PPDS scalable	39

**Note:** Additional fonts can be downloaded to the printer RAM, or optional user flash.

## Media and paper handling

### *Media*

The following table shows the supported media, media weights and media textures which together provide optimal print quality across a variety of media.

<b>Media supported</b>	<b>All models</b>
Paper	✓
Card stock	✓
Transparency	✓
Labels	✓
Envelope	✓
Bond	✓
<b>Media weights</b>	
Heavy	✓
Normal	✓
Light	✓
<b>Media textures</b>	
Rough	✓
Normal	✓
Smooth	✓

**Note:** ✓ Indicates media is supported.

**Standard and optional paper sources**

Media sources	Models	
	101, 102	111
<b>Standard</b>		
Standard input sources:	2	2
<ul style="list-style-type: none"> <li>Integrated 250-sheet tray The 250-sheet drawer supports the following sizes: A4, A5, JIS B5, folio, letter, legal, executive, and statement.</li> </ul>	1	1
<ul style="list-style-type: none"> <li>Multipurpose feeder</li> </ul>	1	1
Standard output destination (150-sheet sensing bin)	1	1
Duplex (standard in models 101 and 102, only)	✓	✗
<b>Options</b>		
Maximum # of optional drawers	2	2
Optional drawers: <b>Note:</b> When two optional drawers are installed, the first must be a 250-sheet drawer.		
<ul style="list-style-type: none"> <li>250-sheet drawer</li> </ul>	✓	✓
<ul style="list-style-type: none"> <li>500-sheet drawer The 500 sheet drawer supports the following sizes: A4, JIS B5, folio, letter, legal, and executive.</li> </ul>	✓	✓
Maximum number of media input sources	4	4
Maximum input sheet capacity (excluding envelopes)	1000	1000
Maximum sheet capacity (excluding envelopes)	150	150
✓ Indicates associated capability is supported. Assumes 20 lb xerographic paper.		

## Input media sources

Supported input sizes *	Integrated 250-sheet tray	Multipurpose feeder	Optional 250-sheet drawer	Optional 500-sheet drawer	Duplex (models 101, 102 only)
Letter	✓	✓	✓	✓	✓
11 x 17					
Legal	✓	✓	✓	✓	✓
A4	✓	✓	✓	✓	✓
A3					
A5	✓	✓	✓		
Folio	✓	✓	✓	✓	✓
Statement	✓	✓	✓		
JIS-B4					
JIS-B5	✓	✓	✓	✓	✓
Executive	✓	✓	✓	✓	✓
Universal	✓	✓	✓	✓	✓
7 3/4 envelope		✓			
9 envelope		✓			
10 envelope		✓			
DL envelope		✓			
C5 envelope		✓			
B5 envelope		✓			
Other envelope		✓			
✓ Size supported without size sensing.					

***Output media***

<b>Supported output sizes</b>	<b>150-sheet standard bin</b>	<b>20-sheet rear exit</b>
Letter	✓	✓
A4	✓	✓
Legal	✓	*
11 x 17		
A3		
Folio	✓	✓
Statement	✓	✓
A5	✓	✓
JIS-B4		
JIS-B5	✓	✓
Executive	✓	✓
Universal	✓	*
7 3/4 envelope	✓	✓
9 envelope	✓	✓
10 envelope	✓	✓
DL envelope	✓	✓
C5 envelope	✓	✓
B5 envelope	✓	✓
Other envelope	✓	✓
* Size supported, but results may be unacceptable.		



---

## Acronyms

ASIC	Application-Specific Integrated Circuit
C	Charge Roll
CRC	Cyclic Redundancy Check
DC	Direct Current
DEV	Developer Roll
DIMM	Dual In-line Memory Module
DRAM	Dynamic Random Access Memory
ECC	Error Checking and Correction
EPROM	Erasable Programable Read-Only Memory
FRU	Field Replaceable Unit
GND	Ground
HVPS	High Voltage Power Supply
IET	Image Enhancement Technology
KB	Kilobyte
LCD	Liquid Crystal Display
LSU	Laser Scanning Unit
LVPS	Low Voltage Power Supply
MPF	Multipurpose Feeder
NAND	Not And (Gate)
NVRAM	Nonvolatile Random Access Memory
PIN	Personal Identification Number
PJL	Printer Job Language
POR	Power-On Reset
POST	Power-On Self Test
PPDS	Personal Printer Data Stream
RAM	Random Access Memory
RIP	Raster Image Processor
SDRAM	Synchronous Dynamic Random Access Memory
SRAM	Static Random Access Memory
T	Transfer (Roll)
TAR	Toner Adder Roll
USB	Universal Serial Bus
V ac	Volts Alternating Current

**4048-1xx**

---

## 2. Diagnostic information

---

### Start



**CAUTION:** Unplug power from the printer before connecting or disconnecting any cable, assembly, or electronic card. This is a precaution for personal safety and to prevent damage to the printer.

This chapter contains the codes and diagnostic tools to aid in providing corrective action for a malfunctioning printer. To determine the corrective action to repair a printer, look for the following information:

- Does the POR stop? Check the:
  - **“Power-On Reset (POR) sequence” on page 2-2**
  - **“POST symptom table” on page 2-3.**
- Do you have a symptom, rather than an error message? Check the **“Symptom tables” on page 2-3.**
- If you have an error message or user message, check the following:
  - **“Service error codes” on page 2-6**
  - **“User attendance messages” on page 2-11.**
- Additional information:
  - **“Service checks” on page 2-36**
  - **“Solving print quality problems” on page 2-56.**

---

## Power-On Reset (POR) sequence

The following is an example of the events that occur during the POR sequence when the printer is turned on.

1. Diamonds are displayed on the operator panel.
2. While code is being loaded into DRAM, dots scroll across the operator panel.
3. A screen is displayed with the memory and processor speed. A typical example of this message is:

* 32 Mb                      366 Mhz
---

4. Performing Self Test is displayed.
5. Busy is displayed.
6. Close Door will be posted if the cover is open.
7. Any cartridge errors, such as Defective Cartridge are posted.
8. Applicable maintenance messages are posted. For example, 80 Scheduled Maintenance.
9. Applicable toner low messages are posted.
10. The printer displays Ready.

## Symptom tables

### POST symptom table

These symptoms may appear during the POST (Power-on Self Test). See **“Power-On Reset (POR) sequence” on page 2-2** for the sequence when a printer is turned on.

Symptom	Action
The main motor, cooling fan and fuser do not come on.	See <b>“Cover interlock switch service check” on page 2-37.</b>
POST completes except display is incomplete or erratic.	See <b>“Operator panel service check” on page 2-43.</b>
POST complete except display does not function.	See <b>“Operator panel service check” on page 2-43.</b>
Main motor does not come on.	See <b>“Main motor service check” on page 2-42.</b>
Fan does not come on.	See <b>“Cooling fan service check” on page 2-36.</b>
Fuser heater does not come on.	See <b>“Cold fuser service check” on page 2-41.</b>
Fuser heater never turns off.	See <b>“Hot fuser service check” on page 2-41.</b>
The paper feed picks and tries to feed paper.	See <b>“Paper feed service checks” on page 2-45.</b>

## Printer symptom table

Symptom	Action
Dead machine (no power)	See <b>“Dead machine service check”</b> on page 2-39.
Fan noisy or not working	See <b>“Cooling fan service check”</b> on page 2-36.
Fuser parts melted	See <b>“Hot fuser service check”</b> on page 2-41.
Fuser heater does not activate	See <b>“Cold fuser service check”</b> on page 2-41.
Toner not fused to the paper	See <b>“Poor fusing of image”</b> on page 2-53.
Blank page	See <b>“Blank page”</b> on page 2-50.
Black page	See <b>“Black page”</b> on page 2-51.
Heavy background	See <b>“Heavy background”</b> on page 2-52.
Light print	See <b>“Light print”</b> on page 2-54.
White or black lines or bands	See <b>“White or black lines or bands”</b> on page 2-54.
Toner on back of page	See <b>“Toner on back of page”</b> on page 2-55.
Paper jams	See <b>“Paper feed service checks”</b> on page 2-45.
Main motor noisy or does not move	See <b>“Main motor service check”</b> on page 2-42.
Paper never picks	See <b>“Paper never picks”</b> on page 2-48.
Paper feeds continuously	See <b>“Paper picks during POST and/or continuously”</b> on page 2-46.
Skewed paper	See <b>Note</b> regarding alignment on page 4-64 or <b>“Paper feed service checks”</b> on page 2-45.

<b>Symptom</b>	<b>Action</b>
Printer not communicating with host	See <b>“Parallel port service check” on page 2-49.</b>
Paper wrinkled or bent	See <b>“Paper “trees,” wrinkles, stacks poorly or curls” on page 2-49.</b>
Top cover will not close	See <b>“Cover interlock switch service check” on page 2-37.</b>
Operator panel button does not respond	See <b>“Operator panel service check” on page 2-43</b> or <b>“Controller card service check” on page 2-38.</b>
Operator panel light does not light or is very dim	See <b>“Controller card service check” on page 2-38.</b>

## Messages and error codes

### Service error codes

Service error codes are generally non-recoverable except in an intermittent condition when you can POR the printer to temporarily recover from the error condition.

#### Service error codes (9xx)

Error	Description	Action
900	RIP software	Server firmware problem. Contact the next level of support.
902	General engine software failure	An unrecoverable system software error. Reset the printer (POR). If the problem continues, replace the controller card.
910	DC exit motor stall	The load on the exit motor is too high or there is a cabling problem. First, check for jams and then move the exit rollers, located between the rear door and fuser, while observing the DC motor. If the torque is too high, isolate the problem to the redrive and repair or replace as necessary. If the torque seems normal, check the cabling for continuity and replace the motor with cabling.
911	DC exit motor	
912	DC exit motor below speed	
913	DC exit motor over speed	
914	DC pick motor—no encoder feedback	Verify motor is plugged into controller card correctly. Also check load condition (see <b>service error 910</b> , above).
917	Transfer roll	The most likely cause is a faulty HVPS. It may also indicate a problem in the transfer roll area. Go to <b>“Transfer roll service check” on page 2-44</b> .
920	Fuser error	Indicates that the fuser is below temperature when printing. Go to <b>“Fuser service check” on page 2-40</b> .
922	Fuser error	Fuser failed to reach standby temperature. Verify line voltage to the fuser. Go to <b>“Fuser service check” on page 2-40</b> .



## Service error codes (9xx) (continued)

Error	Description	Action
923	Fuser error	Fuser is too hot during printing or when printer is idle. Go to <b>“Fuser service check” on page 2-40.</b>
924	Fuser error	An open circuit has been detected in the fuser thermistor circuit. Check cabling and connectors. Go to <b>“Fuser service check” on page 2-40.</b>
929	Toner sensor	The toner sensor is not operating properly, the developer drive assembly is not operating properly, or the print cartridge is defective. Go to <b>“Sensor Test” on page 3-12.</b>
931	Printhead—no first hysnc	Check for unplugged printhead, faulty cabling, or faulty printhead.
932	Printhead—lost hsyncs	Replace the printhead.
934	Mirror motor lost lock	Replace the printhead.
935	Mirror motor unable to reach operating speed.	Faulty printhead, cabling or connector.
936	Transport motor initial lock failure	Indicates a problem with the main drive motor or a jam occurred during the motor ramp-up to speed.
937	Transport motor lost lock	Faulty motor or a jam occurred after motor ramp-up to speed. Possible problem with the main drive.
939	RIP—engine communications	The RIP processor cannot communicate with the engine processor. Replace the controller card. Go to <b>“Controller card assembly removal” on page 4-50.</b> If the problem persists, contact the next level of support.

## Service error codes (9xx) (continued)

Error	Description	Action
940	LV Power Supply 	<p>The low voltage power supply zero crossover test failed. Check the LVPS for correct installation. Make sure the connector on the LVPS assembly is firmly seated with the connector on the interconnect card connector.</p> <p>This error may also be caused by a noisy AC input power source.</p> <ul style="list-style-type: none"> <li>• Be sure the correct LVPS has been installed.</li> <li>• If all the above are correct, replace the LVPS assembly.</li> </ul>
941	Controller card	<p>This error indicates an open fuse in line to tray 2. POR the printer to reset the fuse. Check for +24 V dc on J21, pin 6. If correct, the fuse is okay. If incorrect, remove the drawer and check resistance between pin 6 and 5 of the tray. If the resistance is less than 50 ohms, replace the drawer.</p>
950	Controller card	<p>There is a mismatch between the variables in the EPROM on the operator panel card and those in the secure NVRAM on the controller card. This can only occur after a replacement of one of the two parts and the replaced part is faulty. Replace the controller card or the operator panel.</p> <p><b>Warning:</b> Always replace only one at a time with a POR between.</p>
951	Controller card	<p>The secure NVRAM was not detected on the controller card. Replace the controller card.</p>
952	NV failure:n	<p>Recoverable error. Reset (POR) the printer.</p>
953	NVRAM chip failure	<p>Indicates the NVRAM chip has failed. Replace the controller card.</p>
954	NVRAM CRC failure	<p>Indicates the NVRAM experienced a CRC failure. Replace the controller card.</p>

**Service error codes (9xx) (continued)**

<b>Error</b>	<b>Description</b>	<b>Action</b>
955	Code CRC <loc>	Replace the controller card. Where <loc> = CRC Failure or ECC Failure on the controller card.
956	Controller card	Error codes 956, 957, and 959 are controller card failures. Perform a power on reset (POR). If this does not fix the problem, replace the controller card.
957	ASIC failure	Error codes 956, 957, and 959 are controller card failures. Perform a power on reset (POR). If this does not fix the problem, replace the controller card.
958	NAND failure	Before proceeding, perform a power on reset (POR) to see if the ECC error correction code can reflash NAND. If this does not fix the problem, replace the controller card.
959	SRAM failure	Error codes 956, 957, and 959 are controller card failures. Perform a power on reset (POR). If this does not fix the problem, replace the controller card.
960	RAM soldered on the card is bad	Indicates a DRAM Memory Error on the controller card. Replace the controller card.
961	RAM in slot 1 is bad	If another SDRAM memory DIMM is available, turn the power off and switch the DIMM. If the memory card now works correctly, replace the failing DIMM. If this does not fix the problem, replace the controller card. If another DIMM is not available, replace the memory option first and then the controller card if necessary.

## Service error codes (9xx) (continued)

Error	Description	Action
964	Download emulation CRC failure. Checksum failure detected in the emulation header or emulation file.	Perform the following: 1. Disable the downloaded emulations. See <b>“Download Emuls” on page 3-24.</b> 2. Reprogram the downloaded emulations. If the problem persists, replace the emulation card.
975	Unrecognizable network port	A failure with the network port. If the printer is a network model, replace the controller card. See <b>“Controller card assembly removal” on page 4-50.</b>
976	Software error in network port	
978	Bad checksum while programming network port.	
979	Flash parts failed while programming network port.	
980	<device> Comm The engine is experiencing unreliable communications to the specified device.	Service errors 980 through 984, <device> can be one of the following: Engine, Duplex, or Tray x (x=1, 2, or 3).

## User attendance messages

### User attendance messages

Message	Explanation
Change Cartridge Invalid Refill	Remove the print cartridge and install a new cartridge.
Change <i>&lt;input source&gt;</i> <i>&lt;custom type name&gt;</i>	<p>This message displays when the user should change the media installed in one of the input options.</p> <ul style="list-style-type: none"> <li>• <i>&lt;input source&gt;</i>=Tray 1, Tray 2, Tray 3, or MP feeder.</li> <li>• <i>&lt;Custom Type name&gt;</i>=Custom 1 through Custom 6 using the MarkVision™ utility. When the printer is prompting for one of the custom types which has been named by the user, then only the custom type name is displayed on line 2. The name may be truncated to fit the display.</li> </ul>
Change <i>&lt;input source&gt;</i> <i>&lt;custom string&gt;</i>	<p>This message displays when the user should change the media installed in one of the input options.</p> <ul style="list-style-type: none"> <li>• <i>&lt;input source&gt;</i>=Tray 1, Tray 2, Tray 3, or MP feeder.</li> <li>• <i>&lt;custom string&gt;</i>= a user definable name.</li> </ul>
Change <i>&lt;input source&gt;</i> <i>&lt;size&gt;</i>	<p>This message displays when the user should change the media installed in one of the input options:</p> <ul style="list-style-type: none"> <li>• <i>&lt;input source&gt;</i>=Tray 1, Tray 2, Tray 3, or MP feeder.</li> <li>• <i>&lt;size&gt;</i>=letter, legal, B5, A4, Executive, Universal, A5, Folio, or Statement. For envelopes, <i>&lt;size&gt;</i>=7¼ Envelope, 9 Envelope, 10 Envelope, DL Envelope, C5 Envelope, B5 Envelope, or other Envelope.</li> </ul>

## User attendance messages (continued)

Message	Explanation
Change <i>&lt;input source&gt;</i> <i>&lt;type&gt;&lt;size&gt;</i>	<p>This message displays when the user should change the media installed in one of the input options.</p> <ul style="list-style-type: none"> <li>• <i>&lt;input source&gt;</i>=Tray 1, Tray 2, Tray 3, or MP feeder.</li> <li>• <i>&lt;type&gt;</i>=Bond, Card stock, Colored, Envelope, Labels, Ltrhead, Plain, Preprint, or Transparency.</li> <li>• <i>&lt;size&gt;</i>=letter, legal, B5, A4, Executive, Universal, A5, Folio, or Statement. For envelopes, <i>&lt;size&gt;</i>=7¼ Envelope, 9 Envelope, 10 Envelope, DL Envelope, C5 Envelope, B5 Envelope, or other Envelope.</li> </ul>
Check Tray x Connection	<p>Tray x=Tray 2 or Tray 3.</p> <p>This messages displays for the following conditions:</p> <ul style="list-style-type: none"> <li>• The specified device may have been removed from the printer, possibly to clear a paper jam or to uninstall the option.</li> <li>• The option may be attached to the printer, but a communications problem may prevent the printer from detecting the option. For example, there may be a poor connection or a hardware failure.</li> </ul> <p>The following actions may be taken:</p> <ul style="list-style-type: none"> <li>• If the option was temporarily removed or not connected properly, reattach or reconnect it.</li> <li>• Press <b>Go</b> to execute a configuration change which notifies the printer the option has been hot unplugged (removed with the power on).</li> </ul> <p><b>Note:</b> This action is not available if the printer is in Diagnostics Mode or running diagnostics.</p> <ul style="list-style-type: none"> <li>• If the device is experiencing a hardware problem, turn the printer off and on.</li> </ul>
Close Door	Close the upper front door.

## User attendance messages (continued)

Message	Explanation
Delete All Jobs Go/Stop?	<p>When the user has selected the <b>Print and Hold Delete All Jobs</b> selection, this message is displayed. The following actions may be taken:</p> <ul style="list-style-type: none"> <li>• Press <b>Go</b> to confirm the selection. All jobs are deleted.</li> <li>• Press <b>Return</b> or <b>Stop</b> to cancel the delete operation.</li> </ul>
Insert <tray>	<p><i>Tray</i>=Tray 1 or Tray 2. The printer does not detect the presence or absence of a tray, but that paper was not picked. Replace the tray and press <b>Go</b>.</p> <p><b>Note:</b> This situation usually occurs when the tray is refilled during a job. To refill a tray during a printing session, press <b>Stop</b> and wait for pages to reach the output bin before refilling the tray.</p> <p>The following actions may be taken:</p> <ul style="list-style-type: none"> <li>• Insert the requested tray.</li> <li>• Press <b>Menu</b> until <i>Busy/Waiting</i> displays. The following selections are available: <ul style="list-style-type: none"> <li>– <b>Cancel Job</b></li> <li>– <b>Reset Printer</b></li> </ul> </li> </ul> <p>If the message cannot be cleared, verify whether the paper is being picked. If so, and the paper advances to activate the input sensor, this message would indicate a sensor problem. Otherwise, check the pick tires and pick mechanism.</p>

## User attendance messages (continued)

Message	Explanation
Install Tray x or Cancel Job	<p>Tray x=Tray 2 or Tray 3.</p> <p>This message is displayed when a paper handling option has been hot unplugged. The printer requires the reinstallation of the option to print a page which has been formatted by the interpreter before the option was removed.</p> <p>The following actions may be taken:</p> <ul style="list-style-type: none"> <li>• Install the option.</li> <li>• Press <b>Menu</b> until <i>Busy/Waiting</i> displays. Select one of the following: <ul style="list-style-type: none"> <li>– <b>Cancel Job</b></li> <li>– <b>Reset Printer</b></li> </ul> </li> </ul> <p>If the message cannot be cleared, check connections and then POR the printer with the option attached. If the message persists, check the cables, starting at the controller card.</p>
Load <input source> <custom type name>	<p><i>Input source</i>=Tray 1, Tray 2, Tray 3, or MP Feeder. <i>Custom type name</i> is a user defined media type.</p> <p>The following actions may be taken:</p> <ul style="list-style-type: none"> <li>• Load media in the indicated source.</li> <li>• Press <b>Menu</b> until <i>Busy/Waiting</i> displays. Select one of the following: <ul style="list-style-type: none"> <li>– <b>Cancel Job</b></li> <li>– <b>Reset Printer</b></li> </ul> </li> </ul> <p>If the message cannot be cleared, go to “Input tray(s) service check” on page 2-64.</p>
Load <input source> <size>	<p><i>Input source</i>=Tray 1, Tray 2, Tray 3, or MP Feeder. <i>Size</i>=Letter, Legal, B5, A4, A5, Exec, Univ., Folio, or Stmt.</p> <p>The following actions may be taken:</p> <ul style="list-style-type: none"> <li>• Load media in the indicated source.</li> <li>• Press <b>Menu</b> until <i>Busy/Waiting</i> displays. Select one of the following: <ul style="list-style-type: none"> <li>– <b>Cancel Job</b></li> <li>– <b>Reset Printer</b></li> </ul> </li> </ul> <p>If the message cannot be cleared, go to “Input tray(s) service check” on page 2-64.</p>



## User attendance messages (continued)

Message	Explanation
Load <input source> <type><size>	<p><i>Input source</i>=Tray 1, Tray 2, Tray 3, or MP Feeder. <i>Type</i>=Bond, Cardstock, Colored, Envelope, Labels, Ltrhead, Plain, Preprint, Trnsprncy. <i>Size</i>=letter, legal, B5, A4, A5, Exec, Univ., Folio, or Stmt.</p> <p>The following actions may be taken:</p> <ul style="list-style-type: none"> <li>• Load media in the indicated source.</li> <li>• Press <b>Menu</b> until <i>Busy/Waiting</i> displays. Select one of the following: <ul style="list-style-type: none"> <li>– <b>Cancel Job</b></li> <li>– <b>Reset Printer</b></li> </ul> </li> </ul> <p>If the message cannot be cleared, go to “Input tray(s) service check” on page 2-64.</p>
No Jobs Found Retry?	<p>When a PIN (personal identification number) is added to a Confidential Print job and there are no jobs associated with the PIN number.</p> <p>The following actions may be taken:</p> <ul style="list-style-type: none"> <li>• Press <b>Go</b> to enter another PIN.</li> <li>• Press <b>Return</b> or <b>Stop</b> to exit the PIN entry operation.</li> </ul>
Res Reduced <warning>	<p>This message displays only when the Resolution Reduction setting is enabled. The following actions may be taken:</p> <ul style="list-style-type: none"> <li>• Press <b>Stop</b> to take the printer offline. No more data is processed, but the printer processes all the paper currently in the paper path.</li> <li>• Press <b>Menu</b> to access the <i>Busy/Waiting</i> menu group. Select one of the following: <ul style="list-style-type: none"> <li>– <b>Cancel Job</b></li> <li>– <b>Reset Printer.</b></li> </ul> </li> </ul>
31 Missing or Defective Cart.	<p>The cartridge may be missing and the front door closed. Return the cartridge. Or, the cartridge may be defective. Replace the cartridge.</p>

## User attendance messages (continued)

Message	Explanation
32 Unsupported Print Cartridge	<p>Error 32 displays when the top cover is closed and an unsupported print cartridge is detected. It may take the printer 10-20 seconds to determine if the print cartridge is supported. Depending on the setting of the Machine Class ID, the printer may be allowed to print pages during this 10-20 second interval. If pages are allowed to print, then they are not reprinted once a good print cartridge is inserted. Replace the cartridge.</p>
34 Short Paper	<p>The printer determines the paper length is too short to print the formatted data. This occurs when the printer does not know the actual paper size loaded in the tray. Make sure the Paper Size setting is correct for the size paper that is being used.</p> <p>The following actions may be taken:</p> <ul style="list-style-type: none"> <li>• Press <b>Go</b> to clear the message and continue printing.</li> <li>• Press <b>Menu</b> until <i>Busy/Waiting</i> displays. Select one of the following: <ul style="list-style-type: none"> <li>– <b>Cancel Job</b></li> <li>– <b>Reset Printer</b></li> </ul> </li> </ul>
35 Res Save Off Deficient Memory	<p>The printer lacks sufficient memory to enable Resource Save. The following actions may be taken:</p> <ul style="list-style-type: none"> <li>• Press <b>Go</b> to clear the message. The printer disables Resource Save.</li> <li>• Install additional memory.</li> <li>• Set link buffers to Auto, return to Ready and enable Resource Save and reset the link buffers.</li> </ul>

## User attendance messages (continued)

Message	Explanation
37 Insufficient Collation Area	<p>This message displays when the printer memory is insufficient to perform the Flash Memory Defragment operation.</p> <p><b>Note:</b> This message is posted prior to the actual start of the defragment operation. The printer code determines if enough printer memory is available to complete the defragment operation. The user should not be concerned with losing resources stored in the flash option.</p> <p>The following actions may be taken:</p> <ul style="list-style-type: none"> <li>• Press <b>Go</b> to clear the message.</li> <li>• Press <b>Menu</b> until <i>Busy/Waiting</i> appears. The following actions are available: <ul style="list-style-type: none"> <li>– <b>Cancel Job</b></li> <li>– <b>Reset Printer</b></li> </ul> </li> </ul>
37 Insufficient Defrag Memory	<p>This message displays when the printer memory is fragmented. Defragmentation is required and additional memory is required to complete the task.</p> <ul style="list-style-type: none"> <li>• Press <b>Go</b> to clear the message. Defragmentation will not continue and no changes are made to memory and no resources are lost.</li> <li>• Press <b>Menu</b> until <i>Busy/Waiting</i> appears. The following functions may be available: <ul style="list-style-type: none"> <li>– <b>Cancel Job</b></li> <li>– <b>Reset Printer</b></li> </ul> </li> </ul> <p>The user may clear memory for a defragmentation by:</p> <ul style="list-style-type: none"> <li>• Deleting fonts, macros, and other data in RAM.</li> <li>• Installing additional memory.</li> </ul>

## User attendance messages (continued)

Message	Explanation
<p>37 Insufficient Memory</p> <p>Held Jobs may be lost</p>	<p>This message displays when there is not enough memory available to continue processing a job and Print and Hold feature is in use. The printer frees memory by deleting the oldest Reserve Print and Verify Print jobs. It deletes only the amount needed to continue the incoming job. Some or all of the jobs may not be restored. If, while printing the current job, it runs out of memory again, another message is not posted.</p> <ul style="list-style-type: none"> <li>• Press <b>Go</b> to clear the message. Some of the Print and Hold jobs on the disk will not be restored. They remain on the disk, but cannot be accessed.</li> <li>• Press <b>Menu</b> until <i>Busy/Waiting</i> appears. The function, <b>Reset Printer</b>, may be available.</li> </ul>
<p>38 Memory Full</p>	<p>This message displays when the printer is processing an incoming job and there is insufficient memory available to continue processing the job. The following actions may be taken:</p> <ul style="list-style-type: none"> <li>• Press <b>Go</b> to clear the message. Perform the defragment operation: <ul style="list-style-type: none"> <li>– Simplify the print job.</li> <li>– Delete fonts, macros, and other data in RAM</li> <li>– Install additional memory</li> </ul> </li> <li>• Press <b>Menu</b> to display <i>Busy/Waiting</i>. The following functions may be available: <ul style="list-style-type: none"> <li>– <b>Cancel Job</b></li> <li>– <b>Reset Printer</b></li> </ul> </li> </ul>
<p>39 Complex Page</p>	<p>This message displays when the page is too complex to print. The following actions may be taken:</p> <ul style="list-style-type: none"> <li>• Press <b>Go</b> to clear the message and continue the job. Some data loss may occur. Simplify the print job and reprint, if necessary.</li> <li>• Press <b>Menu</b> until <i>Busy/Waiting</i> appears. The following selections are possible: <ul style="list-style-type: none"> <li>– <b>Cancel Job</b></li> <li>– <b>Reset Printer</b></li> </ul> </li> </ul>

## User attendance messages (continued)

Message	Explanation
40 Unsupported Firmware Card	A firmware card containing network code is installed on a non-network printer or a non-network card is installed on a network printer. Press and hold <b>Go</b> while powering the printer. The unsupported card will be ignored. Remove the card.
41 Unsupported Firmware Card	A firmware card containing unsupported code is detected. Press and hold <b>Go</b> while powering the printer. The unsupported card will be ignored. Remove the card.
50 PPDS Font Error	<p>This message displays when the PPDS interpreter has encountered a font error.</p> <p><b>Note:</b> This error may only occur when the printer is formatting PPDS print data.</p> <p>The following actions may be taken:</p> <ul style="list-style-type: none"> <li>• Press <b>Go</b> to clear the message and continue processing the job.</li> <li>• Press <b>Menu</b> until <i>Busy/Waiting</i> appears. The following are available: <ul style="list-style-type: none"> <li>– <b>Cancel Job</b></li> <li>– <b>Reset Printer</b></li> </ul> </li> </ul>
51 Defective Flash	This message displays when the printer detects a defective flash. This error may occur at power on, or during flash format and write operations. Press <b>Go</b> to clear the message. The flash is marked as bad and normal operation continues. Flash operations are not allowed until the problem is resolved.
52 Flash Full	<p>This message displays when there is not enough free space in the flash memory to hold the resources that have been requested to be written to flash.</p> <p>The following actions may be taken:</p> <ul style="list-style-type: none"> <li>• Press <b>Go</b> to clear the message and continue processing the job.</li> <li>• Press <b>Menu</b> until <i>Busy/Waiting</i> appears. The following are available: <ul style="list-style-type: none"> <li>– <b>Cancel Job</b></li> <li>– <b>Reset Printer</b></li> </ul> </li> </ul>

## User attendance messages (continued)

Message	Explanation
53 Unformatted Flash	This message displays when the printer detects an unformatted flash at power on. Press <b>Go</b> to clear the message. The flash is marked as bad and normal operation continues. Flash operations are not allowed until the flash is formatted.
54 Std Network Software Error	This error displays when a network port is detected, but the printer cannot establish communications with it. Press <b>Go</b> to clear the message. The printer disables all communications to the network interface.
55 Unsupported Flash in Slot x	An unsupported flash option is installed in the solutions port. Turn off the printer and remove the unsupported flash option in the specified slot.
56 Std Parallel Port Disabled	This error is displayed when data is sent to the printer across the parallel port, but the parallel port has been disabled. Once this message is displayed, reporting of further errors is suppressed until the menus are entered, or the printer is reset. The following actions may be taken: <ul style="list-style-type: none"> <li>• Press <b>Go</b> to clear the message. The printer discards any data received on the parallel port.</li> <li>• Press <b>Menu</b> until <i>Busy/Waiting</i> appears and select <b>Reset Printer</b>.</li> </ul>
56 Standard USB Port Disabled	Displayed when status is requested over the USB port, but the port has been disabled. Once the error has been displayed for the first time, reporting of further errors is suppressed until the menus are entered or the printer is reset. The following actions may be taken: <ul style="list-style-type: none"> <li>• Press <b>Go</b> to clear the message. The printer discards any data received on the USB port.</li> <li>• Press <b>Menu</b> until <i>Busy/Waiting</i> appears and select <b>Reset Printer</b>.</li> </ul>
58 Too Many Trays Attached	This error code displays when too many input trays are attached to the printer. Remove the extra trays.

## User attendance messages (continued)

Message	Explanation
58 Too Many Flash Options	<p>This error displays when too many flash options are installed in the printer.</p> <p>The following options may be taken:</p> <ul style="list-style-type: none"> <li>• Turn off the printer and remove the extra flash options.</li> <li>• Press <b>Go</b> to clear the message. The extra flash options are ignored.</li> </ul>
59 Incompatible Tray x	<p>An incompatible tray is installed. For Tray x, x= 2 or 3.</p> <p>Remove the incompatible tray and press <b>Go</b> to clear the message.</p> <p><b>Note:</b> If the user installed the incompatible device to satisfy a Check Device Connections/reattach message, the user should reinstall an associated compatible option or hot unplug the option.</p>
80 Scheduled Maintenance	<p>Replace the fuser assembly, transfer roller, charge roll, and pick rolls at this recommended interval to maintain the print quality and reliability of the printer. The parts are available as a maintenance kit. For more information, see <b>“Scheduled maintenance” on page 6-2.</b></p>
81 Engine Code CRC Failure	<p>This error displays when the microcode to be programmed in the engine flash code module has failed a CRC check. Press <b>Go</b> to clear the message. The microcode data is discarded and must be re-transmitted from the host.</p>
88 Toner Low	<p>This message displays when toner low occurs and the toner low alarm is activated. Press <b>Go</b> to clear this message.</p>

## Paper jam messages

Repeating jams or jam messages can be caused by any of the following:

- Faulty pick solenoids or worn cams of the solenoids.
- Faulty flags or springs.
- Worn backup rollers at the reference guide.
- Improperly adjusted reference guide.
- Debris in the paper path.
- Paper not of the specified length.

## Paper jam messages

Message	Explanation
200 Paper Jam Remove Cartridge	The input sensor under print cartridge is covered too long or is covered during POR or when <b>Go</b> is pressed after clearing a different jam or problem. The exit sensor could also be covered. Remove the print cartridge and open the rear door to remove the media.
201 Paper Jam Remove Cartridge	Paper is jammed between the printer input and exit sensor. Remove the print cartridge to clear the paper path.
202 Paper Jam Open Rear Door	The exit sensor is either covered during POR or covered too long. Open the rear door to access the jam area.
231 Paper Jam Remove Tray1  Pull Down Lever At Printer Rear	A piece of media did not arrive at the duplex input sensor, but did leave the printer exit sensor.
235 Paper Jam Remove Tray1  Pull Down Lever At Printer Front	A piece of media is over the duplex sensor after a sheet has been picked from the duplex.
237 Paper Jam Check Duplex	A piece of media did not reach the printer input sensor after leaving the duplex unit.



## Paper jam messages (continued)

Message	Explanation
238 Paper Jam Check Duplex	A piece of media is most likely jammed in the duplex area. Remove tray 1 and pull down the lever to access the jam area. If the paper is not in the duplex area, then check the rear of the printer by opening the rear door.
239 Paper Jam Remove Tray 1  Pull Down Lever At Printer </oc>	A paper jam has occurred in the duplex unit. Indicates a load problem with the exit motor (also serves as a duplex motor). High load could be from using non-specified (too heavy) media in duplex, paper path obstructions, high frictional forces in the redrive unit (rear cover), or a worn motor.  </oc> can be Front or Rear.
242 Paper Jam Check Tray 2	Tray 2 pass thru sensor is covered during warm-up.  Try opening Tray 2. If the tray is difficult to remove, then you may have to remove the tray above or below the tray to remove the jammed pages.
243 Paper Jam Check Tray 3	Media picked from tray 3 made it through the tray 2 pass thru sensor, but failed to make the input sensor in time.
250 Paper Jam Check MP Feeder	Media in the multipurpose feeder was picked (two attempts, if necessary), but did not make it to the input sensor.
1565 Emul Error Load Emul Option	The emulation version on the card does not function with the printer code. The correct version must be downloaded.

## Sub error codes

The sub error codes are helpful troubleshooting a paper path problem. Each status byte has a different level of troubleshooting value for each area of the printer. The following table displays up to 8 status bytes of data. Some or all of these bytes may be used to help diagnose a printer problem. These status bytes are designed to help isolate paper jams and paper feed problems in the base printer.

DU	xx	xx	xx	xx
DU	xx	xx	xx	xx

To identify the bytes:

	Byte 1	Byte 2	Byte 3	Byte 4
DU	xx	xx	xx	xx
DU	xx	xx	xx	xx
	Byte 5	Byte 6	Byte 7	Byte 8

## Displayed error codes

When a 9xx or 2xx error displays:

1. Press and hold **Return** and press **Select** to enter for sub error codes.

The first screen of information displays. Write down the information.

2. Continue pressing **Return** and **Select** until each screen of information is obtained.

When the last screen displays, the original message displays.

## Printed error codes

Additional information is available by printing the error log. See **“Print Log” on page 3-19**.

## Values

In the table below, the values for common variables are listed below:

- *media source*
  - 10=Multipurpose tray (MPT)
  - 11=Tray 1
  - 12=Tray 2
  - 13=Tray 3
  - 80=Duplex unit
- *media size*
  - 1=Letter
  - 2=Legal
  - 3=B5
  - 4=A4
  - 5=Executive
  - 6=A5
  - 7=Custom size
  - 9=7¾ in. envelope
  - A=#9 Envelope
  - B=#10 Envelope
  - C=8.661 in. Envelope
  - D=C5 Envelope
  - E=B5 Envelope
  - F=Legal envelope

Sub error codes

First 6 bytes sub error code data (xx can be any value)	Explanation	Possible error message
84 xx 00 x1 x2 x3	<p>This code indicates that the input sensor is still actuated from the first sheet and the second sheet is ready to arrive at the sensor. (x1=media size, x2=media source.)</p> <ul style="list-style-type: none"> <li>• Check the printer input sensor and flag for correct operation. The flag should operate freely.</li> <li>• Check for debris in the area of the input sensor.</li> <li>• Check the area of the transfer roll and input to the fuser for anything that might cause the paper to remain over the input sensor.</li> </ul>	200
84 xx 01 x1	<p>The video signal never started within 2 inches after actuating the input sensor. Check input sensor and flag. (x1=media size)</p>	200
84 xx 02 x1 x2	<p>Paper is over the input sensor too long. (x1=media size, x2=source.) Possible causes are:</p> <ul style="list-style-type: none"> <li>• Multi sheet feeding.</li> <li>• Paper size is not the same as expected.</li> <li>• The media feeding from the source is slipping or media is slipping before exiting the input sensor.</li> </ul>	200
84 xx 03 x1	<p>The measured gap between sheets of media at the input sensor is too small to meet video requirements. x1=time by which the gap was too small.</p>	200

## Sub error codes (continued)

First 6 bytes sub error code data (xx can be any value)	Explanation	Possible error message
84 xx 04	<p>The input sensor was covered (activated) during POST.</p> <ul style="list-style-type: none"> <li>• Clear the media or debris from the printer.</li> <li>• Run the base sensor test (input sensor) from the diagnostic tests menu to test the input sensor and flag for correct operation.</li> </ul>	
84 xx 05 x1	<p>There was media at the input sensor too early. There was not enough time between printhead start and the printhead mirror motor to lock.</p> <p>Possible causes for this error are:</p> <ul style="list-style-type: none"> <li>• Paper might be pre-staged in the paper source tray.</li> <li>• Paper is picking too fast due to faulty paper feed assembly.</li> <li>• A defective input sensor.</li> </ul>	200
84 xx 0F x1 x2 x3	<p>The option tray pass thru sensor was never deactivated.</p> <p>(x1=media size, x2=media source, and x3=media source where paper jam was detected)</p> <ul style="list-style-type: none"> <li>• Check the pass thru sensor and flag for correct operation.</li> <li>• Check to see if paper has cleared the pass thru area of the option where the paper jam occurred.</li> </ul>	243
84 xx 18	<p>There is media over the Tray 2 pass thru sensor during warm up. If no media is present, check the pass thru sensor, flag, and cables.</p> <ul style="list-style-type: none"> <li>• Try running the Input Tray Tests for Tray 2 and see if Tray 2 is feeding paper correctly and all the sensors are working correctly.</li> <li>• Make sure the paper size setting is correct for the size paper in the tray.</li> </ul>	242

## Sub error codes (continued)

First 6 bytes sub error code data (xx can be any value)	Explanation	Possible error message
84 xx 20 x1 x2	The imaged page is not the expected page. (x1=media size, x2=media source) Check the pass thru sensor to make sure it is operating properly. If no problem is found, it may still be necessary to try a new pass thru sensor.	200
84 xx 22 x1 x2 00	This code indicates that the media activated the input sensor before the printer EP was ready. (x1=leading edge of media state, x2=trailing edge of media state)	200
84 xx 23 x1 x2 x3	The transfer servo never started. (x1=media size, x2=leading edge of media state, x3=trailing edge state). Possible causes: <ul style="list-style-type: none"> <li>• Slow or missing main motor positional feedback. Paper too fast to input sensor.</li> <li>• Gap too small on interpage servo.</li> </ul>	200
84 xx 26	This code indicates that media has activated the input sensor; however, the printhead fell out of lock condition or expected a stable lock too soon. The media may have also reached the input sensor early.	200
84 xx 2F x1 x2 x3	Laser servo never started due to potential conflict with the transfer servo. (x1=bit 0: transfer servo started, bit 1: transport started; x2+x3=transfer servo count value.) Possible cause is slow or missing transport motor positional feedback.	200

## Sub error codes (continued)

First 6 bytes sub error code data (xx can be any value)	Explanation	Possible error message
84 xx 30 00 00 00	<p>Input sensor never became uncovered from page ahead while trying to feed media out of path during warm-up. Paper originally detected at option tray pass thru sensor.</p> <ul style="list-style-type: none"> <li>• Clear the media or debris from the printer.</li> <li>• Enter Diagnostics and perform the Base Sensor test to verify the proper function of the input sensor. See <b>“Entering Diagnostic Mode” on page 3-2</b> and <b>“BASE SENSOR TEST” on page 3-14.</b></li> </ul>	200
84 00 08	<p>Paper at input sensor when not expected during printing. Possible cause is multiple sheets picked.</p>	200
84 00 10	<p>The main motor driver failed to detect a specific motor after two tries. Possible causes for this error are:</p> <ul style="list-style-type: none"> <li>• The main drive motor has stalled.</li> <li>• An incorrect main drive motor/gearbox assembly has been installed.</li> </ul>	200
84 00 31 00 00 00	<p>Trailing edge never cleared input sensor when feeding out media that was detected during warm-up.</p> <ul style="list-style-type: none"> <li>• Clear the media or debris from the printer.</li> <li>• Enter Diagnostics and perform the Base Sensor test to verify the proper function of the exit sensor. See <b>“Entering Diagnostic Mode” on page 3-2</b> and <b>“BASE SENSOR TEST” on page 3-14.</b></li> </ul>	200

Sub error codes (continued)

First 6 bytes sub error code data (xx can be any value)	Explanation	Possible error message
<p>89 00 01</p> 	<p>The exit sensor at the fuser is activated by a piece of media indicating there is a piece of media in the machine during POST.</p> <p>Check for media in the exit of the fuser assembly or redrive assembly. Feed a sheet of paper, and if the same error occurs after clearing the fuser or the same error occurs when no media is present, check the exit sensor assembly.</p> <p>Turn the printer off, enter the diagnostic tests menu, and select the base sensor test. Select output sensor and check the sensor for correct operation.</p>	<p>202</p>
<p>89 xx 03</p>	<p>The fuser exit sensor did not detect the trailing edge of the media going through the fuser assembly.</p> <ul style="list-style-type: none"> <li>• This failure can be caused by a broken fuser exit sensor flag.</li> <li>• This may also be caused by erratic operation of exit sensor flag or exit sensor or a defective piece of media.</li> </ul>	<p>202</p>
<p>89 xx 04 x1</p>	<p>The fuser exit sensor never actuated from the sheet going through the fuser before the next page begins feeding. (x1=media size)</p>	<p>202</p>
<p>89 xx 0D</p>	<p>The fuser exit sensor bounced. Check the exit sensor for correct operation. Check the sensor cable to J16 on the controller card. Also, the controller card may be failing.</p>	<p>202</p>
<p>89 00 0E 00 00 00</p>	<p>Exit sensor never changed state from sheet ahead of page heading toward exit sensor when feeding out media detected during warm-up.</p>	<p>202</p>
<p>89 00 0F 00 00 00</p>	<p>Trailing edge never cleared exit sensor when feeding out media that was detected during warm-up.</p>	<p>202</p>



## Sub error codes (continued)

First 6 bytes sub error code data (xx can be any value)	Explanation	Possible error message
8D 00 00	<p>The fuser exit sensor was never activated by the leading edge of the media fed through the printer.</p> <ul style="list-style-type: none"> <li>• This error can be displayed after a 201 paper jam.</li> <li>• This can be caused by a defective fuser exit sensor assembly.</li> </ul> <p><b>Note:</b> Enter the diagnostic tests menu, select <b>Base Sensor Tests</b>, select <b>Output Sensor Test</b> and check the fuser exit sensor for correct operation. If the test fails, check the cable connection to J16 on the controller card.</p>	201
8D 00 01 00 00 00	User pressed <b>Go</b> or <b>Continue</b> after an 8D xx 00 jam, but never opened the top cover. Need to open cover and clear any media under cartridge before continuing.	201
8D 00 02 00 00 00	Exit sensor never made by leading edge of paper when feeding out media that was detected during warm-up.	201
8D x1 03 x2 x3 x4	Page arrived at fuser too soon and feed time was too quick. Possibly staged media caused a quick pick.	201
8E xx 00 x1 x2 x3	Sheet coming from duplex unit never made it to the input sensor. (x1=source, x2+x3=timeout value)	237

Sub error codes (continued)

First 6 bytes sub error code data (xx can be any value)	Explanation	Possible error message
8E xx 02 x1 x2	<p>This error can be caused by the input sensor not being activated by a page that was known to have been picked. (x1=size, x2=media source)</p> <ul style="list-style-type: none"> <li>• Ensure the correct source has been selected and the media is feeding from that source.</li> <li>• Enter Diagnostics and go to INPUT TRAY TESTS. Select <b>Sensor Test</b> and the tray to test to verify the function of the pass thru sensor. (TP=Tray present; P-pass thru). See <b>“Sensor Test” on page 3-11.</b></li> </ul>	243
8E xx 06 x1	<p>The second pick failed from the MPF when paper was detected to be in the source. (x1=media source)</p>	250
8E xx 09 x1	<p>The second pick from the MPF or Tray 1 failed. When other sheets were committed to the paper path. (x1=media source)</p>	250
8E 00 0D x1 00 00	<p>Paper reached the input sensor after engine timed out and was feeding the paper ahead to the output tray. x1=media source)</p>	200
8E x1 11 x2 x3 x4	<p>Took too long to ramp up DC redrive motor.</p>	239
8E 00 15 x1 00 x2	<p>Excessive PWM for the DC redrive motor.</p>	239
8E xx 16 00 00 00	<p>Page detected over tray pass thru at warm-up and tried to feed out, but did not reach the input sensor in time.</p>	200
8F xx 00 x1 x2 00	<p>Duplex sensor was never made by leading edge of page. (x1+x2=timeout value)</p>	231

## Sub error codes (continued)

First 6 bytes sub error code data (xx can be any value)	Explanation	Possible error message
8F xx 01 00 00 00	Duplex sensor covered, paper not expected (paper in duplex during warm-up).	238
8F xx 02 x1 x2 00	Duplex sensor never changed state when sheet left duplex (possible sticky sensor). (x1+x2=timeout value).	235

## Disconnects on the controller card

Always print a page from each paper source following a repair action. The following table is an aid to find a problem with a cable connection.

Error or message if cable is unplugged	Condition required to obtain error	Check connection at:	Connector name and description
No backlight and no text on the operator panel	POST. No power delivered to controller card	J17	LVPS (low voltage power supply)
No backlight, no text on operator panel, and 5 beeps	POST	J5	OP-PANEL (operator panel) Go to <b>“Dead machine service check” on page 2-39</b> (second note).
914	POST	J6	EXIT MOTOR (redrive motor)
917	POST	J19	HVPS (high voltage power supply and fan)
924	POST	J18	THERM (thermistor and smart chip)
929	Print multiple pages	J12	MPF SENSOR (multipurpose feeder sensor and toner sensor)
931	POST	J3	LSU (laser printhead)
935	POST	J1	MMTR (mirror motor)
936	POST	J10	MAIN MOTOR (transport motor)
940	POST	J13	LVPS (low voltage power supply control)
Close Door	POST	J2	CO (cover open switch)
Load MP Feeder	Pick paper from MPF	J9	MPF (multipurpose feeder solenoid)

<b>Error or message if cable is unplugged</b>	<b>Condition required to obtain error</b>	<b>Check connection at:</b>	<b>Connector name and description</b>
Load Tray 1	Pick paper from tray1	J14	FD (tray1 feed solenoid)
Paper Jam	Print a page from any source	J20	PAPER DUPLEX (input sensor, narrow media sensor, and duplex sensor)
Remove Paper Standard Bin	POST	J16	EXIT (exit sensor and bin full sensor)
Option tray is not available	Attempt to select option tray in PAPER SOURCE menu	J21	TRAY (option tray)

## Service checks

Service checks involve measuring voltages of the LVPS, HVPS, and controller card assembly. Continuity and resistance verifications are done on cables and components as required.

**Note:** When looking at the printed side of a printed circuit board, connectors are designated with “J” followed by a number. Pin #1 is designated on the board by an adjacent “1” or triangle. Pin numbers index sequentially to the opposite end of the connector. See **“Controller card assembly” on page 5-2** for more information.

The controller card passes +5 V dc and +24 V dc from the LVPS to its clients. Therefore, when either voltage is missing as an output on the controller card, be sure to verify the inputs from the LVPS (J17, sockets 1 and 2 at +24 V dc and socket 5 at +5 V dc).

### Cooling fan service check

FRU	Action
Cooling fan (fuser) Cooling fan (LVPS)	<p>Make sure the plugs of the cooling fan cables are properly seated.</p> <p>Both fans are connected to the same +24 V dc on pin #1 at J19 on the controller. Pin #2 is ground for both fans. Therefore if one fan functions and the other does not, either the fan or the cable is faulty. Turn the printer off and disconnect the cooling fan cable at the suspect cooling fan. Turn the printer on. Within approximately 15 seconds the controller card assembly should apply +24V dc to the fan. See <b>“Controller card assembly” on page 5-2</b> for more information.</p> <ul style="list-style-type: none"> <li>• If voltage is present, reconnect the fan to verify the fan is faulty. If it is, replace the fan.</li> <li>• If voltage is not present, disconnect the cable from the controller card (J19) and check for continuity on each cable. <ul style="list-style-type: none"> <li>– If the cable is good, see <b>“Controller card service check” on page 2-38</b> for more information.</li> <li>– If the cable is damaged, replace the cable.</li> </ul> </li> </ul>

## Cover interlock switch service check

**Note:** Make sure a print cartridge is installed and the cover closes all the way, fully engaging the cover open switch lever.

FRU	Action
Cover interlock switch	<p>Disconnect the cover interlock cable from the interlock switch.</p> <p>Push the cover interlock switch to the closed position and verify continuity between the bottom and middle terminals.</p> <p>Open the switch and verify continuity between the bottom and top terminals. The top and middle terminals should indicate discontinuity at all times.</p> <ul style="list-style-type: none"> <li>• If the switch is good, verify +5 V dc on the middle spade of the cable and ground on the top spade of the cable.</li> <li>• If voltage is not present, see <b>“Controller card service check” on page 2-38.</b></li> </ul> <p>Replace the switch if faulty.</p>

## Controller card service check

**Warning:** Never replace both the operator panel and controller card at the same time. Otherwise, some critical settings will be permanently lost.

FRU	Action
Controller card assembly	<p>Check for +5 V dc and +24 V dc from the LVPS card to the controller card assembly.</p> <ol style="list-style-type: none"> <li>1. Turn the printer off.</li> <li>2. Disconnect the LVPS cable from the controller card at J17.</li> <li>3. Turn the printer on.</li> <li>4. Verify +24 V dc from the cable, connector sockets #1 and #2 and +5 V dc at socket #5.</li> </ol> <p>If voltages are not present or incorrect, see <b>“Low voltage power supply (LVPS) service check” on page 2-39.</b></p> <p><b>Note:</b> With all cables connected, the printer should complete POST within approximately 12–15 seconds in the following sequence:</p> <ol style="list-style-type: none"> <li>a. The operator panel light comes on.</li> <li>b. Diamonds display from left to right.</li> <li>c. Dots display left to right.</li> <li>d. The memory size and processing speed temporarily display.</li> <li>e. The operator panel displays Performing Self Test.</li> <li>f. Ready displays.</li> </ol> <p>If immediately following power-on, the operator panel lights are on, but the printer does not go through steps a and b above, replace the controller card assembly.</p> <p><b>Note:</b> Always check printhead alignment after replacing the controller card assembly. See <b>“Printhead assembly adjustment” on page 4-2</b> for hardware alignment of the printhead.</p> <p><b>Note:</b> U.S. versus non-U.S. and the printer configuration ID can be reset. This affects default measurements and paper size. This can be changed. See <b>“Defaults” on page 3-15</b> in the Diagnostics Mode. See <b>“Diagnostics Mode” on page 3-2</b> for more information.</p>



## Dead machine service check

**Note:** Check the AC line voltage. The voltage should be within the following limits:

- 90 V ac–120 V ac for nominal–100 V model printer
- 100 V ac–127 V ac for the nominal–110 V model printer
- 200 V ac–240 V ac for the nominal–220 V model printer

## Low voltage power supply (LVPS) service check

FRU	Action
<p>Low voltage power supply (LVPS) (100 V, 110 V, or 220 V)</p> 	<p>Unplug the power cord and verify that the cable is correct and functioning. Replace if necessary.</p> <p>With the power cord unplugged, remove the HVPS fan and disconnect the 8-pin (CN2) connector from the LVPS. Pin 8 is the topmost pin of the connector.</p> <ul style="list-style-type: none"> <li>• Verify pins #2, #5, and #6 are ground.</li> </ul> <p>Replug the power cord and turn the printer on.</p> <p><b>CAUTION:</b> Be careful to not ground pins to cage while testing.</p> <ul style="list-style-type: none"> <li>• Verify pin #4 is +5 V dc.</li> <li>• Verify pins #7 and #8 are +24 V dc.</li> </ul> <p>If any one of these is incorrect, replace the LVPS.</p> <p>If these are correct, check the controller card, operator panel, and wiring.</p> <p><b>Note:</b> A “dead machine” implies no power beyond the LVPS. If the printer behaves “dead” but has correct power from the LVPS, unplug all connectors from the controller card except J18 (power from LVPS). Turn the printer on. If the printer does not <i>beep</i> 5 times, replace the controller card. If it does <i>beep</i>, turn the power off and plug in other devices such as sensors and operator panel one at a time. Turn the printer back on and observe any <i>beeps</i> and/or operator panel messages. This technique may be repeated to help isolate a faulty component or short.</p>

## High voltage power supply (HVPS) service check

FRU	Action
HVPS Cartridge	<p>Check continuity between the HVPS and the charge roll, Dr. B (doctor blade), TAR (toner adder roll), the developer roll, and the photoconductor (DC). Check as follows:</p> <ol style="list-style-type: none"> <li>1. Turn printer off.</li> <li>2. Remove the right side cover. See <b>“Right side cover removal” on page 4-12</b> for more information.</li> <li>3. Remove the print cartridge.</li> <li>4. Check from C on the HVPS to the bearing on the left side of the charge roll. See <b>page 5-8</b> for more information.</li> <li>5. Check from the Dr. B, TAR, developer roll (D), transfer roll (T), and photoconductor (DC) respectively to the corresponding pin on the right side frame where the print cartridge makes its contacts.</li> </ol> <p>If any show discontinuity, remove the HVPS and check the cartridge contact assemblies (springs) for continuity and damage. If the charge roll and the cable at C show discontinuity, replace the left guide assembly. See <b>“High voltage power supply (HVPS)” on page 5-8</b> for testing the board.</p>



## Fuser service check

When toner is partially fused to the paper, it is usually caused by low fuser temperature.

The line voltage to the printer must be within the following limits:

- 90 V ac–120 V ac for nominal–100 V model printer
- 100 V ac–127 V ac for the nominal–110 V model printer
- 200 V ac–240 V ac for the nominal–220 V model printer

## Cold fuser service check

FRU	Action
Fuser assembly LVPS 	Unplug the printer and disconnect the fuser heater cable from the LVPS card connector (CN3). See <b>“Low voltage power supply (LVPS)” on page 5-7</b> for more information. Check for continuity across the fuser heater (pins #1 and #3 or outer pins). If there is no continuity, replace the fuser assembly. See <b>“Fuser assembly removal” on page 4-26</b> . If there is continuity, follow these steps: <ol style="list-style-type: none"> <li>1. Reconnect the fuser heater cable.</li> <li>2. Replug and turn the printer on. Measure the voltage between the connectors on the back of the switch. It should match the line voltage.</li> <li>3. If line voltage is not present, replace the LVPS. Make sure the fuser thermistor is correctly connected to the controller card (J18).</li> </ol>
Fuser assembly 	If the fuser heater comes on and a fuser failure error code displays, be sure the thermistor is firmly seated in connector J18 on the controller card assembly. (The thermistor cable goes through the frame by way of a connector.) Unplug the printer and disconnect the thermistor cable from the controller card (J18). Measure the resistance of the thermistor. The resistance measures approximately 240K to 400K ohms when cool (approximately 40°C or 104°F) and 1.5K to 3K ohms hot (immediately after running a printout). Replace the fuser assembly as necessary.

## Hot fuser service check

FRU	Action
Fuser assembly	Unplug the printer and measure the resistance of the thermistor. The resistance measures 240K to 400K ohms when cool (approximately 40°C or 104°F) and 1.5K to 3K ohms hot. Replace the fuser assembly as necessary.

## Main motor service check

FRU	Action
Main motor Main motor cable Controller card assembly	<p>With the printer on, verify +24 V dc on pin #7 at J10 on the controller card assembly.</p> <ul style="list-style-type: none"> <li>• If the voltage is correct, check the main motor cable for continuity.                             <ul style="list-style-type: none"> <li>– If continuity exists on each wire, replace the main motor.</li> <li>– If continuity does not exist on one or more of the wires, replace the motor cable.</li> </ul> </li> <li>• If the voltage is not correct, verify +24 V dc on pins #1 and #2 on J17.                             <ul style="list-style-type: none"> <li>– If voltage is correct, replace the controller card.</li> <li>– If the voltage is not correct, check the LVPS.</li> </ul> </li> </ul> <p><b>Note:</b> Always check printhead alignment after replacing the controller card assembly. See <b>“Printhead assembly adjustment” on page 4-2</b> for hardware alignment of the printhead.</p>

## Operator panel service check

**Warning:** Never replace both the operator panel and controller card at the same time. Otherwise, some critical settings will be permanently lost.

Inspect the operator panel cable for damage. Make sure the cable is plugged in securely.

Run POST and check for proper operation. See **“Power-On Reset (POR) sequence” on page 2-2.**

FRU	Action
Operator panel Operator panel cable Controller card assembly	<p>If the buttons do not depress or <i>click</i> when pressed, replace the operator panel.</p> <p>If the operator panel does not illuminate, turn the printer off and unplug J5 on the controller card. Verify pin #4 is ground. Turn the printer on and verify +5 V dc on pins #2 and #5. Also verify +3.3 V dc on pins #6 and #7.</p> <ul style="list-style-type: none"> <li>• If any of the voltages fail, replace the controller card. See <b>“Controller card assembly removal” on page 4-50.</b></li> <li>• If all of the voltages are correct, verify the continuity of the operator panel cable. If the cable fails continuity, replace it. See <b>“Operator panel cable removal” on page 4-20.</b></li> <li>• Otherwise, replace the operator panel. See <b>“Operator panel assembly removal” on page 4-22.</b></li> </ul> <p>If the operator panel display is erratic during POST, replace the following FRUs one at a time in the order shown:</p> <ul style="list-style-type: none"> <li>• Controller card assembly</li> </ul> <p><b>Note:</b> Always check printhead alignment after replacing the controller card assembly. See <b>“Printhead assembly adjustment” on page 4-2</b> for hardware alignment of the printhead.</p> <ul style="list-style-type: none"> <li>• Operator panel</li> <li>• Operator panel cable</li> </ul>

## Transfer roll service check

FRU	Action
Transfer assembly roll	<p>Check the springs in the left and right transfer roll bearings. The bearing assemblies should support the transfer roll, applying even pressure to the PC drum. The roll should rotate evenly and smoothly.</p> <p>Replace the transfer roll assembly if the springs or bearings indicate damage or lack of proper function.</p> <p>Inspect the transfer roll for signs of wear, damage, or contamination. Replace the assembly as necessary.</p> <p><b>Note:</b> Do not vacuum the roll.</p> <p><b>Note:</b> Always check the bottom margin following a transfer roll replacement. See <b>“REGISTRATION” on page 3-4</b></p>

## Paper feed service checks

### Paper picks and advances approximately four inches

FRU	Action
Reference feed assembly Backup roller assembly Paper feed gear Drive assembly	<p>Turn printer off and remove the print cartridge and left side cover.</p> <p>With a left finger, rotate the main motor counterclockwise while using a right finger to resist gear movement in the reference feed assembly (located in the paper path below the cartridge).</p> <ul style="list-style-type: none"> <li>• If the gear motion cannot be stopped, look for obstructions in the paper path, such as debris or damage.</li> <li>• If the gear motion can be stopped while continuing to rotate the drive motor, one of the following units has to be replaced.</li> </ul> <p>Check or replace the FRUs in the following order:</p> <ul style="list-style-type: none"> <li>– Backup roller assemblies</li> <li>– Reference feed assembly</li> <li>– Drive assembly</li> </ul> <p>When the reference feed assembly is replaced, it has to be adjusted. See <b>“Adjusting paper feed alignment (skew)” on page 4-5</b> for more information.</p>

**Paper jam error indication during POST**

FRU	Action
Stack control flags Photo sensor	<p>If the exit sensor flag is not resting within the paper exit sensor during POST, the printer indicates Remove Paper/Standard Bin. Make sure the flag is operating freely and correctly.</p> <p>Replace the photo sensor and/or the stack control flag as necessary.</p>
Photo sensors (paper path)	<p>Make sure the sensors are working properly. A stuck or incorrectly installed sensor causes this error.</p> <p>The operator panel indicates 200 Paper Jam, 201 Paper Jam, 202 Paper Jam, or 23x Paper Jam. For a 200 or 201 message, look under the cartridge. A 201 is posted if the paper stops between the input sensor under the cartridge and the exit sensor at the fuser. A 202 indicates a jam in the rear door. Errors 231, 235, 237, and 238 indicate jams in the duplex. If the printer functions correctly in the simplex, but posts these errors in duplex, check the sensor cable for continuity and replace the cable or sensor(s) as necessary.</p>

**Paper picks during POST and/or continuously**

FRU	Action
Paper feed assembly Paper feed solenoid	<p>Check the pick mechanism for wear. The solenoid releases the shaft of the D-roll, allowing it to engage with a gear on the main drive. There is a step in the plastic part of the shaft that rests against the solenoid arm. This error occurs if the step is worn or damaged so the solenoid cannot stop the rotation. Replace the paper feed assembly if necessary.</p> <p>Make sure the spring on the solenoid is properly installed. If the spring is improperly installed or missing, the pick roller will continuously pick paper.</p> <p>Replace the solenoid as necessary.</p>



## Paper picks but stops half way through the printer

FRU	Action
Input paper feed sensor Controller card assembly	<p>Make sure the input paper feed sensor is working properly.</p> <p>Check for a broken or stuck flag on the input paper feed sensor.</p> <p>Make sure the cable is seated on the controller card assembly (J20).</p> <p>Verify +5 V dc on pins #1, #4, #7, and ground on pins #3, #6, and #9. See <b>“Locations and connections” on page 5-1</b> for more information.</p> <ul style="list-style-type: none"> <li>• If correct, replace the input paper feed sensor.</li> <li>• If the voltage is not correct, replace the controller card assembly.</li> </ul> <p><b>Note:</b> Always check printhead alignment after replacing the controller card assembly. See <b>“Printhead assembly adjustment” on page 4-2</b> for hardware alignment of the printhead.</p>

**Paper never picks**

FRU	Action
Paper tray	<p>Make sure the paper tray and paper are correctly positioned.</p> <p>Check the input tray for missing or broken parts.</p> <p>Replace the tray as necessary.</p>
Paper feed solenoid Controller card assembly	<p>Make sure solenoid is installed correctly and its cable is plugged into the controller card assembly at J15. See <b>“Locations and connections” on page 5-1</b> for more information.</p> <ul style="list-style-type: none"> <li>• Verify approximately 55 ohms in the solenoid. If not correct, replace the solenoid.</li> <li>• Verify the solenoid has the spring in place and functions mechanically. If this is true and the resistance is correct, replace the controller card assembly.</li> </ul> <p><b>Note:</b> Always check printhead alignment after replacing the controller card assembly. See <b>“Printhead assembly adjustment” on page 4-2</b> for hardware alignment of the printhead.</p>

**Paper occasionally picks or picks multiple sheets at once**

FRU	Action
Paper feed roll Paper feed assembly	<p>Check the paper feed roll (D-roll or pick roll) for wear. Verify that the extension spring is working properly. Replace as necessary.</p> <p>During a paper pick, the paper feed assembly is released by the solenoid. Verify the plastic end of the shaft is not worn allowing the shaft to be released without the solenoid being activated. Replace the paper feed assembly as necessary.</p> <p><b>Note:</b> We recommend that the paper feed roll be replaced when the paper feed assembly is replaced.</p> <p>Also see <b>“Paper picks during POST and/or continuously” on page 2-46</b>.</p>

## Paper “trees,” wrinkles, stacks poorly or curls

FRU	Action
Fuser assembly	This problem is most likely due to a worn backup roller. A worn backup roller causes the printer to run hotter than required for the media being printed. Excessive heat can cause paper treeing problems, poor stacking, or excessive curl.

## Parallel port service check

1. Perform a print test to make sure the printer prints correctly. See **“Prt Quality Pgs” on page 3-6** for more information.
2. Be sure the printer cable is designed for bidirectional printing.
3. Be sure the user application is set up correctly.
4. An extra long parallel cable may require some adjustment in the Par S strobe. See **“Par S Strobe Adj” on page 3-16**.
5. Some computers assume the printer samples data on the trailing edge of the strobe. This printer samples data on the leading edge by default. This process can be switched by turning Parallel Mode 2 off. To change this setting:
  - a. Select **PARALLEL MENU** from the Ready Menu.
  - b. Select **Parallel Mode 2**.  
Selections are **On** and **Off**.
6. If the printer fails to print on command from the host, verify the following:
  - a. Internal print test page prints correctly.
  - b. The user application/printer driver is set up correctly.
  - c. The host computer has been restarted.
  - d. The bidirectional parallel cable is connected correctly and is functional.

If the printer still fails to print correctly, replace the controller card assembly.

**Note:** Always check printhead alignment after replacing the controller card assembly. See **“Printhead assembly adjustment” on page 4-2**.

## Print quality service checks

### Blank page

FRU	Action
Print cartridge (not a FRU)	Remove the print cartridge and gently shake the assembly to evenly distribute the toner. Ensure clean electrical contacts on the right side of the cartridge.
Printhead Printhead cable HVPS Controller card assembly Cartridge contacts assembly	<p>Blank pages can be caused by a defective printhead assembly, HVPS, or controller card assembly. See <b>“Controller card service check” on page 2-38</b> and verify +24 V dc on pin #5 at J1 and +5 V dc on pin #7 at J3. Verify ground on pin #4 at J1 and on pin #6 at J3. If these are not correct, replace the controller card. See <b>“Controller card assembly removal” on page 4-50</b>.</p> <p>If the voltages are correct, check the printhead cable for continuity.</p> <ul style="list-style-type: none"> <li>• If the cable has continuity, replace the printhead. See <b>“Printhead removal” on page 4-46</b></li> <li>• If the cable does not have continuity, replace the cable.</li> </ul> <p>With the cartridge removed and the printer off, check continuity between HVPS (DC designation on outer side of card) and the PC pin inside the printer. The PC pin is directly above the transfer roll gear. Replace the cartridge contacts as necessary.</p> <p>See <b>“High voltage power supply (HVPS)” on page 5-8</b>. Verify input voltages of +24 V dc (pin #4) and +5 V dc (pin #7).</p> <ul style="list-style-type: none"> <li>• If incorrect, verify the continuity of the cable. Replace if necessary.</li> </ul> <p><b>Note:</b> Pins 1–8 on the HVPS correspond to pins 4-11 respectively of J19 on the controller card.</p> <ul style="list-style-type: none"> <li>• If correct, replace the HVPS only after verifying all the above items.</li> </ul>

**Black page**

**Note:** Incorrect laser exposure or incorrect charging of the photoconductor by the charge roll causes an all black page.

FRU	Action
HVPS contacts	Check the contacts for contamination and correct installation. Replace as necessary.
Controller card assembly HVPS cable HVPS Left guide assembly	<p>Ensure the HVPS to controller card and charge roll cables are correctly installed.</p> <p>Check continuity of the charge roll cable from C (printed on outside HVPS) to the bushing at the right side of the charge roll. If continuity fails, replace the left guide assembly which includes this cable.</p> <p>Check continuity from the charge roll left side bushing to the right side shaft. If continuity fails, remove the charge roll and clean the left side shaft and bushing.</p> <p>See <b>“High voltage power supply (HVPS)” on page 5-8</b> and check that the voltage measurements are +24 V dc on socket #4 and +5 V dc on socket #7 on the HVPS. (The pins/sockets are numbered from left to right when facing the installed HVPS. The front door can be opened to check voltages.)</p> <ul style="list-style-type: none"> <li>• If incorrect, verify the continuity of the cable. Replace if necessary.</li> </ul> <p><b>Note:</b> Pins 1-8 on the HVPS correspond to pins 4-11 respectively of J19 on the controller card.</p> <ul style="list-style-type: none"> <li>• If correct, replace the HVPS only after verifying all the above items.</li> </ul>

**Heavy background**

Poor development or poorly charged toner particles cause excessive background. This is more noticeable as the print cartridge nears end of life.

FRU	Action
Print cartridge (not a FRU)	<p>Make sure the print cartridge is correctly installed and the high voltage contacts are clean.</p> <p>If the cartridge is installed correctly and the problem persists, try a new cartridge. The cartridge may be nearing end-of-life.</p>
HVPS card Controller card assembly Cartridge contacts assembly	<p>Check the cartridge contacts for correct installation and contamination where contact is made with the print cartridge and HVPS card. Clean as necessary.</p> <p>If this does not correct the problem, replace the HVPS. If that does not correct the problem, replace the controller card assembly.</p> <p><b>Note:</b> Always check printhead alignment after replacing the controller card assembly. See <b>“Printhead assembly adjustment” on page 4-2</b> for hardware alignment of the printhead.</p>

**Partial blank image/white spots (no periodic pattern)**

FRU	Action
Print cartridge (not a FRU)	<p>Remove the print cartridge and gently shake the assembly to evenly distribute the toner.</p> <p>If the print cartridge is low, try a new one.</p>
Fuser assembly	<p>Check springs at each end of the fuser backup roller to ensure adequate and even pressure is applied to the fuser belt. Replace the fuser if necessary.</p>
Paper (not a FRU)	<p>Make sure recommended paper is being used.</p>

## Variation in image density horizontally across page

FRU	Action
Print cartridge Right guide assembly Left guide assembly	<p>The charge roll may have unbalanced pressure against the PC drum. Check for equal forces at both ends of the charge roll.</p> <p>If one side has a much lower force than the other, check the spring of the guide assembly. Replace the faulty guide assembly (either right or left).</p> <p>If force seems similar, try a new cartridge.</p>
Transfer assembly roll	<p>Check the springs and bearings at both ends of the transfer roller. The bearing assemblies should support the transfer roller, applying even pressure to the PC drum.</p> <p>Replace the transfer roll assembly if either spring shows signs of damage or fatigue. See <b>“Transfer roll assembly” on page 4-43.</b></p> <p>Inspect the transfer roller for signs of wear or damage and replace if necessary.</p> <p><b>Note:</b> Cleaning or vacuuming the transfer roll is not recommended. An uneven distribution of debris on the transfer roll can cause cyclic variation in image density or banding.</p>

## Poor fusing of image

FRU	Action
Fuser	<p>The fuser may not be operating at the proper temperature to fuse the toner to the paper. See <b>“Cold fuser service check” on page 2-41.</b></p> <p>Make sure recommended paper is being used.</p>

## Light print

FRU	Action
Print cartridge (not a FRU)	Make sure the print cartridge is installed correctly and is not low on toner. If the problem continues, install a new cartridge.
Transfer roller HVPS contact (transfer roller) HVPS card	Check the transfer roller for signs of toner buildup and contamination. Inspect the HVPS contact (transfer roller or T) for contamination. Inspect the HVPS card for contamination where it contacts the cartridge contact assemblies. If all components appear free of contamination, replace the following FRUs one at a time in the order shown: <ul style="list-style-type: none"> <li>• Transfer roller</li> </ul> <p><b>Note:</b> Always check the bottom margin following a transfer roll replacement. See <b>“REGISTRATION” on page 3-4</b></p> <ul style="list-style-type: none"> <li>• Cartridge contact assembly</li> <li>• HVPS card</li> </ul>

## White or black lines or bands

FRU	Action
Print cartridge Paper feed drive gears	Banding appears as light or dark horizontal lines on a uniformly gray page or on a page with a large area of graphics. Banding is primarily due to a variation in the speed of the paper as it feeds through the printer especially in the developer and transfer process. Inspect the cartridge and paper feed components, especially the drive gears, for signs of wear, debris, binds, or damage. Replace drive as necessary.



## Toner on back of page

FRU	Action
Print cartridge (not a FRU)	<p>Inspect the overall paper path for signs of spilled toner.</p> <p>Gently clean the contaminated areas with a soft cloth.</p>
Fuser assembly	<p>The fuser belt can deposit toner on the back of the paper if toner is building up on the belt edges. This buildup may transfer to the backup roller, later transferring to the back of the paper.</p> <p>Inspect the belt and backup roller for signs of contamination, and replace fuser assembly as necessary.</p>
Transfer roller	<p>A transfer roller contaminated with toner can cause toner to transfer to the back of printed pages.</p> <p>Inspect the transfer roller for contamination and replace as necessary.</p> <p><b>Note:</b> Always check the bottom margin following a transfer roll replacement. See <b>“REGISTRATION” on page 3-4</b></p>

## Solving print quality problems

To print the Print Quality Pages:

1. Enter Diagnostic Mode:
  - a. Turn the printer off.
  - b. Press and hold the **Go** and **Return** buttons.
  - c. Turn the printer on.
  - d. Release the buttons when *Performing Self Test* displays on the operator panel.
2. Select **PRINT TESTS** from Diagnostics mode.
3. Select **Prt Quality Pgs.**

Four pages print. Additional button presses are ignored until the pages have printed. If duplex is selected, the pages print front and back. The first page is a mix of graphics and text. The second two pages are graphics, and the last page is blank.

The Print Quality Pages can also be printed from the Configuration Menu. See "**Prt Quality Pgs**" on page 3-23.

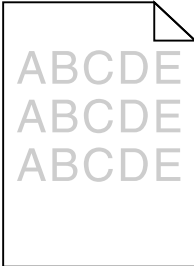
Problem	Action
<p>Light or blurred characters.</p> 	<ul style="list-style-type: none"> <li>• The print cartridge may be getting low on toner. To use the remaining toner, remove the cartridge and shake the cartridge back and forth. Reinstall the cartridge and press <b>Go</b>.</li> <li>• Change the Toner Darkness setting to a value greater than 8.</li> <li>• Make sure you are using recommended print media. Refer to the <i>Card Stock &amp; Label Guide</i> available on the Lexmark Web site at <a href="http://www.lexmark.com">www.lexmark.com</a>.</li> <li>• If the customer is printing on transparencies, card stock, or labels, be sure to check the Paper Type in the printer driver or operator panel. If the media has an uneven surface, adjust the driver or printer Paper Weight and Paper Texture.</li> <li>• The print cartridge may be defective. Replace it.</li> </ul>

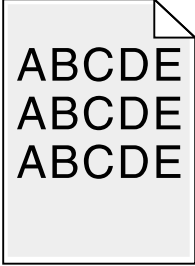
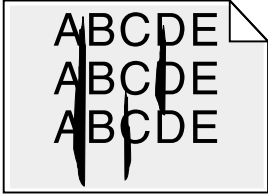
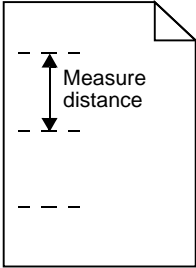
Problem	Action
<p>Toner smudges appear on the front or back of the page.</p> 	<ul style="list-style-type: none"> <li>• Make sure the paper is straight and unwrinkled.</li> <li>• Check for loose toner in the printer.</li> <li>• Clean the printer.</li> <li>• If the problem persists, replace the cartridge.</li> </ul>
<p>Vertical or horizontal streaks appear on the page.</p> 	<ul style="list-style-type: none"> <li>• Replace the print cartridge.</li> </ul>
<p>Marks repeating</p> 	<ul style="list-style-type: none"> <li>• Repeating marks may indicate which component is causing the problem. <ul style="list-style-type: none"> <li>–46mm—Developer roll, charge roll, transfer roll</li> <li>–79.8mm—Fuser belt</li> <li>–80.5mm—Fuser backup roll</li> <li>–95mm—Photo-conductor</li> </ul> </li> <li>• Inspect the component, if possible, for debris or damage.</li> <li>• Replace the component or tone cartridge as necessary.</li> </ul>
<p>Faint images or repetitive spots appear on the page.</p>	<ul style="list-style-type: none"> <li>• Select a different media type or form type setting from your printer driver.</li> <li>• Try a different type of paper. Paper designed for copiers gives the best quality.</li> <li>• Replace the print cartridge.</li> </ul>

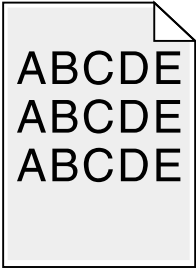
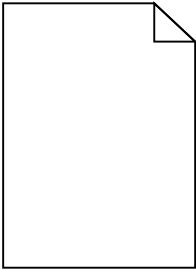
Problem	Action
<p>Toner smears or rubs off the page.</p> 	<ul style="list-style-type: none"> <li>• Try a different kind of paper. Papers designed for copiers give the best quality.</li> <li>• If you are printing on special media, such as, card stock or labels, be sure you select the correct paper type in the printer driver.</li> <li>• Change the media texture setting. You can download the latest driver from the Lexmark Web site, <a href="http://www.lexmark.com">www.lexmark.com</a>.</li> </ul>
<p>The print is getting light but Toner Low does not display.</p>	<ul style="list-style-type: none"> <li>• The message does not display if a print cartridge with less than a 6,000 page yield is installed.</li> <li>• Remove the cartridge and gently shake it from side to side to redistribute the toner.</li> <li>• Replace the cartridge.</li> </ul>
<p>The Toner Low message appears.</p>	<ul style="list-style-type: none"> <li>• Remove the print cartridge and gently shake it from side to side to redistribute the toner.</li> <li>• Replace the cartridge.</li> </ul>
<p>Solid black areas on transparencies or paper contains white streaks.</p>	<ul style="list-style-type: none"> <li>• Choose a different fill pattern in your software application.</li> <li>• Try a different type of paper. Paper designed for copiers gives the best quality.</li> <li>• Remove the print cartridge and gently shake it from side to side to redistribute the toner.</li> <li>• Replace the cartridge.</li> </ul>
<p>Pages are blank.</p> 	<ul style="list-style-type: none"> <li>• The print cartridge may be out of toner or defective. Replace the cartridge.</li> <li>• You may have a software error. Try turning the printer off and back on.</li> <li>• Check the photoconductor circuit for continuity.</li> <li>• Check the printhead.</li> </ul>

Problem	Action
The media skews or buckles.	<ul style="list-style-type: none"> <li>• Don't overfill tray 1 or the optional tray 2 (see media capacities in the media types and sizes table in the <i>User's Reference</i>).</li> <li>• Make sure the paper guides are flush against the edges of the media.</li> </ul>
The paper sticks together/printer feeds multiple sheets of paper.	<ul style="list-style-type: none"> <li>• Remove the paper from tray 1 or the optional tray 2 and fan the paper.</li> <li>• Don't overfill tray 1 or the optional tray 2 (see media capacities in the media types and sizes chart in the <i>User's Reference</i>).</li> </ul>
The paper fails to feed from tray 1 or tray 2.	<ul style="list-style-type: none"> <li>• Remove the paper from tray 1 and fan the paper.</li> <li>• Make sure tray 1 is selected from the printer driver.</li> <li>• Do not overfill the tray.</li> </ul>
The paper fails to feed from the optional tray 2 or tray 3.	<ul style="list-style-type: none"> <li>• Make sure the printer recognizes the optional trays. POR the printer and check the cables.</li> <li>• Make sure the optional tray 2 is selected from the printer driver.</li> <li>• Remove the paper from the optional tray 2 and fan the paper.</li> <li>• Make sure the tray is pushed all the way in.</li> <li>• Make sure the metal plate is pressed down before inserting the tray into the printer.</li> </ul> <div data-bbox="452 1019 941 1235" data-label="Image"> </div> <p data-bbox="469 1255 926 1333"><b>Note:</b> Once the tray is inserted, the metal plate springs up so the paper can feed into the printer.</p> <ul style="list-style-type: none"> <li>• Make sure the paper does not exceed the stack height indicator.</li> <li>• Make sure the paper is under both corner bucklers (see loading paper in the <i>User's Reference</i>).</li> </ul>

Problem	Action
<p>The Load Paper displays even though there is paper loaded in the optional tray 2 or tray 3.</p>	<ul style="list-style-type: none"> <li>• Make sure the tray is pushed all the way in.</li> <li>• Press <b>Go</b>.</li> </ul>
<p>The printer does not print after a paper jam has been cleared.</p>	<ul style="list-style-type: none"> <li>• Press <b>Go</b> or open and close the printer front cover to restart the printer.</li> <li>• Make sure the print cartridge is installed properly.</li> </ul>
<p>Unexpected characters print or characters are missing.</p>	<ul style="list-style-type: none"> <li>• Make sure you are using the correct printer driver.</li> <li>• Select hex trace mode to determine what the problem is. To turn on hex trace:               <ol style="list-style-type: none"> <li>1. Select <b>UTILITIES MENU</b> from the READY MENU.</li> <li>2. Select <b>Hex Trace</b>. To exit Hex Trace, select <b>Reset Printer</b> from the JOB MENU or turn the printer off.</li> </ol> </li> <li>• Restore factory defaults. See <b>“Factory Defaults” on page 3-24</b> for more information.</li> <li>• Make sure the parallel cable or USB cable is firmly plugged in at the back of the printer.</li> </ul>

## 3. Diagnostic aids

This chapter explains the tests and procedures to identify printer failures and verify repairs have corrected the problem.

### Additional service menus

Several service menus are available by selecting particular keys during POR.

Diagnostics Mode	<ol style="list-style-type: none"> <li>1. Press and hold <b>Go</b> and <b>Return</b>.</li> <li>2. Turn on the printer.</li> <li>3. Release the buttons when Performing Self Test displays.</li> </ol>	<p>The Diagnostics Mode group contains the settings and operations used while manufacturing and servicing the printer.</p> <p>See <b>“Diagnostics Mode” on page 3-2</b> for more information.</p>
Configuration Menu	<ol style="list-style-type: none"> <li>1. Press and hold <b>Select</b> and <b>Return</b>.</li> <li>2. Turn on the printer.</li> <li>3. Release the buttons when Performing Self Test displays.</li> </ol>	<p>The Configuration Menu group contains a set of menus, settings, and operations which are infrequently required by a user. Generally, the options made available in this menu group are used to configure a printer for operation.</p> <p>See <b>“Configuration Menu” on page 3-21</b> for more information.</p>

---

## Diagnostics Mode

To run the printer diagnostic tests described in this chapter, you must put the printer in Diagnostics Mode.

### *Entering Diagnostic Mode*

1. Turn the printer off.
2. Press and hold the **Go** and **Return** buttons.
3. Turn the printer on.
4. Release the buttons when *Performing Self Test* displays on the operator panel.

The tests are displayed on the operator panel in the order shown:

#### REGISTRATION

#### PRINT TESTS

Tray 1

Tray 2 (displays only if installed)

Tray 3 (displays only if installed)

MP Feeder

Prt Quality Pages

#### HARDWARE TESTS

LCD Test

Button Test

DRAM Test

Parallel Wrap (displays in some configurations)

#### DUPLEX TESTS

Quick Test

Top Margin

Sensor Test

Duplex Feed 1

#### INPUT TRAY TESTS

Feed Test

Sensor Test

#### BASE SENSOR TEST

Toner

Input

Output

Narrow Media

Front Door



DEVICE TESTS (only displays if flash is installed)

Flash Test

PRINTER SETUP

Defaults

Page Count

Perm Page Count

Serial Number

Engine Setting 1

Engine Setting 2

Engine Setting 3

Engine Setting 4

Model Name

Configuration ID

Edge to Edge

Par S Strobe Adj

EP SETUP

EP Defaults

Fuser Temp

Transfer

Print Contrast

Charge Roll

Gap Adjust

ERROR LOG

Display Log

Print Log

Clear Log

Select **Exit Diagnostics** to exit the Diagnostics Mode and return to normal mode.

## REGISTRATION

To set print registration:

1. Select **REGISTRATION** from the Diagnostics menu.

The Top margin sign/value pair blinks. This indicates it is the margin value being changed.

T=sxx*	B=sxx*
L=sxx*	R=sxx*

2. To select the margin value to be changed press **Select** until the margin value pair you want to change is blinking.

The print registration range is:

Variable	Description	Value
s	sign	blank for positive values, "-" for negative values
B=	Bottom margin	-20 to +20—Each increment causes approximately 0.55 mm shift in the bottom margin.
T=	Top margin	-16 to +16
L=	Left margin	-25 to +25
R=	Right margin	-10 to +10

3. To change the margin value press **Menu**. When the value you want displays, press **Select** to save the value.

To verify the margin values are correct, you must print the Quick Test page. Press **Go** to print the test page. While printing, Quick Test Printing displays. Once the Quick Test page completes printing, the registration screen displays again.

4. To exit, press **Return**.
5. Test the setting by printing the Quick Test page for all the source, see "**PRINT TESTS**" on page 3-5. Select all the available sources. To test the Duplex sources, see "**DUPLEX TESTS**" on page 3-9

Print the Quick Test Page on letter or A4 paper.

## PRINT TESTS

### Tray 1, Tray 2, Tray 3, or MP Feeder

Input source print tests can verify that the printer can print on media from the installed input sources. Only installed sources appear in the menu.

To run the input source test:

1. Select **PRINT TESTS** from Diagnostics Mode.
2. Select the input source from the sources displayed on the **Feed Test** menu. All installed sources are listed.

Menu selections	Description
Tray 1	Standard tray
Tray 2*	Optional tray
Tray 3*	Optional tray
MP Feeder	Multipurpose feeder
* If installed	

3. Select either **Single** (feeds one sheet of blank media from the selected source) or **Continuous** (continues feeding blank media from the selected source until **Return** or **Stop** is pressed).
4. Press **Return** or **Stop** to exit the test.

## Prt Quality Pgs

To print the Print Quality pages:

1. Select **PRINT TESTS** from Diagnostics Mode.
2. Select **Prt Quality Pgs**.
3. Press **Select**.

Four pages print. Additional button presses are ignored until the pages have printed. If duplex is selected, the pages print front and back.

The first page is a mix of graphics and text. The second two pages are graphics, and the last page is blank.

The Print Quality pages can also be printed from the Configuration Menu.

## HARDWARE TESTS

### LCD Test

1. Select **LCD Test** from Diagnostics Mode. The LCD test continually executes the LCD display test.
2. Press **Return** or **Stop** to cancel the test.

### Button Test

1. Select **Button Test** from Diagnostics Mode.

With no buttons pressed, several occurrences of **OP** (Open) appear on the display.

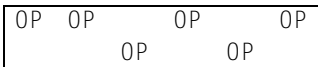

2. To test the proper operation of each button, press each button on the operator panel one at a time and a **CL** (Closed) displays in place of an **OP**.
3. Press **Return** or **Stop** to cancel the test.

## DRAM Test

The purpose of this test is to check the validity of DRAM, both standard and optional. The test writes patterns of data to SDRAM to verify that each bit in memory can be set and read correctly.

To run the SDRAM Memory Test:

1. Select **DRAM Test** from the menu. The power indicator blinks indicating the test is in progress.

DRAM Test	xxxMb
P:#####	F:#####

xxxMB represents the amount of installed DRAM memory in MB.

P:##### represents the number of times the memory test has passed and finished successfully. Initially 000000 displays with the maximum pass count being 999,999.

F:##### represents the number of times the memory test has failed and finished with errors. Initially 00000 displays with the maximum fail count being 99,999.

2. Once the maximum pass count or fail count is reached, the test stops, the power indicator is turned on solid, and the final results display. If the test fails, the message **DRAM Error**, displays for approximately three seconds and the failure count increases by 1.

Turn the power off if you want to stop the test before it completes.

## Parallel Wrap

This test is used with a wrap plug to check operation of the parallel port hardware. Each parallel signal is tested.

To run the Parallel Wrap Test:

1. Disconnect the parallel interface cable and install the wrap plug (P/N 1319128).
2. Select HARDWARE TESTS from Diagnostics Mode.
3. Select **Parallel Wrap**.
4. Select **Parallel Wrap, Parallel 1 Wrap, Parallel 2 Wrap, or Parallel 3 Wrap**.

The power indicator blinks indicating the test is in progress. The test runs continuously until canceled.

```
Parallel Wrap
P:##### F:#####
```

P:##### represents the number of times the memory test has passed and finished successfully. Initially 000000 displays with the maximum pass count being 999,999.

F:##### represents the number of times the memory test has failed and finished with errors. Initially 00000 displays with the maximum fail count being 99,999.

5. Each time the test finishes, the screen updates. If the test passes, the pass count increases by 1, however if the test fails, a message displays for approximately three seconds. One of the following failure messages may display:

```
Sync Busy Error
Byte Interrupt Request Error
Strobe Interrupt Request Error
Init Fail Error
Init Busy Error
Host Busy Error
RAM Data FF Error
RAM Data AA Error
RAM Data 00 Error
RAM Data 55 Error
```

DMA Count Error  
 DMA Address Error  
 DMA Interrupt Error  
 DMA Memory Error  
 DMA Background Error  
 Clear Init Rise Error  
 False Init Rise Error  
 False Init Fail Error  
 Autofeed Rising Interrupt Error  
 Clear Autofeed Rise Error  
 False Autofeed Rise Error  
 Autofeed Failing Interrupt Error  
 Clear Autofeed Fail Error

6. Once the maximum count is reached the test stops. The power indicator goes on solid and the final results display.
7. Press **Return** or **Stop** to exit the test.

## DUPLEX TESTS

### Quick Test

This test is used to verify that the duplex Top Margin is set correctly. This test prints a duplexed version of the Quick Test page that can be used to adjust the Top Margin for the backside of the duplexed page. Since you are measuring the margin on the back of a duplex sheet to the front, make sure you adjust the Top Margin for a single sheet. See **“REGISTRATION” on page 3-4**.

Use either letter or A4 paper to run the test.

Quick Test Printing...     <media width>
---

If wider or narrower paper is used, *media width* appears with either **W** for wide or **N** for narrow paper.

To run the Duplex Quick Test:

1. Select **Duplex Tests** from Diagnostics Mode.
2. Select **Quick Test**.

3. Select **Single** to print a single duplex page or **Continuous** to continue printing until **Return** or **Stop** is pressed.

The printer attempts to print the Quick Test Page from the default paper source. If the default paper source only supports envelopes, then the page is printed from Tray 1.

4. Check the Quick Test Page for the correct offset between the placement of the first scan line on the front and back side of a duplexed sheet.

If adjustment is necessary, see **“Top Margin” on page 3-10**.

5. Press **Return** or **Stop** to exit the test.

## Top Margin

Print the duplex Quick Test to verify the margin on the backside of the duplex page aligns with the front side. See **“Quick Test” on page 3-9**. Since this test aligns against the front page, make sure the front page is aligned (the front side of a duplex page is facedown in the output bin). See **“REGISTRATION” on page 3-4**.

The Duplex Top Margin offset range is -16 to +16 and the default is zero. Adjustment of this setting lets you shift up or down the position of the Top Margin. Changing this parameter by one unit moves the margin 0.25mm. A positive offset moves the text down the page and widens the top margin while a negative offset moves the text up the page and narrows the top margin.



## Sensor Test

This test is used to determine whether or not the duplex sensors and switches are working correctly.

1. Select **Sensor Test** from the Duplex Tests menu.
2. Manually actuate each of the duplex sensors.

Sensor Test  
 Testing...

When the sensor/switch is closed, CL (closed) displays, when the sensor/switch is open, OP (open) displays.

Sensor Test  
 Input=OP

Input refers to the duplex input sensor in the duplex unit.

3. Press **Return** or **Stop** to exit the test.

## Duplex Feed 1

This test feeds a blank sheet of paper to the duplex paper stop position 1.

To run the Duplex Feed 1 Test:

1. Select **Duplex Feed 1** from the Duplex Test menu.  
The power indicator blinks while the paper is feeding.

Duplex Feed 1  
 Feeding...

2. When the paper reaches the duplex paper stop position 1, the power indicator turns on solid and a message appears:

Duplex Feed 1  
 Clear Paper...

3. Remove the paper and press **Go**, **Return**, or **Stop** to end the test.

## INPUT TRAY TESTS

### Feed Test

This test is used to determine if the input tray sensors are working correctly. Observe the paper path as blank media is being fed through the printer. The upper front door cannot be opened during the feed test. To observe the paper path, open MPF door cover to access the multipurpose feeder. Any media that meets the specifications for the printer can be used for this test.

To run the Input Tray Feed Test:

1. Open the MPF door.  
**Note:** Do not open the front cover.
2. Select the **Feed Test** from the Input Tray Test menu.
3. Select the input source. Only installed sources display, but may include **Tray 1, Tray 2, Tray 3, MP Feeder**.
4. Select **Single** to feed a single blank sheet or **Continuous** to feed blank sheets until you press **Return** or **Stop**.

The selected input source appears on the display:

```
<input source>  
Feeding...
```

### Sensor Test

This test is used to determine if the input tray sensors are working correctly.

1. Select the **Sensor Test** from the Input Tray Test menu.
2. Select the input source. Only installed sources display, but may include **Tray 1, Tray 2, Tray 3, MP Feeder**.

```
<input source>  
Testing...
```

3. A list of sensors appears, depending upon the input source selected. For example, if tray 2 were selected:

Tray 2	
TP=OP	P=OP

TP refers to tray present sensor.

P refers to pass thru sensor.

OP indicates the sensor is open.

CL indicates the sensor is closed.

Not all sources have the same set of sensors. The table below indicates which sources should display which sensors.

Source	Tray present (TP)	Pass thru sensor (P)
Tray 1	Yes <sup>1</sup>	No
Tray 2	Yes <sup>2</sup>	Yes <sup>3</sup>
Tray 3	No	Yes <sup>3</sup>
Multipurpose feeder	Yes	No
<sup>1</sup> Only available when tray 2 is installed. <sup>2</sup> Only available when tray 3 is installed <sup>3</sup> Only available if tray is 250-sheet drawer.		

4. Press **Return** or **Stop** to exit the test.

## BASE SENSOR TEST

Base sensor test is used to determine if the sensors inside the printer are working correctly.

To run the Base Sensor Test:

1. Select **BASE SENSOR TEST** from the Diagnostics Mode.
2. Select the sensor to test. The following sensors may be tested:

**Toner** (toner optical sensor)

**Input** (input sensor)

**Output** (exit sensor)

**Narrow Media** (narrow media sensor)

**Front Door** (upper front door sensor)

The selected sensor is displayed with **OP** for open or **CL** for closed. You can actuate the sensors to toggle between open and closed.

## DEVICE TESTS

This menu is only displayed if flash memory is installed.

### Flash Test

This test causes the file system to write and read data on the flash to test the flash.

**Warning:** This test destroys all data on the flash. The flash will be unformatted at the end of the test. **Format Flash** is available from the Utilities menu.

To run the Flash Test:

1. Select **Flash Test** from the DEVICE TESTS menu.

The power indicator blinks while the test is running.

Files will be Lost.                      Go/Stop?
--

2. Select **Go** to continue. Select **Stop** or **Return** to exit.

Flash Test Testing...
--------------------------

The results are displayed and the power indicators turns on solid:

Flash Test Test Passed
---------------------------

Flash Test Test Failed
---------------------------

3. Press **Go**, **Return**, or **Stop** to return to the DEVICE TESTS menu.

## ***PRINTER SETUP***

### **Defaults**

Selections are **U.S.** or **Non-U.S.** This setting affects the following defaults:

<b>Printer setting</b>	<b>U.S. value</b>	<b>Non-U.S. value</b>
Default paper size*	Letter	A4
Envelope size*	10 Envelope	DL Envelope
Fax paper size	Letter	A4
PCL Symbol Set	PC-8	PC-850
PPDS code page	437	850
Units of measure	Inches	Millimeters
* Where input sources do not have size sensing capabilities.		

**Warning:** Changing the Defaults setting causes the printer to reset the printer NVRAM to factory settings.

## Page Count

Reset the page count when an engine card is replaced.

To reset the page count:

1. Select **Page Count** from the PRINTER SETUP menu.

Page Count =1234567*
-------------------------

2. The leftmost number blinks. Use **Menu** to increase or decrease the number and press **Select** to move to the next digit to the right. Continue until the correct number displays. To skip a number without changing it, press **Select**.

When **Select** is pressed after the last digit, the number is saved.

## Perm Page Count

This menu option lets you view the permanent page count. The permanent page count cannot be changed by the operator panel.

Select **Perm Page Count** and the value is displayed.

## Configuration ID

The configuration ID is used to communicate characteristics of certain areas of the printer that cannot be determined by hardware sensors. The configuration ID was originally set when the printer is manufactured and is located on the printer label.

## Edge to Edge

When Edge to Edge is set to **On**, text and graphics are printed with all margins set to the physical edges of the page. This features does not work in PPDS emulation.

## Par S Strobe Adj

This setting adjusts the factory setting for the amount of time strobe is sampled to determine that valid data is available on the parallel port. Incrementing this value by one means the strobe is sampled 50 nanoseconds longer. The range of values are between -4 and +6, in increments of one. A value of zero indicates no change is made from the factory setting.

## ***EP SETUP***

### **EP Defaults**

Restores all EP settings to factory default values. Selections are **Restore** and **Do Not Restore**.

### **Fuser Temp**

Changing this setting can reduce paper curl or melting of some letterhead images. Selections are **Normal** (default), **Lower**, and **Lowest**.

### **Transfer**

Selections are **Low**, **Medium** (default), and **High**.

### **Print Contrast**

Selections are **Low**, **Medium** (default), and **High**.

### **Charge Roll**

Selections are **Low**, **Medium** (default), and **High**.

### **Gap Adjust**

Adjusts the minimum gap between sheets during printing. This setting reduces speed (pages per minute), but can be used to reduce curl of printed media and improve stacking in the output bin.

Range is 0 (default) to 255. Adjusting by one results in 9 mm of increased gap.

## ERROR LOG

### Display Log

The error log provides a history of printer errors. It contains the 12 most recent errors that have occurred on the printer. The most recent error displays in position 1 and the oldest error displays in position 12 (if 12 errors have occurred). If an error occurs after the log is full, the oldest error is discarded. Identical errors in consecutive positions in the log are entered. All 2xx and 9xx error messages are stored in the error log.

To view the error log:

1. Select **Display Log** from the Error Log menu.

The error log is displayed on three screens, but only four entries are shown at a time. To move to the next screen, press **Menu**. For example:

1-200	2-920
3-928	4-922

5-250	6-990
7-230	8-230

9-953	10-000
11-000	12-000

In this example, the last error was a 200 error. In positions 10, 11, and 12, no codes were recorded.

2. Press **Return** to exit the error log.



## Print Log

Additional diagnostic information is available when you print the error log. Some of the additional information includes:

- Detailed printer information, including model and serial number.
- Time and date stamps
- Page counts for each error.

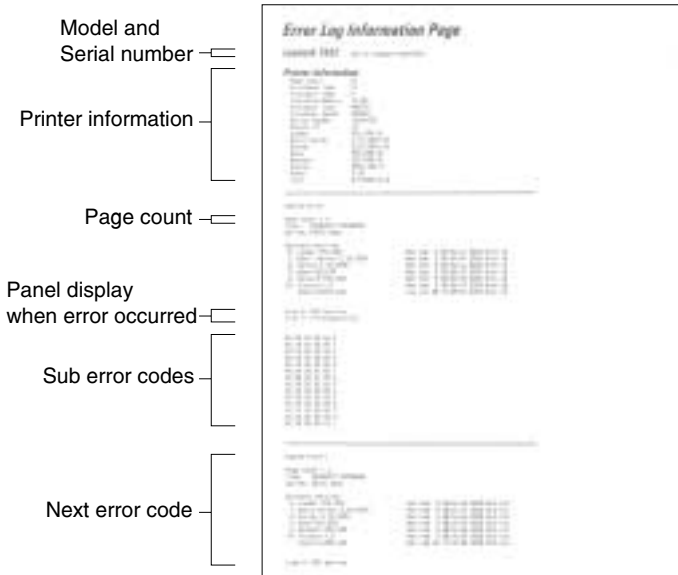

The printed error log can be faxed to Lexmark or your next level of support for verification or diagnosis. This report can also be printed from the Configuration Menu. Because you can clear error logs, the contents of this log may not match the contents when you view the error log.

To print the error log:

1. Select **Print Log** from the Error Log menu.
2. Press **Return** to exit the Error Log menu.

## 4048-1xx

### Clear Log

1. Select **Clear Log** from the Error Log menu.

Clear Log =Yes
-------------------

2. Press **Yes** to confirm. Select **No** to exit without clearing the log.

1-000	2-000
3-000	4-000

3. Press **Return** to exit the Clear Log menu after clearing the log.

### Exit Diagnostics

Select **Exit Diagnostics** to exit the Diagnostic Mode and return to normal mode.

---

## Configuration Menu

### *Entering CONFIG MENU*

1. Turn the printer off.
2. Press and hold the **Select** and **Return** buttons.
3. Turn the printer on.
4. Release the buttons when **Performing Self Test** displays on the operator panel.

The menu items appear on the operator panel in the order shown:

Maint Cnt Value  
Reset Maint Cnt  
Prt Quality Pgs  
Panel Menus  
PPDS Emulation  
Download Emuls  
Demo Mode  
Factory Defaults  
Energy Conserve  
ERROR LOG  
Paper Prompts  
Env Prompts  
Reduced Curl  
Exit Config Menu

Select **Exit Config Menu** to exit the Configuration Menu and return to normal mode.

## **Maint Cnt Value**

This menu lets you view the maintenance count value. It only displays if Maintenance Warning and Intervention function is enabled in the configuration ID. The maintenance interval is determined by page count.

Select **Maint Cnt Value** from the CONFIG MENU.

```
Maint Cnt Value
=1234567
```

Press **Return** to exit.

## **Reset Maint Cnt**

When 80 Scheduled Maintenance appears and the maintenance kit is installed (see **“Scheduled maintenance”** on **page 6-2**), this number should be reset.

To reset the counter:

1. Select **Reset Maint Cnt** from the CONFIG MENU.

```
Reset Maint Cnt
=Reset
```

2. Press **Select** to reset the counter to zero. Press **Return** to cancel.

## ***Prt Quality Pgs***

To print the Print Quality Pages:

1. Select **Prt Quality Pgs** from CONFIG MENU.
2. Press **Select**.

Four pages print. Additional button presses are ignored until the pages have printed. If duplex is selected, the pages print front and back.

The first page is a mix of graphics and text. The second two pages are graphics, and the last page is blank.

The Print Quality Pages can also be printed from the Diagnostics Mode.

## ***Panel Menus***

If no password is set, Panel Menus lets you restrict access to the Ready Menu Group. When a password is set by an administrator, this menu item does not appear.

1. Select **Panel Menus** from the Diagnostics Mode.
2. Select **Disable** to make menus in the Ready Menu Group inaccessible.

To change the setting, select **Panel Menus** and select **Enable** to make the menus available.

## ***PPDS Emulation***

This menu lets you turn on PPDS emulation, if desired.

1. Select **PPDS Emulation** from CONFIG MENU.
2. Select **Activate** to enable PPDS emulation and **Deactivate** to turn it off.

## ***Download Emuls***

This menu item only displays if a downloaded emulator is installed.

To disable downloaded emulations:

1. Select **Download Emuls** from CONFIG MENU.
2. Select **Disable**.

The printer performs POR and starts as if the downloaded emulations were not loaded.

To reactivate downloaded emulations, restart the printer.

## ***Demo Mode***

This menu item lets you turn demo mode on or off.

1. Select **Demo Mode** from CONFIG MENU.
2. Select **Activate** to turn the demo mode on or **Deactivate** to turn demo mode off.

## ***Factory Defaults***

This menu lets you restore the printer settings to their factory default values.

1. Select **Factory Defaults** from the Configuration Menu.
2. Select either **Restore Base** or **Restore Network**. Restore Network is only available if an integrated network adapter is installed.

## ***Energy Conserve***

Select **On** to allow access to the Power Saver menu. If you select **Off**, an additional item appears in the Power Saver menu. **Disable** lets you enable or disable Power Saver from the customer menu.

## ***ERROR LOG***

See **“ERROR LOG” on page 3-18** for a more detailed description. The error log printed from the Diagnostics Mode contains additional debug information for 9xx errors than the error log printed from the Configuration Menu. You can also view or clear the log from the Diagnostics Mode.

## Print Log

Additional diagnostic information is available when you print the error log. This report can also be printed from the Diagnostics Mode. See **“Print Log” on page 3-19**. Also, the error log printed from the Diagnostics Mode contains additional debug information for 9xx errors than the error log printed from the Configuration Menu. Because you can clear error logs you can view, the contents of this log may not match the contents when you view the error log.

To print the error log:

1. Select **Print Log** from the Error Log menu.
2. Press **Return** to exit the Error Log menu.

## *Paper Prompts*

Setting **Paper Prompts** controls which tray a change prompt is directed to when paper is sensed to be the wrong size. Selections include **Auto**, **MP Feeder**, and **Manual Paper**.

## *Env Prompts*

Setting **Env Prompts** controls which tray a change prompt is directed to when envelopes are sensed to be the wrong size. Selections include **Auto**, **MP Feeder**, and **Manual Env**.

## *Reduced Curl*

Use this setting to reduce paper curl problems. The printer engine speed is reduced when this setting is turned on. Only use this for paper. Settings are **Off** and **On** and the default is **Off**.

## *Exit Config Menu*

Select **Exit Config Menu** to exit the Configuration Menu and return to normal mode.



## Paper jams

Most paper jams are caused by improper print media or incorrect loading of the media.

**Note:** To clear the Paper Jam error message, you must remove all jammed print media from the entire paper path.

The following illustration shows the path that print media travels through the printer. The path varies depending on the input source (trays and multipurpose feeder) and output bin you are using. See **“Paper jam messages” on page 2-22** for more information.

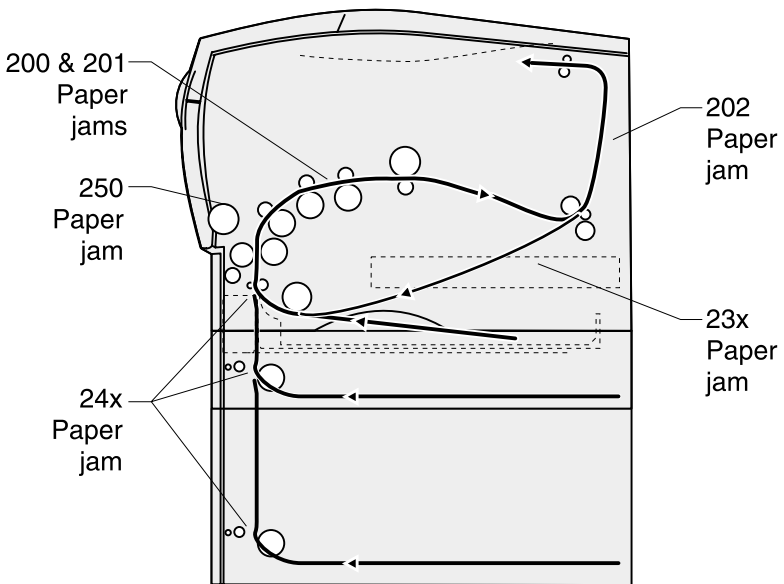

**Note:** To avoid tearing print media, pull all jams out gently and slowly. Use both hands and even pressure, if possible.

**4048-1xx**

---

## 4. Repair information

**Warning:** Read the following before handling electronic parts.

---

### Handling ESD-sensitive parts

Many electronic products use parts that are known to be sensitive to electrostatic discharge (ESD). To prevent damage to ESD-sensitive parts, follow the instructions below in addition to all the usual precautions, such as turning off power before removing logic cards:

- Keep the ESD-sensitive part in its original shipping container (a special “ESD bag”) until you are ready to install the part into the printer.
- Make the least-possible movements with your body to prevent an increase of static electricity from clothing fibers, carpets, and furniture.
- Put the ESD wrist strap on your wrist. Connect the wrist band to the system ground point. This discharges any static electricity in your body to the printer.
- Hold the ESD-sensitive part by its edge connector shroud (cover); do not touch its pins. If you are removing a pluggable module, use the correct tool.
- Do not place the ESD-sensitive part on the printer cover or on a metal table; if you need to put down the ESD-sensitive part for any reason, first put it into its special bag.
- Machine covers and metal tables are electrical grounds. They increase the risk of damage because they make a discharge path from your body through the ESD-sensitive part. (Large metal objects can be discharge paths without being grounded.)
- Prevent ESD-sensitive parts from being accidentally touched by other personnel. Install machine covers when you are not working on the machine, and do not put unprotected ESD-sensitive parts on a table.
- If possible, keep all ESD-sensitive parts in a grounded metal cabinet (case).
- Be extra careful in working with ESD-sensitive parts when cold-weather heating is used because low humidity increases static electricity.

---

## Adjustments

### Printhead assembly adjustment

The printhead needs to be correctly positioned after it has been removed. Align it to the frame or use the same position as the removed printhead.

Skew is caused by a sheet being fed through the printer while misaligned. The entire image is rotated relative to the print media edges. However, a misaligned printhead causes the horizontal lines to appear skewed while the vertical lines remain parallel to the vertical edges.

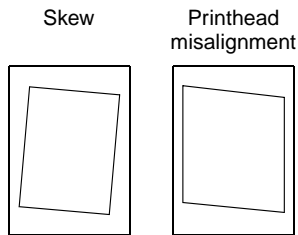

To align the printhead:

1. Enter the Diagnostic Menu. See **“Entering Diagnostic Mode” on page 3-2** and print the Quick Test. To print the test:
  - a. Select **Print Tests** from the Diagnostic Menu.
  - b. Select **Tray 1**.
  - c. Select **Single**. The Quick Test prints.

2. Fold the printed test page on the left side so that a few millimeters of grid lines wrap around the outside of the fold.
3. Fold a second vertical fold near the center so that the left side top edge aligns with the right side top edge.

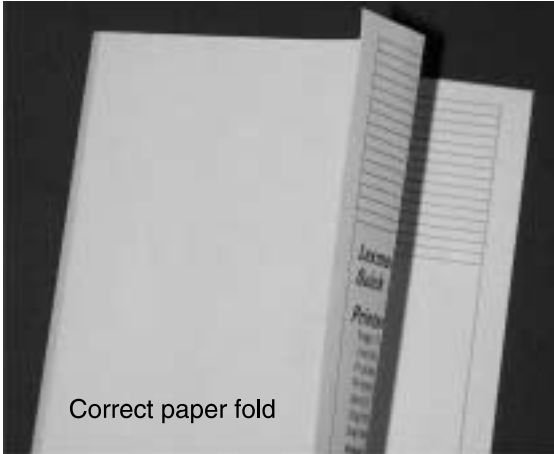

4. If the grid lines of the paper on the right side extend below the grid lines of the left side, adjust the printhead clockwise relative to the printer and recheck. See the left side of the figure below.

Adjust the printhead counterclockwise if the left side grid lines extend below the right side. See the right side of the figure below.

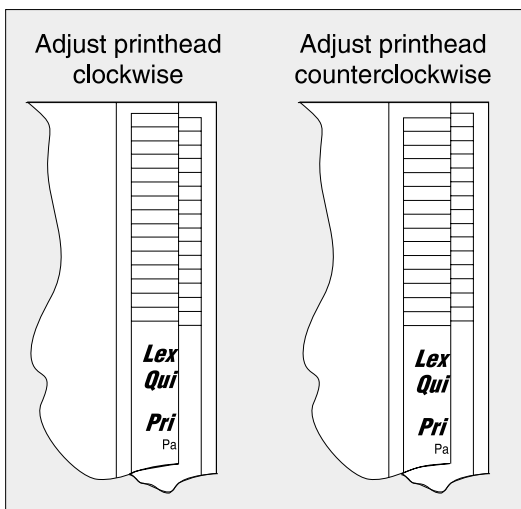

5. After obtaining a properly adjusted image on the paper, tighten all three screws.
6. After adjusting the printhead, if necessary, adjust registration of the left, right, top and bottom margins. See **“REGISTRATION” on page 3-4.**

**Note:** Printhead misalignment results in skewed horizontal lines but a consistent margin top to bottom of page. Paper feed misalignment results in entire image rotated on the paper. See **“Adjusting paper feed alignment (skew)” on page 4-5.**

## Adjusting paper feed alignment (skew)

When a reference feed assembly is removed, it requires realignment. Use a long shank (6–inches) Phillips screwdriver to adjust the rear screw holding the assembly in place. It is accessed through the hole in the main drive assembly. It is between the controller card cage and the main motor board. Adjust the screw counterclockwise which rotates paper counterclockwise in the printer path (image clockwise) and vice versa.

Verify alignment by printing the Quick Test page:

1. Enter the Diagnostic Menu. See **“Entering Diagnostic Mode” on page 3-2**
2. Select **Print Tests** from the Diagnostic Menu.
3. Select **Tray 1**.
4. Select **Single**. The Quick Test prints.

## Lubrication

Several FRUs must be lubricated when installed. The following diagrams indicate the units requiring lubricant and show where to place it. Place a drop size or less at each location and then rotate the gears or mechanism to evenly distribute the lubricant. Use Nyogel 744 (P/N 99A0394) or IBM 23 (P/N 99A0462).

**Note:** Be careful to not spread the grease to other parts of the printer.

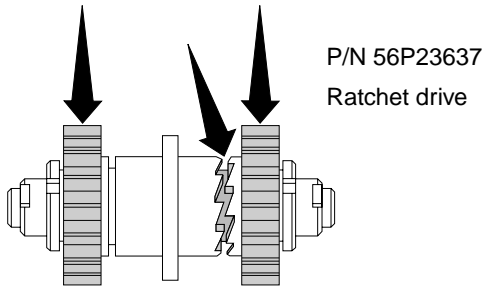

Lubricate the teeth of all the gears in the drive assembly, except the indicated gear.

P/N 56P2326  
Drive assembly

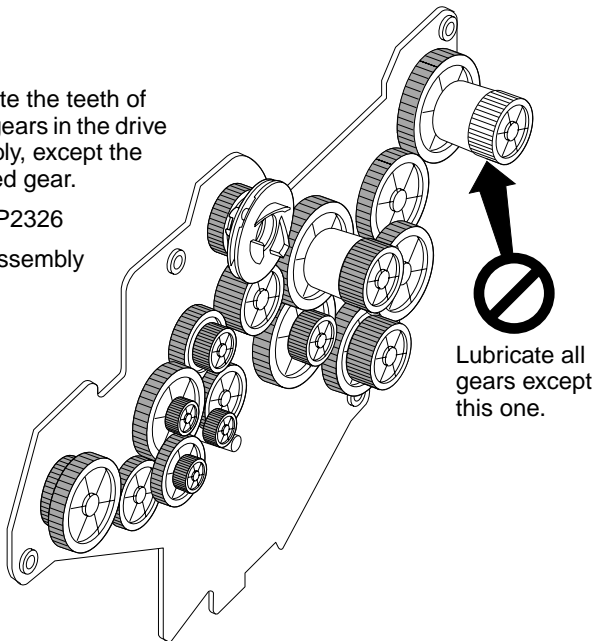



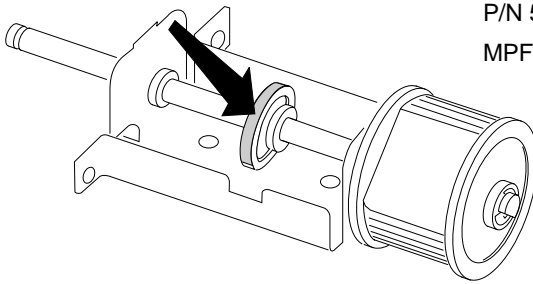

P/N 56P2359

MPF pick roll assembly

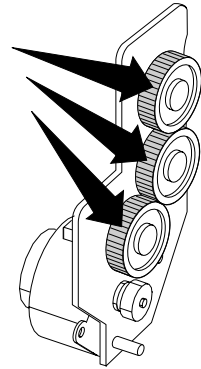

P/N 56P2327

Exit gear drive assembly

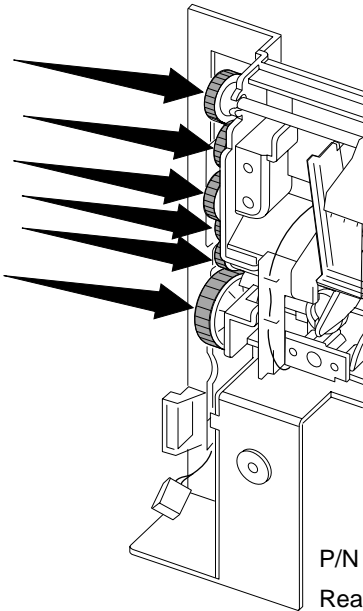

P/N 56P2302

Rear cover assembly

## Reassembly

Ensure all cables are reconnected when reassembling the printer. The printer may not detect a disconnected sensor in some areas without extensive running.

**Note:** Always print a page from each paper source to verify reassembly.

---

## Removal procedures

Be sure to unplug the power cord whenever you are working on the printer with one of the covers removed. Remove the print cartridge and paper tray before you perform removal procedures.

Unless otherwise stated, reinstallations are in reverse order of removal.

### MPF door cover removal

1. Remove the tray.
2. Open the front cover.
3. Open the MPF door to where the latches are just clear of the printer (about 15°).
4. Lift the left side of the cover to release it from the hinge.



5. Move the cover to the left to separate the right pivot.

## Front cover removal

1. Open the front cover.
2. Remove the two screws holding the front cover to the hinge arm (A).

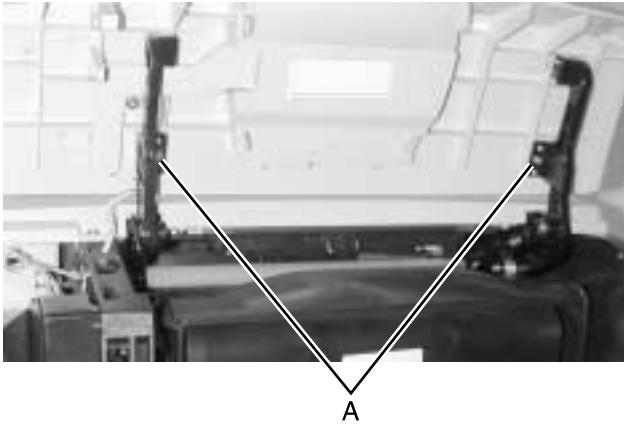

3. Unlatch the ends of the hinge arms.



## 4048-1xx

4. Remove the screw (B) from the operator panel cable cover and remove the cable cover.
5. Disconnect the operator panel cable (C) from the operator panel.

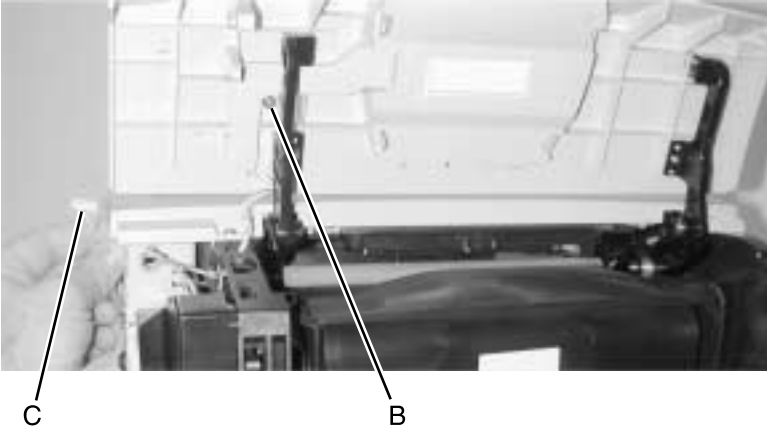

6. Remove the front cover with the operator panel attached. If replacing the front cover, remove the operator panel. See **“Operator panel assembly removal” on page 4-22.**

## Top cover assembly removal

1. Remove the front cover. See **“Front cover removal”** on **page 4-9**.
2. Remove the two screws as shown (A).
3. Remove the E-clips from both hinges that connect the left and right guides to the top cover (B).
4. Remove the stud hinges.

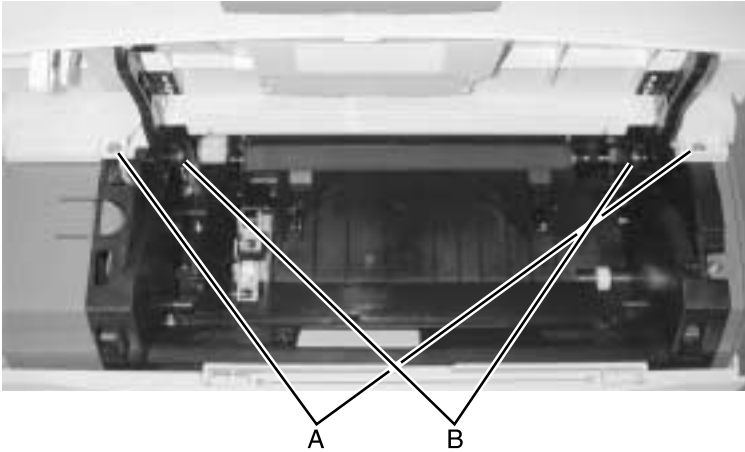

5. Open the rear exit door.
6. Remove the two screws as shown (C).

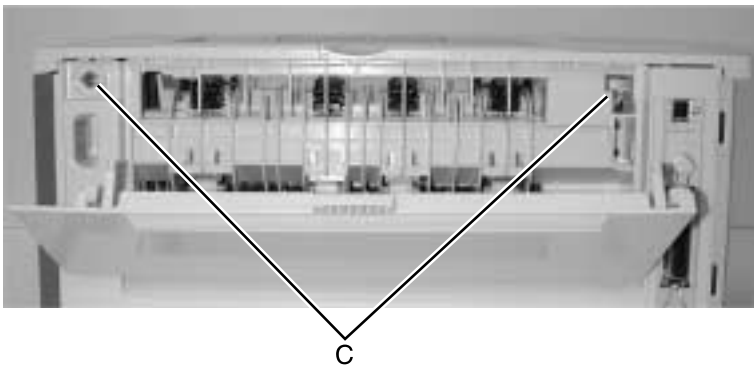

7. Remove the top cover, being careful not to damage the output tray full flags when you remove the cover.

## Right side cover removal

1. Remove the paper tray.
2. Open the front cover.
3. Open the MPF door.
4. Remove the screw below the front cover which fastens the side cover to the frame (A).

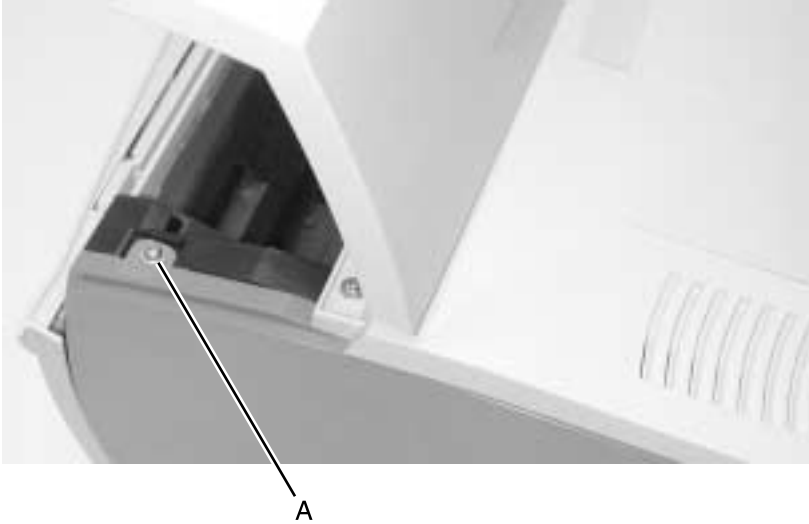

5. Open the rear cover and remove the second screw down from the top left corner (B).

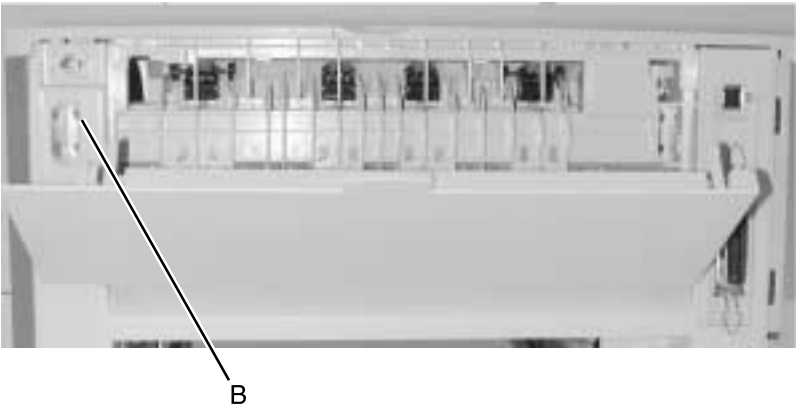

6. Pull the top of the right cover away from the printer slightly.

7. Unlatch the cover from the frame behind the front of tray (C).

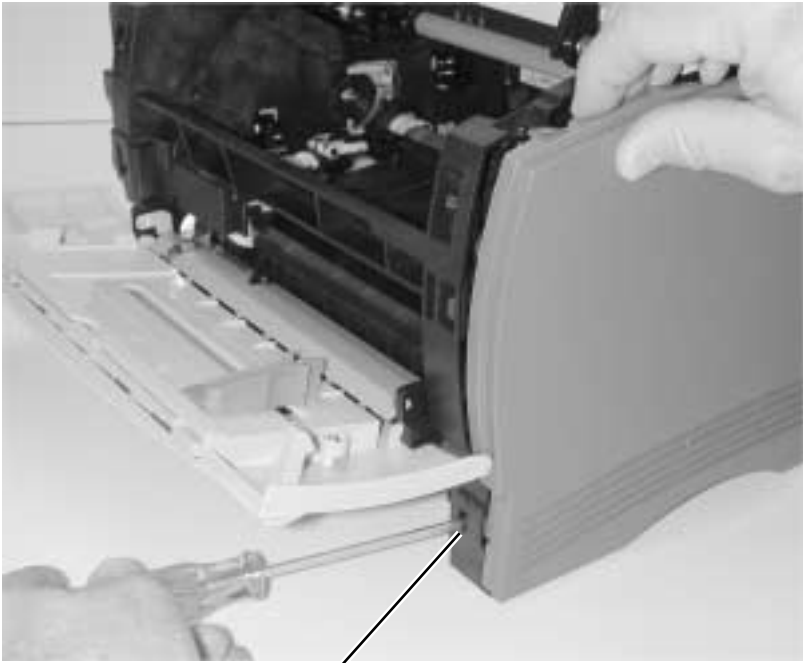

C

8. Remove the cover. The MPF door may need to be lifted slightly for the side cover to clear.

## Left side cover removal

1. Open the front cover and the MPF door.
2. Disengage the two latches (A) located in the front and top.
3. Swing the left side cover away from the printer.

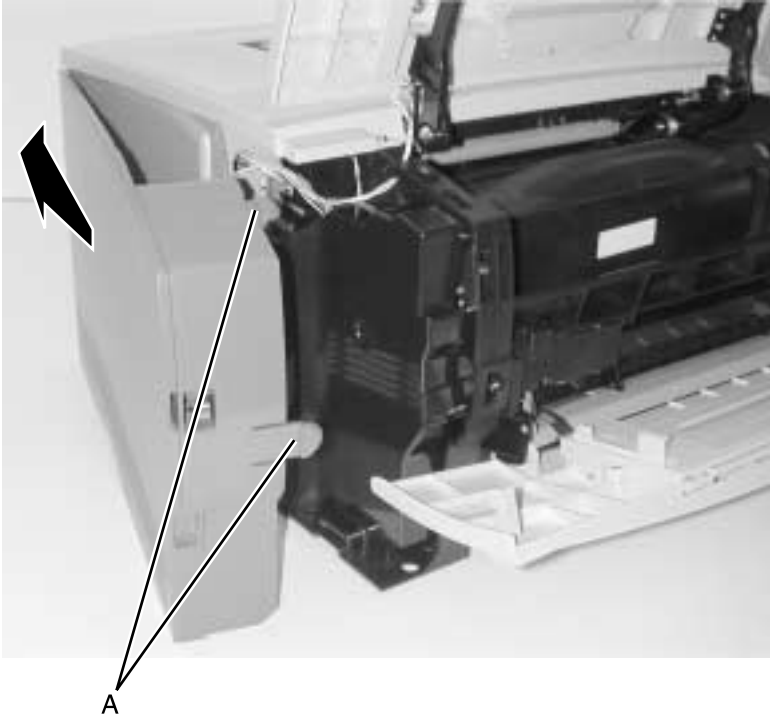



## Rear cover removal

1. Remove the paper tray.
2. Remove the right side cover. See **“Right side cover removal” on page 4-12.**
3. Remove the left side cover. See **“Left side cover removal” on page 4-14.**
4. Disconnect the sensor cable (in-line connector) (A) below the lower left corner of the controller cage.

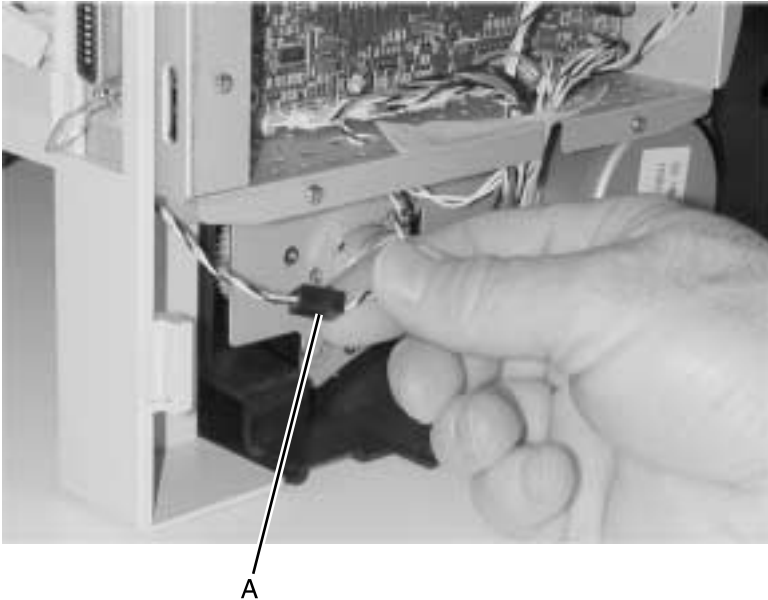

**Note:** Be sure to reconnect the sensor cable when reinstalling the rear cover. The printer fails to operate without this connection.

## 4048-1xx

5. Open the exit tray (rear door).
6. Remove the five remaining screws (B). There are a total of six.

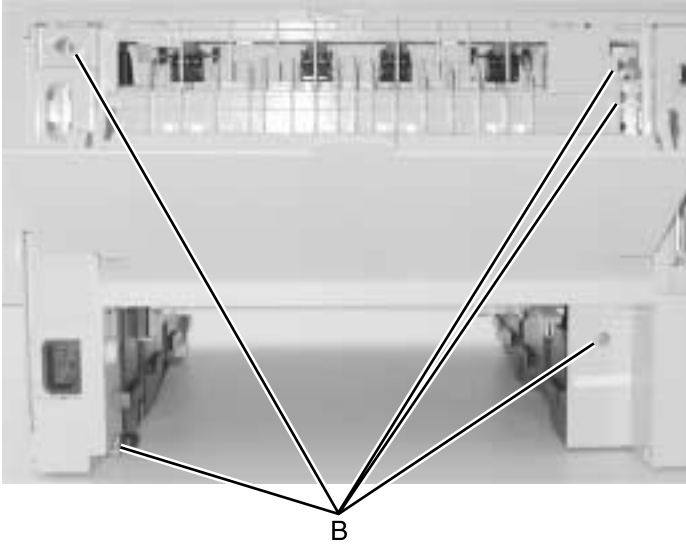

7. Lift the top cover slightly with one hand while pulling out on the rear cover.



### Installation notes:

- Handle carefully. Do not touch the rollers.
- When reinstalling the rear cover, position the fuser exit guide fingers so they are not bound by the rear cover. A bind causes jams.
- Be sure the spring contacts on the left side of the rear cover make good contact with the LVPS cage.

## Rear exit door removal

1. Open the rear exit door.
2. Use your index finger or flatblade screwdriver to disengage the left (facing the back of printer) hinge (A) from the rear cover.

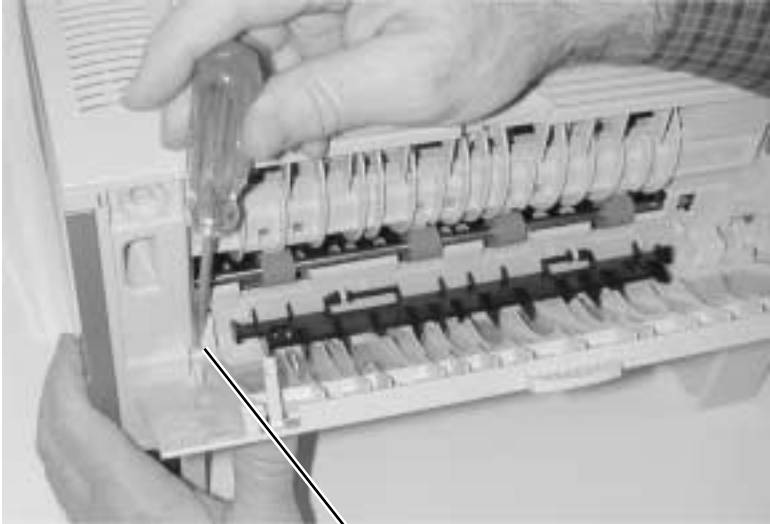

A

3. Swing the left side out to clear the printer and then move the door to the left to disengage the right hinge.



## Output tray full flag removal

1. Open the front cover.
2. Remove the two screws (A) holding the front top cover.

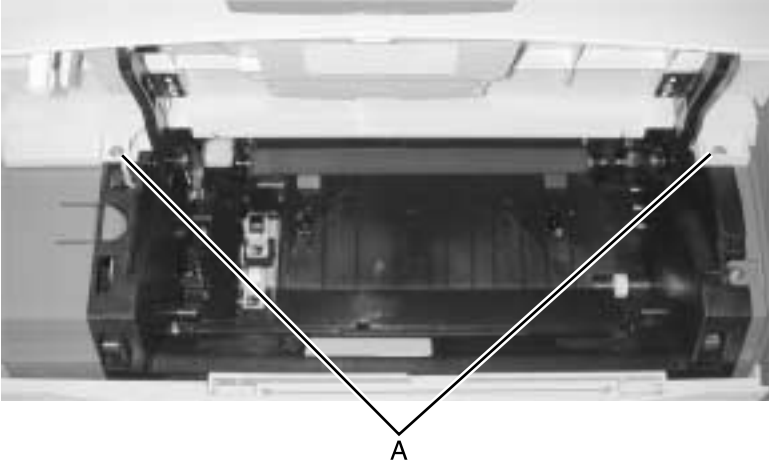

3. Remove the two screws (B) from the rear.

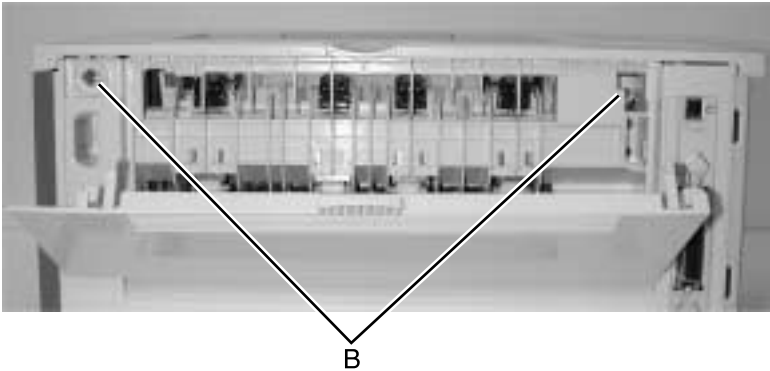

4. Lift the rear part of the top cover to clear the output tray full flags.  
You do not have to disconnect the top cover from the left and right guides.

5. Press the side of the flag to unclip the flag from the frame.

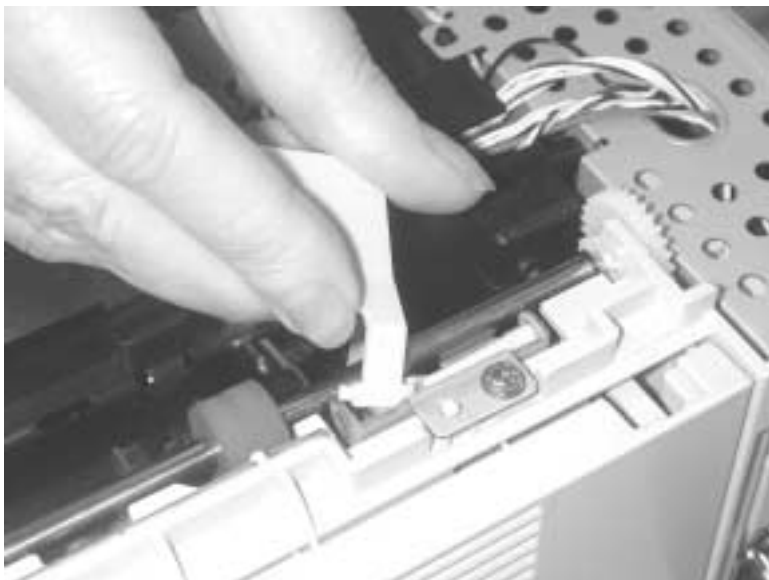

6. Repeat to remove the other flag.

## Operator panel cable removal

1. Remove the left side cover. See **“Left side cover removal”** on page 4-14.
2. Remove the inner shield (A).
3. Loosen the five screws (B), slide the controller card cage cover toward the rear, and remove.
4. Disconnect the cable from the controller card (C).

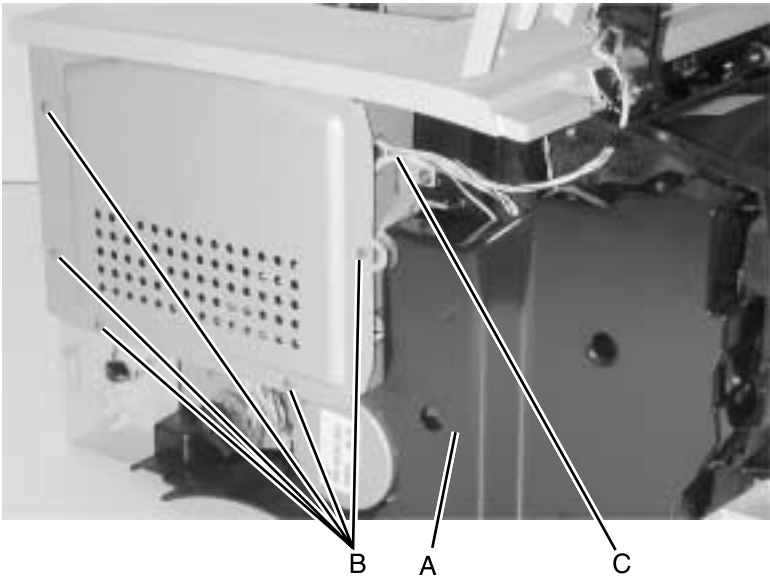

5. Withdraw the cable through the cage and frame.
6. Remove the screw in the front cover holding the cable cover.
7. Remove the cable cover.

8. Disconnect the cable from the operator panel card.



## Operator panel assembly removal

**Warning:** Never replace both the operator panel and controller card at the same time. Otherwise, some critical settings will be permanently lost.

1. Remove the operator panel cable. See **“Operator panel cable removal” on page 4-20.**
2. Lift the front cover, unclip the clear bezel from the bottom of the cover, and lift from the bezel from the operator panel.



3. Set aside the language overlay.



4. Press each of the four tabs (A) while gently prying up the same corner of the operator panel assembly (B) until the panel is free.

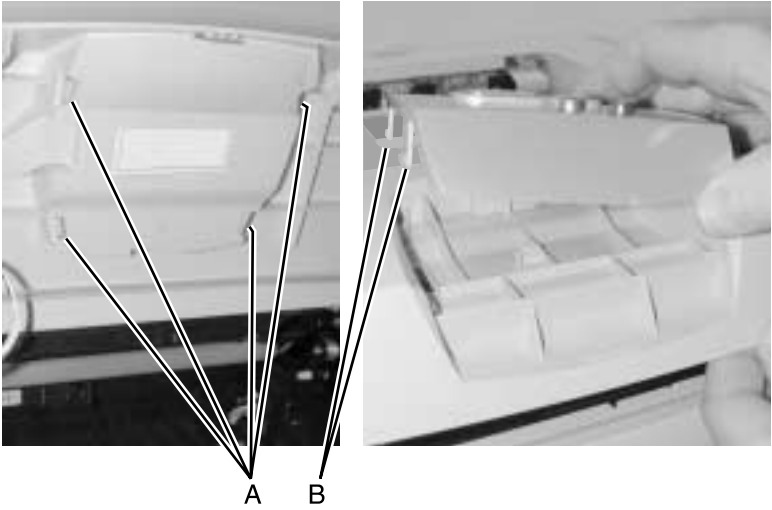

5. Remove the operator panel assembly.

## Duplex tray assembly removal

1. Disconnect the computer and power cables at the back of the printer, if not already removed.
2. Remove the print cartridge.
3. Tilt the printer on its back.
4. Remove the five screws (A) holding the bottom panel.

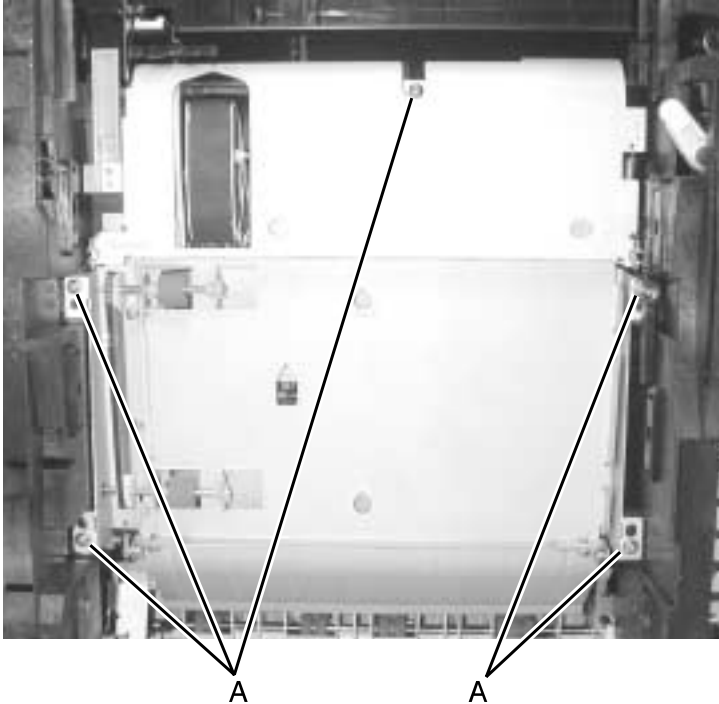

5. Swing the right side away from the printer and disconnect the paper input sensor cable.
6. Remove the duplex assembly.

## Bottom pan removal

This removal is for a model (4048-111) without a duplex unit.

1. Disconnect the computer and power cables at the back of the printer, if not already removed.
2. Remove the print cartridge.
3. Tilt the printer onto its back.
4. Remove the five screws (A) holding the bottom pan.

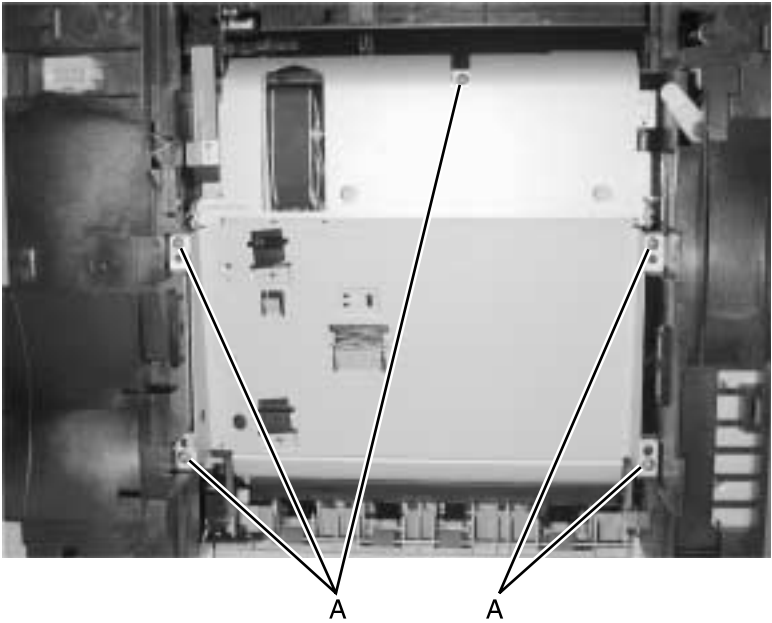

5. Remove the bottom pan.

## Fuser assembly removal



1. Unplug the printer.
2. Remove the left side cover. See **“Left side cover removal” on page 4-14.**
3. Remove the right side. See **“Right side cover removal” on page 4-12.**
4. Remove the rear cover. See **“Rear cover removal” on page 4-15.**
5. Disconnect the thermistor and exit sensor cables (A) at the printer frame to the right of the fuser.
6. Disconnect the fuser from the LVPS (B) on the left side and free the cables from the printer frame.

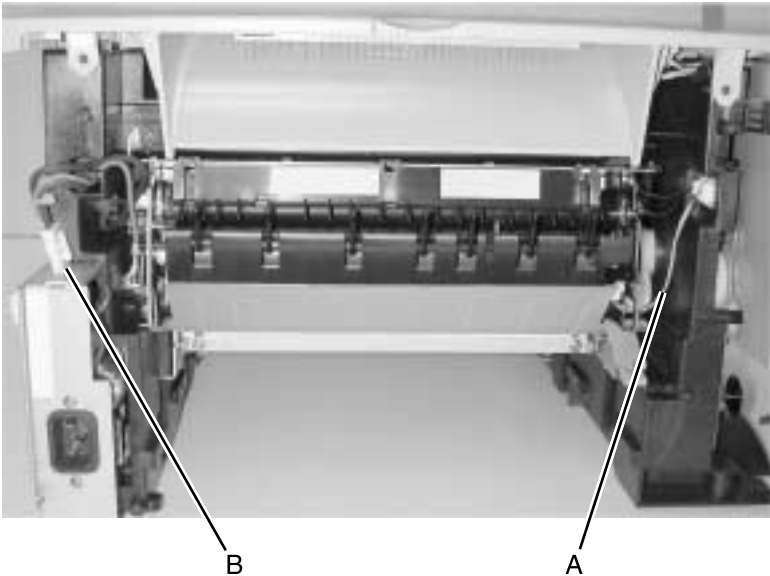

- Using a long shank Phillips screwdriver, remove the four screws (C) which fasten the fuser metal frame to the printer frame.

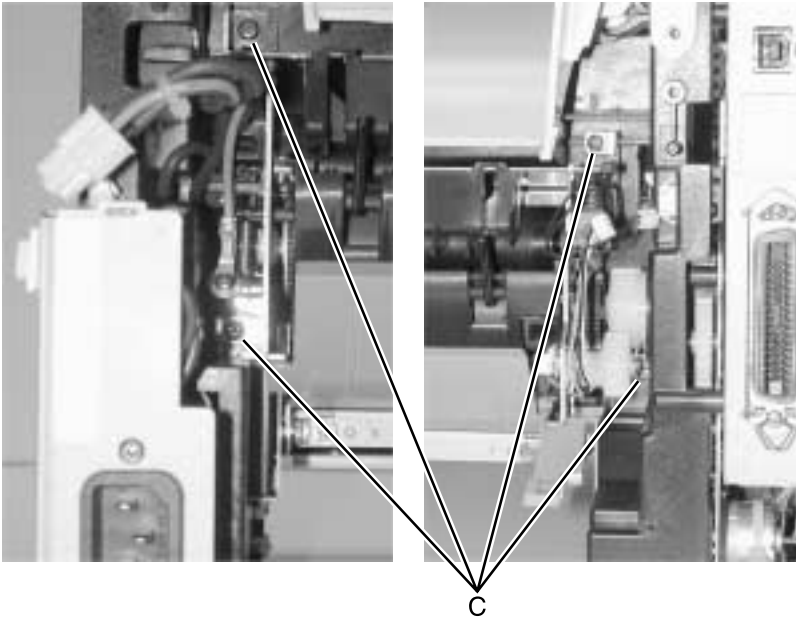

- Carefully slide the fuser out while pressing the duplex diverter. Non-duplex models do not have the diverter. The front cover door must be closed to remove the fuser.



## 4048-1xx

### Installation notes:

- During reassembly of the fuser, keep the front door closed to prevent separation of the roller in the fuser.
- Be sure to route the cables through the frame and through the cable retainer (D).



D

## Fuser paper exit guide assembly removal



1. Unplug the printer.
2. Remove the left side cover. See **“Left side cover removal” on page 4-14.**
3. Remove the right side. See **“Right side cover removal” on page 4-12.**
4. Remove the rear cover. See **“Rear cover removal” on page 4-15.**
5. Using a long shank Phillips screwdriver, remove the four screws (A) which fasten the fuser metal frame to the printer frame.

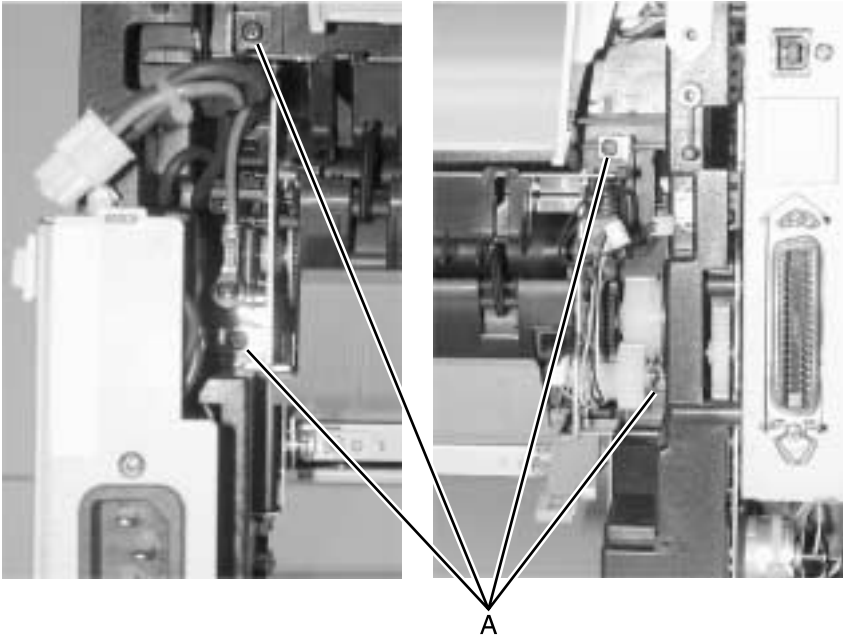

**4048-1xx**

6. Carefully slide the fuser out far enough to reach the screw that holds the exit guide (B). Remove the screw.

**Note:** Insert the screwdriver through the top cover to access the screw with the minimum fuser movement.

If there is a washer between the guide and the fuser, be sure to reinstall the washer.

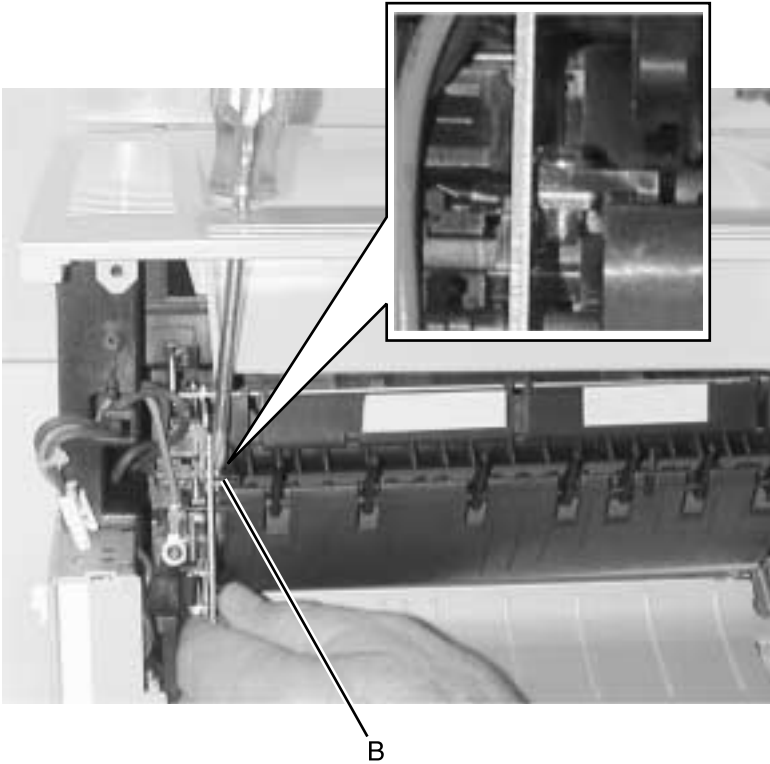



7. Ease the guide back and forth while sliding it to the left and into the opening in the metal frame to allow the right side to disengage from the frame.
8. Swing the right side out enough to clear the metal frame.

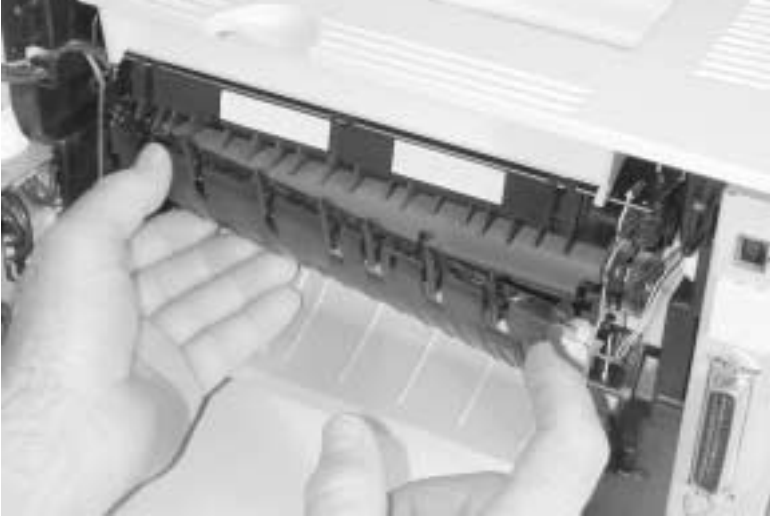

9. Use the springhook to disconnect the spring on the left.

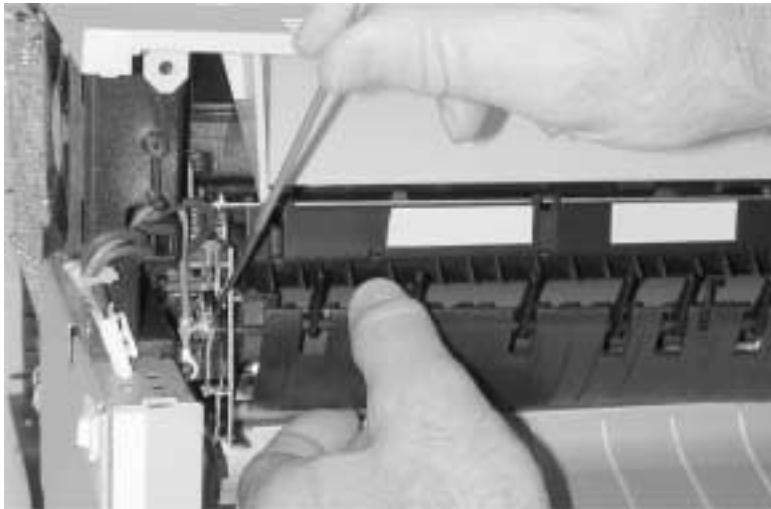

10. Remove the exit guide assembly.

## 4048-1xx

### Installation notes:

- During reassembly of the fuser exit guide assembly, keep the front door closed to prevent separation of the roller in the fuser.
- Be sure to route the cables through the frame and through the cable retainer (C).



C

## Fuser exit sensor removal

1. Remove the fuser paper exit guide. See **“Fuser paper exit guide assembly removal”** on page 4-29.
2. Use your right index finger to push the tangs (A) of the sensor out of the metal frame.

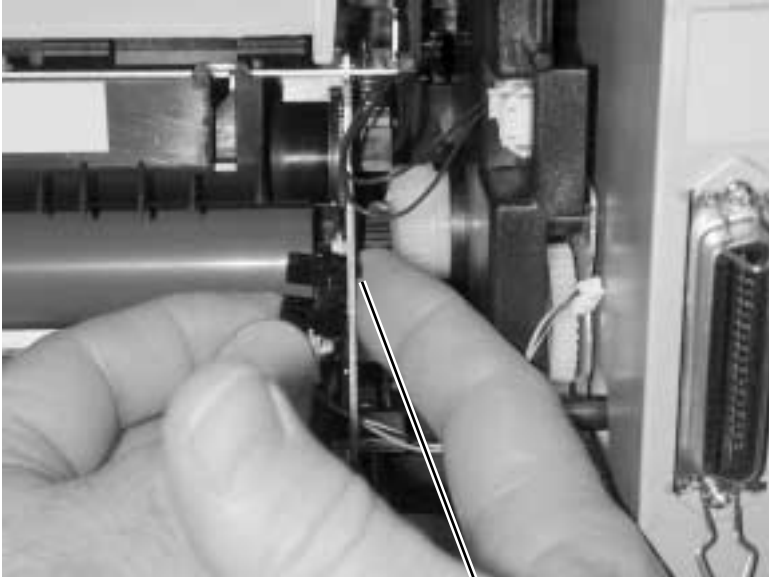

A

3. Disconnect the sensor from the cable and remove.

## Cartridge contact assembly removal

1. Remove the HVPS. See **“HVPS card removal”** on page 4-75.
2. Remove the cartridge contact assemblies (A).

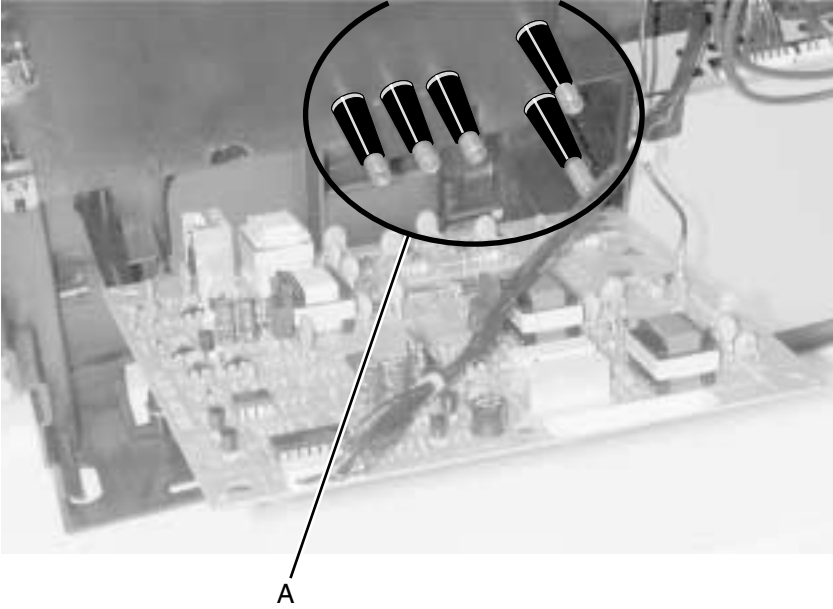

**Note:** The lower right cartridge contact (to the transfer roll) is a different color from the others. Be sure to reinstall this one in the same location.

## Tray damper and spring removal

1. Remove the right side cover. See **“Right side cover removal” on page 4-12.**
2. Remove the tray damper spring from the printer frame post (A).

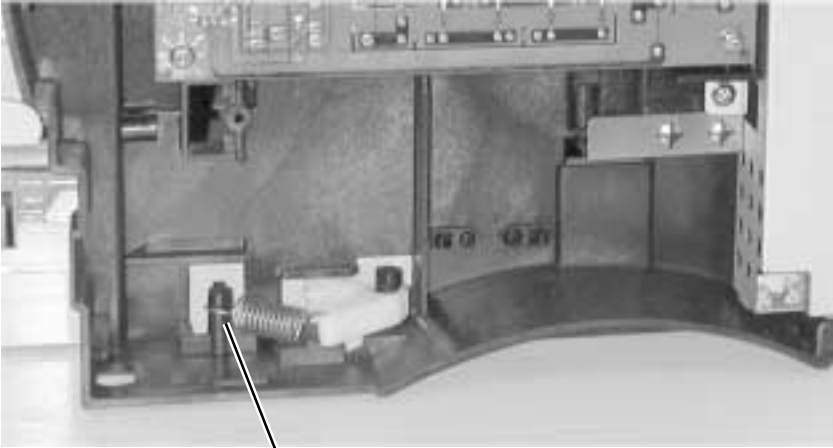

A

3. Rotate the lever counterclockwise as far as possible and lift out.

## Door latch removal

1. Remove the right side cover. See **“Right side cover removal” on page 4-12.**
2. Remove the two screws (A).

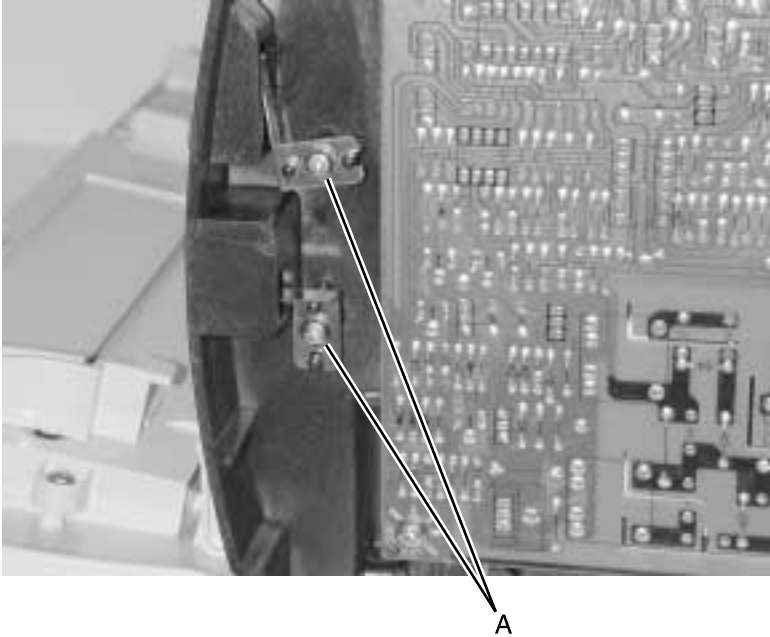

3. Remove the left side cover. See **“Left side cover removal” on page 4-14.**
4. Remove the latch on the left side.

## Paper guide roller removal

1. Remove the HVPS. See **“HVPS card removal”** on page 4-75.
2. Remove the print cartridge.
3. Remove the upper body MPF assembly. See **“Upper MPF housing assembly (with paper flag) removal”** on page 4-66.
4. Unsnap the latch, which is part of the roller hub (A).

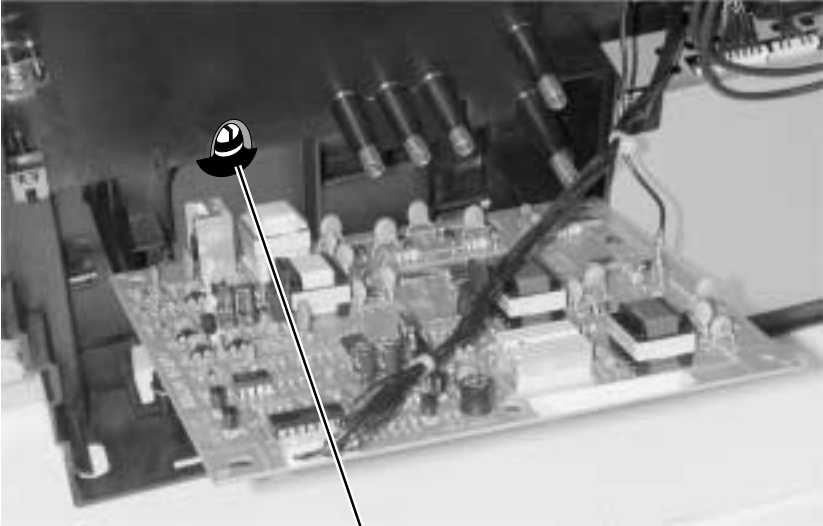

A

5. Remove the paper guide roller.

## Charge roll removal

**Warning:** Handle the charge roll only at the ends and with clean dry hands. Otherwise, use a piece of paper between the charge roll and your fingers.

1. Grasp the charge roll on the right end. Hold the front cover as closed as possible while *unsnapping* the charge roll in the direction of the arrow. The arrow is located to the right of the charge roll assembly.



2. After the right side is *unsnapped* from the bearing, slide the roll from the left side bearing.

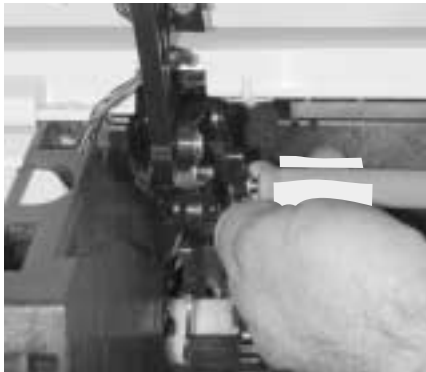



## Right guide removal

1. Remove the top cover. See **“Top cover assembly removal” on page 4-11.**
2. Remove the HVPS. See **“HVPS card removal” on page 4-75.**
3. Remove the charge roll. See **“Charge roll removal” on page 4-38.**
4. Remove two screws in the right guide (above and behind the HVPS).
5. Unsnap the three latches of the right guide.
6. Remove the right guide.

## Left guide removal

1. Remove the controller card cage. See **“Controller card cage (with card in place) removal”** on page 4-48.
2. Remove the charge roll. See **“Charge roll removal”** on page 4-38.
3. Remove the top cover assembly. See **“Top cover assembly removal”** on page 4-11.
4. Remove the three screws as shown (A).
5. Press the three latches (B) while separating the left guide from the frame.

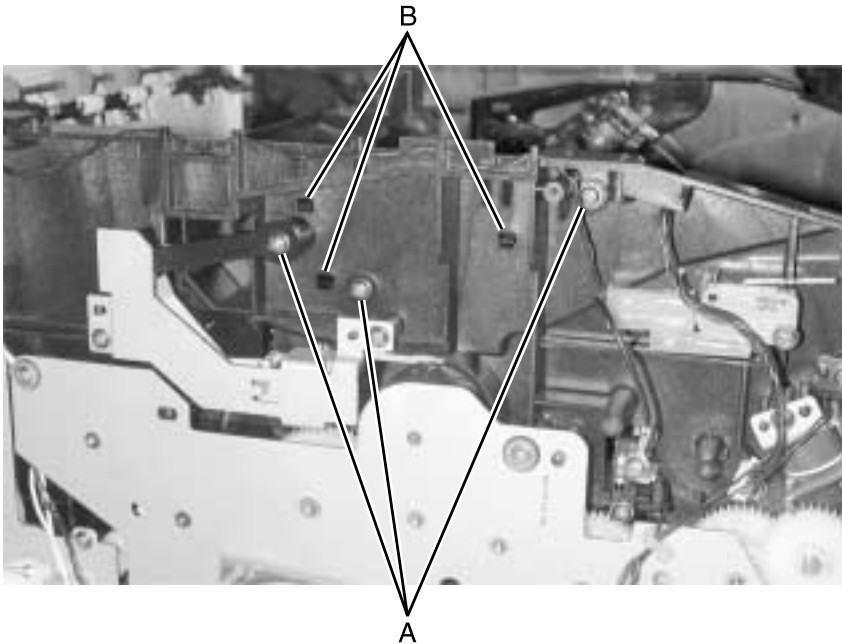

6. Remove the HVPS. See **“HVPS card removal”** on page 4-75.

7. Disconnect the single conductor cable (spade connector) (D).

**Note:** Removal of the printhead is not necessary but gives better visibility and access. Illustrations are with the printhead removed. See **“Printhead removal” on page 4-46.**

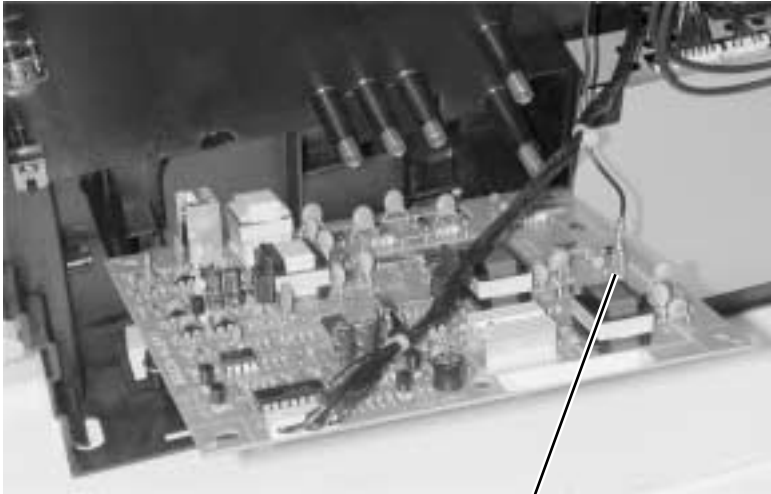

D

8. Remove the cable from the retainers between the printer right side and the left guide.
9. Remove the left guide.

## Cartridge signature button sensor removal

1. Remove the gear train assembly. See **“Main drive assembly removal” on page 4-55.**
2. Remove the two screws and the bracket coupling assembly.
3. To protect the charge roll from touching, either remove it (see **“Charge roll removal” on page 4-38**) or cover it with a sheet of paper.
4. Remove the screw holding the cartridge signature button sensor (A).
5. Remove the two screws in the cable cover retainer (B).

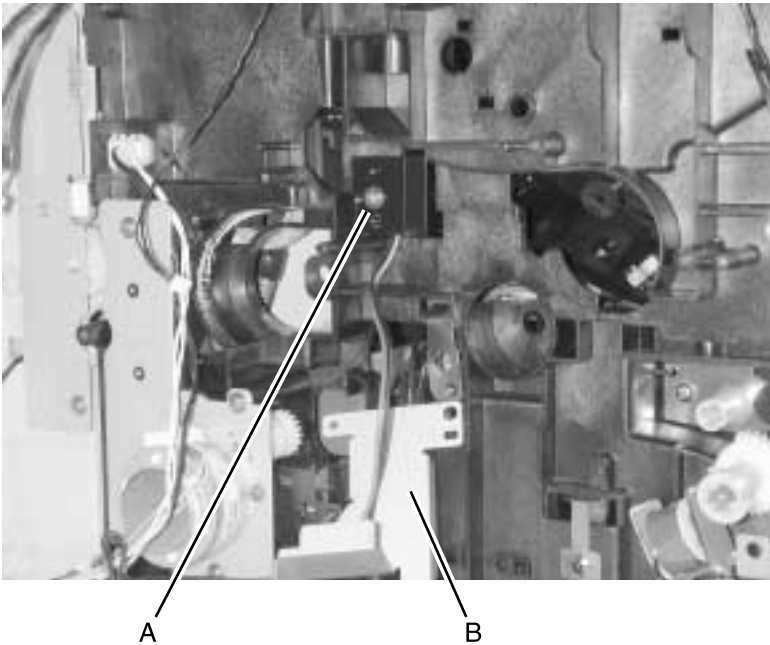

6. Remove the sensor.

**Note:** Unplug the thermistor cable to remove the cartridge signature button sensor. Both share the same connector at J18.

## Transfer roll assembly

**Note:** Do not touch the transfer roll except on the ends.

1. Unlatch and lift the left transfer support bearing.

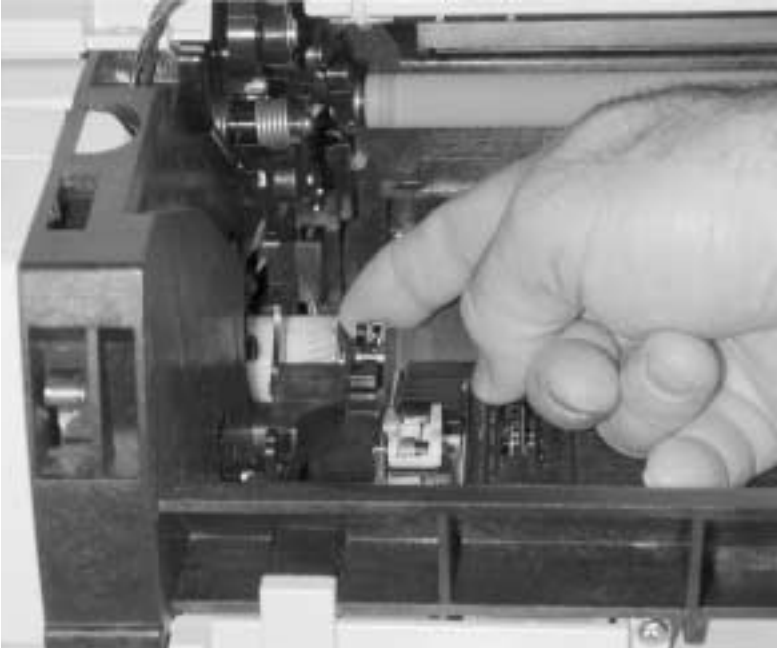

2. Unlatch and lift the right transfer support bearing.
3. Remove the transfer roll.

**Note:** After reinstalling the transfer roll, use a thin screwdriver to push the copper tab on the right side fully into the slot.

**Note:** Always check the bottom margin following a transfer roll replacement. See **“REGISTRATION” on page 3-4.**

## Bracket, paper detect (input sensor) removal

1. Remove the print cartridge to expose latches in the bracket. Leave the door open.
2. Remove the duplex tray assembly (see **“Duplex tray assembly removal” on page 4-24**) or bottom pan in the simplex model (see **“Bottom pan removal” on page 4-25**).
3. Disconnect the cable to the sensor or remove the sensor and cable together.
4. Unlatch the bracket by pushing from inside the printer and pulling from the duplex side.

## D-roll feed removal, tray 1

1. Remove the duplex tray. See **“Duplex tray assembly removal” on page 4-24**. In a non-duplex printer, remove the bottom plate. See **“Bottom pan removal” on page 4-25**.
2. Disconnect extension spring (A) from the D-roll.
3. Using a flat-blade screwdriver as a wedge between the D-roll and bearing wall, force the D-roll to unsnap from the shaft.
4. Disengage the D-roll from the shaft (B) until the D-roll can be rotated to allow clearance for removal.

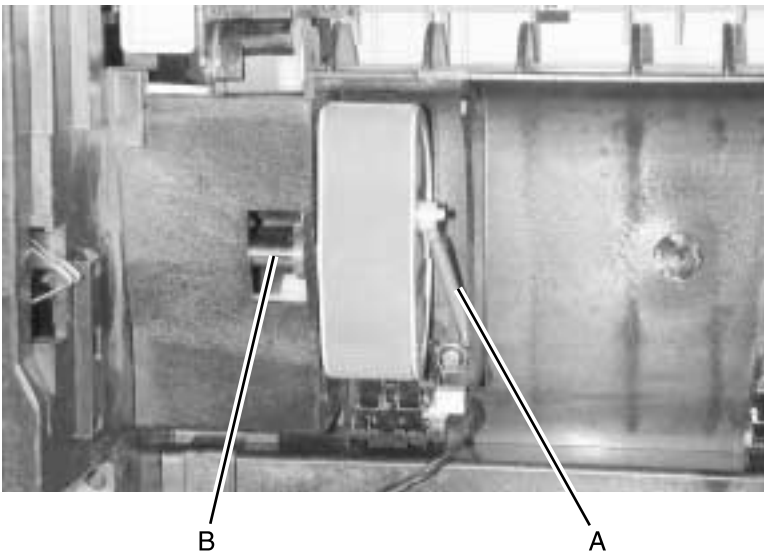

## D-roll shaft assembly removal, tray 1

1. Remove the left side cover. See **“Left side cover removal” on page 4-14.**
2. Remove the gear train assembly. See **“Main drive assembly removal” on page 4-55.**
3. Remove the screw and solenoid (A).
4. With the printer on its back, remove the D-roll. See **“D-roll feed removal, tray 1” on page 4-44.**

**Note:** Slowly remove the shaft (B) while facing the D-roll end (see **page 4-44**). Capture the small washer and the bearing. The bearing must be removed and the new one reinserted through the opening adjacent to its operating location.

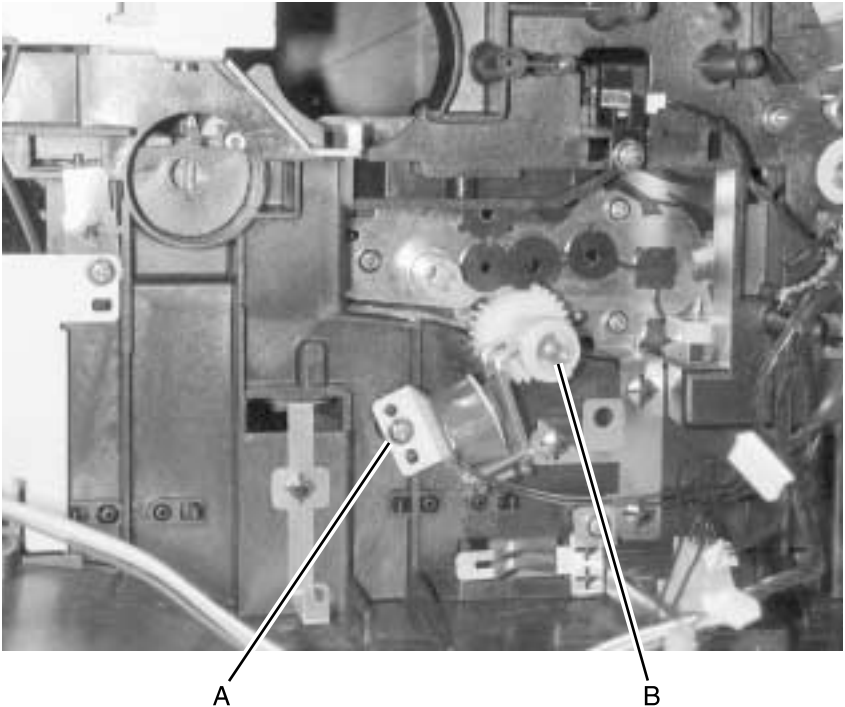

### 3-pin and 2-pin connectors removal

1. Remove the controller card cage. See **“Controller card cage (with card in place) removal”** on page 4-48.
2. Remove the rear cover. See **“Rear cover removal”** on page 4-15.
3. Unplug the wires on both sides of the connectors.
4. Unsnap connectors and remove toward the controller card side.

### Printhead removal

1. Open the front cover.
2. Remove the two screws fastening the top cover to the printer frame (A).

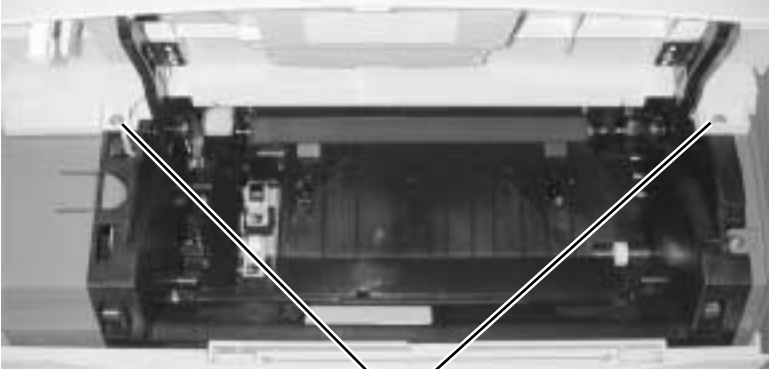

A

3. Open the rear exit tray and remove the upper left and right screws fastening the top cover to the printer frame (B).



B



4. Lift the rear part of the top cover to clear the output tray full flags.

You do not have to disconnect the top cover from the left and right guides to access the printhead.

5. Use a sharp pencil or other tool to mark the position of the printhead on the frame for re-alignment at installation.
6. Remove the three screws holding the printhead (C).
7. Remove the printhead.
8. Disconnect the printhead cables (D).

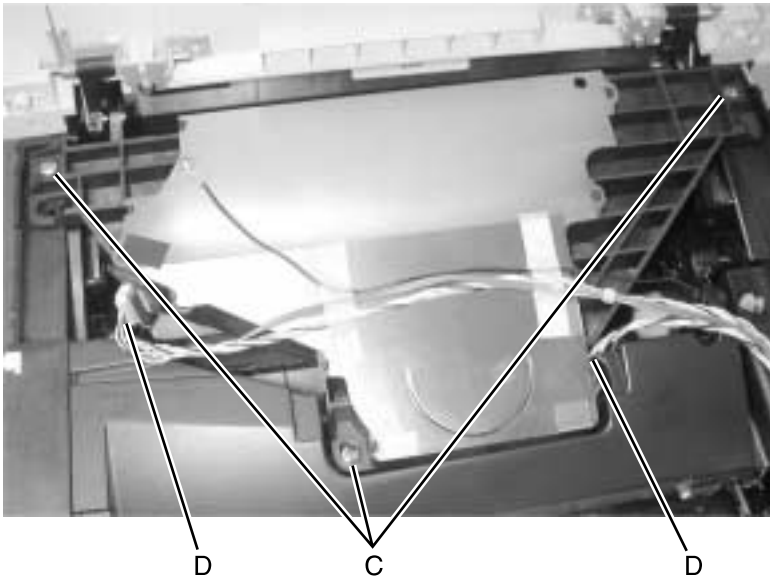

**Note:** When reinstalling the printhead, check the alignment of the printhead to the frame and perform the **“Printhead assembly adjustment”** on page 4-2 before reinstalling the top cover.

## Controller card cage (with card in place) removal

1. Remove the left side cover. See **“Left side cover removal” on page 4-14.**
2. Remove the four screws that fasten the top cover to the frame. See **“Top cover assembly removal” on page 4-11.**
3. Remove the screw (A) and remove the inner shield.
4. Loosen the five screws (B) in the controller card cage cover and slide the cover to the rear and remove it.

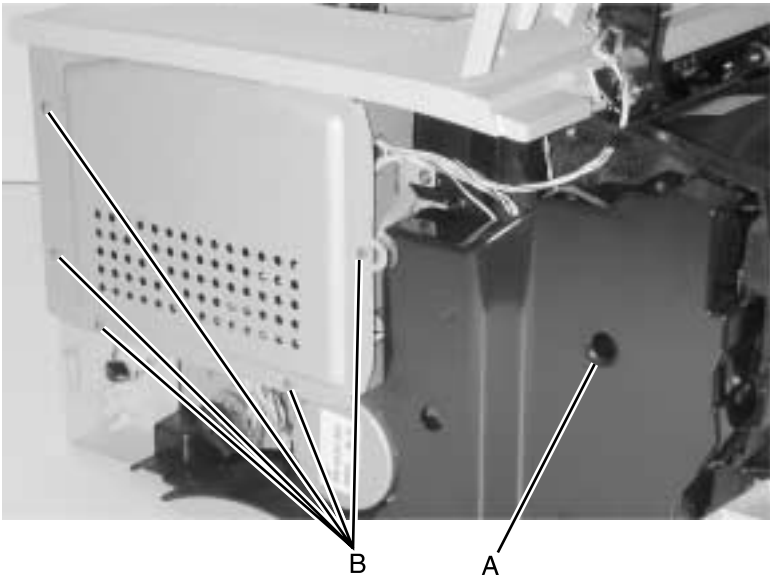

5. Disconnect all cables from the controller card assembly.
6. Remove the three screws (C) in the controller card and one at the front face of the cage.

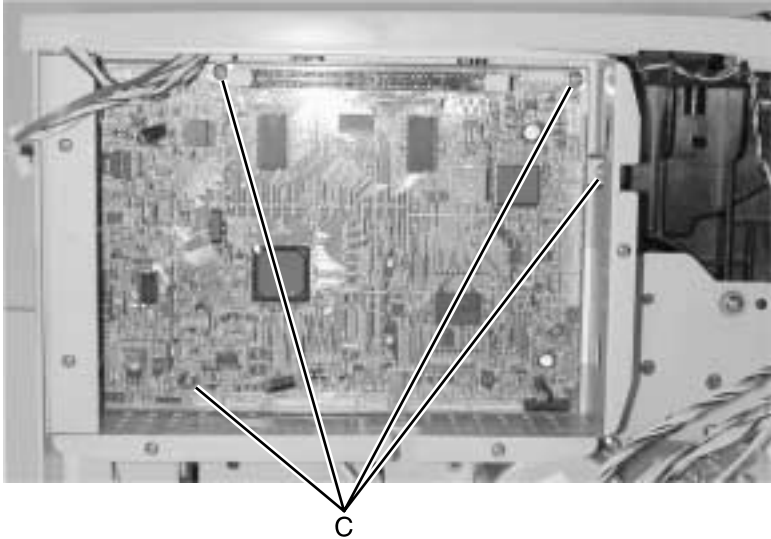

7. Gently pull the bottom of the cage out and lift up and off the two posts at the top.

## Controller card assembly removal

**Warning:** Never replace both the operator panel and controller card at the same time. Otherwise, some critical settings will be permanently lost.

1. Remove the left side cover. See **“Left side cover removal” on page 4-14.**
2. Remove the screw (A) and remove the inner shield.
3. Loosen the five screws (B) in the controller card cage cover and slide the cover to the rear and remove it.

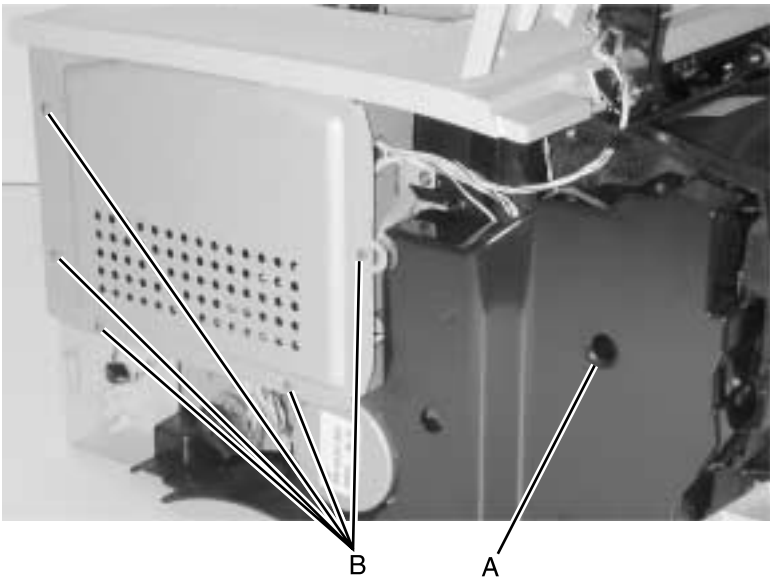

4. Disconnect all cables and extract the ones from the right side and bottom of the cage.
5. Remove the four screws on the face of the card (D) and three screws on the back holding the USB and parallel port connectors (E).

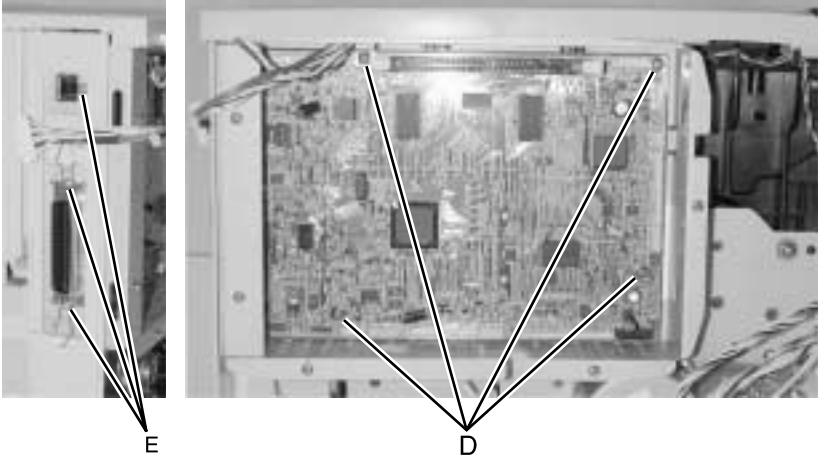

6. Remove the card by rotating the front of the controller card from the cage and sliding the card to the right.

## MPF gear removal

1. Remove the left side cover. See **“Left side cover removal”** on page 4-14.
2. Remove the inner shield.
3. Lift the solenoid arm (A) to release the gear.
4. Rotate the main motor (B) counterclockwise until the gear clears the main motor drive bracket (C)
5. Pull the latch (D) away from the shaft and slide the gear off the shaft.

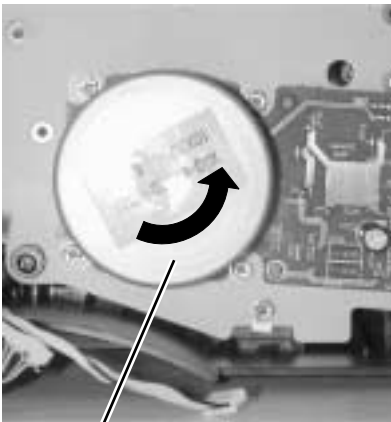

B

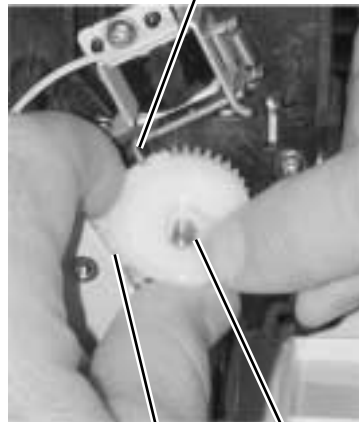

C

D

## Main drive motor assembly removal

1. Remove the left side cover. See **“Left side cover removal” on page 4-14.**
2. Remove the screw (A) and remove the inner shield.

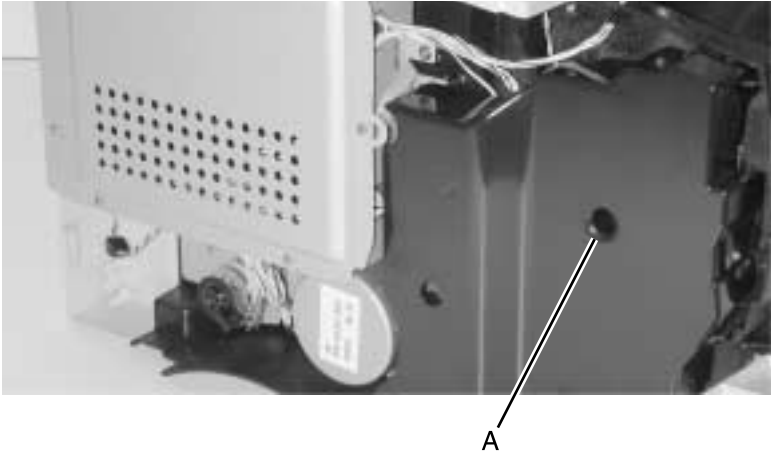

**4048-1xx**

3. Disconnect the cable (B) to the card for the drive motor.
4. Remove the four screws (C) holding the metal base plate to the gear train assembly.

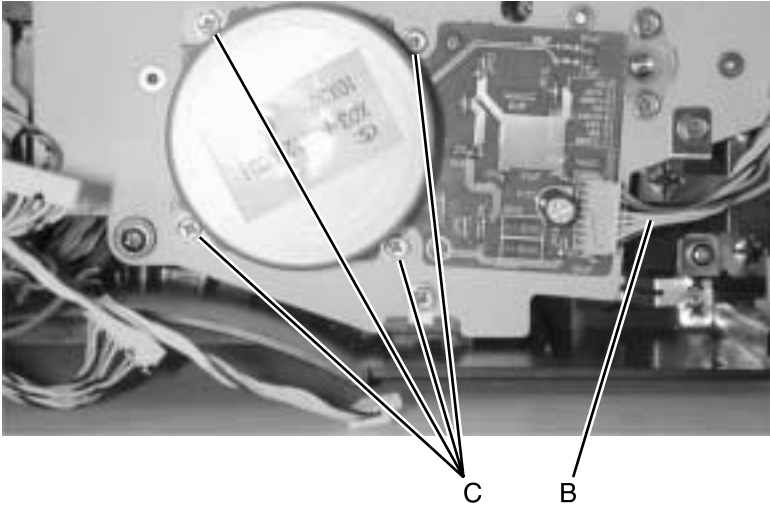

5. Remove the motor assembly.

**Note:** Be very careful when reinstalling the motor. Do not allow the motor drive shaft to touch the mating gears until the shaft is fully inserted. Install one screw and confirm the motor is seated against the drive plat before installing the remaining screws.



## Main drive assembly removal

1. Remove the controller card cage. See **“Controller card cage (with card in place) removal”** on page 4-48.
2. Remove the inner shield by removing the screw (A).

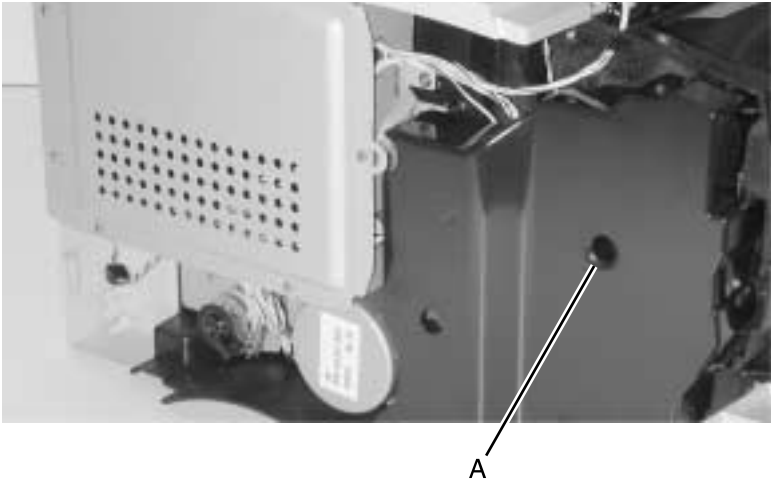

3. Release the solenoid latch (B).
4. Rotate the drive motor until the MPF gear clears the drive gear bracket.

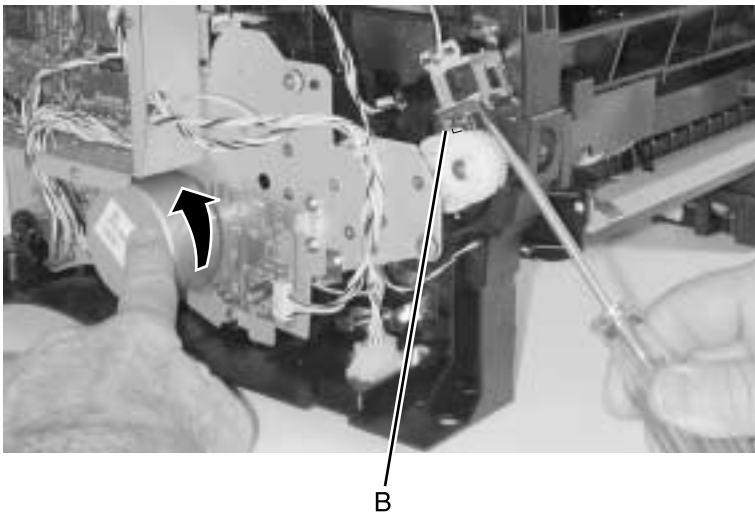

**4048-1xx**

5. Pull the latch (C) away from the shaft and slide the gear off the shaft.

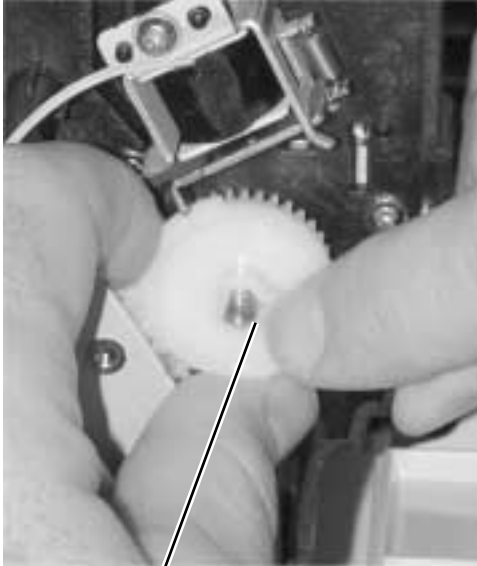

C

6. Remove the cables from the two cable clamps on the right side of the gear drive.

7. Remove the six screws (D) in the gear train assembly.
8. Disconnect the drive motor cable.
9. Remove the two screws (E) and the plastic bearing at the upper right corner of the main drive motor. This allows more movement for the gear assembly.

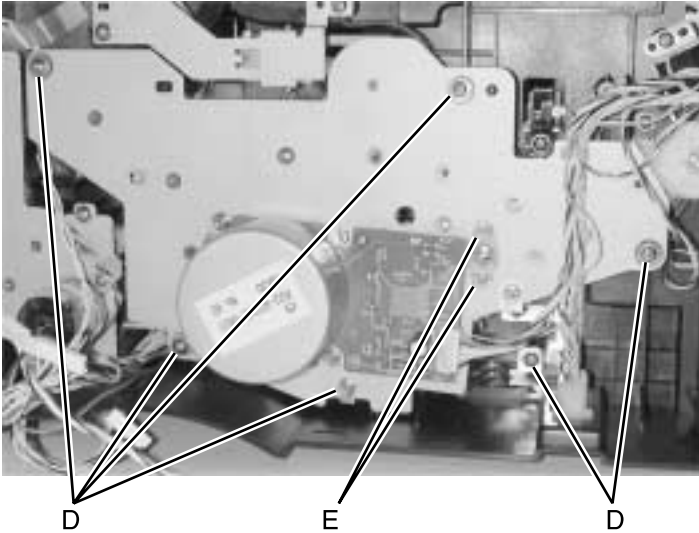

10. Gently lift and work the gear train assembly out.

## Exit drive motor removal

1. Remove the left side cover. See **“Left side cover removal”** on page 4-14.
2. Loosen the five screws (A) in the controller card cage cover and slide the cover to the rear and remove it.

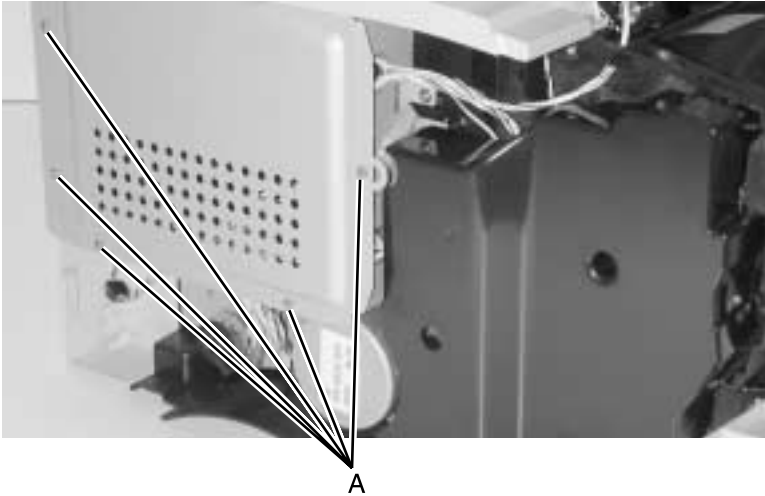

3. Disconnect the exit motor cable at J6 (upper right side of controller card).
4. Remove the two screws (B). The controller card cage does not have to be removed.

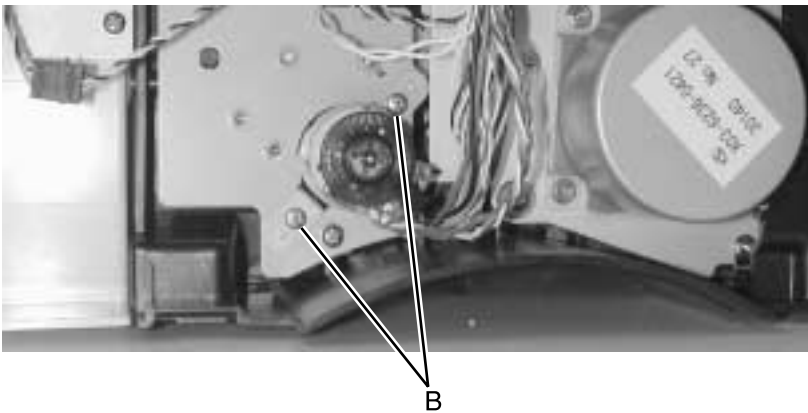

5. Slide the motor out.

## Exit drive assembly removal

1. Remove the controller card cage. See “**Controller card cage (with card in place) removal**” on page 4-48.
2. If replacing the drive assembly, remove the exit drive motor. See “**Exit drive motor removal**” on page 4-58.
3. Remove three screws (A) and the screw holding the ground strap (B).

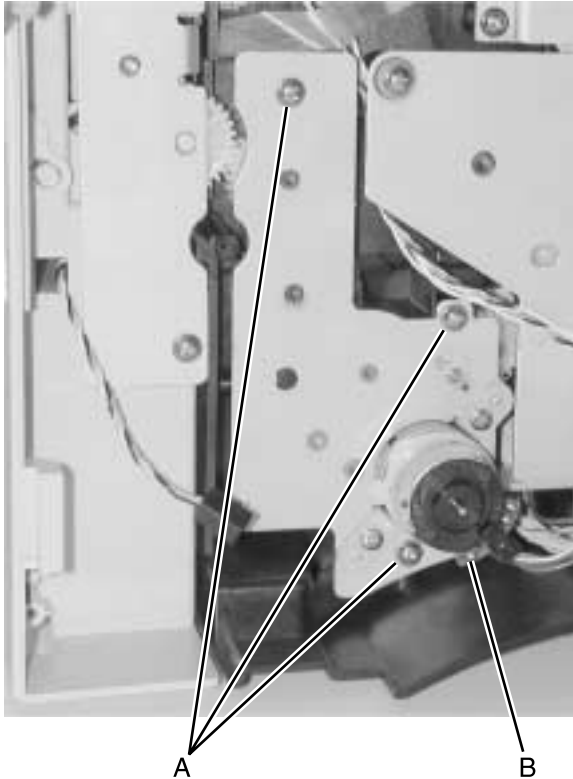

4. Remove the assembly. Be careful to avoid dropping the ratchet drive gears from the back of the exit drive assembly.
5. If the exit drive is being replaced, remove the motor assembly and install it on the new drive.

**Note:** Reinstall the ratchet drive before you reinstall the assembly.

**Note:** Be sure to reattach the ground strap (B) when you reinstall the assembly.

## Ratchet drive removal

1. Remove the exit drive assembly. See **“Ratchet drive removal” on page 4-60.**
2. Gently remove the ratchet drive (A) from the back of the exit drive assembly.
3. Remove the bushing (B) from the exit drive assembly.

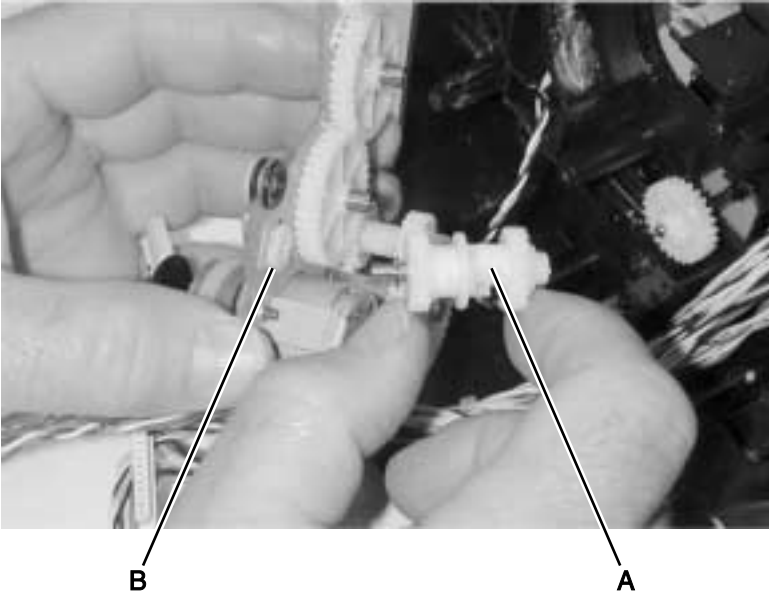

**Installation:**

1. Place the printer on the right side.
2. Install the bushing (C), aligning it with the slots.

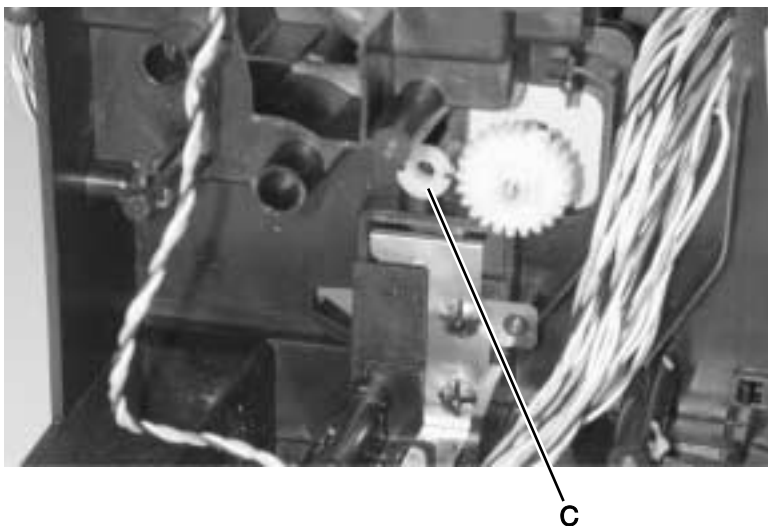

3. Insert the ratchet.

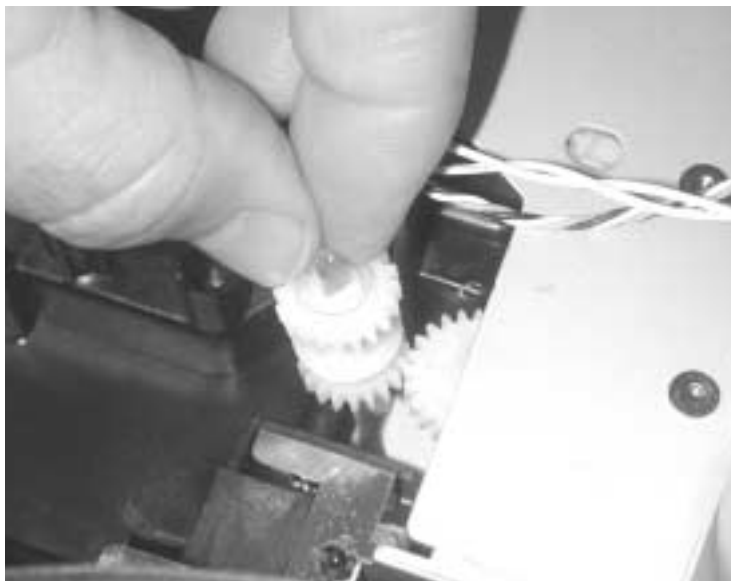

4. Complete the installation of the exit drive.

## Reference feed assembly removal

1. Remove the gear train assembly. See **“Main drive assembly removal” on page 4-55.**
2. Remove the three screws (A) fastening the assembly plate to the frame.

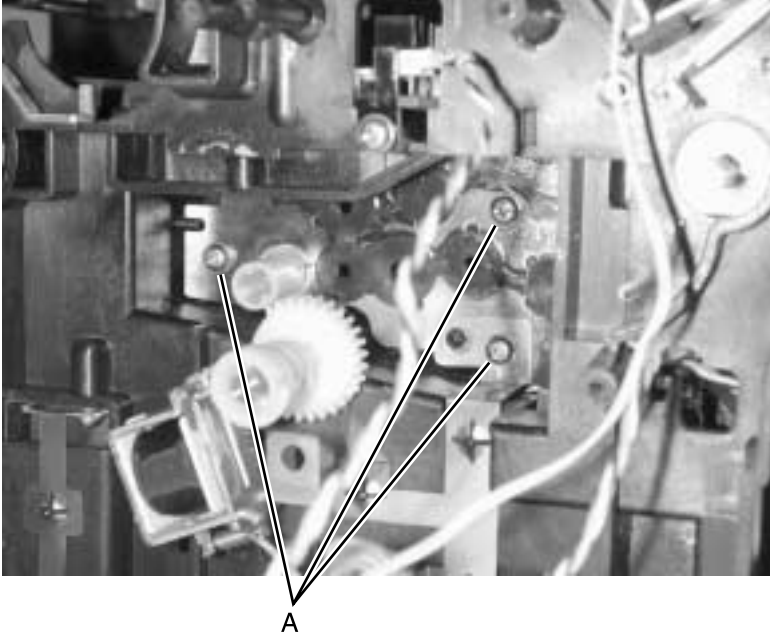

3. Remove the MPF door cover. See **“MPF door cover removal” on page 4-8.**
4. Remove the lower body MPF assembly. See **“MPF paper sensor removal” on page 4-67.**



5. Remove the two screws (B) holding the upper body MPF assembly, and carefully lift the assembly out.

**Note:** A sensor flag is attached below the upper body.

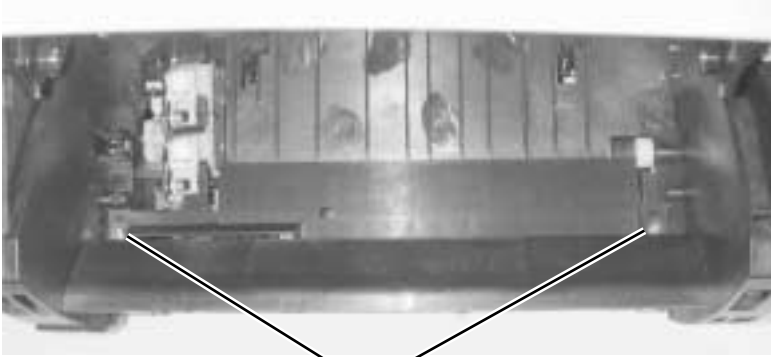

B

6. Remove the screw (C) and inside cover which is adjacent to the assembly plate.



C

7. Remove the MPF pick roller assembly. See **“MPF pick roller assembly removal”** on page 4-73.

## 4048-1xx

8. Remove the reference feed assembly through the front of the printer.



### Installation note:

When a reference feed (reference edge) assembly is removed, reinstallation requires alignment. Use a long shank (approximately 6 inches) Phillips screwdriver to adjust the rear screw holding the assembly in place. Access the adjusting screw through the hole in the main drive assembly between the controller card cage and the main motor board. Adjusting the screw counterclockwise rotates the paper counterclockwise in the printer path resulting in the image appearing clockwise on the paper.

## Cartridge coupling assembly removal

1. Remove the left cover. See “**Left side cover removal**” on **page 4-14**.
2. Remove the controller card cage. See “**Controller card cage (with card in place) removal**” on **page 4-48**.
3. Remove the two screws (A).

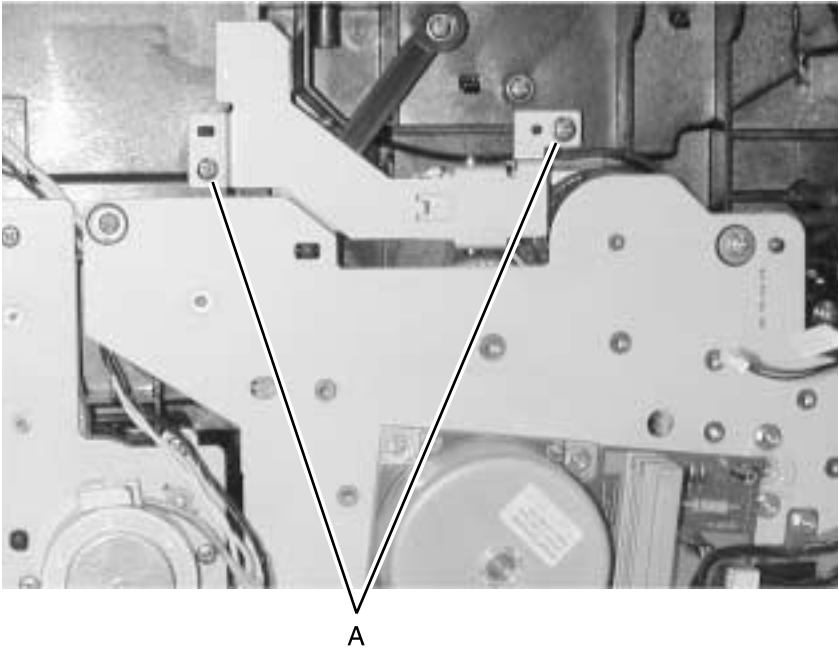

4. Remove the bracket.

**Note:** The print cartridge coupling may need to be compressed during removal.

## Upper MPF housing assembly (with paper flag) removal

1. Open the front cover.
2. Remove two screws (A) holding the assembly.

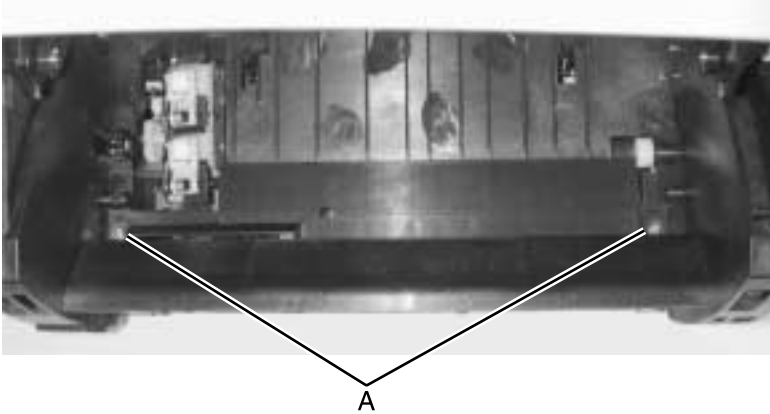

3. Carefully lift the assembly out.

**Note:** A sensor flag is attached below the housing.

## MPF paper sensor removal

See the **“MPF paper sensor installation:” on page 4-69** for information about installing the FRU.

1. Remove the MPF door cover. See **“MPF door cover removal” on page 4-8.**
2. At the lower right assembly hinge, use a flat blade screwdriver to separate the metal plate from the plastic housing.



**4048-1xx**

3. Support the left side with the left hand while separating the left hinge.

**Note:** There is a loaded compression spring (A) on the left side and under the metal plate. Note the location before removing the spring.

4. Rotate the metal plate until you can access the sensor (B).
5. Push the latches underneath the sensor and housing and disconnect the cable to the sensor.

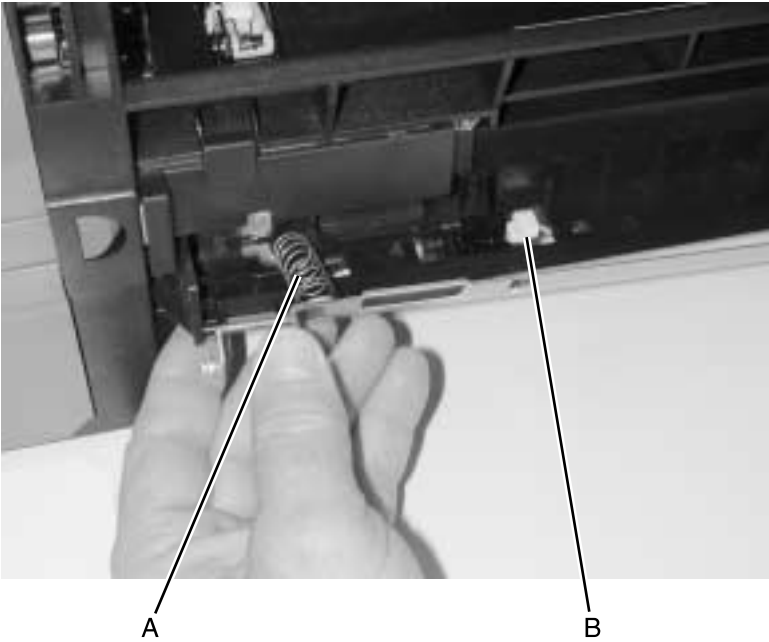

**MPF paper sensor installation:**

To verify the spring is correctly reinstalled:

1. Reinstall the metal plate. Make sure the compression spring (A) is in the proper location and captured at its ends.
2. Release the solenoid latch (A).
3. Rotate the main motor counterclockwise until the gear arm engages the solenoid latch. The metal plate (B) raises and lowers as the latch engages and releases the drive to rotate.

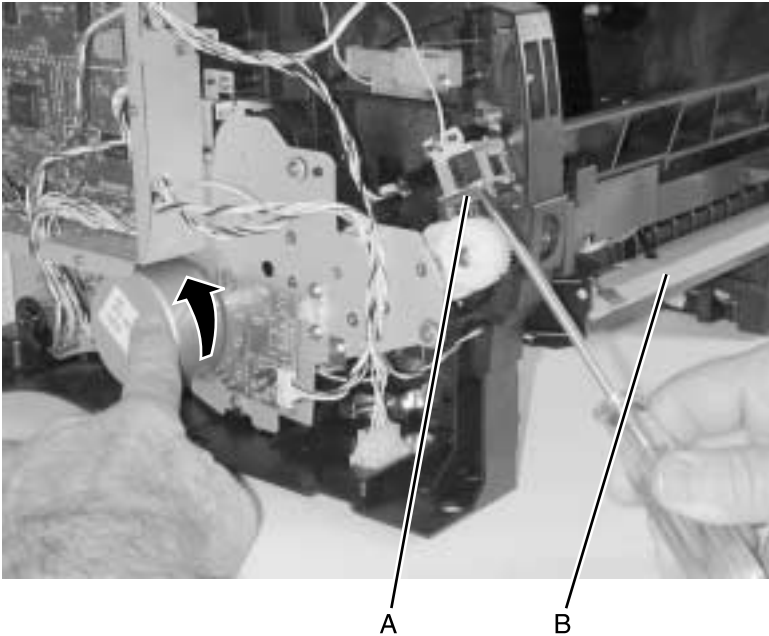

## Lower MPF housing assembly removal

1. Remove the MPF door cover. See **“MPF door cover removal” on page 4-8.**
2. Remove the left side cover. See **“Left side cover removal” on page 4-14.**
3. Remove the inner shield (A).
4. Loosen the five screws (B) to slide the controller card cage cover to the rear to remove.

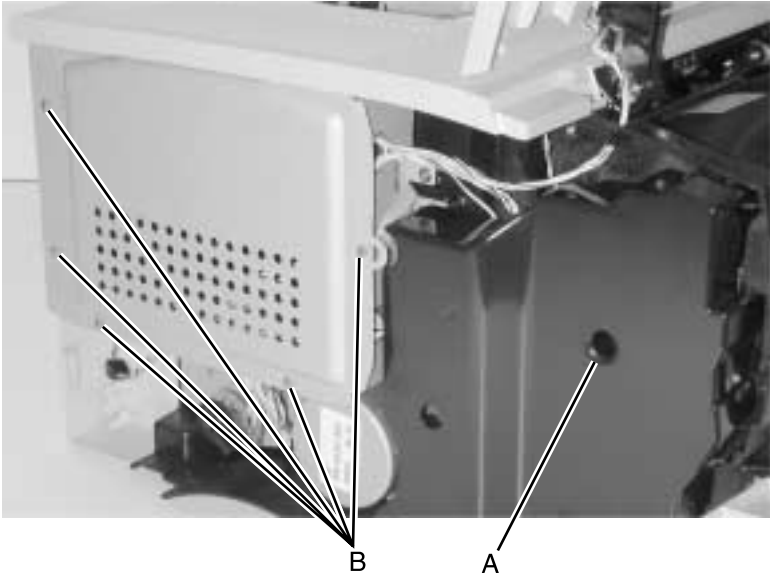



5. Disconnect the MPF cable on the right side of the controller card (C) and the toner level sensor (D).

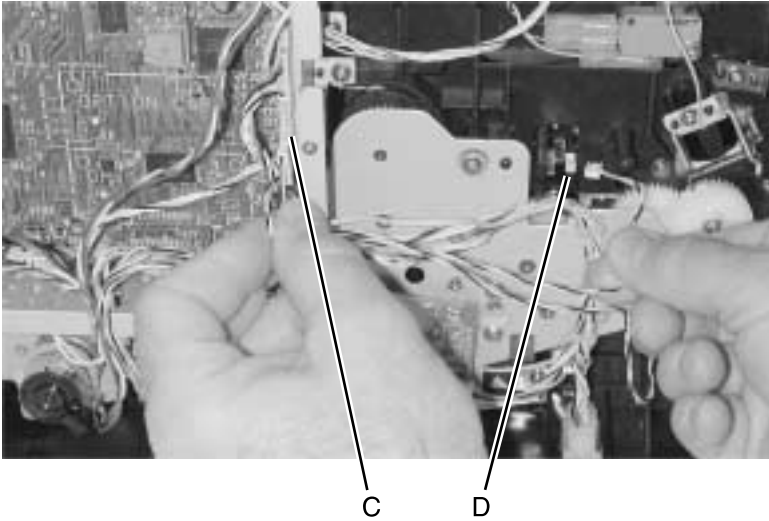

6. Remove the three screws (E) on the front of the lower body MPF assembly and gently remove the assembly.

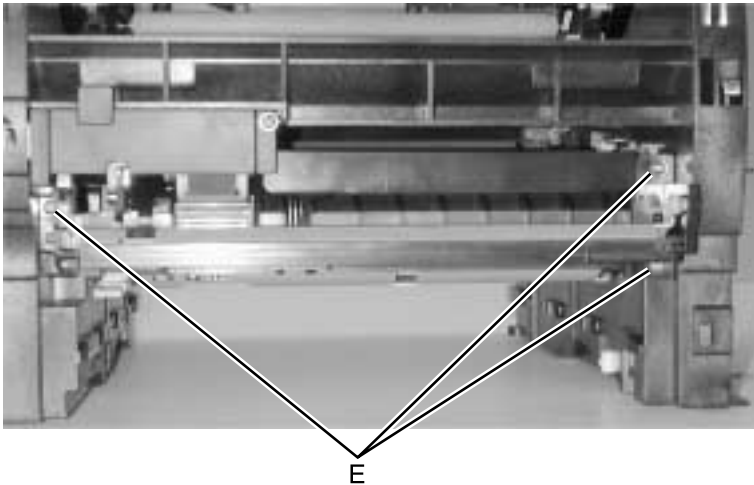

## Backup feed roller assembly removal

1. Using a flat-bladed screw driver and springhook, release the spring (A) from the metal anchor.

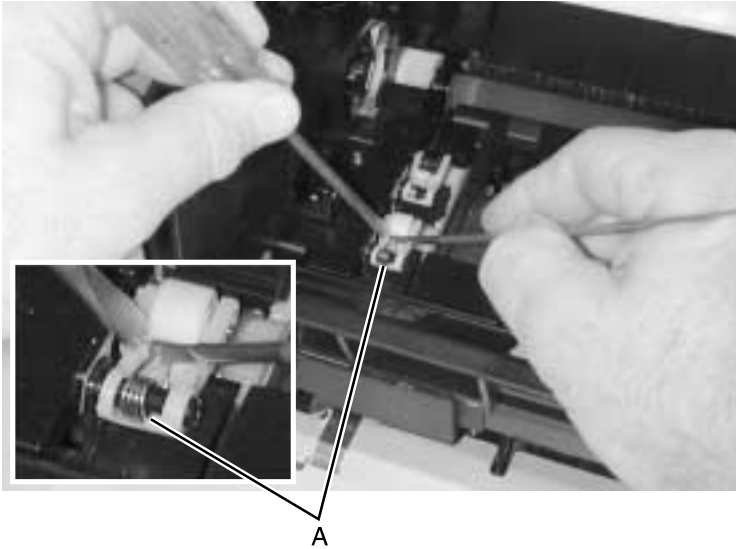

2. With the screwdriver, remove the backup feed roller assembly.



**Note:** A third assembly is below the upper MPF housing. When one assembly needs replacing, replace all three assemblies one at a time. The assembly with the black roller should be installed in the back, farthest from the door.

## MPF pick roller assembly removal

1. Remove the left side cover and inner shield. See **“Left side cover removal” on page 4-14.**
2. Remove the roller cover, one screw. See **“Lower MPF housing assembly removal” on page 4-70.**
3. Pull the latch (A) away from the shaft and slide the gear off.

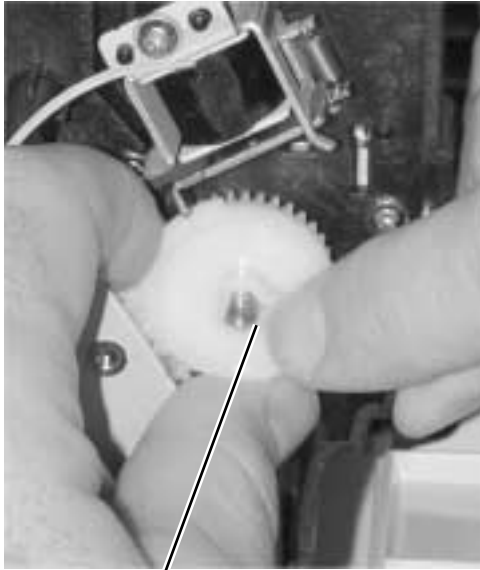

A

**4048-1xx**

4. Remove two screws (B) holding the roller assembly and one screw (C) facing the front of the printer.

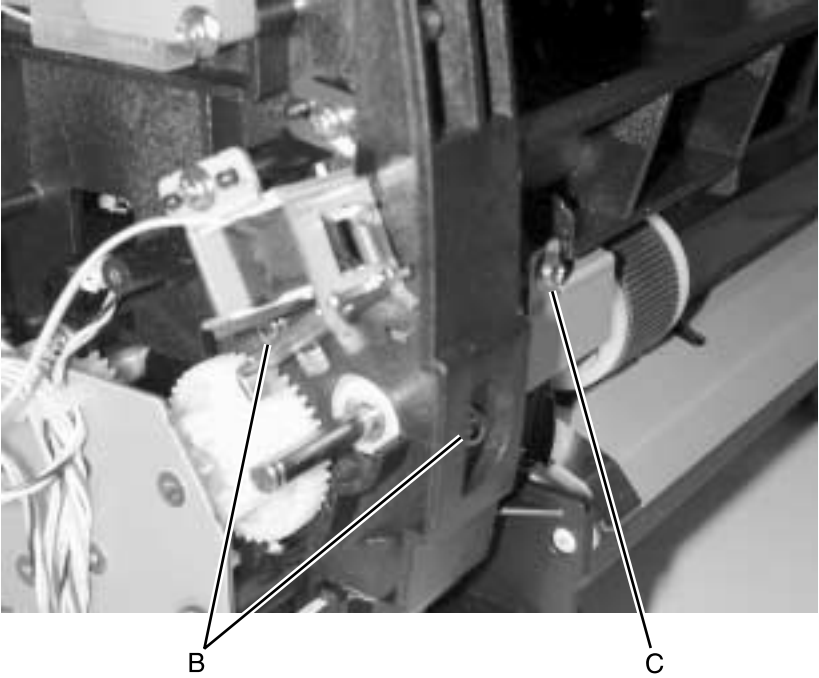

5. Remove the roller assembly.

**Note:** Push the MPF plate down to give clearance.

**Warning:** When reinstalling, replace the two screws (B) first and then the front screw (C).

## HVPS card removal

1. Remove the right side cover. See **“Right side cover removal” on page 4-12.**
2. Disconnect the HVPS cable at the top left corner of the board.
3. Remove the four screws (A).

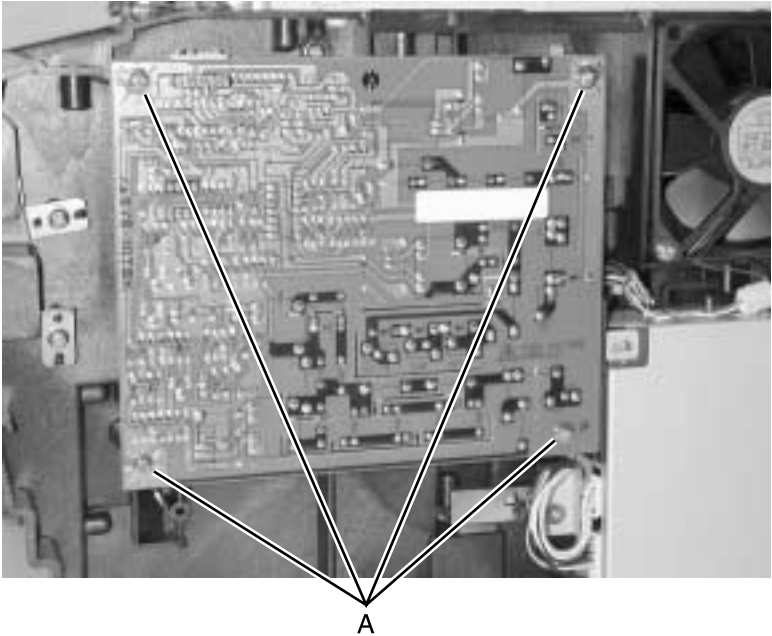

4. Disconnect the charge roll cable (spade connector).
5. Remove the HVPS card.

## LVPS fan removal

1. Remove the right side cover. See **“Right side cover removal” on page 4-12.**
2. Disconnect the fan (A).
3. Remove the two screws (B).

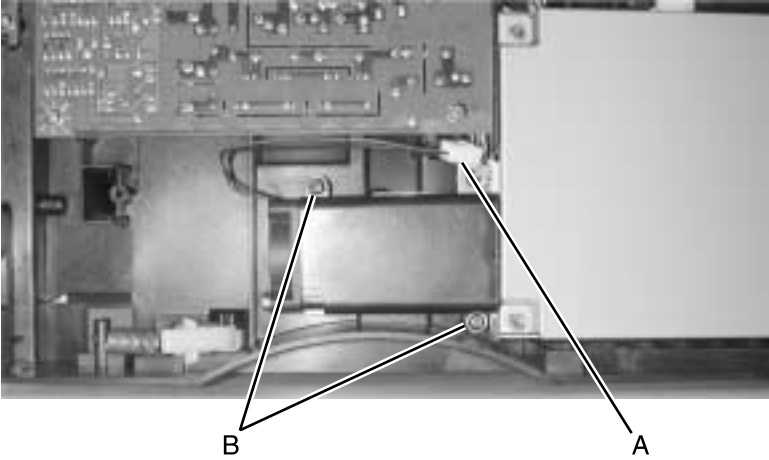

4. Remove the LVPS fan.

## LVPS card removal



1. Unplug the printer.
2. Remove the right side cover. See **“Right side cover removal” on page 4-12.**
3. Remove the LVPS fan. See **“LVPS fan removal” on page 4-76.**
4. Disconnect all cables attached to the LVPS card.  
The fuser connector has a latch on the back side. If it cannot be reached, complete steps 5 and 6 first.
5. Remove the four screws (A).

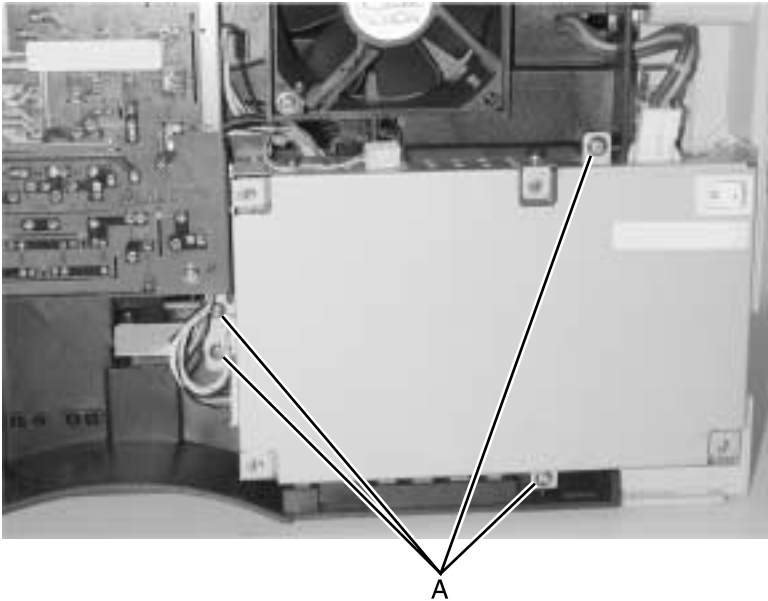

6. Remove the LVPS.

## Inner link and outer link assembly removal

**Note:** Links are shown in light color for visibility. They are actually dark in color.

1. Remove the controller card cage. See **“Controller card cage (with card in place) removal” on page 4-48.**
2. Remove the fuser. See **“Fuser assembly removal” on page 4-26.**
3. Remove the charge roll. See **“Charge roll removal” on page 4-38.**
4. Remove the remaining screws fastening the top cover and tilt the cover forward onto the front cover.
5. Remove the screw behind the card cage which holds the outer link assembly and the inner link together.
6. Remove the screw behind the card cage, which fastens the link guide to the left guide assembly.



7. Use a flat blade screwdriver to wedge the charge roll arm from the left guide assembly and remove the inner link.



**4048-1xx**

8. Remove the bellcrank while holding the link guide.

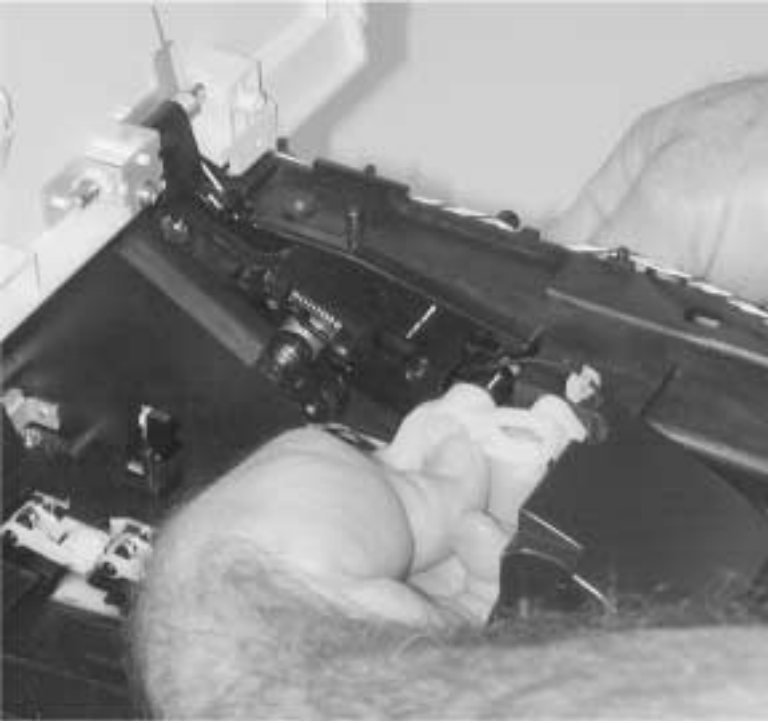

9. Remove the inner link. The outer link can also be removed.

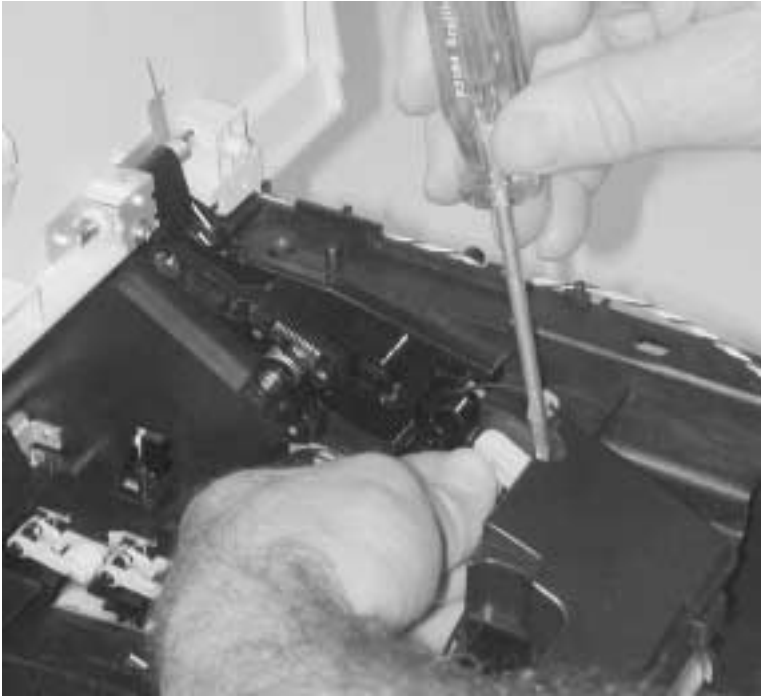

**Note:** The outer link assembly is disconnected and must be reconnected at reassembly. A diagram of the linkages is shown.

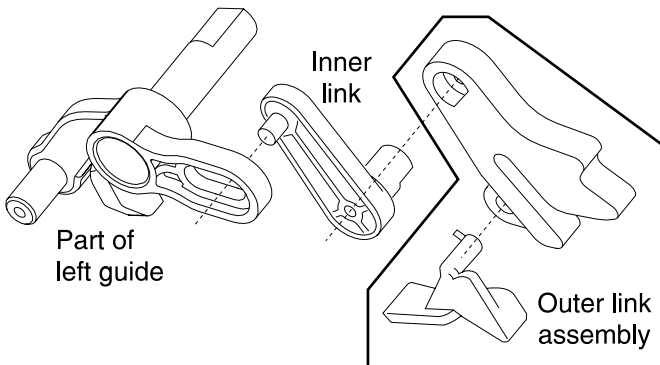

## Cooling fan removal

1. Remove the top cover. See **“Top cover assembly removal” on page 4-11.**
2. Remove the right side cover. See **“Right side cover removal” on page 4-12.**
3. Disconnect the fan cable.
4. Remove the two screws (A).

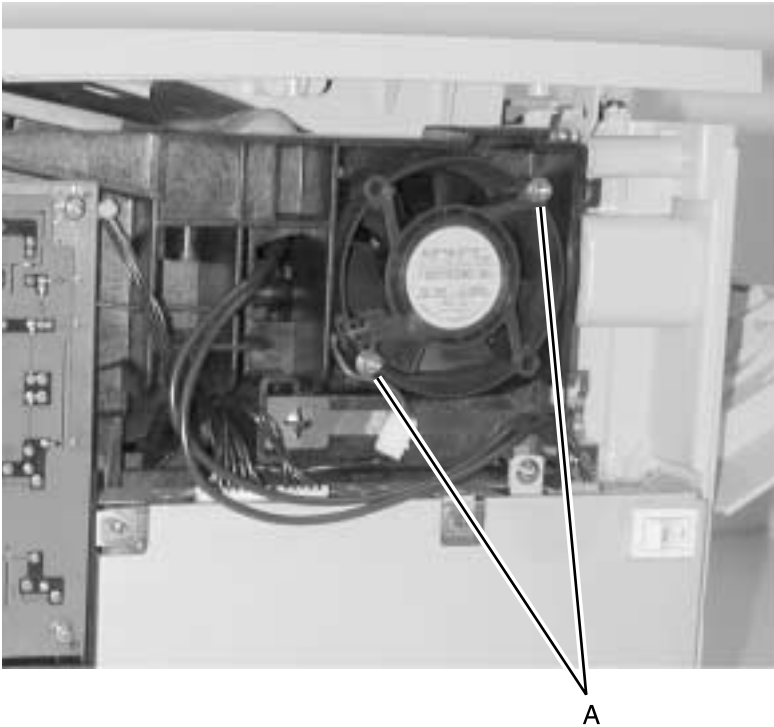

5. Remove the fan.

---

## 5. Locations and connections

---

### Exterior locations

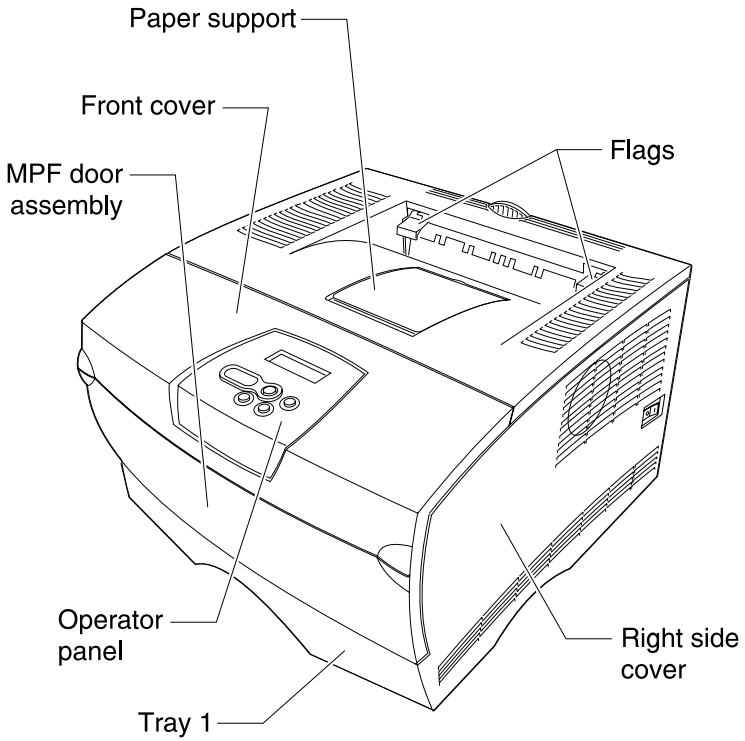

# Connectors

**Note:** Pin number 1 is designated on the printed circuit card by either a white triangle, a number 1, or both. The pin numbers follow chronologically to the opposite end of the connector. Voltages shown on the following pages are made with the printer turned on.

**CAUTION:** Voltages are exposed.

## Controller card assembly

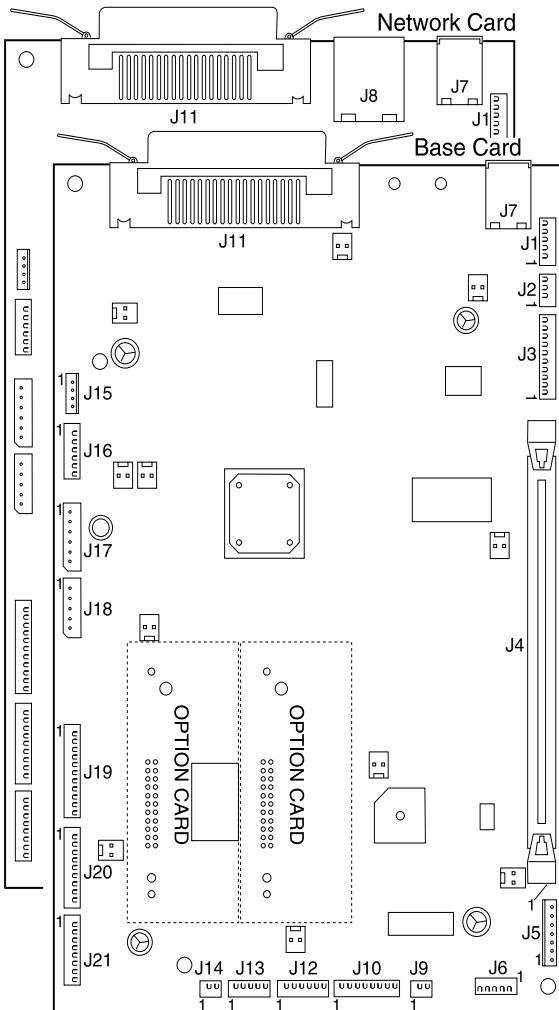

**Controller card assembly connectors (see “Controller card assembly” on page 5-2)**

Connector	Name	# of pins	Pin #	Signal
J1-MMTR	Mirror motor	5	4	Ground
			5	+24 V dc
J2-CO	Cover	3	2	+5 V dc
			3	Ground
J3-LSU	LSU (printhead)	10	3	Ground
			6	Ground
			7	+5 V dc (cover closed)
			9	Ground
J4-DIMM	SDRAM	100	1	Ground
			12	Ground
			21	+3.3 V dc
			26	Ground
			36	Ground
			42	+3.3 V dc
			47	Ground
			50	+3.3 V dc
			51	Ground
			56	+3.3 V dc
			62	Ground
			71	+3.3 V dc
76	Ground			
81	+3.3 V dc			

**Controller card assembly connectors (see “Controller card assembly” on page 5-2)**

Connector	Name	# of pins	Pin #	Signal
J4–DIMM (continued)	SDRAM	100	86	Ground
			92	+3.3 V dc
			97	Ground
J5–OP PANEL	Operator panel	7	2	+5 V dc
			4	Ground
			7	+3.3 V dc
J6–Exit motor	Exit motor	5	1	Ground
			3	+5 V dc
			4	+24 V dc
			5	+24 V dc
J7–USB	USB connector	4	1	USB power – +5 V dc (USB cable attached)
J9–MPF	MPF solenoid	2	1	+24 V (measured to ground)
			2	+24 V (measured to ground)
J10–MAIN MOTOR	Main motor	7	1	Ground
			6	Ground
			7	+24 V dc
			8	+5 V dc
J12–MPF SN	Sensor; MPF, toner	6	1	+5 V dc
			3	Ground
			4	+5 V dc
			6	Ground



**Controller card assembly connectors (see “Controller card assembly” on page 5-2)**

Connector	Name	# of pins	Pin #	Signal
J13–LVPS	LVPS control	5	5	Ground
J14–FD	Paper feed solenoid	2	1	+24 V dc only during tray 1 pick
J16–EXIT	Fuser exit tray full sensor	6	1	+5 V dc
			3	Ground
			4	+5 V dc
			6	Ground
J17–LVPS	LVPS DC power	6	1	+24 V dc
			2	+24 V dc
			3	Ground
			4	Ground
			5	+5 V dc
			6	Ground
J18–THERM	Thermistor, Smart IC	5	1	+2–5 V dc
			2	Ground
			5	Ground
J19–HVPS	HVPS	11	1	+24 V–fans
			2	Ground–fans
			5	Ground
			7	+24 V dc

**Controller card assembly connectors (see “Controller card assembly” on page 5-2)**

Connector	Name	# of pins	Pin #	Signal
J20—Paper Duplex	Paper input, narrow media, duplex	9	1	+5 V dc
			3	Ground
			4	+5 V dc
			6	Ground
			7	+5 V dc
			9	Ground
J21—TRAY	2nd drawer interface	8	1	+5 V dc
			2	+5 V dc
			3	+5 V dc
			4	+5 V dc
			5	Ground
			6	+24 V dc
			7	+5 V dc

## Low voltage power supply (LVPS)

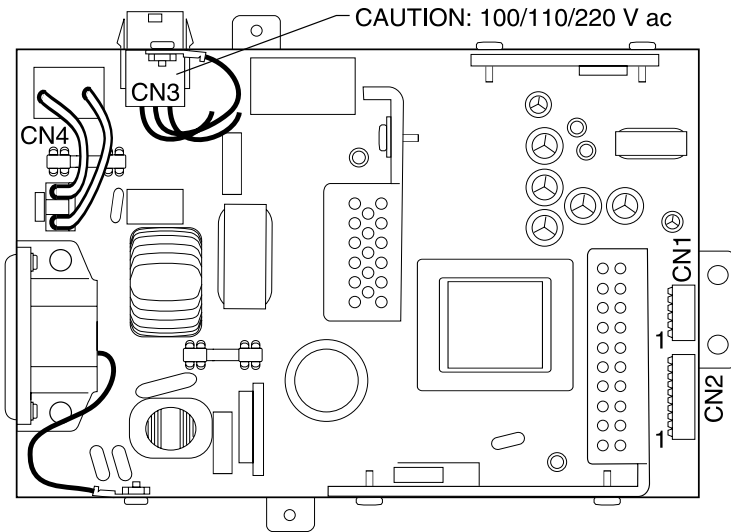

Connector	Name	Pins	Pin #	Signal
Controller card/LVPS control	CN1	5	1	Ground
110 / 220 Volts	CN2	8	2	Ground
			4	+5 V dc
			5	Ground
			6	Ground
			7	+24 V dc
			8	+24 V dc
Heater	CN3	2	1	100/110 / 220 V ac
			2	100/110 / 220 V ac
On/off switch	CN4-S/W	2	1	110 / 220 V ac
			2	110 / 220 V ac

## High voltage power supply (HVPS)

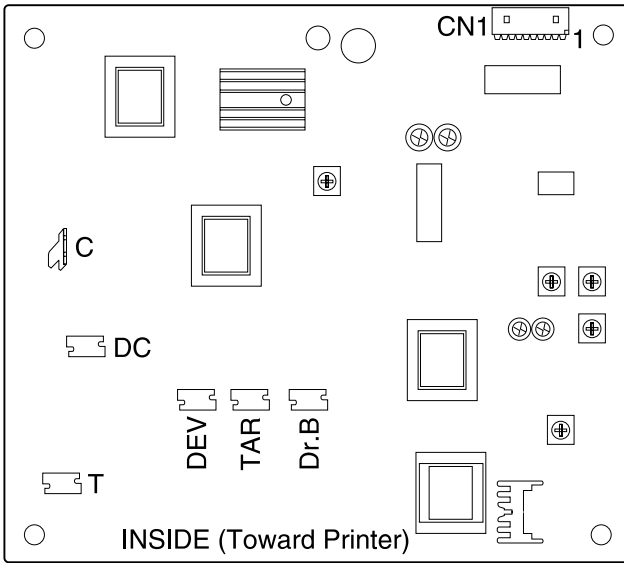

Connector	Name	# of Pins	Pin #	Signal
To controller card	CN1 (connects to J19 on the controller card)	8	2	Ground
			4	+24 V dc
			7	+5 V dc
C	Charge roll	(Terminal)		
DC	Photoconductor	(Contact)		
T	Transfer roll	(Contact)		
DEV	Development roll	(Contact)		
TAR	Toner adder roll	(Contact)		
Dr. B	Doctor blade	(Contact)		

---

## 6. Preventive maintenance

This chapter describes procedures for printer preventive maintenance. Following these recommendations can help prevent problems and maintain optimum performance.

---

### Safety inspection guide



This guide is to aid you in identifying unsafe conditions.

If any unsafe conditions exist, find out how serious the hazard could be and if you can continue before you correct the hazard.

Check the following items:

- Damaged, missing, or altered parts, especially in the area of the on/off switch and the power supply.
- Damaged, missing, or altered covers, especially in the area of the top cover and the power supply cover.
- Possible safety exposure from any non-Lexmark attachments.

---

### Lubrication specifications

Lubricate only when parts are replaced or as needed, not on a scheduled basis. Use of lubricants other than those specified can cause premature failure. Some unauthorized lubricants may chemically attack polycarbonate parts. Use IBM no. 10 oil, P/N 1280443 (approved equivalents: Mobil DTE27, Shell Tellus 100, Fuchs Renolin MR30), IBM no. 23 grease, PN 99A0462 (approved equivalent: Shell Darina 1), or P/N 99A0394 to lubricate appropriate areas of the printer.

## Scheduled maintenance

The operator panel displays the message 80 Scheduled Maintenance at a fixed page count interval. It may be necessary to replace the fuser assembly, transfer roller, charge roll, and pick tires at this interval to maintain the print quality and reliability of the printer. The parts are available as a maintenance kit with the following part numbers:

### Maintenance kits

Description	Part number
110 V maintenance kit	56P2333
220 V maintenance kit	56P2337
100 V maintenance kit	56P2338

After replacing the kit, the maintenance count must be reset to zero to clear the 80 Scheduled Maintenance message. See **“Reset Maint Cnt” on page 3-22.**

### Maintenance kit contents

Description	Part number
Tray 1 paper feed roll	56P2352
Transfer roll assembly	56P2329
Charge roll	56P0640
Fuser assembly	See note below
Rear cover assembly	56P2302
Lower MPF housing assembly	56P2311
Lubricant, Nyogel 744	99A0394
Maintenance kit parts group	56P2364

**Note:**

- The 110 V maintenance kit (P/N 56P2333) contains P/N 56P2330 fuser assembly.
- The 220 V kit (P/N 56P2337) contains P/N 56P2331 fuser assembly.
- The 100 V kit (P/N 56P2338) contains P/N 56P2332 fuser assembly.

## Maintenance kit parts group

The maintenance kit parts group (P/N 56P2364) includes the following items:

- MPF rubber pick roll
- Metal plate for tray 1 with pad
- Metal plates for optional 250-sheet trays with pads
- Rubber pick rolls for optional 250-sheet trays
- Metal plate for 500-sheet tray with pad
- Rubber pick roll for 500-sheet tray.

**4048-1xx**



---

## 7. Parts catalog

---

### How to use this parts catalog

---

Abbreviations used in the parts catalog include the following:

- NS: (Not Shown) in the Asm-Index column indicates that the part is procurable but is not pictured in the illustration.
- 101, 102, or 111: FRUs may be identified by model numbers. The following table lists the models and their descriptions.

<b>Machine type and model</b>	<b>Description</b>
4048-101	Duplex, non-network
4048-102	Duplex, network
4048-111	Simplex, non-network

# Assembly 1: Covers

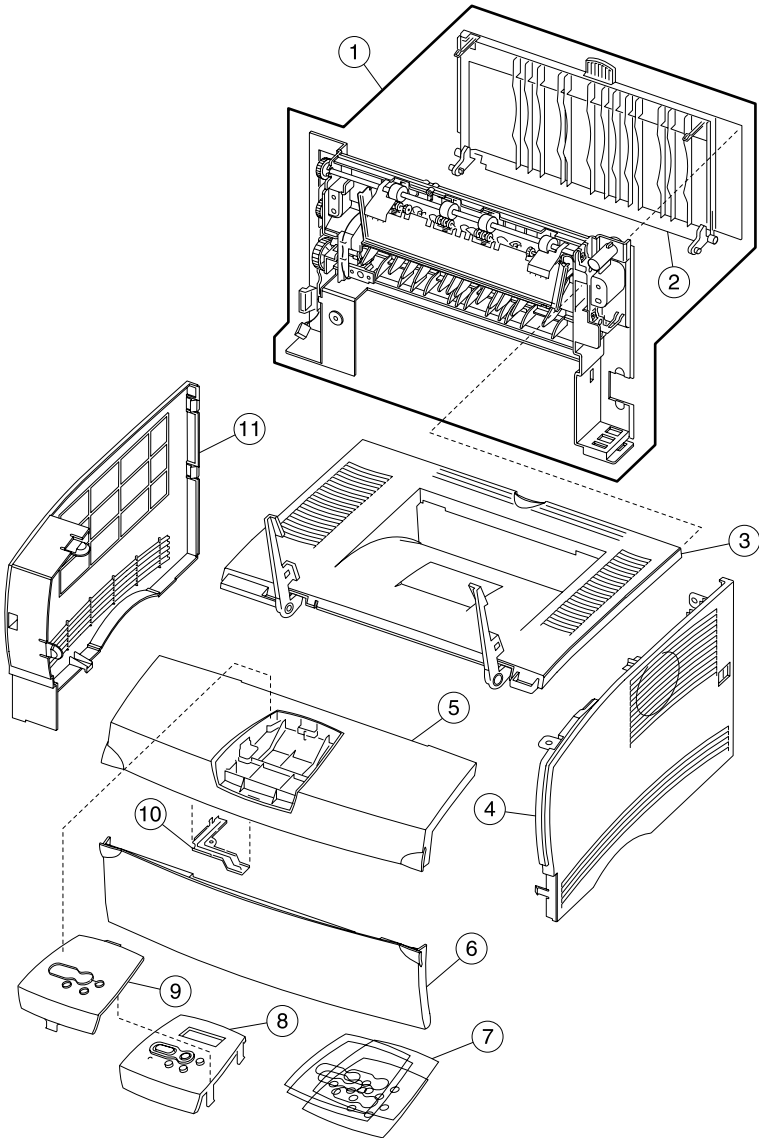

## Assembly 1: Covers

Asm-index	Part numbers	Units	Description
1-1	56P2302	1	Rear cover assembly
2	56P2301	1	Rear exit door assembly
3	56P2306	1	Top cover assembly
4	56P2307	1	Right cover assembly
5	56P2305	1	Front cover assembly
6	56P2303	1	MPF door cover assembly
7	56P2342	1	Language overlay group
8	56P2353	1	Operator panel assembly
8	56P2356	1	Operator panel assembly (Japan)
9	56P2343	1	Clear bezel with logo
10	56P2354	1	Operator panel cable cover
11	56P2300	1	Left cover assembly

# Assembly 2: Paper feed

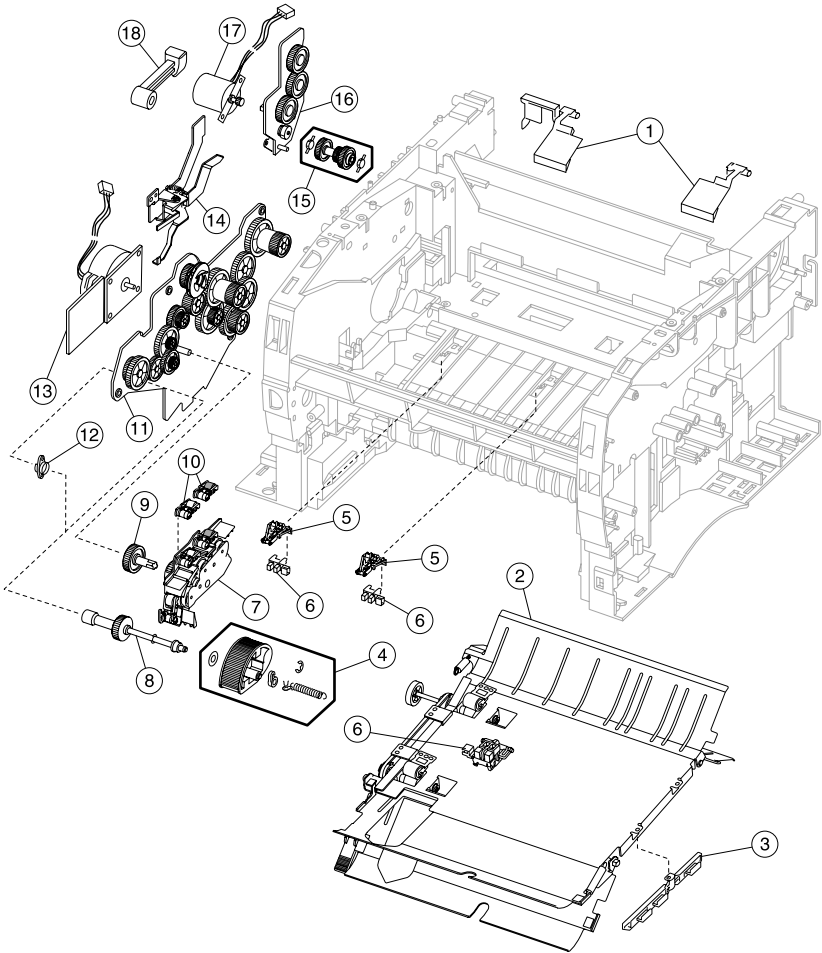

## Assembly 2: Paper feed

Asm-index	Part numbers	Units	Description
2-1	56P2304	1	Stack control flags (output tray full flags)
2	56P0651	1	Duplex assembly (101, 102)
3	56P2365	1	Paper guide bracket
4	56P2352	1	Paper feed roll
5	56P0655	2	Paper sensor bracket, one per package
6	56P0645	1	Photo sensor, one per package
7	56P2309	1	Reference feed CBM
8	56P0657	1	Paper feed assembly
9	56P0634	1	Paper feed gear
10	56P2308	1	Backup feed roller assembly (top front and rear)
11	56P2326	1	Drive assembly Order a lubricant to use with these gears, P/N 99A0394, (FRU, Nyogel 744). See <b>page 4-6</b> .
12	56P2334	1	Paper feed/drive bushing
13	56P2325	1	Main drive motor assembly
14	56P0638	1	Cartridge coupling
15	56P2363	1	Ratchet drive Order a lubricant to use with these gears, P/N 99A0394, (FRU, Nyogel 744). See <b>page 4-6</b> .
16	56P2327	1	Exit gear drive assembly Order a lubricant to use with these gears, P/N 99A0394, (FRU, Nyogel 744). See <b>page 4-6</b> .
17	56P2360	1	Exit drive motor
18	56P0639	1	Guide bracket

# Assembly 3: Frame

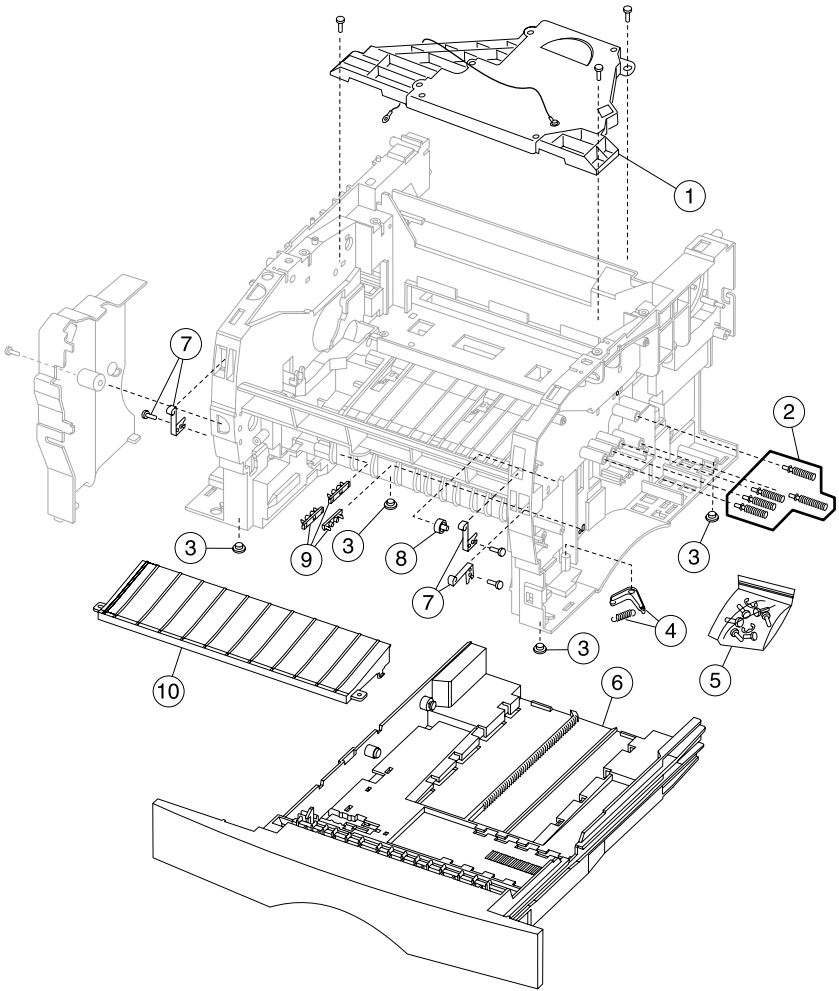

**Assembly 3: Frame**

<b>Asm-index</b>	<b>Part numbers</b>	<b>Units</b>	<b>Description</b>
3-1	56P2319	1	Printhead assembly
2	56P0629	1	Cartridge contact assembly (includes 5)
3	56P0662	1	Base feet
4	56P0661	1	Tray damper
5	56P0668	1	Parts packet, screws and E-rings
6	56P2310	1	Main tray assembly, 250
7	56P0667	1	Door latch (includes 3)
8	56P0660	1	Paper guide roller
9	56P0672	1	Tray body bracket (includes 4)
10	56P2351	1	Entrance guide assembly with brush

## Assembly 4: Multipurpose feeder (MPF)

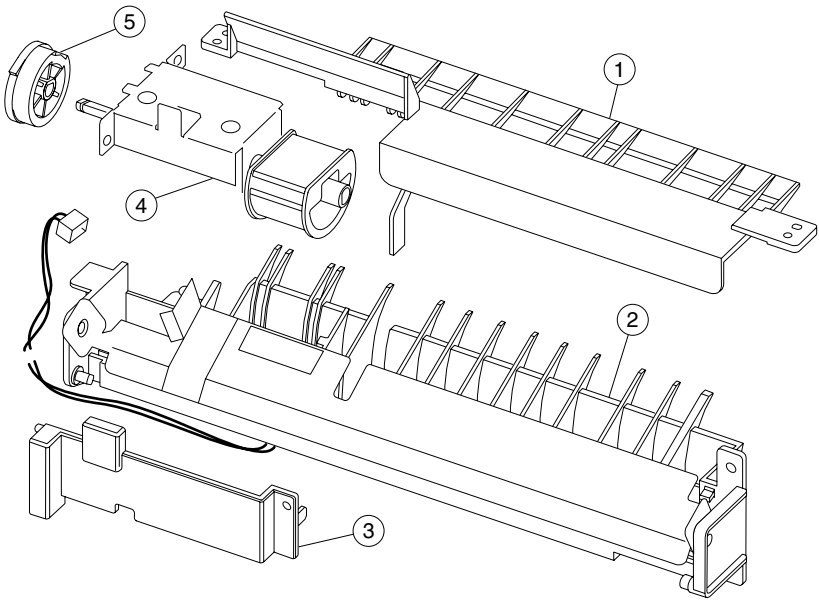

Asm-index	Part numbers	Units	Description
4-1	56P2312	1	Upper MPF housing assembly
2	56P2311	1	Lower MPF housing assembly
3	56P0615	1	MPF paper feed cover cap
4	56P2359	1	MPF pick roll assembly
5	56P2358	1	MPF paper pick gear (order lubricant to use with this gear, P/N 99A0394)



## Assembly 5: Fuser

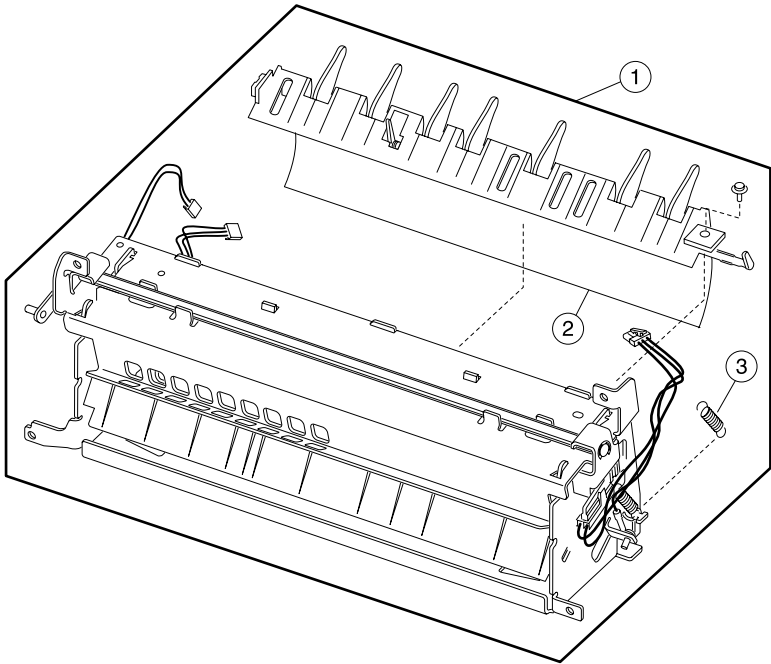

Asm-index	Part numbers	Units	Description
5-1	56P2330	1	Fuser assembly, 110 V
1	56P2331	1	Fuser assembly, 220 V
1	56P2332	1	Fuser assembly, 100 V
2	56P2355	1	Fuser paper exit guide assembly
3	56P0676	1	Fuser exit spring

# Assembly 6: Charging

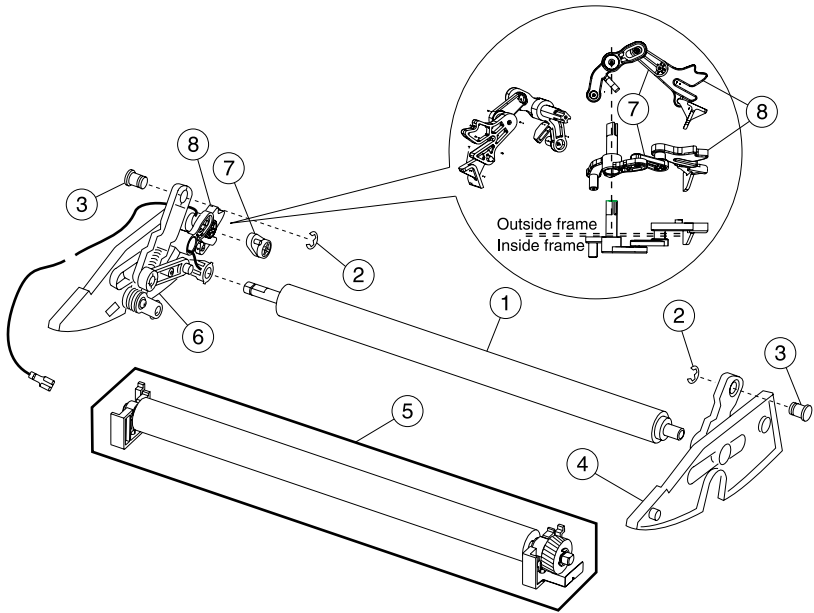

## Assembly 6: Charging

Asm-index	Part numbers	Units	Description
6-1	56P0640	1	Charge roll <b>Note:</b> Customer replaceable unit is a different part number; order CRU P/N 56P2341
2	56P0668	1	Parts packet, screws and E-rings
3	56P0669	1	Pivot hinge (quantity 2)
4	56P2328	1	Right guide assembly
5	56P2329	1	Transfer roll assembly
6	56P2340	1	Left guide assembly
7	56P2349	1	Fuser lift (inner) link
8	56P2348	1	Fuser lift (outer) link assembly

# Assembly 7: Electronics and cables 1

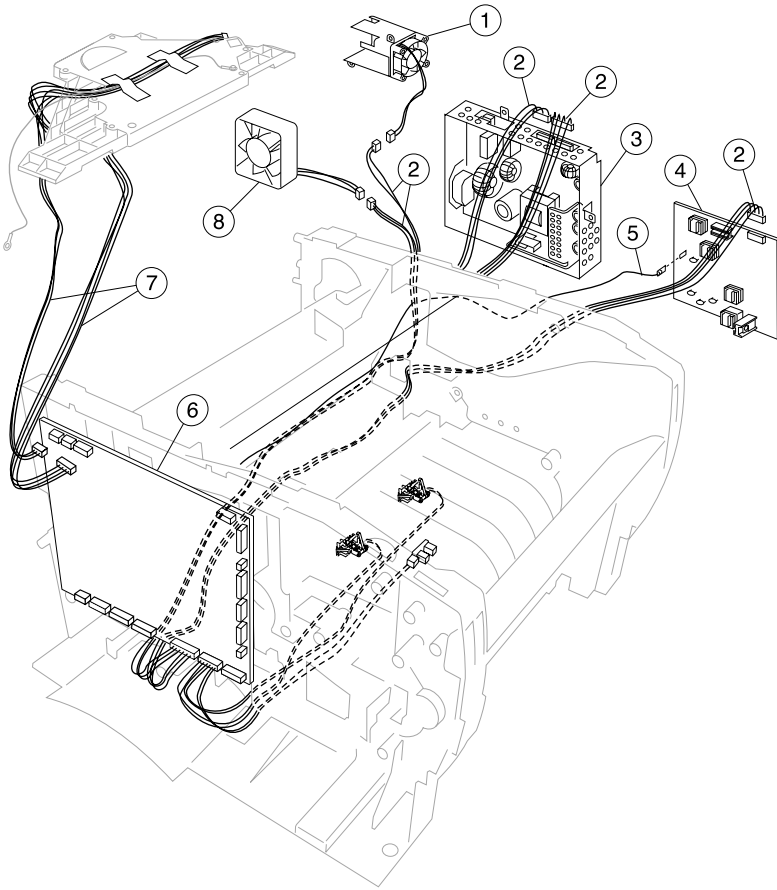

## Assembly 7: Electronics and cables 1

Asm-index	Part numbers	Units	Description
7-1	56P2357	1	LVPS fan and housing assembly
2	56P2335	1	Main harness cable assembly, including wiring to the following locations: <ul style="list-style-type: none"> <li>• LVPS fan/fuser fan</li> <li>• HVPS</li> <li>• Main fan</li> <li>• LVPS power</li> <li>• LVPS control</li> <li>• Paper-input sensor/duplex</li> </ul>
3	56P2320	1	Power supply, 110 V
3	56P2321	1	Power supply, 220 V
3	56P2339	1	Power supply, 100 V
4	56P2322	1	High voltage power supply
5	56P2340	1	Left guide assembly (only the end of the cable shown)
6	56P2369	1	Controller card assembly, non-network (101, 111)
6	56P2370	1	Controller card assembly, network (102)
7	56P2318	1	Printhead cable assembly
8	56P2323	1	Fuser cooling fan

## Assembly 8: Electronics and cables 2

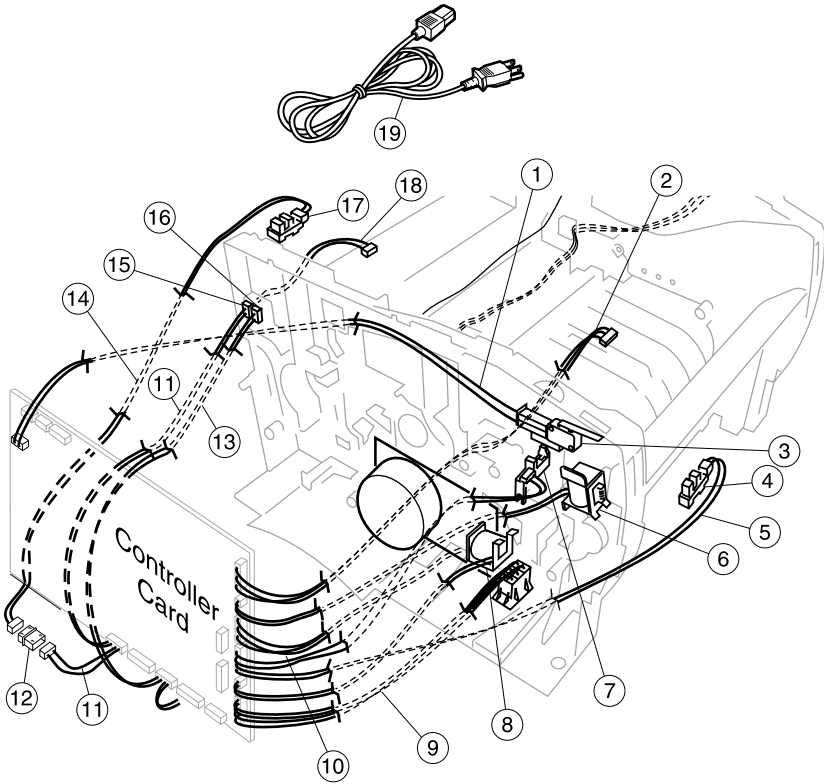

## Assembly 8: Electronics and cables 2

Asm-index	Part numbers	Units	Description
8-1	56P0624	1	Cover switch cable assembly
2	56P2317	1	Operator panel cable assembly
3	56P0625	1	Interlock cover switch
4	56P0645	6	Photo sensor, included with P/N 56P2311 (lower MPF housing)
5			Available only with P/N 56P2311
6 and 8	56P2313	2	Paper feed solenoid
7	56P0653	1	Toner level sensor
9	56P2324	1	Drawer cable assembly
10	56P2316	1	Motor cable assembly
11	56P2336	1	Output full and fuser exit cable assembly
12			Double 3-pin connector, available only with P/N 56P2336
13	56P2350	1	Cartridge signature button switch (attached cable shown)
14	56P0682	1	Output full sensor cable
15	56P0665	1	3-pin connector
16	56P0666	1	2-pin connector
17	56P0645	1	Photo sensor
18	56P0649	1	Fuser exit cable assembly

# Assembly 8 (cont.): Electronics and cables II

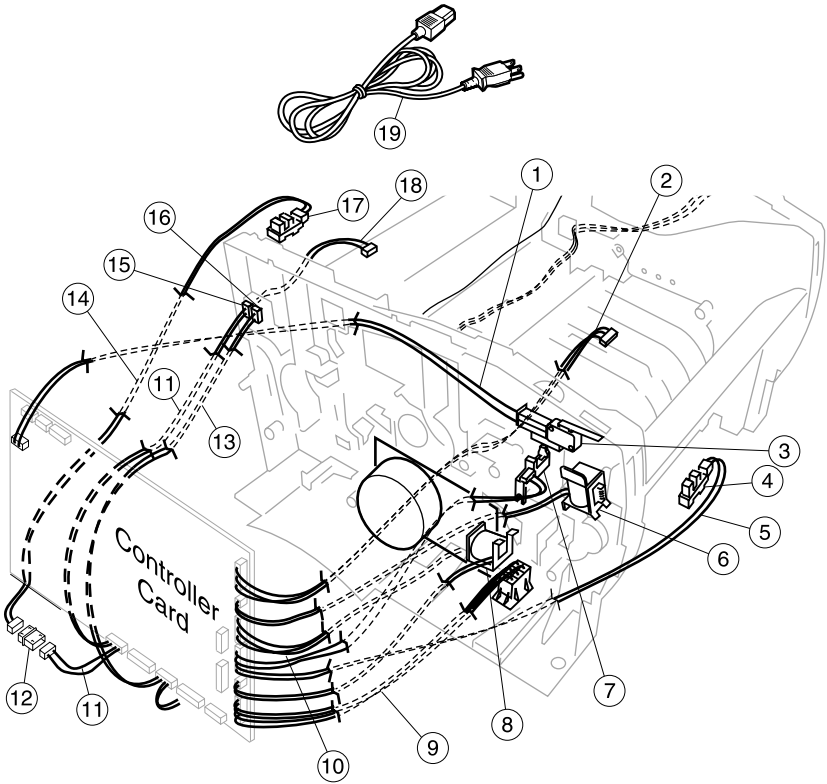



## Assembly 8 (cont.): Electronics and cables II

Asm-index	Part numbers	Units	Description
8-19	70G0478	1	Power cord, US, Bolivia, Canada, Caribbean countries, Columbia, Costa Rica, Dominican Republic, Ecuador, El Salvador, Guatemala, Honduras, Japan, Mexico, Nicaragua, Panama, Peru, Puerto Rico, Saudi Arabia, Taiwan, The Virgin Islands, Venezuela, AP-LV
19	1339528	1	Power cord, Bahrein, Cyprus, Iraq, Ireland, Kuwait, Oman, Qatar, UAE, UK, Yemen (HV)
19	1339529	1	Power cord, Austria, Belgium, Bosnia, Bulgaria, Catalan, Croatia, Czech, Egypt, Albania (Euro English and other East), Finland, France, Germany, Greece, Hungary, Iceland, Iran, Italy, Jordan, Lebanon, Macedonia, Netherlands, Norway, Paraguay, Poland, Portugal, Romania, Russia and CIS, Slovak countries, Slovenia, Spain, Sweden, Syria, Turkey, Yugoslavia (Serbia and Montenegro)(HV)
19	1339530	1	Power cord, Israel (HV)
19	1339531	1	Power cord, Switzerland (HV)
19	1339532	1	Power cord, Lybia, Pakistan, South Africa (HV)
19	1339533	1	Power cord, Chile, Uruguay (HV)
19	1339534	1	Power cord, Denmark (HV)
19	43H5545	1	Power cord, PR China (HV)
19	1339548	1	Power cord, Brazil (LV)
19	11D0330	1	Power cord, Argentina
19	1339520	1	Power cord, U.S. (HV) RPQ

# Assembly 9: Sensors

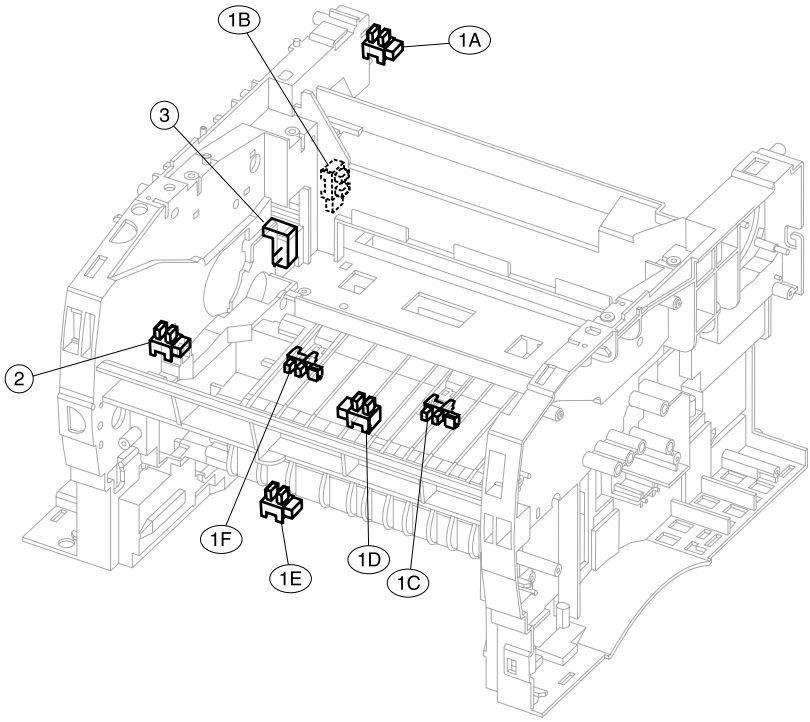

## Assembly 9: Sensors

Asm-index	Part numbers	Units	Description
9-1	56P0645	1	Photo sensor, locations found: A—Paper path exit flag B—Fuser exit sensor C—Paper path below cartridge D—Paper path duplex E—Paper path MPF F—Paper path below cartridge
2	56P0653	1	Toner level sensor
3	56P2350	1	Cartridge signature button switch

# Assembly 10: Options

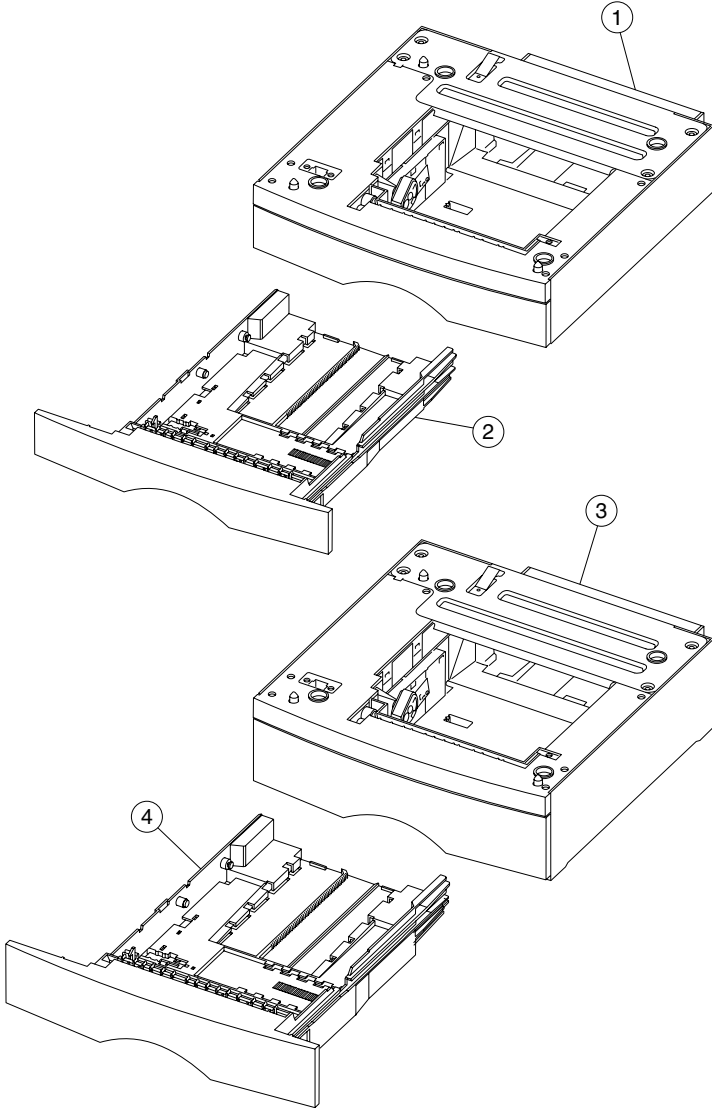

## Assembly 10: Options

Asm-index	Part numbers	Units	Description
10-1	56P2346	1	Drawer assembly, 250 T2 and base
2	56P2344	1	Tray assembly, 250-sheet T2
3	56P2347	1	Drawer assembly, 500 T3 and base
4	56P2345	1	Tray, assembly, 500-sheet T3
NS	56P0696	1	16MB SDRAM DIMM
NS	56P0697	1	32MB SDRAM DIMM
NS	56P0698	1	64MB SDRAM DIMM
NS	56P0699	1	128MB SDRAM DIMM
NS	56P2361	1	256MB PC100 kit DIMM
NS	56P1417	1	16MB flash card assembly
NS	56P1418	1	32MB flash card assembly
NS	56P1427	1	Optra Forms™ 32 MB flash card asm.
NS	56P1428	1	Optra Forms 16 MB flash card assembly
NS	56P3845	1	Lexmark Forms card assembly
NS	56P3304	1	ImageQuick™ card assembly (T430)
NS	56P3305	1	PRESCRIBE card assembly
NS	56P3144	1	PrintCryption card
NS	56P3317	1	Bar code card
NS	56P1429	1	Simplified Chinese font card assembly
NS	56P1430	1	Traditional Chinese font card assembly
NS	56P1438	1	Japanese font card assembly
NS	56P2231	1	Korean font card assembly
NS	12G9833	1	MarkNet™ X2011e Ethernet 10/100 BaseTX
NS	12G9832	1	MarkNet X2012e Ethernet 10/100 BaseTX/10Base2
NS	12G9831	1	MarkNet X2031e Ethernet 10/100 BaseTX
NS	12G9830	1	MarkNet X2030t Token-Ring
NS	56P3837	1	IPDS and SCS/TNe card assembly
NS	99A0545	1	External serial adapter
NS	1329605	1	High-speed bidi parallel cable (10 ft)
NS	12A2405	1	USB cable, 2 m
NS	1038693	1	Serial cable, 50 ft

## Assembly 11: Miscellaneous

Asm-index	Part numbers	Units	Description
NS	7370971	1	Field relocation kit
NS	56P2333	1	110 V maintenance kit
NS	56P2337	1	220 V maintenance kit
NS	56P2338	1	100 V maintenance kit
NS	56P2364	1	Maintenance kit parts group, see <b>“Maintenance kit parts group” on page 6-3.</b>
NS	56P2341	1	Customer replaceable (CRU) charge roll

# Index

## Numerics

- 2-pin connector
  - parts **7-15**
  - removal **4-46**
- 2xx paper jams **2-22–2-23**
- 3-pin connector
  - parts **7-15**
  - removal **4-46**
- 3x—9x attendance messages **2-16–2-21**
- 56P2370 Controller card assembly, network **7-13**
- 9xx service errors **2-6–2-10**
- 1565 Emul Error **2-23**

## A

- acronyms **1-11**
- adjustments
  - lubrication **4-6**
  - paper feed alignment **4-5**
  - printhead assembly **4-2**
  - reassembly **4-7**
- alignment
  - paper feed **4-5**
  - printhead **4-2**

## B

- bottom pan removal **4-25**
- Button Test **3-6**

## C

- cable, bad connections **2-34**
- cables **7-12, 7-14, 7-16**
- cartridge contact assembly
  - parts catalog **7-7**
  - removal **4-34**
- cartridge coupling assembly
  - parts **7-5**
  - removal **4-65**
- charge roll
  - removal **4-38**
  - tests **3-17**

## Config Menu

- Demo Mode **3-24**
  - description **3-1**
  - Download Emuls **3-24**
  - Energy Conserve **3-25**
  - entering **3-21**
  - Env Prompts **3-26**
  - Error Log, Print Log **3-26**
  - Exit Config Menu **3-26**
  - Factory Defaults **3-24**
  - Maint Cnt Value **3-22**
  - Panel Menu **3-23**
  - Paper Prompts **3-26**
  - PPDS Emulation **3-23**
  - Prt Quality Pgs **3-23**
  - Reduced Curl **3-26**
  - Reset Maint Cnt **3-22**
  - configuration ID **3-16**
  - connectors
    - controller card assembly **5-2**
    - HVPS **5-8**
    - LVPS **5-7**
  - controller card
    - card and cage removal **4-48**
    - card removal **4-50**
    - connections **5-2**
    - disconnects **2-34**
    - service check **2-38**
  - cooling fan
    - parts catalog **7-13**
    - removal **4-82**
    - service check **2-36**
    - symptoms **2-3**
  - covers
    - locations **1-2**
    - parts catalog **7-2**
    - removals **4-8**
- ## D
- data streams **1-5**
  - defaults **3-15**
  - Demo Mode **3-24**
  - Diagnostics Mode

## 4048-1xx

- Base Sensor Test **3-14**
  - description **3-1**
- Device Tests
  - Flash Test **3-14**
- Duplex Tests
  - Duplex Feed 1 **3-11**
  - Quick Test **3-9**
  - Sensor Test **3-11**
  - Top Margin **3-10**
- entering **3-2**
- EP Setup
  - Charge Roll **3-17**
  - EP Defaults **3-17**
  - Fuser Temp **3-17**
  - Gap Adjust **3-17**
  - Print Contrast **3-17**
  - Transfer **3-17**
- Error Log
  - Clear Log **3-20**
  - Display Log **3-18**
  - Print Log **3-19**
- Exit Diagnostics **3-20**
- Hardware Tests
  - Button Test **3-6**
  - DRAM Test **3-7**
  - LCD Test **3-6**
  - Parallel Wrap **3-8**
- Input Tray Tests
  - Feed Test **3-12**
  - Sensor Test **3-12**
- Print Tests
  - MP Feeder **3-5**
  - Prt Quality Pgs **3-6**
  - Tray 1 **3-5**
  - Tray 2 **3-5**
  - Tray 3 **3-5**
- Printer Setup
  - Configuration ID **3-16**
  - Defaults **3-15**
  - Edge to Edge **3-16**
  - Page Count **3-16**
  - Par S Strobe Adj **3-16**
  - Perm Page Count **3-16**
- Registration **3-4**
- Download Emuls **3-24**
- DRAM Test **3-7**
- duplex assembly

- parts catalog **7-5**
- tray removal **4-24**
- Duplex Feed 1 **3-11**
- duplex input sensor, Sensor Test **3-11**

## E

- Edge to Edge **3-16**
- Energy Conserve **3-25**
- Env Prompts **3-26**
- EP defaults **3-17**
- error codes **2-6**
- error log
  - Clear Log **3-20**
  - Display Log **3-18**
  - Print Log **3-19**
  - Print Log (configuration menu) **3-26**
- error messages
  - disconnected cables **2-34**
  - paper jams **2-22**
  - service error codes **2-6**
  - sub error codes **2-24**
  - user attendance messages **2-11**
- ESD-sensitive parts **4-1**
- exit drive assembly
  - lubrication **4-7**
  - parts catalog **7-5**
  - removal **4-59**
- exit drive motor
  - parts catalog **7-5**
  - removal **4-58**

## F

- factory defaults **3-24**
- fan
  - cooling **4-82**
  - LVPS **4-76, 7-13**
- Feed Test **3-12**
- field relocation kit **7-22**
- flash memory
  - options **7-21**
  - specifications **1-5**
  - test **3-14**
- Flash Test **3-14**
- fonts **1-6**
- fuser assembly
  - parts catalog **7-9**



- removal **4-26**
- service check **2-40**
- Fuser Temp **3-17**

## G

- Gap Adjust **3-17**

## H

- high voltage power supply (HVPS)
  - card removal **4-75**
  - connectors **5-8**
  - parts catalog **7-13**
  - service check **2-40**

## I

- input sensor, removal **4-44**

## L

- Laser notices **iv-vii**
- LCD Test **3-6**
- locations
  - duct cover assembly **5-1**
  - flags **5-1**
  - front cover **5-1**
  - MPF door **5-1**
- low voltage power supply (LVPS)
  - card removal **4-77**
  - connectors **5-7**
  - fan removal **4-76**
  - parts catalog **7-13**
  - service check **2-39**
- lubrication
  - drive assembly **4-6**
  - exit drive assembly **4-6**
  - exit gear drive assembly **4-7**
  - MPF pick roll assembly **4-7**
  - ratchet drive **4-6**
  - ratchet drive assembly **4-6**
  - rear cover assembly **4-7**
- lubrication specifications **6-1**

## M

- main drive assembly
  - lubrication **4-6**
  - parts catalog **7-5**
  - removal **4-55**

- main drive motor assembly
  - parts catalog **7-5**
  - removal **4-53**
  - service check **2-42**
- maintenance
  - handling ESD-sensitive parts **4-1**
  - lubrication **4-6**
  - maintenance kit **6-2**
  - maintenance kit parts group **6-3**
  - preventive **6-1**
- maintenance approach **1-1**
- maintenance kits **6-2**
- media
  - input sources **1-9**
  - options **1-8**
  - output sources **1-10**
  - paper sources **1-8**
- memory options **1-5**
- messages
  - paper jam messages **2-22**
  - service error codes **2-6**
  - user attendance messages **2-11**
- models **1-1**
- MPF pick roll assembly
  - lubrication **4-7**
- multipurpose feeder (MPF)
  - door cover removal **4-8**
  - housing assembly removal **4-70**
  - input tray tests **3-5**
  - locations **5-1**
  - lower housing assembly removal **4-70**
  - parts catalog **7-8**
  - roller assembly removal **4-73**
  - upper housing assembly removal **4-66**

## N

- network controller card **7-13**

## O

- operator panel
  - diagram **1-3**
  - parts catalog **7-3**
  - removal **4-22**
  - service checks **2-43**

## 4048-1xx

operator panel cable 4-20, 7-15  
options  
    memory 1-5  
    paper sources 1-8  
    parts catalog 7-20  
output tray full flags  
    parts catalog 7-5  
    removal 4-18

## P

packaging 7-22  
page count 3-16  
Panel Menus 3-23  
paper feed alignment 4-5  
paper flag, MPF 4-66  
paper handling options 1-7  
paper jams 2-22, 3-27  
Paper Prompts 3-26  
parallel port service check 2-49  
Parallel Wrap 3-8  
parts catalog  
    cables 7-16  
    charging 7-10  
    covers 7-2  
    electronics 7-16  
    electronics and cables I 7-12  
    electronics and cables II 7-14  
    frame 7-6  
    fuser 7-9  
    how to use 7-1  
    miscellaneous 7-22  
    multipurpose feeder (MPF) 7-8  
    options 7-20  
    paper feed 7-4  
    sensors 7-18  
permanent page count 3-16  
power cords 7-17  
power-on reset (POR) 2-2  
power-on self test (POST) 2-3  
PPDS Emulation 3-23  
Print Contrast 3-17  
print quality 1-4, 2-56  
    black page 2-51  
    blank page 2-50, 2-58  
    does not print 2-60  
    faint images 2-57

heavy background 2-52  
light or blurred characters 2-56  
light print 2-54  
Load Paper displays 2-60  
media skews 2-59  
multiple feeds 2-59  
paper fails to feed 2-59  
paper sticks 2-59  
poor fusing 2-53  
repeating marks 2-57  
solid black areas 2-58  
streaks 2-57  
Toner Low does not display 2-58  
Toner Low message 2-58  
toner on back of page 2-55  
toner smudges 2-57, 2-58  
unexpected characters print 2-60  
variation in image density 2-53  
white or black lines or bands 2-54  
white streaks 2-58  
print quality pages 3-6  
printer identification 1-2  
printhead  
    adjustment 4-2  
    parts catalog 7-7  
    removal 4-46  
printhead cable, parts catalog 7-13  
Prt Quality Pgs  
    CONFIG MENU 3-23  
    Diagnostic Mode 3-6  
    diagnostics 2-56

## Q

Quick Test 3-4  
Quick Test (duplex) 3-9

## R

ratchet drive assembly  
    lubrication 4-6  
    parts 7-5  
    removal 4-60  
rear cover assembly  
    lubrication 4-7  
    removal 4-15  
reassembly 4-7  
reference feed assembly

- parts 7-5
- removal 4-62
- registration 3-4
- removals
  - 2-pin connector 4-46
  - 3-pin connector 4-46
  - bottom pan (non-duplex) 4-25
  - cartridge contact assembly 4-34
  - cartridge coupling assembly 4-65
  - cartridge signature button sensor 4-42
  - charge roll 4-38
  - controller card 4-50
  - controller card and cage 4-48
  - cooling fan 4-82
  - covers
    - front 4-9
    - left side 4-14
    - MPF door cover 4-8
    - rear 4-15
    - rear exit door 4-17
    - right side 4-12
    - top cover assembly 4-11
  - door latch 4-36
  - duplex tray assembly 4-24
  - exit drive assembly 4-59
  - exit drive motor 4-58
  - fuser assembly 4-26
  - fuser exit sensor 4-33
  - fuser paper exit guide 4-29
  - HVPS card 4-75
  - left guide 4-40
  - lower (MPF) housing assembly 4-70
  - LVPS card 4-77
  - LVPS fan 4-76
  - main drive assembly 4-55
  - main drive motor assembly 4-53
  - MPF paper sensor 4-67
  - MPF pick roller assembly 4-73
  - operator panel assembly 4-22
  - operator panel cable 4-20
  - output tray full flags 4-18
  - paper detect bracket 4-44
  - paper guide roller 4-37
  - printhead 4-46
  - ratchet drive 4-60

- reference feed assembly 4-62
- right guide 4-39
- transfer roll assembly 4-43
- tray 1 D-roll shaft assembly 4-45
- tray 1 feed D-roll 4-44
- tray damper and spring 4-35
- upper MPF housing assembly 4-66
- resolution 1-4

## S

- safety information i-xviii
- safety inspection guide 6-1
- scheduled maintenance 6-2
- Sensor Test 3-11, 3-12
- sensors
  - cartridge signature button 4-42
  - duplex input sensor 3-11
  - exit sensor 3-14
  - fuser exit
    - removal 4-33
  - input sensor 3-14
  - MPF paper sensor removal 4-67
  - narrow media sensor 3-14
  - paper detect (input) and bracket removal 4-44
  - paper sensor (MPF)
    - removal 4-67
  - parts catalog 7-18
  - pass thru sensor 3-13
  - toner optical sensor 3-14
  - tray present sensor 3-13
  - upper front door sensor 3-14
- serial number 1-2
- service checks
  - controller card 2-38
  - cooling fan 2-36
  - cover interlock switch 2-37
  - dead machine 2-39
  - fuser
    - cold fuser 2-41
    - hot fuser 2-41
  - high voltage power supply (HVPS) 2-40
  - low voltage power supply (LVPS) 2-39
  - main motor 2-42

## 4048-1xx

- operator panel **2-43**
- paper feed **2-45**
- parallel port **2-49**
- print quality **2-50**
- transfer roll **2-44**
- service error codes **2-6**
- specifications
  - connectivity **1-1**
  - data streams **1-5**
  - fonts **1-6**
  - input sizes **1-9**
  - lubrication **6-1**
  - media **1-7**
  - memory **1-5**
  - models **1-1**
  - operator panel **1-3**
  - options **1-8**
  - output sources **1-10**
  - print area **1-6**
  - resolution **1-4**
  - standard trays **1-8**
  - supplies **1-6**
- start **2-1**
- sub error codes **2-24**
- supplies **1-6**
- symptoms
  - POST symptoms **2-3**
  - printer symptoms **2-4**

## T

- test pages
  - duplex quick test **3-9**
  - input source **3-5**
  - input tray feed **3-12**
  - print quality pages **3-23**
  - Prt Quality Pgs **3-6**
  - Quick Test **3-4**
- tests
  - Device Tests **3-14**
  - Duplex Tests **3-9**
  - EP Setup **3-17**
  - Hardware Tests **3-6**
  - Input Tray Tests **3-12**
  - Print Tests **3-5**
  - Printer Setup **3-15**
  - Quick Test page **3-4**

- Registration **3-4**
- tools **1-2**
- Top Margin **3-10**
- top margin **3-4**
- Transfer **3-17**
- transfer roll assembly
  - parts catalog **7-11**
  - removal **4-43**
  - service check **2-44**

## U

- upper MPF housing assembly
  - removal **4-66**
- user attendance messages **2-11**

## W

- wiring diagram, end of book

# Part number index

P/N	Description	Page
1038693	Serial cable, 50 ft . . . . .	7-21
11D0330	Power cord . . . . .	7-17
12A2405	USB cable, 2 m . . . . .	7-21
12G9830	MarkNet X2030t Token-Ring . . . . .	7-21
12G9831	MarkNet X2031e Ethernet 10/100 BaseTX . . . . .	7-21
12G9832	MarkNet X2012e Ethernet 10/100 BaseTX/10Base2 . . . . .	7-21
12G9833	MarkNet X2011e Ethernet 10/100 BaseTX . . . . .	7-21
1329605	High-speed bidirectional parallel cable (10 ft) . . . . .	7-21
1339520	Power cord . . . . .	7-17
1339528	Power cord . . . . .	7-17
1339529	Power cord . . . . .	7-17
1339530	Power cord . . . . .	7-17
1339531	Power cord . . . . .	7-17
1339532	Power cord . . . . .	7-17
1339533	Power cord . . . . .	7-17
1339534	Power cord . . . . .	7-17
1339548	Power cord . . . . .	7-17
43H5545	Power cord . . . . .	7-17
56P0615	MPF paper feed cover cap . . . . .	7-8
56P0624	Cover switch cable assembly . . . . .	7-15
56P0625	Interlock cover switch . . . . .	7-15
56P0629	Cartridge contact assembly . . . . .	7-7
56P0634	Paper feed gear . . . . .	7-5
56P0638	Cartridge coupling . . . . .	7-5
56P0639	Guide bracket . . . . .	7-5
56P0640	Charge roll . . . . .	6-2, 7-11
56P0645	Photo sensor . . . . .	7-5, 7-15, 7-19
56P0649	Fuser exit cable assembly . . . . .	7-15
56P0651	Duplex assembly (101, 102) . . . . .	7-5
56P0653	Toner level sensor . . . . .	7-15, 7-19
56P0655	Paper sensor bracket . . . . .	7-5
56P0657	Paper feed assembly . . . . .	7-5
56P0660	Paper guide roller . . . . .	7-7
56P0661	Tray damper . . . . .	7-7
56P0662	Base feet . . . . .	7-7
56P0665	3-pin connector . . . . .	7-15
56P0666	2-pin connector . . . . .	7-15
56P0667	Door latch . . . . .	7-7
56P0668	Parts packet, screws and E-rings . . . . .	7-7, 7-11

## 4048-1xx

56P0669 Pivot hinge	7-11
56P0672 Tray body bracket (includes 4)	7-7
56P0676 Fuser exit spring	7-9
56P0682 Output full sensor cable	7-15
56P0696 16MB SDRAM DIMM	7-21
56P0697 32MB SDRAM DIMM	7-21
56P0698 64MB SDRAM DIMM	7-21
56P0699 128MB SDRAM DIMM	7-21
56P1417 16MB flash card assembly	7-21
56P1418 32MB flash card assembly	7-21
56P1427 Optra Forms 32 MB flash card assembly	7-21
56P1428 Optra Forms 16 MB flash card assembly	7-21
56P1429 Simplified Chinese font card assembly	7-21
56P1430 Traditional Chinese font card assembly	7-21
56P1438 Japanese font card assembly	7-21
56P2231 Korean font card assembly	7-21
56P2300 Left cover assembly	7-3
56P2301 Rear exit door assembly	7-3
56P2302 Rear cover assembly	4-7, 6-2, 7-3
56P2303 MPF door cover assembly	7-3
56P2304 Stack control flags (output tray full flags)	7-5
56P2305 Front cover assembly	7-3
56P2306 Top cover assembly	7-3
56P2307 Right cover assembly	7-3
56P2308 Backup feed roller assembly (top front and rear)	7-5
56P2309 Reference feed CBM	7-5
56P2310 Main tray assembly, 250	7-7
56P2311 Lower MPF housing assembly	6-2, 7-8
56P2312 Upper MPF housing assembly	7-8
56P2313 Paper feed solenoid	7-15
56P2316 Motor cable assembly	7-15
56P2317 Operator panel cable assembly	7-15
56P2318 Printhead cable assembly	7-13
56P2319 Printhead assembly	7-7
56P2320 Power supply, 110 V	7-13
56P2321 Power supply, 220 V	7-13
56P2322 High voltage power supply	7-13
56P2323 Fuser cooling fan	7-13
56P2324 Drawer cable assembly	7-15
56P2325 Main drive motor assembly	7-5
56P2326 Drive assembly	4-6, 7-5
56P2327 Exit gear drive assembly	4-7, 7-5
56P2328 Right guide assembly	7-11
56P2329 Transfer roll assembly	6-2, 7-11

56P2330 Fuser assembly, 110 V	6-2, 7-9
56P2331 Fuser assembly, 220 V	6-2, 7-9
56P2332 Fuser assembly, 100 V	6-2, 7-9
56P2333 110 V maintenance kit	6-2, 7-22
56P2334 Paper feed/drive bushing	7-5
56P2335 Main harness cable assembly	7-13
56P2336 Output full and fuser exit cable assembly	7-15
56P2337 220 V maintenance kit	6-2, 7-22
56P2338 100 V maintenance kit	6-2, 7-22
56P2339 Power supply, 100 V	7-13
56P2340 Left guide assembly	7-11, 7-13
56P2341 Customer replaceable (CRU) charge roll	7-11, 7-22
56P2342 Language overlay group	7-3
56P2343 Clear bezel with logo	7-3
56P2344 Tray assembly, 250-sheet T2	7-21
56P2345 Tray, assembly, 500-sheet T3	7-21
56P2346 Drawer assembly, 250 T2 and base	7-21
56P2347 Drawer assembly, 500 T3 and base	7-21
56P2348 Fuser lift (outer) link assembly	7-11
56P2349 Fuser lift (inner) link	7-11
56P2350 Cartridge signature button switch	7-15, 7-19
56P2351 Entrance guide assembly with brush	7-7
56P2352 Paper feed roll	6-2, 7-5
56P2353 Operator panel assembly	7-3
56P2354 Operator panel cable cover	7-3
56P2355 Fuser paper exit guide assembly	7-9
56P2356 Operator panel assembly (Japan)	7-3
56P2357 LVPS fan and housing assembly	7-13
56P2358 MPF paper pick gear	7-8
56P2359 MPF pick roll assembly	4-7, 7-8
56P2360 Exit drive motor	7-5
56P2361 256MB PC100 kit DIMM	7-21
56P2363 Ratchet drive	4-6, 7-5
56P2364 Maintenance kit parts group	6-2, 7-22
56P2365 Paper guide bracket	7-5
56P2369 Controller card assembly, non-network	7-13
56P3144 PrintCryption card	7-21
56P3304 ImageQuick card assembly	7-21
56P3305 PRESCRIBE card assembly	7-21
56P3317 Bar code card	7-21
56P3837 IPDS and SCS/TNe card assembly	7-21
56P3845 Forms Merger card assembly	7-21
70G0478 Power cord	7-17
7370971 Field relocation kit	7-22

**4048-1xx**

99A0394 Lubricant, Nyogel 744 ..... 4-6, 6-1, 6-2, 7-5, 7-8  
99A0462 Lubricant, IBM 23 ..... 4-6  
99A0545 External serial adapter ..... 7-21



# Lexmark T430 Wiring diagram

