

FM 34-54

TECHNICAL INTELLIGENCE

HEADQUARTERS, DEPARTMENT OF THE ARMY

DISTRIBUTION RESTRICTION: Approved for public release; distribution is unlimited.

PREFACE

This field manual provides guidance to commanders and staffs of military intelligence (MI) and other units responsible for technical intelligence (TECHINT) or having an association with TECHINT. It provides general guidance and identifies the tactics, techniques, and procedures (TTP) used in the collection, exploitation, and dissemination of TECHINT in satisfying the warfighter's requirements.

TECHINT is an integral part of the overall battlefield operating system (BOS) and supports Army operations through the analysis and exploitation of foreign equipment, weapons, and other war materiel.

This field manual describes the TECHINT process at all echelons and identifies responsibilities. It further describes the MI TECHINT organizations, other services, and the strategic level intelligence agencies supporting the process.

On today's battlefield, Army forces will likely deploy as part of a joint or combined military operation. For that reason, while this manual supports Army operations, it does so in the context of Army operations as part of a joint or combined task force.

This field manual applies to all Army personnel, to include Active Component (AC) and Reserve Components (RC) commanders and their staffs, US Army Training and Doctrine Command (TRADOC) Centers and Schools, and MI elements.

The proponent of this publication is US Army Intelligence Center and Fort Huachuca (USAIC&FH). Send comments and recommendations on DA Form 2028 (Recommended Changes to Publications and Blank Forms) directly to Commander, US Army Intelligence Center and School, ATTN: ATZS-TDL-D, Fort Huachuca, AZ 85613-6000.

The doctrine in this publication conforms with and supports the principles in FM 34-1 and FM 100-5. This manual does not implement any international standardization agreements but complies with the following Standardization Agreements:

STANAG 1059 - National Distinguishing Letters for Use by NATO Forces (Edition 6).

STANAG 2014 - Operations Plans, Warning Orders, and Administrative/Logistics Orders (Edition 7).

STANAG 2044 - Procedures for Dealing With Prisoners of War (Edition 5).

STANAG 2084 - Handling and Reporting of Captured Enemy Equipment and Documents (Edition 5).

STANAG 2097 - Nomenclature and Classification of Equipment (Edition 6).

STANAG 2143 - Explosive Ordnance Reconnaissance/Explosive Ordnance Disposal (Edition 4).

STANAG 2389 - Minimum Standards of Proficiency for Trained Explosive Ordnance Disposal Personnel (Edition 1).

STANAG 2834 - The Operation of the Explosive Ordnance Disposal Technical Information Center (EODTIC) (Edition 2).

Unless this publication states otherwise, masculine nouns and pronouns do not refer

FM 34-54

exclusively to men. The use or mention of any commercial or private organization's name or trademark and the organization's services and/or funds by the US Army does not express or imply an endorsement of the sponsor or its products and services by the US Army.

TECHNICAL INTELLIGENCE

TABLE OF CONTENTS

	Page
PREFACE v	
CHAPTER 1 – TECHNICAL INTELLIGENCE MISSION AND SUPPORT.....	1-1
General	1-1
Mission.....	1-1
TECHINT Support to the Warfighter	1-1
Historical Perspective.....	1-2
Lessons Learned.....	1-8
CHAPTER 2 – SCIENTIFIC AND TECHNICAL INTELLIGENCE.....	2-1
Introduction	2-1
The S&TI Community	2-1
Structure.....	2-3
CHAPTER 3 – BATTLEFIELD TECHNICAL INTELLIGENCE OPERATIONS.....	3-1
Introduction	3-1
203d MI Battalion (TECHINT)	3-3
Battlefield TECHINT Channels.....	3-6
Joint Technical Intelligence Branch	3-6
Captured Materiel Exploitation Center	3-7
JCMEC and CJCMEC	3-8
TECHINT Liaison Elements	3-8
Corps CMEC (Forward)	3-9
Battlefield TECHINT Collection Teams.....	3-9
CHAPTER 4 – INTELLIGENCE CYCLE APPLIED TO TECHNICAL INTELLIGENCE OPERATIONS.....	4-1
Plan and Direct	4-1
Collect.....	4-3
Process.....	4-6
Produce.....	4-6

DISTRIBUTION RESTRICTION: Approved for public release; distribution is unlimited.

*This publication supersedes FM 34-54, 5 April 1990.

	Page
Disseminate	4-6
Battlefield TECHINT Reporting Sequence	4-7
Battlefield TECHINT Analysis	4-8
 CHAPTER 5 – RESPONSIBILITIES	 5-1
Introduction	5-1
Staff Sections	5-1
Assistant Chief of Staff, J1/G1, Personnel	5-1
Assistant Chief of Staff, J2/G2, Intelligence	5-2
Assistant Chief of Staff, J3/G3, Operations	5-3
Assistant Chief of Staff, J4/G4, Logistics	5-4
Assistant Chief of Staff, J5/G5, Civil Affairs	5-4
Special Staff Officers	5-5
Units and Organizations	5-7
 APPENDIX A – MEASUREMENT AND SIGNATURE INTELLIGENCE	 A-1
APPENDIX B – JCMEC OPERATIONS	B-1
APPENDIX C – HANDLING AND EVACUATION	C-1
APPENDIX D – INTELLIGENCE ANNEX WITH TECHINT INPUT	D-1
APPENDIX E – TECHNICAL INTELLIGENCE REPORTS	E-1
APPENDIX F – COLLECTION AND EXPLOITATION REQUIREMENTS	F-1
APPENDIX G – FOREIGN LANGUAGE TEXT RECOGNITION	G-1
APPENDIX H – CHEMICAL AND BIOLOGICAL WARFARE SAMPLING PROCEDURES	 H-1
APPENDIX I – FACILITY EXPLOITATION CHECKLISTS	I-1
 GLOSSARY	
Acronyms	Glossary-1
Terms and Definitions	Glossary-12
 REFERENCES	 References-1
 INDEX	 Index-1

LIST OF FIGURES

	Page
Figure 2-1. Department of Defense S&TI community.	2-2
Figure 3-1. TECHINT operations	3-2
Figure 3-2. The 203d MI Battalion (TECHINT) organization.	3-3
Figure 3-3. TECHINT team organization	3-5
Figure 3-4. Possible locations of TECHINT LNEs when supporting a JTF.	3-9
Figure 4-1. Planning and directing	4-1
Figure 4-2. TECHINT target folder.	4-2
Figure 4-3. Flow of CEM guidance and decisions	4-4
Figure 4-4. Transportation operations	4-5
Figure 5-1. Staff sections responsibilities	5-2
Figure A-1. HQDA agencies and their MASINT responsibilities.	A-3
Figure B-1. Joint Captured Materiel Exploitation Center (JCMEC) Organization.	B-4
Figure B-2. TECHINT communications architecture	B-7
Figure C-1. Evacuation of captured petroleum, oils, and lubricants	C-4
Figure C-2. Evacuation of captured ammunition and explosives	C-4
Figure C-3. Captured medical materiel evacuation system	C-5
Figure C-4. Evacuation of captured aviation items	C-5
Figure C-5. Front and reverse sides of an EPW tag.	C-11
Figure C-6. Front and reverse sides of a CEE tag.	C-12
Figure C-7. Example of a CEE tag flagged for TECHDOCs.	C-13
Figure D-1. Example of an extract from a Theater Army Intelligence Annex	D-1
Figure D-2. Example of a Joint Theater TECHINT Appendix	D-4
Figure D-3. Example of a TAB D to a TECHINT Appendix of a Theater Army Intelligence Annex.	D-11
Figure E-1. Example of a SALUTE report.	E-2
Figure E-2. Format for a PRETECHREP.	E-3
Figure E-3. Format for a COMTECHREP - Type A.	E-4
Figure E-4. Format for a COMTECHREP - Type B.	E-7
Figure E-5. Format for a COMTECHREP - Type C.	E-9
Figure G-1. A partial list of spoken languages and locations where they are spoken.	G-3
Figure G-2. Table of diacritics.	G-4
Figure G-3. The occurrence of diacritics in various languages.	G-5
Figure G-4. Distinguishing major Slavic languages from Russian.	G-10
Figure G-5. Cyrillic alphabet and transliteration chart.	G-12
Figure G-6. International, Arabic, and Persian numbers.	G-16
Figure G-7. The Arabic alphabet.	G-17
Figure G-8. The diacritics of Arabic and Persian.	G-18
Figure G-9. Printed Arabic.	G-18
Figure G-10. Typewritten Arabic.	G-19
Figure G-11. Printed Persian (arrows indicate distinguishing features).	G-19
Figure G-12. Sample of Chinese text.	G-21
Figure G-13. Sample of Japanese text.	G-21
Figure G-14. Shows Korean with fewer Chinese symbols used.	G-22
Figure G-15. The fifty most common Chinese character radicals.	G-23
Figure G-16. The Japanese Hiragana syllabary.	G-24
Figure G-17. The Japanese Katakana syllabary.	G-24

FM 34-54

Figure G-18. The Korean alphabet. G-25
Figure H-1. Sample DA Form 1971-6-R (Chemical/Biological Sample Documentation) . H-4
Figure H-2. Example of an equipment list. H-5
Figure H-3. Description of responsibilities for a sample evacuation. H-10
Figure H-4. Sample collection guidelines. H-13
Figure H-5. Sample identification and control. H-14
Figure I-1. Collection Checklist-Airfields. I-1
Figure I-2. Collection Checklist-Electric Power. I-5
Figure I-3. Checklist-Petroleum and Natural Fields. I-8
Figure I-4. Facility Physical Security Checklist. I-11
Figure I-5. Checklist-Railways. I-14
Figure I-6. Checklist-Underground Facilities. I-18

Chapter 1

TECHNICAL INTELLIGENCE MISSION AND SUPPORT

GENERAL

This chapter describes the TECHINT mission, how it supports the warfighter, and presents TECHINT in a historical perspective. TECHINT results from the collection, evaluation, and analysis of foreign warfighting equipment and associated materiel. At the strategic level, the exploitation and interpretation of foreign weapons systems, materiel, and technologies is referred to as scientific and technical intelligence (S&TI). This S&TI covers—

- Foreign developments in basic and applied research and in applied engineering techniques.
- Scientific and technical (S&T) characteristics, capabilities, and limitations of all foreign military systems, weapons, weapon systems, and materiel.
- Research and development (R&D) related to these systems and the production methods employed for their manufacture.

MISSION

The TECHINT mission ensures that the warfighter has a clear understanding of the full technological capabilities residing in his opponent's equipment. With this knowledge, the warfighter adopts countermeasures, operations, and tactics, as necessary, to be successful in any assigned mission.

TECHINT SUPPORT TO THE WARFIGHTER

STRATEGIC LEVEL:

The US has relied on its military strength as a strategic deterrent to war. The strength of the US military lies, in part, to the diversity and extent of its technology base. While the US aspires to be the leader in integrating technology, the actual products are available to any buyer. An adversary can achieve temporary technological parity or advantage by acquiring modern systems or capabilities. The world arms market is willing to provide these advanced systems to countries or individuals with the resources to

pay for them. A concerted TECHINT program is vital to providing precise direction and purpose within the US R&D process to ensure that this parity or advantage is neutralized quickly and efficiently.

OPERATIONAL AND TACTICAL LEVEL:

For the Army, technology is changing how we organize, how we train and develop leaders, and how we conduct operations. Advances in electronics, communications, automation, reconnaissance and surveillance (R&S), contamination avoidance, precision-guided munitions, and the exploitation of space-based capabilities have increased the lethality, range, accuracy, and reliability of our weaponry.

Operational and tactical commanders rely on this technological advantage to successfully synchronize and execute complex modern Army operations. The introduction of a surprise technological capability by an adversary causes confusion and delay mission accomplishment until the capability is understood and countered. TECHINT is the key to the early identification of an adversary's technical capabilities and the development of countermeasures for the operational and tactical commander.

HISTORICAL PERSPECTIVE

In the 1920's, Germany was developing the weapons and systems it would use against the Allies in the 1940's. Because Allied nations did not integrate TECHINT into peacetime collection efforts, German S&T advances went largely unnoticed. When information did come to light, Washington and London ignored or ridiculed it. Later, when the Germans fielded their advanced weapons and systems in war, the resulting technological surprise on the battlefield was devastating.

WORLD WAR II:

During the air battle for Europe, the British used TECHINT to counter the German antiaircraft and night-fighter defenses. This was accomplished by exploiting captured aircraft radios and a captured radar station. (See below a discussion of the Bruneval Raid.)

The Allies captured many German and Italian weapons in North Africa. This collection led to the publishing of new technical material, such as—

- Technical manual E9 series handbooks on enemy weapons.
- Special series publications on German weapons.
- Training aids.

- Updates to handbooks on the German and Italian armies.

TECHINT exploitation of captured German Tiger and Panther tanks led to several important battlefield countermeasures. One of these was the adoption of new armor tactics while another was the development of more powerful antitank rockets.

The United States started a successful TECHINT program in the fall of 1943 called the ALSOS mission. This unit was made up of Counterintelligence (CI) Corps agents, scientists, and interpreters. Their mission was to capture and exploit personnel and material of S&T value.

The successes of this unit included:

- Exploitation of Italian and German nuclear scientists.
- Removal of significant quantities of uranium ore from the Albert Canal.
- Recovery of the international radium standards from what was to be the Soviet occupied sector of Germany.

Throughout the remainder of the 1940's a Foreign Materiel Intelligence Branch at the Ordnance Center, Aberdeen Proving Grounds, MD, continued to conduct exploitation work on captured German and Japanese equipment.

THE RAID ON BRUNEVAL—AN OFFENSIVE TECHINT OPERATION:

At 2100Z on 27 February 1942, 119 British soldiers of Company C, 2nd Battalion, the Parachute Regiment, parachuted into a drop zone near the small village of Bruneval, in Occupied France. The company's mission was to raid a suspected German radar site on a cliff a few hundred yards from an accessible beach to bring back an item of extreme TECHINT interest—the WUERZBURG radar.

The WUERZBURG radar was believed to be a mobile, short-range, high-precision radar responsible for the sudden and serious increase in Allied heavy bomber losses. Routine Allied photographic reconnaissance originally discovered the installation in January 1942. French resistance forces were sent to investigate. They confirmed the site as well as a garrison troop strength of nearly 200 enemy signal, support, and security troops. They also reported that the nearby beach was not mined.

It was the intelligence and urgent need to protect Allied planes that resulted in the commando raid that night. Once on the ground, the commandos moved quickly and split into three equal groups. The first group secured

the beach. The second group spread out and took up positions to act as a reserve or blocking force. The last group, the collection team and a special radar technical expert, moved forward to take the target.

The collection team slipped through enemy defender positions, entered the installation, and found the radar. They used hacksaws, crowbars, and precision hand tools to dismantle the main components. As each part of the radar was exposed, it was sketched and photographed. The team also captured a German signalman—the radar operator.

When they finished, the team destroyed what they couldn't take with them and began their move to the beach under progressively heavy fire. The surviving commandos were picked up by Allied landing craft and escaped across the Channel to England.

Exactly three and one-half hours after the mission began it was over. Although two men were killed, six wounded, and six more listed as missing in action, the raid was deemed a great success. Not only was it the first raid on the continent following the disaster at Dunkirk but also it resulted in the successful capture of a valuable piece of enemy material—material that later proved to be of vital TECHINT interest.

Allied TECHINT experts examined the material as soon as they got it. The exploitation of this radar, along with the sketches and the photographs, quickly began to provide valuable TECHINT. For example, just from the recovered metal manufacturer's plates, analysts accurately determined how many Wuerzburg radars had been produced and their current rate of production. When the German signalman was interrogated, he provided valuable information about the level of operator skills and operator training. Most important, though, TECHINT scientists used the captured material to build an operational Wuerzburg radar mockup.

When the mockup was completed, they had a multifrequency radar that seemed, at first, to be almost impossible to jam. Scientists went to work to develop countermeasures to neutralize the radar's capabilities. Their efforts resulted in thin metallic strips cut to different lengths that could be dropped from airplanes. These strips reflected radar signals and effectively jammed the new radars. They dubbed these strips *chaff*. CHAFF turned out to be one of the most successful countermeasures developed during World War II—being particularly useful during the Normandy Invasion.

THE KOREAN WAR:

It wasn't until the beginning of the Korean War, when North Korean troops in Soviet-designed and Chinese-built armor rolled south, that the United States discovered it had little confirmed data on enemy weapons systems.

We realized that to be able to develop effective countermeasures, TECHINT had to be an ongoing process. As a result, we once again began a concerted TECHINT effort, with the Foreign Material Intelligence Branch at Aberdeen Proving Grounds training and fielding TECHINT teams to Korea.

In the Korean War, the warfighters found that their 2.36-inch bazooka rockets could not penetrate the T-34/85 tanks' frontal armor. With this combat deficit identified, commanders began to support the TECHINT process by evacuating captured T-34/85 tanks and other material to TECHINT elements for exploitation. TECHINT both in the theater and back in the United States at the Chrysler Corporation analyzed the captured material. The US Army responded by giving combat commanders new tactics, a redesigned M-48 tank, and a 3.5-inch bazooka.

The TECHINT effort also supported the political effort to prove Soviet involvement on behalf of the North Korean aggressor. Captured modern Soviet weapons were regularly paraded before the UN Security Council as evidence of Soviet support.

THE VIETNAM WAR:

Following the Korean War, the United States did not disband its TECHINT capability completely, as had been done at the conclusion of all previous hostilities. But neither did we maintain it at its wartime level. Three small TECHINT detachments remained in place at the Army's research and development centers. By 1962 two of the detachments merged to form the Army's Foreign Science and Technology Center. The third detachment established the Missile Intelligence Agency at Redstone Arsenal. The Surgeon General also operated a Medical Intelligence Center at Fort Detrick, MD.

An agency called the Captured Materiel Exploitation Center (CMEC) came into being in 1966. Its wartime mission was to manage, coordinate, and analyze captured enemy equipment (CEE), and technical captured enemy documents (CEDs). The CMEC did this on a tactical level by dispatching teams of experts and analysts into the tactical zone of each corps. These teams analyzed captured materiel in the field and recommended countermeasures to tactical commanders. American personnel working in the CMEC were assigned to Delta Company, 519th MI Battalion.

The North Vietnamese employed Soviet designed man-portable systems with considerable success. The Soviet AT-3 Sagger anti-tank guided missile (ATGM) was used against South Vietnamese armored vehicles, communications bunkers, and even small outposts. In addition, the SA-7 heat-seeking surface-to-air missile (SAM) was employed and became an even more serious threat because it could disrupt allied control of the air

space over the battlefield. Lastly, the 122-mm rocket was employed as the North Vietnamese Army's (NVA) primary artillery weapon in a variety of configurations. While samples of these weapons undoubtedly fell into the hands of the South Vietnamese, nothing was done with them because of the September 1969 inactivation of American TECHINT units in Vietnam. And, by October 1971, the 55th Military Intelligence Detachment, a corps support unit with a TECHINT capability, had also been inactivated.

GRENADA (OPERATION URGENT FURY):

Following the commitment of US forces to Grenada on 25 October 1983, large quantities of foreign military equipment were discovered thus requiring TECHINT support.

Two elements of the 203d MI Battalion, 513th MI Group, were deployed to Grenada. Five soldiers participated as members of a Defense Intelligence Agency (DIA) Team formed at the request of the Commander in Chief, Atlantic (CINCLANT) operational commander for URGENT FURY. The first element arrived in Grenada on 31 October 1983 and was tasked to identify, sort, and provide approximate inventories of foreign material and to establish priorities for shipment to the United States. Nineteen other soldiers established the 203d MI Battalion (Forward) and operated a modified CMEC. Together the 203d soldiers type-classified and developed inventories; assisted combat units in searches for materiel; operated a collection point for CEE and captured enemy materiel (CEM); and shipped appropriate items to the continental United States (CONUS).

In 1985 the 203d MI Battalion was redesignated the Foreign Materiel Intelligence Group. In 1989 it was again redesignated as the Foreign Materiel Intelligence Battalion (FMIB).

THE GULF WAR (OPERATIONS DESERT SHIELD and DESERT STORM):

DESERT SHIELD and DESERT STORM were the largest battlefield TECHINT operations since the Vietnam War, and the largest joint and combined TECHINT operations since World War II. The Joint Captured Materiel Exploitation Center (JCMEC) was formed with the Army's FMIB to serve as the nucleus and headquarters. Augmentation to the FMIB included TECHINT personnel from every element of the Department of Defense (DOD), the national S&TI community, Great Britain, Canada, and Australia.

During Sadaam Hussein's attack on the Saudi Arabian city of Khafji in February 1991, a previously unseen and highly modified tank was captured. This tank, a modified T-55, had vastly improved external armor and possibly new fire control, weapons, and optical systems. A team from the JCMEC was dispatched forward to conduct a hasty exploitation and to

find out if this tank required a tactical capabilities reassessment. In layman's terms, could this new tank, with its improved armor, defeat a broader array of friendly weaponry? Within 2 days, the TECHINT collection team soldiers, analysts at the JCMEC, and national S&TI agencies in the United States were able to report their findings to the theater commander and his staff.

DESERT SHIELD and DESERT STORM produced the largest amount of CEM in the shortest amount of time since World War II. As a result of lessons learned from prior deployments, TECHINT provided unprecedented timely and accurate information to the warfighter and the national S&TI community.

SOMALIA (OPERATION RESTORE HOPE) :

On 4 December 1992, the FMIB alerted a TECHINT liaison element (LNE) for deployment in support of the US Marine Corps (USMC) II Expeditionary Force, the core headquarters for Joint Task Force (JTF) Somalia.

The TECHINT LNE deployed to Somalia on 16 December and established operations at the US Embassy compound in southwest Mogadishu on 18 December. The TECHINT LNE made several significant contributions to the operations and intelligence efforts in Somalia.

On 21 December, the LNE accompanied a delegation from the JTF Somalia headquarters on a tour of compounds controlled by rival warlords in Mogadishu. During the 5 to 10 minutes the LNE was inside of each of the five compounds, the TECHINT LNE personnel compiled lists of the foreign and US weapons, equipment, and ordnance controlled by the warlords. This order of battle (OB) intelligence was key in planning the eventual US forces attack against one of those compounds.

After determining there was no theater-wide plan for the collection and processing of CEM, the TECHINT LNE established the Centralized Weapons Collection Center (CWCC). In conjunction with explosive ordnance disposal (EOD) personnel, the CWCC processed, screened for intelligence value, and disposed of thousands of captured weapons and hundreds of thousands of rounds of ammunition.

On 6 January, several SA-7 man-portable SAMs were captured in the Mogadishu area. In conjunction with EOD personnel, and with input from the US Missile and Space Intelligence Center (MSIC), the TECHINT LNE reported that the missiles were functional. This intelligence prompted a change in the air defense artillery (ADA) threat status and flight operations in Somalia.

On 14 January, several French MILAN antitank missiles were captured in

the Mogadishu area. The TECHINT LNE conducted testing and evaluation of captured missiles with personnel from the French contingent of Commander, Joint Task Force (CJTF) Somalia. The missiles were functional and capable of defeating all but the heaviest armor in the Somali theater of operations.

HAITI (OPERATIONS RESTORE DEMOCRACY and UPHOLD DEMOCRACY) :

In September 1994 FMIB deployed a 14-soldier TECHINT contingency support detachment (CSD) and a 2-soldier LNE in support of US Operation RESTORE DEMOCRACY. TECHINT LNE personnel, in conjunction with JTF 180 and JTF 190 planners, developed handling and processing procedures for CEM, including weapons received as part of the "Cash for Guns" program.

The CSD established the JCMEC (Forward) in Port-au-Prince. The CSD screened, processed, and inventoried over 10,000 weapons and thousands of rounds of ammunition by hand without the benefit of materiel-handling equipment. The resulting database provided OB analysts a tool for assessing the threat to US forces as well as the success of the "Cash for Guns" program. Additionally, the "by serial number" inventory was forwarded to national law enforcement agencies via CI liaison channels to aid in arms smuggling investigations.

At the time of redeployment, CSD personnel had accomplished all assigned national TECHINT collection requirements, and through intelligence discipline integration, played key roles in various signals intelligence (SIGINT) and human intelligence (HUMINT) operations.

LESSONS LEARNED

The historical experience of the nation in times of peace and war clearly demonstrates the need for a fully operational Army TECHINT capability. A robust TECHINT collection and analysis capability, with dynamic links to S&TI centers in the United States is especially vital in the future's technologically sophisticated battlefield. This capability is required to correctly portray the battlespace for warfighting commanders. Furthermore, TECHINT enhances force protection. To neglect TECHINT during the planning and execution of Army operations invites the possibility of technological surprise.

Chapter 2

SCIENTIFIC AND TECHNICAL INTELLIGENCE

INTRODUCTION

TECHINT is the end product of a complex process. It is the result of collecting, analyzing, and processing information on foreign technological developments. It is also the result of studying the performance of foreign materiel and its operational capabilities.

TECHINT has two goals:

- To ensure the US armed forces maintain technological advantage against any adversary.
- To provide tailored, timely, and accurate TECHINT support to the warfighter throughout the entire range of military operations.

This support includes providing US forces information and training on foreign weapons systems to an extent that allows use of the CEE. The TECHINT system accomplishes both missions.

THE S&TI COMMUNITY

The S&TI community satisfies the nation's overall TECHINT objectives during peacetime, and the strategic TECHINT requirements in wartime. The S&TI community starts at the DOD level. Figure 2-1 shows this organizational structure.

S&TI is designed to track and analyze foreign technological developments. It is used to analyze the performance and operational capabilities of foreign materiel that may have military application.

Although the primary function of the S&TI community is to satisfy strategic TECHINT objectives, it also makes significant contributions toward fulfilling operational and tactical TECHINT requirements. Strategic communications between battlefield TECHINT units and S&TI centers allow the use of their comprehensive databases and expertise to rapidly satisfy the TECHINT requirements of the warfighter.

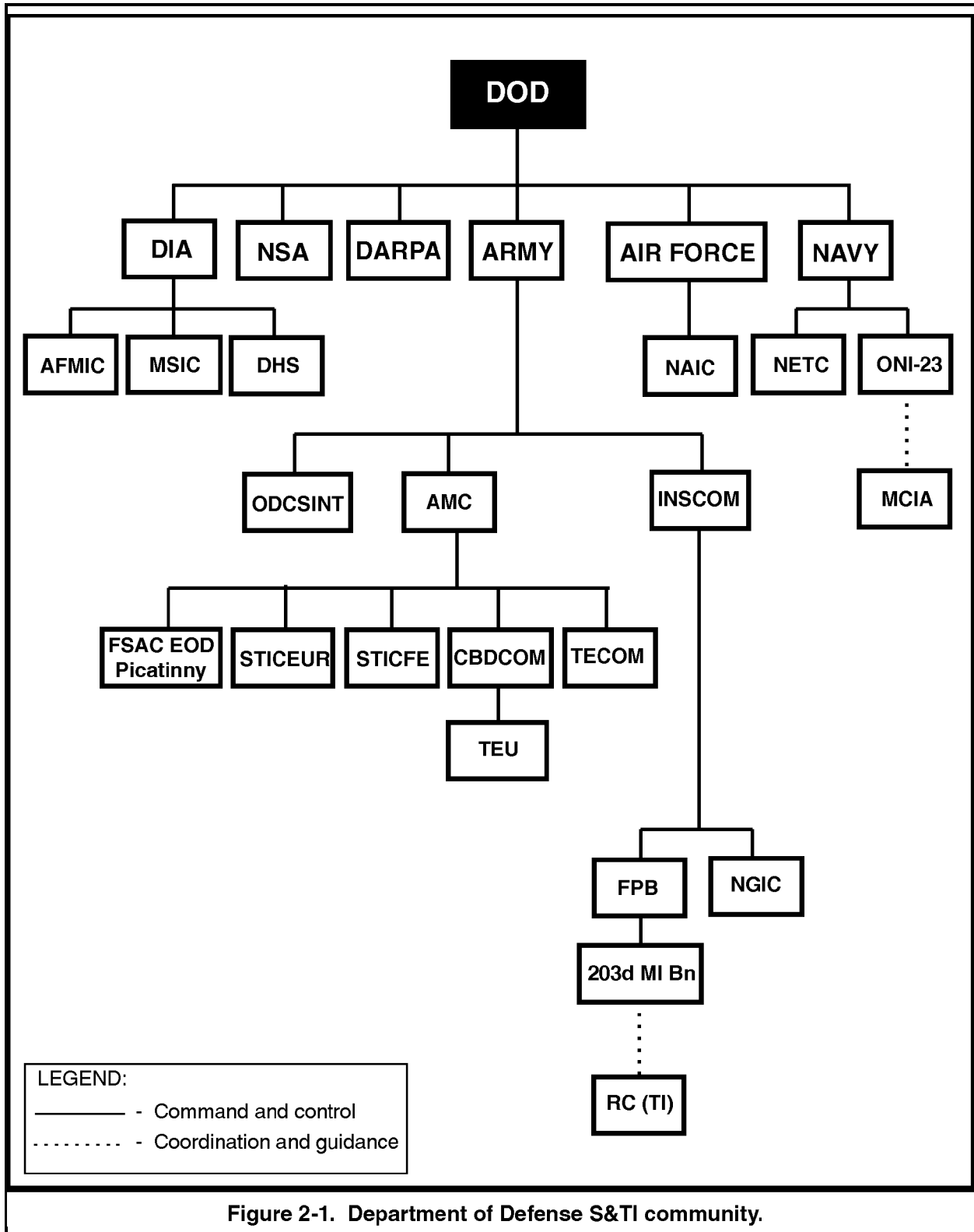

STRUCTURE

DEFENSE INTELLIGENCE AGENCY:

DIA manages and reviews overall TECHINT activities throughout DOD during peacetime and war. The S&TI directorate within DIA is the action element for TECHINT. This directorate coordinates with external TECHINT agencies on nonpolicy matters concerning the production of S&TI.

Armed Forces Medical Intelligence Center (AFMIC). AFMIC, based at Fort Detrick, MD, is a DOD intelligence production center under control of DIA. AFMIC is responsible for exploiting foreign medical materiel. The director supports the Army Foreign Materiel Exploitation Program (FMEP) and Army medical R&D requirements. The director coordinates with the Deputy Chief of Staff, Intelligence (DCSINT) in planning, programming, and budgeting. AFMIC—

- Studies and reports foreign medical S&TI and general medical intelligence to DOD and other Federal agencies.
- Studies and reports foreign biological warfare S&TI capabilities.
- Administers the DOD Foreign Medical Materiel Exploitation Program (FMMEP).
- Provides "quick response" foreign medical intelligence support to DOD and other Federal agencies.
- Maintains a mutually beneficial S&TI exchange with the US Army Intelligence and Security Command (INSCOM) to complement Army capabilities.

Missile and Space Intelligence Center (MSIC). MSIC, based at Redstone Arsenal, AL, is a DOD intelligence production center under control of DIA and supports the FMEP. The MSIC acquires, produces, maintains, and disseminates S&TI pertaining to missile and space weapons systems, subsystems, components, and activities. The S&TI produced at MSIC also covers foreign state-of-the-art technology and research applicable to missiles. MSIC analyzes—

- Directed energy weapons.
- Antisatellite technology.
- Tactical air defense.

- Short-range ballistic missiles (SRBMs).
- Antitank guided missiles (ATGMs).

Defense HUMINT Service (DHS). DHS conducts worldwide HUMINT operations in support of foreign materiel acquisition and exploitation.

NATIONAL SECURITY AGENCY (NSA):

NSA is the SIGINT organization of the US Government. It is responsible for exploiting cryptologic and electronic warfare (EW) materiel.

DEFENSE ADVANCED RESEARCH PROJECTS AGENCY (DARPA):

DARPA is the central R&D organization for DOD. It manages and directs selected basic and applied R&D projects for DOD and pursues research and technology where risk and payoff are both very high and where success may provide dramatic advances for traditional military roles and missions. DARPA sponsors R&D in all aspects of TECHINT, including imagery intelligence (IMINT), SIGINT, HUMINT, and measurement and signature intelligence (MASINT). For the latest description of DARPA projects, visit the DARPA World Wide Web site on the Internet: <http://www.arpa.mil/>.

AIR FORCE:

National Air Intelligence Center (NAIC). NAIC is the primary DOD agency producing foreign aerospace S&TI. It satisfies DIA requirements and supports the Air Force Assistant Chief of Staff for Intelligence (AFACSI). NAIC acquires, analyzes, produces, and disseminates S&TI related to current and future enemy aerospace capabilities.

NAVY:

Naval EOD Technical Division and Fire Support and Armament Command EOD. These are the primary training centers of all Joint EOD personnel. Augmented by Army EOD specialists from Picatinny Arsenal, they act as primary centers establishing identification, render safe procedures (RSPs) and demolition procedures for foreign ordnance.

Office of Naval Intelligence. The Navy proponent for TECHINT in the Office of Naval Intelligence (ONI) is designated ONI-23. ONI-23 provides

S&TI on technical characteristics and capabilities of foreign naval forces and merchant systems. It provides S&TI support to the Commander of the ONI and the Chief of Naval Operations.

ARMY:

Office of the Deputy Chief of Staff, Intelligence (ODCSINT). Although ODCSINT does not produce intelligence, it does have general staff responsibility for all Army TECHINT activities. The ODCSINT—

- Formulates policies and procedures for S&TI activities.
- Supervises and carries out the Army S&TI program.
- Coordinates Department of the Army (DA) staff and major subordinate command requirements for TECHINT.
- Is responsible for the Army Foreign Materiel Program (FMP).

US Army Materiel Command (AMC). AMC is a major Army command (MACOM) with a significant support role in TECHINT. Among AMC elements are a series of research, development, and engineering centers (RDECs), the Army Research Laboratory System, and the US Army Test and Evaluation Command (TECOM). Each plays a role in wartime in conducting highly technical evaluations of foreign equipment. In peacetime, the AMC conducts foreign materiel exploitation (FME) on equipment purchased by each laboratory and RDEC for the intelligence community and for DOD as part of the International Materiel Evaluation Program (IMEP).

AMC's Foreign Ordnance exploitation team is at the Fire Support Armaments Center (FSAC) EOD (Picatinny Arsenal). They exploit foreign ground ordnance and develop RSP for foreign ordnance. They also prepare detailed intelligence reports to support EOD, Intelligence, and US munitions developer communities.

Additionally, AMC operates the Scientific Intelligence Center Europe (STICEUR) and Scientific Intelligence Center Far East (STICFE) with the purpose of overtly collecting information on foreign technical developments by attending arms shows and technology exhibitions.

AMC's Chemical and Biological Defense Command (CBDCOM) is the headquarters for the US Army Technical Escort Unit (TEU). This unit has the mission to collect and escort nuclear, biological, and chemical (NBC) samples from the battlefield to CONUS for testing and evaluation.

US Army Intelligence and Security Command (INSCOM). Under the direction of Headquarters, Department of the Army (HQDA), INSCOM is responsible for peacetime TECHINT operations. Headquarters, INSCOM, fulfills its responsibilities through its TECHINT oversight function and manages the Army's Foreign Materiel for Training (FMT) Program and FMEP. It does this by—

- Providing the interface with strategic S&TI agencies in support of foreign materiel exploitation.
- Organizing, training, and equipping echelons above corps (EAC) TECHINT organizations during peacetime.

Headquarters, INSCOM, controls two organizations that facilitate TECHINT: National Ground Intelligence Center (NGIC) and the 203d MI Battalion.

National Ground Intelligence Center:

Headquarters, INSCOM, exercises direct operational control over the NGIC. NGIC produces and maintains intelligence on foreign scientific developments, ground force weapons systems, and associated technologies. NGIC analysis includes, but is not limited to, military communications-electronics (C-E) systems which include—

- Types of aircraft used by foreign ground forces (usually rotary wing).
- NBC systems.
- Basic research in civilian technologies with possible military applications.

203d Military Intelligence Battalion:

The 203d MI Battalion, headquartered at Aberdeen Proving Ground, MD, is the only AC TECHINT battalion. The 203d MI Battalion is subordinate to the Force Projection Brigade (FPB) supporting national level S&TI. It—

- Conducts TECHINT and MASINT collection and reporting in support of validated S&TI objectives and MASINT data requirements (MDRs).
- Acts as the HQDA executive agent for foreign materiel used for training purposes.
- Conducts formalized TECHINT and MASINT training for DOD analysts

and RC TECHINT personnel.

- Supports INSCOM's foreign materiel acquisition (FMA) operations and FME operations as directed.
- Supports the Technical Reconnaissance and Surveillance (TECRAS) Program through its MASINT detachment. See Appendix A for MASINT support to TECHINT operations.

All TECHINT assets that reside in the RC are Wartraced to the 203d MI Battalion. Their primary peacetime mission focuses on training. However, certain RC TECHINT units and individuals are tasked to augment real world S&TI missions.

Chapter 3

BATTLEFIELD TECHNICAL INTELLIGENCE OPERATIONS

INTRODUCTION

This chapter describes battlefield TECHINT operations, functions, and procedures. Battlefield TECHINT operations consist of collection, hasty exploitation, initial TECHINT reporting, analysis, evacuation (as necessary), detailed exploitation and analysis, and production and dissemination of final TECHINT products. The term "battlefield" includes any area of operation that US forces occupy while conducting the full range of military operations.

Battlefield TECHINT can start with one conscientious soldier identifying something new in the area of operations and taking the proper steps to report it. The information or item is initially exploited to ascertain if it represents an advantage for the enemy. If it does, the information or item then undergoes increasing levels of analysis until a countermeasure is developed and the technological advantage is neutralized. While a single weapon or technology seldom means the difference between final victory or defeat, it can give one side a battlefield advantage.

A mutually dependent relationship exists between the support the warfighter gets from the TECHINT process and the support TECHINT gets from the warfighter. Operational and tactical commanders identify, capture, protect, and evacuate CEM that undergoes analysis for TECHINT value. TECHINT analysts receive CEM, conduct detailed exploitation, and recommend countermeasures to overcome an enemy's technological advantage.

Another result of this analysis is the development of a new US technology or an enhancement to an existing technology. In any case the end result is the neutralization of the adversary's technological advantage.

Commanders further ensure the success of the process by demanding TECHINT support to accomplish their assigned missions.

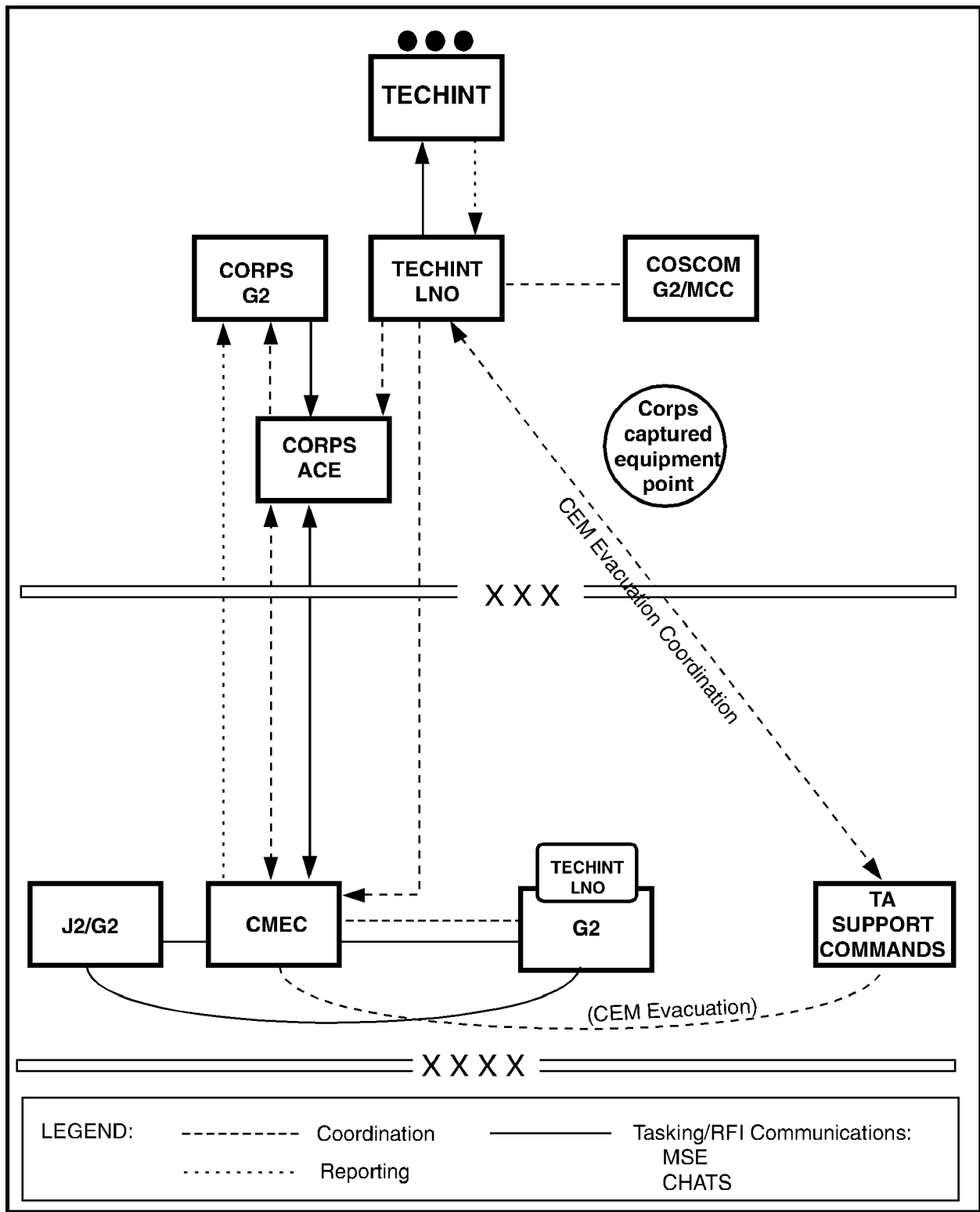

Figure 3-1. TECHINT operations.

203D MI BATTALION (TECHINT):

The 203d MI Battalion (TECHINT) mission during conflict and war is to provide near-real-time (NRT) intelligence derived from the exploitation of weapons, equipment, and other materiel found, captured, or acquired within the theater area of operations. This includes all items of an S&T nature. This battalion is the centerpiece of the theater TECHINT mission; task-organizing personnel and equipment to support several echelons. Figure 3-2 shows the 203d MI Battalion (TECHINT) organization. The HHC and the TECHINT Exploitation Company form the CMEC. This union is discussed below.

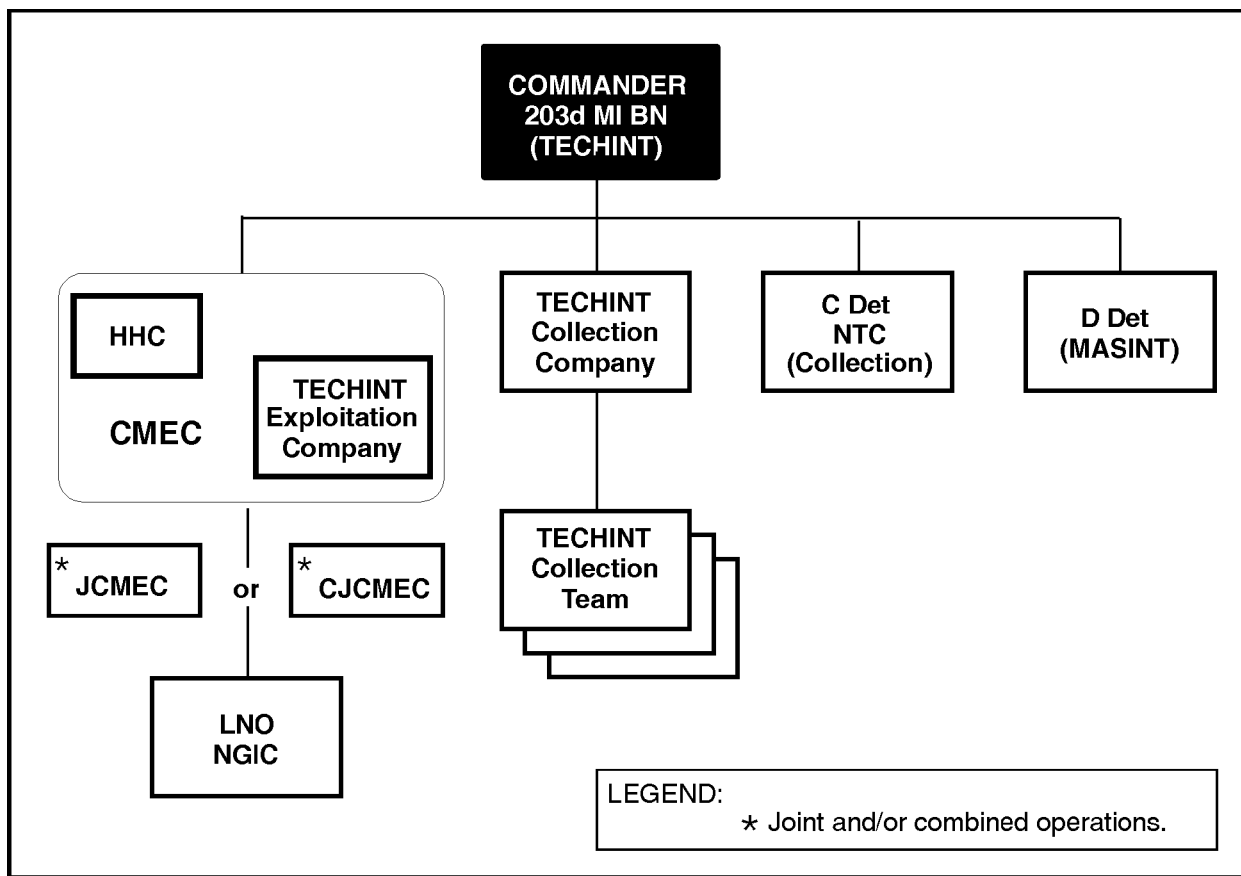

Figure 3-2. The 203d MI Battalion (TECHINT) organization.

HEADQUARTERS AND HEADQUARTERS COMPANY (HHC):

HHC conducts normal service support operations. In addition, its personnel may be tasked to perform duties as LNEs at various echelons. The S4 section, besides its normal maintenance and logistics staff responsibilities, also plays a significant role in the TECHINT concept of operations. The S4—

- Conducts warehouse operations for all CEE maintained at the CMEC.
- Monitors CEE at the Corps level collection points.
- Monitors captured ammunition and ordnance at Corps ammunition points.
- Assists in the transportation and tracking of equipment from theater to CONUS.

TECHINT EXPLOITATION COMPANY:

The TECHINT Exploitation Company consists of TECHINT collection managers and senior technical analysts in weapons and armaments, mobility systems, EW and communications systems, and chemical, medical, and logistics systems.

During joint and/or combined operations the CMEC may receive joint and/or combined augmentees. In this case, the CMEC is redesignated as the JCMEC or Combined Joint Captured Materiel Exploitation Center (CJCMEC). In all three configurations, the CMEC is commanded by the Commander, 203d MI Battalion. See Appendix B for JCMEC operations and responsibilities.

TECHINT COLLECTION COMPANY:

The TECHINT Collection Company consists of three TECHINT collection teams that normally are attached one per Corps MI brigade. The teams' mission is to conduct the initial identification and exploitation of foreign equipment in support of the Corps and, when directed, theater and national requirements. Additionally, the teams help monitor evacuation of the equipment off the battlefield.

The MI Team (TECHINT) (Collection) serves as the intelligence collection system for the battalion. It consists of TECHINT-qualified soldiers trained in the military occupational specialties (MOSSs) shown in Figure 3-3. These teams, trained in TECHINT analysis, deploy forward of the JCMEC

into the Corps area and receive their taskings from the CMEC through

TECHINT LNEs at the Corps G2. CEE is stored in the theater COSCOM.

NTC AND MASINT DETACHMENTS:

The Naval Technical Center (NTC) TECHINT Detachment, currently C Detachment, 203d MI Battalion (TECHINT), is similar to the TECHINT Collection Company in its mission to conduct initial identification and exploitation of foreign equipment in support of Corps, theater, and national requirements. It is organized similar to the TECHINT collection teams that are subordinate to the TECHINT Collection Company. During wartime or contingency it would have the same command and control relationships as a TECHINT collection team. It also has the additional mission of supporting INSCOM's FMT Program at the National Training Center.

The MASINT Detachment attaches MASINT analysts to the TECHINT collection teams and also provides senior analysts to the TECHINT Collection Company.

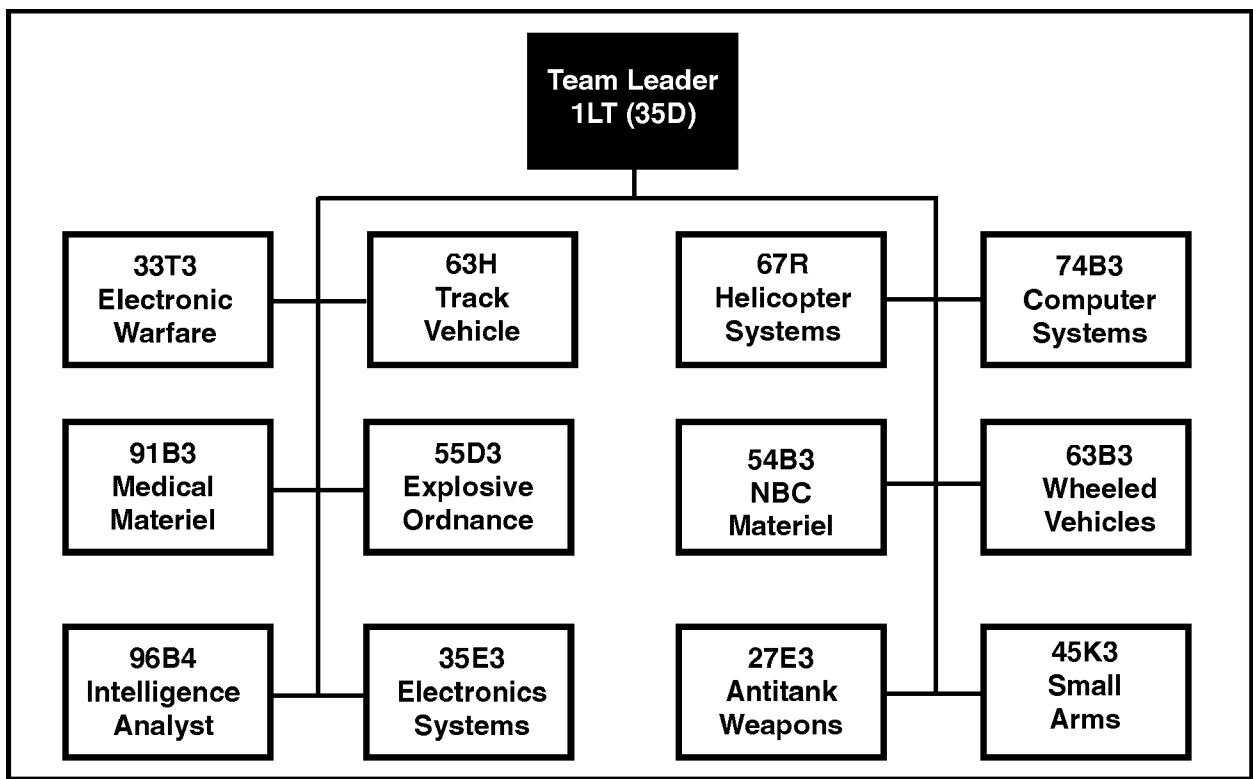

Figure 3-3. TECHINT team organization.

BATTLEFIELD TECHINT CHANNELS

The battlefield TECHINT channels are designed to support both operational and tactical levels of war. They support warfighting commanders at all levels (see Figure 2-1).

EAC TECHINT support consists of the Joint Technical Intelligence Branch (JTIB) located at the Theater Joint Intelligence Center (JIC), the CMEC formed around the 203d MI Battalion, and TECHINT LNEs located at various EAC analysis and control elements (ACEs). These EAC TECHINT assets provide general support to the theater.

Echelons corps and below (ECB) TECHINT support initially consists of TECHINT collection teams and TECHINT LNEs detached from the 203d MI Battalion. At a minimum, one TECHINT collection team is attached to each Corps MI Brigade. The team takes operational direction from the G2 via the TECHINT liaison officer (LNO) in providing direct support to ECB units from forward locations on the battlefield. A TECHINT LNE is attached to each Corps G2 or component equivalent. Upon mobilization, RC TECHINT units augment the 203d MI Battalion.

Regardless of the echelon, TECHINT elements are equipped to give the supported commander timely, relevant, accurate, and predictive information and recommended countermeasures based on CEM exploitation. This exploitation includes identifying, analyzing, and coordinating the evacuation of CEE, CED, and other CEM. See Appendix C for procedures for handling and evacuating CEM.

JOINT TECHNICAL INTELLIGENCE BRANCH

The JTIB is formed during joint operations. The JTIB is located at the Theater JIC and is composed of military and civilian TECHINT subject matter experts (SMEs). The JTIB chief is normally the DIA representative and serves as the senior advisor on TECHINT matters to the Theater Commander and the J2.

The JTIB conducts the following missions:

- Coordinates all national, operational, and tactical TECHINT requirements for the theater.
- Develops the theater TECHINT collection plan.
- Coordinates with the J2 and the JCMEC to execute all TECHINT

requirements.

- Provides liaison and coordination support for the JCMEC and the TECHINT collection teams at the JTF level.

CAPTURED MATERIEL EXPLOITATION CENTER

The main effort of the TECHINT mission is executed through a CMEC formed from TECHINT personnel from the 203d MI Battalion. The CMEC is the first major processor of CEM of TECHINT value. The CMEC—

- Exploits CEM based on national, Theater, and supported commanders' requirements.
- Produces TECHINT reports (including countermeasures) for tactical commanders.
- In coordination with EOD, provides render safe procedures (RSPs) for foreign munitions to combat units.
- Coordinates the safe handling and evacuation of CEM.
- Coordinates evacuation of special-interest CEM from ECB locations to the CMEC.
- Supervises evacuation of CEM from theater to CONUS.
- Coordinates with the Theater or Joint Interrogation Facility for the selection and technical interrogation of enemy prisoners of war (EPWs) assessed to have TECHINT-related knowledge. TECHINT analysts may assist interrogators and strategic debriefers during interrogation of a wide range of HUMINT sources of TECHINT interest by conducting "quarterback" debriefing operations with the debriefers.
- Provides accountability for CEE and CEDs within the theater TECHINT structure.
- Recommends CEM disposition to the Theater and Corps commands.
- Maintains the theater TECHINT database.
- Maintains the theater S&TI and battlefield TECHINT requirements.

The CMEC normally is located in the theater rear area near main supply routes (MSRs) and air and sea ports to accommodate rapid evacuation of

equipment. Every effort should be made to collocate the CMEC with the Theater Interrogation Facility to enhance the integration of HUMINT and TECHINT operations.

Additionally, being collocated provides a single geographical area where subordinate units bring captured personnel and CEM, as well as consolidating many transportation and security requirements. Regardless of its location, it is fully equipped with sensitive and sophisticated test and communication equipment. Analyst teams use this equipment to perform detailed in-theater exploitations.

The CMEC can also organize a team from organic CMEC assets to meet immediate requirements of echelons without TECHINT support. These teams can deploy forward or support rear area units as required.

JCMEC AND CJCMEC

The JCMEC and CJCMEC are organized and conduct the same missions as the CMEC. The JCMEC and CJCMEC differ as follows. They—

- Allow a free flow of information, reports, and TECHINT exploitation summaries between joint forces and/or allies; this is because the intelligence support staff is joint and/or combined.
- Coordinate scientific exploitation assistance from joint and/or allied TECHINT analysts.
- May provide direct support US and allied TECHINT teams to joint and/or allied ECB units as required.

TECHINT LIAISON ELEMENTS

The TECHINT LNEs are composed of TECHINT personnel from the 203d MI Battalion. The LNEs serve as advisors on all TECHINT-related matters. The TECHINT LNEs provide coordination and tasking support for the CMEC and the theater TECHINT effort. The TECHINT LNEs consist of one to three TECHINT personnel. Figure 3-4 shows the possible locations of TECHINT LNEs if deployed as part of a JTF.

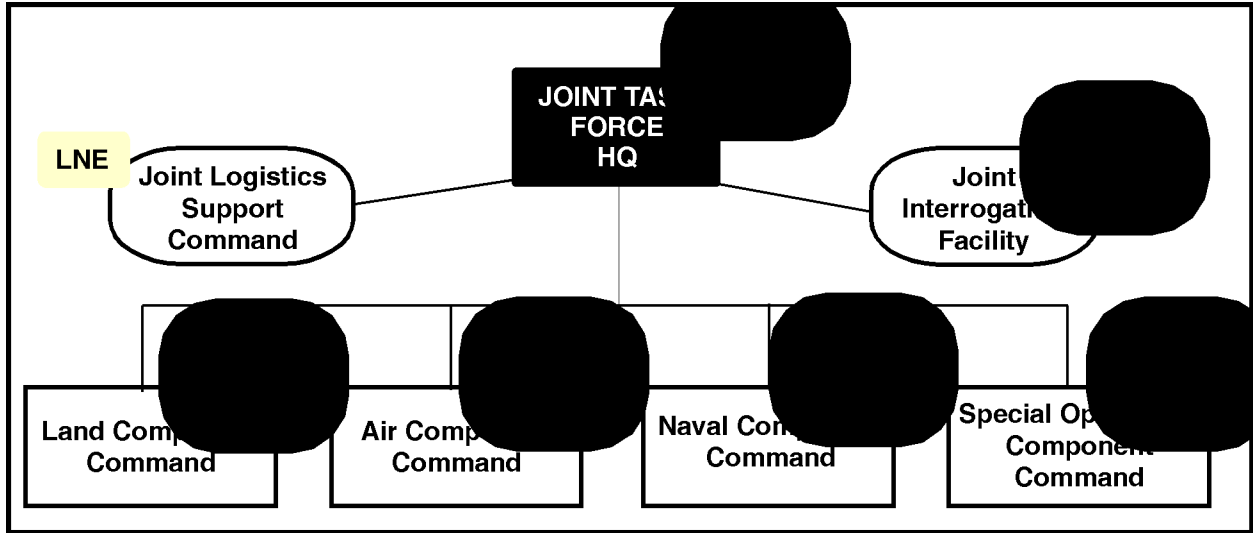

Figure 3-4. Possible locations of TECHINT LNEs when supporting a JTF.

CORPS CMEC (FORWARD)

An RC TECHINT section may staff a Corps level CMEC (Forward) normally located at the Corps Support Command (COSCOM) area Class VII collection point. Its primary mission is to inventory and identify CEE located at the COSCOM Class VII collection point and screen it for items of TECHINT value.

After identifying an item of TECHINT value, the CMEC (Forward) coordinates with the Corps G4 through the supporting TECHINT LNE for the transportation of the item back to the CMEC. The CMEC (Forward) supports the movement of the CEE by packing or crating it when required. The RC TECHINT section conducts preliminary exploitation and reporting on the identified materiel and assists the Corps TECHINT teams as required.

The RC TECHINT section normally consists of 15 personnel with organic transportation. The section's detailed analysis of CEE may be limited due to number of personnel and organic equipment.

BATTLEFIELD TECHINT COLLECTION TEAMS

The 203d MI Battalion provides direct support TECHINT collection teams to ECB MI Brigades or Marine Expeditionary Force (MEF) intelligence elements. These teams are mobile and organized according to available resources and subordinate command requirements.

TECHINT collection teams perform their mission as a tactical extension of the CMEC. They concentrate on the initial identification and exploitation of CEM and provide TECHINT assistance to Corps and Division G2s. Detailed analysis by these teams is limited due to personnel limitations and lack of extensive diagnostic equipment. The TECHINT collection team normally will have 14 TECHINT analysts and 2 MASINT analysts.

TECHINT collection teams are usually staffed with analysts capable of exploiting threat equipment and documents in eight functional areas: C-E, automation systems, weapons, munitions, NBC, medical, mobility, and signatures analysis. The areas are described below:

- C-E TECHINT is the analysis and exploitation of foreign and threat communications, computers, radars, intercept and jamming equipment, and like systems, including electro-optic and directed-energy technology.
- Automation systems TECHINT is the analysis and exploitation of foreign automation hardware and software.
- Weapons TECHINT involves the analysis of threat weapons and weapon systems, including rocket, tube artillery, mortars, small arms, ATGMs, other missiles, and associated fire control.
- Munitions TECHINT involves the analysis of threat munitions including missiles, NBC munitions, direct and indirect fire weapons ammunition, explosives, and mines.
- NBC TECHINT is based on the analysis of threat offensive and defensive NBC material including NBC samples, flame materials, and obscurants. This analysis determines threat strengths and vulnerabilities in relation to NBC operations.
- Medical TECHINT focuses on the identification, evaluation, and exploitation of medical materiel, general purpose systems modified for medical support, and biological agents sampling.
- Mobility TECHINT exploits threat vehicles, engineer equipment, materiel handling equipment, and power generation. Mobility TECHINT determines the capabilities and vulnerabilities of the enemy to maneuver and support its combat forces on the battlefield.
- Signatures analysis involves collecting and analyzing the acoustic, infrared, and hyperspectral and seismic signatures of foreign equipment.

Historical Vignette

The XVIII Airborne Corps in support of a JTF is engaged in military operations in the country of Zula. During search operations, Company A of the 1st Battalion, 25th Infantry, discovers a recently vacated facility that contains chemicals.

The commander notifies the 1st Battalion S2 and secures the facility until a permanent security force arrives. The Battalion S2 notifies the Brigade S2, who in turn requests that the battlefield TECHINT collection team investigates the facility.

The battlefield TECHINT collection team arrives at the facility and does a cursory evaluation. Upon initial identification, several chemical samples are removed and transported to the Corps CMEC (Forward). The battlefield TECHINT collection team submits a report through channels to the JTF J2 stating that certain suspect chemicals have been found; they've been identified as nerve gas; they will be moved to the Corps CMEC (Forward), and the team will confirm its initial findings in a follow-up report within 4 hours.

Upon receipt, the Corps CMEC (Forward) coordinates with the Corps G4, through the supporting TECHINT LNE, to transport the chemicals to the Corps CMEC.

If identification is made at the Corps CMEC, then the Corps G2 submits a report through the Corps ACE to the JTF J2, for dissemination to the XVIII Airborne Corps G2, 1st Brigade S2, and 1st Battalion S2 for further dissemination to the Commander of Company A (the unit that found the chemicals). The Corps G2 also provides the report to other commanders and staffs within the AO. If identification or further analysis is required, the Corps CMEC coordinates the safe handling and evacuation of chemicals to CONUS for identification and reporting.

Chapter 4

INTELLIGENCE CYCLE APPLIED TO TECHNICAL INTELLIGENCE OPERATIONS

The five-step process known as the intelligence cycle is applied to TECHINT operations to ensure synchronization with the overall all-source intelligence mission and collection plan.

PLAN AND DIRECT

Intelligence preparation of the battlefield (IPB) is the primary intelligence task which helps the J2/G2 focus and direct this step of TECHINT and the remaining steps of the intelligence cycle. Figure 4-1 shows an example of planning and directing.

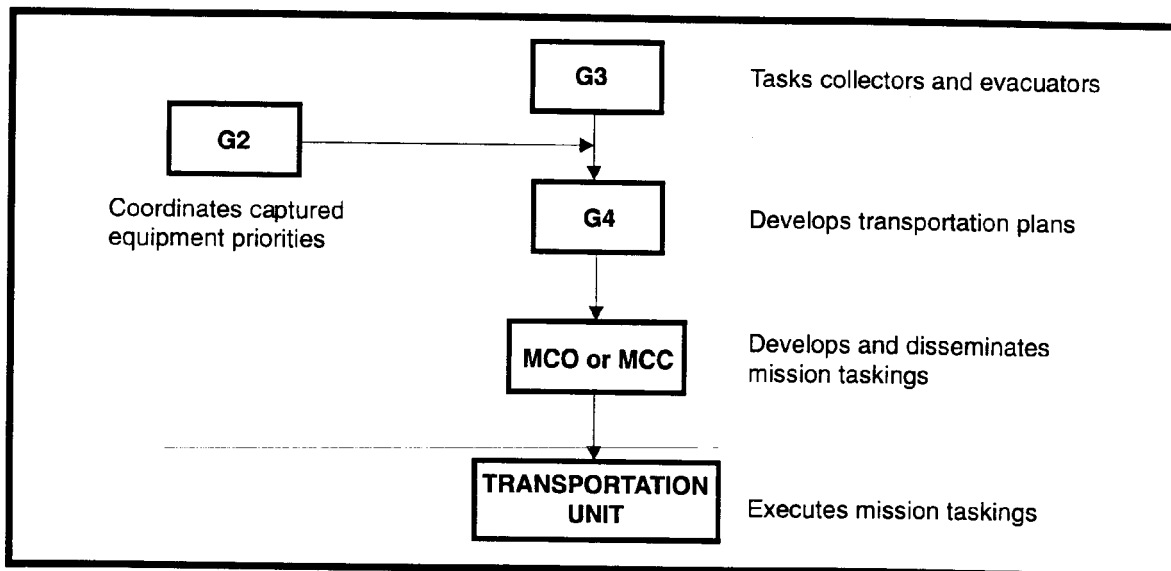

Figure 4-1. Planning and directing.

The JTIB develops the commander's TECHINT priority intelligence requirements (PIR), TECHINT information requirements (IR), and specific information requests (SIR). The JTIB helps develop TECHINT commander's critical information requirements (CCIR) and SIR of a TECHINT nature. The JTIB ensures requirements are closely coordinated with combatant command J2, or theater Army G2 as well as major subordinate commands; for example, corps G2. The JTIB then integrates and deconflicts these CCIR and SIR with other items of special interest to the S&TI community and develops a prioritized TECHINT collection list.

The TECHINT CCIR and SIR and the prioritized TECHINT collection list normally are found in the TECHINT Appendix to the Intelligence Annex to the operations order (OPORD) at all echelons maneuver brigade or group and above.

Through all-source analysis, the JTIB and JCMEC template are where items of TECHINT interest are most likely to be found on the battlefield. This is referred to as "TECHINT templating." Appropriate units are notified, through intelligence, that these items may be within their areas of operations and are tasked for collection through collection management channels. The taskings must be translated into terms that combat, support, and specific collectors can understand.

The taskings should include a TECHINT target folder (TTF). Figure 4-2 shows an example of a TTF. At a minimum, the TTF should include a description of the item, with what major combat systems the item is associated, as well as handling instructions, reporting instructions, and a photograph or sketch if available. The JCMEC and Corps level CMEC (Forward) are responsible for producing TTFs.

1. General information:
 - a. Target folder inventory/index.
 - b. Record of changes/updates.
 - c. Validation/review sheet.
 - d. Target identification data—
 - (1) Name.
 - (2) Description.
 - (3) Photographs or sketches (imagery showing location on major end item if TECHINT item is subcomponent).
 - (4) Country of origin.
 - (5) Other equipment associated with materiel.
 - (6) General description/significance (brief explanation of importance of materiel in terms of direct results should its use be denied partially or totally).
 - (7) Type of unit materiel is associated with (unit designation if available).
 - (8) Disposition instructions.
 - (9) References.

Figure 4-2. TECHINT target folder.

Additionally, the JCMEC must develop TECHINT-related indicators and SOR for other intelligence disciplines to augment and complement the single-source TECHINT effort. One example would be the development of TECHINT-related screening questions for EPWs as they are processed. Another might be to request that imagery analysts keep an

eye out for a suspected external modification on a particular model of main battle tank during the normal course of their duty.

COLLECT

TECHINT collection is acquiring foreign materiel, associated technical documents, or other information of TECHINT interest and providing these to the processing and production elements. It includes the maneuver and positioning of intelligence assets to locations favorable to satisfying TECHINT collection objectives.

All TECHINT collection is guided by CCIR, SIR, and the TECHINT collection list. Battlefield TECHINT collection includes capturing, reporting, and evacuating CEM. For that reason, tactical TECHINT and intelligence planners must include a CEM appendix in the Logistics Annex to the OPOD. Logistics is critical in TECHINT collection operations.

Forward deployed units capture or collect items of known or possible TECHINT interest. Capturing units will normally safeguard CEM and report it through intelligence channels to the first TECHINT element in the reporting chain, normally the TECHINT LNE at Corps G2. The Corps TECHINT LNE then forwards the report simultaneously to the JCMEC and JTIB and verifies if the type of materiel captured is required. Further disposition is determined, appropriate coordination is made by the Corps TECHINT LNE with G2/G3 staff, and the capturing unit receives guidance through operational (G3/S3) channels. Figure 4-3 describes the flow of CEM guidance and decisions.

A TECHINT collection team may be sent forward to confirm the identification and conduct initial exploitation of the materiel at the site. Often the items of TECHINT value are subcomponents of major end items. In this case, the collection team removes and evacuates the items using organic transportation, as shown in Figure 4-4.

The capturing unit may be ordered to evacuate the materiel with its organic equipment. In this instance, they will receive detailed instructions from the Corps LNE or direct support TECHINT collection team via G3/S3 channels. The Corps LNE or TECHINT collection team moves to the materiel's location at the Corps CEM collection point when the materiel is not taken directly to a Corps CMEC (Forward) or Theater JCMEC.

TECHINT collection can prove to be a significant force protection multiplier. One example is TECHINT team identification of NBC materiel prior to transport, handling, or destruction of munitions or samples.

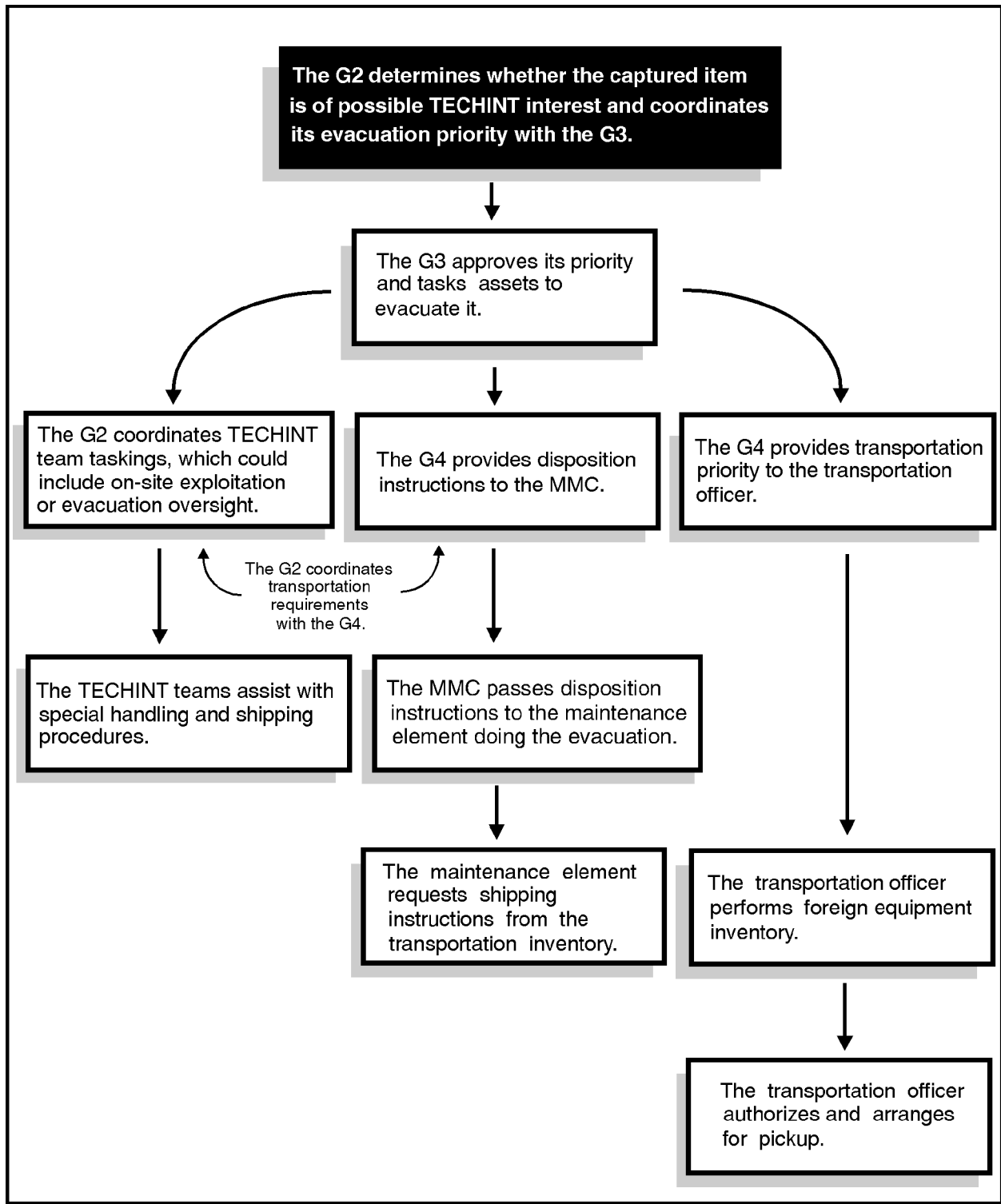

Figure 4-3. Flow of CEM guidance and decisions.

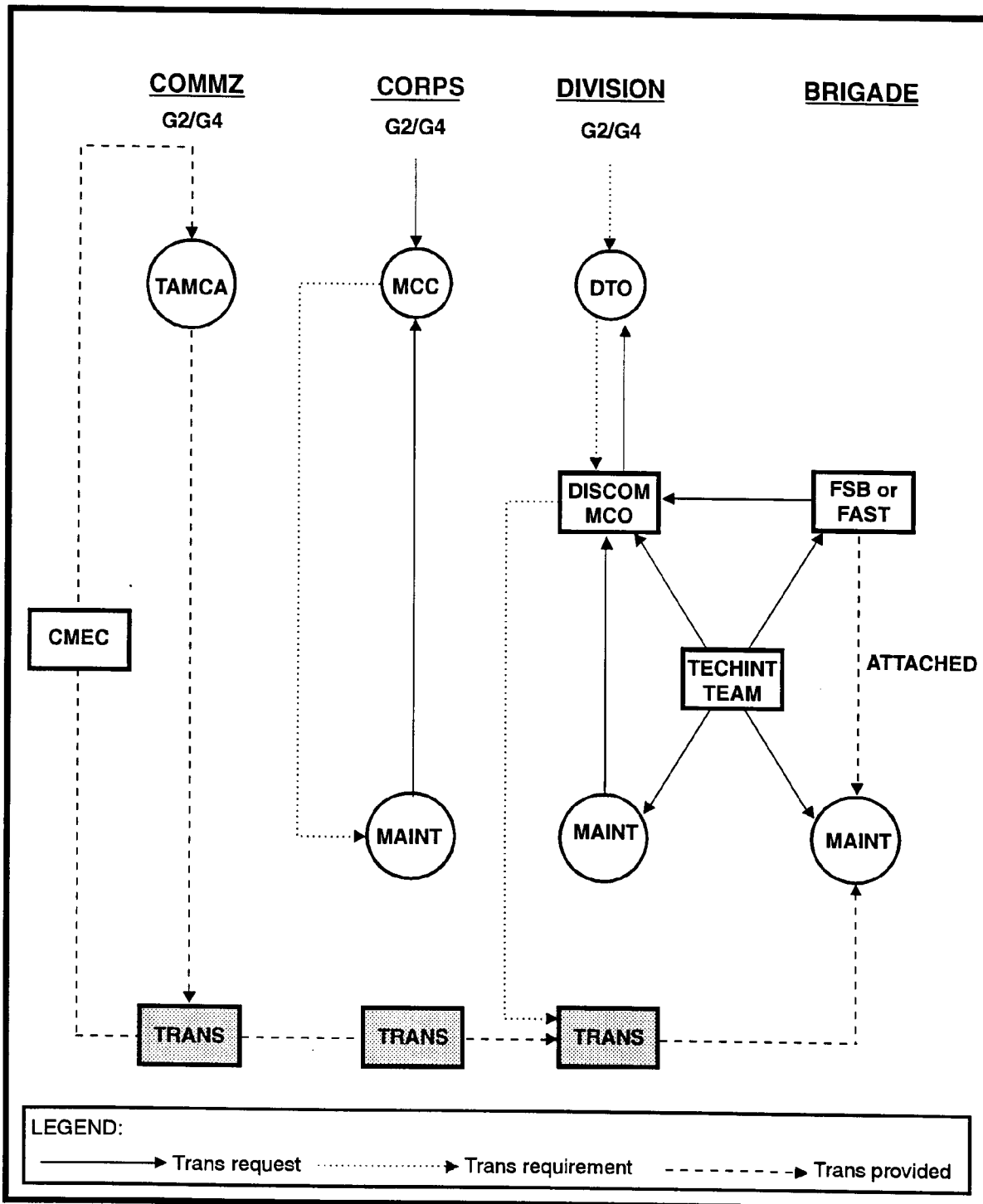

Figure 4-4. Transportation operations.

PROCESS

Processing is the conversion of collected information into a suitable form that can be readily used to produce intelligence. Processing includes data from conversion, photographic development, and transcription and translation of foreign language materiel. Effective processing management ensures that critical information is extracted and processed ahead of information of lesser immediate value. Reports are generated and sent to all appropriate theater and national assets during this process.

TECHINT processing starts with the capture of a piece of equipment of TECHINT value. This confirms that the enemy is indeed employing this materiel. A TECHINT collection team normally conducts a hasty exploitation at the capture site. After the hasty exploitation, a decision is made at the JCMEC or JTIB as to whether the process continues. If it does, the items are sent to the Corps CMEC (Forward) or Theater JCMEC. If the item is deemed to yield no immediate tactical intelligence value, it may still be evacuated to the S&TI centers in CONUS for further analysis if the systems represent a change in the technological posture of an enemy.

PRODUCE

Producing involves the integration, evaluation, analysis, and synthesis of information from single or multiple sources into intelligence. At the tactical level, time constraints and demands of the battle tend to make the processing and producing steps indistinguishable.

TECHINT reports (along with interrogation reports from EPWs with TECHINT knowledge) and digital imagery both funnel into the JCMEC where they undergo the dynamics of production mentioned above. They are then sent to the JTIB and Theater ACE as a single-source TECHINT product.

DISSEMINATE

Dissemination is the timely conveyance of intelligence to users in an easily consumable form. The diversity of forms and means requires interoperability among command, control, communications, and intelligence (C³I) systems. TECHINT reporting from JCMEC to the Theater ACE will be conducted through existing communications links (See Appendix B for communications architecture).

The JCMEC sends its completed products to the JTIB and to the Theater ACE. This report is based on the standard intelligence information report

(IIR) format. TECHINT reports are then disseminated through two channels. The ACE fuses the TECHINT single-source product into its all-source reports and disseminates them through normal J2/G2/S2 channels. While the TECHINT single-source product is being integrated into the ACE all-source product, the JTIB disseminates the single-source TECHINT product through TECHINT communications channels to the national S&TI centers in CONUS. This ensures both the rapid dissemination of TECHINT and the fusion of TECHINT into all-source products.

The intelligence cycle is a continuous process in which steps are executed concurrently, although not always sequentially. For example, while new information is being collected to satisfy one set of TECHINT requirements, a new TECHINT item may be reported on the battlefield. The JTIB plans and redirects efforts while the intelligence produced from the previously collected materiel or information is disseminated. One or several iterations of the intelligence cycle may be conducted depending on the time constraints of the mission.

BATTLEFIELD TECHINT REPORTING SEQUENCE

THE CAPTURE:

A soldier either captures or observes an item of possible TECHINT interest and does not tamper with it. The soldier quickly reports the encounter via the size, activity, location, unit, time, and equipment (SALUTE) spot report format through the chain of command to the Battalion S2. The soldier then either safeguards the items or continues the mission as directed (see Figure 3-1).

BATTALION S2:

The battalion S2 coordinates security or continued observation of the item with the S3 and ensures the item is not tampered with in any way.

WARNING

Components, control knobs, and switches on C-E equipment **MUST NOT** be touched until the equipment is photographed or positions recorded by TECHINT or other trained personnel to avoid the possibility of immediate personal injury or damage to equipment.

The battalion S2 reports the items in the SALUTE format to the brigade S2, and continues security or observation of the items until receiving further instructions. When possible, the capturing units identify associated items requiring immediate screening for combat information by other supporting

MI elements. This could include C-E systems, code books, or technical documents such as operator manuals.

TECHINT LNE:

The TECHINT LNE at Corps (or lowest level) receives the SALUTE report through intelligence reporting channels. He then compares report information with outstanding requirements to see if collection is necessary. Depending on the priority of the requirement and tactical situation, the Corps LNE may—

- Coordinate with the G3 and MI Brigade Commander to dispatch the Corps direct support TECHINT collection team to the capture site.
- Give further instructions for exploitation and/or evacuation procedures to the capturing unit S2.

If an intelligence requirement no longer exists for the captured equipment, the LNE informs the capturing S2 who disposes of the materiel within normal logistics channels.

In any case, the Corps TECHINT LNE forwards an information copy of the SALUTE report with details of initial actions taken to the JTIB, JCMEC, and other TECHINT LNEs.

BATTLEFIELD TECHINT ANALYSIS

Once a TECHINT unit takes custody of a TECHINT item, battlefield TECHINT exploitation begins. TECHINT analysts and specialists use checklists established by S&TI agencies and the JCMEC to exploit each type of threat equipment for which requirements exist. S&TI and the JCMEC develop battlefield exploitation procedures from four sources:

- The US Army Test and Evaluation Command's international test operation procedures.
- Coordination with S&TI analysts.
- Theater and Corps TECHINT requirements.
- Their own experience.

Exploitation procedures are standardized yet constantly updated and included in different exploitation plans based on the type of equipment or documents being exploited. These plans steer the analysis process.

As the materiel moves through the TECHINT chain, each succeeding level of the exploitation process is completed. TECHINT units maintain procedures and plans for sampling, exploiting, and handling materiel in the following categories:

- Missile guidance systems, warheads, fuses, and propellants.
- Munitions, mines, explosives, and their effects.
- Direct and indirect fire systems of all types and their effects.
- Tracked and wheeled vehicles and transports.
- Various types of armor, radios, and radar.
- EW, intercept, and jamming equipment.
- Communications, antenna, relay, and telephone equipment.
- Teletypes.
- Directed energy weapons.
- Automated data processing (ADP) hardware and software.
- NBC offensive and defensive equipment.
- Tactical aviation.
- Medical equipment capabilities and vulnerabilities.

Although exploitation plans are extremely useful, it is the analyst who determines the actual steps to use in each procedure. Analysis always begins with what is, and what is not, known about the piece of equipment.

Chapter 5

RESPONSIBILITIES

INTRODUCTION

This chapter outlines the various responsibilities of each staff element in units on the battlefield when supporting the overall battlefield TECHINT effort. Battlefield TECHINT elements are resourced and responsible for collecting and processing CEM. Yet to work properly, the battlefield TECHINT structure relies on many other units for mission support, such as combat units which capture items, and the transportation units which evacuate items of TECHINT interest. Figure 5-1 shows staff responsibilities.

STAFF SECTIONS

The duties of coordination staff sections and how they relate to TECHINT direction, collection, processing, production, and dissemination are discussed below. From the J1/G1 to the J5/G5, every staff section contributes in some way to the successful production and use of TECHINT.

ASSISTANT CHIEF OF STAFF, J1/G1, PERSONNEL

The J1/G1 is the principal staff element for the commander on all matters concerning human resources. The J1/G1's involvement in the battlefield TECHINT effort is a result of their primary staff responsibilities for—

- Planning and handling EPW evacuation and processing. The prisoner evacuation channel is one of the richest sources of CEM. All J1/G1 annexes to OPORDs and operations plans (OPLANS) need to state that all CEE will be inspected by TECHINT personnel, and/or be transported to the Corps Captured Equipment Point by the transportation unit within the Corps.
- Directing the command surgeon in captured medical supply disposition and medical intelligence responsibilities.
- Coordinating with the J3/G3 to identify and assign special duty personnel such as JCMEC translators and SMEs.

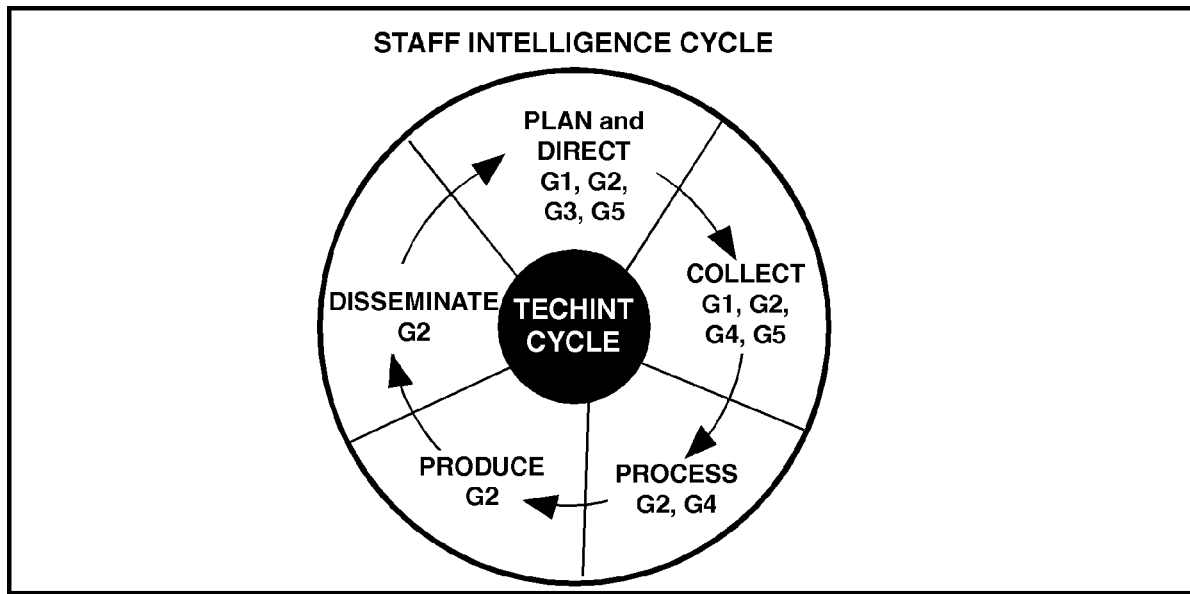

Figure 5-1. Staff sections responsibilities.

ASSISTANT CHIEF OF STAFF, J2/G2, INTELLIGENCE

The J2/G2 is the principal staff section for the commander on all intelligence matters and, as such, has primary responsibility for the command's battlefield TECHINT effort. The J2/G2's primary battlefield TECHINT responsibilities include, but are not limited to—

- Providing staff supervision over captured and detained persons with S&T expertise and exploiting CEM.
- Supervising battlefield TECHINT planning, directing, processing, producing, and disseminating.
- Exercising staff supervision over the JCMEC or attached battlefield TECHINT team operations.
- Coordinating battlefield TECHINT collection tasking, with the J3/G3, MI, EOD, NBC, and other combat and combat support units.
- Coordinating with the JCMEC to provide instructions to units capturing enemy materiel, captured medical materiel exploitation, evacuation, and disposition with the command surgeon.
- Coordinating CEM evacuation with the J4/G4. This includes coordinating transportation priorities, disposition, and opportunities to screen CEM in logistic channels.

- Coordinating with the J5/G5 the TECHINT screening of materiel obtained from local nationals, displaced persons, and civilian detainees.
- Coordinating with the staff judge advocate (SJA) to ensure compliance with the Geneva Conventions regarding exploitation of captured personnel and materiel. Ensure that the SJA includes instructions on CEM in the legal annex to OPORDs and OPLANs regarding war trophies and souvenirs.
- Coordinating with the military historical officer to ensure all items of possible historical value are initially screened for TECHINT value.

ASSISTANT CHIEF OF STAFF, J3/G3, OPERATIONS

The J3/G3 is the principal staff section for the commander in matters concerning operations, plans, organization, and training. The J3/G3's involvement in the battlefield TECHINT effort is a result of their primary staff responsibilities. As they relate to battlefield TECHINT, these responsibilities include—

- Coordinating terrain management and clearance or movement issues for TECHINT teams to move about the battlefield as missions dictate.
- Exercising primary staff responsibility over the supporting aviation, chemical, engineer, fire support coordination officers, and the provost marshal (PM).
- Preparing, coordinating, and publishing the command standing operating procedures (SOPs), OPLANs, and OPORDs. This includes instructions for handling CEM, such as collection, reporting, exploitation, evacuation, and disposition.
- Reviewing subordinate command SOPs, OPLANs, and OPORDs to ensure provisions for battlefield TECHINT are included.
- Incorporating TECHINT into current and future operations and plans.
- Assigning, attaching, and detaching battlefield TECHINT assets to subordinate and adjacent commands.
- Advising the commander on friendly use of CEM. This includes to whom the materiel should be allocated, such as irregular or other local national forces.
- Training US troops in the safe disposition and use of CEM.

ASSISTANT CHIEF OF STAFF, J4/G4, LOGISTICS

The J4/G4 is the principal staff section for the commander in matters concerning supply, maintenance, transportation, and services. As the logistical planner, the J4/G4 conducts vital coordination for the TECHINT system. This includes—

- Exercising primary staff responsibility over the EOD officer and the transportation officer.
- Coordinating with the Support Command Commander, who is responsible for logistical support operations; and the J3/G3 for support of battlefield TECHINT collection operations.
- Coordinating and developing command policy for the evacuation and disposition of CEM. Give particular attention to "back-haul" transportation plans for CEM.
- Ensuring that the Service Support Annex to the OPORD has an appendix that addresses CEM.
- Recommending to the J3/G3 the MSR and the main evacuation route of EPWs and CEM.
- Supervising the establishment and the operation of CEM collection points in the unit support area, normally near the Class VII collection point.
- Coordinating the setup and support of the JCMEC and CMEC (Forward) at the Corps collection points.
- Ensuring inventory and storage location records are properly maintained and are reported through materiel management centers (MMC) and TECHINT or JCMEC channels.
- Recommending policies and procedures for the use of captured nonintelligence-value equipment and providing technical staff assistance to the command's MI unit.

ASSISTANT CHIEF OF STAFF, J5/G5, CIVIL AFFAIRS

The J5/G5 is the commander's principal staff officer in all matters

concerning civilians and their impact on military operations. This includes the political, economic, and social effects of military operations on civilian personnel. The J5/G5's involvement in the battlefield TECHINT effort is a result of their primary coordinating staff responsibilities for civilian liaison and Civil Affairs (CA). These responsibilities include—

- Supervising CA functions of the command regarding care and handling of displaced persons, refugees, and any incidental foreign S&T materiel CA personnel may secure.
- Ensuring inclusion of TECHINT collection and notification procedures in all CA SOPs, OPLANs, and OPORDs.
- Coordinating with the command's battlefield TECHINT unit for the screening, exploitation, and evacuation of any CA-secured CEM.
- Coordinating with the J2/G2 and J4/G4 for the return of CEM to the civilian populace.

SPECIAL STAFF OFFICERS

Because TECHINT covers such a broad spectrum of disciplines, activities, and operations performed on the battlefield, the following special staff officers also play an important role in battlefield TECHINT.

AVIATION OFFICER:

- Coordinates with staff movement and transportation personnel for air evacuations of CEM and chemical and biological (CB) samples.

CHEMICAL OFFICER:

- Advises the commander on NBC intelligence matters.
- Recommends employment of chemical troops in support of battlefield TECHINT teams, analysis, and collection operations.
- Plays a key role in the success of the CB sampling mission; ensures that the mission is explained in the chemical Annex of the OPORD.

ENGINEER OFFICER:

- Plans and constructs engineering requirements.
- Incorporates battlefield TECHINT analyses and studies regarding

mobility and survivability characteristics of enemy weapon systems into these OPLANs and OPORDs.

- Provides construction support to JCMEC activities.

EXPLOSIVE ORDNANCE DISPOSAL OFFICER:

- Establishes, operates, and supervises EOD-related TECHINT reporting procedures; includes these reporting procedures in the EOD portion of the OPLAN.
- Coordinates with EOD TECHINT personnel at the JTIB, JCMEC, and TECHINT collection teams for dissemination of EOD TECHINT information.

PROVOST MARSHAL:

- Provides security for designated units, facilities, and convoys, including CEM, along the evacuation route and for TECHINT facilities when tasked by the J3/G3.
- Coordinates with customs for the TECHINT screening of all CEM found at US redeployment or staging sites.
- Establishes procedures to ensure military police confiscate, tag, report, and turn over to TECHINT personnel new or unidentified CEM discovered incidental to EPW handling operations.

THEATER AND SUPPORTING COMMAND SURGEON:

- Uses TECHINT when advising the commander on medical effects of NBC weapons on personnel.
- Coordinates with the theater chemical officer to implement CB sampling procedures.
- Includes CB sampling procedures in the medical portion of the OPLAN.
- Coordinates TECHINT support to examine and process captured medical supplies and equipment; this includes planning and coordinating medical laboratories and personnel to assist in sample analyses.
- Recommends medically related TECHINT PIR and IR to the J2/G2.
- Coordinates the analysis of biological warfare agent specimens collected on the battlefield at the theater medical laboratory.

Coordinates with the J2/G2 and J3/G3 and provides countermeasures, quarantine recommendations, and other appropriate actions to safeguard friendly forces.

AMMUNITION OFFICER:

- Establishes policies for the safe storage and accountability of foreign munitions; also is responsible for the safety certification of foreign munitions designated for reissue to friendly troops.

STAFF JUDGE ADVOCATE:

- Coordinates the Theater war souvenir policy with the JCMEC Commander, JTIB, and the J2. This policy is determined by the deploying commander, based upon recommendations from JAG, G4, and TECHINT procedures.
- Advises on legal matters concerning the movement of CEM out of the Theater.

UNITS AND ORGANIZATIONS

This section describes the responsibilities and duties of specific organizations and units on the battlefield that support TECHINT operations.

JOINT CAPTURED MATERIEL EXPLOITATION CENTER:

The JCMEC's primary function is processing CEM into combat information and TECHINT. The JCMEC is organized around the 203d MI Battalion. When it is further augmented by experts from other nations, it becomes a CJCMEC. Regardless of the command or echelon it supports, it has the same capabilities. The JCMEC—

- Exploits CEE, CED, and CEM.
- Produces TECHINT reports, that include countermeasures, for tactical commanders.
- Provides studies, OPLANs, OPORDs, maps, and special reports to disseminate the JCMEC findings.
- Provides RSPs to combat units for found enemy weapons and enemy munitions, with coordination through joint EOD.
- Coordinates the safe handling and evacuation of CEM with EOD elements.

- Coordinates evacuation of special-interest CEM from ECB locations to JCMEC.
- Supervises evacuation of CEM from theater to CONUS.
- Coordinates with the joint interrogation facility the selection of EPWs for TECHINT exploitation. Supplies interrogators with TECHINT requirements for EPW interrogation.
- Provides accountability for CEM within the theater TECHINT structure.
- Recommends CEM disposition to the Theater and Corps commands.
- Maintains the theater TECHINT database.
- Maintains S&TI and battlefield PIR, IR, and list of special interest items.

CAPTURING UNITS:

Combat units are usually the first to encounter new or modified threat materiel. However, other units such as engineers, military police, NBC teams, and logistic units may also encounter or capture such materiel. This materiel often comes with operating instructions and other technical documents. The intelligence officer at each echelon coordinates with J2/G2/S2 regarding TECHINT and captured or encountered threat materiel and documents. Together, they establish unit security, RSPs, reporting, and dissemination procedures for CEM.

Capturing units must strive not to destroy TECHINT materiel known or believed to answer PIR, IR, special interest lists, or unidentified or new items before receiving disposition instructions. CEM and logistics complexes must be safeguarded and reported through intelligence channels. Captured items known or believed to answer TECHINT requirements are reported via SALUTE format to higher command normally to the Corps TECHINT LNE.

MILITARY INTELLIGENCE UNITS:

The attachments of TECHINT teams less operational control (OPCON) to MI units (for example, one TECHINT team per corps MI brigade) enhances TECHINT operations, as well as improves coordination and synergy among all MI disciplines. MI units are normally best able to provide administrative and logistical support to forward deployed TECHINT teams due to like missions and collocation.

All MI units are responsible for establishing SOPs and having procedures for handling, screening, and reporting TECHINT-related items or

information encountered incidental to normal organizational activities. The following items relate to enemy C-E systems:

- Code books.
- Frequency tables.
- C-E operations instructions.
- C-E standing instructions.
- Cryptographic data.
- Cryptographic items.
- Encrypted items.
- C-E hardware or software.
- Examples of materiel, including CEE and CED, requiring immediate MI screening.

SPECIAL OPERATIONS FORCES:

Special Operations Forces consist of special forces and ranger units, special operations aviation units, psychological operations (PSYOP) teams, and CA elements.

Special Forces and Ranger Units. These forces usually operate deep in enemy-controlled areas. This means they are generally the first to discover, identify, and provide information on a variety of TECHINT-related CEE, CEDs, or facilities. They can provide—

- New or previously unacquired materiel.
- Locations of enemy materiel.
- Other technical data.
- Capture of enemy S&T personnel.

Special Operations Aviation Units. Special operations aviation units provide aviation support to units conducting special operations missions usually deep within enemy-controlled areas. These units can provide technical data on enemy radars, as well as on observed enemy equipment. Incidental to assigned air missions, special operations aviation units can often "back-haul" limited amounts of priority CEM to rear areas.

Psychological Operations Teams. PSYOP personnel support theater, corps, and division. Historically, PSYOP has supported TECHINT collection through creative PSYOP designed to secure TECHINT-related CEM, information, and/or personnel.

An example of a PSYOP success comes from the Korean War. A North Korean pilot was paid a \$100,000 bounty for flying his Soviet MiG-15 to the south, after the bounty was offered by leaflet and radio. The benefits were enormous. The Communists grounded all MiG flights for eight days; and getting the MiG turned out to be a TECHINT windfall.

PSYOP specifically designed to provide TECHINT occurred during the Vietnam War. A PSYOP campaign encouraged enemy soldiers to surrender with their weapons and equipment intact; rewards were offered and paid to Viet Cong and NVA troops who did this. This type of campaign not only reduced the number of weapons available to the enemy but also provided a continuous source of materiel for the CMEC to exploit.

Civil Affairs Elements. These elements provide support to tactical and operational commanders by coordinating between military forces, civil authorities, and area of operations personnel. CA support to the battlefield TECHINT process includes—

- Providing SMEs to assist in the TECHINT analysis of food and agriculture; public communications, health, transportation, and supply; public works and utilities; and centers of commerce and industry.
- Securing TECHINT-related materiel and foreign experts having CA wartime responsibility for civil administration and refugee handling.

ENGINEER TOPOGRAPHIC AND TERRAIN UNITS:

These units are responsible for collecting, evaluating, and disseminating topographic information and terrain intelligence. They normally function at theater, corps, and division levels. TECHINT units use engineer topographic and terrain products to support TECHINT collection planning. Engineers also support analysis and exploitation of CEM and facilities when this materiel is within their field of expertise.

MILITARY POLICE:

The military police fulfill a wide range of duties on the battlefield, to include providing route security for evacuating CEM and handling EPWs. In performance of these duties they often confiscate CEM from EPWs. Military police follow specific procedures for notifying MI personnel of equipment or documents of intelligence interest discovered incidental to EPW handling operations.

If not done previously, military police mark or tag all CEM and personnel in their custody. Since EPWs and materiel may become separated, military police use a three-part capture tag to clearly identify which prisoner the CEM came from. Accurate identification of the capture tag helps TECHINT analysts and interrogators match materiel with associated EPWs. It also makes it easier to return certain property to the EPW. (See Appendix C for an example of an EPW capture tag.)

NBC RECONNAISSANCE TEAMS:

NBC reconnaissance teams locate, identify, and mark contaminated areas. They collect, identify, and evacuate suspected samples of nuclear materials and CB warfare agents. This function is an important supplement to normal TECHINT collection capabilities. Collecting, handling, storing, and shipping these samples must be done using SOPs developed in a coordinated effort between the command surgeon, the staff NBC officer, and the staff S2. All parties involved must ensure they maintain a legal chain of custody of NBC samples for later possible war crimes processing.

MEDICAL UNITS:

Combat zone and communications zone medical support units are capable of giving specialized medical, laboratory, and medical intelligence assistance to TECHINT and other MI disciplines. The medical unit's S2 coordinates this assistance to MI units.

EXPLOSIVE ORDNANCE DISPOSAL:

One of the most critical and early sources of TECHINT on the battlefield is explosive ordnance. To safely exploit this source, EOD units provide specially trained personnel to support TECHINT collection teams and units in the area of operations. EOD personnel examine existing databases and prepare reports on new and unusual items of explosive ordnance for TECHINT purposes.

TECHINT personnel should be familiar with EOD activities, capabilities, and responsibilities, as described in AR 75-15. Foreign explosive ordnance is extremely important to TECHINT analysts. TECHINT personnel coordinate closely with EOD personnel for proper disposal and evacuation of explosive ordnance, particularly when conducting initial inspections during hasty exploitations of CEM on the battlefield.

DANGER

Exercise extreme care and awareness when encountering possible booby-trapped CEM. Materiel may be booby trapped and cause immediate death or permanent injury.

Only EOD personnel actually handle explosive ordnance. Conversely, EOD units must notify TECHINT personnel of the types and locations of foreign equipment and munitions they encounter.

Appendix A

MEASUREMENT AND SIGNATURE INTELLIGENCE

INTRODUCTION

This appendix describes the MASINT mission, organization, responsibilities, and their relevance to TECHINT. Specific definitions are in the glossary. This appendix delineates MASINT's dual mission of supporting the S&TI community as well as providing unique time-critical information to the supported tactical commander that contributes to battlespace dominance.

MISSION

PEACETIME:

The mission of MASINT operations in peacetime includes fulfillment of intelligence collection and transition to war requirements. Army MASINT efforts are focused at EAC MI force at the force projection brigades. Technical reconnaissance and surveillance (TECRAS) systems fielded at EAC demonstrate the feasibility of MASINT support at that level.

Successful demonstration is expected to lead to the development of tactical intelligence and related activities (TIARA) systems and their progressive fielding at appropriate EAC and ECB units. EAC conducts operations to fulfill collection requirements levied by the Army component command, theater, DOD, or national levels. The force projection brigade's mission includes the collection of S&TI to support baseline signature requirements for reprogrammable munitions in support of Army, DOD, and national requirements.

WARTIME:

In addition to its contributions to S&TI, MASINT also serves the warfighting commander. MASINT collection of threat battlefield equipment signatures aids in the prevention of technological surprise and is critical to US ability to produce effective countermeasures. Continued signature collection by MASINT sensors permits reprogramming of precision-guided, smart, or brilliant munitions. Specific MASINT missions are to—

- Detect, identify, and locate targets with sufficient timeliness and accuracy for operational planning, targeting, and combat action.

- Support IPB.
- Support force protection via identification, friend or foe (IFF) systems.
- Support terrain visualization and geographic intelligence.
- Provide intelligence on threat signatures and equipment and technological advances not discernible by other intelligence collection means.
- Support indications and warnings (I&W) intelligence in peacetime and provide an indication of threat escalation from conventional to nuclear war.
- Provide intelligence to support the commanders' demands for situation development, target development, battle damage assessment (BDA), and intelligence operations in close, deep, and rear operations.
- Provide information to detect or confirm enemy deception operations.
- Provide information of threat strategic facilities, such as power plants, design bureaus, production facilities, proving grounds, and test areas.
- Provide commanders with information of friendly signature profiles. This information will be used for IFF to minimize fratricide and to alter signatures for operations security (OPSEC) or friendly deception operations.

ORGANIZATION

The Army's MASINT organization is shown at Figure 2-1.

RESPONSIBILITIES

Figure A-1 shows the responsible agencies, along with their MASINT functions.

AGENCY	RESPONSIBILITY
--------	----------------

DIA, Central MASINT Office	Executive agent for MASINT.
HQDA, DCSINT	Functional manager of TECRAS Program.
AMC, DCSINT	Materiel developer.
INSCOM, DCSOPS	Manages and oversees operational MASINT EAC collection operations. Develops operational requirements documents and mission needs statements.
NGIC, Signatures Division	Primary consumer of TECRAS data.
Force Projection Brigades	Ensure national MASINT sensors are tasked to support commander's PIR. Serve as focal point for collection management and dissemination for MASINT. Collect baseline signatures in support of the TECRAS Program. Augment the Theater IPC upon request. Act as the conduit for fielding selected RDTE MASINT systems.

Figure A-1. HQDA agencies and their MASINT responsibilities.

DEFINITIONS

The definitions for MASINT and electro-optical intelligence (ELECTRO-OPTINT), as defined in JCS Publication 1-02, are shown in the terms and definitions section of the glossary.

ELECTRO-OPTINT:

ELECTRO-OPTINT may provide detailed information on the radiant intensities, dynamic motion, spectral and spatial characteristics, and the materials composition of the targeted objective. Electro-optical data collected has broad applications to a variety of tasks. Data may be collected by a variety of optically sensitive devices, such as radiometers, spectrometers, non-literal imaging systems, lasers or laser radar—laser detection and ranging (LIDAR).

RADAR INTELLIGENCE (RADINT):

RADINT is the collection, processing, analysis, and exploitation of radar energy reflected (re-radiated) from a target or objective. Instruments for active target illuminations may include monostatic or bistatic, line-of-sight (LOS) phased array, synthetic aperture radar (SAR), and over-the-horizon systems. RADINT collection provides information on radar cross-sections, tracking, precise spatial measurements of components, motion, and radar reflectance and absorption characteristics for dynamic targets and objectives.

RADIO FREQUENCY INTELLIGENCE:

This includes radio frequency/electromagnetic pulse intelligence (RF/EMPINT) and unintentional radiation intelligence (RINT).

- RF/EMPINT is the collection, processing, analysis, and exploitation of radio frequency electromagnetic pulse emissions associated with nuclear testing or other high energy events for the purpose of determining power levels, operating characteristics, and signatures of advanced technologic weapons, power, or propulsion systems.
- RINT is the integration and specialized application of multiple MASINT collection, processing, analysis, and exploitation techniques against unintentional radiation sources that are incidental to the design and operating characteristics of military and civil propulsion units, power sources, weapons systems, electronic systems, machinery, equipment, or instruments. These techniques may be valuable in detecting, tracking, and monitoring a variety of activities of interest.

GEOPHYSICAL INTELLIGENCE:

This is the collection, processing, exploitation, and analysis of emitted or reflected sounds, pressure waves, or vibration in the atmosphere (acoustic), in the water (acoustical intelligence), or in the earth's surface (seismic). Acoustic and seismic sensors may be valuable in target detection and classification, measuring aircraft and ship performance characteristics, detecting weapons testing and large military movements.

MATERIALS INTELLIGENCE:

This is the physical collection, processing, analysis, and exploitation of atmospheric trace elements; gaseous, liquid, or solid particulate; effluents; or debris. Materials intelligence has specific applications to NBC warfare, military and civil production, and economic and environmental problems.

NUCLEAR INTELLIGENCE (NUCINT):

NUCINT is intelligence information derived from the collection and analysis of radiation and other effects resulting from radioactive sources, such as nuclear weapons, processes, materials, devices, or facilities. Nuclear monitoring includes nuclear radiation detection, identification, and characterization of sources and events. Data exploitation results in nuclear signature of weapons or materials.

TECHNICAL RECONNAISSANCE AND SURVEILLANCE:

TECRAS is DA's special program using a low density of instrumented collection sensors which provide a quick-reaction capability for collection.

ARMY REPROGRAMMING ANALYSIS TEAM (ARAT):

The ARAT is involved in altered signatures identification and associated weapon systems impact. The US Army target sensing systems (TSSs) incorporate software algorithms used to make threat identification based on embedded preprogrammed threat parameter data.

As the threat capabilities change, or as new threats become operational, there is a risk that these systems will not correctly identify the threats. To the extent the threat is misidentified, incorrect countermeasures may be implemented putting friendly forces at risk.

Reprogramming the weapon systems provides the commander an essential element in battle space dominance by allowing him to defeat enemy countermeasures. The production centers and the intermediate processing centers (IPCs) validate suspected change signatures or countermeasures. The ARAT receives data upon which the threat change is identified and system assessments made. The ARAT determines impact of validated threat changes on assigned Army equipment and weapon systems and develops a suitable and achievable counter to the changes. The mission requirements center (MRC) within the systems manager's organization determines requirements for Army systems. The software support center (SSC) is responsible for developing the change program and validating the change.

CONCLUSIONS

MASINT's chief contribution to the Army to date has been support to force modernization, a role which is likely to continue. However, it is also an evolving discipline which holds significant potential for warfighting intelligence as adversaries develop means to deceive or evade imagery

and signals sensors.

Much can be gained by integrating MASINT and TECHINT. The disciplines are not competing but complementary. Many MASINT technologies and subdisciplines lend themselves towards bringing traditional TECHINT into the information age. Sensors are used to derive information in NRT, so that it can be fed to the supported commander in time to effect the decision cycle.

Appendix B

JCMEC OPERATIONS

This appendix provides an overview of JCMEC operations and responsibilities; it is used as an example for an annex to a combatant command's TTP document. Each reference to the "supported Theater Commander" may be replaced by the appropriate unified or joint combatant command acronym (for example, ACOM, PACOM, CENTCOM).

INTRODUCTION

The JCMEC (in part or whole) normally will be established for any operation where significant amounts or types of CEM will be available and/or require field exploitation. The supported Theater commander has the mission of establishing and operating a JCMEC through the 203d MI Battalion (TECHINT), FPB, and provides for the day-to-day operation of the JCMEC to include administration, logistics, systems, communications, and maintenance.

The supported Theater commander also has staff responsibility for—

- Ensuring security of the materiel.
- Arranging for the evacuation and movement of CEM.
- Providing legal guidance concerning disposition of certain CEM, structures, and facilities.
- Coordinating for EOD.
- Coordinating the issue of CEM to US forces.

The Theater J2 exercises operational control of the JCMEC through the JTIB located at the JIC. The JTIB consists of the senior TECHINT representatives from DIA's Technical Directorate and Service TECHINT organizations (National Ground, Air, and Maritime Intelligence Centers as needed). The JTIB will be augmented with an LNE from the 203d MI Battalion (TECHINT).

The purpose of a JCMEC is to provide a central in-theater location for the collection, safeguarding, identification, battlefield exploitation and

reporting, and destruction and/or evacuation of specified captured foreign and US manufactured materiel. The JTIB—

- Provides TECHINT advice and assistance to the Theater J2.
- Acts as the TECHINT collection manager for the Theater J2.

CONCEPT

The JCMEC will be sited by the supported Theater commander. The site should facilitate evacuating, storing, and shipping CEM. The JCMEC also will—

- Locate to facilitate security.
- Ensure safety for nearby forces and the local populace.
- Provide easy access to communications, transportation, and other support facilities.
- Locate near the Theater ordnance storage site.

JCMEC facilities have common site selection criteria and complementary functions which provide efficient allocation of assets for evacuation, movement, safeguarding, and exploitation of EPWs and CEM.

JCMEC will be staffed by the 203d MI Battalion (TECHINT) and augmented by selected service technical representatives and support personnel. Through the supported Theater commander, the JCMEC will have support from military police or security forces, ground and aviation transportation elements, EOD, and other activities as needed.

In accordance with DOD directives, service regulations, and other established policies, all units will collect, identify, tag, secure, and evacuate CEM to designated collection points.

In coordination with the JCMEC, and through technical teams and liaisons, Corps and equivalent units will transport or arrange for the transportation of selected items to the JCMEC. In cases of the reported capture of designated CEM of high TECHINT priority and/or time sensitivity, a TECHINT collection team will be deployed to the capture site to conduct initial exploitation and then coordinate and prepare the materiel for hasty evacuation directly to the JCMEC.

JCMEC will function as the Theater's central captured materiel exploitation facility. As such it will—

- Establish procedures for the exploitation, destruction, or other

disposition of CEM in coordination with the J4.

- Recommend the theater souvenir and war trophy policy, to include demilitarization procedures.
- Issue and provide training on the operation of CEM to US forces, allied, and host nation forces based upon J3 requirements and priorities.
- Return specified CEM to the sovereign nation at the end of the conflict as directed.

ORGANIZATION

The JCMEC and its components can and will be tailored for each operation depending on types and quantities of CEM. Although operationally responsible through the supported Theater commander for the JCMEC, the commander and deputy are responsible to the J2 through the JTIB for intelligence collection management and oversight of the JCMEC. Figure B-1 shows the JCMEC organization. Following are specific functions of the JCMEC components.

COMMANDER AND THE DEPUTY:

The 203d MI Battalion (TECHINT) commander is dual hatted also as the JCMEC commander and is assisted by a deputy, battalion S3, or Executive Officer (XO). The commander will tailor the CMECs to meet the worldwide mission.

LIAISON ELEMENTS:

FME LNEs will be attached to each component G2, Air Force and Navy Intelligence, and Corps, or the equivalent subordinate command. These LNEs will advise the supported command on CEM handling, control, and evacuation procedures and coordinate these efforts with the JCMEC.

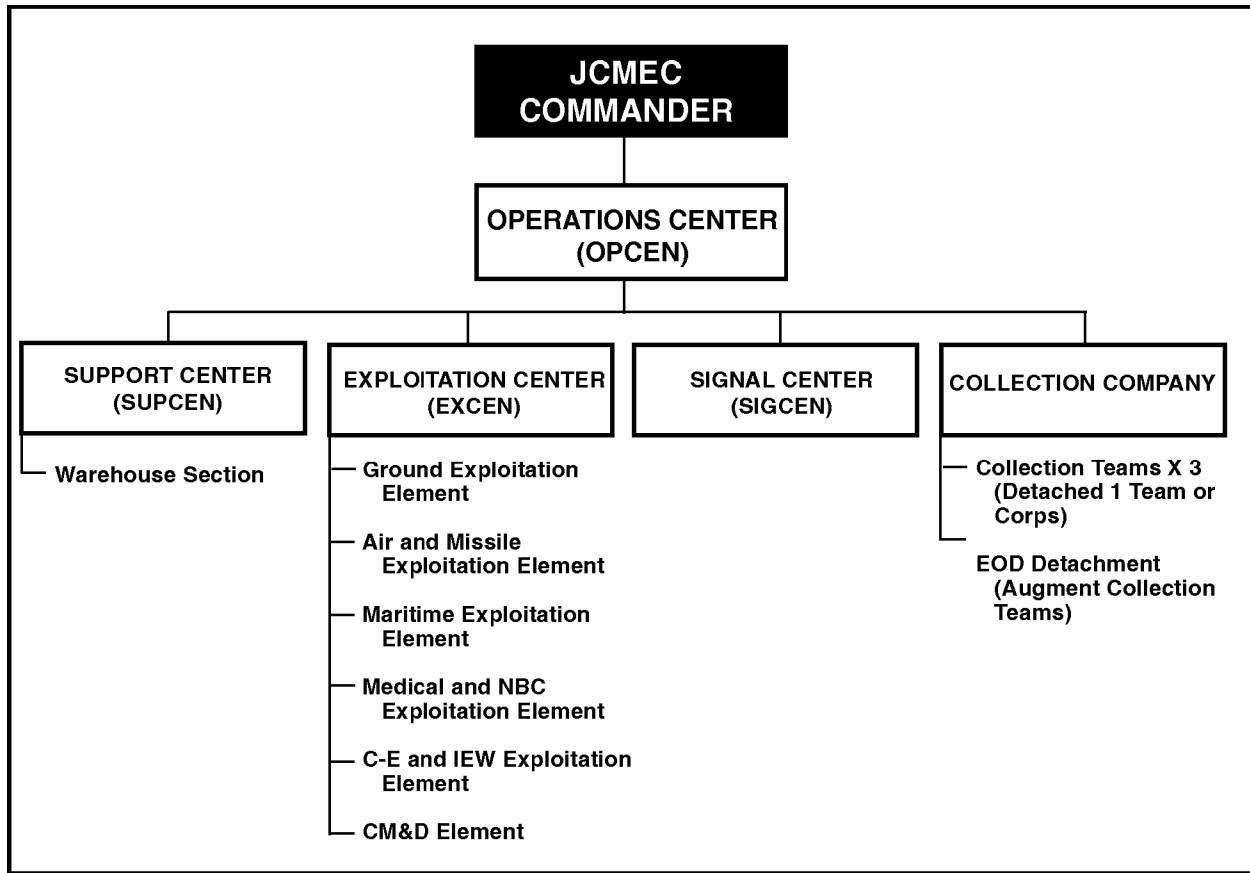

Figure B-1. Joint Captured Materiel Exploitation Center (JCMEC) organization.

OPERATIONS CENTER (OPCEN):

The OPCEN director works directly for the JCMEC commander. The OPCEN is responsible for planning and coordinating all current and projected JCMEC operations, to include deploying TECHINT collection teams and maintaining the current intelligence situation.

SUPPORT CENTER (SUPCEN):

The SUPCEN director works directly for the JCMEC commander. The SUPCEN provides administrative and logistics support to all JCMEC elements.

The warehouse section chief works directly for the SUPCEN director. This section maintains all records on CEM, structures, and facilities that are processed through or by the JCMEC. Specifically, the Warehouse Section—

- Serves as the point of contact (POC) for the various units or organizations delivering and/or transferring materiel.
- Ensures that documents, manuals, inventory records, and other related items are cataloged and properly exploited.
- Ensures exploitation elements are informed of materiel and documents received at the JCMEC.
- Coordinates and monitors the shipping of materiel to CONUS and/or issuance to US forces, allies, or host nation as directed.

EXPLOITATION CENTER (EXCEN):

The EXCEN director works directly for the JCMEC commander. The EXCEN director prioritizes, coordinates, and deconflicts the efforts of his subordinate elements based on the JCMEC commander's guidance. Elements subordinate to the EXCEN director and their functions are as follows:

- **Ground Exploitation Element.** This element processes validated requirements; exploits captured ground materiel (to include helicopters and ground-based missile systems); produces tactical TECHINT reports; ensures that reports are forwarded to the CM&D section expeditiously; and participates in technical interrogations in coordination with the joint interrogation facility.
- **Air and Missile Exploitation Element.** The structure and functions are the same as for the Ground Exploitation Element except that the focus is on aviation (aircraft, air delivered weapons systems, and associated radar and tracking systems) and missile-related materiel.
- **Maritime Exploitation Element.** The structure and function are the same as the Ground Exploitation Element except that the focus is on naval and marine materiel (to include naval mines, vessels, naval aviation, and naval-related missile systems).
- **Medical and NBC Exploitation Element.** This element's function, in addition to exploitation and reporting on NBC weapons and materiel, is to be responsible for removal and shipment of samples from the area of operation. This element will ship suspected samples to the Theater Army Medical Laboratory (TAML), if available, or to CONUS- based laboratories for analysis.
- **C-E and IEW Exploitation Element.** This element focuses on

communications, computers, intelligence and electronic warfare (IEW), and related systems.

- CM&D Element. The collection management and dissemination (CM&D) element provides a single POC to ensure that effective coordination is maintained between the JCMEC and the numerous component, theater, national, allied, and host government units. This element will ensure the receipt and satisfaction of all requirements. Specific functions are as follows:
 - Operate joint and Army automated file servers and associated work stations that are used for receiving requirements and disseminating technical reports. Figure B-2 shows the TECHINT communications architecture.
 - Coordinate directly with the J2 TECHINT collection manager for receipt of validated requirements (collection and production). Ensure that exploitation elements receive these requirements; monitor the status of the requirements; and close them when appropriate.
 - Take reports from the elements and ensure that they are disseminated expeditiously to units and organizations that need the information. Dissemination can be by any or all means; for example, secure voice, facsimile, message, Joint Deployable Intelligence Support System (JDISS). Information should be given the widest dissemination possible.

SIGNAL CENTER (SIGCEN):

The SIGCEN director works directly for the JCMEC commander. The SIGCEN provides communications, systems, and related maintenance support to all of the JCMEC elements. It acts as the focal point for all communications in and out of the JCMEC.

COLLECTION COMPANY:

The commander of the TECHINT Collection Company works directly for the JCMEC commander. This company is augmented by a Joint EOD detachment and forward deploys three TECHINT collection teams. The collection teams assist in recovering, processing, tagging, and shipping materiel to the JCMEC. They also perform screening and make field assessments of "first seen" materiel encountered by US personnel. The EOD detachment consists of personnel from the Services who are familiar with weapons systems, ammunition, and ordnance related to their

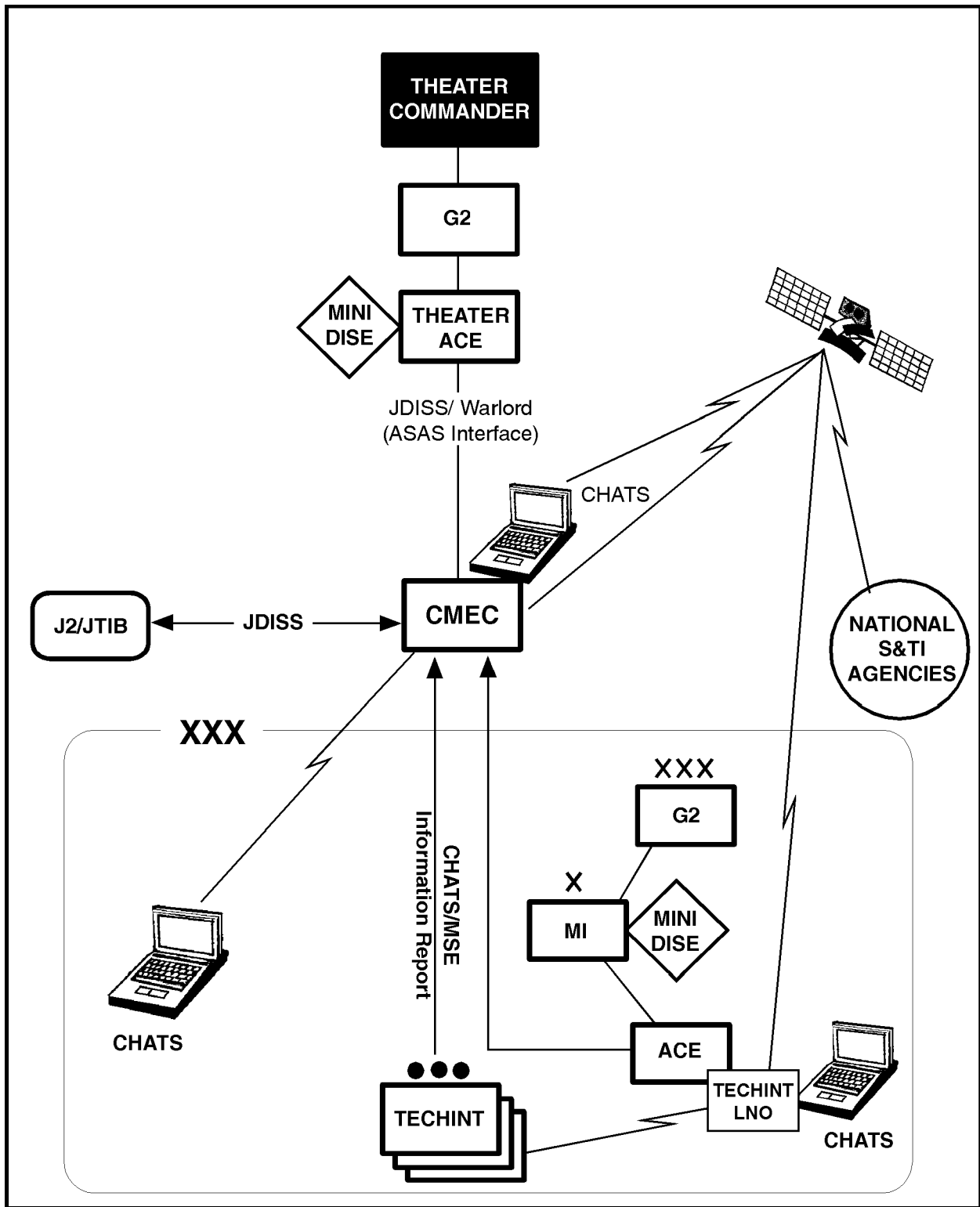

Figure B-2. TECHINT communications architecture.

respective areas. This detachment works for the TECHINT Collection Company commander but provides EOD support to all JCMEC elements.

SPECIAL ACTIVITIES:

There will be times and places where other US, allied, or host nation government agencies, organizations, or elements may be required to support the foreign materiel efforts of the JCMEC.

COMMUNICATIONS

The supported commander provides communications for the JCMEC. The J2/G2 validates all requirements and coordinates with the J6 to ensure that the required bandwidth and types of circuits are provided.

Normal JCMEC operations will require the following minimum intelligence processors and connective communications capabilities:

- JDISS and/or a compatible file server and workstations. This system is essential for access to databases, collection and production requirements processing, and dissemination. Since there will be a requirement for a Sensitive Compartmented Information Facility (SCIF), and split-based operations to and from Aberdeen Proving Ground, MD, both DSNET 1 and DSNET 3 connectivity with a minimum of 32 Kb bandwidth will be essential.
- Disk operating system (DOS) stand-alone terminals for report writing and records administration.
- Automated message access.
- Dial-up STU-III secure telephone.
- Classified and unclassified facsimile.
- Other specialized communications as required to support the forward teams (such as tactical high frequency, ultra high frequency, super high frequency, and satellite communications [SATCOM]).

OTHER REQUIREMENTS

See DIAMs 58-4, 58-13, and 75-1 and references herein for procedures and requirements for identifying, safeguarding, controlling, and disposing of CEM.

Appendix C

HANDLING AND EVACUATION

INTRODUCTION

This appendix covers the procedures for handling and evacuating routine CEM, as well as TECHINT CEM. Some basic guidelines and procedures on how to handle TECHINT interest items follow:

- CEM evacuation channels and handling procedures are usually the same as similar US end items. A captured tank generally will go to the same location as a US tank at the Class VII point. (Definitions for classes of supply are in the glossary.)
- The element requiring a specific type item is responsible for coordinating and tasking evacuation and handling.
- As time permits, as much CEM should be collected from the battlefield and taken to the echelon's CEM points for disposition.
- The capturing unit always notifies higher command of capture and then safeguards the known or possible TECHINT item, if possible, until higher command provides disposition instructions.
- All echelons will establish CEM points and keep logistical and intelligence channels informed of their status.
- Special handling and evacuation procedures are often situation dependent and cannot always be included in SOPs and OPORDs.

The plans, policies, and procedures for evacuating foreign materiel are prescribed by joint, unified, and theater headquarters. These plans are based on DA and DOD policies and guidance. Each command echelon in the theater must ensure that its plans comply with theater directives and the Joint TECHINT plan. The final disposition of CEM and associated technical documents rests with the theater commander.

As stated before, the CMEC is responsible for coordinating the handling and evacuation of CEM of TECHINT value. Routine CEM evacuation guidance, such as raw material found in railroad yards, is best established in advance in the command's various OPORDs and SOPs. CEM should be policed off the battlefield to the prescribed collection points as soon as possible. Special situations, as in the case of high priority TECHINT

interest items, require active coordination among the JCMEC and the command's different assets to move the item quickly.

Coordinating and tasking is the job of the echelon commander's staff for normal CEM movement. Their ability to coordinate between the logistic units that move the item and the specialist elements such as TECHINT, EOD, and NBC is the key to the reuse, intelligence exploitation, and removal of CEM.

LOGISTIC CHAIN OF RESPONSIBILITIES AND FUNCTIONS

Logistic assets will evacuate CEM to the collection points, Corps CMEC (Forward), theater CMEC, or CONUS. They do this according to available assets and the priorities set by the commander and staff. The J4/G4 is the principal staff element charged with coordinating this task. The command surgeon, responsible for medical items, coordinates disposition of Class VIII not of TECHINT value.

The J4/G4 provides staff guidance to the MMC and the movement control office (MCO) or the movement control center (MCC). The MMC controls combat service support (CSS) and maintenance inventories and is the management arm that ensures proper accountability of CEM during transit.

The support commands are the Division Support Command (DISCOM), COSCOM, and Theater Army Area Command (TAACOM). They exercise command and control over supporting units in carrying out the directives issued by the J4/G4. The division medical supply officer (DMSO) or the medical, supply, optical, and maintenance (MEDSOM) are the first elements that manage the command's collection, inventory, and evacuation procedures and functions for captured medical materiel.

The MMC manages the command's collection, inventory, and evacuation functions. This includes the operation of the CEM point. The MMC operations staff is organized by function and commodity, Class I through Class VII, and Class IX materiel. CEM will normally be managed by the Class VII operations staff. The MMC keeps the records of the CEM at the CEM point. TECHINT elements, such as the Corps CMEC (Forward) or TECHINT teams, would provide support to logistical personnel operating the CEM point for identification of CEM.

TRANSPORTATION PLANNING AND ALLOCATION

The J4/G4 coordinates logistic support for evacuation of CEM operations by developing a command transportation plan. The command transportation officer and the movement control element use the transportation plan to task individual transportation units. Transportation elements can be effectively used to backhaul CEM to the CEM points on their return trips from forward units. Transportation elements are tasked to support critical TECHINT missions when required.

EVACUATION CHANNELS

As stated in the introduction, US forces will usually evacuate CEM along the same channels as like US items. The system must, however, have the flexibility to evacuate high priority intelligence items directly from division collection points to the Theater CMEC and CONUS when required. This evacuation will be described in the logistical and intelligence appendixes to OPLANs. The routine evacuation channels are described below. Figures C-1 to C-4 provide examples of evacuation channels for CEM.

Abandoned or unserviceable US and captured foreign materiel are evacuated to each echelon's collection points for classification, segregation, and disposition. Collection points operate wherever needed throughout the theater of operations and should always be planned for ahead of time. In stability and support operations (SASO), it may take more time to evacuate larger items due to limited resources and environment.

In the Corps area, at least one materiel collection point is established. Other points are established in the TAACOM. Collection points in the communications zone (COMMZ) are generally operated by the collection and classification element of the general support maintenance battalion near the Class VII point.

In the division areas, DISCOM maintenance companies operate CEM points. During offensive operations, these points will be temporary until the Corps elements take control. CEM is handled and processed the same way as similar US items.

Salvage points, including Class VII, established by related supply units are located near unit maintenance collection points. These two points handle the collection, classification, inventory, and disposition of Classes II, VII, and IX materiel. The heavy division and Corps have the most

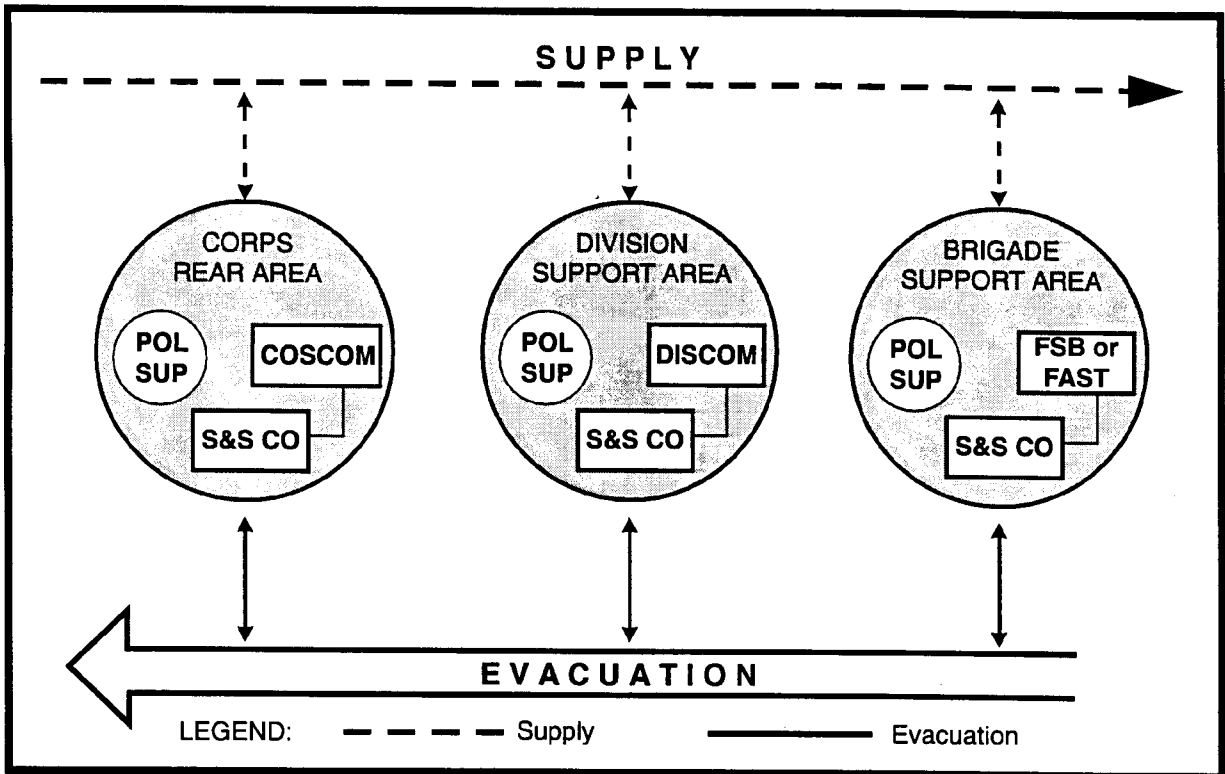

Figure C-1. Evacuation of captured petroleum, oils, and lubricants.

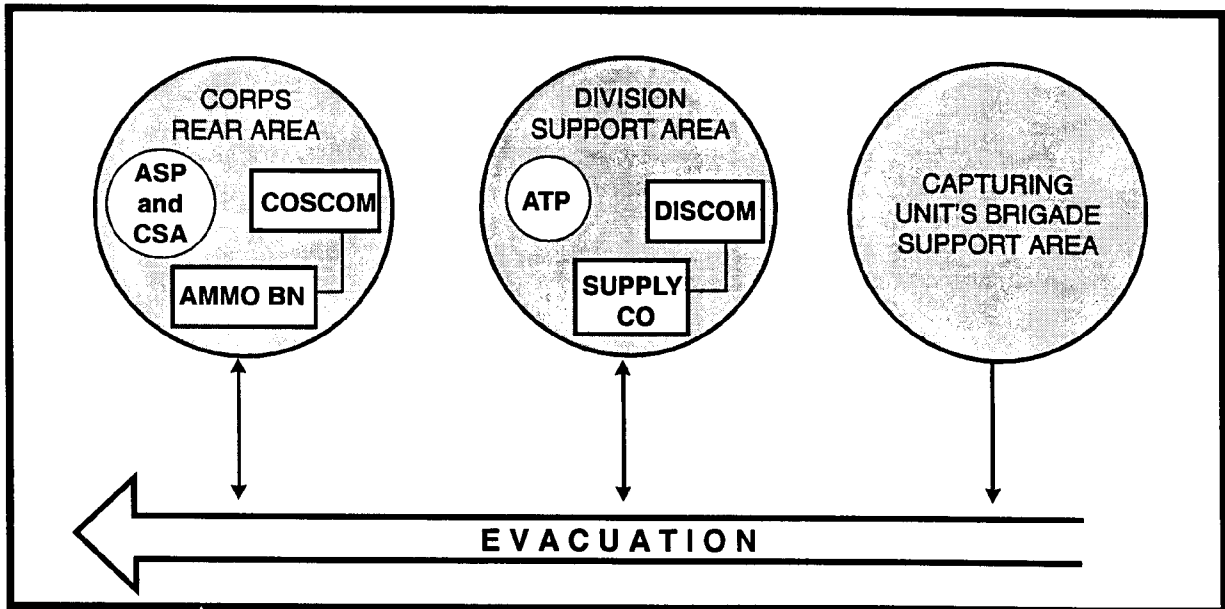

Figure C-2. Evacuation of captured ammunition and explosives.

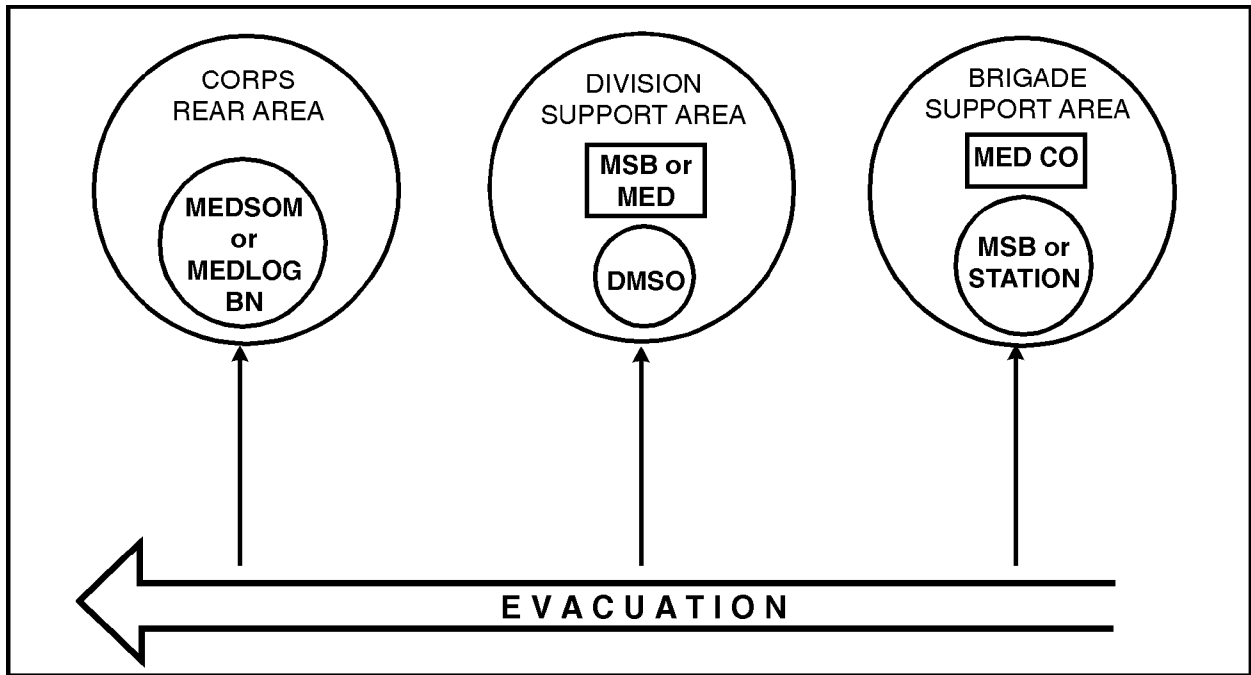

Figure C-3. Captured medical materiel evacuation system.

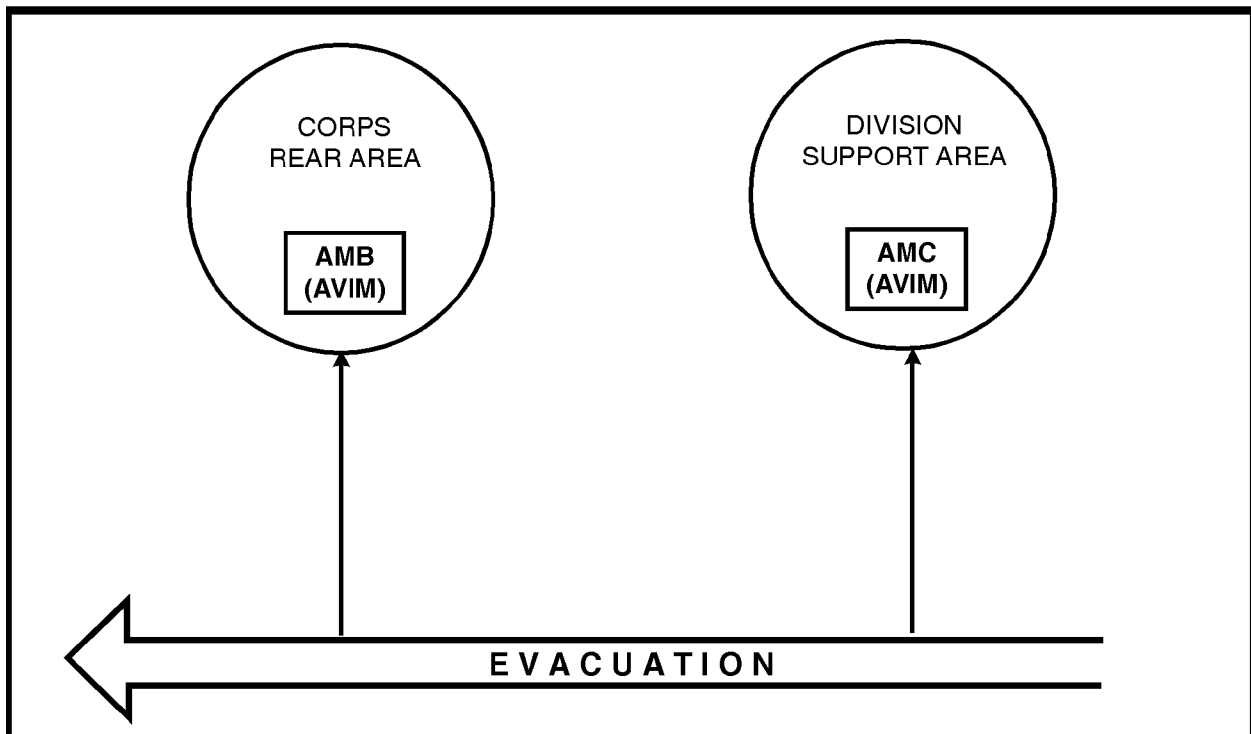

Figure C-4. Evacuation of captured aviation items.

suitable assets for evacuation of large amounts of foreign materiel, such as tanks. The process is much the same in the light divisions. However, evacuation of the heavier items will be normally handled by COSCOM assets since the division lacks heavy transportation elements.

Petroleum, oils, and lubricants (POL) units establish their own collection sites to handle captured POL materiel. Supply units can also establish POL collection sites. Commanders will test and use captured POL at the lowest echelon possible. Samples will always be taken and sent to the Corps CMEC or TECHINT collection teams.

Class V ordnance, including missiles, is evacuated through conventional ammunition supply points (ASPs). Ammunition supply units will establish their own collection sites to handle captured Class V. It is critical that the CEM ASPs provide a detailed inventory of ammunition to logistical and intelligence channels. TECHINT elements must move assets to the CEM ASP to assist in identifying ammunition of intelligence value.

Class VIII medical items are evacuated through established medical supply points, the DMSO, and the MEDSOM elements. TECHINT elements must have full access to the medical materiel to identify items of medical value.

Captured aviation items, especially airframes, are evacuated to either the Class VIII CEM collection points, or the nearest aviation units airfield. All CEM, except NBC hazardous materiel and war trophies, that require evacuation to CONUS are eventually shipped to the Transportation Officer, Military Operations Division, Aberdeen Proving Ground, MD.

RESPONSIBILITIES

The personnel, activities, and elements responsible for the recovery and evacuation of CEM are usually the same as those responsible for handling like US items. A good example is the military police responsibilities.

Since military police are responsible for controlling prisoners, they have similar evacuation responsibilities for EPW and CEM. MI interrogators and TECHINT analysts exploit these sources of intelligence along the evacuation chain.

THE CAPTURING UNIT

The capturing unit always is responsible for reporting, safeguarding, and initiating accountability of CEM. The capturing unit reports the capture with a SALUTE report (see Figure E-1). It safeguards the materiel, within its mission parameters, until relieved or as long as possible. It initiates accountability by marking and tagging the item according to established procedures.

The capturing unit may be tasked to move CEM wanted for intelligence exploitation to a collection point. If the capturing unit is tasked with evacuation, it coordinates any assistance with the command responsible for direct support maintenance at their echelon.

The capturing unit may be tasked with the destruction of the item. This may require coordination with either EOD or NBC assets to do it safely. It is illegal to destroy captured enemy medical materiel. According to the Laws of Land Warfare, if friendly forces cannot use it for EPWs, refugees, and indigenous population, the medical materiel will remain in place and unharmed.

The capturing unit must report the discovery of unusual mechanisms used as booby traps through intelligence channels to the nearest TECHINT element and EOD by SALUTE report. Countermeasures must be coordinated with EOD personnel. EOD personnel are responsible for the final disposition of explosive components or hazardous materials associated with such devices and recovered ammunition.

EXPLOSIVE ORDNANCE DISPOSAL

As discussed, TECHINT units have a profound interest in foreign explosive ordnance. The assistance of EOD personnel in the examination, movement, and evacuation of explosive ordnance cannot be overemphasized. All items of foreign ordnance should first be rendered safe by EOD personnel. If this is not feasible, the item should be rendered safe in place by any destructive method that minimizes damage to the item.

Collection of TECHINT data may require dismantling of ordnance and stripping fuses and other dangerous components. These operations will be performed only by experienced personnel. Dismantling and stripping are conducted only in response to a specific requirement for such action. The request must be placed through TECHINT and EOD staffs. Only

trained weapons and munitions specialists should analyze or test captured mines and booby traps.

DANGER

Exercise extreme caution when encountering taut wire, pull releases, or similar devices due to the possibility of immediate death or permanent injury.

NUCLEAR, BIOLOGICAL, AND CHEMICAL

All CB hazardous items are handled and shipped in accordance with command SOPs, national policy, and theater TECHINT plan. Evacuation is best handled after coordination with either an NBC reconnaissance team, NBC qualified TECHINT team, or a task-organized medical element. NBC samples, after theater tactical exploitation, will be shipped to CONUS laboratories.

TECHINT ELEMENTS ECB, EAC, AND THE CMEC

When evacuation is either unknown or is delayed, TECHINT personnel will be tasked to perform onsite analysis. This can provide immediate tactical information and countermeasures vital to the combat force commander. Onsite analysis also ensures the recovery of intact components which become useless once wires are clipped and subcomponents have been disturbed. This type of analysis is limited by the battlefield situation and available assets.

During onsite analysis, TECHINT teams look for—

- Equipment operational characteristics, performance, capabilities, and vulnerabilities.
- New weapons and devices.
- Modifications.
- Possible countermeasures.
- Identification and proper handling of radioactive materiel.
- Specific orientation and siting of equipment.
- Recovery and evacuation of explosive ordnance and NBC munitions.

At times, a large number of like items will be acquired. The TECHINT teams or elements must have the opportunity to examine the materiel

thoroughly. They will be especially interested in any modifications done to the equipment.

TECHINT teams may also be tasked to supervise the materiel handling and evacuation onsite. The Corps TECHINT LNE or theater TECHINT elements will coordinate with appropriate staffs to evaluate the need to use TECHINT personnel to—

- Supervise the evacuation.
- Arrange necessary technical escorts to the Corps CMEC (Forward), CMEC, or CONUS.

TECHINT elements are capable of coordinating the handling and shipping with necessary medical, intelligence, NBC, and strategic level elements for captured CB materiel.

MARKING AND TAGGING

Labeling CEM properly is vital to the timely exploitation of the item. It speeds up the often slow process of producing effective countermeasures for the soldier in combat. Proper labeling provides the analyst information necessary for the item's timely exploitation. It also allows interrogators and TECHINT elements to match up knowledgeable prisoners with the CEM from which they became separated in the evacuation process.

RESPONSIBILITIES:

The capturing unit is responsible for properly marking and tagging CEM. The responsibilities must be clearly established by command SOP. The equipment and document tags accompany the materiel to its final destination. Article 103 of the Uniform Code of Military Justice is printed on the reverse side of the tag to prevent indiscriminate tampering.

As part of core training, all personnel should be instructed on how to tag CEM. They should know the consequences when personnel and equipment are not properly tagged. Training should stress protecting and preserving the original markings on materiel at the time of capture. Weather-resistant capture tags are used. They are normally produced within the theater. They are securely attached to the item itself and to the shipping container. If weather-resistant tags are not available, use any material (for example, rations packing) on which pertinent capture data can be recorded.

There are two procedures for marking and tagging CEM. The procedure used depends on whether or not the captured item is associated with a

captured person.

CEM WITH EPWs:

For CEM with personnel, tag the captured person and any associated CEM with the three-part tag (Form PE 96C-18). An example of this tag is at Figure C-5.

CEM BY ITSELF:

For CEM by itself, tag the piece of equipment and associated document with the tag shown at Figure C-6. Be careful to use this tag to label **ONLY** items captured with or known to be associated with a particular EPW. In addition, label all documents believed to be of a technical nature (such as operator manuals) with the flag word "TECHDOC." An example is shown in Figure C-7.

<p>ATTACH TO PW</p> <p>DATE OF CAPTURE () _____</p> <p>NAME () _____</p> <p>SERIAL NUMBER () _____</p> <p>RANK () _____</p> <p>DATE OF BIRTH () _____</p> <p>UNIT () _____</p> <p>LOCATION OF CAPTURE () _____</p> <hr/> <p>CAPTURING UNIT () _____</p> <p>SPECIAL CIRCUMSTANCES OF CAPTURE () _____</p> <hr/> <p>WEAPONS/DOCUMENTS () _____</p> <hr/> <p>FORWARD TO UNIT</p> <p>DATE OF CAPTURE () _____</p> <p>NAME () _____</p> <p>SERIAL NUMBER () _____</p> <p>RANK () _____</p> <p>DATE OF BIRTH () _____</p> <p>UNIT () _____</p> <p>LOCATION OF CAPTURE () _____</p> <hr/> <p>CAPTURING UNIT () _____</p> <p>SPECIAL CIRCUMSTANCES OF CAPTURE () _____</p> <hr/> <p>WEAPONS/DOCUMENTS () _____</p> <hr/> <p>ATTACH TO ITEM</p> <p>DATE OF CAPTURE () _____</p> <p>NAME () _____</p> <p>SERIAL NUMBER () _____</p> <p>RANK () _____</p> <p>DATE OF BIRTH () _____</p> <p>UNIT () _____</p> <p>LOCATION OF CAPTURE () _____</p> <hr/> <p>DESCRIPTION OF WEAPONS/DOCUMENTS () _____</p> <hr/> <p>DOCUMENT AND WEAPONS CARD</p> <p>FRONT () ○ ()</p> <p style="text-align: center;">SYANAG 2044 C - 1 - 1</p>	<div style="text-align: center;">  </div> <p>Search Thoroughly ()</p> <p>Tag Correctly ()</p> <p>Report Immediately ()</p> <p>Evacuate Rapidly ()</p> <p>Segregate by Category ()</p> <p>Safeguard from Danger/Escape ()</p> <p style="text-align: center;">P W</p> <hr/>
--	--

DO NOT DISTURB

THIS EQUIPMENT

PE 96C-18

NATO UNCLASSIFIED

Figure C-5. Front and reverse sides of an EPW tag.



<p style="text-align: center;">TECHDOC </p> <p style="text-align: center;">TO BE AFFIXED TO CAPTURED ENEMY EQUIPMENT</p> <p style="text-align: center;">DO NOT DISTURB</p> <p>NOMENCLATURE: <u>MT-140-A</u></p> <p>SERIAL NO: <u>1234567</u></p> <p>DATE/PLACE CAPTURED: <u>27 Feb 99</u> <u>CA 123456</u></p> <p>CAPTURING UNIT: <u>1 INF Co/2/3 Regt</u></p> <p>QUANTITY: <u>ONE EACH</u></p> <hr/> <p style="text-align: center;">BELOW FOR USE BY TECH INTEL UNITS ONLY</p> <hr/> <p style="text-align: center;">NOTICE</p> <p style="text-align: center;">THIS EQUIPMENT IS BEING HELD FOR:</p> <p style="text-align: center;">ANALYSIS UTILIZATION DESTRUCTION</p> <p style="text-align: center;">BY AUTHORITY OF THE JOINT U.S. FORCES COMMANDER.</p> <p>SIGNATURE _____ PRINTED NAME _____</p> <p>UNIT _____ DATE _____</p> <p style="text-align: center;">DO NOT DISTURB</p>	<p style="text-align: center;">TECHDOC </p> <p style="text-align: center;">TECH INTEL USE ONLY</p> <p>TIME OF RECEIPT: _____</p> <p>DATE OF RECEIPT: _____</p> <p>INSPECTED BY: _____ NAME RANK</p> <p>DISPOSITION: _____</p> <hr/> <p style="text-align: center;">DO NOT DISTURB THIS EQUIPMENT</p> <hr/> <p style="text-align: center;">PROPERTY U.S. GOVERNMENT</p> <hr/> <p style="text-align: center;">PERSONNEL TAMPERING WITH THIS EQUIPMENT WILL BE SUBJECT TO PROSECUTION UNDER ARTICLE 103, UCMJ</p>
--	---

Figure C-7. Example of a CEE tag flagged for TECHDOCs.

SECURITY AND ESCORT

Many items of foreign materiel acquired by US forces and determined to be of TECHINT value require safeguarding in storage as well as during evacuation. Such items may be sensitive due to their criticality or because of the US classification assigned. At all stages during the exploitation process, CEM will be placed under guard to prevent looting, misuse, or destruction.

Initially, the capturing unit is responsible for safeguarding materiel, based on instruction from the next higher headquarters. When foreign materiel is sensitive or of special value, military police elements normally provide physical security during its evacuation.

RECOVERY AND EVACUATION OF TECHNICAL DOCUMENTS

Technical publications and manuscripts of concern to TECHINT relate to the technical design or operation of the materiel. Such documents may be acquired from the materiel to which they refer. Therefore, it is essential that TECHINT personnel coordinate with interrogation elements to exchange information about related documents.

CEM BY ITSELF:

All enemy documents captured on the battlefield are sent immediately to the first intelligence staff officer in the chain. The S2/G2 routes all CEDs to the nearest interrogation element for tactical exploitation. Interrogators screen the documents for immediate information and forward them to higher command, as required.

In any case, all known or suspected technical documents are marked "TECHDOC" and treated with highest priority and forwarded through intelligence channels to the higher command until their value has been determined.

CEM ASSOCIATED WITH EPWs:

Documents obtained through liaison with interrogation elements should be accompanied by pertinent interrogation reports. These reports can be in—

- SALUTE reports.
- Tactical interrogation reports.

- Special interrogation reports.
- Intelligence information reports.
- Biographic reports in accordance with DIAM 58-13.
- Knowledgeability briefs.

CRYPTOGRAPHIC AND OTHER ELECTRONIC EQUIPMENT AND DOCUMENTS

TECHINT units use special procedures for handling captured C-E equipment and documents. These items are tagged and evacuated to the nearest target exploitation (TAREX) element as soon as possible after the initial tactical exploitation.

WAR TROPHIES

Foreign equipment is frequently a target of souvenir hunters. An effective war trophy policy must be established to ensure that these items are not retained by the capturing unit.

FOREIGN MATERIEL NUMBERING SYSTEM

It is the responsibility of the COSCOM and Theater support command to tag all CEE that is sent to them in accordance with the foreign materiel numbering system. All inventories of CEE will use this system to keep track of materiel.

**THIS APPENDIX COMPLIES WITH STANAG 2044
AND IMPLEMENTS STANAG 2084.**

Appendix D

INTELLIGENCE ANNEX WITH TECHINT INPUT

INTRODUCTION

This appendix provides examples of TECHINT input to an intelligence annex and TECHINT-related tabs to that annex. The TECHINT appendix is used—

- As the primary example for the J4/G4 appendix on captured weapons.
- As the example for the J1/G1 appendix on equipment taken from EPWs. (See Figures C-1 through C-3 for CEE and EPW tags.)

THEATER ARMY INTELLIGENCE ANNEX:

Figure D-1 shows input for TECHINT operations. This example is tailored for a Theater Army headquarters. All headquarters, however, should include TECHINT operations input.

1. SUMMARY OF ENEMY SITUATION.

2. INTELLIGENCE REQUIREMENTS.

a. PIR:

- (1) Does the enemy have significant quantities of night vision devices?
- (2) Is there unusual or unexplained damage to US equipment and materiel?
- (3) Has there been unexpected defensive and/or offensive capabilities of enemy equipment?

b. IR:

- (1) What are the capabilities and/or limitations of the AT-5 ATGM?

3. INTELLIGENCE ACQUISITION TASKS.

Figure D-1. Example of an extract from a Theater Army Intelligence Annex.

a. General: Capture of any enemy materiel will be immediately reported through intelligence channels in accordance with priorities described below.

(1) 15th Corps. Priority of collection on foreign equipment is T-64B, AT-5, and SA-13.

(2) 25th Corps. Priority of collection on foreign equipment is BTR-70, BMP-I, and individual protective vest (body armor).

(3) 23d MI Brigade (EAC).

(a) 1st Battalion.

(b) 2d Battalion.

(c) 3d Battalion.

1 One TECHINT collection team and TECHINT LNE to operate within each corps area, attached to each corps MI brigade (command less OPCON).

2 Screening and exploitation of captured IEW priorities described in FM 34-54, Appendix B.

3 Fully integrate TECHINT operations and teams with IEW and EPW operations.

4. MEASURES FOR HANDLING PERSONNEL, DOCUMENTS, AND MATERIEL.

a. Personnel.

b. Documents.

c. Materiel.

(1) All materiel will be reported in accordance with procedures and priorities described in Appendix __, TECHINT.

(2) All materiel will be evacuated to the nearest collection point and held for TECHINT screening in accordance with Appendix __, TECHINT.

(3) Items designated by TECHINT personnel as possessing intelligence value will be evacuated to destinations designated by TECHINT personnel in accordance with priorities described in Appendix __, TECHINT.

Figure D-1. Example of an extract from a Theater Army Intelligence Annex (continued).

(4) No materiel will be diverted for other uses until screened and released by TECHINT personnel.

5. REPORTS AND DISTRIBUTION. All equipment-related intelligence, SALUTE, and EPW reports will include the J2/G2 and CMEC as an addressee.

Figure D-1. Example of an extract from a Theater Army Intelligence Annex (continued).

(TAB B) JOINT THEATER TECHNICAL INTELLIGENCE APPENDIX:

Figure D-2 is an example of a Joint Theater TECHINT appendix. It shows how CEM must be handled, reported, and disposed of.

Appendix ____, TECHINT, to Annex ____, Intelligence, to OPLAN/OPORD ____.

REFERENCES:

- a. OPLAN _____
- b. FM 34-54.
- c. FM 3-19-1.
- d. Chemical and Biological Sampling, Transport, and Evaluation Management Procedures, dated February 1986.

1. PURPOSE: This appendix establishes policy and prescribes responsibilities and procedures for the proper handling, reporting, intelligence assessment, and disposition of CEM. Additionally, it establishes the procedures for the safe and expedient collection of suspected CB agents to the laboratory for processing, analysis, and identification.

2. POLICY:

- a. The J2 controls and directs the theater captured materiel exploitation program. The CMEC OPCON to the J2 carries out exploitation activities.
- b. The CMEC will be formed from elements of the 203d MI Battalion (TECHINT), _____ MI Brigade.
- c. The _____ J2 exercises staff responsibility over the intelligence exploitation of CEM throughout the area of operations and establishes requirements for evacuation of specific items to CONUS for further exploitation. An LNE from the JCMEC will be located in the J2.
- d. Commander, 203d MI Battalion (TECHINT)—
 - (1) Establishes the CMEC and attaches a TECHINT team to each Corps; positions an LNE with the J2, each Corps G2, the theater MI Brigade, and theater interrogation.
 - (2) In coordination with the Theater/Army Surgeon General, advises the J2/G2 on all matters of CB sampling.

Figure D-2. Example of a Joint Theater TECHINT Appendix .

(3) Recommends a theater souvenir and war trophy policy in accordance with FM 34-54, Appendix C.

e. The J3—

(1) In coordination with the J2, approves requests and assigns priorities for issue of CEM to US units engaged in special missions or training based on the following prioritized uses of captured materiel:

- (a) Intelligence.
- (b) Special warfare.
- (c) Special Operation Forces.
- (d) Issue to friendly forces.
- (e) Internal defense.
- (f) Substitutes or supplements to US equipment.
- (g) Distribution to friendly foreign units or groups.

(2) Coordinates provisions of EOD support as required in the exploitation of CEM in accordance with AR 75-15 and to fill requirements stated by the J2.

f. The J4 exercises staff supervision over the evacuation and movement of CEM of intelligence value in the theater to the JCMEC, and coordinates evacuation of high priority items back to CONUS.

g. The Staff Judge Advocate provides legal guidance concerning the disposition of certain categories of enemy materiel, structures, and facilities.

h. See Tab D of this appendix for CB sampling responsibilities.

3. RESPONSIBILITIES:

a. The CMEC is charged with the conduct and coordination of assessment of CEM within the command. Support in the assessment of enemy naval and aerodynamic systems and materiel will be provided by intelligence personnel from the Navy and Air Force components attached to the CMEC. The scope of responsibilities include:

- (1) Assign an LNE to the J2, G2, and the theater interrogation facility.

Figure D-2. Example of a Joint Theater TECHINT Appendix (continued) .

(2) Deploy TECHINT collection teams forward to each deployed Corps to conduct preliminary screening of evacuated materiel and to respond to targets of opportunity which cannot be processed in a normal manner.

(3) Receive and process validated intelligence requirements for items of enemy materiel.

(4) Participate in the technical interrogation of EPWs and assist in screening CEDs.

(5) Examine and evaluate TECHINT reporting and classification of CEM.

(6) Participate with TAREX elements to fully integrate the exploitation of specified C-E items.

(7) Participate with medical, NBC, and Special Operations units for coordinating the delivery of CB samples through MI channels to the TAML.

b. Subordinate Commands:

(1) Each Corps will—

(a) Designate and operate collection points. Report locations of collection points where CEM will be stored and amounts and types stored at each location. Forward reports to Cdr, CMEC, with an information copy to the J2/G2 and J4/G4s. The collection point will receive, store and, only upon direction, dispose or issue CEM.

(b) Designate and operate ammunition storage areas for the storage of captured ammunition and explosive items, as required. Store captured chemical munitions similarly to like US chemical munitions. Report locations of ammunition storage areas and amounts and types stored to Cdr, CMEC, with an information copy to J2/G2 and J4/G4.

(c) Provide necessary logistics support, as required, to evacuate CEM and CB samples needed for intelligence operations, or other purposes, from collection points to the CMEC.

(d) Ensure all CEM is promptly tagged.

(e) Provide logistics and administrative support for all TECHINT assets operating within their areas.

(2) NBC reconnaissance units, Special Operations units, and medical units are responsible for the transfer of CB samples to TEUs or TECHINT collection teams at Corps, or directly to the TAML.

Figure D-2. Example of a Joint Theater TECHINT Appendix (continued) .

4. PROCEDURES:

a. Procedures for handling and processing CEM.

(1) The recovery and evacuation of CEM is a command responsibility at all levels. The prescribed method of evacuation is through normal logistics channels and in accordance with priorities established in Tab A and Tab B to this Appendix.

(2) Enemy materiel captured by US military personnel is the property of the United States and must be protected from pilferage, cannibalizing, and souvenir hunters. Commanders at all levels will provide adequate security for CEM until it has been screened by TECHINT personnel.

(3) Specific intelligence collection requirements and Top Ten End Item requirements items of enemy materiel for which the tactical commander and intelligence agencies have a need are listed at Tab A and Tab B to this Appendix. These Tabs will be published upon execution of the OPLAN.

(a) When items listed in Tab A and Tab B or any of their updates are captured or otherwise obtained, commanders will ensure that the acquisition is reported through intelligence channels to the Corps TECHINT LNE to Cdr, CMEC, with an information copy to J2/G2.

(b) Report as in (a) above (at a PRIORITY precedence) the capture of standard types of foreign materiel that have been apparently modified in a major way or are having a greater impact on combat operations than expected. These items will be evacuated to COSCOM collection points by available backhaul capabilities on a PRIORITY basis. Equipment will be held pending further disposition instructions from the J2 through the Corps TECHINT LNE.

(c) The capture of items listed in Tab A and Tab B will be reported by IMMEDIATE precedence through intelligence channels and expeditiously evacuated to at least the supporting collection point to await further disposition instructions from J2.

(d) Report as in (a) above (at a ROUTINE precedence) all CEM. These items will be evacuated to collection points by available backhaul capabilities on a space-available basis. They will be held at the collection point until screened by TECHINT personnel. Disposition will be per paragraph 4d below.

(e) The J2, in coordination with the J4, is the focal point for evacuation of key items of intelligence interest to CONUS for national exploitation.

Figure D-2. Example of a Joint Theater TECHINT Appendix (continued) .

(4) The assessment of CEM below division and separate brigade levels will be limited. Their primary responsibility is the recovery, reporting the capture, and initial evacuation of enemy materiel from the capture location to the nearest collection point. Exception is for medical supplies which will be handled through medical supply channels. Significant items of CEM which cannot be evacuated, either because of the tactical situation or due to their size, will be left in place and reported immediately.

(5) Assessment of CEM at division and separate brigade level is performed by intelligence and operations personnel to the extent necessary to determine the immediate tactical significance of the materiel. Assessment at this level does not replace the need for detailed evaluation and analysis of CEM by technical specialists from the JCMEC. For this reason, the prompt evacuation of significant items of CEM must not be delayed.

(6) Screening and preliminary field assessment of CEM is performed by JCMEC TECHINT collection teams. These teams will operate in the Corps areas and are attached (command less OPCON) to the Corps MI Brigade. When required, these teams can also provide assistance to capturing units. Assessment functions are normally carried out at the Corps support area collection points. Items of intelligence interest or items needed to fill other requirements by the JCMEC are selected for evacuation. Selected items will be evacuated to the JCMEC, or a designated location, by collection point personnel through logistics channels.

(7) Selected CEM evacuated to the CMEC is subjected to detailed examination and evaluation to—

- (a) Determine enemy materiel threats, performance capabilities, and limitations.
- (b) Produce information from which military countermeasures may be developed.
- (c) Provide inputs continuously to the national and integrated S&TI Program in accordance with DIA and Theater policies.
- (d) Provide intelligence that can be of timely use to the tactical commander.

b. Materiel Requiring Special Handling.

(1) C-E Equipment. All CEM in this category must be evacuated immediately with their dial settings, frequencies, and so forth, and recorded and sent to the supporting EW unit by the quickest and most secure means possible. All such materiel will be evacuated to Corps support area collection points for screening by TECHINT and other specialized personnel.

Figure D-2. Example of a Joint Theater TECHINT Appendix (continued) .

(2) Ammunition and Explosives. The complete recovery and expeditious evacuation of enemy ammunition and components is essential to the identification of known or new enemy weapons systems and the threat posed by each. EOD teams are responsible for preparing PRETECHREPs on first-time-seen enemy ammunition or explosives. If there are no TECHINT personnel to assist in the area, EOD teams will also be responsible for preparing COMTECHREPs.

(3) Medical Materiel. Medical materiel normally will not be destroyed. It will be left in place if it cannot be evacuated. It will be handled in accordance with normal Class VIII procedures.

(4) Significant Items: All intelligence requirements specified in Tab A and Tab B will be afforded special handling as described in paragraph 4a above.

(5) Technical Documents: Captured or recovered technical documents consist of firing tables, logbooks, packing slips, and other documentation. If the tactical situation does not permit the equipment to be evacuated, the documents will be forwarded to the JCMEC and will include a description of the equipment.

(6) CB Samples. See Tab D to this appendix.

c. Requirements.

(1) DIA provides national intelligence requirements for CEM to the Theater. In-theater intelligence requirements for enemy materiel are submitted through J2 and G2.

(2) In-theater operational and training requirements for other than Army subordinate units are submitted through J3 to the J2 for review, approval, and assignment of priority.

(3) The intelligence requirements are published in Tab A and Tab B.

d. Disposition.

(1) Items required in support of operational requirements or for distribution to host-country forces will be separately designated by the J3. Tab C to this Appendix contains such equipment.

(2) Items determined by the J2 to have no intelligence significance and by the J3 to have no operational need will then be identified and reported through logistics channels to the J4. Items will be retained within designated collection points for further disposition by the J4. No items will be released for war trophies until released by J2.

Figure D-2. Example of a Joint Theater TECHINT Appendix (continued) .

e. Destruction. The destruction of CEM, excluding medical items, will be accomplished only in the event that recapture is imminent, due to its location, or in those cases where materiel is declared by EOD or TECHINT personnel to be hazardous to the safety of troops. In the event destruction of materiel is necessary, all factory markings should be carefully recorded and photographs taken, if possible, before the materiel is destroyed. Medical items normally will not be destroyed, but left in place.

OFFICIAL:

TABS:

A = Top Ten Priority Items (TBP)

B = General Collection Requirements (TBP)

C = Equipment Releasable to Allies (TBP)

D = Chemical, Biological, and Biomedical Sampling

Figure D-2. Example of a Joint Theater TECHINT Appendix (continued) .

(TAB D) CHEMICAL, BIOLOGICAL, AND BIOLOGICAL SAMPLING PROCEDURES:

Figure D-3 is an example of a Tab D to a TECHINT Appendix of a Theater Army Intelligence Annex. It shows disposition instructions for CB samples.

1. PURPOSE: To establish the procedures for the safe and expedient collection and evacuation of suspected CB agents to the laboratory for processing, analysis, and identification.

2. RESPONSIBILITY:

a. The Cdr, JCMEC, with the Army and Theater Surgeon General, are responsible for advising the J2/G2 and J3/G3 on all matters of CB samplings.

b. Corps G2, SOCCENT J2, MARCENT G2, Navy intelligence, and Air Force intelligence will be responsible for transferring samples to MI channels via TEU teams or TECHINT collection teams.

c. Medical personnel will coordinate with combat units and Graves Registration Service units through local medical units and hospitals for obtaining biomedical samples, for the expedient transfer of personnel deceased as a result of a CB attack.

d. The Cdr, JCMEC, will be responsible for coordinating shipment of suspected biological samples to the TAML for preliminary analysis, and suspected chemical or biological-chemical mixed to CONUS-based laboratories.

e. The TEU is responsible for coordinating shipment to the US Army Chemical Research Development and Engineering Center (ERDEC) at Aberdeen Proving Ground, MD, if it is a chemical sample; or to the US Army Research Institute of Infectious Diseases (USARIID) at Fort Detrick, MD, if it is a combination CB sample or if it is a suspected biological sample only.

3. SAMPLING RESPONSIBILITY: Samples suspected of containing CB agents are divided into environmental and biomedical samples on the basis of their origin. Both medical and nonmedical teams are responsible for collecting samples suspected of containing CB agents.

a. **ENVIRONMENTAL SAMPLES.** Environmental CB agent samples are collected in the field. They include samples like aerosols or vapors; liquids other than water, soil, vegetation; water; used chemical equipment; and ordnance. The acquisition of these samples is the responsibility of—

(1) NBC reconnaissance teams.

Figure D-3. Example of a TAB D to a TECHINT Appendix of a Theater Army Intelligence Annex.

- (2) Technical escort field teams.
- (3) TECHINT collection teams.
- (4) Preventative medicine units (potable water sources only).
- (5) Special operation teams.

b. **BIOMEDICAL SAMPLES.** Biomedical samples are derived primarily from acutely ill soldiers who exhibit symptoms of CB agent intoxication or from personnel who were killed in an attack. Collection of the biomedical samples will be the responsibility of personnel in—

- (1) Battalion-level medical units.
- (2) Division-level medical treatment facilities.
- (3) Combat support hospitals.
- (4) Evacuation hospitals.
- (5) Theater medical hospitals.
- (6) NBC reconnaissance teams (small animals only).
- (7) Technical escort field teams.
- (8) TECHINT collection teams.

4. SAMPLING: Sampling will be initiated if the following are observed:

- a. Significant numbers of unexplained sickness or death of personnel or animals occur.
- b. Ordnance (munitions) are found which contain known or suspected CB agents.
- c. An attack is suspected or is known to have occurred but the causative agent cannot be identified.
- d. The widespread outbreak of unusual mission-degrading behavior occurs.
- e. Sampling of known identified agents to verify first use is required.

Figure D-3. Example of a TAB D to a TECHINT Appendix of a Theater Army Intelligence Annex (continued).

5. PROCEDURES:

a. Procedures for the collection, packaging, documentation, and transporting of CB samples to laboratories must be precise to ensure the credibility of the analysis conducted on the samples. Ensuring the credible analysis of suspected CB samples is critical for both battlefield commanders concerned with possible retaliation and contamination avoidance, and medical personnel concerned with prophylactic or post-contamination treatments.

b. When possible, a background sample from "clean" areas beyond the perimeter of the attack site should be obtained as baseline data for comparison; collection should be identified to sample collected data from contaminated areas and packaged separately.

c. The best biomedical sample is an acutely ill soldier or a cadaver which is sent back to CONUS immediately. A copy of the physical examination or an extract of significant findings will be enclosed with biomedical samples. Samples will be collected in triplicate, distributing two to CONUS and one to the TAML.

d. All samples will be forwarded from the TAML to either ERDEC or USAMRIID laboratories 12 to 24 hours after collection; delay beyond 24 hours rapidly degrades the intelligence value of the samples.

6. NOTIFICATION MESSAGE: A notification message will be sent from the TAML or TECHINT unit by PRIORITY precedence upon receipt and screening of samples to the Theater Surgeon General, J2, J3, and CDR, ERDEC APG MD//CBATEB//: The notification message will contain the following information:

a. The sample identification number and details which relate to the acquisition of the sample. This message will be confirmed to provide the following information:

- (1) Background information.
- (2) Physical description.
- (3) Results of preliminary tests after sample collection.
- (4) Where, when, and under what conditions the sample was acquired.
- (5) Description of incident.
- (6) Casualty symptoms (if applicable).
- (7) Shipment information, such as—

Figure D-3. Example of a TAB D to a TECHINT Appendix of a Theater Army Intelligence Annex (continued).

- (a) Date of shipment.
- (b) Mode of transportation.
- (c) Flight number and destination.
- (d) Estimated time of arrival CONUS.
- (e) Description of shipment (for example, size and weight).
- (f) Names of escort personnel.

Figure D-3. Example of a TAB D to a TECHINT Appendix of a Theater Army Intelligence Annex (continued).

Appendix E

TECHNICAL INTELLIGENCE REPORTS

INTRODUCTION

This appendix describes the nine basic reports, which are listed below, that battlefield TECHINT analysts use.

- SALUTE report (Figure E-1).
- Preliminary Technical Report (PRETECHREP) (Figure E-2).
- Complementary Technical Intelligence Report (COMTECHREP) (Figures E-3, E-4, and E-5).
- Detailed Technical Report (DETECHREP).
- Technical Intelligence Update Report.
- Technical Intelligence Summary (TECHSUM).
- Technical Intelligence Report (TIR).
- Special technical reports. These reports are generated in response to requests for information. The formats vary by request and usually address a specific question or requirement from a TECHINT consumer.
- Other equipment information reports. These reports focus on aspects of equipment that do not necessarily relate to intelligence needs per se. For example, the Theater commander may have a war trophy policy that permits units to evacuate certain equipment to their home stations for static displays. These reports may include driver's instructions, handling considerations, render-safe procedures, and demilitarization standards for equipment.

The SALUTE report is an oral or written report prepared by the acquiring units or intermediate command echelons. It is used to report rapidly, by electrical or other means, the capture of foreign materiel. These reports are forwarded to either the TECHINT LNEs at Corps, other TECHINT LNEs, or directly to the JCMEC. As a result of this information, a TECHINT team could be dispatched or the CEM could be moved to the Corps CMEC or the theater JCMEC. Figure E-1 gives an example of a completed SALUTE report.

SALUTE REPORT	
TO: G2 V Corps	DTG: 230900Z Aug 98
FROM: G2 24th Inf Div (Mech)	REPORT NO: 07-0623
<ol style="list-style-type: none"> 1. SIZE: NA. 2. ACTIVITY: Capture of shoulder-fired laser target designator by 1/64th Armor Bn 2d Bde 24th Inf Div (Mech) (include capturing unit). 3. LOCATION: Town of Al-Dahran (UTM EH556937) (as a minimum always give grid coordinates). 4. UNIT: 3d Republican Guards Regiment (include enemy unit if known). 5. TIME: Item captured on 230230Z AUG 98 (always use ZULU time). 6. EQUIPMENT: One laser target designator and sighting device (give best possible description). 	

Figure E-1. Example of a SALUTE report.

PRELIMINARY TECHNICAL REPORT

The PRETECHREP contains a general description of the CEE. It alerts the CMEC, other technical elements, and the tactical units to significant technical information of immediate tactical importance. It can also be used for reporting inventories at collection points through intelligence channels so that location, quantities, and type of equipment can be monitored. Figure E-2 shows an example of a PRETECHREP.

Corps TECHINT teams and possibly CMEC teams will prepare a PRETECHREP on all CEM after preliminary screening. This report is first transmitted by radio directly to the Corps TECHINT LNE, from the captured equipment site. It is then forwarded to the CMEC. The report will normally be treated as unclassified during this transmission.

The CMEC's technical analysts determine what is of importance from the report, and give the team instructions through the LNE on what items need more detailed reporting or evacuation. During this time the team will collect all documents off the CEE and will record—

(Classification)
PRETECHREP
A. Type of equipment and quantity.
B. Date and time of capture.
C. Location (map reference).
D. Capturing unit and circumstances of capture.
E. Enemy formation from which captured and origin.
F. Brief description with serial numbers and, if possible, manufacturer.
G. Technical characteristics with an immediate value, including information or any photographs available.
H. Time and origin of message.
I. Present location of CEE.
(Classification)

Figure E-2. Format for a PRETECHREP.

- All radio frequencies of communication equipment.
- All serial markings of important equipment.
- The battle damage done to the CEE.

These information requirements and actions will be taken at all CEE sites. The radio frequencies will be sent only by secured means.

COMPLEMENTARY TECHNICAL INTELLIGENCE REPORT

The COMTECHREP is categorized by Types A, B, or C, depending on what type of CEE is being reported. The COMTECHREP contains a more detailed description of the CEE than the PRETECHREP. It alerts the JCMEC, other technical elements, and the tactical units to significant detailed technical information of immediate tactical and technical importance.

Corps TECHINT teams, and possibly JCMEC teams, will prepare a COMTECHREP on all CEM that the JCMEC tells it to do. If the TECHINT collection team is out of contact with the JCMEC, it will follow the TECHINT collection plan and use its best judgment on reporting.

This report is first transmitted normally by secure computer data transmission over landline to the Corps TECHINT LNE from the team's base. If possible, it is transmitted from the CEE site over secure computer or radio data transmission via satellite. It is then transmitted to the JCMEC. The report normally will be treated as classified during this transmission.

All electronic images of the CEE and computer scanning of critical CED will be transmitted with the COMTECHREP. If data transmission is not on hand, the report will be transmitted by the nearest message center at no less than PRIORITY precedence.

COMPLEMENTARY INTELLIGENCE TECHNICAL REPORT - TYPE A

The COMTECHREP - Type A is provided to Air Force TECHINT personnel. Air Force teams usually are not on the scene of captured or downed enemy aircraft before destruction, recapture, or loss. Army TECHINT personnel usually are the first elements on the scene and will examine the CEM and submit a COMTECHREP - Type A. This report often constitutes the only information that can be provided to Air Force TECHINT. If naval CEM is acquired, the Type A report format can be modified for reporting such acquisition. Figure E-3 shows an example of a COMTECHREP - Type A.

(Classification)
COMTECHREP - TYPE A
The COMTECHREP - Type A is used to report information about aircraft. The JCMEC normally will require this report to be done right after the PRETECHREP on the aircraft.
A. Type of Aircraft, fixed wing (examples):
(1) Air-superiority (F-15C, SU-27B)
(2) Multi-role fighter (F-16, MiG-29C)
(Classification)

Figure E-3. Format for a COMTECHREP - Type A.

(Classification)

- (3) Fighter-bomber (F-111, YAK-141)
- (4) Close Air Support/Ground Attack (A-10, SU-25, SU-22)
- (5) Bomber (B-2, TU-160)
- (6) Observation (OV-10)
- (7) Transport (C-130, IL-76)
- (8) Airborne Early Warning (AWACS, Israeli PHZ)
- (9) Electronic Warfare/Suppression of Enemy Air Defense (EA-63, F-4G)
- (10) Special Mission (for example, Intelligence Collection)

B. General Aircraft Configuration:

- (1) Overall length
- (2) Wingspan
- (3) Wing sweep angle
- (4) Variable geometry wings
- (5) Number of vertical stabilizers and orientation
- (6) Number of seats and orientation
- (7) Number of engines
- (8) Intake type and location
- (9) Landing gear type and orientation
- (10) Distinct control surfaces present (flaperons, elevons)
- (11) Other distinguishing features (wing fences, wingtip winglets, antennas, canards)

C. Identifying Marks:

- (1) Fin flashes
- (2) Paint scheme
- (3) Individual or squadron markings

D. Overall Condition:

- (1) Describe extent of damage and salvageable parts
- (2) Assess cause of crash, if possible
- (3) Did Aircrew survive

E. Cockpit Avionics (not all equipment is present in every aircraft):

- (1) Type (brand and model) of airborne intercept, bombing and navigation, weather radars
- (2) Type of communications gear, frequency settings if possible
- (3) IFF or Transponder type, settings
- (4) Type EA equipment
- (5) Type of RWR gear
- (6) Type of weapon guidance gear (laser designation equipment, TV guidance equipment)

(Classification)

Figure E-3. Format for a COMTECHREP-Type A (continued).

(Classification)
(7) Type of IRSTS if present
(8) Are the following flight controls present: HUD, fly-by-wire controls, MFD, HOTAS (9)
Type of chaff or flare dispenser system
F. Armament:
(1) Number of cannons present, caliber, and location
(2) Bombs or rockets present
(3) Air-to-air missiles present
(4) Air-to-surface missiles present
(5) Number of launch rails or weapon mounts present and location
G. General remarks and special points or unusual features not mentioned.
H. Photos of at least:
(1) Airframe
(2) Engine
(3) All other items that could be of importance
I. Designation of TECHINT collection team conducting exploitation:
J. Time and origin of message:
(Classification)

Figure E-3. Format for a COMTECHREP - Type A (continued).

COMPLEMENTARY TECHNICAL INTELLIGENCE REPORT - TYPE B

The COMTECHREP - Type B is used to report information about explosive ordnance. TECHINT teams prepare these reports, normally done by the EOD member of the team. EOD companies will also prepare them in absence of TECHINT personnel or when required by higher headquarters. This report must be as complete and detailed as possible. EOD personnel prepare and send this report by the fastest means through an EOD control unit. The JCMEC coordinates with EOD battalions to receive copies of these reports as soon as possible.

NOTE: Initial overall classification of EOD Reports. Non-nuclear (COMTECHREP B) will be in accordance with OPNAVINST S5513.3B-24.1.

The initial classification of the COMTECHREP B with RSP is Confidential and will not be released to non-US personnel without the written consent of Commanding Officer, NAVEODTECHDIV. The release of RSP to non-EOD qualified personnel is forbidden.

A complete and accurate report is essential; lives of other EOD personnel rely on this report, strive for the most complete report possible. However, when a detailed report might result in serious delay and the items are of extreme significance, complete as much of the report as possible. Items of EOD interest will at a minimum be photographed (with electronic imaging systems if available), X-rays (digital) and have detailed drawings with measurements (metric). Figure E-4 shows an example of a COMTECHREP - TYPE B.

The unit completing the report will distribute copies of the COMTECHREP - TYPE B (EOD Report) to all deployed US EOD units and provide copies to:

Commander
USATECHDET
2008 Stump Neck Road
Indian Head, MD 20640

Commander
USAARDEC
ATTN: AMSTA-AR-FSX
Picatinny Arsenal, NJ 07806-5000

Commanding Officer
NAVEODTECHDIV
2008 Stump Neck Road
Indian Head, MD 20640

Commander
NGIC
ATTN: IANGIC-RMS
220 7th Street, NE
Charlottesville, VA 22901-5396

(Confidential when filled in)
COMTECHREP-TYPE B (EOD Report)
Section I. (U) DESCRIPTIVE INFORMATION
1. (U) IDENTIFICATION. See Figure __ for physical appearance and dimensions. NOTE: This will be an external view (when possible) and not show internal components.
a. (U) Designation. Ordnance designation (if known) with transliteration of foreign alphabet. Example: M45.
b. (U) Type. Used to summarize the key functional aspects of the items. Example: This is a High Explosive Rocket Assist (HERA) projectile.

Figure E-4. Format for a COMTECHREP - TYPE B.

c. (U) Painting and Markings. Record all paintings, surface treatments, and markings.

d. (U) Features. Point out unique or distinguishing external features of the item that are not obvious in the drawings.

2. (U) DESCRIPTION.

a. (U) Material. Include information pertaining to the major external components; for example, "plastic," "aluminum."

b. (U) Weight. Give the approximate weight if known.

3. (U) HAZARDOUS COMPONENTS.

ITEM	QTY	LOCATION	EXPLOSIVE	HE WEIGHT
List Hazardous components (if known).				

4. (U) FUNCTIONING. Explain the operation of the ordnance, particularly the components of the ordnance involved with initiating the explosive train.

5. (U) APPEARANCE. It must be known for certain that the item is unarmed if the item is to be treated as such.

a. (U) Unarmed Condition. Example: The item is unarmed if not fired.

b. (U) Armed Condition. Example: Consider the item armed if it has been fired.

Section II. (C) EOD PROCEDURES. (EOD USE ONLY)

6. (U) RENDER SAFE PROCEDURE FOR THE UNARMED CONDITION.

a. (C) PROPOSED: (Develop and record prior to completing RSP).

b. (U) Proceed to disposal.

7. (U) RENDER SAFE PROCEDURE FOR THE ARMED CONDITION WARNINGS.

a. (C) PROPOSED: (Develop and record prior to completing RSP).

b. (U) Proceed to Disposal.

continued:

8. (U) DISPOSAL PROCEDURE.

Figure E-4. Format for a COMTECHREP - Type B (continued).

<p>a. (U) Unarmed. Transport hazardous components to safe disposal area and dispose of by detonation.</p> <p>b. (C) Armed.</p> <p>(1) (Include quantity of explosives used to dispose of item).</p> <p>(2) Detonate remotely.</p> <p style="text-align: center;">(Confidential when filled in)</p>
--

Figure E-4. Format for a COMTECHREP - Type B (continued).

COMPLEMENTARY TECHNICAL INTELLIGENCE REPORT - TYPE C

The COMTECHREP - Type C is used to report items not reported under COMTECHREP (Types A and B). COMTECHREP - Type C is submitted as soon as possible. Figure E-5 shows an example of a COMTECHREP - Type C.

(Classification)
<p>COMTECHREP - TYPE C</p> <p>A. Date found and location (map reference).</p> <p>B. Type of equipment and quantity.</p> <p>C. Origin.</p> <p>D. Description with distinguishing marks (additional details).</p> <p>E. Condition of equipment.</p> <p>F. Technical characteristics of immediate tactical value (additional details).</p> <p>G. Recommended disposal.</p> <p>H. Name plates photographed.</p> <p>I. Photographs taken.</p> <p style="text-align: center;">(Classification)</p>

Figure E-5. Format for a COMTECHREP - Type C.

(Classification)
J. Other information.
K. Designation of TECHINT collection team doing this initial exploitation.
L. Time and origin of message.
(Classification)

Figure E-5. Format for a COMTECHREP - Type C (continued).

DETAILED TECHNICAL REPORT

The DETECHREP normally is prepared at the JCMEC by the Exploitation Company, with the assistance of the national S&TI analysis personnel at the JCMEC. The DETECHREP normally is classified. The CM&D section of the Exploitation Company sends the DETECHREP through the JTIB to the national S&TI community. They also send a summary of the report to Theater units.

TECHNICAL INTELLIGENCE UPDATE REPORT

The TECHINT Update Report is a one- to two-paragraph report on an item of equipment that has an impact on tactical operations. The report comes from information provided in PRETECHREPs and COMTECHREPs, and is unclassified. The goal of the report is to reach the lowest level—the soldier—with information of value to the soldier. The CM&D section of the Operations Company sends the report by electronic message and computer data transmission.

TECHNICAL INTELLIGENCE SUMMARY

The TECHINT Summary is a collection of information on more than one item of equipment that has an impact on theater tactical operations. The information comes from PRETECHREPs and COMTECHREPs from over a period of time or from a large CEE location. The report normally is unclassified, but if put into an overall intelligence summary, it can be classified. The CM&D section of the Exploitation Company sends the report by electronic message and computer data transmission to the JTIB. The JTIB then makes dissemination to the lowest possible level with JTF C³I assets.

TECHNICAL INTELLIGENCE REPORT

The TIR is a critical report which goes to the highest levels of the intelligence hierarchy. The report comes from information from PRETECHREPs, COMTECHREPs, and DETECHREPs. This report is always classified and follows the format in DIAM 58-13. The CM&D section sends TIRs by electronic message to the JTIB. The JTIB disseminates them to the highest and lowest intelligence units and agencies possible.

Appendix F

COLLECTION AND EXPLOITATION REQUIREMENTS

INTRODUCTION

This appendix includes guidance on how to develop a TECHINT collection plan, and a listing of general exploitation categories regarding items of interest to battlefield TECHINT. It is included only as a field guide, and is not an all-inclusive exploitation plan.

TECHINT COLLECTION PLAN GUIDANCE

TECHINT elements are a very limited resource requiring specific collection planning to be effective. The most critical TECHINT items for collection are found in the TECHINT Appendix to the OPLAN or OPORD. The following steps help determine pertinent items in the collection plan before it is accepted.

STEP 1. Identify the equipment OB for the threat; for example, items such as individual soldier's equipment, maps, small arms, heavy weapons, and explosives. Also include every type of equipment the threat could have on the battlefield. This is an ongoing effort, with the OB always being updated. In addition to the collection plan, include overlays of locations of ASPs, maintenance points, SAMs, communications centers, and other locations that contain quantities of equipment for collection.

STEP 2. In coordination with DIA, national S&TI requirements, and Theater and Corps PIR and IR, the TECHINT unit prioritizes collection of items from the OB. If coordination is not possible, the equipment that is the greatest threat to the conduct of tactical operations is prioritized.

STEP 3. The DOD Foreign Acquisition List is used to guide TECHINT priorities. These collection priorities are published in the Intelligence Annex to the OPORD in the form of a collection plan. As collection takes place, the updated collection plan is then sent to TECHINT and theater units in message format.

STEP 4. The TECHINT collection requirements are then cross-referenced to the known threat OB. TECHINT elements are then tasked, if possible, with specific collection of items from the threat units that they are facing. In addition, the Corps TECHINT LNE coordinates with the Corps G2 to give specific collection requirements to the Corps units. The JTIB coordinates

with the Theater J2 to give collection requirements to theater units such as Special Operations units.

STEP 5. In addition to the TECHINT collection priority list for equipment, TECHINT elements are tasked to collect, inspect, or develop the following items:

- Threat equipment manuals or documents.
- Threat installations.
- Listing of TECHINT questions for the interrogation of EPWs.
- CB laboratories and samples.

STEP 6. The 203d MI Battalion, in coordination with national S&TI agencies, maintains contingency TECHINT collection plans for possible threat forces. When a TECHINT element deploys, it is given the TECHINT collection plan in order to prepare and train for operations.

EXPLOITATION PLANS AND REQUIREMENTS

GENERAL EXPLOITATION PLAN:

The JCMEC is expected to conduct this level of exploitation on all equipment in theater. The Corps RC TECHINT sections at the CMEC conduct this level on equipment that matched the MOSs in their elements. The TECHINT collection teams are prepared to do this, but normally would not do it on a large scale.

Preliminary requirements for exploitation include—

- Preliminary photographs of CEM outside and inside (to show status of equipment before assessment).
- An inventory.
 - Examine system for any written information (documents, operator manuals, maps), markings, data plates, or operating instructions.
 - Identify all individual equipment components requiring separate analysis.
- If equipment requires further analysis beyond initial exploitation, begin planning for further detailed exploitation with national S&TI personnel.

- The exploitation, with finished report, is accomplished within 48 hours.

The JCMEC normally is the primary center for all detailed exploitations in theater.

Once the general exploitation is accomplished, a more detailed exploitation begins. This is in coordination with the national S&TI SME at the JCMEC. The plan is provided by the national S&TI community.

The JCMEC maintains in the Exploitation Company detailed exploitation plans for collection priority equipment. These plans are part of the contingency database for the threat equipment. The time limit for a detailed exploitation is determined by the tactical needs of the theater and national requirements.

Appendix G

FOREIGN LANGUAGE TEXT RECOGNITION

INTRODUCTION

When TECHINT personnel are able to correctly identify foreign languages used in documents or equipment, it has two immediate benefits. First, it helps identify the equipment or type of document and where or who is using it. Second, it ensures that TECHINT personnel request the correct linguistic support.

This appendix contains language identification hints that will enable TECHINT personnel to quickly identify some of the many languages used in documents, on equipment plates, and on other materiel. TECHINT personnel can speed up the entire battlefield TECHINT process by following the guidance herein.

The language identification hints were compiled by NGIC. There are thousands of languages and dialects in use in the world today; therefore, this material is not complete. The following include examples of the use of language identification during TECHINT operations.

- A TECHINT team discovers an ADA system that looks like a Russian ZPU-4 ADA gun. But on closer examination, the technical analysis identifies Chinese characters on a data plate and on the tires. This could mean that this ADA gun is from China, and this observation needs to be reported to TECHINT elements and to the CMEC.
- TECHINT personnel find a document in Arabic, but the country they are in speak and write only Spanish. This document could be of intelligence value and would require being reported to TECHINT elements and to document exploitation (DOCEX) personnel.

LANGUAGE SYSTEMS

The world's written languages can be divided into alphabet languages and character languages. The only present-day character system is the Chinese system, which has been borrowed by other languages. But there are many alphabets. The most important alphabets currently in use are—

- The Roman alphabet (used by English and many other languages).

- The Cyrillic alphabet (used by Russian, some other Slavic languages, and most of the minority languages of Russia).
- The Arabic alphabet (used in the Middle East and other areas influenced by Islam).

Other alphabets exist, but their use is more restricted. (Figure G-1 shows some of these spoken languages and some of the locations where they are spoken.)

- The Hebrew alphabet for Hebrew and Yiddish; the Greek alphabet for Greek.
- The Devanagari alphabet for Sanskrit and other languages of India.

In addition, there are special alphabets for languages like Georgian, Telugu, the other Dravidian languages in southern India, Laos, and other languages in southeast Asia, and Amharic in Ethiopia.

Illustrations of the main alphabets are normally available in standard desktop dictionaries. Many unusual scripts are illustrated in Romanization Guides, revised and enlarged edition, put out by the Office of the Geographer, Directorate for Functional Research, Bureau of Intelligence and Research, US Department of State, and the US Board on Geographic Names, dated 1 April 1972.

Reliable detailed information about foreign languages for people who cannot actually read them is available in manuals compiled for professional librarians. These manuals can be found at your local library.

ROMAN ALPHABET LANGUAGES

The most complex language recognition problem is to distinguish between the numerous languages that use the Roman alphabet. The 26-letter alphabet is used here as the basic alphabet. The other Roman alphabet languages use these same letters, but many use fewer than 26 and a few use more.

Unfortunately, just because a letter is not used is not a very useful language recognition criterion. This is because it is difficult to know whether a letter is absent because it is never used or because it simply was not needed to write the text in question.

Language	Location
Chinese	People's Republic of China, Taiwan, Hong Kong, Thailand
English	United States, Canada, Great Britain, Ireland, Australia, New Zealand
Spanish	Spain, South America, Central America, Mexico
Hindi	North Central India
Russian	Soviet Union, Europe
Arabic	Saudi Arabia, Yemen, South Yemen, United Arab Emirates, Oman, Kuwait, Bahrain, Qatar, Iraq, Syria, Jordan, Lebanon, Egypt, Sudan, Libya, Tunisia, Algeria, Morocco
Portuguese	Portugal, Brazil, Africa, Asia
Japanese	Japan
German	Germany, Austria, Switzerland
Urdu	Pakistan, India
French	France, Belgium, Switzerland, Canada, Morocco, Tunisia, Algeria, Lebanon, Syria, Laos, Cambodia, Vietnam
Korean	Korea, China, Japan
Italian	Italy, Switzerland
Vietnamese	Vietnam
Turkish	Turkey, Bulgaria, Greece, Cyprus
Persian (Farsi, Dari)	Iran, Afghanistan (Tadzhik, USSR)
Polish	Poland, United States, Soviet Union
Ukrainian	Ukrainian SSR
Rumanian	Romania, Moldavian SSR
Serbian (Croatian)	Yugoslavia
Pashto	Afghanistan, Northwest Pakistan
Czech (Slovak)	Czechoslovakia
Dutch	Netherlands, Suriname, Belgium
Hungarian	Hungary, Romania, Czechoslovakia, Yugoslavia
Danish (Norwegian)	Denmark, Norway
Bulgarian	Bulgaria
Swedish	Sweden
Belorussian	Belorussian SSR
Finnish	Finland
Albanian	Albania, Yugoslavia
Lithuanian	Lithuanian SSR
Latvian	Latvian SSR
Slovenian	Slovenia (Northwest Yugoslavia)
Estonian	Estonian SSR
Macedonian	Macedonia (Yugoslavia)

Figure G-1. A partial list of spoken languages and locations where they are spoken.

Five of the letters <a, e, i, o, u> are referred to collectively as "vowels," while the rest are called collectively "consonants." The rules designating letters as vowels or consonants vary from language to language. Some languages, for instance, consider <l>, <r>, or <y> to be vowels. Most of the Roman alphabet languages modify letters by putting extra marks above, in, or below them. **These marks are called diacritics. They are among the best criteria for language recognition.**

DIACRITICS

Figure G-2 shows the principal diacritics used by various languages to modify the Roman alphabet. Figure G-3 shows the languages that use these diacritics. It also summarizes the occurrence of various diacritics in selected Roman alphabet languages and gives examples of letters with diacritics on them. The diacritics are divided into three groups, depending on whether they are written above, in, or below the letter. They are given standard names for convenience; their actual names vary from language to language.

DIACRITICS ABOVE THE LETTER					
Grave	<` >	Acute	<^ >	Circumflex	<^ >
Hacek	<ˇ >	Breve	<˘ >	Macron	<¯ >
Tilde	<~ >	Krouzek	<˚ >	Dot	<· >
Dieresis	<¨ >	Double Acute	<¨ >	Apostrophe	<' >
Question	<? >	Umlaut	<ä >	Back Apostrophe	<ë >
DIACRITICS IN THE LETTER					
Bar	<- >	Slash	</ >	Horn	<' >
DIACRITICS UNDER THE LETTER					
Cedilla	<¸ >	Ogonek	<˛ >	Comma	<¸ >
		Low Dot	<· >		

Figure G-2. Table of diacritics.

WESTERN EUROPEAN LANGUAGES

Western European languages include those commonly called Romance and Germanic languages.

DIACRITICS WRITTEN ABOVE THE LETTER	
<`> grave:	French, Italian, Portuguese, Vietnamese, e.g., <à>
<`> acute:	Croatian, Czech, French, Greek, Hungarian, Italian, Polish <N, O, S, C, Z>, Slovak, Spanish, Portuguese, Vietnamese; e.g., <á, ó>
<^> circumflex:	French, Italian, Portuguese, Rumanian, Vietnamese, Turkish, e.g., <â, ô>
<v> hacek:	Croatian, Czech, Estonian, Latvian, Lithuanian <S, Z, C>, Slovak, Slovenian, e.g., <č, ě>
< > breve:	Rumanian, Turkish, Vietnamese; e.g., <ă, ğ>
<¯> macron:	Latvian, Lithuanian; e.g., <ā, ū>
<~> tilde:	Estonian, Portuguese, Spanish, Vietnamese; e.g., <ã, ñ>
<°> krouzek:	Czech, Danish, Norwegian, Swedish; e.g., <å, e>
<.> dot:	Lithuanian <e>, Polish, Turkish, e.g., <è, ź>
<u> dieresis:	Albanian, Estonian, Finnish, French, German, Hungarian, Slovak, Portuguese <ü>, Spanish, Swedish, Turkish; e.g., <ä, ë>
<"> double acute:	Hungarian; e.g., <ő, ű>
<'> apostrophe:	Czech, French, Slovak; e.g., <ď, ť>
<?> question:	Vietnamese; e.g., <a, e>
<{> back apostrophe:	Latvian; e.g., <g>
DIACRITICS WRITTEN IN (OR TOUCHING) THE LETTER	
<-> bar:	Croatian, Polish, Vietnamese; e.g., <d, l, a>
</> slash:	Danish, Norwegian, Polish; e.g., <1, 0>
<»> horn:	Vietnamese; e.g., <ũ, õ>
DIACRITICS WRITTEN UNDER THE SEAT	
<,> cedilla:	Albanian, French, Portuguese, Turkish, e.g., <ç, ş>
<o> ogonek:	Lithuanian
<,> comma:	Latvian, Rumanian; e.g., <k, ş>
<.> low dot:	Vietnamese; e.g., <a, e>

Figure G-3. The occurrence of diacritics in various languages.

DISTINGUISHING FRENCH, GERMAN, AND DUTCH

FRENCH:

French is generally easiest to recognize because it is so familiar and has so many words in common with English. French uses acute <`> and grave <`> on <e>. Acute is not used on any other letters, but grave is used occasionally on <a> and <u>. Circumflex <^> is used on <a, e, i, o, u> and cedilla <,> is used under <c>. The French commonly omit diacritics over capital letters and in typescript. Definite article forms: le, la, les. French also uses a tréma <oe, ï, ë>.

GERMAN:

German uses the umlaut <u> on <a, o, u>. This is the language's only diacritic. German also uses a special letter, the Eszett < >, which does not begin a word. In regular prose, capitalization is rather frequent since all nouns are capitalized. Definite article forms: der, die, das, des, dem, den.

DUTCH:

Dutch can be mistaken for German; however, Dutch does not capitalize its nouns in regular prose. Dutch adopted a few diacritical forms from the French language. These include: acute <een>; grave <crepe>; apostrophe <'t, z'n, d'r, etc.>; dieresis <België>; and sometimes the cedilla <, >. Definite article forms: de and het.

DISTINGUISHING SPANISH, PORTUGUESE, AND ITALIAN

For Spanish, look for acutes occasionally over vowels, tilde <~> over <n> but not over vowels, no grave accents, and words that end in <n>. For Portuguese look for the tilde over <a> and <o> but not over <n>, the cedilla under <c>, and some words that end in <m>. For Italian look for occasional graves over vowels, no tildes or cedillas, and numerous doubled consonants; for example, <tt>, <gg>, <pp>, <vv>, and so forth. Of course, look for the definite articles; they are frequently used and mostly different in the three languages.

SPANISH:

Spanish uses acute <'> on vowels <a, e, i, o, u> and tilde <~> on <n>. Since the acute marks irregular word accent, there will normally be no more than one acute per word and it will appear on the last vowel or third from last vowel. Dieresis <u> is used occasionally over <u>. Grave <'> and circumflex <^> are not used. Definite article forms: el, la, los, las.

PORTUGUESE:

Portuguese uses acute <'>, grave <'>, and circumflex <^> occasionally over vowels, and tilde <~> frequently over <a> and <o>. Cedilla <, > is used under <c>. Dieresis <u> is used over vowels occasionally. Definite article forms: o, os, a, as.

ITALIAN:

Italian uses acute <^> on <e> and grave <`> on vowels <a, e, i, o, u> to indicate unusual accent. Some type fonts may substitute circumflex <^> for grave. Normally there will be no more than one grave per word, and it will appear on the last vowel or third from last vowel. Definite article forms: il, lo, i, gli, la, le.

NORTHERN EUROPEAN LANGUAGES

Northern European languages include North Germanic and Slavic, as well as unique languages of the Finno-Ugric family. The distinguishing features of each are described below.

SWEDISH:

Swedish uses dieresis <u> on <a> and <o> and krouzek <^o> on <a>. A frequent word is och; meaning "and."

DANISH AND NORWEGIAN:

Danish and Norwegian use the same alphabet as Sweden. They use krouzek <^o> on <a> and slash </> on <o>, and a special letter, the ae digraph <Æ, æ>. Written Danish and Norwegian are difficult to tell apart, but anyone who can read one can make sense out of the other. A frequent word in both languages is og; meaning "and."

FINNISH:

Finnish is very different from the other northern European languages, but it is similar to Estonian. Finnish uses dieresis <u> on <a> and <o>. About 60 percent of the average text consists of vowels (including <y>). Look for frequent double vowels; <aa>, <ee>, <ii>, etc.

ESTONIAN:

Estonian uses tilde <~> on <o>, dieresis <u> on <a, o, u>, and hacek <^v> on <s, z> infrequently in foreign words. At first glance Estonian looks very much like Finnish, and both are of the Finno-Ugric family. To tell the two languages apart, look for <y> (Finnish) or <u> with dieresis (Estonian).

HUNGARIAN:

Hungarian uses acute <^> on <a, e, i, o, u>, dieresis <u> on <o, u>, and double acute <^^> on <o, u>. These three diacritics are very frequent and should all appear in an average paragraph. Definite article forms: a, az. Although not Northern European, Hungarian is listed here because it is in the Finno-Ugric family.

ROMAN ALPHABET SLAVIC LANGUAGES

It is often difficult to distinguish between the Roman alphabet Slavic languages. Of these languages, Polish is easiest to distinguish from the rest because it does not use hacek <^v>, whereas the others do; and because it uses <w> frequently and <v> almost never, whereas the opposite situation occurs in the other languages.

The languages of Czechoslovakia—Czech and Slovak—can be distinguished from the Roman alphabet languages of the former Yugoslavia, Croatia, and Serbia because Czech and Slovak use acute <'> on vowels (including <y>) and Croatian and Slovenian do not. Acutes are so frequent in Czech and Slovak that the absence of acutes in an average-length sentence can be taken as a valid negative test.

The presence of the diacritics listed above for Croatian indicate that it may be Croatian; but there is no convenient way to test for Slovenian against Croatian. If in doubt between Croatian and Slovenian, assume Croatian unless it can be established that the text was published in Ljubljana.

POLISH:

Polish uses acute <'> on <c, n, o, s, z>; ogonek <_˛> on <a, e>; bar <-> (occasionally depending on font as a substitute for slash) on <L, 1, Z>, such as <L, 1, Z>; and <˙> dot on <z>. Letters <w> and <z> are very frequent in Polish, and the <v> almost never occurs.

CZECH:

Czech uses acute <'> on <a, e, i, o, u, y>, hacek <^v> on <c, d, e, n, r, s, t, z>, krouzek <^o> on <u>. The letter <r> with hacek is frequent in Czech and lacking in Slovak.

SLOVAK:

Slovak uses acute <'> on <a, e, i, l, r, o, u, y>; dieresis <u> on <a>; circumflex <^> on <o>; hacek <^v> on <c, d, l, n, s, t, z>; and apostrophe <'> on <d, l, t>. The digraph <ie> is fairly frequent in Slovak and very infrequent in Czech. Slovak is used in eastern Czechoslovakia. Suspect Slovak if Bratislava is the origin.

CROATIAN:

Croatian uses acute <'> on <c>, hacek <^v> on <c, s, z>, and bar <-> on <d>. Croatian is used in northern and coastal Yugoslavia around the city of Zagreb.

SLOVENIAN:

Slovenian uses hacek <^v> on <c, s, z> and no other diacritics. Slovenian is used in extreme northwest Yugoslavia around the city of Ljubljana.

RUMANIAN:

Rumanian uses breve <^v> on <a>, circumflex <^> on <a, i>, and comma <,> under <s, t>.

ALBANIAN:

Albanian uses dieresis <u> on <e> and cedilla <,> under <c>. The <e> with dieresis is very common. Another recognition mark of Albanian is the use of <q> without <u>.

LITHUANIAN:

Lithuanian uses hacek <^v> on <c, s, z>, macron <˘> on <u>, dot <˙> on <e>, and ogonek <˛> under <a, e, i, u>. The frequent occurrence of ogonek is a good recognition sign for Lithuanian.

LATVIAN:

Latvian uses hacek <^v> on <c, s, z>, macron <˘> on <a, e, i, o, u>, and comma <,> under <k, l, n>. Comma is also used under <G> (upper case letter only), while back apostrophe <`> is used on <g> (lower case letter only). In this case the two marks are variant forms of the same diacritic. The macrons and commas are a good recognition sign for Latvian.

OTHER ROMAN ALPHABET LANGUAGES

Turkish and Vietnamese use the Roman alphabet with unusual diacritics.

TURKISH:

Turkish uses breve <^v> on <g>, dieresis <u> on <o, u>, and cedilla <,> on <c>. Turkish has two forms of the letter <i>. One has the upper case <I> and a corresponding lower <i> that looks like an "i" without the dot. The other letter has the lower case form <i> (the same as English) and a corresponding upper case form that looks like English "I" with a dot <İ>. Turkish also uses circumflex <^> <latif> <lugat>.

VIETNAMESE:

Vietnamese uses a very complex system of diacritics. It uses breve <^v> on <a>, circumflex <^> on <a, e, o>, horn <^> on <o, u>, and bar <-> on <d>. In addition to these, the following five diacritics are used with vowels to indicate tone: grave <`>, acute <^>, low dot <.>, question <?>, and tilde <~>. Vowels with breve, circumflex, and horn can, and often do, have a tone diacritic. So, in Vietnamese, one letter can have two diacritics on it.

CYRILLIC ALPHABET LANGUAGES

The Cyrillic alphabet is used to write Russian, Ukrainian, Belorussian, and many minority languages from the former Soviet Union. It is also used to write Bulgarian and Serbian. The Cyrillic alphabet and the Roman alphabet are both derived from forms of the Greek alphabet so there is a general resemblance. Some Cyrillic letters seem to Americans to be backwards or oddly shaped. Figure G-4 shows the characters and diacritics not found in Russian. With the exception of one letter, , which is only used sometimes in Russian, none of these letters appear in the normal Russian text.

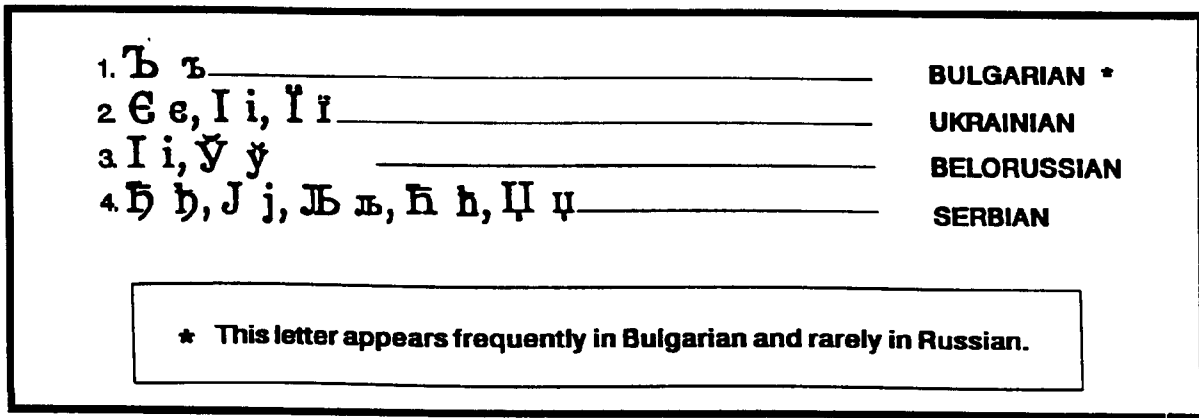

Figure G-4. Distinguishing major Slavic languages from Russian.

SLAVIC LANGUAGES:

Figure G-4 gives the simplest recognition guide for identifying documents that look like Russian but are actually other Slavic languages or minority languages.

TRANSLITERATION:

Figure G-5 shows the different forms of the Cyrillic alphabet for five principal Cyrillic alphabet languages and the recommended transliterations for each letter. Pay particular attention to the transliteration of Russian. These equivalents must be used when reporting on materiel bearing Russian nameplates. **DO NOT REPORT ON FOREIGN EQUIPMENT AND DOCUMENTS USING THE ORIGINAL CYRILLIC CHARACTER.** The Figure classifies each letter as "C" for consonant or "N" for nonconsonant.

RUSSIAN:

Russian is the most frequently encountered Cyrillic alphabet language and should always be the prime suspect. The key to recognizing Russian is the fact that it uses both letter 12 and letter 39 and does not use letter 13 at all. (See Figure G-5.)

BULGARIAN:

Bulgarian is perhaps the second most frequently encountered Cyrillic alphabet language and the most difficult for the nonspecialists to differentiate from Russian. Bulgarian uses fewer letters than Russian.

NOTE: In the following discussion, the letters are referred to by their numbers on the chart in Figure G-5.

For example, a letter used often in Russian and never in Bulgarian is the letter 39; however, the way to be sure that it is not Bulgarian is to see if the letter 38 comes before a consonant or "C" letter. Note that letter 38 is frequent in Bulgarian and rare in Russian; moreover, when letter 38 occurs in Russian, it always occurs before an "N" letter.

Proper transliteration is very important. When an analyst reads a Russian nameplate and writes down P-105A, but it is actually an R-105D (P is not P, rather "R," and < > is wrongly symbolized by A); then it results in incorrect reporting.

The column in Figure G-5 marked "Other" is not supplied with any transliteration equivalents. This column contains similar letters that are encountered in the written languages of various minority nationalities in the former USSR. These languages belong mainly to the Uralic family or the Altaic family, and a Russian linguist will be unable to make any sense out of them. Recognition of any documents in these languages as non-Slavic is a helpful first step in DOCEX.

No.	Russian	Ukrainian	Belorussian	Bulgarian	Serbian	Other
1. N	А а	А а	А а	А а	А а	
2. С	Б б	Б б	Б б	Б б	Б б	Л а Л а Аз
3. С	В в	В в	В в	В в	В в	-
4. С	Г г	Г г	Г г	Г г	Г г	-
5. С	Д д	Д д	Д д	Д д	Д д	Г г Б б
6. С	-	-	-	-	-	-
7. N	Е е	Е е	Е е	Е е	Е е	-
8. N	Е е	-	Е е	Е е	Е е	Е е Э э
9. N	-	Е е	Е е	-	-	-
10. С	Ж ж	Ж ж	Ж ж	Ж ж	Ж ж	-
11. С	З з	З з	З з	З з	З з	Ж ж Ж ж
12. N	И и	И и	-	И и	И и	З з З з
13. N	-	І і	І і	-	-	И и И и
14. N	-	І і	-	-	-	І і І і
15. С	Й й	Й й	Й й	Й й	-	-
16. С	-	-	-	-	-	-
17. С	К к	К к	К к	К к	К к	К к К к
18. С	Л л	Л л	Л л	Л л	Л л	Л л
19. С	-	-	-	-	-	Л л
20. С	М м	М м	М м	М м	М м	-
21. С	Н н	Н н	Н н	Н н	Н н	-
22. С	-	-	-	-	-	Н н Н н Н н
23. N	О о	О о	О о	О о	О о	-
24. С	П п	П п	П п	П п	П п	О о О о О о
25. С	Р р	Р р	Р р	Р р	Р р	-
26. С	С с	С с	С с	С с	С с	-
27. С	Т т	Т т	Т т	Т т	Т т	С с
28. С	-	-	-	-	-	Т т
29. N	У у	У у	У у	У у	У у	-
30. С	-	-	У у	У у	У у	У у У у У у
31. С	Ф ф	Ф ф	Ф ф	Ф ф	Ф ф	У у V v V v
32. С	Х х	Х х	Х х	Х х	Х х	-
33. С	Ц ц	Ц ц	Ц ц	Ц ц	Ц ц	Х х
34. С	Ч ч	Ч ч	Ч ч	Ч ч	Ч ч	-
35. С	-	-	-	-	-	Ч ч Ч ч Ч ч
36. С	Ш ш	Ш ш	Ш ш	Ш ш	Ш ш	Ч ч
37. С	Щ щ	Щ щ	-	Щ щ	Щ щ	Ч ч
38. N	Ъ ъ	-	-	Ъ ъ	-	-
39. N	Ы ы	-	Ы ы	-	-	-
40. N	Ь ь	Ь ь	Ь ь	Ь ь	-	-
41. N	Э э	-	Э э	-	-	Ы ы
42. N	Ю ю	Ю ю	Ю ю	Ю ю	Ю ю	-
43. N	Я я	Я я	Я я	Я я	Я я	-

Figure G-5. Cyrillic alphabet and transliteration chart.

NOTES:

1. The letters are numbered sequentially for ease of reference. The alphabetic order given is the convenient one, which is not necessarily the traditional one.
2. The letters marked "N" are nonconsonants; and the letters marked "C" are consonants.
3. Letters 7 and 8 have alternate transliterations for Russian and Belorussian. In all cases, the first transliteration is used when the letter occurs after a "C" letter; the second transliteration is used in all other cases, including when the letter begins the word.
4. Letter 8 is not considered a separate letter and its dieresis is often omitted.
5. Letter 4 is pronounced something like "h" in Ukrainian and Belorussian and "h" is often the recommended transliteration. However, transliteration "g" is recommended here to eliminate confusion with the letters transliterated "sh" and "zh."
6. The "Other" category refers to various minority languages in the Soviet Union, many of which are Uralic or Altaic languages.

Figure G-5. Cyrillic alphabet and transliteration chart (continued) .

UKRAINIAN:

Ukrainian is distinguished by the use of letters 12 and 13 and the non-use of letter 39. Letters 9 and 14 also are unique to Ukrainian, but their frequency is low and their absence may be accidental. When Ukrainian is identified, pay particular attention to the transliteration of letter 12. The recommended transliteration for letter 4 is "g" even though its pronunciation is closer to English "h."

BELORUSSIAN:

Belorussian is distinguished by the use of letters 13 and 39 and the non-use of letter 12. Letter 30 is unique to Belorussian, but its frequency is not high enough to use it as an identification sign. As in Ukrainian, letter 4 in Belorussian is transliterated "g" and pronounced like "h."

SERBIAN:

Serbian is spotted easily by the several unique letters it uses: letters 6, 16, 19, 22, 28, and 35. Serbian is conventionally transliterated into Croatian, and this is what the chart gives. The diacritics of the Croatian script are discussed in the **"ROMAN ALPHABET LANGUAGES"** section above.

MACEDONIAN:

Macedonian is spoken by perhaps two million people in southeastern Yugoslavia. The Macedonian alphabet is similar to the Serbian, except that letters 6 and 28 are not used and three other letters are added. The added letters are letter 4 with an acute <`>, letter 17 with an acute <^>, and <S, s>. Macedonian language documents are rare.

ARABIC ALPHABET LANGUAGES

The Arabic alphabet has generally followed the spread of Islam and has been used to write numerous languages, some of which (notably Turkish) no longer use it. This alphabet, appropriately modified, currently is used for all the dialects of Arabic and for Persian, Urdu, and other Indo-Iranian languages, such as Dari, Pashto, and Kurdish. The Russian and Cyrillic alphabets seem even more related to one another when compared to Arabic.

ARABIC AND PERSIAN:

The best distinction a nonlinguist can make is to separate Persian documents from Arabic documents. Persian linguists cannot read Arabic, and vice versa, unless they know both languages.

ARABIC:

Arabic is spoken over a large area extending from Morocco on the west to borders of ancient Persia (modern Iran) on the east. The spoken language varies widely in this area, but the written language is fairly standard. Only a specialist could hope to distinguish the varieties of Arabic, but a sharp-eyed nonlinguist can learn to recognize Arabic and distinguish it from Persian. The best indication is perhaps the presence of letter 32, which is not used in Persian. The next best indication is perhaps the frequent occurrence of the definite article < >, which is spelled with letter 1 (initial) and letter 27 (initial). A final characteristic is the absence of the special Persian letters: letters 3, 7, 14, and 26. Since this is a negative indication, however, it cannot be used by itself to prove that a text is Arabic.

PERSIAN:

Persian is used in Iran. It is indicated by the presence of the special Persian letters 3, 7, 14, and 26, and by the absence of letter 32. Other indications are a paucity of letter 1 and 27 combinations (the Arabic definite article) and a slightly different preference in numeral usage.

ARABIC NUMERALS:

In school, the numerals used in the United States and most of the rest of the world are often called "Arabic numerals," but these are not the same forms used in Arabic alphabet languages. The real Arabic numerals are illustrated in Figure G-6. This figure also shows Arabic and Persian variants of the numerals along with their international equivalents. Unlike the Arabic alphabet (which is, of course, read from right to left), **ARABIC NUMERALS ARE READ FROM LEFT TO RIGHT, THE SAME WAY AS OUR OWN NUMERALS ARE READ.**

Document collectors should familiarize themselves with the Arabic numerals so they can read page numbers in collected documents and properly reassemble documents that have come apart. Collectors should remember that one of the results of the right-to-left orientation of the Arabic alphabet is that the apparent "back" of a document is actually the front.

Figure G-7 illustrates the Arabic alphabet in its Arabic and Persian variants. Notice that each letter has four forms, labeled "alone," "final," "medial," and "initial." Notice that "initial" is to the right of "final." These column labels indicate two of the main differences between Arabic script and Roman script: First, the letters change in order to connect to other letters, and second, **THE SCRIPT IS WRITTEN FROM RIGHT TO LEFT.**

The letters with asterisks by their numbers cannot connect to a following letter. The initial form is used to begin a word or when the letter follows a nonconnectable letter. The medial form is used after a connectable letter or when it is used by itself; for example, to letter paragraphs in a document.

DIACRITICS:

Another feature of the Arabic alphabet is the use of diacritics to differentiate many of the letters. Figure G-8 illustrates the diacritics used in Arabic and Persian.

Using Figures G-7 and G-8, note that letters 2, 3, 4, 5, 29, and (partially) 33 have the same base form with the following diacritics: high dot < ` >, letter 29; low dot < \$ >, letter 2; high double dot < ^ >, letter 4; low double dot < .. >, letter 33, initial and medial only; high triple dot < ^ >, letter 5; and low triple dot < † >, letter 3.

Letter 8 is the base form for another diacritic set: High dot < ` >, letter 9; low dot < \$ >, letter 6; low triple dot < † >, letter 7. Letter 10 is the base form, and letter 11 adds high dot < ` >. Letter 12 is the base form. A Letter 13 adds high dot < ` >, and letter 14 adds high triple dot < ^ >. Letter 15 is the base form and letter 16 adds high triple dot < ^ >.

<u>International</u>	<u>Arabic</u>	<u>Persian</u>	<u>International</u>	<u>Arabic</u>	<u>Persian</u>
0	•	◦ or ◦	6	٦	٦ or ٦
1	١	١	7	٧	٧
2	٢	٢	8	٨	٨
3	٣	٣	9	٩	٩
4	٤	٤ or ٤	10	١٠	١٠ or ١٠
5	٥	٥ or ٥	20	٢٠	٢٠ or ٢٠

Figure G-6. International, Arabic, and Persian numbers.

Letters 17, 19, and 21 are the base forms for letters 18, 20, and 22 respectively; the added diacritic for all three is high dot <'>. Letters 23 and 24 have approximately the same base form with high dot <'> on letter 23 and high double dot <''> on letter 24. Letters 25 and 26 have the same base form. Letter 25 uses flag <'> on its initial and medial forms and hamza sign <^> on its final and alone forms.

Letter 26 uses double flag <''> on all its forms and hamza sign <^> on its final and alone forms. Letter 31 is the base form, and letter 32 uses high double dot <''>. For grammatical reasons, letter 32 is not used initially or medially.

SAMPLES OF ARABIC AND PERSIAN

Figure G-9 gives a sample of printed Arabic. Note the frequent occurrences of letter 1 and letter 27: the definite article at word beginnings. Remember, words begin on the right. The seventh line from the top, for instance, has four obvious occurrences and two other occurrences in modified forms that have not been discussed here. There are 18 occurrences of letter 32, at least one occurrence in every line except lines 9 and 11 and four occurrences in lines 3 and 8.

No.	Arabic				Persian			
	Alone	Final	Medial	Initial	Alone	Final	Medial	Initial
1.	ا	ا	ا	ا	ا	ا	ا	ا
2.	ب	ب	ب	ب	ب	ب	ب	ب
3.	ت	ت	ت	ت	ت	ت	ت	ت
4.	ث	ث	ث	ث	ث	ث	ث	ث
5.	ج	ج	ج	ج	ج	ج	ج	ج
6.	ح	ح	ح	ح	ح	ح	ح	ح
7.	خ	خ	خ	خ	خ	خ	خ	خ
8.	د	د	د	د	د	د	د	د
9.	ذ	ذ	ذ	ذ	ذ	ذ	ذ	ذ
10.	ر	ر	ر	ر	ر	ر	ر	ر
11.	ز	ز	ز	ز	ز	ز	ز	ز
12.	س	س	س	س	س	س	س	س
13.	ش	ش	ش	ش	ش	ش	ش	ش
14.	ص	ص	ص	ص	ص	ص	ص	ص
15.	ض	ض	ض	ض	ض	ض	ض	ض
16.	ط	ط	ط	ط	ط	ط	ط	ط
17.	ظ	ظ	ظ	ظ	ظ	ظ	ظ	ظ
18.	ع	ع	ع	ع	ع	ع	ع	ع
19.	ف	ف	ف	ف	ف	ف	ف	ف
20.	ق	ق	ق	ق	ق	ق	ق	ق
21.	ك	ك	ك	ك	ك	ك	ك	ك
22.	گ	گ	گ	گ	گ	گ	گ	گ
23.	ل	ل	ل	ل	ل	ل	ل	ل
24.	م	م	م	م	م	م	م	م
25.	ن	ن	ن	ن	ن	ن	ن	ن
26.	و	و	و	و	و	و	و	و
27.	ز	ز	ز	ز	ز	ز	ز	ز
28.	ح	ح	ح	ح	ح	ح	ح	ح
29.	خ	خ	خ	خ	خ	خ	خ	خ
30.	د	د	د	د	د	د	د	د
31.	ذ	ذ	ذ	ذ	ذ	ذ	ذ	ذ
32.	ر	ر	ر	ر	ر	ر	ر	ر
33.	س	س	س	س	س	س	س	س

Figure G-7. The Arabic alphabet.

< ˙ >	High Dot	< ˙˙ >	High Double Dot	< ˙˙˙ >	High Triple Dot
< ˘ >	Low Dot	< ˘˘ >	Low Double Dot	< ˘˘˘ >	Low Triple Dot
< ˆ >	Flag High	< ˆˆ >	Double Flag High	< ˆˆˆ >	Hamza Sign Persian
< ˘˘ >	Flag Low	< ˘˘˘ >	Double Flag Low	< ˘˘˘ >	Hamza Sign Arabic

Figure G-8. The diacritics of Arabic and Persian.

وفضلا عن ذلك فلقد كان في كل القوانين القائمة ما يكفي لمواجهة الأحداث والاضطرابات التي وقعت وكذلك للنظر في أمر ما نسبه رئيس الجمهورية في خطابه إلى أحزاب الأقلية ، وإلى الجماعات الإسلامية ، وإلى بعض الشخصيات المدنية المسلمة ، والمسيحية . . فالقوانين القائمة تكفل الحفاظ على أمن البلاد وسلامتها ضد ما يهدد وحدتها الوطنية من أخطار وبالتالي فإن القرار المطعون فيه لا يمكن أن يعتبر- بحال- عملا من أعمال الضرورة - كما أن القرار المطعون فيه خالف صريح نص المادة ٤١ من الدستور التي تنص على عدم جواز القبض أو تقييد الحريات في غير حالة التلبس إلا بأمر من القاضي المختص أو النيابة العامة ، تستلزمه ضرورة التحقيق وصيانة أمن المجتمع وفقا لأحكام القانون - وأنه لم يرد في أوراق الدعوى أى دليل على أن المتحفظ عليهم ضبطوا في حالة تلبس أو أنه أجرى معهم تحقيق سابق على التحفظ ، حتى يتضح منه أن هذا التحفظ كان اجراء لازما .

Figure G-9. Printed Arabic.

Figure G-10 illustrates typewritten Arabic. Note that lines 1, 2, 5, and 10 begin (on the right) with the definite article (letter 1 and letter 27). There are 20 other obvious occurrences of these letters at the beginning of words and several others that are less obvious. Lines 1, 2, and 9 end (on the left) with letter 32. Letter 32 occurs five other times in the sample. Arabic script permits some letters to be stretched in order to even out text on the left. The long lines at the left of the sample are instances of this.

الدفع ببطلان اجراءات التحقيق لعدم توفير حماية
 التحقيق الابتدائي وهو حق المتهم في الاستعانة
 بمحام - اصلا لنص المادتين ٦٩ / ٧١ من الدستور
 والمواد ٧٢ - ١٢٤ - ١٢٥ من قانون الاجراءات
 الجنائية وأنه لا يقدح من ذلك أن المتهمين لم يودعوا
 تقريرا في قلم كتاب المحكمة بأسماء محاميهم وذلك
 لان ظروف المتهمين والحالة التي كانوا عليها قبل
 عرضهم على النيابة العامة كانت لا تسمح لهم بايداع
 تقرير في قلم كتاب المحكمة بأسماء محاميهم وأن العبارة
 التي يشتمها المحقق في صور محضر التحقيق من أنه
 سأل المتهم عما اذا كان لديه محام نفى ذلك - وهي

Figure G-10. Typewritten Arabic.

Figure G-11 illustrates printed Persian. Note the double flags <“>, two in the first line and eight more in the rest of the sample. Note the low triple dots <+>, one in the first line and eight more in the rest of the sample. Neither of these diacritics occurs in Arabic.

بعد از شاه عباس بزرگ در سال ۱۰۳۸ کمپانی تجاری هند شرقی انگلیس فرمان
 تازه در باب تجارت ابریشم از شاه صفی جانشین وی گرفتند ولی نتوانستند تمام
 امتیازات و حقوق را که در زمان شاه عباس بزرگ تحصیل کرده بودند بار دیگر
 بدست آورند و با آنکه از طرف چارلز اول پادشاه انگلیس در ماه شعبان ۱۰۳۹
 (۱۶۳۰) نماینده و نامه برای کمک و مساعدت بتجار و اتباع انگلیسی در ایران
 برای شاه صفی آمد و از طرف پادشاه ایران هم بخوبی این اظهار مودت و دوستی
 پذیرفته شد ولی در زمان این پادشاه اساساً قسمت مهم تجارت ایران بدست تجار
 هلندی بود و بار دیگر چارلز اول برای کمک بشرکت هند شرقی انگلیس نامه
 دیگر برای شاه صفی فرستاد و از طرف پادشاه صفوی هم این نامه بخوبی پذیرفته

Figure G-11. Printed Persian (arrows indicate distinguishing features).

OTHER ARABIC ALPHABET LANGUAGES

DARI:

Dari is used in Afghanistan and favored by the government. Since its written form is heavily influenced by Persian models, there is no easy way for the nonspecialist to distinguish it from Persian.

KURDISH, PASHTO, AND URDU:

The other notable Arabic alphabet languages are Kurdish, Pashto, and Urdu. Kurdish is spoken by the Kurdish tribes of Iraq, Iran, and Turkey. Pashto is used widely in Afghanistan, and Urdu is the predominant language of Pakistan. These languages contain letters and diacritics not listed for Arabic or Persian. If one of these languages is suspected, refer the problem to a linguist.

CHARACTER LANGUAGES

Character languages use writing systems with symbols that stand for words or meaningful elements of words rather than for sounds. Character languages, such as hieroglyphic Egyptian, existed in earlier times; but today, the only character languages are Chinese and languages that have wholly or partially borrowed the Chinese system, such as Japanese and Korean.

DISTINGUISHING CHINESE, JAPANESE, AND KOREAN:

The easy way to distinguish the three languages is to look for the distinctive phonetic symbols of Japanese and Korean. If these symbols are not present, conclude that the language is Chinese. Chinese is the model for the other two, and these languages borrow freely from Chinese. Figures G-12, G-13, and G-14 give sample texts of Chinese, Japanese, and Korean.

Figure G-12 shows Chinese characters. They are more detailed, complex, and square or precise than Japanese or Korean.

Korean and Japanese language texts use Chinese characters whenever it might be unclear to use one of their own symbols. This means that the higher or more academic a text is the more Chinese characters it will have.

出版说明

《汉英词典》是由北京外国语学院英语系编写的。编写工作于一九七一年开始，一九七八年夏完成，历时八载。先后参加编写、修改等工作的中外专家共五十余人。

本书的主编为北京外国语学院英语系主任吴景荣教授。除编写组编辑人员外，还有不少专家和学者先后参加过这项工作。周珏良主持了初稿的编写，弗兰克·怀利(Frank Wylie)和何南喜(Nancy Hodes)参加了英语修改工作。在组内工作了较长时间的还有初大告、水天同、王锡钧、张道真、王瑞、俞天民、吴国瑞、杨志才、吴石牧、陈国成、张月平等。在词典编写过程中，还得到丘茉莉(Elsie Fairfax-Cholmeley)、舒裕禄(Norman Shulman)和裘克安等对本书的编辑和出版提出了许多宝贵的意见。

本书是一部中型语工工具书，全书收汉语单字条目六千多，其中包括极少数的音变字，收入的多字条目五万余，连同合成词、词化短语、及例证等共达十二万余。

除一般词语外，还收一些常见的文言词语、方言、成语、谚语，以及自然科学和社会科学的常用词语。

Figure G-12. Sample of Chinese text.

改訂増補の序

辞書は造られた日から古くなりつつある。こう言えば、辞書編集者には、まことに皮肉に響くのであるが、しかも半面の真理を含んでいる。研究社「新英和大辞典」については、1953年版の発行と同時に、改訂のため待機姿勢が整えられたのであるが、縦植の訂正はもちろんのこと、内容と形式の統一について一層適切な処置を施すことに、たゆみない努力がなされた。これについては、使用者各位の親切な指示に負うものもあつた点感謝するところであるが、それとは別に、開巻第1ページから順を追って検討が進められたのであつて、河村重治郎氏はもっぱらその任に当られ、半年にわたつて本辞典の内容改善のため尽力された。この改訂にはページの要動増加を来さない範囲という枠がはめられていた。

ところが時日の経過につれて、世界情勢の進展に伴い改訂の項目は増進し新語句・新語義の追加すべきものも急増して来たので、漸く巻末に増補追加の案が台頭したのであるが、その間、当用漢字表・かなづかい法の改正に伴う校訂の業も加わつて来た。さらに印刷の面からは金漢字を新刷して版面の面目を一新し、また版面を拡大するという大掛りな改良案も登場するに至つた。ここにおいて、終に、なんらの枠を設けない全面的改訂に踏みきることとなり、以来鋭意その業が継続せられ、勉勵数年、このたび漸く完成の日を迎えるに至つた。

Figure G-13. Sample of Japanese text.

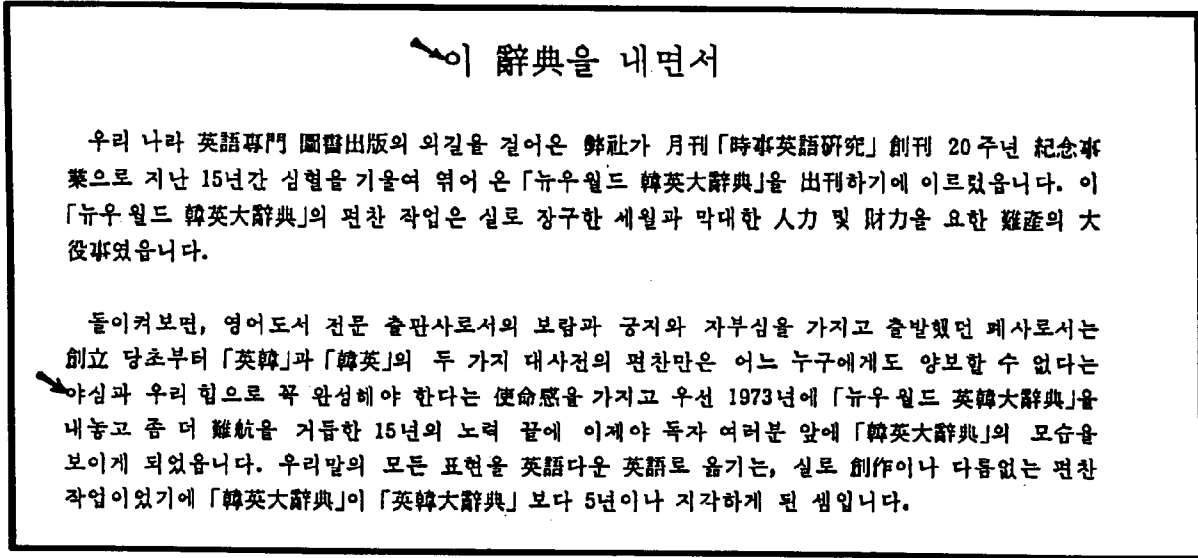

Figure G-14. Shows Korean with fewer Chinese symbols used.

NOTE: North Korean text seldom has any Chinese characters as a matter of official policy.

CHINESE:

Chinese is written with several thousand symbols called characters. International numerals are widely used and scientific and technical Chinese will contain quoted European words in Roman letters. The characters are constructed according to a complex system based on the use of only a few different stroke types (less than 10) and a large set of elements called "radicals" (about 200). Radicals are made up of one or more elements associated with them. These radicals and strokes are used to construct the characters. The characters are thought of as occupying a rectangular space and good calligraphy allots about the same area to each character, regardless of complexity.

Figure G-15 shows the 50 most common radicals in Chinese. Some will occur by themselves as characters. Most will more frequently occur as constituents of more complex characters. The People's Republic of China has recently changed the form of some of these elements, but most are unchanged and the traditional forms still occur even there.

Except for numerical zeroes and the small circles that are used as punctuation marks to indicate the end of a sentence, printed Chinese does not have any circles. If the text has a lot of circles and curves, suspect some language other than Chinese.

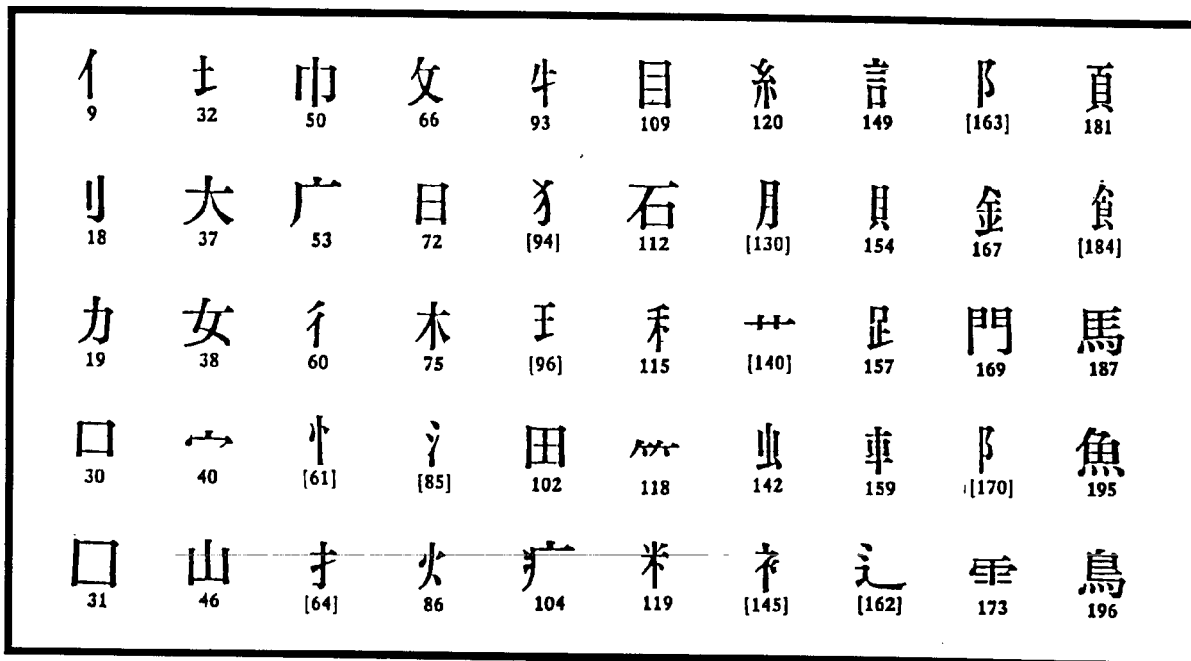

Figure G-15. The fifty most common Chinese character radicals.

JAPANESE:

Japanese has a mixed writing system. Like the Chinese, the Japanese normally use international numerals in their S&T literature; but this is not the real reason their writing system is mixed. Japanese writing is mixed because, in general, it uses Chinese characters to write the lexical stem of nouns and verbs (the part of the word that conveys the basic meaning); and a set of phonetic symbols invented in Japan called **hiragana** to write the grammatical affixes of the nouns and verbs as well as entire auxiliary words.

Japanese also use another set of phonetic symbols, also invented in Japan, called **katakana** to write words borrowed from European languages. The presence of these katakana symbols distinguishes Japanese. Normal prose will contain perhaps 60 to 70 percent hiragana symbols. Unlike Chinese characters, hiragana are written with curved strokes. Katakana are less frequent.

The hiragana are illustrated in Figure G-16 and the katakana are illustrated in Figure G-17. Pay particular attention to the fifth symbol from the left in the bottom row of the hiragana (Figure G-16), the one labeled "no." This symbol is used to write a very common grammatical affix. It will almost always occur frequently in any Japanese text.

あ a	か ka	さ sa	た ta	な na	は ha	ま ma	や ya	ら ra	わ wa	
い i	き ki	し shi	ち chi	に ni	ひ hi	み mi	い (y)i	り ri	る (w)i	
う u	く ku	す su	つ tsu	ぬ nu	ふ fu	む mu	ゆ yu	る ru	う (w)u	
え e	け ke	せ se	て te	ね ne	へ he	め me	え (y)e	れ re	ゑ (w)e	
お o	こ ko	そ so	と to	の no	ほ ho	も mo	よ yo	ろ ro	を (w)o	ん n

Figure G-16. The Japanese Hiragana syllabary.

ア a	カ ka	サ sa	タ ta	ナ na	ハ ha	マ ma	ヤ ya	ラ ra	ワ wa	
イ i	キ ki	シ shi	チ chi	ニ ni	ヒ hi	ミ mi	イ (y)i	リ ri	キ (w)i	
ウ u	ク ku	ス su	ツ tsu	ヌ nu	フ fu	ム mu	ユ yu	ル ru	ウ (w)u	
エ e	ケ ke	セ se	テ te	ネ ne	ヘ he	メ me	エ (y)e	レ re	エ (w)e	
オ o	コ ko	ソ so	ト to	ノ no	ホ ho	モ mo	ヨ yo	ロ ro	ヲ (w)o	ン n

Figure G-17. The Japanese Katakana syllabary.

KOREAN:

Korean can be written entirely in its native alphabet. Therefore, symbols from this script will overwhelmingly predominate in any normal Korean text. Chinese characters, however, are considered learned and prestigious, so a certain number of them will be encountered in quantities that vary with the pretensions of the author.

The Korean alphabet was developed under the influence of Chinese writing models, so to the untrained eye Korean alphabetic writing looks like Chinese characters. The letters of European alphabets form words, but the symbols of the Korean alphabet are grouped together to form a syllable. This means that a Korean word may extend over several groupings.

Also, while the letters of European words are read horizontally, Korean

alphabetic symbols are read vertically—from the top to the bottom of each group—with the left preceding the right when the symbols are side-by-side.

Figure G-18 illustrates the symbols of the Korean alphabet. Pay close attention to the second symbol from the left in the third row, the one that looks like a circle with a stem at the 12 o'clock position. It is a very frequent symbol and does not look like anything that occurs in Chinese or Japanese.

ㄱ	ㅋ	ㆁ	ㄷ	ㅌ	ㄴ	ㄹ	ㄺ
ㄴ	ㄷ	ㄹ	ㄷ	ㄹ	ㄷ	ㄹ	ㄺ
ㄷ	ㅇ	ㅈ	ㅊ	ㅋ	ㆁ	ㄷ	ㄹ
ㄹ	ㅈ	ㅊ	ㅊ	ㅊ	ㅣ	ㄷ	ㅈ
ㅈ	ㅊ	ㅊ	ㅊ	ㅊ	ㅣ	ㄷ	ㅈ

Figure G-18. The Korean alphabet.

Appendix H

CHEMICAL AND BIOLOGICAL WARFARE SAMPLING PROCEDURES

INTRODUCTION

This appendix provides procedures for the safe and expeditious collection, transportation, and receipt of suspected CB agent samples from the integrated battlefield to approved CONUS and OCONUS laboratories for processing, analysis, and identification.

BACKGROUND

During the 1980's, at the time of the Soviet occupation of Afghanistan and the Iran-Iraq War, the ability of US forces to collect and analyze toxic agents was questionable.

In response to this concern, an examination was conducted on the mechanisms in place to preserve the integrity of the suspected CB samples collected on the battlefield.

Procedures for collecting, packaging, documenting, and transporting CB samples to laboratories must be precise to ensure the credibility of the analysis conducted on the samples.

The credible analysis of suspected CB samples is critical for both battlefield commanders concerned with chemical retaliation and contamination avoidance, and medical personnel concerned with prophylactic or post-contamination treatment.

OPERATIONAL CONCEPT

SITUATION:

Current battle doctrine describes a nonlinear battlefield where the Threat NBC weapons are tactically integrated. The principles of NBC reconnaissance and detection and TECHINT teams apply equally across the battlefield.

SAMPLING:

Sampling will be initiated when the following are observed:

- Significant numbers of unexplained sickness or death of personnel or animals occur.
- Ordnance (munitions) are found which contain known or suspected CB agents.
- An attack is suspected or is known to have occurred but the causative agent cannot be identified.
- The widespread outbreak of unusual mission-degrading behavior occurs.
- Sampling of known or identified agents to verify first use is required.

SAMPLING RESPONSIBILITY:

Samples suspected of containing CB agents are divided into environmental and biomedical samples on the basis of their origin. Both medical and nonmedical units and teams have the responsibility for collecting samples suspected of containing CB agents.

- Environmental Samples. Environmental CB agent samples are collected in the field. They include samples of aerosols or vapors, liquids other than water, soil, vegetation, water, used equipment, and ordnance. The acquisition of these samples is the responsibility of—
 - NBC reconnaissance teams.
 - TEU field teams.
 - Preventive medicine units (potable water sources only).
 - TECHINT collection teams.
 - Biological Integrated Detection System (BIDS) team.
- Biomedical Samples. Biomedical samples are derived primarily from acutely ill soldiers who exhibit symptoms of CB agent intoxication or from personnel who were killed in an attack. Collection of the biomedical samples will be the responsibility of personnel in—
 - Battalion-level medical units.
 - Division-level medical treatment facilities.

- Combat support hospitals.
- Evacuation hospitals.
- NBC reconnaissance teams (small animals only).
- TECHINT collection teams.
- BIDS teams.

SAMPLE ACQUISITION

ENVIRONMENTAL SAMPLES:

Responsible personnel for collection:

- Commander, NBC reconnaissance teams.
- Commander, TEU.
 - Commander, CMEC.
 - Commander, preventive medicine units.

NOTE: When possible, background samples from "clean" areas beyond the perimeter of the attack site should be obtained as baseline data for comparisons. Collect these identically to samples from contaminated areas and package them separately.

The methodology for collecting environmental samples in order to analyze them for CB-agent presence will be specific for the type of sample (for example, liquid aerosols or vapors, soil, vegetation, water, other liquids, ordnance, equipment). Complete DA Form 1971-6-R for all environmental samples. A sample form is at Figure H-1.

In conjunction with collection of environmental samples, any positive results using the chemical agent detector kits should be recorded on DA Form 1971-6-R. Sampling will be accomplished as instructed. Figure H-2 is an example of an equipment list containing components of a suggested environmental sampling kit. (See FM 3-3.)

Chemical/Biological Specimen Documentation	
For use of this form, see FM 3-3; the proponent agency is TRADOC.	
INSTRUCTIONS	
Place the biological sample inside a refrigerator, ice chest, or insulated container; and keep it as cool as possible at all times.	
Specimen Identification Number: <u>0001</u>	
Date and Time Specimen Collected: <u>121500 JUL 97</u>	
Reason for Collection (check those that apply):	
<input checked="" type="checkbox"/> Chem/Bio Attack <input type="checkbox"/> Positive M258 Chemical Detection <input type="checkbox"/> Soldiers Becoming Sick <input type="checkbox"/> Other _____	<input type="checkbox"/> Chem/Bio Alarm Activated <input checked="" type="checkbox"/> Positive Recon Team Findings <input type="checkbox"/> Soldiers Dying
Location of Attack <u>DHAHRAN</u> <small>(UTM or place)</small>	Unit Identification <u>B Co 203d MI Bn 515th MI Bde</u> <small>(Co, Bn, Bde, Div, Corps)</small>
Date and Time of Attack <u>121345 JUL 97</u>	
Terrain Description (check those that apply):	
<input checked="" type="checkbox"/> Flat <input type="checkbox"/> Hills <input type="checkbox"/> Mountains <input type="checkbox"/> Desert <input type="checkbox"/> Jungle <input type="checkbox"/> Forest <input type="checkbox"/> Urban <input checked="" type="checkbox"/> Grassy <input type="checkbox"/> Sparse Trees/Shrubs <input type="checkbox"/> Other _____	
Weather (check those that apply):	
<input type="checkbox"/> Clear <input checked="" type="checkbox"/> Cloudy <input type="checkbox"/> Rain <input type="checkbox"/> Fog <input type="checkbox"/> Snow <input type="checkbox"/> Dust <input type="checkbox"/> Mist <input type="checkbox"/> Other _____	
Wind at Collection Site (check only one):	
<input type="checkbox"/> None/Calm <input type="checkbox"/> Mild Breeze <input checked="" type="checkbox"/> Windy <input type="checkbox"/> Gusts	
Odor (check those that apply):	
<input type="checkbox"/> None <input type="checkbox"/> Sweet <input type="checkbox"/> Fruity <input checked="" type="checkbox"/> Irritating <input type="checkbox"/> Pepper <input type="checkbox"/> Flower <input type="checkbox"/> Changing <input type="checkbox"/> Other _____	
Symptoms (check those that apply):	
<input type="checkbox"/> None <input type="checkbox"/> Skin Swelling <input type="checkbox"/> Difficulty Breathing <input type="checkbox"/> Blurred Vision <input checked="" type="checkbox"/> Dizziness <input checked="" type="checkbox"/> Skin Rash <input type="checkbox"/> Nausea <input type="checkbox"/> Dry Mouth <input type="checkbox"/> Fever <input type="checkbox"/> Dark Skin Blotches <input type="checkbox"/> Unconscious <input checked="" type="checkbox"/> Headache <input type="checkbox"/> Bleeding Sores <input type="checkbox"/> Other _____	
Symptoms:	
Time of Onset: <u>121400 JUL 97</u>	Duration (of Symptoms): <u>15 Minutes</u>

DA Form 1971-6-R, AUG 92

Figure H-1. Sample DA Form 1971-6-R (Chemical/Biological Specimen Documentation).

Delivery Method (check those that apply): <input type="checkbox"/> Unknown <input checked="" type="checkbox"/> Artillery <input type="checkbox"/> Mortar <input type="checkbox"/> RPG/Grenade <input type="checkbox"/> Rocket <input type="checkbox"/> Aircraft <input type="checkbox"/> Aerosol <input type="checkbox"/> Generator <input type="checkbox"/> Other _____	
State of Agent at Time of Collection (check only one): <input type="checkbox"/> Liquid <input checked="" type="checkbox"/> Vapor <input type="checkbox"/> Powder <input type="checkbox"/> Solid <input type="checkbox"/> Smoke <input type="checkbox"/> Mist <input type="checkbox"/> Dust (cloud) <input type="checkbox"/> Gel <input type="checkbox"/> Other _____	
Description of Sample (check only one): <input type="checkbox"/> Vegetation <input checked="" type="checkbox"/> Soil <input type="checkbox"/> Other _____ <div style="text-align: right;">Biomedical: <input type="checkbox"/> Urine <input type="checkbox"/> Blood <input type="checkbox"/> Tissue</div>	
Color of Sample _____ Size of Sample _____ Other _____	
Additional Remarks:	

DA Form 1971-6-R, AUG 92

Figure H-1. Sample DA Form 1971-6-R (Chemical/Biological)

FM 34-54

Description:	
labels, paper, pressure sensitive	7530-00-577-4376
Edmont Wilson gloves 8-9	8415-00-J02-2802
Edmont Wilson gloves 9-9	8415-00-634-4639
tape, pressure, sensitive, adhesive 1"	7510-00-582-4772
pliers #47 8"	8820-00-543-5350
screwdriver, flat tip 1/4 inch	5120-00-596-5653
tongs, Teflon tips	AF 15-202-5
micro spatula with Teflon ends AF 21-401-50A	
scissors, universal type	AF 08-951-30
sterile sampler scoops 2 oz	AF 14-241-10A
spoon spatula with Teflon	AF 14-356-10
knife, pocket	5110-00-526-8740
PFA sample bottles, 6 oz	CP J-6103-50
pipet, jumbo transfer type	AF 13-711-7
pipet, graduated transfer type	AF 13-711-9A
insulated bag, type 1	AF 01-814-8
insulated bag, type 2	AF 01-814-10
whirl/pak bag, 6 oz	AF 01-812-6B
ph paper; non-bleeding plastic strip	SW 8-65271
SEP-PAK C18	
syringe, hyp 50 or 60 mL	6515-00-168-8913
R3602 clear laboratory tubing	AF 14-169-3B
marking pen, waterproof	AF 13-381
Tenax tubes	EC ST-023
blade surgical knife detach no. 21	6515-00-860-0007
blade surgical os 21 1508	6515-01-009-5297
igloo type container	
ice pack	CP TR-6345-20
pad, non-adherent 3 x 4 100s	6510-00-111-0708
pad, cooling chemical 49	6530-00-133-4299
piglette	
tape, antiseizing	8030-00-889-3535
personal air sampler	LSS G4980 +
methanol	GJ4981
distilled water	
matches, waterproof	
mylar bags	
Field Expedient Packing Materials	
tin foil	
Saran wrap polyethylene without plasticizers	
Thermos bottles	
pressure sensitive tape	
Cool Paks	
butcher paper	
newspaper	
igloo cooler	
canteens	
Mess kits	
glass bottles	
packing material	
Teflon plumbers tape	
medical supplies	

Figure H-2. Example of an equipment list.

Contaminated sampling equipment not transported with the sample will be decontaminated and double wrapped in plastic and undergo a sampling protocol to certify the items as "XXX." The XXX refers to decontamination to the point that equipment can be reused, but is not releasable from DOD.

Liquid Aerosol and Vapor Samples:

- Use an electric or hand pump (record the run time for electric pump or number of aspirations for hand pump to determine volume), collect the liquid aerosol remove (LAR) in two Tenax GC-Type Sorbent Tubes.
- Return the sampling tube to the piglette, mark on the outside with a sample identification code and close the ends tightly. Attach a DA Form 1971-6-R. Pack the sample.

Vegetation Samples:

- Collect vegetation which appears in any way to be different from normal, nearby vegetation (for example, discolored or withered vegetation, or vegetation having powder or droplets present).
- Collect vegetation samples at several locations within suspected contaminated areas.
- Cut several affected leaves and/or a handful of grass. Do not crush the sample. Instead, place it in a mylar bag and seal. Collect similar reference vegetation from an unaffected area and place it in a separate mylar bag and seal it. The minimum sample size of value is three leaves or three handfuls of grass. One leaf is of little value (but it is better than nothing). Bark is acceptable but not preferred.
- Mark the bag with a sample identification number.

Soil Samples: Collect samples from areas stained with oils or powders, from areas that are discolored, or from areas that are otherwise different in appearance from the surrounding soil. A similar soil sample from an unaffected area is required for reference (soil of the same type and texture is preferred). The minimum sample volume is approximately that of a cigarette pack laying on its side.

- Use a knife, spoon, spatula, or piece of metal to collect the sample.
- Place the sample in a mylar bag.
- Mark the bag with a sample identification number.

Water Samples: Use the M272 water test kit or other appropriate test kit to determine the presence of chemical agents, record the test results on a DA Form 1971-6-R. Take samples at standing pools or along streams where dead animals are observed.

- Collect bulk water samples (preferred when oily globules or suspended solids are present) as follows:
 - Skim surface water into Teflon bottle.
 - Fill the bottle, screw on the top, and ensure that the seal is leak proof with paraffin wax or plumber's antiseize tape.
 - Mark a sample identification number on the bottle.
- When using the SepPak Cartridge for liquid sampling, consider the following:
 - The C-18 SepPak cartridge extracts and concentrates contaminants from a water source.
 - Methanol and distilled water are used to prime the SepPak.
 - 200 milliliter (mL) of sample water is drawn slowly through cartridge with a 50 mL syringe. Discard liquid and syringe.
 - The cartridge is placed in a Teflon bottle marked with a sample identification number.
- When obtaining a sample of sludge on the shore or in a shallow bottom, scoop the top of solids with an open bottle; close the bottle and seal it with paraffin wax. Mark the bottle with an identification number.

Packaging Samples: Place several sample bags in one mylar bag. Place the reference samples in a separate mylar bag. Do not overfill. Press excess air from the bag and seal the adhesive end. Seal the package with tape, and mark sample identification numbers. Include the DA Form 1971-6-R.

Packaging Small Animals (Mammals Preferred): Place the animal in a mylar bag, press excess air from the bag, and seal it. Mark the bag with the sample identification number and place the marked bag into a second mylar bag. Press excess air from the bag, seal the adhesive flap, and seal the bag with tape. Mark with sample identification numbers and attach the DA Form 1971-6-R.

Packaging Ordnance or Protective Equipment or Clothing: Prior to approaching or handling any ordnance, exploded or unexploded, contact the EOD unit in the area for assistance. The EOD unit will attempt to identify the ordnance by physical characteristics or markings and render it safe. If the ordnance is CB in origin, EOD will perform initial packing in the

field and transfer the sample to an MI unit for transfer to CONUS. The sample must be marked with a sample identification number and documented with the DA Form 1971-6-R and DD Form 1911.

Protective equipment and clothing from casualties can be an important source of a CB agent for identification purposes. To do this, place the equipment or clothing in a large mylar bag, fold, expel excess air from the bag, and seal it. Mark the bag with a sample identification number. Place the bag in a second mylar bag, seal, and mark with a sample identification number. Then complete and attach the DA Form 1971-6-R. Finally, forward the sample to Technical Intelligence for transfer to Corps G2. Document the transfer on DA Form 3147.

BIOMEDICAL SAMPLES:

Responsible personnel for collecting samples are located in—

- Battalion-level medical units.
- Division-level medical treatment facilities.
- Combat support hospitals.
- Evacuation hospitals.
- TECHINT collection teams. In the theater of operations, the TECHINT teams will have the capability to obtain biomedical samples from patients and cadavers.

The best biomedical sample is an acutely ill soldier sent back to CONUS immediately. DA Form 1971-6-R is to be completed on all biomedical samples. In addition, a copy of the physical examination or an extract of significant findings are to be enclosed with the biomedical samples.

Additionally, the following samples should be collected whenever casualties occur and should be collected in triplicate, distributing two within CONUS and one to the TAML. Once collected, the samples should be refrigerated or chilled immediately. DO NOT FREEZE.

DA Form 1971-6-R will be completed on all biomedical samples. Medical personnel should perform biomedical sample collection to obtain a valid sample.

Use the following guidance to collect samples:

- Collect samples from patients during acute phase and at day 7.

- Collect urine samples (20 to 50 mL per sample x 3) in urine specimen cups, the top secured with wide tape, and placed in individual sealable bags.
- Collect whole blood or serum samples (5 mL per sample x 3) in red-top blood tubes and placed in individual, sealable bags.
- Collect sputum only from acutely ill patients (x 3). They should be collected in urine cups. Secure the cup with wide tape and place in individual sealable mylar bags.
- Collect cerebral spinal fluid (2 mL per sample x 3) in red-top blood tubes and placed in individual, sealable bags.
- Take at least 30 grams of organs and tissues (human, post-mortem x 3), place in a sterile container in individual, sealable bags, and refrigerate immediately: liver, spleen, lung, subcutaneous fat, cerebral spinal fluid, kidney, heart, and brain.
- Collect at least two mediastinal lymph nodes.
- Take animal tissue samples as a lower priority to human samples. Animals should be mammalian (no birds).
- Once critical and significant biomedical samples are identified in OCONUS, these samples should be turned over to the tactical intelligence channel for disposition to appropriate laboratories (CONUS or OCONUS).
- Sample and corroborative information is provided for on DA Form 1971-6-R.

Packaging Biomedical Samples: Place the mylar bags or sample containers in a plastic bag. Remove excess air and seal tightly. Mark the container with a sample identification number. Place 1 to 2 inches of packing material (for example vermiculate or foam) around the sample bag in a rigid container. Wrap jars, tubes, or specimen cups in bubble wrap or other suitable material so they do not move in the container. Place a lid on the container and seal with wide tape. Place a warning on the outside of the container as follows:

DANGER
Do not open. Contains hazardous material or suspected CB agents which may cause immediate death or personal injury.

DISPOSITION OF ENVIRONMENTAL AND BIOMEDICAL SAMPLES:

Place the environmental and biomedical samples in an insulated chest; ensure that the sample is packed tightly and an adequate supply of refrigerant is available. Seal the chest and label accordingly prior to its departure from the OCONUS theater of operation to CONUS.

The procedure should further meet the specifications contained in TM 38-250, paragraph 10-51, for etiologic agents. Document all samples with DA Form 1971-6-R. Number the samples. Units are responsible for forwarding samples through intelligence channels to Corps G2. Document the sample transfer with DA Form 3147. Figures H-3 through H-5 are examples of responsibilities, collection guidelines, and identification and control for a sample evacuation.

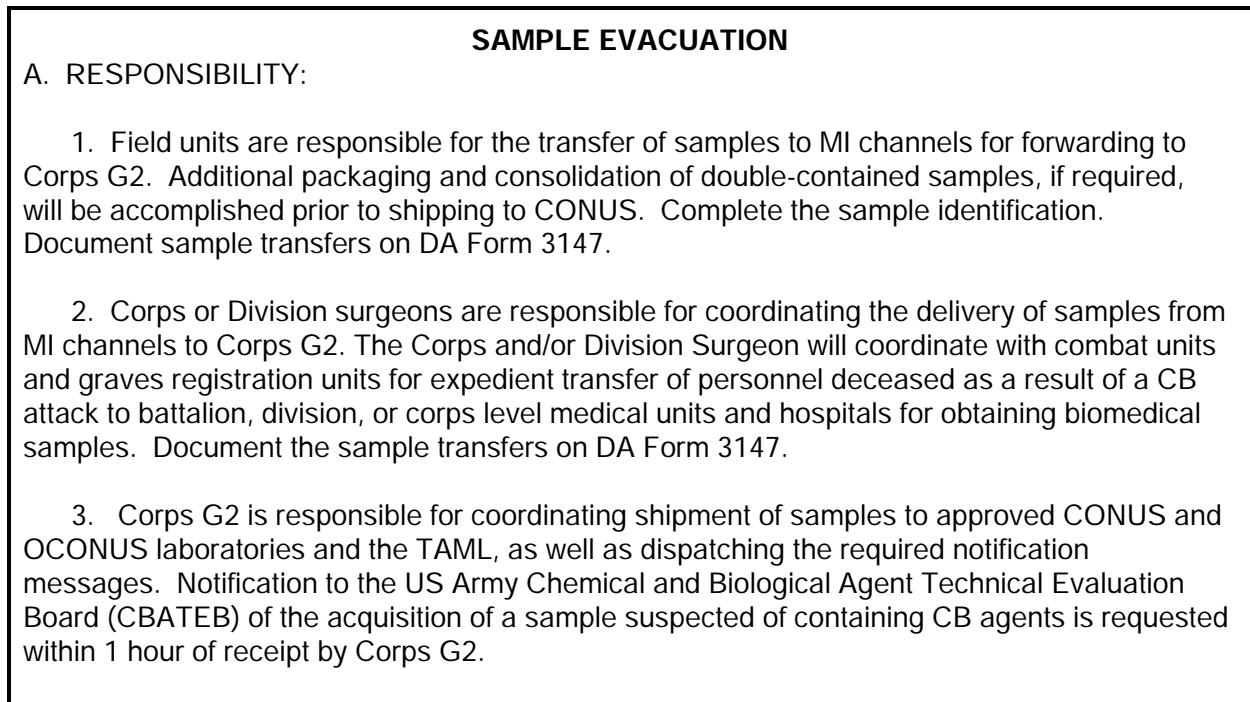

Figure H-3. Description of responsibilities for a sample evacuation.

IMPORTANT NOTES

- (a) Properly packaged samples do not constitute a hazard to personnel.
- (b) All outer packaging is to be inspected visually for physical evidence of leakage or loss of envelope integrity.
- (c) DO NOT UNWRAP. Overwrap if any irregularities exist.
- (d) If overwrapping is required, provide the time, date, place, and the reason.
- (e) Refrigerate or chill (DO NOT FREEZE) all samples.
- (f) Delay must be minimized.
- (g) All samples will be forwarded from the theater to approved CONUS and OCONUS laboratories and TAML 12 to 24 hours after collection. Delay beyond 24 hours rapidly degrades the operational and intelligence value of the samples. The most efficient means of shipment will be used; address all samples to CBATEB, Aberdeen Proving Ground, MD, and TAML.

B. DOCUMENTATION REQUIRED ON ALL SAMPLES:

- 1. DA Form 1971-6-R.
- 2. DA Form 3147.

C. NOTIFICATION MESSAGE: The notification message sent by Corps G2 should be sent as an IMMEDIATE precedence and with appropriate security classification. The action addressee is Technical Director, ERDEC APG MD//CBATEB//. The notification message will contain the sample identification number and details which relate to the acquisition of the sample. The message will be configured to provide the following information:

- 1. Background information.
- 2. Physical description.
- 3. Results of preliminary tests after sample collection.
- 4. Where, when, and under what conditions the sample was acquired.

Figure H-3. Description of responsibilities for a sample evacuation (continued).

5. Description of incident.
6. Casualty symptoms (if applicable).
7. Shipment information, such as—
 - (a) Date of shipment.
 - (b) Mode of transportation.
 - (c) Flight number and destination.
 - (d) Estimated time of arrival CONUS.
 - (e) Description of shipment (size, weight, and so forth).

D. NOTIFICATION: Upon receipt of the notification message, the Chairman, CBATEB, is responsible for notifying the appropriate agencies.

REFERENCES:

1. FM 3-3 Chemical and Biological Contamination Avoidance, 16 Nov 92.
2. FM 3-5 NBC Decontamination, 17 Nov 93.
3. FM 3-101-2 NBC Reconnaissance Squad/Platoon Operations Tactics, Techniques, and Procedures, 10 Aug 94.
4. AR 59-8 Department of Defense (DOD) Common User Airlift, 20 Aug 82.
5. TM 38-250 Preparing of Hazardous Materials for Military Air Shipments, 25 Nov 94.

Figure H-3. Description of responsibilities for a sample evacuation (continued).

SAMPLE COLLECTION GUIDELINES

1. PROTECT YOURSELF:

Do not handle contaminated samples with your bare hands. If neoprene gloves are not available, use a stick or other object to move a sample into a container. Respiratory and/or skin protective equipment may also be required.

2. TAKE THE SAMPLE:

If an area appears to have been contaminated, use whatever field expediency is necessary to get a sample.

3. LABEL THE SAMPLE:

Once a sample is collected, the container should be labeled immediately so that it is not confused with another sample.

4. PROTECT THE SAMPLE:

Most environmental and biomedical samples should be sealed and chilled to avoid cross-contamination and decomposition. Samples should not be frozen if possible. Above all, avoid freeze-and-thaw situations.

5. DOCUMENT THE SAMPLE:

Record the circumstances surrounding the collection of the sample. Data such as how, where, when, why, and by whom is required. Diagrams and maps of areas are useful.

6. FORWARD THE SAMPLE:

CB samples are time sensitive. They should be reported and forwarded for analysis as quickly as possible (within 12 to 24 hours).

7. PROTECT YOUR SOURCE:

All transactions involving CBW samples are highly sensitive. All knowledge and information (written and verbal) pertaining to the source are automatically considered SECRET. All samples and associated papers and diagrams, for example, will be released only to individuals known to be cleared and having a need to know; and they will be SIGNED FOR. All samples and associated papers must remain in the physical custody of authorized US persons only.

Figure H-4. Sample collection guidelines.

SAMPLE IDENTIFICATION AND CONTROL

1. Samples acquired by a governmental source or provided by another source must be carefully controlled to be of the greatest value. To accomplish this, physical custody of the sample is maintained by a government representative. A sample identification number is also assigned and affixed to the sample or its container.

2. To prevent confusion, the sample number must be used when referring to the sample or to information concerning its acquisition. A sample number consists of the following elements:

(a) Country of Acquisition. This is a 2-digit alphabetic code for the country in which the sample was collected. The codes are found in DIAM 58-13, Volume II, Section E, dated 28 March 1988.

(b) Date Acquired. DTG sample acquired (local or Zulu time, as directed by higher headquarters).

(c) Sample Sequence Number. This is a 3-digit numerical code which is assigned per collector, and begins each collection day. The first sample collected is 001, the second is 002, and so forth.

(d) Unit Identification Code. UIC of the unit that the collector is assigned to.

(e) Collector Identification. The initials of the collector.

EXAMPLE

LA-121300Z FEB 90-002-WH60AA-JD

LA = Sample was acquired in Laos

121300Z FEB 9 = DTG sample was collected

002 = This is the second sample obtained on the date above by the collector

WH60AA = Unit of assignment of collector

JD = The sample was collected by John Doe

Figure H-5. Sample identification and control.

Appendix I

FACILITY EXPLOITATION CHECKLISTS

The following sample checklists can be used to guide the actual eyes-on or hands-on exploitation of facilities or to guide the interrogation of EPWs with knowledge of facilities.

COLLECTION CHECKLIST-AIRFIELDS
<ol style="list-style-type: none"> 1. IDENTIFICATION. Local name (both romanized and ideograph) and military designation. 2. LOCATION. <ol style="list-style-type: none"> a. Map reference. Include series and sheet number(s) of both tactical and air-ground series. b. Political unit, area, nearest town, and specified reference point (both UTM and geographic coordinates). 3. AIRFIELD CATEGORY. Liaison, surveillance, light lift, medium lift, tactical, or heavy lift. 4. STATUS. 5. TYPE. Civilian, military, or joint. 6. PRINCIPAL USE. 7. LAYOUT. 8. ELEVATION (feet and meters). 9. NUMBER OF RUNWAYS. 10. EACH RUNWAY. <ol style="list-style-type: none"> a. Identification. b. Azimuth. c. Length and width. d. Surface, base, subbase course (material, thickness, and condition). e. Longitudinal grade (minimum and maximum change per 100 feet). f. Transverse grade (maximum).

Figure I-1. Collection Checklist-Airfields.

- g. Shoulders, clear area, and overrun (width, transverse grade, and surface material).
 - h. Lateral safety zone (width, transverse slope, and obstacles).
 - i. End clear zones (length, width, and maximum slope).
 - j. Approach zones (length, width, glide slope, and obstacles).
 - k. Condition.
11. EACH TAXIWAY.
- a. Identification.
 - b. Azimuth.
 - c. Length and width.
 - d. Grade (maximum longitudinal and transverse).
 - e. Surface, base, subbase material (thickness).
 - f. Bearing capacity (pounds per square inch).
 - g. Shoulders and clear area (width, transverse grade, surface, and obstacles).
 - h. Turn radii.
 - i. Condition.
12. PARKING AND WARM-UP APRONS.
- a. Number.
 - b. Total area and individual area.
 - c. Description of each apron.
 - d. Total capacity (specify aircraft type).
13. HARDSTANDS.
- a. Total number.
 - b. Aircraft capacity (specify).
 - c. Description of each hardstand.
14. PETROLEUM, OIL, AND LUBRICANTS. Describe facilities and storage.
- a. Jet fuel by type (J rating).
 - b. Aviation gasoline.
 - c. Jet oil.
 - d. Aviation oil.
 - e. Lubricants.
 - f. Pipelines (cross-reference to pipeline collection file).
15. NAVIGATION FACILITIES. Describe the type of facility.
16. LIGHTING FACILITIES. Describe all lighting at airfield.

Figure I-1. Collection Checklist-Airfields (continued).

17. COMMUNICATION FACILITIES. Cross-reference to communication collection file.
18. MAINTENANCE FACILITIES (aircraft).
19. OXYGEN AVAILABILITY.
20. SPECIAL EQUIPMENT.
 - a. Crash and fire.
 - b. Construction and ground maintenance.
21. COVERED STORAGE.
22. SANITATION.
23. HANGARS.
 - a. Number and locations.
 - b. Type and material.
 - c. Condition.
24. HOUSING FACILITIES.
 - a. Type, location, and number.
 - b. Capacity and condition.
25. MUNITIONS STORAGE.
 - a. Type and location.
 - b. Cubage, normal use, and condition.
26. ADMINISTRATION BUILDINGS (identify).
27. ELECTRICITY. Cross-reference to electric power collection file.
 - a. Sources.
 - b. Current characteristics.
28. JET STARTING UNITS.
29. AUXILIARY POWER UNITS.

Figure I-1. Collection Checklist-Airfields (continued).

- 30. ANTI-DETONATION FLUID OR WATER-ALCOHOL.
 - a. Type and location.
 - b. Quantities.
- 31. DEFENSES.
- 32. ADJACENT TERRAIN. Cross-reference to appropriate collection files.
- 33. MEDICAL FACILITIES.
 - a. Type and location.
 - b. Capacity and characteristics.
- 34. WEATHER FACILITIES. Cross-reference to weather collection file.
 - a. Type and location.
 - b. Characteristics and condition.

Figure I-1. Collection Checklist-Airfields (continued).

COLLECTION CHECKLIST-ELECTRIC POWER	
POWERPLANTS	
1. IDENTIFICATION. Local name and military designation.	
a. Map reference. Include series and sheet numbers of both tactical and air-ground series.	
b. Political unit, area, nearest town, UTM coordinates, and geographical coordinates.	
2. TYPE. Conventional-steam thermal, nuclear-steam thermal, internal combustion-thermal, hydro-turbine storage, hydro-turbine run-of-river, solar, wind, tidal, and so forth.	
3. OWNERSHIP. Government or private.	
4. FUNCTION. Public utility, industrial, or both.	
5. AREA SERVED.	
6. PURPOSE. Base load, peak load, or stand-by.	
7. STATISTICS.	
a. Total capacity (kW or kVA) and annual production (kWh).	
b. Generators (numbers, type, and rating of each).	
8. CURRENT CHARACTERISTICS.	
a. Type (direct current; alternating current).	
b. Generating voltage.	
c. Phase and hertz.	
9. OVERALL CONDITION AND AGE.	
10. POWERHOUSE CONSTRUCTION. Material, number of stories, windows, and so forth.	
11. TRANSMISSION LINE CONNECTIONS. Number and voltage.	
12. FUEL DATA (thermal plants only).	
a. Type (by grades).	
b. Quantity used per annum (tons, gallons, cubic feet, pounds, and so forth).	
c. Sources.	

Figure I-2. Collection Checklist-Electric Power.

- d. Calorific content (conventional-steam).
 - e. Waste disposal (nuclear-steam).
13. BOILER, REACTOR OR ENGINE DATA (thermal powerplants only).
- a. Number, manufacturer, and rating (kW; hp).
 - b. Cooling facilities (type and source).
 - c. Steam pressure in psi (conventional-steam only).
 - d. Efficiency (calories; Btu/kWh) (conventional-steam only).
 - e. Operating temperature (conventional-steam only).
 - f. Neutron flux (nuclear-steam only).
 - g. Shielding and control mechanism (nuclear-steam only).
14. WATER SOURCE, HYDRO-TURBINE POWERPLANTS.
- a. Identification.
 - b. Flow, cubic feet per second (average, minimum, and maximum).
 - c. Reservoirs (location, volume, area, head, and so forth).
 - d. Dams (name, location, dimensions, diversion canal).
15. HYDRO-TURBINES (HYDRO-TURBINE POWERPLANTS ONLY).
- a. Type, number, and rating (hp).
 - b. Head (feet; meters) and Flow (cubic meters per second).
- SUBSTATION**
1. IDENTIFICATION. Local name and military designation.
2. LOCATION.
- a. Map reference. Include series and map sheet numbers of both tactical and air-ground series.
 - b. Political unit, area, UTM coordinates, and geographic coordinates.
3. TYPE. Transmission, distribution, or industrial.
4. FUNCTION. Switching, transforming, converting, or inverting.
5. OWNERSHIP. Government or private.
6. TRANSFORMERS. Number, capacity (kVA), and voltage ratio (220/110, and so forth).
7. CONVERTERS OR INVERTERS. Number and capacity (kW; kVA).

Figure I-2. Collection Checklist-Electric Power (continued).

8. LINES. Number and voltage (kV).

9. AREA SERVED.

TRANSMISSION LINES

1. LOCATION. (Same as 2 above.)

2. NUMBER OF LINES.

3. OWNERSHIP. Government or private.

4. PLACEMENT. Overhead, underground, submarine cable, and so forth.

5. WIRE CHARACTERISTICS.

6. TYPE OF TOWER. Metal, wood, or concrete.

7. ALIGNMENT AND LENGTH.

8. VOLTAGE (kV).

9. PHASE.

10. MAINTENANCE. Failure causes, effects, and frequency.

Figure I-2. Collection Checklist-Electric Power (continued).

CHECKLIST-PETROLEUM AND NATURAL GAS FIELDS	
1. IDENTIFICATION.	Local name and military designation.
2. LOCATION.	
a.	Map reference. Include series and sheet numbers of both tactical and air-ground series.
b.	Political unit, area, nearest town, UTM coordinates, and geographic coordinates.
3. OWNERSHIP.	Government or private.
4. TYPE.	Wet or dry.
5. AREA EXTENT.	
6. STATUS.	Exploited or unexploited.
7. PRODUCTION.	Barrels, tons, cubic feet, per time unit.
8. NUMBER OF PRODUCING WELLS.	
9. PERCENTAGE OF NATIONAL PRODUCTION.	
10. PRODUCT.	Type and characteristics.
11. RESERVES.	Proven and unproven.
12. PLANNED EXPANSION.	Expected increase, date, and method.
13. TRANSPORTATION.	
a.	Method (pipeline, railroad, road, water).
b.	Identification and destination.
PROCESSING PLANTS	
1. IDENTIFICATION.	(Same as 1 above.)
2. LOCATION.	(Same as 2 above.)
3. TYPE OF PLANT.	Complete, skimming, cracking, distilling, synthetic, and so forth (oil or gas).

Figure I-3. Checklist-Petroleum and Natural Fields.

4. OWNERSHIP. Government or private.
5. PERCENTAGE OF NATIONAL REFINING OR CRACKING CAPACITY.
6. YEAR COMPLETED.
7. GENERAL CONDITION.
8. RATED PRODUCTION CAPACITY. Barrels, tons, cubic feet, per time unit.
9. EQUIPMENT.
 - a. Number and type.
 - b. Rated capacity and condition.
10. OUTPUT. Product, quantity, and quality.
11. POWER SOURCE.
12. WATER SOURCE.
13. TRANSPORTATION.
 - a. Raw materials in (identification, method, and origin).
 - b. Finished products out (identification, method, and destination).
14. PLANNED EXPANSION.
15. BUILDINGS. Type, number, and characteristics.

STORAGE FACILITIES

1. IDENTIFICATION. (Same as 1 above.)
2. LOCATION. (Same as 2 above.)
3. TYPE. Gas or petroleum.
4. OWNERSHIP. Government or private.
5. TOTAL STORAGE CAPACITY. Barrels, tons, or cubic meters.
6. PERCENTAGES OF NATIONAL TOTAL.

Figure I-3. Checklist-Petroleum and Natural Fields (continued).

7. GENERAL CONDITION.
8. STORAGE TANKS.
9. STORAGE DRUMS.
 - a. Manufacturing (location and capacity).
 - b. Cleaning and reclamation (location and capacity).
 - c. Filling facilities (location, equipment, and capacity).
10. TRANSPORTATION.
 - a. In (method and origin).
 - b. Out (method and destination).
11. BUILDINGS. Number, type, and characteristic.

Figure I-3. Checklist-Petroleum and Natural Fields (continued).

FACILITY PHYSICAL SECURITY CHECKLIST	
1. IDENTIFICATION.	
<ul style="list-style-type: none"> a. Local and official name. b. Functional description. c. Local address. d. Map reference. e. Geographic coordinates. f. Additional information. 	
2. BUILDING DESCRIPTION.	
<ul style="list-style-type: none"> a. Identification. b. Type of construction material. c. Type of roof. d. Blueprints. e. Floor plans. f. Description of roof. <ul style="list-style-type: none"> (1) Entrances to building. (2) Skylights. (3) Air-conditioning ducts. (4) Maintenance accesses. (5) Elevator shafts. (6) Emergency exits and fire escapes. (7) Ventilation systems. (8) Ladders. (9) Additional information. g. Entrances to building. <ul style="list-style-type: none"> (1) Main entrance. (2) Other entrances or exits. (3) Non-standard access points. h. Sewage and drainage systems. i. Water system. j. Interior description of building. <ul style="list-style-type: none"> (1) Floors. (2) Corridors. (3) Doors. (4) Windows. 	

Figure I-4. Facility Physical Security Checklist.

(5) Locks.
 (6) Stairways.
 (7) Elevators.
 (8) Physical barriers.
 (9) Lighting

k. Active security.

(1) Security guards.

(a) Posts.
 (b) Arms
 (c) Ammunition.
 (d) Riot control devices.
 (e) Additional information.

(2) Contract watchmen.
 (3) National police agents.
 (4) Additional information.

l. Communications equipment available.

MODEL	TYPE	NUMBER	LOCATION	FREQUENCY/CHANNELS	ANTENNAS
	m. Telephone system.				
	n. Emergency lighting and power system.				
	o. Additional information.				

3. DESCRIPTION OF GROUNDS.

a. Structures.
 b. Entrances to grounds.
 c. Perimeter fence.
 d. Terrain.
 e. Vegetation.
 f. Lighting-external.
 g. Map or sketch.

4. DESCRIPTION OF SURROUNDING AREA (24 Block Area).

a. Possible observation points.
 b. Relative distances of key terrain.
 c. Additional information.

Figure I-4. Facility Physical Security Checklist (continued).

5. KEY TERRAIN.

- a. Predominant terrain.
- b. Drop zones.
- c. Landing and Pickup Zones.
- d. Airfields.
- e. Critical lines of communications.
- f. Additional information.

6. MEDICAL CONSIDERATIONS.

- a. Medical staff and facilities.
- b. Civilian hospitals.
- c. Additional information.

Figure I-4. Facility Physical Security Checklist (continued).

CHECKLIST-RAILWAYS
<p>1. IDENTIFICATION. Route designation (native, military, or other) and segment being studied.</p>
<p>2. LOCATION.</p> <ul style="list-style-type: none">a. Map reference. Include series and sheet numbers on both tactical and air-ground series.b. End points of segment. Political unit, area, UTM coordinates, and geographical coordinates.
<p>3. OWNERSHIP.</p>
<p>4. TOTAL TRACK LENGTH. Double and single tracks in kilometers.</p>
<p>5. END POINTS OF DOUBLE TRACK SECTIONS. Location (UTM) and area name.</p>
<p>6. TRACK.</p> <ul style="list-style-type: none">a. Gage (millimeters).b. Rails.c. Roadway (total width and double or single track).d. Ditches (depth, width, side slope, lining, condition, cross-section, and structures).
<p>7. ROADBED. Material, total width, and width of shoulders.</p>
<p>8. SUBBALLAST. Material and thickness.</p>
<p>9. BALLAST. Material, size, thickness, and condition.</p>
<p>10. TIES. Material, length, width, depth, and spacing.</p>
<p>11. SPACING OF TRACKS. Centerline-to-centerline.</p>
<p>12. RADIUS OF TIGHTEST CURVE. Location (UTM) and radius.</p>
<p>13. MAXIMUM GRADE. Direction of travel and location.</p>
<p>14. BRIDGES. Cross-reference to bridge collection file.</p> <ul style="list-style-type: none">a. Total number of bridges in segment.b. Total length of bridging in segment.

Figure I-5. Checklist-Railways.

15. FERRIES. Cross-reference to ferry collection file.
16. TUNNELS, GALLERIES, AND SNOW SHEDS (TGSS). Cross-reference to TGSS collection file.
17. UNDERPASSES. Cross-reference to bridge collection file.
18. MINIMUM CLEARANCES. Horizontal and vertical.
19. AXLE LOAD LIMIT. Metric tons.
20. CULVERTS. Location (UTM) and total number, type, construction material, and bypasses.
21. ELECTRIFICATION.
 - a. End points of electrified sections (UTM).
 - b. Power feed (overhead or third rail).
 - c. Current characteristics (direct current; alternating current).
 - d. Source of power.
22. MAINLINE JUNCTIONS. Location (UTM), identification of connecting line, and type switch.
23. CROSSOVERS. Location (UTM) and type of switch.
24. PASSING SIDINGS. Locations (UTM), number, double-end or single-end, length, and type of turn.
25. STATIONS.
 - a. Location (local name and UTM coordinates).
 - b. Function (passenger, freight, or both).
 - c. Facilities.
26. FREIGHT-HANDLING FACILITIES.
 - a. Location (local name and UTM coordinates).
 - b. Side-loading platforms (number and length).
 - c. End-loading bays.
 - d. Sidings with access roads.
 - e. Freight sheds.

Figure I-5. Checklist-Railways (continued).

- f. Turntables (number and diameter).
 - g. Cranes (type, number, and capacity).
27. YARDS.
- a. Location (local name and UTM coordinates).
 - b. Function (receiving, classification, departure, storage, and so forth).
 - c. Hump or flat.
 - d. Number of tracks.
 - e. Fuel facilities (type of fuel, quantity normally on hand, and maximum storage capacity).
 - f. Other facilities (water, sand, compressed air, and so forth).
 - g. Electrification (overhead or third rail).
28. FUEL FACILITIES.
- a. Location (local name and UTM coordinates).
 - b. Type of fuel.
 - c. Type of storage and capacity.
 - d. Quantity of fuel normally on hand.
 - e. Method of loading.
29. REPAIR SHOPS AND LOCOMOTIVE TERMINALS.
- a. Location (local name and UTM coordinates).
 - b. Engine house or turntable.
 - c. Service facilities.
30. WATERING FACILITIES.
- a. Location (local name and UTM coordinates).
 - b. Source and type of storage.
31. SIGNALS AND TRAIN CONTROL. Location (UTM) and type.
32. CRITICAL POINTS.
- a. Type (points subject to rock slides, snow slides, flooding, or subject to interdiction and ambush).
 - b. Location (local name and UTM coordinates).
33. USE. Average number of trains per day (both passenger and freight).

Figure I-5. Checklist-Railways (continued).

- 34. SECTIONS IN NEED OF REPAIR. Location and nature of repair, and effort required to repair.
- 35. CONSTRUCTION, MAINTENANCE, AND REPAIR EQUIPMENT.
 - a. Type and characteristics of equipment.
 - b. Location of park where kept (UTM coordinates).
- 36. MAINTENANCE SCHEDULE.
- 37. PLANNED EXTENSIONS AND IMPROVEMENTS.
- 38. MAINTENANCE AND CONSTRUCTION STANDARDS.
- 39. SAFETY AND SECURITY STANDARDS.
- 40. ROLLING STOCK.

Figure I-5. Checklist-Railways (continued).

CHECKLIST-UNDERGROUND FACILITIES
<p>1. IDENTIFICATION. Native name, military designation, and tunnel number.</p> <p>2. LOCATION OF PORTALS.</p> <ul style="list-style-type: none">a. Map reference. Include series and sheet numbers of both tactical and air-ground series.b. Political unit, kilometer points, UTM coordinates, and geographic coordinates.c. Landmark reference. Description and location of landmark, and azimuth and distance from landmark to nearest portal. <p>3. LENGTH (portal to portal).</p> <p>4. TYPE. TGSS.</p> <p>5. CROSS-SECTION.</p> <ul style="list-style-type: none">a. Shape (semicircular, elliptical, horseshoe, square with arched ceiling).b. Width of traveled way.c. Width at widest part.d. Height of widest part.e. Height of ceiling at center.f. Height of ceiling at edge of traveled way.g. Rise of arch. <p>6. CONSTRUCTIONS (HORIZONTAL AND VERTICAL). Type, least clearance, and location (meters from nearest portal).</p> <p>7. RAILROAD TRACKS.</p> <ul style="list-style-type: none">a. Number for which tunnel was designed.b. Number in use.c. Gage.d. Center-to-center spacing.e. Cross-reference to railway collection file. <p>8. HIGHWAY.</p> <ul style="list-style-type: none">a. Wearing surface (material, thickness, and condition).b. Base course.c. Subgrade.d. Cross-reference to highway collection file.

Figure I-6. Checklist-Underground Facilities.

9. CHANNEL (water tunnels).
 - a. Cross-section dimensioned.
 - b. Sides (material and thickness).
 - c. Bottom (material and thickness).
 - d. Normal depth.
 - e. Normal current velocity.
10. ALIGNMENT.
 - a. Horizontal (position, curve radius, and curve location).
 - b. Vertical (grade percent, length, and location).
11. NUMBER OF MANWAYS. Dimensions and spacing.
12. OBSTACLE TUNNELED.
13. PORTAL. Design and material.
14. LINING MATERIAL. Type, thickness, condition, and points of change.
15. SHORING AND BRACING.
 - a. Location and spacing.
 - b. Design.
 - c. Materials.
 - d. Dimensions of members.
 - e. Arrangement and spacing of members.
16. STRUCTURAL DESIGN, MATERIALS, AND DIMENSIONS OF GALLERIES AND SNOWSHEDS.
17. GEOLOGICAL DATA.
 - a. Material through which tunnel passes.
 - b. Geology of adjacent areas.
18. OVERHEAD COVER. Material and depth.
19. DEMOLITION CHAMBERS. Location and dimensions.
20. VENTILATION. Description and adequacy.

Figure I-6. Checklist-Underground Facilities (continued).

21. DRAINAGE. Description, location, and adequacy.
22. LIGHTING FACILITIES. Type, location, and power source.
23. YEAR COMPLETED.
24. BYPASSES. Location, condition, effort required to establish.
25. ALTERNATE ROUTES. (Cross-reference to highway collection file).
26. TRAFFIC CONTROL MARKINGS.
27. APPROACHES. Characteristics, grade, surface, curves, turnouts, and parking areas.
28. SURFACE FEATURES OVER TUNNELS. Vegetation, structures, and surface configuration.
29. EFFECTS OF CLIMATE AND WEATHER.
 - a. Snow blockage (probable occurrence, effects, and duration).
 - b. Flooding (periods of occurrence, effects, and duration).
30. SPECIAL GEOPHYSICAL PHENOMENA.
31. SUSCEPTIBILITY TO ABOVE-GROUND DEMOLITIONS.
32. CAMOUFLAGE AND DEFENSES.
33. PRESENT USE.

Figure I-6. Checklist-Underground Facilities (continued).

GLOSSARY

ACRONYMS

AC	Active Component		Defense Command
ACE	analysis and control element	CCIR	commander's critical information requirements
ACOM	US Atlantic Command		
ADA	air defense artillery	C-E	communications-electronics
ADP	automated data processing	CED	captured enemy document
AFACSI	Air Force Assistant Chief of Staff for Intelligence	CEE	captured enemy equipment
AFMIC	Armed Forces Medical Intelligence Center	CEM	captured enemy materiel
AL	Alabama	CENTCOM	US Central Command
AMB	aviation maintenance battalion	CHATS	CI/HUMINT Automation Tool Set
AMC	US Army Materiel Command	CI	counterintelligence
ammo	ammunition	CINCLANT	Commander in Chief, Atlantic
APG	Aberdeen Proving Ground	CJCMEC	Combined Joint Captured Materiel Exploitation Center
ARAT	Army Reprogramming Analysis Team	CJTF	Commander, Joint Task Force
ARCENT	US Army Central Command	CM&D	collection management and dissemination
ASP	ammunition supply point	CMEC	Captured Materiel Exploitation Center
ATGM	antitank guided missile	COMTECHREP	Complementary Technical Intelligence Report
ATP	ammunition transfer point	COMMZ	communication zone
Aug	August	CONUS	continental United States
AVIM	aviation intermediate maintenance	COSCOM	Corps Support Command
AWACS	Airborne Early Warning	CSA	corps storage area
AZ	Arizona	CSD	contingency support detachment
BDA	battle damage assessment	CSS	combat service support
BIDS	Biological Integrated Detection System	CWCC	Centralized Weapons Collection Center
bn	battalion	DA	Department of the Army
BOS	battlefield operating system	DARPA	Defense Advanced Research Projects Agency
Btu	British thermal unit	DCSINT	Deputy Chief of Staff, Intelligence
C ³ I	command, control, communications, and intelligence	DCSOPS	Deputy Chief of Staff for Operations
CA	Civil Affairs	DETECHREP	Detailed Technical Report
CB	chemical and biological	DHS	Defense HUMINT Service
CBATEB	US Army Chemical and Biological Agent Technical Evaluation Board	DIA	Defense Intelligence Agency
CBDCOM	Chemical and Biological	DIAM	Defense Intelligence Agency Manual

FM 34-54

DISCOM	Division Support Command	G2	Assistant Chief of Staff, G2, Intelligence
DISE	Deployable Intelligence Support Element	G3	Assistant Chief of Staff, G3, Operations
div	division	G4	Assistant Chief of Staff, G4, Logistics
DMSO	division medical supply officer	G5	Assistant Chief of Staff, G5, Civil Affairs
DOD	Department of Defense		
DOCEX	document exploitation		
DOS	disk operating system		
DSNET	Defense Secure Network		
DTG	date-time group	HERA	High Explosive Rocket Assist
DTO	district transportation officer	HHC	headquarters and headquarters company
EA	electronic attack	HOTAS	hands on throttle and stick
EAC	echelons above corps	HQDA	Headquarters, Department of the Army
EACIC	echelons above corps intelligence center	hp	horsepower
ECB	echelons corps and below	HUD	heads-up display
ELECTRO-OPTINT	electro-optical intelligence	HUMINT	human intelligence
EOD	explosive ordnance disposal		
EODTIC	Explosive Ordnance Disposal Technical Information Center	I&W	indications and warnings
EP	electronic protection	IEW	intelligence and electronic warfare
EPW	enemy prisoner of war	IFF	identification, friend or foe
ERDEC	US Army Chemical Research Development and Engineering Center	IIR	intelligence information report
EW	electronic warfare	IMEP	International Materiel Evaluation Program
EXCEN	exploitation center	IMINT	imagery intelligence
FSAC	Fire Support Armaments Center	inf	infantry
FMA	foreign materiel acquisition	INSCOM	US Army Intelligence and Security Command
FME	foreign materiel exploitation	IPB	intelligence preparation of the battlefield
FMEP	Foreign Materiel Exploitation Program	IPC	intermediate processing center
FMMEP	Foreign Medical Materiel Exploitation Program	IR	information requirements
FMIB	Foreign Materiel Intelligence Branch	IRSTS	infrared search and track set
FMP	Foreign Materiel Program	J1	Assistant Chief of Staff, J1, Personnel
FMT	Foreign Materiel for Training	J2	Assistant Chief of Staff, J2, Intelligence
FPB	Force Projection Brigade	J3	Operations Directorate
G1	Assistant Chief of Staff, G1, Personnel	J4	Logistics Directorate
		J5	Joint staff plans and policy
		J6	Communications-Electronic Directorate
		JCMEC	Joint Captured Materiel

JDISS	Exploitation Center Joint Deployable Intelligence Support System	NAIC	National Air Intelligence Center
JIC	Joint Intelligence Center	NATO	North Atlantic Treaty Organization
JTF	Joint Task Force	NAVEODTECHDIV	Naval EOD Technical Division
JTIB	Joint Technical Intelligence Branch	NBC	nuclear, biological, and chemical
Kb	kilobyte	NETC	see NAVEODTECHCEN
kV	kilovolt	NGIC	National Ground Intelligence Center
kVA	kilovoltampere	NO	number
kW	kilowatt	NRT	near-real time
kWh	kilowatthour	NSA	National Security Agency
LAR	liquid aerosol remove	NTC	Naval Technical Center
LIDAR	laser detection and ranging	NUCINT	nuclear intelligence
LNE	liaison element	NVA	North Vietnamese Army
LNO	liaison officer	OB	order of battle
LOS	line-of-sight	OCONUS	outside continental United States
MACOM	major Army command	ODCSINT	Office of the Deputy Chief of Staff, Intelligence
MASINT	measurement and signature intelligence	ONI	Office of Naval Intelligence
MCC	movement control center	OPCON	operational control
MCO	movement control office	OPCEN	operations center
MD	Maryland	OPLAN	operations plan
MDR	MASINT data requirements	OPORD	operations order
mech	mechanized	OPSEC	operations security
med	medical	PACOM	US Pacific Command
MEDLOG	medical logistic battalion	PIR	priority intelligence requirements
MEDSOM	medical, supply, optical, and maintenance	POC	point of contact
MEF	Marine Expeditionary Force	POL	petroleum, oils, and lubricants
MFD	multifunctional display	PM	provost marshal
MI	military intelligence	PRETECHREP	Preliminary Technical Intelligence Report
mL	milliliter	PSYOP	psychological operations
MMC	materiel management center	psi	pounds per square inch
MOS	military occupational specialty	RADINT	radar intelligence
MRC	mission requirements center		
MSB	maintenance support battalion		
MSE	mobile subscriber equipment		
MSIC	US Missile and Space Intelligence Center		
MSR	main supply route		
NA	not applicable		

FM 34-54

RC	Reserve Components	STU-III	Secure Telephone Unit-Third Generation
RDTE	research, development, test, and evaluation	sup	supply
R&D	research and development	SUPCEN	support center
R&S	reconnaissance and surveillance	TA	Theater Army
RDEC	research, development, and engineering center	TAACOM	Theater Army Area Command
RF/EMPINT	radiofrequency/ electromagnetic pulse intelligence	TAMCA	Theater Army Movement Control Agency
RINT	radiation intelligence	TAML	Theater Army Medical Laboratory
RSP	render safe procedure	TAREX	target exploitation
RWR	radar warning receiver	TBP	to be published
		TECHSUM	Technical Intelligence Summary
S2	Intelligence Officer (US Army)	TECHINT	technical intelligence
S3	Operations and Training Officer (US Army)	TECOM	US Army Test and Evaluation Command
S4	Supply Officer (US Army)	TECRAS	technical reconnaissance and surveillance
S&T	scientific and technical	TEU	US Army Technical Escort Unit
S&TI	scientific and technical intelligence	TGSS	tunnels, galleries, and snow sheds
SALUTE	size, activity, location, unit, time, equipment (spot report format)	TIARA	tactical intelligence and related activities
SAM	surface-to-air missile	TIR	Technical Intelligence Report
SAR	synthetic aperture radar	TRADOC	US Army Training and Doctrine Command
SASO	stability and support operations	trans	transportation
SATCOM	satellite communications	TSS	target sensing system
SCIF	Sensitive Compartmented Information Facility	TTF	TECHINT target folder
SIGCEN	signal center	TTP	tactics, techniques, and procedures
SIGINT	signals intelligence	TV	television
SIR	specific information requests	UAV	unmanned aerial vehicle
SJA	Staff Judge Advocate	UIC	unit identification code
SME	subject matter expert	US	United States
SOP	standing operating procedure	USAARDEC	US Army Armament Research, Development, and Engineering Center
SOR	specific orders and requests	USAF	US Air Force
SRBM	short-range ballistic missile	USAIC&FH	US Army Intelligence Center and Fort Huachuca
SSC	software support center		
STANAG	Standardization Agreement		
STICEUR	Scientific Intelligence Center Europe		
STICFE	Scientific Intelligence Center Far East		

USAMRIID	US Army Medical Research Institute of Infectious Diseases	UTM	universal transverse mercator
USATECHDET	US Army Technical Detachment	XO	Executive Officer
USMC	US Marine Corps		

TERMS AND DEFINITIONS

acoustic intelligence	Intelligence derived from the collection and processing of acoustic phenomena.
captured enemy document	Documents captured from the enemy.
captured enemy equipment	Equipment captured from the enemy.
captured enemy materiel	The combination of documents, equipment, and material captured from the enemy.
Class I	Subsistence items and gratuitous health and welfare items (B-rations; meals, ready to eat; fresh fruits; and vegetables).
Class II	Equipment, other than principal items, prescribed in authorization and allowance tables (individual equipment, clothing items, tentage, tool sets, administrative supplies, housekeeping supplies).
Class III	POL, which are petroleum fuels, hydraulic and insulating oils, chemical products, antifreeze compounds, compressed gases, and coal. Class III (bulk) is normally fuel; for example, diesel, motor gasoline, and aviation fuel. Class III (package) is other elements such as lubricants, antifreeze, and fog oil.
Class IV	Construction and barrier materials (lumber, sandbags, and barbed wire).
Class V	Ammunition (small-arms ammunition, artillery rounds, hand grenades, explosives, mines, fuzes, detonators, missiles, and bombs, including special ammunition—chemical and nuclear rounds).
Class VI	Personal demand items; the items that are normally sold through the exchange system

(cigarettes, candy, soap, and so forth, contained in ration supplemental sundries packs).

Class VII	Major end items (final combinations of items that are assembled for their intended use: vehicles, self-propelled artillery pieces, missile launchers, and major weapon systems—the weapons themselves, not the crews).
Class VIII	Medical material (medicines, stretchers, surgical instruments, and medical equipment repair parts).
Class IX	Repair parts and components, including kits and assemblies, and items required for maintenance support of all equipment (batteries, spark plugs, and axles).
Class X	Material required to support nonmilitary programs; the items used to support CA operations (commercial design tractor for use by local civilians, farms tools, and so forth).
combined operations	Operations conducted by forces of two or more allied nations acting together for the accomplishment of a single mission.
communications intelligence	Technical and intelligence information derived from foreign communications by other than the intended recipients. Also called COMINT.
etiologic agent	The cause of a disorder or disease as determined by medical diagnosis.
electro-optical intelligence	Intelligence other than signal intelligence derived from the optical monitoring of the electromagnetic spectrum from ultraviolet (0.01 micrometers) through far infrared (1,000 micrometers). Also called ELECTRO-OPTINT. The collection, processing, exploitation, and analysis of emitted or reflected energy across the optical portion (infrared, visible, and ultraviolet) of the electromagnetic spectrum.
foreign materiel	The all-encompassing term for the weapons

systems, equipment, apparatus, documents, and supplies of a foreign military force or nonmilitary organization.

Foreign Material Program

The Army program for exploiting, developing, or providing foreign military materiel, commercial representations of foreign materiel with potential military application, related foreign documents in the Army inventory, and exploitation reports on this materiel of value to US intelligence, RDTE, and military planning, operations, and training.

This includes planning concerning intelligence and non-intelligence acquisition requirements, management of signature and simulator programs, participation in evacuation efforts, and support to the Opposing Forces Program.

joint operations

The integrated military activities of two or more service components—Army, Navy, Air Force, Marine Corps—of the US military.

measurement and signature intelligence

S&TI information obtained by quantitative and qualitative analysis of data (metric, angle, spatial, wavelength, time dependence, modulation, plasma, and hydromagnetic) derived from specific technical sensors for the purpose of identifying any distinctive features associated with the source, emitter, or sender and to facilitate subsequent identification and/or measurement of the same. Also called MASINT.

materials

Raw substances, scrap, semifinished and finished; supplies.

materiel

All items (including ships, tanks, self-propelled weapons, aircraft, and so forth, and related spares, repair parts and support equipment, but excluding real property, installations, and utilities) necessary to equip, operate, maintain,

and support military activities without distinction as to its application for administrative or combat purposes.

medical intelligence	That category of intelligence resulting from collection, evaluation, analysis, and interpretation of foreign medical, bio-scientific, and environmental information which is of interest to strategic planning and to military medical planning and operations for the conservation of the fighting strength of friendly forces and the formation of assessments of foreign medical capabilities in both military and civilian sectors.
nuclear intelligence	Intelligence information derived from the collection and analysis of radiation and other effects resulting from radioactive sources. Also called NUCINT.
radar intelligence	Intelligence derived from data collected by radar. Also called RADINT.
scientific and technical intelligence	The product resulting from the collection, evaluation, intelligence analysis, and interpretation of foreign scientific and technical information which covers: a. foreign developments in basic applied research and in applied engineering techniques; and b. scientific and technical characteristics, capabilities, and limitations of all foreign military systems, and materiel, the research and development related thereto, and the production methods employed for their manufacture. Also called S&TI.
technical intelligence	Intelligence derived from exploitation of foreign material, produced for strategic, operational, and tactical level commanders. Technical intelligence begins when an individual service member finds something new on the battlefield and takes the proper steps to report it. The item is then exploited at succeeding higher levels until a countermeasure is produced to neutralize the adversary's technological advantage. Also called TECHINT.
unintentional radiation intelligence	Intelligence derived from the collection and analysis of noninformation-bearing elements extracted from the electromagnetic energy unintentionally emanated by foreign devices, equipment, and systems, excluding those

FM 34-54

generated by the detonation of nuclear weapons.
Also called RINT.

REFERENCES

REQUIRED PUBLICATIONS

Required publications are sources that users must read in order to understand or to comply with this publication.

Field Manuals (FMs)

3-3	Chemical and Biological Contamination Avoidance, 16 Nov 92.
3-5	NBC Decontamination, 17 Nov 93.
34-1	Intelligence and Electronic Warfare Operations, 27 Sep 94.
34-37	Echelons Above Corps (EAC) Intelligence and Electronic Warfare (IEW) Operations, 15 Jan 91.
100-5	Operations, 14 Jun 93.
101-5-1	Operational Terms and Symbols, 21 Oct 85.

RELATED PUBLICATIONS

Related publications are sources of additional information. They are not required in order to understand this publication.

Army Regulations (ARs)

27-52	Consular Protection of Foreign Nationals Subject to the Uniform Code of Military Justice, 5 Nov 68.
59-8	Department of Defense (DOD) Common User Airlift, 20 Aug 82.
75-15	Responsibilities and Procedures for Explosive Ordnance Disposal, 1 Nov 78.
350-2	Opposing Force Program, 15 Jun 83.
380-5	Department of the Army Information Security Program, 25 Feb 88.
380-6	Laser Guidance System Security Classification Guide, 1 Dec 83.
(S) 381-26	Army Foreign Materiel Exploitation Program (U), 27 May 91.
700-99	Acquisition, Accounting, Control, and Disposal of Captured Enemy Equipment and Foreign Materiel, 27 Apr 76.

Defense Intelligence Agency Manual (DIAM)

(S) 58-4	Defense Intelligence Collection Operations Manual (DICOM) (U) Jun 65.
(U) 58-8	Measurements and Signature Intelligence (MASINT) Requirements, 30 Jul 87.
(C) 75-1	Scientific and Technical Intelligence Production (U), 24 Oct 88

Forms

DA Form 1971-6-R	Chemical/Biological Specimen Documentation, Aug 92.
DA Form 2028	Recommended Changes to Publications and Blank Forms, 1 Feb 74.
DD Form 1911	Materiel Courier Receipt, May 82.

FM 34-54

Field Manuals (FMs)

- 3-101-2 NBC Reconnaissance Squad/Platoon Operations, Tactics, Techniques, and Procedures, 10 Aug 94.
- 5-30 Engineer Intelligence, 22 Sep 67.
- 9-15 Explosive Ordnance Disposal Service and Unit Operations, 8 May 96.
- 21-3 Soldier's Manual of Common Tasks (Skill Levels 2, 3, and 4), 1 May 81.
- 34-3 Intelligence Analysis, 15 Mar 90.
- 34-52 Intelligence Interrogation, 2 Sep 92.
- 34-130 Intelligence Preparation of the Battlefield, 8 Jul 94.
- 101-5 Staff Organization and Operations, 25 May 84.

Joint Chiefs of Staff Publication (JCS Pub)

- 1-02 Department of Defense Dictionary of Military and Associated Terms, 23 Mar 94.

Standardization Agreements (STANAGs)

- 1059 National Distinguishing Letters for Use by NATO Forces, Edition 5
- 2014 Operations Orders, Warning Orders, and Administrative/Logistics Orders, Edition 5
- 2044 Procedures for Dealing with Prisoners of War, Edition 4
- 2084 Handling and Reporting of Captured Enemy Equipment and Documents, Edition 5
- 2097 Nomenclature for Soviet Bloc Army Weapons and Equipment, Edition 5

Supply Bulletin (SB)

- 708-21 Federal Supply Classification: Part I, Groups and Classes, 1 Jan 89.

Technical Manual (TM)

- 38-250 Preparing of Hazardous Materials for Military Air Shipments, 25 Nov 94.

INDEX

- AFMIC**, 2-2, 2-3
- Air and Missile Exploitation Element**, B-4, B-5, *See also* JCMEC
- Air Force**, 2-2, 2-4
- ammunition officer**, 5-7
- ARAT**. *See also* MASINT
IPC, A-5
production centers, A-5
TSS, A-5
- areas of exploitation**, 3-8
- Army**, 2-2, 2-5
AMC, 2-2, 2-5
INSCOM, 2-2, 2-3, 2-5, 2-6
ODCSINT, 2-2, 2-5
- Army Foreign Materiel Program**, 2-5
- Army Materiel Command**
CBDCOM, 2-2, 2-5
STICEUR, 2-2, 2-5, A-3
STICFE, 2-2, 2-5
TECOM, 2-2, 2-5
TEU, 2-2, 2-5
- automation systems**, 3-9
- aviation officer**, 5-5
- battlefield TECHINT**, 3-1
203d MI Battalion role, 3-1, 3-3
ammunition officer role, 5-7
analysis, 4-8
aviation officer role, 5-5
channels, 3-5
chemical officer role, 5-5
CMEC role, 3-2, 3-6
Collection Company, 3-3
command surgeon role, 5-6
definition, 3-1
elements, 5-1
engineer officer role, 5-5
EOD role, 5-6
exploitation, 4-7
Exploitation Company, 3-3
JCMEC role, 5-7
MASINT Detachment, 3-3
NTC Detachment, 3-3
provost marshal role, 5-6
reporting sequence, 4-7
reports, E-1
responsibilities, 5-1
Staff Judge Advocate role, 5-7
- BDA**, A-2. *See also* MASINT
- biomedical samples**, Appendix H
- CA elements**, 5-10
- CB sampling**
environmental, H-2
liquid and vapor, H-7
packaging, H-8
procedures, H-1
soil, H-7
vegetation, H-7
water, H-7
- CBDCOM**, 2-5
- CCIR**, 4-1
- C-E and IEW Exploitation Element**, B-4, B-6, *See also* JCMEC
- C-E TECHINT**, 3-10
- CED**. *See* CEM
- CEE**. *See* CEM

FM 34-54

CEM, 1-6, 1-7, 3-1

aviation officer role, 5-5
battlefield TECHINT responsibilities for,
3-1, 4-3, 5-1,
CMEC responsibilities, 3-3 through 3-9,
D-5
command responsibilities, D-6
disposition and destruction, D-9, D-10
exploitation of, 3-4, 3-5
exploitation requirements, F-2
handling and evacuation of, Appendix C,
D-4
handling and processing, B-2 through D-8,
information flow, 4-4
JCMEC responsibilities, 5-7, Appendix B
marking and tagging, B-2, C-9 through
C-13, D-6
policy, D-4
provost marshal role, 5-6
recovery, C-14
reporting, D-3, D-4, Appendix E
reporting procedures, Appendix E
requirements, D-9
S4 responsibilities, 3-4
SJA role, 5-7
staff responsibilities, 5-1 through 5-4

checklists, Appendix I

chemical officer, 5-5

CJCMEC, 3-3, 3-4, 3-8, 5-7. See also
CMEC and JCMEC

CM&D element, B-4, B-6. See also JCMEC

CMEC, 1-5, 3-2, C-1, C-2, C-6, C-8, F-2
See also CJCMEC; JCMEC; JTIB
functions, 3-3 through 3-10, D-6
S4 responsibilities, 3-4

CMEC (Forward)

functions, 3-7
handling CEM, 4-3, 4-5, C-9
J4/G4 responsibilities, 5-4
logistic functions, C-2

responsibilities, 4-2, 4-6

collection. See TECHINT collection

collection company, B-4, B-6. See Also
JCMEC

collection managers, 3-3

collection plan, F-1

command surgeon, 5-6

COMTECHREP, E-1, E-3

Type A, E-4

Type B, E-6

Type C, E-9

conflict. See military environments

DARPA, 2-2, 2-4

Defense Intelligence Agency

AFMIC, 2-2, 2-3

DHS, 2-2, 2-4

MSIC, 2-2, 2-3

DETECHREP, E-1, E-10

DHS, 2-2, 2-4

dissemination, See also

TECHINT

definition, 4-6

of CEM, 5-8

of EOD information, 5-6

of TECHINT products, 3-1, 4-6

of TIRs, E-1, E-11

staff section duties, 5-1

DOD S&TI community, 2-2

EAC, 2-6

at force projection brigades, A-1

TECHINT support, 3-6, D-2

ELECTRO-OPTINT, A-3

engineer officer, 5-6

engineer topographic and terrain units, 5-11

EPW

evacuation and processing, 5-1, C-6
tags, C-9 through C-13

EXCEN, B-4, B-5. *See also* JCMEC

Air and Missile Exploitation Element, B-5
C-E and IEW Exploitation Element, B-6
CM&D Element, B-6
Ground Exploitation Element, B-5
Maritime Exploitation Element, B-5
Medical and NBC Exploitation Element, B-5

force projection brigades, 2-2, 2-6, A-3

foreign materiel exploitation, 2-5, 2-7, B-3

Foreign Materiel Exploitation Program, 2-3, 2-6

Foreign Materiel for Training Program, 2-6, 3-5

Foreign Materiel Intelligence Branch, 1-6

Foreign Medical Materiel Exploitation Program, 2-3

foreign technological developments, 2-1

geophysical intelligence, A-4

Ground Exploitation Element, B-4, B-5.
See also JCMEC

historical perspectives

Grenada, 1-6
Gulf War, 1-6

Haiti, 1-8

Korean War, 1-5

Raid on Bruneval, 1-3

Somalia, 1-7

Vietnam, 1-5

World War II, 1-2

information requirements, 5-6, D-1, F-1
developed by JTIB, 4-1
JCMEC role, 5-7

INSCOM functions, 2-6

FPB, 2-2, 2-6

FMEP 2-3, 2-6

FMT Program, 2-5

MASINT responsibilities, A-2

NGIC, 2-2, 2-6

S&TI exchange, 2-3

TECHINT operations responsibilities, 2-5

intelligence collection

management, B-3

MASINT mission, A-1

intelligence cycle, 4-1, 4-6

intelligence production center

AFMIC, 2-3

MSIC, 2-3

intermediate processing centers, A-5

J1/G1

responsibilities, 5-1, D-1

J2/G2, 3-2

compliance with Geneva Convention, 5-3

relationship with capturing units, 5-8

relationship with Command Surgeon, 5-6, D-4

responsibilities, 4-1, 5-2

J3/G3 responsibilities, 5-1 through 5-6

J4/G4 responsibilities, 5-4, C-3

J5/G5 responsibilities, 5-5

FM 34-54

JCMEC, 1-6, 3-4, 3-8. *See also* JTIB; CMEC; CJCMEC
exploitation requirements, 3-7, F-2,
in joint or combined operations, 3-4
LNE, 4-8, D-4
organization, 3-3, B-4
purpose, B-1
responsibilities, 3-8, 4-2, 5-7, B-1,
D-11
role in intelligence cycle, 4-1 through 4-8
required reports, 4-7, Appendix E

JTIB, 4-1, B-1, B-2. *See also* JCMEC;
CMEC; CJCMEC
in joint operations, 3-6
missions, 3-6, 4-7
TECHINT reports, 4-6, E-1

lessons learned, 1-8

liaison elements. *See also* TECHINT
composition, 3-2, 3-8, B-1, B-3
responsibilities, 3-4, 3-5, 4-3, 4-8, B-3, E-1

Maritime Exploitation Element, B-4, B-5.
See also JCMEC

MASINT, 2-4, 2-6, A-1
agency responsibilities, A-2
BDA, A-2
data requirements, 2-6
in support of
collection teams, 3-4, 3-8
force modernization, A-6
S&TI, 2-6
TECRAS, 2-6
mission, 3-3, A-1
RINT integration, A-4
TIARA systems, A-1
training, 2-7

materials intelligence, A-4

**Medical and NBC Exploitation
Element**, B-4, B-5. *See also* JCMEC

Index-4

medical TECHINT, 3-10

medical units, 5-11, D-12
collection of samples, H-2, H-9, H-11

MEF intelligence element, 3-9

military environments
conflict, 1-2, 3-3, B-3
peacetime, 1-2, 2-5, A-1
war, 1-2, 1-5, 1-8, 3-3, 3-6, A-1

military police, 5-6, C-6
CEM role, 5-6, 5-8, 5-11, C-6, C-14
duties on the battlefield, 5-11
in support of JCMEC, B-2
responsibilities of, 5-6, 5-11, C-6, C-14

mobility TECHINT, 3-10

MSIC, 2-2, 2-3

munitions TECHINT, 3-10

NAIC, 2-2, 2-4

National Ground Intelligence Center, 2-2,
2-6, A-3, G-1

Navy, 2-2, 2-4
MCIA, 2-2
ONI, 2-2, 2-4
EOD training, 2-4

NBC, B-5, C-2, C-6, C-8, H-1, H-3, H-13
capturing unit role, 5-8
chemical officer role, 5-5
command surgeon role, 5-6
equipment, 4-9
functional area of TECHINT, 3-10,
4-3, 4-9, C-7
J2/G2 responsibilities, 5-2
materials intelligence, A-4

NBC (continued)
role of TEU, 2-2, 2-5
samples, 5-11, D-11, H-3

NBC reconnaissance teams

responsibilities, 5-11, H-2, H-3, D-6, D-11, D-12

NBC TECHINT, 3-10**NSA, 2-2, 2-4****NTC mission, 3-5****NUCINT, A-5****ODCSINT, 2-2**

responsibilities, 2-3, 2-5, A-3

OPCEN, B-4. See also JCMEC**operational support, H-1, 3-4 through 3-10**

role of commanders, 1-2, B-3
TECHINT requirements, 2-1, 3-4, 3-5

peacetime engagement. See military environments**PIR, D-1, F-1**

capturing units, 5-8
command surgeon, 5-6
JCMEC, 5-8

POL, C-4, C-6, I-2**PRETECHREP, E-1, E-2, E-3****processing. See TECHINT****production. See TECHINT****provost marshal, 5-6****PSYOP teams, 5-9, 5-10****radar intelligence, A-4****radio frequency intelligence, A-4****RC TECHINT, 3-6, 3-9****RDEC, 2-5****responsibilities of**

capturing units, 5-8
engineer topographic and terrain units, 5-10
EOD, 5-6, 5-12
J1/G1, 5-1
J2/G2, 5-2
J3/G3, 5-3
J4/G4, 5-4
J5/G5, 5-5
JCMEC, 3-8, 4-2, 5-7, B-1, D-11
military police, 5-6, 5-11, C-6, C-14
MI units, 5-9
NBC reconnaissance teams, 5-11
SOF, 5-9
staff officers, 5-5

S&TI. See also S&T

203d MI Bn, 2-6, 2-7
AFMIC role, 2-3
Air Force role, 2-4
Army role, 2-5
characteristics, 1-1
CMEC role, 3-7
community structure, 2-1, 2-2, F-3
definition of, 1-1
DIA role, 2-3, F-1
directorate responsibilities, 2-3
exploitation of, 4-8
fulfilling TECHINT requirements, 2-3
historical perspective, 1-6, 1-7, 1-8
JCMEC role, 5-8, F-3
JTIB role, 4-2, 4-6
MSIC role, 2-3
NAIC role, 2-4
Navy role, 2-4
ODCSINT responsibilities, 2-5
process and procedures, 4-6, 4-8
purpose of, 2-1

FM 34-54

S&TI community, 2-1, 2-2, 4-2

S&TI directorate, 2-3

SALUTE

example of, E-1, E-2
reporting, 4-7, 5-8, C-7, C-14, D-3

scientific and technical information.

See S&TI

SIGCEN, B-4, B-6. *See also* JCMEC

signatures analysis, 3-10

SIR, 4-1, 4-3

SJA, 5-3. *See also* J2/G2

SOF

aviation units, 5-10
CA elements, 5-10
PSYOP teams, 5-10
ranger units, 5-9

Special Forces and Ranger Units, 5-9

Special Operations Aviation Units, 5-10

special technical reports, E-1

SUPCEN, B-4

STICEUR, 2-5

203d MI Battalion, 2-6

CMEC function, 3-3, 3-4
collection company, 3-3, 3-4
exploitation company, 3-3, 3-4
HHC, 3-3
JCMEC and CJCMEC, 3-3, 3-8
MASINT Detachment, 3-3, 3-5
mission, 2-6, 3-3, F-2
NGIC, 3-3
NTC Detachment, 3-3, 3-5
organization, 3-3

TAML, B-5, D-6, D-13, H-9, H-11, H-12

Index-6

target folder, 4-2

target sensing systems, A-5

TECHINT

at operational level, 1-2
at strategic level, 1-1, 2-1
at tactical level, 1-2
battlefield operations, 3-1, 3-2
CEM, C-1
collection, 3-1 through 3-10 4-3, F-1
definition, 2-1
dissemination, 4-6
goals, 2-1
historical perspective, 1-1 through 1-9
in force protection, 1-9
input to Intelligence Annex, D-1
in relation to MASINT, A-1, A-6
intelligence cycle, 4-1, 4-7
lessons learned, 1-8
liaison elements, 3-5, 3-9, 4-3, 4-8, D-2, F-1
mission, 1-1
objectives, 2-1
processing, 4-6
production, 4-6
reports, E-1
responsibilities, 5-1
support to the warfighter, 1-1
target folder, 4-2
templating, 4-2

TECHINT analysts, 3-7

CEM responsibilities, 3-1, 5-12
exploitation function, 3-4, 3-8, 4-8, 4-9, C-6
reports, E-1

TECHINT collection, 3-1 through 3-10, 5-11

chemical officer role, 5-5
CM&D, B-6
definition, 4-3
historical perspective, 1-8

TECHINT Collection (continued)

intelligence cycle, 4-1 through 4-7
J2/G2 role, 5-2

J4/G4 role, 5-4
 J5/G5 role, 5-5
 JCMEC role, B-1 through B-6
 JTIB role, B-2
 NBC reconnaissance role, 5-11
 of CB samples, D-11 through D-14
 of CEM, D-4, B-2
 POL unit role, C-4, C-6
 priorities, D-7

TECHINT Collection Company, 3-4, B-6

TECHINT collection plan, F-1

TECHINT collection teams

automation systems, 3-10
 C-E, 3-10
 Medical, 3-10
 Mobility, 3-10
 Munitions, 3-10
 NBC, 3-10
 Weapons, 3-10

TECHINT Exploitation Company, 3-3.
See also HHC and CMEC

TECHINT LNEs, 3-2 through 3-8
 at Corps, 4-8, 5-8, C-9, E-1, E-4
 composition, 3-8

TECHINT operations, 3-2

TECHINT reports

COMTECHREP, E-1 through E-10
 DETECHREP, E-1, E-10
 PRETECHREP, E-1, E-2, E-3
 SALUTE, E-1, E-2
 special technical reports, E-1
 Technical Intelligence Update Report, E-1, E-10

TECHSUM, E-1, E-10
 TIR, E-1, E-11

TECHINT training, 2-6

technical escort unit, 2-5, H-2, H-3

technical intelligence. *See* TECHINT

Technical Intelligence Update Report.

See TECHINT reports

TECHSUM. *See* TECHINT reports

TECOM, 2-5

TECRAS, 2-7, A-1, A-3

templating, 4-2

Theater ACE, 4-6

Theater and Supporting Command Surgeon, 5-6

Theater Surgeon General, D-4, D-11, D-13

TIARA, A-1

TIR. *See* TECHINT reports

war. *See* military environments

warfighter

mission, 1-1
 TECHINT support, 1-1, 1-7, 2-1, 3-1

war trophies, 5-3, B-3, C-6, C-15

weapons TECHINT, 3-10

By Order of the Secretary of the Army:

Official:



JOEL B. HUDSON

*Administrative Assistant to the
Secretary of the Army*

04298

DENNIS J. REIMER
*General, United States Army
Chief of Staff*

DISTRIBUTION:

Active Army, Army National Guard, and U.S. Army Reserve: To be distributed in accordance with the initial distribution number 111132, requirements for FM 34-54.