



Fig. 7-1



Fig. 7-2



Fig. 7-3



Fig. 7-3a



Fig. 7-3b



Fig. 7-4



Fig. 7-4a



Fig. 7-4b



Fig. 7-5



Fig. 7-5a



Fig. 7-5b



Fig. 7-6



Fig. 7-7



Fig. 7-8



Fig. 7-8a



Fig. 7-8b



Fig. 7-9



Fig. 7-10



Fig. 7-11



Fig. 7-11A



Fig. 7-11b



Fig. 7-12



Fig. 7-13



Fig. 7-13a



Fig. 7-14

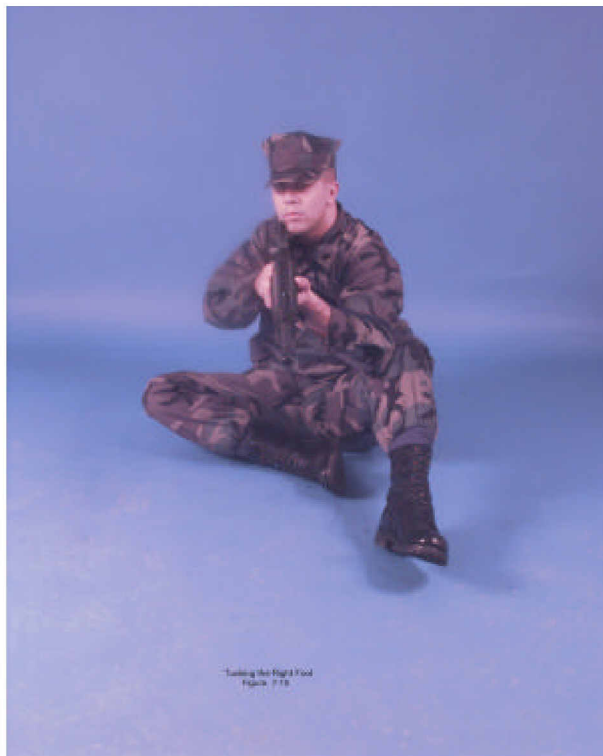

Fig. 7-15



Fig. 7-16

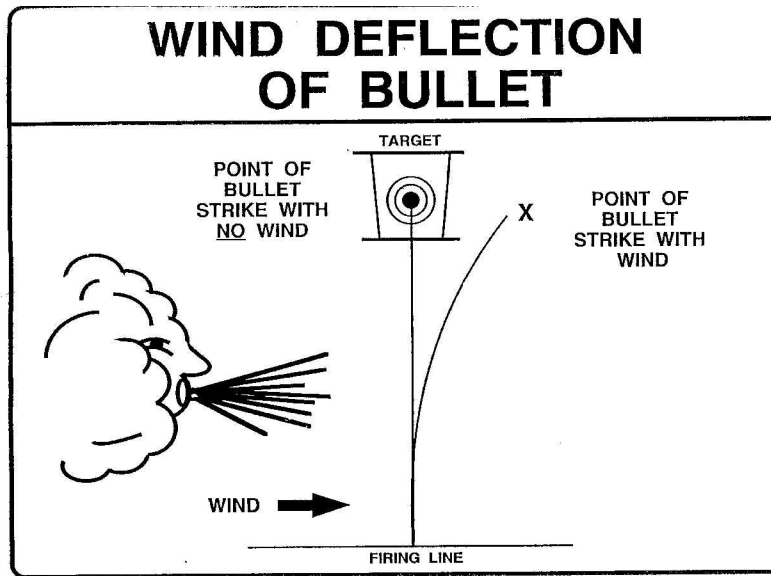

Figure 8-1

Fig. 8-1

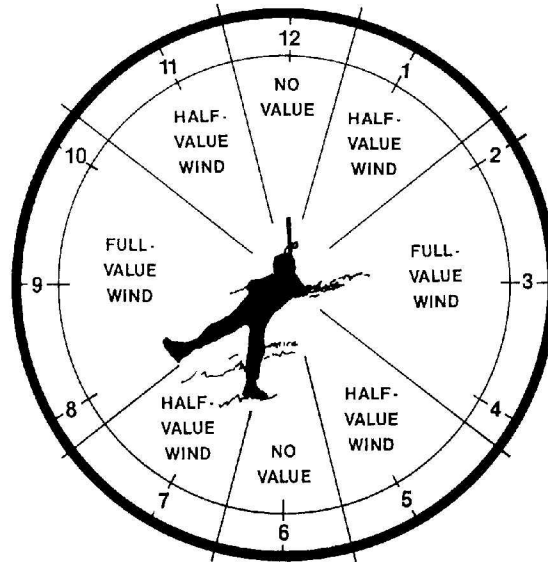

Figure 6-1. Clock System.

Fig. 8-2

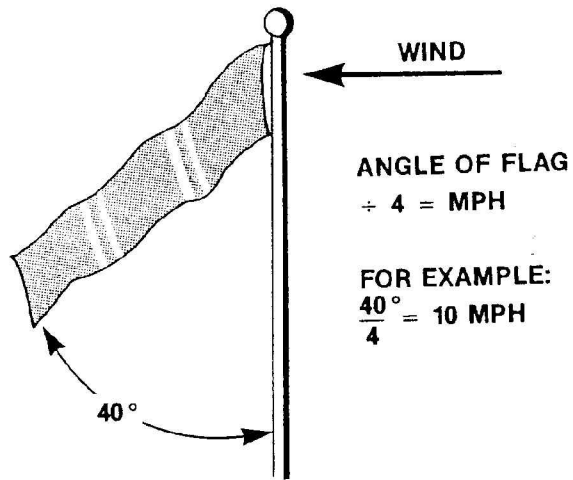

Figure 6-3. Flag Method.

Fig. 8-3



RANGE FLAG ANGLES	 5 MPH		 10 MPH		 15 MPH		 20 MPH		 25 MPH	
	WIND VALUE		WIND VALUE		WIND VALUE		WIND VALUE		WIND VALUE	
RANGE YARDS	F U L L	$\frac{1}{2}$	F U L L	$\frac{1}{2}$	F U L L	$\frac{1}{2}$	F U L L	$\frac{1}{2}$	F U L L	$\frac{1}{2}$
200	2	1	3	1	5	2	6	3	8	4
300	3	1	6	3	10	5	13	6	16	8
400	4	2	9	4	13	6	18	9	22	11
500	6	3	12	6	18	9	24	12	30	15
600	8	4	15	7	23	11	31	16	39	20
700	10	5	20	10	30	15	39	20	49	24
800	12	6	25	12	37	18	50	25	62	31

Figure 6-4. Windage Click Chart.

Fig. 8-5



Fig. 8-6

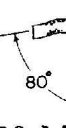
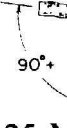
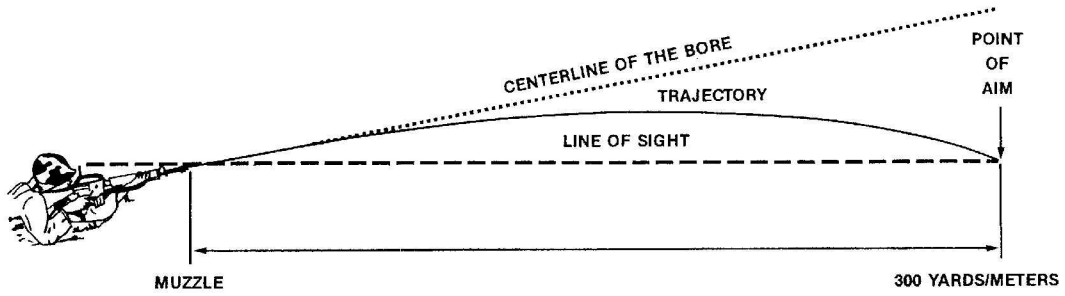

Figure 7-1. Elements of Zeroing.

7-1

Fig. 9-1

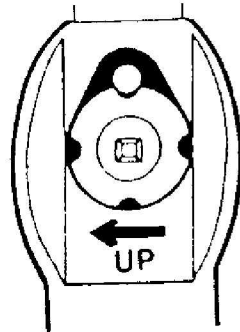

Figure 7-3. Front Sight.

Fig. 9-2

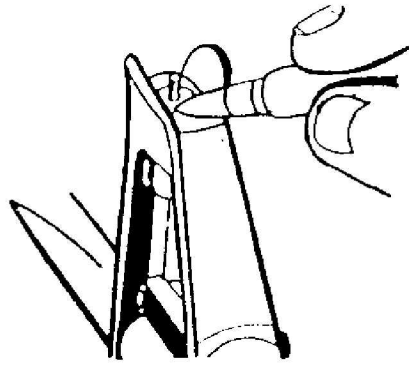

Figure 7-4. Front Sight Adjustment.

Fig. 9-3

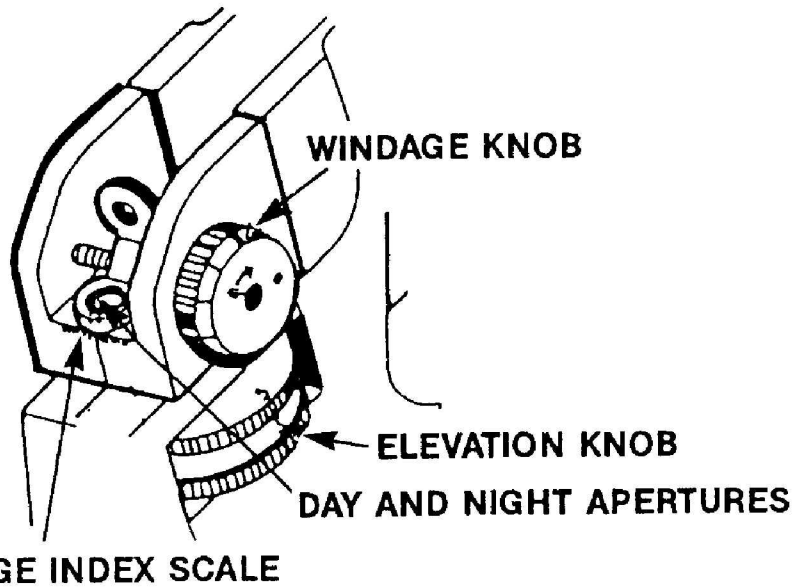

Figure 7-6. Rear Sight.

Fig. 9-4

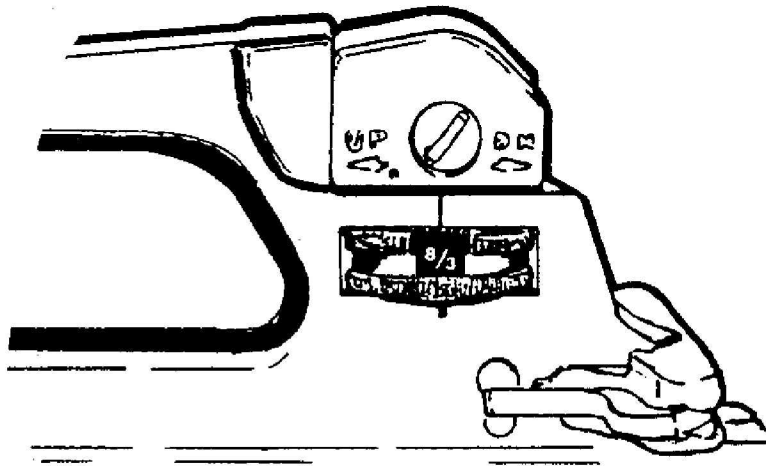

Figure 7-9. Elevation Knob Set at 8/3.

Fig. 9-5



Fig. 9-6



Fig. 9-7

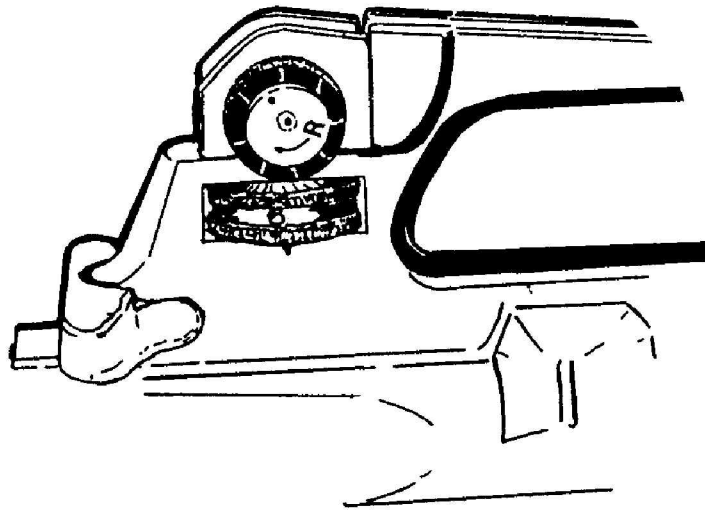

Figure 7-10. Windage Knob.

Fig. 9-8



Fig. 9-9

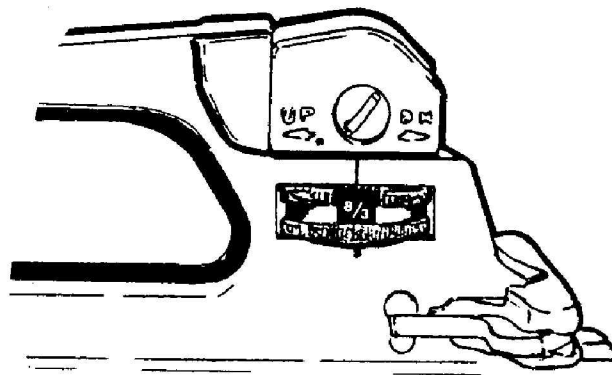

Figure 7-9. Elevation Knob Set at 8/3.

Fig. 9-10

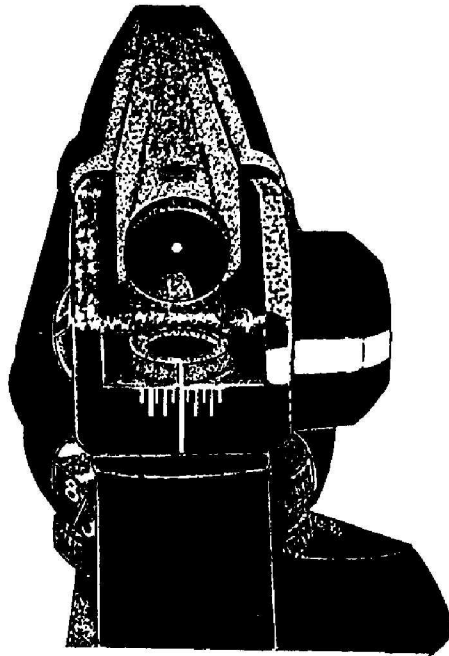

Figure 7-12. Marking Windage Knob.

Fig. 9-11

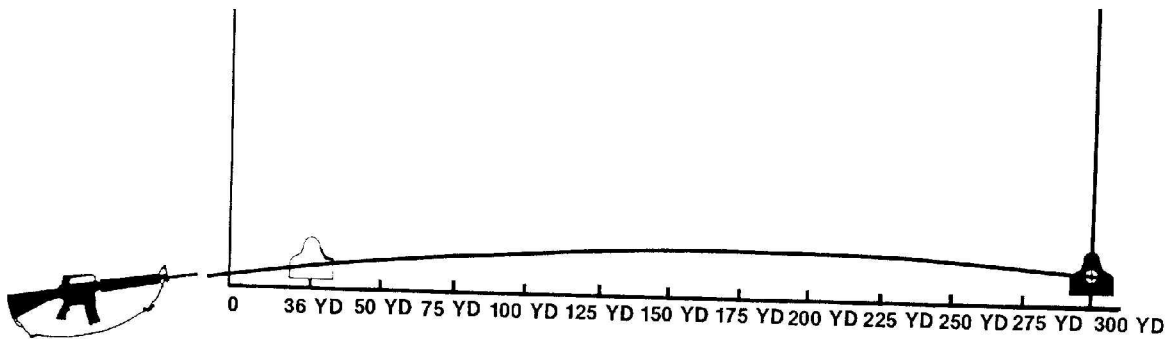

Figure 7-2. 300-Yard Zero.

Fig. 9-15