

**SX-50® DIGITAL PRIVATE
AUTOMATIC BRANCH EXCHANGE
(DPABX)**

Customer Data Entry Forms

NOTICE

The information contained in this document is believed to be accurate in all respects but is not warranted by Mitel Corporation (MITEL®). The information is subject to change without notice and should not be construed in any way as a commitment by Mitel or any of its affiliates or subsidiaries. Mitel and its affiliates and subsidiaries assume no responsibility for any errors or omissions in this document. Revisions of this document or new editions of it may be issued to incorporate such changes.

Table of Contents

1. INTRODUCTION

General	102 1-1
Reason for Reissue	102 1-1

2. CUSTOMER DATA ENTRY FORMS

General	102 2-1
Physical Configuration	102 2-1
Programming Errors	102 2-3
Exit From Error Mode	102 2-4

List of Figures

Figure 2-1 Alarm Message Format	102 2-6
Figure 2-2 Programmable Function Keys	102 2-35

List of Tables

Table 2-1 Card and Module Types	102 2-1
Table 2-2 Programming Error Codes	102 2-4
Table 2-3 Station Equipment Numbers	102 2-6

1.

INTRODUCTION**General**

- 1.1 After the successful mechanical installation of the SX-50® system (refer to Section 9104-091-200-NA, Shipping, Receiving and Installation Information), the system is ready for programming. This Section provides forms for the installer to record customer data. For information on programming options and access to CDE from the Console or Test Line, refer to Section 9104-091-210-NA.

Reason for Reissue

- 1.2 Section 9104-091-102-NA, Customer Data Entry Forms, has been reissued to include a description of the SUPERSET™ 410 and *SUPERSET 420* telephones, the Digital Network Interface Circuit (DNIC) Line Card and the functionality provided by MS55 software.

2.

CUSTOMER DATA ENTRY FORMS

General

- 2.1 The following forms enable the installer to plan customer programming prior to actual data entry. Space is allocated to record the customer data.

This Section omits Commands which cannot be edited. Refer to Section 9104-091-350-NA, Troubleshooting Procedures and General Maintenance Information, for details. These Commands include:

- Command 980, System Status Display
- Command 981, Inter-DX Link Status Display
- Command 982, Station Status Display
- Command 983, *SUPERSET* Telephone Status Display
- Command 984, Trunk Status Display
- Command 999, Software Identity Display

Physical Configuration

- 2.2 Form 2-1 provides space to record the placement of circuit cards and Universal Card modules in the system. Table 1-1 lists the available card and module types.

Table 2-3 enables the installer to determine quickly the equipment number of any station or trunk in the system. Many command registers require the entry of equipment numbers.

Table 2-1 Card and Module Types	
Card/Module Type	Abbreviation
ONS Line Card (16 Lines)	ONS 16
ONS Line Card (8 Lines)	ONS 8
OPS Line Card (8 Lines)	OPS 8
OPS Line Card (4 Lines)	OPS 4
DID Trunk Card (8 Trunks)	DID 8
DID Trunk Card (4 Trunks)	DID 4
DNIC Line Card (8 Lines)	DNIC 8
COV Line Card (8 Lines)	COV 8
LS/GS Trunk Card (8 Trunks)	LS/GS 8

Page 1 of 2

Table 2-1 Card and Module Types (continued)	
Card/Module Type	Abbreviation
LS/GS Trunk Card (4 Trunks)	LS/GS 4
Universal Card	UNIVERSAL
• Music on Hold/Pager Module	MOH/PAGER
• E&M Trunk Module	E&M MOD
• RMATS Module	RMATS
Control Card	MCC1
Control Card 2 *	MCC2
Page 2 of 2	

* Music on Hold/Pager capability requires MS53 software

Form 2-1 Card And Module Placement

Slot Number	Card Type
1	
2	
3	
4	
5	
6	
7	
8	
9	
10	

Note: Slots 9 (nine) and 10 (ten) cannot be used for DNIC Line Cards.

Universal Card 1		Universal Card 2	
Module Position	Module Type	Module Position	Module Type
1		1	
2		2	
3		3	
4		4	
Universal Card 3		Universal Card 4	
Module Position	Module Type	Module Position	Module Type
1		1	
2		2	
3		3	
4		4	

Programming Errors

- 2.3 The *SX-50* system can detect certain errors made during CDE. The detection of a programming error results in a display similar to that shown in Figure 2-1, Alarm Message Format. The meaning of each code is listed in Table 2-2, Programming Error Codes.

Exit From Error Mode

2.4 After the error code has been checked and the correct data determined, the programmer can exit the Error Mode by:

- pressing the CANCEL key on *SUPERSET 410* or *SUPERSET 420*,
OR
- pressing the QUIT softkey on the Attendant Console,
OR
- pressing the CANCEL softkey from the Test Line (*SUPERSET 4* Telephone),
OR
- dialing * # from the Test Line (DTMF set),
OR
- flashing the switchhook twice on the Test Line (Rotary Dial set).

The system restores the original data and data entry begins at the start of the register.

Table 2-2 Programming Error Codes

Error Code	Description
E01	Illegal Command Identity
E02	Digit keyed while Access Mode Error displayed
E03	Directory Number already exists
E04	Data out of range
E05	Illegal Directory Number length
E06	Directory Number range insufficient
E07	Too many digits keyed
E08	Illegal Device range
E09	Write protected command
E10	Insufficient software package level
E11	Write protected data
E12	Data field incomplete
E13	RESERVED
E14	Maximum Limit Exceeded
E15	Hunt Groups linked into a loop; e.g, linked Hunt Group 1 to Hunt Group 6 then linked Hunt Group 6 to Hunt Group 1
E16	Duplicate assignment of Programmable Function Key
E17	Attempt to program non-idle key

**Table 2-2 Programming Error Codes
(continued)**

Error Code	Description
E18	<i>SUPERSET</i> Telephone Prime Line Programming Error
E20	Invalid double-digit command
E21	Directory number already in Ring Group
E22	Device must be an extension
E23	ARS Busy – Calls in progress
E24	Digit String already programmed
E25	Digit String register overflow
E26	No Digit String entered
E27	Digit area is full
E28	The start time entered for this time period is earlier than or equal to the start time of the preceding period. Time periods must be entered in ascending order.
E29	The start time entered for this time period is later than the start time of the next period. Time periods must be entered in ascending order.
E30	RESERVED
E31	Attempt to program a DTS, DLS or Private Line in <i>SUPERSET</i> Telephone Programming when the trunk is not assigned to a Trunk Group. Refer to Commands 501 → 580, Trunk Programming.
E32	<i>SUPERSET 4</i> Telephone key type conflict
E33	Attempt to display System Security Code
E34	Attempt to display User Security Code
E35	Attempt to display DISA Access Code
E36	RESERVED
E37	Specified card type not found in slot position
E38	Attempt to overflow current Trunk Group
E39	Invalid Trunk Number keyed
E40	RESERVED
E41	RESERVED
E42	RESERVED
E43	Invalid base Directory Number
E44	Invalid Directory Number
E45	Contact monitor conflict. Attempted to assign as an answer point an ONS circuit programmed as a contact monitor.
E46	VAC Length Conflict. Attempted to change length of VAC before deleting all existing VACs

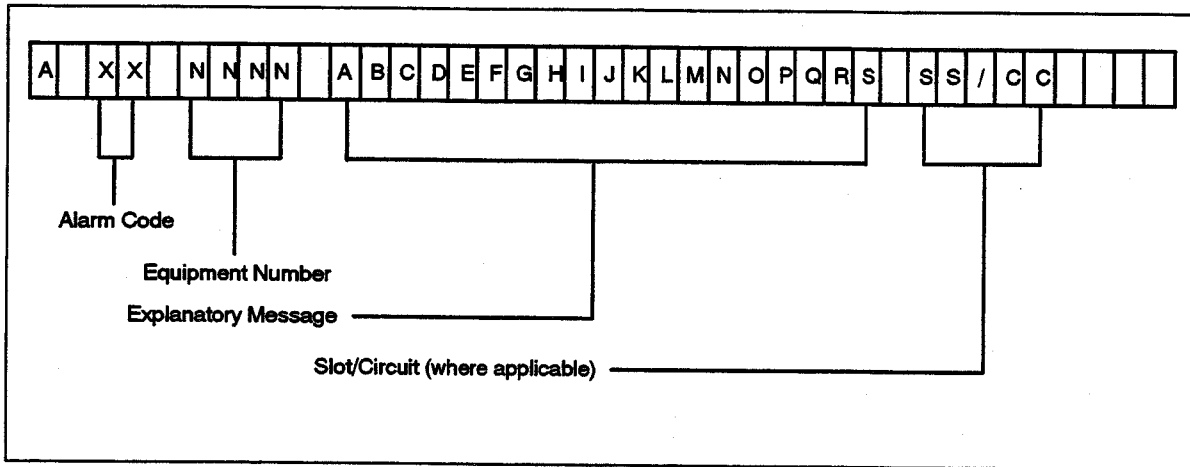

Figure 2-1 Alarm Message Format

Table 2-3 Station Equipment Numbers

Circuit Number	Slot Number									
	1	2	3	4	5	6	7	8	9	10
01	001	017	033	049	065	081	097	113	129	145
02	002	018	034	050	066	082	098	114	130	146
03	003	019	035	051	067	083	099	115	131	147
04	004	020	036	052	068	084	100	116	132	148
05	005	021	037	053	069	085	101	117	133	149
06	006	022	038	054	070	086	102	118	134	150
07	007	023	039	055	071	087	103	119	135	151
08	008	024	040	056	072	088	104	120	136	152
09	009	025	041	057	073	089	105	121	137	153
10	010	026	042	058	074	090	106	122	138	154
11	011	027	043	059	075	091	107	123	139	155
12	012	028	044	060	076	092	108	124	140	156
13	013	029	045	061	07	093	109	125	141	157
14	014	030	046	062	078	094	110	126	142	158
15	015	031	047	063	079	095	111	127	143	159
16	016	032	048	064	080	096	112	128	144	160

SUPERSET/Trunk Equipment Numbers

Circuit Number	Slot Number									
	1	2	3	4	5	6	7	8	9	10
01	01	09	17	25	33	41	49	57	65	73
02	02	10	18	26	34	42	50	58	66	74
03	03	11	19	27	35	43	51	59	67	75
04	04	12	20	28	36	44	52	60	68	76
05	05	13	21	29	37	45	53	61	69	77
06	06	14	22	30	38	46	54	62	70	78
07	07	15	23	31	39	47	55	63	71	79
08	08	16	24	32	40	48	56	64	72	80

Note: E&M Trunks use ODD Equipment Numbers only.

COMMAND 100 SYSTEM OPTIONS PROGRAMMING

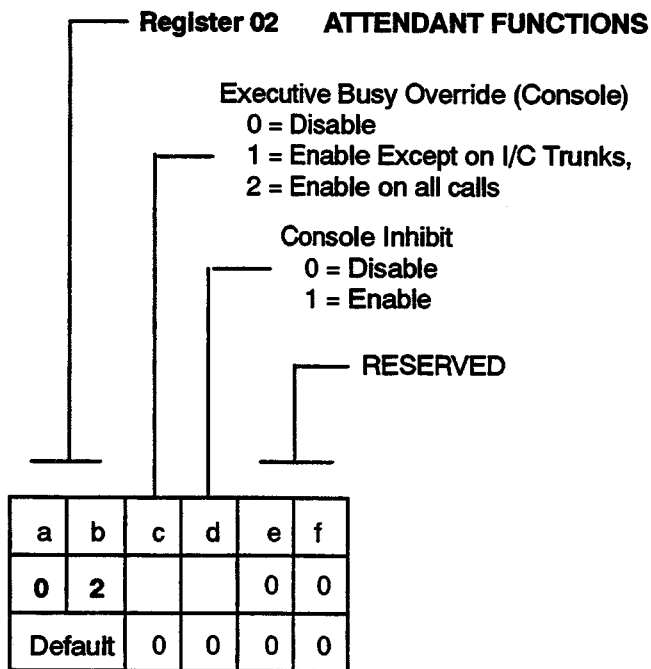
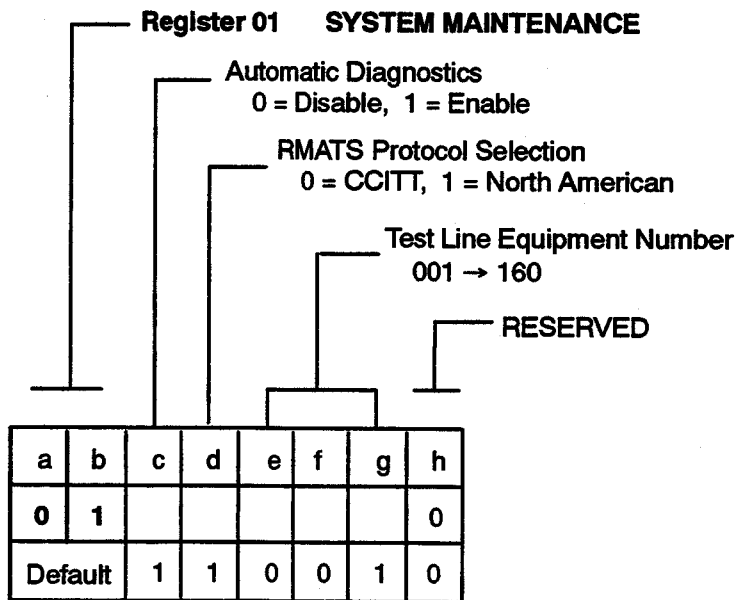

COMMAND 100

SYSTEM OPTIONS PROGRAMMING

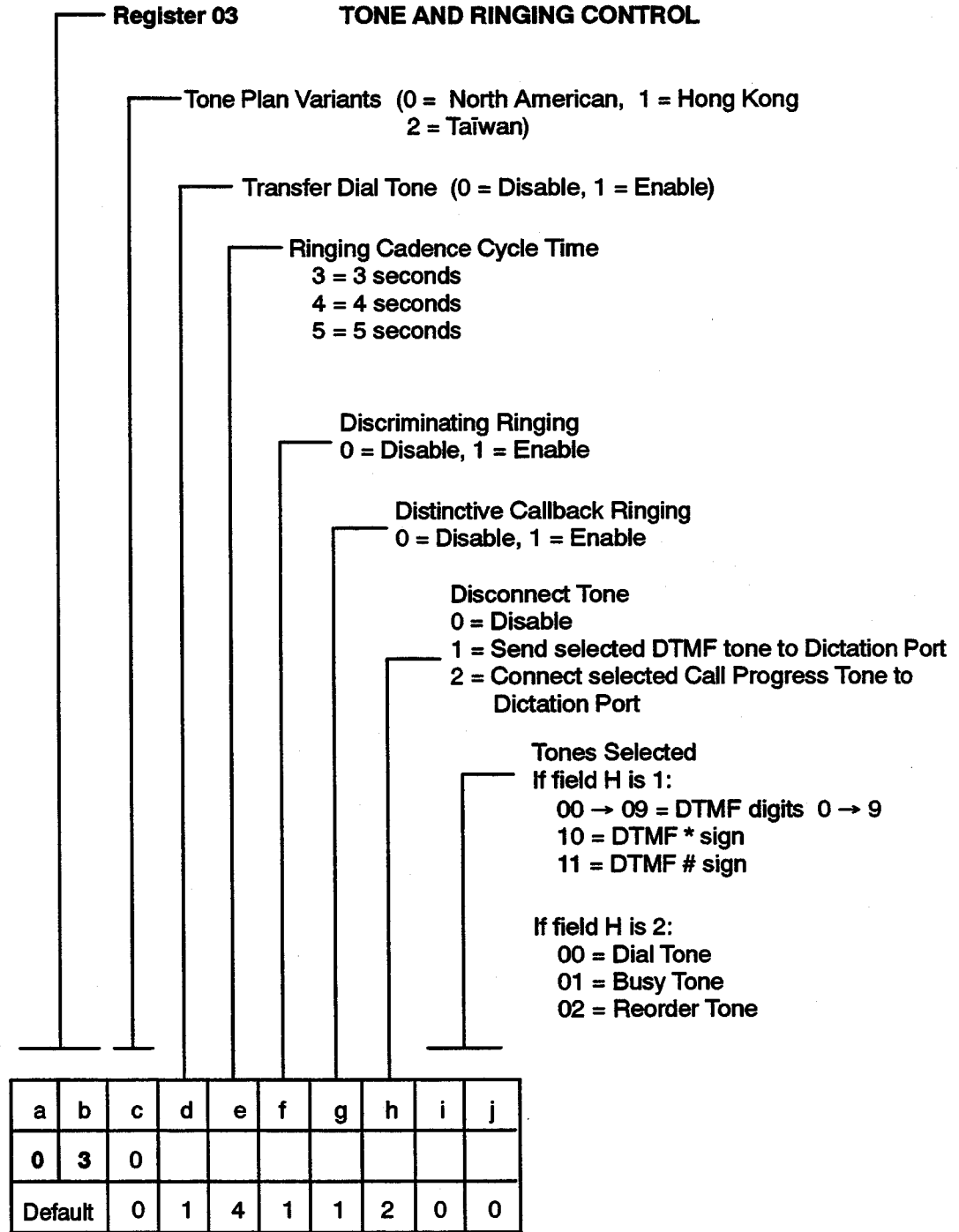

COMMAND 100

SYSTEM OPTIONS PROGRAMMING

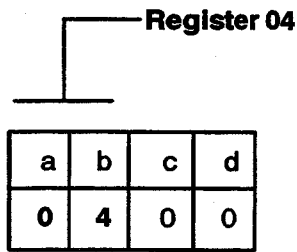

Register 04 field values should not be changed.

COMMAND 100

SYSTEM OPTIONS PROGRAMMING

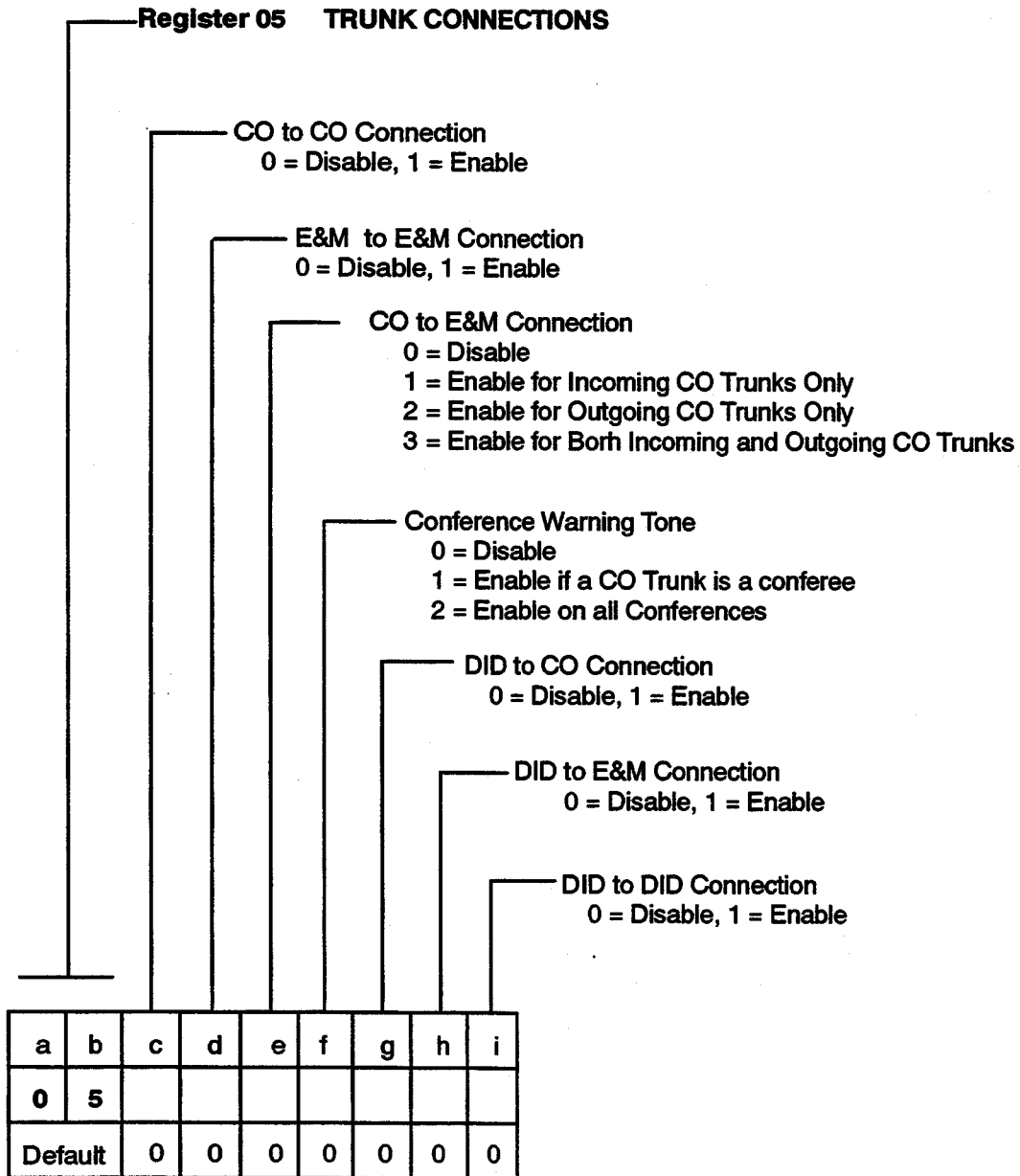

COMMAND 100

SYSTEM OPTIONS PROGRAMMING

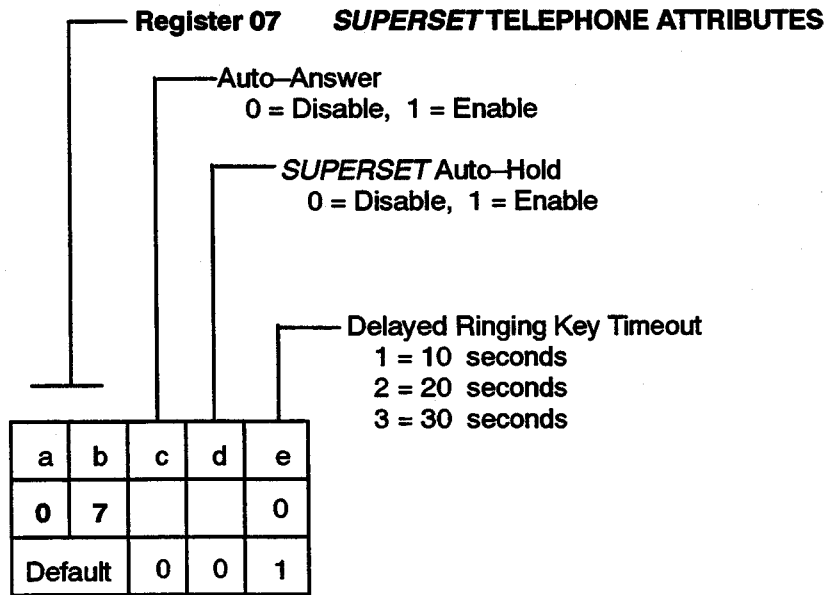
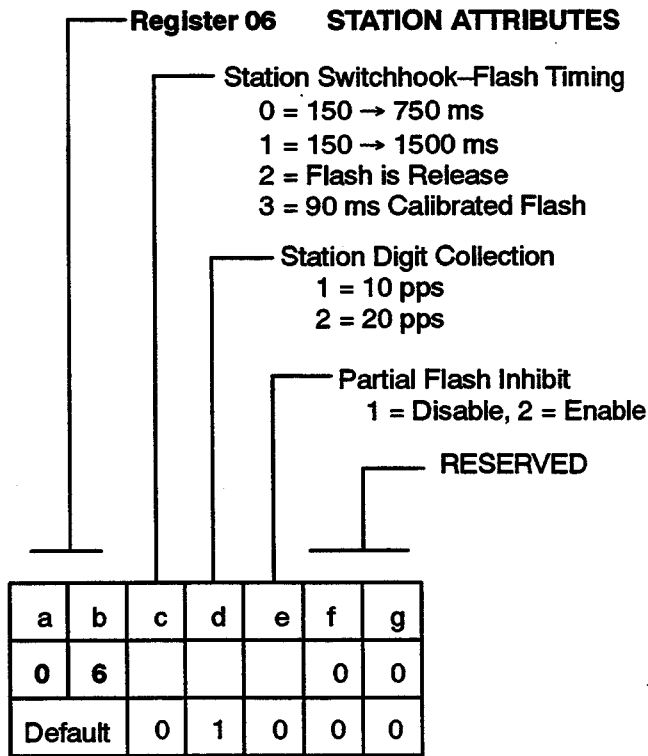

COMMAND 100

SYSTEM OPTIONS PROGRAMMING

Register 08 OVERFLOW CONTROL

Overflow Mode in Day Service

- 0 = Disable
- 1 = Immediate Switching to Overflow
- 2 = Automatic Switching to Overflow after Time-out
- 3 = Automatic Switching to Night Service

Overflow Mode in Night Service

- 0 = Disable
- 1 = Immediate Switching to Overflow
- 2 = Automatic Switching to Overflow after Time-out

Automatic Switch to Overflow Time-out
(1 → 7) x 10 seconds

Internal Calls to Console Routed to Overflow

- 0 = Disable
- 1 = Enable During Day Service
- 2 = Enable During Night Service
- 3 = Enable During Both Day and Night Service

Overflow Point

- 000 = Night Bell
- 001 → 160 = Station (Equipment Number)
- 161 → 166 = Hunt Group
- 167 = Ring Group

a	b	c	d	e	f	g	h	i
0	8							
Default	2	0	3	2	0	0	0	

COMMAND 100

SYSTEM OPTIONS PROGRAMMING

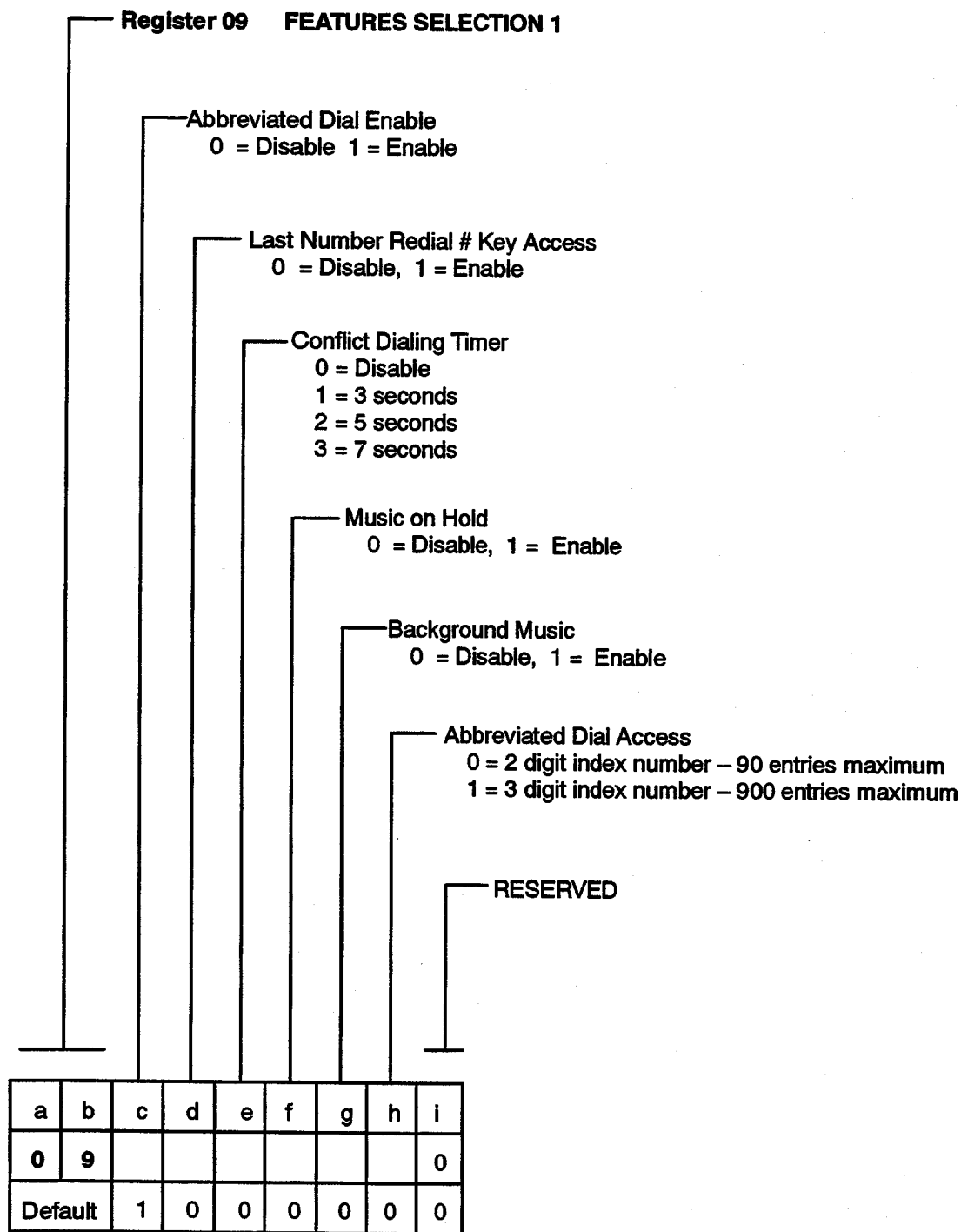

COMMAND 100

SYSTEM OPTIONS PROGRAMMING

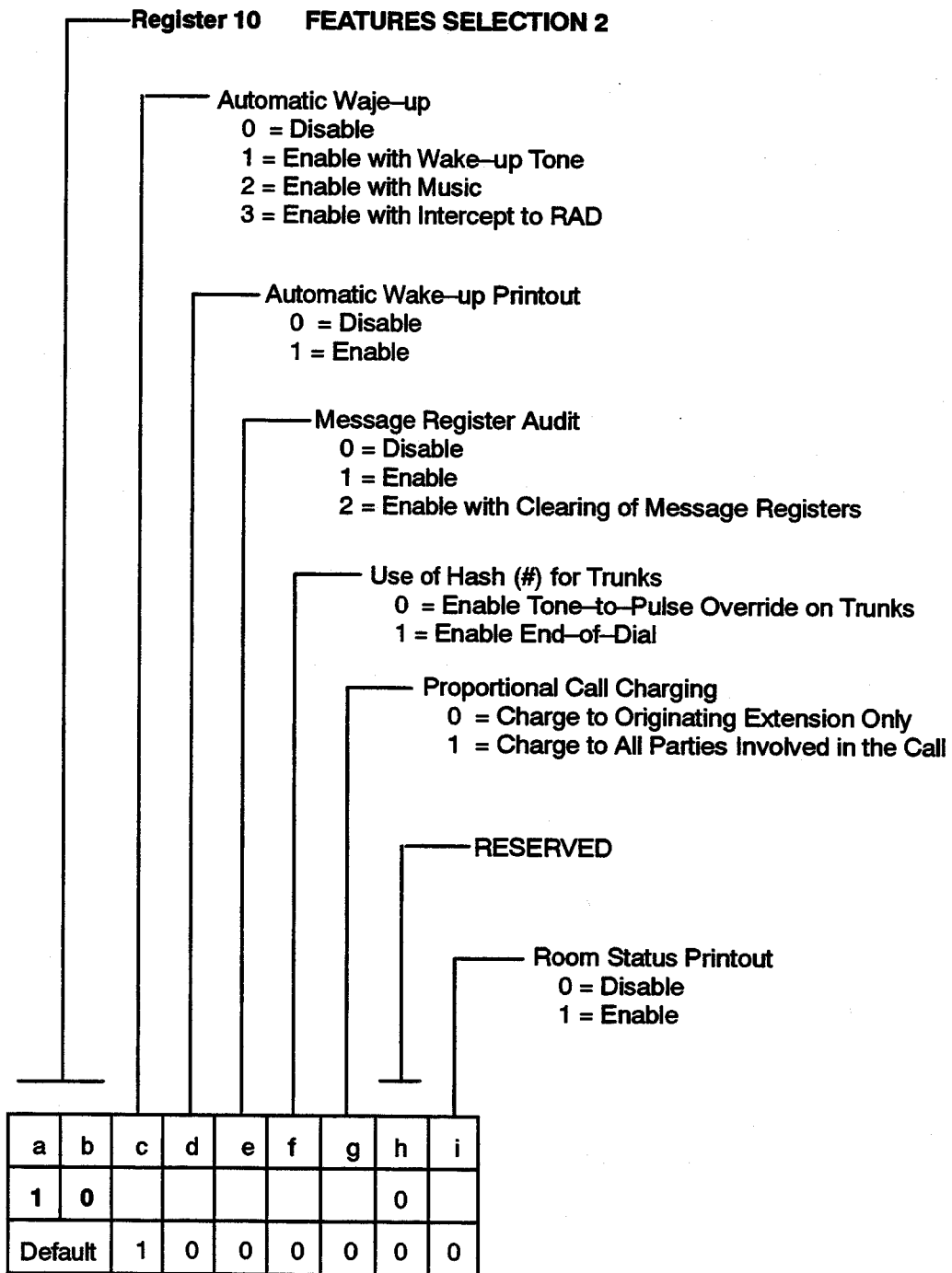

COMMAND 100

SYSTEM OPTIONS PROGRAMMING

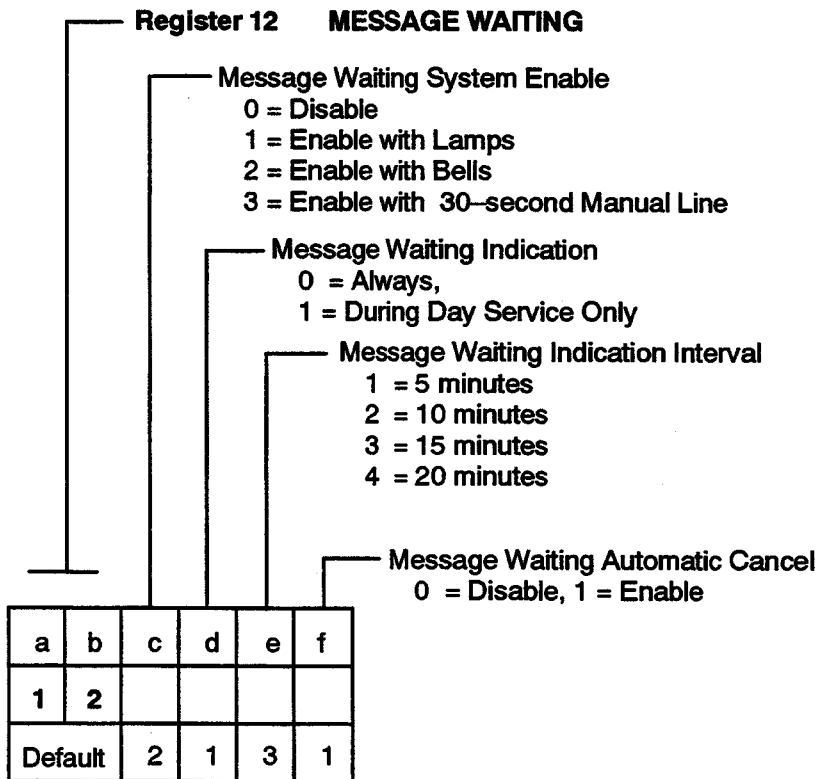
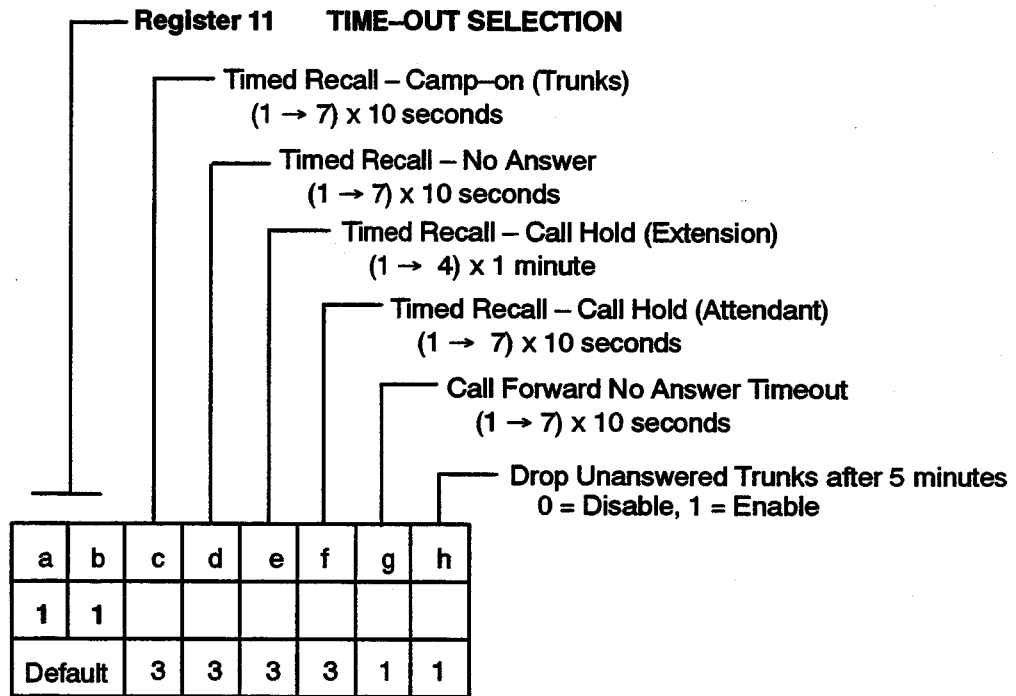

COMMAND 100

SYSTEM OPTIONS PROGRAMMING

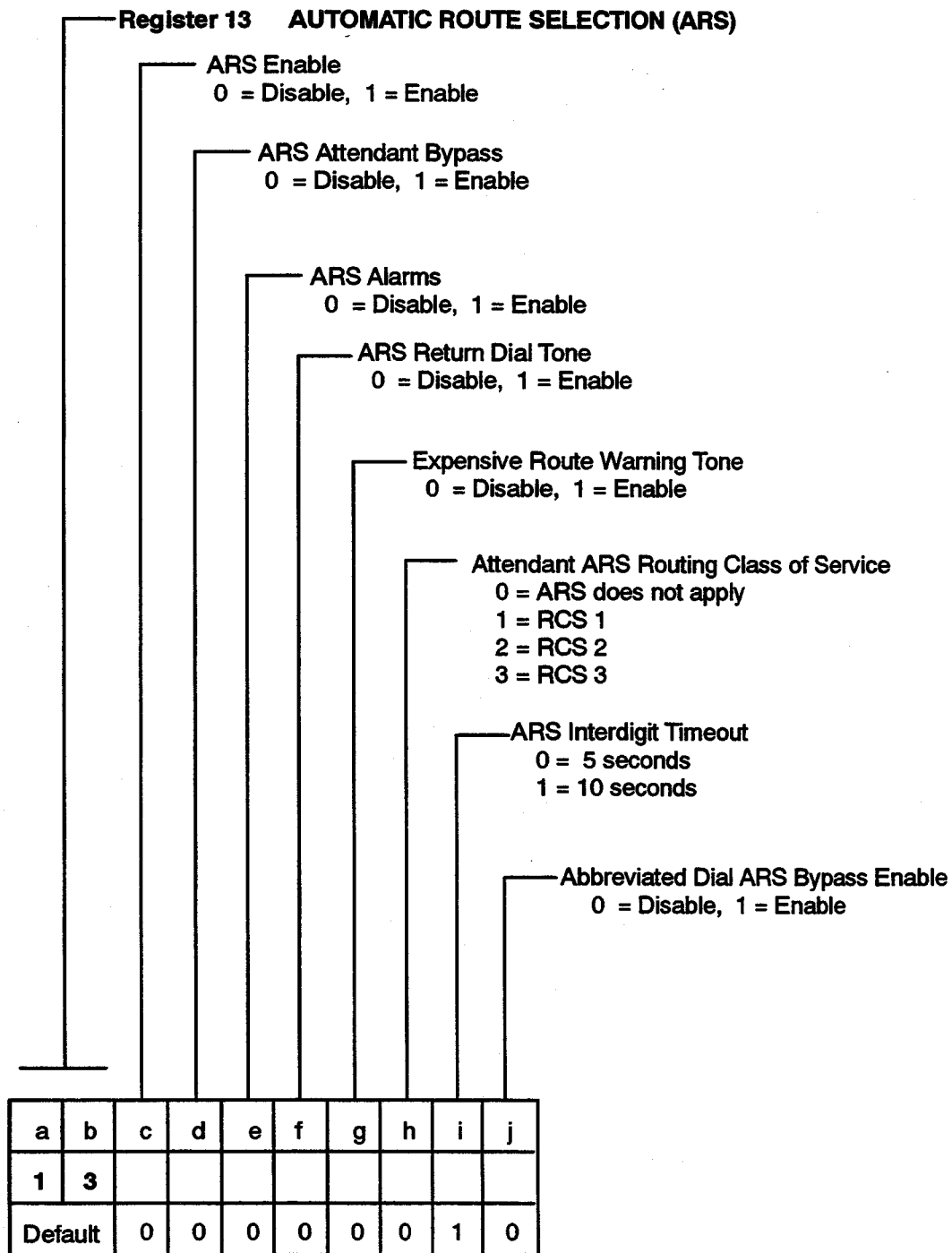

COMMAND 100

SYSTEM OPTIONS PROGRAMMING

Register 14 SYSTEM MESSAGE DETAIL RECORDING (SMDR)

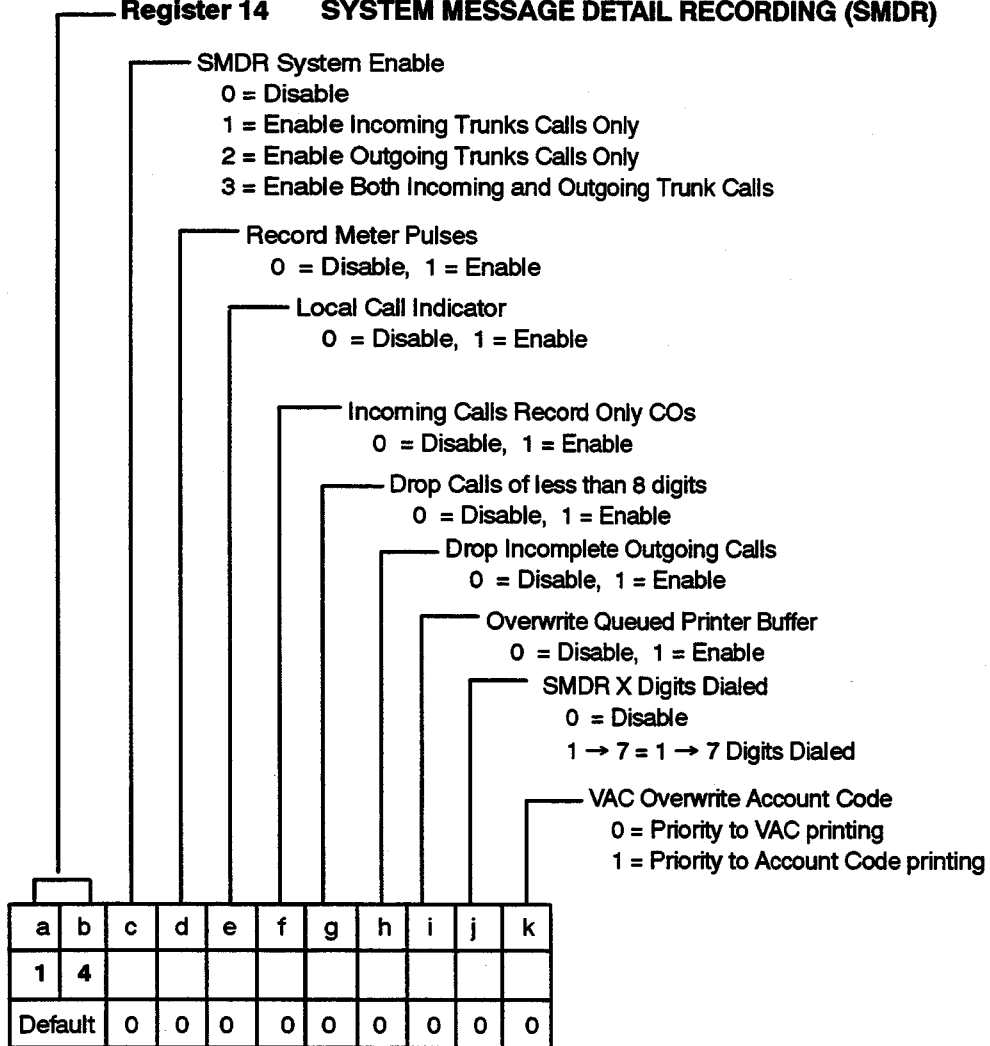

Register 15 ACCOUNT CODE CONTROL

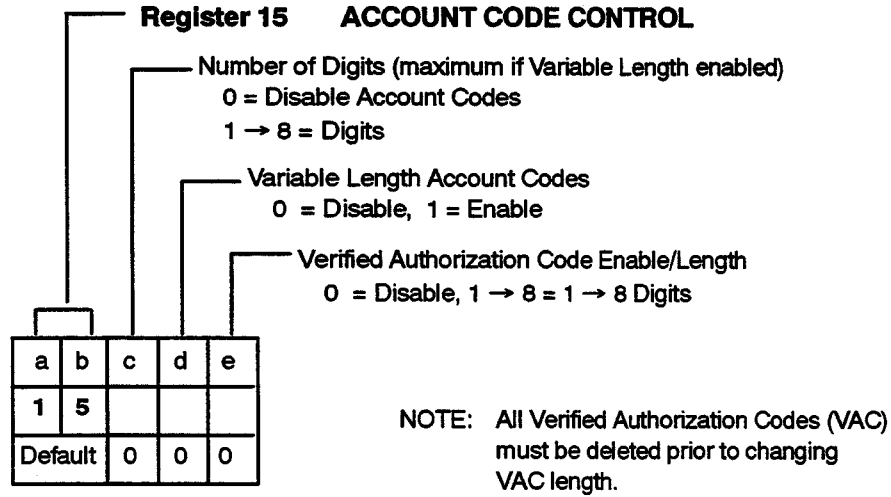

COMMAND 100

SYSTEM OPTIONS PROGRAMMING

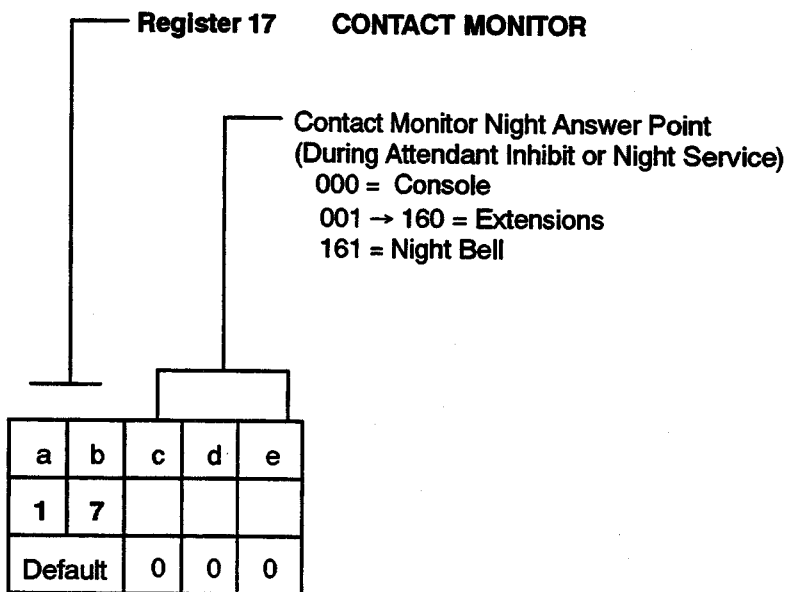
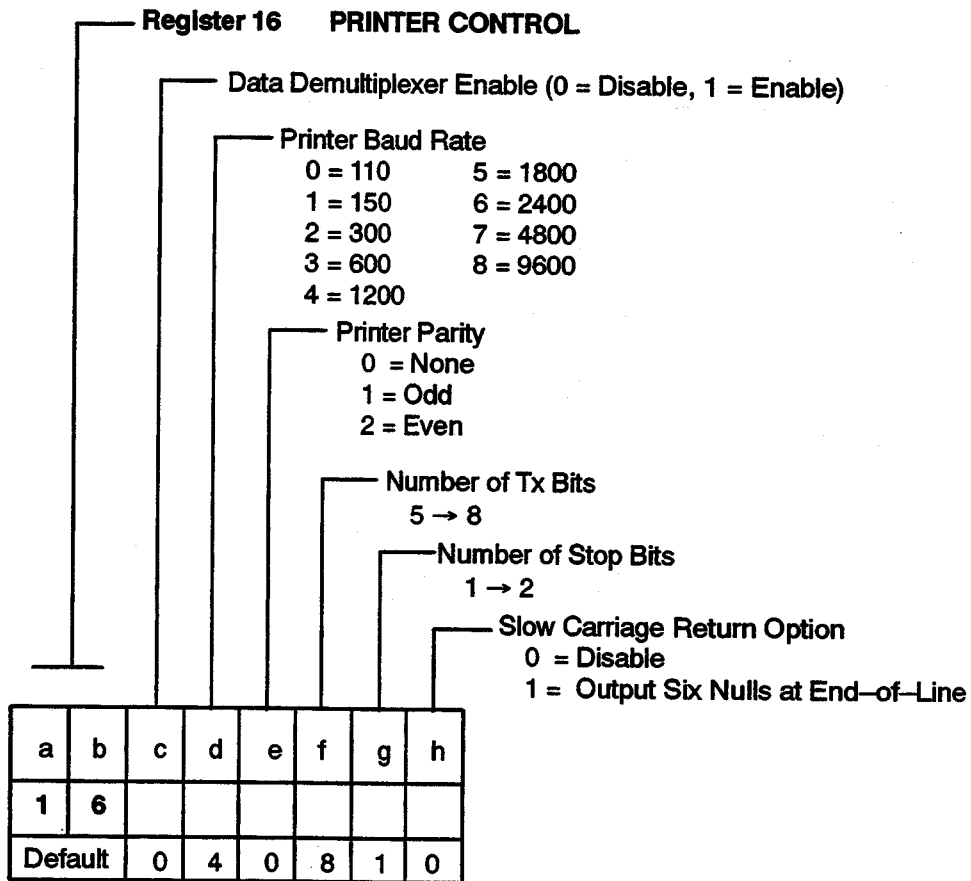

COMMAND 110

FEATURE ACCESS CODE PROGRAMMING

Feature:

- 01 — DIAL ACCESS TO ATTENDANT
- 02 — PAGING ACCESS
- 03 — CALL HOLD
- 04 — CALL HOLD RETRIEVE — LOCAL
- 05 — CALL HOLD RETRIEVE — REMOTE
- 06 — DIAL CALL PICKUP
- 07 — SYSTEM ABBREVIATED DIAL ACCESS
- 08 — CALL FORWARD — FOLLOW ME
- 09 — TAFAS PICKUP

- 10 — CALL FORWARD — NO ANSWER
- 11 — CALL FORWARD — BUSY
- 12 — CALL FORWARD — BUSY/NO ANSWER
- 13 — PROGRAMMING ACCESS
- 14 — ATTENDANT FUNCTIONS
- 15 — CLEAR ALL FEATURE
- 16 — CALL PARK (ATTENDANT) 1
- 17 — CALL PARK (ATTENDANT) 2
- 18 — CALL PARK (ATTENDANT) 3

Access Code

a	b	c	d	e	f
0	1				
0	2				
0	3				
0	4				
0	5				
0	6				
0	7				
0	8				
0	9				
1	0				
1	1				
1	2				
1	3				
1	4				
1	5				
1	6				
1	7				
1	8				

DEFAULT VALUES

a	b	c	d	e	f
0	1	0			
0	2	5	0		
0	3	5	1		
0	4	5	2		
0	5	5	3		
0	6	5	4		
0	7	5	5		
0	8	5	6		
0	9	5	7		
1	0	5	8		
1	1	5	9		
1	2	6	0		
1	3	7	0		
1	4	7	1		
1	5	4	4	4	
1	6	4	5	1	
1	7	4	5	2	
1	8	4	5	3	

COMMAND 110

FEATURE ACCESS CODE PROGRAMMING

Feature:

- 19 — HUNT GROUP 1 ACCESS
- 20 — HUNT GROUP 2 ACCESS
- 21 — HUNT GROUP 3 ACCESS
- 22 — HUNT GROUP 4 ACCESS
- 23 — HUNT GROUP 5 ACCESS
- 24 — HUNT GROUP 6 ACCESS
- 25 — RING GROUP ACCESS
- 26 — RMATS MODEM ACCESS
- 27 — ONS MESSAGE WTG ACTIVATE
- 28 — ACCOUNT CODE ENTRY
- 29 — Reserved

- 30 — ATTENDANT/DIRECTED CALL PICKUP
- 31 — MAILD IN ROOM
- 32 — CALLBACK SETUP
- 33 — DO NOT DISTURB
- 34 — HUNT GROUP LOGIN/LOGOUT
- 35 — DID LDN 1 ACCESS
- 36 — DID LDN 2 ACCESS
- 37 — DID LDN 3 ACCESS
- 38 — ONS MSG WTG CALLBACK
- 39 — ONS CANCEL MSG WTG
- 40 — VERIFIED AUTHORIZATION CODES
- 41 — WAKEUP FROM EXTENSION

Access Code

	a	b	c	d	e	f
1	9					
2	0					
2	1					
2	2					
2	3					
2	4					
2	5					
2	6					
2	7					
2	8					
2	9					
3	0					
3	1					
3	2					
3	3					
3	4					
3	5					
3	6					
3	7					
3	8					
3	9					
4	0					
4	1					

DEFAULT VALUES

	a	b	c	d	e	f
1	9	4	9	1		
2	0	4	9	2		
2	1	4	9	3		
2	2	4	9	4		
2	3	4	9	5		
2	4	4	9	6		
2	5	4	9	7		
2	6	4	9	8		
2	7	7	2			
2	8	7	5			
2	9	7	6			
3	0	6	1			
3	1	7	4	7		
3	2	6	2			
3	3	6	3			
3	4	6	4			
3	5					
3	6					
3	7					
3	8	6	5			
3	9	6	6			
4	0	6	7			
4	1	6	9			

COMMANDS 121 → 129

COS 1 → COS 9 PROGRAMMING

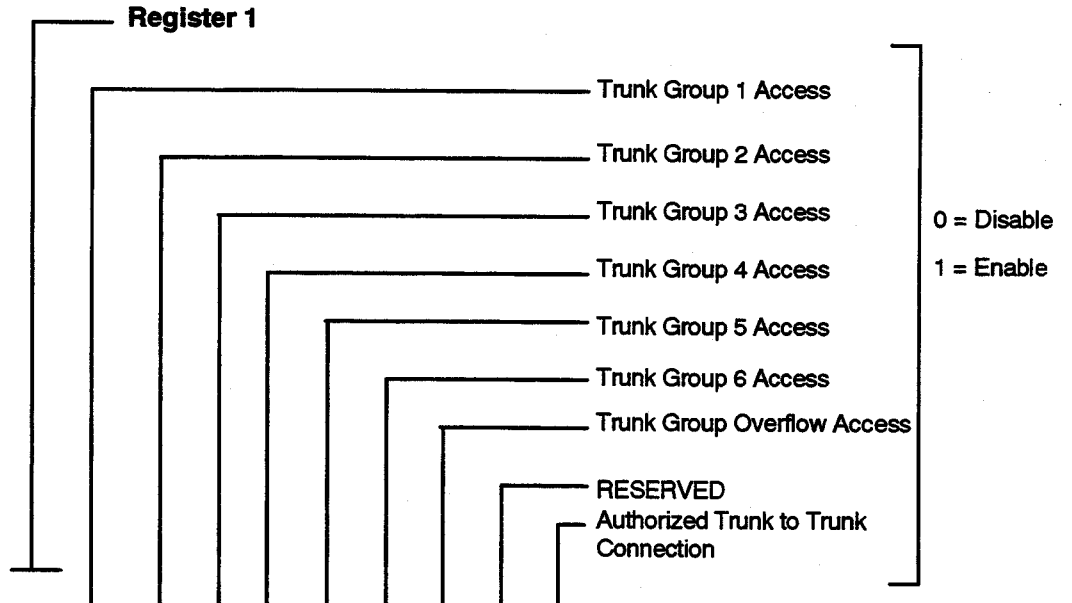

Command	a	b	c	d	e	f	g	h	i	j	
121	1										COS 1
122	1										COS 2
123	1										COS 3
124	1										COS 4
125	1										COS 5
126	1										COS 6
127	1										COS 7
128	1										COS 8
129	1										COS 9
Default	1	1	1	1	1	1	1	0	0	1	

COMMANDS 121 → 129

COS 1 → COS 9 PROGRAMMING

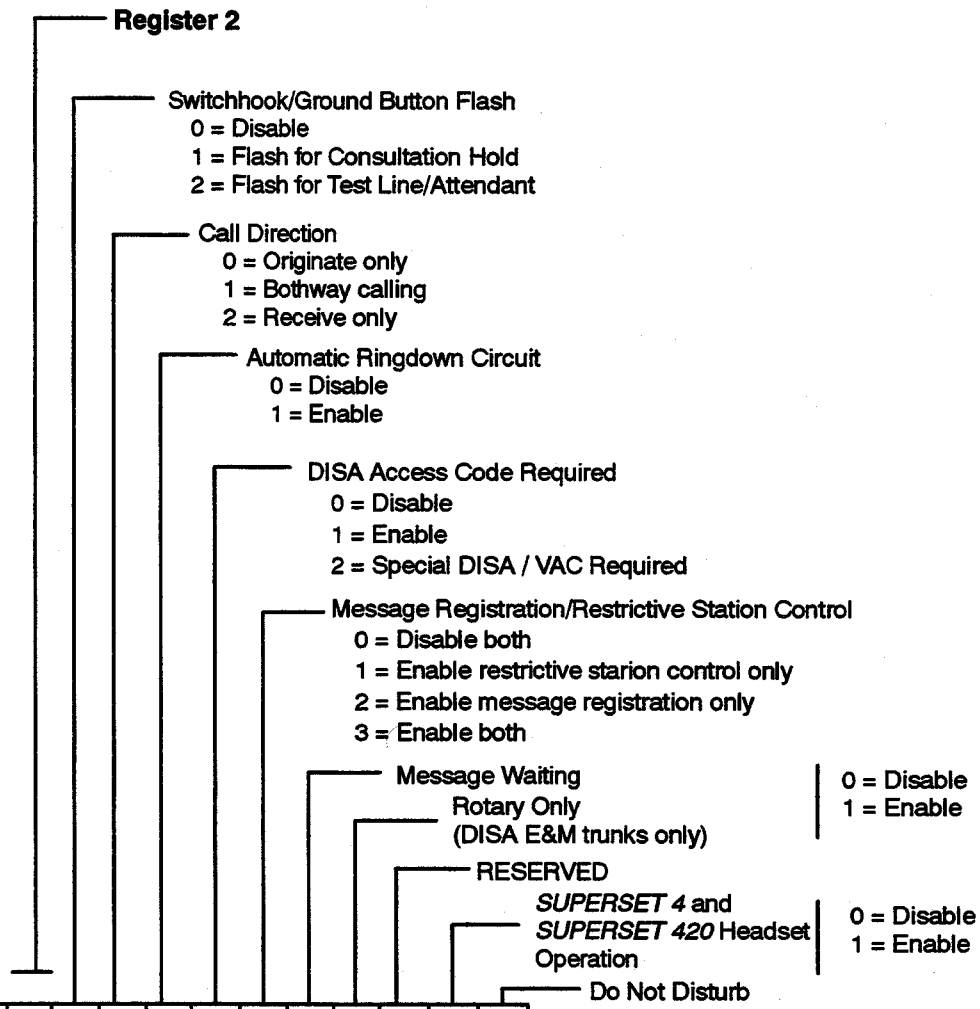

Command	a	b	c	d	e	f	g	h	i	j	k
121	2								0		
122	2								0		
123	2								0		
124	2								0		
125	2								0		
126	2								0		
127	2								0		
128	2								0		
129	2								0		
Default	2	1	1	0	0	0	1	0	0	0	0

COS 1
COS 2
COS 3
COS 4
COS 5
COS 6
COS 7
COS 8
COS 9

COMMANDS 121 → 129

COS 1 → COS 9 PROGRAMMING

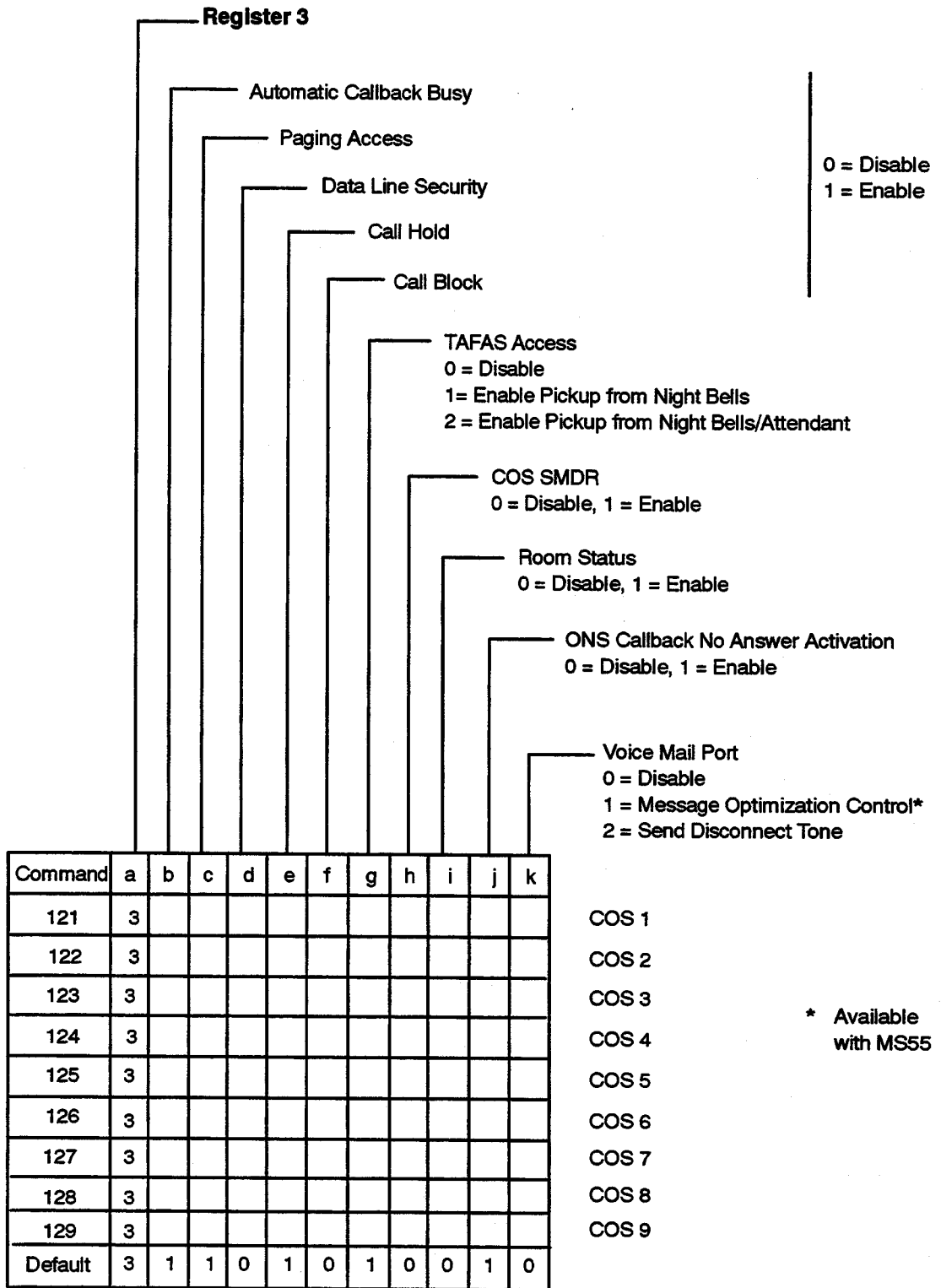

COMMANDS 121 → 129

COS 1 → COS 9 PROGRAMMING

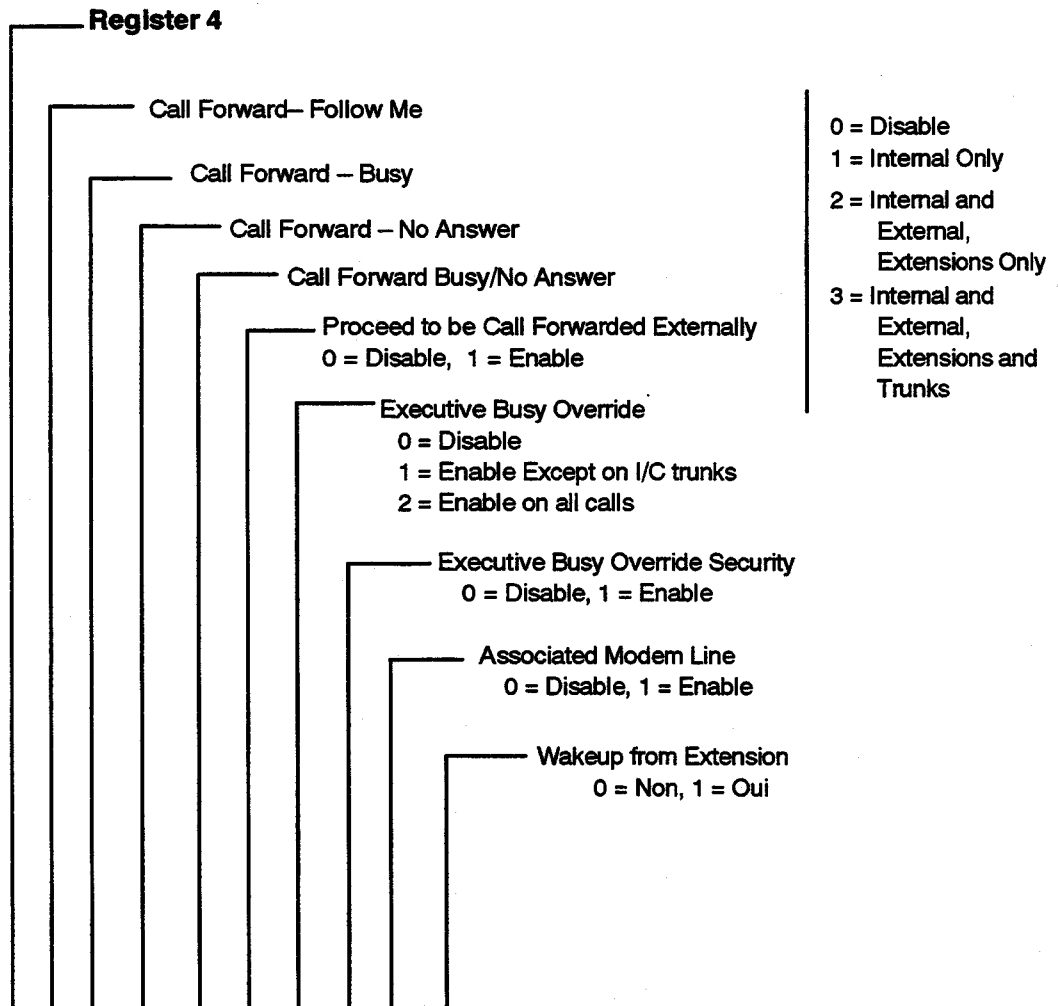

- 0 = Disable
- 1 = Internal Only
- 2 = Internal and External, Extensions Only
- 3 = Internal and External, Extensions and Trunks

Command	a	b	c	d	e	f	g	h	i	j
121	4									
122	4									
123	4									
124	4									
125	4									
126	4									
127	4									
128	4									
129	4									
Default	4	1	1	1	1	0	0	0	0	0

COS 1
 COS 2
 COS 3
 COS 4
 COS 5
 COS 6
 COS 7
 COS 8
 COS 9

COMMANDS 121 → 129

COS 1 → COS 9 PROGRAMMING

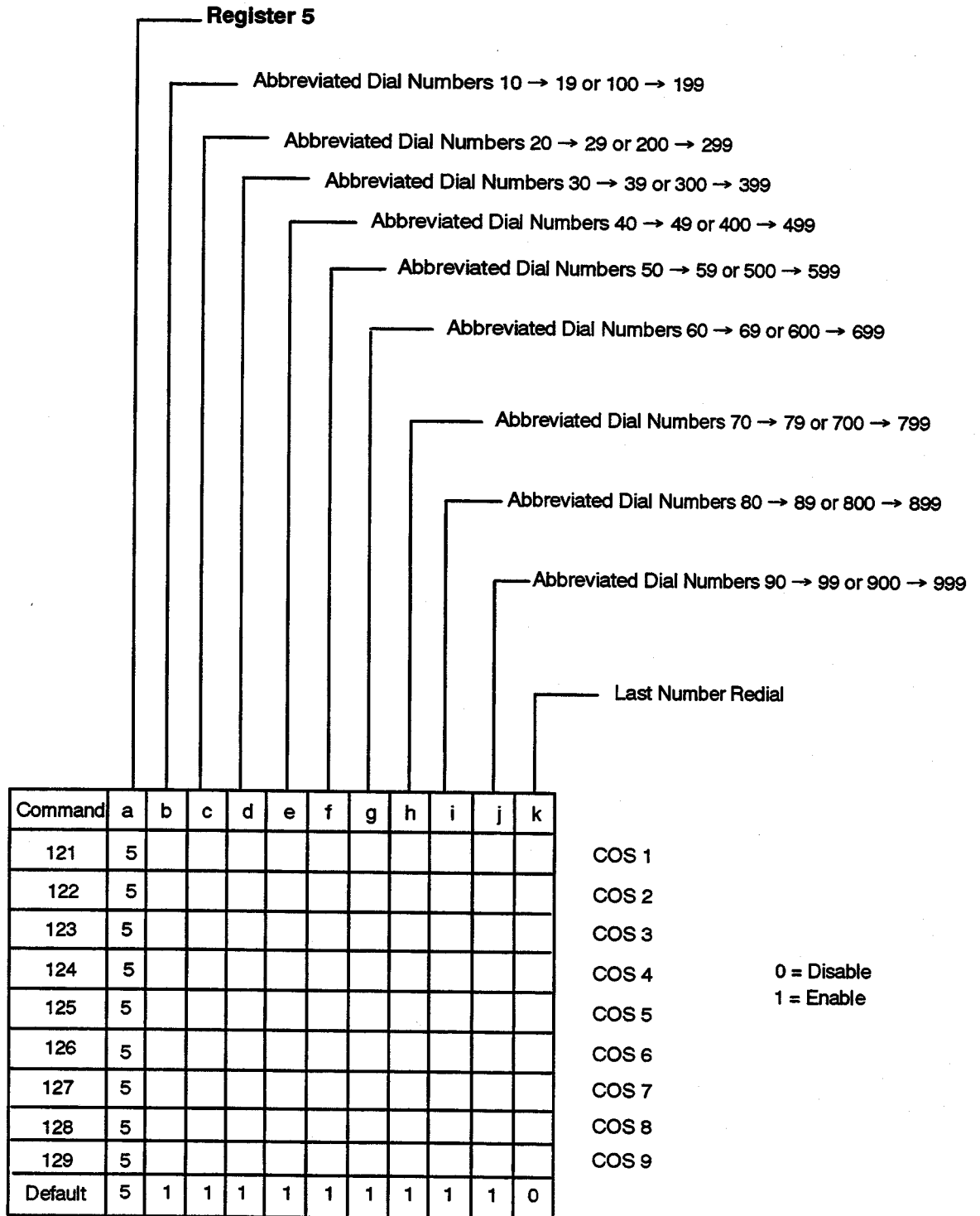

COMMANDS 121 → 129

COS 1 → COS 9 PROGRAMMING

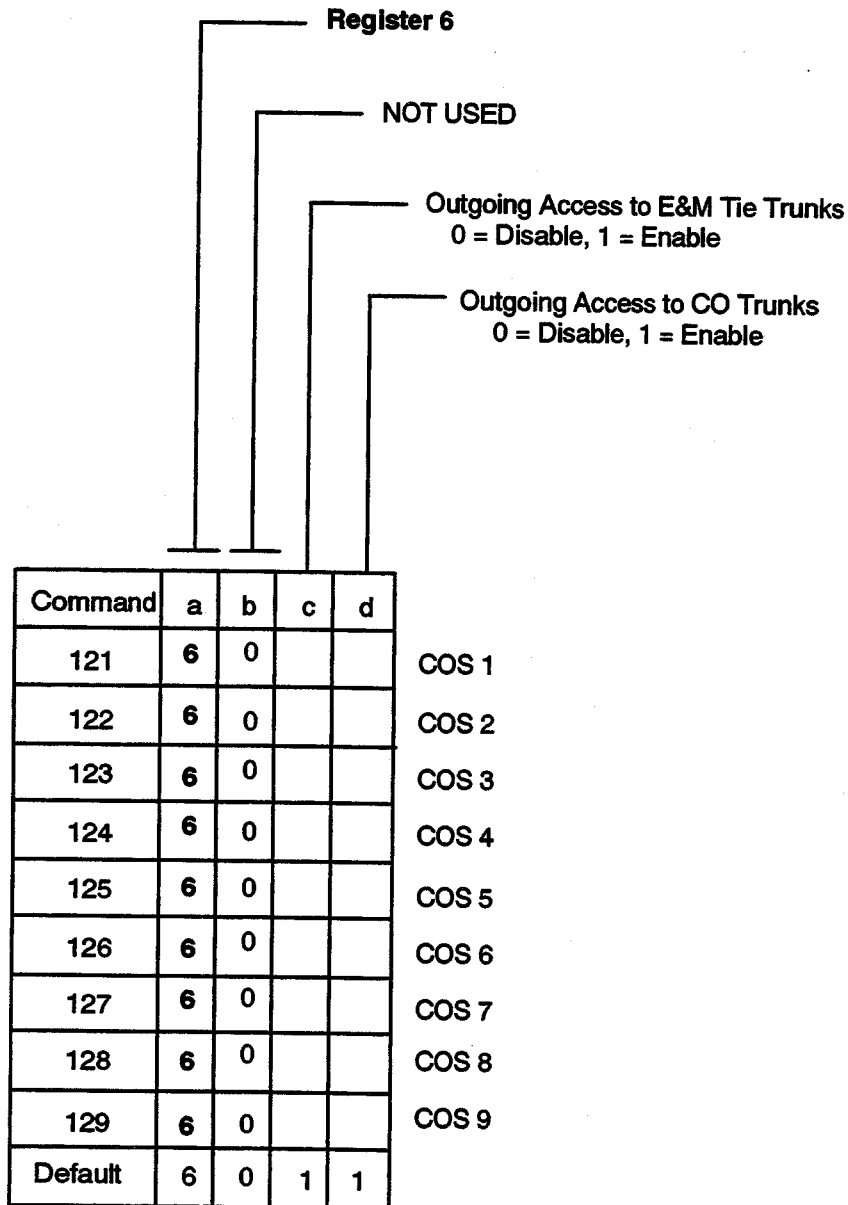

COMMANDS 121 → 129

COS 1 → COS 9 PROGRAMMING

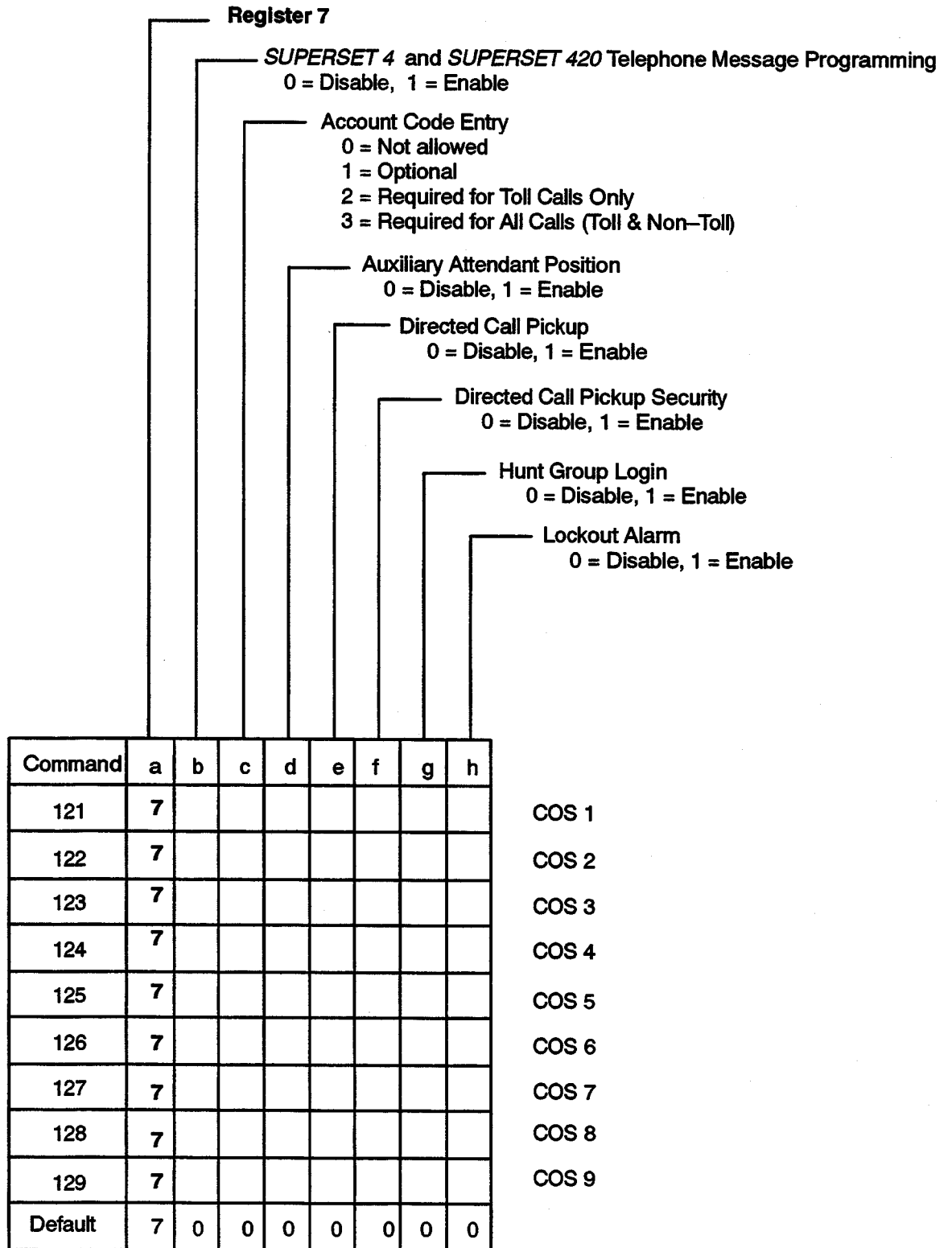

COMMANDS 121 → 129

COS 1 → COS 9 PROGRAMMING

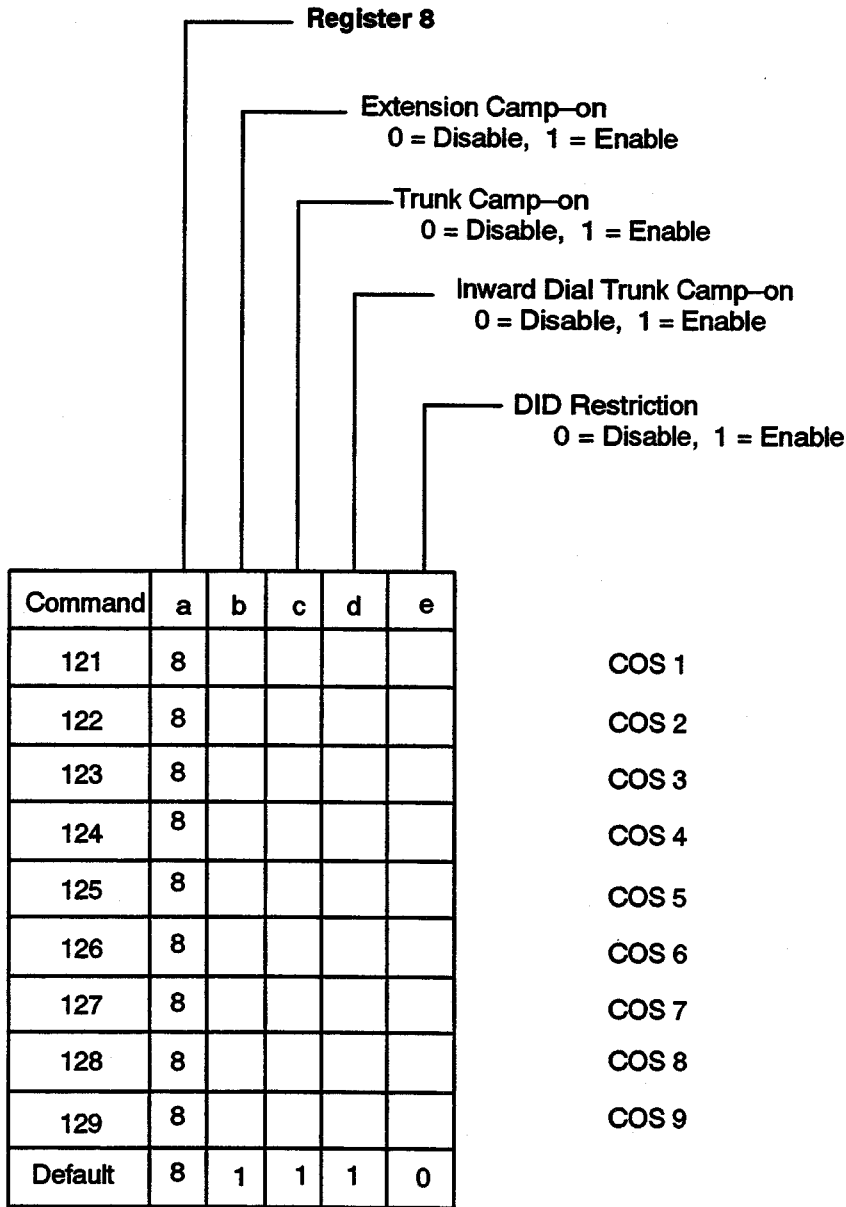

COMMANDS 151 → 156

TRUNK GROUP PROGRAMMING

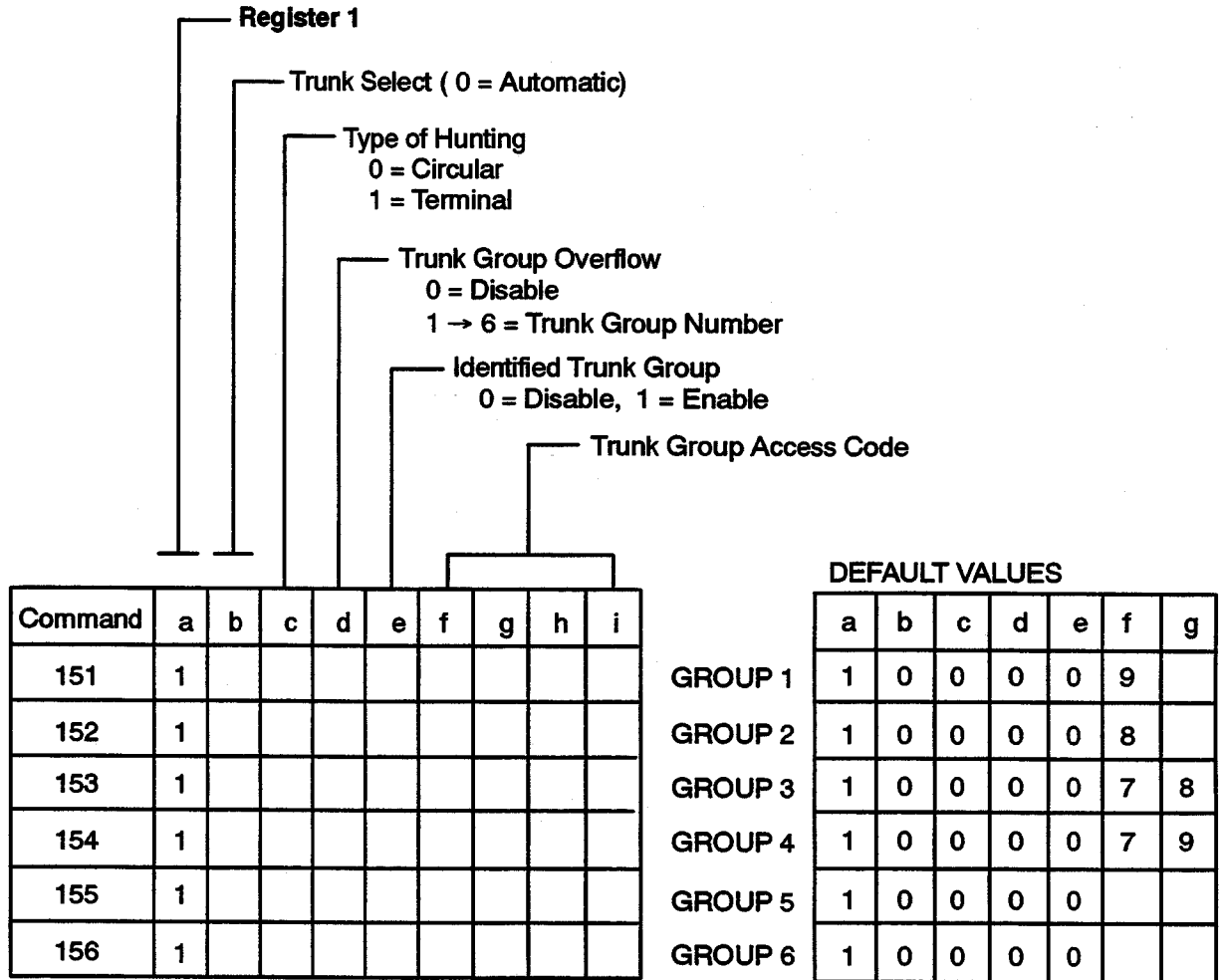

COMMANDS 151 → 156

TRUNK GROUP PROGRAMMING

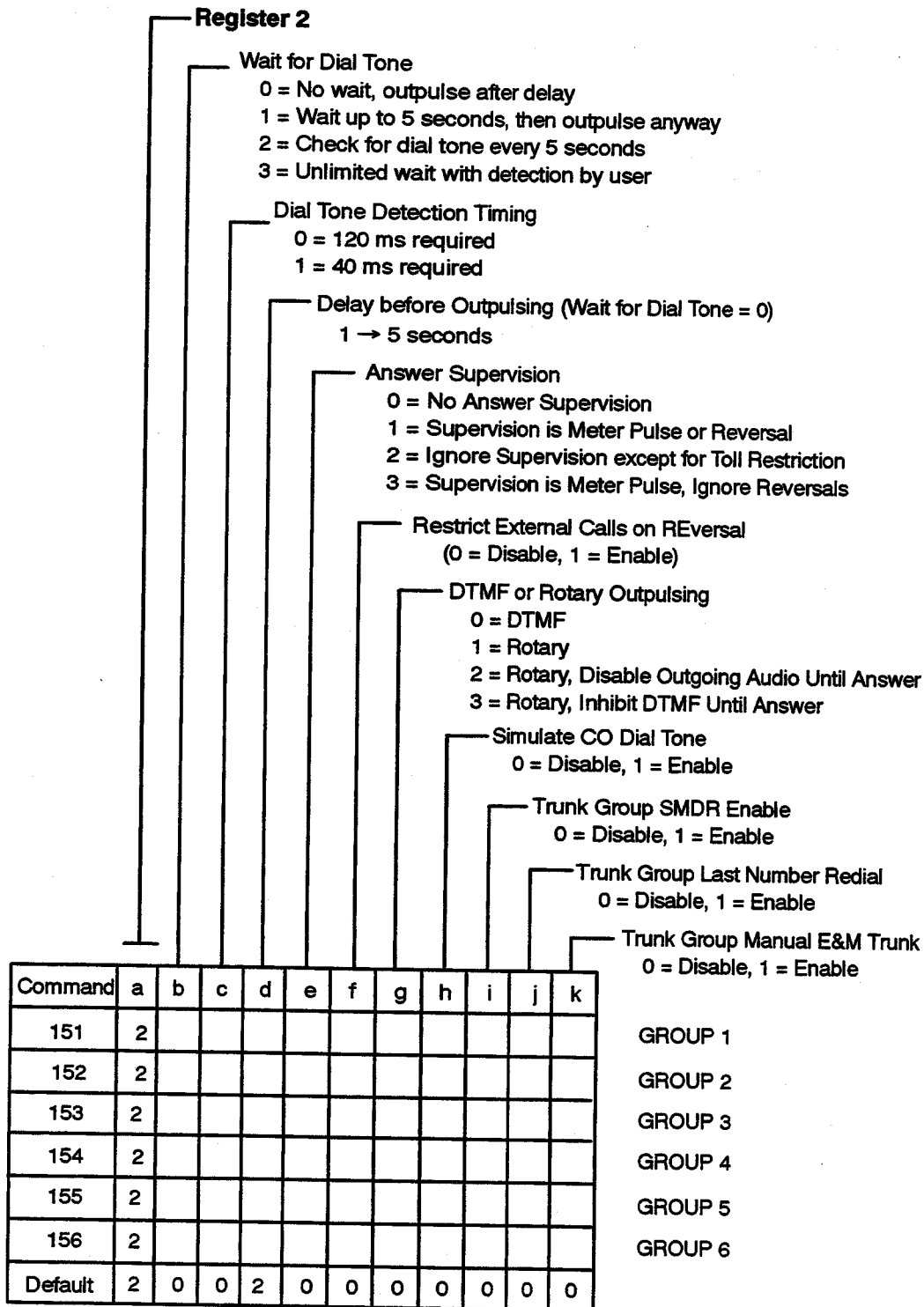

COMMANDS 151 → 156

TRUNK GROUP PROGRAMMING

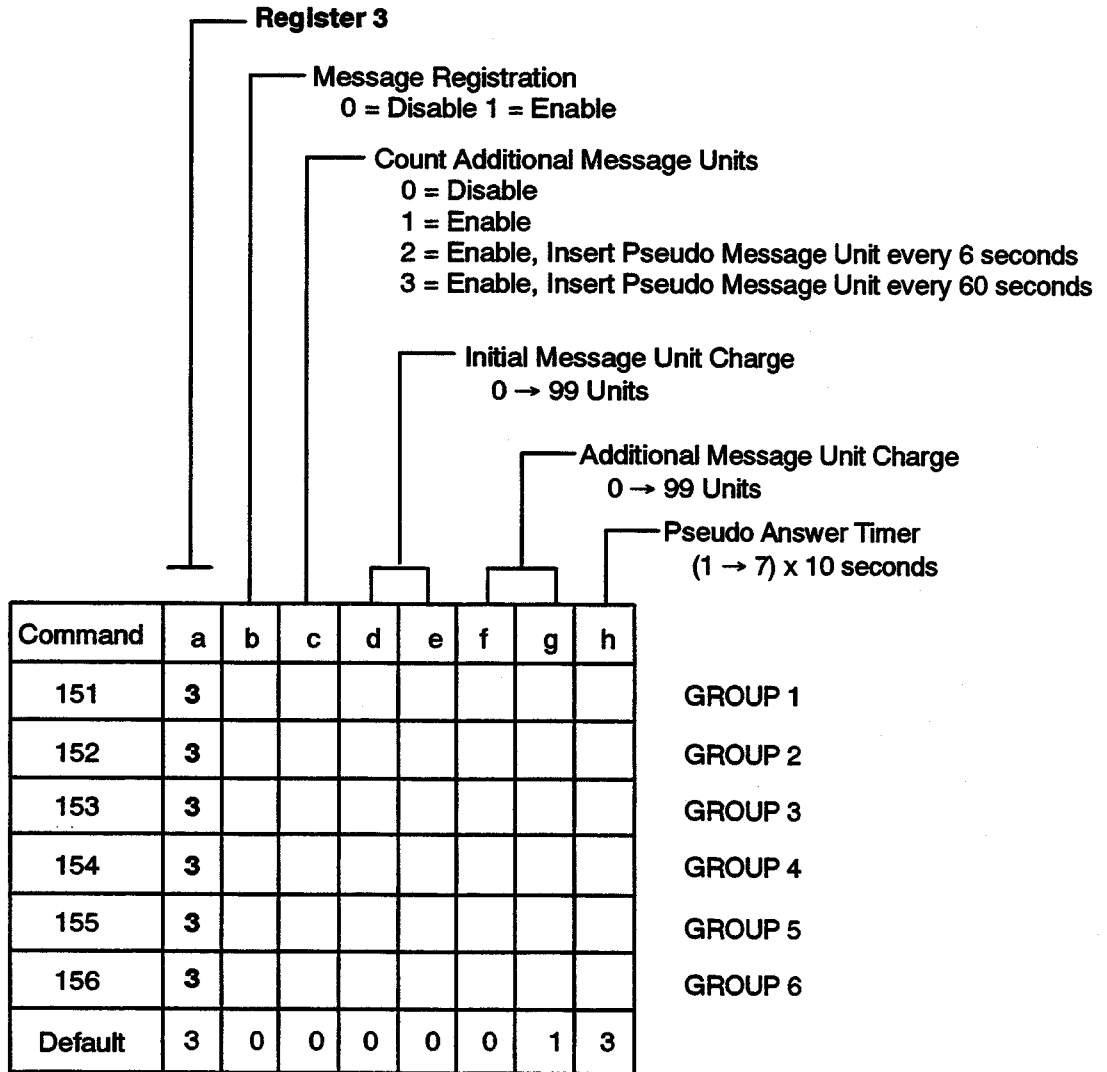

COMMANDS 151 → 156

TRUNK GROUP PROGRAMMING

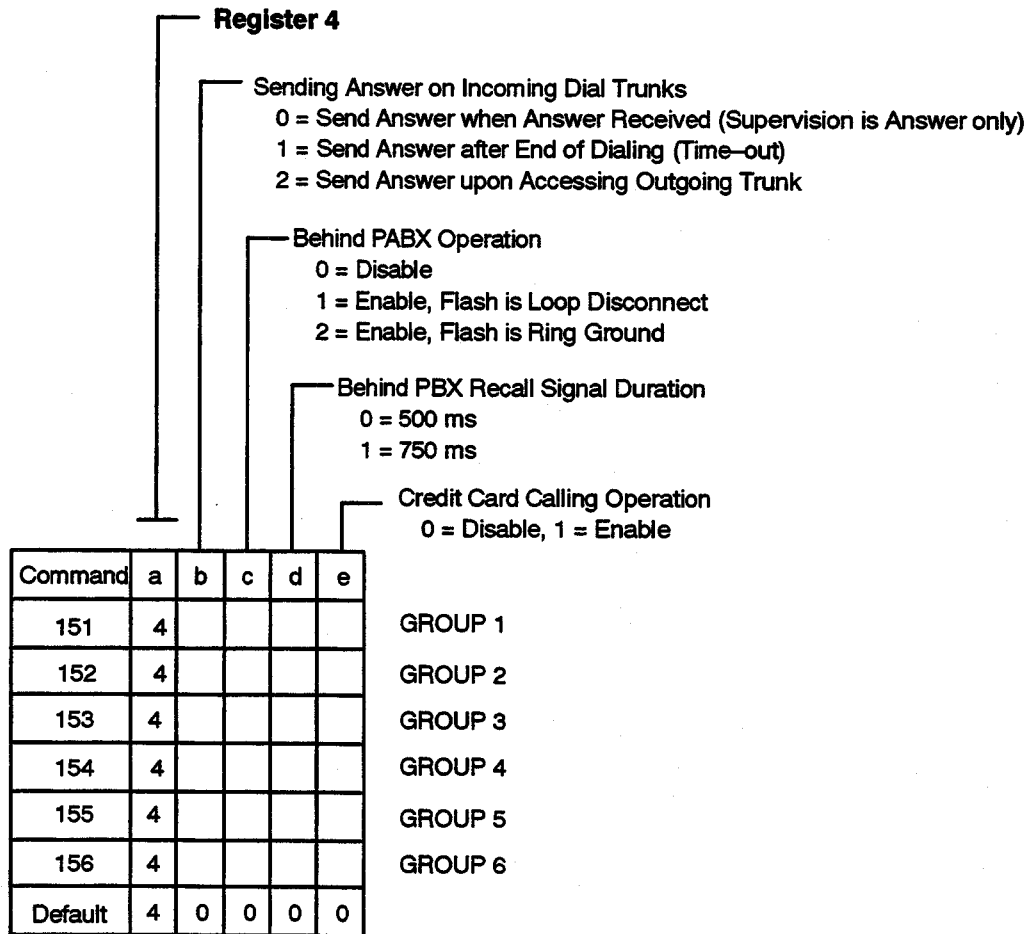

COMMAND 180

USER PROGRAMMING ACCESS

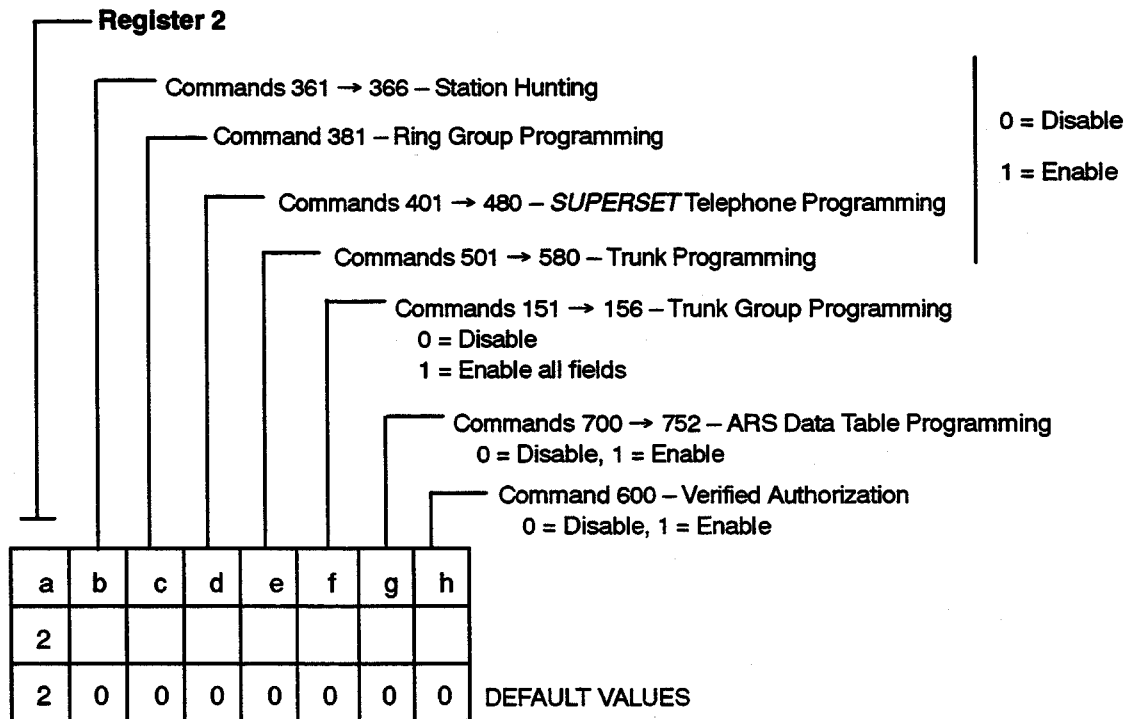
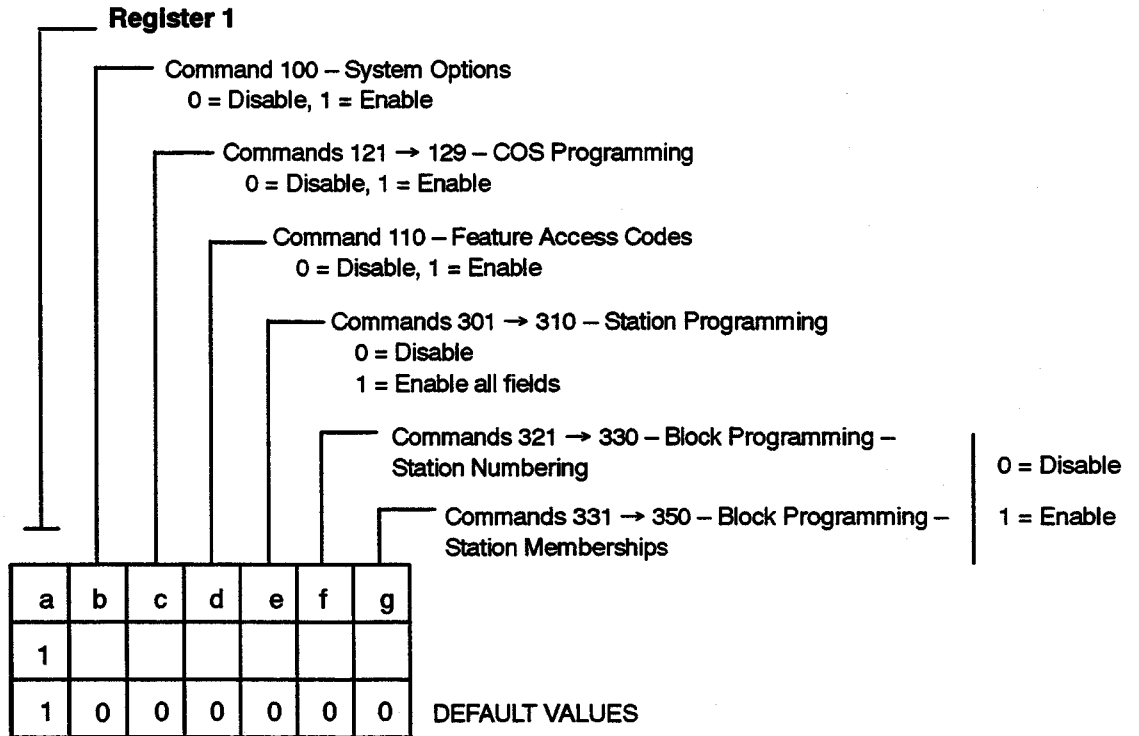

COMMAND 180

USER PROGRAMMING ACCESS

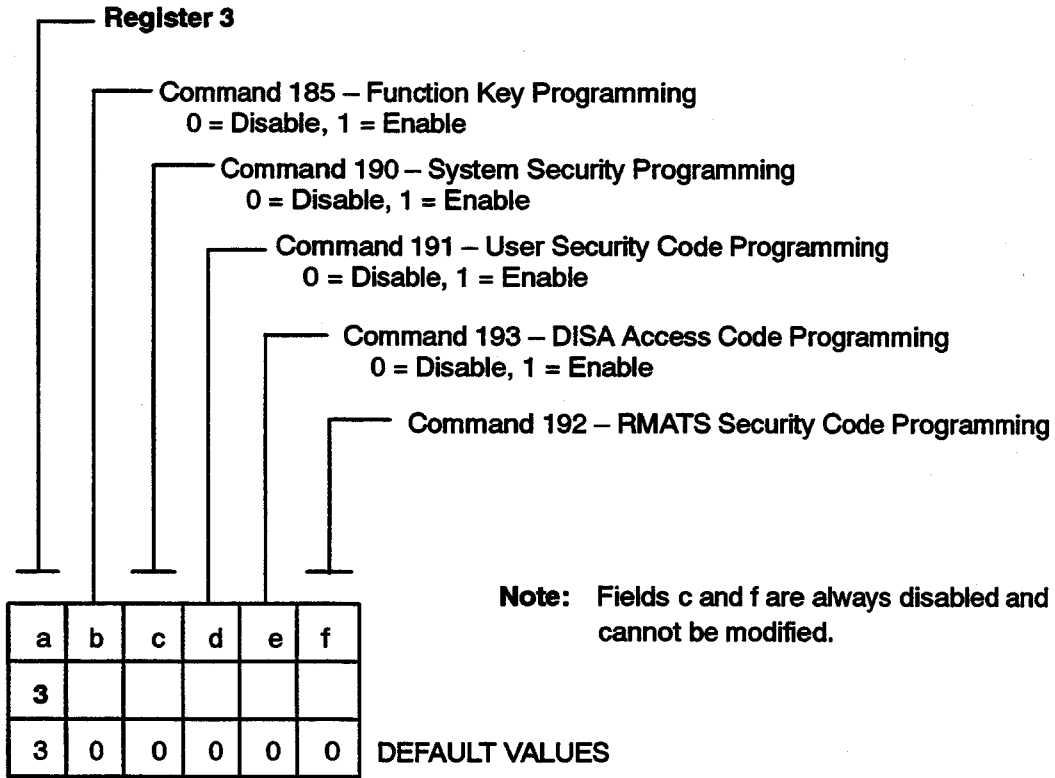

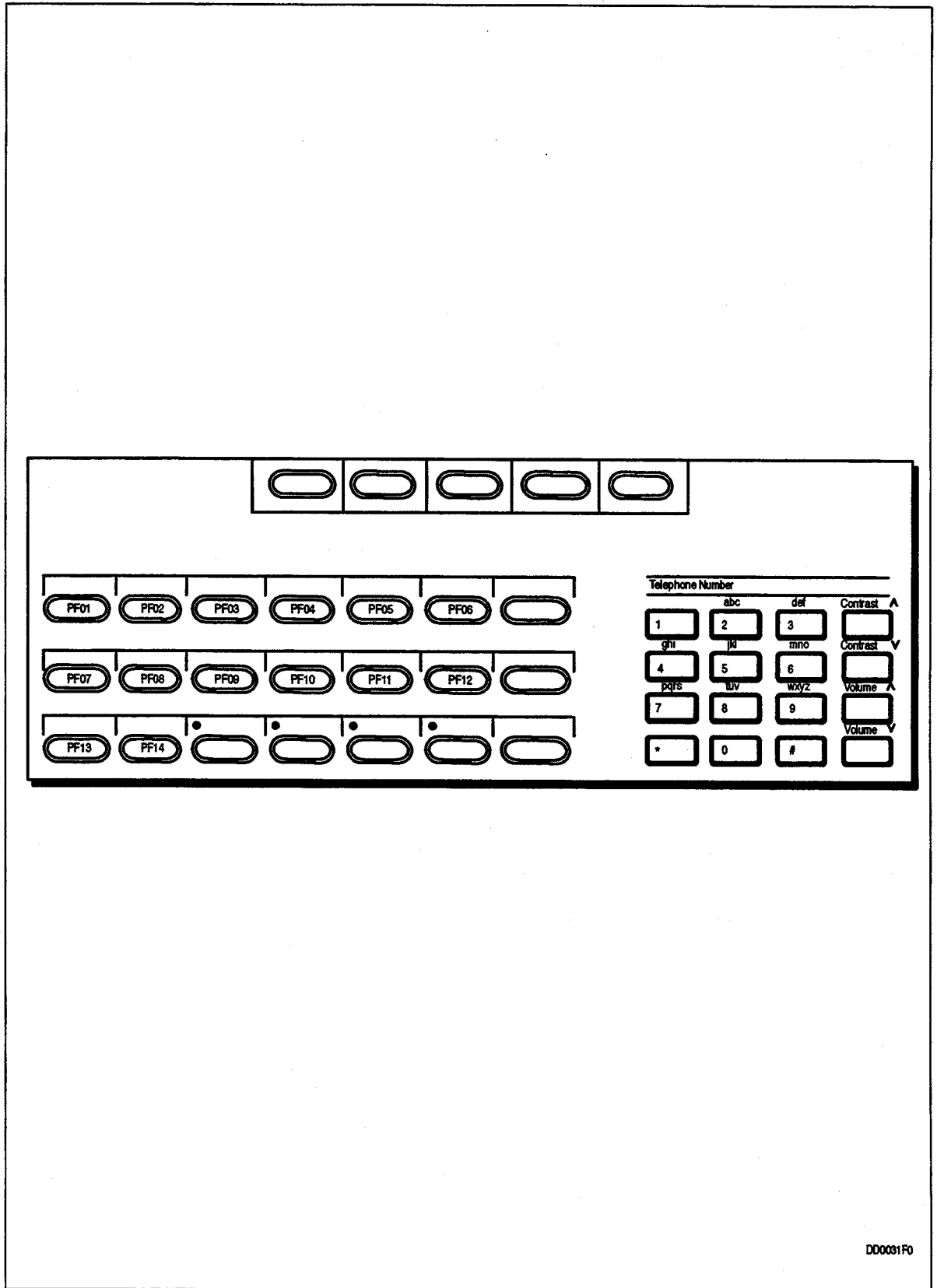

DD0031F0

Figure 2-2 Programmable Function Keys

COMMAND 185

ATTENDANT CONSOLE FUNCTION KEY PROGRAMMING

Key Number (1 → 14)

Key Function:

- 00 = Unassigned
- 01 = Message Registration / Restrictive Station Control
- 02 = Override
- 03 = Page
- 04 = Call Block
- 05 = TAFAS
- 06 = Automatic Wake-up
- 07 = Trunk Status
- 08 = Account Code Entry
- 09 = Message Waiting
- 10 = Function
- 11 = Mute
- 12 = Night
- 13 = Swap/Split
- 14 = Status
- 15 = Both
- 16 = Room Status
- 17 = Do Not Disturb
- 18 = Attendant Tone Signalling
- 19 = Restrict DID
- 20 = VAC Entry
- 21 = Attendant Call Pickup

DETAILED TABLE:

Key Number	a	b	c	d
00	0	1		
01	0	2		
02	0	3		
03	0	4		
04	0	5		
05	0	6		
06	0	7		
07	0	8		
08	0	9		
09	1	0		
10	1	1		
11	1	2		
12	1	3		
13	1	4		

DEFAULT VALUES:

Key Number	a	b	c	d
00	0	1	1	0
01	0	2	1	4
02	0	3	0	7
03	0	4	0	4
04	0	5	0	5
05	0	6	0	3
06	0	7	0	6
07	0	8	0	1
08	1	9	0	2
09	1	0	0	9
10	1	1	1	5
11	1	2	1	3
12	1	3	1	1
13	1	4	1	2

COMMAND 190

SYSTEM SECURITY CODE PROGRAMMING

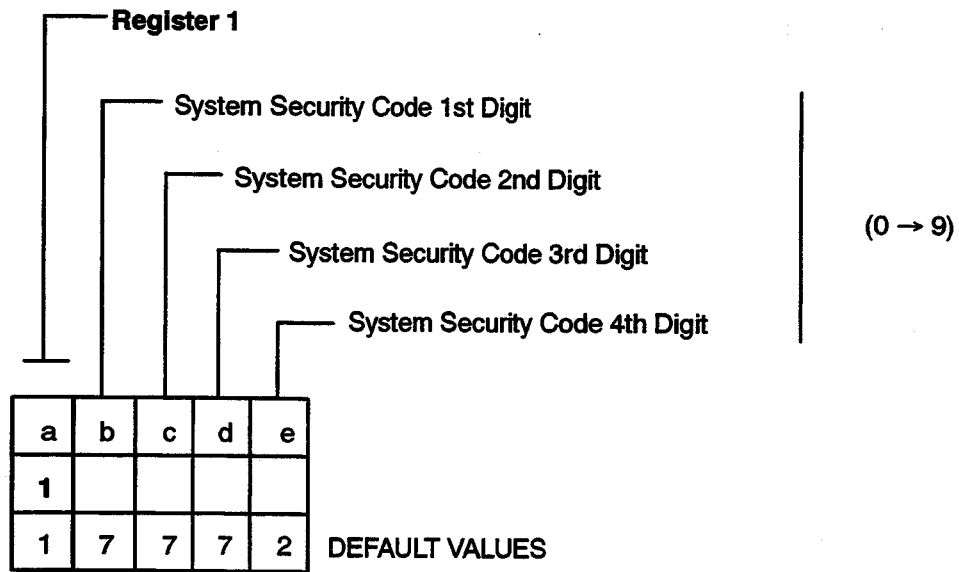

COMMAND 191

USER SECURITY CODE PROGRAMMING

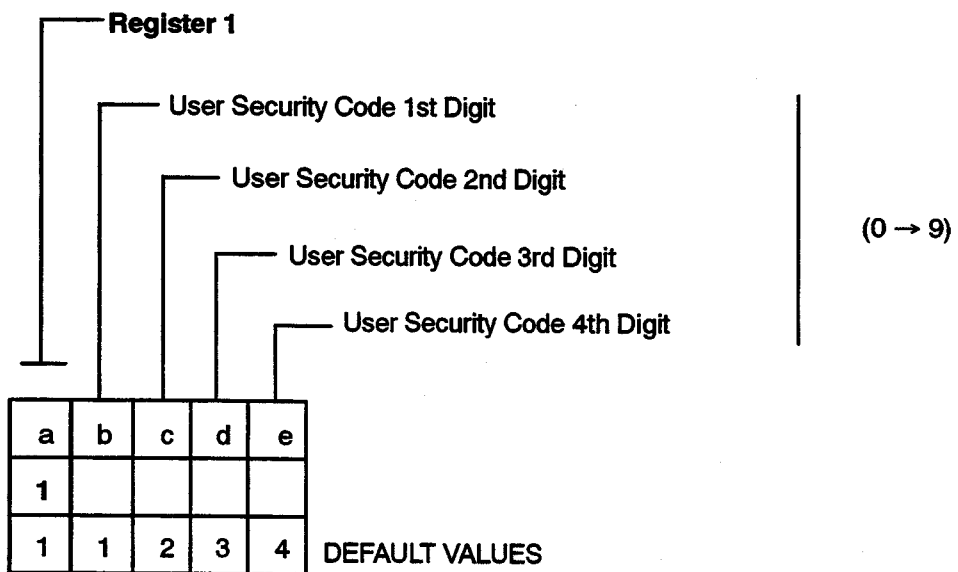

COMMAND 192

RMATS SECURITY CODE PROGRAMMING

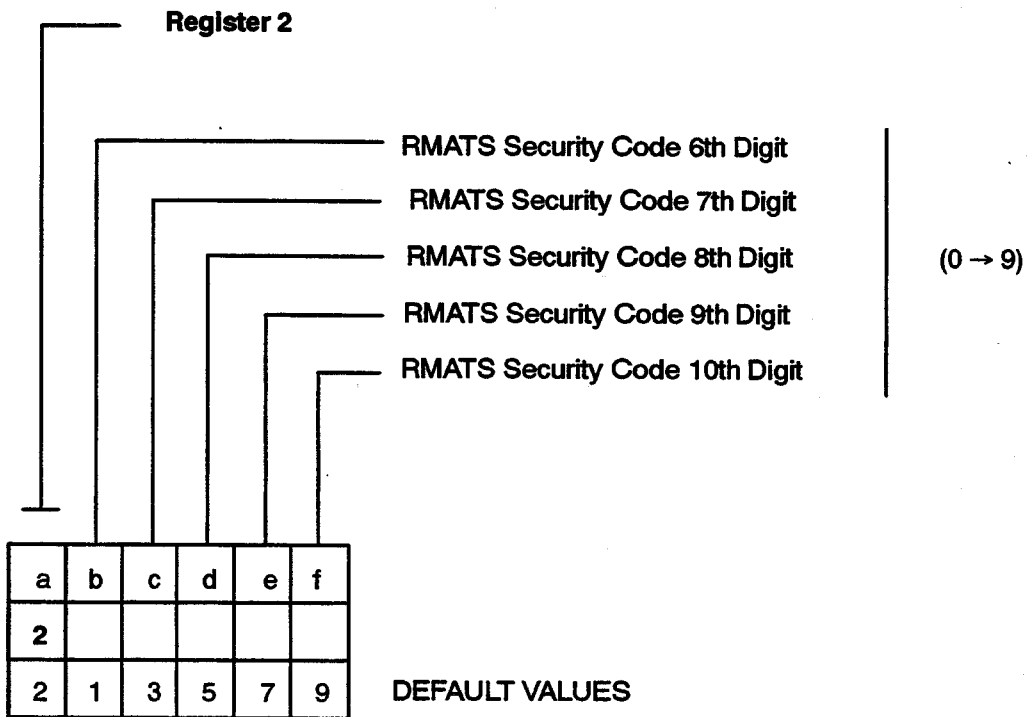
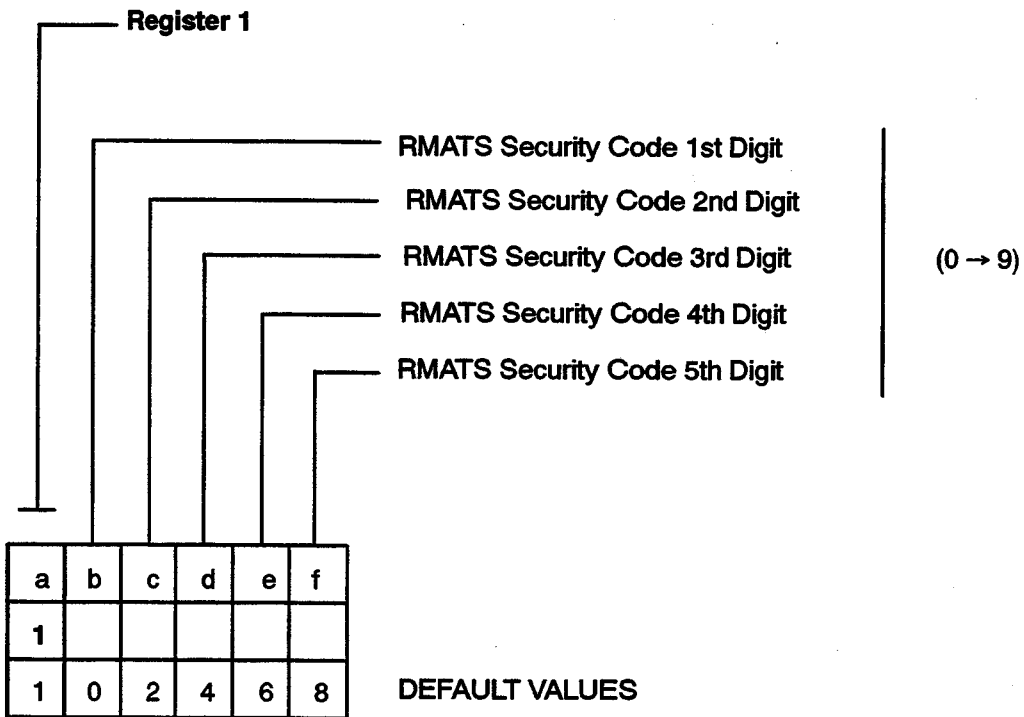

COMMAND 193

DISA ACCESS CODE PROGRAMMING

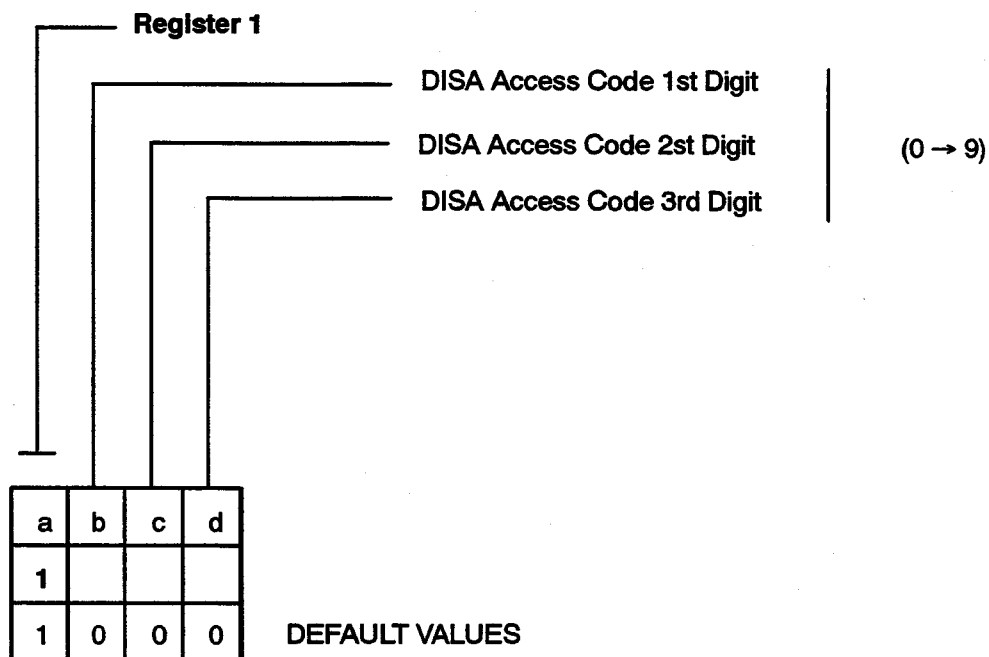

Callers on a DISA Trunk with DISA Access Code Required enabled in its Class of Service must enter the Access Code. By default, the DISA Access Code is not required and callers have immediate access to SX-50 system features.

COMMAND 3 (301 → 310)

EXTENSION PROGRAMMING

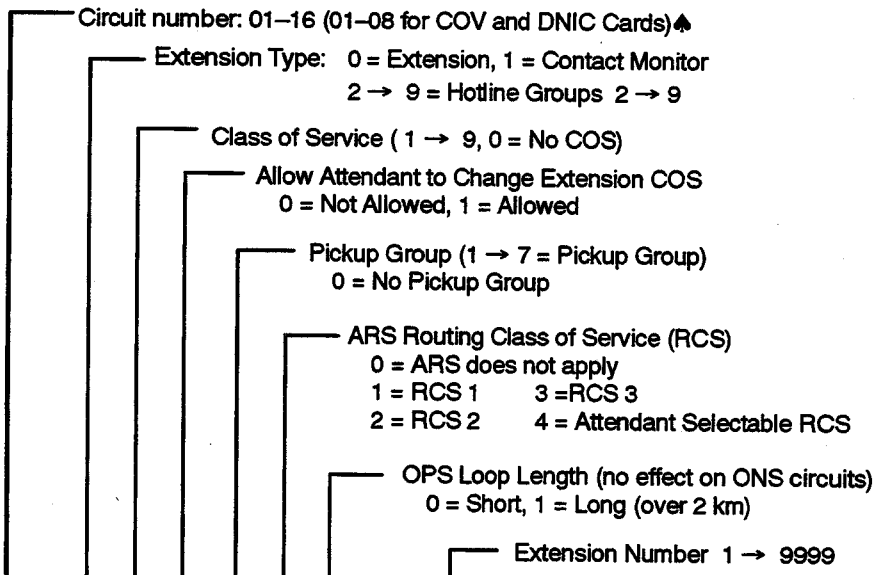

a	b	c	d	e	f	g	h	i	j	k	l	comment
0	1											
0	2											
0	3											
0	4											
0	5											
0	6											
0	7											
0	8											
0	9											
1	0											
1	1											
1	2											
1	3											
1	4											
1	5											
1	6											
Default	0	1	0	1	0	0						

♣ Only odd-numbered circuits are valid for OPS extensions.

COMMAND 3 ___ (301 → 310)

EXTENSION PROGRAMMING

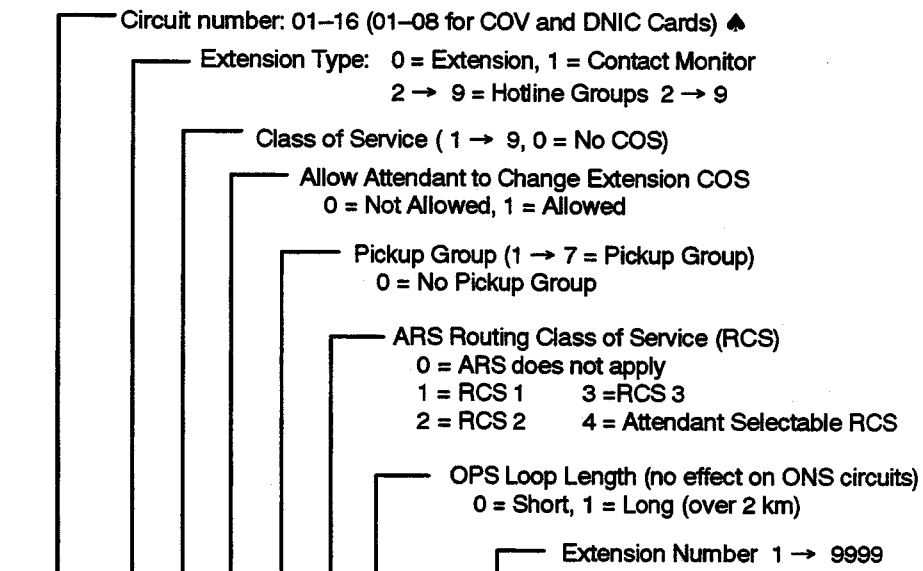

a	b	c	d	e	f	g	h	i	j	k	l	comment
0	1											
0	2											
0	3											
0	4											
0	5											
0	6											
0	7											
0	8											
0	9											
1	0											
1	1											
1	2											
1	3											
1	4											
1	5											
1	6											
Default	0	1	0	1	0	0						

♣ Only odd-numbered circuits are valid for OPS extensions.

COMMAND 3 ___ (301 → 310)

EXTENSION PROGRAMMING

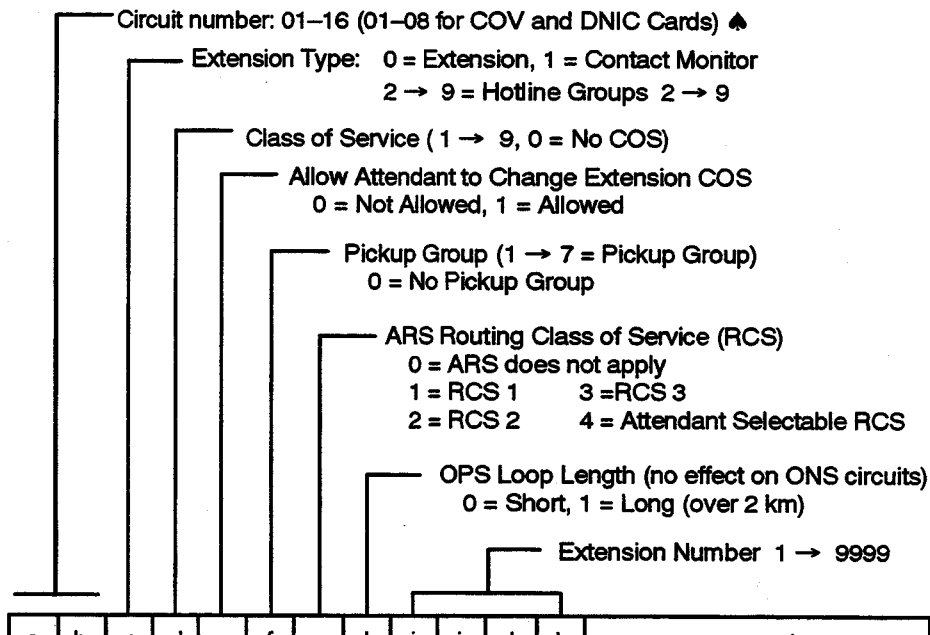

a	b	c	d	e	f	g	h	i	j	k	l	comment
0	1											
0	2											
0	3											
0	4											
0	5											
0	6											
0	7											
0	8											
0	9											
1	0											
1	1											
1	2											
1	3											
1	4											
1	5											
1	6											
Default	0	1	0	1	0	0	0					

♣ Only odd-numbered circuits are valid for OPS extensions.

COMMANDS 321 → 330

EXTENSION NUMBERING – BLOCK PROGRAMMING

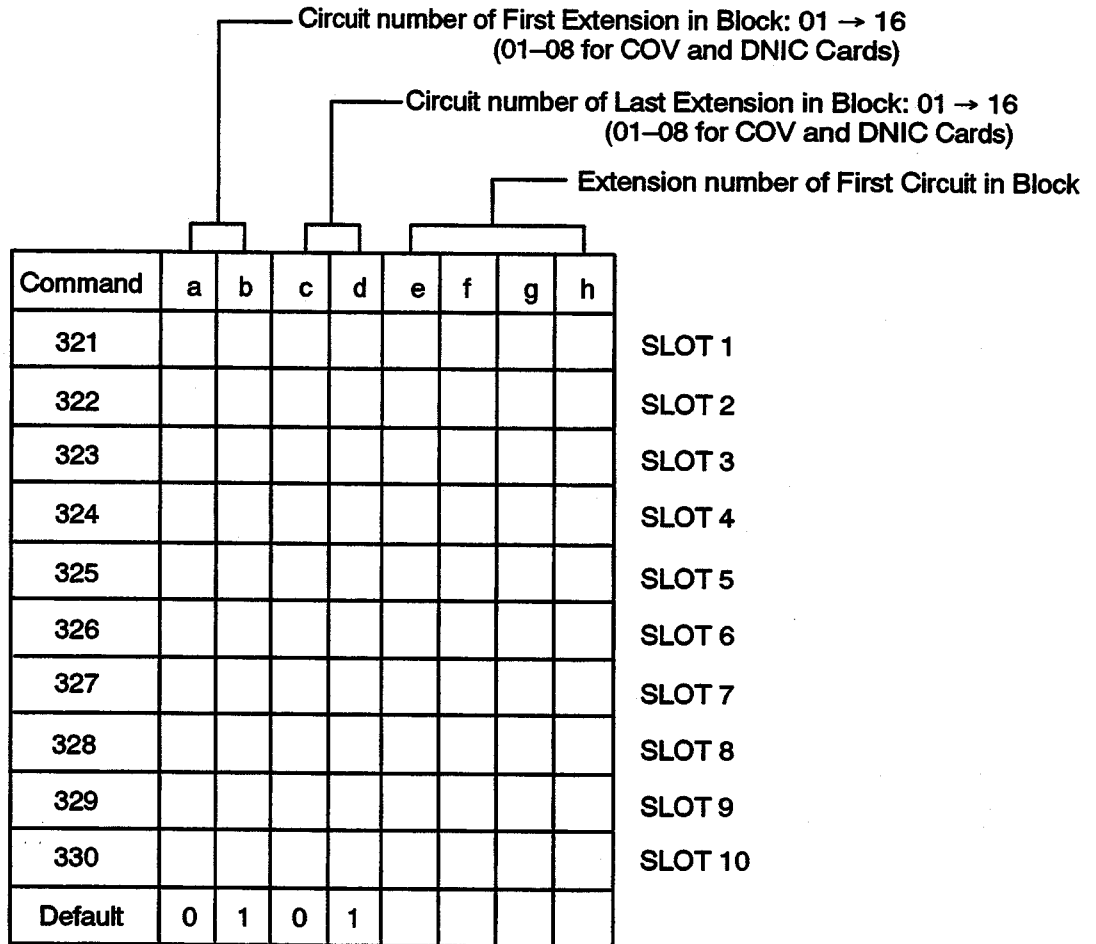

Note: Slots 9 (nine) and 10 (ten) not available for DNIC Telephones.

COMMANDS 341 → 350

EXTENSION MEMBERSHIPS – BLOCK PROGRAMMING

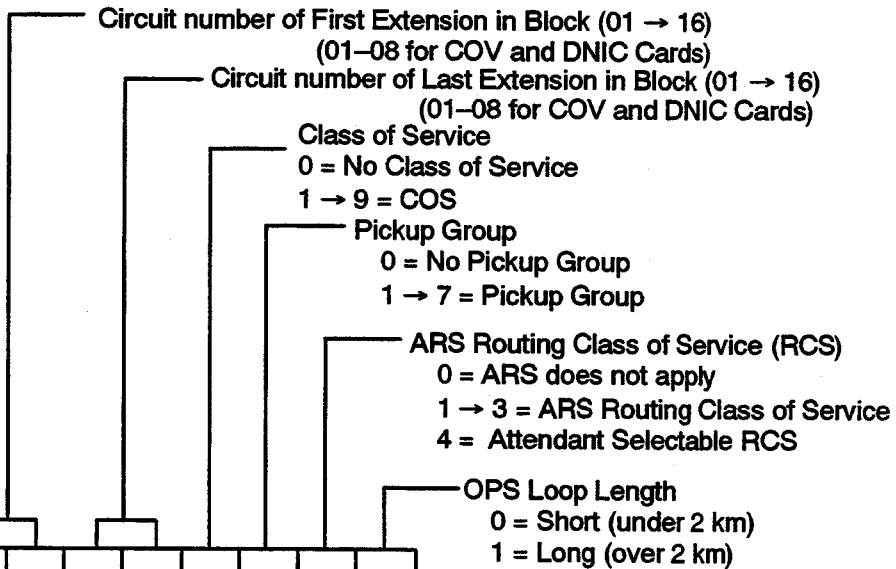

Command	a	b	c	d	e	f	g	h
341								
342								
343								
344								
345								
346								
347								
348								
349								
350								
Default	0	1	0	1	1	1	0	0

SLOT 1
SLOT 2
SLOT 3
SLOT 4
SLOT 5
SLOT 6
SLOT 7
SLOT 8
SLOT 9
SLOT 10

COMMAND 361

EXTENSION HUNT GROUP 1 PROGRAMMING

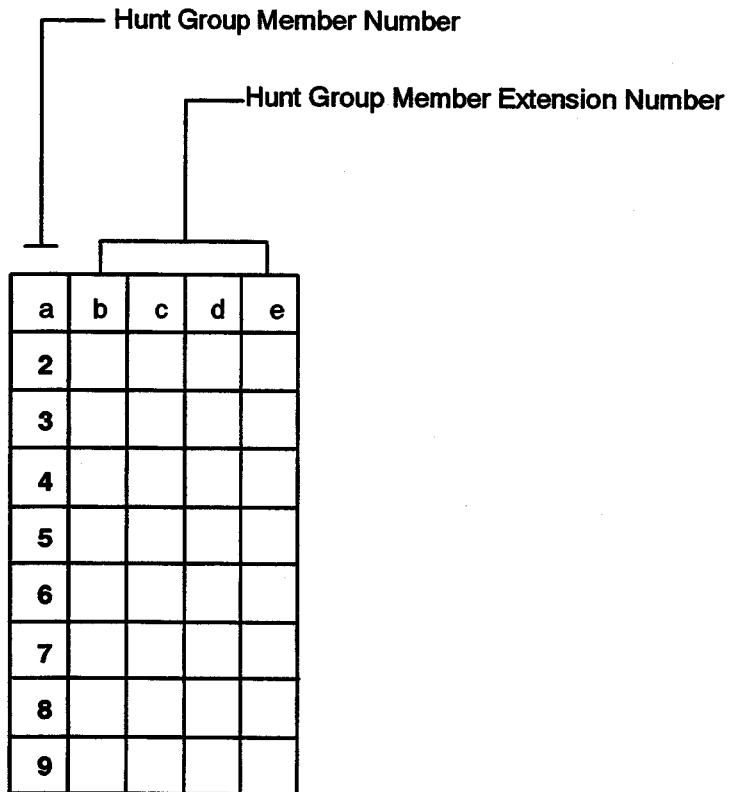
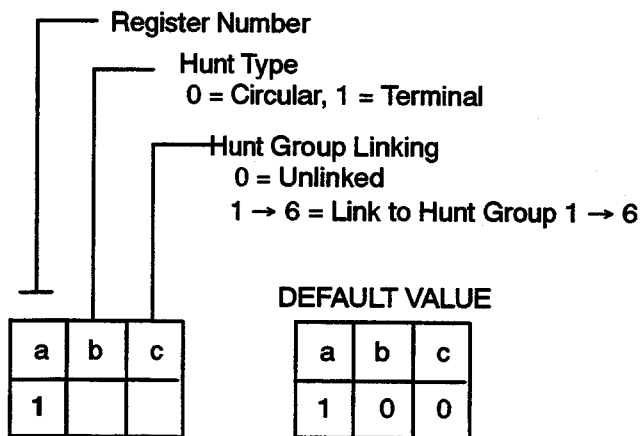

COMMAND 362

EXTENSION HUNT GROUP 2 PROGRAMMING

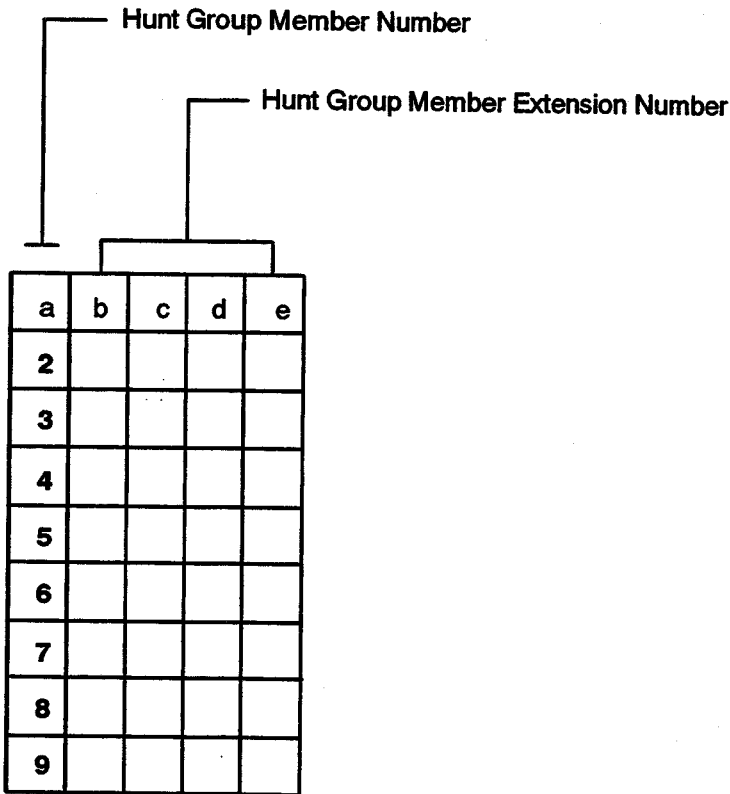
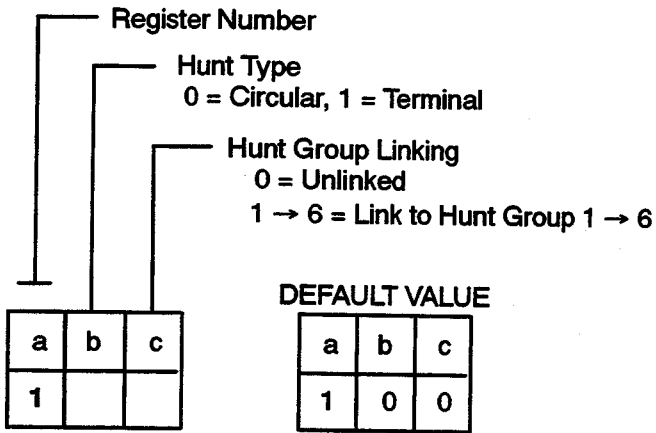

COMMAND 363

EXTENSION HUNT GROUP 3 PROGRAMMING

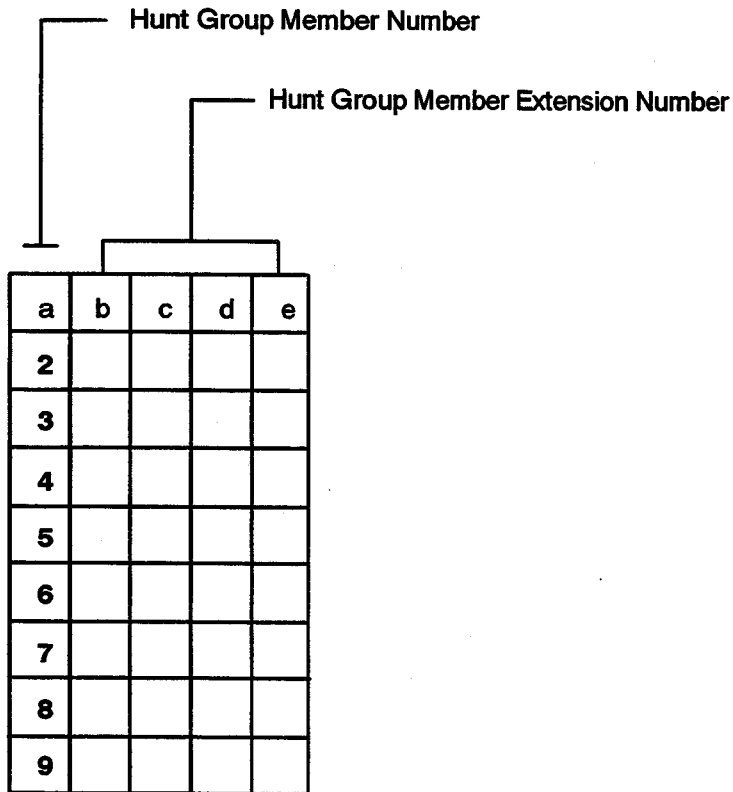
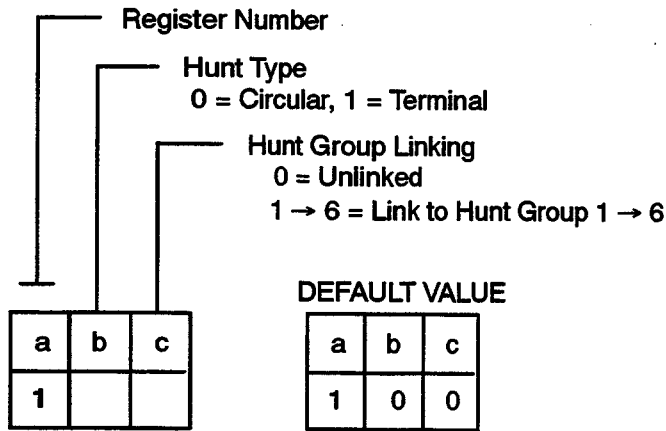

COMMAND 364

EXTENSION HUNT GROUP 4 PROGRAMMING

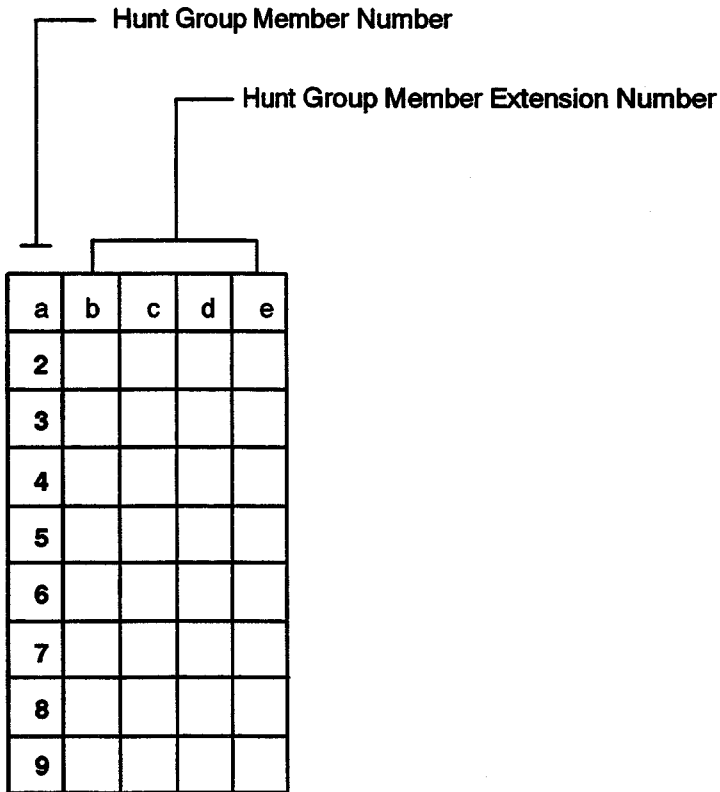
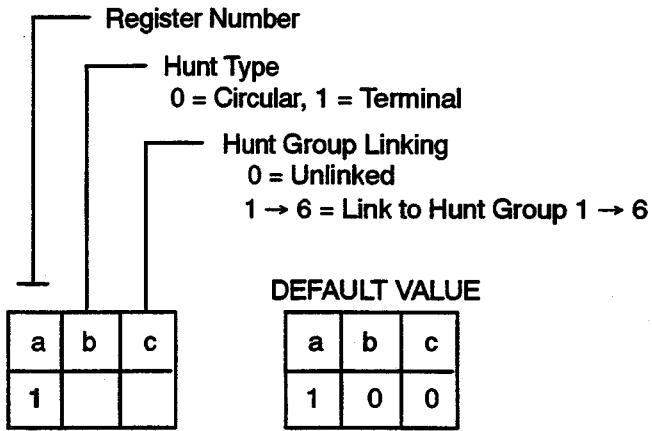

COMMAND 365

EXTENSION HUNT GROUP 5 PROGRAMMING

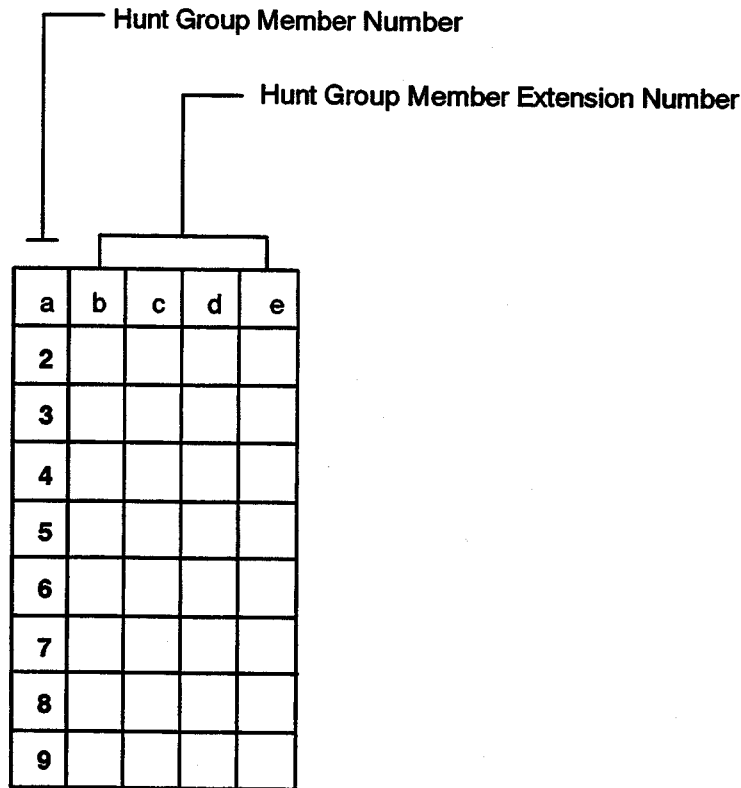
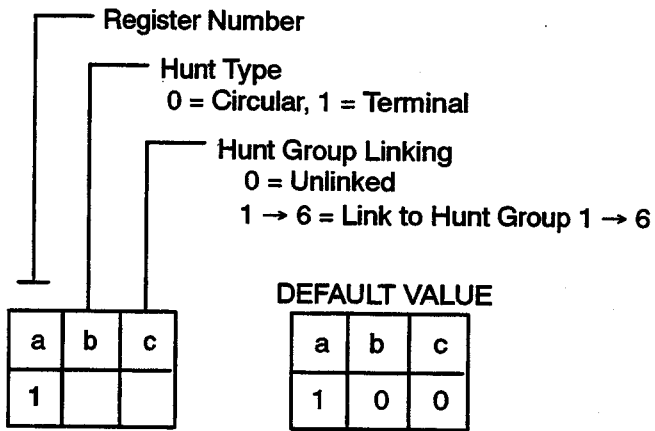

COMMAND 366

EXTENSION HUNT GROUP 6 PROGRAMMING

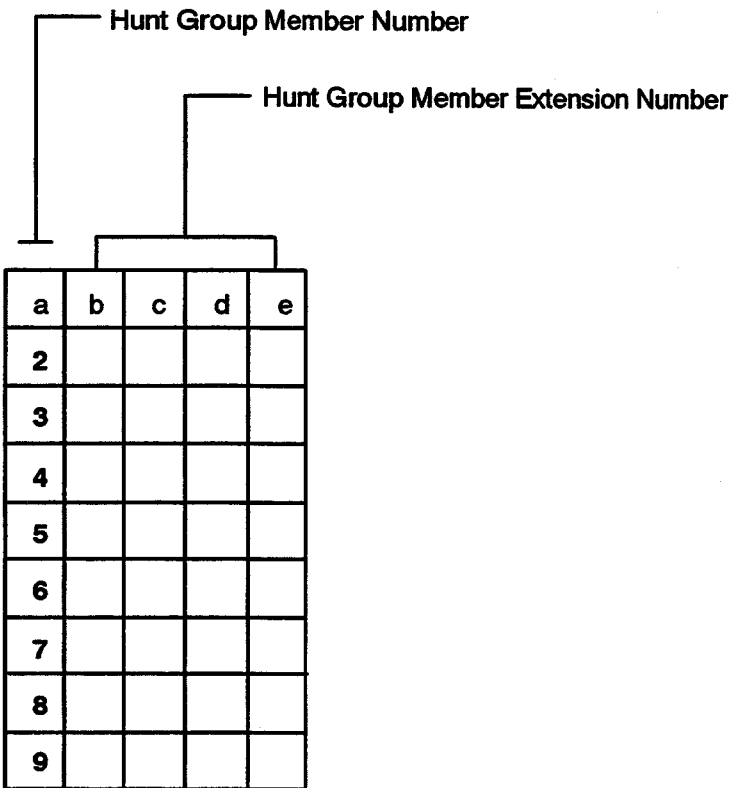
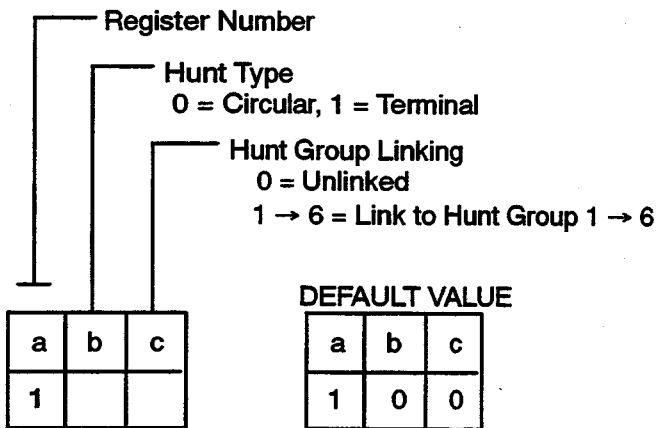

COMMAND 381

EXTENSION RING GROUP PROGRAMMING

Ring Group Member Number

Extension Number (1 → 9999)

	a	b	c	d	e
1					
2					
3					
4					
5					
6					
7					
8					
9					

COMMAND 4 _____

SUPERSET TELEPHONES PROGRAMMING

EXT: _____

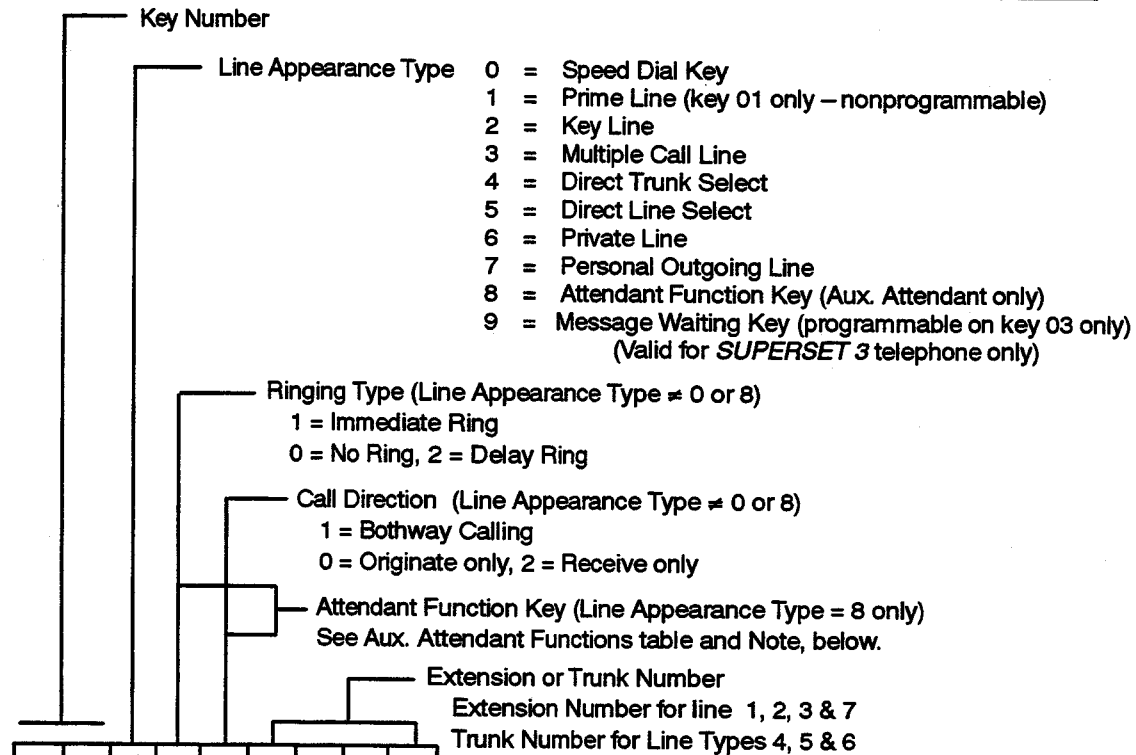

a	b	c	d	e	f	g	h	i
0	1	1	1	1				
0	2							
0	3							
0	4							
0	5							
0	6							
0	7							
0	8							
0	9							
1	0							
1	1							
1	2							
1	3							
1	4							
1	5							
Default	0							

AUX. ATTENDANT FUNCTIONS	
01	= DIAL "0"
02	= DO NOT DISTURB
03	= RECALL
04	= HOLD 1
05	= HOLD 2
06	= HOLD 3
07	= LDN 1
08	= LDN 2
09	= LDN 3
10	= MESSAGE WAITING
11	= MSG REGISTER
12	= NIGHT SERVICE
13	= OVERFLOW

Note: A maximum of FIVE appearances of each Auxiliary Attendant function key can be programmed on the SX-50 system.

COMMAND 4 _____

SUPERSET TELEPHONES PROGRAMMING

EXT: _____

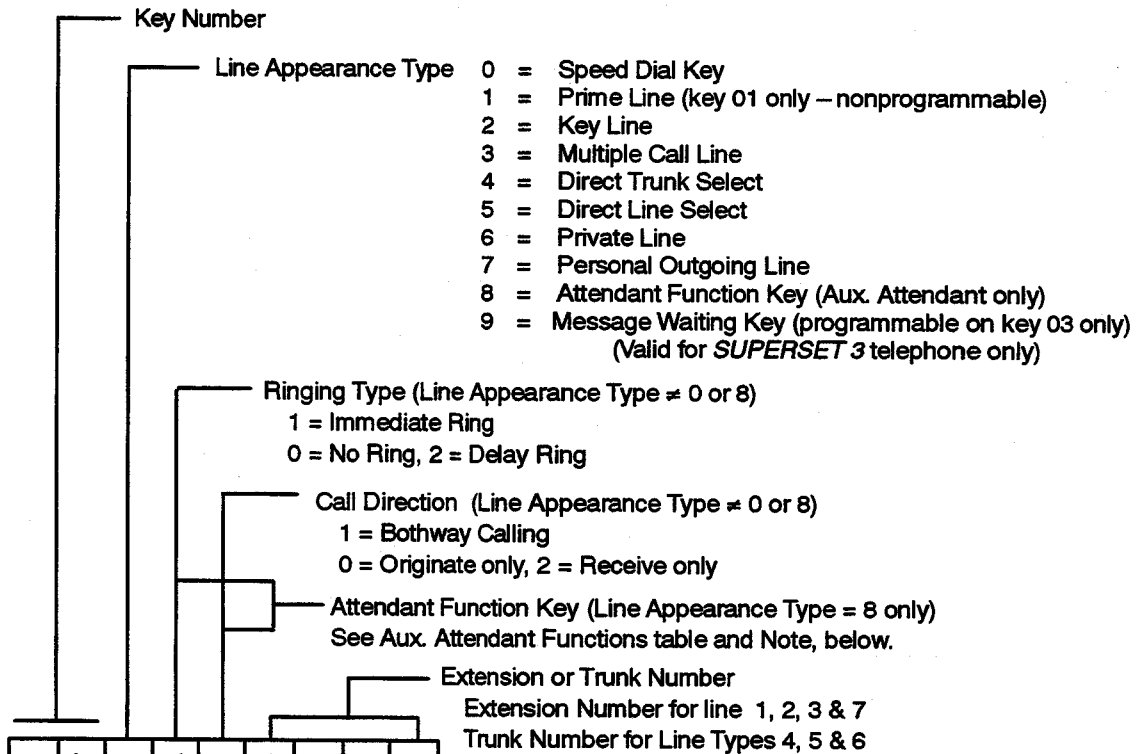

	a	b	c	d	e	f	g	h	i
0	1	1	1	1					
0	2								
0	3								
0	4								
0	5								
0	6								
0	7								
0	8								
0	9								
1	0								
1	1								
1	2								
1	3								
1	4								
1	5								
Default	0								

AUX. ATTENDANT FUNCTIONS	
01	= DIAL "0"
02	= DO NOT DISTURB
03	= RECALL
04	= HOLD 1
05	= HOLD 2
06	= HOLD 3
07	= LDN 1
08	= LDN 2
09	= LDN 3
10	= MESSAGE WAITING
11	= MSG REGISTER
12	= NIGHT SERVICE
13	= OVERFLOW

Note: A maximum of FIVE appearances of each Auxiliary Attendant function key can be programmed on the SX-50 system.

COMMAND 4 _____

SUPERSET TELEPHONES PROGRAMMING

EXT: _____

Key Number

Line Appearance Type

- 0 = Speed Dial Key
- 1 = Prime Line (key 01 only – nonprogrammable)
- 2 = Key Line
- 3 = Multiple Call Line
- 4 = Direct Trunk Select
- 5 = Direct Line Select
- 6 = Private Line
- 7 = Personal Outgoing Line
- 8 = Attendant Function Key (Aux. Attendant only)
- 9 = Message Waiting Key (programmable on key 03 only)
(Valid for SUPERSET 3 and SUPERSET 410 telephones only)

Ringing Type (Line Appearance Type ≠ 0 or 8)

- 1 = Immediate Ring
- 0 = No Ring, 2 = Delay Ring

Call Direction (Line Appearance Type ≠ 0 or 8)

- 1 = Bothway Calling
- 0 = Originate only, 2 = Receive only

Attendant Function Key (Line Appearance Type = 8 only)
See Aux. Attendant Functions table and Note, below.

Extension or Trunk Number

- Extension Number for line 1, 2, 3 & 7
- Trunk Number for Line Types 4, 5 & 6

a	b	c	d	e	f	g	h	i
0	1	1	1	1				
0	2							
0	3							
0	4							
0	5							
0	6							
0	7							
0	8							
0	9							
1	0							
1	1							
1	2							
1	3							
1	4							
1	5							
Default	0							

AUX. ATTENDANT FUNCTIONS

- 01 = DIAL "0"
- 02 = DO NOT DISTURB
- 03 = RECALL
- 04 = HOLD 1
- 05 = HOLD 2
- 06 = HOLD 3
- 07 = LDN 1
- 08 = LDN 2
- 09 = LDN 3
- 10 = MESSAGE WAITING
- 11 = MSG REGISTER
- 12 = NIGHT SERVICE
- 13 = OVERFLOW

Note: A maximum of FIVE appearances of each Auxiliary Attendant function key can be programmed on the SX-50 system.

COMMAND 4 _____

SUPERSET TELEPHONES PROGRAMMING

EXT: _____

Key Number

Line Appearance Type

- 0 = Speed Dial Key
- 1 = Prime Line (key 01 only – nonprogrammable)
- 2 = Key Line
- 3 = Multiple Call Line
- 4 = Direct Trunk Select
- 5 = Direct Line Select
- 6 = Private Line
- 7 = Personal Outgoing Line
- 8 = Attendant Function Key (Aux. Attendant only)
- 9 = Message Waiting Key (programmable on key 03 only)
(Valid for SUPERSET 3 and SUPERSET 410 telephones only)

Ringing Type (Line Appearance Type ≠ 0 or 8)

- 1 = Immediate Ring
- 0 = No Ring, 2 = Delay Ring

Call Direction (Line Appearance Type ≠ 0 or 8)

- 1 = Bothway Calling
- 0 = Originate only, 2 = Receive only

Attendant Function Key (Line Appearance Type = 8 only)

See Aux. Attendant Functions table and Note, below.

Extension or Trunk Number

- Extension Number for line 1, 2, 3 & 7
- Trunk Number for Line Types 4, 5 & 6

a	b	c	d	e	f	g	h	i
0	1	1	1	1				
0	2							
0	3							
0	4							
0	5							
0	6							
0	7							
0	8							
0	9							
1	0							
1	1							
1	2							
1	3							
1	4							
1	5							
Default	0							

AUX. ATTENDANT FUNCTIONS

- 01 = DIAL "0"
- 02 = DO NOT DISTURB
- 03 = RECALL
- 04 = HOLD 1
- 05 = HOLD 2
- 06 = HOLD 3
- 07 = LDN 1
- 08 = LDN 2
- 09 = LDN 3
- 10 = MESSAGE WAITING
- 11 = MSG REGISTER
- 12 = NIGHT SERVICE
- 13 = OVERFLOW

Note: A maximum of FIVE appearances of each Auxiliary Attendant function key can be programmed on the SX-50 system.

COMMAND 4 _____

SUPERSET TELEPHONES PROGRAMMING

EXT: _____

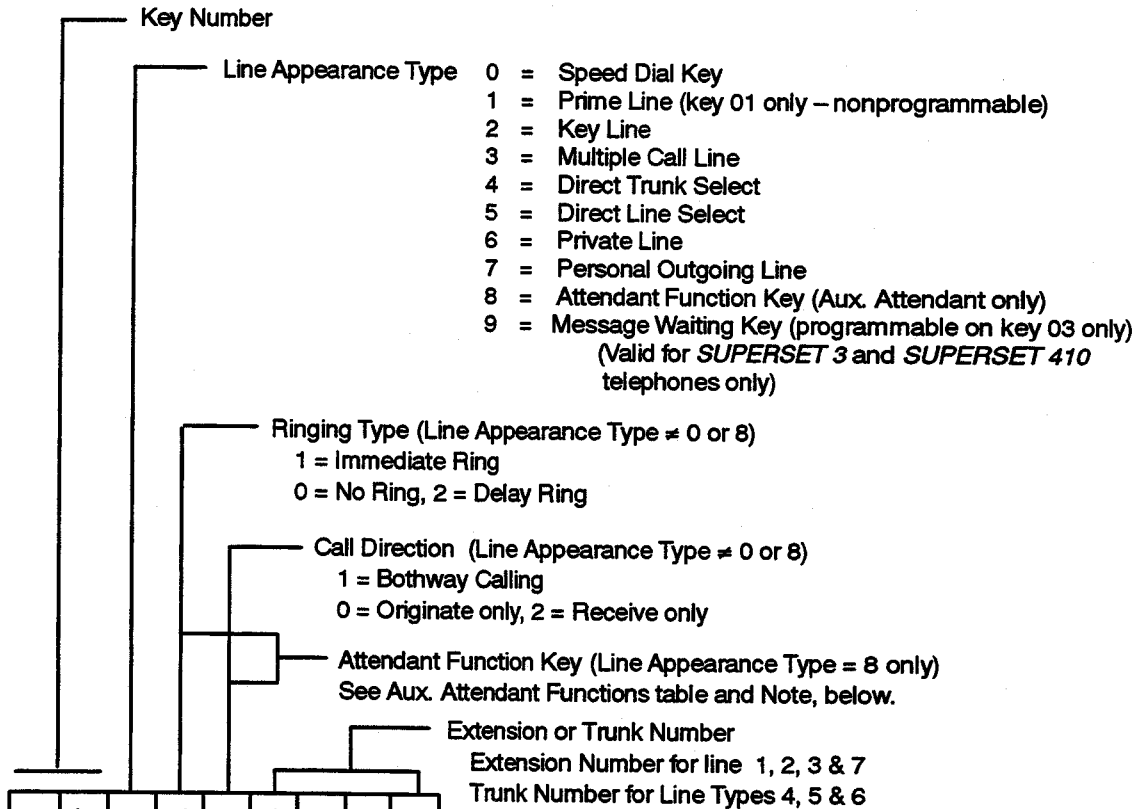

a	b	c	d	e	f	g	h	i
0	1	1	1	1				
0	2							
0	3							
0	4							
0	5							
0	6							
0	7							
0	8							
0	9							
1	0							
1	1							
1	2							
1	3							
1	4							
1	5							
Default	0							

AUX. ATTENDANT FUNCTIONS	
01	= DIAL "0"
02	= DO NOT DISTURB
03	= RECALL
04	= HOLD 1
05	= HOLD 2
06	= HOLD 3
07	= LDN 1
08	= LDN 2
09	= LDN 3
10	= MESSAGE WAITING
11	= MSG REGISTER
12	= NIGHT SERVICE
13	= OVERFLOW

Note: A maximum of FIVE appearances of each Auxiliary Attendant function key can be programmed on the SX-50 system.

COMMAND 4 _____

SUPERSET TELEPHONES PROGRAMMING

EXT: _____

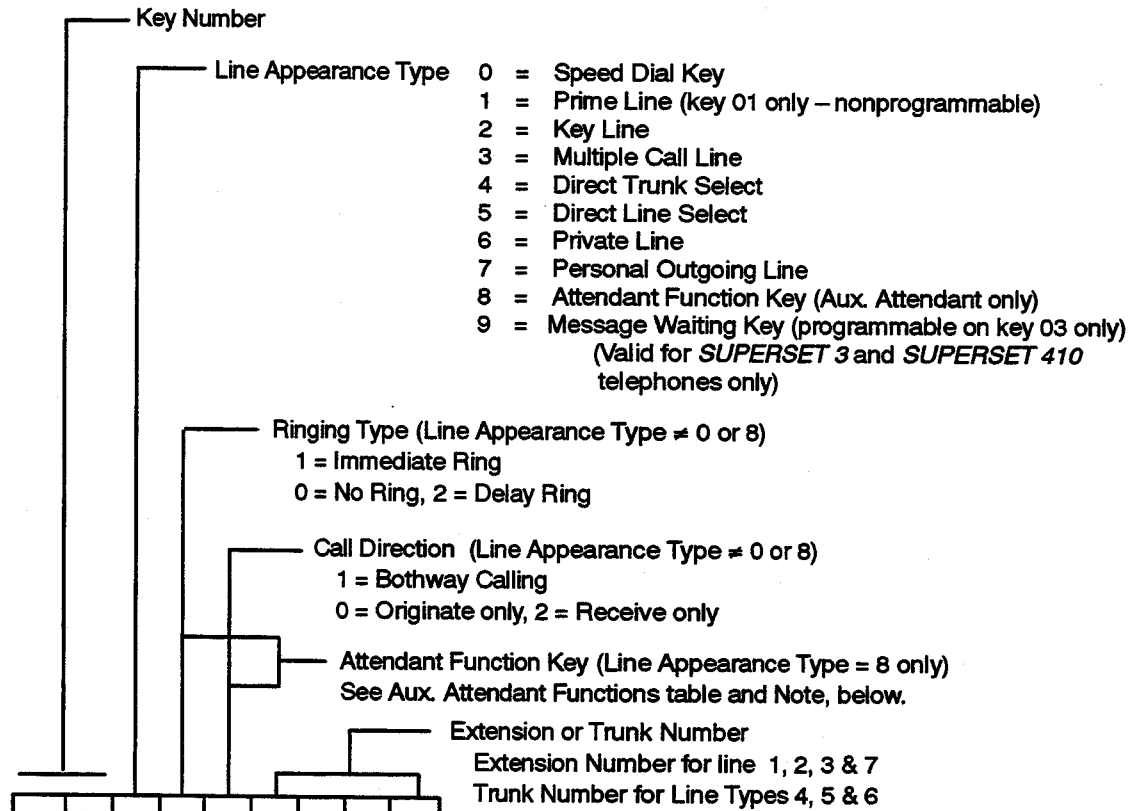

a	b	c	d	e	f	g	h	i
0	1	1	1	1				
0	2							
0	3							
0	4							
0	5							
0	6							
0	7							
0	8							
0	9							
1	0							
1	1							
1	2							
1	3							
1	4							
1	5							
Default	0							

AUX. ATTENDANT FUNCTIONS	
01	= DIAL "0"
02	= DO NOT DISTURB
03	= RECALL
04	= HOLD 1
05	= HOLD 2
06	= HOLD 3
07	= LDN 1
08	= LDN 2
09	= LDN 3
10	= MESSAGE WAITING
11	= MSG REGISTER
12	= NIGHT SERVICE
13	= OVERFLOW

Note: A maximum of FIVE appearances of each Auxiliary Attendant function key can be programmed on the SX-50 system.

COMMAND 4 _____

SUPERSET TELEPHONES PROGRAMMING

EXT: _____

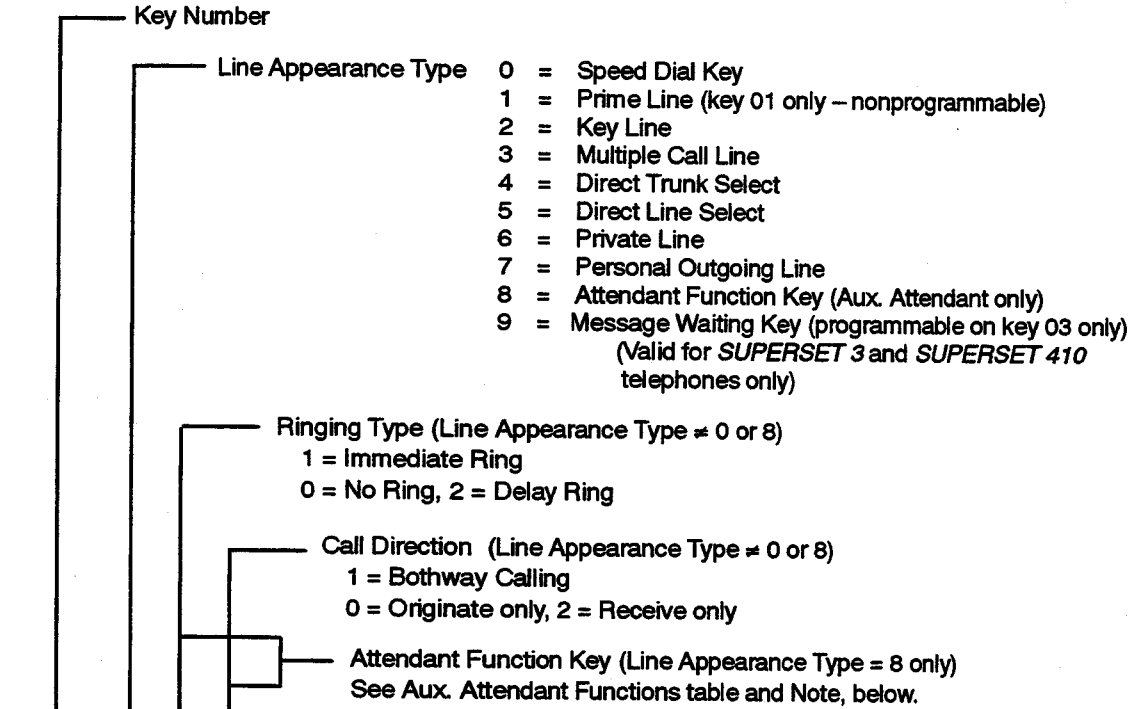

Extension or Trunk Number
 Extension Number for line 1, 2, 3 & 7
 Trunk Number for Line Types 4, 5 & 6

	a	b	c	d	e	f	g	h	i
0	1	1	1	1					
0	2								
0	3								
0	4								
0	5								
0	6								
0	7								
0	8								
0	9								
1	0								
1	1								
1	2								
1	3								
1	4								
1	5								
Default	0								

AUX. ATTENDANT FUNCTIONS	
01	= DIAL "0"
02	= DO NOT DISTURB
03	= RECALL
04	= HOLD 1
05	= HOLD 2
06	= HOLD 3
07	= LDN 1
08	= LDN 2
09	= LDN 3
10	= MESSAGE WAITING
11	= MSG REGISTER
12	= NIGHT SERVICE
13	= OVERFLOW

Note: A maximum of FIVE appearances of each Auxiliary Attendant function key can be programmed on the SX-50 system.

COMMAND 4 _____

SUPERSET TELEPHONES PROGRAMMING

EXT: _____

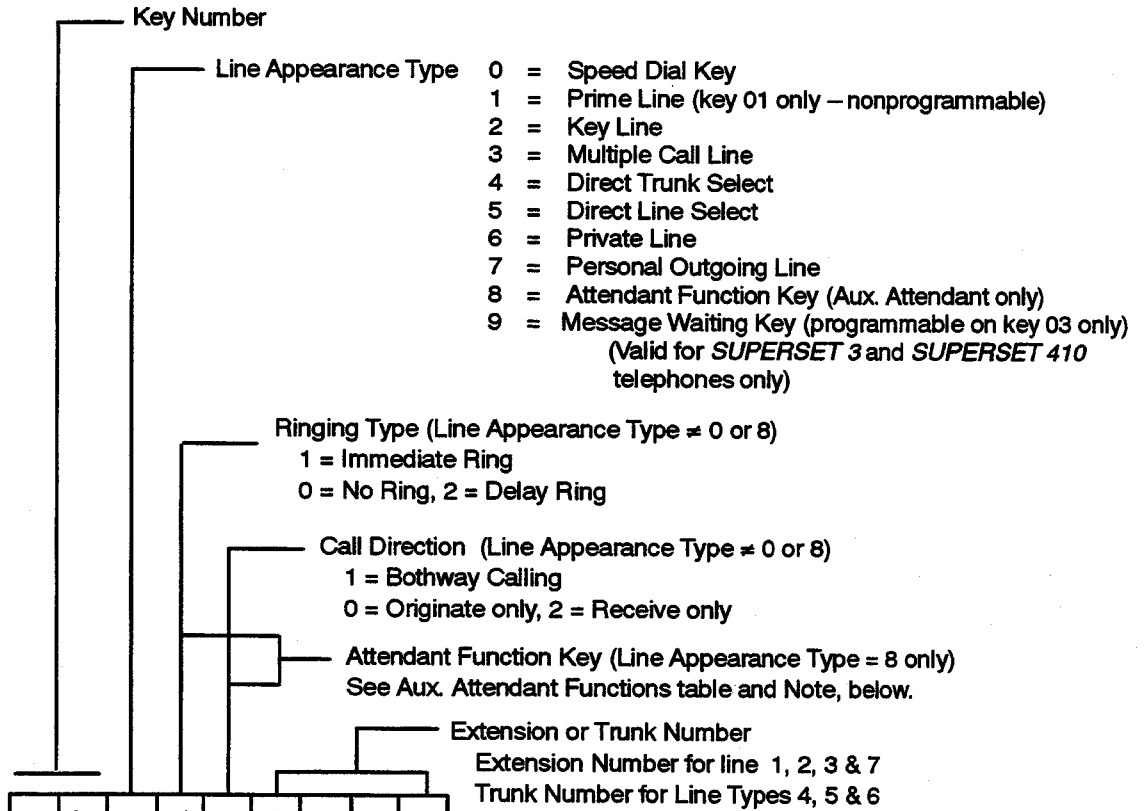

a	b	c	d	e	f	g	h	i
0	1	1	1	1				
0	2							
0	3							
0	4							
0	5							
0	6							
0	7							
0	8							
0	9							
1	0							
1	1							
1	2							
1	3							
1	4							
1	5							
Default	0							

AUX. ATTENDANT FUNCTIONS	
01	= DIAL "0"
02	= DO NOT DISTURB
03	= RECALL
04	= HOLD 1
05	= HOLD 2
06	= HOLD 3
07	= LDN 1
08	= LDN 2
09	= LDN 3
10	= MESSAGE WAITING
11	= MSG REGISTER
12	= NIGHT SERVICE
13	= OVERFLOW

Note: A maximum of FIVE appearances of each Auxiliary Attendant function key can be programmed on the SX-50 system.

COMMANDS 501 → 580

TRUNK PROGRAMMING

TYPE: _____

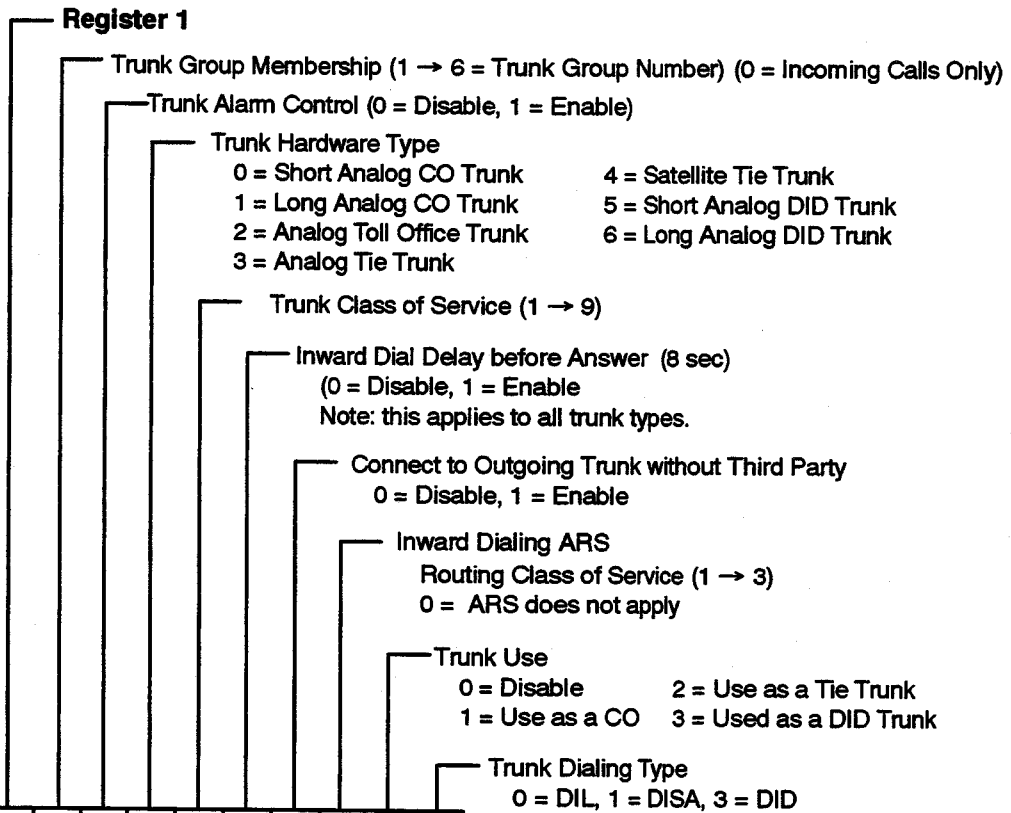

Command	a	b	c	d	e	f	g	h	i	j
5__	1									
5__	1									
5__	1									
5__	1									
5__	1									
5__	1									
5__	1									
5__	1									
Default	1	1	1	1	1	0	1	0	1	0
Default	1	2	1	3	1	0	1	0	2	1
Default	1	0	1	6	1	0	1	0	3	2

CO TRUNK
E&M TRUNK
DID TRUNK

COMMANDS 501 → 580

TRUNK PROGRAMMING

TYPE: _____
SLOT: _____

Register 2

Trunk Outpulsing Break/Make Ratio

- 0 = 60/40
- 1 = 65/35
- 2 = 30/20
- 3 = 35/15

Disconnect Supervision Guaranteed?

- 0 = No, 1 = Yes

Disappearance of Reversal

- 0 = is ignored
- 1 = means disconnect

Reversal Meaning on Call Origination

- 0 = Not Incoming Call
- 1 = Incoming Call

Disconnect Timing

- 0 = 60 ms
- 1 = 500 ms
- 2 = 1.5 sec
- 3 = 4.0 sec
- 4 = 10.0 sec
- 5 = Disconnect Ignored

Start Type (CO Trunks)

- 0 = Loop Start
- 1 = Ground Start

Trunk Hang-up Delay (Guard) Timer

- 01 → 16 = 1 → 16 seconds

Command	a	b	c	d	e	f	g	h	i
5__	2								
5__	2								
5__	2								
5__	2								
5__	2								
5__	2								
5__	2								
5__	2								
Default	2	0	0	0	0	1	0	0	1

COMMANDS 501 → 580

TRUNK PROGRAMMING

TYPE: _____

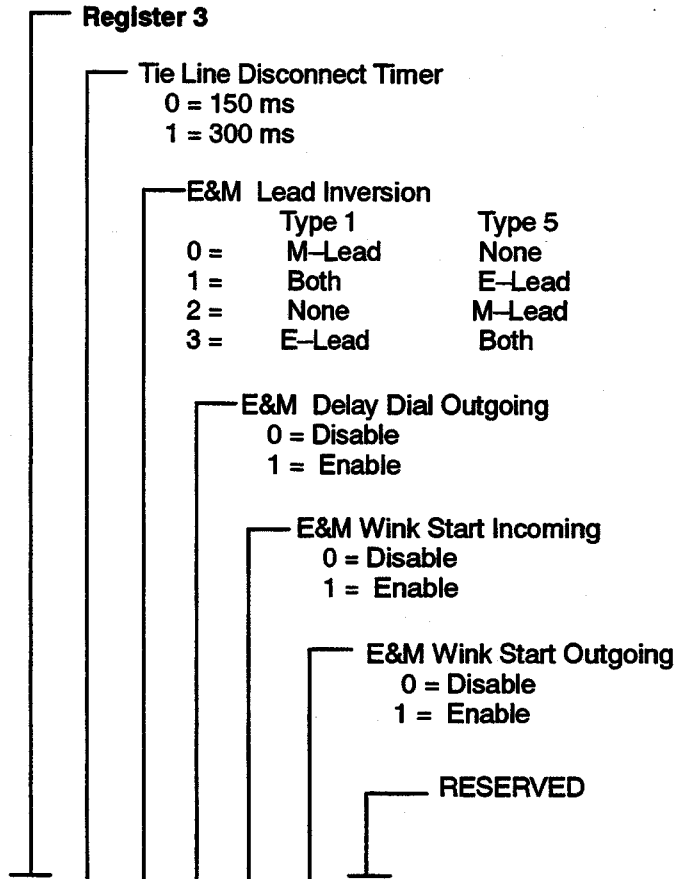

Command	a	b	c	d	e	f	g
5__	3						2
5__	3						2
5__	3						2
5__	3						2
5__	3						2
5__	3						2
5__	3						2
5__	3						2
5__	3						2
Default	3	1	2	0	0	0	2

COMMANDS 501 → 580

TRUNK PROGRAMMING

TYPE: _____

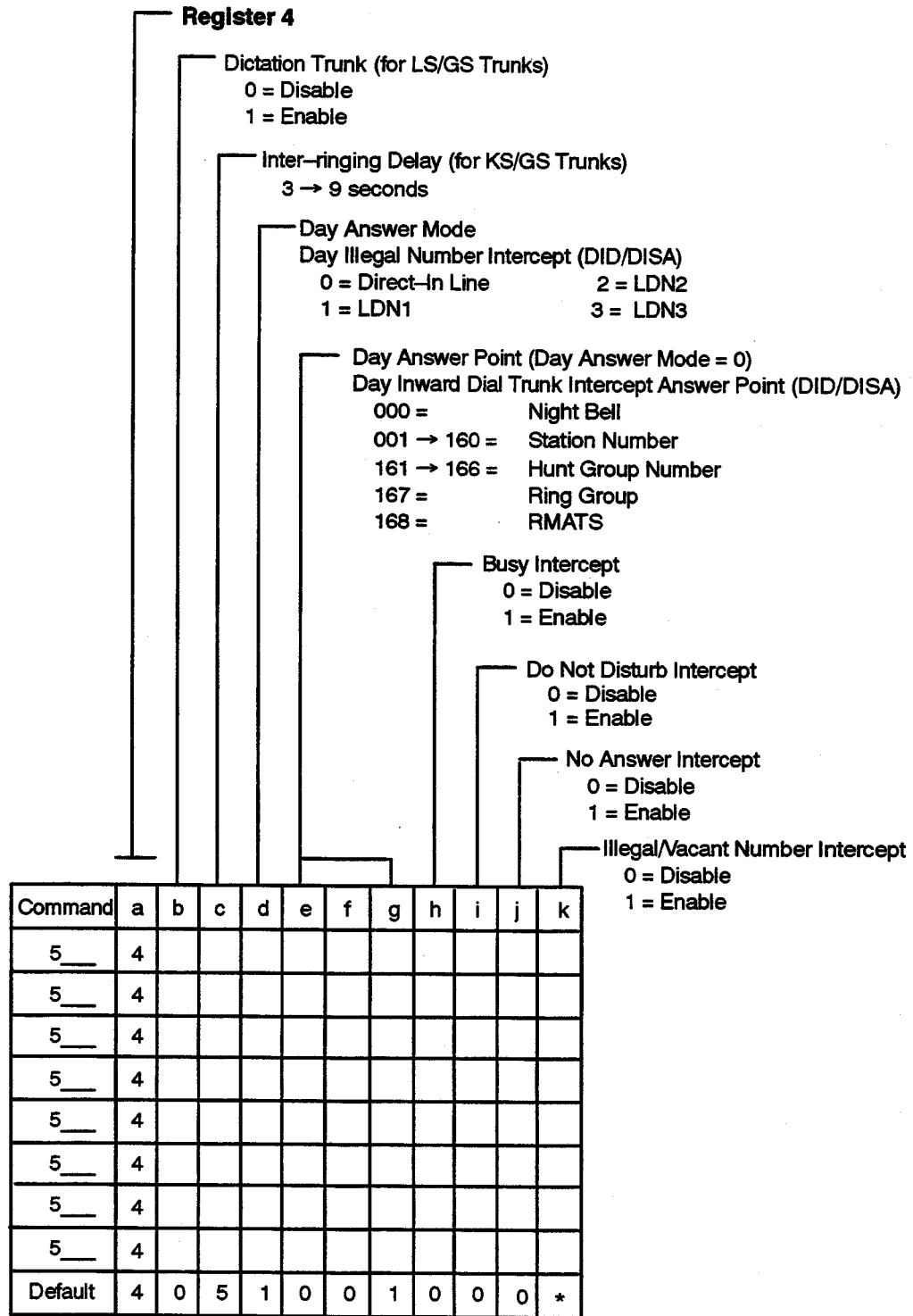

* = 0 for CO & DID Trunks; 1 for E&M Trunks

COMMANDS 501 → 580

TRUNK PROGRAMMING

TYPE: _____

Register 5

Night answer Mode
 Night Illegal Number Intercept (DID/DISA)
 0 = Flexible Night Service
 1 = LDN 1
 2 = LDN 2
 3 = LDN 3

Night Answer Point (Night Answer Mode = 0)
 Night Inward Dial Trunk Intercept Answer Point (DID/DISA)
 000 = Night Bell
 001 → 160 = Station Number
 161 → 166 = Hunt Group Number
 167 = Ring Group
 168 = RMATS

DID Night Answer Point
 0 = Disable
 1 = Enable

Command	a	b	c	d	e	f
5__	5					
5__	5					
5__	5					
5__	5					
5__	5					
5__	5					
5__	5					
5__	5					
Default	5	0	0	0	0	0

COMMANDS 501 → 580

TRUNK PROGRAMMING

TYPE: _____

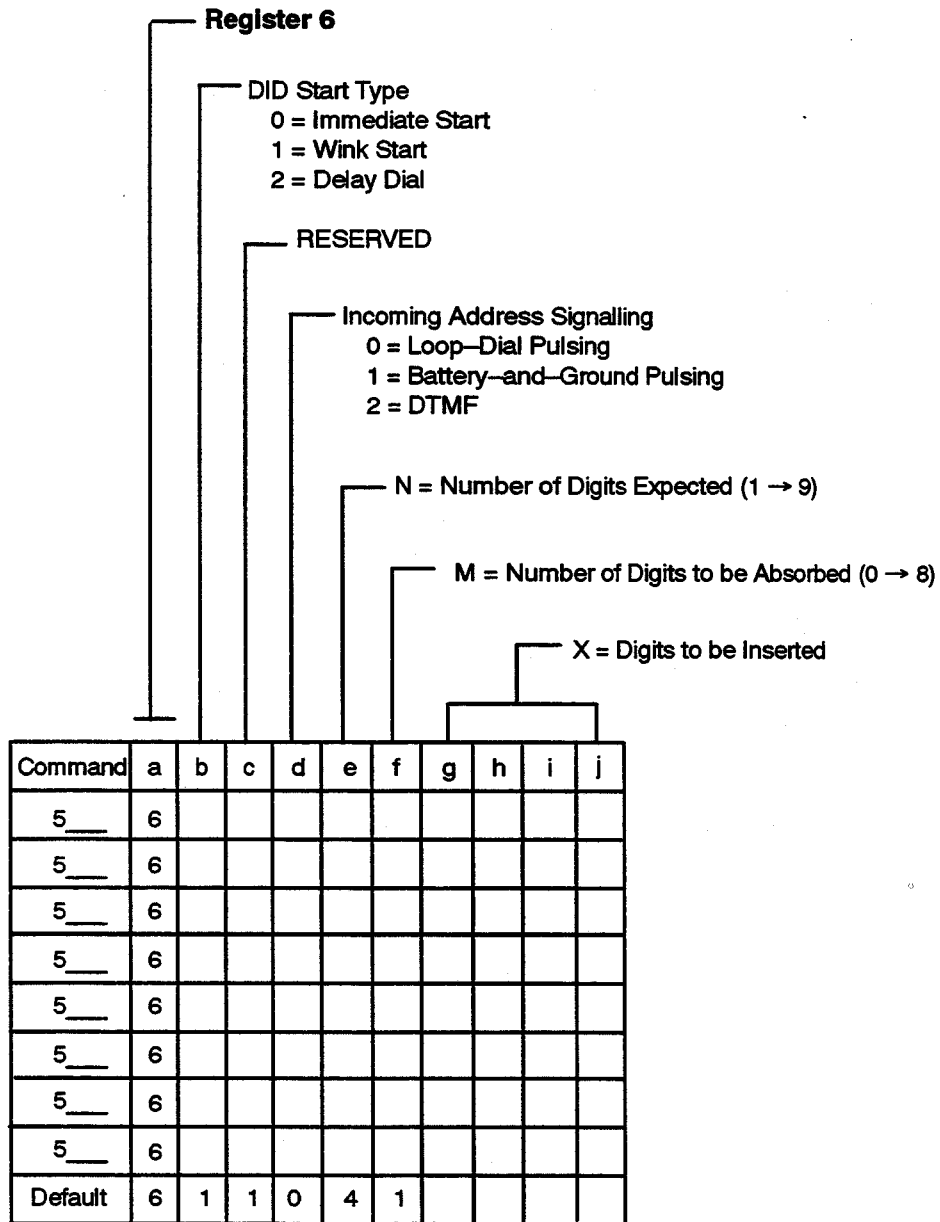

COMMANDS 501 → 580

TRUNK PROGRAMMING

TYPE: _____

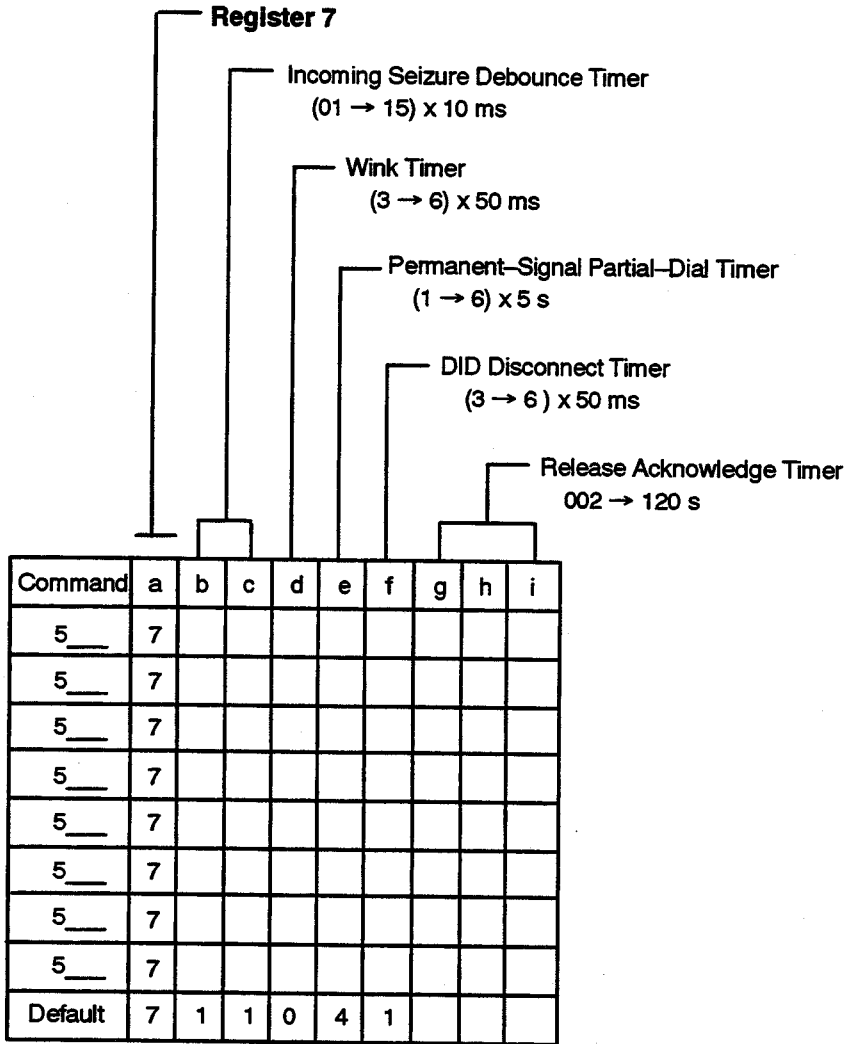

COMMAND 600

VERIFIED AUTHORIZATION CODE PROGRAMMING

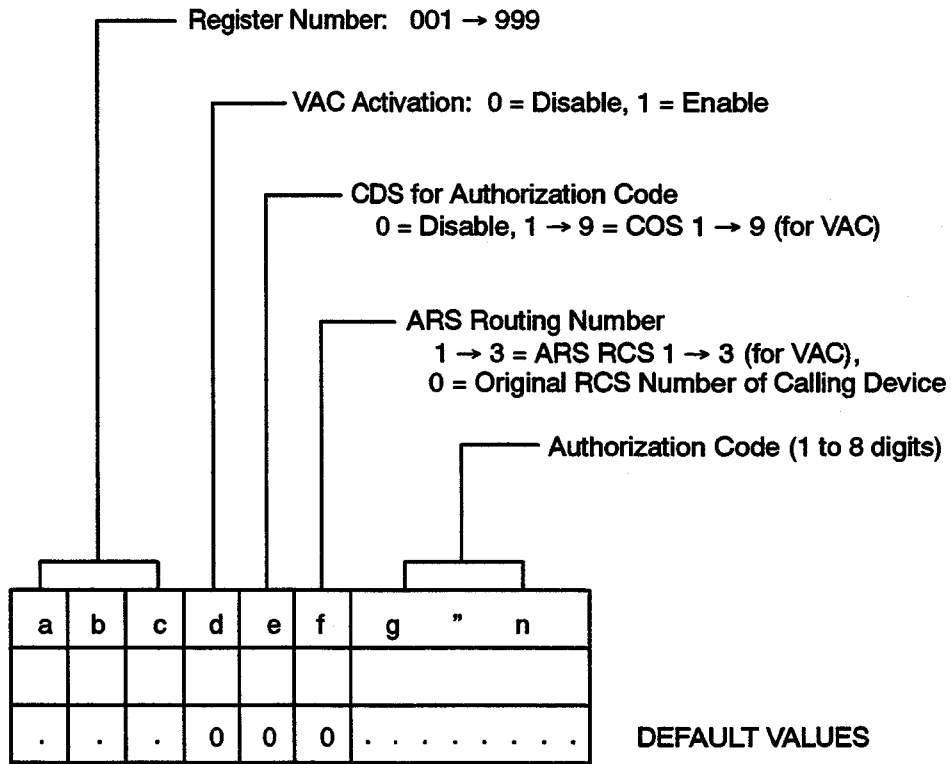

COMMAND 700

ARS DIGIT COMPARISON TABLE PROGRAMMING

Entry Number
001 → 800

Time-of-Day Table Number
01 → 45

a	b	c	d	e	f	Dialed Digits String (maximum of 32 digits)	m
					[]
					[]
					[]
					[]
					[]
					[]
					[]
					[]
					[]
					[]
					[]
					[]
					[]
					[]
					[]
					[]
					[]
					[]
					[]
					[]
					[]
					[]
					[]
					[]
					[]
					[]
					[]
					[]
					[]
					[]
					[]
					[]
					[]
					[]
					[]
					[]
					[]

102 2-68
Technical Manuals Online! - <http://www.tech-man.com>

Revision 0

9104-091-102-NA Issue 3

COMMANDS 701 → 745

ARS TIME-OF-DAY TABLE PROGRAMMING

COMMAND 7__

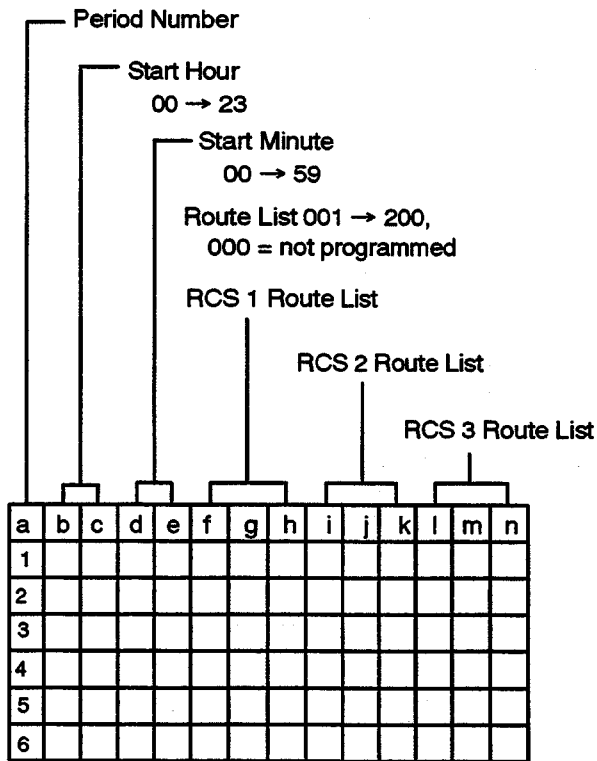

COMMAND 7__

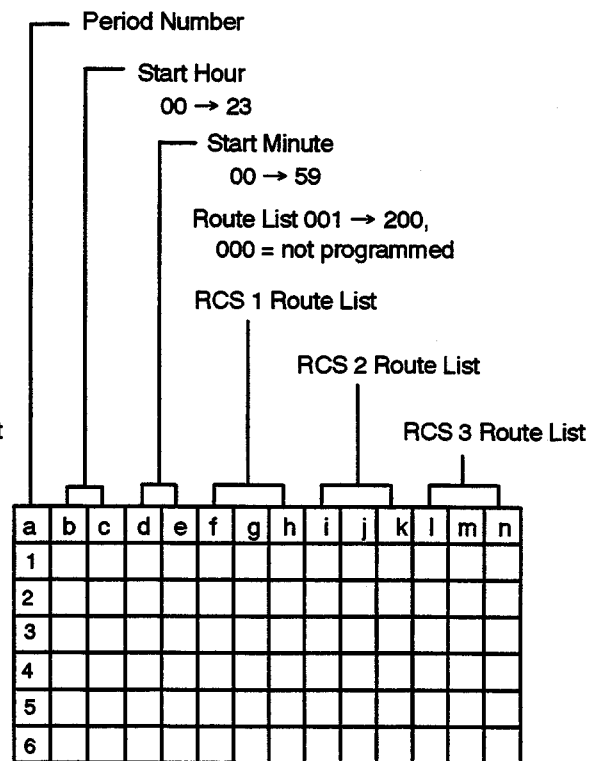

- - - - 0 0 0 0 0 0 0 0 0 0

Default

- - - - 0 0 0 0 0 0 0 0 0 0

Default

COMMANDS 701 → 745

ARS TIME-OF-DAY TABLE PROGRAMMING

COMMAND 7__

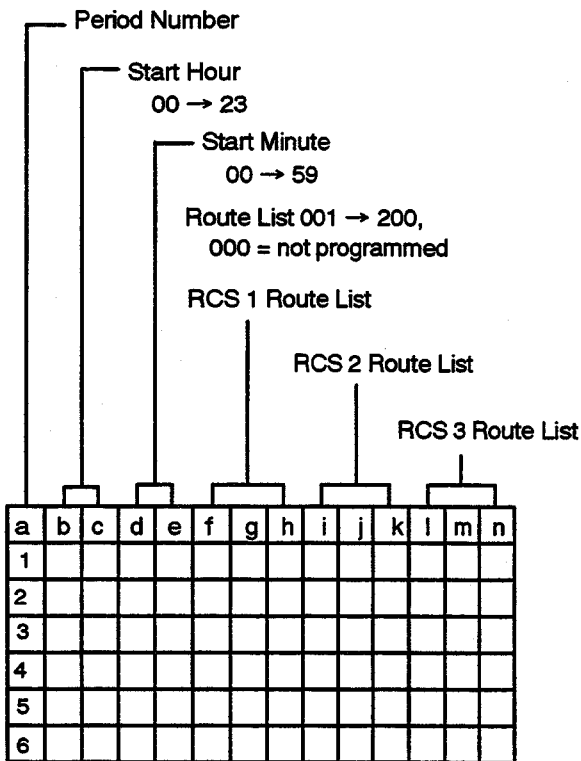

COMMAND 7__

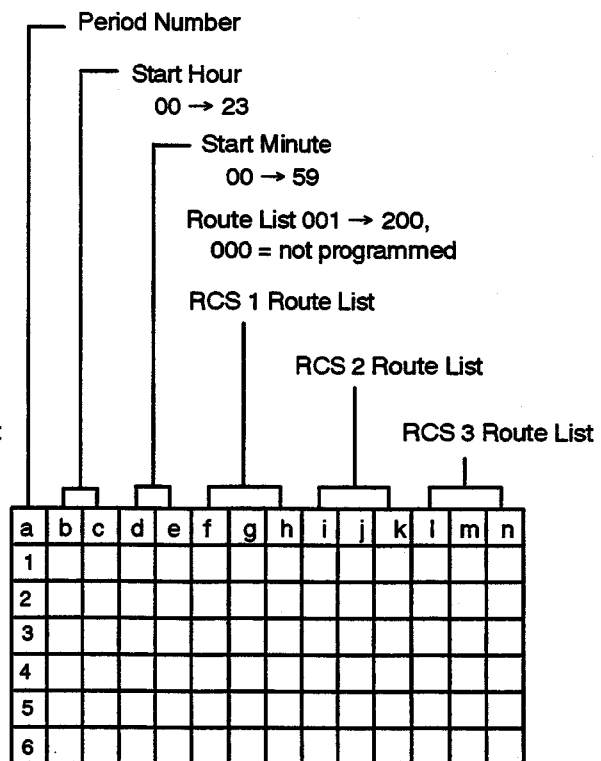

--- 0 0 0 0 0 0 0 0 0 0

Default

--- 0 0 0 0 0 0 0 0 0 0

Default

COMMAND 750 ARS ROUTE LIST TABLE PROGRAMMING

Route List Number (001 → 200)

1st Choice Route Number

2nd Choice Route Number

3rd Choice Route Number

4th Choice Route Number

a	b	c	d	e	f	g	h	i	j	k	l	m	n	o

COMMAND 751

ARS ROUTE TABLE PROGRAMMING

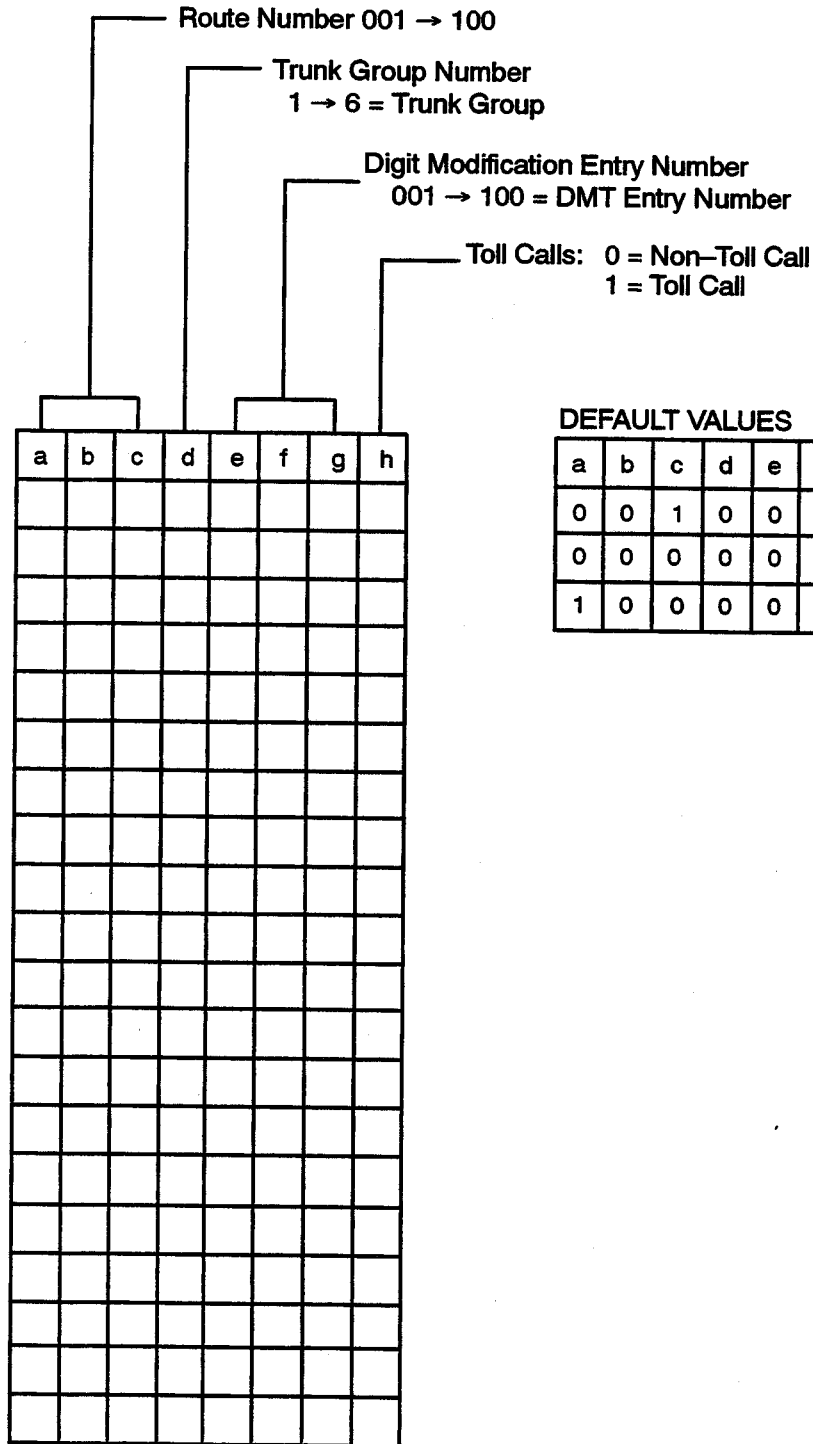

DEFAULT VALUES

a	b	c	d	e	f	g	h
0	0	1	0	0	0	0	0
0	0	0	0	0	0	0	0
1	0	0	0	0	0	0	0

COMMAND 752

ARS DIGIT MODIFICATION TABLE PROGRAMMING

Digit Modification Number 001 → 100

Number of Digits to be Deleted 00 → 26

Digits to Insert (maximum of 26 digits)
 0 → 9, #, *, P, W
 Where P = Pause for 5 seconds
 W = Wait for dial tone

a	b	c	d	e	f	Digits to Insert	m
						[]]]
						[]]]
						[]]]
						[]]]
						[]]]
						[]]]
						[]]]
						[]]]
						[]]]
						[]]]
						[]]]
						[]]]
						[]]]
						[]]]
						[]]]
						[]]]
						[]]]
						[]]]
						[]]]
						[]]]
						[]]]
						[]]]
						[]]]
						[]]]
						[]]]
						[]]]
						[]]]
						[]]]
						[]]]
						[]]]