



**Voice/Fax Over IP Networks
Model MVP110**

Proprietary Mode

User Guide



User Guide

S0000220 Revision A

MultiVOIP 100 (Model MVP110)

This publication may not be reproduced, in whole or in part, without prior expressed written permission from Multi-Tech Systems, Inc. All rights reserved.

Copyright © 2001, by Multi-Tech Systems, Inc.

Multi-Tech Systems, Inc. makes no representations or warranties with respect to the contents hereof and specifically disclaims any implied warranties of merchantability or fitness for any particular purpose. Furthermore, Multi-Tech Systems, Inc. reserves the right to revise this publication and to make changes from time to time in the content hereof without obligation of Multi-Tech Systems, Inc. to notify any person or organization of such revisions or changes.

Record of Revisions

Revision	Description
A (06/06/01)	Manual released.

Patents

This Product is covered by one or more of the following U.S. Patent Numbers: **6151333, 5757801, 5682386**. Other Patents Pending.

TRADEMARK

Trademark of Multi-Tech Systems, Inc. is the Multi-Tech logo.

Windows is a registered trademark of Microsoft.

Multi-Tech Systems, Inc.
2205 Woodale Drive
Mounds View, Minnesota 55112
(763) 785-3500 or (800) 328-9717
Fax 763-785-9874
Tech Support (800) 972-2439
Fax-Back (763) 717-5888
Internet Address: <http://www.multitech.com>

Contents

Chapter 1 - Introduction and Description	5
Introduction	6
Preview of this Guide	7
Typical Application	8
Front Panel Description	11
Back Panel Description	12
Power Connector	12
Command Connector	12
Ethernet Connector	12
Phone Connector	12
Specifications	13
Ethernet Port	13
Command Port	13
Voice/Fax Channel	13
Electrical/Physical	13
Chapter 2 - Installation	14
Installing Your MultiVOIP	15
Configure and Install Your Host MultiVOIP	15
Configure Your Client MultiVOIPs	15
Deploy the VOIP Network	15
Safety Warning Telecom	15
Unpacking Your MultiVOIP	16
Safety Warnings	16
Valid VOIP Network Connections	16
Cabling Your MultiVOIP	17
Cabling Procedure	17
Chapter 3 - Software Loading and Configuration	18
Installing Your MultiVOIP Software	19
Configuring Your Host MultiVOIP	19
Configuring Your Client MultiVOIPs	28
Deploy the VOIP Network	32
Remote Site Administrator	33
Chapter 4 - MultiVOIP Software	34
Introduction	35
Before You Begin	35
MultiVOIP Configuration	35
Changing Channel Parameters	36
Interface tab	36
Voice/Fax tab	37
Billing/Security tab	38
Regional tab	39
Changing the Phone Directory Database	39
Changing IP Parameters	41
ProxyServer	42
Viewing Call Progress	42
Applications Setup	43
Viewing Statistics	44
IP Statistics	44
SNMP Statistics	45

Viewing Logs	45
Viewing Log Entry Details	46
Viewing Channel Totals	46
Reports	47
Upgrade Procedures	48
One-Step Upgrade	48
Manual Upgrade Procedure	49
Chapter 5 - Remote Configuration	50
Introduction	51
Remote Configuration	51
Modem-Based	51
LAN-Based	52
Telnet	54
Web Management	55
Chapter 6 - Warranty, Service and Tech Support	57
Introduction	58
Limited Warranty	58
Online Warranty Registration	58
Service	59
Tech Support	60
Contacting Technical Support	60
Recording MultiVOIP Information	60
About the Internet	60
Appendixes	61
Appendix A - TCP/IP (Transmission Control Protocol/Internet Protocol) Description	62
Appendix B - Cabling Diagrams	65
Appendix C - Regulatory Information	67
Class A Statement	67
Fax Branding Statement	67
FCC Part 68 Telecom	67
Canadian Limitations Notice	69
EMC, Safety and Terminal Directive Compliance	69
Glossary	70
Index	83



Chapter 1 - Introduction and Description



Introduction

Welcome to Multi-Tech's new voice/fax gateway, the MultiVOIP 100, model MVP110. The MultiVOIP 100 allows analog voice and fax communication over a traditional data communications/data networking digital Internet. Multi-Tech's new voice/fax gateway technology allows voice and fax communication to ride, with no additional expense, over your existing communications Internet, which has traditionally been data-only. To access this free voice and fax communication, all you have to do is connect the MultiVOIP 100 to a phone or to your existing in-house phone system, and then to your existing Internet connection. Once configured, the MultiVOIP 100 then allows voice and fax to travel down the same path as your traditional data communications.

The MVP110 is designed with one FXS voice/fax channel, a 10 Mbps Ethernet LAN interface, and a command port for configuration. System management is provided through the command port using bundled Windows® software which provides easy-to-use configuration menus and a comprehensive Help system.



MultiVOIP MVP 110

Preview of this Guide

This guide describes the MultiVOIP and tells you how to install and configure the unit. The information contained in each chapter is as follows:

Chapter 1 - Introduction and Description

Chapter 1 describes the MultiVOIP. Front panel indicators, and back panel connector descriptions are provided. In addition, a list of relevant specifications is provided at the end of the chapter.

Chapter 2 - Installation

Chapter 2 provides information on unpacking and cabling your MultiVOIP. The installation procedure describes each cable connection.

Chapter 3 - Software Loading and Configuration

Chapter 3 provides instructions for software loading and initial configuration. The MultiVOIP software disks are Windows® based. Later chapters, as well as the online Help, describe the MultiVOIP software in more detail.

Chapter 4 - MultiVOIP Software

Chapter 4 describes the MultiVOIP software package designed for the Windows® environment. This chapter describes the software from an applications standpoint, and in so doing, not every element of the user interface is shown nor defined. For explanations and parameters, refer to the Help.

Chapter 5 - Remote Configuration and Management

Chapter 5 provides procedures for changing the configuration of a remote MultiVOIP. Remote configuration enables you to change the configuration of a unit by simply connecting two modems between the two MultiVOIPs and remotely controlling the unit. Chapter 5 also describes typical client applications, such as Telnet and Web-based management, used for remote configuration of the MultiVOIP.

Chapter 6 - Warranty, Service and Tech Support

Chapter 6 provides instructions on getting service for your MultiVOIP at the factory, a statement of the limited warranty, information about our Internet presence and user bulletin board service, and space for recording information about your MultiVOIP prior to calling Multi-Tech's Technical Support.

Typical Application

Before Voice Over IP (VOIP), a corporate office had a data connection to the Internet and a voice connection to the public telephone network. With VOIP, the two networks can be tied together. To accomplish this, a MultiVOIP is connected between the public telephone network and the data network. A typical application for a MultiVOIP is shown below.

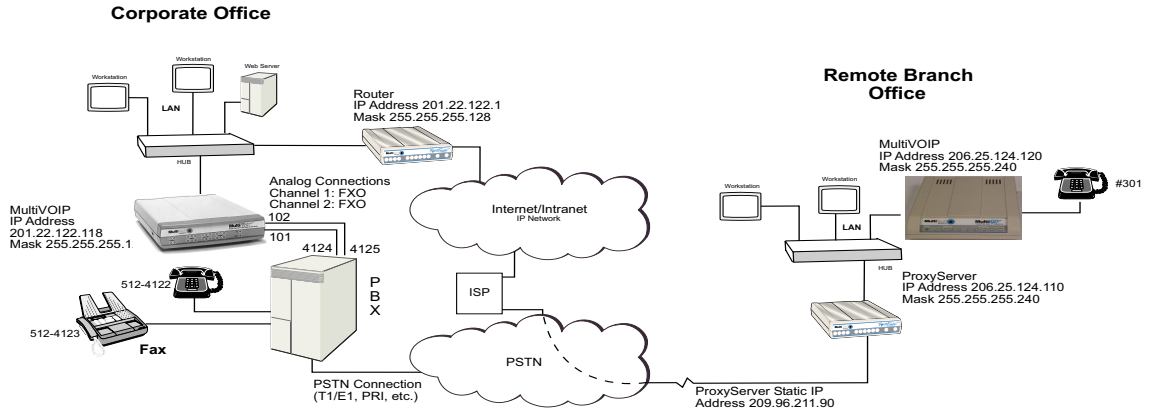

Typical VOIP Application

To set up the VOIP network, a MultiVOIP at the corporate office is connected between the data network and the corporate telephone switch (PBX). To connect the MultiVOIP to the data network, an Ethernet cable is connected to the Ethernet port on the MultiVOIP and the other end of the cable is plugged into a hub on the data network.

To set up an MVP110 at the remote branch office, connect the Ethernet port on the MultiVOIP to the hub, then connect and a phone, fax, or KTS to the Phone port.

To configure the MVP110, the COM port of a PC is connected to the Command port on the MultiVOIP. Configuration software is loaded on to your PC and your unique LAN parameters are entered. The configuration software is based on a standard Windows Graphical User Interface (GUI) which simplifies your selection process to a single parameter group within a dialog box. For example, your LAN IP parameters are contained on a single dialog box. You can configure the IP address and mask for the MultiVOIP, and the gateway address for the corporate router, on the same dialog box. Once the LAN parameters are entered, you can set up the voice channel parameters.



Next, build your VOIP phone directory database that connects your MultiVOIPs together. From the phone directory database you can construct a VOIP phone book and a VOIP dialing directory.

Phone Number	IP Address	Channel	Description
101	201.22.122.118	Channel 1	New York Office
102	201.22.122.119	Channel 1	Human Resources Desk

Before you construct the phone directory database, you must determine the Host-Client relationship between MultiVOIPs. The host MultiVOIP controls the phone directory database. Clients receive the phone directory database through the IP connection. The phone directory database defines each phone number that can be dialed on the VOIP network. Each phone number entry in the database identifies a phone connection. For example, Station Phone Number 101 is at the corporate office. This phone number is connected to the voice/fax channel on the corporate office MultiVOIP. The voice/fax channel is connected to extension 4124 on the corporate phone switch. So if a person in the corporate facility wants to access the VOIP network, they would dial extension 4124 or 4125. Then, after getting a second dial tone, dial 301 or 302 from the phone directory. However, if someone at the remote branch office wants to access the corporate phone system, they have to dial Station Phone Number 101 or 102.

Similarly, a remote branch office employee can pick up the phone at 301 and dial VOIP extension 102. This routes the call to the corporate office MultiVOIP where a second dial tone is heard. The remote branch office employee then dials extension 4122 after getting a second dial tone from the PBX at the corporate office and a conversation can take place between the two phones.

VOIP Dialing Directory		
To call from	Call Process	Dialing Sequence
Corporate Office to Remote Branch Office	Pick up any phone and dial an extension number (e.g., 4124 or 4125). Upon hearing the second dial tone, dial the Remote Branch Office MultiVOIP (301).	4124 301
Remote Branch Office to Corporate Office	Pick up telephone and dial 101 or 102. Upon hearing the second dial tone, dial 4124 or, for the fax machine, 4125.	101 4124

VOIP Dialing Directory

Front Panel Description

The front panel has two groups of LEDs that provide the status of the Ethernet connection (Ethernet), the Voice/Fax channel, and an LED for the Boot status. The front panel is shown below, and a description of each LED follows.

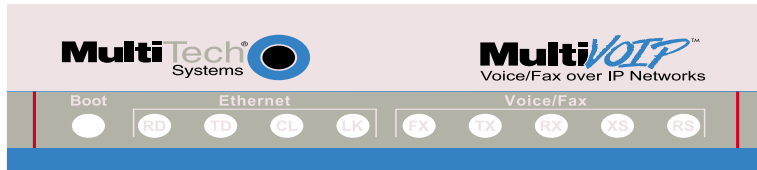

MVP110 Front Panel

Boot

The Boot indicator lights when the MultiVOIP is booting or downloading setup.

Ethernet

- RD** Receive Data indicator blinks when packets are being received from the local area network.
- TD** Transmit Data indicator blinks when packets are being transmitted to the local area network.
- LK** Link indicator lights when the Ethernet link senses voltage from a concentrator or external device.
- CL** Collision indicator lights when a collision is detected on the Ethernet link.

Voice/Fax

- FX** Fax indicator lights when there is fax traffic on the voice/fax channel.
- TX** Transmit indicator blinks when voice packets are being transmitted to the local area network.
- RX** Receive indicator blinks when voice packets are being received from the local area network.
- XS** Transmit Signal indicator lights when the voice/fax channel is off-hook.
- RS** Receive Signal indicator lights when the voice/fax channel is ringing.

Back Panel Description

The cable connections for the MultiVOIP are made at the back panel. Connectors include Power, Command Port (RS232), Ethernet (10BASE-T), and the Voice/Fax Channel. The cable connectors are shown below and defined in the following groups.



MVP110 Back Panel

Power Connector

The Power connector is used to connect the power transformer to the MultiVOIP.

Command Connector

The Command connector is used to configure the MultiVOIP using a PC with an available serial port and running Windows® software. The Command connector is an RJ-45 jack, and an adapter cable is provided to convert to a standard serial port DB9 female connector.

Ethernet Connector

The Ethernet connector is used to connect the MultiVOIP to a LAN using unshielded twisted cable. This connector is an RJ-45 jack.

Phone Connector

Connects the Voice/Fax Channel to a station device such as an analog phone, a KTS phone system, or a fax machine. This connector is an RJ-11 jack.

Specifications

- One 1 Meg by 32 byte at 70 nanosecond SIMM is 4 Mb DRAM
- Two Megabytes of flash memory

Ethernet Port

- Single Ethernet Interface--10BASE-T (twisted pair) keyed RJ-45 connector.

Command Port

- Single 19.2K bps asynchronous Command Port using an RJ-45 to DB9 cable with a DB9 female connector

Voice/Fax Channel

- One RJ-11 jack (FXS)

Electrical/Physical

- Voltage - 115 VAC (Standard), 240 Volts AC (Optional)
- Frequency - 47 to 63 Hz
- Power Consumption - 4.3 Watts
- Dimensions - 1.0" high x 4.3" wide x 5.6" deep
(2.5 cm x 10.8 cm x 14.2 cm)
- Weight - 8 oz. (224 g)



Chapter 2 - Installation



Installing Your MultiVOIP

The basic steps of installing your MultiVOIP network involve unpacking the units, connecting the cables, and configuring the units using the included management software (MultiVOIP Configuration). The recommended installation process includes three phases that, when completed, result in a fully functional Voice Over IP network. A general description of each phase is provided below, and detailed instructions are provided in [Chapter 3, Software Loading and Configuration](#).

Configure and Install Your Host MultiVOIP

First, the VOIP administrator configures the MultiVOIP designated as the “Host” unit. This includes the assignment of a unique LAN IP address, subnet mask, and Gateway IP address. Once all connections have been made, the VOIP administrator configures the unit and builds the Phone Directory Database that will reside with the Host unit.

Configure Your Client MultiVOIPs

Unique LAN IP addresses, subnet masks, and Gateway IP addresses are assigned to the MultiVOIPs designated as “Client” units. When this is done, the Phone Directory Database option is set to Client, and the IP address of the Host MultiVOIP is entered. Once all client units are configured, the network is ready for deployment.

Deploy the VOIP Network

When the Client MultiVOIPs are sent to their remote sites, the remote site administrators need only to connect the units to their LAN and telephone equipment. A full Phone Directory Database (supplied by the Host MultiVOIP) will be loaded into their unit within minutes of being connected and powered up.

The final task of the VOIP Administrator is to develop the VOIP Dialing Directory based on the Phone Directory Database and telephone numbers of the interfacing telephone equipment. At this point, a VOIP user can call any person on the VOIP network.

Safety Warning Telecom

1. Never install phone wiring during a lightning storm.
2. Never install phone jacks in wet locations unless the jacks are specifically designed for wet locations.
3. This product is to be used with UL and cUL listed computers.
4. Never touch uninsulated phone wires or terminals unless the phone line has been disconnected at the network interface.
5. Use caution when installing or modifying phone lines.
6. Avoid using a phone (other than a cordless type) during an electrical storm. There may be a remote risk of electrical shock from lightning.
7. Do not use the phone to report a gas leak in the vicinity of the leak.
8. To reduce the risk of fire, use only No. 26 AWG or larger telecommunications line cord.

Unpacking Your MultiVOIP

Remove all items from the box. (See Figure 6.)



Figure 6. Unpacking

Safety Warnings

Caution: Danger of explosion if battery is incorrectly replaced.

A lithium battery on the circuit board provides backup power for the time keeping capability. The battery has an estimated life expectancy of ten years.

When the battery starts to weaken, the date and time may be incorrect. If the battery fails, the board must be sent back to Multi-Tech Systems for battery replacement.

The Phone and Ethernet ports are not designed to be connected to a Public Telecommunication Network.

Valid VOIP Network Connections

The following VOIP network connections can be made at this time:

€ FXS to FXS

€ FXS to E&M

€ FXS to FXO

The MVP110 supports only FXS. However, these are valid VOIP network connections.

E&M to E&M

FXO to E&M

FXO to FXO

Cabling Your MultiVOIP

Cabling your MultiVOIP involves making the proper Power, Command Port, and Internet connections. Figure 2-2 shows the back panel connectors and the associated cable connections. The Cabling Procedure has step-by-step instructions for cabling your MultiVOIP.

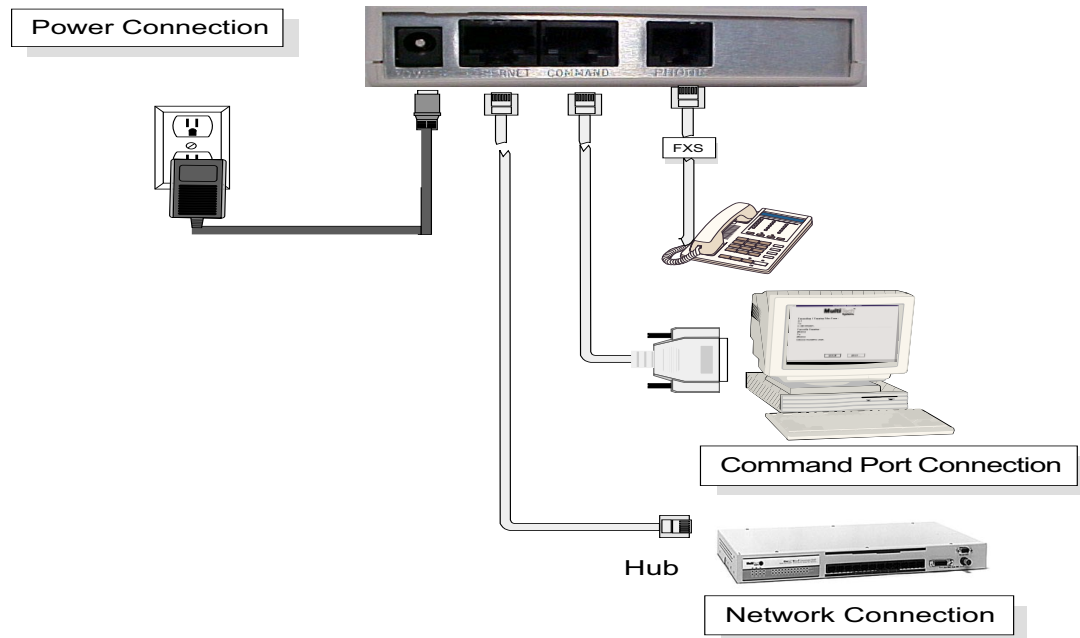

Cable Connections

Cabling Procedure

1. Using the supplied cable, connect the power supply to a live AC outlet, then plug the power supply into the MultiVOIP as shown in Figure 7.
2. Connect the MultiVOIP to a PC using the RJ-45 to DB9 (female) cable provided with your unit. Plug the RJ-45 end of the cable into the **Command** port of the MultiVOIP and connect the other end to the PC serial port you are using. See Figure 7.
3. Connect a network cable to the **Ethernet** connector on the back of the MultiVOIP. Connect the other end of the cable to your network.
4. If you are connecting a station device such as an analog telephone, a fax machine, or a Key Telephone System (KTS) to your MultiVOIP, connect one end of an RJ-11 cable to the **Phone** connector on the back of the MultiVOIP and the other end to the station device.
5. Turn on power to the MultiVOIP by moving the power switch on the right side panel to the ON position. Wait for the Boot LED on the MultiVOIP to go off before proceeding. This may take a few minutes.

Note: If the Ethernet connection is not active, none of the LEDs will be on after booting. This unit does not have a Power LED.

Proceed to the Chapter 3, Software Loading and Configuration, to load the MultiVOIP software.



Chapter 3 - Software Loading and Configuration



Installing Your MultiVOIP Software

The following installation procedures do not provide every screen or option in the process of installing the MultiVOIP software. It is assumed that a technical person with a thorough knowledge of Windows and the software loading process is doing the installation. Additional information on the MultiVOIP software is provided in Chapter 4, MultiVOIP Software, and in the online Help.

Configuring Your Host MultiVOIP

Configuring your Host MultiVOIP involves software loading and configuration.

Software Loading

If you are installing a MultiVOIP behind a firewall, add the following UDP ports to your firewall.

- 900 Signaling Information
- 5000 Status Information
- 5004 RTP Packets
- 5005 RTCP Packets

Refer to your firewall user documentation to enter and open these ports.

1. Verify that your MultiVOIP 100 has been properly cabled, that the power is turned on, and that the **Boot** LED is off.

Note: If the Ethernet connection is not active, none of the LEDs will be on after booting. This unit does not have a Power LED.

2. Insert the MultiVOIP 100 CD into your CD-ROM drive. The CD should start automatically. It may take 10 to 20 seconds for the MultiTech CD installation window to display.



If the Multi-Tech Installation CD window does not display automatically, click **My Computer**, then right click the CD ROM drive icon, click **Open**, and then click the **Autorun** icon.

3. When the Multi-Tech Installation CD dialog box displays, click the **Install Software** icon.

- The **MultiVOIP Setup** welcome window displays.

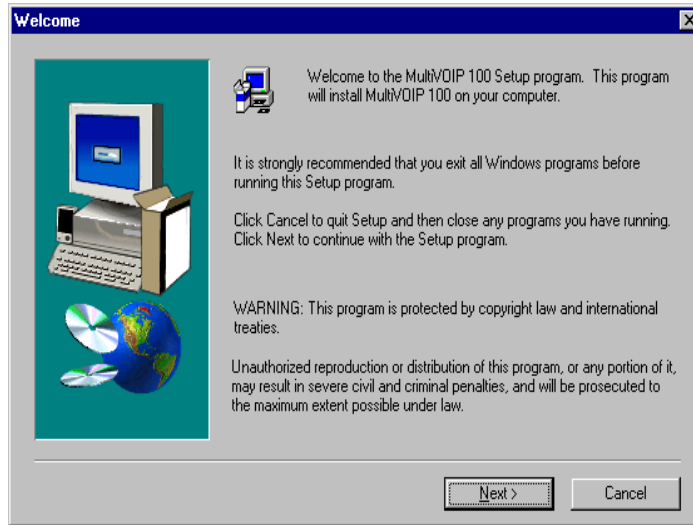

Press **Enter** or click **Next** to continue.

- Follow the on-screen instructions to install your MultiVOIP software.

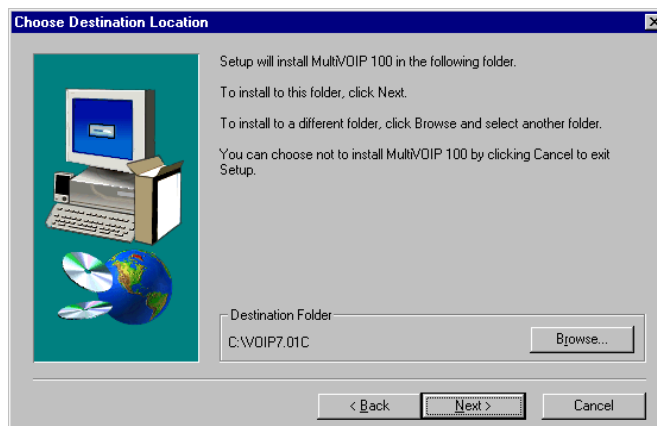

- The following dialog box selects the COM port of your PC connected to the Command port of the MultiVOIP. From the **Select Port** list, select the COM port of your PC.

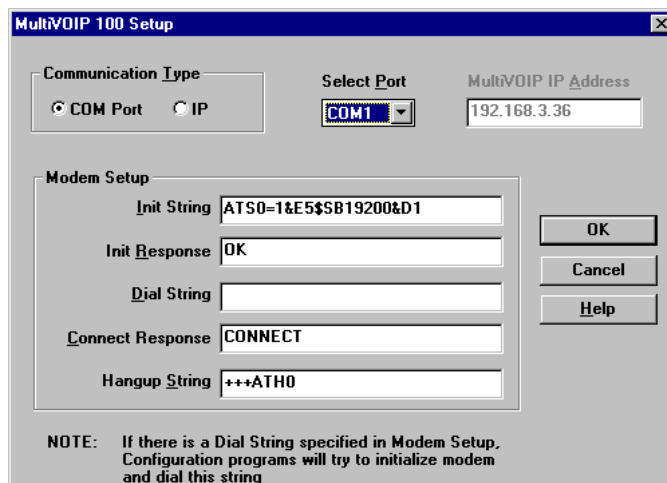

Click **OK** to continue.

7. The **Setup Complete** dialog displays.

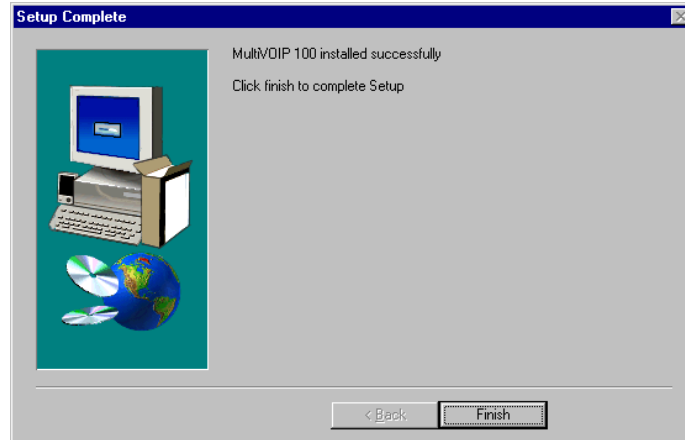

Click **Finish** to continue.

8. The following message displays:

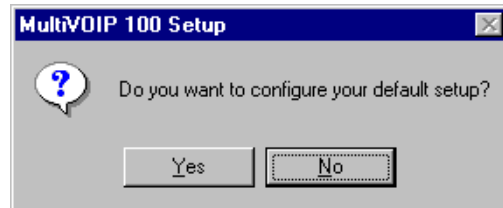

Click **No** to continue.

9. The following dialog box displays.

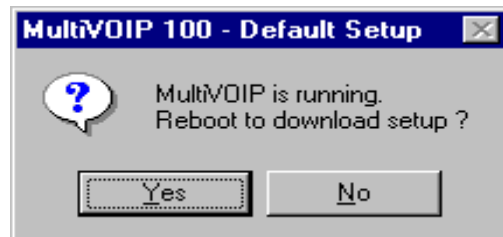

Click **No** to continue.

9. In the program group, double-click **Upgrade Software**.

10. The following window displays.



Click **Yes** to continue.

11. The **IP Protocol Default Setup** dialog box displays.



The default **Frame Type** is **TYPE_II**. If this does not match your IP network, change the Frame Type by selecting SNAP from the **Frame Type** list. The available Frame Type choices are **TYPE_II** and **SNAP**.

12. In the **Ethernet** group, enter your unique LAN IP address in the **IP Address** box, then enter the **Subnet Mask** and **Gateway Address** for your LAN in the corresponding boxes.

The IP address is your unique LAN IP address, and the Gateway address is the IP address of the device connecting your MultiVOIP to the Internet.

Click **OK** when you are finished.

13. The **Channel Setup** dialog box displays. It is used to define the voice/fax channel interface, voice coder, fax parameters, billing options, security settings, and regional phone parameters (tone pairs) for each channel. The **Interface** tab displays the interface, max dial digits, inter digit time, flash hook time, auto call, current loss, and ring count settings.

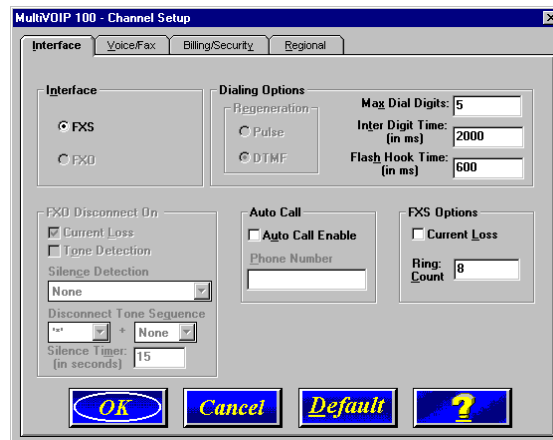

In the **Max Dial Digits** box, enter the maximum number of digits allowed when dialing a phone number. The default setting is 5. In the **Inter Digit Time** box, enter the maximum amount of time in milliseconds that the unit will wait before mapping the dialed digits to an entry in the Phone Directory Database. If too much time elapses between digits and the wrong numbers are mapped, you hear a rapid busy signal. If this happens, hang up and dial again. This option is available for all interface types. In the **Flash Hook Time** box, enter the time, in milliseconds, for the duration of flash hook signals output on the FXS interface.

To dedicate the voice/fax channel to a remote voice/fax channel, (so you will not have to dial the remote channel) select the **Auto Call Enable** check box. Enter the phone number of the remote MultiVOIP in the **Phone Number** box.

The **FXS Options** control how the selected channel interacts with answering machines. If the **Current Loss** check box is selected, the local MultiVOIP interrupts power from the Phone port when a call is hung up on the remote end. The remote MultiVOIPs must also be configured for current loss. The **Ring Count** box contains the maximum number of rings allowed before the caller hears a fast Busy signal. If this happens, hang up and try again. The default setting is 8 rings.

The **Voice/Fax** tab displays the parameters for the voice coder, faxing, and DTMF gain.

14. To change the voice coder, select the new voice coder entry from the **Voice Coder** list.

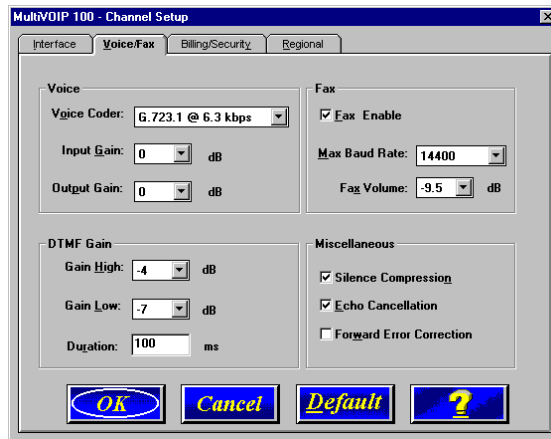

If you changed the voice coder, ensure that the same voice coder is used on the voice/fax channel you are calling. Otherwise, you will get a busy signal.

15. The **Fax** group enables you to select the maximum baud rate for faxes and adjust the fax volume. If you do not plan to send or receive faxes on a given voice/fax channel, you can disable faxes in the **Fax** group.
16. You can enable the voice/fax advanced features by selecting the **Silence Compression**, **Echo Cancellation**, or **Forward Error Correction** check boxes in the **Miscellaneous** group.

The **Silence Compression** check box defines whether silence compression is enabled for the selected voice channel. If enabled, the MultiVOIP will not transmit voice packets when silence is detected, thereby reducing the amount of network bandwidth being used by the voice channel.

The **Echo Cancellation** check box defines whether echo cancellation is enabled for the selected voice channel. If enabled, the MultiVOIP will remove echo, which improves sound quality.

The **Forward Error Correction (FEC)** check box enables recovery of some corrupted or lost voice packets. FEC adds 50 % overhead to the VOIP's required network bandwidth while the call is active.

17. The **Billing/Security** tab displays the parameters for automatic disconnection, billing options, and call authentication.

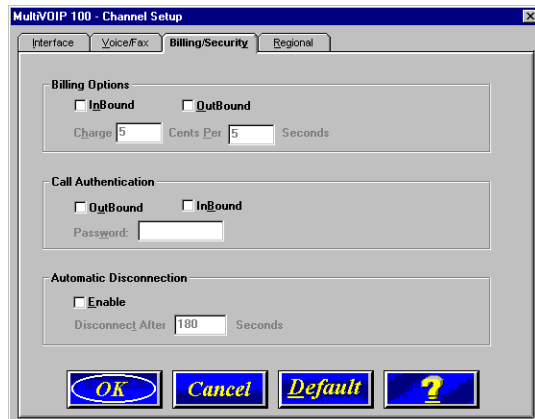

18. You can set up billing options for inbound and outbound calls by selecting them in the **Billing Options** group and then entering the charge in cents per number of seconds.
19. The **Call Authentication** option enables password protection for outbound and inbound calls on the selected voice/fax channel. If you enable password protection on inbound or outbound calls, you need to also enter a password of up to 14 numeric characters in the **Password** box.
20. The **Automatic Disconnect** option limits call duration to the number of seconds entered in the **Disconnect After** box. The default value of 180 seconds can be changed to any other value up to 65,535 (roughly 18.2 hours).

If your country/region is not the default USA, click the **Regional** tab and proceed to step 23. Otherwise, proceed to step 24 to begin building your phone directory database.

21. To change the Tone Pairs on the **Regional** tab, select your country or region from the **Country/Region** list. See Chapter 4 for more information.

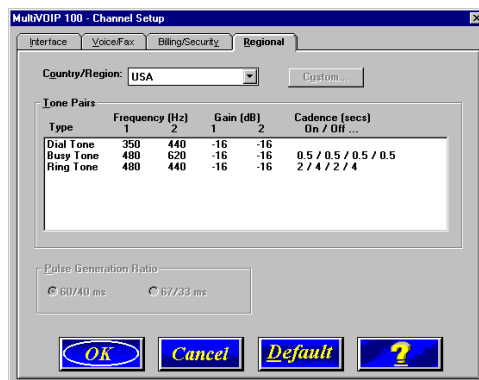

The **Tone Pairs** group parameters change per your choice. Click **OK** when finished.

22. The following dialog box displays.

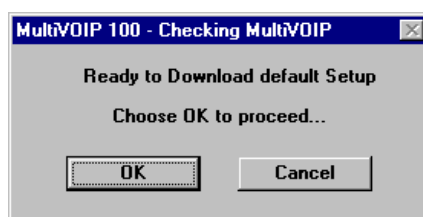

Click **OK**. The upgrade process begins. Each component is loaded in succession.

23. From the Program Group, double-click **MultiVOIP Configuration**. Click **Phone Book**. The **Phone Directory Database** dialog box displays. You will build your personalized MultiVOIP Phone Directory in the following steps.

The MultiVOIP configured as a “Host” will contain the host database. The host database has the phone numbers of all the MultiVOIP’s available for communication on an IP network. This database is downloaded to each Client MultiVOIP as it comes online.

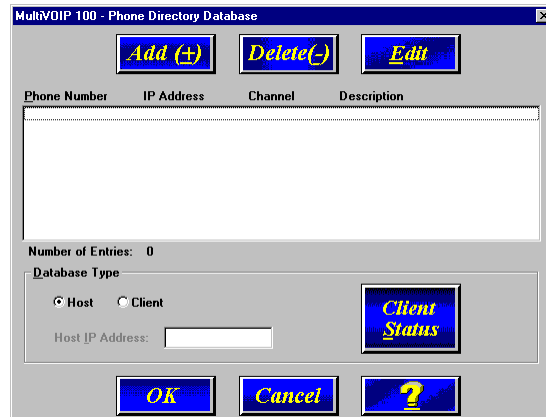

Click **Add** to begin building your phone directory database.

24. The **Add/Edit Phone Entry** dialog box displays.

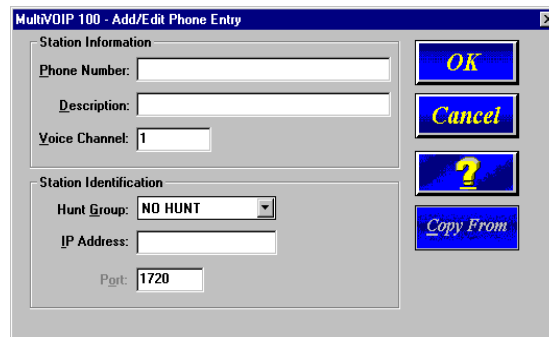

In the **Station Information** group, enter the unique phone number of the local device connected to Channel 1 in the **Phone Number** box. For example phone number 101.

25. The **Description** is optional, but can be useful in associating the channel to the extension. If you want, enter a description of your local phone number. This description identifies the phone number you entered in the previous step.
26. Select the **Permit Hunting** check box if you want calls to roll over to a second voice/fax on an answering 2, 4, or 8-port client MultiVOIP when the first channel is busy.

Note: The Host MultiVOIP must have a static IP address that the remote MultiVOIP can reference to obtain a downloaded copy of the host phone directory database.

27. In the **MultiVOIP Identification** group, enter the IP address of the Host MultiVOIP in the **IP Address** box. For example, 204.22.122.118. Then obtain the 12-digit Node ID# (0008005xxxxx) from the ID plate on the back panel of the MultiVOIP and enter this number in the **Ethernet Node ID** box. If the ID plate is missing or damaged, you can also Telnet to the MultiVOIP and, on the MultiVOIP Telnet Server menu enter **1** to advance to the Main Menu,

then enter **3** for System Information where item 1 is the Ethernet Port Address you want to enter in the **Ethernet Node ID** box.

MultiVOIP 100 - Add/Edit Phone Entry

Station Information

Phone Number: 101

Description: New York Office

Voice Channel: Channel 1

Permit Hunting

MultiVOIP Identification

Type

Dynamic

Static

Identified By

IP Address: 201.22.122.118

Ethernet Node ID: 000800801912

OK

Cancel

?

28. Click **OK** and you are returned to the **Phone Directory Database** dialog box, which now includes phone number 101 with its IP address, channel number, and description.

MultiVOIP 100 - Phone Directory Database

Add (+) Delete (-) Edit

Phone Number	IP Address	Channel	Description
101	201.22.122.118	Channel 1	New York Office

Number of Entries: 1

Database Type

Host Client

Host IP Address:

Client Status

OK Cancel ?

29. Click **Add** and the **Add/Edit Phone Entry** dialog box displays again.
30. Enter the phone number for the client MultiVOIP in the **Station Information** group **Phone Number** box. For example, 201.
31. Enter a description for the client MultiVOIP phone number for Channel 1 in the **Description** box.

Note: If the remote MultiVOIP is located behind a proxy server that uses a dynamically assigned IP address, select **Dynamic** (disabling Static IP Address) and leave the **IP Address** box blank. The Host MultiVOIP will learn the IP address when it is contacted by the client MultiVOIP.

32. Enter the IP address of the client MultiVOIP in the **IP Address** box in the **MultiVOIP Identification** group. For example, 202.56.39.100.

MultiVOIP 100 - Add/Edit Phone Entry

Station Information

Phone Number: 102

Description: Human Resources Desk

Voice Channel: Channel 1

Permit Hunting

MultiVOIP Identification

Type

Dynamic

Static

Identified By

IP Address: 201.22.122.119

Ethernet Node ID: 000800801935

OK

Cancel

?

33. Click **OK** and you are returned to the **Phone Directory Database** dialog box, which now includes the second number and related information in the **Phone Number** list.

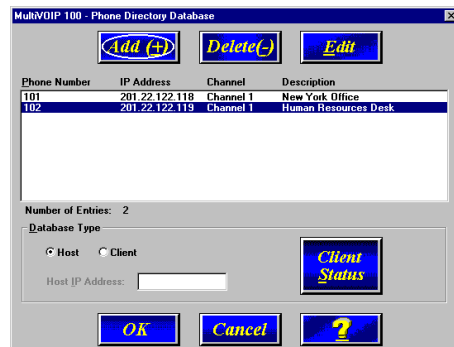

34. When you have finished, click **OK** to download the setup configuration to the MultiVOIP.
35. The **Checking MultiVOIP** dialog box displays.

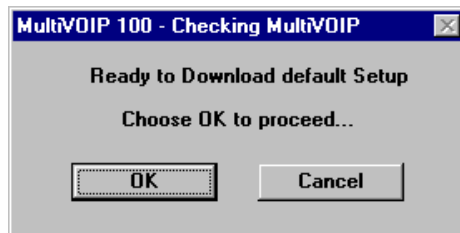

Click **OK** to proceed.

36. After the setup is written to the MultiVOIP, the unit is rebooted.
37. Verify that the **BOOT** LED on the MultiVOIP is off after the download is complete. This may take several minutes as the MultiVOIP reboots.
38. You are returned to your MultiVOIP folder which is open and visible on your desktop.

At this time, your host MultiVOIP is configured. Proceed to the next section to configure the client MultiVOIPs.

Configuring Your Client MultiVOIPs

If you are installing a MultiVOIP behind a firewall, you need to add the following UDP ports to your firewall.

900 Q.931 Signaling Information

5000 Status Information

5004 RTP Packets

5005 RTCP Packets

Refer to your firewall user documentation to enter and open these ports.

1. Disconnect the PC from the command port of the Host MultiVOIP and connect it to the command port on the Client MultiVOIP.
2. From your desktop, click **Start | Programs | MultiVOIP | Upgrade Software**. The following dialog box displays.



3. Click **Yes**. The **IP Protocol Default Setup** dialog box displays.



The default **Frame Type** is **TYPE_II**. If this does not match your IP network, select the Frame Type from the **Frame Type** list. The Frame Type choices are **TYPE_II** and **SNAP**.

4. In the **Port Address** group, enter the **IP Address** and **IP Mask**. In the **Gateway Address** group, enter the gateway IP address for the client unit.

The IP address is your unique LAN IP address, and the Gateway address is the IP address of the device connected to the Internet/Intranet.

Click **OK** when you are finished. The **Channel Setup** dialog box displays.

5. The **Channel Setup** dialog box defines the channel interface, voice coder, fax parameters, and regional telephone parameters for each channel.

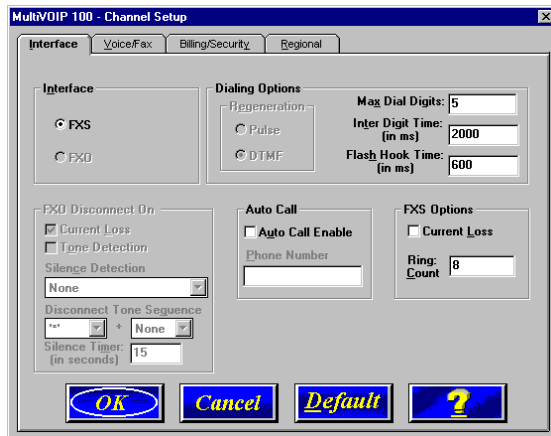

Configure each channel for the type of interface you are connecting to. To change the channel number, select the channel you want to configure from the **Select Channel** list.

6. The **Interface** group defaults to **FXS (Loop Start)**. Select the interface option to correspond to the interface type being connected to the Voice/Fax connector on the back panel of the MultiVOIP.

If you are connecting a station device such as an analog telephone, a fax machine, or a Key Telephone System (KTS) to the Voice/Fax connector on the back of the unit, **FXS (Loop Start)** will likely be the correct Interface option most of the time.

In the **Max Dial Digits** box, enter the maximum number of digits allowed when dialing a phone number. The default setting is 5. In the **Inter Digit Time** box, enter the maximum amount of time in milliseconds that the unit will wait before mapping the dialed digits to an entry in the Phone Directory Database. If too much time elapses between digits and the wrong numbers are mapped, you hear a rapid busy signal. If this happens, hang up and dial again. This option is available for all interface types. In the **Flash Hook Time** box, enter the time, in milliseconds, for the duration of flash hook signals output on the FXS interface.

To dedicate a local voice/fax channel to a remote voice/fax channel, (so you will not have to dial the remote channel) select the **Auto Call Enable** check box. Enter the phone number of the remote VOIP in the **Phone Number** box.

The **FXS Options** control how the selected channel interacts with answering machines. If the **Current Loss** check box is selected, the local VOIP hangs up when the electrical current is lost. The remote VOIPs must also be configured for current loss. The **Ring Count** box contains the number of rings before the caller hears a fast Busy signal. If this happens, hang up and try again. The default setting is 8 rings.

The **Voice/Fax** tab displays the parameters for the voice coder, faxing, and DTMF gain.

7. To change the voice coder, select the channel from the **Select Channel** list, then select the new voice coder entry from the **Voice Coder** list.

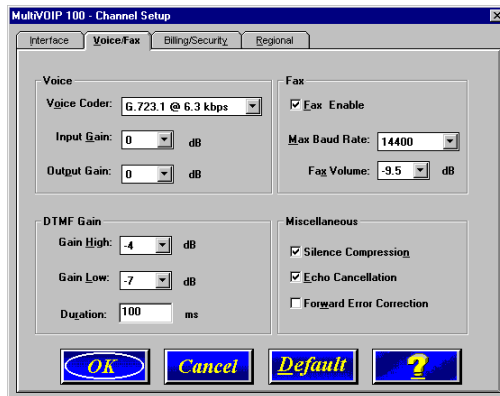

If you changed the voice coder, ensure that the same voice coder is used on the voice/fax channel you are calling. Otherwise, you will always get a busy signal.

9. The **Fax** group enables you to select the maximum baud rate for faxes. If you do not plan to send or receive faxes on a given voice/fax channel, you can disable faxes in the Fax group.
10. You can enable the voice/fax advanced features by selecting the **Silence Compression**, **Echo Cancellation**, or **Forward Error Correction** check boxes in the **Miscellaneous** group.

The **Silence Compression** check box defines whether silence compression is enabled for the selected voice channel. If enabled, the MultiVOIP 400/800 will not transmit voice packets when silence is detected, thereby reducing the amount of network bandwidth being used by the voice channel.

The **Echo Cancellation** check box defines whether echo cancellation is enabled for the selected voice channel. If enabled, the MultiVOIP 400/800 will remove echo-delay, which improves sound quality.

The **Forward Error Correction (FEC)** check box enables recovery of some corrupted or lost voice packets. FEC adds 50 % overhead to the total network bandwidth.

11. The **Billing/Security** tab displays the parameters for automatic disconnection, billing options, and dialing options.

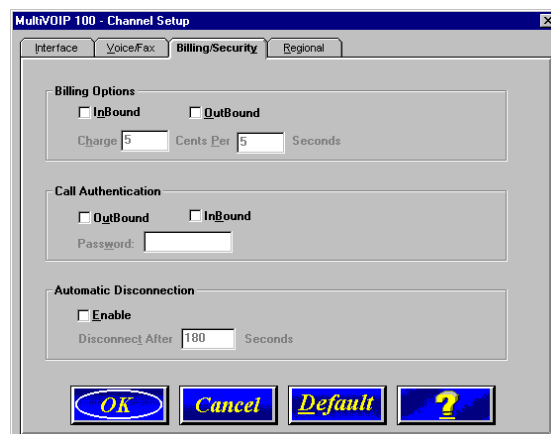

13. You can set up billing options for inbound and outbound calls by selecting them in the **Billing Options** group and then entering the charge in cents per number of seconds.

14. The **Call Authentication** option enables password protection for outbound and inbound calls on the voice/fax channel. If you enable password protection on inbound or outbound calls, you need to also enter a password of up to 14 numeric characters in the **Password** box.
15. The **Automatic Disconnect** option limits call duration to the number of seconds entered in the **Disconnect After** box. The default value of 180 seconds can be changed to any other value up to 65,535 (roughly 18.2 hours).

If your country/region is not the default USA, click the **Regional** tab and proceed to step 15. Otherwise, proceed to step 16 to begin building your phone directory database.

16. To change the Tone Pairs on the **Regional** tab, select your specific country or region from the **Country/Region** list.

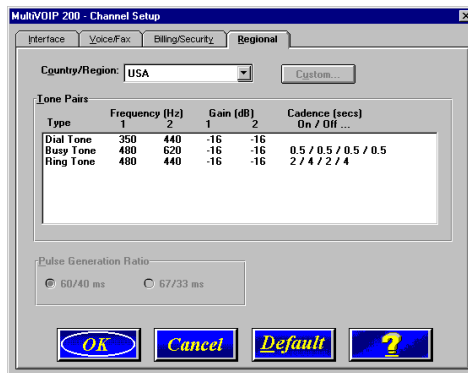

The **Tone Pairs** group parameters change per your selections. Click **OK**. The following dialog box displays.

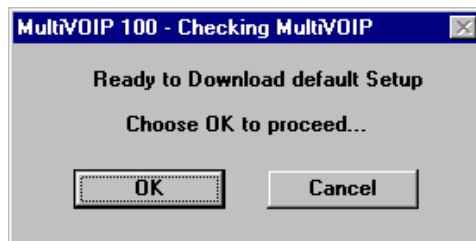

17. Click **OK**. After the upgrade is complete, click Start | Programs | MultiVOIP | MultiVOIP Configuration. On the main menu, click **Phone Book** to display the **Phone Directory Database** dialog box.

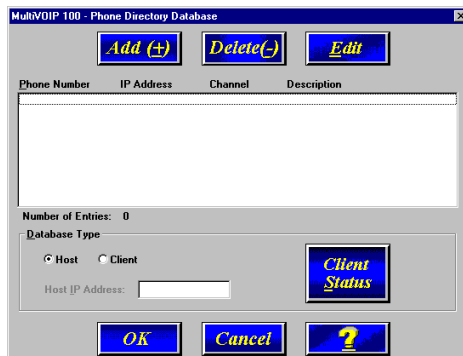

In the **Database Type** group, click the **Client** option. The **Update Database From** group becomes active.

18. Enter the IP address of the host MultiVOIP in the **Host IP Address** box.

19. Click **OK** and you are returned to the main menu.
20. Click **Download Setup** to write the new configuration to the client unit. The **Save Setup** dialog box displays.

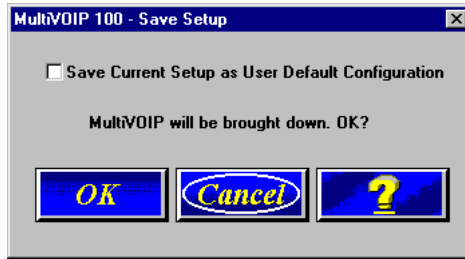

21. Select the **Save Current Setup as User Default Configuration** check box and click **OK**. After the setup is written to the MultiVOIP, the unit reboots.
22. Verify that the **Boot** LED on the MultiVOIP is Off after the download is complete. This may take several minutes as the MultiVOIP reboots.
23. You are returned to the main menu.

Your MultiVOIP is operational at this time.

Repeat this procedure for each of the client units. When all clients have been configured, proceed with deploying the VOIP network.

Deploy the VOIP Network

Deploying the VOIP network involves the VOIP Administrator developing the VOIP Dialing Directory and deploying the pre-configured client MultiVOIPs to their remote sites. The remote site administrators need only connect power to the pre-configured MultiVOIP, connect it to their Ethernet LAN and predefined telephone equipment, and then wait for the phone directory database to be downloaded.

Perform the following procedure to deploy your VOIP network.

VOIP Administrator

1. Establish your VOIP Dialing Directory based on your Phone Directory Database for the numbers to connect the MultiVOIPs to your VOIP network and the telephone extension number you need to connect to the Voice/Fax channels. A sample VOIP Dialing Directory is provided below for your consideration and use.

VOIP Dialing Directory		
To call from	Call Process	Dialing Sequence

2. Send the client MultiVOIPs to their remote sites.

Remote Site Administrator

3. Unpack your MultiVOIP.
4. Connect one end of the power supply to a live AC outlet and connect the other end to the **Power** connection on your MultiVOIP.

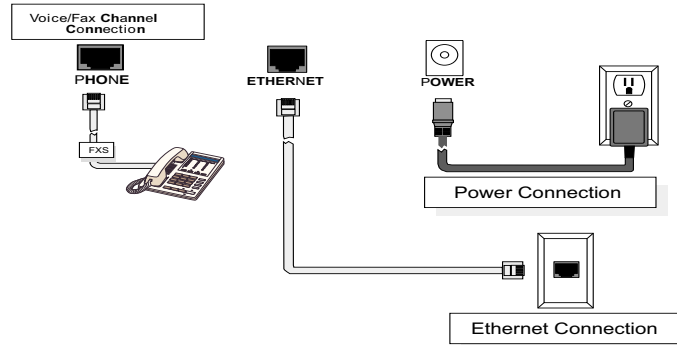

Figure 8. Remote Site Cable Connection

5. Connect a network cable to the **ETHERNET** (RJ-45) connector on the back of your MultiVOIP.
6. If you are connecting a station device such as an analog telephone, a fax machine, or a Key Telephone System (KTS) to your MultiVOIP, connect one end of an RJ-11 cable to the **Phone** connector on the back of the MultiVOIP and the other end to the station device.
7. Turn on power to the MultiVOIP by moving the ON/OFF switch on the right side panel to the ON position. Wait for the **Boot** LED on the MultiVOIP to go off before proceeding. This may take a couple of minutes.
8. At this time your VOIP network should be fully operational. Dial one of the sites in your network using the dialing directory supplied by your network Administrator.



Chapter 4 - MultiVOIP Software



Introduction

This chapter describes various features of the MultiVOIP software that enable you to change (update) the configuration of your MultiVOIP. The basic configuration parameters were entered during the loading of the software (Chapter 3). The MultiVOIP software and configuration utilities described in this chapter enable you to change that initial configuration as necessary.

The primary interface to the MultiVOIP software is a main menu (with **MultiVOIP 200 Setup** in the title bar) with individual buttons that enable you to quickly and easily select a desired function. These features are discussed in detail in the MultiVOIP Configuration section later in this chapter.

The other six configuration utilities in the MVP 110 software provide additional functionality. The **Configuration port setup** utility enables you to change the method by which you access the MultiVOIP (through a direct connection of a PC to the Command Port on the MultiVOIP, or via your Internet or LAN connection to the LAN port on the MultiVOIP). The **Date and Time setup** utility enables you to easily set the date and time used for data logging in the MultiVOIP. **Download Factory Defaults** enables you to return the configuration to the original factory settings. **Download Firmware** enables you to download new versions of firmware as enhancements become available. **Download User Defaults** enables you to download your own default settings or profile. **Download Voice Coders** enables you to download voice coders to the MultiVOIP. The **Uninstall MultiVOIP Configuration** utility removes the MVP 110 software from your PC.

Before You Begin

The MultiVOIP software operates in a Microsoft Windows® environment. The MultiVOIP 100 program group contains icons for all the utilities described above. You can access the individual utility programs either by clicking **Start | Programs | MultiVOIP 100 | (utility)**.

MultiVOIP Configuration

The MultiVOIP Setup menu enables you to display and change the voice channels and IP protocol parameters, display and manage the Phone Book listing, view statistics and call progress, and change features such as SNMP Agent, Telnet Server, WEB Server, and assign a MultiVOIP password.

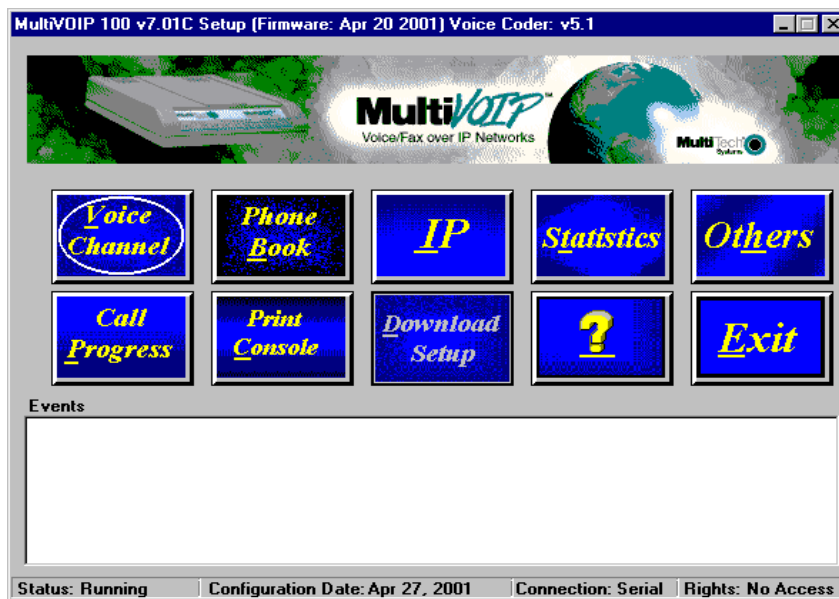

The Events window in the lower third of the Setup menu provides information about the boot process.

The status bar at the bottom of the Setup menu displays the current status of the unit and shows, for example, if it is Running, the most recent date the unit was configured, the type of connection you

have to the unit, and your rights. It shows if your PC is connected directly to the command port of the MultiVOIP or is communicating with the Ethernet port.

The **Rights** box displays whether the user has Read/Write or Read-Only rights. The first user to use the MultiVOIP has Read/Write rights and can view and change the configuration of the MultiVOIP. Subsequent users have only Read-Only rights and can view the configuration of the MultiVOIP but cannot change it.

Changing Channel Parameters

The channel parameters include the interface type and its options, voice and fax settings, and voice communications for the country and region in which the MultiVOIP is operating. The **Channel Setup** dialog box is accessed by clicking **Voice Channel** on the Setup menu.

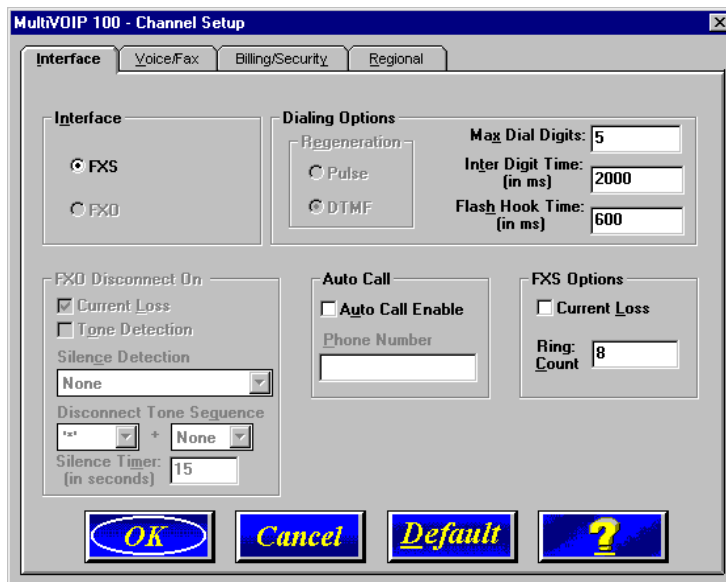

Interface tab

The Interface tab defines the parameters related to the physical interface of the voice/fax channel.

The **Max Dial Digits** indicates the maximum number of digits the MultiVOIP will allow you to enter when dialing one of the numbers in the Phone Directory Database. As soon as you have entered this number of digits, the MultiVOIP will immediately attempt to match the digits you have dialed with an entry in the database. The range for the Max Dial Digits is from zero to 16 digits with a default of five.

The **Inter Digit Time** (in milliseconds) option in the **Dialing Options** group defines the amount of time the MultiVOIP waits between digits as they are entered by the user. If this timer expires, the MultiVOIP will immediately attempt to match the digits entered to an entry in the Phone Directory Database. The range for this option is 200 to 10,000 with a default of 2,000. In the **Flash Hook Time** box, enter the time, in milliseconds, for the duration of flash hook signals output on the FXS interface.

The **Auto Call** option allows the local MultiVOIP to call a remote MultiVOIP without the user having to dial a Phone Directory Database number. As soon as you access the local MultiVOIP voice/fax channel, the MultiVOIP immediately connects to the remote MultiVOIP that you identified in the Remote MultiVOIP Phone Number box of this option.

FXS

The FXS Interface is used to connect telephones, fax machines, and key telephone systems to the MultiVOIP.

The **FXS Options** group controls how the selected channel interacts with answering machines. If the **Current Loss** check box is selected, the local MultiVOIP interrupts power from the Phone port when a call is hung up on the remote end. The remote MultiVOIPs must also be configured for current loss. The **Ring Count** box contains the maximum number of rings allowed before the caller hears a fast busy signal. If this happens, hang up and try again. The default setting is 8 rings.

Voice/Fax tab

The **Voice/Fax** tab controls the voice coder, Input and Output gains, Fax settings, DTMF gain, and some miscellaneous options.

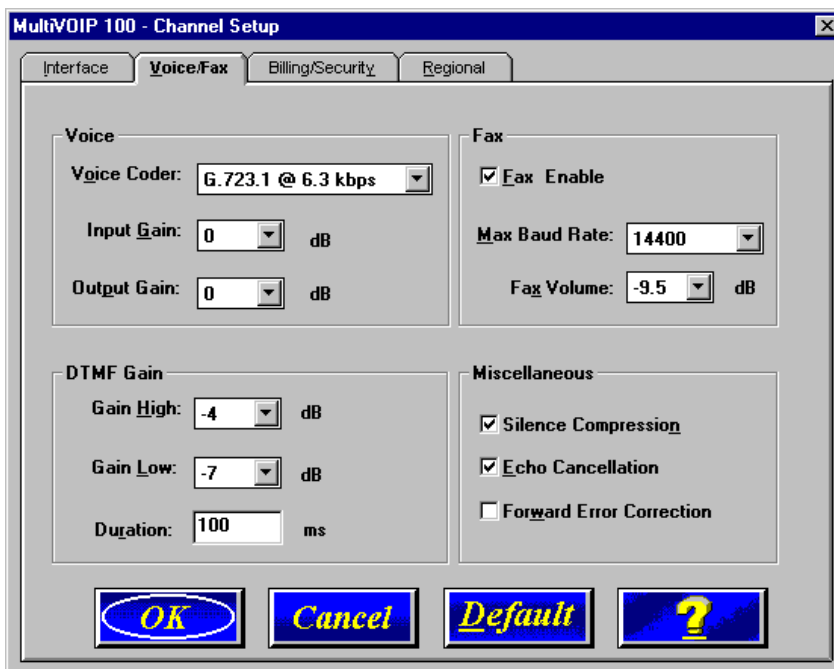

The MultiVOIP supports many state-of-the-art ITU (International Telecommunications Union) voice coders. The **Voice Coder** list enables you to select from a range of coders with specific bandwidths. The higher the bps rate, the more bandwidth is used. The channel that you are calling has to have the same voice coder selected. Otherwise, you will always get a Fast Busy signal.

The **Input Gain** and **Output Gain** lists enable you to select the amount of gain you want. Gain is the increased signalling power that occurs as the signal is boosted by the MVP110. The **Input Gain** list defines the voice input gain for the Voice/Fax channel. Before the MVP110 digitizes voice, the volume can be increased or decreased. Input gain modifies the level of audio coming into the voice channel before it is sent over the Internet to a remote MultiVOIP. The valid range for this option is +31dB to -31 dB. The recommended and default value is **0**. The **Output Gain** list defines the voice output gain for the Voice/Fax channel. Before the MVP110 converts digital voice back to analog, the volume can be increased or decreased. The output gain modifies the level of the audio being output to the device attached to the Voice/Fax channel. The valid range for this option is +31dB to -31 dB. The recommended and default value is **0**.

The **Fax** group enables a fax machine to transmit and receive faxes through the MultiVOIP. If a fax machine is connected to the voice/fax channel, the **Max Baud Rate** should be set to match the baud rate of the fax machine. Refer to user documentation for your fax. The **Fax Volume** setting controls the output level of the fax tones, and this setting should be changed only under the direction of Multi-Tech's Technical Support personnel. See [Chapter 6 - Warranty, Service and Tech Support](#).

You can enable the voice/fax advanced features by selecting the **Silence Compression**, **Echo Cancellation**, or **Forward Error Compression** check boxes in the **Miscellaneous** group.

The **Silence Compression** check box defines whether silence compression is enabled for the selected voice channel. If enabled, the MultiVOIP will not transmit voice packets when silence is detected, thereby reducing the amount of network bandwidth being used by the voice/fax channel.

The **Echo Cancellation** check box defines whether echo cancellation is enabled for the voice/fax channel. If enabled, the MultiVOIP will remove echo-delay, which improves sound quality.

The **Forward Error Correction (FEC)** check box enables recovery of some corrupted or lost voice packets. FEC adds 50 % overhead to the total network bandwidth.

The **DTMF Gain** group controls the volume level of the digital tones sent out for Touchtone dialing. The **Gain High** and **Gain Low** boxes control the gain in dB (decibels) of the High and Low tones in the tone pairs; the default gain values are -4 dB and -7 dB, respectively. DTMF Gain should not be changed except under supervision of MultiTech's Technical Support.

Billing/Security tab

The **Billing/Security** tab displays the parameters for billing options, call authentication, and automatic disconnection.

The screenshot shows the 'MultiVOIP 100 - Channel Setup' dialog box with the 'Billing/Security' tab selected. The dialog is divided into four tabs: 'Interface', 'Voice/Fax', 'Billing/Security', and 'Regional'. The 'Billing/Security' tab contains three main sections:

- Billing Options:** Includes checkboxes for 'InBound' and 'OutBound'. Below these are input fields for 'Charge' (set to 5), 'Cents Per' (set to 5), and 'Seconds'.
- Call Authentication:** Includes checkboxes for 'OutBound' and 'InBound', and a 'Password:' input field.
- Automatic Disconnection:** Includes an 'Enable' checkbox and a 'Disconnect After' input field (set to 180) followed by 'Seconds'.

At the bottom of the dialog are four buttons: 'OK', 'Cancel', 'Default', and a help icon (a question mark).

You can set up billing options for inbound and outbound calls by selecting them in the **Billing Options** group and then entering the charge in cents per number of seconds.

The **Call Authentication** option enables password protection for outbound and inbound calls on the selected voice/fax channel. If you enable password protection on inbound or outbound calls, you need to also enter a password of up to 14 numeric characters in the **Password** box.

The **Automatic Disconnect** option limits call duration to the number of seconds entered in the **Disconnect After** box. The default value of 180 seconds can be changed to any other value up to 65,535 (roughly 18.2 hours).

Regional tab

The regional tab controls the voice communications for the country or region in which the MultiVOIP is being used.

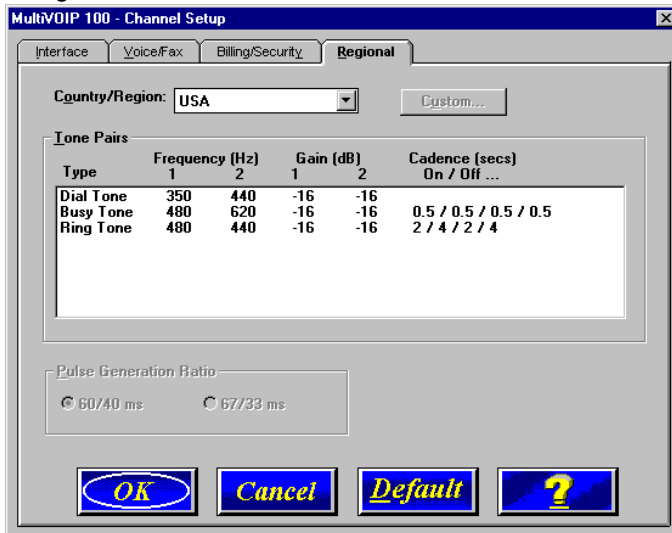

From the **Country/Region** list you can select the country or region for which you are configuring the MultiVOIP. The **Tone Pairs** group always displays the tones used in the country or region currently selected. In addition to Australia, Central America, Chile, Europe, France, Japan, UK, and USA, there is a Custom selection (with defaults identical to USA) that will make the **Custom** button active. Clicking **Custom** enables you to edit the Tone Pairs and establish custom sets of tone pairs for Dial Tone, Ring, and Busy on a **Custom Tone Pair Settings** dialog box.

The **Pulse Generation Ratio** group contains two ratios: the 60/40 is for the USA, and the 67/33 ratio is for international applications.

Changing the Phone Directory Database

The **Phone Directory Database** dialog box displays all the phone numbers in your MultiVOIP network. The database displays the phone numbers in numerical order with the IP Address, Channel assignment, and description.

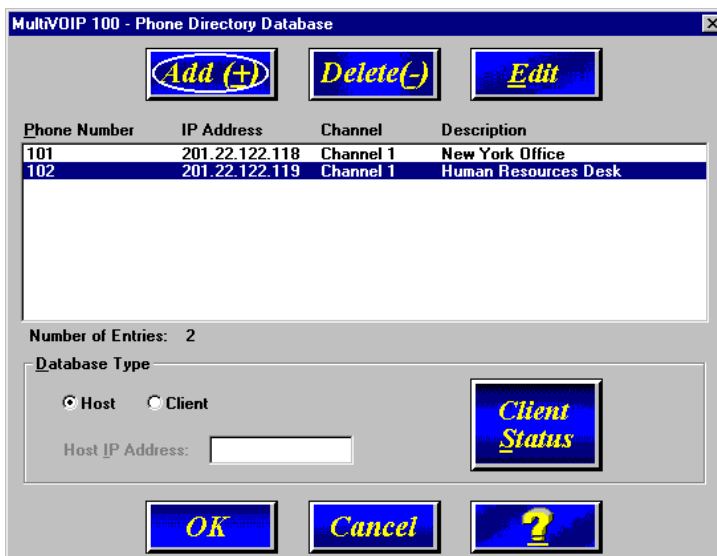

Access this database by clicking **Phone Book** on the MultiVOIP Main menu. You can add, delete, or edit any entry in the database and you can change the host-client relationship of the database. Click

Client Status to display the status of all the client units in your VOIP network. The Phone Number of each client displays with its IP Address, current line status, and the description of the phone number.

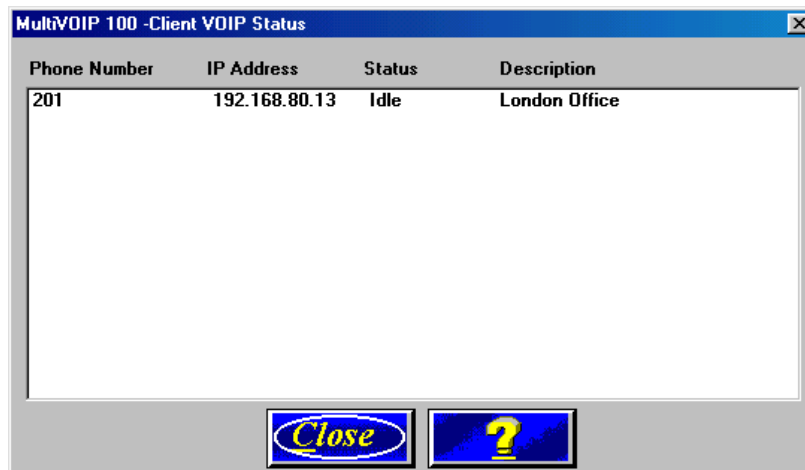

Phone Number	IP Address	Status	Description
201	192.168.80.13	Idle	London Office

The phone number does not have to be a conventional phone number such as 555-1234. It can be a single digit or several digits, except it cannot be longer than the entry in the **Max Dial Digits** box in the **Channel Setup** dialog box. For example, you could enter a phone number of 101 with a description of New York Office. If you want the call to be rolled over to a second channel, select the **Permit Hunting** check box. If the assigned channel is busy, then the call is rolled over to the next channel.

The **MultiVOIP Identification** group defines the type of addressing (**Dynamic** or **Static**) for the host and client units for their respective Phone Numbers. The Phone Numbers assigned to the host MultiVOIP have to be Static addressing and the Phone Numbers assigned to the client MultiVOIP can be either dynamic or static depending on whether a Proxy Server is providing the connection to the Internet. If a Proxy Server is in front of the MultiVOIP providing the Internet connection and the Proxy Server is using dynamic addressing (the ISP is assigning the Proxy Server IP address), then this client MultiVOIP will be defined as using Dynamic addressing and the **IP Address** box in the **Identified By** group will be unavailable.

If a Proxy Server with a static IP address is in front of the client MultiVOIP, then the **Identified By IP Address** box must contain the public or WAN IP address of the Proxy Server.

If the client MultiVOIP is connected directly to the Internet, then its addressing mode must be Static. If the client unit is using Static addressing, then the **IP Address** box in the Identified By group has to contain the Static IP address of the client MultiVOIP.

The **Ethernet Node ID** is a 12-digit Identification Number assigned to each unit. This Ethernet Node ID number is a hardware identification number that is affixed to each unit during the manufacturing process and cannot be changed. This ID number (for example, 0008005xxxxx) is located on an ID label attached to every unit. This ID number has to be entered in the **Ethernet Node ID** box for the telephone number entered in the **Phone Number** box. If you are assigning a Phone Number for a client unit, the Ethernet Node ID has to be for that client unit.

If this label is damaged or missing, you can also obtain the ID number by Telneting to the unit. From the MultiVOIP Telnet Server menu, choose the Voice over IP Configuration option which takes you to the Main Menu. In the Main Menu, choose System Information and the ID number is presented in the Ethernet Port Address of the System Information menu.

MultiVOIP 100 - Add/Edit Phone Entry

Station Information

Phone Number: 101

Description: New York Office

Voice Channel: Channel 1

Permit Hunting

MultiVOIP Identification

Type

Dynamic

Static

Identified By

IP Address: 201.22.122.118

Ethernet Node ID: 000800801912

OK

Cancel

?

When you enter this information and click **OK**, the information is loaded into the phone directory database.

To add a second entry, click **Add** and the **Add/Edit Phone Entry** dialog box displays again. After the host entries are added to the database, the same data has to be added for each client MultiVOIP.

To establish the phone directory database for a client MultiVOIP, you do not have to enter phone numbers, but you have to check the **Client** option in the **Database Type** group. When you click the Client option, the Update Database From group becomes active. Enter the IP address of the Host MultiVOIP. Once online, the client MultiVOIP will receive the phone directory database from the Host.

Changing IP Parameters

The IP Setup dialog box establishes the IP addressing for the local Ethernet LAN, defines the Internet gateway address, and for a client MultiVOIP the global-to-local IP address translation is defined on the **Proxy Setup** tab. The **IP Setup** dialog box is accessed by clicking **IP** on the MultiVOIP 100 Setup menu.

MultiVOIP 100 - IP Setup

Ethernet Proxy Setup

Frame Type: TYPE_II

Port Address

IP Address: 169.254.26.12

IP Mask: 255.255.255.0

Gateway Address

IP Address:

OK

Cancel

?

When the **IP Setup** dialog box displays, the IP address of your MultiVOIP displays with its IP Mask. The Gateway Address is the IP address of the device connected to the Internet.

ProxyServer

The **Proxy Setup** tab is used when a ProxyServer is used to connect the LAN to the Internet.

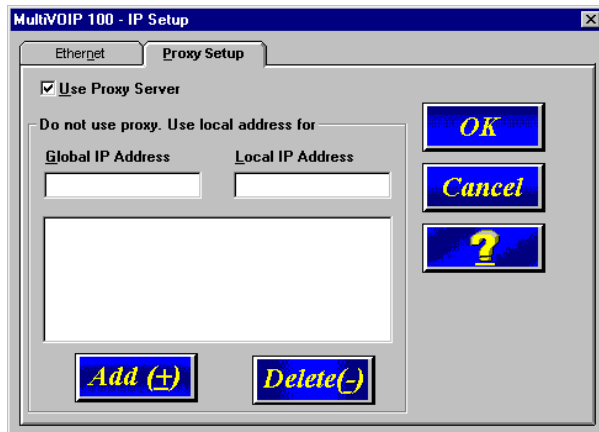

If a ProxyServer is used in a MultiVOIP network, an address translation takes place within the ProxyServer to direct the phone call to the correct MultiVOIP.

When a MultiVOIP's connection to the Internet is through a ProxyServer, the WAN port on the ProxyServer must have a static registered IP address. Remote MultiVOIPs will only be able to access a MultiVOIP located behind a ProxyServer at the static IP address. This static IP address will be used in the Phone Directory Database when assigning directory numbers to this MultiVOIP.

The **Global IP Address** box must contain the static IP address of the WAN port of the ProxyServer. The **Local IP Address** box must contain the local IP address of the MultiVOIP. In this case the local IP address is not used in the Phone Directory Database. There must be a unique static IP address on the Wan side of the proxy server for each MultiVOIP located behind the proxy server.

Viewing Call Progress

The **Call Progress** dialog box displays the status of a call in progress. This dialog box is accessed from the **Setup** menu by clicking **Call Progress**.

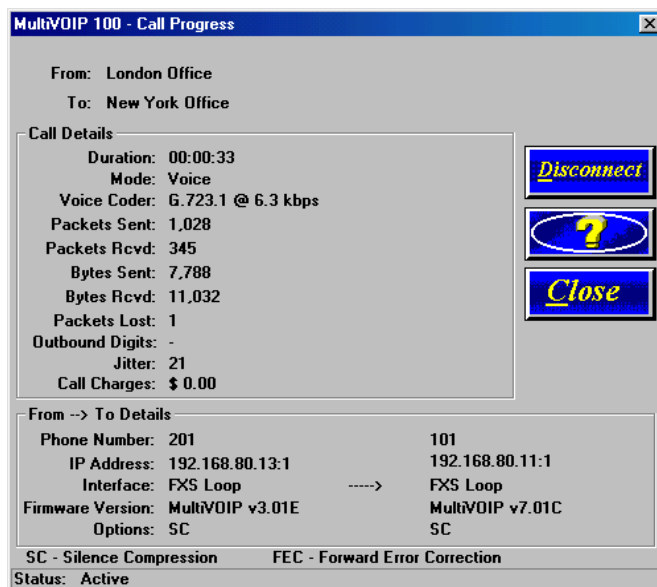

The ratio of Packets Lost versus Packets Received provides a general indication of the integrity of the

Internet connection. To reduce the frequency of lost packets, select a low-bit-rate coder, such as G.723 or Netcoder. Selecting the **Forward Error Correction** check box on the **Voice/Fax** tab in the **Channel Setup** dialog box enables the MultiVOIP to recover many of the lost packets.

The Jitter (ms) value indicates the mean deviation of the difference in packet spacing at the receiver compared to the sender for a pair of packets.

Applications Setup

Clicking **Others** on the Setup menu displays the **Applications Setup** dialog box. You can select the **Enable SNMP Agent** check box and set up all the necessary parameters, enable or disable various remote configuration methods such as TFTP (Trivial File Transfer Protocol) Server, Web Server, Dumb Terminal Management, and Telnet Server; and assign a Password to the MultiVOIP for Internet security. These applications enable remote viewing and changing of the MultiVOIP configuration from anywhere on the connected internetwork.

Verify that the desired applications are selected. The default condition is all applications are checked. To disable a given application, click to uncheck the check box and disable support.

SNMP related operations can be performed only when the **SNMP Agent** is enabled on this dialog box. The IP address of the system, such as SNMP Manager that will receive the Traps from the MultiVOIP should be entered in the **IP Address** box in the Trap Manager group. The **Community Name** of the SNMP Manager receiving the Traps can be a maximum of 19 characters and is case sensitive. The default **Port Number** of the SNMP Manager receiving the Traps is 162. The MultiVOIP currently supports a maximum of two community users at a time, and they can be assigned either Read/Write or Read Only rights.

The **Password** group enables you to enter a password, up to 13 alphanumeric characters, to be used for Internet Security. Once the password is entered (in the **MultiVOIP Password** box) and confirmed (in the **Confirm Password** box), users will be queried to enter the password before gaining access to the MultiVOIP. The same password is used for all configuration methods.

For more information on using these applications, refer to Chapter 5, Remote Configuration and Management.

Viewing Statistics

The Statistics dialog box enables you to view statistics for major events of the MultiVOIP operation. This dialog box is accessed by clicking **Statistics** on the **Setup** menu.

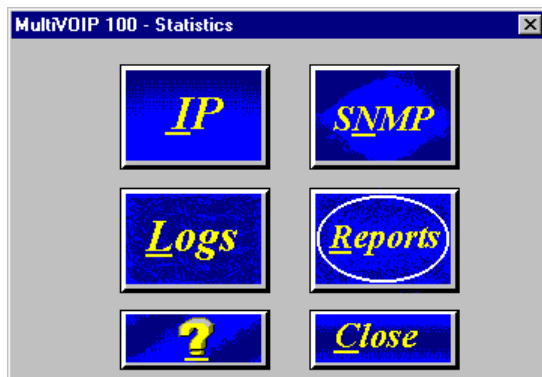

Statistics can be a helpful troubleshooting tool. For example, viewing the Voice Channel statistics you can see the attempted and completed calls, call duration, average call length, bytes/packets sent and received, and so on.

IP Statistics

IP is a connection-less network protocol residing in the network layer of a conventional OSI layered model (for more information on this model, refer to [Appendix A](#)). Depending on what is going on at the application layer, IP will typically use one of two transport layer protocols: User Datagram Protocol (UDP), a connection-less transport layer protocol used with TFTP or SNMP; and Transport Control Protocol (TCP) is a connection-oriented transport layer protocol used with FTP, Telnet, and SNMP.

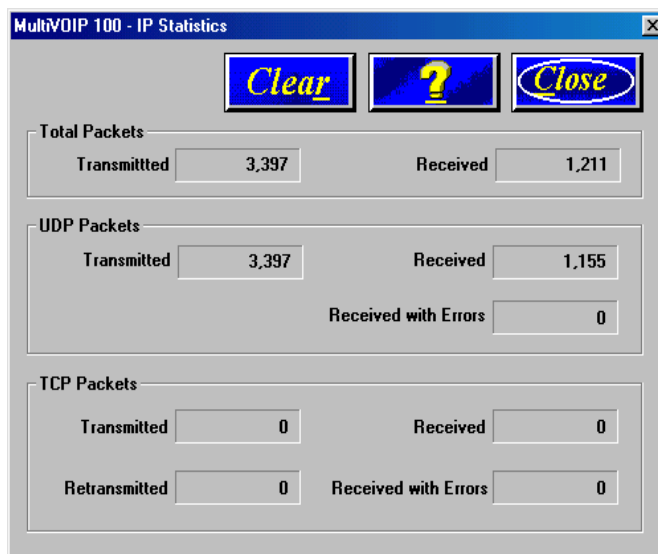

UDP makes use of the port concept and has no measures for flow control, reliability, or error recovery. It is used when the full services of TCP are not required, and the reliability measures must be assumed by another layer.

TCP works well in environments where the reliability measures are not assumed by other layers. It is connection-oriented and has a full range of services.

For the most part these statistics are informational, and their use as a troubleshooting tool will be contingent on the applications running in the upper layers. For example, if you were having problems connecting to the MultiVOIP's web server, you would look under the TCP section to see if any packets

are being transferred. If not, that may indicate the web server is not enabled. Or, if you were having problems establishing a remote connection through TFTP, you could look in the UDP section to see if any packets are being received. If not, you may need to review your network addressing.

SNMP Statistics

The **SNMP Statistics** dialog box provides statistical information on Simple Network Management Protocol (SNMP).

SNMP is an application layer protocol that facilitates the exchange of management information between network devices. There are three key components in SNMP: the devices that are to be managed, agents, and the network management systems. The managed device is the network device, like a router. The agent is the software module residing in the managed device pertaining to network management. The network management system runs the SNMP application that controls the managed devices and monitors their status. Four primary operations (Set, Get, Get Next, and Trap) are performed using SNMP.

Viewing Logs

The **Log Entries** dialog box displays a chronological history of all calls into and out of this unit. This dialog box is accessed by clicking **Logs** in the **Statistics** dialog box.

Event #	Start Date, Time	Duration	Status	Mode	From->To
1	01/01/2000, 12:42:20 AM	00:02:08	S	V	201-->101
2	01/01/2000, 12:47:09 AM	00:00:28	S	V	101-->301
3	01/01/2000, 12:49:56 AM	00:00:05	S	V	101-->201
4	01/01/2000, 12:50:13 AM	00:00:33	S	V	101-->201
5	01/01/2000, 09:16:56 PM	00:02:27	S	V	201-->101

S - Successful U - Unsuccessful V - Voice F - Fax

The **Log Entries** dialog box displays each call as a sequentially numbered Event with the date, time, duration of the call, the status of the call (**Successful** or **Unsuccessful**), Mode (**Voice** or **Fax**), and the from and to numbers.

Viewing Log Entry Details

The **Log Entry Details** dialog box displays the status of a completed call. This dialog box displays the same details as the **Call Progress** dialog box after a call is completed.

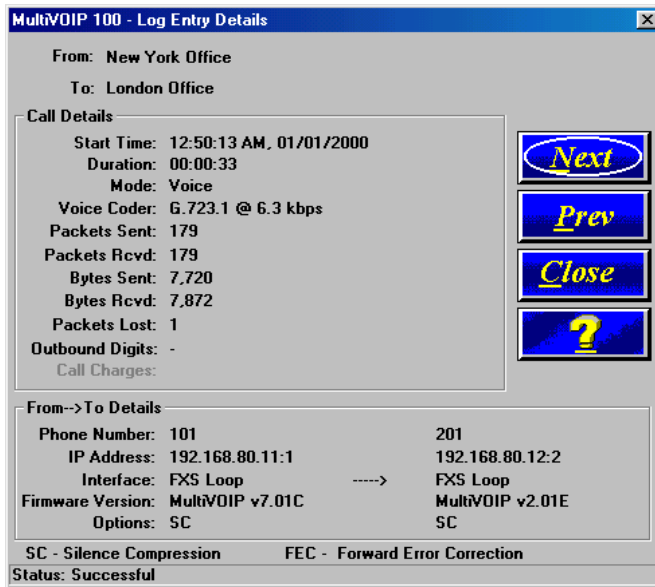

Viewing Channel Totals

The **Channel Totals** dialog box displays Outgoing and Incoming calls with their Attempted and Completed numbers for each channel on this MultiVOIP. The Total Connected Time for the channel also displays.

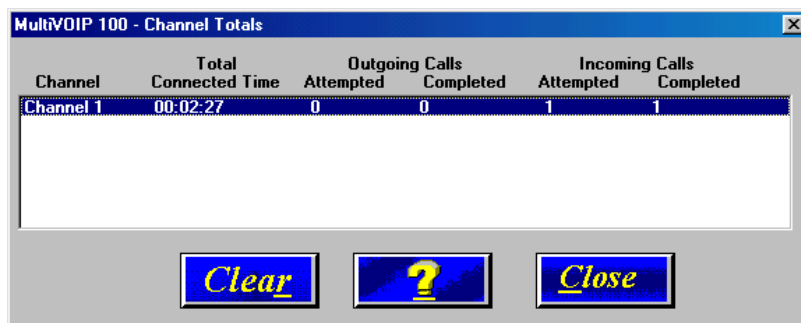

Reports

A report of the contents of the **Log Entries** dialog box can be generated using the Windows Notepad accessory and then printed from your local PC. The report is generated by entering the To and From dates in the **Report Generation** dialog box and then clicking **Generate**. This function provides a hard copy of the **Log Entries** dialog box.

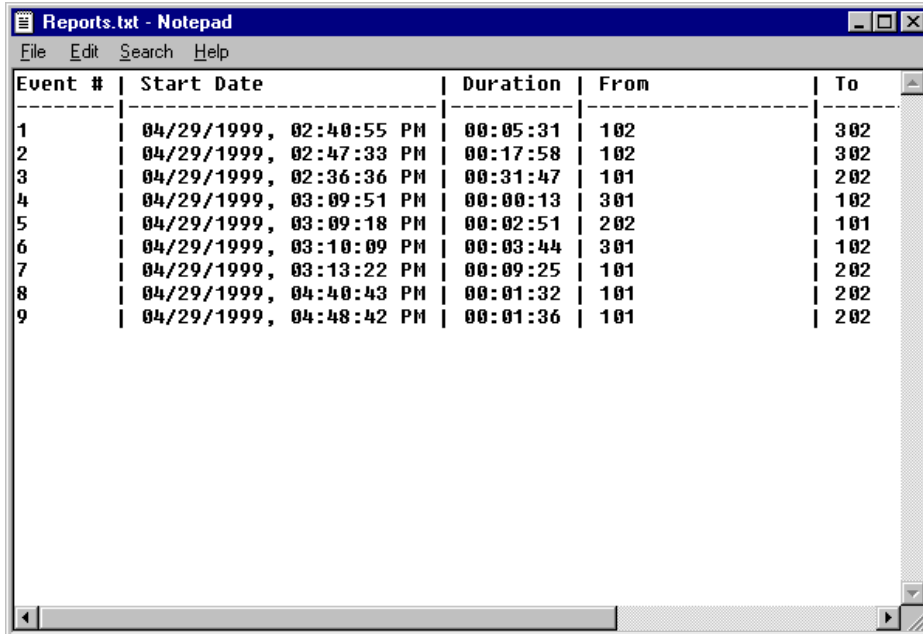

Event #	Start Date	Duration	From	To
1	04/29/1999, 02:40:55 PM	00:05:31	102	302
2	04/29/1999, 02:47:33 PM	00:17:58	102	302
3	04/29/1999, 02:36:36 PM	00:31:47	101	202
4	04/29/1999, 03:09:51 PM	00:00:13	301	102
5	04/29/1999, 03:09:18 PM	00:02:51	202	101
6	04/29/1999, 03:10:09 PM	00:03:44	301	102
7	04/29/1999, 03:13:22 PM	00:09:25	101	202
8	04/29/1999, 04:40:43 PM	00:01:32	101	202
9	04/29/1999, 04:48:42 PM	00:01:36	101	202

Upgrade Procedures

Whenever you upgrade your version of the MultiVOIP software, you must first install the new software on your PC. Then, download the Firmware, the Factory Defaults, and the Voice Coders to upgrade the MultiVOIP.

Before starting the upgrade process, view the current configuration and write down important data such as your IP address, phone book contents, and voice channel configurations. These settings must be put back in place after the software has been upgraded.

Two utility programs included in the MultiVOIP software are to be used only after the unit has been repaired or upgraded. They are **Download Firmware** and **Download Voice Coders**.

You can also use the Upgrade Software utility. This is recommended. This utility upgrades the boot code, factory defaults, firmware, and voice coders in one step. After the files download to the MultiVOIP, the unit reboots and is ready for use with upgraded firmware and voice coders.

One-Step Upgrade

Click **Start | Programs | MultiVOIP 100 v701C | Upgrade Software**.

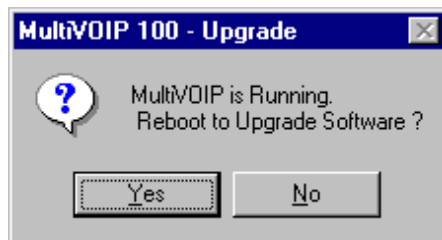

Click **Yes**. The download process begins.

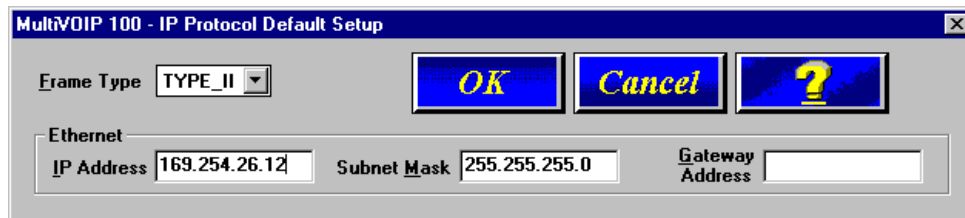

Enter your LAN IP Address, Subnet Mask, and Gateway Address in the **IP Protocol Default Setup** dialog box. Click **OK** when finished.

Enter your current configuration in the **Channel Setup** dialog box. Click **OK** when finished.

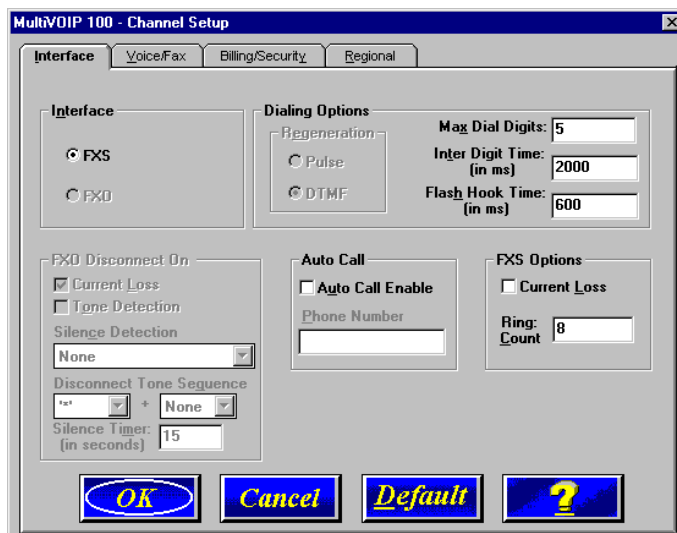

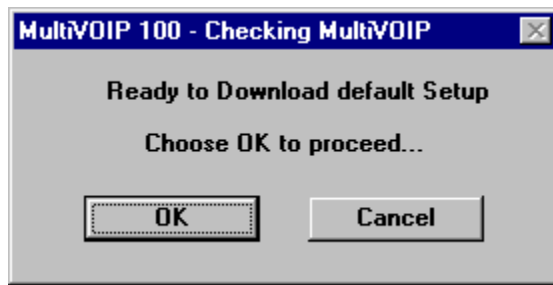

Click **OK**. The MultiVOIP firmware and coders download, then the MultiVOIP reboots.

Manual Upgrade Procedure

Use this procedure only if you want to manually upgrade your MultiVOIP.

Note: Steps 4-8 must be performed via the command port.

1. Run MultiVOIP Configuration from your old version of the MultiVOIP software. Note the current settings. Your MultiVOIP will be reset to factory defaults during this upgrade.
2. Uninstall your old version of MultiVOIP software by selecting the **Uninstall MultiVOIP Configuration** option from the program group.
3. Install the proprietary software from the MultiVOIP CD.
4. From the program group of the MultiVOIP software, select **Download Voice Coders**. Select the default file.
5. From the program group of the MultiVOIP software, select Download Factory Defaults.
6. From the program group of the MultiVOIP software, select **Download Firmware**. Enter "*.upg" in the **File name** box and press ENTER. Select the file named boot.upg.
7. From the program group of the MultiVOIP software, select Download Firmware. Select the file named mtvoip.bin.
8. Select MultiVOIP Configuration from the program group and reconfigure your MultiVOIP. The upgrade is complete.



Chapter 5 - Remote Configuration



Introduction

This chapter provides procedures for viewing or changing the configuration of a remote unit. Two methods are provided to access a remote unit; the first method is modem based and the second method is using IP. Within the IP method, three applications can be used: 1) LAN-Based using TFTP (Trivial File Transfer Protocol), 2) Telnet as a client application, or 3) a standard web browser on the Internet.

Remote Configuration

Remote configuration requires the MultiVOIP software to be loaded on the local PC. The local PC then controls the remote MultiVOIP using either the modem connection or the Ethernet link.

Modem-Based

To remotely configure a MultiVOIP, a local PC needs to be connected to a dial-up line and the MultiVOIP software configured to call the remote MultiVOIP. The remote MultiVOIP needs to have a modem connected to a dial-up line and the Command Port. Once the connection to the remote unit is made, you can change the configuration as you see fit. Once the configuration is changed, you can download the new configuration to the remote MultiVOIP. Refer to the Modem-Based Remote Configuration Procedure in this chapter to remotely configure a MultiVOIP.

1. At the remote site, remove the serial cable from the PC to the Command Port connector on the back panel of the MultiVOIP.
2. At the remote site, connect a special cable (Remote Configuration Cable) from the Command Port connector on the back panel of the MultiVOIP to the RS232 connector on the modem. The special cable is a serial cable with male connectors on both ends. Refer to Appendix B for cable details.

Connect the modem to your local telephone line.

Provide your telephone number to the person verifying your configuration.

Configure the modem serial port for 19200 bps and turn on Force DTR.

3. At the main site, connect your local PC to a modem that is connected to a dial-up line.
4. Install the MultiVOIP software on the local PC. When installed, click **Start | Programs | MultiVOIP 100 | Configuration Port Setup**, or double click on the **Configuration Port** icon in the MultiVOIP 100 program group.
5. The **MultiVOIP 100 Setup** dialog box displays.

Verify that the **Communication Type** is set for **COM Port** and the **Select Port** box is set for the COM port of your local PC.

In the **Dial String** box, enter the AT command for dialing (ATDT) plus the phone number of the remote MultiVOIP.

If your Modem Initialization String, Initialization Response, or Connect Response values are different than the defaults in the dialog box, refer to your modem user documentation and change the default values to match your modem.

Click **OK** when you are satisfied with your selections.

6. Run the MultiVOIP Configuration program. Click **Start | Programs | MultiVOIP 100 | MultiVOIP Configuration**, or double-click the **MultiVOIP Configuration** icon in the program group.
7. The **Dialing** dialog box displays while software is dialing the remote modem.
8. The **Reading Setup** dialog box displays.
9. The **MultiVOIP 100 Setup** menu displays. This is the dialog box of the remote MultiVOIP. Refer to the online Help provided with your software for a description of each dialog box and box within a dialog box.

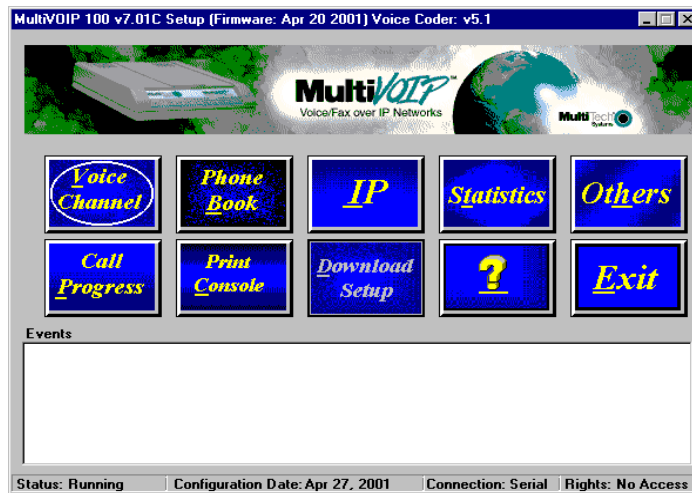

10. After you have changed the configuration of the remote MultiVOIP, click **Download Setup** to update the configuration. The remote MultiVOIP will be brought down, the new configuration written to the unit, and the unit will reboot.
11. Click **Exit** after the download completes.
12. The **Hangup connection?** dialog box displays. Click **Yes** to disconnect the phone connection to the remote site.
13. If the same telephone number is not going to be used again in the immediate future, you can remove it from the **Port Setup** dialog box.

LAN-Based

The LAN-based remote configuration requires a Windows Sockets compliant TCP/IP stack. TCP/IP protocol software must be installed and functional before the configuration program can be used.

1. You must assign an Internet (IP) address for the PC and for each node that will be managed by the configuration program. Refer to the protocol software documentation for instructions on how to set the IP addresses.

Once you have completed this step, you should be able to use the protocol Ping command for

the PC host name. You should also test the network interface configuration by Pinging another TCP/IP device that is connected to the network.

2. Install the MultiVOIP software on the local PC. When installed click **Start | Programs | MultiVOIP 100 | Configuration Port Setup**, or double-click on the **Configuration Port Setup** icon in the **MultiVOIP 100** program group.
3. The **MultiVOIP Port Setup** dialog box displays.

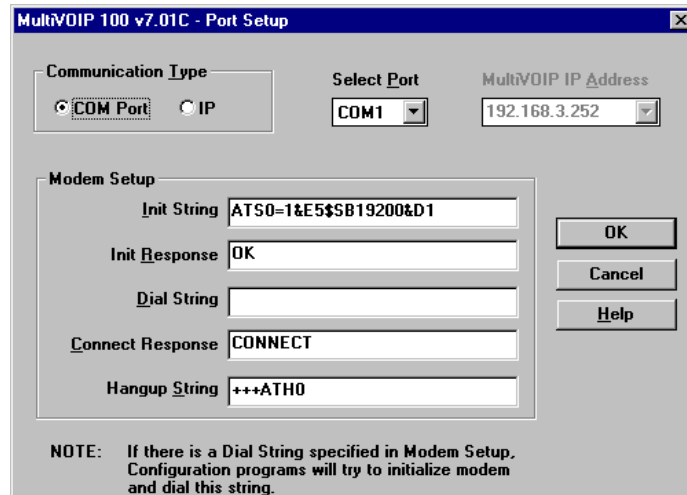

Verify that the **IP** option is selected in the **Communication Type** group.

In the **MultiVOIP IP Address** box, enter the IP Address of the remote MultiVOIP.

4. Click **OK** when you are satisfied with your selections.
5. Run the MultiVOIP Configuration program. Click **Start | Programs | MultiVOIP 100 | MultiVOIP Configuration**, or double-click on the **MultiVOIP Configuration** icon in the **MultiVOIP 100** program group.
6. The **MultiVOIP 100 Setup** dialog box displays. This is the dialog box of the remote MultiVOIP. Refer to the online Help provided with your MultiVOIP for the definition of each dialog box.

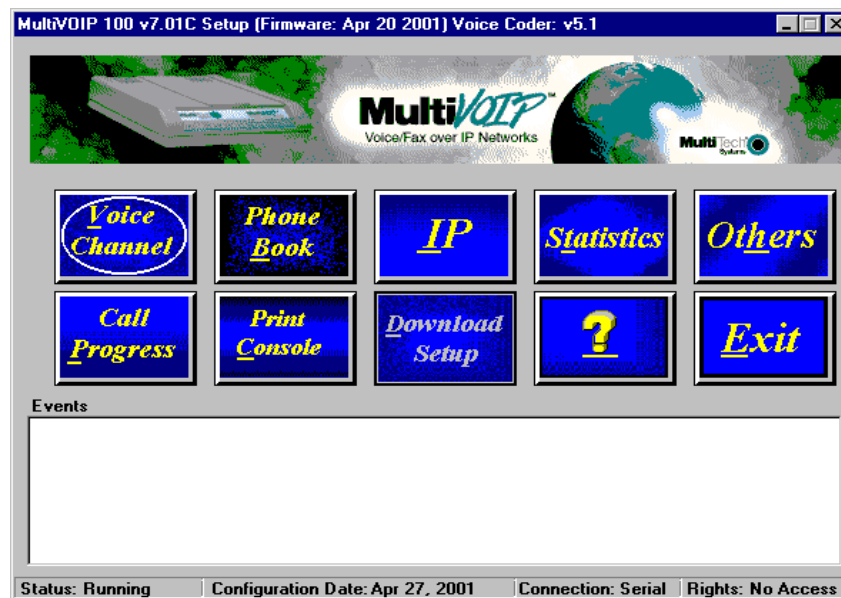

7. After you have changed the configuration of the remote MultiVOIP, click **Download Setup** to update the configuration. The remote MultiVOIP will be brought down, the new configuration written to the unit, and the unit will reboot.
8. Click **Exit** when the downloading is complete.
9. Double-click the **MultiVOIP Configuration** icon in the program group to verify that the MultiVOIP is running.

Telnet

A typical Telnet client application is described next. The MultiVOIP has a built-in Telnet Server that enables Telnet client PCs to access the MultiVOIP. A typical Telnet client is allowed to configure the MultiVOIP. In addition, the MultiVOIP can be remotely accessed and configured from any where on the Internet through its Web interface.

MultiVOIP Telnet Server Menu

The MultiVOIP Telnet Server menu provides three basic options: Voice over IP Configuration, Phone Directory Database, and Phone Directory Configuration. A further option enables you to close the Telnet session.

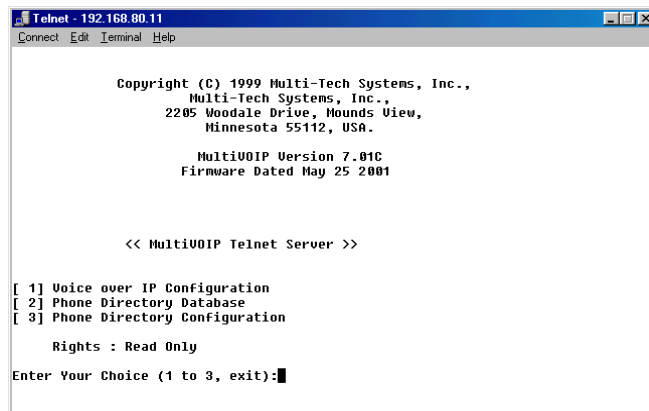

```
Telnet - 192.168.80.11
Connect Edit Terminal Help

Copyright (C) 1999 Multi-Tech Systems, Inc.,
Multi-Tech Systems, Inc.,
2205 Woodale Drive, Mounds View,
Minnesota 55112, USA.

MultiVOIP Version 7.01C
Firmware Dated May 25 2001

<< MultiVOIP Telnet Server >>

[ 1] Voice over IP Configuration
[ 2] Phone Directory Database
[ 3] Phone Directory Configuration

Rights : Read Only
Enter Your Choice (1 to 3, exit):
```

Voice over IP Configuration

Selecting **Option 1** displays the main menu, which allows further configuration options. These options include Protocol Stacks (option 1), Applications (option 2), System Information (option 3), and Voice Channels (option 4). For further descriptions of these options, refer to [Chapter 4 - MultiVOIP Software](#).

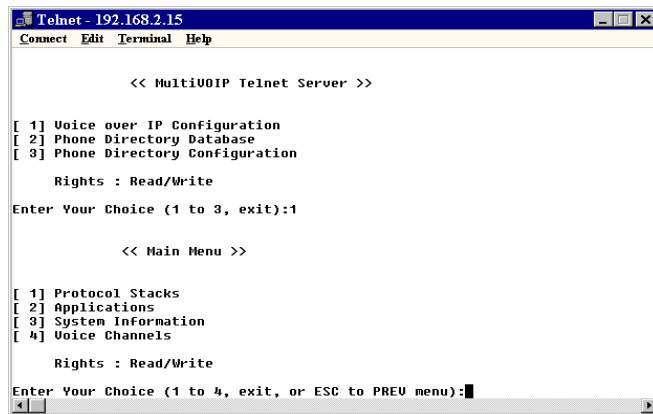

Phone Directory Database

Selecting **Option 2** enables you to add entries to the **Phone Directory Database**. Refer to [Chapter 4, MultiVOIP Software](#), for more details on the database.

Phone Directory Configuration

Selecting **Option 3** enables you to configure and manage the **Phone Directory**. The various options are described in detail in [Chapter 4 - MultiVOIP Software](#).

Web Management

The MultiVOIP can be accessed, using a standard Web browser, from anywhere on the connected Internet. In order to provide this support, select the **WEB Server** check box in the **Applications Setup** dialog box (see [Chapter 4, MultiVOIP Software](#)).

Once enabled, users can access the MultiVOIP by entering its IP address in the **Address** box of their Web browser. The following Web page appears.



If a Password was entered in the **Applications Setup** dialog box, enter the password and click **Enter**.

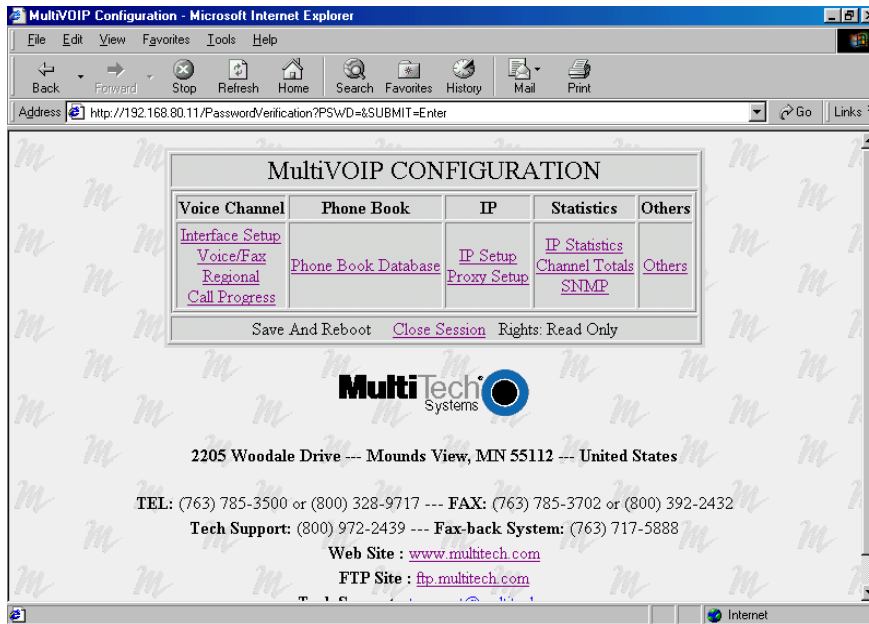

From this Web page, you can access all the configuration options. Refer to [Chapter 4 - MultiVOIP Software](#), for a description of the various options.



Chapter 6 - Warranty, Service and Tech Support



Introduction

This chapter starts out with statements about your MultiVOIP 2-year warranty. The next section, Tech Support, should be read carefully if you have questions or problems with your MultiVOIP. It includes the technical support phone numbers, space for recording your product information, and an explanation of how to send in your MultiVOIP should you require service. The final section explains how to get support through the Internet.

Limited Warranty

Multi-Tech Systems, Inc. ("MTS") warrants that its products will be free from defects in material or workmanship for a period of two years from the date of purchase, or if proof of purchase is not provided, two years from date of shipment. **MTS MAKES NO OTHER WARRANTY, EXPRESSED OR IMPLIED, AND ALL IMPLIED WARRANTIES OF MERCHANTABILITY AND FITNESS FOR A PARTICULAR PURPOSE ARE HEREBY DISCLAIMED.** This warranty does not apply to any products which have been damaged by lightning storms, water, or power surges or which have been neglected, altered, abused, used for a purpose other than the one for which they were manufactured, repaired by the customer or any party without MTS's written authorization, or used in any manner inconsistent with MTS's instructions.

MTS's entire obligation under this warranty shall be limited (at MTS's option) to repair or replacement of any products which prove to be defective within the warranty period, or, at MTS's option, issuance of a refund of the purchase price. Defective products must be returned by Customer to MTS's factory transportation prepaid.

MTS WILL NOT BE LIABLE FOR CONSEQUENTIAL DAMAGES AND UNDER NO CIRCUMSTANCES WILL ITS LIABILITY EXCEED THE PURCHASE PRICE FOR DEFECTIVE PRODUCTS.

Online Warranty Registration

To register your MultiVOIP online, click the following link:

<http://www.multitech.com/register/>

Service

If your tech support specialist decides that service is required, your MultiVOIP may be sent (freight prepaid) to our factory. Return shipping charges will be paid by Multi-Tech Systems.

Include the following with your MultiVOIP:

- a description of the problem
- return billing and return shipping addresses
- contact name and phone number
- check or purchase order number for payment if the MultiVOIP is out of warranty. Check with your technical support specialist for the standard repair charge for your MultiVOIP.
- if possible, note the name of the technical support specialist with whom you spoke.

If you need to inquire about the status of the returned product, be prepared to provide the serial number of the product sent.

Send your MultiVOIP to this address:

MULTI-TECH SYSTEMS, INC.
2205 WOODALE DRIVE
MOUNDS VIEW, MINNESOTA 55112
ATTN: SERVICE OR REPAIRS

You should also check with the supplier of your MultiVOIP on the availability of local service and loaner units in your part of the country.

Tech Support

Multi-Tech has an excellent staff of technical support personnel available to help you get the most out of your Multi-Tech product. If you have any questions about the operation of this unit, call 1-800-972-2439. Please fill out the MultiVOIP information (below), and have it available when you call. If your MultiVOIP requires service, the tech support specialist will guide you on how to send in your MultiVOIP (refer to the next section).

Contacting Technical Support

Country	By E-mail	By Telephone
France:	support@multitech.fr	+(33) 1-64 61 09 81
India:	support@multitechindia.com	+91 (124) 6340778
U.K.:	support@multitech.co.uk	+(44) 118 959 7774
U.S. and Canada:	support@multitech.com	(800) 972-2439
Rest of the World:	support@multitech.com	+(763) 717-5863

Recording MultiVOIP Information

Please fill in the following information on your Multi-Tech MultiVOIP. This will help tech support in answering your questions. The same information is requested on the Warranty Registration Card.

Model No.: _____
Serial No.: _____
Software Version: _____

The model and serial numbers are on the bottom of your MultiVOIP.

Please note status of your MultiVOIP including LED indicators, screen messages, diagnostic test results, problems with a specific application, and so on. Use the space below to note the MultiVOIP status:

About the Internet

If you prefer to receive technical support through the Internet, you can contact Tech Support via e-mail at the following address:

support@multitech.com

Multi-Tech's presence includes a Web site at:

http://www.multitech.com

and an ftp site at:

ftp://ftp.multitech.com



Appendixes



Appendix A - TCP/IP (Transmission Control Protocol/Internet Protocol) Description

TCP/IP is a protocol suite and related applications developed for the U.S. Department of Defense in the 1970s and 1980s specifically to permit different types of computers to communicate and exchange information with one another. TCP/IP is currently mandated as an official U.S. Department of Defense protocol and is also widely used in the UNIX community.

Before you install TCP/IP on your network, you need to establish your Internet addressing strategy. First, choose a domain name for your company. A domain name is the unique Internet name, usually the name of your business, that identifies your company. For example, Multi-Tech's domain name is `multitech.com` (.com indicates this is a commercial organization; .edu denotes educational organizations, .gov denotes government organizations). Next, determine how many IP addresses you'll need. This depends on how many individual network segments you have, and how many systems on each segment need to be connected to the Internet. You will need an IP address for each network interface on each computer and hardware device.

IP addresses are 32 bits long and come in two types: network and host. Network addresses come in five classes: A, B, C, D, and E. Each class of network address is allocated a certain number of host addresses. For example, a class B network can have a maximum of 65,534 hosts, while a class C network can have only 254. The class A and B addresses have been exhausted, and the class D and E addresses are reserved for special use. Consequently, companies now seeking an Internet connection are limited to class C addresses.

Early IP implementations ran on hosts commonly interconnected by Ethernet local area networks (LAN). Every transmission on the LAN contains the local network, or medium access control (MAC), address of the source and destination nodes. The MAC address is 48-bits in length and is non-hierarchical; MAC addresses are never the same as IP addresses.

When a host needs to send a datagram to another host on the same network, the sending application must know both the IP and MAC addresses of the intended receiver. Unfortunately, the IP process may not know the MAC address of the receiver. The Address Resolution Protocol (ARP), described in RFC 826 (located at <ftp://ds.internic.net/rfc/rfc826.txt>) provides a mechanism for a host to determine a receiver's MAC address from the IP address. In the process, the host sends an ARP packet in a frame containing the MAC broadcast address; and then the ARP request advertises the destination IP address and asks for the associated MAC address. The station on the LAN that recognizes its own IP address will send an ARP response with its own MAC address. An ARP message is carried directly in an IP datagram.

Other address resolution procedures have also been defined, including those which allow a diskless processor to determine its IP address from its MAC address (Reverse ARP, or RARP), provides a mapping between an IP address and a frame relay virtual circuit identifier (Inverse ARP, or InARP), and provides a mapping between an IP address and ATM virtual path/channel identifiers (ATMARP).

The TCP/IP protocol suite comprises two protocols that correspond roughly to the OSI Transport and Session Layers; these protocols are called the Transmission Control Protocol and the User Datagram Protocol (UDP). Individual applications are referred to by a port identifier in TCP/UDP messages. The port identifier and IP address together form a "socket". Well-known port numbers on the server side of a connection include 20 (FTP data transfer), 21 (FTP control), 23 (Telnet), 25 (SMTP), 43 (whois), 70 (Gopher), 79 (finger), and 80 (HTTP).

TCP, described in RFC 793 (<ftp://ds.internic.net/rfc/rfc793.txt>) provides a virtual circuit (connection-oriented) communication service across the network. TCP includes rules for formatting messages, establishing and terminating virtual circuits, sequencing, flow control, and error correction. Most of the applications in the TCP/IP suite operate over the "reliable" transport service provided by TCP.

UDP, described in RFC 768 (<ftp://ds.internic.net/rfc/rfc768.txt>) provides an end-to-end datagram (connectionless) service. Some applications, such as those that involve a simple query and response,

are better suited to the datagram service of UDP because there is no time lost to virtual circuit establishment and termination. UDP's primary function is to add a port number to the IP address to provide a socket for the application.

The Application Layer protocols are examples of common TCP/IP applications and utilities, which include:

- Telnet (Telecommunication Network): a virtual terminal protocol allowing a user logged on to one TCP/IP host to access other hosts on the network, described in RFC 854 (<ftp://ds.internic.net/rfc/rfc854.txt>).
- FTP: the File Transfer Protocol allows a user to transfer files between local and remote host computers per IETF RFC 959 (<ftp://ds.internic.net/rfc/rfc959.txt>).
- Archie: a utility that allows a user to search all registered anonymous FTP sites for files on a specified topic.
- Gopher: a tool that allows users to search through data repositories using a menu-driven, hierarchical interface, with links to other sites, per RFC 1436 (<ftp://ds.internic.net/rfc/rfc1436.txt>).
- SMTP: the Simple Mail Transfer Protocol is the standard protocol for the exchange of electronic mail over the Internet, per IETF RFC 821 (<ftp://ds.internic.net/rfc/rfc821.txt>).
- HTTP: the Hypertext Transfer Protocol is the basis for exchange of information over the World Wide Web (WWW). Various versions of HTTP are in use over the Internet, with HTTP version 1.0 (per RFC 1945) (<ftp://ds.internic.net/rfc/rfc1945.txt>) being the most current.
- HTML: WWW pages are written in the Hypertext Markup Language (HTML), an ASCII-based, platform-independent formatting language, per IETF RFC 1866 (<ftp://ds.internic.net/rfc/rfc1866.txt>).
- Finger: used to determine the status of other hosts and/or users, per IETF RFC 1288 (<ftp://ds.internic.net/rfc/rfc1288.txt>).
- POP: the Post Office Protocol defines a simple interface between a user's mail reader software and an electronic mail server; the current version is POP3, described in IETF RFC 1460 (<ftp://ds.internic.net/rfc/rfc1460.txt>).
- DNS: the Domain Name System defines the structure of Internet names and their association with IP addresses, as well as the association of mail, name, and other servers with domains.
- SNMP: the Simple Network Management Protocol defines procedures and management information databases for managing TCP/IP-based network devices. SNMP, defined by RFC 1157 (<ftp://ds.internic.net/rfc/rfc1157.txt>) is widely deployed in local and wide area network. SNMP Version 2 (SNMPv2), per RFC 1441 (<ftp://ds.internic.net/rfc/rfc1441.txt>) adds security mechanisms that are missing in SNMP, but is also more complex.
- Ping: a utility that allows a user at one system to determine the status of other hosts and the latency in getting a message to that host. Ping uses ICMP Echo messages.
- Whois/NICNAME: Utilities that search databases for information about Internet domain and domain contact information, per RFC 954 (<ftp://ds.internic.net/rfc/rfc954.txt>).
- Traceroute: a tool that displays the route that packets will take when traveling to a remote host.

Internet Protocol (IP)

IP is the Internet standard protocol that tracks Internetwork node addresses, routes outgoing messages and recognizes incoming messages, allowing a message to cross multiple networks on the way to its final destination. The IPv6 Control Protocol (IPV6CP) is responsible for configuring, enabling, and disabling the IPv6 protocol modules on both ends of the point-to-point link. IPV6CP uses the same packet exchange mechanism as the Link Control Protocol (LCP). IPV6CP packets are not exchanged until PPP has reached the Network-Layer Protocol phase. IPV6CP packets received before this phase is reached are silently discarded. See also TCP/IP.

Before you install TCP/IP on your network, you need to establish your Internet addressing strategy. You first choose a domain name for your company. A domain name is the unique Internet name, usually the name of your business, that identifies your company. For example, Multi-Tech's domain name is multitech.com (where .com indicates this is a commercial organization; .edu denotes educational organizations, .gov denotes government organizations). Next, you determine how many IP addresses you'll need. This depends on how many individual network segments you have, and how many systems on each segment need to be connected to the Internet. You need an IP address for each network interface on each computer and hardware device.

IP addresses are 32 bits long and come in two types: network and host. Network addresses come in five classes: A, B, C, D, and E. Each class of network address is allocated a certain number of host addresses. For example, a class B network can have a maximum of 65,534 hosts, while a class C network can have only 254. The class A and B addresses have been exhausted, and the class D and E addresses are reserved for special use. Consequently, companies now seeking an Internet connection are limited to class C addresses. The current demand for Internet connections will exhaust the current stock of 32-bit IP addresses. In response, Internet architects have proposed the next generation of IP addresses, Ipng (IP Next Generation). It features 16-bit addressing, surpassing the capacities of 32-bit IP.

An IP address can serve only a single physical network. Therefore, if your organization has multiple physical networks, you must make them appear as one to external users. This is done via "subnetting", a complex procedure best left to ISPs and others experienced in IP addressing. Since IP addresses and domain names have no inherent connection, they are mapped together in databases stored on Domain Name Servers (DNS). If you decide to let an Internet Service Provider (ISP) administer your DNS server, the ISP can assist you with the domain name and IP address assignment necessary to configure your company's site-specific system information. Domain names and IP addresses are granted by the InterNIC. To check the availability of a specific name or to obtain more information, call the InterNIC at (703) 742-4777.

Appendix B - Cabling Diagrams

Command Port Cable

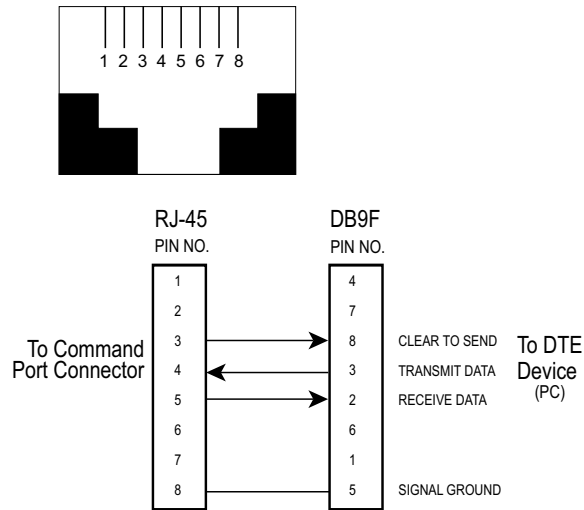

LAN Cable

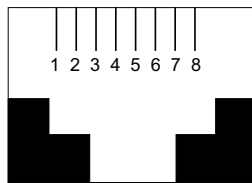

Pin	Circuit	Signal Name
1	TD+	Data Transmit Positive
2	TD-	Data Transmit Negative
3	RD+	Data Receive Positive
6	RD-	Data Receive Negative

Voice/Fax Channel Connectors

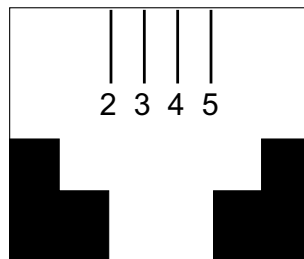

Pin Connections

FXS	Description
1	N/C
2	Tip
3	Ring
4	N/C

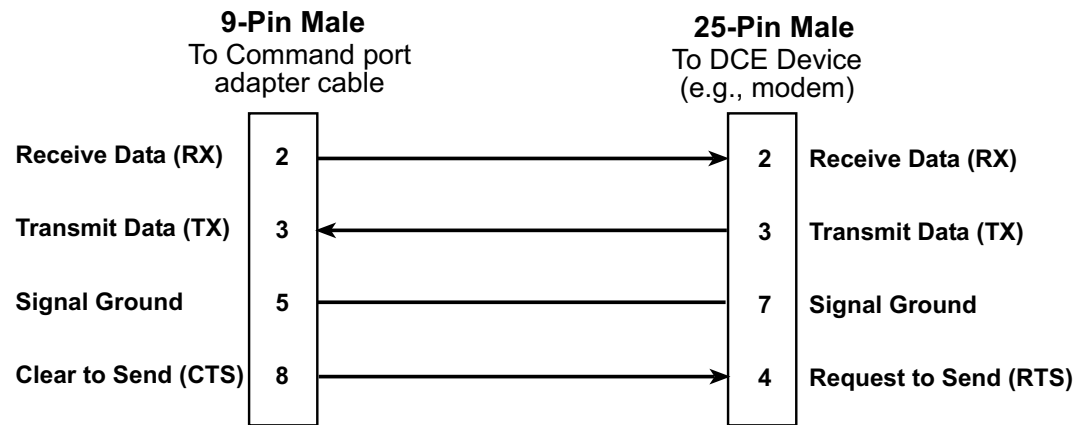
Remote Configuration Cable

Appendix C - Regulatory Information

Class A Statement

FCC Part 15

NOTE: This equipment has been tested and found to comply with the limits for a **Class A** digital device, pursuant to Part 15 of the FCC Rules. These limits are designed to provide reasonable protection against harmful interference when the equipment is operated in a commercial environment. This equipment generates, uses and can radiate radio frequency energy and, if not installed and used in accordance with the instruction manual, may cause harmful interference to radio communications. Operation of this equipment in a residential area is likely to cause harmful interference, in which case the user will be required to correct the interference at his own expense.

This device complies with Part 15 of the FCC rules.
Operation is subject to the following two conditions:

- (1) This device may not cause harmful interference.
- (2) This device must accept any interference that may cause undesired operation.

Warning: Changes or modifications to this unit not expressly approved by the party responsible for compliance could void the user's authority to operate the equipment.

Industry Canada

This **Class A** digital apparatus meets all requirements of the Canadian Interference-Causing Equipment Regulations.

Cet appareil numérique de la classe A respecte toutes les exigences du Règlement sur le matériel brouilleur du Canada.

Fax Branding Statement

The Telephone Consumer Protection Act of 1991 makes it unlawful for any person to use a computer or other electronic device, including fax machines, to send any message unless such message clearly contains the following information:

- Date and time the message is sent
- Identification of the business or other entity, or other individual sending the message
- Phone number of the sending machine or such business, other entity, or individual

This information is to appear in a margin at the top or bottom of each transmitted page or on the first page of the transmission. (Adding this information in the margin is referred to as *fax branding*.)

Since any number of Fax software packages can be used with this product, the user must refer to the Fax software manual for setup details. Typically, the Fax branding information must be entered via the configuration menu of the software.

FCC Part 68 Telecom

1. This equipment complies with Part 68 of the Federal Communications Commission (FCC) rules. On the outside surface of this equipment is a label that contains, among other information, the FCC registration number. This information must be provided to the telephone company.
2. As indicated below, the suitable jack (Universal Service Order Code connecting arrangement) for this equipment is shown. If applicable, the facility interface codes (FIC) and service order codes (SOC) are shown.
3. An FCC-compliant telephone cord with modular plug is provided with this equipment. This equipment is designed to be connected to the phone network or premises wiring using a compatible modular jack which is Part 68 compliant. See installation instructions for details.

4. If this equipment causes harm to the phone network, the phone company will notify you in advance that temporary discontinuance of service may be required. But if advance notice is not practical, the phone company will notify the customer as soon as possible. Also, you will be advised of your right to file a complaint with the FCC if you believe it is necessary.

5. The phone company may make changes in its facilities, equipment, operations, or procedures that could affect the operation of the equipment. If this happens, the phone company will provide advance notice in order for you to make necessary modifications in order to maintain uninterrupted service.

6. If trouble is experienced with this equipment (the model of which is indicated below) please contact Multi-Tech Systems, Inc., at the address shown below for details of how to have repairs made. If the equipment is causing harm to the network, the phone company may request that you remove the equipment from the network until the problem is resolved.

7. No repairs are to be made by you. Repairs are to be made only by Multi-Tech Systems or its licensees. Unauthorized repairs void registration and warranty.

8.	Manufacturer:	Multi-Tech Systems, Inc.
	Trade name:	MultiVOIP
	Model Numbers:	MVP110
	FCC Registration Number:	AU7USA-25715-DF-N
	Modular Jack (USOC):	RJ-11C or RJ-11W
	Service Center in U.S.A.:	Multi-Tech Systems, Inc. 2205 Woodale Drive Mounds View, MN 55112 (763) 785-3500 Fax (763) 785-9874

Canadian Limitations Notice

Ringer Equivalence Number

Notice: The ringer equivalence number (REN) assigned to each terminal device provides an indication of the maximum number of terminals allowed to be connected to a phone interface. The termination on an interface may consist of any combination of devices subject only to the requirement that the sum of the ringer equivalence numbers of all the devices does not exceed 5.

Notice: The Industry Canada label identifies certified equipment. This certification means that the equipment meets certain telecommunications network protective, operational and safety requirements. The Department does not guarantee the equipment will operate to the user's satisfaction.

Before installing this equipment, users should ensure that it is permissible to be connected to the facilities of the local telecommunications company. The equipment must also be installed using an acceptable method of connection. The customer should be aware that compliance with the above conditions may not prevent degradation of service in some situations. Repairs to certified equipment should be made by an authorized Canadian maintenance facility designated by the supplier. Any repairs or alterations made by the user to this equipment, or equipment malfunctions, may give the telecommunications company cause to request the user to disconnect the equipment.

Users should ensure for their own protection that the electrical ground connections of the power utility, phone lines and internal metallic water pipe system, if present, are connected together. This precaution may be particularly important in rural areas.

Caution: Users should not attempt to make such connections themselves, but should contact the appropriate electric inspection authority, or electrician, as appropriate.



EMC, Safety and Terminal Directive Compliance

The CE mark is affixed to this product to confirm compliance with the following European Community Directives:

Council Directive 89/336/EEC of 3 May 1989 on the approximation of the laws of Member States relating to electromagnetic compatibility.

and

Council Directive 73/23/EEC of 19 February 1973 on the harmonization of the laws of Member States relating to electrical equipment designed for use within certain voltage limits:

and

Council Directive 98/13/EC of 12 March 1998 on the approximation of the laws of Member States concerning telecommunications terminal and Satellite earth station equipment.



Glossary



A

Access: The T1 line element made up of two pairs of wire that the phone company brings to the customer premises. The Access portion ends with a connection at the local telco (LEC or RBOC).

Accunet Spectrum of Digital Services (ASDS): The AT&T 56K bps leased (private) line service. Similar to services of MCI and Sprint. ASDS is available in $nx56/64K$ bps, where $n=1, 2, 4, 6, 8, 12$.

ACK (ACKnowledgement code) (pronounced "ack"): A communications code sent from a receiving modem to a transmitting modem to indicate that it is ready to accept data. It is also used to acknowledge the error-free receipt of transmitted data. Contrast with NAK.

Adaptive Differential Pulse Code (ADCPM): In multimedia applications, a technique in which pulse code modulation samples are compressed before they are stored on a disk. ADCPM, an extension of the PCM format, is a standard encoding format for storing audio information in a digital format. It reduced storage requirements by storing differences between successive digital samples rather than full values.

Address: A numbered location inside a computer. It is how the computer accesses its resources, such as a video card, serial ports, and memory.

AMI line coding: One of two common methods of T1 line coding (with B8ZS). AMI line coding places restrictions on user data (B8ZS does not).

Analog signal: A waveform which has amplitude, frequency and phase, and which takes on a range of values between its maximum and minimum points.

Analog Transmission: One of two types of telecommunications which uses an analog signal as a carrier of voice, data, video, and so on. An analog signal becomes a carrier when it is modulated by altering its phase, amplitude, and frequency to correspond with the source signal. Compare with digital transmission.

Application Program Interface (API): A software module created to allow dissimilar, or incompatible applications programs to transfer information over a communications link. APIs may be simple or complex; they are commonly required to link PC applications with mainframe programs.

ASCII (American Standard Code for Information Interchange) (pronounced "askey"): A binary code for data that is used in communications and in many computers and terminals. The code is used to represent numbers, letters, punctuation and control characters. The basic ASCII code is a 7-bit character set which defines 128 possible characters. The extended ASCII file provides 255 characters.

Asynchronous Transfer Mode (ATM): A very high-speed method of transmission that uses fixed-size cells of 53 bytes to transfer information over fiber; also known as cell relay.

AT Commands: A standard set of commands used to configure various modem parameters, establish connections and disconnect. The "AT" is used to get the "attention" of the modem before the actual command is issued.

Availability: The measure of the time during which a circuit is ready for use; the complement of circuit "outage" (100% minus % outage = % available).

B

B7ZS (Bipolar 7 Zero Suppression) line coding: One method of T1 line coding (see also "B8ZS" and "AMI"). B7ZS line coding does not place restrictions on user data (AMI does).

B8ZS (Bipolar 8 Zero Suppression) line coding: One of two common methods of T1 line coding (with AMI). B8ZS line coding does not place restrictions on user data (AMI does). A coding method used to produce 64K bps "clear" transmission. See also "B7ZS" and "AMI" line coding.

Backbone: 1) A set of nodes and their interconnecting links providing the primary data path across a network. 2) In a local area network multiple-bridge ring configuration, a high-speed link to which the rings are connected by means of bridges. A backbone may be configured as a bus or as a ring. 3) In a wide area network, a high-speed link to which nodes or data switching exchanges (DSEs) are connected. 4) A common distribution core that provides all electrical power, gases, chemicals, and other services to the sectors of an automated wayer processing system.

Background: An activity that takes place in the PC while you are running another application. In other words, the active user interface does not correspond to the 'background' task.

Bandwidth: The transmission capacity of a computer channel, communications line or bus. It is expressed in cycles per second (hertz), the bandwidth being the difference between the lowest and highest frequencies transmitted. The range of usable frequencies that a transmission medium will pass without unacceptable attenuation or distortion. Bandwidth is a factor in determining the amount of information and the speed at which a medium can transmit data or other information.

Backward Explicit Congestion Notification (BECN): A bit that tells you that a certain frame on a particular logical connection has encountered heavy traffic. The bit provides notification that congestion-avoidance procedures should be initiated in the opposite direction of the received frame. See also FECN (Forward Explicit Congestion Notification).

Basic Rate Interface (BRI): An ISDN access interface type comprised of two B-channels each at 64K bps and one D-channel at 64K bps (2B+D).

Bell Operating Companies (BOC): The family of corporations created during the divestiture of AT&T. BOCs are independent companies which service a specific region of the US. Also called Regional Bell Operating Companies (RBOCs).

Bell Pub 41450: The Bell publication defining requirements for data format conversion, line conditioning, and termination for direct DDS connection.

Bell Pub 62310: The Bell publication defining requirements for data format conversion, line conditioning, and termination for direct DDS connection.

Binary Synchronous Communication (BSC): A form of telecommunication line control that uses a standard set of transmission control characters and control character sequences, for binary synchronous transmission of binary-coded data between stations.

Bit (Binary digIT): A bit is the basis of the binary number system. It can take the value of 1 or 0. Bits are generally recognized as the electrical charge generated or stored by a computer that represent some portion of usable information.

Bit Error Rate Test (BERT): A device or routine that measures the quality of data transmission. A known bit pattern is transmitted, and the errors received are counted and a BER (bit error rate) is calculated. The BER is the ratio of received bits in error relative to the total number of bits received, expressed in a power of 10.

Bit robbing: The use of the least significant bit per channel in every sixth frame for signaling. The line signal bits "robbed" from the speech path conveys sufficient pre-ISDN telephony signaling information with the remaining line signal bits providing sufficient line signaling bits for recreating the original sound. See "robbed bit signaling".

Blue Alarm: An error indication signal consisting of all 1s indicating disconnection or attached device failure. Contrast "Red Alarm" and "Yellow Alarm".

Bps (bits per second): A unit to measure the speed at which data bits can be transmitted or received. Bps differs from baud when more than one bit is represented by a single cycle of the carrier.

Bridges: 1) A functional unit that interconnects two local area networks that use the same logical link protocol but may use different medium access control protocols. 2) A functional unit that interconnects multiple LANs (locally or remotely) that use the same logical link control protocol but that can use different medium access control protocols. A bridge forwards a frame to another bridge based on the medium access control (MAC) address. 3) In the connection of local loops, channels, or rings, the equipment and techniques used to match circuits and to facilitate accurate data transmission.

Buffer: A temporary storage register or Random Access Memory (RAM) used in all aspects of data communications which prevents data from being lost due to differences in transmission speed. Keyboards, serial ports, muxes and printers are a few examples of the devices that contain buffers.

Bus: A common channel between hardware devices either internally between components in a computer, or externally between stations in a communications network.

Byte: The unit of information a computer can handle at one time. The most common understanding is that a byte consists of 8 binary digits (bits), because that is what computers can handle. A byte holds the equivalent of a single character (such as the letter A).

C

Call Setup Time: The time to establish a circuit-switched call between two points. Includes dialing, wait time, and CO/long distance service movement time.

Carrier Group Alarm (CGA): A T1 service alarm generated by a channel bank when an OOF condition occurs for a predefined length of time (usually 300mS to 2.5 seconds). The CGA causes the calls using a trunk to be dropped and for trunk conditioning to be applied.

Carrier signal: An analog signal with known frequency, amplitude and phase characteristics used as a transport facility for useful information. By knowing the original characteristics, a receiver can interpret any changes as modulations, and thereby recover the information.

CCITT (Consultative Committee for International Telephone and Telegraph): An advisory committee created and controlled by the United Nations and headquartered in Geneva whose purpose is to develop and to publish recommendations for worldwide standardization of telecommunications devices. CCITT has developed modem standards that are adapted primarily by PTT (post, telephone and telegraph) organizations that operate telephone networks of countries outside of the U.S. See also ITU.

Central Office (CO): The lowest, or most basic level of switching in the PSTN (public switched telephone network). A business PABX or any residential phone connects to the PSTN at a central office.

Centrex: A multi-line service offered by operating telcos which provides, from the telco CO, functions and features comparable to those of a PBX for large business users. See also "Private Branch Exchange", "Exchange".

Channel: A data communications path between two computer devices. Can refer to a physical medium (such as UTP or coax), or to a specific carrier frequency.

Channel bank: A device that acts as a converter, taking the digital signal from the T1 line into a phone system and converting it to the analog signals used by the phone system. A channel bank acts as a multiplexer, placing many slow-speed voice or data transactions on a single high-speed link.

Circuit-switched Network: A technology used by the PSTN that allocates a pair of conductors for the exclusive use of one communication path. Circuit switching allows multiple conversations on one talk path only if the end-users multiplex the signals prior to transmission.

Circuit switching: The temporary connection of two or more communications channels using a fixed, non-shareable path through the network. Users have full use of the circuit until the connection is terminated.

Clear Channel: A transmission path where the full bandwidth is used (no bandwidth needed for signaling, carrier framing or control bits). A 64K bps digital circuit usually has 8K bps used for signaling. ISDN has two 64K bps circuits, and a 16K bps packet service of which part is used for signaling on the 64K channels.

Client-Server: In TCP/IP, the model of interaction in distributed data processing in which a program at one site sends a request to a program at another site and awaits a response. The requesting program is called a client; the answering program is called a server.

Cluster Controller: A device that can control the input/output operations of more than one device connected to it. A cluster controller may be controlled by a program stored and executed in the unit, or it may be entirely controlled by hardware.

Committed Burst Size: The maximum number of bits that the frame relay network agrees to transfer during any measurement interval

Committed Information Rate (CIR): An agreement a customer makes to use a certain minimum data transmission rate (in bps). The CIR is part of the frame relay service monthly billing, along with actual usage, that users pay to their frame relay service provider.

Compression: 1) The process of eliminating gaps, empty fields, redundancies, and unnecessary data to shorten the length of records or blocks. 2) In SNA, the replacement of a string of up to 64-repeated characters by an encoded control byte to reduce the length of the data stream to the LU-LU session partner. The encoded control byte is followed by the character that was repeated (unless that character is the prime compression character). 3) In Data Facility Hierarchical Storage Manager, the process of moving data instead of allocated space during migration and recall in order to release unused space. 4) Contrast with decompression.

COMx Port: A serial communications port on a PC.

Congestion: A network condition where there is too much data traffic. The ITU I.233 standard defines congestion management in terms of speed and burstiness.

Congestion Notification: The function in frame relay that ensures that userdata transmitted at a rate higher than the CIR are allowed to slow down to the rate of the available network bandwidth.

Consecutive Severely Errored Seconds (CSES): An error condition that occurs when from 3 to 9 SES (Severely Errored Seconds) are logged consecutively.

Customer Premise Equipment (CPE): The generic term for data comm and/or terminal equipment that resides at the user site and is owned by the user with the following exclusions: over-voltage protection equipment, inside wiring, coin operated or pay telephones, "company-official" equipment, mobile phone equipment, "911" equipment, equipment necessary for the provision of communications for national defense, or multiplexing equipment used to deliver multiple channels to the customer.

D

D4: The T1 4th generation channel bank.

D4 channelization: Refers to the compliance with AT&T TR 62411 for DS1 frame layout.

D4 framing: The T1 format for framing in AT&T D-Series channel banks, in which there are 12 separate 193-bit frames in a super-frame. A D4 framing bit is used to identify the channel and the signaling frame. Signalling for voice channels is carried in-band for every channel, along with the encoded voice. See "robbed-bit signaling".

Data Communications Equipment (DCE): Any device which serves as the portal of entry from the user equipment to a telecommunications facility. A modem is a DCE for the phone network (PSTN) that is commonly on site at the user's premises. Packet Switched Networks have another level of DCE which is most often located at a central office.

Data Link Connection Identifier (DLCI): One of the six components of a frame relay frame. Its purpose is to distinguish separate virtual circuits across each access connection. Data coming into a frame relay node is thus allowed to be sent across the interface to the specified "address". The DLCI is confirmed and relayed to its destination, or if the specification is in error, the frame is discarded.

Dataphone Digital Service (DDS): A private line digital service that offers 2400, 4800, 9600 and 56K bps data rates on an inter-LATA basis by AT&T and on an intra-LATA basis by the BOCs.

Data Service Unit (DSU): A device that provides a digital data service interface directly to the data terminal equipment. The DSU provides loop equalization, remote and local testing capabilities, and a standard EIA/CCITT interface.

Dedicated Line: A communication line that is not switched. The term leased line is more common.

Default: This is a preset value or option in software packages, or in hardware configuration, that is used unless you specify otherwise.

Device driver: Software that controls how a computer communicates with a device, such as a printer or mouse.

Digital Cross-connect System (DCS): The CO device which splits and redistributes the T1 bandwidth. The DCS takes time slots from various T1 lines and alters them to provide the needed connectivity. DCS connections are made with software at an administrator's workstation.

Digital Data: Information represented by discrete values or conditions (contrast "Analog Data").

Digital Loopback: A technique used for testing the circuitry of a communications device. Can be initiated locally, or remotely (via a telecommunications device). The tested device decodes and encodes a received test message, then echoes the message back. The results are compared with the original message to determine if corruption occurred en route.

Digital PBX: A Private Branch Exchange that operates internally on digital signals. See also "Exchange".

Digital Service, level 0 (DS0): The world-wide standard speed (64K bps) for digital voice conversation using PCM (pulse coded modulation).

Digital Service, level 1 (DS1): The 1.544M bps voice standard (derived from an older Bell System standard) for digitized voice transmission in North America. The 1.544M bps consists of 24 digitally-encoded 64K bps voice channels (north America) and 2.048M bps (30 channels) elsewhere.

Digital Signal: A discrete or discontinuous signal (for example, a sequence of voltage pulses). Digital devices, such as terminals and computers, transmit data as a series of electrical pulses which have discrete jumps rather than gradual changes.

Digital Signaling Rates (DSn): A hierarchical system for transmission rates, where "DS0" is 64K bps (equivalent to ISDN B channel), and DS1 is 1.5 Mbps (equivalent to ISDN PRI).

Digital Transmission: A method of electronic information transmission common between computers and other digital devices. Analog signals are waveforms: a combination of many possible voltages. A computer's digital signal may be only "high" or "low" at any given time. Therefore, digital signals may be "cleaned up" (noise and distortion removed) and amplified during transmission.

Digitize: To convert an analog signal to a digital signal.

DIP switch (pronounced "dip switch"): A set of tiny toggle switches, built into a DIP (dual in-line package), used for setting configurable parameters on a PCB (printed circuit board).

Driver: A software module that interfaces between the Operating System and a specific hardware device (color monitors, printers, hard disks, and so on.). Also known as a device driver.

Drop and Insert: The process where a portion of information carried in a transmission system is demodulated ("Dropped") at an intermediate point and different information is included ("Inserted") for subsequent transmission.

DTE (Data Terminating Equipment): A term used to include any device in a network which generates, stores or displays user information. DTE is a telecommunications term which usually refers to PCs, terminals, and printers.

DTMF (Dual-Tone MultiFrequency): A generic push-button concept made popular by AT&T TouchTone.

E

E&M: A telephony trunking system used for either switch-to-switch, or switch-to-network, or computer/telephone system-to-switch connection.

EIA: The Electronics Industries Association is a trade organization in Washington, DC that sets standard for use of its member companies. See RS-232, RS-422, RS530.

Encapsulation: A technique used by network-layer protocols in which a layer adds header information to the protocol data unit from the preceding layer. Also used in "enveloping" one protocol inside another for transmission. For example, IP inside IPX.

Errored Seconds (ES): Any second of operation that all 1.544M bits are not received exactly as transmitted. Contrast "Error Free Seconds".

Error Free Seconds (EFS): Any second of operation that all 1.544M bits are received exactly as transmitted. Contrast "Errored Seconds".

ESF Error Event: A T1 error condition that is logged when a CRC-6 error or an OOF error occurs.

Ethernet: A 10-megabit baseband local area network that allows multiple stations to access the transmission medium at will without prior coordination, avoids contention by using carrier sense and deference, and resolves contention by using collision detection and transmission. Ethernet uses carrier sense multiple access with collision detection (CSMA/CD).

Excess Zeros: A T1 error condition that is logged when more than 15 consecutive 0s or less than one 1 bit in 16 bits occurs.

Exchange: A unit (public or private) that can consist of one or more central offices established to serve a specified area. An exchange typically has a single rate of charges (tariffs) that has previously been approved by a regulatory group.

Exchange Area: A geographical area with a single uniform set of charges (tariffs), approved by a regulatory group, for phone services. Calls between any two points within an exchange area are local calls. See also "Digital PBX", "PBX".

Exchange Termination (ET): The carrier's local exchange switch. Contrast with "Loop Termination-LT".

Explicit Congestion Management: The method used in frame relay to notify the terminal equipment that the network is overly busy. The use of FECN and BECN is called explicit congestion management. Some end-to-end protocols use FECN or BECN, but usually not both options together. With this method, a congestion condition is identified and fixed before it becomes critical. Contrast with "implicit congestion".

Extended Super Frame (ESF): One of two popular formats for framing bits on a T1 line. ESF framing has a 24-frame super-frame, where robbed bit signaling is inserted in the LSB (bit 8 of the DS-0 byte) of frames 6, 12, 18 and 24. ESF has more T1 error measurement capabilities than D4 framing. ESF and B8ZS are typically both offered to provide clear channel service.

E

Failed Seconds: A test parameter where the circuit is unavailable for one full second.

Failed Signal: A T1 test parameter logged when there are more than 9 SES (Severely Errored Seconds).

Fax (facsimile): Refers to the bit-mapped rendition of a graphics-oriented document (fax) or to the electronic transmission of the image over phone lines (faxing). Fax transmission differs from data transmission in that the former is a bit-mapped approximation of a graphical document and, therefore, cannot be accurately interpreted according to any character code.

Firmware: A category of memory chips that hold their content without electrical power, they include ROM, PROM, EPROM, and EEPROM technologies. Firmware becomes "hard software" when holding program code.

Foreground: The application program currently running on and in control of the PC screen and keyboard. The area of the screen that occupies the active window. Compare with "background".

Fractional T1 (FT1): A digital data transmission rate between 56K bps (DS0 rate) and 1.544M bps (the full T1 rate - in North America). FT1 is typically provided on 4-wire (two copper pairs) UTP. Often used for video conferencing, imaging and LAN interconnection due to its low cost and relatively high speed. FT1 rates are offered in 64K bps multiples, usually up to 768K bps.

Frequency: A characteristic of an electrical or electronic signal which describes the periodic recurrence of cycles. Frequency is inversely proportional to the wavelength or pulse width of the signal: long wavelength signals have low frequencies and short wavelength signals yield high frequencies.

Foreign Exchange (FX): A CO trunk with access to a distant CO, allowing ease of access and flat-rate calls anywhere in the foreign exchange area.

Foreign Exchange Office (FXO): Provides local phone service from a CO outside of ("foreign" to) the subscriber's exchange area. In simple form, a user can pick up the phone in one city and receive a tone in the foreign city.

Connecting a POTS phone to a computer telephony system via a T1 link requires a channel bank configured for the FX connection. To generate a call from the POTS set to the computer telephony system, a FXO connection must be configured.

Foreign Exchange Station (FXS): See FX, FXO. To generate a call from the computer telephony system to the POTS set, a FXS connection must be configured.

Forward Explicit Congestion Notification (FECN): A bit that tells you that a certain frame on a particular logical connection has encountered heavy traffic. The bit provides notification that congestion-avoidance procedures should be initiated in the same direction of the received frame. See also BECN (Backward Explicit Congestion Notification).

Frame: A group of data bits in a specific format to help network equipment recognize what the bits mean and how to process them. The bits are sent serially, with a flag at each end signifying the start and end of the frame.

Frame Relay: A form of packet switching that uses small packets and that requires less error checking than other forms of packet switching. Frame relay is effective for sending "bursty" data at high speeds (56/64K, 256K, and 1024K bps) over wide area networks. Frame Relay specifications are defined by ANSI documents ANSI T1.602, T1.606, T1S1/90-175, T1S1/90-213, and T1S1/90-214. In using frame relay, blocks of information (frames) are passed across a digital network interface using a "connection number" that is applied to each frame to distinguish between individual frames.

Frame Relay Forum: A non-profit organization of 300+ vendors and service providers, based in Foster City, CA, that are developing and deploying frame relay equipment.

Frame Relay Implementors Forum: A group of companies supporting a common specification for frame relay connection to link customer premises equipment to telco network equipment. Their specification supports ANSI frame relay specs and defines extensions such as local management.

Frame Relay Access Device (FRAD): A piece of equipment that acts as a concentrator or frame assembler/dissassembler that can support multiple protocols and provide basic "routing" functions.

G

Gateway: 1) A functional unit that interconnects two computer networks with different network architectures. A gateway connects networks or systems of different architectures. A bridge interconnects networks or systems with the same or similar architectures. 2) A network that connects hosts.

Graphical User Interface (GUI): A type of computer interface consisting of a visual metaphor of a real-world scene, often of a desktop. Within that scene are icons, representing actual objects, that the user can access and manipulate with a pointing device.

H

Handshaking: A process that two modems go through at the time of call setup to establish synchronization over the data communications link. It is a synchronization and negotiation process accomplished by the exchange of predefined, mutually recognized control codes.

High-level Data Link Control (HDLC): An ISO standard, bit-oriented data communications protocol that provides nearly error-free data transfers.

I

Hexadecimal: A base 16 numbering system used to represent binary values. Hex uses the numbers 0-9 and the letters A-F: usually notated by an "h" (for example, "4CF h", read "four charley fox, hex"). The result is that one hex digit represents a 4-bit value.

Implicit congestion management: A method of informing the terminal that the network is busy. This method relies on the end-system protocol to detect and fix the congestion problem. TCP/IP is an example of a protocol using only implicit congestion management. See also "explicit congestion management".

In-band: Refers to the type of signalling over the conversion path on an ISDN call. Contrast "out-of-band".

Insufficient Ones: A T1 error condition that is logged when less than one 1 in 16 0s or less than 12.5 % average 1s density is received.

Inter Exchange Carrier (IEC): The long distance company (LE) who's central office provides the point of reference for T1 access. Any common carrier authorized by the FCC to carry customer transmissions between LATAs.

Internet: Refers to the computer network of many millions of university, government, and private users around the world. Each user has a unique Internet Address.

Internet Address (IP Address): A unique 32-bit address for a specific TCP/IP host on a network. Normally printed in dotted decimal format (for example, 129.128.44.227).

Internet Protocol (IP): A protocol used to route data from its source to its destination in an Internet environment. The Internet Protocol was designed to connect to local area networks. Although there are many protocols that do this, IP refers to the global system of interconnecting computers. It is a highly distributed protocol (each machine only worries about sending data to the next step in the route).

Internetwork Packet Exchange (IPX): A NetWare communications protocol used to route messages from one node to another. IPX packets include network addresses and can be routed from one network to another. An IPX packet can occasionally get lost when crossing networks, thus IPX does not guarantee delivery of a complete message. Either the application has to provide that control, or NetWare's SPX protocol must be used.

Interoperable: Devices from different vendors that can exchange information using a standard's base protocol.

I/O Addresses: Locations within the I/O address space of your computer used by a device, such as an expansion card, a serial port, or an internal modem. The address is used for communication between software and a device.

IRQ Level (Interrupt Request Level): The notification a processor receives when another portion of the computer's hardware requires its attention. IRQs are numbered so that the device issuing the IRQ can be identified, and so IRQs can be prioritized.

ISA (Industry Standards Architecture) (pronounced "ice a"): The classic 8 or 16-bit architecture introduced with IBM's PC-AT computer.

ISDN (Integrated Services Digital Network): An International telecommunications standard for transmitting voice, video and data over a digital communications line. ISDN is a world-wide telecommunications service that uses digital transmission and switching technology to support voice and digital data communications. Frame relay was partially based on ISDN's data link layer protocol (LAPD). Frame relay can be used to transmit across ISDN services offering circuit-switched connection at 64K bps and higher speeds. Contrast Public Switched Telephone Network (PSTN).

ITU-TSS (formerly CCITT): International Telecommunications Union-Telecommunications Sector; the United Nations organization that prepares standards ("Recommendations") for resolving communications issues and problems.

K

Key Telephone System (KTS): Phone devices with multiple buttons that let you select incoming or outgoing CO phone lines directly. Similar in operation to a PBX, except a KTS you don't have to dial a "9" for a call outside the building.

Key Service Unit (KSU): A small device containing the switching electronics for a business key telephone system (KTS).

Key Set: A phone set with several buttons for call holding, line pickup, intercom, and autodialing. Also called a touchtone phone (Ericsson) and a KTS (Key Telephone Set).

L

LAPB: Link Access Procedure Balanced; based on the X.25 Layer 2 specification. A full-duplex point-to-point bit-synchronous protocol commonly used as a data link control protocol to interface X.25 DTEs. LAPB is the link initialization procedure that establishes and maintains communications between the DTE and the DCE.

LAPD: Link Access Protocol for the D-Channel; based on the ISDN Q.921 specification. A full-duplex point-to-point bit-synchronous link-level protocol for ISDN connections; different from LAPB in its framing sequence. Transmission is in units called "frames", and a frame may contain one or more X.25 packets.

Line Coding: The representation of 1s and 0s on a T1 line. The two methods of line coding commonly used, B8ZS and AMI, differ in the restrictions placed on user data. T1 line coding ensures that sufficient timing information is sent with the digital signal to ensure recovery of all the bits at the far end. Timing information on the T1 line is included in the form of 1s in the data stream; a long string of 0s in the data stream could cause problems recovering the data.

Line Termination (LT): The electronics at the ISDN network side of the user/network interface that complements the NT1 at the user side. The LT and the NT1 together provide the high-speed digital line signals required for BRI access.

Listed Directory Number (LDN): The main number assigned by the telco; the number listed in the phone directory and also provided by Directory Assistance. Some devices can have more than one LDN, such as ISDN devices that have one LDN for voice and another LDN for data.

Local Area Network (LAN): 1) A computer network located on a user's premises within a limited geographical area. Communication within a local area network is not subject to external regulations; however, communication across the LAN boundary may be subject to some form of regulation. 2) A LAN does not use store and forward techniques. 3) A network in which a set of devices are connected to one another for a communication and that can be connected to a larger network.

Local Access and Transport Area (LATA): A post-divestiture geographical area generally equivalent to a Standard Metropolitan Statistical Area. At divestiture, the territory served by the Bell system was divided into approximately 161 LATAs. The Bell Operating Companies (BOCs) provide Intra-LATA services.

Local Exchange Carrier (LEC): The local phone company which provides local (not long distance) transmission services. Also known as "telco". LECs provide T1 or FT1 access to LDCs (unless the T1 circuit is completely intra-LATA). Inter-LATA T1 circuits are made up of a combination of Access and Long Haul facilities.

Local Management Interface (LMI): A specification for frame relay equipment that defines status information exchange.

Local Loop: A transmission path, typically twisted-pair wire, between an individual subscriber and the nearest public telecommunications network switching center. The wires provide ISDN service, but require an NT1 at the user end and an LT at the network end. (also known as "loop" or "subscriber loop".)

Logical Link Control (LLC2): In a local area network, the protocol that governs the exchange of transmission frames between data stations independently of how the transmission medium is shared. The LLC2 protocol was developed by the IEEE 802 committee and is common to all LAN standards.

Logical Unit (LU): A type of network accessible unit that enables end users to gain access to network resources and communicate with each other.

Long Haul: The T1 element that connects to the Access portion of the long distance company's (LDC's) central office. The LDC is commonly called the point of presence (POP). Each LDC has a number of POPs, located throughout the country. The LDC is also called an IEC (Inter Exchange Carrier).

Long Haul Communications: The type of phone call reaching outside of a local exchange (LE).

M

Management Information Base (MIB): A database of network management information used by the Common Management Information Protocol (CMIP) and the Simple Network Management Protocol (SNMP).

Megacom: An AT&T service with a normal WATS line (typically T1) between the customer premise and the AT&T serving class 4 CO are the customer's responsibility.

MegaLink: BellSouth's leased T1 service.

Message: Associated with such terms as packet, frame, and segment. 1) In information theory, an ordered series of characters intended to convey information. 2) An assembly of characters and sometimes control codes that is transferred as an entry from an originator to one or more recipients.

Modem: A communications device that enables a computer to transmit information over a phone line. It converts the computer's digital signals into analog signals to send over a phone line and converts them back to digital signals at the receiving end. Modems can be internal and fit into an expansion slot, or external and connect to a serial port.

Multiplexer (Mux): 1) A device that takes several input signals and combines them into a single output signal in such a manner that each of the input signals can be recovered. 2) A device capable of interleaving the events of two or more activities or capable of distributing the events of an interleaved sequence to the respective activities. 3) Putting multiple signals on a single channel.

Multiprotocol: A device that can interoperate with devices utilizing different network protocols.

Multithreading: The ability of a software system to be able to handle more than one transaction concurrently. This is contrasted to the case where a single transaction is accepted and completely processed before the next transaction processing is started.

N

Nailed Connection: A permanent or dedicated circuit of a previously switched circuit or circuits.

Nailed-up Circuit: A semipermanent circuit established through a circuit-switching facility for point-to-point connectivity.

NAK (Negative Acknowledgment): Communications code used to indicate that a message was not properly received, or that a terminal does not wish to transmit. Contrast with ACK.

Network: A group of computers connected by cables or other means and using software that enables them to share equipment, such as printers and disk drives to exchange information.

Node: Any point within a network which has been assigned an address.

O

Object-Orientated: A method for structuring programs as hierarchically organized classes describing the data and operations of objects that may interact with other objects.

Office Channel Unit-Data Port (OCU-DP): The CO channel bank used as the interface between the customer's DSU and the channel bank.

Off-hook: The condition of a device which has accessed a phone line, with or without using the line. In modem use, this is equivalent to a phone handset being picked up. Dialing and transmission are allowed, but incoming calls are not answered. Contrast "on-hook".

Off Premise Extension (OPX): An extension or phone that terminates in a location other than that of the PBX. Commonly used to provide a corporate member with an extension of the PBX at home.

Ones Density: The measure of the number of logical 1s on a T1 line compared to a given total number of bits on that line; used for timing information in data recovery in AML and B8ZS.

On-Hook: The condition of a device which has not accessed a phone line. In modem use, this is equivalent to a phone handset that has not been picked up. In other words, it can receive an incoming call. Contrast "off-hook".

Open Shortest Path First (OSPF): A hierarchical Interior Gateway Protocol (IGP) routing algorithm for IP that is a proposed standard for Internet. OSPF incorporates least-cost routing, equal-cost routing, and load balancing.

Outage: The measure of the time during which a circuit is not available for use due to service interrupt. Outage is the complement of circuit "availability" (100% minus % available = % outage).

Out-of-band: Signaling that is separated from the channel carrying the information (i.e., the voice/data/video signal is separate from the carrier signal). Dialing and various other "supervisory" signals are included in the signaling element. Contrast "In-band" signaling.

Out of Frame (OOF): A T1 alarm condition that is logged on the loss of 2, 3, or 4 of 5 consecutive FT framing bits.

P

Packet: 1) In data communication, a sequence of binary digits, including data and control signals, that is transmitted and switched as a composite whole. The data, control signals and, possibly, error control information are arranged in a specific format. 2) Synonymous with data frame. 3) In TCP/IP, the unit of data passed across the interface between the Internet layer and the link layer. A packet includes an IP header and data. A packet can be a complete IP datagram or a fragment of an IP diagram. 4) In X.25, a data transmission information unit. A group of data and control characters, transferred as a unit, determined by the process of transmission. Commonly used data box lengths in packets are 128 or 256 bytes. 5) The field structure and format defined in the CCITT X.25 recommendation.

Packet Assembler/Disassembler (PAD): Used by devices to communicate over X.25 networks by building or stripping X.25 information on or from a packet.

Packet Data: The information format ("packetized") used for packet-mode calls.

Packet Mode: Refers to the switching of chunks of information for different users using statistical multiplexing to send them over the same transmission facility.

Parity bit: An extra bit attached to each byte of synchronous data used to detect errors in transmission.

Permanent Virtual Circuit (PVC): A connection between two endpoints dedicated to a single user. In ISDN, PVCs are established by network administration and are held for as long as the user subscribes to the service.

Physical Unit (PU): The component that manages and monitors the resources (such as attached links and adjacent link stations) associated with a node, as requested by an SSCP via an SSCP-PU session. An SSCP activates a session with the physical unit in order to indirectly manage, through the PU, resources of the node such as attached links. This term applies to type 2.0, type 4, and type 5 nodes only.

Point of Presence (POP): The central office's end points of the long distance carriers.

Point to Point Protocol (PPP): A protocol that lets a PC user access TCP/IP (Internet member) using an ISDN terminal adapter or a high-speed modem over a standard phone line.

Port: A location for input or output data exchange. Computers, muxes, and so on have ports for various purposes.

Primary Rate Interface (PRI): Used on ISDN. In North America, and Japan, PRI is one 64Kbps D channel and 23 B channels. Elsewhere, it is one D channel and 30 B channels.

Primitive: An abstract representation of interaction across the access points indicating that information is being passed between the service user and the service provider. The OSI Reference Model defines four types of primitives: Request, Indication, Response and Confirm.

Private Branch Exchange (PBX): A phone exchange located on the customer's premises. The PBX provides a circuit switching facility for phone extension lines within the building, and access to the public phone network. See also "Exchange".

PROM (Programmable Read Only Memory - pronounced "prom"): A permanent memory chip that can be programmed or filled by the customer after by the manufacturer has set initial values. Contrast with ROM.

Protocol: 1) A set of semantic and syntactic rules that determines the behavior of functional units in achieving communication. 2) In Open Systems Interconnection architecture, a set of semantic and syntactic rules that determine the behavior of entities in the same layer in performing communication functions. 3) In SNA, the meanings of and the sequencing rules for requests and responses used for managing the network, transferring data, and synchronizing the states of network components. 4) Synonymous with line control discipline.

PSTN (Public Switched Telephone Network): A worldwide public voice phone network that is used as a telecommunications medium for the transmission of voice, data, and other information.

Public Data Network (PDN): A packet-switched network that is available to the public for individual ("subscriber") use. Typically, controlled by a government or a national monopoly.

Public Switched Telephone Network (PSTN): The group of circuit-switching voice carriers, which are commonly used as analog data communications services.

Pulse Code Modulation (PCM): 1) In data communication, variation of a digital signal to represent information; for example, by means of pulse amplitude modulation (PAM), pulse duration modulation (PDM), or pulse position modulation (PPM). 2) Transmissions of analog information in digital form through sampling and encoding the samples with a fixed number of bits.

Pulse dialing: One of two methods of dialing a phone, usually associated with rotary-dial phones. Compare with "tone dialing".

Q

Quantizing: The process of analog-to-digital conversion by assigning a range, from the contiguous analog values, to a discrete number.

R

Random Access Memory (RAM): A computer's primary workspace. All data must be stored in RAM (even for a short while), before software can use the processor to manipulate the data. Before a PC can do anything useful it must move programs from disk to RAM. When you turn it off, all information in RAM is lost.

Rate Enforcement: The concept in frame relay where frames sent faster than the CIR are to be carried only if the bandwidth is available, otherwise they are to be discarded. The frame relay network assumes that anything exceeding the CIR is of low priority. Rate enforcement makes sure that the network will not get so congested that it is unable to meet the agreed-on CIR

Recognized Private Operating Agency (RPOA): A corporation, private or government-controlled, that provides telecommunications services. RPOAs, such as AT&T, participate as non-voting members in the CCITT.

Red Alarm: A T1 error condition generated when a local failure (for example, loss of synchronization) exists for 2.5 seconds, causing a Carrier Group Alarm (CGA). See also "Blue Alarm" and "Yellow Alarm".

Request for Comment (RFC): A set of papers in which Internet standards (published and proposed), along with generally-accepted ideas, proposals, research results, and so on are published.

Ring Down Box: A device that emulates a CO by generating POTS calls for testing and product demos.

Ring Down Circuit: A tie line connecting phones where picking up one phone automatically rings another phone. A feature used for emergencies to alert the person at the other phone of the incoming call.

RJ-11: An industry standard interface used for connecting a phone to a modular wall outlet. Comes in 4-and 6-wire packages.

RJ-45: An 8-wire modular connector for voice and data circuits.

Robbed Bit Signaling: The popular T1 signaling mechanism where the A and B bits are sent by each side of the T1 termination and are "buried" in the voice data of each voice channel in the T1 circuit. Since the bits are "robbed" infrequently, voice quality is remains relatively uncompromised. See "bit robbing".

The robbed-bit signaling technique is used in D4 channel banks to convey signaling information. The eighth (least significant) bit of each of the 24 8-bit time slots is "robbed" every sixth frame to convey voice-related signaling information such as on-hook, off-hook, and so on, for each channel.

Router: A device that connects two networks using the same networking protocol. It operates at the Network Layer (Layer 3) of the OSI model for forwarding decisions.

Routing Information Protocol (RIP): A distance vector-based protocol that provides a measure of distance, or hops, from a transmitting workstation to a receiving workstation.

RS232-C: An EIA standard for a serial interface between computers and peripheral devices (modem, mouse, etc.). It uses a 25-pin DB-25, or a 9-pin DB-9 connector. The RS-232 standard defines the purposes, electrical characteristics and timing of the signals for each of the 25 lines.

RS-422: The EIA standard for a balanced interface with no accompanying physical connector. RS-422 products can use screw terminals, DB-9, various DB-25, and DB-37 connectors.

RS-530: The EIA standard for the mechanical/electrical interface between DCEs and DTEs transmitting synchronous or asynchronous serial binary data. RS-530 provides for high data rates with the same connector used for RS-232. However, it is incompatible with RS-232.

S

Serial Port: The connector on a PC used to attach serial devices (those that need to receive data one bit after another), such as a mouse, a printer or a modem. This consists of a 9 or 25-pin connector that sends data in sequence (bit by bit). Serial ports are referred to as "COMx" ports, where x is 1 to 4 (COM1 through COM4). A serial port contains a conversion chip called a "UART" which translates between internal parallel and external serial formats.

Service: The requirements offered by an RPOA to its customers to satisfy specific telecommunications needs.

Severely Errored Seconds (SES): Refers to a typical T1 error event where an error burst occurs (a short term, high bit-error rate that is self-clearing). Per the ITU-T (CCITT) G.821: any second in which the BER is less than 1×10^{-3} .

Signaling: The process of establishing, maintaining, accounting for, and terminating a connection between two endpoints (e.g., the user premises and the telco CO). Central office signals to the user premises can include ringing, dial tone, and speech signals. Signals from the user's phone can include off-hook, dialing, speech to far-end party, and on-hook signals.

In-band signaling techniques include pulse and tone dialing. With common channel signaling, information is carried out-of-band.

Simple Network Management Protocol (SNMP): TCP/IP protocol that allows network management.

Simultaneous Voice Data (SVD): A technology for letting a user send data via a modem, and use a handset to talk to another user at the same time over the same connection. The alternative, making a second call, can be expensive or even impossible. The uses for SVD are telecommuting, videoconferencing, distant learning, and tech support.

Stop Bit: One of the variables used for timing in asynchronous data transmission. Depending on the devices, each character may be trailed by 1, 1.5, or 2 stop bits.

Superframe (D4): A T1 transmission format that consists of 12 DS1 frames, or 2316 bits. A DS1 frame consists of 193 bit positions. A frame overhead bit is in the first position, and it is used for frame and signaling phase alignment only.

Subscriber Loop: See "Local loop".

Switched 56: A circuit-switched (full duplex digital synchronous data transmission) service that lets you dial a number and transmit data to it at 56K bps. It is a relatively low cost service, widely used in North America for telecommuting, videoconferencing and high speed data transfers. Many phone companies are (or will be) phasing out Switched 56 in favor of ISDN service.

Switched Virtual Circuit (SVC): A type of data transmission where the connection is maintained only until the call is cleared.

Switched Line: In communications, a physical channel established by dynamically connecting one or more discreet segments. This connection lasts for the duration of the call after which each segment may be used as part of a different channel. Contrast with leased line.

Switched Network: A network in which a temporary connection is established from one point via one or more segments.

Synchronous Data Link Control (SDLC): A discipline conforming to subsets of the Advanced Data Communications Control Procedures (ADCCP) of the American National Standards Institute (ANSI) and High-level Data Link Control (HDLC) of the International Organization for Standardization, for managing synchronous, code-transparent, serial-by-bit information transfer over a link connection. Transmission exchanges may be duplex, or half-duplex over switched or nonswitched links. The configuration of the link connection may be point-to-point, multipoint, or loop.

Synchronous Transmission: The transmission of data which involves sending a group of characters in a packet. This is a common method of transmission between computers on a network or between modems. One or more synchronous characters are transmitted to confirm clocking before each packet of data is transmitted. Compare to Asynchronous Transmission.

Systems Network Architecture (SNA): The description of the logical structure, formats, protocols, and operational sequences for transmitting information units through, and controlling the configuration and operation of, networks.

I

Tariff: The rate/availability schedule for telephone and ISDN services from a regulated service provider.

TCP/IP: A set of communication protocols that support peer-to-peer connectivity functions for both local and wide area networks.

T Carrier: The generic name for a digitally multiplexed carrier system. In the North American digital hierarchy, a T is used to designate a DS (digital signal) level hierarchy. Examples: T1 (DS1) is a 1.544 M bps 24-channel designation. In Europe, T1 is called E1. The T Carrier system was originally designed for transmitting digitized voice signals, but has since been adapted for digital data applications.

T1: A digital transmission link capable of 1.544M bps. T1 uses two pairs of normal UTP, and can handle 24 voice conversations, each digitized at 64K bps. T1 is a standard for digital transmission in the U.S., Canada, Japan and Hong Kong. T1 is the access method for high-speed services such as ATM, frame relay, and SMDS. See also T Carrier, T1 line and FT1.

T1 Channel Tests: A set of diagnostics that vary by carrier, used to verify a T1 channel operation. Can include Tone, Noise Level, Impulse Noise Level, Echo Cancellors, Gain, and Crosstalk testing.

T1 Framing: To digitize and encode analog voice signals requires 8000 samples per second (twice the highest voice frequency of 4000 Hz). Encoding in an 8-bit word provides the basic T1 block of 64K bps for voice transmission. This "Level 0 Signal, as its called, is represented by "DS-0", or Digital Signal at Level 0. Twenty-four of these voice channels are combined into a serial bit stream (using TDM), on a frame-by-frame basis. A frame is a sample of all 24 channels; so adding in a framing bit gives a block of 193 bits ($24 \times 8 + 1 = 193$). Frames are transmitted at 8000 per second (the required sample rate), creating a 1.544M ($8000 \times 193 = 1.544M$) transmission rate.

T1 Line: A digital communications facility that functions as a 24-channel pathway for data or voice. A T1 line is composed of two separate elements: the Access element and the Long Haul element.

T1 Mux: A device used to carry many sources of data on a T1 line. The T1 mux assigns each data source to distinct DS0 time slots within the T1 signal. Wide bandwidth signals take more than one time slot. Normal voice traffic or 56/64K bps data channels take one time slot. The T1 mux may use an internal or external T1 DSU; a "channel bank" device typically uses an external T1 CSU.

Transmission Control Protocol / Internet Program (TCP/IP): A multilayer set of protocols developed by the US Department of Defense to link dissimilar computers across dissimilar and unreliable LANs.

Terminal: The screen and keyboard device used in a mainframe environment for interactive data entry. Terminals have no "box", which is to say they have no file storage or processing capabilities.

Terminal Adapter (TA): An ISDN DTE device for connecting a non-ISDN terminal device to the ISDN network. Similar to a protocol converter or an interface converter, a TA connects a non-ISDN device between the R and S interfaces. Typically a PC card.

Tie line: A dedicated circuit linking two points without having to dial a phone number. The line may be accessed by lifting the phone handset or by pushing a button.

Time-Division Multiplexing (TDM): Division of a transmission facility into two or more channels by allotting the common channel to several different information channels, one at a time.

Time Slot: ne of 24 channels within a T1 line. Each channel has a 64K bps maximum bandwidth. "Time slot" implies the time division multiplexing organization of the T1 signal.

Toll Call: A call to a location outside of your local service area such as a long distance call.

Tone dialing: One of two methods of dialing a phone, usually associated with Touch-Tone® (push button) phones. Compare with pulse dialing.

Topology: Physical layout of network components (cables, stations, gateways, and hubs). Three basic interconnection topologies are star, ring, and bus networks.

Transmission Control Protocol (TCP): A communications protocol used in Internet and in any network that follows the US Department of Defense standards for internetwork protocol. TCP provides a reliable host-to-host protocol between hosts in packet-switched communications networks and in interconnected systems of such networks. It assumes that the Internet protocol is the underlying protocol.

Transport Layer: Layer 4 of the Open Systems Interconnection (OSI) model; provides reliable, end-to-end delivery of data, and detects transmission sequential errors.

Transport Protocol Data Unit (TPDU): A transport header, which is added to every message, contains destination and source addressing information that allows the end-to-end routing of messages in multi-layer NAC networks of high complexity. They are automatically added to messages as they enter the network and can be stripped off before being passed to the host or another device that does not support TPDU's.

Trunk: Transmission links that interconnect switching offices.

TSR (terminate and stay resident): A software program that remains active and in memory after its user interface is closed. Similar to a daemon in UNIX environments.

Tunneling: Encapsulation data in an IP packet for transport across the internet.

Twisted pair wiring: A type of cabling with one or more pairs of insulated wires wrapped around each other. An inexpensive wiring method used for LAN and telephone applications, also called UTP wiring.

U

UART (Universal Asynchronous Receiver/Transmitter) (pronounced "you art"): A chip that transmits and receives data on the serial port. It converts bytes into serial bits for transmission, and vice versa, and generates and strips the start and stop bits appended to each character.

UNIX: An operating system developed by Bell Laboratories that features multiprogramming in a multi-user environment.

Unshielded Twisted Pair (UTP): Telephone-type wiring. Transmission media for 10BASE-T.

V

V.25bis: An ITU-T standard for synchronous communications between a mainframe or host and a modem using HDLC or other character-oriented protocol.

V.54: The ITU-T standard for local and remote loopback tests in modems, DCEs and DTEs. The four basic tests are:

- local digital loopback (tests DTE send and receive circuits),
- local analog loopback (tests local modem operation),
- remote analog loopback (tests comm link to the remote modem), and
- remote digital loopback (tests remote modem operation).

Virtual Circuit: A logical connection. Used in packet switching wherein a logical connection is established between two devices at the start of transmission. All information packets follow the same route and arrive in sequence, but do not necessarily carry a complete address.

Index
A

Archie 63

B

Back Panel 12

C

Collision 11

Command Connector 12

Configuration Port Setup 35

Configuration Utilities 35

Connectors

 Command 12

 Power 12

D

DNS 63

Download Firmware 35

F

Finger 63

Front Panel 9

 Description 11

FTP 63

FTP Site 60

G

Gopher 63

H

HTML 63

HTTP 63

I

Internet

 FTP Site 60

Internet Protocol (IP) 64

IP 64

L

LEDs

56K DSU

 RD 11

Ethernet

 CL 11

 LNK 11

 RD 11

 TD 11

Limited Warranty 58

M

Multi-Tech Fax-Back Service 60

O

On-line Warranty Registration 58

P

Ping 63

POP 63

Power

 Connector 12

Proxy Server Configuration 35, 55

ProxyServer Software 35

R

Receive Data 11

Remote Configuration

 LAN-Based Procedure 52

Remote Management 54

 Telnet 54

 WEB Management 55

S

SMTP 63

SNMP 63

Software 35

 Description 35

Specifications

 Command Port 13

 Electrical/Physical 13

 Ethernet Port 13

T

TCP/IP 62

Telnet 54, 63

 Proxy Server Configuration 55

The Multi-Tech BBS 60

Traceroute 63

Transmit Data 11

U

Uninstall Proxy Server Configuration 35

W

Warranty 58

 On-line Registration 58

WEB Server 55