



**Voice/Fax Over IP Networks
Model MVP120**

H.323 Mode

User Guide

User Guide

MultiVOIP Series 100 - Model MVP120
S0000223 Revision A

Copyright

This publication may not be reproduced, in whole or in part, without prior expressed written permission from Multi-Tech Systems, Inc. All rights reserved.

Copyright © 2001, by Multi-Tech Systems, Inc.

Multi-Tech Systems, Inc. makes no representations or warranties with respect to the contents hereof and specifically disclaims any implied warranties of merchantability or fitness for any particular purpose. Furthermore, Multi-Tech Systems, Inc. reserves the right to revise this publication and to make changes from time to time in the content hereof without obligation of Multi-Tech Systems, Inc. to notify any person or organization of such revisions or changes.

Revision	Date	Description
A	09/27/01	Manual released. Software at Version 7.51x.

Patents

This Product is covered by one or more of the following U.S. Patent Numbers: **5.682.386; 5.757.801; 6.151.333, 6,219,708.** Other Patents Pending.

Trademarks

Multi-Tech and the Multi-Tech logo are registered trademarks and MultiVOIP is a trademark of Multi-Tech Systems, Inc.

Adobe Acrobat is a trademark of Adobe Systems Incorporated.

Microsoft Windows, Windows 2000, Windows 98, Windows 95, Windows NT, and NetMeeting are either registered trademarks or trademarks of Microsoft Corporation in the United States and/or other countries.

World Headquarters

Multi-Tech Systems, Inc.
2205 Woodale Drive
Mounds View, Minnesota 55112

(763) 785-3500 or (800) 328-9717

Fax 763-785-9874

Technical Support (800) 972-2439

Internet Address: <http://www.multitech.com>

Contents

Chapter 1 - Introduction to the MultiVOIP	6
Preview of This Guide	7
Typical Application	8
Front Panel Description	12
Back Panel Description	13
Specifications	14
Chapter 2 - Installation	16
Overview of the Installation Process	16
Unpacking Your MVP120	17
Telecom Safety Warning	17
Other Safety Warnings	17
Cabling Your MVP120	18
Chapter 3 - Installing the MVP120 Software	20
Chapter 4 - Configuring the Master MultiVOIP	24
Registering with a Gatekeeper Phone Directory	28
Building a Proprietary Phonebook Directory	31
Chapter 5 - Configuring the Slave MultiVOIPs	37
Chapter 6 - Deploying the VOIP Network.....	44
Remote Site Administrator	44
Chapter 7 - Using the MultiVOIP Software.....	46
MVP120 Configuration	47
Changing Channel Parameters	48
Interface Tab	48
Voice/Fax Tab	49
Billing/Misc Tab	50
Regional Tab	51
Changing the Phone Directory Database	52
Proprietary Phone Directory Database	53
Gatekeeper Phone Directory Database	55
Changing IP Parameters	57
Viewing Call Progress	58
Applications Setup	58
Viewing Statistics	60
IP Statistics	60
SNMP Statistics	61
Viewing Logs	62
Viewing Log Entry Details	62
Viewing Channel Totals	63
Reports	63
Upgrade Procedures	64
Upgrade Software	64
Manual Upgrade Procedure	66

Chapter 8 - Remote Configuration and Management	68
Modem-Based	68
LAN-Based	70
Telnet.....	72
Web Management	73
Chapter 9 - Warranty, Service, and Technical Support	75
Multi-Tech Systems, Inc. Warranty & Repairs Policies	75
Service	77
Ordering Accessories	77
Technical Support.....	78
Appendix A - TCP/IP Description	80
Appendix B - Cabling Diagrams	83
Appendix C - Regulatory Information	85
Glossary	89
Index	102



Chapter 1

Introduction to the MultiVOIP

Chapter 1 - Introduction to the MultiVOIP

The MultiVOIP 100 (Model MVP120) allows analog voice and fax communication over a traditional IP network. Multi-Tech's new voice/fax gateway technology allows voice and fax communication to be transmitted, with no additional expense, over your existing communications Internet, which has traditionally been data-only. To access this free voice and fax communication, all you have to do is connect the MVP120 to an FXO PBX port or PSTN and then to your existing Internet connection. Once configured, the MVP120 allows voice and fax to travel down the same path as your traditional data communications.

The MVP120 supports the H.323 standards-based protocol enabling your MVP120 to participate in real-time conferencing with other third-party VOIP Gateways or endpoints that support the H.323 protocol (such as Microsoft NetMeeting®). The H.323 standard defines how endpoints make and receive calls, how endpoints negotiate a common set of audio and data capabilities, how information is formatted and sent over the network, and how endpoints communicate with their respective Gatekeepers. Gatekeeper software is optional and if present in a network, it typically resides on a designated PC. It acts as the central point for all calls within its zone and provides call control services to all registered endpoints. In addition, Gatekeepers can perform bandwidth management through support for Bandwidth Request, Confirm, and Reject messages.

Note: A zone consists of all H.323 endpoints that are under the Gatekeeper's control.

The MVP120 is designed with one FXO voice/fax channel, a 10 Mbps Ethernet LAN interface, and a command port for configuration.

System management is provided through the command port using bundled Windows® software which provides easy-to-use configuration menus and a comprehensive Help system.

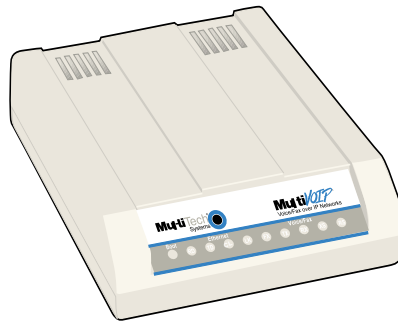

MultiVOIP 100 Series - Model MVP120

Preview of This Guide

This guide describes the MultiVOIP and tells you how to make the cable connections, install the software, and configure it. The information contained in each chapter is as follows:

Chapter 1 - Introduction to the MultiVOIP

This chapter describes the MultiVOIP features, a typical application, and the front and back panels.

Chapter 2 - Installation

This chapter provides an overview of the installation process, describes the contents of the MultiVOIP package, diagrams the cabling instructions, and lists Telecom safety warnings.

Chapter 3 - Installing the MVP120 Software

This chapter describes how to load the MultiVOIP software.

Chapter 4 - Configuring the Master MultiVOIP

This chapter describes how to configure your **Master**.

Chapter 5- Configuring the Slave MultiVOIPs

This chapter describes how to configure your **Slave**.

Chapter 6 - Deploying the VOIP Network.

Chapter 7 - Using the MultiVOIP Software.

This chapter describes how to use the software to make changes and to the configuration of your MultiVOIP.

Chapter 8 - Remote Configuration and Management

This chapter describes how to change the configuration of a remote MultiVOIP. The chapter also describes typical client applications, such as Telnet and Web-based management.

Chapter 9 - Warranty, Service, and Technical Support

This chapter provides a statement of limited warranty, tells you how to get service for your MultiVOIP, and gives you information about the Multi Tech Systems, Inc. Web site.

Typical Application

Before VOIP (Voice Over IP) technology existed, a sales office used a data connection to the Internet **and** a voice connection to the public telephone network. Now, with VOIP, the two networks can be tied together. To accomplish this a Sales Office MultiVOIP is connected between the public telephone network and the data network as shown in the typical application below. The Sales Office MultiVOIP is going to be set up as the master MultiVOIP and the MultiVOIP at the Remote Sales Office is going to be set up as the slave MultiVOIP. With this approach, the person at the Remote Sales Office can pick up the telephone and dial the Sales Office MultiVOIP and, after a second dial tone, can call anyone in the Sales Office, or dial 9 for outside line and call anyone in the calling area as if they were at the Sales Office.

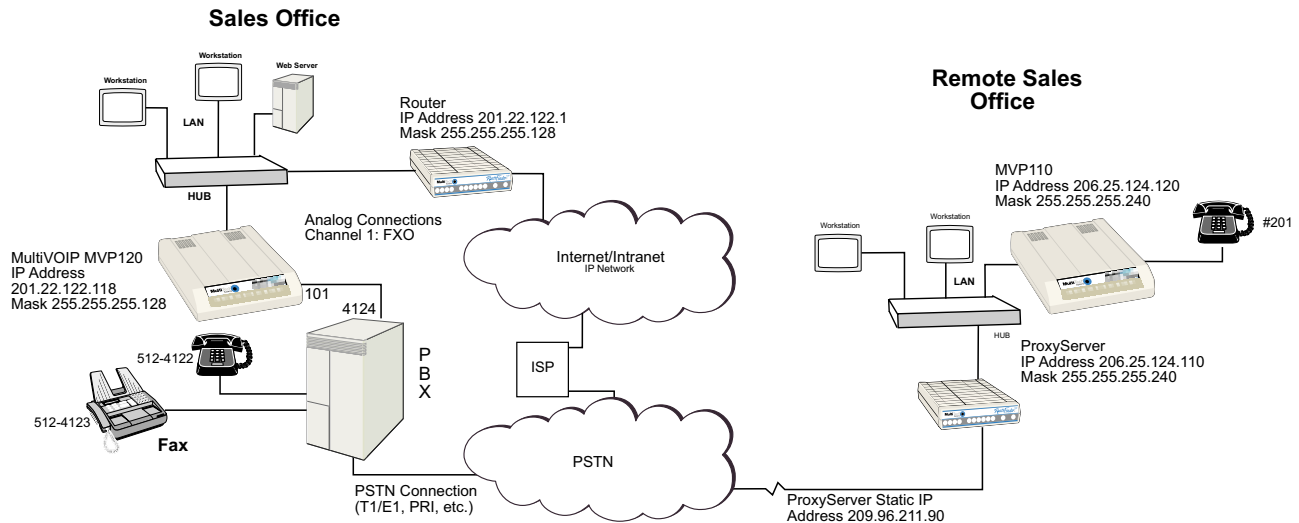

Typical VOIP Application

To set up this VOIP network, an MVP120 at the Sales Office is connected between the data network and the sales office telephone switch (PBX). To connect the MVP120 to the data network, an Ethernet cable is connected to the Ethernet port on the unit and the other end is plugged into a hub on the data network. On the PBX side, one phone cord is connected to the FXO jack on the back of the MVP120 and attached to an FXO port on the phone switch. The line on the PBX occupies phone extension 4124.

To set up a remote sales office, connect the Ethernet jack on an MVP110 to the hub, and connect (by a phone cord) a telephone to the FXS jack on the MVP110.

To configure the MVP120, the COM port of a PC is connected to the Command port on the MVP120. The configuration software is based on a standard Windows Graphical User Interface (GUI) which simplifies your selection process to a single parameter group within a dialog box. For example, your LAN IP parameters are contained on a single dialog box. You can configure your network IP address and mask for the MVP120 and the gateway address for the corporate router on the same dialog box.

After your network configuration is complete, then you can develop your VOIP phone directory database. This database will be developed on the Sales Office MultiVOIP and sent out to the Remote Sales Office.

You will need to add the phone numbers to the phone directory database. Before you set up the phone directory database, you need to consider how the database is going to be used:

- Are you going to have an H.323 Gatekeeper setup your call sessions,**
- or**
- Are you going to control your call sessions using the proprietary phone book?**

The H.323 Gatekeeper acts as the central point for all calls within its zone and provides call control services to registered endpoints. If you choose the proprietary phone book, you establish a master-slave relationship where the master MultiVOIP maintains the phone directory and downloads the directory to each slave unit.

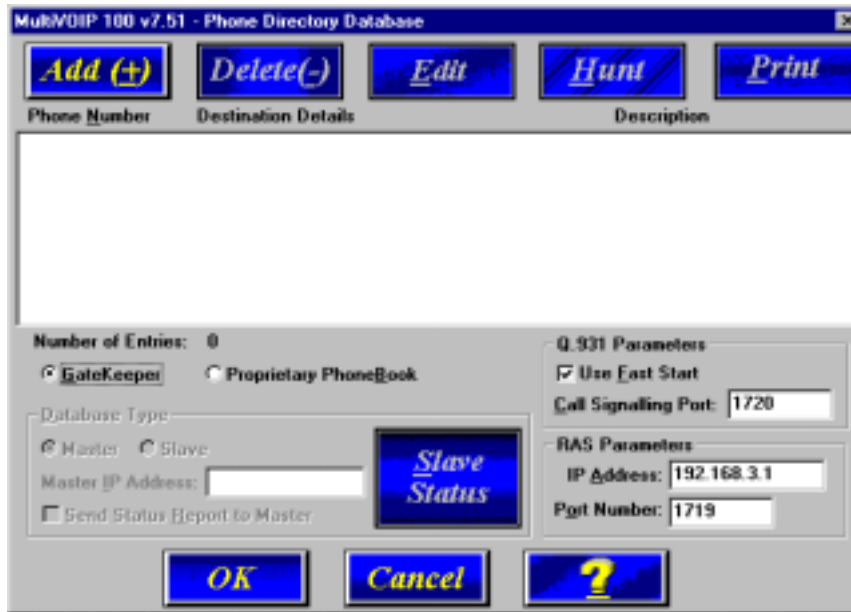

The Gatekeeper/Proprietary Phone Book selection is chosen from the Phone Directory Database dialog box. Before you choose how the data base is going to be used, here are a couple of things to keep in mind:

1. If a Gatekeeper is employed in the network, you need to choose the Gatekeeper option. You can not mix the Proprietary Phone Book with the Gatekeeper. If you choose the Gatekeeper option you can communicate with other third party endpoints that support H.323 (such as Microsoft Netmeeting).
2. If you choose the Proprietary Phone Book, you establish a master-slave relationship in which the master MultiVOIP maintains the phone directory database. All of the phone numbers are listed in the data base so that if you want to communicate with someone in your VOIP network, you can see the phone number in your data base. Everytime you bring up your MultiVOIP the current phone directory is downloaded to your MultiVOIP.

Note: You can still call Netmeeting using the proprietary phone book.

The Gatekeeper

The GateKeeper is a separate application that can operate on a network pc and provides all the controls needed to create, control, and manage an H.323 network zone. The H.323 network zone is all the endpoints (terminals and gateways (MultiVOIPs)) that are registered with the gatekeeper. The gatekeeper function is address translation from LAN aliases for terminals and gateways to IP addresses as defined in the RAS (Registration/Admission/Status) specification. The RAS Protocol defines the communication with a gatekeeper and support for RTP/RTCP for sequencing audio packets. The H.323 Gatekeeper also provides call-authorization for both accepting and placing calls in its zone, and certain monitoring features such as call permissioning and address resolution.

If you choose the Gatekeeper option, initially you need to communicate with the administrator of the Gatekeeper to register your MultiVOIP. The information you need from the Gatekeeper administrator is the IP address of the Gatekeeper and its port number. Then you need to establish your alias address which includes phone number, channel number, H323 ID which can be a numeric or an alphanumeric value, and your MultiVOIP LAN IP address. The port number is 1720, but if the Gatekeeper uses a different port number, you have to ensure that

you use the same port number. The Gatekeeper administrator will then enter your information into the Gatekeeper data base. This concludes the preregistration.

You can enter your alias address information into the **Add/Edit Phone Entry** dialog box. For example, if you were setting up the corporate MultiVOIP, you could enter the following information for the **Voice/Fax Channel: Channel 1** of the corporate MultiVOIP uses extension 101. The **Description** is optional, but it may be helpful if it is assigned to an individual or department.

The H323 ID assigned to this phone number identifies the office using this extension. The IP Address of the Corporate MultiVOIP is 201.022.122.118. The default port number 1720 is used.

Once the MultiVOIP goes online, the Gatekeeper registers it with the above H.323 ID. No other H323 endpoint can use this H.323 ID. This is like your own telephone number.

After you have entered the information in the **Add/Edit Phone Entry** dialog box and clicked **OK**, the new phone number is added to the **Phone Directory Database**.

Proprietary Phone Book

If you choose the **Proprietary Phone Book** option in the **Phone Directory Database** dialog box instead of the **Gatekeeper** option, the Database Type group becomes active and the RAS Parameters group becomes inactive.

When you elect to use the Proprietary Phone Book, you set up a master-slave relationship. This relationship allows one MultiVOIP to maintain the Phone Directory Database and publish this data base to all MultiVOIP participants in the network. This proprietary database allows you to see all the participants in your network and provides you with their phone numbers.

To set up a database so that the corporate MultiVOIP can call the remote branch office and the remote branch office can call the corporate MultiVOIP, the Phone Directory Database will have one entry for the corporate office and one entry for the Remote Branch Office. Extension 101 at the corporate office is tied to voice channel 1. The Description again is optional. The Hunt Group in this example is set for No Hunt. However, if you want to activate a Hunt Group (if an extension on the MultiVOIP is busy and you wanted to look for another extension), you can assign a hunt group to those extensions. In other words, if extension 101 is busy, the corporate MultiVOIP would roll over to extension 102, if you have multiple voice channels.



MultiVOIP 100 - Add/Edit Phone Entry

Station Information

Phone Number: 101

Description: New York Office

Voice Channel: 1

Station Identification

Hunt Group: NO HUNT

IP Address: 201.22.122.118

Port: 1720

Buttons: OK, Cancel, ?, Copy From

Again, the corporate MultiVOIP IP Address needs to be added. The port number is 1720. This adds phone number 101 of the corporate MultiVOIP to the proprietary database. After you have added Channel 1, you need to include Channel 1 at the remote branch office.

The proprietary database would then appear as in the following dialog box and when the remote branch office MultiVOIP is turned on, the current database would be downloaded to the remote branch office MultiVOIP.

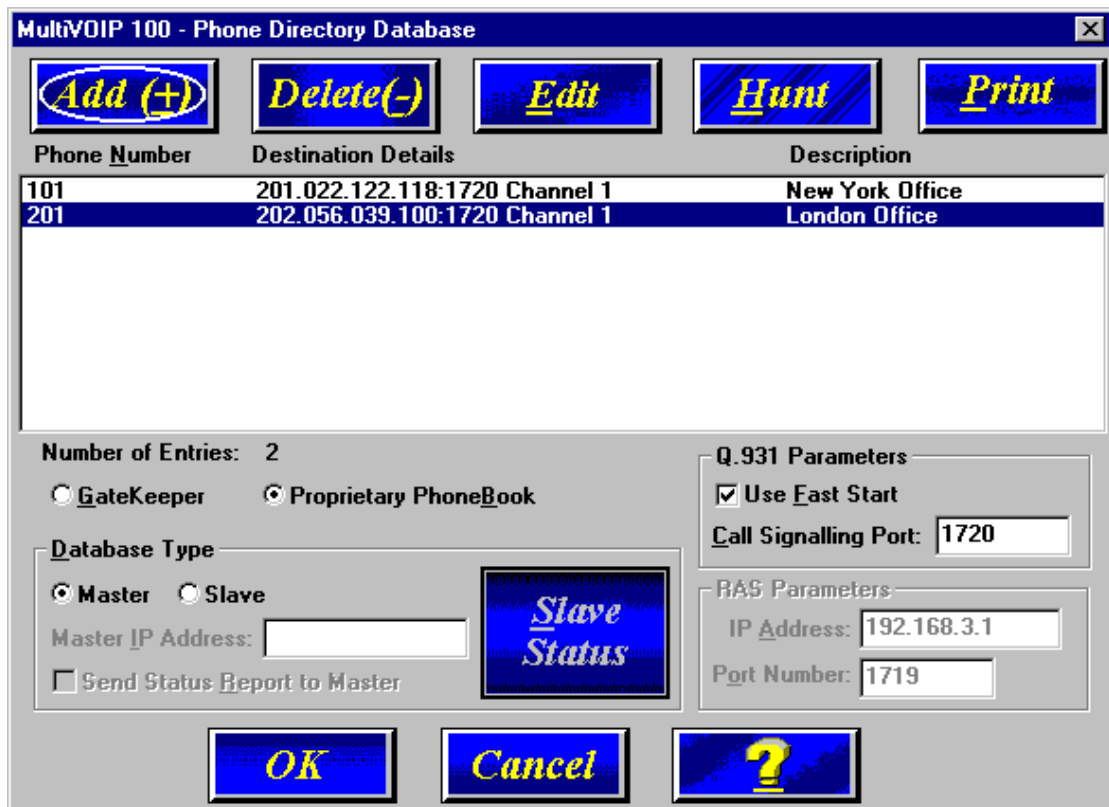

MultiVOIP 100 - Phone Directory Database

Buttons: Add (+), Delete(-), Edit, Hunt, Print

Phone Number	Destination Details	Description
101	201.022.122.118:1720 Channel 1	New York Office
201	202.056.039.100:1720 Channel 1	London Office

Number of Entries: 2

GateKeeper Proprietary PhoneBook

Database Type

Master Slave

Master IP Address:

Send Status Report to Master

Q.931 Parameters

Use Fast Start

Call Signalling Port: 1720

RAS Parameters

IP Address: 192.168.3.1

Port Number: 1719

Buttons: OK, Cancel, ?, Slave Status

So, if a sales person in the Sales Office picked up the telephone and dialed extension 4124, the extension routes the telephone call to the VOIP network. After the second dial tone, the person would dial extension 201. The telephone at the Remote Sales office would ring and a telephone conversation is initiated just as if the Remote Sales office had been called over the regular telephone network.

Similarly, if a person at the Remote Sales office picked up extension 201 and dialed extension 101, the MultiVOIP at the Sales Office would generate a second dial tone and the person at the Remote Sales office would then dial any extension at the Sales Office, or the person could then dial a 9, for example, and get an outside line of the Sales Office Public Switched Telephone network. This person could then dial any telephone number, as if calling from the Sales Office.

Front Panel Description

The MVP120 front panel has three groups of LEDs that provide the status of the Ethernet connection (Ethernet), the Voice/Fax channel, and an LED for boot status. The front panel is shown below and a description of each LED follows.

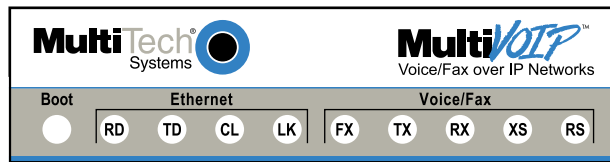

MVP120 Front Panel

Boot

The Boot indicator lights up when the MVP120 is booting during the downloading of the setup.

Ethernet

- RD** Receive Data indicator blinks when packets are being received from the local area network.
- TD** Transmit Data indicator blinks when packets are being transmitted to the local area network.
- LK** Link indicator lights when the Ethernet link senses voltage from a concentrator or external device.
- CL** Collision indicator lights when a collision is detected on the Ethernet link.

Voice/Fax

- FX** Fax indicator lights when there is fax traffic on the voice/fax channel.
- TX** Transmit indicator blinks when voice packets are being transmitted to another H.323 endpoint.
- RX** Receive indicator blinks when voice packets are being received from another H.323 endpoint.
- XS** Transmit Signal indicator lights when the Voice/Fax channel is off-hook.
- RS** Receive Signal indicator lights when the Voice/Fax channel is ringing.

Back Panel Description

The cable connections for the MVP120 are made at the back panel. Connectors include Power, Ethernet, Command Port (RJ-45), and FXO Voice/Fax Channel. The cable connectors are shown and defined below.

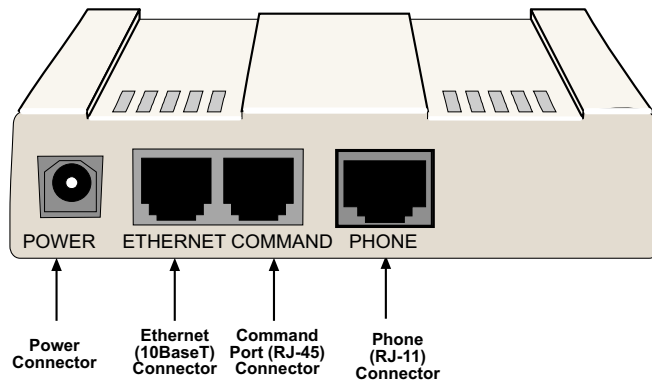

Back Panel

Power Connector

The Power connector is used to connect the external power supply to the MVP120.

Ethernet Connector

The Ethernet connector is used to connect the MVP120 to a LAN using unshielded twisted cable. This connector is an RJ-45 jack.

Command Connector

The Command connector is used to configure the MVP120 using a PC with an available serial port and running Windows software. The Command connector is an RJ-45 jack (an adapter cable is provided to convert to a standard serial port DB9 female connector).

Phone Connector

Connects the FXO Voice/Fax Channel to an FXO/PBX port or PTSN. This connector is an RJ-11 jack.

Specifications

- One 4 MB DRAM (1 Meg by 32-bit, 70 nanosecond SIMM)
Caution: SIMM speed and size cannot be mixed
- Two Megabytes of flash memory

Ethernet Port

- Single Ethernet Interface - 10Base-T (twisted pair) keyed RJ-45 connector.

Command Port

- Single 19.2 Kbps asynchronous Command Port using an RJ-45 to DB9 cable with a DB9 female connector

Voice/Fax Channel

- One RJ-11 jack (FXO)

Power Supply

- Voltage - 115 VAC (Standard), 240 Volts AC (Optional)
- Frequency - 47 to 63 Hz
- Power Consumption - 4.3 Watts

Product

- Dimensions - 1.0" high x 4.3" wide x 5.6" deep
(2.5 cm x 10.8 cm x 14.2 cm)
- Weight - 8 oz. (224 g)



Chapter 2

Installation



Chapter 2 - Installation

Overview of the Installation Process

The basic steps of installing your MVP120 network involve unpacking the units, connecting the cables, and configuring (Configuring is discussed in detail in Chapter 3) the units using the included management software (MultiVOIP Configuration). The recommended installation process includes four phases that, when completed, result in a fully functional Voice Over IP network.

Unpacking and Cabling the MultiVOIP

The MultiVOIP package includes the MultiVOIP 100, a printed Quick Start Guide, a system CD, a power supply, and a RJ-45 cable. If any one of these items is missing, please contact your sales representative. Detailed cabling directions are included in this guide.

Installing the Software and Configuring Your MVP120

The VOIP administrator must first install the MVP120 software and then configure each MVP120 for its specific function. During the configuration process, it's important to note that the Phone Directory Database is configured differently depending on whether or not you have Gatekeeper support on your VOIP network.

If your VOIP network supports Gatekeeper software, you must register all H.323 endpoints with the Gatekeeper. The procedure for doing this is explained in the section "Registering with a Gatekeeper Phone Directory".

If your VOIP network does not have Gatekeeper software or the Gatekeeper software is not enabled, then you must build a proprietary phonebook with a "Master" MultiVOIP and "Slave" MultiVOIPs. The "Master" unit includes the assignment of a unique LAN IP address, subnet mask, and Gateway IP address.

Once configuration of the "Master" MultiVOIP has been completed, the administrator moves on to configure the MVP120(s) designated as "Slave" units. Again, unique LAN IP addresses, subnet masks, and Gateway IP addresses are assigned, and each Voice/Fax channel is configured for the appropriate channel interface type. When this is done, the Phone Directory Database option is set to Slave, and the IP address of the Master MultiVOIP is entered. Once all Slave units are configured, the process moves on to the "Deploying the VOIP Network" section.

Deploying the VOIP Network

The final phase of the installation is deployment of the network. When the remote MultiVOIPs are sent to their remote sites, the remote site administrators need only to connect the units to their LAN and telephone equipment. A full Phone Directory Database (supplied by the Master MultiVOIP Proprietary Phonebook) will be loaded into their units within minutes of being connected and powered up. For remote VOIPs that were configured with the **Gatekeeper** option enabled, each MultiVOIP will be registered with the Gatekeeper (the Gatekeeper phonebook directory is not downloaded to the remote units). The final task of the VOIP administrator or the Gatekeeper administrator is to develop the VOIP Dialing Directory based on the appropriate phone directory database (the Proprietary phonebook database or the Gatekeeper phonebook database).

Unpacking Your MVP120

Remove all items from the box.

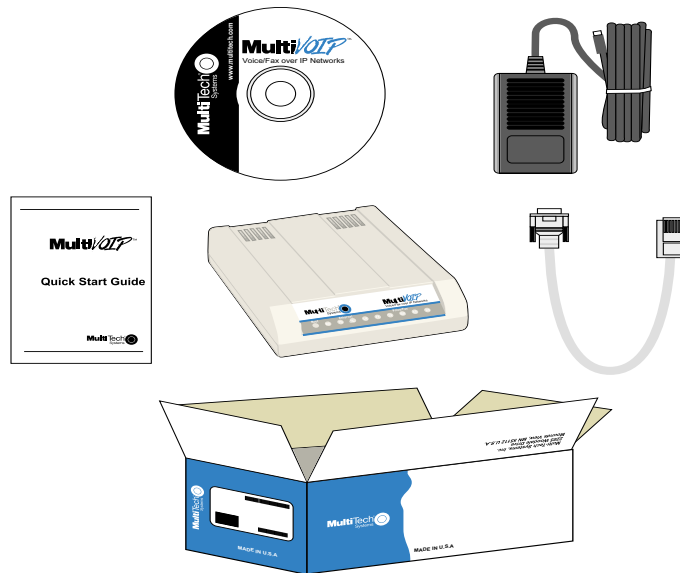

Unpacking

Telecom Safety Warning

1. Never install phone wiring during a lightning storm.
2. Never install phone jacks in wet locations unless the jacks are designed for wet locations.
3. This product is to be used with UL and cUL listed computers.
4. Never touch uninsulated phone wires or terminals unless the phone line has been disconnected at the network interface.
5. Use caution when installing or modifying phone lines.
6. Avoid using a phone during an electrical storm. There may be a remote risk of electrical shock from lightning.
7. Do not use the phone to report a gas leak in the vicinity of the leak.
8. To reduce the risk of fire, use only No. 26 AWG or larger Telecommunication line cord.

Other Safety Warnings

1. A lithium battery on the circuit board provides backup power for the time keeping capability. The battery has an estimated life expectancy of ten years. When the battery starts to weaken, the date and time may be incorrect. If the battery fails, the board must be sent back to Multi-Tech Systems for battery replacement.

Caution: Danger of explosion if battery is incorrectly replaced.

2. The Command port and the Ethernet port are not designed to be connected to a Public Telecommunication Network.
3. Use only the power source supplied with your product or an equivalent power source supplying the minimum power requirements

Cabling Your MVP120

Cabling your MVP120 involves making the proper Power, Command Port, and Network connections. The graphic below shows the back panel connectors and the associated cable connections. The Cabling Procedure section provides step-by-step instructions for cabling your MVP120.

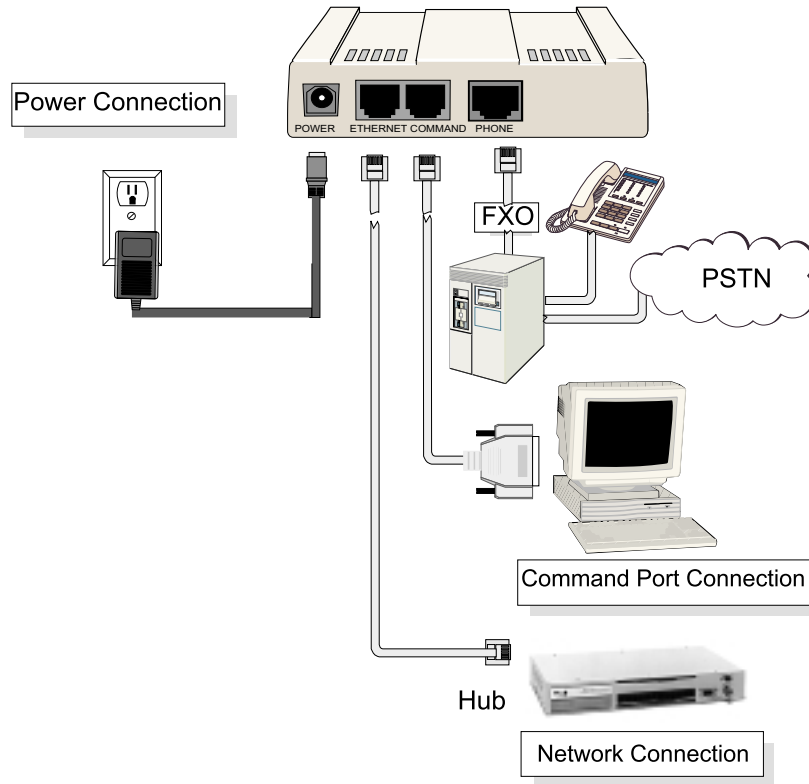

Cable Connections

Cabling Procedure

1. Using the supplied cable, connect the power supply to a live AC outlet, then plug the power supply into the MVP120 as shown above.
2. Connect the MVP120 to a PC using the RJ-45 to DB9 (female) cable provided with your unit. Plug the RJ-45 end of the cable into the **Command** port of the MVP120 and connect the other end to the PC's serial port.
3. Connect a network cable to the **Ethernet 10Base-T** connector on the back of the MVP120. Connect the other end of the cable to your network.
4. If you are connecting a PSTN or FXO/PBX port to your MVP120, connect one end of an RJ-11 cable to the **Phone** connector on the back of the MVP120 and the other end to the PSTN or FXO port on the PBX.
5. Turn on power to the MVP120 by setting the power switch on the right-side panel to the On position. Wait for the **Boot** LED on the MVP120 to go off before proceeding. This may take a couple of minutes.

Note: Since the MVP120 doesn't have a power LED, no LEDs will be on after booting unless the Ethernet link is active.



Chapter 3

Installing the MVP120 Software

Chapter 3 - Installing the MVP120 Software

The section covers the software installation. Note that not every screen or option in the process is included in this chapter. Additional information on the MVP120 software is provided in Chapter 4 and Chapter 5 and in the online **Help**.

Note: The phonebook directory configuration process is different depending on whether or not you have an enabled H.323 Gatekeeper resident in your network. The section on “Configuring Your MVP120” will explain these differences.

The MVP120 software and User Guide are contained on the MVP120 CD. The CD is auto-detectable, so when you insert it into your CD ROM drive it will start up automatically. When you have finished configuring your MVP120, you can view and print the User Guide by clicking on the Install Manuals icon.

CAUTION: If you are installing a MVP120 behind a Firewall, the Firewall must support H.323. Refer to your Firewall user documentation to enable H.323 support.

1. Make certain that your MVP120 has been properly cabled and that it is powered on.
2. Insert the MVP120 CD into a CD-ROM drive. The CD is auto-detectable, so it starts automatically. It may take 10 to 20 seconds for the Multi-Tech Installation CD window to appear.



If the Multi-Tech Installation CD window does not appear automatically, click **My Computer**, then right-click the **CD-ROM drive** icon, click **Open**, then click the **Autorun** icon.

3. When the Multi-Tech Installation CD window displays, click the **Install Software** icon.
You will be prompted to select your software:
H.323 or **Proprietary**. Select **Proprietary**.
4. The **Welcome/Setup** dialog box displays.



Press **Enter** or click **Next** to continue.

5. The **Choose Destination Location** dialog box displays. Follow the on-screen instructions.



You can either choose the Destination Location of your MVP120 software or select the default destination by clicking **Next**. If you click **Browse**, you can select a different destination folder for the MVP120 software.

6. In the **Select Program Folder** dialog box, select where you want the program file to be located.

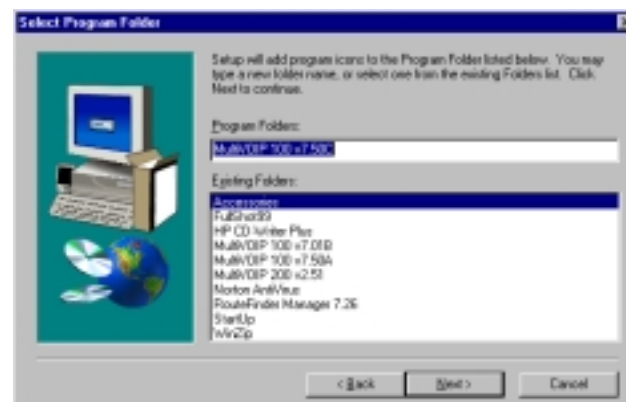

Verify the path and click **Next** to continue.

7. The **Copying program files** window displays, followed by the **MVP120 Setup** dialog box. This dialog box enables you to select the COM port of your PC that is connected to the Command port of the MVP120. From the **Select Port** list, choose the COM port of your PC.



Click **OK** to continue.

8. The **Setup Complete** dialog displays.



Click **Finish** to continue.

9. The following message displays:

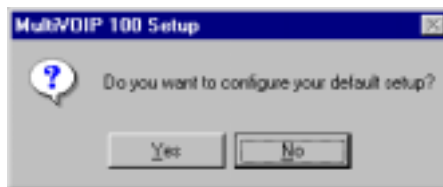

Click **Yes** to continue.

10. The following message displays.



Click **Yes** to continue.

11. The **IP Protocol Default Setup** dialog box displays as you continue now with the configuring of your MultiVOIP, which is continued in Chapter 4.



Chapter 4

Configuring the Master MultiVOIP

Chapter 4 - Configuring the Master MultiVOIP

The following steps provide instructions for configuring your MVP120. The configuration sequence includes IP Protocol default setup, Channel setup, and Phone Directory Database setup. The numbering of steps continues from the previous section.

12. The **IP Protocol Default Setup** dialog box displays.



The default **Frame Type** is **TYPE_II**. If this does not match your IP network, select SNAP from the **Frame Type** list. The available Frame Type choices are **TYPE_II** and **SNAP**.

13. In the **Ethernet** group, enter the **IP Address**, **Subnet Mask**, and **Gateway Address** unique to your IP LAN.

The IP address is the unique LAN IP address that is assigned to the MVP120, and the Gateway address is the IP address of the device connecting your MVP120 to the Internet.

Click **OK** when you are finished.

14. The **Channel Setup** dialog box displays. The four tabs in this dialog box define the Channel Interface, Voice/Fax parameters, Billing/Miscellaneous parameters, and Regional telephone parameters.



Check with your in-house telephone personnel to verify whether your local PBX dial signaling is **Pulse** or **DTMF** (tone). Select the **regeneration option** accordingly.

In the **Inter Digit Time** box, enter the maximum amount of time between dialed digits in milliseconds that the unit will wait before mapping the dialed digits to an entry in the Phone Directory Database. If too much time elapses between digits, the wrong numbers will be mapped and you will hear a rapid busy signal. If this happens, hang up and dial again. The default setting is 2 seconds.

In the **Flash Hook Timer** box, enter the amount of time the duration of flash hook signals output on the interface. The default setting is 600 milliseconds.

15. The **Ring Count FXO** box enables you to set the number of rings received on the FXO interface before hanging up and releasing the line to another call. The default setting is **2** rings.

Note: Zero (0) means no incoming calls will be answered.

For FXO-to-FXO communications, you can enable a specific kind of FXO **Disconnect Options: Current Loss, Tone Detection, or Silence Detection.** Check with your in-house phone personnel to verify the type of disconnect to use. If current loss is checked, the VOIP will hang up when it detects a loss of current on the FXO (phone) port. For **tone detection**, select from the lists one or two tones that will cause the line to disconnect. The person hanging up the call must then press the key or keys that produce those tones to hang up a call. For **silence detection**, select **One Way** or **Two Way**, then set the timer for the number of seconds of silence before disconnect. The default value of 15 seconds may be shorter than desired for your application.

The **Message Waiting Light** check box must be selected on the originating and answering voice channel. This enables the number dialed to connect you to the appropriate voice channel, then output that number on the voice channel.

16. The **Voice/Fax** tab displays the parameters for the voice gain, DTMF (Dual Tone Multi-Frequency) gain, voice coder, faxing, and advanced features such as Silence Compression, Echo Cancellation, and Forward Error Correction.



17. You can set up the input and output voice gain so that the volume can be increased or decreased. Input gain modifies the level of the audio coming into the voice channel before it is sent over the Internet to the remote MVP120. Output gain modifies the level of the audio being output to the device attached to the voice channel. Make your selections from the Input and Output lists in the **Voice Gain** group. The valid range is +31dB to -31dB with a recommended/default value of **0**.

You can also set up the DTMF gain (or output level in decibels - dB) for the higher and lower frequency groups of the DTMF tone pair. Make your selections in the lists in the **DTMF Gain** group. When the **DTMF Out of Band** check box is selected, the tones are passed via RTP packets, and the receiving VOIP reproduces the DTMF tones instead of passing them through like voice.

Note: Only change the DTMF gain under the direction of Multi-Tech Technical Support.

18. To change the voice coder, select the **Manual** option in the Coder group. Select the appropriate coder from the **Selected Coder** list.

If you changed the voice coder, ensure that the same voice coder is used on the voice/fax channel you are calling. Otherwise, you will always get a busy signal.

Note: If **Automatic Coder** is selected, then you need to select the **Max Bandwidth** from the list. Check with your Network Administrator to determine how much bandwidth is available.

19. The **Fax** group enables you to send/receive faxes on the selected voice/fax channel. You can set the maximum baud rate for faxes, the fax volume, and change the jitter value in milliseconds.

When receiving fax packets from a remote MVP120, it is possible for individual packets to be delayed or received out of order due to traffic conditions on the network. To compensate for this effect, the MVP120 uses a Jitter Buffer. The **Jitter Value** box allows the MVP120 to wait a user-definable period of time, in milliseconds, for delayed or out of order fax packets. The range of allowable Jitter Values is 0 to 400 with a default of **400** milliseconds.

If you do not plan to send or receive faxes on a given voice/fax channel, you can disable faxes in the Fax group.

20. You can enable the voice/fax advanced features by selecting the **Silence Compression**, **Echo Cancellation**, or **Forward Error Correction** options.

The **Silence Compression** option defines whether silence compression is enabled for the voice channel. If **Silence Compression** is enabled, the MVP120 will not transmit voice packets when silence is detected, thereby reducing the amount of network bandwidth that is being used by the voice channel.

If **Echo Cancellation** is enabled, the MVP120 will remove echo which improves the quality of sound.

The **Forward Error Correction (FEC)** feature allows some of the voice packets that were corrupted or lost to be recovered. FEC adds an additional 50% overhead to the total network bandwidth consumed by the voice channel.

21. The **Billing/Misc** tab displays the parameters for auto call, automatic disconnection, billing options, and dynamic jitter buffer.

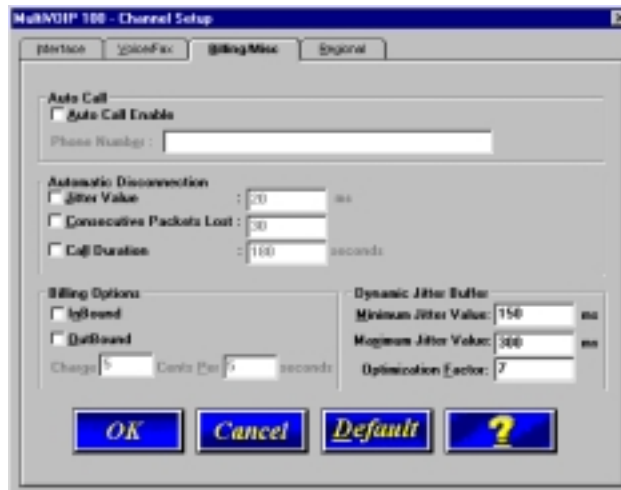

If you want to dedicate a local voice/fax channel to a remote voice/fax channel (so you will not have to dial the remote channel number), click the **Auto Call Enable** option in the **Auto Call** group. Then enter the phone number of the remote channel in the **Phone Number** box.

22. The **Automatic Disconnection** group provides three options to be used singly or in combination.

The **Jitter Value** defines the average inter-arrival packet deviation (in milliseconds) before the call is automatically disconnected. Jitter is the inter-arrival packet deviation (phase shift of digital pulses) over the transmission medium that causes voice breakup which can be particularly disruptive to voice communications. The default is 20 milliseconds. A higher value means that the voice transmission will be more accepting of jitter. A lower value will be less tolerant of jitter.

Consecutive Packets Lost defines the number of consecutive packets that are lost after which the call is automatically disconnected. The default setting is **30**.

Call Duration defines the maximum length of time (in seconds) that a call remains connected before the call is automatically disconnected. The default setting is **180** seconds. A call limit of three minutes may be too short for most configurations. Therefore, you may want to increase this default value.

23. You can set billing options for inbound and/or outbound calls by checking them in the **Billing Options** group and then entering the charge in cents per number of seconds.

24. A minimum and maximum set of values can be set for **Dynamic Jitter Buffer**. When receiving voice packets from a remote MVP120, it is possible to experience varying delays between packets due to traffic conditions on the network. This is called Jitter. To compensate for this effect, the MVP120 uses a Dynamic Jitter Buffer. The Jitter Buffer allows the MVP120 to wait for delayed voice packets by automatically adjusting the length of the Jitter Buffer between configurable minimum and maximum values. An **Optimization Factor** adjustment controls how quickly the length of the Jitter Buffer is increased when jitter increases on the network. The length of the jitter buffer directly effects the voice delay between MVP120 gateways.

The Minimum Jitter Value default setting is **150** milliseconds, the Maximum Jitter Value default setting is **300** milliseconds, and the Optimization Factor default setting is **7**.

If your country/region is not the default USA, click the **Regional** tab and proceed to step 25; otherwise, click **OK** and proceed to step 26 to begin building your phone directory database.

25. To change the Tone Pairs on the **Regional** tab, select your country or region from the **Country/Region** list. If your country or region is not listed, click **Custom** to define it.



The **Tone Pairs** group enables you to select and modify the parameters. Click **OK** when finished. Proceed to Step 26 to begin building your phone directory database.

26. The **Phone Directory Database** dialog box displays with the Proprietary PhoneBook option enabled and no phone numbers entries displayed in the database. This dialog box

enables you to select either the GateKeeper or Proprietary PhoneBook. Once you have chosen the type of Phone Book database, you can proceed to registering with a GateKeeper in the following section (entitled, **Registering with a Gatekeeper Phone Directory**).

If you are building a proprietary phone book, proceed to page 31. On page 31 the **Building a Proprietary Phonebook Directory** section starts with Step 27. It is a continuation of Step 26 on this page.



Registering with a Gatekeeper Phone Directory

This section describes how to register H.323 endpoints with the Gatekeeper. The H.323 Gatekeeper function resides at a PC acting as the central point for all calls within its zone and providing call control services to registered endpoints. The Gatekeeper performs two important call control functions: address translation from LAN aliases to IP addresses, and bandwidth management where the network manager has specified a threshold for the number of simultaneous conferences on the LAN.

In a GateKeeper environment, you will be enabling the GateKeeper option, entering an IP address for the GateKeeper, accepting the default port number, and if the GateKeeper network is servicing Fast Start, accept the defaults in the Q.931 Parameters group. However, if this network zone is primarily non-fast start supported, disable **Use Fast Start**.



27. Enable the **Gatekeeper** option
28. If the GateKeeper network employs Fast Start, then accept the **Use Fast Start** option (default). You may have to verify this with the GateKeeper administrator.
29. Enter the Gatekeeper IP Address in the **IP Address** box.

30. Accept the default **Port Number 1719**.

CAUTION: The default setting for the Gatekeeper Port Number is **1719**. This can be changed to a different value by the Gatekeeper administrator. If you decide to change the default Port Number, you must use the same number on the Gatekeeper and all other H.323 endpoints.

31. When you are finished with this dialog box, click **Add** to begin building your phone directory database. The **Add/Edit Phone Entry** dialog box displays.

32. Enter the unique phone number of the local device in the **Phone Number** box.
33. Leave the **Description** box blank.
34. Enter the **Voice Channel** number corresponding to the phone number entered. MVP120 will always be Channel 1.
35. Fill in the **H.323 ID** / alias box with a description to identify the phone number. For this example, you could enter "New York Office".
36. Enter the IP Address of the MultiVOIP you are currently configuring in the **IP Address** box.

37. Click **OK** when you are finished and the **Phone Directory Database** dialog box displays with the first entry in the window.



38. Click **OK**.
39. The following dialog box displays.

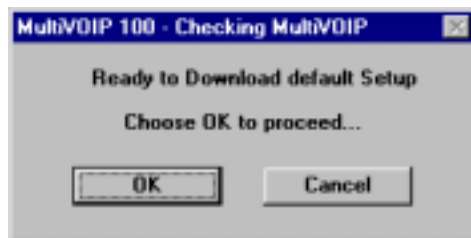

- Click **OK** to download default setup.
40. After the setup has been written to the MVP120, the unit is rebooted.
41. Verify that the **BOOT** LED on the MVP120 is off after the download completes. This may take several minutes as the MVP120 reboots.

Building a Proprietary Phonebook Directory

Note: This section starts at Step 27 as it is a continuation from Step 26 on pages 27-28.

27. To build your proprietary MVP120 Phone Directory (in an H.323 environment without the Gatekeeper option enabled), you will first need to select the **Proprietary Phonebook** option and then configure the “Master” MVP120 and then the “Slave” MVP120s (or other H.323 endpoints). Configuring the “Slave” MVP120 is discussed later in this chapter.

The MultiVOIP configured as Master contain the proprietary phonebook database. All other MultiVOIPs added to the proprietary phonebook database are designated Slaves. The master database contains the phone numbers of all H.323 endpoints available for communication on an IP network. This database is downloaded to each Slave MultiVOIP as it comes online.



28. To configure the “Master” MVP120, make certain that the **Proprietary Phonebook** and **Master** options are enabled. The **Slave** option, **Master IP Address**, and **Send Status Report to Master** will be disabled. The **Slave Status** button displays the **Slave VOIP Status** dialog box used for viewing phone number, IP address, status, and description of slave units (See “Configuring Your Slave MVP120s” for details). **Note:** In the Q.931 Parameters group, **Use Fast Start** is checked for compatibility with other H.323 devices that support Fast Start Capability.

Click **Add** to begin building your phone directory database. The **Add/Edit Phone Entry** dialog box displays.

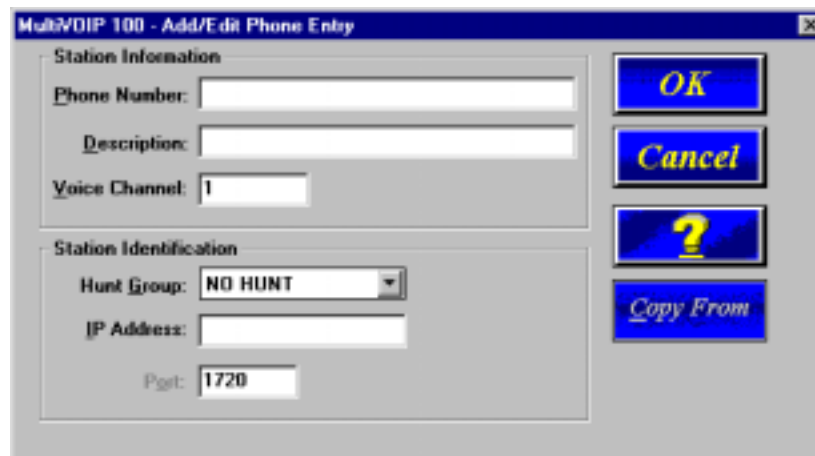

29. Enter a unique phone number for the local VOIP in the **Phone Number** box and enter **1** for the Voice/Fax channel in the **Voice Channel** box. This number must be **1** for each MVP120.
Note: MVP120 and MVP110 will only have one entry and will be Channel 1.
30. The **Description** box is optional, but can be useful in associating the channel to the extension. If you wish, enter a description of your local phone number. This description serves to identify the phone number you entered in the previous step. Normally the “Master” MVP120 resides at the entity’s main office; therefore, for this example you could enter a description such as “New York Office”).
31. The **Station Identification** group includes a **Hunt Group** list. This list enables you to indicate which Hunt Group you want the phone number to be associated with; or, you can select NO HUNT if you don’t want this entry to participate in hunting. Hunting is a series of telephone lines organized in such a way that if the first line is busy the next line is hunted and so on until a free line is found. For this example, assign the phone entry to HUNT GROUP #1.

Once you have assigned this entry to a Hunt Group (or NO HUNT), you must enter the IP Address of the Master MVP120 in the **IP Address** box.

Note: The **Port** box becomes active as you begin to enter the IP Address. The entry is the H.323 industry standard Port value (1720) used to communicate with other H.323 endpoints.



The screenshot shows a dialog box titled "MultiVOIP 100 - Add/Edit Phone Entry". It contains two main sections: "Station Information" and "Station Identification".

- Station Information:**
 - Phone Number: 101
 - Description: New York Office
 - Voice Channel: 1
- Station Identification:**
 - Hunt Group: HUNT GROUP #1 (selected from a dropdown menu)
 - IP Address: 201.22.122.118
 - Port: 1720

On the right side of the dialog, there are four buttons: "OK", "Cancel", a question mark icon, and "Copy From".

32. Click **OK** to return to the **Phone Directory Database** dialog box. It now includes phone number, destination details, and description.

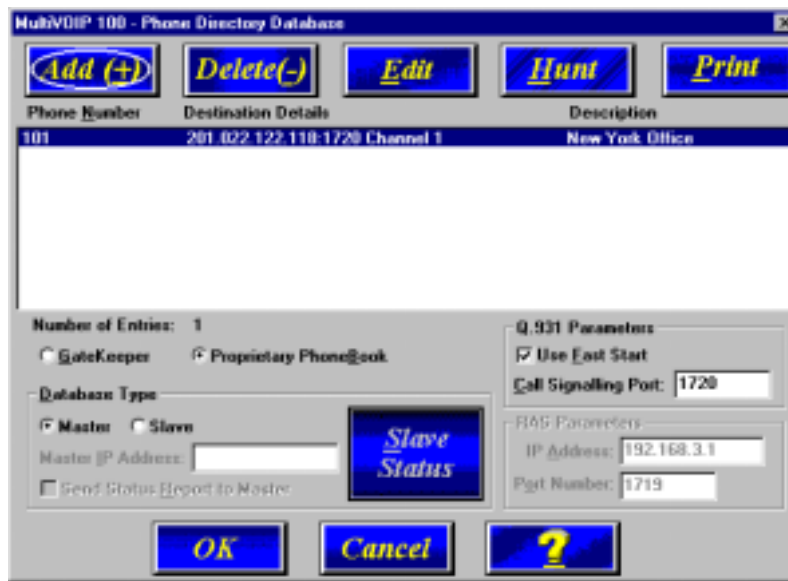

33. Add all other phone numbers (slave units and standalone units) to the Phone Directory database. To add a channel of a slave MultiVOIP, click **Add** and the **Add/Edit Phone Entry** dialog box displays.
34. Enter the phone number for the MultiVOIP in the **Station Information** group **Phone Number** box.
35. Click inside the **Description** box and enter a description for the remote MultiVOIP phone number for the Voice/Fax Channel.
36. In the **Station Identification** group, select HUNT GROUP #2 from the **Hunt Group** list, enter the London Office's IP Address (202.056.039.100), and accept the H.323 industry standard Port value (1720) used to communicate with other H.323 endpoints.
37. Click **OK** and you are returned to the **Phone Directory Database** dialog box which now includes the second number and related information in the **Phone Number** list.

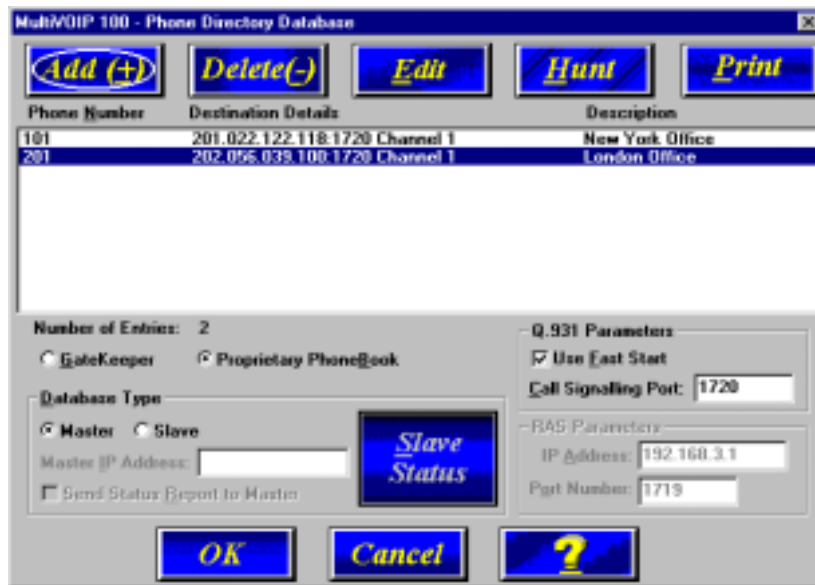

38. To configure a stand-alone endpoint (a PC with NetMeeting software), click **Add** and the **Add/Edit Phone Entry** dialog box displays again.
 39. Enter the phone number for the stand-alone endpoint in the **Station Information** group **Phone Number** box. For example, 301.
 40. Click inside the **Description** box and enter a description for the remote stand-alone phone number. For example, "Human Resources Desk".
- Note:** Because the H.323 endpoint is not a MVP120, the Phone Directory database ignores the Voice Channel entry. Set the Channel to **1**.
41. In the **Station Identification** group, select **NO HUNT** from the **Hunt Group** list, enter the Human Resource Desk's IP Address and accept the H.323 industry standard Port value (1720) used to communicate with other H.323 endpoints.

Note: This stand-alone was not configured as part of a Hunt Group. However, depending on your requirements, you could configure a stand-alone to be part of a Hunt Group.



42. Click **OK** and you are returned to the **Phone Directory Database** dialog box which now includes the stand-alone phone number and related information in the **Phone Number** list.

Phone Number	Destination Details	Description
101	201.022.122.118:1720 Channel 1	New York Office
201	202.056.029.100:1720 Channel 1	London Office
301	202.198.100.004:1720 Channel 1	Human Resources Desk

Number of Entries: 3

GateKeeper
 Proprietary PhoneBook

Database Type

Master
 Slave

Master IP Address:

Send Status Report to Master

Q.931 Parameters

Use Fast Start
 Call Signaling Port: 1720

RAS Parameters

IP Address: 192.168.3.1

Post Number: 1719

Buttons: Add (+), Delete(-), Edit, Hunt, Print, OK, Cancel, ?

43. When you have finished, click **OK** to download the setup configuration to the MVP120.

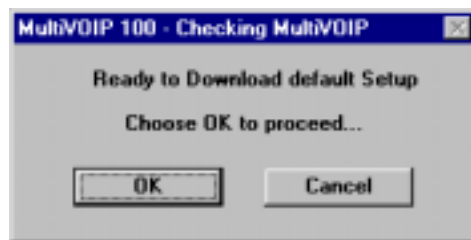

44. Click **OK**. After the setup is written to the MVP120, the unit reboots.
45. Verify that the **BOOT** LED on the MVP120 is off after the download is complete. This may take several minutes as the MVP120 reboots.

At this time your master MVP120 is configured. Proceed to the “Configuring Your Slave MVP120s” section.

Chapter 5

Configuring the Slave MultiVOIPs

Chapter 5 - Configuring the Slave MultiVOIPs

If the **Proprietary Phonebook** option on the **Phone Directory Database** dialog box was enabled, then you will need to configure all remote H.323 endpoints as “Slave” units. For example, the MVP120 at the company’s subsidiary office in London would need to be configured as a “Slave.”

CAUTION: If you are installing a MVP120 behind a Firewall, the Firewall must support H.323. Refer to your Firewall user documentation to enable H.323 support.

1. Disconnect the PC from the Command port of the Master MVP120 and connect it to the Command port on the Slave MVP120.
2. From your desktop, click **Programs | MultiVOIP 100 | MultiVOIP Configuration**. The Main menu displays.



3. Click **IP** to display the **IP Setup** dialog box.

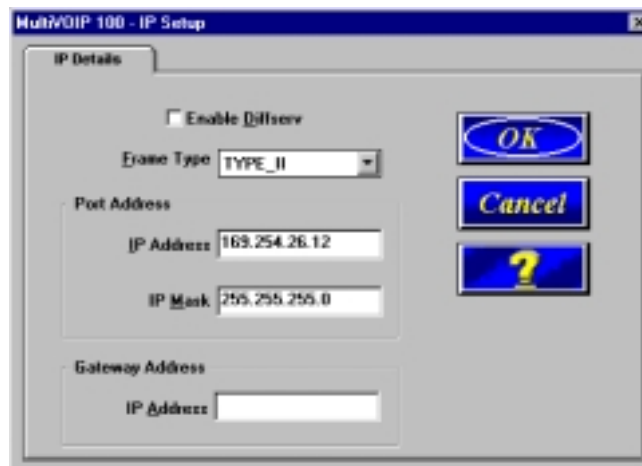

Select the **Enable Diffserv** box if you have routers that support Diffserv (sometimes called IP Precedence). This feature gives priority to voice packets so they are not delayed because of large data files being downloaded.

The default Frame Type is **TYPE_II**. If this does not match your IP network, select the Frame Type from the **Frame Type** list. The Frame Type choices are **TYPE_II** and **SNAP**.

4. In the **Port Address** group, enter the **IP Address** and **IP Mask**. In the **Gateway Address** group, enter the gateway IP address for the slave unit.

The IP Address is the unique IP address that you assign to the MVP120, and the Gateway Address is the IP address of the device (such as a network router) connected to the Internet/ Intranet.

Click **OK** when you are finished. The Main menu displays.

5. From the Main menu, click **Voice Channels** to display the **Channel Setup** dialog box. The **Channel Setup** dialog box displays. The four tabs in this dialog box define the channel interface, voice/fax parameters, Billing/Misc parameters, and regional telephone parameters for the channel.

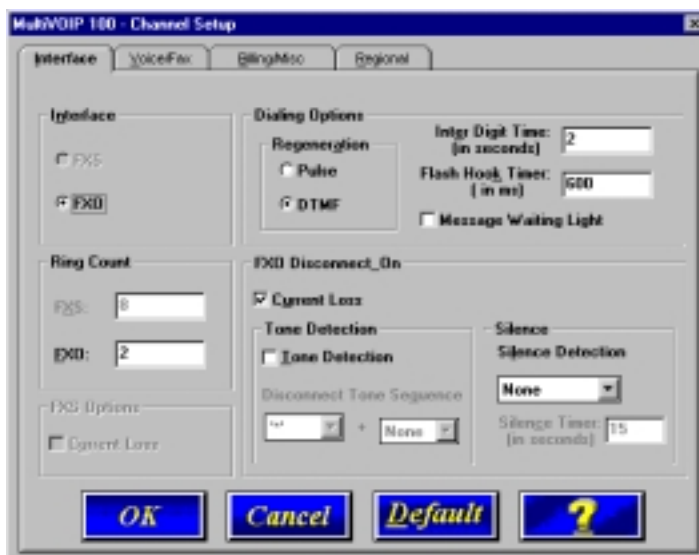

Check with your in-house telephone personnel to verify whether your local PBX dial signaling is **Pulse** or **DTMF** (tone). Select the **Regeneration option** accordingly.

The **Inter Digit Time** option defines the maximum amount of time that the unit will wait before mapping the dialed digits to an entry in the Phone Directory Database. If too much time elapses between digits, and the wrong numbers are mapped, you will hear a rapid busy signal. If this happens, it will be necessary to hang up and dial again. The default is 2 seconds. In the **Flash Timer** box, enter the time, in milliseconds, for the duration of flash hook signals output on the interface.

The **Message Waiting Light** check box must be selected on the originating and answering voice channel. This enables the number dialed to connect you to the appropriate voice channel, then output that number on the voice channel. This feature does not work FXS to FXS.

6. The **Ring Count FXO** box enables you to set the maximum number of rings output on the FXO interface before hanging up and releasing the line to another call. The default setting is 2 rings.

Note: Zero (0) means no incoming calls will be answered.

For FXO-to-FXO communications, you can enable a specific kind of FXO **Disconnect Options: Current Loss, Tone Detection, or Silence Detection**. Check with your in-house phone personnel to verify the type of disconnect to use. If current loss is checked, the VOIP will hang up when it detects a loss of current on the FXO (phone) port. For **tone detection**, select from the lists one or two tones that will cause the line to disconnect. The person hanging up the call must then press the key or keys that produce those tones to hang up a call. For **silence detection**, select **One Way** or **Two Way**, then set the timer for the number of seconds of silence before disconnect. The default value of 15 seconds may be shorter than desired for your application.

7. The **Voice/Fax** tab displays the parameters for the voice gain, DTMF (Dual Tone Multi-Frequency) gain, voice coder, faxing, and advanced features such as Silence Compression, Echo Cancellation, and Forward Error Correction.



8. Input gain modifies the level of the audio coming in to the voice channel before it is sent over the Internet to the remote MVP120. Output gain modifies the level of the audio being output to the device attached to the voice channel. Make your selections from the **Input** and **Output** lists. The valid range is +31dB to -31dB with a recommended/default value of **0**.

You can also set up the **DTMF Gain** (or output level in decibels - dB) for the higher and lower frequency groups of the DTMF tone pair. Make your selections in the lists in the **DTMF Gain** group.

The **DTMF Out of Band** check box is selected so the MVP120 will reproduce the DTMF tones rather than passing them through with voice. When this option is checked the DTMF is sent via RTP packets.

Note: Only change the DTMF Gain under direction of Multi-Tech Technical Support.

9. To change the voice coder, select the **Manual** in the Coder group. Select the appropriate coder from the **Selected Coder** list.

If you changed the voice coder, ensure that the same voice coder is used on the voice/fax channel you are calling. Otherwise, you will always get a busy signal.

10. The **Fax** group enables you to send/receive faxes. You can set the maximum baud rate for faxes and the fax volume in the two lists and change the jitter value in milliseconds.

When receiving fax packets from a remote MVP120, it is possible for individual packets to be delayed or received out of order due to traffic conditions on the network. To compensate for this effect, the MVP120 uses a Jitter Buffer. The **Jitter Value** box allows the MVP120 to wait a user-definable period of time, in milliseconds, for delayed or out of order fax packets. The range of allowable Jitter Values is 0 to 400 with a default of **400** milliseconds.

If you do not plan to send or receive faxes on a given voice/fax channel, you can disable faxes in the Fax group.

11. You can enable the voice/fax advanced features by clicking (checking) the silence compression, echo cancellation, or forward error correction options.

Silence Compression - Defines whether silence compression is enabled for the voice channel. If silence compression is enabled, the MVP120 will not transmit voice packets when silence is detected, thereby reducing the amount of network bandwidth that is being used by the voice channel.

Echo Cancellation - Defines whether echo cancellation is enabled for this voice channel. If echo cancellation is enabled, the MVP120 will remove echo-delay which improves the quality of sound.

Forward Error Correction (FEC) - Defines whether forward error correction is enabled (checked) for this voice channel. The FEC feature allows some of the voice packets that were corrupted (or lost) to be recovered. FEC adds an additional 50% overhead to the total network bandwidth consumed by the voice channel.

The **Billing/Misc** tab displays the parameters for auto call, automatic disconnection, billing options and dynamic jitter buffer.

12. If you want to dedicate a local voice/fax channel to a remote voice/fax channel (so you will not have to dial the remote channel), click the **Auto Call Enable** option in the **Auto Call** group. Then enter the phone number of the remote MVP120 in the **Phone Number** box.
13. The **Automatic Disconnection** group provides three options to be used singly or in combination.

The **Jitter Value** defines the average inter-arrival packet deviation (in milliseconds) before the call is automatically disconnected. Jitter is the inter-arrival packet deviation (phase shift of digital pulses) over the transmission medium that causes voice breakup which can be particularly disruptive to voice communications. The default setting is 20 milliseconds. A higher value means that the voice transmission will be more accepting of jitter. A lower value will be less tolerant of jitter.

Consecutive Packets Lost defines the number of consecutive packets that are lost after which the call is automatically disconnected. The default setting is **30** packets.

Call Duration defines the maximum length of time (in seconds) that a call remains connected before the call is automatically disconnected. The default setting is **180** seconds. A call limit of three minutes may be too short for most configurations. Therefore, you may want to increase this default value.

14. You can set billing options for inbound and/or outbound calls by selecting them in the **Billing Options** group and then entering the charge in cents per number of seconds.
15. A minimum and maximum set of values can be set for **Dynamic Jitter Buffer**. When receiving voice packets from a remote MVP120, it is possible to experience varying delays between packets due to traffic conditions on the network. This is called Jitter. To compensate for this effect, the MVP120 uses a Dynamic Jitter Buffer. The Jitter Buffer allows the MVP120 to wait for delayed voice packets by automatically adjusting the length of the Jitter Buffer between configurable minimum and maximum values. An **Optimization Factor** adjustment controls how quickly the length of the Jitter Buffer is increased when jitter increases on the network. The length of the jitter buffer directly effects the voice delay between MVP120 gateways.

The Minimum Jitter Value default setting is **150** milliseconds, the Maximum Jitter Value default setting is **300** milliseconds, and the Optimization Factor default setting is **7**.

16. To change the Tone Pairs on the **Regional** tab, select your country or region from the **Country/Region** list.

Note: If your country or region is not listed, click **Custom** to define it.



The **Tone Pairs** group enables you to select/modify the parameters according to choice. Click **OK** when finished.

17. From the Main menu, click **Phone Book** to display the **Phone Directory Database** dialog box. Make certain the **Proprietary Phonebook** option is enabled and in the **Database Type** group, click the **Slave** option. The **Master IP Address** field becomes active.

Note: Refer to pages 28-30 if you had chosen Gatekeeper as the type of phone book database during the master phone book setup.



Note: After you have enabled the **Slave** option, the **Slave Status** button is replaced by the **Update** button. Once your Phone Directory database has been established, you can click this button to refresh the entries in the Phone Directory Database window.

18. Enter the IP address (204.022.122.118) of the New York Office MVP120 in the **Master IP Address** box and enable the **Send Status Report to Master** so that status reports are sent to the Master MVP120.

Note: In a Dial-On-Demand (DOD) network, you should leave **Send Status Report to Master** disabled. This allows the router to disconnect whenever there is no voice activity. Note that Slaves with **Send Status Report to Master** disabled will show up as “Unknown” when viewing Slave status on the Master.

19. Click **OK** to return to the Main menu.
20. Click **Download Setup** to write the new configuration to the slave unit. The **Save Setup** dialog box displays.



21. Select the **Save Current Setup as User Default Configuration** check box and click **OK**. The **Writing Setup** dialog box displays as the setup configuration is written to the MVP120.
22. Check that the **Boot** LED on the MVP120 is off after the download is complete. This may take several minutes as the MVP120 reboots.
23. You are returned to the Main menu.

Your MVP120 is operational at this time. Repeat the process for each of the slave units. When all slaves have been configured, go to “Deploying the VOIP Network”.



Chapter 6

Deploying the VOIP Network

Chapter 6 - Deploying the VOIP Network

For a Proprietary Phone Directory database, the VOIP administrator can deploy the pre-configured slave MVP120s to their remote sites. The remote site administrators need only connect power to the pre-configured MVP120, connect the MVP120 to the Ethernet LAN and predefined telephone equipment, and then wait for the phone directory database to be downloaded.

With the **Gatekeeper** option enabled on the **Phone Directory Database** dialog box, all MVP120s are configured as Gatekeeper and cannot be downloaded. In this case, each MVP120 Phone Book will be programmed with phone numbers for its own channel. The phone number is registered with the H.323 Gatekeeper. See the “Registering with a Gatekeeper Phone Directory” section discussed earlier.

Remote Site Administrator

The following steps are for MVP120 H.323 endpoints. For non-MVP120 H.323 endpoints, refer to the appropriate installation documentation.

1. Connect one end of the power supply to a live AC outlet and connect the other end to the **Power** connection on your MVP120 (See Figure 5).

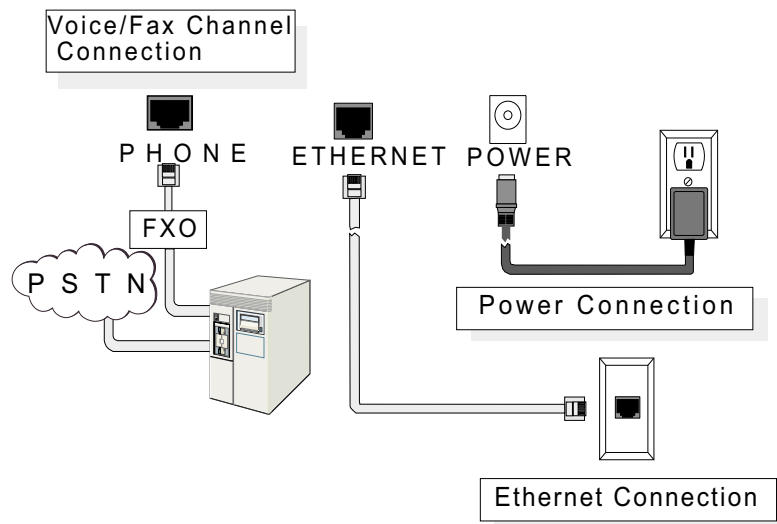

Remote Site Cable Connection

3. Connect a network cable to the **ETHERNET** (RJ-45) connector on the back of your MVP120.
4. If you are connecting an FXO / PBX port or PSTN to your MVP120, connect one end of an RJ-11 cable to the **Phone** connector on the back of the MVP120 and the other end to the FXO or PSTN.
5. Turn on power to the MVP120 by placing the ON/OFF switch on the right side panel in the ON position. Wait for the BOOT LED on the MVP120 to go off before proceeding. This may take a couple of minutes.
6. At this time your VOIP network should be fully operational. Dial one of the sites in your network.



Chapter 7

Using the MultiVOIP Software

Chapter 7 - Using the MultiVOIP Software

This chapter describes various features of the MVP120 software that enable you to change the configuration of your MVP120. The default configuration parameters were entered during the loading of the software. The MVP120 software and configuration utilities described in this chapter enable you to change that initial configuration as necessary.

The primary interface to the MVP120 software is the Main menu (**MultiVOIP 100 Setup** is on the title bar) with individual buttons that enable you to quickly and easily select a desired function. These features are discussed in detail in the MVP120 Configuration section later in this chapter.

The MVP120 Configuration (Main menu) utility along with nine other configuration utilities provide full software functionality for your MVP120.

Configuration Port Setup enables you to change the method by which you access the MVP120, whether through a direct connection from a PC to the Command Port on the MVP120 or via your Internet or LAN connection to the LAN port on the MVP120.

Date and Time Setup enables you to easily set the date and time used for data logging in the MVP120.

Download Factory Defaults enables you to return the configuration to the original factory settings.

Download Firmware enables you to download new versions of firmware as enhancements become available.

Download User Defaults enables you to repeat the download user defaults process (part of software installation) and update the MVP120 configuration with any necessary changes.

Download Voice Coders enables you to download voice coders to the MVP120 after repair or upgrade.

Download H.323 Stack enables you to download the H.323 protocols to the MVP120 after repair or upgrade.

Uninstall MVP120 Configuration removes most of the MVP120 software from your PC.

Upgrade Software downloads boot code, factory defaults, firmware, voice coders, and H.323 stack; and then reboots the MVP120.

The MVP120 software includes a context-sensitive Help system. Clicking a Help [?] button anywhere in the graphical user interface (GUI) will display definitions and recommended values for the buttons, options, and fields on that dialog box or menu. Clicking the green underlined text in the Helps displays a popup box of related supplementary information for that topic. Clicking the Search button (just below the Help menu bar) displays an Index tab with a list of entries. Click an entry, then click the Display button to display the text associated with that topic.

Before You Begin

The MVP120 software operates in a Microsoft Windows environment. The MVP120 program group contains icons for all the utilities described above. You can open the individual utility programs by clicking **Start | Programs | MultiVOIP 100 | (utility)**.

MVP120 Configuration

The MVP120 Setup menu consists of 10 buttons, an Events window in the middle of the menu, and a status bar at the bottom of the menu. The 10 buttons allow you to display and change the voice channels and IP protocol parameters, display and manage the Phone Book listing, view statistics and call progress, and change features such as SNMP Agent, Telnet Server, WEB Server, and assign a MVP120 password.



The Events window in the lower third of the Setup menu provides information about the boot process.

The status bar at the bottom of the Setup menu displays the current status of the unit and shows, for example, if it is Running, the most recent date the unit was configured, the type of connection you have to the unit, and your rights. It shows if your PC is connected directly to the command port of the MVP120 or is communicating with the Ethernet port. The Rights box which displays whether you have Read/Write or Read-Only rights. The first user to communicate with the MVP120 command port has Read/Write rights that enable the user to view and/or change the configuration of the MVP120. Any additional simultaneous users have Read-Only rights and can only display the configuration of the MVP120 but are prohibited from changing the configuration.

Changing Channel Parameters

The channel parameters include the interface type and its options, voice and fax settings, billing and security, and voice communications for the country and region in which the MVP120 is operating. The **Channel Setup** dialog box, accessed by clicking Voice Channels on the Setup menu, has four tabs that display the following categories of channel information -- Interface, Voice/Fax, Billing/Misc, and Regional.



Interface Tab

Check with your in-house telephone personnel to verify whether your local PBX dial signaling is **Pulse** or **DTMF** (tone). Select the **Regeneration option** accordingly.

In the **Inter Digit Time** box, enter the maximum amount of time between dialed digits in milliseconds that the unit will wait before mapping the dialed digits to an entry in the Phone Directory Database. If too much time elapses between digits, the wrong numbers will be mapped and you will hear a rapid busy signal. If this happens, hang up and dial again. The default setting is 2 seconds.

In the **Flash Hook Timer** box, enter the amount of time the duration of flash hook signals output on the interface. The default setting is 600 milliseconds.

The **Ring Count FXO** box enables you to set the maximum number of rings output on the FXO interface before hanging up and releasing the line to another call. The default setting is 2 rings.

Note: Zero (0) means no incoming calls will be answered.

The **Message Waiting Light** check box must be selected on the originating and answering voice channel. This enables the number dialed to connect you to the appropriate voice channel, then output that number on the voice channel.

For FXO-to-FXO communications, you can enable a specific kind of FXO **Disconnect Options: Current Loss, Tone Detection, or Silence Detection**. Check with your in-house phone personnel to verify the type of disconnect to use. If current loss is checked, the VOIP will hang up when it detects a loss of current on the FXO (phone) port. For **tone detection**, select from the lists one or two tones that will cause the line to disconnect. The person hanging up the call must then press the key or keys that produce those tones to hang up a call. For **silence detection**, select **One Way** or **Two Way**, then set the timer for the number of seconds of silence before disconnect. The default value of 15 seconds may be shorter than desired for your application.

Voice/Fax Tab

The Voice/Fax tab controls voice and DTMF gain, voice coder, fax settings, and advanced options.



In the **Voice Gain** group you can select the Input and Output voice gain. Gain is the increased signaling power that occurs as the signal is boosted by the MVP120. The **Input Gain** list defines the input gain for this voice channel. Before your MVP120 digitizes voice, the volume can be increased or decreased. Input gain modifies the level of the audio coming into the voice channel before it is sent over the Internet to the remote MVP120. The valid range for this option is +31dB to -31dB. The recommended and default value is **0**. The **Output Gain** list defines the voice output gain for this voice channel. Before your MVP120 converts digital voice back to analog, the volume can be increased or decreased. The output gain modifies the level of the audio being output to the device attached to the voice channel. The valid range for this option is +31dB to -31dB. The recommended and default value is **0**.

The **DTMF Gain** (Dual Tone Multi-Frequency) group controls the volume level of the digital tones sent out for Touchtone dialing. The **Gain High** and **Gain Low** lists control the gain in dB (decibels) of the High and Low tones in the tone pairs. The default gain values are **-4 dB** and **-7 dB**, respectively. DTMF Gain should not be changed except under supervision of MultiTech's Technical Support.

The **DTMF Out of Band** check box is selected so the MVP120 will reproduce the DTMF tones rather than passing them through with voice. When this option is checked the DTMF is sent via RTP packets.

The MVP120 supports many state-of-the-art ITU (International Telecommunications Union) voice coders. The **Voice Coder** list enables you to select from a range of coders with specific bandwidths. The higher the bps rate, the more bandwidth is used. The channel that you are calling has to have the same voice coder selected. Otherwise, you will always get a Busy signal.

The **Fax** group enables a fax machine to transmit and receive faxes through the MVP120. If a fax machine is connected to the via PBX port or PTSN, the **Max Baud Rate** should be set to match the baud rate of the fax machine (refer to user documentation). The **Fax Volume** setting controls the output level of the fax tones, and this setting should be changed only under the direction of Multi-Tech's Technical Support personnel. The **Jitter Value** setting defines the inter-arrival packet deviation (in milliseconds) for the fax transmission. A higher value will increase the amount of delay (allowing for a higher percentage of packets to be reassembled) and a lower value would decrease the amount of delay (a lower percentage of packets would be reassembled).

The **Advanced Features** group allows you to enable **Silence Compression** so that a MVP120 will not transmit voice packets when silence is detected, thereby reducing the amount of network bandwidth that is being used by the voice channel; **Echo Cancellation** for the voice channel will remove echo and improve the quality of sound; and, **Forward Error Correction** allowing some of the voice packets that were corrupted (or lost) to be recovered. FEC adds an additional 50% overhead to the total network bandwidth consumed by the voice channel.

Billing/Misc Tab

This tab controls the parameters for auto call, automatic disconnection, billing options, and dynamic jitter buffer.



The **Auto Call** option allows the local MVP120 to call a remote MVP120 without the user having to dial a Phone Directory Database number. As soon as you access the local MVP120 voice/fax channel, the MVP120 immediately connects to the remote MVP120 that you identified in the Remote MVP120 Phone Number field of this option.

The **Automatic Disconnection** group provides three options which can be used singly or in any combination. The **Jitter Value** defines the average inter-arrival packet deviation (in milliseconds) before the call is automatically disconnected. The default is **20** milliseconds. A higher value means voice transmission will be more accepting of jitter. A lower value is less tolerant of jitter.

Consecutive Packets Lost defines the number of consecutive packets that are lost after which the call is automatically disconnected. The default is 30 packets.

Call Duration defines the maximum length of time (in seconds) that a call remains connected before the call is automatically disconnected. The default is 180 seconds. A call limit of three minutes may be too short for most configurations. Therefore, you may want to increase this default value.

Billing Options can be used to track the cost of Inbound and/or Outbound calls on the FXO interface. The amount to be charged in cents is entered in the **Charge () Cents** box together with the associated time duration in the **Per () Seconds** box. While a given call is active, the accumulated charges can then be viewed on the **Call Progress** dialog box. When the call ends, the charges are transferred to a Log File that can be viewed by selecting the call event in the **Log Entries** dialog box and selecting **Details**.

Dynamic Jitter Buffer defines a minimum and a maximum jitter value for voice communications. When receiving voice packets from a remote MVP120, it is possible to experience varying delays between packets due to traffic conditions on the network. This is called Jitter. To compensate for this effect, the MVP120 uses a Dynamic Jitter Buffer. The Jitter Buffer allows the MVP120 to wait for delayed voice packets by automatically adjusting the length of the Jitter Buffer between configurable minimum and maximum values. An Optimization Factor adjustment controls how quickly the length of the Jitter Buffer is increased when jitter increases on the network. The length of the jitter buffer directly effects the voice delay between MVP120 gateways.

The default minimum dynamic jitter buffer of **150** milliseconds is the minimum delay that would be acceptable over a low jitter network. The default maximum dynamic jitter buffer of **300** milliseconds is the maximum delay tolerable over a high jitter network.

The **Optimization Factor** determines how quickly the length of the Dynamic Jitter Buffer is changed based on actual jitter encountered on the network. Selecting the minimum value of 0 means low voice delay is desired, but increases the possibility of jitter induced voice quality problems. Selecting the maximum value of 12 means highest voice quality under jitter conditions is desired at the cost of increased voice delay.

The Optimization Factor can be configured in the range of 0 to 12 with a default setting of 7.

Regional Tab

The Regional tab controls the voice communications for the country or region in which the MVP120 is being used.



From the **Country/Region** list, select the country or region for which you are configuring the MVP120. The **Tone Pairs** group always displays the tones used in the country or region currently selected. In addition to Australia, Central America, Chile, Europe, France, Japan, UK, and USA, there is a **Custom** selection (with defaults identical to USA) . Clicking the **Custom** button enables you to edit the Tone Pairs and establish custom sets of tone pairs for Dial Tone, Ring, and Busy on a **Custom Tone Pair Settings** dialog box.

The **Pulse Generation Ratio** group contains two ratios: the 60/40 is for the USA, and the 67/33 ratio is for international applications.

Changing the Phone Directory Database

The MultiVOIP provides two phone directory database architectures; the proprietary database and a database using an H.323 protocol gatekeeper that provides a centralized call control center. The gatekeeper centralized call control center contains the phone directory database when all VOIP gateways and endpoints support the H.323 protocol. The proprietary database is based on a master and slave relationship in which the master VOIP maintains the phone directory database and distributes it to its slave VOIPs. The centralized call center handles call control, call routing, address translation from LAN aliases to IP addresses, and bandwidth management. The H.323 protocol allows other third party gateways and end points that support the H.323 protocol standards to participate in the VOIP network (e.g., Microsoft NetMeeting®).



The database displays the phone numbers in numerical order with destination details (IP Address or H323 ID \ alias), channel assignment, and a brief description of the entry. The method for changing the phone directory database is dependent on whether the **Gatekeeper** option or the **Proprietary Phonebook** option is enabled.

If the **GateKeeper** option is enabled, the RAS Parameters group is enabled and the IP address of the GateKeeper needs to be entered in the IP Address window. The Port Number is the port on the GateKeeper which it communicates with its endpoints. The Q.931 Parameters group is enabled in both the GateKeeper and Proprietary Phone Book Database architectures. The Use Fast Start option is used when the VOIP network supports Fast Start capability.

In the GateKeeper phone directory database, the phone directory database is developed through the Add/Edit Phone Entry dialog box. The Add/Edit Phone Entry dialog box defines the Station Information, phone number and voice channel of the unit, and station identification, H323 ID / alias which defines the LAN alias and the IP address of the local unit. In the GateKeeper phone directory database, only the phone entry of the local unit displays.

If the **Proprietary PhoneBook** option is enabled, the Database Type group is active which defines the Master and Slave relationship. If the database type is master, then the **Add**, **Delete**, **Edit**, **Hunt**, and **Print** buttons at the top of the database dialog box are active. This allows the master database to build the phone directory. You can click **Slave Status** to view the status of the slave units.

The **Add/Edit Phone Entry** dialog box for the Proprietary PhoneBook is used to add, delete, and edit entries. This information displays in the **Phone Directory Database** dialog box.

If the database type is set to slave, then the IP address of the master MultiVOIP needs to be entered in the Master IP Address window, the Send Status Report to Master option can be enabled, and all the buttons at the top of the directory database dialog box become inactive, except for the Print button.

Proprietary Phone Directory Database

In the **Proprietary Phone Directory Database**, you can add, delete, or edit any entry in the phone directory database and you can set up Hunt groups that locate another phone number if the called number is busy. You can print the phone directory database so that you have a hardcopy of the phone directory.

To add an entry to the Phone Directory database, click **Add** and the Add/Edit Phone Entry dialog box displays.

The screenshot shows the 'MultiVOIP 100 - Add/Edit Phone Entry' dialog box. It is divided into two main sections: 'Station Information' and 'Station Identification'. The 'Station Information' section includes a 'Phone Number' field, a 'Description' field, and a 'Voice Channel' field. The 'Station Identification' section includes a 'Hunt Group' dropdown menu, an 'IP Address' field, and a 'Port' field. On the right side of the dialog box, there are four buttons: 'OK', 'Cancel', a question mark icon, and 'Copy From'.

The Add/Edit Phone Entry dialog box contains two groups of information: the **Station Information** which contains the phone number, an optional description window, and the **voice channel number**. The **Station Identification** group contains the Hunt Group listing and the IP Address window for the IP Address of the MultiVOIP assigned the phone number. The Port number is not used in the proprietary phone book.

The **Station Information** identifies the calling unit by the phone number and voice channel of the unit doing the calling. The Phone Number does not have to be a conventional telephone number. It can be, for example, a three digit number like 101.

The **Description** is similar to a local telephone book listing. It identifies the calling party. The voice channel window defines the voice channel associated with the phone number.

The screenshot shows the 'MultiVOIP 100 - Add/Edit Phone Entry' dialog box with sample data. The 'Station Information' section has 'Phone Number' set to '101', 'Description' set to 'New York Office', and 'Voice Channel' set to '1'. The 'Station Identification' section has 'Hunt Group' set to 'NO HUNT', 'IP Address' set to '201.22.122.118', and 'Port' set to '1720'. The buttons on the right are 'OK', 'Cancel', a question mark icon, and 'Copy From'.

The **Station Identification** group enables you to assign the entry to a Hunt Group, provide the IP Address of the MultiVOIP being assigned the phone number, and accept the H.323 industry standard Port number. A Hunt Group is a series of telephone lines organized in such a way that if the first line is busy the next line is hunted and so on until a free line is found. It is a set of links which provides a common resource and which is assigned a single hunt group designation. A user requesting that designation may then be connected to any member of the Hunt Group.

You can view the details of the current Hunt Group configuration by clicking the Phone Directory Database's **Hunt** button. The current Phone numbers for HUNT GROUP #1 are displayed.

Select the Hunt Group you wish to view. The **Phone no's** window displays the telephone numbers associated with that Hunt Group and the **No. of Entries** field displays the running total of entries.

Note: You can change the name of the Hunt Group by clicking on the entry that you want to change, editing the change in the Hunt Group name window, and then clicking the **Set** button.

Click **Slave Status** on the **Phone Directory Database** dialog box to view the status of all the slave units in your VOIP network (Send Status Report to Master must be enabled on the Slave). The Phone Number of each Slave displays with its IP Address, current line status, and the description of the phone number.

Gatekeeper Phone Directory Database

With the **Gatekeeper Phone Directory Database**, the Gatekeeper acts as the central point for all calls within its zone and provides call control services to registered endpoints. The Gatekeeper performs address translation from LAN aliases to IP addresses and provides bandwidth management where the network manager has specified a threshold for the number of simultaneous calls on the LAN. The H.323 ID is an alias. The Gatekeeper may use other information as an alias such as a URL or an e-mail address.

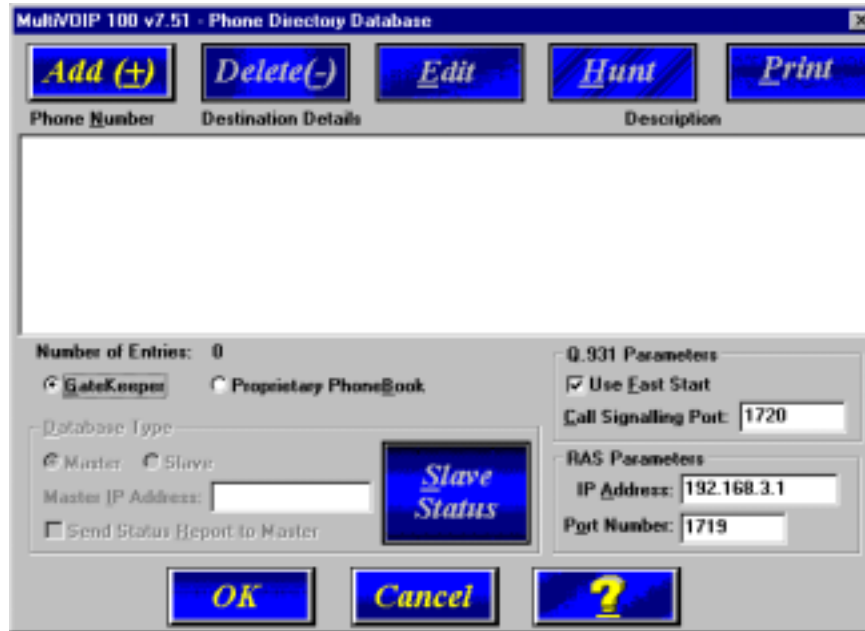

When the Gatekeeper Phone Directory Database option is enabled, the RAS Parameters group is enabled with the IP address of the Gatekeeper displayed in the IP Address box. The Port Number is the port of the endpoint communicating with the Gatekeeper. If this number is changed, it should only be changed with consultation with Gatekeeper administrator. The port numbers have to match with the Gatekeeper.

If the H.323 Gatekeeper network supports Q.931 Fast Start servicing, then the Use Fast Start option on all endpoints should be enabled. The Call Signalling Port of 1720 is the port on the MultiVOIP unit supporting the Q.931 parameters.

The Phone Directory Database in a H.323 Gatekeeper network only displays the station information and station identification of the local unit. The station information and identification must be entered in conjunction with the Gatekeeper administrator so that the identification of the endpoint is the same. To add an entry to the Database, click **Add**. The **Add/Edit Phone Entry** dialog box displays.



The **Add/Edit Phone Entry** dialog box contains two groups of information: 1. Station Information which contains the phone number, description window which can be left blank, and the voice channel number. Station Identification group contains the H.323 ID and the IP Address window for the IP Address of the MultiVOIP assigned the phone number, and the Port number of the MultiVOIP unit communicating with the Gatekeeper. This port number has to match the port number pair used by the Gatekeeper. If the port number on either end is changed, communication between endpoint and the Gatekeeper is lost.

The **Station Information** identifies the calling unit by the phone number, and voice channel of the unit doing the calling. The Phone Number does not have to be a conventional telephone number. It can be a three digit number such as 101. The **Description** box and the **H323 ID/alias** box may contain the same information. It is recommended that the **Description** box be left blank and the identifying information be entered in the H323 ID/alias window. The voice channel box defines the voice channel associated with the phone number.

The **Station Identification** group allows you to define the MultiVOIP unit by entering the H323 ID/alias which can be the same, as for example, your name in your local telephone book listing. The Gatekeeper associates the H323 ID/alias with the address of the local unit in the IP Address window. The Port number 1720 is the port of the MultiVOIP communicating with the Gatekeeper.

The Station Information and Identification of the MultiVOIP unit have to be identical to the information used by the Gatekeeper in order for the MultiVOIP unit to be registered with the Gatekeeper. The Gatekeeper can allow an open registration or a secure registration in which the endpoints are pre-defined by the Gatekeeper. The registration method is determined by the Gatekeeper administrator and will require communication with each endpoint in order to develop the H.323 compatible network.

The Phone Directory Database for the local unit holds the local phone numbers, destination details of the IP address, port number, and channel number of the local unit. The description is the same as the entry in the H323 ID entry in the Add/Edit Phone Entry dialog box.



Changing IP Parameters

The **IP Setup** dialog box establishes the IP address for the local Ethernet LAN and defines the Internet gateway address. The **IP Setup** dialog box is accessed by clicking **IP** on the MVP120 Main menu.



With **IP Setup** dialog box displayed you can change the status of **Diffserv**, the Ethernet Frame Type, the IP address and IP Mask of your H.323 endpoint, and the Gateway Address of the IP address of the device connected to the Internet.

Selecting the **Enable Diffserv** check box enables **Diffserv**. **Diffserv** provides priority to voice packets so that they are not delayed whenever large data files need to be downloaded. Check with your systems administrator to determine if any routers in the VOIP network support this feature. If so, enable this function.

The **Frame Type** list enables you to change the Ethernet Frame Type so that it matches your IP network. If the current entry does not match your IP network, select the Frame Type from the Frame Type list. The Frame Type choices are **TYPE_II** and **SNAP**.

The **Port Address** group enables you to change the unique **IP Address** and **IP Mask** of the local LAN.

The **Gateway Address** group enables you to change the gateway **IP Address** of the device connected to the Internet/Intranet.

Viewing Call Progress

The **Call Progress** dialog box is a read-only screen that displays the status of a call in progress. This dialog box is accessed from the MVP120 Setup menu by clicking the **Call Progress** button.

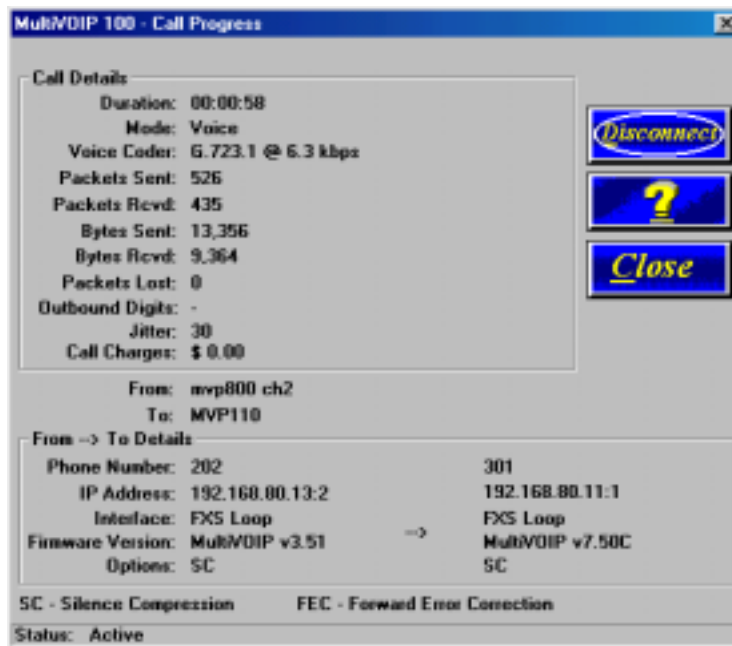

The ratio of Packets Lost versus Packets Received provides a general indication of the integrity of the Internet connection. To reduce the frequency of lost packets, select a low-bit-rate coder, such as, G.723 or Netcoder. In addition, enabling the Forward Error Correction option on the Voice/Fax tab on the **Channel Setup** dialog box will enable the MVP120 to recover many of the lost packets.

The Jitter value (measured in milliseconds) indicates the mean deviation of the difference in packet spacing at the receiver compared to the sender for a pair of packets.

Applications Setup

Clicking **Others** on the Setup menu displays the **Applications Setup** dialog box. This dialog box allows you to enable SNMP Agent (the default is disabled) and set up all the necessary parameters; enable or disable various remote configuration methods such as TFTP (Trivial File Transfer Protocol) Server, Web Server, Dumb Terminal Management, and Telnet Server; and assign a Password to the MVP120 for security. These applications enable remote viewing and changing of the MVP120 configuration, or updating firmware, from anywhere on the connected network.

Verify that the desired applications are selected. All applications are selected by default. To disable a given application, clear its check box.

SNMP related operations can be performed only when the **SNMP Agent** check box is selected on this dialog box. The IP address of the system (i.e., SNMP Manager) that will receive the Traps from the MVP120 should be entered in the **IP Address** field in the Trap Manager group. The **Community Name** of the SNMP Manager receiving the Traps can be a maximum of 19 characters and is case sensitive. The default **Port Number** of the SNMP Manager receiving the Traps is 162. The MVP120 currently supports a maximum of two community users at a time, and they can be assigned either Read/Write or Read Only rights. **Note:** if you have SNMP client software and enable SNMP Agent, you can (in the lower right corner of the dialog box) choose to read logs through the SNMP Manager instead of the COM port.

The **Password** group enables you to enter a password, up to 13 alphanumeric characters, to be used for security. Once the password is entered and confirmed, remote users will be queried to enter the password before gaining access to the MVP120 for configuration purposes.

Note: If you forget your password, contact Technical Support for instructions.

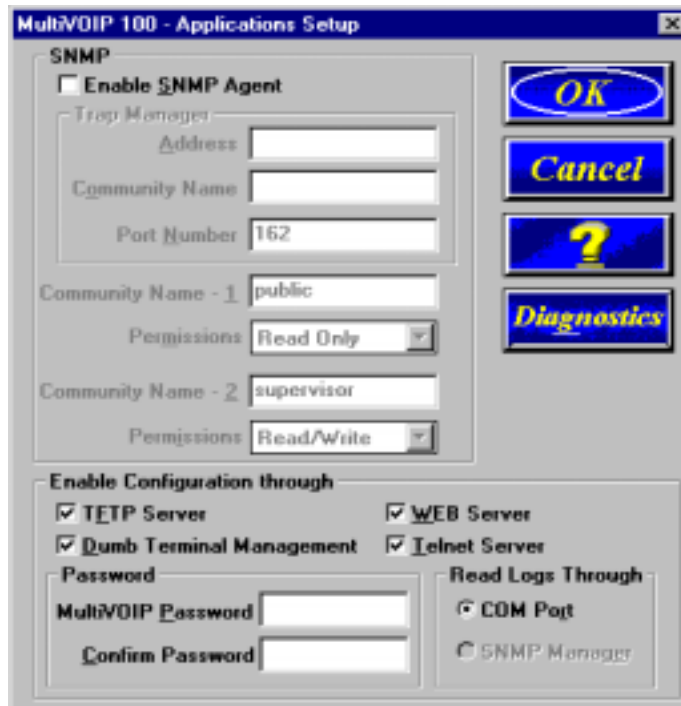

For more information on using these applications, refer to Chapter 5, Remote Configuration and Management.

Viewing Statistics

The **Statistics** dialog box enables you to view statistics for major events of the MVP120 operation. This dialog box is accessed by clicking **Statistics** on the MVP120 Main menu.



The Voice Channel statistics shows the attempted and completed calls, call duration, average call length, bytes/packets sent and received. These statistics can be a helpful troubleshooting tool.

IP Statistics

IP is a connection-less network protocol residing in the network layer of a conventional OSI layered model (for more information on this model, refer to [Appendix A](#)). Depending on what is going on at the application layer, IP will typically use one of two transport layer protocols. User Datagram Protocol (UDP), a connection-less transport layer protocol used with TFTP or SNMP; and Transport Control Protocol (TCP), a connection-oriented transport layer protocol used with FTP, Telnet, and SNMP.



UDP makes use of the port concept and has no measures for flow control, reliability, or error recovery. It is used when the full services of TCP are not required, and the reliability measures must be assumed by another layer.

TCP works well in environments where the reliability measures are not assumed by other layers. It is connection-oriented and has a full range of services.

These statistics are informational, and their use as a troubleshooting tool will be contingent on the applications running in the upper layers. For example, if you were having problems

connecting to the MVP120's web server, you would look under the TCP section to see if any connections are being established. If not, that may indicate the web server is not enabled. Or, if you were having problems establishing a remote connection through TFTP, you could look in the UDP section to see if any packets are being received. If not, you may need to review your network addressing.

SNMP Statistics

The **SNMP Statistics** dialog box provides statistical information on Simple Network Management Protocol (SNMP).

Packets Received with	
Set Request	0
Get Request	0
Get Next Request	0
Get Response Request	0
Bad Values	0
Bad Communities	0
Bad Community Users	0
No Such Names Error	0

Packets	
Transmitted	0
Received	0

Asn Parse Errors	
Asn Parse Errors	0

Traps Received	
Traps Received	0

Others	
Transmit Variable too Big	0
Read Only Packets	0
Total Set Variable Packets	0
Total Request Variable Packets	0
Packets Sent with Get Response	0
Packets Received with Wrong Version	0

SNMP is an application layer protocol that facilitates the exchange of management information between network devices. There are three key components in SNMP: (1) the devices that are to be managed, (2) agents, and (3) the network management systems. The managed device is the network device, like a router. The agent is the software module residing in the managed device pertaining to network management. The network management system runs the SNMP application that controls the managed devices and monitors their status. Four primary operations -- Set, Get, Get Next, and Trap -- are performed using SNMP.

Viewing Logs

The **Log Entries** dialog box displays a chronological history of all calls into and out of this unit. This dialog box is opened by clicking **Logs** on the **Statistics** dialog box.

Event #	Start Date, Time	Duration	Status	Mode	From-->To
8	01/01/2000, 12:01:32 AM	00:01:19	S	V	Unknown-->80
9	01/01/2000, 12:01:03 AM	00:08:40	S	V	202-->110
10	01/01/2000, 12:13:05 AM	00:00:16	S	V	202-->110
11	01/01/2000, 12:13:27 AM	00:00:17	S	V	110-->201
12	01/01/2000, 02:21:29 AM	00:00:00	U	V	202-->110
13	01/01/2000, 02:32:53 AM	00:00:00	U	V	202-->110
14	01/01/2000, 03:02:00 AM	00:00:15	S	V	110-->201
15	01/01/2000, 04:02:20 AM	00:00:00	U	V	202-->110
16	01/01/2000, 04:02:31 AM	00:00:16	S	V	201-->110
17	01/01/2000, 04:06:17 AM	00:00:06	S	V	110-->201
18	01/01/2000, 04:08:54 AM	00:00:44	S	V	110-->202
19	01/01/2000, 04:16:48 AM	00:00:23	S	V	202-->110
20	01/01/2000, 04:29:46 AM	00:00:14	S	V	110-->201
21	01/01/2000, 04:30:26 AM	00:00:17	S	V	110-->201
22	05/30/2001, 04:06:56 PM	00:00:24	S	V	301-->110

S - Successful U - Unsuccessful V - Voice F - Fax

Buttons: **Details**, **Totals**, **Clear**, **Close**, **?**

The **Log Entries** dialog box displays each call as a sequentially numbered Event with the date, time, duration of the call, the status of the call (**S**uccessful or **U**nsuccessful), Mode (**V**oice or **F**ax), and the from and to numbers.

Viewing Log Entry Details

The **Log Entry Details** dialog box displays the status of a completed call. This dialog box displays the same details as the **Call Progress** dialog box after a call is completed.

Call Details	
Start Time:	04:06:56 PM, 05/30/2001
Duration:	00:00:24
Mode:	Voice
Voice Coder:	G.723.1 @ 6.3 kbps
Packets Sent:	229
Packets Rcvd:	371
Bytes Sent:	7,064
Bytes Rcvd:	10,708
Packets Lost:	0
Outbound Digits:	-
Call Charges:	

From:
To:.mvp110

From-->To Details		
Phone Number:	301	110
IP Address:	192.168.80.13:1	192.168.80.11:1
Interface:	FXS Loop	FXS Loop
Firmware Version:	MultiVOIP v3.51	MultiVOIP v7.50C
Options:	SC	SC

SC - Silence Compression FEC - Forward Error Correction

Status: Success: Disconnected Due To Local User On Hook

Buttons: **Next**, **Prev**, **Close**, **?**

Viewing Channel Totals

The **Channel Totals** dialog box displays Outgoing and Incoming calls with their Attempted and Completed numbers for each channel on this MVP120. The Total Connected Time for the channel is also displayed. This can provide you with a sense of successful call completions on each channel of the unit.

Channel	Total Connected Time	Outgoing Calls Attempted	Outgoing Calls Completed	Incoming Calls Attempted	Incoming Calls Completed
Channel 1	00:00:33	1	1	0	0

Reports

A report of the contents of the **Log Entries** dialog box can be generated using the Windows Notepad accessory and then printed from your local PC. The report is generated by entering the To and From dates in the **Report Generation** dialog box and then clicking **Generate**. This function provides a hard copy of the **Log Entries** dialog box.

Event #	Start Date, Time	Duration	Status	Mode	From-->To
8	01/01/2000, 12:01:32 AM	00:01:19	S	V	Unknown-->80
9	01/01/2000, 12:01:03 AM	00:08:40	S	V	202-->110
10	01/01/2000, 12:13:05 AM	00:00:16	S	V	202-->110
11	01/01/2000, 12:13:27 AM	00:00:17	S	V	110-->201
12	01/01/2000, 02:21:29 AM	00:00:00	U	V	202-->110
13	01/01/2000, 02:32:53 AM	00:00:00	U	V	202-->110
14	01/01/2000, 03:02:00 AM	00:00:15	S	V	110-->201
15	01/01/2000, 04:02:20 AM	00:00:00	U	V	202-->110
16	01/01/2000, 04:02:31 AM	00:00:16	S	V	201-->110
17	01/01/2000, 04:06:17 AM	00:00:06	S	V	110-->201
18	01/01/2000, 04:08:54 AM	00:00:44	S	V	110-->202
19	01/01/2000, 04:16:48 AM	00:00:23	S	V	202-->110
20	01/01/2000, 04:29:46 AM	00:00:14	S	V	110-->201
21	01/01/2000, 04:30:26 AM	00:00:17	S	V	110-->201
22	05/30/2001, 04:06:56 PM	00:00:24	S	V	301-->110

S - Successful U - Unsuccessful V - Voice F - Fax

Upgrade Procedures

Whenever you upgrade your version of the MVP120 software, you must first install the new software on your PC. Then use the Upgrade Software function, the Factory Defaults, or download the Firmware, the Voice Coders, and the H.323 stack to upgrade the MVP120 itself.

Before starting the upgrade process, view the current configuration and write down important data such as your IP address, and voice channel configurations; these settings must be put back in place after the software has been upgraded. Multi-Tech also recommends that you use the **Print** button on the Phone Directory Database dialog box to have a copy of the phone directory contents.

Upgrade Software

Note: The software upgrade can be done from the command port or via IP utilizing tftp.

If you have obtained a new software version from the Multi-Tech Web site or another source, do the following:

1. Install the software by clicking **Programs | MultiVOIP 100 | Upgrade Software**.

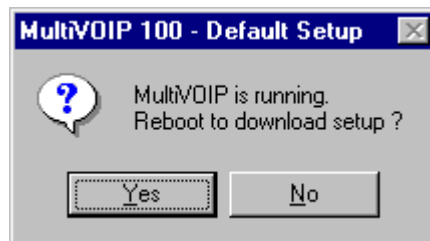

2. Click **Yes**. The download process begins.



3. Enter your LAN IP address, mask, and gateway address in the **IP Protocol Default Setup** dialog box. Click **OK** when finished.
4. Enter your current configuration in the **Channel Setup** dialog box.



- Click **OK** when finished. The **Checking MultiVOIP** dialog box displays. When you click **OK** in this box, the MultiVOIP firmware, voice coders, and H.323 stack are downloaded, and then the MVP120 reboots.

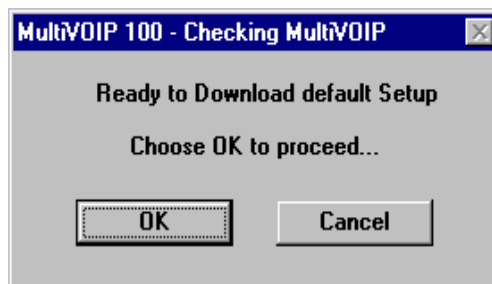

Upgraded versions of the Boot Code (firmware, coders, and H.323 stack) can be downloaded individually using the following manual procedures.

Manual Upgrade Procedure

Follow this procedure only if you want to manually upgrade your MultiVOIP.

Note: Steps 4-8 may be performed via the command port or over IP.

1. Run MultiVOIP Configuration from your old version of the MultiVOIP software. Note the current settings. Your MultiVOIP will be reset to factory defaults during this upgrade.
2. Uninstall your old version of MultiVOIP software by selecting the **Uninstall MultiVOIP Configuration** option from the program group.
3. Install the H.323 compatible software from the MultiVOIP CD.
4.
 - a. From the program group of the MultiVOIP software, select **Download Firmware**.
 - b. Enter ***.upg** in the **File name** box and press ENTER.
 - c. Select the file named **boot_100.upg**, if you are using the command port.
OR
Select **tftp.upg** if you are using IP.
5. From the program group of the MultiVOIP software, select **Download Factory Defaults**.
6. From the program group of the MultiVOIP software, select **Download Firmware**. Select the file named **mtvoip.bin**.
7. From the program group of the MultiVOIP software, select **Download Voice Coders**. Select the default file.
8. From the program group of the MultiVOIP software, select **Download H323 Stack**. Select the default file.
9. Select MultiVOIP Configuration from the program group and reconfigure your MultiVOIP. The upgrade is complete.



Chapter 8

Remote Configuration and Management

Chapter 8 - Remote Configuration and Management

This chapter provides procedures for viewing or changing the configuration of a remote unit. Two methods are provided to access a remote unit; the first method is modem based and the second method uses IP. Within the IP method, three applications can be used: 1) LAN-Based using TFTP (Trivial File Transfer Protocol), 2) Telnet as a client application, or 3) a standard web browser on the Internet.

Remote configuration requires the MVP120 software to be loaded on the local PC. The local PC then controls the remote MVP120 either via the modem connection or the LAN.

Modem-Based

To remotely configure a MVP120, a local PC with a modem needs to be connected to a dial-up line and the MVP120 software configured to call the remote MVP120. The remote MVP120 needs to have a modem connected to a dial-up line and the Command Port. Once the connection to the remote unit is made, you can change the configuration as required. Once the configuration is changed, you can download the new configuration to the remote MVP120. Refer to the Modem-Based Remote Configuration Procedure in this chapter to remotely configure a MVP120.

1. At the remote site, remove the serial cable from the PC to the Command Port connector on the back panel of the MVP120.
2. At the remote site, connect a special cable (Remote Configuration Cable) from the Command Port connector on the back panel of the MVP120 to the RS-232 connector on the modem. The special cable is a serial cable with male connectors on both ends. Refer to Appendix B for cable details.

Connect the modem to your local telephone line.

Provide your telephone number to the person verifying your configuration.

Configure the remote modem for 19200 baud and turn on Force DTR.

3. At the main site, connect your local PC to a modem that is connected to a dial-up line.
4. Install the MVP120 software on the local PC. When installed, click **Start | Programs | MultiVOIP 100 | Configuration Port Setup**, or double-click the **Configuration Port** icon in the MultiVOIP 100 program group.
5. The **MultiVOIP 100 Setup** dialog box displays.

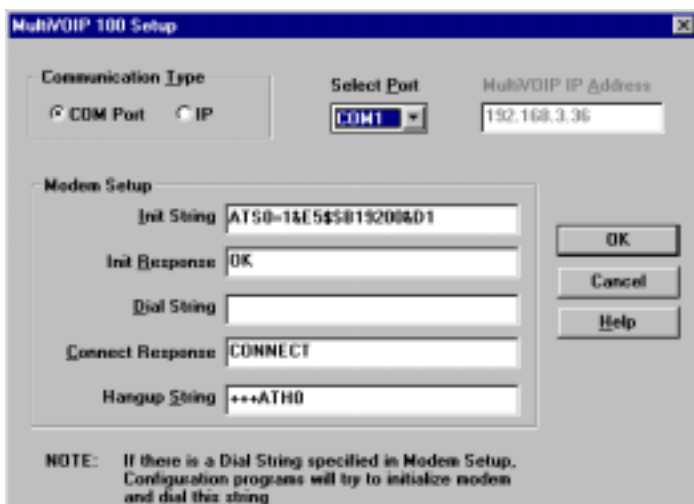

Verify that the **Communication Type** is set for **COM Port** and the COM port of your local PC is selected in the **Select Port** list.

In the **Dial String** box, enter the AT command for dialing (ATDT) plus the phone number of the remote MVP120.

If your Modem Initialization String, Initialization Response, or Connect Response values are different from the defaults in the dialog box, refer to your modem user documentation and change the default values to match your modem.

Click **OK** when you are satisfied with your selections.

6. Run the MVP120 Configuration program. Click **Start | Programs | MultiVOIP 100 | MultiVOIP Configuration**, or double-click the **MultiVOIP Configuration** icon in the MultiVOIP 100 program group.
7. The **Dialing** dialog box displays while software is dialing the remote MultiVOIP.
8. The **Reading Setup** dialog box displays.
9. The **MultiVOIP 100 Setup** menu displays. This is the dialog box of the remote MultiVOIP. Refer to the online Help for a description of the user interface.



10. After you have changed the configuration of the remote MultiVOIP, click **Download Setup** to update the configuration. The remote MultiVOIP will be brought down, the new configuration written to the unit, and the unit will reboot.
11. Click **Exit** when downloading is complete.
12. The **Hangup connection?** dialog box displays.
Click **Yes** to disconnect the phone connection to the remote site.
13. If the same telephone number is not going to be used again in the immediate future, you can remove it from the **Port Setup** dialog box.

LAN-Based

The LAN-based remote configuration requires a Windows Sockets compliant TCP/IP stack. TCP/IP protocol software must be installed and functional before the configuration program can be used.

1. You must assign an Internet (IP) address for the PC and for each node that will be managed by the configuration program. Refer to the protocol software documentation for instructions on how to set the IP addresses. It is recommended that you ping each MultiVOIP to verify the connection and its IP address.

Once you have completed this step, you should be able to use the protocol Ping command for the PC host name. You should also test the network interface configuration by Pinging another TCP/IP device that is connected to the network.

2. Install the MVP120 software on the local PC. When installed, click **Start | Programs | MultiVOIP 100 | Configuration Port Setup**, or double-click the **Configuration Port Setup** icon in the **MultiVOIP 100** program group.
3. The **MultiVOIP Port Setup** dialog box displays.

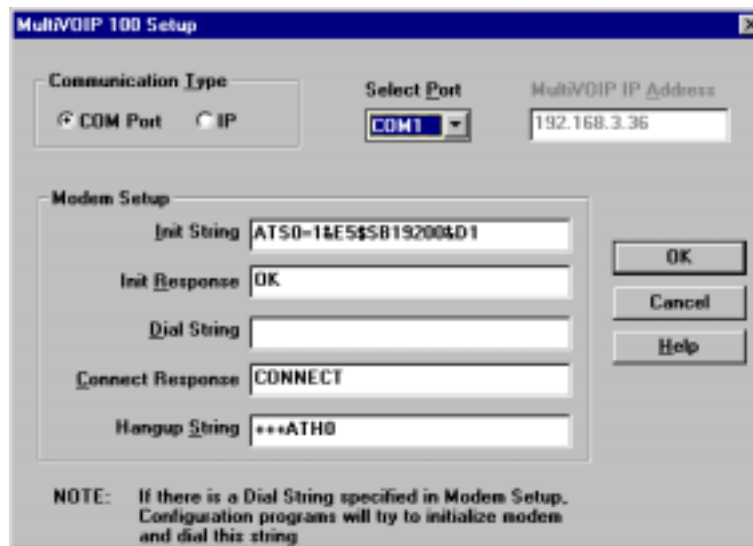

Verify that **IP** is set for the Communication Type.

In the **MultiVOIP IP Address** box, enter the IP Address of the remote MultiVOIP.

4. Click **OK** when you are satisfied with your selections.
5. Run the MultiVOIP Configuration program. Click **Start | Programs | MultiVOIP 100 | MultiVOIP Configuration**, or double-click the **MultiVOIP Configuration** icon in the **MultiVOIP 100** program group.
6. The **MultiVOIP 100 Setup** dialog box displays. This is the dialog box of the remote MultiVOIP. Refer to the online Help provided with your MultiVOIP for the definition of each dialog box and field within a dialog box.



7. After you have changed the configuration of the remote MultiVOIP , click **Download Setup** to update the configuration. The remote MultiVOIP will be brought down, the new configuration written to the unit, and the unit will reboot.
8. Click **Exit** when downloading is complete.
9. Double-click the **MultiVOIP Configuration** icon in the **MultiVOIP 100** program group to verify that the MultiVOIP is running.

Telnet

A typical Telnet client application is described next. The MVP120 has a built-in Telnet Server that enables Telnet client PCs to access the MVP120. A typical Telnet client is allowed to configure the MVP120. In addition, the MVP120 can be remotely accessed and configured from anywhere on the Internet through its Web interface.

The Telnet Server option has to be selected from the **Applications Setup** dialog box using the MultiVOIP 100 Configuration icon. Click **Start | Run** and enter telnet in the Run window and a blank Telnet screen displays. Click **Connect | Remote System** and the **Connect** dialog box displays. Select from the drop-down list (or enter) a **Host Name** (the IP address of the MultiVOIP). Then select **Telnet** from the Port list and **vt100** from the Term Type list.

Once you have entered a valid Host Name (IP address), Port, and Term Type, click **Connect** to be connected to the target MultiVOIP. The MultiVOIP Telnet Server menu displays.

MultiVOIP Telnet Server Menu

The MultiVOIP Telnet Server menu provides three basic options: Voice over IP Configuration, Phone Directory Database, and Phone Directory Configuration. A further option enables you to close the Telnet session.



Voice over IP Configuration

Selecting **Option 1** displays the Main menu, which allows further configuration options. These options include Protocol Stacks (option 1), Applications (option 2), System Information (option 3), and Voice Channels (option 4).

Phone Directory Database

Selecting **Option 2** enables you to add entries to the **Phone Directory Database**.

Phone Directory Configuration

Selecting **Option 3** enables you to configure and manage the **Phone Directory**.

Web Management

The MVP120 can be accessed, via a standard Web browser, from anywhere on the connected Internet. In order to provide this support, the **WEB Server** option has to be enabled from the **Applications Setup** dialog box (see [Chapter 4 - MVP120 Software](#)).

Once enabled, you can access the MVP120 by entering its IP address in your web browser. The following page displays.



If a Password was entered in the **Applications Setup** dialog box, then enter the password and the **Enter**.

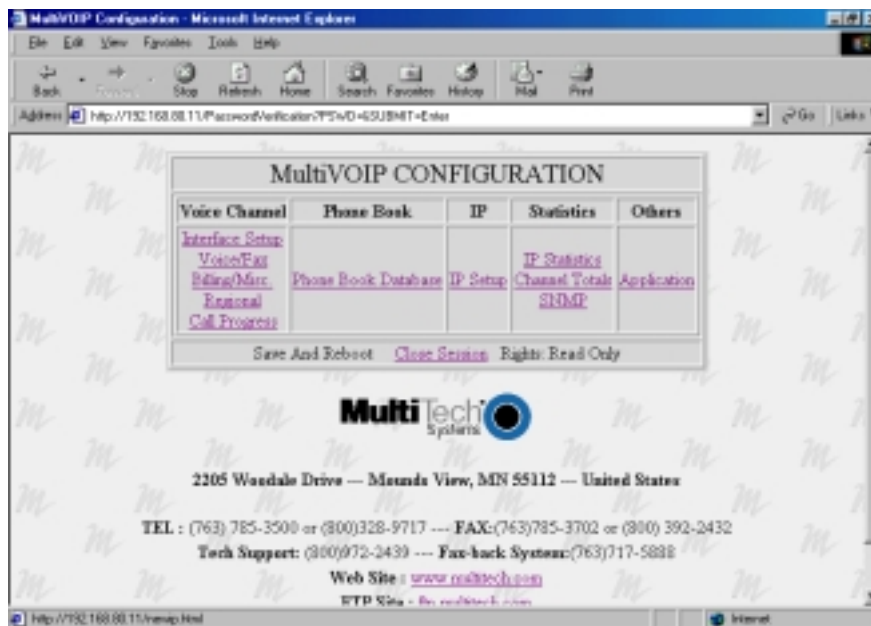

From this page you can access all the configuration options. Refer to [Chapter 4 - MVP120 Software](#), for a description of the configuration options.



Chapter 9

Warranty, Service, and Technical Support

Chapter 9 - Warranty, Service, and Technical Support

This chapter starts out with statements about your MVP120 2-year warranty. The next section, Tech Support, should be read carefully if you have questions or problems with your MVP120. It includes the technical support phone numbers, space for recording your product information, and an explanation of how to send in your MVP120 should you require service. The final section explains how to receive support from the Internet.

Multi-Tech Systems, Inc. Warranty & Repairs Policies

Warranty

Multi-Tech Systems, Inc., (hereafter "MTS") warrants that its products will be free from defects in material or workmanship for a period of two, five, or ten years (depending on model) from date of purchase, or if proof of purchase is not provided, two, five, or ten years (depending on model) from date of shipment.

MTS MAKES NO OTHER WARRANTY, EXPRESS OR IMPLIED, AND ALL IMPLIED WARRANTIES OF MERCHANTABILITY AND FITNESS FOR A PARTICULAR PURPOSE ARE HEREBY DISCLAIMED.

This warranty does not apply to any products which have been damaged by lightning storms, water, or power surges or which have been neglected, altered, abused, used for a purpose other than the one for which they were manufactured, repaired by Customer or any party without MTS's written authorization, or used in any manner inconsistent with MTS's instructions.

MTS's entire obligation under this warranty shall be limited (at MTS's option) to repair or replacement of any products which prove to be defective within the warranty period or, at MTS's option, issuance of a refund of the purchase price. Defective products must be returned by Customer to MTS's factory – transportation prepaid.

MTS WILL NOT BE LIABLE FOR CONSEQUENTIAL DAMAGES, AND UNDER NO CIRCUMSTANCES WILL ITS LIABILITY EXCEED THE PRICE FOR DEFECTIVE PRODUCTS.

Repair Procedures for U.S. and Canadian Customers

In the event that service is required, products may be shipped, freight prepaid, to our Mounds View, Minnesota factory:

Multi-Tech Systems, Inc.
2205 Woodale Drive
Mounds View, MN 55112
Attn: Repairs, Serial # _____

A Returned Materials Authorization (RMA) is not required. Return shipping charges (surface) will be paid by MTS.

Please include, inside the shipping box, a description of the problem, a return shipping address (must have street address, not P.O. Box), your telephone number, and if the product is out of warranty, a check or purchase order for repair charges.

For out of warranty repair charges, go to www.multitech.com/documents/warranties

Extended two-year overnight replacement service agreements are available for selected products. Please call MTS at (888) 288-5470, extension 5308 or visit our web site at

<http://www.multitech.com/programs/orc/> for details on rates and coverage's.

Please direct your questions regarding technical matters, product configuration, verification that the product is defective, etc., to our Technical Support department at (800) 972-2439 or email tsupport@multitech.com. Please direct your questions regarding repair expediting, receiving, shipping, billing, etc., to our Repair Accounting department at (800) 328-9717 or (763) 717-5631, or email mtsrepair@multitech.com.

Repairs for damages caused by lightning storms, water, power surges, incorrect installation, physical abuse, or user-caused damages are billed on a time-plus-materials basis.

Repair Procedures for International Customers (Outside U.S.A. and Canada)

Your original point of purchase Reseller may offer the quickest and most economical repair option for your Multi-Tech product. You may also contact any Multi-Tech sales office for information about the nearest distributor or other repair service for your Multi-Tech product.

<http://www.multitech.com/COMPANY/offices/DEFAULT.ASP>

In the event that factory service is required, products may be shipped, freight prepaid to our Mounds View, Minnesota factory. Recommended international shipment methods are via Federal Express, UPS or DHL courier services, or by airmail parcel post; shipments made by any other method will be refused. A Returned Materials Authorization (RMA) is required for products shipped from outside the U.S.A. and Canada. Please contact us for return authorization and shipping instructions on any International shipments to the U.S.A. Please include, inside the shipping box, a description of the problem, a return shipping address (must have street address, not P.O. Box), your telephone number, and if the product is out of warranty, a check drawn on a U.S. bank or your company's purchase order for repair charges. Repaired units shall be shipped freight collect, unless other arrangements are made in advance.

Please direct your questions regarding technical matters, product configuration, verification that the product is defective, etc., to our Technical Support department nearest you or email tsupport@multitech.com. When calling the U.S., please direct your questions regarding repair expediting, receiving, shipping, billing, etc., to our Repair Accounting department at +(763) 717-5631 in the U.S.A., or email mtsrepair@multitech.com.

Repairs for damages caused by lightning storms, water, power surges, incorrect installation, physical abuse, or user-caused damages are billed on a time-plus-materials basis.

Repair Procedures for International Distributors

Procedures for International Distributors of Multi-Tech products are on the distributor web site.

<http://www.multitech.com/PARTNERS/login/>

Copyright © Multi-Tech Systems, Inc. 2001
10-Sep-01

Service

If your tech support specialist decides that service is required, your MVP120 may be sent (freight prepaid) to our factory. Return shipping charges will be paid by Multi-Tech Systems.

Include the following with your MVP120:

- a description of the problem
- return billing and return shipping addresses
- contact name and phone number
- check or purchase order number for payment if the MVP120 is out of warranty (Check with your technical support specialist for the standard repair charge for your MVP120)
- if possible, note the name of the technical support specialist with whom you spoke

If you need to inquire about the status of the returned product, be prepared to provide the **serial number** of the product sent.

Send your MVP120 to this address:

MULTI-TECH SYSTEMS, INC.
2205 WOODALE DRIVE
MOUNDS VIEW, MINNESOTA 55112
ATTN: SERVICE OR REPAIRS

You should also check with the supplier of your MVP120 on the availability of local service and/or loaner units in your part of the country.

Ordering Accessories

SupplyNet, Inc. supplies replacement transformers, cables and connectors for select Multi-Tech products. You can place an order with SupplyNet via mail, phone, fax or the Internet at:

Mail: SupplyNet, Inc.
614 Corporate Way
Valley Cottage, NY 10989

Phone: 800 826-0279

Fax: 914 267-2420

Email: info@thesupplynet.com

Internet: <http://www.thesupplynet.com>

Technical Support

Multi-Tech has an excellent staff of technical support personnel available to help you get the most out of your Multi-Tech product. If you have any questions about the operation of this unit, call 1-800-972-2439. Please fill out the MVP120 information (below), and have it available when you call. If your MVP120 requires service, the tech support specialist will guide you on how to send it in (refer to the next section).

Recording MVP120 Information

Please fill in the following information on your Multi-Tech MVP120. This will help tech support in answering your questions. (The same information is requested on the Warranty Registration Card.)

Model No.: _____

Serial No.: _____

Software Version: _____

The model and serial numbers are on the bottom of your MVP120.

Please note status of your MVP120 including LED indicators, screen messages, diagnostic test results, problems with a specific application, etc. Use the space below to note the MVP120 status:

About the Internet

Multi-Tech's presence includes a Web site at:

<http://www.multitech.com>



Appendixes



Appendix A - TCP/IP Description

TCP/IP (Transmission Control Protocol/Internet Protocol) is a protocol suite and related applications developed for the U.S. Department of Defense in the 1970s and 1980s specifically to permit different types of computers to communicate and exchange information with one another. TCP/IP is currently mandated as an official U.S. Department of Defense protocol and is also widely used in the UNIX community.

Before you install TCP/IP on your network, you need to establish your Internet addressing strategy. First, choose a domain name for your company. A domain name is the unique Internet name, usually the name of your business, that identifies your company. For example, Multi-Tech's domain name is multitech.com (.com indicates this is a commercial organization; .edu denotes educational organizations, .gov denotes government organizations). Next, determine how many IP addresses you'll need. This depends on how many individual network segments you have, and how many systems on each segment need to be connected to the Internet. You'll need an IP address for each network interface on each computer and hardware device.

IP addresses are 32 bits long and come in two types: network and host. Network addresses come in five classes: A, B, C, D, and E. Each class of network address is allocated a certain number of host addresses. For example, a class B network can have a maximum of 65,534 hosts, while a class C network can have only 254. The class A and B addresses have been exhausted, and the class D and E addresses are reserved for special use. Consequently, companies now seeking an Internet connection are limited to class C addresses.

Early IP implementations ran on hosts commonly interconnected by Ethernet local area networks (LAN). Every transmission on the LAN contains the local network, or medium access control (MAC), address of the source and destination nodes. The MAC address is 48-bits in length and is non-hierarchical; MAC addresses are never the same as IP addresses.

When a host needs to send a datagram to another host on the same network, the sending application must know both the IP and MAC addresses of the intended receiver. Unfortunately, the IP process may not know the MAC address of the receiver. The Address Resolution Protocol (ARP), described in RFC 826 (located at <ftp://ds.internic.net/rfc/rfc826.txt>) provides a mechanism for a host to determine a receiver's MAC address from the IP address. In the process, the host sends an ARP packet in a frame containing the MAC broadcast address; and then the ARP request advertises the destination IP address and asks for the associated MAC address. The station on the LAN that recognizes its own IP address will send an ARP response with its own MAC address. An ARP message is carried directly in an IP datagram.

Other address resolution procedures have also been defined, including those which allow a diskless processor to determine its IP address from its MAC address (Reverse ARP, or RARP), provides a mapping between an IP address and a frame relay virtual circuit identifier (Inverse ARP, or InARP), and provides a mapping between an IP address and ATM virtual path/channel identifiers (ATMARP).

The TCP/IP protocol suite comprises two protocols that correspond roughly to the OSI Transport and Session Layers; these protocols are called the Transmission Control Protocol and the User Datagram Protocol (UDP). Individual applications are referred to by a port identifier in TCP/UDP messages. The port identifier and IP address together form a "socket". Well-known port numbers on the server side of a connection include 20 (FTP data transfer), 21 (FTP control), 23 (Telnet), 25 (SMTP), 43 (whois), 70 (Gopher), 79 (finger), and 80 (HTTP).

TCP, described in RFC 793 (<ftp://ds.internic.net/rfc/rfc793.txt>) provides a virtual circuit (connection-oriented) communication service across the network. TCP includes rules for formatting messages, establishing and terminating virtual circuits, sequencing, flow control, and error correction. Most of the applications in the TCP/IP suite operate over the "reliable" transport service provided by TCP.

UDP, described in RFC 768 (<ftp://ds.internic.net/rfc/rfc768.txt>) provides an end-to-end datagram (connectionless) service. Some applications, such as those that involve a simple query and response, are better suited to the datagram service of UDP because there is no time lost to virtual circuit establishment and termination. UDP's primary function is to add a port number to the IP address to provide a socket for the application.

The Application Layer protocols are examples of common TCP/IP applications and utilities, which include:

- Telnet (Telecommunication Network): a virtual terminal protocol allowing a user logged on to one TCP/IP host to access other hosts on the network, described in RFC 854 (<ftp://ds.internic.net/rfc/rfc854.txt>).
- FTP: the File Transfer Protocol allows a user to transfer files between local and remote host computers per IETF RFC 959 (<ftp://ds.internic.net/rfc/rfc959.txt>).
- Archie: a utility that allows a user to search all registered anonymous FTP sites for files on a specified topic.
- Gopher: a tool that allows users to search through data repositories using a menu-driven, hierarchical interface, with links to other sites, per RFC 1436 (<ftp://ds.internic.net/rfc/rfc1436.txt>).
- SMTP: the Simple Mail Transfer Protocol is the standard protocol for the exchange of electronic mail over the Internet, per IETF RFC 821 (<ftp://ds.internic.net/rfc/rfc821.txt>).
- HTTP: the Hypertext Transfer Protocol is the basis for exchange of information over the World Wide Web (WWW). Various versions of HTTP are in use over the Internet, with HTTP version 1.0 (per RFC 1945) (<ftp://ds.internic.net/rfc/rfc1945.txt>) being the most current.
- HTML: WWW pages are written in the Hypertext Markup Language (HTML), an ASCII-based, platform-independent formatting language, per IETF RFC 1866 (<ftp://ds.internic.net/rfc/rfc1866.txt>).
- Finger: used to determine the status of other hosts and/or users, per IETF RFC 1288 (<ftp://ds.internic.net/rfc/rfc1288.txt>).
- POP: the Post Office Protocol defines a simple interface between a user's mail reader software and an electronic mail server; the current version is POP3, described in IETF RFC 1460 (<ftp://ds.internic.net/rfc/rfc1460.txt>).
- DNS: the Domain Name System defines the structure of Internet names and their association with IP addresses, as well as the association of mail, name, and other servers with domains.
- SNMP: the Simple Network Management Protocol defines procedures and management information databases for managing TCP/IP-based network devices. SNMP, defined by RFC 1157 (<ftp://ds.internic.net/rfc/rfc1157.txt>) is widely deployed in local and wide area network. SNMP Version 2 (SNMPv2), per RFC 1441 (<ftp://ds.internic.net/rfc/rfc1441.txt>) adds security mechanisms that are missing in SNMP, but is also more complex.
- Ping: a utility that allows a user at one system to determine the status of other hosts and the latency in getting a message to that host. Ping uses ICMP Echo messages.
- Whois/NICNAME: Utilities that search databases for information about Internet domain and domain contact information, per RFC 954 (<ftp://ds.internic.net/rfc/rfc954.txt>).
- Traceroute: a tool that displays the route that packets will take when traveling to a remote host.

Internet Protocol (IP)

IP is the Internet standard protocol that tracks Internetwork node addresses, routes outgoing messages and recognizes incoming messages, allowing a message to cross multiple networks on the way to its final destination. The IPv6 Control Protocol (IPV6CP) is responsible for configuring, enabling, and disabling the IPv6 protocol modules on both ends of the point-to-point link. IPV6CP uses the same packet exchange mechanism as the Link Control Protocol (LCP). IPV6CP packets are not exchanged until PPP has reached the Network-Layer Protocol phase. IPV6CP packets received before this phase is reached are silently discarded. (See also TCP/IP.)

Before you install TCP/IP on your network, you need to establish your Internet addressing strategy. You first choose a domain name for your company. A domain name is the unique Internet name, usually the name of your business, that identifies your company. For example, Multi-Tech's domain name is multitech.com (where .com indicates this is a commercial organization; .edu denotes educational organizations, .gov denotes government organizations). Next, you determine how many IP addresses you'll need. This depends on how many individual network segments you have, and how many systems on each segment need to be connected to the Internet. You need an IP address for each network interface on each computer and hardware device.

IP addresses are 32 bits long and come in two types: network and host. Network addresses come in five classes: A, B, C, D, and E. Each class of network address is allocated a certain number of host addresses. For example, a class B network can have a maximum of 65,534 hosts, while a class C network can have only 254. The class A and B addresses have been exhausted, and the class D and E addresses are reserved for special use. Consequently, companies now seeking an Internet connection are limited to class C addresses. The current demand for Internet connections will exhaust the current stock of 32-bit IP addresses. In response, Internet architects have proposed the next generation of IP addresses, Ipng (IP Next Generation). It features 16-byte addressing, surpassing the capacities of 32-bit IP.

An IP address can serve only a single physical network. Therefore, if your organization has multiple physical networks, you must make them appear as one to external users. This is done via "subnetting", a complex procedure best left to ISPs and others experienced in IP addressing. Since IP addresses and domain names have no inherent connection, they are mapped together in databases stored on Domain Name Servers (DNS). If you decide to let an Internet Service Provider (ISP) administer your DNS server, the ISP can assist you with the domain name and IP address assignment necessary to configure your company's site-specific system information. Domain names and IP addresses are granted by the InterNIC. To check the availability of a specific name or to obtain more information, call the InterNIC at (703)742-4777.

Appendix B - Cabling Diagrams

Command Port Cable

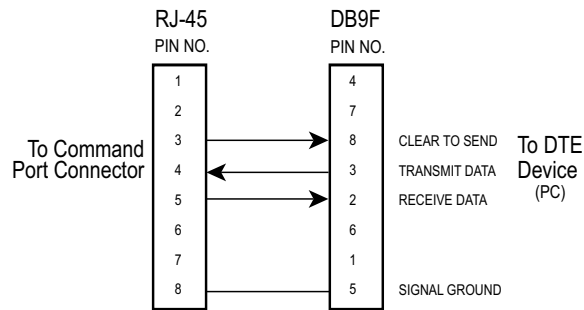
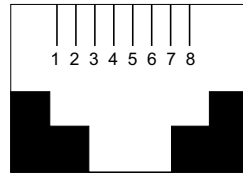

LAN Cable

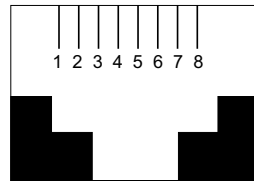

Pin	Circuit Signal Name
1	TD+ Data Transmit Positive
2	TD- Data Transmit Negative
3	RD+ Data Receive Positive
6	RD- Data Receive Negative

Phone Connector

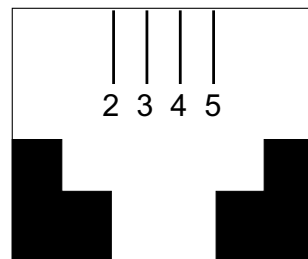

Pin Connections

FXO	Description
2	N/C
3	Tip
4	Ring
5	N/C

Remote Configuration Cable

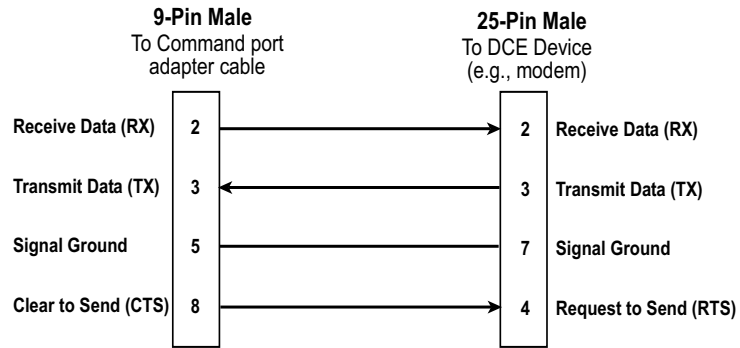

Appendix C - Regulatory Information

Class A Statement

FCC Part 15

NOTE: This equipment has been tested and found to comply with the limits for a **Class A** digital device, pursuant to Part 15 of the FCC Rules. These limits are designed to provide reasonable protection against harmful interference when the equipment is operated in a commercial environment. This equipment generates, uses and can radiate radio frequency energy and, if not installed and used in accordance with the instruction manual, may cause harmful interference to radio communications. Operation of this equipment in a residential area is likely to cause harmful interference, in which case the user will be required to correct the interference at his own expense.

This device complies with Part 15 of the FCC rules.
Operation is subject to the following two conditions:

- (1) This device may not cause harmful interference.
- (2) This device must accept any interference that may cause undesired operation.

Warning: Changes or modifications to this unit not expressly approved by the party responsible for compliance could void the user's authority to operate the equipment.

Industry Canada

This **Class A** digital apparatus meets all requirements of the Canadian Interference-Causing Equipment Regulations.

Cet appareil numérique de la classe A respecte toutes les exigences du Règlement sur le matériel brouilleur du Canada.

Fax Branding Statement

The Telephone Consumer Protection Act of 1991 makes it unlawful for any person to use a computer or other electronic device, including fax machines, to send any message unless such message clearly contains the following information:

- Date and time the message is sent
- Identification of the business or other entity, or other individual sending the message
- Phone number of the sending machine or such business, other entity, or individual

This information is to appear in a margin at the top or bottom of each transmitted page or on the first page of the transmission. (Adding this information in the margin is referred to as fax branding.)

Since any number of Fax software packages can be used with this product, the user must refer to the Fax software manual for setup details. Typically, the Fax branding information must be entered via the configuration menu of the software.

FCC Part 68 Telecom

1. This equipment complies with Part 68 of the Federal Communications Commission (FCC) rules. On the outside surface of this equipment is a label that contains, among other information, the FCC registration number and ringer equivalence number (REN). If requested, this information must be provided to the telephone company.
2. As indicated below, the suitable jack (Universal Service Order Code connecting arrangement) for this equipment is shown. If applicable, the facility interface codes (FIC) and service order codes (SOC) are shown. An FCC-compliant telephone cord and modular plug is provided with this equipment. This equipment is designed to be connected to the telephone network or premises wiring using a compatible modular jack which is Part 68 compliant. See installation instructions for details.
3. The ringer equivalence number (REN) is used to determine the number of devices which may be connected to the telephone line. Excessive REN's on the telephone line may result in the devices not ringing in response to an incoming call. In most, but not all areas, the sum of the REN's should not exceed five (5.0). To be certain of the number of devices that may be connected to the line, as determined by the total REN's, contact the telephone company to determine the maximum REN for the calling area.
4. If this equipment causes harm to the telephone network, the telephone company will notify you in advance that temporary discontinuance of service may be required. But if advance notice isn't practical, the telephone company will notify the customer as soon as possible. Also, you will be advised of your right to file a complaint with the FCC if you believe it is necessary.
5. The telephone company may make changes in its facilities, equipment, operations, or procedures that could affect the operation of the equipment. If this happens, the telephone company will provide advance notice in order for you to make necessary modifications in order to maintain uninterrupted service.
6. If trouble is experienced with this equipment (the model of which is indicated below) please contact Multi-Tech Systems, Inc., at the address shown below for details of how to have repairs made. If the equipment is causing harm to the telephone network, the telephone company may request that you remove the equipment from the network until the problem is resolved.
7. No repairs are to be made by you. Repairs are to be made only by Multi-Tech Systems or its licensees. Unauthorized repairs void registration and warranty.
8. This equipment cannot be used on public coin service provided by the telephone company. Connection to Party Line Service is subject to state tariffs. (Contact the state public utility commission, public service commission or corporation commission for information.)
9. If so required, this equipment is hearing-aid compatible.

Manufacturer:	Multi-Tech Systems, Inc.
Trade name:	MultiVOIP
Model Numbers:	MVP120
FCC Registration Number:	AU7USA-25715-DF-N
Modular Jack (USOC):	RJ-11C or RJ-11W
Service Center in U.S.A.:	Multi-Tech Systems Inc. 2205 Woodale Drive Mounds View, MN 55112 (763) 785-3500 Fax (763) 785-9874

Canadian Limitations Notice

Ringer Equivalence Number

Notice: The ringer equivalence number (REN) assigned to each terminal device provides an indication of the maximum number of terminals allowed to be connected to a phone interface. The termination on an interface may consist of any combination of devices subject only to the requirement that the sum of the ringer equivalence numbers of all the devices does not exceed 5.

Notice: The Industry Canada label identifies certified equipment. This certification means that the equipment meets certain telecommunications network protective, operational and safety requirements. The Department does not guarantee the equipment will operate to the user's satisfaction.

Before installing this equipment, users should ensure that it is permissible to be connected to the facilities of the local telecommunications company. The equipment must also be installed using an acceptable method of connection. The customer should be aware that compliance with the above conditions may not prevent degradation of service in some situations. Repairs to certified equipment should be made by an authorized Canadian maintenance facility designated by the supplier. Any repairs or alterations made by the user to this equipment, or equipment malfunctions, may give the telecommunications company cause to request the user to disconnect the equipment.

Users should ensure for their own protection that the electrical ground connections of the power utility, phone lines and internal metallic water pipe system, if present, are connected together. This precaution may be particularly important in rural areas.

Caution: Users should not attempt to make such connections themselves, but should contact the appropriate electric inspection authority, or electrician, as appropriate.



EMC, Safety and Terminal Directive Compliance

The CE mark is affixed to this product to confirm compliance with the following European Community Directives:

Council Directive 89/336/EEC of 3 May 1989 on the approximation of the laws of Member States relating to electromagnetic compatibility.

and

Council Directive 73/23/EEC of 19 February 1973 on the harmonization of the laws of Member States relating to electrical equipment designed for use within certain voltage limits:

and

Council Directive 98/13/EC of 12 March 1998 on the approximation of the laws of Member States concerning telecommunications terminal and Satellite earth station equipment.



Glossary

Glossary

A

Access: The T1 line element made up of two pairs of wire that the phone company brings to the customer premises. The Access portion ends with a connection at the local telco (LEC or RBOC).

Accunet Spectrum of Digital Services (ASDS): The AT&T 56K bps leased (private) line service. Similar to services of MCI and Sprint. ASDS is available in $n \times 56/64K$ bps, where $n=1, 2, 4, 6, 8, 12$.

ACK (ACKnowledgement code) (pronounced "ack"): A communications code sent from a receiving modem to a transmitting modem to indicate that it is ready to accept data. It is also used to acknowledge the error-free receipt of transmitted data. Contrast with NAK.

Adaptive Differential Pulse Code (ADCPM): In multimedia applications, a technique in which pulse code modulation samples are compressed before they are stored on a disk. ADCPM, an extension of the PCM format, is a standard encoding format for storing audio information in a digital format. It reduced storage requirements by storing differences between successive digital samples rather than full values.

Address: A numbered location inside a computer. It's how the computer accesses its resources, like a video card, serial ports, memory, etc.

AMI line coding: One of two common methods of T1 line coding (with B8ZS). AMI line coding places restrictions on user data (B8ZS does not).

Analog signal: A waveform which has amplitude, frequency and phase, and which takes on a range of values between its maximum and minimum points.

Analog Transmission: One of two types of telecommunications which uses an analog signal as a carrier of voice, data, video, etc. An analog signal becomes a carrier when it is modulated by altering its phase, amplitude and frequency to correspond with the source signal. Compare with digital transmission.

Application Program Interface (API): A software module created to allow dissimilar, or incompatible applications programs to transfer information over a communications link. APIs may be simple or complex; they are commonly required to link PC applications with mainframe programs.

ASCII (American Standard Code for Information Interchange) (pronounced "askey"): A binary code for data that is used in communications and in many computers and terminals. The code is used to represent numbers, letters, punctuation and control characters. The basic ASCII code is a 7-bit character set which defines 128 possible characters. The extended ASCII file provides 255 characters.

Asynchronous Transfer Mode (ATM): A very high-speed method of transmission that uses fixed-size cells of 53 bytes to transfer information over fiber; also known as cell relay.

AT Commands: A standard set of commands used to configure various modem parameters, establish connections and disconnect. The "AT" is used to get the "attention" of the modem before the actual command is issued.

Availability: The measure of the time during which a circuit is ready for use; the complement of circuit "outage" (100% minus % outage = % available).

B

B7ZS (Bipolar 7 Zero Suppression) line coding: One method of T1 line coding (see also "B8ZS" and "AMI"). B7ZS line coding does not place restrictions on user data (AMI does).

B8ZS (Bipolar 8 Zero Suppression) line coding: One of two common methods of T1 line coding (with AMI). B8ZS line coding does not place restrictions on user data (AMI does). A coding method used to produce 64K bps "clear" transmission. (See also "B7ZS" and "AMI" line coding)

Backbone: 1. A set of nodes and their interconnecting links providing the primary data path across a network. 2. In a local area network multiple-bridge ring configuration, a high-speed link to which the rings are connected by means of bridges. A backbone may be configured as a bus or as a ring. 3. In a wide area network, a high-speed link to which nodes or data switching exchanges (DSEs) are connected. 4. A common distribution core that provides all electrical power, gases, chemicals, and other services to the sectors of an automated wager processing system.

Background: An activity that takes place in the PC while you are running another application. In other words, the active user interface does not correspond to the 'background' task.

Bandwidth: The transmission capacity of a computer channel, communications line or bus. It is expressed in cycles per second (hertz), the bandwidth being the difference between the lowest and highest frequencies transmitted. The range of usable frequencies that a transmission medium will pass without unacceptable attenuation or distortion. Bandwidth is a factor in determining the amount of information and the speed at which a medium can transmit data or other information.

Backward Explicit Congestion Notification (BECN): A bit that tells you that a certain frame on a particular logical connection has encountered heavy traffic. The bit provides notification that congestion-avoidance procedures should be initiated in the opposite direction of the received frame. See also FECN (Forward Explicit Congestion Notification).

Basic Rate Interface (BRI): An ISDN access interface type comprised of two B-channels each at 64K bps and one D-channel at 64K bps (2B+D).

Bell Operating Companies (BOC): The family of corporations created during the divestiture of AT&T. BOCs are independent companies which service a specific region of the US. Also called Regional Bell Operating Companies (RBOCs).

Bell Pub 41450: The Bell publication defining requirements for data format conversion, line conditioning, and termination for direct DDS connection.

Bell Pub 62310: The Bell publication defining requirements for data format conversion, line conditioning, and termination for direct DDS connection.

Binary Synchronous Communication (BSC): A form of telecommunication line control that uses a standard set of transmission control characters and control character sequences, for binary synchronous transmission of binary-coded data between stations.

Bit (Binary digIT): A bit is the basis of the binary number system. It can take the value of 1 or 0. Bits are generally recognized as the electrical charge generated or stored by a computer that represent some portion of usable information.

Bit Error Rate Test (BERT): A device or routine that measures the quality of data transmission. A known bit pattern is transmitted, and the errors received are counted and a BER (bit error rate) is calculated. The BER is the ratio of received bits in error relative to the total number of bits received, expressed in a power of 10.

Bit robbing: The use of the least significant bit per channel in every sixth frame for signaling. The line signal bits "robbed" from the speech path conveys sufficient pre-ISDN telephony signaling information with the remaining line signal bits providing sufficient line signaling bits for recreating the original sound. See "robbed bit signaling".

Blue Alarm: An error indication signal consisting of all 1s indicating disconnection or attached device failure. Contrast "Red Alarm" and "Yellow Alarm".

Bps (bits per second): A unit to measure the speed at which data bits can be transmitted or received. Bps differs from baud when more than one bit is represented by a single cycle of the carrier.

Bridges: 1. A functional unit that interconnects two local area networks that use the same logical link protocol but may use different medium access control protocols. 2. A functional unit that interconnects multiple LANs (locally or remotely) that use the same logical link control protocol but that can use different medium access control protocols. A bridge forwards a frame to another bridge based on the medium access control (MAC) address. 3. In the connection of local loops, channels, or rings, the equipment and techniques used to match circuits and to facilitate accurate data transmission.

Buffer: A temporary storage register or Random Access Memory (RAM) used in all aspects of data communications which prevents data from being lost due to differences in transmission speed. Keyboards, serial ports, muxes and printers are a few examples of the devices that contain buffers.

Bus: A common channel between hardware devices either internally between components in a computer, or externally between stations in a communications network.

Byte: The unit of information a computer can handle at one time. The most common understanding is that a byte consists of 8 binary digits (bits), because that's what computers can handle. A byte holds the equivalent of a single character (such as the letter A).

C

Call Setup Time: The time to establish a circuit-switched call between two points. Includes dialing, wait time, and CO/long distance service movement time.

Carrier Group Alarm (CGA): A T1 service alarm generated by a channel bank when an OOF condition occurs for a predefined length of time (usually 300mS to 2.5 seconds). The CGA causes the calls using a trunk to be dropped and for trunk conditioning to be applied.

Carrier signal: An analog signal with known frequency, amplitude and phase characteristics used as a transport facility for useful information. By knowing the original characteristics, a receiver can interpret any changes as modulations, and thereby recover the information.

CCITT (Consultative Committee for International Telephone and Telegraph): An advisory committee created and controlled by the United Nations and headquartered in Geneva whose purpose is to develop and to publish recommendations for worldwide standardization of telecommunications devices. CCITT has developed modem standards that are adapted primarily by PTT (post, telephone and telegraph) organizations that operate telephone networks of countries outside of the U.S. See also ITU.

Central Office (CO): The lowest, or most basic level of switching in the PSTN (public switched telephone network). A business PABX or any residential phone connects to the PSTN at a central office.

Centrex: A multi-line service offered by operating telcos which provides, from the telco CO, functions and features comparable to those of a PBX for large business users. See also "Private Branch Exchange", "Exchange".

Channel: A data communications path between two computer devices. Can refer to a physical medium (e.g., UTP or coax), or to a specific carrier frequency.

Channel bank: A device that acts as a converter, taking the digital signal from the T1 line into a phone system and converting it to the analog signals used by the phone system. A channel bank acts as a multiplexer, placing many slow-speed voice or data transactions on a single high-speed link.

Circuit-switched Network: A technology used by the PSTN that allocates a pair of conductors for the exclusive use of one communication path. Circuit switching allows multiple conversations on one talk path only if the end-users multiplex the signals prior to transmission.

Circuit switching: The temporary connection of two or more communications channels using a fixed, non-shareable path through the network. Users have full use of the circuit until the connection is terminated.

Clear Channel: A transmission path where the full bandwidth is used (i.e., no bandwidth needed for signaling, carrier framing or control bits). A 64K bps digital circuit usually has 8K bps used for signaling. ISDN has two 64K bps circuits, and a 16K bps packet service of which part is used for signaling on the 64K channels.

Client-Server: In TCP/IP, the model of interaction in distributed data processing in which a program at one site sends a request to a program at another site and awaits a response. The requesting program is called a client; the answering program is called a server.

Cluster Controller: A device that can control the input/output operations of more than one device connected to it. A cluster controller may be controlled by a program stored and executed in the unit, or it may be entirely controlled by hardware.

CODEC (COmpression/DEcompression): The term is used to describe the conversion of voice signals from their analog form to digital signals acceptable to modern digital PBXs and digital transmission systems. It then converts those digital signals back to analog so that you can hear and understand what the other person is saying. In some phone systems, the CODEC is in the PBX and shared by many analog phone extensions. In other phone systems, the CODEC is actually in the phone. Thus the phone itself sends out a digital signal and can, as a result, be more easily designed to accept a digital RS-232-C signal.

Committed Burst Size: The maximum number of bits that the frame relay network agrees to transfer during any measurement interval

Committed Information Rate (CIR): An agreement a customer makes to use a certain minimum data transmission rate (in bps). The CIR is part of the frame relay service monthly billing, along with actual usage, that users pay to their frame relay service provider.

Compression: 1. The process of eliminating gaps, empty fields, redundancies, and unnecessary data to shorten the length of records or blocks. 2. In SNA, the replacement of a string of up to 64-repeated characters by an encoded control byte to reduce the length of the data stream to the LU-LU session partner. The encoded control byte is followed by the character that was repeated (unless that character is the prime compression character). 3. In Data Facility Hierarchical Storage Manager, the process of moving data instead of allocated space during migration and recall in order to release unused space. 4. Contrast with decompression.

COMx Port: A serial communications port on a PC.

Congestion: A network condition where there is too much data traffic. The ITU I.233 standard defines congestion management in terms of speed and burstiness.

Congestion notification: The function in frame relay that ensures that user data transmitted at a rate higher than the CIR are allowed to slow down to the rate of the available network bandwidth.

Consecutive Severely Errored Seconds (CSES): An error condition that occurs when from 3 to 9 SES (Severely Errored Seconds) are logged consecutively.

Customer Premise Equipment (CPE): The generic term for data comm and/or terminal equipment that resides at the user site and is owned by the user with the following exclusions: Over voltage protection equipment, inside wiring, coin operated or pay telephones, "company-official" equipment, mobile phone equipment, "911" equipment, equipment necessary for the provision of communications for national defense, or multiplexing equipment used to deliver multiple channels to the customer.

D

D4: the T1 4th generation channel bank.

D4 channelization: Refers to the compliance with AT&T TR 62411 for DS1 frame layout.

D4 framing: The T1 format for framing in AT&T D-Series channel banks, in which there are 12 separate 193-bit frames in a super-frame. A D4 framing bit is used to identify the channel and the signaling frame. Signalling for voice channels is carried in-band for every channel, along with the encoded voice. See "robbed-bit signaling".

Data Communications Equipment (DCE): Any device which serves as the portal of entry from the user equipment to a telecommunications facility. A modem is a DCE for the phone network (PSTN) that is commonly on site at the user's premises. Packet Switched Networks have another level of DCE which is most often located at a central office.

Data Link Connection Identifier (DLCI): One of the six components of a frame relay frame. Its purpose is to distinguish separate virtual circuits across each access connection. Data coming into a frame relay node is thus allowed to be sent across the interface to the specified "address". The DLCI is confirmed and relayed to its destination, or if the specification is in error, the frame is discarded.

Dataphone Digital Service (DDS): A private line digital service that offers 2400, 4800, 9600 and 56K bps data rates on an inter-LATA basis by AT&T and on an intra-LATA basis by the BOCs.

Data Service Unit (DSU): A device that provides a digital data service interface directly to the data terminal equipment. The DSU provides loop equalization, remote and local testing capabilities, and a standard EIA/CCITT interface.

Dedicated Line: A communication line that is not switched. The term leased line is more common.

Default: This is a preset value or option in software packages, or in hardware configuration, that is used unless you specify otherwise.

Device driver: Software that controls how a computer communicates with a device, such as a printer or mouse.

Digital Cross-connect System (DCS): The CO device which splits and redistributes the T1 bandwidth. The DCS takes time slots from various T1 lines and alters them to provide the needed connectivity. DCS connections are made with software at an administrator's workstation.

Digital Data: Information represented by discrete values or conditions (contrast "Analog Data").

Digital Loopback: A technique used for testing the circuitry of a communications device. Can be initiated locally, or remotely (via a telecommunications device). The tested device decodes and encodes a received test message, then echoes the message back. The results are compared with the original message to determine if corruption occurred en route.

Digital PBX: A Private Branch Exchange that operates internally on digital signals. See also "Exchange".

Digital Service, level 0 (DS0): The world-wide standard speed (64K bps) for digital voice conversation using PCM (pulse coded modulation).

Digital Service, level 1 (DS1): The 1.544M bps voice standard (derived from an older Bell System standard) for digitized voice transmission in North America. The 1.544M bps consists of 24 digitally-encoded 64K bps voice channels (north America) and 2.048M bps (30 channels) elsewhere.

Digital Signal: A discrete or discontinuous signal (e.g., a sequence of voltage pulses). Digital devices, such as terminals and computers, transmit data as a series of electrical pulses which have discrete jumps rather than gradual changes.

Digital Signaling Rates (DSn): A hierarchical system for transmission rates, where "DS0" is 64K bps (equivalent to ISDN B channel), and DS1 is 1.5 Mbps (equivalent to ISDN PRI).

Digital Transmission: A method of electronic information transmission common between computers and other digital devices. Analog signals are waveforms: a combination of many possible voltages. A computer's digital signal may be only "high" or "low" at any given time. Therefore, digital signals may be "cleaned up" (noise and distortion removed) and amplified during transmission.

Digitize: To convert an analog signal to a digital signal.

DIP switch (pronounced "dip switch"): A set of tiny toggle switches, built into a DIP (dual in-line package), used for setting configurable parameters on a PCB (printed circuit board).

Driver: A software module that interfaces between the Operating System and a specific hardware device (i.e. color monitors, printers, hard disks, etc.). Also known as a device driver.

Drop and Insert: The process where a portion of information carried in a transmission system is demodulated ("Dropped") at an intermediate point and different information is included ("Inserted") for subsequent transmission.

DTE (Data Terminating Equipment): A term used to include any device in a network which generates, stores or displays user information. DTE is a telecommunications term which usually refers to PCs, terminals, printers, etc.

DTMF (Dual-Tone MultiFrequency): A generic push-button concept made popular by AT&T TouchTone.

E

E1: The European equivalent of the North American 1.544M bps T-1, except that E-1 carries 2.048M bps. It is characterized by thirty 64 Kbps digital channels for voice or data calls, plus a 64 Kbps channel for signaling and a 64 Kbps channel for framing (synchronization) and maintenance.

E&M: A telephony trunking system used for either switch-to-switch, or switch-to-network, or computer/telephone system-to-switch connection.

EIA: The Electronics Industries Association is a trade organization in Washington, DC that sets standard for use of its member companies. (See RS-232, RS-422, RS530.)

Encapsulation: A technique used by network-layer protocols in which a layer adds header information to the protocol data unit from the preceding layer. Also used in "enveloping" one protocol inside another for transmission. For example, IP inside IPX.

Endpoint: The clients in an H.323 network. They are typically video conferencing, audio conferencing, or other multimedia systems implemented by end users to communicate in real time. The H.323 standard requires that every endpoint support certain functions and codecs (Coder/Decoder) that have previously been defined by the ITU.

Errored Seconds (ES): Any second of operation that all 1.544M bits are not received exactly as transmitted. Contrast "Error Free Seconds".

Error Free Seconds (EFS): Any second of operation that all 1.544M bits are received exactly as transmitted. Contrast "Errored Seconds".

ESF Error Event: A T1 error condition that is logged when a CRC-6 error or an OOF error occurs.

Ethernet: A 10-megabit baseband local area network that allows multiple stations to access the transmission medium at will without prior coordination, avoids contention by using carrier sense and deference, and resolves contention by using collision detection and transmission. Ethernet uses carrier sense multiple access with collision detection (CSMA/CD).

Excess Zeros: A T1 error condition that is logged when more than 15 consecutive 0s or less than one 1 bit in 16 bits occurs.

Exchange: A unit (public or private) that can consist of one or more central offices established to serve a specified area. An exchange typically has a single rate of charges (tariffs) that has previously been approved by a regulatory group.

Exchange Area: A geographical area with a single uniform set of charges (tariffs), approved by a regulatory group, for phone services. Calls between any two points within an exchange area are local calls. See also "Digital PBX", "PBX".

Exchange Termination (ET): The carrier's local exchange switch. Contrast with "Loop Termination - LT".

Explicit Congestion Management: The method used in frame relay to notify the terminal equipment that the network is overly busy. The use of FECN and BECN is called explicit congestion management. Some end-to-end protocols use FECN or BECN, but usually not both options together. With this method, a congestion condition is identified and fixed before it becomes critical. Contrast with "implicit congestion".

Extended Super Frame (ESF): One of two popular formats for framing bits on a T1 line. ESF framing has a 24-frame super-frame, where robbed bit signaling is inserted in the LSB (bit 8 of the DS-0 byte) of frames 6, 12, 18 and 24. ESF has more T1 error measurement capabilities than D4 framing. ESF and B8ZS are typically both offered to provide clear channel service.

F

Failed Seconds: A test parameter where the circuit is unavailable for one full second.

Failed Signal: A T1 test parameter logged when there are more than 9 SES (Severely Errored Seconds).

Fax (facsimile): Refers to the bit-mapped rendition of a graphics-oriented document (fax) or to the electronic transmission of the image over phone lines (faxing). Fax transmission differs from data transmission in that the former is a bit-mapped approximation of a graphical document and, therefore, cannot be accurately interpreted according to any character code.

Firmware: A category of memory chips that hold their content without electrical power, they include ROM, PROM, EPROM and EEPROM technologies. Firmware becomes "hard software" when holding program code.

Foreground: The application program currently running on and in control of the PC screen and keyboard. The area of the screen that occupies the active window. Compare with "background".

Fractional T1 (FT1): A digital data transmission rate between 56K bps (DS0 rate) and 1.544M bps (the full T1 rate - in North America). FT1 is typically provided on 4-wire (two copper pairs) UTP. Often used for video conferencing, imaging and LAN interconnection due to its low cost and relatively high speed. FT1 rates are offered in 64K bps multiples, usually up to 768K bps.

Frequency: A characteristic of an electrical or electronic signal which describes the periodic recurrence of cycles. Frequency is inversely proportional to the wavelength or pulse width of the signal (i.e., long wavelength signals have low frequencies and short wavelength signals yield high frequencies).

Foreign Exchange (FX): A CO trunk with access to a distant CO, allowing ease of access and flat-rate calls anywhere in the foreign exchange area.

Foreign Exchange Office (FXO): provides local phone service from a CO outside of ("foreign" to) the subscriber's exchange area. In simple form, a user can pick up the phone in one city and receive a tone in the foreign city.

Connecting a POTS phone to a computer telephony system via a T1 link requires a channel bank configured for the FX connection. To generate a call from the POTS set to the computer telephony system, an FXO connection must be configured.

Foreign Exchange Station (FXS): See FX, FXO. To generate a call from the computer telephony system to the POTS set, a FXS connection must be configured.

Forward Explicit Congestion Notification (FECN): A bit that tells you that a certain frame on a particular logical connection has encountered heavy traffic. The bit provides notification that congestion-avoidance procedures should be initiated in the same direction of the received frame. See also BECN (Backward Explicit Congestion Notification).

Frame: A group of data bits in a specific format to help network equipment recognize what the bits mean and how to process them. The bits are sent serially, with a flag at each end signifying the start and end of the frame.

Frame Relay: A form of packet switching that uses small packets and that requires less error checking than other forms of packet switching. Frame relay is effective for sending "bursty" data at high speeds (56/64K, 256K, and 1024K bps) over wide area networks. Frame Relay specifications are defined by ANSI documents ANSI T1.602, T1.606, T1S1/90-175, T1S1/90-213, and T1S1/90-214. In using frame relay, blocks of information (frames) are passed across a digital network interface using a "connection number" that is applied to each frame to distinguish between individual frames.

Frame Relay Forum: A non-profit organization of 300+ vendors and service providers, based in Foster City, CA, that are developing and deploying frame relay equipment.

Frame Relay Implementors Forum: A group of companies supporting a common specification for frame relay connection to link customer premises equipment to telco network equipment. Their specification supports ANSI frame relay specs and defines extensions such as local management.

Frame Relay Access Device (FRAD): A piece of equipment that acts as a concentrator or frame assembler/dissassembler that can support multiple protocols and provide basic "routing" functions.

G

Gatekeeper: An H.323 entity that provides address translation, control access, and sometimes bandwidth management to the LAN for H.323 endpoints.

Gateway: 1. A functional unit that interconnects two computer networks with different network architectures. A gateway connects networks or systems of different architectures. A bridge interconnects networks or systems with the same or similar architectures. 2. A network that connects hosts. 3. An H.323 entity that provides real-time, two-way communications between H.323 terminals on the LAN and other ITU terminals on a WAN, or to another H.323 Gateway.

Graphical User Interface (GUI): A type of computer interface consisting of a visual metaphor of a real-world scene, often of a desktop. Within that scene are icons, representing actual objects, that the user can access and manipulate with a pointing device.

H

H.323: An umbrella recommendation from the International Telecommunications Union (ITU) that sets standards for multimedia communications over Local Area Networks (LANs) that do not provide a guaranteed Quality of Service (QoS).

H.323 Endpoint: The clients in an H.323 network. They are typically video conferencing, audio conferencing, or other multimedia systems implemented by end users to communicate in real time. The H.323 standard requires that every endpoint support the G.711 ITU standard for speech compression, H.245 protocol for controlling media between H.323 endpoints, Q.931 signal protocol for establishing and terminating calls, RAS (Registration/Admissions/Status) channel data stream used to communicate with a gatekeeper (optional), and RTP/RTCP (Real-Time Protocol/Real-Time Control Protocol) for carrying packetized real-time media on IP networks.

H.323 Entity: Any H.323 component, including terminals, Gateways, Gatekeepers, Multipoint Controllers (MCs), Multipoint Processors (MPs), and Multipoint Control Units (MCUs).

Handshaking: A process that two modems go through at the time of call setup to establish synchronization over the data communications link. It is a synchronization and negotiation process accomplished by the exchange of predefined, mutually recognized control codes.

High-level Data Link Control (HDLC): An ISO standard, bit-oriented data communications protocol that provides nearly error-free data transfers.

I

Hexadecimal: A base 16 numbering system used to represent binary values. Hex uses the numbers 0-9 and the letters A-F: usually notated by an "h" (e.g., "4CF h", read "four charley fox, hex"). The result is that one hex digit represents a 4-bit value.

Implicit congestion management: A method of informing the terminal that the network is busy. This method relies on the end-system protocol to detect and fix the congestion problem. (TCP/IP is an example of a protocol using only implicit congestion management.) See also "explicit congestion management".

In-band: Refers to the type of signalling over the conversion path on an ISDN call. Contrast "out-of-band".

Insufficient Ones: A T1 error condition that is logged when less than one 1 in 16 0s or less than 12.5 % average 1s density is received.

Inter Exchange Carrier (IEC): The long distance company (LE) who's central office provides the point of reference for T1 access. Any common carrier authorized by the FCC to carry customer transmissions between LATAs.

Internet: Refers to the computer network of many millions of university, government and private users around the world. Each user has a unique Internet Address.

Internet Address (IP Address): A unique 32-bit address for a specific TCP/IP host on a network. Normally printed in dotted decimal format (e.g., 129.128.44.227).

Internet Protocol (IP): A protocol used to route data from its source to its destination in an Internet environment. The Internet Protocol was designed to connect to local area networks. Although there are many protocols that do this, IP refers to the global system of interconnecting computers. It is a highly distributed protocol (each machine only worries about sending data to the next step in the route).

Internetwork Packet Exchange (IPX): A NetWare communications protocol used to route messages from one node to another. IPX packets include network addresses and can be routed from one network to another. An IPX packet can occasionally get lost when crossing networks, thus IPX does not guarantee delivery of a complete message. Either the application has to provide that control, or NetWare's SPX protocol must be used.

Interoperable: Devices from different vendors that can exchange information using a standard's base protocol.

I/O Addresses: Locations within the I/O address space of your computer used by a device, such as an expansion card, a serial port, or an internal modem. The address is used for communication between software and a device.

IRQ Level (Interrupt Request Level): The notification a processor receives when another portion of the computer's hardware requires its attention. IRQs are numbered so that the device issuing the IRQ can be identified, and so IRQs can be prioritized.

ISA (Industry Standards Architecture) (pronounced "ice a"): The classic 8 or 16-bit architecture introduced with IBM's PC-AT computer.

ISDN (Integrated Services Digital Network): An International telecommunications standard for transmitting voice, video and data over a digital communications line. ISDN is a world-wide telecommunications service that uses digital transmission and switching technology to support voice and digital data communications. Frame relay was partially based on ISDN's data link layer protocol (LAPD). Frame relay can be used to transmit across ISDN services offering circuit-switched connection at 64K bps and higher speeds. Contrast Public Switched Telephone Network (PSTN).

ITU-TSS (formerly CCITT): International Telecommunications Union-Telecommunications Sector; the United Nations organization that prepares standards ("Recommendations") for resolving communications issues and problems.

K

Key Telephone System (KTS): Phone devices with multiple buttons that let you select incoming or outgoing CO phone lines directly. Similar in operation to a PBX, except a KTS you don't have to dial a "9" for a call outside the building.

Key Service Unit (KSU): A small device containing the switching electronics for a business key telephone system (KTS).

Key Set: A phone set with several buttons for call holding, line pickup, intercom, autodialing, etc. Also called a touchtone phone (Ericsson) and a KTS (Key Telephone Set).

L

LAPB: Link Access Procedure Balanced; based on the X.25 Layer 2 specification. A full-duplex point-to-point bit-synchronous protocol commonly used as a data link control protocol to interface X.25 DTEs. LAPB is the link initialization procedure that establishes and maintains communications between the DTE and the DCE.

LAPD: Link Access Protocol for the D-Channel; based on the ISDN Q.921 specification. A full-duplex point-to-point bit-synchronous link-level protocol for ISDN connections; different from LAPB in its framing sequence. Transmission is in units called "frames", and a frame may contain one or more X.25 packets.

Line Coding: The representation of 1s and 0s on a T1 line. The two methods of line coding commonly used, B8ZS and AMI, differ in the restrictions placed on user data. T1 line coding ensures that sufficient timing information is sent with the digital signal to ensure recovery of all the bits at the far end. Timing information on the T1 line is included in the form of 1s in the data stream; a long string of 0s in the data stream could cause problems recovering the data.

Line Termination (LT): The electronics at the ISDN network side of the user/network interface that complements the NT1 at the user side. The LT and the NT1 together provide the high-speed digital line signals required for BRI access.

Listed Directory Number (LDN): The main number assigned by the telco; the number listed in the phone directory and also provided by Directory Assistance. Some devices can have more than one LDN, such as ISDN devices that have one LDN for voice and another LDN for data.

Local Area Network (LAN): 1. A computer network located on a user's premises within a limited geographical area. Communication within a local area network is not subject to external regulations; however, communication across the LAN boundary may be subject to some form of regulation. 2. A LAN does not use store and forward techniques. 3. A network in which a set of devices are connected to one another for a communication and that can be connected to a larger network.

Local Access and Transport Area (LATA): A post-divestiture geographical area generally equivalent to a Standard Metropolitan Statistical Area. At divestiture, the territory served by the Bell system was divided into approximately 161 LATAs. The Bell Operating Companies (BOCs) provide Intra-LATA services.

Local Exchange Carrier (LEC): The local phone company which provides local (i.e., not long distance) transmission services. AKA "telco". LECs provide T1 or FT1 access to LDCs (unless the T1 circuit is completely intra-LATA). Inter-LATA T1 circuits are made up of a combination of Access and Long Haul facilities.

Local Management Interface (LMI): A specification for frame relay equipment that defines status information exchange.

Local Loop: A transmission path, typically twisted-pair wire, between an individual subscriber and the nearest public telecommunications network switching center. The wires provide ISDN service, but require an NT1 at the user end and an LT at the network end. (AKA, "loop" or "subscriber loop".)

Logical Link Control (LLC2): In a local area network, the protocol that governs the exchange of transmission frames between data stations independently of how the transmission medium is shared. The LLC2 protocol was developed by the IEEE 802 committee and is common to all LAN standards.

Logical Unit (LU): A type of network accessible unit that enables end users to gain access to network resources and communicate with each other.

Long Haul: The T1 element that connects to the Access portion of the long distance company's (LDC's) central office. The LDC is commonly called the point of presence (POP). Each LDC has a number of POPs, located throughout the country. The LDC is also called an IEC (Inter Exchange Carrier).

Long Haul Communications: The type of phone call reaching outside of a local exchange (LE).

M

Management Information Base (MIB): A database of network management information used by the Common Management Information Protocol (CMIP) and the Simple Network Management Protocol (SNMP).

Megacom: An AT&T service with a normal WATS line (typically T1) between the customer premise and the AT&T serving class 4 CO are the customer's responsibility.

MegaLink: BellSouth's leased T1 service.

Message: Associated with such terms as packet, frame, and segment. 1. In information theory, an ordered series of characters intended to convey information. 2. An assembly of characters and sometimes control codes that is transferred as an entry from an originator to one or more recipients.

Modem: A communications device that enables a computer to transmit information over a phone line. It converts the computer's digital signals into analog signals to send over a phone line and converts them back to digital signals at the receiving end. Modems can be internal and fit into an expansion slot, or external and connect to a serial port.

Multicast: A process of transmitting from one source to many destinations. The actual mechanism may be different for different LAN technologies.

Multiplexer (Mux): 1. A device that takes several input signals and combines them into a single output signal in such a manner that each of the input signals can be recovered. 2. A device capable of interleaving the events of two or more activities or capable of distributing the events of an interleaved sequence to the respective activities. 3. Putting multiple signals on a single channel.

Multipoint Conference: A conference between three or more terminals, which may be on the LAN or on the Circuit Switched Network.

Multipoint Control Unit (MCU): An H.323 endpoint on the LAN which enables three or more terminals and Gateways to participate in a multipoint conference. The MCU includes a mandatory Multipoint Controller and optional Multipoint Processors.

Multipoint Controller (MC): An H.323 entity which provides for the control of three or more terminals in a multipoint conference.

Multipoint Processor (MP): An H.323 entity which provides for the processing of audio, video, and/or data streams in a multipoint conference. The MP provides for the mixing, switching, or other processing of media streams under the control of the MC.

Multiprotocol: A device that can interoperate with devices utilizing different network protocols.

Multithreading: The ability of a software system to be able to handle more than one transaction concurrently. This is contrasted to the case where a single transaction is accepted and completely processed before the next transaction processing is started.

N

Nailed Connection: A permanent or dedicated circuit of a previously switched circuit or circuits.

Nailed-up Circuit: A semipermanent circuit established through a circuit-switching facility for point-to-point connectivity.

NAK (Negative Acknowledgment): Communications code used to indicate that a message was not properly received, or that a terminal does not wish to transmit. Contrast with ACK.

Network: A group of computers connected by cables or other means and using software that enables them to share equipment, such as printers and disk drives to exchange information.

Node: Any point within a network which has been assigned an address.

O

Object-Orientated: A method for structuring programs as hierarchically organized classes describing the data and operations of objects that may interact with other objects.

Office Channel Unit - Data Port (OCU-DP): The CO channel bank used as the interface between the customer's DSU and the channel bank.

Off-hook: The condition of a device which has accessed a phone line (with or without using the line). In modem use, this is equivalent to a phone handset being picked up. Dialing and transmission are allowed, but incoming calls are not answered. Contrast "on-hook".

Off Premise Extension (OPX): An extension or phone that terminates in a location other than that of the PBX. Commonly used to provide a corporate member with an extension of the PBX at home.

Ones Density: the measure of the number of logical 1s on a T1 line compared to a given total number of bits on that line; used for timing information in data recovery in AMI and B8ZS.

On-Hook: The condition of a device which has not accessed a phone line. In modem use, this is equivalent to a phone handset that has not been picked up. In other words, it can receive an incoming call. Contrast "off-hook".

Open Shortest Path First (OSPF): A hierarchical Interior Gateway Protocol (IGP) routing algorithm for IP that is a proposed standard for Internet. OSPF incorporates least-cost routing, equal-cost routing, and load balancing.

Outage: The measure of the time during which a circuit is not available for use due to service interrupt. Outage is the complement of circuit "availability" (100% minus % available = % outage).

Out-of-band: Signaling that is separated from the channel carrying the information (i.e., the voice/data/video signal is separate from the carrier signal). Dialing and various other "supervisory" signals are included in the signaling element. Contrast "In-band" signaling.

Out of Frame (OOF): A T1 alarm condition that is logged on the loss of 2, 3 or 4 of 5 consecutive FT framing bits.

P

Packet: 1. In data communication, a sequence of binary digits, including data and control signals, that is transmitted and switched as a composite whole. The data, control signals and, possibly, error control information are arranged in a specific format. 2. Synonymous with data frame. 3. In TCP/IP, the unit of data passed across the interface between the Internet layer and the link layer. A packet includes an IP header and data. A packet can be a complete IP datagram or a fragment of an IP diagram. 4. In X.25, a data transmission information unit. A group of data and control characters, transferred as a unit, determined by the process of transmission. Commonly used data field lengths in packets are 128 or 256 bytes. 5. The field structure and format defined in the CCITT X.25 recommendation.

Packet Assembler/Disassembler (PAD): Used by devices to communicate over X.25 networks by building or stripping X.25 information on or from a packet.

Packet Data: The information format ("packetized") used for packet-mode calls.

Packet Mode: Refers to the switching of chunks of information for different users using statistical multiplexing to send them over the same transmission facility.

Parity bit: An extra bit attached to each byte of synchronous data used to detect errors in transmission.

PBX (Private Branch Exchange): A phone exchange located on the customer's premises. The PBX provides a circuit switching facility for phone extension lines within the building, and access to the public phone network. See also "Exchange".

Permanent Virtual Circuit (PVC): A connection between two endpoints dedicated to a single user. In ISDN, PVCs are established by network administration and are held for as long as the user subscribes to the service.

Physical Unit (PU): The component that manages and monitors the resources (such as attached links and adjacent link stations) associated with a node, as requested by an SSCP via an SSCP-PU session. An SSCP activates a session with the physical unit in order to indirectly manage, through the PU, resources of the node such as attached links. This term applies to type 2.0, type 4, and type 5 nodes only.

Point-of-Presence (POP): The central office's end points of the long distance carriers.

Point-to-Point Protocol (PPP): A protocol that lets a PC user access TCP/IP (Internet member) using an ISDN terminal adapter or a high-speed modem over a standard phone line.

Port: A location for input or output data exchange. Computers, muxes, etc. have ports for various purposes.

PRI (Primary Rate Interface): Used on ISDN. In North America, and Japan, PRI is one 64Kbps D channel and 23 B channels. Elsewhere, it is one D channel and 30 B channels. PRI is the ISDN equivalent of a T-1 circuit.

Primitive: An abstract representation of interaction across the access points indicating that information is being passed between the service user and the service provider. The OSI Reference Model defines four types of primitives: Request, Indication, Response and Confirm.

PROM (Programmable Read Only Memory - pronounced "prom"): A permanent memory chip that can be programmed or filled by the customer after by the manufacturer has set initial values. Contrast with ROM.

Protocol: 1. A set of semantic and syntactic rules that determines the behavior of functional units in achieving communication. 2. In Open Systems Interconnection architecture, a set of semantic and syntactic rules that determine the behavior of entities in the same layer in performing communication functions. 3. In SNA, the meanings of and the sequencing rules for requests and responses used for managing the network, transferring data, and synchronizing the states of network components. 4. Synonymous with line control discipline.

PSTN (Public Switched Telephone Network): A worldwide public voice phone network that is used as a telecommunications medium for the transmission of voice, data and other information.

Public Data Network (PDN): A packet-switched network that is available to the public for individual ("subscriber") use. Typically, controlled by a government or a national monopoly.

Public Switched Telephone Network (PSTN): The group of circuit-switching voice carriers, which are commonly used as analog data communications services.

Pulse Code Modulation (PCM): 1. In data communication, variation of a digital signal to represent information; for example, by means of pulse amplitude modulation (PAM), pulse duration modulation (PDM), or pulse position modulation (PPM). 2. Transmissions of analog information in digital form through sampling and encoding the samples with a fixed number of bits.

Pulse dialing: One of two methods of dialing a phone, usually associated with rotary-dial phones. Compare with "tone dialing".

Q

Quality of Service (QoS): Guarantees network bandwidth and availability for applications.

Quantizing: The process of analog-to-digital conversion by assigning a range, from the contiguous analog values, to a discrete number.

R

Random Access Memory (RAM): A computer's primary workspace. All data must be stored in RAM (even for a short while), before software can use the processor to manipulate the data. Before a PC can do anything useful it must move programs from disk to RAM. When you turn it off, all information in RAM is lost.

RAS Channel: An unreliable channel used to convey the Registration, Admissions and Status messages and bandwidth changes between two H.323 entities.

Rate Enforcement: The concept in frame relay where frames sent faster than the CIR are to be carried only if the bandwidth is available, otherwise they are to be discarded. (The frame relay network assumes that anything exceeding the CIR is of low priority.) Rate enforcement makes sure that the network will not get so congested that it isn't able to meet the agreed on CIR

Recognized Private Operating Agency (RPOA): A corporation, private or government-controlled, that provides telecommunications services. RPOAs, such as AT&T, participate as non-voting members in the CCITT.

Red Alarm: A T1 error condition generated when a local failure (e.g., loss of synchronization) exists for 2.5 seconds, causing a Carrier Group Alarm (CGA). See also "Blue Alarm" and "Yellow Alarm".

Request for Comment (RFC): A set of papers in which Internet standards (published and proposed), along with generally-accepted ideas, proposals, research results, etc. are published.

Ring Down Box: A device that emulates a CO by generating POTS calls for testing and product demos.

Ring Down Circuit: A tie line connecting phones where picking up one phone automatically rings another phone. A feature used for emergencies to alert the person at the other phone of the incoming call.

RJ-11: An industry standard interface used for connecting a phone to a modular wall outlet; comes in 4-and 6-wire packages.

RJ-45: An 8-wire modular connector for voice and data circuits.

Robbed Bit Signaling: The popular T1 signaling mechanism where the A and B bits are sent by each side of the T1 termination and are "buried" in the voice data of each voice channel in the T1 circuit. Since the bits are "robbed" infrequently, voice quality is remains relatively uncompromised. See "bit robbing".

The robbed-bit signaling technique is used in D4 channel banks to convey signaling information. The eighth (least significant) bit of each of the 24 8-bit time slots is "robbed" every sixth frame to convey voice-related signaling information such as on-hook, off-hook, etc., for each channel.

Router: A device that connects two networks using the same networking protocol. It operates at the Network Layer (Layer 3) of the OSI model for forwarding decisions.

Routing Information Protocol (RIP): A distance vector-based protocol that provides a measure of distance, or hops, from a transmitting workstation to a receiving workstation.

RS-232-C: An EIA standard for a serial interface between computers and peripheral devices (modem, mouse, etc.). It uses a 25-pin DB-25, or a 9-pin DB-9 connector. The RS-232 standard defines the purposes, electrical characteristics and timing of the signals for each of the 25 lines.

RS-422: The EIA standard for a balanced interface with no accompanying physical connector. RS-422 products can use screw terminals, DB-9, various DB-25, and DB-37 connectors.

RS-530: The EIA standard for the mechanical/electrical interface between DCEs and DTEs transmitting synchronous or asynchronous serial binary data. RS-530 provides for high data rates with the same connector used for RS-232; however, it is incompatible with RS-232.

S

Serial Port: The connector on a PC used to attach serial devices (those that need to receive data one bit after another), such as a mouse, a printer or a modem. This consists of a 9- or 25-pin connector that sends data in sequence (bit by bit). Serial ports are referred to as "COMx" ports, where x is 1 to 4 (i.e., COM1 through COM4). A serial port contains a conversion chip called a "UART" which translates between internal parallel and external serial formats.

Service: The requirements offered by an RPOA to its customers to satisfy specific telecommunications needs.

Severely Errored Seconds (SES): Refers to a typical T1 error event where an error burst occurs (a short term, high bit-error rate that is self-clearing). Per the ITU-T (CCITT) G.821: any second in which the BER is less than 1×10^{-3} .

Signaling: The process of establishing, maintaining, accounting for, and terminating a connection between two endpoints (e.g., the user premises and the telco CO). Central office signals to the user premises can include ringing, dial tone, speech signals, etc. Signals from the user's phone can include off-hook, dialing, speech to far-end party, and on-hook signals. In-band signaling techniques include pulse and tone dialing. With common channel signaling, information is carried out-of-band.

Simple Network Management Protocol (SNMP): TCP/IP protocol that allows network management.

Simultaneous Voice Data (SVD): A technology for letting a user send data via a modem, and use a handset to talk to another user at the same time over the same connection. The alternative, making a second call, can be expensive or even impossible. The uses for SVD are telecommuting, videoconferencing, distant learning, tech support, etc.

Stop Bit: One of the variables used for timing in asynchronous data transmission. Depending on the devices, each character may be trailed by 1, 1.5, or 2 stop bits.

Superframe (D4): A T1 transmission format that consists of 12 DS1 frames, or 2316 bits. A DS1 frame consists of 193 bit positions. A frame overhead bit is in the first position, and it is used for frame and signaling phase alignment only.

Subscriber Loop: See "Local loop".

Switched 56: A circuit-switched (full duplex digital synchronous data transmission) service that lets you dial a number and transmit data to it at 56K bps. It is a relatively low cost service, widely used in North America for telecommuting, videoconferencing and high speed data transfers. Many phone companies are (or will be) phasing out Switched 56 in favor of ISDN service.

Switched Virtual Circuit (SVC): A type of data transmission where the connection is maintained only until the call is cleared.

Switched Line: In communications, a physical channel established by dynamically connecting one or more discreet segments. This connection lasts for the duration of the call after which each segment may be used as part of a different channel. Contrast with leased line.

Switched Network: A network in which a temporary connection is established from one point via one or more segments.

Synchronous Data Link Control (SDLC): A discipline conforming to subsets of the Advanced Data Communications Control Procedures (ADCCP) of the American National Standards Institute (ANSI) and High-level Data Link Control (HDLC) of the International Organization for Standardization, for managing synchronous, code-transparent, serial-by-bit information transfer over a link connection. Transmission exchanges may be duplex, or half-duplex over switched or nonswitched links. The configuration of the link connection may be point-to-point, multipoint, or loop.

Synchronous Transmission: The transmission of data which involves sending a group of characters in a packet. This is a common method of transmission between computers on a network or between modems. One or more synchronous characters are transmitted to confirm clocking before each packet of data is transmitted. Compare to Asynchronous Transmission.

Systems Network Architecture (SNA): The description of the logical structure, formats, protocols, and operational sequences for transmitting information units through, and controlling the configuration and operation of networks.

T

Tariff: The rate/availability schedule for telephone and ISDN services from a regulated service provider.

TCP/IP: A set of communication protocols that support peer-to-peer connectivity functions for both local and wide area networks. TCP/IP was developed by the US Department of Defense to link dissimilar computers across dissimilar and unreliable LANs.

T Carrier: The generic name for a digitally multiplexed carrier system. In the North American digital hierarchy, a T is used to designate a DS (digital signal) level hierarchy. Examples: T1 (DS1) is a 1.544 M bps 24-channel designation. In Europe, T1 is called E1. The T Carrier system was originally designed for transmitting digitized voice signals, but has since been adapted for digital data applications.

T1: A digital transmission link capable of 1.544M bps. T1 uses two pairs of normal UTP, and can handle 24 voice conversations, each digitized at 64K bps. T1 is a standard for digital transmission in the U.S., Canada, Japan and Hong Kong. T1 is the access method for high-speed services such as ATM, frame relay, and SMDS. See also T Carrier, T1 line and FT1.

T1 Channel Tests: A set of diagnostics that vary by carrier, used to verify a T1 channel operation. Can include Tone, Noise Level, Impulse Noise Level, Echo Cancellors, Gain, and Crosstalk testing.

T1 Framing: To digitize and encode analog voice signals requires 8000 samples per second (twice the highest voice frequency of 4000 Hz). Encoding in an 8-bit word provides the basic T1 block of 64K bps for voice transmission. This "Level 0 Signal, as its called, is represented by "DS-0", or Digital Signal at Level 0. 24 of these voice channels are combined into a serial bit stream (using TDM), on a frame-by-frame basis. A frame is a sample of all 24 channels; so adding in a framing bit gives a block of 193 bits ($24 \times 8 + 1 = 193$). Frames are transmitted at 8000 per second (the required sample rate), creating a 1.544M ($8000 \times 193 = 1.544M$) transmission rate.

T1 Line: A digital communications facility that functions as a 24-channel pathway for data or voice. A T1 line is composed of two separate elements: the Access element and the Long Haul element.

T1 Mux: A device used to carry many sources of data on a T1 line. The T1 mux assigns each data source to distinct DS0 time slots within the T1 signal. Wide bandwidth signals take more than one time slot. Normal voice traffic or 56/64K bps data channels take one time slot. The T1 mux may use an internal or external T1 DSU; a "channel bank" device typically uses an external T1 CSU.

Terminal: 1) The screen and keyboard device used in a mainframe environment for interactive data entry. Terminals have no "box", which is to say they have no file storage or processing capabilities. 2) An H.323 endpoint that provides for real-time, two-way communications with another terminal, gateway, or H.323 MCU. An H.323 terminal must provide audio and may also provide video and/or data.

Terminal Adapter (TA): An ISDN DTE device for connecting a non-ISDN terminal device to the ISDN network. Similar to a protocol converter or an interface converter, a TA connects a non-ISDN device between the R and S interfaces. Typically a PC card.

Tie line: A dedicated circuit linking two points without having to dial a phone number (i.e., the line may be accessed by lifting the phone handset or by pushing a button).

Time-Division Multiplexing (TDM): Division of a transmission facility into two or more channels by allotting the common channel to several different information channels, one at a time.

Time Slot: One of 24 channels within a T1 line. Each channel has a 64K bps maximum bandwidth. "Time slot" implies the time division multiplexing organization of the T1 signal.

Toll Call: A call to a location outside of your local service area (i.e., a long distance call).

Tone dialing: One of two methods of dialing a phone, usually associated with Touch-Tone® (push button) phones. Compare with pulse dialing.

Topology: Physical layout of network components (cables, stations, gateways, and hubs). Three basic interconnection topologies are star, ring, and bus networks.

Transmission Control Protocol (TCP): A communications protocol used in Internet and in any network that follows the US Department of Defense standards for internetwork protocol. TCP provides a reliable host-to-host protocol between hosts in packet-switched communications networks and in interconnected systems of such networks. It assumes that the Internet protocol is the underlying protocol.

Transport Layer: Layer 4 of the Open Systems Interconnection (OSI) model; provides reliable, end-to-end delivery of data, and detects transmission sequential errors.

Transport Protocol Data Unit (TPDU): A transport header, which is added to every message, contains destination and source addressing information that allows the end-to-end routing of messages in multi-layer NAC networks of high complexity. They are automatically added to messages as they enter the network and can be stripped off before being passed to the host or another device that does not support TPDU's.

Trunk: A communication line between two switching systems or offices. Central office trunks connect a PBX to the switching system at the central office. A tie trunk connects two PBXs.

TSR (terminate and stay resident): A software program that remains active and in memory after its user interface is closed. Similar to a daemon in UNIX environments.

Tunneling: Encapsulation data in an IP packet for transport across the Internet.

Twisted pair wiring: A type of cabling with one or more pairs of insulated wires wrapped around each other. An inexpensive wiring method used for LAN and telephone applications, also called UTP wiring.

U

UART (Universal Asynchronous Receiver/Transmitter) (pronounced "you art"): A chip that transmits and receives data on the serial port. It converts bytes into serial bits for transmission, and vice versa, and generates and strips the start and stop bits appended to each character.

UNIX: An operating system developed by Bell Laboratories that features multiprogramming in a multi-user environment.

Unshielded Twisted Pair (UTP): Telephone-type wiring. Transmission media for 10Base-T.

V

V.25bis: An ITU-T standard for synchronous communications between a mainframe or host and a modem using HDLC or other character-oriented protocol.

V.54: The ITU-T standard for local and remote loopback tests in modems, DCEs and DTEs. The four basic tests are:

- local digital loopback (tests DTE send and receive circuits),
- local analog loopback (tests local modem operation),
- remote analog loopback (tests comm link to the remote modem), and
- remote digital loopback (tests remote modem operation).

Virtual Circuit: A logical connection. Used in packet switching wherein a logical connection is established between two devices at the start of transmission. All information packets follow the same route and arrive in sequence (but do not necessarily carry a complete address).

Z

Zone: A collection of all H.323 endpoints and MCUs managed by a single Gatekeeper. A zone must include may include LAN segments connected by using routers.

Index

A

About the Internet	78
Accessories, ordering	77
Add/Edit Phone Entry	31
Applications setup, changing	59
Archie	81
Auto Call	40, 50
Auto Call Enable	26, 40
Automatic Disconnection	26, 40
Automatic disconnection, billing/security	50

B

Back panel, description	13
Billing options	51
Billing/Misc default setup, Master	27, 41
Billing/Misc parameters, changing	50
Billing/Misc tab	40
Boot LED	12
Building a proprietary phonebook	31

C

Cable Connection	
Remote Site	44
Cabling	18
Local site	18
Cabling the MVP120	
Remote site	44
Call Duration	27, 41
Call progress, viewing	58, 62
Canadian limitations notice	87
Channel interface default setup, Master	38
Channel interface default setup, Slave	38
Channel totals, viewing	63
Coder, voice/fax	49
Collision	12
Command connector	13
Command port cable, diagram	83
Configuration port setup	46
Configuration utilities	46
Configuration utilities, overview	46
Configuring Your Client MultiVOIPs	36
Connectors	
Command	13
Power	13
Consecutive Packets Lost	27, 40
Custom tone pair settings	51

D

DNS	81
DTMF gain, voice/fax	49
Dynamic Jitter Buffer	27
Dynamic jitter buffer	51

E

EMC, safety and terminal directive compliance	87
Ethernet (10Base-T) connector	13
Ethernet, front panel	12

F

Fax branding statement	85
FCC Part 15 statement	85
FCC Part 68 Telecom statement	86
Finger	81
Firewall	20
Flash Timer box	24, 48
Front panel, description	12
FTP (File Transfer Protocol)	81

G

Gatekeeper	28
Registering phone numbers	28
Glossary	89
Gopher	81

H

H.323 protocol	
Overview	6
HTML	81
HTTP	81
Hunt Group	32

I

Industry Canada statement	85
Installing MultiVOIP software	20
Inter Digit Time	24, 48
Internet	
Multi-Tech's Web site	78
Internet protocol (IP)	82
IP default setup, Master	24
IP default setup, Slave	37
IP parameters, changing	57
IP statistics	60

J

Jitter buffer, dynamic	51
Jitter Value	26, 40
Jitter value	50

L

LAN cable, diagram	83
LAN-based remote configuration	70
LEDs	
56K DSU	
RD	12
Ethernet	
CL	12
LNK	12
RD	12
TD	12
Log entries, reports	63
Log entry details, viewing	62

M

Manual Upgrade Procedure	66
Max Baud rate, voice/fax	50
Message Waiting Light	48
Modem-based remote configuration	68
MultiVOIP Main menu, introduction	46
MultiVOIP Main menu, screen	47
MultiVOIP, Telnet server menu	72
MVP120	
Back panel	13
Cabling diagrams	83
Configuring the Slave MultiVOIP	37
Deploying the VOIP network	44
Front panel	12
Installing the MultiVOIP software	20
Introduction	6
Service	77
Specifications	14
Technical support	78
Typical application	8
Unpacking	17
Upgrade procedure	64

O

Optimization Factor	27
Optimization factor	51
Ordering accessories	77

P

Packets lost/received	58
Password, SNMP	59
Phone directory database, changing	52
Ping	81
POP	81
Power connector	13
Proprietary phonebook	
Building	31
Pulse generation ratio	51

R

Receive data	12
Regional default setup, Master	27, 41
Regional parameters, changing	51
Registering with the Gatekeeper	28
Regulatory information	85
Remote configuration	
LAN-based procedure	70
Modem-based procedure	68
Remote management	
Telnet	71
WEB management	73
Remote site administrator, deployment	44
Remote site cable connection	44
Reports, log entries	63
Ring Count FXO	48
Ringer equivalence number	87

S

Safety warning	
General	17
Telecom	17
Send Status Report to Master	31
Service	77
Slave status	54
SMTP	81
SNMP	81
SNMP agent, enabling	59
SNMP statistics	61
Software	46
Description	46
Software installation procedure	20
Specifications	
Command Port	14
Ethernet Port	14
Station Identification	32
Station identification	54
Statistics, viewing	
IP	60
SNMP	61

T

TCP packets	60
TCP/IP	80
Technical specifications	14
Technical support	78
Telnet	71, 81
Proxy Server Configuration	73
Telnet server menu	72
Tone Pairs	27, 41
Tone pairs, customizing	51
Traceroute	81
Transmit data	12
Typical application	8

U

UDP packets	60
Uninstall ProxyServer configuration	46
Unpacking your MVP120	17
Upgrading software version	64

V

Viewing statistics	60
Voice coder, voice/fax	49
Voice over IP configuration	72
Voice/Fax 1 and 2, front panel	12
Voice/Fax channel connectors, diagram	83
Voice/Fax default setup, Master	25, 39
Voice/Fax parameters, changing	49

W

WEB Server	73
------------------	----