



**Standalone Voice/IP Gateway
Model MVP400 and MVP800**

H.323 Mode

Quick Start Guide



Quick Start Guide

82088202 Revision C

MultiVOIP400 (Model MVP400) and
MultiVOIP800 (Model MVP800)

This publication may not be reproduced, in whole or in part, without prior expressed written permission from Multi-Tech Systems, Inc. All rights reserved.

Copyright © 2001, by Multi-Tech Systems, Inc.

Multi-Tech Systems, Inc. makes no representations or warranties with respect to the contents hereof and specifically disclaims any implied warranties of merchantability or fitness for any particular purpose. Furthermore, Multi-Tech Systems, Inc. reserves the right to revise this publication and to make changes from time to time in the content hereof without obligation of Multi-Tech Systems, Inc. to notify any person or organization of such revisions or changes.

Record of Revisions

Revision	Description
B (5/15/00)	Manual revised; covers software version 3.45.
C (01/15/01)	Manual updated for software version 3.51

Patents

This Product is covered by the following U.S. Patent Numbers:
6151333, 5757801, 5682386. Other Patents Pending.

TRADEMARK

Trademark of Multi-Tech Systems, Inc. is the Multi-Tech logo.
Windows is a registered trademark of Microsoft.

Multi-Tech Systems, Inc.
2205 Woodale Drive
Mounds View, Minnesota 55112
(763) 785-3500 or (800) 328-9717
Fax 763-785-9874
Tech Support (800) 972-2439
Internet Address: <http://www.multitech.com>

Contents

Introduction	4
Related Documentation	5
Installing Your MultiVOIP	6
Installing and Configuring Your MultiVOIP	6
Deploying the VOIP Network	7
Unpacking Your MultiVOIP	8
Safety Warnings	8
Cabling Procedure	9
E&M Jumper Block Positioning Procedure	11
Installing Your MultiVOIP 400/800	12
Configuring Your MultiVOIP 400/800	17
Registering with a Gatekeeper Phone Directory	28
Building a Proprietary Phonebook Directory	34
Configuring Your Slave MultiVOIP 400/800s	46
Deploying the VOIP Network	59
Remote Site Administrator	59
Limited Warranty	62
Technical Support	63
FCC Declaration	63

MultiVOIP Quick Start Guide

Introduction

Welcome to Multi-Tech's new stand-alone Voice/IP Gateways which allow analog voice and fax communication over an IP network. The MultiVOIP model numbers are MVP400 for the four-channel unit and MVP800 for the eight-channel unit. Multi-Tech's voice/fax gateway technology allows voice/fax communication to be transmitted with no additional expense over your existing IP network, which has traditionally been data-only. To access this free voice and fax communication, all you have to do is connect your MultiVOIP to your telephone equipment and then to your existing Internet connection. Once configured, the MultiVOIP allows voice and fax to travel down the same path as your traditional data communications.

The MultiVOIP 400/800 supports the H.323 standards-based protocol enabling your MultiVOIP 400/800 to participate in real-time conferencing with other third-party VOIP Gateways or other endpoints that support the H.323 protocol (for example, Microsoft Netmeeting®). The H.323 standard defines how endpoints make and receive calls, how endpoints negotiate a common set of audio and data capabilities, how information is formatted and sent over the network. This version of the software also supports optional H.323 GateKeeper software residing on a PC which, when enabled, maintains its own phone book database, preregisters all users, controls the bandwidth, and handles all conferencing issues such as transferring of calls.

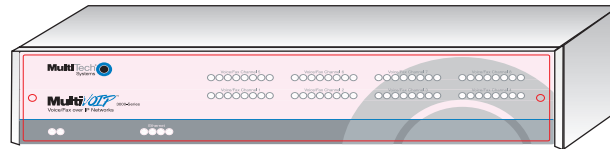

Figure 1. MultiVOIP

The MVP400 is designed with four voice/fax channels (offering three voice/fax interfaces per channel), a 10 Mbps

Ethernet LAN interface, and a command port configuration. The MVP800 is designed with eight voice/fax channels, 10 Mbps Ethernet LAN interface, and command port.

System management is provided through the Command port using bundled Windows® software which provides easy-to-use configuration menus and comprehensive online Help.

Note: Refer to the MultiVOIP 400/800 User Guide for a detailed description of a typical VOIP application.

Related Documentation

The MultiVOIP 400/800 Quick Start Guide is intended to be used by qualified systems administrators and network managers. This Quick Start Guide provides the necessary information for a qualified person to unpack, cable, load software, and configure the unit for proper operation.

A detailed MultiVOIP 400/800 User Guide is included on your system CD and provides in-depth information on the features and functionality of Multi-Tech's MultiVOIP 400/800.

The CD media is produced using Adobe Acrobat™ for viewing and printing the user guide. To view or print your copy of a user guide, load Acrobat Reader™ on your system. The Acrobat Reader is a free download from Adobe's Web site:

<http://www.adobe.com>

The MultiVOIP 400/800 User Guide is also available on Multi-Tech's Web site at:

<http://www.multitech.com>

Viewing and printing a user guide from the Web also requires that you have Acrobat Reader loaded on your system. To select the MultiVOIP 400/800 User Guide from the Multi-Tech Systems home page, click **Documents** and then click **MultiVOIP Manuals**. Select the User Guide from the MVP800 group to view or download the **.pdf** file.

Installing Your MultiVOIP

The basic steps of installing your MultiVOIP network involve unpacking the units, connecting the cables, and configuring the units using the included management software (MultiVOIP Configuration). This process results in a fully functional Voice Over IP network. A brief description is provided below with detailed instructions provided later.

Installing and Configuring Your MultiVOIP

The VOIP administrator must first install the MultiVOIP software and then configure each MultiVOIP 400/800 for its specific function. During the configuration process, it's important to note that the Phone Directory Database is configured differently depending on whether or not you have GateKeeper support on your VOIP network.

If your VOIP network supports GateKeeper software, you must register all H.323 endpoints with the GateKeeper. The procedure for doing this is explained in the section "Registering with a GateKeeper Phone Directory."

If your VOIP network does not have GateKeeper software or the GateKeeper software is not enabled, then you must build a proprietary phone book with a "Master" MultiVOIP 400/800 and "Slave" MultiVOIP 400/800s. The "Master" unit includes the assignment of a unique LAN IP address, subnet mask, and Gateway IP address, as well as the selection of appropriate channel interface type for each of the Voice/Fax channels. Once all connections have been made, the VOIP administrator configures the unit and builds the Phone Directory Database that will reside with the Master unit.

Once configuration of the "Master" MultiVOIP 400/800 has been completed, the administrator moves on to configure the MultiVOIP 400/800(s) designated as "Slave" units. Again, unique LAN IP addresses, subnet masks, and Gateway IP addresses are assigned, and each Voice/Fax channel is configured for the appropriate channel interface type. When

this is done, the Phone Directory Database option is set to Slave, and the IP address of the Master MultiVOIP 400/800 is entered. Once all Slave units are configured, the process moves on to the “Deploying the VOIP Network” section.

Deploying the VOIP Network

The final phase of the installation is deployment of the network. When the remote MultiVOIP 400/800s are sent to their remote sites, the remote site administrators need only connect the units to their LAN and telephone equipment. A full Phone Directory Database (supplied by the Master MultiVOIP 400/800 Proprietary Phonebook will be loaded into their units within minutes of being connected and powered up. For remote VOIPs that were configured with the **Gatekeeper** option enabled, each MultiVOIP 400/800 will be registered with the Gatekeeper (the Gatekeeper phonebook directory is NOT downloaded to the remote units).

The final task of the VOIP administrator or the Gatekeeper administrator is to develop the VOIP Dialing Directory based on the appropriate phone directory database (the Proprietary phonebook database or the Gatekeeper phonebook database).

MultiVOIP Quick Start Guide

Unpacking Your MultiVOIP

Remove all items from the box.

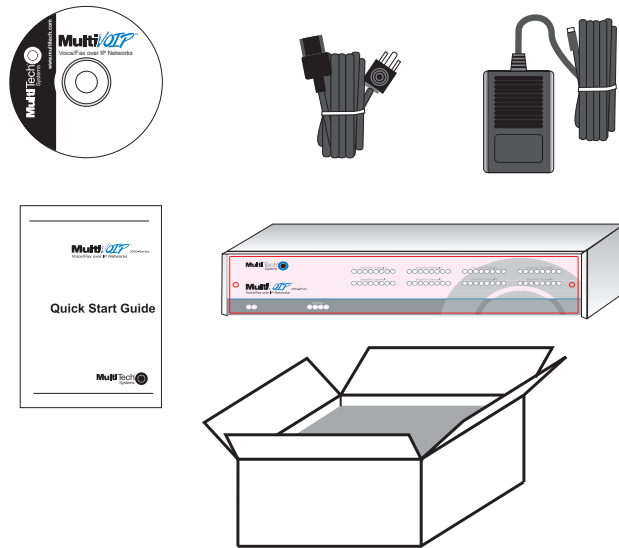

Figure 2. Unpacking

Safety Warnings

Caution

Danger of explosion if battery is incorrectly replaced.

A lithium battery on the voice/fax channel board provides backup power for the time keeping capability. The battery has an estimated life expectancy of ten years.

When the battery starts to weaken, the date and time may be incorrect. If the battery fails, the board must be sent back to Multi-Tech Systems for battery replacement.

The E&M, FXS, and Ethernet ports are not designed to be connected to a Public Telecommunication Network.

Cabling Procedure

Cabling involves connecting the master MultiVOIP to your LAN and telephone equipment.

1. If you are connecting any Voice/Fax Channel to an E&M trunk other than type 2, perform the E&M Jumper Block Positioning procedure in the following section before connecting power to the unit.
2. Connect one end of the power supply to a live AC outlet and connect the other end to the MultiVOIP as shown in Figure 3. The power connector is a 7-pin circular DIN connector.

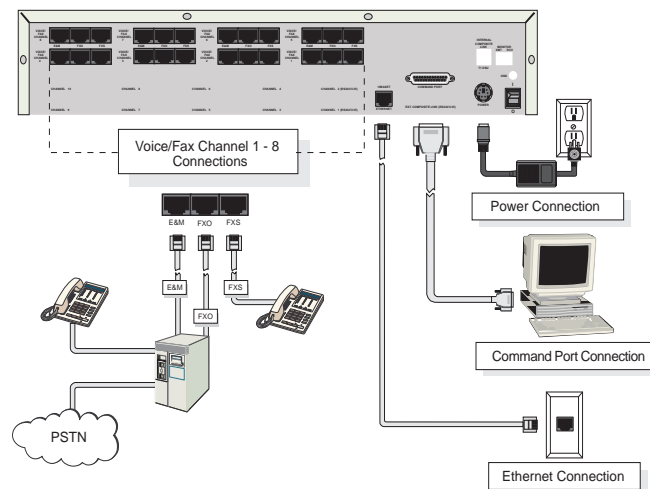

Figure 3. Cable Connections

3. Connect the MultiVOIP to a PC by using a DB-9 to DB-25 cable. Plug the DB-25 end of the cable into the **Command** port of the MultiVOIP and the other end into the serial port on the PC. See Figure 3.
4. Connect a network cable to the **ETHERNET 10BASET** connector on the back of the MultiVOIP. Connect the other end of the cable to your network.

MultiVOIP Quick Start Guide

5. If you are connecting a station device (analog telephone, fax machine, or Key Telephone System (KTS)) to your MultiVOIP, connect one end of an RJ11 phone cord to the **Voice/Fax Channel 1 FXS** connector on the back of the MultiVOIP and the other end to the station device.

If you are connecting a PBX extension to your MultiVOIP, connect one end of an RJ11 phone cord to the **Voice/Fax Channel 1 FXO** connector on the back of the MultiVOIP and the other end to the PBX extension.

If you are connecting an E&M trunk from a telephone switch to your MultiVOIP, connect one end of an RJ45 phone cord to the **Voice/Fax Channel 1 E&M** connector on the back of the MultiVOIP and the other end to the trunk. Refer to the User Guide for E&M pin assignments.

If you are connecting to an E&M trunk, you need to ensure that the E&M trunk jumper is in the correct position for the E&M type trunk. The default E&M jumper position is E&M type 2. To change the E&M jumper position, perform the E&M jumper block positioning procedure in the following section.

6. Repeat the above step to connect the remaining telephone equipment to each Voice/Fax Channel on your MultiVOIP.
7. Turn on power to the MultiVOIP by placing the ON/OFF switch on the back panel to the ON position. Wait for the **BTG** LED on the MultiVOIP to go OFF before proceeding. This may take a couple minutes.

If you need to change the E&M Jumper Block positioning, refer to the following section. Otherwise, proceed to the Installing the Software section to load the MultiVOIP software.

E&M Jumper Block Positioning Procedure

A jumper block exists for each voice/fax channel. The jumper block is to the right of each set of channel jacks. The jumper block contains 8 pairs of pins. The jumper plug fits over three pairs of pins on the jumper block. The E&M type number is labeled on the pc board. The jumper plug must be centered on the E&M type number. To change E&M jumper position:

1. Verify that power is disconnected from the MultiVOIP.
2. Remove the front panel by removing the two Phillips quarter turn screws.
3. Remove the six screws and slide the top cover backward off the chassis to expose the rear panel.
4. To change a jumper position, lift the jumper plug up off the jumper block and move to the new position, ensuring that the center jumper is centered on the E&M type number.

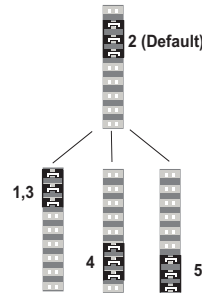

Figure 4. E&M Jumper Block Positions

5. Change the jumper position for each voice/fax channel connecting to an E&M trunk that is not a type 2. If you have two voice/fax channel boards in your unit and you need to change the jumpers on the second board, remove the six screws from the top board and disconnect the ribbon cable from the top board.
6. Slide the top cover back on to the chassis and fasten the six screws.
7. Replace the front panel and fasten the two Phillips quarter turn screws.
8. Return to the Cabling Procedure section.

Installing Your MultiVOIP 400/800

The following installation procedures do not provide every screen or option in the process of installing the MultiVOIP 400/800 software. It is assumed that a technical person with a thorough knowledge of Windows and the software loading process is doing the installation. Once you have installed the software, you will be instructed on how to configure your MultiVOIP 400/800, and finally, on how to deploy your MultiVOIP 400/800. Additional information on the MultiVOIP 400/800 software is provided in the Help.

Note: The phonebook directory configuration process is different depending on whether or not you have an enabled H.323 Gatekeeper resident in your network. The “Configuring Your MultiVOIP 400/800” section will explain these differences.

The MultiVOIP 400/800 software and User Guide are contained on the MultiVOIP 400/800 CD. The CD is auto-detectable, so when you insert it into your CD ROM drive it will start up automatically. When you have finished configuring your MultiVOIP 400/800, you can view and print the User Guide by clicking the **Install Manuals** icon.

CAUTION: If you are installing a MultiVOIP 400/800 behind a firewall, the Firewall must support H.323. Refer to your Firewall user documentation to enable H.323 support.

1. Make certain that your MultiVOIP 400/800 has been properly cabled and that it is powered on.
2. Insert the MultiVOIP 400/800 CD into your CD-ROM drive. The CD should start automatically. It may take 10 to 20 seconds for the MultiTech CD installation window to display.

Installing the Software



If the Multi-Tech Installation CD window does not display automatically, click **My Computer**, then right click the **CD ROM drive** icon, click **Open**, and then click the **Autorun** icon.

3. When the Multi-Tech Installation CD dialog box displays, click the **Install Software** icon.
4. The **MultiVOIP 800 Setup** welcome dialog box displays.



Press **Enter** or click **Next** to continue.

MultiVOIP Quick Start Guide

5. The **Choose Destination Location** dialog box displays. Follow the on-screen instructions.

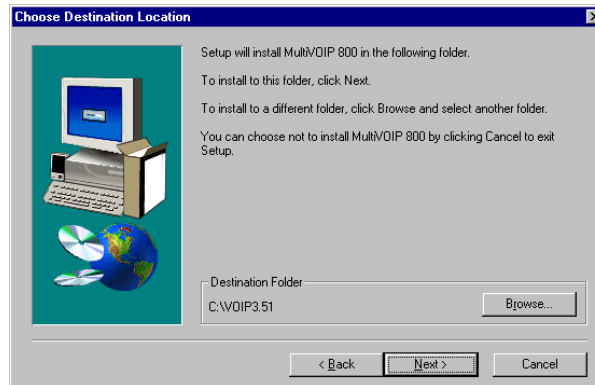

You can either choose the Destination Location of your MultiVOIP 400/800 software or select the default destination by clicking **Next**. Click **Browse** if you want to select a different destination folder for the MultiVOIP 400/800 software.

6. The **Select Program Folder** dialog box enables you to choose where you want the program file to be located.

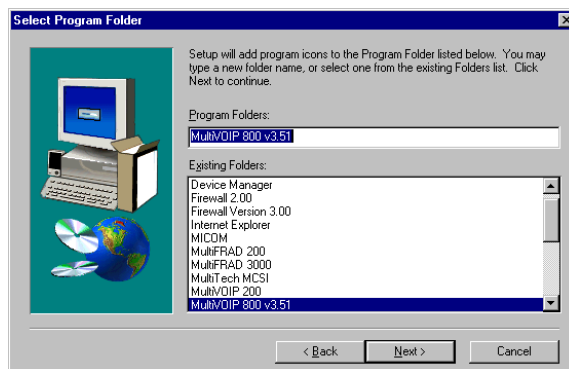

Verify the path and click **Next** to continue.

Installing the Software

7. The **MultiVOIP 800 Setup** dialog box displays. This dialog box enables you to select the COM port of your PC that is connected to the Command port of the MultiVOIP 400/800. From the **Select Port** list, select the COM port of your PC.

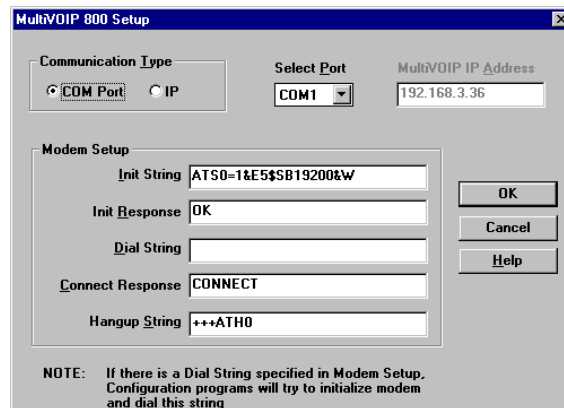

Click **OK** to continue.

8. The **Setup Complete** dialog displays.

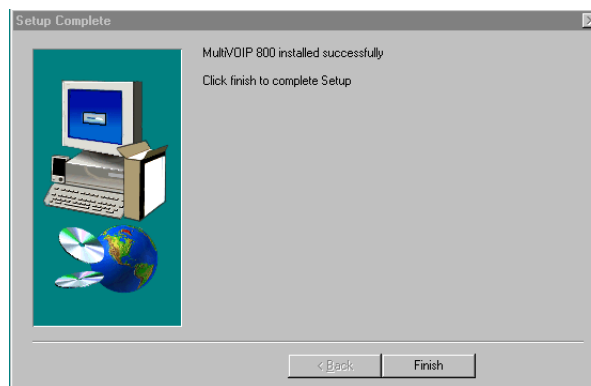

Click **Finish** to continue.

MultiVOIP Quick Start Guide

9. The following message displays:

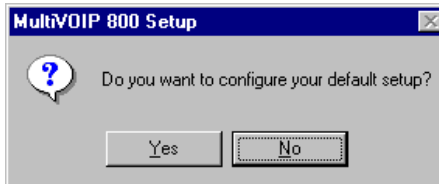

Click **Yes** to continue.

10. The following message displays:

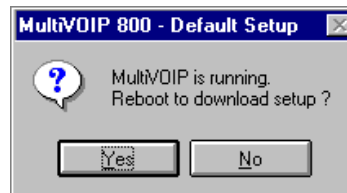

Click **Yes** to continue.

Configuring Your MultiVOIP 400/800

The following steps provide instructions for configuring your MultiVOIP 400/800. The configuration sequence includes IP Protocol default setup, Channel setup, and Phone Directory Database setup. The Phone Directory Database setup is configured differently depending on whether or not the Gatekeeper function is available and enabled on the **Phone Directory Database** dialog box (see Step 26).

11. The **IP Protocol Default Setup** dialog box displays.



The default **Frame Type** is **TYPE_II**. If this does not match your IP network, change the Frame Type by selecting **SNAP** from the **Frame Type** list. The available Frame Type choices are **TYPE_II** and **SNAP**.

12. In the **Ethernet** group, enter the **IP Address**, **Subnet Mask**, and **Gateway Address** unique to your IP LAN. The IP address is the unique LAN IP address that is assigned to the MultiVOIP 400/800, and the Gateway address is the IP address of the device connecting your MultiVOIP 400/800 to the Internet.

Click **OK** when you are finished.

MultiVOIP Quick Start Guide

13. The **Channel Setup** dialog box displays. The four tabs in this dialog box define the channel interface, voice/fax parameters, billing, miscellaneous, and regional telephone parameters for each channel.



Configure each channel for the type of interface you are using. **Channel 1** is selected by default in the **Select Channel** list. To change the channel number, select the channel you want to configure from the list.

Note: Feature options are enabled or unavailable depending on the selected interface type. The one option available for all interface types is the **Inter Digit Time** option. This option defines the maximum amount of time that the unit will wait before mapping the dialed digits to an entry in the Phone Directory Database. If too much time elapses between digits, and the wrong numbers are mapped, you will hear a rapid busy signal. If this happens, hang up and dial again. The default setting is **2** seconds.

Configuring the MultiVOIP

14. The **Interface** group defaults to **FXS (Loop Start)**. Select the interface option that corresponds to the interface type being connected to the Voice/Fax Channel 1 jack on the back panel of the MultiVOIP 400/800.

FXS (Loop Start): If a station device such as an analog telephone, fax machine, or KTS (Key Telephone System) is connected to the Voice/Fax connector on the back of the unit, FXS (Loop Start) will likely be the correct Interface.

FXS (Ground Start): If the station device uses ground start, then choose the FXS (Ground Start) option. Refer to the device's user documentation.

For both FXS Loop Start and FXS Ground Start, the **Ring Count FXS** window allows you to set the maximum number of rings output on the FXS interface before hanging up and releasing the line to another call. The default setting is **8** rings.

Note: Zero (0) means no rings; the caller hears a busy tone.

FXO: If you are using an analog extension from your PBX, then choose the FXO option. Check with your in-house phone personnel to verify the connection type.

If FXO is selected, the **Dialing Options Regeneration**, **Flash Hook Timer**, and **Ring Count** groups are enabled. Check with your local in-house phone personnel to verify whether your local PBX dial signaling is **Pulse** or tone (**DTMF**). Then, set the Regeneration option accordingly. The **Flash Hook Timer** allows you to enter the time, in milliseconds, for the duration of the flash hook signals output on the FXO interface. The default setting is **600** milliseconds. The **Ring Count FXO** window allows you to set the number of rings received on the FXO interface before the MultiVOIP 400/800 answers the incoming call. The default setting is **2** rings.

Note: Zero (0) means that the MultiVOIP 400/800 never answers.

MultiVOIP Quick Start Guide

For FXO-to-FXO communications, you can enable a specific type of FXO Disconnect; **Current Loss**, **Tone Detection**, or **Silence Detection**. Check with your in-house phone personnel to verify the preferred type of disconnect to use. Enabling **Tone Detection** activates the Disconnect Tone Sequence options. For **Disconnect Tone Sequence**, you can select from lists either one or two tones that will cause the line to be disconnected. The person hanging up a call must then hit the key or keys that will produce those tones. For **Silence Detection**, select **One Way** or **Two Way**, then set the timer for the number of seconds of silence before disconnect. The default value of **15** seconds may be shorter than desired for your application.

E&M: If you are connecting to an analog E&M trunk on your PBX, then choose the E&M interface option to enable the E&M Options group. Check with your local in-house phone personnel to determine if the signaling is **Dial Tone** or **Wink** and if the connection is 2-wire or 4-wire. If Wink signaling is used, then the **Wink Timer** is enabled with a default of **250** milliseconds. The range of the Wink Timer is from 100 to 350 milliseconds. Consult with your local in-house phone personnel for this timer setting.

Note: After configuring a given channel, you can copy that channel's configuration by clicking **Copy**. Everything on the **Interface** tab will be copied to the other channel.

15. Repeat the above step to configure the interface type for each voice/fax channel.

Configuring the MultiVOIP

- The **Voice/Fax** tab displays the parameters for the voice gain, DTMF (Dual Tone Multi-Frequency) gain, voice coder, faxing, and advanced features such as Silence Compression, Echo Cancellation, and Forward Error Correction.

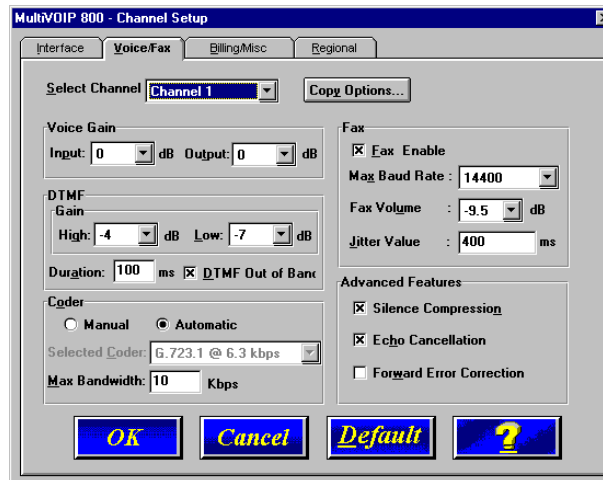

- You can set the input and output voice gain so that the volume can be increased or decreased. Input gain modifies the level of the audio coming in to the voice channel before it is sent over the Internet to the remote MultiVOIP 400/800. Output gain modifies the level of the audio being output to the device attached to the voice channel. Make your selections from the **Input** and **Output** lists in the **Voice Gain** group. The valid range is +31dB to -31dB with a recommended default value of **0**.
You can set up the DTMF gain (output level in decibels) for the higher and lower frequency groups of the DTMF tone pair. Make your selections from the **High** and **Low** lists in the **DTMF Gain** group. When the **DTMF Out of Band** check box is selected, the unit reproduces the DTMF tones instead of passing them through.

MultiVOIP Quick Start Guide

Note: The DTMF gain should be changed only with the assistance of Multi-Tech Technical Support.

18. To change the voice coder, select the channel from the **Select Channel** list, then click **Manual** in the Coder group. Select the new voice coder entry from the **Selected Coder** list.

If you changed the voice coder, ensure that the same voice coder is used on the voice/fax channel you are calling. Otherwise, you will always get a busy signal.

Note: If you allow the Coder to be selected automatically, then you need to enter the **Max Bandwidth**. Check with your network administrator to determine how much bandwidth is available.

19. The **Fax** group enables you to send/receive faxes on the selected voice/fax channel. You can select the maximum baud rate for faxes and the fax volume and enter the jitter value in milliseconds.

When receiving fax packets from a remote MultiVOIP 400/800, it is possible for individual packets to be delayed or received out of order due to traffic conditions on the network. To compensate for this effect, the MultiVOIP 400/800 uses a Jitter Buffer. The **Jitter Value** enables the MultiVOIP 400/800 to wait a user-definable period of time, in milliseconds, for delayed or out of order fax packets. The range of allowable Jitter Values is 0 to 400 milliseconds, with a default of **400** milliseconds.

If you do not plan to send or receive faxes on a given voice/fax channel, you can disable faxes in the Fax group.

20. You can enable the voice/fax advanced features by clicking (checking) the silence compression, echo cancellation, or forward error correction options.

The **Silence Compression** check box defines whether silence compression is enabled for this voice channel. If silence compression is enabled, the MultiVOIP 400/800

Configuring the MultiVOIP

will not transmit voice packets when silence is detected, thereby reducing the amount of network bandwidth that is being used by the voice channel.

The **Echo Cancellation** check box defines whether echo cancellation is enabled for this voice channel. If echo cancellation is enabled, the MultiVOIP 400/800 will remove echo which improves the quality of sound.

The **Forward Error Correction (FEC)** check box defines whether forward error correction is enabled (checked) for this voice channel. The FEC feature allows some of the voice packets that were corrupted (or lost) to be recovered. FEC adds an additional 50% overhead to the total network bandwidth consumed by the voice channel.

Note: After configuring a given channel, you can copy that channel's configuration by clicking **Copy**. Everything on the **Voice/Fax** tab will be copied to the other channel.

21. The **Billing/Misc** tab displays the parameters for auto call, automatic disconnection, billing options, and dynamic jitter buffer.

The screenshot shows the 'MultiVOIP 800 - Channel Setup' dialog box with the 'Billing/Misc' tab selected. The dialog has four tabs: 'Interface', 'Voice/Fax', 'Billing/Misc', and 'Regional'. The 'Billing/Misc' tab contains the following settings:

- Select Channel:** Channel 1 (dropdown menu)
- Copy Options...** (button)
- Auto Call:**
 - Auto Call Enable
 - Phone Number: (text field)
- Automatic Disconnection:**
 - Jitter Value: 20 ms
 - Consecutive Packets Lost: 30
 - Call Duration: 180 seconds
- Billing Options:**
 - InBound
 - OutBound
 - Charge: 5 Cents Per 5 seconds
- Dynamic Jitter Buffer:**
 - Minimum Jitter Value: 150 ms
 - Maximum Jitter Value: 300 ms
 - Optimization Factor: 7

At the bottom of the dialog are four buttons: **OK**, **Cancel**, **Default**, and a help button with a question mark.

MultiVOIP Quick Start Guide

If you want to dedicate a local voice/fax channel to a remote voice/fax channel (so you will not have to dial the remote channel), select the **Auto Call Enable** check box in the **Auto Call** group. Then enter the phone number of the remote MultiVOIP 400/800 in the **Phone Number** box.

22. The **Automatic Disconnection** group provides three options to be used singly or in combination.

The **Jitter Value** defines the average inter-arrival packet deviation (in milliseconds) before the call is automatically disconnected. Jitter is the inter-arrival packet deviation (phase shift of digital pulses) over the transmission medium that causes voice breakup which can be particularly disruptive to voice communications. The default setting is 20 milliseconds. A higher value means that the voice transmission will be more accepting of jitter. A lower value will be less tolerant of jitter.

Consecutive Packets Lost defines the number of consecutive packets that are lost after which the call is automatically disconnected. The default setting is **30**.

Call Duration defines the maximum length of time (in seconds) that a call remains connected before the call is automatically disconnected. The default setting is **180** seconds. A call limit of three minutes may be too short for most configurations. Therefore, you may want to increase this default value.

23. You can set billing options for inbound and/or outbound calls by checking them in the **Billing Options** group and then entering the charge in cents per number of seconds.
24. A minimum and maximum set of values can be set for **Dynamic Jitter Buffer**. When receiving voice packets from a remote MultiVOIP 400/800, it is possible to experience varying delays between packets due to traffic conditions on the network. This is called Jitter. To compensate for this effect, the MultiVOIP 400/800 uses a

Configuring the MultiVOIP

Dynamic Jitter Buffer. The Jitter Buffer allows the MultiVOIP 400/800 to wait for delayed voice packets by automatically adjusting the length of the Jitter Buffer between allowable minimum and maximum values. An **Optimization Factor** adjustment controls how quickly the length of the Jitter Buffer is increased when jitter increases on the network. The length of the jitter buffer directly effects the voice delay between MultiVOIP 400/800 gateways.

The Minimum Jitter Value default setting is **150** milliseconds, the Maximum Jitter Value default setting is **300** milliseconds, and the Optimization Factor default setting is **7**.

Note: After configuring a given channel, you can copy that channel configuration to the other channel by clicking **Copy Options**. Everything on the **Billing/Misc** tab will be copied to the other channel.

If your country/region is not the default USA, click the **Regional** tab and proceed to step 25. Otherwise, proceed to step 26 to begin building your phone directory database.

MultiVOIP Quick Start Guide

25. To change the Tone Pairs on the **Regional** tab, select your country or region from the **Country/Region** list.

Note: If your country or region is not listed, click **Custom** to define it.

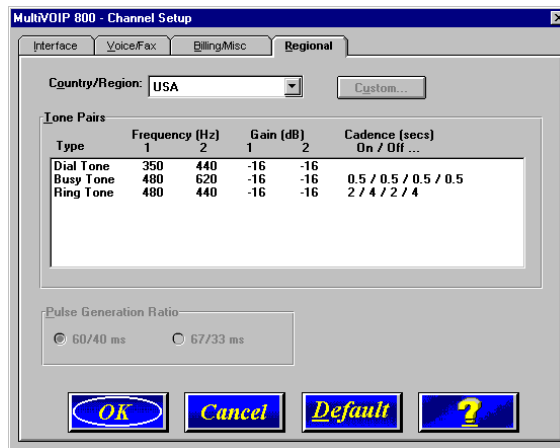

The **Tone Pairs** group enables you to select and modify the parameters. Click **OK** when finished. Proceed to step 26 to begin building your phone directory database.

Configuring the MultiVOIP

26. The **Phone Directory Database** dialog box displays with the **Proprietary PhoneBook** option selected and no phone numbers entries displayed in the database. This dialog box enables you to select either the GateKeeper or Proprietary PhoneBook. Once you have selected the type of Phone Book database, you can proceed to Registering with a GateKeeper Phone Directory in the following section. Or, if you are building a proprietary phone book, proceed to the Building a Proprietary Phonebook Directory section later in this manual.

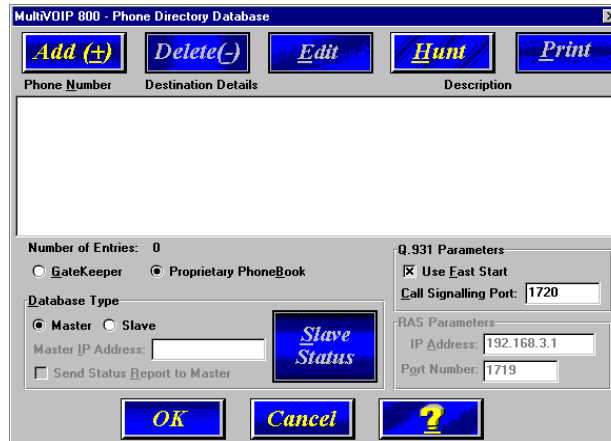

Registering with a Gatekeeper Phone Directory

This section describes how to register H.323 endpoints with the Gatekeeper. The H.323 Gatekeeper function resides at a PC acting as the central point for all calls within its zone and providing call control services to registered endpoints. The Gatekeeper performs two important call control functions: address translation from LAN aliases to IP addresses, and bandwidth management where the network manager has specified a threshold for the number of simultaneous conferences on the LAN.

In a GateKeeper environment, you will be selecting the **GateKeeper** option, entering an IP address for the GateKeeper, and accepting the default port number. If the GateKeeper network is servicing Fast Start, accept the defaults in the **Q.931 Parameters** group. If this network zone is primarily non-Fast Start supported, you will clear the **Use Fast Start** check box.

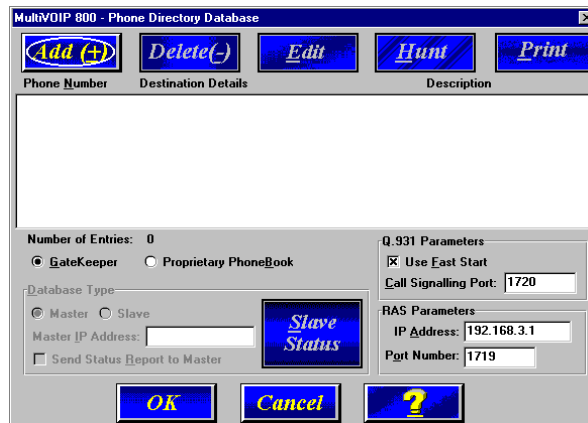

1. Select the **GateKeeper** option.
2. The **Use Fast Start** check box is selected by default. If the GateKeeper network employs Fast Start, leave this selected. You may have to verify whether Fast Start is used with the GateKeeper administrator.

Configuring the MultiVOIP

3. Enter the Gatekeeper IP Address in the IP Address box of the **RAS Parameters** group.
4. Accept the default **Port Number 1719**.
CAUTION: The default setting for the Gatekeeper Port Number is **1719**. This can be changed to a different value by the Gatekeeper administrator. If you decide to change the default Port Number, you must use the same number on the Gatekeeper and all other H.323 endpoints.
5. Click **Add** when you are finished to begin building your phone directory database. The **Add/Edit Phone Entry** dialog box displays.

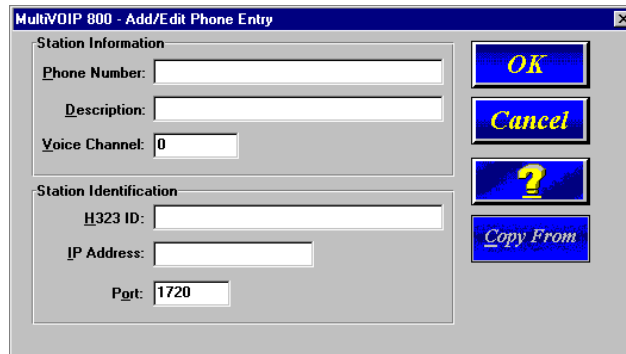

The screenshot shows a dialog box titled "MultiVOIP 800 - Add/Edit Phone Entry". It is divided into two main sections: "Station Information" and "Station Identification".

- Station Information:** Contains three input fields: "Phone Number" (empty), "Description" (empty), and "Voice Channel" (set to 0).
- Station Identification:** Contains three input fields: "H323 ID" (empty), "IP Address" (empty), and "Port" (set to 1720).

On the right side of the dialog box, there are four buttons: "OK", "Cancel", a question mark icon, and "Copy From".

6. Enter the unique phone number of the local device in the **Phone Number** box. For example, 101.
7. Leave the **Description** box blank.
8. Enter the **Voice Channel** number that corresponds to the phone number entered.
9. Enter a description in the **H.323 ID** box with a description to identify the phone number. For this example, you could enter "New York Office 1".

MultiVOIP Quick Start Guide

10. Enter the Port IP Address of the MultiVOIP you are currently configuring in the **IP Address** box.

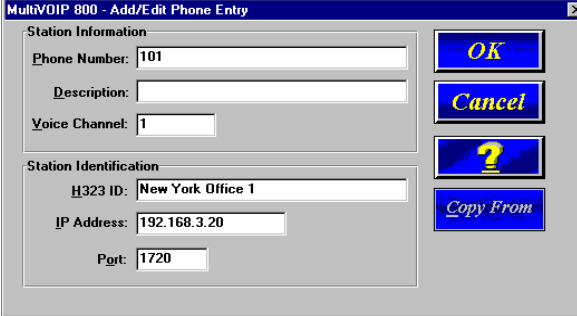

The screenshot shows the 'MultiVOIP 800 - Add/Edit Phone Entry' dialog box. It is divided into two main sections: 'Station Information' and 'Station Identification'. In the 'Station Information' section, the 'Phone Number' field contains '101', the 'Description' field is empty, and the 'Voice Channel' field contains '1'. In the 'Station Identification' section, the 'H323 ID' field contains 'New York Office 1', the 'IP Address' field contains '192.168.3.20', and the 'Port' field contains '1720'. On the right side of the dialog, there are four buttons: 'OK', 'Cancel', a question mark icon, and 'Copy From'.

11. Click **OK** when you are finished. The **Phone Directory Database** dialog box displays your first entry.



The screenshot shows the 'MultiVOIP 800 - Phone Directory Database' dialog box. At the top, there are five buttons: 'Add (+)', 'Delete(-)', 'Edit', 'Hunt', and 'Print'. Below these buttons is a table with three columns: 'Phone Number', 'Destination Details', and 'Description'. The table contains one entry with '101' in the 'Phone Number' column and 'New York Office 1' in the 'Destination Details' column. Below the table, there are several settings sections: 'Number of Entries' is set to '1'; 'Database Type' has 'GateKeeper' selected; 'RAS Parameters' includes 'Use Fast Start' checked and 'Call Signalling Port' set to '1720'; and 'RAS Parameters' also includes 'IP Address' set to '192.168.3.1' and 'Port Number' set to '1719'. At the bottom, there are three buttons: 'OK', 'Cancel', and a question mark icon.

12. Click **Add** to enter your next phone listing. The **Add/Edit Phone Entry** dialog box displays.
13. Enter the second unique phone number of the local device in the **Phone Number** box. For example, 102.
14. Leave the **Description** box blank.

Configuring the MultiVOIP

15. Enter the **Voice Channel** number corresponding to the phone number entered.
16. Enter a description in the **H.323 ID** box to identify the phone number. For this example, you could enter a description such as “Jerry’s Desk”.
17. Enter the Port IP Address of the MultiVOIP you are currently configuring in the **IP Address** box.

The screenshot shows a dialog box titled "MultiVOIP 800 - Add/Edit Phone Entry". It is divided into two main sections: "Station Information" and "Station Identification".

Station Information:

- Phone Number: 102
- Description: (empty)
- Voice Channel: 2

Station Identification:

- H323 ID: Jerry's Desk
- IP Address: 192.168.3.20
- Port: 1720

On the right side of the dialog, there are five buttons: "OK", "Cancel", a question mark icon, and "Copy From".

18. Click **OK** when you are finished. The **Phone Directory Database** dialog box displays with your second entry in the window.

The screenshot shows a dialog box titled "MultiVOIP 800 - Phone Directory Database". It features a table with two columns: "Phone Number" and "Destination Details".

Phone Number	Destination Details	Description
101	New York Office 1	
102	Jerry's Desk	

Below the table, there are several configuration options:

- Number of Entries: 2
- GateKeeper Proprietary PhoneBook
- Database Type: Master Slave
- Master IP Address: (empty)
- Send Status Report to Master
- Q.931 Parameters: Use Fast Start, Call Signalling Port: 1720
- RAS Parameters: IP Address: 192.168.3.1, Port Number: 1719

At the bottom, there are three buttons: "OK", "Cancel", and a question mark icon. A "Slave Status" button is also visible.

MultiVOIP Quick Start Guide

19. Repeat this process for all channels and then click **OK** in the **Phone Directory Database** dialog box.

Note: When entering multiple channels, you can also click **Copy From** in the **Add/Edit Phone Entry**, enter the phone number you want to copy, click **OK** in the **COPY FROM** dialog box. Change the information as needed, and click **OK** in the **Add/Edit Phone Entry** dialog box.

20. The following dialog box displays. Click **OK** to download setup.

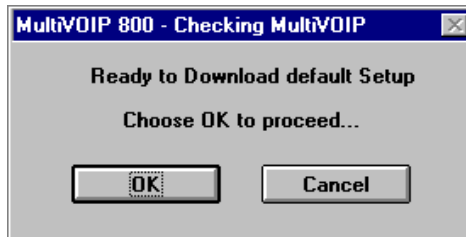

21. Once the setup program receives a response from the MultiVOIP 400/800, the **Writing Setup** dialog box displays, indicating that the setup configuration is being written to the MultiVOIP 400/800.

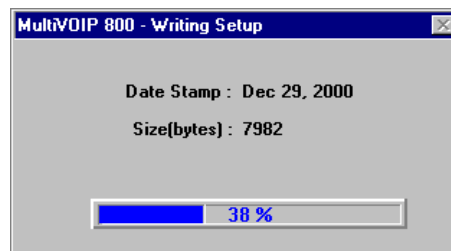

22. After the setup has been written to the MultiVOIP 400/800, the unit is rebooted.

Configuring the MultiVOIP

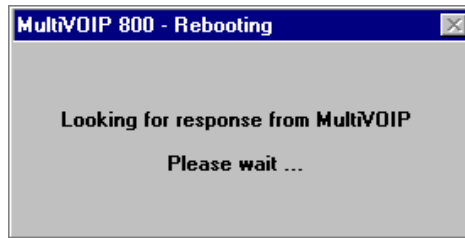

23. Check to ensure that the **BTG** LED on the MultiVOIP 400/800 is Off after the download is complete. This may take several minutes as the MultiVOIP 400/800 reboots.
24. You are returned to the Multi-Tech Installation CD screen from which you can load the Acrobat Reader to your PC. This allows you to view and/or print the User Guide by clicking the **Install Manuals** icon.

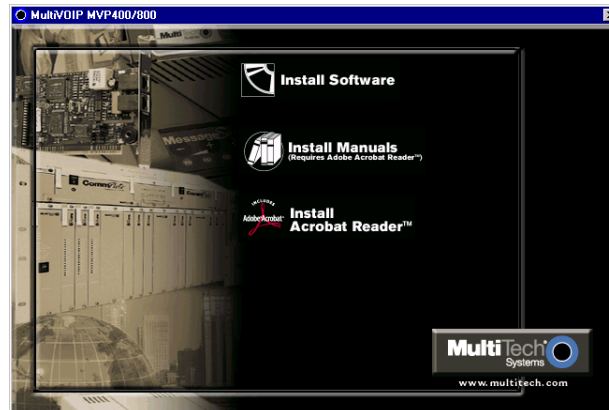

Building a Proprietary Phonebook Directory

To build your proprietary MultiVOIP 400/800 Phone Directory (in an H.323 environment without the **GateKeeper** option enabled), select the **Proprietary Phonebook** option, then configure the “Master” MultiVOIP 400/800 and then add the “Slave” MultiVOIP 400/800s (or other H.323 endpoints). Configuring the “Slave” MultiVOIP 400/800 is discussed later.

The first MultiVOIP 400/800 to be configured is designated the “Master” and contains the proprietary phonebook database. All subsequent MultiVOIP 400/800s added to the proprietary phonebook database are designated “Slaves”. The master database contains the phone numbers of all H.323 endpoints available for communication on an IP network. This database is downloaded to each Slave MultiVOIP 400/800 as it comes online.

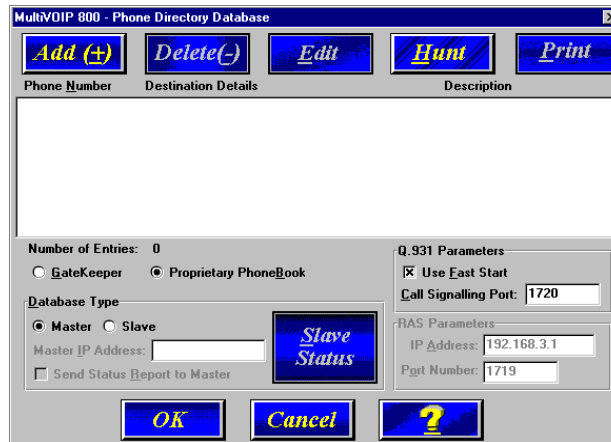

To configure the “Master” MultiVOIP 400/800, verify that the **Proprietary Phonebook** and **Master** options are enabled. The **Master IP Address**, **Send Status Report to Master**, and **RAS Parameters** group will be unavailable.

Configuring the MultiVOIP

Note: The **Slave Status** button displays the **Slave VOIP Status** dialog box used for viewing phone number, IP address, status, and description of slave units. See “Configuring Your Slave MultiVOIP 400/800s” for details.

1. Click **Add** to begin building your phone directory database. The **Add/Edit Phone Entry** dialog box displays.

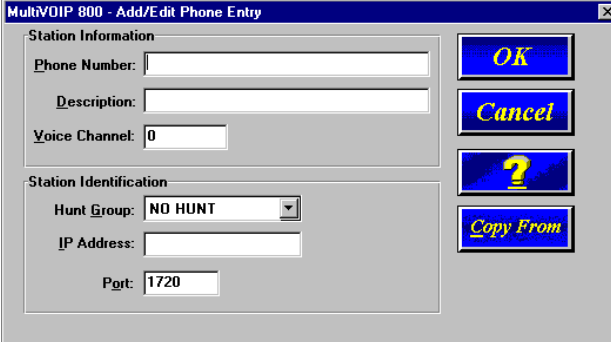

2. Enter the unique phone number of the local device in the **Phone Number** box (for example, 101) and indicate that the local device is connected to Channel 1 in the **Voice Channel** box.
3. The **Description** box is optional, but can be useful in associating the channel to the extension. If you wish, enter a description of your local phone number. This description serves to identify the phone number you entered in the previous step. For example, normally the “Master” MultiVOIP 400/800 resides at the entity’s main office. For this example you could enter a description such as “New York Office 1”.
4. The **Station Identification** group includes a **Hunt Group** list. This list enables you to indicate which Hunt Group you want the phone number to be associated with. Or, you can select NO HUNT if you do not want this entry to participate in hunting.

MultiVOIP Quick Start Guide

Note: Hunting is a series of telephone lines organized in such a way that if the first line is busy the next line is hunted and so on until a free line is found. For this example, assign the phone entry to HUNT GROUP #1.

Once you have assigned this entry to a Hunt Group (or NO HUNT), you must enter the IP Address of the Master MultiVOIP 400/800 in the **IP Address** box (for example, 204.022.122.118).

Note: The **Port** box becomes active as you begin to enter the IP Address. The entry is the H.323 industry standard Port value (1720) used to communicate with other H.323 endpoints.



The screenshot shows a dialog box titled "MultiVOIP 800 - Add/Edit Phone Entry". It contains two main sections: "Station Information" and "Station Identification".

- Station Information:**
 - Phone Number: 101
 - Description: New York Office 1
 - Voice Channel: 1
- Station Identification:**
 - Hunt Group: HUNT GROUP #1 (dropdown menu)
 - IP Address: 204.022.122.118
 - Port: 1720

On the right side of the dialog, there are four buttons: "OK", "Cancel", a question mark icon, and "Copy From".

5. Click **OK** to return to the **Phone Directory Database** dialog box. It now includes phone number (101), destination details (204.022.122.118 Channel 1), and description (New York Office 1).

Configuring the MultiVOIP

MultiVOIP 800 - Phone Directory Database

Buttons: Add (+), Delete (-), Edit, Hunt, Print

Phone Number	Destination Details	Description
101	204.022.122.118:1720 Channel 1	New York Office 1

Number of Entries: 1

GateKeeper Proprietary PhoneBook

Database Type: Master Slave

Master IP Address:

Send Status Report to Master

Q.931 Parameters: Use East Start, Call Signalling Port: 1720

RAS Parameters: IP Address: 192.168.3.1, Port Number: 1719

Buttons: OK, Cancel, ?

- To configure Channel 2 on the Master MultiVOIP 400/800, click **Add** and the **Add/Edit Phone Entry** dialog box displays again.

MultiVOIP 800 - Add/Edit Phone Entry

Station Information

Phone Number: 102

Description: New York Office 2

Voice Channel: 2

Station Identification

Hunt Group: HUNT GROUP #1

IP Address: 204.022.122.118

Port: 1720

Buttons: OK, Cancel, ?, Copy From

- Enter the phone number for the MultiVOIP 400/800 in the **Station Information** group **Phone Number** box. For example, 102.
- Enter a description in the **Description** box for the remote MultiVOIP 400/800 phone number for Channel 2. For example, "New York Office 2." Then, enter the voice channel number in the **Voice Channel** box.

MultiVOIP Quick Start Guide

- In the **Station Identification** group, select HUNT GROUP #1 from the **Hunt Group** list, enter the New York Office 2's IP Address (204.022.122.118), and accept the H.323 industry standard Port value (1720) used to communicate with other H.323 endpoints.
- Click **OK** and you are returned to the **Phone Directory Database** dialog box which now includes the second number and related information in the **Phone Number** list.

MultiVOIP 800 - Phone Directory Database

Add (+) **Delete (-)** **Edit** **Hunt** **Print**

Phone Number	Destination Details	Description
101	204.022.122.118:1720 Channel 1	New York Office 1
102	204.022.122.118:1720 Channel 2	New York Office 2

Number of Entries: 2

GateKeeper Proprietary PhoneBook

Database Type

Master Slave

Master IP Address:

Send Status Report to Master

Slave Status

Q.931 Parameters

Use East Start

Call Signalling Port:

RAS Parameters

IP Address:

Port Number:

OK **Cancel** **?**

Note: When entering multiple channels, you can also click **Copy From** in the **Add/Edit Phone Entry**, enter the phone number you want to copy, click **OK** in the **COPY FROM** dialog box. Change the information as needed, and click **OK** in the **Add/Edit Phone Entry** dialog box.

Both voice channels belong to Hunt Group # 1. If a call from an H.323 endpoint (a MultiVOIP 400/800 or a stand-alone H.323 endpoint) to Phone Number 101 is unable to be connected, it will automatically connect to the next available phone number in Hunt Group #1, such as Phone Number 102.

Configuring the MultiVOIP

11. Add all other phone numbers (slave units and stand-alone units) to the Phone Directory database. To add Channel 1 of the Slave MultiVOIP 400/800, click **Add**. The **Add/Edit Phone Entry** dialog box displays again.
12. Enter the phone number for the “Slave” MultiVOIP 400/800 in the **Phone Number** box. For example, 201.
13. Click inside the **Description** box and enter a description for the remote MultiVOIP 400/800 phone number for Channel 1. For example, “London Office 1”.
14. In the **Station Identification** group, select HUNT GROUP #2 from the **Hunt Group** list, enter the London Office 1’s IP Address (202.056.039.100), and accept the H.323 industry standard Port value (1720) used to communicate with other H.323 endpoints.

MultiVOIP 800 - Add/Edit Phone Entry

Station Information

Phone Number: 201

Description: London Office 1

Voice Channel: 1

Station Identification

Hunt Group: HUNT GROUP #1

IP Address: 202.056.039.100

Port: 1720

OK

Cancel

?

Copy From

15. Click **OK** and you are returned to the **Phone Directory Database** dialog box which now includes the remote phone number and related information in the **Phone Number** list.

MultiVOIP Quick Start Guide

Phone Number	Destination Details	Description
101	204.022.122.118 Channel 1	New York Office 1
102	204.022.122.118 Channel 2	New York Office 2
201	202.056.039.100 Channel 1	London Office 1

Number of Entries: 3

GateKeeper Proprietary PhoneBook

Database Type:
 Master Slave

Master IP Address:

Send Status Report to Master

RAS Parameters:
IP Address: 192.168.3.1
Port Number: 1719

16. To add Channel 2 of the Slave MultiVOIP 400/800, click **Add**. The **Add/Edit Phone Entry** dialog box displays again.
17. Enter the phone number for the remote (Slave) MultiVOIP 400/800 in the **Station Information** group **Phone Number** box. For example, 202.
18. Enter a description for the remote MultiVOIP 400/800 phone number for Channel 2 in the **Description** box. For example, "London Office 2".
19. In the **Station Identification** group, select HUNT GROUP #2 from the **Hunt Group** list, enter the London Office 2's IP Address (202.056.039.100), and accept the H.323 industry standard Port value (1720) used to communicate with other H.323 endpoints.

Note: Depending on your requirements, you may want calls that cannot make a connection to London Office 1 (Hunt Group #2) to roll over to the New York office instead. In this case, you would configure that phone entry to be listed as a member of HUNT GROUP #1.

Configuring the MultiVOIP



The dialog box is titled "MultiVOIP 800 - Add/Edit Phone Entry". It is divided into two main sections: "Station Information" and "Station Identification".

Station Information:

- Phone Number: 202
- Description: London Office 2
- Voice Channel: 2

Station Identification:

- Hunt Group: HUNT GROUP #2 (dropdown menu)
- IP Address: 202.056.039.100
- Port: 1720

Buttons on the right side: OK, Cancel, a question mark icon, and Copy From.

20. Click **OK** and you are returned to the **Phone Directory Database** dialog box which now includes the remote phone number and related information in the **Phone Number** list.

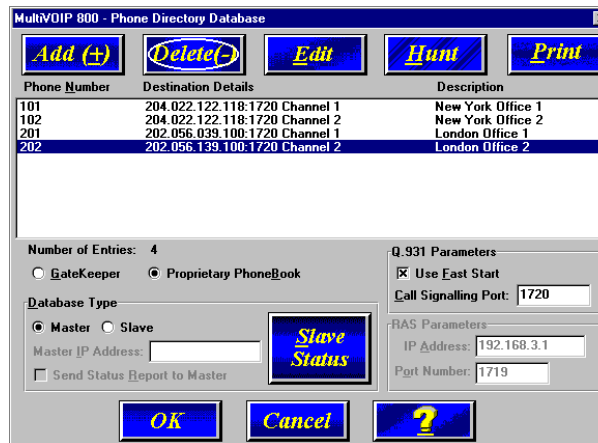

The dialog box is titled "MultiVOIP 800 - Phone Directory Database". It features a table of phone entries and several configuration sections.

Buttons: Add (+), Delete (-), Edit, Hunt, Print

Phone Number	Destination Details	Description
101	204.022.122.118:1720 Channel 1	New York Office 1
102	204.022.122.118:1720 Channel 2	New York Office 2
201	202.056.039.100:1720 Channel 1	London Office 1
202	202.056.139.100:1720 Channel 2	London Office 2

Number of Entries: 4

GateKeeper: GateKeeper Proprietary PhoneBook

Database Type: Master Slave

Master IP Address: []

Send Status Report to Master

Q.931 Parameters: Use Fast Start, Call Signalling Port: 1720

RA5 Parameters: IP Address: 192.168.3.1, Port Number: 1719

Buttons at the bottom: OK, Cancel, a question mark icon, and a Slave Status button.

21. To configure a stand-alone endpoint (for example, a PC with NetMeeting software), click **Add** and the **Add/Edit Phone Entry** dialog box displays again.
22. Enter the phone number for the stand-alone endpoint in the **Station Information** group **Phone Number** box. For example, 301.

MultiVOIP Quick Start Guide

23. Click inside the **Description** box and enter a description for the remote MultiVOIP 400/800 phone number. For example, "Human Resources Desk".

Note: Because the H.323 endpoint is not a MultiVOIP 400/800, the Phone Directory database ignores the Voice Channel entry. It does not matter what value is entered.

24. In the **Station Identification** group, select NO HUNT from the **Hunt Group** list. Enter the Human Resource Desk's IP Address (for example, 202.198.100.04), and accept the H.323 industry standard Port value (1720) used to communicate with other H.323 endpoints.

Note: This stand-alone was not configured as part of a Hunt Group. However, depending on your requirements, you could configure a stand-alone to be part of a Hunt Group.

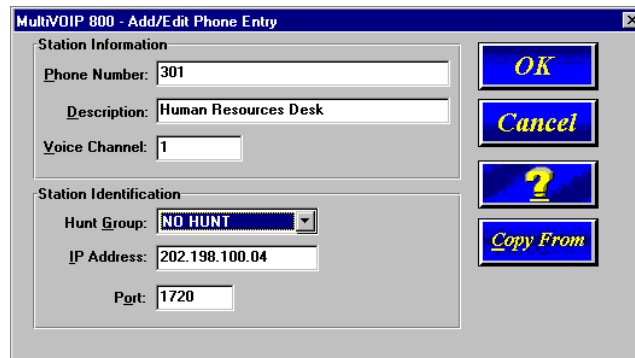

MultiVOIP 800 - Add/Edit Phone Entry

Station Information

Phone Number: 301

Description: Human Resources Desk

Voice Channel: 1

Station Identification

Hunt Group: NO HUNT

IP Address: 202.198.100.04

Port: 1720

Buttons: OK, Cancel, ?, Copy From

25. Click **OK** and you are returned to the **Phone Directory Database** dialog box which now includes the stand-alone phone number and related information in the **Phone Number** list.

Configuring the MultiVOIP

Phone Number	Destination Details	Description
101	204.022.122.118:1720 Channel 1	New York Office 1
102	204.022.122.118:1720 Channel 2	New York Office 2
201	202.056.039.100:1720 Channel 1	London Office 1
202	202.056.139.100:1720 Channel 2	London Office 2
301	202.198.100.004:1720 Channel 1	Human Resources Desk

Number of Entries: 5

GateKeeper Proprietary PhoneBook

Database Type

Master Slave

Master IP Address:

Send Status Report to Master

Q.931 Parameters

Use Fast Start

Call Signalling Port:

RAS Parameters

IP Address:

Port Number:

Slave Status

Buttons: OK, Cancel, ?

26. When you have finished, click **OK** to download the setup configuration to the MultiVOIP 400/800.
27. The **Checking MultiVOIP 400/800** dialog box displays.

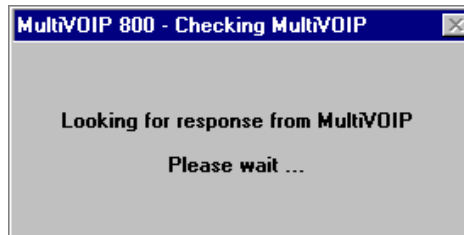

28. Once the setup program receives a response from the MultiVOIP 400/800, the **Writing Setup** dialog box displays indicating that the setup configuration is being written to the MultiVOIP 400/800.

MultiVOIP Quick Start Guide

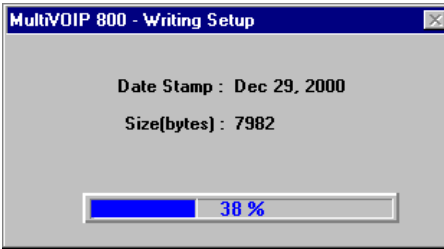

29. After the setup has been written to the MultiVOIP 400/800, the unit is rebooted.

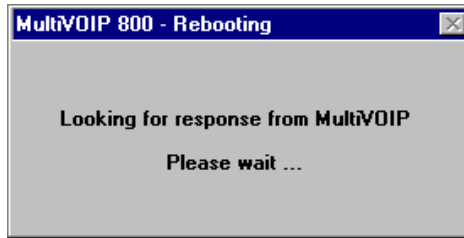

30. Check to ensure that the **BTG** LED on the MultiVOIP 400/800 is Off after the download is complete. This may take several minutes as the MultiVOIP 400/800 reboots.
31. You are returned to the Multi-Tech Installation CD screen from which you can load the Acrobat Reader to your PC. This allows you to view and/or print the User Guide by clicking the **Install Manuals** icon.

Configuring the MultiVOIP



At this time your master MultiVOIP 400/800 is configured. Proceed to the “Configuring Your Slave MultiVOIP 400/800s” section.

MultiVOIP Quick Start Guide

Configuring Your Slave MultiVOIP 400/800s

If the Proprietary Phone Book option is selected in the Phone Directory Database dialog box, you will need to configure all H.323 endpoints as “Slave” units. For example the MultiVOIP 400/800 at the company’s London office would need to be configured as a “Slave”.

CAUTION: If you are installing a MultiVOIP 400/800 behind a firewall, the firewall must support H.323. Refer to your firewall user documentation to enable H.323 support.

1. Disconnect the PC from the Command port of the Master MultiVOIP 400/800 and connect it to the Command port on the Slave MultiVOIP 400/800.
2. **Win 3.1 users** - from the Program Manager, click the **MultiVOIP 800 Configuration** icon in the MultiVOIP 400/800 Program Group. The Main menu displays.

Win2000/NT/98/95 users - from your desktop, click **Programs | MultiVOIP 800 | MultiVOIP 800 Configuration**. The Main menu displays.

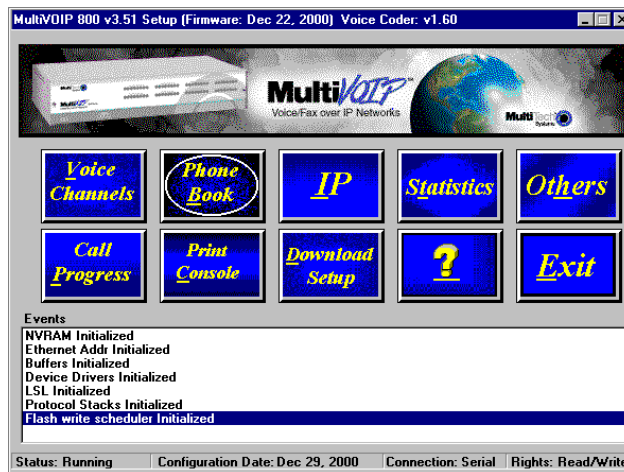

3. Click **IP** to display the **IP Setup** dialog box.

Configuring the MultiVOIP

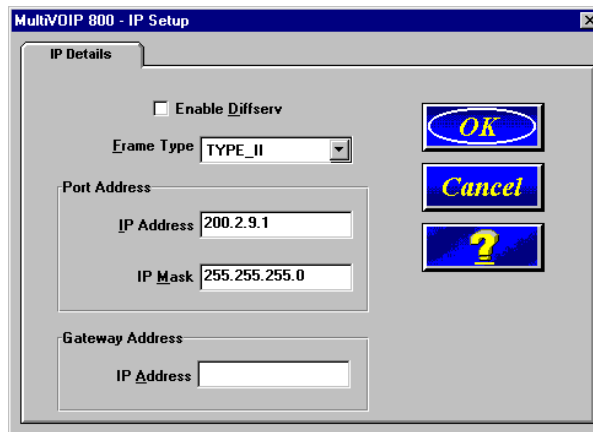

Select the **Enable Diffserv** check box to enable differentiated services on routers that support this service. This feature provides priority to voice packets so that they are not delayed because of large data files being downloaded.

The default **Frame Type** is **TYPE_II**. If this does not match your IP network, change the Frame Type by clicking on the drop-down arrow. The Frame Type choices are **TYPE_II** and **SNAP**.

4. In the **Port Address** group, enter the **IP Address** for the slave unit and the **IP Mask**. In the **Gateway Address** group, enter the gateway IP address.

The IP Address is the unique IP address that you assign to the MultiVOIP 400/800, and the Gateway Address is the IP address of the device (such as a network router) connected to the Internet/Intranet.

Click **OK** when you are finished. The Main menu displays.

5. From the Main menu, click **Voice Channels** to display the **Channel Setup** dialog box. The **Channel Setup** dialog box displays. The four tabs in this dialog box define the channel interface, voice/fax parameters, Billing/Misc

MultiVOIP Quick Start Guide

parameters, and regional telephone parameters for each channel.

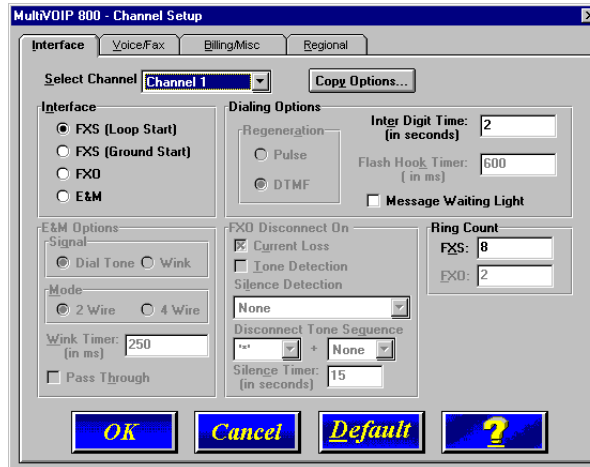

Configure each channel for the type of interface you are using. **Channel 1** displays by default on the **Interface** tab. To change the channel number, select the channel you want to configure from the **Select Channel** list.

Feature options are enabled or unavailable according to the interface type that you select. The **Inter Digit Time** check box is available for all interface types. This option defines the maximum amount of time that the unit will wait before mapping the dialed digits to an entry in the Phone Directory Database. If too much time elapses between digits, and the wrong numbers are mapped, you will hear a rapid busy signal. If this happens, it will be necessary to hang up and dial again. The default is 2 seconds.

6. The **Interface** group defaults to **FXS (Loop Start)**. Select the interface option that corresponds to the interface type being connected to the Voice/Fax Channel 1 jack on the back panel of the MultiVOIP 400/800.

Configuring the MultiVOIP

FXS (Loop Start): If a station device such as an analog telephone, fax machine, or KTS (Key Telephone System) is connected to the Voice/Fax connector on the back of the unit, FXS (Loop Start) will likely be the correct Interface option.

FXS (Ground Start): If the station device uses ground start, then choose the FXS (Ground Start) option. Refer to the device's user documentation.

For both FXS Loop Start and FXS Ground Start, the **Ring Count FXS** window allows you to set the maximum number of rings before hanging up and releasing the line to another call. The default setting is **8** counts.

Note: Zero (0) means no rings - caller hears a busy tone.

FXO: If you are using an analog extension from your PBX, then choose the FXO option. Check with your in-house phone personnel to verify the connection type.

If FXO is selected, the **Dialing Options Regeneration**, **Flash Hook Timer**, and **Ring Count** groups are enabled. Check with your local in-house phone personnel to verify whether your local PBX dial signaling is **Pulse** or **DTMF** (tone). Then, set the Regeneration option accordingly. The **Flash Hook Timer** allows you to enter the time, in milliseconds, for the duration of the flash hook signal output on the FXO interface. The default setting is **600** milliseconds. The **Ring Count FXO** window allows you to set the number of rings received on the FXO interface before the MultiVOIP 400/800 answers the incoming call. The default setting is **2** counts.

Note: Zero (0) means that the MultiVOIP 400/800 never answers.

For FXO-to-FXO communications, you can enable a specific type of FXO Disconnect: **Current Loss**, **Tone Detection**, or **Silence Detection**. Check with your in-house phone personnel to verify the preferred type of disconnect to use. Enabling **Tone Detection** activates the

MultiVOIP Quick Start Guide

Disconnect Tone Sequence options. For **Disconnect Tone Sequence**, you can select from the lists either one or two tones that will cause the line to be disconnected; the person hanging up a call must then hit the key or keys that will produce those tones. For **Silence Detection**, select **One Way** or **Two Way**, then set the timer for the number of seconds of silence before disconnect. Note that the default value of **15** seconds may be shorter than desired for your application.

E&M: If you are connecting to an analog E&M trunk on your PBX, then choose the E&M interface option to enable the E&M Options group. Check with your in-house phone personnel to determine if the signaling is **Dial Tone** or **Wink** and if the connection is 2-wire or 4-wire. If Wink signaling is used, then the **Wink Timer** is enabled with a default of **250** milliseconds. The range of the Wink Timer is from 100 to 350 milliseconds. Consult with your in-house phone personnel for this timer setting.

Note: After configuring a given channel, you can copy that channel's configuration by clicking **Copy Options**. Everything on the **Interface** tab will be copied to the other channel.

7. Repeat the above step to configure the interface type for voice/fax channel 2.
8. The **Voice/Fax** tab displays the parameters for the voice gain, DTMF (Dual Tone Multi-Frequency) gain, voice coder, faxing, and advanced features such as Silence Compression, Echo Cancellation, and Forward Error Correction.

Configuring the MultiVOIP

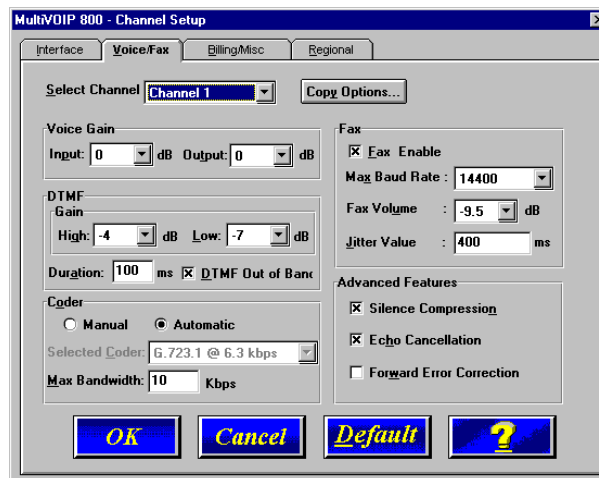

9. You can set up the input and output voice gain so that the volume can be increased or decreased. Input gain modifies the level of the audio coming in to the voice channel before it is sent over the Internet to the remote MultiVOIP 400/800. Output gain modifies the level of the audio being output to the device attached to the voice channel. Make your selections from the **Input** and **Output** lists in the **Voice Gain** group. The valid range is +31dB to -31dB with a recommended default value of **0**.

The **DTMF Gain** group controls the volume level of the digital tones sent out for touchtone dialing. The selections from the **Gain High** and **Gain Low** lists control the gain in decibels of the high and low tones in the tone pairs. The default gain values are -4 dB and -7 dB respectively. The DTMF gain should be changed only with the assistance of Multi-Tech Technical Support.

When the **DTMF Out of Band** check box is selected, the MultiVOIP reproduces DTMF tones rather than passing them from input to output.

MultiVOIP Quick Start Guide

10. To change the voice coder, the channel from the **Select Channel** list, then click **Manual** in the Coder group. To select the appropriate coder, select your new voice coder entry from the **Selected Coder** list.

If you changed the voice coder, ensure that the same voice coder is used on the voice/fax channel you are calling; otherwise, you will always get a busy signal.

Note: If you allow the Coder to be selected automatically, enter the **Max Bandwidth**. Check with your network administrator to determine how much bandwidth is available.

11. The **Fax** group enables you to send/receive faxes on the selected voice/fax channel. You can set the maximum baud rate for faxes and the fax volume in the two drop-down lists and change the jitter value in milliseconds.

When receiving fax packets from a remote MultiVOIP 400/800, it is possible for individual packets to be delayed or received out of order due to traffic conditions on the network. To compensate for this effect, the MultiVOIP 400/800 uses a Jitter Buffer. The **Jitter Value** allows the MultiVOIP 400/800 to wait a user-definable period of time, in milliseconds, for delayed or out-of-order fax packets. The range of allowable Jitter Values is 0 to 400 milliseconds with a default of **400** milliseconds.

If you do not plan to send or receive faxes on a given voice/fax channel, you can disable faxes in the **Fax** group.

12. You can enable the voice/fax advanced features by selecting the **Silence Compression**, **Echo Cancellation**, or **Forward Error Correction** check boxes.

The **Silence Compression** check box defines whether silence compression is enabled for this voice channel. If silence compression is enabled, the MultiVOIP 400/800 will not transmit voice packets when silence is detected, thereby reducing the amount of network bandwidth that is being used by the voice channel.

Configuring the MultiVOIP

The **Echo Cancellation** check box defines whether echo cancellation is enabled for this voice channel. If echo cancellation is enabled, the MultiVOIP 400/800 will remove echo-delay which improves the quality of sound.

The **Forward Error Correction (FEC)** check box defines whether forward error correction is enabled for this voice channel. The FEC feature allows some of the voice packets that were corrupted (or lost) to be recovered. FEC adds an additional 50% overhead to the total network bandwidth consumed by the voice channel.

Note: After configuring a given channel, you can copy that channel's configuration by clicking **Copy Options**. Everything on the **Voice/Fax** tab will be copied to the other channel.

The **Billing/Misc** tab displays the parameters for auto call, automatic disconnection, billing options and dynamic jitter buffer.

The screenshot shows the 'MultiVOIP 800 - Channel Setup' dialog box with the 'Billing/Misc' tab selected. The 'Select Channel' dropdown is set to 'Channel 1'. The 'Auto Call' section has the 'Auto Call Enable' checkbox unchecked. The 'Automatic Disconnection' section has three checkboxes: 'Jitter Value' (unchecked, 20 ms), 'Consecutive Packets Lost' (unchecked, 30), and 'Call Duration' (unchecked, 180 seconds). The 'Billing Options' section has 'InBound' and 'OutBound' checkboxes unchecked, with 'Charge' set to 5 and 'Cents Per' set to 5 seconds. The 'Dynamic Jitter Buffer' section has 'Minimum Jitter Value' set to 150 ms, 'Maximum Jitter Value' set to 300 ms, and 'Optimization Factor' set to 7. At the bottom are buttons for 'OK', 'Cancel', 'Default', and a help icon.

13. If you want to dedicate a local voice/fax channel to a remote voice/fax channel (so you will not have to dial the remote channel), click the **Auto Call Enable** check box in

MultiVOIP Quick Start Guide

the **Auto Call** group. Then enter the phone number of the remote MultiVOIP 400/800 in the **Phone Number** box.

14. The **Automatic Disconnection** group provides three options to be used singly or in combination.

The **Jitter Value** defines the average inter-arrival packet deviation (in milliseconds) before the call is automatically disconnected. Jitter is the inter-arrival packet deviation (phase shift of digital pulses) over the transmission medium that causes voice breakup which can be particularly disruptive to voice communications. The default setting is **20** milliseconds. A higher value means that the voice transmission will be more accepting of jitter. A lower value will be less tolerant of jitter.

Consecutive Packets Lost defines the number of consecutive packets that are lost after which the call is automatically disconnected. The default setting is **30** packets.

Call Duration defines the maximum length of time (in seconds) that a call remains connected before the call is automatically disconnected. The default setting is **180** seconds. A call limit of three minutes may be too short for most configurations. Therefore, you may want to increase this default value.

15. You can set billing options for inbound and outbound calls by selecting them in the **Billing Options** group and then entering the charge in cents per number of seconds.
16. A minimum and maximum set of values can be set for **Dynamic Jitter Buffer**. When receiving voice packets from a remote MultiVOIP 400/800, it is possible to experience varying delays between packets due to traffic conditions on the network. This is called Jitter. To compensate for this effect, the MultiVOIP 400/800 uses a Dynamic Jitter Buffer. The Jitter Buffer allows the MultiVOIP 400/800 to wait for delayed voice packets by automatically adjusting the length of the Jitter Buffer

Configuring the MultiVOIP

between allowable minimum and maximum values. An **Optimization Factor** adjustment controls how quickly the length of the Jitter Buffer is increased when jitter increases on the network. The length of the jitter buffer directly effects the voice delay between MultiVOIP 400/800 gateways.

The Minimum Jitter Value default setting is **150** milliseconds, the Maximum Jitter Value default setting is **300** milliseconds, and the Optimization Factor default setting is **7**.

Note: After configuring a given channel, you can copy that channel's configuration to the other channel by clicking **Copy Options**. Everything on the **Billing/Misc** tab will be copied to the other channel.

If your country/region is not the default USA, click the **Regional** tab and proceed to step 17. Otherwise, proceed to step 18 to begin building your phone directory database.

MultiVOIP Quick Start Guide

17. To change the Tone Pairs on the **Regional** tab, select your specific country or region from the **Country/Region** list.

Note: If your country or region is not listed, click **Custom** to define it.

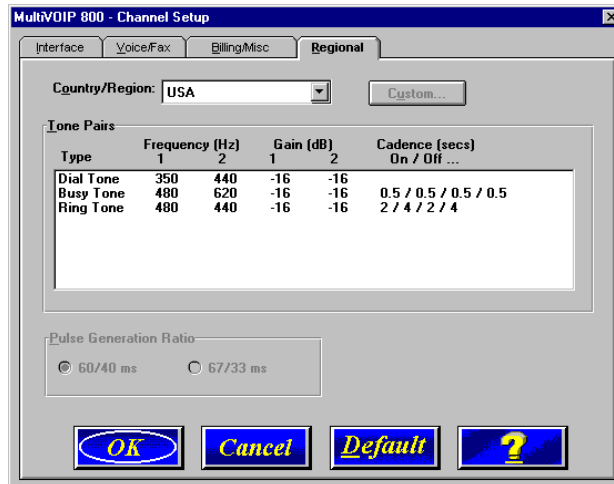

The **Tone Pairs** group enables you to select/modify the parameters according to choice. Click **OK** when finished and proceed to step 6 to begin building your phone directory database.

18. From the Main menu, click **Phone Book** to display the **Phone Directory Database** dialog box. Make certain the **Proprietary Phonebook** option is selected. In the **Database Type** group, select the **Slave** option. The **Master IP Address** box becomes active.

Configuring the MultiVOIP

The screenshot shows a window titled "MultiVOIP 800 - Phone Directory Database". At the top, there are five buttons: "Add (+)", "Delete(-)", "Edit", "Hunt", and "Print". Below these buttons are three columns: "Phone Number", "Destination Details", and "Description". The main area is currently empty. At the bottom, there are several configuration options:

- Number of Entries: 0
- Radio buttons for "GateKeeper" and "Proprietary PhoneBook" (selected).
- Database Type: Radio buttons for "Master" (selected) and "Slave".
- Master IP Address: [Empty text box]
- Send Status Report to Master: [Unchecked checkbox]
- Q.931 Parameters: "Use East Start" (checked), "Call Signalling Port: 1720" (text box).
- RAS Parameters: "IP Address: 192.168.3.1" (text box), "Port Number: 1719" (text box).

At the bottom right, there is a "Slave Status" button. At the bottom center, there are "OK", "Cancel", and a help button (question mark).

Note: After you have enabled the **Slave** option, the **Slave Status** button is replaced by the **Update** button. Once your Phone Directory database has been established, you can click **Update** to refresh the entries in the Phone Directory Database window.

19. Enter the IP address (204.022.122.118) of the Master MultiVOIP 400/800 in the **Master IP Address** box and select the **Send Status Report to Master** check box. This established the New York office MultiVOIP 400/800 as the Master.

Note: In a Dial-On-Demand (DOD) network, you should leave the **Send Status Report to Master** check box cleared. This allows the router to disconnect whenever there is no voice activity. Note that Slaves with the **Send Status Report to Master** check box cleared will show up as "Unknown" when viewing Slave status on the Master.

20. Click **OK** to return to the Main menu.
21. Click **Download Setup** to write the new configuration to the slave unit. The **Save Setup** dialog box displays.

MultiVOIP Quick Start Guide

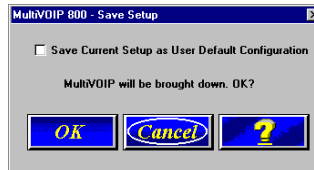

22. Select the Save Current Setup as User Default Configuration and click **OK**. The **Writing Setup** dialog box displays as the setup configuration is written to the MultiVOIP 400/800.

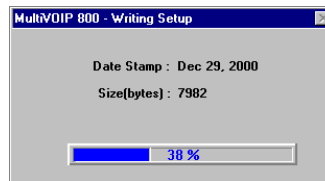

After the setup is written to the MultiVOIP 400/800, it reboots.

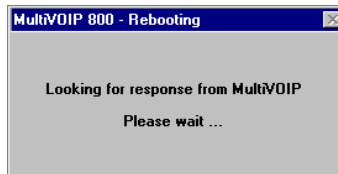

23. Check that the **BTG** LED on the MultiVOIP 400/800 is off after the download is complete. This may take several minutes as the MultiVOIP 400/800 reboots.
24. You are returned to the Main menu.

Your MultiVOIP 400/800 is operational at this time.

Repeat the process for each of the slave units. When all slaves have been configured, go to the "Deploying the Network" section.

Deploying the VOIP Network

For a proprietary phone directory database, the VOIP administrator can deploy the pre-configured slave MultiVOIP 400/800s to their remote sites. The remote site administrators need only connect power to the pre-configured MultiVOIP 400/800, connect the MultiVOIP 400/800 to their Ethernet LAN and predefined telephone equipment, and then wait for the phone directory database to be downloaded.

With the **Gatekeeper** option enabled on the **Phone Directory Database** dialog box, all MultiVOIP 400/800s are configured as “Master” and cannot be downloaded. In this case, each MultiVOIP 400/800 Phone Book will be programmed with phone numbers for its own channels. These phone numbers are remotely registered with the H.323 Gatekeeper. See the “Registering with a Gatekeeper Phone Directory” section for more information.

Remote Site Administrator

The following steps are for MultiVOIP 400/800 H.323 endpoints. For non-MultiVOIP 400/800 H.323 endpoints, refer to the appropriate installation documentation.

1. Unpack your MultiVOIP 400/800.
2. Connect one end of the power supply to a live AC outlet and connect the other end to the **Power** connection on your MultiVOIP 400/800 (See Figure 5).

MultiVOIP Quick Start Guide

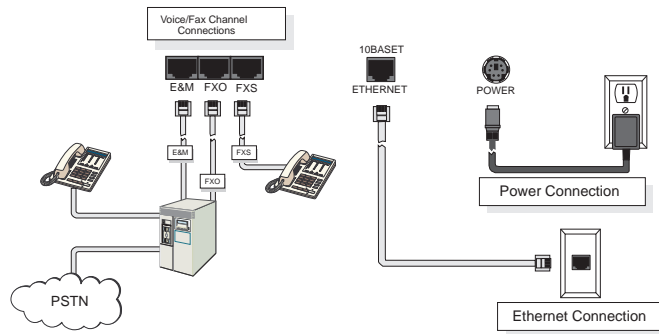

Figure 5. Remote Site Cable Connection

3. Connect a network cable to the **ETHERNET 10BASET** (RJ-45) connector on the back of your MultiVOIP 400/800.
4. If you are connecting a station device (analog telephone, fax machine, or Key Telephone System (KTS) to your MultiVOIP 400/800, connect the smaller end of a special adapter cable (supplied) to the **Voice/Fax Channel 1 FXS** connector on the back of the MultiVOIP 400/800 and the other end to the station device.

If you are connecting a PBX extension to your MultiVOIP 400/800, connect the smaller end of a special adapter cable (supplied) to the **Voice/Fax Channel 1 FXO** connector on the back of the MultiVOIP 400/800 and the other end to the PBX extension.

If you are connecting an E&M trunk from a telephone switch to your MultiVOIP 400/800, connect one end of an RJ-45 phone cord to the **Voice/Fax Channel 1 E&M** connector on the back of the unit and the other end to the trunk phone jack.

If you are connecting to an E&M trunk, you need to ensure that the E&M trunk jumper is in the correct position for the E&M type trunk. The default E&M jumper position is E&M type 2. To change the E&M jumper position, perform the E&M jumper block positioning procedure.

Deploying the VOIP Network

5. Repeat the above step to connect the remaining telephone equipment to each Voice/Fax Channel on your MultiVOIP.
6. Turn on power to the MultiVOIP 400/800 by placing the ON/OFF switch on the back panel to the ON position. Wait for the **BTG** LED on the MultiVOIP 400/800 to go off before proceeding. This may take a couple of minutes.
7. At this time your VOIP network should be fully operational. Dial one of the sites in your network using the dialing directory supplied by your network Administrator.

If your H.323 endpoint is not a MultiVOIP 400/800 (for example, a PC with Netmeeting software), the Systems Administrator for your VOIP network should do the following:

1. Make certain that the H.323 endpoint (for example, a PC with Netmeeting, or router with voice) have been properly connected to the network. Refer to the appropriate end user documentation.
2. Acquire the relevant IP Addresses and/or H323 IDs (H323 IDs are required if Gatekeeper is enabled) from the other H.323 endpoints that will participate in H.323 calls.
3. Enter the IP Addresses and MultiTech H323 IDs (H323 IDs are required if Gatekeeper is enabled) in your phonebook directory. You do not have to enter non-MultiTech H.323 IDs in the phonebook directory if a gatekeeper is enabled.

MultiVOIP Quick Start Guide

Limited Warranty

Multi-Tech Systems, Inc. ("MTS") warrants that its products will be free from defects in material or workmanship for a period of two years from the date of purchase, or if proof of purchase is not provided, two years from date of shipment. MTS MAKES NO OTHER WARRANTY, EXPRESSED OR IMPLIED, AND ALL IMPLIED WARRANTIES OF MERCHANTABILITY AND FITNESS FOR A PARTICULAR PURPOSE ARE HEREBY DISCLAIMED. This warranty does not apply to any products which have been damaged by lightning storms, water, or power surges or which have been neglected, altered, abused, used for a purpose other than the one for which they were manufactured, repaired by the customer or any party without MTS's written authorization, or used in any manner inconsistent with MTS's instructions.

MTS's entire obligation under this warranty shall be limited (at MTS's option) to repair or replacement of any products which prove to be defective within the warranty period, or, at MTS's option, issuance of a refund of the purchase price. Defective products must be returned by Customer to MTS's factory transportation prepaid.

MTS WILL NOT BE LIABLE FOR CONSEQUENTIAL DAMAGES AND UNDER NO CIRCUMSTANCES WILL ITS LIABILITY EXCEED THE PURCHASE PRICE FOR DEFECTIVE PRODUCTS.

Warranty and Regulatory Information

Technical Support

Multi-Tech Systems has an excellent staff of technical support personnel available to help you get the most out of your Multi-Tech product. If you have any questions about the operation of this unit, or experience difficulty during installation you can contact Tech Support via the following:

Phone:

(800) 972-2439 (USA and Canada)

(763) 785-3500 (international and local)

Internet:

<http://www.multitech.com/>

Please have your product information available, including model and serial number.

FCC Declaration

NOTE: This equipment has been tested and found to comply with the limits for a **Class A** digital device, pursuant to Part 15 of the FCC Rules. These limits are designed to provide reasonable protection against harmful interference when the equipment is operated in a commercial environment. This equipment generates, uses and can radiate radio frequency energy, and if not installed and used in accordance with the instructions, may cause harmful interference to radio communications. Operation of this equipment in a residential area is likely to cause harmful interference in which case the user will be required to correct the interference at his own expense.

Warning: Changes or modifications to this unit not expressly approved by the party responsible for compliance could void the user's authority to operate the equipment.



82088202