

NITSUKO AMERICA[★]

Digital
System **DS**

Administrator's Guide

Contents



Tips



About
Acrobat





- Provides on-line viewing and printing.
- Extensive search and navigation capabilities.
- Ensures more timely turnaround of documents.
- When we provide an Acrobat manual with a product (e.g., Nitsuko TAPI Driver), you are assured of having the most up-to-date manual available.
- With the installation of a PC fax/modem, it makes faxing of any brochure, user guide, proposal or manual quick and easy.
- Acrobat Reader programs for Macintosh, DOS and UNIX platforms also can be provided, if required.
- For Technical Support for the Acrobat Reader, contact:

Adobe Systems, Inc.

1585 Charleston Road

P.O. Box 7900

Mountain View, CA 94039-7900

Telephone Number: 415-961-4400

Adobe FaxY1 (technical/product information by fax): 206-628-5737

Adobe Electronic Bulletin Board (on-line information): 206-623-6984

URL: <http://www.adobe.com>

- To return to the opening screen, press the **HOME** key.



- In **Edit** ⇨ **Preferences** ⇨ **General**, set the following:
 - **Default Magnification** = Fit Width
 - **Display Splash Screen at Startup** = Disabled (box not checked)
 - **Display Open Dialog Box at Startup** = Disabled (box not checked)
- For easiest reading on-screen, select **View** ⇨ **Fit Width** (or **Ctrl K**). This option is automatically enabled if you set the *Default Magnification* in General Preferences as described above.
- To return to the opening screen at any time, press **Home**.
To scroll up or down on a page, press **PageDown** or **PageUp**.
To navigate between pages, press **→** or **←**.
- To increase the speed with which your Acrobat files load, try one of the following:
 - In **Windows 3.1**, add *ACROREAD.EXE* to your **Startup Group** (with the Run Minimized box checked).
 - In **Windows 95**, add *ACROREAD.EXE* to the **Windows\Start Menu\Programs\Startup** folder (with Run Minimized selected).
You'll have to maximize the first Acrobat file you run.

Contents

- Initializing a New Digital System
- Start-up Programming
- Introduction
- Features
- Programs

NITSUKO AMERICA[★]

Digital
System **DS**

Administrator's Guide

N1872ADG03



This manual has been developed by Nitsuko America. It is intended for the use of its customers and service personnel, and should be read in its entirety before attempting to install or program the system. Any comments or suggestions for improving this manual would be appreciated. Forward your remarks to:

Nitsuko America, Telecom Division
4 Forest Parkway
Shelton, CT 06484

Attention: Manager, Technical Publications

Nothing contained in this manual shall be deemed to be, and this manual does not constitute, a warranty of, or representation with respect to, any of the equipment covered. This manual is subject to change without notice and Nitsuko America has no obligation to provide any updates or corrections to this manual. Further, Nitsuko America also reserves the right, without prior notice, to make changes in equipment design or components as it deems appropriate. No representation is made that this manual is complete or accurate in all respects and Nitsuko America shall not be liable for any errors or omissions. In no event shall Nitsuko America be liable for any incidental or consequential damages in connection with the use of this manual. This document contains proprietary information that is protected by copyright. All rights are reserved. No part of this document may be photocopied or reproduced without prior written consent of Nitsuko America.

©1994 by Nitsuko America. All Rights Reserved.
Printed in U.S.A.

Initializing a New DIGITAL SYSTEM

You must initialize your system (i.e., run Program 20) before using it for the first time. Initialization automatically enables the factory-installed Default Programming.

CAUTION: Initialization erases all the system programming and replaces it with the factory-installed default settings.

To initialize your system (run Program 20):

1. Install a display keyset at extension 300 (port 00).

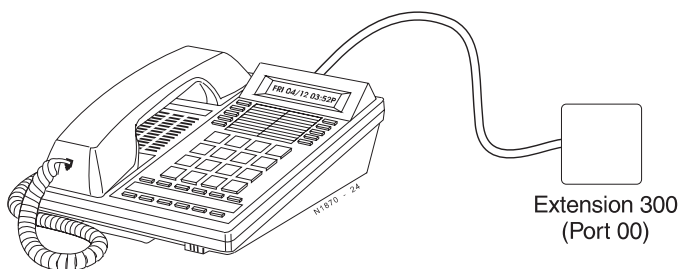

2. Enter the programming mode.

- Without lifting the handset, dial #775312#.



3. Press key 20 to select Program 20, System Initialization.

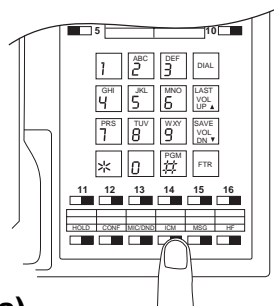
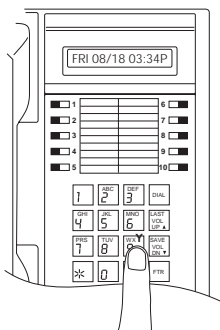

4. Dial 9 (for yes).

This begins initialization. All calls in progress will be dropped. Wait 30 seconds before programming.

Start-up Programming

Using the following table, you can quickly:

- Customize the programmable keys for each extension user
- Change the way calls ring system telephones
- Set up Voice Mail (if installed)
- Program Speed Dial numbers for extension users

When you first initialize, your system starts up with all keysets, Electronic Single Line telephones and DSS Consoles functioning. Each extension user can place and answer calls on all installed lines. In addition, outside calls flash the line keys and ring at extensions 300, 302 and 303. All other extensions flash for outside calls but do not ring.

1	Customize an extension's programmable keys to meet the user's needs. For 16-button keysets in an 8-line system, keys 1-8 are line keys and keys 9-16 are undefined. In a 16-line system, keys 1-16 are line keys. Turn to Programmable Keys on page 151 and Program 17 on page 250 to find out more. For example, use Program 17 to assign an extension's keys for Park Orbits (PO + Park Orbit 60-69 + #) or Voice Mail Record (RK + #).
2	Set the ringing for the outside lines at each phone. Review Outside Calls (Answering) on page 132, then go to Program 18 (II) on page 263 to set ringing for extensions (RA or DRA + # + Line key + Y or N + #). You can change an extension's Access Level in Program 15 (page 244) and allow the user to set the ringing options themselves.
3	Set up Voice Mail. If your system has Voice Mail (see page 185), you'll need to set up the following programs: Program 14 (page 239) Assign circuit type 51 (CIRCUIT TYPE = 51) to each Voice Mail port. Program 18 (I) (page 256) Assign the Voice Mail feature to each Voice Mail port (VX + # + Y + #) Program 19 (page 272) Program the Voice Mail ports into a UCD hunt group. Program 3 (page 205) Indicate that Voice Mail is installed and select a master extension number (VOICE MAIL = Y + N + # then VX MSTR EXT = Master extension + #) Program 12 (page 234) Directly terminate each line the Automated Attendant should answer (DTD or DTN + # + Master extension + #)
4	Program System and Personal Speed Dial (see page 162). Use Program 18 (II) (page 263) to enter Personal and System Speed Dial numbers. <i>User-Programmable Features</i> let co-workers store their own Personal numbers. If you have an extension installed at 303, use Program 18 (I) (page 256) to assign it a Speed Dial block. Otherwise, the extension has no Personal Speed Dial.

Introduction	1
How To Use This Guide	1
How to Use Part I	1
How to Use Part II (Customizing the System)	3
General Programming Tips	4
Using Your Telephone	6
The Type of Phone You Have	6
Using a Programmable Key with Three Functions	6
If Your Phone Has an Alphanumeric Display	7
Your Phone's Key Lights	7
Using Handsfree Instead of the Handset	7
Dialing Codes to Use Features	8
If You Have a DSS Console	8
Customize with User-Programmable Features	8
Charts and Illustrations	12
The System Number (Dialing) Plan	12
User-Programmable Features	13
Flash Rates for Keysets with Dual Color (Red and Green) LEDs	14
Flash Rates for Keysets with Single Color (Red) LEDs	15
Multibutton Telephone Key Layout	16
Electronic Single Line (ESL) Key Callouts	17
DSS Console Key Layout	18
About Related Documents	19
 Features A – H	 23
Account Codes	23
Alarms	24
Alphanumeric Display	25
Alternate Attendant	30
Analog Station Interface and Dual OPX/ASI Module	31
Analog Station Interface	31
Dual OPX/ASI Module	31
Automatic Call Distribution	36
Supervisor Functions	36
Supervisor's DSS Console	36
ACD Announcements	37
Automatic Ringdown	39
Automatic Route Selection	40
Call Routing	40
Dialing Translation (Special Dialing Instructions)	40
Time of Day Selection	40
Hierarchical Class of Service Control	40
Forced Authorization Code	40
Separate Routing for Operator Assisted, International and Equal Access Calls	40
Independently Programmed Restriction for Exchanges 976 and 555	40
Background Music	42
Battery Backup	43

Table of Contents

Call Forwarding	44
Call Forwarding, Off-Premise	46
Call Forwarding System Cancel	47
Call Intercept	48
Call Timer	49
Callback	50
Caller ID	51
Caller ID Displays	51
Hardware Considerations	52
Camp-On (Call Waiting)	55
Centrex/PBX Feature Keys	57
Class of Service	58
Conference	60
Data	61
Delayed Ringing Assignment	62
Dialing Number Preview	63
Direct Inward Lines	64
Direct Station Selection, DSS Console	66
Direct Station Selection	69
Directed Call Pickup	71
Directory Dialing	72
Do Not Disturb	74
Door Box	75
Relay Box	75
DP and DTMF Compatibility	77
Pulse to Tone Conversion	77
Equal Access Compatibility	79
Extended Ringing	80
Extension Hunting	81
Circular Hunting	81
Terminal Hunting	81
Uniform Call Distribution (UCD)	82
External Alerting Device	84
Flash	85
Flexible Numbering Plan	86
Forced Line Disconnect	87
Group Call Pickup	88
Group Listen	90
Group Ringing	91
Handsfree	93
Handsfree, Automatic	94
Headset	95
Hold, Automatic	97
Hold, Exclusive	98
Hold, Regular	99
Hotline	101
Features I – Z	103
Intercom	103
Intrusion (Barge-In)	106
Last Number Redial	107

Table of Contents

Line Queuing	108
Maintenance Utilities and Reports.	110
Meet-Me Conference	111
Message Center	112
Message Waiting	113
Microphone Mute	115
Microphone On/Off	116
Monitor	117
Multiple Attendants	118
Music On Hold.	120
Night Answer (Off-Hours Ringing).	121
Night Ringing	124
Non-Blocking Architecture	125
Off-Hook Signaling/Whisper Page	126
Whisper Page	126
Off-Hook Ringing.	126
Operator Assistance	128
Caller Dialing Options	128
Simultaneous Call Answering.	128
Programmable OPA Messages	128
Automatic Attendant Overflow	129
Other Common Carriers	131
Outside Calls, Answering	132
Outside Calls, Placing	134
Using a Line Key	134
Using Prime Line	134
Using Line Dial-Up	134
Using Direct Line (Trunk) Access	134
Using Direct Line Group Access	134
Using PBX/Centrex Lines	135
Paging.	138
Internal Zone Paging.	138
External Zone Paging	138
Park	141
Peripheral Control Unit (PCU) Module	143
Personal Greeting.	145
Power Failure Telephone	147
Privacy	148
Privacy Release	149
Private Lines.	150
Programmable Keys.	151
Line Key	151
Park Orbit	151
One-Touch Speed Dial	151
Hotline	151
Loop Group	151
Loop Switch	151
Pickup Group	151
Call Coverage	151
Page Zone	151

Table of Contents

Automatic Call Timer or Manual Call Timer	151
Record Key	151
Removing Lines and Extensions	153
Ringing Assignments	154
Ringing Line Preference	155
Ringing Patterns	156
Distinctive Ringing	156
Save	158
Selectable Display Messages	159
Silent Monitor	161
Speed Dial	162
Personal Speed Dial	162
System Speed Dial	162
One-Touch Speed Dial	162
Storing a Pause, Flash or Delay	163
Split	167
Station Call Coverage	169
Station Message Detail Recording	171
System Timers	172
Telemarketing Dial	174
Tenant Service	175
Time and Date	177
Toll Restriction	178
Tone Patterns	180
Traffic Management Reporting	181
Transfer	182
Unsupervised Conference (Tandem Calls)	184
Voice Mail/Automated Attendant	185
Call Forward to Voice Mail (Mailbox Call Forward)	185
Mailbox Message Waiting (Leaving a Voice Message)	185
Message View	185
Transfer to Voice Mail (Mailbox Transfer)	185
Conversation Record	185
Personal Answering Machine Emulation	185
Voice Module Unit	189
Voice Prompting Messages	191
Volume Controls	193
Walking Class of Service	194
Programming System Options	197
Program 1: Class of Service	197

Table of Contents

Only Intercom Calls at Night	197
Off-Premise Call Forward	198
Break-In (Intrusion)	198
Camp-On to Busy Extension	198
Internal Call Forwarding	198
Toll Restriction Level	198
Only Local Calls (Day or Night)	198
Only Local Calls at Night	198
Extended Ring	199
Callback (Line Queuing) Priority	199
Direct Trunk Access and Camp-On to Busy Line	199
Initiate All Call Page	199
Access Page Zones 1-3	199
Silent Monitor	199
No Flash for Single Line and ACD Supervisor = Y	199
Single Ring for ASI Calls or Only CO Calls Call Forward to Voice Mail	200
Program 2: Intercom Signaling	202
Call Waiting (Camp-On) Tones	202
Handsfree Reply on Intercom Calls	202
Voice-Announced Intercom Calls	202
Automatic Handsfree	202
Program 3: System Features	205
Number of Operators	205
Operator Extension	205
Number of Digits in a System Speed Dial Code	205
Side Tone Test Digit	205
Voice Mail Installed	206
Voice Mail Master Extension Number	206
Enable Dial-Out of # in a Speed Dial Number	206
Dial 1 Before Area Code (NPA) Calls	206
Walking Class of Service Security Code	206
Play MOH for Transferred Calls	206
Baud Rate of Auxiliary Module's Port	206
Program 4: System Timers	210
(01) Park Orbit	210
(02) Hold Recall	210
(03) Camp-On	210
(04) Line Response	210
(05) Modem Reserve	210
(06) Number of Rings Before Recall	210
(07) Number of Delayed Rings	211
(08) Flash Response	211
(09) Dial Tone Detect	211
(10) Make	211
(11) Break	212
(12) Interdigit	212
Program 5: PBX Access Codes	214
Program 6: Toll Restriction	216

Table of Contents

Active Dialpad (Continuous Dialing)	216
Special N11 Dialing	216
0 + Dialing	217
International Dialing	217
Equal Access Dialing	217
1 + NNX Dialing with Allow/Deny Tables	217
NNX Dialing with Allow/Deny Tables	217
NPA Dialing with Allow/Deny Tables	218
6-Digit Analysis with Allow/Deny Tables	218
Program 7: Music and Paging	223
Enable Background Music	223
Enable Music on Hold	223
External Page Zone 1	223
Audible Ring Over External All Call Page	223
External Page Zone 2 (only if Expansion CEU #1 is installed)	224
BGM to All External Page Zones	224
Interrupted Ring Relays	224
Paging and Music Gain (Volume) Over External Speakers	224
Relay 01 Owner (for the Main CEU only)	224
Relay 02 Owner (for Expansion CEU #1 only)	224
Program 8: Display Messages	227
Programming Line Options	229
Program 10: Line Port Characteristics	229
Line Circuit Type	229
Line Gain	229
PBX Line	229
Side Tone Test	229
Line Name	229
Program 11: Line Groups	232
Program 12: Line Features	234
Call Pickup Group	234
Toll Restrict	234
Direct Termination (Day)	234
Direct Termination (Night)	234
Class of Service	235
Programming Extension Options	239
Program 14: Extension Port Char.	239
Extension Numbering Plan for Ports 00-47	239
Circuit Type	239
DSS Owner Extension (For DSS Consoles Only)	241
DSS Block Number (For DSS Consoles Only)	241
Extension Name	241
Program 15: Access Level	244
Program 16: Line & Group Access	247
Program 17: Key Assignments	250
Undefined Key (UK)	250
Line Key (LK)	250
Loop Switch (LS)	250
Loop Group (LG)	250

Table of Contents

Park Orbit (PO)	251
One-Touch Speed Dial Key (SD)	251
Hotline (HL)	251
Group Pickup (GP)	251
Call Coverage (CCK)	251
Page Zone (PO)	251
Automatic Call Timer (CTA)	251
Manual Call Timer (CTM)	252
Record Key (RK)	252
Data Key	252
Program 18: Extension Features (I)	256
Do Not Disturb (DND)	256
Class of Service (COS)	256
Ring Group Member (RG)	256
Call Pickup Group Member (CPG)	256
Privacy Release Group Member (PRG)	257
Off-Hook Ringing (OHR)	257
DSS/BLF Lamps (BLF)	257
Line Dial-Up (LDU)	257
Page Zone Member (PZ)	257
Extension's (Station's) Operator (SO)	257
Speed Dial Block (SDB)	257
Voice Mail (VX)	258
Dataset (DS)	258
Door Box (receive chimes) (DB)	258
Program 18: Extension Features (II)	263
Day/Night Ringing Assignments (RA)	263
Night Ringing (NR)	263
Delayed Ring Assignment (DRA)	263
Prime Line Assignment (PLA)	264
Ringing Line Preference (RLP)	264
Direct Station Selection (DSS)	264
Hotline Key Assignments (DSS)	264
Headset Installed (HS)	264
Incoming Voice-Announced Call (VA)	264
Voice Page (VP) Thru Speaker	264
Whisper Page (VO)	265
Speed Dial (SD)	265
Program 19: Hunt Groups	272
Circular Hunt Groups	272
Terminal Hunt Groups	272
ACD and UCD Hunt Groups	272
Initializing the System	279
Program 20	279

- For your notes -

The DIGITAL SYSTEM Administrator's Guide is in two parts:

- **Part I: DIGITAL SYSTEM Features**
- **Part II: DIGITAL SYSTEM Programs**

The number plan used in this manual assumes that your system does not have an AUX Module installed. For example, extension numbers are presented as 300-347. To find out more about your system's number plan, and how it changes when you install an AUX Module, review the chart on page 12.

Part I: DIGITAL SYSTEM Features

Use Part I to learn about the DIGITAL SYSTEM features. Part I describes each feature, its operating instructions and programming requirements. The features are arranged in alphabetical order for easy reference.

Each feature in Part I contains the following:

- An *Application/Benefit* in the leading paragraph. For example, the benefit for Park looks like this:



Be sure a call gets sent to a person even when you don't know what part of the building they are in.

- A *Description* of the feature.
- The *Initial Configuration* describing how the feature was programmed at the factory.
- *Using the Feature*, which tells you how to operate the feature.
- *Understanding Related Programming* listing the programs you would use to customize the feature.

How to Use Part I

To use Part I of this guide:

1. Read about a feature.
2. Check its *Initial Configuration*.
3. If the initial configuration meets your needs, you don't have to do any additional programming for that feature.

OR

If the initial configuration does not meet your needs, check the required programs under the heading *Understanding Related Programming* and find them in Part II.

Part II: DIGITAL SYSTEM Programs

Part II contains the programs you use to customize the features. This part describes each program and its data codes. Part II also shows you how to enter those data codes into system memory from a programming extension.

How To Use This Guide

The programs are arranged in numerical order (1-20), and divided into four categories. The first three categories are system, line, and extension programs. The fourth category contains only Program 20. **Program 20 resets (initializes) the system.**

IMPORTANT

When you program the system for the first time, run Program 20 before any others. Program 20 initializes your system. It ensures that the initial values are installed in Programs 1-19. Failure to run Program 20 as described may result in erratic system operation.

Each DIGITAL SYSTEM program (1-20) in Part II includes:

- A **Description** of its programmable options.
- A **Feature Reference** for each programmable option under the heading *FOR FEATURE INFORMATION*. Here you'll find the DIGITAL SYSTEM feature in Part I that is related to a programmable option.
- The **Initial Configuration** in the leading paragraph. For example, the initial configuration for Program 2 looks like this:
A *Y* means *Yes* or *Enabled*, and an *N* means *No* or *Disabled*.



Program 2 is initially set as follows:

- Call Waiting (Camp-On)Tones = Y
 - Handsfree Reply on Intercom Calls = Y
 - Voice-Announced Intercom Calls = Y
 - Automatic Handsfree = Y
- **Filling Out the Program Record Form**, which lists the data codes for each programmable option and shows you how to enter them on the Program Record Form (P/N N1872PRF03).
 - **Entering Data into Memory**, which provides step-by-step instructions for entering the data codes into memory.
 - **Understanding Related Programming** listing the related DIGITAL SYSTEM programs.

How to Use Part II (Customizing the System)

After you read about a feature in Part I and determine you need to customize it by using its related programs:

1. Read about a program in Part II. If you are programming the system for the first time, check the initial configuration. Make sure you need to change it.
2. Go to the heading, *Filling Out the Program Record Form*. Enter the required data codes on the Program Record Form.
3. Repeat steps 1-2 for each program a feature requires, and for all features you must customize.
4. Connect a Display Phone to port 00 (extension 300). You can also program the system from an extension that has program access level 04 (see Program 15).
5. Do the following (described in the box) if you are programming the system for the first time. Otherwise, go to step 6.

IMPORTANT

When you program the system for the first time, run Program 20 before any others. Program 20 initializes your system. It ensures that the initial values are installed in Programs 1-19. Failure to run Program 20 as described may result in erratic system operation.

6. Use the instructions on the Program Record Form to enter the data codes into memory from extension 300. You can also use the instructions provided with the program (see the heading *Entering Data into Memory*).

General Programming Tips

Each program has specific instructions on how to enter its data codes into memory. There are, however, four basic steps to using any program. Once you become familiar with them, you will not need to continually refer to the specific programming instructions.

Using a Program

To use a program:

1. Enter the program mode from extension 300 or any extension that has program access level 04.
-You must use a Display Phone.
2. Enter a program.
3. Enter the data codes using the dial pad, erase any mistakes you make, and move through the program's feature options.
4. Save and Exit.

Entering the Program Mode:

To enter the program mode:

Use the Display Phone at extension 300 (or an extension with program access level 04 [see Program 15]).

1. Do not lift the handset.
2. Press #.
3. Dial SP.
-The code SP stands for "System Program" and is 77 on the dial pad.
4. Dial 5312.
-The code 5312 is the DIGITAL SYSTEM's password.
5. Press #.
-If you leave the system in the program mode too long without pressing a key or dialing a code, two things happen: you'll hear reorder (fast busy) tone and the system will automatically exit the program mode.

Entering a Program

To enter a program after you enter the program mode:

1. Press the program's key.
-Programmable keys 1-16, the HOLD, CONF, MIC/DND and ICM keys give you access to programs 1-20, respectively. Keys 1-5 are on the left, keys 6-10 are on the right, keys 11-16 are right under the dialpad. The HOLD (Program 17), CONF (Program 18), MIC/DND (Program 19), and ICM keys (Program 20) are in the last row of keys.

Entering Data, Erasing Mistakes and Moving Through Program Options

To enter data after you enter a program:

1. Dial the data.
2. Press the # key.
-This step stores the data and moves you to the next feature option.

For example:

To enter the data code Y or N (for "Yes" or "No"):

1. Dial Y or N, which is 9 or 6 on the dial pad.
2. Press #.

When you dial data for the last feature option in a program and press #, you exit the level you are working in and return to the previous level. In some cases, "returning to the previous level" means you exit the program and, therefore, do not have to press the SAVE key to exit the program (see below).

To accept (i.e., not change) the data on display and move to the next feature option:

1. Press the # key.

To erase a mistake:

1. Dial * right after you dial the mistake but before you press the # key to store it.
*-If you make an invalid data entry and press #, you will hear reorder (fast busy) tone. You should then dial * and re-enter data.*

Saving and Exiting

To save and exit after entering data:

1. Press the SAVE key.
-Pressing SAVE moves you out of a program, one level at a time.
-You may have to press SAVE several times to exit all the way out.

Using Your Telephone

The Type of Phone You Have

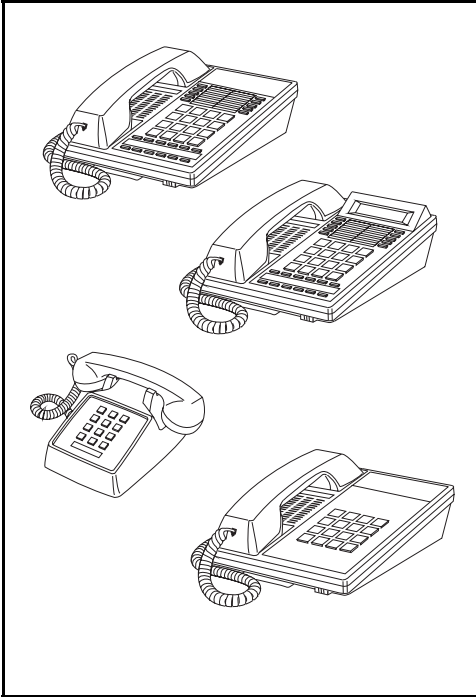

As the System Administrator, you have a 16-button telephone (This can also be referred to as a keyset or a multibutton phone). Other system users may have 16-button telephones as well. Or, they may have Electronic Single Line (ESL) or 2500 type (single line) telephones. Instructions for using 16-button and ESL telephones are included with each feature under the heading *Using the Feature*. For instructions on 2500 type telephones, refer to the Analog Station Interface feature on page 31.

Your phone has 16 programmable keys and other feature keys that give you one-button access to certain features. For example, to place or answer a Message Waiting, just press MSG. Or, press MIC/DND to quickly put your phone in Do Not Disturb. For an illustration of all the keys on your phone and what they do, turn to page 16.

Using a Programmable Key with Three Functions

Each of your programmable keys may have up to three functions. For example, a

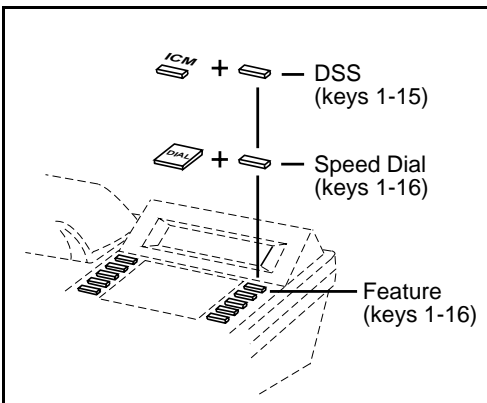

single key can be a line, Speed Dial **and** Direct Station Selection (DSS) key. When you just press the key, you get its first level function (e.g., line key). When you press ICM, the key automatically turns into a DSS key. Press DIAL, and the key becomes a Speed Dial key.

To find out more about your programmable keys, turn to page 151.

If Your Phone Has an Alphanumeric Display

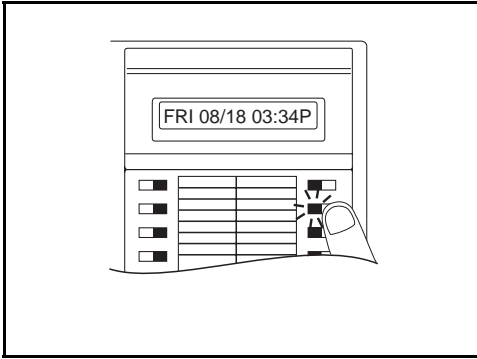

Your telephone's Alphanumeric Display helps you use features and tells you about your calls. For example, a ringing outside line may show you the number of the caller before you answer. Page 25 shows all of your phone's displays. You can also adjust the brightness of your display. To find out how, turn to page 29.

Your Phone's Key Lights

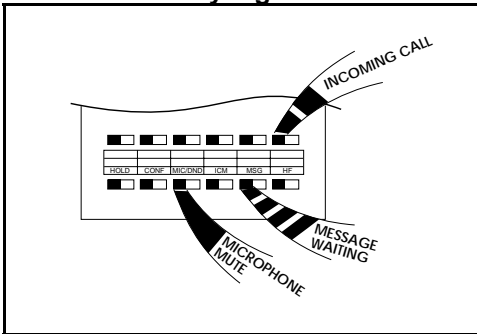

The lights in your phone's keys help you use the features. The way they flash tells you about your call. Depending on the model of your phone, your key lights can be red or both red and green. To find out more about your key lights, turn to the charts on pages 14 and 15.

Using Handsfree Instead of the Handset

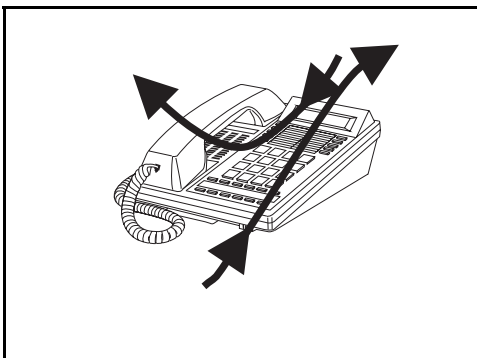

Your telephone may have a Speakerphone for Handsfree operation. This means you can place and answer calls just by pressing HF. If your phone has Automatic Handsfree, you can press a line key for a Handsfree call without first pressing HF. With Monitor, you can press HF to place a call but must lift the handset to talk or answer. Turn to page 93 for more on using the Handsfree options.

Using Your Telephone

Dialing Codes to Use Features

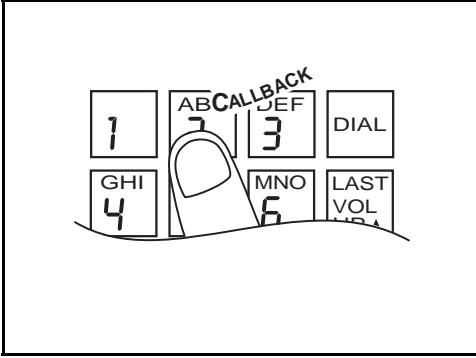

You can call co-workers, place outside calls and use many features by dialing feature access codes. Often, the code you dial is the first letter in the feature's name. For example, dial **C** to leave a *Callback* at a busy co-worker's phone. To find out the codes to dial for outside lines and co-workers, turn to the chart on page 12.

If You Have a DSS Console

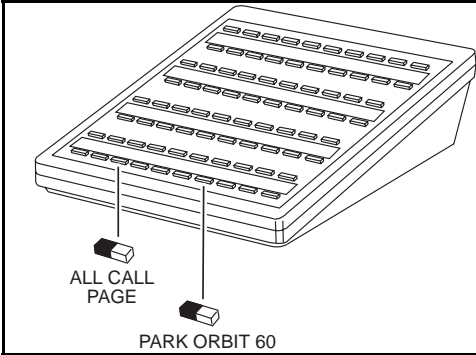

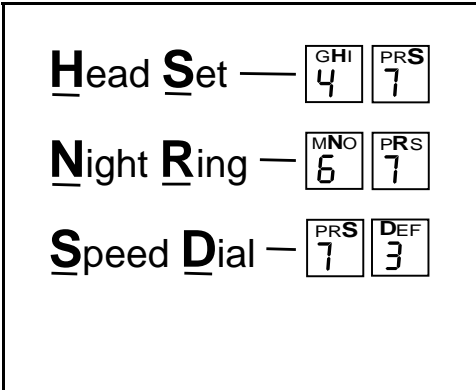

You may have a DSS Console next to your phone. When you first use your DSS Console, many of the keys are programmed for you. By just pressing a key, you can easily call (Hotline) co-workers, Park calls or use Page. For an illustration of the initial layout of your DSS Console, turn to page 18. To find out more on what your DSS Console can do, turn to page 66.

Customize with User-Programmable Features



With your DIGITAL SYSTEM, you can customize selected features from your phone. For an easy-to-use chart that shows your customizing options, turn to page 13. Other users with the proper access level may also be able to customize features right from the phone.

Know when to use your features . . .	
Look up what you want to do	Then turn to page 
Calling a co-worker	Intercom Calls.....103 Paging138 External Alerting Device84 Automatic Ringdown.....39 Multiple Attendants118
Outside calls	Placing and Answering132 Prime Line Selection.....134 Ringing Line Preference155 Ringing Assignments154 Delayed Ringing62 Direct Inward Lines64 Private Lines150 Account Codes23 Dialing Number Preview63 Call Timer49 Flash.....85 Centrex/PBX Feature Keys.....57 DP/DTMF Compatibility.....77 Other Common Carriers131 Equal Access79 Music on Hold120
Handling and rerouting your calls	Handsfree93 Monitor117 Hold.....99 Split167 Transfer182 Park141 Call Forwarding44 Selectable Display Messages159 Volume Controls193 Alphanumeric Display25 Ringing Patterns.....156 Tone Patterns.....180
When your call can't go through	Camp-On.....55 Off-Hook Signaling126 Callback50 Line Queuing108 Message Waiting113 Message Center.....112 Voice Mail185 Whisper Page126 Intrusion106
The power of digital voice processing	Personal Greeting.....145 Operator Assistance128 Voice Prompting Messages.....191

Know when to use your features . . .	
Look up what you want to do	Then turn to page 
Placing calls quickly	Speed Dial 162 Direct Station Selection 69 Last Number Redial 107 Save 158 Directory Dialing 72
When you work in groups	Privacy Release 149 Group Call Pickup..... 88 Group Ringing..... 91 Directed Call Pickup 71 Extension Hunting..... 81
If you need privacy	Do Not Disturb 74 Microphone Mute, On/Off 115 Headset 95 Background Music 42
Have a telephone meeting	Conference 60 Unsupervised Conference 184 Group Listen..... 90 Meet Me Conference..... 111
Streamlining and personalizing your telephone	Hotline 101 Direct Station Selection 69 Programmable Keys 151 Station Call Coverage 169
Advanced features and call processing	Automatic Call Distribution..... 36 Caller ID 51 Telemarketing Dial 174 Voice Module Unit 189 Walking Class of Service 194 Data 61
Features just for attendants	Alarms 24 Alternate Attendant 30 Silent Monitor 161 Night Answer 121 Removing Lines and Ext..... 153 Forced Line Disconnect 87 Time and Date 177 Call Forward System Cancel..... 47
Unique extension types	Door and Relay Box..... 75 Analog Station Interface 31 Dial OPX/ASI Module..... 31 PCU Module..... 143

Know when to use your features . . .

Look up what you want to do	Then turn to page 
Managing your system	Automatic Route Selection40
	Battery Backup43
	Power Failure Telephone147
	Call Intercept.....48
	Class of Service58
	Extended Ringing80
	Flexible Numbering Plan.....86
	Maintenance Reports/Utilities110
	Non-Blocking System.....125
	Privacy.....148
	SMDR171
	System Timers.....172
	Tenant Service.....175
Toll Restriction.....178	
Traffic Management.....181	

Charts and Illustrations

This section contains handy charts and illustrations for your reference. You'll find:

- The dialing plan (the numbers you dial) — see below
- A chart for the system's User-Programmable features — see page 13
- Flash rates for telephones with dual color (red and green) LEDs — see page 14
- Flash rates for telephones with single color (red) LEDs — see page 15
- Multibutton telephone key layout — see page 16
- Electronic Single Line (ESL) key layout — see page 17
- DSS Console key layout (page 18)

The System Number (Dialing) Plan

Your System's Dialing Plan		
This chart shows the numbers you dial for extensions, outside lines, Ring Groups and Selectable Display Messages. Ask your communications manager which system you have, so you'll know which numbers to dial.		
	DIGITAL SYSTEM w/o AUX	DIGITAL SYSTEM w/AUX
Extensions	300-323	300-371
Outside Lines	801-808	801-824
Outside Line Codes	01-08	01-24
Outside Line Groups	9, 90-98	9, 90-98
Outside Line Extensions	348-355	372-395
PCU Extensions	–	368-371
Ring Groups	364-371	396-403
Selectable Display Messages	00-15	00-15
Speed Dial Bocks (see Speed Dial on page 162)	01-28	01-57

User-Programmable Features

DIGITAL SYSTEM USER-PROGRAMMABLE FEATURES	
To program a feature, press # and the feature's code. For example, to set Night Ring, press # and dial NR. The remaining steps vary with each feature. Your access level determines the features you can program. See your communications manager. Note that enabling RA or NR disables DRA and vice versa. To disable ringing, disable NR, RA <i>and</i> DRA.	
DELAYED RING ASSIGNMENT	# + DRA + Line key + Y(es) or N(o) + SAVE
DSS	# + DSS + DSS key + ext. + SAVE
HEADSET	# + HS + Y(es) or N(o) + SAVE
HOTLINE	# + HL + Hotline key + ext. + SAVE
NIGHT RING	# + NR + Line key + Y(es) or N(o) + SAVE
PAGE	# + VP + Y(es) or N(o) + SAVE
PRIME LINE	# + PLA + Line key + Y(es) or N(o) + SAVE
RING ASSIGNMENT	# + RA + Line key + Y(es) or N(o) + SAVE
RINGING LINE PREFERENCE	# + RLP + Y(es) or N(o) + SAVE
SPEED DIAL	# + SD + One-Touch Speed key (or bin + #) + (Display set only) Name or # + line key (or line/group code + #) or INTERCOM + number (32 digits max.) + SAVE
TIME AND DATE	# + TD + Month (01-12) + # + Date (1-31) + # + Year (2 digits) + # + Hour (00-23) + # + Minutes (00-59) + SAVE
VOICE ANNOUNCE	# + VA + Y(es) or N(o) + SAVE
WHISPER PAGE	# + VO + Y(es) or N(o) + SAVE

Charts and Illustrations

Flash Rates for Keysets with Dual Color (Red and Green) LEDs

Graphite Phone with Dual Color LEDs	
<i>Your phone is idle (not on a call)</i>	All LEDs out (dark)
Outside Calls	
<i>An outside line is busy</i>	The line key is On Red
<i>An outside call is ringing your phone</i>	The line key flashes Slowly Red if it's shared, Off then Quickly Flashing Green if it's just for you
<i>And then you answer it</i>	The line key is On Green
<i>Or answer it with Privacy released</i>	The line key flashes Quickly Green
<i>You place the outside call on Hold</i>	The line key is On then Slowly Flashing Green
<i>Or a co-worker places it on Hold</i>	The line key flashes Moderately Red
<i>Or you place the outside call on Exclusive Hold</i>	The line key is On then Quickly Flashing Green
<i>If a call on Hold recalls to you</i>	The line key is Off then Quickly Flashing Green
Intercom Calls	
<i>An Intercom call rings your phone</i>	ICM flashes Slowly Green
<i>You answer the Intercom call</i>	ICM flashes Quickly Red
<i>You place the Intercom call on Hold</i>	HOLD flashes Quickly Green then On
<i>And then it recalls to you</i>	ICM flashes Slowly Green
Miscellaneous Features	
<i>You activate Microphone Mute</i>	MIC/DND is On Red
<i>You activate Do Not Disturb</i>	MIC/DND flashes Quickly Red
<i>You have a Message Waiting</i>	MSG flashes Quickly Red
<i>You activate Call Forwarding, Personal Greeting or Selectable Display Messaging</i>	MSG flashes Slowly Green

Flash Rates for Keysets with Single Color (Red) LEDs

Phone with Single Color (Red) LEDs	
<i>Your phone is idle (not on a call)</i>	All LEDs out (dark)
Outside Calls	
<i>An outside line is busy</i>	The line key is On
<i>An outside call is ringing your phone</i>	The line key flashes Slowly if it's shared, Off then flashing Quickly if it's just for you
<i>And then you answer it</i>	The line key is On
<i>Or answer it with Privacy released</i>	The line key flashes Quickly
<i>You place the outside call on Hold</i>	The line key is On then flashing Moderately
<i>Or a co-worker places the call on Hold</i>	The line key flashes Moderately
<i>Or you place the outside call on Exclusive Hold</i>	The line key is On then flashing Quickly
<i>If a call on Hold recalls to you</i>	The line key is Off then flashing Quickly
Intercom Calls	
<i>An Intercom call rings your phone</i>	ICM flashes Slowly
<i>You answer the Intercom call</i>	ICM flashes Quickly
<i>You place the Intercom call on Hold</i>	HOLD is ON then flashes Quickly
<i>And then it recalls to you</i>	ICM flashes Slowly
Miscellaneous Features	
<i>You activate Microphone Mute</i>	MIC/DND is On
<i>You activate Do Not Disturb</i>	MIC/DND flashes Quickly
<i>You have a Message Waiting</i>	MSG flashes Quickly
<i>You activate Call Forwarding, Personal Greeting or Selectable Display Messaging</i>	MSG flashes Slowly

Charts and Illustrations

Multibutton Telephone Key Layout

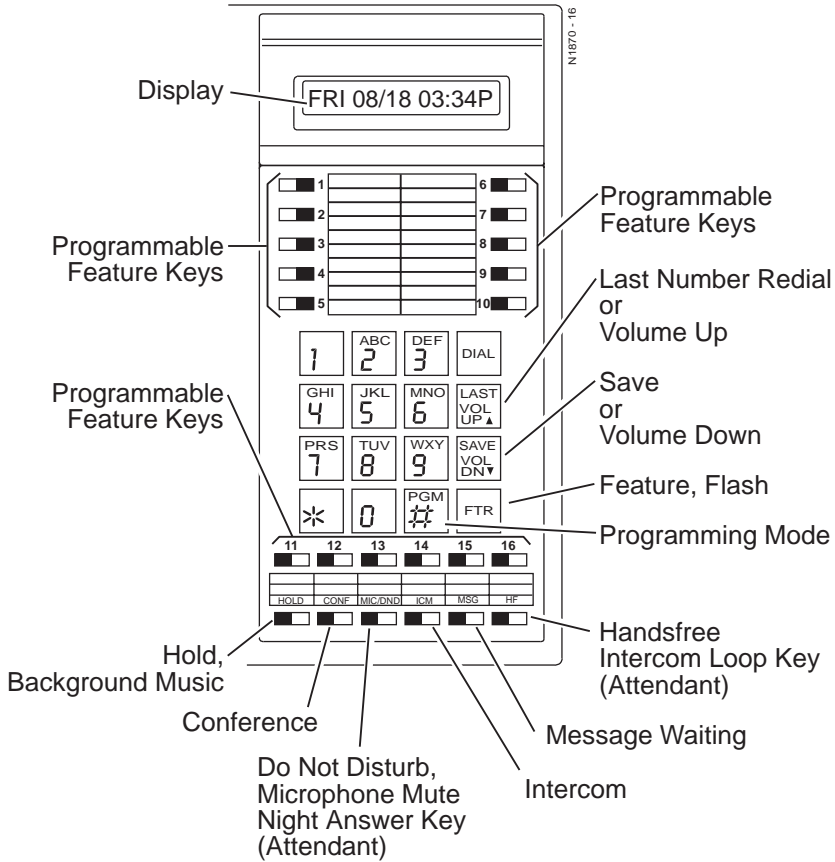

Electronic Single Line (ESL) Key Callouts

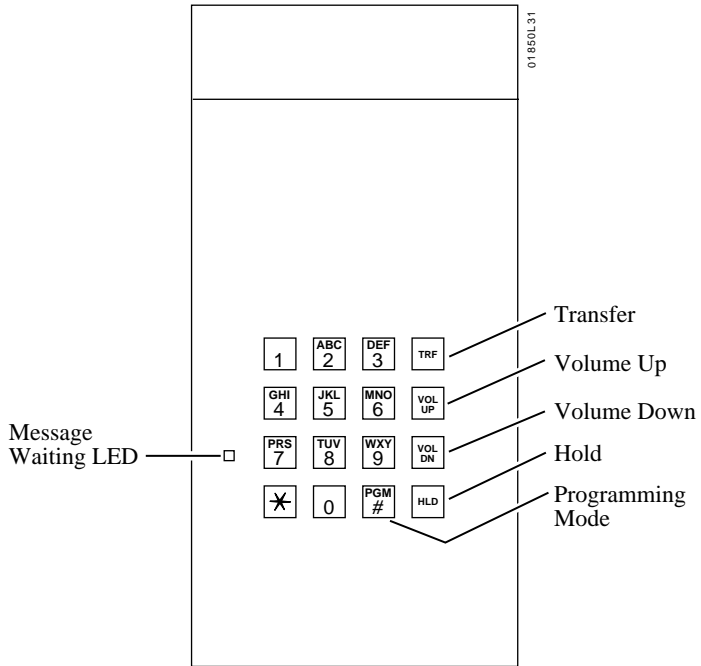

Charts and Illustrations

DSS Console Key Layout

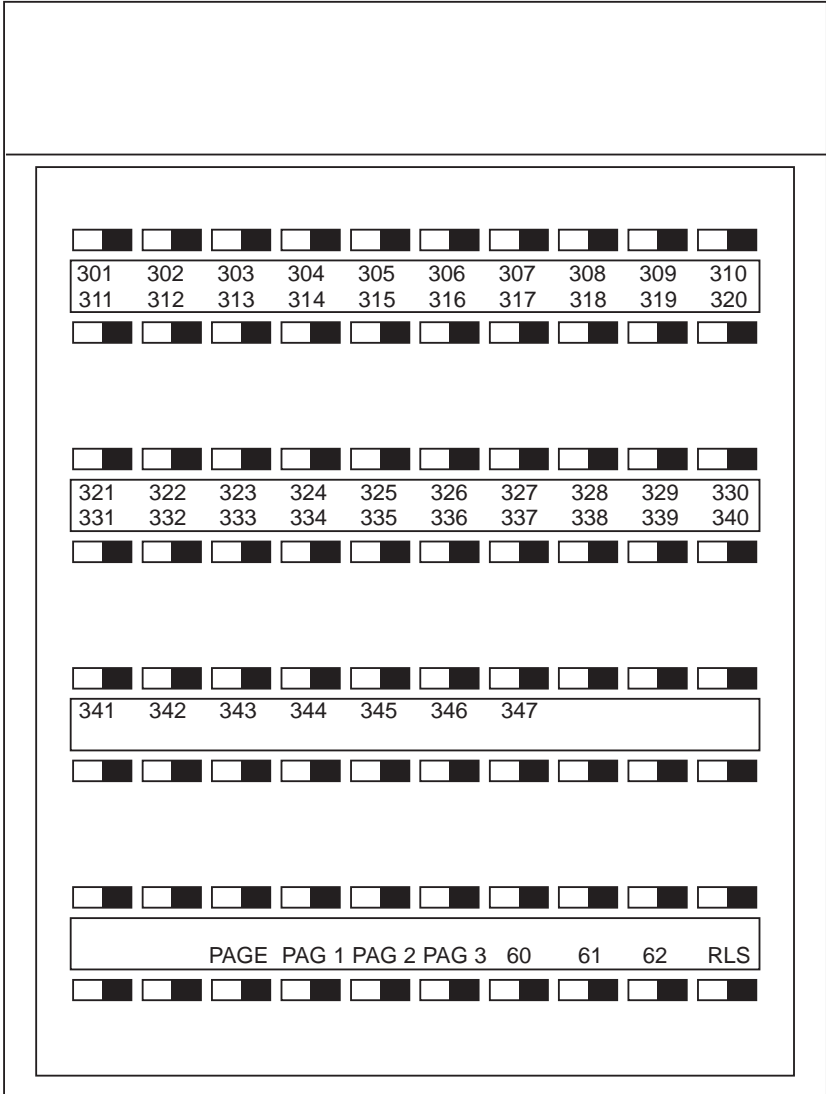

About Related Documents

Below are the other DIGITAL SYSTEM manuals and guides that you will find useful. Periodically check with your Sales Representative to be sure you have most up-to-date versions.

Description	Part Number	Helps you . . .
DIGITAL SYSTEM Program Record Form	N1872PRF03	Record the data codes for each DIGITAL SYSTEM program and shows you how to enter the data codes into memory
DIGITAL SYSTEM Hardware Manual	N1870INS02	Understand the DIGITAL SYSTEM equipment and how to install it
DIGITAL SYSTEM Installation Template	960-592-00	Quickly install the DIGITAL SYSTEM and get it up and running
DIGITAL SYSTEM Feature and Terminal Programming Manual	N1870SWG03	Understand the DIGITAL SYSTEM features and shows you how to program them from a terminal connected to the AUX Module
DIGITAL SYSTEM Multibutton Telephone Feature Handbook	N1870MFH03	Use the DIGITAL SYSTEM features from a Multibutton Telephone
DIGITAL SYSTEM Multibutton Telephone Quick Reference Guide	N1872MBG03	Quickly access the most commonly used features from a Multibutton Telephone
DIGITAL SYSTEM Electronic Single Line User Guide	N1872SLO02	Quickly access the most commonly used features from an electronic Single Line Telephone

- For your notes -

Part I

DIGITAL SYSTEM Features

- For your notes -



Uniquely identify a call with a special number so it is easy to keep track of who you talked to and, if necessary, charge them for your time.

When your system is equipped with Station Message Detail Recording (SMDR), you can assign a 10-digit Account Code to a call. The Account Code will print out with the other SMDR data for that call. You enter the code while placing the call or while on the call.

For introductory information on SMDR, see page 171.

Account Codes and SMDR require the AUX Module and a customer-provided ASCII record collection device (e.g., printer or terminal). Account Code and SMDR options are programmed through a terminal connected to the AUX Module. For more information, see Account Codes and SMDR in the DIGITAL SYSTEM Feature and Terminal Programming Manual.

Initial Configuration

Account Codes not allowed

Using the Feature

N/A

Understanding Related Programming

Program 3 To set the baud rate of the AUX Module's port for terminal programming (**LOCAL BAUD** = 00 [300], 01 [1200], 02 [2400], 03 [4800], 04 [9600] or 05 [19.2K] + #)

Alarms



You can, as the attendant, quickly zero in on a system problem and report it to your service center and/or remove the problem line or extension from service.

If you are an attendant, your phone's display may show Alarm messages. You can view the cause of the Alarm by pressing a single button.

You may see MINOR ALARM, MAJOR ALARM or MAJOR/MINOR ALARM. A minor alarm occurs when an extension is unplugged or fails, or when a line fails. A major alarm occurs when an expansion KSU (CEU) fails. A major/minor alarm occurs when both a major and minor alarm occur simultaneously. After you view an extension or line failure, you may want to remove the extension or line from service (see page 153).

When an Alarm displays, your phone will not ring normally for incoming calls. If your phone has Off-Hook Ringing, it rings with a single beep (repeated). If your phone does not have Off-Hook Ringing, calls do not ring at all.

Initial Configuration

Alarms occur at attendant extension 300

Using the Feature

To View Alarms from your attendant phone:

1. Do not lift handset.
2. Press MSG.
-The display shows you the cause of the alarm. For example, you may see STA 302 FAILED or LINE 02 FAILED.
3. Press MSG to see if there are more alarms.
-When you see the first failure message again, you have gone through the entire list.
4. Lift and replace handset to clear the alarms.

Understanding Related Programming

- | | |
|----------------|---|
| Program 18 (I) | To assign Off-Hook Ringing to an attendant extension so their phone "rings" while Alarms display (OHR + # + Y or N + #) |
| Program 3 | To assign attendant extensions (OPR nn EXT = Extension number + #) |



See which extension is calling you, which call you are picking up, etc.

If you have a Display Phone, you see "feature status messages" on your display when you use your phone. For example, you see any number you dial, the extension that is calling you, the name of the line you are answering (if names are programmed), a recalling Transfer (when the destination extension does not answer it), etc. When your phone is idle, the display shows you the time and date. In addition, you can control the brightness of your display.

All the feature status display messages are listed below in alphabetical order. Some only appear at the attendant phone, and are so noted. See also Selectable Display Messages on page 159.

This display . . .	Appears when you . . .
ACCESS DENIED	Try to use company-wide (System Speed Dial) Directory Dialing from a restricted extension
ALT OPR ASSIGNED (Attendant extension only)	Enable Alternate Attendant
B name	Answer a Transfer recall from busy extension with indicated name
Bin No. = nn	Dial # SD, then first digit of a Speed Dial bin
BUSY RECALL nnn	Answer a Transfer recall from busy extension nnn
CALL FROM nnn	Receive an Intercom call from extension nnn
CALL FROM Lnn	Press a key to answer line nn
CALL FROM ORBIT	Retrieve a call from a Park Orbit
Caller's name	Receive a call from an extension or answer a line with indicated name
CANCEL ALT OPR (Attendant extension only)	Cancel Alternate Attendant
CFWD FROM nnn	Receive a call forwarded from extension nnn
COMPANY WIDE DIR	Dial C for company-wide (System Speed Dial) Directory Dialing
CONFERENCE CALL	Establish a Conference or join a call using Privacy Release
DATE = nn	Set the Time and Date
Date and Time	Look at your phone while it is idle
DAY & NIGHT RING	Dial # RA to program Ring Assignments

Alphanumeric Display

This display . . .	Appears when you . . .
DELAYED RING	Dial # DRA to program Delayed Ringing Assignment
DIAL PREVIEW	Dial * to activate Dialing Number Preview
Digits	Dial a call
DND OFF	Disable Do Not Disturb
DND ON	Enable Do Not Disturb
DO NOT DISTURB	Call an extension in Do Not Disturb
DSS ASSIGNMENT	Dial # DSS to program Direct Station Selection
DSS LAMP FIELD	Press ICM
DSS, EXT, 6,9,8 ?	Press ICM # (system shows you what you can do next: press DSS key, dial extension or 6 for Selectable Display Messages [9 & 8 not available])
EXP. KSU FAILED (Attendant extension only)	Receive a MAJOR ALARM from the system that the expansion KSU failed
EXT	Press ICM # (with DSS suppressed) and system shows selection options (you can dial an extension)
F name FWD to nnn	Place an Intercom call to an extension that has forwarded its calls to extension nnn or to extension with assigned name
GROUP-R PICK-UP	Answer (pick up) an outside call ringing a Ring Group (when your extension is not a member of the group)
HEADSET =	Dial # HS to program Headset operation
HF CIRCUIT BUSY	Try to use Handsfree and no system Handsfree (Speakerphone) circuits are available
HOLD RECALL nnn	Pick up a call abandoned on Hold by extension nnn
HOLD/WAIT xx/yy	Transfer a call to a busy extension that has xx calls on Hold and yy calls Camped-On (waiting)
HOT LINES	Dial # HL to program Hotline keys
HOUR = nn	Set Time and Date
ICM DIRECTORY	Dial I for Intercom directory
ICM NO:	Press a Direct Station Selection or Hotline key to program it
INC VOICE CALL =	Dial # VA to program voice-announced Intercom calls

This display . . .	Appears when you . . .
LINE nn	Answer an outside call on line nn
LINE nnn FAILED (Attendant extension only)	Press MSG to view a MINOR ALARM and line nnn has failed
MAJOR ALARM (Attendant extension only)	Receive major alarm from the system
MAJOR/MINOR ALRM (Attendant extension only)	Receive both major and minor alarms from the system simultaneously
MIKE MUTED	Press MIC/DND to turn off the phone's mic
MINOR ALARM (Attendant extension only)	Receive minor alarm from the system
MINUTES = nn	Set the Time and Date
MONTH =	Set the Time and Date
MSG FRM nnn	View Message Waitings and have one from extension nnn
Name	Place a call, answer a call, or view a Message Waiting for an extension with a programmed name
NIGHT MODE OFF (Attendant extension only)	Press MIC/DND to disable Night Mode operation
NIGHT MODE ON (Attendant extension only)	Press MIC/DND to enable Night Mode operation
NIGHT RING	Dial # NR to program Night Ringing for lines
NO RAM INSTALLED	Try to use Speed Dial Directory Dialing in a system without an AUX Module
NO SPEED DIAL	Try to use Personal Speed Dial Directory Dialing with no Speed Dial blocks assigned in programming
NO. OF MSG = nn	Press MSG to check the number of Voice Mail messages
ORBIT RECALL nnn	Answer a parked call that is recalling extension nnn
OUT OF AREA	(Requires Caller ID) Outside caller has dialed from an area that does not support Caller ID
P Assigned name	Pick up (answer) a call for extension with assigned name
PAGE THRU SPKR =	Dial # VP to program paging thru the speaker
PARKED IN nn	Park a call in orbit nn

Alphanumeric Display

This display . . .	Appears when you . . .
PERSONAL DIR.	Dial P for Personal Directory Dialing
PICKUP FROM nnn	Pick up a call ringing extension nnn
PRIME LINE	Dial # PLA to program a Prime Line
PRIVACY	Press line key to have Privacy
PRIVATE	(Requires Caller ID) Outside caller has blocked Caller ID
PRIVATE CALL	Press a line key for a line that has Privacy enabled
PROGRAM	Dial # to program a feature
R Assigned name	Answer recalling line from extension with assigned name
RELEASE PRIVACY	Press a line key to release Privacy on a call for which you previously established Privacy
RING LINE PREF =	Dial # RLP to program Ringing Line Preference
RING NO ANS nnn	Answer a line recalling from extension nnn
SELECT LNE/GRP	Dial # SD + bin (system wants line or group no.)
SELECT IDLE LINE	Press DIAL to place call (using Dial Number Preview) and system asks you to select a line
SPEED DIAL	Dial # SD to store a Speed Dial number
SPEED DIAL BINS	Press DIAL to use Speed Dial
Speed Dial name	Make a Speed Dial call with a stored name
STA nnn FAILED (Attendant extension only)	Receive a MINOR ALARM that extension nnn failed
UNAVAILABLE	(Requires Caller ID) The telephone company's Caller ID is out of service
UNLISTED NAME	Try to access Directory Dialing and the system has no names programmed
WELCOME	Unplug and plug in your extension
WHISPER PAGE =	Dial # VO to program Whisper Page
YEAR = nn	Set Time and Date

Initial Configuration

All displays appear (without names) at Display phones

Using the Feature

To control the brightness
(contrast) of the display:

1. Press VOL UP or VOL DN while your phone is idle
(Background Music not playing).

Understanding Related Programming

- Program 14** To assign extension names so they appear in displays (See the extension name entry procedure on page 242)
- Program 10** To assign line names so they appear in displays (See the line name entry procedure on page 230)

Alternate Attendant



Temporarily leave your attendant position without missing calls or asking a co-worker to take your place.

If you are an attendant, Alternate Attendant lets you send your incoming calls to another extension. When you activate Alternate Attendant, outside calls ring your attendant extension and the alternate extension. Intercom calls ring only the alternate unless the alternate is busy; then they ring your attendant extension instead.

Initial Configuration

Alternate Attendant enabled for extension 300

Using the Feature

To activate Alternate Attendant at an attendant extension:

(This procedure automatically cancels a Do Not Disturb or Call Forward condition that is active at the alternate.)

1. Lift handset.
-If you have a One-Touch Speed Dial key, you can press it instead of using steps 2-5.
2. Press ICM.
3. Dial #.
4. Dial alternate's extension number.
-Do not dial another attendant extension.
5. Dial 3.
-MSG and MIC/DND keys flash.
6. Hang up.
- If the alternate activates DND after you send calls there, the alternate assignment is canceled.
-An alternate cannot forward calls to yet another extension.

To cancel Alternate Attendant:

1. Do not lift handset.
2. Press MIC/DND.
-MSG and MIC/DND keys go out.

Understanding Related Programming

- Program 1 To enable/disable Internal Call Forwarding for Class of Service 00 (**CFWD + Y or N + #**). This enables or disables Alternate Attendant for Class of Service 30 (the attendant's Class of Service).

Analog Station Interface and Dual OPX/ASI Module

Analog Station Interface

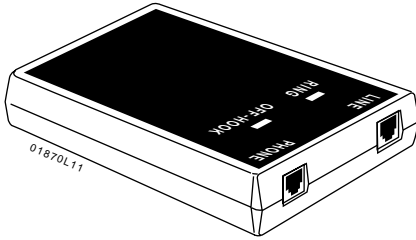

The Analog Station Interface (ASI) module (P/N 89749) provides standard 2500 set DTMF service at an extension port. The 2500 set connects to the ASI and the ASI connects to a extension port. Each ASI module has an internal DTMF receiver. For installation instructions, see P/N N1850ASI03.

Dual OPX/ASI Module



The Dual OPX/ASI Module (P/N 88750) provides two 2500 type DTMF ports from a single extension connection. The Dual OPX/ASI Module is a dual port device that connects to the even (lower) numbered port of adjacent even and odd numbered station ports. The Dual OPX/ASI uses *both* extension positions (e.g., 304 and 305), even though it connects only the the lowest

numbered port in the pair. The Dual OPX/ASI Module has two internal DTMF receivers. For installation instructions, see P/N N1853DPX05.

The ASI and Dual OPX/ASI Module are helpful when you need to install a limited number of analog interfaces — but do not want to dedicate a line port to each one.

Other devices that can connect to an ASI or Dual OPX/ASI Module include:

- FAX machines
- Credit card terminals
- Modems
- Voice Mail/Automated Attendant

Notes:

- A connected device must:
 - Meet FCC Part 68 requirements for Type B ringers (with a REN of 1.0 or less). For outdialing, the device connected must provide standard DTMF signals. The ASI provides 50 volt peak-to-peak square wave ringing. The Dual OPX/ASI Module provides 75 volt peak-to-peak square wave ringing.
 - Not use an electromechanical ringer
 - (ASI only) Be installed indoors — not off-premise with outdoor wiring)
- Dual OPX/ASI circuits meet the requirements of EIA Specification RS-464-A for OPS class C (loop resistance to 3,300 ohms, loop current = 16 mA or greater).
- For each device connected to the ASI or Dual OPX/ASI Module, set its Flash timer to 600-750 mS.

Initial Configuration

No ASI or Dual OPX/ASI Modules installed

Analog Station Interface and Dual OPX/ASI Module

Using the Feature

The DIGITAL SYSTEM features available to the ASI and Dual OPX/ASI Module are listed below with abbreviated operating instructions. To find more information on a feature, refer to the page number provided.

In the instructions that follow:

- "Lift" = Lift handset.
- "Hookflash" = hold down the hookswitch for about .5 seconds, then release it.

Handling Calls: The Basics	
Placing an Outside Call (see page 134)	Using Line Dial-Up: Lift + line code (801-816) + number
	Using Direct Line (Trunk) Access: Lift + line code (348-363) + number
	Using Direct Line Group Access: Lift + line group (90-98) + number
Placing an Intercom Call (see page 103)	Lift + extension or 0 for attendant
Answering a Call (see page 103 and page 132)	To answer any call (all calls ring): Lift
Regular Hold (see page 99)	To hold: Hookflash + hang up
	To retrieve: Lift + * 7
	To retrieve call on hold at another extension: Lift + * + extension (300-347) or line (801-816)
Transfer (see page 182)	To transfer: Hookflash + extension + wait for answer + announce call + hang up
	To return to call if party does not answer: Hookflash + * 7
	To receive a Transfer when announced: Stay on line (you are connected when the transferer hangs up)

Features (In Alphabetical Order)	
Account Codes (see page 23)	After dialing a number: # + account code + #
	While on a call: Hookflash + # + account code + # + * 7 (to return to call)

Analog Station Interface and Dual OPX/ASI Module

Features (In Alphabetical Order)	
Call Forwarding (see page 44 and page 46)	To an extension: Lift + # + extension + forwarding code + hang up Code 1: Forwards unanswered calls Code 2: Forwards unanswered and busy calls Code 3: Forwards all calls
	To an outside number: Lift + # + 1 + line (01-16) that calls will forward on + number to receive calls + hang up
	To cancel forwarding: Lift + # + hang up
Callback (see page 50)	To leave callback at busy tone: 2 + hang up
	To answer ring: Lift (you get connected to previously busy extension)
	To cancel a callback: Call busy extension again + * + hang up
	To cancel all callbacks: Lift + # * + hang up
Camp-On (Call Waiting) (see page 55)	To send beeps at busy tone: 2 + wait
	To answer beeps: Hookflash + * 2 (see also Split)
Conference (see page 60)	Establish call + hookflash + establish call + hookflash + * #
Directed Call Pickup (see page 71)	Lift + * + extension
Flash (see page 85)	<i>This option is only available with AUX Module software version 02.10 and higher.</i> While on an outside call: Hookflash + 7 *
Forced Line Disconnect (see page 87)	Lift + line (348-363 or 801-816 for lines 01-16) + # (to use line for a call: line + number)
Group Call Pickup (see page 88)	Lift + * 1
Group Ring (see page 91)	Lift + Ring Group (364-371 without AUX, 396-403 with AUX)
Intrusion (Barge-In) (see page 106)	At busy tone: 4
Last Number Redial (see page 107)	Lift + * *

Analog Station Interface and Dual OPX/ASI Module

Features (In Alphabetical Order)	
Line Queuing (see page 108)	At busy tone: 2 + hang up
	To answer ring: Lift (you have outside dial tone and can dial number)
	To cancel one: Try to access busy line again + * + hang up
	To cancel all: Lift + # * + hang up
Meet-Me Conference (see page 111)	To set up Meet-Me: Page parties + announce Meet-Me code (11 or 12) + hookflash + 11 or 12 + do not hang up
	To join Meet-Me: Lift + 11 or 12
Night Answer (see page 121)	To answer ring over page: Lift + * 0
Off-Hook Signaling (see page 126)	To send at ring-busy tone: 1 + speak after beeps or wait for answer
Paging (see page 138)	To make a page: Lift + 1 * - 8 * + announce + hang up
Park (see page 141)	To park your call: Hookflash + * + park orbit (extension or 5 + 60-69) + page person to receive call + hang up
	To pick up parked call: Lift + park orbit
Selectable Display Messages (see page 159)	To select: Lift + # 6 + message number 00-15 + hang up
	To cancel: Lift + # + hang up
Silent Monitor (see page 161)	At busy tone: 6
Speed Dial (see page 162)	To store: Lift + # + Personal bin (50-59, 20-29) or System bin (700-799) + line (01-16) or line group (90-98) + number + hang up
	To call: Lift + Personal bin or System bin
Split (see page 167)	To answer waiting call (beeps): Hookflash + * 2
	To split between calls: Hookflash + * 7
Tandem Calls (see page 184)	Establish call + hookflash + establish call + hookflash + * # + hang up
Walking Class of Service (see page 194)	Lift + # # + WCOS code + line (01-16) + dial number

Understanding Related Programming

- Program 14 To assign the correct circuit type to an ASI port
(**CIRCUIT TYPE** = 51 + #)
- Program 1 To assign a single ring to all calls that ring an ASI in a
Class of Service (see also Program 18 [I]) (**SINGLE
RING** = Y + #)
- Program 18 (I) To assign a Class of Service (from Program 1) to an
extension (**COS** = 00-27 + #)

Automatic Call Distribution



The system automatically distributes calls to co-workers (agents) in the same department. No need to have receptionist or attendant screen and route calls for a department.

Automatic Call Distribution (ACD) uniformly distributes incoming calls among members of a department (ACD group). Each ACD group consists of member extensions, called agents, and a master number. When a call rings the master number, the system automatically routes the call to the agent that has been idle (on hook) the longest. The call can be a transferred call or Intercom call to the master number.

Supervisor Functions

Each ACD group can have a supervisor extension. The supervisor must have a display telephone with a DSS Console. This lets the supervisor monitor the status of the ACD group and each agent extension. When all ACD agents are busy, the supervisor's display shows:

- The number of calls waiting
- The line or extension that has been waiting the longest
- How long the extension or line has been waiting

Using their DSS Console, the supervisor can also take agent extensions in and out of service as the traffic into the ACD group changes. ACD agents can also remove and reinstall their own extensions. However, the supervisor can always reinstall an extension if it was removed by an agent.

Supervisor's DSS Console

The supervisor's DSS Console should have a Hotline key for each ACD agent. This shows at a glance the status of each agent.

When the DSS key is...	Agent is...
Off	Idle
On	Busy
Slow Flash	Removed from service
Fast Flash	In Do Not Disturb

Optionally, the supervisor's DSS Console can have a Hotline key for the ACD master number. This shows the status of the entire ACD group. The key lights when all agents in the department are busy. As soon as an agent becomes free, the key goes out.

ACD Announcements

ACD Announcements require a Voice Module Unit (P/N 88522) and an AUX Module with software versions 02.10 or higher. ACD Announcements are not available with Base software.

An ACD group caller can optionally hear an All Agents Busy announcement when they first call into the ACD group. This announcement occurs when all ACD agents are busy and the system automatically queues the call for a free agent. The ACD supervisors and the attendant can customize the All Agents Busy announcement, if desired. The system provides one All Agents Busy announcement, shared by all ACD groups.

Notes:

- Activating Call Forwarding at an ACD group extension disrupts normal hunting.
- Activating Do Not Disturb (DND) at an ACD Group extension temporarily removes it from the group.
- The ACD supervisor display timer requires an AUX Module. If your system doesn't have an AUX Module, the supervisor's display does not show how long a call has been waiting for an available agent.
- The supervisor cannot be the overflow destination for the ACD group.
- With software versions AUX Module 02.10/Base 02.00 and higher, an ACD agent with a headset hears silence when they place a call on Hold. With software versions prior to AUX Module 02.10/Base 02.00, the agent hears dial tone when they place a call on Hold. Refer to page 95 for more on Headset operation.

Initial Configuration

No ACD groups

Using the Feature

To remove or install a member agent (from the supervisor's extension):

1. Lift handset.
2. Press ICM.
3. Dial #.
4. Press DSS Console key for agent you want to change.
5. Dial 7 to remove an agent; 4 to install.
6. Hang up.

To remove or install yourself as an agent (from your agent extension):

1. Lift handset.
2. Press ICM (except at an ESL set).
3. Dial 6 to remove yourself as an agent; 4 to install.
4. Press # and hang up.

Understanding Related Programming

Program 19 To set up ACD/Hunt Groups (page 272)

Program 4 To set two timers: Camp-On Time (Timer **03** + # + Duration + # – how long a call waits at a busy ACD group before ringing the Overflow destination - if any) and Rings Before Recall (Timer **06** + # + Duration + # – the

Automatic Call Distribution

number of times a call rings an ACD Hunt Group extension before going to the next one)

- Program 17** To assign a DSS Console Hotline key for an ACD master number (**HL** + Partner extension + #). The key lights when all members are busy.
- Program 12** To directly terminate a line to an ACD master number so calls ring it instead of having to be transferred to it (**DTD** + # + Master number + #)



Call for information (for example, a reservation desk) just by lifting the handset.

Automatic Ringdown requires an AUX Module with software version 02.10 or higher. Automatic Ringdown is not available with Base software.

With Automatic Ringdown, an ESL or 2500 set user (connected to an ASI or Dual OPX/ASI module) automatically calls a programmed destination when they lift the handset. This would be helpful, for example in an airline terminal with dedicated reservation phones. As soon as the caller lifts the handset, the phone rings the reservation desk. The ringdown phone cannot access any system features (e.g., cannot dial digits). The ringdown phone can, however, receive calls.

Initial Configuration

Automatic Ringdown disabled.

Using the Feature

To use Automatic
Ringdown:

1. Lift handset.

-You hear two beeps or ringing. If you hear ringing, wait for the called party to answer. If you hear two beeps, you may begin speaking.

Understanding Related Programming

Refer to the DIGITAL SYSTEM Feature and Terminal Programming Manual.

Automatic Route Selection



Calls go out on the most cost-effective routes, according to the digits users dial. For example, a call to a branch office can automatically route over the company's WATS line.

Automatic Route Selection (ARS) provides call routing and call restriction based on the digits a user dials. ARS lets you obtain the most cost-effective use of your system's connected long distance carriers.

ARS gives you over 8,000 call routing choices — without a custom-ordered rate structure database. You can make modifications to the routing choices quickly and easily. This is often necessary as the cost structure of the connected services change.

Note: ARS is an on-line call routing program. You can only customize it from the programming terminal. To have ARS, your system must be equipped with an AUX Module.

ARS provides:

Call Routing

ARS can apply 3-digit (Area Code) and 6-digit (Area Code and Exchange) analysis to every number.

Dialing Translation (Special Dialing Instructions)

ARS can automatically execute stored dialing instructions when it chooses a route for a call.

Time of Day Selection

You can program route selection according to the time of day/day of week.

Hierarchical Class of Service Control

ARS allows or denies call route choices based on an extension's Class of Service.

Forced Authorization Code

Designated routes may require the user to enter an Authorization Code before ARS allows routing. This code is verifiable and is enforced by an extension's Class of Service.

Separate Routing for Operator Assisted, International and Equal Access Calls

To provide unique control, you can program separate routing instructions for Operator Assisted, International and Equal Access calls.

Independently Programmed Restriction for Exchanges 976 and 555

Restriction for these exchanges is hierarchical according to an extension's Class of Service.

Initial Configuration

ARS not installed

Using the Feature

- To place a call using ARS:
1. Lift handset. If you have an ARS loop key, press it and skip to step 4.
 2. Press ICM (except at an ESL set). You hear Intercom dial tone.
 3. Dial ARS access code (9 or 90). You hear another (higher pitched) dial tone.
 4. Dial number.

Understanding Related Programming

You can only program Automatic Route Selection from the programming terminal. Refer to the DIGITAL SYSTEM Feature and Terminal Programming Manual.

Background Music



Add music to your private work area to create a pleasant atmosphere.

With a touch of a key you can have Background Music (BGM) play over the speaker of your extension while it is idle. If a page or call comes in while BGM is playing, the music stops and starts again when the page or ringing stops.

BGM is available only if the DIGITAL SYSTEM is equipped with an outside music source (such as a tape player). BGM can also play over external paging speakers, if your system is equipped and programmed for it.

Initial Configuration

BGM disabled

Using the Feature

BGM is not available to attendant extensions.

To turn BGM on or off while your extension is idle:

A system reset or activating Do Not Disturb automatically turns off BGM.

1. Do not lift handset.
2. Press HOLD.

To adjust the volume of BGM:

1. Press VOL UP or VOL DN while BGM is on.
-This simultaneously adjusts paging and ringing volume.

Understanding Related Programming

BGM uses line circuit #04. A line cannot be connected to it. The music source must meet the following specifications:

Input Impedance	100 K Ohms
Maximum Input	-10 dBm

Program 7 To enable BGM (**ENABLE BGM = Y + #**)

To have music play over customer-provided external paging speakers, also do the following:

- Enable External Page Zone 1 (**EXT PAGE ZN 1 = Y**)
- Enable External Page Zone 2 if you have Expansion CEU #1 (**EXT PAGE ZN 2 = Y**)
- Enable BGM to All External Page Zones (**BGM TO PG ZN = Y**).
- Adjust Paging and Music Gain (Volume) Over External Speakers (**PG/MUSIC GAIN = 01-05**)

To install external speakers, see the Hardware Manual.



The DIGITAL SYSTEM performs normally during a power failure.

The Battery Backup feature automatically supplies battery power to a CEU during AC power failures or brownouts. The recommended battery backup unit is the Valcom VPB260, and one is required for each CEU. The VPB260 supplies power to a fully loaded system for approximately two hours.

Initial Configuration

Battery Backup allowed, but only with required equipment

Using the Feature

To install the VPB260, see the Hardware manual. Once installed, Battery Backup is automatic during a power failure or brownout.

Understanding Related Programming

N/A

Call Forwarding



Go to a meeting in a co-worker's office and not miss your calls. Simply send them there.

Call Forwarding lets you reroute your incoming Intercom calls and some outside calls to a co-worker's extension or Voice Mail. You can forward one of four types of calls:

- Ringing calls that you do not answer after a programmed number of rings
- Ringing calls that you do not answer after a programmed number of rings, and calls that try your phone when it is busy
- All calls, immediately
- Calls picked up by Voice Mail in the Personal Answering Machine Emulation mode (see page 185)

Notes:

- The system does not forward: Intercom calls from the forwarded destination, Ring Group calls, calls that ring a Call Coverage key, and outside calls not on Direct Inward Lines.
- Attendants cannot use Call Forwarding; they use Alternate Attendant (on page 30) instead.

Initial Configuration

- Internal Call Forwarding enabled
- A call rings an extension 5 times before being forwarded

Using the Feature

Call Forwarding is not available to an Alternate Attendant. See Alternate Attendant on page 30 instead.

To forward your calls to another extension:

At the destination phone, do not do this to forward calls back to your own phone; simply cancel Call Forwarding instead.

1. Lift handset.
-If you have a One-Touch Speed Dial key, you can press it instead of using steps 2-5.
2. Press ICM (except at ESL set) and dial #.
3. Dial extension to receive calls.
-To forward your calls to Voice Mail, press MSG instead of dialing a co-worker's extension. Refer to page 185 for more on Voice Mail.
4. Dial Call Forward code (1,2,3).
*-Code 1 forwards ring-no-answer calls
-Code 2 forwards ring-no-answer and busy calls
-Code 3 forwards all calls
-(If forwarded to Voice Mail) Code 4 to enable Personal Answering Machine Emulation (see page 185)*
5. Hang up.
-MSG key flashes.

- To cancel Call Forwarding:** The attendant can also cancel your Call Forwards (see Call Forwarding Cancel on page 47). A power failure, system reset, or activating Do Not Disturb cancels them automatically.
1. Lift handset.
-Press ICM (except at ESL set).
 2. Dial # and hang up.
-MSG key goes out.

Understanding Related Programming

- Program 1** To enable/disable Internal Call Forwarding in a Class of Service (**CALL FWD** = Y or N + #) (see also Program 18 [I])
- Program 18 (I)** To assign a Class of Service (from Program 1) to an extension (**COS** + # + 01-27 + #)
- Program 4** To set the Number of Rings Before Recall timer (Timer **06** + # + Duration + # – the number of times a call rings before being forwarded)
- Program 12** To assign Direct Inward Lines to an extension (**DTD** + # + Extension number + #). Only calls on these lines will get forwarded.

Call Forwarding, Off-Premise



Go home early in the day and have your calls follow you there or to your car phone.

If your phone has Direct Inward Lines, Off-Premise Call Forwarding lets you reroute calls on those lines to an outside telephone number.

Note: To use Call Forwarding, the DIGITAL SYSTEM must be equipped with a Line module that provides disconnect supervision. In addition, the connected CO line must also provide disconnect supervision.

Initial Configuration

Off-Premise Call Forwarding disabled

Using the Feature

To forward your calls off-premise:

1. Lift handset.
-If you have a One-Touch Speed Dial key, you can press it instead of using steps 2-5.
2. Press ICM (except at an ESL set).
3. Dial # 1 and the line (01-16) you want your calls to forward out on.
-Use a line you have access to.
4. Dial telephone number to receive your calls.
5. Hang up.
-MSG key flashes slowly.

To cancel Call Forwarding:

The attendant can also cancel your Call Forwards. A power failure, system reset, or activating Do Not Disturb cancels them automatically.

1. Lift handset.
2. Press ICM (except at an ESL set).
3. Dial #.
4. Hang up.
-MSG key goes out.

Understanding Related Programming

- | | |
|----------------|---|
| Program 1 | To enable/disable Off-Premise Call Forwarding in a Class of Service (OFF-P CFWD = Y or N + #) (see also Program 18 [I]) |
| Program 18 (I) | To assign a Class of Service (from Program 1) to an extension (COS + # + 01-27 + #) |
| Program 12 | To assign Direct Inward Lines (DTD + # + Extension number) |
| Program 16 | To give an extension access to the line it will use to forward calls out on (L + LINE NO. + # + 02 + #) |



With Call Forwarding Cancel you can, as the attendant, return the system to normal status at the end of the work day or after the weekend so incoming calls ring their normal (not forwarded) destinations.

If you are an attendant, Call Forwarding System Cancel lets you cancel all Call Forwarding conditions in the system at once. Using Call Forwarding System Cancel also cancels three other conditions system-wide: Do Not Disturbs, Personal Greetings and Selectable Display Messages.

Initial Configuration

Call Forward Cancel allowed for attendant extension 300

Using the Feature

To activate Call Forwarding Cancel from your attendant extension:

1. Lift handset.
2. Press ICM.
-ICM lights and you hear dial tone.
3. Press #.
-Dial tone stops.
4. Dial *.
-You hear dial tone again.
5. Hang up.

Understanding Related Programming

Program 3 To assign attendant extensions (**OPR nn EXT =**
Extension number + #)

Call Intercept



Users quickly know when they dial an invalid code.

Call Intercept sends fast busy tone to anyone who dials an invalid code while making a call. In other words, the system automatically prevents (intercepts) an invalid call.

Initial Configuration

Intercept always occurs when appropriate

Using the Feature

N/A

Understanding Related Programming

N/A



Easily keep track of how much time you spend on a call.

If you have a Display Phone, the Call Timer feature lets you time your outside calls. The duration shows on your display.

Your phone can be programmed for Automatic or Manual Call Timer:

- With Automatic Call Timer, the timer automatically starts when you establish an incoming or outgoing call.
- With Manual Call Timer, you start the timer by pressing the Manual Call Timer key.

In addition, you can use the Call Timer feature while your phone is idle to time events, much like a stopwatch.

Note: If your system has Station Message Detail Recording (SMDR), the system records and times your calls.

Initial Configuration

Call Timer disabled (no Timer keys programmed)

Using the Feature

To start timing a call when you have a Manual Call Timer key:

1. Press Timer key.
-The key lights.

To stop timing a call before or after you hang up:

1. Press Timer key.
*-The key goes out.
-To reset the timer back to 00:00, press the Timer key again. After a few seconds, the date and time reappear.*

To use the Call Timer as a stopwatch while your phone is idle:

1. Press Timer key to start and stop the stopwatch.
*-The key is lit while the stopwatch is on.
-To reset the timer back to 00:00 after you stop, press the Timer key again. After a few seconds, the date and time reappears.*

Understanding Related Programming

- Program 17** To assign Automatic (Press key + **CTA** + #) or Manual (Press key + **CTM** + #) Call Timer keys to an extension

Callback



Save time retrying a busy extension. The DIGITAL SYSTEM calls you back when it becomes idle.

When you make an Intercom call and get busy tone, you can place a Callback request, hang up, and continue using your extension. The system then does the following for you:

- Monitors the busy extension and your extension, and calls you back (rings you) when both extensions are free.
- Calls the previously busy extension when you answer the "callback" ring.

You can leave one Callback per busy extension. For extensions with several Callbacks, the system processes them in the order they were left.

Note: Attendants cannot use Callback.

Initial Configuration

Callback always allowed

Using the Feature

To use Callback after you call an extension and hear busy tone or ring-busy tone:

You cannot use Callback if you hear fast busy tone.

1. Dial C and hang up.

To answer Callback (long) rings:

You must answer within five rings or the system cancels the Callback.

1. Lift handset.

-This connects you to the previously busy extension.

To cancel a specific Callback after you leave it:

1. Call the busy extension again.
2. Dial * at busy tone and hang up.

To cancel all your Callbacks (and Line Queuing requests):

1. Lift handset and press ICM (except at an ESL set).
2. At a multibutton phone, dial * and press FTR.
OR
At an ESL set, dial # *.
3. Hang up.

Understanding Related Programming

N/A



See your callers name and number before you answer.

Caller ID requires software version AUX Module 2.10/ Base 02.00 or higher.

If your phone has a display, Caller ID can show your incoming caller’s number and optional name. The Caller ID information will show as either a *post-answer* or *pre-answer* display. With the post-answer display, you’ll see the caller’s number and optional name *after* you answer the call. The pre-answer display lets you see the caller’s number and optional name *before* you answer the call. You can also use the pre-answer display to preview incoming calls before you answer them. The Caller ID pre-answer display is available only if your telephone does not have Automatic Handsfree (see page 94).

Caller ID supports the phone company’s Called Number Identification (CNI) and Called Number Delivery (CND) service, when available. These services provide the Caller ID information (i.e., messages) between the first and second rings of an incoming call. There are two types of Caller ID message formats currently available: Single Message Format and Multiple Message Format. With Single Message Format, the phone company sends only the caller’s phone number (DN). The DN is either 7 or 10 digits long. In Multiple Message Format, the phone company sends the DN and the caller’s name. The DN for this format is also 7 or 10 digits long, and the name provided consists of up to 15 characters.

Once installed, Caller ID is enabled for all types of outside calls, including:

- Outside calls that normally ring a phone (see Ring Assignments on page 154)
- Calls transferred from another extension (see Transfer on page 182)
- Calls transferred from Operator Assistance via the Voice Module Unit (see Operator Assistance on page 128)
- Calls transferred from Voice Mail (see Voice Mail on page 185)
- Direct Inward Lines (DILs) (see See Direct Inward Lines on page 64)
- Assigned Night Answer (ANA) Calls (see Night Answer on page 121)

Caller ID Displays

The Table below shows the DN format for each type of Caller ID call:

Type of Call	Format of Display
7-digit	NNX-nnnn
8-digit	nNNX-nnnn

Caller ID

In addition to displaying the DN and name, Caller ID can also display several unique messages received from the telco:

Message	Description
PRIVATE	Caller has blocked Caller ID. Telco will not pass the DN.
OUT OF AREA	Caller has dialed from an area that does not support Caller ID.
UNAVAILABLE	Telco's Caller ID is out of service.

Your system provides unique displays for incoming Caller ID (CND) and non-Caller ID (non-CND) trunks. The information a display keyset user sees depends on the type of incoming trunk call *and* the type of trunk. The following chart describes the telephone display for each type of incoming CND and non-CND trunk call for software versions AUX Module 02.20/Base 02.10 and higher. For software versions prior to AUX Module 02.20/Base 02.10, the telephone display always showed the incoming trunk's Caller ID information (for CND trunks) or programmed name (for non-CND trunks).

	CND Trunk	Non-CND Trunk
Unscreened Transfers	Caller ID data for the incoming trunk.	The name/number for the incoming trunk.
Screened Transfers	The screening extension's name/number, followed by the Caller ID data for the incoming trunk.	The screening extension's name/number (even after the screening caller hangs up).
Calls Transferred by Voice Mail	The Caller ID data for the transferred trunk.	The transferring Voice Mail port's name/number.
Key Ring (post-answer) & Direct Inward Lines	Caller ID data for the incoming trunk.	Name/number for the incoming trunk.

Hardware Considerations

Caller ID requires the installation of at least one 4CO/CND Caller ID Module (P/N 88512). The Caller ID Module is a standard 4CO Module with additional Caller ID capability. Each module provides Caller ID service for the lines connected to it. For example, the inside Caller ID Module in the Main CEU provides Caller ID capability for lines 1-4. Your system (without an AUX Module) can have up to two Caller ID Modules, providing Caller ID capability to all eight lines.

Notes:

- Caller ID requires software version AUX Module 2.10/ Base 02.00 or higher. Do not install Caller ID Modules in a system that uses software prior to AUX Module 2.10/ Base 02.00. Caller ID is compatible, however, with older system databases. This allows you to upgrade software without initializing the system.

- Caller ID information prints on the SMDR report along with other call information. SMDR requires an AUX Module and an SMDR collection device or printer. Refer to the DIGITAL SYSTEM Feature and Terminal Programming Manual for more about SMDR.

Initial Configuration

- Caller ID enabled automatically after you install a Caller ID Module.
- Caller ID pre-answer display disabled (i.e., Automatic Handsfree enabled).

Caller ID

Using the Feature

To answer a Caller ID call
(with the pre-answer
display disabled):

1. Lift handset or press flashing line key.
*-You see the incoming caller's name and number
and you answer the call.*

To answer a Caller ID call
(with the pre-answer
display enabled):

(Your phone must have Automatic Handsfree disabled to use this feature.)

1. Press the flashing line key to display the incoming caller's phone number.
-You can press another flashing line key instead of going to the next step.
2. Press the flashing line key again to display the incoming caller's name.
-If the telephone company does not offer the name option, you skip to the next step.
-You can press another flashing line key instead of going to the next step.
3. Lift the handset to answer the call.
-If you previewed several ringing lines, you'll answer the call on the most recently pressed line key.

To re-display the Caller ID
information for the call
you are on:

1. Press the line key for the call.

Understanding Related Programming

Program 2 To disable Automatic Handsfree (**ENABLE AUTO HF** = N + #) in order to enable the Caller ID pre-answer display.



Be assured that you are connected to a busy extension as soon as it becomes free.

When you make an Intercom call and get busy tone, Camp-On lets you dial a code and wait off-hook for the busy extension to become available. Dialing the code may send Call Waiting beeps to the busy user (if enabled in programming). The DIGITAL SYSTEM automatically connects you to that extension when the busy user hangs up or if the busy user chooses to interrupt their call and respond to your beeps.

When a line you want to use is busy, Camp-On also lets you dial a code and wait off-hook for it to become free. When free, the system gives you dial tone on the line.

On the other hand, when you are busy on a call, you'll hear Call Waiting beeps when:

- An Intercom caller sends them
- Someone transfers an outside call to you
- You receive an outside call on a line that normally rings your phone. If several calls come in while you are busy on a call, you'll hear the beeps only for the first one. You will not, however, hear any Call Waiting beeps if your extension is programmed for Privacy.

Initial Configuration

- All extensions can use Camp-On
- Call Waiting tones enabled system-wide
- Privacy disabled except for attendant extension 300
- Attendant extension 300 can Camp-On to a busy line

Using the Feature

To Camp-On to an extension when you call it and hear busy tone or ring-busy tone:

You cannot Camp-On if you hear fast busy tone (the extension is in Do Not Disturb).

1. Dial C.
-You hear ringing while you wait.
2. Do not hang up and wait to be connected.
-If you choose to hang up, the system converts your Camp-On to a Callback (see page 50).

To have a Transfer Camp-On to an extension after you call it and hear busy or ring-busy tone:

1. Simply hang up when you hear the busy or ring-busy tone.
-See also Transfer on page 182.

To Camp-On to a busy line:

1. Try to access the busy line.
2. Dial C when you hear busy tone.
-Busy tone stops.
3. Do not hang up and wait for dial tone.
-If you choose to hang up, the system converts your Camp-On to a Line Queuing request (see page 108).

Camp-On (Call Waiting)

To answer Call Waiting beeps from an Intercom call:

You hear two beeps and ICM flashes.

1. At a multibutton phone, press ICM to answer the waiting call.

OR

At an ESL set, press HLD and dial * 2.

-Your first call goes on Hold.

-To alternate between the calls, see Split on page 167.

To answer Call Waiting tones from an outside call:

You hear two beeps and a Line/Loop key flashes.

1. Press HOLD to hold the call you are on.
2. At a multibutton phone, press flashing Line/Loop key.

OR

At an ESL set, dial * 2.

-To alternate between the calls, see Split on page 167.

Understanding Related Programming

Program 1 To allow/deny Camp-On to a busy extension or line in a Class of Service (**CAMP ON** or **DIR ACC/CMP-ON = Y** or **N + #** (see also Program 18 [I])

To allow/deny Privacy in a Class of Service (**PRIVACY = Y** or **N + #**). Allow Privacy for any extension that should not receive Call Waiting beeps (see also Program 18 [I]).

Program 18 (I) To assign a Class of Service from Program 1 (**COS + # + 01-27 + #**) to an extension

To enable/disable Off-Hook Ringing at an extension (**OHR + # + Y** or **N + #**). If enabled, the system converts the extension's Call Waiting tones to a ring signal over the speaker.

Program 2 To enable/disable Call Waiting beeps system-wide (**CALL WAIT TONE = Y + #**)



Access a PBX/Centrex feature with a single touch.

When your system is installed behind a PBX or Centrex, a PBX/Centrex key lets you access a PBX/Centrex feature without dialing the feature code. The feature code is stored in a key so you can just press the key.

PBX/Centrex keys can be enabled only through terminal programming, which requires the AUX Module. To enable PBX/Centrex keys, see Centrex Compatible Feature Keys in the DIGITAL SYSTEM Feature and Terminal Programming Manual.

Initial Configuration

No PBX/Centrex keys assigned

Using the Feature

See the DIGITAL SYSTEM Feature and Terminal Programming Manual.

Understanding Related Programming

Program 3 To set the baud rate of the AUX Module's port for terminal programming (**LOCAL BAUD** = 00 [300], 01 [1200], 02 [2400], 03 [4800], 04 [9600] or 05 [19.2K] + #)

Class of Service



Each extension can have a customized group of features depending on its needs.

A Class of Service (COS) is a group of feature and dialing options that you can assign to an extension. First, you customize a COS by enabling or disabling each option, then you assign the COS to an extension. You can customize up to 28 different COSs (00-27), and you can assign the same COS to any number of extensions. In addition, there is a special COS (30) for attendant extensions.

Below are the COS options, their initial setting, and a feature reference. A "Y" code means the feature is allowed, "N" means denied.

Initial Configuration

- Attendant extension 300 has COS 30 (equivalent to COS 00)
- Extensions 301-347 have COS 01
- Place only Intercom Calls during Night Answer = N
See Night Answer on page 121.
- Off-Premise Call Forward = N
See Off-Premise Call Forward on page 46.
- Break-In (Intrusion) = Y for COS 00; N for others
See Intrusion (Barge-In) on page 106.
- Camp-On (Busy Extension) = Y
See Camp-On on page 55.
- Internal Call Forwarding = Y
See Call Forwarding, Internal on page 44.
- System Speed Dial Access = Y
See Speed Dial on page 162.
- Toll Restriction Level = 00 (not restricted)
See Toll Restriction on page 178.
- Place Only Local Calls (Day or Night Answer mode) = N
See Toll Restriction on page 178.
- Place Only Local Calls during Night Answer = N
See Toll Restriction on page 178.
- Extended Ring = N
See Extended Ringing on page 80.
- Privacy = N
See Privacy on page 148.
- Callback (Line Queuing) Priority = N
See Line Queuing on page 108.
- Direct Line Access & Camp-On to Busy Line = Y for COS 00; N for others
See Placing Outside Calls (Using Direct Line Access) on page 134.
- Initiate All Call Page = Y
See Paging on page 138.
- Access Page Zones 1-3 = Y
See Paging on page 138.
- Silent Monitor = N
See Silent Monitor on page 161.
- No Flash for Electronic Single Line Phones = N
ACD Supervisor Keyset = N
See Automatic Call Distribution on page 36.

- Single Ring for ASI Calls = N
See Analog Station Interface on page 31.

Using the Feature

N/A

Understanding Related Programming

- | | |
|----------------|---|
| Program 1 | To customize Class of Service for an extension or line (see also Program 18 [I]) |
| Program 18 (I) | To assign a Class of Service from Program 1 to an extension (COS + # + 01-27 + #) |

Conference



Conduct a telephone meeting with inside and/or outside parties so you do not have to leave your office.

Conference lets you set up a three-way telephone conversation. To set up a Conference, you establish an Intercom or outside call, then add someone to it. You can add an outside party or an extension user.

To set up a Conference with two outside parties, your system must be equipped with loop start lines that have disconnect supervision.

Initial Configuration

Conference allowed

Using the Feature

Conference is temporarily unavailable when the system is already accommodating the maximum number of three-party conversations, which is 8 per system.

- To set up a Conference:**
1. Establish first call.
 2. Press CONF.
 - Your call goes on Hold.*
 - Busy tone means that all Conference circuits are busy. Try again later.*
 3. Establish second call.
 4. Press CONF again.
 - CONF lights and all three of you are connected.*
 - If the Conference includes at least one other extension user, you can hang up (leave the Conference) without disconnecting the remaining parties.*

Understanding Related Programming

N/A



The DIGITAL SYSTEM can also be used for data communications.

The Data feature lets you connect a Data Module (P/N 88400), a Dataport PCB (P/N 89460), and/or a Modem Pooling PCB (P/N 89465) to the system for data communications with computers, terminals, printers and other RS-232 devices.

Note: Depending on the version of the your system, you may need to install an AUX Module to use Dataport and Modem Pooling PCBs. For more information on all Data devices, see the Data Products Manual (P/N N1850DMG01).

Initial Configuration

For a Data Module:

Baud Mode: Slave	Allow DTR Disconnect: Yes
Parity: None, 8 bits	Allow Break Disconnect: Yes
Interactive Mode: Yes	Auto Baud: Yes
Interactive Echo: Yes	Busy on DTR Low: No
RS-232 Controls Active: Yes	

Using the Feature

See the Data Products Manual (P/N N1850DMG01).

Understanding Related Programming

- | | |
|-----------------------|--|
| Program 14 | To assign the correct circuit type (CIRCUIT TYPE = Z + #) to a Data Module |
| Program 18 (I) | To configure an extension as a Dataset (DS + # + Y + #) when it is installed with a Data Module |
| Program 3 | To set the baud rate of the AUX Module's port for terminal programming (LOCAL BAUD = 00 [300], 01 [1200], 02 [2400], 03 [4800], 04 [9600] or 05 [19.2K] + #) |
| Program 4 | To set the Modem Reserve timer (Timer 05 + # + Duration + #) when using a Modem Pooling PCB |

Delayed Ringing Assignment



Have your calls ring at your secretary's phone, then at your phone after a short delay. This way, you are not disturbed by a ringing call unless your secretary cannot get to it right away.

Delayed Ringing Assignment (DRA) lets you enable or disable delayed day/night ringing for:

- Lines
- Call Coverage keys
- Pickup Group keys

A call rings the line or key after a pre-programmed delay instead of right away. To enable/disable DRA, your extension must have program access level 2-5. Enabling DRA disables immediate Ringing Assignment (see page 154) or Night Ringing (see page 124).

Initial Configuration

- DRA disabled at all extensions
- Extension 300-305 can program DRA. All other extensions only have program access level 01.

Using the Feature

To enable/disable Delayed Ringing Assignment (DRA) when your extension has program access level 2-5:

1. Do not lift handset.
2. Press #.
3. Dial DRA.
-Your Line, Call Coverage, Pickup keys flash or light steadily. Flashing means Delayed Ring is on; steadily lit means it is off.
4. Press desired key or dial desired line number.
5. To enable DRA, dial Y.
OR
To disable DRA, dial N.
6. Press # and return to step 4, or press SAVE to finish.

Understanding Related Programming

- | | |
|------------------------|--|
| Program 18 (II) | To enable/disable Delayed Ringing for an extension (DRA + # + line + Y or N + #) |
| Program 15 | To assign program access level 2-5 to extensions so they can program Delayed Ringing themselves (PGM ACC LEVEL = 02-05 + #) |
| Program 4 | To set the Delayed Rings timer (Timer 07 + # + Duration + #) |
| Program 17 | To assign Line (LK + Line 01-16 + #), Call Coverage (CCK + ext. + #), Pickup (GP + Pickup group 01-07 + #) keys to an extension |
| Program 16 | To assign line access to an extension (L + Line 01-16 + # + 01 or 02 + #) |



Make a mistake in dialing and not have to redial the entire number.

If you have a Display Phone, Dialing Number Preview lets you dial an outside number, review its digits on your display and correct them, if necessary, before the system dials out the call. To correct a mistake, you back up to the mistake and enter the correct digit. Then you simply press a few keys to have the system dial out your call.

Initial Configuration

Dialing Number Preview always allowed at Display Phones

Using the Feature

To use Dialing Number Preview:

1. Do not lift handset (unless you are using an attendant extension).
2. Dial *.
-HF lights.
3. Dial number.
4. Correct any mistakes as follows:
-Press VOL DN to move the cursor left to the incorrect digit. If you go to far, press VOL UP to move the cursor right. If the number is correct, go to step 6.
-Dial the correct digit.
5. Press FTR to move the cursor to the end of the number.
6. Press DIAL.
-If your phone has a Prime Line key (page 134), this step dials out the call and you can skip step 7.
7. Press Line key to have the system dial your call.

To exit Dialing Number Preview without dialing the call:

1. Press HF.
-At an attendant extension, hang up.

Understanding Related Programming

- Program 16** To give an extension outgoing access to a line (L + Line 01-16 + # + 02 + #)

Direct Inward Lines



A DIGITAL SYSTEM line can be assigned to a specific extension so outside callers can directly reach that extension. For example, a DIL could ring a Sales Manager's extension, and if unanswered, all the other salespeople in the group.

The Direct Inward Line (DIL) feature lets you program a line so it rings a specific destination, and if unanswered, rings other extensions. The initial destination (termination) for a DIL can be:

- An extension
- The master extension for a UCD Hunt Group (including Voice Mail master extensions)
- A Ring Group

A DIL always rings its initial destination; there is no need to assign ringing through system programming. In addition, an extension user can place calls on a DIL.

A DIL can have a day termination and a night termination:

- A line with a day termination to an attendant (operator) rings at the night termination when the attendant activates Night Answer (see page 121).
- A line with a day termination to a non-attendant extension rings at the night termination when that extension activates Do Not Disturb (see page 74).
- A line with a day termination to a UCD master extension rings the night termination when the master extension's attendant (assigned in Program 18 [I]) activates Do Not Disturb (see page 74).
- A line with a day termination to a Ring Group rings at the night termination when extension 300 activates Night Answer.

If the terminated extension or group does not answer the DIL within a programmed time, the DIL may ring extensions programmed for ringing on that DIL (called "key ring"). More specifically:

- If a terminated extension does not answer the DIL, the DIL converts to key ring.
- If a member of a terminated UCD Hunt Group does not answer the DIL, the DIL rings the overflow extension (if one is programmed). If the overflow extension does not answer, the DIL converts to key ring.
- If a member of a terminated Ring Group does not answer the DIL, the DIL continues to ring the Ring Group until someone answers or the caller hangs up.

For more information on Ring Groups see page 91. For more information on UCD Hunt Groups see page 81.

Initial Configuration

No DILs

Using the Feature

N/A

Understanding Related Programming

- Program 12** To make DILs (**DTD** + # + Extension number + #) (i.e., to directly terminate a line to an extension, UCD master extension, or Ring Group)
- Program 17** To assign a DIL to a key at an extension (**LK** + Line number 01-16 + #). If you do not assign it to a key, it rings a Loop key.
- Program 16** To give an extension (other than the terminated extension) access to the DIL so they can answer it if it diverts to their extension (**L** + Line no. 01-16 + # + 01 or 02 + #)
- Program 18 (II)** To assign ringing to the DIL at extensions other than the terminated extension (**RA** or **DRA** + # + Y or N + #)
- Program 4** To set the Rings Before Recall timer (Timer **06** + # + Duration + # - how long a DIL rings an idle/busy terminated extension or a UCD overflow extension before diverting to key ring; and, how long a DIL rings a Hunt Group extension before going to the next Hunt Group extension)
- To set the Camp-On timer (Timer **03** + # + Duration + # - how long a DIL rings a busy UCD group before going to the overflow extension)
- Program 10** To assign names to the DILs (See line name programming on page 230)

Direct Station Selection, DSS Console



Get 80 additional keys to make Intercom calls and use selected features with one touch. No need to remember, look up, or dial extension numbers. Your DSS Console can remember and dial them for you.

A Direct Station Selection (DSS) Console gives you 80 keys for one-button access to extensions and selected features. This saves time if you do a lot of call processing. You can have DSS Console keys for:

- Hotline to extensions (see page 101)
- Park Orbits (see page 141)
- Outside Lines (see page 134)
- Page Zones (see page 138)
- DSS Console (One-Touch) Speed Dial (see page 162)
- Release (always on key 80)

DSS Console Busy Lamp Field

The DSS Console Busy Lamp Field shows the status of the associated extension, line or feature. See the chart below. When programmed for Hotline, the key shows when the extension is idle, busy or in Do Not Disturb. If the key is a line key, it shows when the assigned line is ringing, idle, busy, on Hold or recalling. For a Park orbit key, the key is on when the orbit is in use. If a key is a Page zone or Speed Dial key, the key is on when the feature is active.

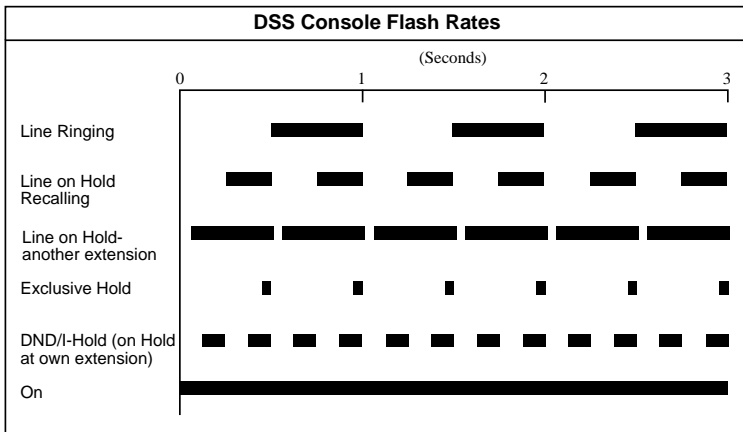

Notes:

- You cannot install a DSS Console in the expansion cabinet.
- The DSS Console is a dual port device, using adjacent even and odd numbered ports. **You must install the DSS Console in the lower (even-number) port of a port pair.** For example, you must plug the console into port 02 (extension 302) when using the 02/03 port pair.
- You can install as many DSS Consoles as there are available dual ports. However, the system allows only four unique DSS Console key configurations (layouts). See Understanding Related Programming below.
- For attendants, pressing a DSS Console key while on an outside call automatically puts the outside call on Hold (Automatic Hold).

Initial Configuration

- The DSS Console is automatically enabled (circuit type 06) when you plug it in
- Each console is assigned to extension 300
- Each console uses Block (configuration) 01, with key assignments as follows:

Key	Assignment
1-47	Extensions 301-347
48-72	Undefined
73-76	Page zones 0-3
77-79	Park orbits 60-62
80	Release

Using the Feature

- To use your DSS Console keys:
1. Lift handset.
 2. Press DSS Console key for desired function.

- To use your DSS Console Hotline keys to Transfer your outside call:
1. Lift handset.
 2. Press ICM.
 - If you are an attendant, skip this step to Transfer the call unscreened.
 3. Press DSS Console Hotline key.
 - If you hear two beeps, speak.
 - If you hear ringing, wait for an answer.
 - If you hear busy tone, dial C to send Call Waiting beeps.
 - If you hear fast busy, dial I to intrude (override DND).

Understanding Related Programming

- Program 14** To assign Circuit Type (**CIRCUIT TYPE** = 06), DSS Owner (**DSS OWNER** = Extension number), DSS Block (**DSS BLOCK** = 01-04) and optional name (see extension name programming on page 242) to each DSS Console. The system does, however, assign the correct circuit type, DSS Owner 300 and DSS Block 01 when you plug in the DSS Console.
- Program 17** To designate the function of each DSS Console key (see chart below). You must use Program 17 from the extension assigned to the console.

For this key . . .	Enter this code . . .
Undefined	UK + #

Direct Station Selection, DSS Console

For this key . . .	Enter this code . . .
Line key	LK + Line number (01-16) + #
Park Orbit	PO + Park Orbit (60-69) + #
Speed Dial	SD + 1-79 + #
Hotline	HL + Partner ext. (300- 347) + #
Page Zone	PO + Page Zone (00-07) (00=All Call) + #

Program 18 (I) To assign a Personal Speed Dial block to a DSS Console if the console has Speed Dial keys (**SDB** + # + Block number 01-28 + #).

Program 18 (II) Program Personal Speed Dial (**SD** + # + Bin or key + # + Line name [see page 230] + number + # for the console's One-Touch keys).



Make Intercom calls with two touches. No need to remember, look up, or dial extension numbers. Your phone can remember and dial them for you.

Direct Station Selection (DSS) lets you call an extension by pressing two keys: ICM, then the DSS key for the desired extension. Keys 1-15 are the DSS keys. You can program a DSS key to call whichever extension you wish as long as your extension has program access level 1-5. You can also use DSS keys to Transfer calls.

In addition, when you press ICM, the DSS keys show you the status of their associated extensions (the status is called Busy Lamp Field [BLF] and is described below).

When the DSS/BLF key is . . .	The extension is . . .
Off	Idle
On	Busy or ringing
Flashing fast	in Do Not Disturb

Direct Station Selection also does the following:

- Signals a busy extension if it is programmed for Off-Hook Signaling (see page 126).
- Lets you manually send Call Waiting beeps (see page 55) to a busy extension if it is not programmed for Off-Hook Signaling

Direct Station Selection does not, however, let you contact an extension in Do Not Disturb unless your extension is programmed for Intrusion (see page 106).

Initial Configuration

- DSS/BLF enabled for keys 1-15
- All DSS keys call extension 300
- All extensions can change DSS extension assignments
- DSS keys automatically activate Off-Hook Signaling (Whisper Page)
- Intrusion allowed for attendant extension 300

Using the Feature

To assign an extension to a DSS key when your extension has program access level 1-5:

1. Do not lift handset.
2. Press #.
3. Dial DSS. DSS keys flash fast.
4. Press desired DSS key.
-The key flashes slowly.
5. Dial extension, press #.
6. Return to step 4.

OR

Press SAVE to finish.
-All keys go out.

Direct Station Selection

To place a call using a DSS key:

1. Lift handset.
2. Press ICM.
-If ICM does not light, you do not have DSS keys.
3. Press lit or unlit DSS key to call the extension.
-If you hear two beeps, speak.
-If you hear ringing, wait for an answer.
-If you hear busy tone, dial C to send Call Waiting beeps.
-If you hear fast busy, dial I to intrude (override DND).

To transfer a call using a DSS key:

1. Press ICM.
-This puts your call on Hold. If ICM does not light, you do not have DSS keys.
2. Press lit or unlit DSS key to call the extension.
-See step 3 above for your options.
3. Announce the call and hang up.
OR
Hang up to have the call wait at your partner's extension unannounced.
-If the person does not pick up the Transfer, it recalls your phone like a normal Transfer.

Understanding Related Programming

- | | |
|-----------------|---|
| Program 18 (I) | To enable/disable DSS capability on keys 1-15 (BLF + # + Y or N + #) |
| Program 18 (II) | To assign extensions to the DSS keys after you enable them in Program 18 [I] (DSS + # + Key + Extension number + #) |
| Program 15 | To assign a program access level to an extension (PGM ACC LEVEL = 00-05 + #) |



Answer someone else's call from your phone as long as you know their extension number.

Directed Call Pickup lets you answer, from your extension, a call that is ringing a co-worker's extension. You must, however, know the number of the ringing extension.

Directed Call Pickup does not answer calls ringing another extension's Call Coverage keys.

Initial Configuration

Directed Call Pickup always allowed

Using the Feature

To answer a call that is ringing another extension:

1. Lift handset.
-If you have a One-Touch Speed Dial key, you can press it instead of using steps 2-4.
2. Press ICM (except at an ESL set).
-You hear dial tone.
3. Dial *.
-Dial tone stops.
4. Dial number of ringing extension.
*-This procedure picks up calls other than calls ringing other extensions. The pick-up order is as follows:
Ringing Intercom calls
Personal Park calls
Ringing outside calls and Direct Inward Lines
Calls on Hold*

Understanding Related Programming

- Program 16** To give an extension access to any line it should be able to pick up (L + Line 01-16 + # + 02 + #)

Directory Dialing



Place Intercom or Speed Dial calls by displaying the name of the person you want to call — the DIGITAL SYSTEM does the rest for you. No need to refer to a list of Intercom and Speed Dial numbers filed away at your desk.

If you have a Display Phone, Directory Dialing lets you make an Intercom or Speed Dial call by name instead of by number. It works like this:

- You display the name of the person you want to call from a stored directory ("phone book")
- Press a button to have the system dial the person's number

Intercom Directory Dialing is always available if the system administrator has stored extension names in memory.

Speed Dial Directory Dialing is available only if your system is equipped with an AUX Module. If so, you can store names with your Personal Speed Dial numbers as long as your extension has program access level 1-5. If your extension has program access level 4-5, you can store 100 System Speed Dial names. To store Speed Dial names from your phone, see Speed Dial on page 162. Optionally, the system administrator can store Speed Dial names from a terminal connected to the AUX Module.

Initial Configuration

Directory Dialing always allowed at Display Phones, but no names are stored initially

Using the Feature

To place a call using
Directory Dialing:

1. Lift handset.
2. Dial code (I, P, or C) for names.
 - I = Intercom names
 - P = Personal Speed Dial names
 - C = System (Company-Wide) Speed Dial names.
 - To scroll through the directory, go to step 5.
 - If you see, **NO RAM INSTALLED**, this means only Intercom Directory Dialing is available.
3. Dial first letter of the desired name.
 - For example, to dial G: Dial 4. To dial a blank, Q or Z: Dial 0 (zero).
 - After you dial G, for example, the display shows:
1=G, 2=H, 3=I. "1=G" because G is the first letter on the 4 button, etc.
4. Dial the number (1, 2, or 3) that corresponds to the letter you just dialed.
 - The display shows you the first name stored for that letter. If you see **UNLISTED NAME**, this means there are no stored names for that letter.
5. Press VOL UP or VOL DN to scroll through the directory until you see the name you want.
 - To begin scrolling from the first name again, dial #.

6. Press DIAL to have the system dial your call.

To exit Directory Dialing
at any time:

1. Hang up.

Understanding Related Programming

- Program 14** To assign a name to an extension for Intercom Directory Dialing (see extension name programming on page 242)
- Program 18 (I)** To assign a Speed Dial block to an extension (**SDB** + # + 01-28 + #). Names cannot be stored at extensions with blocks 51-57. Remember: Speed Dial names can be stored only if the system has an AUX card.
- Program 18 (II)** To store Speed Dial numbers and names (**SD** + # + Bin or key + # + Line name [refer to line name programming on page 230] + Number + #)
- Program 15** To assign program access level 1-5 (**PGM ACC LEVEL** = 01-05 + #) to extensions so they can store their own Personal Speed Dial numbers and names
- To assign program access level 4-5 (**PGM ACC LEVEL** = 04-05 + #) to any extension that should be able to store System Speed Dial names

Do Not Disturb



Work uninterrupted by phone calls when you have paper work to do.

Do Not Disturb (DND) lets you block incoming pages, ringing, and Intercom voice announcements. While in DND, you can still use your extension to process calls and use features. Incoming outside calls still flash the Line keys and you can answer them, if you wish.

Someone using Hotline (at a phone or DSS Console) or Intrusion, can however, override your DND and get through. Likewise, you can use these features to contact an extension in DND.

Notes:

- Attendants cannot use Do Not Disturb
- Extension Hunting considers an extension in DND to be busy. *This may disrupt normal hunting.*

Initial Configuration

Do Not Disturb enabled

Using the Feature

DND is not available to the attendant, even if the attendant is programmed for it. Pressing the DND key at an attendant extension puts the system in the Night Answer mode.

To activate DND for your extension:

1. Do not lift handset.
2. Press DND until it flashes.

Activating DND does the following at your extension:

- Turns off Background Music, if it was on
- Cancels any Call Forwards
- Makes your extension appear busy if it is a Hunt Group member

To cancel DND at your extension:

- The attendant can automatically cancel a DND condition at your extension by making it an Alternate Attendant or by canceling system-wide.
1. Do not lift handset.
 2. Press DND until it goes out.

Understanding Related Programming

Program 18 (I) To allow/deny Do Not Disturb for an extension (**DND + # + Y or N + #**)

 **From a Door Box installed at an entrance door, a visitor can press the call button (like a door bell) to ring your phone.**

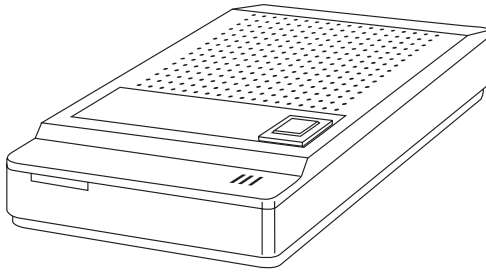

The Door Box (P/N 88545) is a self-contained Intercom unit typically used to monitor an entrance door. A visitor at the door can press the Door Box call button (like a door bell). The Door Box then sends chime tones to all extensions programmed to receive chimes. To answer the chime, the called extension user just lifts the handset. This lets the user talk to the visitor at the Door Box. The

Door Box is convenient to have at a delivery entrance, for example. It is not necessary to have a co-worker monitor the delivery entrance; they just answer the Door Box chimes instead.

The system can have up to four Door Boxes (numbered 1-4), installed at extensions 310, 311, 322 and 323 in the Main CEU. Each Door Box has a distinctive chime pattern.

Relay Box

The Relay Box (P/N 88546) provides relay contacts for up to four Door Box locations. A relay typically enables an electric strike on an entrance door next to a Door Box. After answering the Door Box chimes, you can press a dial pad key to enable the relay which releases the door. The visitor at the door can then enter without you having to open the entrance door for them.

You can only install a Relay Box at extension 309 in the Main CEU. This provides relays for the Door Boxes at extensions 311, 322 and 323. The Relay Box has a normally open (NO) and normally closed (NC) contact for each Door Box. The relay for the Door Box at extension 310 is currently unavailable.

Notes:

- The Door Box is a weather-tight unit, with an operating temperature range of 20°C to 60°C (-4°F to 140°F). It is not, however, intended for an outdoor installation directly exposed to the elements (e.g. rain or sunlight).
- You can only use a Door Box with software AUX Module Y2.0/Base Y5.0 or higher.

Initial Configuration

- No Door Boxes installed
- Relay Box not installed.

Using the Feature

- To use the Door Box:
1. Press and release the Door Box button.

Door Box

To answer the Door Box chimes (from your phone):

1. Lift handset.
-If you have a Hotline or Call Coverage key, it will flash. Press the key to answer the Door Box.

To call the Door Box (from your phone):

1. Lift handset.
2. Press ICM (except at ESL set) and dial Door Box extension number.
-If the Door Box is idle, your call connects. You don't hear any tones or ringing before you go through.
-If you have a Hotline or Call Coverage key, you can press it to call the Door Box.
3. (Optional) Release the door strike.
At multibutton set:
Press and hold FTR to release the door.
OR
At ESL set
Dial * (but do not hold it down).
-At a multibutton set, the relay activates as long as you hold down the FTR key (up to 60 seconds).
-At an ESL set, the relay activates for six seconds and then automatically releases.
-You can have Relay Boxes for the Door Boxes at extensions 311, 322 and 323 only.
4. Hang up.

Understanding Related Programming

- Program 17** To assign which extensions should have Hotline (Key + **HL** + Door Box extension number + #) or Call Coverage (**CCK** + Door Box extension number) keys for Door Boxes.
- Program 18 (I)** To assign each Door Box Class of Service 28 (**COS** + # + 28 + #).

Also, to assign which extensions should receive chime tones from which Door Boxes (**DB** + # + **DOOR ALERT** = Y or N + # for each Door Box).



Any combination of DP and DTMF Central Office lines can be connected to the DIGITAL SYSTEM.

With Pulse to Tone Conversion, use your pulse (rotary) lines to access computer services that require tone dialing (such as banking, MCI, Sprint, etc.).

You can program the system for either DP or DTMF lines from the Central Office.

Pulse to Tone Conversion

Pulse to Tone Conversion lets you dial digits on a Dial Pulse (rotary) line, then convert to tone dialing. After you dial the pulse digits, you simply stop dialing for six seconds. Any digits you dial after the six-second pause will be dialed out as tones. When you hang up the call, the dialing mode automatically reverts to pulse.

Initial Configuration

All Lines are CO Loop Start DTMF
Pulse to Tone Conversion enabled

Using the Feature

To convert to tone dialing when using a pulse line:

1. Place call on pulse line and wait six seconds.
2. Dial more digits.
-If you call a Speed Dial number that contains a pulse line and a pause, the system automatically dials tone digits after the pause.

Understanding Related Programming

To set the dialing mode of a line

Program 10 To identify the type of line (**CIRCUIT TYPE** = 10 + # for CO loop start DTMF, **CIRCUIT TYPE** = 11 + # for CO loop start DP) connected to a line port

Program 4 To set the Make (Timer **10** + # + Duration + #), Break (Timer **11** + # + Duration + #), and Interdigit timers (Timer **12** + # + Duration + #) for DP lines

To set the Line Response timer (Timer **04** + # + Duration + #) for DP and DTMF lines

DP and DTMF Compatibility

To set up Pulse to Tone Conversion

- Program 6** To make sure the Active Dialpad option is enabled (**ACT DIAL PAD = Y**) in a Toll Restriction level so a user can continue dialing after a pause; otherwise, Pulse to Tone Conversion would be disabled (see also Program 1)
- Program 1** To assign a Toll Restriction level (**TOLL RESTRICT = 01-07**) from Program 6 to a Class of Service (see also Program 18 [I])
- Program 18 (I)** To assign a Class of Service from Program 1 (**COS = 01-27 + #**) to an extension
- Program 10** To identify a line as a pulse line (**11 = CO loop start DP + #**)
- Program 16** To give an extension outgoing access to a line (**L + Line 01-16 + # + 02 + #**)



Use an alternative long distance service without dialing its telephone number.

If the DIGITAL SYSTEM is installed in an Equal Access area, you can dial a code to access a long distance carrier other than your main one (i.e., the one you access when you dial 1). The code is in the form 10XXX, where XXX is the carrier's identification code. The identification code is set up by the local telephone company.

In software AUX Module Y2.0/Base Y5.0 or later, the system does not restrict Equal Access codes. However, it restricts the phone number according to Toll Restriction.

In software versions prior to AUX Module Y2.0/Base Y5.0, once you manually dial an Equal Access code, you can dial any number (i.e., you have unrestricted dialing) unless your phone has any of the following options enabled in its Class of Service:

- Only Intercom Call at Night, which prevents Equal Access dialing during the Night Answer mode.
- Only Local Calls at Night, which prevents Equal Access dialing to long distances numbers during the Night Answer mode.
- Only Local Calls (Day or Night), which prevents Equal Access dialing to long distance numbers.

The system never restricts an Equal Access call that is stored in System Speed Dial bin.

Initial Configuration

Equal Access Dialing allowed (if the system is in an Equal Access area)

Using the Feature

- To use Equal Access Dialing:
1. Access an outside line.
-See Placing an Outside Call on page 134.
 2. Dial Equal Access code.
 3. Dial number.

Understanding Related Programming

- | | |
|----------------|--|
| Program 6 | (Versions prior to AUX Module Y2.0/Base Y5.0)
To allow/deny Equal Access Dialing (EQUAL ACCESS = Y or N + #). See also Program 1. With AUX Module terminal programming (AP command), you can allow/deny specific 10XXX codes. |
| Program 1 | To assign a Toll Level from Program 6 (TOLL RESTRICT = 01-07 + #) to a Class of Service (see also Program 18 [I])

To limit Equal Access Dialing using Class of Service dialing options (see the explanation above) |
| Program 18 (I) | To assign a Class of Service (COS + #+ 01-27 + #) from Program 1 to an extension |

Extended Ringing



Calls can ring longer than usual to assist people who can't readily get to their phones (like a warehouse worker, for example).

Extended Ringing forces an unanswered call to ring an extension 15 times before the system can reroute it to another extension. For example, a Transfer would ring an extension 15 times before recalling the extension that transferred it.

If an extension has Extended Ringing, the following types of calls ring it 15 times before being rerouted:

- A Hunting call
- A Transfer
- A recalling call on Hold
- A ring-no-answer forwarded call
- A Direct Inward Line
- A Direct Inward Dialing call

Initial Configuration

Extended Ringing disabled

Using the Feature

N/A

Understanding Related Programming

Note: Enabling Extended Ringing overrides Timer 06 (Number of Rings Before Recall).

- | | |
|-----------------------|---|
| Program 1 | To enable/disable Extended Ringing in a Class of Service (EXTENDED RING = Y or N + #). See also Program 18 (I). |
| Program 18 (I) | To assign a Class of Service (COS + # + 01-27 #) from Program 1 to an extension |



Call handling among people in a sales or service department becomes very efficient. If one person is busy handling a customer, the DIGITAL SYSTEM sends a new call to another person in the group. No need for an attendant to look for an available person to take a call.

Extension Hunting sends a call through a group of extensions until it is answered. In other words, if a call tries a Hunt Group extension and it is busy, the call tries (hunts for) the next available extension in the group, and so on.

The following types of calls hunt when they come into a Hunt Group extension:

- Ringing Intercom calls
- Transferred calls
- Direct Inward Lines
- DISA calls

Voice-announced Intercom calls and lines assigned to a Hunt Group extension through Program 16 do not hunt.

A Hunt Group can have any number of members, and the system can have any number of Hunt Groups. However, an extension can be in only one Hunt Group.

There are three types of Extension Hunting:

Circular Hunting

A Circular Hunt Group consists of extensions programmed into an ordered "circular" list, where the first and last extension are the same (e.g., 304, 305, 306, 307, 304). If a call is unanswered at one extension, it moves to the next extension in the list. If still unanswered, it rings all remaining members, circling back to the top of the list if necessary. If not picked up after ringing all group members:

- An Intercom call continues to ring the last extension in the group
- An outside call rings all extensions programmed for ringing on that line (an unanswered Transfer call may recall the transferer before ringing the other extensions)

Terminal Hunting

A Terminal Hunt Group consists of extensions programmed into a ordered list (e.g., 304, 305, 306, 307). If a call is unanswered at one extension, it moves to the next extension in the list. If still unanswered, it rings the remaining members until it reaches the bottom of the list; it does not circle back to the top of the list. If still unanswered:

- An Intercom call continues to ring the last extension in the group
- An outside call can ring the attendant or all extensions programmed for ringing on that line (an unanswered Transfer may recall the transferer before ringing the other extensions)

Extension Hunting

Uniform Call Distribution (UCD)

A UCD Hunt Group consists of extensions programmed into a list, and the group is assigned a master extension number. The UCD Hunting process begins when a call comes into the master extension number (such as a call transferred to the master number). The order in which the call rings the member extensions depends on how busy the extensions have been. The first extension rung is the one that has been idle the longest. The last extension rung is the one that has been busiest. If all UCD members are busy, the call waits (Camps-On) for the programmed Camp-On time, then moves to the overflow extension (if any). If not answered at the overflow extension, a waiting outside call rings all extensions programmed for ringing on that line.

Notes:

- Hunt Groups can be linked together. For example, a UCD master number can be the last member of a Terminal Hunt Group, or the overflow for another UCD Hunt Group.
- Activating at a Hunt Group extension disrupts normal hunting.
- Activating DND at a Hunt Group extension temporarily removes it from the group. If a "Circular" extension is in DND, an outside call continually cycles through the group.
- Two attendants (e.g., 307, 304) can be in a circular Hunt Group for special Night Answer operation (the group = 307, 304, 307 with type 02). Both attendants must activate Night Answer to put their lines into the Night Answer mode.
- Automatic Call Distribution is similar to UCD Hunting, but with unique supervisor and agent features. Refer to page 36 for the specifics.
- Extension Hunting considers an extension in DND to be busy. *This may disrupt normal hunting.*

Initial Configuration

Extension Hunting disabled (No Hunt Groups assigned)

Using the Feature

N/A

Understanding Related Programming

- Program 19** To set up Hunt Groups (see page 272)
- Program 4** To set two timers: Camp-On (Timer **03** + # + Duration + # – how long a call waits at a busy UCD group) and Rings Before Recall (Timer **06** + # + Duration + # – the number of times a call rings a Hunt Group extension before going to the next one; and, before ringing all extensions with ringing and access for that line)
- Program 17** To assign a Call Coverage (**CCK** + Master extension number + #) or Hotline (**HL** + Master extension number + #) key for a UCD master number (key lights when all members are busy)
- Program 12** To directly terminate a line to a UCD master number (**DTD** or **DTN** + # + master number + #) so calls ring it instead of having to be transferred to it
- Program 18 (II)** To disable Whisper Page (**VO** + # + Y or N + #) for extensions in Circular and Terminal Hunt Groups

External Alerting Device



The ringing for incoming calls is amplified so it can be heard in large noisy areas, such as a machine shop.

An External Alerting Device, such as a bell, can be connected to Relay 01 (located in the Main CEU) and Relay 02 (located in Expansion CEU #1). You can program the system so that a relay activates and the bell rings when an incoming call rings one of the following destinations:

- A line (348-363)
- An extension (300-347)
- A Ring Group (364-371 without AUX, 396-403 with AUX)

The relay activates for day and Night Answer calls with one exception: If you select extension 300 for a relay, the relay activates only for calls that ring extension 300 while it is in the Night Answer mode. You can also program the relays to have a steady or interrupted closure, depending on what the External Alerting Device requires.

An External Alerting Device must be compatible with the following relay specifications:

Maximum Load	60 mA @ 30 Vdc 10 mA @ 90 Vdc
--------------	----------------------------------

Initial Configuration

- Relays 01 and 02 activate when a call rings extension 300 during the Night mode
- Relays 01 and 02 are programmed for steady closure

Using the Feature

See Answering an Outside Call on page 132 or Night Answer on page 121.

Understanding Related Programming

Program 7 To select the type of call that activates a relay (**RELAYnn OWNER** = line, extension or Ring Group + #)

To select interrupted or steady closure for the relays (**INTRUP RING RLY** = Y or N + #)

Program 16 To give an extension access to the line you assign to a relay so the extension can answer a call on that line (**L** + Line 01-16 + # + 01 or 02 + #)



Use your DIGITAL SYSTEM phone to access the PBX/Centrex features that you are accustomed to.

When your system is installed behind a PBX or Centrex, Flash lets you access features of the PBX/Centrex while on an outside call. You simply press a key on your phone and dial the code for the PBX/Centrex feature.

Initial Configuration

- Flash allowed
- Flash timer set at .7 seconds

Using the Feature

To use Flash while you are on an outside call:

1. Press FTR.
 -If your system has software version AUX Module 02.10 or higher, you can use the steps below to Flash at a 2500 set:
 - Hookflash
 - Dial 7 *
2. Wait for PBX/Centrex dial tone.
3. Dial the code for the desired PBX/Centrex feature.

Understanding Related Programming

- | | |
|------------|---|
| Program 4 | To set the Flash timer (Timer 08 + # + Duration + #) |
| Program 10 | To identify a line as a PBX line (PBX LINE = Y + #) |
| Program 5 | To store PBX Access Codes to access outside lines (PBX ACC nn = Enter digits + #) |
| Program 16 | To give an extension access to a line (L + Line 01-16. + # + 02 + #) |

Refer to the DIGITAL SYSTEM Feature and Terminal Programming Manual to enable Flash at a 2500 set (AUX Module software version 02.10 and higher).

Flexible Numbering Plan



The DIGITAL SYSTEM numbering plan can be changed to a numbering plan the customer is more familiar with, if necessary.

Flexible Numbering Plan lets you change the digits that access lines, extensions and features. For instance, you can change the extension numbers from 300-347 to 500 to 547. The following system numbers can be changed:

- The digit that forces Intercom calls to ring
- First digit of Personal Speed Dial bins
- First digit of System Speed Dial bin numbers
- First digit of extension numbers
- First digit of Ring Group numbers
- First digit of Line numbers
- First digit of Park Orbit codes
- First digit of Line Dial-Up codes
- First digit of Line Group numbers
- The single digit that calls the main attendant

Changing these codes also affects other feature codes.

The Flexible Numbering Plan feature requires the AUX Module and terminal programming. For more information, see Flexible Numbering Plan in the DIGITAL SYSTEM Feature and Terminal Programming Manual.

Initial Configuration

- The digit that forces Intercom calls to ring = 1
- The Personal Speed Dial bin numbers = 50-59, 20-29
- System Speed Dial bin numbers = 70-79 or 700-799
- Extension numbers = 300-347
- Line numbers = 348-363
- Ring Group numbers = 364-371 without AUX, 396-403 with AUX
- Park Orbit codes = 60-69
- Line Dial-Up codes = 801-816
- Line Group numbers = 90-98
- The single digit that calls the main attendant = 0

Using the Feature

NA

Understanding Related Programming

Program 3 To set the baud rate of the AUX Module's port for terminal programming (**LOCAL BAUD** = 00 [300], 01 [1200], 02 [2400], 03 [4800], 04 [9600] or 05 [19.2K] + #)

 **Quickly get an outside line for an emergency call when all lines are busy.**

Forced Line Disconnect lets you disconnect an outside call that is going on at another extension. The outside line becomes idle and you can use it, for example, to make a call. You can also use Forced Line Disconnect to disconnect a busy (seized) outside line if it does not properly disconnect after the outside party hangs up. Normally, only attendants use Forced Line Disconnect.

Forced Line Disconnect is primarily for attendants to use in emergencies and for maintenance technicians to use when there is a problem with a line.

Initial Configuration

Forced Line Disconnect enabled for attendant extension 300

Using the Feature

To disconnect a busy line
(by dialing a code):

1. Lift handset.
2. Press ICM.
3. Dial the busy line's number (348-363) for lines 01-16.
-You hear busy tone.
4. Dial # to disconnect the line.
-You hear Intercom dial tone. To place a call on the line, do step 3 again and dial the number.

To disconnect a busy line
(by pressing a Line key):

1. Lift handset.
2. Press Line key for busy line.
-You hear busy tone.
3. Dial # to disconnect the line.
-The Line key goes out and you hear Intercom dial tone. To place a call on the line, press the Line key and dial the number.

Understanding Related Programming

- | | |
|-----------------------|---|
| Program 1 | To enable Direct Line (Trunk) Access in a Class of Service (DIR ACC/CMP-ON = Y + #); it must be enabled for Forced Line Disconnect to work (see also Program 18 [I]) |
| Program 18 (I) | To assign a Class of Service from Program 1 (COS + # + 01-27 + #) to each extension that should be able to use Forced Line Disconnect |
| Program 16 | To give an extension access to a line (L + Line 01-16 + # + 02 + #) |
| Program 17 | To assign a line to a key at an extension (LK + Line 01-16 + #) |

Group Call Pickup



Easily answer a call ringing your group (e.g., department) even if you don't know which extension is ringing.

Group Call Pickup places your extension in a Pickup Group with other extensions so you can easily pick up (answer) each other's calls. In other words, anyone in the group can pick up a call ringing any other extension in the group by dialing a simple code (* 1). Group Call Pickup answers the following types of calls:

- Ringing Intercom calls
- Transferred Calls
- Outside calls on Direct Inward Lines
- Outside calls on lines that have been assigned, through system programming, to the Pickup Group

To further simplify answering calls that ring a Pickup Group, your extension can be assigned a Pickup Group key. This way, when a call rings any extension in the group, the key flashes and you simply press it to answer the call. If your extension has program access level 2-5, you can assign ringing to a Pickup Group key so when a call rings an extension in the group, your extension rings. Also see Delayed Ringing Assignment on page 62 and Ringing Assignment on page 154.

The system can accommodate up to seven Pickup Groups (01-07). Any number of extensions can be in a group, but an extension can only be in one group.

Initial Configuration

- No Pickup Groups
- No Pickup Group keys
- No Direct Inward Lines assigned to extensions
- No lines assigned to Pickup Groups
- Extension 301-305 can program ringing. All other extensions only have access level 01.

Using the Feature

To answer a call ringing your Pickup Group from any extension in that Pickup Group:

This procedure does not answer Ring Group calls at other extensions in the Pickup Group.

1. Lift handset.
-If you have a One-Touch Speed Dial key, you can press it instead of using steps 2-4.
2. Press ICM (except at an ESL set).
3. Dial *.
4. Dial 1.

To answer a call ringing a Pickup Group using the Pickup key for the group:

1. Lift handset.
2. If not connected, press flashing Pickup key.

Understanding Related Programming

- Program 18 (I)** To assign an extension to a Pickup Group (**CPG + # + Group number 01-07 + #**)
- Program 17** To assign a Pickup Group key to an extension (**GP + Group number 01-07 + #**). You can also assign a Pickup Group key to an extension that is not in a Pickup Group so the extension can answer calls ringing that group.
- Program 18 (II)** To assign ringing to a Pickup key at an extension (**RA or DRA + # + Key + Y + #**)
- Program 15** To assign program access level 2-5 (**PGM ACC LEVEL = 02-05 + #**) to Pickup Group extensions so they can program ringing for Pickup keys themselves
- Program 12** To assign a line to a Pickup Group (**CPG + # + Pickup Group 01-07 + #**)

Group Listen



Broadcast an important call over your speaker so all your colleagues can hear the information at once. They can give you feedback on the information without the person on the line hearing their comments.

While you talk to someone using the handset, you can activate Group Listen to broadcast that person's voice over your phone's speaker. Anyone in the general vicinity of your phone can hear what the caller says, but that person will only hear what you say into the handset.

Note: Attendants cannot use Group Listen.

Initial Configuration

Group Listen always allowed

Using the Feature

Attendant and Headset extensions cannot use Group Listen.

To activate Group Listen while on a handset call:

1. Press HF, but do not hang up.
-HF flashes slowly and the speaker is on.

To cancel Group Listen (without terminating your call):

1. Do not hang up the handset.
2. Press HF. HF goes out and the speaker is off.
-You can still talk to the other person using the handset.

To terminate (hang up) a call after activating Group Listen:

1. Press HF, then hang up the handset.
OR
Hang up the handset, then press HF.

Understanding Related Programming

N/A



Call a group of extensions by dialing a single code.

The extensions in your system can be placed into Ring Groups. When you make an Intercom call or Transfer to a Ring Group, all extensions in the group ring simultaneously. If your extension is in a Ring Group, you can answer any call that rings your group by simply lifting the handset.

Your system can also be set up so that incoming outside calls ring all extensions in a Ring Group directly (i.e., without having to be transferred to the group).

The system can accommodate up to eight different Ring Groups (01-08). The dial-up codes for Ring Groups 01-08 are 364-371 (without AUX) or 396-403 (with AUX).

Note:

If you upgrade your Base CEU by adding an AUX Module with software version 01.05 or higher, you must reprogram the Ring Group direct terminations in Program 12. See *Understanding Related Programming* on the next page.

Initial Configuration

No Ring Groups programmed

Using the Feature

To make an Intercom call
to a Ring Group:

1. Lift handset.
2. Press ICM (except at an ESL set).
-ICM lights and you hear dial tone.
3. Dial Ring Group number (364-371 without AUX, 396-403 with AUX).

To transfer your outside
call to a Ring Group:

1. Press ICM.
-At an ESL set, press TRF instead. Your call goes on Hold.
2. Dial Ring Group number (364-371 without AUX, 396-403 with AUX).
3. Hang up.
-If the group is busy, the transferred call Camps-On (waits) until someone in the group is free or the transferred caller hangs up. The call will not recall your extension.

To answer a call that
rings your Ring Group:

The call rings like any other Intercom or outside call.

1. Lift handset.
-You cannot use Automatic Handsfree to answer the call.

Group Ringing

To answer a call that rings someone else's Ring Group:

If it's an outside call, you can answer it only if you have access to that line.

1. Lift handset.
-If you have a Call Coverage key (see page 169) for the other group, just press the key instead of using steps 2-4.
2. Press ICM (except at an ESL set).
-ICM lights and you hear dial tone.
3. Dial *. Dial tone stops.
4. Dial Ring Group number (364-371 without AUX, 396-403 with AUX).

Understanding Related Programming

- Program 18 (I)** To assign extensions to a Ring Group (**RG** + # + Ring Group Number 01-08 + #). Do not assign an attendant or Hunt Group extension to a Ring Group.
- Program 12** To directly terminate a line (i.e., assign a Direct Inward Line [DIL]) to a Ring Group (**DTD** + # + Ring Group extension number 364-371 w/o AUX or 396-403 w/AUX + #). When a call comes in on the DIL, all extensions in the group ring.
- Program 17** To assign a DIL to a key (**LK** + Line number 01-16 + #) at every extension in the Ring Group (if desired)

To change the first digit of Ring Group numbers, see Flexible Numbering Plan on page 86



Move across the office while on a call and still talk to the caller — your phone's microphone picks up your voice from any point in the room.

With a Handsfree phone, you can place calls, answer ringing calls, and activate features without lifting the handset; instead, you use the speaker and microphone in your phone (see also Automatic Handsfree on the next page). If you do not have a Handsfree phone, read Monitor on page 117.

To answer a voice-announced Intercom call Handsfree, see Intercom Call on page 103.

Note: Attendants cannot use Handsfree.

Initial Configuration

Handsfree capability at all Handsfree phones

Using the Feature

Handsfree is not available to attendant or Headset extensions, or when the system is already accommodating the maximum number of Handsfree conversations, which is 12 per CEU.

- | | |
|--|--|
| To activate Handsfree instead of lifting the handset: | <ol style="list-style-type: none">1. Press HF. HF lights.
<i>- If MIC/DND also lights, your phone does not have Handsfree or all Handsfree circuits are busy.</i> |
| To talk on a Handsfree call: | <ol style="list-style-type: none">1. Speak toward the phone.
<i>-To turn off the mic, see Microphone Mute on page 115 . If you hear a beep while on a call, see Split on page 167.</i> |
| To hang up a Handsfree call: | <ol style="list-style-type: none">1. Press HF.
<i>-HF goes out.</i> |
| To change a handset call into a Handsfree call: | <ol style="list-style-type: none">1. Press HF. HF flashes.2. Hang up the handset.
<i>-HF lights steadily.</i> |
| To change a Handsfree call into a handset call: | <ol style="list-style-type: none">1. Lift handset.
<i>-HF goes out.</i> |

Understanding Related Programming

N/A

Handsfree, Automatic



Use the Handsfree (HF) feature without pressing the HF key.

Automatic Handsfree lets you activate Handsfree for a call or feature by just pressing the primary key for that call or feature. There is no need to press the HF key first (see also Handsfree on page 93).

With a Handsfree phone, you can always use Automatic Handsfree for:

- Dialing Number Preview
- Directory Dialing
- Intercom (when you press ICM)
- Last Number Redial and Save
- Speed Dial (when you press a One-Touch Speed Dial key or DIAL)

You can also use Automatic Handsfree for the features below, but only if the system is programmed for Automatic Handsfree:

- Outside Calls (for all types of Line keys)
- Group Call Pickup (with a Pickup key)
- Paging (with a Page key)
- Park (with a Park Orbit key)
- Call Coverage (with a Call Coverage key)

If you do not have a Handsfree phone, see Monitor on page 117.

Initial Configuration

Automatic Handsfree enabled

Using the Feature

Automatic Handsfree is not available to attendant or Headset extensions, or when the system is already accommodating the maximum number of Handsfree conversations, which is 12 per CEU.

- | | |
|------------------------------------|--|
| To use Automatic Handsfree: | Do not lift handset or press HF.
1. Press (first) key for feature.
<i>-HF lights, Handsfree is activated.</i>
2. Press remaining keys for feature. To place a call, for example:
<i>-Press Line key to get dial tone over the speaker.</i>
<i>-Dial the number.</i> |
|------------------------------------|--|

Understanding Related Programming

- | | |
|-------------------|--|
| Program 2 | To allow/deny Automatic Handsfree system-wide (HF REPLY = Y or N + #) |
| Program 17 | To assign a line/feature to a key at an extension (see page 250) |



Have the privacy of a handset call without having to hold the handset. And, the Headset frees up both hands so you can easily process paperwork while you are on a call.

If you have a multibutton phone, you can use a Headset instead of a handset to process calls. While in the Headset mode, you hear the following signals in the Headset instead of the speaker: ringing, Paging, Background Music. If your extension has program access level 2-5, you can enable/disable Headset operation right from your phone. The recommended Headset is the Plantronic Supra Star Mate (Model MH0530-1).

With a Headset, you cannot use: Group Listen, Handsfree, Microphone Mute, Prime Line, Ringing Line Preference, and you will not receive voice-announced Intercom calls.

Notes:

- If you are an attendant, you should have a DSS Console when using a headset.
- Enabling the headset lowers the volumes at your phone. To readjust the volumes, refer to Volume Controls on page 193.

CAUTION: Do not enable Distinctive Ringing for an outside line if any extensions use headsets. See page 156 for more on Distinctive Ringing.

Initial Configuration

- Headset operation disabled
- Extensions 300-305 can enable/disable Headset operation. All other extensions only have program access level 01.

Using the Feature

To install the Headset while your phone is idle:

1. Make sure your phone is programmed for a Headset.
2. Unplug the handset.
-Leave it in the cradle.
3. Plug in the Headset.

To enable/disable Headset operation when your extension has program access level 2-5:

1. Do not lift handset.
2. Press #.
3. Dial HS.
4. Dial Y to enable Headset.
OR
Dial N to disable Headset.
5. Press SAVE.

To use the Headset for all features in this guide (multibutton phone only):

1. Press HF when you see "Lift handset" or "Hang up".
-HF lights when you are on a call and goes out when you hang up.

Headset

To answer a call using the Headset (attendant's only):

1. Press RLS on the DSS Console.
-If you have Ringing Line Preference, this answers the call.
2. Press the flashing line or Intercom loop key.

To place a call using the headset (attendant's only):

1. Press RLS on the DSS Console.
2. Press the line or Intercom loop key.
-If you have Ringing Line Preference, press the line or Intercom loop key before pressing RLS.

Understanding Related Programming

- Program 18 (II)** To enable/disable Headset operation for an extension (**HS + # + Y** or **N + #**)
- Program 15** To assign program access level 2-5 (**PGM ACC LEVEL = 02-05 + #**) to extensions so they can enable/disable Headset operation themselves



Speed up your call processing by pressing one less key.

Automatic Hold lets you be on a call and activate a feature without first pressing the HOLD key to hold your call. The system automatically places a call on Regular Hold for you when you press the following keys: ICM, CONF, Call Coverage, Hotline, or Page. This way, for example, you can be on a call and start a Conference call by simply pressing CONF — no need to press HOLD, then CONF.

If you are an attendant and on a call, pressing a Line key also places your call on Regular Hold automatically.

For more information on Regular Hold, see page 99.

Initial Configuration

Automatic Hold always allowed when you press above mentioned keys

Using the Feature

See above

Understanding Related Programming

See Regular Hold on page 99.

Hold, Exclusive



Ensure that a held call of a sensitive nature does not get picked up at another extension.

Exclusive Hold lets you place an outside call on Hold at your extension so that it cannot be picked up at another extension. An outside line on Exclusive Hold appears busy to all other extensions that have access to the line. While a call waits on Exclusive Hold, you can process other calls or use another feature. Callers on Exclusive Hold hear Music on Hold or silence, not the conversation in your work area.

If you leave a call on Exclusive Hold longer than the programmed Hold Recall time, the call recalls (rings) your extension to remind you. If you do not answer the recall, the call rings all extensions that normally ring on that line.

Initial Configuration

- Exclusive Hold always allowed
- Hold Recall time is 30 seconds
- Held calls recall for 5 rings before ringing other extensions
- Music on Hold disabled

Using the Feature

To place an outside call
on Exclusive Hold:

1. Press HOLD twice.
-The Line/Loop key flashes at your extension; lights steadily (appearing busy) at all others.
2. Hang up.

To retrieve an outside call
on Exclusive Hold:

1. Lift handset at your phone.
2. Press flashing Line/Loop key.
-The key lights steadily.

Understanding Related Programming

- | | |
|-----------|---|
| Program 4 | To set two timers: Hold Recall (Timer 02 + # + Duration + #) and Rings Before Recall (Timer 06 + # + Duration + # – number of times a recall rings before ringing all extensions with ringing on that line) |
| Program 7 | To enable/disable Music On Hold (ENABLE MOH = Y or N + #) when the system is equipped with a customer-provided music source (for more information, see Music on Hold on page 120) |

 **Answer an outside call at co-worker's phone, then go to your own phone to retrieve it. Or vice versa.**

Regular Hold lets you place an outside or Intercom call in a temporary waiting state. While a call waits on Regular Hold, you can process other calls or use another feature. A waiting caller on Hold hears silence or Music on Hold, not the conversation in your work area. See also Automatic Hold on page 97 and Exclusive Hold on page 98.

When you place an outside call on Regular Hold, it can be picked up from any extension with access to that line. When you place an Intercom call on Regular Hold, it can be picked up only from the phone you used to hold it.

If you leave a call on Regular Hold longer than the programmed Hold Recall time, the call recalls (rings) your extension to remind you. If you do not answer a recalling outside call within a programmed number of rings, it rings all extensions that normally receive ringing on that line.

Initial Configuration

- Regular Hold always allowed
- Hold Recall time is 30 seconds
- Held outside calls recall for 5 rings before ringing other extensions
- Music on Hold disabled

Using the Feature

To place a call on Regular Hold:

1. Press HOLD.
-Outside calls flash at your extension and at others with access to the line. To see the difference in the flash patterns, see pages 14 and 15.
2. Hang up.
-Do not hang up if it's a Handsfree or voice-announced Intercom call (the system will disconnect these calls).

To retrieve an outside call from Regular Hold when the call is flashing a key:

1. Lift handset.
2. Press flashing Line/Loop key.
-The Line key lights steadily.

To retrieve an outside call on Regular Hold when the call is not flashing a key:

This is the case when someone places a call on Regular Hold at another extension and you do not have a Line key for the call.

1. Lift handset.
2. Press ICM (except at an ESL set).
-ICM lights and you hear dial tone.
3. Dial *.
-Dial tone stops.

Hold, Regular

4. Dial line access code (801-816) or extension number (300-347).

-Dialing an extension number in step 4 also picks up other types of calls at that extension. The pick-up order is as follows:

Ringing Intercom calls

Personal Park calls

Ringing outside calls and Direct Inward Lines

Calls on Hold

To retrieve an Intercom call from Regular Hold before it recalls (i.e., when the HOLD key is still flashing):

1. Lift handset.
2. If you hear dial tone, press ICM.
-Otherwise, skip this step. Also, if you have an ESL set, skip this step.
3. Press flashing HOLD key.
-HOLD goes out, ICM flashes fast.

To retrieve an Intercom call from Regular Hold when it is recalling (when HOLD is out and ICM is flashing fast):

1. Lift handset if you hear ringing.
OR
Speak toward the phone if you hear two beeps.

Understanding Related Programming

- Program 4** To set two timers: Hold Recall (Timer **02** + # + Duration + #) and Rings Before Recall (Timer **06** + # + Duration + # – number of times a recall rings before ringing all extensions with ringing on that line)
- Program 16** To give an extension access to every line it should be able to pick up from Hold (**L** + Line 01-16 + # + 01 or 02 + #)
- Program 7** To enable/disable Music On Hold (**ENABLE MOH** = Y or N + #). For more information, see Music on Hold on page 120.



Speed up Intercom calls to co-workers you frequently call. Touch one button to get through.

Hotline lets you place a call or Transfer a call to another extension (your Hotline partner) by pressing a single key — the Hotline key for that extension. If your extension has programming access level 2-5, you can change the partner extension associated with a Hotline key.

In addition, a Hotline key shows you the status of the partner extension:

When the key is...	The partner extension is...
Off	Idle
On	Busy or ringing
Flashing fast	In Do Not Disturb (DND)

The Hotline feature also does the following:

- Signals your partner extension when it is busy, if your partner is programmed for Off-Hook Signaling (see page 126)
- Lets you manually send Call Waiting beeps to your busy partner, if your partner is not programmed for Off-Hook Signaling
- Lets you contact your partner extension when it is in Do Not Disturb

Initial Configuration

- No Hotline keys programmed.
- Extensions 300-305 can change Hotline partner extensions. All other extensions only have program access level 01.
- Hotline automatically activates Off-Hook Signaling

Using the Feature

To assign a partner to your Hotline key when your extension has program access level 2-5:

1. Do not lift handset.
2. Press #.
3. Dial HL.
4. Press desired Hotline key.
5. Dial desired extension number.
6. Return to step 4.

OR

Press SAVE to finish.

To place a call to your Hotline partner:

1. Lift handset.
2. Press Hotline key once if it is lit or unlit.
 - If you hear two beeps, speak.
 - If you hearing ringing, wait for an answer.
 - If you hear busy tone, dial C to send Call Waiting beeps.
 - If you hear fast busy tone, this means your partner is on a call while in DND. You cannot get through.

Hotline

OR

Press Hotline key twice if it is flashing fast.

-This overrides your partner's DND and you hear ringing.

To transfer your outside call to your Hotline partner:

1. Press Hotline key once if it is lit or unlit.

-See step 2 above for your options. If you hear busy tone, you do not have to dial C to send beeps. Just hang up (see step 2 below).

OR

Press Hotline key twice if the key is flashing.

-In either case, your outside call goes on Hold.

2. Announce the call and hang up.

OR

Hang up to have the call wait at your partner's extension unannounced.

-If your partner does not pick up the Transfer, it recalls your phone like a normal Transfer.

Understanding Related Programming

- | | |
|-----------------|--|
| Program 17 | To assign Hotline keys and partners to an extension (HL + Partner extension + #) |
| Program 18 (II) | To change Hotline assignments (DSS + # + Key + Partner extension + #) |
| Program 15 | To give extensions program access level 2-5 (PGM ACC LEVEL = 02-05 + #) so they change Hotline partner extensions themselves |

Easily contact your co-workers.

The DIGITAL SYSTEM Intercom feature lets you call another DIGITAL SYSTEM extension user by dialing their extension number. You can also call attendant extensions by dialing their extension number or 0 for the main attendant, 01- 04 for other attendants.

Your system can be programmed for ringing or voice-announced Intercom calls. In other words, when you place an Intercom call to an extension, your call will either:

- Ring the extension
- Alert the extension with two beeps. After you hear the beeps, you can speak -- your voice will be announced over the speaker of that extension.

If your system is programmed for ringing Intercom calls, voice-announced Intercom calls are not available.

If your system is programmed for voice-announced Intercom calls, you can:

- Force an Intercom call to ring the called extension, if you wish.
- Disable incoming voice-announced Intercom calls so all Intercom calls ring your extension. Your extension must, however, have program access level 3-5.
- Answer a voice-announced call by just speaking toward the phone if your system is programmed for Handsfree Reply. If not, you answer a voice-announced Intercom call by lifting the handset.

Notes:

- Attendants and Headset extensions do not receive voice-announced Intercom calls.
- When placing a Handsfree Intercom call *from* a non-Handsfree telephone *to* a Handsfree telephone, your call will ring. The call will not voice-announce.

Initial Configuration

- Voice-announced Intercom calls enabled system-wide
- Handsfree Reply enabled
- Extensions 301-305 can program voice-announced calls. All other extensions only have program access level 01.
- One attendant at extension 300
- Dialing 0 calls extension 300
- Extension ports 00-47 have extension numbers 300-347, respectively
- No extensions have names (at a Display Phone, the extension's name appears in all displays that would normally show the extension's number)

Using the Feature

Also see Handsfree on page 93.

To place an Intercom call: 1. Lift handset.

-If you do not lift the handset and your phone does not have Handsfree, your call always rings the other extension.

2. Press ICM (except at an ESL set).
 - ICM lights and you hear dial tone.
 - To force the call to ring the extension, dial 1 before dialing the extension number in step 3.
3. Dial extension (300-347).
 - OR
 - Dial 0 for main attendant or 01-04 for other attendants.
 - ICM flashes fast when the call goes through.
 - You cannot call your attendant during the Night Answer mode.
4. If you hear ringing, wait for an answer.
 - OR
 - If you hear two beeps, you can speak right away.

To answer an Intercom call that comes over your speaker (you hear two short beeps):

1. Speak toward the phone.
 - If you hear two long beeps, this means one of two things:
 - The microphone is off (see page 116). Turn it on or lift the handset to speak.
 - Handsfree Reply is disabled. Lift the handset to speak.

To answer an Intercom call that rings your phone:

- If you are an attendant, the HF key flashes slowly. If you are not an attendant, ICM flashes slowly.
1. Lift handset.
 - ICM flashes fast.
 2. Press HF (if you are the attendant).

To enable/disable voice-announced Intercom calls when your extension has program access level 3-5:

- You can do this only if the system is programmed for voice-announced Intercom calls.
1. Do not lift handset.
 2. Press #.
 3. Dial VA.
 4. Dial Y to enable voice-announced calls.
 - OR
 - Dial N to disable voice-announced calls (i.e., to enable ringing calls).
 5. Press SAVE.

Understanding Related Programming

- | | |
|----------------|--|
| Program 2 | To enable/disable voice-announced Intercom calls system-wide (VOICE CALLS = Y or N + #)
To enable/disable Handsfree Reply system-wide (HF REPLY + Y or N + #) |
| Program 18 (I) | To enable/disable voice-announced Intercom calls for specific extensions (VA + # + Y or N + #). The system |

- must be programmed for voice-announced Intercom calls in Program 2.
- Program 15** To assign program access level 3-5 (**PGM ACC LEVEL** = 03-05 + #) to extensions so they can enable/disable voice-announced Intercom calls themselves
- Program 18(l)** To assign an attendant to an extension (**SO** + # + Extension + #). This is the attendant that gets called when the extension user dials 0.
- Program 14** To assign extension numbers to ports (**STN PORT nn** = 300-323 + #) and to assign the correct circuit type to an extension port (**CIRCUIT TYPE** = 00 [ESL], 01 [MB] or 02 [MB Display])
- To program a name for an extension (refer to extension name programming on page 242). Display Phone users see this name in displays instead of the extension's number.
- Program 3** To assign the number of attendants (operators) in the system (**NO. OF OPRS** = 01-04 + #) and to assign their extension numbers (**OPR nn EXT** = Extension + #)

To change the first digit of extension numbers, the digit that forces Intercom calls to ring, or the single digit that calls the operator, see Flexible Numbering Plan on page 86.

Intrusion (Barge-In)



Quickly interrupt a co-worker's telephone call to deliver an emergency message

Intrusion (Barge-In) lets you use your phone to break into a co-worker's telephone call and have a three-party conversation. You can also use Intrusion to contact an extension in Do Not Disturb (DND). You cannot use Intrusion to break into a Conference call or an extension programmed for Privacy.

CAUTION: An unauthorized Intrusion may be interpreted as an invasion of privacy.

Initial Configuration

- Intrusion enabled for attendant extension 300
- Privacy disabled except for attendant extension 300

Using the Feature

Intrusion is temporarily unavailable when the system is already accommodating the maximum number of three-party conversations, which is 8 per system.

To use Intrusion after you call an extension and hear busy tone, fast busy tone (for DND), or ring-busy tone:

1. Dial I (digit 4).
 - Busy tone stops and the system sends two warning beeps to your co-worker.*
 - If busy tone continues, you cannot intrude.*
 - You hear ringing if you override DND. Wait for an answer (skip steps 2-3).*
2. Wait for the CONF key to light.
3. Speak.

Understanding Related Programming

- | | |
|----------------|--|
| Program 1 | To enable/disable Intrusion in a Class of Service (BREAK-IN = Y or N + #). See also Program 18 (I).
To allow/deny Privacy in a Class of Service (PRIVACY = Y or N + #). Allow Privacy for any extension that should not be intruded upon (see also Program 18 [I]). |
| Program 18 (I) | To assign a Class of Service from Program 1 to an extension (COS + # + 01-27 + #) |



Remake your last call by touching two buttons. Very handy for retrying busy numbers.

Last Number Redial lets you redial the last outside number you called without manually redialing the digits. The system remembers the last call you made and will dial it out for you on the same line you used for the original call unless you manually select a different one.

You can use Last Number Redial to redial calls up to 24 digits long. If, however, you wait more than six seconds between dialing the digits of the original call, Last Number Redial only redials the digits after the six-second pause.

Initial Configuration

Last Number Redial always enabled

Using the Feature

A power failure erases the last number you called and you cannot use Last Number Redial to redial it.

To place a call using Last Number Redial:

1. Lift handset.
-To have the call dial out on a line other than the original one: Access an idle outgoing line before you do step 2.
2. Press DIAL.
-You hear dial tone.
3. Press LAST to have the call dial out.
-Immediate busy tone means the original line is busy. Press an idle outgoing Line key to have your call go out.

Understanding Related Programming

- | | |
|-------------------|---|
| Program 16 | To give an extension outgoing access to a line (L + Line number + # + 02 + #) |
| Program 17 | To assign a line to a key at an extension (LK + Line number 01-16 + #) |

Line Queuing



Wait for a busy line to become free without "watching your phone" or retrying the line. The DIGITAL SYSTEM monitors the line and gives it to you when it's free.

Line Queuing lets you place your extension in queue (on a "waiting list") for a busy outgoing line to become free. As soon as it does, the DIGITAL SYSTEM rings your phone with a long ("callback") ring. When you answer it, you have dial tone on that line. If your extension is busy when the line is free, the DIGITAL SYSTEM rings your extension later.

If a few extensions queue for a line, the DIGITAL SYSTEM rings the ones programmed for Line Queuing Priority (if any), then any others that queued, in the order they queued.

Initial Configuration

Line Queuing always allowed

Using the Feature

Line Queuing is not available to attendant extensions.

- | | |
|--|---|
| To queue for a busy line: | <p>You can also do this when you use Last Number Redial, Save, or Speed Dial and immediately get busy tone, which means the stored line is busy.</p> <ol style="list-style-type: none">1. Try to access the busy line.
<i>-You hear busy tone.</i>2. Dial C.3. Hang up. |
| To answer a callback (long) ring: | <p>If you do not answer, the DIGITAL SYSTEM removes your extension from the queue.</p> <ol style="list-style-type: none">1. Lift handset.
<i>-You hear outside dial tone (or your Last Number Redial, Save, or Speed Dial call dialing out).</i> |
| To cancel a Line Queuing request before the system calls you: | <ol style="list-style-type: none">1. Try to access the busy line.
<i>-You hear busy tone.</i>2. Dial *.3. Hang up. |
| To cancel all your Line Queuing (and Callback) requests: | <p>A power failure or system reset automatically cancels them.</p> <ol style="list-style-type: none">1. Lift handset.2. Press ICM (except at an ESL set).3. At a multibutton phone, dial * and press FTR.
OR
At an ESL set, dial # *.4. Hang up. |

Understanding Related Programming

- Program 1** To allow Line Queuing (Callback) Priority in a Class of Service (**CBACK PRIORITY = Y + #**). See also Program 18 (I).
- Program 18 (I)** To assign a Class of Service from Program 1 to each extension that should have Line Queuing Priority (**COS + # + 01-27 + #**)

Maintenance Utilities and Reports



**It's easy to investigate and diagnose a problem in the system.
There may be no need for a service call.**

The system provides diagnostic and maintenance utilities and reports to help troubleshoot the system.

There are 30-35 diagnostic/maintenance/report options, five of which are shown below:

- List Toll Restriction data
- Swap extension ports
- Reset expansion CEUs
- Display the status of every line and extension
- List programmable key data

Maintenance Utilities and Reports requires the AUX Module and terminal programming. For more information, see System Reports, Diagnostics and Maintenance Utilities in the DIGITAL SYSTEM Feature and Terminal Programming Manual.

Initial Configuration

Diagnostics/Maintenance Utilities and Reports not available without the AUX Module and terminal programming

Using the Feature

N/A

Understanding Related Programming

- Program 3** To set the baud rate of the AUX Module's port for terminal programming (**LOCAL BAUD** = 00 [300], 01 [1200], 02 [2400], 03 [4800], 04 [9600] or 05 [19.2K] + #)

Conduct a telephone meeting with two people in the office even when you don't know where they are.

Meet-Me Conference lets you set up a three-way telephone conversation. You page the people you want in the Conference and wait without hanging up. Then, from any phone, they dial the Meet-Me Conference code (11 or 12) to be connected to you.

Initial Configuration

Meet Conference always allowed

Using the Feature

Meet-Me Conference is temporarily unavailable when the system is already accommodating the maximum number of three-party conversations, which is 8 per system.

To set up a Meet-Me Conference:

1. Page parties and announce the Meet-Me Conference Code (11 or 12). Do not hang up.
-See Paging on page 138.
2. Press ICM (except at an ESL set).
-You hear dial tone.
3. Dial the Meet-Me Conference code you announced in step 1.
4. Do not hang up. Wait for parties to join.
-When the first person joins, ICM flashes fast.
-When the second person joins, CONF lights.
-One party can hang up without disconnecting the other two.

To join a Meet-Me Conference after you are paged:

- You must respond within one minute of the page.
1. Lift handset and press ICM (except at ESL set).
-You hear dial tone.
 2. Dial announced Meet-Me Conference code (11 or 12).
-When the first person joins, ICM flashes fast.
-When the second person joins, CONF lights.
-One party can hang up without disconnecting the other two.

Understanding Related Programming

N/A

Message Center



Share a mailbox with co-workers. Leave messages in the Message Center, or listen to messages others have left.

A Message Center is a shared mailbox available to a keyset user with a programmed Message Center key. Any keyset user with a Message Center key can leave a message in the Message Center or listen to messages others have left. For example, a Service Department dispatcher could have Message Center keys for each of the company's products. When all technicians are busy, the dispatcher could send any additional calls to the Message Center assigned to the specific product. As technicians become available, they can select the messages for the product group they want to service first.

Since each Message Center requires an uninstalled (phantom) extension port, the system allows as many Message Centers as there are available uninstalled extensions. In addition, a keyset can have as many Message Center keys as it has available programmable keys.

Notes:

- Message Center requires an AUX Module with software version 02.10 or higher. Message Center is not available with Base software.
- Message Center requires NVM-2002 software version 2.06 or higher or NVM-202 software version 1.03 or higher. For more information on installing and using Voice Mail, refer to page 185.

Initial Configuration

Message Center not installed.

Using the Feature

- | | |
|-----------------------------|--|
| To call the Message Center: | 1. Lift handset or press HF. |
| | 2. Press the Message Center key. |
| | -When the Message Center has messages waiting, your Message Center key flashes at a unique rate. |

Understanding Related Programming

Refer to the DIGITAL SYSTEM Feature and Terminal Programming Manual.



Let a busy co-worker know you need a return call without having to leave a note at their desk.

When you call a busy, "no-answer," or DND (Do Not Disturb) extension, Message Waiting lets you leave a message indication at that extension requesting a return call. The message indication is a flashing MSG key, and the message recipient can respond at their convenience. When the recipient responds (answers the Message Waiting), the system automatically places an Intercom call to you (the person who left it).

You can leave a Message Waiting at any number of extensions, and any number of your co-workers can leave a Message Waiting at your extension.

You can also do the following with Message Waiting:

- Cancel all Message Waitings left at your extension
- Cancel Message Waitings that you left
- View the extensions that left you Message Waitings (if you have a Display Phone)

Initial Configuration

Message Waiting always allowed (except if Voice Mail is installed)

Using the Feature

A power failure or system reset cancels all active Message Waitings.

To leave a Message Waiting when you call an extension and hear busy tone, ring-busy, fast busy, or get no-answer:

You cannot leave a Message Waiting at an attendant extension.

1. At a multibutton phone, press MSG.

OR

At an ESL set, dial 6.

2. Hang up.

-The MSG key flashes fast at the extension you called.

To cancel a Message Waiting you left:

This option is not available in systems using AUX Module software version 02.10 and higher.

1. Lift handset.
2. Press ICM (except at an ESL set).
3. Dial extension that has your Message Waiting.
4. Hang up.

To cancel all Message Waitings left at your extension:

In systems using AUX Module Software version 02.10 and higher, this is the only way to cancel Message Waitings. Note that this also cancels Callback and Line Queuing requests.

1. Lift handset.
2. Press ICM (except at an ESL set).
3. Dial # *.
4. Hang up.

Message Waiting

To answer a Message Waiting (your MSG key is flashing fast):

1. Lift handset.
 2. At a multibutton phone, press MSG.
- OR

At an ESL set, dial * 6.

-MSG goes out and the system connects you to the extension that left the message.

-If MSG continues to flash, this means you have more messages.

To view and selectively answer your messages (if you have a Display phone):

1. Do not lift handset.
2. Press MSG to see the first message.
3. Repeatedly press MSG to see other messages, if any.
4. When you see the extension you want to call: Lift handset, press MSG.

-MSG goes out and the system connects you to the extension that left the message. If MSG continues to flash, this means you have more messages.

Understanding Related Programming

N/A



Privately confer with someone in your work area while on a Handsfree call.

Microphone Mute lets you turn off the microphone while you are on a Handsfree call. With the microphone off, you can listen to the person on the other end, but that person will not be able to hear what people are saying in your work area. To talk to the person on the phone, you must cancel Microphone Mute (i.e., turn the microphone back on). See also Microphone On/Off on page 116.

Initial Configuration

Microphone Mute always allowed

Using the Feature

Microphone Mute is not available to attendant or Headset extensions.

To activate Microphone Mute while on a Handsfree call:

1. Press MIC/DND.
-MIC/DND lights.

To cancel Microphone Mute:

- Canceling it automatically cancels any Call Forwards or Selectable Display Messages at your extension.
1. Press MIC/DND until it goes out.
-If MIC/DND flashes, your microphone is back on but your extension is in Do Not Disturb. Press it again.

Understanding Related Programming

N/A

Microphone On/Off



Make sure a conversation in your work area is not overheard by Intercom callers.

Microphone On/Off lets you turn off your phone's microphone while your phone is idle. With the microphone off, Intercom callers who make voice announcements over your speaker will not be able to hear what people are saying in your work area at the moment the call comes through. To talk to the Intercom caller, you must turn the microphone back on or lift the handset. See also Microphone Mute on page 115.

Initial Configuration

Microphone On/Off always allowed

Using the Feature

Microphone On/Off is not available to attendant or Headset extensions.

To turn off the microphone while your phone is idle:

1. Press MIC/DND.
-MIC/DND lights.
-When a voice-announced Intercom call comes in, you will hear two long beeps instead of the usual two short beeps.

To turn your microphone back on:

- Turning it back on automatically cancels any Call Forwards or Selectable Display Messages at your extension.
1. Press MIC/DND until it goes out.
-If MIC/DND flashes, your microphone is back on but your extension is in Do Not Disturb. Press it again.

Understanding Related Programming

N/A



Dial a call, then use both hands to work while you wait for someone to answer — no need to hold the handset to your ear while you wait. Or, use Monitor to wait on Hold without holding the handset to your ear.

Monitor lets you dial calls and activate features without lifting the handset; instead, you press the HF key. When you want to talk, however, you must lift the handset.

Note: The Monitor feature, as described here, is for non-Handsfree phones. If you have a Handsfree phone, read Handsfree on page 93 or Automatic Handsfree on page 94.

Initial Configuration

Monitor capability at all non-Handsfree phones

Using the Feature

Monitor is not available to attendant or Headset extensions.

To use Monitor to dial a call or activate a feature:

1. Do not lift handset.
2. Press HF instead of lifting handset.
 - HF and MIC/DND light.
 - If MIC/DND does not light, use Handsfree instead.
 - If your system has Automatic Handsfree, you can skip steps 1 and 2.
3. Press keys for call or feature.

To talk on the phone during Monitor:

1. Lift handset.
 - HF goes out.

To hang up while using Monitor call:

1. Press HF.
 - HF goes out.

To change from the handset to Monitor:

- You can do this while on Hold, waiting for the other party to return.
1. Press HF.
 - HF flashes.
 2. Hang up the handset.
 - HF lights steady.

Understanding Related Programming

Program 2 To allow/deny Automatic Handsfree (**ENABLE AUTO HF = Y or N + #**)

Multiple Attendants



Incoming calls can be split up among attendants to speed up call processing.

The DIGITAL SYSTEM can have up to four attendants. This lets you reduce the call traffic into the main attendant phone by assigning some lines to the main attendant and the remaining lines to another attendant.

Each attendant must have a Display Multibutton Telephone. Two keys on the attendant's Display Telephone have different functions than those same keys on a non-attendant Display Phone.

The following DIGITAL SYSTEM features can be activated only from an attendant extension:

- Alarms (see page 24)
- Automatic Hold using a Line key (see page 97)
- Alternate Attendant (see page 30)
- Forced Line Disconnect (see page 87)
- Removing Extensions and Lines From Service (see page 153)
- Night Answer (see page 121)

The following DIGITAL SYSTEM features are not available to an attendant extension:

- Call Forwarding
- Callback
- Do Not Disturb
- Group Listen
- Handsfree, Automatic Handsfree, Monitor
- Line Queuing
- Message Waiting (receiving)
- Off-Hook Signaling (receiving)
- Paging (receiving)

In addition, the attendants should not have Ringing Line Preference or Prime Line.

Initial Configuration

One attendant at extension 300

Using the Feature

The attendant phone is used like any other Multibutton (any exceptions are noted in individual feature operations).

To call an attendant, see Intercom Calls on page 103.

Understanding Related Programming

Program 3 To assign attendants (**OPR nn EXT** = Extension number + #). Attendant 01 must be extension 300.

- Program 18 (I)** To assign Off-Hook Ringing to an attendant (**OHR** + # + Y or N + #). This allows the phone to ring (beep) while Alarms display at the attendant phone.
- To assign an attendant (operator) to each extension (**SO** + # + Extension number + #). This is the attendant that gets called when the user presses ICM and dials 0.
- Program 16** To assign line access to attendant extensions (**L** + Line number 01-16 + # + 02 + #)
- Program 17** To assign a line to a key at an attendant extension (**LK** + Line number 01-16 + #)
- Program 18 (I)** To manually assign the proper Class of Service (**COS** + # + 01-27 + #) to an extension when you change it from an attendant to a non-attendant. Non-attendant extensions use COS 01-27; attendant extensions use COS 30.

Music On Hold



Callers on Hold can listen to music while they wait.

Music On Hold (MOH) sends music to calls on Hold, parked calls, and transferred calls. If there is no Music On Hold in the system, callers on Hold hear silence. Music on Hold requires a customer-provided music source (e.g., tape player or receiver).

Note: In accordance with U.S. copyright law, a license may be required from the American Society of Composers, Authors and Publishers (ASCAP) or other similar organizations, if radio, television broadcasts or music and other material not in the public domain are transmitted through the Music On Hold feature of telecommunications systems. Your equipment manufacturer and supplier hereby disclaim any liability arising out of the failure to obtain such a license.

The music source must be compatible with the following system specifications:

Input Impedance	100 K Ohms
Maximum Input	- 10 dBm

The music source can also be used for Background Music (see page 42). To install the music source, see the Hardware Manual.

Initial Configuration

- Music on Hold not available
- MOH for Transfers disabled

Using the Feature

N/A

Understanding Related Programming

- Program 7 To enable/disable MOH (**ENABLE MOH** = Y or N + #)
- Program 3 To enable/disable MOH on transfer (**PLAY MOH TRANS** = Y or N + #)

 **You can, as the attendant: Send calls to extensions at night so other people (perhaps security personnel) can answer them until you return in the morning.**

If you are the attendant, Night Answer (Off-Hours Ringing) lets you place the system in the "night" mode so your incoming calls ring at other destinations. Your system may be set up for Assigned Night Answer or Universal Night Answer.

- Assigned Night Answer sends calls to extensions, Ring Groups or UCD Hunt Group extensions.
- Universal Night Answer sends calls to the external paging system so they ring over the paging speakers. Or, the calls can ring an External Alerting Device, such as a bell. You activate Assigned Night Answer and Universal Night Answer in the same way.

Note: Non-attendant extensions or UCD Groups with Direct Inward Lines can put their extensions in the "Night Answer" mode by activating Do Not Disturb (see Direct Inward Lines on page 64 and Do Not Disturb on page 74).

Initial Configuration

- Night Answer is available to attendant extension 300
- No night destinations assigned

Using the Feature

To activate Night Answer at an attendant extension:

1. Do not lift handset.
2. Press MIC/DND until it flashes.
-MIC/DND flashes fast. Extension users cannot make Intercom calls to your attendant extension while it is in the Night mode.
-If your attendant extension is in a Circular Hunt Group with another attendant extension, both of you have to activate Night Answer in order for the system to go into the Night Answer mode.

To cancel Night Answer:

1. Do not lift handset.
2. Press flashing MIC/DND.
-MIC/DND goes out.

To answer a call that rings an extension during Night Answer:

1. Lift handset.
2. Press flashing key.
-If Ringing Line Preference is enabled, there is no need to press the key.

To answer a call that rings the paging speakers or a bell:

1. Lift handset.
2. Press ICM (except at an ESL set)
-ICM lights and you hear dial tone.
3. Dial *.
-Dial tone stops.
4. Dial 0.

Night Answer (Off-Hours Ringing)

-If you hear busy tone, you cannot answer that line from that phone.

Understanding Related Programming

For Universal or Assigned Night Answer:

- Program 18 (I)** To enable Do Not Disturb for any attendant extension that should be able to activate Night Answer (**DND + # + Y** or **N + #**)
- Program 3** To assign attendant extensions (**OPR nn EXT =** Extension number + #)
- Program 19** To assign two attendants to a Circular Hunt Group, if desired (**HUNT TYPE = 01, 02** or **03 + Extension + #**). First and last extension in the group must be the same. Both attendants must activate Night Answer for the system to go into the Night mode.

For Assigned Night Answer:

- Program 12** To enable day and night ringing destinations. For a line that should ring an attendant during the day and elsewhere at night:
1. Make the line's day destination (termination) an attendant extension (**DTD + # + Extension + #**). This makes the line ring that attendant during the day mode.
 2. Make the line's night termination a particular extension, UCD master number, or Ring Group (**DTN + # + Extension, UCD master or Ring Group + #**). This makes the line ring the night termination when its attendant (assigned in step 1) activates Night Answer. If an extension or UCD group does not answer, the call rings all extension with access (see Program 16) and ringing (see Program 18 [II]).
- OR
- Make the line's night termination 300, which is the initial (default) setting for all lines (**DTN + # + 300 + #**). When the line's attendant (assigned in step 1) activates Night Answer, the line rings at any extension that has incoming access (see Program 16) and ringing (see Program 18 [II]) for that line.
- Program 16** To give an extension access to a line (**L + Line number 01-16 + # + 01** or **02 + #**)
- Program 18 (II)** To assign day/night ringing or just night ringing to a line at an extension (**RA** or **NR + # + Line key + Y** or **N + #**)

For Universal Night Answer (ringing over paging speakers)

Line port 04 must be available for the External All Call Page Zone. To install the Paging Speakers, see the Hardware Manual.

Night Answer (Off-Hours Ringing)

- Program 7** To enable External Page Zones 1 or 2 (**EXT PAGE ZN 1** or **EXT PAGE ZN 2 = Y + #**)
To enable audible (ringing) over the External All Call Page (**AUDIBLE RNG = Y + #**)
- Program 12** To assign extension 300 as the night termination of any line that should ring over the paging speakers (**DTN + # + 300 + #**). The line rings over the paging speakers when extension 300 goes into the Night Answer mode.
- Program 16** To let an extension access the lines that ring over the paging speakers so they can answer them (**L + Line number 01-16 + # + 01 or 02 + #**)

For Universal Night (ringing a bell):

See External Alerting Devices on page 84.

Night Ringing



Help answer calls at night, when the attendant goes home.

Night Ringing (NR) lets you make a line ring at your extension only when the line's attendant goes into the Night Answer mode. A line's attendant is usually the attendant who answers the line. Night Ringing is for those lines that appear at your extension, but do not normally ring it.

To enable or disable NR, your extension must have program access level 2-5. Enabling NR automatically disables Ringing Assignment (see page 154) or Delayed Ringing Assignment (see page 62).

Initial Configuration

- NR disabled at all extensions
- Extension 300-305 can program NR. All other extensions only have access level 01.

Using the Feature

To enable/disable Night Ringing (NR) for a line:

1. Do not lift handset.
2. Press #.
3. Dial NR.
-Your Line keys flash or light steadily. Flashing means Night Ring is on; steadily means it is off.
4. Press desired Line key.
OR
Dial line number (01-16).
5. To enable Night Ring, dial Y.
OR
To disable Night Ring, dial N.
6. Press # and return to step 4, press SAVE to finish

Understanding Related Programming

- | | |
|-----------------|--|
| Program 16 | To assign incoming lines to an extension (L + Line number 01-16 + # + 01 or 02 + #) |
| Program 18 (II) | To enable/disable Night Ringing for a line at an extension (NR + # + Line key + Y or N + #). A line follows its Night Ringing assignment under two conditions (set in Program 12): When its night termination is 300 (DTN + # + 300 + #) and when its terminated day attendant (DTD + # + Extension + #) activates Night Answer. |
| Program 15 | To assign program access level 2-5 (PGM ACC LEVEL = 02-05 + #) to extensions so they can program NR themselves |



Everyone can be on the phone at once.

Non-Blocking Architecture means that all the extensions and lines can be busy on calls simultaneously, without blocking or interfering with one another.

The system allows simultaneous handset and Handsfree calls, with a maximum of 12 simultaneous Handsfree calls per CEU. So if 12 Handsfree calls are in progress and someone tries to make a Handsfree call, the system emits a busy tone and the person must make a handset call instead.

Note: The DIGITAL SYSTEM has 12 dialing buffers. This means that a maximum of 12 people can simultaneously dial calls (i.e., without being blocked).

Initial Configuration

Non-Blocking architecture always available

Using the Feature

N/A

Understanding Related Programming

N/A

Off-Hook Signaling/Whisper Page



You can break into a co-worker's call and talk to them without the other person on the line hearing you.

When you call a busy multibutton extension, Off-Hook Signaling lets you send a signal to the busy user. Depending on programming, sending the signal can result in a Whisper Page or Off-Hook Ringing.

Whisper Page

Whisper Page sends two beeps into the handset of the busy user. After the beeps sound, you can speak. The busy user hears your voice over their conversation, but the other person does not hear you. The busy user can also respond to you without the other person hearing. Whisper Pages do not occur if the busy user is on a Handsfree/Monitor call. Off-Hook Ringing may occur instead, depending on programming.

Off-Hook Ringing

Off-Hook Ringing sends a beep (repeated) over the speaker of the busy extension. While the beep sounds at the busy extension, you hear ringing and must wait for the busy user to respond.

On the other hand, when you receive a Whisper Page or Off-Hook Ringing, you can respond or not respond, as is convenient. If your extension has program access level 3-5, you can disable or enable incoming Whisper Pages. To block Off-Hook Signals while on a particular call, activate Do Not Disturb.

Initial Configuration

- Whisper Page enabled
- Off-Hook Ringing disabled
- Extension 301-305 can enable/disable Whisper Page. All other extensions only have access level 01.

Using the Feature

To use Off-Hook Signaling when you call an extension and hear ring-busy tone:

You can't send a signal if you hear busy tone.

1. Dial 1.

2. If you hear two beeps: Speak.

OR

If you hear ringing: Wait for the called party to answer.

OR

If you hear busy or fast busy tone, you cannot send a signal. Hang up.

-Pressing a lit Hotline, Call Coverage, or DSS key automatically activates Off-Hook Signaling. For more information, see Hotline on page 101, Call Coverage on page 169, and Direct Station Selection on page 69.

Using the Feature

To enable/disable incoming Whisper Page when your extension has program access level 3-5:

1. Do not lift handset.
2. Press #.
3. Dial VO.
4. Dial Y to enable.
OR
Dial N to disable.
5. Press SAVE.

To respond to a Whisper Page in your handset:

You hear two beeps, then your co-worker's voice. The ICM key flashes fast.

1. Press and hold MIC/DND to talk.
2. Release MIC/DND to talk to initial caller.

To answer an Off-Hook Signal you hear over your speaker:

You hear a single beep repeated. ICM flashes fast if you are on an Intercom call or slowly if you are on an outside call.

1. Press HOLD to hold an Intercom call.
-If you are on an outside call, you can skip this step (doing step 2 automatically places an outside call on Exclusive Hold).
2. Press flashing ICM.
-If you are on an outside call, the HOLD and Line key flashes.
-If you are on an Intercom call: HOLD and ICM flashes.
-To switch (alternate) between the two calls, see Split on page 167.

Understanding Related Programming

- | | |
|-----------------|---|
| Program 18 (II) | To enable/disable incoming Whisper Pages for an extension (VO + # + Y or N + #) |
| Program 15 | To assign program access level 3-5 to extensions so they can enable/disable Whisper Page themselves (PGM ACC LEVEL = 03-05 #) |
| Program 18 (I) | To assign Off-Hook Ringing to an extension (OHR + # + Y or N + #) |

Operator Assistance



Have your system automatically answer outside calls and provide dialing options to your callers — even without Voice Mail.

Operator Assistance requires a Voice Module Unit (P/N 88522) and an AUX Module with software version 02.10 or higher. Operator Assistance is not available with Base software.

Operator Assistance (OPA) automatically answers calls on designated trunks and provides dialing options to callers. With OPA, callers can dial extensions and hunt groups directly, without human intervention. OPA saves system users call processing time and provides immediate call answering to outside callers.

Operator Assistance provides:

- Caller Dialing Options
 - Direct dialing to any extension, ring group or ACD/UCD hunt group
 - Single-digit access to selected extensions, ring groups or ACD/UCD hunt groups
- Simultaneous call answering
- Programmable OPA messages
- Automatic attendant overflow

Caller Dialing Options

When a call rings a trunk, OPA answers the call (if programmed) and plays a prerecorded message to the caller. The message normally provides a company greeting and describes the options the caller may dial. For example, a caller may hear, "Hello. You have reached XYZ Corporation. Dial 4 for Technical Service or 5 for Sales." The outside caller listens to the message (up to 16 seconds long) and dials accordingly. The caller may then dial:¹

- Leading digit 3 plus any three-digit extension, ring group or ACD/UCD hunt group number. In software versions AUX Module 2.0/Base 5.0 and higher, the leading digit can be any digit from 1-9.
- A single digit for an extension, ring group or ACD\UCD hunt group. Allowed single-digit options are 1, 2, and 4-9

Simultaneous Call Answering

OPA can answer up to three calls simultaneously, using three separate VMU ports. If all VMU ports are busy, the call queues for an idle port and the outside caller hears ringing. If the internal extension dialed is busy, the outside caller hears a special message describing additional dialing options.

Programmable OPA Messages

The system allows the attendant to record six Operator Assistance messages, numbered 02-07. In programming, the system administrator can assign an incoming call to any one of these messages. This allows OPA to answer an incoming call and play the appropriate message to the caller.

¹If the caller does not dial a digit, the call rings all extensions with programmed key ringing for the trunk. This is the only option available to Dial Pulse (DP) telephone callers.

Automatic Attendant Overflow

Operator Assistance also provides call overflow for attendants. With call overflow, an unanswered call to an attendant routes to an OPA message after a programmed interval. The caller can then use the announced options.

Initial Configuration

Operator Assistance not installed.

Using the Feature

To initialize (erase) all OPA messages (if you are an attendant or ACD Supervisor):

This also erases the ACD All Agents Busy message and Personal Greetings. **You must initialize all messages after you first install the VMU.**

1. Lift handset.
2. Press ICM.
3. Press #.
4. Dial 68.
5. Press #.
6. Dial 9.

-If you change your mind, dial 6 to cancel this procedure.

To record an OPA message (if you are an attendant or ACD Supervisor):

1. Lift handset.
2. Press ICM.
3. Press #.
4. Dial 68.
5. Dial OPA message number (02-07).

-Message 02 is the error message. A caller dialing an incorrect code hears message 02. Make sure you program this message.

-Message 00 is the ACD/UCD overflow message. Refer to Automatic Call Distribution.

-Message 01 is the "All lines are busy..." message. Even though you can record message 01, the system uses the preset "All lines are busy..." message instead.

6. Wait for voice instructions, then begin recording.
-You can record a message up to 16 seconds long. The system indicates if your message is too long.

To listen to a previously recorded OPA message (from your attendant or ACD Supervisor extension):

1. Lift handset.
2. Press ICM.
3. Press #.
4. Dial 685.
5. Dial OPA message number (02-07).

-You can also listen to messages 00 and 01.

Operator Assistance

- To call into the system using Operator Assistance:
1. Dial system telephone number.
 2. After OPA answers your call, dial announced option:
Dial single-digit option.
OR
Dial 3 plus the extension number you wish to reach.

Understanding Related Programming

Refer to the DIGITAL SYSTEM Feature and Terminal Programming Manual.



Use Other Common Carriers such as, MCI, GTE Sprint, etc.

The DIGITAL SYSTEM lets you access Other Common Carriers (OCCs), like MCI and GTE Sprint, in two different ways. You can:

- Manually dial their telephone number and any other required codes.
- Store their telephone number, a pause, and their security code (or other required numbers) in a Personal Speed Dial bin. When you access the bin, the system dials out the number, then pauses (waits) for dial tone from the OCC. When the DIGITAL SYSTEM detects OCC dial tone, it dials out any other stored digits.

Optionally, the system administrator can store an OCC telephone number and other required codes in a System Speed Dial bin for quick access by everyone in the system.

Initial Configuration

The DIGITAL SYSTEM is always compatible with OCCs

Using the Feature

To manually make a call to an OCC: See Placing an Outside Call on page 134.

To store an OCC's number in a Speed Dial bin: See Speed Dial on page 162.

Understanding Related Programming

- | | |
|-----------------------|---|
| Program 6 | To enable/disable Active Dialpad (Continuous Dialing) in a Toll Restriction level (ACT DIAL PAD = Y or N + #). Enabling it lets a user manually dial digits during an established outside call. This way, a user can establish a call to an OCC, wait for OCC dial tone, then dial more digits (see also Program 1).

Note: Continuous Dialing is always allowed at ASIs. |
| Program 1 | To assign a Toll Level (from Program 6) to a Class of Service (TOLL RESTRICT = 01-07 + #). You can assign Toll Level 0 or a Toll Level that has Active Dialpad enabled (see also Program 18 [I]). |
| Program 18 (I) | To assign a Class of Service from Program 1 to an extension (COS + # + 01-27 + #). |

Outside Calls, Answering



Answering an outside call can be just as easy as lifting the handset.

When an outside call comes into your extension, its Line key flashes slowly, if the line has a designated key. If a line does not have a designated key, the call flashes a "catch-all" key, called a Loop key.

The call may ring or not ring, depending on programming. If your extension has program access level 2-5, you can program, right from your phone, how the lines ring (see Ringing Assignments starting on page 154).

In addition, calls may ring over the paging speakers or they may ring a bell (especially at night).

Initial Configuration

- All extensions have incoming and outgoing access to all lines
- If the system has one CEU, keys 1-8 are Line keys and access lines 01-08. Keys 9-16 are undefined. With two or three CEUs, keys 1-16 are Line keys and access lines 01-16.
- No Loop keys assigned
- Outside calls to extensions 300, 302, 303 flash and ring. Outside calls to other extensions only flash.
- Extensions 300-305 can program ringing. All other extensions only have program access level 01.
- All lines are CO Loop Start and have no name assigned (a line's name appears when a Display Phone user answers a call on that line)

Using the Feature

To answer an outside call that comes into your extension:

1. Lift handset.
2. If not connected, press flashing Line or Loop key.
-If the line is a Prime Line (see page 134) or your extension is programmed for Ringing Line Preference (see page 155), you do not have to press the key to answer the call.

To answer an outside call that rings over the paging speakers or a bell:

1. Lift handset.
2. Press ICM (except at an ESL set).
-ICM lights, you hear dial tone.
3. Dial * 0.

Understanding Related Programming

Program 10

To define line attributes:

Type (**CIRCUIT TYPE** = 10 or 11 + #)

Gain (**LINE GAIN** = 01-05 + #)

Side tone (**SIDE TONE TEST** = Y or N)

Name (refer to page 230 for more on programming line names)

Program 16 To allow/deny an extension incoming access to a line (**L** + Line number 01-16 + # + 01 or 02 + #)

Program 17 To assign a line to a key at an extension (**LK** + Line number 01-16 + #)

To assign a Loop (Switch) key to every extension (**LS** + #). A Loop key flashes for incoming calls that do not appear under a Line key. Make sure you assign one Loop key to each extension so all incoming calls can appear somewhere.

Program 18 (II) To assign ringing to a line at an extension (**RA** or **DRA** + # + Line key + Y or N + #). Make sure the attendant extension has ringing for all lines (this ensures that a call rings or recalls somewhere).

Program 15 To assign program access level 2-5 (**PGM ACC LEVEL** = 02-05 + #) to extensions so they can program ringing right from their phones

Program 4 To set the Delayed Ring timer (Timer **07** + # + Duration + #) if you assign Delayed Ringing to a line in Program 18 (II)

For additional ways of routing incoming calls to extensions, see:

- Direct Inward Lines (see page 64)
- Group Ring (see page 91)
- Extension Hunting (see page 81)
- Multiple Attendants (see page 118)
- Night Answer (see page 121)
- Private Lines (see page 150)

To have an incoming call ring a bell, see External Alerting Device on page 84.

To have an incoming call ring the external paging speakers, see Paging on page 138.

Outside Calls, Placing



You can place outside calls by:

- Using a Line Key
- Using Prime Line
- Using Line Dial-Up
- Using Direct Line (Trunk) Access
- Using Direct Line Group Access
- Using PBX/Centrex Lines

Placing an outside call simply involves getting an outside line, then dialing your number. Your system may, however, be set up with certain Toll Restrictions which limit the types of calls you can place (e.g., international calls).

The different ways you can place a call include:

Using a Line Key

You press a Line key to get an outside line, then dial your number.

Using Prime Line

You lift your handset to get outside dial tone on a specific Line key, then dial your number. If your extension has program access level 2-5, you can program, right from your phone, the Line key you want to be your Prime Line key. Prime Line keys are not, however, meant for attendant or Headset extensions.

Note: If you assign a Prime Line, the system automatically assigns Ringing Line Preference to that line (see page 155). And, Ringing Line Preference overrides Prime Line (i.e., if a call rings in and you lift the handset, you answer the call instead of getting dial tone on your Prime Line).

Using Line Dial-Up

You dial a three-digit code to get an outside line, then dial your number. Codes 801-816 access lines 01-16.

Using Direct Line (Trunk) Access

You dial a three-digit code to get an outside line, then dial your number. Codes 348-363 access lines 01-16.

This method is primarily for attendants because it also provides access to special features. With Direct Line Access you can also:

- Place any type of call (unrestricted dialing)
- Camp-On to a busy line (see page 55)
- Use Forced Line Disconnect (see page 87),
- Remove Lines and Extensions from Service (see page 153)

Using Direct Line Group Access

You dial a two-digit code to get the first available line in a group of lines, then dial your number. Codes 90-98 access line groups 00-08. If your phone has a key for a particular group, you can just press the key instead of dialing the group's code. If your system has Automatic Route Selection (ARS), you'll dial either 9 or 90 before placing your call. See page 40 for more information on ARS.

Note: To have line groups, the DIGITAL SYSTEM must be equipped with an AUX Module.

Using PBX/Centrex Lines

When the DIGITAL SYSTEM is installed behind a PBX/Centrex, you place an outside call as follows:

- Use one of the above methods to get PBX/Centrex dial tone.
- Dial a one- or two-digit PBX/Centrex Access Code to get outside dial tone.
- Dial your number. To call a PBX/Centrex extension, you do not dial the PBX/Centrex Access Code. To access PBX/Centrex features, see page 136.

Initial Configuration

- No PBX/Centrex lines (all lines are CO Loop Start DTMF)
- All extensions have outgoing and incoming access to all lines
- If the system has one CEU, keys 1-8 are Line keys and access lines 01-08. Keys 9-16 are undefined. With two or three CEUs, keys 1-16 are Line keys and access lines 01-16.
- Line Dial-Up enabled
- Prime Line disabled. Extensions 301-305 can program Prime Lines. All other extensions only have program access level 01.
- Direct Line (Trunk) Access enabled for attendant extension 300
- Direct Line Group Access disabled (no groups programmed)
- No Toll Restrictions (all types of calls are allowed)

Using the Feature

See also Headset on page 95 and Handsfree on page 93.

- | | |
|--|---|
| To place a call using a Line key: | <ol style="list-style-type: none">1. Lift handset and press Line key.
<i>-The key lights, you hear dial tone.</i>2. Dial number. |
| To program a Line key for Prime Line Assignment (PLA) when your extension has program access level 2-5: | <p>Do not program PLA if you are an attendant or are using a Headset.</p> <ol style="list-style-type: none">1. Do not lift handset.2. Press # and dial PLA.3. Press desired Line key.4. Dial Y to enable; N to disable.5. Press SAVE. |
| To place a call using your Prime Line key: | <ol style="list-style-type: none">1. Lift handset.
<i>-The key lights, you hear dial tone.</i>2. Dial number.
<i>-To use another Line key, press it before dialing your number.</i> |
| To answer a call on your Prime Line: | <ol style="list-style-type: none">1. Lift handset.
<i>-The key lights steadily.</i> |

Outside Calls, Placing

To place a call using Line
Dial-Up or Direct Line
(Trunk) Access or Direct
Line Group Access:

1. Lift handset.
2. Press ICM (except at an ESL set), then dial:
-801-816 for lines 01-16
-348-363 for lines 01-16
-90-98 for line groups 00-08
-When you press ICM, the key lights and you hear Intercom dial tone.
-When you dial a code, ICM goes out and you hear outside dial tone.
OR
Press key for line group. You hear outside dial tone.
3. Dial number.

To place a call on a
PBX/Centrex line:

1. Lift handset.
2. Use one of the methods above to get PBX/Centrex dial tone.
3. Dial PBX Access code to get outside dial tone. To place a call to a PBX/Centrex extension, skip step 3.
4. Dial number.

Understanding Related Programming

For all calling methods:

- Program 10** To define line attributes:
Circuit type (**CIRCUIT TYPE** = 10 or 11 + #)
Gain (**LINE GAIN** = 01-05 + #)
Line type (**PBX LINE** = Y or N + #)
Side tone (**SIDE TONE TEST** = Y or N)
Name (refer to page 230 for more on programming line names)
- Program 16** To allow/deny an extension outgoing access to a line (**L** + Line number 01-16 + # + 00, 01 or 02 + #)
- Program 4** To set the Line Response timer (Timer **04** + # + Duration + #)
- Program 6** To set up Toll Restrictions (see page 216 for more information)

To change the first digit of line numbers, line dial-up codes, or line group numbers, see Flexible Numbering Plan on page 86.

Make sure you refer to the programming above before you do the programming that follows.

For Line Keys:

- Program 17** To assign a line to a key at an extension or DSS Console (**LK** + Line number 01-16 + #)

For Prime Line:

- Program 17 To assign a line to a key to an extension (**LK** + Line number 01-16 + #)
- Program 18 (II) To enable/disable a Prime Line key for an extension (**PLA** + # + Press key + Y or N + #)
- Program 15 To assign program access level 2-5 to extensions so they can program their own Prime Line key (**PGM ACC LEVEL** = 02-05 + #)

For Line Dial-Up:

- Program 18 (I) To allow/deny Line Dial-Up for an extension (**LDU** + # + Y or N + #)

For Direct Line Access:

- Program 1 To allow/deny Direct Line (Trunk) Access in a Class of Service (**DIR ACC/CMP-ON** = Y or N + #). See also Program 18 (I).
- Program 18 (I) To assign an extension a Class of Service from Program 1 (**COS** + # + 01=27 + #)

For Direct Line Group Access (when DIGITAL SYSTEM has AUX Module):

If you program line groups, the FCC classifies the DIGITAL SYSTEM as a hybrid. Use the FCC registration number on your CEU that has "MF-E" on the end. If you do not program line groups, the FCC classifies the DIGITAL SYSTEM as a key system. Use the FCC registration number on your CEU that has "KF-E" on the end.

- Program 11 To place lines into groups (**TRK GRP NO.** = 90-98 + # + Line 0-16 + # [repeat last two steps to add additional lines])
- Program 16 To allow/deny an extension access line groups (**G** + Group number 90-98 + # + Y or N + #). With a terminal, you can program one-digit access to line group 90 using the QY command
- Program 17 To assign a line group to a key at an extension (**LG** + Loop group 00-08 for line groups 90-98 + #)

For PBX Lines:

- Program 5 To store PBX Access Codes (**PBX ACC nn** = Enter code + #)
- Program 4 To set the Flash timer (Timer **08** + # + Duration + #)

Paging



Make an important announcement to a group of people. Or, quickly locate someone who is away from their phone.

Paging lets you use your phone to broadcast an announcement over speakers. The announcement can be up to 90 seconds long. There are two types of Paging: Internal Zone Paging and External Zone Paging.

Internal Zone Paging

Internal Zone Paging lets you broadcast an announcement over the speakers of idle Multibutton extensions. You can page:

- A group of extensions (Internal Page Zone), or
- All Internal Page Zones at once (All Call Page). An All Call Page automatically overrides an Internal Zone Page that is in progress.

Regarding incoming pages to your extension:

- If your phone has program access level 3-5, you can enable or disable incoming pages over your speaker.
- If you are the attendant, you do not receive pages over your speaker.
- If you are using a Headset, you hear incoming pages in your Headset.
- You can activate Do Not Disturb to block incoming pages.

External Zone Paging

External Zone Paging lets you broadcast an announcement over external paging speakers (called External Zones), if your system is equipped with them. These speakers are typically installed in the ceilings or walls.

With one CEU, your system can have an External Zone 1. With two CEUs, your system can also have External Zone 2. Making an All Call Page (to all Internal Zones) also sends your announcement to all external paging speakers. Making a page sends your announcement to the external paging speakers in that zone. In software versions prior to AUX Module Y2.0/Base Y5.0, the Main CEU broadcasts All Call Page. The Expansion CEU #1 broadcasts All Call Page and Zone 1.

In addition, if your extension has a Page key for a particular zone, you can use the key to make pages. When the key is lit, the zone is busy. When the key is unlit, the zone is available.

Initial Configuration

- All extensions can make and receive All Call pages
- No Internal Pages Zones
- No External Page Zones
- Extension 301-305 can enable/disable incoming pages. All other extensions have program access level 01.

Using the Feature

To make an All Call Page or Zone Page:

Remember: You can make an All Call Page even if an Internal Zone Page is in progress.

1. Lift handset.

-If you have a Page key or One-Touch Speed Dial key for the desired zone, you can press it instead of using steps 2-3.

2. Press ICM (except at an ESL set).
-ICM lights and you hear dial tone.

3. Dial Page Zone code.
-For: Dial:
All Call 1 *
Zone 1 2 *
Zone 2 3 *
Zone 3 4 *
Zone 4 5 *
Zone 5 6 *
Zone 6 7 *
Zone 7 8 *

-You hear two beeps. If you hear busy tone, try again later.

4. Make announcement.
5. Hang up.

To enable or disable incoming pages when your extension has program access level 3-5:

1. Do not lift handset.
2. Press #.
3. Dial VP (for voice page).
4. Dial Y to enable.
OR
Dial N to disable.
5. Press SAVE.

Understanding Related Programming

For Internal Paging:

- | | |
|-----------------|--|
| Program 1 | To allow/deny the capability of initiating an All Call Page in a Class of Service (ALL CALL PAGE = Y or N + #). See also Program 18 (I).

To allow/deny the capability of initiating a Page to Internal Zone 1-3 in a Class of Service (PAGE ZONE n = Y or N + #). See also Program 18 (II). |
| Program 18 (I) | To assign a Class of Service (from Program 1) to an extension (COS + # + 01-27 + #)

To assign an extension to an Internal Page Zone (PZ + # + Page zone 01-07 + #). An extension can be in only one Internal Zone. |
| Program 18 (II) | To enable or disable incoming pages for an extension (VP + # + Y or N + # to receive only All Call Page). Also see Program 15. |
| Program 15 | To assign program access level 3-5 to extensions so they can enable/disable incoming pages themselves (PGM ACC LEVEL = 03-05 + #) |

Paging

Program 17 To assign a page zone to a key at an extension (**P0 + # + Page zone 01-07 or 00 for All Call + #**)

For External Paging:

If you have External Zone 1 Paging, the system disables line port 04 in the Main CEU. If you have External Zone 2 Paging, the system disables line port 04 in Expansion CEU #1 (line port 04 is equivalent to line 12). To install the speakers, see the Hardware Manual.

Program 7 To enable External Page Zone 1 in the Main CEU (**EXT PAGE ZN 1 = Y + #**).

To enable External Page Zone 2 in Expansion CEU #1 (**EXT PAGE ZN 2 = Y + #**).

(Prior to software version AUX Module Y2.0/Base Y5.0, this program assigned All Call to the Main CEU and Zone 1 to Expansion CEU #1.)

To control the volume of pages (**PG/MUSIC GAIN = 01-05 + #**). This option only appears if you also program Background Music to play over External Page Zones (**BGM TO PG ZN = Y + #**).

To have music play over the External Paging Speakers, see Background Music on page 42.

To have Night Answer calls ring over external paging speakers, see Night Answer on page 121.



Be sure that a call gets sent to a person even when you don't know what part of the building they are in.

Park lets you send an outside call into an "Orbit" (which is a special waiting state) so that a person can pick it up from any extension in the system. After you park a call using a Park Orbit code, you page the person for whom it is intended. The paged person then dials the Park Orbit code from any extension to pick up the call.

You can park a call so it waits in a:

- System Orbit, by using codes 60-69 or a Park Orbit key (if your phone has one). If someone does not pick up the call within the Park Orbit time, it recalls your extension. If you do not answer a recall within the Rings Before Recall time, the call rings all extensions that normally ring on that line.
- Personal Orbit (at someone's extension), by using an extension number. If someone does not pick up the call within the Hold Recall time, it recalls your extension. If you do not answer a recall within the Rings Before Recall time, the call rings all extensions that normally ring on that line.

Initial Configuration

- Park allowed
- No Park Orbit keys assigned
- Park Orbits 60-67 are 60 seconds, Park Orbits 68-69 are permanently 300 seconds (five minutes)
- The Hold Recall time for Personal Orbits is 60 seconds
- The Rings Before Recall time is 5 rings

Using the Feature

To park a call in a System or Personal Orbit:

1. At a multibutton phone, press ICM while on a call.
OR
At an ESL set, press TRF.
-If you have a One-Touch Speed Dial key, you can press it instead of using steps 1-2.
2. For System Park: Dial Park Orbit code (60-69) or press Park Orbit key.
OR
For Personal Park: Dial *, then extension number.
-If you hear busy tone, press ICM and dial a different code (only one call can wait in a System Orbit).
-With Personal Park, the call goes on Exclusive Hold at your extension and the other (it does not ring). You can park any number of calls at the same extension.
3. Page person to receive call and announce orbit.
-See Paging on page 138.
4. Hang up.

- To pick up a parked call:** To pick up a parked outside call, you must use an extension that has access to that line.
1. Lift handset.
-If you have a One-Touch Speed Dial key, you can press it instead of using steps 2-3.
 2. Press ICM (except at an ESL set).
 3. For System Park: Dial announced Park Orbit Code or press Park Orbit key for that Orbit.
OR
For Personal Park: Dial *, then announced extension number.
-The procedure for picking up Personal Park calls also picks up other types of calls. The pick-up order is as follows:
Ringing Intercom calls
Personal Park calls
Ringing outside calls and Direct Inward Lines
Calls on Hold

Understanding Related Programming

- Program 4** To change the Park Orbit time for Orbits 60-67 (Timer **01** + # + Duration + #)
- Program 17** To assign a System Park Orbit (60-69) to a key at an extension (**PO** + Park Orbit 60-69 + #)
- Program 16** To let an extension access any line it should be able to pick up from an Orbit (**L** + Line number 01-16 + # + 01 or 02 + #)

To change the first digit of System Park Orbit codes, see Flexible Numbering Plan on page 86.

Peripheral Control Unit (PCU) Module

 **Install a PCU to get two more External Page Zones, fax switching, alarm sensors, tone (DTMF) decoders and 500/2500 set connections.**

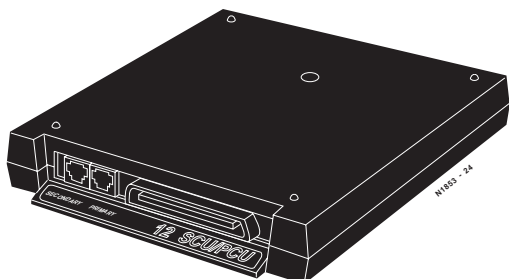

The Peripheral Control Unit (PCU) requires AUX Module software version Y2.1 or higher. The PCU is not available with Base software.

The 12SCU/PCU Peripheral Control Unit (PCU) Module (P/N 88530) provides 12 digital station ports and gives your system the following additional features:

- **Two External Paging Zones**
Each PCU provides two External Paging zones with associated control circuits. These zones are in addition to the external zones in each CEU. When you call the external zone, the system automatically activates the associated PCU control circuits. *If your system uses the PCU for External Paging, it cannot also use it for Tone Decoding, On-Premise Telephones or Fax Switching.*
- **Tone Decoder**
The PCU Module has an internal Tone Decoder that you can use for DTMF detection. You'll need DTMF detection if your system has DISA trunks connected. *If your system uses the PCU for Tone Decoding, it cannot also use it for External Paging, On-Premise Telephones or Fax Switching.*
- **On-Premise 500/2500 Type Telephone Connection**
You can connect up to two single line (500 or 2500 type) telephones to each PCU. Both phones share the same circuit for "party line" type operation. *If your system uses the PCU for On-Premise Telephones, you cannot also use it for External Paging, Tone Decoding or Fax Switching.* Also, you cannot use the 500/2500 port for Voice Mail applications.
- **Fax Switching**
With the Fax Switching feature, the PCU can answer an incoming call and automatically switch it to a fax machine or modem. *If you use the PCU for Fax Switching, you cannot also use it for External Paging, Tone Decoding or On-Premise Telephones.*
- **Alarm Sensor**
Each PCU has an Alarm Sensor that you can connect to either a Normally Open or Normally Closed dry alarm relay contact. When the alarm activates, the system alerts selected extensions with a distinctive signal. You can use the Alarm Sensor function with either the External Paging, Tone Decoding, On-Premise Telephones or Fax Switching functions.

Peripheral Control Unit (PCU) Module

Note: You can install up to four PCUs in a system: two in the main CEU and two in Expansion CEU #1. You cannot install PCUs in Expansion CEU #2. For additional PCU installation and programming instructions, refer to P/N N1853PCU01.

Initial Configuration

Not enabled.

Using the Feature

Refer to the PCU Installation and Programming Instructions (P/N N1853PCU01).

Understanding Related Programming

Refer to the PCU Installation and Programming Instructions (P/N N1853PCU01).



While you're away from your phone, handle your calls with a personal touch. Let your Personal Greeting pick up your call and then automatically forward it to a co-worker.

Personal Greeting requires a Voice Module Unit (P/N 88522) and an AUX Module with software version 02.10 or higher. Personal Greeting is not available with Base software.

You can record a Personal Greeting (i.e., brief message) for your extension. Once recorded, callers to your extension hear the Personal Greeting. After playing the message, Personal Greeting can automatically forward calls to an extension you specify. You can have the recorded greeting optionally play for all calls or just Intercom calls.

Personal Greeting lets you handle unanswered calls with a personal touch. For example, you (e.g., Fred Jones) could record, "***Hello, this is Fred Jones. I'm on vacation this week and Joan Smith will be handling my calls. Thank you.***" You could then redirect your calls to Joan Smith's extension. Callers to your phone would first hear the recorded message, then the system would then send them to Joan's phone.

There are three broadcast channels and two record channels in the VMU Module. This means that the system can play and record three greetings at the same time. The system queues users for an available record channel by consecutive extension number. The queued users hear ringing while waiting.

Notes:

- Personal Greetings cannot be longer than 16 seconds. The total of all Personal Greetings cannot exceed 4 minutes and 15 seconds (i.e., 256 seconds).
- Personal Greetings are lost when power fails.

Initial Configuration

No Personal Greetings recorded.

Using the Feature

To record a Personal Greeting:

If you already have a Personal Greeting recorded, the new greeting replaces the old.

1. Lift handset.
2. Press ICM.

-If you have an ESL set, skip this step.

3. Press #.
4. Dial 68.
5. Dial Personal Greeting option. The options are:

-2 All Calls forwarded, greeting plays for all callers (and Transfer screens)

-4 All Calls forwarded, greeting for Intercom calls only

-A voice message asks you to start recording.

Personal Greeting

-If you hear, "Audio file is full," you cannot record a Personal Greeting. The system greeting total exceeds 256 seconds. Go to "To cancel your Personal Greeting" and cancel your greeting.

6. Start recording when you hear the beep.
-Your Personal Greeting cannot be longer than 16 seconds.
7. (Optional) Dial the number of the extension that should receive your calls.
-If you skip this step, callers just hear your message. The forwarding assignment remains until you cancel it, even if the VMU fails or is removed.
8. Hang up.

To cancel your Personal Greeting:

1. Lift handset.
2. Press ICM.
-If you have an ESL set, skip this step.
3. Press # and hang up.
-If you want to use Personal Greeting again, you'll have to record a new greeting.

To erase all Personal Greetings system-wide (from your attendant or ACD Supervisor extension):

This also erases all the system's Operator Assistance messages and the ACD All Agents Busy announcement.

1. Lift handset.
2. Press ICM.
3. Press #.
4. Dial 68.
5. Press #, 9.
-To cancel this procedure, dial 6.

Understanding Related Programming

Refer to the DIGITAL SYSTEM Feature and Terminal Programming Manual.



Use a standard 2500 set as a Power Failure Telephone.

A standard 500/2500 set can be connected to a Line module so that if AC power fails, you can use the 500/2500 set to place and receive calls. One 500/2500 set can be connected to each Line module. To install a 500/2500 set as a Power Failure Telephone, see the Hardware Manual.

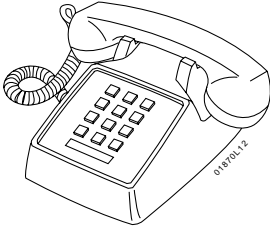

2500 Set

Initial Configuration

No Power Failure Telephones installed

Using the Feature

To make a call on a Power Failure telephone:

1. Lift handset.
2. Dial number.

To answer a call when the Power Failure telephone rings:

1. Lift handset.

Understanding Related Programming

N/A

Privacy



Calls in progress are not interrupted by other callers.

Privacy prevents an extension from receiving the following interruptions while on a call:

- Intrusion (Barge-In) attempts (page 106)
- Silent Monitor attempts (page 161)
- Camp-On (Call Waiting) signals (page 55)

Privacy does not prevent Off-Hook Signaling attempts (page 126).

Note: While on an Intercom call, a user with Privacy will hear Intrusion and Call Waiting beeps directed to the other extension user. However, this will not occur if the other extension also has Privacy enabled.

Initial Configuration

Privacy disabled except for attendant extension 300

Using the Feature

N/A

Understanding Related Programming

- | | |
|-----------------------|--|
| Program 1 | To enable/disable Privacy in a Class of Service (PRIVACY = Y or N + #). See also Program 18 (I). |
| Program 18 (I) | To assign a Class of Service (from Program 1) to an extension (COS + # + 01-27 + #) |



Convert an outside call into a Conference call with a single touch. No need to dial codes.

Privacy Release lets you quickly join a co-worker's outside call, creating a three-party Conference. You can use Privacy Release as long as your co-worker:

- Is a member of your Privacy Release Group
- Has not activated Privacy
- Is not on Conference call

Initial Configuration

No Privacy Release Groups defined

Using the Feature

Privacy Release is temporarily unavailable when the system is already accommodating the maximum number of three-party conversations, which is 8 per system.

To join a co-worker's outside call (when your co-worker is a member of your Privacy Release Group):

1. Lift handset.
-If that group member just placed the call, you must wait six seconds before doing step 2.
2. Press the busy Line key for the call you want to join.
-The CONF key lights at your phone and at your co-worker's. You hear the conversation and can join it.
-If you hear busy tone, you cannot join the call.

To prevent a member of your Privacy Release Group from interrupting an outside call you are on (i.e., to activate Privacy):

1. Press the flickering Line key of your call.
-The Line key lights steadily. No group members can join that call.

Understanding Basic Programming

- | | |
|-----------------------|--|
| Program 18 (I) | To assign an extension to a Privacy Release Group (PRG + # + Privacy Release Group 01-99 + #) |
| Program 16 | To give Privacy Release Group members outgoing access to lines they should be able to join (L + Line 01-16 + # + 02 + #) |
| Program 17 | To assign a key to each line intended for Privacy Release at an extension (LK + Line number 01-16 + #) |

Private Lines



An executive or group of executives can have their own line.

A Private Line is a line that is dedicated to an extension or group of extensions. A Private Line can be incoming only or incoming and outgoing.

Initial Configuration

No Private Lines

Using the Feature

You place, answer, and Transfer calls on a Private Line as you would on any other line.

Understanding Related Programming

Program 16 To assign an extension access to the Private Line (**L** + Line 01-16 + # + 02 + #)

Since a Private Line is assigned to an extension like any other line (i.e., by using Program 16), it has all the features and restrictions of normal (non-Private) lines.

Program 17 To assign the Private Line to a key at an extension (**LK** + Line number 01-16 + #)

Program 18 (II) To assign ringing to the Private Line (**RA** or **DRA** + # + Key + Y or N + #)

Program 10 To assign the correct circuit type (**CIRCUIT TYPE** = 10 [loop start DTMF] or 11 [loop start DP] + #) and name to a Private Line. Refer to page 230 for more on storing line names.

Programmable Keys

The multibutton phone has 16 Programmable Keys (shaded), numbered 1-16. Keys 1-5 are on the left, 6-10 on the right, and 11-16 under the dialpad.

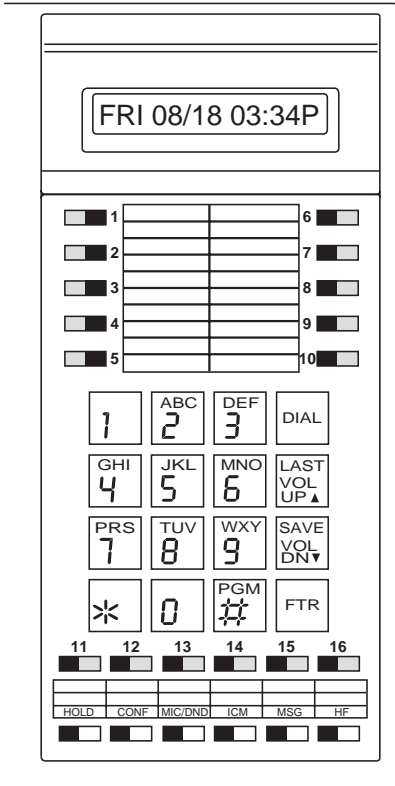

Each key can be assigned a function, through system programming, so you can just press the key to activate the assigned function.

The available functions for a programmable key are listed below:

Line Key

For Placing an Outside Call (see page 134) and Answering an Outside Call (see page 132)

Park Orbit

For Park (see page 141)

One-Touch Speed Dial

For Speed Dial (see page 162)

Hotline

For Hotline (see page 101)

Loop Group

For Placing an Outside Call/Using Direct Line Group Access (see page 134)

Loop Switch

For Answering an Outside Call (see page 132)

Pickup Group

For Group Call Pickup (see page 88)

Call Coverage

For Call Coverage (see page 169)

Page Zone

For Paging (see page 138)

Automatic Call Timer or Manual Call Timer

For Call Timer (see page 49)

Record Key

For Voice Mail (see page 185)

Programmable Keys

On multibutton phones, some programmable keys may have two additional functions. Keys 1-16 become Speed Dial keys when you press DIAL (see page 162). When you press ICM, keys 1-15 become DSS keys (see page 69).

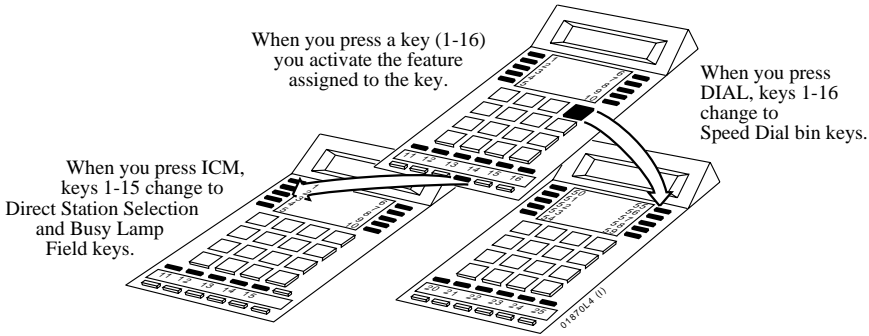

Initial Configuration

- If the system has one CEU, keys 1-8 are programmed as Line keys and access lines 01-08. Keys 9-16 are undefined.
- If the system has two or three CEUs, keys 1-16 are programmed as Line keys and access lines 01-16.
- When you press ICM, DSS keys 1-15 each call extension 300.
- When you press DIAL, keys 1-5 access Personal Speed Dial bins 50-54, keys 6-10 access bins 55-59, and keys 11-16 access bins 20-25.

Using the Feature

See the page reference for each programmable key.

Understanding Related Programming

- Program 17 To assign a function to a programmable key (see page 250).



As the attendant, you can ensure maximum system performance by removing a noisy or faulty extension or line from service until it can be repaired.

If you are an attendant, you can remove lines and extensions from service. You may want to do this after viewing an Alarm that tells you an extension or line failed (see page 24). When you remove an extension or line from service, that extension or line appears busy to anyone trying to use or call it. After the line or extension is repaired, you can return it to service.

Initial Configuration

Attendant extension 300 can remove extensions and lines from service

Using the Feature

Removing an extension from service automatically cancels its Call Forwarding conditions or Selectable Display Messages (if any).

To remove a line or extension from service:

1. Lift handset.
2. Press ICM.
-ICM lights and you hear dial tone.
3. Press #.
-Dial tone stops.
4. Dial line (348-363 for lines 01-16) or extension (300-347).
5. Dial 0.
-You hear dial tone again.
6. Hang up.
-The key for the line or extension (if there is one) lights.

To return a line or extension to service:

1. Lift handset and press ICM.
-ICM lights and you hear dial tone.
2. Press #.
-Dial tone stops.
3. Dial line (348-363 for lines 01-16) or extension and hang up.
-The key associated with the line and/or extension goes out.

Understanding Related Programming

- | | |
|-----------|---|
| Program 1 | To allow/deny Direct Line (Trunk) Access in Class of Service 00, which is the attendant's COS (DIR ACC/CMP-ON = Y or N + #). If you deny it, the attendant cannot remove lines/extensions from service. |
| Program 3 | To assign attendant extensions (OPR nn EXT = Extension number + #) |

Ringling Assignments



Select the lines you want to ring.

Ringling Assignments (RA) lets you enable or disable immediate day/night ringling for:

- Lines
- Call Coverage keys
- Pickup Group keys

To enable/disable Ring Assignments, your extension must have program access level 2-5. Enabling RA automatically disables Delayed Ringling Assignment (see page 62) or Night Ring (see page 124).

Initial Configuration

- RA enabled for lines 1-16 at extensions 300, 302, 303 only
- RA disabled for Call Coverage and Pickup Group keys
- Extension 300-305 can program RA. Other extensions only have access level 01.

Using the Feature

To enable/disable Ringling Assignments (RA) when your extension has program access level 2-5:

1. Do not lift handset.
2. Press #.
3. Dial RA.
-Your Line, Call Coverage, Pickup keys flash or light steadily. Flashing means immediate ring is on; steadily lit means it is off.
4. Press desired key.
OR
Dial desired line number.
5. To enable immediate ring, dial Y.
OR
To disable immediate ring, dial N.
6. Press # and return to step 4, or press SAVE.

Understanding Related Programming

- | | |
|-----------------|---|
| Program 18 (II) | To enable/disable Ring Assignments for an extension (RA, NR or DRA + # + Press key + Y or N + #) |
| Program 15 | To assign program access level 2-5 to extensions (PGM ACC LEVEL = 02-05 + #) so they can enable/disable Ring Assignments themselves |
| Program 16 | To assign line access to an extension (L + Line 01-16 + # + 01 or 02 + #) |
| Program 17 | To assign Line, Call Coverage, and Group Pickup keys to an extension.
For a <i>line</i> key: LK + Line number 01-16 + #
For a <i>Call Coverage</i> key: CCK + Covered extension + #
For a <i>Group Pickup</i> key: GP + Pickup Group 01-07 |



Answer calls in a single step, much like you do with your phone at home.

Ringing Line Preference (RLP) lets you answer calls ringing a Line or Loop key by just lifting the handset. To enable or disable RLP, your extension must have program access level of 2-5. If several calls are ringing your extension, RLP answers Intercom calls first, then outside calls, starting with the one on the lowest numbered line.

Notes:

- If you have a Prime Line Key (see page 134), the system automatically assigns RLP to that line.
- Ringing Line Preference overrides Prime Line. So if a call rings in, lifting the handset answers the call; it does not give you dial tone on your Prime Line.

Initial Configuration

- RLP disabled at all extensions
- Extensions 301-305 can program RLP. All other extensions only have program access level 01.

Using the Feature

Do not enable Ringing Line Preference for attendant or Headset extensions.

- To enable/disable Ringing Line Preference (RLP) when your extension has program access level 2-5:**
1. Do not lift handset.
 2. Press #.
 3. Dial RLP.
 4. To enable RLP, dial Y.
OR
To disable RLP, dial N.
 5. Press SAVE.

- To answer a call when RLP is enabled:**
1. Lift handset.

Understanding Related Programming

- | | |
|------------------------|--|
| Program 18 (II) | To enable/disable RLP for an extension (RLP + # + Y or N + #) |
| Program 15 | To assign program access level 2-5 (PGM ACC LEVEL = 02-05 + #) to extensions so they can enable or disable RLP themselves |
| Program 16 | To assign line access to an extension (L + Line number 01-16 + # + 01 or 02 + #) |

Ringin9 Patterns



Easily identify the type of call ringin9 your phone.

The DIGITAL SYSTEM provides ringin9 at three different durations so you know which kind of call is ringin9 your phone (see the chart below). As you can see from the chart, outside calls ring with two short rings, Intercom calls with one long ring (repeated). The Callback ring is the ring you hear for the Callback and Line Queuin9 features.

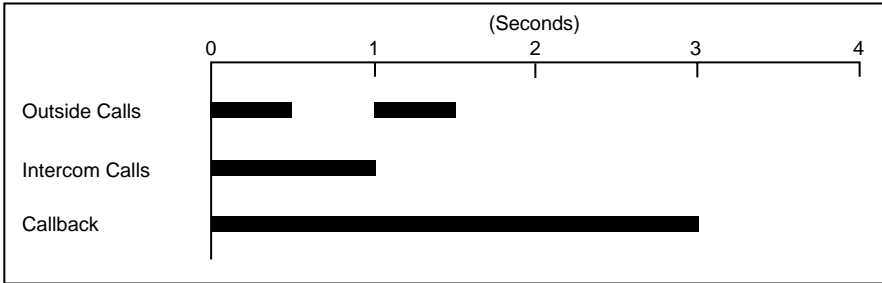

The DIGITAL SYSTEM also provides ringin9 at four different pitches. Extension 300 rings at one pitch, 301 at another, 302 at another, and 303 at yet another. Then the pattern repeats for the next group of four extensions (e.g., extension 304 rings at the same pitch as 300).

Distinctive Ringin9

Optionally, you can have certain outside calls ring with two high-pitched tones, rather than the two normal rings. You may want to do this if your system has a *customer-provided* Door Box connected to a line circuit. Ringin9 on the Door Box line will sound different than the ringin9 on your other lines. This Distinctive Ringin9 option is only available on software versions AUX Module Y2.0/Base Y5.0 and above.

CAUTION: Do not enable Distinctive Ringin9 for a line if any extensions use headsets.

Initial Configuration

All calls ring as described above

Using the Feature

N/A

Understanding Related Programming

- Program 1** To assign a single ring to all calls that ring an ASI in a Class of Service (**SINGLE RING = Y + #**). See also Program 18 (I). This means Intercom calls, outside calls, and Callbacks ring with a single ring at the Intercom duration (1 second).
- Program 12** To assign COS 20 (**COS + # + 20 + #**) to each line with Distinctive Ringing
- Program 18 (I)** To assign a Class of Service from Program 1 to an extension (**COS + # + 01-27 + #**)



Call a busy number in the morning, quickly "save" it in memory, then periodically retry it throughout the day by touching two keys. You do not waste time looking up the number again.

Save lets you store (save) in memory the last outside number you dialed so you can easily redial it later on. Save lets you store numbers up to 24 digits long. After you save a number, you can make other calls without affecting it. The saved number stays in memory until you save a new one in its place.

When you call a saved number, the system dials it out on the same line used for the original call unless you manually select a different line.

Initial Configuration

Save always allowed

Using the Feature

A power failure or system reset erases a saved number from memory.

To save an outside number after you dial it:

1. Do not hang up.
2. Press DIAL.
-The Line key goes out.
3. Press SAVE.
-The Line key lights again.

To call a saved outside number:

1. Lift handset.
-To have the call dial out on a line other than the original one: Access an idle outgoing line before you do step 2.
2. Press DIAL.
-You hear dial tone.
3. Press SAVE to have the call dial out.
-Immediate busy tone means the original line is busy. Press an idle outgoing Line key to have your call go out.

Understanding Related Programming

- Program 16** To give an extension outgoing access to a line (**L** + Line number 01-16 + # + 02 + #)
- Program 17** To assign a line to a key at an extension (**LK** + Line number 01-16 + #)



Let co-workers know your whereabouts without having to call each one individually.

The Selectable Display Messages feature lets you "attach" a message to your phone so Display Phone users see it on their display when they call you. For example, when you leave for vacation, you could select the message: ON VACATION (if your system has it). This way, when Display Phone users call and you do not answer, they know why.

Your system can store up to 16 messages for you to choose from, numbered 00-15. Messages 00-07 are special in that you can add digits to the end of them as long as the entire message does not exceed 16 characters (including blank spaces). For example, you could add a telephone number to the end of the message, CALL. This way, the message would read CALL XXX XXXX so people would know where to reach you.

Initial Configuration

00 = CALL	08 = BACK BY 10AM
01 = BACK BY	09 = BACK BY 11AM
02 = MEETING IN RM	10 = BACK BY NOON
03 = OUT TO LUNCH	11 = BACK BY 2PM
04 = GONE FOR THE DAY	12 = BACK BY 4PM
05 = ON VACATION	13 = BACK TOMORROW
06 = ON BUSINESS TRIP	14 = BACK NEXT WEEK
07 = IN THE MEETING	15 = HAVE A GOOD DAY

If the system has an AUX Module, there are no messages initially.

Using the Feature

You can select only one message for your phone at a time. You do not have to cancel an old message in order to select a new message.

To directly select a specific Selectable Display Message:

These steps automatically cancel a Call Forwarding condition.

1. Lift handset.
-If you have a One-Touch Speed Dial key, you can press it instead of using steps 2-6.
2. Press ICM (except at an ESL set).
-You hear dial tone.
3. Press #.
-Dial tone stops.
4. Dial M.
5. Dial message number (00-15).
-To add digits to 00-07, dial them.
6. Hang up.
-MSG flashes.

Selectable Display Messages

To select a message by scrolling through them (when you have a Display Phone):

This automatically cancels a Call Forwarding condition at your phone.

1. Lift handset.
2. Press ICM.
-You hear dial tone.
3. Press #.
-Dial tone stops.
4. Dial M.
5. Press VOL UP or VOL DN to scroll through the messages. Stop at the one you want.
-VOL UP scrolls this way: Message 00, 01, 02,...15.
-VOL DN scrolls this way: 00, 15, 14, 13...01.
-To add digits to messages 00-07, simply dial them.
6. Press DIAL, then SAVE.
-If you add digits to messages 00-07, skip this step.
7. Hang up.
-MSG flashes.

To cancel a message:

Activating Do Not Disturb automatically cancels a message.

1. Lift handset.
2. Press ICM (except at an ESL set).
-You hear dial tone.
3. Press #.
-Dial tone stops.
4. Hang up.
-MSG goes out.

Understanding Related Programming

- Program 8** To store or change the messages (**MESSAGE NO.** = 600-615 + # + Enter message). Refer to page 227 for more on programming messages.



As a Customer Service supervisor, for example, listen to the way a trainee handles outside callers.

Silent Monitor lets you enter a co-worker's outside call and listen to the conversation without sending any warning tones to indicate your presence. You simply call your co-worker's extension and dial the Silent Monitor code. If your co-worker is on an Intercom call, you hear only the person who is talking to your co-worker, not the co-worker you called. Normally, Silent Monitor is only for attendants and supervisors.

Silent Monitor does not let you break into calls at extensions programmed for Privacy.

CAUTION: Since Silent Monitor provides no warning tones, using this feature may be interpreted as an invasion of privacy.

Initial Configuration

- Silent Monitor disabled
- Privacy disabled except for attendant extension 300

Using the Feature

If your extension is in a Call Pickup Group, you can only monitor other extensions in the group.

To use Silent Monitor to listen to a call at another extension:

1. Lift handset.
2. Press ICM (except at an ESL set).
3. Dial number of extension you want to monitor.
-You hear busy tone.
4. Dial 6 to break in and listen.
-If you still hear busy tone, this means you cannot monitor the call.

To cancel Silent Monitor: 1. Hang up.

Understanding Related Programming

- | | |
|----------------|--|
| Program 1 | To allow/deny Silent Monitor in a Class of Service (MONITOR = Y or N + #). Also see Program 18 (I).
To allow/deny Privacy in a Class of Service (PRIVACY = Y or N + #). Allow Privacy for any extension that should not be monitored (see also Program 18 [I]). |
| Program 18 (I) | To assign a Class of Service from Program 1 to an extension (COS + # + 01-27 + #) |

Speed Dial



Save time dialing the outside numbers you frequently call.

Speed Dial allows a number to be stored in a memory bin so you can call the number by dialing its bin or by pressing its key. If the DIGITAL SYSTEM is equipped with an AUX Module, a 16-character name can be stored with a number. The name appears on a Display Phone when the number is called.

There are two types of Speed Dial: Personal and System.

Personal Speed Dial

Personal Speed Dial lets you store 20 numbers at your extension as long as your extension has program access level 1-5. You store numbers in bins 50-59 and 20-29 and call them as follows:

- Press DIAL, then dial the bin number, or
- Press DIAL, then press the corresponding bin key (1-16).
-There are no keys for bins 26-29. To dial these bins you need to dial the bin number.

The system administrator can also store numbers for you.

System Speed Dial

System Speed Dial lets the system administrator store numbers in system memory from any extension that has program access level 4-5. System Speed Dial numbers can be called from any extension in the system. For example, the system administrator may store the number for your company's branch office so everyone has quick access to it. The system does not apply your Toll Restrictions to System Speed Dial numbers (i.e., you can call them even if you are normally restricted from manually placing the same call). Depending on how your system is programmed, there may be 10 System numbers stored in bins 70-79 or 100 numbers stored in bins 700-799.

One-Touch Speed Dial

In addition, the system administrator can assign *One-Touch Speed Dial* keys to your extension. A One-Touch Speed Dial key also corresponds to a bin number. You just press the key to call the stored number. There is no need to press DIAL first. You can also store "Intercom" feature codes in a One-Touch Speed Dial key. For example, you could store the Call Forwarding codes (#, extension, Call Forward code) in a bin and activate Call Forwarding by pressing the key. If you have a DSS Console, you can have One-Touch Speed Dial on keys 1-79 for an additional 79 Personal Speed Dial bins.

Storing Long Numbers

A bin can store 16 digits, including a pause or "#" character (if allowed). Numbers longer than 16 digits flow to the next consecutive bin. Long numbers can also be stored in two consecutive bins, then linked together when you want to call the long number.

Storing a Pause, Flash or Delay

You can store a *Pause* in a Speed Dial bin by pressing HOLD where you want the Pause to occur. When you use the stored number, the system stops dialing when it encounters the pause and waits for a second dial tone. If the second dial tone occurs, dialing continues. You might want to use a Pause if your Speed Dial number calls a dial-up service (like a banking service) that automatically returns second dial tone. The pause ensures that your number doesn't dial out too soon. (If you don't get second dial tone, you can always dial * to force the remaining digits to dial out.)

In some cases, you may want to store a *Delay* in lieu of a Pause. A Delay is a fixed wait interval that doesn't monitor for second dial tone. Use Delay, for example, if you're not sure the dial-up service will return second dial tone. After the first part of your Speed Dial bin dials out, the system waits the Delay interval and then dials the remaining digits. To store a Delay, press DIAL where you want the delay to occur. The Delay option is only available in software version AUX Module 02.10/Base 02.00 and higher.

You can also store a *Flash* command in a Speed Dial bin. You might want to do this if your system is behind a Centrex or PBX and you need to use certain Centrex or PBX features. For example, a Flash command frequently initiates a PBX Transfer. To enter the Flash command while programming the Speed Dial bin, press MSG where you want the Flash to occur. The Flash option is only available in software version AUX Module 02.10/Base 02.00 and higher.

Initial Configuration

- Each extension can store 20 Personal Speed Dial numbers except 303 (there is no Speed Dial block of memory assigned to 303)
- Extensions 300-305 can store System Speed Dial numbers. All other extensions only have program access level 01.
- There are 100 System Speed Dial bins (700-799)
- All extensions can access System Speed Dial numbers
- Speed Dial Names can only be stored if the system has an AUX Module
- One-Touch Speed Dial keys not assigned
- The system waits 10 seconds for dial tone before sending out a Speed Dial number. The system waits 30 seconds for dial tone when it encounters a pause.

Using the Feature

To store a Personal or System Speed Dial number:

To store a Personal Speed Dial number, your extension must have program access level 1-5.

To store a System Speed Dial number, your extension must have access level 4-5.

1. Do not lift handset.
2. Press #.
3. Dial SD.
4. For System Speed Dial: Dial bin 70-79 or 700-799, press #.

OR

For Personal Speed Dial: Dial bin (50-59, 20-29) and press # or press illuminated One-Touch Speed Dial key (on phone or DSS Console).

5. If the system lets you store a name:
At a Display Phone: Enter a name, press #. Or, to skip the name, press # and go to step 6.
At a Standard Phone: Press # and go to step 6.
OR
If the system does not let you store a name, go to step 6
-To enter a letter in a name:
Dial letter: Zero button = blank, Q, Z, (in that order).
Dial digit (1, 2, 3) = letter's position on button (e.g., dial 1 to get the 1st letter). To erase last letter, press LAST.
6. Dial a line (01-16) or group 90-98 (if your system has line groups) and press #, or press a Line key.
-To store Intercom codes, press ICM instead of storing a line, then dial the codes in step 7.
7. Dial number, including a pause *, # (if allowed).
-To enter a pause, press HOLD.
-To enter a Flash, press MSG.
-To enter a Delay, press DIAL.
-To enter *: Press DIAL, dial *.
-To enter #: Press DIAL, dial #.
8. Hang up.

To call a Personal or System Speed Dial number (by using the bin number or bin key):

1. Lift handset.
-To preselect a line instead of using the line stored with the number:
Press desired Line key.
Press ICM in step 2, then go to step 3.
2. Press DIAL (except at an ESL set).
3. Dial System Speed Dial bin (70-79, 700-799).
OR
Dial Personal Speed Dial bin (50-59 or 20-29).
OR
Press Personal Speed Dial bin key (1-16).
-Your number dials out.
-Immediate busy tone means the stored line is busy.
Press an idle outgoing Line key to have your call dial out.
-If the number contains a pause, you may have to dial * to restart the dialing.

To call a Personal or System Speed Dial number (by pressing a One-Touch Speed Dial key):

1. Lift handset.
-To preselect a line instead of using the line stored with the number: *Simply press the desired Line key.*
2. Press One-Touch Speed Dial key (on your phone or DSS Console) for desired number.

-Your number dials out. Immediate busy tone means the stored line is busy. Press an idle outgoing Line key to have your call dial out.

*-If the number contains a pause, you may have to dial * to restart the dialing.*

To link Speed Dial numbers stored in different bins (multibutton phones only):

1. Place first Speed Dial call.
2. Press One-Touch Speed Dial key for next number.
OR
Press DIAL, then dial bin or press bin key for next number.

Understanding Related Programming

- | | |
|-----------------|--|
| Program 1 | To allow/deny access to System Speed Dial numbers in a Class of Service. Also see Program 18 (I). |
| Program 18 (I) | <p>To assign a Class of Service from Program 1 to an extension (COS + # + 01-27 + #)</p> <p>To assign a Speed Dial block of memory to an extension (SDB + # + 01-28 + #). A block lets a user store 20 numbers. If the system has an AUX Module, the block also lets a user store a name with a number except for blocks 51-57.</p> <p>Note: Initially, extension 303 has no Speed Dial block assigned. If you have an extension installed at 303, and it needs Speed Dial, use this program to assign it an available Speed Dial block.</p> <p>To enable Line Dial-Up (LDU + # + Y + #) for each extension that should be allowed to dial line codes (01-16) while storing Speed Dial numbers.</p> |
| Program 3 | <p>To determine how many digits are in a System Speed Dial code (# SYS SD DGTS = 02 or 03). Two digits allows 10 numbers to be stored under codes 70-79; 3 digits allows 100 numbers to be stored under codes 700-799).</p> <p>To enable or disable the dialing out of a "#" character in a System Speed Dial number (DIAL # ENABLE = Y or N + #)</p> |
| Program 17 | To assign One-Touch Speed Dial keys to an extension or DSS Console (SD + # + Bin number [50-59 or 20-29 at telephone, Bin number 700-799 at DSS Console] + #) |
| Program 4 | To set the Dial Tone Detection timer (Timer 09 + # Duration + #). This sets the amount of time the system should wait for dial tone before sending out a Speed Dial number or after a stored pause. |
| Program 18 (II) | To store Personal Speed Dial or System Speed Dial numbers (see page 269) |

Speed Dial

- Program 15** To assign a program access level to extensions so they can store Speed Dial numbers themselves (**PGM ACC LEVEL** = 01-05 for personal, 04 & 05 for system + #)
- Program 16** To give an extension outgoing access to a line so it can store and call Speed Dial numbers (**L** + Line number 01-16 + # + 01 or 02 + #)

To change the first digit of Personal or System Speed Dial codes, see Flexible Numbering Plan on page 86.



Handle two calls at once.

When you are on a call and you hear two Call Waiting beeps in your handset or Off-Hook Ringing (ringing over your speaker), this means another call is trying to reach you. Split lets you answer the second call, then alternate between the two.

If you are on a call and hear two beeps in your handset followed by your co-worker's voice, see Off-Hook Signaling/Whisper Page on page 126.

Initial Configuration

- Split always allowed
- Call Waiting beeps enabled
- Off-Hook Ringing disabled
- Whisper Page enabled

Using the Feature

At your multibutton phone, to answer an Intercom call when you are on the phone (ICM flashes):

1. Press ICM.
-Your first call goes on Hold.
2. To alternate: Press ICM, dial * 7.

At your multibutton phone, to answer an outside call when you are on an Intercom call (a Line/Loop key flashes):

1. Press HOLD to hold your Intercom call.
2. Press flashing Line key.
3. To alternate: Press ICM, dial * 7.

At your multibutton phone, to answer an outside call when you are on an outside call (a Line/Loop key flashes):

1. Press HOLD to hold the call you are on.
2. Press flashing Line or Loop key.
3. To alternate, repeat steps 1-2.

At your ESL set, to Split between a new call and your current call:

1. Press HLD to put current call on Hold.
2. Dial * 2 to answer waiting call.
3. Press HLD again.
4. Dial * 7 to answer the call on hold.
-Repeat steps 3 and 4 to continue alternating between the calls.

Understanding Related Programming

- Program 2 To enable/disable Call Waiting beeps (**CALL WAIT TONE** = N + #)
- Program 18 (II) To enable/disable incoming Whisper Page at an extension (**VO** + # + Y or N + #)
- Program 18 (I) To enable/disable Off-Hook Ringing at an extension (**OHR** + # + Y or N + #)



Touch one key at your phone to answer a co-worker's call. No codes to dial.

Call Coverage lets you answer a call ringing a co-worker's extension by pressing your Call Coverage key for that extension (called the "covered" extension). In addition, you can use the Call Coverage key to make an Intercom call or Transfer to the covered extension. The Call Coverage key shows you the status of the covered extension:

When the Call Coverage key is...	The covered extension is...
Off	Idle
On	Busy
Flashing Slowly	Ringing
Flashing fast	In Do Not Disturb

The Call Coverage feature also does the following:

- Signals a busy covered extension, if it's programmed for Off-Hook Signaling (see page 126)
- Lets you Camp-On to the busy covered extension, if it's not programmed for Off-Hook Signaling (see page 126)
- Lets you contact the covered extension when it is in Do Not Disturb

And, if your extension has the proper program access level, you can enhance the Call Coverage feature as follows:

- With access level 2-5, you can assign ringing to a Call Coverage key so when a call rings the covered extension, your extension rings, too. See Delayed Ringing Assignment on page 62 and Ringing Assignment on page 154.
- With program access level 1-5, you can change the covered extension assigned to a Call Coverage key (see Direct Station Selection on page 69).

Initial Configuration

- No Call Coverage keys programmed
- All Call Coverage keys activate Off-Hook Signaling (Whisper Page)
- Extensions 300-305 can program ringing for Call Coverage keys. All other extensions have program access level 01.
- All extensions can change a Call Coverage key's extension

Using the Feature

- To answer a call using a Call Coverage key:**
1. Lift handset.
 2. Press (slow) flashing Call Coverage key.
-The key goes out, ICM or a Line key lights.

- To place a call to a covered extension:**
1. Lift handset.
 2. Press Call Coverage key once if it is lit or unlit.
*-If you hear two beeps, speak.
-If you hearing ringing, wait for an answer.*

Station Call Coverage

-If you hear busy tone, dial C to Camp-On.

-If you hear fast busy tone, this means your partner is busy on a call and has DND on. You cannot get through.

OR

1. Lift handset
2. Press Call Coverage key twice if it is flashing fast.
- This overrides the covered extension's DND and you hear ringing.

To Transfer an outside call to a covered extension:

1. Press Call Coverage key.
-The call goes on Exclusive Hold (Line key and HOLD key flash). ICM flashes fast.

2. Announce the call, then hang up.

OR

Hang up to send the call unannounced.

-If you hear beeps, speak. If you hear ringing, wait for an answer.

-You can also hang up when you hear busy tone to have the call Camp-On (wait) at that extension.

Understanding Related Programming

- | | |
|-----------------|---|
| Program 17 | To assign Call Coverage keys to an extension (CCK + # + Covered extension + #). If you want Call Coverage keys for ACD/UCD master numbers, your system must have an AUX Module. |
| Program 16 | To give an extension access to any line it should be able to answer at the covered extension (L + Line number 01-16 + # + 01 or 02 + #) |
| Program 18 (II) | To assign ringing to a Call Coverage key (RA or DRA + # + Press key + Y or N + #) |
| Program 15 | To assign program access level 2-5 to extensions so they program ringing themselves (PGM ACC LEVEL = 02-05 + #) |



It's easy to keep track of the calls made at each extension.

Station Message Detail Recording (SMDR) provides a record of the system's outside calls. The record can display on a terminal or be sent to a printer. The record shows the following information about a call:

- Date of the call
- Last extension on the call
- Line used for the call
- Number dialed (for outgoing calls only)
- Account Code, if entered (for more information, see Account Codes on page 23)
- Start time of the call
- Duration of the call

SMDR requires the AUX Module and a customer-provided ASCII record collection device (e.g., terminal or printer). SMDR options are programmed through a terminal connected to the AUX Module. For more information, see SMDR in the DIGITAL SYSTEM Feature and Terminal Programming Manual.

Initial Configuration

SMDR not available without an AUX Module and terminal programming

Using the Feature

N/A

Understanding Related Programming

- Program 3** To set the baud rate of the AUX Module's port for terminal programming (**LOCAL BAUD** = 00 [300], 01 [1200], 02 [2400], 03 [4800], 04 [9600] or 05 [19.2K] + #)



Customize the duration of certain feature options.

There are timers in the system that can be customized through programming. The timers affect extensions, lines, features and system performance. The available timers are as follows:

The **Park Orbit** timer determines how long a call stays in a system Park Orbit before it recalls the extension that parked it (see Park on page 141).

The **Hold Recall** timer determines how long a call stays on Hold before it recalls the extension that placed it on Hold (see Regular Hold on page 99, Exclusive Hold on page 98, and Automatic Hold on page 97).

The **Camp-On** timer determines how long a transferred call or Direct Inward Line Camps-On to a:

- Busy UCD Hunt Group before it rings the overflow extension
- Busy ESL/ASI before it recalls the transferring extension

The **Line Response** timer determines how long the system waits before assuming that a seized outgoing line is defective (i.e., defective = the system does not detect loop current from the telephone company). The time you select must be compatible with your local telephone company.

The **Modem Reserve** timer determines how long the system reserves a modem (for a user) from the modem pool before returning it to the pool.

The **Number of Rings Before Recall** timer sets the number of times:

- A recalling held outside call rings the extension that placed it on Hold before it changes to "key ring" and rings all extensions programmed for ringing on that line
- A transferred call rings an idle or busy Multibutton extension before recalling the transferring extension (see Transfer on page 182)
- A transferred call rings an idle ESL/ASI before recalling the transferring extension
- A recalling Transfer rings the transferer before it changes to "key ring" and rings all extensions programmed for ringing on that line
- A call rings a Hunt Group extension before ringing the next extension in the group (see Extension Hunting on page 81)
- A call rings an extension in the ring-no-answer Call Forwarding mode before the system forwards the call to the destination extension (see Call Forwarding on page 44)
- A Direct Inward Line (i.e., a directly terminated line in Program 12) rings an idle or busy Multibutton or UCD overflow extension before it changes to "key ring" and rings all extensions programmed for ringing on that line (see Direct Inward Lines on page 64)

The **Number of Delayed Rings** timer determines how many rings the system suppresses before a call audibly rings an extension that is programmed for Delayed Ringing (see Delayed Ringing Assignment on page 62).

The **Flash Response** timer determines how long a line circuit opens to allow the CO or PBX to recognize it as a Flash. The value you select must be compatible with your CO or PBX (see Flash on page 85).

The **Dial Tone Detect** timer determines how long the system waits to detect dial tone before sending out a Speed Dial call. The system uses three times this value for a pause in a Speed Dial number (see Speed Dial on page 162).

The **Make** timer determines how long the relays close on Dial Pulse (DP) lines.

The **Break** timer determines how long the relays open on Dial Pulse (DP) lines.

The **Interdigit** timer determines how long of a pause there is between digits dialed on a Dial Pulse (DP) line.

Initial Configuration

- Park Orbit = 60s
- Hold Recall = 60s
- Camp-On = 60s
- Line Response = 1.5s
- Modem Reserve = 30s
- Number of Rings Before Recall = 5
- Number of Delayed Rings = 3
- Flash Response = .7s
- Dial Tone Detect = 10s
- Make = 40ms
- Break = 60ms
- Interdigit = 640ms

Using the Feature

N/A

Understanding Related Programming

Program 4 To set the duration of the timers (Timer number **01-12** + # + Duration + #)

Telemarketing Dial



Have the PC connected to your keyset dial your outside calls.

Telemarketing Dial requires an AUX Module with Software Version 02.10 or higher. Telemarketing Dial is not available with Base software.

If you have a keyset, Telemarketing Dial lets you have your PC dial outside calls. This is great if you are a telemarketer, for example, because you can use auto-dialing or database dialing for placing calls. To use Telemarketing Dial, you must have:

- Your PC connected to a modem, which is in turn connected to an ASI
- A Call Coverage key for the ASI
- Communications software installed in the PC

After the PC places the call, the supervisory tones provided through the modem help you monitor the progress of the call. When the called party answers, just press the Call Coverage key to converse.

Initial Configuraton

Telemarketing Dial not enabled.

Using the Feature

- To use Telemarketing Dial:
1. From the PC connected to the ASI, use the communication software's Directory Dialing to place the call.
 2. When the called party answers, press the Call Coverage Key for the ASI.
-The call is in the Privacy Release mode (line key flashes fast). To enable privacy for the call, press the line key.

Understanding Related Programming

Refer to the DIGITAL SYSTEM Feature and Terminal Programming Manual.



A single DIGITAL SYSTEM can serve more than one business.

The DIGITAL SYSTEM can be divided up so that more than one tenant (business) can use it. If each tenant requires its own attendant (operator), the DIGITAL SYSTEM can accommodate up to four tenants. Otherwise, the DIGITAL SYSTEM can accommodate any number of tenants.

In addition to having its own attendant, each tenant can have their own:

- Outside lines or line groups
- Internal Page Zones (seven zones are available)

Note: Members of one tenant group can place Intercom calls to members of another tenant group.

Initial Configuration

All extensions in same tenant group (they are all assigned to attendant 300)

Using the Feature

N/A

Understanding Related Programming

For attendant programming, use:

- | | |
|----------------|---|
| Program 3 | To assign the number of attendants/operators (NO. OF OPRS = 01-04 + #) and their extension numbers (OPR nn EXT = Extension number + #). If there are two tenants and each wants its own operator, enter 2 in this program and then enter the desired extension numbers. |
| Program 18 (I) | To assign to an extension its attendant extension from Program 3 (SO + # + Extension number + #). The attendant you assign to an extension is the one that gets called when the extension user dials 0. |

For line and line group programming:

- | | |
|------------|--|
| Program 11 | To make line groups (TRK GRP NO. = 90-98 + # + Enter line number + # [repeat last two steps to add more lines to group]) |
| Program 16 | To assign lines and/or line groups to each extension in a tenant group. Make sure each tenant has access to a different set of lines/groups.
For lines: L + Line 01-16 + # + 01/02 for access or 00 for no access + #
For line groups: G + Line Group number 90-98 + # + Y for access or N for no access + # |
| Program 17 | To assign a line to a key at an extension (LK + Line 0-16 + #) |

Tenant Service

- Program 18 (II)** To assign ringing to lines at an extension (**RA** or **DRA** + # + Press line + Y or N + #).
See also Placing an Outside Call on page 134 and Answering an Outside Call on page 132.

For Paging programming:

- Program 1** To enable/disable the capability of making an All Call Page in a Class of Service (**ALL CALL PAGE** = Y or N + #). Also see Program 18(I). Since all tenant groups would probably not want to hear an All Call Page, you may want to disable this.

To enable/disable the capability of making a Page to Zones 1-3 in a Class of Service (**PAGE ZONE n** = Y or N + #). Also see Program 18(I). You may want to enable zone 1 paging for one tenant and disable it for another. All extensions can page zones 4-7, regardless of programming.

- Program 18 (I)** To assign a Class of Service from Program 1 to an extension (**COS** + # + 01-27 + #)

To assign extensions to Internal Page Zones (**PZ** + # + 01-07 + #). Tenant A's extensions should not be in the same page zones as tenant B's extensions.

See also Paging on page 138.



Quickly see both the time and date in a glance. No need to refer to a separate clock and calendar. And you can reset it, if necessary.

The Time and Date feature shows you the time and date on your phone's display.

The time and date also appear on the following system features:

- Station Message Detail Recording
- Diagnostic/Maintenance Utilities and System Reports
- Traffic Management Report

If your extension has program access level 4-5, you can reset the Time and Date from your phone. If you do, you reset the Time and Date for all of the above mentioned features.

Initial Configuration

Extension 300-305 can set the Time and Date. All other extensions only have access level 01.

Using the Feature

To reset the time and date (TD) when your extension has program access level

4 or 5:

1. Do not lift handset.
2. Press #.
3. Dial TD.
4. Dial month (01-12), press #.
5. Dial date (1-31), press #.
6. Dial last two digits of the year, press #.
7. Dial hour (00-23), press #.
-For example, 14 = 2:00 PM
8. Dial minutes (00-59), press #.
9. Press SAVE.
-You hear a confirmation tone.
-If, for example, you wish to change only the minutes, do steps 1-3, then press the # key until you see, MINUTES =. Dial the new minutes, press #, then press SAVE.

Understanding Related Programming

- Program 15** To assign program access level 4-5 to any extension that should be able to change the Time and Date (**PGM ACC LEVEL = 04 or 05 + #**)

Toll Restriction



Long distance calls can be limited to control the cost of communications.

Toll Restriction limits the types of calls a user may dial from their extension. The system applies Toll Restriction (i.e., limits calls) for a particular extension according to the Toll Restriction level (01-07) assigned to that extension through its Class of Service. Each Toll Restriction level can be customized to enable or disable the following:

- Continuous dialing (for access to special services, such as MCI)
- Special access (N11) dialing (such as 411 Directory Assistance)
- Outside Operator (0 +) dialing
- Direct international dialing
- Equal Access dialing (see page 79)
- 1 + NNX (long distance exchange) dialing
- NXX (local exchange) dialing
- NPA (area code) dialing
- Six-digit (NPA and NNX) dialing. This type of dialing limits a user to dialing only specific exchanges (NNX) within specific area codes (NPA).

When the DIGITAL SYSTEM is installed behind a PBX, the system applies Toll Restriction after the user dials the PBX Access Code.

Toll Restriction does not restrict 911 calls, System Speed Dial calls, or calls made using Direct Line (Trunk) Access. A user can also activate Walking Class of Service to override dialing restrictions (see Walking Class of Service on page 194).

Additional dialing restrictions can be set up in a Class of Service (Only Intercom Calls at Night, Only Local Calls Day or Night, Only Local Calls at Night). These restrictions override any restrictions set up in a Toll Restriction level (01-07).

Note: Beginning with AUX Module software version Y2.0, the system accommodates telephone companies that use exchange (NNX) numbering for Area Codes (NPAs). This option is not available in Base software.

Initial Configuration

No Toll Restriction (all types of calls allowed)

Using the Feature

When a user dials a call that is restricted, the system sends a fast busy tone to the user. If Station Message Detail Recording (SMDR) is installed, the restricted (blocked) call shows up on the SMDR report.

Understanding Related Programming

Program 6 To set up Toll Restriction levels 01-07 (see page 216). Also see Program 1.

- Program 1** To assign a Toll Restriction level from Program 6 to a Class of Service (**TOLL RESTRICT = 01-07 + #**). Also see Program 18 (I).
- To set up the following (additional) dialing restrictions in a Class of Service:
Only Intercom Calls at Night (**ICM NITE ONLY + Y + #**)
Only Local Calls Day or Night (**LOCAL ONLY = Y + #**)
Only Local Calls at Night (**LOCAL NIGHT = Y + #**).
Also see Program 18 (I).
- These restrictions override any restrictions set up in Program 6.
- Program 18 (I)** To assign a Class of Service from Program 1 to an extension (**COS + # + 01-27 + #**)
- Program 12** To assign Toll Restriction to a line (**TR + # + Y + #**). Initially, Toll Restriction is applied to every line at an extension. You would want to leave it that way except for WATS line, for example.
- Program 3** To identify whether the calling area requires a "1" before dialing an area code (NPA) (**1 + NPA REQUIRED = Y or N + #**)
- Program 16** To give an extension outgoing access to lines (**L + Line 01-16 + # + 02 + #**)

Tone Patterns



Identify certain feature conditions by becoming familiar with their corresponding tone patterns.

The DIGITAL SYSTEM provides tones of different durations to indicate certain conditions (see the chart below).

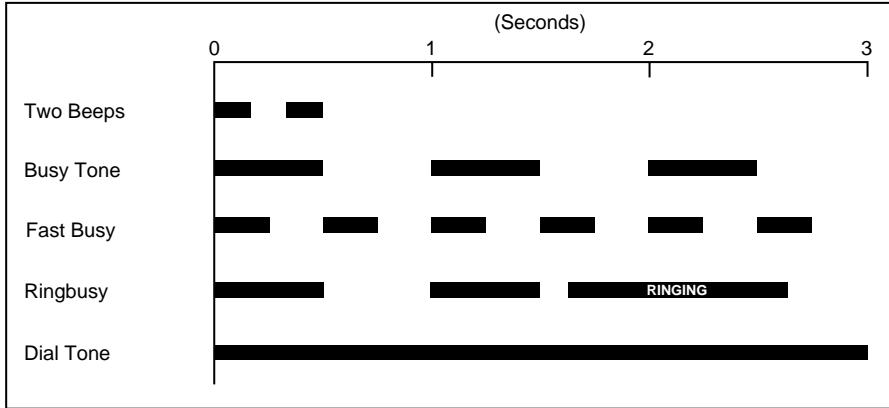

You most commonly hear:

- Two beeps when you make a voice-announced Intercom call to an extension or send Call Waiting signals
- Busy tone when you call a busy extension
- Fast busy tone when you call an extension in Do Not Disturb
- Ring-Busy tone when you call a busy extension that is programmed for Off-Hook Signaling
- Dial tone when you press ICM or a Line key to a make a call

You may also hear some of these tones when you use other features. If so, this guide will tell you in the operating instructions for a feature.

Initial Configuration

As described above

Using the Feature

N/A

Understanding Related Programming

N/A



It's easy to see which lines and extensions are being overused or underused so you can make the appropriate adjustments.

Traffic Management System (TMS) Reporting provides a record of the system's call activity for both Intercom and outside calls. The record can display on a terminal or be sent to a printer. A TMS record shows the call activity for each installed extension, line, line group, and Uniform Call Distribution (UCD) group. For example, the TMS report would show the following call activity data for a line:

- Total number of calls received, answered, and terminated
- Total number of "Long Wait" calls (calls that ring longer than the TMS "Long Wait" time)
- Total number of abandoned calls (where the outside caller hangs up while the call is on Hold, parked or being transferred)
- Total number of outgoing calls
- Total time the line was in use

Traffic Management Reporting requires the AUX Module and a customer-provided ASCII record collection device (e.g., terminal or printer). Traffic Management Reporting options are programmed through a terminal connected to the AUX Module. For more information, see Traffic Management Reporting in the DIGITAL SYSTEM Feature and Terminal Programming Manual.

Initial Configuration

Traffic Management Reporting not available without AUX Module and terminal programming

Using the Feature

N/A

Understanding Related Programming

Program 3 To set the baud rate of the AUX Module's port for terminal programming (**LOCAL BAUD** = 00 [300], 01 [1200], 02 [2400], 03 [4800], 04 [9600] or 05 [19.2K] + #)

Transfer



Quickly send a call to another extension when your caller needs to talk to someone else in your company.

Transfer lets you send your outside call to another extension. You can Transfer any outside line to another extension, even if that extension does not have access to the line. And you can Transfer calls to busy extensions. The transferred call Camps-On (waits) at the busy extension and sends two beep tones to the busy user (if your system is programmed for Call Waiting tones).

You can Transfer a call in two ways. You can:

- Announce (screen) the Transfer before actually completing the Transfer
- Transfer the call directly, without announcing (screening) it

A transferred caller may hear Music on Hold (if available).

If the extension receiving the Transfer does not pick up (answer) the Transfer, it recalls your extension. If you do not answer the recall, the call rings at all extensions that are programmed for ringing on that line.

Initial Configuration

- Transfer always allowed
- Transfers to busy extension and sends the busy extension Call Waiting beeps
- Transfers will ring busy ASIs for 60 seconds and other extensions for 3 rings before recalling the transferer
- Transfers will recall for 3 rings before ringing other extensions
- Transferred callers do not hear Music on Hold

Using the Feature

To Transfer your outside call:

You can also use a Hotline key (page 101), Call Coverage key (page 169), or DSS key (see page 69).

1. Press ICM.

OR

If you have an ESL set, press TRF.

-ICM lights, you hear dial tone. Your call goes on Exclusive Hold under the HOLD key.

2. Dial extension number.

-You see the Line key for the call. If you hear busy tone, hang up to have the call Camp-On.

3. Announce the call:

If you hear beeps, you can speak right away. If the person does not want the Transfer, press the key for the call.

OR

If you hear ringing, wait for an answer, then speak.

-To Transfer the call unannounced, skip step 3.

4. Hang up.

-Your Transfer goes through.

- To receive a Transfer: The Line key for the transferred line flashes. If you do not have a Line key for the transferred line, your Loop key flashes.
1. Lift handset.
 2. If not connected, press flashing Line/Loop key.

Understanding Related Programming

- Program 2** To enable/disable Call Waiting tones system-wide (**CALL WAIT TONE = Y** or **N + #**). If enabled, Transfers to busy extensions send the tones to the busy user.
- Program 3** To enable/disable Music On Hold for transferred calls (**PLAY MOH TRANS = Y** or **N + #**)
- Program 4** To set Rings Before Recall timer (Timer **06 + # + Duration + #**). This is the number of times a Transfer rings an idle or busy Multibutton or an idle ESL/ASI before recalling; and, the number of times a Transfer recall rings before ringing all extensions that are programmed for ringing on that line.
- To set the Camp-On timer (Timer **03 + # + Duration + #**). This is how long a call Camps-On to a busy ESL/ASI before recalling.
- Program 16** To give an extension access to a line (**L + Line 01-16 + # + 01** or **02 + #**)
- Program 17** To assign a line to a key at an extension (**LK + Line 01-16 + #**)
- To assign a Loop key to an extension.
 For Loop Switch: **LS + #**
 For Loop Group: **LG + Group (00-08 for groups 90-98) + #**
- Program 18 (II)** To assign ringing to a line at any extension that should ring during Transfer recall (**RA** or **DRA + # + Line key + Y** or **N + #**). Transfers themselves always ring the destination extension.

Unsupervised Conference (Tandem Calls)



You can, as a dispatcher: Answer a call from a salesman who is on the road, then connect his call to a salesman in another state. No need for the first salesman to hang up and call the other salesman.

Tandem Calls let you set up a Conference with two outside parties, then drop out of the conversation leaving the two outside parties connected.

Initial Configuration

Tandem Calls disabled

Tandem Calls can be enabled only through terminal programming, which requires the AUX Module. To enable Tandem Calls, see Tandem Trunking in the DIGITAL SYSTEM Feature and Terminal Programming Manual.

Note: To use Tandem Calls, the DIGITAL SYSTEM must be equipped with a Line module that provides disconnect supervision. In addition, the connected CO line must also provide disconnect supervision.

Using the Feature

N/A

Understanding Related Programming

Program 3 To set the baud rate of the AUX Module's port for terminal programming (**LOCAL BAUD** = 00 [300], 01 [1200], 02 [2400], 03 [4800], 04 [9600] or 05 [19.2K] + #)



Send and receive recorded messages. No need to carry a hand-written note to someone's desk. Also, have the Automated Attendant automatically answer your company's outside calls.

Your DIGITAL SYSTEM is compatible with Integrated Voice Messaging, which provides Automated Attendant and Voice Mail.

The Automated Attendant answers your company's incoming calls. An outside caller hears a recording which explains their dialing options. The caller can then dial an extension or the code for Voice Mail.

Voice Mail lets an outside caller leave a recorded message in your voice "mailbox", and it lets you leave one in a co-worker's mailbox. More specifically, Voice Mail enhances the DIGITAL SYSTEM with the following features:

Call Forward to Voice Mail (Mailbox Call Forward)

Lets you send your incoming calls to Voice Mail. Voice Mail answers the call and lets the caller leave a message.

Mailbox Message Waiting (Leaving a Voice Message)

Lets you call a busy, no-answer, DND extension, then press a key to leave a recorded message in that person's mailbox.

Message View

Lets you view the number of voice messages you have, if you have a Display Phone.

Transfer to Voice Mail (Mailbox Transfer)

Lets you Transfer a call to your own mailbox or to a co-worker's mailbox.

Conversation Record

Lets you record a phone conversation, if your phone has a Record key. The conversation gets stored in your mailbox as if it were a message.

Personal Answering Machine Emulation

(Only available on software versions AUX Module Y2.1/Base Y5.1 or higher)

Lets you screen calls to your mailbox, just like a personal answering machine. When your mailbox answers, you hear two alert tones and your caller's incoming message. You can lift the handset to intercept the message or let it go through. (If you don't want to hear the incoming message, just press HF after it begins. It will go to your mailbox anyway.) This option applies to all calls that ring your extension directly (not Call Coverage, Group Call Pickup and Group Ring calls). Personal Answering Machine Emulation can answer all calls or just trunk calls.

If Voice Mail is installed, the DIGITAL SYSTEM's Message Waiting feature is not available.

Initial Configuration

Voice Mail not installed

Voice Mail/Automated Attendant

Using the Feature

For more specifics, see the documentation for your Integrated Voice Messaging system.

To call your mailbox (from your multibutton phone):

1. Lift handset.
2. Press MSG.
3. Wait for the voice prompt.
4. Dial your security code.
 - You can store your security code in a One-Touch Speed Dial key.*

To call your mailbox (from your ESL set):

1. Lift handset.
2. Dial voice mail master number.
3. Wait for the voice prompt.
4. Dial # and your mailbox number.
5. Wait for the voice prompt.
6. Dial your security code.

To activate Call Forwarding to Voice Mail:

1. Lift handset.
2. Press ICM (except at an ESL set).
3. Dial #.
4. Press MSG key or dial Voice Mail master extension number.
5. Dial Call Forward code (1,2,3,4).
 - Code 1 forwards ring-no-answer calls*
 - Code 2 forwards ring-no-answer and busy calls*
 - Code 3 forwards all calls*
 - Code 4 activates Personal Answering Machine Emulation*
6. Hang up.
 - MSG key flashes.*

To cancel Call Forwarding to Voice Mail:

1. Lift handset.
2. Press ICM (except at an ESL set).
 - You hear dial tone.*
3. Dial #.
 - Dial tone stops.*
4. Hang up.
 - MSG key goes out.*

To Transfer a call to a co-worker's mailbox (multibutton phone only):

1. Press ICM.
 - Your call goes on Exclusive Hold.*
2. Press MSG.
3. Dial co-worker's extension.
 - With AUX Module software version 02.10 and higher, you can Transfer to any destination within the system's number plan (000-999).*
4. Hang up.

To record a conversation
(if your multibutton phone
has a record key):

1. Press Record key to start and stop recording.

To view how many voice
messages you have (if
you have a display
phone):

- MSG flashes fast when you have messages in your mailbox.
1. Do not lift handset.
 2. Press MSG.

Understanding Related Programming

Voice Mail requires Analog Station Interfaces (see page 31).

Note: Use the programs below in the order they are listed.

- Program 14** To assign an ASI circuit type (**CIRCUIT TYPE** = 51) to each extension port intended for Voice Mail
- Program 18 (I)** To assign the Voice Mail feature to each Voice Mail extension port selected in Program 14 (**VX + # + Y + #**)
- Program 19** To set up a UCD Hunt Group as follows:
- Hunt Type = 05 (**HUNT TYPE** = 05 + #)
 - Master Extension = Voice Mail master extension that you selected in Program 3 (**MASTER EXT** = Master extension + #)
 - Overflow Extension = Operator Extension that you assigned to the Voice Mail master extension in Program 18 (I) (**UCD OVERFLOW** = Master extension + #)
 - UCD Members = Voice Mail extensions you selected in Program 18 (**UCD MEMBER** + Extension number + # [repeat last two steps to add more members])
- Program 3** To indicate that a Voice Mail system is installed (**VOICE MAIL** = Y + #). Also, select a master extension number for Voice Mail (**VX MSTR EXT** = Extension number + #). Use any of the Voice Mail extensions selected in Program 14.
- Program 12** To directly terminate each line that the Automated Attendant should answer to the Voice Mail master extension you selected in Program 3 (**DTD** or **DTN** + # + Voice mail master extension + #)
- Program 17** To assign a Record key to an extension (**RK** + #)
- Program 16** To assign to each Voice Mail port (selected in Program 14) outgoing access to the lines used by the VX Message Notification and Message Reminder features (**L** + Line number 01-16 + # + 01 or 02 + #)

Voice Mail/Automated Attendant

To enable the Mailbox Message Waiting feature for an extension, also use:

Program 19 To form a Terminal Hunt Group with the following members: the extension that should have the Mailbox Message Waiting feature and the Voice Mail master extension (in that order).

HUNT TYPE = 01, 02 or 03 + #

HUNT STN = Extension number + # (repeat last two steps to add more members)

Turn to page 272 for more information on programming a Terminal Hunt Group.

For Personal Answering Machine Emulation, also use:

Program 1 To assign a Class of Service that enables Personal Answering Machine Emulation for all calls (**SINGLE RING** = N) or just outside calls (**SINGLE RING** = Y). This only applies to software versions AUX Module Y2.1/Base Y5.1 or higher.

Add digital voice recording and playback to your system — along with the standard DIGITAL SYSTEM Voice Prompting Messages.

The Voice Module Unit (P/N 88522) requires an AUX Module with software version 02.10 or higher. The Voice Module Unit is not available with Base software.

The Voice Module Unit (P/N 88522) is a 12 Station Module enhanced with three channels of digital recording and playback capability. When added to your system, the VMU provides the following important new features:

- ACD Announcements
- Operator Assistance (OPA)
- Personal Greeting
- Voice Prompting Messages

In addition to playing back the standard DIGITAL SYSTEM Voice Prompting Messages, the VMU can also store additional system and user messages. The VMU provides up to 63 seconds of system message storage and 4 minutes and 15 seconds of user storage. The system messages are those recorded for Operator Assistance and ACD/UCD purposes. The user messages are the Personal Greetings (which can be up to 16 seconds long). The system messages are battery backed-up and are retained for about two weeks without system power. The user messages are dynamic and are lost when power fails or the system resets.

Note:

- You must install the VMU only as the inside station module in the main CEU. ***Do not install the VMU in any other cabinet or any other position.*** The VMU is operational about 20 seconds after system power-up, reset or initialization of the VMU messages.
- Before using the VMU for the first time, you must initialize the VMU messages.

Initial Configuration

VMU is fully functional after it is installed and initialized. See *Using the Feature* below for initialization instructions.

Using the Feature

To initialize the VMU messages:

Before using the VMU for the first time, you must initialize the VMU messages.

-Initializing erases all the existing VMU messages, if any.

1. Lift handset.
2. Press ICM.
3. Press #.
4. Dial 68.
5. Press #.
6. Dial 9.

-If you change your mind, dial 6 to cancel this procedure.

Voice Module Unit

Understanding Related Programming

N/A

 **Voice Prompting Messages tell you the status of your call, remind you when you activate certain features, and even announce the time and your own extension number.**

Voice Prompting Messages require a Voice Module Unit (P/N 88522) and an AUX Module with software version 02.10 or higher. Voice Prompting Messages are not available with Base software.

The system plays Voice Prompting Messages to inform a user of the status of their call. Voice Prompting Messages help a user as the call progresses. In addition, Voice Prompting Messages remind users when they have activated certain features (such as Call Forwarding). The chart below shows the Voice Prompting Messages.

Voice Prompting Messages	
This message...	Occurs when user...
<i>All lines are busy. For automatic Callback please press the Callback key.</i>	Tries to place a call when all lines in the rotary are busy.
<i>Audio file is full.</i>	Tries to record a Personal Greeting and no VMU Module memory is available.
<i>Please do not disturb.</i>	Calls an extension in DND.
<i>Please hold on. All lines are busy. Your call will be answered when a line becomes free.</i>	Calls a busy UCD or ACD group.
<i>Please hold on, your call is being rerouted.</i>	Calls an extension that is Call Forwarded off-premise.
<i>Please start recording <beep>.</i>	Starts to record a Personal Greeting, OPA announcement, etc.
<i><beep> Recording finished.</i>	Exceeds time allotted for recording a Personal Greeting, OPA announcement, etc. Also occurs if user pauses too long while recording.
<i>The lowest cost line is busy. Please wait for the next one.</i>	Places a call using ARS when all trunks in the preferred service are busy.
<i>The number you have dialed is not in service.</i>	Calls a valid, but inoperative extension.
<i>The time is...</i>	Dials 8 on an idle extension.
<i>This is station...</i>	Dials 6 on an idle extension.
<i>You have a message.</i>	Has a Message Waiting (voice or Voice Messaging System).
<i>Your call cannot go through. Please call the operator.</i>	Tries to place a Toll Restricted call.

Voice Prompting Messages

Voice Prompting Messages	
This message...	Occurs when user...
<i>Your calls have been forwarded.</i>	Has forwarded calls. Message periodically reminds user that calls are forwarded.
<i>Vacant number.</i>	Calls an invalid (not installed) extension.

Initial Configuration

Voice Prompting Messages occur as indicated in the chart above when the VMU Module is installed and initialized.

Using the Feature

N/A

Understanding Related Programming

Refer to the DIGITAL SYSTEM Feature and Terminal Programming Manual.



Adjust the volume of calls and certain features. Handy when it's especially noisy in the office.

You can use the VOL UP and VOL DN keys to raise or lower the volume of the following:

- Background Music (adjusting this volume also changes the volume of incoming ringing and paged announcements)
- Voice levels over the handset
- Voice levels over the speaker (i.e., Handsfree volume)

You can also use VOL UP and VOL DN to control the brightness of your display.

When you adjust the volume for Background Music or voice levels on Intercom calls, the volume remains where you set it until you change it again.

When you adjust the volume for voice levels on outside calls, the volume remains where you set it only for the duration of the call. The volume returns to a pre-set (usually mid-range) value for the next outside call.

Note: Beginning with AUX Module software Y2.0, the system can optionally retain the user-set volume for trunk calls. This option is not available with Base software.

Initial Configuration

Mid-range volume

Using the Feature

To adjust the volume of Background Music, incoming ringing, paged announcements, and the brightness of your display:

1. Press VOL UP or VOL DN while the feature is active or while the phone is idle.

To adjust the volume for handset or Handsfree voice levels:

1. Press VOL UP or VOL DN while on a call.

Understanding Related Programming

- Program 10** To set the volume (gain) for a line (**LINE GAIN** = 01-05 + #). This is the "preset" volume a line takes on after the user hangs up a call on that line.

Walking Class of Service



Make any type of outside call from any phone in the system, regardless of the phone's dialing restrictions. No need to find an "unrestricted" phone when you need to make a special call.

Walking Class of Service lets you temporarily override an extension's dialing restrictions by dialing a security code at that extension. Dialing the code overrides the restrictions set up in Class of Service (Program 1).

For example, if an extension's Class of Service restricts long distance calls, dialing the security code at that extension removes those restrictions and all others. In other words, once you dial the security code, you can place any type of call on that extension's outgoing lines. When you hang up, the extension's normal dialing restrictions are automatically reinstated, though you can redial the call you just made without using the security code. You can redial it using Last Number Redial or Save.

Initial Configuration

Walking Class of Service disabled (no security code is programmed)

Using the Feature

To use Walking Class of Service to place an outside call:

1. Lift handset.
2. Press ICM (except at an ESL set).
-ICM lights and you hear dial tone.
3. Dial # twice.
-Dial tone stops.
4. Dial Walking Class of Service security code.
-ICM goes out and you hear Intercom dial tone again.
5. Dial an access code or press a Line key for an outgoing line at that extension.
-Codes 801-816 for lines 1-16 (if Line Dial-Up is allowed)
-Codes 348-363 for lines 1-16 (if Direct Line (Trunk) Access is allowed)
-Codes 90-98 for Line Groups (if line group access is allowed)
6. Dial your call.
-After you dial the call, you can redial it using Last Number Redial. You can also store the number at that phone using Save, then redial it later using Save.

Understanding Related Programming

- Program 3 To define a Walking Class of Service security code (SECURITY + Up to eight digits + #)

Part II

DIGITAL SYSTEM Programs

- For your notes -



Program 1 is initially set as follows for each COS:

- Only Intercom Calls at Night = N
- Off-Premise Call Forward = N
- Break-In (Intrusion) = Y for COS 00; N for COS 01-27
- Camp-On (Busy Extension) = Y
- Internal Call Forwarding = Y
- System Speed Dial Access = Y
- Toll Restriction Level = 00 (not restricted)
- Only Local Calls (Day or Night) = N
- Only Local Calls at Night = N
- Extended Ring = N
- Privacy = N
- Callback (Line Queuing) Priority = N
- Direct Trunk Access and Camp-On to Busy Line = Y for COS 00; N for COS 01-27
- Initiate All Call Page = Y
- Access Page Zones 1-3 = Y
- Silent Monitor = N
- No Flash for Single Line *or*
ACD Supervisor = N (i.e., Flash allowed and ACD Supervisor not allowed)
- Single Ring for ASI Calls *or*
Only CO Call Forwarding to Voice Mail (software version AUX Module Y2.1/Base Y5.1 or higher) = N

Program 1 lets you customize a Class of Service (COS). You do this by enabling or disabling each of its feature options (see below). After you customize a COS, you use Program 18 (I) to assign it to an extension so the extension has access to (or cannot access) the COS's features.

You can customize up to 28 COSs (00-27), and you can assign the same COS to more than one extension. COS 30 is a special COS reserved for the attendant. The system automatically assigns COS 30 to any extension you designate as an operator in Program 3. You customize COS 30 by customizing COS 00.

Below are the COSs feature and dialing options:

Only Intercom Calls at Night

Use this option to determine whether an extension can place only Intercom Calls during the Night Answer mode. If you enter "Y," the extension cannot place outside calls (or use Flash) when its attendant (assigned in Program 18 [I]) goes into the Night Answer Mode. This holds true even if the extension's COS has a Toll Restriction Level (see next page) that allows outside calls.

FOR FEATURE INFORMATION: See Night Answer on page 121.

Off-Premise Call Forward

Use this option to allow/deny Off-Premise Call Forwarding.

FOR FEATURE INFORMATION: See Call Forwarding, Off-Premise on page 46.

Break-In (Intrusion)

Use this option to allow/deny Intrusion (Barge-In). Extensions programmed for Intrusion cannot intrude upon extensions programmed for Privacy (see below).

FOR FEATURE INFORMATION: See Intrusion (Barge-In) on page 106.

Camp-On to Busy Extension

Use this option to allow/deny Camp-On to a busy extension.

FOR FEATURE INFORMATION: See Call Waiting (Camp-On) on page 55.

Internal Call Forwarding

Use this option to allow/deny Internal Call Forwarding. Allowing Internal Call Forwarding for COS 00 lets the attendant activate Alternate Attendant.

FOR FEATURE INFORMATION: See Call Forwarding on page 44, and Alternate Attendant on page 30.

System Speed Dial Access

Use this option to determine whether an extension can call System Speed Dial numbers.

FOR FEATURE INFORMATION: See Speed Dial on page 162.

Toll Restriction Level

Use this option to assign a Toll Restriction Level (00-07) to an extension.

FOR FEATURE INFORMATION: See Toll Restriction on page 178.

Only Local Calls (Day or Night)

Use this option to determine whether an extension can place only local and Intercom calls (during Day or Night Answer mode). If you enter a "Y," the extension can place the following types of outside calls:

- 7-digit calls
- 1 + 911 and 911 calls
- 1 + 800 + NNX + nnn calls

The extension will not be able to place toll (1 + NNX) or long distance calls to other area codes even if the extension's COS has a Toll Restriction Level (see above) that normally allows them.

FOR FEATURE INFORMATION: N/A

Only Local Calls at Night

Use this option to determine whether an extension can place only local and Intercom calls during the Night Answer mode. If you enter a Y, the extension can place the following outside calls when its attendant (assigned in Program 18 [I]) goes into the Night Answer mode:

- 7-digit calls
- 1 + 911 and 911 calls
- 1 + 800 + NNX + nnn calls

The extension will not be able to place toll (1 + NNX) or long distance calls to other area codes even if the extension's COS has a Toll Restriction Level (see above) that normally allows them.

FOR FEATURE INFORMATION: N/A

Extended Ring

Use this option to enable/disable Extended Ringing.

FOR FEATURE INFORMATION: See Extended Ringing on page 80.

Privacy

Use this option to enable/disable Privacy.

FOR FEATURE INFORMATION: See Privacy on page 148.

Callback (Line Queuing) Priority

Use this option to determine whether an extension has priority status when there are several Line Queuing requests in the system. If you enter "Y," the priority extension receives a Callback before any non-priority extensions. If a few priority extensions make a Line Queuing request, the one that makes it first gets called back first, and so on.

FOR FEATURE INFORMATION: See Line Queuing on page 108.

Direct Trunk Access and Camp-On to Busy Line

Use this option to determine whether an extension can use Direct Line (Trunk) Access and Camp-On for a busy line.

FOR FEATURE INFORMATION: See Placing an Outside Call (Using Direct Line [Trunk] Access) on page 134 and Camp-On on page 55.

Initiate All Call Page

Use this option to determine whether an extension can make All Call Pages. See also Access to Page Zones 1-3 below.

FOR FEATURE INFORMATION: See Paging on page 138.

Access Page Zones 1-3

Use this option to determine whether an extension can make pages to Internal Zones 1-3. All extensions can always access Internal Zones 4-7. Also see Initiate All Call Page above.

FOR FEATURE INFORMATION: See Paging on page 138.

Silent Monitor

Use this option to allow/deny Silent Monitor. Silent Monitor cannot break into a call at an extension programmed for Privacy (see above).

FOR FEATURE INFORMATION: See Silent Monitor on page 161.

No Flash for Single Line and ACD Supervisor = Y

For ESL sets, use this option to determine whether the ESL extension can use the Flash feature. For ACD Supervisor keysets, use this option to indicate that the extension is an ACD supervisor.

Note: Entering "Y" for No Flash for Single Line means the system does not support Flash for Single Line phones, while entering "N" means it does.

FOR FEATURE INFORMATION: See Flash on page 85 and Automatic Call Distribution on page 36.

Single Ring for ASI Calls or Only CO Calls Call Forward to Voice Mail

Use this option to enable/disable a Single Ring for calls into an Analog Station Interface (ASI). If you enable Single Ring, outside calls, Intercom calls, and Callbacks ring with a single ring repeated (i.e., they follow the typical Intercom ring pattern).

For software versions AUX Module Y2.1/Base Y5.1 or higher, also use this option to control the types of calls Voice Mail Personal Answering Machine Emulation answers. If enabled (Y), Personal Answering Machine Emulation answers only outside calls. Intercom calls to the extension go through normally. If disabled (N), Personal Answering Machine Emulation answers all calls (Intercom and outside).

FOR FEATURE INFORMATION: See Ringing Patterns on page 156, Analog Station Interface on page 31 and Voice Mail (Personal Answering Machine Emulation) on page 185.

Filling Out the Program Record Form

1. Select a COS (00-27).
2. Enter data from the following chart.

In this box . . .	Enter this data . . .
A feature's data box	Y to enable the feature N to disable the feature
Toll Restriction Level	Enter 00 - Not restricted 01-07 (Toll Levels 01-07)

Example

COS 03 has Internal Call Forwarding disabled (only this option will be shown).

COS	Only Intercom Calls at Night	Off-Premise Call Forward	Break-In (Intrusion)	Camp-On (Busy Extension)	Internal Call Forward	System Speed Dial	Toll Restriction Level	Only Local Calls	Only Local Calls (Day/Night)	Extended Ring	Privacy	Callback Priority	Direct Trunk Access	Page Zone 1 Access	Page Zone 2 Access	Page Zone 3 Access	Silent Monitor	No Single Line Flash/ACD Supervisor	Single Ring for ASI/OPX	Only CO Call FWD to VX
03					N															

0185311 (D)

Entering Data Into Memory

- To enter Program 1 data:
1. Enter program mode.
-Press # + dial SP + dial 5312 + press #.
 2. Press key 1 to enter Program 1.
 3. Dial COS No., press #.
 4. To accept the displayed data: Press #.
OR
To change or enter data: Dial data, press #.
*-To erase data before pressing #: Dial *.*
 5. Repeat step 4 for all data.
-If you finish and do not see "COS. NO.": Press SAVE before step 6.
 6. Select an option:
To program another COS: Go to step 3.
OR
To exit Program 1: Press SAVE once.
OR
To exit the program mode: Press SAVE twice.
-To enter another program after exiting: Press its key.

Understanding Related Programming**After customizing a Class of Service, use:**

Program 18 (I) To assign a COS to one or more extensions

For Camp-On to a busy extension:

Program 2 To enable (Camp-On) Call Waiting tones system-wide

For Toll Restriction:

Program 6 To set up different types of Toll Restrictions

For Internal Page Zones:

Program 18 (I) To assign extensions to internal zones

For the ACD Supervisor:

Program 19 To set up ACD Groups



Program 2 is initially set as follows:

- Call Waiting (Camp-On) Tones = Y
- Handsfree Reply on Intercom Calls = Y
- Voice-Announced Intercom Calls = Y
- Automatic Handsfree = Y

Program 2 lets you enable or disable the following options for all extensions in the system:

Call Waiting (Camp-On) Tones

Use this option to enable/disable Call Waiting Tones (double-beeps).

If you assign Off-Hook Ringing to a particular extension (Program 18 [I]), the system converts its Call Waiting tones into Off-Hook Ringing.

FOR FEATURE INFORMATION: See Call Waiting (Camp-On) on page 55.

Handsfree Reply on Intercom Calls

Use this option to enable/disable Handsfree Reply for voice-announced Intercom calls. Enabling this option has no affect on the system unless you enable voice-announced Intercom calls for the system (see the option below).

FOR FEATURE INFORMATION: See Intercom on page 103.

Voice-Announced Intercom Calls

Use this option to enable/disable voice-announced Intercom calls. If you disable them, the extensions can only receive ringing Intercom calls.

Note: Attendants, extensions in the Headset mode, and ASI ports do not receive voice-announced calls even if you enable them in this program.

FOR FEATURE INFORMATION: See Intercom calls page 103.

Automatic Handsfree

Use this option to enable/disable Automatic Handsfree.

FOR FEATURE INFORMATION: See Automatic Handsfree on page 94.

Filling Out the Program Record Form

In this box . . .	Enter this data . . .
A feature's data box	Y to enable the feature N to disable the feature

Example

Voice-Announced Intercom calls are disabled.

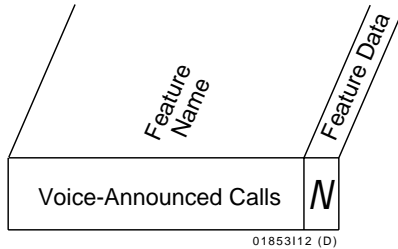

Entering Data Into Memory

- To enter Program 2 data:
1. Enter program mode.
-Press # + dial SP + dial 5312 + press #.
 2. Press key 2 to enter Program 2.
 3. To accept the displayed data: Press #.
OR
To change or enter data: Dial data, press #.
*-To erase data before pressing #: Dial *.*
 4. Repeat step 3 for all data.
*-If you finish and do not see, "SAVE TO EXIT":
Press SAVE before step 5.*
 5. Select an option:
To enter another program: Press its key.
OR
To exit the program mode: Press SAVE once.

Understanding Related Programming

For Call Waiting Tones:

- Program 1 To allow/deny an extension the capability of sending Waiting Tones in a Class of Service (see also Program 18 [I])

- To enable/disable Privacy for an extension in a Class of Service (see also Program 18 [I]). If enabled, an extension does not receive Call Waiting tones.
- Program 18 (I)** To assign a Class of Service (from Program 1) to an extension
- To have an extension hear the Call Waiting tones as Off-Hook Ringing instead of a double beep
- Program 4** To set the Rings Before Recall timer (how long a call waits at a busy extension before recalling the extension that sent the Call Waiting tones)

For Voice-Announced Intercom calls (when they are programmed system-wide):

- Program 18 (II)** To enable/disable incoming voice-announced calls at an extension
- Program 15** To assign a program access level 3-5 to extensions so they can enable/disable incoming voice-announced Intercom calls themselves



Program 3 is initially set as follows:

- Number of Operators = 01
- Operator Extension = 300 for Operator 01
- Number of Digits in a System Speed Dial Code = 03 (the codes are 700-799)
- Side Tone Test Digit = 2
- Voice Mail Installed = N
- Voice Mail Master Extension Number = 300 (none assigned)
- Enable Dial-out of # in a Speed Dial Number = N
- Dial 1 Before Area Code (NPA) Calls = Y
- Walking Class of Service Security Code = None
- Play MOH for Transferred Calls = N
- Baud Rate of Auxiliary Module's Port = 300

Program 3 lets you set the following options for the system:

Number of Operators

Use this option to determine the number of operators (attendants) in the system. The system can accommodate up to four operators. If you ever decrease the number of operators in the system (i.e. you remove an operator), you must change the Class of Service of the old operator extension to 01-27. Otherwise, it still behaves as an operator extension. Also see Operator Extension below.

FOR FEATURE INFORMATION: See Multiple Attendants on page 118.

Operator Extension

Use this option to assign the operator (attendant) extensions (300-347). The main operator (01) should be 300. Also see Number of Operators above.

FOR FEATURE INFORMATION: See Multiple Attendants on page 118.

Number of Digits in a System Speed Dial Code

Use this option to select the number of digits in a System Speed Dial code (bin). The bins can have two or three digits.

If you select two-digit bins, the system uses bin numbers 70-79 to store up to 10 System Speed Dial numbers.

If you select three-digit bins, the system uses bin numbers 700-799 to store up to 100 System Speed Dial numbers.

FOR FEATURE INFORMATION: See Speed Dial on page 162.

Side Tone Test Digit

Use this option to select the side tone test digit (0-9). This is the digit that the system dials out on a line to adjust the transmission characteristics (side tone) of that line. The system tests all installed lines upon power-up or when you request a side tone test through Program 10. Be sure that the digit you select does not access an operator, trunk, or feature.

FOR FEATURE INFORMATION: N/A

Voice Mail Installed

Use this option to indicate whether or not a Voice Mail system is installed.

Note: Use the VX programs in the following order: 14, 18 (I), 3, 19, 12, 17, 16.

FOR FEATURE INFORMATION: See Voice Mail on page 185.

Voice Mail Master Extension Number

Use this option to select the master extension number (301-347) for Voice Mail (VX).

Note: Use the VX programs in the following order: 14, 18 (I), 3, 19, 12, 17, 16.

FOR FEATURE INFORMATION: See Voice Mail on page 185.

Enable Dial-out of # in a Speed Dial Number

Use this option to determine whether the DIGITAL SYSTEM can dial out a "#" character stored in a Speed Dial bin. You may have to disallow dial-out when the DIGITAL SYSTEM is installed behind a PBX that uses "#" to access certain features.

FOR FEATURE INFORMATION: See Speed Dial on page 162.

Dial 1 Before Area Code (NPA) Calls

Use this option to specify whether the system is in an area that requires the user to dial 1 before an area code.

FOR FEATURE INFORMATION: See Dialing (Toll) Restrictions on page 178.

Walking Class of Service Security Code

Use this option to define a Walking Class of Service Security Code (up to 8 digits).

FOR FEATURE INFORMATION: See Walking Class of Service on page 194.

Play MOH for Transferred calls

Use this option to enable/disable Music On Hold for transferred calls.

FOR FEATURE INFORMATION: See Music on Hold on page 120.

Baud Rate of Auxiliary Module's Port

Use this option to select the baud rate for the communications port on the AUX Module. Do this if you want to program the DIGITAL SYSTEM from a terminal connected to the AUX port. For more information, see the DIGITAL SYSTEM Feature and Terminal Programming Manual.

FOR FEATURE INFORMATION: N/A

Filling Out the Program Record Form

In this box . . .	Enter this data . . .
# Operators	00-04
Operator XX Extension	300-347
# System Speed Dial Digits	02-03
Side Tone Test Digit	0-9
Voice Mail	Y - installed N - not installed
Voice Mail Master Ext	300 - none assigned 301-347 (extensions 301-347)
Dial-out "#" in Speed Dial	Y - enable dial-out N - disable dial-out
Dial 1 Before Area Code	Y - 1 is required N - 1 is not required
Walking COS Security Code	Up to eight digits
Play MOH on Transfer	Y - enable N - disable
AUX Port's Baud Rate	00 - 300 baud 01 - 1200 baud 02 - 2400 baud 03 - 4800 baud 04 - 9600 baud 05 - 19.2 K baud

Example

There are two digits in a Speed Dial bin.



01853111 (D)

Entering Data Into Memory

- To enter Program 3 data:
1. Enter program mode.
-Press # + dial SP + dial 5312 + press #.
 2. Press key 3 to enter Program 3.
 3. To accept the displayed data: Press #.
OR
To change or enter data: Dial data, press #.
-To erase data before pressing #: Dial *.
 4. Repeat step 3 for all data.
-If you finish and do not see, "SAVE TO EXIT":
Press SAVE before step 5.
 5. Select an option:
To select another program: Press its key.
OR
To exit the program mode: Press SAVE once.

Understanding Related Programming

For attendant (operator):

Program 1 To customize the attendant Class of Service 00

To manually assign the proper Class of Service (COS) to an extension when you change it from an attendant phone to a non-attendant phone. Non-attendant phones use COS 01-27.

For Side Tone Test Digit:

Program 10 To activate Side Tone test

For Voice Mail (VX):

Program 14 To assign an ASI circuit type (51) to each extension port intended for VX

Program 18 (I) To assign the VX feature to each VX extension, selected in Program 14

Program 19 To set up a UCD Hunt Group with the following characteristics:

- (a) Hunt Type = 05
- (b) Master Extension = VX master extension selected in Program 3
- (c) Overflow Extension = Operator extension assigned to the VX master extension in Program 18 (I)
- (d) UCD Members = VX extensions selected in Program 18

Program 12 To directly terminate each line the Automated Attendant should answer to the VX master extension selected in Program 3

Program 17 To assign a Record key to an extension for recording conversations

Program 16 To assign to each Voice Mail extension (selected in Program 18) outgoing access to the lines used by the VX's Message Notification and Message Reminder features

For Dial 1 + Area Code:

Program 6 To set up Toll Restrictions



Program 4 is initially set as follows for timers 01-12:

- (01) Park Orbit = 60s
- (02) Hold Recall = 60s
- (03) Camp-On = 60s
- (04) Line Response = 1.5s
- (05) Modem Reserve = 30s
- (06) Number of Rings Before Recall = 5
- (07) Number of Delayed Rings= 3
- (08) Flash Response = .7s
- (09) Dial Tone Detect = 10s
- (10) Make = 40ms
- (11) Break = 60ms
- (12) Interdigit = 640ms

Program 4 lets you set the duration of the following system timers:

(01) Park Orbit

Use this timer to determine how long (00-970 seconds) a call stays in a System Park Orbit (60-67) before it recalls the extension that parked it. Park Orbits 68 and 69 are permanently set at 5 minutes (300 seconds) each.

FOR FEATURE INFORMATION: See Park on page 141.

(02) Hold Recall

Use this timer to determine how long (00-970 seconds) a call stays on Hold before it recalls the extension that placed it on Hold.

FOR FEATURE INFORMATION: See Regular Hold on page 99, Exclusive Hold on page 98, and Automatic Hold on page 97.

(03) Camp-On

Use this timer to determine how long (00-970 seconds) a transferred call or Direct Inward Line Camps-On to a:

- Busy UCD Hunt Group before it rings the overflow extension
- Busy ESL/ASI before it recalls the transferer

FOR FEATURE INFORMATION: See Extension Hunting on page 81, Transfer on page 182, Direct Inward Line on page 64.

(04) Line Response

Use this timer to determine how long (.5-9.9 seconds) the system waits before assuming that a seized outgoing line is defective (i.e., defective = the system does not detect loop current from the telco). The time you select must be compatible with your local telco.

(05) Modem Reserve

Use this timer to determine how long (0-970 seconds) the system reserves a modem (for a user) from the modem pool before returning it to the pool.

FOR FEATURE INFORMATION: See Data on page 61.

(06) Number of Rings Before Recall

Use this timer to set the number of times (03-15):

- A recalling held outside call rings the extension that placed it on Hold before it changes to "key ring" and rings all extensions programmed for ringing on that line
- A transferred call rings an idle or busy Multibutton or an idle ESL/ASI before recalling the transferring extension
- A recalling Transfer rings the transferring extension before it changes to "key ring" and rings all extensions programmed for ringing on that line
- A call rings a Hunt Group extension before ringing the next extension in the group
- A call rings an extension in the ring-no-answer Call Forwarding mode before the system forwards the call to the destination extension
- A Direct Inward Line (i.e., a directly terminated line in Program 12) rings an idle or busy Multibutton or UCD overflow extension before it changes to "key ring" and rings all extensions programmed for ringing on that line

FOR FEATURE INFORMATION: See Regular Hold on page 99, Transfer on page 182, Extension Hunting on page 81, Call Forwarding, Internal on page 44, and Direct Inward Lines on page 64.

(07) Number of Delayed Rings

Use this timer to determine how many rings (01-10) the system suppresses before a call audibly rings an extension programmed for Delayed Ringing (Program 18 [II]).

FOR FEATURE INFORMATION: See Delayed Ringing Assignment on page 62.

(08) Flash Response

Use this timer to determine how long (0-2.5 seconds) a line circuit must open for the PBX/Centrex to recognize it as a Flash (time must be compatible with PBX/Centrex).

Note: The actual duration of the Flash is approximately 50ms less than the number you enter, so enter a value 50ms higher than the PBX/Centrex requires.

FOR FEATURE INFORMATION: See Using Flash for Centrex/PBX on page 85.

(09) Dial Tone Detect

Use this timer to determine how long (10-60 seconds) the system waits for dial tone before sending out a Speed Dial call. The system uses three times this value for a pause you insert in a Speed Dial number.

Note: The system needs the first dial tone to be at least .5 seconds long, and the second dial tone to be at least 2.5 seconds long.

FOR FEATURE INFORMATION: See Speed Dial on page 162.

(10) Make

Use this timer to determine how long (04-1020 milliseconds) the relays close on Dial Pulse (DP) lines. You can only enter a value that is a multiple of 04 (e.g., 04, 08, etc.), and it must be compatible with the requirements of the local telco.

FOR FEATURE INFORMATION: See Dial Pulse (DP) and Dual Tone Multifrequency (DTMF) Compatibility on page 77.

(11) Break

Use this timer to determine how long (04-1020 milliseconds) the relays open on Dial Pulse (DP) lines. You can only enter a value that is a multiple of 04 (e.g., 04, 08, etc.), and it must be compatible with the requirements of the local telco.

FOR FEATURE INFORMATION: See Dial Pulse (DP) and Dual Tone Multifrequency (DTMF) Compatibility on page 77.

(12) Interdigit

Use this timer to determine how long (04-1020 milliseconds) of a pause there is between digits dialed on a Dial Pulse (DP) line. You can only enter a value that is a multiple of 04 (e.g., 04, 08, etc.), and it must be compatible with the local telco.

FOR FEATURE INFORMATION: See Dial Pulse (DP) and Dual Tone Multifrequency (DTMF) Compatibility on page 77.

Filling Out the Program Record Form

In the Duration boxes for . . .	Enter this data . . .
(01) Park Orbit	00-970
(02) Hold Recall	00-970
(03) Camp-On	00-970
(04) Line Response	05-99 (5 = .5s; 99 = 9.9s)
(05) Modem Reserve	00-970
(06) # Rings Bef. Recall	03-15
(07) # Delayed Rings	01-10
(08) Flash Response	00-25 (e.g., 01 = .1s or 100 ms) Note: The actual duration of the Flash is approximately 50ms less than the number you enter
(09) Dial Tone Detect	01-06 (01 = 10s; 06 = 60s)
(10) Make	04, 08, 12, 16...1020
(11) Break	04, 08, 12, 16...1020
(12) Interdigit	04, 08, 12, 16...1020

Example

The Hold Recall timer is set for 90 seconds.

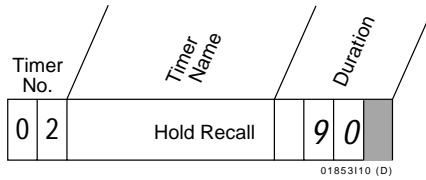

Entering Data Into Memory

To enter Program 4 data:

1. Enter program mode.
-Press # + dial SP + dial 5312 + press #.
2. Press key 4 to enter Program 4.
3. Dial Timer No., press #.
4. To accept the displayed data: Press #.
 OR
 To change or enter data: Dial data, press #.
*-To erase data before pressing #: Dial *.*
5. Repeat steps 3-4 for remaining timers.
6. Select an option:
 To exit Program 4: Press SAVE once.
 OR
 To enter another program after exiting: Press its key.
 OR
 To exit the program mode: Press SAVE twice.

Understanding Related Programming

N/A



Program 5 is initially set as follows:

- PBX Access Codes = None

Program 5 lets you store up to 11 PBX Access Codes in system memory. A PBX Access Code is a code that a DIGITAL SYSTEM extension user dials for an outside line when the DIGITAL SYSTEM is installed behind a PBX. The codes can be one or two digits long, and a two-digit code can have a wild card character (X). For example, if you enter 9X, the system recognizes 90-99 as valid PBX Access codes.

Use this program to store PBX Access Codes only if the DIGITAL SYSTEM is providing Toll Restriction (via Program 6). If the PBX is providing Toll Restriction instead, simply identify the PBX lines in Program 10, and leave Program 5 empty.

FOR FEATURE INFORMATION: See PBX/Centrex Feature Keys on page 57.

Filling Out the Program Record Form

1. Select an ID number (01-11).
2. Enter data from the following chart.

In this box . . .	Enter this data . . .
PBX Access Code	One or two digits (enter an "X" for a wild card)

Example PBX Access Code 01 is 9.

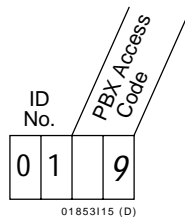

Entering Data Into Memory

To enter Program 5 data:

1. Enter program mode.
-Press # + dial SP + dial 5312 + press #.
2. Press key 5 to enter Program 5.
3. To accept the displayed data: Press #.
OR
To change or enter data: Dial data, press #.
-To erase a code: Dial *, press #.
-To enter a wild card: Press DIAL, then dial X (digit 9).
4. Repeat step 3 for all data.

*-If you finish and do not see, "SAVE TO EXIT":
Press SAVE before step 5.*

5. Select an option:
To enter another program: Press its key.
OR
To exit the program mode: Press SAVE once.

Understanding Related Programming

Program 10 To identify a line as a PBX line



Program 6 is initially set as follows for Toll Restriction levels (01-07):

- Active Dialpad = Y
- Special N11 Dialing = Y
- 0 + Dialing = Y
- International Dialing = Y
- Equal Access Dialing = Y
- 1 + NNX Dialing = Y
Allow or Deny Tables = Empty
- NNX Dialing = Y
Allow or Deny Tables = Empty
- NPA Dialing = Y
Allow or Deny Tables = Empty
- 6-Digit Analysis = Y
Allow or Deny Tables = Empty

Program 6 lets you customize a Toll Restriction level. A Toll Restriction level is a set of nine dialing options for making outside calls. You customize a Toll Restriction level by enabling or disabling these dialing options. For example, you can customize a Toll Restriction Level so that long distance calls to other area codes are disabled.

You can customize up to seven unique Toll Restriction levels (01-07). After you customize a Toll Restriction level, you assign it to an extension to define the type of outside calls that can be made from the extension. You make the assignment in two steps:

- Use Program 1 to assign the Toll Restriction level to a Class of Service.
- Use Program 18 (Part I) to assign the Class of Service to an extension.

In addition, you can customize three other dialing options in a Class of Service (Program 1). They are called: Only Local Calls (Day or Night), Only Local Calls at Night, and Only Intercom Calls at Night. Enabling any of these overrides (takes precedence over) any restrictions set up in a COS's Toll Restriction Level.

The nine Toll Restriction options are as follows:

Active Dialpad (Continuous Dialing)

Use this option to determine whether a user can manually dial digits during an established outside call. The need to dial digits during a call typically arises when a user calls an Other Common Carrier (OCC). After the OCC answers, the user needs to dial more digits (security code and other digits the OCC requires).

FOR FEATURE INFORMATION: See Using Other Common Carriers on page 131.

Special N11 Dialing

Use this option to allow/deny manually-dialed calls to N11 or 1 + N11 (N = 2 to 8). The system does not restrict 911 or 1 + 911. For information on international calls (011), see the next two options.

FOR FEATURE INFORMATION: See Toll Restriction on page 178.

0 + Dialing

Use this option to allow or deny manually-dialed calls that begin with a zero (0). These calls usually include operator-assisted or credit card calls, and international calls (011 +). Disabling "0 +" dialing automatically disables international calls and you can ignore the option below.

To disable international calls but allow other calls that begin with a zero, enter Y for this option and N for the next option (below).

FOR FEATURE INFORMATION: See Toll Restriction on page 178.

International Dialing

Use this option to allow or deny international calls that begin with 011. To allow or deny international calls that begin in a different way (e.g., calls to certain parts of Mexico or Canada that start with an area code), use the NPA Dialing option below.

To allow International dialing, you must also allow "0 +" dialing above.

FOR FEATURE INFORMATION: See Toll Restriction on page 178.

Equal Access Dialing

Use this option to determine whether a user can manually dial calls using Equal Access Codes (10XXX). This option only applies to software versions prior to AUX Module Y2.0/Base Y5.0.

FOR FEATURE INFORMATION: See Equal Access Compatibility on page 79.

1 + NNX Dialing with Allow/Deny Tables

Use this option to allow or deny manually-dialed toll calls to specific exchanges (i.e., 1 + NNX calls, where NNX is the exchange).

To deny all 1 + NNX calls: Enter N and leave the Allow/Deny Tables empty.

To allow all 1 + NNX calls: Enter Y and leave the Allow/Deny Tables empty.

To allow only specific 1 + NNX calls: Enter Y for this option, then create an Allow or Deny Table.

- With an Allow Table: Enter the NNX codes (up to 48) the users can dial. Any codes you do not enter are automatically denied.
- With a Deny Table: Enter the NNX codes (up to 48) the users cannot dial. Any codes you do not enter are automatically allowed.

FOR FEATURE INFORMATION: See Toll Restriction on page 178.

NNX Dialing with Allow/Deny Tables

Use this option to allow or deny manually-dialed calls to specific exchanges (i.e., NNX calls, where NNX is the exchange or conflict code).

To deny all NNX calls: Enter N and leave the Allow/Deny Tables empty.

To allow all NNX calls: Enter Y and leave the Allow/Deny Tables empty.

To allow only specific NNX calls: Enter Y for this option, then create an Allow or Deny Table.

- With an Allow Table: Enter the NNX codes (up to 48) the users can dial. Any codes you do not enter are automatically denied.
- With a Deny Table: Enter the NNX codes (up to 48) the users cannot dial. Any codes you do not enter are automatically allowed.

FOR FEATURE INFORMATION: See Toll Restriction on page 178.

NPA Dialing with Allow/Deny Tables

Use this option to allow or deny manually-dialed calls to specific area codes (i.e., NPA calls or 1 + NPA calls, where NPA is the area code).

To deny all NPA or 1 + NPA calls: Enter N and leave the Allow/Deny Tables empty.

To allow all NPA or 1 + NPA calls: Enter Y and leave the Allow/Deny Tables empty.

To allow only specific NPA or 1 + NPA calls: Enter Y for this option, then create an Allow or Deny Table.

- With an Allow Table: Enter the NPA codes (up to 48) the users can dial. Any codes you do not enter are automatically denied.
- With a Deny Table: Enter the NPA codes (up to 48) the users cannot dial. Any codes you do not enter are automatically allowed.

Make sure you allow NPA or 1 + NPA calls if you want 6-digit analysis (see below).

FOR FEATURE INFORMATION: See Toll Restriction on page 178.

6-Digit Analysis with Allow/Deny Tables

Use this option to allow or deny manually-dialed calls to specific exchanges (NNX) in specific area codes (NPA). In other words, the call is allowed or denied based on the first 6 digits of the telephone number.

To bypass 6-digit analysis: Enter N and leave the Allow/Deny Tables empty.

To use 6-digit analysis: Enter Y for NPA calls (above). Enter Y for 6-digit analysis. Enter each area code (up to 10) intended for 6-digit analysis with its allowed or denied exchanges.

- With an Allow Table: Enter the NNX codes (up to 48) the users can dial. Any codes you do not enter are automatically denied.
- With a Deny Table: Enter the NNX codes (up to 48) the users cannot dial. Any codes you do not enter are automatically allowed.

FOR FEATURE INFORMATION: See Toll Restriction on page 178.

Filling Out the Program Record Form

Before you fill in the data, make a copy of the three Toll Restriction forms for each toll level you wish to program.

In this box . . .	Enter this data . . .
Toll Level	01-07
Feature boxes (except Allow/Deny)	Y - enable the feature N - disable the feature
Allow/Deny boxes	A - for an "Allow" table D - for a "Deny" table

In this table . . .	Enter this data . . .
Table # 1	At top of table: Circle "Allow" or "Deny" In body of table: Enter allowed or denied NNX codes for toll calls
Table # 2	At top of table: Circle "Allow" or "Deny" In body of table: Enter allowed or denied NNX codes for local calls

In this table . . .	Enter this data . . .
Table # 3	At top of table: Circle "Allow" or "Deny" In body of table: Enter allowed or denied NPA codes for long distance calls
Tables # 4-13	At top of table: Circle "Allow" or "Deny." Enter NPA code intended for 6-digit analysis In body of table: Enter allowed or denied NNX codes

Filling Out the Program Record Form

Example

For Toll Level 02, International Dialing is not allowed, but all other calls that begin with zero (0) are allowed (only this option will be shown).

Toll Level	Active Dial Pad	Special N11 Dialing	0 + Dialing	International Dialing	Equal Access Dialing	1 + NXX Dialing	Allow or Deny	NXX Dialing (See Table #1)	Allow or Deny (See Table #1)	NPA Dialing (See Table #2)	Allow or Deny (See Table #2)	6-Digit Analysis	6-Digit Analysis (See Table #3)
02			Y	N									

0185312 (D)

Entering Data Into Memory

To enter Program 6 data:

1. Enter program mode.
 -Press # + dial SP + dial 5312 + press #.
2. Press key 6 to enter Program 6.
3. For first-time programming or to initialize (reset) all toll restriction levels: Dial I to initialize, then dial Y. Otherwise, go to step 4.
 -If you change your mind after dialing I, dial N. You return to the TOLL PROG/INIT? prompt (i.e., the beginning of step 3).
4. Dial P to program (change) the toll restriction values.
 -If you hear re-order tone and leave the program mode, this means you must go to step 1 and initialize in step 3.
5. Dial toll restriction level, press #.
6. To accept the displayed data: Press #.
 OR
 To change or enter data: Dial data, press #.
 -To erase data before pressing #: Dial *.
 -You do not need to press # after dialing "A" or "D".
 -When you see, "ADD-DELETE-LIST", you can add, delete or list codes in the Allow/Deny Tables (go to the proper Tables on the next two pages).
7. Repeat steps 6 until you enter all data for a toll level.
 -If you finish and do not see, "TOLL LEVEL": Press # until you do see it.

8. Select an option:
To program another toll level: Go to step 5.
OR
To exit Program 6: Press SAVE once.
OR
To exit the program mode: Press SAVE twice.
-To enter another program after exiting: Press its key.

To use the 1 + NXX, NNX, or NPA Tables when you see "ADD-DELETE-LIST" on the display:

1. Dial A for ADD, D for DELETE, or L for LIST.
OR
Press # to exit the table and go to step 6 in the first procedure.
-If you list, you see four codes at a time.
2. To add/delete codes: Dial them.
OR
To list more codes or exit at the end of the list: Press # and go to step 1 in this procedure.
-Step 3 does not apply to listing.
3. To save changes and exit the table: Press # and go to step 6 in the first procedure.
OR
To save changes and return to "ADD-DELETE-LIST": Press SAVE and go to step 1 in this procedure.

To use the 6-Digit Analysis Tables when you see ADD-DELETE-LIST on the display:

1. Dial A for ADD, D for DELETE, or L for LIST.
OR
Press # to exit the table (and the program).
2. Dial the area code intended for 6-digit analysis.
-If you selected "listing" in step 1, you see the codes now, four at a time. To see more codes or exit at the end of the list: Press # and return to step 1 in this procedure. Steps 3-6 do not apply to listing.
3. Dial A for an Allow Table of NXX codes.
OR
Dial D for a Deny Table of NXX codes.
4. Dial codes to be added or deleted.
5. Select an option:
To save changes and go to "ADD-DELETE-LIST" for another area code: Press SAVE and go to step 1 in this procedure.
OR
To save changes and exit the toll level: Press # and go to step 6 in the first procedure.
OR
To save and exit Program 6: Press SAVE three times.
OR
To save and exit the program mode: Press SAVE four times.

-To enter another program after exiting: Press its key.

Understanding Related Programming

- Program 1** To assign a Toll Level (from Program 6) to a Class of Service (see also Program 18 [I])
To set up additional dialing restrictions in a Class of Service: Only Local Calls (Day or Night), Only Local Calls at Night, Only Intercom Calls at Night (see also Program 18 [I])
- Program 18 (I)** To assign a Class of Service (from Program 1) to an extension
- Program 3** To identify whether the calling area requires a "1" before dialing an area code (NPA)
- Program 12** To assign Toll Restriction to a line. Initially, Toll Restriction is applied to every line. You would want to leave it that way except for a WATS line, for example.



Program 7 is initially set as follows:

- Enable Background Music = N
- Enable Music on Hold = N
- External Page Zone 1 = N
- Audible Ring Over External All Call Page = Y
- External Page Zone 2 (with Expansion CEU #1 only) = N
- BGM to All External Page Zones = N
- Interrupted Ring Relays = N
- Paging and Music Gain (Volume) Over External Speakers = - 6dB
- Relay 01 Owner (for the Main CEU only) = 300
- Relay 02 Owner = 300 (for Expansion CEU #1 only)

Program 7 lets you select various options for:

- Music On Hold
- Background Music
- External Paging
- Relays for the External Alerting Devices

Enable Background Music

Use this option to enable/disable BGM.

Note: If you enable BGM, you cannot connect a line to line port 04 because the system uses it for BGM. As soon as you enter Y for BGM, the system enters X in Program 10 for line 04's circuit type, which means "uninstalled."

FOR FEATURE INFORMATION: See Background Music on page 42.

Enable Music on Hold

Use this option to enable/disable MOH. If you enable MOH, but not BGM, only outside calls receive MOH. If you enable MOH and BGM, outside and Intercom calls receive MOH.

FOR FEATURE INFORMATION: See Music On Hold on page 120.

External Page Zone 1

Use this option to send Internal Zone 1 pages over external paging speakers. Also see *Paging and Music Gain (Volume) Over External Speakers* in this program. Prior to software version AUX Module Y2.0/Base Y5.0, this option enabled All Call Page.

Note: If you enable External Page Zone 1, you cannot connect a line to line port 04 in the main CEU. The system uses it for External Paging Zone 1. As soon as you enter Y for External Paging Zone 1, the system enters X in Program 10 for line 04's circuit type, which means "uninstalled". **Do not connect the Paging amplifier to line 04. See your hardware manual for additional details.**

FOR FEATURE INFORMATION: See Paging on page 138.

Audible Ring Over External All Call Page

Use this option to send ringing over the External All Call Page when a call comes into extension 300 during the Night Answer mode.

FOR FEATURE INFORMATION: See Paging on page 138.

External Page Zone 2 (only if Expansion CEU #1 is installed)

Use this option to send Internal Zone 2 pages over external paging speakers. Also see *Paging and Music Gain (Volume) Over External Speakers* below. Prior to software version AUX Module Y2.0/Base Y5.0, this enabled External Page Zone 1.

Note: If you enable External Page Zone 2, you cannot connect a line to line port 04 (line 12) in Expansion CEU #1. The system uses it for External Page Zone 2. As soon as you enter Y for External Zone 2, the system enters X in Program 10 for line 12's circuit type, which means "uninstalled." **Do not connect the Paging amplifier to line 12. See your hardware manual for additional details.**

FOR FEATURE INFORMATION: See Paging on page 138.

BGM to All External Page Zones

Use this option to send Background Music over the external paging equipment when the equipment is idle (e.g., not receiving a page). Also enable the following in this program: *Enable Background Music, External Page Zone 1, External Page Zone 2, Paging and Music Gain (Volume) Over External Speakers.*

FOR FEATURE INFORMATION: See Background Music on page 42.

Interrupted Ring Relays

Use this option to control the operation of Relays 01 and 02 (see below). You can force the relays to follow a call's ring cycle (i.e., interrupted closure) or you can force the relays to stayed closed until someone answers the call (uninterrupted/steady closure).

FOR FEATURE INFORMATION: See External Alerting Devices on page 84.

Paging and Music Gain (Volume) Over External Speakers

Use this option to control the volume of Paging and Background Music over the external paging speakers. This option is only available if you enable *BGM to All External Page Zones* above.

FOR FEATURE INFORMATION: See Background Music on page 42, and Paging on page 138.

Relay 01 Owner (for the Main CEU only)

Use this option to determine which type of day/night call activates Relay 01 for an External Alerting Device. There are three choices:

- A call on a specific line (348-363)
- A call to a specific Ring Group (364-371 without AUX, 396-403 with AUX)
- A call to an extension (300-347), except Callbacks

Note: When you assign extension 300 as the Relay 01 owner, only Night calls that ring 300 activate the relay.

FOR FEATURE INFORMATION: See External Alerting Devices on page 84.

Relay 02 Owner (for Expansion CEU #1 only)

Use this option to determine which type of day/night call activates Relay 02 for an External Alerting Device. There are three choices:

- A call on a specific line (348-363)
- A call to a specific Ring Group (364-371 without AUX, 396-403 with AUX)

- A call to an extension (300-347), except Callbacks

Note: If you select 300, only Night calls that ring 300 activate the relay.

FOR FEATURE INFORMATION: See External Alerting Devices on page 84.

Filling Out the Program Record Form

In this box . . .	Enter this data . . .
Background Music (BGM)	Y - enable N - disable
Music On Hold	Y - enable N - disable
Ext. Page Zone 1	Y - enable N - disable
Ring over All Call	Y - enable N - disable
Ext. Page Zone 2	Y - enable N - disable
BGM Music to Ext. Zones	Y - enable N - disable
Interrupted Ring Relays	Y - interrupted N - uninterrupted
Page/Music Volume	01 - -6 dB (soft) 02 - -3 dB 03 - 0 dB (medium) 04 - +3 dB 05 - +6 dB (loud)
Relay 01 Owner	348-363 for calls on lines 300-347 for calls to extensions 364-371 (without AUX) or 396-403 (with AUX) for Ring Group Calls
Relay 02 Owner	348-363 for calls on lines 300-347 for calls to extensions 364-371 (without AUX) or 396-403 (with AUX) for Ring Group Calls

Example

The Paging/Music Volume is set at the medium volume.

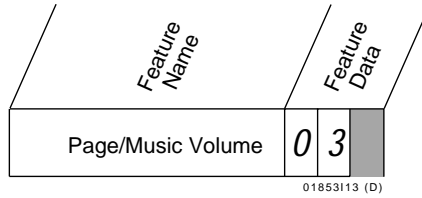

Entering Data Into Memory:

- To enter Program 7 data:
1. Enter program mode.
-Press # + dial SP + dial 5312 + press #.
 2. Press key 7 to enter Program 7.
 3. To accept the displayed data: Press #.
 OR
 To change or enter data: Dial data, press #.
*-To erase data before pressing #: Dial *.*
 4. Repeat step 3 for all data.
*-If you finish and do not see, "SAVE TO EXIT":
 Press SAVE before step 5.*
 5. Select an option:
 To enter another program: Press its key.
 OR
 To exit the program mode: Press SAVE.

Understanding Related Programming

- For Relays: Program 16 To provide an extension with incoming access to a line so it can answer that line when it rings over an External Page Zone



Program 8 is initially set as follows for messages 600-615:

- 600 = CALL
- 601 = BACK BY
- 602 = MEETING IN RM
- 603 = OUT TO LUNCH
- 604 = GONE FOR THE DAY
- 605 = ON VACATION
- 606 = ON BUSINESS TRIP
- 607 = IN THE MEETING
- 608 = BACK BY 10AM
- 609 = BACK BY 11AM
- 610 = BACK BY NOON
- 611 = BACK BY 2PM
- 612 = BACK BY 4PM
- 613 = BACK TOMORROW
- 614 = BACK NEXT WEEK
- 615 = HAVE A GOOD DAY

Note: When the system has an AUX Module, there are no messages initially.

Program 8 lets you store up to 16 messages in system memory for the Selectable Display Messages feature.

You store the messages under the numbers 600-615 (the corresponding numbers a user would dial for these messages are 00-15). Each message can contain up to 16 characters (numbers, letters, and blank spaces). Messages 600-607 are special in that an extension user can add digits to the end of them as long as the entire message does not exceed 16 characters. For example, a user can add a telephone number to the end of message 600 so it reads, CALL XXX XXXX. If you choose to change the initial messages for 600-607, be sure to add a blank space at the end of the message so that any digits a user may add do not appear right next to the last character of the message.

FOR FEATURE INFORMATION: See Selectable Display Messages on page 159.

Filling Out the Program Record Form

In this box . . .	Enter this data . . .
Message	Up to 16 characters (numbers, letters, blank spaces)

Example

Message 600 is as follows: IN CONFERENCE.

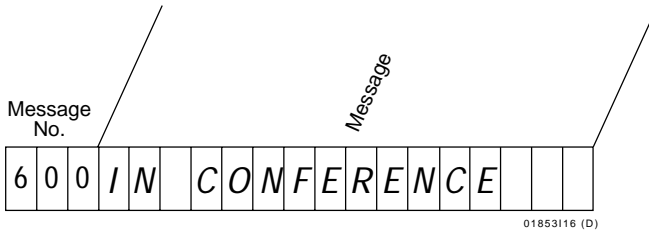

Entering Data Into Memory

To enter Program 8 data:

1. Enter program mode.
 -Press # + dial SP + dial 5312 + press #.
2. Press key 8 to enter Program 8.
3. Dial Message No., press #.
4. To accept the displayed data: Press #.
 OR
 To erase the displayed data: Dial *, then enter message data or (press # and go to step 3).
 OR
 To change or enter data: Enter the message, press #. To enter a message:
 -Press the dial pad button for the desired letter or number. To enter a blank space, Q, or Z, press 0.
 -To make a letter appear: Dial the number (1, 2, or 3) that corresponds to the letter's position on the button (e.g. dial 1 if you want the first letter on the button).
 OR
 To make a number appear: Dial 4.
Note: To make a blank space, Q, or Z to appear: Dial 1, 2, or 3, respectively.
 -Repeat a-b for all characters (to erase the previous character, press LAST).
5. Repeat steps 3-4 for all messages.
6. Select an option:
 To exit Program 8: Press SAVE once.
 OR
 To exit the program mode: Press SAVE twice.
 -To enter another program after exiting: Press its key.

Understanding Related Programming

N/A

**Program 10 is initially set as follows for each line (01-16):**

- Line Circuit Type = CO (Central Office) Loop Start Line with DTMF signaling
- Line Gain = 0 dB
- PBX Line = N
- Side Tone Test = N
- Line Name = Unassigned

Program 10 lets you define the following characteristics for each line (01-16):

Line Circuit Type

Use this option to identify the type of line connected to each line port.

FOR FEATURE INFORMATION: See Dial Pulse (DP) and Dual Tone Multifrequency (DTMF) Compatibility on page 77.

Line Gain

Use this option to adjust the audio volume for a line. The extension user can also adjust the volume of a conversation on an outside line by pressing the VOL UP and VOL DN keys (the user cannot, however, adjust the volume past the highest or lowest volume offered in this program). With each press, the volume raises or lowers 3 dB. When a user hangs up an outside call, the line's volume returns to the value you select here.

FOR FEATURE INFORMATION: See Volume Controls on page 193.

PBX Line

Use this option to identify a line as a PBX line.

FOR FEATURE INFORMATION: See Placing an Outside Call (Using PBX/Centrex Lines) on page 135.

Side Tone Test

Use this option to activate a side tone test on the line. This is a test that the system performs on a line to adjust the transmission characteristics of the line. The system tests all installed lines upon power-up or when you request one using this program.

FOR FEATURE INFORMATION: N/A

Line Name

Use this option to assign a 16-character name to a line. The name you select for line XX replaces the display "LINE XX" when a user answers a call on that line.

FOR FEATURE INFORMATION: N/A

Filling Out the Program Record Form

In this box . . .	Enter this data . . .
Circuit Type	10 - CO Loop Start, DTMF 11 - CO Loop Start, DP X - Not installed
Line Gain	01 - -6 dB 02 - -3 dB 03 - 0 dB (normal) 04 - +3 dB 05 - +6 dB
PBX Line	Y - PBX Line N - Non-PBX Line
Side Tone Test	Y - enable side tone test N - bypass side tone test
Name	Up to 16 characters (letters, numbers, blank spaces)

Example

Line 04 is a CO Loop Start DP line with normal Line Gain, no Side Tone Test and the name, MR. JONES.

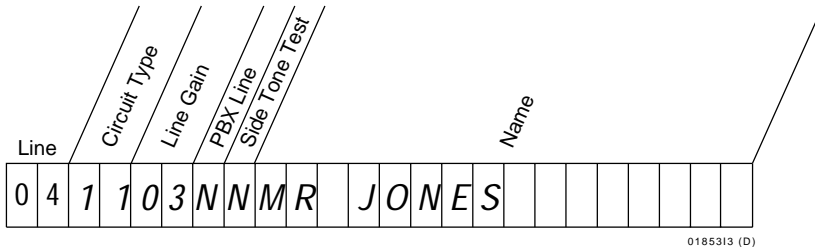

0185313 (D)

Entering Data Into Memory

To enter Program 10 data:

1. Enter program mode.
-Press # + dial SP + dial 5312 + press #.
2. Press key 10 to enter Program 10.
3. Dial Line No., press #.
4. To accept the displayed data: Press #.

OR

To change or enter data: Dial data, press #. To enter a name:

*-Press the dial pad button for the letter or number.
To enter a blank space, Q, or Z, press 0.*

-To get a letter to appear: Dial the number (1, 2, or 3) that corresponds to the letter's position on the button (e.g. dial 1 if you want the first letter).

OR

To make a number appear: Dial 4.

***Note:** To make a blank space, Q, or Z appear: Dial 1, 2, or 3, respectively.*

-Repeat a-b for all characters (to erase the previous character, press LAST).

*-To erase data before pressing #: Dial *. To enter circuit type X: Press DIAL, dial X (9).*

5. Repeat step 4 for all data.

-If you finish and do not see, "LINE NO.": Press SAVE before step 6.

6. Select an option:

To enter data for another line: Go to step 3.

OR

To exit Program 10: Press SAVE once.

OR

To exit the program mode: Press SAVE twice.

-To enter another program after exiting: Press its key.

Understanding Related Programming

Program 3	To select a digit for the side tone test
Program 5	To store PBX Access Codes if there are PBX lines
Program 11	To place lines into groups
Program 12	To assign features to lines
Program 16	To let an extension access a line or line group
Program 17	To assign a line to a key at an extension
Program 18 (II)	To assign ringing to lines at an extension



Program 11 is initially set as follows:

- No Line Groups

Program 11 lets you place lines into groups for placing outside calls. When an extension user selects a line group to place a call, the DIGITAL SYSTEM gives the user the first available line in the group. You can program line groups only if the DIGITAL SYSTEM is equipped with an AUX Module.

The DIGITAL SYSTEM can accommodate up to nine line groups, numbered 90-98. Any number of lines can be in a group, but a group should contain similar types of lines (e.g., WATS band 5 or WATS band 3). You also place Direct Inward Lines (assigned in Program 12) into a group. If you do this and someone uses a DIL for an outgoing call, the DIL is simply not available for incoming calls.

If the DIGITAL SYSTEM has line groups, the FCC classifies it as a hybrid. You must use the FCC registration number on your CEU that ends in "MF-E." If your system does not use line groups, the FCC classifies it as a key system. You must use the FCC registration number on your CEU that ends in "KF-E."

FOR FEATURE INFORMATION: See Placing an Outside Call (Using Direct Line Group Access) on page 134.

Filling Out the Program Record Form

1. Select a group (90-98).

In this box . . .	Enter this data . . .
Line Group Members	Lines (01-16) that belong to the group. List the lines in the order the DIGITAL SYSTEM should check them for availability.

Example

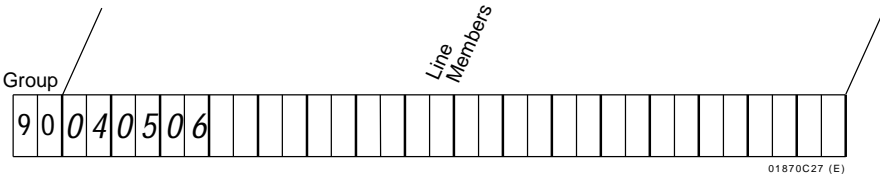

Line group 90 contains lines 04, 05, 06.

Entering Data Into Memory

- To enter Program 11 data:
1. Enter program mode.
-Press # + dial SP + dial 5312 + press #.
 2. Press key 11 to enter Program 11.
 3. Dial Line (Trunk) Group No., press #.
 4. To accept the displayed data: Press #.
OR
To change or enter data: Dial line data, press #.
*-To erase a data entry before you press #: Dial *.*
*-To remove a line from a group, dial * when you see it. Dialing * when you see the first line removes all lines from the group.*
 5. Repeat steps 4-5 for all lines.
 6. Press SAVE.
 7. Select an option:
To enter data for another group: Go to step 3.
OR
To exit Program 11: Press SAVE once.
OR
To exit the program mode: Press SAVE twice.
-To enter another program after exiting: Press its key.

Understanding Related Programming

- | | |
|----------------------|--|
| Program 16 | To give an extension access to a line group
To give an extension access to the lines in a line group |
| Program 10 | To assign the correct circuit type to all lines in a group |
| Program 17 | To assign a line group to a key at an extension |
| QY (terminal) | To let users access line group 90 by dialing 9 (if you can do terminal programming through the AUX Module).
With "dial 9" access, the user cannot access line groups 91-98. |

To change the first digit of line group numbers, see Flexible Numbering Plan on page 86.



Program 12 is initially set as follows for each line (01-16):

- Call Pickup Group = 00 (does not ring a Pickup Group)
- Toll Restrict = Y
- Direct Termination (Day) = 300 (not directly terminated)
- Direct Termination (Night) = 300 (not directly terminated)
- Class of Service = 01 (no Distinctive Ringing)

Program 12 lets you assign the following features to each line (01-16) in the system:

Call Pickup Group

Use this option to have an incoming line ring all the extensions in a Pickup Group (01-07).

FOR FEATURE INFORMATION: See Group Call Pickup on page 88.

Toll Restrict

Use this option to enable/disable Toll Restriction for calls made on a line. Typically, if you set up Toll Restrictions in Program 6, you would want the system to apply them to all lines except, for example, WATS lines.

FOR FEATURE INFORMATION: See Toll Restriction on page 178.

Direct Termination (Day)

Use this option to determine the day termination for a Direct Inward Line (DIL). A DIL can ring one of the following terminations during the day:

- An extension (301-347), but not a Data Module
- A UCD or Voice Mail (VX) master extension (301-347)
- A Ring Group (364-371 without AUX or 396-403 with AUX)

A terminated extension/group has both incoming and outgoing access to the DIL and ringing on the DIL. There is no need to assign access in Program 16 or ringing in Program 18 (II).

Note: If a line’s day termination is 300, this means the line is not directly terminated (i.e., is not a DIL). The line follows the access assignments made in Program 16 and the ring assignments made in Program 18 (II).

FOR FEATURE INFORMATION: See Direct Inward Lines on page 64.

Direct Termination (Night)

Use this option to determine the night termination for a Direct Inward Line (DIL). A DIL can ring one of the following terminations during the Night Answer mode:

- An extension (301-347), but not a Data Module
- A UCD or Voice Mail master extension (301-347)
- A Ring Group (364-371 without AUX or 396-403 with AUX)

A terminated extension/group has both incoming and outgoing access to the DIL and ringing on the DIL. There is no need to assign access in Program 16 or ringing in Program 18 (II).

Note: If a line’s night termination is 300, this means the line is not directly terminated (i.e., is not a DIL). The line follows the access assignments made in Program 16 and the ring assignments made in Program 18 (II).

FOR FEATURE INFORMATION: See Direct Inward Lines on page 64.

Class of Service

Use this option to set Class of Service for outside lines (normally COS 01). If you want an outside line to have Distinctive Ringing, assign it COS 20.

FOR FEATURE INFORMATION: See Ringing Patterns (Distinctive Ringing) on page 156. *Do not assign Distinctive Ringing if any extensions have headsets.*

Filling Out the Program Record Form

1. Select a Line (01-16).

In this box . . .	Enter this data . . .
CPG (Call Pickup Group)	00 - Rings no group 01-07 - Rings group 01-07
TR (Toll Restrict)	Y - enable N - disable
DTD (Direct Termination Day)	300 - Not directly terminated 301-347 - Ext. or Master Ext. 364-371 (without AUX) or 396-403 (with AUX) for Ring Group
DTN (Direct Termination Night)	300 - Not directly terminated 301-347 - Ext. or Master Ext. 364-371 (without AUX) or 396-403 (with AUX) for Ring Group
COS (Class of Service)	01- Distinctive Ringing disabled 20- Distinctive Ringing enabled

Example

Line 03 belongs to Call Pickup Group 06, receives Toll Restriction, and is directly terminated to extension 308 during the day.

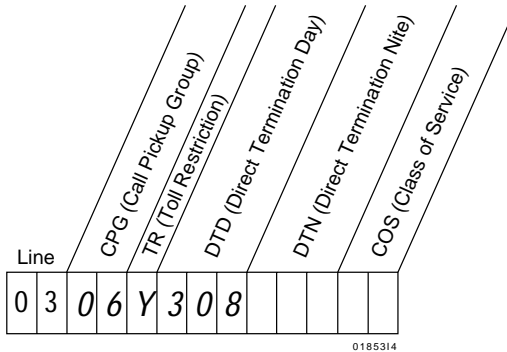

0185314

Entering Data Into Memory

- To enter Program 12 data:
1. Enter program mode.
-Press # + dial SP + dial 5312 + press #.
 2. Press key 12 to enter Program 12.
 3. Dial Line No., press #.
 4. Dial abbreviation for desired feature, press #.
 5. To accept the displayed data: Press #.
OR
To change or enter data: Dial data, press #.
-To accept DTD or DTN data, you may have to press SAVE instead.
-To erase a data entry before you press #: Dial *
 6. Repeat steps 4-5 for all features.
 7. Press SAVE.
 8. Select an option:
OR
To enter data for another line: Dial Y and go to step 3.
OR
To exit Program 12: Press SAVE once.
OR
To exit the program mode: Press SAVE twice.
-To enter another program after exiting: Press its key.

Understanding Related Programming

For lines in Pickup Groups:

- Program 18 (I) To place extensions in Pickup Groups
- Program 17 To assign a Pickup Group to a key (if desired)
- Program 18 (II) To assign ringing to Pickup Group keys (if desired)

For directly terminated lines (DILs):

- Program 17 To assign a DIL to a key (if desired)
- Program 18 (I) To make a Ring Group (if a DIL terminates there)
- Program 19 To make a UCD Hunt Group (if a DIL terminates there)

- Program 4** To set the Rings Before Recall timer (how long the DIL rings before diverting)
To set the Camp-On timer for DILs to UCD Hunt Groups
- Program 10** To assign a name to a DIL
- Program 16** To give an extension (other than the terminated extension) access to the DIL so they can answer it if it diverts to their extension
- Program 18 (II)** To assign ringing to the DIL at extensions other than the terminated extension

- For your notes -



Program 14 is initially set as follows for each station (extension) port:

- Extension Numbering Plan for Ports 00-47 = extensions 300-347, respectively
- Extension Circuit Type = X (not installed)
- DSS Owner Extension = 300
- DSS Block Number = 01
- Extension Name = Unassigned

Program 14 lets you define the following characteristics for each extension port (00-47):

Extension Numbering Plan for Ports 00-47

Use this option to assign an extension number (300-347) to an extension port (00-47). If you change the initial numbering plan, the system makes sure there are not duplicates (e.g., if you assign port A's extension number to port B, the system automatically assigns port B's extension to port A).

FOR FEATURE INFORMATION: N/A

Circuit Type

Use this option to identify the device installed at an extension port. The chart below shows the circuit type for each device, its load (power) factor and the number of ports it requires. The load factor helps you determine the maximum number of devices you can connect to a CEU. The load factor maximum per CEU is 24.

Device	Circuit Type	Load Factor	No. of Ports
Standard keyset	01 (auto-ID)	1	1
Display keyset	02 (auto-ID)	1	1
DSS Console	06 (auto-ID)	2	2
Dual OPX/ASI Module	51 (no auto-ID)	3	2
ASI	51 (no auto-ID)	1	1
ESL	00 (auto-ID)	1	1
Door Box	X (no auto-ID)	1	1 (310/311/ 322/323 only)
Relay Box	X (no auto-ID)	1	1 (309 only)
– For information only –			
PCU Module	-	2	(Main and Exp CEU # 1 only)
VMU Module	-	0	(Main CEU only)
AUX Module	-	0	(Main CEU only)
SAUX Module	-	0	Exp CEU # 1 (w/2 CEUs) Exp CEU #2 (w/3 CEUs)

Program 14: Extension Port Char. Extension Options

Device	Circuit Type	Load Factor	No. of Ports
XAUX Module	-	0	Exp CEU #1 (w/3 CEUs)
Data Module (see text below)	Z/01 (no auto-ID)	1	1

You can also install a Data Module (P/N 88400). Before you install the Data Module, you should do the required programming (see below). If you install the Data Module (with or without an extension) before you do the programming, you must unplug the Data Module and extension (if any), then plug them back in.

To program a stand-alone Data Module:

Use Program 14 to assign circuit type Z to the Data Module's port (you must actually enter ZY on the Program Record Form).

To program a Data Module (installed in an odd port) with a Multibutton Phone (installed in the consecutive even port):

1. Use Program 14 to assign circuit type 01 to the odd port.
2. Use Program 14 to assign the correct Multibutton circuit type to the even port (01 for a Standard Multibutton or 02 for a Display Multibutton).
3. Use Program 18 (I) to enable the Dataset (DS) option for the even port.

The initial configuration of a Data Module is as follows:

Baud Mode: Slave	Allow DTR Disconnect: Yes
Parity: None, 8 bits	Allow Break Disconnect: Yes
Interactive Mode: Yes	Auto Baud: Yes
Interactive Echo: Yes	Busy on DTR Low: No
RS-232 Controls Active: Yes	

To change these settings and for installation instructions, see the Data Products Manual (N1850DMG01).

Notes:

- Attendant 01 should be extension 300 and have a Display Phone.
- The DSS Console is a dual port device, using adjacent even and odd numbered ports. **You must install the DSS Console in the lower (even-number) port of a port pair.** For example, you must plug the console into port 02 (extension 302) when using the 02/03 port pair.
- You cannot change the circuit type of a system programming extension while using it to program; you must use another extension with access level 04 (see Program 15).
- When you install a Multibutton telephone, the system assigns the correct circuit type. This does not happen for a Data Module, the Multibutton paired with a Data Module, or an ASI or a Dual OPX/ASI Module.

Extension Options Program 14: Extension Port Char.

FOR FEATURE INFORMATION: See *The Type of Phone You Have* on page 6, Analog Station Interface on page 31 and Data on page 61.

DSS Owner Extension (For DSS Consoles Only)

Use this option to identify the extension that is paired with a DSS Console.

FOR FEATURE INFORMATION: See Direct Station Selection, DSS Console on page 66.

DSS Block Number (For DSS Console Only)

Use this option to assign a memory block (01-04) to a Console for its key configuration.

FOR FEATURE INFORMATION: See Direct Station Selection, DSS Console on page 66.

Extension Name

Use this option to assign a 16-character name to an extension. The name can include letters, numbers, and blank spaces (the first character cannot be a number). This name appears in displays instead of the extension's number and is used for Directory Dialing.

FOR FEATURE INFORMATION: See Alphanumeric Display on page 25 and Directory Dialing on page 72.

Filling Out the Program Record Form

1. Select a port (00-47).

In this box . . .	Enter this data . . .
Extension No.	300-347
Circuit Type	00 - Electronic Single Line 01 - Multibutton Non-Display 02 - Multibutton Display 06 - DSS Console 51 - ASI or Dual OPX/ASI 52 - Digital Voice Mail Port Card Z - Stand-Alone Data Module X - Not installed Note: For details on programming a Data Module with an extension, see previous page.
DSS Owner	300-347 - Extension paired with the DSS Console
DSS Block	01-04
Name	Up to 16 letters, numbers, blanks

Example

Port 03 is set up as follows: It has extension number 307, an Electronic Single Line Phone connected to it, and the name MR. SMITH.

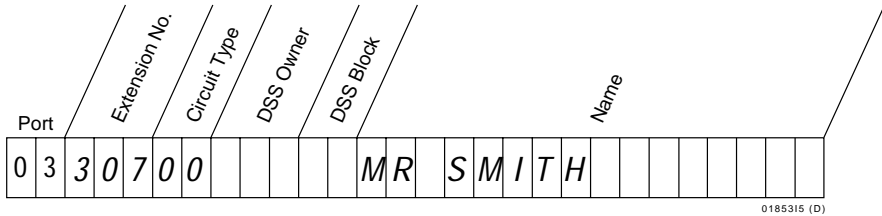

Entering Data Into Memory

To enter Program 14 data:

1. Enter program mode.
-Press # + dial SP + dial 5312 + press #.
2. Press key 14 to enter Program 14.
3. Dial Port No., press #.
4. To accept the displayed data: Press #.

OR

To change or enter data: Dial data, press #.

- To erase a data entry before you press #: Dial *.
- To enter a circuit type of X: Press DIAL, dial X. To enter circuit type Z: Press DIAL, dial 0.

To enter a name

- Press the dial pad button for the desired letter or number. To enter a blank space, Q, or Z, press 0.
- To make a letter appear: Dial the number (1, 2, or 3) that corresponds to the letter's position on the button (e.g. dial 1 if you want the first letter on the button).

OR

To make a number appear: Dial 4.

Note: To make a blank space, Q, or Z to appear: Dial 1, 2, or 3, respectively.

-Repeat a-b for all characters (to erase the previous character, press LAST).

5. Repeat step 4 for all data.
-If you finish and do not see, "STN PORT NO.": Press SAVE before step 6.
6. Select an option:
To enter data for another port: Go to step 3.
OR
To exit Program 14: Press SAVE.
OR
To exit the program mode: Press SAVE twice.

-After exiting, you can select another program.

Understanding Related Programming

For a Data Module installed with an extension:

Program 18 (I) To program the extension as a Dataset



Program 15 is initially set as follows:

- Extension 300 has access level 05.
- Extensions 301-305 have access level 04.
- Extensions 306-347 have access level 01.

Program 15 lets you assign a programming access level (00-04) to extensions (301-347). Extension 300 permanently has access level 05, and you cannot assign level 05 to any other extension. The access level determines:

- Whether you can use the extension to do system programming. You can always do system programming from extension 300, which has access level 05, or from any extension that has access level 04.
- Which features the user can program from their phone (see the table below). For example, with access level 01, an extension user can program two of these features from their own phone: Direct Station Selection and Speed Dial numbers. From the system programming extension, however, you can program any of these features (except Time and Date) for an extension even if its access level does not allow the user to program that feature (see Program 18 [Part II]).

User-Programmable Features	Access Level					
	00	01	02	03	04	05
Delayed Ring Assignment FOR FEATURE INFORMATION:	—	—	—	—	✓	✓
	See Delayed Ringing on page 62.					
Direct Station Selection FOR FEATURE INFORMATION:	—	✓	✓	✓	✓	✓
	See Direct Station Selection on page 69.					
Hotline FOR FEATURE INFORMATION:	—	—	—	✓	✓	✓
	See Hotline on page 101.					
Headset FOR FEATURE INFORMATION:	—	—	✓	✓	✓	✓
	See Headset on page 95					
Night Ringing FOR FEATURE INFORMATION:	—	—	✓	✓	✓	✓
	See Night Ringing on page 124.					
Prime Line Assignment FOR FEATURE INFORMATION:	—	—	✓	✓	✓	✓
	See Placing an Outside call (Using Prime Line) on page 134.					
Ringling Assignment FOR FEATURE INFORMATION:	—	—	✓	✓	✓	✓
	See Ringing Assignments on page 154.					

User-Programmable Features	Access Level					
	00	01	02	03	04	05

Ring Line Preference

FOR FEATURE INFORMATION: See Ringing Line Preference on page 155.

	—	✓	✓	✓	✓	✓
--	---	---	---	---	---	---

FOR FEATURE INFORMATION: See Speed Dial on page 162.

	—	—	—	—	✓	✓
--	---	---	---	---	---	---

FOR FEATURE INFORMATION: See Speed Dial on page 162.

	—	—	—	—	✓	✓
--	---	---	---	---	---	---

FOR FEATURE INFORMATION: See Time and Date on page 177.

	—	—	—	✓	✓	✓
--	---	---	---	---	---	---

FOR FEATURE INFORMATION: See Intercom Calls on page 103.

	—	—	—	✓	✓	✓
--	---	---	---	---	---	---

FOR FEATURE INFORMATION: See Off-Hook Signaling/Whisper Page on page 126.

	—	—	—	✓	✓	✓
--	---	---	---	---	---	---

FOR FEATURE INFORMATION: See Paging on page 138.

Filling Out the Program Record Form

1. Select an extension.

In this box . . .	Enter this data . . .
Program Access Level	00-05

Example

Extension 305 has programming access level 03.

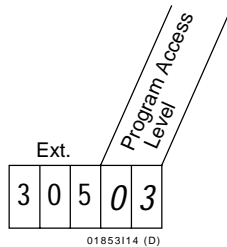

Entering Data Into Memory

- To enter Program 15 data:
1. Enter program mode.
-Press # + dial SP + dial 5312 + press #.
 2. Press key 15 to enter Program 15.
 3. Dial extension number, press #.
*-To erase a data entry before you press #: Dial *.*
 4. To accept the displayed data: Press #.
OR
To change or enter data: Dial data, press #.
 5. Repeat steps 3-4 for all extensions.
 6. Select an option:
To exit Program 15: Press SAVE once.
OR
To exit the program mode: Press SAVE twice.
-To enter another program after exiting: Press its key.

Understanding Related Programming

N/A

Extension Options Program 16: Line & Group Access



Program 16 is initially set as follows for each extension:

- Access to Lines 01-16 = Incoming and Outgoing
- Access to Line Groups 90-98 = Y, though no Line Groups exist in Program 11

Program 16 lets you give an extension access to lines 01-16 and line groups 90-98. You can give an extension:

- No access to a line.
- Only incoming access to a line, so the extension can only answer calls on that line.
- Both incoming and outgoing access to a line, so the extension can place and answer calls on that line.
- No access to line groups 90-95 (you cannot prevent an extension from using line groups 96-98).
- Outgoing access to a line group so the extension can use it to place calls. An extension cannot have incoming access to a line group.

FOR FEATURE INFORMATION: See Placing an Outside Call on 134 and Answering an Outside Call on page 132.

Filling Out the Program Record Form

1. Select an extension (300-347).

In this box . . .	Enter this data . . .
Line XX Access	0 - No access to line XX 1 - Only incoming access to line XX 2 - Incoming & outgoing access to line XX
Group XX Access	Y - enable outgoing access to group XX N - disable access to group XX

Example

In an 8-Line system, extension 305 has full access to lines 01, 03, 06; no access to the other lines; and outgoing access to line group 90.

Ext.	Line 01 Access	Line 02 Access	Line 03 Access	Line 04 Access	Line 05 Access	Line 06 Access	Line 07 Access	Line 08 Access	Line 09 Access	Line 10 Access	Line 11 Access	Line 12 Access	Line 13 Access	Line 14 Access	Line 15 Access	Line 16 Access	Group 90 Access	Group 91 Access	Group 92 Access	Group 93 Access	Group 94 Access	Group 95 Access
305	2	0	2	0	0	2	0	0									Y	N	N	N	N	N

01870C22 (D)

Entering Data Into Memory

- To enter Program 16 data:
1. Enter program mode.
-Press # + dial SP + dial 5312 + press #.
 2. Press key 16 to enter Program 16.
 3. Dial extension number, press #.
*-To erase a data entry before you press #: Dial *.*
 4. Dial L to enter line access data.
OR
Dial G to enter group data.
 5. Dial Line No., press #.
OR
Dial Group No., press #.
 6. To accept the displayed data: Press #.
OR
To change or enter data: Dial data, press #.
 7. Repeat steps 5-6 for remaining lines or groups.
 8. Press SAVE.
 9. Select an option:
To enter line or group data for same extension: Go to step 4.
OR
To exit Program 16: Press SAVE twice.
OR
To exit the program mode: Press SAVE three times.
-To enter another program after exiting: Press its key.

Understanding Related Programming

For line access:

- | | |
|----------------|---|
| Program 10 | To identify line characteristics (type, gain, name) |
| Program 17 | To assign a line to a key at an extension
To assign a Loop key to an extension. The Loop key flashes for incoming calls on lines without Line keys. |
| Program 18 (I) | To assign ringing to lines at an extension |
| Program 1 | To enable/disable Direct Line (Trunk) Access in a Class of Service (see also Program 18 [I]). Direct Line Access lets a user access lines 01-16 by dialing 348-363. |
| Program 18 (I) | To assign a Class of Service (from Program 1) to an extension
To allow Line Dial-Up for an extension. This lets a user access lines 01-16 by dialing 801-816. |
| Program 12 | To directly terminate a line to an extension so it rings only that extension. A directly terminated line is both incoming and outgoing without making it so in Program 16. For more information, see Direct Inward Line on page 64. |

For line group access:

Program 10 To identify line characteristics (type, gain, name)

Program 11 To place lines into groups

Program 17 To assign a line group to a key



Program 17 is initially set as follows:

- **On a Multibutton Phone in an 8-Line System:**
 - Keys 1-8 = Lines 1-8
 - Keys 9-16 = Undefined
- **On a Multibutton Phone in a 16-Line System:**
 - Keys 1-16 = Lines 1-16
- **On a DSS Console:**
 - Keys 1-47 = Hotlines to extensions 301-347
 - Keys 48-72 = Undefined
 - Key 73 = All Call Page
 - Key 74 = Internal Page Zone 1
 - Key 75 = Internal Page Zone 2
 - Key 76 = Internal Page Zone 3
 - Key 77 = Park Orbit 60
 - Key 78 = Park Orbit 61
 - Key 79 = Park Orbit 62
 - Key 80 = Release

Program 17 lets you assign functions to the programmable keys at a:

- Multibutton Telephone. Keys 1-16 are programmable.
- 80-Button DSS Console. Keys 1-79 are programmable.

For example, you can assign a Park Orbit (60-69) to a key so that a user can just press the key to access the orbit instead of dialing the Park Orbit code.

The choices for a programmable key are below. All of them are available to a Multibutton Phone, but not all to a DSS Console. (The key functions that are not available to a DSS Console are labeled "Multibutton Only").

Undefined Key (UK)

Use this option to give a key no function.

FOR FEATURE INFORMATION: N/A

Line Key (LK)

Use this option to assign a line (01-16) to a key. Do not assign the same line to two different keys.

FOR FEATURE INFORMATION: See Placing an Outside Call (Using a Line key) on page 134 and Answering an Outside Call on page 132.

Loop Switch (LS)

(Multibutton Only) Use this option to assign a Loop Switch key to an extension. A Loop Switch key flashes for incoming calls that do not appear under a Line key. Make sure you assign one Loop key to each extension so incoming calls can appear somewhere.

FOR FEATURE INFORMATION: See Answering an Outside Call on page 132.

Loop Group (LG)

(Multibutton Only) Use this option to assign a line group (00-08) to a key. Codes 00-08 correspond to line groups 90-98 .

FOR FEATURE INFORMATION: See Placing an Outside Call (Using Direct Line Group Access) on page 134.

Park Orbit (PO)

Use this option to assign a System Park Orbit (60-69) to a key.

FOR FEATURE INFORMATION: See Park on page 141.

One-Touch Speed Dial Key (SD)

Use this option to assign a Speed Dial bin to a key. On a Multibutton phone, you can assign a Personal bin (50-59, 20-29) or a System bin (70-79 or 700-799). On a DSS Console, you can assign bins 1-79 to the keys.

Note: On a Multibutton phone, keys 1-16 automatically represent Personal Speed Dial bins 50-59 and 20-25 (i.e., without using Program 17). Note that bins 26-29 do not have keys assigned to them but can be called by pressing DIAL, then the two digits of the appropriate bin. To call a number that is stored under the bin keys, a user presses DIAL, then the key (a two-touch call). If you use Program 17 to make a one-touch Personal Speed Dial key, the bin you assign: (a) overwrites the original personal bin number (b) lets the user call the stored number by just pressing the key (no need to press DIAL).

FOR FEATURE INFORMATION: See Speed Dial on page 162.

Hotline (HL)

Use this option to assign a Hotline key and its associated extension (300-347).

FOR FEATURE INFORMATION: See Hotline on page 101.

Group Pickup (GP)

(Multibutton Only) Use this option to assign a Pickup Group (01-07) to a key.

FOR FEATURE INFORMATION: See Group Call Pickup on page 88.

Call Coverage (CCK)

(Multibutton Only) Use this option to assign a Call Coverage key.

Notes:

- If you assign the Call Coverage function to a DSS key (1-15), the system changes the DSS key's extension assignment to match the Call Coverage extension and vice versa.
- You can use the DSS procedure in Program 18 (II) to change a Call Coverage extension even if the Call Coverage key is not also a DSS key.

FOR FEATURE INFORMATION: See Call Coverage on page 169.

Page Zone (PO)

Use this option to assign a page zone (00-07) to a key.

FOR FEATURE INFORMATION: See Paging on page 138.

Automatic Call Timer (CTA)

(Multibutton Only) Use this option to assign an Automatic Call Timer key.

FOR FEATURE INFORMATION: See Call Timer on page 49.

Manual Call Timer (CTM)

(Multibutton Only) Use this option to assign a manual Call Timer key.

FOR FEATURE INFORMATION: See Call Timer on page 49.

Record Key (RK)

(Multibutton Only) Use this option to assign a Record key when the system is installed with Voice Mail.

FOR FEATURE INFORMATION: See Voice Mail on page 185.

Data Key

(Multibutton Only) To assign a Data Key to a phone, you must define the phone as a Dataset in Program 18 (I). When you do, key 16 automatically becomes the Data key; there is no need to make any assignment in Program 17. Be sure, however, that you do not assign some other function to key 16 using Program 17.

FOR FEATURE INFORMATION: See Data on page 61.

Filling Out the Program Record Form

1. Select a key on the appropriate phone drawing.

To assign this function . . .	Enter this abbreviation + number code (if any) . . .
Undefined key	UK
Line key	LK + Line number (01-16)
Loop Switch (Multibutton Only)	LS
Loop Group (Multibutton Only)	LG + Group (00-08)
Park Orbit	PO + Park Orbit (60-69)
Speed Dial	<u>On a Multibutton:</u> SD + Personal bin (50-59, 20-29) OR SD + System bin (700-799) <u>On a DSS Console:</u> SD + 1-79
Hotline	HL + Partner ext. (300-347)
Group Pickup (Multibutton Only)	GP + Pickup Group (00-07) Note: 00 = Not a member
Call Coverage key (Multibutton Only)	CCK + Covered ext. (300-347)
Page Zone	P0 (zero) + Page Zone (00-07) Note: 00 = All Call
Call Timer (Automatic) (Multibutton Only)	CTA
Call Timer (Manual) (Multibutton Only)	CTM
Record key (Multibutton Only)	RK
Data key (Multibutton Only)	See Program 18 (I), Dataset

Example

Extension 307 is a Multibutton phone with the following key assignments:
 Keys 1-5 are Loop Switch keys, keys 6-8 are lines 01-03, key 9 accesses Page Zone 07, and key 10 accesses Park Orbit 62 (no assignments will be shown for the other keys).

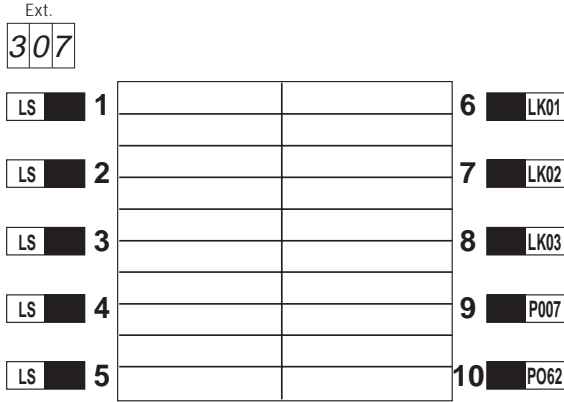

Entering Data Into Memory

- To enter Program 17 data:
1. Enter program mode.
 - Press # + dial SP + dial 5312 + press #.
 - If you are programming assignments for a DSS Console, you must program from the phone assigned to the console.
 2. Press key 17 (HOLD key) to enter Program 17.
 - You see "DEST. ICM NO:" (for destination extension).
 3. Dial extension (XXX) to be programmed, press #.
 - You see "SOURCE:" (for source extension). If you are programming assignments for your DSS Console, enter your extension number.

4. To program the keys at extension XXX: Dial extension XXX again, press #.
OR
To copy keys from extension YYY onto XXX: Dial YYY, press #, then go to step 8 if you do not need to change certain keys after you copy; otherwise, go to step 5.
 - If you are programming assignments for your DSS Console, enter your extension number.
 - This procedure does not copy:
 - Speed Dial (stored) numbers.
 - Ring Assign. (Program 18 [II])
 - Line Access (Program 16)
5. Press key you wish to program.
 - For DSS Consoles, press the DSS Console key.
6. To accept the displayed data: Press #.
OR
To change or enter data: Dial data, press #.
7. Repeat steps 5-6 for all keys.
8. Press SAVE.
9. Select an option:
 - To program another extension: Dial Y, then go to step 3.
 - OR
To exit Program 17: Press SAVE once.
 - OR
To exit the program mode: Press SAVE twice.
 - To enter another program after exiting: Press its key.

Understanding Related Programming

See the feature reference for each key.



Program 18 is initially set as follows for each extension:

- Do Not Disturb = Y
- Class of Service =
 - 30 for ext. 300
 - 01 for ext. 301-347
- Ring Group Member = 00 (not a member)
- Call Pickup Group Member = 00 (not a member)
- Privacy Release Group Member = 00 (not a member)
- Off-Hook Ringing = N
- Busy Lamp Field (BLF) and Direct Station Selection (DSS) for Keys 1-15 on a Multibutton Phone = Y
- Line Dial-Up = Y
- Page Zone Member = 00 (receives only All Call pages)
- Extension's (Station's) Operator = 300
- Speed Dial Block =
 - Blocks 01-05 for System Speed Dial numbers
 - Block 06-07 for exts. 300-301; 08 for 302; 00 (no block) for 303; 09-28 for 304-323
- Voice Mail = N
- Dataset = N
- Door Box (receive chimes) = N

Program 18 (Part I) lets you assign the following features to an extension. For information on other extension features, see Program 18 (Part II).

Do Not Disturb (DND)

Use this option to allow/deny Do Not Disturb at an extension. Enabling Do Not Disturb for an attendant extension lets the attendant put the system in the Night Answer mode.

FOR FEATURE INFORMATION: See Do Not Disturb on page 74, and Night Answer on page 121.

Class of Service (COS)

Use this option to assign a Class of Service (00-27) to an extension. The system automatically assigns COS 30 to any extension you designate as an operator in Program 3. COS 30 is the same as COS 00. When, however, you remove an operator from the system, you must manually assign it a non-operator COS (01-27).

FOR FEATURE INFORMATION: See Class of Service on page 58.

Ring Group Member (RG)

Use this option to make an extension a member of a Ring Group (01-08). A Ring Group extension should not also be in a Hunt Group or an attendant extension. Ring Groups 01-08 correspond to Ring Group numbers 364-371 (without AUX) or 396-403 (with AUX).

FOR FEATURE INFORMATION: See Group Ringing on page 91.

Call Pickup Group Member (CPG)

Use this option to assign an extension to a Pickup Group (01-07).

FOR FEATURE INFORMATION: See Group Call Pickup on page 88.

Privacy Release Group Member (PRG)

Use this option to assign a Multibutton extension to a Privacy Release Group (01-99).

FOR FEATURE INFORMATION: See Privacy Release on page 149.

Off-Hook Ringing (OHR)

Use this option to enable/disable Off-Hook Ringing at an extension. Enabling Off-Hook Ringing for an extension also converts its Call Waiting beeps into Off-Hook Ringing.

Always assign Off-Hook Ring to an attendant. Analog Station Interfaces do not receive Off-Hook Ringing even if you enable it here.

To see how Off-Hook Ringing and Whisper Page programming interact, see Whisper Page in Program 18 (II).

FOR FEATURE INFORMATION: See Off-Hook Signaling/Whisper Page on page 126.

DSS/BLF Lamps (BLF)

Use this option to let a Multibutton extension use keys 1-15 as Direct Station Selection/Busy Lamp Field (DSS/BLF) keys.

FOR FEATURE INFORMATION: See Direct Station Selection on page 69.

Line Dial-Up (LDU)

Use this option to determine whether an extension can access lines (01-16) by dialing codes 801-816. Enable this option for each extension that should be allowed to dial line codes (01-16) while storing Speed Dial numbers.

FOR FEATURE INFORMATION: See Placing an Outside Call (Using Line Dial-Up) on page 134 and Speed Dial on page 162.

Page Zone Member (PZ)

Use this option to assign an extension to an Internal Page Zone (00-07). An extension can be in only one Internal Zone. An extension in Zones 01-07 receives a page made to its assigned zone and All Call Pages. An extension in Zone 00 receives only All Call Pages.

FOR FEATURE INFORMATION: See Paging on page 138.

Extension's (Station's) Operator (SO)

Use this option to designate which operator (attendant) gets called when the extension user dials 0.

FOR FEATURE INFORMATION: See Intercom page 103.

Speed Dial Block (SDB)

Use this option to assign a Personal Speed Dial block (of memory) to an extension or DSS Console. If your system doesn't have an AUX Module, there are 28 Speed Dial blocks in the system, numbered 01-28, and each block can store 20 Speed Dial numbers (i.e., each block has 20 storage bins). However, not all 28 blocks are available for Personal Speed Dial numbers. The blocks available for Personal Speed Dial numbers depends on how many System Speed Dial numbers (bins) you select for the system in Program 3 (see table below).

Program 18: Extension Features (I) Extension Options

# System Speed Numbers	Blocks Used for System Speed Dial	Blocks Available for Personal Speed Dial
10	1/2 of 01	(1/2 of 01)-28
100	01-05	06-28

Three more things you need to know about assigning blocks are these:

- A DSS uses four consecutive blocks. So if you assign block 05, for example, the DSS Console actually uses 05, 06, 07, and 08.
- You can assign the same block to more than one extension when, for example, there are more extensions than blocks. The extension users would share access to the 20 bins in the block. For example, one person could use bins 50-59 and the other could use bins 20-29 (to store Speed Dial numbers, see Program 18 [Part II]).
- If your system has an AUX Module, you have 57 Speed Dial blocks (numbered 1-57).
- Initially, extension 303 has no Speed Dial block assigned. If you have an extension installed at 303, and it needs Speed Dial, use this program to assign it a block.

FOR FEATURE INFORMATION: See Speed Dial on page 162.

Voice Mail (VX)

Use this option to assign the Voice Mail (VX) feature to each ASI extension port designated for Voice Mail in Program 14.

Note: Use the VX programs in the following order: 14, 18 (I), 3, 19, 12, 17, 16.

FOR FEATURE INFORMATION: See Voice Mail on page 185.

Dataset (DS)

Use this option to program an extension as a Dataset when the extension is installed with a Data Module. Remember: The extension must be installed in an even-numbered port and you should program the port before you plug in the extension. If you plug it in before programming it, you must unplug it and plug it back in. As soon as you program an extension as a Dataset, key 16 becomes the Data key.

FOR FEATURE INFORMATION: See Data on page 61.

Door Box (receive chimes) (DB)

Use this option to program an extension to receive Door Box chime tones.

FOR FEATURE INFORMATION: See Door Box on page 75.

Filling Out the Program Record Form

1. Select an extension (300-347).

Extension Options Program 18: Extension Features (I)

In this box . . .	Enter this data . . .
DND (Do Not Disturb)	Y - enable N - disable
COS (Class of Service)	00-30
RG (Ring Group)	00-08 Note: 00 = Not a member
CPG (Call Pickup Group)	00-07 Note: 00 = Not a member
PRG (Privacy Release Group)	00-99 Note: 00 = Not a member
OHR (Off-Hook Ring)	Y - enable N - disable
BLF (DSS/BLF Lamps)	Y - enable N - disable
LDU (Line Dial-Up)	Y - enable N - disable
PZ (Page Zone)	00 - Receives All Call only 01-07 - Receives All Call and pages to Zones 01-07
SO (Station Operator)	Ext. 300-347
SDB (Speed Dial Block)	00-28 Note: 00 = No block assigned
VX (Voice Mail)	Y - enable N - disable
DS (Dataset)	Y - enable N - disable
DB (Door Boxes 1-4)	Y - enable N - disable

Program 18: Extension Features (I) Extension Options

Filling Out the Program Record Form

Example

Extension 305 has Do Not Disturb disabled (no other options will be shown).

Ext.	DND (Do Not Disturb)	COS (Class of Service)	RG (Ring Group)	CPG (Call Pickup Group)	PRG (Privacy Pickup Group)	OHR (Off-Hook Ring)	BLF (DSS/BLF Lamps)	LDU (Line Dial-Up)	PZ (Page Zone Member)	SO (Station Operator)	SDB (Speed Dial Block)	VX (Voice Mail)	DS (Database)	DB (Door Box)	DB (Door Box) - Alert 1	DB (Door Box) - Alert 2	DB (Door Box) - Alert 3	DB (Door Box) - Alert 4
305	N																	

0185318 (D)

Entering Data Into Memory

To enter Program 18 (Part I) data:

1. Enter program mode.
-Press # + dial SP + dial 5312 + press #.
2. Press key 18 (CONF key) to enter Program 18.
3. Dial extension number, press #.
4. Dial abbreviation for desired feature, press #.
-To dial PZ: Dial P, then 0 (zero).
5. To accept the displayed data: Press #.
OR
To change or enter data: Dial data, press #.
-To erase a data entry before you press #: Dial *.
-To accept the SO (station operator) data, you may have to press SAVE instead.
6. Repeat steps 4-5 for all features.
7. Press SAVE.
OR
Enter Program 18 (Part II) data for the same extension as follows: Go to step 4 in the procedures for Program 18 (Part II).
8. Select an option:
To enter data for another extension: Dial Y, then go to step 3.
OR
To exit Program 18: Press SAVE once.
OR
To exit the program mode: Press SAVE twice.
-To enter another program after exiting: Press its key.

Understanding Related Programming

For Class of Service:

Program 1 To set up a Class of Service

For Privacy Release Groups:

Program 16 To give an extension outgoing access to the lines intended for Privacy Release

Program 17 To assign a Privacy Release line to a key at an extension

For DSS/BLF:

Program 18 (II) To determine which extensions the DSS keys call

For Line Dial-Up:

Program 16 To give an extension outgoing access to lines

For Page Zones:

Program 18 (II) To enable/disable incoming pages at an extension

For Speed Dial Blocks:

Program 3 To select the number of System Speed Dial numbers

For Voice Mail (VX):

Program 14 To assign an ASI circuit type (51) to each extension intended for VX

Program 3 To install VX and select a VX master number from the ones selected in Program 18 (I)

Program 19 To set up the following UCD Hunt Group:

- (a) Hunt Type = 05
- (b) Master Extension = VX master number selected in Program 3
- (c) Overflow Extension = Operator extension assigned to VX master extension in Program 18 (I)
- (d) UCD Members = VX extensions selected in Program 18

Program 12 To directly terminate each line the Automated Attendant should answer to the VX master number selected in Program 3

Program 17 To assign a Record key to an extension

Program 16 To assign to each Voice Mail port (selected in Program 14) outgoing access to the lines used by the VX's Message Notification and Message Reminder features.

For a Dataset extension:

Program 14 To program the accompanying Data Module with the correct circuit type

Program 18: Extension Features (I) Extension Options

For Door Box:

Program 18(I) Each Digital Door Box extension must have Class of Service 28.



Program 18 is initially set as follows for each extension:

- Day/Night Ringing Assignments = Y for all lines at ext. 300; N for all lines at all other extensions; N for all Call Coverage and Pickup keys
- Night Ringing = N for all lines
- Delayed Ringing Assignment = N for all lines; N for all Call Coverage and Pickup keys
- Prime Line Assignment = N for all lines
- Ringing Line Preference = N for all lines
- Direct Station Selection Key Assignments = Keys 1-15 at a Multibutton phone each call extension 300
- Hotline Key Assignments
- Headset Installed = N
- Incoming Voice-Announced Call = N
- Voice Page Thru Speaker = Y
- Whisper Page = Y
- Speed Dial = No numbers stored

Program 18 (Part II) lets you assign the following features to an extension. With the proper programming access level, a Multibutton extension user can also program these features from their phone (see Program 15).

For information on other extension features, see Program 18, Part I.

Day/Night Ringing Assignments (RA)

Use this option to enable/disable immediate day/night ringing for an extension's lines, Call Coverage keys, and Pickup Group keys. Enabling immediate ring automatically disables Night Ringing or Delayed Ringing (see below).

Note: To have a line ring an ESL/ASI phone, you must directly terminate the line to the phone using Program 12.

FOR FEATURE INFORMATION: See Ringing Assignments on page 154.

Night Ringing (NR)

Use this option to enable or disable immediate ringing during the Night Answer mode for the lines at a Multibutton phone. Enabling Night Ring automatically disables Delayed Ringing or Day/Night Ringing Assignments (see below and above).

FOR FEATURE INFORMATION: See Night Ringing on page 124 and Night Answer on page 121.

Delayed Ring Assignment (DRA)

Use this option to enable/disable delayed day/night ringing for an extension's lines, Call Coverage keys, and Pickup Group keys. Enabling Delayed Ringing Assignment automatically disables ringing assigned through Ringing Assignment or Night Ringing (see above).

Note: Do not enable Delayed Ringing for a Call Coverage key assigned to the UCD master extension number unless your system has an AUX Module.

FOR FEATURE INFORMATION: See Delayed Ringing Assignment on page 62.

Program 18: Extension Features (II) Extension Options

Prime Line Assignment (PLA)

Use this option to enable/disable a Prime Line key for a Multibutton phone. When you enable Prime Line for a Line key, the system automatically assigns Ringing Line Preference (below) to that Line key. Do not assign a Prime Line to an attendant or Headset extension.

FOR FEATURE INFORMATION: See Placing an Outside call (Using Prime Line) on page 134.

Ringing Line Preference (RLP)

Use this option to assign Ringing Line Preference to a Multibutton extension. Do not assign Ringing Line Preference to a headset or attendant extension.

FOR FEATURE INFORMATION: See Ringing Line Preference on page 155.

Direct Station Selection (DSS)

Use this option to change a DSS (or Call Coverage) key's assigned extension.

Notes:

- You must assign the Call Coverage function (and extension) to a key through Program 17 before you can use this DSS procedure to change its extension.
- If you change the extension for a DSS key that is also a Call Coverage key, the system assigns that extension to the Call Coverage key.

FOR FEATURE INFORMATION: See Direct Station Selection on page 69 or Call Coverage on page 169.

Hotline Key Assignments (DSS)

Use this option to change a Hotline key's assigned extension.

FOR FEATURE INFORMATION: See Hotline on page 101.

Headset Installed (HS)

Use this option to enable/disable Headset capability for an extension. If you enable Headset, do not enable Prime Line Assignment or Ringing Line Preference (above).

FOR FEATURE INFORMATION: See Headset on page 95.

Incoming Voice-Announced Call (VA)

Use this option to enable/disable voice-announced Intercom calls at an extension. This option does not apply to attendant extensions (attendants do not receive voice-announced Intercom calls) and ASI extensions.

FOR FEATURE INFORMATION: See Intercom Calls on page 103.

Voice Page (VP)Thru Speaker

Use this option to enable/disable incoming pages over the speaker of an extension. This option does not apply to attendant extensions (attendants do not receive pages) and ASI extensions.

FOR FEATURE INFORMATION: See Paging on page 138.

Extension Options Program 18: Extension Features (II)

Whisper Page (VO)

Use this option to determine whether a Multibutton extension receives Whisper Page. This option does not apply to attendant extensions (attendants do not receive Whisper Page). Disable Whisper Page for extensions in Circular or Terminal Hunt Groups.

The chart below shows you how Off-Hook Ringing (Program 18 [I]) and Whisper Page (VO) programming interact when the caller is using the handset or Handsfree and the person receiving the Off-Hook Signaling ("Dest.") is using the handset or Handsfree.

Caller	Dest.	OHR	VO	Result after dialing 1
Handset	Handset	N	Y	Whisper Page to dest.
Handset	Handsfree	N	Y	No Off-Hook Signaling
Handsfree	Handset	N	Y	No Off-Hook Signaling
Handsfree	Handsfree	N	Y	No Off-Hook Signaling
Handset	Handset	N	N	Off-Hook Signaling
Handset	Handsfree	N	N	Off-Hook Signaling
Handsfree	Handset	N	N	No Off-Hook Signaling
Handsfree	Handsfree	N	N	No Off-Hook Signaling
Handset	Handset	Y	Y	Whisper Page to dest.
Handset	Handsfree	Y	Y	Off-Hook Signaling
Handsfree	Handset	Y	Y	No Off-Hook Signaling
Handsfree	Handsfree	Y	Y	Off-Hook ring if dest. has HF – otherwise no Off-Hook Signals
Handset	Handset	Y	N	Off-Hook Signaling
Handset	Handsfree	Y	N	Off-Hook Signaling
Handsfree	Handset	Y	N	Off-Hook Signaling
Handsfree	Handsfree	Y	N	Off-Hook Signaling

FOR FEATURE INFORMATION:

See Off-Hook Signaling (Whisper Page) on page 126.

Speed Dial (SD)

Use this option to store Personal Speed Dial numbers at an extension/DSS Console or System Speed Dial numbers for the system. You can store Personal Speed Dial numbers in bins 50-59 and 20-29 at a Multibutton phone. You can also store Personal Speed Dial numbers in extension and DSS Console One-Touch Speed Dial keys. You can store System Speed Dial numbers in bins 70-79 or 700-799 (i.e., in whatever bins you selected in Program 3). If you have a DSS Console, you can also use this option to store numbers in your console One-Touch Speed Dial keys.

Note: From a system programming extension you can store, at an extension, any Personal Speed Dial number that is allowed by the toll level of that system programming extension.

FOR FEATURE INFORMATION:

See Speed Dial on page 162.

Program 18: Extension Features (II) Extension Options

Filling Out the Program Record Form

For Day/Night Ring Assignment (RA), Night Ringing (NR), Delayed Ring Assignment (DRA), Prime Line Assignment (PLA):

1. Select a feature (e.g., RA).

In this box . . .	Enter this data . . .
Line (01-16)	Y - enable feature for the line N - disable feature for the line

For Direct Station Selection (DSS) and Call Coverage:

In this box . . .	Enter this data . . .
Key	Extension to be called (300-347)

For Headset (HS), Voice-Announced Calls (VA), Voice Page Thru Speaker (VP), Whisper Page (VO), Ringing Line Preference (RLP):

In this box . . .	Enter this data . . .
Feature Data	Y - enable feature N - disable feature

For Personal Speed Dial (SD):

Across from this heading . . .	Enter this data . . .
Bin or Key	Telephone Number, up to 32 digits (when a number is longer than 16 digits, record digits 17-32 in the next consecutive bin)

Extension Options Program 18: Extension Features (II)

For System Speed Dial (SD):

Across from this heading . . .	Enter this data . . .
Bin	Complete the bin number (70-79 or 700-799), then enter the telephone number, up to 32 digits (when a number is longer than 16 digits, record digits 17-32 in the next consecutive bin)

Example

In an 8-Line system, extension 307 has immediate Day/Night ringing on lines 1-5 (no other options will be shown).

Ext.			Feature Name	Line 01	Line 02	Line 03	Line 04	Line 05	Line 06	Line 07	Line 08	Line 09	Line 10	Line 11	Line 12	Line 13	Line 14	Line 15	Line 16
3	0	7		RA (Ringing Assign.)	Y	Y	Y	Y	Y	N	N	N							

01853117 (D)

Entering Data Into Memory

To enter Program 18 data for RA, NR, DRA, PLA:

1. Enter the program mode.
-Press # + dial SP + dial 5312 + press #.
2. Press key 18 (CONF key) to enter Program 18.
3. Dial extension number, press #.
4. Dial the abbreviation for the desired feature, press #.
-The Line keys you can program light steadily or flash. Steady means the feature is disabled, flashing means it is enabled.
5. Store a line as follows: Dial a line number or press a lit Line key.
6. To change or enter data: Dial data (Y[es] or N[o]), press #.
7. Repeat steps 5-6 for all lines.
8. Select an option:
To program another feature: Press SAVE and go to step 4 (in a Program 18 procedure).
OR
To program another extension: Press SAVE twice, dial Y, and go to step 3 (in any Program 18 procedure).
OR
To exit Program 18: Press SAVE three times.
OR
To exit the program mode: Press SAVE four times.
-To enter another program after exiting: Press its key.

Program 18: Extension Features (II) Extension Options

To enter Program 18 data for DSS (or Call Coverage) and Hotline:

1. Enter the program mode.
-Press # + dial SP + dial 5312 + press #.
2. Press key 18 (CONF key) to enter Program 18.
3. Dial ext. number, press #.
4. Dial DSS or HL, press #. DSS keys (1-15), any Call Coverage and Hotline keys flash.
5. Press a flashing key.
6. To accept the displayed data:
Press #.
OR
To change or enter data: Dial data, press #.
7. Repeat steps 5-6 for all keys.
8. Select an option:
To program another extension for DSS or the other features: Press SAVE twice, dial Y, and go to step 3 (in any Program 18 procedure).
OR
To program another feature for the same extension: Press SAVE and go to step 4 (in any Program 18 procedure).
OR
To exit Program 18: Press SAVE three times.
OR
To exit the program mode: Press SAVE four times.
-To enter another program after exiting: Press its key.

To enter Program 18 data for HS, VA, VP, VO, RLP:

1. Enter the program mode.
-Press # + dial SP + dial 5312 + press #.
2. Press key 18 (CONF key) to enter Program 18.
3. Dial extension number, press #.
4. Dial the abbreviation for the desired feature, press #.
5. To accept the displayed data: Press #.
OR
To change or enter data: Dial data, press #.
6. Select an option:
To program another feature: Go to step 4 (in any Program 18 procedure).
OR
To program another extension: Press SAVE, dial Y, and go to step 3 (in any Program 18 procedure).
OR
To exit Program 18: Press SAVE twice.
OR
To exit the program mode: Press SAVE three times.
-To enter another program after exiting: Press its key.

Extension Options Program 18: Extension Features (II)

To enter Program 18 data
for SD:

1. Enter the program mode.
-Press # + dial SP + dial 5312 + press #.
2. Press key 18 (CONF key) to enter Program 18.
3. Dial extension number, press #.
-For System Speed Dial, dial the number of the extension you are programming from.
4. Dial SD, press #.
5. Press a lit One-Touch Personal Speed Dial key or (Dial Personal bins 50-59 or 20-29, press #).

OR

Dial System Speed Dial bin, press #.

-You make One-Touch Speed Dial keys using Program 17.

6. If you can store a name:

Enter a name, press #. Or, just press # to not store a name and go to step 7.

OR

If you cannot store a name, go to step 7.

To enter a letter, number, blank:

*-Press dial pad button that has desired character.
Zero button= blank, Q, Z, (in that order).*

*-Dial digit (1, 2, 3) = letter's position on button
(e.g., dial 1 for 1st letter),*

OR

Dial 4 for the button's number.

-To erase last char., press LAST.

7. Dial a line (01-16) or press a Line key or dial a group 90-98 (if your system has line groups).
*-Fast busy tone means: Go to step 4, select another line in step 7.
-To store Intercom feature codes: Press ICM in step 7, dial codes in step 8.*
8. To accept the displayed data: Press #.

OR

To change or enter data: Dial telephone number data, press #.

-Numbers longer than 16 digits automatically flow to the next bin.

-To enter a pause, press HOLD.

-To enter a Flash, press MSG, or to enter a Delay, press DIAL. These options are only available with software versions AUX Module 02.10/Base 02.00 and higher.

*-To enter *: DIAL + dial **

-To enter #: DIAL + dial #

*-To erase a data entry before you press #: Dial **

Program 18: Extension Features (II) Extension Options

9. Select an option:
 - To program more bins: Go to step 5.
 - OR
 - To program another feature: Press SAVE once and go to step 4 (in any Program 18 procedure).
 - OR
 - To program another extension: Press SAVE twice, dial Y, and go to step 3 (in any Program 18 procedure).
 - OR
 - To exit Program 18: Press SAVE three times.
 - OR
 - To exit the program mode: Press SAVE four times.
 - To enter another program after exiting: Press its key.

Understanding Related Programming

For any option in Program 18, Part II:

- Program 15 To assign the appropriate program access level to extensions so the users can program Program 18 [III] options themselves

For RA, NR, DRA, PLA, RLP:

- Program 16 To give an extension access to a line
- Program 4 To set the Delayed Ring timer (for DRA only)
- Program 17 To assign a line to a key at an extension (required for PLA only)
- To assign Call Coverage or Pickup keys (for RA, DRA)

For DSS keys:

- Program 18 (I) To enable DSS/BLF keys

For Voice-Announced Intercom calls:

- Program 2 To enable voice calls system-wide

For Voice Pages Thru Speaker:

- Program 18 (I) To assign an extension to a page zone

For Speed Dial numbers:

- Program 16 To provide an extension with access to a line so you can store a line with a Personal Speed Dial number
- Program 1 To allow/deny access to System Speed Dial numbers in a Class of Service (see also Program 18 [I])
- Program 18 (I) To assign a Class of Service (from Program 1) to an extension

Extension Options Program 18: Extension Features (II)

- Program 3 To enable/disable dial-out of # in a Speed Dial number
To select the System Speed Dial bin numbers
- Program 17 To assign Speed Dial keys, if desired
- Program 4 To set the Dial Tone Detection timer (this sets the time the system waits for dial tone before sending out a Speed Dial number or after a stored pause)

**Program 19 is initially set as follows:**

- Circular Hunt Groups = None
- Terminal Hunt Groups = None
- UCD/ACD Hunt Groups = None

Program 19 lets you set up Hunt Groups for the Extension Hunting feature. You can create three types of Hunt Groups:

Circular Hunt Groups

To make Circular Hunt Groups, place extensions into a group in the order you want a call to hunt. Make the first and last extension in the group the same to form the circle (loop). An example of a Circular Hunt Group would be: 304, 305, 306, 307, 304. You must also assign a Hunt Type (01, 02, or 03) to each extension in the group (see the next page for an explanation of these Hunt Types). Each extension in the group can have a different Hunt Type.

Terminal Hunt Groups

To make Terminal Hunt Groups, place extensions into a group in the order you want a call to hunt. You must also assign a Hunt Type (01, 02, or 03) to each extension in the group (see next page for an explanation of these Hunt Types). Each extension in the group can have a different Hunt Type.

Notes:

- To have an unanswered outside call ring an attendant, make sure the last extension in the Terminal Hunt Group is an attendant extension with Hunt Type 00.
- To have an unanswered outside call ring all extensions that have ringing and access on that line, make sure the last extension in the Terminal Hunt Group is a non-attendant extension with Hunt Type 00. In this case, an unanswered transfer recalls the transferer before ringing the other extensions.

ACD and UCD Hunt Groups

To make Uniform Call Distribution (UCD) Hunt Groups, you assign a master extension number to the group, and a hunt type 04 or 05. With type 05, you can also enter an overflow extension. Then, you enter the members of the group in any order. For information on UCD Hunt Types, see the next page.

To form an Automatic Call Distribution (ACD) Hunt Group, first form a UCD group, then assign an ACD Supervisor Extension.

Note:

- The master extension number must be an uninstalled extension unless it is a master number for Voice Mail or Modem Pooling.

FOR FEATURE INFORMATION: See Extension Hunting on page 81 and Automatic Call Distribution on page 36.

Filling Out the Program Record Form

For Circular and Terminal Groups:

In this box . . .	Enter this data . . .
Member Ext.	301-347
Hunt Type	01 - Busy/unanswered outside calls are sent through the group 02 - Busy/unanswered outside and Intercom calls are sent through the group 03 - Unanswered outside calls are sent through the group

For UCD/ACD Groups

In this box . . .	Enter this data . . .
Hunt Type	04-UCD with no overflow 05-UCD with overflow
Master Ext.	301-347
Overflow Ext. (for type 05)	301-347 (do not use Superv. ext.)
Member Ext.	301-347
Supervisor Ext.	301-347

Example

There is a type 05 ACD group for Sales with Master Ext. 306, Overflow Ext. 307, Supervisor Ext. 301 and Member Exts. 310, 311, 312, 313.

Group Name Sales

Hunt Type	Master Ext.	Overflow Ext.	Supervisor Ext.
0	5	3	0
6	3	0	7
3	0	1	

Member Ext.	Member Ext.	Member Ext.	Member Ext.	Member Ext.	Member Ext.	Member Ext.
3	1	0				
3	1	1				
3	1	2				
3	1	3				

01853C14 (H)

Entering Data Into Memory

To enter Program 19 data for Circular/Terminal Hunt (types 01, 02, 03):

1. Enter program mode.
-Press # + dial SP + dial 5312 + press #.
2. On a Multibutton phone, press key 19 (MIC/DND key) to enter Program 19.
3. Dial 01, 02, or 03 to let the system know you want Circular or Terminal Hunting, not UCD.
-It doesn't matter which of the three numbers you enter.
4. Dial Member Ext., press #.
5. Dial Hunt Type for the extension, press #.
6. Repeat steps 4-5 for all Member Exts.

7. Select an option:
 To program another group: Press # until you see HUNT TYPE -, then go to step 3 (in any Program 19 procedure).
 OR
 To exit Program 19: Press SAVE once.
 OR
 To exit the program mode: Press SAVE twice.
-To enter another program after exiting: Press its key.

To delete a member of a Circular/Terminal Group:

1. Enter program mode.
-Press # + dial SP + dial 5312 + #.
2. On a Multibutton phone, press key 19 (MIC/DND key) to enter Program 19.
3. Dial 01, 02, or 03 to let the system know you want Circular or Terminal Hunt, not UCD.
-It doesn't matter which of the three numbers you dial.
4. Dial first Member Ext. in group, press #.
5. Press # until you see the extension you want to delete.
6. If the extension is the last extension in a Terminal Hunt: Dial 300, press #.
 OR
 If the extension is in the middle of the group: Dial the extension that comes after it, press #.
*If the group is 304, 305, 306 and you want to delete 305:
 -Press # until you see 305 (as explained in step 5).
 -Dial 306, press # (as explained in step 6).*
7. Continue as follows:
*-Press # until you see HUNT TYPE - .
 -Dial 01, 02, or 03, press #.
 -Dial the extension you just deleted, press #.
 -Dial 00 for Hunt Type, press #.*
8. Press SAVE until you exit the program mode.

To add a member to a Circular or Terminal Group:

1. Enter program mode.
-Press # + dial SP + dial 5312 + press #.
2. On a Multibutton phone, press key 19 (MIC/DND) to enter Program 19.
3. Dial 01, 02, or 03 to let the system know you want Circular or Terminal Hunting, not UCD Hunt.
-It doesn't matter which of the three numbers you dial.
4. Dial first Member Ext., press #.
5. Press # until you see the extension before which you want to add an extension.

-For example, if the group is 304, 305, 306 and you want to add 307 before 306, press # until you see 306.

6. Dial the extension you want to add, press #. Dial its Hunt Type, press #. Repeat for the extension after it.
-Using the example, above, do this step for 307, then 306.
7. Press # until you see "HUNT TYPE-."
8. Press SAVE until you exit the program mode.

To enter (or delete)
Program 19 data for
UCD/ACD Hunt Groups
(type 04, 05):

1. Enter program mode.
-Press # + dial SP + dial 5312 + press #.
2. On a Multibutton phone, press key 19 (MIC/DND key) to enter Program 19.
3. Dial Hunt Type, press #.
4. Dial Master Ext., press #. After step 4 or 5 (depending on Hunt type), you see the "MASTER EXT." prompt again.
5. If using type 04: Go to step 6.
OR
For using 05: Dial the overflow extension, press #.
6. Press # to move past "MASTER EXT." prompt.
- You see: UCD MEMBER
OR
To delete the entire group: Dial *, press SAVE, go to step 10.
7. To enter a Member Ext.: Dial Member Ext., press #.
OR
To delete a Member Ext.: Dial * (you'll see the next member).
-To add a Member Ext. to an existing group: Press # until you see: UCD MEMBER (without an extension). Then, dial the Member Ext., press #.
8. Repeat step 7 for all members and press SAVE.
9. Select an option:
To program another group: Go to step 3 (in any Program 19 procedure).
OR
To exit Program 19: Press SAVE.
OR
To exit the program mode: Press SAVE twice.
-To enter another program after exiting: Press its key.

To enter Program 19 data
for ACD Supervisor:

1. Enter program mode.
-Press # + dial SP + dial 5312 + press #.
2. On a Multibutton phone, press key 19 (MIC/DND key) to enter Program 19.
3. Dial 00 for Hunt Type, press #.

4. Dial Master Ext. for the Supervisor's group, press #.
-You see "UCD MEMBER."
5. Dial Supervisor Ext., press #.
6. Select an option:
To program another Supervisor: Go to step 3.
OR
To exit Program 19: Press SAVE.
OR
To exit the program mode: Press SAVE twice.
-To enter another program after exiting: Press its key.

To delete an ACD Supervisor:

1. Enter program mode.
-Press # + dial SP + dial 5312 + press #.
2. On a Multibutton phone, press key 19 (MIC/DND key) to enter Program 19.
3. Dial Hunt Type for Supervisor's group, press #.
4. Dial Master Ext. for Supervisor's Group, press #.
5. Press # until you see the Supervisor's extension number.
6. Dial *.
7. Press SAVE.
8. Select an option:
To delete more Supervisors: Go to step 3.
OR
To exit Program 19: Press SAVE.
OR
To exit the program mode: Press SAVE twice.
-To enter another program after exiting: Press its key.

Understanding Related Programming

For UCD or ACD Groups:

- | | |
|-------------------|--|
| Program 3 | To select a VX Master Extension Number if the system is installed with Voice Mail |
| Programs 1,18 (!) | To set up a Class of Service (COS) that allows an ACD Supervisor; To assign that COS to the Supervisor extensions |
| Program 17 | To assign Hotline or Call Coverage keys to the Supervisor's Console or Supervisor's extension for each ACD member and for the master extension |
| Program 4 | To set the Camp-On timer |
| Program 12 | To directly terminate a trunk to an UCD/ACD master extension |

- For your notes -



Program 20 is initially set as follows:

- N/A

Program 20 automatically assigns the initial (default) value to all the feature options in Programs 1-19. To quickly review the initial values of a program, turn to the first page of that program and refer to the shaded box in the upper left-hand corner.

FOR FEATURE INFORMATION: N/A

Filling Out the Program Record Form

N/A

Entering Data Into Memory

- To use Program 20:
1. Enter program mode.
-Press # + dial SP + dial 5312 + press #.
 2. On a Multibutton phone, press key 20 (ICM key) to enter Program 20.
 3. Dial Y to initialize and wait for the date and time.
OR
Dial N to exit Program 20.
-When you see the date and time, this means the database has been initialized.
-To select another program: Press its key.
OR
To exit the program mode: Press SAVE.

Understanding Related Programming

N/A

- For your notes -

1+NNX Dialing, Programming Allow/ Deny Tables 217
 500/2500 Sets as Power Failure Telephones 6, 147
 6-Digit Analysis, Programming Tables 218

A

Access Level, Extension, Programming 244 - 246
 Access Page Zones 1-3, Programming 199
 Account Codes 23
 ACD
 ACD Announcements 37
 See Automatic Call Distribution
 ACD Supervisor Programming 199
 Active Dial Pad, Programming 216
 Adjusting the Volume Controls 193
 Alarm 24
 Alerting Device, External 84
 All Agents Busy, ACD 37
 All Page (Initiate), Programming 199
 Alphanumeric Display 25 - 29
 Display Brightness 29
 Introduction to 7
 Alternate
 See Split
 Alternate Attendant 30
 Analog Station Interface 31 - 35
 Feature Operation 32
 Answering Machine Emulation 185
 Answering Outside Calls 132 - 133
 ARS
 See Automatic Route Selection
 ASI
 See Analog Station Interface
 Assigned Night Answer 121
 Assigning Ringing at Night 124
 Attendant
 Extension's Operator, Programming 257
 Attendant Features Only
 Alarm 24
 Alternate Attendant 30
 Call Forwarding System Cancel 47
 Forced Line Disconnect 87
 Night Answer 121
 Silent Monitor 161
 Attendant, Features Not Available to
 Call Forwarding 44
 Callback 50
 Do Not Disturb 74
 Group Listen 90
 Handsfree 93
 Attendants

Index

Multiple Positions	118 - 119
Authorization Codes, Forced	
ARS	40
Automated Attendant	185 - 188
See also Operator Assistance	
Automatic Call Answering	
See Voice Mail	
Automatic Call Distribution	36 - 38
Supervisor Functions	36
Supervisor's DSS Console	36
Automatic Handsfree	94
Automatic Handsfree, Programming	202
Automatic Hold	97
Automatic Ringdown	39
Automatic Route Selection	40 - 41
976/555 Restriction	40
Call Routing	40
Class of Service Control	40
Dialing Translation	40
Forced Authorization Codes	40
Options	40
Separate Routing	40
Time of Day Selection	40
AUX Port Baud Rate, Programming	206

B

Background Music	42
Adjusting the Volume	42
See also Music and Paging	
Turning On and Off	42
Background Music Enable, Programming	223
Barge-In	106
Battery Backup	43
Baud Rate, AUX Port, Programming	206
BGM	
See Background Music	
BGM to External Page Zones, Programming	224
Blocking Signals from Other Callers	
See Privacy	
Break Time	173
Break Time, Programming	212
Break-In (Intrusion), Programming	198

C

Call Coverage	169 - 170
Call Coverage Key, Programming	251
Call Forwarding	44 - 45
Canceling	45
Enabling	44
Personal Greeting	145 - 146
To Voice Mail	185

Call Forwarding at Attendant
 See Alternate Attendant

Call Forwarding System Cancel 47

Call Forwarding, Off Premise 46

Call Intercept 48

Call Park 141 - 142

Call Pickup
 Directed. 71

Call Pickup Group, Line, Programming 234

Call Pickup, Group 88 - 89

Call Privacy 148

Call Routing, ARS 40

Call Timer 49
 Auto. 49
 Automatic, Key Programming 251
 Manual 49
 Manual, Key Programming. 252

Call Waiting 55 - 56

Call Waiting (Camp On), Programming 202

Callback 50
 Canceling 50
 Line 108 - 109

Callback (Line Queuing) Priority, Programming 199

Called Number Delivery (CND)
 See Caller ID

Called Number Identification (CNI)
 See Caller ID

Caller ID 51 - 54
 Displays. 51
 Hardware Considerations 52
 Post-Answer Display 51
 Pre-Answer Display 51

Camp-On 55 - 56

Camp-On Timer. 172

Camp-On Timer, Programming 210

Camp-On to Busy Extension, Programming. 198

Canceling Call Forwarding System-Wide. 47

Centrex Lines. 135

Centrex/PBX Feature Keys 57

Circuit Type, Lines, Programming 229

Circular Hunting 81

Class of Service 58 - 59
 Access Page Zones 1-3, Programming 199
 ACD Supervisor Programming. 199
 All Page (Initiate), Programming 199
 Assigning to an Extension 256
 Break-In (Intrusion), Programming 198
 Callback (Line Queuing) Priority, Programming. 199
 Camp-On to Busy Extension, Programming 198
 Direct Trunk Access & Camp-On, Programming 199
 Extended Ring, Programming 199

Index

Internal Call Forwarding, Programming	198
Lines	235
No Flash at ESL, Programming	199
Off-Premise Call Forward, Programming	198
Only Intercom Calls at Night, Programming	197
Only Local Calls (Day or Night), Programming	198
Only Local Calls at Night, Programming	198
Privacy, Programming	199
Silent Monitor, Programming	199
Single Ring for ASI Calls, Programming	200
System Speed Dial Access, Programming	198
Toll Restriction Level, Programming	198
Walking	194
See also Walking Class of Service	
Class of Service Control	
Automatic Route Selection	40
CND	
See Caller ID	
CO Calls	
Answering	132 - 133
Placing	134 - 137
Codes	
Dialing Codes to Use Features	8
Conference	60
Add On	60
Meet-Me	111
Unsupervised	184
Continuous Dialing, Programming	216
Conversation Record	185
Cutting off the Microphone	116
D	
Data	61
Data Key, Programming	252
Dataset, Programming	258
Date and Time	177
Delay, in a Speed Dial Bin	163
Delayed Ringing	13
Delayed Ringing Assignment	
Programming	263
Delayed Ringing Assignments	62
Dial 1 Before Area Code, Programming	206
Dial Tone Detect Time	173
Dial Tone Detect Time, Programming	211
Dialing Codes to Use Features	8
Dialing from Your PC	
See Telemarketing Dial	
Dialing Handsfree	93
Dialing Number Preview	63
Dialing Plan	12
Dialing Restrictions	

See Toll Restriction

Dialing Translation, ARS 40

Digital Door Box 75 - 76

DIL

 Direct DIL Termination (Day), Programming 234

DILs

 See Direct Inward Lines

Direct DIL Termination (Night), Programming 234

Direct Inward Lines 64 - 65

Direct Station Selection

 DSS Console 66 - 68

 Extension 69 - 70

 Programming 257, 264

Direct Trunk Access & Camp-On Programming 199

Directed Call Pickup 71

Directory Dialing 72 - 73

Disconnecting Lines 87

Display Messages 159 - 160

Display Messages, Programming 227 - 228

Distinctive Ringing 156

 Programming 235

DND

 See Do Not Disturb

Do Not Disturb 74

 Programming 256

Door Box 75 - 76

Door Strike Release

 See Relay Box

DP and DTMF Compatibility 77 - 78

DSS

 If You Have a DSS Console 8

DSS Console 66 - 68

DSS Console Block, Programming 241

DSS Console Owner, Programming 241

E

Equal Access Compatibility 79

Equal Access Dialing, Programming 217

Equal Access Routing

 ARS 40

Exchange Restriction

 ARS 40

Exclusive Hold 98

Extended Ring, Programming 199

Extended Ringing 80

Extending Calls to a Co-Worker

 See Transfer

Extension Callback 50

Extension Circuit Type, Programming 239

Extension Class of Service 58 - 59

Extension Features (I)

- Class of Service, Assigning to an Extension 256
- Dataset, Programming 258
- Direct Station Selection, Programming 257
- Do Not Disturb, Programming 256
- Group Call Pickup, Member Programming 256
- Group Ring Member, Programming 256
- Line Dial Up, Programming 257
- Off-Hook Signaling, Programming 257
- Operator for Extension, Programming 257
- Paging, Zone Member, Programming 257
- Privacy Release Groups, Programming 257
- Speed Dial Block, Programming 257
- Voice Mail Key, Programming 258
- Extension Features (II)
 - Direct Station Selection, Programming 264
 - Headset, Programming 264
 - Hotline, Programming 264
 - Incoming Voice Call, Programming 264
 - Night Ringing 263
 - Page (Voice Page), Programming 264
 - Prime Line Assignment, Programming 264
 - Ringin g Assignments, Day/Night, Programming 263
 - Ringin g Assignments, Delayed, Programming 263
 - Ringin g Line Preference, Programming 264
 - Speed Dial, Storing (Using Program 18 [II]). 265
 - Whisper Page, Programming 265
- Extension Hotline 101 - 102
- Extension Hunting 81 - 83
 - Circular Hunting 81
 - Programming 272 - 278
 - Terminal Hunting 81
 - Uniform Call Distribution (UCD) 82
- Extension Key Assignments
 - Automatic Call Timer Key, Programming 251
 - Call Coverage, Programming 251
 - Data Key, Programming 252
 - Group Pickup, Programming 251
 - Hotline, Programming 251
 - Line Key, Programming 250
 - Loop Group Keys, Programming 250
 - Manual Call Timer Key, Programming 252
 - One-Touch Speed Dial Key, Programming 251
 - Page Zone Key, Programming 251
 - Park Orbit Key, Programming 251
 - Record Key, Programming 252
 - Switched Loop Keys, Programming 250
 - Undefined Key, Programming 250
- Extension Numbering, Programming 239
- Extension Port Characteristics
 - Circuit Type, Programming 239
 - DSS Owner 241

Extension Name	241
Extension Numbering, Programming	239
Extension Port Characteristics, Programming	239
Extensions	
Access Level, Programming	244 - 246
Key Assignments, Programming	250 - 255
Line Access, Programming	247 - 249
Line Group Access, Programming	247 - 249
Name, Programming	241
Operator, Programming	257
Removing	153
External Alerting Device	84
External Zone Paging	138

F

Feature Keys for Centrex/PBX	57
Flash.	85
In a Speed Dial Bin	163
Flash Response Time.	173
Flash Response Time, Programming.	211
Flexible Numbering Plan.	86
Flexible Numbering Plan, Extensions	239
Forced Authorization Codes	
ARS	40
Forced Line Disconnect.	87

G

Gain, Lines, Programming	229
Group Call Pickup	88 - 89
Key Programming	251
Member, Programming	256
Group Listen	90
Group Ring	
Member, Programming	256
Group Ringing	91 - 92
Groups	
Call Pickup	88 - 89
Line Group Access, Extensions, Programming	247 - 249
Groups, Lines, Programming	232 - 233
GTE Sprint	
See Other Common Carriers	

H

Handsfree.	93
Automatic	94
Using Handsfree Instead of the Handset	7
Handsfree Dialing (without a speakerphone)	117
Handsfree Reply on Intercom, Programming	202
Headset	
Programming	264
Headset.	95 - 96

Index

Hearing Tones from Other Callers See Off-Hook Signaling	
Hierarchical Class of Service Control, ARS	40
Hold	
Automatic	97
Exclusive	98
Regular	99 - 100
Hold Recall Timer	172
Hold Recall Timer, Programming	210
Hold, Intercom	
See Hold, Regular	
Hold, System	
See Hold, Regular	
Hotline	101 - 102
Programming	251, 264
Hunting	
Circular	81
Terminal	81
UCD	82
Hunting, Extension	81 - 83
I	
Identifying Tone Patterns	180
Incoming Voice Call, Programming	264
Integrated Voice Messaging	
See Voice Mail	
Intercept of Calls	48
Intercom	
Incoming Voice Call, Programming	264
Intercom	103 - 105
Intercom Signaling	
Automatic Handsfree, Programming	202
Call Waiting (Camp On), Programming	202
Handsfree Reply on Intercom, Programming	202
Voice Announced Intercom Calls, Programming	202
Interdigit Time	173
Interdigit Time, Programming	212
Internal Call Forwarding, Programming	198
Internal Zone Paging	138 - 140
International Call Routing	
ARS	40
International Dialing, Programming	217
Intrusion (Barge-In)	106
K	
Keys, Extensions, Programming	250 - 255
L	
Last Number Redial	107
Leaving a Message Waiting	113 - 114
Leaving a Voice Message	185

LEDs	
Your Telephone's Key Lights	7
Line & Group Access, Extensions, Programming	247 - 249
Line Circuit Type, Programming	229
Line Disconnect	
Forced	87
Line Features	
Call Pickup Group, Programming	234
Class of Service	235
Direct DIL Termination (Day), Programming	234
Direct DIL Termination (Night), Programming	234
Toll Restriction, Programming	234
Line Gain, Programming	229
Line Groups, Programming	232 - 233
Line Keys, Programming	250
Line Name, Programming	229
Line Preference	155
Line Queuing	108 - 109
Line Response Time	172
Line Response Timer, Programming	210
Line Rotaries	
See Line Groups	
Lines	
Circuit Type, Programming	229
Direct DIL Termination (Day), Programming	234
Direct DIL Termination (Night), Programming	234
Group Call Pickup, Programming	234
Keys, Programming	250
Line Gain, Programming	229
Line Name, Programming	229
PBX Line, Programming	229
Removing	153
Side Tone Test, Programming	229
Toll Restriction, Programming	234
Loop Keys, Programming	250
Loud Ringing	84
M	
Mailbox Call Forwarding	185
Mailbox Transfer	185
Mailboxes	
See Voice Mail	
Maintenance Utilities and Reports	110
Make Time, Programming	211
Make Timer	173
MCI	
See Other Common Carriers	
Meet-Me Conference	111
Message Center	112
Message View, Voice Mail	185
Message Waiting	113 - 114

Index

To Voice Mail	185
Messages, from VMU	191 - 192
Microphone Cutoff	116
Microphone Mute	115
Modem Reserve Time	172
Modem Reserve Timer, Programming	210
MOH	
See Music on Hold	
Monitor	
Silent.	161
Monitor.	117
Multibutton Telephone	6
Programmable Keys	151 - 152
Multiple Attendant Positions	118 - 119
Multiple Tenants	
See Tenant Service	
Music and Paging	
Background Music Enable, Programming	223
BGM to External Page Zones, Programming	224
Music on Hold Enable, Programming	223
Paging and Music Gain, Programming	224
Paging, External All Call Audible Ring.	223
Paging, External All Call, Programming	223
Paging, External Zone 1, Programming.	223
Paging, External Zone 2, Programming.	224
Paging, Relay 01 Owner, Programming	224
Paging, Relay 02 Owner, Programming	224
Ringing, Interrupted Ring Relays, Programming	224
Music and Paging Gain, Programming	224
Music on Hold	120
See also Music and Paging	
Music on Hold Enable, Programming	223
Muting the Microphone	115

N

N11 (Special) Dialing, Programming.	216
Name, Extensions, Programming.	241
Name, Lines, Programming	229
Night Answer	121 - 123
External Alerting	123
Night Ringing	
Assignments, Programming	263
Direct DIL Termination (Night), Programming.	234
Night Ringing Assignments	124
Night Service	121 - 123
NNX Dialing, Programming Allow/Deny Tables.	217
No Flash at ESL, Programming	199
Non-Blocking System Architecture	125
NPA Dialing, Programming Allow/Deny Tables	218
Number of Delayed Rings	172
Number of Delayed Rings, Programming	211

Number of Operators, Programming 205
 Number of Rings Before Recall 172
 Number of Rings Before Recall, Programming 210
 Number of System Speed Dial Dgts, Programming 205
 Number Preview 63
 Number Redial 107
 Number Save 158
 Numbering
 Flexible 86

O

OCC
 See Other Common Carriers
 Off-Hook Ringing 126
 Off-Hook Signaling 126 - 127
 Programming 257
 Off-Hours Ringing 121 - 123
 Off-Premise Call Forwarding, Programming 198
 One-Touch Speed Dial Key, Programming 251
 Only Intercom Calls at Night, Programming 197
 Only Local Calls (Day or Night), Programming 198
 Only Local Calls at Night, Programming 198
 Operator
 Programming 257
 Operator (0+) Dialing, Programming 217
 Operator Assistance 128 - 130
 Operator Assistance Routing
 ARS 40
 Operator Extension, Programming 205
 Operators (Number of), Programming 205
 OPX Call Forwarding 46
 Other Common Carriers 131
 Outside Calls
 Answering 132 - 133
 Placing 134 - 137
 Placing, using Direct Line (Trunk) Access 134
 Placing, using Direct Line Group Access 134
 Placing, using Line Dial-Up 134
 Placing, using PBX/Centrex lines 135
 Placing, using Prime Line 134
 Private Lines 150
 Transfer 182 - 183
 Outside Calls, Answering
 Caller ID 51 - 54
 Outside Calls, Placing
 Line Dial Up, Programming 257
 Overriding Dialing Restrictions
 See Walking Class of Service

P

Page	Programming	264
Paging	138 - 140
	External	138
	Internal	138 - 140
	See also Music and Paging	
	Page Zone Key, Programming	251
	Zone Member, Programming	257
Paging and Music Gain, Programming		224
Paging, External All Call Audible Ring		223
Paging, External All Call, Programming		223
Paging, External Zone 1, Programming		223
Paging, External Zone 2, Programming		224
Paging, Relay 01 Owner, Programming		224
Paging, Relay 02 Owner, Programming		224
Park		141 - 142
	Orbit Key, Programming	251
Park Orbit Time, Programming		210
Park Orbit Timer		172
Pause, in a Speed Dial Bin		163
PBX Feature Keys		57
PBX Line, Programming		229
PBX/Centrex Lines		135
PC Dialing		174
PCU (Peripheral Control Unit)		143 - 144
Peripheral Control Unit (PCU)		143 - 144
Personal Answering Machine Emulation		185
Personal Greeting		145 - 146
Personal Park Orbits		141 - 142
Personal Speed Dial		162
Phones		
	The Type You Have	6
Pickup		
	Group Call	88 - 89
Pickup Group, Line, Programming		234
Placing Outside Calls		134 - 137
Play MOH for Transferred Calls, Programming		206
Power Failure Telephone		147
Prime Line Selection		134
	Programming	264
Privacy		148
Privacy Release		149
	Group, Programming	257
Privacy Release Groups		
	See Privacy Release	
Privacy, Programming		199
Private Lines		150
Program 10: Line Port Characteristics		229 - 231
Program 11: Line Groups		232 - 233
Program 12: Line Features		234 - 238

Program 14: Extension Port Characteristics 239 - 243

Program 15: Access Level (Extension) 244 - 246

Program 16: Line and Group Access. 247 - 249

Program 17: Key Assignments 250 - 255

Program 18: Extension Features (I) 256 - 262

Program 18: Extension Features (II). 263 - 271

Program 19: Hunt Groups 272 - 278

Program 1: Class of Service 197 - 201

Program 20: System Initialization. 279 - 280

Program 2: Intercom Signaling 202 - 204

Program 3: System Features 205 - 209

Program 4: System Timers 210 - 213

Program 5: PBX Access Codes 214 - 215

Program 6: Toll Restriction 216 - 222

Program 7: Music and Paging 223 - 226

Program 8: Display Messages 227 - 228

Programmable Keys 151 - 152

 Call Coverage 151

 Call Timer 151

 Hotline. 151

 Line Keys 151

 Loop Group. 151

 Loop Switch 151

 One-Touch Speed Dial 151

 Page Zone 151

 Park Orbit Keys. 151

 Pickup Group 151

 Record Key 151

 Tri-Level Keys 152

 Using a Key with Three Functions 6

Programmable Keys, Assignments 250 - 255

Prompts, Voice 191 - 192

Pulse to Tone Conversion 77 - 78

Q

Queuing for Lines 108 - 109

R

Record Conversation 185

Redial 107

Regular Hold 99 - 100

Relay Box 75

Removing Lines and Extensions 153

Reports 110

 Traffic Management Reporting. 181

Reports

 SMDR 171

Restricting Outside Calls

 See Toll Restriction

Restriction for Exchanges 976 and 555 40

Ringdown, Automatic 39

Ringing	
Extended	80
External	84
Ringing Assignments	13, 154
At Night	124
Day/Night, Programming	263
Delayed	62
Ringing Assignments, Delayed	
See Delayed Ringing Assignments	
Ringing Assignments, Night	
See Night Ringing	
Ringing Line Preference	155
Programming	264
Ringing Patterns	156 - 157
Ringing, Group	91 - 92
Ringing, Interrupted Ring Relays, Programming	224
RLP	
See Ringing Line Preference	
Rotaries	
See Line Groups	
S	
Save	158
Selectable Display Messages	159 - 160
Selectable Display Messages, Programming	227 - 228
Sending Calls to a Co-Worker	
See Transfer	
Separate Routing	
ARS	40
Setting the Time and Date	177
Side Tone Test, Programming	205, 229
Silent Monitor	161
Silent Monitor, Programming	199
Single Ring for ASI Calls	200
SMDR	171
Speed Dial	
Block, Programming	257
Line Dial-Up Programming	257
One-Touch Speed Dial	162
One-Touch Speed Dial Key, Programming	251
Personal	162 - 166
Storing (Using Program 18 [II])	265
Storing a Pause, Flash or Delay	163
Storing Long Numbers	162
System	162
Speed Dial Access, Programming	198
Speed Dial Enable # Dial-Out, Programming	206
Split	167 - 168
Station Call Coverage	169 - 170
Station Message Detail Recording	171
Station-to-Station Calling	

See Intercom

Supervisor Monitoring 161

Switching Between Calls
See Split

System Architecture, Non-Blocking 125

System Features

- AUX Port Baud Rate, Programming 206
- Dial 1 Before Area Code, Programming 206
- Number of Operators, Programming 205
- Number of System Speed Dial Dgts, Programming 205
- Operator Extension, Programming 205
- Play MOH for Transferred Calls, Programming 206
- Side Tone Test, Programming 205
- Speed Dial Enable # Dial-Out, Programming 206
- Voice Mail Installed (Enabled), Programming 206
- Walking Class of Service Code, Programming 206

System Hold
See Hold, Regular

System Numbering
Flexible 86

System Options
Voice Mail Master Extension, Programming 206

System Park Orbits 141 - 142

System Reports
SMDR 171
Traffic Management Reporting 181

System Reports and Utilities 110

System Speed Dial 162

System Timers 172 - 173

- Break 173
- Break Timer, Programming 212
- Camp-On 172
- Camp-On Timer, Programming 210
- Dial Tone Detect 173
- Dial Tone Detect Timer, Programming 211
- Flash Response 173
- Flash Response Timer, Programming 211
- Hold Recall 172
- Hold Recall Timer, Programming 210
- Interdigit 173
- Interdigit Timer, Programming 212
- Line Response 172
- Line Response Timer, Programming 210
- Make 173
- Make Timer, Programming 211
- Modem Reserve 172
- Modem Reserve Timer, Programming 210
- Number of Delayed Rings 172
- Number of Delayed Rings, Programming 211
- Number of Rings Before Recall 172
- Number of Rings Before Recall, Programming 210

Park Orbit	172
Park Orbit Timer, Programming	210
System Tones	
Tone Patterns	180

T

Table of Displays	25
Tandem Calls.	184
Telemarketing Dial	174
Telephone Key Lights (LEDs)	7
Telephone Tone Patterns	180
Tenant Service.	175 - 176
Terminal Hunting	81
Text Messages	159 - 160
Time and Date	177
Time of Day Selection, ARS.	40
Timers	
See System Timers	
TMS Reports	
See Traffic Management Reporting	
Toll Restriction	178 - 179
1+NNX Dialing, Programming Allow/Deny Tables	217
6-Digit Analysis, Programming Tables	218
Active Dial Pad, Programming	216
Equal Access Dialing, Programming	217
International Dialing, Programming	217
N11 (Special) Dialing, Programming	216
NNX Dialing, Programming Allow/Deny Tables	217
NPA Dialing, Programming Allow/Deny Tables	218
Operator (0+) Dialing, Programming	217
Toll Restriction Level, Programming	198
Toll Restriction Override	
See Walking Class of Service	
Toll Restriction, Line, Programming	234
Tone Patterns.	180
Traffic Management Reporting.	181
Transfer	
Voice Mail	185
Transfer.	182 - 183
Trunk Calls	
Answering	132 - 133
Placing	134 - 137
Placing, Using a Line Key	134
Trunk Disconnect	
Forced	87
Trunk Queuing	108 - 109
Trunks	
See Lines, Removing	153

U

UCD (Uniform Call Distribution) Hunting	82
UCD Messages	191
Undefined Key, Programming	250
Universal Night Answer	121
Unsupervised Conference	184
UPS	
See Battery Backup	
User Programming	
Chart	13
User-Programmable Features	
Chart	13
Customize with User-Programmable Features	8
Delayed Ringing Assignment	62
Direct Station Selection	69 - 70
Group Call Pickup	88 - 89
Headset	95 - 96
Hotline	101 - 102
Intercom Voice Announcements	103 - 105
Night Ringing	124
One-Touch Speed Dial Keys	162
Paging	138 - 140
Prime Line Selection	134
Ringing Assignments	154
Ringing Line Preference	155
See Program 18 (II)	263 - 271
Station Call Coverage	169 - 170
Utilities and Reports	110

V

Viewing Voice Mail Messages	185
VMU (Voice Module Unit)	189 - 190
Voice Mail	185 - 188
Answering Machine Emulation	185
Call Forwarding	185
Conversation Record	185
Key Programming	258
Leaving a Message	185
Mailbox Message Waiting	185
Message Center	112
Message View	185
Personal Answering Machine Emulation	185
Record Key, Programming	252
Transfer	185
Voice Mail Installed (Enabled), Programming	206
Voice Mail Master Extension, Programming	206
Voice Module Unit	189 - 190
Voice Over	
see Whisper Page	
Voice Prompting Messages	191 - 192

Index

Voice-Announced Intercom Calls, Programming	202
Volume Controls	193

W

Walking Class of Service	194
Walking Class of Service Code, Programming	206
Whisper Page	126 - 127
Programming	265

NITSUKO AMERICA

**Nitsuko America, Telecom Division
4 Forest Parkway
Shelton, CT 06484**

TEL: 203-926-5400
FAX: 203-929-0535

Other Important Telephone Numbers

Sales	203-926-5450
Customer Service	203-926-5444
Customer Service FAX	203-926-5454
Technical Service	203-925-8801
Discontinued Product Service	900-990-2541
Technical Training	203-926-5430
Emergency Technical Service (After Hours) (Excludes discontinued products)	203-929-7920

NITSUKO AMERICA

4 Forest Parkway, Shelton, CT 06484
TEL: 203-926-5400 FAX: 203-929-0535