

**NEC**

**Electra – 616**

**(With Addendum-001)**

# SECTION 100

## GENERAL INSTALLATION

### CONTENTS

	Page
110 Installation Site Requirements .....	100-1
110.1 Physical Environment of Equipment	
120 Electrical and Grounding Requirements .....	100-1
120.1 AC Power Requirements	
120.2 Grounding Requirements	
130 Other Considerations .....	100-2
130.1 Electrical Noise Generators	
130.2 Pre-installation Site Survey	
130.3 Additional Equipment	
140 Specifications .....	100-2
140.1 System Capacity	
140.2 Cabling Requirements	
140.3 Power Requirements	
140.4 Surge Protection	
140.5 Environmental Conditions	
140.6 CO/PBX Line Type	
140.7 Dimensions and Weight	
140.8 Network and Control	
140.9 Visual and Audible Indications	
140.10 Dialing Specification	
140.11 External Equipment Interfacing	
150 List of Equipment .....	100-5
150.1 General Information	
150.2 Equipment Description	
160 System Configuration .....	100-7
160.1 To Determine Required Equipment	
160.2 To Determine Optional Equipment	

## SECTION 100 GENERAL INSTALLATION

### 110 Installation Site Requirements

#### 110.1 Physical Environment of Equipment

The following conditions should be met at the site chosen for mounting the central equipment (Key Service Unit).

1. The KSU should normally be wall-mounted to protect against accident or flooding. Where possible use of a wooden backboard is recommended for this purpose.
2. The KSU should not be located directly beneath pipes due to the possibility of leaks or condensation causing damage.
3. The area in which the KSU is located must be free of: corrosive or inflammable gases, excessive chemical or industrial dusts, and other materials which could cause hazard to personnel or to the proper functioning of the equipment.
4. Heat and humidity must be within the limits found in Section 140 "Specifications" in this manual.
5. Although its virtually noiseless operation allows a wide choice of installation sites, care should be taken that the KSU not present a hazard to office traffic. For purposed of economy a central location (to minimize cabling) is often preferable.

### 120 Electrical and Ground Requirements

#### 120.1 AC Power Requirements

1. They system should have a dedicated 117V AC outlet separately fused for 15 AMPS.
2. The AC outlet should be a standard 125V three-prong type which provides conduit ground.
3. The AC power must be within the limits found in Section 140 "Secifications" in this manual.
4. If the AC outlet is subject to power surges, it is recommended that the best locally available AC surge protection be installed.

#### 120.2 Grounding Requirements

The KSU must be well-grounded. If a good conduit ground is not present at the dedicated AC outlet, the following steps should be taken:

1. Provide a suitable waterpipe ground in accordance with the local operating (telephone) company procedures.
2. If no waterpipe is available, a ground rod should be installed in accordance with local operating company procedures.
3. In the case where a ground other than conduit ground is used a grounding terminal is provided on the ES-6-1 as shown below in Figure 120-1.

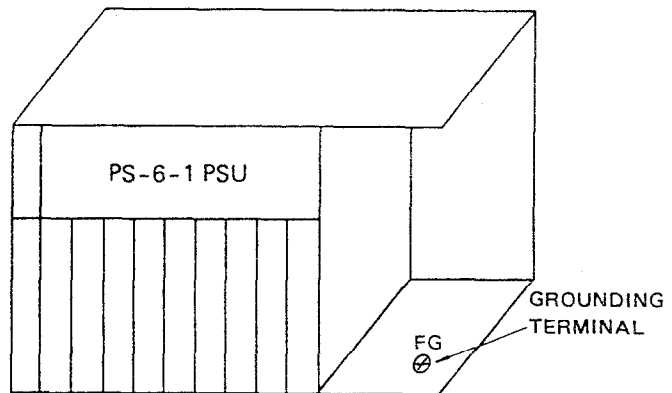

Fig. 120-1 Outsideview of ES-6-1

## 130 Other Considerations

### 130.1 Electrical Noise Generators

Certain equipment, such as welding machines, thyristor-driven power supplies, large electrical motors, etc. generate electrical noise. As a stored program machine the Electra-616 System is vulnerable to this noise. When this type of machine is present at an installation, the following precautionary steps are urged:

1. Locate KSU, telephone sets, and cabling away from these machines.
2. If cables must pass near these machines, use shielded cable with the shield grounded.
3. Ensure all machines of this type are well-grounded to a separate ground to minimize noise interference.

### 130.2 Pre-installation Site Survey

Since a pre-installation survey is generally required to plan for application and installation, a check of the matters covered so far in this section at this time will prevent later problems.

### 130.3 Additional Equipment

In addition to electronic station equipment and the KSU and their contents, other equipment is required. This includes cables, modular connecting jacks, quick-connect blocks (or similar apparatus), etc. This additional equipment must be locally supplied.

## 140 Specifications

### 140.1 System Capacity

The Electra-616 system capacity is as follows:

CO/PBX Lines	6 max.
Intercom Paths	2 max.
Internal and External Paging Path	1 max.
Station Sets	16 max.
BLF Consoles	2 max.
Door Phones	2 max.

### 140.2 Cabling Requirements

1. Cabling required for Key Telephone Sets, BLF Consoles, Door Phones is as follows:

- 1) Required Cable

- Key Telephone Set: Twisted 2-pair cable
- BLF Console: Twisted 1-pair cable
- Door Phone: Twisted 1-pair cable

- 2) Maximum Loop Resistance and Cable Length at 24AWG

- Key Telephone Set: 40 ohms, 700 ft. (210m)
- BLF Console: 40 ohms, 700 ft. (210m)
- Door Phone: 40 ohms, 700 ft. (210m)

- 3) Maximum Cable Length at 22AWG

- Key Telephone Set: 1,150 ft. (350m)
- BLF Console: 1,150 ft. (350m)
- Door Phone: 1,150 ft. (350m)

2. BLF Consoles require a local power supply (provided with each unit), which plugs into a 117V AC outlet. The cable provided with these units is 6 feet in length.

### 3. Fuse Replacement

Replace fuses in accordance with Table 140-1.

**Table 140-1 Fuse Specifications For PS-6-1 and KSI-S**

DESIGNATION	SPECIFICATION	DESCRIPTION
F1	125V., 5A	AC Input
F1 ~ F8	125V., 0.5A	KSI-S

**Note 1:** F1 is 1/4" x 1-1/4" size normal blown glass tube or ceramic fuse. Buss 3AG 125V., 4A fuse.

**Note 2:** KSI-S F1 ~ F8 are 13/64" c 45/64" (5 mm; x 20 mm) size normal blown glass tube fuse. Buss GMA 125V., 0.5A fuse.

Do not install any "slow blow" fuses in the ES-6-1 KSU.

### 140.3 Power Requirements

#### 1. AC Input

- 117V AC  $\pm$  10%, 50 or 60Hz  $\pm$  10%, single phase
- Max. current draw: 4.0A
- Dedicated outlet separately fused at 15A max.

#### 2. Power Supply Outputs (PS-6-1)

DC Voltage	Max. Current
+5V $\pm$ 0.25V	4.0A
+12V $\pm$ 0.5V	1.2A
+24V $\pm$ 1.0V	2.0A
+41V $\pm$ 1.0V	1.4A

#### 3. BLF Console Power Supply

Output Voltage: 9V DC

Max. Output Current: 0.3A

### 140.4 Surge Protection

If an installation is subject to AC power surges it is recommended that the most effective locally available form of surge protection be supplied. CO Lines are protected by the local operating (telephone) company. It is recommended that the most effective locally available form of protection be installed on CO/PBX lines by the local operating (telephone) company.

**Note:** This is *NOT* a recommendation that more than one set of protectors be installed on CO lines at installation premises. Improper installation of additional protection can be a serious safety hazard.

### 140.5 Environmental Conditions

#### 1. Temperature:

Operating: +32° F ~ 104° F (0°C ~ 40°C)

Recommended long term: +50° F ~ 90° F

#### 2. Humidity:

Operating 10 ~ 90 percent

### 140.6 CO/PBX Line Type

CO/PBX Line Type: 2 wire, loop start

### 140.7 Dimensions and Weight

ES-6-1 KSU W/PSU 490(W) x 195.5(D) x 421(H)mm, 40 Lbs (18kg)

ET-6-1 TEL 210(W) x 222(D) x 82(H)mm, 2.9 Lbs (1300g)

EB-6-1 BLF 75(W) x 222(D) x 82(H)mm, 1.3 Lbs (600g)

DP-6-1 Door Phone 100(W) x 132(D) x 31.5(H)mm, 0.4 Lbs (200g)

### 140.8 Network and Control

#### 1. Control

- Control: Stored program
- Central processor: 8085A
- Microprocessor in keyset:  $\mu$ COM43N (4 bit one-chip microcomputer)
- Clock (KSU-keyset): 33kHz
- Transmission data: 9 bits (from KSU to keyset)
- Scanning time for each keyset: Every 50 msec.
- Number of cable pairs from KSU to each station: 2 pair wire for keyset
- For keyset, one pair: Voice and signalling  
one pair: Data sending and receiving
- For Door Phone, one pair: Voice and signalling
- For BLF, one pair: Data receiving

2. Network

- Matrix: Single stage, non blocking C-MOS switch array
- Keyset network: Electronic circuit using custom LSI (Equivalent to 500 type standard network)
- Transmitter and Receiver: Dynamic type (Equivalent to 500 type standard telephone transmitter and receiver)

3. Transmission

- Cross talk attenuation: More than 75 dB for 300-3, 500kHz
- Insertion loss, station to trunk: Less than 1.8 dB at 1kHz

140.9 Visual and Audible Indications

1. Visual

Lamp indications of a Keyset are as follows:

- Idle condition: Not lit
- Busy CO/PBX and intercom path: Steady light
- Incoming CO/PBX and intercom call: Flashing light at 60IPM
- Call hold CO/PBX: Winking light at 120IPM
- I-Hold indication (CO/PBX): Intermittent wink light
- Hold reminder: Flashing light at 600IPM

2. Audible Indication

1) CO/PBX call

- Incoming call on CO/PBX (idle): 483Hz/645Hz modulated by 10Hz, 1 sec. ON/1 sec. OFF
- Incoming call on CO/PBX (Receiver off hook): 1200Hz/580Hz
- Hold reminder: 1200Hz, 0.5 sec. ON/0.5 sec. OFF

2) Intercom call

- Calling signal for called station: Voice signalling after tone burst (580Hz, 0.75 sec.)
- Ringback tone: 580Hz, 0.75 sec.
- Busy tone: 580Hz, 0.5 sec. ON/0.5 sec. OFF
- Call waiting tone: 1200Hz, 0.5 sec. ON/0.5 sec. OFF
- Override tone: 580Hz, 0.75 sec.
- Error tone: 1200Hz, 0.25 sec. ON/0.25 sec. OFF
- Store speed dial tone: 580Hz

140.10 Dialing Specification

1. Dial Pulse Address Signalling

- a) Pulse rate: 10 pps or 20 pps
- b) Percent break: 61 ± 3 percent
- c) Interdigital interval: 800 msec.

2. DTMF Address Signalling

- a) Frequencies: Two sinusoidal signals, one from a high group of three frequencies and one from a low group of four frequencies.

Nominal High Group Frequencies (Hz)

	1209	1336	1477	
Nominal	697	1	2	3
Low Group	770	4	5	6
Frequencies (Hz)	852	7	8	9
	941	*	0	#

- b) Frequency deviation: Within ± 1.5%

c) Signal level

- Minimum level per frequency:

Low group: -10dBm

High group: - 8dBm

d) Duration of two frequency signal: 60 msec. min.

e) Interdigital time: 100 msec. min.

3. Dialing Memories

a) Last CO/PBX Number Redial: 16 digits max. (including pause)

b) Speed Dialing-Station: 16 numbers (16 digits, including any pauses)

c) Speed Dialing-System: 40 numbers (16 digits, including any pauses)

140.11 External Equipment Interfacing

1. External Paging

- Output power: 1 watt
- Required speaker impedance: 600 ohms

2. Output to External Amplifier for External Paging

- Output power: -15 dBm
- Output impedance: 600 ohms

3. BGM Input to PBS-S

- Input level: 1 watt (nominal)
- Required output impedance of amplifier: 600 ohms

4. MOH Input

- Input level: 1m watt (nominal)/8 ohms
- Required output impedance of signal source: 8 ohms

## 150 List of Equipment

### 150.1 General Information

1. The Key Service Unit (ES-6-1 KSU) comes equipped with two common control cards (CPU-S KTU, CLK-S KTU), a power supply (PS-6-1 PSU), and an Installation Service Manual (ND-17314). A wall mounting bracket is also supplied for wall mounting the KSU. All other equipment must be ordered according to application requirements. All customer-provided optional equipment (external amplifier, MOH music source, speakers, etc.) must be locally provided.

### 150.2 Equipment Description

1. ES-6-1 KSU (Key Service Unit) is the Key Service Unit. This steel cabinet houses two common cards, Power Supply and various Key Telephone Units (KTUs). It provides service for up to 6 CO/PBX lines, 16 Keysets, 2 Door Phones, 2 BLFs and various system options.
2. PS-6-1 PSU is the Power Supply required for the ES-6-1 KSU. The PS-6-1 is provided mounted in the ES-6-1 KSU and supplies the required voltages to KTUs installed within, and station equipment connected to the ES-6-1 KSU.
3. CPU-S KTU (Central Processing Key Telephone Unit) is composed of three sections: the Central Processor, The ROM section for storing the generic programmed instructions, and the RAM section for storing system configuration and day to day data. The CPU-S KTU contains an 8085A 8 bit microprocessor which executes many different functions under the control sequence of programmed instructions stored in ROM. The CPU-S KTU is provided installed in the ES-6-1 KSU.
4. CLK-1 KTU (Clock Generator Key Telephone Unit) is composed of 5 sections: The I/O section distributes the data signals sent to or from the CPU. It provides an amplifier for internal paging, clocking for rotary dial pulse signalling and a control circuit for external CO/PBX signalling. The Tone source section of the CLK generates the signal for CO/PBX ringing in the system.
5. DCI-S KTU (Dial Pulse Converter Interface Key Telephone Unit) provides circuits to serve up to 3 CO/PBX lines and contains circuitry for CO/PBX ring detection, hold and control functions. It also sends rotary dial pulse signalling to CO/PBX lines in accordance with dialing from keysets. A DCI-S KTU and a MFI-S KTU can be mixed in a system.

6. MFI-S KTU (Dual-Tone Multip Frequency Interface Key Telephone Unit) provides circuits to serve up to 3 CO/PBX lines, and contains circuitry for CO/PBX ring detection, hold and control functions. It also sends DTMF dial signalling to CO/PBX lines in accordance with dialing from keysets. A MFI-S KTY and a DCI-S KTU can be mixed in a system.
7. KSI-S KTU (Keyset Interface Key Telephone Unit) provides data control to the Electronic Key Telephone set (ET-6-1). Each KSI-S KTU provides circuits to serve up to 8 Electronic Key Telephone Sets.
8. SWM-S KTU (Switch Matrix Key Telephone Unit) contains a 8 x 12 semi-conductor switching matrix for connection of keysets to CO/PBX lines, intercom paths, door phones, and paging trunks. Each SWM-S connects 8 keysets to 3 CO/PBX lines, 2 door phones, 2 intercom paths and internal and external paging trunks. Each SWM-S provides a talk battery supply for up to 8 ET-6-1 Telephones.
9. ET-6-1 Telephone is a fully-modular push button dial electronic key telephone set with 35 nonlocking buttons, a 2 digit LED display and a speaker and microphone for voice page and handsfree answerback on ICM calls. 6 of the buttons are CO/PBX line buttons, 13 buttons are function buttons, and 16 buttons are used both for DSS (Direct Station Selection) and Station Speed Dialing. Each keyset requires 2 pair cabling to the Main Distribution Frame (MDF).
10. AHR-S KTU (Automatic Hold Release Key Telephone Unit) serves up to 6 CO/PBX lines. This option provides for restoration of a held line to idle status when the outside party abandons the call. A timed disconnect signal must be sent from the central office or PBX to activate this feature. One AHR-S KTU can be installed in the ES-6-1 KSU for this feature.
11. PBS-S KTU (External Paging/Busy Lamp Field/Security Key Telephone Unit) provides circuitry for three optional features. It contains a 1-watt amplifier and a control circuit for single-zone external paging. For applications where a 1-watt amplifier is insufficient, a locally provided high power amplifier may be used in addition to the PBS-S KTU. The Busy Lamp Field circuitry to detect a signal from an external source which activates an audible alarm in idle keysets and a visual alarm in the display of all keysets. Two security circuits are provided for this purpose.

When any combination of these features is required in the system, one PBS-S KTU must be installed in the ES-6-1 KSU.

**Note:** *This security feature should not be used as a primary source of protection. A power outage or component failure, for example, will not result in an alarm indication.*

12. DPH-S KTU (Door Phone Key Telephone Unit) contains amplifiers and voice switching circuits to provide a 2-way communication to keysets in the system. It can also be used as a monitor phone in areas where monitoring of audible activity is desired. This KTU can serve up to 2 door/monitor phones and can provide a tone to signal assigned keysets programmed to ring when the door phone is activated.
13. DP-6-1 Door Phone is a speaker unit with a speaker, microphone, and a control button to provide two-way communication to any keyset in the system. With the DPH-S KTU installed in the KSU up to two door phones can be connected at the Main Distribution Frame (MDF). One pair cabling is required for each door phone.
14. DB-6-1 BLF is a modular Electronic Busy Lamp Field with 21 LEDs. 16 LEDs show station status, 1 LED each shows paging status (both internal and external), Night Transfer, and BLF Power On status. 2 LEDs show the status of the door phones. The EB-6-1 comes equipped with a local power supply with a 117V AC plug and requires 1 pair cabling to the Main Distribution Frame (MDF).



## 160 System Configuration

### 160.1 To Determine Required Equipment

1. Determine how many electronic key telephones are required in the system. Refer to Table A if the number of keysets are 8 or less. Refer to Table B if the number of keysets are more than 8.
2. Determine how many CO/PBX lines are required. The result will tell you which line of the selected table to use. See Table 160-1.

Table 160-1 Required Quantities of KTUs

TABLE A: Total Number of Keysets is 1 ~ 8

CO/PBX LINES	DCI-S/MFI-S	SWM-S	KSI-S
1 ~ 3	1	1	1
4 ~ 6	2	2	1

TABLE B: Total Number of Keysets is 9 ~ 16

CO/PBX LINES	DCI-S/MFI-S	SWM-S	KSI-S
1 ~ 3	1	2	2
4 ~ 6	2	2	2

Note: Power Failure Transfer is provided in ES-6-1 KSU for CO/PBX Lines 1 and 2.

### 160.2 To Determine Optional Equipment

1. Required KTUs for options are:

Table 160-2

OPTION	KTU	NO. OF KTU	MAX. NO. OF ADDITIONAL OPTIONAL EQUIPMENT
Automatic Hold Release	AHR-S	1	
Door Phone	DPH-S	1	2 Door Phones
External Paging	PBS-S	1	
BLF Console	PBS-S	1	2 BLF Consoles
Security Alarm	PBS-S	1	

Note: One PBS-S KTU provides circuits for external paging, 2 BLF consoles, and 2 security alarm circuits.

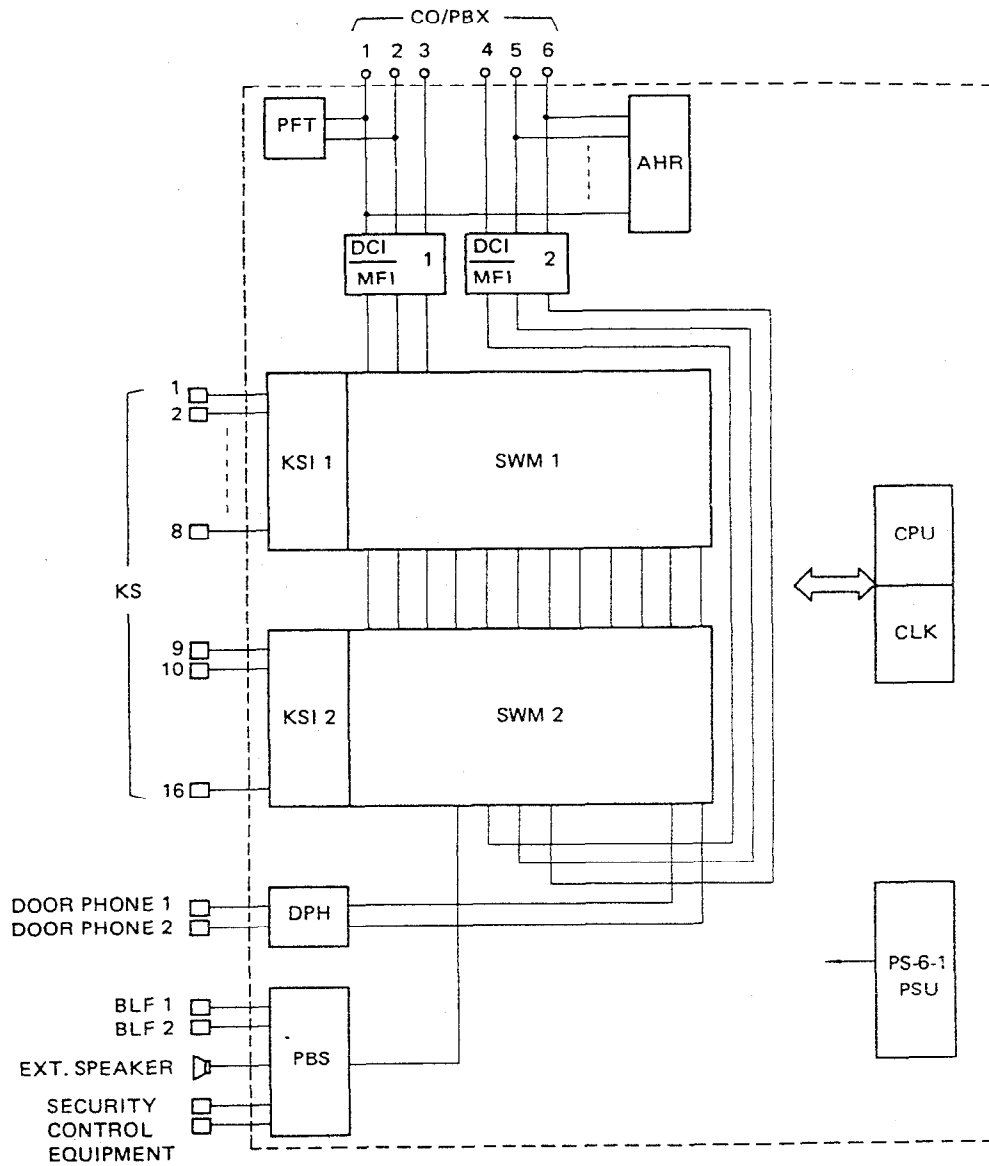

[ ] installed in ES-6-1 KSU

Fig. 160-1 System Block Diagram

# SECTION 200

## HARDWARE INSTALLATION

### CONTENTS

	Page
210 Installation of the Key Service Unit .....	200-1
210.1 Wall Mounting the KSU	
210.2 Floor Mounting the KSU	
220 Connecting and Testing the Power Supply .....	200-2
230 Installation of KTUs .....	200-3
230.1 General Information	
230.2 Installing Basic KTUs	
230.3 Installing Common KTUs	
230.4 Installing Optional KTUs	
230.5 Volume Controls	
240 MDF Installation .....	200-6
240.1 CO/PBX Connection	
240.2 Station Cabling Connection	
250 Installing Station Equipment .....	200-9
250.1 ET-6-1 Installation	
250.2 EB-6-1 Installation	
250.3 DP-6-1 Installation	
260 Installing Options .....	200-14
260.1 Music On Hold	
260.2 External Paging Speaker	
260.3 External Background Music when PBS-S KTU is Used	
260.4 External Tone Ringer	
260.5 External Paging Amplifier	
260.6 External Background Music when External Amplifier is Used	
260.7 Power Failure Telephones	
260.8 Security Control Equipment	
260.9 External Amplifier Control	

## SECTION 200 HARDWARE INSTALLATION

### 210 Installation of the Key Service Unit

#### 210.1 Wall Mounting the KSU

1. The ES-6-1 KSU is supplied with a wall mounting bracket. The bracket should be mounted on a back-board secured in a manner capable of holding the weight of the KSU. With the mounting tabs of the bracket facing upward, install appropriate screws into the 6 holes of the bracket. Loosen the securing screw located in the upper right position of the bracket.
2. Align the mounting slots of the KSU with the mounting tabs of the bracket, and push down to seat the KSU securely.
3. Remove the front cover of the KSU, and locate and tighten the securing screw through the hole provided above the J1 connector.

#### 210.2 Floor Mounting the KSU

1. The same bracket that is provided for wall mounting can also be used to anchor a floor mounted KSU. Set the bracket on a level surface with the 6 screw holes down and the securing screw facing up and the floor mounting slot to the right.
2. Loosen the securing screw located in the rear right position of the bracket.
3. Engage the mounting tabs on the bracket into the slots on the bottom of the KSU and push forward to seat the KSU securely.
4. Locate and tighten the securing screw through the hold provided on the bottom panel of the KSU.

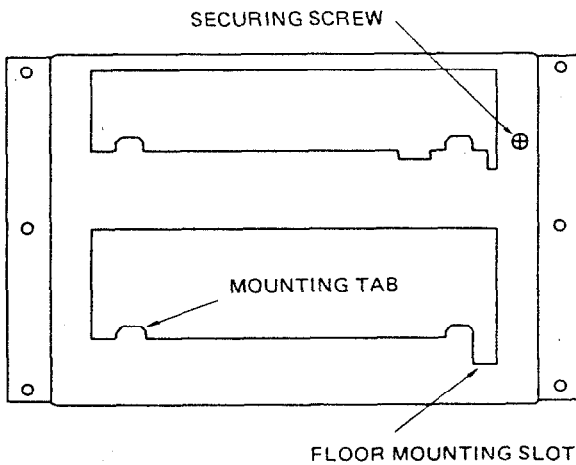

Fig. 210-1 Front View of Mounting Bracket

## 220 Connecting and Testing the Power Supply

**Note 1:** Verify that the AC outlet is supplying 117V AC and provides good conduit ground. If there is a problem with the AC voltage, have it corrected. If there is no conduit ground, provide alternate ground as explained in Section 120, "Grounding Requirements", of this manual.

**Note 2:** Before proceeding, ensure that the PS-6-1 Power Cord is unplugged. The PS-6-1 Power Switch should be off, and its power indicator lamps should be off.

1. Remove the 9-pin connector-ended cable of the power supply from the connector of the KSU.
2. Plug the AC cord of the power supply into an AC outlet. Set PSU Power switch to on position. The PSU Power Indicator Lamp should light. Use a voltmeter, to the figure below:

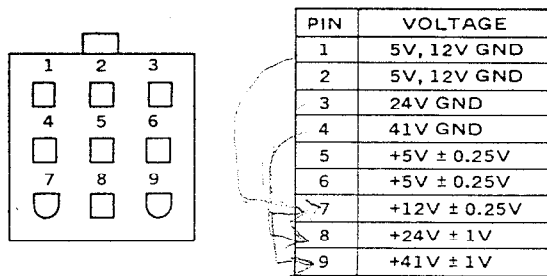

Fig. 220-1 Front View of 9-pin Connector of PS-6-1

3. Set PSU Power Switch to Off Position

**Note:** Verify that step 3 has been completed before proceeding. Verify that PS-6-1 Power Indicator Lamp is off.

4. Connect the 9-pin connector-ended cable of the Power Supply Unit to the 9-pin connector of the KSU. Ensure that the locking tabs are engaged.
5. Turn the PSU Power Switch on. DC voltage (under load) can now be read on the TB1 terminal block located on the left side of KSU.

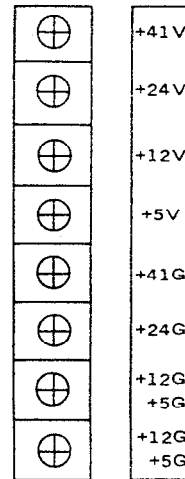

Fig. 220-2 View of TB1 Terminal Block

When measuring DC voltages, note that each voltage has its own reference ground.

6. The Power Supply Switch must be set in the Off position before proceeding with installation.

**Note:** Verify that Step 6 has been completed before proceeding. Verify that PS-6-1 Power indicator Lamp is off.

## 230 Installation of KTUs

**Note:** *The following KTUs cannot be inserted or removed with power on:*

CPU-S	KSI-S	DPH-S
CLK-S	DCI-S	PBS-S
SWM-S	MFI-S	AHR-S

### 230.1 General Information

1. The KTUs specified directly above cannot be inserted or removed with power on. It is recommended that power be OFF during installation and during maintenance unless this will seriously inconvenience the user. This will prevent accidental damage to equipment.
2. The KTUs used in the Electra-616 system make extensive use of CMOS technology. Care must be taken to avoid static discharge when handling these KTUs.
3. KTUs are provided with a guide slot to prevent mis-installation. KTU connectors are provided with a guide key. These guide keys must not be removed.

### 230.2 Installing Basic KTUs

#### 1. DCI-S and MFI-S KTUs

When installing DCI-S and MFI-S KTUs there may be more KTU circuits installed (since there are 3 per KTU) then will actually be used. Any non-used circuits should be programmed as "not installed" when programming for CO/PBX line assignment. See Section 300 "Programming" of this manual for instructions on programming CO/PBX line assignment. This will avoid confusion when attempts to access unconnected CO/PBX lines are made. The DCI-S or MFI-S in the first designated KTU position (DCI/MFI 1) serve CO/PBX lines 1 through 3. A DCI-S or MFI-S in the second designated KTU position (DCI/MFI 2) serve CO/PBX lines 4 through 6. Refer to figure 230-2 for KTU positions in the Key Service Unit. See AHR-S KTU in Section 230 for information on wiring change for providing Automatic Hold Release feature when AHR-S KTU is installed.

#### 2. KSI-S KTU

There are two designated KSI KTU positions within the Key Service Unit. The KSI-S in the first position (KSI 1) serves stations 1 through 8, while a KSI-S in the second position (KSI 2) serves stations 9 through 16. Located on each KSI-S KTU are 8 fuses which

are 5mm by 20mm and are rated 0.5A 125V: one fuse for each keyset. The fuse provides protection on the data transmission pairs (DT and DR). When a fuse must be replaced refer to Section 140, "Fuse Replacement" of this manual.

#### 3. SWM-S KTU

An SWM-S KTU must always be installed in SWM1. An SWM-S KTU must be installed in SWM2 when either stations 9 ~ 16 and/or CO/PBX lines 4 ~ 6 are to be connected.

Table 230-1 Installing SWM-S KTUs

SWM-S SLOT	WHEN
SWM1	For Stations 1 ~ 8 and CO/PBX lines 1 ~ 3.
SWM2	For Stations 9 ~ 16 and/co CO/PBX lines 4 ~ 6.

### 230.3 Installing Common KTUs

#### 1. CPU-S KTU

Before programming the Network Plan Memory (NPM), ensure that the SW1 switch located on the CPU-S KTU is set to the ON position. This will provide battery back-up for the NPM, speed dial, and last number dialed memories when power is lost to the KSU. If there is a power failure and switch is left in the OFF position, the system will lose the contents of memory and return to the Resident System Program. For a description of the Resident System Program see Section 300 "Programming". When the CPU-S KTU is removed for long-term storage, set the SW1 switch to the OFF position. This will prevent the battery from constantly discharging until it is no longer capable of holding a charge. The battery, when fully charged, will protect the memory for approximately 60 days.

**Note:** *The battery only supplies back-up to the volatile memory of the CPU-S. It will not provide battery back-up to the Electra-616 system during a power failure.*

ON ←    → OFF

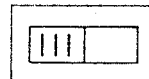

SW1

Fig. 230-1 CPU-S Switch for Volatile Memory

On the CPU-S KTU is a momentary switch for system reset. Depressing the reset switch causes any program changes to enter the working program and interrupts all system operation in progress.

2. CLK-S KTU

When DCI-S KTU(s) is installed ensure the switches SW1 and SW2 on the CLK-S KTU are set to appropriate positions. Refer to Table 230-2 below. The switch settings are subject to the dialing specifications of the CO or PBX. The switches have been set by the manufacturer at 10pps dial speed and at 39% make ratio.

Table 230-2 Rotary Dial Pulse Signalling Switch Settings

Dial Speed SW1	10pps 20pps
Make Ratio SW2	33% 39%

230.4 Installing Optional KTUs

1. PBS-S KTU

Install PBS-S KTU in ES-6-1 KSU when External Paging, Busy Lamp Field and/or Security options are required. Refer to Section 250.2 "EB-6-1 Installation" for BLF connection. When installing External Paging and/or Security options, see Section 260, "Installing Options".

2. DPH-S KTU

When a DPH-S KTU is installed in the ES-6-1 KSU, two DP-6-1 can be used as Door Phone or Monitor Phone separately.

When Door Phone 1 is required as a Door Phone, set the SW1 to the "D" position on the DPH-S KTU. (In the case of Door Phone 2, set the SW3 to the "D" position.)

When Door Phone 1 is required as a Monitor Phone, set the SW1 to the "M" position on the DPH-S KTU. (In the case of Door Phone 2, set the SW3 to the "M" position.) and remove the straps S1 and S2 on the DPH-S KTU. (In the case of Door Phone 2, remove the straps S3 and S4). Then the voice from Key Set will be cut off when Door Phone is accessed, and the voice from DP-6-1 is more amplified compared with being used as Door Phone.

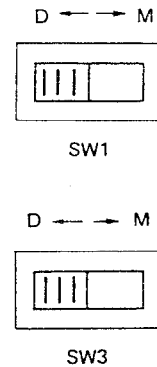

Fig. 230-2 Door Phone/Monitor Phone Select Switches

3. AHR-S KTU

Located on each DCI-S and MFI-S KTUs are three straps (one for each line circuit) that should be removed when AHR-S KTU is installed for Automatic Hold Release option. When AHR-S KTU is not installed, the straps should be left connected to the solder terminals. Refer to Figure 230-3 for terminal designations. The AHR-S will release a CO/PBX line which is on hold when the outside party abandons the call. A timed disconnect signal of more than 150 milliseconds must be provided from the CO or PBX to enable this option (the AHR-S does not recognize a reversal of polarity). The AHR-S KTU serves up to 6 CO/PBX lines and is installed in ES-6-1 KSU. Remove the straps when AHR-S KTU is installed.

DCI-S 1 or MFI-S 1	TP1 TP2	Line Circuit 1
	TP3 TP4	Line Circuit 2
	TP5 TP6	Line Circuit 3
DCI-S 2 or MFI-S 2	TP1 TP2	Line Circuit 4
	TP3 TP4	Line Circuit 5
	TP5 TP6	Line Circuit 6

Fig. 230-3 DCI-S and MFI-S AHR Straps

**230.5 Volume Controls**

1. All tones from the built-in speaker in a keyset are controlled at the keyset by adjusting the volume dial located at the front of the keyset.
2. System wide CO/PBX ring (station idle) and intercom all call and zone paging are controlled by adjusting volume controls on the CLK-S KTU. Tone level is increased by turning the volume control clockwise.

All volumes are pre-adjusted by the manufacturer. Refer to Table 230-3.

**Table 230-3 CLK Volume Controls**

VR1 (CO)	CO/PBX Ring (Station idle)
VR2 (Page)	Internal Paging

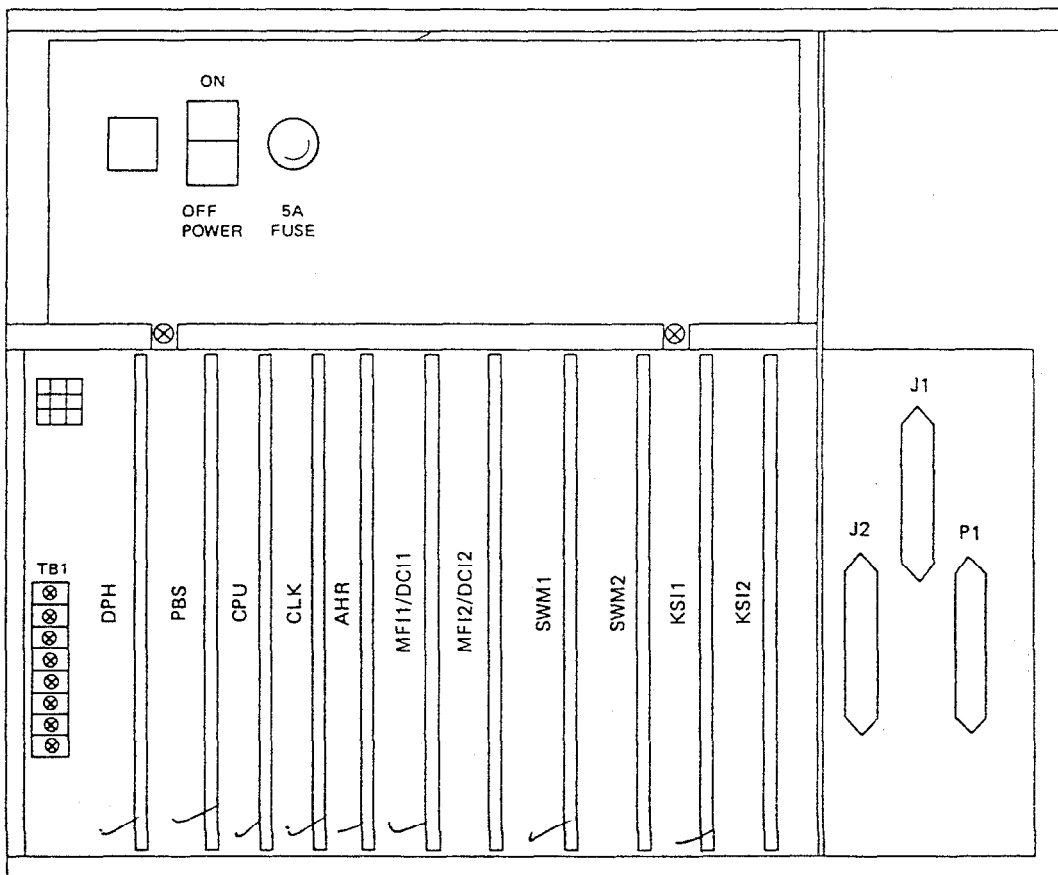

**Fig. 230-4 ES-6-1 KSU Card Layout**



## 240 MDF Installation

### 240.1 CO/PBX Connection

1. The FCC approved USOC number for 50 position miniature ribbon jack for connection of CO lines is RJ21X. The CO lines are to be connected in sequence consecutively within this jack.
2. Use of 66B50 or 66M50 quick-connect type blocks is recommended for ease of trouble location and correction. Use of bridging clips allows easy separation of the system to determine cause of trouble.

3. The following Table 240-1 gives complete information on 50 position connector pin number, lead function, running cable color, circuit designation, associated DCI/MFI slot:

### 240.2 Station Cabling Connection

1. The following tables give complete information on KSU, cable, 50 position connection pin number, running cable color, lead designation, station cable color, intercom number assignment, KSI-S slot assignment, etc. for all stations. Refer to Table 240-2 and 240-3.

Table 240-1  
CO/PBX Connection Information  
P1 Connector & Cable ES-6-1 KSU

PIN	FUNCTION	CABLE COLOR	CIRCUIT	SLOT
26 1	1T 1R	WH-BL BL-WH	CO/PBX 1	DCI/MFI1
27 2	2T 2R	WH-OR OR-WH	CO/PBX 2	
28 3	3T 3R	WH-GN GN-WH	CO/PBX 3	
29 4	4T 4R	WH-BR BR-WH	CO/PBX 4	DCI/MFI2
30 5	5T 5R	WH-SL SL-WH	CO/PBX 5	
31 6	6T 6R	RD-BL BL-RD	CO/PBX 6	

The rest of P1 Cable is spare and is not used.

#### CO/PBX Connection:

1. FCC approved connector USOC code is RJ21X.
2. Connector-ended cable for CO/PBX lines to plug into ES-6-1 KSU requires Jack (Female) 50 position miniature ribbon connector.

**Table 240-2 Station Connection Information**  
**J1 – J2 Connectors and Cables ES-6-1 KSU**

PIN	RUNNING CABLE	STATION CABLE	KEY SET LEADS	ES-6-1			
				SLOT	CABLE J1	SLOT	CABLE J2
26	WH-BL	GN	VT	KSI 1	(See Note)	KSI 2	(See Note)
1	BL-WH	RD	VR		STA. 1		STA. 9
27	WH-OR	YL	DT		(ATT)		(ATT)
2	OR-WH	BK	DR				
28	WH-GN	GN	VT		STA. 2		STA. 10
3	GN-WH	RD	VR				
29	WH-BR	YL	DT		STA. 3		STA. 11
4	BR-WH	BK	DR				
30	WH-SL	GN	VT		STA. 4		STA. 12
5	SL-WH	RD	VR				
31	RD-BL	YL	DT		STA. 5		STA. 13
6	BL-RD	BK	DR				
32	RD-OR	GN	VT		STA. 6		STA. 14
7	OR-RD	RD	VR				
33	RD-GN	YL	DT		STA. 7		STA. 15
8	GN-RD	BK	DR				
34	RD-BR	GN	VT	STA. 8	STA. 16		
9	BR-RD	RD	VR				
35	RD-SL	YL	DT				
10	SL-RD	BK	DR				
36	BK-BL	GN	VT				
11	BL-BK	RD	VR				
37	BK-OR	YL	DT				
12	OR-BK	BK	DR				
38	BK-GN	GN	VT				
13	GN-BK	RD	VR				
39	BK-BR	YL	DT				
14	BR-BK	BK	DR				
40	BK-SL	GN	VT				
15	SL-BK	RD	VR				
41	YL-BL	YL	DT				
16	BL-YL	BK	DR				

**Note:** Two stations in the system can be assigned as attendant stations. Stations 1 and 9 are initially assigned these positions. Station 1 must be installed for programming purposes.

Table 240-3 Connector Running List

P1				J1				J2			
26	1T	WH-BL	LIN	26	1VT	WH-BL		26	9VT	WH-BL	
1	1R	BL-WH	1	1	1VR	BL-WH	TEL	1	9VR	BL-WH	TEL
27	2T	WH-OR	LIN	27	1DT	WH-OR	1	27	9DT	WH-OR	9
2	2R	OR-WH	2	2	1DR	OR-WH		2	9DR	OR-WH	
28	3T	WH-GN	LIN	28	2VT	WH-GN		28	10VT	WH-GN	
3	3R	GN-WH	3	3	2VR	GN-WH	TEL	3	10VR	GN-WH	TEL
29	4T	WH-BR	LIN	29	2DT	WH-BR	2	29	10DT	WH-BR	10
4	4R	BR-WH	4	4	2DR	BR-WH		4	10DR	BR-WH	
30	5T	WH-SL	LIN	30	3VT	WH-SL		30	11VT	WH-SL	
5	5R	SL-WH	5	5	3VR	SL-WH	TEL	5	11VR	SL-WH	TEL
31	6T	RD-BL	LIN	31	3DT	RD-BL	3	31	11DT	RD-BL	11
6	6R	BL-RD	6	6	3DR	BL-RD		6	11DR	BL-RD	
32		RD-OR		32	4VT	RD-OR		32	12VT	RD-OR	
7		OR-RD		7	4VR	OR-RD	TEL	7	12VR	OR-RD	TEL
33		RD-GN		33	4DT	RD-GN	4	33	12DT	RD-GN	12
8		GN-RD		8	4DR	GN-RD		8	12DR	GN-RD	
34		RD-BR		34	5VT	RD-BR		34	13VT	RD-BR	
9		BR-RD		9	5VR	BR-RD	TEL	9	13VR	BR-RD	TEL
35		RD-SL		35	5DT	RD-SL	5	35	13DT	RD-SL	13
10		SL-RD		10	5DR	SL-RD		10	13DR	SL-RD	
36		BK-BL		36	6VT	BK-BL		36	14VT	BK-BL	
11		BL-BK		11	6VR	BL-BK	TEL	11	14VR	BL-BK	TEL
37		BK-OR		37	6DT	BK-OR	6	37	14DT	BK-OR	14
12		OR-BK		12	6DR	OR-BK		12	14DR	OR-BK	
38		BK-GN		38	7VT	BK-GN		38	15VT	BK-GN	
13		GN-BK		13	7VR	GN-BK	TEL	13	15VR	GN-BK	TEL
39		BK-BR		39	7DT	BK-BR	7	39	15DT	BK-BR	15
14		BR-BK		14	7DR	BR-BK		14	15DR	BR-BK	
40		BK-SL		40	8VT	BK-SL		40	16VT	BK-SL	
15		SL-BK		15	8VR	SL-BK	TEL	15	16VR	SL-BK	TEL
41		YL-BL		41	8DT	YL-BL	8	41	16DT	YL-BL	16
16		BL-YL		16	8DR	BL-YL		16	16DR	BL-YL	
42		YL-OR		42	1BLT	YL-OR	BLF	42	2BLT	YL-OR	BLF
17		OR-YL		17	1BLR	OR-YL	1	17	2BLR	OR-YL	2
43		YL-GN		43	1DVT	YL-GN	DOOR PHONE	43	2DVT	YL-GN	DOOR PHONE
18		GN-YL		18	1DVR	GN-YL	1	18	2DVR	GN-YL	2
44		YL-BR		44	1SE	YL-BR	SECURITY	44	2SE	YL-BR	SECURITY
19		BR-YL		19	1SEG	BR-YL	1	19	2SEG	BR-YL	2
45		YL-SL		45	MOH	YL-SL	MOH	45	EA	YL-SL	EXT
20		SL-YL		20	MOHG	SL-YL		20	EAG	SL-YL	AMP
46		VI-BL		46	SKR	VI-BL	EXT.	46	EAB	VI-BL	EXT
21		BL-VI		21	SKRG	BL-VI	SPEAKER	21	EAS	BL-VI	AMP
47		VI-OR		47	BGM	VI-OR	BGM	47	EAM	VI-OR	CONTROL
22		OR-VI		48	ERA	VI-GN	EXT. RINGER	22		OR-VI	
48		VI-GN		23	ERB	GN-VI	CONTROL	48		VI-GN	
23		GN-VI		49	1PFT	VI-BR	POWER	23		GN-VI	
49		VI-BR		24	1PFR	BR-VI	FAILURE 1	49		VI-BR	
24		BR-VI		50	2PFT	VI-SL	POWER	24		BR-VI	
50		VI-SL		25	2PER	SL-VI	FAILURE 2	50		VI-SL	
25		SL-VI						25		SL-VI	

## 250 Installing Station Equipment

### 250.1 ET-6-1 Installation

The ET-6-1 is a fully-modular electronic key telephone set. Each keyset requires 2-pair cabling to the Main Distribution Frame (MDF). The maximum cable length is 700 ft. using standard 24 AWG cable and 1,150 ft. using standard 22 AWG cable. Refer to Section 140, "Cabling Requirements", of this manual. For keyset connection, see Figures 250-1 and 250-2 and Table 240-2.

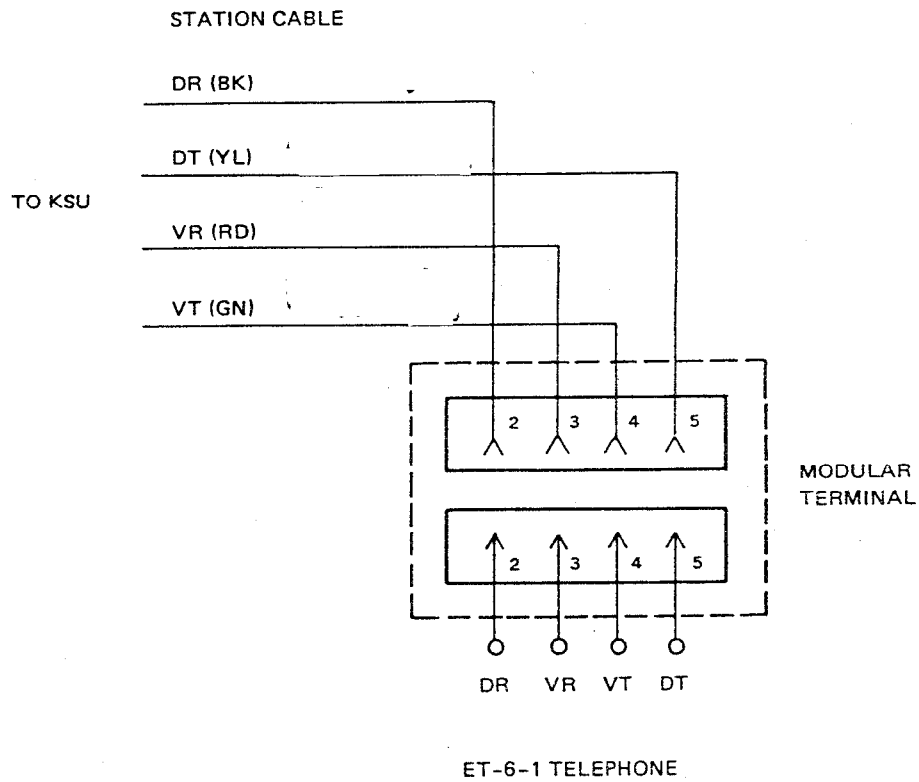

Fig. 250-1 Simplified Schematic – ET-6-1 Telephone Connection

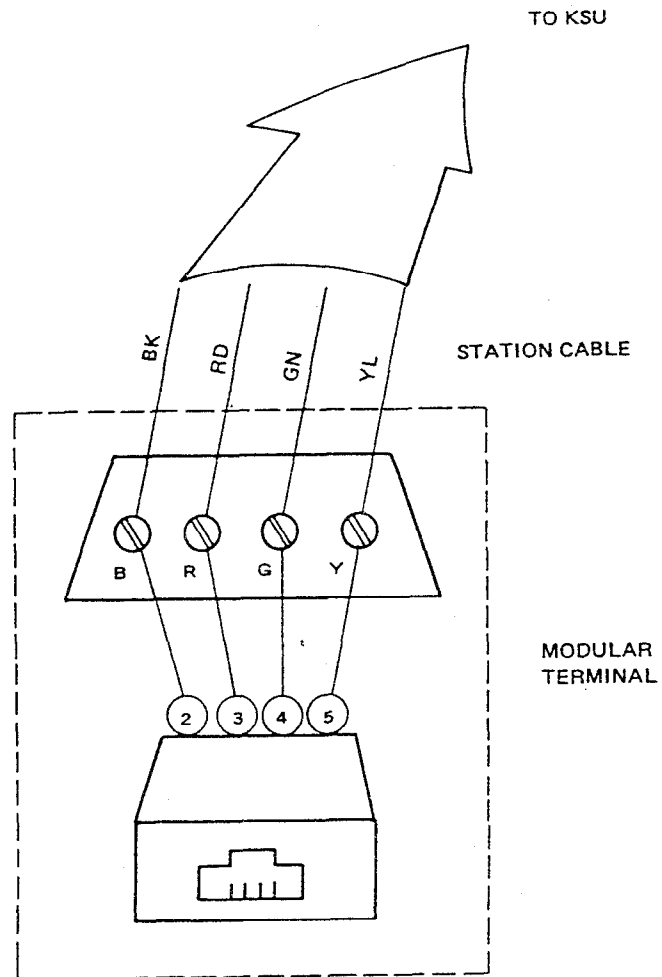

Fig. 250-2 View of Modular Terminal for Connection of ET-6-1 Telephone

## 250.2 EB-6-1 Installation

The EB-6-1 is a modular electronic busy lamp field. Each unit is provided with a 9V DC 0.3A power supply for LED illumination. The power supply is to be plugged into a standard 117V AC outlet. Each BLF requires 1-pair cabling to the main distribution frame (MDF). The maximum cable length is 700 ft. using standard 24 AWG cable and 1,150 ft. using standard 22 AWG cable. Refer to Section 140, "Cabling Requirements", of this manual. For BLF connection, see Figures 250-3, 250-4 and 250-5 and Table 240-3.

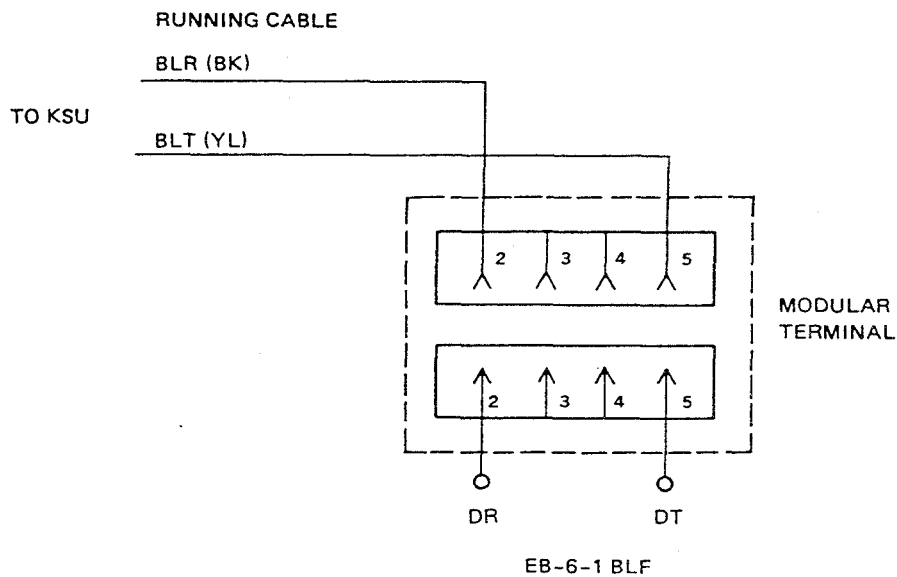

Fig. 250-3 Simplified Schematic — EB-6-1 BLF Connection

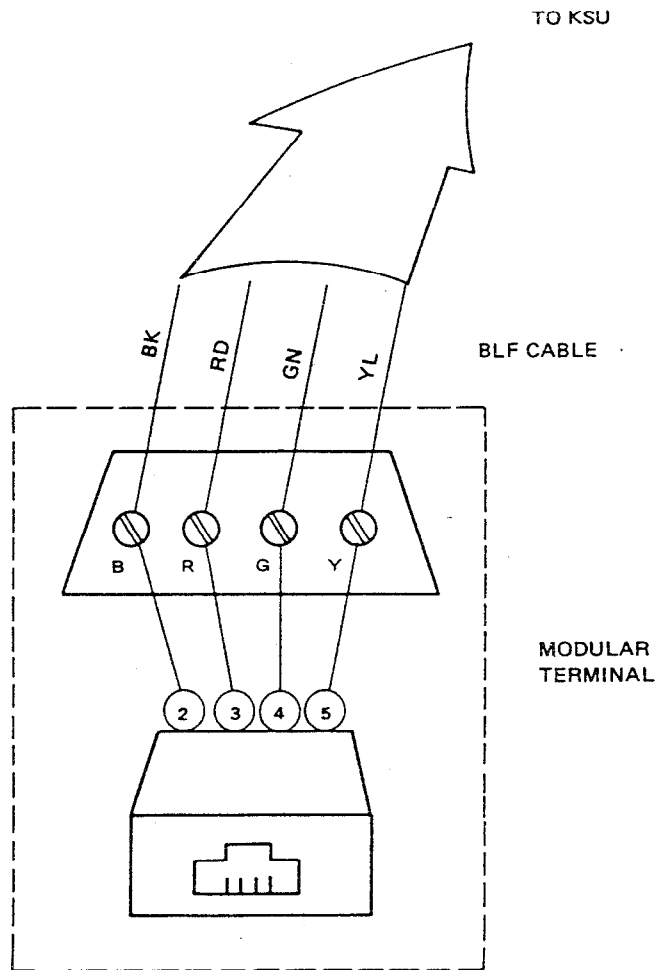

Fig. 250-4 View of Modular Terminal for Connection of EB-6-1 BLF

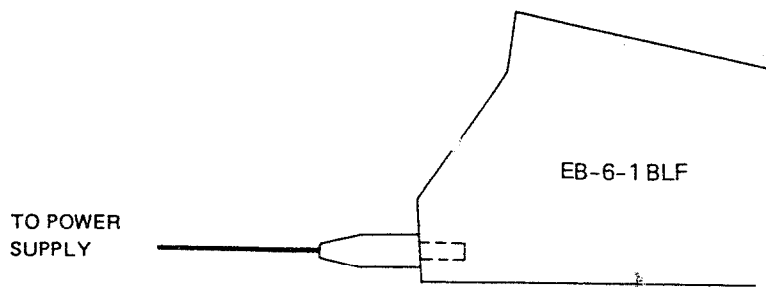

Fig. 250-5 Power Supply Connection

### 250.3 DP-6-1 Installation

The DP-6-1 is a Door/Monitor phone unit. Each door phone requires 1-pair cabling to the Main Distribution Frame (MDF). The maximum cable length is 700 ft. using standard 24 AWG cable and 1,150 ft. using standard 22 AWG cable. Refer to Section 140, "Cabling Requirements" of this manual.

To prepare the door phone for wall mounting loosen the set screw and remove the door phone unit from the mounting plate. Use the two screws provided or other appropriate fasteners to firmly connect to wall surface. For door phone cable connection, see Figure 250-6 and Table 240-3. Refer to Section 340, "Programming Sheets" for Door Phone assignment.

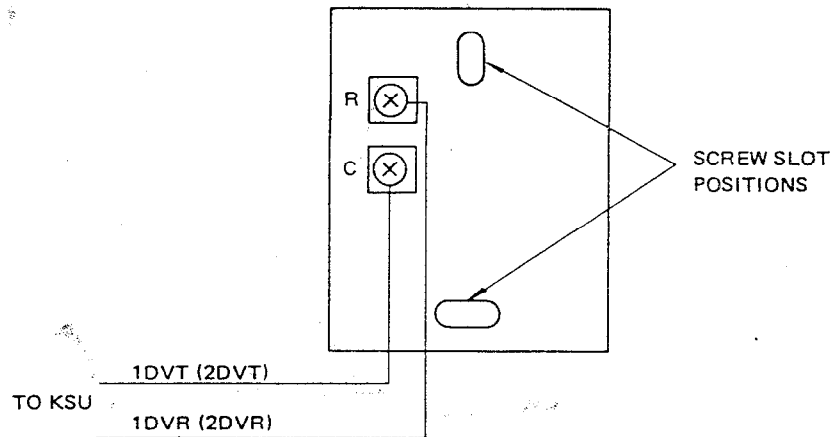

Fig. 250-6 Rear View of DP-6-1 Door Phone



## 260 Installing Options

### 260.1 Music On Hold

Provision has been made to allow connection of a locally provided external music source to provide Music-On-Hold for held CO/PBX calls. Connection of the Music Source is made at the J1 Block of the Main Distribution Frame (MDF). The output signal level should be approximately 1 milliwatt with 8 ohms impedance. See Figure 260.3 and Table 240.3 for connection information to MDF.

### 260.2 External Paging Speaker

When a PBS-S KTU is installed in the ES-6-1 KSU, external paging with meet-me answer can be provided. The PBS-S KTU contains a 1-watt Amplifier and Control Circuit for one-zone paging (when a 1-watt amplifier is insufficient, see Section 260.5.) The External Speaker should be locally-supplied in correspondence to the output impedance of 600 ohms. The Volume Control (VR1), located on the PBS-S, provides a way to increase or decrease the output signal of the amplifier to the speakers. To adjust output signal, turn VR1 clockwise to increase signal, and counter-clockwise to lower signal. An LED is provided on PBS-S KTU to indicate when paging is being used. When an External Page is answered (meet-me-answer), the PBS-S is released to allow access for another page. See Figure 260-3 and Table 240-3 for connection information to MDF.

### 260.3 External Background Music when PBS-S KTU is Used

When a PBS-S KTU is installed, an external locally-provided music source can be used to supply background music over the External Paging System. The recommended output of the music source is 1-watt with 600 ohms impedance. When external paging is accessed music is cut off from the paging speaker. Connection is made on the J1 block of the MDF. See Figure 260-3 and Table 240-3 for connection information to MDF.

### 260.4 External Tone Ringer

Provision has been made to allow connection of locally provided External Tone Ringer to supply common audible on all incoming CO/PBX calls. For this purpose a relay contact is prepared on the CLK-S KTU, which provides an interrupted closure (1 SEC. on/1 SEC. off) during the CO/PBX Ring Cycle. The signal of the tone ringer can be controlled by a locally provided control switch. See Figure 260-3 and Table 240-3 for connection information to MDF.

### 260.5 External Paging Amplifier

The PBS-S KTU contains a 1-watt Amplifier and control circuit for external paging. For applications where 1-watt is insufficient, an external amplifier may be used. Provision has been made to allow connection of a locally-provided amplifier to the MDF for this purpose. The PBS-S KTU is required when an external amplifier is used. See Figure 260-4 and Table 240-3 for connection information to the MDF.

### 260.6 External Background Music when External Amplifier is Used

To provide for background music with an external amplifier installed, set the SW4 switch to the "ON" position and the SW3 switch to the "OFF" position on the PBS-S KTU. When background music is not required set the SW3 switch to the "ON" position and the SW4 switch to the "OFF" position. Music will be cut off from the paging speakers when external paging is accessed. The output level and impedance of the music source should match the input level and impedance of the external amplifier. See Figure 260-4 and Table 240-3 for connection information to the MDF.

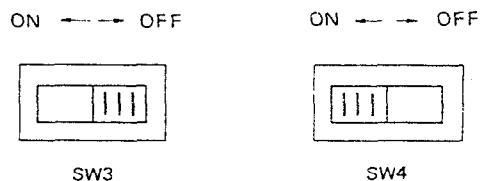

Fig. 260-1 PBS-S Switches for BGM

### 260-7 Power Failure Telephones

ET-6-1 Key Telephone Sets cannot be used to originate or answer calls during a commercial power failure. Locally-provided single line telephone sets can be installed for this purpose. The KSU provides automatic power failure for CO/PBX lines 1 and 2. No optional KTU is required. Connection of the Single Line Telephones is made at the J1 block of the MDF. Single Line Telephones with appropriate dials (rotary or DTMF) should be installed if the capability of dialing out during a power outage is desired. See Figure 260-3 and Table 240-3 for connection information to MDF.

### 260-8 Security Control Equipment

Provision has been made to allow connection of a locally-provided security control system. For this purpose the PBS-S KTU contains 2 individual control circuits that, when activated, provide an audible alarm through all idle keyset speakers and a visual alarm on each keyset display. Each security circuit can be activated by means of an external make (closed) or break (open) contact. The SW1 switch on the PBS-S KTU is used to set the desired break or make detection for security circuit one and the SW2 switch performs the same function for security circuit two. For connection information to the MDF see Figure 260-3 and 260.4 and Table 240-3.

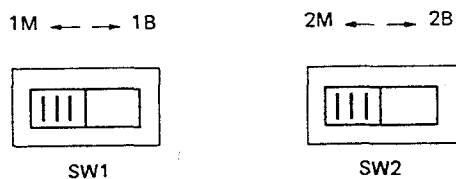

Fig. 260-2 PBS-S Security Control Switches

### 260.9 External Amplifier Control

A set of dry contacts is provided on the PBS-S KTU, which can be used to control an auxiliary relay for External Paging. Although this option is not required when an external amplifier is used, it may be desired in some applications. When an external page is activated the EAS and EAM contacts are closed for the duration of the page. In the idle condition the closure is made between the EAS and EAB contacts. See Figure 260-4 and Table 240-3 for connection information to the MDF.

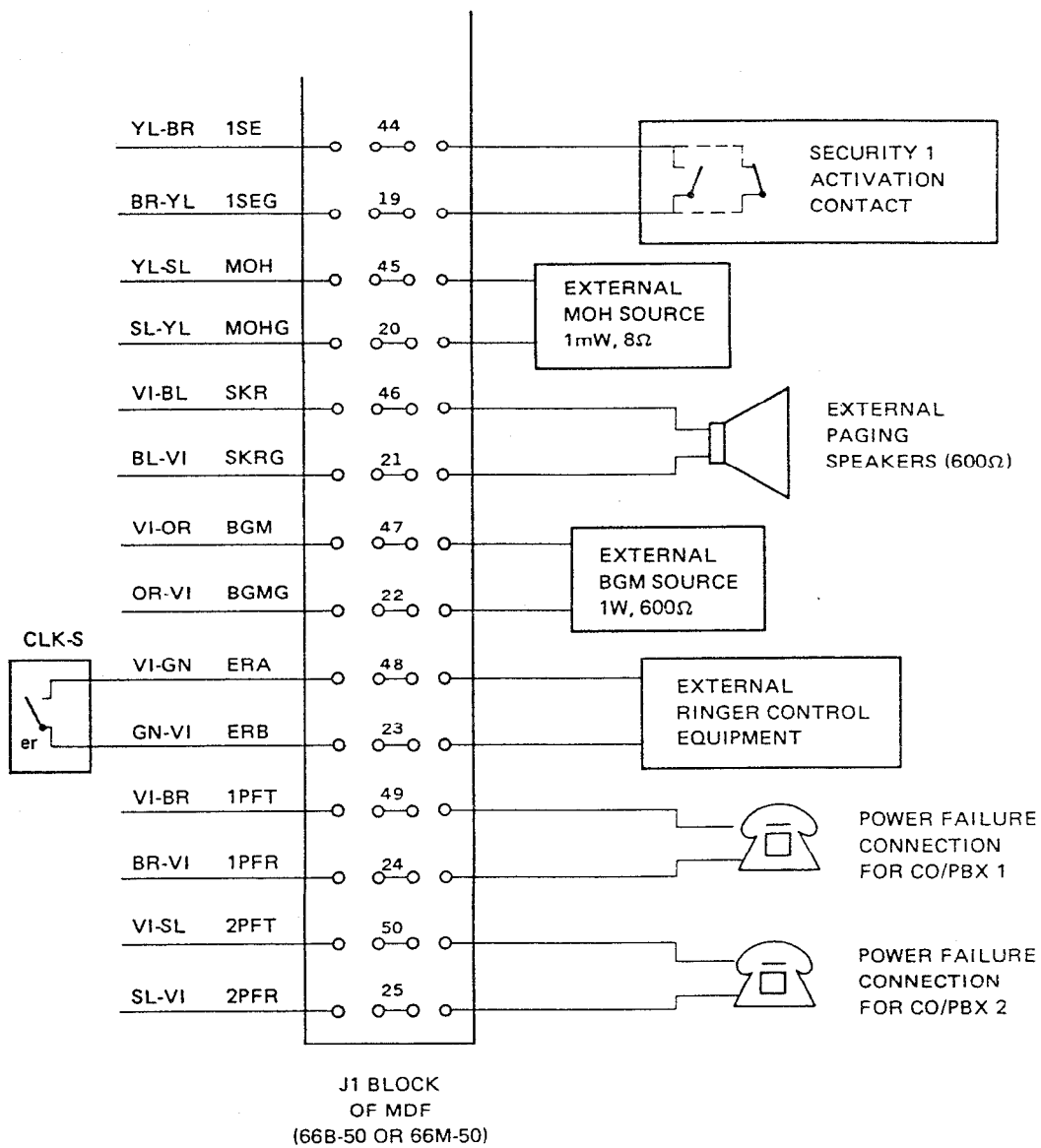

Fig. 260-3 Connection of Optional Features

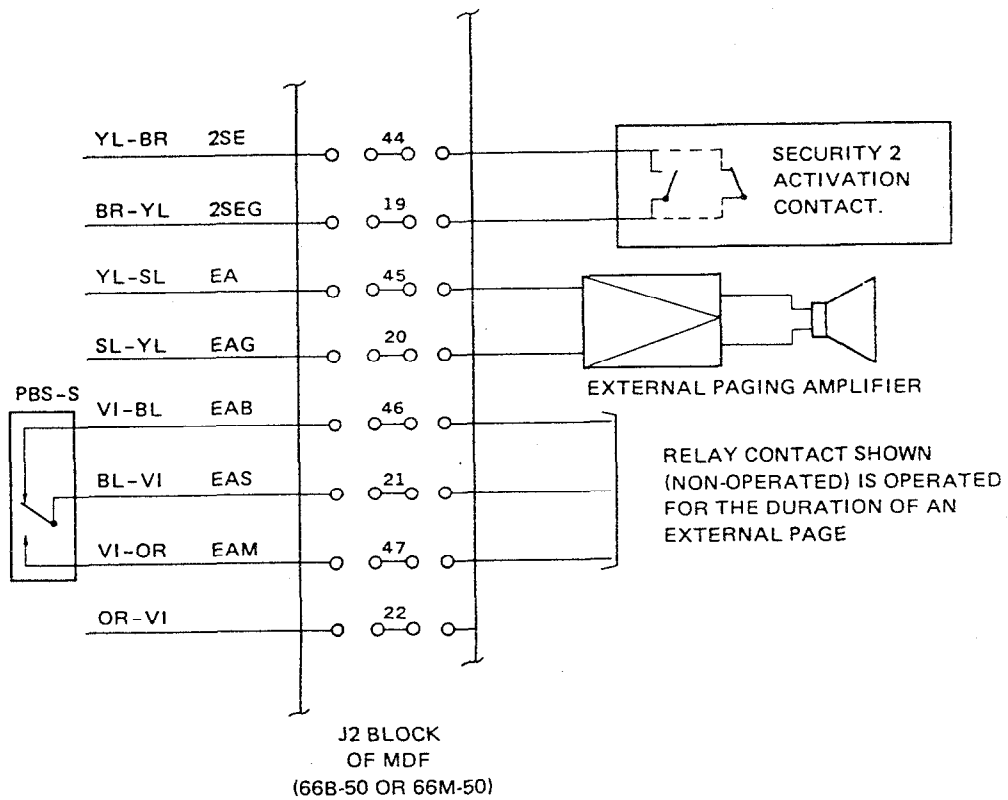

Fig. 260-4 Connection of Optional Features

# SECTION 300

## PROGRAMMING

### CONTENTS

	Page
<b>310</b> Explanation of Programming .....	300-1
<b>320</b> Programming Operations .....	300-3
320.1 Going Off-Line from Keypad 1	
320.2 Selecting a Memory Block	
320.3 Selecting Addresses Using the Dial Pad	
320.4 Entering Data	
320.5 Use of Function Buttons in Programming	
320.6 Going On-Line	
320.7 Resetting System to Change Contents of NPM	
320.8 To Return System to Resident System Program	
<b>330</b> Job Specifications .....	300-6
330.1 Instructions for Completing Job Specification	
<b>340</b> Programming Sheets .....	300-12
340.1 Programming Details	
340.2 Memory Block 1	
340.3 Memory Block 2	
340.4 Memory Block 3	
340.5 Memory Block 4	

## SECTION 300 PROGRAMMING

### 310 Explanation of Programming

1. The Electra-616 Electronic Key Telephone System comes provided with a Resident System Program in PROM (Programmable Read Only Memory). When the system is powered this Resident System Program is duplicated in RAM (Random Access Memory) and becomes the Network Plan Memory (NPM). The NPM is the program the system actually utilizes. This NPM will normally be supplemented by programming performed at each installation to provide the system program desired for the individual site. The additional programming is entered into RAM which is volatile, but which has been provided a battery to retain program during power outage.

**Note:** Before programming, ensure that the "back-up" battery provided on the CPU-S KTU is switched "on" or the additional programming in RAM will be lost with the first loss of Power to the KSU.

2. Keyset 1 must be installed to allow System Programming. No other station can program system data. The programming procedure includes the following steps:
  1. Completion of job specification
  2. Completion of programming work sheets.
  3. Taking keyset 1 "Off-line"
  4. Selecting a memory block (using DSS buttons), thus selecting the general area of the memory to be modified.
  5. Selecting addresses via the dial pad.
  6. Entering data via CO/PBX button 1 -6, MIC button and DND button.
  7. Displaying data, clearing data, changing address (plus or minus 1 address increment) and writing data using the Add-On, Last NBR, Hold and Speed Dial buttons.
  8. Repeat steps 4 thru 7 until all desired data has been written into memory.
  9. Return keyset 1 to "on-line" mode.
10. Put the program into the working Network Plan Memory. This function will occur automatically when the entire system is idle. An alternate method is to depress the reset button on the CPU-S KTU; this will interrupt service. Testing of the new program can then be performed.

The contents of the Resident System Program (default value) are given below in the following Table 310.1:

**Table 310.1 Resident System Program Contents**

FUNCTION	DEFAULT VALUE
Recall Button Timing	Time is 0.4 sec.
Pause Timing	Time is 1.0 sec.
Paging Timeout	Time is 60 sec.
Hold Recall	Time is 60 sec.
System Refresh Basis	Based on no change in status
Day Mode CO/PBX Ringing Assignment	Stations 1 and 9 ring for all CO/PBX lines
Night Mode CO/PBX Ringing Assignment	Stations 1 and 9 will ring
Door Phone Assignment	Door Phone not assigned
Door Phone Chime Assignment	Stations 1 and 9 chime
Off Hook Ringing Assignment	Stations 1 and 9 ring
Internal Paging Zone Assignment	No stations in any zone
Attendant Station Assignment	1 and 9 are attendant stations
Prime Line Pick-Up Assignment	Not assigned
Prime Line Pick-Up for Incoming Calls	No prime line on incoming calls
Prime Line Assignment	No private lines
CO/PBX Line Scan Assignment	Scan goes from CO/PBX line 2 to 1
CO/PBX Line Assignment	All lines are CO
PBX Access Code Assignment	PBX access code "9" is assigned
CO/PBX Group Assignment	All lines are group A
Station Class Assignment	All stations are class 0 (non-restricted)
"1" + Dialing Assignment	"1" + Dialing
Digit Rejection Assignment	No digits rejected
Speed Dial Toll Override Assignment	Toll restriction is overridden
Toll Restriction Override Table Assignment	No 3-digit codes in table



### 320 Programming Operations

#### 320.1 Going Off-Line from Keyset 1

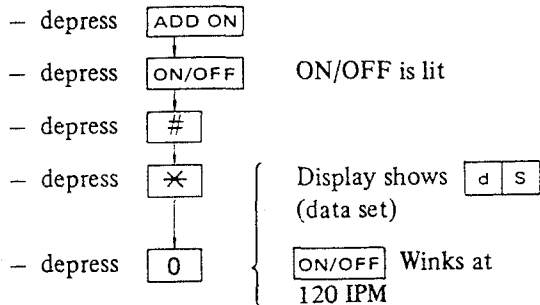

Keyset 1 is "Off-Line"

#### 320.2 Selecting a Memory Block

- To select a memory block, depress the appropriate DSS button on Keyset 1 while in off-line status. To simplify programming of system data, use the programming overlays provided with each ES-6-1 KSU.

**Note:** Taking Keyset 1 off-line removes that keyset from service. The rest of the Electra-616 system continues to work. If Station 1 is the Attendant Keyset, it may be desirable to enter night mode to provide ringing while keyset 1 is off-line. This depends on the installation.

#### 320.3 Selecting Addresses Using the Dial Pad

After selecting the memory block, the first address desired must be entered by using the dial pad. After dialing 1 or 2 digits (dialing a 0 first is not required for addresses numbering less than 10) the display will show the address selected. If programming deals with consecutive addresses there is no need to redial as addresses are automatically increased by 1 after writing data into memory. Manual operation of function buttons also allows increasing or decreasing the address by increments of 1. Redialing to change an address is possible at anytime.

#### 320.4 Entering Data

- To enter data the CO/PBX, MIC and DND buttons are used. The LED's associated with each of these buttons show the status of the datum corresponding to those buttons. When an address is in "clear" mode, no LED is lit.

- The method of entry using the CO/PBX, MIC and DND vary from address to address. Sometimes they are used singly as for a yes/no choice, sometimes in groups to write numbers in binary. The programming sheets for the different features show how to enter data for each individual address under consideration.

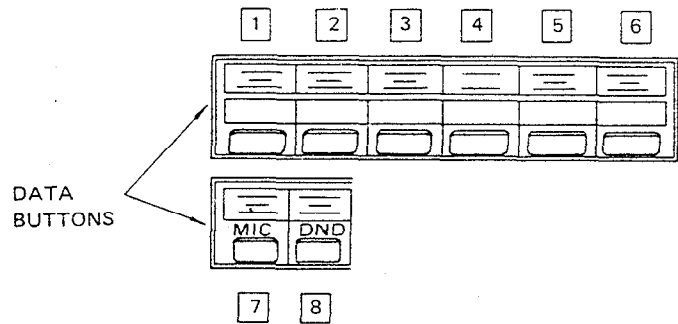

Fig. 320-1 Buttons 1 - 8 are used to Enter Data

Please note that buttons 7 and 8 are the MIC and DND buttons. In the programming instructions, they will be referred to as buttons 7 and 8.

#### 320.5 Use of Function Buttons in Programming

- Last NBR Button**  
The Last NBR button is used to perform a clear. When a data button is depressed and its LED is lit depressing the data button will change this status; the Last NBR button will clear the entire address (up to 8 data buttons) which can then be reprogrammed. The Last NRB button will only clear that single address except when Keyset 1 is engaged in programming Memory Block 5.
- The HOLD or ADD-ON button depressed once after dialing an address will cause the contents of that address to be displayed: immediately after dialing an address one of these buttons must be depressed. Each subsequent depression of the HOLD button will decrease the address by 1 and display the contents of that new address. Each subsequent depression of the ADD-ON button will increase the address by 1 and display the contents of that new address. Only the first use of either button after dialing an address will display that address without changing it.



### 3. Speed Dial Button

The Speed Dial button is used to write the contents of the address as it is currently displayed into the programming RAM: all previous operations will not result in any program change until this step is completed. In this memory block, all addresses can be cleared and written to initialize the RAM memories and return the system to the Resident System Program.

– depress  Data Lamps Go Off

– depress

Keyset 1 is returned to on-line mode. The Electra-616 system will not return to the Resident System Program until either the entire system is idle or the reset button on the CPU-S KTU is depressed.

### 320.6 Going On-Line

1. Depress ON/OFF button (Restore the handset) to return keyset 1 to On-Line mode. The display of keyset 1 will show  until program is accepted into the working NPM memory. Other displays will temporarily override this display, but it will return whenever the display is otherwise idle until the system working program changes.

### 320.7 Resetting System to Change Contents of NPM

1. It is possible to reset the system by depressing Reset button on the CPU-S KTU. This may not be necessary because the system memory will be rewritten when the entire system is idle. While this may cause delay, it does not drop all service in progress as does the reset.

### 320.8 To Return System to Resident System Program

1. Memory Block 5 can be used to initialize all system NPM memories at once when desired. Use of this memory block will return the system to the Resident System Program (in PROM).
2. Procedure to Return System to the Resident System Program.

with keyset 1 Off-Line                      Display Shows

– depress                      

– depress                                      

– depress                                      

– depress data button 1, 3, 5 and 7

Data Lamps should be lit as shown.

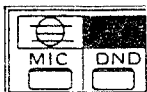
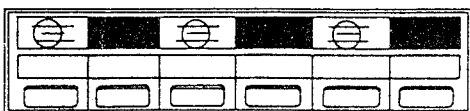

### Programming Procedures

#### 1. To go Off-Line

– depress

– depress

– depress

– depress

– depress

#### 2. To Select Memory Block

– depress DSS button for desired block (1 ~ 5)

#### 3. To Select Address

– dial 1 or 2 digit number.

#### 4. To Read Address

– depress  or

#### 5. To Increase 1 Address

– depress

#### 6. To Decrease 1 Address

– depress

#### 7. To Clear An Address

– depress

#### 8. To Write An Address

– depress

#### 9. To Go On-Line

– depress   
or pick up handset

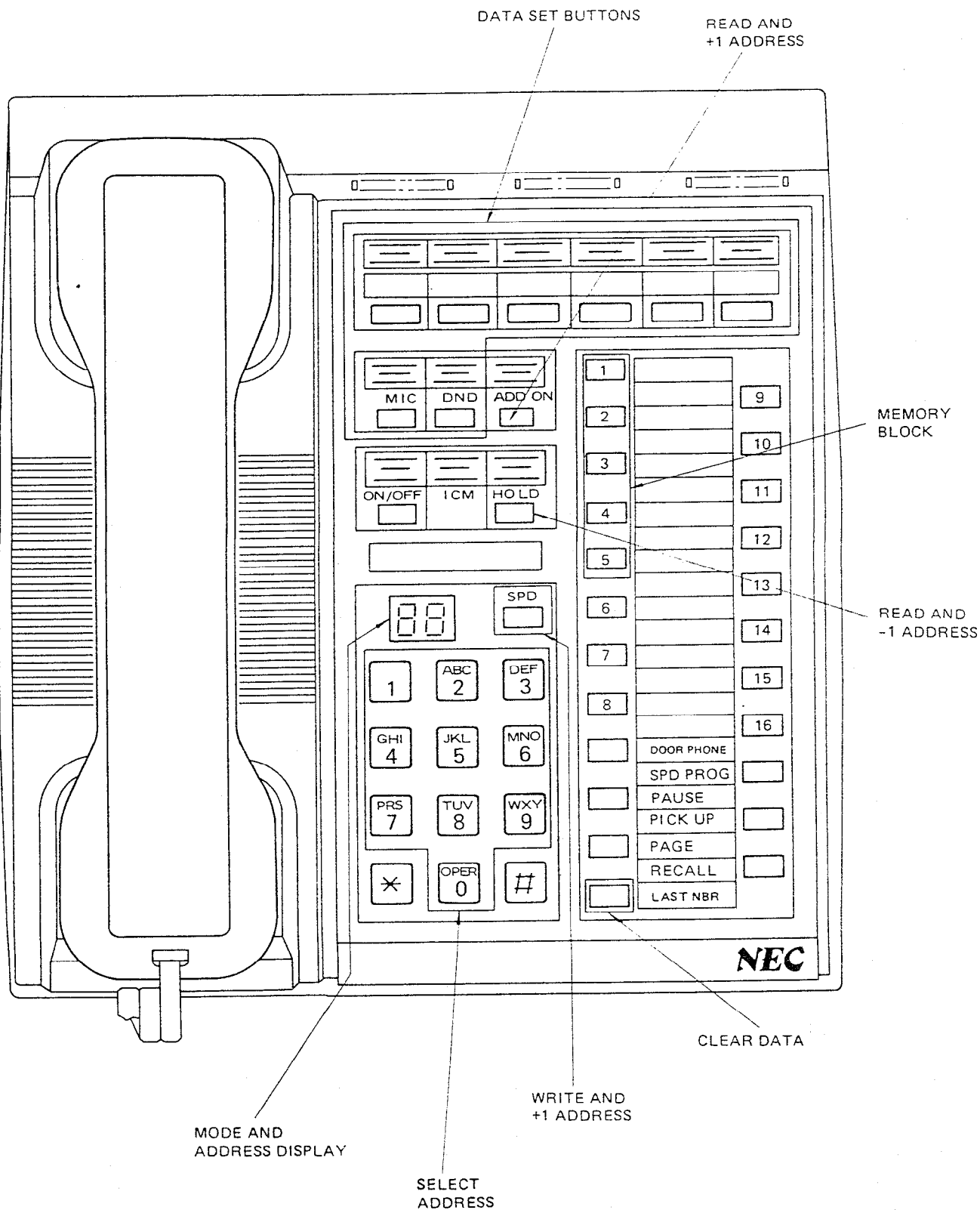

Fig. 320-2 Keyset Layout for Programming

SITE	A INSTALLATION	B ISSUED	C
Name: _____	Supervisor: _____	By: _____	
Address: _____	Cutover Date: _____	Number: _____	
_____	Ref. No. : _____		
_____	Additional: _____		
Tel. No. : _____	_____	_____	
Contact: _____	_____	_____	
Ref. No. : _____	_____	_____	

**1. System Size:**

- \_\_\_\_\_ Number of CO/PBX Lines
- \_\_\_\_\_ Number of Keysets
- \_\_\_\_\_ Number of BLFs
- \_\_\_\_\_ Number of Door Phones

**2. KTU options installed:**

- AHR-S
- PBS-S
- DPH-S

**3. External equipment installed:**

\_\_\_\_\_

\_\_\_\_\_

\_\_\_\_\_

\_\_\_\_\_

\_\_\_\_\_

\_\_\_\_\_

\_\_\_\_\_

\_\_\_\_\_

\_\_\_\_\_

\_\_\_\_\_

**4. Comments:** \_\_\_\_\_

\_\_\_\_\_

\_\_\_\_\_

\_\_\_\_\_

\_\_\_\_\_

\_\_\_\_\_

\_\_\_\_\_

\_\_\_\_\_

\_\_\_\_\_

\_\_\_\_\_

\_\_\_\_\_

**5. Use as Desired.**

6. CO/PBX ASSIGNMENTS

REF. NO.		PROGRAMMING DATA									
CO/PBX LINE NUMBER	KTU				CO/PBX LINE NUMBERS	PBX LINE Y/N	CO/PBX LINE GROUP				COMMENTS
	DCI-S		MFI-S				A	B	C	NOT INSTALLED	
	SLOT	POSITION	SLOT	POSITION							
1		1		1							
2	1	2	1	2							
3		3		3							
4		1		1							
5	2	2	2	2							
6		3		3							

## 7. STATION ASSIGNMENT

Ref. No.	PROGRAMMING DATA																							
	Station Number	CO/PBX Ring Assignment						Restriction				Prime Line 1~6	Private Line 1~6	Internal Zone Page			ATT. STA.	Door Phone Chime		KSI-S		Cable		
		Day					Night	Off	STA. Class 0~15	Code				1	2	3		Door Phone 1	Door Phone 2	Slot	Pos.	J	Wire Pairs in Running Cable	
		1	2	3	4	5	1~6	Hook		A	B													C
1																			1		WH-BL WH-OR			
2																			2		WH-GN WH-BR			
3																			3		WH-SL RD-BL			
4																			4	J1	RD-OR RD-GN			
5																			5		RD-BR RD-SL			
6																			6		BK-BL BK-OR			
7																			7		BK-GN BK-BR			
8																			8		BK-SL YL-BL			
9																			1		WH-BL WH-OR			
10																			2		WH-GN WH-BR			
11																			3		WH-SL RD-BL			
12																			4	J2	RD-OR RD-GN			
13																			5		RD-BR RD-SL			
14																			6		BK-BL BK-OR			
15																			7		BK-GN BK-BR			
16																			8		BK-SL YL-BL			

Note: Station 1 is used for System Programming and must be installed.

### CO/PBX LINE SCAN

		STATION															
		1	2	3	4	5	6	7	8	9	10	11	12	13	14	15	16
CO/PBX LINE	1																
	2																
	3																
	4																
	5																
	6																

8. SYSTEM ASSIGNMENTS

TIMEOUTS	DURATION IN SECONDS			
	0.4	0.6	1.0	1.5
HOOK FLASH TIME	0.4	0.6	1.0	1.5
PAUSE TIME	1.0	3.5		
PAGING TIME	30	60	90	NO TIME OUT
HOLD RECALL TIME	30	60	120	240

	NO CHANGE	IDLE
SYSTEM REFRESH BASIS		

DOOR PHONE

	INSTALLED	NOT INSTALLED
DOOR PHONE 1		
DOOR PHONE 2		

PRIME LINE FOR INCOMING CALLS

	ALLOW	DISALLOW
PRIME LINE FOR INCOMING CALLS		

TOLL RESTRICTION ENTER NUMBERS DESIRED

PBX ACCESS CODE				
REJECTION CODES				
OVERRIDE TABLE				

	ALLOW	DISALLOW
1 + DIALING		
SPEED DIAL TOLL OVERRIDE		

## 340 Programming Sheets

### 340.1 Programming Details

#### 1. Programming Work Sheets

The following programming work sheets, along with the programming overlays are intended to ease programming work sheets, if kept up to date with respect to program changes, can also be used as record of existing installation.

In the following pages the words "default value" will be seen. This is the value which has been programmed in the Resident System Program and is the value which will remain if you "default", (if you do not change the value). The following symbols are also seen in the programming work sheets:



LED  
OFF



LED  
ON

### 340.2 Memory Block 1

#### 1. Recall Button Timing (See Fig. 340-1)

This area of the program allows choice on a system basis of how long the disconnect signal produced by depressing the recall button on the keysets last. The recall button can be used for "flashing" when behind a PBX or as a recall button when the system is connected to Central Office lines. Address 1 is the memory location used to select this time-out. Buttons 7 and 8 offer time outs of 0.4 seconds, 0.6 seconds, 1.0 seconds, or 1.5 seconds. The default value is 0.4 seconds.

#### 2. Pause Timing (See Fig. 340-2)

This area of the program selects on a system basis the duration of the pause interval by the depression of the pause button on the keyset. The pause button can be used when programming for station or system speed dialing where intervals between dialing patterns may be desired. Address 2 is used to select the duration of the pause. Button 8 offers a duration of 1.0 second or 3.5 seconds. The default value is 1.0 second.

#### 3. Paging Time-Out (See Fig. 340-3)

This area of the program is used to set the duration of internal and external paging. Possible values are 30 seconds, 90 seconds, or no time out. Address 3 is used to select the duration of paging. Buttons 7 and 8 select the time out value. The default value is 60 seconds.

#### 4. Hold Recall Timing (See Fig. 340-4)

This area of the programming provides for selecting the length of time before recall of non-exclusive held calls and of exclusively held calls. The time-out on hold doesn't begin until the telephone handset is returned to the cradle. Address 4 is used to select the timing. Buttons 7 and 8 are used to select one of the time-outs. The default value for hold recall is 60 seconds.

#### 5. System Refresh Basis (See Fig. 340-5)

System refresh (a "cleaning" of system RAM to remove any false data caused by AC voltage problems or other causes) can be set to begin after one of two conditions have been met for a period of approximately five hours.

- 1) There is no change in status; devices may be busy but no new activity has taken place in approximately five hours.
- 2) All stations have been idle; all stations have been "ON HOOK" for approximately five hours.

Address 5 is used to program this choice of system refresh basis. Button 8 is used in either/or mode to select the style of refresh. The default value is no change is status.

### 340.3 Memory Block 2

#### 1. Day Mode CO/PBX Ringing Assignment (See Fig. 340-6)

This area of memory uses 12 addresses. Each CO/PBX line uses 2 addresses for ring assignments. This allows flexible ring assignment for all CO/PBX lines. Each address uses 8 buttons: each one corresponds to a station 1 and 9 ring for all CO/PBX lines.

#### 2. Night Mode CO/PBX Ringing Assignment (See Fig. 340-7)

This area of the program is used to assign stations to ring when the system enters night mode. A station programmed for Night Mode Ring will ring for all 6 CO/PBX lines. Addresses 13 and 14 are the assigned memory locations for all 16 stations. Each button 1 ~ 8 represents a station. The default value is stations 1 and 9 which ring for all CO/PBX lines. When the system is in night mode.

#### 3. Door Phone Assignment (See Fig. 340-8)

This program area is used in enabling Door Phones when connected. Two Door Phones can be installed in the system. Address 15 is used to assign this option.

Button 7 represents Door Phone 1 and button 8 represents Door Phone 2. The default value is that Door Phones are not assigned. A Door Phone that is connected to the MDF and not assigned in the system program (NPM) will not operate.

4. Door Phone Chime Assignment (See Fig. 340-9)

When Door Phones are installed in the system it is necessary to assign station(s) within the system to chime when the Door Phone is activated. Each station can be programmed to chime on Door Phone 1 and/or Door Phone 2. Addresses 16 and 17 are used to assign stations to chime when Door Phone 1 is activated. Addresses 18 and 19 are used to assign stations to chime when Door Phone 2 is activated. Buttons 1 ~ 8 of each address corresponds to a station. The default value is stations 1 and 9 will chime for Door Phone 1 and Door Phone 2.

5. Off-Hook Ringing Assignment (See Fig. 340-10)

This area of the program is used to assign Off-Hook CO/PBX Ringing on a per station basis. When this option is programmed, stations that are assigned Off-Hook Ringing and are off-hook (using the handset) will receive CO ring over their speaker at half volume. Off-Hook Ringing has a distinct ring from On-Hook Ringing. Both ringing rate and tone frequency are different. Addresses 20 and 21 are used to assign this option. Buttons 1 ~ 8 of each address represents a station. The default value is that stations 1 and 9 ring off-hook.

#### 340.4 Memory Block 3

1. Internal Paging Zone Assignment (See Fig. 340-11)

This area of the program is used to assign stations into Internal Paging Zones. Stations can be in any of the zones or in no zone, they cannot be assigned to more than one zone.

Addresses 1 ~ 4 are used to assign stations into zones. Buttons 1 ~ 8 are used in pairs; 1 and 2, 3 and 4, 5 and 6, 7 and 8, with each pair representing a station. The default value is that all stations are not in any zone.

2. Attendant Station Assignment (See Fig. 340-12)

This area of the program is used to assign 2 stations as Attendant Stations. Attendant Station features are: to set and cancel Night Transfer, to program and confirm System Speed Dial and to cancel Security Alarm Signal. Only these features can be transferred by changing attendant station assignment. The default value is that stations 1 and 9 are Attendant Stations. Although any

2 stations can be assigned as Attendant Stations, only station 1 can program system data.

Address 5 is used for this assignment. Buttons 1 ~ 4 are used to assign on station, buttons 5 ~ 8 are used for the second. The binary format corresponds to the individual stations DSS number.

3. Prime Line Pick-Up Assignment (See Fig. 340-13)

This program area is used to allow a keyset to seize a selected CO/PBX line without depressing that line's button. The line will be selected when it is idle or on a systemwide basis, the line can be selected when idle or ringing (see Fig. 340-13). More than one station can be assigned the same CO/PBX line as its prime line. No station can be assigned more than one prime line. Each address from 6 ~ 13 corresponds to two stations. Buttons 1 ~ 4 and 5 ~ 8 are used to program a CO/PBX line number in a binary format. For no prime line the binary number 0 is used. The default value is no prime line assigned for any station.

4. Prime Line Pick-Up For Incoming Calls (See Fig. 340-14)

This area of the program affects on a systemwide basis whether CO/PBX lines which are in ringing status are eligible for Prime Line Pick-up. Address 14, button 8, sets the value. The default value is that Prime Line Pick-up will not seize ringing lines.

5. Private Line Assignment (See Fig. 340-15)

Two lines in the system can be assigned as private lines. These lines can be accessed and will provide an led appearance only on the assigned stations. Stations that are not assigned a private line cannot successfully be programmed to ring on that line. Two stations can be assigned the same private line, and two lines can be assigned to the same station or two stations can be assigned a private line each. Addresses 15 and 17 are used to enter each private line. Buttons 5 ~ 8 are used in a binary format to represent lines 1 ~ 6. Addresses 16 and 18 are used to enter the stations that are assigned private lines. Buttons 4 ~ 8 represent the stations. The default value is that no stations are assigned private lines.

6. CO/PBX Line Scan Assignment (See Fig. 340-16)

This area of the program is used to select which CO/PBX lines will be scanned for idle status in response to a station speed dial request for a CO/PBX line. The system will always scan from the highest numbered selected line to the lowest numbered selected line (from right to left).



**Note:** *That lines can be omitted from the scan.*

Each station is assigned an address where selection can be made on which lines to scan. Addresses 19 ~ 34 correspond to a station and buttons 1 ~ 6 of each address represents the lines. The default value is that all stations scan from lines 2 to 1.

#### 340.5 Memory Block 4

##### 1. CO/PBX Line Assignment (See Fig. 340-17)

This program area assigns lines as either CO lines, or as PBX lines to provide for a pause when stations use speed dial or last number dialed. For proper functioning, especially when Toll Restriction is installed, it is important that PBX lines be assigned as such.

Address 1 and buttons 1 ~ 6 are used to program line assignment. Each button 1 ~ 6 represents a line. The default value for line assignment is all lines are CO lines.

##### 2. PBX Access Code Assignment (See Fig. 340-18)

This area of the program is used to allow up to 2 single digit access codes to be dialed without the Toll Restriction Inspection occurring. This allows more flexibility in Toll Restriction when a PBX station or access code is to be dialed and inspection is not desired.

Two individual digits may be programmed.

Address 2 is used to enter both single digit access codes to be allowed without inspection. The buttons 1 ~ 4 and 5 ~ 8 are used to write both numbers in binary from 1 ~ 10 (10 is equivalent to 0 on the dial pad). The default value is assigned digit "9" as PBX access code.

##### 3. CO/PBX Group Assignment (See Fig. 340-19)

This program area is used to assign a CO/PBX line into one of three groups. The CO/PBX group assignment affects toll and Outgoing Restriction Assignment. Programming a line as "not installed" prevents access to unterminated lines and provides for error tone when the corresponding keyset button is depressed. Address 3 corresponds to CO/PBX lines 1 ~ 4. Each pair of buttons, 1 and 2, 3 and 4, 5 and 6, 7 and 8 are used to program these lines into a group. Address 4 corresponds to CO/PBX lines 5 and 6. Buttons 1 and 2, 3 and 4 are used to program lines 5 and 6 into a group. The default value for CO/PBX group is for all lines to be in group A.

##### 4. Station Class Assignment (See Fig. 340-20)

This program area is used in assigning restrictions to stations. The programming work sheet has a chart which shows how each class of station 0 ~ 15 is restricted with regard to each of the 3 CO/PBX line groups. In the chart, N stands for Not Restricted, T for Toll Restricted and O for Outgoing Restricted. The classes range from Not Restricted on all 3 groups, (class 0) through Toll Restricted on all 3 groups (class 7), to Outgoing Restricted on all 3 groups (class 15).

Please note that not all possible combinations are to be found.

The default value for station class is 0 (Not Restricted on all 3 groups of CO/PBX lines for all stations). Each address from 5 ~ 12 corresponds to two stations. CO/PBX buttons 1 ~ 4 are used for one station and buttons 5 ~ 8 for the other. The station class number is entered in binary format.

##### 5. 1+ Dialing Assignment (See Fig. 340-21)

This area of the program is used to select a Toll Restriction format to suit the installation Site Requirements.

In some locations it is necessary to dial a "1" before dialing a foreign area code and local exchanges have 3-digit office codes with the same format as area codes. If 1+ Dialing is entered into the program, calls beginning with 1 (calls to foreign area codes) will be denied when the station is Toll Restricted on that line, but local (for instance to a local exchange 408) will be allowed. In other locations, it is not necessary to dial a "1" before dialing a foreign area code; in this case 1+ Dialing should be removed from the program.

Address 13, button 8, is used to select which type of inspection process is desired. The default value is that 1+Dialing is assigned.

##### 6. Digit Rejection Assignment (See Fig. 340-22)

This area of the program is used to prevent repeated dialing of the same digit from the beginning of the dialing process to defeat the Toll Restriction Inspection Process. This ability has been entered into the program so that when an exchange "ignores" a particular digit or digits, if they are the first digits dialed and merely continues to offer dial tone, the Toll Inspection Process will still be valid. A toll restricted station dialing a number listed in the digit rejection table will be dropped from the CO/PBX line and receive error tone. Up to 4 separate digits can be entered.

7. Speed Dial Toll Override Assignment (See Fig. 340-23)

This area of the program is used to permit or deny Toll Restricted Stations using the System Speed Dial access numbers 40 ~ 59 to override toll restriction. This choice only applies to system speed dial memory access numbers 40 ~ 59 and all toll restricted stations on a system wide basis. Address 16 button 8 is used to allow or disallow system speed dial buffers 40 ~ 59 toll override. The default value is that System Speed Dial will override toll restriction.

8. Toll Restriction Override Table (See Fig. 340-24)

This area of the program can be used to enter up to 30 3-digit codes to override the Toll Restriction. Some uses for this table would be to provide access to common service codes such as 911, 611 and 411 and to allow dialing 800 numbers and selected foreign area codes. Two addresses are used for each code. The first four buttons of an odd-numbered address are used to enter the first digit. The second four buttons are used to enter the second digit. The first four buttons of the following even-numbered address are used to enter the third digit. The numbers are entered in binary with 10 equal to 0 on the dial pad. Any address which is completely blank (no LEDs lit) is recognized as terminating the Override Table so no address can be skipped when programming. The default value of the Override Table is that no 3-digit codes are entered.

**Table 340.1 Memory Block and Address Content**

**MEMORY BLOCK 1**

Address 1	Recall Button Timing Assignment
2	Pause Timing Assignment
3	Paging Timeout Assignment
4	Hold Recall Timing Assignment
5	System Refresh Basis

**MEMORY BLOCK 2**

Address 1 ~ 12	Day Mode CO/PBX Ringing Assignment
13 ~ 14	Night Mode CO/PBX Ringing Assignment
15	Door Phone Assignment
16 ~ 19	Door Phone Chime Assignment
20 ~ 21	Off-Hook Ringing Assignment

**MEMORY BLOCK 3**

Address 1 ~ 4	Internal Paging Zone Assignment
5	Attendant Station Assignment
6 ~ 13	Prime Line Pick-Up Assignment
14	Prime Line Pick-Up for Incoming Calls Assignment
15 ~ 18	Private Line Assignment
19 ~ 34	CO/PBX Line Scan Assignment

**MEMORY BLOCK 4**

Address 1	CO/PBX Line Assignment
2	PB Access Code Assignment
3 ~ 4	CO/PBX Group Assignment
5 ~ 12	Station Class Assignment
13	"1" + Dialing Assignment
14 ~ 15	Digit Rejection Assignment
16	Speed Dial Toll Override Assignment
17 ~ 76	Toll Restriction Override Table Assignment

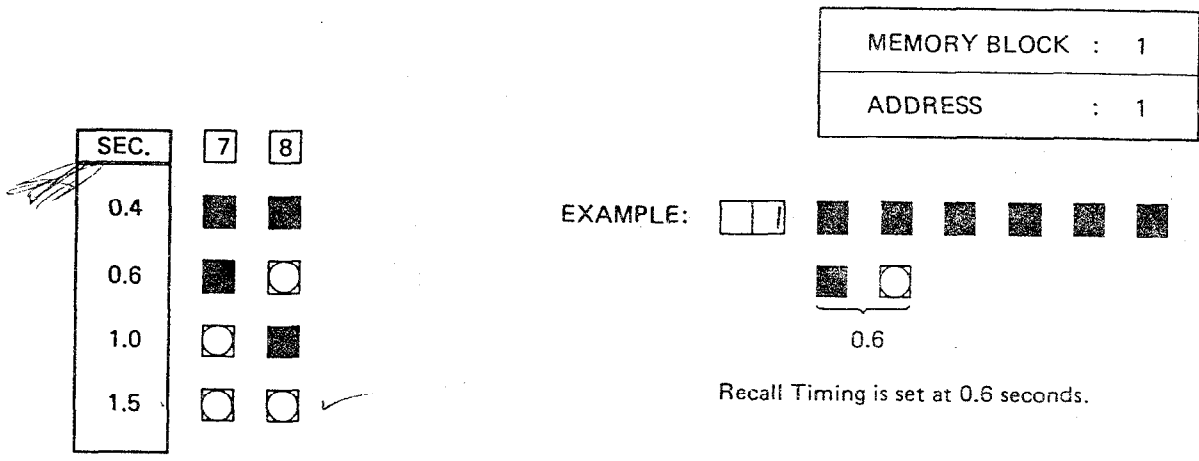

Fig. 340-1 Recall Button Assignment

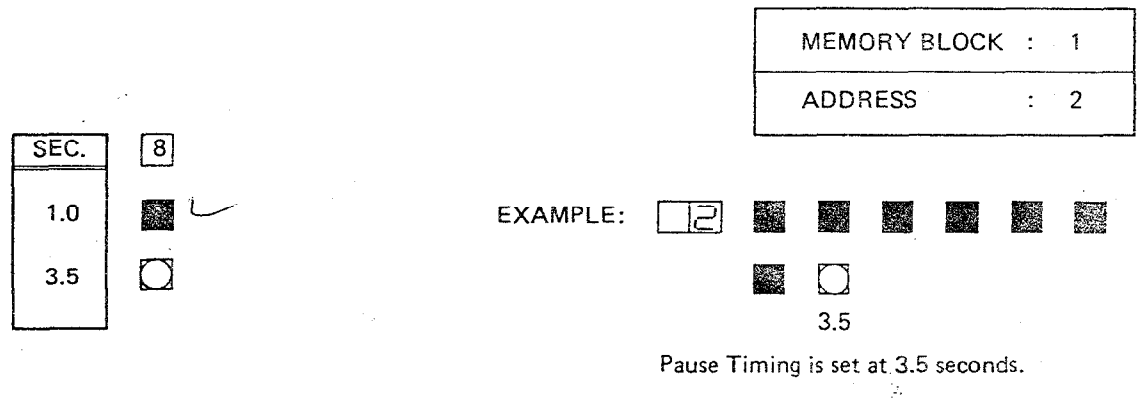

Fig. 340-2 Pause Timing Assignment

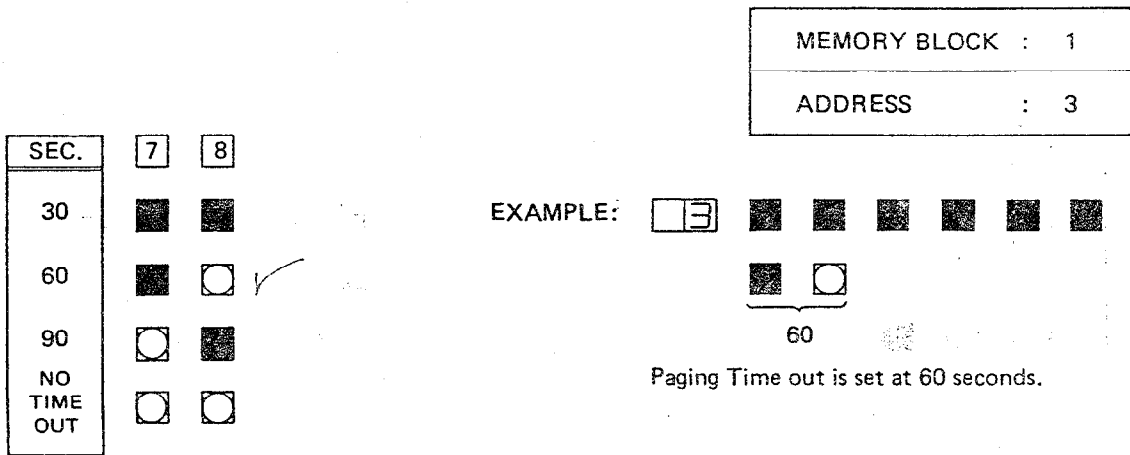

Fig. 340-3 Paging Time Out Assignment

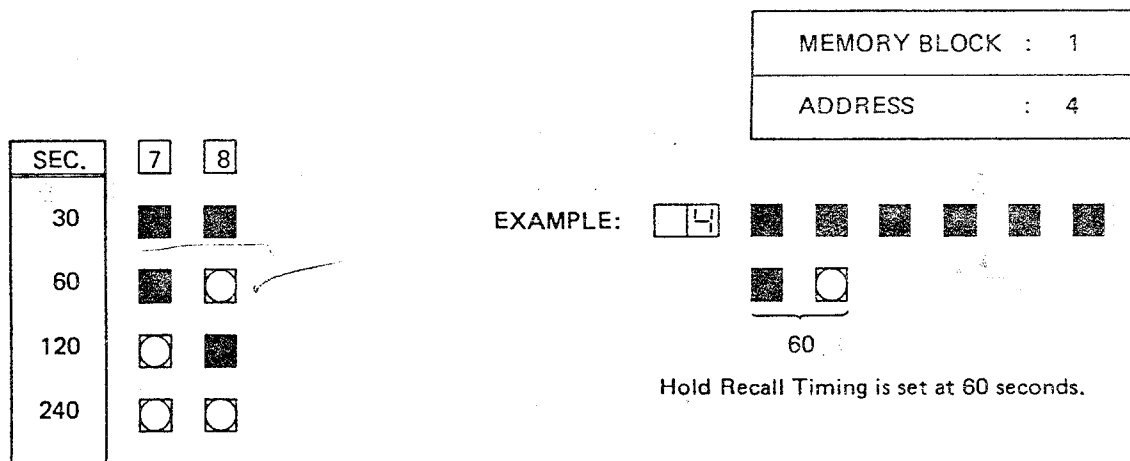

Fig. 340-4 Hold Recall Timing

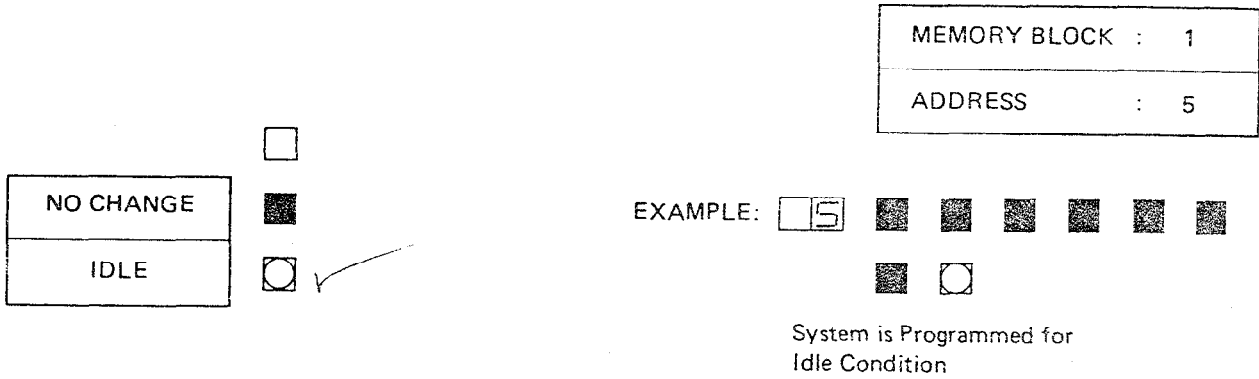
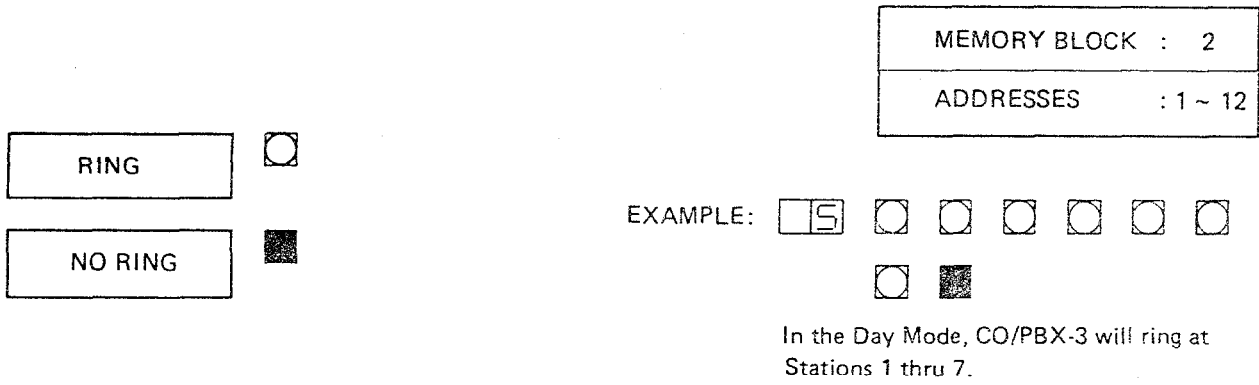

Fig. 340-5 System Refresh Basis



		1	2	3	4	5	6	7	8	
CO.	ADD.	STATION NUMBERS								
1	1	1	2	3	4	5	6	7	8	
	2	9	10	11	12	13	14	15	16	
2	3	1	→							
	4								16	
3	5	1	→							
	6								16	
4	7	1	→							
	8								16	
5	9	1	→							
	10								16	
6	11	1	→							
	12								16	

Fig. 340-6 Day Mode CO/PBX Ringing Assignment

RING

NO RING

MEMORY BLOCK : 2

ADDRESSES : 13, 14

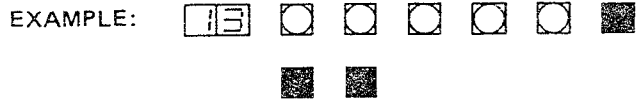

In the Night Mode CO/PBX 1 - 6 will ring at Station 1 thru 5.

		1	2	3	4	5	6	7	8
CO.	ADD.	STATION NUMBERS							
1-6	13	1	2	3	4	5	6	7	8
	14	9	10	11	12	13	14	15	16

1-6 also on  
1-6

Fig. 340-7 Night Mode CO/PBX Ringing Assignment

ASSIGNED

NOT ASSIGNED

MEMORY BLOCK : 2

ADDRESS : 15

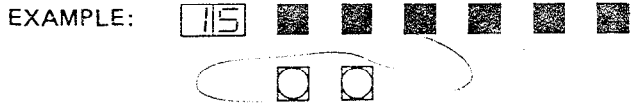

Door Phone 1 and 2 are enabled.

	CO
DOOR PHONE 1	7
DOOR PHONE 2	8

Fig. 340-8 Door Phone Assignment

CHIME

NO CHIME

MEMORY BLOCK : 2  
ADDRESSES : 16~19

EXAMPLE: 15

Door Phone 1 will chime at Stations 2, 4, 6, and 8.

		1	2	3	4	5	6	7	8
DOOR PHONE	ADD.	STATION NUMBERS							
1	16	1	2	3	4	5	6	7	8
	17	9	10	11	12	13	14	15	16
2	18	1							8
	19	9							16

Fig. 340-9 Door Phone Chime Assignment

NO OFF-HOOK RINGING   
OFF-HOOK RINGING

MEMORY BLOCK : 2  
ADDRESSES : 20~21

EXAMPLE: 20

Stations 1 thru 4 will ring off-hook.

		1	2	3	4	5	6	7	8
CO.	ADD.	STATION NUMBERS							
1-6	20	1	2	3	4	5	6	7	8
	21	9	10	11	12	13	14	15	16

Fig. 340-10 Off-Hook Ringing Assignment



MEMORY BLOCK : 3
ADDRESSES : 1~4

1 2

3 4

5 6

7 8

ZONE
A
B
C
NO ZONE

■ □

□ ■

□ □

■ ■

EXAMPLE:



- STA. 5: ZONE A
- STA. 6: ZONE B
- STA. 7: ZONE C
- STA. 8: NO ZONE

	1	2	3	4	5	6	7	8
ADD.	STATION NUMBERS							
1	1	2	3	4				
2	5	6	7	8				
3	9	10	11	12				
4	13	14	15	16				

Fig. 340-11 Internal Paging Zone Assignment

MEMORY BLOCK	: 3
ADDRESS	: 5

STA.	1	2	3	4
	5	6	7	8
1	■	■	■	■
2	■	■	■	□
3	■	■	□	■
4	■	■	□	□
5	■	□	■	■
6	■	□	■	□
7	■	□	□	■
8	■	□	□	□
9	□	■	■	■
10	□	■	■	□
11	□	■	□	■
12	□	■	□	□
13	□	□	■	■
14	□	□	■	□
15	□	□	□	■
16	□	□	□	□

EXAMPLE:

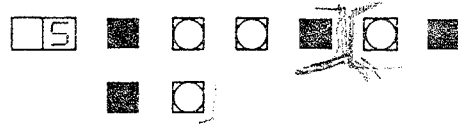

Stations 7 and 10 are assigned as Attendant Stations.

	1	2	3	4	5	6	7	8
ADD.	ATT. STATION				ATT. STATION			
5								

Fig. 340-12 Attendant Station Assignment

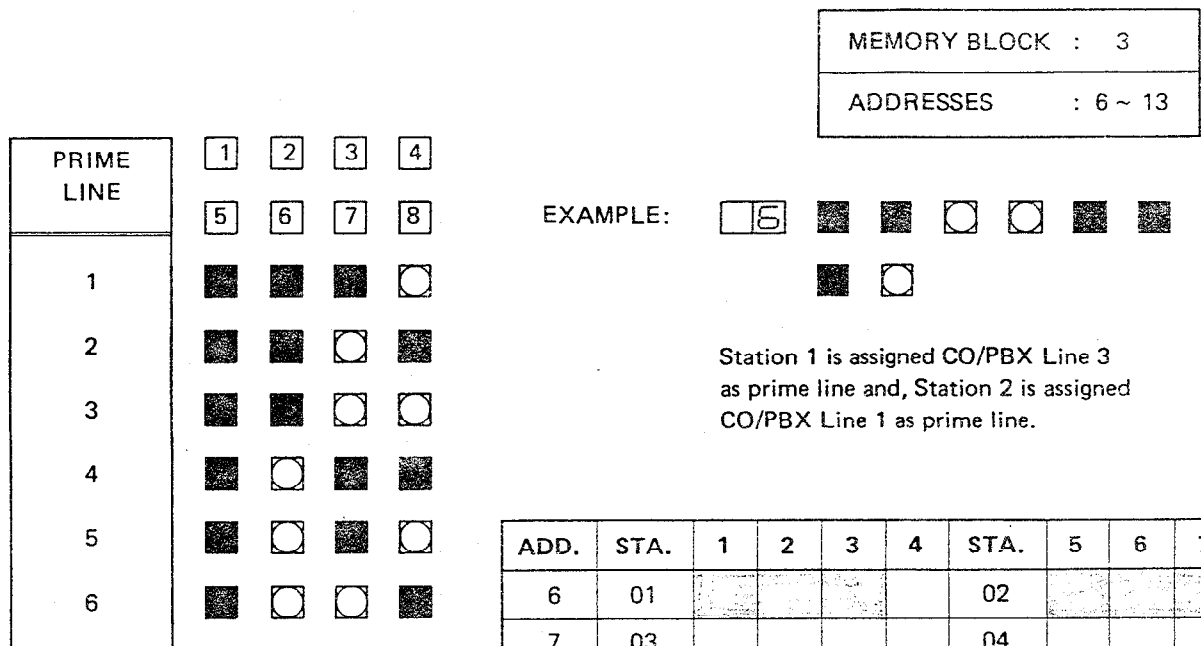

ADD.	STA.	1	2	3	4	STA.	5	6	7	8
6	01	■	■	■		02	■	■	■	■
7	03					04				
8	05					06				
9	07					08				
10	09					10				
11	11					12				
12	13					14				
13	15					16				

Fig. 340-13 Prime Line Pick-Up Assignment

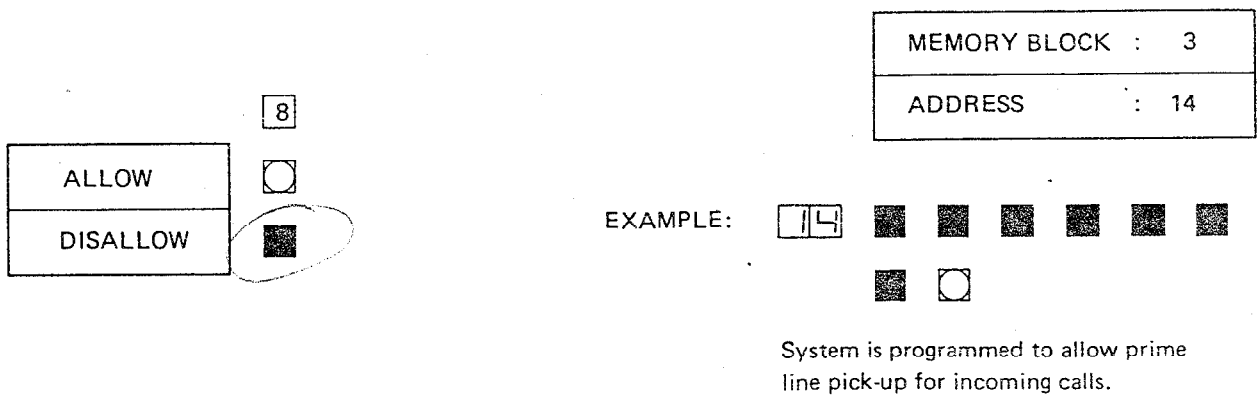

Fig. 340-14 Prime Line Pick-Up for Incoming Calls

CO/PBX LINE	5	6	7	8
1	■	■	■	□
2	■	■	□	■
3	■	■	□	□
4	■	□	■	■
5	■	□	■	□
6	■	□	□	■

MEMORY BLOCK:	3
ADDRESSES	: 15 ~ 18

EXAMPLE: 15 ■ ■ ■ ■ ■ ■

□ □

EXAMPLE: 18 ■ ■ ■ □ ■ □

□ □

Station 8 is assigned private line on CO/PBX Line 3.

*Note: Addresses 15 and 17 are used to assign private CO/PBX line. Addresses 16 and 18 are used to assign private line station(s).*

STA.	4	5	6	7	8
1	□	■	■	■	■
2	□	■	■	■	□
3	□	■	■	□	■
4	□	■	■	□	□
5	□	■	□	■	■
6	□	■	□	■	□
7	□	■	□	□	■
8	□	■	□	□	□
9	□	□	■	■	■
10	□	□	■	■	□
11	□	□	■	□	■
12	□	□	■	□	□
13	□	□	□	■	■
14	□	□	□	■	□
15	□	□	□	□	■
16	□	□	□	□	□

	ADD.	4	5	6	7	8
CO	15					
STA.	16					
CO	17					
STA.	18					

Fig. 340-15 Private Line Assignment

MEMORY BLOCK :	3
ADDRESSES :	19 ~ 34

NOT SCAN

SCAN

EXAMPLE:

Station 2 is assigned scanning CO/PBX Line 6, 3 and 1.

STA.	ADD.	LINE 1	LINE 2	LINE 3	LINE 4	LINE 5	LINE 6
		1	2	3	4	5	6
1	19						
2	20						
3	21						
4	22						
5	23						
6	24						
7	25						
8	26						
9	27						
10	28						
11	29						
12	30						
13	31						
14	32						
15	33						
16	34						

Fig. 340-16 CO/PBX Line Scan Assignment

CO



PBX



MEMORY BLOCK : 4
ADDRESS : 1

EXAMPLE:

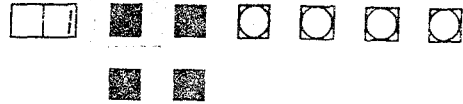

Line 1 and 2 are assigned as CO Line 3 thru 6 are assigned as PBX.

	1	2	3	4	5	6
ADD.	LINE 1	LINE 2	LINE 3	LINE 4	LINE 5	LINE 6
1	/	/	/	/	/	/

Fig. 340-17 CO/PBX Line Assignment

X

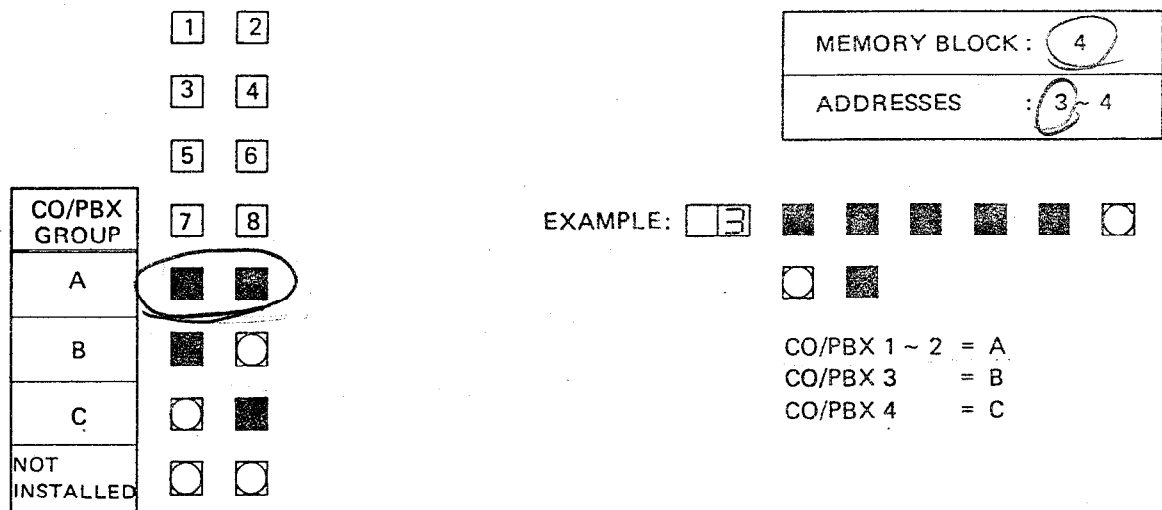

ADD.	CO.	1	2	CO.	3	4	CO.	5	6	CO.	7	8
3	1		/	2	/		3			4		
4	5			6								

Fig. 340-19 CO/PBX Group Assignment

MEMORY BLOCK :	4
ADDRESS	2

PBX CODE
1
2
3
4
5
6
7
8
9
0
NONE

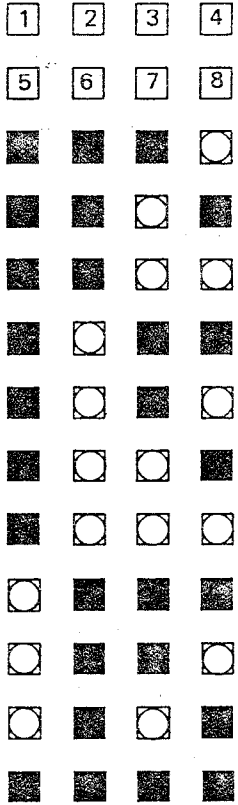

EXAMPLE



PBX access codes have been set at 9 and 8.

ADD.	1	2	3	4	5	6	7	8
2	■	○	■	■	○	○	■	■

Fig. 340-18 PBX Access Code Assignment



CPU-3A.

MEMORY BLOCK : 4  
ADDRESSES : 5 ~ 12

STA. CLASS	CO GROUP			1	2	3	4
	A	B	C	5	6	7	8
0	N	N	N	■	■	■	■
1	N	T	N	■	■	■	□
2	N	O	N	■	■	□	■
3	O	T	N	■	■	□	□
4	T	N	N	■	□	■	■
5	T	T	N	■	□	■	□
6	T	O	N	■	□	□	■
7	T	T	T	■	□	□	□
8	N	N	O	□	■	■	■
9	N	T	O	□	■	■	□
10	N	O	O	□	■	□	■
11	O	T	O	□	■	□	□
12	T	N	O	□	□	■	■
13	T	T	O	□	□	■	□
14	T	O	O	□	□	□	■
15	O	O	O	□	□	□	□

EXAMPLE: 

5	■	□	□	□	□	■
□	■					

STATION 1: CLASS 7  
STATION 2: CLASS 10

ADD.	STA.	1	2	3	4	STA.	5	6	7	8
5	1	<del>10</del>				2		<del>2</del>		
6	3					4				
7	5		2			6				
8	7					8				
9	9					10				
10	11					12				
11	13					14				
12	15					16				

Dial 8

↓  
SPD

CO

9

N = Not r/s  
T = toll  
O = out going

Fig. 340-20 Station Class Assignment

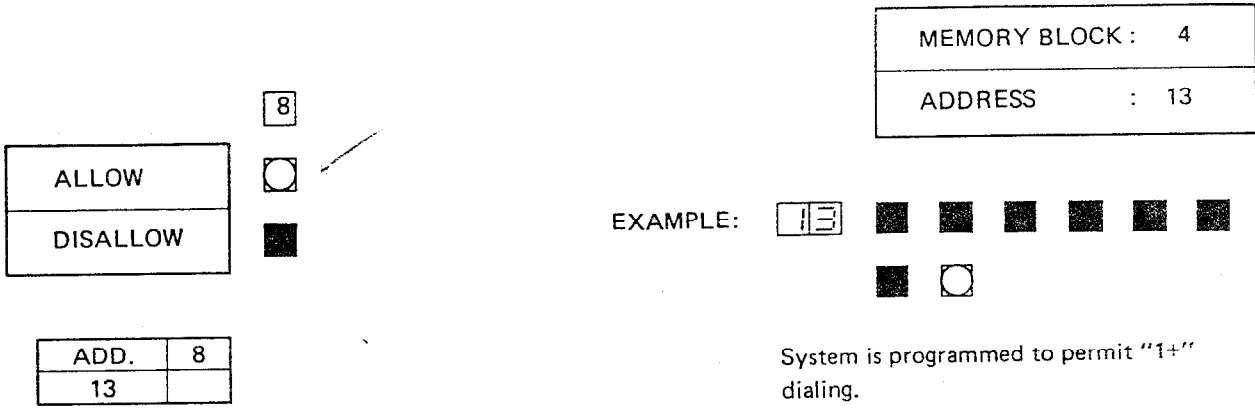

Fig. 340-21 1+ Dialing Assignment

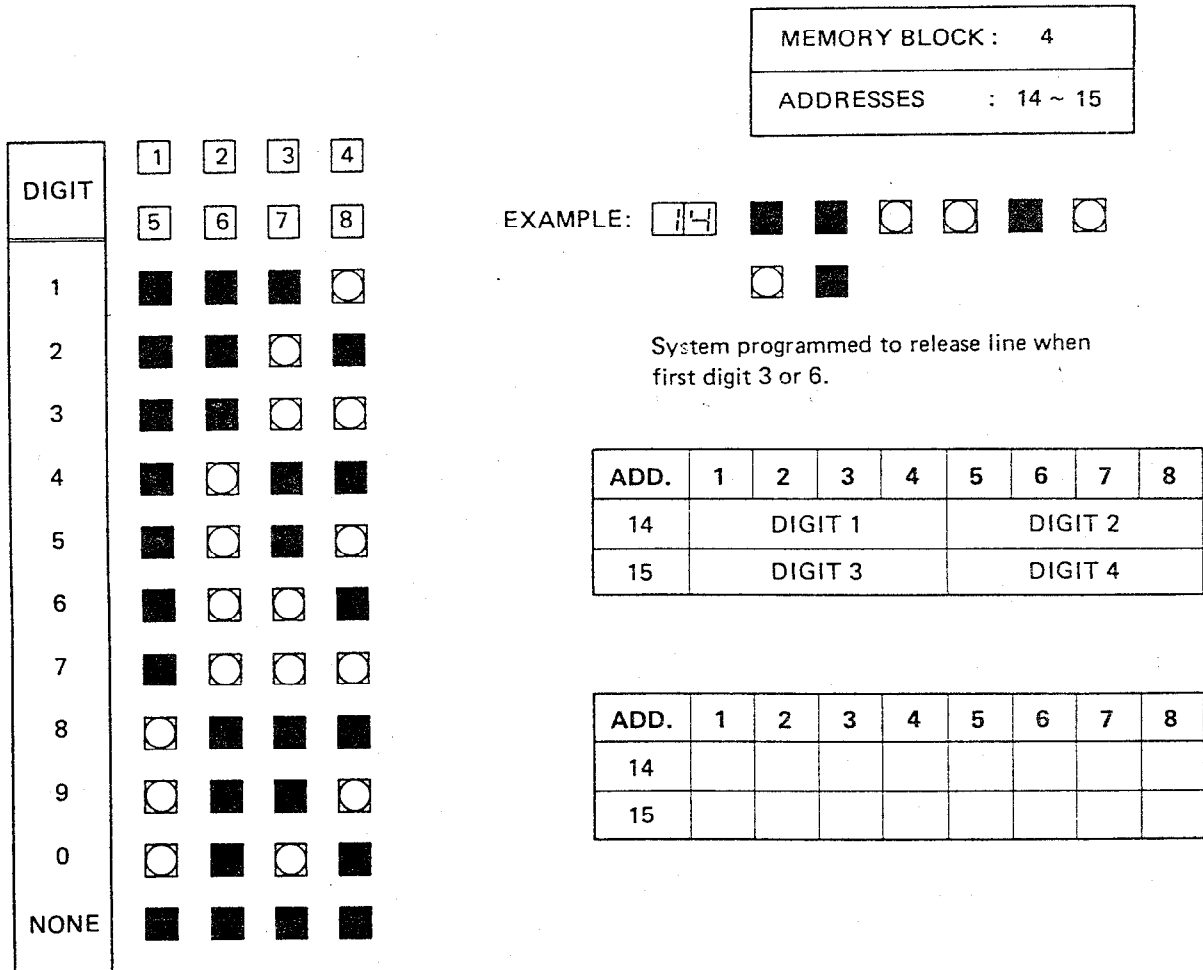

Fig. 340-22 Digit Rejection

ALLOW	<input type="checkbox"/>
DISALLOW	<input checked="" type="checkbox"/>

8

MEMORY BLOCK :	4
ADDRESS :	16

EXAMPLE:  16

System speed dial is restricted.

ADD.	8
16	

Fig. 340-23 Speed Dial Toll Override Assignment

DIGIT	1	2	3	4
	5	6	7	8
1	<input checked="" type="checkbox"/>	<input checked="" type="checkbox"/>	<input checked="" type="checkbox"/>	<input type="checkbox"/>
2	<input checked="" type="checkbox"/>	<input checked="" type="checkbox"/>	<input type="checkbox"/>	<input checked="" type="checkbox"/>
3	<input checked="" type="checkbox"/>	<input checked="" type="checkbox"/>	<input type="checkbox"/>	<input type="checkbox"/>
4	<input checked="" type="checkbox"/>	<input type="checkbox"/>	<input checked="" type="checkbox"/>	<input checked="" type="checkbox"/>
5	<input checked="" type="checkbox"/>	<input type="checkbox"/>	<input checked="" type="checkbox"/>	<input type="checkbox"/>
6	<input checked="" type="checkbox"/>	<input type="checkbox"/>	<input type="checkbox"/>	<input checked="" type="checkbox"/>
7	<input checked="" type="checkbox"/>	<input type="checkbox"/>	<input type="checkbox"/>	<input type="checkbox"/>
8	<input type="checkbox"/>	<input checked="" type="checkbox"/>	<input checked="" type="checkbox"/>	<input checked="" type="checkbox"/>
9	<input type="checkbox"/>	<input checked="" type="checkbox"/>	<input checked="" type="checkbox"/>	<input type="checkbox"/>
0	<input type="checkbox"/>	<input checked="" type="checkbox"/>	<input type="checkbox"/>	<input checked="" type="checkbox"/>

MEMORY BLOCK :	4
ADDRESSES :	17 ~ 76

EXAMPLE:  17

18

The first 3-digit code in this table is 212.

ADD.	1	2	3	4	5	6	7	8
17	CODE DIG. 1			CODE DIG. 2				
18	CODE DIG. 3			/				
19	CODE DIG. 1							
20	CODE DIG. 3			/				
21	CODE DIG. 1							
22	CODE DIG. 3			/				
75	CODE DIG. 1							
76	CODE DIG. 3			/				

Fig. 340-24 Toll Override Table

213 - 714

### TOLL OVERRIDE TABLE CHART

NO.	ADD.	1	2	3	4	5	6	7	8
1	17	✓	✓		✓	✓	✓	✓	
	18	✓	✓						
2	19	✓				✓	✓	✓	
	20	✓		✓	✓				
3	21								
	22								
4	23								
	24								
5	25								
	26								
6	27								
	28								
7	29								
	30								
8	31								
	32								
9	33								
	34								
10	35								
	36								
11	37								
	38								
12	39								
	40								
13	41								
	42								
14	43								
	44								
15	45								
	46								

NO.	ADD.	1	2	3	4	5	6	7	8
16	47								
	48								
17	49								
	50								
18	51								
	52								
19	53								
	54								
20	55								
	56								
21	57								
	58								
22	59								
	60								
23	61								
	62								
24	63								
	64								
25	65								
	66								
26	67								
	68								
27	69								
	70								
28	71								
	72								
29	73								
	74								
30	75								
	76								

Fig. 340-25

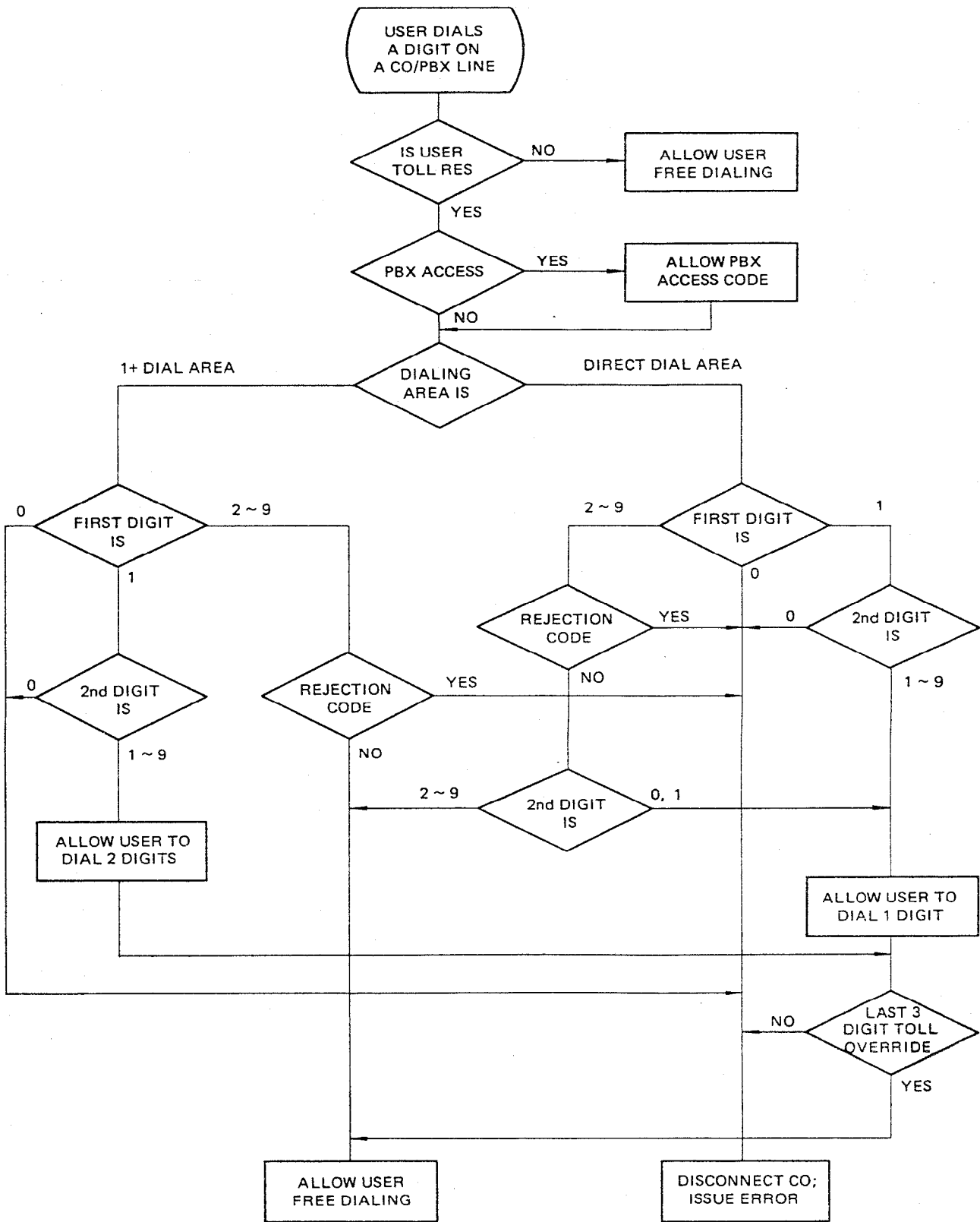

Fig. 340-26 Electra-616 Toll Denial Algorithm

## SECTION 400 STATION OPERATION PROCEDURE

### 410 Key Telephone Operation

#### 410.1 CO/PBX (Outside Calls)

##### 1. Originating

###### Using Manual Dialing

- depress idle (unlit)  CO
- lift handset or depress  ON  
 OFF
- receive dial tone
- dial desired number
- when party answers, use handset to talk

###### Using Last CO/PBX Number Redial

- depress idle (unlit)  CO
- lift handset or depress  ON  
 OFF
- receive dial tone
- depress Last Number Key
- display shows  L  n
- when party answers, use handset to talk

###### Using Speed Dialing – Station and System

- depress idle (unlit)  CO
- lift handset or depress  ON  
 OFF
- receive dial tone
- depress Speed Dial Key  SPD
- display shows  S  d

###### For Station Speed Dialing

- depress desired  DSS

or,

###### For System Speed Dialing

- dial 20 ~ 59 for the particular number desired
- display shows Speed Dial Buffer Number  x  x

**Note:** Use of station or system Speed Dialing can automatically seize an acceptable CO/PBX line eliminating the need to depress a CO/PBX line. For a particular CO/PBX line, depress CO before depressing the Speed Dial Key.

###### Using Prime Line Pick-Up

- lift handset or depress  ON  
 OFF
- receive dial tone
- use any of the dialing methods discussed here

**Note:** For consecutive dialing, depressing the Speed Dial Key initiates speed dialing at any time. The keypad is always live for manual dialing.

##### 2. Answering

###### When a slow Flashing CO is present on Keypad

- depressing flashing  CO
- lift handset
- respond to caller

##### 3. Placing a Call On Hold

###### Placing a CO/PBX Call on Non-Exclusive Hold

- during CO/PBX conversation, depress  HOLD once
- display shows  H  d
- or,
- depress  OSS for ICM call. The call in progress will automatically be put on hold.

**Note:** Depressing the page, door phone or pick-up buttons will also automatically place the CO call on non-exclusive hold and activate the selected feature.

###### Placing a CO/PBX Call on Exclusive Hold

- during CO/PBX conversation, depress  HOLD twice
- display shows  E  H

### Removing a CO/PBX Line from Hold

- depress fluttering or intermittent winking  CO
- lift handset

### 4. Hold Recall

**Note:** An audible recall signal, a fluttering CO/PBX LED and a display are provided to idle keysets that have left a CO/PBX line on hold or exclusive hold for longer than the programmable time.

- display shows  H  X
- X corresponds to CO line recalling
- depress fluttering  CO
- lift handset

**Note:** Display will indicate the held lines of the station sequentially, for 0.8 sec each.

### 5. Abandoning a Call

#### Abandoning a Call

- at the end of the call, depress the Recall Key
- CO call is released, but the line is retained and new dial tone is heard.
- dial next call

#### Abandoning Using Handset

- restore handset
- CO/PBX line is released

#### Abandoning when in Monitor Mode

- depress  ON  OFF
- ON  OFF LED goes off and CO/PBX line is released

## 410.2 Intercom (Internal) Calls

### 1. Originating

#### To an Idle Station

- lift handset or depress  ON  OFF

- depress  OSS for desired station
- (if a previous CO/PBX call was in progress, the call is placed on hold automatically)
- receive tone burst
- display shows called station number  X  X
- after response, use handset to talk

#### To a Busy Station

- same as above (first 3 steps)
- receive call waiting tone
- wait until called station answers or restore handset.

**Note:** Calling party will receive busy tone when called station is in Do Not Disturb mode or receiving an ICM call. The called station's display will not show the calling station's number.

### 2. Answering

#### Idle Station

- receive tone burst
- display shows calling station's number  X  X , ICM Flashes
- converse hands-free or pick-up handset

#### Busy Station on CO/PBX Line

- receive half volume tone burst from speaker
- display shows calling station's number  X  X , ICM Flashes
- depress  HOLD and converse immediately with calling party,
- or
- continue existing CO conversation

**Note:** After call is abandoned and busy station becomes idle, the display will show the number of the last ICM party that called for 3 seconds.

### 410.3 Conferencing

**Note:** When the conference circuit is busy,  will light on all keysets. No additional conferences can be made at this time.

The allowable conference configurations are:

2 stations	1 CO/PBX line
1 stations	2 CO/PBX lines
3 stations	No CO/PBX lines

#### 1. Originating

##### Three Party Conference

(1 station 2 CO/PBX lines or 2 stations 1 CO/PBX line)

- with CO or ICM call in progress
- depress  ,  flashes
- originate CO or ICM call and wait for called party to answer
- depress  ,  is lit
- conference is established, use handset to talk

##### Three party conference (3 internal parties)

- with ICM call in progress
- depress  ,  flashes
- depress  for desired station
- wait for called party to answer with handset
- depress  ,  is lit
- conference is established, use handset to talk

**Note:** Called ICM party must answer with handset to established conference.

#### 2. Holding

##### 1 Station 2 CO/PBX Conference

- depress  , both  wink

**Note:** This allows individual handling of the two CO/PBX calls. Conversation cannot continue during the station's absence.

### 410.4 Transfer

- during CO conversation
- depress desired  ,  winks
- after receiving tone burst, voice page to request called station to pick-up held CO/PBX line.
- wait for response or monitor held CO/PBX status until answered (CO lit steady).
- restore handset

### 410.5 Do Not Disturb

1. To Enter Do Not Disturb Mode
  - depress  ,  is lit
2. To Leave Do Not Disturb Mode
  - depress  ,  is off

**Note:** The following speaker activity will stop when a station enters Do Not Disturb Mode: CO/PBX ring, ICM calls, paging and door phone ring.

### 410.6 Intercom Call Pick-Up

1. To Pick-Up an Intercom Call to a Station
  - lift handset or depress
  - depress Call Pick-Up Key
  - display shows
  - depress  of called station
  - use handset to talk

### 410.7 Paging

#### 1. Internal 3-Zone Paging

##### To Originate an Internal Zone Page

- lift handset or depress
- depress Paging Key
- display shows



– on keypad dial

for Internal Zone 1

for Internal Zone 2

for Internal Zone 3

for All Internal Zones

– display shows

X digit dialed on keypad

## 2. External Paging

### To Originate an External Page

– lift handset or depress

– depress Paging Key

– display shows

– on keypad dial

– display shows

– use handset to page

## 3. To Answer Any Internal or External Page

– lift handset or depress

– depress paging key

– display shows

– depress  on keypad

– display shows

– use handset to talk

## 410.8 Door Phone

### 1. Originating

#### To an Idle Door Phone

– lift handset or depress

– depress door phone key

– display shows

– on keypad dial  or

– display shows

– use handset to talk

X digit dialed on keypad

#### To a Busy Door Phone

– lift handset or depress

– depress door phone key

– display shows

– on keypad dial  or

– receive busy tone, display goes off

## 2. Answering

– display shows   or

– lift handset

– depress door phone key

– on keypad, dial  or

– use handset to talk

## 3. Monitoring

– depress

– depress door phone key

– display shows

– on keypad dial  or

– display shows

X digit dialed on keypad

## 410.9 Programming Speed Dial

### 1. To Program Station Speed Dial with Key Telephone Idle

– depress  Key

– record tone is heard over speaker

– display shows

– depress desired

– display shows  number

– record tone stops

- dial telephone number
- each digit is displayed as dialed   x
- depress  SPD PROG Key
- display goes Off

**Note:** Each Key Telephone has 16 SPD buffers, 16 digits each, available for its own use.

## 2. To Program System Speed Dial

(Attendant Keyset Only)

- depress  SPD PROG Key
- record tone is heard over speaker
- display shows  S  d
- dial desired buffer number  x  x
- record tone stops
- dial telephone number
- each digit is displayed as dialed   x
- depress  SPD PROG Key
- display goes off

**Note 1:** The system is provided with 40 System Speed Dial access buffers, 16 digits each. The access numbers are 20 thru 59.

**Note 2:** When programming station or System Speed Dial, a pause may be inserted at any time. Each sequential depression of the pause key will increase the duration of the pause. Each pause will count as a digit.

**Note 3:** To reprogram a speed dial buffer, follow the same instructions as programming. To erase a speed dial buffer, follow the instructions for programming, but don't enter a telephone number.

## 3. To Confirm Station Speed Dial Number

With Key Telephone Idle

- depress Speed Dial Key  SPD
- depress desired  DSS
- display shows  DSS number and each digit of the stored number sequentially

## 4. To Confirm System Speed Dial Number

With Key Telephone Idle

- depress Speed Dial Key  SPD
- on keypad dial desired buffer 20 ~ 59
- display shows buffer number and each digit of the stored number sequentially

**Note:** Display shows  E  E when there is no memory in buffer.

## 410.10 Night Mode

### 1. To Enter Night Mode

With Key Telephone Idle

- depress  HOLD
- display shows  -  -
- on keypad dial  6 ,  8
- display shows  6  8
- depress  HOLD ,  HOLD is lit
- display shows  n  E for 10 seconds

### 2. To Cancel Night Mode

With Key Telephone Idle

- depress  HOLD
- display shows  -  -
- on keypad dial  6 ,  8
- display shows  6  8
- depress  HOLD ,  HOLD goes out

#### 410.11 Security Alarm

Display shows 

A	1
---	---

 or 

A	2
---	---

##### 1. To Cancel Alarm

###### With Key Telephone Idle

- depress 

HOLD
------
- display shows 

-	-
---	---
- on keypad dial 

7
---

 , 

8
---
- display shows 

7	8
---	---
- depress 

HOLD
------
- alarm stops, display will remain until circuit is reset.  
After reset, display goes out.

27  
27

**NEC**

Electra-616

Issue 1

# INSTALLATION OF CPU-SA KTU

and ET-6H-( )

**Key Telephone Set with Speakerphone**

(ND-17314 Addendum-001)

ti

February 1984

NEC TELEPHONES, INC.

## INTRODUCTION

This addendum supplements the Electra-616 Installation Service Manual ND-17314. This addendum should be used whenever a CPU-SA KTU is installed in an ES-6-( ) KSU and when an ET-6H-( ) Key Telephone Set with built-in speakerphone is installed in an Electra-616 system. Because all ES-6-3 KSU's initially contain a CPU-SA KTU it is recommended that all installation and maintenance personnel become familiar with this addendum.

GENERAL

This addendum is divided into four sections:

100 ET-6H-( ) Key Telephone Set with Internal Speakerphone

200 Changes in Standard Programming with CPU-SA

300 Menu Programming

400 How to Operate New Features

Access Code List

Alphanumeric Display Character List

100 ET-6H-( ) KEY TELEPHONE SET WITH INTERNAL SPEAKERPHONE

110 Installation

From a hardware standpoint, the ET-6H-( ) Key Telephone set is installed exactly as the ET-6-( ) Key Telephone set. Cable and connector requirements remain the same. No local power source need be provided for the ET-6H-( ) speakerphone.

120 Programming

In order to initiate intercom calls with the ET-6H-( ) internal speakerphone, the station must be assigned as a hands-free telephone in the system program. See Figure 120.1A. An alternate way of programming the ET-6H-( ) from the station as a speakerphone is provided by Section 300 menu programming. See Section 320 Menu Programming From Any Keypad.

MEMORY BLOCK: 9
ADDRESS : 2-3

ET - 6H - ( )
ET - 6 - ( )



EXAMPLE

	2
--	---

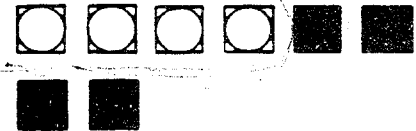

STATIONS 1 ~ 4 ARE  
 ASSIGNED AS ET-6H-( )  
 STATIONS 5 ~ 8 ARE  
 ASSIGNED AS ET-6-( )

	1	2	3	4	5	6	7	8
ADDRESS	STATION NUMBERS							
2	1	2	3	4	5	6	7	8
3	9	10	11	12	13	14	15	16

Figure 120-1A: Hands-free Telephone Assignment.

*1  
2 need phone*



200 CHANGES IN STANDARD PROGRAMMING

210 Programming Operations

All programming procedures remain standard as in Section 300 of the Electra-616 Installation Service Manual ND-17314. This includes all procedures for going off-line, for selecting memory blocks and addresses, for entering data, etc.

210.1 Programming Details

Several parameters have been added to the programmable contents of the system memory, these are:

--Privacy release which disables privacy on selected lines enabling up to four stations to talk to an outside party on any CO/PBX line assigned to be without privacy.

--Assignment of ET-6H-( ) Key Telephone Sets with internal speakerphone to allow full hands-free operation including initiation of intercom calls.

--Selection of a vacant station position to enable tandem conference (a tandem conference being an unsupervised conference of two outside (CO/PBX) parties with manual re-entry to monitor conference status).

--A method of resetting the system by programming (without using the momentary button on the CPU) has been added.

220 Default Values

The default values for these additional parameters are:

--Privacy release: All CO/PBX lines retain the privacy feature.

--All stations are ET-6-( ) Key Telephone sets (no internal speakerphone).

--Tandem Conference is allowed when station 8 is not installed; when station 8 is installed there is no Tandem conference allowed unless another station position with no station installed is chosen and programmed.

230 Programming Details

230.1 Memory Block 8

1) System Reset. This memory block is only used to do a system reset. If this memory block is selected while the programming station is in off-line mode, the entire system is reset (just as it would be by depressing the reset button on the CPU-SA). The programming station returns to on-line mode because of the system reset and all calls in progress will be dropped.

--depress  Add-On

--depress  ON/OFF

--depress  #,  \*,  0

--depress  DSS 8

Reset occurs at this time with the programming station returning to "on-line" mode.

## 230.2 Memory Block 9

1) Privacy Release Assignment (See Figure 340-27). Any combination of CO/PBX lines can be selected to lose the privacy feature. This enables up to four stations to join a conversation with an outside party on the chosen CO/PBX line without privacy. Parties attempting to enter after a fourth party has entered will receive error tone. The default value is that all CO/PBX lines retain the privacy feature. Address 1 buttons 1 ~ 6 are used with each button representing its corresponding CO/PBX line.

2) Hands-Free Telephone Assignment (See Figure 340-28). With the introduction of the ET-6H-( ) Key Telephone Sets this area of the program is used to allow hands-free initiation of intercom calls. Addresses 2 and 3 are used with each of the buttons 1 ~ 8 representing a station in each of the addresses. The default value is that all stations are ET-6-( ) telephone (without internal speakerphones).

3) Tandem Conference Assignment (See Figure 340-29). This area of the program is used to reserve a station position to be used for tandem conferences. A tandem conference is an

unsupervised two CO/PBX line conference with exit and re-entry available to the station which originated the conference.

Address 4, buttons 4 ~ 8 are used to designate the station position reserved for tandem conference. The corresponding SW-S RTU must be installed. If the selected station is later installed it will take precedence and the tandem conference feature will become inoperative. The default value is that the position of station 8 is reserved for tandem conferences.

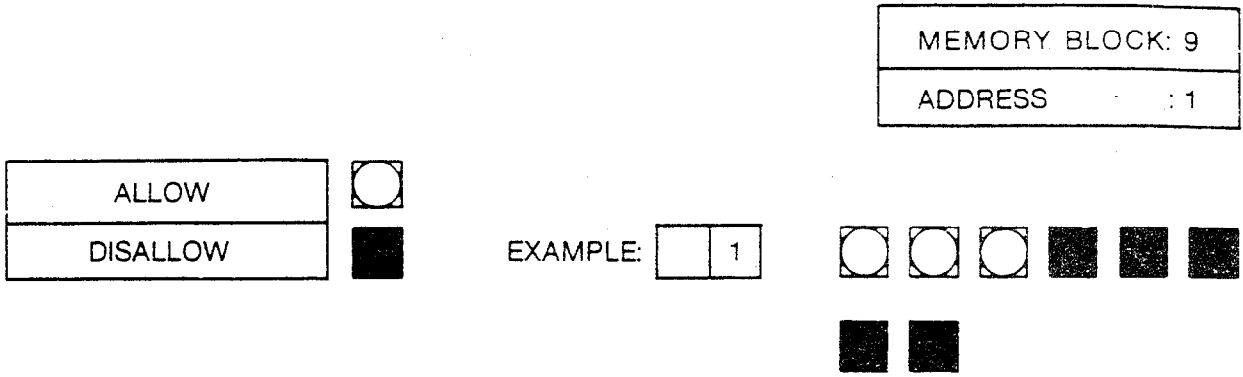

CO/PBX lines 1 thru 3 will allow privacy release.

**Figure 340-27: Privacy Release Enable Assignment**

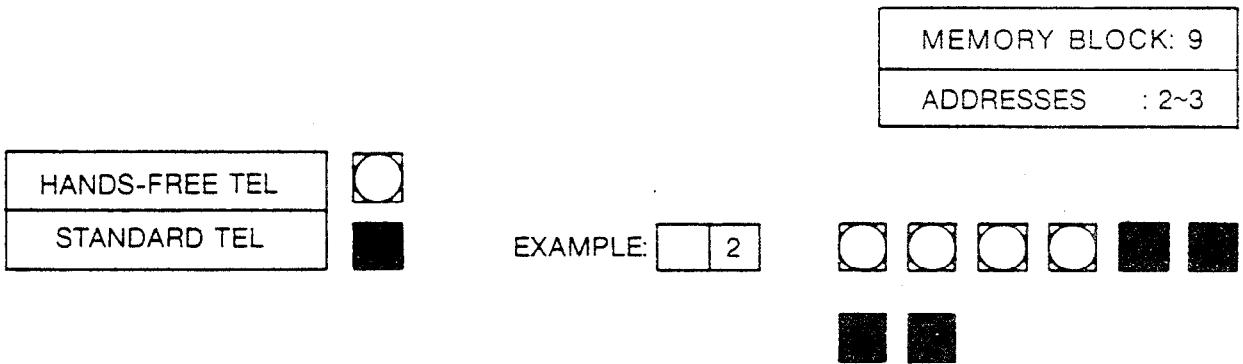

Stations 1 thru 4 are assigned as Hands-Free Tel.  
Stations 5 thru 8 are assigned as Standard Tel.

ADD	STATION NUMBERS							
2	1	2	3	4	5	6	7	8
3	9	10	11	12	13	14	15	16

1  
2  
3  
4  
5  
6  
7  
8  
9  
10  
11  
12  
13  
14

**Figure 340-28: Hands-Free Telephone Assignment**

MEMORY BLOCK: 9
ADDRESS : 4

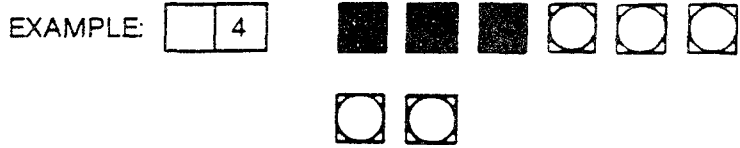

Station 16 is assigned  
Tandem Conference Line

STA	4	5	6	7	8
1					
2					
3					
4					
5					
6					
7					
8					
9					
10					
11					
12					
13					
14					
15					
16					

ADDRESS	4	5	6	7	8
4					

Figure 340-29: Tandem Conference Line Assignment

Menu programming is a new method of programming the Electra-616. Menu programming supplements the standard system programming and can be performed partially from the programming station (Station 1) and partially from each individual station. Not all parameters can be changed via the menu programming mode.

Parameters which can be programmed from station 1 using the menu mode are:

- Feature Assignment - one of 48 possible selections is chosen to fit the system requirements (See Table 300-1A)
- Ringing Assignment (per trunk, per station basis)
- Call Restriction (outgoing toll and non-restriction on a per trunk per station basis).

Parameters which are programmed from the individual station sets are:

- Prime Line Pickup
- Speakerphone (ET-6H-( ) assignment)
- Off-hook ringing

Detailed procedures for menu programming follow.

## 1) Feature Assignment (1 through 48)

**NOTE:** This programming utilizes the Feature Assignment Menu table and all access codes are determined from Table 300-1A.

--choose access code (1 ~ 48) from Table 300-1A  
--place programming overlay (when available) on station keypad 1  
--depress **ADD-ON** key (or "MENU READ OUT" **1** on overlay)  
--depress **ON/OFF** key (or "EXIT" **2** on overlay)  
--depress **SPD PROG** key (or **3** on overlay)  
--on keypad dial access code (1 ~ 48)  
--depress **SPD** key (or "MENU ENTER" on overlay)

## 2) Verifying Program Acceptance

--depress **ADD-ON** key (or "MENU READ OUT" **1** on overlay)  
--depress **ON/OFF** key (or "EXIT" **2** on overlay)  
--depress **SPD PROG** key (or **3** on overlay)  
--depress **ADD-ON** key (or "MENU READ OUT" **1** on overlay)  
--display shows programmed access code (1 ~ 48)  
--depress **ON/OFF** key (or "EXIT" **2** on overlay)



### 3) Ringing Assignment

--place programming overlay (if available) on station keyset 1

depress **ADD-ON** key (or "MENU READ OUT" **1** on overlay)

--depress **ON/OFF** key (or "EXIT" **2** on overlay)

--depress **SPD PROG** key (or **3** on overlay)

--depress **MIC** key (or "RING" on overlay)

--depress desired station select key (1 ~ 16) to be programmed

--depress desired line key(s) (1 ~ 6) to ring at selected station

--repeat last two steps for each station being programmed

--depress **ON/OFF** key (or "EXIT" **2** on overlay)

### 4) Call Restriction

**NOTE:** Visual indication at each CO/PBX line button (1 ~ 6) identifies the type of restriction for that line. Each button depression changes the restriction status of associated CO/PBX line.

IDLE = Non-restriction  
STEADY = Toll restriction  
(depress once)  
FLASHING = Outgoing restriction  
(depress twice)

Depress third time to return to IDLE.

--place programming overlay (if available) on station keyset 1

--depress **ADD/ON** key (or "MENU READ OUT" **1** on overlay)

--depress **ON/OFF** key (or "EXIT" **2** on overlay)

--depress **SPD PROG** key (or 3 on overlay)

--depress **DND** key (or "RESTRICT" on overlay)

--depress desired station select key (1 ~ 16) to be programmed

--depress desired line key(s) (1 ~ 6) to be restricted at selected station - see note above for LED status indication of the various restriction states

--repeat last two steps for each station being programmed

--depress **ON/OFF** key (or "EXIT" **2** on overlay)

#### 5) System Reset Using Keyset No. 1

--depress **ADD/ON** key (or "MENU READ OUT" **1** on overlay)

--depress **ON/OFF** key (or "EXIT" **2** on overlay)

--depress **#**

--depress **\***

--depress **0**

--depress **DSS8**

--keyset No. 1 is now in "on-line" mode

## 1a) Prime Line Assignment - With Key Telephone Idle

--depress **[SPD PROG]** key  
--display shows **[Sd]**  
--record tone is heard over speaker  
--depress desired CO/PBX line key  
--display shows chosen CO/PBX /line **[L\*]**  
with \* = 1 ~ 6  
--record tone stops  
--depress **[PICK UP]** key  
--display goes off

## 1b) Cancelling Prime Line Assignment - With Key Telephone Idle

--depress **[SPD PROG]** key  
--display shows **[Sd]**  
--record tone is heard over speaker  
--depress **[PICK UP]** key  
--display shows **[nL]** for 3 seconds  
--record tone stops

2a) Hands-Free Telephone Assignment - With Hands-Free Telephone  
Idle

--depress SPD PROG key  
--display shows Sd  
--record tone is heard over speaker  
--depress LAST NBR key  
--display shows HA for 3 seconds  
--record tone stops

2b) Cancelling Hands-Free Telephone Assignment

--depress SPD PROG key  
--display shows Sd  
--record tone is heard over speaker  
--depress LAST NBR key  
--display shows St for 3 seconds  
--record tone stops

3a) Off Hook Ringing Assignment - With Key Telephone Idle

--depress SPD PROG key  
--display shows Sd  
--record tone is heard over speaker  
--depress PAGE key  
--display shows OH for 3 seconds  
--record tone stops

3b) Cancelling Off Hook Ringing Assignment - With Key Telephone  
Idle

--depress SPD PROG key  
--display shows Sd  
--record tone is heard over speaker  
--depress PAGE key  
--display shows dn for 3 seconds  
--record tone stops

## Group Call-Pick-Up - With Key Telephone Off-Hook

- depress  PICK UP key
- display shows  UP
- depress  \* key
- display shows called station number  XX

## Call Back Request

Upon receiving no answer (or busy indication at called station:

- depress  #
- display shows  S for message sent (or  d for message denied)

**NOTE:** Each keyset can receive up to two call back requests. Display showing  d indicates there are already two call back requests for the called station.

## Tandem Conference Call

**NOTE:** One station position must be vacant for system to provide tandem conference capabilities.

--establish communication with a CO/PBX line  
--depress ADD/ON key  
--CO/PBX line key LED shows hold indication  
--establish communication with second CO/PBX line  
--depress ADD/ON key  
--both CO/PBX line keys and ADD/ON key LED indicators light steadily (the two CO/PBX lines and the station are in conference)

If station desires to leave conference while maintaining the two CO/PBX lines in tandem conference:

--depress RECALL key and go on-hook  
--ADD/ON key indicator flashes, both CO/PBX line indicators light steady

To re-enter tandem conference:

--go off hook and depress RECALL key  
--ADD/ON key indicator lights steady and conference can be heard via handset  
--if tandem conference is finished, restore handset to release both CO/PBX lines  
--if the tandem conference is still in progress, depress RECALL key and restore handset

--continued--

--**ADD/ON** indicator flashes, both CO/PBX line indicators light steady, tandem conference continues

**NOTE:** Approximately 3 minutes into the tandem conference, an audible time reminder is provided and the **ADD/ON** key indicator starts fluttering. Thereafter, every 3 minutes the tone reminder will be heard until the tandem conference is re-entered and terminated.



## 330 Job Specifications

### 330.1 Instructions for Completing Job Specification

1. The first page contains items A ~ C and 1 ~ 5. These have been provided as a convenience and do not affect programming.
  2. Item 6 is CO/PBX Assignments. Much of this table is also provided as a convenience. Two sections, REFERENCE NUMBER and PPROGRAMMING DATA, are used in programming.
    - A) REFERENCE NUMBER is the number the CO/PBX line will be referred to in programming material.
    - B) PBXLINE refers to the origin of the line connected; is it from a PBX or from a Central Office? This will affect speed dialing, last CO/PBX number redial and restriction features.
    - C) LINE GROUP (A, B, C, or NOT INSTALLED). Every CO/PBX line installed must be assigned a line group, even if all lines are in the same group. At the time of installation all CO/PBX lines will be in Group A as is provided by the resident system program. Every installed CO/PBX line circuit which does not receive a CO/PBX line must be assigned as NOT INSTALLED. This will prevent access to unterminated circuits. Restriction feature is also affected by this assignment.
  3. Item 7 is Station Assignments. Two sections of this table are used in programming, reference number and programming data.
    - A) REFERENCE NUMBER is the station's DSS Number and is the number the station will be referred to in programming material.
    - B) CO/PBX RING ASSIGNMENT provides space to record requirements for day and Night Mode Ring and OFF-Hook Ring. When a station is to ring in any of these requirements, place an appropriate mark in the space provided. The station programmed for night ring will ring for all CO/PBX lines when system is set for Night Mode Ring.
    - C) RESTRICTION CLASS and CODE. Only the class is required for programming. Each CLASS has a unique CODE, and adding the code will make understanding the restriction easier. See the table located on the Station Class Assignment Table in Section 340 Programming Work Sheets.
  - D) PRIME LINE. This assigns a "Prime Line" which will be seized by a station going "Off-Hook" without depressing CO/PBX button. This feature will only operate when the "Prime Line" is in idle status unless a separate programming choice is exercised; then the line will be seized when ringing or idle.
  - E) PRIVATE LINES. This assignment provides space to record which station and which line on that station will be programmed for a private line. Note that only two lines can be assigned as private lines, Two stations can be assigned the same private line, and two lines can be assigned to the same station.
  - F) INTERNAL ZONE PAGE. This assignment provide space to record zone paging groups: 1, 2 and 3. Any number of stations can be in a zone, no station can be in more than one zone. All stations remain in the "all call" group.
  - G) ATTENDANT STATION. This assignment provides space to record 2 attendant station positions. The station (s) programmed as an attendant station is capable of performing the following additional functions: to program and confirm system speed dial, to set and cancel night transfer and to cancel security alarm signal.
  - H) DOOR PHONE CHIME. This assignment provides space to record which stations will chime when Door Phone 1 and/or 2 are activated. Any number of stations can be assigned to chime for either or both Door Phone 1 and Door Phone 2.
- #### CO/PBX LINE
- I) CO/PBX LINE SCAN. This section provides space to record which CO/PBX lines will be scanned by individual stations when speed dial is activated. The system will start no scan from the highest line number programmed for that station. Prime Line Pick-up feature will have priority over Line Scan feature.
4. Item 8 is System Assignments. These assignments apply system wide and include Time Outs, Door Phone Connection assignment, Prime Line for incoming calls and Toll Restriction assignments.
  - A) TIME OUTS are listed with durations in seconds. The desired Time Out can be circled.