

NEC

i-Series

Multibutton Telephone Quick Reference Guide

92600MQG06
April 2001

Printed in the U.S.A. (2562)



Using Your Telephone

Due to the flexibility built into the system, your **Dialing Codes** and **Feature Capacities** may differ from those in this guide. Check with your communications manager and make a note of any differences.

The **Soft Keys** provide quick and easy access to features - just follow the menu on the display (not available on all models).

The **A** feature option your c

These **Volume Controls** are for ringing calls (not available on all models).

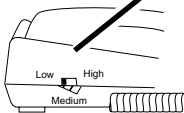

If you're on a Handsfree Call (see *Handsfree Options* below), lift the **handset** for privacy.

MW flashes when you have Messages Waiting. If you don't have a Voice Mail key, it also flashes when you have Voice Mail messages left in your mailbox.

Press CALL1 then **LND** to automatically redial the last number you called. Press CALL1, **DIAL** and dial a bin number for Common Abbreviated Dialing.

While on a call, press **CONF** to set up a Conference. This key may be TRF on some models.

These **Volume Controls** are for speaker and handset. For phones without the volume switch, this also controls the volume for ringing calls.

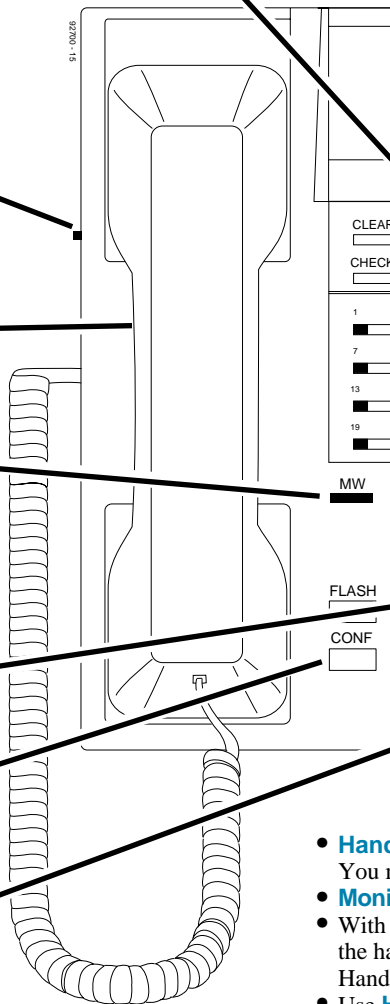

- **Hand**
- You r
- **Moni**
- With
- the ha
- Hand
- Use **H**
- toward

Alphanumeric Display helps you use
es and tells you about your calls. With
al Caller ID, a ringing line may show
caller's number and name.

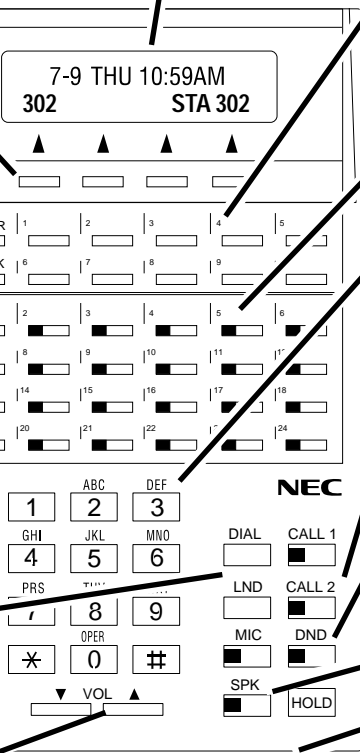

Press a **One-Touch Key** for one-button
contact with co-workers and outside callers,
or when using certain features. Ask your
communications manager.

These are **LINE** and/or **FUNCTION** keys. See
Programming Function Keys for more on
setting up these keys.

Dial **D** (3) to select a call from a list of names.
See *Directory Dialing* for more.

Line Appearance Keys are Intercom keys
for placing and answering calls. If you're busy
on one – just use the other.

Enable **Do Not Disturb** to block your calls
when you don't want to be interrupted. This
key will also flash when Call Forwarding is
activated.

Press **SPK** for **Handsfree** calls, or use the
handset instead. See *Handsfree Options* below.
While on a handset call, press SPK once for
Handsfree; twice for **Group Listen**.

The **Microphone** picks up your voice for
Handsfree calls. Press **MIC** to turn off the
microphone.

Handsfree Options

Handsfree lets you place and answer calls by pressing **SPK** instead of using the handset.
You must have a speakerphone to have Handsfree.

Speakerphone lets you place a call without lifting the handset, but you must lift the handset to speak.

Automatic Handsfree, you can press a line or Line Appearance key without lifting
the handset. You may have to lift the handset to speak, depending on whether you have
Speakerphone or Monitor. Normally, you have Automatic Handsfree.

Handsfree Answerback to answer a voice-announced Intercom call by speaking
into your phone — without lifting the handset.

Placing Calls



Placing an Outside Call . . .





Press a line key for quick access:



1. (Optional) Lift handset.
2.  + Listen for dial tone + Outside number.
 - *You can have function keys for lines or line groups.*
 - *If your system is behind a PBX, you may have to dial 9 before your number.*

OR

Dial codes for outside lines:

1. (Optional) Lift handset.
2.  +  + Outside number.

OR
2.  +    + Line group (1-9, 01-99 or 001-128) + Outside number.

OR
2.  +   + Line number (e.g., 05 or 005 for line 5) + Outside number.

Calling a Co-Worker . . .

Dial using the Intercom:

1. (Optional) Lift handset.
 - *For one-touch calling, press a Call Coverage or Hotline function key instead of going on to step 2.*
2.  + Co-worker's extension number.
 - *Your call will ring or voice-announce. If you hear ringing, wait for an answer. If you hear two beeps, begin speaking. Dialing 1 changes mode.*
 - *For your **Voice Mailbox**, dial *8.*
 - *For **Paging**, dial *1 + 0 for All Call or *1 + 1-64 for zones.*



If your call doesn't go through . . .

Camp On and Callback

When you hear system busy, use Camp On or Callback:

1.  to **Camp On** (wait without hanging up).
 - (Intercom calls) When you hear ringing, wait for the called party to answer. If you hear busy/ring instead of busy before camping on, you can optionally dial 6 to send a Voice Over.
 - (Outside calls) When you hear new dial tone, place your call again.

OR

1.  and hang up to leave a **Callback** for a free line or extension.
 - Wait for the system to call you back.
2.  or lift handset.
 - (Outside calls) Place your call again.
 - (Intercom calls) Speak to co-worker.

To cancel your Callback:

1. (Optional) Lift handset.
2.  +    + Hang up.

Message Waiting (Direct Messaging)

Leave a Message Waiting (flashing MW key) when your co-worker doesn't answer:

1. Do not hang up + .
 - Your co-worker's MW flashes fast. Your MW is lit.
 - With Voice Mail, dial 8 to leave a message in your co-worker's mailbox.

To answer a Message Waiting left for you:

1.  +  .
 - To cancel Messages Waiting (those you left and those left for you): CALL1 + 873.

Answering Calls

Answering Outside Calls . . .

Listen for two rings and look for a flashing line key:

1.  or lift handset.
 - Press line or loop key if not connected.





Answering Intercom Calls . . .

Listen for two short beeps:



1. Speak toward your phone.
 - You can lift the handset for privacy.
 - If you hear one long ring instead, press SPK or lift handset to answer.
 - CALL1 + 823 makes incoming Intercom calls ring your phone. CALL1 + 821 makes them voice-announce.

Picking up calls not ringing your phone . . .

If a call is ringing over the Page after hours:



1.  or lift handset.
2.  +  .

When a call is ringing a co-worker's phone:

1.  or lift handset.
 - You can press a Group Call Pickup or Call Coverage function key instead of step 2.
2.   + Co-worker's extension.

Have a telephone meeting (Conference) . . .

Use Conference to have a telephone meeting:

1. Place/answer call + .
2. Place/answer next call + 
 - Repeat this step to add more parties. You may be able to have up to 32 callers.
3. After adding all parties, press  again to begin the Conference.



Handling Your Calls



Your call can wait at your phone . . .

Hold

Use Hold instead of leaving the handset off-hook:

1. Do not hang up + .
 - This puts your outside call on System Hold. Your co-workers can take the call off Hold. **To place the call on Exclusive Hold, press your Exclusive HOLD function key.**
 - Intercom calls automatically go on Exclusive Hold when you press HOLD.



Easily retrieve a call from Hold:

1.  or lift handset.
2. Press flashing .
OR
2.  if the call was not on a line key (or was an Intercom call).

Send the call you're on to a co-worker . . .



Transfer

Send (Transfer) your call to a co-worker:



1. Do not hang up + .
2. Dial your co-worker's extension.
 - You can press a One-Touch key instead of dialing your co-worker.
 - To transfer the call to Voice Mail, press your **Voice Mail** key before dialing your co-worker.**OR**
3.  (Hotline).

Park a call in orbit

Park a call in orbit so a co-worker can pick it up:



1. Do not hang up.
2.  +   + Park Orbit.
 - *Park Orbits are 1-64. For **Personal Park**, dial 857 instead of #6.*
3. Page your co-worker to pick up the call.
 - *For **Paging**, dial *1 + 0 for All Call or *1 + 1-64 for zones.*
4. Hang up.

Or pick up a call a co-worker parked for you:

1. (Optional) Lift handset for privacy.
2.  +   + Park Orbit.
 - *For **Personal Park**, dial 857 (if Parked at your phone) or ** + Extension.*

Forward (reroute) your calls to a co-worker . . .

While at your desk, forward your calls to a co-worker, Voice Mail or off-premise:

1.  +  .
 - *To forward off-premise: *46 + Line access code (e.g., 9) + Number + HOLD.*
 - *To cancel: *46 + HOLD + Hang up.*
2. Dial Call Forwarding condition:
 - 1 = Personal Answering Machine Emulation (then skip to step 4).
 - 2 = Busy or not answered.
 - 4 = Immediate.
 - 6 = Not answered.
 - 7 = Immediate with both ringing (not for Voice Mail).
 - 0 = Cancel.
3. Dial destination extension, Voice Mail master number or press Voice Mail key.
4. Dial Call Forwarding type:
 - 2 = All calls
 - 3 = Outside calls only
 - 4 = Intercom calls only
 - *DND flashes slowly. A voice prompt may remind you that your calls are forwarded.*

Placing Calls Quickly

Automatically redial calls . . .

Last Number Redial

Quickly redial your last outside call:

1. (Optional) Lift handset.

2.  + .

- The system selects an outside line.

OR

2.  + .

- The call uses the line you select.

Save

Save your call for quick dialing later on:

Then redial your saved number:

1.  (Save).

1. (Optional) Lift handset.

2.  +  (Save).

- The system selects an outside line.

OR

2.  +  (Save).

- The call uses the line you select.

Quickly dial co-workers and outside calls . . .

One-Touch Calling





Use One-Touch Keys to save time calling co-workers:







1. (Optional) Lift handset + .

- You can have One-Touch Keys for Direct Station Selection, Personal Speed Dial (outside calls) or feature codes. See Programming One-Touch Keys.



Abbreviated Dialing (Speed Dial)



Store Common or Group Abbreviated Dialing numbers:

- (Optional) Lift handset.
-  +    (for Common).

OR
-  +    (for Group).
- Dial Abbreviated Dialing bin number.
 - Ask your communications manager for your bin numbers.
- Dial phone number to store + .
 - The number can be up to 24 digits, using 0-9, # and *. Press MIC to enter a pause.
- Enter the name for stored number + .
 - See *Entering Names* below.

To dial your stored Abbreviated Dialing number:

- (Optional) Lift handset.
-  +   + Bin (for common).

OR
-  +   + Bin (for group).
 - You may also have function keys for *Abbreviated Dialing*.

Entering Names

When entering names, use One-Touch Keys to enter letters. For example, press One-Touch Key 1 once for A, twice for B, three times for C, and four times for D.

1 = A - D
2 = E - H
3 = I - L

4 = M - P
5 = Q - T
6 = U - Z

7 = Hyphen
8 = Space
9 = Symbols

10 = Punctuation

- Use the dial pad digits to enter 1-9, # and *.
- CONF deletes entries.
- CHECK saves the One-Touch entry after you select it. (You don't have to press CHECK after dial pad entries.)

Quick Reference for Other Features

Do Not Disturb: **DND + 1** to block your outside calls **OR 2** to block Paging, Intercom calls, Call Forwards and transferred outside calls **OR 3** to block all calls **OR 4** to block Call Forwards **OR 0** to cancel.

Name Storing: **CALL1 + 800 + Name** (See Abbr. Dialing) + **HOLD**.

Memo Dial: *While on a call, store a number for easy recalling:* **Memo Dial** function key + Number to store + **Memo Dial** key to save.
To dial number: **Memo Dial** key + **Line** key.

Meet Me Conference: *To set up a telephone meeting:* While on a call, **CONF + Page** party and announce zone + **CONF** twice when co-worker answers.
To join: **CALL1 + 864 + Announced zone**.

Park and Page: *To have your phone greet your callers and Page you:*
CALL1 + * 47 + Record Personal Greeting + # + 7 + Record Page + # + Dial Page zone (e.g., 801 + 1 for zone 1) + **2 (All) or 3 (CO) + CALL1** to hang up.
To cancel: **CALL1 + * 47 + 3**.
To pick up: **CALL1 + * * + Announced extension**.

(Your communications manager can tell you if you can use this feature.)



Personal Greeting: *To have your phone greet callers and forward your calls:*
CALL1 + * 47 + Record Personal Greeting + # + 2 (Busy/No Answer), 4 (Immediate) or 6 (No Answer) + Extension to receive calls + **2 (All) or 3 (CO) + CALL1** to hang up.
To cancel: **CALL1 + * 47 + 3**.

Repeat Redial: *To automatically redial your outside call if it's not answered:* Place outside call + **Repeat Redial** function key (or **DIAL + LND**) + Hang up + Lift handset when call goes through.
To cancel: **DIAL + LND** or press **Repeat Redial** key.

Time/Date: **CALL1 + 828 + time/date password** (usually 0000) + 2 digits for year + 2 digits for month + 2 digits for day + day of week (0=Sunday, 6=Saturday) + 2 digits for hour (24 hour format) + 2 digits for minutes + **CALL1** to hang up.

Directory Dialing

At your display telephone, select a co-worker or outside call from a list of names (rather than dialing the phone number):

1.  or  (Directory Dialing).
2. Dial Directory Dialing type:
2 (C) = Common Abbreviated Dialing.
3 (D) = Group Abbreviated Dialing.
7 (P) = Your One-Touch Keys (1-10).
9 (X) = Co-worker's extension numbers.
3. Dial letter/number range for the party you want to call (e.g., dial 2 for A, B, C or 2).
4. Dial the digit for the letter/number selected above (e.g., 1 for A, 2 for B).
5. Press volume **▲** or **▼** to scroll through the list.
6.  or lift handset to place call.

Programming One-Touch Keys

To program: **CALL1 + 855 + Key + Number + HOLD + Name**
(see *Entering Names* under *Abbreviated Dialing*) + **HOLD**.

DSS: Enter **Co-worker's extension number + SPK** to hang up.

Personal Speed Dial: Enter **9 + Outside number** or
Enter **804 + Line group number** (1-9, 01-99 or 001-128) +
Outside number or
Enter **#9 + Line number** (e.g., 05 or 005) + **Outside number**
+ **SPK** to hang up.

Service Codes: Enter **Service Code + SPK** to hang up. For example, you can make a Save Number Clear key by entering 885.

Programming Function Keys

To program: **CALL1 + 851 + Key + Code + Optional Data**.

Call Forwarding: Enter **1080** for Call Forwarding to extension or Voice Mail (the same as dialing * 2).
Enter **1081** for Selectable Display Messaging, Call Forwarding Off Premise and Personal Greeting/Park and Page (the same as dialing * 4).

Conference: Enter **1016** if you want a Conference key.

Directory Dialing: Enter **1082**.

Hold: For Exclusive Hold, enter **1044**.

Hotline: Enter **1058** + Partner's extension.

Line and Loop Keys: Enter **0001 - 0192** for lines, **0000** to undefine.
Enter **1078 + 0** (Incoming), **1** (Outgoing) or **2** (Both) + **001-128**
(Trunk Group) or **000** (for ARS).

Memo Dial: Enter **1015**.

Save Number Dialed: Enter **1014**.

Repeat Redial: Enter **1075**.

Voice Mail: Method A¹: Enter **1059**.
Method B¹: Enter **1059** + Your extension number.
¹ Check with your communications manager.

Park: Enter **1033 + Orbit number** (1-64).

Page: Enter **1006 + Zone** (1-64) for Internal.
Enter **1004 + Zone** (1-8) for External.
Enter **1005** for Combined (External and Internal) All Call.

NEC

NEC America, Inc., Corporate Networks Group
4 Forest Parkway, Shelton, CT 06484
TEL: 203-926-5400 FAX: 203-929-0535
cng.nec.com

