

NEC

ND-45504 (E)
ISSUE 2
PART OF STOCK # 151900

NEAX[®] 2000 IVS

Circuit Card Manual

DECEMBER, 1997

NEC America, Inc.

LIABILITY DISCLAIMER

NEC America Inc. reserves the right to change the specifications, functions, or features, at any time, without notice.

NEC America Inc. has prepared this document for use by its employees and customers. The information contained herein is the property of NEC America Inc. and shall not be reproduced without prior written approval from NEC America Inc.

NEAX and D^{term} are registered trademarks of NEC Corporation.

Copyright 1997

NEC America Inc.

Printed in the U.S.A.

PAGE No.	ADD. No.								PAGE No.	ADD. No.							
	001	002	003	004	005	006	007	008		001	002	003	004	005	006	007	008
i		2.2							35		2.2						
ii	2.1								36		2.2						
iii									37								
iv									38								
1									39		2.2						
2									40	2.1	2.2						
3		2.2							41		2.2						
4	2.1								42								
5	2.1								43								
6									44								
7									45								
8									46								
9		2.2							47								
10		2.2							48								
11		2.2							49								
12		2.2							50								
13									51								
14	2.1								52	2.1							
15									53								
16									54								
17									55								
18									56								
19									57								
20									58								
21		2.2							59								
22									60								
23									61								
24									62								
25									63								
26									64								
27									65								
28									65-1	2.1							
29	2.1								65-2	2.1							
30									65-3	2.1							
31		2.2							65-4	2.1							
32	2.1	2.2							66								
33		2.2							67	2.1							
34		2.2							68								
ADDENDUM-001				ADDENDUM-002				ADDENDUM-003				ADDENDUM-004					
DATE	JULY, 1998			DATE	OCTOBER, 1998			DATE				DATE					
ADDENDUM-005				ADDENDUM-006				ADDENDUM-007				ADDENDUM-008					
DATE				DATE				DATE				DATE					
NEAX2000 IVS Circuit Card Manual																	
														Addendum Revision Sheet 1/2			
ND-45504 (E) ISSUE 2																	

PAGE No.	ADD. No.								PAGE No.	ADD. No.							
	001	002	003	004	005	006	007	008		001	002	003	004	005	006	007	008
68-1	2.1								97								
68-2	2.1								98								
68-3	2.1								99								
68-4	2.1								100								
69									101								
70	2.1								102								
71	2.1								103								
72									104								
73									105								
74									106								
75									107								
76									108								
77									109								
78									110								
78-1	2.1								111								
78-2	2.1								112								
78-3	2.1								113								
78-4	2.1								114								
78-5	2.1								115								
78-6	2.1								116								
79									117								
80									118								
81									119								
82									120								
83									121								
84									122								
85									123								
86									124								
87									125								
88									126								
89									127								
90									128								
91									129								
92									130								
93									131								
94									132								
95									133								
96									134								

ADDENDUM-001		ADDENDUM-002		ADDENDUM-003		ADDENDUM-004	
DATE	JULY, 1998	DATE	OCTOBER, 1998	DATE		DATE	
ADDENDUM-005		ADDENDUM-006		ADDENDUM-007		ADDENDUM-008	
DATE		DATE		DATE		DATE	

NEAX2000 IVS
Circuit Card Manual

Addendum Revision Sheet 2/2

ND-45504 (E) ISSUE 2

NEAX2000 IVS Circuit Card Manual

TABLE OF CONTENTS

	Page
LIST OF FIGURES	iii
LIST OF TABLES	iv
CHAPTER 1 INTRODUCTION	1
1. PURPOSE	1
2. OUTLINE OF THE MANUAL	1
CHAPTER 2 FUNCTIONAL OUTLINE OF CIRCUIT CARDS	3
1. CONTROL CIRCUIT CARDS	3
2. APPLICATION CIRCUIT CARDS	4
3. LINE/TRUNK CIRCUIT CARDS	6
CHAPTER 3 CIRCUIT CARD INSTALLATION CONDITIONS	9
1. CIRCUIT CARD MOUNTING SLOTS	9
2. INSTALLATION CONDITIONS FOR CONTROL CIRCUIT CARDS	11
2.1 PN-CP00/PN-CP00-B/PN-CP00-C (MP)	11
2.2 PN-CP01 (FP)	11
2.3 PN-CP02/PN-CP02-C (MP)	12
2.4 PN-BS00-A/PN-BS00-B (BS00), PN-BS01-A/PN-BS01-B (BS01)	13
2.5 PN-PW00 (EXTPWR)	13
2.6 PZ-PW86 (PWR)	13
3. INSTALLATION CONDITIONS FOR APPLICATION CIRCUIT CARDS	14
4. INSTALLATION CONDITIONS FOR LINE/TRUNK CIRCUIT CARDS	16
CHAPTER 4 LAMP INDICATIONS AND SWITCH SETTINGS	17
1. PRECAUTION IN HANDLING	18
2. LAMP INDICATIONS AND SWITCH SETTINGS OF CONTROL CIRCUIT CARDS	21
PN-BS00-A/PN-BS00-B (BS00)	22
PN-BS01-A (BS01)	24
PN-BS01-B (BS01)	26
PN-CP00 (MP)	28
PN-CP00-B/PN-CP00-C (MP)	31
PN-CP03/PN-CP03-C (MP)	34
PN-CP01 (FP)	37
PN-CP02/PN-CP02-C (MP)	39
PN-PW00 (EXTPWR)	42
PZ-PW86 (PWR)	44
PZ-PW86-A (PWR)	46
PZ-PW86 (C) (PWR)	48
PZ-PW86 (D) (PWR)	50

3. LAMP INDICATIONS AND SWITCH SETTINGS OF APPLICATION CIRCUIT CARDS	52
PN-AP00-A (AP00)	53
PN-AP01 (AP01)	59
PN-BRTA (BRI)	62
PN-2BRTC (BRI)	65-1
PN-CC00 (ETHER)	66
PN-CC01 (ETHER)	68-1
PN-CK00 (PLO)	69
PN-24DTA (DTI)	72
PN-24DTA-A (DTI)	75
PN-30DTC/30DTC-A (DTI)	78-1
PN-ME00 (EXTMEM)	79
PN-4RSTB (MFR)	84
PN-4RSTC (CIR)	86
PN-SC00 (CCH)	88
PN-SC01 (DCH)	91
PN-SC02 (ICH)	94
PN-SC03 (ICH)	96
PN-SC03 (CSH)	98
4. LAMP INDICATIONS AND SWITCH SETTINGS OF LINE/TRUNK CIRCUIT CARDS	100
PN-2AMPA (AMP)	101
PN-AUCA (AUC)	102
PN-CFTA (CFT)	103
PN-4COTB (COT)	104
PN-4COTG (COT)	105
PN-2DATA (DAT)	106
PN-DK00 (DK)	108
PN-4DITB (DIT)	109
PN-2DLCB (DLC)	110
PN-2DLCC (DLC)	111
PN-2DLCN (DLC)	112
PN-4DLCA (DLC)	113
PN-4DLCD (DLC)	114
PN-4DLCF (DLC)	115
PN-4DLCM (DLC)	116
PN-4DLCQ (DLC)	117
PN-2DPCB (DPC)	118
PN-2ILCA (ILC)	121
PN-4LCD/4LCD-A (LC)	124
PN-4LCJ (LC)	125
PN-M03 (M03)	126
PN-2ODTA (ODT)	129
PN-8RSTA (PBR)	130
PN-TNTA (TNT)	131
PN-2CSIA (CSI)	133

LIST OF FIGURES

Figure	Title	Page
3-1	Circuit Card Mounting Slots	9
3-2	MP/FP Card Mounting Slots	11
3-3	MP/FP Card Mounting Slots for Back up MP System	12
3-4	BS00/BS01 Card Mounting Slots	13
3-5	Application Circuit Card Mounting Slots	15
3-6	Line/Trunk Circuit Card Mounting Slots	16
4-1	Static Electricity Precautions (1 of 2)	18
4-2	Circuit Card Handling Precautions	20

LIST OF TABLES

Table	Title	Page
2-1	Functional Outline of Control Circuit Cards	3
2-2	Functional Outline of Application Circuit Cards	4
2-3	Functional Outline of Line/Trunk Circuit Cards	6
4-1	Table of Control Circuit Cards	21
4-2	Table of Application Circuit Cards	52
4-3	Table of Line /Trunk Circuit Cards	100

CHAPTER 1 INTRODUCTION

1. PURPOSE

For installers and maintenance technicians of the NEAX2000 IVS (PBX), this manual explains the functional outline and installation conditions of the circuit cards, and explains the meaning of each indicator lamp (LED) and the switch settings on the circuit cards.

2. OUTLINE OF THE MANUAL

This manual consists of four chapters. The contents of Chapter 2 through 4 are as outlined below.

- Chapter 2: Functional Outline of Circuit Cards

This chapter outlines various circuit cards used in the system by means of tables.

- Chapter 3: Circuit Card Accommodating Conditions

This chapter explains the conditions for installing various circuit cards used in the system.

- Chapter 4: Lamp Indications and Switch Settings

This chapter explains the meaning of lamp indications and the switch settings of various circuit cards used in the system.

Each switch setting table provided in Chapter 4 has a “CHECK” column. Make necessary entries in the CHECK column during and/or after system installation and maintenance. After the result of switch setting has been checked, use each table as a reference for subsequent system maintenance and operations.

This page is for your notes.

CHAPTER 2 FUNCTIONAL OUTLINE OF CIRCUIT CARDS

This chapter explains the functional outline of various circuit cards used in the NEAX2000 IVS. Explanations are given in alphabetical order of the circuit card names for each kind (Control, Application, and Line/Trunk) of circuit cards.

1. CONTROL CIRCUIT CARDS

Table 2-1 shows the functional outline of each control circuit card.

Table 2-1 Functional Outline of Control Circuit Cards

CARD NAME	FUNCTIONAL NAME	FUNCTIONAL OUTLINE
PN-BS00-A /PN-BS00-B	BS00	Bus interface card for PIM0. This card functions as a driver/receiver of various signals, adjusts gate delay timing and cable delay timing, monitors the I/O Bus and PCM Bus, and controls the power supply. When the system consists of more than one PIM, this card is mounted in PIM0. Only one per system is used.
PN-BS01-A /PN-BS01-B	BS01	Bus interface card for PIM1 through PIM7. This card functions as a driver/receiver of various signals, adjusts gate delay timing and cable delay timing, monitors the I/O Bus and PCM Bus, and controls the power supply. When the system consists of more than one PIM, one each of this card is mounted respectively in PIM1 through PIM7.
PN-CP00 /PN-CP00-B /PN-CP00-C	MP	Main Processor card. This card is equipped with Memory, TDSW (1024CH × 1024CH), 16-Line CFT, PB Sender, Clock, PLO (slave mode 2 ports), RS-232C Ports (2 ports), Modem for remote maintenance, and Internal Music-On-Hold tone source. One card per system.
PN-CP03 /PN-CP03-C	MP	Main Processor card. This card is equipped with Memory, TDSW (1024CH × 1024CH), 16-Line CFT, PB Sender, PB Receiver, Clock, PLO (slave mode 2 ports), RS-232C Ports (2 ports) for MAT/Built-in SMDR, Modem for remote maintenance, Internal/External Music-On-Hold tone source. One card per system (This card can be used only in 1 or 2 PIM system).
PN-CP01	FP	Firmware Processor card. This card is equipped with Line/Trunk Interface and Memory. When the system consists of more than one PIM, one each of this card is mounted respectively in PIM0, PIM2, PIM4 and PIM6.
PN-CP02 /PN-CP02-C	MP	Main Processor card for Back Up MP System only. This card is equipped with Memory, TDSW (1024CH × 1024CH), 16-Line CFT, PB Sender, Clock, PLO (slave mode 2 ports), RS-232C Ports (2 ports), Modem for remote maintenance, and Music-On-Hold tone source. Two cards per Back up MP System.
PN-PW00	PW00	Power Supply card for SN716 Desk Console. This card provides -48 V DC power for one SN716 Desk Console, and is mounted in the LT/AP slot of PIM. Max. 3 PN-PW00 cards per PIM and max. 4 cards per 4 PIM.

Table 2-1 Functional Outline of Control Circuit Cards (Continued)

CARD NAME	FUNCTIONAL NAME	FUNCTIONAL OUTLINE
PZ-PW86/ PZ-PW86-A	PWR	Main power supply card. Input: AC100 V/200 V (50 Hz/60 Hz) Output: -27 V (8 A), +5 V (8.5 A), CR (30 mA) One card per PIM.
PZ-PW86(C)	PWR	Main power supply card. Input: AC100 V/200 V (50 Hz/60Hz) Output: -27 V (4.5 A), +5 V (7.5 A), CR (30 mA), +80 V (110 mA) One card per PIM.
PZ-PW86(D)	PWR	Main power supply card. Input: AC100 V/200 V (50 Hz/60 Hz) Output: -27 V (4.5 A), +5 V (7.5 A), CR (30 mA), +80 V (110 mA) One card per PIM.

2. APPLICATION CIRCUIT CARDS

Table 2-2 shows the functional outline of each application circuit card.

Table 2-2 Functional Outline of Application Circuit Cards

CARD NAME	FUNCTIONAL NAME	FUNCTIONAL OUTLINE
PN-AP00-A	AP00	Application Processor card. This card is equipped with four RS-232C ports, and is used for SMDR, H/M Printer, PMS functions and MCI. One card per system.
PN-AP01	AP01	Application Processor card. This card is equipped with one RS-232C port and one Ethernet interface port, and is used for OAI function. Also, this card is used to expand authorization code and ACD. One card per system.
PN-BRTA	BRI	Basic Rate (2B+D) Interface Trunk card. (S/T Interface) This card has one circuit of Basic Rate interface and provides one 2-channel PCM digital line. This card is used for BRI trunks from the Telco to the PBX.
PN-2BRTC	BRI	Basic Rate (2B+D) Interface Trunk card. This card has two circuits of Basic Rate interface and provides two 2-channel PCM digital lines. This card is used for BRI trunks from the Telco to the PBX.
PN-ME00	EXTMEM	Memory Expansion card. This card is used with PN-AP00-A card for providing expansion memory. This card can be equipped with a SRAM card (1MB) as extra SMDR data memory.
PN-CC00	ETHER	Ethernet Control card. This card is used with the PN-AP01 card to accommodate the Ethernet, transmitting/receiving a signal of TCP/IP protocol.

Table 2-2 Functional Outline of Application Circuit Cards (Continued)

CARD NAME	FUNCTIONAL NAME	FUNCTIONAL OUTLINE
PN-CC01	ETHER	Ethernet Control card. This card is used with the PN-AP01 card to accommodate the Ethernet, transmitting/receiving a signal of TCP/IP protocol. 10 BASE-T twisted pair cable can be connected directly to this card.
PN-CK00	PLO	Phase Locked Oscillator card. This card is a phase locked oscillator for providing a synchronized clock signal with the network. This card is used when the PBX is a master office or when the PBX requires two clock supply routes and those frequencies differ.
PN-24DTA /PN-24DTA-A	DTI	Digital Trunk Interface (23B+D, 1.5 Mbps) card. This card accommodates one 24-channel PCM digital lines.
PN-30DTC /PN-30DTC-A	DTI	Digital Trunk Interface (2 Mbps) card. This card accommodates one 30-channel PCM digital line.
PN-4RSTB	MFR	4-line MF Receiver Trunk card. This card is used for MF Signaling on Digital DID trunks. A maximum of four cards can be provided per one system, including the PN-4RSTC card.
PN-4RSTC	CIR	4-line CALLER ID Receiver Trunk card. This card is used for CALLER ID (CLASS SM) on analog trunks. A maximum of four cards can be provided per one system, including the PN-4RSTB card.
PN-SC00	CCH	Common Channel Handler card. This card transmits/receives signals on the common signaling channel of No. 7 CCIS.
PN-SC01	DCH	D-channel Handler card. This card transmits/receives signals on the D channel of ISDN Primary Rate (23B+D).
PN-SC02 /PN-SC03	ICH	ISDN-channel Handler card. This card provides the D channel signaling interface and controls an ILC (Layer 2 and 3). There are 2 types of the ICH card. PN-SC02 is the 2-channel ICH card. PN-SC03 is the 8-channel ICH card.
PN-SC03	CSH	Zone Transceiver Channel Handler card. This card provides 8 D-channel signaling interface through the PN-2CSIA to the Zone Transceiver for the Wireless Communication System.

3. LINE/TRUNK CIRCUIT CARDS

Table 2-3 shows the functional outline of each line/trunk circuit card.

Table 2-3 Functional Outline of Line/Trunk Circuit Cards

CARD NAME	FUNCTIONAL NAME	FUNCTIONAL OUTLINE
PN-2AMPA	AMP	2-line Amplifier Trunk card. This card is equipped with the functions of Echo Canceller (EC), Automatic Gain Controller (AGC) and Tone Disabler (TD).
PN-AUCA	AUC	2-line Long-Line circuit card provided with the Power Failure Transfer (PFT) function. Line resistance in the case of a long-line circuit: Max. 2500 ohms (inclusive of the internal resistance of the distant office equipment) This card is internally equipped with a –48 V DC On-Board Power Supply. This card can also be used as a 2-line Direct Inward Dialling trunk card.
PN-CFTA	CFT	Conference Trunk card Use of one card: Can control a conference of up to six participants. Use of two cards: Can control a conference of up to ten participants.
PN-4COTB	COT	4-line Central Office Trunk card (Ground Start/Loop Start trunk) equipped with the functions for loop detection, sending/detecting ground on Ring/Tip wire.
PN-4COTG	COT	4-line Central Office Trunk card (Loop Start trunk) equipped with the functions for loop detection, receiving/sending the CALLER ID (CLASS SM) signal.
PN-2DATA	DAT	2-line Digital Announcement Trunk card. Duration: Max. 60 seconds.
PN-DK00	DK	Circuit card for External Relay Control/External Key Scan. This card is provided with eight circuits, and can provide the above-mentioned control functions on a per circuit basis.
PN-4DITB	DIT	4-line Direct In Dialling Trunk card. This card is equipped with the function for loop detection, sending reverse signal and PB to DP signal conversion. This card is internally equipped with –48 V DC On-Board Power supply.
PN-2DLCB	DLC	2-line Digital Line Circuit card for D ^{term} Series E/Series III/DSS Console. [–48V Version, 2-wire type, line length: max. 850 m (2789 ft.)] This card is equipped with quick diagnostics to detect short line conditions and the normality (Synchronous/Asynchronous) of the terminal. This card is internally equipped with a –48 V DC On-Board Power Supply.
PN-2DLCC	DLC	2-line Digital Line Circuit card for D ^{term} Series II/SN610 Attendant Console. [–48 V Version, 4-wire type, line length: max. 1200 m (3940 ft.)] This card is equipped with quick diagnostics to detect short line conditions and the normality (Synchronous/Asynchronous) of the terminal. This card is internally equipped with –48 V On-Board Power Supply.
PN-2DLCN	DLC	2-line Digital Line Circuit card for D ^{term} Series E/Series III/DSS Console. [–48 V Version, 2-wire type, line length: max. 850 m (2789 ft.)] This card is equipped with quick diagnostics to detect short line conditions and the normality (Synchronous/Asynchronous) of the terminal. This card is internally equipped with a –48 V DC On-Board Power Supply.

Table 2-3 Functional Outline of Line/Trunk Circuit Cards (Continued)

CARD NAME	FUNCTIONAL NAME	FUNCTIONAL OUTLINE
PN-4DLCA	DLC	4-line Digital Line Circuit card for D ^{term} Series E/Series III/ElectraPro/DSS Console. [-27 V Version, 2-wire type, line length: max. 200 m (656 ft.)] This card is equipped with quick diagnostics to detect short line conditions and the normality (Synchronous/Asynchronous) of the terminal.
PN-4DLCD	DLC	4-line Digital Line Circuit card exclusively used for D ^{term} Series E/Series III. [-27 V Version, 2-wire type, line length: max. 200 m (656 ft.)] This card is equipped with quick diagnostics to detect short line conditions and the normality (Synchronous/Asynchronous) of the terminal.
PN-4DLCF	DLC	4-line Digital Line Circuit card for D ^{term} Series II/SN610 Attendant Console [-27 V Version, 4-wire type, line length: max. 300 m (984.3 ft.)]. This card is equipped with quick diagnostics to detect short line conditions.
PN-4DLCM	DLC	4-line Digital Line Circuit card for D ^{term} Series E/Series III/ElectraPro/DSS Console. [-27 V Version, 2-wire type, line length: max. 200 m (656 ft.)] This card is equipped with quick diagnostics to detect short line conditions and the normality (Synchronous/Asynchronous) of the terminal.
PN-4DLCQ	DLC	4-line Digital Line Circuit card exclusively used for D ^{term} Series E/Series III. [-27 V Version, 2-wire type, line length: max. 200 m (656 ft.)] This card is equipped with quick diagnostics to detect short line conditions and the normality (Synchronous/Asynchronous) of the terminal.
PN-2DPCB	DPC	2-line Data Port Controller card. This card is used for the intra-office or inter-office digital data transmission on fixed path connection. And this card can accommodate a maximum of two DTE with V.11 (X.21) interface or V.24/V.28 (RS-232C) interface.
PN-2ILCA	ILC	2-line ISDN Line Circuit card. This card provides a physical interface to ISDN Terminals.
PN-4LCD	LC	4-line Analog Line Circuit card for single line telephones. This card is equipped with the function for controlling Message Waiting Lamp. Loop resistance: Max. 600 ohms. This card is equipped with quick diagnostics to detect short and open line conditions. This card is internally equipped with a +80 V DC-DC Power Supply circuit and a relay for momentary open (only in No.3 circuit).
PN-4LCD-A	LC	4-line Analog Line Circuit card for single line telephones. This card is equipped with momentary open function. This card is equipped with the function for controlling Message Waiting Lamp. Loop resistance: Max. 600 ohms. This card is equipped with quick diagnostics to detect short and open line conditions. This card is internally equipped with a +80 V DC-DC Power Supply circuit.

Table 2-3 Functional Outline of Line/Trunk Circuit Cards (Continued)

CARD NAME	FUNCTIONAL NAME	FUNCTIONAL OUTLINE
PN-4LCJ	LC	4-line Analog Line Circuit card for single line telephones. This card provides 4 circuits with Disconnect Supervision. Loop resistance: Max. 600 ohms. This card is equipped with quick diagnostics to detect short and open line conditions.
PN-M03	M03	V.35 DTE interface card. This card is used together with the PN-2DPCB card to provide the V.35 interface.
PN-2ODTA	ODT	2-line OD Trunk card. This card can be used as either a 2-wire E&M trunk or a 4-wire E&M trunk, and is internally equipped with a –48 V DC On-Board Power Supply. Both No. 0 and No. 1 circuits must be set to same purpose (2-wire or 4-wire) in one card.
PN-8RSTA	PBR	8-line PB Receiver card. This card can be used for a PB station line, DID or tie line.
PN-TNTA	TNT	2-line Tone/Music Source interface card. This card is used for BGM or Music on Hold, and is equipped with two interface for an external tone/music source.
PN-2CSIA	CSI	2-line Zone Transceiver Interface card. The CSI is used to interface with the Wireless Communication System to the Zone Transceiver, based on ISDN S-interface. Each CSI occupies 7 time slots.

CHAPTER 3 CIRCUIT CARD INSTALLATION CONDITIONS

This chapter explains the conditions for installing various kinds of circuit cards used in the PBX.

1. CIRCUIT CARD MOUNTING SLOTS

Figure 3-1 below shows circuit card mounting slots allocated in the PIM based on circuit card type.

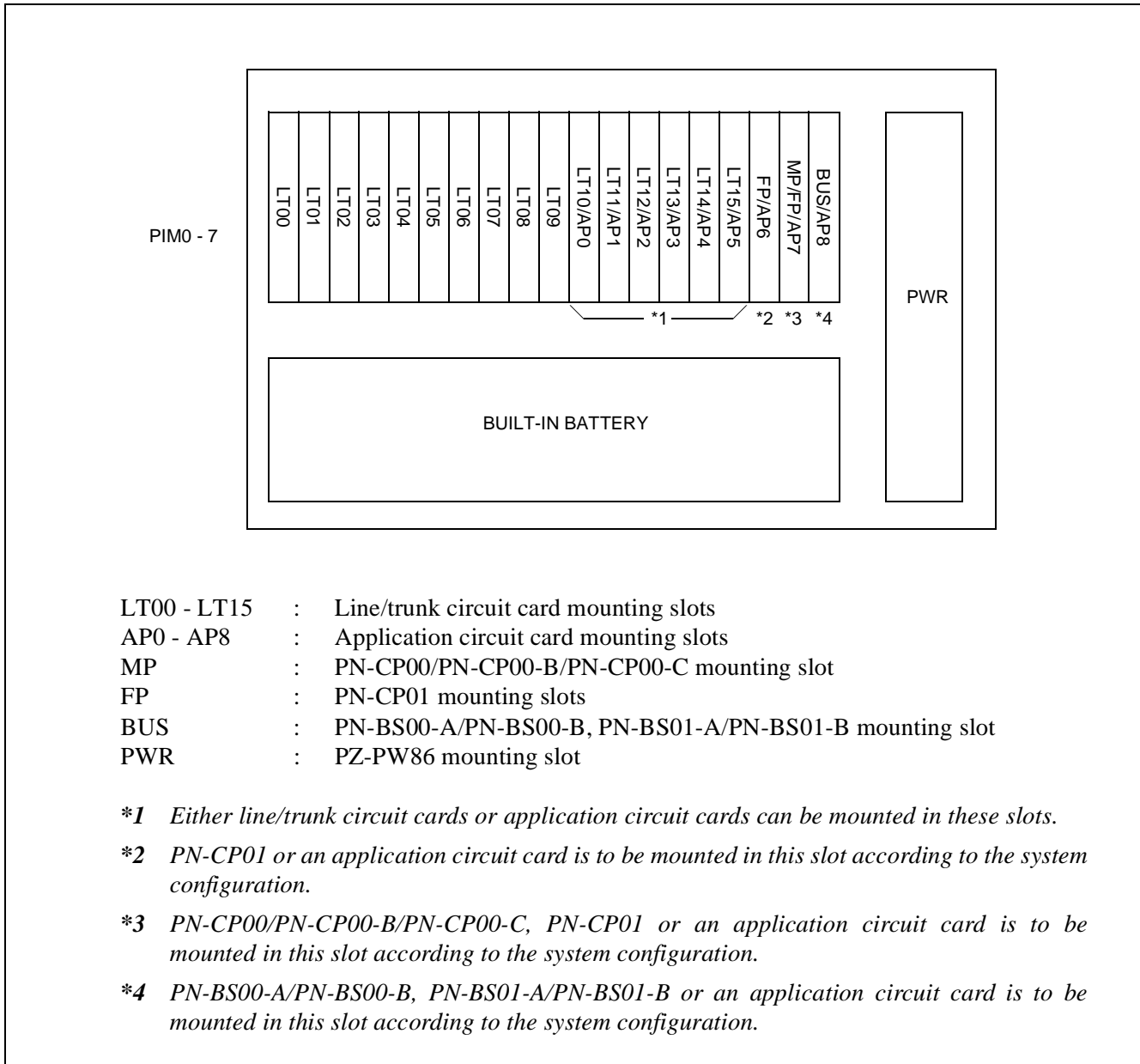
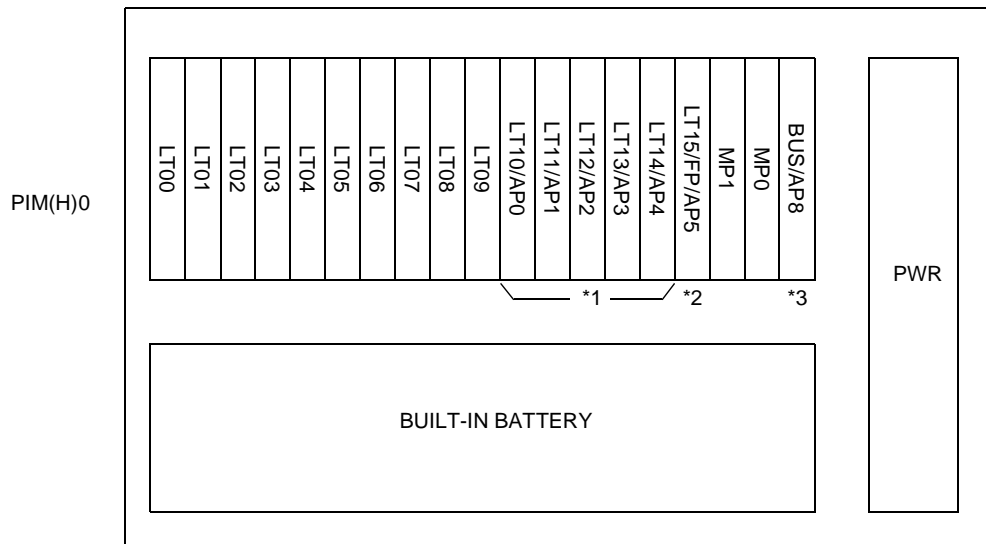

Figure 3-1 Circuit Card Mounting Slots



- LT00 - LT15 : Line/trunk circuit card mounting slots
- AP0 - AP8 : Application circuit card mounting slots
- MP0, MP1 : PN-CP02/PN-CP02-C mounting slot
- FP : PN-CP01 mounting slots
- BUS : PN-BS00-A/PN-BS00-B, PN-BS01-A/PN-BS01-B mounting slot
- PWR : PZ-PW86/PZ-PW86-A/PZ-PW86 (C)/(D) mounting slot

- *1 Either line/trunk circuit cards or application circuit cards can be mounted in these slots.
- *2 Either line/trunk circuit card, PN-CP01 or an application circuit card is to be mounted in this slot according to the system configuration.
- *3 PN-BS00-A/PN-BS00-B, PN-BS01-A/PN-BS01-B or an application circuit card is to be mounted in this slot according to the system configuration.

Figure 3-1 Circuit Card Mounting Slots (Continued)

2. INSTALLATION CONDITIONS FOR CONTROL CIRCUIT CARDS

2.1 PN-CP00/PN-CP00-B/PN-CP00-C (MP)

Mount the PN-CP00/PN-CP00-B/PN-CP00-C in the MP slot of PIM0.

2.2 PN-CP01 (FP)

1. The PN-CP01 is required only if any of the following is true.
 - More than one PIM is used.
 - A PN-2DLCC is used.
 - A PN-AP01 is used.
 - OAI, ACD, No. 7 CCIS or ISDN is used.
2. When the system is equipped with two PIMs, mount one PN-CP01 in the FP slot of PIM0. When the system is equipped with more than two PIMs--depending on the number of additional PIMs used--mount one PN-CP01 in the FP slot of PIM0 and one PN-CP01 in the MP/FP slot of PIM2, PIM4 and PIM6.

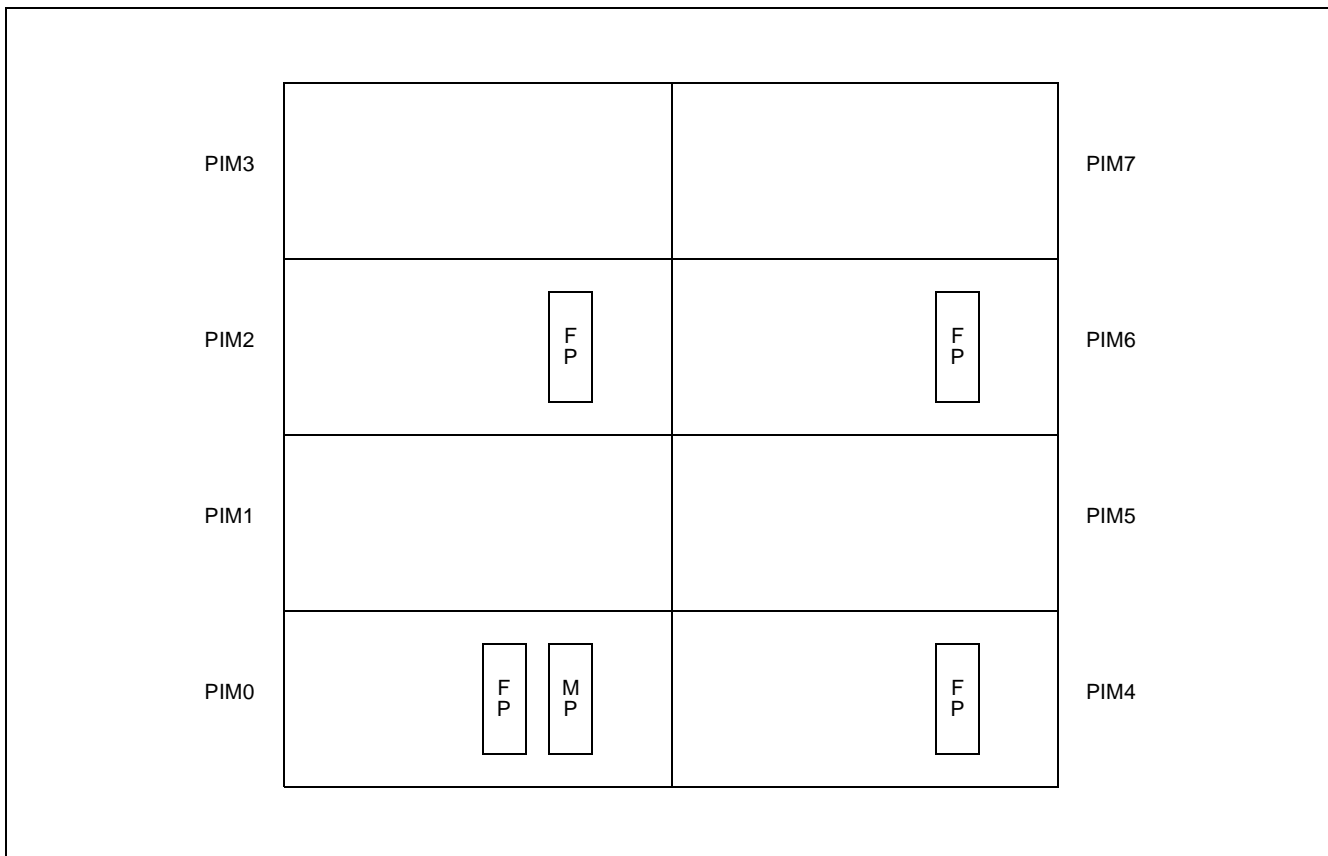

Figure 3-2 MP/FP Card Mounting Slots

2.3 PN-CP02/PN-CP02-C (MP)

Mount the PN-CP02/PN-CP02-C in the MP0 and MP1 slot of PIM(H)0.

This card is used only for Back up MP system.

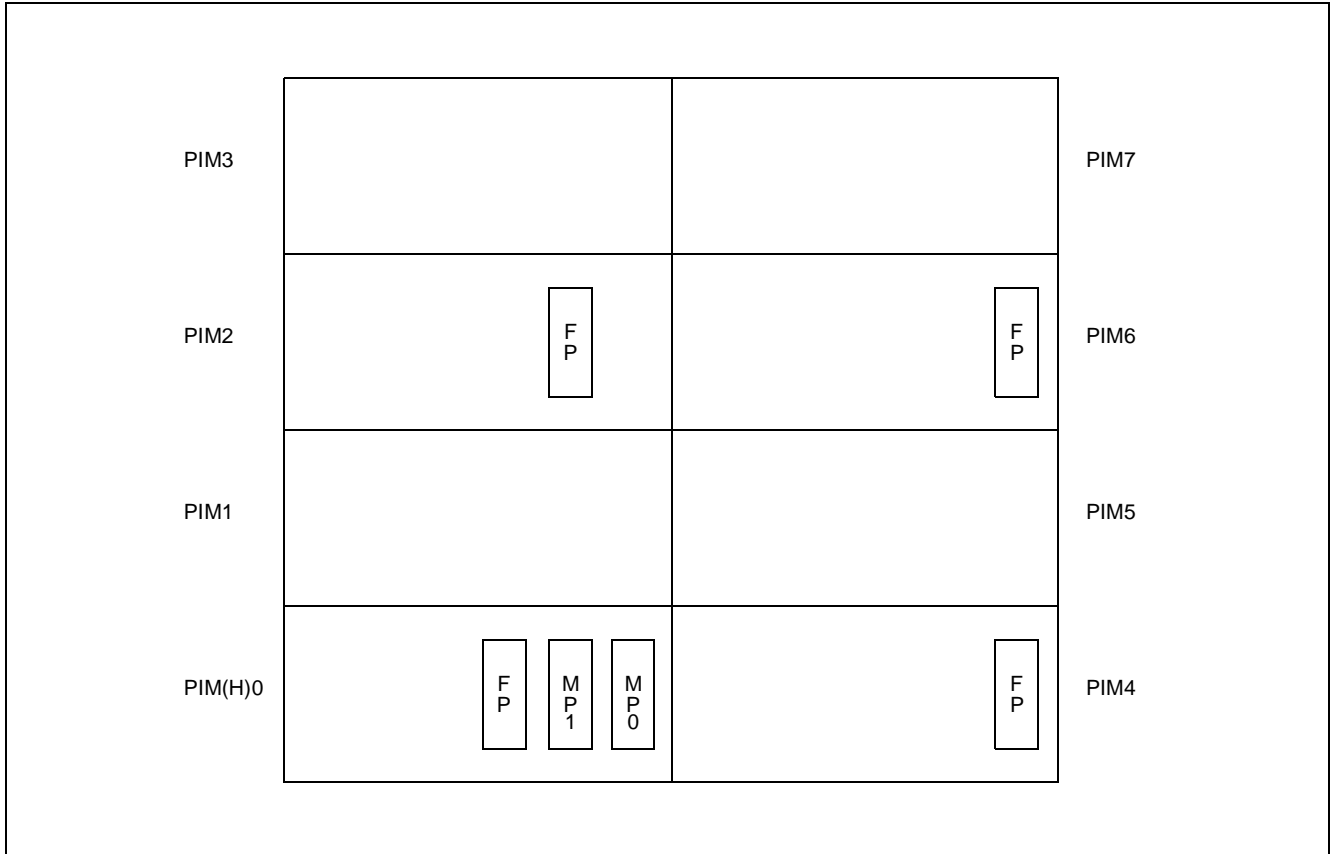

Figure 3-3 MP/FP Card Mounting Slots for Back up MP System

2.4 PN-BS00-A/PN-BS00-B (BS00), PN-BS01-A/PN-BS01-B (BS01)

1. In a one-PIM system, neither the PN-BS00-A/PN-BS00-B nor the PN-BS01-A/PN-BS01-B is needed.
2. When the system is equipped with more than one PIM, mount a PN-BS00-A/PN-BS00-B in the BUS slot of PIM0 or PIM(H)0.
3. When the system is equipped with more than one PIM, mount one PN-BS01-A/PN-BS01-B in the BUS slot of PIM1 through PIM7, as required.

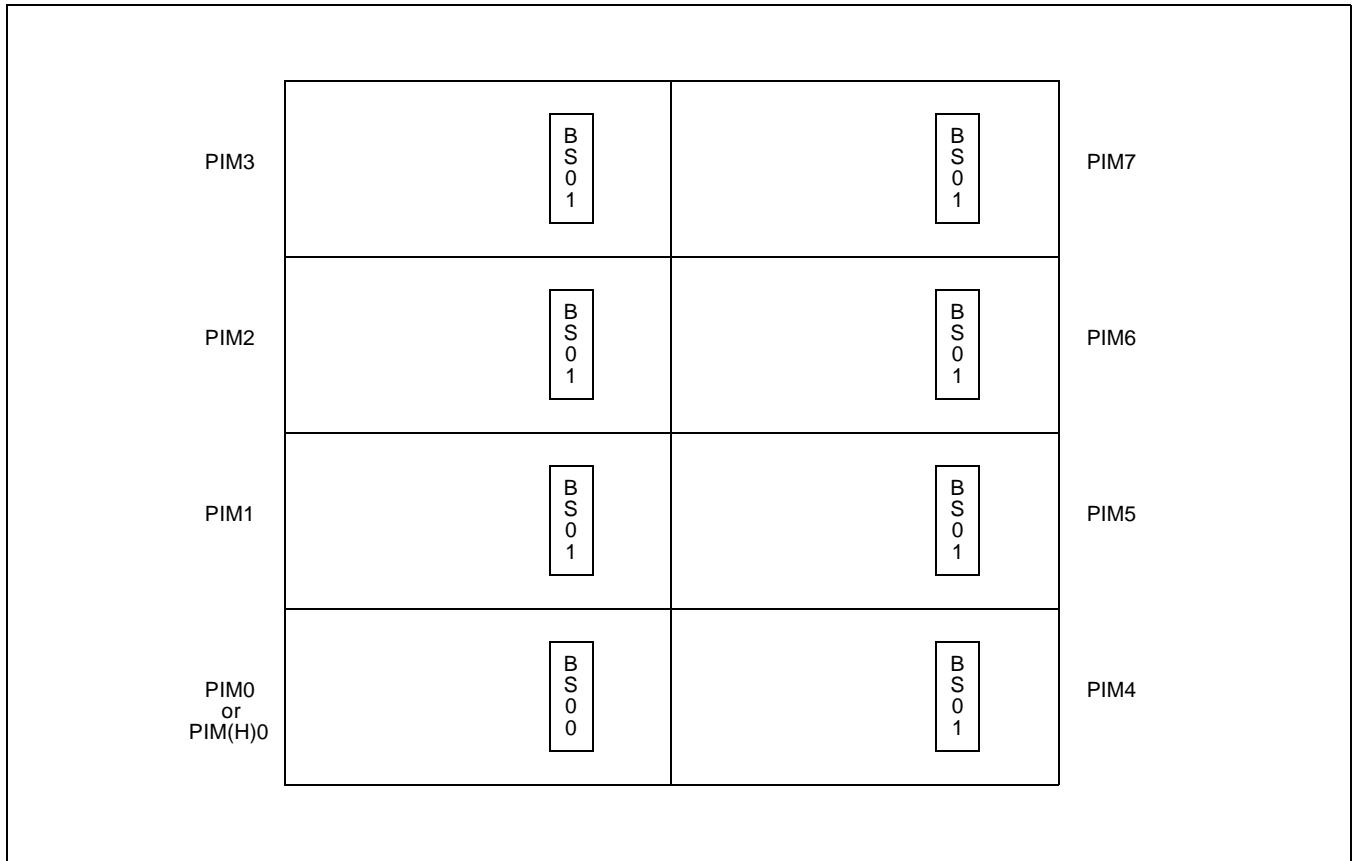

Figure 3-4 BS00/BS01 Card Mounting Slots

2.5 PN-PW00 (EXTPWR)

Mount the PW00 card into the LT01-AP8 slot. A maximum of three PW00 cards can be mounted in one frame (4PIMs).

Note: *The PW00 card occupies the adjoining left side (smaller number) slot because of its two-stories structure.*

2.6 PZ-PW86 (PWR)

Mount one PZ-PW86 in the PWR slot of PIM0/PIM(H)0 through PIM7, as required.

3. INSTALLATION CONDITIONS FOR APPLICATION CIRCUIT CARDS

1. When the system is equipped with only one PIM:
 - An application circuit card can be mounted in the AP0 through AP6, and AP8 slots.
 - An application circuit card can not be mounted in the AP6 slot if any of the following is true.
 - A PN-2DLCC is used.
 - A PN-AP01 is used.
 - OAI, ACD, No. 7 CCIS or ISDN is used.
 - The PN-CP02s are used.
2. When the system is equipped with more than one PIM:
 - An application circuit card can be mounted in the AP0 through AP5 slots of PIM0/PIM(D)0.
 - An application circuit card can be mounted in the AP0 through AP6 slots of PIM2, 4 and 6.
 - An application circuit card can be mounted in the AP0 through AP7 slots of PIM1, 3, 5 and 7.
 - If the system is equipped with CP02s, the AP5 and AP6 slot of PIM(H)0 cannot be used for an application circuit card.

Note 1: *The application circuit card (PN-24DTA/PN-24DTA-A/PN-30DTC/PN-30DTC-A) cannot be mounted in either the AP7 or the AP8 slot since neither of these slots have a connection to the MDF through the Back Wiring Board.*

Note 2: *The application circuit card (PN-24DTA/PN-24DTA-A/PN-30DTC/PN-30DTC-A [DT10, DT11] which receives a clock signal must be mounted in the AP0 through AP5 slots of PIM0/PIM(H)0.*

Note 3: *The application circuit card (PN-CK00) must be mounted in the AP0 through AP6 slots of PIM0/PIM(H)0.*

Note 4: *The application circuit card (PN-CC00/PN-CC01) can be mounted in any one of the LT slots or the AP slots.
PN-CC00 card needs two LT/AP slots per one card.*

Note 5: *The application circuit card (PN-CC00/PN-CC01) should be mounted in a LT/AP slot that adjoins an AP slot for the PN-AP01 card because the cable (48-TW0.3 CONN CA) is connected between the PN-CC00/PN-CC01 card and the PN-AP01 card.*

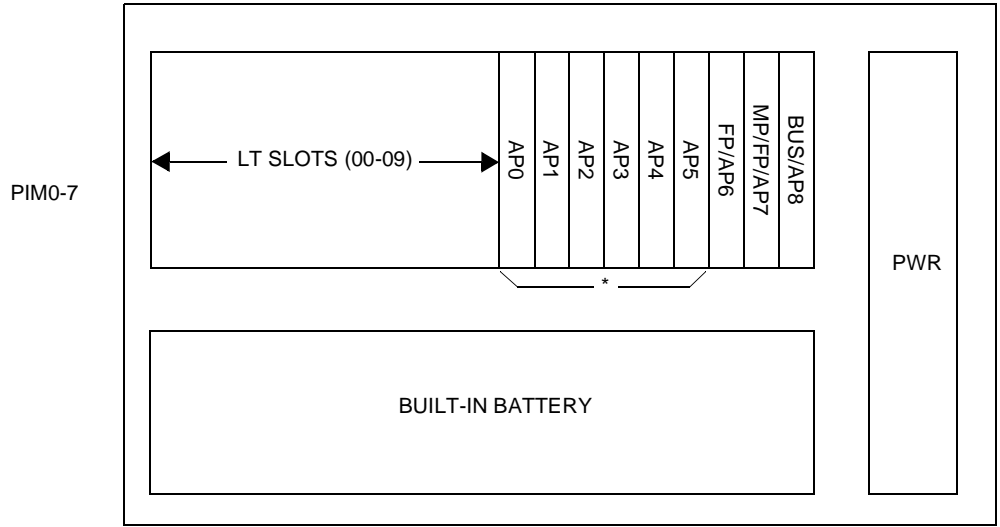

- *Line/trunk circuit cards can also be mounted in AP0 - AP5 slots.*

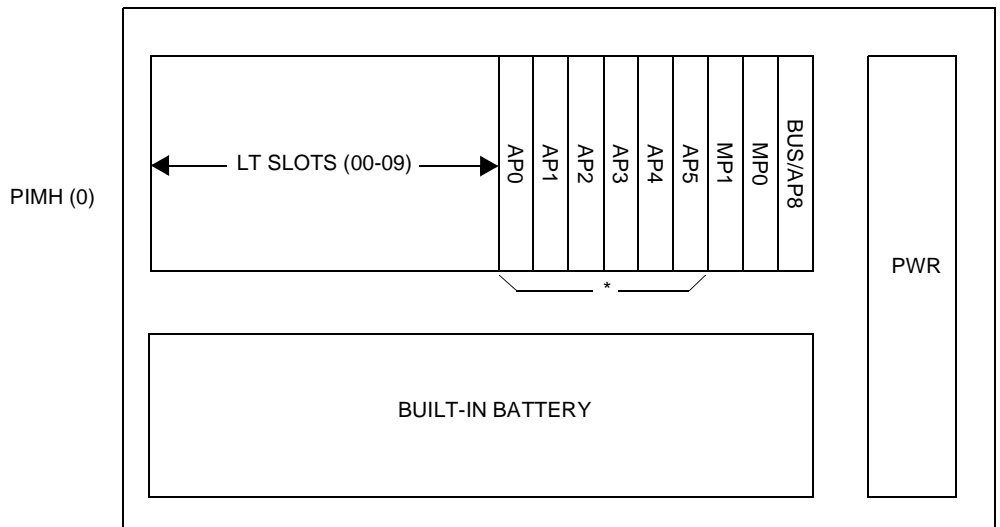

- *Line/trunk circuit cards can also be mounted in AP0 - AP5 slots.*

Figure 3-5 Application Circuit Card Mounting Slots

4. INSTALLATION CONDITIONS FOR LINE/TRUNK CIRCUIT CARDS

Mount the line/trunk circuit cards in the LT00 through LT15 slots of PIM0/PIM(H)0 through PIM7.

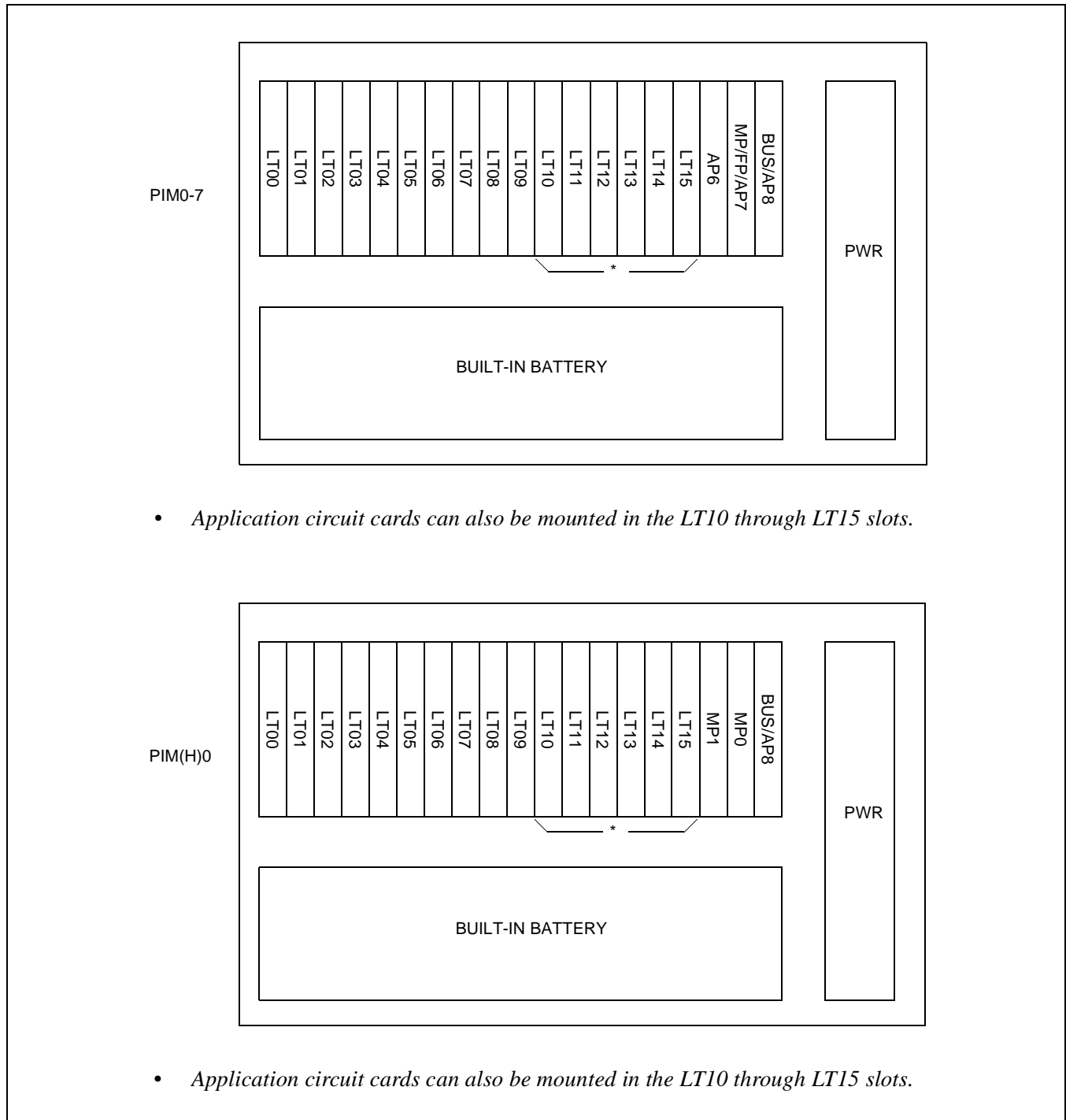

Figure 3-6 Line/Trunk Circuit Card Mounting Slots

CHAPTER 4 LAMP INDICATIONS AND SWITCH SETTINGS

This chapter explains various circuit cards used in the PBX with respect to the following items. Explanations are given in the alphabetical order of the circuit card names within each circuit card category (Control, Application, and Line/Trunk).

1. Locations of Lamps, Switches, and Connectors

The locations of lamps, switches, and connectors of each circuit card are shown by a face layout.

2. Lamp Indications

The name, color, and functions of each indicator lamp equipped on each circuit card are shown and described in a table.

3. Switch Settings

The name, settings, and functions of each switch equipped on each circuit card are shown and described in a table.

Each switch setting table has a "CHECK" column. Make necessary entries in the CHECK column during and/or after system installation and maintenance, and use each table as a reference for subsequent system maintenance and operations.

1. PRECAUTION IN HANDLING

When handling a circuit card, the installer must wear a grounded wrist strap to protect the circuit card from static electricity.

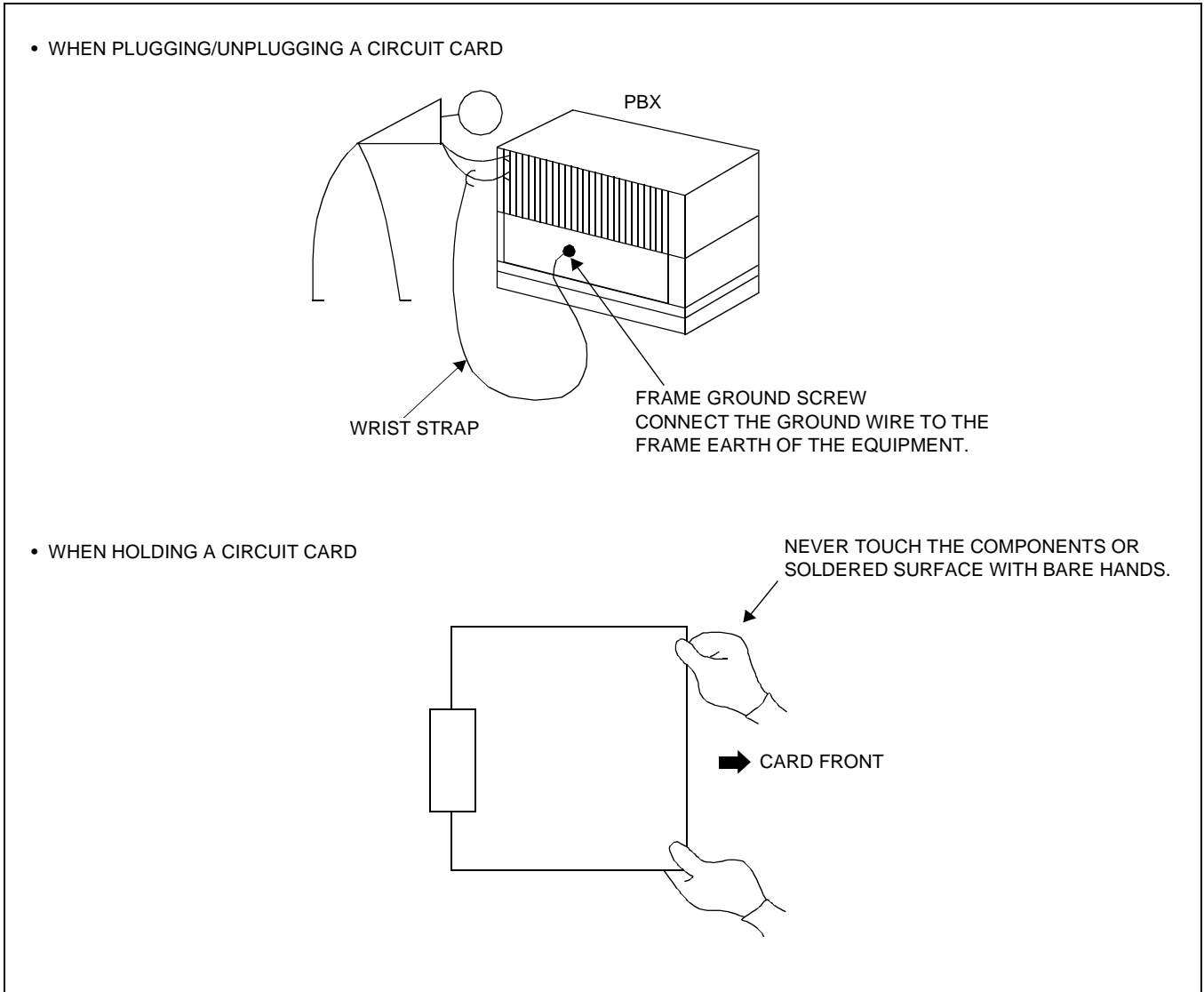
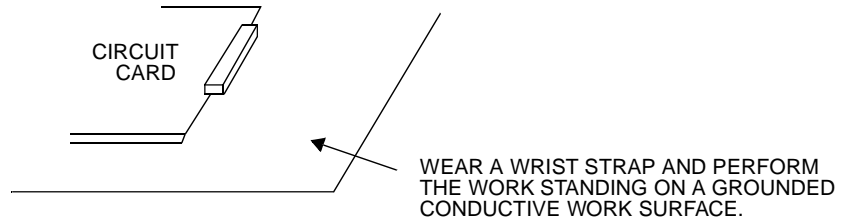

Figure 4-1 Static Electricity Precautions (1 of 2)

- WHEN SETTING SWITCHES ON A CIRCUIT CARD



- WHEN CARRYING A CIRCUIT CARD

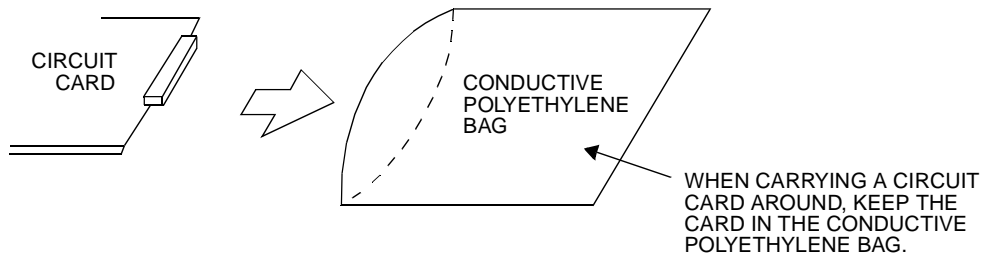

Figure 4-1 Static Electricity Precautions (2 of 2)

CAUTION

The installer must hold the edge of circuit card, when plugging or unplugging the circuit card. If you touch another area, you may be exposed to hazardous voltages.

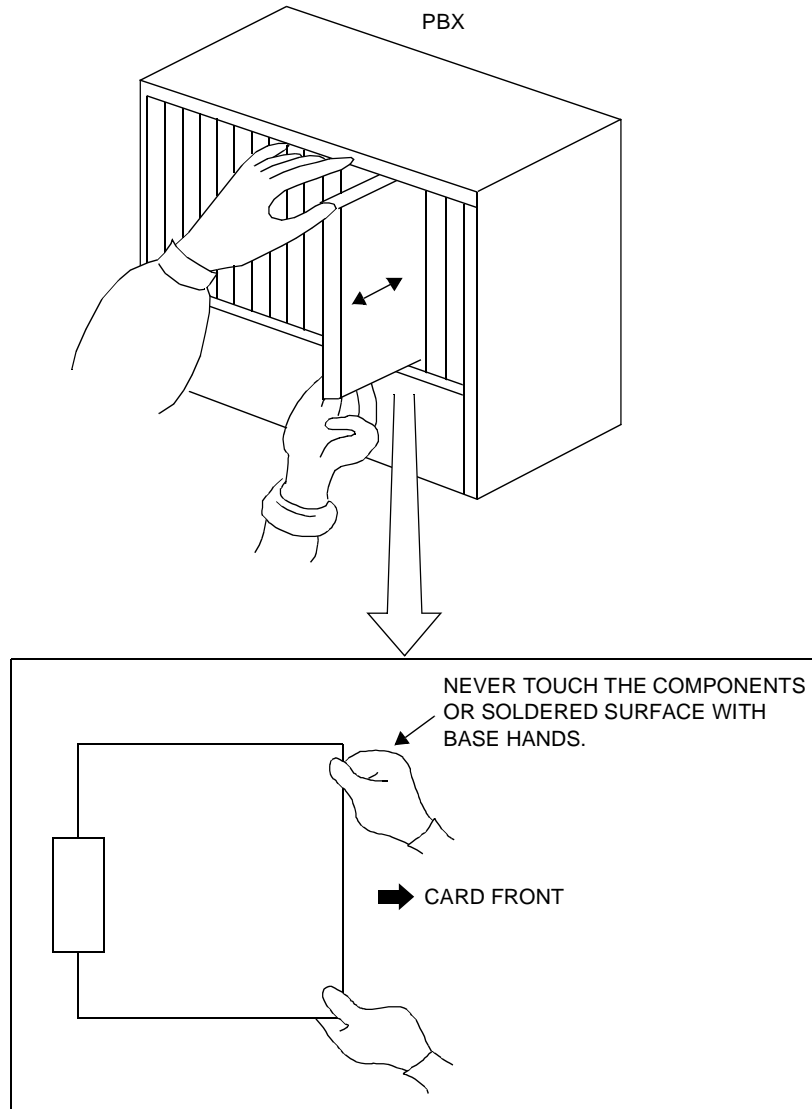

Figure 4-2 Circuit Card Handling Precautions

2. LAMP INDICATIONS AND SWITCH SETTINGS OF CONTROL CIRCUIT CARDS

Table 4-1 below shows the control circuit cards to be explained in this section.

Table 4-1 Table of Control Circuit Cards

NAME (FUNCTIONAL NAME)	EXISTENCE OF LAMPS X: PROVIDED —: NOT PROVIDED	EXISTENCE OF SWITCHES X: PROVIDED —: NOT PROVIDED	EXTRACTION/INSERTION WITH POWER ON X: ALLOWED Δ: ALLOWED AFTER MB* —: NOT ALLOWED	REFERENCE PAGE
PN-BS00-A/ PN-BS00-B (BS00)	—	X	Δ	22
PN-BS01-A (BS01)	—	X	Δ	24
PN-BS01-B (BS01)	—	X	Δ	26
PN-CP00 (MP)	X	X	—	28
PN-CP00-B /PN-CP00-C (MP)	X	X	—	31
PN-CP03 /PN-CP03-C (MP)	X	X	—	34
PN-CP01 (FP)	X	X	Δ	37
PN-CP02 /PN-CP02-C (MP)	X	X	Δ	39
PN-PW00 (EXTPWR)	X	X	Δ	42
PZ-PW86 (PWR)	X	X	—	44
PZ-PW86-A (PWR)	X	X	—	46
PZ-PW86(C) (PWR)	X	X	—	48
PZ-PW86(D) (PWR)	X	X	—	50

* MB = Make Busy

PN-BS00-A/PN-BS00-B (BS00)

1. Locations of Lamps, Switches, and Connectors

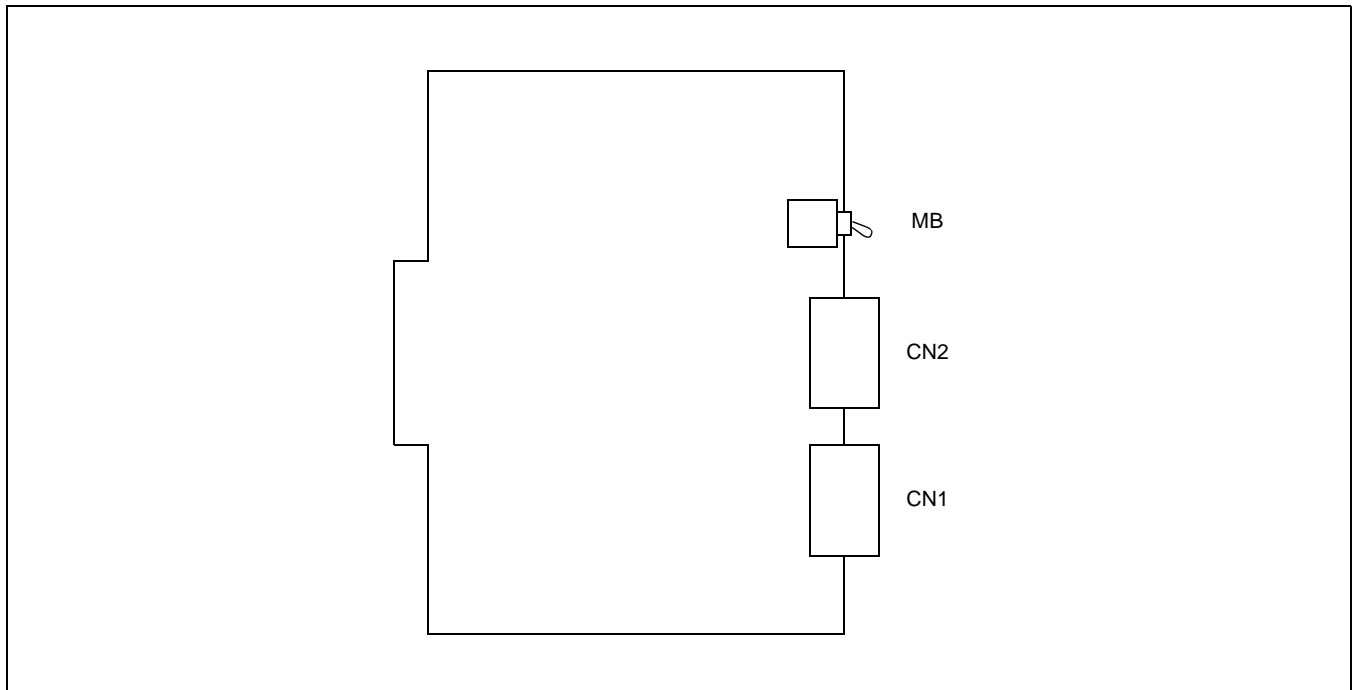



PN-BS00-A/PN-BS00-B (BS00) Card



2. Lamp Indications

This card has no indicator lamps.

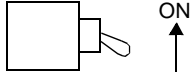
(3) Switch Settings

Switch Settings

SWITCH NAME	SWITCH NUMBER	SETTING POSITION	FUNCTION	CHECK
MB (Toggle SW)  Note		UP	For make-busy	
			For normal operation	

The figure in the SWITCH NAME column and the position in  in the SETTING POSITION column indicate the standard setting of the switch. When the switch is not set as shown by the figure and , the setting of the switch varies with the system concerned.

Note: When the power is on, flip the MB switch to ON (UP position) before plugging/unplugging the circuit card.

PN-BS01-A (BS01)

1. Locations of Lamps, Switches, and Connectors

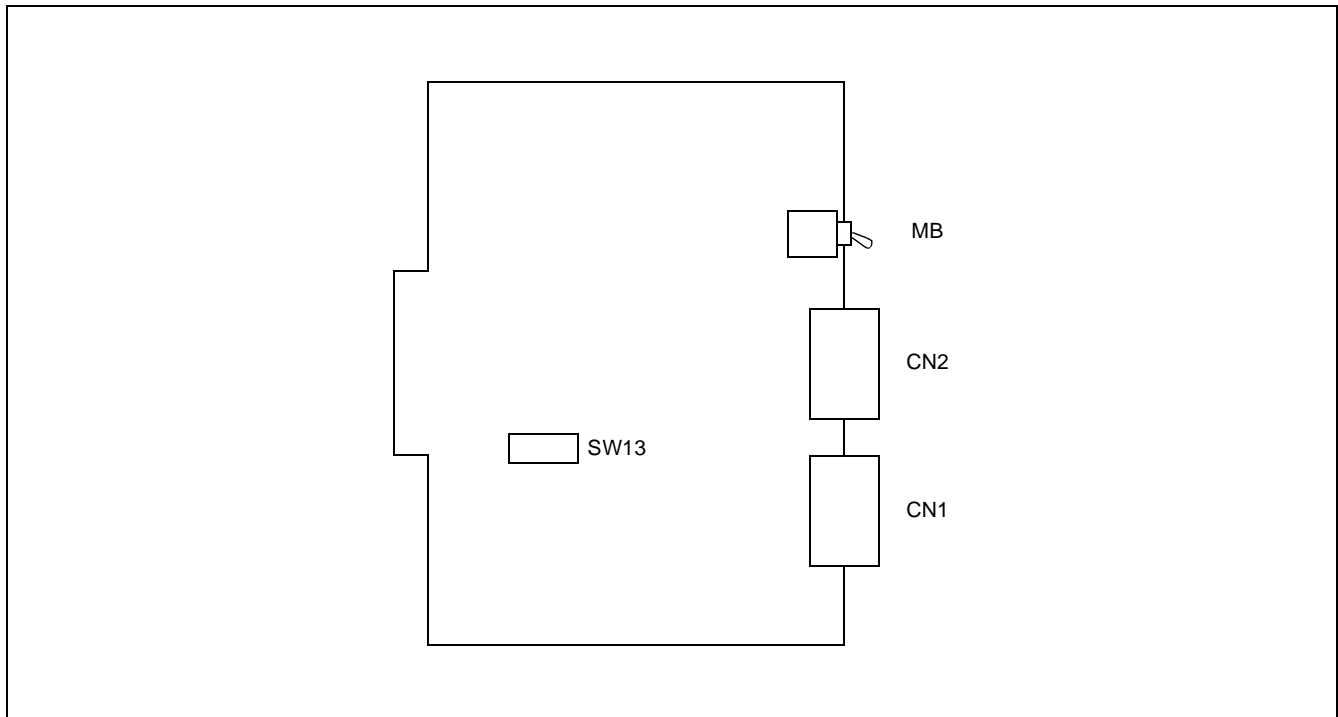

PN-BS01-A (BS01) Card



2. Lamp Indications

This card has no indicator lamps.

(3) Switch Settings

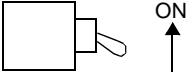
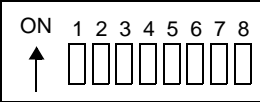
Switch Settings

SWITCH NAME	SWITCH NUMBER	SETTING POSITION	FUNCTION	CHECK																									
MB (Toggle SW)  Note		UP	For make-busy																										
		DOWN	For normal operation																										
SW13 (Dip SW) 	1, 5	ON	Set SW13 according to the mounting location of this card. <table border="1" data-bbox="756 655 1328 873"> <thead> <tr> <th>SWITCH No.</th> <th>SW13 -1, 5</th> <th>SW13 -2, 6</th> <th>SW13 -3,7</th> <th>SW13 -4, 8</th> </tr> </thead> <tbody> <tr> <td>PIM1</td> <td>ON</td> <td>OFF</td> <td>OFF</td> <td>OFF</td> </tr> <tr> <td>PIM2, PIM3</td> <td>OFF</td> <td>ON</td> <td>OFF</td> <td>OFF</td> </tr> <tr> <td>PIM4, PIM5</td> <td>OFF</td> <td>OFF</td> <td>ON</td> <td>OFF</td> </tr> <tr> <td>PIM6, PIM7</td> <td>OFF</td> <td>OFF</td> <td>OFF</td> <td>ON</td> </tr> </tbody> </table>	SWITCH No.	SW13 -1, 5	SW13 -2, 6	SW13 -3,7	SW13 -4, 8	PIM1	ON	OFF	OFF	OFF	PIM2, PIM3	OFF	ON	OFF	OFF	PIM4, PIM5	OFF	OFF	ON	OFF	PIM6, PIM7	OFF	OFF	OFF	ON	
		SWITCH No.		SW13 -1, 5	SW13 -2, 6	SW13 -3,7	SW13 -4, 8																						
	PIM1	ON		OFF	OFF	OFF																							
	PIM2, PIM3	OFF		ON	OFF	OFF																							
	PIM4, PIM5	OFF		OFF	ON	OFF																							
	PIM6, PIM7	OFF		OFF	OFF	ON																							
	OFF																												
	2, 6	ON																											
		OFF																											
	3, 7	ON																											
OFF																													
4, 8	ON																												
	OFF																												

The figure in the SWITCH NAME column and the position in  in the SETTING POSITION column indicate the standard setting of the switch. When the switch is not set as shown by the figure and , the setting of the switch varies with the system concerned.

Note: When the power is on, flip the MB switch to ON (UP position) before plugging/unplugging the circuit card.

PN-BS01-B (BS01)

1. Locations of Lamps, Switches, and Connectors

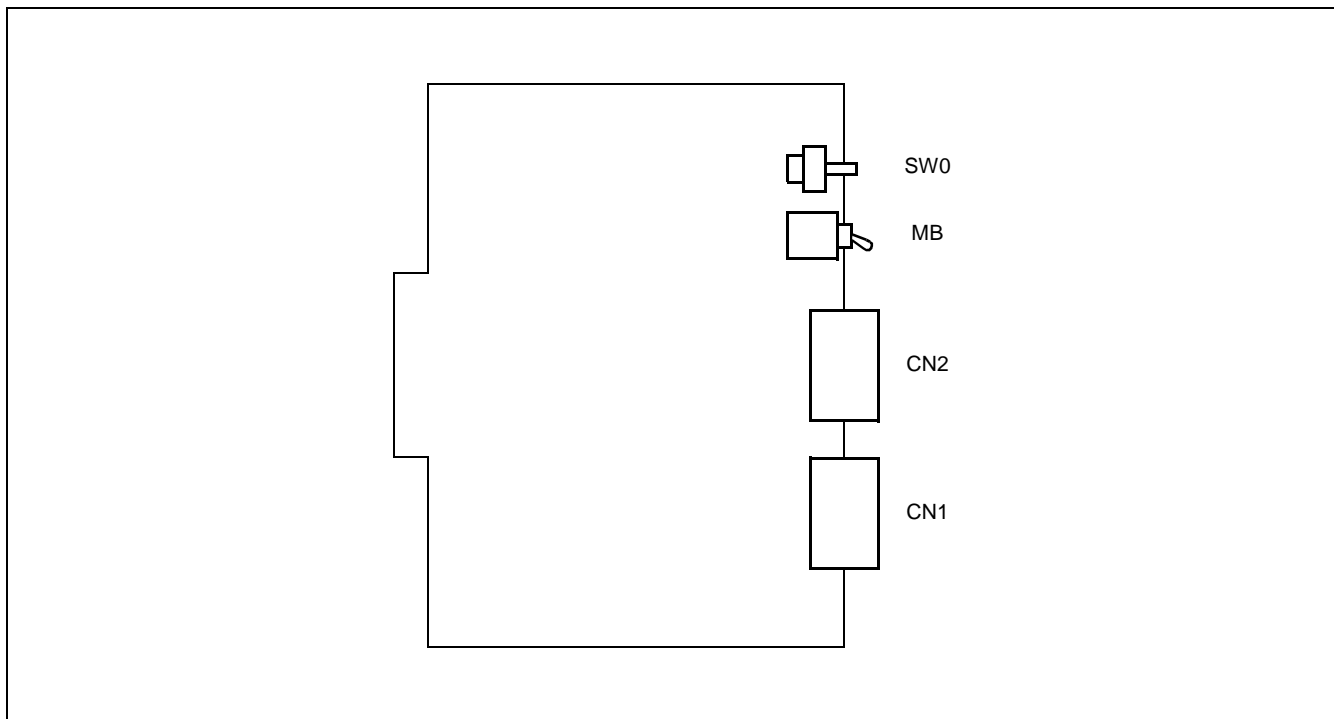

PN-BS01-B (BS01) Card



2. Lamp Indications

This card has no indicator lamps.

(3) Switch Settings

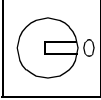
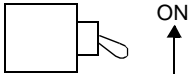
Switch Settings

SWITCH NAME	SWITCH NUMBER	SETTING POSITION	FUNCTION	CHECK
SW0 (Rotary SW)  Note 1	0 - 3		Set this rotary switch to match the location in which this circuit card is to be mounted.	
		0	For mounting this card in PIM1	
		1	For mounting this card in PIM2, 3	
		2	For mounting this card in PIM4, 5	
	3	For mounting this card in PIM6, 7		
	4 - F		Not used	
MB (Toggle SW)  Note 2		UP	For make-busy	
		DOWN	For normal operation	

The figure in the SWITCH NAME column and the position in  in the SETTING POSITION column indicate the standard setting of the switch. When the switch is not set as shown by the figure and , the setting of the switch varies with the system concerned.

Note 1: Set the groove on the switch knob to the desired switch position.

Note 2: When the power is on, flip the MB switch to ON (UP position) before plugging/unplugging the circuit card.

PN-CP00 (MP)

1. Locations of Lamps, Switches, and Connectors

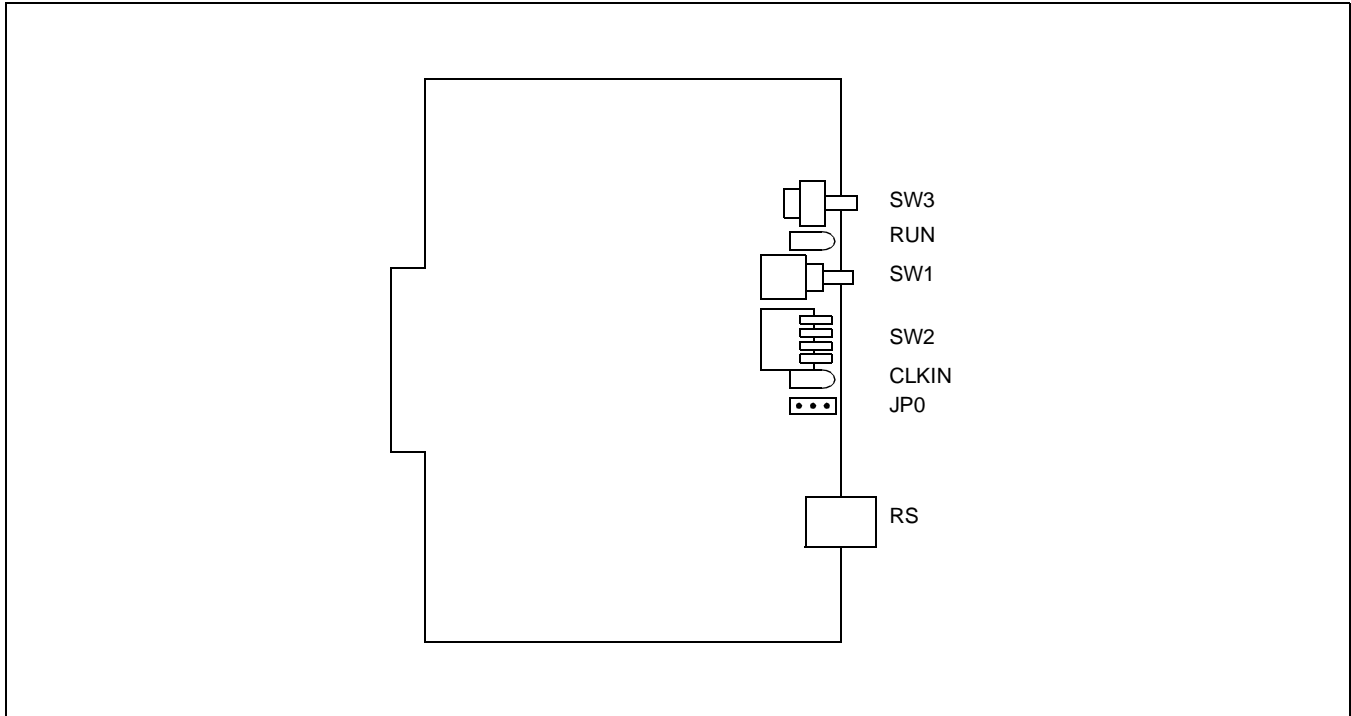

PN-CP00 (MP) Card

2. Lamp Indications

Lamp Indications



LAMP NAME	COLOR	FUNCTION
RUN	Green	Flashes at 120 IPM while the circuit card is operating normally.
CLKIN	Green	Lights while receiving clock signals to the PLO oscillator.

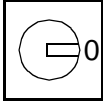
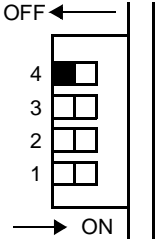

(3) Switch Settings

Switch Settings

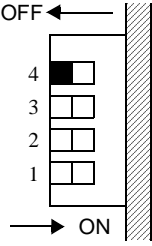
SWITCH NAME	SWITCH NUMBER	SETTING POSITION	FUNCTION	CHECK																	
SW3 (Rotary SW)  Note	0 ~ F	0	On Line (Call processing is in progress)																		
		2	Off Line (Call processing is stopped) • I/O port: Depending on CM40 YY=08																		
		3	Off Line (Call processing is stopped) • I/O port: 1200 bps (Fixed)																		
		B	For clearing the office data																		
		C	For setting the resident system program																		
		1, 4 ~ 9 A, D ~ F	Not used																		
SW1 (Push SW)			For initializing the CPU																		
SW2 (Piano Key SW) 	1	ON	KF Mode																		
		OFF	MF/PF Mode.																		
	2, 3	Selection of PLO (Phase Locked Oscillator) • When using the internal PLO of MP card:																			
		<table border="1"> <thead> <tr> <th colspan="2">SWITCH NUMBER</th> <th rowspan="2">FUNCTION</th> </tr> <tr> <th>2</th> <th>3</th> </tr> </thead> <tbody> <tr> <td>OFF</td> <td>OFF</td> <td>1.5 MHz clock [For PN-24DTA/PN-24DTA-A]</td> </tr> <tr> <td>ON</td> <td>OFF</td> <td>192 kHz clock [For PN-BRTA]</td> </tr> <tr> <td>OFF</td> <td>ON</td> <td>2 MHz clock [For PN-30DTC/PN-30DTC-A/ PN-2BRTC]</td> </tr> <tr> <td>ON</td> <td>ON</td> <td>Not used</td> </tr> </tbody> </table>		SWITCH NUMBER		FUNCTION	2	3	OFF	OFF	1.5 MHz clock [For PN-24DTA/PN-24DTA-A]	ON	OFF	192 kHz clock [For PN-BRTA]	OFF	ON	2 MHz clock [For PN-30DTC/PN-30DTC-A/ PN-2BRTC]	ON	ON	Not used	
SWITCH NUMBER		FUNCTION																			
2	3																				
OFF	OFF	1.5 MHz clock [For PN-24DTA/PN-24DTA-A]																			
ON	OFF	192 kHz clock [For PN-BRTA]																			
OFF	ON	2 MHz clock [For PN-30DTC/PN-30DTC-A/ PN-2BRTC]																			
ON	ON	Not used																			

Switch Settings (Continued)

SWITCH NAME	SWITCH NUMBER	SETTING POSITION	FUNCTION	CHECK								
<p>SW2 (Piano Key SW)</p> 	2, 3	<ul style="list-style-type: none"> When using the PLO card (PN-CK00): <table border="0" style="margin-left: 40px;"> <tr> <td style="text-align: center;"><u>SW2-2</u></td> <td style="text-align: center;"><u>SW2-3</u></td> </tr> <tr> <td style="text-align: center;">OFF</td> <td style="text-align: center;">ON</td> </tr> </table> When not using the internal PLO and the PLO card: <table border="0" style="margin-left: 40px;"> <tr> <td style="text-align: center;"><u>SW2-2</u></td> <td style="text-align: center;"><u>SW2-3</u></td> </tr> <tr> <td style="text-align: center;">OFF</td> <td style="text-align: center;">OFF</td> </tr> </table> 	<u>SW2-2</u>	<u>SW2-3</u>	OFF	ON	<u>SW2-2</u>	<u>SW2-3</u>	OFF	OFF		
<u>SW2-2</u>	<u>SW2-3</u>											
OFF	ON											
<u>SW2-2</u>	<u>SW2-3</u>											
OFF	OFF											
	4	OFF	Not used									
<p>JP0 (Jumper pin)</p> 		LEFT	For factory testing									
		RIGHT	For normal operation									
<p>JP2 (Jumper pin)</p> 		UP	For normal operation Memory backup connected									
		DOWN	For factory test only Disconnect battery									

The figure in the SWITCH NAME column and the position in  in the SETTING POSITION column indicate the standard setting of the switch. When the switch is not set as shown by the figure and , the setting of the switch varies with the system concerned.

Note: Set the groove on the switch knob to the desired switch position.

CAUTION

When the operating power is being supplied to this circuit card, do not plug/unplug this circuit card into/from its mounting slot.

PN-CP00-B/PN-CP00-C (MP)

1. Locations of Lamps, Switches, and Connectors

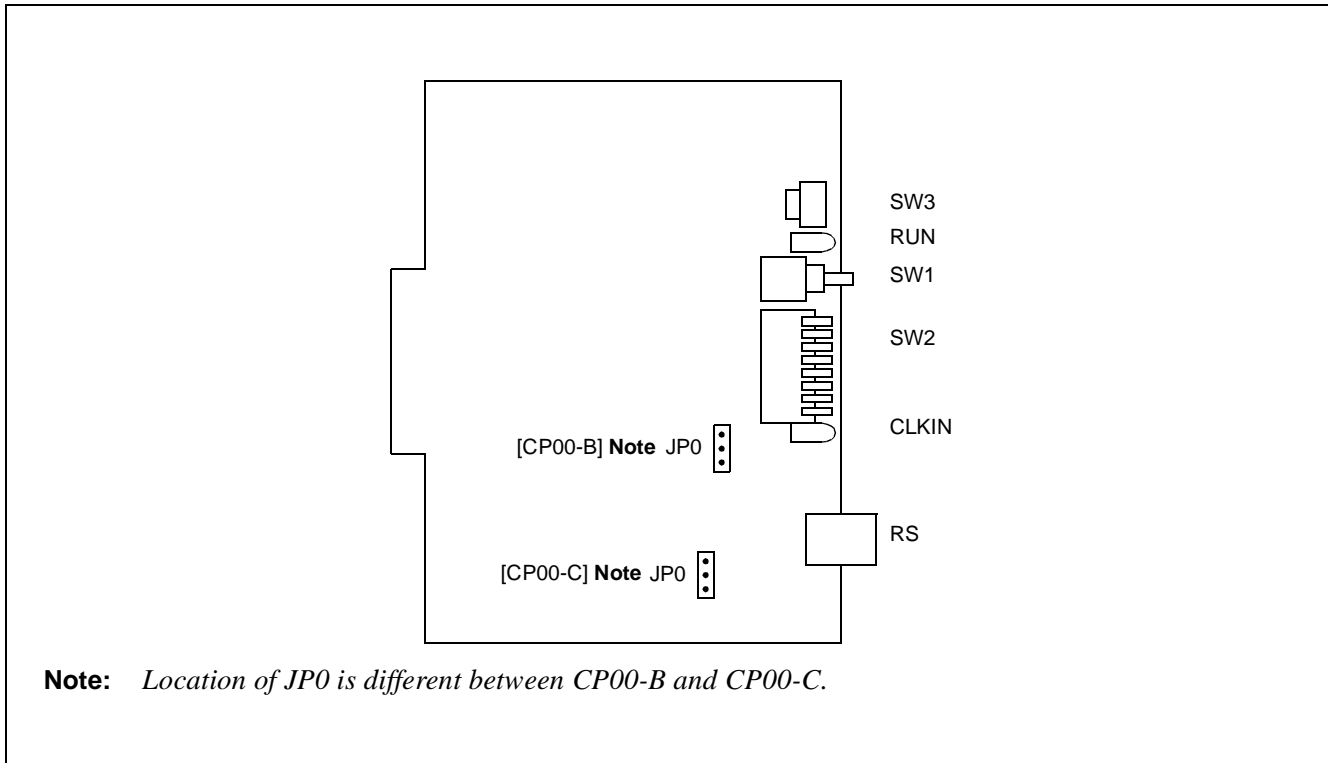

Note: Location of JP0 is different between CP00-B and CP00-C.

PN-CP00-B/PN-CP00-C (MP) Card

2. Lamp Indications

Lamp Indications

LAMP NAME	COLOR	FUNCTION
RUN	Green	Flashes at 120 IPM while the circuit card is operating normally.
CLKIN	Green	Lights while receiving clock signals to the PLO oscillator.

(3) Switch Settings

Switch Settings

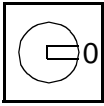
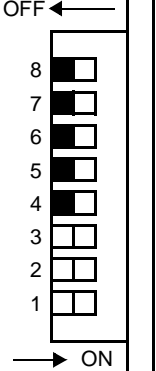
SWITCH NAME	SWITCH NUMBER	SETTING POSITION	FUNCTION	CHECK																
SW3 (Rotary SW)  Note	0 ~ F	0	On Line (Call processing is in progress)																	
		2	Off Line (Call processing is stopped) • I/O port: Depending on CM40 YY=08																	
		3	Off Line (Call processing is stopped) • I/O port: 1200 bps (Fixed)																	
		B	For clearing the office data																	
		C	For setting the resident system program																	
		1, 4 ~ 9 A, D ~ F	Not used																	
SW1 (Push SW)			For initializing the CPU																	
SW2 (Piano Key SW) 	1	ON	KF Mode																	
		OFF	MF/PF Mode																	
	2, 3	Selection of PLO (Phase Locked Oscillator) • When using the internal PLO of MP card:																		
<table border="1"> <thead> <tr> <th colspan="2">SWITCH NUMBER</th> <th rowspan="2">FUNCTION</th> </tr> <tr> <th>2</th> <th>3</th> </tr> </thead> <tbody> <tr> <td>OFF</td> <td>OFF</td> <td>1.5 MHz clock [For PN-24DTA/PN-24DTA-A]</td> </tr> <tr> <td>ON</td> <td>OFF</td> <td>192 kHz clock [For PN-BRTA]</td> </tr> <tr> <td>OFF</td> <td>ON</td> <td>2 MHz clock [For PN-30DTC/PN-30DTC-A /PN-2BRTC]</td> </tr> <tr> <td>ON</td> <td>ON</td> <td>Not used</td> </tr> </tbody> </table>		SWITCH NUMBER		FUNCTION	2	3	OFF	OFF	1.5 MHz clock [For PN-24DTA/PN-24DTA-A]	ON	OFF	192 kHz clock [For PN-BRTA]	OFF	ON	2 MHz clock [For PN-30DTC/PN-30DTC-A /PN-2BRTC]	ON	ON	Not used		
SWITCH NUMBER		FUNCTION																		
2			3																	
OFF		OFF	1.5 MHz clock [For PN-24DTA/PN-24DTA-A]																	
ON	OFF	192 kHz clock [For PN-BRTA]																		
OFF	ON	2 MHz clock [For PN-30DTC/PN-30DTC-A /PN-2BRTC]																		
ON	ON	Not used																		

Switch Settings (Continued)

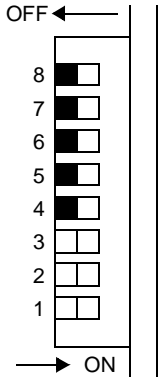
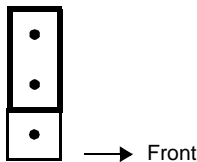
SWITCH NAME	SWITCH NUMBER	SETTING POSITION	FUNCTION	CHECK								
<p>SW2 (Piano Key SW)</p> 	2, 3	<ul style="list-style-type: none"> When using the PLO card (PN-CK00): <table border="0" style="margin-left: 20px;"> <tr> <td style="text-align: center;"><u>SW2-2</u></td> <td style="text-align: center;"><u>SW2-3</u></td> </tr> <tr> <td style="text-align: center;">OFF</td> <td style="text-align: center;">ON</td> </tr> </table> When not using the internal PLO and the PLO card: <table border="0" style="margin-left: 20px;"> <tr> <td style="text-align: center;"><u>SW2-2</u></td> <td style="text-align: center;"><u>SW2-3</u></td> </tr> <tr> <td style="text-align: center;">OFF</td> <td style="text-align: center;">OFF</td> </tr> </table> 	<u>SW2-2</u>	<u>SW2-3</u>	OFF	ON	<u>SW2-2</u>	<u>SW2-3</u>	OFF	OFF		
	<u>SW2-2</u>	<u>SW2-3</u>										
OFF	ON											
<u>SW2-2</u>	<u>SW2-3</u>											
OFF	OFF											
4 ~ 8	<input type="checkbox"/> OFF	Not used										
<p>JP0 (Jumper pin)</p> 		<input type="checkbox"/> UP	For normal operation Memory backup connected									
		DOWN	For factory testing (Disconnect battery for memory backup.)									

The figure in the SWITCH NAME column and the position in in the SETTING POSITION column indicate the standard setting of the switch. When the switch is not set as shown by the figure and , the setting of the switch varies with the system concerned.

Note: Set the groove on the switch to the desired switch position.

CAUTION

When the operating power is being supplied to this circuit card, do not plug/unplug this circuit card into/from its mounting slot.

PN-CP03/PN-CP03-C (MP)

1. Locations of Lamps, Switches, and Connectors

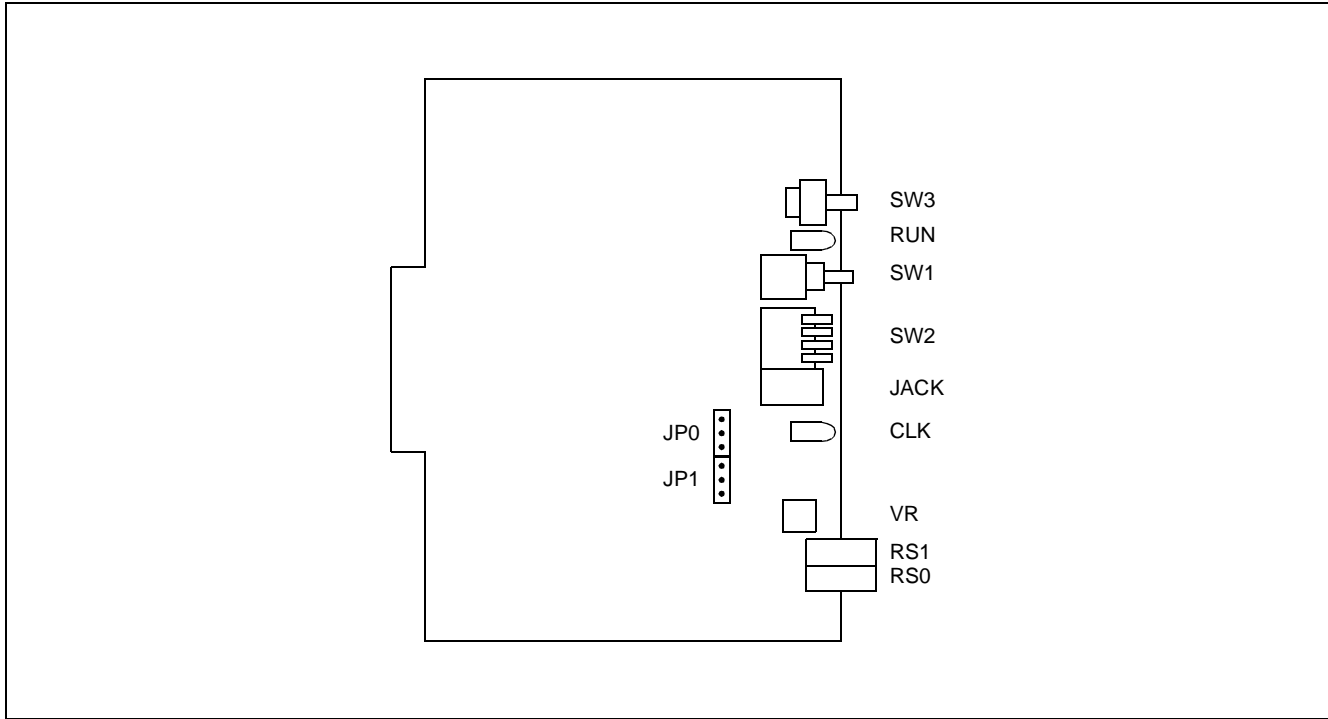

PN-CP03/PN-CP03-C (MP) Card

2. Lamp Indications

Lamp Indications

LAMP NAME	COLOR	FUNCTION
RUN	Green	Flashes at 120 IPM while the circuit card is operating normally.
CLKIN	Green	Lights while receiving clock signals to the PLO oscillator.

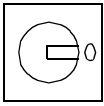
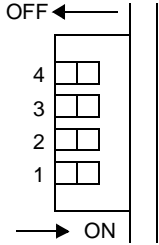

(3) Switch Settings

Switch Settings

SWITCH NAME	SWITCH NUMBER	SETTING POSITION	FUNCTION	CHECK																
SW3 (Rotary SW)  Note	0 ~ F	0	On Line (Call processing is in progress)																	
		2	Off Line (Call processing is stopped) • I/O port: Depending on CM40 YY=08																	
		3	Off Line (Call processing is stopped) • I/O port: 1200 bps (Fixed)																	
		B	For clearing the office data																	
		C	For setting the resident system program																	
		1, 4 ~ 9 A, D ~ F	Not used																	
SW1 (Push SW)			For initializing the CPU																	
SW2 (Piano Key SW) 	1	ON	KF Mode																	
		OFF	MF/PF Mode																	
	Selection of PLO (Phase Locked Oscillator) When using the internal PLO of MP card: <table border="1" data-bbox="678 940 1312 1249"> <thead> <tr> <th colspan="2">SWITCH NUMBER</th> <th rowspan="2">FUNCTION</th> </tr> <tr> <th>2</th> <th>3</th> </tr> </thead> <tbody> <tr> <td>OFF</td> <td>OFF</td> <td>1.5 MHz clock [For PN-24DTA/PN-24DTA-A]</td> </tr> <tr> <td>ON</td> <td>OFF</td> <td>192 kHz clock [For PN-BRTA]</td> </tr> <tr> <td>OFF</td> <td>ON</td> <td>2 MHz clock [For PN-30DTC/PN-30DTC-A /PN-2BRTC]</td> </tr> <tr> <td>ON</td> <td>ON</td> <td>Not used</td> </tr> </tbody> </table>	SWITCH NUMBER		FUNCTION	2	3	OFF	OFF	1.5 MHz clock [For PN-24DTA/PN-24DTA-A]	ON	OFF	192 kHz clock [For PN-BRTA]	OFF	ON	2 MHz clock [For PN-30DTC/PN-30DTC-A /PN-2BRTC]	ON	ON	Not used	2, 3	
SWITCH NUMBER		FUNCTION																		
2			3																	
OFF		OFF	1.5 MHz clock [For PN-24DTA/PN-24DTA-A]																	
ON		OFF	192 kHz clock [For PN-BRTA]																	
OFF	ON	2 MHz clock [For PN-30DTC/PN-30DTC-A /PN-2BRTC]																		
ON	ON	Not used																		

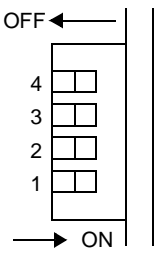
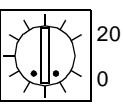
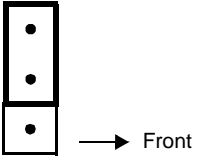
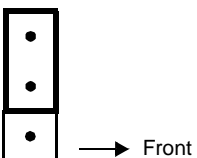
Switch Settings (Continued)

SWITCH NAME	SWITCH NUMBER	SETTING POSITION	FUNCTION	CHECK
SW2 (Piano Key SW) 	2, 3	<ul style="list-style-type: none"> When using the PLO card (PN-CK00): SW2-2 SW2-3 OFF ON When not using the internal PLO and the PLO card: SW2-2 SW2-3 OFF OFF 		
		4	ON	When using RS1 port for built-in MODEM
			OFF	When using RS1 port for RS-232C.
VR (Rotary SW) 			Variable Resister for External Hold Tone Source (0 - 20 KΩ: Clockwise)	
JP0 (Jumper pin) 		UP	For normal operation Memory backup connected	
		DOWN	For factory testing (Disconnect battery for memory backup.)	
JP1 (Jumper pin) 		UP	For normal operation	
		DOWN	For using External Tone Source	

The figure in the SWITCH NAME column and the position in  in the SETTING POSITION column indicate the standard setting of the switch. When the switch is not set as shown by the figure and , the setting of the switch varies with the system concerned.

Note: Set the groove on the switch knob to the desired switch position.

CAUTION

When the operating power is being supplied to this circuit card, do not plug/unplug this circuit card into/from its mounting slot. When the CP03/CP03-C is plugged in and power is on, do not move Jumper JP1.

PN-CP01 (FP)

1. Locations of Lamps, Switches, and Connectors

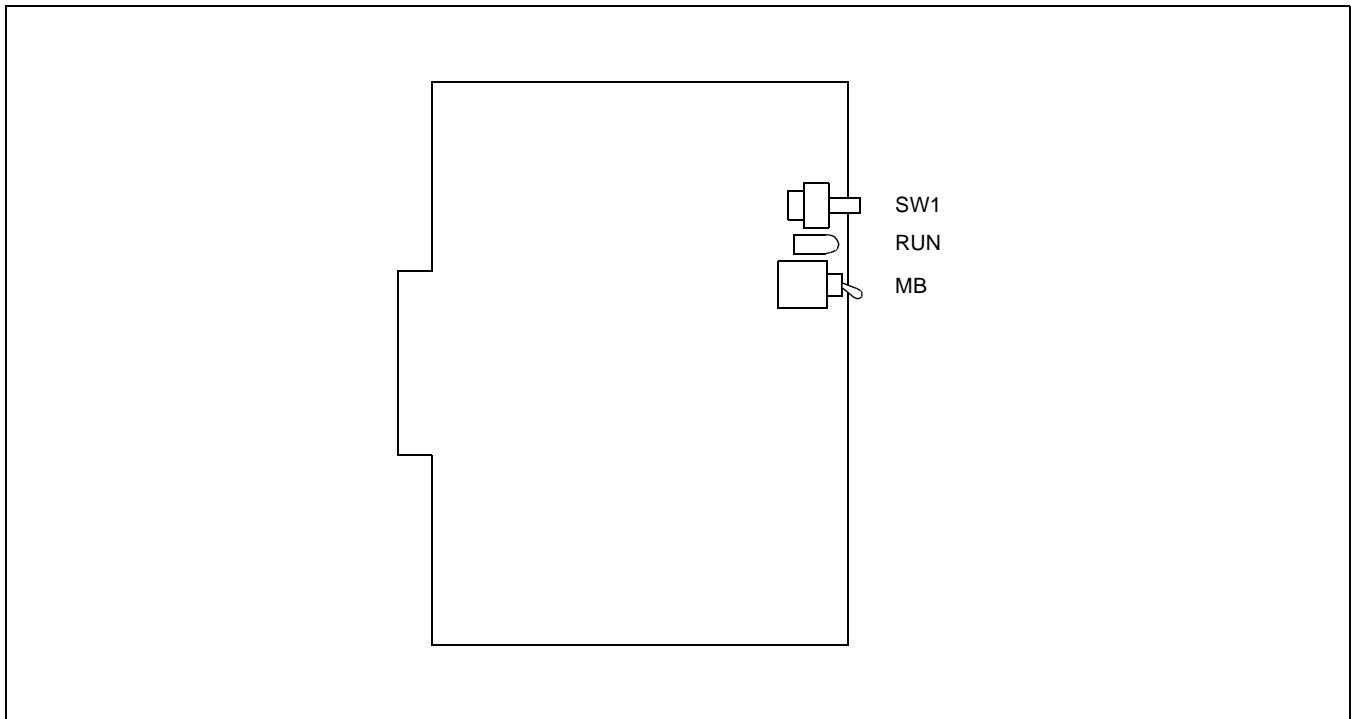

PN-CP01 (FP) Card

2. Lamp Indications



Lamp Indications



LAMP NAME	COLOR	FUNCTION
RUN	Green	Flashes at 120 IPM while the circuit card is operating normally.

PN-CP01 (FP)

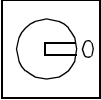
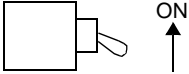
(3) Switch Settings

Switch Settings

SWITCH NAME	SWITCH NUMBER	SETTING POSITION	FUNCTION	CHECK
SW1 (Rotary SW)  Note 1	0 – 3	Set this rotary switch to match the location in which this circuit card is to be mounted.		
		0	For mounting this card in PIM0	
		1	For mounting this card in PIM2	
		2	For mounting this card in PIM4	
	3	For mounting this card in PIM6		
	4 – F		Not used	
MB (Toggle SW)  Note 2		UP	For make-busy	
			For normal operation	

The figure in the SWITCH NAME column and the position in  in the SETTING POSITION column indicate the standard setting of the switch. When the switch is not set as shown by the figure and , the setting of the switch varies with the system concerned.

Note 1: *Set the groove on the switch knob to the desired switch position.*

Note 2: *When the power is on, flip the MB switch to ON (UP position) before plugging/unplugging the circuit card.*

Note 3: *The PN-CP01 is required only if any of the following is true:*

- *More than one PIM is used.*
- *A PN-2DLCC is used.*
- *A PN-AP01 is used.*
- *OAI, ACD, No. 7 CCIS, or ISDN is used.*

PN-CP02/PN-CP02-C (MP)

1. Locations of Lamps, Switches, and Connectors

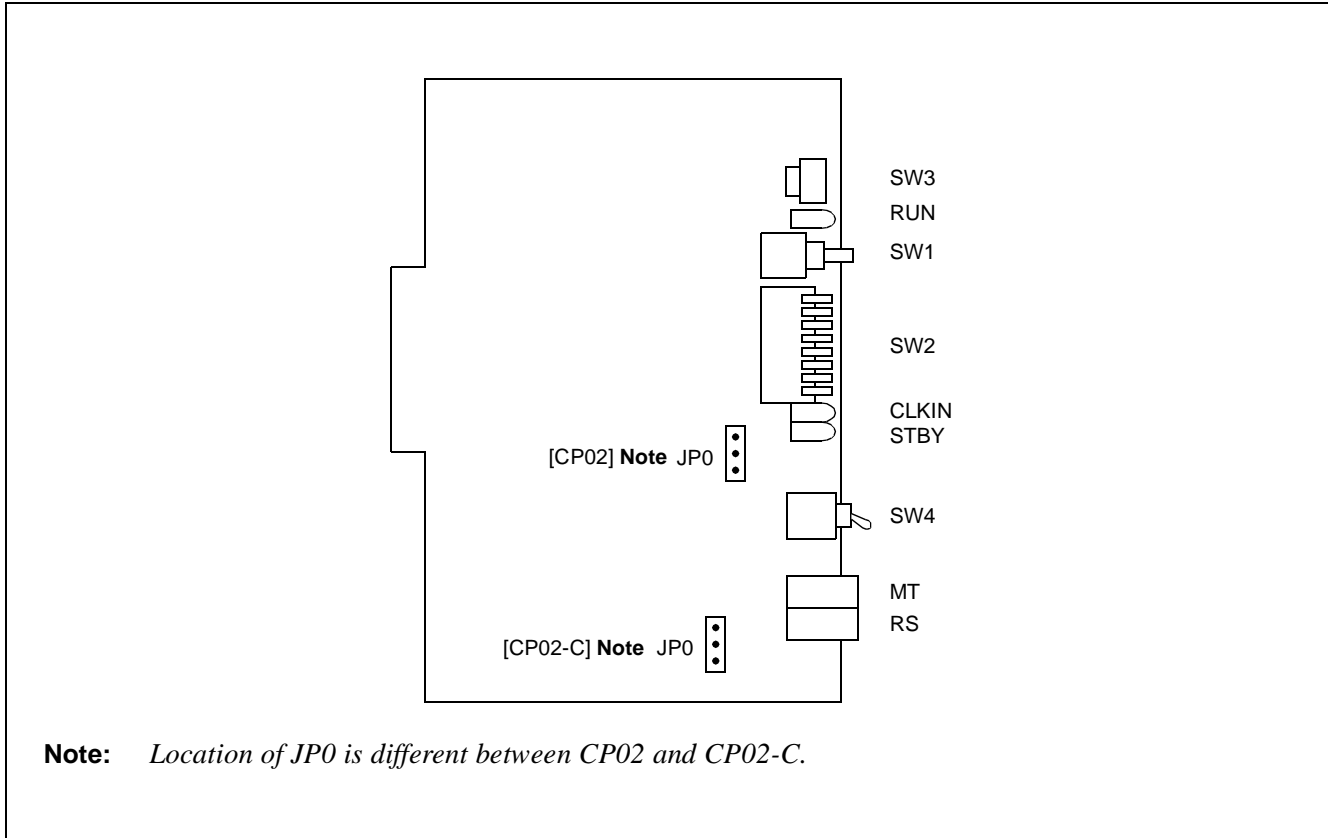

Note: Location of JP0 is different between CP02 and CP02-C.

PN-CP02/PN-CP02-C (MP) Card



2. Lamp Indications

Lamp Indications

LAMP NAME	COLOR	FUNCTION
RUN	Green	<ul style="list-style-type: none"> Flashes at 120 IPM while the circuit card is active status and operating normally. Flashes at 30 IPM or 15 IPM while the circuit card is stand by status. <p>[Normally operating: 30 IPM (1 sec - ON, 1 sec - OFF) Copying office data: 15 IPM (3 sec - ON, 1 sec - OFF)]</p>
CLKIN	Green	Lights while receiving clock signals to the PLO oscillator.
STBY	Red	Lights when the circuit card is in the standby mode.

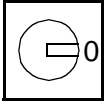

(3) Switch Settings

Switch Settings

SWITCH NAME	SWITCH NUMBER	SETTING POSITION	FUNCTION	CHECK																	
SW3 (Rotary SW)  Note 1	0 ~ F Note 2	0	On Line (Call processing is in progress)																		
		2	Off Line (Call processing is stopped) • I/O port: Depending on CM40 YY=08																		
		3	Off Line (Call processing is stopped) • I/O port: 1200 bps (Fixed)																		
		B	For clearing the office data																		
		C	For setting the resident system program																		
		1, 4 ~ 9 A, D ~ F	Not used																		
SW1 (Push SW)			For initializing the CPU																		
SW2 (Piano Key SW) 	1	ON	KF Mode																		
		OFF	MF/PF Mode																		
	2, 3	Selection of PLO (Phase Locked Oscillator) • When using the internal PLO of MP card:																			
		<table border="1"> <thead> <tr> <th colspan="2">SWITCH NUMBER</th> <th rowspan="2">FUNCTION</th> </tr> <tr> <th>2</th> <th>3</th> </tr> </thead> <tbody> <tr> <td>OFF</td> <td>OFF</td> <td>1.5 MHz clock [For PN-24DTA/PN-24DTA-A]</td> </tr> <tr> <td>ON</td> <td>OFF</td> <td>192 kHz clock [For PN-BRTA]</td> </tr> <tr> <td>OFF</td> <td>ON</td> <td>2 MHz clock [For PN-30DTC/PN-30DTC-A/PN-2BRTC]</td> </tr> <tr> <td>ON</td> <td>ON</td> <td>Not used</td> </tr> </tbody> </table>		SWITCH NUMBER		FUNCTION	2	3	OFF	OFF	1.5 MHz clock [For PN-24DTA/PN-24DTA-A]	ON	OFF	192 kHz clock [For PN-BRTA]	OFF	ON	2 MHz clock [For PN-30DTC/PN-30DTC-A/PN-2BRTC]	ON	ON	Not used	
		SWITCH NUMBER		FUNCTION																	
2		3																			
OFF	OFF	1.5 MHz clock [For PN-24DTA/PN-24DTA-A]																			
ON	OFF	192 kHz clock [For PN-BRTA]																			
OFF	ON	2 MHz clock [For PN-30DTC/PN-30DTC-A/PN-2BRTC]																			
ON	ON	Not used																			

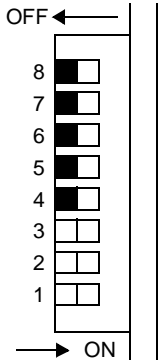
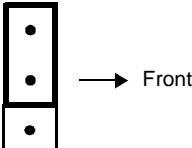
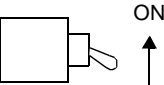
Switch Settings (Continued)

SWITCH NAME	SWITCH NUMBER	SETTING POSITION	FUNCTION	CHECK								
<p>SW2 (Piano Key SW)</p> 	2, 3	<ul style="list-style-type: none"> When using the PLO card (PN-CK00): <table border="0" style="margin-left: 40px;"> <tr> <td style="text-align: center;">SW2-2</td> <td style="text-align: center;">SW2-3</td> </tr> <tr> <td style="text-align: center;">OFF</td> <td style="text-align: center;">ON</td> </tr> </table> When not using the internal PLO and the PLO card: <table border="0" style="margin-left: 40px;"> <tr> <td style="text-align: center;">SW2-2</td> <td style="text-align: center;">SW2-3</td> </tr> <tr> <td style="text-align: center;">OFF</td> <td style="text-align: center;">OFF</td> </tr> </table> 	SW2-2	SW2-3	OFF	ON	SW2-2	SW2-3	OFF	OFF		
	SW2-2	SW2-3										
	OFF	ON										
	SW2-2	SW2-3										
OFF	OFF											
4 ~ 7	OFF	Not used										
8 Note 3	ON	Allowed to use MAT										
	OFF	For normal operation (Not allowed to use MAT)										
<p>JPO (Jumper pin)</p> 	/	UP	For normal operation Memory backup connected									
		DOWN	For factory test only (Disconnect battery for memory backup.)									
<p>SW4 (Toggle SW)</p>  <p>Note 4</p>	/	UP	For make-busy									
		DOWN	For normal operation									

The figure in the SWITCH NAME column and the position in  in the SETTING POSITION column indicate the standard setting of the switch. When the switch is not set as shown by the figure and , the setting of the switch varies with the system concerned.

Note 1: Set the groove on the switch to the desired switch position.

Note 2: On the stand by status circuit card, the SW3 can be set to only “0” or “B”. Do not set to the other position (1-9, A, C-F).

Note 3: MP0 and MP1 must not set to “ON” at the same time.

Note 4: When the power is on, flip the MB switch to ON (UP position) before plugging/unplugging the circuit card.

PN-PW00 (EXTPWR)

1. Locations of Lamps, Switches and Connectors

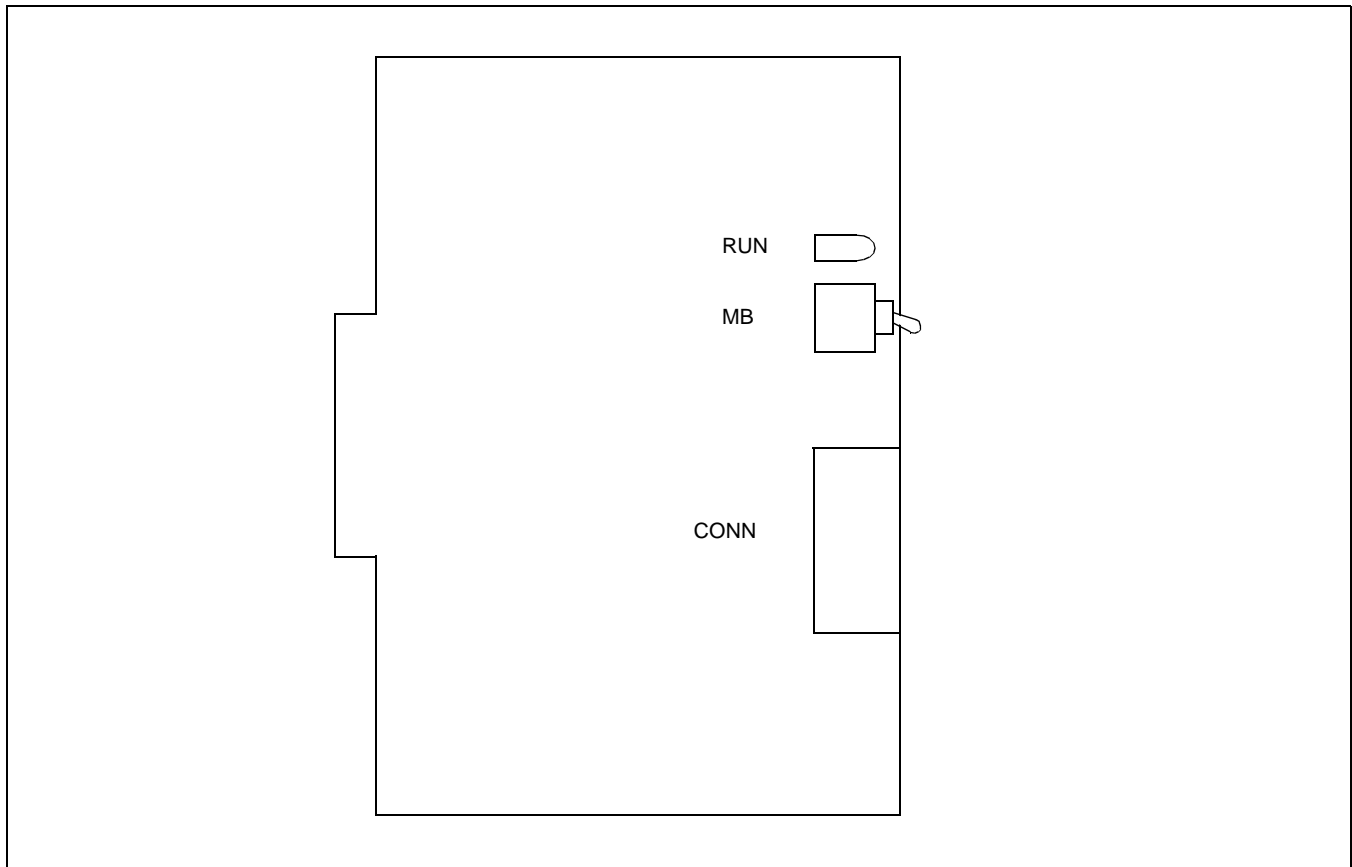

PN-PW00 (EXTPWR) Card

2. Lamp Indications



Lamp Indications

LAMP NAME	COLOR	FUNCTION
RUN	Green	Remains lit while -48 V power is being supplied

(3) Switch Setting

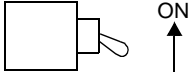
Switch Settings

SWITCH NAME	SWITCH NUMBER	SETTING POSITION	FUNCTION	CHECK
MB (Toggle SW)  Note	/	UP	For make-busy (-48 V power off)	
		DOWN	For normal operation (-48 V power on)	

The figure in the SWITCH NAME column and the position in  in the SETTING POSITION column indicate the standard setting of the switch. When the switch is not set as shown by the figure and , the setting of the switch varies with the system concerned.

Note: *When the power is on, flip the MB switch to ON (UP position) before plugging/unplugging the circuit card.*

PZ-PW86 (PWR)

1. Locations of Lamps, Switches, and Connectors

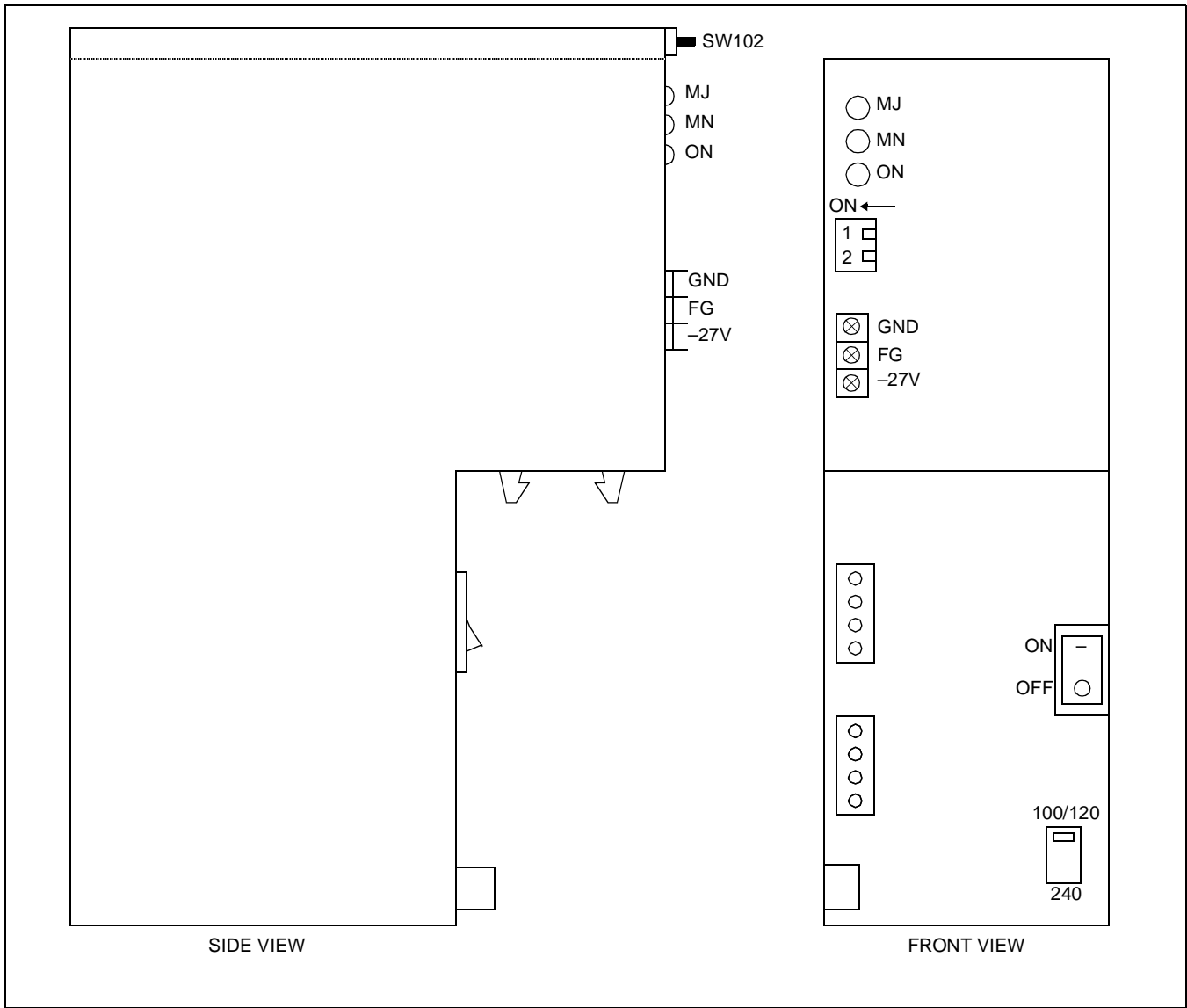

PZ-PW86 (PWR) Card



2. Lamp Indications



Lamp Indications

LAMP NAME	COLOR	FUNCTION
MJ	Red	Lights upon occurrence of a major trouble
MN	Yellow	Lights upon occurrence of a minor trouble
ON	Green	Remains lit while the operating power is being supplied

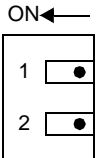
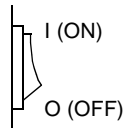
(3) Switch Settings

Switch Settings

SWITCH NAME	SWITCH NUMBER	SETTING POSITION	FUNCTION	CHECK
	1	ON	Set to ON.	
	2	ON	Standard setting (for equalize charging)	
		OFF	Not used	
SW 		ON	For turning AC source power on	
		OFF	For turning AC source power off	
100/120  240		UP	AC INPUT: 90 V - 138 V	
		DOWN	AC INPUT: 180 V - 276 V	

The figure in the SWITCH NAME column and the position in  in the SETTING POSITION column indicate the standard setting of the switch. When the switch is not set as shown by the figure and , the setting of the switch varies with the system concerned.

CAUTION

- *When the operating power is being supplied to this circuit card, do not plug/unplug this circuit card into/from its mounting slot.*
- *Set the appropriate voltage by using the AC voltage select switch (slide switch) before powering on.*

PZ-PW86-A (PWR)

1. Locations of Lamps, Switches, and Connectors

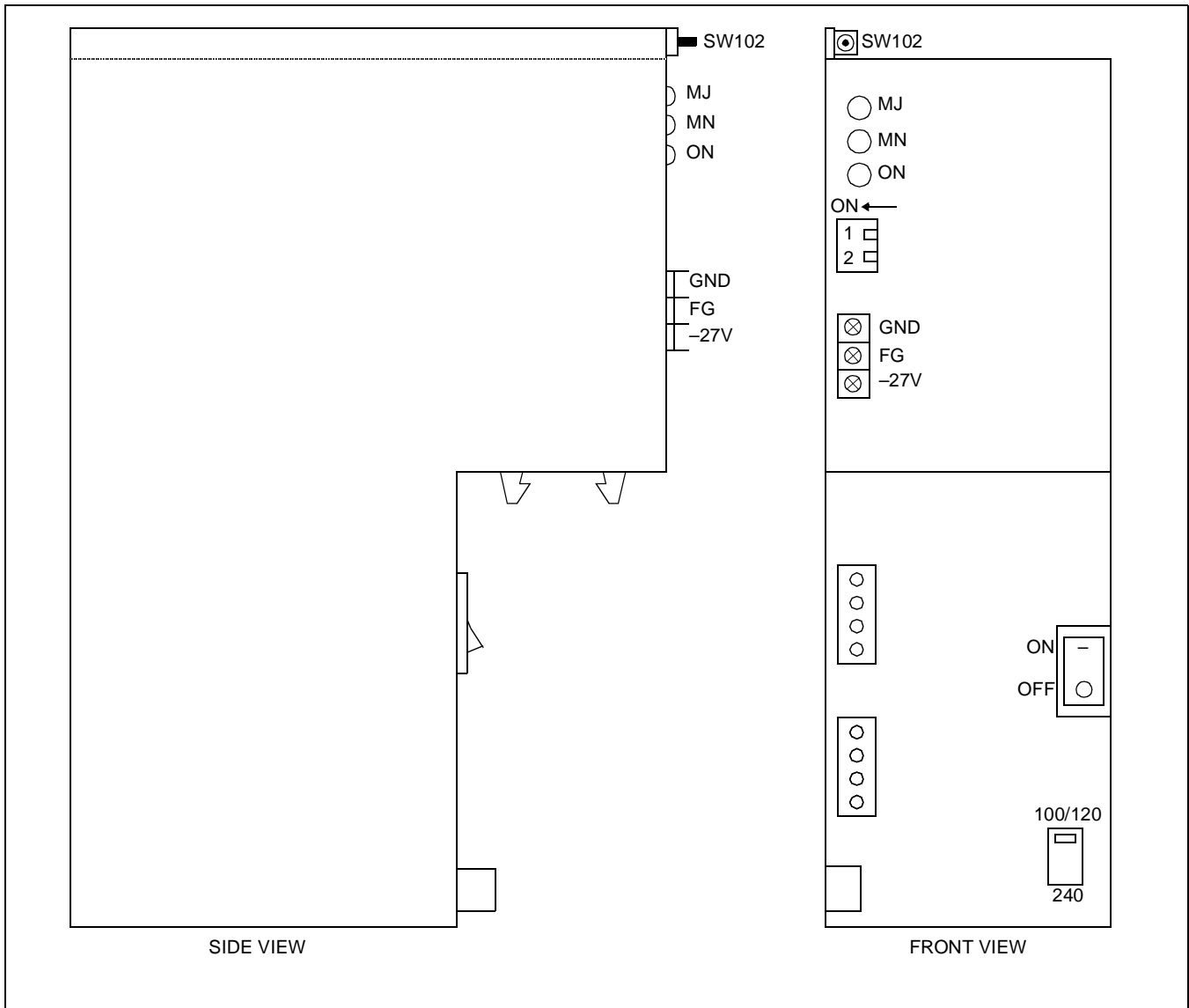

PZ-PW86-A (PWR) Card





2. Lamp Indications

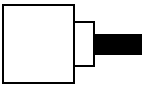
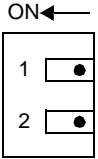

Lamp Indications

LAMP NAME	COLOR	FUNCTION
MJ	Red	Lights upon occurrence of a major trouble
MN	Yellow	Lights upon occurrence of a minor trouble
ON	Green	Remains lit while the operating power is being supplied

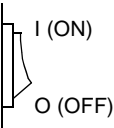
(3) Switch Settings

Switch Settings

SWITCH NAME	SWITCH NUMBER	SETTING POSITION	FUNCTION	CHECK
SW102 		PRESS MOMENTARILY	To start each PIM on battery power, when AC power is not provided (Switch "SW" must be ON).	
	1		Set to ON.	
	2	ON	For float charging	
OFF		Standard setting for equalize charging (Set to equalize for Gel cell or no battery.)		
SW 		ON	For turning AC source power on	
		OFF	For turning AC source power off	
100/120  240			AC INPUT: 90 V - 138 V	
		DOWN	AC INPUT: 180 V - 276 V	

The figure in the SWITCH NAME column and the position in  in the SETTING POSITION column indicate the standard setting of the switch. When the switch is not set as shown by the figure and , the setting of the switch varies with the system concerned.

CAUTION

- When the operating power is being supplied to this circuit card, do not plug/unplug this circuit card into/from its mounting slot.
- Set the appropriate voltage by using the AC voltage select switch (slide switch) before powering on.

PZ-PW86 (C) (PWR)

1. Locations of Lamps, Switches, and Connectors

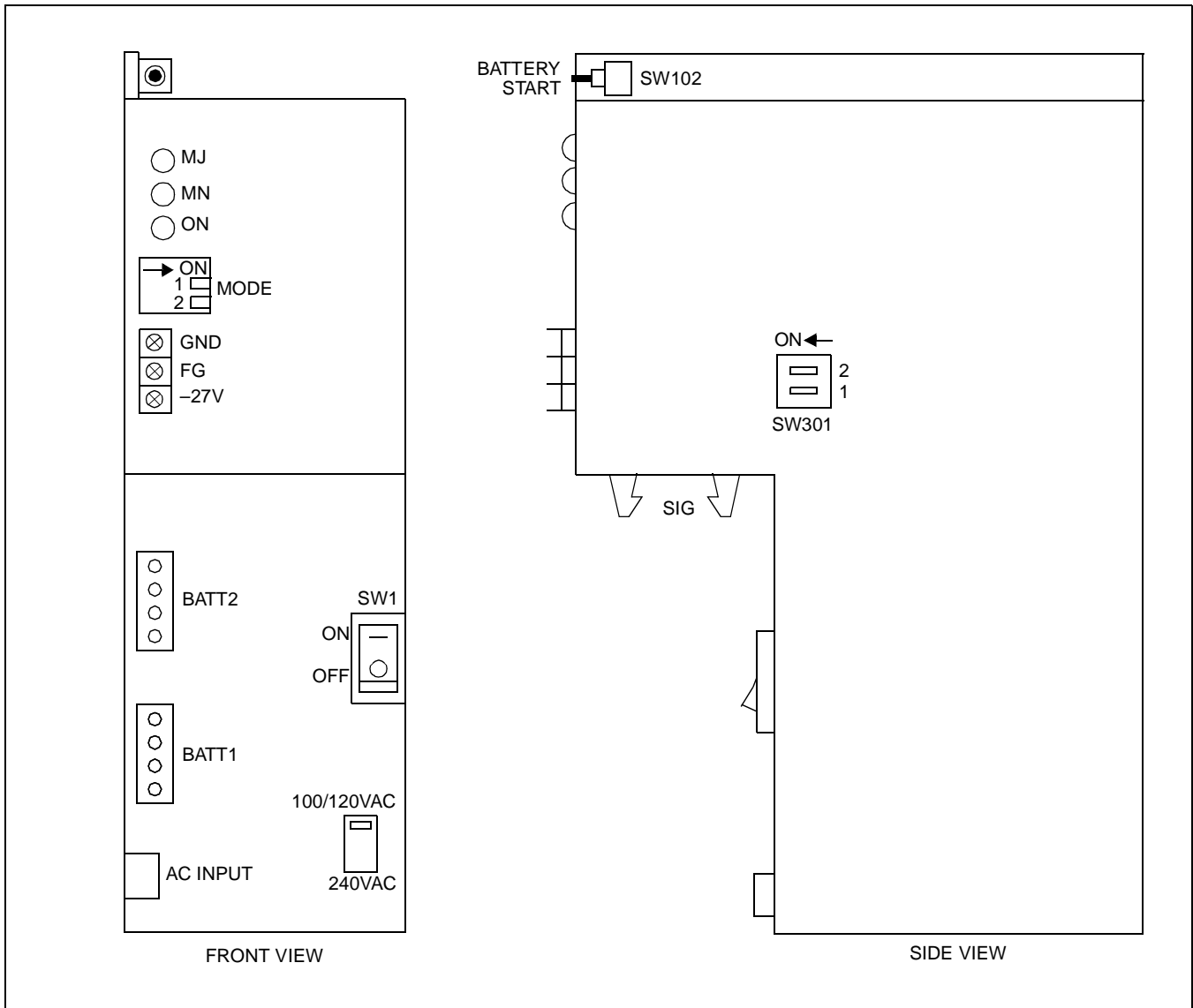

PZ-PW86(C) (PWR) Card

2. Lamp Indications

Lamp Indications

LAMP NAME	COLOR	FUNCTION
MJ	Red	Lights upon occurrence of a major trouble
MN	Orange	Lights upon occurrence of a minor trouble
ON	Green	Remains lit while the operating power is being supplied

(3) Switch Settings

Switch Settings

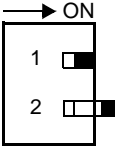
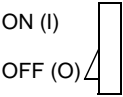
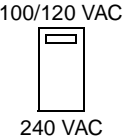
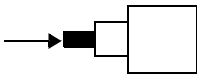
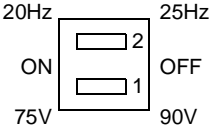
SWITCH NAME	SWITCH NUMBER	SETTING POSITION	FUNCTION	CHECK
MODE 	1	<input type="radio"/> OFF	Always set to OFF	
	2	<input type="radio"/> ON	Float charging, for sealed batteries (Normal Setting). OPTION: Periodic Equalize charging of external vented batteries.	
		OFF	Float charging, for vented batteries only.	
SW1 		<input type="radio"/> ON	For turning AC power and the battery on	
		OFF	For turning AC power and the battery off	
		<input type="radio"/> UP	AC INPUT: 90 V - 138 V	
		DOWN	AC INPUT: 180 V - 264 V	
SW102 		PRESS MOMENTARILY	To start each PIM on battery power, when AC power is not provided (switch "SW" must be ON)	
SW301 	1	ON	CR Voltage: 75 Vrms	
		<input type="radio"/> OFF	CR Voltage: 90 Vrms	
	2	<input type="radio"/> ON	Frequency: 20 Hz	
		OFF	Frequency: 25 Hz	

The figure in the SWITCH NAME column and the position in in the SETTING POSITION column indicate the standard setting of the switch. When the switch is not set as shown by the figure and , the setting of the switch varies with the system concerned.

PZ-PW86 (D) (PWR)

1. Locations of Lamps, Switches, and Connectors

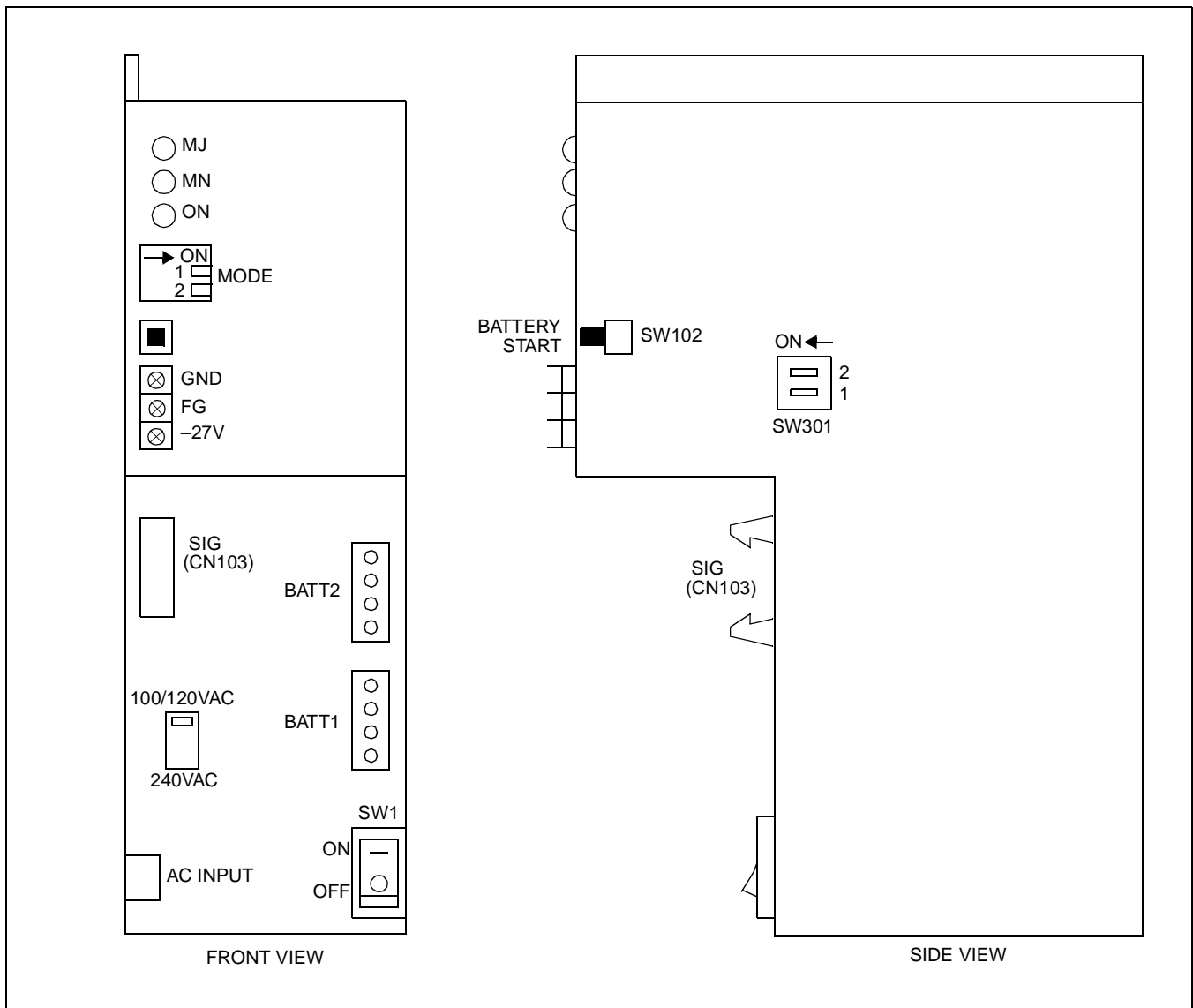

PZ-PW86(D) (PWR) Card

2. Lamp Indications

Lamp Indications

LAMP NAME	COLOR	FUNCTION
MJ	Red	Lights upon occurrence of a major trouble
MN	Orange	Lights upon occurrence of a minor trouble
ON	Green	Remains lit while the operating power is being supplied

(3) Switch Settings

Switch Settings

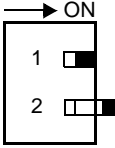
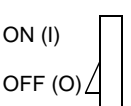
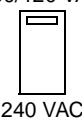
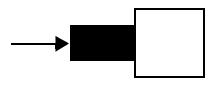
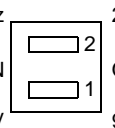
SWITCH NAME	SWITCH NUMBER	SETTING POSITION	FUNCTION	CHECK
MODE 	1	<input type="radio"/> OFF	Always set to OFF	
	2	<input type="radio"/> ON	Float charging, for sealed batteries (Normal Setting). OPTION: Periodic Equalize charging of external vented batteries.	
		OFF	Float charging, for vented batteries only.	
SW1 ON (I)  OFF (O)		<input type="radio"/> ON	For turning AC power and the battery on	
		<input type="radio"/> OFF	For turning AC power and the battery off	
100/120 VAC  240 VAC		<input type="radio"/> UP	AC INPUT: 90 V - 138 V	
		<input type="radio"/> DOWN	AC INPUT: 180 V - 264 V	
SW102 		PRESS MOMENTARILY	To start each PIM on battery power, when AC power is not provided (switch "SW" must be ON)	
SW301 20Hz 25Hz ON OFF  75V 90V	1	<input type="radio"/> ON	CR Voltage: 75 Vrms	
		<input type="radio"/> OFF	CR Voltage: 90 Vrms	
	2	<input type="radio"/> ON	Frequency: 20 Hz	
		<input type="radio"/> OFF	Frequency: 25 Hz	

The figure in the SWITCH NAME column and the position in in the SETTING POSITION column indicate the standard setting of the switch. When the switch is not set as shown by the figure and , the setting of the switch varies with the system concerned.

3. LAMP INDICATIONS AND SWITCH SETTINGS OF APPLICATION CIRCUIT CARDS

Table 4-2 below shows the application circuit cards to be explained in this section.

Table 4-2 Table of Application Circuit Cards

NAME (FUNCTIONAL NAME)	EXISTENCE OF LAMPS X: PROVIDED —: NOT PROVIDED	EXISTENCE OF SWITCHES X: PROVIDED —: NOT PROVIDED	EXTRACTION/INSERTION WITH POWER ON X: ALLOWED Δ: ALLOWED AFTER MB* —: NOT ALLOWED	REFERENCE PAGE
PN-AP00-A (AP00)	X	X	Δ	53
PN-AP01 (AP01)	X	X	Δ	59
PN-BRTA (BRI)	X	X	Δ	62
PN-2BRTC (BRI)	X	X	Δ	65-1
PN-CC00 (ETHER)	X	X	X	66
PN-CC01 (ETHER)	X	X	Δ	68-1
PN-CK00 (PLO)	X	X	Δ	69
PN-24DTA (DTI)	X	X	Δ	72
PN-24DTA-A (DTI)	X	X	Δ	75
PN-30DTC/30DTC-A (DTI)	X	X	Δ	78-1
PN-ME00 (EXTMEM)	X	X	Δ	79
PN-4RSTB (MFR)	X	X	Δ	84
PN-4RSTC (CIR)	X	X	Δ	86
PN-SC00 (CCH)	X	X	Δ	88
PN-SC01 (DCH)	X	X	Δ	91
PN-SC02 (ICH)	X	X	Δ	94
PN-SC03 (ICH)	X	X	Δ	96
PN-SC03 (CSH)	X	X	Δ	98

* MB=Make Busy

PN-AP00-A (AP00)

1. Locations of Lamp, Switches, and Connectors

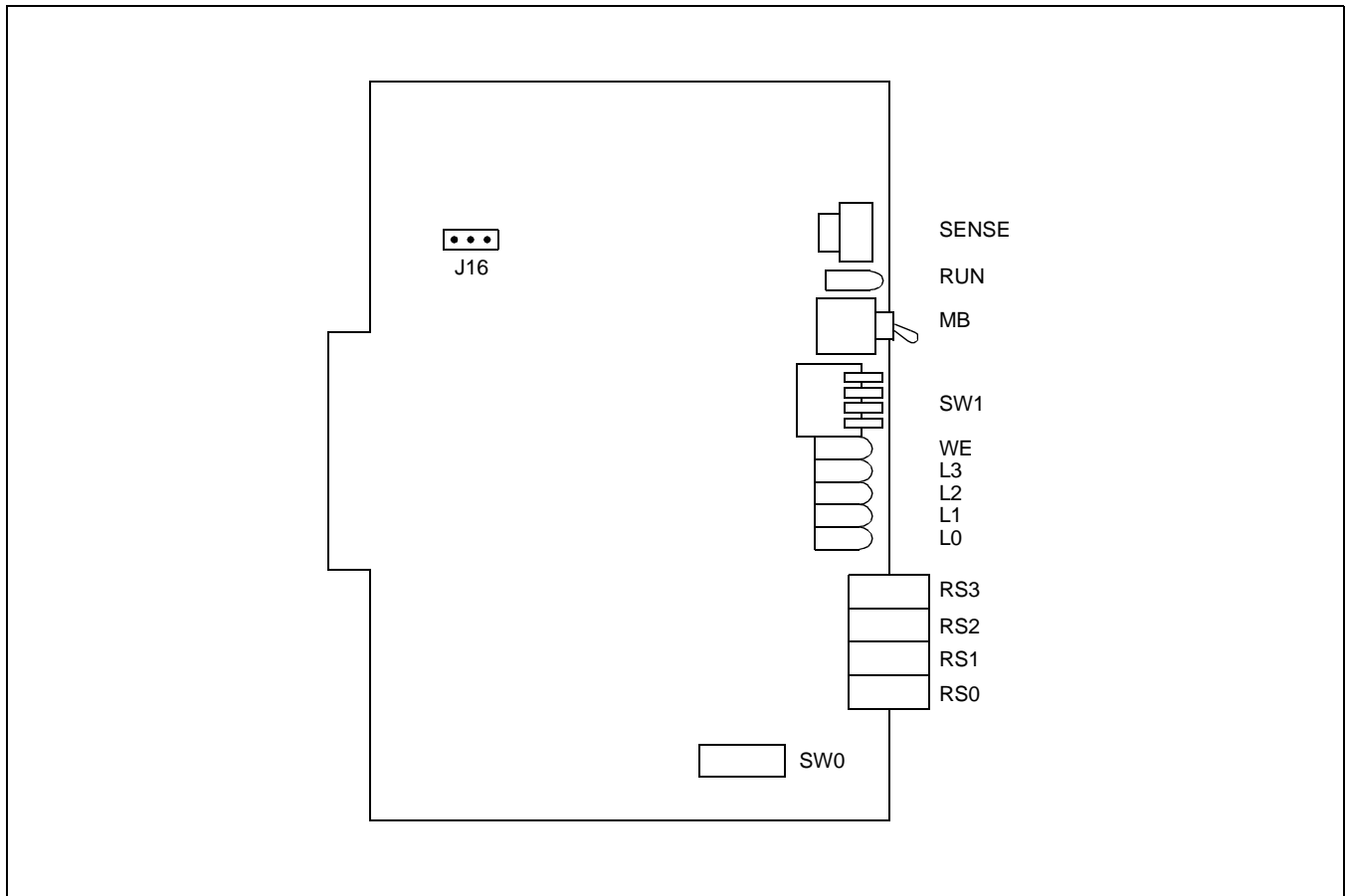

PN-AP00-A (AP00) Card

(2) Lamp Indications

Lamp Indications

LAMP NAME	COLOR	FUNCTION		
RUN	Green	Flashes at 120 IPM while this card is operating normally.		
WE	Red	Not used.		
L0 - L3	Green	Second data setting value for the first data 250 of CM D001		
		0	1 (port 0) - 3 (port 2)	
		L3	Indication of the transmitting status of port 0	Indication of the status of CTS signal on port 0 - 2
		L2	Indication of the transmitting status of port 1	Indication of the status of DCD signal on port 0 - 2
		L1	Indication of the transmitting status of port 2	Indication of the status of TXD signal on port 0 - 2
		L0	Indication of the transmitting status of port 3	Indication of the status of RXD signal on port 0 - 2

(3) Switch Settings

Switch Settings

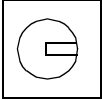
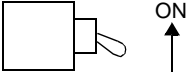
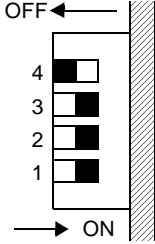
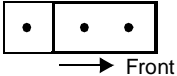
SWITCH NAME	SWITCH NUMBER	SETTING POSITION	FUNCTION	CHECK																											
SENSE (Rotary SW)  Note 1	4 - F	Set the switch to match the AP Number (04 - 15) to be set by CM05.																													
		<table border="1"> <tr> <td>AP NO.</td> <td>04</td> <td>05</td> <td>06</td> <td>07</td> <td>08</td> <td>09</td> <td>10</td> <td>11</td> <td>12</td> <td>13</td> <td>14</td> <td>15</td> </tr> <tr> <td>SW NO.</td> <td>4</td> <td>5</td> <td>6</td> <td>7</td> <td>8</td> <td>9</td> <td>A</td> <td>B</td> <td>C</td> <td>D</td> <td>E</td> <td>F</td> </tr> </table>				AP NO.	04	05	06	07	08	09	10	11	12	13	14	15	SW NO.	4	5	6	7	8	9	A	B	C	D	E	F
		AP NO.	04	05		06	07	08	09	10	11	12	13	14	15																
SW NO.	4	5	6	7	8	9	A	B	C	D	E	F																			
0 - 3	Not used																														
MB (Toggle SW)  Note 2		UP	For make-busy																												
		DOWN	For normal operation																												
SW1 (Piano Key SW) 	1	ON	For normal operation																												
		OFF	Not used																												
	2	ON	For normal operation																												
		OFF	For AP data clearing by CMD100/CMD101																												
	3	ON	For normal operation																												
		OFF	For AP data clearing by CMD100/CMD101																												
	4	OFF	Always set to OFF																												
	J16 (Jumper pin) 		RIGHT	Memory backup ON																											
LEFT			Memory backup OFF																												

Switch Settings (Continued)

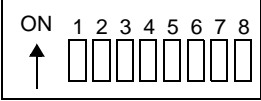
SWITCH NAME	SWITCH NUMBER	SETTING POSITION	FUNCTION	CHECK
SW0 (Dip SW) 	1 Note 3	ON	Enables the receive clock from the DCE (Modem) side when the No. 0 Port is synchronous. (Clock is received at the RXC terminal.)	
		OFF	<ul style="list-style-type: none"> • Uses the internal clock as the receive clock when the No. 0 Port is synchronous • When the No. 0 Port is asynchronous 	
	2	ON	Enables transmit clock from the DCE (Modem) side when the No. 0 Port is synchronous. (Clock is received at the TXC (2) terminal.)	
		OFF	<ul style="list-style-type: none"> • Uses the internal clock as the send clock when the No. 0 Port is synchronous • When the No. 0 Port is asynchronous 	
	3	ON	For transmitting the send clock from the DTE (this card) when the No. 0 Port is synchronous. (Clock is transmitted from the TXC (1) terminal.)	
		OFF	<ul style="list-style-type: none"> • For not transmitting the send clock from the DTE (this card) side when the No. 0 Port is synchronous • When the No. 0 Port is asynchronous 	
	4	ON	When the No. 0 Port is asynchronous	
		OFF	When the No. 0 Port is synchronous	

Switch Settings (Continued)

SWITCH NAME	SWITCH NUMBER	SETTING POSITION	FUNCTION	CHECK
SW0	5 Note 4	ON	<ul style="list-style-type: none"> • Uses the internal clock as the receive clock when the No. 0 Port is synchronous. • When the No. 0 Port is asynchronous. 	
		OFF	Enables receive clock from the DCE (Modem) side when the No. 0 Port is synchronous. (Clock is received at the RXC terminal)	
	6 Note 5	ON	Set No. 0 port forcibly in a state which DSR signal is always provided. Force DSR signal high for port 0. No SMDR buffering.	
		OFF	Receive DSR signal from the DCE on No. 0 port. Detect DSR signal from DCE for port 0. Allows SMDR records to buffer.	
	7 Note 5	ON	Set No. 1 port forcibly in a state which DSR signal is always provided. Force DSR signal high for port 1. No SMDR buffering.	
		OFF	Receive DSR signal from the DCE on No. 1 port. Detect DSR signal from DCE for port 1. Allows SMDR records to buffer.	
	8 Note 5	ON	Set No. 2 port forcibly in a state which DSR signal is always provided. Force DSR signal high for port 2. No SMDR buffering.	
		OFF	Receive DSR signal from the DCE on No. 2 port. Detect DSR signal from DCE for port 2. Allows SMDR records to buffer.	

The figure in the SWITCH NAME column and the position in in the SETTING POSITION column indicate the standard setting of the switch. When the switch is not set as shown by the figure and , the setting of the switch varies with the system concerned.

PN-AP00-A (AP00)

Note 1: *Set the groove on the switch knob to the desired switch position.*

Note 2: *When the power is on, flip the MB switch to ON (UP position) before plugging/unplugging the circuit card.*

Note 3: *The SW 1 is used to select the AP operating mode as shown below.*

SWITCH	ON LINE	OFF LINE
SW 1-4	OFF	OFF
SW 1-3	ON	OFF
SW 1-2	ON	OFF
SW 1-1	ON	ON

On line : Normal operating mode. The AP should be always in the “On line”, other than when you delete the AP data.

Off line : The mode for AP data clearing by the command CMD100/CMD101.

Note 4: *The use of the external clock (from the distant end) or the internal clock is determined by the following table:*

CLOCK	SW0	
	1	5
External	ON	OFF
Internal	OFF	ON

Note 5: *When the DCE connected to the port does not provide a function to send the DSR signals, set the switch to ON. In this case, the AP00 card can not recognize the actual state of the DCE, so that the call records or system messages will not be stored in the memory buffer on the AP00 card even if the cable is disconnected from the DCE.*

When the switch is set to OFF, the call records or system messages will be stored when the cable is disconnected, and will be sent when the cable is re-connected.

PN-AP01 (AP01)

1. Locations of Lamps, Switches, and Connectors

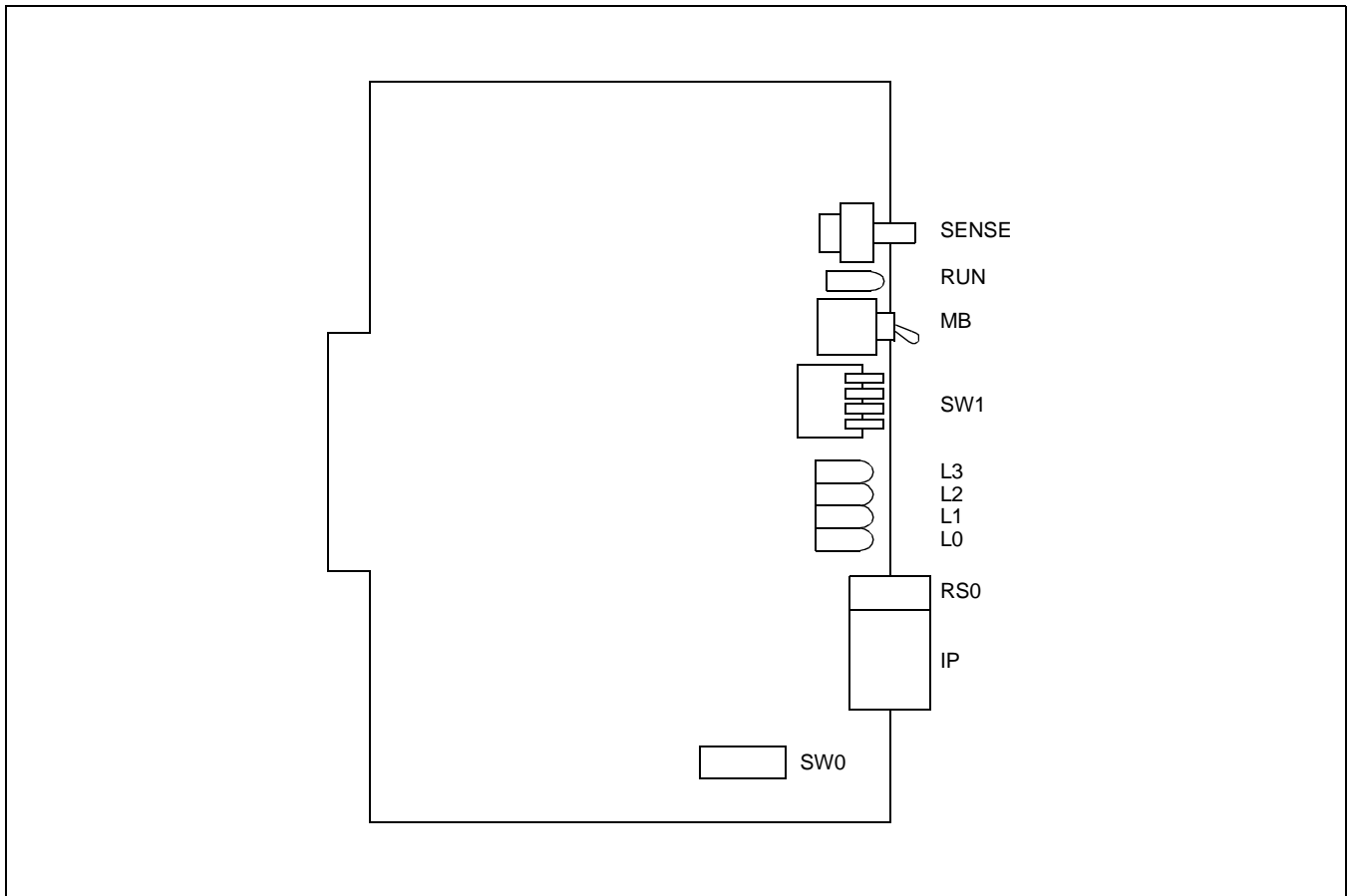

PN-AP01 (AP01) Card

2. Lamp Indications

Lamp Indications

LAMP NAME		COLOR	FUNCTION
RUN		Green	Flashes at 120 IPM while this card is operating normally.
L0-L3	L3	Green	Indication of the status of CTS signal on the RS-232C port.
	L2		Indication of the status of DCD signal on the RS-232C port.
	L1		Indication of the status of TXD signal on the RS-232C port
	L0		Indication of the status of RXD signal on the RS-232C port.

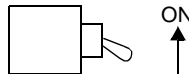
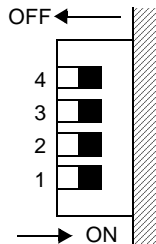

(3) Switch Settings

Switch Settings

SWITCH NAME	SWITCH NUMBER	SETTING POSITION	FUNCTION	CHECK																										
SENSE (Rotary SW)  Note 1	4 - F	Set the switch to match the AP Number (04 - 15) to be set by CM05.																												
	<table border="1"> <tr> <td>AP NO.</td> <td>04</td> <td>05</td> <td>06</td> <td>07</td> <td>08</td> <td>09</td> <td>10</td> <td>11</td> <td>12</td> <td>13</td> <td>14</td> <td>15</td> </tr> <tr> <td>SW NO.</td> <td>4</td> <td>5</td> <td>6</td> <td>7</td> <td>8</td> <td>9</td> <td>A</td> <td>B</td> <td>C</td> <td>D</td> <td>E</td> <td>F</td> </tr> </table>		AP NO.	04	05	06	07	08	09	10	11	12	13	14	15	SW NO.	4	5	6	7	8	9	A	B	C	D	E	F		
	AP NO.	04	05	06	07	08	09	10	11	12	13	14	15																	
SW NO.	4	5	6	7	8	9	A	B	C	D	E	F																		
0 - 3	Not used																													
MB(Toggle SW)  Note 2		UP	For make-busy																											
		DOWN	For normal operation																											
SW1 (Piano Key SW) 	1	ON	For normal operation																											
		OFF	Not used																											
	2	ON	For normal operation																											
		OFF	Not used																											
	3	ON	For normal operation																											
		OFF	Not used																											
	4	ON	For normal operation																											
		OFF	Not used																											

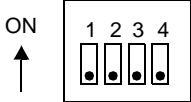
Switch Settings (Continued)

SWITCH NAME	SWITCH NUMBER	SETTING POSITION	FUNCTION	CHECK
SW0 (Dip SW) 	1	OFF	Always set to OFF	
	2	OFF	Always set to OFF	
	3	OFF	Always set to OFF	
	4	OFF	Always set to OFF	

The figure in the SWITCH NAME column and the position in  in the SETTING POSITION column indicate the standard setting of the switch. When the switch is not set as shown by the figure and , the setting of the switch varies with the system concerned.

Note 1: Set the groove on the switch knob to the desired switch position.

Note 2: When the power is on, flip the MB switch to ON (UP position) before plugging/unplugging the circuit card.

PN-BRTA (BRI)

PN-BRTA (BRI)

1. Locations of Lamps, Switches, and Connectors

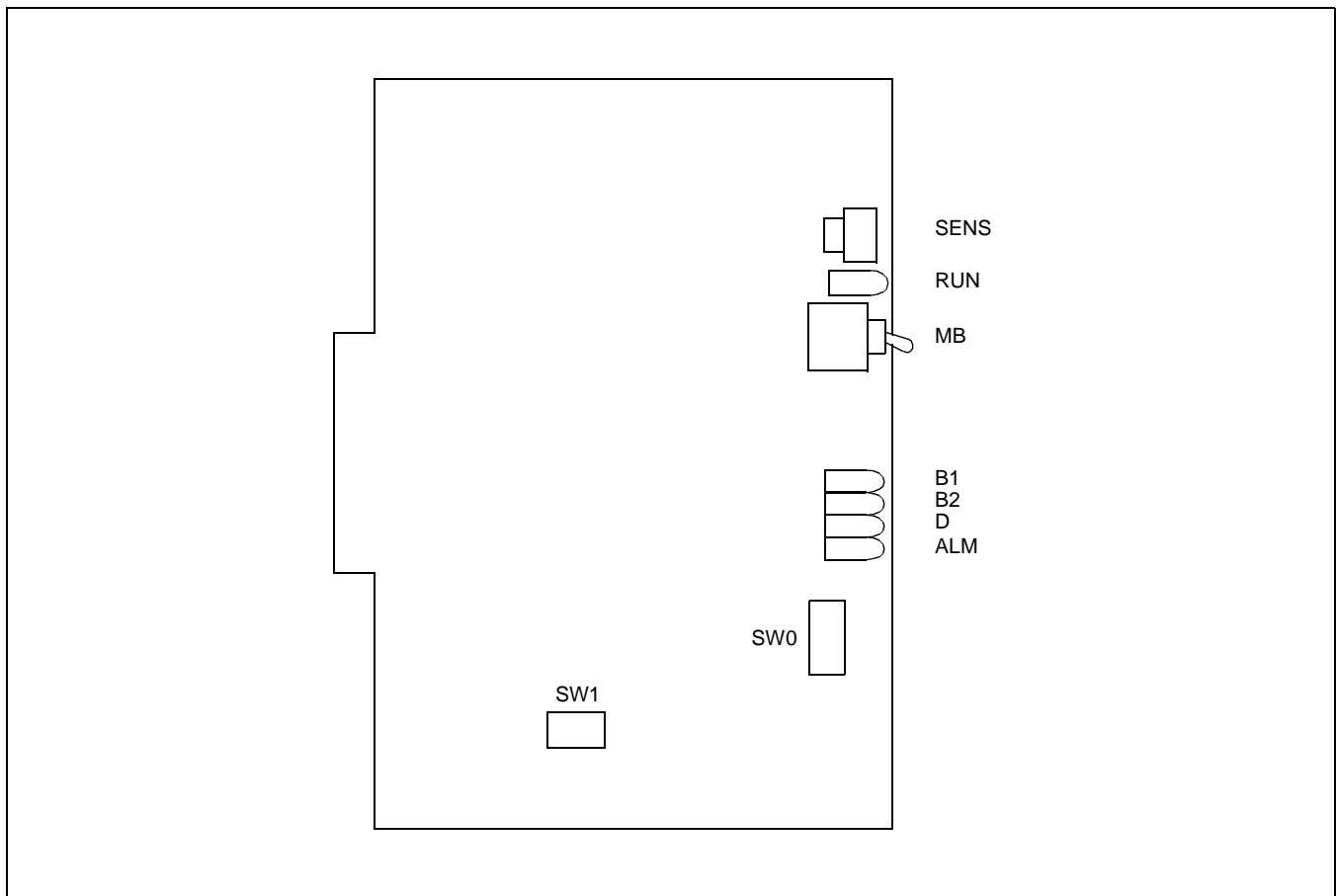

PN-BRTA (BRI) Card

(2) Lamp Indications

Lamp Indications on the PN-BRTA (BRI) Card



LAMP NAME	COLOR	FUNCTION
RUN	Green	Flashes at 120 IPM while this card is operating normally.
B1	Green	B1 channel status ON: Busy OFF: Idle Flash (60 IPM):Make Busy
B2	Green	B2 channel status ON: Busy OFF: Idle Flash (60 IPM):Make Busy
D	Green	D channel status ON: Busy OFF: Idle
ALM	Red	Transmission line fault status ON: Line fault OFF: Normal operation

PN-BRTA (BRI)

(3) Switch Settings

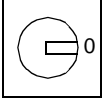
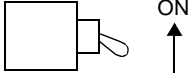
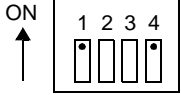
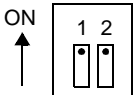
Switch Settings on the PN-BRTA (BRI) Card

SWITCH NAME	SWITCH NUMBER	SETTING POSITION	FUNCTION	CHECK																											
SENS (Rotary SW)  Note 1	4 - F	Set the switch to match the AP Number (04 - 15) as set by CM05.																													
	<table border="1"> <tr> <td>AP NO.</td> <td>04</td> <td>05</td> <td>06</td> <td>07</td> <td>08</td> <td>09</td> <td>10</td> <td>11</td> <td>12</td> <td>13</td> <td>14</td> <td>15</td> </tr> <tr> <td>SW NO.</td> <td>4</td> <td>5</td> <td>6</td> <td>7</td> <td>8</td> <td>9</td> <td>A</td> <td>B</td> <td>C</td> <td>D</td> <td>E</td> <td>F</td> </tr> </table>		AP NO.		04	05	06	07	08	09	10	11	12	13	14	15	SW NO.	4	5	6	7	8	9	A	B	C	D	E	F		
	AP NO.	04	05		06	07	08	09	10	11	12	13	14	15																	
SW NO.	4	5	6	7	8	9	A	B	C	D	E	F																			
0 - 3	Not used																														
MB (Toggle SW)  Note 2	/	UP	For make-busy																												
		DOWN	For normal operation																												
SW0 (Dip SW)  Note 3	1	ON	For normal operation (BRI mode)																												
		OFF	Not used																												
	2	ON	Clock signal from a master office is sent to the PLO of MP card according to the switch setting of SW0-3.																												
		OFF	Clock signal from a master office is not sent to the PLO of MP card.																												
	3	ON	Clock signal is sent to PLO 0 of MP card.																												
		OFF	Clock signal is sent to PLO 1 of MP card.																												
	4	ON	For normal operation																												
		OFF	Not used																												
SW1 (Dip SW) 	1	ON	For terminating the transmitting side of channels B1 and B2 with 100 ohms.																												
		OFF	To remove the terminating resistor on the transmitting side of channels B1 and B2.																												
	2	ON	For terminating the receiving side of channels B1 and B2 with 100 ohms.																												
		OFF	To remove the terminating resistor on the receiving side of channels B1 and B2.																												

The figure in the SWITCH NAME column and the position in  in the SETTING POSITION column indicate the standard setting of the switch. When the switch is not set as shown by the figure and , the setting of the switch varies with the system concerned.

Note 1: Set the groove on the switch knob to the desired switch position.

Note 2: When the power is on, set the MB switch to ON (UP position) before plugging/unplugging the circuit card.

Note 3: Set SW0-2 and SW0-3 as follows.

No. of BRI SW CONDITIONS	BRI 0		BRI 1		BRI 2		BRI 11		REMARKS	
	SW 0-2	SW 0-3	SW 0-2	SW 0-3	SW 0-2	SW 0-3	SW 0-2	SW 0-3		
When one BRI is provided.	ON	ON									The MP card will receive the clock signal from BRI 0 at its PLO 0 input.
When more than one BRI is provided.	ON	ON	ON	OFF	OFF	ON	OFF	ON	The MP card will receive the clock signal from BRI 0 at its PLO 0 input under normal conditions. Should a clock failure occur on BRI 0, the MP card will automatically switch to the PLO 1 input, and so derive the clock from BRI 1.	

PN-2BRTC (BRI)

PN-2BRTC (BRI)

1. Locations of Lamps, Switches, and connectors

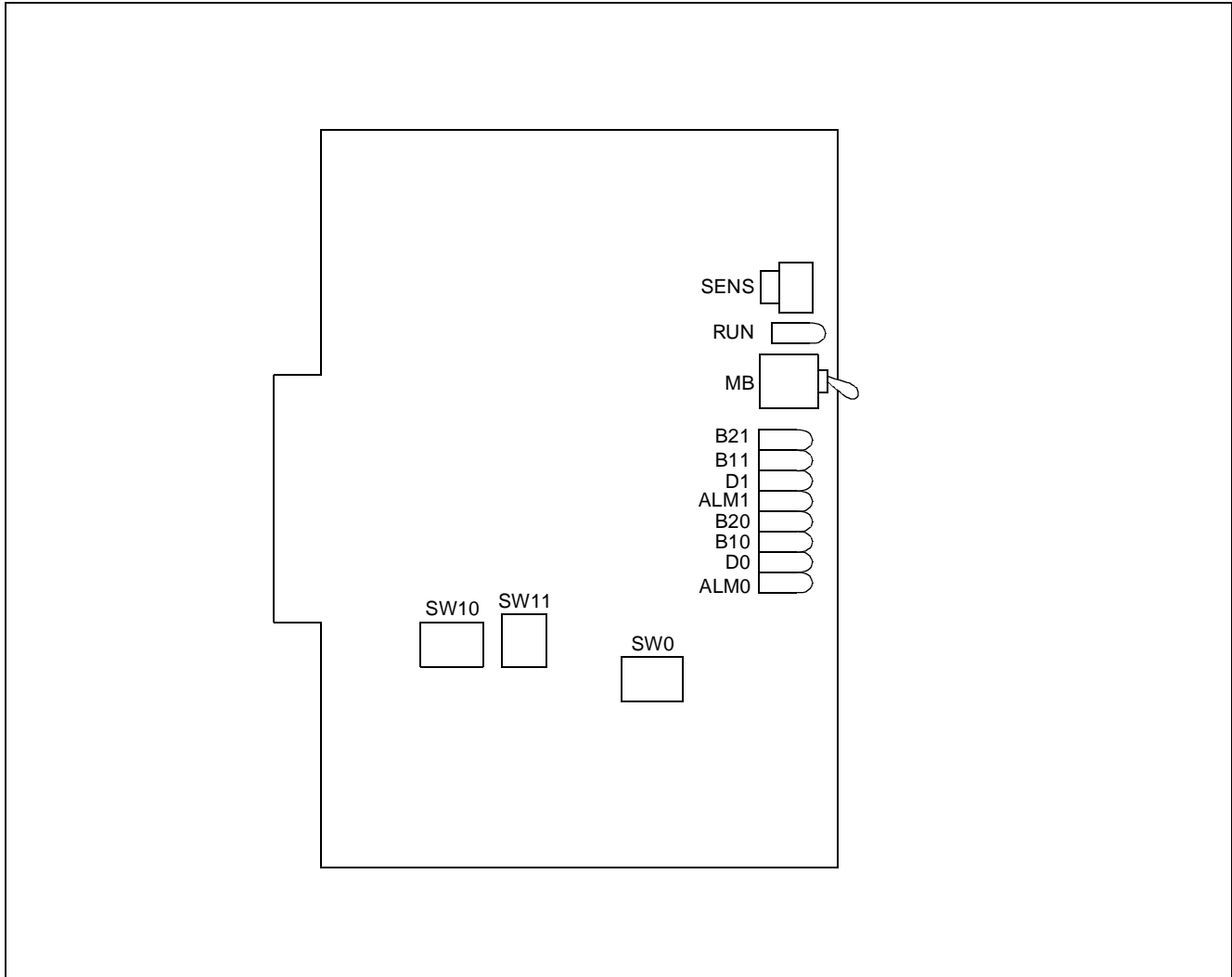

PN-2BRTC (BRI) Card

2. Lamp Indications

Lamp Indications

LAMP NAME	COLOR	FUNCTION	
RUN	Green	Flashes at 120 IPM while this card is operating normally.	
B21	Red	No.1 Circuit	B2 channel status ON: Busy OFF: Idle Flash (60 IPM): Make Busy
B11	Red		B1 channel status ON: Busy OFF: Idle Flash (60 IPM): Make Busy
D1	Green		D channel status ON: Busy OFF: Idle
ALM1	Red		Transmission line fault status ON: Line fault OFF: Normal operation
B20	Red		No.0 Circuit
B10	Red	B1 channel status ON: Busy OFF: Idle Flash (60 IPM): Make Busy	
D0	Green	D channel status ON: Busy OFF: Idle	
ALM0	Red	Transmission line fault status ON: Line fault OFF: Normal operation	

3. Switch Settings

Switch Settings

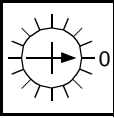
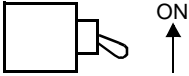
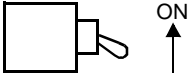
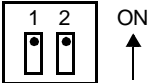
SWITCH NAME	SWITCH NUMBER	SETTING POSITION	FUNCTION	CHECK																									
SENS (Rotary SW) 	4 ~ F	Set the switch to match the AP Number (04-15) as set by CM05.																											
	<table border="1" data-bbox="431 474 1305 564"> <tr> <td>AP No.</td> <td>04</td><td>05</td><td>06</td><td>07</td><td>08</td><td>09</td><td>10</td><td>11</td><td>12</td><td>13</td><td>14</td><td>15</td> </tr> <tr> <td>SW No.</td> <td>4</td><td>5</td><td>6</td><td>7</td><td>8</td><td>9</td><td>A</td><td>B</td><td>C</td><td>D</td><td>E</td><td>F</td> </tr> </table>		AP No.		04	05	06	07	08	09	10	11	12	13	14	15	SW No.	4	5	6	7	8	9	A	B	C	D	E	F
AP No.	04	05	06	07	08	09	10	11	12	13	14	15																	
SW No.	4	5	6	7	8	9	A	B	C	D	E	F																	
Note 1 	0 ~ 3	Not used																											
MB (Toggle SW) 	/	UP	For make-busy																										
		DOWN	For normal operation																										
SW0, SW10 (Dip SW) 	1	ON	For terminating the transmitting side of channels B1 and B2 with 100 ohms.																										
		OFF	To remove the terminating resistor on the transmitting side of channels B1 and B2.																										
	2	ON	For terminating the receiving side of channels B1 and B2 with 100 ohms.																										
		OFF	To remove the terminating resistor on the receiving side of channels B1 and B2.																										

Switch Settings (Continued)

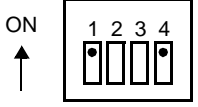
SWITCH NAME	SWITCH NUMBER	SETTING POSITION	FUNCTION	CHECK
SW11 (Dip SW) 	1	<input checked="" type="checkbox"/>	For normal operation (BRI mode)	
		OFF	Not used	
	2 Note 3	ON	Output clock signals according to the switch setting of SW11-3.	
		OFF	Do not output clock signals.	
	3 Note 3	ON	Output clock signals to PLO 0 of MP.	
		OFF	Output clock signals to PLO 1 of MP.	
	4	<input checked="" type="checkbox"/>	For normal operation	
		OFF	Not used	

The figure in the SWITCH NAME column and the position in in the SETTING POSITION column indicate the standard setting of the switch. When the switch is not set as shown by the figure and , the setting of the switch varies with the system concerned.

Note 1: Set the groove on the switch knob to the desired switch position.

Note 2: When the power is on, set the MB switch to ON (UP position) before plugging/unplugging the circuit card.

Note 3: The system can supply clock signals from two clock supply routes. In normal condition, the system synchronizes to the clock signals supplied on the PLO 0 of MP card via the Back Wiring Board, and if the clock signals are failed, the clock supply route takes over to PLO1 automatically. Set SW11-2 and SW11-3 as follows.

No. of BRI	BRI 0		BRI 1		BRI 2		----	BRI 11		REMARKS
	SW 11-2	SW 11-3	SW 11-2	SW 11-3	SW 11-2	SW 11-3	----	SW 11-2	SW 11-3	
When one BRI is provided.	ON	ON								The clock signals are supplied to the PLO through No. 0 circuit the BRI. If the clock supply route of No. 0 circuit is failed, the clock supply route of No. 1 circuit takes over automatically.
When more than one BRI is provided.	ON	ON	ON	OFF	OFF	ON	----	OFF	ON	The system can supply the clock signals from BRI 0 or BRI 1. The system is synchronized to the BRI 0 clock signals normally, and if both No. 0 circuit clock supply route and No. 1 circuit clock supply route is failed, the BRI 1 takes over.

PN-CC00 (ETHER)

PN-CC00 (ETHER)

1. Locations of Lamps, Switches, and Connectors

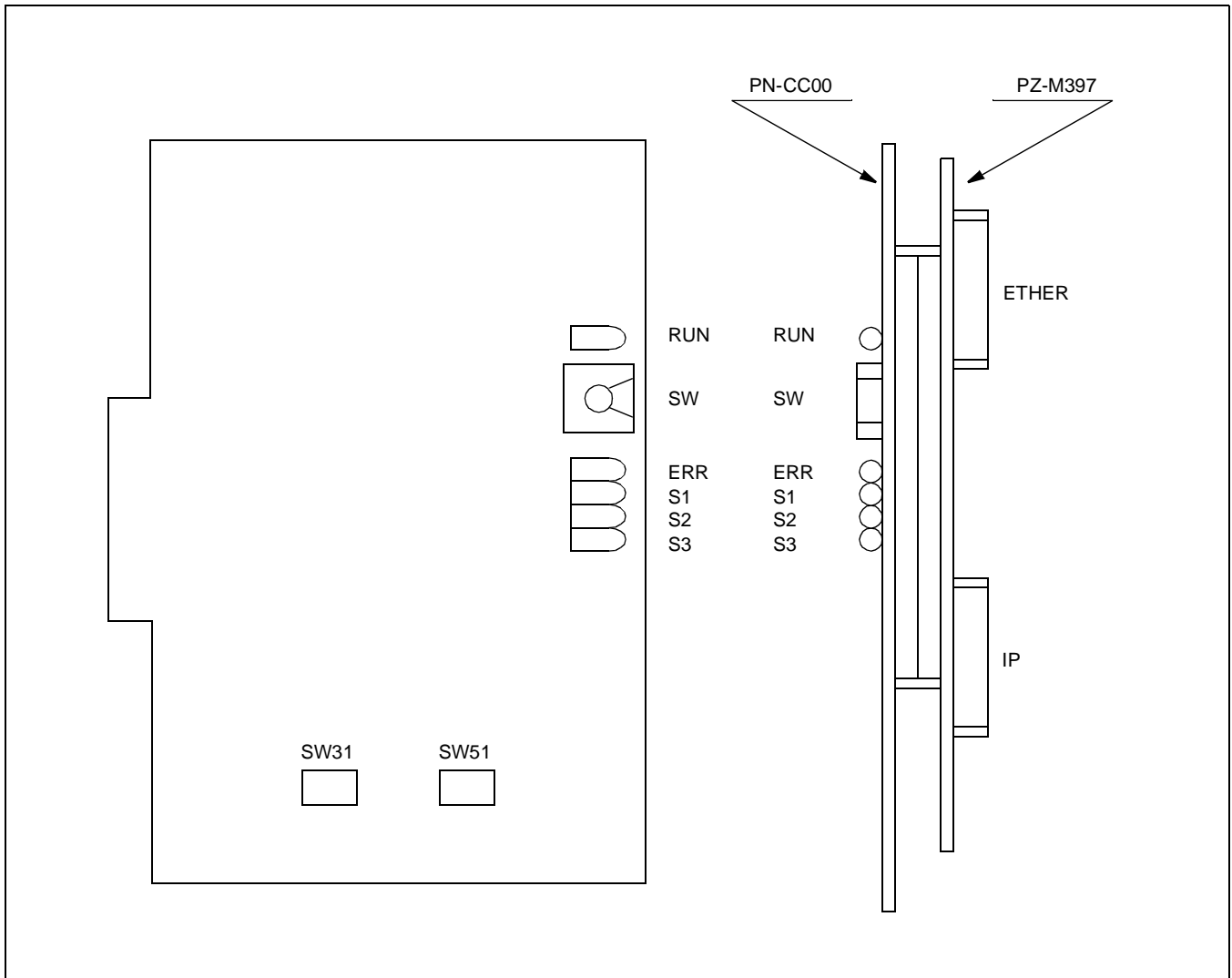

PN-CC00 (ETHER) Card

2. Lamp Indications

Lamp Indications

LAMP NAME	COLOR	FUNCTION
RUN	Green	Steadily lights while this card is operating normally.
ERR	Red	Flashes at 120 IPM when system error occurs.
S1	Green	Lights when it is transmitting or receiving the data.
S2	Green	Lights when it can transmit or receive the data.
S3	Green	Lights when the power sets ON.

PN-CC00 (ETHER)

(3) Switch Settings

Switch Settings

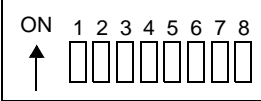
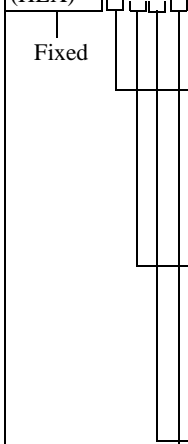
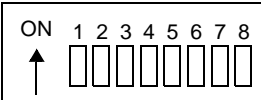
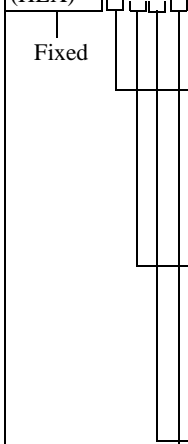
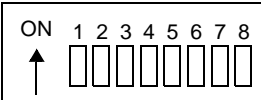
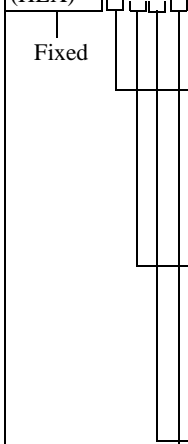
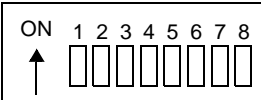
SWITCH NAME	SWITCH NUMBER	SETTING POSITION	FUNCTION	CHECK																																																																										
SW (Rotary SW) 		0	Always set to 0																																																																											
		1-F	Not used																																																																											
SW51 (Dip SW) <div style="border: 1px solid black; padding: 5px; display: inline-block;">  </div> <p>Note</p>	1 (D15)	ON	<table border="1"> <thead> <tr> <th colspan="2">MAC ADDRESS</th> <th colspan="2">SWITCH SETTING</th> </tr> </thead> <tbody> <tr> <td colspan="2">00003225 1 X X X (HEX)</td> <td colspan="2">ON:0 OFF:1</td> </tr> <tr> <td rowspan="4">  </td> <td>SW51-1 (D15)</td> <td>ON</td> </tr> <tr> <td>SW51-2 (D14)</td> <td>ON</td> </tr> <tr> <td>SW51-3 (D13)</td> <td>ON</td> </tr> <tr> <td>SW51-4 (D12)</td> <td>OFF</td> </tr> <tr> <td rowspan="4"> </td> <td>SW51-5 (D11)</td> <td>ON/OFF</td> </tr> <tr> <td>SW51-6 (D10)</td> <td>ON/OFF</td> </tr> <tr> <td>SW51-7 (D9)</td> <td>ON/OFF</td> </tr> <tr> <td>SW51-8 (D8)</td> <td>ON/OFF</td> </tr> <tr> <td rowspan="8">SW31 (Dip SW) <div style="border: 1px solid black; padding: 5px; display: inline-block;">  </div> <p>Note</p> </td> <td>1 (D7)</td> <td>ON</td> <td rowspan="8"> </td> <td></td> </tr> <tr> <td rowspan="2">2 (D6)</td> <td>ON</td> <td rowspan="2">SW31-1 (D7)</td> <td>ON/OFF</td> </tr> <tr> <td>OFF</td> <td>SW31-2 (D6)</td> <td>ON/OFF</td> </tr> <tr> <td rowspan="2">3 (D5)</td> <td>ON</td> <td rowspan="2">SW31-3 (D5)</td> <td>ON/OFF</td> </tr> <tr> <td>OFF</td> <td>SW31-4 (D4)</td> <td>ON/OFF</td> </tr> <tr> <td rowspan="2">4 (D4)</td> <td>ON</td> <td rowspan="2">SW31-5 (D3)</td> <td>ON/OFF</td> </tr> <tr> <td>OFF</td> <td>SW31-6 (D2)</td> <td>ON/OFF</td> </tr> <tr> <td rowspan="2">5 (D3)</td> <td>ON</td> <td rowspan="2">SW31-7 (D1)</td> <td>ON/OFF</td> </tr> <tr> <td>OFF</td> <td>SW31-8 (D0)</td> <td>ON/OFF</td> </tr> <tr> <td rowspan="2">6 (D2)</td> <td>ON</td> <td rowspan="2">7 (D1)</td> <td>ON</td> <td></td> </tr> <tr> <td>OFF</td> <td>OFF</td> <td></td> </tr> <tr> <td rowspan="2">7 (D1)</td> <td>ON</td> <td rowspan="2">8 (D0)</td> <td>ON</td> <td></td> </tr> <tr> <td>OFF</td> <td>OFF</td> <td></td> </tr> </tbody> </table>	MAC ADDRESS		SWITCH SETTING		00003225 1 X X X (HEX)		ON:0 OFF:1			SW51-1 (D15)	ON	SW51-2 (D14)	ON	SW51-3 (D13)	ON	SW51-4 (D12)	OFF		SW51-5 (D11)	ON/OFF	SW51-6 (D10)	ON/OFF	SW51-7 (D9)	ON/OFF	SW51-8 (D8)	ON/OFF	SW31 (Dip SW) <div style="border: 1px solid black; padding: 5px; display: inline-block;">  </div> <p>Note</p>	1 (D7)	ON			2 (D6)	ON	SW31-1 (D7)	ON/OFF	OFF	SW31-2 (D6)	ON/OFF	3 (D5)	ON	SW31-3 (D5)	ON/OFF	OFF	SW31-4 (D4)	ON/OFF	4 (D4)	ON	SW31-5 (D3)	ON/OFF	OFF	SW31-6 (D2)	ON/OFF	5 (D3)	ON	SW31-7 (D1)	ON/OFF	OFF	SW31-8 (D0)	ON/OFF	6 (D2)	ON	7 (D1)	ON		OFF	OFF		7 (D1)	ON	8 (D0)	ON		OFF	OFF	
	MAC ADDRESS			SWITCH SETTING																																																																										
	00003225 1 X X X (HEX)			ON:0 OFF:1																																																																										
		SW51-1 (D15)		ON																																																																										
		SW51-2 (D14)		ON																																																																										
		SW51-3 (D13)		ON																																																																										
		SW51-4 (D12)		OFF																																																																										
		SW51-5 (D11)		ON/OFF																																																																										
		SW51-6 (D10)		ON/OFF																																																																										
		SW51-7 (D9)		ON/OFF																																																																										
		SW51-8 (D8)		ON/OFF																																																																										
	SW31 (Dip SW) <div style="border: 1px solid black; padding: 5px; display: inline-block;">  </div> <p>Note</p>	1 (D7)		ON																																																																										
2 (D6)		ON	SW31-1 (D7)	ON/OFF																																																																										
		OFF		SW31-2 (D6)		ON/OFF																																																																								
3 (D5)		ON	SW31-3 (D5)	ON/OFF																																																																										
		OFF		SW31-4 (D4)		ON/OFF																																																																								
4 (D4)		ON	SW31-5 (D3)	ON/OFF																																																																										
		OFF		SW31-6 (D2)		ON/OFF																																																																								
5 (D3)		ON	SW31-7 (D1)	ON/OFF																																																																										
	OFF	SW31-8 (D0)		ON/OFF																																																																										
6 (D2)	ON	7 (D1)	ON																																																																											
	OFF		OFF																																																																											
7 (D1)	ON	8 (D0)	ON																																																																											
	OFF		OFF																																																																											

Note: Each equipment must have a unique MAC address to distinguish between systems. Therefore, when more than one PBX is installed in the same network, assign the lower 3 digits of the following MAC address by SW31 and SW51 to prevent duplicate addresses.

000032251 XXX (HEX)

Fixed

According to the switch setting of SW51 (D11-D8) and SW31 (D7-D0).

PN-CC01 (ETHER)

1. Location of Lamps, Switches, and Connectors

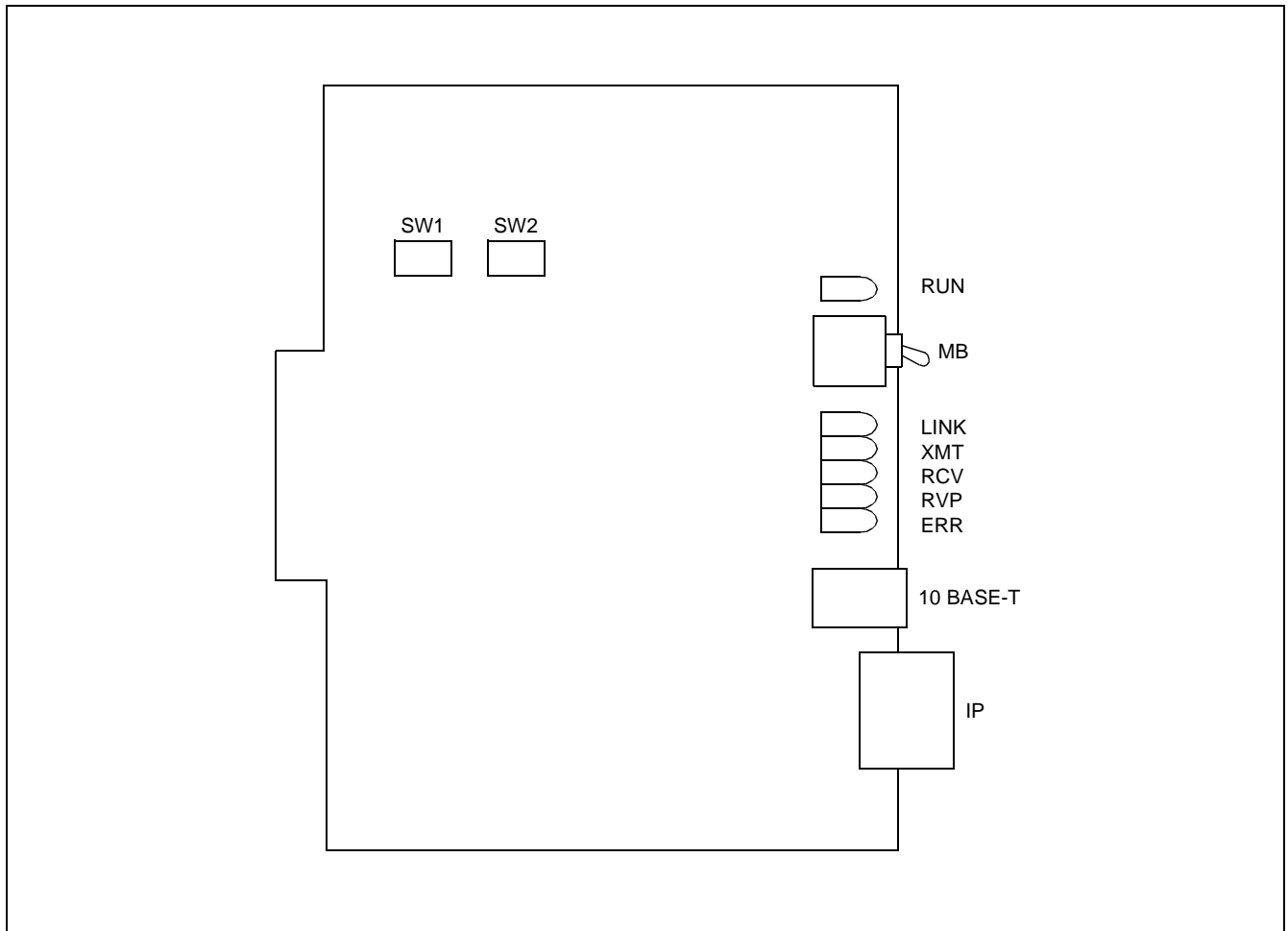

PN-CC01 (ETHER) Card

2. Lamp Indications

Lamp Indications

LAMP NAME	COLOR	FUNCTION
RUN	Green	Flashes at 60 IPM while this card is operating normally.
LINK	Green	Lights when link is established.
XMT	Green	Lights when it is transmitting the data.
RCV	Green	Lights when it is receiving the data.
RVP	Green	Lights only when it is receiving the data with its own IP address.
ERR	—	Not used

3. Switch Settings

Switch Settings

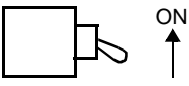
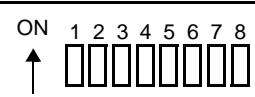
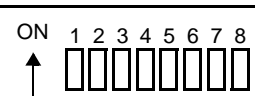
SWITCH NAME	SWITCH NUMBER	SETTING POSITION	FUNCTION	CHECK																																																						
MB (Toggle SW)  Note 1	/	UP	For make-busy																																																							
		DOWN	For normal operation																																																							
SW1 (Dip SW)  Note 2	1 (D15)	ON	<table border="1" style="width: 100%; border-collapse: collapse;"> <thead> <tr> <th colspan="2" style="text-align: center;">MAC ADDRESS</th> <th colspan="2" style="text-align: center;">SWITCH SETTING</th> </tr> <tr> <th colspan="2" style="text-align: center;">00004CA4 X X X X (HEX)</th> <th colspan="2" style="text-align: center;">ON: 0 OFF: 1</th> </tr> </thead> <tbody> <tr> <td rowspan="4" style="vertical-align: middle;">Fixed</td> <td style="text-align: center;"> </td> <td rowspan="4" style="vertical-align: middle;">}</td> <td>SW1-1 (D15)</td> <td>ON/OFF</td> </tr> <tr> <td style="text-align: center;"> </td> <td>SW1-2 (D14)</td> <td>ON/OFF</td> </tr> <tr> <td style="text-align: center;"> </td> <td>SW1-3 (D13)</td> <td>ON/OFF</td> </tr> <tr> <td style="text-align: center;"> </td> <td>SW1-4 (D12)</td> <td>ON/OFF</td> </tr> <tr> <td rowspan="4" style="vertical-align: middle;">}</td> <td rowspan="4" style="vertical-align: middle;">}</td> <td>SW1-5 (D11)</td> <td>ON/OFF</td> </tr> <tr> <td>SW1-6 (D10)</td> <td>ON/OFF</td> </tr> <tr> <td>SW1-7 (D9)</td> <td>ON/OFF</td> </tr> <tr> <td>SW1-8 (D8)</td> <td>ON/OFF</td> </tr> <tr> <td rowspan="4" style="vertical-align: middle;">}</td> <td rowspan="4" style="vertical-align: middle;">}</td> <td>SW2-1 (D7)</td> <td>ON/OFF</td> </tr> <tr> <td>SW2-2 (D6)</td> <td>ON/OFF</td> </tr> <tr> <td>SW2-3 (D5)</td> <td>ON/OFF</td> </tr> <tr> <td>SW2-4 (D4)</td> <td>ON/OFF</td> </tr> <tr> <td rowspan="4" style="vertical-align: middle;">}</td> <td rowspan="4" style="vertical-align: middle;">}</td> <td>SW2-5 (D3)</td> <td>ON/OFF</td> </tr> <tr> <td>SW2-6 (D2)</td> <td>ON/OFF</td> </tr> <tr> <td>SW2-7 (D1)</td> <td>ON/OFF</td> </tr> <tr> <td>SW2-8 (D0)</td> <td>ON/OFF</td> </tr> </tbody> </table>	MAC ADDRESS		SWITCH SETTING		00004CA4 X X X X (HEX)		ON: 0 OFF: 1		Fixed		}	SW1-1 (D15)	ON/OFF		SW1-2 (D14)	ON/OFF		SW1-3 (D13)	ON/OFF		SW1-4 (D12)	ON/OFF	}	}	SW1-5 (D11)	ON/OFF	SW1-6 (D10)	ON/OFF	SW1-7 (D9)	ON/OFF	SW1-8 (D8)	ON/OFF	}	}	SW2-1 (D7)	ON/OFF	SW2-2 (D6)	ON/OFF	SW2-3 (D5)	ON/OFF	SW2-4 (D4)	ON/OFF	}	}	SW2-5 (D3)	ON/OFF	SW2-6 (D2)	ON/OFF	SW2-7 (D1)	ON/OFF	SW2-8 (D0)	ON/OFF	2 (D14)	ON	
	MAC ADDRESS			SWITCH SETTING																																																						
	00004CA4 X X X X (HEX)			ON: 0 OFF: 1																																																						
	Fixed			}	SW1-1 (D15)	ON/OFF																																																				
					SW1-2 (D14)	ON/OFF																																																				
					SW1-3 (D13)	ON/OFF																																																				
					SW1-4 (D12)	ON/OFF																																																				
	}	}		SW1-5 (D11)	ON/OFF																																																					
				SW1-6 (D10)	ON/OFF																																																					
				SW1-7 (D9)	ON/OFF																																																					
				SW1-8 (D8)	ON/OFF																																																					
	}	}		SW2-1 (D7)	ON/OFF																																																					
				SW2-2 (D6)	ON/OFF																																																					
				SW2-3 (D5)	ON/OFF																																																					
				SW2-4 (D4)	ON/OFF																																																					
	}	}		SW2-5 (D3)	ON/OFF																																																					
SW2-6 (D2)			ON/OFF																																																							
SW2-7 (D1)			ON/OFF																																																							
SW2-8 (D0)			ON/OFF																																																							
3 (D13)	ON																																																									
4 (D12)	OFF																																																									
5 (D11)	ON																																																									
	OFF																																																									
6 (D10)	ON																																																									
	OFF																																																									
7 (D9)	ON																																																									
	OFF																																																									
8 (D8)	ON																																																									
	OFF																																																									
SW2 (Dip SW)  Note 2	1 (D7)	ON																																																								
	2 (D6)	OFF																																																								
		ON																																																								
	3 (D5)	ON																																																								
		OFF																																																								
	4 (D4)	ON																																																								
		OFF																																																								
	5 (D3)	ON																																																								
OFF																																																										
6 (D2)	ON																																																									
	OFF																																																									
7 (D1)	ON																																																									
	OFF																																																									
8 (D0)	ON																																																									
	OFF																																																									

Note 1: When the power is on, set the MB switch to ON (UP position) before plugging/unplugging the Circuit card.

Note 2: Each equipment must have a unique MAC address to distinguish between systems. Therefore, when more than one PBX is installed in the same network, assign the lower 4 digits of the following MAC address by SW1 and SW2 to prevent duplicate addresses.

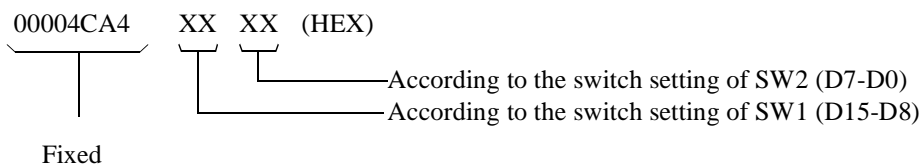

This page is for your notes.

PN-CK00 (PLO)

1. Locations of Lamps, Switches, and Connectors

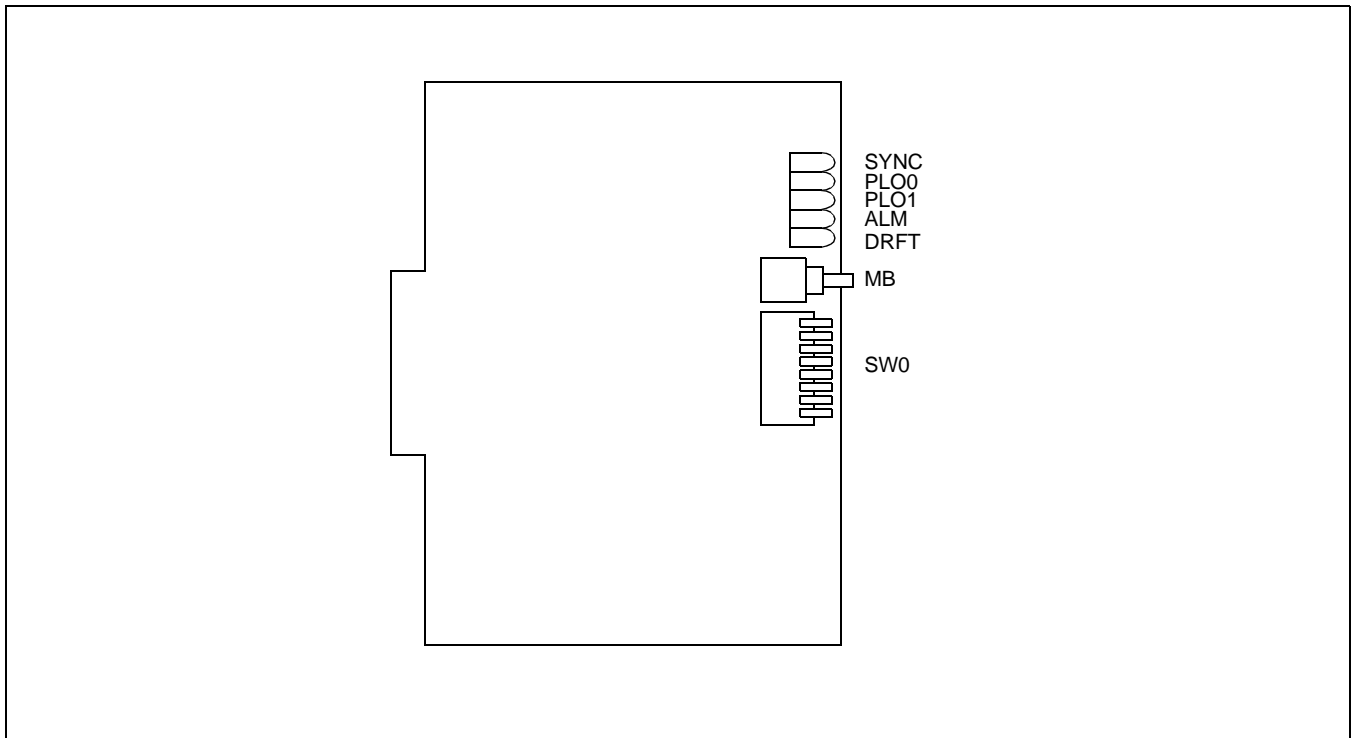

PN-CK00 (PLO) Card

2. Lamp Indications

Lamp Indications

LAMP NAME	COLOR	FUNCTION
SYNC	Green	Lights while clock signals from this card are sent out and are not DRIFT status.
PLO0	Green	Lights while receiving clock signals from the network to the PLO0 input on this card.
PLO1	Green	Lights while receiving clock signals from the network to the PLO1 input on this card.
ALM	Red	Lights while clock signal from this card are not sent out.
DRFT	Red	Lights while clock signals are DRIFT status.



DRIFT: Means the status which the oscillation of clock signal from the PN-CK00 is not synchronized with the network.

PN-CK00 (PLO)

(3) Switch Settings

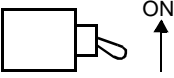
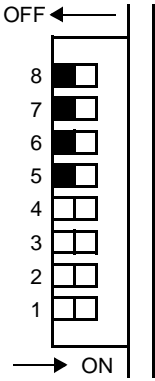
Switch Settings

SWITCH NAME	SWITCH NUMBER	SETTING POSITION	FUNCTION	CHECK																	
MB (Toggle SW)  Note	/	UP	For make-busy																		
		DOWN	For normal operation																		
SW0 (Piano Key SW) 	1, 2	Selection of PLO 0 (Phase Locked Oscillator)																			
		<table border="1" style="width: 100%; border-collapse: collapse;"> <thead> <tr> <th colspan="2">SWITCH NUMBER</th> <th rowspan="2">FUNCTION</th> </tr> <tr> <th>1</th> <th>2</th> </tr> </thead> <tbody> <tr> <td style="text-align: center;">ON</td> <td style="text-align: center;">ON</td> <td>2 MHz clock [For PN-30DTC/PN-30DTC-A/ PN-2BRTC]</td> </tr> <tr> <td style="text-align: center;">OFF</td> <td style="text-align: center;">ON</td> <td>1.5 MHz clock [For PN-24DTA/PN-24DTA-A]</td> </tr> <tr> <td style="text-align: center;">ON</td> <td style="text-align: center;">OFF</td> <td>192 kHz clock [For PN-BRTA]</td> </tr> <tr> <td style="text-align: center;">OFF</td> <td style="text-align: center;">OFF</td> <td>Not used</td> </tr> </tbody> </table>			SWITCH NUMBER		FUNCTION	1	2	ON	ON	2 MHz clock [For PN-30DTC/PN-30DTC-A/ PN-2BRTC]	OFF	ON	1.5 MHz clock [For PN-24DTA/PN-24DTA-A]	ON	OFF	192 kHz clock [For PN-BRTA]	OFF	OFF	Not used
SWITCH NUMBER		FUNCTION																			
1	2																				
ON	ON	2 MHz clock [For PN-30DTC/PN-30DTC-A/ PN-2BRTC]																			
OFF	ON	1.5 MHz clock [For PN-24DTA/PN-24DTA-A]																			
ON	OFF	192 kHz clock [For PN-BRTA]																			
OFF	OFF	Not used																			
	3, 4	Selection of PLO 1 (Phase Locked Oscillator)																			
		<table border="1" style="width: 100%; border-collapse: collapse;"> <thead> <tr> <th colspan="2">SWITCH NUMBER</th> <th rowspan="2">FUNCTION</th> </tr> <tr> <th>3</th> <th>4</th> </tr> </thead> <tbody> <tr> <td style="text-align: center;">ON</td> <td style="text-align: center;">ON</td> <td>2 MHz clock [For PN-30DTC/PN-30DTC-A/ PN-2BRTC]</td> </tr> <tr> <td style="text-align: center;">OFF</td> <td style="text-align: center;">ON</td> <td>1.5 MHz clock [For PN-24DTA/PN-24DTA-A]</td> </tr> <tr> <td style="text-align: center;">ON</td> <td style="text-align: center;">OFF</td> <td>192 kHz clock [For PN-BRTA]</td> </tr> <tr> <td style="text-align: center;">OFF</td> <td style="text-align: center;">OFF</td> <td>Not used</td> </tr> </tbody> </table>			SWITCH NUMBER		FUNCTION	3	4	ON	ON	2 MHz clock [For PN-30DTC/PN-30DTC-A/ PN-2BRTC]	OFF	ON	1.5 MHz clock [For PN-24DTA/PN-24DTA-A]	ON	OFF	192 kHz clock [For PN-BRTA]	OFF	OFF	Not used
SWITCH NUMBER		FUNCTION																			
3	4																				
ON	ON	2 MHz clock [For PN-30DTC/PN-30DTC-A/ PN-2BRTC]																			
OFF	ON	1.5 MHz clock [For PN-24DTA/PN-24DTA-A]																			
ON	OFF	192 kHz clock [For PN-BRTA]																			
OFF	OFF	Not used																			
	5 ~ 7	OFF	Not used																		
	8	ON	PLO frequency hold circuit OFF																		
		OFF	PLO frequency hold circuit ON																		

The figure in the SWITCH NAME column and the position in  in the SETTING POSITION column indicate the standard setting of the switch. When the switch is not set as shown by the figure and , the setting of the switch varies with the system concerned.

Note 1: When the power is on, flip the MB switch ON (UP position) before plugging/unplugging the circuit card.

Note 2: When using this card, set the SW2 switch on the PN-CP00/PN-CP00-B/PN-CP03 (MP) as follows.

SW2-2: OFF

SW2-3: ON

Note 3: When using this card for providing a master office clock signal, set the SW0 switch on the PN-CK00 and the SW switch on the PN-24DTA/PN-24DTA-A or the PN-30DTC/PN-30DTC-A mounted in PIM0 as follows.

- | | | |
|---|--|--|
| <ul style="list-style-type: none"> • PN-CK00 card SW0-1: OFF SW0-2: OFF SW0-3: OFF SW0-4: OFF SW0-8: ON | <ul style="list-style-type: none"> • PN-24DTA/PN-24DTA-A card SW-1: OFF SW-2: OFF | <ul style="list-style-type: none"> • PN-30DTC/PN-30DTC-A card SW-1: OFF SW-2: OFF |
|---|--|--|

Note 4: When using this card as a sub-master, set the SW0 switch on the PN-CK00 and the SW switch on the PN-24DTA/PN-24DTA-A or the PN-30DTC/PN-30DTC-A as follows:

For 1.5MHz interface:

- | | |
|--|---|
| <ul style="list-style-type: none"> • PN-CK00 card SW0-1: OFF SW0-2: ON SW0-3: OFF SW0-4: ON* SW0-8: ON | <ul style="list-style-type: none"> • PN-24DTA/PN-24DTA-A card SW-1: ON SW-2: OFF |
|--|---|

* Set to ON, when more than one DTI card is mounted in PIM0, or set to OFF when only one DTI card is mounted in PIM0.

For 2MHz interface:

- | | |
|--|---|
| <ul style="list-style-type: none"> • PN-CK00 card SW0-1: ON SW0-2: ON SW0-3: ON SW0-4: ON* SW0-8: ON | <ul style="list-style-type: none"> • PN-30DTC/PN-30DTC-A card SW-1: ON SW-2: OFF |
|--|---|

* Set to ON, when more than one DTI card is mounted in PIM0, or set to OFF when only one DTI card is mounted in PIM0.

PN-24DTA (DTI)

1. Locations of Lamps, Switches, and Connectors

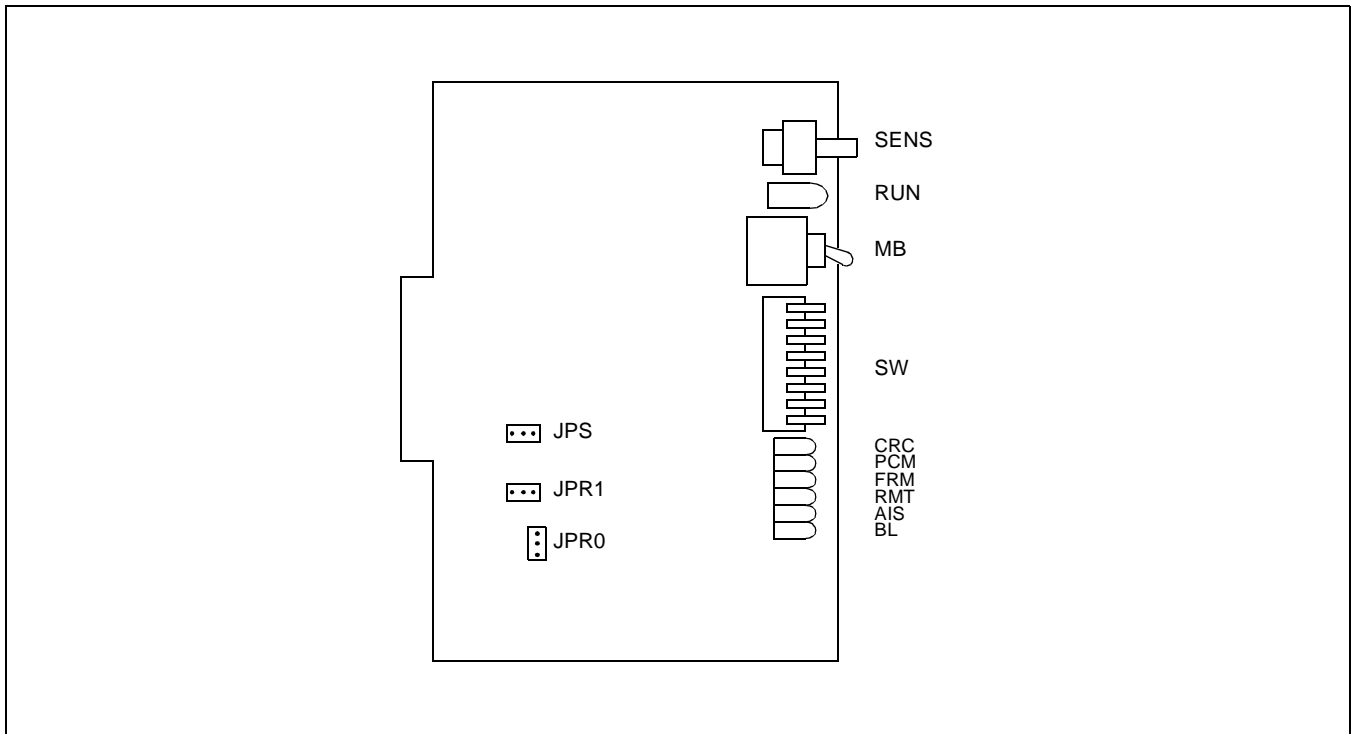

PN-24DTA (DTI) Card

2. Lamp Indications

Lamp Indications



LAMP NAME	COLOR	FUNCTION
RUN	Green	Flashes at 120 IPM while this card is operating normally.
CRC	Red	Lights when detecting Cyclic Redundancy Checking (CRC) errors.
PCM	Red	Lights when detecting PCM signal loss.
FRM	Red	Lights when detecting a Frame Alignment signal loss.
RMT	Red	Lights when receiving a Frame Alignment signal loss alarm from a distant office.
AIS	Red	Lights when a pattern of consecutive "1" bits is received. The distant office transmits this signal for a loop-back test.
BL	Red	B channel status ON : More than 10 channels are busy OFF : All channels are idle Flash (60 IPM): Only one channel is busy Flash (120 IPM): 2 through 10 channels are busy

(3) Switch Settings

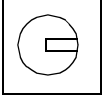
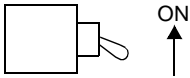
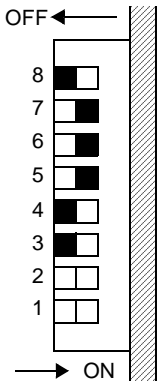
Switch Settings

SWITCH NAME	SWITCH NUMBER	SETTING POSITION	FUNCTION	CHECK																												
SENS (Rotary SW) 	4 - F	Set the switch to match the AP Number (04 - 15) to be set by CM05.																														
		<table border="1"> <tr> <td>AP NO.</td> <td>04</td> <td>05</td> <td>06</td> <td>07</td> <td>08</td> <td>09</td> <td>10</td> <td>11</td> <td>12</td> <td>13</td> <td>14</td> <td>15</td> </tr> <tr> <td>SW NO.</td> <td>4</td> <td>5</td> <td>6</td> <td>7</td> <td>8</td> <td>9</td> <td>A</td> <td>B</td> <td>C</td> <td>D</td> <td>E</td> <td>F</td> </tr> </table>			AP NO.	04	05	06	07	08	09	10	11	12	13	14	15	SW NO.	4	5	6	7	8	9	A	B	C	D	E	F		
	AP NO.	04	05	06	07	08	09	10	11	12	13	14	15																			
SW NO.	4	5	6	7	8	9	A	B	C	D	E	F																				
0 - 3	Not used																															
MB (Toggle SW) 		UP	For make-busy																													
		DOWN	For normal operation																													
SW (Piano Key SW) 	1	ON	Clock signal from a master office is sent to the PLO 0 input on the MP card.																													
		OFF	Clock signal from a master office is not sent to the PLO 0 input on the MP card.																													
	2	ON	Clock signal from a master office is sent to the PLO 1 input on the MP card.																													
		OFF	Clock signal from a master office is not sent to the PLO 1 input on the MP card.																													
	3	ON	Remote loop-back																													
		OFF	For normal operation																													
	4	ON	Local loop-back (AIS send)																													
		OFF	For normal operation																													
	5	ON	Set the equalizer according to the cable length between the PBX and the MDF.																													
		OFF																														
	6	ON	<table border="1"> <thead> <tr> <th>SW-5</th> <th>SW-6</th> <th>SW-7</th> <th>CABLE LENGTH</th> </tr> </thead> <tbody> <tr> <td>ON</td> <td>ON</td> <td>ON</td> <td>0 - 40 m (0 - 131.2 ft.)</td> </tr> <tr> <td>ON</td> <td>ON</td> <td>OFF</td> <td>40 - 80 m (131.2 - 262.5 ft.)</td> </tr> <tr> <td>ON</td> <td>OFF</td> <td>ON</td> <td>80 - 120 m (262.5 - 394 ft.)</td> </tr> <tr> <td>ON</td> <td>OFF</td> <td>OFF</td> <td>120 - 160 m (394 - 525 ft.)</td> </tr> <tr> <td>OFF</td> <td>ON</td> <td>ON</td> <td>160 - 200 m (525 - 656 ft.)</td> </tr> <tr> <td>OFF</td> <td>OFF</td> <td>OFF</td> <td>Signal is not sent</td> </tr> </tbody> </table>	SW-5	SW-6	SW-7	CABLE LENGTH	ON	ON	ON	0 - 40 m (0 - 131.2 ft.)	ON	ON	OFF	40 - 80 m (131.2 - 262.5 ft.)	ON	OFF	ON	80 - 120 m (262.5 - 394 ft.)	ON	OFF	OFF	120 - 160 m (394 - 525 ft.)	OFF	ON	ON	160 - 200 m (525 - 656 ft.)	OFF	OFF	OFF	Signal is not sent	
		SW-5		SW-6	SW-7	CABLE LENGTH																										
		ON		ON	ON	0 - 40 m (0 - 131.2 ft.)																										
	ON	ON	OFF	40 - 80 m (131.2 - 262.5 ft.)																												
	ON	OFF	ON	80 - 120 m (262.5 - 394 ft.)																												
	ON	OFF	OFF	120 - 160 m (394 - 525 ft.)																												
OFF	ON	ON	160 - 200 m (525 - 656 ft.)																													
OFF	OFF	OFF	Signal is not sent																													
7	ON																															
	OFF																															
8	OFF	Always set to OFF																														

Switch Settings (Continued)

SWITCH NAME	SWITCH NUMBER	SETTING POSITION	FUNCTION	CHECK
JPS (Jumper pin) 		<input type="radio"/> Right	Neutral grounding on the transmitting line is not provided.	
		<input type="radio"/> Left	Neutral grounding on the transmitting line is provided.	
JPR0 (Jumper pin) 		<input type="radio"/> Up	Neutral grounding on the receiving line is not provided.	
		<input type="radio"/> Down	Neutral grounding on the receiving line is provided.	
JPR1 (Jumper pin) 		<input type="radio"/> Right	Line impedance : 110 ohms	
		<input type="radio"/> Left	Line impedance : 100 ohms	

The figure in the SWITCH NAME column and the position in in the SETTING POSITION column indicate the standard setting of the switch. When the switch is not set as shown by the figure and , the setting of the switch varies with the system concerned.

Note 1: Set the groove on the switch knob to the intended switch position.

Note 2: When the power is on, flip the MB switch to ON (UP position) before plugging/unplugging the circuit card.

Note 3: Set SW-1 and SW-2 as follows:

NO. OF DTI CONDITIONS	DTI0		DTI1		DTI2		DTI3		DTI4		REMARKS	
	SW -1	SW -2	SW -1	SW -2	SW -1	SW -2	SW -1	SW -2	SW -1	SW -2		
When one DTI is provided	ON	OFF										The MP card receives the clock signal from DTI0 at its PLO0 input.
When more than one DTI is provided	ON	OFF	OFF	ON	OFF	OFF	OFF	OFF	OFF	OFF	OFF	The MP card receives the clock signal from DTI0 at its PLO0 input under normal conditions. Should a clock failure occur with DTI0, the MP card switches to the PLO1 input, which gets clock from DTI1.

Note 4: When the PBX is the master office, set the SW-1 and SW-2 on all the DTI cards mounted in PIM0 to "OFF".

PN-24DTA-A (DTI)

1. Location of Lamps, Switches, and Connectors

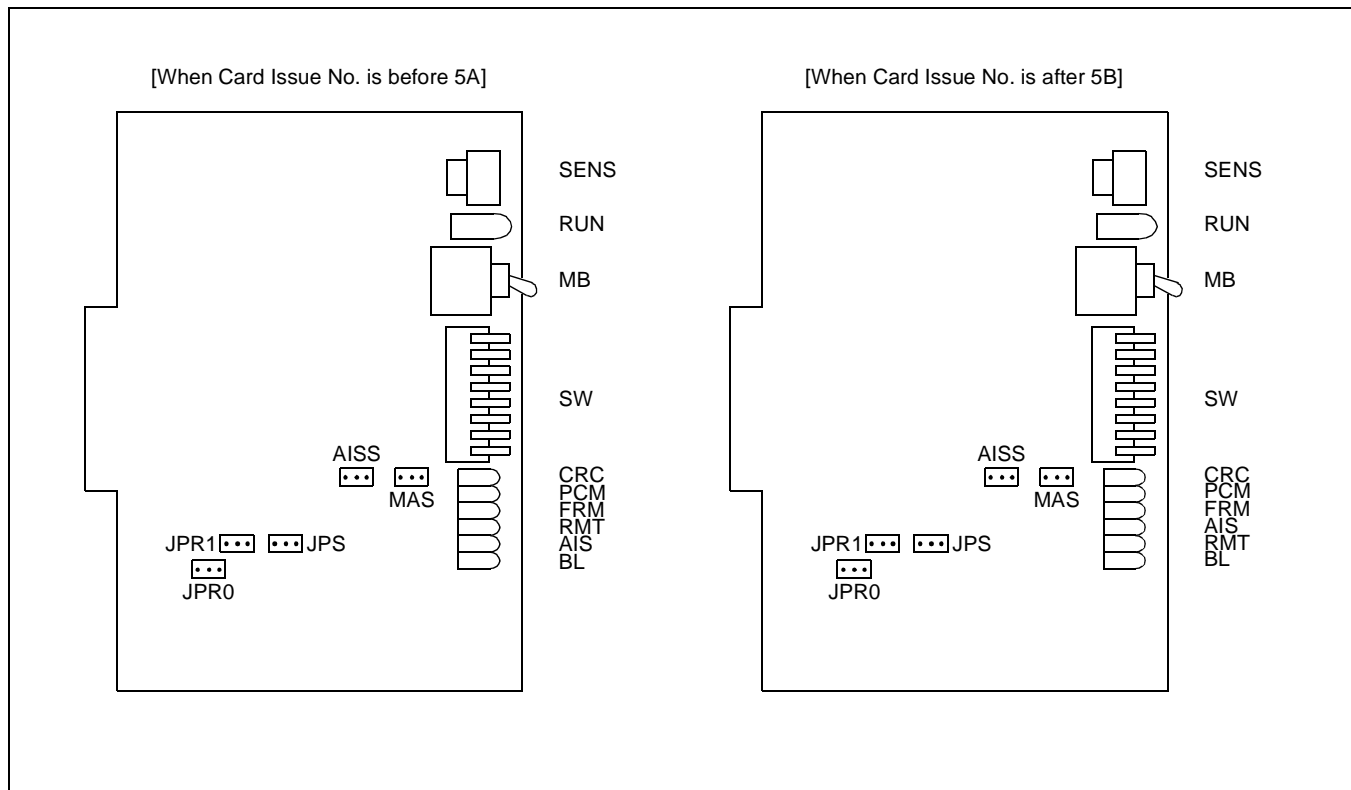

PN-24DTA-A (DTI) Card

2. Lamp Indications

Lamp Indications





LAMP NAME	COLOR	FUNCTION
RUN	Green	Flashes at 120 IPM while this card is operating normally.
CRC	Red	Lights when detecting Cyclic Redundancy Checking (CRC) errors.
PCM	Red	Lights when detecting PCM signal loss.
FRM	Red	Lights when detecting a Frame Alignment signal loss.
RMT	Red	Lights when receiving a Frame Alignment signal loss alarm from a distant office.
AIS	Red	Lights when a pattern of consecutive "1" is received. The distant office transmits this signal for a loop-back test.
BL	Red	B channel status ON : More than 10 channels is busy OFF : All channels are idle Flash (60 IPM): Only one channel is busy Flash (120 IPM): 2 through 10 channels are busy

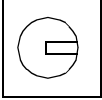
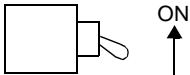
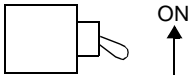
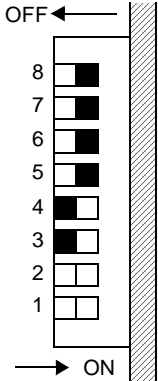

(3) Switch Settings

Switch Settings

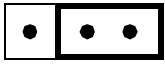
SWITCH NAME	SWITCH NUMBER	SETTING POSITION	FUNCTION	CHECK																												
SENS (Rotary SW) 	4 ~ F	Set the switch to match the AP Number (04 ~ 15) to be set by CM05.																														
		<table border="1"> <tr> <td>AP NO.</td> <td>04</td> <td>05</td> <td>06</td> <td>07</td> <td>08</td> <td>09</td> <td>10</td> <td>11</td> <td>12</td> <td>13</td> <td>14</td> <td>15</td> </tr> <tr> <td>SW NO.</td> <td>4</td> <td>5</td> <td>6</td> <td>7</td> <td>8</td> <td>9</td> <td>A</td> <td>B</td> <td>C</td> <td>D</td> <td>E</td> <td>F</td> </tr> </table>	AP NO.	04		05	06	07	08	09	10	11	12	13	14	15	SW NO.	4	5	6	7	8	9	A	B	C	D	E	F			
AP NO.	04	05	06	07	08	09	10	11	12	13	14	15																				
SW NO.	4	5	6	7	8	9	A	B	C	D	E	F																				
Note 1 	0 ~ 3	Not used																														
MB (Toggle SW) 	/	UP	For make-busy																													
		DOWN	For normal operation																													
SW (Piano Key SW) 	1	ON	Clock signal from a master office is sent to the PLO 0 input on the MP card.																													
		OFF	Clock signal from a master office is not sent to the PLO 0 input on the MP card.																													
	2	ON	Clock signal from a master office is sent to the PLO 1 input on the MP card.																													
		OFF	Clock signal from a master office is not sent to the PLO 1 input on the MP card.																													
	3	ON	Remote loop-back																													
		OFF	For normal operation																													
	4	ON	Local loop-back (AIS send)																													
		OFF	For normal operation																													
	5	ON	Set the equalizer according to the cable length between the PBX and the MDF.																													
		OFF																														
	6	ON	<table border="1"> <thead> <tr> <th>SW-5</th> <th>SW-6</th> <th>SW-7</th> <th>CABLE LENGTH</th> </tr> </thead> <tbody> <tr> <td>ON</td> <td>ON</td> <td>ON</td> <td>0 - 40 m (0 - 131.2 ft.)</td> </tr> <tr> <td>ON</td> <td>ON</td> <td>OFF</td> <td>40 - 80 m (131.2 - 262.5 ft.)</td> </tr> <tr> <td>ON</td> <td>OFF</td> <td>ON</td> <td>80 - 120 m (262.5 - 394 ft.)</td> </tr> <tr> <td>ON</td> <td>OFF</td> <td>OFF</td> <td>120 - 160 m (394 - 525 ft.)</td> </tr> <tr> <td>OFF</td> <td>ON</td> <td>ON</td> <td>160 - 200 m (525 - 656 ft.)</td> </tr> <tr> <td>OFF</td> <td>OFF</td> <td>OFF</td> <td>Signal is not sent</td> </tr> </tbody> </table>	SW-5	SW-6	SW-7	CABLE LENGTH	ON	ON	ON	0 - 40 m (0 - 131.2 ft.)	ON	ON	OFF	40 - 80 m (131.2 - 262.5 ft.)	ON	OFF	ON	80 - 120 m (262.5 - 394 ft.)	ON	OFF	OFF	120 - 160 m (394 - 525 ft.)	OFF	ON	ON	160 - 200 m (525 - 656 ft.)	OFF	OFF	OFF	Signal is not sent	
		SW-5	SW-6	SW-7	CABLE LENGTH																											
		ON	ON	ON	0 - 40 m (0 - 131.2 ft.)																											
		ON	ON	OFF	40 - 80 m (131.2 - 262.5 ft.)																											
	ON	OFF	ON	80 - 120 m (262.5 - 394 ft.)																												
	ON	OFF	OFF	120 - 160 m (394 - 525 ft.)																												
OFF	ON	ON	160 - 200 m (525 - 656 ft.)																													
OFF	OFF	OFF	Signal is not sent																													
OFF																																
7	ON																															
	OFF																															
8	ON	Always set to ON																														

Switch Settings (Continued)

SWITCH NAME	SWITCH NUMBER	SETTING POSITION	FUNCTION	CHECK
JPS (Jumper pin) 	/	Right	Neutral grounding on the transmitting line is not provided.	
		Left	Neutral grounding on the transmitting line is provided.	
JPR0 (Jumper pin) 	/	Right	Neutral grounding on the receiving line is provided.	
		Left	Neutral grounding on the receiving line is not provided.	
JPR1 (Jumper pin) 	/	Right	Line impedance : 110 ohms	
		Left	Line impedance : 100 ohms	
AISS (Jumper pin) 	/	Right	AIS signal is sent out when make-busy or power on.	
		Left	AIS signal is not sent out when make-busy or power on.	
MAS (Jumper pin) 	/	Right	When this card is used for factory testing.	
		Left	When this card is used for normal operation.	

The figure in the SWITCH NAME column and the position in  in the SETTING POSITION column indicate the standard setting of the switch. When the switch is not set as shown by the figure and , the setting of the switch varies with the system concerned.

Note 1: Set the groove on the switch knob to the intended switch position.

Note 2: When the power is on, flip the MB switch to ON (UP position) before plugging/unplugging the circuit card.

PN-24DTA-A (DTI)

Note 3: Set SW-1 and SW-2 as follows:

No. of DTI SW CONDITIONS	DTI0		DTI1		DTI2		DTI3		DTI4		REMARKS
	SW-1	SW-2	SW-1	SW-2	SW-1	SW-2	SW-1	SW-2	SW-1	SW-2	
When one DTI is provided.	ON	OFF									The MP card will receive the clock signal from DTI0 at its PLO0 input.
When more than one DTI is provided.	ON	OFF	OFF	ON	OFF	OFF	OFF	OFF	OFF	OFF	The MP card will receive the clock signal from DTI0 at its PLO0 input, under normal conditions. Should a clock failure occur with DTI0, the MP card will switch to the PLO1 input which gets clock from DTI1.

Note 4: When the PBX is the master office, set the SW1-1 and SW1-2 on all the DTI cards mounted in PIM0 to "OFF".

PN-30DTC/30DTC-A (DTI)

1. Locations of Lamps, Switches, and Connectors

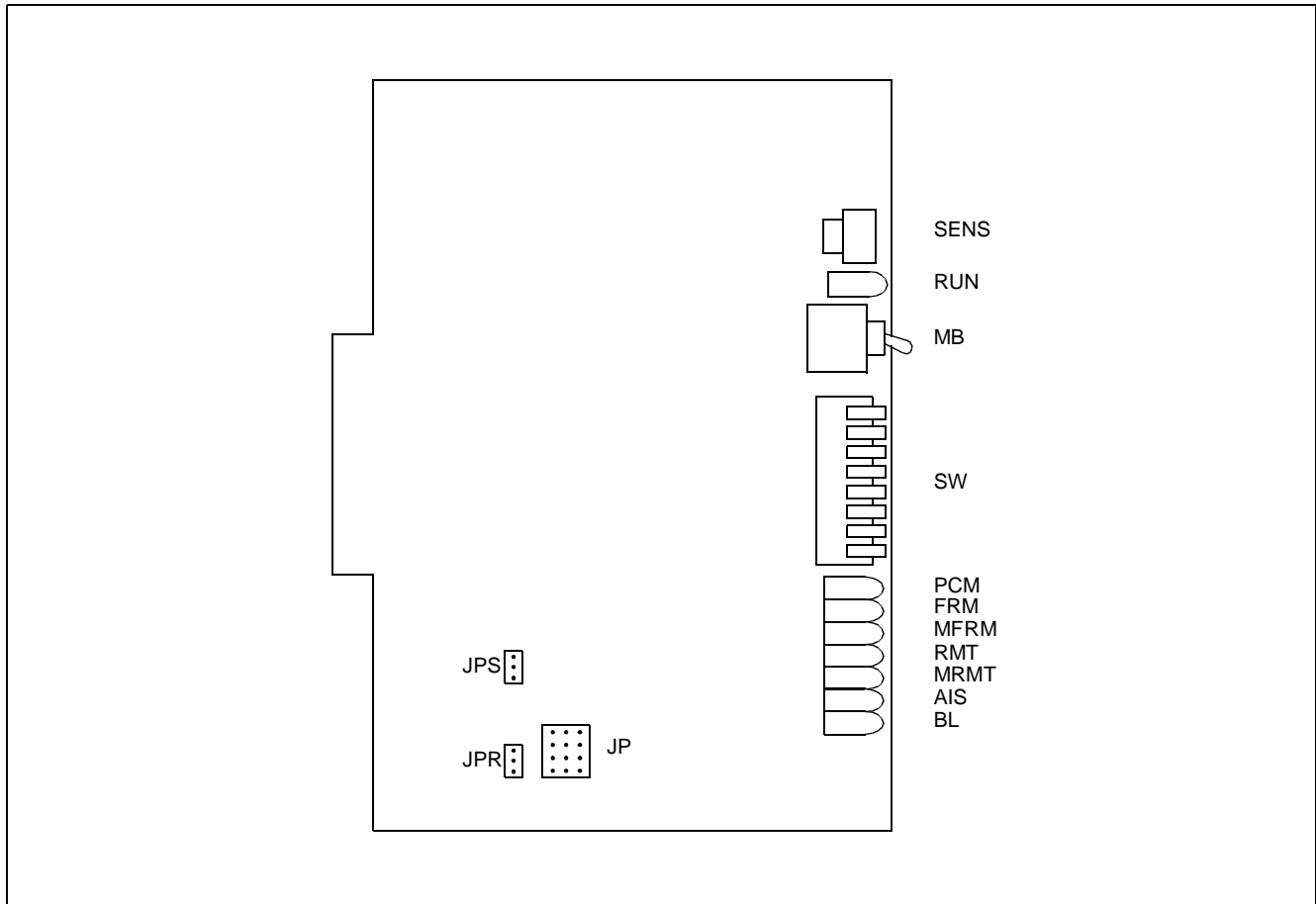

PN-30DTC/30DTC-A (DTI) Card



2. Lamp Indications

Lamp Indications

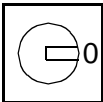
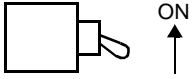

LAMP NAME	COLOR	FUNCTION
RUN	Green	Flashes at 120 IPM when this card is normally operating.
PCM	Red	Lights when detecting PCM signal loss.
FRM	Red	Lights when detecting Frame Alignment signal loss.
MFRM	Red	Lights when detecting Multi-Frame Alignment signal loss on time slot 16.
RMT	Red	Lights when receiving an alarm because Frame Alignment signal loss has been detected at the distant office.
MRMT	Red	Lights when receiving an alarm because Multi-Frame Alignment signal loss has been detected at the distant office.
AIS	Red	Lights when indicating that the pattern of consecutive "1" is being received. (The distant office transmits this signal for a loop-back test).
BL	Red	B channel status ON : More than 10 channels are busy OFF : All channels are idle Flash (60 IPM) : Only one channel is busy Flash (120 IPM) : 2 to 10 channels are busy

3. Switch Settings

Switch Settings

SWITCH NAME	SWITCH NUMBER	SETTING POSITION	FUNCTION	CHECK																									
SENS (Rotary SW) 	4 ~ F	Set the switch to match the AP Number (04-15) as set by CM05.																											
	<table border="1" style="width: 100%; border-collapse: collapse; text-align: center;"> <tr> <td>AP NO.</td> <td>04</td><td>05</td><td>06</td><td>07</td><td>08</td><td>09</td><td>10</td><td>11</td><td>12</td><td>13</td><td>14</td><td>15</td> </tr> <tr> <td>SW NO.</td> <td>4</td><td>5</td><td>6</td><td>7</td><td>8</td><td>9</td><td>A</td><td>B</td><td>C</td><td>D</td><td>E</td><td>F</td> </tr> </table>				AP NO.	04	05	06	07	08	09	10	11	12	13	14	15	SW NO.	4	5	6	7	8	9	A	B	C	D	E
AP NO.	04	05	06	07	08	09	10	11	12	13	14	15																	
SW NO.	4	5	6	7	8	9	A	B	C	D	E	F																	
Note 1	0 ~ 3	Not used																											
MB (Toggle SW) 	/	UP	For make-busy																										
		DOWN	For normal operation																										
Note 2																													
SW (Piano Key SW) 	1	ON	Clock signal from master office is sent to PLO 0 on the MP card.																										
		Note 3 OFF	Clock signal from master office is not sent to PLO 0 on the MP card.																										
	2	ON	Clock signal from master office is sent to PLO 1 on the MP card.																										
		Note 3 OFF	Clock signal from master office is not sent to PLO 1 on the MP card.																										
	3	ON	Remote loop-back																										
		OFF	For normal operation																										
	4	ON	Local loop-back (AIS send)																										
		OFF	For normal operation																										
	5	ON	Transmission line cable: Coaxial (75 Ω) Note 4																										
		OFF	Transmission line cable: Twisted-pair (120 Ω)																										
	6	OFF	Always set to OFF																										
	7	OFF																											
8	ON	Always set to ON																											

Switch Settings

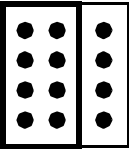
SWITCH NAME	SWITCH NUMBER	SETTING POSITION	FUNCTION	CHECK
JPS (Jumper pin) 	/	<input type="radio"/> UP	Balanced transmission (For twisted-pair cable)	
		DOWN	TA is grounded on the transmission line (For coaxial cable) Note 4	
JPR (Jumper pin) 	/	<input type="radio"/> UP	Balanced transmission (For twisted-pair cable)	
		DOWN	RA is grounded on the transmission line (For coaxial cable)	
JP (Jumper pin) 	/	RIGHT	Line impedance: 75 ohms (For coaxial cable) Note 4	
		<input type="radio"/> LEFT	Line impedance: 120 ohms (For twisted-pair cable)	

The figure in the SWITCH NAME column and the position in in the SETTING POSITION column indicate the standard setting of the switch. When the switch is not set as shown by the figure and , the setting of the switch varies with the system concerned.

Note 1: Set the groove on the switch knob to the intended switch position.

Note 2: When the power is on, set the MB switch to ON (UP position) before plugging/unplugging the circuit card.

Note 3: Set SW-1 and SW-2 as follows.

No. of DTI CONDITIONS	DTI 0		DTI 1		DTI 2		DTI 3		REMARKS
	SW-1	SW-2	SW-1	SW-2	SW-1	SW-2	SW-1	SW-2	
When one DTI is provided.	ON	OFF							The MP card will receive the clock signal from DTI 0 at its PLO 0 input.
When more than one DTI is provided.	ON	OFF	OFF	ON	OFF	OFF	OFF	OFF	The MP card will receive the clock signal from DTI 0 at its PLO 0 input, under normal conditions. Should a clock failure occur on DTI 0, the MP card will automatically switch to the PLO 1 input, and so derive the clock from DTI 1.

Note 4: Coaxial cable connection to the PN-30DTC/30DTC-A is not available in the U.S.

This page is for your notes.

PN-ME00 (EXTMEM)

1. Locations of Lamps, Switches, and Connectors

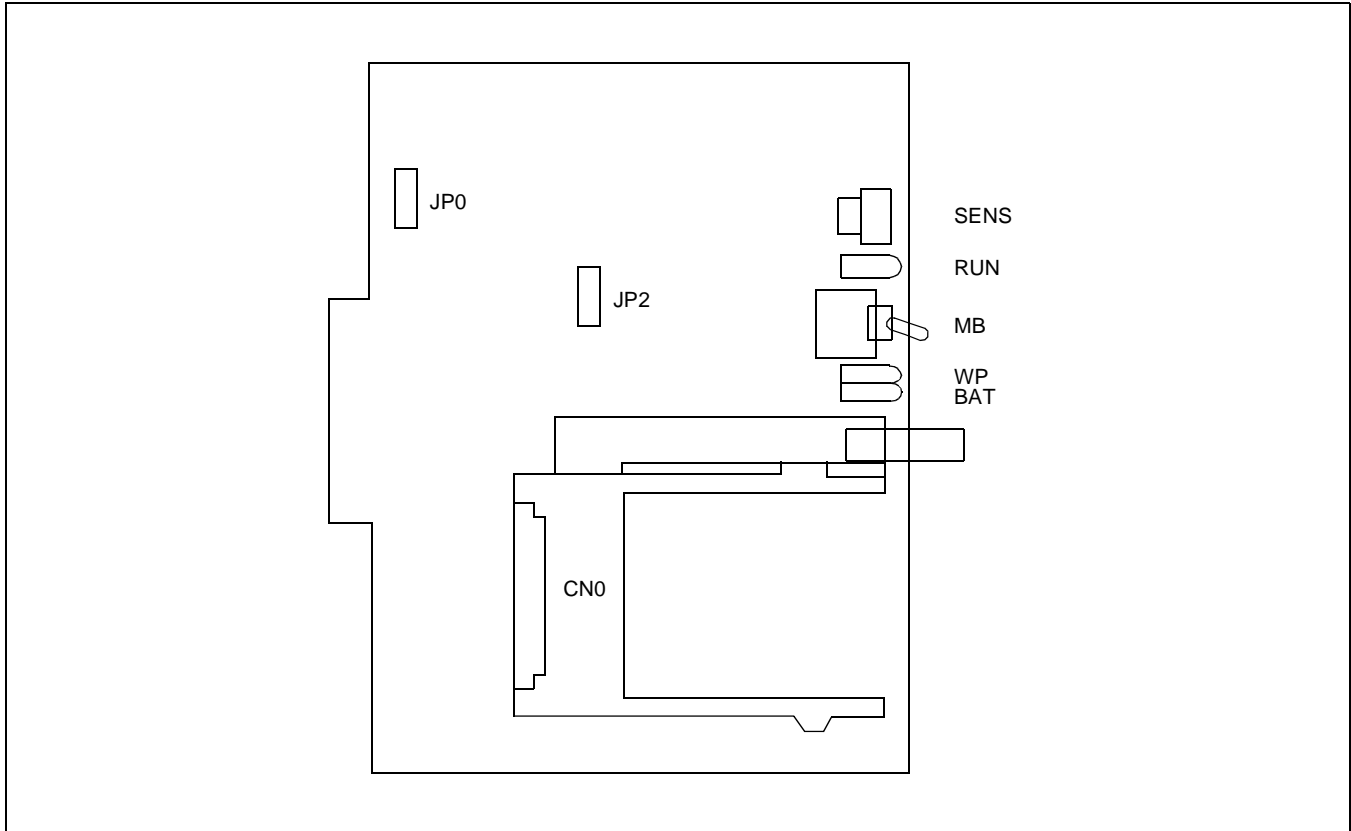

PN-ME00 (EXTMEM) Card

2. Lamp Indications

Lamp Indications

LAMP NAME	COLOR	FUNCTION															
RUN	Green	Flashes at 120 IPM while this circuit card is operating normally.															
WP	Red	Lights when the RAM is being accessed.															
BAT	Red	Lights indicating the status (Write Protect Switch status and the battery voltage status) of the SRAM card on this circuit card.															
		<table border="1"> <thead> <tr> <th>LAMP STATUS</th> <th>WRITE PROTECT SWITCH STATUS</th> <th>BATTERY VOLTAGE STATUS</th> </tr> </thead> <tbody> <tr> <td>On</td> <td>Protect On</td> <td>OK</td> </tr> <tr> <td>Flash (60 IPM)</td> <td>Protect Off</td> <td>Needs to be replaced</td> </tr> <tr> <td>Flash (120 IPM)</td> <td>Protect On</td> <td>Needs to be replaced</td> </tr> <tr> <td>Off</td> <td>Protect Off</td> <td>OK</td> </tr> </tbody> </table>	LAMP STATUS	WRITE PROTECT SWITCH STATUS	BATTERY VOLTAGE STATUS	On	Protect On	OK	Flash (60 IPM)	Protect Off	Needs to be replaced	Flash (120 IPM)	Protect On	Needs to be replaced	Off	Protect Off	OK
		LAMP STATUS	WRITE PROTECT SWITCH STATUS	BATTERY VOLTAGE STATUS													
		On	Protect On	OK													
		Flash (60 IPM)	Protect Off	Needs to be replaced													
Flash (120 IPM)	Protect On	Needs to be replaced															
Off	Protect Off	OK															

How to Handle the SRAM Card

■ Mounting the SRAM Card

- ① Slide the lock switch downward (Lock Release), then remove the battery case from the SRAM card.
- ② Mount the battery on the battery case, then insert the battery case into the SRAM card.
- ③ Slide the lock switch upward (Lock).
- ④ Mount the SRAM card in the PN-ME00 card.
- ⑤ Slide the write protect switch downward (Active).

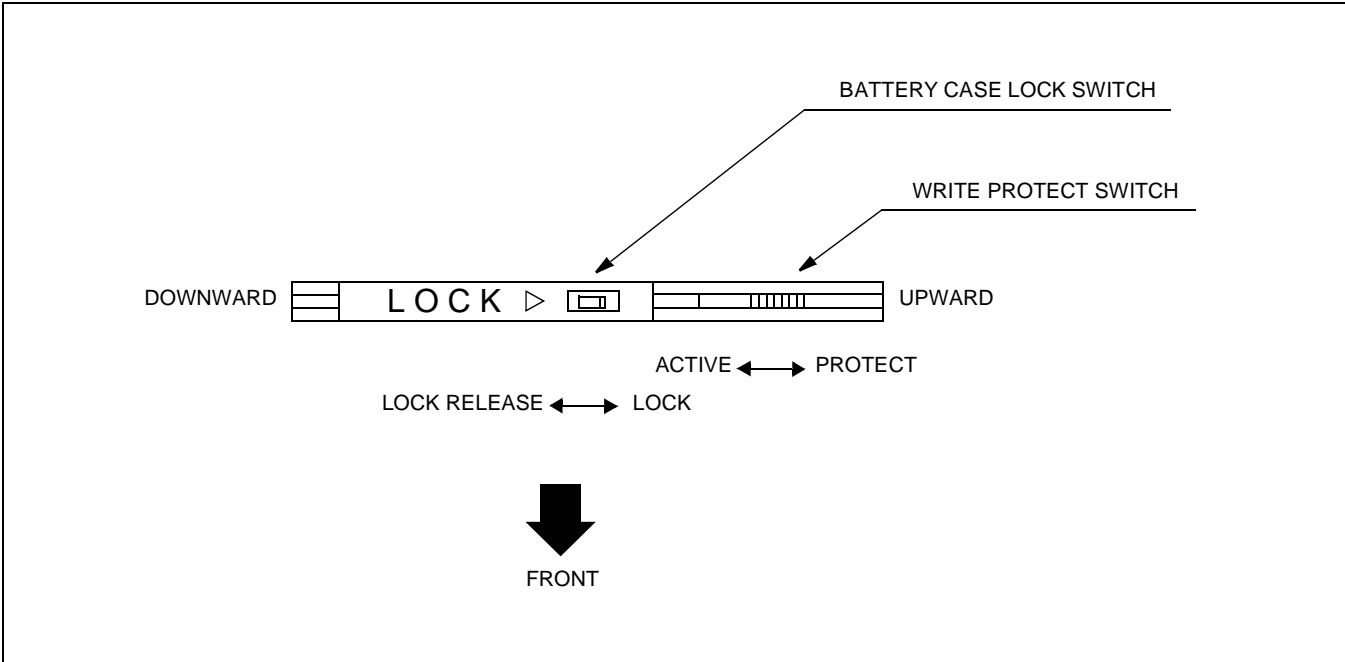

Front View of the SRAM Card

■ Removing the SRAM Card

- ① Push the card slot bar of the PN-ME00 card.
- ② Remove the SRAM card.

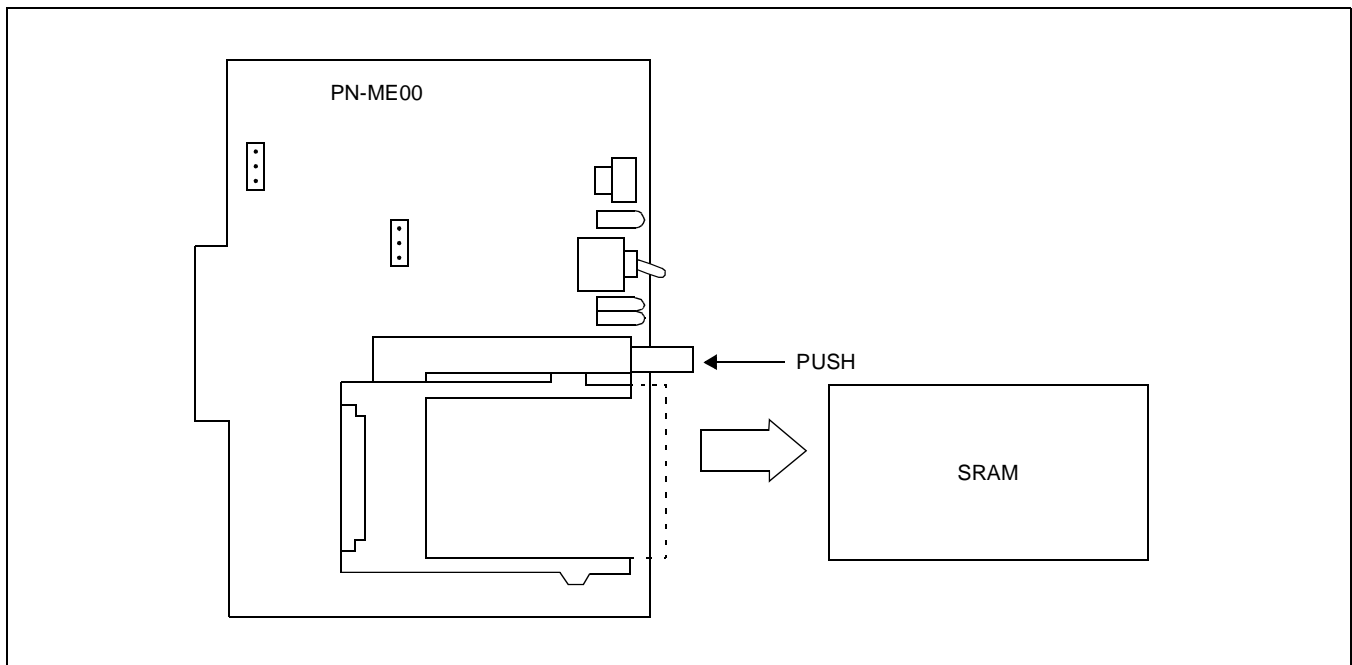

Removing the SRAM Card

■ Replacing the SRAM Battery

CAUTION

To prevent loss of memory on an active system, the battery must be replaced when the SRAM card is installed on the PN-ME00, and the PN-ME00 is installed in the system. Also, power to the system must be "ON".

- ① Slide the lock switch downward (Lock Release), then remove the battery case from the SRAM card.
- ② Replace the battery, then insert the battery case into the SRAM card.
- ③ Slide the lock switch upward (Lock).

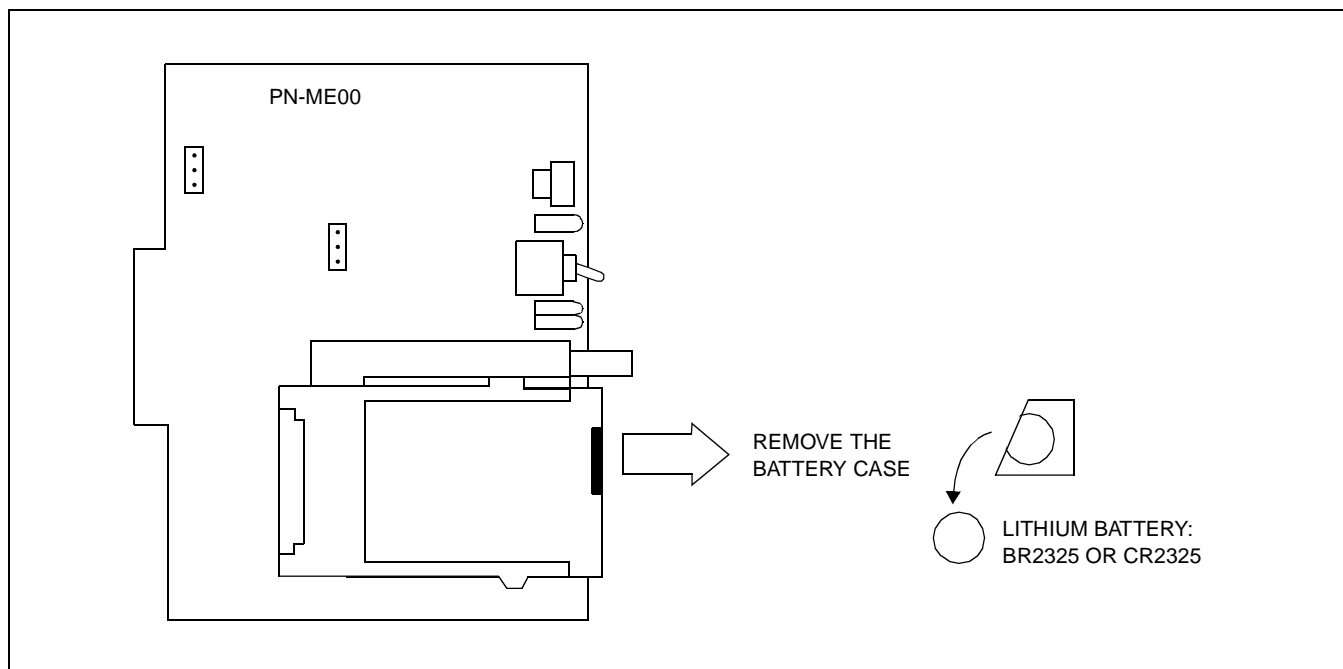



Replacing the SRAM Battery

(3) Switch Settings

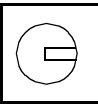
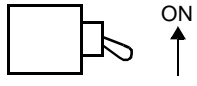
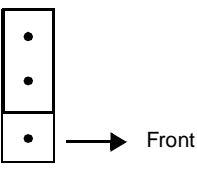
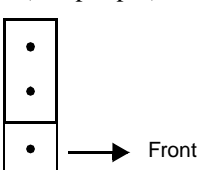
Switch Settings

SWITCH NAME	SWITCH NUMBER	SETTING POSITION	FUNCTION	CHECK																										
SENSE (Rotary SW)  Note 1	4 - F	Set the switch to match the AP Number (04 - 15) to be set by CM05.																												
		<table border="1"> <tr> <td>AP NO.</td> <td>04</td> <td>05</td> <td>06</td> <td>07</td> <td>08</td> <td>09</td> <td>10</td> <td>11</td> <td>12</td> <td>13</td> <td>14</td> <td>15</td> </tr> <tr> <td>SW NO.</td> <td>4</td> <td>5</td> <td>6</td> <td>7</td> <td>8</td> <td>9</td> <td>A</td> <td>B</td> <td>C</td> <td>D</td> <td>E</td> <td>F</td> </tr> </table>	AP NO.	04	05	06	07	08	09	10	11	12	13	14	15	SW NO.	4	5	6	7	8	9	A	B	C	D	E	F		
	AP NO.	04	05	06	07	08	09	10	11	12	13	14	15																	
SW NO.	4	5	6	7	8	9	A	B	C	D	E	F																		
0 - 3	Not used																													
MB(Toggle SW)  Note 2		UP	For make-busy																											
		DOWN	For normal operation																											
JP0 (Jumper pin)  Note 3	/	UP	For normal operation																											
		DOWN	For normal operation																											
JP2 (Jumper pin) 	/	UP	For normal operation																											
		DOWN	For normal operation																											

The figure in the SWITCH NAME column and the position in  in the SETTING POSITION column indicate the standard setting of the switch. When the switch is not set as shown by the figure and , the setting of the switch varies with the system concerned.

- Note 1:** Set the groove on the switch knob to the desired switch position.
- Note 2:** When the power is on, flip the MB switch to ON (UP position) before plugging/unplugging the circuit card.
- Note 3:** Do not touch the JP0. If the jumper is pulled off, the data in the memory of the ME00 card is cleared.

PN-4RSTB (MFR)

1. Locations of Lamps, Switches and Connectors

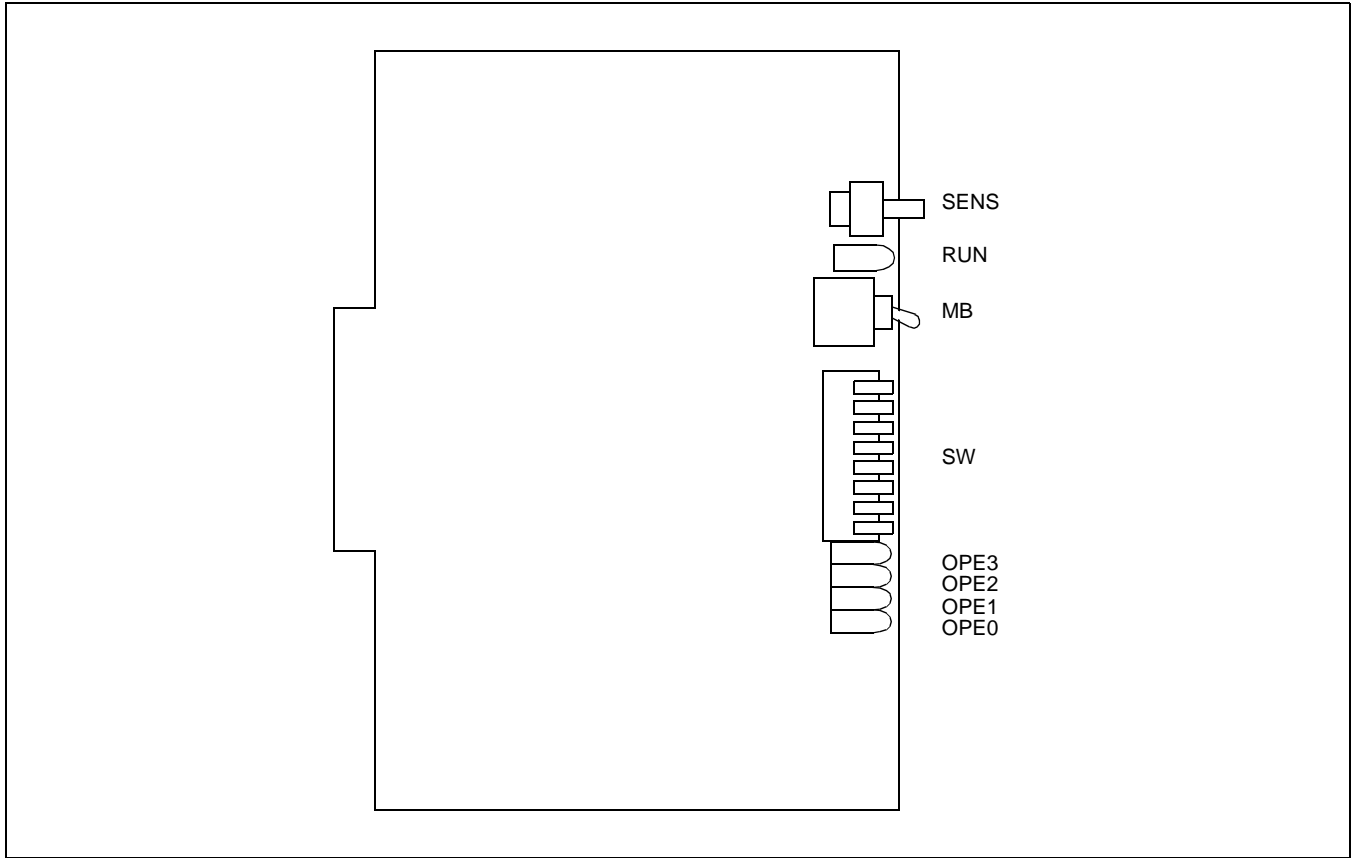

PN-4RSTB (MFR) Card

2. Lamp Indications

Lamp Indications

LAMP NAME	COLOR	FUNCTION
RUN	Green	Flashes at 120 IPM while the circuit card is operating normally.
OPE	Red	<ul style="list-style-type: none"> Lights when the corresponding circuit is in use. Flashes at 60 IPM when the corresponding circuit is in the make-busy state or the system data for this card is not assigned.

(3) Switch Settings

Switch Settings

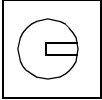
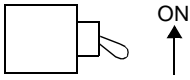
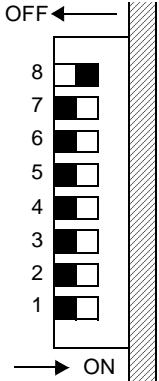
SWITCH NAME	SWITCH NUMBER	SETTING POSITION	FUNCTION	CHECK																										
SENS (Rotary SW)  Note 1	4 - F	Set the switch to match the AP Number (04 - 15) to be set by CM05.																												
	<table border="1" style="width: 100%; text-align: center;"> <thead> <tr> <th>AP NO.</th> <th>04</th> <th>05</th> <th>06</th> <th>07</th> <th>08</th> <th>09</th> <th>10</th> <th>11</th> <th>12</th> <th>13</th> <th>14</th> <th>15</th> </tr> </thead> <tbody> <tr> <th>SW NO.</th> <td>4</td> <td>5</td> <td>6</td> <td>7</td> <td>8</td> <td>9</td> <td>A</td> <td>B</td> <td>C</td> <td>D</td> <td>E</td> <td>F</td> </tr> </tbody> </table>				AP NO.	04	05	06	07	08	09	10	11	12	13	14	15	SW NO.	4	5	6	7	8	9	A	B	C	D	E	F
AP NO.	04	05	06	07	08	09	10	11	12	13	14	15																		
SW NO.	4	5	6	7	8	9	A	B	C	D	E	F																		
	0 - 3	Not used																												
MB (Toggle SW)  Note 2	/	UP	For make-busy																											
		DOWN	For normal operation																											
SW (Piano Key SW) 	1	ON	For make-busy No. 0 circuit																											
		OFF	For normal operation																											
	2	ON	For make-busy No. 1 circuit																											
		OFF	For normal operation																											
	3	ON	For make-busy No. 2 circuit																											
		OFF	For normal operation																											
	4	ON	For make-busy No. 2 circuit																											
		OFF	For normal operation																											
	5	OFF	Not used																											
	6	OFF																												
7	OFF																													
8	ON	Always set to ON																												

Note 1: Set the groove on the switch knob onto the desired switch position.

Note 2: When the power is on, flip the MB switch to ON (UP position) before plugging/unplugging the circuit card.

PN-4RSTC (CIR)

PN-4RSTC (CIR)

1. Locations of Lamps, Switches and Connectors

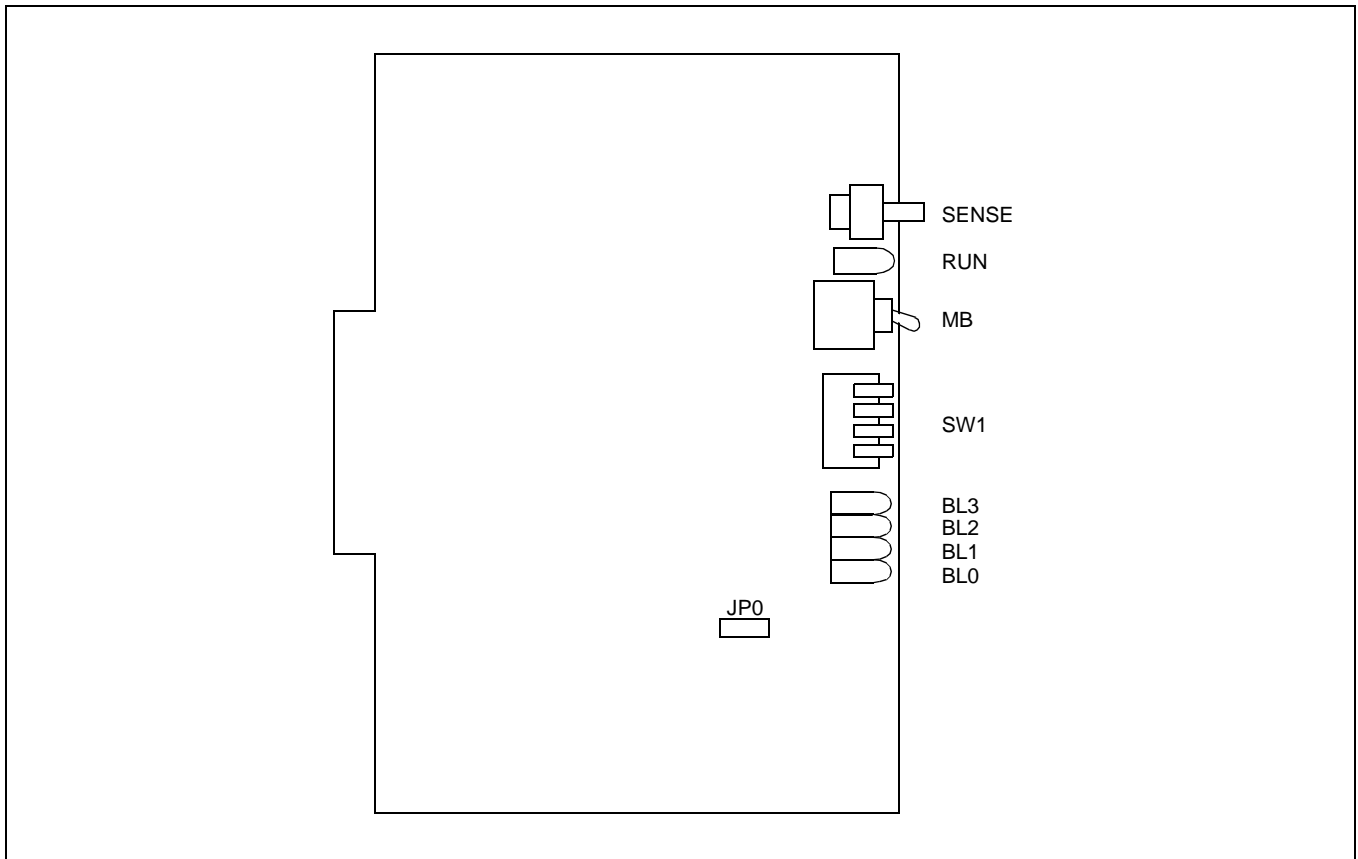

PN-4RSTC (CIR) Card

2. Lamp Indications

Lamp Indications

LAMP NAME	COLOR	FUNCTION
RUN	Green	Flashes at 120 IPM while the circuit card is operating normally.
BL0-3	Red	Lights when receiving a CALLER ID (CLASS SM) signal.

(3) Switch Settings

Switch Settings

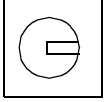
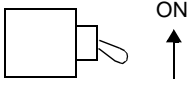
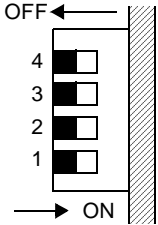
SWITCH NAME	SWITCH NUMBER	SETTING POSITION	FUNCTION	CHECK																											
SENSE (Rotary SW) 	4 - F	Set the switch to match the AP Number (04 - 15) to be set by CM05.																													
		<table border="1"> <tr> <td>AP NO.</td> <td>04</td> <td>05</td> <td>06</td> <td>07</td> <td>08</td> <td>09</td> <td>10</td> <td>11</td> <td>12</td> <td>13</td> <td>14</td> <td>15</td> </tr> <tr> <td>SW NO.</td> <td>4</td> <td>5</td> <td>6</td> <td>7</td> <td>8</td> <td>9</td> <td>A</td> <td>B</td> <td>C</td> <td>D</td> <td>E</td> <td>F</td> </tr> </table>			AP NO.	04	05	06	07	08	09	10	11	12	13	14	15	SW NO.	4	5	6	7	8	9	A	B	C	D	E	F	
		AP NO.	04	05	06	07	08	09	10	11	12	13	14	15																	
SW NO.	4	5	6	7	8	9	A	B	C	D	E	F																			
Note 1 0 - 3	Not used																														
MB(Toggle SW) 		UP	For make-busy																												
		DOWN	For normal operation																												
SW1 (Piano Key SW) 	1	ON	For make-busy No. 0 circuit																												
		OFF	For normal operation																												
	2	ON	For make-busy No. 1 circuit																												
		OFF	For normal operation																												
	3	ON	For make-busy No. 2 circuit																												
		OFF	For normal operation																												
	4	ON	For make-busy No. 3 circuit																												
		OFF	For normal operation																												
JP0 (Jumper pin)		Right	For normal operation																												

Note 1: Set the groove on the switch knob onto the desired switch position.

Note 2: When the power is on, flip the MB switch to ON (UP position) before plugging/unplugging the circuit card.

PN-SC00 (CCH)

1. Locations of Lamps, Switches and Connectors

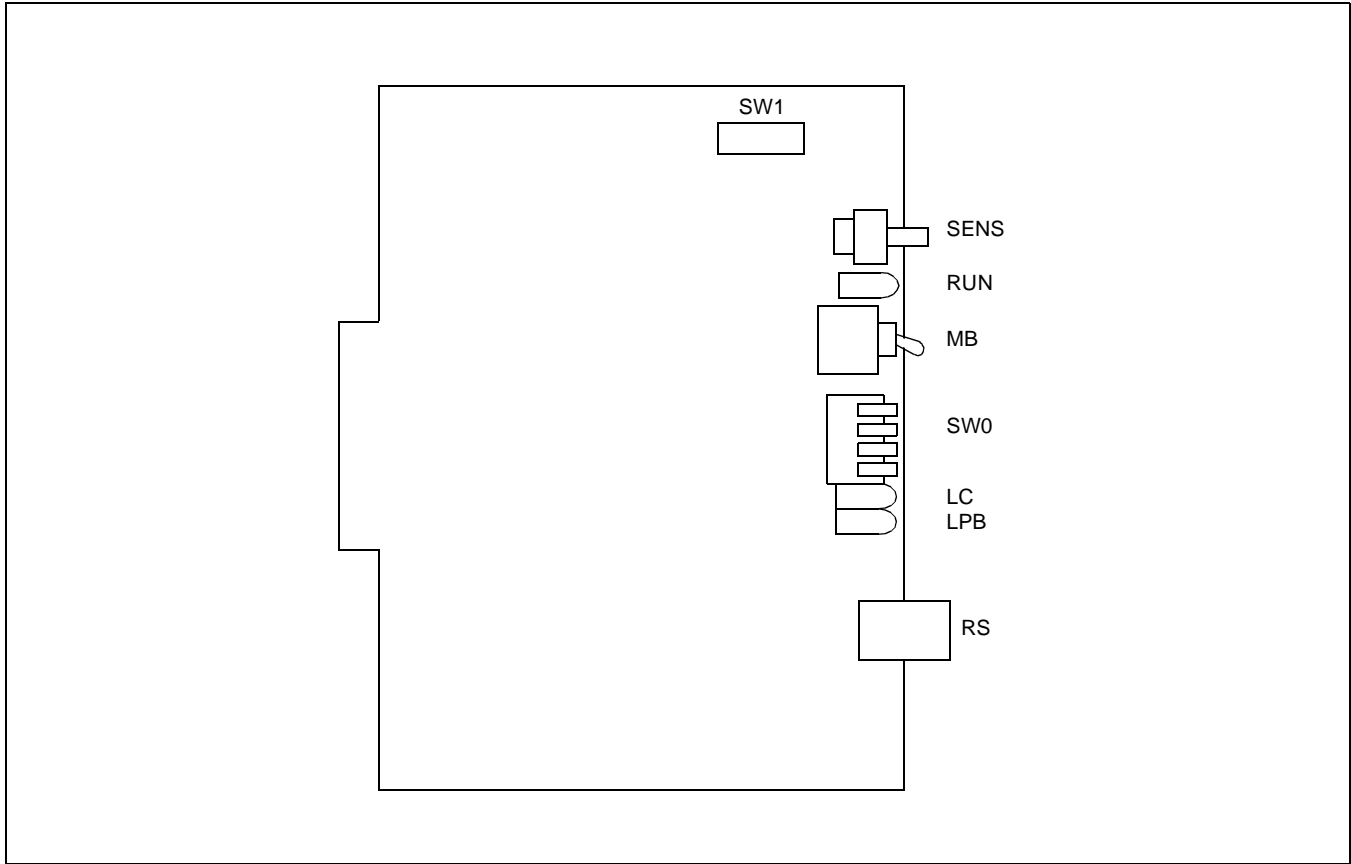

PN-SC00 (CCH) Card

2. Lamp Indications

Lamp Indications

LAMP NAME	COLOR	FUNCTION
RUN	Green	Flashes at 120 IPM while this card is operating normally.
LC	Green	Lights when communications are normally ongoing with the common signalling channel data links connected.
LPB	Green	Lights when a loop-back test is in progress.

(3) Switch Settings

Switch Settings

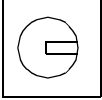
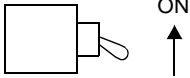
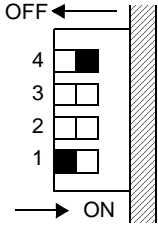
SWITCH NAME	SWITCH NUMBER	SETTING POSITION	FUNCTION	CHECK																											
<p>SENS (Rotary SW)</p>  <p>Note 1</p>	4 - F	Set the switch to match the AP Number (04 - 15) to be set by CM05.																													
	<table border="1"> <tr> <td>AP NO.</td> <td>04</td> <td>05</td> <td>06</td> <td>07</td> <td>08</td> <td>09</td> <td>10</td> <td>11</td> <td>12</td> <td>13</td> <td>14</td> <td>15</td> </tr> <tr> <td>SW NO.</td> <td>4</td> <td>5</td> <td>6</td> <td>7</td> <td>8</td> <td>9</td> <td>A</td> <td>B</td> <td>C</td> <td>D</td> <td>E</td> <td>F</td> </tr> </table>		AP NO.		04	05	06	07	08	09	10	11	12	13	14	15	SW NO.	4	5	6	7	8	9	A	B	C	D	E	F		
	AP NO.	04	05		06	07	08	09	10	11	12	13	14	15																	
SW NO.	4	5	6	7	8	9	A	B	C	D	E	F																			
0 - 3	Not used																														
<p>MB(Toggle SW)</p>  <p>Note 2</p>		UP	For make-busy																												
		DOWN	For normal operation																												
<p>SW0 (Piano Key SW)</p> 	1	ON	Loop-back test																												
		OFF	For normal operation																												
	2	ON	Analog interface																												
		OFF	Digital interface																												
	3	ON	RS-232C RTS signal (to MODEM) ON Note 3																												
		OFF	RS-232C RTS signal (to MODEM) OFF																												
	4	ON	Always set to ON																												

Switch Settings (Continued)

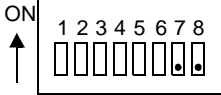
SWITCH NAME	SWITCH NUMBER	SETTING POSITION	FUNCTION	CHECK																														
SW1(Dip SW) 	1	ON	<ul style="list-style-type: none"> Common channel signalling data transmission speed (For Digital Interface) <table border="1" data-bbox="747 367 1274 556"> <thead> <tr> <th>TRANSMISSION SPEED</th> <th>SW 1-1</th> <th>SW 1-2</th> <th>SW 1-3</th> <th>SW 1-4</th> <th>SW 1-5</th> </tr> </thead> <tbody> <tr> <td>48Kbps "</td> <td>ON</td> <td>ON</td> <td>OFF</td> <td>OFF</td> <td>ON</td> </tr> <tr> <td>48Kbps †</td> <td>ON</td> <td>ON</td> <td>ON</td> <td>OFF</td> <td>ON</td> </tr> <tr> <td>56Kbps</td> <td>ON</td> <td>ON</td> <td>OFF</td> <td>ON</td> <td>ON</td> </tr> <tr> <td>64Kbps</td> <td>ON</td> <td>ON</td> <td>ON</td> <td>ON</td> <td>ON</td> </tr> </tbody> </table> <ul style="list-style-type: none"> Common channel signalling data transmission speed (For Analog Interface) Set switches (SW1-1 - SW1-5) to OFF. 	TRANSMISSION SPEED	SW 1-1	SW 1-2	SW 1-3	SW 1-4	SW 1-5	48Kbps "	ON	ON	OFF	OFF	ON	48Kbps †	ON	ON	ON	OFF	ON	56Kbps	ON	ON	OFF	ON	ON	64Kbps	ON	ON	ON	ON	ON	
		TRANSMISSION SPEED		SW 1-1	SW 1-2	SW 1-3	SW 1-4	SW 1-5																										
	48Kbps "	ON		ON	OFF	OFF	ON																											
	48Kbps †	ON		ON	ON	OFF	ON																											
	56Kbps	ON		ON	OFF	ON	ON																											
	64Kbps	ON		ON	ON	ON	ON																											
	OFF																																	
	2	ON																																
		OFF																																
	3	ON																																
		OFF																																
	4	ON																																
		OFF																																
	5	ON																																
		OFF																																
	6	ON		A-Law																														
OFF		μ-law																																
7	<input type="radio"/>	Always set to OFF																																
8	<input type="radio"/>	Always set to OFF																																

The figure in the SWITCH NAME column and the position in in the SETTING POSITION column indicate the standard setting of the switch. When the switch is not set as shown by the figure and , the setting of the switch varies with the system concerned.

- Note 1:** Set the groove on the switch knob to the desired switch position.
- Note 2:** When the power is on, flip the MB switch to ON (UP position) before plugging/unplugging the circuit card.
- Note 3:** This setting is available when SW0-2 is set to ON (Analog Interface).
- Note 4:** The following two kinds of rate adaptation method are available when using 48 Kbps data transmission. The rate adaptation method must be set to match the rate adaptation of the master office.

① SW1-3: OFF

② SW1-3: ON

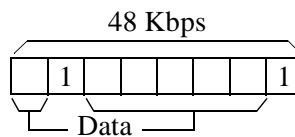
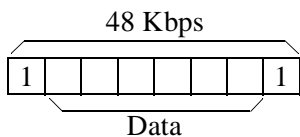

PN-SC01 (DCH)

1. Locations of Lamps, Switches and Connectors

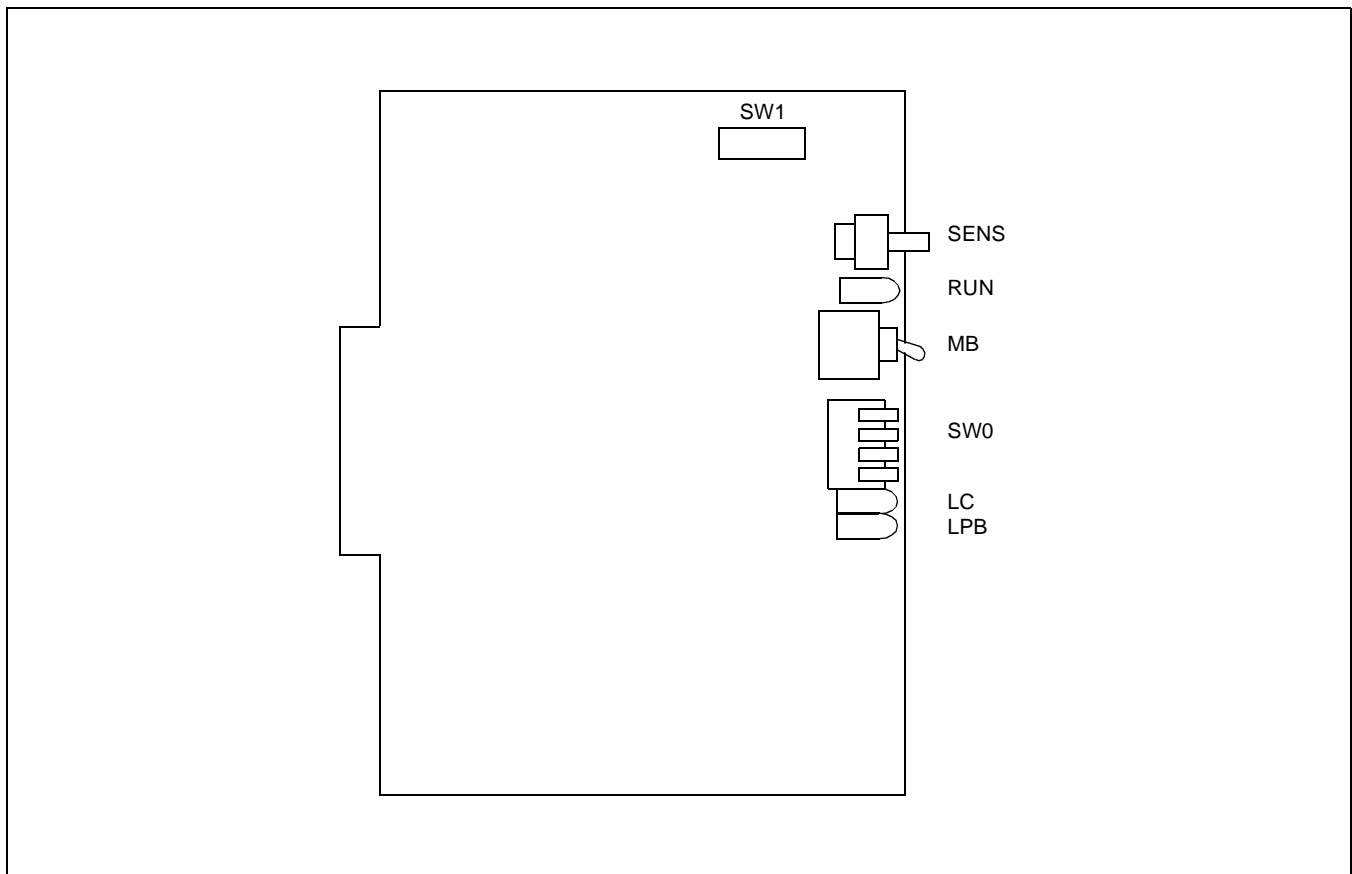

PN-SC01 (DCH) Card

2. Lamp Indications



Lamp Indications

LAMP NAME	COLOR	FUNCTION
RUN	Green	Flashes at 120 IPM while this card is operating normally.
LC	Green	Lights when communications are normally ongoing with the D channel data links connected.
LPB	Green	Not used.

(3) Switch Settings

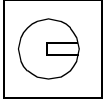
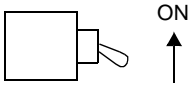
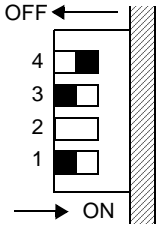
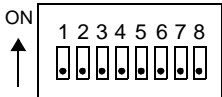
Switch Settings

SWITCH NAME	SWITCH NUMBER	SETTING POSITION	FUNCTION	CHECK																									
SENS (Rotary SW) 	4 - F	Set the switch to match the AP Number (04 - 15) to be set by CM05.																											
	<table border="1" data-bbox="383 396 1252 495"> <tr> <td>AP NO.</td> <td>04</td> <td>05</td> <td>06</td> <td>07</td> <td>08</td> <td>09</td> <td>10</td> <td>11</td> <td>12</td> <td>13</td> <td>14</td> <td>15</td> </tr> <tr> <td>SW NO.</td> <td>4</td> <td>5</td> <td>6</td> <td>7</td> <td>8</td> <td>9</td> <td>A</td> <td>B</td> <td>C</td> <td>D</td> <td>E</td> <td>F</td> </tr> </table>				AP NO.	04	05	06	07	08	09	10	11	12	13	14	15	SW NO.	4	5	6	7	8	9	A	B	C	D	E
AP NO.	04	05	06	07	08	09	10	11	12	13	14	15																	
SW NO.	4	5	6	7	8	9	A	B	C	D	E	F																	
Note 1 0 - 3	Not used																												
MB(Toggle SW) 		UP	For make-busy																										
		DOWN	For normal operation																										
SW0 (Piano Key SW) 	1	OFF	AT&T Interface																										
		ON	Northern Telecom Interface																										
	2	OFF	No deletion																										
		ON	Delete the first three digits of all 011 International Calls.																										
3	OFF	Always set to OFF																											
4	ON	Always set to ON																											
SW1 (Dip SW) 	1	OFF	Always set to OFF																										
	2	OFF	Always set to OFF																										
	3	OFF	Always set to OFF																										
	4	OFF	Always set to OFF																										
	5	OFF	Always set to OFF																										
	6	OFF	Always set to OFF																										
	7	OFF	Always set to OFF																										
	8	OFF	Always set to OFF																										

The figure in the SWITCH NAME column and the position in  in the SETTING POSITION column indicate the standard setting of the switch. When the switch is not set as shown by the figure and , the setting of the switch varies with the system concerned.

Note 1: *Set the groove on the switch knob onto the intended switch position.*

Note 2: *When the power is on, flip the MB switch to ON (UP position) before plugging/unplugging the circuit card.*

PN-SC02 (ICH)

1. Locations of Lamps, Switches, and Connectors

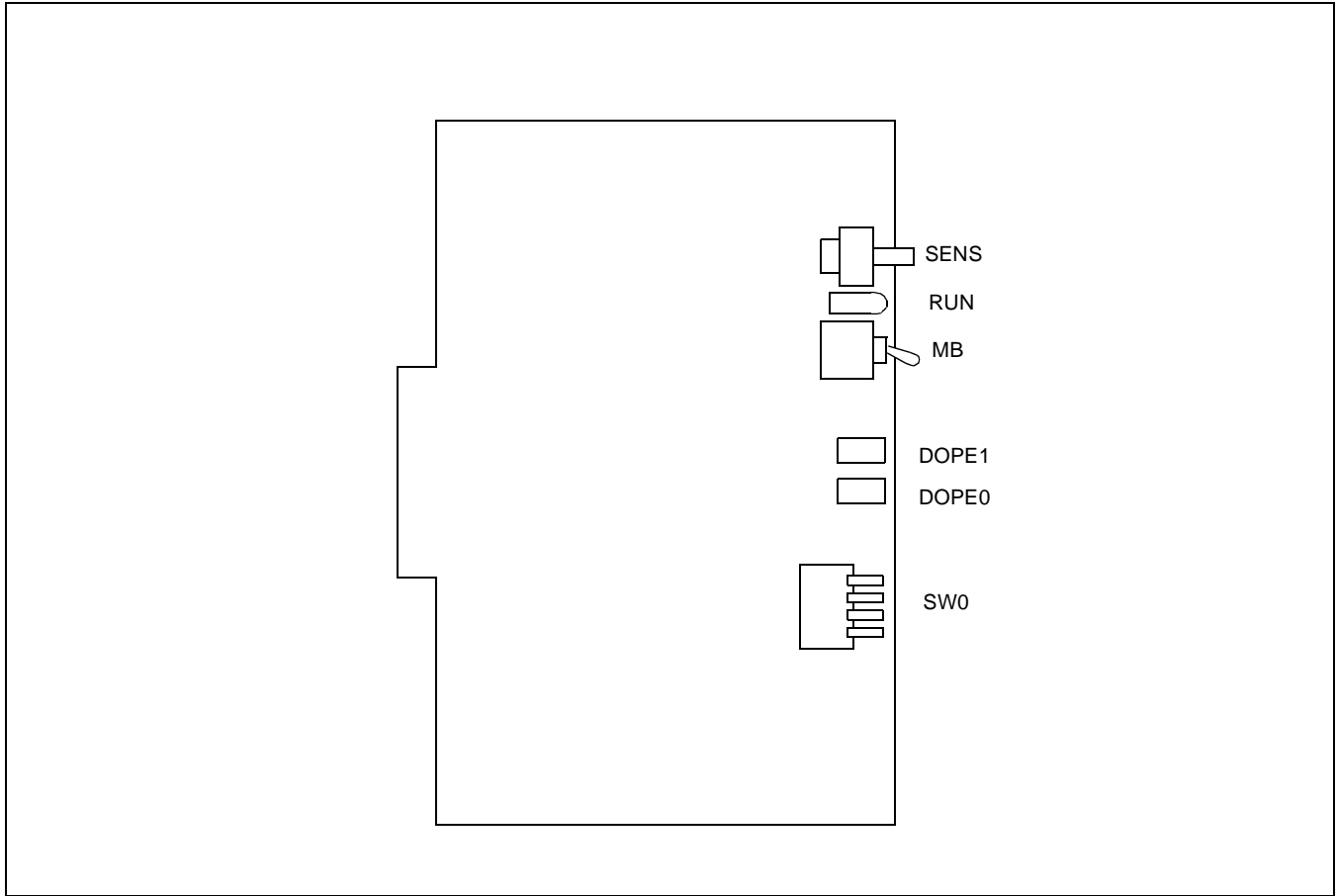

PN-SC02 (ICH) Card







2. Lamp Indications

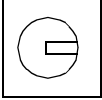
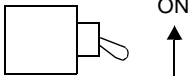

Lamp Indications

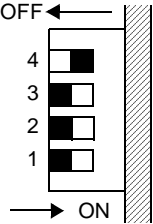
LAMP NAME	COLOR	FUNCTION
RUN	Green	Flashes at 120 IPM while this card is operating normally.
DOPE0	Green	ON: No. 0 circuit D channel link is connected. OFF: No. 0 circuit D channel link is not connected.
DOPE1	Green	ON: No. 1 circuit D channel link is connected. OFF: No. 1 circuit D channel link is not connected.

(3) Switch Settings

Switch Settings

SWITCH NAME	SWITCH NUMBER	SETTING POSITION	FUNCTION	CHECK																											
SENS (Rotary SW)  Note 1	4 - F	Set the switch to match the AP Number (04 - 15) to be set by CM05.																													
	<table border="1"> <tr> <td>AP NO.</td> <td>04</td> <td>05</td> <td>06</td> <td>07</td> <td>08</td> <td>09</td> <td>10</td> <td>11</td> <td>12</td> <td>13</td> <td>14</td> <td>15</td> </tr> <tr> <td>SW NO.</td> <td>4</td> <td>5</td> <td>6</td> <td>7</td> <td>8</td> <td>9</td> <td>A</td> <td>B</td> <td>C</td> <td>D</td> <td>E</td> <td>F</td> </tr> </table>		AP NO.		04	05	06	07	08	09	10	11	12	13	14	15	SW NO.	4	5	6	7	8	9	A	B	C	D	E	F		
	AP NO.	04	05		06	07	08	09	10	11	12	13	14	15																	
SW NO.	4	5	6	7	8	9	A	B	C	D	E	F																			
0 - 3	Not used																														
MB (Toggle SW)  Note 2		UP	For make-busy																												
			For normal operation																												
SW0 (Piano Key SW) 	1		Always set to OFF																												
	2		Always set to OFF																												
	3		Always set to OFF																												
	4		Always set to ON																												

The figure in the SWITCH NAME column and the position in  in the SETTING POSITION column indicate the standard setting of the switch. When the switch is not set as shown by the figure and  , the setting of the switch varies with the system concerned.

Note 1: Set the groove on the switch knob to the desired switch position.

Note 2: When the power is on, flip the MB switch to ON (UP position) before plugging/unplugging the circuit card.

PN-SC03 (ICH)

1. Locations of Lamps, Switches, and Connectors

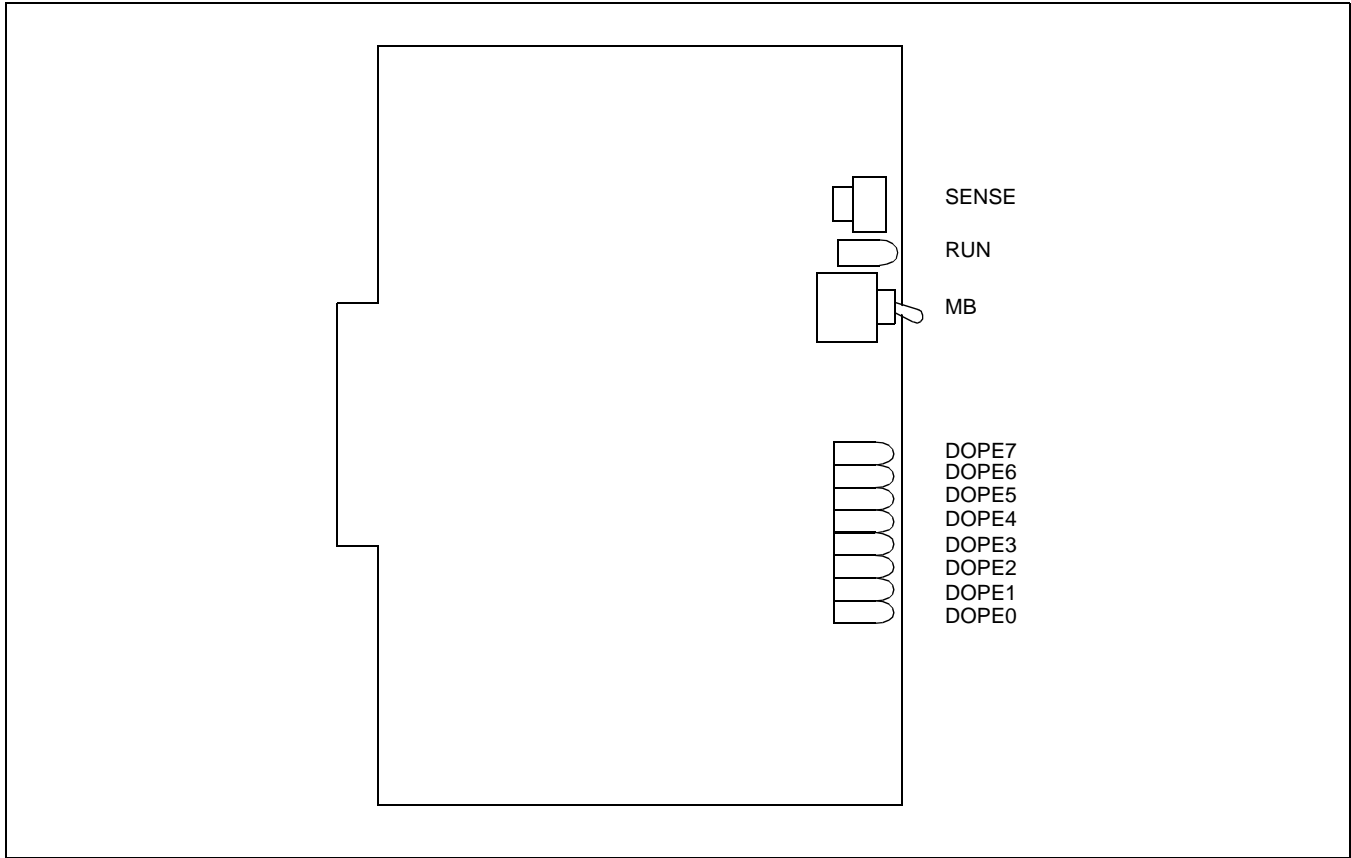

PN-SC03 (ICH) Card

2. Lamp Indications



Lamp Indications on ICH Card

LAMP NAME	COLOR	FUNCTION
RUN	Green	Flashes at 120 IPM while the card is operating normally.
DOPE7	Green	Lights when No.7 circuit D channel link is connected.
DOPE6	Green	Lights when No.6 circuit D channel link is connected.
DOPE5	Green	Lights when No.5 circuit D channel link is connected.
DOPE4	Green	Lights when No.4 circuit D channel link is connected.
DOPE3	Green	Lights when No.3 circuit D channel link is connected.
DOPE2	Green	Lights when No.2 circuit D channel link is connected.
DOPE1	Green	Lights when No.1 circuit D channel link is connected.
DOPE0	Green	Lights when No.0 circuit D channel link is connected.

(3) Switch Settings

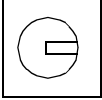
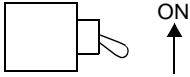
Switch Settings on ICH Card

SWITCH NAME	SWITCH NUMBER	SETTING POSITION	FUNCTION	CHECK																										
SENSE (Rotary SW)  Note 1	4 ~ F	Set the switch to match the AP Number (04 ~ 15) to be set by CM05.																												
		<table border="1"> <tr> <td>AP No.</td> <td>04</td> <td>05</td> <td>06</td> <td>07</td> <td>08</td> <td>09</td> <td>10</td> <td>11</td> <td>12</td> <td>13</td> <td>14</td> <td>15</td> </tr> <tr> <td>SW No.</td> <td>4</td> <td>5</td> <td>6</td> <td>7</td> <td>8</td> <td>9</td> <td>A</td> <td>B</td> <td>C</td> <td>D</td> <td>E</td> <td>F</td> </tr> </table>	AP No.		04	05	06	07	08	09	10	11	12	13	14	15	SW No.	4	5	6	7	8	9	A	B	C	D	E	F	
	AP No.	04	05		06	07	08	09	10	11	12	13	14	15																
SW No.	4	5	6	7	8	9	A	B	C	D	E	F																		
0 ~ 3	Not used																													
MB (Toggle SW)  Note 2	/	UP	For make-busy																											
		DOWN	For normal operation																											

The figure in the SWITCH NAME column and the position in  in the SETTING POSITION column indicate the standard setting of the switch. When the switch is not set as shown by the figure and , the setting of the switch varies with the system concerned.

Note 1: Set the groove on the switch knob to the intended switch position.

Note 2: When the power is on, flip the MB switch to ON (UP position) before plugging/unplugging the circuit card.

PN-SC03 (CSH)

1. Locations of Lamps, Switches, and Connectors

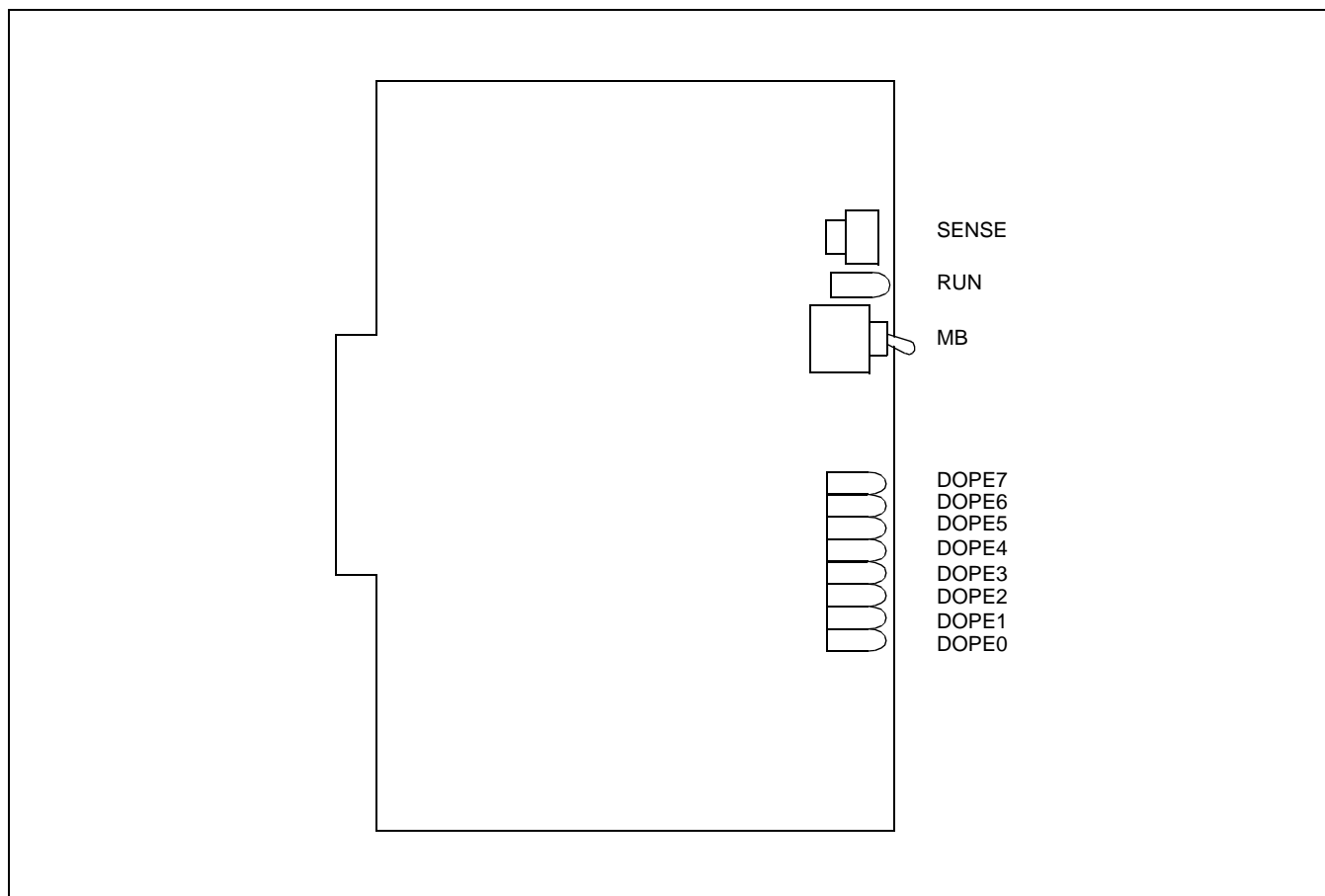

PN-SC03 (CSH) Card

(2) Lamp Indications



Lamp Indications on CSH Card

LAMP NAME	COLOR	FUNCTION
RUN	Green	Flashes at 120 IPM while the card is operating normally.
DOPE7	Green	Lights when No.7 circuit D channel link is connected.
DOPE6	Green	Lights when No.6 circuit D channel link is connected.
DOPE5	Green	Lights when No.5 circuit D channel link is connected.
DOPE4	Green	Lights when No.4 circuit D channel link is connected.
DOPE3	Green	Lights when No.3 circuit D channel link is connected.
DOPE2	Green	Lights when No.2 circuit D channel link is connected.
DOPE1	Green	Lights when No.1 circuit D channel link is connected.
DOPE0	Green	Lights when No.0 circuit D channel link is connected.

3. Switch Settings

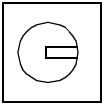
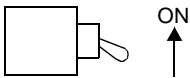
Switch Settings on CSH Card

SWITCH NAME	SWITCH NUMBER	SETTING POSITION	FUNCTION	CHECK																									
SENSE (Rotary SW) 	4 ~ F	Set the switch to match the AP Number (04 ~ 15) to be set by CM05.																											
		<table border="1"> <thead> <tr> <th>AP No.</th> <td>04</td><td>05</td><td>06</td><td>07</td><td>08</td><td>09</td><td>10</td><td>11</td><td>12</td><td>13</td><td>14</td><td>15</td> </tr> <tr> <th>SW No.</th> <td>4</td><td>5</td><td>6</td><td>7</td><td>8</td><td>9</td><td>A</td><td>B</td><td>C</td><td>D</td><td>E</td><td>F</td> </tr> </thead> </table>	AP No.	04	05	06	07	08	09	10	11	12		13	14	15	SW No.	4	5	6	7	8	9	A	B	C	D	E	F
		AP No.	04	05	06	07	08	09	10	11	12	13		14	15														
SW No.	4	5	6	7	8	9	A	B	C	D	E	F																	
0 ~ 3	Not used																												
MB (Toggle SW) 	/	UP	For make-busy																										
		DOWN	For normal operation																										

The figure in the SWITCH NAME column and the position in  in the SETTING POSITION column indicate the standard setting of the switch. When the switch is not set as shown by the figure and , the setting of the switch varies with the system concerned.

Note 1: Set the groove on the switch knob to the intended switch position.

Note 2: When the power is on, flip the MB switch to ON (UP position) before plugging/unplugging the circuit card.

4. LAMP INDICATIONS AND SWITCH SETTINGS OF LINE/TRUNK CIRCUIT CARDS

Table 4-3 below shows the line/trunk circuit cards to be explained in this section.

Table 4-3 Table of Line /Trunk Circuit Cards

NAME (FUNCTIONAL NAME)	EXISTENCE OF LAMPS X: PROVIDED — : NOT PROVIDED	EXISTENCE OF SWITCHES X: PROVIDED — : NOT PROVIDED	EXTRACTION/INSER- TION WITH POWER ON X: ALLOWED — : NOT ALLOWED	REFERENCE PAGE
PN-2AMPA (AMP)	X	—	X	101
PN-AUCA (AUC)	X	—	X	102
PN-CFTA (CFT)	X	—	X	103
PN-4COTB (COT)	X	—	X	104
PN-4COTG (COT)	X	—	X	105
PN-2DATA (DAT)	X	X	X	106
PN-DK00 (DK)	—	—	X	108
PN-4DITB (DIT)	X	—	X	109
PN-2DLCB (DLC)	X	—	X	110
PN-2DLCC (DLC)	X	—	X	111
PN-2DLCN (DLC)	X	—	X	112
PN-4DLCA (DLC)	X	—	X	113
PN-4DLCD (DLC)	X	—	X	114
PN-4DLCF (DLC)	X	—	X	115
PN-4DLCM (DLC)	X	—	X	116
PN-4DLCQ (DLC)	X	—	X	117
PN-2DPCB (DPC)	X	X	X	118
PN-2ILCA (ILC)	X	X	X	121
PN-4LCD/4LCD-A (LC)	X	—	X	124
PN-4LCJ (LC)	X	—	X	125
PN-M03 (M03)	X	X	X	126
PN-2ODTA (ODT)	X	—	X	129
PN-8RSTA (PBR)	—	—	X	130
PN-TNTA (TNT)	—	X	X	131
PN-2CSIA (CSI)	X	X	X	133

PN-2AMPA (AMP)

1. Locations of Lamps, Switches and Connectors

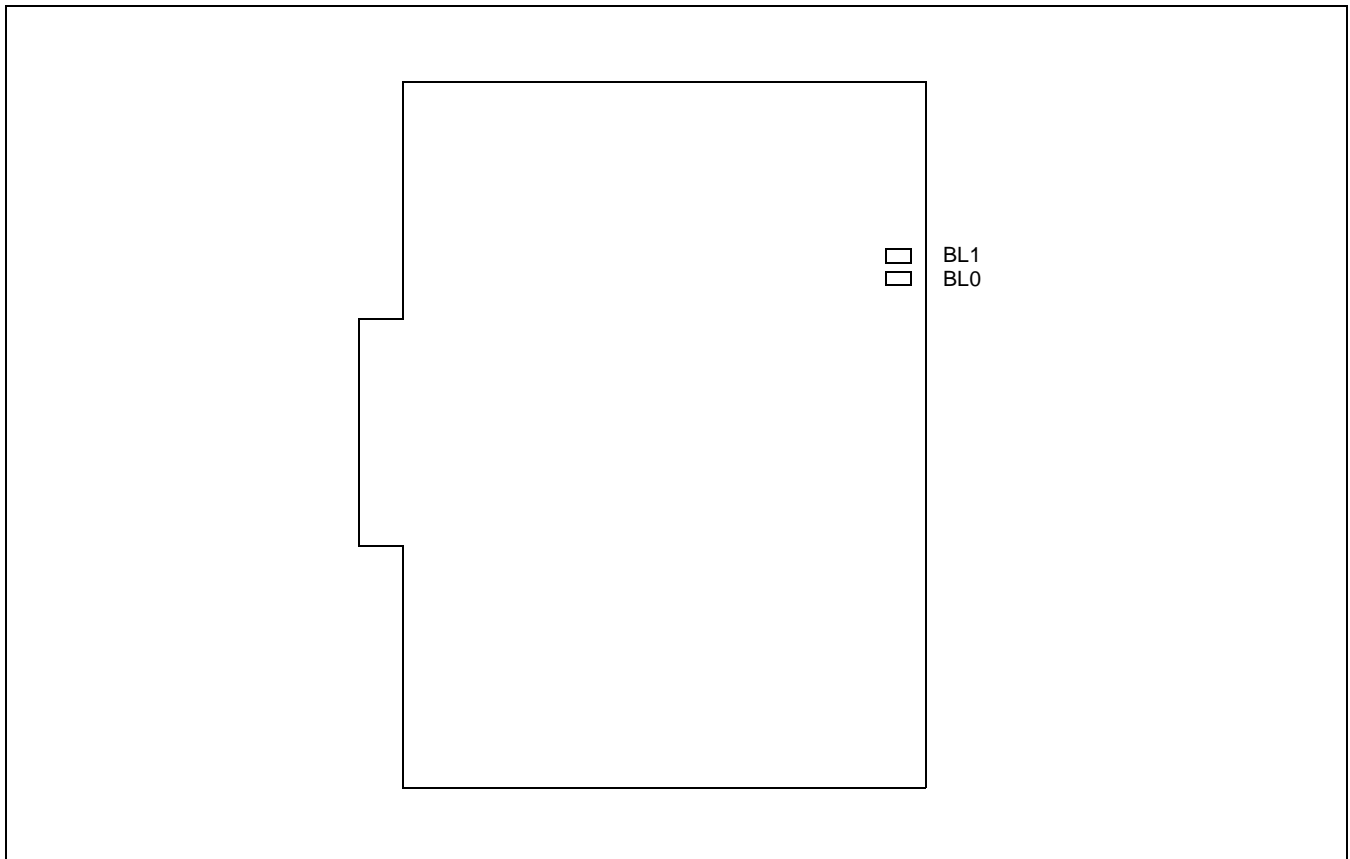

PN-2AMPA (AMP) Card

2. Lamp Indications

Lamp Indications

LAMP NAME	COLOR	FUNCTION
BL0, 1	Red	<ul style="list-style-type: none"> Remains lit when the corresponding circuit is in use. Flashes at 60 IPM when the corresponding circuit is in the make-busy state or the system data for this card is not assigned.

3. Switch Settings

This card has no switches.

PN-AUCA (AUC)

PN-AUCA (AUC)

1. Locations of Lamps, Switches and Connectors

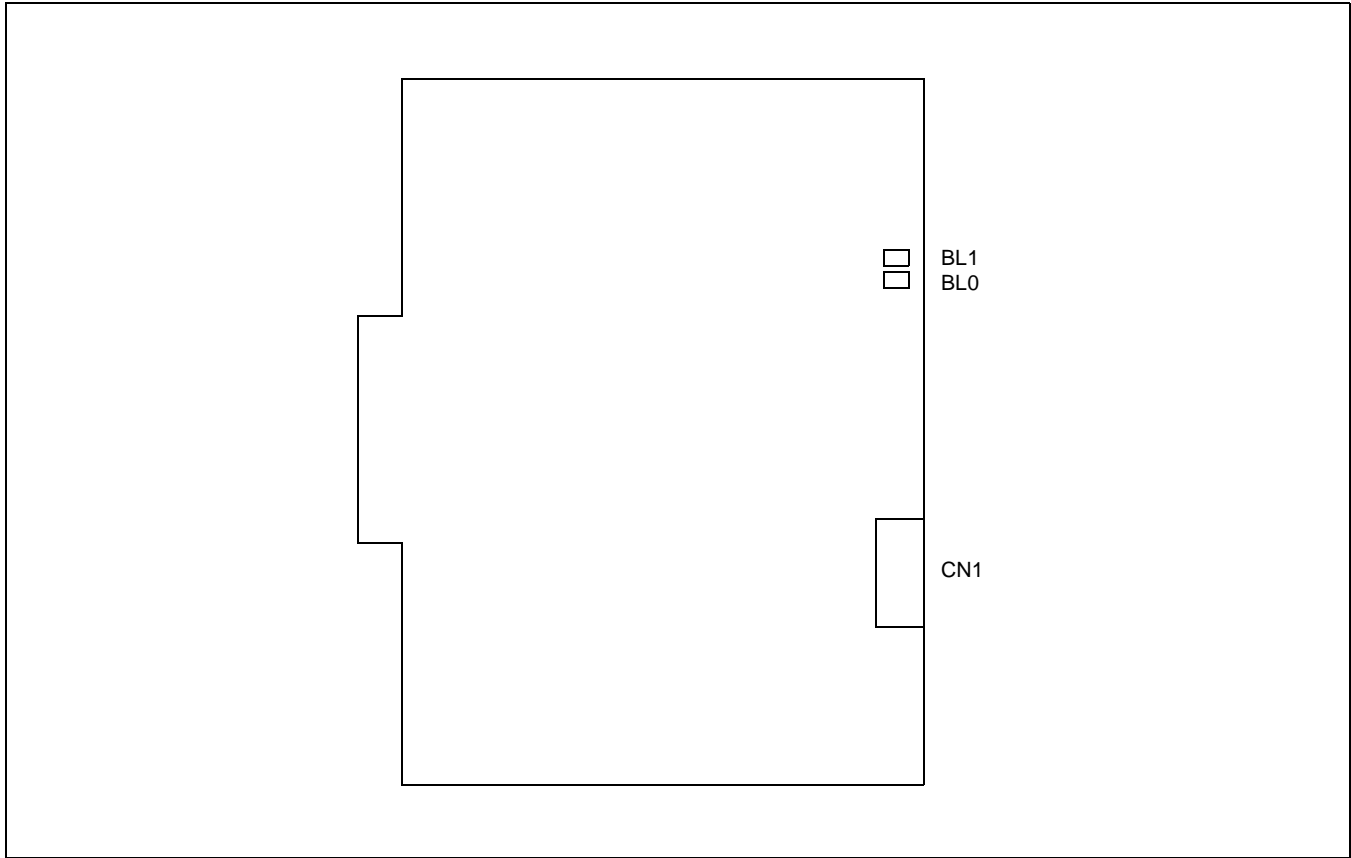

PN-AUCA (AUC) Card

2. Lamp Indications

Lamp Indications

LAMP NAME	COLOR	FUNCTION
BL0, 1	Red	<ul style="list-style-type: none">Remains lit when the corresponding circuit is in use.Flashes at 60 IPM when the corresponding circuit is in the make-busy state or the system data for this card is not assigned.

3. Switch Settings

This card has no switches.

PN-CFTA (CFT)

1. Locations of Lamps, Switches and Connectors

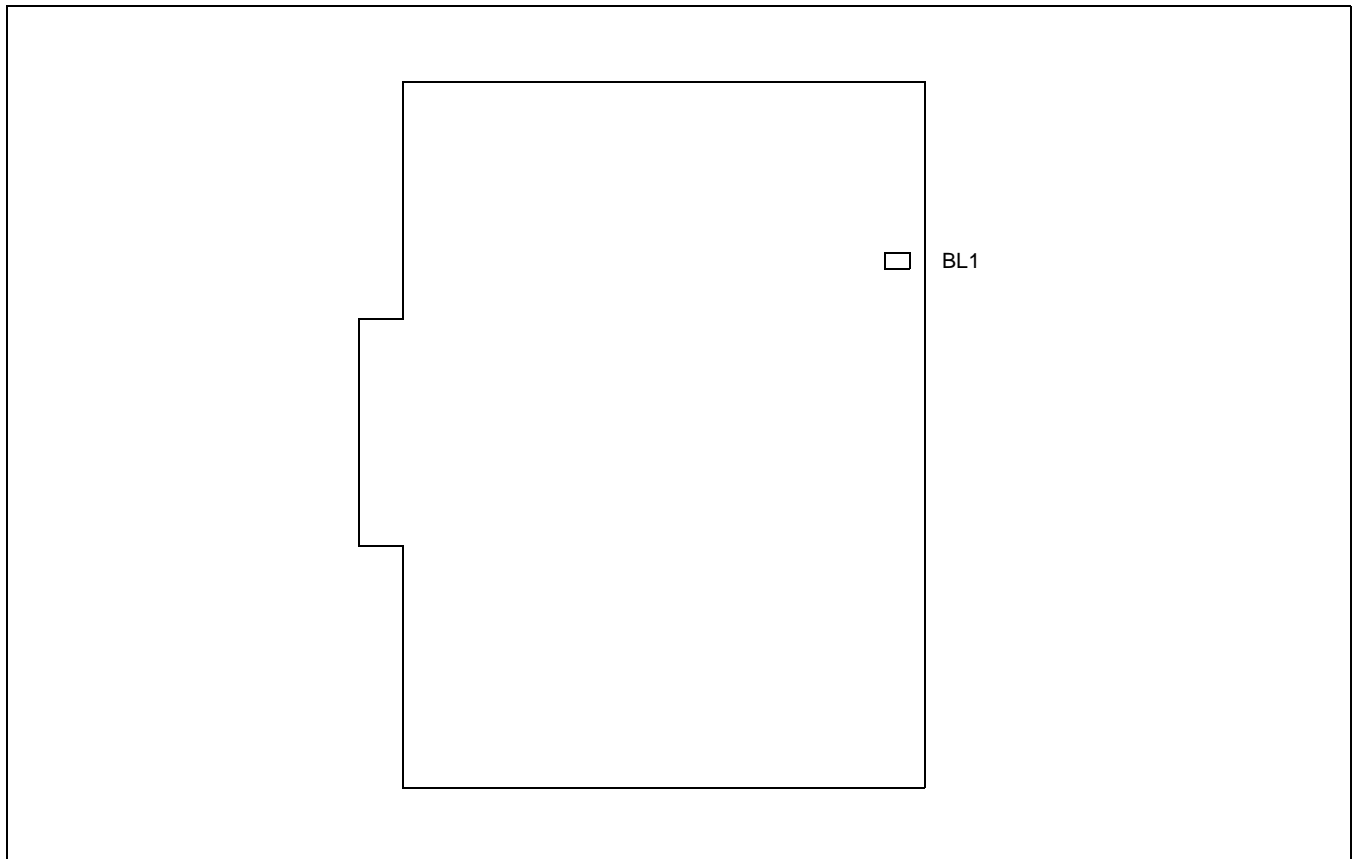

PN-CFTA (CFT) Card

2. Lamp Indications

Lamp Indications

LAMP NAME	COLOR	FUNCTION
BL0	Red	<ul style="list-style-type: none"> Remains lit when the card is in use. Flashes (60 IPM) When the circuit on the card is in the make-busy state on the system data for this card is not assigned.

3. Switch Settings

This card has no switches.

PN-4COTB (COT)

PN-4COTB (COT)

1. Locations of Lamps, Switches and Connectors

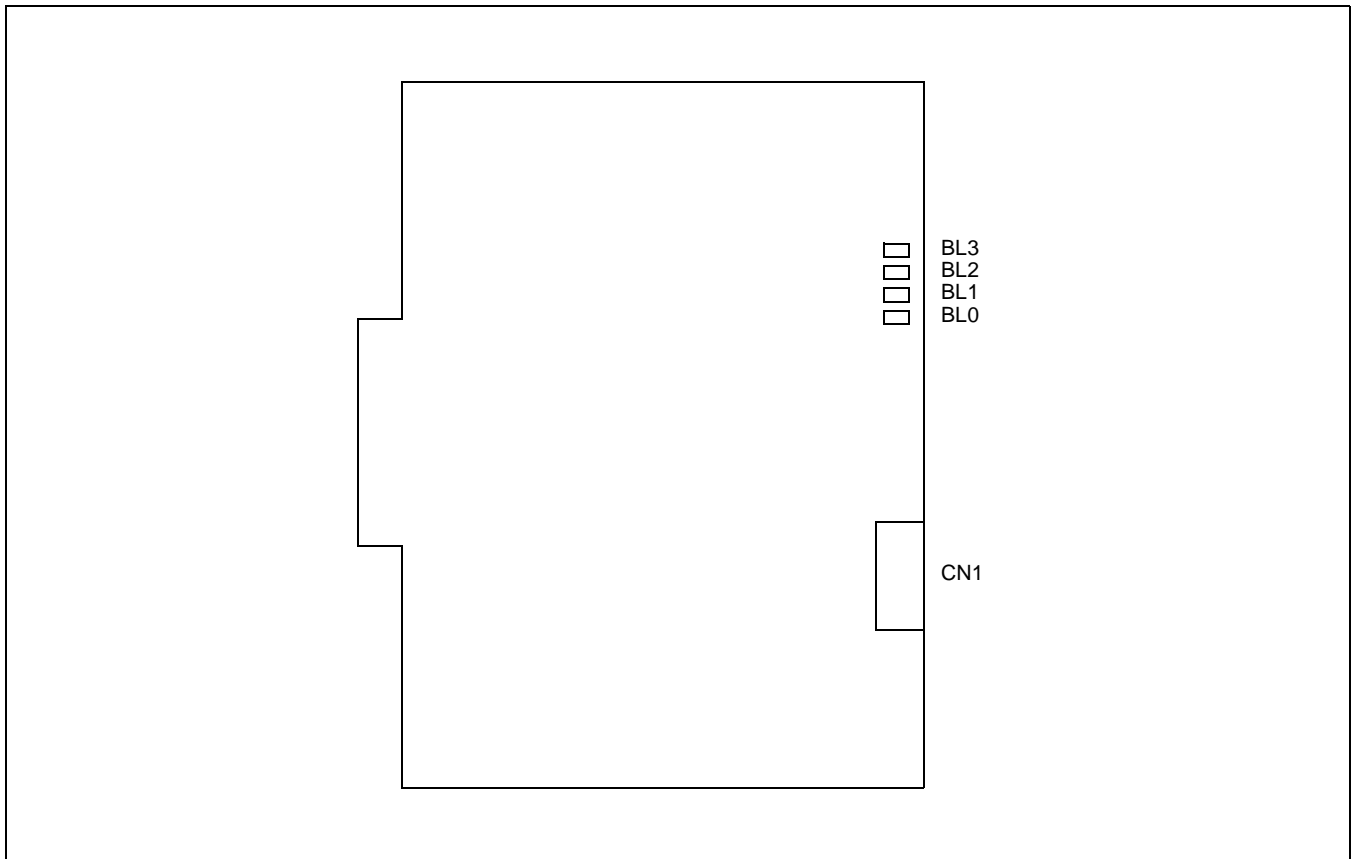

PN-4COTB (COT) Card

2. Lamp Indications

Lamp Indications

LAMP NAME	COLOR	FUNCTION
BL0 - 3	Red	<ul style="list-style-type: none">• Remains lit when the corresponding circuit is in use.• Flashes at 60 IPM when the corresponding circuit is in the make-busy state or the system data for this card is not assigned.

3. Switch Settings

This card has no switches.

PN-4COTG (COT)

1. Locations of Lamps, Switches and Connectors

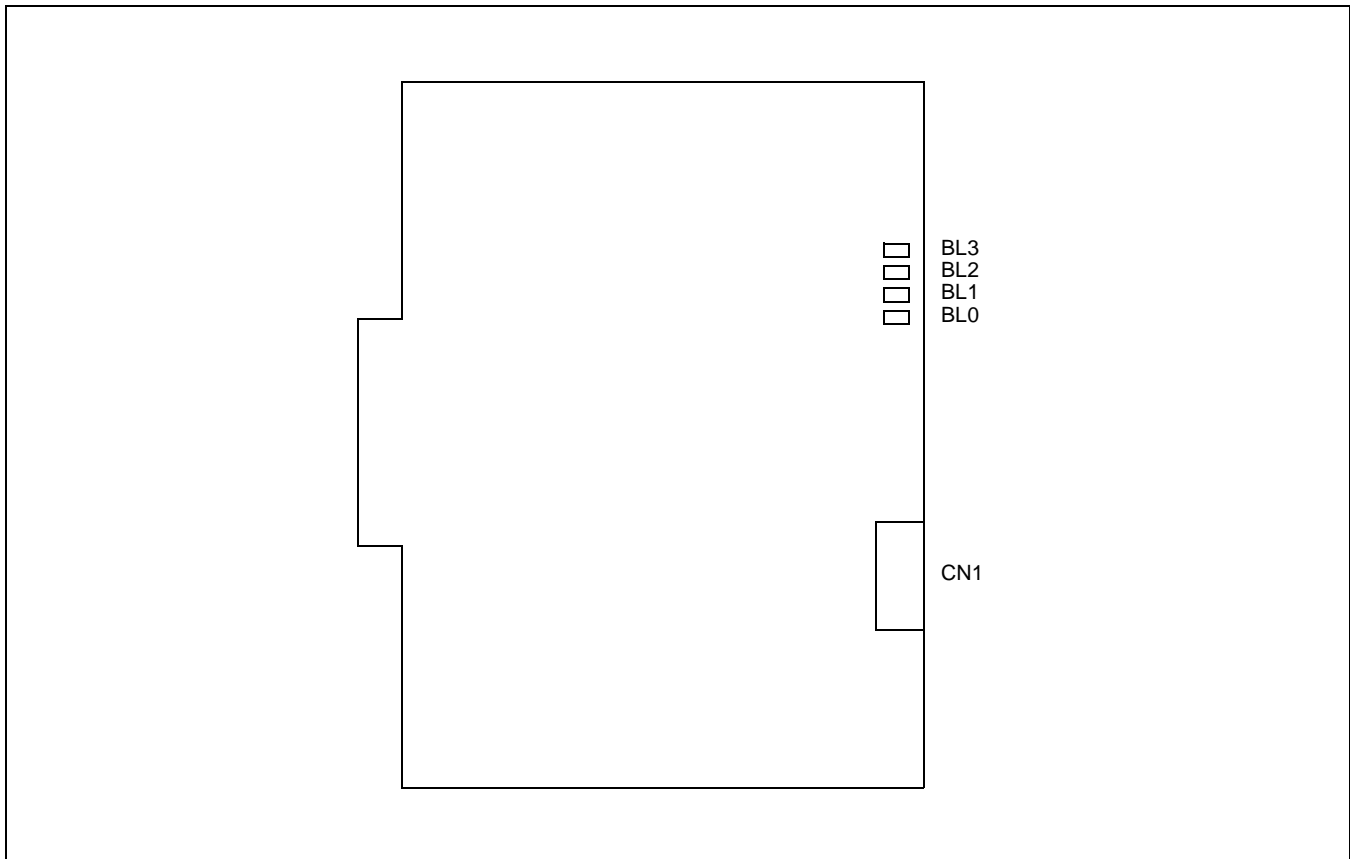

PN-4COTG (COT) Card

2. Lamp Indications

Lamp Indications

LAMP NAME	COLOR	FUNCTION
BL0 - 3	Red	<ul style="list-style-type: none"> Remains lit when the corresponding circuit is in use. Flashes at 60 IPM when the corresponding circuit is in the make-busy state or the system data for this card is not assigned.

3. Switch Settings

This card has no switches.

PN-2DATA (DAT)

PN-2DATA (DAT)

1. Locations of Lamps, Switches and Connectors

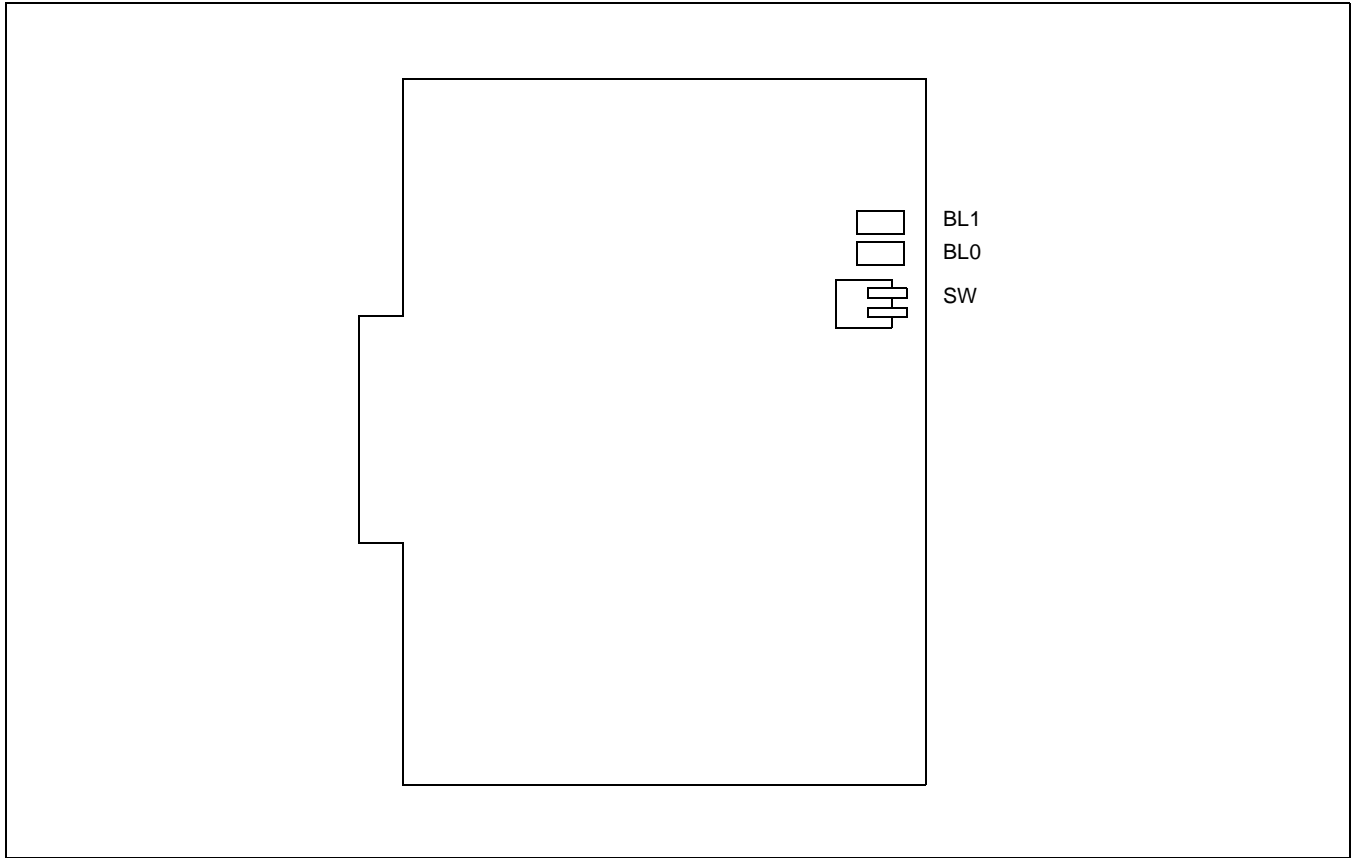

PN-2DATA (DAT) Card

2. Lamp Indications

Lamp Indications

LAMP NAME	COLOR	FUNCTION
BL0, 1	Red	<ul style="list-style-type: none">• Remains lit when the corresponding circuit is in use.• Flashes at 60 IPM when the corresponding circuit is in the make-busy state or the system data for this card is not assigned.

(3) Switch Settings

Switch Settings

SWITCH NAME	SWITCH NUMBER	SETTING POSITION	FUNCTION	CHECK
<p>SW (Piano Key SW)</p> <p>ON ←</p> <p>SW1</p> <p>SW0</p> <p>→ OFF</p>	SW-0	ON	Data write into the No.1 circuit is disabled.	
		<input type="radio"/>	Data write into the No.1 circuit is enabled.	
	SW-1	ON	Data write into the No.1 circuit is disabled.	
		<input type="radio"/>	Data write into the No.1 circuit is enabled.	

The figure in the SWITCH NAME column and the position in in the SETTING POSITION column indicate the standard setting of the switch. When the switch is not set as shown by the figure and , the setting of the switch varies with the system concerned.

PN-DK00 (DK)

1. Locations of Lamps, Switches and Connectors

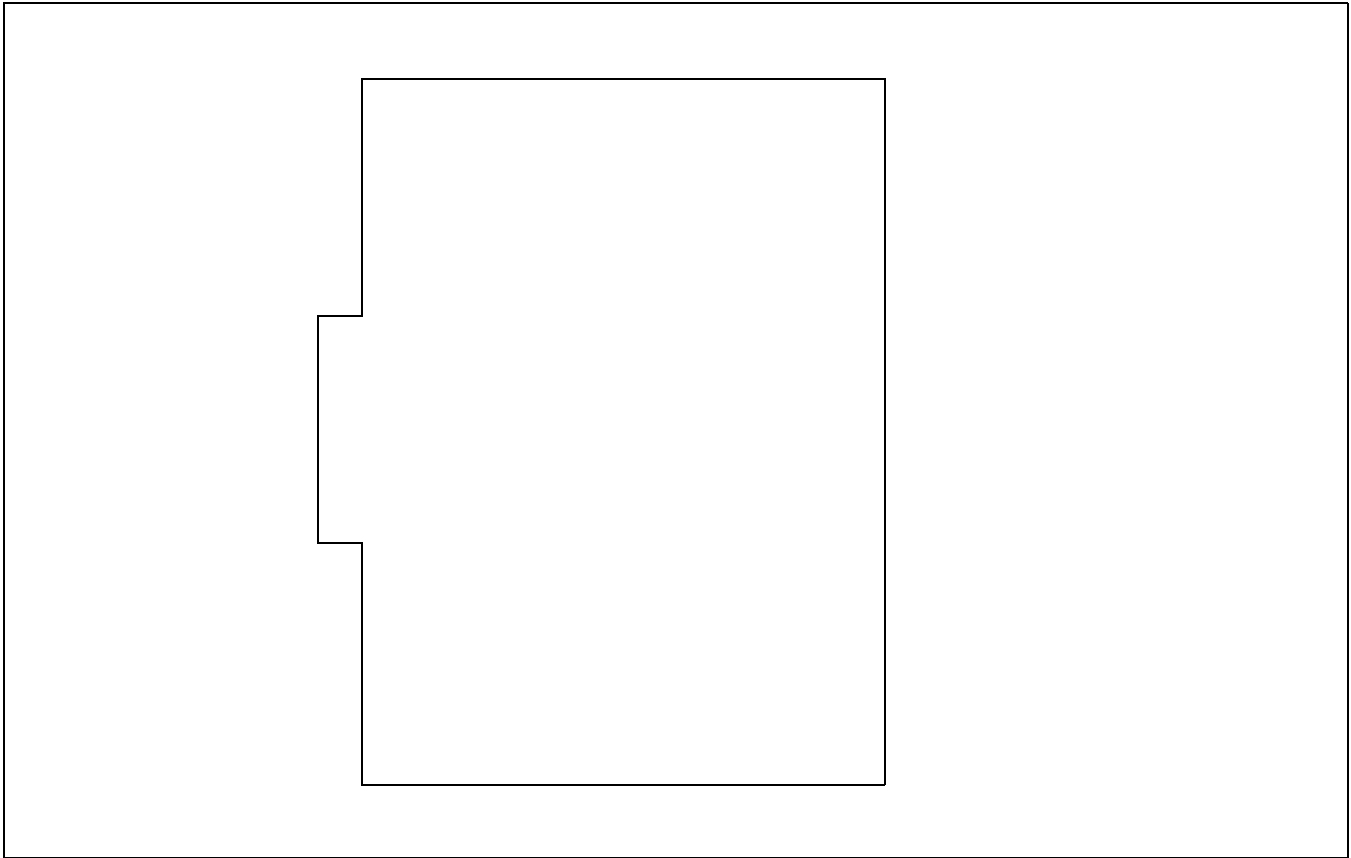

PN-DK00 (DK) Card

2. Lamp Indications

This card has no indicator lamps.

3. Switch Settings

This card has no switches.

PN-4DITB (DIT)

1. Locations of Lamps, Switches, and Connectors

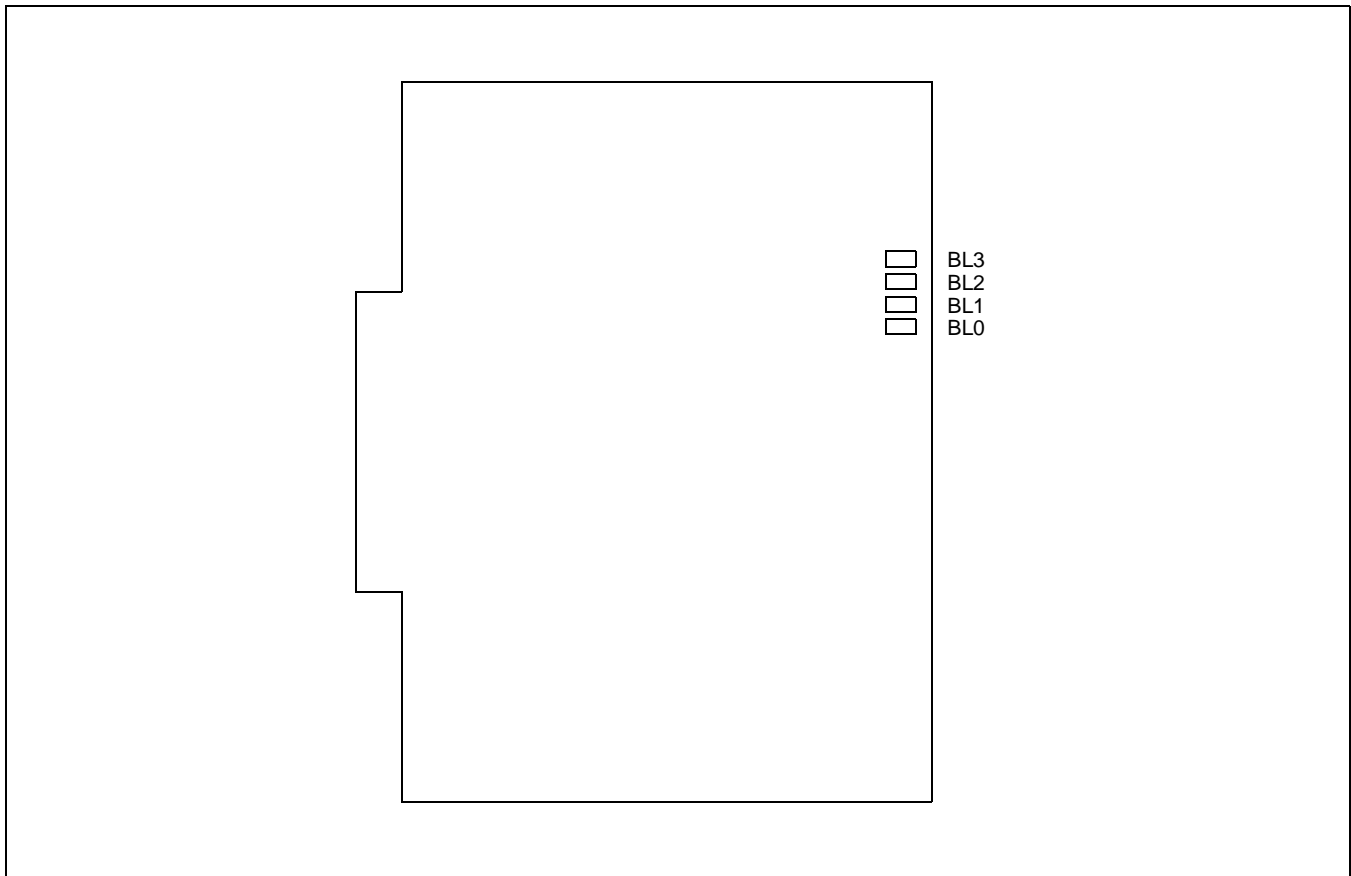

PN-4DITB (DIT) Card

2. Lamp Indications

Lamp Indications

LAMP NAME	COLOR	FUNCTION
BL0 ~ 3	Red	<ul style="list-style-type: none"> Light when the corresponding circuit is in use. Flashes at 60 IPM when the corresponding circuit is in the make-busy state or the system data for this card is not assigned.

3. Switch Settings

This card has no switches.

PN-2DLCB (DLC)

1. Locations of Lamps, Switches and Connectors

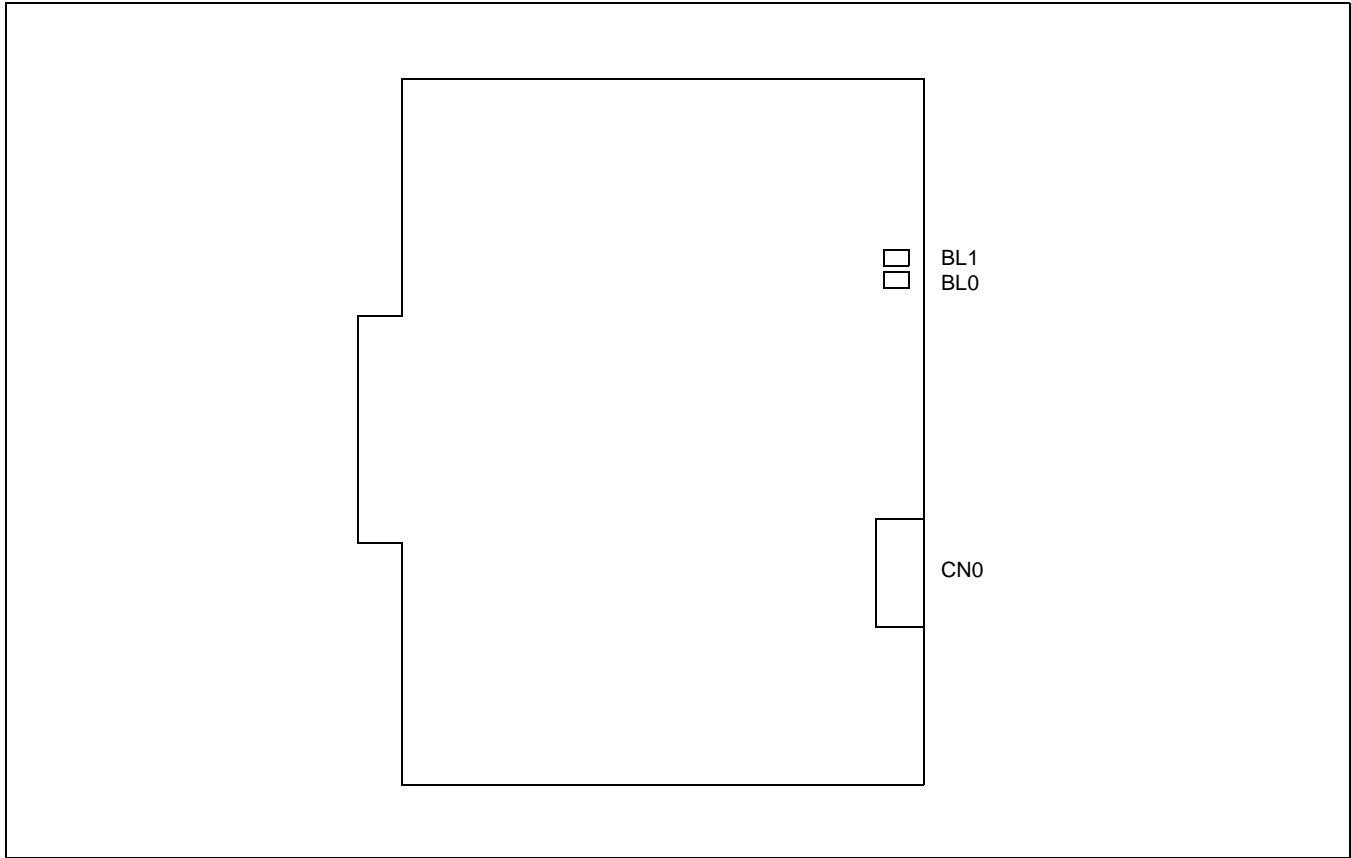

PN-2DLCB (DLC) Card

2. Lamp Indications

Lamp Indications

LAMP NAME	COLOR	FUNCTION
BL0 , 1	Red	<ul style="list-style-type: none">Remains lit when the corresponding circuit is in use.Flashes at 60 IPM when the corresponding circuit is in the make-busy state or the system data for this card is not assigned.

3. Switch Settings

This card has no switches.

PN-2DLCC (DLC)

1. Locations of Lamps, Switches and Connectors

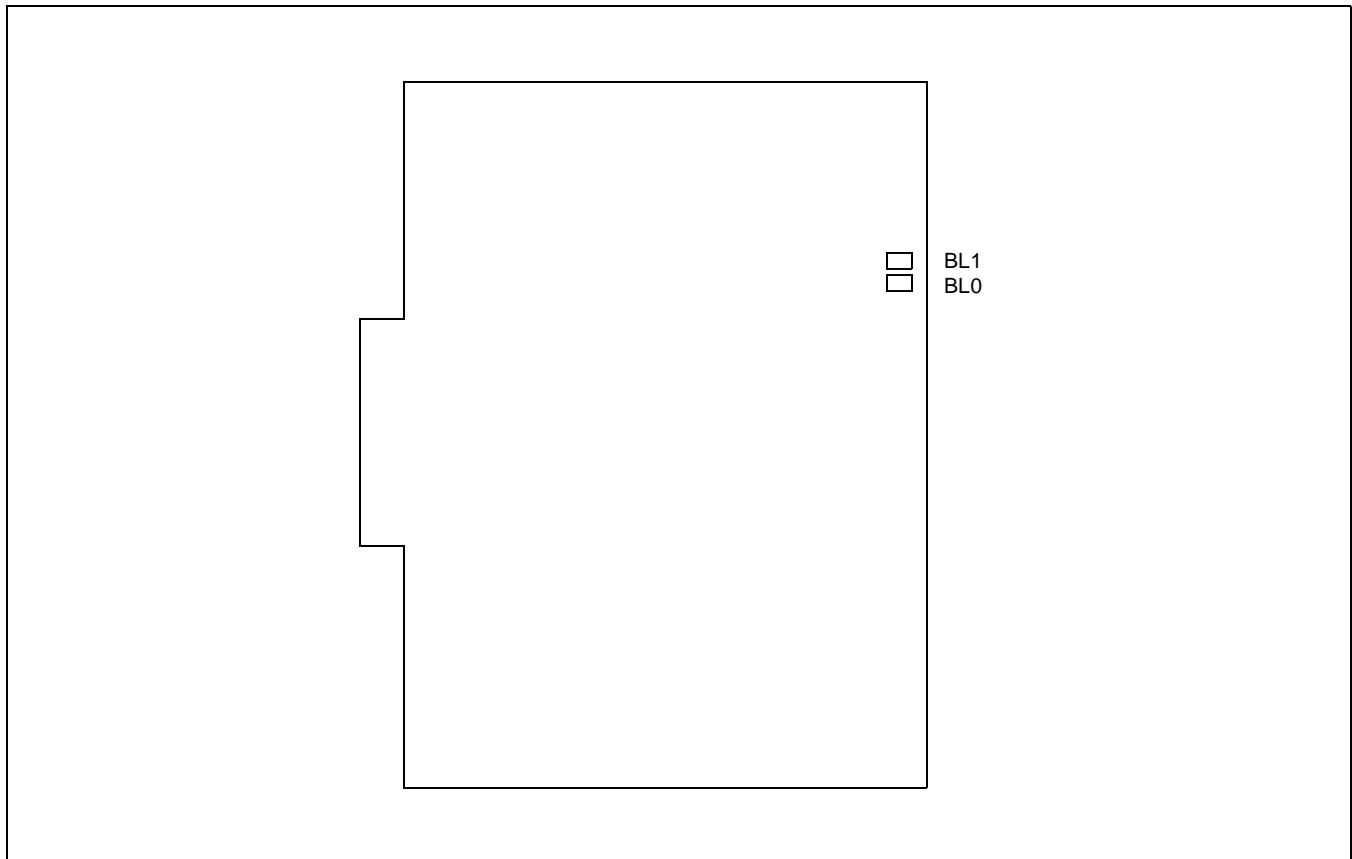

PN-2DLCC (DLC) Card

2. Lamp Indications

Lamp Indications

LAMP NAME	COLOR	FUNCTION
BL0 , 1	Red	<ul style="list-style-type: none"> Remains lit when the corresponding circuit is in use. Flashes at 60 IPM when the corresponding circuit is in the make-busy state or the system data for this card is not assigned.

3. Switch Settings

This card has no switches.

PN-2DLCN (DLC)

PN-2DLCN (DLC)

1. Locations of Lamps, Switches and Connectors

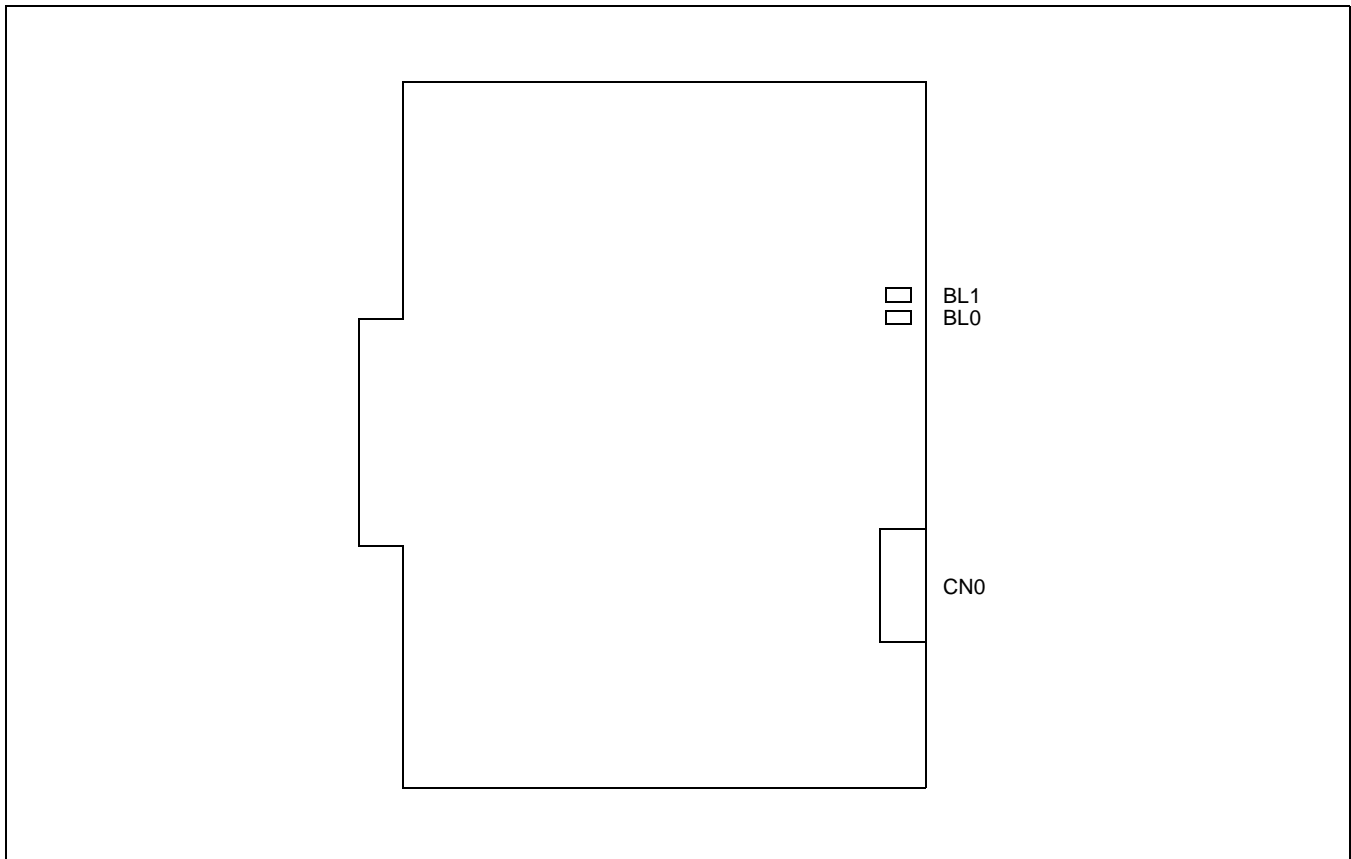

PN-2DLCN (DLC) Card

2. Lamp Indications

Lamp Indications

LAMP NAME	COLOR	FUNCTION
BL0, 1	Red	<ul style="list-style-type: none">Remains lit when the corresponding circuit is in use.Flashes at 60 IPM when the corresponding circuit is in the make-busy state or the system data for this card is not assigned.

3. Switch Settings

This card has no switches.

PN-4DLCA (DLC)

1. Locations of Lamps, Switches and Connectors

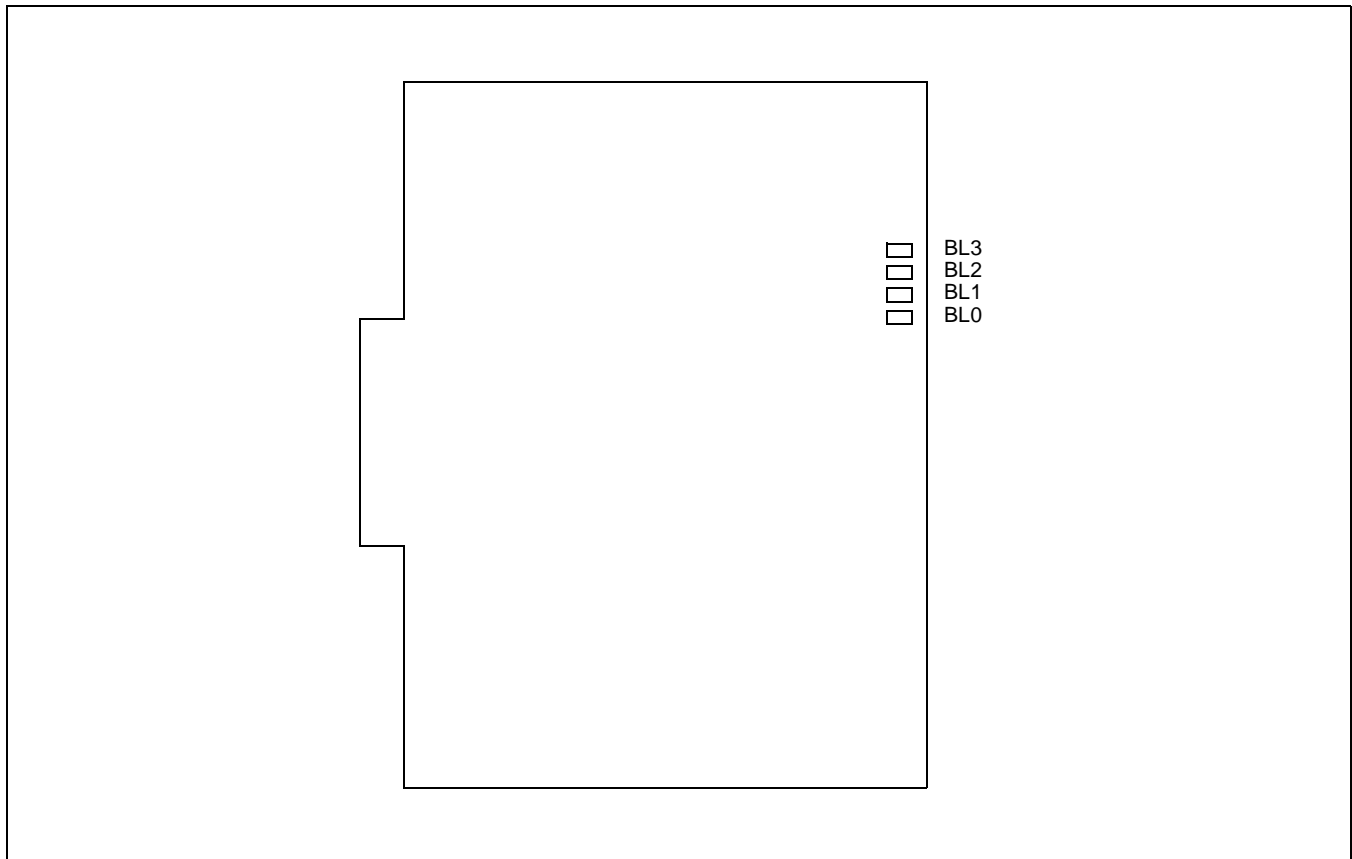

PN-4DLCA (DLC) Card

2. Lamp Indications

Lamp Indications

LAMP NAME	COLOR	FUNCTION
BL0 - 3	Red	<ul style="list-style-type: none"> Remains lit when the corresponding circuit is in use. Flashes at 60 IPM when the corresponding circuit is in the make-busy state or the system data for this card is not assigned.

3. Switch Settings

This card has no switches.

PN-4DLCD (DLC)

PN-4DLCD (DLC)

1. Locations of Lamps, Switches and Connectors

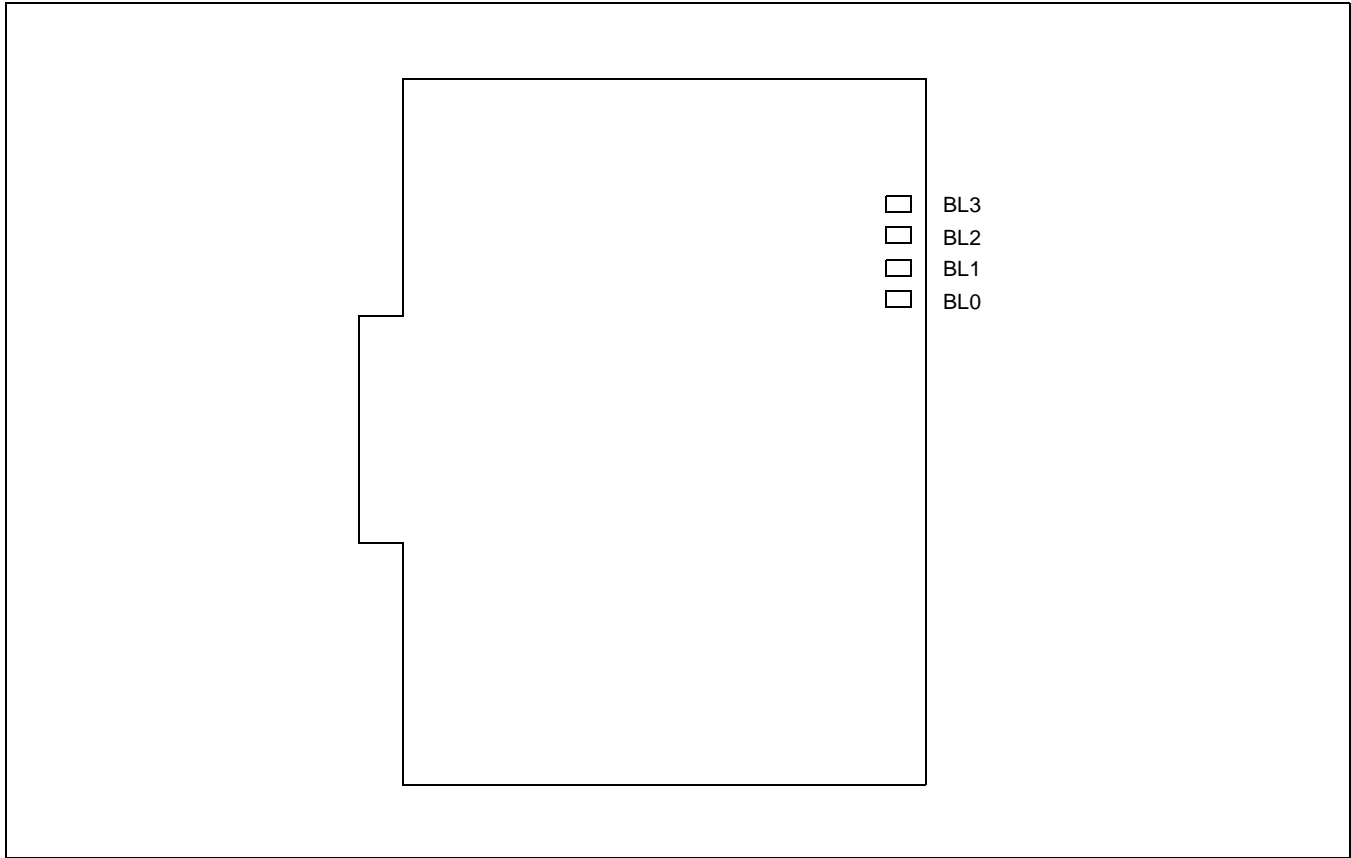

PN-4DLCD (DLC) Card

2. Lamp Indications

Lamp Indications

LAMP NAME	COLOR	FUNCTION
BL0-3	Red	<ul style="list-style-type: none">• Remains lit when the corresponding circuit is in use• Flashes at 60 IPM when the corresponding circuit is in the make-busy state or the system data for this card is not assigned

3. Switch Settings

This card has no switches.

PN-4DLCF (DLC)

1. Locations of Lamps, Switches and Connectors

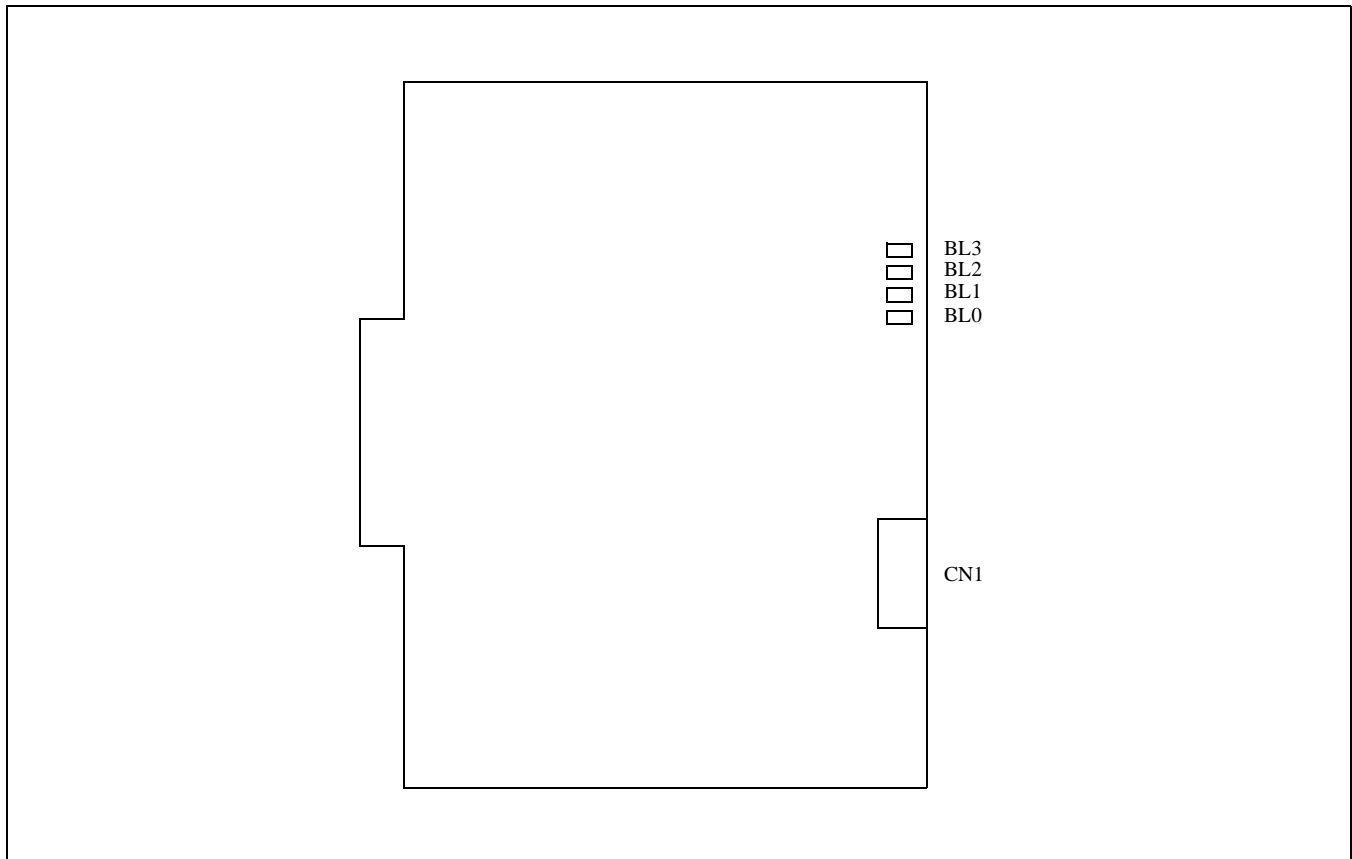

PN-4DLCF (DLC) Card

2. Lamp Indications

Lamp Indications

LAMP NAME	COLOR	FUNCTION
BL0 - 3	Red	<ul style="list-style-type: none"> Remains lit when the corresponding circuit is in use. Flashes at 60 IPM when the corresponding circuit is in the make-busy state or the system data for this card is not assigned.

3. Switch Settings

This card has no switches.

PN-4DLCM (DLC)

PN-4DLCM (DLC)

1. Locations of Lamps, Switches and Connectors

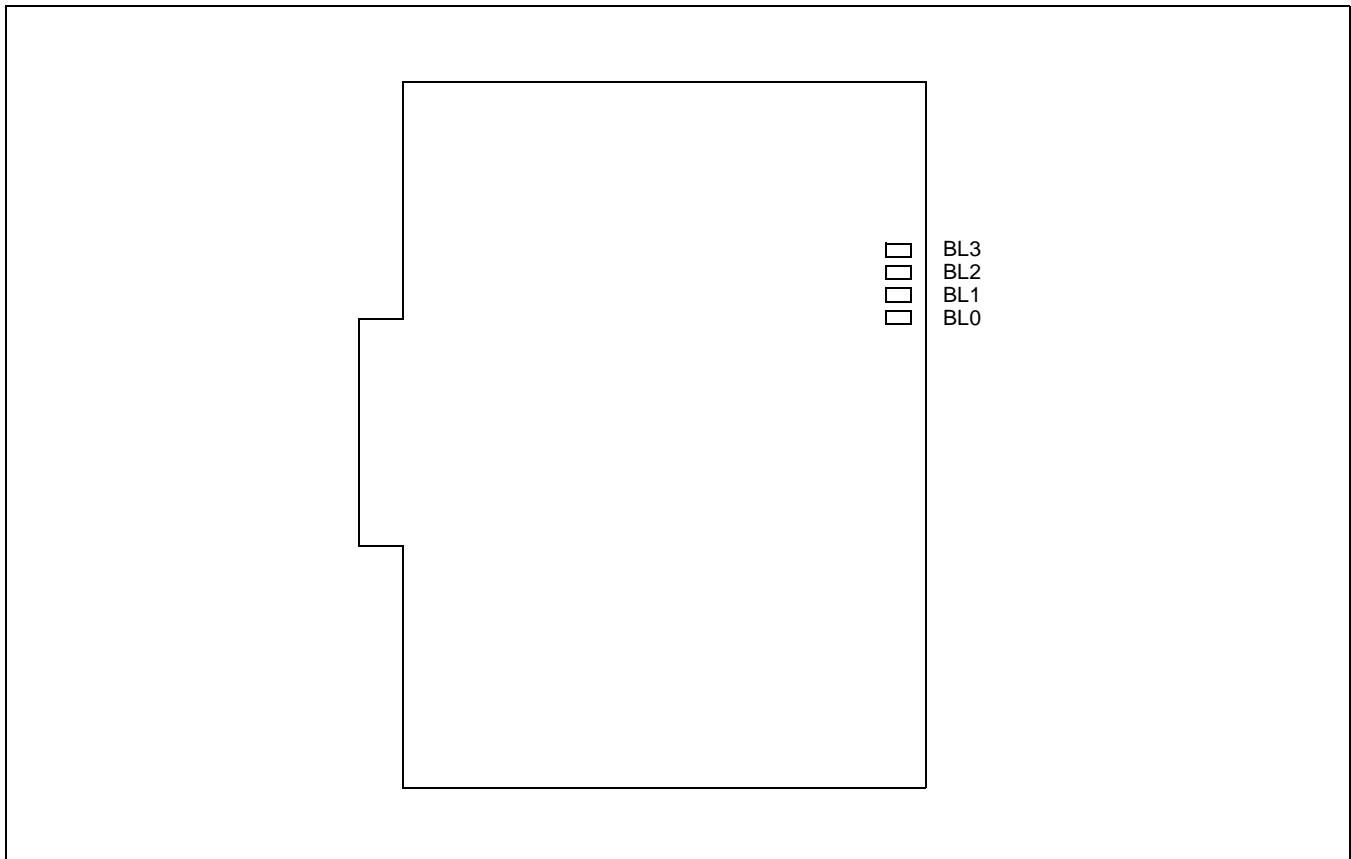

PN-4DLCM (DLC) Card

2. Lamp Indications

Lamp Indications

LAMP NAME	COLOR	FUNCTION
BL0-3	Red	<ul style="list-style-type: none">Remains lit when the corresponding circuit is in use.Flashes at 60 IPM when the corresponding circuit is in the make-busy state or the system data for this card is not assigned.

3. Switch Settings

This card has no switches.

PN-4DLCQ (DLC)

1. Locations of Lamps, Switches and Connectors

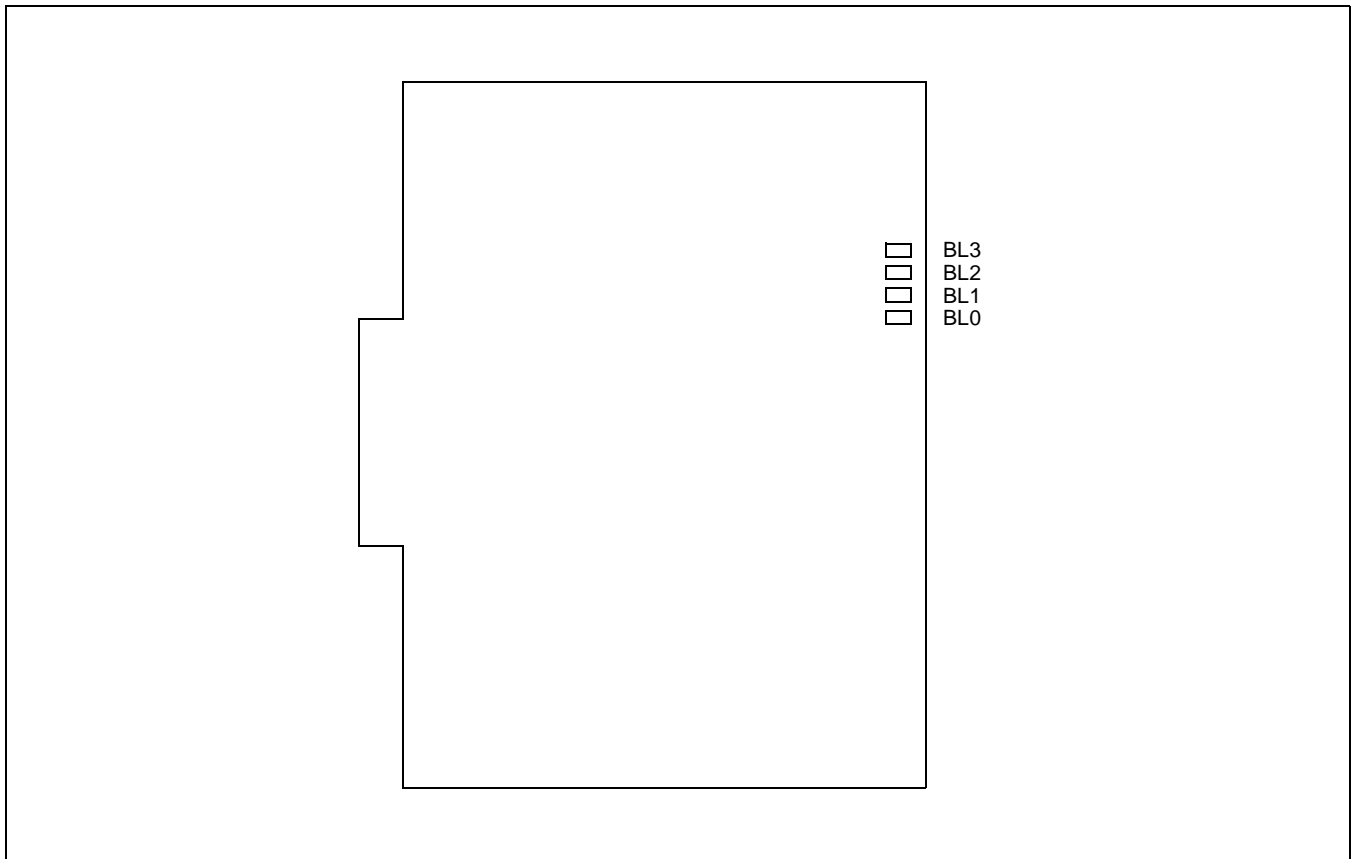

PN-4DLCQ (DLC) Card

2. Lamp Indications

Lamp Indications

LAMP NAME	COLOR	FUNCTION
BL0-3	Red	<ul style="list-style-type: none"> Remains lit when the corresponding circuit is in use. Flashes at 60 IPM when the corresponding circuit is in the make-busy state or the system data for this card is not assigned.

3. Switch Settings

This card has no switches.

PN-2DPCB (DPC)

PN-2DPCB (DPC)

1. Location of Lamps, Switches and Connectors

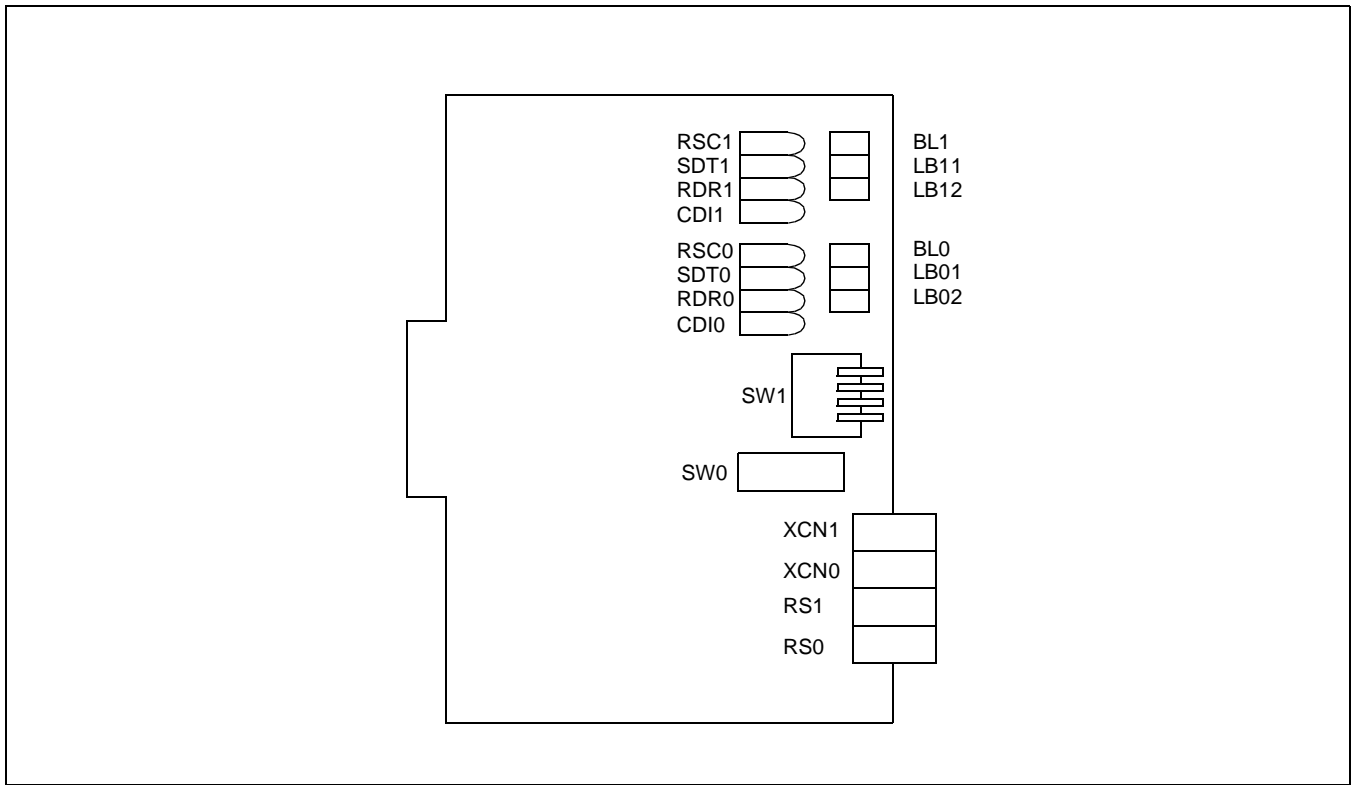

PN-2DPCB (DPC) Card

(2) Lamp Indications

Lamp Indications

LAMP NAME	COLOR	FUNCTION	
BL0	Red	No. 0 Circuit	ON: Ready for digital data transmission or the circuit is busy. OFF: Fixed path is not connected. Flash (60IPM): Make-busy state or the system data for this card is not assigned. Flash (120IPM): Fixed path is connected.
LB01	Red		ON: Loop Back 1 is set. OFF: Normally operating.
LB02	Red		ON: Loop Back 2 is set. OFF: Normally operating.
RSC0	Green		ON: RTS/C signal ON. OFF: RTS/C signal OFF.
SDT0	Green		ON: TXD/T signal is "0". OFF: TXD/T signal is "1".
RDR0	Green		ON: RXD/R signal is "0". OFF: RXD/R signal is "1".
CDI0	Green		ON: DCD/I signal ON. OFF: DCD/I signal OFF.
BL1	Red	No. 1 Circuit	ON: Ready for digital data transmission or the circuit is busy. OFF: Fixed path is not connected. Flash (60IPM): Make-busy state or the system data for this card is not assigned. Flash (120IPM): Fixed path is connected.
LB11	Red		ON: Loop Back 1 is set. OFF: Normally operating.
LB12	Red		ON: Loop Back 2 is set. OFF: Normally operating.
RSC1	Green		ON: RTS/C signal ON. OFF: RTS/C signal OFF.
SDT1	Green		ON: TXD/T signal is "0". OFF: TXD/T signal is "1".
RDR1	Green		ON: RXD/R signal is "0". OFF: RXD/R signal is "1".
CDI1	Green		ON: DCD/I signal ON. OFF: DCD/I signal OFF.

PN-2DPCB (DPC)

(3) Switch Settings

Switch Settings

SWITCH NAME	SWITCH NUMBER	SETTING POSITION		FUNCTION	CHECK		
SW1 (Piano Key SW) 	1	ON	No. 0 Circuit	Loop Back 1 ON			
		<input type="radio"/> OFF		Loop Back 1 OFF			
	2	ON		No. 1 Circuit	Loop Back 2 ON		
		<input type="radio"/> OFF			Loop Back 2 OFF		
	3	ON	No. 0 Circuit		Loop Back 1 ON		
		<input type="radio"/> OFF			Loop Back 1 OFF		
	4	ON		No. 1 Circuit	Loop Back 2 ON		
		<input type="radio"/> OFF			Loop Back 2 OFF		
	SW0 (Dip SW) 	1	ON		No. 0 Circuit	Forcibly turning the DTR signal to ON	
			OFF			The DTR signal from DTE goes through the card	
		2	ON	No. 1 Circuit		Forcibly turning the RTS/C signal to ON	
			OFF			The RTS/C signal from DTE goes through the card	
3		<input type="radio"/> OFF	Not used				
4		ON	No. 0 Circuit			V.11 (X.21) interface	
		OFF				V.24/V.28 (RS-232C) interface	
5		ON				No. 1 Circuit	Forcibly turning the DTR signal to ON
		OFF			The DTR signal from DTE goes through the card		
6		ON			No. 0 Circuit		Forcibly turning the RTS/C signal to ON
		OFF		The RTS/C signal from DTE goes through the card			
7		<input type="radio"/> OFF		Not used			
8		ON		No. 1 Circuit			V.11 (X.21) interface
		OFF	V.24/V.28 (RS-232C) interface				

The figure in the SWITCH NAME column and the position in in the SETTING POSITION column indicate the standard setting of the switch. When the switch is not set as shown by the figure and , the setting of the switch varies with the system concerned.

Note: When the power is on, disconnect the cables before unplugging the circuit card, and connect the cables after plugging the circuit card.

PN-2ILCA (ILC)

1. Locations of Lamps, Switches, and Connectors

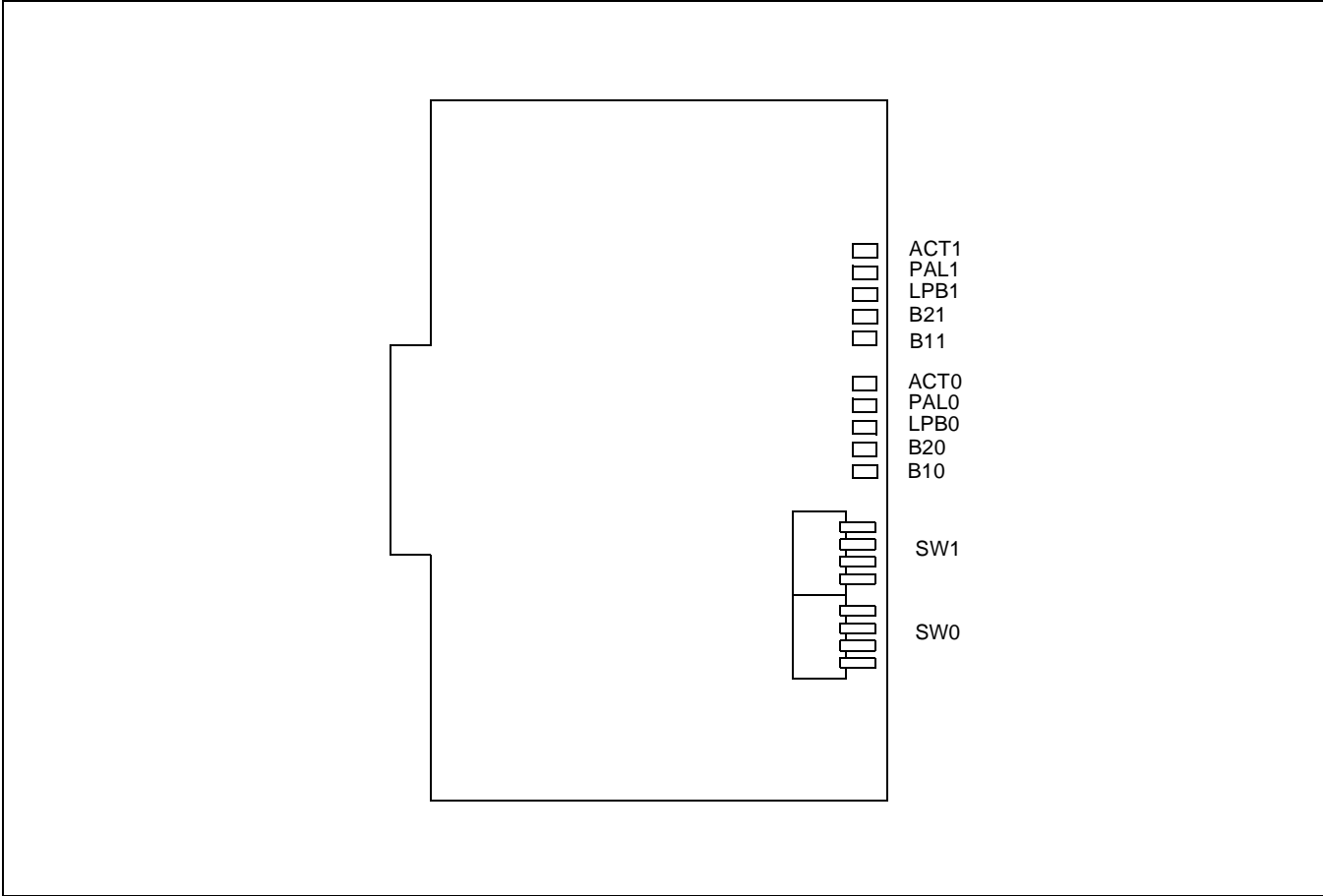

PN-2ILCA (ILC) Card

PN-2ILCA (ILC)

(2) Lamp Indications

Lamp Indications

LAMP NAME	COLOR	FUNCTION	
ACT1	Green	No. 1 Circuit	ON: Normally operating. OFF: Not operating.
PAL1	Red		ON: Line is short-circuiting. OFF: Normally operating.
LPB1	Red		OFF: Not used.
B21	Green		ON: B2 channel is in use. OFF: B2 channel is idle.
B11	Green		ON: B1 channel is in use. OFF: B1 channel is idle.
ACT0	Green	No. 0 Circuit	ON: Normally operating. OFF: Not operating.
PAL0	Red		ON: Line is short-circuiting. OFF: Normally operating.
LPB0	Red		OFF: Not used.
B20	Green		ON: B2 channel is in use. OFF: B2 channel is idle.
B10	Green		ON: B1 channel is in use. OFF: B1 channel is idle.

(3) Switch Settings

Switch Settings

SWITCH NAME	SWITCH NUMBER	SETTING POSITION	FUNCTION		CHECK
SW1 (Piano Key SW) 	1	<input type="radio"/> OFF	Always set to OFF		
	2	<input type="radio"/> OFF	Always set to OFF		
	3	<input type="radio"/> OFF	Always set to OFF		
	4	<input type="radio"/> OFF	Always set to OFF		
SW0 (Piano Key SW) 	1	<input type="radio"/> ON	No. 0 Circuit (Receiving)	Terminating register is provided.	
		<input type="radio"/> OFF		Terminating register is not provided.	
	2	<input type="radio"/> ON	No. 0 Circuit (Sending)	Terminating register is provided.	
		<input type="radio"/> OFF		Terminating register is not provided.	
	3	<input type="radio"/> ON	No. 1 Circuit (Receiving)	Terminating register is provided.	
		<input type="radio"/> OFF		Terminating register is not provided.	
	4	<input type="radio"/> ON	No. 1 Circuit (Sending)	Terminating register is provided.	
		<input type="radio"/> OFF		Terminating register is not provided.	

The figure in the SWITCH NAME column and the position in in the SETTING POSITION column indicate the standard setting of the switch. When the switch is not set as shown by the figure and , the setting of the switch varies with the system concerned.

PN-4LCD/4LCD-A (LC)

PN-4LCD/4LCD-A (LC)

1. Locations of Lamps, Switches and Connectors

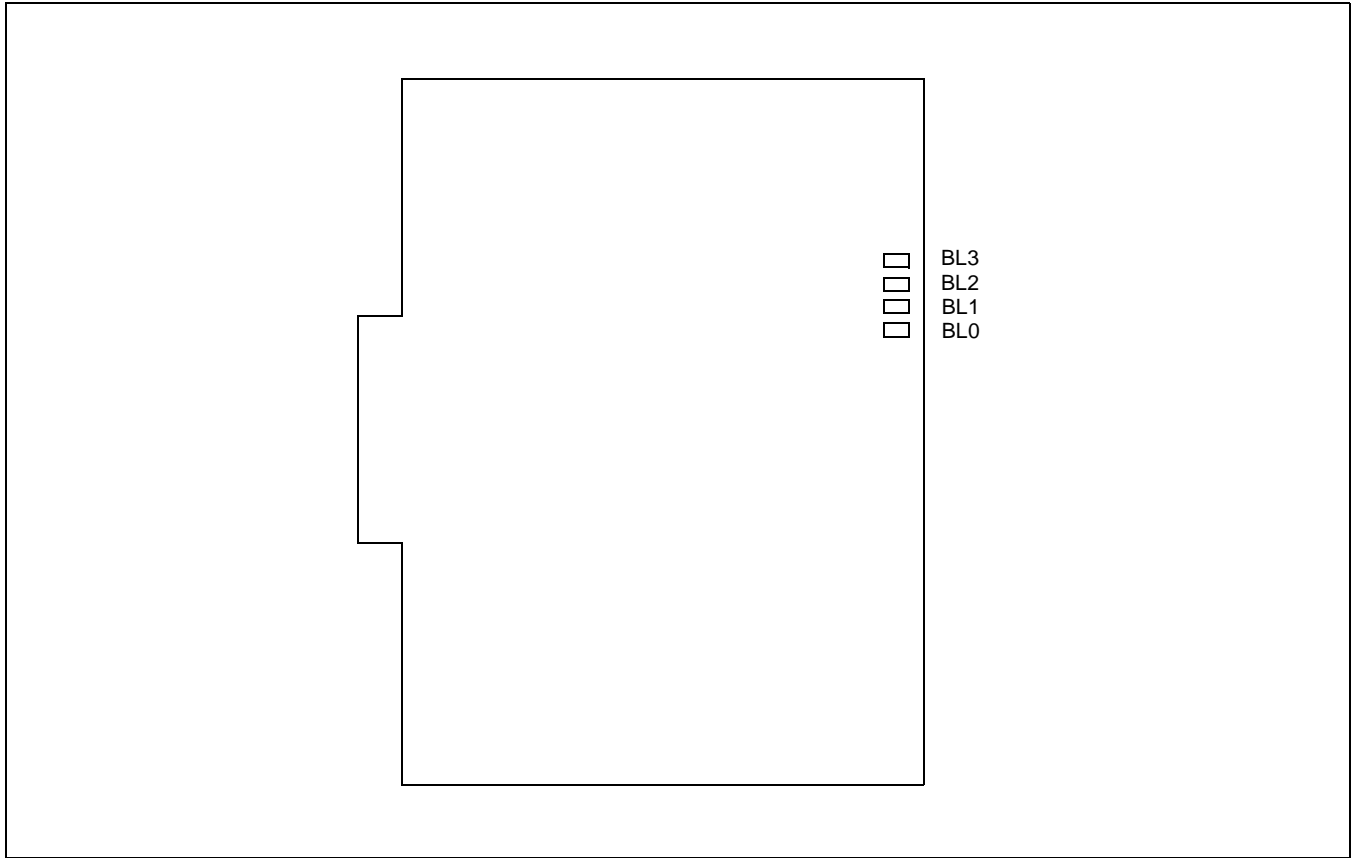

PN-4LCD/4LCD-A (LC) Card

2. Lamp Indications

Lamp Indications

LAMP NAME	COLOR	FUNCTION
BL0-3	Red	<ul style="list-style-type: none">• Remains lit when the corresponding circuit is in use.• Flashes at 60 IPM when the corresponding circuit is in the make-busy state or the system data for this card is not assigned.

3. Switch Settings

This card has no switches.

PN-4LCJ (LC)

1. Locations of Lamps, Switches and Connectors

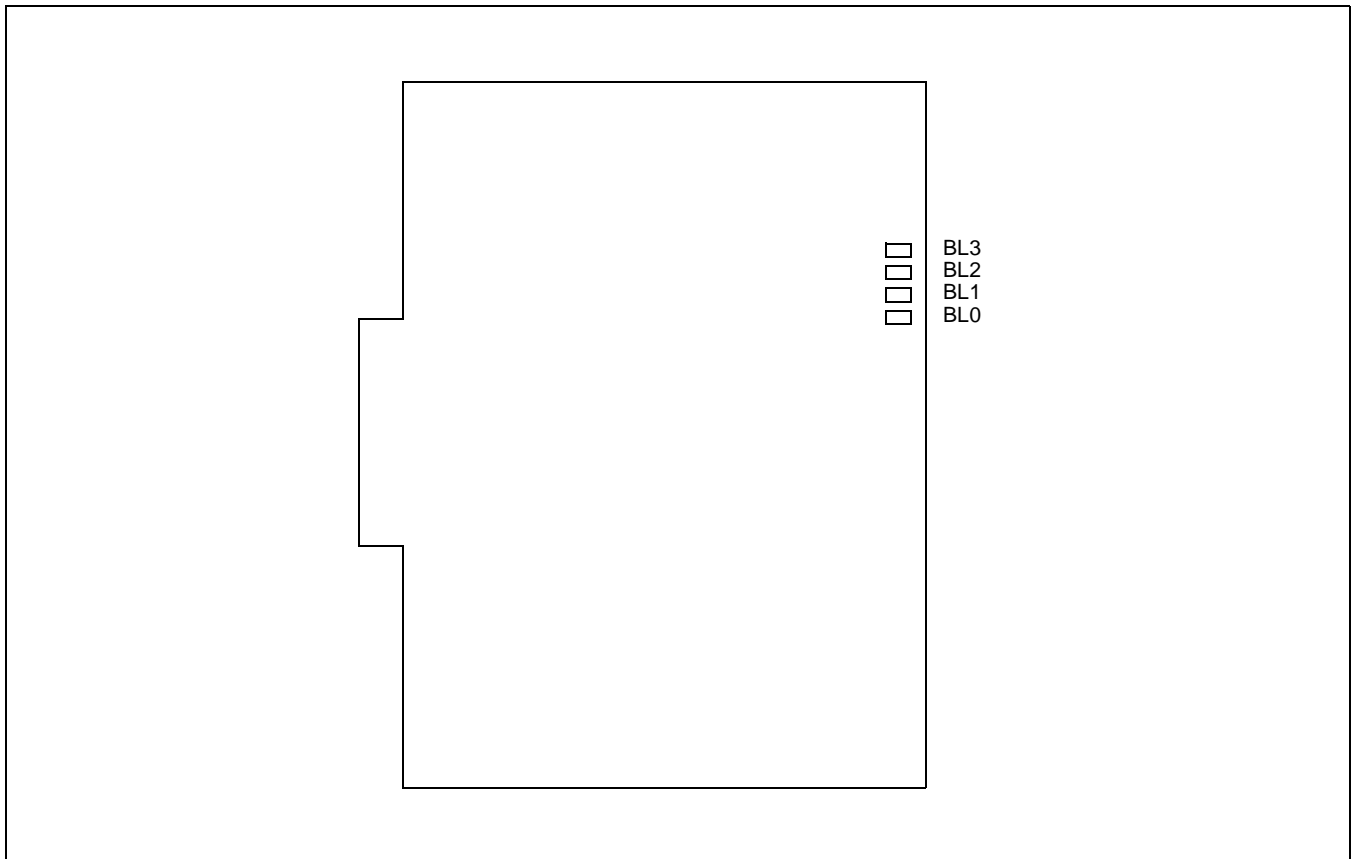

PN-4LCJ (LC) Card

2. Lamp Indications

Lamp Indications

LAMP NAME	COLOR	FUNCTION
BL0 - 3	Red	<ul style="list-style-type: none"> Remains lit when the corresponding circuit is in use. Flashes at 60 IPM when the corresponding circuit is in the make-busy state or the system data for this card is not assigned.

3. Switch Settings

This card has no switches.

PN-M03 (M03)

PN-M03 (M03)

1. Locations of Lamps, Switches and Connectors

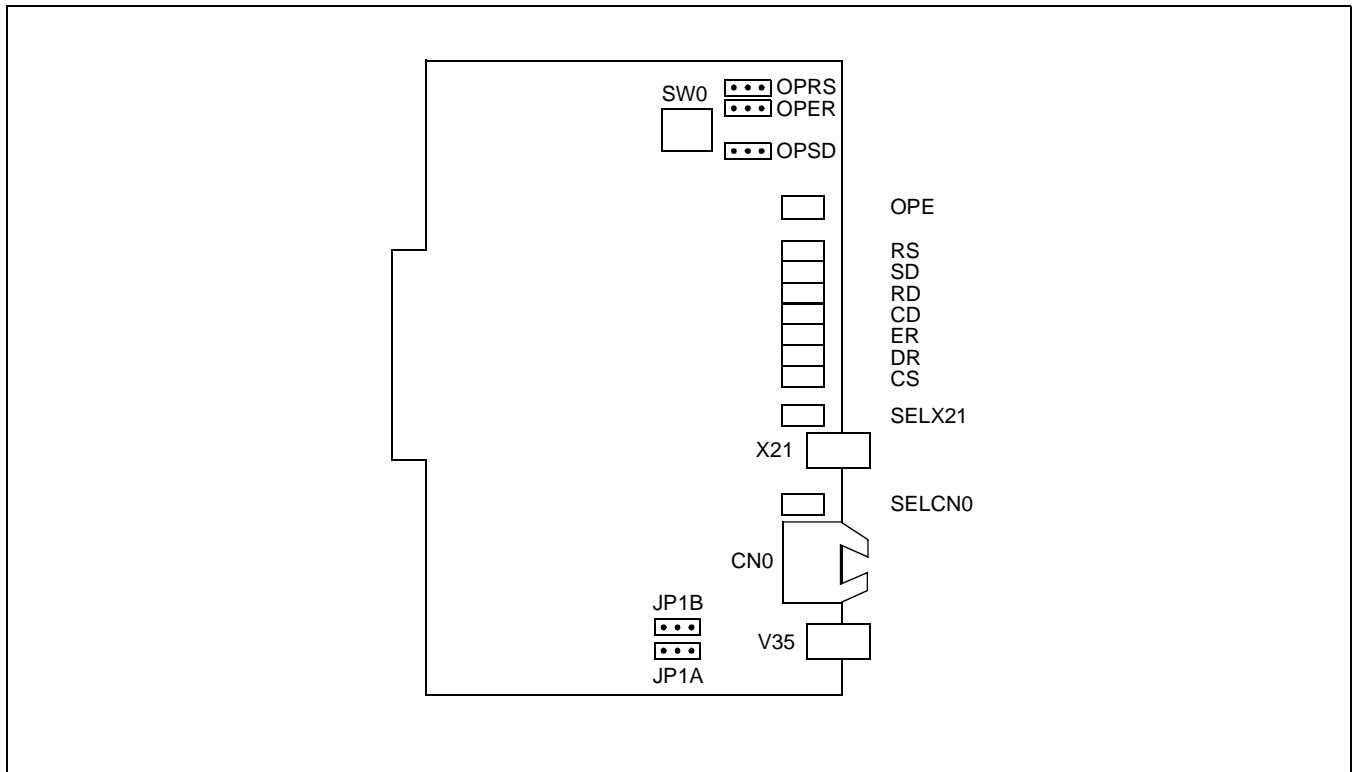

PN-M03 (M03) Card







(2) Lamp Indications

Lamp Indications

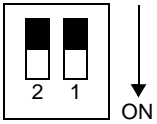
LAMP NAME	COLOR	FUNCTION
OPE	Green	ON: This card is normally connected to the PN-2DPCB. OFF: This card is abnormally connected to the PN-2DPCB.
RS	Green	ON: RTS signal is ON. OFF: RTS signal is OFF.
SD	Green	ON: TXD signal is "0" (Space condition). OFF: TXD signal is "1" (Mark condition).
RD	Green	ON: RXD signal is "0" (Space condition). OFF: RXD signal is "1" (Mark condition).
CD	Green	ON: DCD signal is ON. OFF: DCD signal is OFF.
ER	Green	ON: DTR signal is ON. OFF: DTR signal is OFF.
DR	Green	ON: DSR signal is ON. OFF: DSR signal is OFF.
CS	Green	ON: CTS signal is ON. OFF: CTS signal is OFF.
SELX21	Green	ON: Connecting to the PN-2DPCB is available. OFF: Connecting to the PN-2DPCB is not available.
SELCN0	Green	Not used.

(3) Switch Settings

Switch Settings

SWITCH NAME	SWITCH NUMBER	SETTING POSITION	FUNCTION	CHECK
SW0 (Dip SW) 	1	<input type="radio"/> OFF	Always set to OFF.	
	2	<input type="radio"/> OFF	Not used.	
JP1A (Jumper pin)  Note	/	<input type="radio"/> Right	TXC(2) signal is sent out.	
		Left	TXC(2) signal is inputted.	
JP1B (Jumper pin)  Note	/	<input type="radio"/> Right	TXC(2) signal is sent out.	
		Left	TXC(2) signal is inputted.	
OPSD (Jumper pin) 	/	Right	Set the function of extending distance for TXD signal.	
		<input type="radio"/> Left	Cancel the function of extending distance for TXD signal.	
OPRS (Jumper pin) 	/	Right	Set the function of extending distance for RTS signal.	
		<input type="radio"/> Left	Cancel the function of extending distance for RTS signal.	
OPER (Jumper pin) 	/	Right	Set the function of extending distance for DTR signal.	
		<input type="radio"/> Left	Cancel the function of extending distance for DTR signal.	

Note: The JP1A and JP1B must be set to the same position each other.

The figure in the SWITCH NAME column and the position in in the SETTING POSITION column indicate the standard setting of the switch. When the switch is not set as shown by the figure and , the setting of the switch varies with the system concerned.

PN-2ODTA (ODT)

1. Locations of Lamps, Switches and Connectors

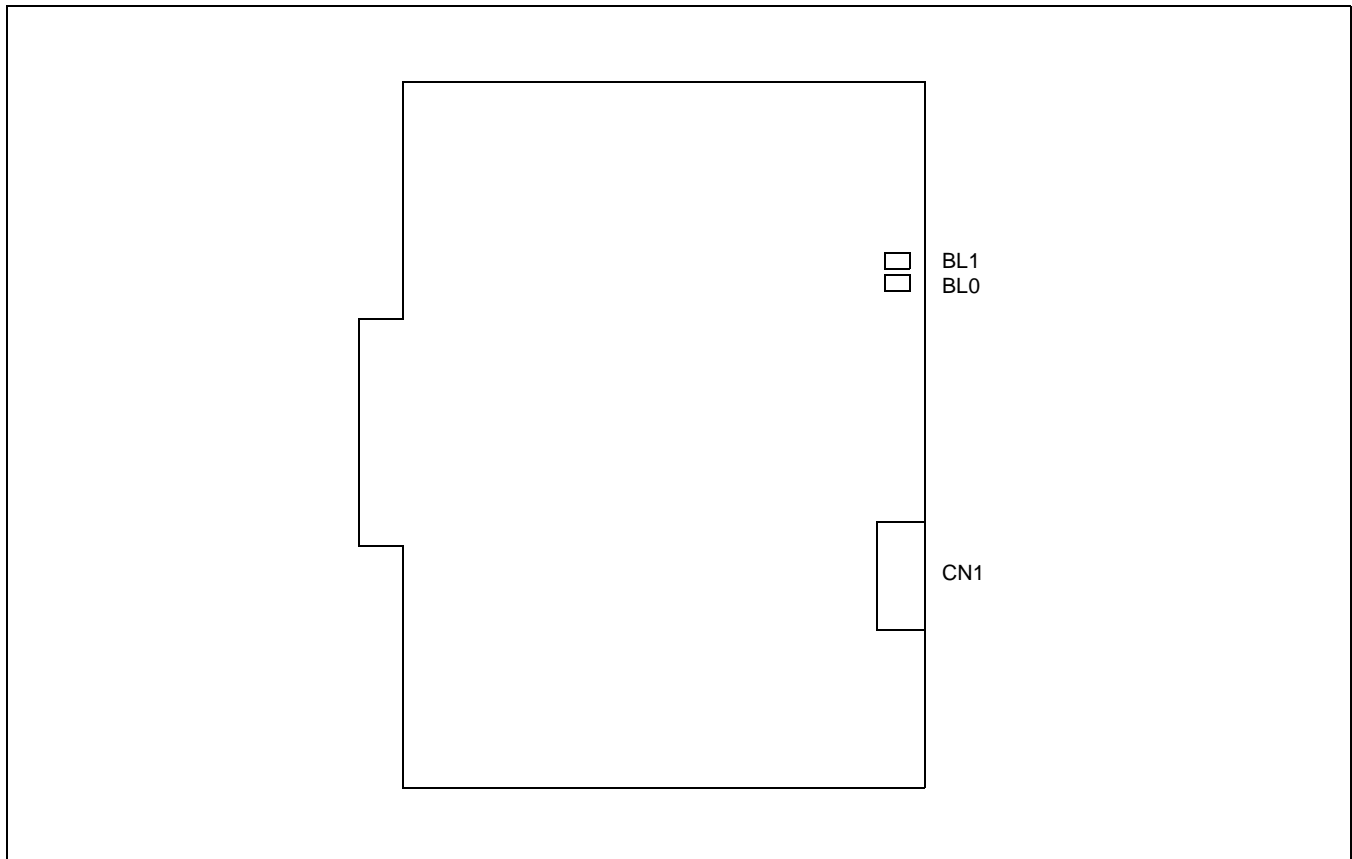

PN-2ODTA (ODT) Card

2. Lamp Indications

Lamp Indications

LAMP NAME	COLOR	FUNCTION
BL0, 1	Red	<ul style="list-style-type: none"> Remains lit when the corresponding circuit is in use. Flashes at 60 IPM when the corresponding circuit is in the make-busy state or the system data for this card is not assigned.

3. Switch Settings

This card has no switches.

PN-8RSTA (PBR)

1. Locations of Lamps, Switches and Connectors

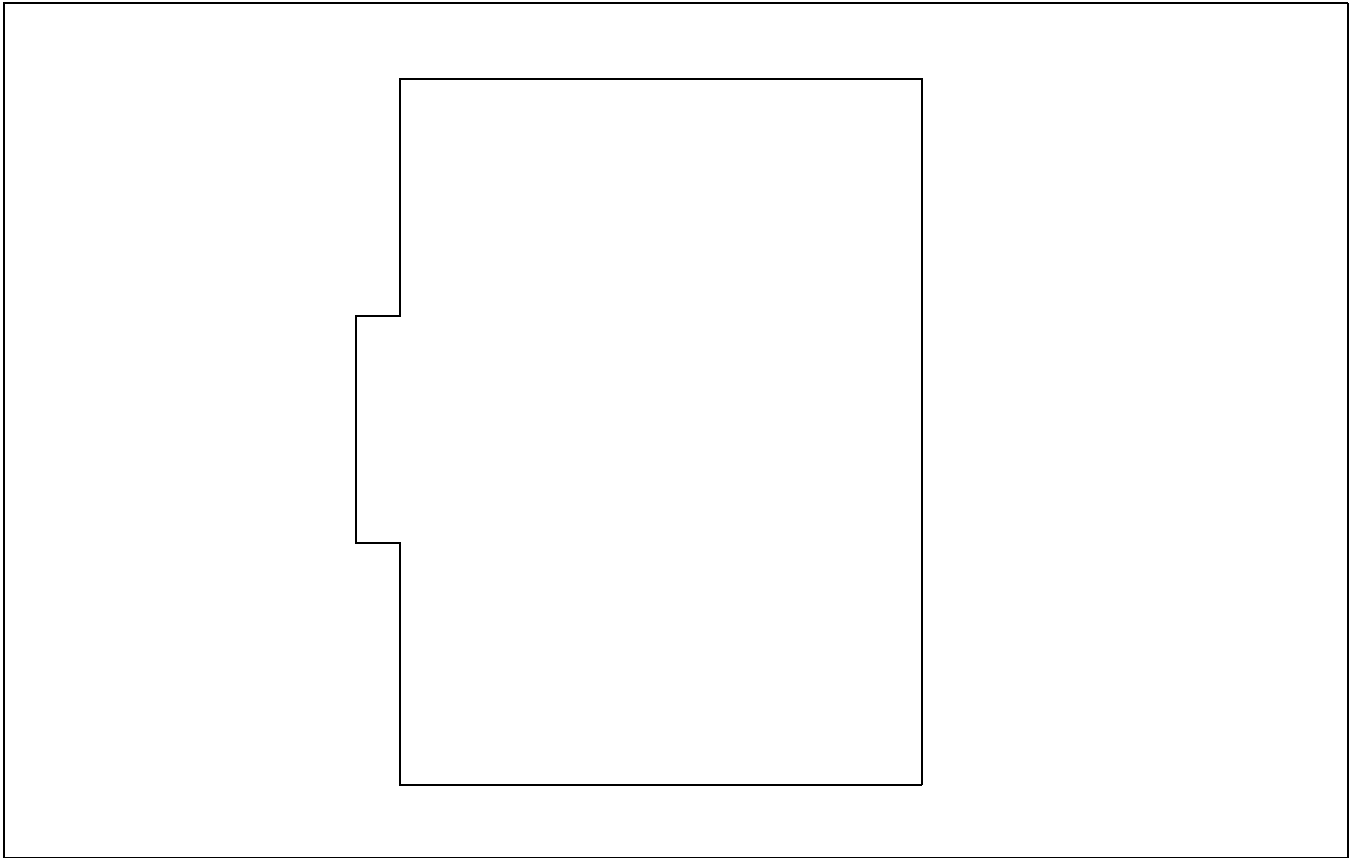

PN-8RSTA (PBR) Card

2. Lamp Indications

This card has no indicator lamps.

3. Switch Settings

This card has no switches.

PN-TNTA (TNT)

1. Location of Lamps, Switches and Connectors

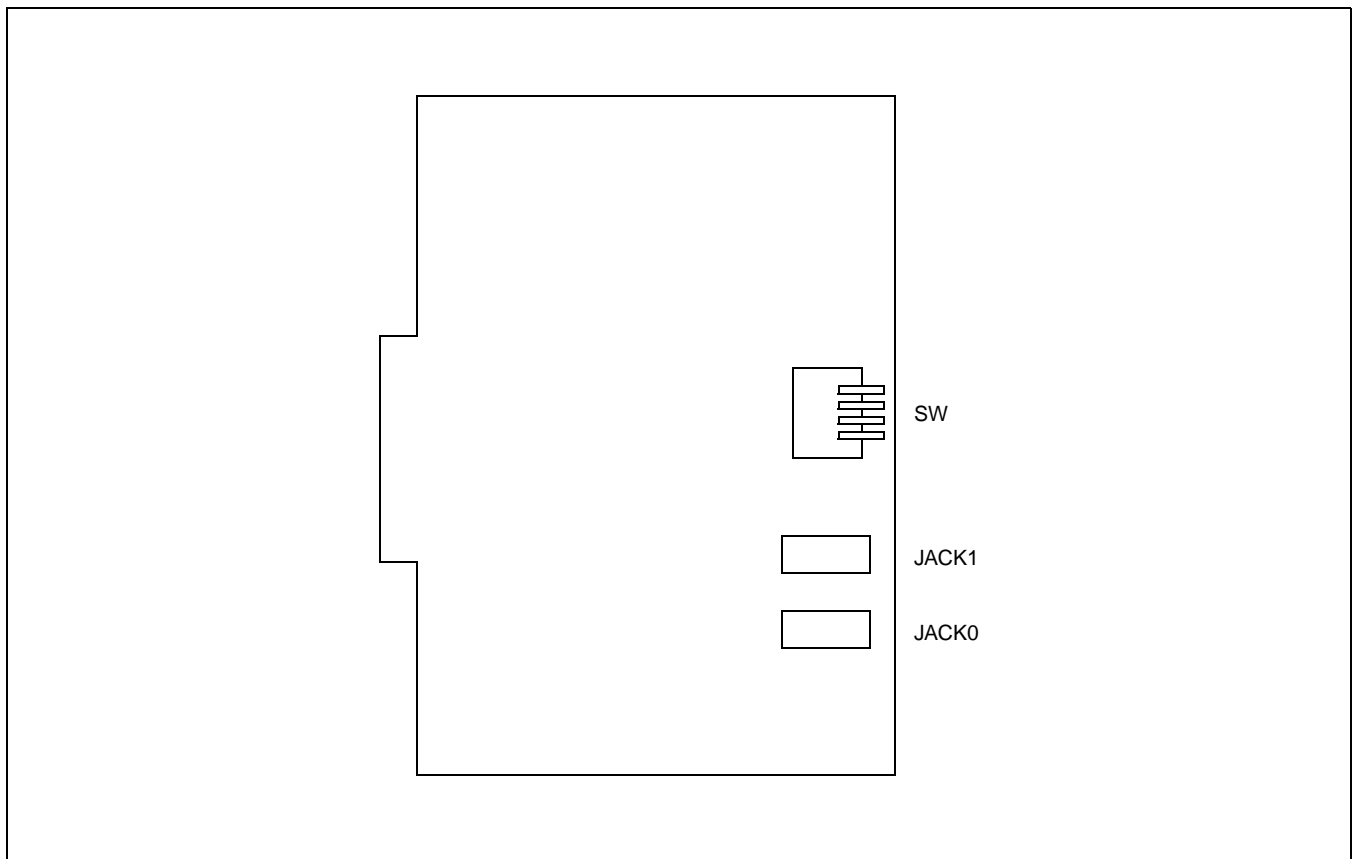

PN-TNTA (TNT) Card

2. Lamp Indications

This card has no lamps.

PN-TNTA (TNT)

3. Switch Settings

Switch Settings

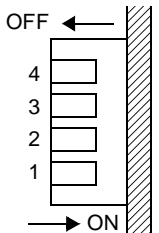
SWITCH NAME	SWITCH NUMBER	SETTING POSITION	FUNCTION	CHECK																	
SW (Piano Key SW) 	1, 2		Volume adjustment for No. 0 circuit <table border="1" data-bbox="571 445 1325 636"> <thead> <tr> <th colspan="2">SWITCH NUMBER</th> <th rowspan="2">VOLUME</th> </tr> <tr> <th>1</th> <th>2</th> </tr> </thead> <tbody> <tr> <td>OFF</td> <td>OFF</td> <td>-10 dB</td> </tr> <tr> <td>ON</td> <td>OFF</td> <td>-7 dB</td> </tr> <tr> <td>OFF</td> <td>ON</td> <td>-4 dB</td> </tr> <tr> <td>ON</td> <td>ON</td> <td>-1 dB</td> </tr> </tbody> </table>	SWITCH NUMBER		VOLUME	1	2	OFF	OFF	-10 dB	ON	OFF	-7 dB	OFF	ON	-4 dB	ON	ON	-1 dB	
	SWITCH NUMBER		VOLUME																		
1	2																				
OFF	OFF	-10 dB																			
ON	OFF	-7 dB																			
OFF	ON	-4 dB																			
ON	ON	-1 dB																			
3, 4		Volume adjustment for No. 1 circuit <table border="1" data-bbox="571 768 1325 959"> <thead> <tr> <th colspan="2">SWITCH NUMBER</th> <th rowspan="2">VOLUME</th> </tr> <tr> <th>3</th> <th>4</th> </tr> </thead> <tbody> <tr> <td>OFF</td> <td>OFF</td> <td>-10 dB</td> </tr> <tr> <td>ON</td> <td>OFF</td> <td>-7 dB</td> </tr> <tr> <td>OFF</td> <td>ON</td> <td>-4 dB</td> </tr> <tr> <td>ON</td> <td>ON</td> <td>-1 dB</td> </tr> </tbody> </table>	SWITCH NUMBER		VOLUME	3	4	OFF	OFF	-10 dB	ON	OFF	-7 dB	OFF	ON	-4 dB	ON	ON	-1 dB		
SWITCH NUMBER		VOLUME																			
3	4																				
OFF	OFF	-10 dB																			
ON	OFF	-7 dB																			
OFF	ON	-4 dB																			
ON	ON	-1 dB																			

PN-2CSIA (CSI)

1. Locations of Lamps, Switches, and Connectors.

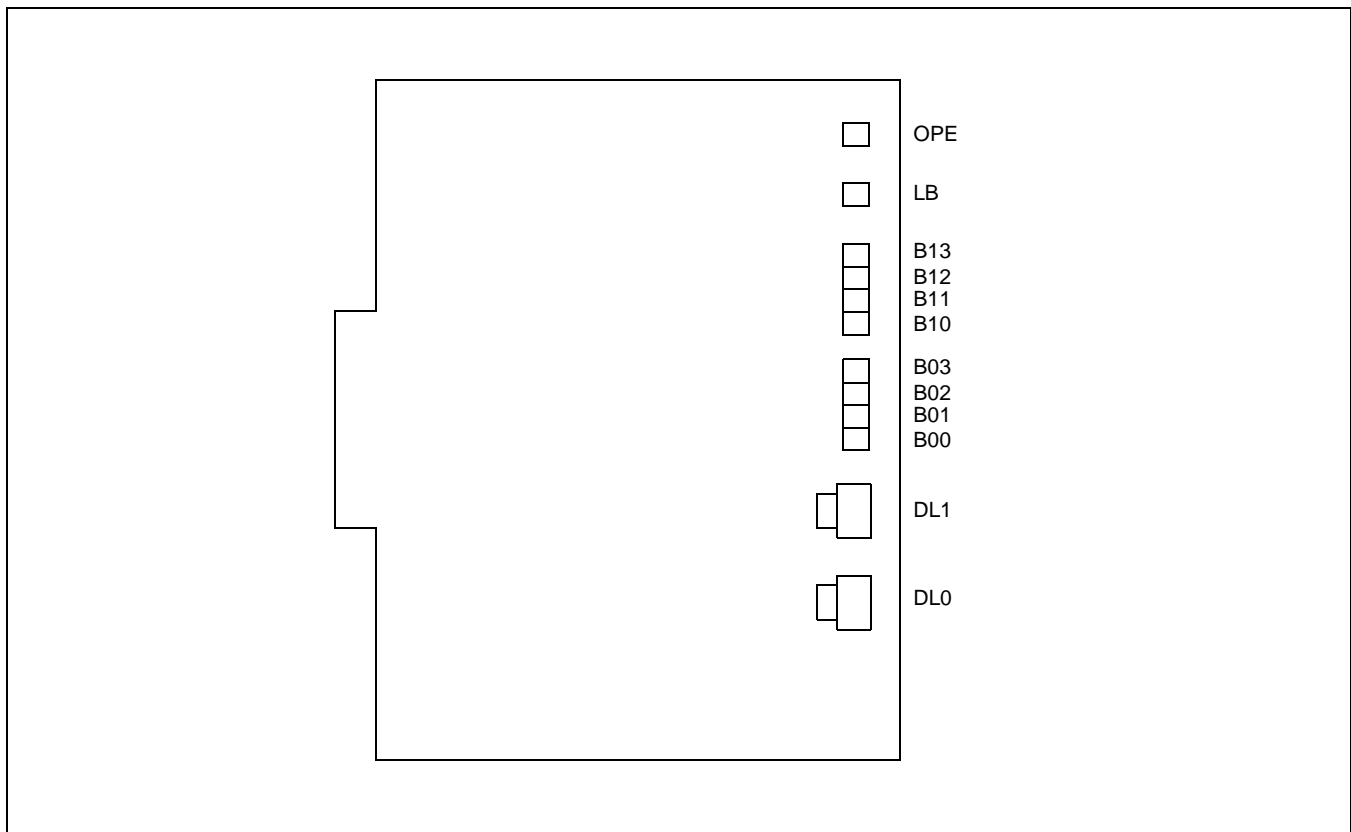

PN-2CSIA (CSI) Card

2. Lamp Indications

Lamp Indications



LAMP NAME	COLOR	FUNCTION
OPE	Green	Lights when the corresponding circuit is in use.
LB	Red	Lights when a loop-back is in progress.
B13	Red	Not used (Flash [60IPM])
B12	Red	B channel status ON : B2 channel of the No. 1 circuit is in use. OFF : B2 channel of the No. 1 circuit is in idle. Flash (60 IPM) : ZT is not connected to the No. 1 circuit. ZT is in make-busy status.
B11	Red	B channel status ON : B1 channel of the No. 1 circuit is in use. OFF : B1 channel of the No. 1 circuit is in idle. Flash (60 IPM) : ZT is not connected to the No. 1 circuit. ZT is in make-busy status.



Lamp Indications

LAMP NAME	COLOR	FUNCTION
B10	Red	B channel status ON : B0 channel of the No. 1 circuit is in use. OFF : B0 channel of the No. 1 circuit is in idle. Flash (60 IPM) : ZT is not connected to the No. 1 circuit. ZT is in make-busy status.
B03	Red	Not used (Flash[60 IMP])
B02	Red	B channel status ON : B2 channel of the No. 0 circuit is in use. OFF : B2 channel of the No. 0 circuit is in idle. Flash (60 IPM) : ZT is not connected to the No. 0 circuit. ZT is in make-busy status.
B01	Red	B channel status ON : B1 channel of the No. 0 circuit is in use. OFF : B1 channel of the No. 0 circuit is in idle. Flash (60 IPM) : ZT is not connected to the No. 0 circuit. ZT is in make-busy status.
B00	Red	B channel status ON : B0 channel of the No. 0 circuit is in use. OFF : B0 channel of the No. 0 circuit is in idle. Flash (60 IPM) : ZT is not connected to the No. 0 circuit. ZT is in make-busy status.

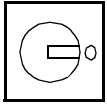
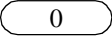
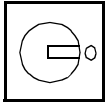
3. Switch Settings

Switch Settings

SWITCH NAME	SWITCH NUMBER	SETTING POSITION	FUNCTION	CHECK
DL0 (Rotary SW) 	0 ~ F		For normal operation	
		1 ~ F	Not used	
DL1 (Rotary SW) 	0 ~ F		For normal operation	
		1 ~ F	Not used	

The figure in the SWITCH NAME column and the position in  in the SETTING POSITION column indicate the standard setting of the switch. When the switch is not set as shown by the figure and , the setting of the switch varies with the system concerned.

Note: Set the groove on the switch knob to the intended switch position.