

NEC

InfoSet™ 408

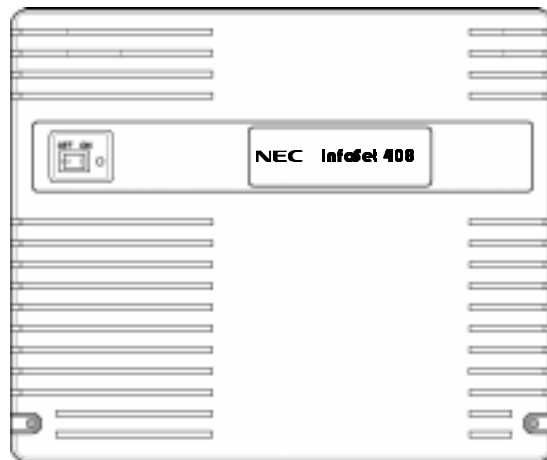

SYSTEM MANUAL

NEC America, Inc.

Stock Number 760409

Issue 1A

Contents of this manual are subject to change without prior notice at the discretion of **NEC America, Inc.** This document has been prepared for the use of employees and customers of **NEC America, Inc.** and may not be reproduced without prior written approval of **NEC America, Inc.**

InfoSet is a trademark of NEC America, Inc., *D^{term}* and Electra Elite are registered trademarks of NEC America, Inc. Windows and Microsoft Internet Explorer are registered trademarks of Microsoft Corporation. Netscape and Netscape Communicator are registered trademarks of Netscape Communications Corporation.

Copyright 2000

NEC America, Inc.
1555 Walnut Hill Lane
Irving, TX 75038

Business Terminals Division

Regulatory Information

GENERAL INFORMATION

The Federal Communications Commission (FCC) has established rules that permit this telephone system to be directly connected to the telephone network. A jack is provided by the telephone company. Jacks for this type of customer provided equipment are not provided on party lines or coin lines.

The telephone company may make changes in its technical operations and procedures. If such changes affect the compatibility or use of the InfoSet 408 system, the telephone company is required to give adequate notice of the changes.

COMPANY NOTIFICATION

Before connecting this telephone system to the telephone network, the following information must be provided to the telephone company:

1. Your telephone Number.
2. FCC registration number:
 - If the system is to be installed as a Key Function system (no dial access to outside lines), use the following number:
AY5-THA-40116-KF-E
 - If the system is to be installed as a Multifunction system (Dial "9" access to outside lines), use the following number:
AY5-THA-40117-MF-E

The following table lists the Facility Interface Codes (FIC), Ringer Equivalent Numbers (REN), Service Order Codes (SOC), and Jack Types for the interface ETUs.

FIC, REN, SOC, and Jack Types for InfoSet 408 System ETUs

Interface ETU Type	FIC	REN	SOC	Jack
BRT(1)-B10 ETU	02IS5	N/A	6.0P	N/A
COI(2)-B10 ETU (Loop Start)	02LS2	2.1B	N/A	RJ11C RJ21X

INCIDENCE OF HARM

If the system is malfunctioning, it may also be causing harm to the telephone network. The telephone system should be disconnected until the source of the problem can be determined and until repair has been made. If this is not done, the telephone company may temporarily disconnect service.



RADIO FREQUENCY INTERFERENCE

In compliance with FCC Part 15 rules, the following statement is provided:

IMPORTANT NOTE

“Except as noted below, this equipment generates, uses, and can radiate radio frequency energy and if not installed and used in accordance with the installation instructions, may cause interference to radio communications. This equipment has been tested and approved for compliance with the limits for a Class B computing device pursuant to Part 15 of FCC Rules, that are designed to provide reasonable protection against such interference when operated in a commercial environment. Operation of this telephone system in a residential area is likely to cause interference, in which case, the user, at his or her own expense, is required to take whatever measures may be required to correct the interference.”

The following telephone sets are in compliance with Class B limits:

-  DTB-16-1 (BK)/(WH) TEL
-  DTB-16D-1 (BK)/(WH) TEL

The following telephone sets are in compliance with Class A limits:

-  DTU-8-1 (BK)/(WH) TEL
-  DTU-8D-2 (BK)/(WH) TEL
-  DTU-16-1 (BK)/(WH) TEL
-  DTU-16D-2 (BK)/(WH) TEL
-  DTU-32-1 (BK)/(WH) TEL
-  DTU-32D-2 (BK)/(WH) TEL
-  DTP-2DT-1 (WH) TEL
-  DTP-1-1 (WH) TEL
-  DTP-1HM-1 (WH) TEL
-  DTU-4R-1 (BK) TEL
-  ETW-4R-1 (BK) TEL

Note: *If this system is to be used in a residential area, then only telephones that meet Class B limits shall be used.*

HEARING AID COMPATIBILITY

The NEC Multiline telephones and NEC single line telephones that are provided for this system are hearing aid compatible and comply with the volume control requirements. The manufacturer of other single line telephones for use with the system must provide notice of hearing aid compatibility to comply with FCC rules that now prohibit the use of non-hearing aid compatible telephones.

MUSIC ON HOLD

IMPORTANT NOTE

"In accordance with U.S. Copyright Law, a license may be required from the American Society of Composers, Authors and Publishers, or other similar organization, if radio or TV broadcasts are transmitted through the Music On Hold feature of this telecommunication system. NEC America Inc., hereby disclaims any liability arising out of the failure to obtain such a license."

SERVICE REQUIREMENTS



If equipment malfunctions, all repairs will be performed by an authorized agent of NEC America, Inc. or by NEC America, Inc. The user requiring service is responsible for reporting the need for service to an NEC America, Inc. authorized agent or to NEC America, Inc.

SAFETY REQUIREMENTS



High Leakage Current

Connect permanent earthing conductor before connecting telephone lines.

-  A supplementary equipment earthing conductor is to be installed between the product or system and earth, that is, in addition to the equipment earthing conductor in the power supply cord.
-  The supplementary equipment earthing conductor may not be smaller in size than the unearthed branch circuit supply conductors. The supplementary equipment earthing conductor is to be connected to the product at the terminal provided, and connected to earth in a manner that will retain the earth connection when the power supply cord is unplugged. The connection to earth of the supplementary earthing conductor shall be in compliance with the appropriate rules for terminating bonding jumpers in Part K of Article 250 of the National Electrical Code, ANSI/NFPA 70, and Article 10 of Part 1 of the Canadian Electrical Code, Part 1, C22.1.

Termination of the supplementary equipment earthing conductor is permitted to be made to building steel, to a metal electrical raceway system, or to an earthed item that is permanently and reliably connected to the electrical service equipment earthed.



Bare, covered or insulated earthing conductors are acceptable. A covered or insulated earthing conductor must have a continuous outer finish that is either green or green with one or more yellow stripes.

UL 1950 INFORMATION

This equipment has been listed by Underwriters Laboratories and found to comply with all applicable requirements of the standard for information technology equipment, UL1950, 3rd edition.

INDUSTRY CANADA

Industry Canada has established rules that permit this telephone system to be directly connected to the telephone network. Prior to the connection or disconnection of this telephone system to or from the telephone network, the telephone company must be provided with the following information.

1. Your telephone number.
2. IC certification number: **14010421A**
3. Ringer Equivalence Number (REN) of the equipment: **2.1B**

The Industry Canada label identifies certified equipment. This certification means that the equipment meets certain telecommunications network protective, operational and safety requirements as prescribed in the applicable Terminal Equipment Technical Requirements document(s). The Department does not guarantee that equipment operates to the user satisfaction.

Before installing this equipment, users should ensure that it is permissible to be connected to the facilities of the local telecommunications company. The equipment must also be installed using an acceptable method of connection. The customer should be aware that compliance with the above conditions may not prevent degradation of service in some situations.

Repairs to certified equipment should be coordinated by a representative designated by the supplier. Any repairs or alterations made by the user to this equipment, or equipment malfunctions, may give the telecommunications company cause to request the user to disconnect the equipment.

Users should ensure for their own protection that the electrical ground connections of the power utility, telephone lines and internal metallic water pipe system, if present, are connected together. This precaution may be particularly important in rural areas.

CAUTION

Users should not attempt to make such connections themselves, but should contact the applicable electric inspection authority or electrician.

The Ringer Equivalence Number (REN) assigned to each terminal device provides an indication of the maximum number of terminals allowed to be connected to a telephone interface. The termination of an interface may consist of any combination of devices subject only to the requirement that the sum of the Ringer Equivalent Numbers of all the devices does not exceed 5.

This equipment complies with all applicable requirements of the Canadian Standards Association standard for information technology equipment C 22.2 No. 950, and bears the CUL mark.

This equipment meets IC requirements CS03.

This digital apparatus does not exceed the Class A limits for radio noise emissions from digital apparatus as set out in the radio interference regulations of Industry Canada.

Le present appareil numerique n'emet pas de bruits radioelectriques depassant les limites applicables aux appareils numeriques de Classe A prescrites dans le reglement sur le brouillage radioelectrique edicte par Industrie Canada.

BATTERY DISPOSAL

The InfoSet 408 system includes the batteries listed below. When disposing of these batteries, KSUs, and/or ETUs, you must comply with applicable federal and state regulations regarding proper disposal procedures.

Battery Types and Quantities for KSUs and ETUs

Unit Name	Type of Battery	Quantity
B408-B10 KSU	Lead Acid	2
B408-B10 KSU	Lithium	1
DTP-1HM-1 (SW) TEL	Lithium	1

The InfoSet 408 B408-B10 KSU provides memory backup (lithium battery) for a minimum of two years.

IMPORTANT SAFEGUARDS FOR BATTERY DISPOSAL

DO NOT PLACE USED BATTERIES IN YOUR REGULAR TRASH! THE PRODUCT YOU PURCHASED CONTAINS A NICKEL-CADMIUM OR SEALED LEAD BATTERY. NICKEL-CADMIUM OR SEALED LEAD BATTERIES MUST BE COLLECTED, RECYCLED, OR DISPOSED OF IN AN ENVIRONMENTALLY SOUND MANNER.

The incineration, landfilling or mixing of nickel-cadmium or sealed lead batteries with the municipal solid waste stream is PROHIBITED BY LAW in most areas. Contact your local solid waste management officials for other information regarding the environmentally sound collection, recycling, and disposal of the battery.

Nickel-Cadmium (or sealed lead) batteries must be returned to a federal or state approved nickel-cadmium (or sealed lead) battery recycler. This may be where the batteries were originally sold or a local seller of automotive batteries. Contact your local waste management officials for other information regarding the environmentally sound collection, recycling and disposal of the battery contained in this product. For Ni-Cd batteries, you can also call 1-800-8-BATTERYSM if further information is required.

The packaging for the InfoSet 408 system contains the following labels regarding proper disposal.

PRODUCT PACKAGE LABELING**Ni-Cd**

CONTAINS NICKEL-CADMIUM BATTERY.
BATTERY MUST BE RECYCLED OR
DISPOSED OF PROPERLY. MUST NOT BE
DISPOSED OF IN MUNICIPAL WASTE.

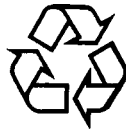
**Pb**

CONTAINS SEALED LEAD BATTERY.
BATTERY MUST BE RECYCLED. MUST NOT
BE DISPOSED OF IN MUNICIPAL WASTE.

Table of Contents

Chapter 1 System Overview

Section 1	Your System	1-1
Section 2	Equipment	1-1
Section 3	Power Requirements	1-5
3.1	Power Supply Inputs	1-5
3.2	Power Supply Consumption	1-6
Section 4	Cabling Requirements and Specifications	1-6
Section 5	Environmental Conditions	1-8
5.1	Temperature	1-8
5.2	Humidity	1-8
Section 6	Weights and Dimensions	1-8
Section 7	Outside Line Type	1-9
Section 8	Network and Control	1-10
8.1	Transmission, Network, and Control Specifications	1-10
8.1.1	Transmission	1-10
8.1.2	Network	1-10
8.1.3	Control	1-10
8.1.4	Telephone	1-10
Section 9	External Equipment Connection	1-11
9.1	Music Sources for Music on Hold via KSU	1-11
9.2	External Paging (Audio) via KSU	1-11
9.3	External Tone Ringer	1-12
9.4	SMDR Output	1-12

9.5	PC Connection	1-12
9.6	Relay Contact	1-12
Section 10	Battery Backup	1-12
10.1	System Backup	1-12
10.2	Memory Backup	1-12

Chapter 2 Installation

Section 1	Basic Installation	2-1
1.1	Unpacking the KSU	2-1
1.2	Opening the KSU and Attaching the Batteries	2-2
1.3	Wall Mounting the KSU	2-5
1.4	Installing the External Speaker Relay Cable	2-7
Section 2	Installing Electronic Telephone Units	2-10
2.1	Installing the ESI(3)-B10 ETU	2-10
2.2	Installing the COI(2)-B10 ETU	2-12
2.3	Installing the CID(2)-B10 UNIT	2-15
2.4	Installing the SLI(2)-B10 ETU	2-18
2.5	Installing the PBR-B10 ETU	2-21
2.6	Installing the MIF-B10 ETU	2-22
2.7	Installing the DPH-B10 ETU	2-25
Section 3	Installing Background Music for Music On Hold and External Speakers for Paging	2-29
Section 4	Connecting Telephones Cords	2-30
4.1	Connecting InfoSet Telephones	2-30
4.2	Connecting Electra Elite Telephones	2-31

Section 5	Installing a <i>D^{term}</i>® Cordless Lite Telephone	2-32
5.1	Selecting an Installation Location	2-32
5.2	Connecting the Telephone Cords	2-33
5.3	Applying Power to the Base Unit	2-33
Section 6	Installing the <i>D^{term}</i>® Cordless Telephone	2-34
6.1	Selecting an Installation Location	2-34
6.2	Connecting the Telephone Cords	2-35
6.3	Applying Power to the Base Unit	2-35
Section 7	Replacing Batteries and Fuses	2-36
7.1	Replacing the Backup Batteries in the KSU	2-36
7.2	Replacing the Lithium Batteries in the KSU	2-39
7.3	Replacing a Fuse	2-41

Chapter 3 Features

Section 1	Introduction	3-1
Section 2	Differences in Telephone Types	3-1
	All Call Page	3-3
	Ancillary Device Connection	3-5
	Answer Hold	3-6
	Answer Key	3-7
	Attendant Positions	3-8
	Automatic Callback	3-9
	Automatic Day/Night Mode Switching	3-10
	Automatic Hold	3-11
	Automatic Pause - Behind PBX	3-12
	Automatic Redial	3-13
	Automatic Release	3-16
	Background Music - External Speakers	3-17

Background Music - Multiline Telephone Speakers.....	3-18
Barge-In (Interrupting an External Call).....	3-20
Battery Backup – System Memory	3-22
Battery Backup – System Power (Built-In).....	3-23
Busy Lamp Field - Multiline Telephones	3-24
Callback Request.....	3-25
Call Elapsed Timer	3-27
Call Forward - All Calls	3-28
Call Forward – Busy/No Answer	3-30
Caller Identification	3-33
Caller ID Scrolling	3-34
Call Pickup Group.....	3-35
Call Restriction.....	3-37
Call Restriction Override using System Speed Dial.....	3-39
Call Transfer	3-40
Call Waiting Indication	3-43
Character Registration.....	3-44
Clock/Calendar Display	3-47
Confirmation Dial	3-49
Conference Add-On.....	3-51
Consecutive Speed Dial	3-54
Digital Voice Mail	3-55
Delayed Ringing	3-56
Direct Inward Termination.....	3-57
Direct Paging Access.....	3-58
Direct Station Selection	3-60
Distinctive Ringing	3-62
Door Lock Release	3-63
Door/Monitor Telephone	3-64
Do Not Disturb (DND)	3-66

DP to DTMF Switching	3-67
Extension Hunting	3-69
Extension Name Assignment	3-71
External Paging (Meet-Me).....	3-72
External Tone Ringer via External Speaker	3-74
Flash Key.....	3-75
Flexible Line Key	3-76
Flexible Numbering Plan	3-77
Flexible Ringing Assignment	3-78
Flexible Timeout	3-79
Full Handsfree Operation	3-82
Handset Microphone Control.....	3-84
Handsfree Answerback	3-85
Handsfree Dialing and Monitoring	3-86
Headset Connection	3-87
Holdfree Transfer.....	3-89
Hold with Recall (Exclusive and Non-Exclusive)	3-90
Howler Tone Service	3-93
Icon Display	3-94
I-Hold Indication.....	3-95
Incoming Call Identification.....	3-96
Internal Recall.....	3-98
Internal Voice/Tone Signaling.....	3-99
I-Use Indication.....	3-101
Key Function/Multifunction Registration	3-102
Manual Line Seizure	3-103
Manual Pause.....	3-104
Message Waiting Indication for Voice Mail	3-105
Microphone Control	3-106
Music on Hold	3-107

Nesting Dial	3-108
Night Mode	3-111
Off-Hook Ringing	3-114
One-Touch/Feature Access Keys – User Programmable	3-115
PC Programming	3-119
Power Failure Transfer	3-121
Preset Dialing	3-122
Prime Line Assignment	3-123
Privacy on all Calls	3-125
Programmable Pause for Speed Dial	3-127
Programming from Multiline Telephone	3-128
Resident System Program	3-129
Ringling Line Preference	3-130
Room Monitor Telephone	3-131
Seized Trunk Name/Number Display	3-133
Single Line Telephone Access	3-135
Single Line Telephone Adapter	3-138
Softkeys	3-140
SPD (InfoSet) or Redial (Electra Elite) Key	3-144
Specified CO/PBX Line Seizure	3-146
Speed Dial – Extension	3-147
Speed Dial – System	3-151
Station Message Detail Recording (SMDR)	3-154
Step Call	3-156
Stored Hookflash	3-157
System Set Button	3-159
Telephone Volume Control	3-160
Tenant Service	3-162
Timed Alarm	3-164
Tone Override	3-166

Trunk Outgoing Restriction	3-168
Trunk Queuing	3-169
Two-Color LEDs (Lamp)	3-171
User Programming	3-172

Chapter 4 Telephones

Section 1 Introduction	4-1
1.1 InfoSet 408 Telephones	4-1
1.2 Electra Elite Telephones	4-2
Section 2 Wall Mounting Telephones	4-6
2.1 Wall Mounting the InfoSet Telephones	4-6
2.2 Wall Mounting the Electra Elite Telephones	4-10
2.2.1 Wall Mounting using the Base Unit	4-10
2.2.2 Installing the Wall Mount Unit and Mounting the Telephone using the WMU-U Unit	4-16
2.3 Wall Mounting Single Line Telephones	4-20
Section 3 Adjusting the Height of Telephones	4-23
3.1 Adjusting the Height of InfoSet Telephones	4-23
3.2 Adjusting the Height of the Electra Elite Telephones	4-24
3.3 Adjusting the LCD on the Electra Elite Display Telephones	4-26
Section 4 Installing Line Card Labels and Protective Plastic Panels on Telephones	4-27
4.1 Installing the Line Card Labels and Protective Plastic Panel on the InfoSet Telephones	4-27
4.2 Installing the Line Card Labels and Protective Plastic Panel on the Electra Elite Telephones	4-29
4.3 SLT(1)-U10 ADP (Single Line Telephone Adapter)	4-30
4.3.1 Connecting the SLT(1)-U10 ADP to the System	4-30
4.3.2 Wall Mounting the SLT(1)-U10 ADP	4-32

Section 5 Wall Mounting Template for InfoSet Telephones4-33

Chapter 5 Optional Equipment

Section 1 General Information5-1

Section 2 Preparing the Telephone for Adapter Installation5-1

Section 3 Installing Adapters5-5

3.1 ACA-U Unit (AC Adapter) 5-5

3.1.1 Connecting the ACA-U Unit5-5

3.2 ADA-U Unit (Ancillary Device Adapter) 5-6

3.2.1 Connecting Cables to the ADA-U Unit5-6

3.2.2 Switch Settings5-10

3.2.3 Installing an ADA-U Unit on an Electra
Elite Telephone5-11

3.3 APR-U Unit (Analog Port Ringer)5-12

3.3.1 Installing an APR-U Unit on a Telephone5-13

3.3.2 Switch Settings5-14

3.3.3 Connecting Cables on the APR-U Unit5-15

3.4 HFU-U (BK)/(WH) Unit (Handsfree Unit) 5-16

3.4.1 Installing an HFU-U (BK)/(WH) Unit on a Telephone5-16

3.4.2 Installing the External Microphone5-16

3.4.3 Switch Settings5-17

3.5 CTA-U Unit (Computer Telephony Application)5-18

3.5.1 Installing the CTA-U Unit5-19

3.5.2 Connecting the Cables on the CTA-U Unit5-20

3.5.3 Installing the Driver on the PC5-20

Chapter 6 Telephone Programming

Section 1	Introduction	6-1
Section 2	Entering Programming Mode	6-1
	2.1 Programming Guidelines	6-2
Section 3	Programming Functions	6-4

Chapter 7 PC Programming

Section 1	Introduction	7-1
Section 2	Hardware and Software Requirements	7-1
Section 3	Installing PC Programming Software	7-2
Section 4	Starting PC Programming	7-2
Section 5	Using PC Programming	7-3
Section 6	Infoset 408 Programming Menus	7-5
	6.1 Main Menu Screen	7-5
	6.2 Switch Menu	7-6
	6.3 Phones	7-8
	6.3.1 Line Keys	7-9
	6.3.2 One-Touch Keys	7-11
	6.3.3 Speed Dialing	7-13
	6.4 Ringing	7-16
	6.5 Restricted Dialing	7-18
	6.6 New File	7-21
	6.7 Load File	7-23
	6.8 Save File	7-24
	6.9 Copy	7-26
	6.10 D.E.S.I.	7-28

6.11	Report	7-30
6.11.1	System Report	7-31
6.11.2	Telephone-Based Report	7-33
6.11.3	Trunk-Based Report	7-35
6.11.4	Non-Default Value Report	7-37
6.12	Help	7-38
6.13	Connect	7-40
6.14	Upload	7-41
6.15	Download	7-42
6.16	Disconnect	7-43
6.17	Expert	7-44
6.18	Wizard	7-46

Appendix A Feature Access Codes and Special Numbers Lists

Appendix B Tone Patterns

Appendix C Glossary of Terms

List of Figures

Figure 1-1	Connecting the ESI to the Multiline Telephone Using Twisted 2-Pair Cable	1-7
Figure 2-1	Removing the Front Cover	2-2
Figure 2-2	Attaching the Backup Battery Connectors	2-3
Figure 2-3	Installing the Lithium Battery	2-3
Figure 2-4	Setting the Battery Memory Switch	2-4
Figure 2-5	Securing the KSU to the Wall	2-5
Figure 2-6	Connecting the Trunk Lines and Telephones to the System	2-6
Figure 2-7	Removing the Plastic Knockout	2-7
Figure 2-8	Attaching the Speaker Relay Cables	2-8
Figure 2-9	Inserting the Connector into the Terminal	2-9
Figure 2-10	Inserting the Telephone Cord into the Jack	2-9
Figure 2-11	Installing the ESI ETU into the KSU	2-11
Figure 2-12	Connecting the Telephones to the KSU	2-11
Figure 2-13	Installing the COI ETU into the KSU	2-12
Figure 2-14	Removing the ISDN Knockout	2-13
Figure 2-15	Inserting the Cable into the ISDN Slot	2-13
Figure 2-16	Inserting the Cable into the COI ETU	2-13
Figure 2-17	Connecting Additional Lines to the KSU	2-14
Figure 2-18	Connecting Optional Devices to the COI ETU	2-14
Figure 2-19	Installing the First CID Unit	2-15
Figure 2-20	Installing the Second CID Unit	2-16
Figure 2-21	Piggybacking the COI(2) ETU and CID Unit	2-16

Figure 2-22	Inserting the COI ETU into the KSU	2-17
Figure 2-23	Installing the SLI ETU	2-18
Figure 2-24	Removing the Plastic Knockout for the SLT	2-19
Figure 2-25	Attaching the RJ-11 Cables	2-20
Figure 2-26	Installing the PBR ETU on the KSU	2-21
Figure 2-27	Installing the DB-9 Connector Plate	2-22
Figure 2-28	Attaching the Grounding Wire	2-23
Figure 2-29	Installing the MIF ETU on the KSU	2-23
Figure 2-30	Plugging the DB-9 Cable into the DB-9 Connector	2-24
Figure 2-31	Installing the DPH ETU into the KSU	2-25
Figure 2-32	Removing the Plastic Knockout for DPH and DPR	2-26
Figure 2-33	Connecting Doorphones	2-26
Figure 2-34	Wrapping the Connector Cables	2-27
Figure 2-35	Attaching RJ-11 Cords to the DPH and DPR Connectors	2-28
Figure 2-36	RCA Jacks for Music and Paging	2-29
Figure 2-37	Connecting InfoSet Telephone Cords	2-30
Figure 2-38	Connecting Electra Elite Telephone Cords	2-31
Figure 2-39	Leading Line Cords on the Electra Elite Telephone	2-31
Figure 2-40	Dterm Cordless Lite Telephone	2-32
Figure 2-41	Connecting the Base Unit of the DTU-4R-1 (BK) TEL	2-34
Figure 2-42	Connecting and Supplying Power to the Base Unit on the ETW-4R-1 (BK) TEL	2-36
Figure 2-43	Inserting New Batteries into the KSU	2-37
Figure 2-44	Attaching the Battery Connectors	2-38
Figure 2-45	Replacing the Lithium Battery	2-39
Figure 2-46	Replacing the Fuse	2-41

Figure 4-1	InfoSet 408 Telephones	4-1
Figure 4-2	Electra Elite Telephones	4-3
Figure 4-3	Single Line Telephones	4-5
Figure 4-4	Removing the Stoppers from the Adjustment Stand	4-6
Figure 4-5	Attaching the Hanger to the Cradle of the InfoSet Telephone	4-7
Figure 4-6	Routing the Telephone Cord Inside the Adjustment Stand	4-8
Figure 4-7	Fastening the Stoppers to the Wall	4-8
Figure 4-8	Hanging the InfoSet Telephone on the Wall	4-9
Figure 4-9	Positioning the Handset Hanger on Electra Elite Telephones	4-10
Figure 4-10	Raising the Base Plate on an Electra Elite Telephone	4-10
Figure 4-11	Unlocking the Tab on an Electra Elite Telephone	4-11
Figure 4-12	Releasing the Right Tab on an Electra Elite Telephone	4-11
Figure 4-13	Removing Bottom Cover on an Electra Elite Telephone	4-12
Figure 4-14	Removing the Knockout from an Electra Elite Telephone	4-12
Figure 4-15	Attaching the Base Plate to the Wall	4-13
Figure 4-16	Attaching the Base Plate using a Modular Jack	4-13
Figure 4-17	Plugging in the Line Cord using a Wall Jack	4-14
Figure 4-18	Plugging in the Line Cord Using a Modular Jack	4-14
Figure 4-19	Attaching the Bottom Tabs of the Electra Elite Telephone to the Base Cover	4-15
Figure 4-20	Attaching the Top Tabs of the Electra Elite Telephone to the Base Plate	4-15
Figure 4-21	Installed Wall Mount Unit on an Electra Elite Telephone	4-16
Figure 4-22	Removing the Tabs from the Adapter	4-17
Figure 4-23	Removing the Tabs from the WMU-U Unit	4-18
Figure 4-24	Leading the Line Cord out of the WMU-U Unit	4-18

Figure 4-25	Attaching the WMU-U Unit to the Wall	4-19
Figure 4-26	Attaching the Telephone to the WMU-U Unit	4-19
Figure 4-27	Removing the Hook from a Single Line Telephone	4-20
Figure 4-28	Turning the Hook Over	4-20
Figure 4-29	Sliding the Hook into Position on a Single Line Telephone	4-20
Figure 4-30	Removing the Screws from the Base of a Single Line Telephone	4-21
Figure 4-31	Replacing the Plate and Screws in the Base of the Single Line Telephone	4-21
Figure 4-32	Protruding Screws	4-22
Figure 4-33	Mounting the Telephone	4-22
Figure 4-34	InfoSet Telephone Stand	4-23
Figure 4-35	Adjusting the Height of the InfoSet Telephone	4-23
Figure 4-36	Locating the Adjustment Tabs on the Electra Elite Telephone	4-24
Figure 4-37	Raising the Base Plate on the Electra Elite Telephone	4-24
Figure 4-38	Adjusting the Line Cord Length on the Electra Elite Telephone	4-25
Figure 4-39	Lowering the Base Plate on the Electra Elite Telephone	4-25
Figure 4-40	Adjusting the LCD on the Electra Elite Telephone	4-26
Figure 4-41	Line Card Label for InfoSet Telephones	4-27
Figure 4-42	Plastic Panel for InfoSet Telephones	4-28
Figure 4-43	Installing the Plastic Cover on the InfoSet Telephone	4-28
Figure 4-44	Installing Line Card and Plastic Panel on a Telephone	4-29
Figure 4-45	Installing Plastic Panel on a Telephone	4-29
Figure 4-46	Removing the Plastic Panel from the Electra Elite Telephone	4-30
Figure 4-47	Connecting a Single Line Telephone to the System using an SLT(1)-U10 ADP	4-31
Figure 4-48	Connecting the SLT(1)-U10 ADP	4-31

Figure 4-49	Removing the Screws from the SLT(1)-U10 ADP	4-32
Figure 4-50	Attaching the SLT(1)-U10 ADP to the Wall	4-32
Figure 5-1	Raising the Base Plate on an Electra Elite Telephone	5-1
Figure 5-2	Unlocking the Tab on an Electra Elite Telephone	5-2
Figure 5-3	Releasing the Right Tab on an Electra Elite Telephone	5-2
Figure 5-4	Removing Bottom Cover on an Electra Elite Telephone	5-3
Figure 5-5	Removing the Base Plate Dummy End	5-3
Figure 5-6	Cutting the Dummy End in Half	5-4
Figure 5-7	Installing the Adapter in Connector 1	5-4
Figure 5-8	Installing Dummy End B	5-5
Figure 5-9	Connecting the ACA-U Unit	5-6
Figure 5-10	ADA-U Unit	5-7
Figure 5-11	Attaching Cables to the ADA-U Unit	5-7
Figure 5-12	ADA-U Unit Switch Settings	5-10
Figure 5-13	Attaching the ADA-U Unit to an Electra Elite Telephone	5-11
Figure 5-14	Leading the Audio Cable out from the ADA-U Unit	5-12
Figure 5-15	APR-U Unit	5-12
Figure 5-16	Attaching the Unit to the Telephone	5-13
Figure 5-17	Leading the Telephone Cord out from the Unit	5-13
Figure 5-18	Closing the Base Plate Cover	5-14
Figure 5-19	APR-U Unit Switches	5-14
Figure 5-20	Connecting Cables on the APR-U Unit	5-15
Figure 5-21	HFU-U(BK)/(WH) Unit	5-16
Figure 5-22	Microphone with Mute	5-16
Figure 5-23	Attaching a Microphone to a Telephone	5-17
Figure 5-24	HFU-U(BK)/(WH) Unit Switches	5-17

Figure 5-25	Attaching an Electra Elite Telephone to a PC	5-18
Figure 5-26	CTA-U Unit	5-19
Figure 5-27	Attaching the Unit to the Telephone	5-19
Figure 5-28	Connecting the RS-232C Cable to the CTA-U Unit on the Telephone	5-20
Figure 7-1	Navigational Bars for Internet Browsers	7-3
Figure 7-2	Main Menu	7-5
Figure 7-3	Switch Screen	7-6
Figure 7-4	Phones Screen	7-8
Figure 7-5	Line Key Screen	7-9
Figure 7-6	One-Touch/Feature Access Keys	7-11
Figure 7-7	Station Speed Dials	7-13
Figure 7-8	System Speed Dials	7-14
Figure 7-9	Ringling Screen	7-16
Figure 7-10	Restricted Dialing Screen	7-18
Figure 7-11	Quick Setup of Dialing Restrictions	7-19
Figure 7-12	File New Screen	7-21
Figure 7-13	File Load Screen	7-23
Figure 7-14	File Save Screen	7-24
Figure 7-15	Copy Screen	7-26
Figure 7-16	D.E.S.I. Screen	7-28
Figure 7-17	D.E.S.I. Label Screen	7-29
Figure 7-18	Select Report Type Screen	7-30
Figure 7-19	System Report Configuration Screen	7-31
Figure 7-20	System Report Sample	7-32
Figure 7-21	Telephone-Based Report Configuration Screen	7-33
Figure 7-22	Telephone-Based Report Sample	7-34

Figure 7-23	Trunk-Based Report Screen	7-35
Figure 7-24	Trunk-Based Report Sample	7-36
Figure 7-25	Non-Default Value Report	7-37
Figure 7-26	Help Screen	7-38
Figure 7-27	Help Example	7-39
Figure 7-28	Connect Screen	7-40
Figure 7-29	Upload Screen	7-41
Figure 7-30	Download Screen	7-42
Figure 7-31	Disconnect Screen	7-43
Figure 7-32	Expert Screen	7-44
Figure 7-33	Wizard Index Screen	7-46
Figure 7-34	Wizard Feature List Screen	7-47
Figure 7-35	Wizard Feature Programming Screen	7-48

List of Tables

Table 1-1	Equipment List	1-1
Table 1-2	Power Consumption	1-6
Table 1-3	Multiline Telephone Loop Resistance and Cable Length	1-6
Table 1-4	Cable Connection Between the Analog Port Adapter and the Single Line Telephone	1-7
Table 1-5	Weights and Dimensions	1-8
Table 3-1	InfoSet and Electra Elite Telephone Keys	3-1
Table 3-2	Dial Pad Keys Used When Entering Names	3-45
Table 3-3	Flexible Timeouts	3-79
Table 3-4	Speed Dial Search Keys	3-141
Table 5-1	ADA-U Cable Connections	5-8
Table 5-2	ADA-U Unit Switch Settings	5-10
Table 5-3	APR-U Unit Switch Settings for SW1 and SW3	5-15
Table 5-4	HFU-U Unit Switch Settings	5-18
Table 6-1	Navigational Keys for Telephone Programming	6-3
Table 6-2	Programming Functions Quick Reference Chart	6-5
Table 7-1	Quick Guide to InfoSet Programming Menus	7-4
Table A-1	Feature Access Codes List for Multiline Telephones	A-1
Table A-2	Feature Access Codes List for Single Line Telephones	A-4
Table A-3	Special Internal Dial Numbers List	A-4
Table C-1	Glossary of Terms	C-1

SECTION 1 YOUR SYSTEM

Your InfoSet 408 key service unit (KSU) provides you a complete communications system to enhance your business. The InfoSet 408 provides for a maximum of four lines and eight telephones. This system is easy to install, operate, and maintain and provides you the benefits and many of the features of a larger key telephone system.

You can easily install your system and using the system defaults have your system operational in a very short time. Should you need to customize your system you can make changes using PC Programming or Telephone Programming. PC Programming is an easy-to-use Windows 95/98 PC based software program. Telephone Programming allows you to make changes using an InfoSet or Elite telephone.

Your system provides battery backup in case of a power outage. System programming and speed dialing is retained for a minimum of 2 years, if your CPU lithium battery is fully charged. The built-in batteries located in key service unit allow your telephones to continue operating for approximately 30 minutes in the event of a power outage.

SECTION 2 EQUIPMENT

The following table lists the equipment that is available with your system. The System Maximum column indicates the maximum number of pieces of hardware that can be installed for each system.

Table 1-1 Equipment List

Equipment Name	Description	System Maximum
Key Service Units, Power Supply Units, and Adapters		
B408-B10 KSU	The Basic Key Service Unit (KSU) for the InfoSet system provides service for outside lines and interconnection of the telephones. The basic KSU provides up to two trunk lines and five telephones. The B408-B10 KSU has a dedicated ESI slot, SLI or VMS slot, DPH slot, PBR slot, and MIF slot. The B408-B10 KSU also provides a COI/BRT shared slot.	N/A

Equipment Name	Description	System Maximum
Common Electronic Telephone Units		
MIF-B10 ETU	This unit provides additional memory for processing and backup for PC programming and SMDR.	1 per system
Interface Electronic Telephone Units		
BRT(1)-B10 ETU	This Basic Rate Interface unit supports one circuit (two voice channels) for ISDN Basic Rate Interface. This ETU is installed in the BRT/COI slot.	1 ETU (2B)
CID(2)-B10 UNIT	The Caller ID Unit detects Caller ID signals from the central office and sends caller identification to the main board. This information is then displayed on the LCD of the telephones. This ETU is installed on the main board and COI(2)-B10 ETU as a piggyback.	2 Units
COI(2)-B10 ETU	Electrical fuses (posistors) are built into this ETU. This unit supports two outside (CO/PBX) lines and provides circuitry for ring detection, holding, and dialing. The outside lines must be Loop Start DTMF trunks. This ETU is installed in the BRT/COI slot.	1 ETU 2 CO/PBX lines
ESI(3)-B10 ETU	The Electronic Station Interface ETU contains three circuits. Each circuit can support any type of multiline telephone, or single line telephone adapter. This ETU is installed in slot ESI in the B408-B10 KSU. A five-channel ESI circuit is built in on the B408-B10 KSU.	1 ETU 3 Extensions
SLI(2)-B10 ETU	The Single Line Interface ETU supports a maximum of two single line telephones. This ETU provides Ringing Signal Generator (RSG) to single line telephones. This ETU is installed in the VMS/SLI slot in the B408-B10 KSU.	1 ETU 2 ports
Optional Electronic Telephone Units		
DPH-B10 ETU	The doorphone interface ETU allows two DP-D-1A doorphones to be connected. One call is allowed, and two door lock release relays are provided. This card provides two PBR circuits. This ETU is installed in the DPH slot in the B408-B10 KSU.	1 ETU
PBR-B10 ETU	The Push Button Receiver ETU detects and translates DTMF tones generated by single line telephones, modems, or facsimile machines. This ETU is installed in the PBR slot in the B408-B10 KSU.	1 ETU
VMS(2)-B10 ETU	This ETU provides two digital channels of built-in voice mail. This ETU is installed in the VMS/SLI slot.	1 ETU

Equipment Name	Description	System Maximum
InfoSet Telephones		
DTB-16-1 (BK)/(WH) TEL	This digital multiline telephone has eight line keys (unused line keys can be programmed for one-touch key operation), eight programmable one-touch keys, a built-in speakerphone, a large LED to indicate incoming calls and messages.	7
DTB-16D-1 (BK)/(WH) TEL	This digital multiline telephone is equipped with eight line keys (unused line keys can be programmed for one-touch key operation), eight programmable one-touch keys, a built-in speakerphone, a large LED to indicate incoming calls and messages. This telephone also has a 32-character, 2-line Liquid Crystal Display (LCD).	8
Electra Elite Telephones		
DP-D-1A	This doorphone may be used when DPH-B10 ETU is installed.	2
DTP-1-1 (WH) TEL	This single line telephone is a fully modular telephone with a flash key, redial key, three-level receive volume control, two-level ring volume control, data jack, and message waiting lamp. Each telephone connects to an SLI(2)-B10 ETU or SLT(1)-U10 ADP.	9 (Maximum capacity uses two ports from the SLI and seven ports using SLT adapters)
DTP-1HM-1 (WH) TEL	This single line telephone is a fully modular telephone with a flash key, REDIAL key, three-level receive volume control, two-level ring volume control, data jack, message waiting lamp, and eight programmable One-Touch/Speed Dial keys. Each telephone connects to an SLI(2)-B10 ETU or SLT(1)-U10 ADP.	9 (Maximum capacity uses two ports from the SLI and seven ports using SLT adapters)
DTP-2DT-1 (WH) TEL	This telephone is a fully modular instrument with two line keys (each line key is equipped with a two-color LED; unused line keys can be programmed for one-touch key operation), eight function keys, built-in speakerphone, and a large LED to indicate incoming calls and messages.	7
DTU-4R-1 (BK) TEL	This <i>D^{term}</i> Cordless Lite telephone can be connected to the InfoSet system using an ESI port. The telephone has a cordless handset, a 16-digit, 2-line LCD, dial pad, TALK key, HOLD key, TRF key, CNF key, MUTE key, a MSG LED, buzzer, and four function keys with red LEDs. When connected to a multiline telephone, this <i>D^{term}</i> Cordless Lite telephone can be switched to the multiline telephone connected to it by pressing the DESK key on the base unit of the idle <i>D^{term}</i> Cordless Lite Telephone.	8

Equipment Name	Description	System Maximum
ETW-4R-1(BK) TEL	<p>This <i>D^{term}</i> Cordless telephone can be connected to the system using an ESI port. The telephone has a cordless handset, a 10-digit, 2-line, LCD, dial pad, TALK key, HOLD key, TRF key, CNF key, SPD key, a MSG LED, optional buzzer and four function keys with red LEDs.</p> <p>The <i>D^{term}</i> Cordless telephone can be switched to an Electra Elite telephone, which is connected to it, by pressing the DESK key on the base unit of the idle <i>D^{term}</i> Cordless telephone.</p>	8
DTU-8-1 (BK)/(WH) TEL	<p>This digital multiline telephone has eight line keys (each line key is equipped with a two-color LED; unused line keys can be programmed for one-touch key operation), built-in speakerphone, a Large LED to indicate incoming calls and messages, headset jack, and compatibility with ADA-U, APR-U, and HFU-U Units.</p>	7
DTU-8D-2 (BK)/(WH) TEL	<p>This digital multiline telephone has eight line keys (each line key is equipped with a two-color LED; unused line keys can be programmed for one-touch key operation) built-in speakerphone, a Large LED to indicate incoming calls and messages, headset jack, and compatibility with ADA-U, APR-U, and HFU-U Units.</p> <p>This telephone is also equipped with a 24-character, 3-line, adjustable Liquid Crystal Display (LCD).</p> <p>The DTU-8D-2 (BK)/(WH) TEL provides four softkeys.</p>	8
DTU-16-1 (BK)/(WH) TEL	<p>This digital multiline telephone has 16 programmable line keys (each with a two-color LED), a built-in speakerphone, a Large LED to indicate incoming calls and messages, headset jack, and compatibility with ADA-U, APR-U, and HFU-U Units.</p>	7
DTU-16D-2 (BK)/(WH) TEL	<p>This digital multiline telephone has 16 programmable line keys (each with a two-color LED), a built-in speakerphone, a Large LED to indicate incoming calls and messages, headset jack, and compatibility with ADA-U, APR-U, and HFU-U Units.</p> <p>This telephone also has a 24-character, 3-line, adjustable Liquid Crystal Display (LCD).</p> <p>The DTU-16D-2 (BK)/(WH) TEL provides four softkeys.</p>	8
DTU-32-1 (BK)/(WH) TEL	<p>This digital multiline telephone has 32 programmable line keys (each with a two-color LED), a built-in speakerphone, a Large LED to indicate incoming calls and messages, headset jack, and compatibility with ADA-U, APR-U, and HFU-U Units.</p>	7
DTU-32D-2 (BK)/(WH) TEL	<p>This digital multiline telephone is equipped with 32 programmable line keys (each with a two-color LED), a built-in speakerphone, a Large LED to indicate incoming calls and messages, headset jack, and compatibility with ADA-U, APR-U, and HFU-U Units.</p> <p>This telephone has a 24-character, 3-line, adjustable Liquid Crystal Display (LCD).</p> <p>The DTU-32D-2 (BK)/(WH) TEL provides four softkeys.</p>	8

Equipment Name	Description	System Maximum
Adapters and Optional Units		
ACA-U Unit	The AC Adapter unit connects to one of the following: APR-U Unit, or HFU-U Unit.	One per Multiline Telephone as required
ADA-U Unit	This Ancillary Device adapter provides the digital multiline telephone with connection for a tape recorder. This adapter can be installed on any Electra Elite multiline telephone.	8
APR-U Unit	When this Analog Port Ringer adapter is used, an additional single line telephone or a modem can be connected to an Electra Elite multiline telephone. This adapter can be installed on any Electra Elite multiline telephone.	8
HFU-U (BK)/(WH) Unit	This optional Handsfree Unit provides full-duplex handsfree communication. This unit comes with the handsfree adapter and an external microphone. This adapter can be installed on any Electra Elite multiline telephone.	8
SLT(1)-U10 ADP	This Adapter provides an interface for single line telephones and other similar devices from an ESI ETU channel. This adapter is connected to any ESI port.	7

SECTION 3 POWER REQUIREMENTS

The InfoSet 408 KSU has eight dedicated slots, one each for BRT/COI, ESI, VMS/SLI, PBR, DPH, MIF, and DSL ETUs.

3.1 Power Supply Inputs

The AC input requirements for the InfoSet 408 system are listed below.

AC Input

- 117 Vac \pm 10%
- 60 Hz \pm 10%
- Single Phase
- 12A circuit
- A dedicated outlet, separately fused and grounded, is required.

3.2 Power Supply Consumption

The power consumption for the InfoSet 408 system is listed in [Table 1-2 Power Consumption](#).

Table 1-2 Power Consumption

KSU	Maximum RMS Current	Watts Used (Idle)	Watts Used (Maximum)
B408-B10 KSU	2.5 A	120	230

SECTION 4

CABLING REQUIREMENTS AND SPECIFICATIONS

This section provides cabling requirements and specifications for various equipment used in the InfoSet 408 system.

- BRT(1)-B10 ETU
- COI(2)-B10 ETU
- DPH-B10 ETU
- ESI(3)-B10 ETU
- SLI(2)-B10 ETU

The KSU is connected with each of the Multiline Telephones and Single Line Telephones by a separate twisted 1-pair cable or 2-pair cable (only for Multiline Telephones). (Refer to [Table 1-3 Multiline Telephone Loop Resistance and Cable Length](#) for the loop resistance and cabling requirements for Multiline Telephones and adapters.)

Table 1-3 Multiline Telephone Loop Resistance and Cable Length

Terminal or Adapter	Maximum Loop Resistance (Ohms)	Maximum Feet by Twisted 1-Pair Cable	Maximum Feet by Twisted 2-Pair Cable
		24 AWG	24 AWG
DTB-16-1 TEL	26	450	900
DTB-16D-1 TEL	26	450	900
DP-D-1A	20	N/A	N/A
DTP-1-1 (WH) TEL	600	N/A	N/A
DTP-1HM-1 (WH) TEL	600	N/A	N/A
DTP-2DT-1(WH) TEL	35	600	1000
DTU 4R-1(BK) TEL	N/A	650	1000
DTU-8-1(BK)/(WH) TEL	35	600	1000
DTU-8D-2(BK)/(WH) TEL	35	600	1000
DTU-16-1(BK)/(WH) TEL	26	450	900

Table 1-3 Multiline Telephone Loop Resistance and Cable Length (Continued)

Terminal or Adapter	Maximum Loop Resistance (Ohms)	Maximum Feet by Twisted 1-Pair Cable	Maximum Feet by Twisted 2-Pair Cable
		24 AWG	24 AWG
DTU-16D-2(BK)/(WH) TEL	26	450	900
DTU-32-1(BK)/(WH) TEL	21	360	720
DTU-32D-2(BK)/(WH) TEL	21	360	720
ETW-4R-1 (BK) TEL	N/A	650	650
SLT(1)-U10 ADP	35	600	1000

- ☞ The length for the specified SLT Adapter is the length between the SLT Adapter and the ESI port.
- ☞ The loop resistance for the DTP-1-1 (WH) TEL and the DTP-1HM-1 (WH) TEL includes the resistance of the single line telephone.
- ☞ The loop resistance for the DP-D-1A does not include the resistance of the DP-D-1A telephone.

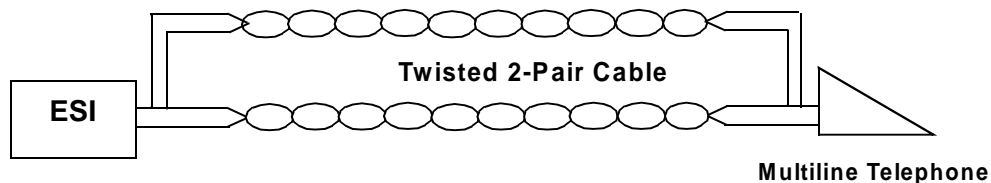

Figure 1-1 Connecting the ESI to the Multiline Telephone Using Twisted 2-Pair Cable

Table 1-4 Cable Connection Between the Analog Port Adapter and the Single Line Telephone

Connected Equipment	Cable	Maximum Loop Resistance from Connected Equipment to Telephone	Maximum Feet by Twisted 1-Pair Cable (24 AWG)
APR-U	Twisted Pair	5.4 Ohms	50 Feet
SLT(1)-U10 ADP			

- ☞ Mixing digital and analog ports through the same 25-pair cable runs is not recommended.

SECTION 5 ENVIRONMENTAL CONDITIONS

5.1 Temperature

- Operating: +32°F ~ +104°F (0°C ~ 40°C)
- Recommended Long Term: +50°F ~ +90°F (10°C ~ 32.2°C)

5.2 Humidity

- Operating: 10% ~ 90% noncondensing

SECTION 6 WEIGHTS AND DIMENSIONS

Table 1-5 [Weights and Dimensions](#) shows shipping weight, height, width, and depth for the InfoSet 408 KSU, optional ETUs, telephones and adapters.

Table 1-5 Weights and Dimensions

Unit	Shipping Weight*	Height	Width	Depth
ACA-U Unit	22.5 oz (638 g)	3.4" (86 mm)	4.2" (107 mm)	5.2" (133 mm)
ADA-U Unit	2.3 oz (65 g)	1.1" (29 mm)	2.3" (59 mm)	3.9" (99 mm)
APR-U Unit	4.3 oz (122 g)	2.6" (66 mm)	2.3" (59 mm)	4.8" (121 mm)
B408-B10 KSU	14.33 lbs (6.5 kg)	12.63" (320 mm)	15.19" (385 mm)	4.88" (124 mm)
BRT(1)-B10 ETU	4.59" (130 g)	3.69" (93 mm)	5.44" (138 mm)	.82" (21 mm)
COI(2)-B10 ETU	6.53 oz (185 g)	3.69" (93 mm)	5.44" (138 mm)	1.13" (29 mm)
CID(2)-B10 UNIT	3.36 oz (98 g)	2.38" (60 mm)	4.31" (110 mm)	1.13" (28 mm)
DPH-B10 ETU	4.94 oz (140 g)	3.69" (93 mm)	5.44" (138 mm)	.82" (21 mm)
DTU-4R-1 TEL	15.4 oz (437 g)	2.25" (57 mm)	4.25" (108)	7.5" (191)
DTU-8-1(BK)/(WH) TEL	41.0 oz (1163 g)	4.8" (123 mm)	7.8" (197 mm)	9.3" (235 mm)
DTU-8D-2 (BK)/(WH) TEL	43.5 oz (1233 g)	4.8" (123 mm)	7.8" (197 mm)	9.3" (235 mm)
DTU-16-1 (BK)/(WH) TEL	41 oz (1162 g)	4.8" (123 mm)	7.8" (197 mm)	9.3" (235 mm)
DTU-16D-2 (BK)/(WH) TEL	43.5 oz (1233 g)	4.8" (123 mm)	7.8" (197 mm)	9.3" (235 mm)

Unit	Shipping Weight*	Height	Width	Depth
DTU-32-1() (BK)/(WH) TEL	46 oz (1304 g)	4.8" (123 mm)	8.7" (220 mm)	9.3" (235 mm)
DTU-32D-2 (BK)/(WH) TEL	48 oz (1361 g)	4.8" (123 mm)	8.7" (220 mm)	9.3" (235 mm)
DTP-1-1 (WH) TEL	26.8 oz (760 g)	2.36" (60 mm)	6.22" (158 mm)	8.81" (224 mm)
DTP-1HM-1 (WH) TEL	26.8 oz (760 g)	2.36" (60 mm)	6.22" (158 mm)	8.81" (224 mm)
DTP-2DT-1 (WH) TEL	41 oz (1163 g)	4.8" (123 mm)	7.8" (197 mm)	9.3" (235 mm)
ETW-4R-1 (BK) TEL	26 oz (737 g)	3.42" (87 mm)	5.51" (140 mm)	7.48" (190 mm)
ESI(3)-B10 ETU	4.59 oz (130 mm)	3.69" (93 mm)	5.44" (138 mm)	.81" (20 mm)
DTB-16-1 (BK)/(WH) TEL	38.8 oz (1100 g)	9.13" (231 mm)	6.63" (168 mm)	3.38" (86 mm)
DTB-16D-1 (BK)/(WH) TEL	40.46 oz (1180 g)	9.13" (231 mm)	6.63" (168 mm)	3.38" (86 mm)
HFU-U (BK)/(WH) Unit	7.1 oz (201 g)	3.4" (86 mm)	4.2" (107 mm)	5.2" (133 mm)
MIF-B10 ETU	11.66 oz (340 g)	3.69" (93 mm)	5.44" (138 mm)	.82" (21 mm)
PBR-B10 ETU	3.60 oz (102 g)	3.69" (93 mm)	5.44" (138 mm)	.82" (21 mm)
SLI(2)-B10 ETU	6 oz (170 g)	3.69" (93 mm)	5.44" (138 mm)	.94" (24 mm)
SLT(1)-U10 ADP	9 oz. (255 g)	1.8" (45 mm)	2.8" (70 mm)	4.8" (120 mm)
VMS(2)-B10 ETU	32 oz. (907 g)	5" (127 mm)	10" (254 mm)	8.5" (216 mm)
WMU-U Unit	10.6 oz (301 g)	4.1" (104 mm)	5.9" (151 mm)	7.1" (180 mm)

* Shipping weight includes the shipping carton.

Weights and dimensions have been rounded to the nearest decimal.

SECTION 7

OUTSIDE LINE TYPE

The following outside line types can be used with the InfoSet 408 system.

- 2-wire, Loop Start Trunks
- ISDN-BRI Trunks (2B)

SECTION 8 NETWORK AND CONTROL

8.1 Transmission, Network, and Control Specifications

8.1.1 Transmission

- Data Length
 - From Multiline Telephone to ESI(3)-B10 ETU: 23 bits
 - From ESI(3)-B10 ETU to Multiline Telephone: 23 bits
- Data Transmission Rates:
 - Between ESI(3)-B10 ETU and Multiline Telephone: 184K bps (voice and signaling)
- Scanning Time for each Multiline Telephone: 32 ms.

8.1.2 Network

Time Division Multiplexing allows transmission of a number of separate data, voice and/or video simultaneously over one communications medium. The information below indicates the specifications the InfoSet 408 system uses for switching, clock, data bus, timeframe.

- TDM Switching: PCM (μ Law)
- TDM Clock: 2.048 MHz
- TDM Data Bus: 8 bit
- TDM Timeframe: 125 μ s.

8.1.3 Control

This section indicates the speed and capacities of the control.

- Control: Stored program with distributed processing
- Central Processor: 8-bit microprocessor
- Clock: 12.288 MHz
- Sub-processor: 8-bit microprocessor
- Multiline Telephone: 8-bit microprocessor
- SLT Adapter: 4-bit microprocessor

8.1.4 Telephone

The voltage, current, ring signal information for the InfoSet 408 multiline telephones, single line telephone equipment, and APR units are listed below.

- Multiline Telephone
Voltage: -11 ~ -26 Vdc
Maximum Current: 250 mA

Acoustical characteristics meet Electronic Industry Association (EIA) standard proposal SP-1286 and standard EIA RS-470.

- Single Line Telephone
Standard 2500 Set: 500 type network
Nominal Current: 35 mA
Ring Signal: 56 Vac RMS @ 20 Hz
- SLT(1)-U10 ADP
Standard 2500 Set: 500 type network
Nominal Current: 30 mA
Ring Signal: 56 Vac RMS @ 20 Hz
- APR-U Unit
Standard 2500 Set: 500 type network
Nominal Current: 30 mA
Ring Signal: 70 Vac RMS @ 18 Hz

SECTION 9 EXTERNAL EQUIPMENT CONNECTION

9.1 Music Sources for Music on Hold via KSU

- Auxiliary Input: 0.6V PPS Signal Level
- Input Impedance: 600 Ω

9.2 External Paging (Audio) via KSU

- Output Power: -10 dBm Signal Level
- Output Impedance: 600 Ω

9.3 External Tone Ringer

- Output Level: -10 dBm
- Output Impedance: 600 Ω
- Relay Contact Rating: 1A, 24 Vdc

9.4 SMDR Output

- Male Connector (System Output) Standard RS-232C (DB-9)

9.5 PC Connection

- Male Connector (System Output) Standard RS-232C (DB-9)

9.6 Relay Contact

- All Relay Contact Ratings: 1A, 24Vdc

SECTION 10

BATTERY BACKUP

The InfoSet 408 system has battery backup functions for system backup and for memory backup.

10.1 System Backup

During a power failure, the system is backed up using a rechargeable battery. This battery backup supports all system operations for approximately 30 minutes.

10.2 Memory Backup

The B408-B10 KSU has a lithium battery installed to provide backup of system memory. The system memory (programmed data) is retained for a minimum of two years.

SECTION 1 BASIC INSTALLATION

This section provides instructions for the basic installation of the system. Before the system is operational the backup battery must be attached, the lithium battery that retains system memory must be installed, the memory backup switch must be moved to the “Hold” position, and the system must be wall mounted.

There are two standard configuration which can be expanded to a maximum of four trunk lines (ports) and eight telephones by purchasing the necessary expansion boards and installing them. Instructions for installing the expansion boards are provided in [Section 2 Installing Electronic Telephone Units on page 2-10](#).

1.1 Unpacking the KSU

Unpack the KSU from the box. The contents include:

- B408-B10 KSU
- Wall Mounting Template
- One-Sheet Installation Guide
- 4 Phillips Head Wood Screws
- Speaker Relay Cable
- Lithium Battery
- 2 Replacement Fuses
- 2 Tie Wraps
- InfoSet 408 System Manual (CD-ROM)

The tools needed include:

- Phillips Head Screwdriver

1.2 Opening the KSU and Attaching the Batteries

The two batteries, located in the lower left corner of the KSU, provide complete system backup power for approximately 30 minutes during power outages. This provides backup for the entire system (the key system and telephones) in case of a power outage. ***It is important that these be connected before the system is installed.***

1. Remove the cover by loosening the two bottom screws with a Phillips head screwdriver (the screws remain in the cover to keep from misplacing them). Pull the cover away from the KSU and lift upward.

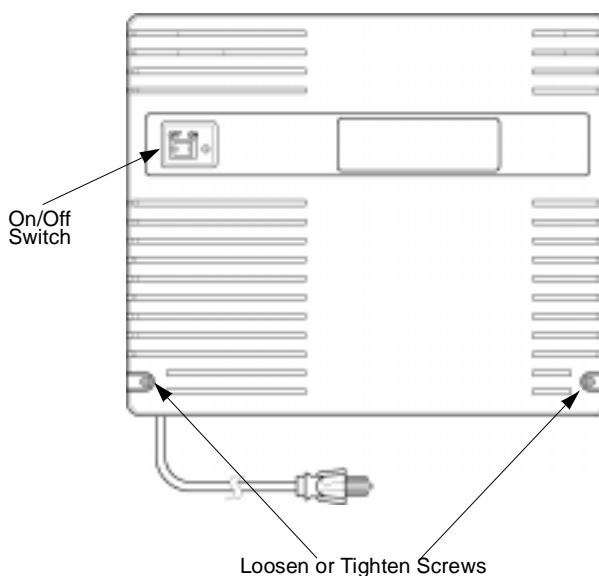

Figure 2-1 Removing the Front Cover

2. Locate the backup batteries in the lower left side of the KSU. Identify the battery cables, which are marked with blue and yellow tags. Attach the blue tagged battery cable connector to the blue battery terminal labeled CN3 (BATT1) and the yellow tagged battery cable connector to the yellow battery terminal labeled CN4 (BATT2). The battery terminals are located on the backplane of the KSU. The connector tab should be placed over the terminal tab. There is only one direction the tabs can be placed into the connector terminals, therefore, you cannot attach them incorrectly.

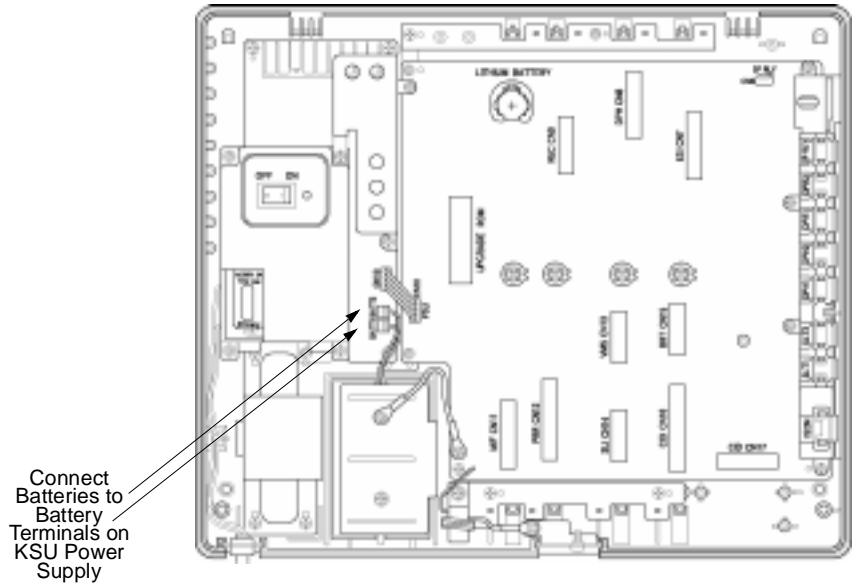

Figure 2-2 Attaching the Backup Battery Connectors

3. Locate the lithium battery receptacle on the backplane of the KSU. Using the provided battery, place it at an angle and push downward and inward to install. The battery should slide into place.

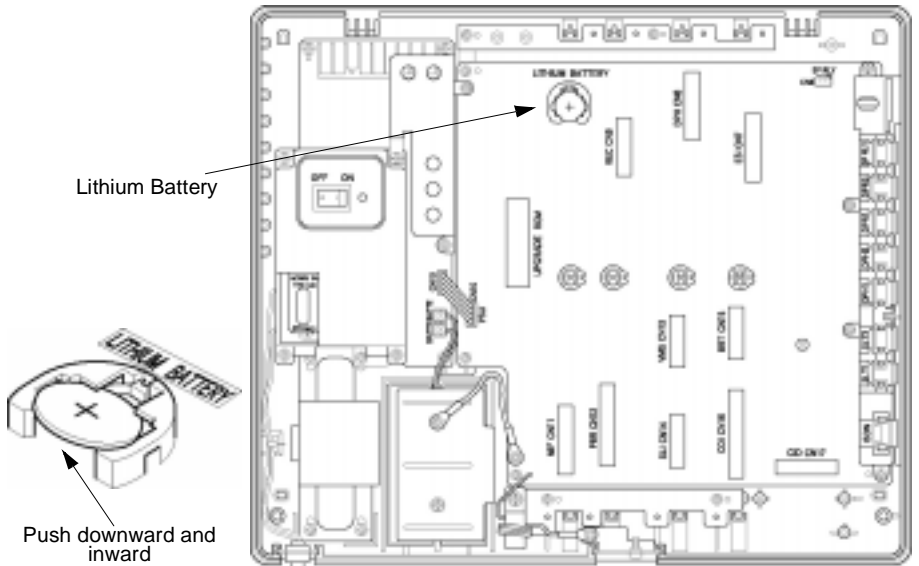

Figure 2-3 Installing the Lithium Battery

4. Locate the battery memory switch in the upper left side of the KSU. Move the switch to the right toward the "HOLD" position.

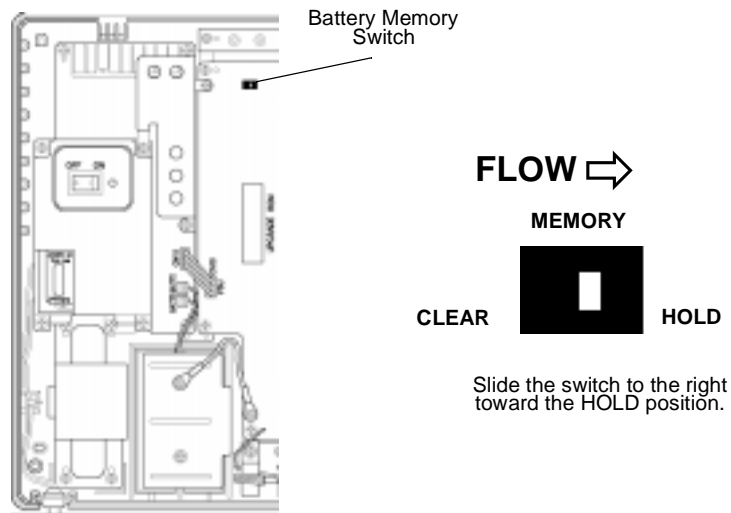

Figure 2-4 Setting the Battery Memory Switch



If you are wall mounting the KSU or want to install the speaker relay receptacle, or any other optional equipment, do so now before replacing the KSU cover.

To ensure memory retention, the battery memory switch must be set to HOLD. (Refer to [Figure 2-4 Setting the Battery Memory Switch.](#))

5. Replace the cover and tighten the screws.
6. Turn the on/off switch on the KSU to the ON position.

1.3 Wall Mounting the KSU

A wall mounting template is provided with the KSU to help mark the position of the KSU on the wall.

1. Use the wall mounting template to mark the position of the KSU on the wall. Be sure to select a sturdy wall (not metal).
2. Insert two of the provided Phillips head wood screws into the wall. Leave about 1/2" of the screw extruding from the wall.
3. If the cover has been replaced, remove the KSU cover by loosening the two bottom screws with a Phillips head screwdriver (the screws remain in the cover to keep from losing them). Pull the cover away from the KSU and lift upward.
4. Hang the KSU onto the wall by matching the holes on the back of the KSU with the screws in the wall. Lift up on the KSU and then lower the KSU over the screws.
5. Insert the two remaining Phillips head wood screws into the holes located at the bottom corners of the KSU and tighten all of the wood screws.

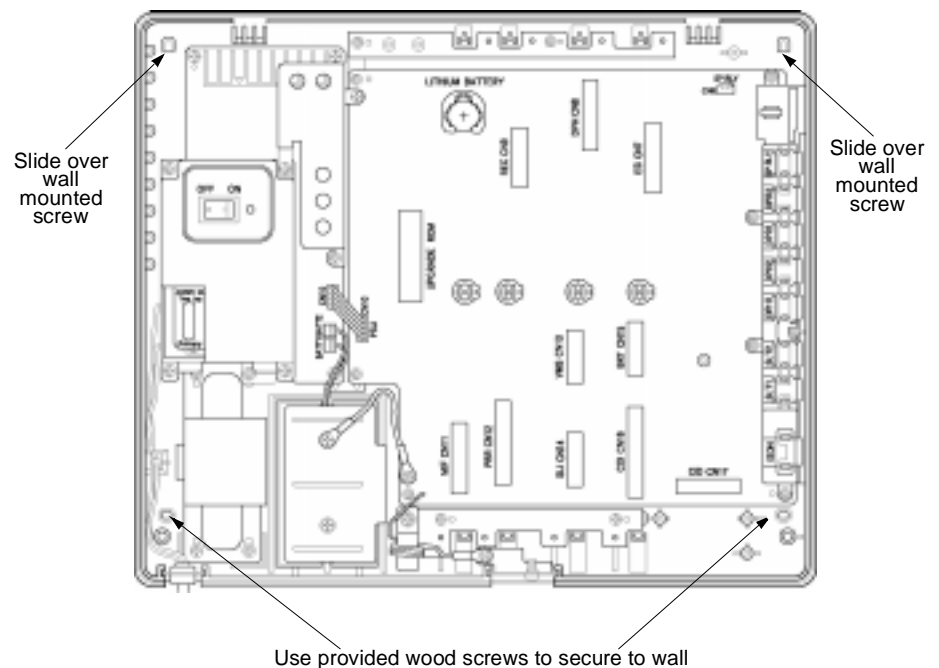

Figure 2-5 Securing the KSU to the Wall



If you want to install the speaker relay or any other optional equipment, do so now before replacing the KSU cover.

6. Attach the cover and tighten the screws.
7. Using a standard RJ-11 cord (user-provided) attach the trunk lines (ports) into the RJ-11 jacks marked 1 and 2. This provides connection to the telephone service provider.
8. Using a standard RJ-11 cord (user-provided) connect the telephones into RJ-11 jacks marked 1~5. This connects your telephones to the system.

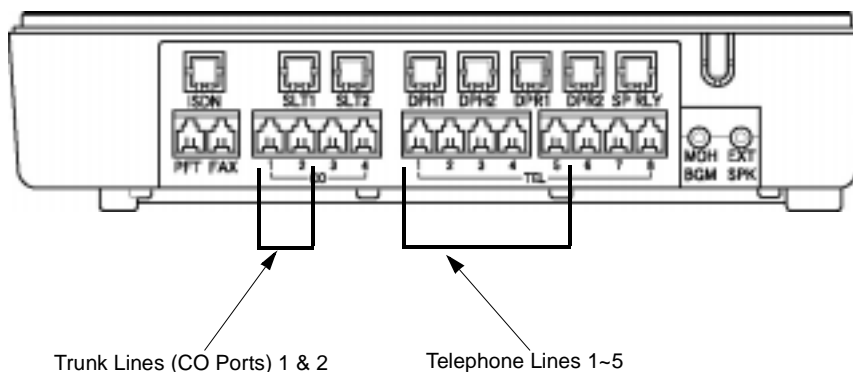

Figure 2-6 Connecting the Trunk Lines and Telephones to the System

9. Plug the system into a standard wall outlet and turn the on/off switch on the KSU to the ON position. (Refer to [Chapter 1 System Overview, Section 3 Power Requirements on page 1-5](#) for AC input requirements.) Your system should now be fully operational. You can use the system with the factory selected defaults or you can use PC Programming or Telephone Programming to customize your system. (Refer to [Chapter 6 Telephone Programming on page 6-1](#) and [Chapter 7 PC Programming on page 7-1.](#))



A dedicated outlet, separately fused and grounded, is required.

1.4 Installing the External Speaker Relay Cable

This cable allows you to connect a paging system with a power control function that requires a relay contact. The power ratings are: 24 Vdc, 1A or 120 Vac, 0.5A.

1. Be sure the system is turned **off** during the installation process.
2. Remove the KSU cover by loosening the two bottom screws with a Phillips head screwdriver (the screws remain in the cover to keep from misplacing them). Pull the cover away from the KSU and lift upward. (Refer to [Figure 2-1 Removing the Front Cover on page 2-2.](#))
3. Remove the plastic knockout labeled SP RLY (located on the sideplane of the KSU). You may need to use a screwdriver to gently loosen the tabs holding the knockout.

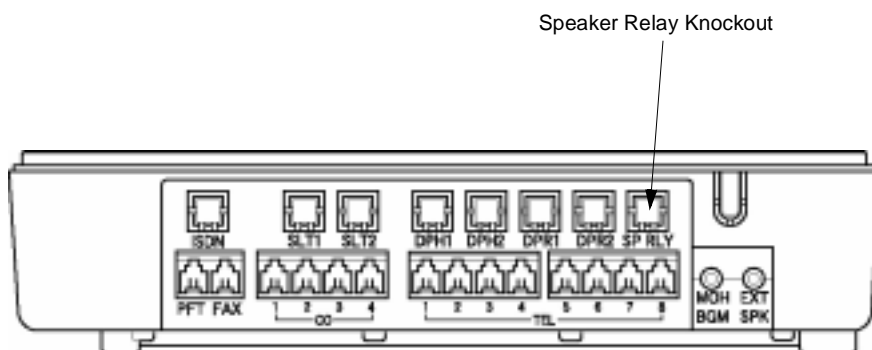

Figure 2-7 Removing the Plastic Knockout

4. Using the provided speaker relay cable, slide the gray RJ-11 end into the slot inside the sideplane of the KSU marked SP RLY.

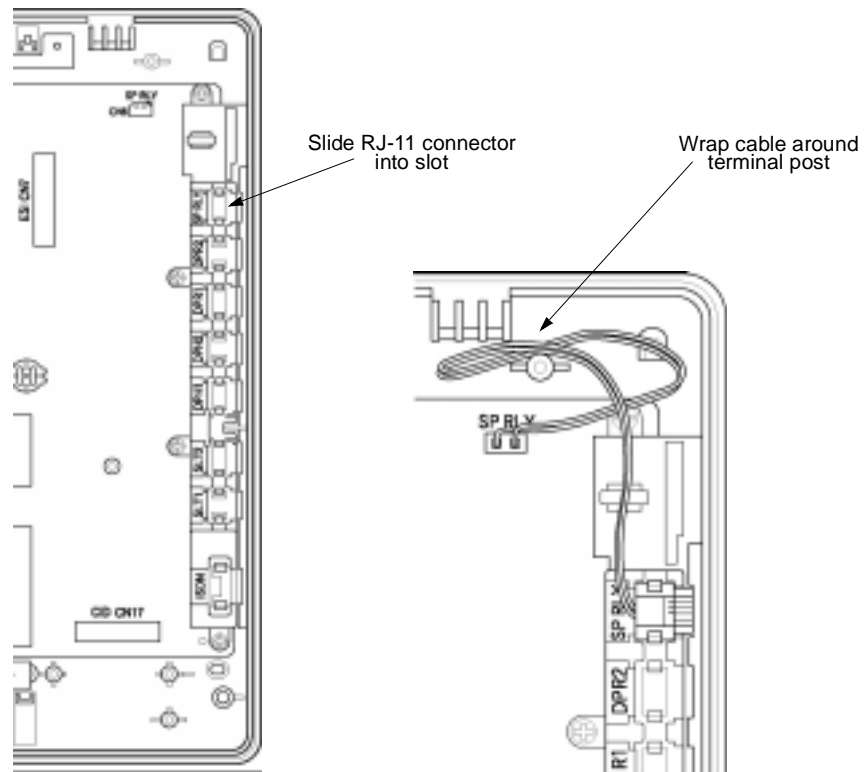

Figure 2-8 Attaching the Speaker Relay Cables

5. Locate the connector terminal labeled SP RLY on the KSU backplane. Insert the small white connector end of the speaker relay cable into the connector terminal on the backplane. Take the cables and wrap them around the terminal post to the right of the terminal connector.

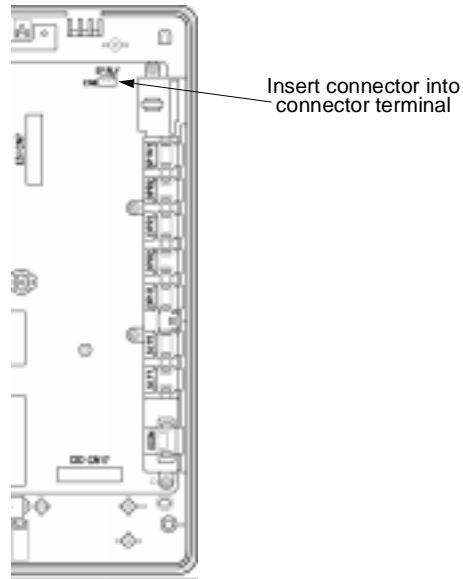

Figure 2-9 Inserting the Connector into the Terminal

6. Attach the cover and tighten the screws.
7. Locate the RJ-11 jack (labeled SP RLY) located on the sideplane of the KSU. Attach one end of an RJ-11 cord (user-provided) into the jack and attach the other end into an paging control system (user-provided).

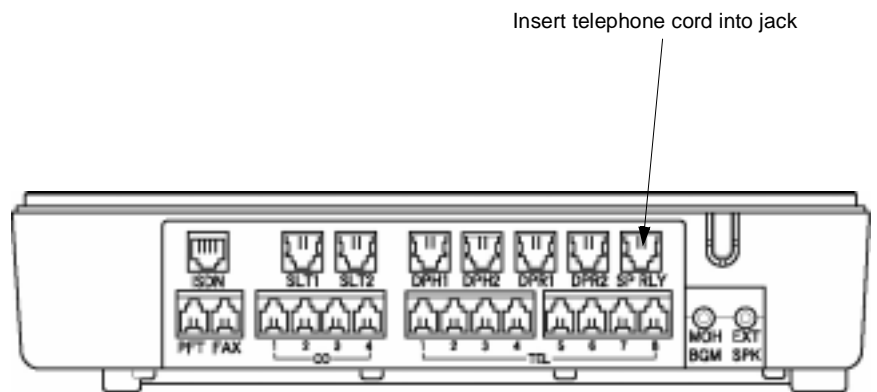

Figure 2-10 Inserting the Telephone Cord into the Jack

8. Turn the on/off switch on the KSU to the ON position.

SECTION 2 **INSTALLING ELECTRONIC TELEPHONE UNITS**

Electronic Telephone Units (ETUs) can be installed at the same time that the KSU is initially installed or individually as needed. The instructions for each individual ETU assumes the unit is being installed at a later time, therefore, there are steps which will not apply (i.e., turning the KSU off/on and removing the cover). If installing the unit(s) at the same time as the KSU, ignore the steps that are not applicable.

2.1 Installing the ESI(3)-B10 ETU

This board allows three additional telephones to be connected to the system. A maximum of eight telephones can be connected to the system when this board is installed.

1. Be sure the system is turned **off** during the installation process.
2. Remove the cover by loosening the two bottom screws with a Phillips head screwdriver (the screws remain in the cover to keep from misplacing them). Pull the cover away from the KSU and lift upward. (Refer to [Figure 2-1 Removing the Front Cover on page 2-2.](#))
3. Carefully remove the ESI board from the protective packaging. Use a wrist strap that is connected to the frame ground on the KSU to avoid static discharge and possible damage to the KSU.
4. Locate the area on the KSU backplane marked ESI and slide the ESI board between the grooved posts. Press firmly down on the board until the connector on the ESI board (labeled CN1) and the connector terminal on the KSU backplane (labeled CN7) are securely attached.

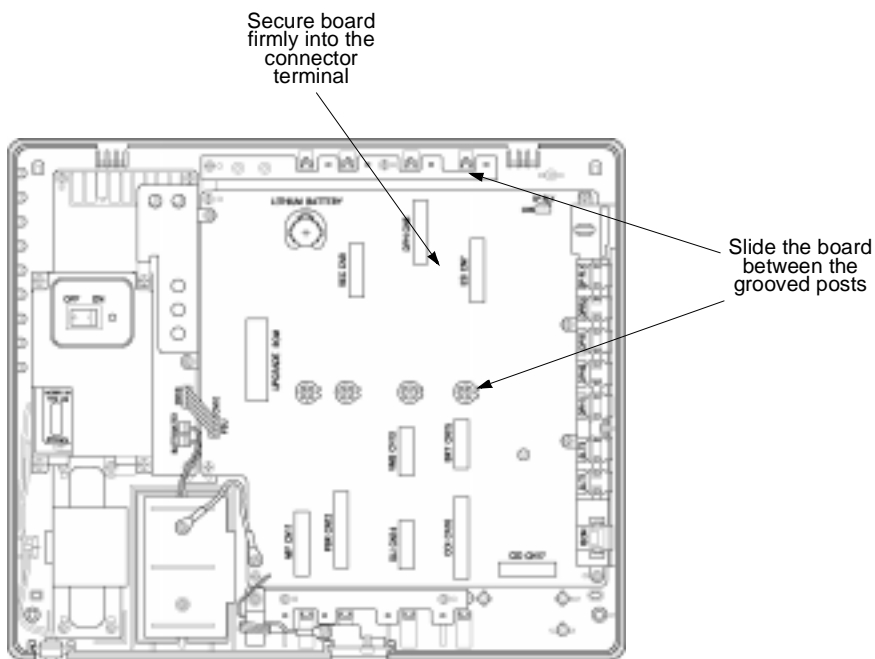

Figure 2-11 Installing the ESI ETU into the KSU

5. Using a Phillips head screwdriver, secure the ESI board to the KSU by tightening the screw.
6. Attach the cover and tighten the screws.
7. Using a standard RJ-11 cord (user-provided) connect the additional telephones into RJ-11 jacks marked 6~8.

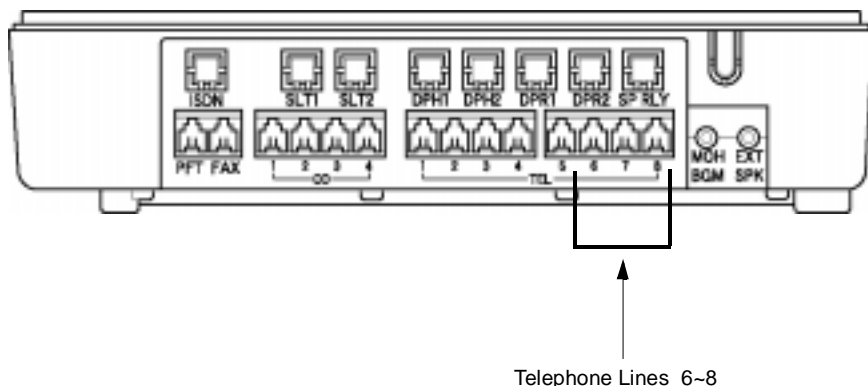

Figure 2-12 Connecting the Telephones to the KSU

8. Attach the other end of the RJ-11 cord into the telephones.
9. Turn the on/off switch on the KSU to the ON position.

2.2 Installing the COI(2)-B10 ETU

This board allows two additional trunk lines (for a maximum of four trunk lines) and one additional fax/modem connection (for a maximum of three fax/modem connections) to be installed.

1. Be sure the system is turned **off** during the installation process.
2. Remove the cover by loosening the two bottom screws with a Phillips head screwdriver (the screws remain in the cover to keep from misplacing them). Pull the cover away from the KSU and lift upward. (Refer to [Figure 2-1 Removing the Front Cover on page 2-2.](#))
3. Carefully remove the COI board from the protective packaging. Use a wrist strap that is connected to the frame ground on the KSU to avoid static discharge and possible damage to the KSU.
4. Locate the area on the KSU backplane labeled COI and slide the COI board between the grooved posts. Press firmly down on the board until the connector on the COI board (labeled CN1) and the connector terminal (labeled CN16) are securely attached.

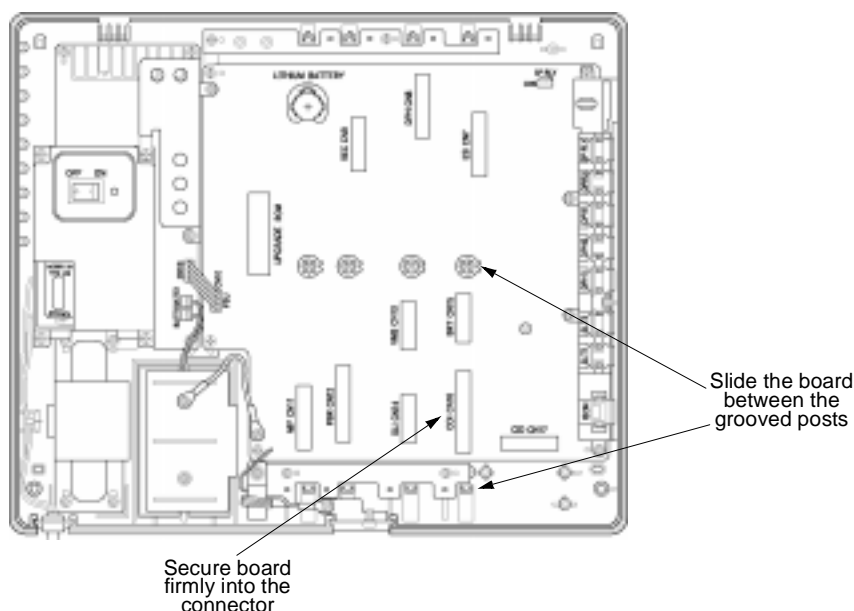

Figure 2-13 Installing the COI ETU into the KSU

5. Using a Phillips head screwdriver, secure the COI board to the KSU by tightening the screw.

6. Remove the plastic knockout labeled ISDN (located on the sideplane of the KSU). You may need to use a screwdriver to gently loosen the tabs holding the knockout.

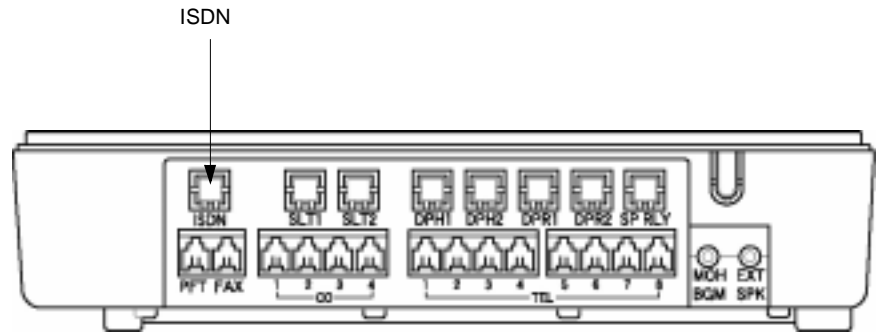

Figure 2-14 Removing the ISDN Knockout

7. Locate the slot labeled ISDN on the inside of the KSU sideplane. Using the RJ-45 cable (provided), slide the RJ-45 jack end into this slot to provide connection for a third fax/modem port.

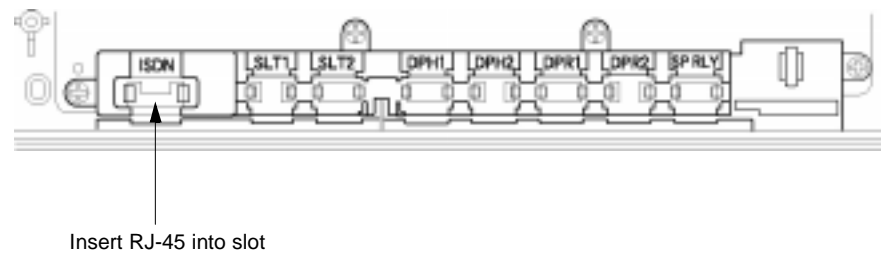

Figure 2-15 Inserting the Cable into the ISDN Slot

8. Insert the white connector end of the RJ-45 cable into the connector terminal (labeled CN7) on the COI board.

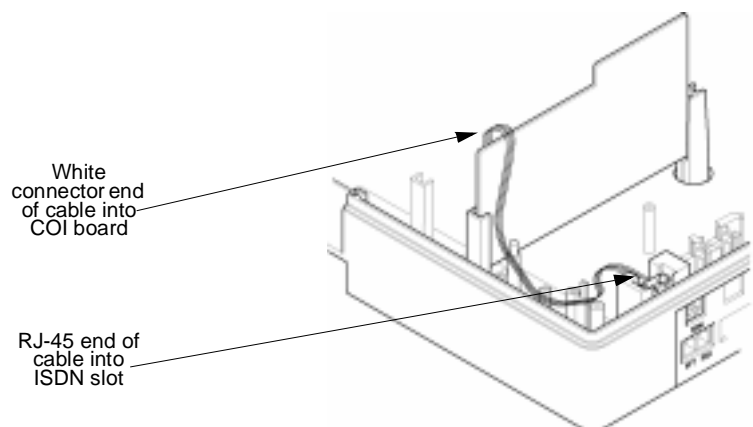

Figure 2-16 Inserting the Cable into the COI ETU

9. Attach the cover and tighten the screws.
10. Using a standard RJ-11 cord (user-provided) connect the additional trunk lines into RJ-11 jacks labeled 3 and 4.

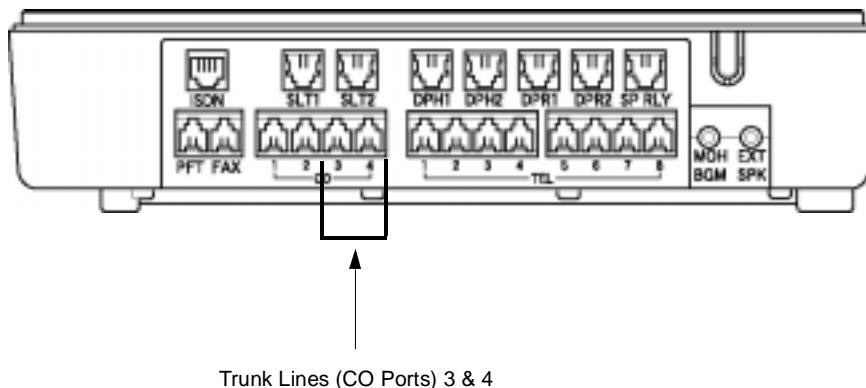

Figure 2-17 Connecting Additional Lines to the KSU

11. Using a standard RJ-11 cord (user-provided) connect the optional device into the RJ-45 to RJ-11 convertor cable (provided). Plug the RJ-45 to RJ-11 convertor cable into the jack labeled ISDN. This port allows you to install devices such as a facsimile machines, modems, credit card machines, or answering machines. This jack can also be used for power failure transfer (PFT) connection.

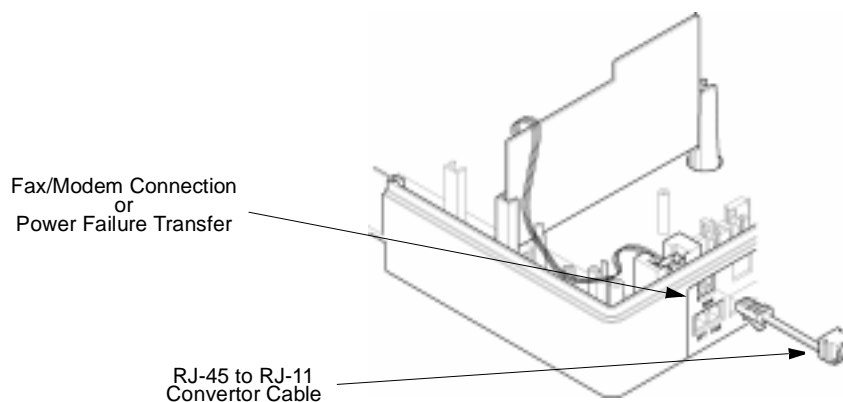

Figure 2-18 Connecting Optional Devices to the COI ETU

12. Turn the on/off switch on the KSU to the ON position.

2.3 Installing the CID(2)-B10 UNIT

This unit provides caller ID. To support four caller ID ports you will need two cards.

1. Be sure the system is turned **off** during the installation process.
2. Remove the KSU cover by loosening the two bottom screws with a Phillips head screwdriver (the screws remain in the cover to keep from misplacing them). Pull the cover away from the KSU and lift upward. (Refer to [Figure 2-1 Removing the Front Cover on page 2-2.](#))
3. If the COI(2)-B10 ETU is installed, remove the screw with a Phillips head screwdriver and carefully lift the board from the back plane of the KSU.
4. Remove the CID(2)-B10 Unit from the protective packaging. Use a wrist strap that is connected to the frame ground on the KSU to avoid static discharge and possible damage to the KSU.
5. To install the first CID(2)-B10 Unit, locate the area labeled CID on the KSU backplane. Line up the small hole in the CID board with the post on the backplane of the KSU and slide the board into place. Press firmly down on the board until the connector on the CID board (labeled CN1) and the connector terminal on the KSU backplane (labeled CN17) are securely attached. Using the two provided screws, secure the board by tightening the screws with a Phillips head screwdriver.

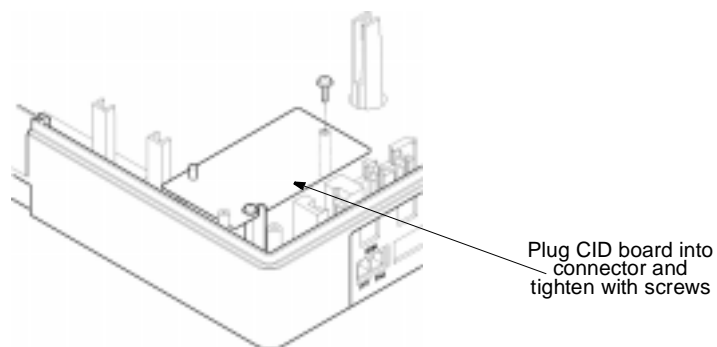

Figure 2-19 Installing the First CID Unit

6. To install the second CID(2)-B10 Unit, attach the three plastic standoffs (provided) to the CID board by pressing the large flanged end into the hole on the board. Place these on the side of the CID board where the CN1 connector is located.

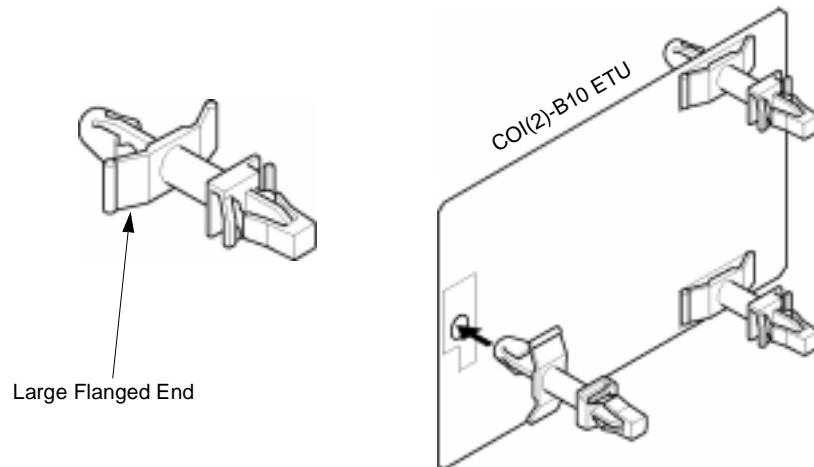

Figure 2-20 Installing the Second CID Unit

7. Push the CID board into the three holes on the COI board (match the connector on the CID board (labeled CN1) with the connector on the COI board (labeled CN2)). Press firmly to secure to two boards.

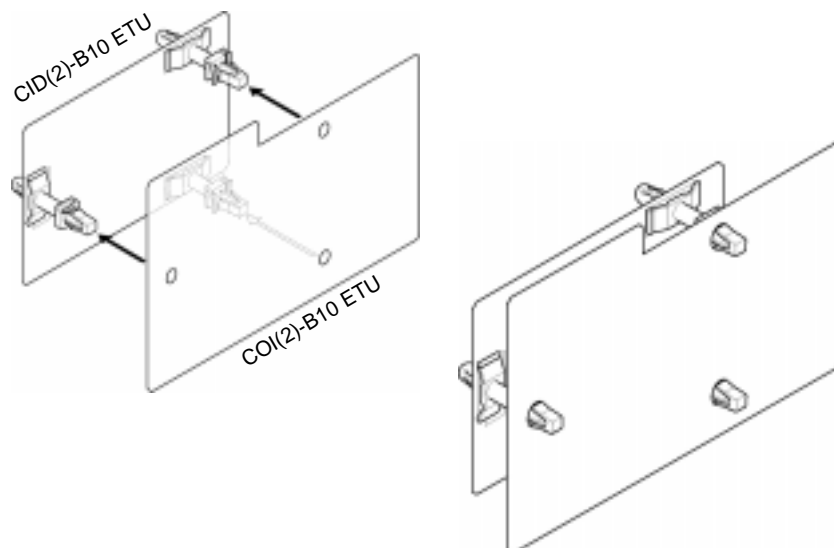

Figure 2-21 Piggybacking the COI(2) ETU and CID Unit

8. Locate the area on the KSU backplane labeled COI and slide the COI board between the grooved posts. Press firmly down on the board until the connector on the COI board (labeled CN1) and the connector terminal on the KSU backplane (labeled CN16) are securely attached.

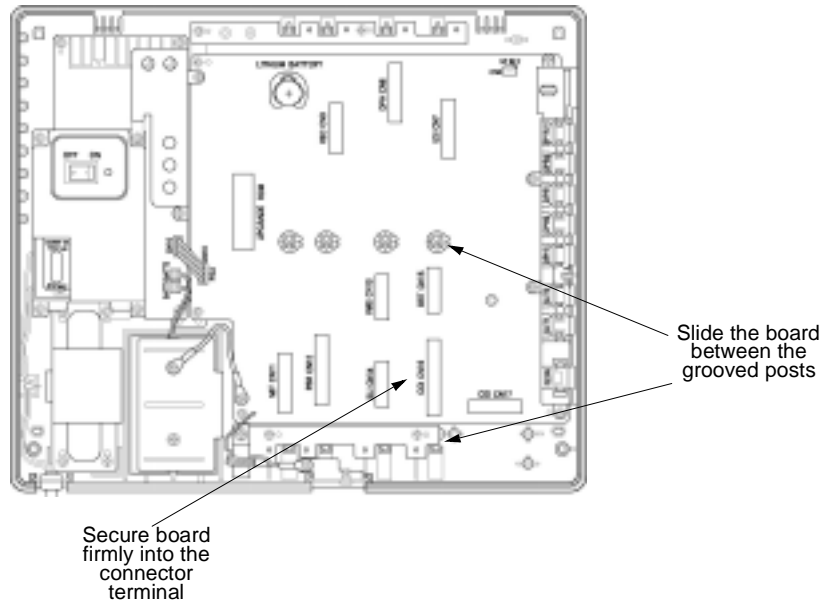

Figure 2-22 Inserting the COI ETU into the KSU

9. Using a Phillips head screwdriver, secure the COI board to the KSU by tightening the screw.
10. Attach the cover and tighten the screws.
11. Turn the on/off switch on the KSU to the ON position.

2.4 Installing the SLI(2)-B10 ETU

This board allows you to add two additional single line telephones to the system. If the VMS(2)-B10 ETU is installed this board must be removed. When the VMS(2)-B10 ETU is removed, voice mail is no longer provided.

☞ When the SLI(2)-B10 ETU is installed, the PBR-B10 ETU must also be installed.

1. Be sure the system is turned **off** during the installation process.
2. Remove the cover by loosening the two bottom screws with a Phillips head screwdriver (the screws remain in the cover to keep from misplacing them). Pull the cover away from the KSU and lift upward. (Refer to [Figure 2-1 Removing the Front Cover on page 2-2.](#))
3. Carefully remove the SLI board from the protective packaging. Use a wrist strap that is connected to the frame ground on the KSU to avoid static discharge and possible damage to the KSU.
4. Locate the area on the KSU backplane labeled SLI and slide the SLI board between the grooved posts. Press firmly down on the board until the connector on the SLI board (labeled CN1) and the connector terminal on the KSU backplane (labeled CN14) are securely attached.

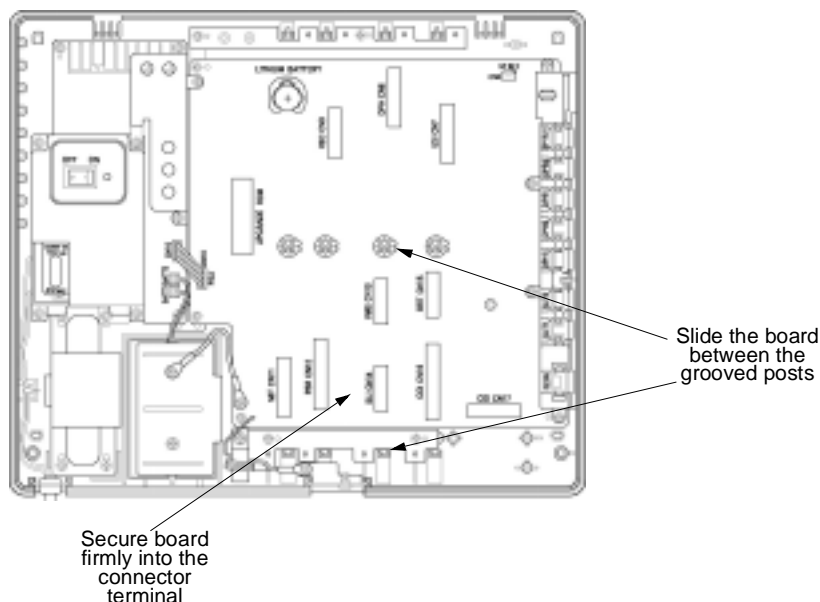

Figure 2-23 Installing the SLI ETU

5. Using a Phillips head screwdriver, secure the SLI board to the KSU by tightening the screw.
6. Remove the plastic knockouts on the sideplane of the KSU in the areas labeled SLT1 and SLT2. You may need to use a screwdriver to gently loosen the tabs holding the knockout.

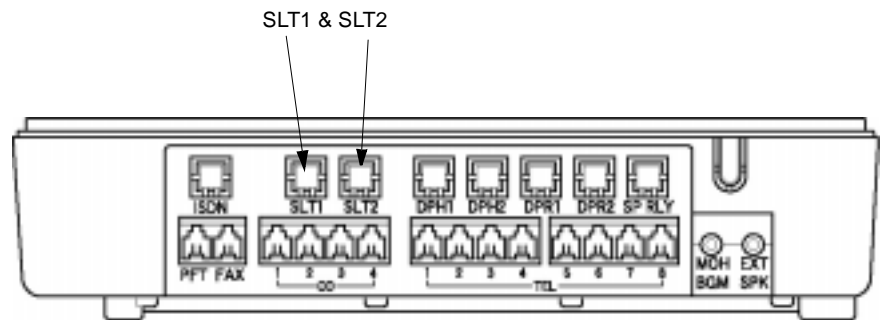

Figure 2-24 Removing the Plastic Knockout for the SLT

7. Using the provided RJ-11 cable (two cables are provided with the SLI board), slide one of the jacks into the connector slot labeled SLT1 (located inside the sideplane) and insert the small white connector end into the connector terminal on the SLI board labeled CN6-CN2 SLT1. Insert the other jack into the connector slot marked SLT2 (located inside sideplane) and insert the small white connector end into the connector terminal on the SLI board labeled CN6-CN3 SLT2. Be sure that you have matched the cables correctly – Jack SLT1 to CN6-CN2 SLT1 and Jack SLT2 to CN6-CN3 SLT2.

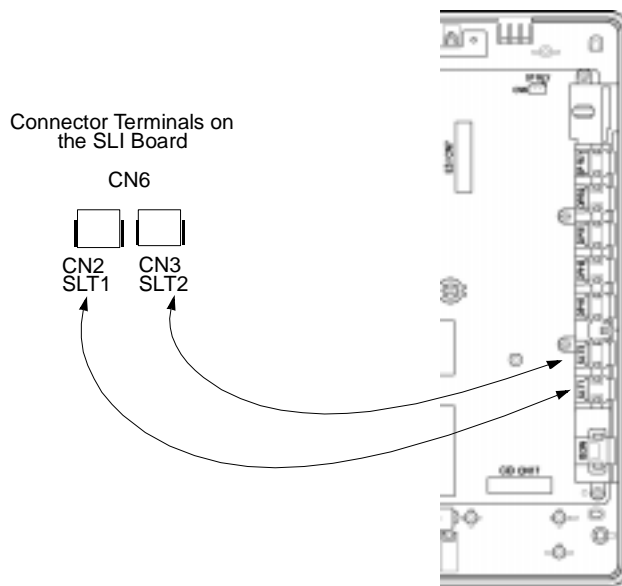

Figure 2-25 Attaching the RJ-11 Cables

8. Wrap the cables around a terminal post (located on the side of the interior of the KSU).
9. Attach the cover and tighten the screws.
10. Turn the on/off switch on the KSU to the ON position.

2.5 Installing the PBR-B10 ETU

The PBR board has four push button receiver (PBR) circuits. These circuits detect and translate dual-tone multifrequency (DTMF) signals (often referred to as touchtone) sent by single line telephones, facsimile machines, modems and other analog devices.

☞ When the SLI(2)-B10 is installed, this board must also be installed.

1. Be sure the system is turned **off** during the installation process.
2. Remove the cover by loosening the two bottom screws with a Phillips head screwdriver (the screws remain in the cover to keep from misplacing them). Pull the cover away from the KSU and lift upward. (Refer to [Figure 2-1 Removing the Front Cover on page 2-2.](#))
3. Carefully remove the PBR board from the protective packaging. Use a wrist strap that is connected to the frame ground on the KSU to avoid static discharge and possible damage to the KSU.
4. Locate the area on the KSU backplane labeled PBR and slide the PBR board between the grooved posts. Press firmly down on the board until the connector on the PBR board (labeled CN1) and the connector terminal on the KSU backplane (labeled CN12) are securely attached.

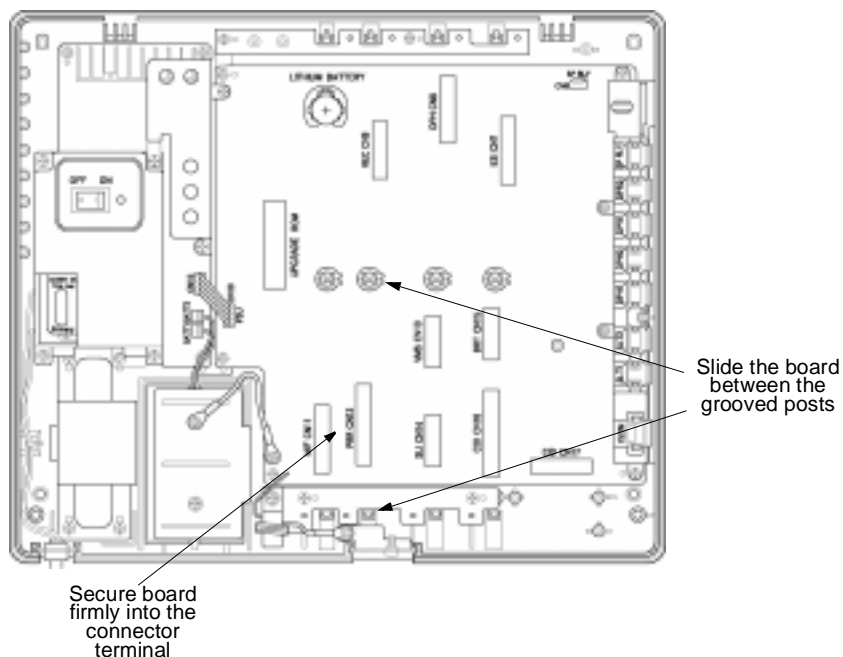

Figure 2-26 Installing the PBR ETU on the KSU

5. Using a Phillips head screwdriver, secure the PBR board to the KSU by tightening the screw.
6. Attach the cover and tighten the screws.
7. Turn the on/off switch on the KSU to the ON position.

2.6 Installing the MIF-B10 ETU

The MIF board provides additional memory to operate PC programming and Station Message Detail Recording (SMDR).

1. Be sure the system is turned **off** during the installation process.
2. Remove the cover by loosening the two bottom screws with a Phillips head screwdriver (the screws remain in the cover to keep from misplacing them). Pull the cover away from the KSU and lift upward. (Refer to [Figure 2-1 Removing the Front Cover on page 2-2.](#))
3. Remove the ground plate (located at the bottom of the KSU) by loosening the screw inside the KSU.
4. Slide the DB-9 connector plate into the slot where the ground plate was removed.

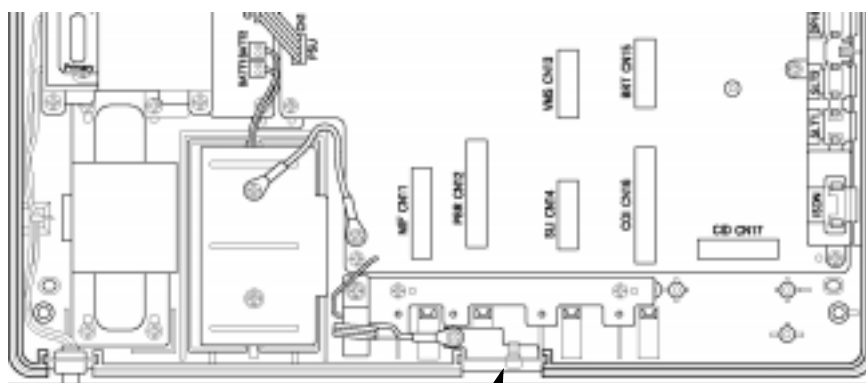

Remove Ground Plate and replace with DB-9 Connector Plate

Figure 2-27 Installing the DB-9 Connector Plate

5. Place the green grounding wire on top of the DB-9 connector plate and tighten with the screw.

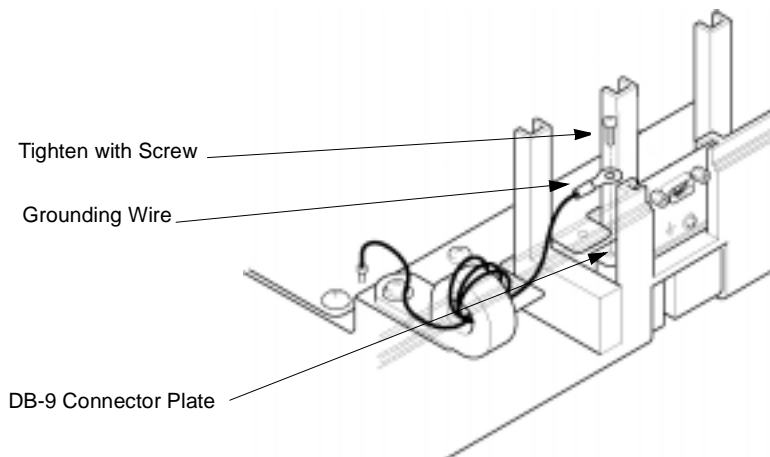

Figure 2-28 Attaching the Grounding Wire

6. Carefully remove the MIF board from the protective packaging. Use a wrist strap that is connected to the frame ground on the KSU to avoid static discharge and possible damage to the KSU.
7. Locate the area on the KSU backplane labeled MIF and slide the MIF board between the grooved posts. Press firmly down on the board until the connector on the MIF board (labeled CN1) and the connector terminal on the KSU backplane (labeled CN11) are securely attached.

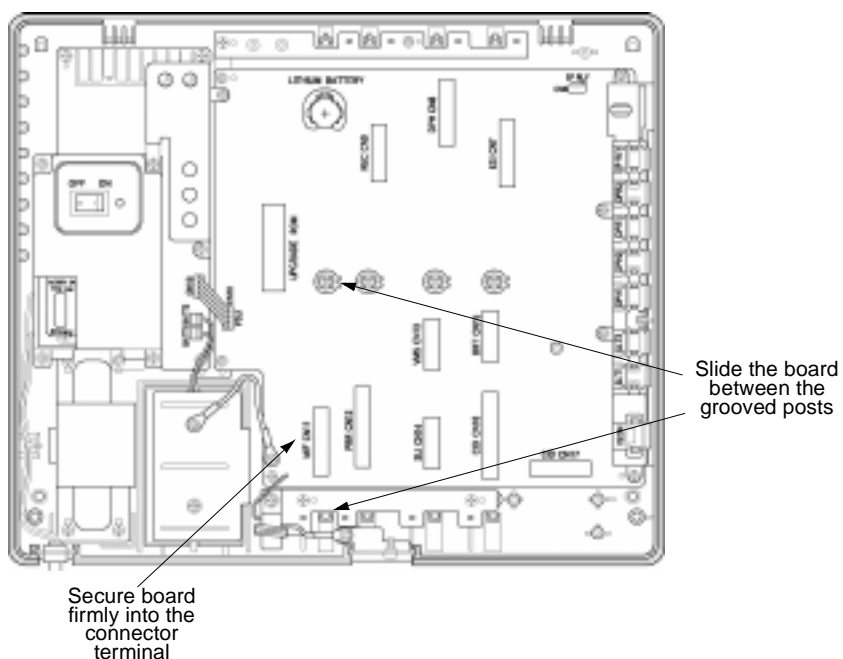

Figure 2-29 Installing the MIF ETU on the KSU

8. Using a Phillips head screwdriver, secure the MIF board to the KSU by tightening the screw.
9. Plug the white connector end of the DB-9 cable into the connector terminal on the MIF board labeled CN2.

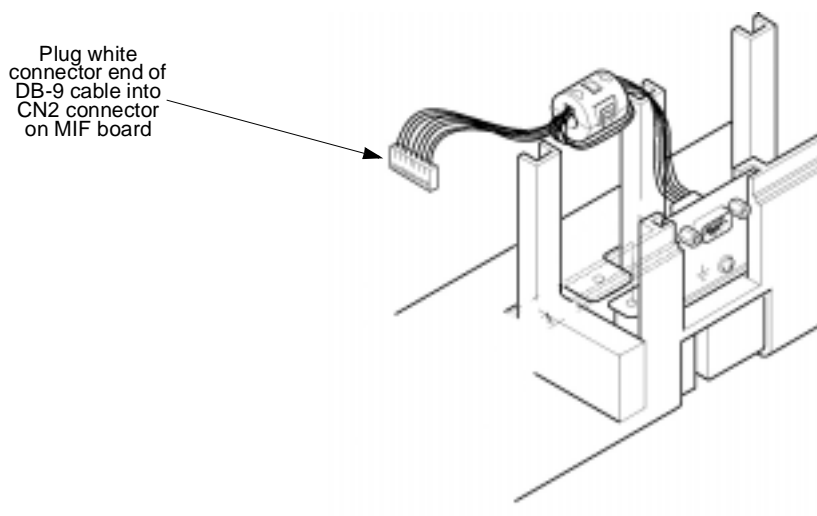

Figure 2-30 Plugging the DB-9 Cable into the DB-9 Connector

10. Attach the cover and tighten the screws.
11. Turn the on/off switch on the KSU to the ON position.

2.7 Installing the DPH-B10 ETU

The DPH board provides connection for two doorphones and two doorlock releases.

1. Be sure the system is turned **off** during the installation process.
2. Remove the cover by loosening the two bottom screws with a Phillips head screwdriver (the screws remain in the cover to keep from misplacing them). Pull the cover away from the KSU and lift upward. (Refer to [Figure 2-1 Removing the Front Cover on page 2-2.](#))
3. Carefully remove the DPH board from the protective covering. Use a wrist strap that is connected to the frame ground on the KSU to avoid static discharge and possible damage to the KSU.
4. Locate the area on the KSU backplane labeled DPH and slide the DPH board between the grooved posts. Press firmly down on the board until the connector on the DPH board (labeled CN1) and the connector terminal on the KSU backplane (labeled CN8) are securely attached.

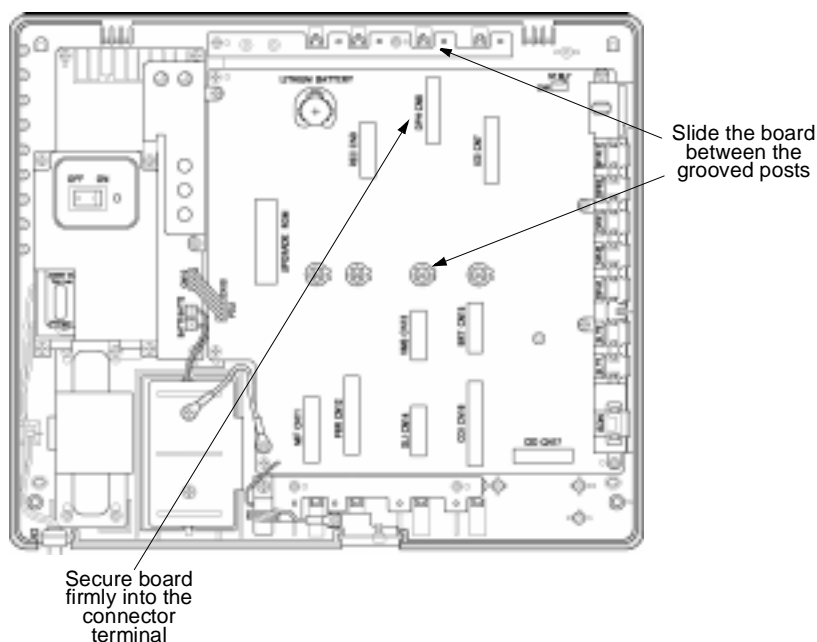

Figure 2-31 Installing the DPH ETU into the KSU

5. Using a Phillips head screwdriver, secure the DPH board to the KSU by tightening the screw.

6. Remove the plastic knockout on the right side of the KSU in the area marked DPH1, DPH2, DPR1, or DPR2. You may need to use a screwdriver to gently loosen the tabs holding the knockout.

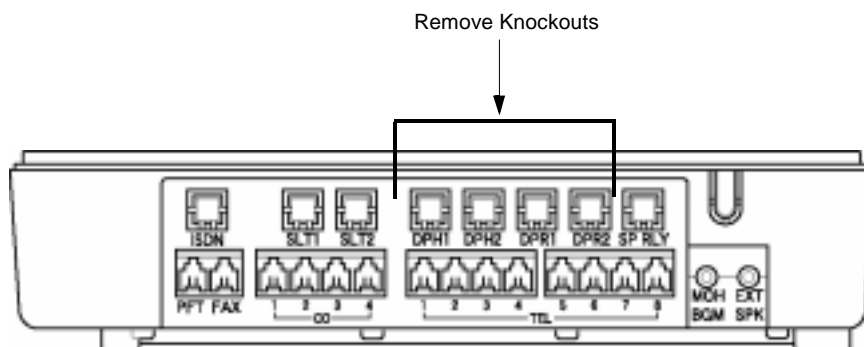

Figure 2-32 Removing the Plastic Knockout for DPH and DPR

7. To connect the doorphones use the RJ-11 connector cables (four cables provided with board). Slide the jack end of the cable into the slot (located on the inside of the sideplane) labeled DPH1, DPH2, DPR1, or DPR2. Using the small white connector end of the cable, press the connector into one of the connector terminals (located on the DPH board) labeled CN6-CN2 (DPH1), CN6-CN3 (DPH2), CN6-CN4 (RLY1), or CN6-CN5 (RLY2). Refer to the table for connection configurations.

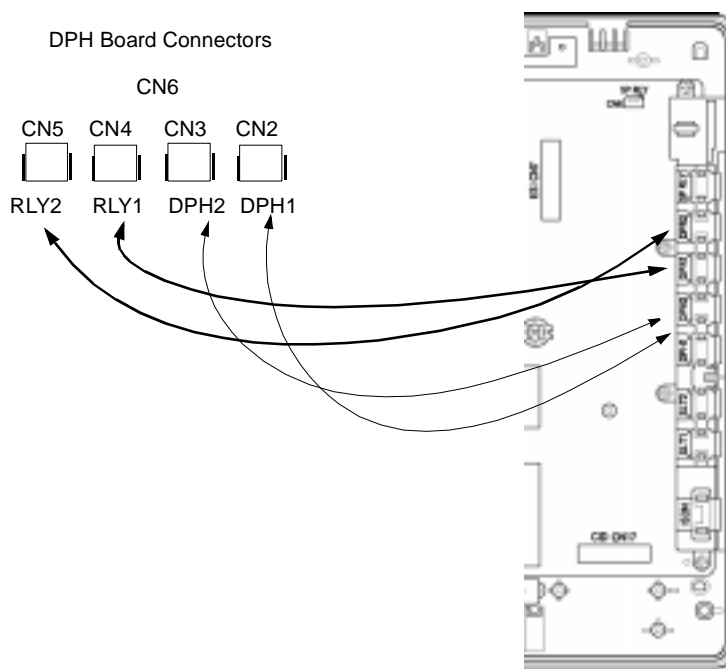

Figure 2-33 Connecting Doorphones

The table shows the connections that must be made between jacks, located on the sideplane of the KSU and the connector terminals on the DPH board. How the connections are made determines whether you have doorphone connection or doorphone connection and doorlock release for a doorphone. It is important that these connections be made correctly for the doorphone to operate properly.

Jack	↗	Connector on DPH Board	Description
DPH1	↗	CN6-CN2 (DPH1)	Provides connection to doorphone #1
DPH2	↗	CN6-CN3 (DPH2)	Provides connection to doorphone #2
DPH1 <i>and</i> DPR1	↗	CN6-CN2 (DPH1) <i>and</i> CN6-CN4 (RLY1)	Provides connection <i>and</i> doorlock release for doorphone #1
DPH2 <i>and</i> DPR2	↗	CN6-CN3 (DPH2) <i>and</i> CN6-CN5 (RLY2)	Provides connection <i>and</i> doorlock release for doorphone #2

8. Wrap the connector cables wires around the post in the upper right corner of the KSU.

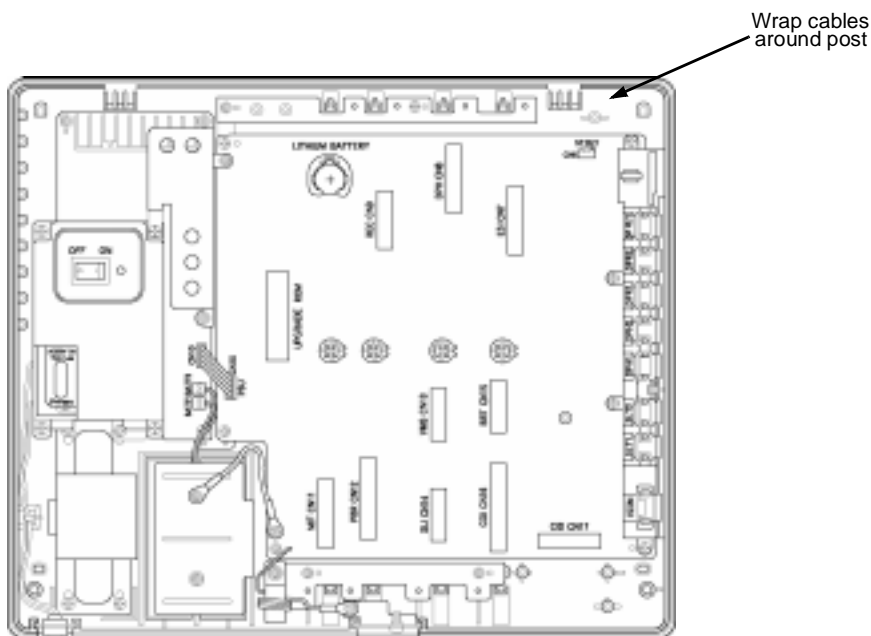

Figure 2-34 Wrapping the Connector Cables

9. Attach the cover and tighten the screws.
10. Using a standard RJ-11 cord (user-provided) connect the doorphones to either DPH1 and/or DPH2 and attach the doorphone relays to DPR1 and/or DPR2 as appropriate.

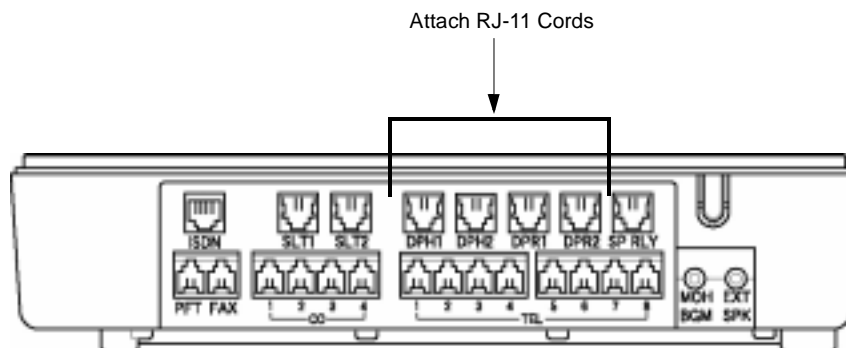

Figure 2-35 Attaching RJ-11 Cords to the DPH and DPR Connectors

11. Turn the on/off switch on the KSU to the ON position.

SECTION 3 **INSTALLING BACKGROUND MUSIC FOR MUSIC ON HOLD AND EXTERNAL SPEAKERS FOR PAGING**

Background Music and Music on Hold can be provided using external sources such as radio, CD player, etc.

To attach a music source (user-provided) for background music or music on hold, insert one end of the RCA cable into the RCA jack labeled MOH BGM (located on the sideplane of the KSU). Insert the other end of the RCA cables into the RCA jack on the music source.

To attach an external speaker (user-provided) for paging, insert one end of the RCA cable into the RCA jack labeled EXT SPK (located on the sideplane of the KSU). Insert the other end of the RCA cable into the RCA jack on the external speaker. Note that different connections are required for various types of speaker connections.

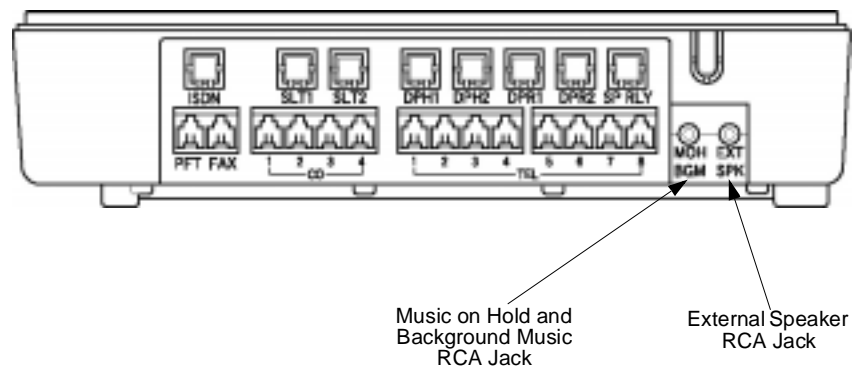

Figure 2-36 RCA Jacks for Music and Paging

SECTION 4 CONNECTING TELEPHONES CORDS

4.1 Connecting InfoSet Telephones

1. Plug the telephone cord into the modular jack on the bottom side of the telephone. Attached the handset to the jack located on the bottom right side of the telephone.

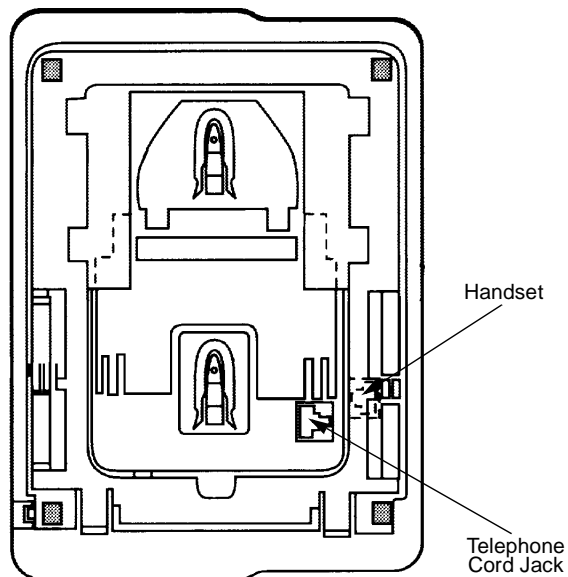

Figure 2-37 Connecting InfoSet Telephone Cords

4.2 Connecting Electra Elite Telephones

These instructions apply to all Electra Elite telephones that are used with the InfoSet system.

1. Plug the telephone cord into the modular jack on the bottom side of the telephone. The handset is also attached to the bottom side of the telephone.

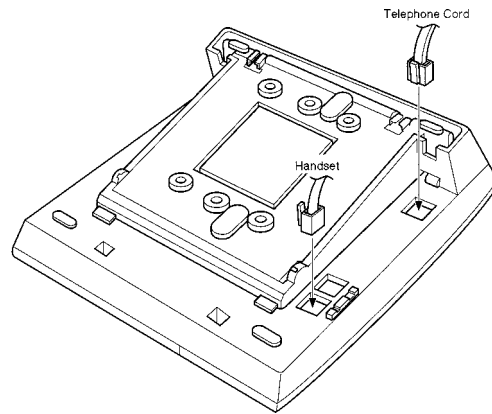

Figure 2-38 Connecting Electra Elite Telephone Cords

2. Lead the telephone and handset cords through the appropriate grooves.

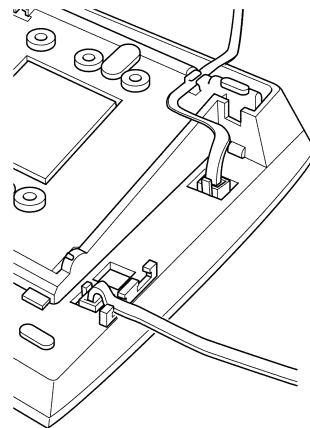

Figure 2-39 Leading Line Cords on the Electra Elite Telephone

SECTION 5 INSTALLING A *D^{term}*® CORDLESS LITE TELEPHONE

The *D^{term}* Cordless Lite telephone [DTU-4R-1 (BK) TEL] can be used with the InfoSet system. The cordless telephone is connected to the system using an ESI port. The cordless telephone provides the user the ability to be away from their desk, yet still be able to have access to their telephone.

5.1 Selecting an Installation Location

Select a location for the *D^{term}* Cordless Lite telephone to avoid excessive heat or humidity. The base unit should be placed on a desk or tabletop near a standard 120 Vac outlet and within reach of the telephone line connection on the Electra Elite telephone. Keep the base unit and the handset away from sources of electrical noise (motors, fluorescent lighting).

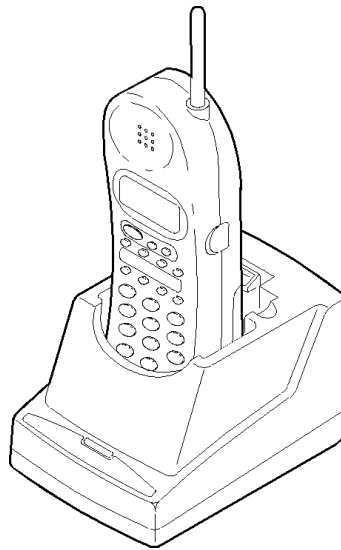

Figure 2-40 *D^{term}* Cordless Lite Telephone

5.2 Connecting the Telephone Cords

The *D^{term}* Cordless telephone can be connected to either the telephone line or a line with the host telephone. Begin by unplugging the telephone line cord from the host telephone to the telephone line.

There are two telephone line jacks on the back of the base unit of the *D^{term}* Cordless telephone; LINE IN and LINE OUT.

Using the telephone line cords supplied with the *D^{term}* Cordless telephone, make the following connections:

- Connect the LINE IN jack to the telephone line.
- Connect the LINE OUT jack to the host telephone.



Observe the following warnings during installation.

- Never install telephone wiring during a lightning storm.
- Never touch uninsulated telephone wires or terminals unless the telephone line has been disconnected at the network interface.
- Use caution when installing or modifying telephone lines.

5.3 Applying Power to the Base Unit

1. Plug the AC adapter cord into the AC adapter input jack on the base unit.

 Use only the AC adapter supplied with the *D^{term}* Cordless telephone.

2. Plug the AC adapter into a standard 120 Vac wall outlet.

3. Route the power cord where it does not create a trip hazard or where it could become chafed and create a fire or other electrical hazards.

 The AC adapter furnished with this phone can be equipped with a polarized line plug (a plug having one blade wider than the other). This plug fits into the power outlet only one way. If you cannot insert the plug fully into the outlet, reverse the plug. If the plug still does not fit, contact your facilities coordinator about replacing the obsolete plug. Do not alter the shape of the blades of the polarized plug.

- ☞ The *D^{term}* Cordless telephone uses the black/yellow pair of station cable. Always short the red wire to the black wire and the green wire to the yellow wire inside the wall jack to reduce interference.

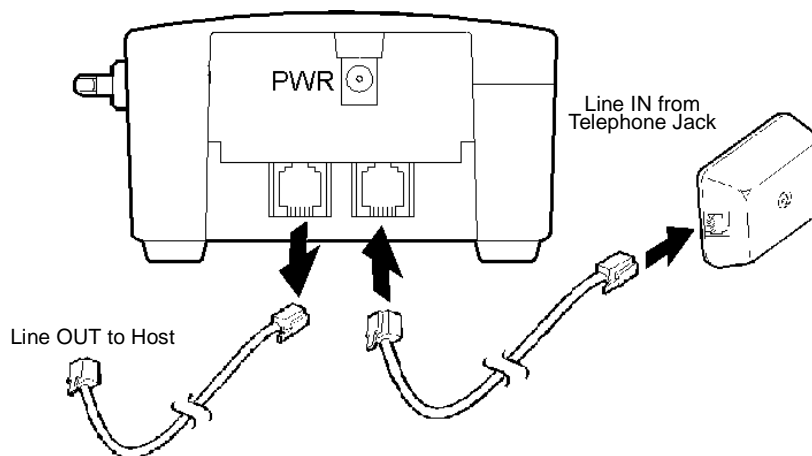

Figure 2-41 Connecting the Base Unit of the DTU-4R-1 (BK) TEL

SECTION 6

INSTALLING THE *D^{TERM}*® CORDLESS TELEPHONE

The *D^{term}* Cordless telephone [ETW-4R-1 (BK) TEL] can be used with the InfoSet system. The cordless telephone is connected to the system using an ESI port. The cordless telephone provides the user the ability to be away from their desk, yet still be able to have access to their telephone.

6.1 Selecting an Installation Location

Select a location for the *D^{term}* Cordless Telephone to avoid excessive heat or humidity. The Base Unit of your *D^{term}* Cordless telephone should be placed on a desk or tabletop near a standard 120 Vac outlet and within reach of the digital telephone line connection to your multiline telephone. Keep the base unit and handset away from sources of electrical noise (motors, fluorescent lighting).

6.2 Connecting the Telephone Cords

The *D^{term}* Cordless Telephone can be connected as a stand-alone device or in conjunction with the digital host telephone. Begin by unplugging the digital telephone line cord from your host telephone. There are two RJ-11 line jacks on the back of the base unit of the *D^{term}* Cordless telephone: "LINE IN" and "LINE OUT."

Using the telephone line cord supplied with your *D^{term}* Cordless telephone, make the following connections:

1. Connect the jack labeled LINE IN to the digital telephone line jack.
2. Connect the jack labeled LINE OUT to your digital host telephone (when used in conjunction with a digital telephone).
3. The *D^{term}* Cordless Terminal uses the black/yellow pair of the station cable for the **InfoSet Type Telephone Interface**. Always open the red and green wires inside the wall jack. This is done to reduce the potential for interference.

(Refer to [Figure 2-42 Connecting and Supplying Power to the Base Unit on the ETW-4R-1 \(BK\) TEL.](#))

6.3 Applying Power to the Base Unit

1. Plug the AC adapter cord into the AC adapter input jack on the base unit.
 - ☞ Use only the AC adapter supplied with the *D^{term}* Cordless telephone.
2. Plug the AC adapter into a standard 120 Vac wall outlet.
3. Route the power cord where it will not create a trip hazard or where it could become chafed and create a fire or other electrical hazards. Refer to [Figure 2-42 Connecting and Supplying Power to the Base Unit on the ETW-4R-1 \(BK\) TEL.](#)
 - ☞ The AC adapter furnished with this phone may be equipped with a polarized line plug (a plug having one blade wider than the other.) This plug will fit into the power outlet only one way. If you are unable to insert the plug fully into the outlet, try reversing the plug. If the plug should still fail to fit, contact your facilities coordinator about replacing the obsolete outlet. Do not alter the shape of the blades of the polarized plug.

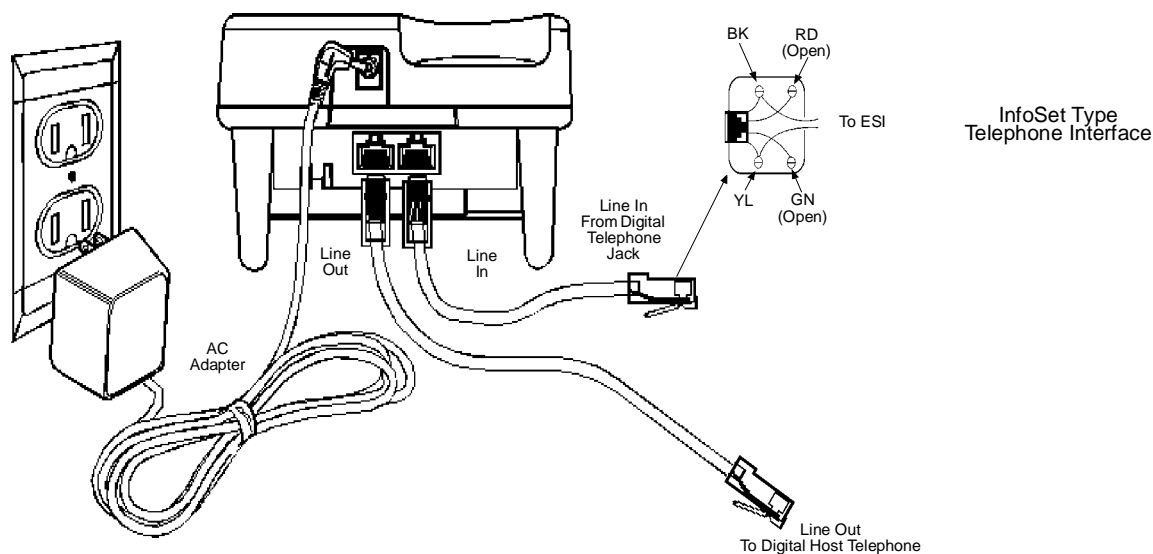

Figure 2-42 Connecting and Supplying Power to the Base Unit on the ETW-4R-1 (BK) TEL

SECTION 7

REPLACING BATTERIES AND FUSES

7.1 Replacing the Backup Batteries in the KSU

These batteries provide power for the system in case of a power outage. Fully charged batteries provide power for approximately 30 minutes. When replacing these batteries use a 12V 0.8A rechargeable lead acid battery.

1. Be sure the system is turned **off** during the installation process.
2. Remove the cover by loosening the two bottom screws with a Phillips head screwdriver (the screws remain in the cover to keep from misplacing them). Pull the cover away from the KSU and lift upward. (Refer to [Figure 2-1 Removing the Front Cover on page 2-2.](#))
3. Remove the screw that is attached to the grounding cable and loosen the second screw that secures the metal plate to the batteries. Slide the metal plate until it clears the remaining screw and lift upward to remove the metal plate.

4. Detach the batteries cables from the connector terminals CN3 (BATT1) and CN4 (BATT2).
5. Lift out the old batteries.
6. Insert the new batteries into the slots. Place the notched end of the battery toward the casing on the KSU. Place the battery cables between the inside of the battery and the posts located on the inside of the battery casing.

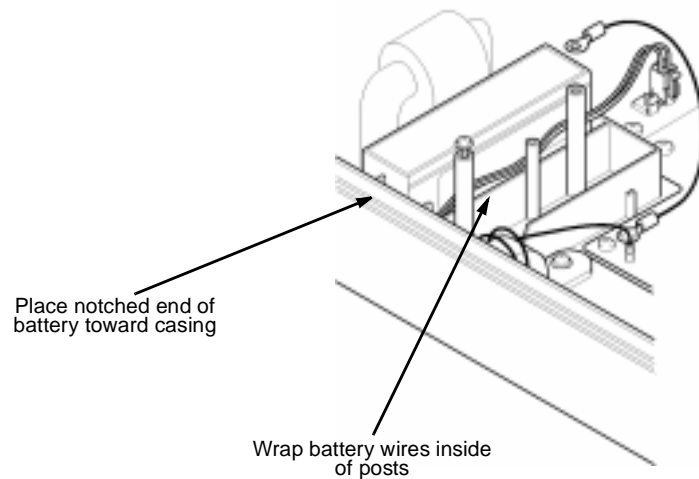

Figure 2-43 Inserting New Batteries into the KSU

7. Replace the metal plate on top of the new batteries. Place the grounding cable on top of the hole and tighten the screw using a Phillips head screwdriver.
8. Locate the backup batteries in the lower left side of the KSU. Identify the battery cables, which are marked with blue and yellow tags. Attach the blue tagged battery cable connector to the blue battery terminal labeled CN3 (BATT1) and the yellow tagged battery cable connector to the yellow battery terminal labeled CN4 (BATT2). The battery terminals are located on the backplane of the KSU. The connector tab should be placed over the terminal tab. There is only one direction the tabs can be placed into the connector terminals, therefore, you cannot attach them incorrectly.

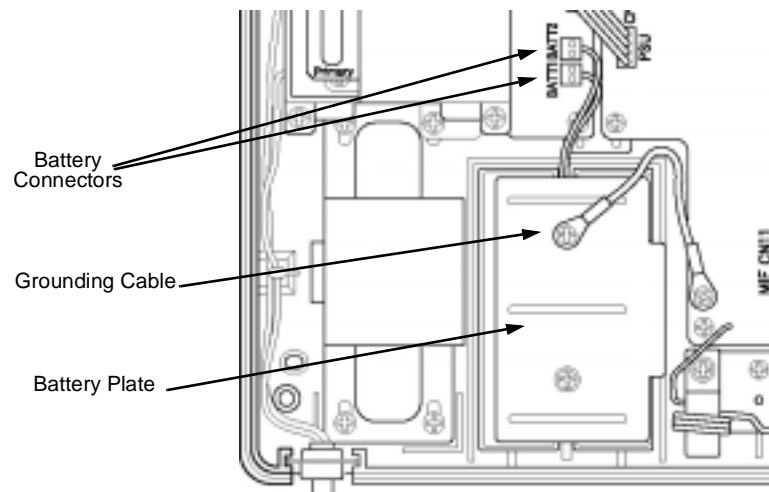

Figure 2-44 Attaching the Battery Connectors

9. Attach the cover and tighten the screws.
10. Turn the on/off switch on the KSU to the ON position.

7.2 Replacing the Lithium Batteries in the KSU

This battery provides backup for system memory. When fully charge, it provides a minimum of two years backup in case of a power outage.

1. Be sure the system is turned **off** during the installation process.
2. Remove the cover by loosening the two bottom screws with a Phillips head screwdriver (the screws remain in the cover to keep from misplacing them). Pull the cover away from the KSU and lift upward. (Refer to [Figure 2-1 Removing the Front Cover on page 2-2.](#))
3. Locate the lithium battery on the backplane of the KSU. Push inward and pull upward on the battery and lift it out.

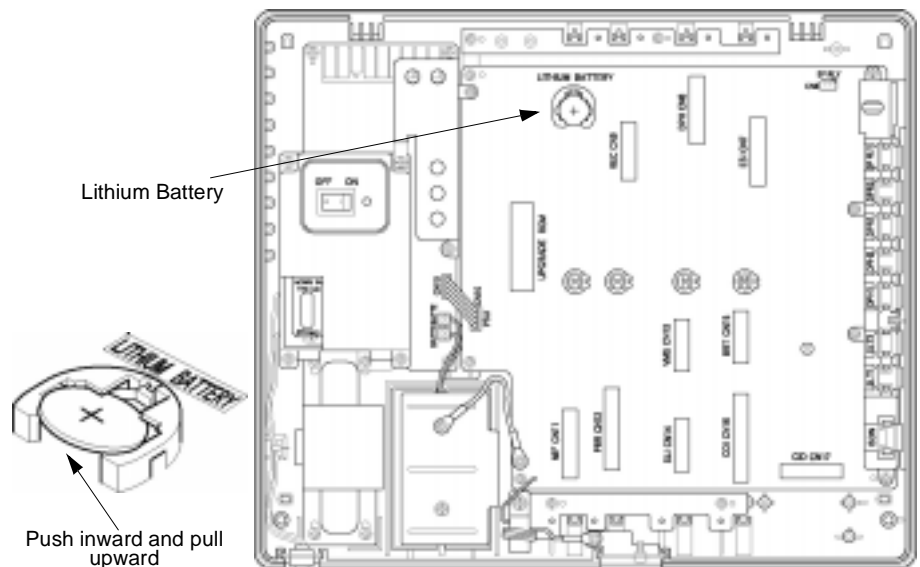

Figure 2-45 Replacing the Lithium Battery

4. Using a CR2032 lithium battery, replace the battery by placing the battery at an angle and pushing downward and inward. The battery should slide into place.
5. Attach the cover and tighten the screws.
6. Turn the on/off switch on the KSU to the ON position.

IMPORTANT SAFEGUARDS FOR BATTERY DISPOSAL

DO NOT PLACE USED BATTERIES IN YOUR REGULAR TRASH! THE PRODUCT YOU PURCHASED CONTAINS A NICKEL-CADMIUM OR SEALED LEAD BATTERY. NICKEL-CADMIUM OR SEALED LEAD BATTERIES MUST BE COLLECTED, RECYCLED, OR DISPOSED OF IN AN ENVIRONMENTALLY SOUND MANNER.

The incineration, landfilling or mixing of nickel-cadmium or sealed lead batteries with the municipal solid waste stream is PROHIBITED BY LAW in most areas. Contact your local solid waste management officials for other information regarding the environmentally sound collection, recycling, and disposal of the battery.

Nickel-Cadmium (or sealed lead) batteries must be returned to a federal or state approved nickel-cadmium (or sealed lead) battery recycler. This may be where the batteries were originally sold or a local seller of automotive batteries. Contact your local waste management officials for other information regarding the environmentally sound collection, recycling and disposal of the battery contained in this product. For Ni-Cd batteries, you can also call 1-800-8-BATTERYSM if further information is required.

7.3 Replacing a Fuse

Two replacement fuses are included with the KSU.

1. Be sure the system is turned **off** during the installation process.
2. Remove the cover by loosening the two bottom screws with a Phillips head screwdriver (the screws remain in the cover to keep from misplacing them). Pull the cover away from the KSU and lift upward. (Refer to [Figure 2-1 Removing the Front Cover on page 2-2.](#))
3. Lift the plastic casing off of the fuse. (It may require a flat head screwdriver to lift the plastic casing. Be careful not to damage the components.)
4. Lift out the old fuse and replace with a 250 volt, 2 amp slow blow fuse.

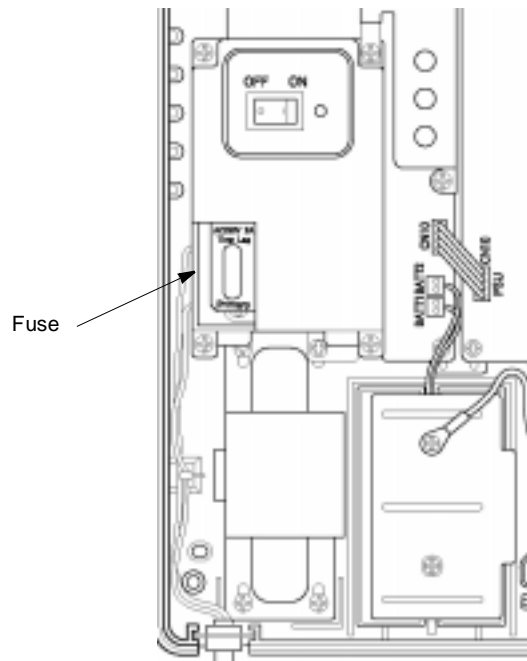

Figure 2-46 Replacing the Fuse

5. Attach the cover and tighten the screws.
6. Turn the on/off switch on the KSU to the ON position.

SECTION 1 INTRODUCTION

This section describes each feature and its operation. Features are listed alphabetically by feature name.

SECTION 2 DIFFERENCES IN TELEPHONE TYPES



In this chapter the operations are written showing the keys on the InfoSet telephones. Unless otherwise noted, the same key is also used on the Electra Elite telephones. (Table 3-1 InfoSet and Electra Elite Telephone Keys shows the keys on the InfoSet and Electra Elite telephones. In some cases, keys on the two types of telephones may perform the same function but are labeled differently on the different telephones. For example, the key used for speed dialing is labeled  on the InfoSet telephones and  on the Electra Elite telephones.

Table 3-1 InfoSet and Electra Elite Telephone Keys















































InfoSet Keys	Electra Elite Keys
	
	
	
	
	
	
	
	
	
	
	

Table 3-1 InfoSet and Electra Elite Telephone Keys

InfoSet Keys	Electra Elite Keys
	
	
	
	
	
	
	
	
	
	
	
	

All Call Page

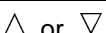
All Call Page allows simultaneous paging (internal and external) of all idle multiline telephones. The page is heard over the built-in speaker on the telephone and/or over external paging speakers.

Paging allows persons, away from their desk but within hearing distance of the telephone or external speakers to respond to a page. The user can answer the page by dialing a specified number.

This feature is available for the InfoSet and Electra Elite multiline telephones.

Feature Operation

Paging:

1. Go off-hook.
2. Dial .
3. Page.
4. Go on-hook.

Answering a page:

1. Go off-hook.
2. Dial and answer the call.

Associated Programming

All programming functions associated with this feature are listed in the following table. Some functions must be programmed before the feature is operational and other functions are optional. The optional functions can affect how the feature operates.

Function Number	Function Name	Required (Y)es or (N)o
002-2	External Speaker Connection	N
002-3	External Paging Tone Assignment	N
002-4	Internal All Call Page Tone Assignment	N

Special Conditions

- All Call Paging is directed only to telephones when “No External Speaker” is specified in system programming.
- A busy condition is generated if an All Call Page (internal or external) has been originated at another telephone.
- If an external paging call is made while a ringing tone is being sent over the external speaker, ringing is temporarily suspended and the external paging call is performed. Ringing resumes after the page is completed.
- All Call Paging is supported for single line telephones. Single line telephones can be used to answer an All Call Page.
- A tone burst is generated as an alert tone to indicate the page.

Ancillary Device Connection

This feature allows ancillary (peripheral) devices such as tape recorders, headsets, single line telephones, to be connected to the system.

The feature is only available when using the Electra Elite multiline telephones.

Feature Operation

Refer to the operation for the device that is being connected.

Special Conditions

- When using ancillary equipment, the following units can be installed to provide connection to the system.

Unit	Description
ACA-U Unit	AC Adapter - an AC adapter for use with the APR-U Unit, CTA-U Unit, or HFU-U Unit.
ADA-U Unit	Ancillary Device Adapter - provides connection for cassette recorders.
APR-U Unit	Analog Port Ringer - provides connection for a single line telephone or modem.
CTA-U Unit	Computer Telephony Adapter (or TAPI - Microsoft Telephony Application Programming Interface) - provides connection for a PC.
HFU-U Unit	Handsfree Unit - provides connection for headsets allowing handsfree operation.

- Headset and handsfree units cannot be used simultaneously.
- The APR-U Unit can only be connected to DTMF (touchtone) telephones.

Answer Hold

Answer Hold allows the multiline telephone user to answer an external call by pressing the answer key (). If the user is on a call, that call is placed on hold when the new call is answered.







This feature is available for the InfoSet and Electra Elite multiline telephones.

Feature Operation

Answering a call when a call is in progress:

Press  to answer the call. If already engaged on a call, the existing call is placed on hold.

Special Conditions

- On Electra Elite telephones, the Answer Key () LED flashes when there is an external line ringing. The Answer Key () on the InfoSet does not have an LED.
- If using the Answer Key () to answer an internal or external call, and the existing call is an internal call, doorphone call, or paging call; the existing call is disconnected.
- The Answer Key () on Electra Elite telephones does not flash when an internal call is received.
- The Answer Key () on Electra Elite telephones does not flash when an external call is received at another multiline telephone.
- The Answer Key () on Electra Elite telephones does not flash during a ringing transfer call.
- This feature is not available during automatic redialing or conference calling.

Answer Key

Users answer calls by simply pressing one key; the Answer Key ().

This feature is available for the InfoSet and Electra Elite multiline telephones.

Feature Operation

Answering a call:







Press  and  or lift the handset.

Associated Programming

All programming functions associated with this feature are listed in the following table. Some functions must be programmed before the feature is operational and other functions are optional. The optional functions can affect how the feature operates.

Function Number	Function Name	Required (Y)es or (N)o
301 ~ 304	Day Ringing for Trunk Lines 1~4	N
311 ~ 314	Night Ringing for Trunk Lines 1 ~ 4	N

Special Conditions

- If more than one call rings into the system, the system processes the calls in the order they are received. As a result, when the user presses , calls are answered in the order they are received.
- If there is no external ringing call and  is pressed, “[BUSY]” is displayed in the telephone LCD and a busy tone is heard.
- Incoming external calls to other tenant groups cannot be answered by pressing  (ring tone is not provided for these calls).
- On Electra Elite telephones, the Answer Key () LED flashes. When an incoming external call is received, the red LED flickers at a higher speed to differentiate from other types of calls. The Answer Key () on the InfoSet does not have an LED.
- An Electra Elite telephone must be programmed to provide an audible ring tone for incoming calls before the  LED will flash.

Attendant Positions

This feature allows the first two multiline telephones to be assigned as attendant positions. These telephones can be used as “programming telephones” and can perform certain attendant feature operations.

This feature is available for the InfoSet and Electra Elite multiline telephones.

Feature Operation

Listed below are the operations that can be performed using a telephone assigned as an attendant position. The access code necessary to perform the operation is also provided.

Operation	Access Code
System Reset for Call Forward – All Calls, Call Forward – Busy/No Answer, and Do Not Disturb	Feature <input type="text"/> 6 <input type="text"/> MNO <input type="text"/> 8 <input type="text"/> TUV <input type="text"/> Feature
System Reset for Callback Request	Feature <input type="text"/> 8 <input type="text"/> TUV <input type="text"/> 8 <input type="text"/> TUV <input type="text"/> Feature
System Reset Timed Alarm	Feature <input type="text"/> 5 <input type="text"/> JKL <input type="text"/> 8 <input type="text"/> TUV <input type="text"/> Feature
System One-Touch Dialing	N/A
SMDR/PC Switching	Feature <input type="text"/> 9 <input type="text"/> WXYZ <input type="text"/> 6 <input type="text"/> MNO <input type="text"/> Feature
SMDR Test Printing	Feature <input type="text"/> 9 <input type="text"/> WXYZ <input type="text"/> * <input type="text"/> Feature
Battery Low Indication Erase	Feature <input type="text"/> 7 <input type="text"/> PQRS <input type="text"/> 5 <input type="text"/> JKL <input type="text"/> Feature
System Speed Dialing	N/A

Also refer to the specific attendant related features listed below:

- [Automatic Callback on page 3-9](#)
- [Callback Request on page 3-25](#)
- [Call Forward - All Calls on page 3-28](#)
- [One-Touch/Feature Access Keys – User Programmable on page 3-115](#)
- [Speed Dial – System on page 3-151](#)
- [Timed Alarm on page 3-164](#)

Special Conditions

- Only ports 1 and 2 (normally extensions 10 and 11) are used as attendant positions.

Automatic Callback

When calling a busy telephone and hearing a busy tone, users can set an automatic callback. When both telephones are idle, the system signals the person who originated the callback. When the callback originator answers, the system then signals the other telephone user of the call.

This feature is available for the InfoSet and Electra Elite multiline telephones and single line telephones.

Feature Operation

Setting automatic callback when an internal party is called and busy tone is heard:

1. Go off-hook.
2. Dial the extension number. Busy tone is heard.
3. Dial OPER .
4. After hearing the set tone, hang up.

Special Conditions

- If an Automatic Callback is not answered within 30 seconds, the callback is released.
- Automatic Callback can be set for any tenant group.
- Automatic Callback can be set using a single line telephone.
- An individual user can set a maximum of two callbacks from their telephone at one time.
- Only one Automatic Callback be set to a specific telephone; duplicate attempts are ignored.
- An Automatic Callback can only be answered at the telephone where it is set; other user's cannot pickup the call from their telephones.
- An Automatic Callback cannot be canceled by the user once it is set.
- When a telephone is in Do Not Disturb mode, Automatic Callback cannot be set.

Automatic Day/Night Mode Switching

This feature allows the user to program the system to automatically switch from day to night mode at a preset time.

-  Refer to [Night Mode on page 3-111](#) for a description of manual day/night mode switching.

Feature Operation

Not applicable.

Associated Programming

All programming functions associated with this feature are listed in the following table. Some functions must be programmed before the feature is operational and other functions are optional. The optional functions can affect how the feature operates.

Function Number	Function Name	Required (Y)es or (N)o
014	Night Mode Start Time (Assignment 1)	Y
015	Night Mode End Time (Assignment 1)	Y
016	Night Mode Start Time (Assignment 2)	Y
017	Night Mode End Time (Assignment 2)	Y
018-1 ~ 018-7	Night Mode Monday ~ Sunday	Y

Special Conditions

- When the system is switched into night mode, night mode is applied system-wide and the night mode features are enabled.
- After powering on or resetting the time, the system checks the current system program settings and switches to day/night mode depending on the time of day detected.

Automatic Hold

This feature allows a user to press a DSS key (Direct Station Selection) to page an internal caller while an external call is in progress. Once the DSS key is pressed, the external caller is automatically placed on non-exclusive hold.

This feature is available for the InfoSet and Electra Elite multiline telephones.

Feature Operation

Placing a call on automatic hold:

1. While engaged on an external call, press the DSS key for the internal party. The external caller is automatically placed on hold and the internal call is made.
2. Talk with the called party or page the called party.
3. If you want to return to the holding party, press the appropriate line key.

Special Conditions

- After the preset hold recall timer expires, a hold recall is generated.

Automatic Pause - Behind PBX

When a user places an external call using speed dial, redial, or saved dial through a PBX line, the system automatically inserts a pause into the dialed number.

Feature Operation

Not applicable.

Associated Programming

All programming functions associated with this feature are listed in the following table. Some functions must be programmed before the feature is operational and other functions are optional. The optional functions can affect how the feature operates.

Function Number	Function Name	Required (Y)es or (N)o
010	Outgoing Call Access Code for PBX	N

Special Conditions

- The pause time is three seconds (fixed).
- The initial value used by the system to indicate a pause is "9 -" (the system dials 9 and inserts a pause).
- A maximum of six digits (three dialed digits and three pauses) can be programmed for the PBX originating code. However, only one pause can be inserted between digits (i.e., two pauses cannot be dialed consecutively).





Automatic Redial

Automatic Redial simplifies repeated dialing to a busy telephone or when there is no answer. When set, redialing is automatically repeated at preassigned intervals. The intervals are assigned in system programming.

This feature is available for InfoSet and Electra Elite multiline telephones.

Feature Operation

Setting automatic redial:

1. After receiving a busy tone or when there is no answer, press .
2. Press .
3. Press .
4. The call is redialed automatically. The number of redial attempts is assigned in system programming. (Default = 7)
5. When the called party answers, either lift the handset or press  and begin talking.

Note: If the call is not answered, it is disconnected.

Canceling automatic redial:

Press  or lift the handset, then restore the handset.

- OR -

Automatic redial is automatically canceled when the specified number of redial attempts has been exceeded.







Associated Programming



All programming functions associated with this feature are listed in the following table. Some functions must be programmed before the feature is operational and other functions are optional. The optional functions can affect how the feature operates.

Function Number	Function Name	Required (Y)es or (N)o
005	Automatic Redial Timer	N

Special Conditions

- ☑ If an external call is made using a PBX line, the call elapsed timer displays but does not have any affect on the Automatic Redial condition.
- ☑ If a disconnect or busy signal is detected by the system while on an analog external line during Automatic Redial, the call is placed into wait mode (the time between redial attempts).
- ☑ When using an ISDN external line, a busy tone is not detected and the line is placed into wait mode until release notification is received. Automatic Redial continues until the programmed number of retries is exceeded.
- ☑ If the user cancels Automatic Redial during wait mode, the external line is released and the telephone returns to the idle condition (if the handset is in the cradle and the speaker is off). If the handset is off of the cradle or the speaker is on, internal dialtone is received.
- ☑ After the number of redials has exceeded the programmed number of redial attempts, the external line is released and automatic redialing ends.
- ☑ The following operations are enabled during automatic redialing. A description of the operation and the method for initiating the operation are provided below.

Microphone On/Off	Feature  + 
Handset Mute On/Off	Feature  + 
Automatic Redial Enable	Feature  + Redial 
Cancel Automatic Redial	Lift Handset (off-hook)
Speaker On	Handset in Cradle (on-hook)
Cancel Automatic Redial or Releases External Line	Speaker 

- ☑ If a call is answered at the telephone where Automatic Redial was initiated, redialing is canceled.
- ☑ When Automatic Redial is set, the line key LED on the telephone where Automatic Redial is initiated lights green. The line key LED on all other telephones lights red.
- ☑ If Automatic Redial is set while the handset is outside the cradle and the handset remains outside the cradle during redialing, the user must press  to cancel Automatic Redial. If  is not pressed, Automatic Redial restarts when the user hangs up.
- ☑ When outgoing calls are restricted on a line, automatic redialing is not allowed. When a Automatic Redial is attempted using that line, an error tone is generated.
- ☑ When a telephone is being used for automatic redialing, that telephone cannot be used to place an external call on hold.

- ☑ Barge-in is not allowed while a telephone is being used for automatic redialing.
- ☑ The user must manually cancel Automatic Redial; the system cannot automatically cancel the operation.
- ☑ Automatic Redial can only be set during a call attempt.

Automatic Release

This feature signals the system to release the line when an external caller abandons the call.

This feature is available for InfoSet and Electra Elite multiline telephones and single line telephones.

Feature Operation

Not applicable.

Associated Programming

All programming functions associated with this feature are listed in the following table. Some functions must be programmed before the feature is operational and other functions are optional. The optional functions can affect how the feature operates.

Function Number	Function Name	Required (Y)es or (N)o
007	Disconnect Detection Duration	Y

Special Conditions

- The timer for disconnect signal detection is specified in programming for external lines. This setting applies system-wide.
- If a disconnect signal is received, the external line is automatically disconnected.
- If a telephone is disconnected while accessing an external line, the associated line key LED goes off.
- Automatic Release functions during holding (exclusive/non-exclusive) and conference calling.
- When the user is engaged on a single-party call and the external party hangs up, the user receives a busy tone.

Background Music - External Speakers

When connecting with a Background Music (BGM) source, background music is provided over external speakers.

Feature Operation

Not applicable.

Associated Programming

All programming functions associated with this feature are listed in the following table. Some functions must be programmed before the feature is operational and other functions are optional. The optional functions can affect how the feature operates.

Function Number	Function Name	Required (Y)es or (N)o
002-2	External Speaker Connection	Y
002-6	Background Music Source	Y
011	Background Music Destination	Y

Special Conditions

- Music is not heard over external speakers unless background music speaker connection is specified in system programming.
- If paging, external ringing, and background music occur at the same time, the system prioritizes the order they are processed as follows:
 1. External Speaker Paging
 2. External Ringing
 3. Background Music

Background Music - Multiline Telephone Speakers

When connected to a background music (BGM) source, multiline telephone users can listen to music over the multiline telephone speakers, while the telephone is idle.

Feature Operation

Setting background music when the telephone is idle:

1. Press ^{Feature} .
2. Dial (background music access code).
3. Press ^{Feature} . Music is heard over the multiline telephone speakers.

Canceling background music:

1. Press ^{Feature} .
2. Dial (background music access code).
3. Press ^{Feature} . Music is stopped over the multiline telephone speakers.

Associated Programming

All programming functions associated with this feature are listed in the following table. Some functions must be programmed before the feature is operational and other functions are optional. The optional functions can affect how the feature operates.

Function Number	Function Name	Required (Y)es or (N)o
002-6	Background Music Source	Y
011	Background Music Destination	Y

Special Conditions

- ☑ Background music toggles between the set and cancel settings each time the background music access code is dialed (^{Feature} ^{WXYZ} ^{DEF} ^{Feature}).
- ☑ Background music volume is controlled by using up (Δ) and down (∇) volume controls on the telephone.
- ☑ The set/cancel setting is preserved in the backup memory of the telephone.
- ☑ If background music has not been specified in system programming, "ERROR" is displayed in the telephone LCD when attempting to set background music using the set/cancel access code.
- ☑ Background music is heard only when the telephone is in the idle condition. Background music is temporarily suspended when the telephone is *not* idle.





Barge-In (Interrupting an External Call)

This feature allows one multiline telephone user to interrupt another user's conversation. Barge-In can be programmed with or without an audible alert.

This feature is available for InfoSet and Electra Elite multiline telephones.

Feature Operation

Interrupting a conversation using an outside line key:

1. Press  or lift the handset.
2. When you hear dialtone, press .
3. Press .
4. Press  (line key) to be interrupted. Barge-In is enabled .

Special Conditions

- Barge-in is enabled and disabled in system programming (default is disabled).
- When barge-in is in progress, the conference key () LED flashes on the telephone used to initiate barge-in and remains solid on the telephone where barge-in occurs.
- When barge-in is in progress and the user (where barge-in occurs) places their existing call on hold, the caller who initiated the barge-in is also placed on hold. When the call is picked up again (taken off of hold), the barge-in caller is also able to resume listening to the conversation.
- Barge-in also works for telephones programmed to only receive calls (i.e., those telephones restricted from dialing out).
- Barge-in is not allowed during the following conditions:
 - when Automatic Redial is in progress.
 - when dialing is in progress.
 - before an internal user answers a call or before the user initiates an outgoing external call.
 - all conditions other than an external call in progress (i.e., hold, conference call, etc.).
 - the called telephone is a member of a different tenant group.
- A single line telephone cannot be used to initiate a barge-in. However, single line telephone conversations can be interrupted.

- ☑ A telephone cannot be used to initiate a barge-in if it is part of a conference.
- ☑ A barge-in cannot be completed if the telephone that is the target of the barge-in is part of a conference.
- ☑ If all of the conference circuits in the system are in use, no barge-in is allowed. Barge-in requires the use of a conference circuit.

Battery Backup – System Memory

A battery is provided on the central processing unit (CPU) in the KSU. This battery retains system memory if the power fails. When fully charged, a new lithium battery maintains backup power for a minimum two years. This allows the system to return to normal operation once power is restored.

Feature Operation

Not applicable.

Special Conditions

- Programming and status condition is retained for the following:
 - Background Music
 - Call Forward – All Calls
 - Call Forward – Busy/No Answer
 - Clock/Calendar
 - Do Not Disturb
 - Incoming Ring Mode for Single Line Telephones (when the Electra Elite APR-U Unit is attached)
 - LCD Contrast (Electra Elite telephones only)
 - Microphone Status
 - Night Mode
 - Redial
 - Room Monitor
 - Speed Dial Entries (Telephone/System)
 - System Data
 - Timed Alarms
 - Volume

- Status condition *is not* retained for the following:
 - Automatic Callback
 - Trunk Queuing

Battery Backup – System Power (Built-In)

A built-in battery provides complete system operating power for approximately 30 minutes. This allows the entire telephone system (key system and telephones) to remain operational during a power outage.

Feature Operation

Not applicable.

Special Conditions

- The backup batteries are charged from the power supply.

Busy Lamp Field - Multiline Telephones

The Busy Lamp Field (BLF) is an LED on the multiline telephone which is used to indicate the telephone status (idle, in-use, do-not-disturb mode, etc.).

This feature is available for the InfoSet and Electra Elite multiline telephones.

Feature Operation

Not applicable.

Special Conditions

- Busy Lamp Field indication is provided for the following conditions:

Busy Lamp Field	Condition
Slow Red Flash	Do Not Disturb Set Telephone in programming mode Feature Key assignment in progress Scrolling in progress
Fast Red Flash	Call Forward – All Calls Set Call Forward – Busy/No Answer Set
Solid Red	Telephone is busy
Off	Telephone is idle

- If a line key is not assigned as a trunk line, it can be assigned as a Busy Lamp Field.

Callback Request

This feature is used to leave notification at the called party's telephone that you have called.

This feature is available for InfoSet and Electra Elite multiline telephones (sending and answering callback request) and single line telephones (sending callback request).

The telephone must be set for Dual Tone Multifrequency mode (touchtone) for this feature to be used.

Feature Operation

Setting a callback request.

When calling and receiving a busy tone, press .

Note: When callback request is set, the LED flashes on the calling party's telephone and the telephone display (for those telephones equipped with an LCD) at the called party's telephone indicates the calling party's extension number.





Returning a callback request:

1. Lift the handset or press .
2. Press .

Canceling a callback request from a multiline telephone:

If the called party does not respond to the callback, call again.

Canceling a callback request from an attendant position:

1. Press .
2. Dial  .
3. Press .

Note: When this procedure is performed, do not disturb and all call forward settings are also cleared.

When canceling callback request from an attendant position, all callback requests are cleared system-wide.

Special Conditions

- A telephone user can set callback requests to more than one telephone. Callback requests can be sent to other telephone users regardless of the tenant group to which they belong.
- A telephone that is not equipped with an LCD answers a callback in the same way users of telephones equipped with an LCD.
- A maximum of three callback requests can be set to an individual telephone.
- Single line telephone users can set callback requests. Single line telephone users cannot receive callback requests.
- A callback request can be set to a telephone that has do not disturb set.
- If a power outage occurs, all callback requests are canceled.

Call Elapsed Timer

This timer appears in the LCD (liquid crystal display) on the telephone. The timer keeps track of the amount of time that has elapsed since the call was answered. When the user hangs up, the timer disappears from the LCD.

This feature is available for the InfoSet and Electra Elite multiline telephones.

Feature Operation

Not applicable.

Special Conditions

- ☑ The call elapsed timer disappears from the LCD when a call is placed on hold (exclusive and non-exclusive). While the call is on hold, the timer continues counting and is redisplayed when the call is removed from hold, when the call is transferred and answered, or when the call is transferred and recalls to the telephone that originated the transfer.
- ☑ The elapsed call time is maintained separately for each external line. When more than one external line is placed on hold, the timer is redisplayed for each call as it is removed from hold.
- ☑ During an add-on conference, which includes at least one external line, the elapsed call time of the last external line that is seized is displayed in the LCD.
- ☑ The call elapsed timer is not displayed while a call transfer or tone override is received or when dialing is performed during a call using an external line. The call elapsed timer redisplayed five seconds after the last digit is dialed.
- ☑ During an add-on conference that contains one external line and two internal lines, the elapsed conference time is displayed on the LCD of all the multiline telephones involved in the conference.
- ☑ The maximum time that can be indicated is 59 minutes and 59 seconds. After 59 minutes and 59 seconds is reached, the timer resets to 00 minutes and 00 seconds.

Call Forward - All Calls

This feature is used to forward calls received at one multiline telephone to another telephone. This feature can also be set or cancelled from the telephone where the calls will be forwarded. Forwarding can be cancelled for the entire system using a telephone assigned as an attendant position.

Feature Operation

Setting call forward:

1. Press ^{Feature} .
2. Dial (access code).
3. Dial the extension number or telephone number where calls will be forwarded.
4. Press ^{Feature} .

Canceling an individual call forward setting:

1. Press ^{Feature} .
2. Dial .
3. Dial the extension number of the forward destination or .
4. Press ^{Feature} .

Canceling call forward system-wide from an attendant (normally extension 10 or 11):

1. Press ^{Feature} .
2. Dial .
3. Press ^{Feature} .

Special Conditions

- All internal and transferred calls to the telephone follow the forwarding settings assigned to that telephone.
- Any telephone in the system can be the call forward destination for any number of other telephones.
- Call Forward – All Calls can be directed to any other telephone in the system even if the telephone is the member of a different tenant group.

- ☑ Any telephone in the system can be set to forward all calls to a voice mail port.
- ☑ Call Forward – All Calls settings can be individually reset for each telephone by clearing the setting using **Feature** **9** **9** **WXYZ** **WXYZ** .
- ☑ If two internal callers attempt to call one another and they have each other as their Call Forward – All Calls destination, a busy tone is generated.
- ☑ The Call Forward – All Calls setting takes precedence over the Call Forward - Busy/ No Answer setting when both are enabled.
- ☑ When Call Forward – All Calls is assigned to a One-Touch Key and that key is equipped with an LED, the LED lights red when the call forward feature is enabled.
- ☑ If a telephone is programmed for Direct Inward Termination (DIT), allowing calls to bypass the attendant and ring directly at a designated extension, call forwarding follows assigned to that telephone.
- ☑ On InfoSet telephones, “Call FWD” is displayed in the telephone LCD when the Call Forward – All Calls is enabled.
- ☑ Only one call forward can be set to the same telephone at one time. The first call forward must be canceled before setting another call forward. If multiple call forward destinations are entered, only the last destination is valid; all other entries are canceled.
- ☑ Only the telephone that is used to originate Call Forward – All Calls can cancel the Call Forward – All Calls setting.
- ☑ A maximum of two call forward destinations can be “chained.” For example, telephone A is set to forward calls to telephone B and telephone B is set to forward calls to telephone C. Telephone C attempts to forward to D. Telephone C will be the final forward destination for both telephones; forwarding to D is not allowed.

Call Forward – Busy/No Answer

This feature is used to forward calls received at one multiline telephone to another telephone or to an Attendant Position. This feature can also be set or canceled from the telephone where the calls will be forwarded. This feature only applies to internal calls.

This feature is available for InfoSet and Electra Elite multiline telephones.

Feature Operation

Setting call forwarding:

1. Press ^{Feature} .
2. Dial .
MNO PQRS
3. Dial the extension number of the telephone where calls will be forwarded.
4. Press ^{Feature} .

Canceling an individual call forward setting:

1. Press ^{Feature} .
2. Dial .
MNO PQRS
3. Dial the extension number of the forward destination or .
OPER OPER
4. Press ^{Feature} .

Canceling call forward system-wide from an attendant (extension 10 or 11):

1. Press ^{Feature} .
2. Dial .
MNO TUV
3. Press ^{Feature} .

Associated Programming

All programming functions associated with this feature are listed in the following table. Some functions must be programmed before the feature is operational and other functions are optional. The optional functions can affect how the feature operates.

Function Number	Function Name	Required (Y)es or (N)o
008	Call Forward – No Answer Duration	N

Special Conditions

- After receiving internal dialtone, a single line telephone can set busy/no answer by dialing an access code () and the destination extension number.
- All internal calls, Direct Inward Termination (DIT) calls, and ringing transfer calls directed to the target extension are forward to the call forward destination.
- A telephone can be the destination of multiple busy/no answer settings (i.e., more than one telephone in the system can have the same telephone as the call forward destination).
- An attendant (extension 10 or 11) can be used to reset the call forward - busy/no answer setting system-wide. When resetting Do Not Disturb (DND) calls, Call Forward - All Calls, Call Forward - Busy/No Answer, all calls are reset system-wide.
- Call Forward – Busy/No Answer settings can be individually reset for each multiline telephone by clearing the setting using .
- Call Forward - Busy/No Answer calls can be directed to telephones that are members of a different tenant group.
- If two internal callers attempt to call one another and they have each other as their Call Forward – Busy/No Answer destination, and one of the parties is busy, the call is placed into call waiting status.
- Call Forward – All Calls takes precedence over Call Forward – Busy/No Answer when both features are enabled.

- ☑ Programming Call Forward – Busy No/Answer to operate on a one-touch key simplifies enabling the feature. By pressing the one-touch key while the telephone is in idle mode enables the feature. The LED associated with the LED lights red when the feature is enabled.
- ☑ The one-touch key toggles to turn the busy no/answer feature on and off. When enabled the LED lights red and when disabled the LED is not lighted.
- ☑ Multiple one-touch keys can be assigned with different call forward destinations. When a one-touch key is pressed to enable the feature, any previous call destination setting is canceled. For example, if the user presses a one-touch key where extension 14 is the call forward destination and extension 12 is the previous setting, then the setting for extension 12 is canceled. The associated LED for the one-touch key used to set extension 12 as the destination goes off and the associated LED for the one-touch key used to set extension 14 as the destination lights red.
- ☑ If a one-touch key is assigned to a non-existent extension number and the key is pressed, the busy/no-answer settings are preserved but none of the LEDs change. An error is displayed in the telephone LCD.
- ☑ Only one call forward busy/no answer can be set from the same telephone at one time. The first call forward must be canceled before setting another call forward. If multiple call forward destinations are entered, only the last destination is valid; all other entries are canceled.
- ☑ Call forward busy/no answer setting do not follow chained forwarding.
- ☑ Only the extension used to set/reset the call forward busy/no answer setting can be used to change that setting.
- ☑ Voice announced calls will not follow the call forward busy/no answer settings.

Caller Identification

The Caller Identification (Caller ID) feature allows the user to see the calling party's name and phone number in their telephone display.

A CID-B10 Unit is required to provide caller identification. Two CID units are required to provide caller identification for all four telephone lines.

This feature is available for InfoSet and Electra Elite multiline telephones.

Feature Operation

Not applicable.

Special Conditions

- ☑ Caller ID uses information sent from the central office and displays the information (name and/or number) in the telephone LCD. If Caller ID information is not provided, the system displays the number assigned in system programming to the trunk line.
- ☑ When displayed, the caller's number is shown on the top row of the display and the their name on the second row of the display. Both the name and number are preceded by the trunk line number where the call rings into.



Display Example:

01/9727517632

NEC America

- ☑ If the call is an internal call, Caller ID information is not provided from the central office, the system searches the system speed dialing entries and if the number and associated name is stored in system data, that information is displayed in the telephone LCD.
- ☑ There is no system limitation to the number of telephones that can display Caller ID information.
- ☑ When multiple external calls ring into the system, Caller ID information is stored for each of the incoming calls. Caller ID information is displayed in the order that the calls are detected (i.e., the first incoming trunk call is detected and the information is displayed until the call is answered; as additional calls are answered, the stored Caller ID information is displayed until answered).



Caller ID Scrolling

When caller identification information is provided, the user can browse through the list of the last 20 numbers by pressing  and . The user can dial the displayed Caller ID number by pressing  or by lifting the handset.

This feature is available for InfoSet and Electra Elite multiline telephones equipped with a display.



Feature Operation

Confirming Caller ID information:

1. While the telephone is idle, press .
2. Press  to display the most recent Caller ID information. The date and time that the call was received and the caller's number are displayed.
3. To scroll through the list of Caller ID information, continue to press .



Note: When the end of the list is reached, the first Caller ID is displayed when  is pressed.

Placing a call using the displayed Caller ID information:

While the Caller ID information is displayed, press  (external line key), lift the handset, or press .

Special Conditions

General

- If no Caller ID information exists, the telephone remains idle when  and  are pressed.
- If  (external line key) is pressed while scrolling through the Caller ID information, the displayed number is dialed.
- When the call is received, both the name and number are displayed (if provided). When scrolling only the number is displayed.

Call Pickup Group

This feature allows any user to pickup a call that is intended for another user.

A call pickup group allows telephones in the system to be grouped together so users can pick up any incoming calls in that group by dialing a preassigned two-digit number. Groups are defined using tenant assignment.

The feature is available for InfoSet and Electra Elite multiline telephones and single line telephones.

Feature Operation

Answering a call:

User B performs this procedure to answer a call that is received at user A's telephone.

1. Go off-hook.
2. Dial the access code. Default access codes are:
 - = Pick up calls ringing in a different tenant group (CO/PBX calls only)
 - = Pick up calls ringing in the same tenant group (Internal and Direct Inward Termination calls)
 - = Pick up ISDN calls only 9 (available with software version 2.0 or higher)
3. Speak with the calling party.

Associated Programming

All programming functions associated with this feature are listed in the following table. Some functions must be programmed before the feature is operational and other functions are optional. The optional functions can affect how the feature operates.

Function Number	Function Name	Required (Y)es or (N)o
401	Trunk Line Assignment for Tenant 1	N
402	Trunk Line Assignment for Tenant 2	N
403	Telephone-to-Tenant Assignment	N

Special Conditions

- ☑ When there is more than one type of call that rings into the system, the system picks up calls in the following order:
 - Internal Voice/Tone/Call Waiting
 - Ringing Transfer
 - Incoming External Calls to another Tenant
- ☑ If there is more than one call ringing into the system, calls are picked up beginning with the lowest numbered extension (i.e., if extension 10 and 11 ring at the same time, extension 10 is picked up first).
- ☑ If there are no calls and a users attempts to pick up a call using one of the call pick up access codes, "BUSY" is displayed in the telephone LCD.
- ☑ When more than one Direct Inward Termination (DIT)/Voice Mail/Automated Attendant (AA) ringing transfer call rings at a telephone, they are picked up in the order in which the system first detects the calls.
- ☑ External calls picked up by a user in another tenant group can be taken off of hold by the user who placed them on hold.
- ☑ Incoming internal calls call on be picked up by a user in the same tenant group.
- ☑ Only ringing transferred calls can be picked up by users who are members of another tenant group. Once the call is picked up it can be placed on hold and removed from hold as necessary.

Call Restriction

This feature allows outgoing calls to be restricted. Dialing is restricted based on the first eight digits that are dialed. The restricted numbers are entered and stored into tables accessed by system programming. When a user dials a restricted number, an error tone is sent and “ERROR” appears in the LCD of the multiline telephone.

This feature allows companies to save on long distance charges by restricting number that can be dialed. Restriction can be placed on individual telephones within the system.

This feature is available for the InfoSet and Electra Elite multiline telephones and single line telephones.

Feature Operation

Dialing a restricted number from an external line:

1. Lift the handset or press .
2. Dial the number. The system checks for restricted or authorized numbers. If the number matches a number recorded in one of the restriction tables, the system returns an error tone.

Associated Programming

All programming functions associated with this feature are listed in the following table. Some functions must be programmed before the feature is operational and other functions are optional. The optional functions can affect how the feature operates.

Function Number	Function Name	Required (Y)es or (N)o
020~021	Restricted Dialing – Tables 1 & 2	Y
022~023	Authorized Dialing – Tables 1 & 2	Y
219	Restricted Calling for External Calls	Y
220	Restricted Dialing Table Selection	Y
221	Authorized Dialing Table Selection	Y
222	Authorized Dialing for External Speed Dial Calls	N
223	Automatic Outgoing Calling	Y

Special Conditions

- ☑ There are four tables that contain numbers that the system accesses for call restriction: two tables containing restricted numbers (numbers that cannot be dialed) and two tables containing numbers that are authorized (numbers that can be dialed). Each telephone can be assigned to access any of the tables or individual telephones can be assigned to access all four tables.
- ☑ Each entry in the authorized and restricted tables is a maximum of eight digits. Each table can have a maximum of eight entries.
- ☑ Individual telephones can be programmed to override the entries in the authorized/restricted tables using speed dialing.
- ☑ If the same number is entered in the authorized table and the restricted table, the entry in the restricted table takes precedence.
- ☑ At system default, no restrictions are imposed for calling.
- ☑ Call restriction works in systems that must dial a digit (such as 9) when making external calls.







Call Restriction Override using System Speed Dial

This feature allows telephones, which have been be restricted from making outgoing calls, to make calls using the preassigned system speed dial numbers.

This feature is available for the InfoSet and Electra Elite multiline telephones and single line telephones.

Feature Operation

Using call restriction override by dialing a system speed dial number:





1. Press  (line key programmed to access an outside line).
2. Press  or  .
3. Dial   ~   to indicate the desired speed dial memory location.

Associated Programming

All programming functions associated with this feature are listed in the following table. Some functions must be programmed before the feature is operational and other functions are optional. The optional functions can affect how the feature operates.

Function Number	Function Name	Required (Y)es or (N)o
222	Authorized Dialing for External Speed Dial Calls	Y

Special Conditions

- System speed dial memory locations (  ~  ) can be assigned to override the toll restriction settings.

Call Transfer



This feature allows any user to transfer an external call to any other system user. The user receiving the call simply goes off-hook to answer the call. The call can be transferred using two methods:

- ❑ A user transfers the call and hangs up. The caller receiving the transferred call hears ringing and answers the call.
- ❑ A user transfers a call and waits the called user to answer. Once the call is verbally announced, the caller who transferred the call hangs up.



This feature is available for the InfoSet and Electra Elite multiline telephones and single line telephones.

Feature Operation

Transferring a call:

1. Press ^{Hold} . The call is put on hold.
2. Call the party's extension where the call will be transferred.
3. Press ^{Transfer}  or hang up.

Transferring a call with a call in progress:

1. Press ^{Transfer} . The call is put on hold.
2. When you hear the dialtone, dial the party's extension number where the call will be transferred.
3. When the called party answers, press ^{Transfer}  or hang up.

- OR -

When the called party answers, voice announce the transfer and hang up.

- OR -

If the called extension is busy or there is no answer, press the line key where the external call is holding or press ^{Conf}  to return to the holding internal call.

Transferring a call from a single line telephone with a call in progress:

1. Hookflash.
2. When you hear dialtone, dial the extension number where the call will be transferred.
3. Hang up.

- OR -

If the called extension is busy or the call is denied, retrieve the call by pressing hookflash.

Associated Programming

All programming functions associated with this feature are listed in the following table. Some functions must be programmed before the feature is operational and other functions are optional. The optional functions can affect how the feature operates.

Function Number	Function Name	Required (Y)es or (N)o
001-4	Ring Transfer	N
001-5	Automatic Transfer	N
001-9	Single Line Telephone Hookflash Assignment	N

Special Conditions

- Outgoing trunk line calls can be transferred.
- Calls can be transferred to extensions that are members of a different tenant.
- If the transferred call is not answered at the destination extension within 30 seconds, the call recalls to the transferring extension. An alarm tone is generated at the transferring extension and the telephone's display shows the destination extension number.
- Calls can be transferred to a telephone even when the telephone is busy or is in Do Not Disturb mode.
- A 3-party conference can be established while an outside call is in progress by pressing and dialing the number. When the party answers, press .

- ☑ When a call is transferred, the outside line key LED flashes green on the destination telephone and flashes red on all other telephones in the tenant group.
- ☑ Transferred calls follow the call forwarding that is on the destination telephone (if enabled).
- ☑ A single line telephone cannot be used to transfer a call if Function “001-9 – Single Line Telephone Hookflash Assignment” is set to “Hookflash”.

Call Waiting Indication

The system provides a visible indication to the called party that they have an incoming call. This indication allows the user to put the existing call on hold and answer the incoming call, terminate the existing call and answer the incoming call, or ignore the incoming call.

This feature is available for InfoSet or Electra Elite multiline telephones and single line telephones.

Feature Operation

Not applicable.

Special Conditions















- When an internal call is received, the extension number user who is calling is displayed in the telephone LCD.
- When an external call is received, the external line where the call is received flashes red.

Character Registration

The feature allows users to assign names to system and individual speed dial numbers and to numbers assigned to one-touch keys. The telephone number and the associated name are displayed in the telephone LCD when the number is dialed.













This feature is available for the InfoSet and Electra Elite multiline telephones.

Entering alphanumeric characters:

1. Press ^{Feature} .
2. Press ^{SPD}  ( for Elite telephones).
3. Either dial the speed dial memory location number (  ~   or    ~   ) or press the appropriate programmed speed dial key.
4. Press ^{Transfer}  to enable alphanumeric character entry.
5. Enter the name associated with the stored number by using the dial pad keys. (Refer to [Table 3-2 Dial Pad Keys Used When Entering Names.](#))
6. Press ^{Feature}  to store the name and associated telephone number into memory.

Verifying alphanumeric characters:

For a specific memory location:

1. Press ^{Conf} .
2. Press ^{SPD}  ( for Elite telephones).
3. Enter the speed dial memory location number (  ~   or    ~   ).

Note: Telephone numbers and alphanumeric characters are displayed for 10 seconds.

For a specific one-touch/feature access key:

1. Press ^{Feature} .
2. Press the one-touch/feature-access key.

Note: Telephone numbers and alphanumeric characters are displayed for 10 seconds.

Deleting a name and/or telephone number:

1. Press ^{Feature} .
2. Press ^{SPD} (^{Redial} for Electra Elite telephones).
3. Press the speed dial memory location number (⁰ ^{OPER} ^{OPER} ~ ⁹ ^{WXYZ} ^{WXYZ} or ⁰ ^{OPER} ^{OPER} ^{OPER} ~ ¹ ^{WXYZ} ^{WXYZ}).
4. Press ^{Feature} to delete only the telephone number. Press ^{Transfer} and ^{Feature} to delete the name *and* number.

Table 3-2 Dial Pad Keys Used When Entering Names

Key	Usage
<input type="button" value="*"/>	Shifts the cursor one character to the left and deletes the character.
<input type="button" value="#"/>	Creates a blank character to the right of the cursor.
^{Conf} <input type="button" value="1"/>	Toggles between uppercase and lowercase letters.
<input type="button" value="1"/>	1
<input type="button" value="2"/> A B C	A B C, a b c, or 2
<input type="button" value="3"/> D E F	D E F, d e f, or 3
<input type="button" value="4"/> G H I	G H I, g h i, or 4
<input type="button" value="5"/> J K L	J K L, j k l, or 5
<input type="button" value="6"/> M N O	M N O, m n o, or 6
<input type="button" value="7"/> P Q R S	P Q R S, p q r s, or 7
<input type="button" value="8"/> T U V	T U V, t u v, or 9
<input type="button" value="9"/> W X Y Z	W X Y Z, w x y z, or 9
<input type="button" value="0"/> OPER	& @ or 0
^{Transfer} <input type="button" value="0"/>	Toggles between alphabetic and numeric entry.
^{SPD} <input type="button" value="0"/> (^{Redial} <input type="button" value="0"/> for Elite telephones)	' - :

Special Conditions

- ☑ If consecutive speed dialing is used, alphanumeric data in redial memory is changed.
- ☑ The input character mode is indicated in the second line of the telephone LCD. When only numeric characters can be entered, "NUMERIC" is displayed in the LCD. When alphanumeric characters can be entered, "ALPHA" is displayed in the LCD.
- ☑ When a call is originated using speed dialing (whether dialing is done manually or using a one-touch key assigned a speed dial number) and the speed dial number has alphanumeric data associated with it, old alphanumeric data is cleared.
- ☑ Alphanumeric characters can be assigned to a speed dial memory location number or a one-touch key.
- ☑ Alphanumeric data associated with system speed dialing can only be entered, modified or erased using an attendant multiline telephone (normally extension 10 or 11) or using PC programming.
- ☑ A maximum of 16 characters can be assigned to a speed dial number.





Clock/Calendar Display













On multiline telephones equipped with an LCD (liquid crystal display), the time (hour and minutes) and the date (day, day of week and year) are displayed.

This feature is available on InfoSet and Elite multiline telephones.

Feature Operation

Setting the clock/calendar:

1. Press ^{Feature} .
2. Dial   .
3. Press the appropriate dial pad keys to enter the time.

Note: Use  to move the cursor to the left and  to move the cursor to the right.
4. Place the cursor under a.m. or p.m. and press ^{Flash}  ( for the Elite telephones) to select.
5. Press ^{Hold}  to switch between the date and time displays.
6. Press ^{Flash}  ( for the Elite telephones) to change the day of the week.
7. Dial  and move the cursor to the date.
8. Using the dialpad, enter the date.
9. Move the cursor to the desired month and press ^{Flash}  ( for the Elite telephones) to select the month.
10. Dial  and move the cursor to the year.
11. Using the dialpad, enter the year.
12. Press ^{Feature}  to save the changes and exit.

Associated Programming

All programming functions associated with this feature are listed in the following table. Some functions must be programmed before the feature is operational and other functions are optional. The optional functions can affect how the feature operates.

Function Number	Function Name	Required (Y)es or (N)o
002-7	Time Format for Telephone Display	N

Special Conditions

- Date and time can be changed using any multiline telephone in the system.
- By default, the clock is set to January 1, 1999 (Friday), 12:00 a.m.
- If  is pressed while setting the date and time, the procedure is canceled and exits. The telephone is returned to the idle condition.
- Leap years are automatically set when the date (year) is specified.
- The time format (12-hour or 24-hour) is set using Function "002-7 – Time Format for Telephone Display".
- Daylight savings time is not switched automatically, this must be done manually.
- If "99" is entered, the date is 1999. If set 00~98 is entered, the date is 2000~2098.





Confirmation Dial

This feature allows users to dial a telephone number which is displayed for confirmation during speed dialing, one-touch dialing, and scrolling caller identification numbers.



This feature is available for InfoSet and Electra Elite multiline telephones.

Feature Operation

Confirmation dialing using a speed dial memory location number:

1. Press .
2. Press  ( for Electra Elite telephones).
3. Dial the speed dial memory location number to display the stored telephone number.
4. Press  (the appropriate outside line key) while the telephone number is displayed. The system automatically dials the displayed number.

Confirmation dialing using a one-touch key:

1. Press .
2. Press  (one-touch key) you want to confirm.
3. Press  (the appropriate outside line key) while the telephone number is displayed. The system automatically dials the displayed number.

Special Conditions

- Confirmation dialing is available for the following conditions:
 - Speed Dialing (system, extension and nested speed dialing)
 - One-Touch Dialing
 - Caller ID Scrolling
- Simple searches are possible when speed dial numbers are displayed by using # or *. For example, if 19 is displayed and # is pressed, the display scrolls to 20.
 - # = scrolls to the next stored speed dial number
 - * = scrolls to the previous stored speed dial number
- If an empty speed dial memory location is detected during a simple search, "Empty" is displayed in the telephone LCD.

- ☑ When performing simple searches and the last speed dial memory location number is reached, the system scrolls to the first speed dial memory location number. For example, if 199 is displayed (system is set for 200 memory locations) and the user presses #, the system “rolls over” to 000. If 000 is displayed and * is pressed, the system “rolls back” to 199.
- ☑ When calling preference is set to CO/PBX line preference using Function “209 – Outgoing Call Priority Mode”, confirmation dialing is accomplished by lifting the handset.
- ☑ Call restriction applies during confirmation dialing.

Conference Add-On

This feature allows conference calling. A maximum of three parties (various combinations of internal and external callers) are allowed in each conference. Conference calling increases efficiency by allowing multiple parties to enter into a conversation. Music is provided to callers while they are on hold waiting to enter the conference.



The possible conference combinations are:

- One internal party and two external parties.
- Two internal parties and one external party.
- Three internal parties.

This feature is available for the InfoSet and Electra Elite multiline telephones and single line telephones.

Feature Operation

Initiating a conference call with a call in progress:

1. If adding an internal party, dial the party's extension number. If adding an external party, dial the party's telephone number.
2. Press . The party is put on hold.
3. If adding an internal party, dial the party's extension number. If adding an external party, press the appropriate line key to access an outside line, then dial the party's telephone number.
4. Press  to add the caller on hold to the conference

Setting up a conference call using a single line telephone while a call is in progress:





1. Press hookswitch to place the first party on hold.
2. Dial the party's extension number.
Note: Only internal callers can be added to a conference when a single line telephone is used to initiate the conference call.
3. Press hookswitch again to add the holding party to the conference.

Associated Programming

All programming functions associated with this feature are listed in the following table. Some functions must be programmed before the feature is operational and other functions are optional. The optional functions can affect how the feature operates.







Function Number	Function Name	Required (Y)es or (N)o
106	Automatic Release of Trunk Line	N

Special Conditions











- Barge-In is not allowed for any outside line or telephone that is part of a conference.
- Only one internal party, who is a part of a conference, can put a conference on hold. The telephone used to put the conference on hold cannot participate in another conference.
- When a conference consists of two outside lines and one internal line and the conference is put on hold and one of the outside lines is selected, the conference is canceled. The other outside line is not dropped but is on exclusive hold.
- If Function 106 "Automatic Release of Trunk Line" is enabled in programming and the outside line is released, the remaining parties continue talking. If automatic release is not disabled, a busy tone is heard and the conference is terminated.
- When three internal parties are in conference and one of the parties exits the conference, the two remaining parties resume a 2-party call.
- The  LED lights red when a conference is in progress.
- When both of the conference circuits are busy, both of the  LEDs light red.
- When a multiline telephone is used to place a call on conference hold, the lines keys associated with the conference hold flashes green (indicating exclusive hold) and the  LED flashes red. On other telephones in the system, the  LED is solid red.
- A 3-party internal conference can also be put on hold.
- When an external line is on hold, recall is provided for single line telephones (if the handset is placed in the cradle).

- ☑ During a conference call some of the keys on the telephone can be used and some cannot be used, these are listed below.

Available Keys:

- Feature  Accesses available functions.
- Feature   Toggles to turn the microphone on and off.
- Feature   Toggles to set and reset handset mute.
- Hold  Places a conference on hold.
- Speaker  Toggles to turn the speaker on and off or cancels a conference.

Unavailable Keys:

-  Outside line key that is part of a conference.
-  One-touch keys programmed for a function.
- Conf 
- SPD  Or 
- Flash  Or 
- Answer 
- Redial 
- Transfer 

Consecutive Speed Dial

Consecutive Speed Dial enables users to simplify complicated dialing sequences by allowing them to consecutively dial a combination of system speed dial or individual speed dial numbers and/or manually dialed numbers.

This feature is useful when verifying credit cards, accessing service providers, or any other application that requires dialing a series of numbers (i.e., authorization codes, customer numbers, etc.).



This feature is available for InfoSet or Electra Elite multiline telephones and single line telephones.

Feature Operation

Consecutive dialing:

1. Go off-hook by lifting the handset or pressing  .
2. When you hear dialtone, use any combination of manual dialing or speed dialing.

Consecutive dialing using a single line telephone:

1. Go off-hook by lifting the handset.
2. When you hear internal dialtone, enter the speed dial access code ( ) and dial the speed dial memory location number.
3. Manually dial the desired number.

Special Conditions

- If a call is made using a speed dial number that has a “name” defined for it, the associated alphanumeric “name” is displayed.
- Each speed dial number can have a maximum of 24 digits. Each pause, flash, # and * counts as a digit.
- When using a single line telephone, only manual dialing of speed dial memory locations is allowed.
- If the system is a multifunction system, a dial access code (normally “9”) is required when dialing an outside telephone number. If the dial access code is not part of the stored number, an error code is generated when dialing is attempted and the line key is released. This occurs only for the first speed dial call. An error tone is not generated for chain dialing once the call is originated.
- If the system is a key function system, a dial access code (normally “9”) is not required.

Digital Voice Mail

Digital voice mail is part of the InfoSet 408 system. Users can leave messages for other system users. The large LED on the telephone lights solid red to indicate the user has a message waiting.

This feature is available for the InfoSet and Electra Elite multiline telephones (single line telephones users can only leave a message).

Feature Operation

Refer to the manuals accompanying voice mail.

Associated Programming

All programming functions associated with this feature are listed in the following table. Some functions must be programmed before the feature is operational and other functions are optional. The optional functions can affect how the feature operates.

Function Number	Function Name	Required (Y)es or (N)o
206	Extension Number Assignment	N

Special Conditions

- Extension numbers 50 and 51 are used as the voice mail extension numbers. The primary extension is 50. All calls ring at the primary extension unless it is busy. If extension 50 is busy, then the system automatically routes the calls to extension 51. The user always dials 50 to access voice mail.
- Message waiting can only be set or canceled using the voice mail system.
- The message waiting status is retained in system memory by the backup battery.
- All programming for voice mail is done using the telephone.
- A maximum of 20 subscribers are supported.
- A maximum of 20 call routing boxes and one key call routing box are supported.
- The system recording capacity is two hours.
- A maximum of 20 message groups are supported.
- When users call the voice mail extension, they are automatically routed to their mail box (auto subscriber login).

Delayed Ringing

Delayed Ringing allows some telephones to ring immediately for incoming calls and other telephones to ring after a programmed delay.

This feature is available for the InfoSet and Electra Elite multiline telephones and single line telephones.

Feature Operation

Assigned in system programming.

Associated Programming

All programming functions associated with this feature are listed in the following table. Some functions must be programmed before the feature is operational and other functions are optional. The optional functions can affect how the feature operates.

Function Number	Function Name	Required (Y)es or (N)o
124	External Speaker Ringing for Day Mode	N
125	External Speaker Ringing for Night Mode	N
301~304	Day Ringing for Trunk Lines 1~4	Y
311~314	Night Ringing for Trunk Lines 1~4	N

Special Conditions

- Delayed ringing can be assigned different values for day and night modes.
- Multiline telephones that are not assigned to ring can still answer calls.
- The external line key flashes immediately when calls are received. This setting is independent of ringing and occurs whether ringing is enabled or disabled for the telephone.

Direct Inward Termination

Direct Inward Termination (DIT) allows external lines to be programmed to ring directly at a specified extension. A separate night ringing DIT assignment is available. This feature is primarily used for voice mail automated attendant.

This feature is available for the InfoSet and Electra Elite multiline telephones and single line telephones.

Feature Operation

Not applicable.

Associated Programming

All programming functions associated with this feature are listed in the following table. Some functions must be programmed before the feature is operational and other functions are optional. The optional functions can affect how the feature operates.

Function Number	Function Name	Required (Y)es or (N)o
140~143	Direct Calling for Day Mode on Trunk Lines 1~4 (DIT Assignment)	Y
144~147	Direct Calling for Night Mode on Trunk Lines 1~4 (DIT Assignment)	Y
148	Direct Calling Answer Delay Time (DIT Assignment)	Y
149	Direct Calling Answer Delay for Night Mode (DIT Assignment)	Y
206	Extension Number Assignment	Y

Special Conditions

- DIT transfers or forwarded calls are handled as if they are internal incoming calls.
- When DIT is assigned, the system checks if call forwarding is enabled or disabled. After the DIT answer delay duration timer expires, the call is forwarded if call forwarding is enabled.
- Normally, DIT calls will be transferred to the voice mail system. Extensions other than the voice mail extension, can only receive one transferred call.
- The transferred extension number follows forwarding set for extension hunting.
- If an incoming call fails to be transferred, the system waits for an available internal line.









Direct Paging Access

This feature allows a user to assign a key on the telephone to directly access the paging function.









This feature is available for InfoSet and Electra Elite multiline telephones.

Feature Operation



Assigning a key for paging:

1. Press ^{Feature}  ^{SPD}  (InfoSet telephones) or  (Electra Elite telephones).
2. Press  (one-touch key where direct paging access assigned).
3. Dial   .
4. If assigning a name that will be displayed in the telephone LCD when the one-touch key is pressed, press ^{Transfer}  and enter the alphanumeric characters using the dialpad. (Refer to [Character Registration on page 3-44](#) and [Table 3-2 Dial Pad Keys Used When Entering Names on page 3-45](#).)
5. Press ^{Feature} .

Assigning a key for answering a page:

1. Press ^{Feature}  ^{SPD}  (InfoSet telephones) or  (Electra Elite telephones).
2. Press  (one-touch key where direct paging access assigned).
3. Dial   .
4. If assigning a name that will be displayed in the telephone LCD when the one-touch key is pressed, press ^{Transfer}  and enter the alphanumeric characters using the dialpad. (Refer to [Character Registration on page 3-44](#) and [Table 3-2 Dial Pad Keys Used When Entering Names on page 3-45](#).)
5. Press ^{Feature} .

To page using one-touch key:

1. Press ^{Speaker}  or lift the handset.
2. Press  (one-touch key assigned for paging).
3. Make the paging announcement.

Special Conditions

- Internal and/or external paging is accomplished by using the appropriate one-touch/feature access key assigned as the paging key.
- The paging access codes include:
 - 70 Internal Page
 - 74 Page Answer
 - 75 External Page
 - 77 Internal/External Page (provides both internal and external paging)
- The maximum number of digits that can be dialed for an internal line, assigned to a one-touch/feature access key, is 16 digits.
- When multiple paging calls are made in system, the system processes internal pages first and then processes the external pages.









Direct Station Selection

The Direct Station Selection (DSS) feature allows users to assign internal telephone numbers to one-touch/feature access keys allowing them to make calls by pressing one key.

This feature is available for the InfoSet and Electra Elite multiline telephones and single line telephones.

Feature Operation



Programming extension 12 to a one-touch key:

1. Press ^{Feature}  while the telephone is in the idle condition.
2. Press ^{SPD}  (for InfoSet telephones) or  (for Electra Elite telephones).
3. Press  (one-touch/feature access key).
4. Dial  (internal access code).
5. Dial  .
6. Press ^{Feature} .





Making a call using the one-touch key:

Press the programmed one-touch key on your telephone. If programmed, you may hear a tone, otherwise, announce the call when the party answers. (You can remain on the speakerphone or lift the handset when the call is answered.)

Verifying the information stored in a one-touch key:

1. Press ^{Feature}  while the telephone is in the idle condition.
2. Press  (one-touch/feature access key).

Deleting information stored on a one-touch key:

1. Press ^{Feature}  while the telephone is in the idle condition.
2. Press ^{SPD}  (for InfoSet telephones) or  (for Electra Elite telephones).
3. Press  (one-touch/feature access key).
4. Press ^{Feature} .

Associated Programming

All programming functions associated with this feature are listed in the following table. Some functions must be programmed before the feature is operational and other functions are optional. The optional functions can affect how the feature operates.

Function Number	Function Name	Required (Yes or No)
001-1	Internal Call Notification	N

Special Conditions

- If a called telephone is busy, a call waiting tone is returned to the telephone that originated the call.
- A one-touch key that is programmed for DSS also serves as a busy lamp field (BLF). The BLF provides visual indication of the status of the telephone.
- Most single line telephones are not equipped with one-touch/feature access keys. However, it is possible to call a single line telephone using one-touch/feature access keys on a multiline telephone.
- If an invalid extension number is assigned to a one-touch key, "ERROR" is displayed in the telephone LCD when the one-touch/feature access key is pressed.

Distinctive Ringing

This feature allows users to assign different ringing patterns to internal and external calls to easily identify the type of call they are receiving.

This feature is available for the InfoSet or Electra Elite multiline telephones.

Feature Operation

Not applicable.

Associated Programming

All programming functions associated with this feature are listed in the following table. Some functions must be programmed before the feature is operational and other functions are optional. The optional functions can affect how the feature operates.

Function Number	Function Name	Required (Y)es or (N)o
119	Ring Tone Type	Y
361~364	Ringing Cycle for Trunk Lines 1~4	Y

Special Conditions

- When ringing is specified for individual speed dial numbers, the specifications assigned to speed dialing take precedence over the ring tone type programmed.
- Users can specify ring tone type for each external line or each multiline telephone using system programming.
- When a number is stored in a speed dial memory location a distinctive, ring tone can be assigned to that number. If that number rings into the system and can be identified by Caller ID, then the distinctive ring tone that was stored for that speed dial number is used.

Door Lock Release

While the multiline telephone user is talking with the doorphone user, the telephone user can unlock the door by entering a code assigned for door lock release.

- ☞ For this feature to be available, the DPH-B10 ETU must be installed in the system.

This feature is available for the InfoSet and Electra Elite multiline telephones.

Feature Operation

To unlock the door with a call in progress:

1. Press Feature.
2. Dial 6
MNO.

Associated Programming

All programming functions associated with this feature are listed in the following table. Some functions must be programmed before the feature is operational and other functions are optional. The optional functions can affect how the feature operates.

Function Number	Function Name	Required (Y)es or (N)o
210	Doorphone 1 Tone for Day Mode	Y
211	Doorphone 2 Tone for Day Mode	Y
213	Doorphone 1 Tone for Night Mode	Y
214	Doorphone 2 Tone for Night Mode	Y
501	Doorphone Call Timer	N

Special Conditions

- This feature is only enabled when a call is in progress using a doorphone.
- The doorphone relay cannot be activated from a single line telephone.
- Doorphone 1 operates with release relay 1 and doorphone 2 operates with release relay 2.
- The specified relay (doorphone 1 or 2) is held for five seconds during door lock release processing. The timer (five seconds) is restarted when the door lock release code is dialed while the door lock release relay is active.

Door/Monitor Telephone

Two doorphones can be installed in the system to provide 2-way communication with a location such as a front door area or to monitor a room. The DPH-B10 ETU must be installed in the key system to provide for this feature. When the doorphone unit is used as a doorphone, multiline telephones are assigned to ring when the doorphone key is pressed. When the doorphone is used as a room monitor any telephone can be used to access the doorphone and monitor the area.





This feature is available for InfoSet and Electra Elite multiline telephones and single line telephones.

Feature Operation





Answering a doorphone call from a multiline telephone that receives doorphone ringing tone:

1. Lift the handset or press  .
2. Talk with the calling party.

Answering a doorphone call from a a multiline telephone that does not receive doorphone ringing tone:

1. Lift the handset or press  .
2. Dial  .
3. Dial  (to access doorphone 1) or  (to access doorphone 2).
4. Talk with the calling party.

Monitoring an area:

1. Lift the handset or press  .
2. Dial  .
3. Dial  (to access doorphone 1) or  (to access doorphone 2).
4. Monitor the area.

Associated Programming

All programming functions associated with this feature are listed in the following table. Some functions must be programmed before the feature is operational and other functions are optional. The optional functions can affect how the feature operates.

Function Number	Function Name	Required (Y)es or (N)o
210	Doorphone 1 Tone for Day Mode	Y
211	Doorphone 2 Tone for Day Mode	Y
213	Doorphone 1 Tone for Night Mode	Y
214	Doorphone 2 Tone for Night Mode	Y
501	Doorphone Call Timer	N

Special Conditions

- A maximum of two doorphones can be installed in the system.
- Only one doorphone call is allowed at a time because the doorphone unit has only one communication path.
- When an incoming doorphone call is in progress, only monitoring for answering incoming external calls is allowed.
- There is 2-way communication between a doorphone and a telephone.
- All multiline telephones and single line telephones can be programmed to ring on incoming doorphone calls and can answer incoming calls originating from the doorphone by lifting the handset.





Do Not Disturb (DND)

This feature is used to temporarily eliminate all audible incoming call signals to the user's telephone. Visual indications to the telephone display and LEDs continue.



This feature is available for InfoSet and Electra Elite multiline telephones.

Feature Operation

Setting/canceling Do Not Disturb:

1. While the telephone is idle, press ^{Feature} .
2. Dial   (access code).
3. Press ^{Feature} .

Special Conditions

- Automatic Callback, Hold With Recall (Exclusive and Non-exclusive) and Timed Alarm features are enabled even in DND mode.
- Tone override cannot be sent to a telephone that is in DND mode.
- The ^{Feature}  LED flashes red when the telephone is in DND mode. If the DND enable/disable access code ( ) is assigned to a one-touch key equipped with an LED, the one-touch key LED lights solid red to indicate DND mode.
- Any busy lamp field (BLF), associated with a telephone that is in DND mode, flashes red.
- If DND mode is being set at the same time an incoming call rings into the telephone, ringing for that call continues. Ringing for subsequent incoming calls is suppressed.
- Background music is available during DND mode.
- Automatic callback cannot be set to a telephone that is in DND mode. However, a telephone in DND mode can set automatic callback to other telephones.
- Extensions 10 and 11 can reset DND mode system-wide.

DP to DTMF Switching

This feature allows a telephone to be switched from dial pulse (rotary) dialing to dual tone multifrequency dialing (touchtone). DTMF dialing is required for operations such as data transmission and communicating with a computer.

This feature is available for InfoSet and Electra Elite multiline telephones. It is also available for single line telephones that are connected to a dial pulse line.

Feature Operation

Switching from a dial pulse dialing to a dual tone multifrequency dialing:

1. Press while a call is in progress.
2. Dial the desired number. The digits are transmitted using dual tone multifrequency signaling.



Associated Programming

All programming functions associated with this feature are listed in the following table. Some functions must be programmed before the feature is operational and other functions are optional. The optional functions can affect how the feature operates.

Function Number	Function Name	Required (Y)es or (N)o
109	Trunk Line Dialing Type	Y
110	Touchtone Signal Duration and Pause Interval	N

Special Conditions

- If is pressed while a call is in progress, DP dialing is not available.
- This feature is only supported for push button telephones.
- If any digit other than # is pressed after *, the call does not switch to DTMF mode.
- An external line that has been switched to DTMF mode is returned to DP mode when the user hangs up.
- When DTMF mode is selected while an external call is in progress, subsequent dialing is transmitted in DTMF mode.

- ☑ DTMF switching operation can be assigned to a speed dial memory location. When assigning DTMF switching to a speed dial memory location, it may be necessary to add a pause to the dialing string. This pause allows the called party to respond and establish the call before DTMF digits are sent.
- ☑ After switching to DTMF mode, DP mode can be restored by pressing  (for InfoSet telephones) or  (for Electra Elite telephones).

Extension Hunting

This feature allows internal calls to be distributed to other telephones when the called telephone is busy. Telephones can be grouped together into hunt groups. A primary hunt number (hunt group pilot number) is assigned to a hunt group. When calls are received and the called telephone is busy, the system automatically tries a second telephone, third telephone and so forth until an idle telephone is found. This feature is primarily used for voice mail extensions. Voice mail extensions are assigned to a voice mail hunt group.

This feature is available for the InfoSet and Electra Elite multiline telephones and single line telephones.

Feature Operation

Calling an extension in a hunt group:

1. Lift the handset or press . (Internal dialtone must be heard.)
2. Dial the desired extension number.
3. Talk when the call is answered.

Associated Programming

All programming functions associated with this feature are listed in the following table. Some functions must be programmed before the feature is operational and other functions are optional. The optional functions can affect how the feature operates.

Function Number	Function Name	Required (Y)es or (N)o
019-1	Hunt Group Pilot Number 10	Y
019-2	Hunt Group Pilot Number 20	Y
019-3	Hunt Group Pilot Number 30	Y
019-4	Hunt Group Pilot Number 40	Y
019-5	Hunt Group Pilot Number 50	Y
206	Extension Number Assignment	Y

Special Conditions

- Each of the five hunt groups are assigned a hunt group pilot number (10, 20, 30, 40, or 50). Telephones are grouped together and assigned to one of the hunt groups. The extension numbers in each hunt group must be assigned consecutive extension numbers. For example, extensions in hunt group 10 are assigned numbers 10~19.
- Hunt groups can be assigned independently of tenant groups.
- When a telephone in the hunt group is set for call forwarding, that telephone is skipped during extension hunting.
- When used with automated attendant or voice mail applications, a hunt group can be assigned for outside lines to ring into the system. If both voice mail ports are busy, the first voice mail port to become idle will answer the call.



Extension Name Assignment

When this feature is used, the name or number of the internal caller or the paging originator is displayed on the called party (parties) telephone(s). The telephones must be equipped with an LCD for this feature to be used.

This feature is available for InfoSet and Electra Elite display telephones.

Feature Operation





Entering a caller's name:

1. Press ^{Feature} .
2. Dial  .
3. Dial the extension number for the party whose name will be entered.
4. Enter the name. Refer to [Character Registration on page 3-44](#) and [Table 3-2 Dial Pad Keys Used When Entering Names on page 3-45](#) for instructions for entering alphanumeric characters.

Note: A maximum of six alphanumeric characters can be entered for the name.

5. Press ^{Feature}  to save the entry.

Deleting a caller's name:

1. Press ^{Feature} .
2. Dial  .
3. Dial the extension number associated with the party's name that will be deleted.
4. Press ^{Feature}  to delete the entry .

Special Conditions

- The extension number and associated name are displayed during the telephone's idle condition.
- The extension name can be assigned using PC programming.

External Paging (Meet-Me)

This feature allows paging through a user-provided external speaker. The paged party answers by dialing a specified access code.

This feature is available for the InfoSet and Electra Elite multiline telephones and single line telephones.

Feature Operation



Initiating a page:

1. Lift the handset.
2. Dial the access code for the desired zone or press a one-touch key that has been programmed with the access code. The external paging access codes are listed below.

70	Internal All Call Paging
74	External/Internal Meet-Me (Answer Page
75	External Paging
77	All External/Internal Paging

3. Announce the page.

Answering a page:

1. Press ^{Speaker}  or lift the handset.
2. Dial   .
3. Answer the page.

Associated Programming

All programming functions associated with this feature are listed in the following table. Some functions must be programmed before the feature is operational and other functions are optional. The optional functions can affect how the feature operates.

Function Number	Function Name	Required (Y)es or (N)o
002-2	External Speaker Connection	Y
002-3	External Paging Tone Assignment	Y

Special Conditions

- When external paging is originated, a tone burst is heard from the external speaker.
- A busy tone is also generated when a user attempts a page and external paging is in use.
- If background music is on or if an outside call is ringing in to the telephone, ringing or background music is suspended during a paging announcement. Ringing or background music is resumed after the page is completed.
- When a meet-me is in progress and someone dials the meet-me access code, the page is discontinued and an internal call is established.
- If the external speaker connection has not been programmed using Function "002-2 External Speaker Connection" and a page is attempted, a busy tone is generated.
- Only one external speaker can be connected to the system.

External Tone Ringer via External Speaker

A user-provided external speaker can be programmed to ring when incoming calls are received. Ringing can be individually set for day mode and night mode.

Feature Operation

Answering a call:

1. Lift the handset or press  .
2. Press the appropriate flashing line key.
3. Answer the call.

Associated Programming

All programming functions associated with this feature are listed in the following table. Some functions must be programmed before the feature is operational and other functions are optional. The optional functions can affect how the feature operates.

Function Number	Function Name	Required (Y)es or (N)o
002-2	External Speaker Connection	Y
124	External Speaker Ringing for Day Mode	Y
125	External Speaker Ringing for Night Mode	Y

Special Conditions

- The feature only operates for incoming external calls.
- Only one external speaker can be connected to the system.



Flash Key

If a system is connected to a PBX, it can be programmed to transfer the PBX call to the system using a flash signal. The duration of the flash signal is assigned in system programming.

This feature is available for the InfoSet and Electra Elite multiline telephones.

Feature Operation

Transferring a PBX call:







1. Press  (for InfoSet telephones) or  (for Electra Elite telephones).
2. Hang up, the call is transferred.

Associated Programming

All programming functions associated with this feature are listed in the following table. Some functions must be programmed before the feature is operational and other functions are optional. The optional functions can affect how the feature operates.

Function Number	Function Name	Required (Y)es or (N)o
006	Hookflash Duration	Y
107	Trunk Line Type	N

Special Conditions

- Pressing  (for InfoSet telephones) or  (for Electra Elite) telephones releases the line and then reseizes the line after the hookflash duration expires.
- If an external line is outgoing restricted (dialing external numbers is denied) and the user presses  and then attempts to dial a restricted number, the external line is dropped and an error tone is generated.
- When  is pressed, digits dialed before and after pressing  are stored in separate redial memory locations. If  is pressed while dialing, the redial memory location is cleared.

Flexible Line Key

The line keys on the multiline telephones are designed for flexibility of use. Line keys that are not used to access external lines can be assigned for:

- speed dialing
- one-touch/feature access key operation for seizing internal of external telephone lines
- dialing access codes that are used to set/cancel features such as microphone on/off and headset on/off.

This feature is available for InfoSet and Electra Elite multiline telephones.

Feature Operation

Not applicable.

Associated Programming

All programming functions associated with this feature are listed in the following table. Some functions must be programmed before the feature is operational and other functions are optional. The optional functions can affect how the feature operates.

Function Number	Function Name	Required (Y)es or (N)o
109	Trunk Line Dialing Type	Y

Special Conditions

- Line keys 1~4, at system default, are assigned as external line keys. These line keys can also be assigned for other uses if Function 109 "Trunk Line Dialing Type" is set to uninstalled.

Flexible Numbering Plan

This feature allows extension numbers to be changed to meet individual customer's needs. When the system is first turned on, the system automatically assigns default extension numbers. As necessary, these settings can be changed in system programming.

This feature is available for the InfoSet and Electra Elite multiline telephones and single line telephones.

Feature Operation

Not applicable.

Associated Programming

All programming functions associated with this feature are listed in the following table. Some functions must be programmed before the feature is operational and other functions are optional. The optional functions can affect how the feature operates.

Function Number	Function Name	Required (Y)es or (N)o
206	Extension Number Assignment	Y

Special Conditions

- The extension numbers range from 10~59 creating the flexible numbering plan.
- The system cannot check for duplicate extension numbers. If the same extension number is assigned to more than one telephone, the telephone attached to the lowest numbered port (internal line) in the system rings.

Flexible Ringing Assignment

External calls can be programmed to ring at specified telephones or to an external speaker. Separate day and night ringing assignments can also be specified in programming.

This feature is available for InfoSet and Electra Elite multiline telephones and single line telephones.

Feature Operation

Not applicable.

Associated Programming

All programming functions associated with this feature are listed in the following table. Some functions must be programmed before the feature is operational and other functions are optional. The optional functions can affect how the feature operates.

Function Number	Function Name	Required (Y)es or (N)o
124	External Speaker Ringing for Day Mode	Y
125	External Speaker Ringing for Night Mode	Y
301~304	Day Ringing for Trunk Lines 1~4	Y
311~314	Night Ringing for Trunk Lines 1~4	Y
401~402	Trunk Line Assignment for Tenants 1~2	N
403	Tenant-to-Telephone Assignment	N

Special Conditions

- When “No Ring” is assigned to a telephone (using Functions 301~304 Day Ringing for Trunk Lines 1~4 and 311~314 Night Ringing for Trunk Lines 1~4), the audible tone is silent. However, the large LED flashes to indicate an incoming call.
- Trunks that are assigned to a different tenant, from the tenant the telephone is assigned to, do not provide audible or visual indication of an incoming call.
- Direct Inward Termination (DIT) and ringing transferred calls ring directly to the telephone where the call is transferred. As a result, these calls do not allow flexible ringing.
- If a DIT call or ringing transferred call is received while a page is being announced, paging stops at the telephone where the call is received.

Flexible Timeout

Flexible Timeouts are the system defaults for a variety of times selections. These preset values allow the system to operate without any initial program changes. Many of these values can be changed in system programming to meet individual user specifications.

Feature Operation

Not applicable.

The flexible timeout table provides a list of the timers that can be programmed in the system. The timer, the definition and the timer value are provided in the table. The default timing value is indicated by (D). Some of the timing values are fixed, this means they cannot be changed. If the timer is fixed and cannot be changed, that is noted in the Timer/Function column. If the timing values can be changed, the Function number where the value is programmed is listed in the Timer/Function column.

Table 3-3 Flexible Timeouts

Timer/Function	Definition	Timing Value															
Automatic Callback Time Selection Fixed	The length of time allowed for an automatic callback to occur before the callback request is automatically canceled.	30 sec															
Automatic Redial Time Selection 005 – Automatic Redial Timer	Specifies the call time, wait time, and number of attempts for automatic redialing.	<table style="width: 100%; border-collapse: collapse;"> <thead> <tr> <th style="width: 33%;">Call Time</th> <th style="width: 33%;">Waiting Time</th> <th style="width: 33%;">Number of Times</th> </tr> </thead> <tbody> <tr> <td>0 = 5 sec</td> <td>5 sec</td> <td>7</td> </tr> <tr> <td>1 = 10 sec</td> <td>30sec</td> <td>7 (D)</td> </tr> <tr> <td>2 = 15 sec</td> <td>60 sec</td> <td>7</td> </tr> <tr> <td>3 = 15 sec</td> <td>90 sec</td> <td>7</td> </tr> </tbody> </table>	Call Time	Waiting Time	Number of Times	0 = 5 sec	5 sec	7	1 = 10 sec	30sec	7 (D)	2 = 15 sec	60 sec	7	3 = 15 sec	90 sec	7
Call Time	Waiting Time	Number of Times															
0 = 5 sec	5 sec	7															
1 = 10 sec	30sec	7 (D)															
2 = 15 sec	60 sec	7															
3 = 15 sec	90 sec	7															
Automatic Release Disconnection Signal Detection Time Selection 007 – Disconnect Detection Duration	The signal detection time for releasing an external (CO/PBX) line when a disconnect signal is received from a distant CO/PBX system.	<table style="width: 100%; border-collapse: collapse;"> <tbody> <tr> <td>0 = Not Detected</td> <td>5 = 250 ms</td> </tr> <tr> <td>1 = 50 ms</td> <td>6 = 300 ms</td> </tr> <tr> <td>2 = 100 ms</td> <td>7 = 350 ms (D)</td> </tr> <tr> <td>3 = 150 ms</td> <td>8 = 400 ms</td> </tr> <tr> <td>4 = 200 ms</td> <td>9 = 500 ms</td> </tr> </tbody> </table>	0 = Not Detected	5 = 250 ms	1 = 50 ms	6 = 300 ms	2 = 100 ms	7 = 350 ms (D)	3 = 150 ms	8 = 400 ms	4 = 200 ms	9 = 500 ms					
0 = Not Detected	5 = 250 ms																
1 = 50 ms	6 = 300 ms																
2 = 100 ms	7 = 350 ms (D)																
3 = 150 ms	8 = 400 ms																
4 = 200 ms	9 = 500 ms																
Bounce Protect Time Selection 502 – Single Line Telephone Bounce Time	Specifies the length of time before a valid hookflash can be detected from a single line telephone.	<table style="width: 100%; border-collapse: collapse;"> <tbody> <tr> <td>0 = 0 ms</td> <td>2 = 600 ms</td> </tr> <tr> <td>1 = 300 ms (D)</td> <td>3 = 900 ms</td> </tr> </tbody> </table>	0 = 0 ms	2 = 600 ms	1 = 300 ms (D)	3 = 900 ms											
0 = 0 ms	2 = 600 ms																
1 = 300 ms (D)	3 = 900 ms																
Call Forward – Busy/No Answer Timer Selection 008 – Call Forward – No Answer Duration	The length of time before incoming calls are forwarded to another telephone when there is no answer at the original destination.	<table style="width: 100%; border-collapse: collapse;"> <tbody> <tr> <td>0 = 10 sec (D)</td> <td>3 = 25 sec</td> </tr> <tr> <td>1 = 15 sec</td> <td>4 = 30 sec</td> </tr> <tr> <td>2 = 20 sec</td> <td>5 = 60 sec</td> </tr> </tbody> </table>	0 = 10 sec (D)	3 = 25 sec	1 = 15 sec	4 = 30 sec	2 = 20 sec	5 = 60 sec									
0 = 10 sec (D)	3 = 25 sec																
1 = 15 sec	4 = 30 sec																
2 = 20 sec	5 = 60 sec																

Table 3-3 Flexible Timeouts (Continued)

Timer/Function	Definition	Timing Value
CO Ring Transfer Recall Timer Selection Fixed	Specifies the interval from the time a telephone user transfers an incoming call until the time the destination telephone user does not respond. When there is no response, the timer expires and an alarm is generated at the transferring user's telephone.	30 sec
CO/PBX DTMF Duration/ Interdigit Assignment 110 – Touchtone Signal Duration and Pause Interval	Specifies the tone duration and interdigit time when DTMF signaling is used.	0 = Duration 400ms / Pause 100ms 1 = Duration 100ms / Pause 70ms (D)
Disconnect Time Selection Fixed	The minimum time that must elapse before a disconnected line can be accessed again.	1 sec
Doorphone Display Time Selection 501 – Doorphone Call Timer	Specifies the time during which "DPH 1" or "DPH 2" is to be displayed on the telephone LCD. This timer applies to incoming calls from a doorphone.	0 = 15 sec (D) 1 = 30 sec
DP Interdigit Time Selection Fixed	Specifies the minimum length of the pause interval between digits dialed for dial pulse dialing.	10pps:650ms/20pps:500ms
DTMF Receiver Release Timer Selection Fixed	The interval during which a receiver circuit is connected to a DTMF-type single line telephone while waiting for digits to be dialed.	30 sec
Elapsed Call and SMDR Start Timer Selection Fixed	Specifies the amount of time that passes before the call duration and start timer begins after the number has been dialed.	10 sec
Exclusive Hold Recall Timer Selection 004 – Exclusive Hold Warning Tone Timer	Specifies the interval before an exclusive hold recall tone is generated. No hold alarm is generated if "No Limit" is selected.	0 = 1 min (D) 3 = 4 min 1 = 2 min 4 = No Limit 2 = 3 min
Hold Recall Timer Selection 003 – Hold Warning Tone Timer	Specifies the interval before a recall tone is generated for a holding external (CO/PBX) call. No hold alarm tone is generated if "No Limit" is selected.	0 = 1 min (D) 3 = 4 min 1 = 2 min 4 = No Limit 2 = 3 min

Table 3-3 Flexible Timeouts (Continued)

Timer/Function	Definition	Timing Value	
Hookflash End Time Selection 504 – Single Line Telephone Hookflash End Time	Specifies the maximum duration that a single line telephone has to receive dial tone. The times are added to the Hookflash Start Time. For example, if the Hookflash Start Time (HST) = 1 and the Hookflash End Time (HET) = 1, add 150 ms. and 100 ms. to determine the maximum duration. (HST + HET = Max. Hookflash Duration)	0 = 0 ms 1 = 100 ms 2 = 200 ms 3 = 400 ms 4 = 500 ms	5 = 700 ms (D) 6 = 900 ms 7 = 1.1 sec 8 = 1.3 sec 9 = 1.5 sec
Hookflash Start Time Selection 503 – Single Line Telephone Hookflash Start Time	Specifies the minimum hookflash duration from a single line telephone.	0 = 100 ms 1 = 150 ms 2 = 200 ms 3 = 300 ms (D) 4 = 350 ms	5 = 450 ms 6 = 550 ms 7 = 650 ms 8 = 750 ms 9 = 850 ms
Hookflash Time Selection: (Multiline Telephone) 006 – Hookflash Duration	Specifies the break time (the break of the DC loop of a CO/PBX line) sent to the central office or PBX when the flash recall key is pressed.	0 = 60 ms 1 = 100 ms 2 = 140 ms 3 = 200 ms 4 = 400 ms	5 = 600 ms (D) 6 = 800 ms 7 = 1.0 sec 8 = 1.5 sec 9 = 2.0 sec
Incoming Outside Ringing Delay Time 301~304 – Day Ringing for Trunk Lines 1~4 311~314 – Night Ringing for Trunk Lines 1~4	Specifies time delay that elapses before ringing sounds for external incoming calls.	0 = 0 sec (D) 1 = 10 sec 3 = 30 sec	4 = 60 sec 5 = No Ring
Pause Time Selection Fixed	Specifies the length of the pause inserted between the digits dialed on external (CO/PBX) lines or when using speed dialing.	3 sec	
Prepause Time Selection Fixed	Specifies the pause time inserted after dial access to an external (PBX trunk) line.	1 sec	
Time Display (12h/24h) Selection 002-7 – Time Format for Telephone Display	Specifies whether the clock on the telephone displays the time in 12-hour format (12:00 a.m. to 11:59 p.m.) or 24-hour format (0:00 to 23:59).	7 = 12 hour (D) – = 24 hour	
Trunk Queuing Recall Time Selection Fixed	Specifies the interval during which the telephone that is enabled for queuing is called. After the timer expires, the queue is automatically canceled.	10 sec	



Full Handsfree Operation

Multiline telephones allows the user to make and answer calls without using the handset. Users can talk using the telephone's built-in microphone (the microphone must be turned on).

This feature is available for the InfoSet and Electra Elite multiline telephones.



Feature Operation

Turning the microphone on:

1. Press ^{Feature} .
2. Dial .

Note: This operation toggles the microphone on/off. The microphone LED is red if the microphone is on.

Making an internal call:

1. Press ^{Speaker} .
2. When you hear dialtone, dial  .
3. When the party answers, begin speaking.

Answering an internal call:

When the call is received, ensure the microphone LED is on and begin talking.

Making an external call:

1. Press  (line key assigned to seize an external line).
2. When you hear dialtone, dial the telephone number.
3. When the party answers, begin speaking.

Answering an external call:

1. Press ^{Answer} .
2. When the party answers, ensure that the microphone LED is on, and begin speaking using the built-in speaker.

Associated Programming

All programming functions associated with this feature are listed in the following table. Some functions must be programmed before the feature is operational and other functions are optional. The optional functions can affect how the feature operates.

Function Number	Function Name	Required (Y)es or (N)o
216	Handsfree Assignment	Y



Handset Microphone Control

When making a call, users can mute the transmission speech path. This allows the user to continue to hear the other party, but the other party cannot hear their conversation. Mute is reset (to off) when the call is terminated or it can be manually reset during a call.

This feature is available for the InfoSet and Electra Elite multiline telephones.

Feature Operation

Setting and resetting handset mute:

1. Press ^{Feature} .
2. Dial  (toggles between on/off)

Special Conditions

- If handset microphone control is set while a call is in progress, it automatically resets when the user hangs up.
- Handset microphone control automatically resets when an internal or external call is placed on hold.
- This feature can be assigned to a one-touch/feature access key. (Refer to [One-Touch/Feature Access Keys – User Programmable on page 3-115.](#))
- When the handset microphone control feature is set/reset, one of the following messages is displayed: Set = Mute On/Reset = Mute Off.

Handsfree Answerback

This feature allows users of multiline telephones to answer internal voice announced calls when the microphone is turned on.

This feature is available for InfoSet and Electra Elite multiline telephones.

Feature Operation

Initiating a handsfree answerback:

1. Press .
2. Dial the internal extension number. The called party begins talking.

Special Conditions

- This feature is enabled regardless of the system setting if the microphone is on.
- Handsfree answerback is not possible for an internal voice call unless Dial 1 is enabled to allow switching between tone/voice signal calls.
- Tone override is available during handsfree answerback.
- Voice/tone signal calls are controlled by the calling party (initial tone/signal call).
- Voice calls can be made from a single line telephone to the key system.

Handsfree Dialing and Monitoring

A telephone feature which allows the user to place external calls and listen to the progress of those calls without lifting the handset on the telephone.

This feature is available for InfoSet and Electra Elite multiline telephones.

Feature Operation

Placing an outside call:

1. Press the line key to access an outside line.
2. Dial the party's telephone number. When the called party answers you can either remain off-hook and talk through the telephone speaker or you can lift the handset.

Placing an internal call:

1. Press . Speaker
2. Dial the party's extension number. When the called party answers you can either remain off-hook and talk through the telephone speaker or you can lift the handset.

Associated Programming

All programming functions associated with this feature are listed in the following table. Some functions must be programmed before the feature is operational and other functions are optional. The optional functions can affect how the feature operates.

Function Number	Function Name	Required (Y)es or (N)o
001-6	Trunk Line Direct Access	N
105	Trunk Line Function	N
351~354	Restricting Outgoing Calls for Trunk Lines 1~4	N
401~402	Trunk Line Assignment for Tenants 1~2	N
403	Tenant-to-Telephone Assignment	N



Headset Connection

A headset can be connected to an Electra Elite multiline telephone. A one-touch/feature access key must be assigned to toggle the headset on/off.

This feature is only available for Electra Elite multiline telephones.

Feature Operation

Assigning headset operation to a one-touch/feature access key:

1. Press .
2. Press .
3. Press  (one-touch/feature access key programmed for headset enable/disable).

Note: This one-touch/feature access key toggles between the on-hook/off-hook operations.

4. Dial   .
5. Press .

Placing a call:

1. Press  (one-touch key programmed for headset enable/disable).
2. Dial the party's telephone number and begin talking when the party answers.

Terminating a call:

Press  (one-touch key programmed for headset enable/disable).

Switching to the handset:

1. Pick up the handset.
2. Press  (one-touch key programmed for headset enable/disable).

Associated Programming

All programming functions associated with this feature are listed in the following table. Some functions must be programmed before the feature is operational and other functions are optional. The optional functions can affect how the feature operates.

Function Number	Function Name	Required (Y)es or (N)o
218	Headset Connection	Y

Special Conditions

- The headset enable/disable one-touch/feature access key must be used to switch from on-hook to off-hook.



Holdfree Transfer

Holdfree Transfers allows users to answer a transferred call without using the hold key. The system can be programmed to answer the calls by pressing a line key.

This feature is available for the InfoSet and Electra Elite multiline telephones.

Feature Operation

Transferring a call:

1. Lift the handset or press  on the telephone where the call is received.
2. Press . This is line key on the telephone where the call is received.
3. The user at the telephone where the call was initially received hangs up.

Associated Programming

All programming functions associated with this feature are listed in the following table. Some functions must be programmed before the feature is operational and other functions are optional. The optional functions can affect how the feature operates.

Function Number	Function Name	Required (Y)es or (N)o
002-8	Private Call	Y

Special Conditions

- Holdfree transfer is enabled/disabled in system programming.
- Trunk queuing using a line key is disabled if holdfree transfer is enabled.
- When the user who receives the holdfree transfer presses  (external line key where the call is received) the extension number where the call transferred from and the trunk line number is displayed in the LCD of the user receiving the holdfree transfer (e.g., **XX L *** – XX = Extension Number and * = Trunk Line Number).
- If the following conditions occur, the user is not able to pick up the call during a holdfree transfer, a message is displayed in the LCD indicating the telephone is in use (e.g., **XX In Use** – XX = Extension Number).
 - A telephone that is the transfer destination has picked up the external line and is waiting for the user who initially answered the call to hang up.
 - The external line is part of an add-on conference.

Hold with Recall (Exclusive and Non-Exclusive)



When a call is on hold for longer than the preprogrammed interval, the call recalls to the originating telephone. There are two types of held calls. *Exclusive Hold* is a held call that can be picked up only on the telephone where it was placed on hold. *Non-Exclusive Hold* is a held call that can be picked up from any telephone in the system that has access to the line where the call is holding.

This feature is available for the InfoSet and Electra Elite multiline telephones and single line telephones.

Feature Operation

Putting a call on Exclusive or Non-Exclusive Hold:

If placing a call on Exclusive Hold, press  .

If placing a call on Non-Exclusive Hold, press , then  .

Retrieving a call from exclusive or non-exclusive hold:

Press  (flashing line key).

Placing a single line telephone call on exclusive hold:

Momentarily press the hookswitch to place the call on hold.

Retrieving a single line telephone call from exclusive hold:

Momentarily press the hookswitch to retrieve the call from hold.

Associated Programming

All programming functions associated with this feature are listed in the following table. Some functions must be programmed before the feature is operational and other functions are optional. The optional functions can affect how the feature operates.

Function Number	Function Name	Required (Y)es or (N)o
002-1	Music Source for Music on Hold	N
003	Hold Warning Tone Timer	Y
004	Exclusive Hold Warning Tone Timer	Y
012	Music on Hold Melody	N

Special Conditions

- After an external line (exclusive or non-exclusive) is placed on hold, a recall tone is generated to the telephone that placed the call after a preprogrammed interval has expired.
- The non-exclusive hold recall start timer and exclusive hold recall start timer can be set independently or each other.
- When a hold recall tone is sent to a multiline telephone and a call is holding, the trunk number associated with the line key is displayed in the telephone LCD.
- Telephones that are part of the same tenant group can pick up calls on hold.
- The LED of the line key that is placed on hold flashes green indicating the I-Hold condition. The line key LEDs on other telephones flash red indicating the call is on hold.
- If a telephone is busy, a recall cannot be answered.
- If the telephone is not idle when the hold recall timer expires, the hold recall tone is suppressed until the telephone becomes idle.
- After a call is placed on hold, the telephone can seize another external outside line to make a call or can answer other incoming calls.
- Only the telephone used to place a call on exclusive hold can pick up that call.
- Outside line key LEDs of telephones that are members of another tenant do not flash when a call is placed on hold.

- ☑ When a call is placed on hold, privacy is released.
- ☑ When a single line telephone is used to place a call on hold (by pressing the Flash Key), the handset should remain *off* of the cradle. If the handset is placed back on the cradle, a recall tone is immediately generated.
- ☑ The hold recall timer is specified in system programming using Function “003 – Hold Warning Tone Timer” (default - 1 minute). If “No Limit” is specified for the hold recall timer, a hold recall tone *is not* generated.

Howler Tone Service

Howler tone is provided if a telephone remains off-hook after a call has been completed or if the user goes off-hook and fails to dial before the preprogrammed time interval expires.

This feature is available for the InfoSet and Electra Elite multiline telephones and single line telephones.

Feature Operation

Not applicable.

Special Conditions

- Dialtone is sent for 15 seconds before a busy tone is heard. After an additional 20 seconds, a howler tone is heard signaling an off-hook condition.

Icon Display

Some icons are displayed in the LCD of the telephone to indicate certain conditions. For example, a clock is displayed to indicate an alarm has been set.

This feature is available only for InfoSet telephones.

Feature Operation

Not applicable.

Special Conditions

- The operations that are available for icon display include:
 - Night Mode
 - Call Forward – All Calls
 - Clock/Calendar Display (Month)
 - Timed Alarm set

I-Hold Indication

This feature provides easy identification of calls that a user has placed on hold. The system provides two colors to identify the holding calls. On the multiline telephone where a call originates, the line key LED flashes green. On the other telephones in the system, the line key LED flashes red.

This feature is available for the InfoSet and Electra Elite multiline telephones.

Feature Operation

Not applicable.

Associated Programming

All programming functions associated with this feature are listed in the following table. Some functions must be programmed before the feature is operational and other functions are optional. The optional functions can affect how the feature operates.

Function Number	Function Name	Required (Y)es or (N)o
003	Hold Warning Tone Timer	N
004	Exclusive Hold Warning Tone Timer	N
101~104	Telephone Number Display for Trunk Lines 1~4	N
401~402	Trunk Line Assignment for Tenants 1~2	N
403	Tenant to Telephone Assignment	N

Special Conditions

- The external line LED on telephones that are not members of the tenant will not flash to indicate I-Hold.
- The external line key LED on the transferring telephone remains lighted when a call is transferred to a telephone that is not a member of the transferring telephone's tenant.
- If an external call is transferred to a telephone that is in a different tenant group and that telephone picks up the call and places the call on hold, the line key LED on the telephone that originated the transfer goes off (i.e., the originating telephone no longer has call appearance for that call).
- When a call is placed on exclusive hold, the LED indication for other telephone is solid red (indicating the telephone busy).

Incoming Call Identification

This feature provides identification of incoming calls. If the call is from an internal or external user, the call is identified by showing the caller's name and extension/external line number in the telephone display.

This feature is available for InfoSet and Electra Elite multiline telephones that are equipped with an LCD.

Feature Operation

Entering an internal extension name:

1. Press ^{Feature} .
2. Dial .
TUV GHI
3. Dial the extension number.
4. Enter the name to be associated with the extension. (Refer to [Character Registration on page 3-44](#) for instructions for entering names.)
5. Press ^{Feature} .





Deleting an internal extension name:

1. Press ^{Feature} .
2. Dial .
TUV GHI
3. Dial the extension number.
4. Press ^{Feature} .

Entering an external line name:

1. Press ^{Feature} .
2. Dial .
TUV JKL
3. Dial the external line number.
4. Enter the name to be associated with the telephone number. (Refer to [Character Registration on page 3-44](#) for instructions for entering names.)
5. Press ^{Feature} .

Deleting an external line name:

1. Press ^{Feature} .
2. Dial  .
3. Dial the external line number.
4. Press ^{Feature} .

Associated Programming

All programming functions associated with this feature are listed in the following table. Some functions must be programmed before the feature is operational and other functions are optional. The optional functions can affect how the feature operates.

Function Number	Function Name	Required (Y)es or (N)o
101~104	Telephone Number Display for Trunk Lines 1~4	N
206	Extension Number Assignment	N
401~402	Trunk Line Assignment for Tenants 1~2	N

Special Conditions

- The name can be displayed on the telephone LCD during the idle condition.
- The telephone display shows incoming call identification information as follows:
10 ← [11] Bob
 In this example, extension 10 is calling extension 11.
- Before a telephone name can be displayed it must be programmed into the system by the user. The name can be a maximum of six alphanumeric characters.
- The name display takes precedence over the transferred call indication during a transferred call. The name disappears from the display when the transferred call is answered.
- The name display for an automatic transferred call takes precedence over the transferred call indication when the transferred call is completed. The call time is reached five seconds after the call is answered and the name disappears.
- During a conference call, only the extension number is displayed even if the name has been programmed into the system.
- A maximum of three extension numbers can be displayed during a conference add-on. If an extension is placed on hold during an conference add-on, the holding party's display changes from [XX] to <XX> on the LCD of the held party (XX = Extension Number).



Internal Recall

When hearing a busy tone or error tone, users can capture dialtone for internal calls by pressing a specified key on multiline telephones or by pressing hookswitch on single line telephones.

This feature is available for InfoSet and Electra Elite multiline telephones and single line telephones.

Feature Operation

Capturing dialtone:

After hearing a busy or error tone, press  (for InfoSet telephones) or  (for Electra Elite telephones), or hookswitch (single line telephone). Internal dialtone is provided.

Associated Programming

All programming functions associated with this feature are listed in the following table. Some functions must be programmed before the feature is operational and other functions are optional. The optional functions can affect how the feature operates.

Function Number	Function Name	Required (Y)es or (N)o
001-9	Single Line Telephone Hookflash Assignment	N

Special Conditions

- Internal recall is enabled in the following situations:
 - System is waiting for the second digit of an internal extension number to be dialed.
 - Busy signal is received when placing an external call.
- If a single line telephone has been programmed to seize an external line when going off-hook, the user must perform a hookflash to access internal dialtone.

Internal Voice/Tone Signaling

In system programming, internal calls can be assigned to signal an incoming call by either ringing or voice announcement. The caller can override the system setting for individual calls by dialing (access code).

This feature is available for the InfoSet and Electra Elite multiline telephones.

Feature Operation

Making a call when the system is programmed for voice/tone signaling:

1. Lift the handset.
2. When you hear internal dialtone, dial the desired extension number.
3. When you hear the tone, voice announce the call or dial to provide ringing.
4. The called party can reply handsfree if the call is voice announced. If the call provides ringing, the called party answers by lifting the handset or by pressing Speaker .

Making a call when the system is programmed for tone/voice signaling:

1. Lift the handset.
2. When you hear internal dialtone, dial the desired extension number.
3. The called party's telephone rings. If you wish to voice announce the call, dial .
4. The called party can reply handsfree if the call is voice announced. If the call provides ringing, the called party answers by lifting the handset or by pressing Speaker .

Associated Programming

All programming functions associated with this feature are listed in the following table. Some functions must be programmed before the feature is operational and other functions are optional. The optional functions can affect how the feature operates.

Function Number	Function Name	Required (Y)es or (N)o
001-1	Internal Call Notification	Y

Special Conditions

- ☑ Users can toggle between voice/tone by dialing while a call is in progress.
- ☑ A single line telephone can be used to make voice announcements to multiline telephone users.
- ☑ A one-touch key can be programmed to switch between voice and tone. A one-touch key can be programmed to dial the desired extension number and the access code ().
- ☑ Voice or tone signaling is assigned system-wide using system programming.
- ☑ Voice announcement is the system default setting.
- ☑ The telephone microphone must be activated for handsfree answer when telephone receives a voice announced call.
- ☑ Users cannot voice announce to single line telephones.
- ☑ Switching between voice announcement and tone signaling is disabled when calling a single line telephone.
- ☑ Tone override is disabled during an incoming voice call.
- ☑ The call can only be switched between voice/tone using the multiline telephone originating the call.

I-Use Indication

This feature provides indications about the line that is in use by illuminating the green LED associated with the line key. Busy lines are illuminated in red, this allows the user to quickly identify those lines that are in use.

This feature is available for InfoSet and Electra Elite multiline telephones.

Feature Operation

Not applicable.

Associated Programming

All programming functions associated with this feature are listed in the following table. Some functions must be programmed before the feature is operational and other functions are optional. The optional functions can affect how the feature operates.

Function Number	Function Name	Required (Y)es or (N)o
206	Extension Number Assignment	N
209	Outgoing Call Priority Mode	N
301~304	Day Ringing for Trunk Lines 1~4	N
311~314	Night Ringing for Trunk Lines 1~4	N
401~402	Trunk to Tenant Assignment Tenants 1~2	N

Special Conditions

- If an external call is transferred to an extension that is a member of another tenant group, LED indication is provided. For all other types of calls, no LED indication is provided to extensions that are members of a different tenant group.
- A solid green LED indicates the I-Use condition on the telephone with a call in progress. Other telephones in the system display a red LED to indicate the line is in use.
- I-Hold condition is indicated by a flashing green LED.

Key Function/Multifunction Registration

The system can be registered as a Key Function (KF) or a Multifunction (MF) telephone system using system programming.

Feature Operation

Not applicable.

Associated Programming

All programming functions associated with this feature are listed in the following table. Some functions must be programmed before the feature is operational and other functions are optional. The optional functions can affect how the feature operates.

Function Number	Function Name	Required (Y)es or (N)o
009	Outgoing Call Line Selection	Y
209	Outgoing Call Priority Mode	N
331~334	Automatic Line Selection for Trunk Lines 1~4	N

Special Conditions

- When a system is set to KF, the external line key must be pressed to access the external line. External calls cannot be made from internal dialtone using a trunk access code ($\overline{9}$ \overline{WXYZ}). Calls can be made from internal dialtone if a specified trunk access code is dialed first ($\overline{6}$ \overline{MNO} $\overline{3}$ \overline{DEF} + **X**) (X = Trunk Number 1~4).
- When the system is set to multifunction, external lines can be accessed from internal dialtone by dialing the trunk access code ($\overline{9}$ \overline{WXYZ}).
- When the system is set to KF, the following external calls are prohibited:
 - Prime Line with Automatic Trunk Selection
 - Speed Dial with Automatic Trunk Selection
 - Last Number Redial with Automatic Trunk Selection
- Key function or multifunction selection is made in system programming using Function "009 – Outgoing Call Line Selection".
- In KF mode, single line telephones can be used for internal calls and can access external lines using the trunk access code ($\overline{9}$ \overline{WXYZ}).



Manual Line Seizure

An outside line can be accessed by pressing a line key.

This feature is available for InfoSet and Electra Elite multiline telephones.

Feature Operation

Manually accessing an outside line:

1. Press  (external line key). The  LED lights and dialtone is heard.
2. Remain on the speakerphone or lift the handset.

Special Conditions

- An error is displayed in the telephone LCD when the user presses a line key that cannot seize an external line (e.g., the external line is a member of another tenant).
- The line key LED on the telephone that seizes the line lights green, all other telephone LEDs light red.
- When manual line seizure is attempted by more than one telephone user simultaneously, the line key LED on the first telephone to select the external line lights green. The other telephones receive the message "IN USE" in the telephone LCD.



Manual Pause

This feature allows users to insert a pause while dialing a telephone number. The pause can also be programmed on a one-touch/feature access key or can be inserted by dialing an access code.







This feature is available for InfoSet and Electra Elite multiline telephones.

Feature Operation

Inserting a pause:

1. Lift the handset or press .
2. Press .
3. Dial . The pause is inserted.

Assigning a one-touch key to manually insert a pause:

1. Press .
2. Press  ( for Electra Elite telephones).
3. Press  (line key to be programmed as the one-touch/feature access key).
4. Press  .
5. Press .

Special Conditions

- Call restriction is not checked for a pause.
- Manual pauses are stored in the last number redial memory location and can be stored in speed dial memory locations.

Message Waiting Indication for Voice Mail

When a user has a voice message, the large LED lights solid red. This provides distinctive indication that there is a message waiting.

This feature is available for the InfoSet and Electra Elite telephones.

Feature Operation

To respond to a voice mail message indication:

1. Call the extension number for voice mail.
2. After the voice mail system answers, follow the prompts to retrieve messages.

Special Conditions

- Only the voice mail system can set or cancel the message waiting indication.
- Message waiting status is retained by the system memory backup battery.

Microphone Control

The microphone can be turned on and off and the on/off status is indicated on the multiline telephone. A one-touch key can be programmed for microphone control or an access code can be dialed to mute the microphone for privacy during incoming voice announced calls and during calls that use the built-in speaker phone.

This feature is available for InfoSet or Electra Elite multiline telephones.

Feature Operation

Using a one-touch key to turn the microphone on/off:

Press the one-touch key programmed to control the microphone. The microphone toggles on and off.

Using an access code to turn the microphone on/off:

Press ^{Feature}  . The microphone toggles on and off.

Associated Programming

All programming functions associated with this feature are listed in the following table. Some functions must be programmed before the feature is operational and other functions are optional. The optional functions can affect how the feature operates.

Function Number	Function Name	Required (Y)es or (N)o
216	Handsfree Assignment	N

Special Conditions

- When the system is initially powered up, all microphones are turned on. If the system loses power or is turned off and then on, the microphones retain the on/off status that was set before the power loss.
- When calling another telephone within the system, the user's voice is heard through the speaker at the called telephone.
- When the microphone is on, the MIC LED lights red. When the microphone is off, the MIC LED is off.
- A telephone that is disabled for handsfree speakerphone operation can still use the speakerphone for internal voice announcements.
- If the handsfree option is not turned on when ^{Speaker}  is pressed, the speakerphone operation will not function.

Music on Hold

Music can be provided to caller's on hold using the system's internal music source or by connecting an external music source (user-provided) such as a radio, tape player, or compact disc.

This feature is available for the InfoSet and Electra Elite multiline telephones and single line telephones.

Feature Operation

Not applicable.

Associated Programming

All programming functions associated with this feature are listed in the following table. Some functions must be programmed before the feature is operational and other functions are optional. The optional functions can affect how the feature operates.

Function Number	Function Name	Required (Y)es or (N)o
002-1	Music Source for Music on Hold	N
012	Music on Hold Melody	N

Special Conditions

- The external music on hold and background music share the same input source on the KSU.
- Music on hold can be generated in internal an external calls that are placed on hold.
- The music on hold source can be selected from the internal or external music on hold source, which is connected to external hold tone/background music on the KSU.
- When using external music on hold, the music source (e.g., tape deck, radio, CD) must be connected to the system. Music is not generated if the external music on hold is specified but the external music source has not been connected.

Nesting Dial

This feature allows speed dial buffer numbers (either system or individual) to be nested or chained into another buffer, allowing numbers to be dialed consecutively by simply pressing one button.

This feature is available for the InfoSet and Electra Elite multiline telephones and single line telephones. Note that the single line telephones cannot be used to program nesting dial, but they can use the nesting dial feature.

Feature Operation

Programming nested dialing

1. Press ^{Feature} .
2. Press ^{SPD} .
3. Dial the speed dial memory location number where the other speed dial memory location numbers will be stored (² ⁰ ^{A B C} ^{OPER} ~ ⁹ ⁹ ^{W X Y Z} ^{W X Y Z} or ⁰ ⁰ ⁰ ^{OPER} ^{OPER} ^{OPER} ~ ¹ ⁹ ⁹ ^{W X Y Z} ^{W X Y Z}).
4. Press ^{Answer} .
5. Dial the speed dial memory location number(s) that will be nested or chain dialed (² ⁰ ^{A B C} ^{OPER} ~ ⁹ ⁹ ^{W X Y Z} ^{W X Y Z} or ⁰ ⁰ ⁰ ^{OPER} ^{OPER} ^{OPER} ~ ¹ ⁹ ⁹ ^{W X Y Z} ^{W X Y Z}). (Repeat steps 4 and 5 for each memory location number to be nested.)
6. Press ^{Transfer} and enter a name if desired. (Refer to [Character Registration on page 3-44](#) for instructions about entering names.)
7. Press ^{Feature} .

Using nested dialing:

1. Press ^{SPD} .
2. Dial the speed dial memory location number where the other memory location numbers that will be consecutively dialed are stored (² ⁰ ^{A B C} ^{OPER} ~ ⁹ ⁹ ^{W X Y Z} ^{W X Y Z} or ⁰ ⁰ ⁰ ^{OPER} ^{OPER} ^{OPER} ~ ¹ ⁹ ⁹ ^{W X Y Z} ^{W X Y Z}).

The system automatically dials the numbers that were stored in each of the memory locations.

Confirming the buffers stored in a nested dialing memory location:

1. Press ^{Conf} .
2. Press ^{SPD} .
3. Dial the speed dial buffer number where the other buffers numbers (~ or ~) that will be consecutively dialed are stored.

The system displays the buffers numbers that were stored in the nested dialing buffer.

4. Press ^{Feature} to scroll to the next page if necessary.

Deleting a nested speed dial memory location:

1. Press ^{Feature} .
2. Press ^{Redial} .
3. Dial the speed dial buffer number where the other buffers numbers (~ or ~) that will be consecutively dialed are stored .
4. Press ^{Feature} .

Deleting a system speed dial memory location and associated name:

1. Press ^{Feature} .
2. Press ^{Redial} .
3. Dial the speed dial buffer number where the other buffers numbers (~ or ~) that will be consecutively dialed are stored .
4. Press ^{Transfer} .
5. Press ^{Feature} .

Associated Programming

All programming functions associated with this feature are listed in the following table. Some functions must be programmed before the feature is operational and other functions are optional. The optional functions can affect how the feature operates.

Function Number	Function Name	Required (Y)es or (N)o
001-2	Speed Dial Assignment	N

Special Conditions

- A maximum of five speed dial memories can be nested. If a sixth speed dial memory location is attempted to be nested, "ERROR" is displayed in the telephone LCD.
- A speed dial memory cannot be nested into itself.
- A speed dial memory with nested numbers cannot be nested in another speed dial memory location.
- Station speed dial memory locations cannot be nested into system speed dial memory locations.
- If a call is originated using speed dialing and the memory location is empty, the following message is displayed in the telephone LCD: **XX: Empty** (XX = Memory Location Number).
- If a call is originated with a speed dial number that has more than three nested speed dial memory locations, only the first three memory locations are displayed in the telephone LCD.
- If a call is originated with a speed dial number that has a "name" associated with it, the "name" is displayed in the telephone LCD. The clock display is restored when the external party answers the call.
- If a system is programmed to allow both central office and PBX lines and a call is originated using a speed dial number for which no PBX access code is included in the dialing string, the external line is released and "ERROR" is displayed in the telephone LCD.
- A maximum of 24 digits can be programmed in a speed dial memory. A nesting dial is counted as three digits in the 80 system speed dial mode and four digits in the 200 system speed dial mode.
- Speed dialing can be used after manually dialing the number for multiline telephones. This cannot be done for single line telephones.
- Nested speed dial numbers cannot be programmed from a single line telephone. However, speed dial calls can be made from a single line telephone.

Night Mode





All telephones in the system can be placed into or out of night mode. This provides changes in the ringing assignment for central office and PBX lines and direct inward termination (DIT) assignments. This mode is set on a system-wide basis.

This feature is available for the InfoSet and Electra Elite multiline telephones.









- ☞ Refer to [Automatic Day/Night Mode Switching on page 3-10](#) for instructions for automatically switching between day/night modes.

Feature Operation

Manually setting night mode:

1. Press ^{Feature}  while the telephone is in the idle condition.
2. Dial  .
3. Press ^{Feature} .

Assigning a one-touch key to set night mode:

1. Press ^{Feature}  while the telephone is in the idle condition.
2. Press ^{SPD} .
3. Press  (the one-touch key to be assigned for night mode).
4. Dial   .
5. Press ^{Transfer}  to enter an associated name. (Refer to [Character Registration on page 3-44](#) for instructions about assigning a name.)
6. Press ^{Feature} .

Associated Programming

All programming functions associated with this feature are listed in the following table. Some functions must be programmed before the feature is operational and other functions are optional. The optional functions can affect how the feature operates.

Function Number	Function Name	Required (Y)es or (N)o
124	External Speaker Ringing for Day Mode	N
125	External Speaker Ringing for Night Mode	N
140~143	Direct Calling for Day Mode on Trunk Lines 1~4 (DIT Assignment)	N
144~147	Direct Calling for Night Mode on Trunk Lines 1~4 (DIT Assignment)	N
148	Direct Calling Answer Delay Time (DIT Answer Delay)	N
149	Direct Calling Delay for Night Mode (DIT Answer Delay)	N
210~211	Doorphones 1~2 Tone for Day Mode	N
213~214	Doorphones 1~2 Tone for Night Mode	N
301~304	Day Ringing for Trunk Lines 1~4	Y
311~314	Night Ringing for Trunk Lines 1~4	Y

Special Conditions

- Ringing is not generated for incoming calls from another tenant group regardless of the settings.
- Multiline telephones without ringing remain silent. However, the external line key LED flashes red.
- Ringing can be assigned to each multiline and single line telephone for both day mode and night mode.
- All telephones can be assigned to ring on incoming calls on all lines for both night mode and day mode.
- When the system switches to night mode, the telephone display switches to:
 - **Night** (InfoSet telephones)
 - **I** (Electra Elite telephones - displayed on the left side of the clock)

- ☑ Night mode toggles on and off when the manual switching operation is performed.
- ☑ Day/Night mode switching affects the following functions:
 - Incoming Call Identification (assigned using Functions “301~304 – Day Ringing for Trunk Lines 1~4” and “311~314 – Night Ringing for Trunk Lines 1~4”)
 - External Ring Control (assigned using Functions “124 – External Speaker Ringing for Day Mode” and “125 – External Speaker Ringing for Night Mode”)
 - Doorphone Ring Assignment (assigned using Functions “210~211 – Doorphones 1~2 for Day Mode” and “213~214 – Doorphones 1~2 for Night Mode”)

Off-Hook Ringing

If a user is currently on a call and receives another external call, off-hook ringing is provided to the telephone's external speaker. Off-hook Ringing is at a lower volume than normal on-hook ringing.

This feature is available for InfoSet and Electra Elite multiline telephones.

Feature Operation

Not applicable.

Associated Programming

All programming functions associated with this feature are listed in the following table. Some functions must be programmed before the feature is operational and other functions are optional. The optional functions can affect how the feature operates.

Function Number	Function Name	Required (Y)es or (N)o
202	Off-Hook Ringing Tone	N

Special Conditions

- Off-hook ringng is only enabled for external lines that have incoming external ringing specified.
- Off-hook ringing volume can be adjusted.
- A multiline telephone that is using the speakerphone or is set for do not disturb does not receive off-hook ringing tone.
- A doorphone can generate off-hook ringing tone.
- Off-hook ringing can be generated during a call where the headset is used (headset is only available for Electra Elite telephones).





One-Touch/Feature Access Keys – User Programmable

Multiline telephone users can press a single key that has been programmed for functions such as speed dialing, extension numbers, access codes, etc. By using the one-touch key the user does not need to go off-hook, they simply press the programmed key and the system seizes a line and dials the number.





This feature is available for the InfoSet and Electra Elite multiline telephones.





Feature Operation

Programming a one-touch/feature access key:



1. Press  while the telephone is in the idle condition.
2. Press  (for InfoSet telephones) or  (for Electra Elite telephones).
3. Press  (one-touch/feature access key).

Note: This must be line key that not being used to seize an external line or has already been assigned as a one-touch/feature access key.





4. Enter the appropriate “dial operation code” (i.e., , , , , or ). These dial operation codes indicate to the system which operation is being stored under the one-touch key. For example, if * is entered then the system expects a CO/PBX number of 24 digits (maximum) to be entered. The following tables list each dial operation code, a description of the operation, the maximum number of digits that can be entered for the number being stored, and the valid number/special “codes” that can be stored for each number.

Dial Operation Code	Dial Operation Description	Maximum Digits	Valid Entry Keys
*	CO/PBX Telephone Number	24	0 ~ 9, *, #  or  = Pause  or  = Hookflash  = Nesting Dial
#	Feature Access Number	16	0 ~ 9, *, #
0	Speed Dial Number	15	0 ~ 9, *, #
1	Extension Number/ Internal Dial No.	16	0 ~ 9, *, #



Dial Operation Code	Dial Operation Description	Maximum Digits	Valid Entry Keys
2	Special Feature Number	2	0 ~ 9, *, #

5. Enter the appropriate telephone number, speed dial memory location number, extension number, special dial number, or feature access code.
6. Press ^{Transfer}  and enter the associated "name" (alphabetic characters). (Refer to [Character Registration on page 3-44](#) for instructions about entering alphanumeric characters.)
7. Press ^{Feature} .





Using the one-touch/feature access key for speed dialing:

1. Press  (CO/PBX line key to seize an external line).
 2. Press  (one-touch /feature access key where the speed dial number is stored).
 3. Remain on the speakerphone or lift the handset to talk when the called party answers.
- OR -**
1. Press ^{Feature} .
 2. Press  (one-touch/feature access key). The stored data is displayed in the telephone LCD.
 3. Press  (CO/PBX line key to seize an external line).
 4. Remain on the speakerphone or lift the handset to talk when the called party answers.







Confirming data stored under a one-touch/feature access key:

1. Press ^{Feature} .
1. Press  (one-touch/feature access where the data is stored). If data has been stored for the one-touch/feature access key it is displayed in the telephone LCD. If no data has been stored, "ERROR" is displayed in the telephone LCD.

Deleting data stored under a one-touch/feature access key:

1. Press ^{Feature}  while the telephone is in the idle condition.
2. Press ^{SPD}  (for InfoSet telephones) or  (for Electra Elite telephones).
3. Press  (one-touch/feature access key).
4. Press ^{Feature} .

Deleting the “name” associated with a one-touch/feature access key:

1. Press ^{Feature}  while the telephone is in the idle condition.
2. Press ^{SPD}  (for InfoSet telephones) or  (for Electra Elite telephones).
3. Press  (one-touch/feature access key).
4. Press ^{Transfer}  to delete the alphanumeric “name” associated with the one-touch/feature access key.
5. Press ^{Feature} .

Associated Programming

All programming functions associated with this feature are listed in the following table. Some functions must be programmed before the feature is operational and other functions are optional. The optional functions can affect how the feature operates.

Function Number	Function Name	Required (Y)es or (N)o
001-2	Speed Dial Assignment	N
001-7	One-Touch Key Direct Access for Outgoing Calls	N
001-8	One-Touch Key Duplication Assignment	N
009	Outgoing Call Line Selection	N
107	Trunk Line Type	N
109	Trunk Line Dialing Type	N

Special Conditions

- ☑ Any unused line keys can be assigned as one-touch/feature access keys.
- ☑ When deleting one-touch/feature access key information, the dialing information and the associated “name” (if assigned) must be deleted in separate operations.
- ☑ If CO and PBX lines are assigned, the call cannot be completed unless the PBX access code is stored under the one-touch/feature access key as part of the dialing string.
- ☑ If duplicate information is stored under more than one one-touch/feature access key, the information that was previously stored is erased and the current information is stored.
- ☑ If the number of speed dial memory locations is changed using “001-2 – Speed Dial Assignment”, all data that is stored under one-touch/feature access keys is deleted.

PC Programming

Users can program the key system using a PC. A PC is connected to the key system using an RS-232C cable which allows the system parameters to be downloaded to the PC and then modified. Once modified, the system parameters are then uploaded to the key system.

An MIF-B10 ETU must be installed in the system for this feature to operate.

The *minimum* requirements for the PC to run this program include:

- 100 MHz Pentium processor
- 16 MB RAM
- 10 MB hard disk space
- 640 x 480 monitor resolution
- Window 95/98
- Internet Explorer 4.1
- Netscape Communicator 4.7

The *recommended* requirements for running PC Programming include:

- 166 MHz Pentium processor
- 64 MB RAM
- 10 MB hard disk space
- 1024 x 768 monitor resolution
- Windows 95/98

Feature Operation

Refer to [Chapter 7 PC Programming](#) for operational instructions.

Special Conditions

- The PC port is used for both SMDR print output and PC programming. The system must be in PC programming mode before connecting a PC to the system. This is accomplished by dialing **Feature** from either extension 10 or 11. (Note that this access code is used to toggle between the SMDR print output mode and PC programming mode.) The mode is displayed in the telephone LCD for five seconds allowing the user to verify that the desired mode has been properly set.

- ☑ When system data is uploaded from the PC to the KSU, the KSU is updated with the data from PC programming. During the upload process, data is temporarily stored in a “working” memory area if any of the telephones are in-use. Once the system is idle, the data is updated in system memory.
- ☑ The baud rate between the MIF ETU and the PC is fixed at 19,200 bps and the Start/Stop bit is set to 1.
- ☑ All user programmable assignments such as one-touch keys and speed dialing can also be assigned using PC programming.

Power Failure Transfer

Power Failure Transfer ensures that a customer has access to the telephone company's central office network during a power outage. When system power is lost and power supplied by the battery backup has expired, the first external telephone line coming into the system is automatically transferred to the power failure transfer connection (RJ-11) on the side of the KSU.

This feature is available for use with single line telephones.

Feature Operation

Not applicable.

Special Conditions

- During a power outage, calls can be made from the single line telephone that is connected to the power failure transfer (PFT) port (external telephone line 1).

Preset Dialing

This feature allows users to dial a telephone number before actually going off-hook. The number is displayed in the telephone LCD allowing the user to verify the number before actually going off-hook. The number is dialed once the user goes off-hook.

This feature is available for InfoSet or Electra Elite multiline telephones.

Feature Operation

Dialing:

1. Before going off-hook, dial the telephone number.
2. Go off-hook by lifting the handset or pressing  (line key).

Associated Programming

All programming functions associated with this feature are listed in the following table. Some functions must be programmed before the feature is operational and other functions are optional. The optional functions can affect how the feature operates.

Function Number	Function Name	Required (Y)es or (N)o
209	Outgoing Call Priority Mode	N

Special Conditions

- A maximum of 24 digits can be entered. If the user attempts to enter more than 24 digits, "ERROR" is displayed in the telephone LCD and preset dialing is canceled.
- If function "209 – Outgoing Call Priority Mode" is set to Internal Line preference, preset dialing is only available when a CO line key is pressed; it is not available by lifting the handset.
- Call Restriction is performed *after* the external line is seized.
- After the digit display timer expires (10 seconds), preset dialing is canceled if the user does not press an available CO line key or lifts the handset.

Prime Line Assignment

Prime Line Assignment allows a user to go off-hook and make an external call from a trunk line without pressing a line key. The system is programmed to automatically select a specified trunk line when the user goes off-hook. Internal calls are made by pressing ^{Speaker}  which accesses internal dialtone.

This feature is available for the InfoSet and Electra Elite multiline telephones and single line telephones.

Feature Operation

Making an external call:

Lift the handset. The outside line is automatically seized.

Making an internal call:

1. Press ^{Speaker}  to access internal dialtone.
2. Remain on the speakerphone or lift the handset and dial the desired extension number.

Associated Programming

All programming functions associated with this feature are listed in the following table. Some functions must be programmed before the feature is operational and other functions are optional. The optional functions can affect how the feature operates.

Function Number	Function Name	Required (Y)es or (N)o
209	Outgoing Call Priority Mode	N
331~334	Automatic Line Selection for Trunk Lines 1~4	N

Special Conditions

- At default all telephones are set to seize the first available external line.
- If a telephone is assigned to seize an external line, preset dialing is performed after the user dials the number and then lifts the handset.

- ☑ If an external line is assigned for automatic answering (using Functions “341~344 – Automatic Answering using Trunks 1~4”), external ringing calls are answered when the handset is lifted. If the external line is a transferred call, that external line is answered when the handset is lifted.
- ☑ The external line is seized after the handset is lifted and the external line key is pressed.
- ☑ If the handset is lifted during trunk queuing, the queued external line is seized.
- ☑ A single line telephone that has been assigned to seize an external line accesses internal dialtone by pressing hookflash.

Privacy on all Calls

The system provides complete privacy on all calls. No other telephone user can enter another's conversation unless that user permits them to enter the conversation by releasing privacy or by adding them to a conference. The Barge-In feature, if enabled, overrides privacy on all calls and allows the barge-in user to enter the conversation.

This feature is available for InfoSet and Electra Elite multiline telephones and single line telephones.

Feature Operation

Releasing privacy:

Press ^{Feature} ⁷ while engaged on a call to release privacy.

Connecting to a call that has been released:

Lift the handset and press the line key of the call where privacy has been released.





Associated Programming

All programming functions associated with this feature are listed in the following table. Some functions must be programmed before the feature is operational and other functions are optional. The optional functions can affect how the feature operates.

Function Number	Function Name	Required (Y)es or (N)o
002-8	Private Call	Y

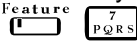
Special Conditions

- Privacy release cannot occur while dialing. After the called party answers or any incoming call is answered, privacy can be released.
- Privacy release cannot occur if an add-on conference is in progress.
- Privacy release cannot be performed if all conference circuits are in use. When all conference circuits are busy, the ^{Conf} LED lights red.
- Only one telephone user can interrupt another's conversation using privacy release.
- A maximum of two external lines can have privacy released.

- ☑ Privacy release can only occur for external lines within the same tenant group. If a call is transferred to another tenant group, privacy cannot be released.
- ☑ Privacy on all calls is the default setting when the system is initially installed.
- ☑ The Barge-In feature can be used to access a telephone line that does not have privacy released. If Barge-In is enabled in system programming, it overrides the privacy assignment. [Refer to [Barge-In \(Interrupting an External Call\)](#) on page 3-20.]
- ☑ Privacy on all calls a can be released by individual users by pressing  while on an external call. If  are pressed again, privacy release is canceled.
- ☑ Privacy release is not available for single line telephones.
- ☑ Privacy for all calls is restored after the external line that has released privacy hangs up or presses hookflash.
- ☑ LCD indication for privacy release is the same as the display for an add-on conference on an external line.
- ☑ The  LED flashes red on the telephone where privacy is released and lights solid red on the  LED on the telephone that picks up the line.
- ☑ A single line telephone can access an external line that has privacy released by dialing   and the external line number.



Programmable Pause for Speed Dial

Users can insert a pause when programming speed dial numbers using this feature. The pause allows a short delay before accessing an external line.

This feature is available for the InfoSet and Electra Elite multiline telephones.

Feature Operation

Programming a pause:

While entering a speed dial number, press  (for InfoSet telephones) or  (for Electra Elite telephones). A pause is inserted between digits.

Special Conditions

- A pause can be programmed as the first digit of a dialing string.
- Pauses cannot be inserted using a single line telephone.
- Pauses can be entered when speed dial numbers are assigned using PC programming.
- A single line telephone can use speed dial numbers that include pauses.
- Pauses can be inserted between digits. Consecutive pauses can also be inserted into a dialing string.
- A pause is counted as one digit (speed dial numbers are a maximum of 24 digits).
- One pause is equivalent to three seconds (fixed).

Programming from Multiline Telephone

The system can be programmed using a multiline telephone. It is necessary to use a telephone with an LCD to view the programmable options. Only ports 1 and 2 (normally assigned to extensions 10 and 11) are used for telephone programming.

This feature is applicable for the InfoSet and Electra Elite display telephones.

Feature Operation

Refer to [Chapter 6 Telephone Programming](#).

Special Conditions

- "PROGRAMMING DATA" is displayed in the telephone LCD while system data is being updated.
- Only one telephone can be in programming mode at a time.
- System data can be programmed while the system is operational.
- Background music and room monitoring are disabled when the system is being programmed.

Resident System Program

When power is supplied to the system, the system scans the hardware configuration and assigns default values. This allows for plug-and-play operation of the system. Once operational, the system can be customized for individual customers.

Feature Operation

Not applicable.

Associated Programming

All programming functions associated with this feature are listed in the following table. Some functions must be programmed before the feature is operational and other functions are optional. The optional functions can affect how the feature operates.

Function Number	Function Name	Required (Y)es or (N)o
109	Trunk Line Dialing Type	N

Special Conditions

- If no COI(2)-B10 ETU is installed, line keys 1~2 are assigned as external line keys.
- Line keys 1~4 are assigned as external line keys when the expansion COI(2)-B10 ETU is installed.
- If there are only two external lines, line keys 3 and 4 can be used as one-touch/feature access keys. If external lines 3 and 4 are installed at a later time (after they have been assigned as one-touch/feature access keys), they become external line keys.
- At default, external line keys 1~4 (depending on hardware configuration) are assigned DTMF (touchtone) signaling.

Ringling Line Preference

When using ringing line preference, the user can answer any ringing line on their multiline telephones by lifting the handset or pressing  (it is not necessary to press the line key first).

This feature is available for the InfoSet and Electra Elite multiline telephones and single line telephones.

Feature Operation

Answering a call at the telephone where Ringling Line Preference is assigned

Lift the handset and talk with the calling party.

Associated Programming

All programming functions associated with this feature are listed in the following table. Some functions must be programmed before the feature is operational and other functions are optional. The optional functions can affect how the feature operates.

Function Number	Function Name	Required (Y)es or (N)o
301 ~ 304	Day Ringing for Trunk Lines 1 ~ 4	Y
311~314	Night Ringing for Trunk Lines 1~4	Y
341~344	Automatic Answering using Trunk Lines 1 ~ 4	Y

Special Conditions

- Answering incoming calls requires the external line to audibly ring at the telephone (including single line telephones).
- Answering incoming calls by going off-hook is assigned in programming using Functions "341~344 – Automatic Answering using Trunk Lines 1~4".
- Ringing line preference calls are answered in the order they are received.
- When more than one call rings into the system, they are answered in the following order:
 - Internal Incoming Call
 - Ringing Transfer Call
 - Incoming External Call
- Ringing line preference takes precedence over prime line preference (when it is assigned).





Room Monitor Telephone

A telephone can be used to monitor a room (e.g., this could be used to monitor a baby's room or a children's play area).

This feature is available for InfoSet and Electra Elite multiline telephones.





Feature Operation

Setting a telephone to be monitored:

1. Press ^{Feature} .
2. Dial  .
3. Press ^{Feature} .

Note: This is the telephone that is located in the room to be monitored. You must perform this procedure from that telephone. This procedure toggles the operation on and off.

Setting a telephone to monitor:

1. Press ^{Feature} .
2. Dial  .
3. Press ^{Feature} .

Note: This is the telephone that is located in the room where you will be listening. You must perform this procedure from that telephone. This procedure toggles the operation on and off.

Special Conditions

- If the monitored telephone is in use, the monitoring (listening) telephone cannot monitor the room area.
- If a user attempts to set a telephone as a monitored telephone (the telephone located in the area to be monitored) and it is already set as a monitoring telephone (listening telephone), "ERROR" is displayed in the telephone LCD.
- If a user attempts to set a telephone as a monitoring telephone (listening telephone) and it is already set as monitored telephone (the telephone located in the area to be monitored), "ERROR" is displayed in the telephone LCD.
- When a telephone is enabled as a monitored telephone (the telephone located in the area to be monitored), background music is no longer heard.

- ☑ Only one monitored telephone (the telephone located in the area to be monitored) can be designated at a time, however any number of multiline telephones can be set as monitoring (listening) telephones.
- ☑ While a telephone is being monitored (the telephone located in the area to be monitored), the microphone LED flashes red.
- ☑ When a telephone is enabled as the monitoring (listening) telephone, the speaker LED flashes red.

Seized Trunk Name/Number Display

The telephone number (assigned in system programming) for each trunk in the system is displayed when this feature is enabled. The telephone number appears in the telephone display when the trunk is seized.



This feature is available for InfoSet and Electra Elite multiline telephones equipped with a display.

Feature Operation



Automatically displaying the telephone number:

Press  (trunk line key) while the telephone is idle. The telephone line is seized and the telephone number and associated name (assigned in system programming) are displayed.

Manually displaying the telephone number with a call in progress:

1. Press .
2. Dial . The trunk line is seized and the telephone number and associated name (assigned in system programming) are displayed.





Assigning a name to a trunk line:

1. Press .
2. Dial  .
3. Enter the name. (Refer to [Character Registration on page 3-44.](#))

Note: The name is a maximum of 16 alphanumeric characters.

4. Press .

Deleting a name:

1. Press .
2. Dial  .
3. Press .

Associated Programming

All programming functions associated with this feature are listed in the following table. Some functions must be programmed before the feature is operational and other functions are optional. The optional functions can affect how the feature operates.

Function Number	Function Name	Required (Y)es or (N)o
101~104	Telephone Number Display for Trunk Lines 1~4	Y

Special Conditions

- Trunk information cannot be displayed during an add-on conference that includes an external line.
- The telephone number assigned to the external trunk line is displayed in the first line of the telephone LCD. The name associated with the external trunk line is displayed in the second line of the telephone LCD.
- If a name has not been assigned for the seized trunk line, the telephone number of external line number is displayed in the first line of the LCD.
- A one-touch/feature access key that has been programmed to verify the external line number and name can only be used while a call is in progress.
- The seized trunk number displayed is shown during redialing. The number is displayed for five seconds and then the elapsed call timer is restored to the LCD.
- A name can be programmed for each trunk line. The name is a maximum of 16 alphanumeric characters.

Single Line Telephone Access

Single line telephones can be connected to the system. These telephones can be used to make external calls, internal calls and paging calls.

To provide this feature for InfoSet 408 systems, an SLI(2)-B10 ETU and PBR-B10 ETU must be installed in the KSU.

Feature Operation

Originating an internal call when the outgoing call priority mode is set to seize an internal line:

1. Lift the handset.
2. Dial the desired extension number.
3. Talk when the called party answers.

Originating an internal call when the outgoing call priority mode is set to seize an external line:

1. Lift the handset.
2. Press hookflash.
3. Dial the desired extension number.
4. Talk when the called party answers.

Originating an external call when the outgoing call priority mode is set to seize an external line:

1. Lift the handset.
2. Dial the desired telephone number.
3. Talk when the called party answers.

Originating an external call when the outgoing call priority mode is set to seize an internal line:

1. Lift the handset.
2. Dial the access code to access a trunk (default: **9**) or feature access code 6
MNO 3
DEF X (X = Trunk Number 1~4).
3. Dial the desired telephone number.
4. Talk when the called party answers.

Answering calls:

Lift the handset and talk with the calling party.

Associated Programming

All programming functions associated with this feature are listed in the following table. Some functions must be programmed before the feature is operational and other functions are optional. The optional functions can affect how the feature operates.

Function Number	Function Name	Required (Y)es or (N)o
001-9	Single Line Telephone Hookflash Assignment	N
206	Extension Number Assignment	N
207	Single Line Port Type	N
208	Single Line Dialing Type	N
209	Outgoing Call Priority Mode	N
502	Single Line Telephone Bounce Time	N
503	Single Line Telephone Hookflash Start Time	N
504	Single Line Telephone Hookflash End Time	N

Special Conditions

- ☑ At default, all stations are programmed to access an available external line when the handset is lifted. If all external lines are busy, the user receives a busy tone.
- ☑ Hookflash can be assigned as hold or as hookflash by assigning Function “001-9 – Single Line Telephone Hookflash Assignment”.
- ☑ Speed dialing, last number redial, call pickup, internal paging, trunk queuing, etc., are available when feature access codes are dialed. Feature access codes must be dialed from internal dialtone.
- ☑ Multiline telephone users can receive voice announced calls from single line telephone users.
- ☑ An SLI(2)-B10 ETU can support two extensions.
- ☑ If a PBR-B10 ETU is not installed in the system and a single line telephone goes off-hook, an error tone is generated.
- ☑ After the single line telephone user goes off-hook, the user has 30 seconds to begin dialing before the DTMF release timer expires. After the DTMF timer expires, a busy tone is generated.
- ☑ The DTMF release timer restarts each time the single line telephone is taken off-hook.

Single Line Telephone Adapter

The Single Line Telephone Adapter allows electronic telephone ports to support single line telephones. A single line telephone can be connected to the telephone port by using a single line adapter and single pair cabling.

To provide this feature, a spare ESI port, an SLT-F(1)-U10 ADP, and PBR-B10 ETU are required.

Feature Operation

Originating an internal call:

1. Lift the handset.
2. Dial the desired extension number.
3. Talk when the called party answers.

Originating an external call:

1. Lift the handset.
2. Dial the access code to access a trunk (default: **9**).
3. Dial the desired telephone number.
4. Talk when the called party answers.

Answering calls:

Lift the handset and talk with the calling party.

Associated Programming

All programming functions associated with this feature are listed in the following table. Some functions must be programmed before the feature is operational and other functions are optional. The optional functions can affect how the feature operates.

Function Number	Function Name	Required (Y)es or (N)o
001-9	Single Line Telephone Hookflash Assignment	N
207	Single Line Port Type	N

Function Number	Function Name	Required (Y)es or (N)o
208	Single Line Dialing Type	N
209	Outgoing Call Priority Mode	N
503	Single Line Telephone Hookflash Start Timer	N
504	Single Line Telephone Hookflash End Timer	N

Special Conditions

- A maximum of two single line telephone adapters can be installed in a system.
- The system automatically detects the connection of single line telephone adapters.
- The dialing type (DP or DTMF) can be individually assigned using Function “208 – Single Line Dialing Type” for each adapter. DTMF is the default.
- A dial pulse telephone can be connected to a single line telephone adapter, however a PBR-B10 ETU is still required.
- Message waiting and voice mail are available for single line telephones.

Softkeys



The Electra Elite multiline telephones provide softkeys speed dial operation. The speed dial directory can be searched using the softkeys. By simply entering either a number or a letter, a list of matching speed dial numbers is displayed. The system allows users to scroll the list and then dial the number.

This feature is available for Electra Elite multiline telephones equipped with softkeys.







Feature Operation



Searching the speed dial directory using a softkey:

User can search the speed dial memory locations by manually scrolling through the Speed Dial Directory.

1. Press  (SYS or STA).
2. Press  (UP or DOWN) to view the list.
3. Press  (external line key) or lift the handset.

Searching the speed dial directory alphabetically or numerically:

The search can be narrowed by entering the first letter of the name or first digit of the phone number. To search using a name, the user dials the first letter(s) of the name using the dialpad keys on the Electra Elite telephone. For example to search for **NEC**, the user dials    (i.e., there are three letters associated with dialpad key 6 – M, N and O). Dialing   displays names starting with the letter the N. The  key is used as an Enter key. Name(s) starting with N are displayed in the telephone LCD. Using  (UP and DOWN softkeys), the user can scroll to the appropriate name and make a selection.



1. While the telephone is idle, press  (SYS or STA) to access system or station speed dial numbers.
2. If searching by name, press the dialpad key with the first letter of the name followed by an  .

If searching by telephone number, press the first digit of the number.

Once the list is displayed, press  (UP or DOWN).

The following example shows how to search the directory for a name or number starting with A, B, C or 2:

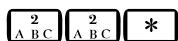

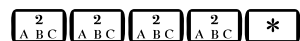







Dial pad key 2 has the letters ABC. To search the name or number starting with:

- A = 
- B = 
- C = 
- 2 = 

Note: If the user dials five 2's (22222) the system scrolls back to A.

Table 3-4 Speed Dial Search Keys provides a list of dialpad keys used to search speed dial directories, the number of times the dialpad key must be pressed and the result.

Table 3-4 Speed Dial Search Keys

Dialpad Key	Press Once	Press Twice	Press Three Times	Press Four Times	Press Five Times
	1	N/A	N/A	N/A	N/A
	A	B	C	2	Returns to A
	D	E	F	3	Returns to D
	G	H	I	4	Returns to G
	J	K	L	5	Returns to J
	M	N	O	6	Returns to M
	P	Q	R	S	7
	T	U	V	8	Returns to T
	W	X	Y	Z	9
	0	N/A	N/A	N/A	N/A

Dialing the selected number once is has been located:

Lift the handset (if the system has been assigned for external line priority mode using Function “209 – Outgoing Call Priority Mode”.)

- OR -

Press an idle  (if the system has been assigned for internal line priority mode using Function “209 – Outgoing Call Priority Mode”.)















Associated Programming

All programming functions associated with this feature are listed in the following table. Some functions must be programmed before the feature is operational and other functions are optional. The optional functions can affect how the feature operates.

Function Number	Function Name	Required (Y)es or (N)o
001-2	Speed Dial Assignment	N
209	Outgoing Call Priority Mode	N

Special Conditions

- If two different keys are pressed while performing a search, the system only recognizes the last key that was pressed before \ast was pressed. For example, if $\begin{matrix} 3 \\ \text{DEF} \end{matrix}$ $\begin{matrix} 2 \\ \text{ABC} \end{matrix}$ and \ast are pressed, the system only recognizes $\begin{matrix} 2 \\ \text{ABC} \end{matrix}$ and displays A.
- Scrolling speed dialing is only available on the Electra Elite telephones that are equipped with softkeys and an LCD. The third line of the telephone LCD displays the following softkeys, which are used to access scrolling and navigate through the speed dial entries.
 - **SYS** Accesses system speed dialing numbers.
 - **STA** Accesses station speed dialing numbers.
 - **UP** Moves “up” to display the previous speed dial number for system or station speed dialing.
 - **DOWN** Moves “down” to display the next speed dial number for system or station speed dialing.
- When scrolling, the system uses the following criteria to display the information in the order listed below:
 - Spaces
Spaces entered at the beginning of a name are ignored during scrolling (e.g., ^^Jean is sorted as Jean, the spaces are ignored during sorting).
 - Alphabetical Characters
Uppercase and lowercase letters are disregarded for sorting purposes.
 - Digits
 - Special Characters
Alphabetic or numeric searches are not allowed using special characters, however they can be searched using the softkeys to scroll sequentially through the speed dial memory locations.

- Pressing  (SYS or STA) has no affect if speed dial numbers have not been stored in the system.
- If duplicate names are stored for different speed dial memory locations, the speed dial memory location with the lowest numbered location number is displayed.
- The system uses the following criteria when displaying both telephone numbers and the associated names.
 - When both the telephone number and associated name are stored, the name is displayed.
 - When only the telephone number is stored, only the telephone number is displayed.
 - When only the name is stored, the system ignores the entry and nothing is displayed.
- The length of the telephone numbers and associated names depends on how many system and personal (station) speed dial memory locations are assigned in system programming using Function "001-2 – Speed Dial Assignment".
 - If the system is programmed for 80 system/20 personal (station) speed dial memory locations, the maximum alphanumeric characters is 13.
 - If the system is programmed for 200 system/0 personal (station) speed dial memory locations, the maximum alphanumeric characters is 12.
- Scrolling mode is canceled when one of the following keys is pressed: , , , , , , or  (DSS key).
- The following keys are ignored if pressed during scrolling mode: ,  (STA or STA), , or .
- If no action is performed for more than 10 seconds while scrolling, scrolling mode is canceled.
- During scrolling mode, calls can only be answered by pressing  or .



SPD (InfoSet) or Redial (Electra Elite) Key

This feature allows users to press the  (on InfoSet telephones) or the  (on Electra Elite telephones), to access speed dial memory locations.

This feature is available for the InfoSet or Electra Elite telephones.

Feature Operation

Accessing speed dial memory locations:

1. Press  (on InfoSet telephones) or  (on Electra Elite telephones).
2. Enter the speed dial memory location number.



The number that has been programmed for the speed dial memory location number is displayed in the telephone LCD and is dialed.



Associated Programming

All programming functions associated with this feature are listed in the following table. Some functions must be programmed before the feature is operational and other functions are optional. The optional functions can affect how the feature operates.

Function Number	Function Name	Required (Y)es or (N)o
009	Outgoing Call Line Selection	N
109	Trunk Line Dialing Type	N
331~334	Automatic Answering using Trunk Lines 1~4	N

Special Conditions

- When dialing using  or , the system accesses the idle external lines by selecting the highest numbered external lines first (e.g., 4, 3, 2, 1). The line must be enabled in system programming using Function “109 – Trunk Line Dialing Type”.
- If an external line is not available “ERROR” is displayed in the telephone LCD and an error tone is heard.
- When placing a call using manual dialing, speed dialing or a combination of manual/speed dialing, the first 24 digits that are dialed are stored in last number redial memory.

- ☑ The  (for InfoSet telephones) or  (for Electra Elite telephones) keys can also be used for the following features/operations:
- Placing pauses between numbers that are stored in speed dial memory locations.
 - Assigning operations to one-touch/feature access keys.
 - Setting the automatic redial feature.



Specified CO/PBX Line Seizure

This feature allows users to seize a specific trunk line by either dialing an access code and the trunk line number.

This feature is available for the InfoSet and Electra Elite multiline telephones and single line telephones.

Feature Operation

Seizing a specific trunk line:

1. Lift the handset or press  .
2. Dial   .
3. Dial the trunk line number.

The trunk line is seized and the user hears dialtone.

Associated Programming

All programming functions associated with this feature are listed in the following table. Some functions must be programmed before the feature is operational and other functions are optional. The optional functions can affect how the feature operates.

Function Number	Function Name	Required (Y)es or (N)o
009	Outgoing Call Line Selection	N

Special Conditions

- External lines that are assigned to a different tenant cannot be seized.
- This feature can be used to access an external line that is on hold. This can be done from any telephone including a single line telephone.















Speed Dial – Extension

Each extension in the system can be allowed up to 20 personal speed dial numbers. For personal speed dial numbers to be available, the system must be set to 80 mode in system programming. Selecting 80 mode reserves 20 personal speed dial numbers for each telephone user.







This feature is available for InfoSet and Electra Elite multiline telephones and single line telephones. Single line telephones can be used to set up and originate speed dialing but it cannot be used to confirm speed dial numbers.

Feature Operation







Programming a speed dial number using a multiline telephone:

1. Press ^{Feature} .
2. Press ^{SPD}  (InfoSet multiline telephones) or  (Electra Elite multiline telephones).
3. Dial the speed dial memory location number (  ~  ).
4. Enter the desired telephone number (maximum of 24 digits).
If a pause is needed, press either ^{SPD}  or . If a hookflash is needed, press either ^{Flash}  or . If nesting numbers, press ^{Answer}  or  to enter the brackets.
If entering an associated “name” (alphabetic characters), press ^{Transfer} . (Refer to [Character Registration on page 3-44](#) for instructions about entering alphanumeric characters.)
5. Press ^{Feature} .







Programming a speed dial number using a single line telephone:

1. Lift the handset.
2. Dial  .
3. Dial the speed dial memory location number (  ~  ) where the telephone number is stored.
4. Enter the desired telephone number to be stored in the speed dial memory location.
5. Place the handset in the cradle.









Speed dialing using a multiline telephone:

1. Press  (external line key).
2. Press  (InfoSet multiline telephones) or  (Electra Elite multiline telephones).
3. Dial the speed dial memory location number (  ~  ) where the telephone number is stored.
4. The number is automatically dialed.

Speed dialing using a single line telephone:

1. Lift the handset.
2. Dial   .
3. Dial the speed dial memory location number (  ~  ) where the telephone number is stored.
4. The number is automatically dialed.

Deleting a speed dial number using a multiline telephone:

1. Press  .
2. Press  (InfoSet multiline telephones) or  (Electra Elite multiline telephones).
3. Dial the speed dial memory location number (  ~  ) where the telephone number is stored.
If deleting the associated “name” (alphabetic characters), press  . If only deleting the speed dial number, proceed to the next step.
4. Press  .

Deleting a speed dial number using a single line telephone:

1. Lift the handset.
2. Dial **8** **5** .
TUV JKL
3. Dial the speed dial memory location number (**0** **0** ~ **1** **9**) where the telephone number is stored.
OPER OPER WXYZ
4. Place the handset in the cradle.

Confirming a speed dial number using a multiline telephone:

1. Press **Conf** .
Conf
2. Press **SPD** (InfoSet multiline telephones) or **Redial** (Electra Elite multiline telephones).
SPD Redial
3. Dial the speed dial memory location number (**0** **0** ~ **1** **9**) where the telephone number is stored.
OPER OPER WXYZ
4. The number is displayed in the telephone LCD.

Special Conditions

- Speed dial numbers are stored in redial memory. Speed dialing memory is stored in the system's backup battery.
- The maximum number of digits that can be stored in a speed dial memory location is 24. If the user attempts to dial more than 24 digits, "ERROR" is displayed in the telephone LCD for five seconds.
 When a pause (*****) or hookflash (**#**) is programmed as part of the speed dial number, it is counted as a digit.
- If a user attempts to initiate speed dialing from a speed dial memory location that has not been programmed, "XX:EMPTY or XXX:EMPTY is displayed in the telephone LCD. (XX or XXX = Speed Dial Memory Location Number).
- If a call is originated for a speed dial memory location that has both the telephone number and associated "name" programmed, the number and name are displayed in the telephone LCD. Once the called party answers, the telephone LCD displays the clock.
- If a call is originated on a CO line using a stored speed dial number for which no PBX access code is defined and the system supports both CO and PBX lines, the CO line is released and an error tone is generated.

- ☑ Entering a pause, hookflash or nesting numbers is only available if programming speed dial numbers on multiline telephones (i.e., these are not available when programming speed dial numbers on single line telephones).
- ☑ A maximum of five system and extension (personal) speed dial memory location numbers can be programmed into one speed dial memory location.
- ☑ An external speed dial memory location number can be assigned to a one-touch/feature access key.
- ☑ System speed dial numbers can be nested under extension (personal) speed dial memory locations however, extension speed dial numbers cannot be nested under system speed dial memory locations.
- ☑ Contents of the speed dial memory location can be verified and cleared.





















Speed Dial – System

Speed dialing can be assigned on a system-wide basis. System speed dialing can be set to 200 numbers or 80 numbers. If 200 is selected, individual users are not allowed to assign personal speed dialing numbers on their telephones. If 80 is selected, then each telephone user can set up to 20 personal speed dial numbers and 80 speed dial numbers are reserved for system speed dialing.













This feature is available for InfoSet and Electra Elite multiline telephones and single line telephones. Single line telephones can be used to set up and originate speed dialing but cannot be used to confirm speed dial numbers. Programming, deleting and verifying speed dial numbers can only be performed using an attendant telephone (ports 1 and 2).

Feature Operation

Programming a speed dial number from an attendant telephone:

1. Press ^{Feature} .
2. Press ^{SPD}  (InfoSet multiline telephones) or  (Electra Elite multiline telephones).
3. Dial the speed dial buffer number where the number will be stored (  ~   or    ~   ).
4. Dial the telephone number (maximum 24 digits).
If a pause is needed, press either ^{SPD}  or . If a hookflash is needed, press either ^{Flash}  or . If nesting numbers, press ^{Answer}  or  to enter the brackets.
If entering an associated “name” (alphabetic characters), press ^{Transfer} . (Refer to [Character Registration on page 3-44](#) for instructions about entering alphanumeric characters.)
5. Press ^{Feature} .

Placing a speed dial call in from a telephone in a key function (squared) system:

1. Press  (outside line key).
2. Lift the handset.
3. When dialtone is heard, press ^{SPD}  (InfoSet multiline telephones) or  (Electra Elite multiline telephones).
4. Dial the appropriate speed dial buffer number (  ~   or    ~   ).

Placing a speed dial call from a telephone in a multifunction (non-squared or hybrid) system:

1. Press $\overset{\text{SPD}}{\square}$ (InfoSet multiline telephones) or Redial (Electra Elite multiline telephones).
2. When dialtone is heard, dial the appropriate speed dial buffer number ($\overset{2}{\square} \overset{0}{\square} \overset{9}{\square} \overset{9}{\square}$ ~ $\overset{9}{\square} \overset{9}{\square}$ or $\overset{0}{\square} \overset{0}{\square} \overset{0}{\square}$ ~ $\overset{1}{\square} \overset{9}{\square} \overset{9}{\square}$).

Placing a speed dial call using a single line telephone:

1. Lift the handset.
2. When internal dialtone is heard, dial $\overset{8}{\square} \overset{3}{\square}$.
3. Dial the speed dial buffer number ($\overset{2}{\square} \overset{0}{\square} \overset{9}{\square} \overset{9}{\square}$ ~ $\overset{9}{\square} \overset{9}{\square}$ or $\overset{0}{\square} \overset{0}{\square} \overset{0}{\square}$ ~ $\overset{1}{\square} \overset{9}{\square} \overset{9}{\square}$).

Deleting a speed dial number using an attendant telephone:

1. Press $\overset{\text{Feature}}{\square}$.
 2. Press $\overset{\text{SPD}}{\square}$ (InfoSet multiline telephones) or Redial (Electra Elite multiline telephones).
 3. Dial the speed dial memory location number where the telephone number is stored ($\overset{2}{\square} \overset{0}{\square} \overset{9}{\square} \overset{9}{\square}$ ~ $\overset{9}{\square} \overset{9}{\square}$ or $\overset{0}{\square} \overset{0}{\square} \overset{0}{\square}$ ~ $\overset{1}{\square} \overset{9}{\square} \overset{9}{\square}$).
- If deleting the associated "name" (alphabetic characters), press $\overset{\text{Transfer}}{\square}$. If only deleting the speed dial number, proceed to the next step.
4. Press $\overset{\text{Feature}}{\square}$.

Confirming a speed dial number using a multiline telephone:

1. Press $\overset{\text{Conf}}{\square}$.
2. Press $\overset{\text{SPD}}{\square}$ (InfoSet multiline telephones) or Redial (Electra Elite multiline telephones).
3. Dial the speed dial memory location number where the telephone number is stored ($\overset{2}{\square} \overset{0}{\square} \overset{9}{\square} \overset{9}{\square}$ ~ $\overset{9}{\square} \overset{9}{\square}$ or $\overset{0}{\square} \overset{0}{\square} \overset{0}{\square}$ ~ $\overset{1}{\square} \overset{9}{\square} \overset{9}{\square}$).
4. The number is displayed in the telephone LCD.

Special Conditions

- ☑ Speed dial numbers are stored in redial memory. Speed dialing memory is stored in the system's backup battery.
- ☑ The maximum number of digits that can be stored in a speed dial memory location is 24. If the user attempts to dial more than 24 digits, "ERROR" is displayed in the telephone LCD for five seconds.

When a pause () or hookflash () is programmed as part of the speed dial number, it is counted as a digit.
- ☑ If a user attempts to initiate speed dialing from a speed dial memory location that has not been programmed, "XX:EMPTY or XXX:EMPTY is displayed in the telephone LCD. (XX or XXX = Speed Dial Memory Location Number).
- ☑ If a call is originated for a speed dial memory location that has both the telephone number and associated "name" programmed, the number and name are displayed in the telephone LCD. Once the called party answers, the telephone LCD displays the clock.
- ☑ If a call is originated on a CO line using a stored speed dial number for which no PBX access code is defined and the system supports both CO and PBX lines, the CO line is released and an error tone is generated.
- ☑ Entering a pause, hookflash or nesting numbers is only available if programming speed dial numbers on multiline telephones (i.e., these are not available when programming speed dial numbers on single line telephones).
- ☑ A maximum of five system and extension (personal) speed dial memory location numbers can be programmed into one speed dial memory location.
- ☑ An external speed dial memory location number can be assigned to a one-touch/feature access key.
- ☑ System speed dial numbers can be nested under extension (personal) speed dial memory locations however, extension speed dial numbers cannot be nested under system speed dial memory locations.
- ☑ Contents of the speed dial memory location can be verified and cleared.

Station Message Detail Recording (SMDR)

Station Message Detail Recording provides detailed calls records of system telephone usage. This feature is useful for controlling costs by identifying telephone users, trunk usages, and numbers dialed. SMDR supports the connection of call accounting equipment that audits local and long distance telephone bills.

An MIF-B10 ETU is required to support this feature.

This feature is available for the InfoSet and Electra Elite multiline telephones and single line telephones.

Feature Operation

Not applicable.

Associated Programming

All programming functions associated with this feature are listed in the following table. Some functions must be programmed before the feature is operational and other functions are optional. The optional functions can affect how the feature operates.

Function Number	Function Name	Required (Y)es or (N)o
002-9	Station Message Detail Recording	Y
024	Print Format	N
025	Baud Rate to Printer	Y
026	Stop Bit for Printer	N

Special Conditions

- If a power failure occurs during a call, the call is terminated and the call record information is lost.
- If the SMDR feature is disabled in system programming (Function "002-9 – Station Message Detail Recording"), printout or data storage is not performed.
- SMDR only generates information for outgoing and transferred outgoing calls.
- If a printer is not connected to the system or if the printer is not operating, the MIF-B10 ETU can store information for 200 calls. Once the memory is full, the oldest call record is erased and the new record is stored.

- ☑ When the memory on the MIF-B10 ETU becomes 80% full, the system generates an alert that is displayed on an attendant position telephone LCD. When the memory falls below 80% the alert clears from the telephone LCD.

- ☑ Using ^{Feature} 9 WXYZ 6 MNO, the user manually switches between PC programming mode and SMDR mode. If PC programming mode is selected, SMDR data is stored in memory on the MIF-B10 ETU. If SMDR mode is selected, SMDR data is sent to the printer connected to the MIF-B10 ETU.

If a PC is connected to the system instead of a printer and SMDR mode has been selected, SMDR data is output to the PC (i.e., no data is stored in memory on the MIF-B10 ETU).

- ☑ When the printer is connected, data stored in memory on the MIF-B10 ETU is printed out. New call records are printed as they are received.

No record is generated if the caller hangs up before the elapsed call timer starts.

- ☑ The print format is:

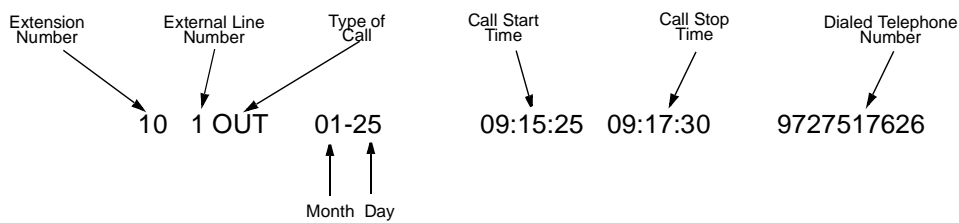

OUT = Outgoing Call
 TRF = Transferred Call

- ☑ The EIA RS-232C port, used to interface with the external device, must conform to the following specifications:

Synchronization:	Start/Stop
Data Length:	8 bits
Parity Bits:	None
Stop Bits:	1
Start Bits:	1
Baud Rate:	Up to 38,400 bps
Cable:	RS-232C (D-sub, 9-pin) straight

Step Call

This feature allows a user, who calls a busy extension, to call the next extension number in the system by simply dialing a preassigned digit. This can be done without having to hang up between call attempts.

This feature is available for the InfoSet and Electra Elite multiline telephones and single line telephones.

Feature Operation

Using the Step Call feature when calling a busy extension:

1. Dial another extension number.
2. If that extension is also busy, continue this process until you reach an idle extension number.

Associated Programming

All programming functions associated with this feature are listed in the following table. Some functions must be programmed before the feature is operational and other functions are optional. The optional functions can affect how the feature operates.

Function Number	Function Name	Required (Y)es or (N)o
206	Extension Number Assignment	N







Stored Hookflash

This feature allows a hookflash to be stored in a speed dial memory location. This allows multiline telephone users to store the hookflash which is used to allow access to features such as transferring calls, conferencing, in a speed dial buffer, etc.







This feature is available for InfoSet and Electra Elite multiline telephones.

Feature Operation

Programming a hookflash on a one-touch/feature access key for speed dialing:

1. Press ^{Feature} .
2. Press ^{SPD}  (for InfoSet telephones) or  (for Elite telephones).
3. Enter the speed dial memory location number.
4. Press ^{Flash}  (for InfoSet telephones) or  (for Elite telephones). This enters a hookflash.
5. Enter the telephone number to be stored in the speed dial memory location.
6. Press ^{Feature} .

Programming a hookflash on a one-touch/feature access key for speed dialing when the external line is a PBX line:

1. Press ^{Feature} .
2. Press ^{SPD}  (for InfoSet telephones) or  (for Electra Elite telephones).
3. Press the one-touch/feature access key where the number will be stored.
4. Press .
5. Press ^{Flash}  (for InfoSet telephones) or  (for Electra Elite telephones).
6. Enter the telephone number to be stored in the speed dial memory location.
7. Press ^{Feature} .

Note: The external line must be assigned as a PBX line using Function “107 – Trunk Line Type”.

Associated Programming

All programming functions associated with this feature are listed in the following table. Some functions must be programmed before the feature is operational and other functions are optional. The optional functions can affect how the feature operates.

Function Number	Function Name	Required (Y)es or (N)o
107	Trunk Line Type	N

Special Conditions

- This feature is only available for multiline telephones.
- A hookflash can be entered for system and station speed dial numbers.

System Set Button

This feature allows the user to enter system programming mode without using the step-by-step method for entering programming.

This feature is only available for the InfoSet telephones.

Feature Operation

Activating the system set button:

1. Remove the protective plastic panel that covers the line keys.
2. Press the Set button (this can be done while engaged on an external call or while the telephone is in the idle condition).

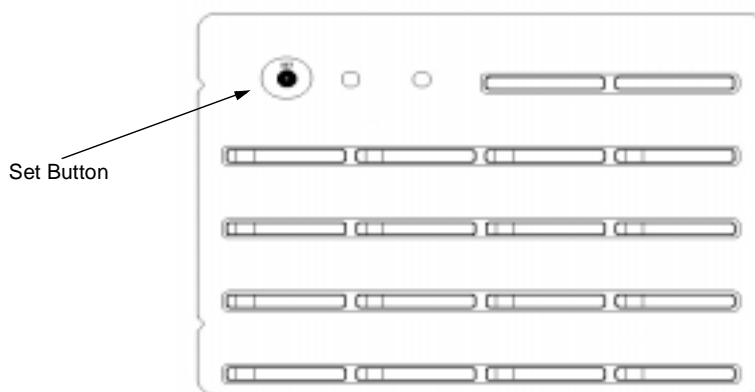

3. Make the system programming changes. (Data is not written to system memory until the telephone is in the idle condition.)

Special Conditions

- System programming can also be accessed by pressing:

Feature **Hold** **#** **0** **OPER** and ***** .







Telephone Volume Control

This feature allows Multiline Telephone users to control the handset and the speaker/ ringing volume by pressing the up and down volume buttons on the telephone. It also allows the user to change the contrast on the LCD of the Electra Elite telephones.





This feature is available for the InfoSet and Electra Elite telephones.

Feature Operation

Changing the on-hook ringing volume on InfoSet or Elite telephones:

1. Press  or lift the handset.
2. Dial  .
3. Dial .
4. Press  (Δ = louder or ∇ = softer) to increase or decrease the volume ( for Elite telephones \wedge = louder or \vee = softer).







Changing the LCD contrast (Electra Elite telephones only):

1. Press .
2. Dial  .
3. Dial .
4. Press  (\wedge = darker \vee = lighter) to increase or decrease the LCD contrast.
5. Go on-hook.



- OR -

While the telephone is idle, press  (\wedge = darker \vee = lighter) to increase or decrease the LCD contrast.



Changing the off-hook ringing volume on InfoSet or Elite telephones:

1. Press  .
2. Dial  .
3. Dial .
4. Lift the handset.
5. Press  (Δ = louder or ∇ = softer) to increase or decrease the volume ( for Elite telephones \wedge = louder or \vee = softer).



Changing the handset receiver volume on InfoSet or Elite telephones:

1. Lift the handset.
2. Press  (Δ = louder or ∇ = softer) to increase or decrease the volume ( for Elite telephones \wedge = louder or \vee = softer).



Setting speaker volume:

1. Press  .
2. Press  (Δ = louder or ∇ = softer) to increase or decrease the volume ( for Elite telephones \wedge = louder or \vee = softer).
3. Go on-hook.

- OR -

While using the speakerphone, press  (Δ = louder or ∇ = softer) to increase or decrease the volume ( for Elite telephones \wedge = louder or \vee = softer).

Special Conditions

- LCD contrast can be adjusted using  (Electra Elite telephones only).
- The manual volume and contrast settings are preserved regardless of the original setting in system programming.
- When the user presses the InfoSet volume key  (Δ = louder or ∇ = softer) while the telephone is in the idle condition, the volume of incoming calls is adjusted. When the user press the Electra Elite volume key  (\wedge = darker or \vee = lighter) while the telephone is in the idle condition, the LCD contrast is adjusted.

Tenant Service

This feature allows the outside lines to be subdivided into two tenant groups or call pickup groups. This allows each tenant to have access to their own assigned outside line. Users cannot pick up calls coming into another tenant group.

Feature Operation

Not applicable.

Associated Programming

All programming functions associated with this feature are listed in the following table. Some functions must be programmed before the feature is operational and other functions are optional. The optional functions can affect how the feature operates.

Function Number	Function Name	Required (Yes or No)
401	Trunk Line Assignment for Tenant 1	Y
402	Trunk Line Assignment for Tenant 2	Y
403	Tenant-to-Telephone Assignment	Y

Special Conditions

- Each external line and telephone is assigned to tenants 1 or 2 using system programming. At default, all external lines and telephones are assigned to tenant 1.
- Each external line can be assigned to more than one tenant (i.e., duplicate tenant allowed). However, telephones can only be a member of one tenant group (i.e., duplicate tenants are not allowed).
- CO/PBX LEDs associated with other tenants will not light when in use.
- The following features are available when users are members of different tenant groups:
 - [All Call Page](#)
 - [Automatic Callback](#)
 - [Call Pickup Group](#)
 - [Call Transfer](#)
 - [Conference Add-On](#)
 - [Internal Voice/Tone Signaling](#)
 - [Step Call](#)
 - [Tone Override](#)

- ☑ The following features *are not* available when users are members of different tenant groups:
 - [Barge-In \(Interrupting an External Call\)](#)
 - [Holdfree Transfer](#)
 - [Manual Line Seizure](#)
 - [Privacy on all Calls](#)
 - [Specified CO/PBX Line Seizure](#)
 - [Trunk Queuing](#)

Timed Alarm

A timed alarm can be set to any multiline telephone as a reminder of a scheduled time. The user can program the system to automatically send a reminder alarm to their telephone. Two timed alarms are available system-wide.

This feature is available for InfoSet and Electra Elite multiline telephones.

Feature Operation

Setting a timed alarm:

1. Press ^{Feature} .
2. Dial (Alarm 1) or (Alarm 2).
3. Enter the time (hours and minutes) when you want the alarm to sound.
4. Press ^{Feature} .

Canceling a timed alarm:

1. Press ^{Feature} .
2. Dial (Alarm 1) or (Alarm 2).
3. Press ^{Feature} .

Confirming a timed alarm :

1. Press ^{Feature} .
2. Dial (Alarm 1) or (Alarm 2).
3. Press ^{Feature} .

Canceling a timed alarm: (attendant position only):

1. Press ^{Feature} .
2. Dial .
3. Press ^{Feature} .

Special Conditions

- ☑ In the following cases, no alarm is sounded:
 - A handsfree call is in progress or room monitoring is in progress.
 - An internal voice announced call or tone signal call is being received.
 - An incoming doorphone ringing call.
- ☑ Alarm 1 automatically resets (releases) when it sounds.
- ☑ Alarm 2 does not reset, it sounds each day at an preassigned time.
- ☑ If both alarms are set to the same time, only alarm 1 sounds. Alarm 2 will sound at the next preassigned time.
- ☑ A user can cancel an alarm that sounds at their telephone by pressing any of the keys on the telephone (except the volume key).
- ☑ Feature access codes and preset times can be assigned to a one-touch/feature access key. When a timed alarm sounds, the LED on the one-touch/feature access key (where the access code or time is assigned) lights red while the alarm sounds.
- ☑ When an alarm sounds, "ALARM: X" is shown in the telephone display for 10 seconds. (X = 1 or 2)
- ☑ An alarm can sound when the user has a call in progress.
- ☑ Preset times must be specified in military time (24-hour clock = 00:00~23:59).
- ☑ Only attendant positions can be used to reset alarms system-wide.
- ☑ Both alarms can be reset system-wide.
- ☑ When a timed alarm is set on an InfoSet telephone, a clock icon is also shown in the telephone display. The icon disappears when Alarm 1 ends, however if Alarm 2 is set, the clock is continually displayed.

Tone Override

Tone Override is used by one user to signal another user, who is engaged on a call, that they have an incoming call. The called party can answer the incoming call by putting the existing call on hold.

This feature also allows the user to switch between a tone override call and an existing call. When the user answers the tone override call, the existing call is put on hold. By pressing ^{Answer} , the user can switch between the two calls.

This feature is available for the InfoSet and Electra Elite multiline telephones and single line telephones.

Feature Operation

Originating a Tone Override:

1. After hearing a tone, dial (set as default) to send the override tone.
2. After hearing a confirmation tone, wait for the called party to answer call.

Answering a Tone Override:

After hearing the override tone, press ^{Hold} and talk with the calling party.

Answering the override call and switching between callers:

1. After hearing the override tone, press ^{Hold} to put the existing call on hold and to answer override call.
2. Talk with the override caller.
3. To switch between the two callers, press ^{Answer} .

Special Conditions

- This feature is not available if the telephone is in one of the following conditions:
 - The telephone is being used to assign one-touch/feature access keys, speed dial numbers, scrolling, etc.
 - The telephone is being used to program the system.
 - A single line telephone is called.
 - The called telephone is set to do not disturb.
- Tone override is only enabled when the called telephone is busy.

- ☑ The user can answer the tone override by pressing ^{Hold}  (during an internal/external call or while engaged in an add-on conference).
- ☑ A single line telephone has 30 seconds to send a tone override before it is disabled.
- ☑ If the user is speaking on the speakerphone and a tone override is received, the speech path is temporarily disrupted and the party sending the tone override hears a call waiting tone.
- ☑ When tone override is released, the telephone display returns to the previous condition.
- ☑ A telephone cannot receive multiple tone overrides.
- ☑ If a user is engaged on an external call and hangs up while a tone override is being received, the call becomes an internal call.
- ☑ A tone override call can be made to users who are members of another tenant group.
- ☑ The tone override tone is generated each time the tone override operation is performed.

Trunk Outgoing Restriction

When telephones are assigned this feature, users are restricted from making some (or all) external calls (such as long distance calls). Users can continue to answer calls however or may be able to make internal calls only. What is restricted is determined by individual needs and is programmed in system programming.

This feature is available for the InfoSet and Electra Elite multiline telephones and single line telephones.

Feature Operation



Depends on how this feature is programmed.

Associated Programming

All programming functions associated with this feature are listed in the following table. Some functions must be programmed before the feature is operational and other functions are optional. The optional functions can affect how the feature operates.

Function Number	Function Name	Required (Y)es or (N)o
351~354	Restricting Outgoing Calls for Trunk Lines 1~4	Y

Special Conditions

- A telephone that has outgoing restriction enabled cannot bypass the restriction by pressing  (for InfoSet telephones) or  (for Electra Elite telephones) when a call is received. If the user attempts to make a call, the call is disconnected and "ERROR" is displayed in the telephone LCD.
- At system default, all external lines and all telephones are enabled for both incoming and outgoing calls.
- Outgoing restriction can be programmed for each external line and telephone using system programming.







Trunk Queuing

When all outside lines are busy, telephone users can queue onto the busy line. When the line becomes available the system rings the telephone user to notify them that the a line is available. The user can cancel the queue at any time.



This feature is available for InfoSet and Electra Elite multiline telephones and single line telephones.

Feature Operation

Setting trunk queuing when all external lines are busy:

1. Press the appropriate external line key.
- OR -.
Lift the handset and dial .
- OR -
Press  and dial .
2. When you hear the busy tone, dial  . The telephone display indicates the queue is set.
3. When you hear the recall, lift the handset or press .
4. Dial the desired telephone number.

Canceling trunk queuing:

1. Lift the handset or press .
2. Dial  . The telephone display indicates the queue is canceled.

Associated Programming

All programming functions associated with this feature are listed in the following table. Some functions must be programmed before the feature is operational and other functions are optional. The optional functions can affect how the feature operates.

Function Number	Function Name	Required (Y)es or (N)o
001-6	Trunk Line Direct Access	N
002-8	Private Call	N
209	Outgoing Call Priority Mode	N

Special Conditions

- Trunk queuing is not allowed if the telephone is a member of a different tenant group.
- Trunk queuing is enabled for the following conditions:
 - When and the trunk number are dialed to seize a specific external line.
 - When dial access code is dialed.
 - When the telephone is set for external line preference.
- If the telephone is not set to seize an external line, trunk queuing is disabled for that telephone and an error tone is heard when trunk queuing is attempted.
- The following messages are displayed when trunk queuing is enabled/disabled:
 - Enabled = TRUNK QUE SET
 - Disabled = TRUNK QUE CNCL
- If the telephone is equipped with an LCD, "LINE IDLE" is displayed to notify the user the line is now available.
- The system provides ring notification to the telephone that set trunk queuing for 10 seconds. After 10 seconds, ringing stops and trunk queuing is released.
- If trunk queuing is set to an external line and an incoming call is received on that line, trunk queuing notification is delayed until after that telephone is idle.
- If there is more than one telephone queued to the same external line, the recall is generated in the order in which the telephones set trunk queuing. If one of the queued telephones is busy when recall is attempted, the recall is directed to the next idle telephone. The busy telephone remains in the queue and will be recalled when the telephone becomes idle.

Two-Color LEDs (Lamp)

The system provides two-color (red and green) LEDs to provide various status indications of the telephone. Hold and call waiting are a couple of examples of status indications.

This feature is available for InfoSet and Electra Elite multiline telephones.

Feature Operation

Not applicable.

Special Conditions

- The line keys on all multiline telephones can light both red and green.
- The LED lights green for the following feature and red for all other features:
 - [Call Transfer](#)
 - [Hold with Recall \(Exclusive and Non-Exclusive\)](#)
 - [I-Hold Indication](#)
 - [I-Use Indication](#)

User Programming

Users are allowed to program the following features using their InfoSet and Electra Elite multiline telephones and single line telephones.

- Ancillary Device Connection
- Attendant Positions
- Call Forward - All Calls
- Call Forward – Busy/No Answer
- Clock/Calendar Display
- Character Registration
- Distinctive Ringing
- Extension Name Assignment***
- Incoming Call Identification
- Nesting Dial
- Off-Hook Ringing
- One-Touch/Feature Access Keys – User Programmable
- Programmable Pause for Speed Dial
- Speed Dial – Extension
- Speed Dial – System
- Stored Hookflash
- Timed Alarm

Special Conditions

- Feature programming must be done while the system is idle.

SECTION 1 INTRODUCTION

The InfoSet 408 system is capable of supporting two telephone types. This allows flexibility for individual customers.

- InfoSet 408 Telephones
- Electra Elite Telephones

1.1 InfoSet 408 Telephones

The following InfoSet 408 telephones can be used with the InfoSet 408 system:

- 16-line telephone without display [DTB-16-1 (BK)/(WH) TEL]
- 16-line telephone with display [DTB-16D-1 (BK)/(WH) TEL]



DTB-16-1 (BK)/(WH) TEL
16-Line Non-Display



DTB-16D-1 (BK)/(WH) TEL
16-Line Display

Figure 4-1 InfoSet 408 Telephones

1.2 Electra Elite Telephones

The following Electra Elite telephones can be used with the InfoSet 408 system:

- 2-line telephone without display [DTP-2DT-1 (WH) TEL]
- 8-line telephone without display [DTU-8-1 (BK)/(WH) TEL]
- 8-line telephone with display [DTU-8D-2 (BK)/(WH) TEL]
- 16-line telephone without display [DTU-16-1 (BK)/(WH) TEL]
- 16-line telephone with display [DTU-16D-2 (BK)/(WH) TEL]
- 32-line telephone without display and 16 programmable One-Touch keys [DTU-32-1 (BK)/(WH) TEL]
- 32-line telephone with display and 16 programmable One-Touch keys [DTU-32D-2 (BK)/(WH) TEL]
- Single line telephone with flash key, redial key, 3-level receive volume control, 2-level ring volume control, data jack and message waiting lamp [DTP-1-1 (WH) TEL]
- Single line telephone with flash key, redial key, 3-level receive volume control, data jack, message waiting lamp and one-touch/feature access keys for speed dialing [DTP-1HM-1 (WH) TEL]

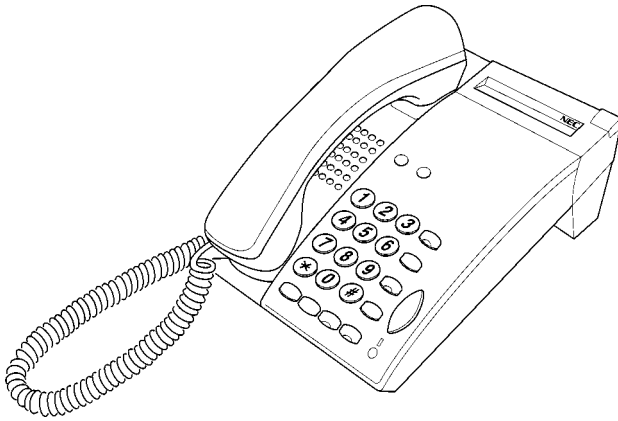

DTP-2DT-1 (WH) TEL
2-Line Non-Display



DTU-8-1 (BK)/(WH) TEL
8-Line Non-Display

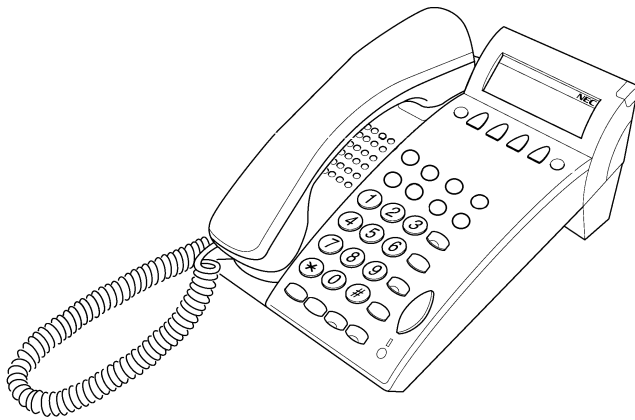

DTU-8D-2 (BK)/(WH) TEL
8-Line Display

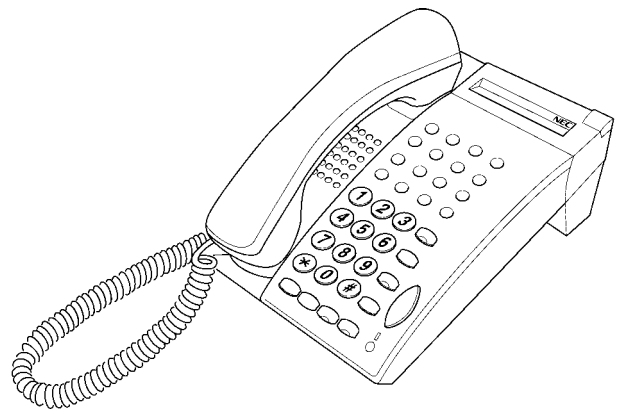

DTU-16-1 (BK)/(WH) TEL
16-Line Non-Display

Figure 4-2 Electra Elite Telephones

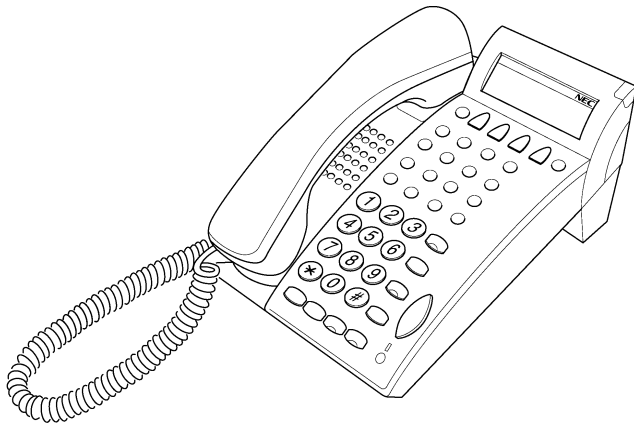

DTU-16D-2 (BK)/(WH) TEL
16-Line Display

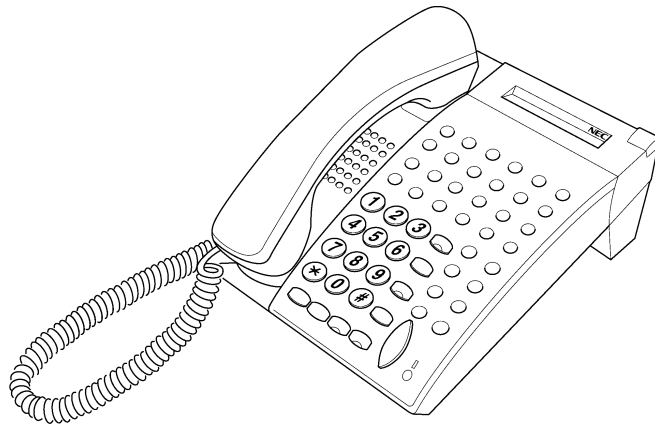

DTU-32-1 (BK)/(WH) TEL
16-Line Non-Display with 16
Programmable One-Touch Keys

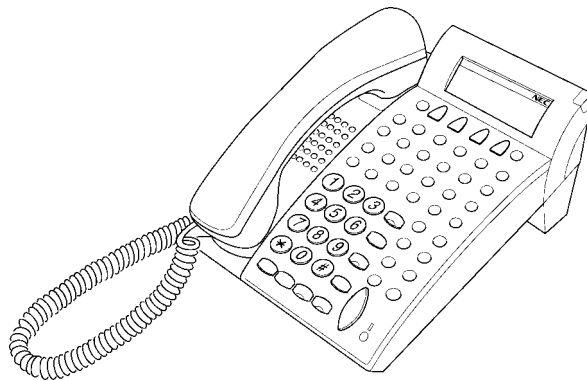

DTU-32D-2 (BK)/(WH) TEL
16-Line Display with 16 Programmable
One-Touch Keys

Figure 4-2 Electra Elite Telephones (Continued)



DTP-1-1 (WH) TEL



DTP-1HM-1 (WH) TEL

Figure 4-3 Single Line Telephones

SECTION 2 WALL MOUNTING TELEPHONES

Two types of telephones are available with the InfoSet system; the InfoSet telephones and the Electra Elite telephones. This section provides instructions for installing both types of telephones.

2.1 Wall Mounting the InfoSet Telephones

The DTB-16-1 (BK)/(WH) TEL and DTB-16-1 (BK)/(WH) TEL can be mounted to a wall.

1. Locate the stoppers under the height adjustment stand on the bottom of the telephone. You will need to lift the adjustment stand to expose the foot stand holding the stoppers. Remove the two plastic stoppers from the foot stand by firmly pushing on them.

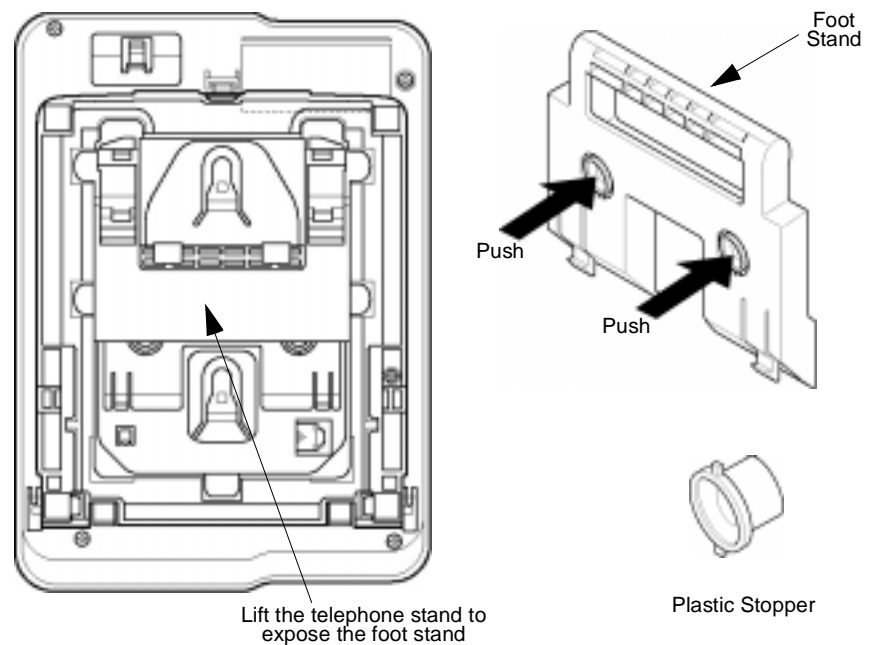

Figure 4-4 Removing the Stoppers from the Adjustment Stand

2. Remove the hanger (located on the bottom of the telephone). Insert the hanger into the holes as indicated in the diagram.

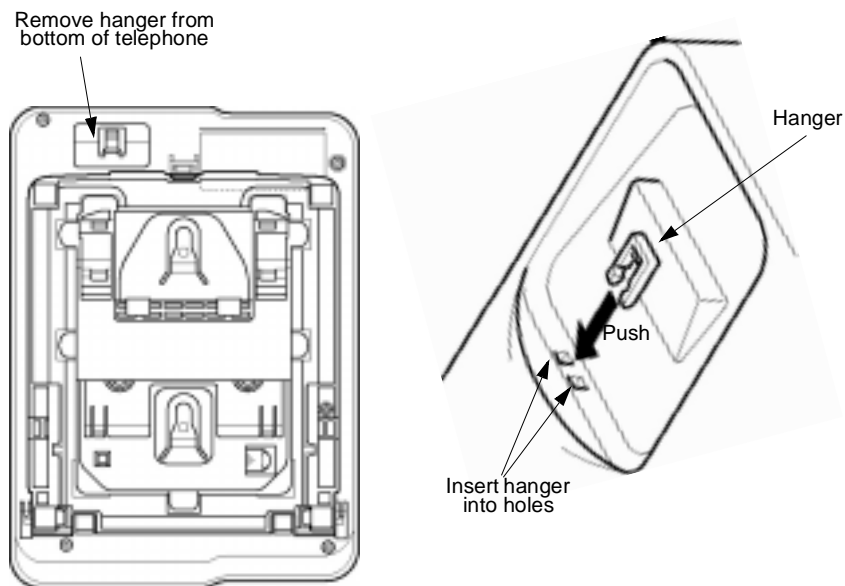

Figure 4-5 Attaching the Hanger to the Cradle of the InfoSet Telephone

3. Use the wall mounting template to mark the screw positions on the wall. The template is provided in [Section 5 Wall Mounting Template for InfoSet Telephones on page 4-33](#).
4. Insert one end of the telephone line cord into the RJ-11 jack. Route the cord inside the height adjustment stand as indicated in the diagram. The cord can be wrapped more than once inside the height adjustment stand to shorten the length of cord. The cord can exit either the top of the telephone or the side, depending on the most convenient location of the RJ-11 wall jack.

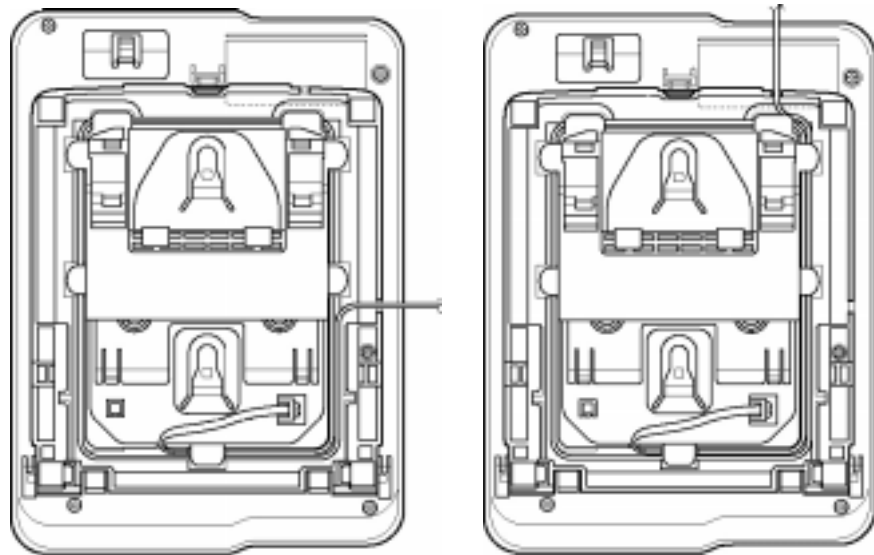

Figure 4-6 Routing the Telephone Cord Inside the Adjustment Stand

5. Using a Phillips head screwdriver, insert the flat head wood screw (provided) into the stopper and fasten to the wall.

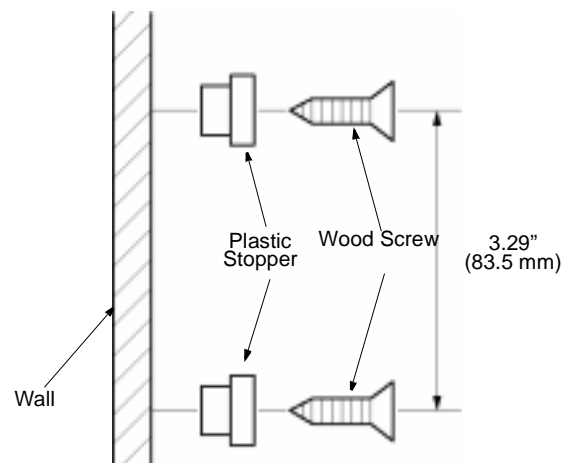

Figure 4-7 Fastening the Stoppers to the Wall

6. To hang the telephone on the wall, place the grooves (located on the bottom of the telephone) over the plastic stopper which has been fastened to the wall. If the telephone is difficult to mount you may want to loosen the screws holding the stopper.

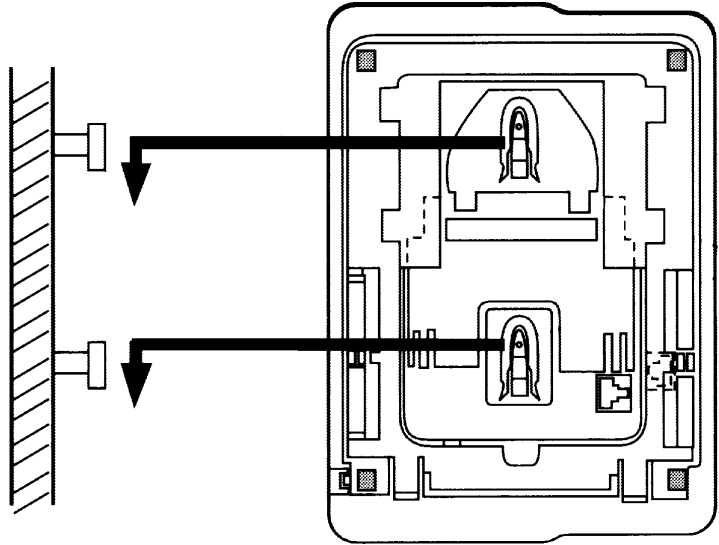

Figure 4-8 Hanging the InfoSet Telephone on the Wall

7. Insert the other end of the telephone line cord into an RJ-11 jack.

2.2 Wall Mounting the Electra Elite Telephones

Electra Elite telephones can be mounted on a wall using the base unit that comes with the telephone or by using the WMU-U Unit to accommodate adapters that are installed on the telephone.

2.2.1 Wall Mounting using the Base Unit

1. Remove the hanger by sliding it out of the slot.
2. Install it back in its original position so that the hanger protrudes providing a rest for the handset. (This procedure applies when using either the base unit or the WMU-U Unit.)

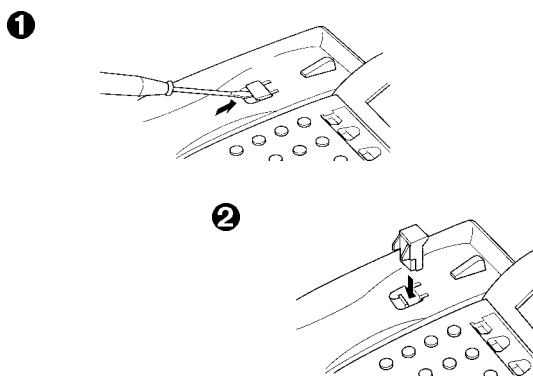

Figure 4-9 Positioning the Handset Hanger on Electra Elite Telephones

3. Unplug the telephone cord from the telephone.
 - ☞ If installing adapters, do so now before proceeding to the next step. (Refer to [Chapter 5 Optional Equipment](#) for detailed instructions for installing adapters.)
4. Turn the telephone upside down. Push the tabs indicated in and raise the inner area of the base plate.

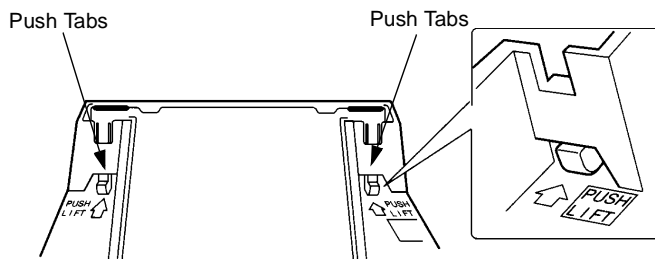

Figure 4-10 Raising the Base Plate on an Electra Elite Telephone

5. Insert the flat head screwdriver into A and press straight down until the tab unlocks.

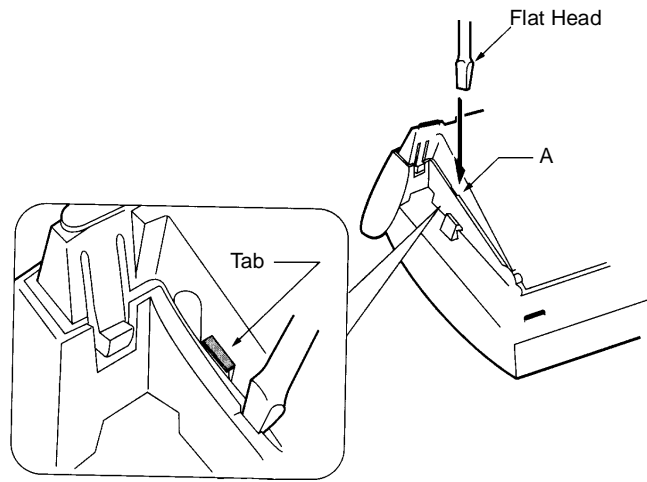

Figure 4-11 Unlocking the Tab on an Electra Elite Telephone

6. Lightly press the right side of leg shown as B and insert the flat head screwdriver at C. Press straight down until other the tab unlocks.

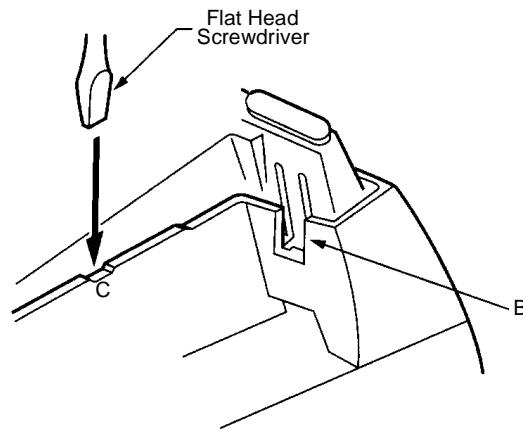

Figure 4-12 Releasing the Right Tab on an Electra Elite Telephone

7. Open and remove the bottom cover by rotating it counterclockwise.

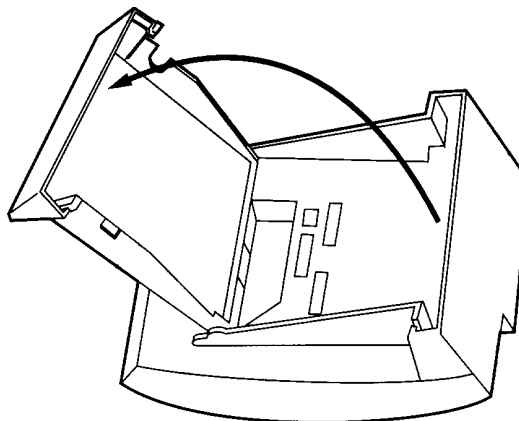

Figure 4-13 Removing Bottom Cover on an Electra Elite Telephone

8. Press both sides of the base cover and turn it left to remove it.
9. Rotate the base cover 180°, and install it again on the telephone.
10. Remove the shaded base plate knockout with nippers.

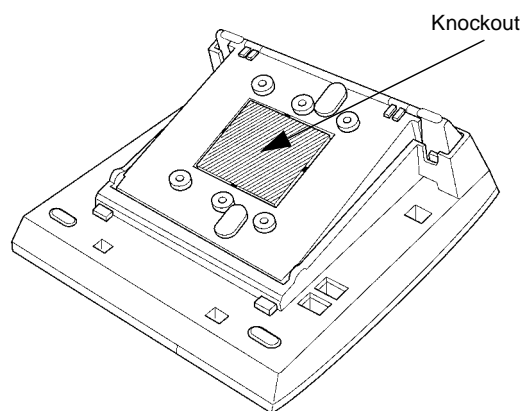

Figure 4-14 Removing the Knockout from an Electra Elite Telephone

11. Assemble the base plate and base cover.

12. Attach the base plate and base cover assembly (wide end down) to the posts on the wall plate (user-provided). Place the screws (user-provided) in the nodes on the base plate and secure the assembly to the wall.

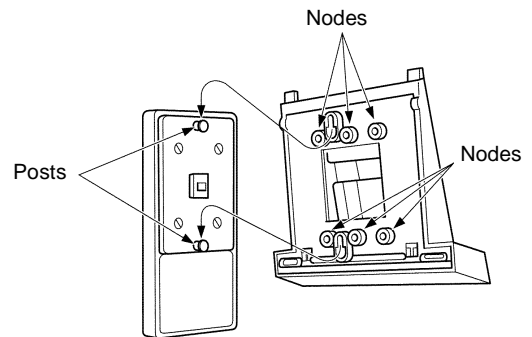

Figure 4-15 Attaching the Base Plate to the Wall

If using a modular jack instead of a wall plate, put the modular jack inside the base unit. Use the user-provided screws to attach the base unit directly to the wall.

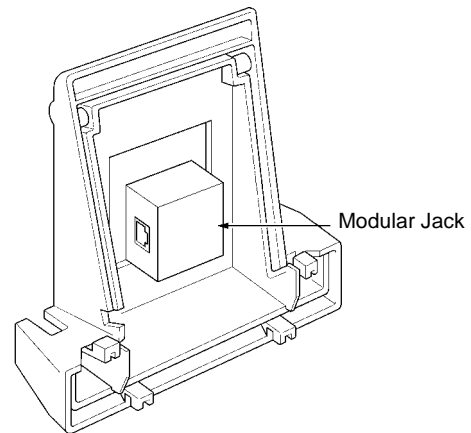

Figure 4-16 Attaching the Base Plate using a Modular Jack

13. Plug the line cord into the jack on the wall plate, wrap the extra cord and secure it with a tie wrap, and lead the line cord out through the groove in the side of the base unit.

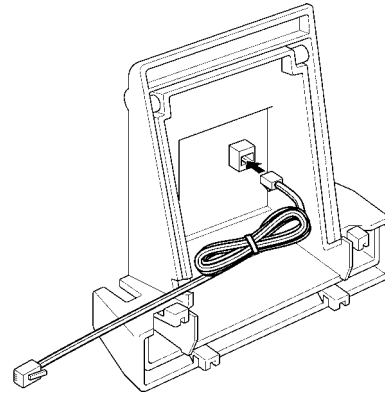

Figure 4-17 Plugging in the Line Cord using a Wall Jack

If using a modular jack instead of a wall plate, plug the line cord into the modular jack, wrap the extra cord and secure it with a tie wrap, and lead the line cord out through the groove in the side of the base unit.

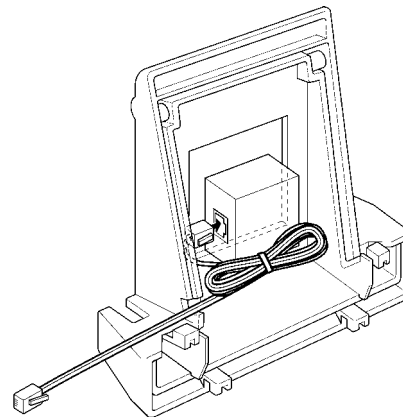

Figure 4-18 Plugging in the Line Cord Using a Modular Jack

14. With the base plate and base cover assembly attached to the wall, hook the two bottom tabs on the base cover into the tab slots on the base of the telephone.

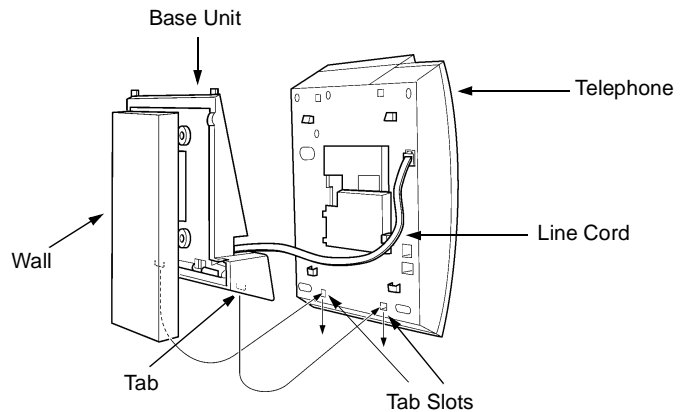

Figure 4-19 Attaching the Bottom Tabs of the Electra Elite Telephone to the Base Cover

15. Push up on the telephone and lock the top tabs on the base cover into the tab slots on the base of the telephone. Turn the telephone slightly clockwise to interface with the base cover.

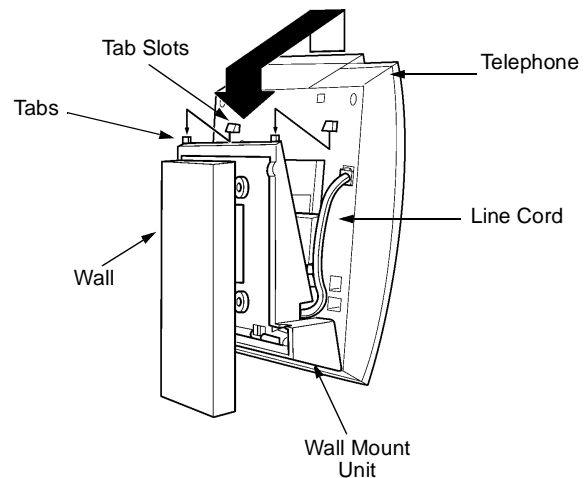



Figure 4-20 Attaching the Top Tabs of the Electra Elite Telephone to the Base Plate

16. When properly installed, the wall mounted telephone looks similar to the one shown in the diagram.

 Do not adjust the tilt panel after the telephone is mounted on the wall.

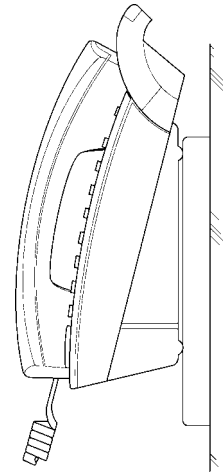



Figure 4-21 Installed Wall Mount Unit on an Electra Elite Telephone

2.2.2 Installing the Wall Mount Unit and Mounting the Telephone using the WMU-U Unit

The WMU-U Unit is used for wall mounting when adapters are installed on the Electra Elite telephones.

1. Remove the hanger by sliding it out of the slot.
2. Install it back in its original position so that the hanger protrudes providing a rest for the handset. (Refer to [Figure 4-9 Positioning the Handset Hanger on Electra Elite Telephones on page 4-10.](#))
3. Unplug the telephone cord from the telephone.

 If installing adapters, do so now before proceeding to the next step. (Refer to [Chapter 5 Optional Equipment](#) for detailed instructions for installing adapters.)
4. Turn the telephone upside down. Push the tabs indicated in and raise the inner area of the base plate. (Refer to [Figure 4-10 Raising the Base Plate on an Electra Elite Telephone on page 4-10.](#))

5. Insert the flat head screwdriver into A and press straight down until the tab unlocks. (Refer to [Figure 4-11 Unlocking the Tab on an Electra Elite Telephone on page 4-11.0](#))
6. Lightly press the right side of leg shown as B and insert the flat head screwdriver at C. Press straight down until other the tab unlocks. (Refer to [Figure 4-12 Releasing the Right Tab on an Electra Elite Telephone on page 4-11.](#))
7. Open and remove the bottom cover by rotating it counterclockwise. (Refer to [Figure 4-13 Removing Bottom Cover on an Electra Elite Telephone on page 4-12.](#))
8. Remove the line cord, base plate and base cover from the telephone.
9. Cut off the tabs on the adapter.

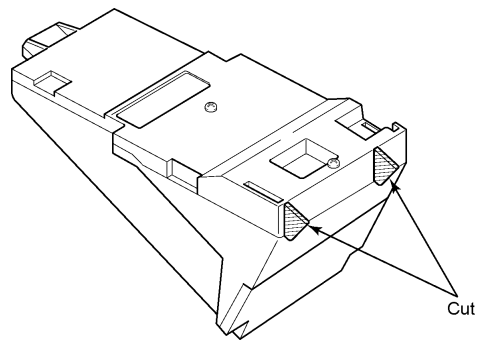

Figure 4-22 Removing the Tabs from the Adapter

10. Remove the tabs from the WMU-U Unit. (The tabs that are removed depend on the telephone type.)

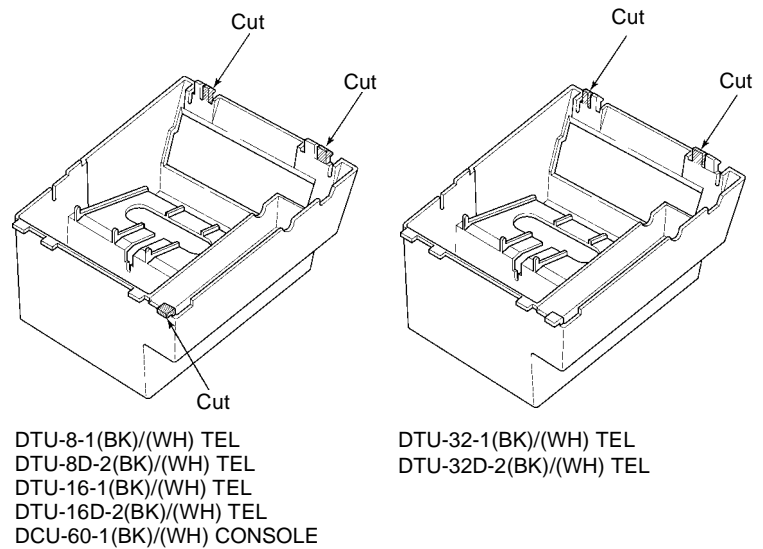

Figure 4-23 Removing the Tabs from the WMU-U Unit

11. Bundle the cord from the modular jack leaving about eight inches. Use a tie wrap to secure the bundled cord.
12. Place the bundled line cord in the space between the WMU-U Unit and the wall. Lead the line cord out through the slits.

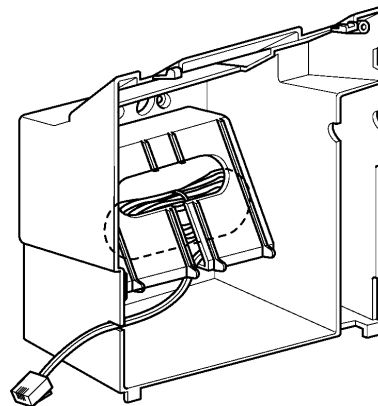

Figure 4-24 Leading the Line Cord out of the WMU-U Unit

13. Attach the WMU-U Unit to the posts on the wall plate (user-provided). Place the user-provided screws in the nodes on the WMU-U Unit and secure the WMU-U Unit to the wall.

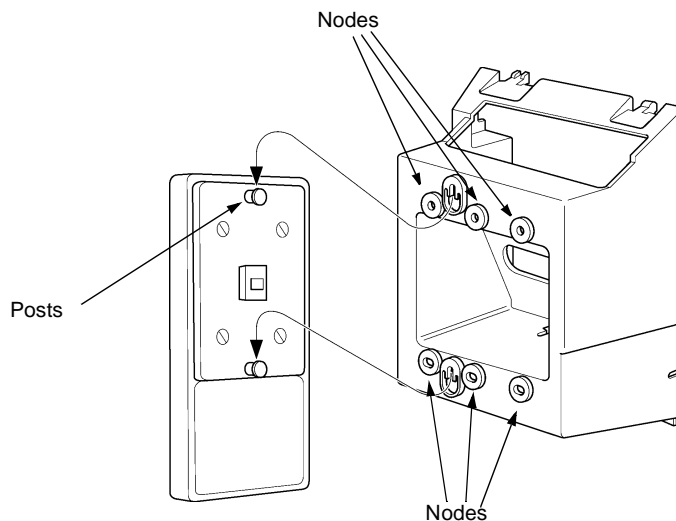

Figure 4-25 Attaching the WMU-U Unit to the Wall

14. Connect the line cord to the telephone.
15. With the WMU-U Unit attached to the wall, hook the two bottom tabs on the WMU-U Mount Unit into the tab slots on the telephone. Then push the two top tabs on the WMU-U Unit into the tab slots on the telephone. If the adapter has a power supply, lead the AC adapter cord out through the opening at the bottom of the telephone.

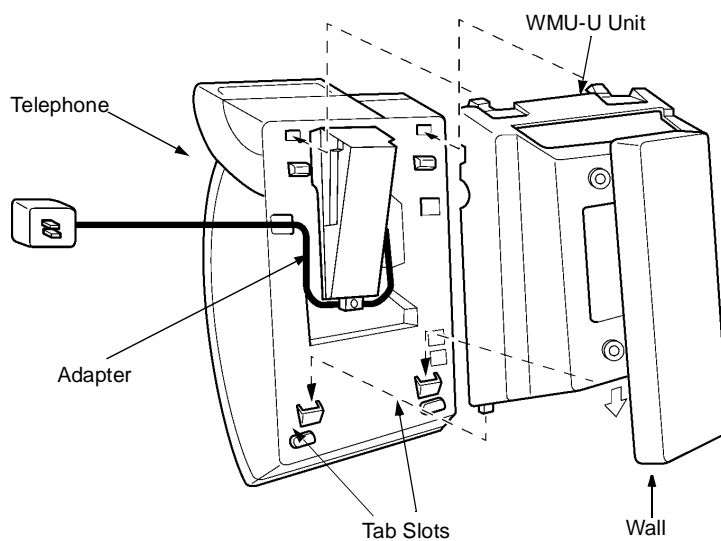

Figure 4-26 Attaching the Telephone to the WMU-U Unit

2.3 Wall Mounting Single Line Telephones

The DTP-1-1 TEL and DTP-1HM-1 TEL can be wall mounted.

1. Remove the hook from the unit.

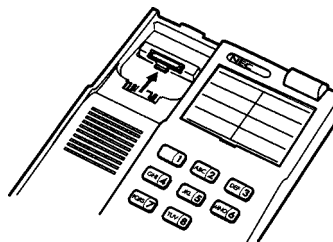

Figure 4-27 Removing the Hook from a Single Line Telephone

2. Turn the hook over (back to the front) with the tab toward the top.



Figure 4-28 Turning the Hook Over

3. Slide the hook on its glides back down into position forming the hanger hook for the handset.

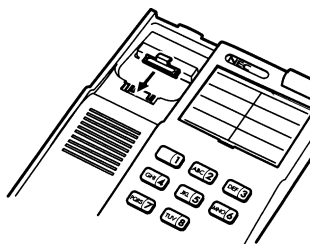

Figure 4-29 Sliding the Hook into Position on a Single Line Telephone

4. Unscrew the three screws on the unit to remove the plate.

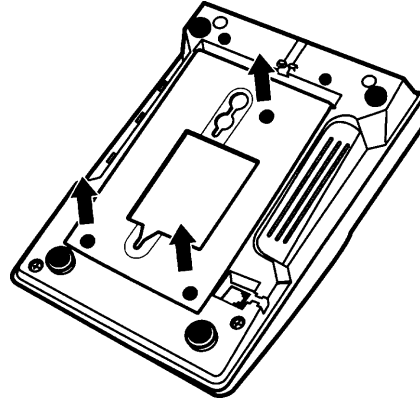

Figure 4-30 Removing the Screws from the Base of a Single Line Telephone

5. Replace the plate and place the screws in the two positions indicated in the diagram. (The one remaining screw can be placed at the original third position.)

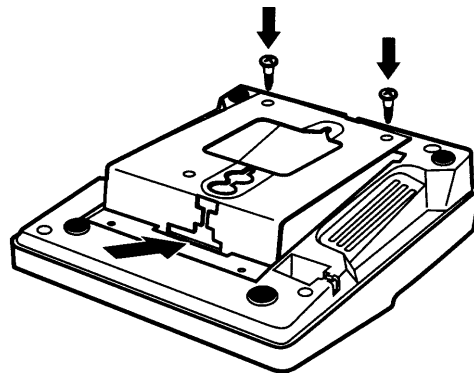

Figure 4-31 Replacing the Plate and Screws in the Base of the Single Line Telephone

6. Loosen the screws on the wall telephone plate. Leave the screws protruding enough to slip the telephone over the screws.

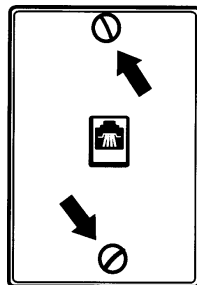

Figure 4-32 Protruding Screws

7. Mount the telephone onto the protruding screws by slipping the telephone over the screws as indicated in the diagram.

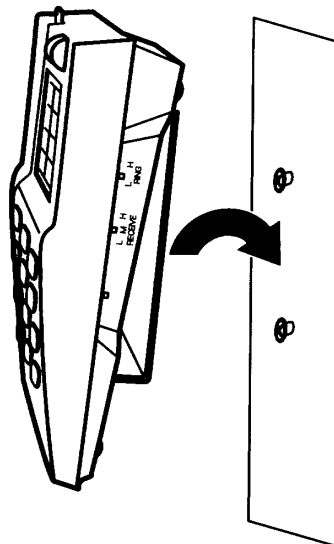

Figure 4-33 Mounting the Telephone

SECTION 3 ADJUSTING THE HEIGHT OF TELEPHONES

3.1 Adjusting the Height of InfoSet Telephones

The telephone stand can be used to prop the telephone at an angle.

1. Locate the telephone stand on the bottom of the telephone.

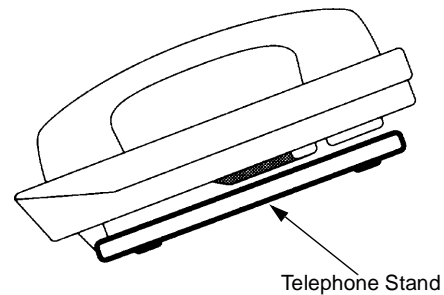

Figure 4-34 InfoSet Telephone Stand

2. Pull the stand away from the telephone and pull up on the foot stand. Select the desired height level and snap the tabs on the foot stand into one of the two sets of grooves on the telephone stand.

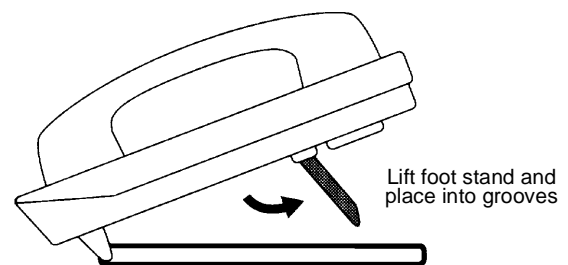

Figure 4-35 Adjusting the Height of the InfoSet Telephone

3. If you want to return the telephone to the lowest position, pull the telephone stand away from the foot stand. Fold the foot stand down toward to base of the telephone and fold the telephone stand over the foot stand and snap it into place.

3.2 Adjusting the Height of the Electra Elite Telephones

The base plate on Electra Elite telephones are hinged. The bottom portion can be adjusted up or down to raise or lower the height of the terminal.

1. Turn the telephone upside down and locate the tabs as shown in [Figure 4-36 Locating the Adjustment Tabs on the Electra Elite Telephone](#).

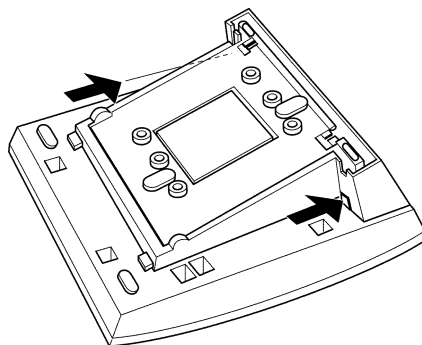

Figure 4-36 Locating the Adjustment Tabs on the Electra Elite Telephone

2. Push the adjustment tabs and raise the base plate until it locks.

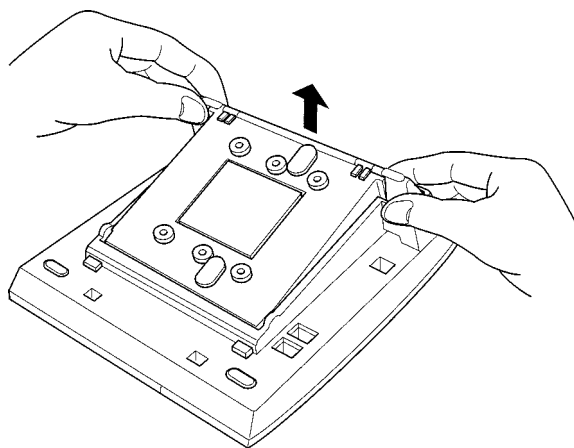

Figure 4-37 Raising the Base Plate on the Electra Elite Telephone

3. The length of the cord can be adjusted by pulling the line cord through the groove in the bottom of the telephone.

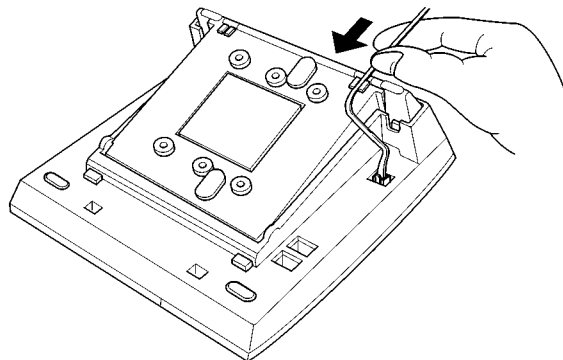

Figure 4-38 Adjusting the Line Cord Length on the Electra Elite Telephone

4. To lower the base plate on the telephone, push on the adjustment tabs and push the base plate downward.

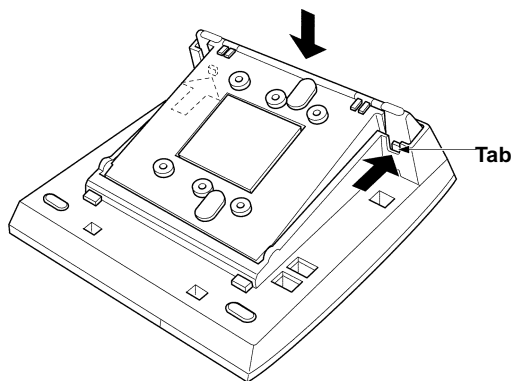

Figure 4-39 Lowering the Base Plate on the Electra Elite Telephone

3.3 Adjusting the LCD on the Electra Elite Display Telephones

The adjustable Liquid Crystal Display (LCD) comes equipped on the display Electra Elite telephones. The LCD can be adjusted by pushing downward and upward as desired.

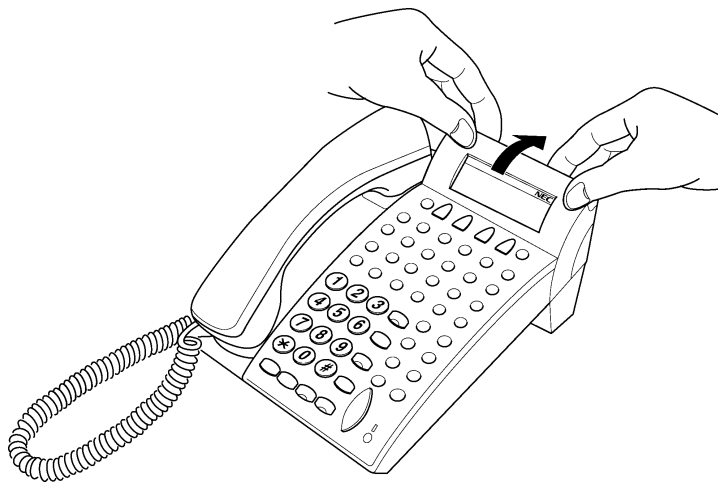

Figure 4-40 Adjusting the LCD on the Electra Elite Telephone

SECTION 4 INSTALLING LINE CARD LABELS AND PROTECTIVE PLASTIC PANELS ON TELEPHONES

4.1 Installing the Line Card Labels and Protective Plastic Panel on the InfoSet Telephones

A peel off label and protective plastic panel are provided with each telephone. The label helps identify the line keys and can be used to record the line key designations associated with each line key on the telephone.

1. Print or type the line key designations for the keys on the provided label.

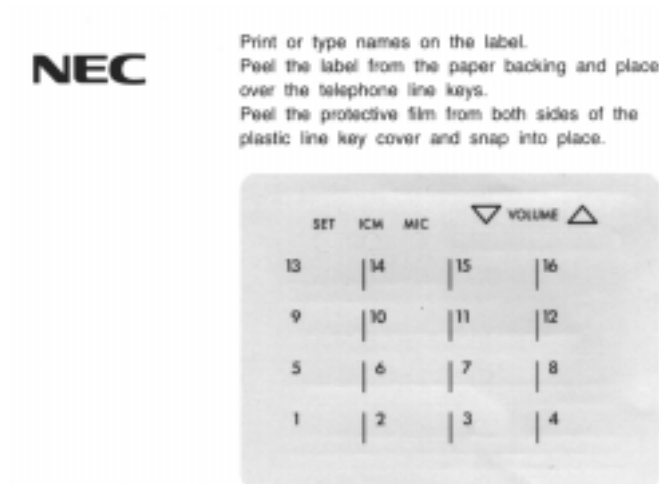

Figure 4-41 Line Card Label for InfoSet Telephones

2. Peel the label from the paper backing and place it over the telephone line keys. Be sure the protective plastic panel has been removed *before* attaching the sticky-backed label.

3. If desired, peel the protective film from both sides of the protective plastic panel.

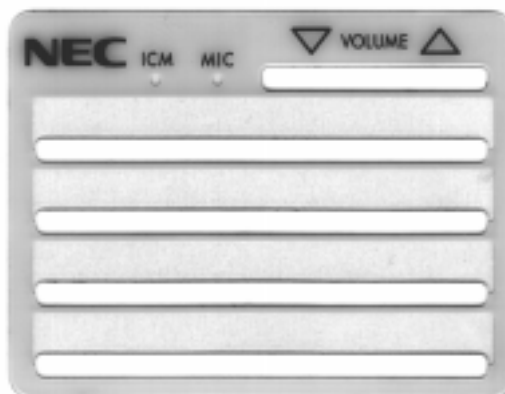

Figure 4-42 Plastic Panel for InfoSet Telephones

4. Locate two V-shaped tabs on each side of the lines keys on the face plate. Gently bend the panel and slip it under the tabs. If inserted properly, the panel will fit snugly against the face plate.

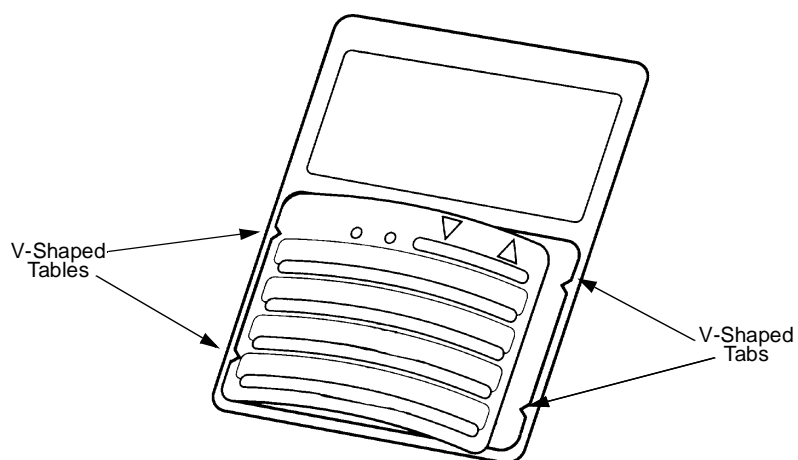

Figure 4-43 Installing the Plastic Cover on the InfoSet Telephone

4.2 Installing the Line Card Labels and Protective Plastic Panel on the Electra Elite Telephones

Line cards can be used to print the line key designations. They are then placed on the telephone to provide a quick reference of line key designations. Line cards can be changed as necessary. The plastic panel is placed on top of the line card to hold it in place.

1. Place the line card over the keys on the telephone.
2. Place the tabs on the bottom of the plastic panel into the grooves at the telephone bottom, and press the top right and left ends to secure plastic panel to the telephone.

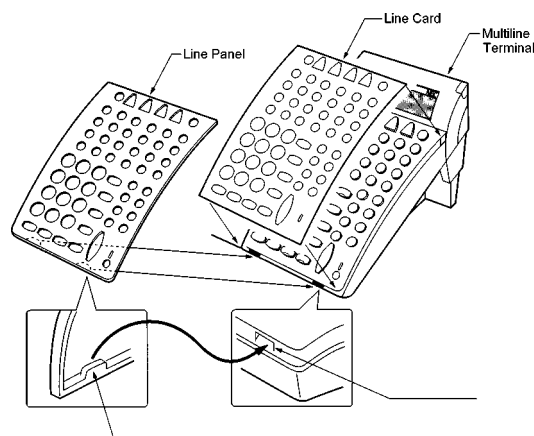

Figure 4-44 Installing Line Card and Plastic Panel on a Telephone



Figure 4-45 Installing Plastic Panel on a Telephone

3. To remove the plastic panel, lift the right corner, raise the panel, and slide the bottom away from the telephone.

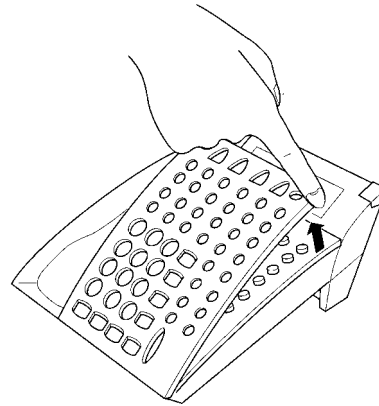

Figure 4-46 Removing the Plastic Panel from the Electra Elite Telephone



Do not pull on the bottom of the plastic panel to remove it; damage to the plastic panel could result.

4.3 SLT(1)-U10 ADP (Single Line Telephone Adapter)

The single line telephone adapter provides an interface for Single line telephones and other similar devices from an ESI ETU channel. This adapter can be connected to any ESI port. A maximum of two single line telephone adapters can be installed in the system.

4.3.1 Connecting the SLT(1)-U10 ADP to the System

1. Connect one end of the RJ-11 to the ESI port on the KSU and one end to the jack on the SLT Adapter marked **ESI**.
2. Connect one end of a second RJ-11 to the jack marked **TEL** on the SLT Adapter and the other end to the single line telephone.

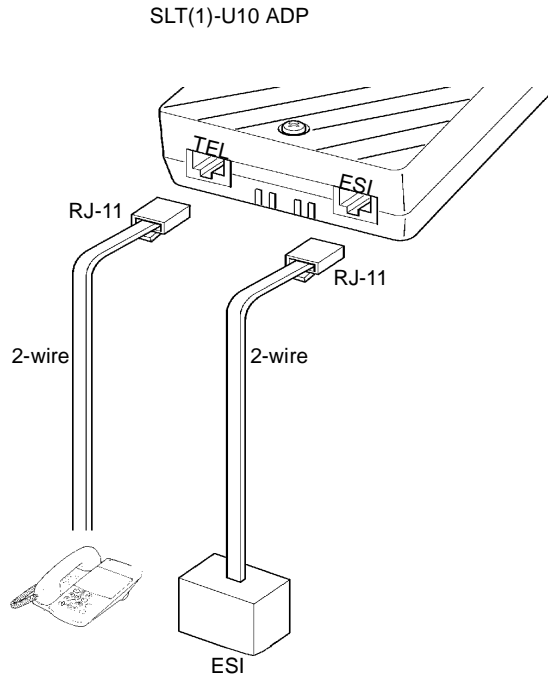
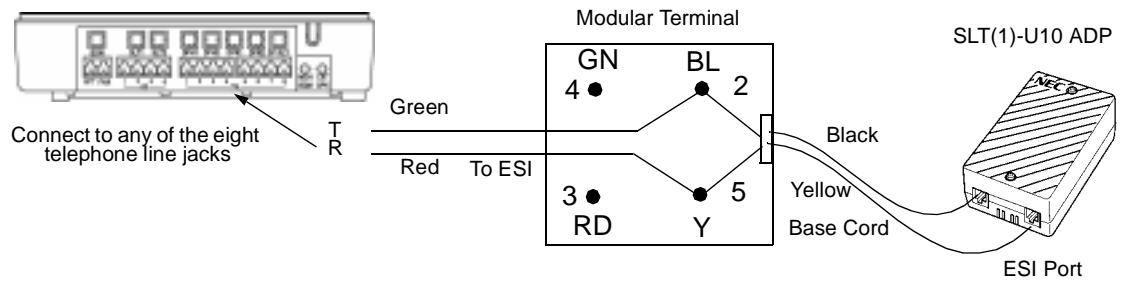
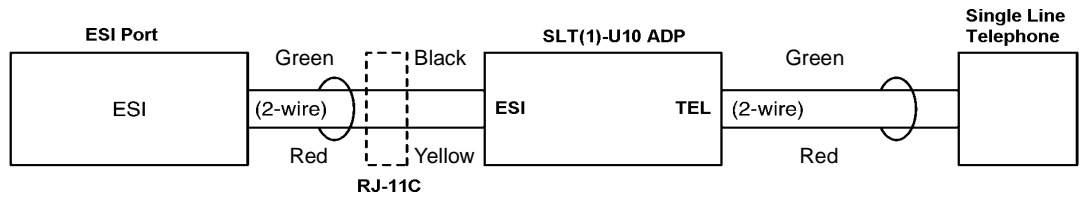

Figure 4-47 Connecting a Single Line Telephone to the System using an SLT(1)-U10 ADP



Modular Terminal Connections



Single Line Telephone Connections

Figure 4-48 Connecting the SLT(1)-U10 ADP

4.3.2 Wall Mounting the SLT(1)-U10 ADP

1. Remove the two screws from the top to open the SLT adapter as shown in the diagram.

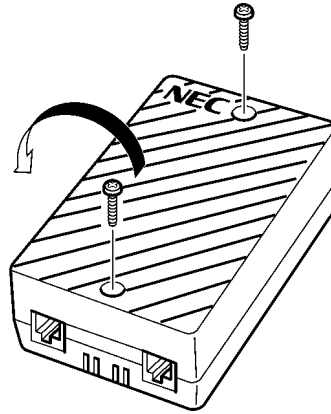

Figure 4-49 Removing the Screws from the SLT(1)-U10 ADP

2. Using the two provided wood screws, attach the unit to the wall. Close the unit and secure it with the two screws that were previously removed.

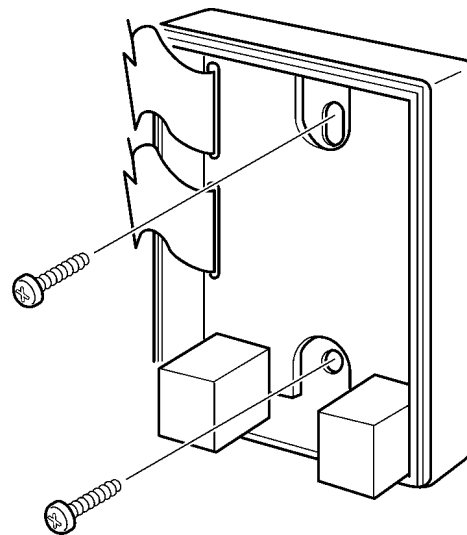
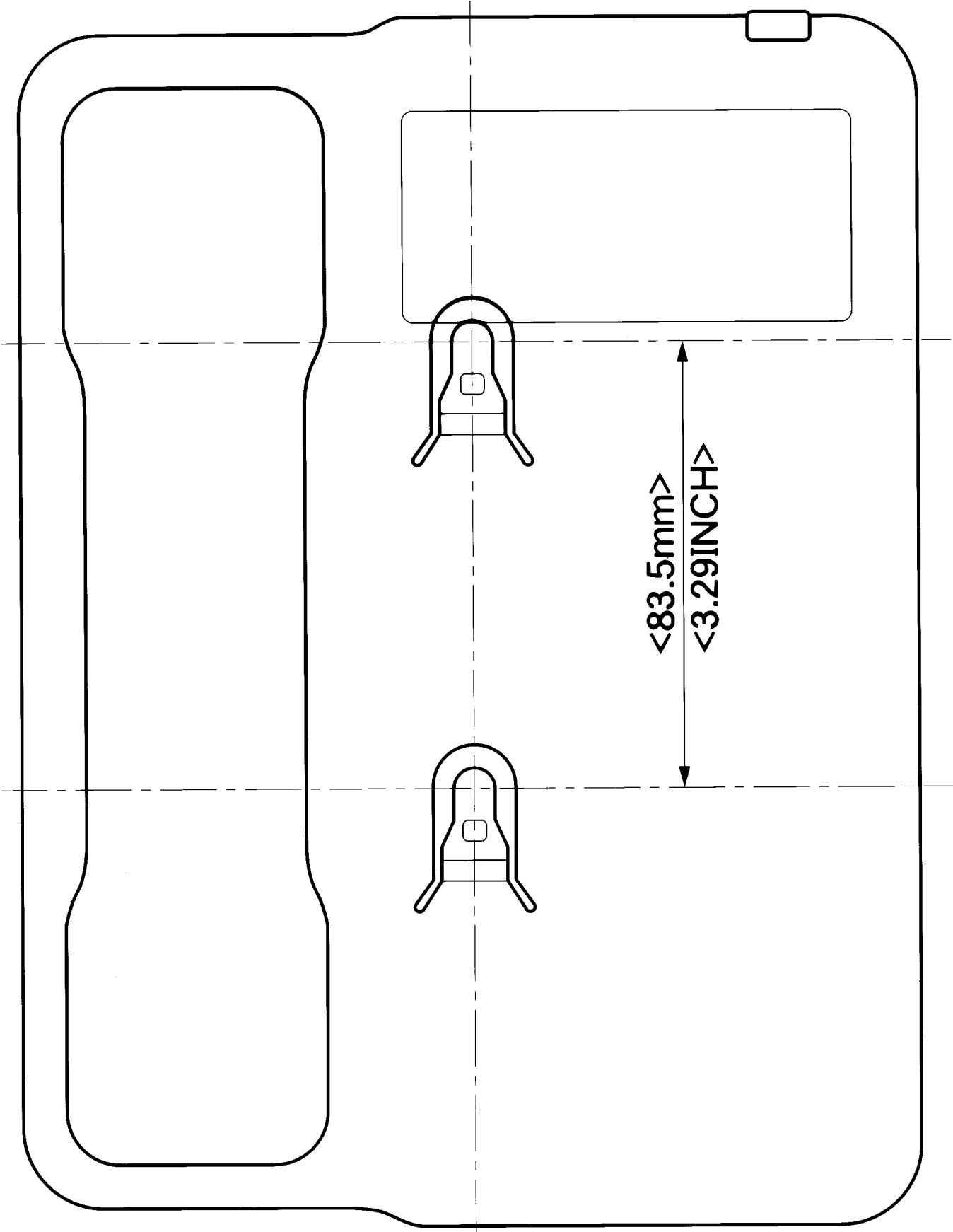

Figure 4-50 Attaching the SLT(1)-U10 ADP to the Wall

SECTION 5**WALL MOUNTING TEMPLATE FOR INFOSET TELEPHONES**

When wall mounting InfoSet 408 telephones, use the template at the end of this chapter to mark the location of the screws on the wall.

NOTE: PRINTER WILL PROVIDE PERFORATED TEMPLATE FOR THIS PAGE. THIS IS JUST AN EXAMPLE



SECTION 1 GENERAL INFORMATION

Optional equipment is available to enhance the InfoSet 408 system. These adapters can be purchased separately from the system and added as your business needs grow. The adapters listed in this chapter can only be installed on the Electra Elite telephones.

A telephone can have up to three adapters installed at the same time. If attaching an APR-U Unit, a CTA-U Unit, or an HFU-U Unit, an external power supply is required. Only **one** power supply is needed even if more than one adapter is installed.

☞ The CTA-U Unit requires system software version 2.0.

When an adapter is installed for the first time into a telephone, the base cover on the telephone may have to be modified. The base cover has two access panels that are removed before the cover can be closed over the adapters to complete the installation.

SECTION 2 PREPARING THE TELEPHONE FOR ADAPTER INSTALLATION

Before adapters can be installed, the following steps must be performed to prepare the telephone.

1. Unplug the telephone cord from the telephone.
2. Turn the telephone upside down. Push the tabs indicated in the diagram and raise the inner area of the base plate.

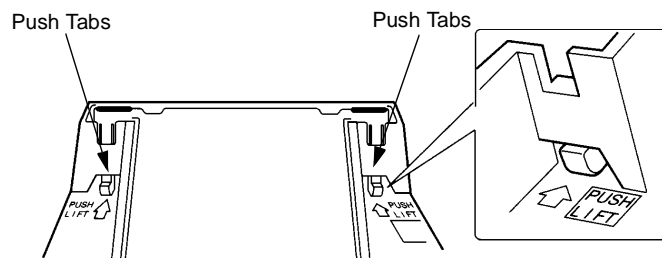

Figure 5-1 Raising the Base Plate on an Electra Elite Telephone

3. Insert the flat head screwdriver into A and press straight down until the tab unlocks.

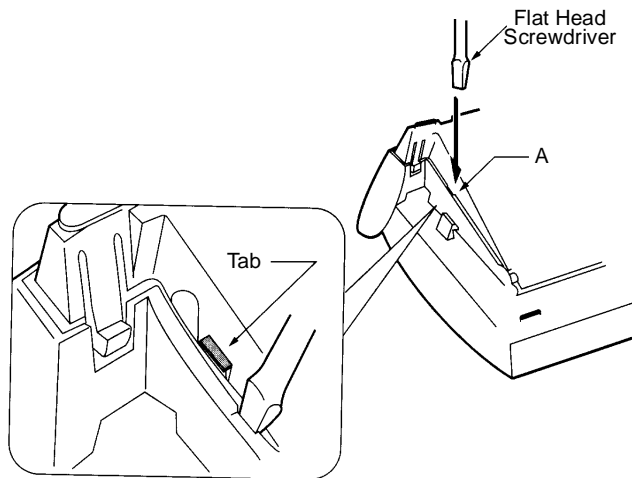

Figure 5-2 Unlocking the Tab on an Electra Elite Telephone

4. Lightly press the right side of leg shown as B and insert the flat head screwdriver at C. Press straight down until other the tab unlocks.

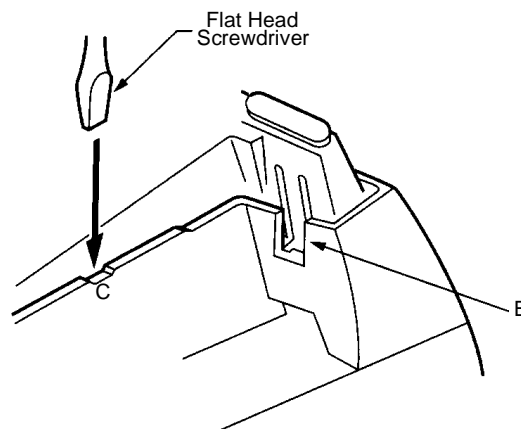

Figure 5-3 Releasing the Right Tab on an Electra Elite Telephone

5. Open and remove the bottom cover by rotating it counterclockwise.

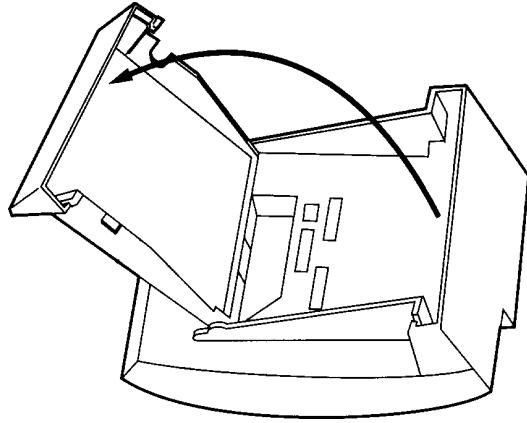

Figure 5-4 Removing Bottom Cover on an Electra Elite Telephone

6. Press tabs A and B to remove the dummy end from the base plate to provide for adapter installation.

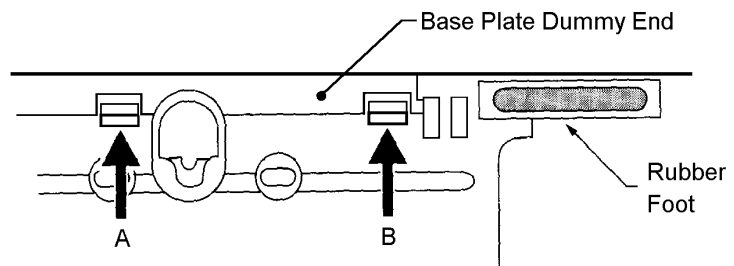

Figure 5-5 Removing the Base Plate Dummy End

- Cut the dummy end in half as indicated in the diagram.

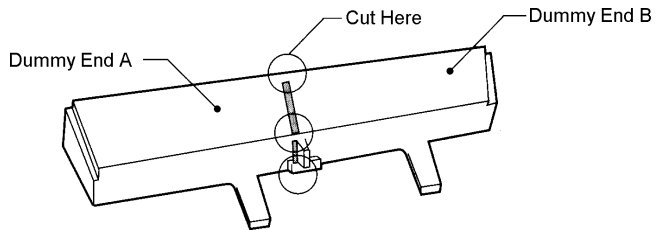

Figure 5-6 Cutting the Dummy End in Half

- If the adapter is installed in Connector 1 install dummy end B.
If the adapter is installed in Connector 2, install dummy end A in the other slot.
(Refer to [Figure 5-7 Installing the Adapter in Connector 1](#) and [Figure 5-8 Installing Dummy End B](#).)

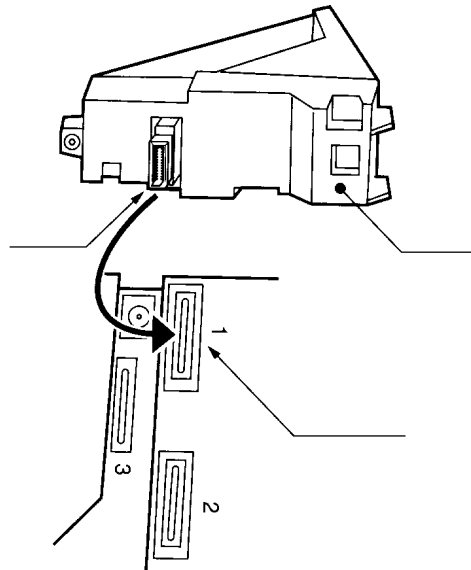

Figure 5-7 Installing the Adapter in Connector 1

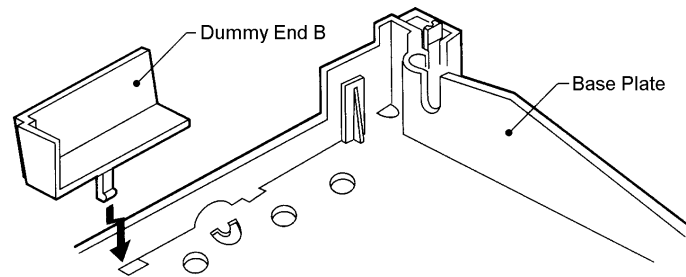

Figure 5-8 Installing Dummy End B

SECTION 3 INSTALLING ADAPTERS

3.1 ACA-U Unit (AC Adapter)

This unit provides power to ancillary devices or Attendant Consoles. The ACA-U Unit must be connected to an adapter that is installed on a telephone. If more than one adapter is installed on a telephone, only one ACA-U Unit is necessary.

The power requirements for the ACA-U Unit are:

- Input: 120V AC, 60 Hz, 30W
- Output: 24V DC, 750 mA
- Polarity: \ominus ————— \oplus

3.1.1 Connecting the ACA-U Unit

1. Unplug the line cord from the telephone and unplug the ACA-U Unit from the AC outlet. (Failing to do this can damage the unit and/or the telephone.)
2. Prepare the telephone for adapter installation as described in [Section 2 Preparing the Telephone for Adapter Installation](#) on page 5-1.

3. Locate the AC adapter plug on the ancillary device that is connected to the bottom of the telephone and plug in the AC adapter.

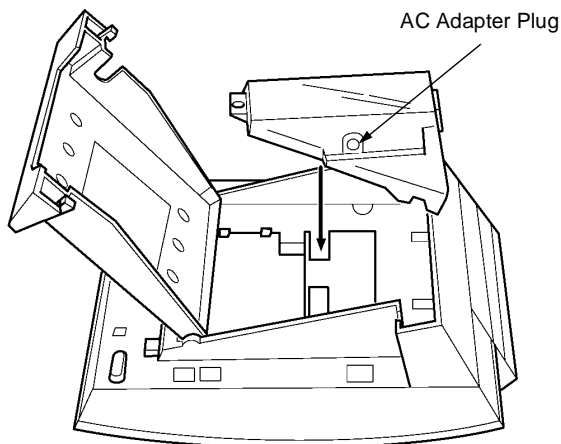

Figure 5-9 Connecting the ACA-U Unit

3.2 ADA-U Unit (Ancillary Device Adapter)

Ancillary Device Adapters allow connection of a tape recorder to Electra Elite telephones.

When installing an ADA-U Unit, first connect the cables to the ADA-U Unit, set the dip switches, and then install the ADA-U Unit on the telephone.

When installing the ADA-U Unit, the cables and switch settings should be done before the unit is installed on the telephone.

3.2.1 Connecting Cables to the ADA-U Unit

Cable terminal connectors are located on the right side of the ADA-U Unit. Cables should be connected on this unit before installing the unit on the telephone.

1. Cut off the plug on one end of the cable.
2. Locate the adapter terminals on the right side of the unit as illustrated in the diagram.

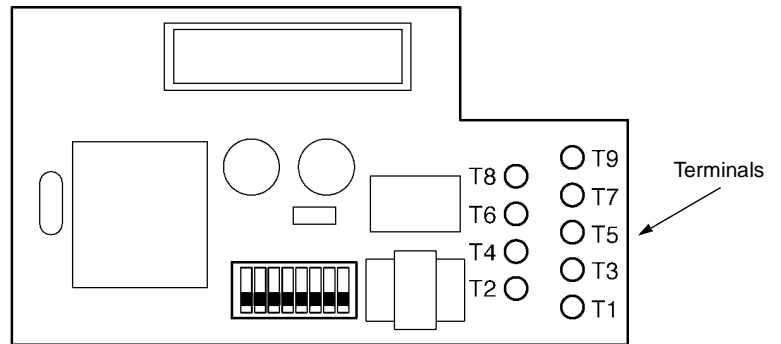

Figure 5-10 ADA-U Unit

3. Remove the cap on the adapter terminal to expose the metal receptacle. Push the cable in the applicable receptacle, and replace the cap. Line up the slot on the cap with the slot on the metal receptacle to ensure proper contact.

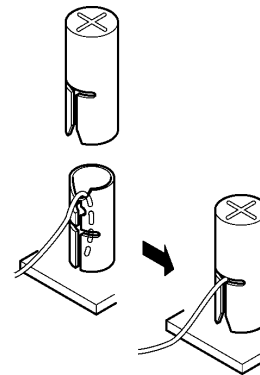

Figure 5-11 Attaching Cables to the ADA-U Unit

4. Insulate the end of the cable that needs to be shielded with insulating tape.

[Table 5-1 ADA-U Cable Connections](#) provides a list of cable connections to ADA-U ADP terminals and describes the specifications for the terminals.

Table 5-1 ADA-U Cable Connections

Terminal Number	Cables to Connect	Terminal Specifications
T1	When warning tone is not being sent from the recorder, connect wire pair input from tone generator to T1:T2. The warning tones from the generator are sent to T1:T2 on a dedicated wire pair while the speech path is sent from the ADA-U on T3:T4 over a separate wire pair to the recorder.	Input Terminal: T1 and T2 are enabled for tone generating device when switches SW1-3 and SW1- 4 are OFF. (If switches SW1- 3 and SW1-4 are ON, a humming sound may be recorded due to impedance mismatch.)
T2		Input Impedance on T1 and T2: 100K Ω Input Level on T1 and T2: -15 dB ~ 40 dB
T3:T4	Connect recorder device wire pair speech input to T3:T4. If the recorder used supplies a warning tone, this tone may also be sent over the T3:T4 wire pair back to the terminal.	Input/Output Terminal: Refer to dip switch settings in Table 5-2 ADA-U Unit Switch Settings .
T5	Connect the bare end of the control cable.	When a telephone is idle, this contact is closed. When the telephone goes off-hook (using the handset, headset, or speakerphone), this contact is open. If recorder owner manual specifies start on open circuit, connect T5 and T6.
T6	Connect the shielded end of the control cable.	Provides common connection for control cable.
T7	Connect the bare end of the control cable.	When the telephone is idle, this contact is open. When the telephone is busy (using the handset, headset, or speakerphone), this contact is closed. If recorder owner manual specifies start on closed circuit, connect T6 and T7.
T8	Unused	
T9	Unused	

Table 5-1 ADA-U Cable Connections (Continued)**Notes:**

- ☞ When recording in handsfree (half-duplex) mode using the built-in speakerphone, the record warning tone may not be audible to the far-end party.
- ☞ The transmit recording level is lower than the receiving voice level for intercom calls; the transmit recording level for CO calls is normal.
- ☞ Depending on the recording device(s), separate cables may be required for the warning tone and speech path. In this case, connect the warning tone cables to input terminals T1 and T2 on the ADA-U Unit. (T3 and T4 are used as the tape recorder input.)
- ☞ If remote control of the recorder is necessary, the record start/stop control is provided by connecting to T5 (or T7) and T6 on the ADA-U Unit. (Connecting to T5 or T7 is determined by the specifications of the recorder.)
- ☞ If a warning Tone is provided from the recording equipment, it should be input via T3 and T4 on ADA-U Unit. (Do not use T1 and T2 to input Beep Tone.)
- ☞ Conversations cannot be recorded from terminals connected to an APR-U Unit. Speakerphone calls through the HFU-U Unit cannot be recorded.

3.2.2 Switch Settings

The DIP Switch is located at the bottom center of the ADA-U Unit. The DIP Switch allows a technician to configure the board to specific settings. [Figure 5-12 ADA-U Unit Switch Settings](#) shows the default settings.

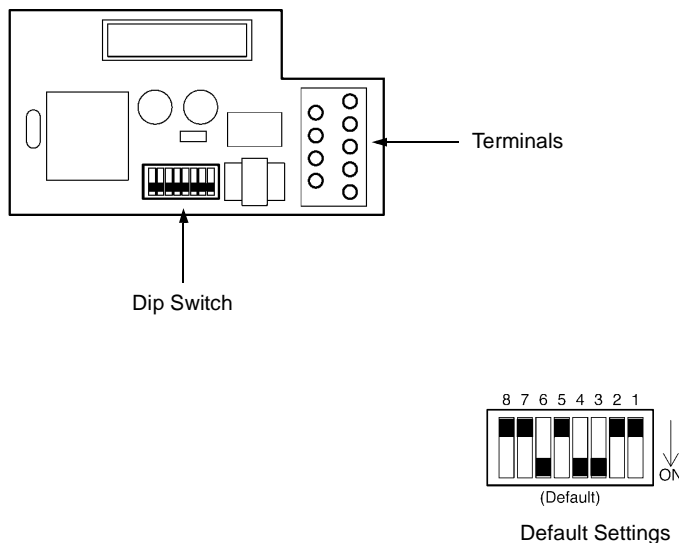

Figure 5-12 ADA-U Unit Switch Settings

The following switch settings should be made on the ADA-U Unit to enable or disable the record start warning tone. Switch settings should be made before installing the ADA-U Unit in the telephone.

Table 5-2 ADA-U Unit Switch Settings

Switch	Setting		Description
SW1-1	On		If the ADA-U provides control to the recorder, SW1-1 should be set to On, otherwise set it to Off.
SW1-2	Off		Leave Off
SW1-3 and SW1-4	SW1-3 ON	SW1-4 ON	Warning Tone from recording device over same wire pair as speech path.
	SW1-3 OFF	SW1-4 OFF	Warning Tone from recorder or generator equipment on dedicated wire pair to recorder MIC input.

Table 5-2 ADA-U Unit Switch Settings (Continued)

Switch	Setting		Description
SW1-5 and SW1-6	SW1-5 OFF	SW1-6 ON	Input impedance is 600 Ω
	SW1-5 ON	SW1-6 OFF	Input impedance is less than 30Ω
SW1-7	ON		If warning tone from any device is sent to telephone
SW1-8	Off		Leave Off

⚠ Do not connect T1 and T2 when switches SW1-3 and SW1-4 are ON.

3.2.3 Installing an ADA-U Unit on an Electra Elite Telephone

1. Unplug the telephone cord from the telephone.
2. Prepare telephone for adapter installation as described in [Section 2 Preparing the Telephone for Adapter Installation on page 5-1](#).
3. Plug the ADA-U Unit connector into the receptacle connector on the back of the telephone. Snap the ADA-U Unit into the hooks on the telephone to secure it.

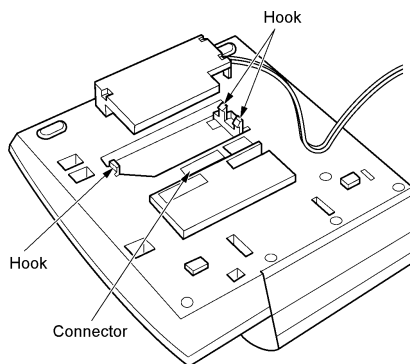

Figure 5-13 Attaching the ADA-U Unit to an Electra Elite Telephone

4. Replace base plate.

5. Lead the audio cable out through the groove on the base cover. Plug in the telephone cord.

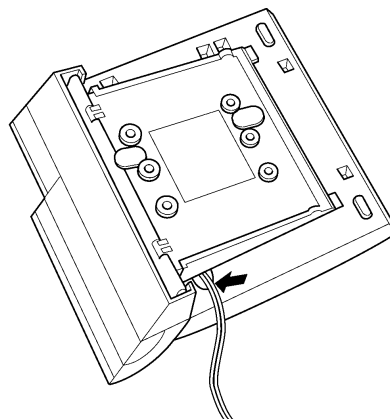

Figure 5-14 Leading the Audio Cable out from the ADA-U Unit

3.3 APR-U Unit (Analog Port Ringer)

The Analog Port Adapter with ringing is the interface for installing single line telephones, modems, and other compatible analog devices. The APR-U Unit also generates ringing signals. By providing ring generation, the user can install a personal fax machine or an answering machine for convenience. Two user-adjustable switches are provided on the adapter; one allows for 600Ω or a complex impedance interface to devices such as a modem or single line telephone, the second switch (SW1) is set to position 2. The APR-U Unit **requires** an AC Adapter. If a CTA-U Unit, or HFU-U Unit and an APR-U Unit are both installed, only one AC Adapter is required.

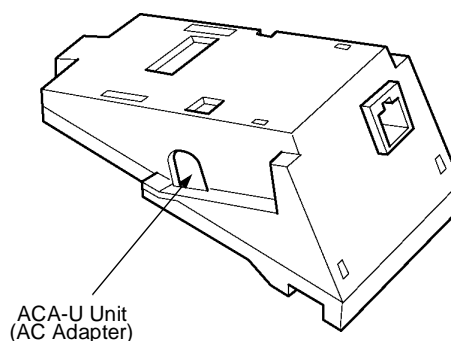

Figure 5-15 APR-U Unit

3.3.1 Installing an APR-U Unit on a Telephone

1. Prepare telephone for adapter installation as described in [Section 2 Preparing the Telephone for Adapter Installation on page 5-1](#).
2. Plug the unit into the receptacle connector inside the base plate.

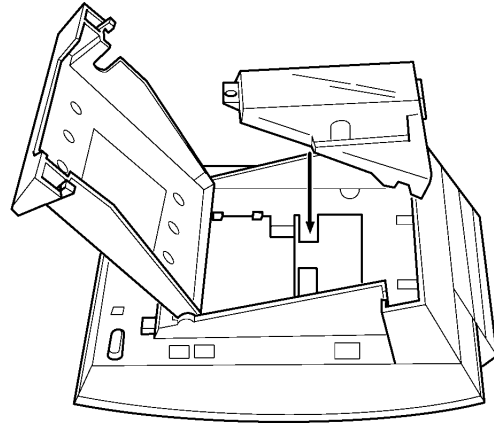

Figure 5-16 Attaching the Unit to the Telephone

3. Plug the cord of the ACA-U Unit (AC adapter) into the jack on the APR-U Unit. Lead the telephone cord out through the groove in the base as shown in the diagram.

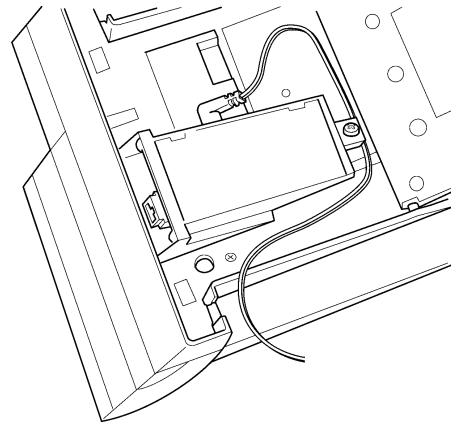

Figure 5-17 Leading the Telephone Cord out from the Unit

4. Close the base plate, lead the AC adapter cord out through the hole, and snap the cover in place.

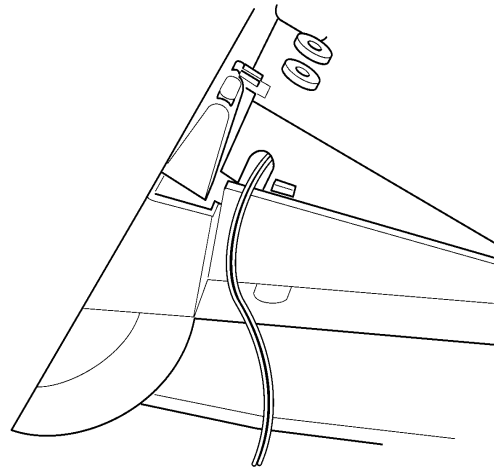

Figure 5-18 Closing the Base Plate Cover

5. Install a ferrite core (provided with the APR-U Unit) by looping the line cord through the core between the terminal (one inch from the terminal) and the ESI port. This core is only used with the APR-U Unit.
6. Plug in the power cord on the AC adapter and the telephone cord in the jack.

3.3.2 Switch Settings

There are two switch settings on the APR-U Unit.

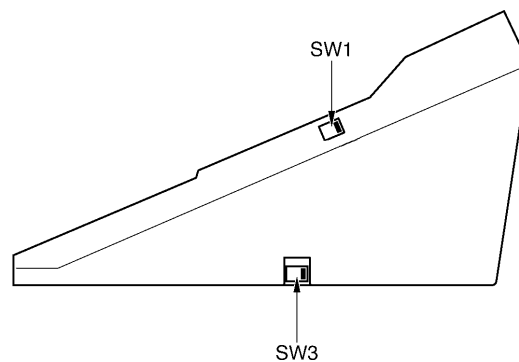

Figure 5-19 APR-U Unit Switches

The following table lists the switch settings for SW1 and SW3.

Table 5-3 APR-U Unit Switch Settings for SW1 and SW3

Switch	Description
SW1-1	Do not use
SW1-2	A Single Line Telephone and telephone are used alternately. (The telephone and the APR-U Unit share the same B1 channel.)
SW3-1	Sets impedance to 600Ω for devices such as modems or facsimile machines.
SW3-2	Used for complex impedance devices such as Single Line Telephones.

3.3.3 Connecting Cables on the APR-U Unit

Plug the telephone cord from the single line telephone into the modular jack on the APR-U Unit.

Limit the cable length from the APR-U Unit to the single line telephone to a maximum of 50 feet.

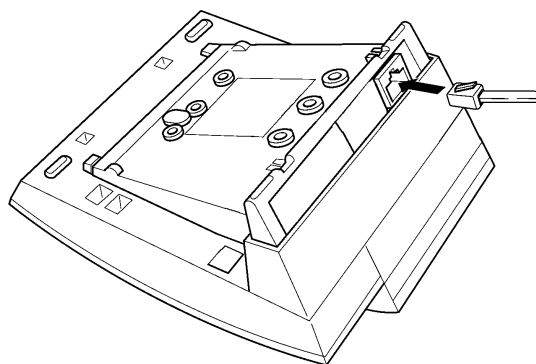

Figure 5-20 Connecting Cables on the APR-U Unit

3.4 HFU-U (BK)/(WH) Unit (Handsfree Unit)

The handsfree unit provides full-duplex handsfree communication. Large areas may cause poor full-duplex operation. This unit comes with the handsfree adapter and an external microphone. With terminal upside down, facing from the bottom of the open cover, install this unit in Telephone Slot 1.

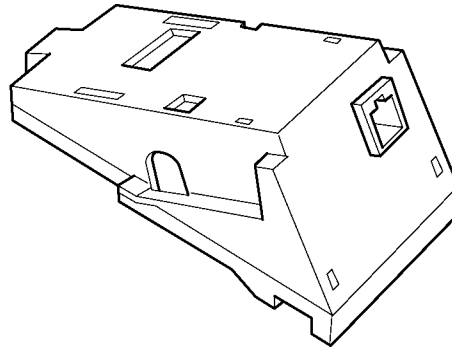

Figure 5-21 HFU-U(BK)/(WH) Unit

3.4.1 Installing an HFU-U (BK)/(WH) Unit on a Telephone

Refer to [3.2.3 Installing an ADA-U Unit on an Electra Elite Telephone on page 5-11](#). The instructions for installing these units are the same.

3.4.2 Installing the External Microphone

An external microphone can be installed on the HFU-U (BK)/(WH) Unit. These instructions apply to the external microphone obtained from NEC. This microphone is equipped with a mute button.

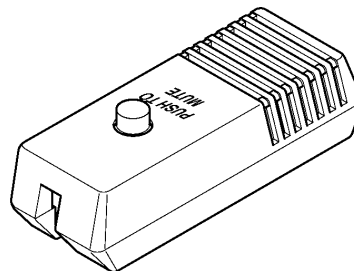

Figure 5-22 Microphone with Mute

1. Plug the microphone cord into the jack on the HFU-U (BK)/(WH) Unit as shown in the diagram.
 - ☞ The microphone should be between one foot and three feet away from the telephone.

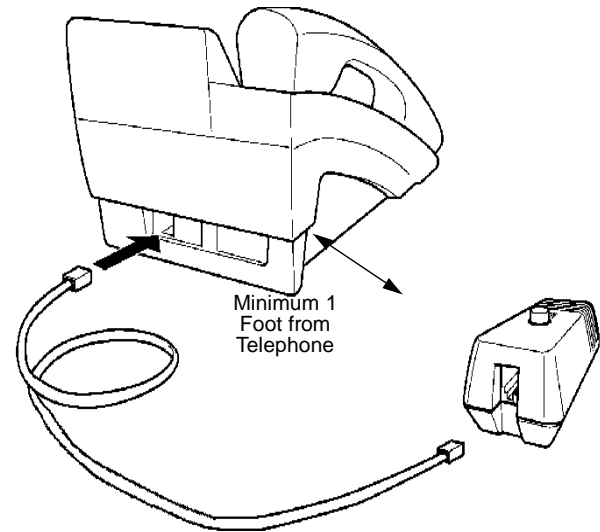

Figure 5-23 Attaching a Microphone to a Telephone

3.4.3 Switch Settings

The HFU-U (BK)/(WH) Unit uses two position switches SW1 and SW2 on the HFU-U (BK)/(WH) Unit.

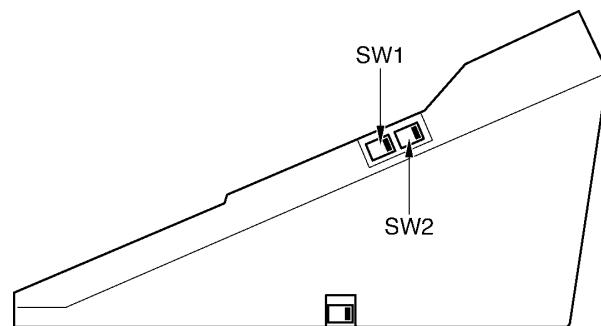

Figure 5-24 HFU-U(BK)/(WH) Unit Switches

The following table lists the SW1 and SW2 switch settings.

Table 5-4 HFU-U Unit Switch Settings

SW1		SW2		Description
Position 1	Position 2	Position 1	Position 2	
OFF	ON	OFF	ON	Full Duplex (Default)
ON	OFF	OFF	ON	Half Duplex (6db mix ratio)
OFF	ON	ON	OFF	Half Duplex (12db mix ratio)
ON	OFF	ON	OFF	Half Duplex (18db mix ratio)

- ☞ Full Duplex: In some large areas or noisy locations half duplex should be used. There are limits to the echo canceling ability of the HFU-U.
- ☞ Half Duplex: If voice clipping occurs, use a lower decibel setting.

3.5 CTA-U Unit (Computer Telephony Application)

Computer Telephony Application allows an Electra Elite telephone to be connected to a PC. The PC can then be used to perform all of the functions of the telephone by using a TAPI-compatible application software.

- ☞ The CTA-U Unit requires system software version 2.0.

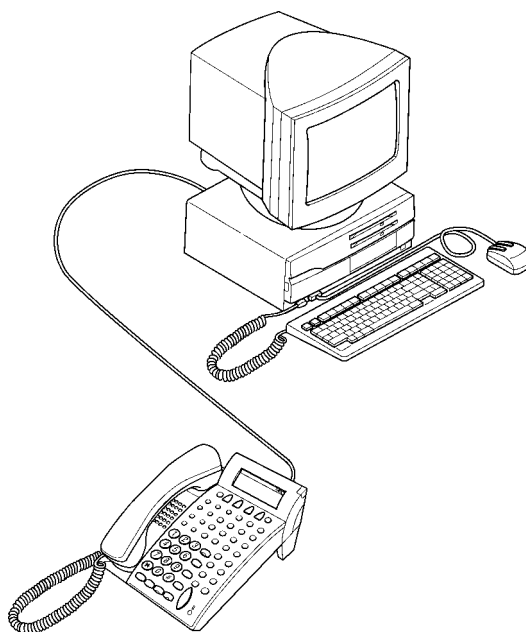

Figure 5-25 Attaching an Electra Elite Telephone to a PC

The CTA-U Unit is attached to the bottom of the Electra Elite telephone.

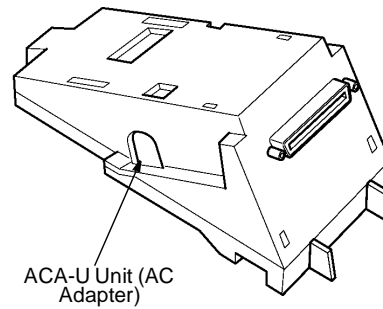

Figure 5-26 CTA-U Unit

3.5.1 Installing the CTA-U Unit

1. Prepare telephone for adapter installation as described in [Section 2 Preparing the Telephone for Adapter Installation on page 5-1](#).
2. Plug the unit into the receptacle connector inside the base plate on the telephone.

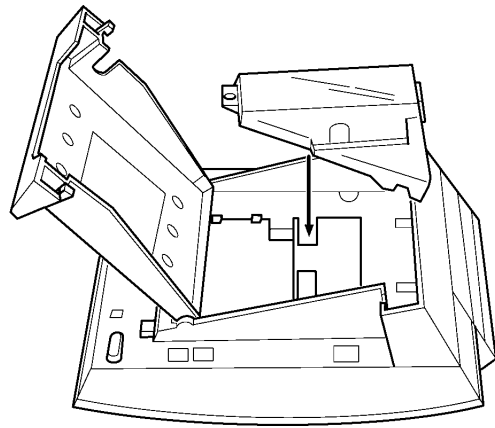

Figure 5-27 Attaching the Unit to the Telephone

3. Close the base plate.

3.5.2 Connecting the Cables on the CTA-U Unit

Connect the RS-232C cable from the computer to the connector on the CTA-U Unit as shown in the diagram.

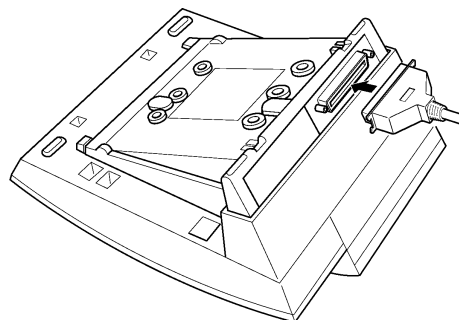

Figure 5-28 Connecting the RS-232C Cable to the CTA-U Unit on the Telephone

3.5.3 Installing the Driver on the PC

Using the setup disk provided with the CTA-U Unit install the driver on your PC. Refer to the *CTA installation Guide* for instructions on installing CTA setup disks.

SECTION 1 INTRODUCTION

When the system is initially installed, it is fully operational with the preset default settings. Users can customize the system by changing system programming values using either telephone programming or PC programming. This chapter provides detailed instructions for programming from a telephone.

Telephone programming is designed primarily for experienced users. Therefore, if you are a first-time user, we strongly recommend that you use PC programming instead of telephone programming.

It should be noted that only one telephone can be in programming mode at a time. If another telephone user attempts to access programming mode, that telephone is blocked from entering programming mode.

The following InfoSet and Electra Elite telephone types can be used as programming telephones.

- DTB-16D-1(BK)/(WH) TEL
- DTU-16D-2(BK)/(WH) TEL
- DTU-32D-2(BK)/(WH) TEL

 Only telephone ports 1 and 2 (normally extensions 10 or 11) can be used to enter telephone program mode.

SECTION 2 ENTERING PROGRAMMING MODE

Once you have entered into programming mode you can access the various programming functions by either using the navigational keys or by manually entering the function number (e.g., 001-1, 002, 220, etc.). The function number provides access to the area you want to program. [Table 6-1 Navigational Keys for Telephone Programming](#) provides a list of keys you can use to navigate the system. [Table 6-2 Programming Functions Quick Reference Chart](#) provides a complete list of all of the programming functions.

To program the system using a telephone, you must first enter programming mode.

1. Press .
2. Press .

3. Dial . The display shows the information for function number 000-1.

P001 SYS SETUP 1
987654321

2.1 Programming Guidelines

When programming you should understand the following:

- The telephone display indicates the function number, function group name and default settings.

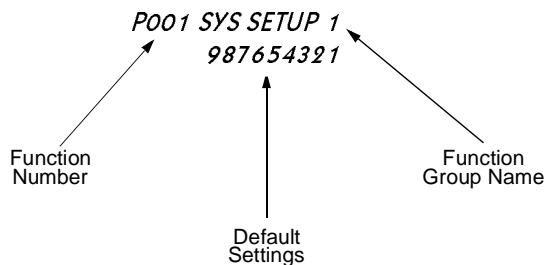

- When function numbers are grouped (e.g., 001-1 ~ 001-9), all of the function numbers are displayed at the same time. To change between the default value and the alternate value, press the dial pad key that corresponds to the last digit of the function number you are changing.















For example:

When you access the function number for 001-1~001-9. The system displays: *P001 SYS SETUP 1*
987654321

If you want to change the programming value for Function 001-4, press on the dial pad. When “-” appears on the display, you have changed to the alternate programming value for that function. The default value is displayed if this is the first time you are using the system. If the system has been previously programmed, the alternate value may be displayed instead of the default value. It is important to note that the series of numbers is displayed in descending order (987654321).

- The following navigational keys are used. Note that the Electra Elite telephones do not have a SPD key. The InfoSet telephones use the and keys to perform many of the same functions that the key does on the Electra Elite telephones. Throughout this chapter any differences are noted where necessary.

Table 6-1 Navigational Keys for Telephone Programming

Key	Description
 	Returns to the previous function. Repeatedly pressing this key allows you to scroll backward through the function numbers.
 	Forwards to the next function. Repeatedly pressing this key allows you to scroll forward through the function numbers.
 	Clears the display allowing you to enter a function number using the dialpad.
 	Exits programming mode and returns the telephone to normal operation.
 	The  key on InfoSet telephones and  on Electra Elite telephones is used to enter a dash into a telephone number.
 	Clears data that was entered using the dialpad.

- ❑ The line keys are numbered differently for the InfoSet and Electra Elite telephones. The diagram below illustrates these differences. It is important to keep these differences in mind when programming.

InfoSet Telephone

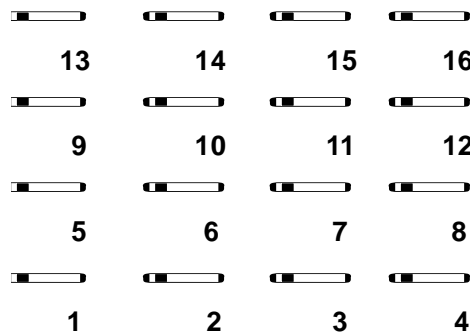

Electra Elite Telephone

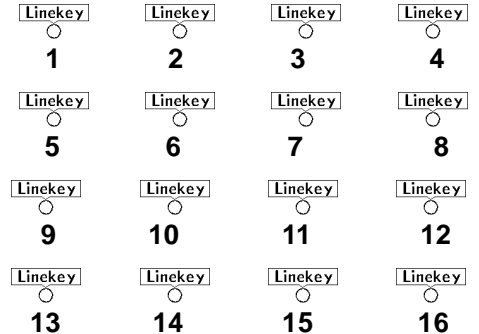

Typically, line keys 1~4 are used for trunk line assignment. However, any unused line keys can be assigned as one-touch/feature access keys.

SECTION 3 PROGRAMMING FUNCTIONS

The table provides a complete list of all of the programming functions. These are listed in order by function number. The table consists of four columns, a brief explanation of each column is listed below.

- ❑ **Function Number**
Lists the number used by the system to access the programming functions.
- ❑ **Function Name/Telephone Display**
Lists the function name and shows how the function appears in the display of the telephone. Since there is limited space in the telephone display, the functions are abbreviated and will not match the function name. To distinguish the function name from the telephone display, the following font is used to indicate the display: *Display Sample Typeface*. The telephone display typically consists of two lines. The first line is the abbreviation and the second line is the default setting. If your system has been previously programmed, the number on your display may be different from the one provided in the table.
- ❑ **Description**
Provides a brief explanation of the function.
- ❑ **Programming Values**
Lists the programmable options for the function. Note that the default values are displayed in bold typeface.

Table 6-2 Programming Functions Quick Reference Chart

Function Number	Function Name and Telephone Display	Description	Programming Values	
001-1	Internal Call Notification <i>P001 SYS SETUP 1 98-654321</i>	Used to indicate how users are notified of internal calls. If Voice is selected, users can voice announce calls. If Signal Tone is selected, the system sends an audible tone to the called party.	1 = Voice - = Signal Tone	
Programming Note: To change the default setting for Functions 001-1~001-9, press the dialpad key that corresponds to the number you want to change. For example, to change the setting for 001-9, press <table border="1" style="display: inline-table; vertical-align: middle;"><tr><td style="text-align: center;">9 WXYZ</td></tr></table> . When you press the number, the system toggles between the two programming values.				9 WXYZ
9 WXYZ				
001-2	Speed Dial Assignment	Used to assign the number of speed dial memory locations used for system (common) speed dialing and telephone (individual) speed dialing.	2 = 80 System/20 Personal - = 200 Slots/0 Personal	
001-3	One-Touch Key Assignment	Used to indicate if a one-touch key is assigned for Call Notification (DSS).	3 = Call Notification - = Not Used	
Programming Note: On InfoSet or Electra Elite telephones, any unused line keys can be assigned as one-touch/feature access keys.				
001-4	Ringing Transfer	Used to enable or disable ringing transfer for external calls. If enabled, the called party hears ringing. If disabled, the called party does not hear ringing and must press the flashing external line key to answer the call.	4 = Enabled - = Disabled	
001-5	Automatic Transfer	Used to enable or disable the automatic transfer function. If enabled, the calling party hangs up and the call is automatically transferred. If disabled, the calling party must remain off-hook until the called party answers.	5 = Enabled - = Disabled	

Table 6-2 Programming Functions Quick Reference Chart (Continued)

Function Number	Function Name and Telephone Display	Description	Programming Values
001-6	Trunk Line Direct Access	Used to assign how an outside line is accessed. If enabled, the user can press the designated line to directly access the outside line. If disabled, the user must press the designated line key and then go off-hook to access an external line.	6 = Enabled - = Disabled
001-7	One-Touch Key Direct Access for Outgoing Calls	Used to assign how a one-touch key accesses an outside line. If enabled, the user can press the one-touch key, the outside line is directly accessed and the number is dialed. If disabled, the user must first manually access the outside line before pressing the one-touch key.	- = Disabled 7 = Enabled
001-8	One-Touch Key Duplication Assignment	This feature is used to set a one-touch feature key. If enabled, the one-touch feature key assignment is duplicated to all other telephones in the system.	8 = Enabled - = Disabled
<p>Programming Note: This function can only be set from the telephone attached to telephone ports 1 or 2 (attendant telephone). When using the InfoSet telephones, line keys (09~16) can be assigned as one-touch/feature access keys. When using Electra Elite telephones, the DTU-32D TEL must be used to set this feature and the one-touch/feature access keys (not the line keys) must be used to set one-touch key duplication.</p>			
001-9	Single Line Telephone Hookflash Assignment	Used to assign how the hookflash is used on a single line telephone.	9 = Used for Hold - = Used for Hookflash
002-1	Music Source for Music On Hold <i>P002 SYS SETUP 2</i> <i>987-5432-</i>	Used to indicate whether the system is connected to an external source for Music on Hold.	1 = Not Connected - = Connected
<p>Programming Note: To change the default setting for Functions 002-1~002-9, press the dialpad key that corresponds to the number you want to change. For example, to change the setting for 002-9, press $\left(\begin{smallmatrix} 9 \\ wxyz \end{smallmatrix}\right)$. When you press the number, the system toggles between the two programming values.</p>			
002-2	External Speaker Connection	Used to indicate if an external speaker is connected to the system.	2= Connected - = Not Connected

Table 6-2 Programming Functions Quick Reference Chart (Continued)

Function Number	Function Name and Telephone Display	Description	Programming Values
002-3	External Paging Tone Assignment	Used to assign if an audible tone is sent from the external speaker when call paging is used.	3 = Enabled – = Disabled
002-4	Internal All Call Page Tone Assignment	Used to enable or disable the ability to receive an all call page tone system-wide.	4 = Enabled – = Disabled
002-5	Barge-In Notification Tone	Used to enable or disable an audible tone when barging into a conversation.	5 = Enabled (Tone Sent) – = Disabled (No Tone Sent)
002-6	Background Music Source	Indicates whether a background music source is connected to the system.	6 = Connected – = Not Connected
002-7	Time Format for Telephone Display	Selects the format used when displaying time on the telephone.	7 = 12-Hour (12:00 a.m. ~ 11:59 p.m.) – = 24-Hour (0:00 ~ 23:59)
002-8	Private Call	Assigns an external line for private use. When used, the assigned line cannot be accessed by another telephone user and no other telephone user has the call indication on their telephone.	8 = Private Call – = Remove Private Call
002-9	Station Message Detail Recording	Enables or disables Station Message Detail Recording (SMDR). SMDR provides detailed telephone usage records.	9 = Enabled – = Disabled
003	Hold Warning Tone Timer <i>P003 HOLD RECALL</i> <i>0</i>	Sets the timer that is used to indicate a call has been on hold past the time set.	0 = 1 minute 1 = 2 minutes 2 = 3 minutes 3 = 4 minutes 4 = No Limit (No warning indication sent)
004	Exclusive Hold Warning Tone Timer <i>P004 EX-HOLD REC</i> <i>0</i>	Sets the timer that is used to indicate a call has been on exclusive hold past the time set.	0 = 1 minute 1 = 2 minutes 2 = 3 minutes 3 = 4 minutes 4 = No Limit (No warning indication sent)

Table 6-2 Programming Functions Quick Reference Chart (Continued)

Function Number	Function Name and Telephone Display	Description	Programming Values																				
005	Automatic Redial Timer <i>P005 REDIAL TIME</i> 1	Used to set three parameters associated with the Automatic Redial feature. <i>Duration</i> indicates the amount of time the system continues to redial the number. <i>Wait Duration</i> is the amount of time the system waits between call attempts. <i>Number of Times</i> indicates the number of times the system redials to a busy number or when there is no answer.	<table style="width: 100%; border: none;"> <tr> <td></td> <td style="text-align: center;">Duration</td> <td style="text-align: center;">Wait Duration</td> <td style="text-align: center;">Number of Times</td> </tr> <tr> <td>0 =</td> <td>5 sec.</td> <td>5 sec.</td> <td>7</td> </tr> <tr> <td>1 =</td> <td>10 sec.</td> <td>30 sec.</td> <td>7</td> </tr> <tr> <td>2 =</td> <td>15 sec.</td> <td>60 sec.</td> <td>7</td> </tr> <tr> <td>3 =</td> <td>15 sec.</td> <td>90 sec.</td> <td>7</td> </tr> </table>		Duration	Wait Duration	Number of Times	0 =	5 sec.	5 sec.	7	1 =	10 sec.	30 sec.	7	2 =	15 sec.	60 sec.	7	3 =	15 sec.	90 sec.	7
	Duration	Wait Duration	Number of Times																				
0 =	5 sec.	5 sec.	7																				
1 =	10 sec.	30 sec.	7																				
2 =	15 sec.	60 sec.	7																				
3 =	15 sec.	90 sec.	7																				
006	Hookflash Duration <i>P006 HOOKFLASH</i> 5	Used to specify time it takes for the system to recognize the signal as a hookflash. A hookflash can be generated by pressing the hookswitch or by pressing a key on a multiline telephone.	<table style="width: 100%; border: none;"> <tr> <td>0 = 40 ms.</td> <td>5 = 600 ms.</td> </tr> <tr> <td>1 = 90 ms.</td> <td>6 = 800 ms.</td> </tr> <tr> <td>2 = 140 ms.</td> <td>7 = 1 sec.</td> </tr> <tr> <td>3 = 200 ms.</td> <td>8 = 1.5 sec.</td> </tr> <tr> <td>4 = 400 ms.</td> <td>9 = 2 sec.</td> </tr> </table>	0 = 40 ms.	5 = 600 ms.	1 = 90 ms.	6 = 800 ms.	2 = 140 ms.	7 = 1 sec.	3 = 200 ms.	8 = 1.5 sec.	4 = 400 ms.	9 = 2 sec.										
0 = 40 ms.	5 = 600 ms.																						
1 = 90 ms.	6 = 800 ms.																						
2 = 140 ms.	7 = 1 sec.																						
3 = 200 ms.	8 = 1.5 sec.																						
4 = 400 ms.	9 = 2 sec.																						
007	Disconnect Detection Duration <i>P007 DISCONNECT</i> 7	Used to specify the time the system waits before a call is considered disconnected.	<table style="width: 100%; border: none;"> <tr> <td>0 = No Detection</td> <td>5 = 250 ms.</td> </tr> <tr> <td>1 = 50 ms.</td> <td>6 = 300 ms.</td> </tr> <tr> <td>2 = 100 ms.</td> <td>7 = 350 ms.</td> </tr> <tr> <td>3 = 150 ms.</td> <td>8 = 400 ms.</td> </tr> <tr> <td>4 = 200 ms.</td> <td>9 = 500 ms.</td> </tr> </table>	0 = No Detection	5 = 250 ms.	1 = 50 ms.	6 = 300 ms.	2 = 100 ms.	7 = 350 ms.	3 = 150 ms.	8 = 400 ms.	4 = 200 ms.	9 = 500 ms.										
0 = No Detection	5 = 250 ms.																						
1 = 50 ms.	6 = 300 ms.																						
2 = 100 ms.	7 = 350 ms.																						
3 = 150 ms.	8 = 400 ms.																						
4 = 200 ms.	9 = 500 ms.																						
008	Call Forward – No Answer Duration <i>P008 FWD NOANS</i> 0	Indicates the time between when a call is received and the time the system recognizes that there is no answer before the call has been forwarded.	<table style="width: 100%; border: none;"> <tr> <td>0 = 10 sec.</td> <td>3 = 25 sec.</td> </tr> <tr> <td>1 = 15 sec.</td> <td>4 = 30 sec.</td> </tr> <tr> <td>2 = 20 sec.</td> <td>5 = 60 sec.</td> </tr> </table>	0 = 10 sec.	3 = 25 sec.	1 = 15 sec.	4 = 30 sec.	2 = 20 sec.	5 = 60 sec.														
0 = 10 sec.	3 = 25 sec.																						
1 = 15 sec.	4 = 30 sec.																						
2 = 20 sec.	5 = 60 sec.																						
009	Outgoing Call Line Selection <i>P009 OUTGOING LN</i> 2	Used to assign the type of line the system connects to when 9– (outside call access code) is used, ^{Redial} is pressed, or a one-touch key is pressed. If KF is specified, the line key must be pressed to access a trunk line. If analog only or analog prioritized is selected, an analog trunk line is selected first. If ISDN prioritized is selected, an ISDN line is selected first.	<table style="width: 100%; border: none;"> <tr> <td>0 = Key Function (KF)</td> </tr> <tr> <td>1 = Multifunction (MF) – Analog Only</td> </tr> <tr> <td>2 = Multifunction (MF) – Analog Prioritized</td> </tr> <tr> <td>3 = Multifunction (MF) – ISDN Prioritized</td> </tr> </table>	0 = Key Function (KF)	1 = Multifunction (MF) – Analog Only	2 = Multifunction (MF) – Analog Prioritized	3 = Multifunction (MF) – ISDN Prioritized																
0 = Key Function (KF)																							
1 = Multifunction (MF) – Analog Only																							
2 = Multifunction (MF) – Analog Prioritized																							
3 = Multifunction (MF) – ISDN Prioritized																							

Table 6-2 Programming Functions Quick Reference Chart (Continued)



Function Number	Function Name and Telephone Display	Description	Programming Values
010	Outgoing Call Access Code for PBX <i>P010 PBX AC</i> <i>9-</i>	Used to specify the code (number) dialed to access an outside line from a PBX.	9– (2-digit access code) Maximum digits = 6 (3 numbers and 3 pauses)
<p>Programming Note: For Function 010, press  on the InfoSet telephone and  on the Electra Elite telephone to enter a pause. You cannot enter two consecutive pauses, there must be a number between a pause.</p>			
011	Background Music Destination <i>P011 BGM DESTIN</i> <i>1</i>	Indicates where background music is heard.	0 = External Speaker 1 = Telephone Speaker 2 = External Speaker and Telephone Speaker 3 = Background Music Not Heard
012	Music On Hold Melody <i>P012 MSC ON HOLD</i> <i>0</i>	Used to select the melody used for the Music on Hold.	0 = “Je te veus” 1 = Minuet
014	Night Mode Start Time (Assignment 1) <i>P014 N MD TM1 ST</i> <i>:</i>	Used to select the time of day the system switches from day mode to night mode.	Not Set Use 24-hour mode to set the time (00:00–23:59).
<p>Programming Note: When setting the time for Functions 014–017, use line key 13 to move the cursor to the left and 16 to move the cursor to the right.</p>			
015	Night Mode End Time (Assignment 1) <i>P015 N MD TM1 ED</i> <i>:</i>	Used to select the time of day the system switches from night mode back to day mode.	Not Set Use 24-hour mode to set the time (00:00 ~ 23:59).
016	Night Mode Start Time (Assignment 2) <i>P016 N MD TM2 ST</i> <i>:</i>	Used to select the time of day the system switches from day mode to night mode.	Not Set Use 24-hour mode to set the time (00:00 ~ 23:59).
017	Night Mode End Time (Assignment 2) <i>P017 N MD TM2 ED</i> <i>:</i>	Used to select the time of day the system switches from night mode back to day mode.	Not Set Use 24-hour mode to set the time (00:00 ~ 23:59).

Table 6-2 Programming Functions Quick Reference Chart (Continued)

Function Number	Function Name and Telephone Display	Description	Programming Values
018-1	Night Mode – Monday <i>P018 NIGHT MODE</i> <i>Monday:0</i>	Used to assign night mode for Monday.	0 = Continuous Day Mode 1 = Night Mode Assignment 1 2 = Night Mode Assignment 2 3 = Continuous Night Mode (Holidays)
018-2	Night Mode – Tuesday <i>P018 NIGHT MODE</i> <i>Tuesday:0</i>	Used to assign night mode for Tuesday.	
018-3	Night Mode – Wednesday <i>P018 NIGHT MODE</i> <i>Wednesday:0</i>	Used to assign night mode for Wednesday.	
018-4	Night Mode – Thursday <i>P018 NIGHT MODE</i> <i>Thursday:0</i>	Used to assign night mode for Thursday.	
018-5	Night Mode – Friday <i>P018 NIGHT MODE</i> <i>Friday:0</i>	Used to assign night mode for Friday.	
018-6	Night Mode – Saturday <i>P018 NIGHT MODE</i> <i>Saturday:0</i>	Used to assign night mode for Saturday.	
018-7	Night Mode – Sunday <i>P018 NIGHT MODE</i> <i>Sunday:0</i>	Used to assign night mode for Sunday.	
<p>Programming Note: When scrolling to the next day of the week, press .</p> <p>It is important to note that programming values 1 and 2 are only available if Functions 014 and 015 (Night Mode Assignment 1) or 016 and 017 (Night Mode Assignment 2) have been programmed. If you attempt to enter 1 or 2 when Functions 014–017 have not been programmed, the system simply ignores the entry.</p>			

Table 6-2 Programming Functions Quick Reference Chart (Continued)

Function Number	Function Name and Telephone Display	Description	Programming Values
019-1	Hunt Group Pilot Number 10 <i>P019 PILOT</i> -----	Used to assign extension numbers 10~19 to Hunt Group Pilot Number 10.	1 = Hunt Group Pilot Number Valid – = Hunt Group Pilot Number Invalid A hunt group consists of a series of extensions that are organized so that if the first extension is busy the system hunts for the next extension in the series that is available.
<p>Programming Note: To change the default setting for Functions 019-1~019-5, press the dialpad key that corresponds to the number you want to change. For example, to change the setting for 019-3, press 3 DEF. When you press the number, the system toggles between the two programming values.</p>			
019-2	Hunt Group Pilot Number 20	Used to assign extension numbers 20~29 to Hunt Group Pilot Number 20.	2 = Hunt Group Pilot Number Valid – = Hunt Group Pilot Number Invalid
019-3	Hunt Group Pilot Number 30	Used to assign extension numbers 30~39 to Hunt Group Pilot Number 30.	3 = Hunt Group Pilot Number Valid – = Hunt Group Pilot Number Invalid
019-4	Hunt Group Pilot Number 40	Used to assign extension numbers 40~49 to Hunt Group Pilot Number 40.	4 = Hunt Group Pilot Number Valid – = Hunt Group Pilot Number Invalid
019-5	Hunt Group Pilot Number 50	Used to assign extension numbers 50~59 to Hunt Group Pilot Number 50.	5 = Hunt Group Pilot Number Valid – = Hunt Group Pilot Number Invalid
020	Restricted Dialing – Table 1 <i>P020 RSTRC DL1</i> <i>01:1X</i> <i>02:0</i>	Used to record numbers that users are not allowed to dial (e.g., long distance numbers, 900 numbers, etc.). The table allows eight numbers to be entered and the maximum length of each number is eight digits.	Enter the numbers (maximum 8 digits) that are restricted dialing.
021	Restricted Dialing – Table 2 <i>P021 RSTRC DL2</i> <i>01:</i>		

Table 6-2 Programming Functions Quick Reference Chart (Continued)

Function Number	Function Name and Telephone Display	Description	Programming Values
<p>Programming Note: When setting the restricted dial number for Functions 020~023, use line keys 13 to move the cursor to the left and 16 to move the cursor to the right.</p> <p>To advance to the next location where the restricted dial numbers can be entered, press <input type="button" value="Transfer"/>.</p> <p>To clear an entry, press <input type="button" value="*"/>. Re-enter the data.</p> <p>To enter an "X", which indicates to the system to use any number where X is found, press <input type="button" value="Answer"/>. An "s" should appear in the second line of the display to indicate shift mode. To enter an "X", which indicates a wildcard number, press <input type="button" value="7 P Q R S"/>. To enter "N", which indicates numbers 2~9, press <input type="button" value="9 W X Y Z"/>. To enter an * or #, press <input type="button" value="*"/> or <input type="button" value="#"/> (you must not be in shift mode).</p>			
<p>022</p>	<p>Authorized Dialing – Table 1</p> <p><i>P022 ALLOW DL1</i></p> <p><i>01:1800</i></p> <p><i>02:1888</i></p> <p><i>03:1877</i></p> <p><i>04:911</i></p>	<p>Used to record numbers that users are permitted to dial (e.g., certain local or long distance numbers). The table allows eight numbers to be entered and the maximum length of each number is eight digits.</p>	<p>Enter the numbers (maximum 8 digits) that are authorized dialing.</p>
<p>023</p>	<p>Authorized Dialing – Table 2</p> <p><i>P023 ALLOW DL2</i></p> <p><i>01:</i></p>		
<p>024</p>	<p>Print Format</p> <p><i>P024 PRN FORMAT</i></p> <p><i>1</i></p>	<p>Used to indicate how the number is printed on the Station Message Detail Report. The options include printing the entire number or just printing the prefix and masking the last four digits.</p>	<p>0 = Only Print Prefix - Mask Last 4 Digits</p> <p>1 = Entire Number</p>
<p>025</p>	<p>Baud Rate to Printer</p> <p><i>P025 PRN SPEED</i></p> <p><i>2</i></p>	<p>Used to assign the baud rate for outputting to the printer.</p>	<p>0 = 1200 bps 3 = 9600 bps</p> <p>1 = 2400 bps 4 = 19200 bps</p> <p>2 = 4800 bps 5 = 38400 bps</p>
<p>026</p>	<p>Stop Bit for Printer</p> <p><i>P026 PRN CONTROL</i></p> <p><i>1</i></p>	<p>Used to assign the stop bit for outputting to the printer.</p>	<p>0 = 2 Stop Bits</p> <p>1 = 1 Stop Bit</p>
<p>027</p>	<p>Disconnect Signal Duration</p> <p><i>P027 DIS TIME</i></p> <p><i>3</i></p>	<p>Used to assign the duration of the disconnect signal when a caller hangs up.</p>	<p>0 = 0.3 sec. 5 = 2.0 sec.</p> <p>1 = 0.5 sec. 6 = 2.5 sec.</p> <p>2 = 0.7 sec. 7 = 3.0 sec.</p> <p>3 = 1.0 sec. 8 = 3.5 sec.</p> <p>4 = 1.5 sec. 9 = 4.0 sec.</p>

Table 6-2 Programming Functions Quick Reference Chart (Continued)

Function Number	Function Name and Telephone Display	Description	Programming Values
060-1~060-3	<i>For future use</i>		
061~064	<i>For future use</i>		
101	Telephone Number Display for Trunk Line 1 <i>P101 LN1 TEL NO</i>	Used to assign the trunk line telephone number that is displayed when making and answering trunk line calls.	Not Assigned Maximum of 13 digits
102	Telephone Number Display for Trunk Line 2 <i>P102 LN2 TEL NO</i>		
103	Telephone Number Display for Trunk Line 3 <i>P103 LN3 TEL NO</i>		
104	Telephone Number Display for Trunk Line 4 <i>P104 LN4 TEL NO</i>		
105	Trunk Line Function <i>P105 TRUNK STS 4321</i>	Used to indicate how the trunk line is used; for outgoing and incoming calls or for incoming calls only.	1~4 = Allows Outgoing/Incoming Calls – = Incoming Calls Only
<p>Programming Note: For Functions 105~107, 109~110, 119, and 124~125, The trunk numbers are listed in descending order (4321). The defaults settings are shown in the display. To change the default setting for trunk numbers 1~4, press the dialpad key that corresponds to the trunk number you want to change. For example, to change the setting for trunk number 3, press <input type="text" value="3 DEF"/>. The number blinks indicating your selection. Press the number that corresponds to the programming value.</p>			
106	Automatic Release of Trunk Line <i>P106 AUTO RLS 4321</i>	Used to indicate if the system automatically releases the trunk line when the called party disconnects.	1~4 = Automatic Release – = No Automatic Release

Table 6-2 Programming Functions Quick Reference Chart (Continued)

Function Number	Function Name and Telephone Display	Description	Programming Values
107	Trunk Line Type <i>P107 TRUNK TYPE</i> <i>4321</i>	Used to indicate the trunk line type; from a Central Office or from a PBX.	1-4 = Central Office Line - = PBX Line
109	Trunk Line Dialing Type <i>P109 CO LN SLCT</i> <i>1111</i>	Used to indicate the type of dialing; Dial Pulse (10 pps/20 pps), Dual Tone Multifrequency, ISDN, or uninstalled. DP = Rotary Dial DTMF = Touchtone ISDN = Integrated Services Digital Network which allows simultaneous voice and data transmission	0 = Uninstalled 1 = Dual Tone Multifrequency (DTMF) or ISDN 2 = Dial Pulse (DP) 10 pps 3 = Dial Pulse (DP) 20 pps
110	Touchtone Signal Duration and Pause Interval <i>P110 MF PATTERN</i> <i>1111</i>	Used to assign the length of the touchtone (Dual Tone Multifrequency) signal and the pause time before the next signal is sent. This is used when DTMF is assigned to the trunk line and Dial Pulse (DP) is assigned for the switching signal.	0 = 400 ms. (duration)/100 ms. (pause) 1 = 100 ms (duration)/70 ms (pause)
119	Ring Tone Type <i>P119 RING CYCLE</i> <i>4321</i>	Used to select either a low or high ringing tone.	1-4 = Low - = High
124	External Speaker Ringing for Day Mode <i>P124 EXTSP DY</i> <i>5555</i>	Used to assign immediate or delayed ringing to the external speaker to indicate an incoming call during day mode.	0 = 0 sec. 3 = 30 sec. 1 = 10 sec. 4 = 60 sec. 2 = 20 sec. 5 = No Tone
125	External Speaker Ringing for Night Mode <i>P125 EXTSP NT</i> <i>5555</i>	Used to assign immediate or delayed ringing to the external speaker to indicate an incoming call during night mode.	

Table 6-2 Programming Functions Quick Reference Chart (Continued)

Function Number	Function Name and Telephone Display	Description	Programming Values
140	Direct Calling for Day Mode on Trunk Line 1 (DIT Assignment) <i>P140 DIT LN1 DY</i>	Used to indicate an extension number (or voice mail number) that is used for direct calls (i.e., calls that are not routed through an attendant). This assignment applies to day mode.	Blank = No Assignment Extension Number 10-59
141	Direct Calling for Day Mode on Trunk Line 2 (DIT Assignment) <i>P141 DIT LN2 DY</i>		
142	Direct Calling for Day Mode on Trunk Line 3 (DIT Assignment) <i>P142 DIT LN3 DY</i>		
143	Direct Calling for Day Mode on Trunk Line 4 (DIT Assignment) <i>P143 DIT LN4 DY</i>		
144	Direct Calling for Night Mode on Trunk Line 1 (DIT Assignment) <i>P144 DIT LN1 NT</i>	Used to indicate an extension number (or external voice mail number) that is used for direct calls (i.e., calls that are not routed through an attendant). This assignment applies to night mode.	Blank = No Assignment Extension Number 10-59
145	Direct Calling for Night Mode on Trunk Line 2 (DIT Assignment) <i>P145 DIT LN2 NT</i>		
146	Direct Calling for Night Mode on Trunk Line 3 (DIT Assignment) <i>P146 DIT LN3 NT</i>		
147	Direct Calling for Night Mode on Trunk Line 4 (DIT Assignment) <i>P147 DIT LN4 NT</i>		

Table 6-2 Programming Functions Quick Reference Chart (Continued)



Function Number	Function Name and Telephone Display	Description	Programming Values
148	Direct Calling Answer Delay Time (DIT Answer Delay Time) <i>P148 DIT DLY 0000</i>	Used to specify the duration of the delay of incoming direct calls (DIT). This applies to calls received on a line assigned for direct calling (DIT).	0 = 0 sec. 1 = 5 sec. 2 = 10 sec. 3 = 20 sec. 4 = 30 sec. 5 = 40 sec. 6 = 50 sec. 7 = 60 sec.
<p>Programming Note: For Functions 148 and 149, the trunk numbers are listed in descending order (4321). To change the default setting for trunk numbers 1~4, press the dialpad key that corresponds to the trunk number you want to change. For example, to change the setting for trunk number 3, press . The number blinks indicating your selection. Press the number that corresponds to the programming value.</p>			
149	Direct Calling Answer Delay for Night Mode (DIT Answer Delay) <i>P149 DIT DLY NT 4321</i>	Used to indicate whether the answer delay for incoming direct calls that are received in night mode are enabled or disabled.	1~4 = Enabled – = Disabled
202	Off-Hook Ringing Tone <i>P202 OFFHK RING 87654321</i>	Used to indicate whether a ringing tone is sent when the user is engaged in a conversation. This tone signals the user that there is an incoming call (on a trunk line).	1~8 = Enabled 2 = Disabled
<p>Programming Note: For Functions 202~203, the telephone ports are displayed in descending order (87654321). To change the default setting, press the dialpad key that corresponds to the port you want to change. For example, if you want to change the setting for port 7, press . When you press the number, the system toggles between the two programming values.</p>			
203	Trunk Line Barge-In <i>P203 CO BRG IN -----</i>	Used to indicate (for each telephone) if barge-in is allowed when the user is engaged in a call using a trunk line.	1~8 = Enabled – = Disabled

Table 6-2 Programming Functions Quick Reference Chart (Continued)





Function Number	Function Name and Telephone Display	Description	Programming Values
206	Extension Number Assignment <i>P206 EXT NUM</i> <i>NO01:10</i>	Used to assign an extension number to each telephone in the system.	Ports 1~10 = Ext. 10~17 Ports 11~12 = Ext. 50~51 (Voice Mail) Available Extension Numbers = 10~59
<p>Programming Note: For Function 206, the telephone port number and extension number are displayed. To change the extension number for the displayed port, press the numbers on the dial pad that correspond to the extension number. To advance to the next station number, press . You can assign eight ports to multiline telephones, two ports to single line telephones, or two ports can be used for voice mail.</p>			
207	Single Line Port Type <i>P207 SLT TYPE</i> 11	Used to designate whether the single line port is connected to a single line telephone.  This function is only valid when a SLI(2)-B10 ETU is installed in the KSU.	0 = Not Connection 1 = Single Line Telephone
<p>Programming Note: For Function 207, the two telephone ports are displayed. To change the default setting for port numbers 1~2, press the dialpad key that corresponds to the port number you want to change. For example, to change the setting for single line port 2, press . When you press the number, the system toggles between the two programming values.</p>			
208	Single Line Dialing Type <i>P208 SLT TYPE</i> 0987654321	Used to assign the dialing type for single line telephones. The options are rotary (Dial Pulse) or touchtone (Dual Tone Multifrequency).	1~10 = Dual Tone Multifrequency (Touchtone) – = Dial Pulse (Rotary)
<p>Programming Note: For Functions 208~211 and 213~214, the 10 telephone ports are displayed in descending order (0987654321). To change the default settings for ports 1~10, press the dialpad key that corresponds to the port number you want to change. For example, if you want to change the setting for port 10, press . When you press the number, the system toggles between the two programming values.</p> <p>These functions apply to the eight allowed ESI ports and the two SLI ports.</p> <p>Even though it is possible to assign all 10 ports as single line telephones using Function 208, this is not recommended. If you are going to use a telephone to program the system, one telephone must be a multiline telephone.</p>			

Table 6-2 Programming Functions Quick Reference Chart (Continued)

Function Number	Function Name and Telephone Display	Description	Programming Values
209	Outgoing Call Priority Mode <i>P209 CALL PREFER</i> <i>0987654321</i>	Used to select the line that is seized first when the user goes off-hook. The system can be programmed to either seize an internal or external line for multiline telephones and single line telephones.	1~10 = External Line – = Internal Line
210	Doorphone 1 Tone for Day Mode <i>P210 DPH1 CHM DY</i> <i>0987654321</i>	Used to assign a specified telephone to produce a tone (chime) signal when the doorphone receives a call. This assignment applies to day mode for multiline and single line telephones.	1~10 = Tone – = No Tone
211	Doorphone 2 Tone for Day Mode <i>P211 DPH2 CHM DY</i> <i>0987654321</i>		
213	Doorphone 1 Tone for Night Mode <i>P213 DPH1 CHM NT</i> <i>----- 21</i>	Used to assign a specified telephone to produce a tone (chime) signal when the doorphone receives a call. This assignment applies to night mode for multiline and single line telephones.	1~2 = Tone (this is the default setting for telephones 1 and 2) – = No Tone (this is the default setting for telephones 3~10)
214	Doorphone 2 Tone for Night Mode <i>P214 DPH2 CHM NT</i> <i>----- 21</i>		

Table 6-2 Programming Functions Quick Reference Chart (Continued)



Function Number	Function Name and Telephone Display	Description	Programming Values
216	Handsfree Assignment <i>HFU</i> <i>87654321</i>	Used to assign (for each multiline telephone) handsfree operation.	1~8 = Enabled – = Disabled
Programming Note: For Functions 216~218, the telephone ports are displayed in descending order (87654321). To change the default setting, press the dialpad key that corresponds to the port you want to change. For example, if you want to change the setting for port 7, press  . When you press the number, the system toggles between the two programming values.			
217	Internal All Call Paging Tone <i>P217 PAGE EXT</i> <i>87654321</i>	Used to enable or disable call paging tone for each multiline telephone. The page will still be displayed on each multiline telephone and can be answered by any multiline telephone in the system.	1~8 = Enabled – = Disabled
218	Headset Connection <i>P218 HEADSET</i> <i>87654321</i>	Used to indicate if a headset is connected an Electra Elite multiline telephone.	1~8 = Not Connected – = Connected
219	Restricted Calling for External Calls <i>P219 REST DIGIT</i> -----	Used to restrict outgoing calls on a specific line. Restrictions can be set for multiline telephones and single line telephones.	– = Not Restricted 1~10 = Restricted
Programming Note: For Function 219, the telephone ports are displayed in descending order (0987654321). To change the default settings for ports 1~10, press the dialpad key that corresponds to the port you want to change. For example, if you want to change the setting for port 10, press  . When you press the number, the system toggles between the two programming values.			
220	Restricted Dialing Table Selection <i>P220 RSTRC TABLE</i> <i>0000000000</i>	Specifies which Restricted Dialing Table (1 and 2) is used for each telephone in the system (includes both multiline and single line telephones).	0 = Not Used 1 = Table 1 (Table assigned using function 020) 2 = Table 2 (Table assigned using function 021) 3 = Use both Tables 1 and 2
Programming Note: For Functions 220~222, the telephone ports are displayed in descending order (0987654321). To change the default values, press the dialpad key that corresponds to the port you want to change. For example, to change the setting for port 10 press  . For Functions 220 and 221, press the number that corresponds to the programming value. For Function 222, the system toggles between the two programming values when you press the number.			

Table 6-2 Programming Functions Quick Reference Chart (Continued)

Function Number	Function Name and Telephone Display	Description	Programming Values
221	Authorized Dialing Table Selection <i>P221 ALLOW TABLE</i> <i>000000000</i>	Specifies which Authorized Dialing Table (1 and 2) is used for each telephone in the system (includes both multiline and single line telephones).	0 = Not Used 1 = Table 1 (Table assigned using function 020) 2 = Table 2 (Table assigned using function 021) 3 = Use both Tables 1 and 2
222	Authorized Dialing for External Speed Dial Calls <i>P222 RST SPD DL</i> <i>0987654321</i>	Used to assign specific system (common) speed dial memory locations (60~99) that users are permitted to dial. When allowed, any number found in the authorized table (such as a long distance number) overrides any restriction assigned in 020 (Restricted Dialing – Table 1) and 021 (Restricted Dialing – Table 2). These speed dial memory locations are fixed and can be used by multiline and single line telephones users.	- = Denied (number cannot be dialed) 1~10 = Allowed (number can be dialed)
223	Automatic Outgoing Calling <i>P223 NO MATCH DL</i> <i>87654321</i>	Used to allow or deny automatic outgoing calling when the dialed number is not found in one of the Restricted or Authorized Dialing Tables (020 ~ 023).	1~10 = Allowed (outgoing calls can be made) - = Denied (outgoing calls cannot be made)
Programming Note: For Function 223, the telephones ports are displayed in descending order (87654321). To change the default setting, press the dialpad key that corresponds to the port you want to change. For example, if you want to change the setting for port 7, press  . When you press the number, the system toggles between the two programming values.			

Table 6-2 Programming Functions Quick Reference Chart (Continued)

Function Number	Function Name and Telephone Display	Description	Programming Values
301	Day Ringing for Trunk Line 1 <i>P301 CO1 RING DY</i> <i>0000000000</i>	Used to assign the duration of the delay between the time the call is received and the time the ringing tone is heard. This option allows you to delay ringing to another telephone. This assignment is for day mode.	0 = 0 sec. 1 = 10 sec. 2 = 20 sec. 3 = 30 sec. 4 = 60 sec. 5 = No Tone
302	Day Ringing for Trunk Line 2 <i>P302 CO2 RING DY</i> <i>0000000000</i>		
303	Day Ringing for Trunk Line 3 <i>P303 CO3 RING DY</i> <i>0000000000</i>		
304	Day Ringing for Trunk Line 4 <i>P304 CO4 RING DY</i> <i>0000000000</i>		
311	Night Ringing for Trunk Line 1 <i>P311 CO1 RING NT</i> <i>0000000000</i>	Used to assign the duration of the delay between the time the call is received and the time the ringing tone is heard. This option allows you to delay ringing to another telephone. This assignment is for night mode.	0 = 0 sec. 1 = 10 sec. 2 = 20 sec. 3 = 30 sec. 4 = 60 sec. 5 = No Tone
312	Night Ringing for Trunk Line 2 <i>P312 CO2 RING NT</i> <i>0000000000</i>		
313	Night Ringing for Trunk Line 3 <i>P313 CO3 RING NT</i> <i>0000000000</i>		
314	Night Ringing for Trunk Line 4 <i>P314 CO4 RING NT</i> <i>0000000000</i>		

Table 6-2 Programming Functions Quick Reference Chart (Continued)



Function Number	Function Name and Telephone Display	Description	Programming Values
331	Automatic Line Selection for Trunk Line 1 <i>P331 CO1 ATL ORG 0987654321</i>	Used to designate which line keys are used for automatic line key selection. This is used to automatically seize a line by pressing  (InfoSet telephones) or  or going off-hook and dialing the appropriate outside line access code. This is designated for each telephone.	1~10 = Enabled - = Disabled
332	Automatic Line Selection for Trunk Line 2 <i>P332 CO2 ATL ORG 0987654321</i>		
333	Automatic Line Selection for Trunk Line 3 <i>P333 CO3 ATL ORG 0987654321</i>		
334	Automatic Line Selection for Trunk Line 4 <i>P334 CO4 ATL ORG 0987654321</i>		
<p>Programming Note: For Functions 331~334, the telephone ports are displayed in descending order (0987654321). To change the default values, press the dialpad key that corresponds to the port you want to change. For example, to change the setting for port 10 press . When you press the number, the system toggles between the two programming values.</p>			

Table 6-2 Programming Functions Quick Reference Chart (Continued)

Function Number	Function Name and Telephone Display	Description	Programming Values
341	Automatic Answering using Trunk Line 1 <i>P341 CO1 ATL ANS</i> <i>87654321</i>	Used to enable or disable the ability to answer an incoming call by going off-hook. If enabled, the user answers the call by going off-hook. If disabled, the user answers the call by going off-hook and pressing the line key where the call is ringing. Only multiline telephones can be assigned this option.	1 = Enabled - = Disabled
342	Automatic Answering using Trunk Line 2 <i>P342 CO2 ATL ANS</i> <i>87654321</i>		
343	Automatic Answering using Trunk Line 3 <i>P343 CO3 ATL ANS</i> <i>87654321</i>		
344	Automatic Answering using Trunk Line 4 <i>P344 CO4 ATL ANS</i> <i>87654321</i>		
<p>Programming Note: For Functions 341~344, the telephones ports are displayed in descending order (87654321). To change the default setting, press the dialpad key that corresponds to the port you want to change. For example, if you want to change the setting for port 7, press . When you press the number, the system toggles between the two programming values.</p>			

Table 6-2 Programming Functions Quick Reference Chart (Continued)

Function Number	Function Name and Telephone Display	Description	Programming Values
351	Restricting Outgoing Calls for Trunk Line 1 <i>P351 CO1 RST OUT</i> <i>0987654321</i>	Used to enable or disable (for each telephone) the ability to make outgoing calls when 105 - Trunk Line Function is set to "Outgoing/Incoming Calls." This option can be used with multiline and single line telephones.	1~10 = Outgoing Calls Enabled – = Outgoing Calls Disabled
352	Restricting Outgoing Calls for Trunk Line 2 <i>P352 CO2 RST OUT</i> <i>0987654321</i>		
353	Restricting Outgoing Calls for Trunk Line 3 <i>P353 CO3 RST OUT</i> <i>0987654321</i>		
354	Restricting Outgoing Calls for Trunk Line 4 <i>P354 CO4 RST OUT</i> <i>0987654321</i>		
<p>Programming Note: For Functions 351~354, the telephone ports are displayed in descending order (0987654321). To change the default values, press the dialpad key that corresponds to the port you want to change. For example, to change the setting for port 10 press . When you press the number, the system toggles between the two programming values.</p>			

Table 6-2 Programming Functions Quick Reference Chart (Continued)



Function Number	Function Name and Telephone Display	Description	Programming Values
361	Ringing Cycle for Trunk Line 1 <i>P361 CO1 RNG SND 00000000</i>	Assigns the ringing cycle for each telephone. If a number in the Caller ID display matches a number stored in system speed dialing, the system will use the same ringing cycle that system speed dialing uses. Refer to Appendix B Tone Patterns for the ringing cycles.	0 = Cycle A 1 = Cycle B 2 = Cycle C 3 = Cycle D
362	Ringing Cycle for Trunk Line 2 <i>P362 CO2 RNG SND 00000000</i>		
363	Ringing Cycle for Trunk Line 3 <i>P363 CO3 RNG SND 00000000</i>		
364	Ringing Cycle for Trunk Line 4 <i>P364 CO4 RNG SND 00000000</i>		
<p>Programming Note: For Functions 361~364, the telephones ports are displayed in descending order (87654321). To change the default setting, press the dialpad key that corresponds to the port you want to change. For example, if you want to change the setting for port 7, press . Press the number that corresponds to the programming value.</p>			
401	Trunk Line Assignment for Tenant 1 <i>P401 TENANT1 CO 4321</i>	Used to specify the trunk lines assigned as part of the tenant.	1~4 =Assigned to Tenant 1 – = Not Assigned to Tenant 1
402	Trunk Line Assignment for Tenant 2 <i>P402 TENANT2 CO - - - -5</i>		– = Not Assigned to Tenant 2 1~4 =Assigned to Tenant 2
<p>Programming Note: For Functions 401~402, the trunk numbers are listed in descending order (4321). To change the default setting for trunk numbers 1~4, press the dialpad key that corresponds to the trunk number you want to change. For example, to change the setting for trunk number 3, press . When you press the number, the system toggles between the two programming values.</p>			

Table 6-2 Programming Functions Quick Reference Chart (Continued)



Function Number	Function Name and Telephone Display	Description	Programming Values
403	Tenant-to-Telephone Assignment <i>P403 TENANT</i> <i>0987654321</i>	Used to assign each telephone to a tenant. Both multiline and single line telephones can be assigned to a tenant.	1~10 = Assigned to Tenant 1 – = Assigned to Tenant 2
<p>Programming Note: For Function 403, the telephone ports are displayed in descending order (0987654321). To change the default values, press the dialpad key that corresponds to the port you want to change. For example, to change the setting for port 10 press . When you press the number, the system toggles between the two programming values.</p>			
501	Doorphone Call Timer <i>P501 DPH RING TM</i> <i>0</i>	Used to indicate how long "Doorphone X" appears on the telephone display when a call is received from a doorphone.  X = Doorphone Number (1 or 2).	0 = 15 sec. 1 = 30 sec.
502	Single Line Telephone Bounce Time <i>P502 BOUNCE TIME</i> <i>1</i>	Used to indicate the time that passes before a valid hookflash is detected from a single line telephone.	0 = 0 ms. 2 = 600 ms. 1 = 300 ms. 3 = 900 ms.
503	Single Line Telephone Hookflash Start Time <i>P503 SLT FLSH ST</i> <i>3</i>	Start time indicates the minimum time that passes before the system accepts a hookflash signal. Start time is used in conjunction with 504 (Single Line Telephone Hookflash End Time).	0 = 40 ms. 5 = 700 ms. 1 = 90 ms. 6 = 900 ms. 2 = 140 ms. 7 = 1.1 sec. 3 = 190 ms. 8 = 1.3 sec. 4 = 240 ms. 9 = 1.5 sec.

Table 6-2 Programming Functions Quick Reference Chart (Continued)

Function Number	Function Name and Telephone Display	Description	Programming Values
504	Single Line Telephone Hookflash End Time <i>P504 SLT FLSH ED</i> 5	End time indicates the maximum time that passes before the system recognizes the flash as a valid hookflash. If the flash is longer than the time set, the system considers the flash as a disconnect signal. To determine the duration of the hookflash signal, the system computes using the following formula: SLT Hookflash Start Time + SLT Hookflash End Time = SLT Duration. End time is used in conjunction with 503 (Single Line Telephone Hookflash Start Time).	0 = 0 ms. 1 = 100 ms. 2 = 200 ms. 3 = 400 ms. 4 = 500 ms. 5 = 700 ms. 6 = 900 ms. 7 = 1.1 sec. 8 = 1.3 sec. 9 = 1.5 sec.
505	Trunk Line Prepause Duration <i>P505 PRE PAUSE</i> 1	Used to specify the time (prepause) before the system sends dial pulse (rotary) or dual-tone multifrequency (touchtone) signals to the local telephone company.	0 = 0 sec. 1 = 1 sec. 2 = 2 sec. 3 = 3 sec. 4 = 4 sec. 5 = 5 sec. 6 = 6 sec. 7 = 7 sec. 8 = 8 sec. 9 = 9 sec.
Programming Note: To access Functions 501~505 you must press <input type="text" value="#"/> to and enter the function number using the dialpad. You cannot access these functions by scrolling.			
<input type="text" value="#"/> + <input type="text" value="Conf"/>	Check ROM Version <i>1:MAIN ROM = 1.3</i>	Used to check the ROM versions for the central processing unit, voice mail, PC programming/SMDR units.	1 = Main ROM (Main CPU) 2 = Optional Sub-CPU 3 = Digital Voice Mail 4 = MIF Unit
<input type="text" value="#"/> + <input type="text" value="Answer"/> + <input type="text" value="1"/> + <input type="text" value="*"/> + Transfer <input type="text" value=""/>	Clear Speed Dial Numbers System-Wide <i>CLR</i>	Used to delete all of the system speed dial numbers for the entire system.	N/A
<input type="text" value="#"/> + <input type="text" value="Answer"/> + <input type="text" value="3"/> <input type="text" value="DEF"/> + <input type="text" value="#"/> + Transfer <input type="text" value=""/>	Clear Speed Dial Numbers for Individual Telephones <i>TEL SPED CLR?</i>	Used to delete all of the extension (personal) speed dial numbers system-wide.	N/A
<input type="text" value="#"/> + <input type="text" value="Answer"/> + <input type="text" value="2"/> <input type="text" value="ABC"/> + <input type="text" value="0"/> <input type="text" value="OPER"/> + Transfer <input type="text" value=""/>	Clear Automatic Speed Dial Numbers <i>AUTO DIAL CLR?</i>	Used to clear all the one-touch numbers system-wide.	N/A

SECTION 1 INTRODUCTION

The PC Programming software allows users to program all of the features and functions of the InfoSet key telephone system. PC Programming is a menu-based program that provides programming for basic and advanced users. PC Programming uses .html files and is viewed using an internet browser. A wizard is provided to help “walk” users through the programming of the features of the system. The Expert button provides access to advanced features of the system. It is recommended that only people with experience programming the system use this area of the software.

SECTION 2 HARDWARE AND SOFTWARE REQUIREMENTS

The minimum PC requirements include:

- Microsoft Windows 95/98 operating system
- Available serial communication port on PC
- Pentium processor-based personal computer
- 16 MB RAM
- 10 MB available hard-disk space

The following ETU must be installed in the InfoSet KSU to provide for PC Programming:

MIF-B10 ETU

Software Requirements:

- Microsoft Internet Explorer 4.1 or higher or Netscape Communicator 4.7 or higher

SECTION 3 **INSTALLING PC PROGRAMMING SOFTWARE**

To install the software:

1. Insert the setup CD in the CD ROM drive.
2. Click the Windows 95/98 **Start** button.
3. Select **Run**.
4. Enter **d:\setup.exe** and click OK.
 (D = the letter of the CD ROM drive.)
5. Follow the installation instructions.

SECTION 4 **STARTING PC PROGRAMMING**

After the PC Programming software has been installed and the appropriate modifications have been made to the internet browser, the program can be launched. To start the program:

1. Click the Win 95/98 **START** button.
2. Select **PROGRAMS** and then **InfoSet 408**.
3. Click **InfoSet 408 PC Programming**. When the program is launched, the program also starts the default internet browser.

SECTION 5 USING PC PROGRAMMING

When PC Programming software is started, it opens in the browser (either Microsoft Internet Explorer or Netscape Communicator) that has been selected as the default browser. The main menu is the first screen that is displayed. Use the internet browser's navigational buttons to navigate in the software (forward, backward, print, etc.). (Refer to [Figure 7-1 Navigational Bars for Internet Browsers.](#))

The PC Programming toolbar is icon-based. The major menus are accessed by pressing the icons that are displayed across the top and left side of the main menu. The main menu is the first screen that is displayed when the program is launched. [Table 7-1 Quick Guide to InfoSet Programming Menus on page 7-4](#) provides a quick reference to each icon on the main menu and a brief description of its function. The remainder of this chapter provides information for each menu and submenu screen used to program the InfoSet system. A wizard is provided to guide users through the programming functions. Instructions for using the wizard are found in [6.18 Wizard on page 7-46](#).



If the system has been previously programmed, be sure to download and save the existing configuration before making any changes. This will allow the user to restore the system to the previous configuration should a problem be encountered with the new changes.

Microsoft Explorer Navigational Bar



















Netscape Communicator Navigational Bar

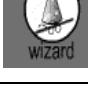

Figure 7-1 Navigational Bars for Internet Browsers

Table 7-1 Quick Guide to InfoSet Programming Menus

Tool Bar Icons			
Icon	Definition	Icon	Definition
	Sets up outside lines, telephones, and extension numbers.		Produces a switch report.
	Sets up line keys, one-touch keys, and speed dials.		Provides on-line help.
	Sets up telephone ringing assignments.		Connects to the Key Telephone System (KTS).
	Sets up telephone dial restrictions.		Uploads data to the Telephone System (KTS).
	Creates a new configuration.		Downloads data from the Telephone System (KTS).
	Loads a configuration file.		Disconnects from the Telephone System (KTS).
	Saves the configuration.		Accessed program items for advanced users.
	Copies data.		Helps to setup different Telephone System (KTS) features.
	Prints the designation labels for the Electra Elite telephones.		

SECTION 6 INFOSET 408 PROGRAMMING MENUS

This sections provides information for each menu and submenu that is available with the PC Programming software. A brief explanation is given for each of the menus and submenus.

6.1 Main Menu Screen

When the InfoSet 408 software program is launched, the Main Menu screen is displayed first. [Figure 7-2 Main Menu](#) provides information and preliminary instructions for connecting to the system. The icons are displayed at the top and on the left side of the screen. If this is the first time you are programming your system you should first program the Switch, Phones, Ringing and Restricted Dialing screens before proceeding to any other screens.

The Expert icon should only be used by users familiar with the system. If you are an inexperienced user and attempt to program the features in this area of the program you may cause your system to become inoperable or you may cause your system to operate improperly.



If you have previously programmed your system, be sure to download and save the existing configuration before making any changes. Refer to [6.15 Download on page 7-42](#) for instructions.



Figure 7-2 Main Menu

6.2 Switch Menu

The Switch screen can be accessed by clicking on the Switch icon from the toolbar on the main menu. If this is the first time you are programming the system, this is the first screen to program.

This screen is used to define the hardware configuration of the InfoSet system. Use this screen to assign the number of outside lines attached to the system. When an outside line is assigned it appears yellow on the screen. For each telephone a unique extension must be assigned and the telephone type must be defined.

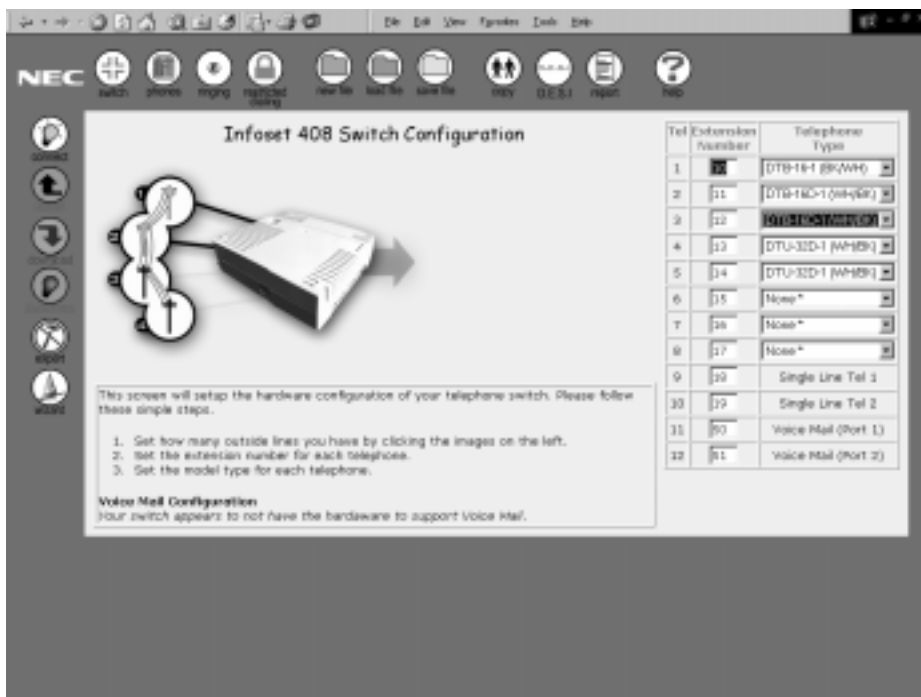

Figure 7-3 Switch Screen

*Field Definitions:***Tel**

This option indicates which telephone is being programmed. This field is for informational purposes only and cannot be changed by the user.

Extension Number

This option indicates the extension number (10~59) assigned to each telephone in the system. The extension number must be unique for each telephone; you cannot assign duplicate extension numbers.

Telephone Type

This pull down menu allows users to select the telephone type. Valid telephone types include: DTU-8D-1 (WH/BK), DTU-16-1 (WH/BK), DTU-16D-1 (WH/BK), DTU-32-1 (WH/BK), DTU-32D-1 (WH/BK), DTP-2DT-1 (WH), DTU-4R-1, DTB-16-1 (BK/WH), DTB-16D-1 (BK/WH), SLT Adaptor and None.

6.3 Phones

The Phones screen can be accessed by clicking on the Phones icon from the toolbar on the main menu. This screen allows users to set up the telephone line keys, the one-touch/feature access keys, and the speed dial keys for each telephone assigned to the system. Click on any of the highlighted and underlined topics or click the appropriate area on the telephone graphic to access the type of keys to be programmed. The bottom right of the screen identifies the type of dialing mode that has been selected (200 mode or 80/20 mode).



Figure 7-4 Phones Screen

6.3.1 Line Keys

The Line Keys screen is accessed by clicking on the Line Keys option on the Phones screen or by pressing the appropriate area on the telephone graphic. The screen that is displayed depends on the telephone type that was assigned to the selected extension. [Figure 7-5 Line Key Screen](#) shows an example of an InfoSet and Electra Elite telephone. The InfoSet telephone has been assigned to Ext. 10 and Electra Elite telephone has been assigned to Ext. 14.

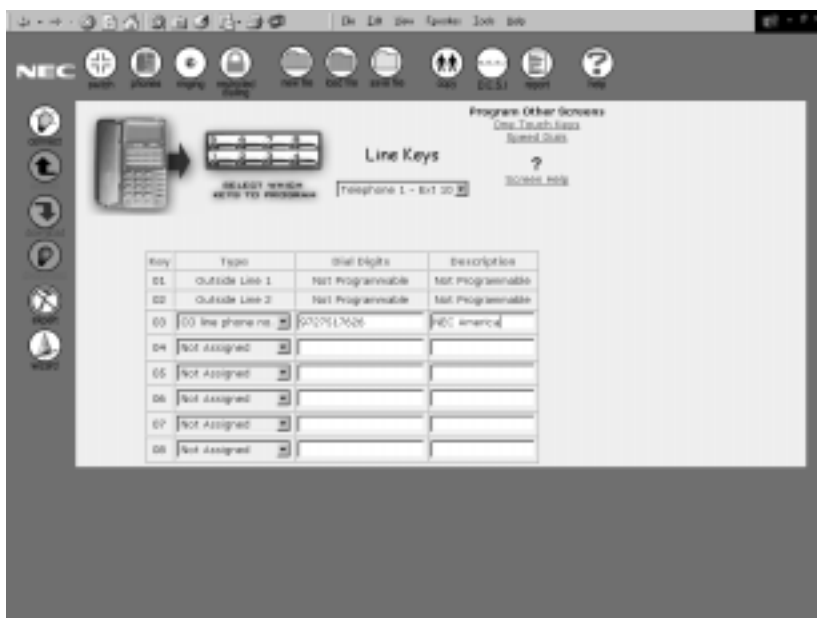

Figure 7-5 Line Key Screen

*Field Definitions:***Line Keys**

This pulldown option identifies the telephone extension that the user is assigning line keys.

Key

The line key number is displayed in this column. This number is for informational purposes and cannot be changed by the user.

Type

This option allows the user to define how the line key is used. The options are: Not Assigned, CO Line Phone No., Speed Dial, Inside Line, Feature, or a Special Number.

Dial Digits

Depending on the type that is selected, the user enters the appropriate number in this field. By pressing Screen Help, the user can access a list of allowable settings, feature access codes and special numbers that can be assigned.

Description

This field can be used to describe the type of number assigned or can be used to enter a "name" associated with the number. For example, if entering a telephone number "NEC America" could be the description.

6.3.2 One-Touch Keys

The One-Touch Keys screen is accessed by clicking the One-Touch Keys option on the Phones screen or by pressing the appropriate area on the telephone graphic.

A one-touch/feature access key allows the user to program a key to access frequently used features or functions by programming that feature or function to a key on the telephone. For example, a one-touch/feature access key can be programmed to set/cancel call forwarding or to set/cancel do not disturb.

When the key is selected, the line key that is being assigned “lights” on the graphic of the one-touch/feature access keys. In [Figure 7-6 One-Touch/Feature Access Keys](#), “1” is the key that is being assigned.

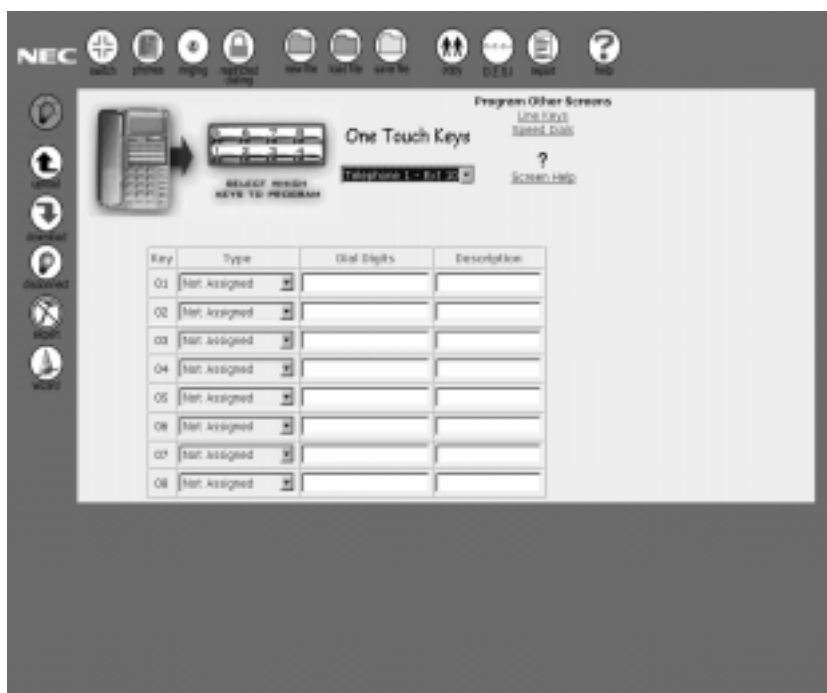

Figure 7-6 One-Touch/Feature Access Keys

*Field Definitions:***Line Keys**

This pulldown option identifies the telephone extension that the user is assigning as a one-touch/feature key.

Key

The line key number is displayed in this column. This number is for informational purposes and cannot be changed by the user.

Type

This option allows the user to define how the line key is used. The options are: Not Assigned, CO Line Phone No., Speed Dial, Inside Line, Feature, or a Special Number.

Dial Digits

Depending on the type that is selected, the user enters the appropriate number in this field. By pressing Screen Help, the user can access a list of allowable settings, feature access codes and special numbers that can be assigned.

Description

This field can be used to describe the type of number assigned or can be used to enter a "name" associated with the number. For example, if assigning a feature access to a one-touch key, "Internal DND" could be the description.

6.3.3 Speed Dialing

The speed dialing screen is accessed by clicking the Speed Dials option on the Phones screen or by pressing the appropriate area on the telephone graphic.

Programming a speed dial key on the telephone allows a user to press the speed dial key to automatically dial the preprogrammed number.

There are two modes for speed dialing – extension speed dialing and system speed dialing. Extension speed dial, assigned as 80/20 mode allows each individual user to program 20 personal speed dial numbers from their telephone and the remaining 80 speed dial numbers are used for common or system-wide speed dial numbers. System speed dialing, assigned as 200 mode, does not allow individual users to program personal speed dial numbers from their telephones. All speed dialing is assigned system-wide.

Figure 7-7 Station Speed Dials shows both types of screens – the Station (Extension) Speed Dials screen that is displayed when 80/20 mode is selected and the System Speed Dials screens that is displayed when 200 mode is selected.

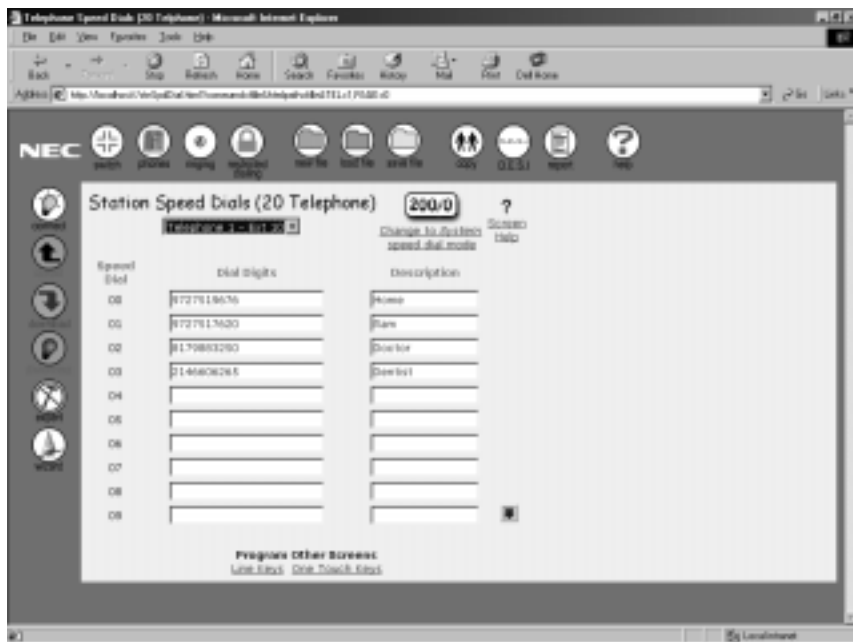

Figure 7-7 Station Speed Dials

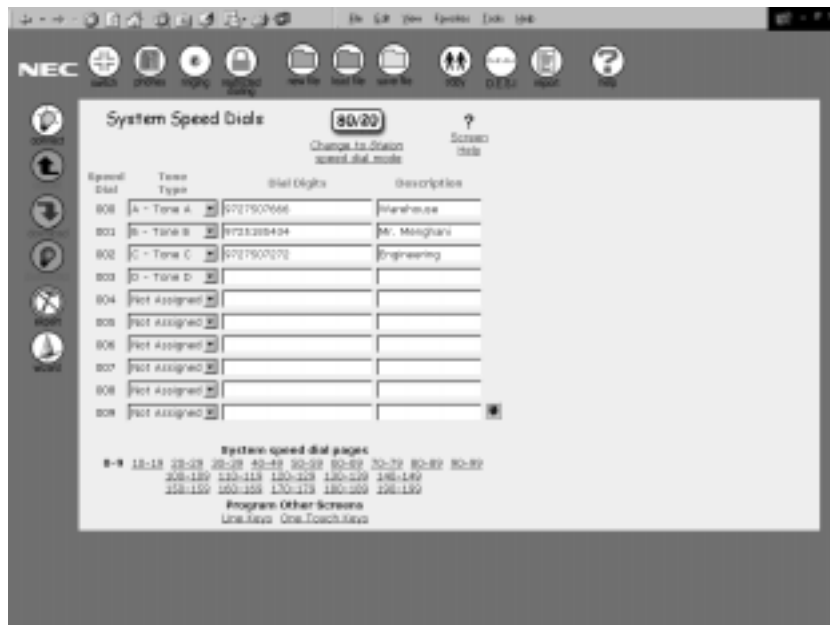

Figure 7-8 System Speed Dials

Station Speed Dials

The following fields are available from the Station (Extension) Speed Dials screen. Note that the user can change the mode setting by pressing the **Change to System Speed Dial Mode**. However, if this is selected, personal speed dial numbers are not allowed. (Refer to [Figure 7-7 Station Speed Dials](#).)

Field Definitions:

Station Speed Dials (20 Telephone)

This pulldown option allows the user to select the telephone and extension for which they will be assigning the speed dial numbers.

Speed Dial

This field represents the memory location number (sometimes referred to as buffer). This is the area in programming where the speed dial numbers are stored and retrieved. Valid memory location numbers are 00~19. The first “page” displays numbers 00~09. The remaining numbers are displayed on the second “page”. To access the second “page”, press the down arrow adjacent to the description field for the last speed dial number.

Dial Digits

Enter the number that will be dialed when the associated speed dial number is pressed.

Description

This field is used to define or describe the number being dialed. For example, home, dentist, doctor, etc.

System Speed Dials

The following fields are available from the System Speed Dials screen. Note that the user can change the mode setting by pressing the **Change to System Speed Dial Mode**. However, if this is selected, personal speed dial numbers are now allowed and the number of system speed dial numbers that can be assigned is reduced to 80. (Refer to [Figure 7-8 System Speed Dials](#).)

*Field Definitions:***Speed Dial**

This field represents the memory location number (sometimes referred to as buffer). This is the area in programming where the speed dial numbers are stored and retrieved. Valid memory locations numbers are 000~199. The first “page” displays numbers 000~009. The remaining numbers are displayed on additional “pages”. To access the additional “pages”, press the down arrow adjacent to the description field for the last speed dial number. The next 10 speed dial numbers are displayed. At the bottom of the screen under the heading **System Speed Dial Pages**, the user can “jump” to any page by pressing the desired range of numbers.

Tone Type

Using the pull-down menu, the user designates the tone type. The option include: Not Assigned, A - Tone A, B - Tone B, C - Tone C, and D - Tone D. This selection identifies the tone used when the number is dialed.

Dial Digits

Enter the number that will be dialed when the associated speed dial number is pressed.

Description

This field is used to define or describe the number being dialed. For example, warehouse, Mr. Menghani, engineering, etc.

6.4 Ringing

The Ringing screen can be accessed by clicking on the Ringing icon from the toolbar on the main menu. This screen is used to assign how each telephone rings when an outside call is received. Different ring settings can be set for day mode and night mode.

Select the telephone line for which the setting will apply by pressing the telephone line graphic. When a telephone line is assigned, it appears yellow on the screen. For each telephone, a unique extension must be assigned and the telephone type must be defined.

Users can quickly switch between day and night mode by pressing the **Change to Day/Night Mode** option.

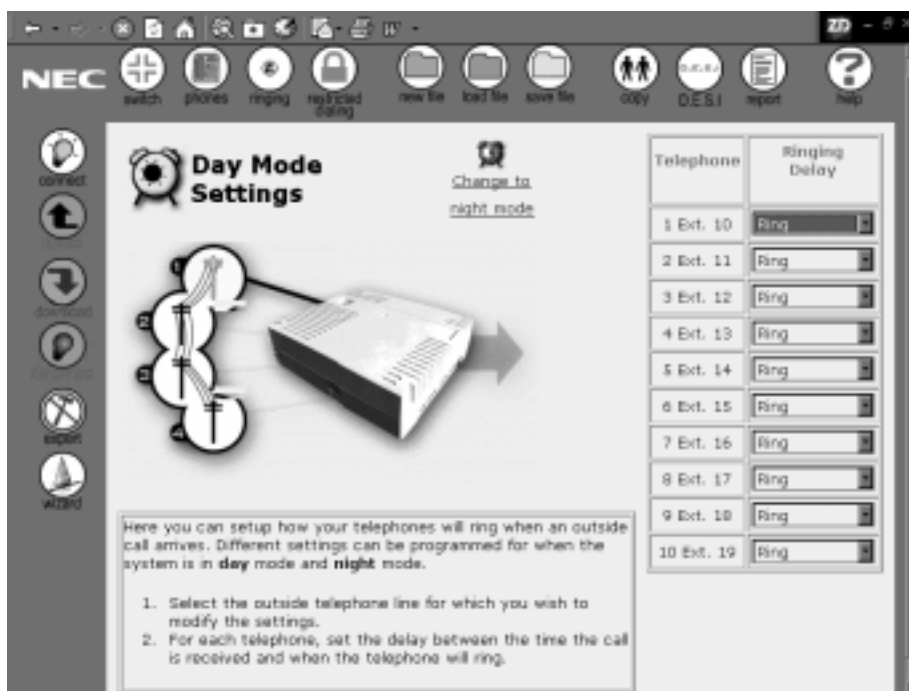

Figure 7-9 Ringing Screen

*Field Definitions:***Telephone**

The outside telephone line and its extension for which settings can be modified.

Ringling Delay

This pulldown option displays the ringing selection. These include: Ring, No Ring, 10 Second Delay, 20 Second Delay, 30 Second Delay, or 60 Second Delay.

6.5 Restricted Dialing

The Dial Restrictions and Authorization screen can be accessed by clicking on the Restricted Dialing icon from the toolbar on the main menu. This screen is used to assign numbers or parts of numbers such as the area code that can or cannot be dialed. There are two types of tables where these numbers can be entered. The restriction table is used to enter numbers that users are not permitted to dial (e.g., long distance numbers or 900 numbers). The authorization table is used to enter numbers that users are permitted to dial. There are two tables (Table 1 and Table 2) for restricted dialing and authorized dialing.

At default, all telephones are assigned as **None** for both the restricted dialing and authorized dialing tables. This allows all telephones to dial any number without restriction.



The entries in these tables applies to ALL telephones in the system (multiline telephones and single line telephones).

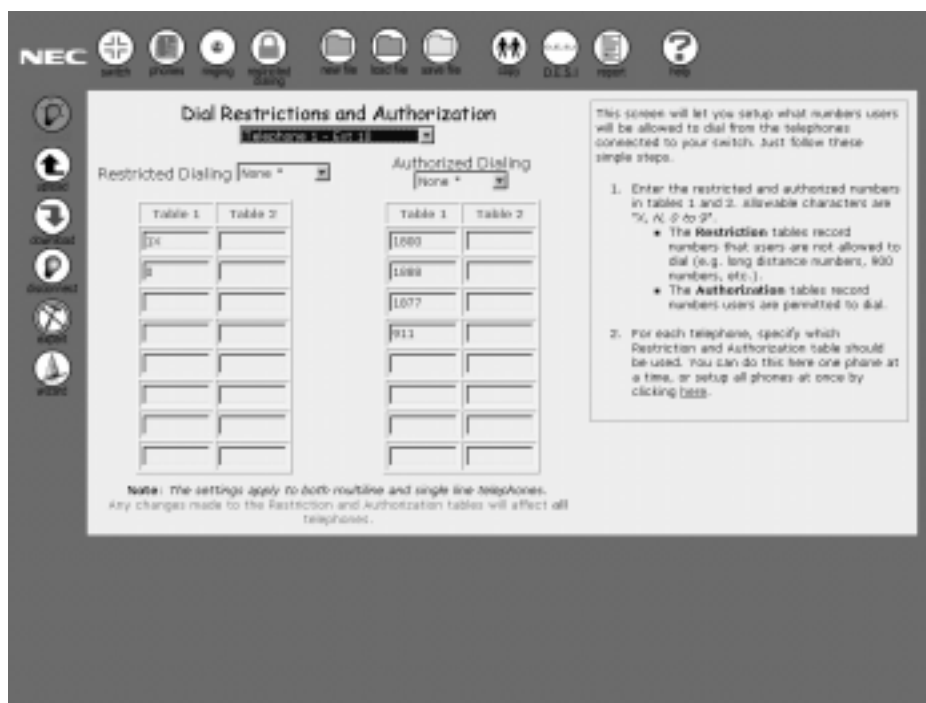

Figure 7-10 Restricted Dialing Screen

Dial Restrictions and Authorization

This pulldown option allows the user to select the telephone and extension for which they will be assigning restricted or authorized tables. To program all telephones at one time, click the text [here](#) located in the notes under item 2. (Refer to [Figure 7-10 Restricted Dialing Screen on page 1-18.](#))

When programming all of the telephones, the Quick Setup of Dialing Restrictions screen is displayed. This screen displays each telephone and associated extension number. Beside each extension, the user can apply the restriction and/or authorization tables to each telephone. Under the Restrictions and Authorization headings, the pulldown options provides a list of values that can be applied. These values include: None, Table 1, Table 2, and Both Tables. To return to the Restricted Dialing Screen, click the text [here](#) located in the notes area on the right side of the screen.

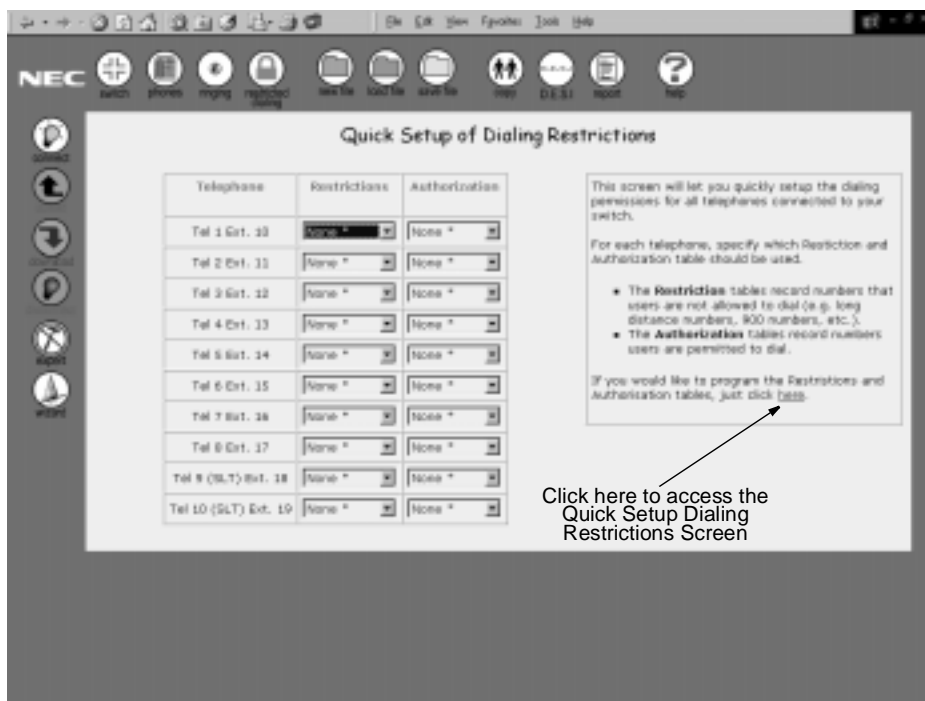

Figure 7-11 Quick Setup of Dialing Restrictions

*Field Definitions:***Restricted Dialing**

This field provides a pulldown menu where users assign (for the designated telephone) the restricted table(s) being used. The values include: None, Table 1, Table 2, and Both.

Authorized Dialing

This field provides a pulldown menu where users assign (for the designated telephone) the authorized table(s) being used. The values include: None, Table 1, Table 2, and Both.

Table1/Table 2

There are two tables for restricted dialing and two tables for authorized dialing. Each table allows eight numbers to be entered. These tables can be applied to each telephone in the system to assign numbers that can and cannot be dialed from individual telephones.

6.6 New File

The File New screen can be accessed by clicking on the New File icon from the toolbar on the main menu. This screen allows users to setup a new file where basic information about the system can be stored and then later retrieved and modified.



Figure 7-12 File New Screen

*Field Definitions:***Outside Telephone Lines (0-4)**

This field is used to enter the number of outside lines that are connected to the system.

Number of Telephones (0-10)

This field is used to enter the number of telephones that are connected to the system. This includes both single line and multiline telephones.

Direct Access

This pulldown menu allows the user to specify whether the system directly accesses the outside lines or if "9" must be dialed to access an outside line. The values include: Dial 9 * and Direct Access.

OK

When pressed, this button saves the configuration changes. A screen is displayed indicating that the default configuration has been successfully completed.

6.7 Load File

The File Load screen can be accessed by clicking on the Load File icon from the toolbar on the main menu. This screen allows users to load existing system configurations (configurations that have been previously saved). From the displayed list of saved configurations, click the file to be loaded. A message is returned indicating the file has been successfully loaded. If no configuration files exist, a message is returned that indicates that there are no backup files that are available for loading.

- ☞ To delete a configuration, access the file using Windows Explorer. Locate the file under the InfoSet 408\Session directory. The saved configuration files have a “.session” extension. Delete the file by highlighting it and pressing the delete key on the PC.

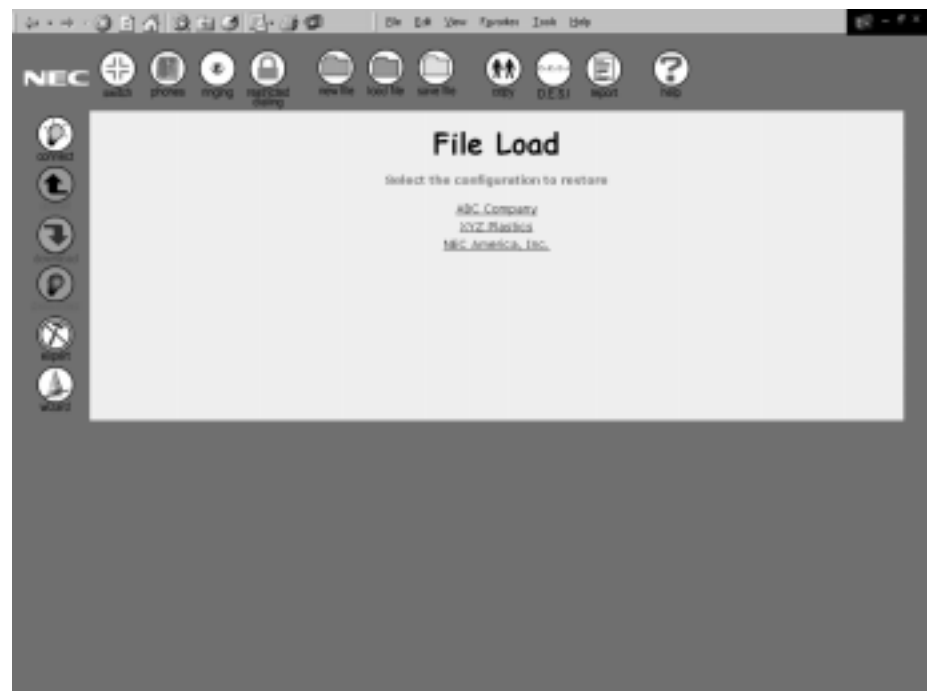

Figure 7-13 File Load Screen

Field Definitions:

Click the Configuration to Restore

The names of previously saved files are listed below this heading. To open the file, click on the file name.

6.8 Save File

The File Save screen can be accessed by clicking on the Save File icon from the toolbar on the main menu. This screen allows users to save system configurations. After assigning the information for the system configuration, it is necessary to save the file. By saving the file, the system configuration can be loaded at a later time and modified as necessary. If configurations have not been saved before, nothing will be listed under the **Existing Configurations** heading. If configurations have been previously saved, the names of the files are listed below the **Existing Configurations** heading.



If setting up a new configuration or modifying an existing configuration, it is necessary to save the file before exiting the browser.

- To delete a configuration, access the file using Windows Explorer. Locate the file under the InfoSet 408\Session directory. The saved configuration files have a “.session” extension. Delete the file by highlighting it and pressing the delete key on the PC.



Figure 7-14 File Save Screen

*Field Definitions:***Save the Current Configuration As**

In the field under this heading, type the name for the saved configuration file.

OK

Press the **OK** button to save the configuration file.

Existing Configurations

If files have been previously saved they are listed under this heading. Click on the name of the file to be opened.

6.9 Copy

The Copy Data screen can be accessed by clicking on the Copy icon from the toolbar on the main menu. This screen is used to copy data from one telephone to another telephone or from one outside line to another outside line. Users can set up the configuration for one telephone or outside line and copy that information to other telephones for which that same information would apply. When data is copied, a message is displayed indicating that the data has been successfully copied.



Data is not copied unless the OK button is pressed.

Extension numbers, names assigned to telephones, and outside lines are not copied.

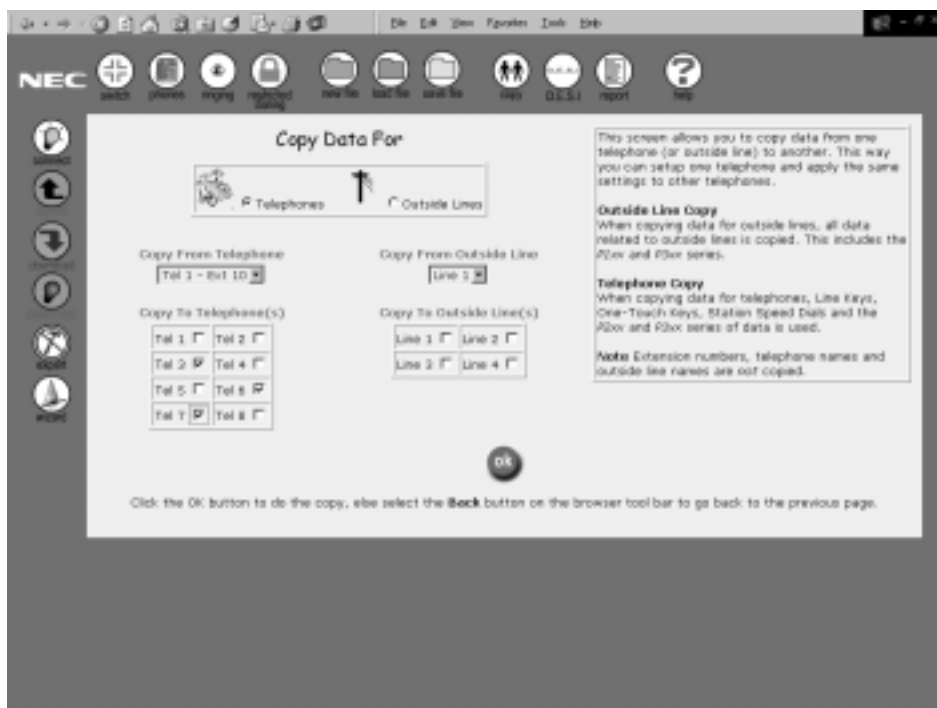

Figure 7-15 Copy Screen

Field Definitions:**Copy Data For**

Select the type of data that is being copied: Telephone or Outside Lines.

Copy From Telephone

This pulldown menu provides a list of the telephones that are installed in the system. Select the telephone that the data will be copied *from*.

Copy From Outside Line

This pulldown menu provides a list of outside lines that are installed in the system. Select the outside line that the data will be copied *from*.

Copy To Telephone(s)

These fields list the telephones where the data will be copied. To select the appropriate telephones, click the box beside the number of the telephone.

Copy To Outside Line(s)

These fields list the outside lines where the data will be copied. To select the appropriate outside line, click the box beside the line number.

OK

When pressed, this button performs the copy.

6.10 D.E.S.I.

The D.E.S.I. screen can be accessed by clicking on the D.E.S.I. icon from the toolbar on the main menu. This screen provides access to creating and printing the designation labels for the telephones. To access the designation label program, it must be installed but must not be running. The PC Programming system will automatically launch the designation label program.



This is only available for the Electra Elite telephones (DTU-type telephones).



Figure 7-16 D.E.S.I. Screen

[Figure 7-17 D.E.S.I. Label Screen](#) is a sample of the designation screen. This screen is used to enter the names that will be printed on the labels.

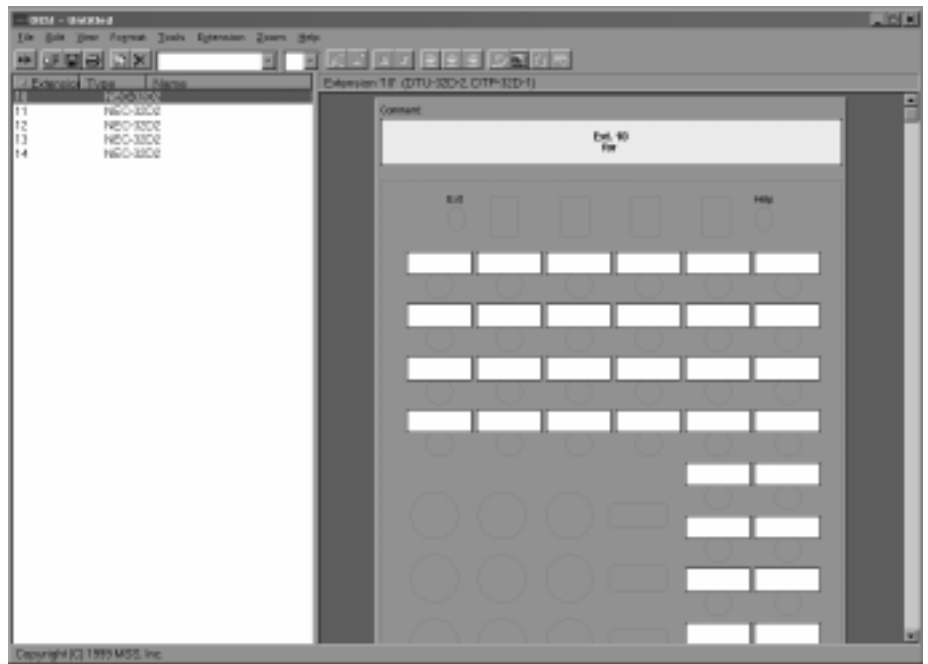

Figure 7-17 D.E.S.I. Label Screen

6.11 Report

The Select the Report Type screen can be accessed by clicking on the Report icon from the toolbar on the main menu. This option allows the user to create their own reports.

When the report type is selected, a screen is displayed that allows the user to select fields to customize the report. The user can select any combination of fields or can select all of the fields.

Report configurations can be saved by assigning a name to it. When the report screen is accessed again, the report configurations that have been saved are listed and can be selected and printed and the configurations can be modified and saved as necessary. To save and modify the same report, type the report name exactly as it appears on the report screen. If it is not typed exactly, a new report is created under the new name. If no reports have been configured and saved, the screen displays **No reports Exist** under the **List of Current Reports** heading.

To delete a report configuration, use Windows Explorer to access the directory where the .html files that were created are stored. Locate the directory under the InfoSet 408\Reports\XXXXX directory. (XXXXX is the report name that was assigned on the individual report configuration screens.) Delete the entire directory by highlighting it and pressing the delete key on the PC.

To print the report, press the print icon on the selected browser.

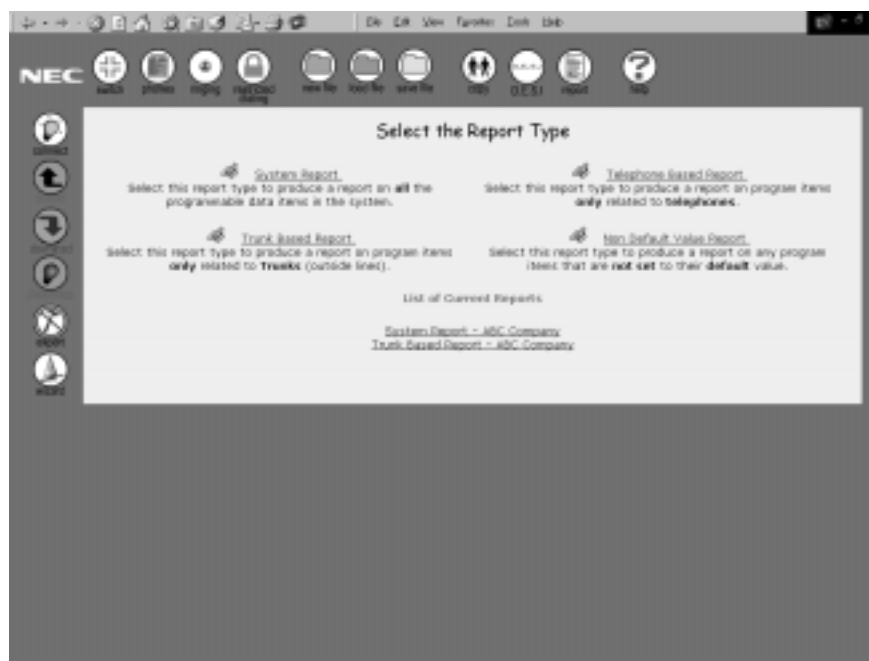

Figure 7-18 Select Report Type Screen

Select Report Type

Each report type is listed on the screen. Select the desired report by clicking on the report name. Four report types are available: System Report, Trunk-Based Report, Telephone-Based Report, and Non-Default Value Report.

6.11.1 System Report

This report contains all of the programmable data items in the system. This report is selected by clicking the System Report option on the Select Report Type screen. Select the items to be included on the report by clicking the box beside each field name. A report name must be entered before the report can be generated.



Figure 7-19 System Report Configuration Screen

Field Definitions:

Field Name

The Field Name column lists the items that can be selected for the report. To select or deselect an item, click in the box beside the field name. The Field Name items include: Name, Description, Allowable Values, Default Values, and Current Values.

Description

The Description column provides a brief description of each Field Name. This area is for informational purposes only.

OK

The **OK** button must be pressed before the report is generated.

Report Sample:

This is a sample page from a System Report. In this report the Name, Default Values, and Current Values fields were selected to be included in the report. The report displays a table of contents that provides quick access to the function numbers (programming functions) that are available in the system. To display information for a specific function number, click on the highlighted number listed in the table of contents. The selected programming function is displayed. The entire report can be printed by pressing the print button in the browser.

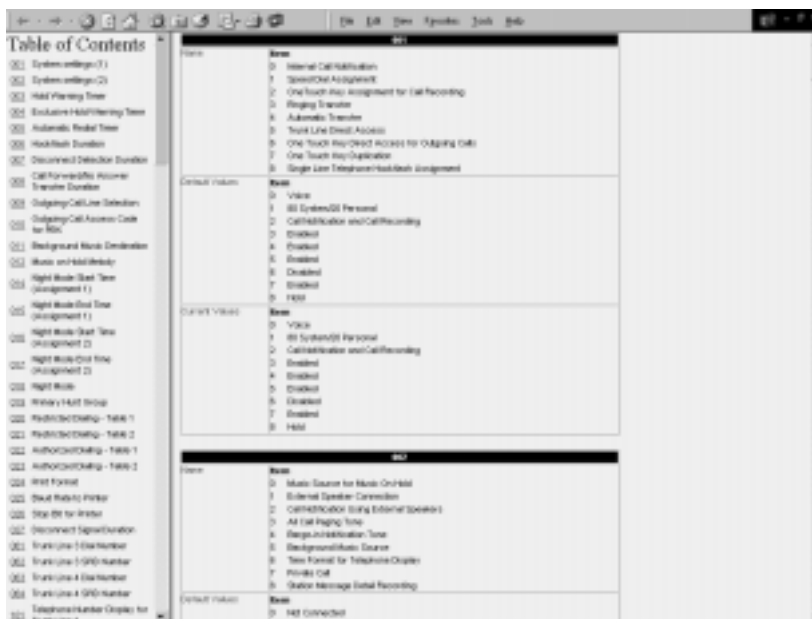

Figure 7-20 System Report Sample

6.11.2 Telephone-Based Report

This report contains the programmable data items relating to telephones. This report is selected by clicking the Telephone Based Report option on the Select Report Type screen. The Telephone Based Report Screen is displayed. The telephones that are to be included in the report must be selected. When the next button is pressed, the Report Information Screen is displayed. This is the same screen that is displayed for the System Report. Select the items to be included on the report by clicking the box beside each field name. A report name must be entered before the report can be generated. (Refer to [Figure 7-19 System Report Configuration Screen on page 7-31](#).)



Figure 7-21 Telephone-Based Report Configuration Screen

Definitions:

Select the Telephones to Report On

Select the telephones to be included in the report by clicking in the box beside each telephone.

Next

Press this button to access the Report Information Screen. Select the fields to be included in the report by clicking in the box beside each field name. Refer to [Figure 7-19 System Report Configuration Screen on page 7-31](#) and to the field descriptions in that section.

Report Sample

This is a sample page from a Telephone-Based Report. In this report the Name, Description, Allowable Values, Default Values, and Current Values fields were selected to be included in the report. The report displays a table of contents that provides quick access to the function numbers (programming functions) that are available in the system for programming the telephone. To display to the information for a specific function number, click on the highlighted number listed in the table of contents. The selected programming function is displayed. The entire report can be printed by pressing the print button in the browser.



Figure 7-22 Telephone-Based Report Sample

6.11.3 Trunk-Based Report

This report contains the programmable data items relating to outside lines (trunks). This report is selected by clicking the Trunk Based Report option on the Select Report Type screen. The Outside Line (Trunk) Based Report Screen is displayed. The outside lines that are to be included in the report must be selected. When the next button is pressed, the Report Information Screen is displayed. This is the same screen that is displayed for the System Report. (Refer to [Figure 7-18 Select Report Type Screen on page 7-30.](#)) Select the items to be included on the report by clicking the box beside each field name. A report name must be entered before the report can be generated.



Figure 7-23 Trunk-Based Report Screen

Definitions:

Select the Outside Lines to Report On

Select the outside lines to be included in the report by clicking in the box beside each line.

Next

Press this button to access the Report Information Screen. Select the fields to be included in the report by clicking in the box beside each field name. Refer to [Figure 7-19 System Report Configuration Screen on page 7-31](#) and to the field descriptions in that section.



This is a sample page from a Trunk-Based Report. In this report the Name, Description, Allowable Values, Default Values, and Current Values fields were selected to be included in the report. The report displays a table of contents that provides quick access to the function numbers (programming functions) that are available in the system for programming the telephone. To display to the information for a specific function number, click on the highlighted number listed in the table of contents. The selected programming function is displayed. The entire report can be printed by pressing the print icon in the browser.



Figure 7-24 Trunk-Based Report Sample

6.11.4 Non-Default Value Report

This option produces a report that lists program items that have been changed from their default values. This report is selected by clicking the Non Default Value Report option on the Select Report Type screen. The Report Information Screen is displayed. This is the same screen that is displayed for the System Report. Select the items to be included on the report by clicking the box beside each field name. A report name must be entered before the report can be generated. Refer to [Figure 7-19 System Report Configuration Screen on page 7-31](#) and the field name descriptions.



This is a sample page from a Non Default Value Report. In this report the Name, Description, Allowable Values, Default Value, and Current Value fields were selected to be included in the report. The report displays a table of contents that provides quick access to the items that have been included in the report. To display the information for a specific item, click on the highlighted item listed in the table of contents. The selected information is displayed. The entire report can be printed by pressing the print icon in the browser.



Figure 7-25 Non-Default Value Report

6.12 Help

The Help screen can be accessed by clicking the Help icon from the toolbar on the main menu. To access the help topic, double-click the appropriate button. The help information is displayed.

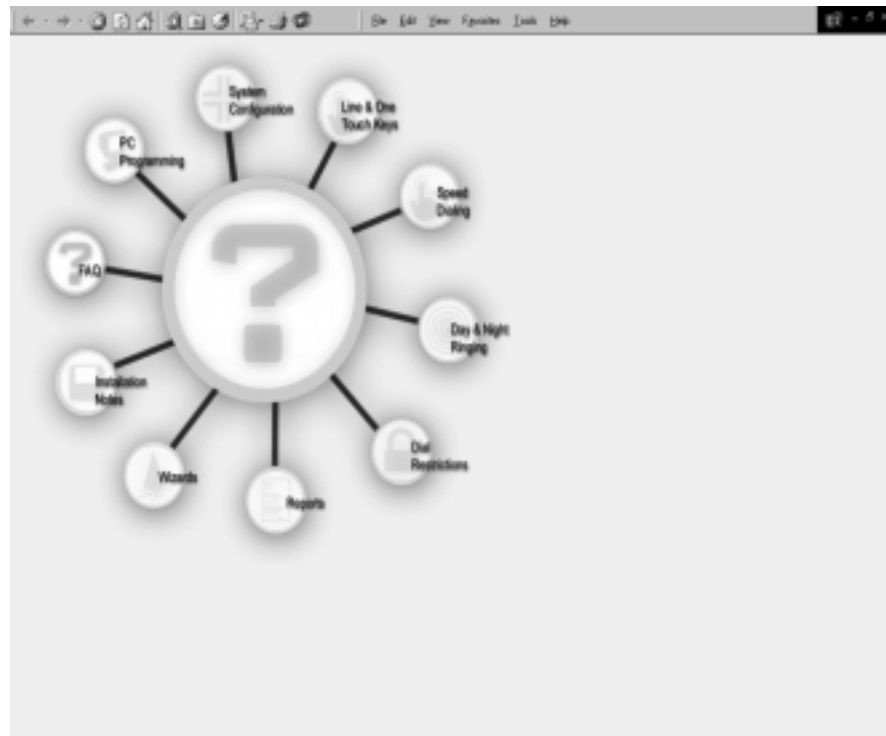

Figure 7-26 Help Screen

Field Definitions:

System Configuration

This selection provides information for configuring the system.

Line & One-Touch Keys

This option provides lists of allowable settings, feature access codes and special numbers.

Speed Dialing

This selection provides information for setting up speed dial numbers.

Day & Night Ringing

This selection provides information for assigning day mode and night mode ringing.

Dial Restrictions

This selection provides information for assigning the restricted and authorized dialing tables.

Reports

This selection provides a brief explanation about each report.

Wizards

This selection provides an explanation of the purpose of wizard and describes the navigational keys used within wizard.

Installation Notes

This selection provides information about installing PC Programming and instructions for modifying the internet browser.

FAQ

This selection provides answers to frequently asked questions regarding the operation of PC Programming.

PC Programming

This selection provides a brief overview for using PC Programming.

The following is an example of a help screen. This example is displayed when the Day & Night Ringing button is pressed.

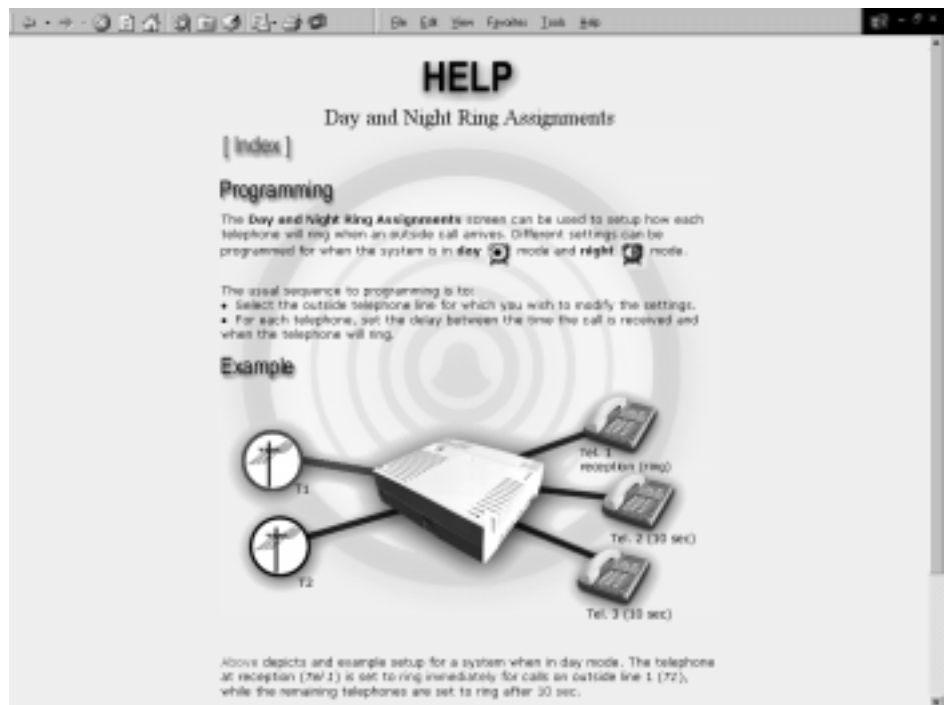

Figure 7-27 Help Example

6.13 Connect

The Connect screen can be accessed by clicking on the Connect icon from the toolbar on the main menu. This option allows the user to program values that provides connection to the KSU. Connection is provided over a direct connection serial cable. If connected properly, the system indicates on the screen that the KTS has been connected. If the hardware is not connected or if proper connection has not been established, a screen is returned indicating that connection could not be made.

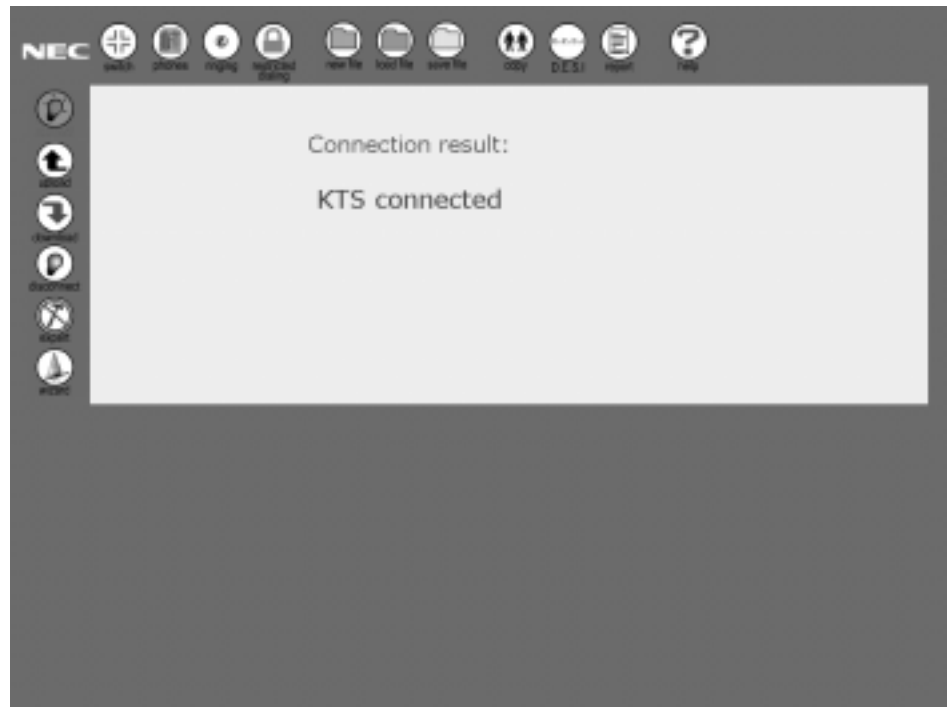

Figure 7-28 Connect Screen

6.14 Upload

The Upload screen can be accessed by clicking on the Upload icon from the toolbar on the main menu. Upload allows programming changes to be uploaded to the key telephone system.

Press the Upload icon to begin the upload process. The screen will display the percentage of upload during the process. When upload is completed, the screen displays "Upload Result: 100%". During the upload process the Cancel button can be pressed. This discontinues the upload process; no information will be changed in system.

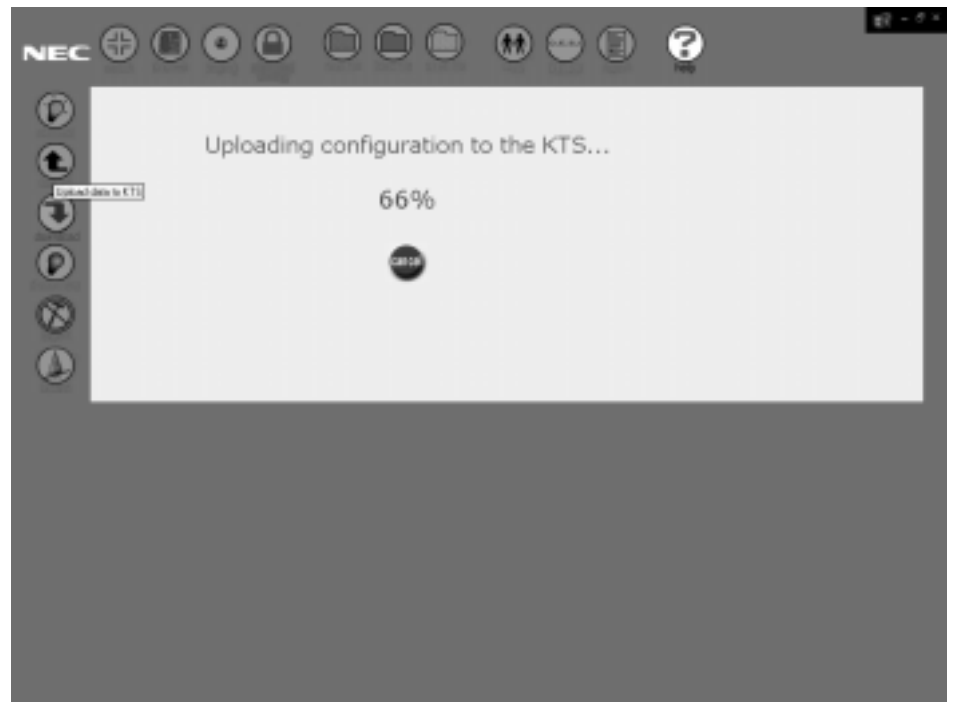

Figure 7-29 Upload Screen

6.15 Download

The Download screen can be accessed by clicking on the Download button from the toolbar on the main menu. Download allows users to copy the information that is stored in the key telephone system memory. The user can store the file for backup purposes.

Press the Download icon to begin the download process. The screen will display the percentage of download during the process. When download is completed, the screen displays "Download Result: 100%". During the download process the Cancel button can be pressed. This discontinues the download process; no information will be downloaded.

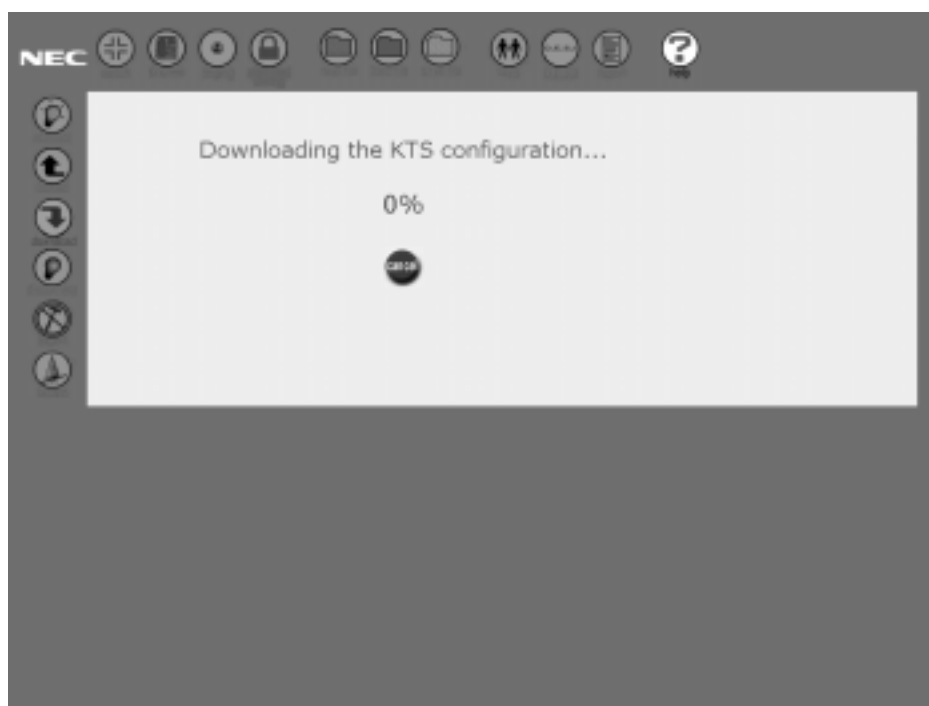

Figure 7-30 Download Screen

6.16 Disconnect

The Disconnect screen can be accessed by clicking on the Disconnect icon from the toolbar on the main menu. Disconnect allows users to disconnect PC Programming from the key telephone system.

Press the Disconnect icon to begin the disconnect process. When the system is disconnected, the screen displays a message indicating that the system has been disconnected.

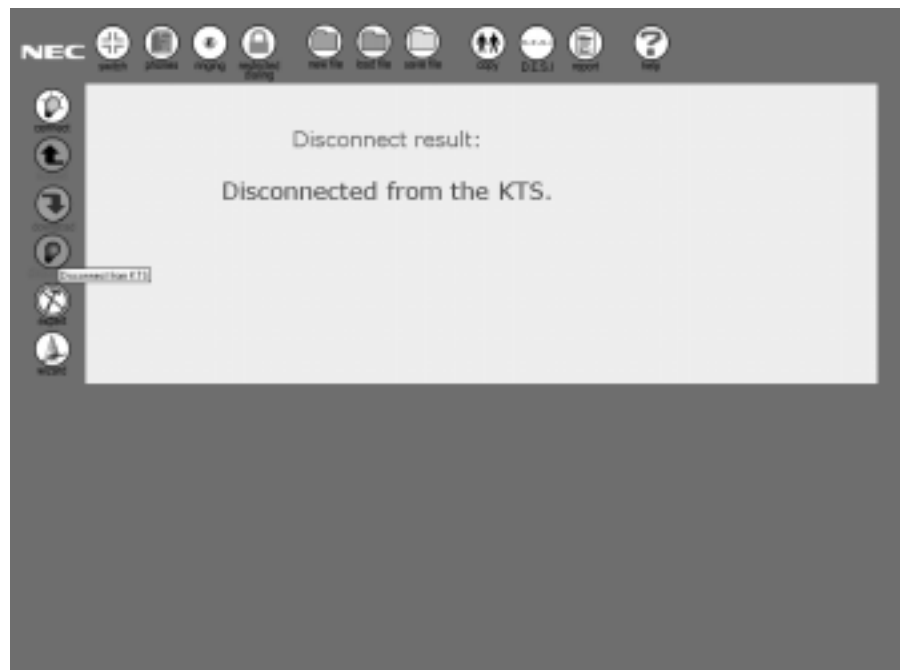

Figure 7-31 Disconnect Screen

6.17 Expert

The Expert screen can be accessed by clicking on the Expert icon from the toolbar on the main menu. This screen provides access to all of the programmable functions of the system. Use the pulldown menu to access and select the list of programmable functions.



This screen is intended for advanced users with a good working knowledge of the system. The items programmed using this screen affect the way the system works. Incorrect programming could result in improper system operation.



Before exiting the browser, be sure to save the changes as a new file or save the changes to an existing file. Refer to [6.8 Save File](#) on page 7-24.



Figure 7-32 Expert Screen

*Field Definitions:***Programmable Function Pulldown Menu**

This pulldown menu provides access to all of the programmable functions available in PC Programming. Click on the arrow to display the list of functions. Select the desired function by clicking on the name. The screen displays the programmable options associated with the selected function. A brief description is provided at the bottom of each screen to help the user understand the purpose of the selected function.

6.18 Wizard

The Wizard screen can be accessed by clicking the Wizard icon from the toolbar on the main menu. The Wizard is used to program features of the system. The Wizard “walks” the user through feature programming by presenting the data that needs to be programmed in the proper sequence for setup.



Before exiting the browser, be sure to save the changes as a new file or save the changes to an existing file and upload the changes to the key telephone system. Refer to [6.8 Save File on page 7-24](#) and [6.14 Upload on page 7-41](#).



Figure 7-33 Wizard Index Screen



Index of Wizards

Wizards are arranged alphabetically by the feature name. To access the Wizard for a specific feature, press the letter of the alphabet that corresponds to the first letter in the feature name. A list of all features beginning with the selected letter is displayed. Refer to [Figure 7-33 Wizard Index Screen](#).

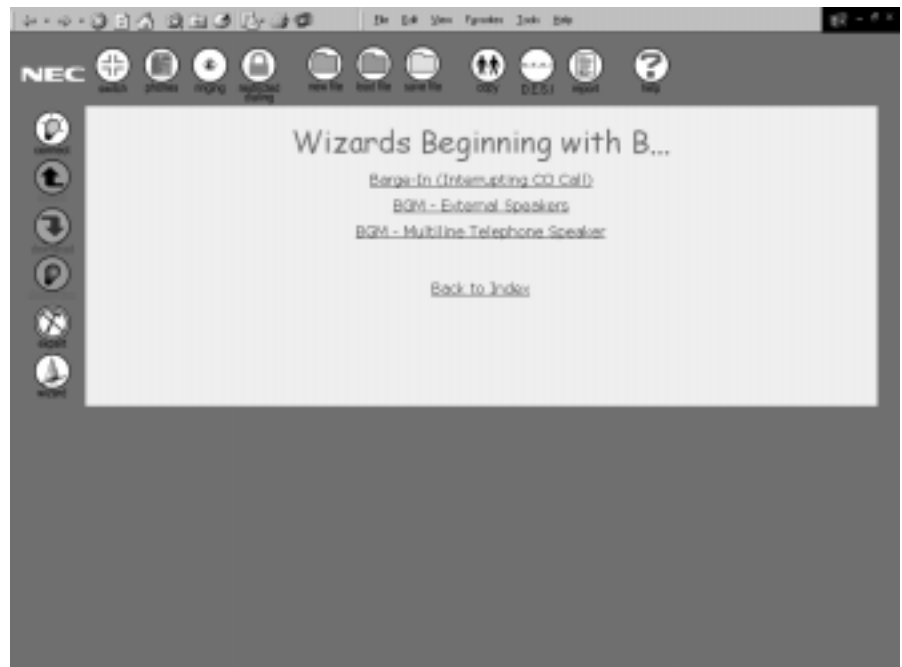

Figure 7-34 Wizard Feature List Screen

Wizard Feature Selection

When the feature list is displayed, click on the name of the feature to be programmed. The first screen that needs to be programmed for the selected feature is displayed. Refer to [Figure 7-35 Wizard Feature Programming Screen on page 7-48](#).

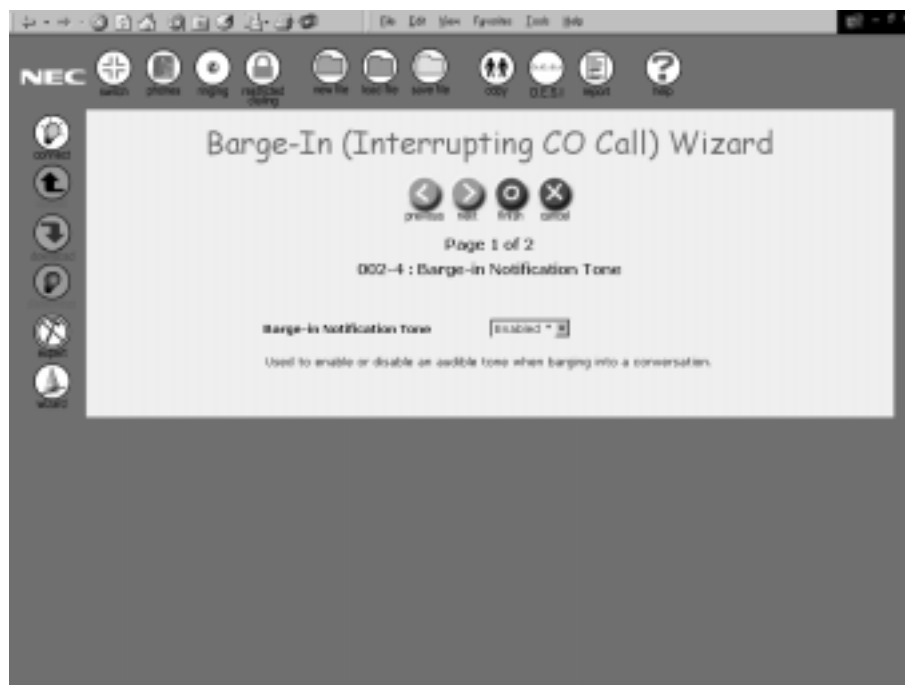

Figure 7-35 Wizard Feature Programming Screen

Field Definitions:

Navigational Buttons

When the feature is selected from the feature list, the first programming screen is displayed. The programming screens have four navigational buttons.



Displays the previous programming screen. If this is the first screen in the programming sequence, pressing this button has no affect.



Displays the next programming screen. If this is the last screen in the programming sequence, pressing this button has no affect.

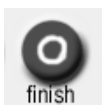

Returns to the Wizard Index screen regardless of where the user is in the programming sequence. The screens that have been programmed are saved even though the sequence has been aborted.

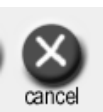

Cancels programming and returns to the Wizard Index screen regardless of where the user is in the programming sequence.

Page Number/Page Count

When the programming screens are displayed, the system indicates the page number which is currently being displayed and the page count (e.g., 1 of 2). This lets the user know how many programming functions are used to program the selected feature.

Programming Function Number and Name

The programming function number and associated name are displayed under the page number and page count.

Programming Values

Programming fields for the selected function are displayed in the body of the screen. Pulldown menus to access the various values for the fields are available where necessary. Fill out the fields as appropriate.

Description

At the bottom of each programming screen is a brief description of the programming function.

Feature Access Codes and Special Numbers Lists

This section provides a list of the feature access code and the special numbers that are used when programming and operating the system. *Feature Access Codes* are codes that are entered to access certain features of the system. Before using feature access codes, the user must press  before and after entering the code. *Special Internal Dials Numbers* are numbers or codes that are entered to access certain functions of the system. Before entering these special numbers, the user must first press an external line and get internal dialtone. All of these codes are fixed in the system. This means that these codes cannot be changed by the user.

Table A-1 Feature Access Codes List for Multiline Telephones

Access Code	Description
1	Handsfree Answer Set/Cancel
2	Handset Mute Set/Cancel
3	Seized Trunk Number Display Internal System Hold
4	Station Number Verify Manual Pause
50	Timed Alarm Verify (Alarm 1)
51	Timed Alarm Cancel (Alarm 1)
52	Timed Alarm Set/Cancel (Alarm 1)
53	Timed Alarm Verify (Alarm 2)
54	Timed Alarm Cancel (Alarm 2)
55	Timed Alarm Set/Cancel (Alarm 2)
56	Room Monitored Telephone Set/Cancel

Table A-1 Feature Access Codes List for Multiline Telephones

Access Code	Description
57	Room Monitoring Telephone Set/Cancel
58	All Telephone Alarm Clear ☞ This feature is only available for telephones assigned to ports 1 and 2.
6	Door Lock Release
6*	Internal Hunt
65	Internal Do Not Disturb Set/Cancel
6600	Call Forward – All Calls Cancel
66XX	Call Forward – All Calls Set/Cancel ☞ XX = Extension Numbers 10~59
6700	Call Forward – Busy/No Answer Cancel
67XX	Call Forward – Busy/No Answer Set/Cancel ☞ XX = Extension Numbers 10~59
68	Call Forward – All Calls Cancel Call Forward – Busy Cancel Call Forward – No Answer (All Telephones) Cancel Do Not Disturb Cancel ☞ This feature is only available for telephones assigned to ports 1 and 2.
690	Incoming Ring Mode (All Modes for Incoming Calls)
691	Incoming Ring Mode (Telephone Mode)
692	Incoming Ring Mode (Common Mode)
7	Privacy Release (Outside Line Calls)
75	Low Battery LCD Indication Reset ☞ This feature is only available for telephones assigned to ports 1 and 2.
80	Night Mode Set/Cancel

Table A-1 Feature Access Codes List for Multiline Telephones

Access Code	Description
84XX	Extension Name Entry (Internal Calls) ☞ XX = Extension Numbers 10-59
85X	Trunk Name Entry (External Call) ☞ X = Outside Line (1-4)
88	Callback Indication Reset
9 #	Date/Time Set
9 *	Test Printing (SMDR) ☞ This feature is only available for telephones assigned to ports 1 and 2.
93	Background Music Telephone Set/Cancel
96	SMDR Printout Start/Stop Toggle (Stop = PC Programming Mode) ☞ This feature is only available for telephones assigned to ports 1 and 2.
99	Feature LED (Lamp) Reset
10	Headset Off-Hook/On-Hook Button

Table A-2 Feature Access Codes List for Single Line Telephones

Access Code	Description
83XX	Speed Dialing
84	Redialing
85XX	Registering/Deleting Speed Dial Numbers

Table A-3 Special Internal Dial Numbers List

Access Code	Description
60	Call Pickup from a different Tenant Group
61	Call Pickup Internal/External from the same Tenant Group
63X	Specified CO/PBX Line Seizure ☎ X = Outside Lines 1~4
65	Do Not Disturb Set/Cancel
6600	Call Forward – All Calls Cancel
66XX	Call Forward – All Calls Set/Cancel ☎ XX = Extension Numbers 10~59
6700	Call Forward – Busy/No Answer
67XX	Call Forward – Busy/No Answer Set/Cancel ☎ XX = Extension Numbers 10~59
68	Trunk Queuing
69	Trunk Queuing Cancel
70	Internal All Call Page

Table A-3 Special Internal Dial Numbers List

Access Code	Description
74	Page Answer
75	External Paging
77	Internal/External All Call Page
79	Call Pickup (ISDN lines)
81	Doorphone 1 Monitor
82	Doorphone 2 Monitor
871	Ringer/Volume Adjustment
872	Contrast Adjustment  This applies to Electra Elite telephones only.
9	Auto Answer Assignment – Dial 9
10~59	Valid Telephone Extension Numbers





Tone Patterns

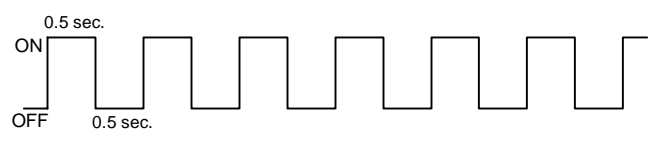
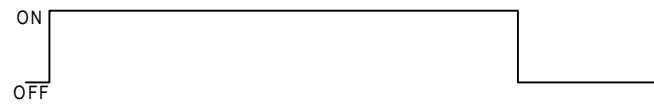
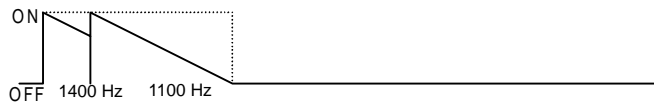
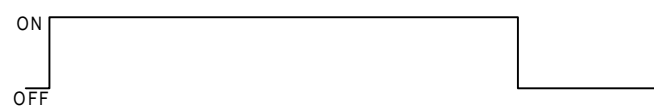
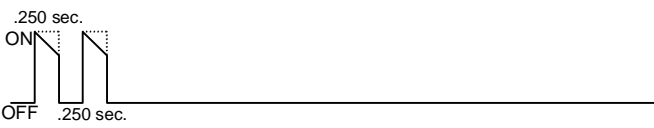
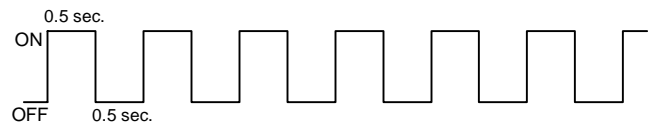
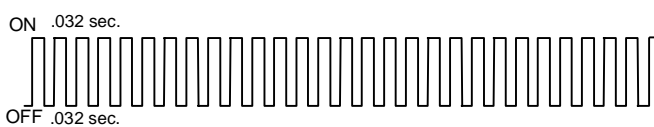
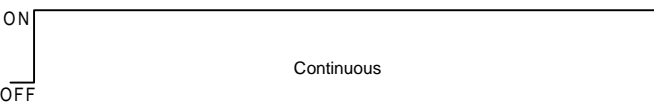
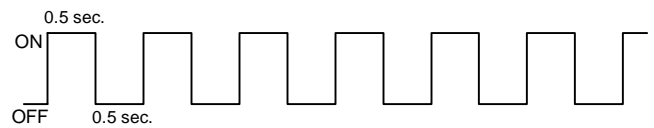
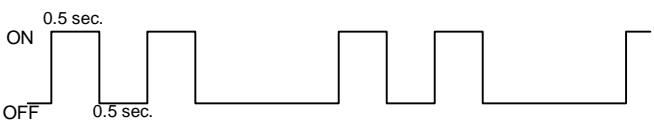

This chart provides the frequency and tone cycle patterns for the tones. Tones are used by the system to inform users of system functions such as dial tone, busy tone and ringback tone. Note that the tones and frequencies are listed for each type of telephone the InfoSet 408 system supports. In the chart (I) beside the frequency indicates the InfoSet telephone and (E) indicates the Electra Elite telephones.

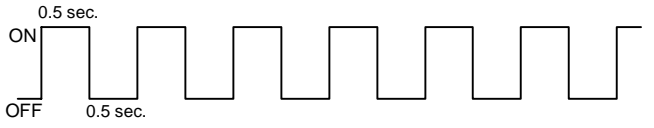
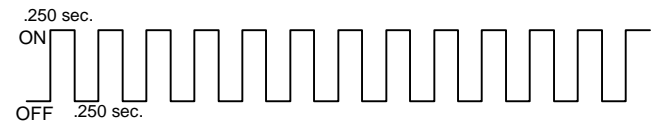
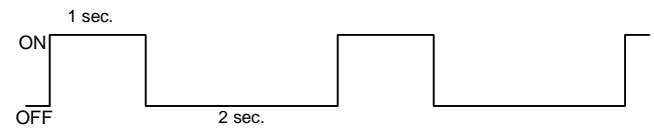
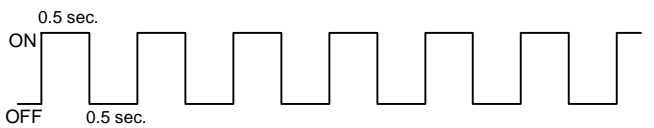
System Tone (Fixed)	Frequency (Hz) (Fixed)	Modulation	Cycle
Automatic Callback	500 Hz (I) 540 Hz (E)	N/A	
Barge-In Tone	440 Hz	N/A	
Busy Tone	480 Hz 620 Hz	N/A	
Call Waiting Tone	440 Hz	N/A	
CO/PBX Ring Tone A	High: 1024 Hz/1285 Hz (I) 1100 Hz/1400 Hz (E) Low: 480 Hz/606 Hz (I) 520 Hz/660 Hz (E)	16	
CO/PBX Ring Tone B	High: 1024 Hz/1285 Hz (I) 1100 Hz/1400 Hz (E) Low: 480 Hz/606 Hz (I) 520 Hz/660 Hz (E)	16	
CO/PBX Ring Tone C	High: 1024 Hz/1285 Hz (I) 1100 Hz/1400 Hz (E) Low: 480 Hz/606 Hz (I) 520 Hz/660 Hz (E)	16	

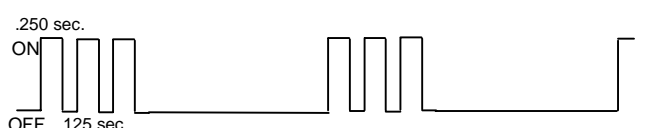
System Tone (Fixed)		Frequency (Hz) (Fixed)	Modulation	Cycle
CO/PBX Ring Tone D		High: 1024 Hz/1285 Hz (I) 1100 Hz/1400 Hz (E) Low: 480 Hz/606 Hz (I) 520 Hz/660 Hz (E)	16	
Doorphone 1	Chime Tone	N/A	N/A	
	Busy Chime Tone	1400 Hz/1100 Hz (I & E)	N/A	
Doorphone 2	Chime Tone	N/A	N/A	
	Busy Chime Tone	1024 Hz (I) 1100 Hz (E)	N/A	
Hold Alarm		1024 Hz (I) 1100 Hz (E)	N/A	
Howler Tone		2400 Hz (I & E)	16 100% AM	
Incoming Dial Tone		360 Hz/440 Hz (I & E)	N/A	
Incoming Ring Transfer		480 Hz/606 Hz (I) 520 Hz/660 Hz (E)	16	
Internal Ring Tone		500 Hz (I) 540 Hz (E)	N/A	

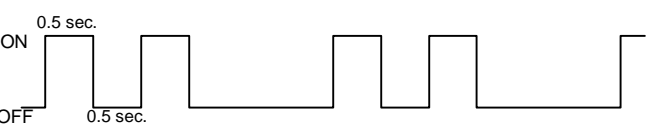
System Tone (Fixed)	Frequency (Hz) (Fixed)	Modulation	Cycle
Key Tone	1100 Hz (I & E)	N/A	
Recall Tone	1024 Hz (I & E)	N/A	
Reorder Tone	480/620 Hz	N/A	
Ringback Tone for External Speaker CO/PBX Ring Tone	440 Hz/480 Hz (I & E)	N/A	
Ringing Transfer Alarm	1024 Hz (I) 1100 Hz (E)	N/A	
Set Tone 1	800 Hz (I & E)	N/A	
Set Tone 2	500 Hz (I) 540 Hz (E)	N/A	
Timed Alarm	1024 Hz (I) 1100 Hz (E)	N/A	
Tone Override	500 Hz (I) 540 HZ (E)	N/A	
Trunk Queuing	500 Hz (I) 540 HZ (E)	N/A	

Glossary of Terms

This glossary is provided to help you understand terms and abbreviations used throughout this document.

Table C-1 Glossary of Terms

Term	Definition
Central Office (CO)	Telephone company facility where subscribers' lines are joined to switching equipment for connecting other subscribers to each other, locally and long distance. Also called CO, as in See-Oh. Sometimes the term central office is the same as the overseas term "public exchange." Sometimes, it means a wire center in which there might be several switching exchanges.
CO	Refer to Central Office.
Dial Pulse (DP)	A means of signaling consisting of regular momentary interruptions of a direct or alternating current at the sending end in which the number of interruptions corresponds to the value of the digit or character. In short, the old style of rotary dialing. Dial the number "five" and you will hear five "clicks." See also DTMF.
Dual Tone Multifrequency (DTMF)	Dual Tone Multi-Frequency. A fancy term describing push button or Touchtone dialing. (Touchtone is a not registered trademark of AT&T, though until 1984 it was.) In DTMF, when you touch a button on a push button pad, it makes a tone, actually a combination of two tones, one high frequency and one low frequency. Thus the name Dual Tone Multi Frequency. In U.S. telephony, there are actually two types of "tone" signaling, one used on normal business or home push button/touchtone phones, and one used for signaling within the telephone network itself. See also Dial Pulse.
DP	Refer to Dial Pulse.
DTMF	Refer to Dual Tone Multifrequency.

Table C-1 Glossary of Terms

Term	Definition
Hybrid System	This term is used to describe a system which has attributes of both Key Telephone Systems and PBXs. The distinguishing feature is that a hybrid key system can use normal single line phones in addition to the normal electronic key phones. A single line phone behind a hybrid works very much like a single line phone behind a PBX. The second distinguishing feature of a hybrid is that it is "non-squared." This means that not every trunk appears as a button on every phone in the system. In a non-squared system, you can have more trunks than you have buttons on each telephone. Some telephones will have trunks that others do not have and vice versa. This allow you to have more trunks on your telephone system than you have buttons on your telephones. This means, for example, that four executives can each have private lines and access to four trunks on a six-button telephone.
ISDN	Integrated Services Digital Network. ISDN comes today in two basic flavors -- BRI, which is 144,000 bits per second and designed for the desktop, and PRI which is 1,544,000 bits per second and designed for telephone switches, computer telephony and voice processing systems. Neither ISDN BRI or ISDN PRI is a standard service, though there are several "standard" configurations. ISDN BRI is a wonderful service in your home or office because it can give you video conferencing, and ultrafaster data communications.
Key Function (KF)	Refer to Squared System
Key Service Unit (KSU)	The Key Service Unit is the main cabinet containing all the equipment, switching and electronics necessary to run a key telephone system.
KF	Refer to Squared System
KSU	Refer to Key Service Unit.
LCD	Refer to Liquid Crystal Display
Liquid Crystal Display (LCD)	Liquid Crystal Display. An alphanumeric display using liquid crystal sealed between two pieces of glass. The display is divided into hundreds or thousands of individual dots, which are charged or not charged, reflecting or not reflecting external light to form characters, letters and numbers. LCD displays have certain advantages. They use little electricity and react reasonably quickly.
MF	Refer to Hybrid System.
Multifunction System (MF)	Refer to Hybrid System.
PBR	Push Button Receiver. Instead of rotary dialing, buttons are pushed to generate the tones needed to place a phone call. Also called Touchtone or DTMF.

Table C-1 Glossary of Terms

Term	Definition
Rotary Dialing	Refer to Dial Pulse
PBX	Private Branch eXchange. A private (i.e. you, as against the phone company owns it), branch (meaning it is a small phone company central office), exchange (a central office was originally called a public exchange, or simply an exchange). In other words, a PBX is a small version of the phone company's larger central switching office. A PBX is also called a Private Automatic Branch Exchange, though that has now become an obsolete term. In the very old days, you called the operator to make an external call, except in Europe. Then later someone made a phone system that you simply dialed nine (or another digit -- in Europe it's often zero), got a second dial tone and dialed some more digits to dial out, locally or long distance. So, the early name of Private Branch Exchange (which needed an operator) became Private AUTOMATIC Branch Exchange (which didn't need an operator). Now, all PBXs are automatic. And now they're all called PBXs, except overseas where they still have PBXs that are not automatic
Squared System	A squared system is a system where each trunk line "appears" as the same button on each phone. The major advanced of the squared system is that you can go to any telephone anywhere in the system and punch any button for any trunk line and know it to be the same button for the same trunk line. This makes telephone operation less confusing. However, there is a limitation to this configuration, you can only have as many trunks on your key system as you have trunk buttons on your key telephones. (See also, Hybrid System.)
Switch	A mechanical, electrical or electronic device which opens or closes circuits, completes or breaks an electrical path, or selects paths or circuits.
Tenant Service	Some businesses acquire a telephone system too large for their needs so they sell parts of the service to smaller offices in their own building or in the surrounding community. There are two ways to make money on tenant service -- renting telephone equipment or reselling long distance lines. There's more money on re-selling long distance lines.
Touchtone Dialing	Refer to Dual Tone Multifrequency.
Trunk Line	A communication line between two switching systems. The term switching systems typically includes equipment in a central office (the telephone company) and PBXs. A tie trunk connects PBXs. Central office trunks connect a PBX to the switching system at the central office.

NEC

InfoSet™ 408

SYSTEM MANUAL

NEC America, Inc.

Issue 1A