

FOREWORD

Thank you for purchasing a NISSAN automobile.

This user's manual is for the Altima navigation system only. This manual contains operating instructions for the NISSAN Navigation System offered in your NISSAN Altima.

Please read this manual carefully to help ensure safe operation of the navigation system.

- Because of possible specification changes, sections of this manual may not apply to your vehicle.
- All information, specifications and illustrations in this manual are those in effect at the time of printing. NISSAN reserves the right to change specifications or design at any time without notice.
- Do not remove this manual from the vehicle when selling this vehicle. The next user of this navigation system may need the manual.

Table of Contents

Introduction	1
Getting started	2
Map settings	3
Setting a destination	4
Route guidance	5
Storing a location/route	6
Viewing technical information	7
Other settings	8
Voice recognition	9
General system information	10
Troubleshooting guide	11
Index	12

1 Introduction

How to use this manual	1-2
For safe operation	1-2
Reference symbols	1-2

Safety information	1-3
Laser product	1-3

HOW TO USE THIS MANUAL

This manual uses special words, symbols and icons, organized by function.

Please refer to the following items and familiarize yourself with them.

Basic operations of the navigation system can be performed in a similar manner for all vehicle models. However, the map screen and setting screen may be different for each model. Set the navigation system as appropriate for your vehicle.

FOR SAFE OPERATION

WARNING

This is used to indicate the presence of a hazard that could cause death or serious personal injury. To avoid or reduce the risk, the procedures must be followed precisely.

CAUTION

This is used to indicate the presence of a hazard that could cause minor or moderate personal injury or damage to your vehicle. To avoid or reduce the risk, the procedures must be followed carefully.

NOTE:

This indicates an item to help you understand and maximize the performance of your vehicle. If ignored, it may lead to a malfunction or poor performance.

REFERENCE SYMBOLS

INFO:

This indicates information that is necessary for efficient use of your vehicle or accessories.

 Reference page:

This indicates the title and page that you should refer to.

MAP:

This is an example of how a button on the control panel will be shown.

“Route”:

This is an example of a key/item displayed on the screen.

 Voice Command:

This indicates an operation by voice command.

SAFETY INFORMATION

This system is primarily designed to help you reach your destination, and it also performs other functions as outlined in this manual. However, you, the driver, must use the system safely and properly. Information concerning road conditions, traffic signs and the availability of services may not always be up-to-date. The system is not a substitute for safe, proper and legal driving.

Before using the navigation system, please read the following safety information. Always use the system as outlined in this manual.

WARNING

- **When the driver wants to operate the navigation system, first park the vehicle in a safe location and set the parking brake. Operating the system while driving can distract the driver and may result in a serious accident.**
- **Do not rely on route guidance alone. Always be sure that all driving maneuvers are legal and safe in order to avoid accidents.**
- **Do not disassemble or modify this system. If you do, it may result in accidents, fire or electrical shock.**

- **Do not use this system if you notice any malfunctions such as a frozen screen or the lack of sound. Continued use of the system may result in accidents, fire or electrical shock.**
- **If you notice any foreign objects in the system hardware, spill liquid on the system or notice smoke or a smell coming from it, stop using the system immediately and contact a NISSAN dealer. Ignoring such conditions may lead to accidents, fire or electrical shock.**

CAUTION

- **Do not keep the navigation system running with the engine stopped. Doing so may discharge the vehicle battery. When you use the navigation system, always keep the engine running.**
- **Some states/provinces may have laws limiting the use of video screens while driving. Use this system only where it is legal to do so.**

LASER PRODUCT

This navigation system is certified as a Class 1 laser product.

The navigation system complies with DHHS Rules 21 CFR Chapter 1, Subchapter J.

WARNING

- **Do not disassemble or modify this system. There are no user serviceable parts in this navigation system.**
- **If maintenance, adjustments and operations other than those specified in this manual are attempted, injury due to laser radiation and exposure could occur.**

MEMO

2 Getting started

Control buttons and functions.....	2-2	Storing your home location/address	2-18
Control panel	2-2	How to store your home.....	2-18
Steering wheel switch.....	2-3	Character (letter and number) input screen.....	2-22
Start-up screen	2-4	Phone number input screen.....	2-23
Menu screen types and how to operate	2-5	List screen.....	2-25
Menu screens and their purposes	2-5	Setting a destination.....	2-26
Using controls to adjust values, levels, etc.	2-8	Searching for a destination	2-26
Map menu screen	2-9	Starting route guidance	2-29
Start menu.....	2-10	Deleting a route	2-30
Functions disabled while driving.....	2-12	Setting the voice guidance	2-31
Operating maps.....	2-13	Turning voice guidance on/off.....	2-31
How to view a map screen.....	2-13	Adjusting voice guidance volume.....	2-33
Map screen types	2-14	Voice recognition.....	2-34
Switching map view	2-15	NISSAN voice recognition.....	2-34
Moving around within a map	2-16	Basic voice control	2-34
Changing the scale of a map.....	2-17	Voice command examples	2-36

CONTROL BUTTONS AND FUNCTIONS

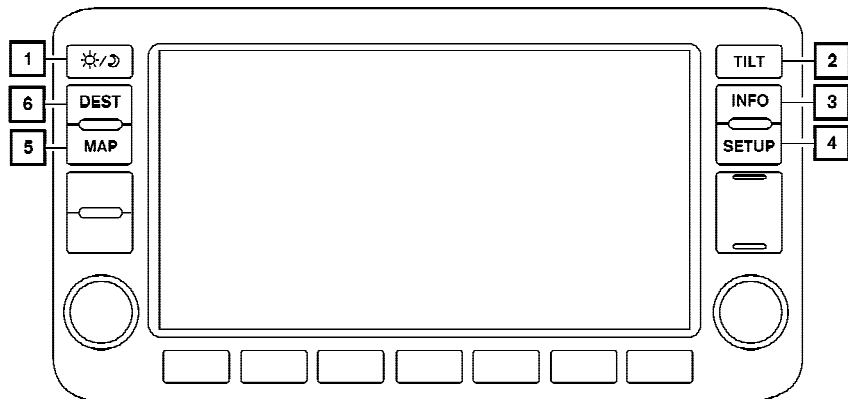

LNV0422

CONTROL PANEL

- 1** DAY/NIGHT:
Press to switch between the day screen (bright) and the night screen (dark).
- 2** TILT:
Press and hold to access the DVD-ROM drive to remove or install the map DVD-ROM.
- 3** INFO:
Press to access system information.
- 4** SETUP:
Press to access system settings.
- 5** MAP:
Press to display the current location map screen.
- 6** DEST:
Press to enter a destination. Various methods for entering a destination are available.
 "4. Setting a destination".

Additional keys/items may appear on the touchscreen after pressing one of the above control panel buttons. For additional information, see the following sections.

"MENU":

Touch to store a location or change settings on the current location map screen.

"Route":

Touch to access guidance control functions (guidance cancellation, route priority, waypoint setting on the route, etc.).

"ZOOM IN", "ZOOM OUT":

Touch to change the map scale.

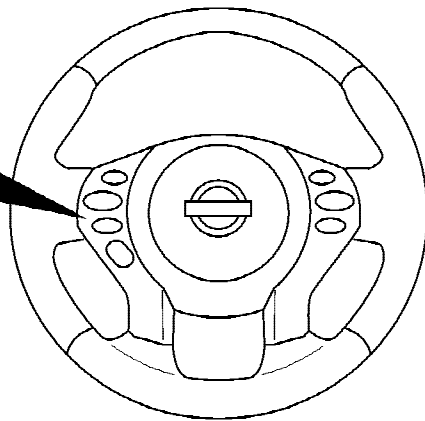
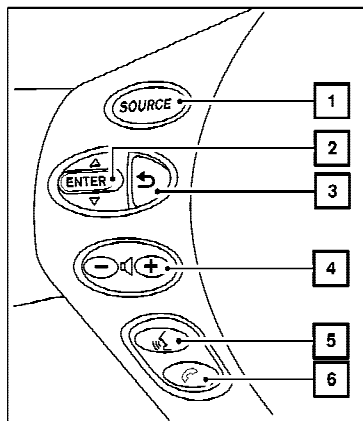



STEERING WHEEL SWITCH

- 1** SOURCE :
Use to switch the audio mode (source). For additional information, see the Owner's Manual.
- 2** ENTER :
Move up or down to highlight an item on the screen, etc. Then press to select the high-lighted item.

LNV0423

- 3**  :
Press this button during a setting operation to return to the previous screen. In certain screens, this button can also be used to apply the setting. This button will only work when the "Back" key is shown on the screen.
- 4** - or + :
Use to adjust the volume. These buttons have the same function as that of the volume knob. For additional information, see the Owner's Manual.

- 5**  :
Press to start the voice recognition mode. Press and hold for 2 seconds to cancel voice commands when in the voice recognition mode.
- 6**  :
Use to enable Bluetooth® Hands-Free Phone. For additional information, see the Owner's Manual.

START-UP SCREEN



LNV0051

1. The navigation system starts when the ignition switch is placed in the ACC or ON position.



LNV0052

2. As the start-up screen is displayed, read the precautions carefully, and touch the "I agree" key.



INFO:

If you do not touch the "I agree" key or push the ENTER button on the steering wheel in less than 30 seconds while the precaution is on the screen, the audio or off screen will be displayed.

Press the DEST, MAP, INFO, SETUP or  button to return to the start-up screen.

MENU SCREEN TYPES AND HOW TO OPERATE

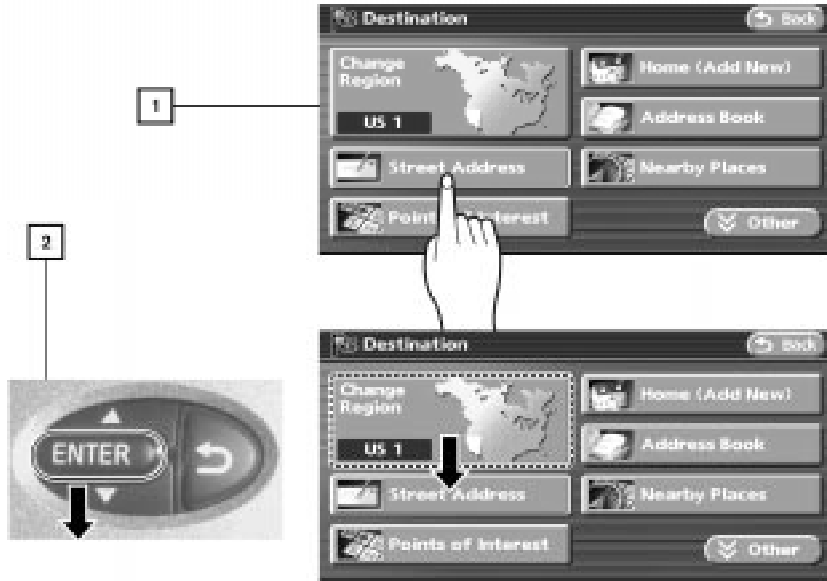

MENU SCREENS AND THEIR PURPOSES

Press the DEST, ROUTE, INFO,  or SETUP button to display the corresponding menu screen.

How to select a menu item

Example: DEST button

There are two ways to select keys or items on the touch-screen.

- 1 To select the preferred menu item, touch the key on the screen or
- 2 Push the up or down button on the steering wheel switch. An item is highlighted accordingly, then press the ENTER button to select it.

LNV0424

Using the touch-screen

Example: DEST screen

1. To select the preferred menu item, touch the key on the screen.



LNV0057

2. Depending on the item selected, a detailed menu screen, a character input screen or a setting screen, etc. is displayed. On the screen displayed, make adjustments, input information, etc. accordingly.



LNV0058

3. Touch the “ Back” key to return to the previous screen without applying any changes.

Using the steering wheel switches

Example: DEST screen

1. To select the preferred menu item, push the up or down button on the steering wheel switches. After an item is highlighted, push the ENTER button on the steering wheel switches to select it.



LNV0057

- Depending on the item selected, a detailed menu screen, a character input screen or a setting screen, etc. is displayed. On the screen displayed, make adjustments, and input information, etc. accordingly.



LNV0058

- Press the  button on the steering wheel switches to return to the previous screen without applying any changes.

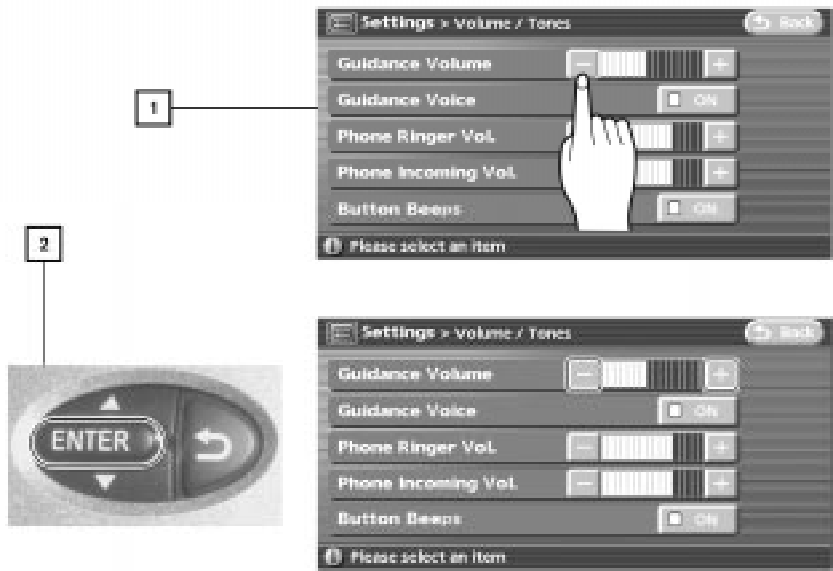

USING CONTROLS TO ADJUST VALUES, LEVELS, ETC.

Touch the keys on the screen or use the steering wheel switches to adjust the volume of the guidance volume, phone ringer vol., etc.

How to adjust

- 1 Touch the “-” or “+” key on the screen. The bars of the corresponding adjustment item changes.
- 2 Use the steering wheel switches by pushing up or down to select/highlight the item and then pressing the ENTER button. The value or bar indicating levels increases or decreases accordingly.

Touch the “Back” key on the touch-screen or the  button on the steering wheel switches to apply the setting.

WNV0548

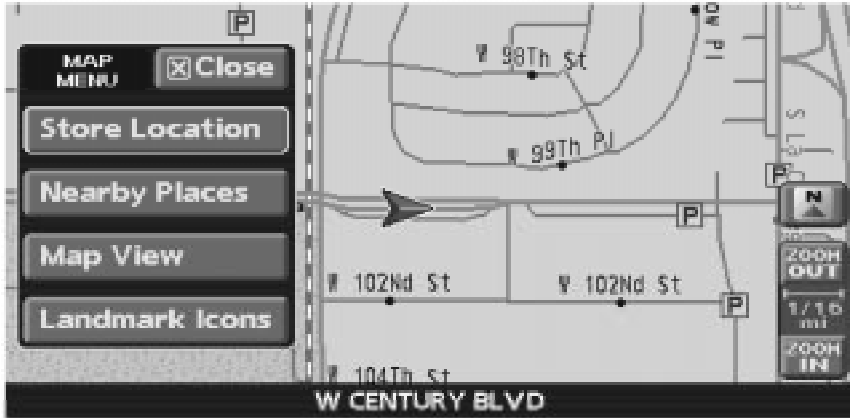

LNV0426

MAP MENU SCREEN

Touch the “MENU” key while the current location map screen or a scrolled map screen is displayed, to display the menu corresponding to that screen.



This menu allows you to quickly use helpful functions, such as storing a location easily and searching for nearby facilities.

To select a menu item, use the method described in “Menu screen types and how to operate” earlier in this section.

Current location map screen

If the “MENU” key is touched while the current location map screen is displayed, the following options are available.

- **Store Location:**
Allows you to store the current vehicle location in the Address Book. The stored location can be retrieved as necessary to set it as a destination (waypoint).
 “STORING A LOCATION”
(page 6-2)

- **Nearby Places:**
Allows you to search for facilities near the current vehicle location, such as restaurants and gas stations, etc.
 “SETTING A NEARBY PLACE”
(page 4-35)
- **Map View:**
Switches the map type. It is used to switch between the 2D Plan View and the 3D Birdview™.
 “SWITCHING THE MAP VIEW”
(page 3-4)
- **Landmark Icons:**
Allows you to display facility icons near the current vehicle location on the map, such as restaurants and gas stations, etc.
 “DISPLAY LANDMARK ICONS”
(page 3-16)

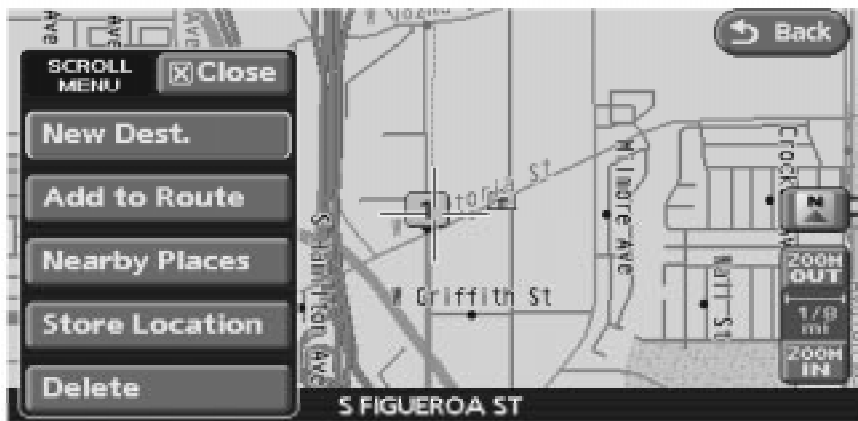

LNV0427

Scrolled location map screen

If the “MENU” key is touched while a scrolled map screen is displayed, the following options are available.

- **New Dest.:**
Allows you to scroll through the map and use the cursor location to set a destination. If a destination is already set, the old destination will be deleted and the new location will be set as the destination.

 “SETTING FROM MAP”
(page 4-13)

- **Add to Route:**
Allows you to set the cursor location as the destination or a waypoint.

This is available only when the suggested route is already set.

 “SETTING A DESTINATION OR WAYPOINT” (page 5-15)

- **Nearby Places:**
Allows you to search for a facility near the location where you scrolled to and set it as a destination or waypoint. Use the same search method as the one for Points Of Interest (POI).

 “SETTING A NEARBY PLACE”
(page 4-35)

- **Store Location:**
Allows you to store the location where you scrolled to in the Address Book. The stored location can be retrieved to set it as a destination or waypoint.

 “STORING A LOCATION”
(page 6-2)

- **Delete:**
Allows you to delete a stored location, destination or waypoint. To delete it, place the cross pointer over the corresponding icon.

START MENU

The start menu can be displayed using the steering wheel switch.

1. Press the ENTER button on the steering wheel switch.

2. Touch the key on the screen or highlight the preferred item and press the ENTER button.





INFO:



The ENTER button on the steering wheel switch can be used to display the start menu only when the map screen is displayed.



LNV0428

Available items

- Home:
Displays the current home location map screen if it has been set and calculates a route home.
 "4. Setting a destination"
- Address Book:
Displays the address book screen. It is the same screen that appears when the DEST button is pressed and the "Address Book" key is selected.
 "4. Setting a destination"

- Nearby Places:
Displays the nearby places screen. It is the same screen that appears when the DEST button is pressed and the "Nearby Places" key is selected.
 "4. Setting a destination"
- Previous Destinations:
Displays the previous destinations screen. It is the same screen that appears when the DEST button is pressed and the "Previous Destinations" key is selected.
 "4. Setting a destination"

FUNCTIONS DISABLED WHILE DRIVING

- Cancel Route Guidance:
Cancels the current guided route.



Not all features can be manually operated while the vehicle is in motion. The text for these restricted features turn from white to gray and can-

not be selected. Alternatively, the voice recognition system may have a related command that can be used at any time.

LNV0540

OPERATING MAPS

In some cases, certain text will not be displayed on the screen.

Park the vehicle in a safe location and then operate the navigation system.

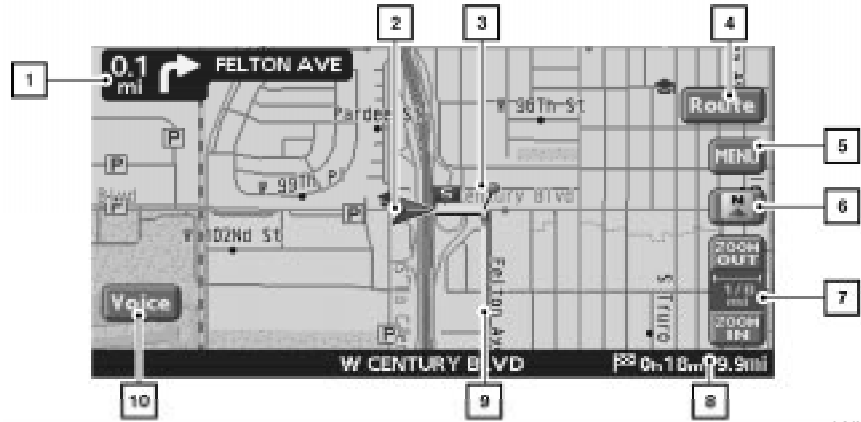





LNV0431

HOW TO VIEW A MAP SCREEN

The navigation system displays various information on the map screen.

Screen information

- 1**  Arrow and distance:
Appears on the upper left corner of the screen when the suggested route is set.
Indicates the distance to the next guide point and the turning direction at that guide point. The system can be set to not display this item.

- 2**  Vehicle icon:
Indicates the current vehicle location and the direction of travel.
- 3**  Guide point:
Indicates a guide point on the route.
- 4**  Route:
Touch this key to access the route settings.
- 5**  Menu:
Touch this key to access the map menu or the map scroll menu.

- 6  /  Direction indicator:

Indicates the direction of the map. Touch this key to switch the orientation of the map.

- 7  Scale indicator:

Indicates the scale of the map.

- 8  Remaining time and distance to the destination:

Indicates the remaining time and distance to the destination.

- 9 Suggested route:

Appears in bold yellow during route guidance.

- 10  Voice:

Touch this key to repeat the voice guidance.

 **INFO:**

- Roads with a width of 10 ft (3 m) or less may not be displayed on the map.
- The system may require a long time for positioning. This is not a malfunction.

MAP SCREEN TYPES

Two types of map views are available: 2D Plan View and 3D Birdview™.



LNV0069

Plan View

Plan View displays the map in a 2-dimensional environment similar to a road map.



LNV0070

Birdview™

Birdview™ displays the view from an elevated perspective. In Birdview™, it is easy to recognize an image of the route because it provides a panoramic view over a long distance.



LNV0069

SWITCHING MAP VIEW

1. Touch the “MENU” key while the current location map screen is displayed.



LNV0071

2. Touch the “Map View” key.



LNV0072

3. Touch the “2D” key for Plan View or touch the “3D” key for Birdview™. The indicator of the selected map view illuminates.

“SWITCHING THE MAP VIEW” (page 3-4)

4. Touch the “Back” key or the MAP button to return to the current location map screen.



INFO:

- When you select a map view, a preview of that view is displayed on the right side of the screen.
- You can also switch the map view using the following procedure.
 1. Press the SETUP button.
 2. Touch the “Navigation” key.
 3. Touch the “Map View” key.

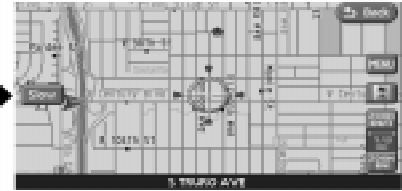
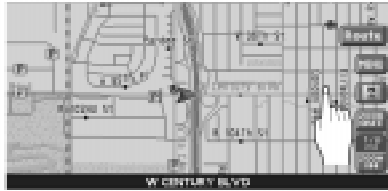

MOVING AROUND WITHIN A MAP

You can manually move across the map to view the surrounding areas or a preferred location.

1. Touch the touch-screen in the direction that you want to move across the map. Touch and hold down on the touch-screen to continuously move across the map in that direction. Once you start moving on the map, the cross pointer appears.
2. Returning to the current location map screen

Press the MAP button or “Back” key to return to the current location map screen, and the cross pointer disappears.

LNV0429

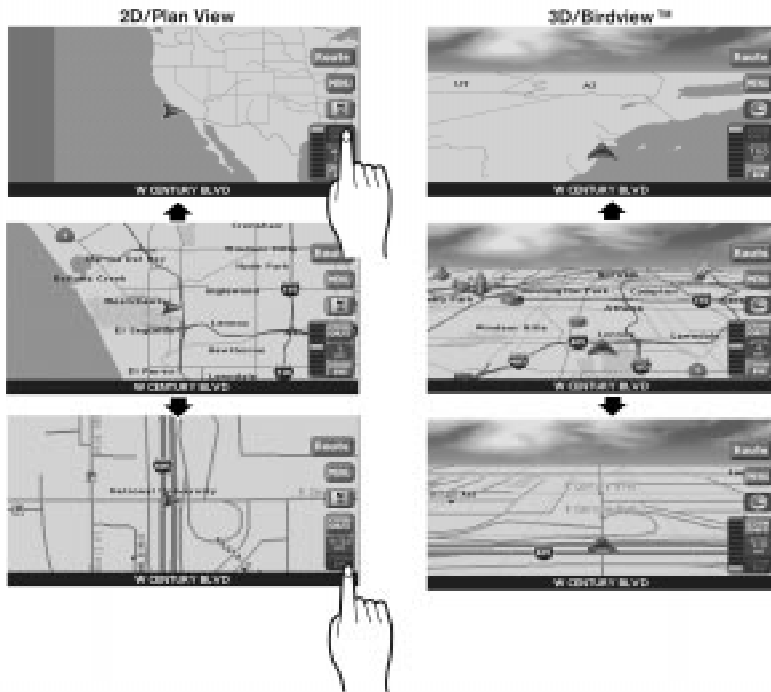

CHANGING THE SCALE OF A MAP

Touch the “ZOOM IN” or “ZOOM OUT” key. The scale numbers change on the screen.

To view the map in detail, touch “ZOOM IN” key.
To view a wider area, touch “ZOOM OUT” key.

LNV0430

STORING YOUR HOME LOCATION/ADDRESS

HOW TO STORE YOUR HOME

If your home location is already stored in the Address Book, it can be easily retrieved to set the route to your home.

The procedure to store your home location is similar as the one for storing a location.

 "4. Setting a destination"



LNV0082

Example 1 , the procedure for storing your home location.

1. Press the DEST button.
2. Touch the "Home (Add New)" key.

 **INFO:**

If you have already stored your home this button may not appear.



LNV0083

 **INFO:**

When you touch the "Home (Add New)" key, a confirmation message is displayed.



LNV0084

3. Choose a way to find your home address. For example, touch the “Street Address” key. A character input screen is displayed.



LNV0085

4. Enter your home information. A list screen is displayed.



LNV0087

5. Touch the preferred home address key from the list.



LNV0089

6. Your home is displayed at the center of the map. If the location is correct touch the "OK" key.

A confirmation message is displayed, and the system sets your home as the destination.

Example 2 ; the procedure for storing your home location by searching for a destination by address is described here.

1. Press the DEST button.



LNV0189

2. Touch the "Address Book" key.

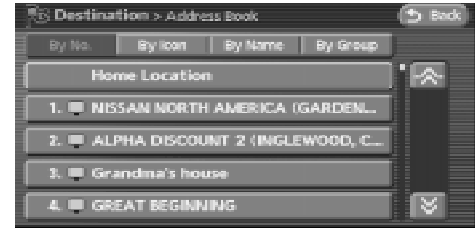

LNV0190

3. Touch the "Home Location (Add New)" key.



LNV0084

4. Touch the “Street Address” key.



LNV0085

5. Enter the address of your home and touch the “OK” key. Depending on what screen you are at another character input screen may appear.



“SETTING A STREET ADDRESS” (page 4-4)



LNV0087

6. A list of possible locations may appear. Touch the correct key that corresponds to your home.
7. A message is displayed and your home location is stored.

You can edit the home location information or move its location. The home icon is displayed on the map.



INFO:

You can also perform the same setting by pressing the SETUP button and touching the “Navigation” key.



“STORING A LOCATION BY SEARCHING” (page 6-2)

CHARACTER (letter and number) INPUT SCREEN

You will have to enter alphanumeric characters when setting a destination, searching for a facility or editing the stored locations, etc.



LNV0091

1. Use the touch-screen or steering wheel switches.



LNV0092

2. Touch one of the character keys on the touch-screen or use the steering wheel switch to highlight the correct character then press the ENTER button. The character is entered.



LNV0093

3. Touch the "Delete" key to delete the last character entered.



INFO:

Touch and hold the "Delete" key for approximately 2 seconds, to delete all characters entered.

Touch the "Space" key to enter a space.



LNV0094

4. After finishing the entry, touch the "OK" key. It may bring you to another character input screen depending on what step or screen you are on.



INFO:

You can touch the "Back" key to return to the previous screen.

PHONE NUMBER INPUT SCREEN

You can enter a phone number as a search method to look for a business or facility.



INFO:

Only the locations included in the database in the map DVD-ROM can be searched by the phone number.

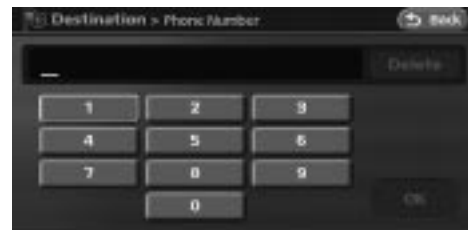

LNV0095

1. Touch the number keys on the touch-screen or use the steering wheel switches to input the numbers.

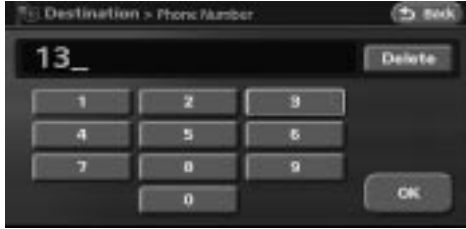

LNV0096

2. The numbers are entered on the screen.



LNV0097

3. Touch the “Delete” key to delete the last number entered.



INFO:

Touch and hold the “Delete” key for approximately 2 seconds, to delete all numbers entered.

Touch the “Back” key to delete all the numbers entered and return to the previous screen.



LNV0098

4. After finishing the entry, touch the “OK” key.



INFO:

You can touch the “Back” key to return to the previous screen at any time.

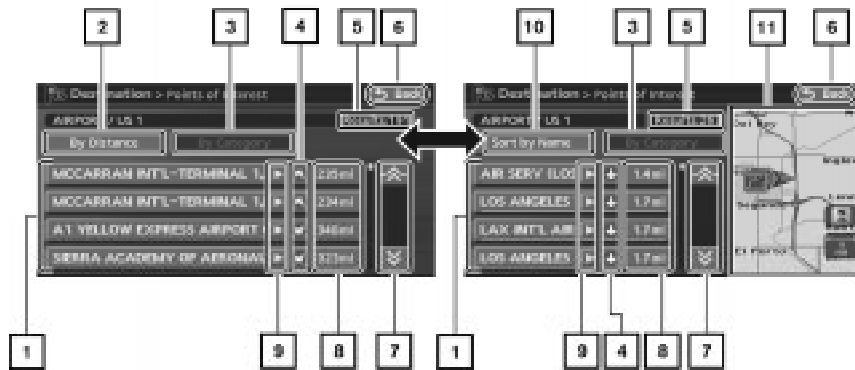

- 10 Touch the “Sort by Name” key to display the list by name.
- 11 When the list is sorted by the shortest distance, you can confirm the selected location in the preview on the right side of the screen.

LIST SCREEN

After searching for locations or facilities, a list screen is displayed.

Depending on the list displayed, it can be sorted.

Items displayed in a list:

- 1 Touch the preferred item key from the list.
- 2 Touch the “By Distance” key to display the list by distance.
- 3 Touch the “By Category” key to display the list by category.
- 4 Direction to the location or facility.
- 5 The system displays the total number of items in the list. Touch the scroll up key or the scroll down key to scroll through the list.
- 6 Touch to return to the previous screen.
- 7 Touch to scroll the list up or down.
- 8 Distance from the current location.
- 9 If a location or facility name is not completely displayed (due to length), touch this key.

LNVO442

SETTING A DESTINATION

SEARCHING FOR A DESTINATION

As an example, the method for setting an airport as the destination using the “Points of Interest” key is described here.

1. Press the DEST button.



LNV0101

2. Touch the “Points of Interest” key.



LNV0102

3. Touch the “Travel” key.

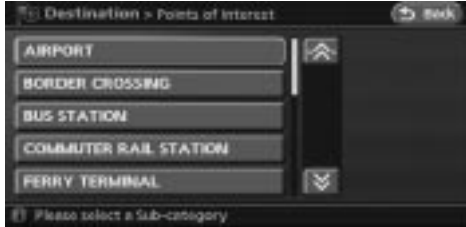

LNV0103

- From the category list, touch the "Airport" key.



LNV0104

- You can choose to search by "Nearby POI", "By Name" or "By City". Touch the "By Name" key; the character input screen is displayed.



LNV0105

- Touch the "OK" key. A list screen is displayed.



INFO:

You can enter the city name and facility name to narrow down your search.

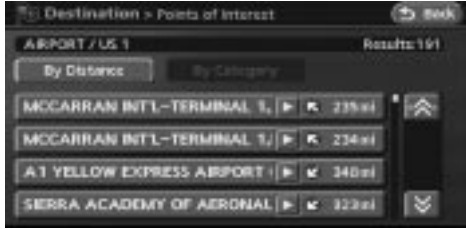

LNV0106

7. Touch the correct airport key from the list.



LNV0107



INFO:

Touch the “By Distance” key, you can sort the list by the shortest distance.



LNV0108

8. The selected destination is displayed at the center of the map. After confirming the location of the displayed destination, touch the “Start” key.



INFO:

The system sets the destination to the selected location and starts calculating a route.



LNV0109



INFO:

Even after setting a destination, you can adjust the location of the destination, store the route, etc.



“OPERATIONS AFTER SETTING A DESTINATION” (page 4-37)



LNV0110

STARTING ROUTE GUIDANCE

After setting the destination and performing route calculation, the suggested route is displayed.

1. Touch the “Start” key.



LNV0111

2. Once route guidance is started, the system navigates you through the guide points using visual and voice guidance.



LNV0112

3. When approaching a guide point, the system automatically changes to the split screen and shows an enlarged view of the intersection in the left screen.



LNV0113

4. When arriving at the destination, route guidance automatically ends.

DELETING A ROUTE

To delete a route already set, use the following procedure. If you delete a route, the destination is also deleted.

1. Press the MAP button.



LNV0114

2. Touch the "Route" key.

SETTING THE VOICE GUIDANCE

TURNING VOICE GUIDANCE ON/OFF

You can activate or deactivate voice guidance and adjust the volume.

1. Press the MAP button.
2. Touch the "Route" key.

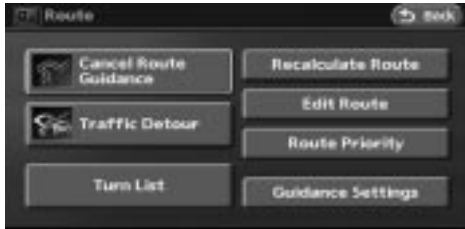

LNV0115

3. Touch the "Cancel Route Guidance" key.

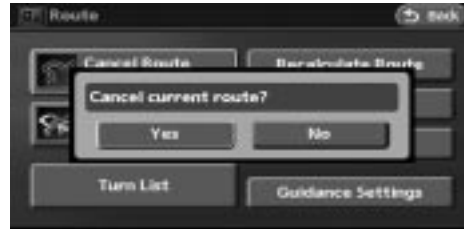

LNV0116

4. A confirmation message is displayed. Touch the "Yes" key.



INFO:

If a route is cancelled, the "Cancel Route Guidance" key changes to the "Resume Route Guidance" key.

Touch the "Resume Route Guidance" key to reactivate the cancelled route.

This is available only until a new route is set.

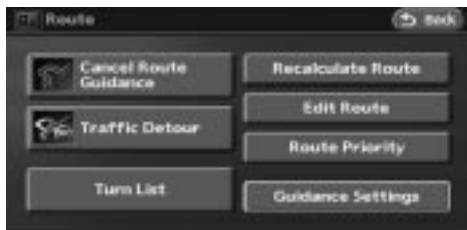

LNV0117

3. Touch the “Guidance Settings” key.

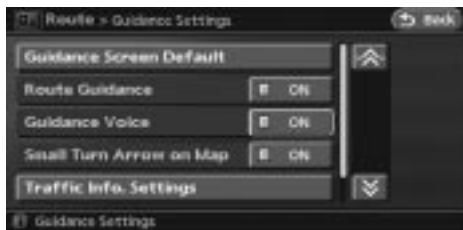

LNV0118

4. Touch the Guidance Voice “ON” key. The indicator illuminates if voice guidance is activated.



WNV0550



INFO:

You can also activate or deactivate voice guidance using the following procedure.

1. Press the SETUP button.
2. Touch the “Volume / Tones” key.
3. Touch the “Guidance Voice” key.

ADJUSTING VOICE GUIDANCE VOLUME

You can adjust the volume of the voice guidance.

1. Press the SETUP button.



LNV0121

2. Touch the "Volumes / Tones" key.



WNV0551

3. Touch the "-" or "+" key on the Guidance Volume item to adjust the volume.

VOICE RECOGNITION

NISSAN VOICE RECOGNITION

You can control the navigation system using voice commands.

After pressing the  button on the steering switch to enter the voice recognition mode, you can say the preferred voice command.



INFO:

- NISSAN Voice Recognition activates only when English is set as the language for the system. NISSAN Voice Recognition cannot be activated by pressing the  button if French is set for the system.
- Refer to the complete list of available voice commands.



“LIST OF VOICE COMMANDS”

(page 9-7) The list of voice commands can also be displayed on the screen.



“COMMAND LIST” (page 9-6)

BASIC VOICE CONTROL

Before starting

To get the best recognition performance out of NISSAN Voice Recognition, observe the following:

- Keep the interior of the vehicle as quiet as possible. Close the windows to eliminate the surrounding noises (traffic noises, vibration sounds, etc.), which may prevent the system from recognizing the voice commands correctly.
- Wait until a tone sounds before speaking a command. Otherwise, the command will not be recognized properly.
- Speak in a natural voice without pausing between words.
- If the air conditioner is set to “Auto”, the fan speed is automatically lowered so that your voice commands can be recognized more easily.

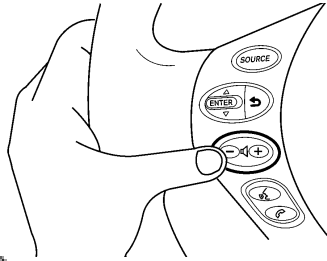

LNVO443



INFO:

You can also adjust the volume by turning the audio system volume knob or pressing the – or + on the steering switch while voice guidance is being announced.

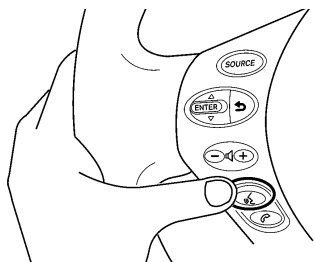



LNV0444

Giving voice commands

1. Press and release the  button located on the steering wheel switches.



WNV0552

2. A list of commands appears on the screen, and the system announces, "Please say a command after a tone".
3. After the tone sounds and the icon on the screen changes from a gray  item to an orange  item, say "Help" or "Command list".

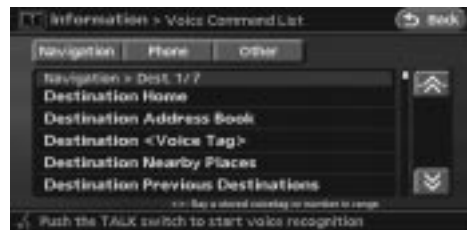



WNV0553

4. The system confirms the recognized command, and a list of command list categories appears.
5. The system will display the first page of several navigation command lists.



INFO:

- If the system did not recognize your command, press and hold the  button for more than 2 seconds to return to the previous screen.
- Voice commands cannot be accepted when the icon  is gray.

VOICE COMMAND EXAMPLES

To use the voice recognition function, speaking one command is sometimes sufficient, but at other times it is necessary to speak two or more commands.

As examples, some additional basic operations by voice commands are described here.



LNV0404

Example 1: Returning to your home

1. Say "Destination home".

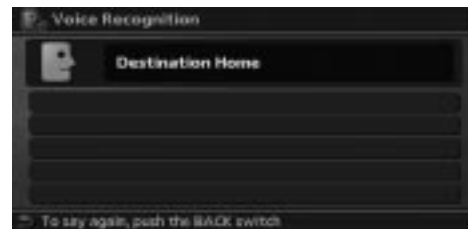

LNV0406

2. The system recognizes your command and calculates a route to your home.



INFO:

To set your home as the destination, your home needs to be stored in the Address Book in advance.



"STORING A LOCATION" (page 6-2)





LNV0407

Example 2: Setting a destination using a nearby place

1. Say "Destination nearby places".
2. Say a category name.



LNV0408

3. Voice feedback will be provided when the command is accepted.
4. After the tone sounds and the icon on the screen changes from a gray  to an orange , say one of the numbers on the list to select the destination.

 "HOW TO SAY NUMBERS"
(page 9-3)

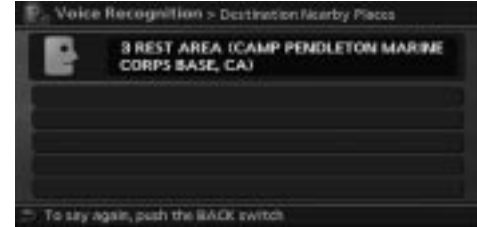

LNV0409

5. Voice feedback will be provided when the command is accepted, and the list of facilities in the category specified in the previous step appears.
6. After the tone sounds and the icon on the screen changes again, say one of the numbers on the list.
7. Voice feedback will be provided when the command is accepted, and the system starts calculating a route to the selected facility.

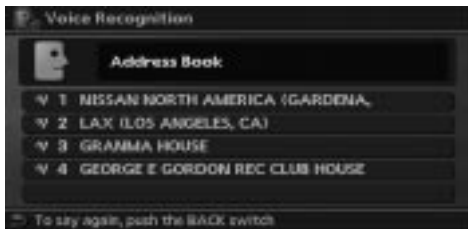

LNV0411

Example 3: Setting a destination from the Address Book

1. Say “Address book”.



LNV0412

2. When the system recognizes your command, the Address Book is displayed. After the tone sounds, say the number corresponding to the entry in the Address Book.



INFO:

To calculate a route using the Address Book, the location needs to be stored in the Address Book in advance.



“STORING A LOCATION” (page 6-2)

3. The system recognizes your command and calculates a route to the location of the specified entry in the Address Book.

How to read the voice command description

The voice command description in this manual can be expressed in various ways. Different phrases are available depending on the conditions of each command. Words that are not in brackets or parenthesis must be spoken. Words identified by a slash inside parenthesis (/) indicate alternatives, one of which must be spoken. Words that are optional are shown in brackets []. Variable items, such as phone numbers, are indicated in italics with < >.

How to say commands

Example:

This command “[Destination] Previous (Destinations/Destination)” can be expressed in the following ways with the same result.

- Destination Previous Destinations
- Destination Previous Destination
- Previous Destinations
- Previous Destination

3 Map settings

Map types	3-2	Changing the scale of the map screen	3-11
Plan view	3-2	Map Scale	3-11
Birdview™	3-3	Other settings for the map screen	3-13
Switching the map view	3-4	Setting of heading/north map view	3-13
Moving a map	3-6	Changing the 3D (Birdview™) angle	3-15
Plan View	3-6	Map icons	3-16
Birdview™	3-7	Displaying landmark icons	3-16
Returning to the current vehicle location	3-8	Map symbols	3-17
Map scrolling information	3-9	XM® NavTraffic™ symbols	3-20



MAP TYPES

Two types of map views are available: 2D (Plan View) and 3D (Birdview™).

PLAN VIEW

Plan View displays the map in a 2-dimensional environment similar to a road map.

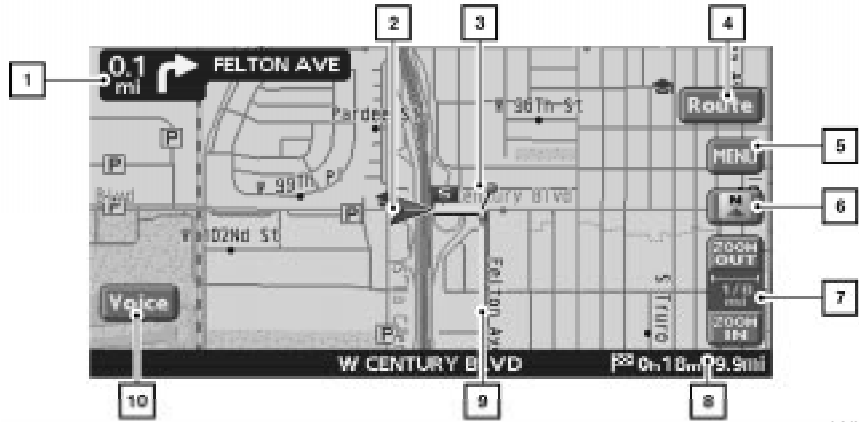

LVN0431

Screen information

- 1  Arrow and distance:

Appears on the upper left corner of the screen when the suggested route is set.

Indicates the distance to the next guide point and the turning direction at that guide point. The system can be set to not display this item.

- 2  Vehicle icon:

Indicates the current vehicle location and the direction that you are traveling.

- 3  Guide point:

Indicates a guide point on the route.

- 4  Route:



Touch this key to access the route settings.

- 5  Menu:

Touch this key to access the map menu or the map scroll menu.

- 6  Direction indicator:

Indicates the direction of the map. Touch this key to switch the orientation of the map.

- 7  Scale indicator:
Indicates the scale of the map.
- 8  Remaining time and distance to the destination:
Indicates the remaining time and distance to the destination.
- 9 Suggested route:
Appears in bold yellow during route guidance.
- 10  Voice:
Touch this key to repeat the voice guidance.

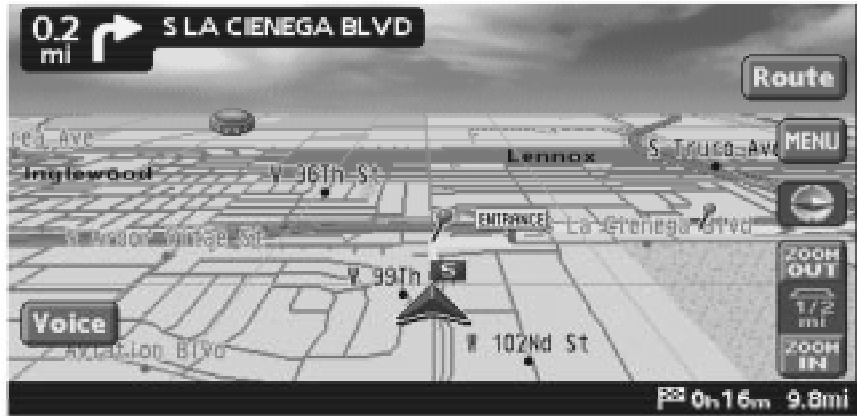

LNV0445

Birdview™

Birdview™ displays the map from an elevated perspective. In Birdview™, it is easy to recognize an image of the route because it provides a panoramic view over a long distance.

INFO:

About the Birdview™ display:

- “Birdview™” is a registered trademark of Xanavi Informatics Corporation.

- The map in Birdview™ always appears with the current forward direction facing up.

SWITCHING THE MAP VIEW

The map view can be changed between 2D (Plan View) and 3D (Birdview™).



LNV0125

1. Touch the “MENU” key while the current location map screen is displayed.



LNV0126

2. Touch the “Map View” key.

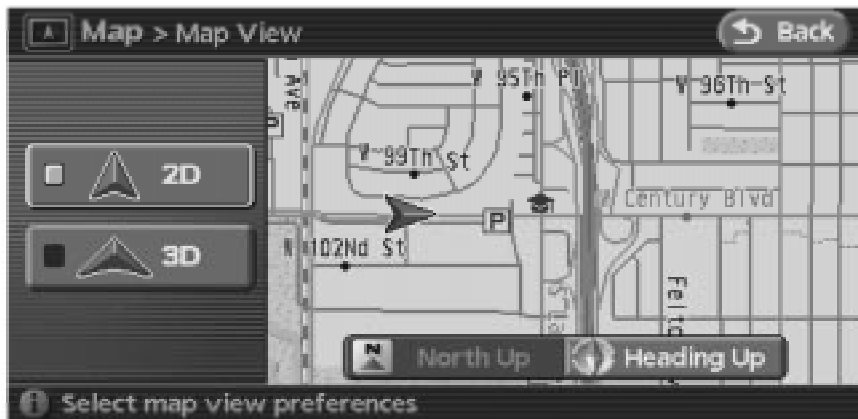

LNV0446

INFO:

- When you select a map view, a preview of that view is displayed on the right side of the screen.
- When you select the “2D” or “3D” key, the corresponding map scale becomes available. This is used to change the scale of the map screen.



“CHANGING THE SCALE OF THE MAP SCREEN” (page 3-11)



LNV0128

INFO:

You can also set the map view using the following procedure.

1. Press the SETUP button.
2. Touch the “Navigation” key.
3. Touch the “Map View” key.

Setting by voice command

1. Press the  button on the steering wheel switches.
 2. After the tone sounds, say a command.
- To display a map in 2D (Plan View) say: “Plan view”.
 - To display a map in 3D (Birdview™) say: “Birdview”.

3. Touch either the “2D” (Plan View) key or the “3D” (Birdview™) key. The indicator of the selected map view illuminates.
4. Press the MAP button or touch the “Back” key to return to the current location map screen.

Available views

- 2D: Switches to Plan View.
- 3D: Switches to Birdview™.

MOVING A MAP

The on screen keys for moving a map are different between 2D (Plan View) and 3D (Birdview™).

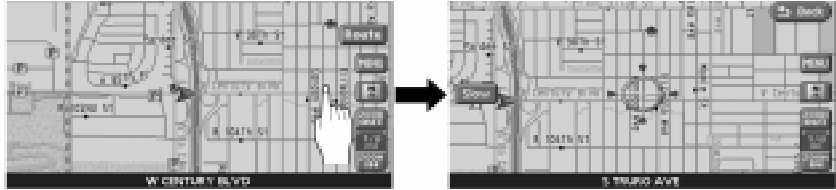

PLAN VIEW

Touch the touch-screen in the direction that you want to move across the map. Hold down on the screen continuously, moving across the map in that direction.

LNVO429
Once you start moving across the map, the cross pointer appears.

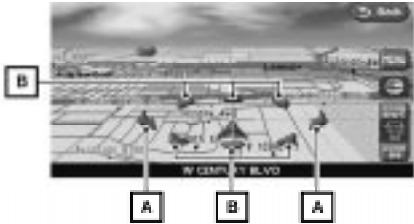

WNV0556

Birdview™

1. Touch the screen in the direction that you want to move across the map.
2. Arrows appear; touch one of the angular arrows **A** to rotate the map.
3. Touch one of the direction arrows **B** to move across the map in that direction.

Touch and hold any of the arrows to continuously move the map.

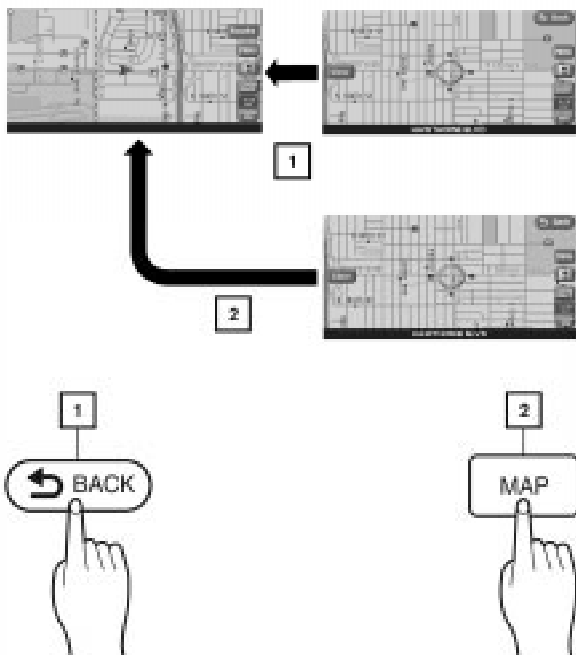

RETURNING TO THE CURRENT VE- HICLE LOCATION

Press the MAP button.

The current location map screen is displayed.



INFO:

- The previous screen can be displayed by touching the “Back” key. You can also return to the current location map screen by touching the “Back” key.
- Depending on the menu selected, pressing the MAP button may not return you to the current location map screen.



Setting by voice command

1. Press the  button on the steering wheel switches.
 2. After the tone sounds, say a command.
- To display the current location map screen say “Map”.

WNV0557

MAP SCROLLING INFORMATION

Information about the location, on which the center of the cross pointer is placed by scrolling on the map, can be set to be displayed.

1. Press the SETUP button.

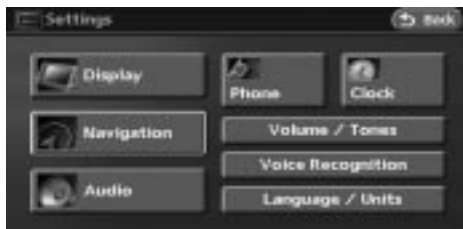

LNV0133

2. Touch the "Navigation" key.

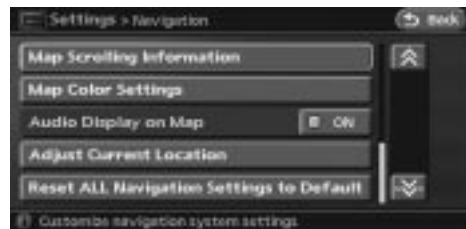

LNV0134

3. Touch the "Map Scrolling Information" key (you might need to scroll down the list to find the right key).

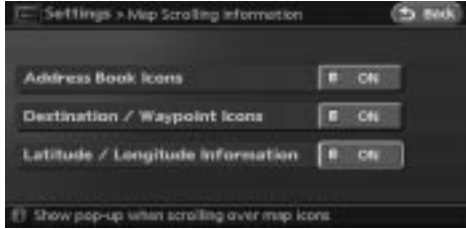

LNV0135

4. Touch the preferred information key. The indicator of the selected information item illuminates.

Available information items:

- Address Book Icons
- Destination/Waypoint Icons
- Latitude/Longitude Information



LNV0136

5. Press the MAP button to return to the current location map screen. Move the cross pointer to the set location to display the information.

CHANGING THE SCALE OF THE MAP SCREEN

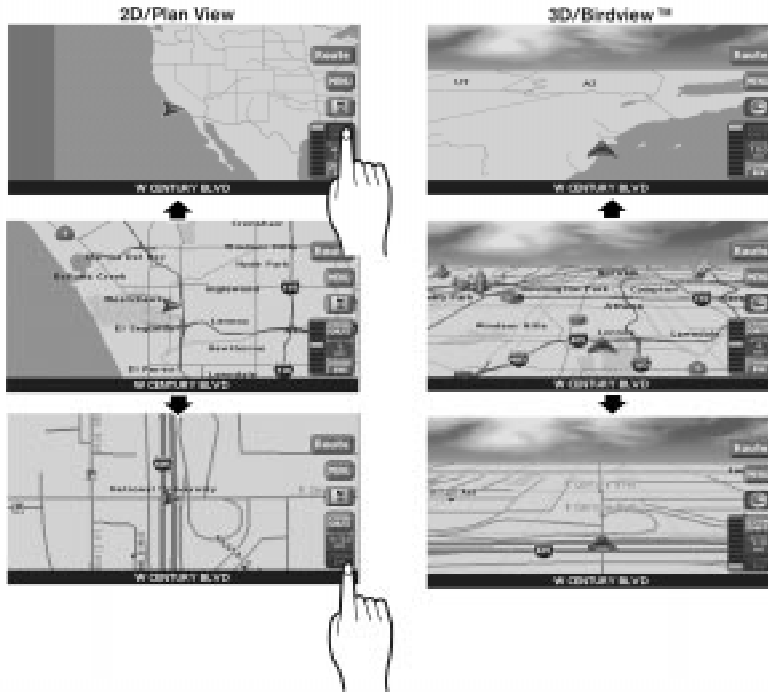

Touch the “ZOOM IN” or the “ZOOM OUT” key. To view the map in detail touch the “ZOOM IN” key. To view a wider area, touch the “ZOOM OUT” key. The zoom keys will be disabled when the “ZOOM IN” or the “ZOOM OUT” key has been touched multiple times.

MAP SCALE

The following scales are available depending on the map view.

- In 2D (Plan View):
Widest (1/51,200,000) to the most detailed (1/5,000).
- In 3D (Birdview™):
Widest (1/20,480,000) to the most detailed (1/25,000).

LNV0430



LNV0138

Example: The most detailed level

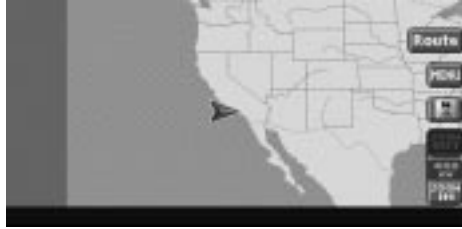

LNV0137

Example: The widest level

Scale level of the Plan View display

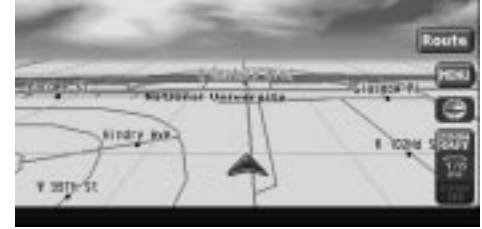

LNV0140

Example: The most detailed level

Map scale	Actual distance
1:51.2 million	400 miles (640 km)
1:5.12 million	32 miles (64 km)
1:1.28 million	8 miles (16 km)
1:320,000	2 miles (4 km)
1:160,000	1 mile (2 km)
1:80,000	1/2 mile (1 km)
1:40,000	1/4 mile (500 m)
1:20,000	1/8 mile (200 m)
1:10,000	1/16 mile (100 m)
1:5,000	1/32 mile (50 m)



LNV0139

Example: The widest level

Scale level of the Birdview™ display

Map scale	Actual distance
1:20.48 million	160 miles (256 km)
1:5.12 million	32 miles (64 km)
1:2.56 million	16 miles (32 km)
1:1.28 million	8 miles (16 km)
1:640,000	4 miles (8 km)
1:320,000	2 miles (4 km)
1:160,000	1 mile (2 km)
1:80,000	1/2 mile (1 km)
1:40,000	1/4 mile (500 m)
1:25,000	1/6 mile (250 m)

Setting by voice command

1. Press the  button on the steering wheel switch.
 2. After the tone sounds, say a command.
- To change the map scale say “Zoom level (1 to 10)”.

OTHER SETTINGS FOR THE MAP SCREEN

Other settings are also available for the map screen, such as changing the map direction, turn list, etc.

SETTING OF HEADING/NORTH MAP VIEW

You can change the map direction (orientation) in Plan View or change the position of the vehicle icon to view a wider area in the traveling direction.

These settings are available only in the Plan View mode.



LNV0141

Touch the compass icon key to toggle between Heading Up or North Up.

Available map orientations:

- North Up:
North is set at the top of the map.
- Heading Up:
The traveling direction is set at the top of the map.



LNV0141

North Up



LNV0142

Heading Up



INFO:

If the map orientation is switched, the icon displayed is also switched



: North Up



: Heading Up



LNV0128



INFO:

You can also set the orientation of the map using the following procedure.



1. Press the SETUP button.
2. Touch the “Navigation” key.
3. Touch the “Map View” key.

CHANGING THE 3D (Birdview™) ANGLE

This changes the 3D angle. This setting is only available in the 3D mode.





LNV0143

1. While in the 3D (Birdview™) map view, touch the  key or  key to change the angle of the map.



LNV0128

You can also set the 3D (Birdview™) angle using the following procedure.

1. Press the SETUP button.
2. Touch the “Navigation” key.
3. Touch the “Map View” key.
4. Touch the “3D” key.
5. Touch the  key or  key to change the angle of the map.

MAP ICONS

Some landmarks in the surrounding area can be displayed as icons on the screen.

DISPLAYING LANDMARK ICONS

This allows you to display or hide the landmark icons by type.

Landmark icons that can be displayed:

- Restaurant
- Gas station
- Hotel
- ATM
- Rest area



LNV0130

1. Touch the “MENU” key while the current location map screen is displayed.



LNV0145

2. Touch the “Landmark Icons” key.



LNV0146

3. Touch the preferred icon by touching the "ON" key.

The icon display setting toggles on and off each time you touch the "ON" key. The indicator of the selected icon illuminates.



LNV0147

4. Press the MAP button or the "Back" key. The activated landmark icons are displayed on the map.



LNV0148



INFO:

You can also set the landmark icons using the following procedure.

1. Press the SETUP button.
2. Touch the "Navigation" key.
3. Touch the "Landmark Icons" key.

MAP SYMBOLS

The navigation system uses symbols to display facilities.

2-D icons (Plan View)



Airport



Ferry Terminal



Military Base



Restaurant



Amusement Park



Golf Course



Museum



Shopping Center



Bank



Gas Station



Open Parking Area



Sports Complex



Car Rental



Historical Monument



Park & Ride



Station



City Hall



Hotel or Motel



Parking Garage



Super Market



Commuter Rail Station



Library



Police Station



Tourist Office



Courthouse



Marina



Service Station
(Rest Area)



University or College



Other facilities

LNV0545

2D icons (Plan View)

3-18 Map settings

3-D icons (Birdview™)

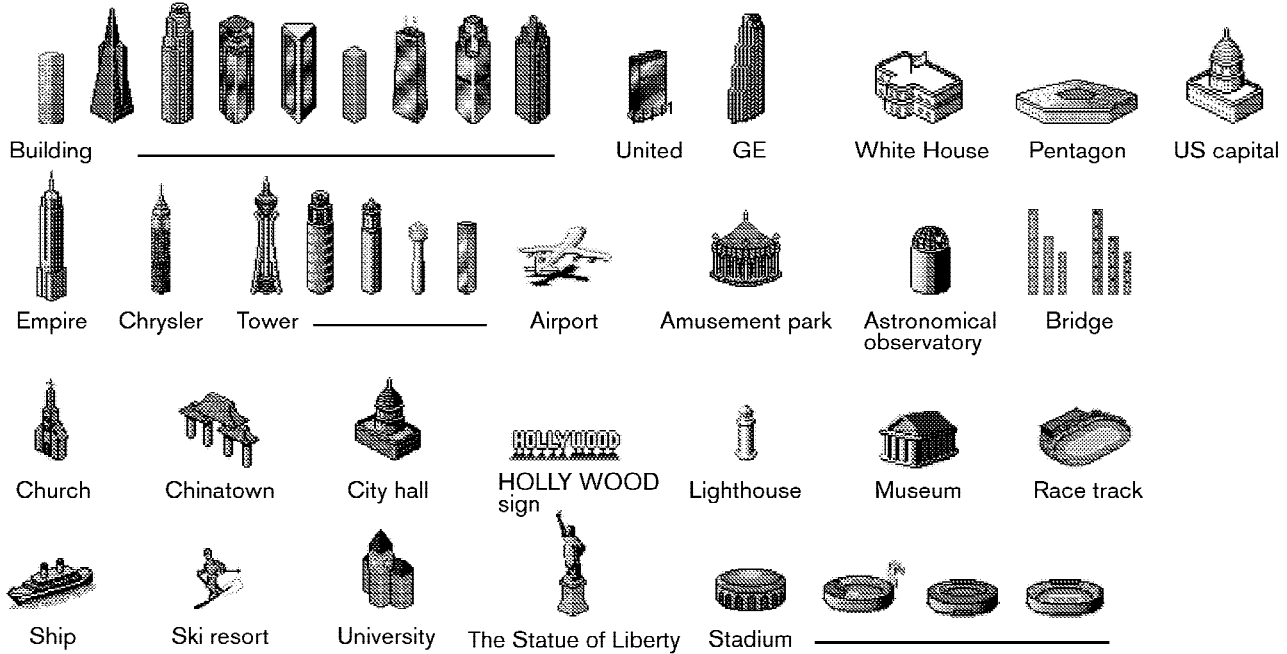

LNV0546

3D icons (Birdview™)

Road color

The road types are differentiated by colors.

Freeway: Red



Main road: Yellow



Narrow street: Gray

Road with incomplete map data: Green

XM® NAVTRAFFIC™ SYMBOLS

When displaying the map with XM® NavTraffic™ (if so equipped) enabled the following might be displayed:

- Colored road meanings:
 - Green: Light traffic.
 - Yellow: Heavy traffic and moving at approximately 21 MPH (34 km) to 44 MPH (71 km).
 - Red: Traffic jam or accident and moving at approximately 20 MPH (30 km) to 0 MPH (0 km).
 - Purple: Road closed.
- Road symbol meanings:
 -  : Accident
 -  : Closed Road

-  : Information
-  : Road Work
-  : Slippery Road
-  : Weather
-  : Incident

4 Setting a destination

Destination screen.....	4-2	Setting the previous starting point.....	4-19
Basic operation.....	4-2	Setting a facility as the destination.....	4-21
Setting a street address/residence as the destination.....	4-3	Setting a point of interest.....	4-21
Changing/setting a region.....	4-4	Category list.....	4-28
Setting a street address.....	4-4	Setting a freeway entrance/exit.....	4-31
Setting a city center.....	4-7	Setting by phone number.....	4-34
Setting an intersection.....	4-10	Setting a nearby place.....	4-35
Setting from map.....	4-13	Operations after setting a destination.....	4-37
Setting a stored location as the destination.....	4-15	Available setting items.....	4-38
Setting your home.....	4-15	Adjusting the location of the destination.....	4-38
Setting from the address book as a destination.....	4-16	Adding additional destination to a route.....	4-39
Setting a previous destination.....	4-18	Viewing information about the searched location.....	4-40
		Storing a location.....	4-41



DESTINATION SCREEN

There are several methods you can use to set your destination. Understand the advantages of each method and select the best method for finding and setting your destination.

BASIC OPERATION

1. Press the DEST button.
2. Touch the preferred setting method.



NOTE:

You may not be able to search by “Street Address”, “Intersection” and “Point of Interest (POI)” for some areas. The map DVD-ROM data may not be available.



LNV0450

Available setting items

- Change Region:
Set the current region you are in.
- Street Address:
Set a street address.
- Points of Interest (POI):
Searches for a destination from various categories of businesses or locations.
- Home (Add New):
Searches for route from current location to previously stored home destination.
- Address Book:
Sets a route to a location stored in the address book.
- Nearby Places:
Searches for a business/location near your vehicle.
- Other:

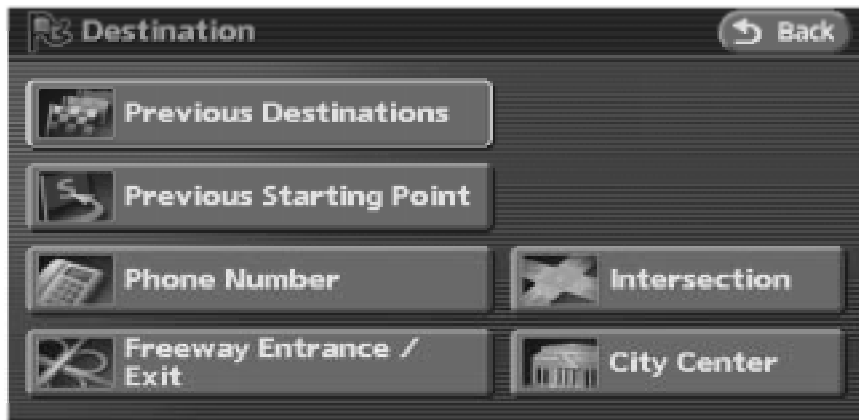

WNV0559

- Previous Destinations:
Sets a previous destination as your current destination.
- Previous Starting Point:
Sets the previous starting point as your destination.
- Phone Number:
Searches for a POI destination by the telephone number. It will not search for residential phone numbers.
- Freeway Entrance/Exit:
Sets a freeway entrance or exit as your destination.
- Intersection:
Sets an intersection as your destination.
- City Center:
Sets the center of a city as the destination.

SETTING A STREET ADDRESS/RESIDENCE AS THE DESTINATION

If you know the address of a friend or business or you are going to a central location (tourist spot, etc.) in a city, the following setting methods are available.

- Change Region
This allows you to set the region in which your vehicle is located.
- Setting a Street Address
If you know the address of your destination, use this method to enter the address and then have the system calculate a route. You can also search for a location near the preferred destination by entering the house number if the map DVD-ROM contains the relevant data.
- Setting a City Center
This allows you to have the system calculate a route to the center of a city, without setting a specific location.
- Setting an Intersection
This allows you to set the destination to an intersection of any two streets, and then have the system calculate a route.

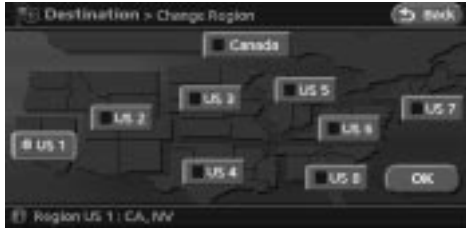

LNV0159

CHANGING/SETTING A REGION

1. Touch the "Change Region" key.
2. Touch one of the region keys.
The indicator of the selected region illuminates.
3. Touch the "OK" or the "Back" key to set the change.



INFO:

The Change Region key will update to display your chosen region.



LNV0151

SETTING A STREET ADDRESS

1. Touch the "Street Address" key.
A character input screen is displayed.



LNV0153

2. Enter the house number; when finished touch the "OK" key.
If you do not know the house number, touch the "No House #" key.



INFO:

Character input screen for Street Address:

- 1 House #: A house number can be entered.
- 2 Street: Enter a name of a street.
- 3 City: "All Cities" is displayed, and all cities in the region are available. Route calculation conditions can be narrowed down by entering the name of the city.

LNV0452

- 4 No House #: Touch this key if you do not know the house number of the location.
- 5 ABC: Touch this key to enable the character input screen.



LNV0154

- Enter the name of the street. After finishing the entry, touch the “OK” key.
A list of possible street addresses is displayed.



LNV0155

- Touch the correct address of the destination from the list.



LNV0156

- The selected destination is displayed at the center of the map. Touch the “Start” key after confirming the location of the displayed destination.
The system sets the destination to the selected location and starts calculating a route.

4-6 Setting a destination



LNV0157



INFO:

Even after setting a destination, you can adjust the location of the destination, store the location, etc.



“OPERATIONS AFTER SETTING A DESTINATION” (page 4-37)



Setting by voice command

1. Press the  button on the steering wheel switch.
 2. After the tone sounds, say a command.
- To set the destination from the stored street address say:
“Destination address book”



LNV0163

SETTING A CITY CENTER

1. Touch the “Other” key.



WNV0558

2. Touch the “City Center” key.
A character input screen is displayed.



LNV0166

- Once you have entered the name of the city, touch the "OK" key to narrow down the route calculation conditions. A list screen is displayed.



INFO:

Character input screen for City Center:

- City:
All cities in the region are available. Route calculation conditions can be narrowed down by entering the name of the city.
- Last 5 Cities:
A list screen of the last 5 searched cities will appear.

LNV0453

- 123:
Numeric keys are displayed by touching the "123" key.
- Symbol1:
Symbol keys are displayed by touching the "Symbol1" key.



INFO:

Touch the "Last 5 Cities" key to display the 5 cities recently set as destinations.

4-8 Setting a destination

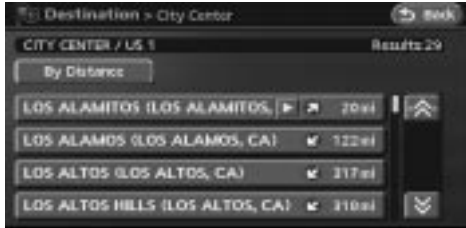

LNV0167

4. Touch the preferred destination key from the list.



LNV0168



INFO:

By touching the “By Distance” key, you can sort the list by the nearest distance.



LNV0169

5. The selected destination is displayed at the center of the map. Touch the “Start” key after confirming the location of the displayed destination.
The system sets the destination to the selected location and starts calculating the route.



LNV0170



INFO:

Even after setting a destination, you can adjust the location of the destination, store the location, etc.



“OPERATIONS AFTER SETTING A DESTINATION” (page 4-37)



LNV0163

SETTING AN INTERSECTION

1. Touch the “Other” key.



WNV0560

2. Touch the “Intersection” key.
A character input screen is displayed.



- LNV0173
3. Enter the name of the 1st street. After finishing the entry touch the “OK” key. A list screen is displayed.



INFO:

Character input screen for Intersection:

- 1 1st Street:
Enter the name of the 1st street of the destination intersection.
- 2 2nd Street:
Enter the name of the 2nd street of the destination intersection.

LNV0454

- 3 City:
“All Cities” is displayed, and all cities in the region are available. Route calculation conditions can be narrowed down by entering the name of the city.
- 4 123:
Numeric keys are displayed by touching the “123” key.
- 5 Symbol 1:
Symbol keys are displayed by touching the “Symbol 1” key.



LNV0174

4. Touch the preferred street key from the list.



LNV0175

5. Enter the name of the 2nd street. After finishing the entry touch the "OK" key. A list screen is displayed.



LNV0176

6. Touch the preferred street key from the list.



LNV0177

- The selected destination is displayed at the center of the map. Touch the “Start” key after confirming the location of the displayed destination.

The system sets the destination to the selected location and starts calculating the route.



LNV0178



INFO:

Even after setting a destination, you can adjust the location of the destination, store the location, etc.



“OPERATIONS AFTER SETTING A DESTINATION” (page 4-37)

SETTING FROM MAP

This allows you to search for a destination by scrolling the map, and then have the system calculate a route to the destination.



LNV0182

- Scroll the map, place the cross pointer over the preferred location, and touch the “MENU” key.



LNV0183

2. Touch the “New Dest.” key.



INFO:

For items except for “New Dest”, refer to “Map menu screen”.



“SCROLLED LOCATION MAP SCREEN” (page 2-10)

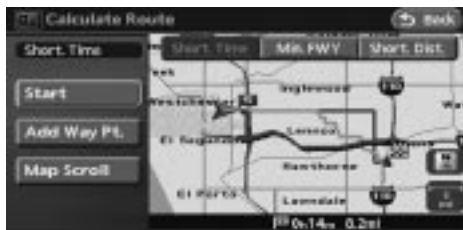

LNV0184

3. The system sets the destination to the selected location and starts calculating a route.

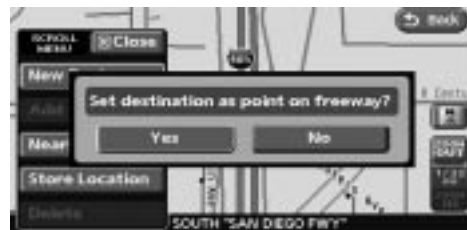

LNV0185



INFO:

If you set the destination on a freeway, a confirmation message is displayed.

SETTING A STORED LOCATION AS THE DESTINATION

The following setting methods are available when setting the destination to your home or any location stored in the Address Book.

- Setting your home

This allows you to set your home as the destination and have the system calculate a route. It is useful especially when you are searching for a route to return to your home.

 "STORING A LOCATION"
(page 6-2)

- Setting from Address Book

This allows you to set the destination to a location stored in the Address Book and have the system calculate a route. To utilize this function more effectively, destinations that you often travel to should be stored in advance.

 "STORING A LOCATION"
(page 6-2)

- Setting a Previous Destination

This allows you to set the destination to a location that you have previously set as the destination and have the system calculate a route. Up to 100 previous destinations will be automatically stored. If the number of previous destinations exceeds 100, the oldest one will be replaced by the new one.

- Setting the Previous Starting Point

This allows you to set the destination to the starting point of the previous route guidance and have the system calculate a route.



LNV0189

SETTING YOUR HOME

1. Press the DEST button.
2. Touch the "Address Book" key.



LNV0190

3. Touch the "Home Location" key.



INFO:

If you have not stored your home yet, the system will automatically display a screen for storing it.



"STORING A LOCATION" (page 6-2)

4. Touch the "Start" key; a confirmation message is displayed and the system sets your home as the destination.



LNV0187

5. Your home is displayed at the center of the map, and the system starts calculating a route.



Setting by voice command

1. Press the  button on the steering wheel switch.
2. After the tone sounds, say a command.
 - To set your home as the destination: "Destination home"

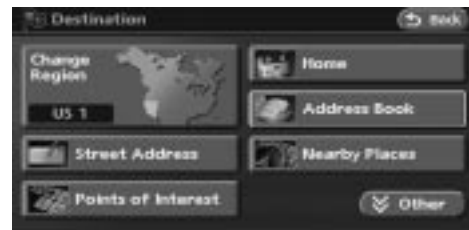

LNV0189

SETTING FROM THE ADDRESS BOOK AS A DESTINATION

1. Press the DEST button.
2. Touch the "Address Book" key. A list screen is displayed.



3. Touch the preferred location key from the list.



INFO:

To use the sort functions, stored locations must be set in advance. You can sort the list by touching one of the following keys:

1 By No:
The address book entries are displayed in ascending numerical order.

2 By Icon:
By selecting a particular icon, a list that contains only the address book entries associated with that icon is displayed.

3 By Name:
The address book entries are displayed in alphabetical order.

4 By Group:
By selecting a particular group (family, friends, leisure, etc.), the selected group is displayed at the top of the list.

LNV0455



LNV0193

4. The selected destination is displayed at the center of the map. Touch the “Start” key after confirming the location of the displayed destination.

The system sets the destination to the selected location and starts calculating a route.



LNVO194



INFO:

Even after setting a destination, you can adjust the location of the destination.



“OPERATIONS AFTER SETTING A DESTINATION” (page 4-37)



Setting by voice command

1. Press the  button on the steering wheel switch.
 2. After the tone sounds, say a command.
- To set the destination from a voicetag say: “Destination <a stored voicetag>”



WNV0558

SETTING A PREVIOUS DESTINATION

1. Press the DEST button.
2. Touch the “Others” key.
3. Touch the “Previous Destination” key.
A list screen is displayed.



LNVO196

4. Touch the preferred previous destination key from the list.



LNV0197

5. The selected destination is displayed at the center of the map. Touch the “Start” key after confirming the location of the displayed destination.
The system sets the destination to the selected location and starts calculating a route.



LNV0198



INFO:

Even after setting a destination, you can adjust the location of the destination.



“OPERATIONS AFTER SETTING A DESTINATION” (page 4-37)



Setting by voice command

1. Press the  button on the steering wheel switch.
 2. After the tone sounds, say a command.
- To display a list of previous destinations say: “Destination previous destinations”



WNV0558

SETTING THE PREVIOUS STARTING POINT

1. Press the DEST button.
2. Touch the “Others” key.
3. Touch the “Previous Starting Point” key.



LNV0200

- The starting point of the route of the previous route guidance is displayed at the center of the map. Touch the "OK" key after confirming the location of the displayed starting point.



LNV0201

- Touch the "Start" key. The system sets the destination to the selected location and starts calculating a route.



LNV0202



INFO:

Even after setting a destination, you can adjust the location of the destination.



"OPERATIONS AFTER SETTING A DESTINATION" (page 4-37)



Setting by voice command

- Press the  button on the steering wheel switch.
- After the tone sounds, say a command.
 - To select a previous starting point say: "Destination previous starting point"

SETTING A FACILITY AS THE DESTINATION

When you are setting the destination to a facility, the following methods are available.

- **Setting a Point of Interest**
This allows you to find a facility by type, and then have the system calculate a route to that destination. Specify the region and city of the destination to find it more quickly.
- **Setting a Freeway Entrance/Exit**
This allows you to set the destination to an entrance or exit of a freeway, and then have the system calculate a route.
- **Setting by Phone Number**
If you know the telephone number of the facility, use this to find the facility by entering the number, and then have the system calculate a route.
- **Setting a Nearby Place**
This allows you to set the destination to a facility located near the current vehicle location or another location that you move to by scrolling the map, and then have the system calculate a route. If there is a particular Point of Interest type that you intend to use frequently, you can store it in the list of nearby Points of Interest.



“CUSTOMIZING NEARBY PLACES”
(page 6-26)



LNV0203

SETTING A POINT OF INTEREST

1. Press the DEST button.
2. Touch the “Points of Interest” key.



LNV0204

3. Touch one of the main category keys.



INFO:

Touch the “By Name” key to include all categories in the route calculation conditions.

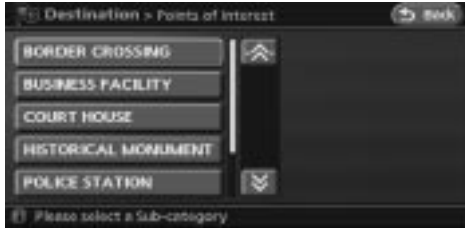

LNV0205

4. Touch one of the subcategory keys.



LNV0206

5. Touch one of the search keys for different ways to find the destination facility.
- Nearby POI:
The system will search for the facility, based on the type selected, near the current vehicle location.
 - By Name:
You input the name of the destination facility.
 - By City:
You input the name of the city where the destination facility is located.



List screen by selecting the “Nearby POI” key for Points of Interest.

- 1 Sort by distance:
The list of destination facilities will be sorted by distance.
- 2 Sort by category:
The list of destination facilities will be sorted by category.

LNV0456



LVN0457

Character input screen is displayed by selecting the "By Name" key for Points of Interest.

- 1 Name:
The name of the destination facility can be selected.
- 2 Category:
The preferred facility type can be selected.

- 3 City:
"All Cities" is displayed, and all cities in the region are available. Route calculation conditions can be narrowed down by entering the name of the city.

- 4 Nearby POI:
The system will search for the facility, based on the type selected, near the current vehicle location.

- 5 Symbol 1:
Symbol keys are displayed by touching this key.

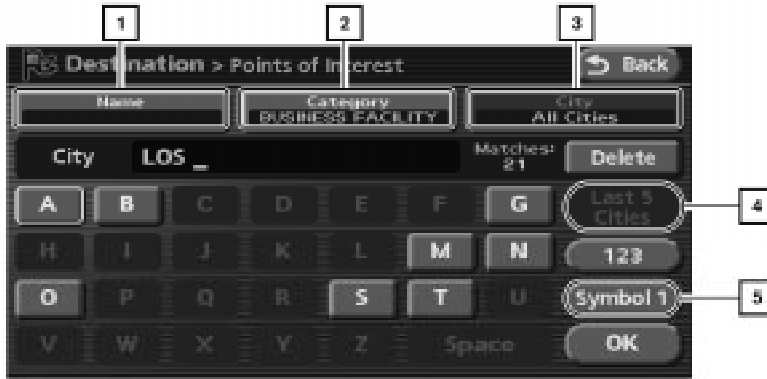

- LNV0214
6. Touch the “By Name” key. Enter the name of the destination facility.

Character input screen by selecting the “By City” key for Points of Interest

- 1 Name:
The name of the destination facility can be selected.
- 2 Category:
The preferred facility type can be selected.

- 3 City:
“All Cities” is displayed, and all cities in the region are available. Route calculation conditions can be narrowed down by entering the name of the city.
- 4 Last 5 Cities:
The system will display 5 cities recently set as destinations to narrow your search for the facility.
- 5 Symbol 1:
Symbol keys are displayed by touching this key.

LNV0459



LNV0215

- After finishing the entry, touch the "OK" key. A list screen is displayed.



LNV0216

- Touch the preferred destination facility key from the list.



LNV0217



INFO:

By touching the "By Distance" key, you can sort the list by the nearest distance.

The position of the selected location is displayed in the preview on the right side of the screen.

By touching the "By Category" key, you can display the list that summarizes the entered names into categories. Select the category to narrow down the search.

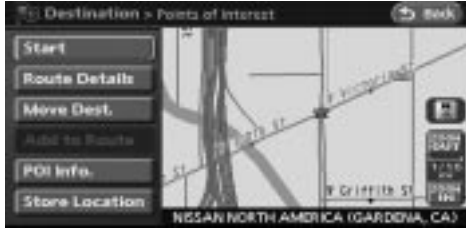

LNV0212

- The selected destination is displayed at the center of the map. Touch the “Start” key after confirming the location of the displayed destination.

The system sets the destination to the selected location and starts calculating a route.



LNV0213



INFO:

Even after setting a destination, you can adjust the location of the destination.



“OPERATIONS AFTER SETTING A DESTINATION” (page 4-37)

CATEGORY LIST

Restaurant	Restaurant all African, American, Austrian, Balkan, Barbecue/Southern, Belgian, Bistro, Bohemian, Brewpub, British Isles, Cajun/Caribbean, Californian, Canadian, Chinese, Continental, Dutch, East European, Fast food, Filipino, French, German, Greek, Grill, Hawaiian/Polynesian, Hungarian, Indian, Indonesian/Malaysian, International, Italian, Japanese, Jewish/Kosher, Korean, Latin American, Maltese, Mexican, Middle Eastern, Oriental, Other, Pizza, Polish, Portuguese, Russian, Sandwich, Scandinavian, Seafood, Soul food, South American, South-western, Southeast Asian, Spanish, Steak house, Swiss, Thai, Turkish, Unknown, Vegetarian, Vietnamese	
Shopping	Grocery store	Grocery store all 7-Eleven, AM PM, Casey's General Store, Circle K, Convenient Food Stores, Cumberland Farms, Dairy Mart, Dominion stores, Holiday Station Store, Kash-N-Karry, Loblaw, Miracle Mart, Others, Pantry, Stop-N-Go, Uni Mart Inc., White Hen Pantry
	Shopping	
Auto service	Auto dealerships	
	Automobile club	
	Gas stations	Gas station all Amoco, Arco, Beacon (Valero), BP, Chevron, Citgo, Conoco, Diamond Shamrock, Esso, Exxon, Getty, Gulf, Husky, Marathon, Mobil, Mohawk, Others, Petro-Canada, Phillips 66, Pioneer, Shamrock, Shell, Sinclair, Speedway, Sunoco, SuperAmerica, Texaco, Ultramar USA, Ultramar (Valero), Unocal 76, Valero
	Rental car agency	
	Auto service & maintenance	
	NISSAN dealer	
	INFINITI dealer	

Travel	Airport	
	Border crossing	
	Bus station	
	Commuter rail station	
	Ferry terminal	
	Hotel	<p>Hotel all</p> <p>America Inn & Suites, Amerihost (Cendant), Amerisuites, Baymont Inn & Suites, Best Western, Candlewood Suites, Clarion, Country Hearth Inn, Country Inn Suites (Carlson Group), Courtyard by Marriott, Crossland Motel, Crowne Plaza, Days Inn, Double Tree (Hilton Group), Drury Inn/Pear Tree by Drury, Econo Lodge, Embassy Suites, Extended Stay, Fairfield Inn, Four Seasons, Hampton Inn, Hawthorn Suites, Hilton, Hilton Garden Inn, Holiday Inn, Holiday Inn Express, Homestead, Homewood, Howard Johnson, Hyatt, Intercontinental, Jameson Inns/Signature Inns, Knights Inn (Cendant), La Quinta Inn, Leows Hotels, Microtel Inn & Suites, Motel 6/Studio 6, Others, Park Inn (Carlson Group), Quality, Radisson, Ramada Inn, Red Roof Inn, Renaissance (Marriott), Residence Inns, Ritz Carlton, Rodeway Inn (Choice), Scottish Inn, Sheraton, Shilo Inn, Shoney's Inn, Sleep Inn (Choice), Spring Hill Suites (Marriott), St Regis (Starwood), Stay-bridge Suites, Studio Plus, Super 8, Towne Place Suites (Marriott), Travelodge, Venture Inns, Village (Cendant), W Hotels, Westin, Wingate Inn (Cendant), Wyndham</p>
	Automobile club	
	Rental car agency	
	Rest area	
	Ski resort	
	Tourist attraction	
	Tourist information	
	Train station	
Auto service & maintenance		
Banking	ATM	
	Bank	
Hospital		

Community	City hall, Community center, Convention/Exhibition center, Court house, Historical monument, Hospital, Library, Marina, Museum, Police station, Park/Recreation area, School, Sports center, Sports complex, Performing arts, Higher education
Leisure	Amusement park, Bowling center, Casino, Movie theater, Convention/Exhibition center, Golf course, Historical monument, Ice skating rink, Marina, Museum, Nightlife, Park/Recreation area, Ski resort, Sports center, Sports complex, Performing arts, Tourist attraction, Tourist information, Winery
Parking	Parking lot
	Park & Ride
	Parking garage
Others	Border crossing, Business facility, Court house, Historical monument, Police station, School, Higher education



LNV0149

SETTING A FREEWAY ENTRANCE/EXIT

1. Press the DEST button.
2. Touch the "Other" key.



WNV0561

3. Touch the "Freeway entrance/exit" key.
A character input screen is displayed.



LNV0223

4. Enter the name of the freeway.
5. After finishing the entry, touch the "OK" key.



LNV0224

6. Touch the freeway key of the destination from the list.



LNV0225

7. Touch the "Entrance" or "Exit" key. A list screen is displayed.



LNV0226

8. Select the preferred destination key from the list. The position of the selected location is displayed in the preview on the right side of the screen.



LNV0227



INFO:

By touching the “By Distance” key, you can sort the list by the nearest distance.



“OPERATIONS AFTER SETTING A DESTINATION” (page 4-37)



LNV0228

- The selected destination is displayed at the center of the map. Touch the “Start” key after confirming the location of the displayed destination.
The system sets the destination to the selected location and starts calculating a route.



LNV0229



INFO:

Even after setting a destination, you can adjust the location of the destination.



“OPERATIONS AFTER SETTING A DESTINATION” (page 4-37)

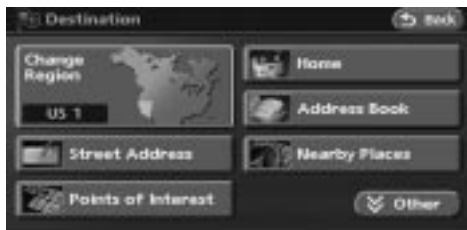

LNV0149

SETTING BY PHONE NUMBER



INFO:

- If the area code of the specified telephone number does not exist in the map data, the system will not search for the location.
- Only the locations included in the database in the map DVD-ROM can be searched by the phone number. Personal phone numbers cannot be used to search for a location.

1. Press the DEST button.
2. Touch the "Other" key.



WNV0562

3. Touch the "Phone Number" key.
The telephone number input screen is displayed.



LNV0231

4. Enter the telephone number including the area code.
5. After finishing the entry, touch the "OK" key.



"Phone number input screen"
(page 2-23)



LNV0232

- The selected destination is displayed at the center of the map. Touch the "Start" key after confirming the location of the displayed destination.

The system sets the destination to the selected location and starts calculating a route.



LNV0233



INFO:

Even after setting a destination, you can adjust the location of the destination.



"OPERATIONS AFTER SETTING A DESTINATION" (page 4-37)



Setting by voice command

- Press the  button on the steering wheel switch.
 - After the tone sounds, say a command.
- To set the destination from the phone number say:
"Destination phone number"



LNV0234

SETTING A NEARBY PLACE

- Press the DEST button.
- Touch the "Nearby Places" key.



LNV0235

3. Touch the preferred destination facility key. A list screen is displayed.



INFO:

If there is a particular Points of Interest type that you intend to use frequently, you can store it in the list of nearby Points of Interest.



“CUSTOMIZING NEARBY PLACES”
(page 6-26)



LNV0237

4. Touch the preferred destination key from the list.

The position of the selected location is displayed in the preview on the right side of the screen.



LNV0236



INFO:

If the suggested route is already set, touch the “Show Along Route” key; the system displays only the facilities located along the route.

OPERATIONS AFTER SETTING A DESTINATION

The following operations are available after you set a destination.



LNV0238

5. The selected destination is displayed at the center of the map. Touch the “Start” key after confirming the location of the displayed destination.

The system sets the destination to the selected location and starts calculating a route.



INFO:

If the route is already set, the selected location becomes a destination.



LNV0240



INFO:

You can also set the destination by touching the “MENU” key in the current location map screen and then touching the “Nearby Places” key.



Setting by voice command

1. Press the  button located on the steering wheel switch.
2. After the tone sounds, say a command.
 - To display the 5 nearest Points of Interest and select the destination from them say: “Show nearby places” after the system prompts, provide a category name. Then select your destination from the list provided.
 - To display the nearby category list and select the destination from it say: “Destination nearby places” after the system prompts, provide a category name. Then say the number of your preferred destination.

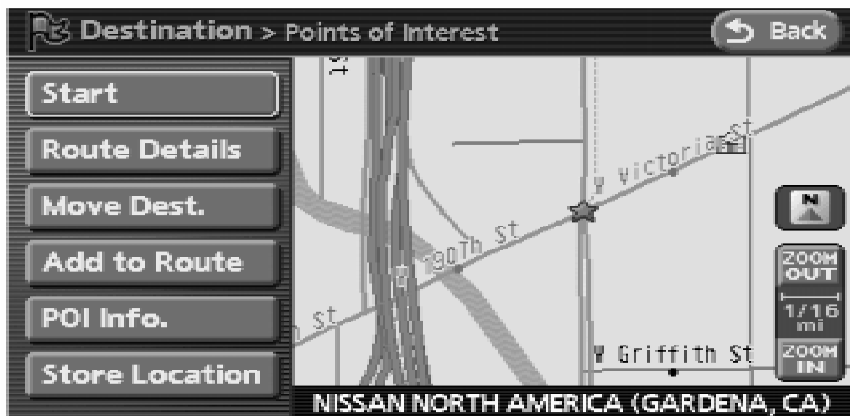

ADJUSTING THE LOCATION OF THE DESTINATION

You can adjust the location of the destination by moving the cross pointer across the map.

LNV0458

AVAILABLE SETTING ITEMS

- **Start:**
Sets the destination. If the route is already set, the location becomes the new destination, and the route is recalculated.
- **Route Details:**
Displays the details of the current route.
 "PROCEDURE AFTER SETTING A DESTINATION" (page 5-2)
- **Move Dest.:**
Displays a map screen where you can adjust the location of the destination.
- **Add to Route:**
Allows you to add a waypoint to the route already set.
- **POI Info.:**
Allows you to view information about the facility that you have set as the destination if it is included in the map DVD-ROM data.
- **Store Location:**
Allows you to store the location in the Address Book.

4-38 Setting a destination

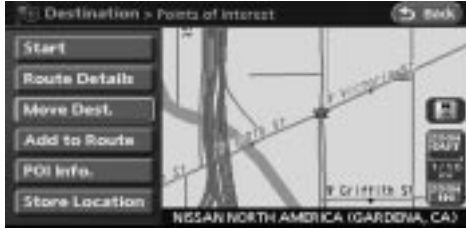

LNV0242

1. Set the destination using an appropriate method.
2. Touch the "Move Dest." key.



LNV0243

3. Adjust the location by moving the cross pointer across the map and touch the "OK" key. The location of the destination is modified.

ADDING ADDITIONAL DESTINATION TO A ROUTE

Even after the route is already set, you can add a searched location as a new destination or way-point to that route. If the route has not been set, the "Add to Route" key cannot be touched.

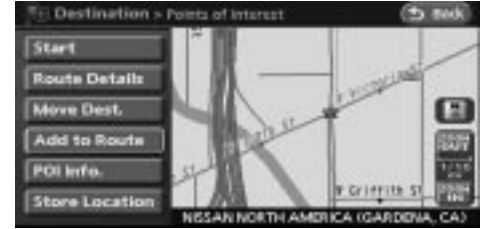

LNV0244

1. Set the destination using an appropriate method.
2. Touch the "Add to Route" key.

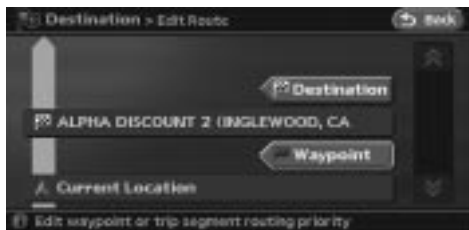

LNV0245

3. Touch the “Destination” or “Waypoint” key.

VIEWING INFORMATION ABOUT THE SEARCHED LOCATION

Information (street address and phone number) about Points of Interest stored in the map DVD-ROM data can be displayed.



LNV0246

1. Set the destination using an appropriate method.
2. Touch the “POI Info.” key.

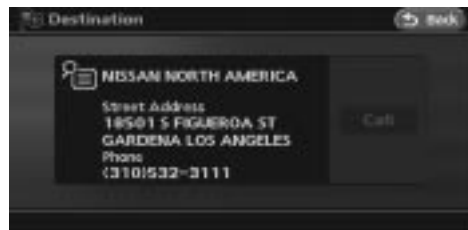

LNV0247

3. Information about the location is displayed.
4. Touch the “Back” key to return to the previous screen.



INFO:

If the “Call” key is selectable and located on the right side of the screen, it is possible to call to the place indicated. You must have a Bluetooth® enabled phone connected to the Bluetooth® Hands-Free Phone System for this option to work. For information on how to pair a phone, see your NISSAN Owner’s Manual.

STORING A LOCATION

A searched location can be stored in the Address Book. Then it can be easily retrieved and set as a destination (or waypoint).

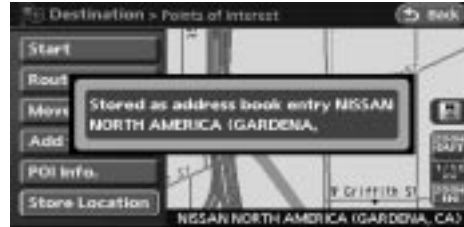

LNV0248

1. Set the destination using an appropriate method.
2. Touch the "Store Location" key.



LNV0249

3. The location is stored in the Address Book. The corresponding icon is displayed at the set location on the map.

MEMO

5 Route guidance

Procedures after setting a destination	5-2	Recalculate route	5-13
Available items after setting a destination	5-2	Editing a route	5-14
Starting route guidance	5-3	Traffic Detour Information	5-19
Adding a destination or waypoint	5-3	Confirming a route	5-20
Map scrolling	5-5	Using turn list	5-21
About route guidance	5-6	Where am I?	5-21
Voice guidance during route guidance	5-6	Route guidance settings	5-21
Guidance screens	5-6	Basic operation	5-21
Route setting	5-8	Visual guidance settings	5-23
Basic operation	5-8	Set average speeds	5-24
Setting conditions for the route calculation	5-10	Deleting/reactivating a route	5-25
Route priority settings	5-10	Deleting a route	5-25
Detailed route priorities	5-10	Reactivating a route	5-26
Change/edit route	5-12		



PROCEDURES AFTER SETTING A DESTINATION

After you set a destination using an appropriate method and touch the "Route Details" key, the system starts calculating a route to the destination. Touch the preferred setting key.



LNV0460

AVAILABLE ITEMS AFTER SETTING A DESTINATION

- Start:
Starts route guidance to the selected destination.
 "STARTING ROUTE GUIDANCE" (page 5-3)
- Add Way Pt.:
Allows you to edit the route by adding a destination or waypoint.
 "ADDING A DESTINATION OR WAYPOINT" (page 5-3)

- Map Scroll:
Allows you to manually scroll the map.
 "MAP SCROLLING INFORMATION" (page 3-9)



LNV0251

STARTING ROUTE GUIDANCE

1. Touch the “Start” key. Route guidance starts.



LNV0252

Available route conditions

- Short. Time (Blue):
Prioritizes by the shortest time.
- Min. FWY (Red):
Minimizes the use of freeways.
- Short. Dist. (Green):
Prioritizes by the shortest distance.



INFO:

- After you select a route, a preview is displayed on the right side of the screen.
- The 3 routes may not always be different.

ADDING A DESTINATION OR WAYPOINT

Before starting route guidance, you can add destinations and/or waypoints. A total of 6 destinations or waypoints can be set.



LNV0254

1. Touch the "Add Way Pt." key.



LNV0255

2. Use one of the appropriate methods for setting a destination.



INFO:

The method of searching for a location is the same as the one for a destination.



"4. Setting a destination"



LNV0256

3. The selected location is displayed at the center of the map. Touch the "Add to Route" key after confirming the location.



INFO:

You can modify the location by touching the "Move Dest." key. The method of adjusting a location is the same as the one for a destination.



"ADJUSTING THE LOCATION OF THE DESTINATION" (page 4-38)

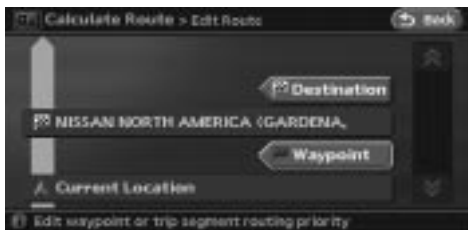

LNV0257

4. Touch the “Destination” key or “Waypoint” key.

The system starts calculating a route that includes the added destination or waypoint. When the calculation is finished, the route is displayed.



INFO:

- If a waypoint was added, different routes cannot be selected.
- If a destination was added, the prior destination becomes a waypoint.

MAP SCROLLING

To manually scroll the map to find a location or set a destination.



LNV0258

1. Touch the “Map Scroll” key.



LNV0259

2. Scroll along the map till you find your destination and touch the “OK” key.

To return to the previous screen touch the “Back” key.

ABOUT ROUTE GUIDANCE

After setting the route, touch the “Start” key to begin route guidance.

Throughout route guidance, the system navigates you through the guide points using visual and voice guidance.



CAUTION

The navigation system’s visual and voice guidance is for reference purposes only. The contents of the guidance may be inappropriate depending on the situation.

When driving along the suggested route, follow all traffic regulations (for example, one-way traffic).



“ROUTE GUIDANCE”

(page 10-11)

VOICE GUIDANCE DURING ROUTE GUIDANCE

When approaching a guide point (intersection or corner), destination, etc. during route guidance, voice guidance announces the remaining distance and/or turning direction.

Touch the “Voice” key to repeat voice guidance.

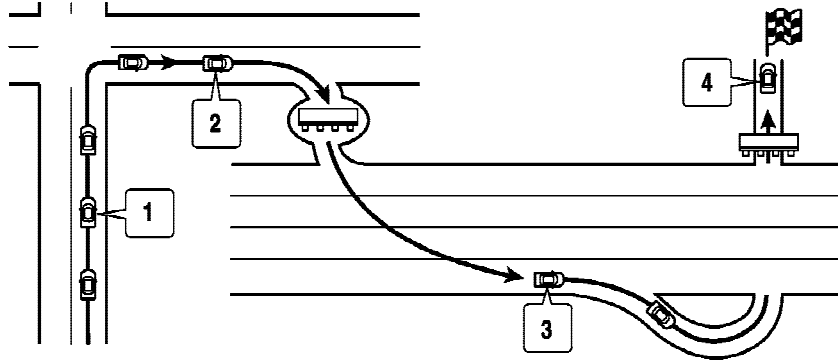

Examples of voice guidance

- 1 “In about one quarter mile (400 meters), right (left) turn.”
“Right (left) turn ahead.”
- 2 “In about one quarter mile (400 meters) freeway entrance on your right.”
“Freeway entrance on your right.”
- 3 “In about one mile (1.6 kilometers), exit on your right.”
“Take the second exit on your right.”

LNV0461

- 4 “You have arrived at your destination. Ending route guidance.”

GUIDANCE SCREENS

Route guidance displays map screens and various information according to the situation.



LNV0260

When route guidance starts, the Small Turn Arrow on Map is displayed in the upper left corner of the map screen. This arrow indicates the turning direction at the next guide point (corner or intersection). The distance is also displayed. At the top of the screen, the distance to the next guide point and the name of the next street to turn on to are displayed.

The Small Turn Arrow on Map can be enabled or disabled by the user.



“ROUTE GUIDANCE SETTINGS”

(page 5-21)



LNV0261

Enlarged intersection view

When approaching a guide point, the system automatically changes to the split screen and shows an enlarged view of the intersection in the left screen. After passing through the intersection, the system automatically returns to the full screen mode.

To switch to the full screen mode while the enlarged intersection view is displayed, press the MAP button.



LNV0262

Junction guidance

While driving on a freeway, when the vehicle is approximately 1 mile (approximately 2 km) from a junction, the system automatically switches to the split screen and displays an enlarged view of the junction (3D) in the left screen. After passing the junction, the system automatically returns to the full screen mode.

To switch to the full screen mode while the enlarged junction view is displayed, press the MAP button.



LNV0263

Turn list

Depending on the setting, the system can constantly display the split screen and show the turn list in the left screen. When approaching a guide point, the left screen automatically switches to an enlarged view of the intersection.

To switch to the full screen mode, press the MAP button.



“ROUTE GUIDANCE SETTINGS”
(page 5-21)

ROUTE SETTING

During route guidance, you can modify the route conditions or confirm the route information. Set the appropriate route condition according to your purpose.

BASIC OPERATION

1. While in the current location map screen touch the “Route” key.
2. Touch the preferred setting item.
3. Press the MAP button to return to the current location map screen.



WARNING

Always stop the vehicle in a safe location before modifying the route conditions.

Modifying the route conditions while driving may cause an accident.



LNV0462

Available setting items



- **Cancel Route Guidance/Resume Route Guidance:**

Allows you to cancel the current route guidance. A cancelled route can also be reactivated. If the suggested route is cancelled, the “Cancel Route Guidance” key changes to the “Resume Route Guidance” key.



“DELETING/REACTIVATING A ROUTE” (page 5-25)

- **Traffic Detour:**
Allows you to find the traffic detours along your route. Requires a subscription to XM® NavTraffic™ service.
- **Turn List:**
Allows you to see a numbered list of turns on your route.
- **Recalculate Route:**
Allows you to add waypoints, map scroll or recalculate your route.

- **Edit Route:**
Allows you to change or edit the route already set.
 “CHANGE/EDIT ROUTE” (page 5-12)
- **Route Priority:**
Allows you to change the route calculation conditions anywhere along the route.
 “SETTING CONDITIONS FOR THE ROUTE CALCULATION” (page 5-10)
- **Guidance Settings:**
You can set various guidance information to be displayed during route guidance and activate or deactivate route and/or voice guidance.
 “ROUTE GUIDANCE SETTINGS” (page 5-21)

SETTING CONDITIONS FOR THE ROUTE CALCULATION

- **Route Priority Settings**
Allows you to set the priority for the route calculation.
- **Detailed Route Priorities**
Allows you to set detailed route conditions.
 “DETAILED ROUTE PRIORITIES”
(page 5-10)

ROUTE PRIORITY SETTINGS

The route can be recalculated after changing the route calculation conditions anywhere along the route.

Basic operation

1. While in the current location map screen, touch the “Route” key.
2. Touch the “Route Priority” key.
3. Touch the preferred condition key. The indicator for the selected condition illuminates.
4. When the current location map screen or route setting screen is displayed, the system recalculates a route with the set conditions.

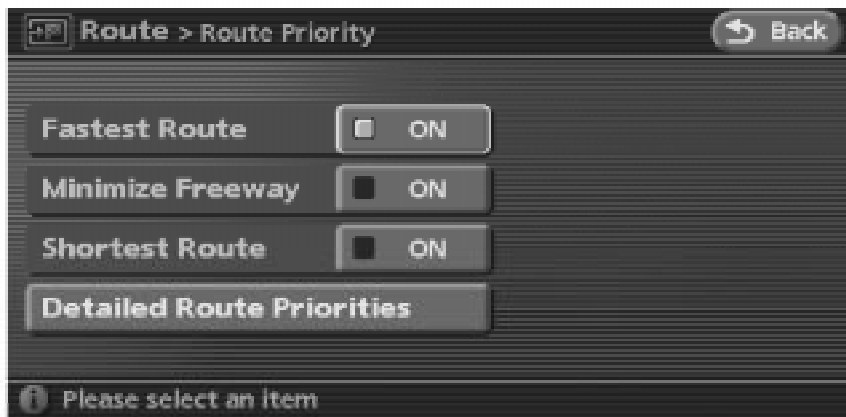

Available conditions

- **Fastest Route:**
Prioritizes by the fastest time.
- **Minimize Freeway:**
Minimizes the use of freeways.
- **Shortest Route:**
Prioritizes by the shortest route.



INFO:

Only one of these conditions can be utilized at a time.

LNV0463

DETAILED ROUTE PRIORITIES

Detailed conditions can be set for the route calculation.

Basic operations

1. While in a current location map screen, touch the “Route” key.
2. Touch the “Route Priority” key.
3. Touch the “Detailed Route Priority” key.
4. Touch the preferred condition. The indicator for the selected condition illuminates.

5. When the current location map screen or route setting screen is displayed, the system recalculates a route with the set conditions.

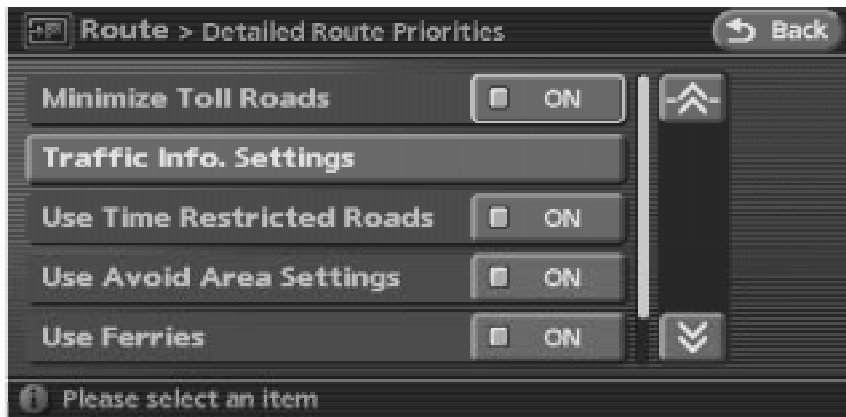

LNV0464

Available setting items

- **Minimize Toll Roads:**
Minimizes the use of toll roads.
- **Traffic Info. Settings:**
Performs a route search taking into consideration the set traffic information. Requires an XM® NavTraffic™ subscription.
 "TRAFFIC INFO. SETTINGS"
(page 7-11)
- **Use Time Restricted Roads:**
Uses any roads subject to time restrictions.
- **Use Avoid Area Settings:**
Enables the avoid area setting.
- **Use Ferries:**
Includes the use of ferries.
- **Auto Reroute:**
If the vehicle deviates from the suggested route, the system automatically recalculates a route that leads the vehicle to the suggested route.



INFO:

- The recalculated route may not be the shortest route because the system prioritizes easy-to-drive roads for safety reasons.
- If you set the route conditions from the “Route Priority” key, all sections in the route are subject to the same route conditions even though you have set different route conditions for different sections in the “Edit Route” key.
- If the “Use Time Restricted Roads” is deactivated, the system calculates a route without any consideration of the regulations concerning the time or day of the week. Therefore, the suggested route may include a road subject to traffic regulations concerning the time or day of the week. When driving along the route, always follow all regulations.
- If the system cannot calculate any alternative routes, it displays the previous route.
- If the vehicle overly deviates from the suggested route, the system calculates a new route.

Traffic Information Settings

To receive traffic information, an XM® NavTraffic™ subscription is required.

The traffic information feature gives you the opportunity to forecast traffic incidents, determine how serious they are, through the guidance mode, and allows you to detour around traffic problems.



“VIEWING TRAFFIC INFORMATION (IF SO EQUIPPED)” (page 7-7)

CHANGE/EDIT ROUTE



LNV0264

You can calculate a detour for a section of the route, edit the route or store the route.

RECALCULATE ROUTE

1. While in a current location map screen, touch the "Route" key.
2. Touch the "Recalculate Route" key.

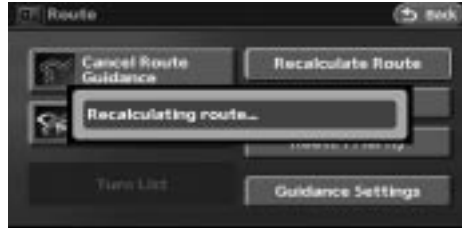

LNV0267

3. A message is displayed, and the route is recalculated.



LNV0268

4. Set the route conditions. After finishing the setting, touch the "Start" key.



"PROCEDURES AFTER SETTING A DESTINATION" (page 5-2)



Setting by voice command

1. Press the  button located on the steering wheel switch.
2. After the tone sounds, say a command.

To recalculate a route say: "Recalculate route"

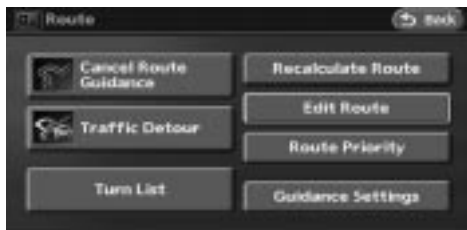

LNV0269

EDITING A ROUTE

1. While in the current location map screen, touch the “Route” key.
2. Touch the “Edit Route” key.
3. Touch the preferred setting key.
4. Press the MAP button or the “Back” key to return to the current location map screen.

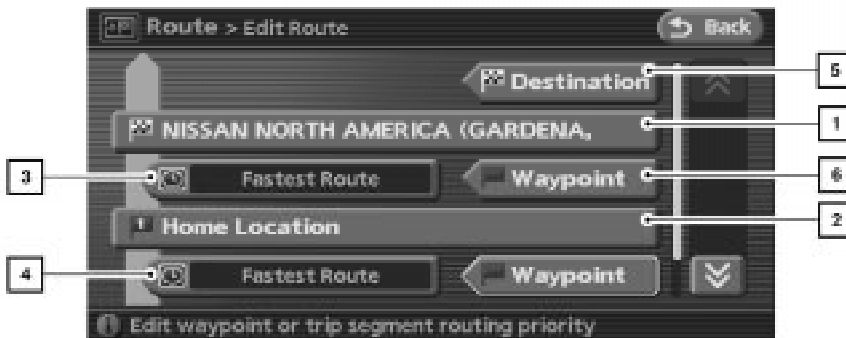

Available setting items

- 1 Current destination:
Allows you to change or delete the destination.
 “EDITING/DELETING A DESTINATION OR WAYPOINT”
(page 5-16)

LNV0465

- 2 Current waypoint:
Allows you to change or delete the waypoint.
 “EDITING/DELETING A DESTINATION OR WAYPOINT”
(page 5-16)

- 3 Condition for calculating a route to the destination:

Allows you to change the conditions for calculating a route to the destination.



“CHANGING ROUTE CALCULATION CONDITIONS”
(page 5-17)

- 4 Condition for calculating a route to a waypoint:

Allows you to change the conditions for calculating a route to a waypoint.



“CHANGING ROUTE CALCULATION CONDITIONS”
(page 5-17)

- 5 Allows you to add a destination.



“SETTING A DESTINATION OR WAYPOINT” (page 5-15)

- 6 Allows you to add a waypoint.



“SETTING A DESTINATION OR WAYPOINT” (page 5-15)

Setting a destination or waypoint

You can add a destination or waypoint to the route already set.

A total of 6 destinations or waypoints can be set.



LNV0271

1. Touch the “Destination” key or “Waypoint” key.



INFO:

If you touch the “Destination” key, the current destination changes to a waypoint.



LNV0272

2. Set a destination or waypoint. The method of searching for a destination or waypoint is the same as the one for a destination.



“4. Setting a destination”



LNV0273

3. The selected location is displayed at the center of the map. Touch the “Add to Route” key after confirming the location.



INFO:

Even after setting a destination/waypoint, you can adjust the destination/waypoint location, store the route, etc.



“OPERATIONS AFTER SETTING A DESTINATION” (page 4-37)



LNV0274

4. Return to the “Edit Route” screen. Set the route conditions as necessary.
5. Press the MAP button to return to the current location map screen. The route you have set is automatically displayed.



INFO:

The prior route is automatically deleted.

Editing/deleting a destination or waypoint

You can modify or delete the destination or waypoint already set.



INFO:

If you modify or delete a location when a suggested route is already set, the prior suggested route will be recalculated accordingly.



LNV0275

1. Touch the name of the current “Destination” key or “Waypoint” key.

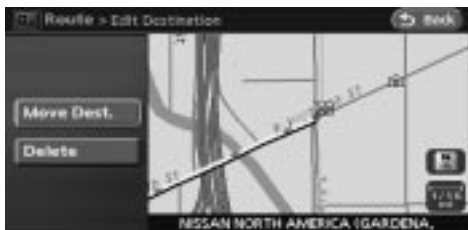

LNV0276

2. Touch the "Move Dest." key to modify the location.



"ADJUSTING THE LOCATION OF THE DESTINATION" (page 4-38)



LNV0277

3. Touch the "Delete" key to delete the location.

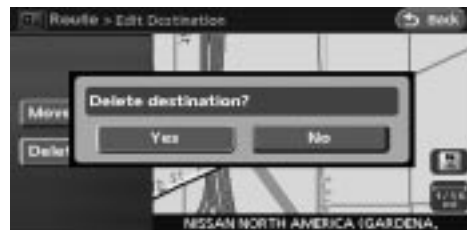

LNV0278

4. A confirmation message is displayed. Confirm the contents of the message, then touch the "Yes" key.

The destination or waypoint is deleted from the route.



INFO:

If the destination is deleted, the final waypoint of the route becomes the destination.

Changing route calculation conditions

Each section of the route between waypoints can have different route calculation conditions. After setting these conditions, you can recalculate the entire route.





LNV0279

1. Touch the preferred section key of the route to the destination or waypoint.



LNV0280

2. Touch the preferred condition key.
- Available conditions:

-  : Fastest Route
-  : Minimize Freeway
-  : Shortest Route

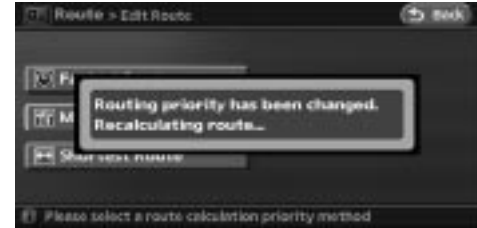

LNV0281

3. The system automatically recalculates a route according to the conditions set. The screen will automatically return to the "Edit Route" screen after route calculation.

TRAFFIC DETOUR INFORMATION



LNV0282

- The icon corresponding to the set route condition is displayed. Press the MAP button to return to the current location map screen.



INFO:

- The recalculated route may not be the shortest route because the system prioritizes easy-to-drive roads for safety reasons.
- If you set the route conditions from the “Route Priority” key, all sections in the route are subject to the same route conditions even though you have set different route conditions for different sections in the “Edit Route” key.

When a traffic restriction event occurs on the route, a detour route to avoid the event is searched for from the vehicle location to the destination.



NOTE:

This feature requires a subscription to XM® NavTraffic™ service.



LNV0264

- Touch the “Traffic Detour” key.

CONFIRMING A ROUTE





LNV0507

2. When the detour search is successful, detailed information about the detour route (left screen) and the comparison screen of the two routes (right screen) are displayed.

- Yellow: Original route
- Pink: Detour route



INFO:

If the entire message is not displayed; you can scroll the message up or down by touching the  or the  key.

3. When you desire to set the detour route as the suggested route, touch the “Yes” key.



INFO:

- If a traffic restriction event has not occurred, this function cannot be operated.



- When “Auto Reroute” and “Use Traffic Info.” keys are turned on, a message will automatically pop up when a traffic restriction event occurs, and a detour route will be searched for.
- When “Traffic Announcement” key is turned on, you will hear the voice guidance and at the same time the message will appear on the screen.
- If you do not select the detour route and provide no further action, the detour route will be automatically cancelled.
- The distance to avoid is automatically selected based on the distance to the event.
- The XM® NavTraffic™ information may not match the actual conditions. You are then required to follow the actual traffic regulations.
- The traffic information system may provide event information that has already passed. This is not a malfunction, and it is due to the fluctuation of traffic conditions.

When the suggested route is displayed after calculation, you can confirm the route information.



LNV0284

USING TURN LIST

1. While in the current location map screen, touch the "Route" key.
2. Touch the "Turn List" key.
3. You can confirm the information (e.g., intersections) on the route to the destination by scrolling the screen, touching the  key or the  key.
4. Press the MAP button to return to the current location map screen.



LNV0367

WHERE AM I?

1. Press the INFO button.
2. Touch the "Where am I?" key.

The Where am I? key allows you to display the information about the vehicle location on the route when driving according to route guidance.



"VIEWING INFORMATION ABOUT CURRENT VEHICLE LOCATION" (page 7-3)

ROUTE GUIDANCE SETTINGS

You can set various guidance information to be displayed during route guidance and activate or deactivate route and/or voice guidance.

BASIC OPERATION



1. While in the current location map screen touch the "Route" key. Then touch the "Guidance Settings" key.
2. Touch the preferred setting key.
3. Touch the "Back" key to return to the previous screen. Press the MAP button to return to the current location map screen.



LNV0466

Available setting items

- **Guidance Screen Default:**
Sets the default display screen for route guidance.
 "VISUAL GUIDANCE SETTINGS"
(page 5-23)
- **Route Guidance:**
Activates or deactivates route guidance. Route guidance is activated when the indicator illuminates. Route information is not available when route guidance is set to OFF.
- **Guidance Voice:**
Activates or deactivates voice guidance. The indicator illuminates if voice guidance is activated.
- **Small Turn Arrow on Map:**
Activates or deactivates the Small Turn Arrow on Map (simplified turn indicator) displayed in the upper left corner of the map screen. The indicator illuminates if the Small Turn Arrow on Map is displayed.

- **Traffic Info. Settings:**
Performs a route search taking into consideration the set traffic information.
 "TRAFFIC INFO. SETTINGS"
(page 7-11)
- **Set Average Speeds:**
Allows you to set an average vehicle speed for each type of road, which is reflected in the calculation of the required time to the destination.
 "SET AVERAGE SPEEDS"
(page 5-24)

5-22 Route guidance



LNV0286

VISUAL GUIDANCE SETTINGS

1. Touch the “Guidance Screen Default” key.
2. The indicator of the selected type of guidance illuminates.



LNV0287

Intersection Map: Enlarged intersection view



INFO:

Press the MAP button to switch to the full map screen.

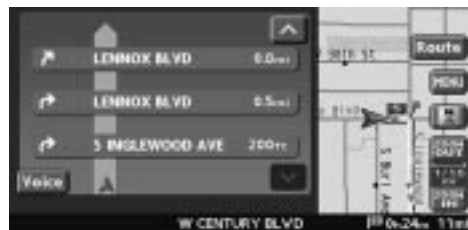



LNV0288

Turn list: Right/Left turn list



INFO:

- Turn list can be scrolled by touching the  key or the  key.
- Pressing the MAP button toggles between the full map screen and the enlarged intersection view.



LNV0289

Regular Map: Default location map view

SET AVERAGE SPEEDS

You can calculate the required time to the destination based on the set vehicle speeds.

Basic operation

1. Touch the "Set Average Speeds" key.
2. Touch the preferred item key.
3. To adjust the speed touch the "-" key or the "+" key. The speed can be increased/decreased by 5 MPH (5 km/h) intervals.
4. After finishing the setting, touch the "Back" key to accept the settings.
5. Touch the "Back" key to return to the previous screen. Press the MAP button to return to the current location map screen.

5-24 Route guidance

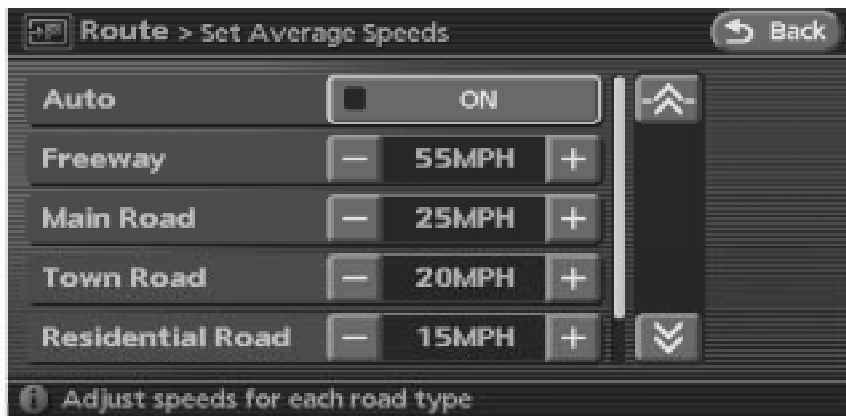

LNV0467

Available setting items

- **Auto:**
If set to ON, the system automatically calculates the required time to the destination, the indicator illuminates and the speed settings cannot be changed.
- **Freeway:**
Allows you to adjust the average vehicle speed on a freeway; touch the "-" key or the "+" key to adjust.
- **Main Road:**
Allows you to adjust the average vehicle speed on a main road; touch the "-" key or the "+" key to adjust.
- **Town Road:**
Allows you to adjust the average vehicle speed on a town road; touch the "-" key or the "+" key to adjust.
- **Residential Road:**
Allows you to adjust the average vehicle speed in a residential area; touch the "-" key or the "+" key to adjust.

DELETING/REACTIVATING A ROUTE

- **Reset:**
Sets the average vehicle speeds to the default values.

You can delete a route already set at any time. If you delete a route, the destination and waypoints are also deleted.

It is also possible to reactivate the route that you deleted.



LNV0291

DELETING A ROUTE

1. Touch the “Cancel Route Guidance” key.

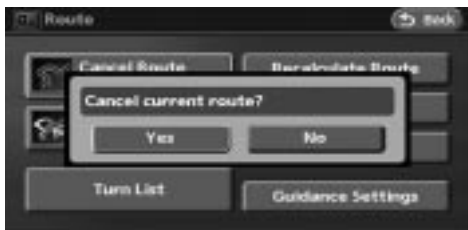

LNV0292

2. A confirmation message is displayed, touch the "Yes" key.
The route is deleted along with the destination and waypoints.

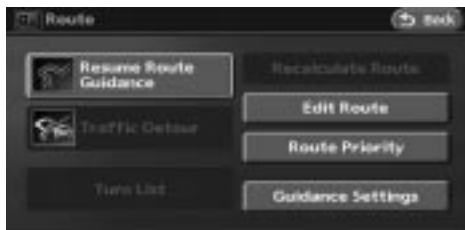

LNV0293

REACTIVATING A ROUTE

1. Touch the "Resume Route Guidance" key.

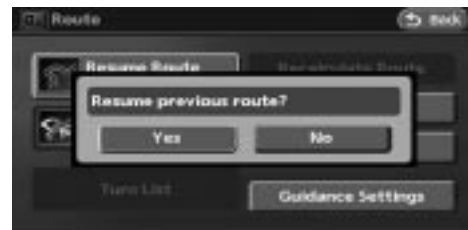

LNV0294

2. A confirmation message is displayed. Touch the "Yes" key.
The route you have deleted is reactivated.



INFO:

If you set a new route, the deleted route cannot be reactivated.

6 Storing a location/route

Storing a location.....	6-2	Minor adjustment of the stored home and locations	6-11
Storing a location by searching.....	6-2	Editing the avoid area	6-20
Storing the current vehicle location	6-4	Deleting a stored item.....	6-21
Storing a location by moving the map.....	6-5	Deleting a stored item individually	6-22
Avoid area settings	6-6	Deleting an individual item on the map	6-23
Editing the address book.....	6-10	Deleting all stored items.....	6-24
Basic operation	6-10	Customizing nearby places	6-26
Editing the stored home location	6-11		



STORING A LOCATION

Locations that you often visit can be stored in the Address Book. The stored locations can be easily retrieved to set them as a destination or waypoint.

- The Address Book can store up to 100 locations.
- New information placed in the same storage position will overwrite the old data.

STORING A LOCATION BY SEARCHING

After you have searched for a location as previously described, you can store the location for future use.

1. Press the SETUP button.



LNV0295

2. Touch the "Navigation" key.



LNV0296

3. Touch the "Address Book" key.



LNV0297

4. Touch the "Stored Location" key.

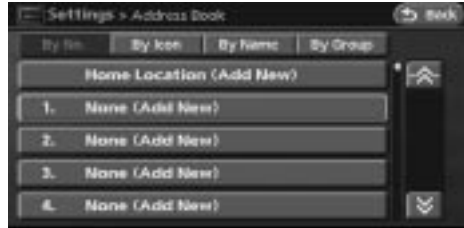

LNV0298

5. Touch the "Home Location (Add New)" key or the "None (Add New)" key.



LNV0299

6. Touch the appropriate method to search for a location key.



"4. Setting a destination"

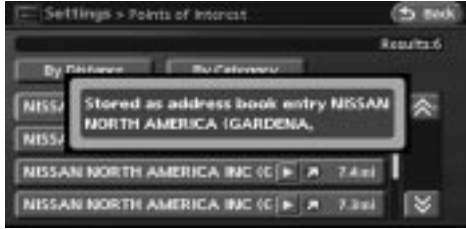

LNV0300

- When your preferred location is displayed at the center of the map, confirm the location. A message is displayed, and the location is stored in the Address Book.



INFO:

You can adjust a location by touching the "Move Locn." key using the same method as the one for a destination.



"ADJUSTING THE LOCATION OF THE DESTINATION" (page 4-38)



LNV0301

- Adjust the location of the stored item and edit the contents of the stored item as necessary. After finishing the setting, touch the "OK" key



LNV0302

STORING THE CURRENT VEHICLE LOCATION

- Touch the "MENU" key on the current vehicle location screen.

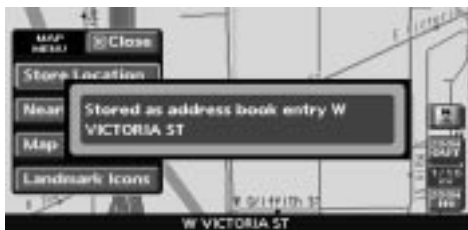

LNV0303

2. Touch the “Store Location” key.
A message is displayed, and the current vehicle location is stored in the Address Book.



INFO:

The location is stored in the first available position number in the Address Book list.



LNV0304

3. Press the MAP button or the “Close” key to return to the current location map screen.
The icon representing the stored location is displayed on the map.



LNV0305

STORING A LOCATION BY MOVING THE MAP

1. Move or scroll to the preferred location on the map. Touch the “MENU” key.

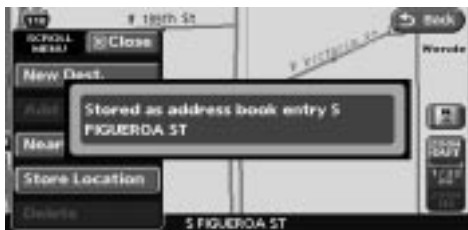

LNV0306

2. Touch the "Store Location" key.
A message is displayed, and the current vehicle location is stored in the Address Book.



INFO:

The location is stored in the first available position number in the Address Book list.



LNV0307

3. Press the MAP button or the "Back" key to return to the current location map screen.
The icon representing the stored location is displayed on the map.

AVOID AREA SETTINGS

An Avoid Area can be stored. The Avoid Area is an area that you want to exclude from a route, such as a road that is always congested.

Once you store Avoid Areas, the system avoids those areas when calculating a route. Up to 5 Avoid Areas can be stored.

1. Press the SETUP button.

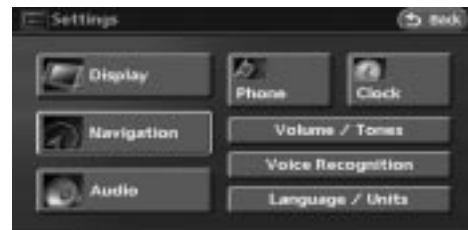

LNV0295

2. Touch the "Navigation" key.



LNV0308

3. Touch the "Avoid Area Settings" key.



INFO:

You can also access and store an Avoid Area from the Address Book.



LNV0309

4. Touch the "None (Add New)" key.



INFO:

A maximum of 5 Avoid Areas can be stored.



"DELETING A STORED ITEM"
(page 6-21)



LNV0310

5. Touch the appropriate method to search for a location.



"4. Setting a destination"



LNV0311

6. Set the following items for the searched location.

- Rename
- Move Locn.
- FWY Incl.
- Delete
- Area Size

7. After finishing the settings, touch the “OK” key.



LNV0312

Rename

1. A character input screen is displayed.
2. Enter the preferred name.
3. Touch the “OK” key.



LNV0313

Move location

1. Move or scroll on the map by touching the touch-screen, to adjust the location of the Avoid Area.
2. After adjusting the location, touch the “OK” key.



LNV0317

FWY incl.

If you want to include freeways in the Avoid Area, touch the "Incl." key to illuminate this indicator.



LNV0318

The Avoid Area is displayed in green if it includes a freeway or in blue if it does not include freeways.



INFO:

If you set an Avoid Area at the current vehicle location, the system will not provide route guidance.

Area Size

Touch the range from 5 available levels.

Touch the smaller grid key or the larger grid key to decrease or increase the Avoid Area size.



INFO:

Touch the "ZOOM OUT" key or the "ZOOM IN" key to change the scale of the map.

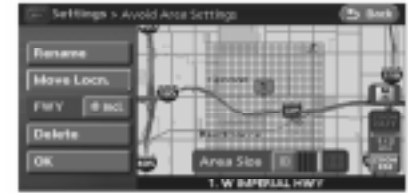

LNV0468

EDITING THE ADDRESS BOOK

Items stored in the Address Book can be modified. You can edit these settings to make the navigation system more useful.

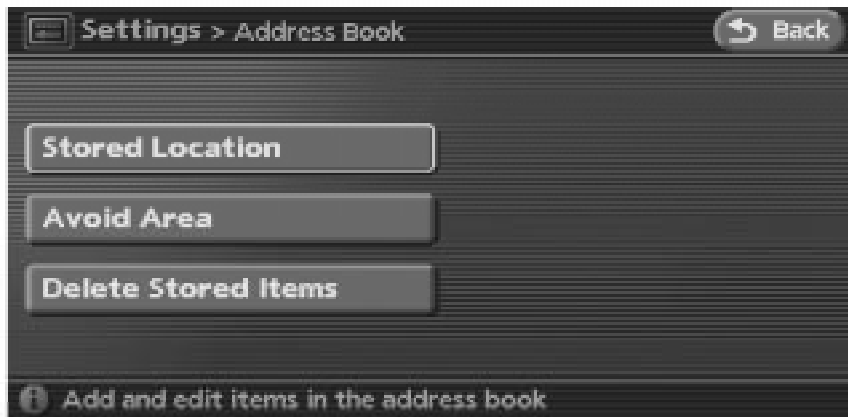

BASIC OPERATION

1. Press the SETUP button.
2. Touch the "Navigation" key.
3. Touch the "Address Book" key.
4. Touch the preferred key.
5. Touch the "Back" key to return to the previous screen. Press the MAP button to return to the current location map screen.



LNV0469

Available setting items

- **Stored Location:**
Edits the information of a stored home and location.
 "EDITING THE STORED HOME AND LOCATION" (page 6-11)
- **Avoid Areas:**
Edits the information of a stored Avoid area.
 "EDITING THE AVOID AREA" (page 6-20)
- **Delete Stored Items:**
Deletes a stored location or route.
 "DELETING ALL STORED ITEMS" (page 6-24)

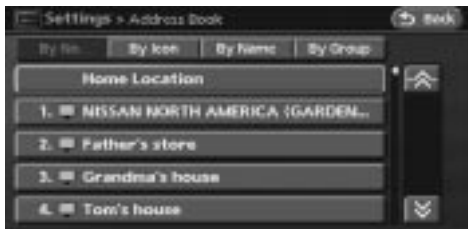

LNV0324

EDITING THE STORED HOME LOCATION

1. Press the preferred stored home location key or one of the stored location keys.



INFO:

Pressing the one of the sort keys displays a list of items sorted by keys.

To use the sort functions, stored locations must be set in advance.



"MINOR ADJUSTMENT OF THE STORED HOME AND LOCATIONS"
(page 6-11)



LNV0325

2. Press the preferred item key.

Available setting items

- Edit:
Edits the stored location information.
- Move Locn.:
Adjusts the location of the stored location.
- Delete:
Deletes the stored location.
- OK:
Applies the settings.

MINOR ADJUSTMENT OF THE STORED HOME AND LOCATIONS

When you press the "Edit" key, you can edit the following items of the home or stored location.

- Show Icon on Map
- Name (only for stored locations [not including home])
- Voicetag (only for stored locations)
- Icon
- Sound
- Direction
- Distance
- Phone No.
- Group (only for stored locations)
- Swap Numbers (only for stored locations)

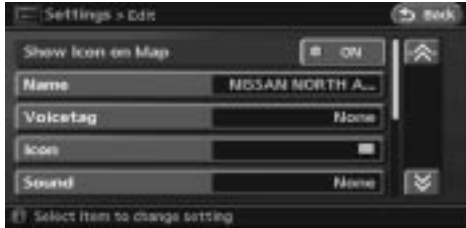

LNVO326

Show icon on map

Displays the home icon or the stored location icon on the map.

1. Touch the "Show Icon on Map" key.
2. The indicator illuminates when the item is set. Then the system displays the icon on the map.



LNVO327

Name (only for stored locations)

Changes the name of a stored location, does not include the "Home" key.

1. Touch the "Name" key. A character input screen is displayed.



LNVO328

2. Enter the preferred name for the stored location.



"CHARACTER (letter and number) INPUT SCREEN"
(page 2-22)

3. Touch the "OK" key, the new name is stored.

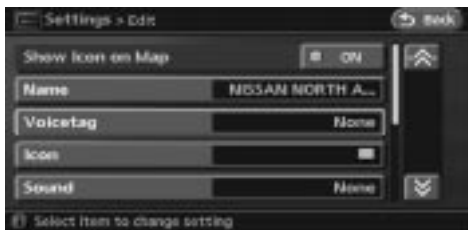

LNV0329

Voicetag (only for stored locations)

Stores a voicetag to be used for voice commands. By storing voicetags, you can set a destination by voice command more easily.

1. Touch the "Voicetag" key.



LNV0330

2. Touch the "Store" key.

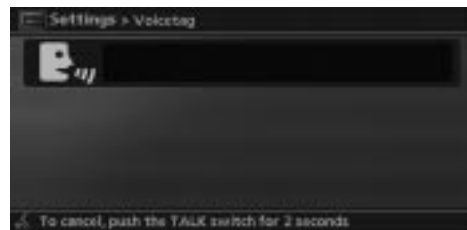

LNV0331

3. A tone sounds, and the system enters the voice command reception mode.
4. Say the name to be used as the voicetag.

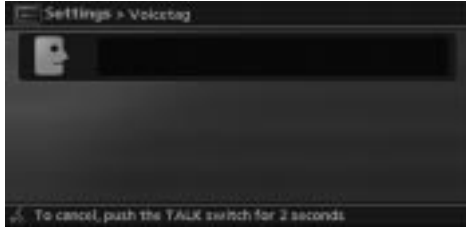

LNV0332

- If the system recognizes it, the voicetag is stored.



INFO:

- The Address Book can store up to 20 voicetags.
- If the voicetag is already set, touch the “Play” key to listen to the stored voicetag.
- If the voicetag is already set, touch the “Delete” key to delete a stored voicetag.
- If the voicetag is already set, the “Stored” key is displayed. To replace the voicetag, touch the “Replace” key.
- Voicetags are specific to each user. For example, the system will not be able to recognize the wife’s voice if the voicetag is recorded in the husband’s voice.



LNV0333

Icon

Changes the icon of the home or stored location to the preferred one. By changing the icons, you can utilize the “By Icon” option of the sort function more effectively.

1. Touch the “Icon” key. A list of icons is displayed.



LNV0334

2. Touch the preferred icon key by scrolling the list then touching on one of the icon keys.

Icon list:



LNV0473

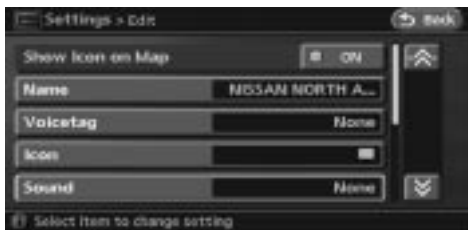

LNV0340

Sound

Sets the tone of the arrival alarm that sounds when the vehicle approaches the home or a stored location.

1. Touch the "Sound" key. A sound list is displayed.



LNV0341

2. Touch the preferred alarm tone key by scrolling the list. Then touch the "ON" key. The indicator of the selected alarm tone illuminates.

Sound list:

None
Chime
Melody
Sound
Dog
Cat
Wave
Church bell
Music box 1
Music box 2
Marimba
Trumpet
Horn
Scratch



LNV0342

Direction

Sets the alarm to sound when approaching from a specific direction.

1. Touch the "Direction" key. The home or stored location is displayed at the center of the map.



LNV0343

2. Set the direction that sounds the alarm touching the arrow keys. Touch the "OK" key. The selected direction is set.



INFO:

After the direction is set, if you touch the "Direction" key once again, a confirmation message is displayed. Confirm the contents of the message, then touch the "Yes" key. The set direction is cancelled.

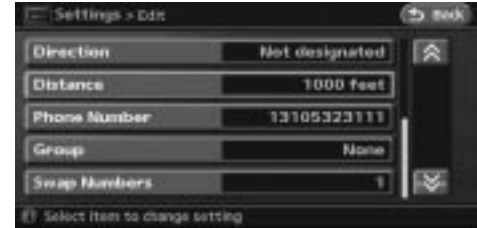

LNV0344

Distance

Sets the alarm to sound when reaching a specific distance to the home or stored location.

1. Touch the "Distance" key.



LNV0345

2. Touch the preferred distance option by touching the “ON” key. The indicator of the selected distance illuminates.

Available distance options:

- 150 feet (50 m)
- 300 feet (100 m)
- 1000 feet (300 m)
- 1500 feet (500 m)

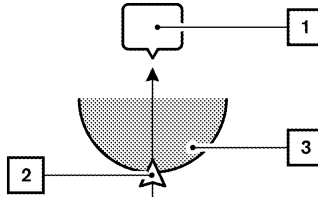

LNV0470



INFO:

Once you set the direction and distance to sound an alarm, the system will sound the alarm when the vehicle icon passes a half circle outline on the map, as shown.

Example: Set to 300 feet (100 m) distance, upward direction

- 1 Stored location icon
- 2 Vehicle icon
- 3 Setting range



LNV0346

Phone No.

Stores the telephone number of the home or a stored location.

1. Touch the “Phone No.” key.
The telephone number entry screen is displayed.



LNV0347

2. Enter the telephone number of the home or stored location.



“PHONE NUMBER INPUT SCREEN” (page 2-23)

3. Touch the “OK” key. The telephone number is stored.



INFO:

If the phone number of your home or a location is stored, the phone number can be used to search for the destination even if it is not included in the map DVD-ROM data.



LNV0348

Group (only for stored locations)

This allows you to group the stored locations.

By grouping the stored locations, you can utilize the By Group option of the sort function more effectively.

1. Touch the “Group” key.



LNV0349

2. Touch the preferred group by touching the “ON” key. When the indicator of the selected group illuminates, the stored location is classified into the applicable group.

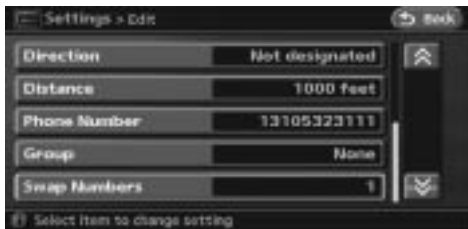

LNV0350

Swap numbers (only for stored locations)

Swaps the position numbers of any two stored locations in the list.

1. Touch the "Swap Numbers" key.
A list of stored locations is displayed.

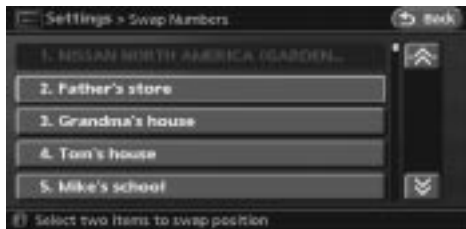

LNV0351

2. Touch the stored locations keys you want to swap. The position numbers of the selected stored locations are swapped.

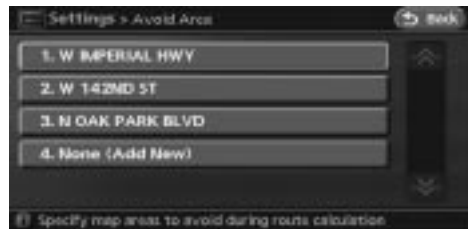

LNV0352

EDITING THE AVOID AREA

1. Press the preferred "Avoid Area" key.
2. Press the preferred item key.
The setting method is the same as the one for the Avoid Area setting.
 "AVOID AREA SETTINGS"
(page 6-6)



INFO:

If you press the "None (Add New)" key, you can add an Avoid Area item.



"AVOID AREA SETTINGS"
(page 6-6)

DELETING A STORED ITEM

You can delete locations and routes stored in the Address Book. Two deletion methods are available; deleting an individual item and deleting all stored items.

! NOTE:

Deleted items cannot be restored. Before deleting an item, always make sure that the item is truly not necessary.



LNV0471

Available setting items

- **Rename:**
Changes the name.
- **Move Locn.:**
Adjusts the location of the Avoid Area.
- **FWY Incl.:**
Avoids freeways.
- **Delete:**
Deletes the stored Avoid Area.
- **OK.:**
Applies the settings.
- **Area Size:**
Adjusts the range of the Avoid Area.



LNV0296

DELETING A STORED ITEM INDIVIDUALLY

1. Press the "Address Book" key.



LNV0297

- Example: "Stored Location" key is selected.
2. Press the preferred item for deletion.

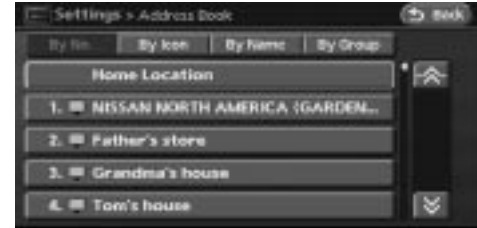

LNV0354

3. Press the preferred location key for deletion.



LNV0355

4. Press the “Delete” key.

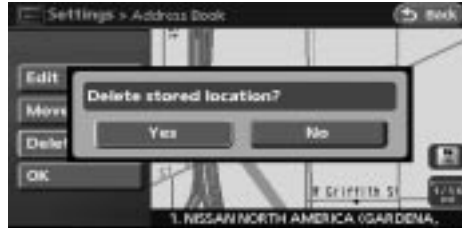

LNV0356

5. A confirmation message is displayed. Confirm the contents of the message; press the “Yes” key. The stored item is deleted from the Address Book.



LNV0358

2. Press the “Delete” key.

DELETING AN INDIVIDUAL ITEM ON THE MAP

1. Align the cross pointer over the preferred stored location for deletion by moving on the map. Press the “MENU” key.

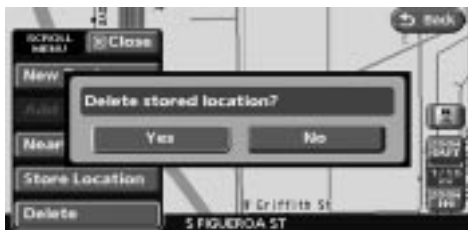

LNV0359

3. A confirmation message is displayed. Confirm the contents of the message, press the "Yes" key. The stored item is deleted from the Address Book.

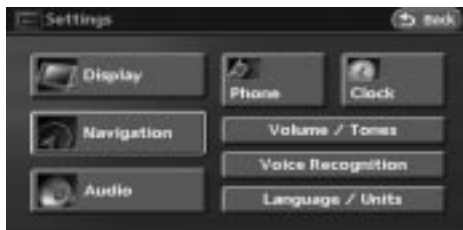

LNV0295

DELETING ALL STORED ITEMS

1. Press the SETUP button.
2. Press the "Navigation" key.



LNV0296

3. Press the "Address Book".



LNV0360

4. Press the “Delete Stored Items” key.

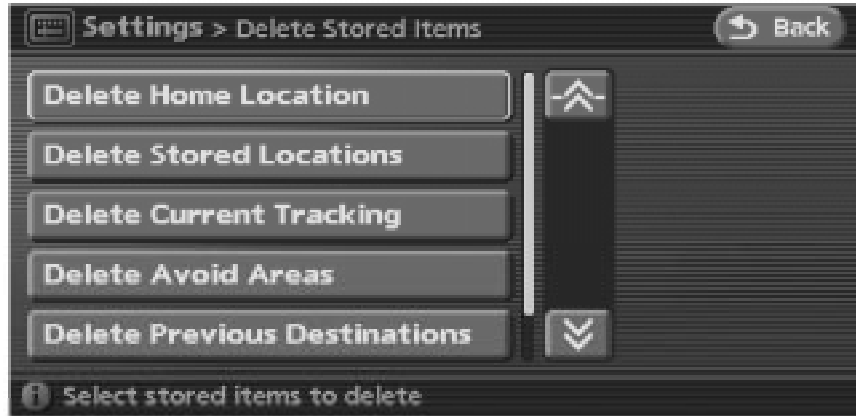

LNV0472

5. Press the preferred item key for deletion.

Items that can be deleted

- Delete Home Location:
Deletes the home location.
- Delete Stored Locations:
Deletes all the stored locations.
- Delete Current Tracking:
Deletes the current tracked route.
- Delete Avoid Areas:
Deletes all the stored avoid areas.
- Delete Previous Destinations:
Deletes all the previous destinations.
- Delete Previous Starting Point:
Deletes the previous starting points.

CUSTOMIZING NEARBY PLACES

You can change the categories used for searching facilities nearby.

The modified list of facilities can be used for searching for a location using the “Nearby Places” key.



“SETTING A NEARBY PLACE”
(page 4-35)

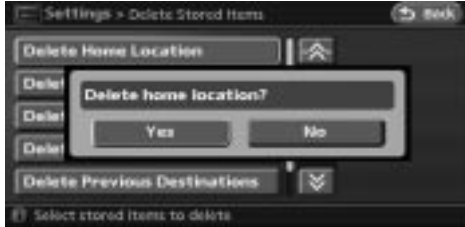

LNV0362

6. A confirmation message is displayed. Confirm the contents of the message; press the “Yes” key. The stored items are deleted from the Address Book.



LNV0295

1. Press the SETUP button
2. Press the “Navigation” key.



LNV0363

3. Press the “Nearby Places Custom Settings” key.



LNV0364

4. Press the preferred item key.
The main category list is displayed.



LNV0365

5. Press a main category key.
The sub category list is displayed.



LNV0366

6. Press a sub category key.
The category setting is modified.
7. Press the MAP button to return to the current location map screen.

7 Viewing technical information

Information screen	7-2	Viewing navigation system version information	7-5
Basic operation	7-2	Basic operation	7-5
Viewing information about current vehicle location.....	7-3	Viewing voice command lists	7-5
Basic operation	7-3	Basic operation	7-5
Viewing GPS current location information	7-4	Viewing traffic information (if so equipped)	7-7
Basic operation	7-4	Basic operation	7-7



INFORMATION SCREEN

This screen allows you to set or view various information that is helpful for using the vehicle safely and comfortably, such as current location information, GPS information, map DVD-ROM version, list of common voice recognition commands and real time traffic information.





BASIC OPERATION

1. Press the INFO button.
2. Touch the preferred item key.



LN0536

Available items

- Traffic Info.:
 "VIEWING TRAFFIC INFORMATION" (page 7-7)
- Where am I?:
 "VIEWING INFORMATION ABOUT CURRENT VEHICLE LOCATION" (page 7-3)
- Navigation Version:
 "VIEWING NAVIGATION SYSTEM VERSION INFORMATION" (page 7-5)
- Voice Command List:
 "VIEWING VOICE COMMAND LISTS" (page 7-5)
- GPS Satellite Info:
 "VIEWING GPS CURRENT LOCATION INFORMATION" (page 7-4)

VIEWING INFORMATION ABOUT CURRENT VEHICLE LOCATION

This allows you to display the information about the vehicle location on the route when driving according to route guidance.

BASIC OPERATION

1. Press the INFO button.
2. Touch the “Where am I?” key.
3. Touch the “Back” key to return to the previous screen. Press the MAP button to return to the current location map screen.



LNVO474

Contents of vehicle location information

- 5 Displays the distance traveled from the previous intersection on the route.

- 1 Next Street:
Displays the next street on the route.
- 2 Current Street:
Displays the current street on the route.
- 3 Previous Street:
Displays the previous street on the route.
- 4 Displays the distance to the next intersection on the route.

VIEWING GPS CURRENT LOCATION INFORMATION

This allows you to display GPS information, such as the positioning status, latitude/ longitude, altitude and satellite locations.

BASIC OPERATION

1. Press the INFO button.
2. Touch the “GPS Satellite Info” key.
3. Touch the “Back” key to return to the previous screen. Press the MAP button to return to the current location map screen.

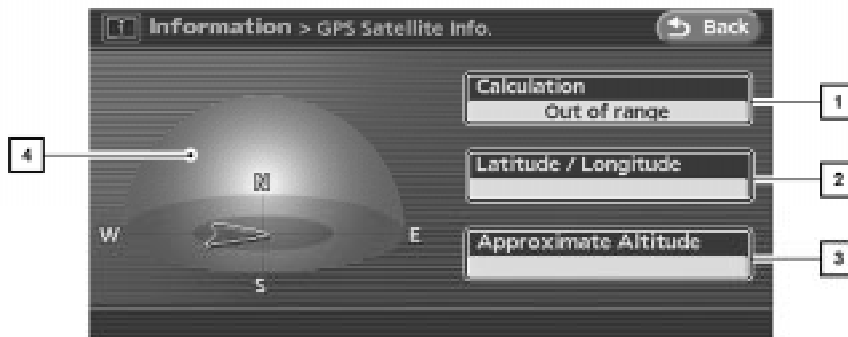

Contents of GPS information

- 1** Calculation:
Displays the GPS positioning method.



3-dimension	Calculating the latitude, longitude and altitude by four or more satellites.
2-dimension	Calculating the latitude, longitude and altitude by three or more satellites.
Out of range	Cannot calculate because no GPS satellites can be located.

- 2** Latitude/Longitude:
Displays the latitude/longitude.

LNV0475

- 3** Approximate Altitude:
Displays the approximate altitude.

- 4** Positioning status:

 green	It indicates that satellites are available.
 gray	It indicates that satellites are being searched for.

VIEWING NAVIGATION SYSTEM VERSION INFORMATION



WNV0554

This allows you to display the map DVD-ROM version information.

BASIC OPERATION

1. Press the INFO button.
2. Touch the "Navigation Version" key.
3. Touch the "Back" key to return to the previous screen. Press the MAP button to return to the current location map screen.

VIEWING VOICE COMMAND LISTS

This allows you to display lists of commonly used voice commands used during voice recognition.

BASIC OPERATION

1. Press the INFO button.
2. Touch the "Voice Command List" key.
3. Touch the "Back" key to return to the previous screen. Press the MAP button to return to the current location map screen.

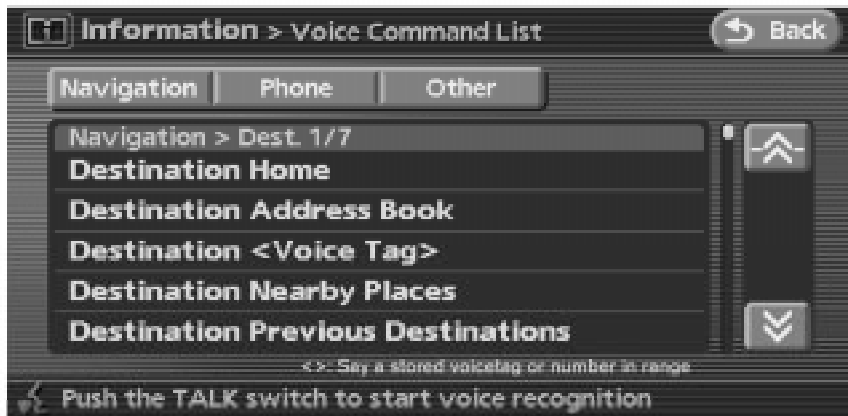

WNV0555

Contents of voice command list

1 Navigation:

Displays commonly used voice commands for navigation.

- Dest list:
Displays commonly used voice commands for setting destinations.
- Search list:
Displays commonly used voice commands for searching for a location.

● Map list:

Displays commonly used voice commands for changing the map views.

● Route list:

Displays commonly used voice commands for changing route properties, while route guidance is on.

● Other list:

Displays commonly used voice commands for certain navigation settings.

2 Phone:



Displays commonly used voice commands for phone.

3 Other:

Displays what to say to view the Voice Command List.



INFO:

- Touch the  scroll up key or  scroll down key to view the other lists.
- Touching the scroll keys repeatedly will bring you through all of the lists available.

VIEWING TRAFFIC INFORMATION (if so equipped)

XM® NavTraffic™ information is a subscription service offered by XM® Satellite Radio.

This service provides real time information regarding traffic flow, accidents, road construction and other incidents, where available.

XM® NavTraffic™ combines information from commercial and public traffic data providers including government departments of transportation, police, emergency services, road sensors, cameras, and aircraft reports. The traffic information is broadcast to the vehicle by the XM® satellites. Available traffic information on the route the driver selected is shown on the navigation screen so traffic conditions between you and the destination are known. Three types of real-time traffic information for major roadways are shown on the navigation system:

- Unscheduled traffic data for example, accidents and disabled vehicles.
- Scheduled traffic data, for example road construction and road closures.
- Traffic flow information (rate of speed data).

WARNING

XM® NavTraffic™ information is not a substitute for attentive driving. Traffic conditions change constantly and emergency situations can arise without warning. Relying only on XM® NavTraffic™ information may lead to a collision and could result in serious personal injury.



NOTE:

Flow information is provided for only roads equipped with traffic sensors and is not available in all markets covered by the service. Flow data may not be available on portions of a road that is under construction.

XM® NavTraffic™ information is available in limited markets. To subscribe or to check if this service is available in your area:

call 1-800-XM-RADIO (1-800-967-2346)

or see www.xmradio.com/xmnavtraffic/

BASIC OPERATION

1. Press the INFO button.
2. Touch the “Traffic Info.” key.
3. Touch the “Back” key to return to the previous screen. Press the MAP button to return to the current location map screen.



LNV0479

1. Touch the "Info. on Route" key. A list screen is displayed.

Contents of available real time traffic information

- 1 Info. on Route:
Displays the list of traffic information found on the recommended route from the current vehicle location to the destination.
- 2 Nearby Traffic Info.:
Displays the list of traffic information around the current vehicle location.
- 3 User Locations:
Allows you to check the traffic information around the stored location.

LNV0510

- 4 Traffic Info. Settings:
Allows you to perform the setting to display the traffic information or to search the route taking the traffic information into consideration.

Info. on route

The list of traffic information found on the recommended route from the current vehicle location to the destination is displayed. Also, you can check the detailed information about the displayed events.

7-8 Viewing technical information



LNV0480

2. Touch one of the preferred traffic location keys.

Detailed information is shown about the selected traffic location key. A preview map is also shown.



INFO:

- While in the detailed information screen touch the scroll keys to view additional information.
- Colored road meanings:
 - Green: Light traffic.
 - Yellow: Heavy traffic and moving at approximately 21 MPH (34 km) to 44 MPH (71 km).
 - Red: Traffic jam or accident and moving at approximately 20 MPH (30 km) to 0 MPH (0 km).
 - Purple: Road closed.

- Road symbol meanings:

- ◆ : Accident
- ⊘ : Closed Road
- ℹ : Information
- ⚙ : Road Work
- ⚠ : Slippery Road
- ☁ : Weather
- 🚚 : Incident

- Touch the "ZOOM OUT" key or the "ZOOM IN" key to change the map scale.

Nearby traffic info.

The list of available traffic information around a radius of 30 miles (50 km) centered at the current vehicle location is displayed. A maximum of 400 events can be displayed.



LNV0484

1. Touch the "Nearby Traffic Info." key. A list screen is displayed.



LNV0485

2. Touch one of the preferred traffic location keys.

Detailed information is shown about the selected traffic location key. A preview map is also shown.



INFO:

- While in the detailed information screen touch the scroll keys to view additional information.
- Colored road meanings:
 - Green: Light traffic.
 - Yellow: Heavy traffic and moving at approximately 21 MPH (34 km) to 44 MPH (71 km).
 - Red: Traffic jam or accident and moving at approximately 20 MPH (30 km) to 0 MPH (0 km).
 - Purple: Road closed.

7-10 Viewing technical information

- Road symbol meanings:

- ◆ : Accident
- ⊘ : Closed Road
- ℹ : Information
- ⚙ : Road Work
- ⚡ : Slippery Road
- ☁ : Weather
- 🚗 : Incident

- Touch the "ZOOM OUT" key or the "ZOOM IN" key to change the map scale.

User locations

You can check the traffic information around the stored location. The method of how to store the location is the same as for the operation with Address Book.



LNV0489

1. Touch the "User Location" key. A list screen is displayed.



LNV0490

2. Touch the “None (Add New)” key.
Use one of the appropriate methods for setting a location.

 “4. Setting a destination”

Available setting items

- Rename: Changes the name.
- Alter Location: Adjusts the location of the stored location.
- Delete: Deletes the stored location.
- OK: Applies the settings.

Display emergency information

When an event related to emergency information occurs around the current vehicle location, a message pops up and a voice announcement is made.

The message includes the icon, event type, event information and the direct distance from the current location to the event.

- Emergency information is displayed regardless of whether the traffic information system is ON or OFF.
- When there are multiple emergency information events, the event with the shortest direct distance from the current location is displayed.
- When emergency information is about a detour route, the detour route notification screen is displayed when the vehicle approaches the detour point.

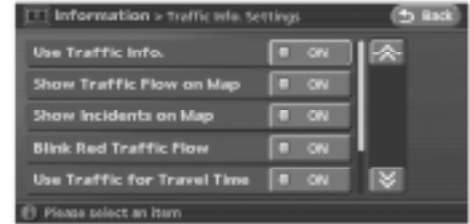

LNV0543

Traffic info. settings

1. Touch the “Traffic Info. Settings” key. Then touch one of the traffic information settings by touching the “ON” key. The indicator will turn off or illuminate.

Available setting items

- Use Traffic Info.:
Enables all of the traffic information.
- Show Traffic Flow on Map.:
Displays the traffic flow with an arrow on the map screen.
 - Purple: Road closed
 - Red: Traffic jam or accident
 - Yellow: Heavy traffic
 - Green: Light traffic

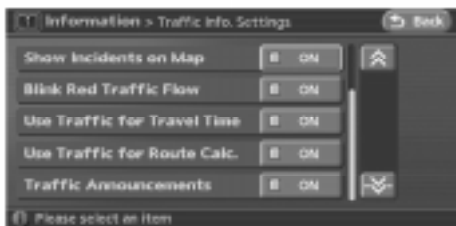

LNV0544

- **Show Incidents on Map:**
Displays the accidents or traffic restrictions on the map screen.
- **Blink Red Traffic Flow:**
Blinks the road that is displayed as having a traffic jam.
- **Use Traffic for Travel Time:**
Allows you to display on the map screen the travel time to the destination with which the traffic information is taken into consideration.
- **Use Traffic for Route Calc.:**
Allows you to perform the route search with the traffic information taken into consideration. When “Auto Reroute” key is set, the detour route search can be performed automatically.

- **Traffic Announcements:**
This can provide you with the announcement of the traffic information event on the route.



INFO:

- If the route is not already set, all of the event icons on the map screen are displayed in red. When the route is already set, the icons on the route are displayed in red, and the icons outside the route are displayed in gray.
- Even when “Show Traffic Flow On Map” and “Show Incidents on Map” key are set to off, the list display of “Info On Route” and “Nearby Traffic Info” key will not be affected.
- Even when “Traffic Announcements” key is set to off, the route guidance will not be affected. Also, the announcement of emergency information will not be turned off.

8 Other settings

Setup screen	8-2
Basic operation	8-2
Display settings	8-3
Volume adjustment	8-6
Clock settings	8-7

Language and units settings	8-8
Map color settings	8-11
Adjusting the current vehicle location	8-12
Reset all navigation settings to default	8-13



SETUP SCREEN

The navigation system can be customized to make it easier for you to use.

BASIC OPERATION





Press the SETUP button.

Touched the preferred setting item key.



LNV0511

Available setting items

- Display:
 "DISPLAY SETTINGS" (page 8-3)
- Phone:
Refer to the Owner's Manual for your vehicle.
- Clock:
 "CLOCK SETTINGS" (page 8-7)
- Volume/Tones:
 "VOLUME ADJUSTMENT"
(page 8-6)
- Voice Recognition:
 "SYSTEM FEEDBACK ANNOUNCEMENT MODES"
(page 9-4)
- Language/Units:
 "LANGUAGE AND UNITS SETTINGS" (page 8-8)
- Audio:
Refer to the Owner's Manual for your vehicle.
- Navigation:
Allows you to adjust various settings of the navigation system. Refer to the instructions in the relevant sections.

DISPLAY SETTINGS

This menu allows you to turn on and off the display and adjust the image quality.

Basic operation

1. Touch the "Display" key.
2. Touch the preferred adjustment item.
3. After setting, touch the "Back" key to apply the setting.
4. Touch the "Back" key to return to the previous screen. Press the MAP button to return to the current location map screen.

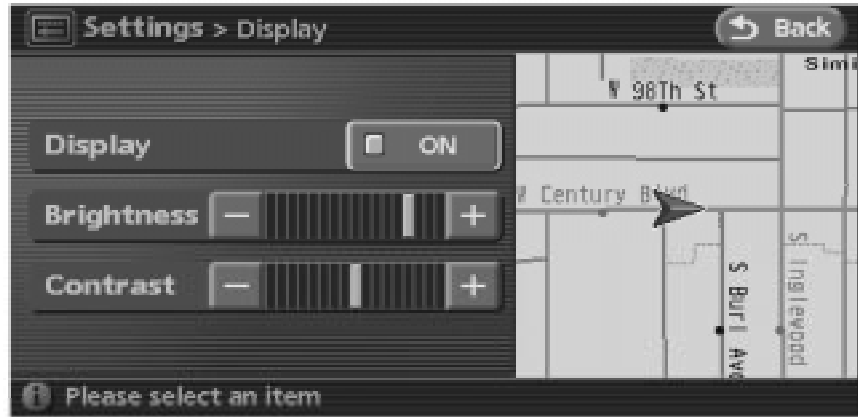

LN0512

Available setting items

- Display:
Allows you to turn on/off the screen.
- Brightness:
Allows you to adjust the screen brightness.
- Contrast:
Allows you to adjust the screen contrast.



LNV0374

Display

To turn off the display, touch the display “ON” key.

The display can also be turned off by pressing and holding the ☀/🌙 button for more than 2 seconds.

When any button is pressed with the display off, the display turns on. The display will automatically turn off 5 seconds after the operation is finished. To turn on the display, press the ☀/🌙 button.



LNV0375



LNV0376

Brightness

To adjust the display brightness, touch the “-” key or the “+” key.



The preview of the map screen is displayed on the right side of the screen.



LNV0377

Contrast

To adjust the display contrast, touch the “-” or the “+” key.



INFO:

The preview of the map screen is displayed on the right side of the screen.



LNV0378

Bright background color Map Background

To change the background of the map; either bright or dark press the ☀/🌙 button to switch between the two settings.



LNV0379

Dark background color

VOLUME ADJUSTMENT

This allows you to turn on and off, as well as adjust, the phone function (ringer and incoming), the voice guide function and the beep function.

Basic operation

1. Touch the “Volumes/Tones” key.
2. Touch the preferred adjustment item.
3. After setting, touch the “Back” key to apply the setting.
4. Touch the “Back” key to return to the previous screen. Press the MAP button to return to the current location map screen.



WNV0549

Available setting items

- **Guidance Volume:**
Adjust the volume level of voice guidance by touching the “-” key or the “+” key.
- **Guidance Voice:**
Touch the “ON” key to toggle the voice guidance function between on and off. The indicator light illuminates when the voice guidance function is set to on.
- **Phone Ringer Vol.:**
Adjust the volume level of the phone ringer by touching the “-” key or the “+” key.
- **Phone Incoming Vol.:**
Adjust the phone incoming volume by touching the “-” key or the “+” key.
- **Button Beeps:**
Touch the “ON” key to toggle the beep function between on and off. The indicator light illuminates when the beep function is set to on. The beep that sounds when pushing and holding a button or when a prohibited operation is performed cannot be set to off.



INFO:

For more details about the Phone Ringer Vol. and Phone Incoming Vol., refer to the Owner's Manual of your vehicle.

CLOCK SETTINGS

This allows you to change the clock settings.

Basic operation

1. Touch the "Clock" key.
2. Touch the preferred adjustment item.
3. After setting, touch the "Back" key to apply the setting.
4. Touch the "Back" key to return to the previous screen. Press the MAP button to return to the current location map screen.



LNV0514

Available setting items

- On-screen Clock:
Touch the "ON" key to toggle the clock display located in the top right corner of the display between on and off. The indicator light illuminates when the clock display is set to on.
- Clock Format:
Touch the left or right arrow to change the clock format between the "12 h" key and the "24 h" key.
- Offset Adjust:
To adjust the offset minute value (between -59 and +59) touch the "-" key or the "+" key.
- Daylight Saving Time:
Touch the "ON" key to toggle the daylight saving time setting between on and off. The indicator light illuminates when the daylight saving time setting is set to on.

- Time Zone:
Touch the “Time Zone” key to set the appropriate time zone from the list that appears when you select this item
 - Pacific
 - Mountain
 - Central
 - Eastern
 - Atlantic
 - Newfoundland

LANGUAGE AND UNITS SETTINGS

This allows you to change the language and measurement unit used in the system.



LNV0382

Language settings

1. Touch the “Language/Units” key.

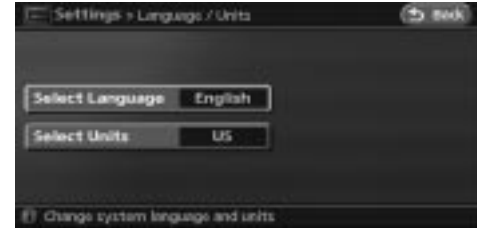

LNV0383

2. Touch the “Select Language” key.

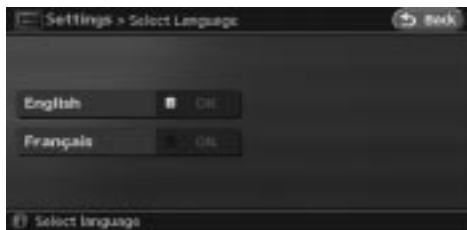

LNV0384

3. Touch the preferred setting item by touching the "ON" key. The indicator light of the selected item illuminates.

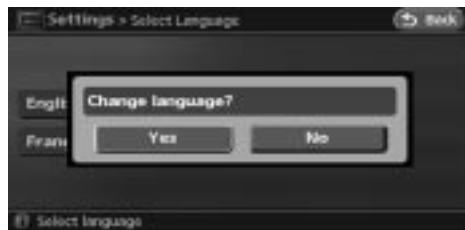

LNV0385

4. A message is displayed. Confirm the contents of the message. After confirming the message, touch the "Yes" key.



NOTE:

If you change the language, the stored voicetags are deleted.

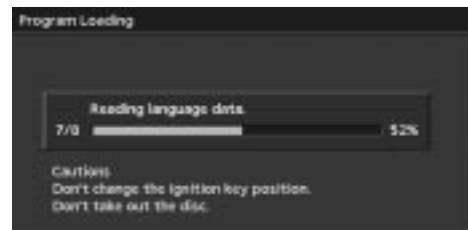

LNV0386

5. The program loading screen is displayed, and the system initiates the language setting. Upon completion, the start-up screen is automatically displayed.

Available languages:

- English
- Français



CAUTION

Do not change the ignition switch position while changing the language. Doing so may cause a system malfunction.



LNV0382

Unit settings

1. Touch the "Language/Units" key.

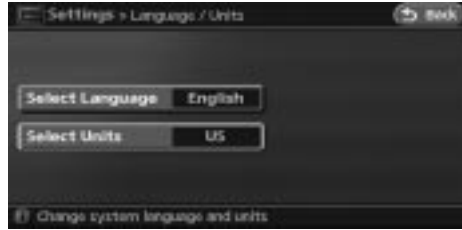

LNV0387

2. Touch the "Select Units" key.



LNV0388

3. Touch the preferred unit by touching the "ON" key. The indicator light of the selected item illuminates.

Available units:

- US:
mile, MPH, °F, MPG
- Metric:
km, km/h, °C, L/100 km

4. Touch the "Back" key to return to the previous screen
Press the MAP button to return to the current location map screen.

MAP COLOR SETTINGS

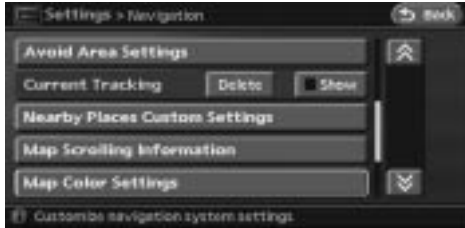

LNV0389

This allows you to change the map color.

1. Touch the "Navigation" key.
2. Touch the "Map Color Settings" key.

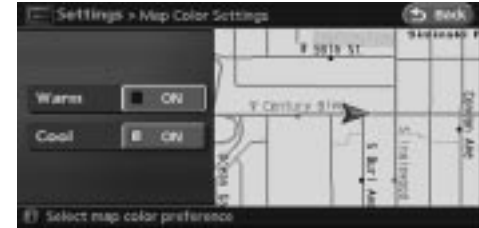

LNV0390

3. Touch the preferred map color by touching the "ON" key. The indicator light of the selected item illuminates.

Available map colors:

- Warm:
Sets warm colors for the map coloring.
- Cool:
Sets cool colors for the map coloring.



INFO:

You can confirm the effect of your setting on the preview displayed on the right side of the screen.

ADJUSTING THE CURRENT VEHICLE LOCATION

If the vehicle icon indicating the current vehicle location is not located in the correct position, you can correct the position of the vehicle icon on the map screen.



INFO:

- Regardless of the map view setting, the map is displayed in Plan View when adjusting the position of the vehicle icon.
- When you correct the position of the vehicle icon, the map is automatically displayed in the North Up mode. After finishing the correction, the map restores the current orientation setting.
- The position and direction of the vehicle icon may be misaligned depending on the external conditions and environment.
- If the vehicle icon is misaligned, drive for a while in a location where the GPS signals can be received. This may correct the position of the vehicle icon.



“BASIC OPERATIONS”

(page 11-3)

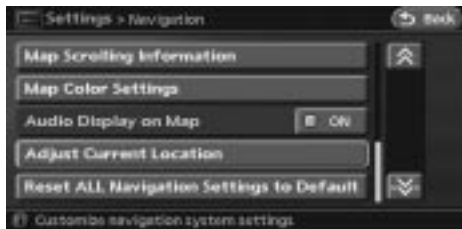

LNV0391

1. Touch the “Navigation” key.
2. Touch the “Adjust Current Location” key.
The current location map screen is displayed.



LNV0392

3. Adjust the position of the vehicle icon by touching on the touch-screen to scroll. After adjusting the position of the vehicle icon touch the “OK” key.



LNV0393

4. Adjust the position of the vehicle icon by touching the arrow keys. After adjusting the direction of the vehicle icon touch the "OK" key.



LNV0394

5. A message is displayed, and the adjusted vehicle location is stored.

RESET ALL NAVIGATION SETTINGS TO DEFAULT

This allows you to restore various settings (display, volume level, etc.) to the default settings.



INFO:

The memory contents, such as the stored locations, will not be deleted.

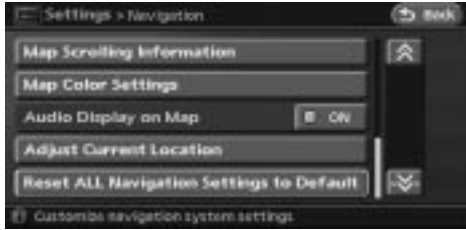

LNV0397

1. Touch the "Navigation" key.
2. Touch the "Reset ALL Navigation Settings to Default" key.

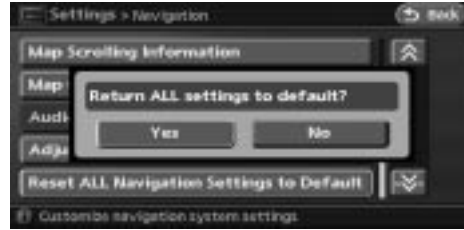

LNV0398

A confirmation message is displayed. Confirm the contents of the message. After confirming the message, touch the "Yes" key.

9 Voice recognition

Nissan voice recognition	9-2
Using the system	9-2
Basic voice control	9-2

Personal vocabulary (voicetags)	9-4
System feedback announcement modes	9-4
Voice command examples	9-5



NISSAN VOICE RECOGNITION

NISSAN Voice Recognition allows hands-free operation of the navigation system and other systems equipped on this vehicle, such as the phone.



INFO:

- Voice recognition can be used to set destination street addresses that exist within the continental United States (48 states). Street addresses in Canada, Alaska and Hawaii cannot be entered using voice recognition.

USING THE SYSTEM

Initialization

When the ignition switch is pushed to the ON position, NISSAN Voice Recognition is initialized, which takes a few seconds. When completed, the system is ready to accept voice commands. If the  is pressed before the initialization completes, the display will show the message: "Phonetic data downloaded. Please wait."

BASIC VOICE CONTROL

Before starting

To get the best recognition performance out of NISSAN Voice Recognition, observe the following:

- The interior of the vehicle should be as quiet as possible. Close the windows to eliminate the surrounding noises (traffic noise and vibration sounds, etc.), which may prevent the system from correctly recognizing the voice commands.
- Wait until the tone sounds before speaking a command. Otherwise, the command will not be recognized properly.
- Speak in a natural conversational voice without pausing between words.

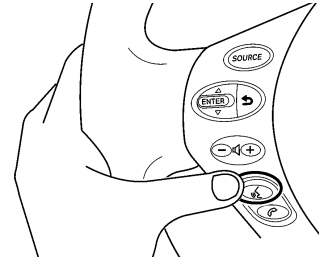

LNV0444

Giving voice commands

1. Press the  button located on the steering wheel switches.

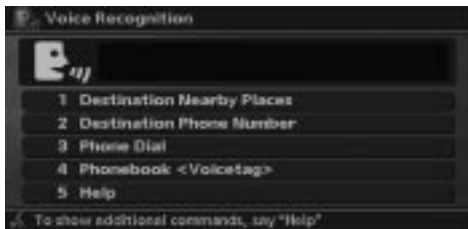

WNV0552

2. A list of commands appears on the screen, and the system announces, "Please say a command".
3. After the tone sounds and the  icon on the screen changes from gray to orange, say "Command list".







WNV0553

4. The system confirms the recognized command, and a list of navigation commands appears.



INFO:

- If the system did not recognize your command, press the  button or the "Back" key to return to the previous screen.
- Voice commands cannot be accepted when the  icon is gray.
- If the command is not recognized, the system announces, "Please say again". Repeat the command in a clear voice.
- Press the  button or the "Back" key once to return to the previous screen.

- If you want to cancel the command, press and hold  button for approximately 2 seconds. The message "Voice input is cancelled" will be announced.
- If you want to adjust the volume of the system feedback, press the volume control buttons + or - on the steering wheel switch or use the audio system volume knob while the system is making an announcement.

How to say numbers

NISSAN Voice Recognition requires a certain way to say numbers in voice commands. Refer to the following examples. (General rule: Either "zero" or "oh" can be used for "0".)

Navigation:

Say commands according to the following examples:

- 2D map - "Two D map"
- Zoom level 5 - "Zoom level five"

PERSONAL VOCABULARY (voicetags)

NISSAN Voice Recognition includes a function that allows you to input personal names for locations to be recognized by the system. These are called "voicetags". Using your own voice, voicetags can be assigned to 20 locations stored in the Address Book.

For further details about storing voicetags, refer to section 6.



"EDITING THE STORED HOME LOCATION" (page 6-11)

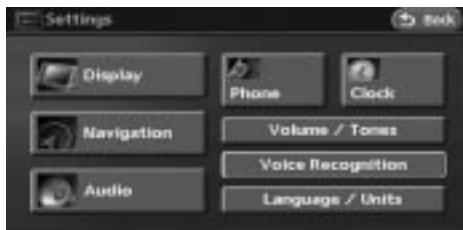

LNV0402

SYSTEM FEEDBACK ANNOUNCEMENT MODES

You can select two modes, long or short, for the announcement by the system.

1. Press the SETUP button.
2. Touch the "Voice Recognition" key.



LNV0403

3. Touch the Voice Feedback "ON" key. The indicator is no longer illuminated, and the system announcement mode switches to the short mode.
4. Touch the "Back" key to return to the previous screen. Press the MAP button to return to the current location map screen.

VOICE COMMAND EXAMPLES

To use the voice recognition function, saying one command is sometimes sufficient, but at other times it is necessary to say two or more commands. As examples, some additional basic operations by voice commands are described here.

Example 1: Switching the map to the Birdview™ mode

1. Press the  button located on the steering wheel switches.

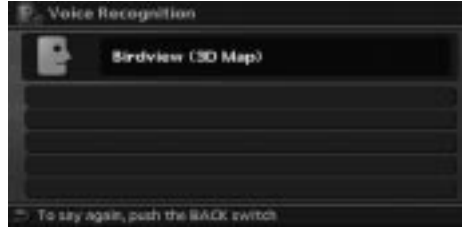

LNV0419

2. The system announces, "Please say a command".
3. After the tone sounds and the  icon on the screen changes from gray to orange, say "Birdview".
4. Voice feedback will be provided when the command is accepted, and the map is displayed in Birdview™.

Example 2: Setting a destination using a nearby place

1. Press the  button located on the steering wheel switch.



LNV0407

2. The system announces, "Please say a command".
3. After the tone sounds and the  icon on the screen changes from gray to orange, say "Destination nearby places".



LNV0408

4. Voice feedback will be provided when the command is accepted, and the list of POI categories appears.
5. The voice feedback will announce "Please say a category name". After the tone sounds and the icon on the screen changes again, say a category name. For example, say "Restaurant".



INFO:

If a route is already set, the system will display the category choices along the current route.

6. Voice feedback will be provided when the command is accepted, and the list of facilities in the category specified in the previous step appears.
7. The system will say "please say a number". After the tone sounds and the icon on the screen changes again, say "One".

9-6 Voice recognition

8. Voice feedback will be provided when the command is accepted, the system will say "Calculating route to destination one". The system starts calculating a route to the selected facility.



WNV0553



Help command

If you are controlling the system by voice commands for the first time or do not know the appropriate voice command, say the following command.

- "Command list" Displays the list of voice commands.



INFO:

The list displayed can be scrolled by touching the  key or the  key on the touch-screen.

Navigation commands

Navigation command list:

Command	Action	Other commands
Destination home	Sets a route to your home that is stored in the Address Book.	Route to home, Home
Destination address book	Sets a route to a location stored in the Address Book.	Address book
Destination <a stored voicetag>	Sets a route to a stored location that has the voicetag specified.	Route to <a stored voicetag>
Destination nearby places	Sets a route to a facility near the current vehicle location.	Nearby places
Destination previous destinations	Sets a route to a previous destination.	Previous destinations, Previous destination
Destination previous starting point	Sets a route to a previous starting point.	Previous starting point
Destination phone number	Searches for a destination by the phone number specified, and sets a route.	
Show nearby places	Shows facility icons near the current vehicle location.	
Show map	Displays the current location map screen.	Map
Show all POI icons	Displays all POI icons on the map.	
Hide all POI icons	Hides all POI icons on the map.	
Birdview (3D map)	Displays the map in Birdview™ (3D).	Birdview
Plan view (2D map)	Displays the map in Plan view (2D).	Plan view
North up	Sets the orientation of the map to north up.	
Heading up	Sets the orientation of the map to heading up.	
Zoom in	Zooms the map in.	

Command	Action	Other commands
Zoom out	Zooms the map out.	
Zoom level <1 to 10>	Changes the scale of the map.	
Shortest time route	Sets the route search condition to the Fastest Route.	
Minimize freeways	Sets the route search condition to the Minimize Freeway.	
Shortest distance route	Sets the route search condition to the Shortest Route.	
Cancel route guidance	Cancels the route setting.	Cancel route
Recalculate route	Recalculates a route.	Recalculate
Voice guidance	Turns on voice guidance.	Guidance voice
Store location	Stores a current location.	Store current location
Repeat voice guidance	Repeats voice guidance once.	Voice repeat, repeat
Address book play directory	Displays the Address Book.	Play address book directory, Address book directory

Category list:

The following category names can be recognized by the system when setting the destination from Points of Interests.

Airport	Ferry Terminal	Park Area
Amusement Park	Gas Station	Parking Garage
ATM	Golf Course	Parking Lot
Auto Dealerships	Grocery Store	Performing Arts
Auto Service & Maintenance	Higher Education	Police Station
Automobile Club	Historical Monument	Rental Car Agency
Bank	Hospital	Rest Area
Border Crossing	Hotel	Restaurant
Bowling Center	Ice Skating Rink	School
Bus Station	INFINITI Dealer	Shopping
Business Facility	Library	Ski Resort
Casino	Marina	Sports Center
City Center	Motorcycle Dealership	Sports Complex
City Hall	Movie Theater	Tourist Attraction
Community Center	Museum	Tourist Information
Commuter Rail Station	Nightlife	Train Station
Convention Center	NISSAN Dealership	Winery
Court House	Park & Ride	

MEMO

10 General system information

Features of this navigation system	10-2	Route calculation	10-9
Route guidance	10-2	Route guidance	10-11
Points of interest (POI) directory	10-2	Basics of voice guidance	10-11
Address book	10-2	Directions provided and the distances to	
Avoid area	10-2	guide points	10-11
XM® NavTraffic™ information	10-2	Repeating voice guidance	10-13
Automatic reroute	10-3	Notes on voice guidance	10-14
Detour	10-3	Map DVD-ROM	10-15
Birdview™	10-3	How to order map DVD-ROM updates	10-15
Voice guidance	10-3	About the map DVD-ROM	10-15
Current vehicle location	10-4	DVD-ROM drive location	10-15
Display of current vehicle location	10-4	Disc replacement	10-16
What is GPS (Global Positioning System)?	10-4	How to handle the DVD-ROM	10-17
Incorrect display of vehicle position	10-6	How to handle the display	10-17
Detailed map coverage areas (MCA) for the		Characteristics of a liquid crystal display	10-17
navigation system	10-8	Maintenance of the display	10-18
When a gray road is displayed on the map	10-9		

FEATURES OF THIS NAVIGATION SYSTEM

ROUTE GUIDANCE

The main features of the NISSAN Navigation System are visual guidance and voice guidance in selected map coverage areas. Utilizing a network of GPS (Global Positioning System) satellites, the NISSAN Navigation System tracks your location on the map and navigates you to a preferred location.

Once you set the destination in a map coverage area, the NISSAN Navigation System will calculate a route from your current location to your destination. The real-time map display and turn-by-turn voice guidance leads the driver along the route.

These features can be especially helpful when driving to unfamiliar locations.

The system may be unable to set a destination and/or calculate a route when the destination is outside the map coverage area. Additionally, voice guidance may not be available if the destination is outside the map coverage area. For more information on how to set a destination, refer to section 4.

POINTS OF INTEREST (POI) DIRECTORY

The NISSAN Navigation System offers an extensive Points of Interest (POI) directory in map coverage areas. This directory includes a wide variety of destinations ranging from gas stations, ATMs, and restaurants to casinos, ski resorts, shopping centers and businesses. By accessing the Points of Interest directory, you can search for addresses and phone numbers for a destination, and just by pushing a button, the NISSAN Navigation System will calculate a route to the destination.

The POI directory has many uses. For example, the directory can be sorted by the various types of restaurants near your current location. If you need an ATM or gas station, the NISSAN Navigation System can navigate you to the closest preferred location.

For more information on how to use the Points of Interest directory, refer to section 4.

ADDRESS BOOK

The Address Book can store up to 100 locations from map coverage areas into a personal directory. This is especially useful for frequently visited locations, such as clients, relatives and friends. The Address Book function allows easy

access to frequently visited locations when setting them as your destination.

For more information on how to use the Address Book, refer to section 6.

AVOID AREA

The Avoid Area function allows you to identify areas or freeways that you would like the NISSAN Navigation System to avoid when calculating routes. For example, if a freeway or area is always congested with traffic, you can set the NISSAN Navigation System to calculate routes that exclude that freeway or area.

For more information on the Avoid Area function, refer to section 6.

XM® NAVTRAFFIC™ INFORMATION

When available, the Traffic Information broadcast allows you to avoid delays due to traffic incidents. Traffic jams, roadwork, closed roads around your current location, etc. are represented graphically on the map by icons depicting the nature of the event. Incidents on the route are automatically brought to your attention when you approach them.

The Traffic Information feature, via the guidance mode, allows you to detour around traffic problems. For more information on the Traffic Information feature, please refer to section 7.

AUTOMATIC REROUTE

If you deviate from the suggested route, the NISSAN Navigation System will automatically recalculate a new route to your destination.

For more information on the Automatic reroute function, refer to section 5.

DETOUR

If you want to make a detour due to traffic conditions, you can use the Detour function to calculate an alternative route. The NISSAN Navigation System can calculate a route using secondary roads that will return you to primary roads after a specified number of miles.

For more information on the Detour function, refer to section 5.

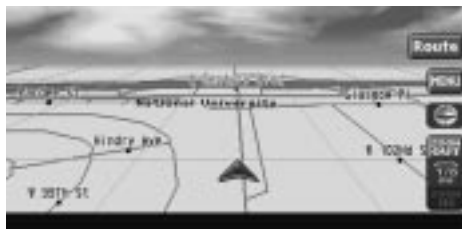

Birdview™

LNV0140

Two map types, 2-dimensional Plan View and 3-dimensional Birdview™, are available in the NISSAN Navigation System. Birdview™ displays the map from an elevated perspective. In Birdview™, it is easy to recognize an image of the route because it provides a panoramic view over a long distance.

For more information on Birdview™, refer to section 3.



VOICE GUIDANCE

LNV0114

Route guidance is provided through voice and visual instructions. Voice guidance announces the appropriate directions when approaching an intersection at which you need to turn.

For more information on voice guidance, refer to section 5.

CURRENT VEHICLE LOCATION

DISPLAY OF CURRENT VEHICLE LOCATION

This navigation system combines the data obtained from the vehicle (by gyro sensor) and from GPS (Global Positioning System) satellites to calculate the current location of the vehicle. This position is then displayed throughout route guidance to a destination.

WHAT IS GPS (Global Positioning System)?

GPS is a position detecting system that uses satellites deployed by the U.S. government. This navigation system receives radio signals from three or more different satellites that orbit 13,049 miles (21,000 km) above the earth in space, and detects the position of the vehicle by utilizing the principle of triangulation.

Positioning adjustment

When the system judges that the vehicle position information is not accurate based on vehicle speed and gyro sensor data calculations, the system will automatically adjust the position of the vehicle icon using GPS signals.

Receiving signals from GPS satellites

The reception of GPS signals can be weak, depending on the environment. Vehicles in the following areas/environments may not receive GPS signals.

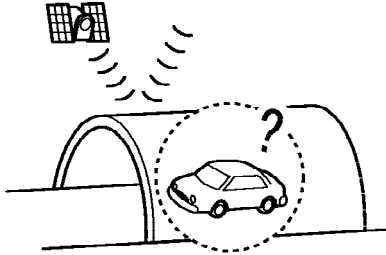

- Inside tunnels or parking garages.

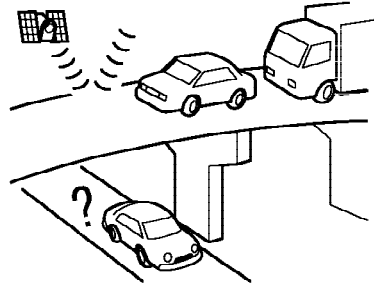

- Under multi-layered highways.

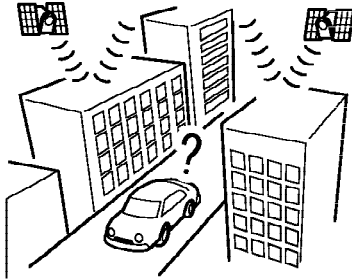

- Areas with numerous tall buildings.

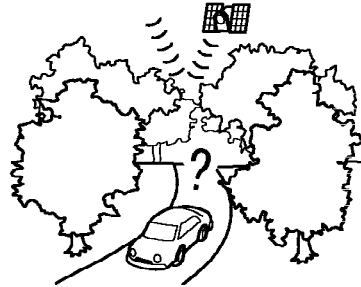

- Under many large trees.

LNV0515

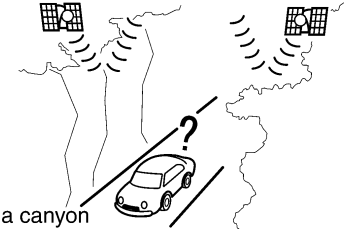

- In a canyon

LNV0528



INFO:

The GPS antenna is located on the instrument panel inside the vehicle. Do not place any objects, especially mobile phones or transceivers, on the instrument panel. Because the strength of the GPS signal is approximately one billionth of that of TV waves, phones and transceivers will affect or may totally disrupt the signal.

Display of GPS information

GPS information can be displayed.



“VIEWING GPS CURRENT LOCATION INFORMATION” (page 7-4)

! NOTE:

Route guidance provided by the navigation system does not take carpool lane driving into consideration, especially when carpool lanes are separated from other road lanes.

INCORRECT DISPLAY OF VEHICLE POSITION

The following cases may affect the display accuracy of the vehicle's position or traveling direction. The accuracy will return to normal if the driving conditions return to normal.

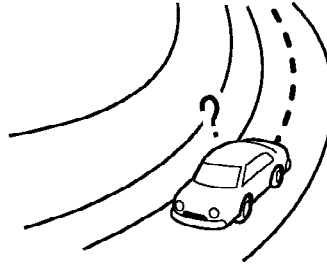

- When there is a similar road nearby.

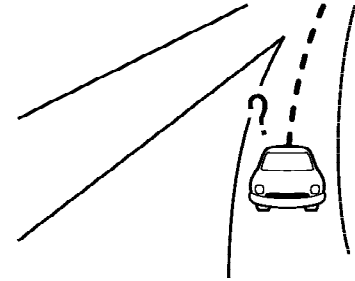

- When the vehicle is passing through a large Y-shaped intersection/junction.

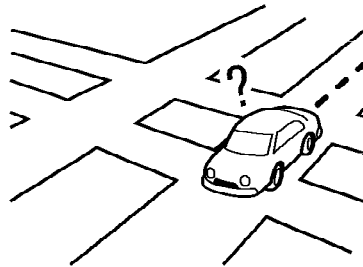

- When the vehicle is traveling in an area with a grid pattern road system.

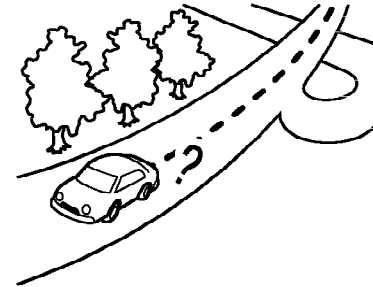

- When the vehicle is traveling on a continuous, slowly curving road.

LNV0516

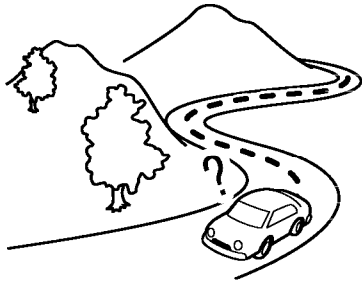

- When the vehicle is traveling on a road with repeating S-shaped curves.



- When the vehicle is on snow-covered or unpaved road.

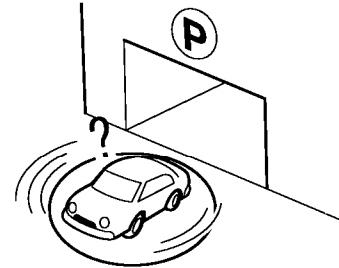

- When the vehicle is rotated on a parking lot turntable while the ignition is off.

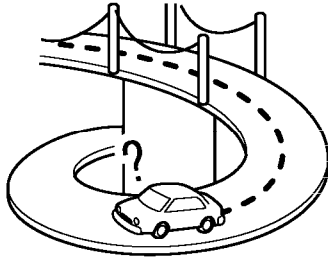

- When the vehicle is on a loop bridge.

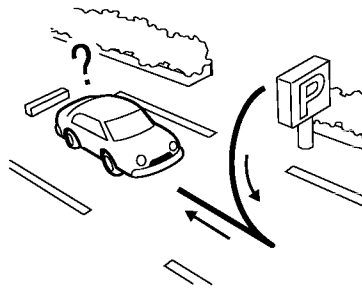

- When repeatedly turning left or right, or driving in zigzags.

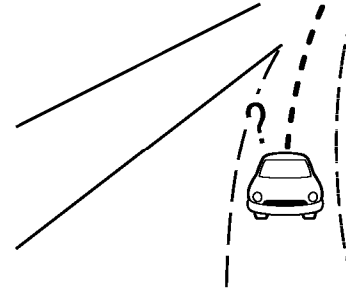

- When driving on a road not displayed on the map screen or a road that has been changed due to additional construction or other reasons.

LNV0517

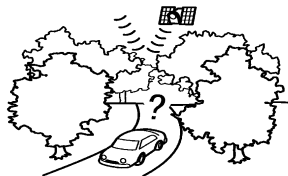

- When the GPS positioning accuracy is low.



INFO:

LNV0518

- The vehicle icon may be misaligned when starting the vehicle just after starting the engine.
- The vehicle icon may also be misaligned if different sized tires or tire chains are installed.
- The system has a function that automatically corrects the vehicle icon position when it is misaligned from the actual position.
- Vehicle position correction by GPS may not function when the vehicle is stopped.
- If the vehicle icon position does not return to normal even after driving for a while, correct the vehicle icon position manually.



“ADJUSTING THE CURRENT VEHICLE LOCATION” (page 7-3)

DETAILED MAP COVERAGE AREAS (MCA) FOR THE NAVIGATION SYSTEM

This system is designed to help you reach your destination, and it also performs other functions as outlined in this manual. However, you, the driver, must use the system safely and properly. Information concerning road conditions, traffic signs and the availability of services may not always be up-to-date. The system is not a substitute for safe, proper and legal driving.

Map data covers select metropolitan areas in the United States.

Map data is available on map DVD-ROMs. For information about map DVD-ROMs, contact a NISSAN dealer or call the NISSAN NAVIGATION SYSTEM HELPDESK. See the contact information on the inside front cover of this manual.

Map data includes two types of areas: “Detailed coverage areas” providing all detailed road data and other areas showing “Main roads only”.



NOTE:

Detailed map data is not available in many areas and is generally limited to select major metropolitan areas.

For information on which metropolitan areas are in detailed coverage areas, please refer to the NISSAN Navigation System Software Booklet (included). When you purchase an updated map DVD-ROM, a new software booklet will be included.

ROUTE CALCULATION

WHEN A GRAY ROAD IS DISPLAYED ON THE MAP

- When you are driving on a road displayed in gray after the vehicle has deviated from the suggested route during route guidance, automatic rerouting may not start immediately.
- The navigation system does not provide route guidance for roads displayed in dark green. Therefore, if the destination is set on a road displayed in dark green, the enlarged map display will return to the ordinary map screen at some point on a suggested route that is near the destination. Also, voice guidance will stop at some point on a suggested route that is near the destination.
- POI information and street names near roads displayed in gray may not be contained in the map data.

- There may be cases that carpool lanes are included on a suggested route when the automatic rerouting function is activated, even if the "Use Time Restricted Roads" is turned off.



"SETTING CONDITIONS FOR THE ROUTE CALCULATION" (page 5-10)

- The navigation system does not provide route guidance for roads displayed in dark green.
- If the destination is set on a dark green road, the enlarged map display will switch to the ordinary map screen at some point and suggest a route that is near the destination. The distance and direction to the endpoint of the suggested route will be displayed in the lower right corner of the screen.

Also, at this time, voice guidance will announce, "The route to your destination includes roads through incomplete map areas. Voice guidance will not be provided in these areas".

When approaching the endpoint of the suggested route, voice guidance will announce, "Entering the road with incomplete map data. Please use the direction arrow and distance information to proceed to your destination." To reach your destination, refer to the map screen. Always follow actual roads and regulations and drive safely.

- The suggested route may not be the shortest, nor are other circumstances, such as traffic jams, considered.
- Because of the inevitable difference in road conditions and circumstances between the time you use this system and the time the information was produced for the map DVD-ROM, there may be discrepancies in roads and regulations. In such cases, follow the actual information available.
- During route calculation, the map will not scroll, however the vehicle icon will move with the actual vehicle's movement.
- During route calculation, buttons such as MAP and DEST will be disabled.
- In some cases, after the calculation is complete, the calculated route may not be immediately displayed.
- Waypoints that have been passed will be disregarded by rerouting calculation.
- If you scroll the map while the suggested route is being drawn, it may take more time to finish drawing.
- If waypoints are set, the system calculates multiple routes between waypoints simultaneously, and the following may result:

- If one section between waypoints cannot be calculated, none of the route will be displayed.
- The route may not connect completely at some waypoints.
- The route may require a U-turn close to some waypoints.
- Route calculation may not be completed in the following cases:
 - If there is no main road within a range of 1.5 miles (2.5 km) from the vehicle, a message saying so will appear on the screen. Try recalculating when the vehicle is closer to a main road.
 - If there is no main road within a range of 1.5 miles (2.5 km) from the destination or waypoint, a message saying so will appear on the screen. Try setting the location closer to a main road.
 - If the vehicle is too close to the destination or if there are no roads to the destination, a message saying so will appear on the screen.
 - If it is impossible to reach the destination or waypoints because of traffic regulations, etc.
- If the only route to reach the destination or waypoints is extremely complicated.
- If the destination, current vehicle position or waypoint is within the “Avoid Area”.
- If a part of the route is included in the “Avoid Area”.
- The following may occur when the route is displayed:
 - If you calculate a route on a main road, the starting point of the route may not exactly match the current vehicle location.
 - The endpoint of the route may not exactly match the destination.
 - If you calculate a route on a main road, the system may display a route from another main road. This may be because the position of the vehicle icon is not accurate. In this case, park the vehicle in a safe location and reset the vehicle icon, or continue driving to see if the position of the vehicle icon is automatically adjusted before recalculating the route.
 - There are cases in which the system shows an indirect route to reach the destination or waypoints, if you set them from stored or facility information. In order to correct this, you must be careful about the traffic direction, especially when lanes with different travel directions are shown separately, such as interchanges and service areas.
- This system makes no distinction between limited traffic control and total control (blockage). It may show an indirect route even if the road is usable.
- Even if the freeway preference is set to OFF, a route that uses the freeway may be suggested.
- Even if the preference is set to OFF, a route that uses a ferry line may be suggested.
- Ferry lines, excluding those that are only for pedestrians, bicycles and motorcycles, are stored in this system. Take into consideration the travel time required and operational condition before deciding whether to use them or not.

10-10 General system information

ROUTE GUIDANCE



INFO:

The announcement of the street name during route guidance is available only when English is set as the language for the system. Street names are not announced if French is set for the system.

BASICS OF VOICE GUIDANCE

Voice guidance announces which direction to turn when approaching an intersection in which a turn is necessary.



NOTE:

- There may be some cases in which voice guidance and actual road conditions do not correspond. This may occur because of discrepancies between the actual road and the information on the map DVD-ROM, or it is due to the vehicle's speed.
- In case voice guidance does not correspond to the actual road conditions, follow the information obtained from traffic signs or notices on the road.
- Route guidance provided by the navigation system does not take carpool lane driving into consideration, especially when carpool lanes are separated from other road lanes.

DIRECTIONS PROVIDED AND THE DISTANCES TO GUIDE POINTS

Directions will differ, depending on the road type.



INFO:

Distances may vary, depending on the vehicle speed.

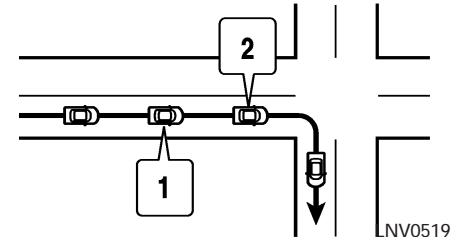

LNV0519

Notification of an intersection on a ordinary road

1. "In about one quarter mile (400 meters), right (left) turn."
2. "Right (left) turn ahead."

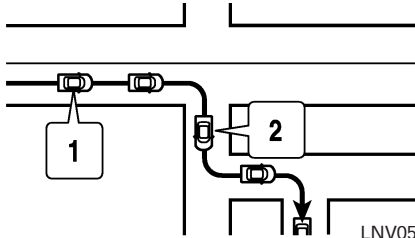

LNV0520

Notification of consecutive intersections on an ordinary road

When the road has three or more consecutive intersections ahead, voice guidance will announce the following.

1. "In about one quarter mile (400 meters), right (left) turn, then left (right) turn."
2. "Right (left) turn ahead, then left (right) turn."

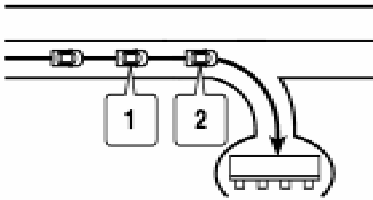

LNV0521

Notification of a freeway entrance

1. "In about one quarter mile (400 meters) freeway entrance on your right onto (road number and direction)."
2. "Freeway entrance on your right onto (road number and direction)."

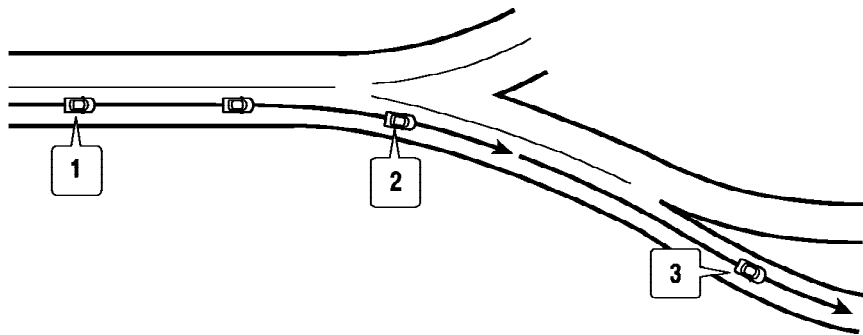

LNV0522

Notification of a freeway junction

1. "In about one mile (1.6 kilometers), keep to the right (left) onto (road number and direction), then in about one quarter mile (400 meters) keep to the right (left)."
2. "Keep to the right (left) onto (road number and direction), then in about one quarter mile (400 meters) keep to the right (left) onto (road number and direction)."
3. "Keep to the right (left) onto (road number and direction)."

Notification of a freeway exit

1. "In about one mile (1.6 kilometers), exit on your right."
2. "Take the second exit on your right."

Notification when approaching the destination

Ordinary road:

When approaching the destination, voice guidance will announce, "You have arrived at your destination. Ending route guidance." To finally reach your destination, refer to the map screen.

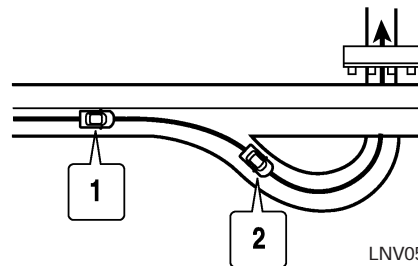

LNV0523

Dark green road:

After passing the last turning point on a suggested route, voice guidance will announce, "En route to your destination, some roads contain incomplete map data. Turn guidance will not be provided in this area." When approaching the endpoint of the suggested road, voice guidance will announce, "Entering the road with incomplete map data. Please use the direction arrow and distance information to proceed to your destination."

REPEATING VOICE GUIDANCE

This function is available throughout route guidance, from the time after the route calculation is completed until the vehicle arrives at the destination.

Touch the "Voice" key.

Voice guidance will be repeated.



INFO:

- If you touch the “Voice” key when you have deviated from the suggested route and when the automatic reroute function is off, voice guidance will announce, “Proceed to the highlighted route.”
- If you touch the “Voice” key when you are going in the wrong direction, voice guidance will announce: “Please make a legal U-turn if possible.”

NOTES ON VOICE GUIDANCE

- Voice guidance in this system should be regarded as a supplementary function. When driving your vehicle, check the route on the map and follow the actual roads and traffic regulations.
- Voice guidance is activated only for intersections with certain conditions.
- There may be cases where the vehicle has to turn, but voice guidance is not provided.
- Voice guidance contents may vary, depending on the direction of the turn and the type of intersection.
- The voice guidance timing will vary depending on the situation.

- When the vehicle has deviated from the suggested route, voice guidance is not available. The system will not announce this to you. Refer to the map and recalculate the route.



“RECALCULATE ROUTE”

(page 5-13)

- Voice guidance may not accurately correspond with road numbers and directions at freeway junctions.
- Voice guidance may not accurately correspond to street names at freeway exits.
- The displayed street names may sometimes differ from the actual names, or “UNKNOWN STREET NAME” may be displayed.
- Voice guidance is not available when the Guidance Voice “ON” key indicator is not illuminated.
- Voice guidance will start when the vehicle enters the suggested route. Refer to the map for directions to the starting point of the route.
- When approaching a waypoint, voice guidance will announce, “You have arrived at waypoint 1 (2, 3, 4,...).” Voice guidance will switch to the next section of the route. When voice guidance is not available, refer to the map for directions.

- In some cases, voice guidance ends before arrival at the destination. Refer to the destination icon on the map to reach the destination.
- If the system recognizes on which side the destination (waypoint) is located, voice guidance will announce “on the right/left” after announcing the arrival at the destination.
- Voice guidance may be partially operational or inoperative due to the angle of roads at an intersection.

MAP DVD-ROM

HOW TO ORDER MAP DVD-ROM UPDATES

To order updated map DVD-ROMs or additional map DVD-ROMs, contact the NISSAN NAVIGATION SYSTEM HELPDESK. See the contact information on the inside front cover of this manual.

ABOUT THE MAP DVD-ROM

1. This map DVD-ROM has been prepared by ZENRIN CO., LTD. under license from Navigation Technologies Corporation. ZENRIN CO., LTD. has added, processed and digitized data based on the digital road map data of Navigation Technologies Corporation. Due to the production timing of the map data, some new roads may not be included in this map data or some of the names or roads may be different from those at the time you use this map DVD-ROM.
2. Traffic control and regulation data used in this map DVD-ROM may be different from those at the time you use this map DVD-ROM due to the data production timing. When driving your vehicle, follow the actual traffic control signs and notices on the roads.
3. Reproducing or copying this map software is strictly prohibited by law.

Published by NISSAN North America, Inc.

© 2002 Navigation Technologies. All rights reserved. "Certain business data provided by infoUSA.com, Inc. Copyright 2002. All rights reserved".

DVD-ROM DRIVE LOCATION



INFO:

The DVD-ROM drive is installed behind the display.

When you purchase this system, a map DVD-ROM is provided.



NOTE:

Please be very careful when handling the disc.

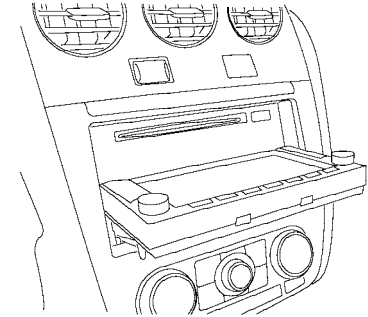

LNV0524

To access the DVD-ROM disc, press and hold the TILT button for approximately 2 seconds. The screen will turn 90 degrees.

To close the screen press the TILT button, the screen will return to its normal viewing angle.

DISC REPLACEMENT



CAUTION

- The included map DVD-ROM is designed specifically for your navigation system. Do not use it in another system as it could cause a malfunction.
- Do not allow the system to get wet. Excessive moisture, such as spilled liquids, may cause the system to malfunction.



NOTE:

Before inserting the map DVD-ROM disc, confirm that there is no disc in the slot.

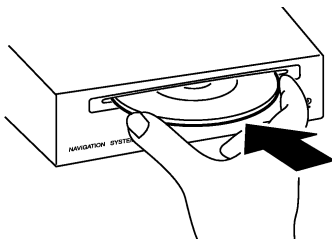

LNV0525

1. To insert a disc: Place the disc in the slot. It will be drawn in automatically. You do not have to push it in all the way.

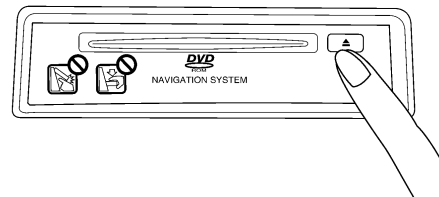

LNV0526

2. To eject the disc: Press the eject button and remove the disc.

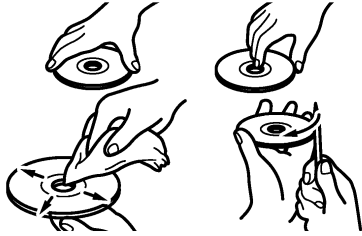

LNV0527

HOW TO HANDLE THE DVD-ROM



CAUTION

- Handle a DVD-ROM by its edges. Never touch the surface of the disc.
- To clean a disc, wipe the surface from the center to the outer edge using a clean, soft cloth. Do not wipe the disc using a circular motion. Do not use a conventional record cleaner, benzine, thinner or alcohol intended for industrial use.
- A new disc may be rough on its inner and outer edges. Remove the rough edges using the side of a pen or pencil as illustrated.

- Never attempt to use a DVD-ROM that has been cracked, deformed or repaired using adhesive. Doing so may damage the equipment.
- Handle the DVD-ROM carefully to avoid contamination or flaws. Otherwise, the data may not be read properly.
- Do not write, draw or attach anything on either side of the DVD-ROM.
- Do not store the DVD-ROM in locations exposed to direct sunlight or in high temperatures or humidity.
- Do not apply any stickers or write anything on either side of the DVD-ROM.

HOW TO HANDLE THE DISPLAY

The display is a liquid crystal display and should be handled with care.



WARNING

Never disassemble the display. Some parts utilize extremely high voltage. Touching them may result in serious personal injury.

CHARACTERISTICS OF A LIQUID CRYSTAL DISPLAY

- If the temperature inside the vehicle is especially low, the display will stay relatively dim or the movement of the images may be slow. These conditions are normal. The display will function normally when the interior of the vehicle has warmed up.
- Some pixels in the display are darker or brighter than others. This condition is an inherent characteristic of liquid crystal displays, and it is not a malfunction.
- You may also notice a remnant of the previous display image on the screen. This screen burn is inherent in displays, and it is not a malfunction.



INFO:

The screen may become distorted by strong magnetic fields.

MAINTENANCE OF THE DISPLAY



CAUTION

- **To clean the display, never use a rough cloth, alcohol, benzine, thinner and any kind of solvent or paper towel with a chemical cleaning agent. They will scratch or deteriorate the panel.**
- **Do not splash any liquid such as water or car fragrance on the display. Contact with liquid will cause the system to malfunction.**

If you need to clean the display screen, use a dry, soft cloth. If additional cleaning is necessary, use a small amount of neutral detergent with a soft cloth. Never spray the screen with water or detergent. Dampen the cloth first, then wipe the screen.

11 Troubleshooting guide

Customer assistance	11-2
Basic operations	11-3
Vehicle icon	11-4
Map DVD-ROM	11-5

Route calculation and visual guidance	11-6
Voice guidance	11-8
Voice recognition	11-9



CUSTOMER ASSISTANCE

For assistance or inquiries about the NISSAN Navigation System, please contact:

The NISSAN NAVIGATION HELPDESK. See the contact information on the inside front cover of this manual.

BASIC OPERATIONS



Symptom	Possible cause	Possible solution
No image is displayed.	The brightness is at the lowest setting.	Adjust the brightness of the display.
	The display is turned off.	Press and hold the Day/Night button to turn on the display.
No voice guidance is available. or The volume is too high or too low.	The volume is not set correctly, or it is turned off.	Adjust the volume of voice guidance.
	Voice guidance is not provided for certain streets (roads displayed in gray).	This is not a malfunction.
No map is displayed on the screen.	The map DVD-ROM is not inserted, or it is inserted upside down.	Insert the map DVD-ROM correctly.
	A screen other than map screen is displayed.	Press the MAP button.
	The pickup lens of the DVD unit is dirty.	The pickup lens can become dirty depending on how you use the vehicle. Contact an NISSAN dealer for cleaning of the pickup lens.
The screen is too dim. The movement is slow.	The temperature in the interior of the vehicle is low.	Wait until the interior of the vehicle has warmed up.
Some pixels in the display are darker or brighter than others.	This condition is an inherent characteristic of liquid crystal displays.	This is not a malfunction.
Some menu items cannot be selected.	Some menu items become unavailable while the vehicle is driven.	Park the vehicle in a safe location, and then operate the navigation system.



NOTE:

Locations stored in the Address Book and other memory functions may be lost if the vehicle's battery is disconnected or becomes discharged. If this occurs, service the vehicle's battery as necessary and re-enter the information in the Address Book.

VEHICLE ICON

Symptom	Possible cause	Possible solution
Names of roads and locations differ between Plan view and Birdview™	This is because the quantity of the displayed information is reduced so that the screen does not become too crowded. There is also a chance that names of the roads or locations may be displayed multiple times, and the names appearing on the screen may be different because of a processing procedure.	This is not a malfunction.
The vehicle icon is not displayed in the correct position.	The vehicle was transported after the ignition switch was pushed off, for example, by a ferry or car transporter.	Drive the vehicle for a while on a road where GPS signals can be received.
	The position and direction of the vehicle icon may be incorrect depending on the driving environments and the levels of positioning accuracy of the navigation system.	This is not a malfunction. Drive the vehicle for a while to automatically correct the position and direction of the vehicle icon.  "CURRENT VEHICLE LOCATION" (page 10-4)
When the vehicle is traveling on a new road, the vehicle icon is located on another road nearby.	Because the new road is not stored in the map data, the system automatically places the vehicle icon on the nearest road available.	Updated road information will be included in the next version of the map DVD-ROM.
The screen does not switch to the night screen even after turning on the headlights.	The daytime screen was set the last time the headlights were turned on.	Set the screen to the night screen mode using the Day/Night button when you turn on the headlights.  "DISPLAY SETTINGS" (page 8-3)
The map does not scroll even when the vehicle is moving.	The current location map screen is not displayed.	Press the MAP button.
The vehicle icon is not displayed.	The current location map screen is not displayed.	Press the MAP button.
The location of the vehicle icon is misaligned from the actual position.	When using tire chains or replacing the tires, speed calculations based on the speed sensor may be incorrect.	Drive the vehicle for a while (at approximately 19 MPH [30 km/h] for about 30 minutes) to automatically correct the vehicle icon position. If this does not correct the vehicle icon position, contact a NISSAN dealer.
	The map data has a mistake or is incomplete (the vehicle icon position is always misaligned in the same area).	Updated road information will be included in the next version of the map DVD-ROM.

MAP DVD-ROM

Symptom	Possible cause	Possible solution
The message "Error" appears.	The map DVD-ROM is dirty or damaged.	Check the map DVD-ROM and wipe it clean with a soft cloth, following the cautions and instructions on page (page 10-17). If you see any damage, replace the map DVD-ROM.

ROUTE CALCULATION AND VISUAL GUIDANCE



Symptom	Possible cause	Possible solution
Waypoints are not included in the auto reroute calculation.	Waypoints that you have already passed are not included in the auto reroute calculation.	If you want to go to that waypoint again, you need to edit the route.
Route information is not displayed.	Route calculation has not yet been performed.	Set the destination and perform route calculation.
	You are not driving on the suggested route.	Drive on the suggested route.
	Route guidance is set to off.	Turn on route guidance.
	Route information is not provided for certain types of roads (roads displayed in gray).	This is not a malfunction.
The auto reroute calculation (or detour calculation) suggests the same route as the one previously suggested.	Route calculations took priority conditions into consideration, but the same route was calculated.	This is not a malfunction.
A waypoint cannot be added.	Five waypoints are already set on the route, including ones that you have already passed.	A maximum of 5 waypoints can be set on the route. If you want to go to 6 or more waypoints, perform route calculations multiple times as necessary.
The suggested route is not displayed.	Roads near the destination cannot be calculated.	Reset the destination to a main or ordinary road, and recalculate the route.
	The starting point and destination are too close.	Set a more distant destination.
	The starting point and destination are too far away.	Divide your trip by selecting one or two intermediate destinations, and perform route calculations multiple times.
	There are time restricted roads (by the day of the week, by time) near the current vehicle location or destination.	Set the "Use Time Restricted Roads" key to off.  "SETTING CONDITIONS FOR THE ROUTE CALCULATION" (page 5-10)
A part of the route is not displayed.	The suggested route includes narrow streets (roads displayed in gray).	This is not a malfunction.
The part of the route that you have already passed is deleted.	A route is managed by sections between waypoints. If you passed the first waypoint, the section between the starting point and the waypoint is deleted. (It may not be deleted depending on the area.)	This is not a malfunction.

Symptom	Possible cause	Possible solution
An indirect route is suggested.	If there are restrictions (such as one-way streets) on roads close to the starting point or destination, the system may suggest an indirect route.	Adjust the location of the starting point or destination.
	The system may suggest an indirect route because route calculation does not take into consideration some areas such as narrow streets (gray roads).	Reset the destination to a main or ordinary road, and recalculate the route.
The landmark information does not correspond to the actual information.	This may be caused by insufficient or incorrect data on the DVD-ROM.	Updated information will be included in the next version of the map DVD-ROM.
The suggested route does not exactly connect to the starting point, waypoints, or destination.	There is no data for route calculation closer to these locations.	Set the starting point, waypoints and destination on a main road, and perform route calculation.

VOICE GUIDANCE

Symptom	Possible cause	Possible solution
Voice guidance is not available.	Voice guidance is only available at certain intersections marked with a  . In some cases, voice guidance is not available even when the vehicle should make a turn.	This is not a malfunction.
	The vehicle has deviated from the suggested route.	Go back to the suggested route or request route calculation again.
	Voice guidance is set to off.	Turn on voice guidance.
	Route guidance is set to off.	Turn on route guidance.
The guidance content does not correspond to the actual condition.	The content of voice guidance may vary, depending on the types of intersections at which turns are made.	Follow all traffic rules and regulations.

VOICE RECOGNITION

Symptom	Possible cause	Possible solution
The system does not recognize your command. or The system recognizes your command incorrectly.	The interior of the vehicle is too noisy.	Close the windows or have other occupants be quiet.
	The volume of your voice is too low.	Speak louder.
	The volume of your voice is too loud.	Speak softer.
	Your pronunciation is unclear.	Speak clearly.
	You are speaking before the voice recognition mode is ready.	Press and release the  button on the steering wheel switches, and speak a command after the tone sounds.
	8 seconds or more have passed after you pressed and released the  button on the steering wheel switches.	Make sure to speak a command within 8 seconds after you press and release the  button on the steering wheel switches.
	Only a limited range of voice commands is usable for each screen.	Use a correct voice command appropriate for the current screen.
	The sound of the fan of the air conditioner is too loud.	Lower the fan speed as necessary.

CURRENT LOCATION MAP SCREEN

"MENU" key

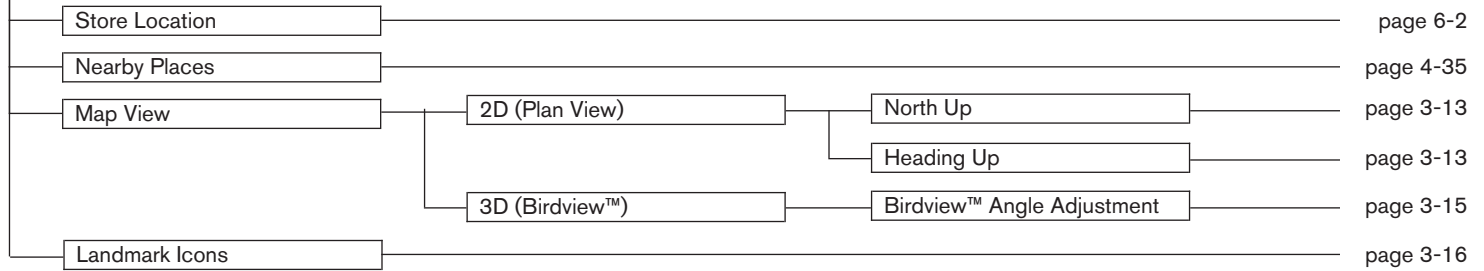

SCROLL LOCATION MAP SCREEN

"MENU" key

New Dest	Start	page 5-3
	Add Way Pt.	page 5-3
	Map Scrolling	page 5-5
Add to Route	Edit Route	page 5-14
Nearby Places		page 4-35
Store Location		page 6-2
Delete		page 6-21

DESTINATION SCREEN

DEST button

Change Region		page 4-4
Home (Add New)		page 4-4
Street Address		page 4-4
Address Book	Home Location	page 4-15
	Stored Location	page 4-16
Nearby Places		page 4-35
Points of Interest		page 4-21
Other	Previous Destinations	page 4-18
	Previous Starting Point	page 4-19
	Phone Number	page 4-34
	Intersection	page 4-10
	Freeway Entrance/Exit	page 4-31
	City Center	page 4-7

ROUTE SCREEN

“Route” key

Cancel Route Guidance	Resume Route Guidance	page 5-26
Recalculate Route		page 5-13
Edit Route	Destination	page 5-15
	Waypoint	page 5-15
Route Priority	Fastest Route	page 5-10
	Minimize Freeway	page 5-10
	Shortest Route	page 5-10
	Detailed Route Priorities	page 5-10
Guidance Settings	Guidance Screen Default	page 5-23
	Route Guidance	page 5-21
	Guidance Voice	page 5-22
	Small Turn Arrow on Map	page 5-22
	Traffic Info. Settings	page 7-11
	Set Average Speeds	page 5-24

Turn List	page 5-21
Traffic Detour	page 5-19

SETUP SCREEN

SETUP button

Display	ON/OFF	page 8-4	
	Brightness	page 8-4	
	Contrast	page 8-5	
Navigation	Landmark Icons	page 3-16	
	Map View	page 3-4	
	Guidance Settings	page 5-21	
	Traffic Info. Settings	page 7-11	
	Address Book	Stored Location	page 6-2
		Avoid Area	page 6-6
		Delete Stored Items	page 6-21
	Avoid Area Settings	page 6-20	
	Nearby Places Custom Settings	page 6-26	
	Map Scrolling Information	page 3-9	
	Map Color Settings	page 8-11	
	Adjust Current Location	page 8-12	
	Reset ALL navigation settings to default	page 8-13	

Volume and Tones	Guidance Volume	page 8-6
	Guidance Voice	page 8-6
	Button Beeps	page 8-6
Voice Recognition	Voice Feedback	page 9-2
Clock	On-screen Clock	page 8-7
	Clock Format	page 8-7
	Offset Adjust	page 8-7
	Daylight Saving Time	page 8-7
	Time Zone	page 8-7
Language/Units	Select Language	page 8-8
	Select Units	page 8-10

INFORMATION SCREEN

INFO button

Where am I?	page 7-3
GPS Satellite Info	page 7-4
Navigation Version	page 7-5
Voice Command List	page 7-5
Traffic Info.	
Info. on Route	page 7-8
Nearby Traffic Info.	page 7-9
User Locations	page 7-10
Traffic Info Settings	page 7-11

MEMO

MEMO

MEMO

12 Index

2D map2-14, 3-2, 3-6
3D map2-15, 3-3, 3-7, 10-3

A

About route guidance5-6
About the map DVD-ROM10-15
Adding a destination or waypoint5-3
Adding additional destinations to a route4-39
Address book10-2
Adjusting the current vehicle location8-12
Adjusting the location of the destination4-38
Adjusting voice guidance volume2-33
Automatic reroute10-3
Available items after setting a destination5-2
Available views3-4
Avoid area10-2
Avoid area settings6-6

B

Background color8-5
Basic operations11-3
Basics of voice guidance10-11
Before starting2-34, 9-2
Birdview™2-15, 3-3, 3-7, 10-3
Brightness8-4

C

Change/edit route5-12
Changing the scale of a map2-17
Changing the scale of the left screen3-15
Character (letter and number) input screen2-22
Characteristics of a liquid crystal display10-17
Clock settings8-7
Command list2-35, 9-2, 9-6
Confirming a route5-20
Control buttons and functions2-2
Current vehicle location10-4
Customer assistance11-2
Customizing nearby places6-26

D

Deleting a route2-30, 5-25
Deleting a stored item6-21
Deleting a stored item individually6-22
Deleting all stored items6-24
Deleting an individual item on the map6-23
Deleting/reactivating a route5-25
Destination screen4-2
Detailed Map Coverage Areas (MCA) for the navigation system10-8
Detailed route priorities5-10
Detour10-3
Directions provided and the distances to guide points10-11
Disc replacement10-16

Display of current vehicle location10-4
Display settings8-3
Displaying landmark icons3-16
DVD-ROM drive location10-15

E

Editing a route5-14
Editing the address book6-10
Editing the avoid area6-20
Editing the stored home and location6-11

F

Features of this navigation system10-2
For safe operation1-2
Functions disabled while driving2-12

H

How to handle the display10-17
How to handle the DVD-ROM10-17
How to order map DVD-ROM updates10-15
How to store your home2-18
How to use this manual1-2
How to view map screen2-13

I

Incorrect display of vehicle position10-6
Information screen7-2

L

Language and unit settings8-8
Laser product1-3
List screen.2-25

M

Maintenance of the display10-18
Map color settings8-11
Map DVD-ROM10-15, 11-5
Map icons3-16
Map menu screen2-9
Map scale3-11
Map screen types2-14
Map scrolling information3-9
Map symbols3-17
Map types.3-2
Menu screens and their purposes.2-5
Minor adjustment of the stored home and locations6-11
Moving a map.3-6
Moving around within a map2-16

N

NISSAN Voice Recognition.2-34, 9-2
Notes on voice guidance10-14

O

Operations after setting a destination4-37
Other settings for the map screen.3-13

P

Personal vocabulary (voicetags).9-4
Phone number input screen2-23
Plan view2-14, 3-2, 3-6
Points Of Interest (POI) directory10-2
Procedures after setting a destination5-2

R

Reactivating a route.5-26
Real Time Traffic (RTT) settings.5-12, 7-11
Recalculate route5-13
Reference symbols.1-2
Repeating voice guidance10-13
Reset all navigation settings to default8-13
Returning to the current vehicle location3-8
Route calculation10-9
Route calculation and visual guidance11-6
Route guidance10-2
Route guidance settings5-21
Route priority settings5-10
Route setting5-8

S

Safety information1-3
Searching for a destination.2-26
Set average speeds5-24
Setting a city center4-7
Setting a facility as the destination4-21
Setting a freeway entrance/exit4-31
Setting a nearby place4-35
Setting a point of interest4-21
Setting a previous destination4-18
Setting a stored location as the destination.4-15
Setting a street address4-4
Setting a street address/residence as the destination4-3
Setting an intersection4-10
Setting by phone number4-34
Setting conditions for the route calculation.5-10
Setting from address book.4-16
Setting from map4-13
Setting the previous starting point.4-19
Setting your home4-15
Start menu.2-10
Starting route guidance.2-29, 5-3
Start-up screen.2-4
Steering wheel switch2-3
Storing a location4-41, 6-2
Storing a location by moving the map.6-5
Storing a location by searching6-2
Storing the current vehicle location6-4
Switching the map view.2-15, 3-4
System feedback announcement modes9-4

T

- Traffic3-20, 5-12, 7-7
- Traffic information settings5-12, 7-11
- Turn list5-8
- Turning voice guidance on/off2-31

U

- Unit setting.8-8, 8-10
- Using controls to adjust values, levels, etc. . .2-8
- Using the system9-2
- Using turn list5-21

V

- Vehicle icon11-4
- Viewing GPS current location information . .7-4
- Viewing information about current vehicle location7-3
- Viewing information about the searched location4-40
- Viewing navigation system version information7-5
- Viewing Real Time Traffic (RTT) information . .7-7
- Viewing traffic information7-7
- Viewing voice command lists7-5
- Visual guidance settings5-23
- Voice command examples2-36, 9-5
- Voice guidance.10-3, 11-8
- Voice guidance during route guidance5-6
- Voice recognition11-9
- Volume adjustment8-6

W

- What is GPS (Global Positioning System)?10-4
- When a gray road is displayed on the map . .10-9

X

- XM® NavTraffic™3-20, 5-12, 7-7