

Modular ICS 6.1 Installer Guide

Norstar and Meridian are trademarks of Nortel Networks
© Copyright Nortel Networks 2003

1-800-4 NORTEL
www.nortel.com/norstar

P0603534 02
Printed in Canada

Table of Contents

Regulations 21

- Installation Safety warning 21
 - Safety and installation 22
 - For equipment with internal power supplies 22
 - For equipment with external power supplies 23
 - Important safety instructions 23
 - North American regulations 25
 - Telecommunication Registration 25
 - Federal Communication Commission (FCC) Notice Radio/TV interference 26
 - Devices intended to be connected to the Public Switched Telephone Network 27
 - US 27
 - Canada 30
 - Signaling method 31
 - Ringer Equivalence Number 31
 - Hearing aid compatibility (HAC) 32
 - Use of a music source 32
 - Programming emergency numbers 33
 - Limited Warranty 34
 - Exclusions 34
 - International Regulatory Information 36
-

How to use this document 37

What's new with Norstar 39

- New features and hardware for version 6.1 39
 - Other feature notes 41
-

Welcome to ISDN 43

- Comparing ISDN to Analog 44
 - Type of ISDN service 44
 - B channels 45
 - D channels 45
 - ISDN layers 45
 - ISDN bearer capability 46
-

- Services and features for ISDN PRI and BRI 47
 - PRI services and features 47
 - BRI services and features 48
- Feature descriptions 49
 - Network name display 49
 - Message Waiting Indicator (MWI) 50
 - Name and number blocking 50
 - External call forwarding 50
 - MCDN trunk features 51
 - Call by Call service selection for PRI 51
 - Emergency 911 dialing 52
 - MCID (Profile 2) 53
 - Network Call Diversion (Profile 2) 53
 - DTI card configured as a PRI card 53
- ISDN hardware 54
 - DTI card configured as PRI 54
 - BRI Card 54
 - BRI-U2 and BRI-U4 card 55
 - BRI-ST card 55
 - U-LT reference point 55
 - U-NT reference points 56
 - S reference point 57
 - T reference points 58
- Clock source for ISDN cards 59
- Other ISDN BRI equipment: NT1 60
- ISDN standards compatibility 61

Working with ISDN 63

- Planning your ISDN network 63
- Ordering ISDN PRI 63
 - Ordering ISDN PRI service in Canada 63
 - Ordering ISDN PRI service in United States 64
- Ordering ISDN BRI 64
 - Ordering service in Canada 64
 - Ordering ISDN service in the U.S. 64
- Supported ISDN protocols 66
- ISDN programming 66
 - Programming ISDN PRI resources 67
 - Programming ISDN BRI resources 68
 - Programming ISDN PRI lines 71
 - Programming ISDN BRI lines 71
 - Programming Direct Inward System Access (DISA) on PRI

- trunks 72
 - Programming ISDN equipment 73
 - Terminal equipment for BRI cards 73
 - Devices on an S or LT loop (BRI cards only) 73
 - ISDN router 76
 - D-packet service (BRI cards only) 76
 - POSTA for ISDN BRI 77
 - Point-of-sale terminal adapter 78
-

Trunks and target lines 79

- Trunk operating modes (T1) 80
 - Ground start trunks (T1 only) 80
 - DID trunks 81
 - Analog loop start trunks 83
 - Analog E&M trunks 85
 - BRI trunks 87
 - PRI trunks 87
 - Target lines 88
-

Remote system access 89

- Use system features during a remote call 89
 - Remote access on loop start and E&M trunks 90
 - Remote access on a private network 90
 - Remote access on Direct Inward Dial (DID) trunks 91
 - Remote access on PRI trunks 91
-

Controlling system access 93

- Class of Service 93
 - Restriction filters 94
 - Direct inward system access (DISA) 96
-

Networking with Norstar 99

- Tie-line networking 100
 - Norstar behind a PBX 101
 - Dialing plans 102
 - Dialing plan using public lines 104
 - Destination code numbering in a network 104
 - Dialing plan using E&M lines 105
 - Dialing plans with shared line pools 109
 - Call-by-Call Services Example 111
 - Norstar Configuration 113
-

- PRI dialing plan example for two-way DID 115
 - Static DID and two-way DID 116
- Private networking using PRI SL-1 117
 - SL-1 networking features 117
 - Features specific to Advanced Private Network 118
 - Private Network Tandem calling 119
 - Calls originating from the public network 120
 - Calls originating in the private network 123
 - Routing for tandem networks 126
 - Advanced Private Networking 128
 - Networking using routing codes 128
 - MCDN Private Networking 134
 - Using a UDP dialing plan 135
 - Using a CDP dialing plan 138
 - MCDN trunk call features 141
 - Network Call Redirection Information 142
 - ISDN Call Connection Limitation 144
 - Trunk Route Optimization 146
 - Trunk Anti-tromboning 148
 - MCDN voice mail/auto attendant call features 150
 - MCDN Meridian 1 attendant MCDN features 150
 - Message Waiting Indication 151
 - Camp-on 152
 - Break-in 154
 - Central voice mail and Auto Attendant with Norstar 156
 - Configuring centralized voice mail 157
 - Local system 157
 - Remote system 158
 - Using centralized voice mail 160
 - Configuring Centralized Auto Attendant (CAA) 160
 - Assigning PNIs 161
 - Assigning PNIs for adjacent nodes 161
 - Local system 162
 - Remote system 163
 - Voice mail configuration 164
- Customer Use 166
 - Public network 166
 - Call one or more Norstar telephones 166
 - Call Norstar and select tie lines to a private network 167
 - Call Norstar and select lines to the public network 169
 - Private network 170
 - Call one or more Norstar telephones 170

- Use tie lines to other nodes in the private network 171
- Select lines to the public network 172
- Select E&M trunks to the private network 173
- Norstar Line Redirection feature 174
- ETSI, MCDN and Network features 176
 - Network Call Diversion 176
 - Allowing NCD 177
 - Feature description 177
 - Programming and restrictions 178
 - Selective Line Redirection 179
 - Programming Extensions 179
 - Enhanced Caller ID 179
- Malicious caller identification (MCID) 180
- Programming MCID capability 181

Data Solutions 183

- Examples of ISDN Scenarios 183
- ISDN applications 183
- Video conferencing and video telephony 183
- Desktop conferencing 183
- File transfer 184
- Telecommuting 184
- Group 4 fax 184
- Remote LAN access 184
- Leased line backup 184
- LAN to LAN bridging 185
- Internet and database access 185

Planning the installation 187

- Planning checklist 188
 - Hardware 188
 - Initial configuration 188
 - System configuration 189
- Required equipment 189
- Expansion equipment 190
- Optional equipment 191
- Equipment for installing the ICS and modules 192
- Location requirements 192
- Electrical requirements 194
- Configuring Trunk Cartridges 195
- Configuring Station Modules 196

- Internal wiring requirements 196
 - Norstar loop 196
 - ISDN S reference point (S Loop) 197
- System overview 198
- Upgrading your Norstar system 199
 - Supported upgrades in MICS 6.1 200
 - Upgrade from versions 4.0 to 6.0 to version 6.1 203
 - Upgrade from pre-4.0 to 6.1 without upgrade tool 204
 - Upgrade from pre-4.0 to later versions using the upgrade tool 205
- Upgrading from MICS 6.1 to MICS-XC 6.1 207
- Trunk and Station Modules 210
 - Global Analog Trunk Cartridge/CLI Cartridge 210
 - Off-core DTI card 211
- Replacing a Modular 8x24 KSU 212
- Trunk module line numbering 216
 - Upgrading ILG functionality with hunt groups 217
 - Planning Hospitality functions 218

Installation 219

- Installation checklist 220
- Testing the ISDN BRI network connection 222
- Installing the cartridges 223
- Mounting the modules 225
 - Installation tips 227
- Installing the ROM Software Cartridge 229
- Inserting a cartridge 231
 - Terminating resistors on BRI-ST Cards 232
 - Shorting straps on a BRI-ST card 233
- Connecting expansion modules 234
 - Order of connection 234
 - Analog Station Module 234
- Installing fiber cables 240
- Fiber cable management system 241
 - Using the fiber cable management system 242
 - Using the fiber spool 244
 - Making fiber connections 245
 - Routing fiber cables 246
- Connecting the wiring 247
 - Connecting the wiring to the distribution panel 247

- Wiring charts 252
 - Port numbering on the wiring charts 252
 - Integrated Communications System (ICS) 252
 - BRI Wiring charts 261
 - Wiring the BRI network interface 267
 - DTI wiring 269
 - E&M/DISA Trunk Cartridge wiring chart 273
 - DID supervisory signaling 276
 - Emergency transfer conditions 276
- Emergency telephone 281
- Moving telephones 283
- Installing ISDN BRI terminal equipment 284
 - S or T wiring for terminal equipment 284
 - S or T extension wiring configurations 284
 - Additional power 285
 - U-LT wiring for terminal equipment 285
- Installing optional equipment 287
 - Auxiliary ringer (customer supplied) 287
 - Auxiliary ringer programming 287
 - External music source (customer supplied) 288
 - External music source programming 288
 - External paging system (customer supplied) 289
- Powering up the system 290
 - Check the power 291

Programming 293

- Programming overview 294
 - Profile, Dialpad and Startup programming 295
 - Installer or System Coordinator Plus programming 296
 - System Coordinator programming 297
 - Admin/Basic programming 297
- Programming tools 298
 - The programming overlay 298
 - Using the telephone buttons for programming 300
 - Special characters on the display 301
 - The display buttons 301
 - The Norstar Programming Record 303
 - Exiting 303
 - Viewing your programming updates 303
 - Entering numbers 304

- Viewing long telephone numbers 304
- Setting up User Preferences 305
- Copying telephone programming 306
 - System ID 309
 - Reviewing programmed settings 309
 - Viewing the programming for a telephone 310
 - Viewing the programming for a line 310
- Programming sequence 311
- Profiles and Dialpads 312
 - Profile programming 312
 - Profile parameters 312
 - Changing the profile 315
 - Dialpad programming 316
- Startup programming 317
 - Performing Startup 317
 - Changing the default telephony template 318
 - Changing the starting DN 319
- Programming 321
 - Entering programming for installers 322
 - Entering programming for system coordinators 323
 - Entering programming using other passwords 324
- Terminals&Sets 325
 - Line access 325
 - Line assignment 326
 - Appearances 327
 - Line pool access 329
 - Prime line 330
 - Intercom keys 331
 - Answer DN's 332
 - OLI # 333
 - Capabilities 335
 - Name 337
 - User preferences 338
 - Restrictions 339
 - Filters 339
 - Default filters 341
 - Set restrns 344
 - Filters 344
 - Set lock 345
 - Allow last no 345
 - Allow saved no 345

Allow link	345
Line/set restrns	346
Telco features	347
Feature assignment (CLID alignment)	347
Caller ID set	347
Extl VMsg set	348
1stDisplay	349
Called ID	349
Log space	349
Lines	351
Trunk/Line data	351
Copying Trunk and Line data	353
Trunk type	353
Line type	354
Line connected to a DTI	355
Dial mode	356
Rec'd #	357
If busy	357
Prime set	358
Auto privacy	358
Trunk mode	359
Ans mode	359
Ans with DISA	360
Link at CO (loop trunks only)	361
Aux. ringer	361
Full AutoHold	362
LossPkg	362
Signal	363
ANI Number	364
DNIS Number	364
Gain	365
Programming distinctive ring patterns	366
Name	367
Restrictions	367
Restrnr filters	368
Line restrns	368
Remote restrns	369
Telco features	370
VMsg center 1	370
Services	371
Common settings	372
Control sets	372

- Schedule names 373
- Schedule times 373
- Ringin service 375
 - Ringin groups 375
 - Sched:Night 376
 - Service 376
 - Trunk answer 376
 - ExtraDial telephone 377
 - Line settings 377
- Restrtn service 379
- Routing service 379
- Routes and destination codes 381
 - Routes 381
 - DialOut 382
 - Use Pool 382
 - Routing table 383
 - Programming the PRI routing table 384
 - Dest codes 385
 - Wild card character 386
 - Normal rte 388
 - Digit Absorption 388
 - Setting up a route for local calling 389
 - Setting up a route for long distance calling 391
 - Adding a long distance carrier access code 393
 - Programming for least cost routing 395
 - Multiple least cost routing 396
 - Sched:Night 397
 - Using dialing restrictions with routing 399
- Sys speed dial 400
- Passwords 401
 - COS pswds 401
 - Pswd 402
 - User flt 402
 - Line flt 402
 - Remote pkg 403
 - Call log pswds 403
 - Progrming pswds 404
 - Installer 404
 - SysCoord+ 405
 - SysCoord 405
 - Basic 405
 - Registration password (MICS-XC only) 405

- Hospitality password 406
 - Desk pswd 406
 - Cond pswd 406
- Silent Monitor password 407
- Time&Date 408
- System prgrming 409
 - Hunt groups 409
 - Adding or removing members from a group 410
 - Moving members of a group 412
 - Assigning or unassigning lines to a group 412
 - Setting the distribution mode 413
 - Setting the hunt delay 414
 - Programming busy line setting 414
 - Programming the queue timeout 415
 - Programming the overflow set 415
 - Setting the Hunt group name 416
 - Allowing/disallowing an auxiliary ringer 416
 - Assigning a distinctive ring pattern to a Hunt Group 416
 - Monitoring Hunt groups 417
- Change DNs 418
- Featr settings 419
 - Backgrnd music 419
 - On hold 419
 - Receiver volume 419
 - Camp timeout 420
 - Park timeout 420
 - Park mode 420
 - Trnsfr callbk 421
 - DRT to prime 421
 - DRT delay 421
 - Held reminder 422
 - Remind delay 422
 - Directd pickup 422
 - Page tone 423
 - Page Timeout 423
 - Daylight time 423
 - AutoTime&Date 424
 - Call log space 425
 - Host delay 425
 - Link time 426
 - AlarmSet 427
 - Set relocation 427

- Msg reply enh 428
- Answer key 429
- Setting SWCA controls 430
- CLID match 432
- Silent Monitor 432
- Direct-dial 433
 - D-Dial1 433
 - Intrnl/Extrnl# 434
 - Line selection 434
- CAP/KIM assign 435
- Dialing Plan 436
 - DN lengths (enbloc dialing) 437
 - Private networks 438
 - Public networks 439
 - Dial Timeout 440
- Access codes 441
 - Line pool codes 441
 - Park prefix 442
 - External code 443
 - Direct-dial # 444
 - Auto DN 444
 - DISA DN 445
 - PrivAccCode 445
 - Carrier Codes 446
 - Remote access 447
 - Rem access pkgs 447
 - Rem line access 447
- Changing Companion DN type 449
- Rec'd # length 450
- DN length 451
- Nat'l length (profile 2, only) 452
- Make/Break (profile 2, only) 452
 - BusName 453
 - Receiving and Sending Calling Party Name 453
 - Receiving and Sending Connected Name 454
 - Network Name Display interactions 454
 - Programming Network Name Display 455
 - Outgoing Name and Number Blocking 456
- Call by Call service selection for PRI 457
 - Line Pools 460
 - Programming Call by Call service selection 460
 - PRI Call by Call Limits 460

- Programming Call by Call Limits 461
- Release Reasons 462
- Programming Hospitality Services 463
 - Room/desk information 463
 - Call restrns 464
 - Setting Service times 465
 - Configuring alarms and expired alarms settings 465
- SM sets 466
- Network Services 467
 - ETSI: Network diversion and MCID 467
 - Network Call Diversion 468
 - Malicious call identification (MCID) 471
 - MCDN services (profiles 1, 2, 4) 472
- Telco features 474
 - VMsg ctr tel#s 474
 - Outgoing Name and Number Blocking 475
 - Programming the analog vertical service code (VSC) 476
 - Programming the BRI VSC 476
 - Setting up the modules for ONN blocking 477
 - Program ONN blocking BRI loop state 478
- Software keys 479
 - ISDN-PRI 479
 - MCDN 479
 - Companion (MICS-XC only) 479
 - System Identification Number 480
 - Call the Nortel Customer Response Center 480
 - Entering the software keys 481
- Hardware 482
- Show module 482
- Cards on KSU 482
 - Provisioning the DTI card for PRI 483
 - Selecting a protocol 484
 - BchanSeq 485
 - Call-by-call routing 485
 - Discon timer 487
 - Answer timer 487
 - CO fail 488
 - I/F levels 488
 - Framing 489
 - Internal CSU 490
 - CSU line bld 490

- Line coding 491
- ClockSrc 492
- Max transits 492
- Modules 492
 - StnMod 492
 - ASM 493
 - TrunkMod 494
- BRI card 498
 - Loop 498
 - Type 498
 - Lines 498
 - No SPIDs assigned 499
 - # of B-channels 499
 - Network DNs 500
 - Call type 500
 - D-packet service 501
 - Lp 501
 - TEIs 502
 - No TEIs on loop 502
 - Sampling 502
- DNs on Loop 503
 - Assign DNs 503
 - Loop DN 503
- Clock Src 504
 - Setting the clock source for DTIs and PRI 508
 - T1 or ISDN-PRI configurations 509
- DataMod 510
 - Type 510

Maintenance 511

- Beginning a Maintenance session 512
- System version 513
 - Checking the version of the system 513
- Port/DN status 514
- Identifying a connected device 515
 - Displays 516
- Checking the device version number 517
- Checking the state of the device 518
- Disabling a device 519
 - Displays 519
- Enabling the device 520

- Returning to the beginning 520
- Module status 521
- Looking at the module inventory 521
- Checking the number of Cartridges 522
- Checking the state of a module 522
- Checking the state of a cartridge 523
- Disabling a module or its cartridges 524
- Enabling a module or its cartridge 524
- Returning to the beginning 525
- System test log 526
- Checking the items in the log 526
 - Checking the current alarm 527
 - Checking when each item occurred 527
 - Checking consecutive repetitions of an event or alarm 527
 - Erasing the log 528
- System administration log 529
 - Checking the items in the log 529
 - Checking the current alarm 530
 - Checking when each item in the log occurred 530
 - Erasing the log 530
- Network evt log 531
- Checking the items in the log 531
 - Checking the current alarm 531
 - Erasing the log 532
 - Checking when each item in the log occurred 532
- Alarm codes 533
 - If you see an alarm code 534
 - Alarm troubleshooting 537
- Event messages 541
 - Dealing with event messages 541
 - Significant event messages 542
 - Event message 799 545
 - Displays 546
- Provisioning BRI and PRI lines 549
- BRI and T1 lines 549
 - Cd1-ICS 549
 - L001 550
 - Provisioning a T1 line 550
- Provisioning a PRI line 550

- Deprovisioning a line 551
- Disabling a PRI Channel 551
- Tests 552
 - Loopback tests for T1 or ISDN-PRI lines 552
 - Tests initiated from Norstar 556
 - Tests initiated by the central office 556
 - Starting a loopback tests 557
 - Operating a Continuity loopback test 558
 - Loopback test for BRI lines 558
 - Operating a payload loopback test 559
- CSU stats 560
- Statistics 560
 - Checking the performance statistics 561
- Checking the CSU alarms 563
 - Checking active alarms 563
 - Checking carrier failure alarms 563
 - Checking bipolar violations 564
 - Checking short term alarms 564
 - Checking defects 564
 - Resetting all statistics 565
- Diagnostic tools 566
- Link Status 567
- Working with fractional PRI 567

Usage Metrics 569

- Hunt groups 569
- Call-by-Call 570
 - Clearing the metrics 571

Troubleshooting 573

- Getting ready 574
- Types of problems 575
 - Misunderstanding a feature 575
 - Programming errors 575
 - Wiring connections 575
 - Equipment defects 575
- General troubleshooting procedure 576
- Problems with telephones 577
 - Set has faulty buttons, display, handset or other hardware problems 577

- Unreadable set display 577
- Telephone dead 578
 - Running a Maintenance session to test a dead telephone 579
 - Replacing a telephone 579
 - Emergency telephone dead 580
- Problems with lines 581
 - Calls cannot be made (but can be received) 581
 - Dial tone absent on external lines 582
 - Hung lines at a telephone 583
 - Auto-answer line rings at a telephone 584
 - Prime telephone gets misdialed calls 586
 - Selected lines reads Not in service or Not available 587
 - Selected line pool displays: No free lines 589
- Problems with optional equipment 591
 - Analog Terminal Adapter 591
 - Running a Maintenance session to test an ATA 591
 - Auxiliary ringer 592
 - External paging 593
 - Music on Hold/Background Music trouble 593
 - KIM not working 594
 - Cold starting the KIM 594
- Problems with trunk cartridges service 596
 - Digital Trunk Interface trouble 597
 - Monitoring the T1 or PRI signal 599
- Problems with BRI service 600
 - The BRI card is connected to the ISDN network (U loop) but the LED for one of more loops is not lit 600
 - Solution 600
 - Out of service displays when a BRI is selected (LED for loop is lit) 601
 - All the LEDs on a BRI Card are flashing 601
 - Caller hears one ring and then a fast busy signal when placing a call on a BRI line 602
- ICS down 603
- Trunk or Station Module down 604
- Data Module down 605
- Problems for network or remote users 606
 - Remote feature code gets no response 606
 - Dialed number gets ringback and the wrong person 606

Dialed number gets stuttered dial tone instead of ringback 607
Dialed number gets dial tone instead of ringback 608
Dialed number gets busy tone 608
Dialed number does not get through 609
Dialed DISA number gets ringback instead of stuttered dial tone 611
Dialed DISA number gets dial tone instead of stuttered dial tone 612
DISA user gets overflow tone when entering COS password 613
Dialed feature code gets overflow tone 614
Dialed feature code gets busy tone 615
Line pool access code gets overflow tone 616
Line pool access code gets ringback 617
Line pool access code gets busy tone 618
Dialed number gets no response 619

Specifications 621

Norstar system 621
Digital Trunk Interface 623

Glossary 625

Index 647

Backup programming overlays 689

Regulations

Installation Safety warning



Only qualified persons should service this system.

The installation and service of this hardware is to be performed only by service personnel having appropriate training and experience necessary to be aware of hazards to which they are exposed in performing a task and of measures to minimize the danger to themselves or other persons.

Electrical shock hazards from the telecommunication network and AC mains are possible with this equipment. To minimize risk to service personnel and users, the system must be connected to an outlet with a third-wire ground.

Service personnel must be alert to the possibility of high leakage currents becoming available on metal system surfaces during power line fault events near network lines. These leakage currents normally safely flow to Protective Earth ground via the power cord.

Therefore, it is mandatory that connection to an earthed outlet is performed first and removed last when cabling the unit. Specifically, operations requiring the unit to be powered down must have the network connections (central office lines) removed first.

This equipment meets all applicable requirements of CSA and UL safety standards for North America and relevant EN60950 specifications for European and other markets.

Safety and installation



The shock hazard symbol within an equilateral triangle is intended to alert personnel to electrical shock hazard or equipment damage.

The following precautions should also be observed when installing telephone equipment.

- Never install telephone wiring during a lightning storm.
- Never install telephone jacks in wet locations unless the jack is specifically designed for wet locations.
- Never touch uninsulated telephone wires or terminals unless the telephone line has been disconnected at the network interface.
- Use caution when working with telephone lines.



The exclamation point within an equilateral triangle is intended to alert the user to the presence of important operating and maintenance (servicing) instructions in the literature accompanying the product.

This symbol (if applicable) on the product is used to identify the following important information:

For equipment with internal power supplies

- Mains nominal AC voltage 110-120 V \sim ; 60Hz
- Mains nominal AC voltage 220-240 V \sim ; 50Hz

For equipment with external power supplies

- Must be powered from an approved Class 2 power source.

For current ratings, refer to product specific documentation and product labels.

Important safety instructions

When using your telephone equipment, basic safety precautions should always be followed to reduce the risk of fire, electric shock and injury of persons, including the following:

- Follow the warnings and instructions marked on the product.
- Unplug this product from the wall outlet before cleaning. Do not use liquid cleaners or aerosol cleaners. Use a damp cloth for cleaning.
- Do not use this product near water, for example, near a bathtub, wash bowl, kitchen sink, or laundry tub, in a wet basement or near a swimming pool.
- Do not place this product on an unstable cart, stand or table. The product may fall, causing serious damage to the product.
- This product should never be placed near or over a radiator or heat register. This product should not be placed in a built-in installation unless proper ventilation is provided.
- Do not allow anything to rest on the power cord. Do not locate this product where the cord will be abused by persons walking on it.
- Do not overload wall outlets and extension cords as this can result in the risk of fire or electric shock.
- Never spill liquid of any kind on the product.

- To reduce the risk of electric shock, do not disassemble this product, but have it sent to a qualified service person when service or repair work is required.
- Unplug this product from the wall outlet and refer servicing to qualified service personnel under the following conditions:
 - a. When the power supply cord or plug is damaged or frayed.
 - b. If the product has been exposed to rain, water or liquid has been spilled on the product, disconnect and allow the product to dry out to see if still operates; but do not open up the product.
 - c. If the product housing has been damaged.
 - d. If the product exhibits a distinct change in performance.
- Avoid using telephone equipment during an electrical storm. There may be a remote risk of electric shock from lightning.
- Do not use the telephone equipment to report a gas leak in the vicinity of the leak.
- To eliminate the possibility of accidental damage to cords, plugs, jacks, and the telephone equipment, do not use sharp instruments during the assembly procedures.
- Do not insert the plug at the free end of the handset cord directly into a wall or baseboard jack. Such misuse can result in unsafe sound levels or possible damage to the handset.
- Disconnect telecommunications lines before unplugging main power cord.
- Save these instructions

North American regulations

Telecommunication Registration

Norstar equipment meets all applicable requirements of both Industry Canada CS-03 and US Federal Commission FCC Part 68 and has been registered under files Industry Canada 332D-5980A and FCC US:AB6KF15B20705 (key system), US:AB6MF15B20706 (hybrid system), and US:AB6PF15B23740 (PBX system). Connection of the Norstar telephone system to the nationwide telecommunications network is made through a standard network interface jack that you can order from your local telecommunications company. This type of customer-provided equipment cannot be used on party lines or coin lines.

Before installing this equipment, users should ensure that it is permissible to be connected to the facilities of the local telecommunications company. The equipment must also be installed using an acceptable method of connection. The customer should be aware that compliance with the above conditions may not prevent degradation of service in some situations.

Repairs to certified equipment should be made by an authorized maintenance facility designated by the supplier. Any repairs or alterations made by the user to this equipment, or equipment malfunctions, may give the telecommunications company cause to request the user to disconnect the equipment. Users should ensure for their own protection that the electrical ground connections of the power utility, telephone lines and internal metallic water pipe system, if

present, are connected together. This precaution may be particularly important in rural areas.



Users should not attempt to make such connections themselves, but should contact the appropriate electric inspection authority, or electrician.

Federal Communication Commission (FCC) Notice Radio/TV interference

This equipment, has been tested and found to comply with the limits for a Class A digital device, pursuant to Part 15 of the FCC Rules. These limits are designed to provide reasonable protection against harmful interference when the equipment is operated in a commercial environment. This equipment generates, uses, and can radiate radio frequency energy and, if not installed and used in accordance with the instruction manual, may cause harmful interference to radio communications. Operation of this equipment in a residential area is likely to cause harmful interference in which case the user will be required to correct the interference at his own expense.

Changes or modifications not expressly approved by the party responsible for compliance could void the user's authority to operate the equipment.

Devices intended to be connected to the Public Switched Telephone Network



State and local requirements for support of Emergency 911 Dialing service by Customer Premises Equipment vary. Consult your local telecommunications service provider regarding compliance with applicable laws and regulations.

US

This telephone equipment complies with Part 68, FCC Rules for direct connection to the Public Switched Telephone Network (The FCC registration number appears on a label affixed to the ICS).

Your connection to the telephone line must comply with these FCC Rules:

- Use only an FCC Standard network interface jacks and FCC compliant line cord and plug to connect this equipment to the telephone line.
- If a network interface jack is not already installed in your location, you can order one from your telephone company. Order the following network jacks along with the corresponding Facility Interface Code (FIC):

Trunk	REN	USOC	SOC	FIC
GATC LSDS (NT7B69AAAA)	0.0 A 0.0 B	RJ21X	9.0F	02LS2
Loop Start/Disconnect Supervision (LS/DS)- NT7B75GA-93	AC 1.5B DC 0.3	RJ21X	9.0F	02LS2

Trunk	REN	USOC	SOC	FIC
GATC CI (NT7B75AAC)	0.0 A 0.0 B	RJ21X	9.0F	02LS2
Call Information (CI)- NT5B41GA-93	AC 1.5B DC 0.3	RJ21X	9.0F	02LS2
DTI (T1 or PRI) - NT7B74AAAA/ A0897902	—	RJ48C	6.0Y	04DU9- 1SN
E&M - NT5B38GA-93	—	RJ2HX	9.0F	TL32M
BRI-U2 and BRI-U4 Cards NT7B86GB-93 and NT7B87GB-93	—	RJ49C	6.0Y	02IS5
BRI-ST - NT7B76GY-93 (when connected to an NT1 which has a U interface to the telephone network)	—	RJ49C	6.0Y	02IS5
DID - NT5B37GA-93	0.0B	RJ21X	AS.2	02RV2-T
Off-premise sets (OPX) - Analog Terminal Adapter	—	RJ11C	9.0F	0L13B



Notify service provider if DTI is disconnected.

You must notify your T1 service provider any time the 1.544 Mbps DTI interface is disconnected from the network.

In some states, customers are permitted to install their own jacks.

- The equipment cannot be used with or connected to a party line or a public coin phone service provided by the telephone company. Connection to Party Line Service is subject to state tariffs. Contact the Public State Utility Commission, Public Service Commission or Corporation Commission for information.
- It is no longer necessary to notify the Telephone Company of your system Registration and REN numbers. However, you must provide this information to the telephone company if they request it.
- If this equipment causes harm to the telephone network, the telephone company will notify you in advance that temporary discontinuance of service may be required. If advance notice is not practical, the telephone company will notify the customer as soon as possible. Also, you will be advised of your right to file a complaint with the FCC if you believe it necessary.
- The telephone company may make changes in its facilities, equipment, operations or procedures that could affect the operation of the equipment. If this happens the telephone company will provide advance notice in order for you to make necessary modifications to maintain uninterrupted service.
- Do not attempt to repair this equipment yourself. If trouble is experienced with this equipment, please refer to the repair and warranty information, noted below. If the equipment is causing harm to the telephone network, the telephone company may request that you disconnect the equipment until the problem is resolved.

- Allowing Direct Inward Dial (DID) Equipment to be operated in such a manner as to not provide for proper answer supervision is a violation of Part 68 of the FCC Rules. Proper answer supervision is when:
 - a. This equipment returns answer supervision to the PSTN when DID calls are:
 - answered by the called station
 - answered by the attendant
 - routed to a recorded announcement that can be administered by the CPE user.
 - routed to a dial prompt
 - b. This equipment returns answer supervision on all DID calls forwarded to the PSTN. Permissible exceptions are:
 - a call is unanswered.
 - a busy tone is received.
 - a reorder tone is received.

Canada

Before installing this equipment, users should ensure that it is permissible to be connected to the facilities of the local telecommunications company. The equipment must also be installed using an acceptable method of connection. The customer should be aware that compliance with the above conditions may not prevent degradation of service in some situations.

Repairs to certified equipment should be made by an authorized Canadian maintenance facility designated by the supplier. Any repairs or alterations made by the user to this equipment, or equipment malfunctions, may give the

telecommunications company cause to request the user to disconnect the equipment.

Users should ensure for their own protection that the electrical ground connections of the power utility, telephone lines and internal metallic water pipe system, if present, are connected together. This precaution may be particularly important in rural areas.

**Caution**

Users should not attempt to make such connections themselves, but should contact the appropriate electric inspection authority, or electrician, as appropriate

This Class A digital apparatus meets all requirements of the Canadian Interference-Causing Equipment Regulations as specified in the Industry Canada Standard ICES-003.

Signaling method

The equipment allows signaling in DTMF tones. It can complete calls to local and long distance lines and can also complete long distance calls via computer phone systems such as MCI or SPRINT. This equipment is capable of providing access to interstate providers of operator services through the use of access codes. Modification of this equipment by call aggregators to block access dialing codes is a violation of the Telephone Operator Consumers Act of 1990.

Ringer Equivalence Number

US

The FCC Registration information on the product label, includes a Ringer Equivalence Number (REN) which is used to determine the number of devices you may connect to your

phone line. A high total REN may prevent ICSs from detecting ringing in response to an incoming call and may make placing calls difficult. In most, but not all areas, the sum of the RENs should not exceed five (5.0). To be certain of the number of devices that may be connected to a line, as determined by the total RENs, contact the local telephone company.

Note: RENs are associated with loop start and ground start ports. Do not use for E&M or digital ports.

Canada

The Ringer Equivalence Number (REN) assigned to each terminal device provides an indication of the maximum number of terminals allowed to be connected to a telephone interface. The termination on an interface may consist of any combination of devices subject only to the requirement that sum of the ringer equivalence numbers of all the devices does not exceed 5.

Hearing aid compatibility (HAC)

The telephone station sets are compatible with hearing aids equipped with an appropriate telecoil and is compliant with the requirements of the Americans with Disabilities Act (ADA).

Use of a music source

In accordance with US, Canadian and international copyright laws, a license may be required from the American Society of Composers, Authors and Publishers, or other composers' or performing rights organization if Radio, TV or other broadcasts to the public are transmitted through the Music On Hold or Background Music features of this telecommunication system.

Programming emergency numbers

When programming emergency numbers and/or making test calls to emergency numbers:

1. Remain on the line and briefly explain to the dispatcher the reason for calling before hanging up.
2. Perform such activities in the off-peak hours, such as early mornings or late evenings.

Substitution of non-approved equipment will void the NORTEL warranty.

Address for warranty and repairs in the US:

Nortel
640 Massman Drive
Nashville TN 37210

Address for warranty and repairs in Canada:

Nortel
30 Norelco Drive
Weston, Ontario M9L 2X6

For more information call 1-800-4NORTEL.

Limited Warranty

Nortel Networks warrants this product against defects and malfunctions during a one (1) year period from the date of original purchase. If there is a defect or malfunction, Nortel Networks shall, at its option, and as the exclusive remedy, either repair or replace the telephone set at no charge, if returned within the warranty period.

If replacement parts are used in making repairs, these parts may be refurbished, or may contain refurbished materials. If it is necessary to replace the telephone set, it may be replaced with a refurbished telephone of the same design and color. If it should become necessary to repair or replace a defective or malfunctioning telephone set under this warranty, the provisions of this warranty shall apply to the repaired or replaced telephone set until the expiration of ninety (90) days from the date of pick up, or the date of shipment to you, of the repaired or replacement set, or until the end of the original warranty period, whichever is later. Proof of the original purchase date is to be provided with all telephone sets returned for warranty repairs.

Exclusions



Nortel Networks does not warrant its telephone sets to be compatible with the equipment of any particular telephone company. This warranty does not extend to damage to products resulting from improper installation or operation, alteration, accident, neglect, abuse, misuse, fire or natural causes such as storms or floods, after the telephone is in your possession.

Nortel Networks shall not be liable for any incidental or consequential damages, including, but not limited to, loss, damage or expense directly or indirectly arising from the

customers use of or inability to use this telephone, either separately or in combination with other equipment. This paragraph, however, shall not apply to consequential damages for injury to the person in the case of telephones used or bought for use primarily for personal, family or household purposes.

This warranty sets forth the entire liability and obligations of Nortel Networks with respect to breach of warranty, and the warranties set forth or limited herein are the sole warranties and are in lieu of all other warranties, expressed or implied, including warranties or fitness for particular purpose and merchantability.

International Regulatory Information

	<p>The CE Marking on this equipment indicates compliance with the following:</p> <p>This device conforms to Directive 1999/5/EC on Radio Equipment and Telecommunications Terminal Equipment as adopted by the European Parliament And Of The Council.</p>	
---	--	---

This is a class A product. In a domestic environment this product may cause radio interference in which case the user may be required to take adequate measures.

Information is subject to change without notice. Nortel Networks reserves the right to make changes in design or components as progress in engineering and manufacturing may warrant. This equipment has been tested and found to comply with the European Safety requirements EN 60950 and EMC requirements EN 55022 (Class A) and EN 55024. These EMC limits are designed to provide reasonable protection against harmful interference when the equipment is operated in a commercial and light industrial environment.



WARNING

This is a class A product. In a domestic environment this product may cause radio interference in which case the user may be required to take adequate measures. The above warning is inserted for regulatory reasons. If any customer believes that they have an interference problem, either because their Nortel Networks product seems to cause interference or suffers from interference, they should contact their distributor immediately. The distributor will assist with a remedy for any problems and, if necessary, will have full support from Nortel Networks.

How to use this document

This guide provides core installation and programming information for MICS 6.1 and MICS-XC 6.1 systems. If you are installing a MICS-XC system, also refer to the *Modular ICS Companion Installer Guide* for Companion installation and programming.

- The MICS system can be a mini (no expansion cartridge installed), a midi (installed with a two-port expansion cartridge), a maxi (installed with a six-port expansion cartridge), or a mega (Combination Fiber six-port Services Cartridges and Services cartridges) system. For more information about the configurations, see *Connecting expansion modules* on page 234. This version of the software does not support Companion.
- The MICS-XC system has all the functionality of MICS, plus it supports the Companion wireless functionality.

Both systems support ISDN PRI and BRI, and T1 functionality. All MICS 6.1 functionality is described in this book. For system coordinators, the *MICS 6.1 System Coordinator Guide* explains how to perform common telephone programming.

Companion wireless programming and installation instructions are documented in the *Modular ICS Companion Installer Guide* and the *Modular ICS Companion System Coordinator Guide*.

Information that is specific to MICS-XC systems or MICS systems is clearly marked within this guide.

Note: Throughout this guide, reference to KSU refers to the Integrated Communication System (ICS).

What's new with Norstar

The Norstar MICS 6.1 includes several new features and a few functionality changes.



To upgrade from any previous version of MICS software to MICS 6.1, refer to *Upgrading your Norstar system* on page 199 for detailed instructions.

New features and hardware for version 6.1

- T24 Key Indicator Module (KIM) and T7316E Business Series Terminal. When put together, the unit is referred to as a Central Answer Position (CAP).

These two pieces of hardware are designed to replace the M7324/CAP module setup. The T7316E can also be deployed as a stand-alone unit, and works the same way as previous versions of the T7316 with some minor changes, including an active handsfree key below the main dialpad. Both units come with installation instructions.

The KIM can be used in two configurations. The ordinary KIM (OKIM) has the same functionality as the current unassigned CAP module. The enhanced KIM (eKIM) supports lines, multiple target lines, and hunt group appearances (*CAP/KIM assign* on page 435).

Up to four KIMs can be attached to an enhanced T7316E, without requiring a system auxiliary power supply (SAPS). A T7316E can only support a maximum of four eKIMs, however, it can support up to nine OKIMs, with the addition of a SAPS. The system can support a maximum of five CAP units using EKIMs. This number

will include any T7324-based CAP installations you might already have. The system can support many more CAP units using OKIMS.

The KIM and T7316E also provide call-specific icons to make call tracking easier.

You cannot program Answer DN keys onto a KIM.

- destination code enhancements
 - 12-digit destination code: You can specify up to 12 digits as a destination code, which allows you to support user expectations of dialing requirements for existing systems. For instance, if your users are used to dialing 91XXX-XXX-XXXX for a long distant call, they can continue to do so, even though the call may go through your private network or may use more than one route. This allows you to provide a seamless transition to network dialing. (*Routes and destination codes* on page 381)
 - multiple least-cost routing: When you specify a schedule other than Normal for a destination code, you can specify up to three possible routes the call can access, in order of preference. (*Programming for least cost routing* on page 395)

- Silent monitor for hunt groups

Your Hunt group supervisors can now monitor hunt group calls, either silently, or by providing a conference tone to indicate that the call is being monitored (*Silent Monitor* on page 432). Other new functionality has been added to allow you to determine which telephones will be allowed to silent monitor (*Capabilities* on page 335), how many monitoring telephones your system will allow (*SM sets* on page 466), and what password is required to enter a monitoring session (*Silent Monitor password* on page 407). Refer to the *Modular ICS 6.1 System Coordinator*

Guide for a detailed description about how to use the feature.

- CLID display enhancements:
 - display an incoming call CLID on a telephone with activated CLID display, where a call is currently active.
- overlap dialing (profile 2 only)
 - For calls over PRI lines that require pauses between dialing sequences, this feature allows the line to send a dialtone to the user between dialing an access code and dialing the telephone number.

Other feature notes

- MCDN Meridian attendant break-in feature correction: Only post-dial break-in is allowed. (*Break-in* on page 154)
- MCDN Meridian attendant camp-on feature note: Meridian attendants need to be notified that they must wait at least five seconds before assuming that a camp-on call has been camped. This is due to remote system requirements for checking for busy on the target telephone and determining if a prime telephone has been assigned.
- MCDN on tandem networks has been adjusted to correct or accommodate some networking issues experienced in previous versions. Changes are invisible to the user.

The Norstar Remote Utility (NRU) application is being replaced by the ICS Remote Tools (ICSRT) application, which has some of the same functionality of Norstar Manager. The *ICSRT Quick Reference Guide* provides an overview of the features of the ICSRT application. The *ICS Remote Tools User Guide* provides details about using the application.

Welcome to ISDN

This chapter provides you with some background information about ISDN, including information about:

- analog vs. ISDN
- type of ISDN service
- ISDN layers
- ISDN bearer capability
- services and features for ISDN PRI and BRI
- ISDN hardware
- ISDN standards compatibility

Integrated Services Digital Network (ISDN) technology provides a fast, accurate, and reliable means of sending and receiving voice, data, images, text, and other information through the telecom network.

ISDN uses existing analog telephone wires. The signal on the wire gets divided into separate digital channels, which dramatically increases the bandwidth.

ISDN uses a single transport to carry multiple information types. What once required separate networks for voice, data, images, or video conferencing is now combined on to one common high-speed transport.

Note: Nortel endeavors to test all variations of ISDN BRI and PRI on Norstar. However, due to the number of variations, this is not always possible. Check with your service provider about compatibility.

Comparing ISDN to Analog

ISDN offers significantly higher bandwidth and speed than analog transmission because of its end-to-end digital connectivity on all transmission circuits. Being digital allows ISDN lines to provide better quality signaling than analog POTS (plain ordinary telephone) lines. Also ISDN out-of-band data channel signaling offers faster call setup and tear down.

While an analog line carries only a single transmission at a time, an ISDN line can carry one or more voice, data, fax and video transmissions simultaneously.

An analog modem operating at 14.4 K takes about 4.5 minutes to transfer a 1 MB data file, while a 28.8K modem takes about half that time. Using one channel of an ISDN line, the transfer time is reduced to only one minute. If two ISDN channels are used, transfer time is just 30 seconds.

When transmitting data, the connect time for an average ISDN call is about three seconds per call, compared to about 21 seconds for the average analog modem call.

Type of ISDN service

Two types of ISDN services (lines) are available: Basic Rate Interface (BRI) and Primary Rate Interface (PRI). Each line is made up of separate channels known as B and D channels which transmit information simultaneously.

- BRI is known as 2B+D because it consists of 2 B-channels and one D-channel.
- PRI is known as 23B+D because it consists of 23 B-channels and one D-channel.

B channels

B channels are the bearer channel. They are used to carry voice or data information and have speeds of 64 kbps. Since each ISDN line (BRI or PRI) has more than one B-channel, more than one transmission can occur at the same time, using a single ISDN line.

D channels

The standard signaling protocol is transmitted over a dedicated data channel called the D-channel. The D-channel carries call setup and feature activation information to the destination. This channel has speeds of 16 kbps (BRI) and 64 kbps (PRI). Data information consists of control and signal information and packet-switched data such as credit card verification.



Tip - *Norstar PRI supports the D-channel on the 24th channel only. Norstar does not include support for a backup D-channel on the span.*

ISDN layers

ISDN layers refer to the standards established to guide the manufacturers of ISDN equipment. The layers include both physical connections, such as wiring, and logical connections, which are programmed in computer software.

When equipment is designed to the ISDN standard for one of the layers, it works with equipment for the layers above and below it.

There are three layers at work in ISDN for Norstar. To support ISDN service, all three layers must be working properly.

Layer 1: A physical connection that supports fundamental signaling passed between the ISDN network (your service provider) and the Norstar ICS. When a DTI card configured as BRI or PRI is used for a network connection, the LED for the loop on the card is lit when the layer 1 is functioning.

Layer 2: A logical connection between the ISDN network (your service provider) and the Norstar ICS. Norstar has two of these connections for each BRI line, one for each of the logical lines. Without Layer 2, call processing is not possible, and there is no dial tone.

Layer 3: Also a logical connection between the ISDN network (your service provider) and the Norstar ICS. For BRI lines, layer 3 is where call processing and service profile identifier (SPID) information is exchanged. This controls which central office services are available to the connection. For example, a network connection can be programmed to carry data calls.

The system of layers is important when you are installing, maintaining, and troubleshooting an ISDN system. See *Problems with BRI service* on page 600 for more information about working with the layers.

ISDN bearer capability

Bearer capability describes the transmission standard used by the BRI or PRI line that allows it to work within a larger ISDN hardware and software network.

The bearer capability for BRI and PRI is voice/speech at 3.1 kHz audio, and data at unrestricted 64 kbps, restricted 64 kbps, 56 kbps.

Services and features for ISDN PRI and BRI

As part of an ISDN digital network, your Modular ICS supports enhanced capabilities and features, including:

- faster call setup and tear down
- high quality voice transmission
- dial-up Internet and local area network (LAN) access
- video transmission
- network name display
- name and number blocking (PRI, BRI and analog)
- access to public protocols (only NI-1 for BRI)

PRI services and features

- call by call service selection
- dialing plan
- Emergency 911 dialing, internal extension number transmission
- Advanced Private Networking to Meridian 1 using SL-1 protocol, providing
 - access to central Voice Mail and Automated Attendant equipment connected to the Meridian system
 - Message Waiting Indication (MWI) from the Voice Mail application
 - Network Call Redirection Information (NCRI), which is built on the existing Call Forward and Call Transfer features
 - trunk route optimization (TRO)
 - trunk anti-tromboning (TAT)
 - ISDN call connection limitation (ICCL)
- tandem networking between Norstar systems

BRI services and features

- data transmission at speeds up to 128 kbps per loop, depending on the bandwidth supported by your service provider
- shared digital lines for voice and data ISDN terminal equipment

Norstar Basic Rate Interface (BRI) cards also support D-channel packet service between a network and terminal connection. This allows you to add applications such as point-of-sale terminals without additional network connections.

Any analog or digital network connections can be shared by all Norstar telephones, peripherals and applications, and ISDN terminal equipment (TE).

Modular ICS supports the following ISDN services and features offered by ISDN service providers:

- D-channel packet service (BRI only) to support devices such as transaction terminals. Transaction terminals are used to swipe credit or debit cards and transmit the information to a financial institution in data packets.
- calling number identification, which appears on both Norstar sets and ISDN terminal equipment with the capability to show the information
- Multi-Line Hunt or DN Hunting which switches a call to another ISDN line if the line usually used by the Network DN is busy. (*BRI only*)
- subaddressing of terminal equipment (TE) on the same BRI loop. However, terminal equipment which supports sub-addressing is not commonly available in North America. (*BRI only*)

Transmission of B-channel packet data is not supported by Modular ICS.

Contact your ISDN service provider for more information about these services and features. Packages for ISDN service in North America are described on page 64.

The terminal equipment (TE) connected to the Norstar system can use some feature codes supported by the ISDN service provider. Refer to *ISDN services and features* in the *Modular ICS 6.1 System Coordinator Guide* for more information.

Feature descriptions

The following section provides brief descriptions about the ISDN features, and links for more programming information.

Network name display

This feature allows ISDN to deliver the Name information of the users to those who are involved in a call that is on a public or private network. For information about system programming for this feature see, *BusName* on page 453.

Systems with Advanced Private Networking connections (MCDN SL-1) to a Meridian system also retain information about sets that have forwarded or transferred a call, as well as the originating caller information. This feature is called Network Call Redirection Information (NCRI). This information is available to all parties involved in the call.

Calls can only be redirected for a defined number of times within the network. This is currently hardcoded to five times. Once this limit is reached, call redirection will be disallowed for any type of outgoing line being presented for redirection.

Instead, the call will be handled in one of these ways:

- If Call Forward on Busy is programmed, the call will ring if a free key is available. Otherwise, it goes to the Prime set. DND Busy programming is ignored.
- If Call Forward All Calls is programmed, the call will go to the Prime set.
- If Call Forward No Answer is programmed, the call will continue to ring at the destination.

Note: If a terminal rejects a call, the call goes to the Prime set, if a Prime set is configured for the target line. If the target line is configured to send a busy tone, the call gets released with the reason as *User Busy*.

Message Waiting Indicator (MWI)

Systems with Advanced Private Networking connections to a Meridian system Voice Mail system provide message-waiting indicators at telephones connected to those lines. Telephones with displays display a message. Non-display terminals may have a lamp that lights when a message is waiting. The setting for this feature is defined from the Meridian system.

Name and number blocking

This feature suppresses the outgoing name and/or number on a call-by-call basis. For information on system programming of this feature see, *Outgoing Name and Number Blocking* on page 456.

External call forwarding

The system now allows you to forward calls to an external number. This feature is activated using 4 from the telephone.

MCDN trunk features

Systems with MCDN Private Networking connections can provide these trunk routing features:

- Trunk Route Optimization (TRO) finds the most direct route through the network to send a call between nodes. This function occurs during the initial alerting phase of a call.
- ISDN Call Connection Limitation: The ICCL feature piggybacks on the call initiation request and acts as a check at transit PBX points to prevent misconfigured routes or calls with errors from blocking channels.
- Trunk Anti-tromboning (TAT) is a call-reroute feature that works to find better routes during a transfer of an active call. This feature acts to prevent unnecessary tromboning of trunks. This action occurs after the speech path has been established.

Call by Call service selection for PRI

Call by Call service selection allows a user to access services or private facilities over a PRI line without the use of dedicated facilities. Various types of services such as FX, Tie, and OUTWATS are available, depending on the Protocol that is selected. Private network settings are used for tandem networking and Advanced Private Networking.

Outgoing calls are routed through a dedicated PRI Pool and the calls can be routed based on various schedules.

For information about system programming of this feature, see *Programming Call by Call service selection* on page 460.

For services information about dialing plans and PRI, see *Networking with Norstar* on page 99 and *Dialing Plan* on page 436.

Refer to the hardware section for *Call-by-call routing* on page 485.

Emergency 911 dialing

Modular ICS 6.1 with the ISDN PRI feature is capable of transmitting the telephone number and internal extension number of a calling station dialing 911 to the Public Switched Telephone Network.

State and local requirements for support of Emergency 911 dialing service by Customer Premises Equipment vary. Consult your local telecommunications service provider regarding compliance with applicable laws and regulations. For most installations, the following configuration rules should be followed, unless local regulations require other settings.

- All PSTN connections must be over PRI.
- In order for all sets to be reachable from the Public Safety Answering Point (PSAP), the system must be configured for DID access to all sets. In order to reduce confusion, the dial digits for each telephone should be configured to correspond to the extension number (DN).
- The OLI digits for each telephone should be identical to the DID dialed digits for the telephone.
- The System Coordinator is responsible for maintaining a site map or location directory that allows emergency personnel to rapidly locate a telephone given its DID number. This list should be kept up to date and readily available, and can be included in the Programming Record

- The routing table should route 911 to a public line or line pool.
- If attendant notification is required, the routing table must be set up for all 911 calls to use a dedicated line which has an appearance on the attendant console.

Note: The actual digit string 911 is not hard-coded into the system. More than one emergency number can be supported

MCID (Profile 2)

The MCID feature allows you to use to have call information recorded on the central office database for an incoming call on a specific line (EUROISDN lines, only).

The user must invoke the feature code during the active call or within 30 seconds (time varies on different networks) after the caller hangs up. The user must remain on the line to enter the code.

Network Call Diversion (Profile 2)

This feature is a network function of ETSI E1 lines that allows forwarding and redirection of calls outside the Norstar network when using an ETSI ISDN line. Functionality is similar to that of External Call Forward (ECF). NCD redirects calls using the same line on which they arrive. Call forward is efficient since there is no need for additional outside lines.

DTI card configured as a PRI card

The DTI card on your Norstar system can be configured to support PRI. For information about configuring a DTI card as a PRI type card, see *Provisioning the DTI card for PRI* on page 483.

ISDN hardware

To support connections to an ISDN network and ISDN terminal equipment, your Modular ICS must be equipped with one or more BRI cards (BRI-U or BRI-ST), a DTI card configured for PRI, and a Combination Fiber 6-port Services Cartridge or a Services Cartridge.

DTI card configured as PRI

A DTI card configured as PRI provides one T loop. Refer to *T reference points* on page 58 for more information.

In most PRI network configurations, you need one DTI card configured as PRI in your ICS to act as the primary clock reference. The only time when you may not have PRI designated as the primary clock reference is in a network where your Norstar system is connected back-to-back with another switch using a PRI link, such as is the case with the Advanced Private Networking configuration.

However, if the other switch is loop-timed to your Norstar system, your DTI card, configured as PRI, can be designated as a timing master.

If your Norstar has two DTI cards configured as PRI, you cannot assign both cards as the primary reference or both cards as the secondary reference. You can only have one primary reference and one secondary reference per system. Refer to *ClockSrc* on page 492 for more information.

BRI Card

The loops on BRI-U and BRI-ST cards can be programmed to support either network or terminal connections. This allows you to customize your arrangement of lines, voice terminals, data terminals and other ISDN equipment.

Detailed wiring information for BRI and PRI network and terminal connections is included in the *Installation* on page 219.

BRI-U2 and BRI-U4 card

A BRI-U2 card supports two loops and the BRI-U4 supports four loops. Each loop can be individually programmed to provide one of the following:

- a U-LT reference point connection for terminal equipment (TE) with built-in NT1 functionality (U interface)
- a U-NT reference point connection for direct connection to an ISDN network

BRI-ST card

A BRI-ST card provides four loops. Each loop can be individually programmed to one of the following:

- an S reference point connection (S loop) to ISDN terminal equipment (TE)
- a T or S reference point connection (T loop or S loop) to an ISDN network using an external NT1

U-LT reference point

The U-LT reference point connection provides a point-to-point digital connection between Norstar and TE equipped with a U interface.

A U-LT loop supports up to eight ISDN DNs, which identify TE to the ICS. Refer to the example below.

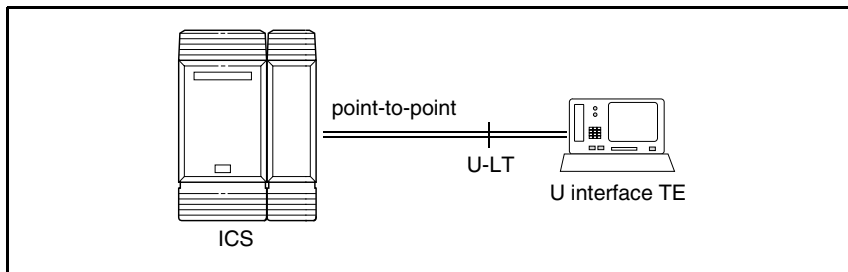

U-NT reference points

The U-NT reference point connection provides a point-to-point digital connection between the ISDN network and the ICS.

A U-NT loop provides lines that can be used by all Norstar telephones, peripherals and applications, and ISDN TE.

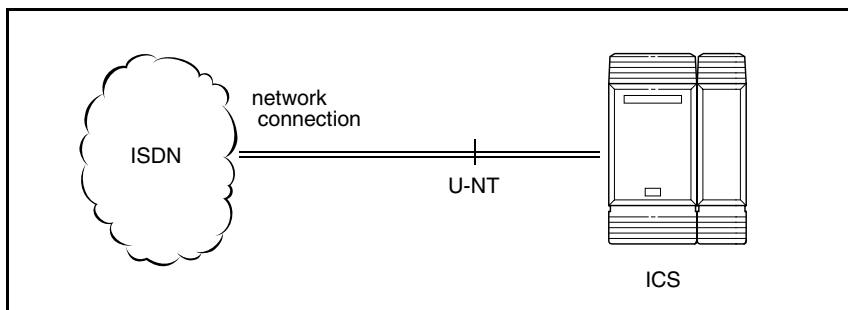

U-NT and U-LT loops can be used in combination to provide D-packet service for a point-of-sale terminal adapter (POSTA) or other D-packet device. D-packet service is a 16 kbps data transmission service that uses the D-channel of an ISDN line.

To deliver D-packet service, a network connection (U-NT) is programmed to work with a terminal connection (U-LT). The loops must be on the same physical card. For example, if the network connection is a loop found on the BRI Card in Slot 1, the terminal connection must be a loop found on the same card.

S reference point

The S reference point connection provides either a point-to-point or point-to-multipoint digital connection between Norstar and ISDN terminal equipment (TE) that uses an S interface.

S loops support up to seven ISDN DNs, which identify TE to the ICS.

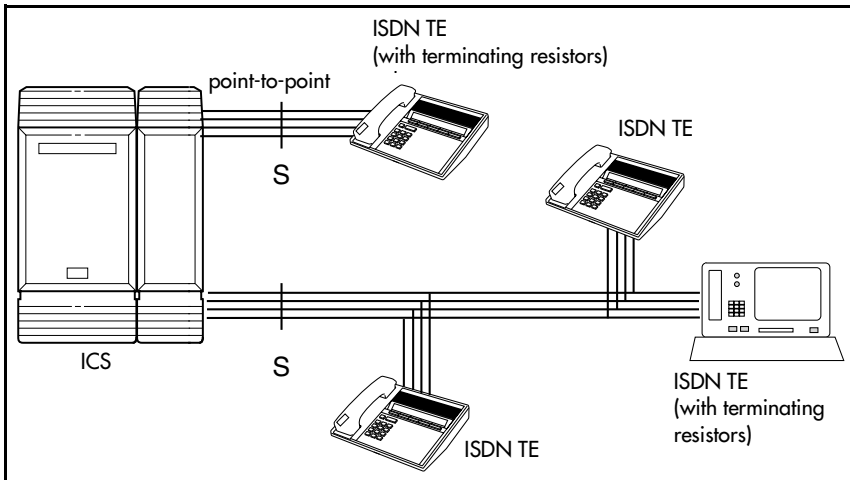

T reference points

The T reference point connections provide a point-to-point digital connection between the ISDN network and Norstar.

A T loop provides lines that can be shared by all Norstar telephones, peripherals and applications, and ISDN TE.

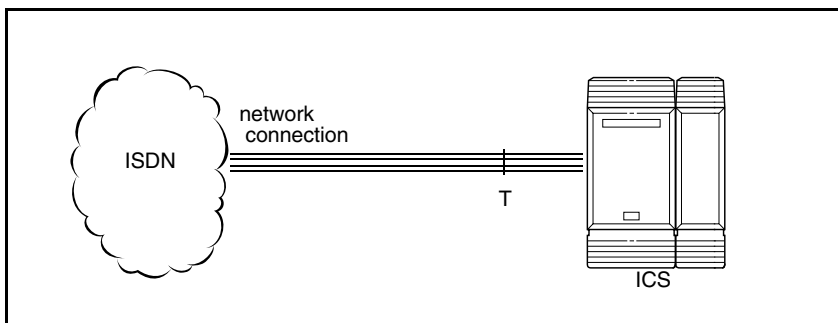

A T loop can be used in combination with an S loop to provide D-packet service for a point-of-sale terminal adapter (POSTA) or other D-packet device. D-packet service is a 16 kbps data transmission service that uses the D-channel of an ISDN line.

To deliver D-packet service, a network connection (T loop) is programmed to work with a terminal connection (S loop). The loops must be on the same physical card. For example, if the network connection is a loop found on the BRI Card in Slot 1, the terminal connection must be a loop found on the same card

Clock source for ISDN cards

Systems with ISDN interfaces need to synchronize clocking with the ISDN network and any connected ISDN terminal equipment. Clocking synchronization is supported by either a Combination Fiber 6-port Services Cartridge or a Services Cartridge.

The Modular ICS derives timing from the network using U-NT and T reference points (loops). Terminal equipment on U-LT and S reference points (loops) derive timing from the ICS.

Systems synchronize clocking to the first-available functional network connection. If there are excessive errors on the reference network connection, or if the loop fails, the next-available functional network connection is used for clock synchronization.

The clock synchronization process generates alarm codes and event messages. See the *Alarm codes* on page 533 and *Event messages* on page 541 for more information.

When you configure the network connections to the Modular ICS, you should take into account the system preferences for selecting loops for synchronization:

- lower numbered loops have preference over higher numbered loops
- the loop preference order is: 201, 202, 203, 204, 225, 226, 227, 228 (Profile 1, 3 and 4), or 201, 202, 203, 204, 231, 232, 233, 234 (Profile 2)
- the system skips U-LT, S, and analog loops when selecting a network connection for synchronization

Systems with only U-LT and S loops act as timing masters for the attached terminal equipment (TE), and are not synchronized to the network. ISDN TE without access to a network connection (BRI lines) has limited or no functionality.

If your system has both a BRI and a DTI card configured as PRI installed, it is recommended that you use PRI as the primary clock source, see *DTI card configured as a PRI card* on page 53.

Other ISDN BRI equipment: NT1

The NT1 (network termination type 1) connects an S interface (four-wire) to a U interface (two-wire). In most cases, it connects loops from a BRI-ST card to the network connection, which uses the U interface. It can also connect S interface terminal equipment (TE) to the U loop from a BRI-U2 or BRI-U4 Card.

An NT1 is not required to connect from the network to BRI-U cards or to connect U interface TE to an ICS equipped with BRI-U cards.

The NT1 converts and reformats data so it can be transmitted to and from the S or T connection. In addition, it manages the maintenance messages travelling between the network and the NT1, and between the NT1 and the ICS.

The NT1 from Nortel Networks is packaged two ways:

- as a stand alone package, which contains one NT1 card (NTBX80XX) and a power supply (NTBX81XX)
- as a modular package, which contains up to 12 NT1 cards (NTBX83XX) and a power supply (NTBX86AA)

ISDN standards compatibility

Norstar ISDN equipment supports National ISDN standards for basic call and calling line identification services.

Norstar BRI is compliant with National-1 and PRI is compliant with National-2.

Modular ICS does not support EKTS (Electronic Key Telephone System) or CACH (Call Appearance Call Handling).

Working with ISDN

Planning your ISDN network

Consult *ISDN hardware* on page 54 and *ISDN programming* on page 66 to determine a configuration of ISDN trunks and terminal equipment (TE) for the Modular ICS, then order the appropriate ISDN capability package from your ISDN service provider.

For ISDN BRI service, your service provider supplies service profile identifiers (SPIDs), network directory numbers (Network DNs), terminal endpoint identifiers (TEIs), and other information, as required, to program your Modular ICS, TE, and other ISDN equipment.

Modular ICS does not support any package with EKTS (Electronic Key Telephone System) or CACH (Call Appearance Call Handling). EKTS is a package of features provided by the service provider and may include features such as Call Forwarding, Link, Three-Way Calling, and Calling Party Identification.

Ordering ISDN PRI

When you order ISDN PRI, order two-way DID because it simplifies provisioning and provides efficient use of the PRI bandwidth.

Ordering ISDN PRI service in Canada

In Canada, order Megalink™ service, the trade name for standard PRI service and set the Norstar equipment to the supported protocol that is identified by your service provider, either DMS-100 or NI-2.

Ordering ISDN PRI service in United States

In the United States order PRI service from your service provider. Set the Norstar equipment to the PRI protocol provided by your service provider.

Ordering ISDN BRI

Ordering service in Canada

In Canada, order Microlink™ service, the trade name for standard BRI service. You can order either regular Microlink™ service, which includes the CLID (Calling Line Identification) feature, or Centrex Microlink™, which includes access to additional ISDN network features (including Call Forwarding).

When ordering Microlink™ service, it must be ordered with EKTS (Electronic Key Telephone System) turned off. If you will be using a point-of-sale terminal adapter (POSTA), ask for D-packet service to be enabled.

Ordering ISDN service in the U.S.

In the U.S., regardless of the CO (Central Office) type, order National ISDN BRI-NI-1 with EKTS (Electronic Key Telephone System) turned off. Use the following packages as a guideline for ordering your National ISDN BRI-NI-1.

However we recommend using packages M or P with the Modular ICS. Contact your service provider for more information about the capability packages it offers.

Bellcore/National ISDN Users Forum (NIUF) ISDN packages supported by Modular ICS (for ordering in U.S.)

	Capability	Feature set	Optional features	Point-of-sale	Voice	Data
M	Alternate voice/circuit-switched data on both B-channels	--	calling line identification	--	✓	✓
P	Alternate voice/circuit-switched data on both B-channels D-channel packet	flexible calling for voice (not supported by Modular ICS) Basic D-Channel Packet	additional call offering (not supported by Modular ICS) calling line identification	✓	✓	✓

If you want to transmit both voice and data, and support D-channel packet service, order package P. However, Modular ICS does not support the flexible calling for voice and additional call offering features that are included in package P.

Multi-Line Hunt may be ordered with your package. When a telephone number (the Network DN) in the group of numbers assigned by your service providers is busy, the Multi-Line Hunt feature connects the call to another telephone number in the group. Norstar supports the feature only on point-to-point, network connections (T loop or U-NT loop). Check with your service provider for more information about Multi-Line Hunt.

Any of the ISDN packages will allow you to use sub-addressing, but your ISDN TE must be equipped to use sub-addressing for the feature to work.

Supported ISDN protocols

The switch used by your service provider must be running the appropriate protocol software and the correct version of that software to support ISDN PRI and ISDN BRI. Each protocol is different and supports different services. Contact your service provider to ensure that your ISDN connection has the protocol you require.

For more information about the supported protocols and services, refer to *Call by Call service selection for PRI* on page 457.

ISDN programming

Most of the configuration programming for PRI and BRI lines and ISDN terminals and devices is done under **Hardware**. This section gives you an overview of programming for PRI and BRI lines, ISDN terminals and devices, and D-packet service.

PRI or BRI programming activity	Programming heading
View or change the card configuration for each slot in the ICS	Hardware
Provision or deprovision loops and lines	Provisioning
Enable or disable BRI or DTI card (PRI)	Module status
View status of line, loop or port	Port/DN status
Enable/disable individual PRI channels	Link Status

Programming ISDN PRI resources

Some steps will not be necessary, depending on the service you are providing.

More detailed information is included under the individual headings and settings in the Programming and Maintenance sections.

For complete card and cartridge installation instructions and safety precautions, see *Installation* on page 219.

1. Collect the information supplied by your service provider to support your ISDN package.
2. Ensure that a Combination Fiber 6-port Services Cartridge, or a Services Cartridge has been installed in the ICS.
3. Install the DTI cards in the ICS. Refer to *Installing the cartridges* on page 223 for information about card placement. If you are not using DTI cards, determine which type of card you will preprogram the ICS to use in each slot.



Tips - *For systems running 6.0 or greater software, a DTI card can be installed off-core on Module 3 or 4 on the Midi system, or module 7 or 8 on the Maxi system to expand the PRI capability of your system. This card is only supported on Profile 1 and 4.*

Note: Legacy DTI cards cannot be used off-core. A new DTI card was released in 2002 that can be used in any position.

4. Disable each card under **Maintenance**.

5. Select a card type (PRI) in **Hardware**. See *Provisioning the DTI card for PRI* on page 483, for information about protocol and other settings you must configure.



Tips - *If you are using one or more of the lines on this card for MCDN private networking, this is where you specify that protocol (SL-1).*

6. Re-enable the card in **Maintenance**.

If required, the card goes through a firmware download process, which takes five to six minutes. During a firmware download, the bottom LED on the DTI card flashes.

Programming ISDN BRI resources

Some steps will not be necessary depending on the service you are providing.

More detailed information is included under the individual headings and settings in the Programming and Maintenance sections.

For complete card and cartridge installation instructions and safety precautions, see *Installation* on page 219.

1. Collect the information supplied by your service provider to support your ISDN package. This includes network service profile identifiers (SPIDs) and Network DNs. If you are supporting a point-of-sale terminal adapter, you also need one or more terminal endpoint identifiers (TEIs).
2. Make sure a Combination Fiber 6-port Services Cartridge, or a Services Cartridge has been installed in the ICS.
3. Install the BRI card in the ICS, Trunk Module. Refer to *Installing the cartridges* on page 223 for information about

BRI card placement. If you are not using a BRI card, determine which type of card you will preprogram the ICS to use in each slot.

4. Disable each card in **Maintenance** under **Module Status**.
5. Under **Hardware**, select a card type: **BRI-ST**, **BRI-U2**, **BRI-U4**.
6. Under **Hardware**, select the type for each loop:
 - for a BRI card, select **T** or **S** if the card type is **BRI-ST**
 - for a BRI-U2 or BRI-U4 card, select **LT** or **NT**
7. If the card uses a T or NT loop, enter the following information, as supplied by your service provider:
 - the SPID assigned to the loop
 - the number of B-channels associated with each SPID
 - the Network DNs used with the network SPID
 - the call type of the Network DN

Repeat the programming for the second network SPID, if any.

If the T or NT loop is used for D-packet service:

- turn on the service
- assign the appropriate S-loop mapping for BRI-ST cards or LT-loop mapping for BRI-U2 or U4 cards
- assign the TEIs to the loop. These are provided by the telco to support a point-of-sale terminal adapter or other D-packet service device.

If the loop type is S, select the sampling used on the loop.

If the loop type is S or LT:

- assign ISDN DNs to the loop
- designate one of the assigned ISDN DNs to be the DN for the loop (Loop DN).

Note: You can have a maximum of 30 ISDN DNs on your system. The default ISDN DN range is 667–696 for a system with three-digit DNs. To change ISDN DN type, see *Change DNs* on page 418.

8. Re-enable the card in **Maintenance**. Refer to *Disabling a PRI Channel* on page 551.

If required, the card goes through a firmware download process, which takes five to six minutes. During a firmware download, the bottom LED on the BRI card flashes.

9. Provision the loops and lines, as appropriate, in **Maintenance**. Refer to *Provisioning BRI and PRI lines* on page 549.

10. If you are configuring auto-answer BRI trunks to map to target lines, program the received number for the target line to be the same as the Network DN supplied by your service provider. This setting is found under **Lines**.

Assign the ISDN lines and target lines to the appropriate ISDN DNs, which are the set of DNs reserved for use by ISDN devices. This setting is found under **Terminals&Sets/Line access**. ISDN lines can also be assigned to the DNs used by the telephones or any other devices connected to the Modular ICS.

Program the ISDN terminals and devices with the appropriate ISDN DNs and terminal SPIDs by following the instructions that come with the devices. For more information, see *Programming ISDN equipment* on page 73.

If you are setting up a D-packet service, program the point-of-sale terminal adapter or other D-packet service device with the appropriate TEI (provided by your service provider), terminal SPID, and DN by following the instructions that come with the device.

Programming ISDN PRI lines

When the configuration programming under **Hardware** is complete, your PRI lines are ready to be programmed. For information about programming your PRI lines, see *Call by Call service selection for PRI* on page 457.

Programming ISDN BRI lines

When the configuration programming under **Hardware** is complete, your BRI lines are ready to be programmed in the same way as analog lines. You can, for example, place them in pools and assign them to Norstar telephones, Business Series Terminals, or ISDN terminal equipment.

However, there are some differences in the way BRI lines work that will influence how you configure them to handle incoming and outgoing calls.

- For BRI lines, in most cases, your service provider supplies two SPIDs – one for each B channel. Each SPID and one or more Network DNs are associated with a single line. Calls to a Network DN come in on a specific line. Pressing a line button selects the same line every time.
- If your service provider supplies you with a single SPID for both B channels, incoming and outgoing calls are handled according to the loop. The two lines provided by the BRI loop are pooled for both incoming and outgoing calls.

For example, if Loop 201 is programmed with a single SPID, which supports lines 001 and 002, incoming calls made to a Network DN associated with the SPID appear on either line 001 or line 002. If you press the line button for line 001, either line 001 or line 002 is selected. For loops which use a single SPID, assign both lines on a loop to a telephone to guarantee that all calls appear at the telephone.

Programming Direct Inward System Access (DISA) on PRI trunks

When a trunk cartridge is set to PRI, all lines on that trunk are set to Auto Answer without Direct Inward System Access (DISA).

DISA can be accessed by one of two methods.

- 1) Define the DISA DN to match the trailing digits of the Called Party Number (CDN).

With Public, Private, and Tie service types, the CDN is simply truncated to the Target Line Receive Digit Length and is parsed to match the Target Line Receive Digits. DISA can be accessed by having the DISA DN match the trailing digits of the CDN. For example, with a Receive Digit Length = 4, and DISA DN = 1234, a call made to Public DN 763-1234 will be handled as follows:

- the ISDN setup message will contain a CDN of 763-1234
- the CDN will be truncated to the four digits, 1234
- 1234 matches the DISA DN
- the call will be answered with DISA

- 2) Use incoming Call by Call (CbC) Service routing to map the call type to the DISA DN. Refer to *Programming Call by Call service selection* on page 460 for more information.

With FX, INWATS, 900, and SDS service types, either a Service Id (SID) or a CDN is mapped to Target Line Receive Digits.

This is programmed under Call-by-Call Routing. DISA may be accessed by having the SID or CDN map to the DISA DN. This example has a Receive Digit Length = 4, DISA DN = 1234, and CbC Routing with (Service Type = FX, Map from SID = 2, Map to digits = 1234).

A call presented to the Norstar system with service type FX and SID 2 will be handled as follows:

- The ISDN setup message will specify FX with SID = 2
- The FX SID = 2 will be mapped to DISA DN digits 1234

The call will be answered with DISA

Programming ISDN equipment

DTI cards configured as PRI support various applications that are enabled by PRI. For a list of the type of applications that are support, see *ISDN applications* on page 183.

Terminal equipment for BRI cards

ISDN devices and terminals connected to the ICS must be configured under the **Hardware** heading in system programming. You choose directory numbers for ISDN equipment from a pre-determined range of DNs (667-696). Any of the ISDN DNs can be assigned to any U-LT or S loop, but each can only be assigned to one loop and one device.

Devices on an S or LT loop (BRI cards only)

Terminal equipment using a U-LT loop or S loop must be assigned an ISDN directory number (ISDN DN). This allows the TE to be assigned lines and to communicate with other devices connected to the ICS. Each DN can be assigned to only one TE and one loop.

You assign ISDN DN's to S loops and LT loops under **Assign DN's** under **Hardware**. Each S or LT loop can be programmed with eight ISDN DN's, but you cannot exceed a total of 30 ISDN DN's for the Modular ICS.

Once you have assigned ISDN DN's to a loop, designate one of the DN's as a Loop DN. The Loop DN acts as a main ISDN DN and completes the configuration of the loop.

The ISDN terminal equipment (TE) on the loop is also programmed with its ISDN DN. See the instructions that come with the ISDN device for information on how to program it to recognize the assigned DN. Most devices will require both a terminal service profile identifier (terminal SPID) and a DN, and some will require two terminal SPIDs and two ISDN DN's. The SPID used with the device should not be confused with a SPID used for network connections using an T or NT loop.

To create a terminal SPID for a device, add at least two zeros to the end of the ISDN DN. Add more zeros to the beginning or end of the ISDN DN until you have the length of SPID required by the TE. For example, if an ISDN telephone requires a six-digit SPID and has a DN of 667, its SPID is 066700. If the same TE requires a minimum of 10 digits, the SPID is 0000066700.

Most ISDN terminals require a five-digit SPID. An ISDN PC card usually requires a 10-digit SPID. Follow the directions that come with the ISDN device to program it with a SPID and ISDN DN.

Adding zeroes to SPIDs

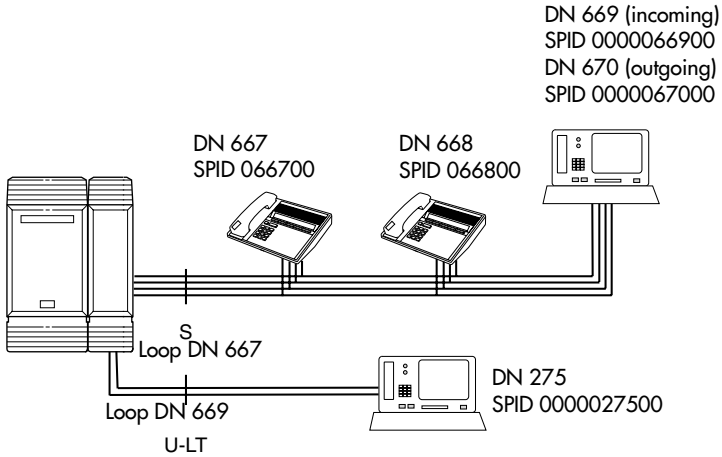

The following table uses the example in the illustration to show the programming for the S loop.

Setting	Option
Loop	201
Type	S
Sampling	Fixed
DNs on Loop 201: Assign DNs	667: Assigned 668: Assigned 669: Assigned 670: Assigned
Loop DN	667

ISDN router

By connecting an ISDN router to your Modular ICS, a group of PCs can share Internet access. This arrangement is best for a workplace where each personal computer occasionally uses an Internet connection.

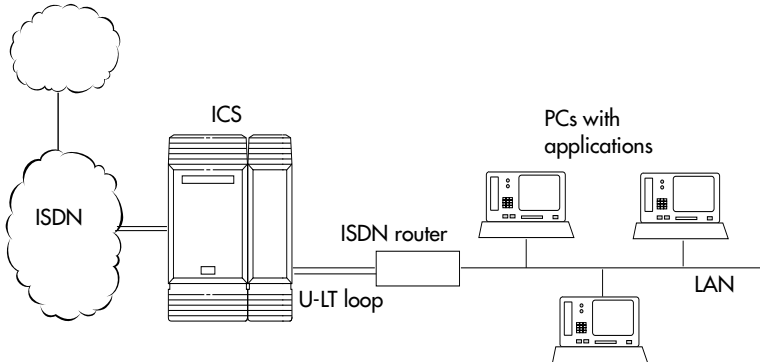

To support Internet access, you must order BRI lines from your service provider, and subscribe to an Internet service from an Internet service provider (ISP). Your personal computer must have an Internet browser and any applications supplied by your ISP.

D-packet service (BRI cards only)

The D-packet service supplied by the Modular ICS supports a point-of-sale terminal adapter (POSTA). Connecting a POSTA allows transaction terminals, such as devices where you swipe credit or debit cards, to transmit information using the D channel of the BRI line. At the same time, the B channels of the BRI line remain available for voice and data calls. A special adapter links transaction equipment, such as cash registers, credit card verification rigs, and point-of-sale terminals, to the X.25 network. This is a data communications network designed to transmit information in the form of small data packets.

To support the D-packet service, your ISDN network and financial institution must be equipped with a D-packet handler. To convert the protocol used by the transaction equipment to the X.25 protocol, your ISDN network must also be equipped with an integrated X.25 PAD.

X.25 PAD works with the following versions of X.25: Datapac 32011, CCITT, T3POS, ITT and API. The ISDN service package you order must include D-packet service, for example, Package P in the U.S. or Microlink™ with D-channel in Canada.

Your service provider supplies a Terminal Endpoint Identifier (TEI) and a DN to support D-packet service. The TEI is a number between 00 and 63 in the U.S. In Canada, the default range is 21-63. Your service provider may also supply you with a DN to program your D-packet device. The DN for D-packet service becomes part of the dialing string used by the D-packet to call the packet handler.

POSTA for ISDN BRI

When you configure D-channel packet service, you are specifying the transmission path between an ISDN loop on the network side of the ICS and the ISDN loop on the telephone side. The telephone side loop is the loop used by the point-of-sale terminal adapter. The service is turned on and configured using the network loop programming found under **Hardware**. Use NT loop for BRI-U2 and BRI-U4 cards and S or T loop for BRI-ST cards.

To set up D-packet service:

- go to the programming settings for the network loop under **Hardware**. (S, T, or NT loop)
- select the S loop or LT loop used by the POSTA

- enter the terminal endpoint identifiers (TEIs) supplied by your service provider

Point-of-sale terminal adapter

The point-of-sale terminal adapter is an analog device that connects to point-of-sale devices using an RS-232 interface and a U-LT loop. It handles the routing of packet information from the devices to the ICS and into the ISDN network.

Your service provider, usually a financial institution, supplies you with information about the compatible controller, which handles the routing of packet information from the devices to the ICS and into the ISDN network.

Trunks and target lines

Trunks are external lines that provide the physical connection between a Norstar system and other systems in a private or public network. Trunks are numbered 001 to 156 in a fully expanded system. Norstar Modular ICS supports six different types of trunks:

- PRI trunks are used for incoming and outgoing calls over an ISDN network. PRI SL-1 lines can provide MCDN network functionality in a private network between other Norstar systems, Meridian 1 systems, or Business Communications Systems, if the appropriate software code has been installed.
- T1 trunks are digital trunks that can be configured to act as loop start, ground start, E&M, DID, or leased lines, depending on your requirements.
 - DID trunks route incoming calls from the public network directly to telephones within Norstar, without an attendant.
 - Loop start trunks handle incoming and outgoing calls between Norstar and the public network.
 - E&M trunks handle incoming and outgoing traffic between the Norstar system and the private network.
- BRI trunks handle incoming and outgoing calls between Norstar and an ISDN network.
- Target lines are virtual communication paths between trunks and telephones on the Norstar system. They are incoming lines only, and cannot be selected for outgoing calls. With 192 target lines in a fully expanded system, you can concentrate auto answer calls on fewer trunks. This type of concentration is an advantage of target lines. Norstar mapping allows you to direct each target line to

one or more telephones. Target lines are numbered 157 to 348 in a fully expanded system, and 157 to 284 in all others.

Telephones can be configured to have an appearance of any type of trunk and line, including target lines, but excluding PRI trunks. If assigned, they are used for monitoring call usage.

Trunk operating modes (T1)

T1 trunks have four operating modes:

- ground start (T1 only)
- loopstart (analog and T1)
- E&M (analog and T1)
- DID (analog and T1)

Ground start trunks (T1 only)

Ground start trunks offer the same features as loop start trunks, but are used when the local service provider does not support disconnect supervision for the digital loop start trunks. Ground start trunks work with T1 only.

By configuring lines as ground start, the system will be able to recognize when a call is released at the far end.



Tips - *You cannot change the trunk mode for a ground start trunk on a DTI. It always has disconnect supervision.*

A DTI can provide a maximum of 24 ground start trunks. Analog ground start trunks are not supported.

DID trunks

DID trunks give you direct inward dialing (DID) from the public network. A typical application of these trunks is to map incoming digits onto target line appearances within the Norstar system. DID trunks can operate only as auto-answer trunks.

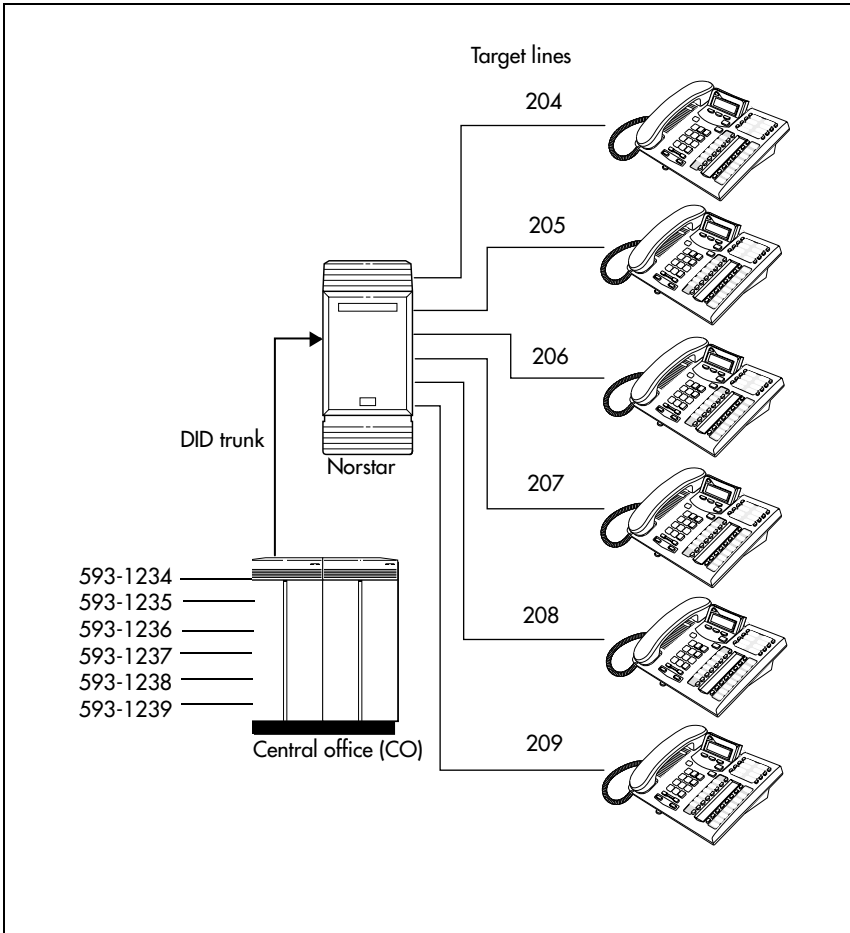

When a call comes in on a DID trunk, the Norstar system interprets the incoming digits in one of the following ways.

- If the digits map onto a target line, the call is routed to all telephones with an appearance of that target line.
- If the digits map onto the DISA DN, the caller hears stuttered dial tone. They must enter a six-digit Class of Service (COS) password from a DTMF telephone to hear system dial tone.

They can then enter a:

- target line number
- line pool access code
- remote feature code
- If the digits map onto the Auto DN, the caller hears system dial tone. They can then enter:
 - a target line number
 - the DISA DN, which will prompt for a Class of Service password
 - a line pool access code
 - a destination code
 - a remote feature code from a DTMF telephone



Tips - *Each DID Trunk Cartridge can provide four DID trunks. Each DID Trunk Cartridge also has four DTMF receivers dedicated to those trunks. A DTI can provide up to 24 DID trunks.*

You cannot configure a DID trunk as the prime line for a Norstar telephone or a Business Series Terminal.

The capabilities available to a remote caller are determined by the remote filters and remote package assigned to a line, or by the set restrictions, line restrictions and remote package assigned to the Class of Service password.

Analog loop start trunks

Loop start trunks give you incoming and outgoing access to the public network. Loop start trunks can be configured as manual-answer or auto-answer. The answer mode determines how the system handles incoming calls.

When a call comes in on a manual-answer loop start trunk, it alerts at all telephones with that line appearance.

When a call comes in on an auto-answer loop start trunk that is configured to answer with direct inward system access (DISA), the caller hears a stuttered dial tone. They must enter a six-digit Class of Service (COS) password from a DTMF telephone to access system dial tone.

Once the caller has system dial tone, they can then enter:

- a target line number
- a line pool access code
- a remote feature code.

By default, auto answer loop start trunks are configured to answer with DISA, and are used to provide controlled access to Norstar system resources.

When a call comes in on an auto-answer loop start trunk that is not configured to answer with DISA, the caller hears system dial tone.

They can then enter:

- a target line number
- the DISA DN, which will prompt for a Class of Service password
- a line pool access code
- a remote feature code from a DTMF telephone

To place an outgoing call, a loop start line can be selected by:

- pressing a line button on the telephone
- dialing a line pool access code
- pressing a memory button that has been programmed with a line pool access code

Configuration tips

- Loop start signaling is supported by Loop Start Trunk Cartridges, Call Information (CI) Trunk Cartridges and Digital Trunk Interfaces (DTI). Each Loop Start Trunk Cartridge or CI Trunk Cartridge can provide four loop start trunks. A DTI can provide up to 24 loop start trunks. If you wish to configure your loop start trunks as auto-answer, the trunks must have disconnect supervision.
- For Loop Start or CI Trunk Cartridges installed in a Trunk Module, you will also need one E&M/DISA Trunk Cartridge for every two loop start trunks that you configure as auto-answer. The E&M/DISA Trunk Cartridge provides two DTMF receivers to receive the incoming digits from the central office. An auto-answer loop start trunk can give you the same kind of direct inward dialing function as a DID trunk.
- If your system includes both loop start trunks and DID trunks, you would typically use loop start trunks for outgoing calls and DID trunks for incoming calls.
- You may configure a loop start trunk as the prime line for a Norstar telephone or a Business Series Terminal.
- The capabilities available to a remote caller are determined by the remote filters and remote package assigned to a line, or by the set restrictions, line restrictions, and remote package assigned to the Class of Service password.

- Two loopstart trunk cartridges are compatible with Modular ICS 6.1. The NT5B40GA-93 can be installed in trunk module (TM) slots only. The NT7B75GA-93 can be installed in either core slots three or four, or TM slots one, two, or three.

Analog E&M trunks

An Analog E&M trunk gives you incoming and outgoing access to other systems in a private network. E&M trunks can be configured as manual-answer or auto-answer. The answer mode determines how the system handles incoming calls.

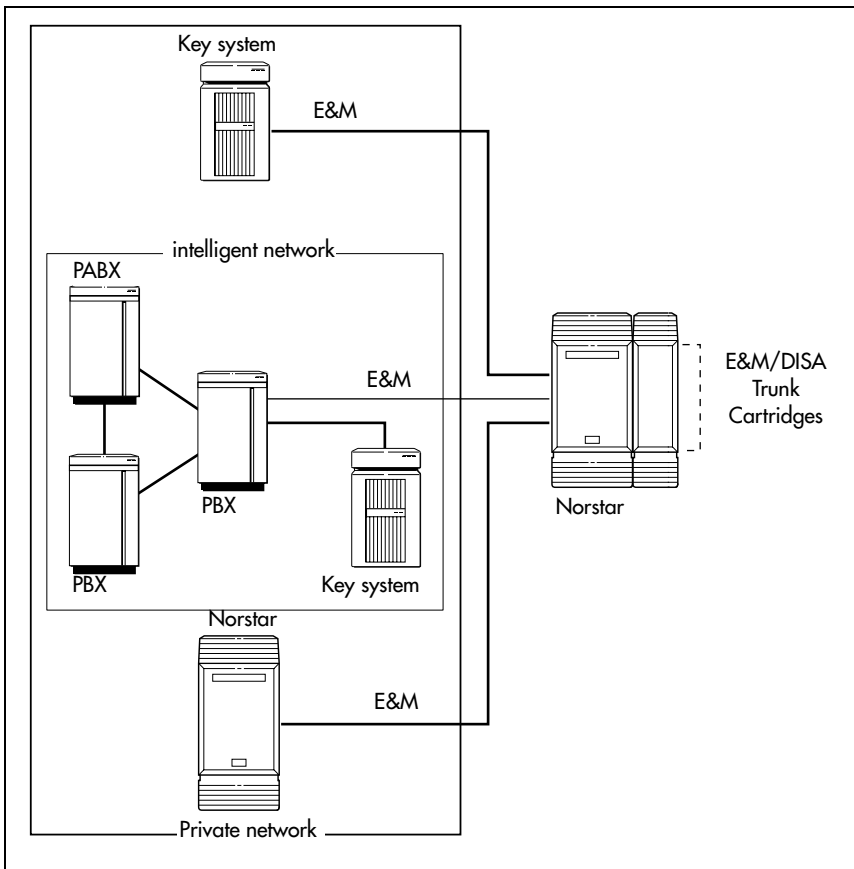

By default, auto-answer E&M trunks are answered by the system with direct inward system access (DISA), and are used to provide controlled access to Norstar system resources.

When a call comes in on a manual-answer E&M trunk, it alerts at all telephones with that line appearance.

When a call comes in on an auto-answer E&M trunk that is configured to answer with DISA, the caller hears stuttered dial tone. They must enter a six-digit COS password from a DTMF telephone to hear system dial tone.

They can then enter a:

- target line number
- line pool access code
- remote feature code

When a call comes in on an auto-answer E&M trunk that is not configured to answer with DISA, the caller hears system dial tone. At that point they can then enter one of the following:

- a target line number
- the DISA DN, which will prompt for a COS password
- a line pool access code or a destination code
- a remote feature code from a DTMF telephone

To place an outgoing call, an E&M trunk can be selected by one of the following:

- pressing a line button on the telephone
- dialing a line pool access code or destination code
- pressing a memory button that has been programmed with a line pool access code or destination code.

BRI trunks

BRI trunks give you incoming and outgoing access to an ISDN network. Like loop start trunks, they can be configured as manual-answer or auto-answer. See *Ans mode* on page 359.

BRI trunks provide a fast, accurate, and reliable means of sending and receiving data, images, text, and voice information. Using BRI lines allows for faster transmission speeds and the addition of a variety of powerful business applications, including remote LAN access, video conferencing, file transfer and Internet access.

For more information, see *Welcome to ISDN* on page 43.

Note Profile 2: European BRI trunks can only be EURO trunks.

PRI trunks

PRI trunks are used for incoming and outgoing calls over an ISDN network. PRI trunks are automatically set to auto-answer.

Incoming calls are routed to system telephones through assigned target lines. Outgoing calls are made using the intercom key assigned to a PRI line pool, or by entering a destination code to which a route has been defined using PRI line pools. You cannot assign a PRI line directly to a telephone.

PRI SI-1 lines also can provide MCDN network functionality over a private network between other Norstar systems, Meridian 1 systems, or Business Communications Systems, if the appropriate keycode has been installed. Private networking is described in *Networking with Norstar* on page 99.

Target lines

A target line is an internal communication path that is reached by means of digits received from an incoming trunk. Target lines are assigned to answer direct-dial incoming calls but they cannot be used to make outgoing calls.

You can program auto-answer trunks to map to target lines to provide for attendant bypass, which allows the call to go directly to a department or individual, and to create line concentration, where one trunk can map onto several target lines.

No target lines are automatically assigned to telephones, except if the DID template has been applied to the system.

Target lines are configured using line numbers 157-348 or 157-284, in the same way as physical lines.



Privacy issue

You can set a target line to Private (default is Public), however, such features as Call Pickup can still answer these lines at other telephones in the group.

Remote system access

The remote access feature allows callers elsewhere on the private or the public network to access a Norstar system by dialing directly into the system without going through an attendant. Once in the system, the remote user can use some of the system resources. The remote access must be enabled in programming before callers can use it.

Norstar systems support remote system access on the following trunk types, which may require the remote caller to enter a COS password for direct inward system access (DISA):

- auto-answer loop start trunks
- auto-answer E&M trunks
- DID trunks, by means of the DISA DN
- PRI trunks, by means of the DISA DN

The system resources, such as dialing capabilities, line pool access and feature access, that a remote user may access depends on the Class of Service (COS) assigned to the user. See *Class of Service* on page 93, *COS pswds* on page 401 and the *Modular ICS 6.1 System Coordinator Guide* for more details.

Use system features during a remote call

To use features on a Norstar system during a remote call-in, press , followed by the feature code. Even if you are calling from another Norstar system or from within a private network, press instead of .

Remote access on loop start and E&M trunks

Loop start trunks provide remote access to Norstar from the public network. E&M trunks provide remote access from a private network. Each must be configured to be auto-answer to provide remote system access.

A loop start trunk **must** have disconnect supervision if it is to operate in auto-answer mode. E&M trunks always operate in disconnect supervised mode.

When a caller dials into the system on a line that has auto-answer, the system answers with system dial tone and no COS password is required. In this case, control over the system capabilities available to the caller is provided only by the restriction filters assigned to the line.

When a caller dials in on a line that has auto-answer with DISA, the system answers with stuttered dial tone. This is the prompt to enter a COS password. The password used by the caller determines which system capabilities are available to the caller.

Remote access on a private network

Nodes on the private network deliver the last dialed digits to the destination Norstar node, for interpretation by the destination Norstar node. The destination Norstar node either matches the digits to a target line or interprets the digits as a remote feature request. The call is either routed to the specified target line, or the remote feature is activated.

By default, E&M trunks are set to answer with DISA. For auto-answer E&M trunks connected to a private network, change the default so that the trunks are **not** answered with DISA. If an auto-answer E&M trunk is configured to answer with DISA, the system tries to interpret any received digits as a COS password.

The DISA DN and the Auto DN allow auto-answer private network and DID calls, in the same way that calls on auto-answer loop start and auto-answer E&M trunks can be answered, with or without DISA. These DNs are described in `System Programming` under `Access codes`.

Remote access on Direct Inward Dial (DID) trunks

Remote system access on DID trunks is similar to that of E&M trunks connected to a private network.

The main differences are:

- a remote caller is on the public network dialing standard local or long-distance telephone numbers
- the digits received are delivered by the central office
- DISA cannot be administered to a DID trunk

As with a private network, the dialed digits may be programmed to match those of a specific target line DN, the DISA DN or the Auto DN.

Remote access on PRI trunks

Remote system access on PRI trunks is similar to that of E&M trunks connected to a private network.

The main differences are:

- a remote caller is on the public network dialing standard local or long-distance telephone numbers
- the digits received are delivered by the central office
- answer with DISA cannot be administered to a PRI trunk since PRI trunks are set to autoanswer.

As with a private network, the dialed digits may be programmed to match those of a specific target line DN, the DISA DN, or the Auto DN.

Controlling system access

Modular ICS programming provides several ways of protecting your Norstar system from unauthorized access or use. These features are used in combination to provide control both to users and to lines.

Class of Service

Class of Service (COS) refers to the capabilities that Norstar provides to users who access the system from the public or private network. A password defines which set of capabilities the user has access to.

The COS includes:

- filters that restrict dialing on the line
- an access package defines the set of line pools that may be accessed and whether or not the user has access to the paging feature

The COS that is applied to an incoming remote access call is determined by:

- the filters that you apply to the incoming trunk
- the Class of Service password that the caller used to gain access to the Norstar system

In cases where DISA is not automatically applied to incoming calls, the remote caller can change the class of service by dialing the DISA DN and entering a COS password.

To program COS passwords, see *Passwords* on page 401 and the *Modular ICS 6.1 System Coordinator Guide*.

Restriction filters

Restriction filters can be used to restrict the numbers that may be dialed on any external line within your Norstar system. Up to 100 restriction filters can be created for the system.

A restriction filter consists of up to 48 restrictions with associated overrides.

To restrict dialing within the system, you can apply filters to:

- outgoing external lines (as line restrictions)
- telephones (as set restrictions)
- external lines on specific telephones (as line/set restrictions)

Restriction filters can also be specified in **Restriction Service**, for times when the system is operating according to a Schedule. See *Services* on page 371 for more details.

Dialed digits must pass both the line restrictions and the set restrictions. The line/set restriction overrides the line restriction and set restriction. Refer to the following diagrams.

Line restrictions

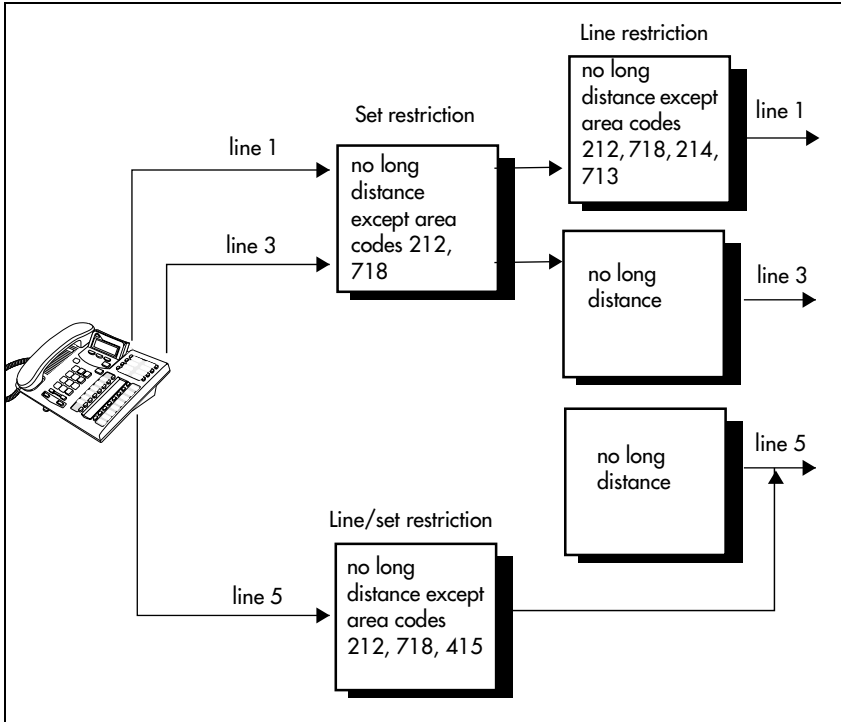

In the previous diagram, a caller using line 1 could only dial long-distance numbers to area codes 212 and 718. A caller using line 3 could not dial any long-distance numbers. A caller using line 5 could dial long-distance numbers to area codes 212, 718, and 415.



Tips - *Set restrictions have no effect on numbers dialed on an E&M trunk.*

To restrict dialing outside the system, once a caller gains remote access, you can apply restriction filters to incoming external lines, as remote restrictions.

Remote caller restrictions

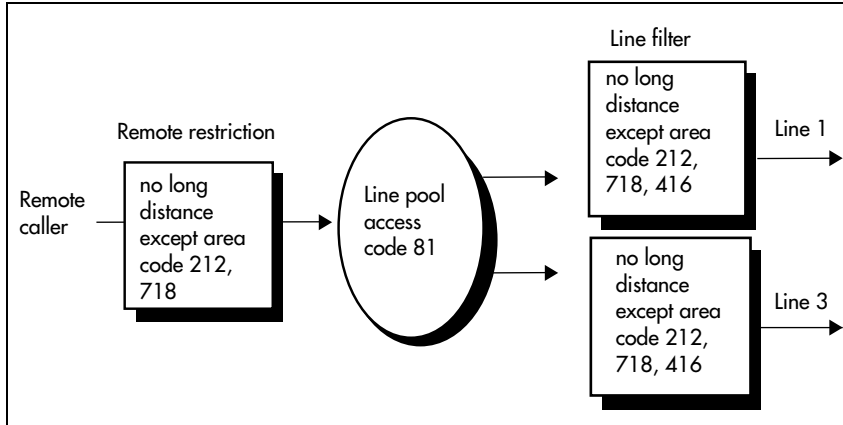

In this case, dialed digits must pass both the remote restriction and the line restriction. A remote caller can override these filters by dialing the DISA DN and entering a COS password.

For restriction filter programming instructions, see *Restrictions* on page 339 and the *Modular ICS 6.1 System Coordinator Guide*.

Direct inward system access (DISA)

To control access from the public or private network, you can configure auto-answer trunks to answer with DISA. Remote callers hear a stuttered dial tone and must then enter a COS password. The password they enter determines what access they are allowed in the system.

Auto-answer loop start and E&M trunks are configured to answer with DISA by default. For DISA programming instructions, see *Ans with DISA* on page 360.



Tips - *You must have one E&M/DISA Trunk Cartridge to provide DTMF receivers for every two auto-answer loop start trunks on Loop Start or CI Trunk Cartridges.*

DID and PRI trunks cannot be configured to answer with DISA. If you want incoming DID or PRI calls to be answered with DISA, configure the system with a DISA DN. Incoming calls that map onto the DISA DN are then routed to a line that has DISA.

In addition to public network connections, Norstar Modular ICS can be integrated into an existing private network, or to other Norstar or Meridian 1 systems to form a corporate telecommunications network.

Networking with Norstar

There are a number of ways you can network Norstar systems together, or network Norstar systems with other Nortel systems into private networks. What types of lines you use to perform the networking will determine the type of services that can be shared between systems.

Keep in mind that each node (Norstar system) is considered an external system by every other node within the network, even though, to the users, it appears to be all one system. This affects how you configure call transfer and call out features on each system. On the home node, all features are configured as local numbers. On all other nodes, all features directed to the home node are configured with external numbers.

As well, each node must have a unique identifying code. What this code will be, and how it is configured for the user, depends on what type of trunks and dialing rules you choose to use. If the network has a Meridian as part of the network, the Meridian administrator will determine identification codes for the systems.

This section describes various configurations of private networks. The general settings that are required to set up the home node for each system are provided to give you a sense of what is required for each type of network.

The common goal is to provide the user with the sense that the network is one large system that provides common access to colleagues in other buildings, cities, or countries. In some systems they may need to enter a destination code before the local number to route the call to the correct system. In other systems, using a common dialing plan allows users to dial colleagues at any location simply by entering the same number of digits they would use to dial a colleague at the next desk.

Tie-line networking

Norstar uses enhanced trunking to join other Norstar or customer equipment in a private network. This allows authorized users access to tie lines, central office lines, and Norstar features from outside the Norstar system.

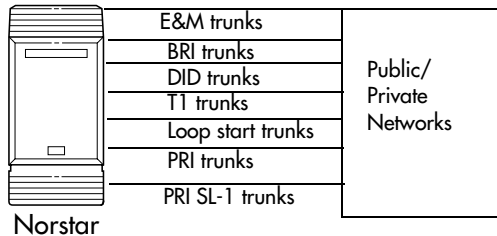

Callers using the Norstar Modular ICS system can:

- call directly to a specific Norstar telephone
- select an outgoing tie line to access a private network
- select an outgoing tie line to access features that are available on the private network
- select an outgoing central office line to access the public network
- use all of the Norstar features

Callers in the public network can:

- call directly to one or more Norstar telephones
- call into the Norstar system and select an outgoing tie line to access a private network
- call into the Norstar system and select an outgoing central office line to access the public network

- call into the Norstar system and use remote features

Callers in the private network can:

- call directly to one or more Norstar telephones
- call into the Norstar system and select an outgoing tie line to access other nodes in a private network
- call into the Norstar system and select an outgoing central office line to access the public network
- call into the Norstar system and use remote features

Norstar behind a PBX

Norstar Modular ICS can be used behind a PBX. In order to support this application, the trunk lines must be set up not to exceed 8 dB total loop loss from the serving central office to the connection point at the Norstar ICS.

Dialing plans

Dialing plans allow users to enter consistent dialing information to call other systems, or out to a public network through another system. The type of network determines what kind of dialing scheme is required.

The Norstar system has routing features that allow you to set up a transparent dialing plan with other systems in a public or private network. In a private network, you can choose to use either a uniform dialing plan (UDP) or a coordinated dialing plan (CDP) to determine how the system recognizes private network dialing strings.

A networked system uses the Public DN length to determine the number of digits that must be collected before the call is dialed outside each node on the system. Calls routed over private networks using CDP also use the public DNs in concert with a destination code that determines the routing of dialed DN. With CDP, the node identifier is included in the dialed DN string and is unique to each node.

If you create a network-wide dialing plan using CDP:

- all telephone DNs across the network need to be the same length (Public DN length)
- the first digit of the DN must be unique to each system, i.e. node A has DNs 2222 to 2999, node B has DNS 3222 to 3999, and so on.
- you indicate that you are using a coordinated dialing plan (**System Programming/Dialing Plan/Private network**)

- you create access codes that are routed out on auto-answer lines connected to the other sites (**Access Codes and Call Routing**)
- a telephone can be reached using the access code and the telephone number, regardless of where the call originates in the network

Calls routed over private networks using UDP require a private DN length, since each node requires an identification code in the dialing string, which makes the DN length different than for a public-routed call.

If you are networked using UDP:

- you indicate a private DN length, which is the number of digits required to access sets in the system (**System Programming/Dialing Plan/Private network**)
- each system has a unique location code (**System Programming/Dialing Plan/Private network**)
- you indicate that you are using a UDP dialing plan (**System Programming/Dialing Plan/Private network**)
- you set up private access codes (**Access codes/Private access codes**)
- a telephone in another node is accessed using the access codes, the location code, and the telephone DN.

Any programming for routing and access codes should be carefully planned using the tables supplied with the *Programming Record*. The settings for routing and destination codes are fully explained in *Services* on page 371.

Note: Network access codes must not conflict with access codes used for other purposes.

Dialing plan using public lines

Installer password required

For example, imagine that you have a system in a network of three offices such as New York, Toronto, and Santa Clara.

If there is no routing, callers would have to dial this way:

- A Norstar user in New York would have to select a line pool and dial a number such as 1-416-555-3227 to reach telephone 3227 in Toronto (416).

If there is routing:

- you could create a destination code of 3, and create a route that uses the proper line pool and DialOut. In this case, the user simply dials 3227, the receiving telephone DN being 227.

In the DialOut, P stands for pause, a host system signaling option. Press to insert a 1.5-second pause in the dialing string. See the *Modular ICS 6.1 System Coordinator Guide* for information about other signals.

Destination code numbering in a network

Because the system checks the initial digits of a call against the routing tables, each type of internal or external call must begin with a unique pattern of digits. The following table gives a sample plan for how initial digits are assigned in a network of systems with three-digit DNs.

Leading Digits	Use
0	Network Direct Dial
221-253 (default)	Intercom calls (DNs)
4	Coordinated Dialing Plan
5	Unused
6	Unused
8	Call Park Prefix
9	All PSTN Calls

In the table, 4 is used as the initial digit for the Coordinated Dialing Plan (CDP), but 5 or 6 could also be used for this purpose.

For PRI you need to define a route with a routing code (destination code), then assign that code to the telephone.

Dialing plan using E&M lines

Installer password required

By properly planning and programming routing tables and destination codes, an installer can create a dialing plan where E&M lines between Norstar systems are available to other systems in the network

The following figure and programming chart shows how to configure a transparent dialing plan for a network of three Norstars over E&M lines.

- Each system must be running the same version of MICS 6.1 or MICS-XC 6.1 software.
- Each system must be equipped with target lines and a Trunk Module with an E&M/DISA Trunk cartridge or an ICS with a DTI with at least one E&M line.

Routing by destination codes over E&M lines

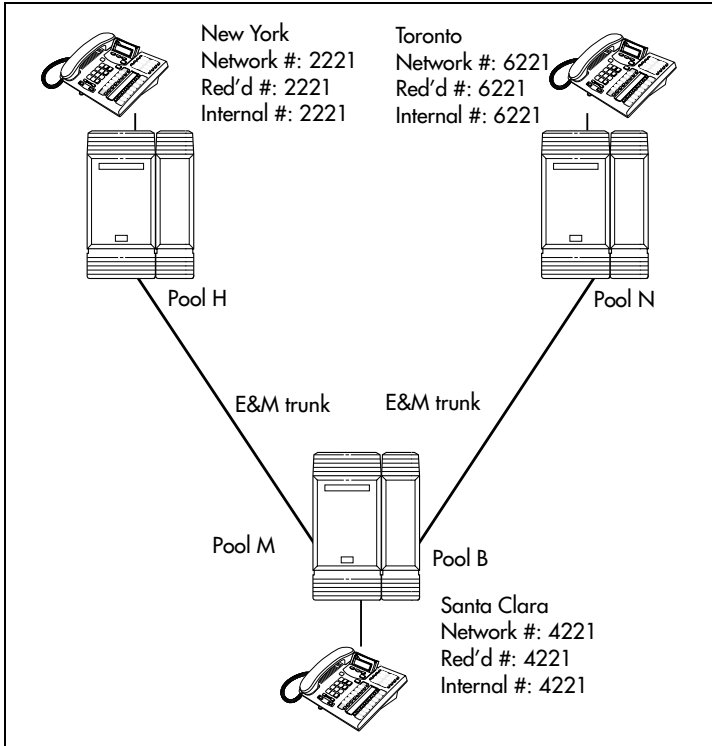

New York:

Trk/Line Data	Line 049	E&M
	Ans Mode	Auto
	Line type	Pool H
	Line 245	Target line
	Rec'd #	2221
Line Access	DN 2221	L245: Ring only
	Line pool access	Line pool H

To Santa Clara:

Routing service	Route	001
	Use	Pool H
	DialOut	None
	DestCode	4
	Normal rte	001
	Absorb	0

To Toronto:

	Absorb	0
Trk/Line Data	Line 049	E&M
	Ans Mode	Auto
	Line type	Pool B
	Absorb	0
	Absorb	0
Remote access	Rem access pkgs	01
	Line pool access	Pool M: ON
	Rem access pkgs	02
	Line pool access	Pool B: ON
	Line abilities	049
	Remote pkg	01
	Line abilities	050
	Remote pkg	02

Toronto:

Trk/Line Data	Line 053	E&M
	Ans Mode	Auto
	Line type	Pool N
	Line 260	Target line
	Rec'd #	6221
Line Access	DN 6221	L260: Ring only
	Line pool access	Line pool N

To New York:

Routing service	Route	001
	Use	Pool N
	DialOut	None
	DestCode	4
	Absorb	0
	Normal rte	001

To Santa Clara:

Absorb	0
--------	---

In the above example:

If a user in New York calls Toronto within the network, they dial 6221. The local Norstar checks the number against the routing tables and routes the call according to the destination code 6, which places the call using Route 001.

There is no DialOut change to the number from New York, so the call appears on the auto answer line on the Norstar in Santa Clara as 6-221.

Because 6 is also a destination code on the Santa Clara system, another call is placed using route 002 from Santa Clara. This call arrives at the Toronto system, where the digits 6-221 are interpreted as a target line received number. The call will now alert at telephone 6221 in Toronto.

Dialing plans with shared line pools

Installer password required

Using routes and destination codes is a powerful and efficient way to create a transparent dialing plan. Line pools offer an alternate method of creating a dialing plan or supplementing the routing and destination codes. This is the type of dialing plan you would create for tandem networking between two or more Norstar systems.

Networking with shared line pools

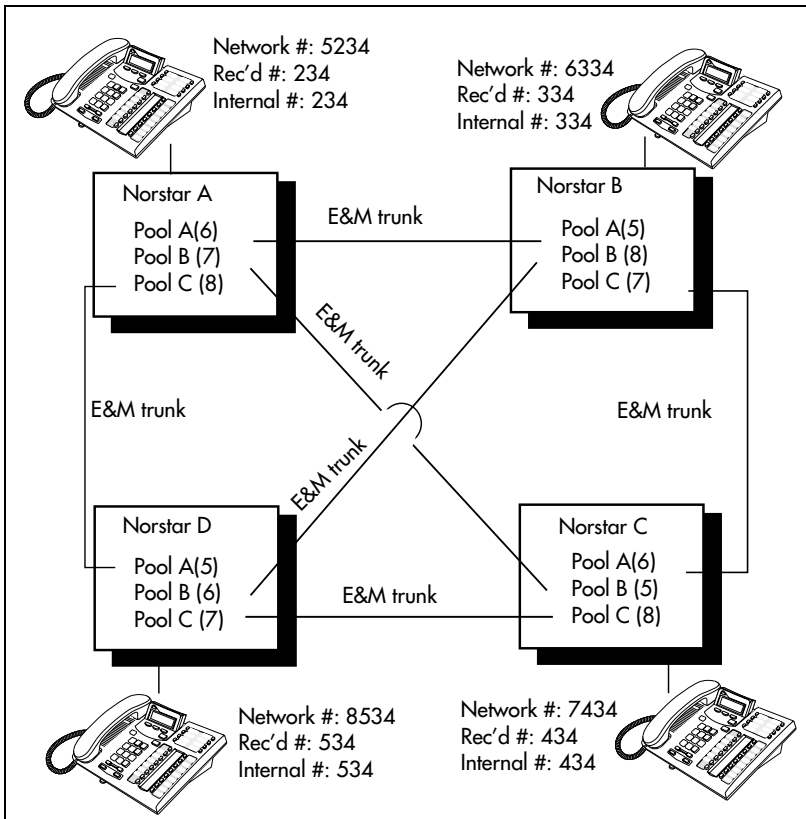

If the Norstar systems are close to each other geographically, you can conserve resources by not duplicating access. For

example, system A, B, and C are all within the same area code. System A has a line pool to Santa Clara, System B has a line pool to Montreal, and system C has a line pool to Miami. A Norstar user in system A can reach Miami by calling system C and using that line pool to Miami.

To simplify access between Norstar systems, all line pools that go to the same destination should have the same line pool access code. For example, system A and system B both have a line pool to Ottawa. You can configure both systems with the same line pool access code for the Ottawa line pool.

A dialing plan similar to the one in the following figure allows you to create a company directory that uses line pool access codes and unique DNs of a uniform length.

For instance, the person on system A at telephone 234 can press an Intercom button and dial 7434.

This means that telephone 234 has dialed the line pool access code of the trunk to system C, and will receive the dial tone of system C. The digits 434 then map to the Received number 434, and ring telephone 434 with an appearance of the associated target line.



Tips - *Network calls that use routes are subject to any restriction filters that are in effect.*



If the telephone used to make a network call has an appearance of a line used by the route, the call will move from the intercom button to the line button.

The telephone used to make a network call must have access to the line pool used by the route.

Routes generally define the path between your Norstar switch and another switch in your network, not other individual telephones on that switch.



Network calls are external calls, even though they are dialed as if they were internal calls. Only the features and capabilities available to external calls can be used.

When programming a button to dial a Network number automatically (autodial), network calls must be treated as external numbers, even though they resemble internal telephone numbers (DNs).

Call-by-Call Services Example

This example highlights the use of PRI Call-by-Call Services.

Call-by-Call routing

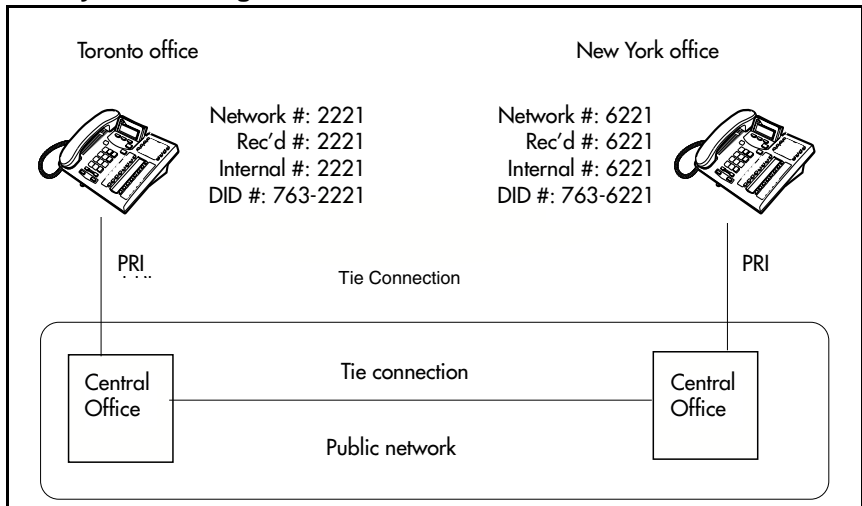

It shows two offices of a company. One office is in New York, the other is in Toronto. Each office is equipped with a Norstar system and a PRI line. Each office has to handle incoming and outgoing calls to the public network. In addition, employees at each office often have to call colleagues in the other office. To reduce long-distance costs, and to allow for a coordinated dialing plan between the offices, private (tie) lines are used to handle inter-office traffic.

If call-by-call services were *not* used, each Norstar system might have to be equipped with the following trunks:

- 12 DID lines needed to handle peak incoming call traffic.
- eight Tie (E&M) lines needed to handle inter-office calls.
- eight lines needed to handle outgoing public calls

The total required is 28 lines. If the Norstar systems were using T1 trunks, then two T1 spans would be required at each office. Note that the total of 28 lines represents the worst case value for line usage. In reality, the total number of lines in use at any one time will generally be less than 28. For example, during periods of peak incoming call traffic, the demand for outgoing lines will be low.

With PRI call-by-call services, it is not necessary to configure a fixed allocation of trunks. Each of the 23 lines on the PRI can be used for DID, Tie, or outgoing public calls. This consolidation means that it may be possible for each office to use a single PRI span, rather than two T1 spans.

With PRI call-by-call services, the only limitation is that there are no more than 23 calls in progress at any one time.

The dialing plan at each Norstar site is configured to determine the call type based on the digits dialed by the user. If a user in Toronto wishes to dial a colleague in New York, they dial the four-digit private DN (such as 6221). The dialing plan recognizes this as a private network DN, and routes the call using Tie service with a private numbering plan.

Incoming Tie calls are routed to telephones based on the digits received by the network, which in this case will be the four-digit private DN.

If a user in either location wishes to dial an external number, they dial 9, followed by the number (such as 9-555-1212). The

dialing plan recognizes this as a public DN, and routes the call using Public service.

Incoming DID calls will be routed to telephones based on the trailing portion of the digits received by the network. For example, if a public network user dials an employee in the Toronto office, the network will deliver digits 4167632221. Norstar will route the call using the last four digits, 2221.

Norstar Configuration

Toronto:

Hardware	Card 1	PRI
	Protocol	NI-2
Trk/Line Data	Line 245	Target line
	Rec'd #	2221
Line Access	DN 2221	L245:Ring only
	Line pool access	Line pool PRI-A

To New York:

Routing Service	Route	001
	DialOut	No numbr
	Use	Pool PRI-A
	Srvctype	Tie
	ServiceID	1
	DN type	Private
	DestCode	6
	Normal rte	001
	Absorb	0

To Public Network:

Routing Service	Route	002
	DialOut	No numbr
	Use	Pool PRI-A
	DN type	Public
	DestCode	9
	Normal rte	002
	Absorb	ALL

New York:

Hardware	Card 1	PRI
	Protocol	NI-2
Trk/Line Data	Line 245	Target line
	Rec'd #	6221
Line Access	DN 6221	L245:Ring only
	Line pool access	Line pool PRI-A

To Toronto:

Routing Service	Route	001
	DialOut	No numbr
	Use	Pool PRI-A
	Srvctype	Tie
	ServiceID	1
	DN type	Private
	DestCode	2
	Normal rte	001
	Absorb	0

To Public Network:

Routing Service	Route	002
	DialOut	No numbr
	Use	Pool PRI-A
	DN type	Public
	DestCode	9
	Normal rte	002
	Absorb	ALL

PRI dialing plan example for two-way DID

The following list shows the steps involved in configuring a dialing plan for two-way DID which uses a Public service. In this example the user dials the prefix 8 to place a call over a PRI line.

Note: Call-by-call is not needed to have two-way DID.

- in **Hardware** programming, configure the DTI card (PRI) to use a **Public** protocol
- for incoming calls you need to program target lines to match the DID digit that is being received on the PRI interface
- set **Dial Out** to None
- select **PRI-A** as the **line Pool**
- set **SrvcType** to **Public**
- in **Services** programming access **Routing Service** to enter a **Destination Code** (8 in this example)
- set the **Absorb Length** to **All**
- the telephone that you are dialing out from must have access to the PRI Pool (programmed in **Terminals/Sets**)

- define **rec'd digits** for target lines
- define limits for incoming and outgoing public calls. Refer to *Programming Call by Call Limits* on page 461

Static DID and two-way DID

When configuring static DID with two-way service, the channels programmed as DID at the CO must be the lowest B-channels on the PRI. On your Norstar system, the BchanSeq mode must be set to **descending**. In this configuration, all calls on the PRI must be Public service.

For example, channels 1 to 4 are configured as DID at the CO. The CO uses ascending mode for B-channel selection, and the ICS uses descending mode.

Private networking using PRI SL-1

You can use PRI SL-1 lines to tandem a number of Norstar units into a private network. This creates a Private Network Tandem Calling (PNTC) configuration. Refer to *Private Network Tandem calling* on page 119.

You can also use PRI SL-1 lines to link one or more Norstar systems to a Meridian 1 system, or to create a network that includes one or more Business Communications Manager systems. This creates an Advanced Private Network (APN) where the MCDN protocol can be used to provide network control features that allow network calls to be delivered and transferred with optimum efficiency. If you also use a central voice mail system or central Auto Attendant system off the Meridian, MCDN provides system-wide Auto Attendant features and line redirection. Refer to *Advanced Private Networking* on page 128.



Tip - *For Modular ICS 6.1 you require both a PRI software key (profile 1, 3, and 4 only) and an MCDN software key to perform SL-1 networking.*

All Norstar systems in the network also must be running MICS 6.1 or MICS-XC 6.1 or greater software.

SL-1 networking features

- common dialing plan using a Uniform Dialing Plan (UDP), or a Coordinated Dialing Plan (CDP)
Note: If Norstar voice mail or Auto Attendant is used as the centralized voice mail system, CDP must be used.
- PRI networks can be used for voice, data, and video calls
- no usage costs when placing remote calls over private networks

- caller information appears on both the caller telephone and the called telephone, regardless of the number of redirections
- PSTN lines connected to one of the nodes in a network can provide local public service, at local rates, to all nodes in the network, regardless of location

Features specific to Advanced Private Network

- centralized voice mail provides call waiting indications on the receiving telephone
- centralized voice mail provides common messages, call-forwarding and transfer options to all networks. If you are using the Meridian attendant system, the attendant console on the Meridian system can use system-wide call parking (camp-on) and break-in features.
- if you have trunk route optimization (TRO) turned on, the system optimizes call routing of redirected calls over the private network
- the Meridian PBX can handle both UDP and CDP, thus providing more flexibility and less reprogramming when networking existing systems. The Norstar Voice mail system requires a CDP dialing plan when it is being used for central call handling.
- Trunk Anti-tromboning (TAT) provides network rerouting that provides more efficient routing of calls to prevent unnecessary tandeming and tromboning of trunks.
- ISDN Call Connection Limitation (ICCL) piggybacks on the call initiation request and acts as a check at transit PBX points to prevent misconfigured routes or calls with errors from blocking channels.

- NCRI count allows a call to be forwarded in the network up to five times before the system releases the call as undelivered. However if TAT or TRO occur, the counter gets reset, as well. This counter is hard-coded.

Private Network Tandem calling

Tandem networking is a chained network established between two or more MICS systems. All the systems are connected via PRI SL-1 lines.

In the network example shown below, nodes A, B, and E are in one location, Nodes C, D, and F are in a second location. The two systems are tied together between nodes A and C.

Nodes A and C are also connected to the local public network.

Tandem network

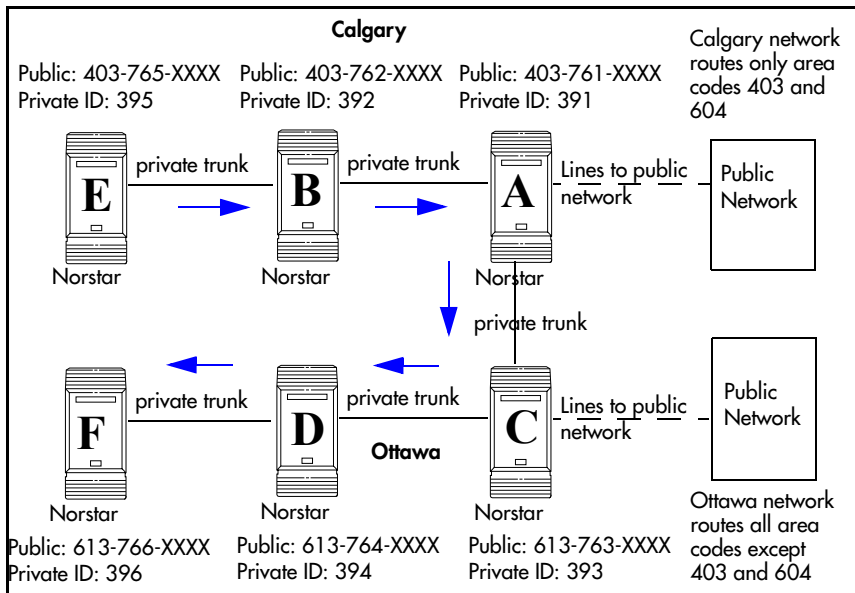

This configuration allows both local network users and remote users on the public network to access the remote PSTNs through the private lines, thus avoiding public call charges.

All nodes have unique three-digit private identification codes as well as public network codes. Routes and destination tables are configured on all systems to correctly route dialed numbers to other nodes. DNs do not necessarily have to be unique, but they must be the same length on all systems.

Calls originating from the public network

Received	Destination	Description
Node A	Node A	User in Calgary dials 761-xxxx number Incoming interface: Public DN type: Public
		Node A receives the call and identifies it as terminating locally. Uses target line to route call. Destination: Local (target line)
Node A	Node B	User in Calgary dials a 762-xxxx number DN type: Public
		Node A receives it and identifies it as being for node B. Uses private trunk to route it to B. Incoming interface: Public Destination: Remote Node Outgoing interface: Private
		Node B receives the call and identifies it as terminating locally. Uses target line to route call. Incoming interface: Private Destination: Local (target line)

Received	Destination	Description
Node A	Node E	User in Calgary dials a 765-xxxx number. DN type: Public
		Node A receives it and identifies it as being for B. Uses private trunk to route call to B. Incoming interface: Public Destination: Remote node Outgoing interface: Private
		Node B receives it and identifies it as being for E. Uses private trunk to route call to E. Incoming interface: Private Destination: Remote node Outgoing interface: Private
		Node E receives the call and identifies it as terminating locally. Uses target line to route call. Incoming interface: Private Destination: Local (target line)
Node A	Node C	User in Calgary dials a 761-xxxx number which is answered with DISA. Incoming interface: Public DN type: Public Destination: Local (DISA DN)
		User enters a COS password and a private DN for Node C i.e. 6 + 393-xxxx DN type: Private
		Node A receives it and identifies it as being for C. Uses the private trunk to route the call to C. Incoming interface: (DISA user) Destination: Remote node
		Node C receives the call and identifies it as terminating locally. Uses target line to route call. Incoming interface: Private Destination: Local (target line)

Received	Destination	Description
Node A	Node D	User in Calgary dials a 761-xxxx number which is answered with DISA. Incoming interface: Public DN type: Public Destination: Local (DISA DN)
		User enters a COS password and a private DN for Node D, i.e. 6 + 394-xxxx DN type: Private
		Node A receives it and identifies it as being for C. Uses the private trunk to route the call to C. Incoming interface: (DISA user) Destination: Remote node
		Node C receives it and identifies it as being the responsibility of D. Uses private trunk to route call to D. Incoming interface: Private Destination: Remote node
		Node D receives the call and identifies it as terminating locally. Uses target line to route call. Incoming interface: Private Destination: Local (target line)
Node A	Ottawa PSTN	User in Calgary dials a 761-xxxx number which is answered with DISA. User enters a COS password and an Ottawa public network number. Incoming interface: Public DN type: Public Destination: Local (DISA DN)
		Node A receives it and identifies it as being for C. Uses the private trunk to route the call to C. Incoming interface: Local (DISA user) Destination: Remote PSTN
		Node C receives the call and identifies it as a public number and routes it out over the local PSTN. Incoming interface: Private Destination: Local PSTN

Calls originating in the private network

Received	Destination	Description
Node B	Node B	<p>DN is internal, therefore no trunk routing is required.</p> <p>Incoming interface: Intercom DN type: Local Destination: Local</p>
Node A	Ottawa PSTN	<p>User in Node A dials the private network access code for Node C, followed by an Ottawa public number.</p> <p>Incoming interface: Intercom DN type: public Destination: Remote PSTN</p>
		<p>Node C receives the call and identifies it as being for the public network. Node C routes the call over the local public network.</p> <p>Incoming interface: Private DN type: Public Destination: Local PSTN</p>
Node B	Calgary PSTN	<p>User on Node B dials a public DN.</p>
		<p>Node B recognizes it as being the responsibility of Node A and uses private trunk to route the call to A.</p> <p>Incoming interface: Intercom Destination: Remote node</p>
		<p>Node A receives the call and identifies it as being for the public network. Node A routes the call over the local public network.</p> <p>Incoming interface: Private Destination: Remote PSTN</p>

Received	Destination	Description
Node B	Node A	User in Node B dials a private DN for a user on A. DN type: Private
		Node B recognizes it as being for Node A. Uses the private trunk to route the call the call to A. Incoming interface: Intercom Destination: Remote node
		Node B receives the call and identifies it as terminating locally. Uses target line to route call. Incoming interface: Private Destination: Local (target line)
Node B	Node C	User on Node B dials a private DN for a user on C. DN type: Private
		Node B recognizes it as being the responsibility of Node A and routes the call over the private trunk to A. Incoming interface: Intercom Destination: Remote node
		Node A receives it and identifies it as being for C. Uses IP trunk to route call to C. Incoming interface: Private Destination: Remote node
		Node C receives the call and identifies it as terminating locally. Uses target line to route call. Incoming interface: Private Destination: Local (target line)

Received	Destination	Description
Node B	Node D	User on B dials a private DN for node D. DN type: Private
		Node B identifies it as being for node A and uses private trunk to route the call to A. Incoming interface: Intercom Destination: Remote node
		Node A receives it and identifies it as being for C. Uses IP trunk to route call to C. Incoming interface: Private Destination: Remote node
		Node C receives it and identifies it as being for D. Uses the private trunk to route call to D. Incoming interface: Private Destination: Remote node
		Node D receives the call and identifies it as terminating locally. Uses target line to route call. Incoming interface: Private Destination: Local (target line)
Node B	Node F	User on B dials a private DN for node F. DN type: Private
		Node B identifies it as being for node A and uses private trunk to route the call to A. Incoming interface: Intercom Destination: Remote node
		Node A receives it and identifies it as being for C. Uses IP trunk to route call to C. Incoming interface: Intercom Destination: Remote node
		Node C receives it and identifies it as being for D. Uses the private trunk to route call to D. Incoming interface: Intercom Destination: Remote node
continued on next page		

Received	Destination	Description
Node B to Node F (continued)		Node D receives it and identifies it as being for F. Uses the private trunk to route call to F. Incoming interface: Intercom Destination: Remote node
		Node F receives the call and identifies it as terminating locally. Uses target line to route call. Incoming interface: Private Destination: Local (target line)

Routing for tandem networks

In tandem networks each node needs to know how to route calls that do not terminate locally. To do this, you set up routes for each connecting node by defining destination codes for each route.

If the node is also connected to the public network, the usual routing is required for that connection.

The following examples show the routing tables for Node A and Node C for externally-terminating calls.

Note: The PRI lines are enbloc lines, so all dialed digits are collected before being dialed out.

Node A Destination Code Table, external termination

Route	Absorb length	Destination code (public DNS)
4 (PSTN)	1	91604
3 (Node B)	0	91403762 (Node B)
3 (Node B)	0	91403765 (Node E)
4 (PSTN)	1	9140376* (not internal network)
4 (PSTN)	1	914037* (not internal network)
4 (PSTN)	1	91403* (not internal network)
4 (PSTN)	1	9* (not internal network)
* This wild card represents a digit between 1 and 9.		

Node A Destination Code Table, internal termination

Route	Absorb length	Destination code (private DNs)
3 (Node B)	0	392 (Node B)
3 (Node B)	0	395 (Node E)
5 (Node C)	0	393 (Node C)
5 (Node C)	0	394 (Node D)
5 (Node C)	0	396 (Node F)

Node C Destination Code Table, external termination

Route	Absorb length	Destination code (Public DNs)
3 (Node B)	0	91613764 (Node D)
3 (Node B)	0	91613766 (Node F)
4 (PSTN)	1	<u>9</u> 161376* (not internal network)
4 (PSTN)	1	<u>9</u> 16137* (not internal network)
4 (PSTN)	1	<u>9</u> 1613* (not internal network)
4 (PSTN)	1	<u>9</u> 161* (not internal network)
4 (PSTN)	1	<u>9</u> 16* (not internal network)
4 (PSTN)	1	<u>9</u> 1* (not internal network)
4 (PSTN)	1	<u>9</u> (not internal network)
* This wild card represents a digit between 1 and 9.		

Node C Destination Code Table, internal termination

Route	Absorb length	Destination code (Private DNs)
3 (Node D)	0	394 (Node D)
3 (Node D)	0	396 (Node F)
5 (Node A)	0	391 (Node A)
5 (Node A)	0	392 (Node B)
5 (Node A)	0	395 (Node E)

Advanced Private Networking

There are two ways of setting up dialing plans for an Advanced Private Network (APN).

- The first method uses routing tables to interconnected systems. This type of network may use SL-1 lines, but it does not use the MCDN protocol, even though the MCDN keycode is required to allow the use of PRI SL-1 lines.
- The second method allows you to network among other Norstar systems, Meridian systems, and Business Communications Manager systems using SL-1 lines and the MCDN protocol. This system uses the private dialing plans in the same way as the Private Network Tandem Calling network does. However, if you are using a Norstar to support your central voice mail or call attendant, you must use a CDP dialing plan. The MCDN protocol provides additional features that support the central voice mail/Auto Attendant as well as system call routing.

Networking using routing codes

If you have a simple private network, composed of one central Meridian 1 and two smaller sites with Norstar systems, you can use routing codes to direct calls. The following example shows a Meridian 1, representing the head office, connected to several smaller branch offices.

In this network, only the head office has trunks connected to the public network. The branch offices access the public network via the private connection to the head office. This configuration allows for cost savings by consolidating the public access trunks. Users at all three locations access the public network by dialing 9, followed by the public number.

For example, a user in the west end branch might dial 9-555-1212 (for a local call) or 9-1-613-555-1212 (for a long distance call). These public calls are routed to the Meridian 1 by the Norstar routing table. Routing tables at the Meridian 1 will then select an appropriate public facility for the call.

Private network calls are made by dialing a four-digit private network DN. For example, if a user in the west end branch wishes to call a user in the east end branch within the private network, they dial 6221.

Private networking using routing tables

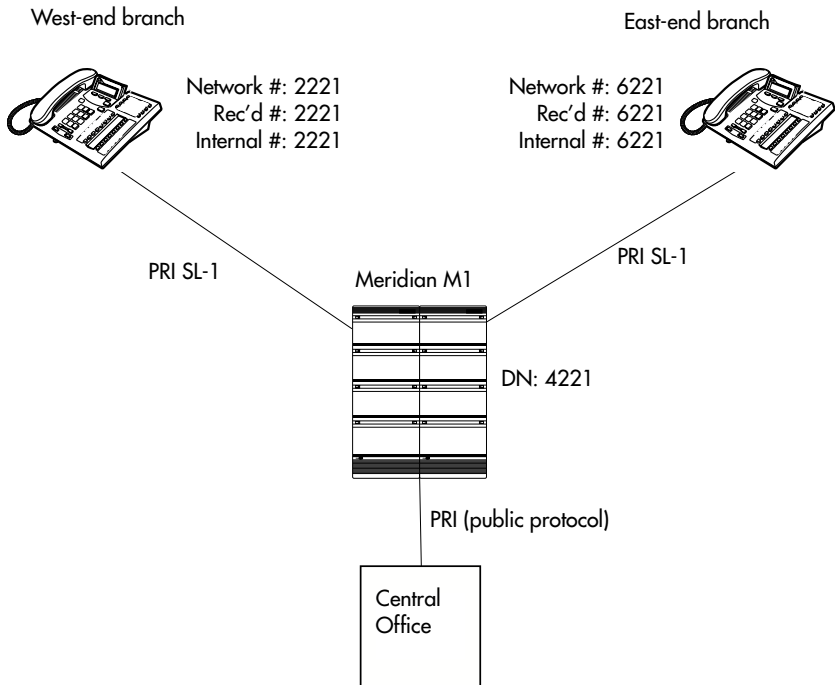

Routing network settings

West End:

Hardware	Card 1	PRI
	Protocol	SL-1
	BchanSeq	Ascend
	ClockSrc	Primary
Trk/Line Data	Line 245	Target line
	Rec'd #	2221
Line Access	DN 2221	L245:Ring only
	Line pool access	Line pool PRI-A

To Head Office:

Routing Service	Route	001
	DialOut	No numbr
	Use	Pool PRI-A
	DN type	Private
	DestCode	4
	Normal rte	001
	Absorb	0

To East End:

Routing Service	DestCode	6
	Normal rte	001
	Absorb	0

To Public Network:

Routing Service	Route	002
	DialOut	No numbr
	Use	Pool PRI-A
	DN type	Public
	DestCode	9
	Normal rte	002
	Absorb	0

East End:

Hardware	Card 1	PRI
	Protocol	SL-1
	BchanSeq	Ascend
	ClockSrc	Primary
Trk/Line Data	Line 245	Target line
	Rec'd #	6221
Line Access	DN 6221	L245:Ring only
	Line pool access	Line pool PRI-A

To Head Office:

Routing Service	Route	001
	DialOut	No numbr
	Use	Pool PRI-A
	DN type	Private
	DestCode	4
	Normal rte	001
	Absorb	0

To West End:

Routing Service	DestCode	2
	Normal rte	001
	Absorb	0

To Public Network:

Routing Service	Route	002
	DialOut	No numbr
	Use	Pool PRI-A
	DN type	Public
	DestCode	9
	Normal rte	002
	Absorb	0

Additional Configuration

In this example, outgoing public network calls dialed from a Norstar telephone are passed to the Meridian 1, and the Meridian 1 is responsible for seizing a public trunk. For this reason, the 9 prefix is left in the number passed to the Meridian 1.

This necessitates modifying the Public DN lengths table on each Norstar to account for the extra leading digit. Essentially, the eight pre-configured entries are modified to include a leading 9 in the prefix digits, and the length value for each entry is increased by one.

The new entries are listed below.

Prefix	Length
Default	8
90	12
900	13
901	18
9011	19
91	12
9411	4
9911	4

Carrier codes:

If a system has a different long-distance service from the local service, or if the long-distance service changes within the schedules, the routing tables can be set up to include a carrier code. You define the code under `System Programming/Access codes/Carrier codes`. You then refer this to the routing tables in `Services/Routing Service/route/`

Carrier codes where you define it as part of the destination code, or part or all of the DialOut string when you set up a routing service schedule.

Meridian M1 Configuration:

- Meridian M1 is the timing master for the private network PRI connections.
- Meridian M1 uses descending mode for PRI B-channel selection.
- The Meridian M1 must recognize calls dialed to 2xxx and 6xxx numbers, and route the call over PRI to either the East or West end offices. The same applies to incoming DID calls from the public network.
- The Meridian M1 must recognize numbers starting with 9 as public numbers, whether the numbers are dialed by Meridian M1 users or by Norstar users.

MCDN Private Networking

When you use MCDN on your private network, you gain the advantages of being able to use a central voice mail/Auto Attendant system to service the entire network, as well as gaining advanced system network features, which keep network traffic flowing along the most efficient paths.

MCDN networking uses PRI SL-1 lines and the MCDN protocol firmware. You need keycodes for each of these features.

To set up calling over an MCDN network, you define a dialing plan that allows the user on any system to experience consistent dialing strings for internal and external calls. For this type of network, the DNs need to be the same length, but they do not have to be unique to the entire network.

If your network is connected to a Meridian 1, and it is the Meridian that you are using for centralized voice mail and Auto Attendant, you can use either a UDP or CDP dialing plan.

- If you use UDP, you dial a unique location code with the local telephone DN range.
- In the case of CDP, the first digit of the DN range denotes the node and is unique to each system.

However, if you are using a Norstar voice mail/Auto Attendant for your centralized voice mail, you must create the calling protocols on the network using CDP. This is a private dialing plan where the first digit of the extensions for each system is unique to that system, and all DNs on all systems are the same length.

Using a UDP dialing plan

To use UDP, the user dials this combination: ACn+LOC+DN
(private/public *AC*cess code, *LOC*ation code, *DN*irectory
Number)

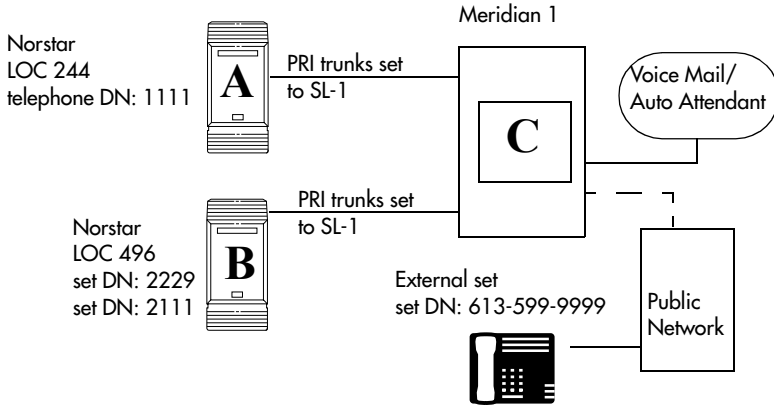

UDP call scenarios

Call scenario	LOC	Dialing String	Calling Party Number	Called Party Number
Calling to another site within the network	244	*6-668-2222	244-1111	668-2222
Calling within the node	496	2229	1111	2229
Calling the public network	244	**9-599-9999	613-763-1111 (OLI Public DN)	599-9999

LOC: This code defines the particular Norstar system.
 * Private Access Code (within network)
 **Public Access Code (out to PSTN)

UDP call routing

From A:

Hardware	Card 1	PRI
	Protocol	SL-1
	BchanSeq	Ascend
	ClockSrc	Primary
Trk/Line Data	Line 245	Target line
	Rec'd #	1111
Line Access	DN 1111	L245:Ring only
	Line pool access	Line pool PRI-A
Dialing Plan	Private	UDP
	PrivNetID	1
	Loc Code	244
	Priv DN len	7

To C:

Routing Service	Route	001
	DialOut	No numbr
	Use	Pool PRI-A
	DN type	Private
	DestCode	4
	Normal rte	001
	Absorb	0
Access Codes	PrivAccCode	4

To B:

Routing Service	DestCode	6
	Normal rte	001
	Absorb	0
Access Codes	PrivAccCode	6

To Public Network:

Routing Service	Route	002
	DialOut	No numbr
	Use	Pool PRI-A
	DN type	Public
	DestCode	9
	Normal rte	002
	Absorb	0
Access Codes	PrivAccCode	9

From B:

Hardware	Card 1	PRI
	Protocol	SL-1
	BchanSeq	Ascend
	ClockSrc	Primary
Trk/Line Data	Line 245	Target line
	Rec'd #	2229
Line Access	DN 2229	L245:Ring only
	Line pool access	Line pool PRI-A
Dialing Plan	Private	UDP
	PrivNetID	2
	Loc Code	496
	Priv DN len	7

To C:

Routing Service	Route	001
	DialOut	No numbr
	Use	Pool PRI-A
	DN type	Private
	DestCode	4
	Normal rte	001
	Absorb	0
Access Codes	PrivAccCode	4

To A:

Routing Service	DestCode	2
	Normal rte	001
	Absorb	0

Access Codes	PrivAccCode	2
--------------	-------------	---

To Public Network:

Routing Service	Route	002
	DialOut	No numbr
	Use	Pool PRI-A
	DN type	Public
	DestCode	9
	Normal rte	002
Access Codes	PrivAccCode	9

Using a CDP dialing plan

To use CDP, the user dials the internal DN for the target telephone. Each node DN range starts with a unique digit.

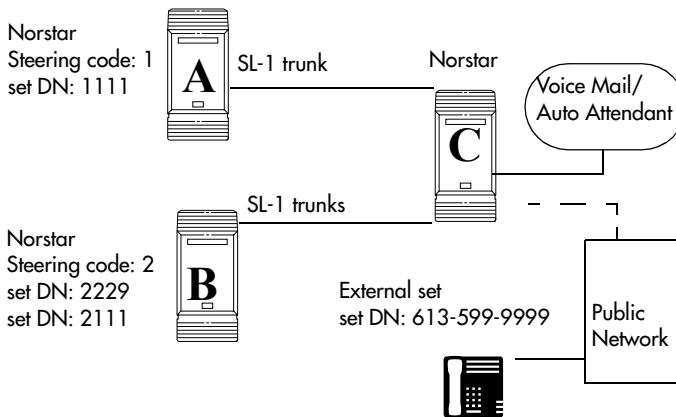

CDP call scenarios

Call scenario	Dialing String	Calling Party Number	Called Party Number
Calling to another site within the network	2229	1111	2229
Calling within the node	2229	2111	2229
Calling the public network	*9-599-9999	613-763-1111 (OLI Public DN)	599-9999
*Public Access Code (out to PSTN)			

CDP call routing**From A**

Hardware	Card 1	PRI
	Protocol	SL-1
	BchanSeq	Ascend
	ClockSrc	Primary
Trk/Line Data	Line 245	Target line
	Rec'd #	1111
Line Access	DN 1111	L245:Ring only
	Line pool access	Line pool PRI-A
Dialing Plan	Private	CDP
	PrivNetID	1

To C:

Routing Service	Route	001
	DialOut	No numbr
	Use	Pool PRI-A
	DN type	Private
	DestCode	4
	Normal rte	001
	Absorb	0

To B:

Routing Service	DestCode	6
	Normal rte	001
	Absorb	0

To Public Network:

Routing Service	Route	002
	DialOut	No numbr
	Use	Pool PRI-A
	DN type	Public
	DestCode	9
	Normal rte	002
	Absorb	0

From B:

Hardware	Card 1	PRI
	Protocol	SL-1
	BchanSeq	Ascend
	ClockSrc	Primary
Trk/Line Data	Line 245	Target line
	Rec'd #	2229
Line Access	DN 2229	L245:Ring only
	Line pool access	Line pool PRI-A
Dialing Plan	Private	CDP
	PrivNetID	2

To C:

Routing Service	Route	001
	DialOut	No numbr
	Use	Pool PRI-A
	DN type	Private
	DestCode	4
	Normal rte	001
	Absorb	0

To A:

Routing Service	DestCode	2
	Normal rte	001
	Absorb	0

To Public Network:

Routing Service	Route	002
	DialOut	No numbr
	Use	Pool PRI-A
	DN type	Public
	DestCode	9
	Normal rte	002
	Absorb	0

MCDN trunk call features

The table below lists the MCDN features that are provided by an SL-1 link with MCDN active (the keycode is installed). The features affect call redirection and trunking functions, as shown in the table below.

MCDN network features

Centralized messaging	<ul style="list-style-type: none"> • network call redirection information (NCRI)
Centralize trunking	<ul style="list-style-type: none"> • ISDN call connection limitation (ICCL) • trunk route optimization (TRO) • trunk anti-tromboning (TAT)

Network Call Redirection Information

NCRI builds on the following call features:

- External Call Forward
- Call Transfer
- Call Forward

NCRI adds the ability to redirect a call across an MCDN network using Call Forward (all calls, no answer, busy) and Call Transfer features. The call destination also receives the necessary redirection information. This feature allows the system to automatically redirect calls from within a Norstar system to the Meridian Mail system, which resides outside the Norstar system on a Meridian 1 or another Norstar.

The figure below shows an example of this situation, where user A calls user B on the same Norstar system. If user B is busy or not answering, the call automatically gets transferred to a Meridian Mail number (user C) across an MCDN link between the Norstar system and the Meridian 1 system (or another Norstar system) where the mailboxes are set up.

Network call redirection path

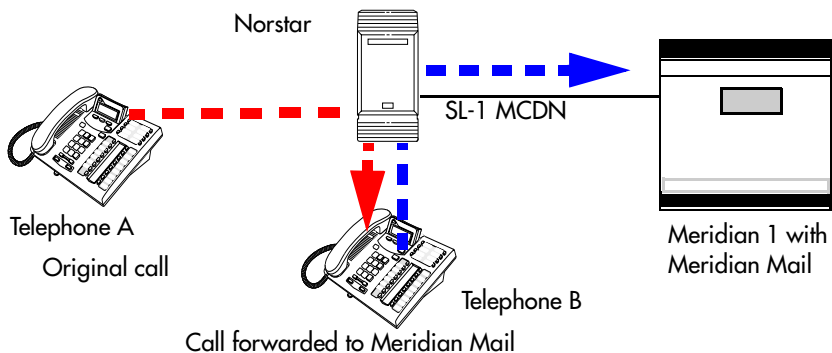

If you are using the centralized voice message system from a Meridian 1 system, you require the following programming on the M1:

M1 programming in LD 17

- NASA set to Yes
- NCRD set to Yes

Verifying NASA is Active <ul style="list-style-type: none"> • Overlay 22, LD 22 • REQ: PRT • TYPE: ADAN DCH (slot number) • NASA should be set to yes 			
If NASA is not on:	Disable the D channel <ul style="list-style-type: none"> • Overlay 96, LD 96 • REQ: CHG • TYPEDIS DCH 	Disable the loop <ul style="list-style-type: none"> • Overlay 60, LD 60 • REQ: CHG • TYPE: DISL (slot number) 	Program the D channel <ul style="list-style-type: none"> • Overlay 17, LD 17 • REQ: CHG • TYPE: ADAN • ADAN: CHG DCH (slot number) • Keep pressing enter until you get to NASA • TYPE: yes • TYPE: end
Verifying NCRD <ul style="list-style-type: none"> • Overlay 20, LD 20 • REQ: PRT • TYPE: TIE • CUST: 0 • Route: Enter the route defined in LD 20 • Keep pressing enter until all values are displayed. Check if NCRD is yes. 		If NCRD is set to no <ul style="list-style-type: none"> • Overlay 16, LD 16 • REQ: CHG • TYPE: RDB • CUST: 0 • ROUT: (route number) from LD 20 • Keep pressing enter until you get NCRD and type Yes • Keep pressing enter until you get the REQ prompt again • TYPE: end 	

ISDN Call Connection Limitation

The ICCL feature piggybacks on the call initiation request and acts as a check at transit PBX points to prevent misconfigured routes or calls with errors from blocking channels.

This feature adds a transit/tandem counter to a call setup message. This counter is compared at each transit PBX with a value programmed into the transit PBX, in a range from 0 to 31. If the call setup counter is higher than the PBX value, the call will be blocked at the PBX and cleared back to the network. This prevents calls from creating loops that tie up lines.

Norstar configurations:

- Setting ICCL
 1. With the display showing `System Prgrming` press until the display shows `NetworkServices`.
 2. Press until `MCDN` displays.
 3. Press . `NetwkICCL:` displays.
 4. Press CHANGE to choose either `Y` (yes) or `N` (no)
- Under `Hardware`, define `Maximum transits` for the card.

The diagram below demonstrates how a call might loop through a network if the system is **not** set up with the ICCL feature.

Call loop on system without ICCL

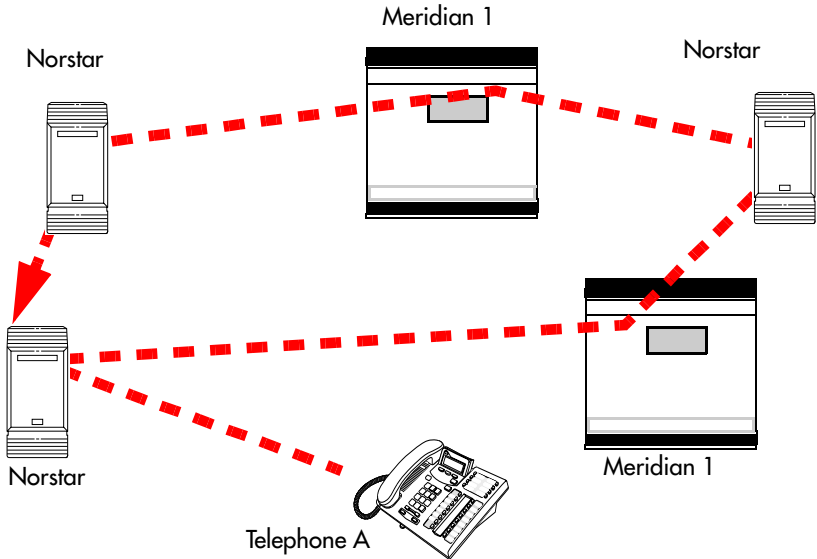

Meridian configurations:

The following settings are required on the Meridian system, using LD15:

- REQ = CHG
- TYPE = CDB
- Net_DATA=Yes
- CUST=0
- ISDN=Yes
- RCNT(5)
- PSTN=No
- TNDM=0-31(15)
- PCMC=0-31(15)
- SATD=0-5(1)
- Number plan CDP, UDP, and access code configured using LD 86, 87 and LD90

Trunk Route Optimization

TRO finds the most direct route through the network to send a call between nodes. This function occurs during the initial alerting phase of a call.

Business Communications Manager configurations:

- Under **Network Settings**, **MCDN**, set **TRO** to **Y**(yes).
- Configure call routing for all optimal routes.
- Configure Call Forward (All Calls, No Answer, Busy) or Selective Line Redirection to use the optimal routes.

This feature avoids the following situation: A call originating from a Norstar system may be networked to a Meridian system, which, in turn, is networked to another Meridian system, which is the destination for the call. If the call routes through the first Meridian (M1) to reach the second Meridian (M2), two trunks are required for the call. An optimal choice is a straight connection to M2. TRO finds these connections and overrides the less-efficient setup.

The following figure shows two call paths. The first route, through the Meridian, demonstrates how a call might route if TRO is not active. The second route, that bypasses the Meridian, demonstrates how TRO selects the optimum routing for a call.

Call paths with and without TRO

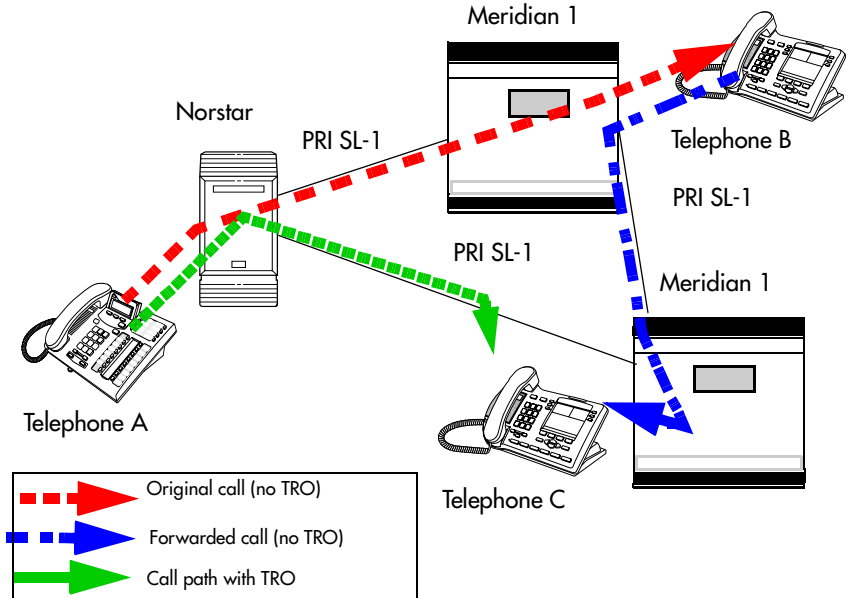

If you are using a Meridian 1 system as part of the network, you need the following programming for each system:

```
M1 TRO set to yes for Card1/Mod 1
Norstar route:
LD 16
TYPE: RDB
Cust: xx
Rout: 0-511
TRO: Yes
```

Norstar configuration:

1. With the display showing **System Programming** press until the display shows **NetworkServices**.
2. Press until **MCDN** displays.
3. Press . **NetwkICCL:** displays.
4. Press until **TRO:Y** displays.

5. Press **CHANGE** to choose either **Y** (yes) or **N** (no).

Trunk Anti-tromboning

TAT is a call-reroute feature that works to find better routes during a transfer of an active call. This feature acts to prevent unnecessary tandeming and tromboning of trunks. This action occurs after the speech path has been established.

Note: This feature is not applicable for alerting calls.
This feature does not activate if TRO is set to yes.

Norstar configuration:

1. With the display showing **System Programming** press until the display shows **NetworkServices**.
2. Press until **MCDN** displays.
3. Press . **NetwkICCL:** displays.
4. Press until **TAT** displays.
5. Press **CHANGE** to choose either **Y** (yes) or **N** (no).

Meridian configuration

The following must be set on the Meridian 1 before this feature can activate:

- MCDN PRI D-channel must have TAT set to yes (using LD17 and TRMB in LD17)
- 1.5 MB/2MB DTI/PRI card configured as PRI with interface type of SL1
- NCRD parameter set to yes for the MCDN PRI routes
- Remote capabilities configured for the D-channel (using LD 17) to include ND2

The diagram below shows how TAT reduces the line requirements. The solid line shows Telephone A calling Telephone B and being transferred over an additional PRI line to Telephone C. With TAT active, the same call is transferred to Telephone C over the same PRI line (the dashed-line).

Call paths with and without TAT

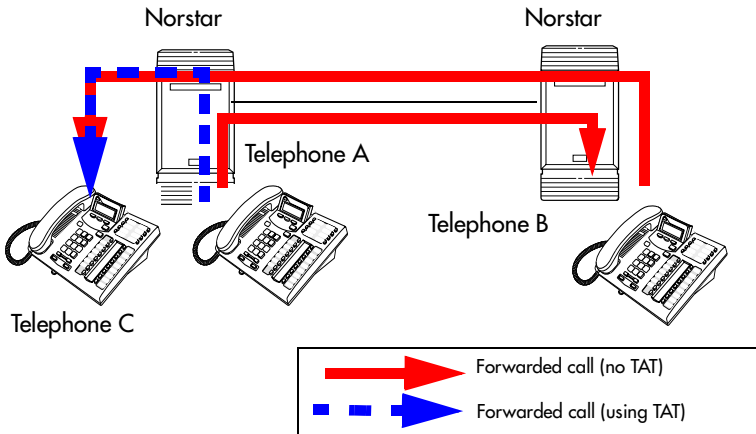

MCDN voice mail/auto attendant call features

Besides the general MCDN features described in *MCDN trunk call features* on page 141, an MCDN connection with a Meridian 1 with attached voice mail system, also provides some special call features.

MCDN Meridian 1 attendant MCDN features

- Meridian attendant features
- message waiting indication (MWI)
 - camp-on
 - break-in

Note: Although these features have the same functions as Camp-on and Priority calls within each Norstar system, MCDN camp-on and break-in from M1 can access all network telephones connected to the centralized voice mail system.

To all Norstar systems on the private network, the centralized voice mail system is viewed as an external call by each system, even though the dialing plan configurations makes it seem like callers are making local calls.

Message Waiting Indication

MWI allows the host system (Meridian 1) to notify a telephone on the Norstar system of a call waiting.

Special requirements:

- Over a PRI SL-1 line: Meridian 1 must be on Release 19 or greater.
- Meridian 1 requires the network ID of the Norstar system, which is defined under **Dialing Plan, Private Network**. This is a number between 1 and 27, and is defined by the Meridian system administrator.

The following figure demonstrates how the Meridian responds when a call is forwarded to a Meridian Mail mailbox.

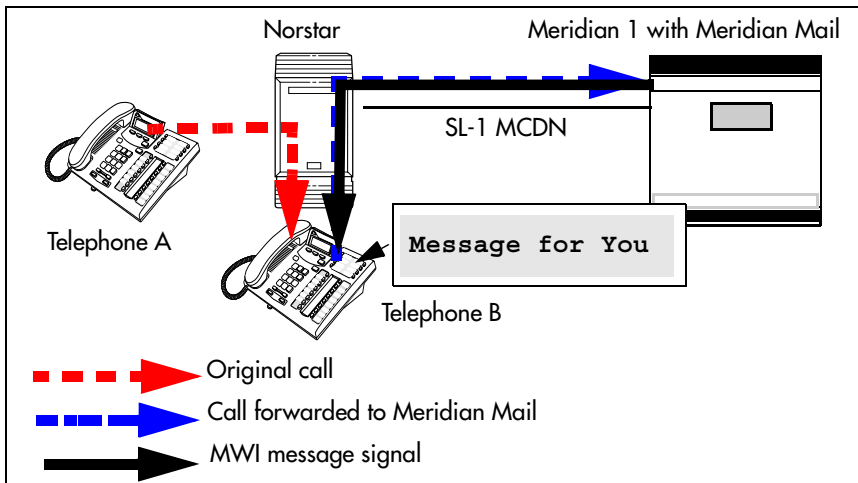

MWI programming

Norstar programming
Telco features, VMMsg Ctr Tel Numbers: <ul style="list-style-type: none"> • Voice Message Center 1 set to DES code plus M1 voice mail DN
Lines, Telco features: <ul style="list-style-type: none"> • choose Voice message Center 1
Terminals&Sets, Telco features: <ul style="list-style-type: none"> • assign target line for each set • set External VMMsg to Y

M1 programming
RCAP set to MWI and ND2 RLS ID set to 25

Camp-on

A call received by the Meridian attendant can be assigned to a telephone anywhere in the MCDN network, when the following situations are valid:



Attendant tip - *If the target telephone is busy, and is not forwarded to a prime telephone, the attendant receives a tone. If the camp-on is successful, there is no tone. However, due to the delay within the target system in determining if the telephone is busy and if the call will be transferred to a prime set, the Meridain attendant needs to wait about five seconds after attempting to camp a call before hanging up. Otherwise, the call will be lost if the telephone is busy.*

- the target telephone rings busy when the attendant calls and there are no free keys on target telephone
- DND regular feature is inactive
- DND on busy feature is inactive

The target user sees that there is a call camped on the telephone. The called user can then:

- clear a busy lines and take the call
- choose to reject the call, using F814
- indicate Do Not Disturb, using F85.

The diagram below demonstrates the call path for a Meridian attendant to camp a call on a telephone in the Norstar system.

Camping a call on a network telephone

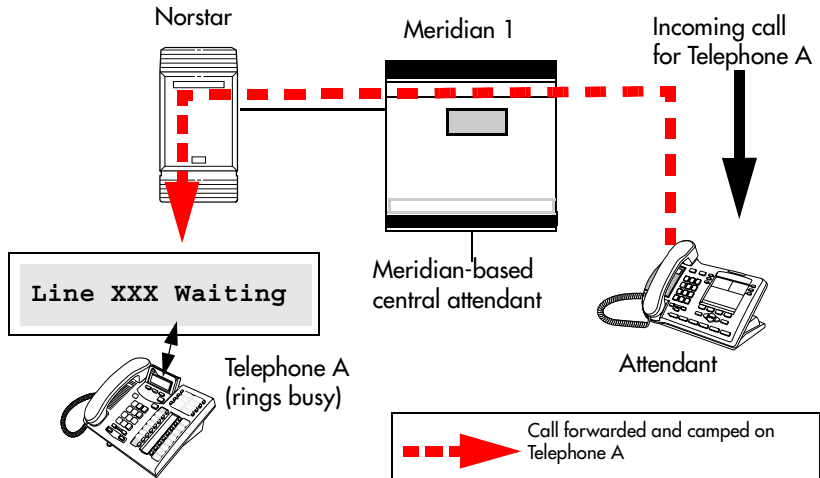

Break-in

The Meridian attendant can break into an on-going call from a telephone in the Norstar system, if these situations are valid:

Break-in can occur when these situations are valid:

- Target Norstar telephone is busy but still has a free intercom or line key.
- There is no camped call on the target telephone.
- DND busy is turned on, although the attendant can override a busy signal, if it is turned off, by pressing the **BKI** key.
- Prime set is also busy, with no free key, and with DND turned on.
- Attendant capability (intrusion) is high (2), and higher than either the target telephone or the caller the target telephone owner is busy with.

A warning tone occurs for both parties on the call before the actual break-in occurs.

The diagram below demonstrates the call path for a Meridian attendant to break into a call between telephones in the Norstar system.

Breaking into a Norstar call path

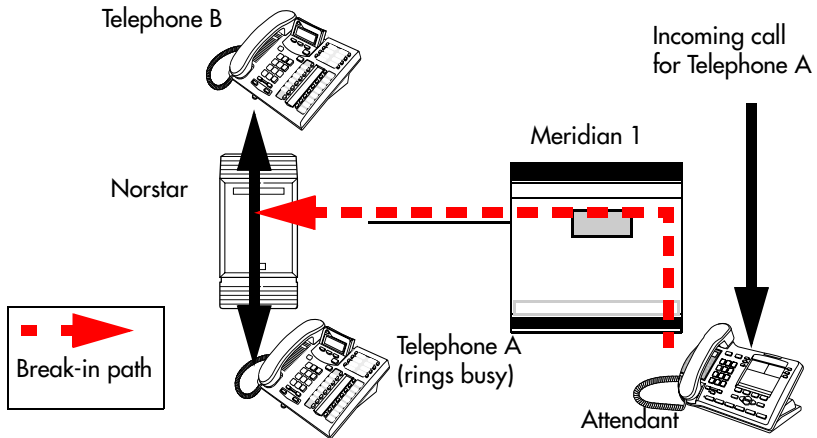

Only post-dial break-in is supported by MCDN:

1. Attendant dials destination number.
2. If a busy tone is heard, the attendant presses the BKI button.
Attendant is given access to the conversation.

You can set a level of priority that will determine if a telephone will allow an attendant to break in. This is referred to as setting the Intrusion level.

How the intrusion hierarchy works:

- Break-in is allowed if Attendant telephone is High and caller telephone is Medium.
- Break-in is not allowed if Attendant telephone is Medium and caller telephone is High.

Set the Intrusion level for each telephone under **Capabilities**.

1. At **Terminals&Sets**, press and enter the DN number for the telephone to which you want to add intrusion levels.
The telephone displays `<set number>:<set number>` or `<name>`.
2. Press . The display shows **Line Access**.
3. Press until you reach **Capabilities**.
4. Press . The display shows **Fwd no answer**.
5. Press until you reach **Intrusion**.
6. Press . The display shows **Protect lvl**.
7. Press **CHANGE** to select **None**, **Low**, **Med**, or **High**.

Central voice mail and Auto Attendant with Norstar

You can use Norstar voice mail (NVM) and Auto Attendant running on a Norstar Application module (NAM) platform as the central voice mail/auto attendant node for your MCDN network. However, this configuration does not allow centralized camp-on or break-in, since these are Meridian-voicemail-based features.

Using NVM requires that all nodes on the network are set up with the CDP dialing rules. You can have a maximum of 10 nodes on a Norstar-based network if you use all three DTI cartridges.

Note: Ensure you have the latest version of NVM if you want to set up this type of centralized system.

Configuring centralized voice mail

System configuration for centralized voice mail depends on where the NAM is connected. The system with the NAM is configured using the voicemail DN and a target line. The systems that are remote to the NAM are configured through the **Telco features** sections.

Installation instructions about installing Norstar voice mail as a centralized voice mail system, are explained in the addendum titled: *Installing Norstar Voice Mail as a Centralized Voice Mail System*. This addendum includes details about voice mail configuration, as well as the Norstar Modular ICS configuration that is included in the following sections.

Local system

To set up the local system, you need to assign a target line to the DN for the voice mail system, then enter that DN into the target line record.

1. After you enter your password, at the **Terminals&Sets** prompt, press .
The prompt displays: **Show set:**
2. Enter the DN number for the voice mail system.
3. Press . The prompt displays **Line access**.
4. Press . The prompt displays **Line assignment**.
5. Enter the target line number for your voice mail system.
6. Press **CHANGE** to change the setting for each line to one of the following: **Unassigned**, **Ring only**, **APPR&Ring**, and **APPR only**.

7. Press until you reach the top level, then press . The prompt displays **Lines**.
8. Press . The prompt displays **Show line**.
9. Enter the target line number you entered in step 5.
10. Press . The prompt displays **Trunk/line data**.
11. Press . The prompt displays **Line Type**.
12. Press . The prompt displays **Rec'd #**.
13. Enter the DN for the voice mail system.
14. Exit programming.

Remote system

On the nodes that are not directly connected to the central voice mail system, you need to use the **Telco Features** headings to identify the route to the voice mail system.

1. After you enter your password, press until the prompt displays **Telco Features:**
2. Press . The prompt displays **UMs9 Center tel#s**.
3. Press . The prompt displays **UMs9 Center 1**.
4. Press . The prompt displays **Use:**
5. Press **CHANGE** to until you reach **Routing tbl**.
6. Press . The prompt displays **Tel #:**
7. Enter the number to access the external voice mail system.

Set Telco features for the VM DN

1. Press until you reach the top level, then press until the prompt displays **Terminals&Sets.**
2. Press . The prompt displays: **Show set:**
3. Enter the DN for the voice mail system.
4. Press . The prompt displays **Line access.**
5. Press until the prompt displays **Telco features.**
6. Press . The prompt displays **Feature Assign.**
7. Press . The prompt displays **Show line.**
8. Enter the line number that connects to the system for the central voice mail system.
9. Press . The prompt displays **Caller ID Set.**
10. Press until the prompt displays **Ext1 VMsg set.**
11. Press **CHANGE** to select **Y** (yes).

Set Telco features for the target line

1. Press until you reach the top level, then press until the prompt displays **Lines.**
2. Press . The prompt displays: **Show line:**
3. Enter the target line number for the voice mail system.
4. Press . The prompt displays: **Trunk/line data:**
5. Press until the prompt displays **Telco features.**
6. Press . The prompt displays **VMsg Center 1.**

7. Press . The prompt displays **Use#:**.
8. Press **CHANGE** to until you reach **Routing tbl.**
9. Press . The prompt displays **Tel #:**.
10. Enter the number to access the external voice mail system.
11. Exit programming.

Using centralized voice mail

If you use NVM, ensure that you provide the correct user cards for system access. Users with telephones connected to the Meridian or Norstar unit on which NVM is installed, use internal voice mail feature codes to use the system (FEATURE 981, and so on). Users on other nodes of the system, use the remote access codes, which are similar to the codes they would use if the central voice mail system was the Meridian-based system.

Note: Meridian mail and Norstar voice mail can co-exist on the same Meridian, however, users can only be configured for one of the systems.

Configuring Centralized Auto Attendant (CAA)

System configuration for centralized Auto Attendant depends on where the NAM is connected. The system with the NAM is configured using the CAA DN and a target line. The systems that are remote to the NAM are configured through the **Telco features** sections.

All nodes must have a unique Private Network Identifier (PNI), which is defined under **Dialing Plan**. On each node, as well, the PNIs of adjacent nodes are programmed under **Hardware**.

Assigning PNIs

1. After you enter your password, press until the prompt displays **System Prgrming:**
2. Press . The prompt displays **Hunt groups.**
3. Press until the prompt displays **Dialing Plan.**
4. Press . The prompt displays **Private Network.**
5. Press . The prompt displays **Type.**
6. Press **CHANGE** to until you reach **CDP.**
7. Press . The prompt displays **PrivNet.ID.**
8. Enter the private network ID for your system.

Assigning PNIs for adjacent nodes

1. After you enter your password, press until the prompt displays **Hardware:**
2. Press . The prompt displays **Show module.**
3. Enter the module where the PRI card you have configured for SL-1 resides.
4. Press . The prompt displays **CdX-KSU.**
5. Press . The prompt displays **Card type.**
6. Press . The prompt displays **Lines.**
7. Enter the line number you want to configure.
8. Press . The prompt displays **Protocol.**
9. Ensure that this displays **SL-1.**
10. Press . The prompt displays **PrivNet.ID:**
11. Enter the PNI of the adjacent node.

12. Repeat these steps for all the modes that are directly adjacent to your system.

Local system

To set up the local system, you need to assign a target line to the DN for the voice mail system, then enter that DN into the target line record.

1. After you enter your password, at the **Terminals&Sets** prompt, press .

The prompt displays: **Show set:**

2. Enter the DN number for the Auto Attendant.
3. Press . The prompt displays **Line access**.
4. Press . The prompt displays **Line assignment**.
5. Enter the target line number for the Auto Attendant system.
6. Press **CHANGE** to change the setting for each line to one of the following: **Unassigned**, **Ring only**, **APPR&Ring**, and **APPR only**.
7. Press until you reach the top level, then press . The prompt displays **Lines**.
8. Press . The prompt displays **Show line**.
9. Enter the target line number you entered in step 5.
10. Press . The prompt displays **Line Type**.
11. Press . The prompt displays **Rec'd #**.
12. Enter the DN for the Auto Attendant system.
13. Exit programming.

Remote system

On the nodes that are not directly connected to the central Auto Attendant system, you need to use the **Telco Features** headings to identify the route to the system.

1. After you enter your password, press until the prompt displays **Telco Features:**
2. Press . The prompt displays **VMs9 Center tel#s.**
3. Press . The prompt displays **VMs9 Center 1.**
4. Press . The prompt displays **Use:**.
5. Press **CHANGE** to until you reach **Routing tbl.**
6. Press . The prompt displays **Tel #:**.
7. Enter the number to access the external Auto Attendant system.

Set Telco features for the CAA DN

1. Press until you reach the top level, then press until the prompt displays **Terminals&Sets.**
2. Press . The prompt displays: **Show set:**
3. Enter the DN for the Auto Attendant system.
4. Press . The prompt displays **Line access.**
5. Press until the prompt displays **Telco features.**
6. Press . The prompt displays **Feature Assign.**
7. Press . The prompt displays **Show line.**
8. Enter the line number that connects to the system for the central voice mail system.

9. Press . The prompt displays **Caller ID Set.**
10. Press until the prompt displays **Ext1 VMs9 set.**
11. Press **CHANGE** to select **Y** (yes).

Set Telco features for the target line

1. Press until you reach the top level, then press until the prompt displays **Lines.**
2. Press . The prompt displays: **Show line:**
3. Enter the target line number for the voice mail system.
4. Press . The prompt displays: **Trunk/line data:**
5. Press until the prompt displays **Telco features.**
6. Press . The prompt displays **VMs9 Center 1.**
7. Press . The prompt displays **Use:**
8. Press **CHANGE** to until you reach **Routing tbl.**
9. Press . The prompt displays **Tel #:**
10. Enter the number to access the external Auto Attendant system.
11. Exit programming.

Voice mail configuration

On the voice mail system, set the following parameters:

- Set **Redirected DN** to **Yes.**
- Under the **F983 AA** prompt, set **ANS: Y** for the voice mail DN assigned target line.
- Under **F983 dial 77** and set **External init** as **Y.**

- From the CVM/CAA lines, use the default greeting table 1.

For detailed directions, refer to the addendum titled: *Installing Norstar Voice Mail as a Centralized Voice Mail System*.

Customer Use

This section shows sample configurations for different types of network access. Each example has four parts:

- A scenario explains the goal of the call and what is required to achieve it.
- A diagram shows the network configuration that supports the application.
- A list shows the Norstar hardware required to support the configuration.
- Tables show the programming. Only those settings that are important to network access are described.

Public network

The calls described in this section all originate from the public network. Callers dial in using a public DN into the system.

Call one or more Norstar telephones

Ms. Nelson is a bank customer with a question for an accountant. She dials the number that maps onto target line 203. All of the telephones ring in the accounting department.

Hardware: ICS, a Trunk Module with a DID Trunk Cartridge, or a DTI with lines programmed as DID.

Trk/Line Data	Rec'd # Line 051	4321 (for Line 203) DID
Rec'd # length	Rec'd # length	four digits (can be from three to seven digits, but must match number of digits sent by central office)

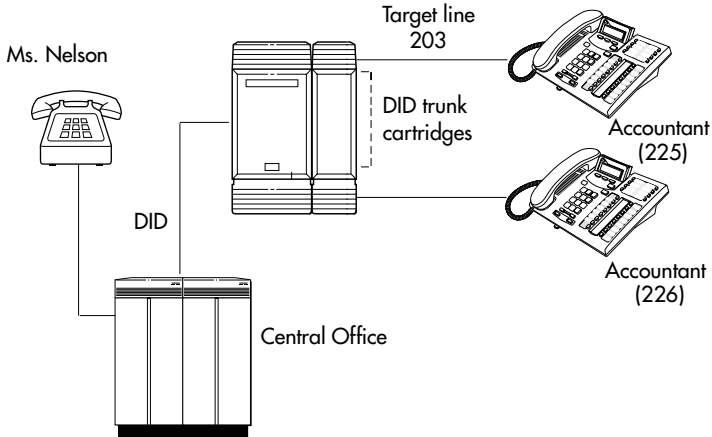

Call Norstar and select tie lines to a private network

A manager in Georgia wants to use the tie lines at headquarters to call Washington. He dials a telephone number that maps onto the DISA DN, enters a Class of Service (COS) password, then dials a line pool access code to select a tie line to Washington.

Using tie lines

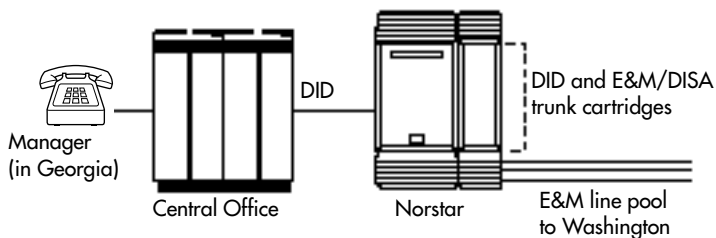

Hardware: ICS, a Trunk Module with a DID Trunk Cartridge, two E&M/DISA Trunk Cartridges for the three trunks in the line pool to Washington, or a DTI with one DID line and three E&M lines.

Incoming trunk:		
Trk/Line Data	Line 049	DID
Access codes	DISA DN	5321
Rec'd # length	Rec'd # length	four digits (three to seven digits, but must match number of digits sent by central office)

Outgoing trunk:		
Trk/Line Data	Line 053	E&M
	Line type	Pool F
Access codes	Line pool F	6 (up to four digits)
COS pswds		Define restrictions. Define remote access pkgs. Assign a restriction filter to the line. Assign COS passwords and filters for each Class of Service.

Call Norstar and select lines to the public network

Gord wants to make a long-distance business call from home. To avoid being charged, he dials the telephone number that maps onto the Auto DN at work. After hearing the dial tone, Gord dials a line pool access code to select a line to the public network. He then dials the long-distance number.

Using DID to dial long-distance

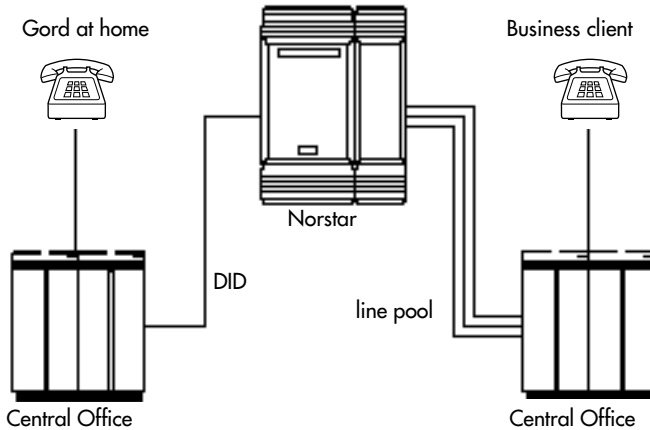

Hardware: ICS, a Trunk Module with a DID Trunk Cartridge or DTI with several DID lines.

Incoming trunk:

Trk/Line Data	Line 049	DID
Access codes	Auto DN	4321
Rec'd # length	Rec'd # length	four digits (can be from three to seven digits, but must match number of digits sent by central office)
Lines /Restrictions and Remote access		Define restriction filters. Define remote access packages. Assign a remote restriction and remote package to the line.

Outgoing trunk:

Trk/Line Data	Line 001	Loop
	Line type	Pool A
Access codes	Line pool A	1234
Lines /Restrictions		Assign a restriction filter to the line.

Private network

All the calls described in this section originate from within the networked system.

Call one or more Norstar telephones

The production supervisor in Houston selects the less-expensive company Tie line to call the manager at the Administration office in Dallas. Once the line is selected, the production supervisor dials the digits that will map onto the target line of the manager in Dallas.

Calling from a Norstar to a remote PBX

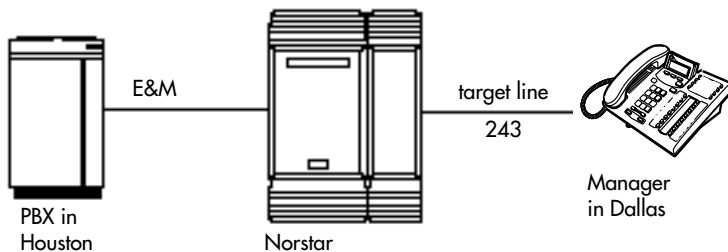

Hardware: ICS, a Trunk Module with an E&M/DISA Trunk Cartridge or a DTI with an E&M line.

Incoming trunk:

Trk/Line Data	Rec'd #	4321 (for target line 243)
	Line 049	E&M
	Ans Mode	Auto

Rec'd # length Rec'd # length four digits (can be from three to seven digits, but must match number sent by central office)

Use tie lines to other nodes in the private network

At a branch office, Joan selects a tie line to the main office. After hearing the dial tone, she dials a line pool access code to select another tie line to a branch office in the next state.

Calling within the network through Tie lines

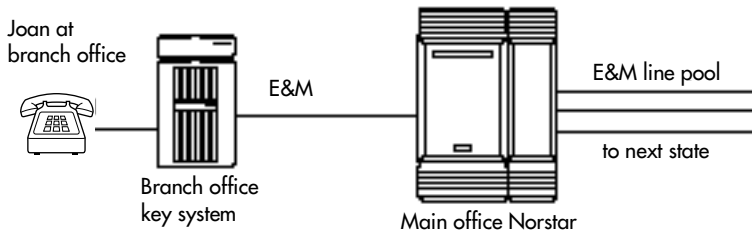

Hardware: ICS, a Trunk Module with two E&M/DISA Trunk Cartridges, for the three lines in the line pool and the one incoming line, or a DTI with four E&M lines.

Incoming trunk:

Trk/Line Data	Line 049	E&M
	Ans mode	Auto

Under Lines / Restrictions / Remote access	Define restriction filters. Define remote access packages. Assign a remote restriction and remote package to the trunk.
--	---

Outgoing trunk:

Trk/Line Data	Line 050	E&M
	Line type	Pool D

Access codes	Line pool D	71 (can be from one to four digits)
--------------	-------------	-------------------------------------

Lines / Restrictions	Assign a restriction filter to the trunk.
-------------------------	---

Select lines to the public network

Liz in Memphis, needs to call long-distance to a client in New York. She selects a tie-line to the branch office in New York. After hearing the dial tone, she dials a line pool access code to select a line to the public network. Then, she dials the external number as a local call.

Using a Tie line and line pool to call remote PSTN

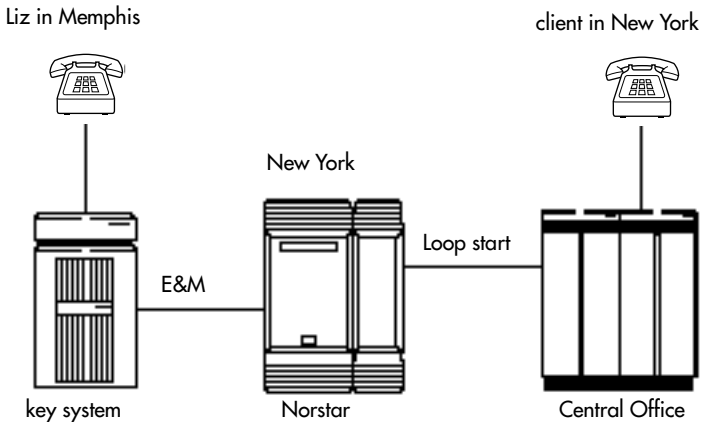

Hardware: ICS, a Trunk Module with an E&M/DISA Trunk Cartridge or DTI with an E&M line.

Incoming trunk:	Line 049	E&M
Trk/Line Data	Ans mode	Auto
Under Lines / Restrictions and Remote access		Define restriction filters and remote access packages. Assign a remote restriction and remote package to the trunk.
Outgoing trunk:		
Trk/Line Data	Line 001	Loop
	Line type	Pool B
Access codes	Line pool B	73 (can be one to four digits)
Lines / Restrictions		Assign a restriction filter to the line.

Select E&M trunks to the private network

For a confidential call, the Montana sales manager presses the line button for a private E&M trunk to the Oregon office. This automatically alerts at the line appearance on the telephone of the Oregon sales manager.

Using private E&M trunks for remote calls

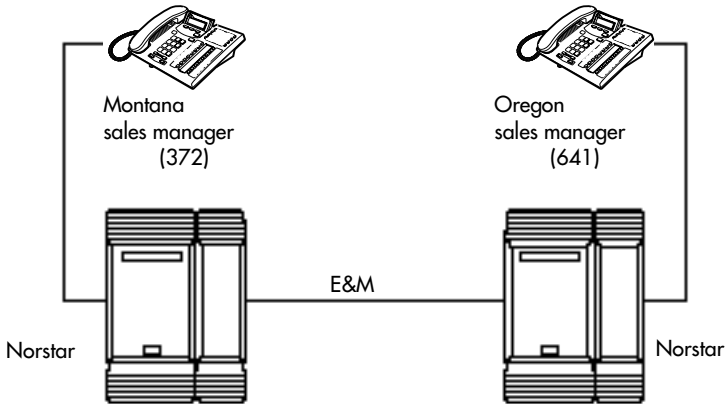

Hardware: (for both systems) ICS, a Trunk Module with an E&M/DISA Trunk Cartridge or a DTI with an E&M line.

Montana:

Outgoing trunk:

Trunk Data (Line 049)	Line	E&M
Line Data (Line 049)	Line type	Private to 372

Oregon:

Incoming trunk:

Trunk Data (Line 057)	Line	E&M
	Ans mode	Manual
	Line type	Private to 641

Norstar Line Redirection feature

The branch office is receiving more calls than it can handle, so it redirects one of its lines to the main office. All calls that come in on target line 232 will be routed out on line 003 to the main office. Whenever a call is redirected, the target line and outgoing line will be busy for the duration of the call.

Line redirection routes

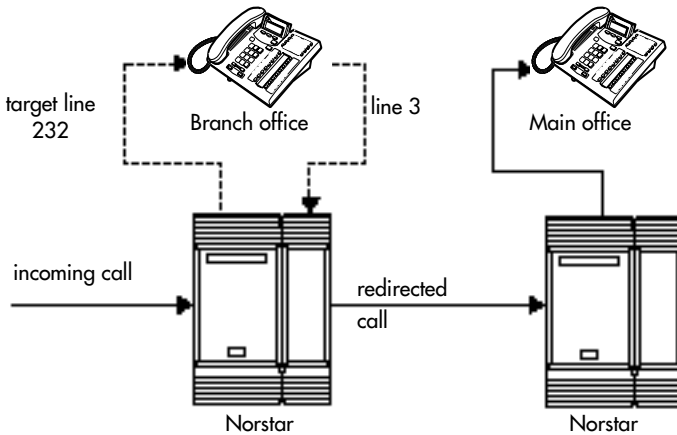

Hardware: ICS, an E&M/DISA Trunk Cartridge if the incoming trunk is E&M or a DID Trunk Cartridge if the incoming trunk is DID, or a DTI with one E&M line or one DID line.



Tips - Any line appearance on a telephone can be selected as the incoming line to be redirected. Restriction filter restrictions on the line are checked against the filter in effect at the time a call is redirected, not when redirection is programmed.

A target line cannot be selected as the outgoing line for redirection.

The incoming trunk must have disconnect supervision.

Incoming trunk:	Line 001:	Loop
Trk/Line Data	Trunk mode:	Super
	Ans mode:	Auto
	OR	
	Line 049:	DID
	OR	
	Line 053:	E&M
	Ans mode:	Auto
	Rec'd #:	4321
	(for target line 232)	
Rec'd # length	Rec'd # length:	four digits (can be from three to seven digits, but must match number of digits sent by central office)
Outgoing trunk:	Line 003:	Loop
Trk/Line Data	OR	
	Line 054:	E&M
Capabilities	Allow redirect:	Y

ETSI, MCDN and Network features

If your system is running Profile 2, and you are using ETSI PRI lines with SL-1 MCDN protocol to network your systems, your network has access to all the MCDN features described in the preceding sections, starting with "Private networking using PRI SL-1" on page 117. MCDN features are set up under **Network Features, MCDN**.

In addition, ETSI lines can provide the following CO network features. Availability of these features is first determined by your service provider, and secondly by turning on the features under **Network Features, ETSI**.



TIP - *In version 6.1 you do not require a PRI keycode to use ETSI PRI lines, however, if you want to use the line to use the ETSI MCDN features, you must obtain and enter an MCDN keycode.*

Network Call Diversion

Norstar Network Call Diversion (NCD) is a network function that allows forwarding and redirection of calls outside the Norstar network when using an ETSI ISDN line. Functionality is similar to that of External Call Forward (ECF).

NCD redirects calls using the same line on which they arrive. Call forward is efficient since there is no need for additional outside lines.

Forwarding calls externally from an extension requires the user to enter either a Destination Code or Line Pool Access Code, and the number to which calls will be forwarded.

Examples of NCD include:

- redirecting all calls from an extension to a mobile phone
- forwarding calls to an external destination (rather than to voicemail), when an extension is busy or the user is unavailable.

Allowing NCD

Installer password required

To use NCD, you must turn the feature on in Network Services.

1. Press until the display reads **System Programming**.
2. Press . The display shows **Hunt groups**.
3. Press until the display shows **Network Services**.
4. Press . The display shows **Network Redirection: N**.
5. Press **CHANGE** and set to **Y** (yes).

Feature description

NCD is available only over ETSI ISDN lines. It can be invoked when calls are presented to Norstar/BST extensions over ISDN lines. The user must program the selected extension. Refer to *External call forwarding* on page 50

NCD is integrated with the following existing Norstar Call Forward features:

- Call Forward Unconditional (CFU)—implemented on Norstar Call Forward All Calls (CFAC) , and Selective Line Redirection (SLR) , also

referred to as Line Redirection. This is programmable by the user.

- Call Forward on Busy (CFB)—implemented on Norstar Call Forward Busy.
- Call Forward on No Response (CFNR)—implemented on Norstar Call Forward No Answer.

Programming and restrictions

NCD features are accessed through existing Norstar features. Extensions requiring redirection must be programmed individually to either CFAC or SLR. CFB or CFNA must be set during programming. **Allow redirect** must be set to Yes for each extension, in **Terminals&Extns/Capabilities**.

Note: Any other programming applied to specific lines and extensions take precedence, for example **Restrictions (extns)** under **Terminals&Extns**.

NCD is used as long as the affected lines are ETSI ISDN, and the affected DIA lines are accessible via ISDN lines. Incoming calls are diverted back to the ISDN. If NCD fails due to network errors, ECF is invoked. If ECF cannot be executed, the incoming call is routed to the prime extension for the line.



ATTENTION!

If a line is configured to appear on several extensions with redirection programmed, predicting which extension will divert the call is not possible. This should be considered during system configuration.

An extension with CFB, CFNA and CFAC programmed will give priority to CFAC for diversion.

Selective Line Redirection

Selective Line Redirection (SLR), also referred to as Line Redirection, is enhanced for use with digital lines and operates in conjunction with NCD.

Diversion by SLR takes precedence over diversion by CFAC. An SLR line cannot be diverted by CFAC. If the call arrives on an extension with SLR programmed, a ring splash will sound (if programmed).

For information about SLR restrictions, refer to *Selective Line Redirection* on page 179. For information about redirecting lines, see Line Redirection in the *Modular Plus System Administration Guide*.

Programming Extensions

The User Interface for programming NCD is the same as for ECF.

Different types of Call Forward are available depending on the extension being programmed. Programming an extension to forward calls externally requires the user to enter a destination code or line pool number, in addition to the external phone number. Therefore, care should be taken to identify your network line types and record the available codes and line pools.

Enhanced Caller ID

When a Norstar/BST extension which has Call Line Identifier (CLID) active receives a redirected call due to NCD, the user will see the DN for the Calling Number. This is followed by a “>” and the redirecting number. This is displayed for as long as the call is active (alerting or answered) at that telephone.

If the alerting extension is not the CLID extension for that line, the line appearance can be pressed to briefly display the information. Pressing or **INFO** while the call is active invokes Call Info. Call Info on MCDN SL-1 displays the redirecting number and the reason for the redirection.

Note: When Norstar requests that an incoming call be redirected by the distance network, Norstar does not inform the network of the redirecting DN. In this case, the diverted-to party will not see the diverting party DN.

Malicious caller identification (MCID)

The MCID feature allows you to use to have call information recorded on the central office system for an incoming call on a specific line (EURO ISDN lines, only).

The user must invoke the feature code without hanging up, and within 30 seconds (time varies on different networks) after the caller hangs up.

Note: This feature must be supplied by your service provider and allowed in network programming to work. Check with your system administrator.

The following information registers on the network:

- called party number
- calling party number
- local time and date of the invocation in the network serving the called user
- service provider option: calling party subaddress, if provided by calling user)

Programming MCID capability

Installer password required

To allow MCID functionality on your system, you must turn the feature on in Network Services.

1. Press until the display reads **System Programming**.
2. Press . The display shows **Hunt Groups**.
3. Press until the display shows **Network Services**.
4. Press . The display shows **ETSI**.
5. Press . The display shows **Network Redirection: N**.
6. Press . The display shows **MCID: N**.
7. Press **CHANGE** and set **MCID** to **Y** (yes).

Data Solutions

Examples of ISDN Scenarios

For information about various ISDN scenarios that may help you to decide on the data solution that is best for you, refer to the following web site: <http://www.nortelnetworks.com/support> and perform a Search for **TIPS**. You will need your user name and access code.

If you do not have a user name and access code, the site provides information about how to get access to this site.

ISDN applications

ISDN terminal equipment delivers a wide range of powerful business applications:

Video conferencing and video telephony

Video conferencing offers instant visual and audio contact between distant parties using either studio-based or desktop ISDN terminals.

Desktop conferencing

ISDN allows computer users in distant locations to share and edit any image, data or text file on their own computer screens while they discuss the information.

File transfer

The ISDN network allows you to transfer files containing data, text, images, data, or audio clips, faster and cheaper than with a conventional modem.

Telecommuting

Convenient retrieval, processing and storage of files is possible for the employee working at home by using ISDN lines to give high-speed access to information resources at the office.

Group 4 fax

ISDN fax applications save money by increasing both transmission speed and the quality of resolution.

Remote LAN access

ISDN provides an affordable and fast means for employees at remote sites, such as at home or in branch offices, to access local area networks (LANs).

Leased line backup

Essential backup for leased lines can be provided using ISDN, as required, rather than duplicating costly permanent leased lines.

LAN to LAN bridging

Local area network (LAN) bridge/routers allow flexible interconnection between LANs using ISDN, with charges only incurred when information is actually transmitted.

Internet and database access

The fast call set up and high bandwidth of ISDN are ideal for accessing information services such as the Internet and databases.

Planning the installation



Only qualified persons should service the system.

The installation and servicing of this unit is to be performed only by service personnel having appropriate training and experience. It is critical that installers have the necessary awareness about hazards to which they are exposed in performing a task, and of the measures required to minimize the danger to themselves or other persons.

Electrical shock hazards from the telecommunication network and AC mains are possible with this equipment. To minimize risk to service personnel and users, the ICS must be connected to an outlet with a third-wire ground. In addition, all unused slots should have filler faceplates installed and the doors should be in place at the completion of any servicing.

Service personnel must be alert to the possibility of high leakage currents becoming available on metal system surfaces during power line fault events near network lines. A risk point on the ICS is the power cord earth ground pin. These leakage currents normally safely flow to Protective Earth ground via the power cord. Therefore, it is mandatory that connection to a grounded outlet is performed first and removed last when cabling the unit. Specifically, operations requiring the unit to be powered down must have the network connections (central office lines) removed first.

Planning checklist

The following section provides a checklist for the setup processes for the MICS system.

Hardware

- Verify that you have all the equipment and supplies you need to install the system. See *Required equipment* on page 189.
- Determine the location for the Integrated Communication System (ICS) and any expansion modules, telephones and other equipment.
- Install the ICS equipment. Refer to *Installation* on page 219.

Initial configuration

Turn on the equipment, and do the following procedures within 10 minutes. If you change the defaults, note the changes in the Programming record.

- Use the Profile code to access the profile interface if you require a profile that is different from the one used for North American systems. Refer to *Profile programming* on page 312.
- Use the Dialpad code to access the dialpad interface if your system uses the CCITT dialpad. Refer to *Dialpad programming* on page 316.
- Use the Startup code to access the template settings. If your system requires a non-default template. Refer to *Performing Startup* on page 317.

System configuration

- Plan and record system programming details in the *Programming Record*.
- Use the System Administrator password to make any changes to the system defaults. Enter any information required for your system lines and telephones.

Required equipment

- Integrated Communication System (ICS)
- Modular ICS ROM software cartridge
- Modular ICS NVRAM cartridge
- Trunk Cartridge(s) for the ICS
- Services Cartridge — one required for T1, PRI or BRI, two required for busy sites or a Combination Fiber 6-port Services Cartridge, which provides the same Services Cartridge functionality
- Digital Trunk Interface (DTI) configured for PRI
- BRI card(s) for the ICS, as required
- emergency telephones — two for ICS, one for each trunk module, as required
- Business Series Terminals or Norstar telephones
- ISDN devices, for example, ISDN equipment or data devices, as required
- distribution panel(s)

Expansion equipment

- Expansion Cartridge — two-port or six-port
- Combination Fiber 6-port Services Cartridge
- Trunk Module(s) (TM)
- Station Module(s) (SM)
- Trunk Cartridge(s) for the TM
- power bar



Your Norstar system requires connection to a grounded outlet.

To prevent possible injury from voltage on the telephone network, disconnect all central office and station lines before removing the plug from the electrical outlet.

The basic Integrated Communication System (ICS) supports up to 32 telephones. With the addition of Trunk Cartridges, you can connect up to 48 digital lines to the ICS.

With the addition of an Expansion Cartridge or a Combination Fiber 6-port Services Cartridge in the ICS, you can add Trunk Modules, Station Modules, Integrated Data Modules, or a combination of modules to increase your system capacity.

Installed in ICS	Additional modules allowed		
	Trunk	Station	Maximum
MICS 6.1 system No Expansion cartridge (mini)	0	0	0
2-port Expansion cartridge (midi)	2	2	2
6-port Expansion cartridge (maxi)	6	6	6
XC system Combination Fiber 6-port Services Cartridge (maxi)	6	6	6

Installed in ICS	Additional modules allowed		
	Trunk	Station	Maximum
Combination Fiber 6-port Services Cartridge and 6-port cartridges (mega)	6	12*	12
Two Combination Fiber 6-port Services Cartridge (mega)	6	12*	12

*The last two ports are reserved for Companion use and for data modules. See the *Modular ICS Companion Installer Guide* for more information about Companion programming.

Optional equipment

- station auxiliary power supply (SAPS)
- Busy Lamp Field (BLF) (for M7310 telephones only)
- one or more central answering position (CAP) modules for M7324 telephones, or key indicator modules (KIM) for T7316E telephones
- Analog Terminal Adapter (ATA or ATA2)
- external music source
- auxiliary ringer
- headset
- telephone loud ring amplifier
- base stations, handsets, antennas and remote power interconnect units
- uninterruptible power supply

If the system is equipped with digital lines, use an uninterruptible power supply so that the DTI keep-alive signal will continue to be sent to the network in the event of a power failure.

Equipment for installing the ICS and modules

- screwdriver
- pliers
- connecting tool (punch-down tool)
- four 19 mm (3/4 in.) wood screws for each of the mounting brackets
- 38 mm (1 1/2 in.) screws for the cable troughs (two screws for the ICS and SM, four screws for the TM)
- 19 mm (3/4 in.) thick wooden backboard

Location requirements

- minimum distance of 4 m (13 ft.) from equipment such as photocopiers, electrical motors, and other equipment that can produce electromagnetic, radio-frequency (RF), or electrostatic interference
- clean, dry, and well-ventilated
- minimum clearance of 150 mm (5 in.) above and 100 mm (4 in.) below the ICS
- the gap between the ICS and the wall should be left completely clear to allow proper heat dissipation
- temperature between 0°C and 50°C (32°F and 122°F)
- humidity between 5% and 95%, non-condensing

Spacing requirements for a typical MICS-XC 6.1 system

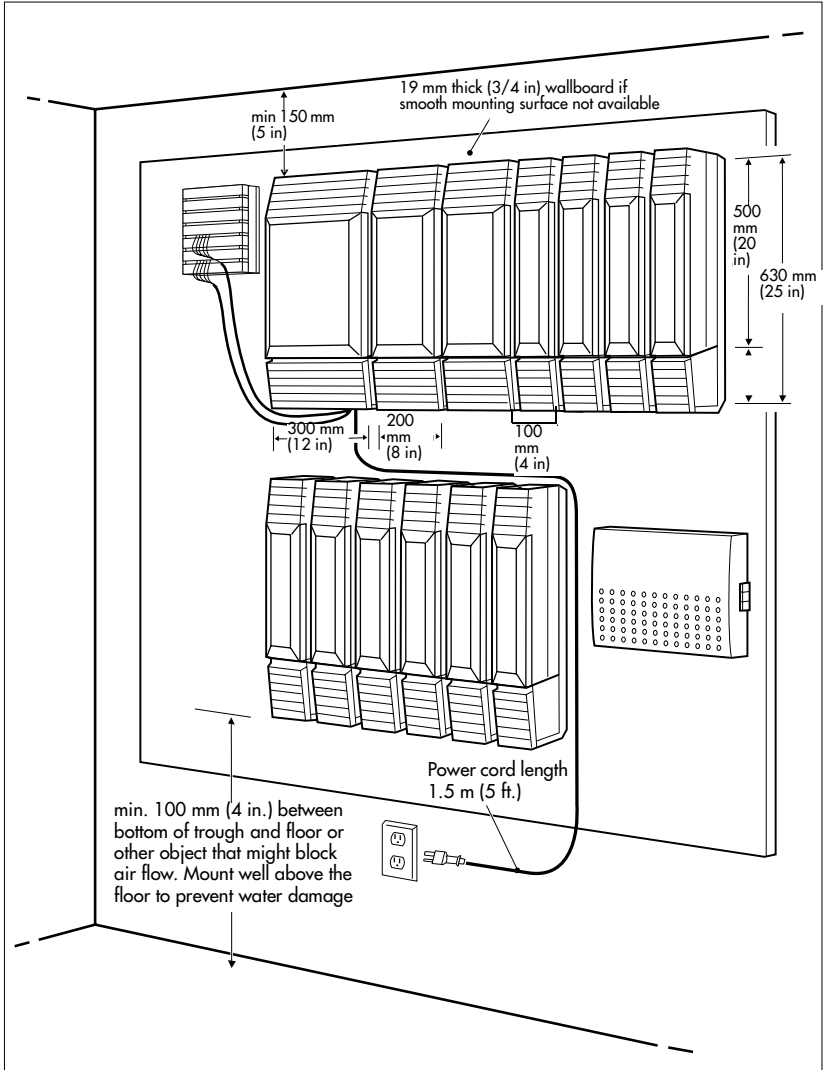

Electrical requirements

- non-switched outlet within 1.5 m (5 ft.) of the ICS
- The ICS and module power cords are 1.5 m (5 ft.) long. You may connect the ICS and modules to a power bar. The power bar must be CSA certified and UL listed with a third-wire ground.
Do not use an extension cord between the ICS and the power bar, or between the power bar and the electrical outlet.
- AC outlet equipped with a third wire safety ground to provide shock protection and avoid electromagnetic interference
- dedicated 110 V AC nominal, 50/60 Hz, 15 A minimum service with a third-wire safety ground



Risk of electric shock.

The safety of this product requires connection to an outlet with a third-wire ground. Use only with three-prong power cord and outlet.



Check ground connections.

Ensure that the electrical ground connections of the power utility, telephone lines and internal metallic water pipe system, if present, are connected together. If they are not connected together, contact the appropriate electrical inspection authority. Do not attempt to make the connections yourself.

Configuring Trunk Cartridges

If you plan to configure lines on a Loop Start Trunk Cartridge as auto-answer, you will need an E&M Trunk Cartridge for every two auto-answer loop start lines. The E&M Trunk Cartridge provides DTMF receivers for auto-answer loop start lines. You can install three additional Trunk Cartridges in each Trunk Module. The following table shows you the line capacity of each Trunk Cartridge.

Trunk Cartridge	Line capacity
DTI configured for T	24
DTI configured for PRI T1	23
DTI configured for ETSI PRI (ICS only)	30 (Profile 2)
BRI-ST & BRI-U4	8
BRI-U2	4
Loop Start with disconnect supervision	4
GATC/CI	4
DID (TM only)	4
E&M (TM only)	2

You can install different types of Trunk Cartridges together in the same Trunk Module. When mixing Trunk Cartridges, use a separate block on the distribution panel for each type of Trunk Cartridge.

Configuring Station Modules

Each Station Module allows you to connect up to 16 additional Norstar telephones to the system.

Mini	Midi		Maxi				Mega				Mega / Companion	
ICS	SM3	SM4	SM5	SM6	SM7	SM8	SM9	SM10	SM11	SM12	SM13	SM14
32	48	64	80	96	112	128	144	160	176	192	208	224



Tips - *The following combinations are not supported with the MICS 6.1 and MICS-XC 6.1 systems:*

- *two 2-port expansion cartridge system (four fiber ports total)*
- *a six-port and a two-port expansion combination (eight fiber ports total)*

In a fully expanded system using 72 digital channels, consider installing two service cartridges to prevent blocking of incoming calls due to lack of DTMF resources, as there are only four DTMF tone receivers per cartridge.

Internal wiring requirements

The following section describes the cable required for the Norstar loop and an ISDN S reference point S loop.

Norstar loop

- one, two or three twisted pair cables per telephone
- dc loop resistance of less than 64 Ω
- cable length (0.5 mm or 24 AWG) less than 300 m (1000 ft.)

- use of a station auxiliary power supply (SAPS) for loops 300 m (1000 ft.) to 790 m (2600 ft.). The SAPS must be a Class 2 power source that is UL listed and CSA certified.
- no bridge taps

ISDN S reference point (S Loop)

- no longer than 1000 m (3,200 ft.) for point to point
- no longer than 450 m (1,475 ft.) on a point-to-multipoint extended passive bus
- no longer than 100 m (300 ft.) for 75 ohm cable or 200 m (600 ft.) for 150 ohm cable on a point-to-multipoint short passive bus

Wiring for the S reference point (S loop) should conform to ANSI T1.605. Wiring for the ISDN U reference point (U loop) should conform to ANSI T1.601.



Verify lightning protectors.

Check the lightning protectors at the cable entry point to the building with special attention to the grounding. Report any problems to the telephone company in writing.

Equipment that is designed to be connected using internal wiring is typically not lightning protected. Norstar telephone equipment and ISDN S loops and T loops should not leave the building where the ICS is installed.

System overview

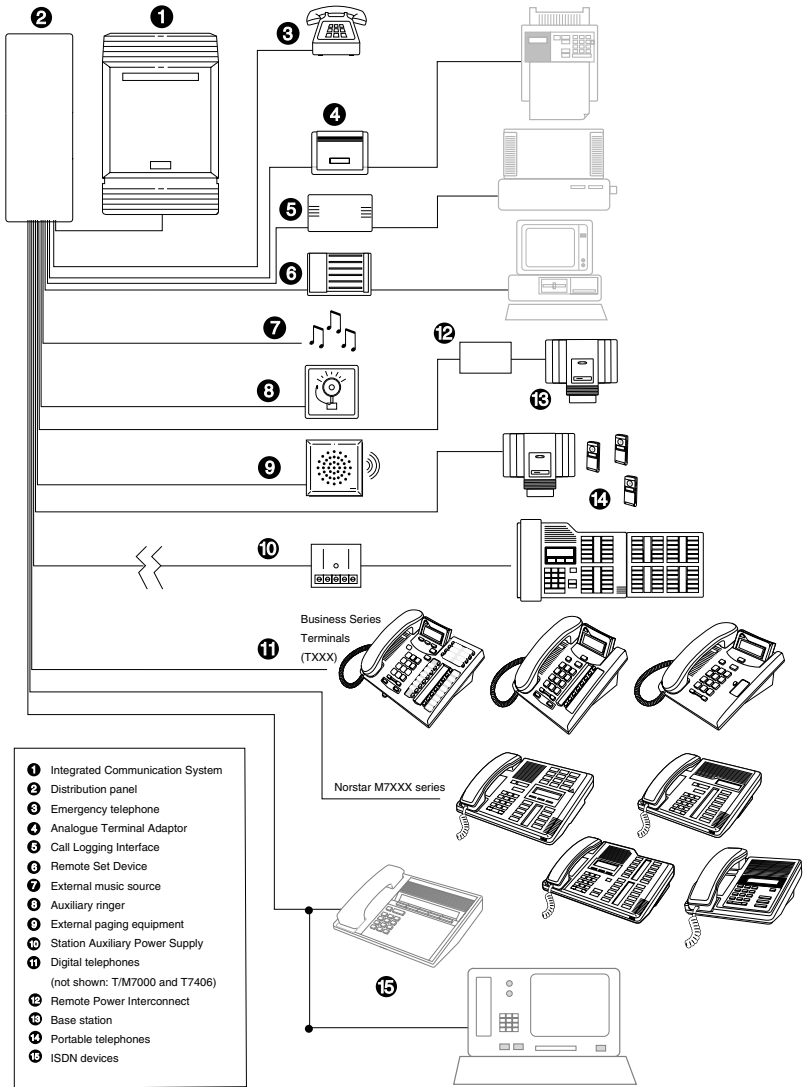

Upgrading your Norstar system

What procedure you use to upgrade your Norstar system will depend on the version of MICS software to which you are upgrading.

Upgrade notes:

- When you are upgrading from a 4.1 or later system, ensure that you have a release version 2 NVRAM cartridge.
- When making simultaneous hardware and software upgrades (e.g. 12-port expansion plus a MICS 6.1 software upgrade), upgrade your software release before making your hardware upgrades.
- Ensure that you power up the system after the new software has been installed, but before any new hardware is added. Upgrading in this order maintains your 0X32 ICS programming data for use with MICS 6.1 and MICS-XC 6.1.
- If you are upgrading from a pre-6.0 system, note that line renumbering will occur. Refer to the wiring charts in *Wiring charts* on page 252 for changes. This renumbering will also affect DN and mailbox numbering for any voice mail or CallPilot applications you have running on your system.



When upgrading, Call Log information may be lost.

During a system restart, Call Log information is not saved. Make sure to notify users if a system restart is planned so any log information can be recorded first.



A loss of UTAM information occurs when upgrading US MICS-XC systems.

UTAM Recovery Codes are required. If you are upgrading the system to include Companion components, see the upgrade instructions included in the *Modular ICS Companion Installer Guide*.

Supported upgrades in MICS 6.1

Upgrading from...	Target Upgrade								
	MICS 6.1	USA-MICS-XC 6.1	CDA-MICS-XC 6.1						
MICS (all versions) 1.0-3.0	<p>To retain programming integrity when upgrading to 6.1 from software versions prior to MICS 4.0, use the MICS upgrade tool for the appropriate system. Also refer to: <i>Legacy hardware and software upgrade notes</i>: on page 201</p> <p>Note: The line numbering for your system will change with this upgrade.</p>								
	<p>Upgrade Tool order numbers:</p> <table style="width: 100%; border: none;"> <tr> <td style="width: 60%;">USA-MICS-XC</td> <td style="text-align: right;">NTAB2587</td> </tr> <tr> <td>CDA-MICS-XC</td> <td style="text-align: right;">NTAB2568</td> </tr> <tr> <td>NA-MICS</td> <td style="text-align: right;">NTAB2569</td> </tr> </table>			USA-MICS-XC	NTAB2587	CDA-MICS-XC	NTAB2568	NA-MICS	NTAB2569
USA-MICS-XC	NTAB2587								
CDA-MICS-XC	NTAB2568								
NA-MICS	NTAB2569								
Default resets after upgrades:	<p>Upgrading from MICS 1.0, MICS 2.0 or MICS 3.0: Routes will be defaulted ILG parameters will be removed but will not be upgraded to Hunt group parameters</p> <p>Upgrading from MICS 1.0: First Destination Code will be deleted Direct Dial parameters will be defaulted Companion parameters will be defaulted</p> <p>Upgrading from MICS 2.0: Auto DN and DISA DN will be defaulted.</p>								

Upgrading from...	Target Upgrade		
	MICS 6.1	USA-MICS-XC 6.1	CDA-MICS-XC 6.1
MICS (all versions) 4.0, 4.1 and 5.0	Insert MICS CS ROM cartridge with appropriate software load. Caution: Ensure you have a release version 2.0 NVRAM cartridge before you attempt the upgrade. Note: The line numbering for your system will change with this upgrade.		
MICS (all versions) 6.0	Insert MICS CS ROM cartridge with appropriate software load.		

Legacy hardware and software upgrade notes:



All old programming is maintained when upgrading from the 0X32 Release 1 - T1 software, with the following exceptions:

- all system passwords are returned to the system defaults
- ATA ans timer setting is returned to the system default setting

There will be line renumbering on systems upgraded from software versions previous to 6.0.

When upgrading from MICS 1.1, note that the Call log space has increased in newer versions.

Reallocate log space after upgrading.

Ensure that you maintain an accurate record of your existing system programming so that you can plan your new system programming appropriately.

If you have a Norstar system with a Modular 8X24 Key Service Unit (KSU), you cannot upgrade your software with the Upgrade Tool. If you want to upgrade to MICS 6.1, you

must replace your older Modular 8X24 KSU with the current 0X32 ICS (Integrated Communication System), and then program the system.

If you have a Norstar system with a Modular 0X32 ICS, you can use your ICS with the new MICS 6.1 and MICS-XC 6.1 software.

About the MICS NVRAM cartridge:



Do not install a MICS NVRAM cartridge from other MICS 6.1 systems. This will cause all the programming to be lost.

Do not attempt to use the MICS NVRAM cartridge as stored data transfer. This will cause the system to cold start.

The NVRAM assembly cartridge has a slot for a credit-card size PC-card, which are also referred to as Flash cards. These cards contain the system software and accommodate future system memory requirements and software downloading.

Upgrade from versions 4.0 to 6.0 to version 6.1

Your MICS 6.1 upgrade includes a modular CS ROM cartridge that contains the new software.

To upgrade from a system running 4.0 or newer software:

1. Power down.
2. Disconnect all amphenol cables.
3. Remove the power to the ICS and all associated modules. Disconnecting the power ensures protection for electronic components and that the data stored in the feature cartridge will not be corrupted.
4. Remove the MICS (4.0, 4.1, 5.0, or 6.0) CS ROM cartridge.

Note: Your system information remains on the NVRAM unit that the CS ROM cartridge fits into.

5. Insert the new MICS 6.1 CS ROM cartridge.
6. Plug the ICS back into the power source.
7. Reconnect all amphenol cables.
8. Deleted step 9.
9. Wait for the system to reboot.

Upgrade from pre-4.0 to 6.1 without upgrade tool

If you want to upgrade from a pre-4.0 system, you need both a MICS Non Volatile Read-only Memory (NVRAM) cartridge with a MICS 6.1 CS ROM cartridge installed.

If you do not need to retain your programming, you do not require the upgrade tool to perform this procedure. If you need to retain your programming, refer to *Upgrade from pre-4.0 to later versions using the upgrade tool* on page 205.

Note: This upgrade will cold start the system back to factory defaults.

To upgrade the software, follow these steps:

1. Power down.
2. Disconnect all amphenol cables.
3. Remove the power to the ICS and all associated modules. Disconnecting the power ensures protection for electronic components and that the data stored in the feature cartridge will not be corrupted.
4. Remove the entire cartridge.
5. Insert the new NVRAM cartridge with the MICS 6.1 CS ROM software.
6. Plug the ICS back into the power source.
7. Reconnect all amphenol cables.
8. Wait for the system to reboot.
9. Run the profile, dialpad, and startup programming within 15 minutes after reboot.
10. Program the system to your requirements.

Upgrade from pre-4.0 to later versions using the upgrade tool

If you want to perform a two-step upgrade from a pre-4.0 system, so you can retain your system information, you need to use the upgrade tool that was introduced with MICS 4.0. The upgrade tool allows you to transfer your NVRAM information to the new style NVRAM cartridge that contains a MICS CS ROM cartridge.

If you do not use the upgrade tool, all or part of your programming will be lost (refer to *Upgrade from pre-4.0 to 6.1 without upgrade tool* on page 204).



Ensure that you use the appropriate MICS upgrade tool when upgrading (NA-MICS, CDA-MICS-XC or USA-MICS-XC).

Your Norstar system will cold start and your data will be lost if the MICS ROM software cartridge that came in your upgrade tool does not match your MICS system software.

Refer to *Supported upgrades in MICS 6.1* on page 200 for order numbers for the upgrade tool.

To use the Upgrade Tool to upgrade from previous versions of MICS (all versions prior to MICS 4.0), follow these steps:

1. Power down.
2. Disconnect all amphenol cables.
3. Remove the power to the ICS and all associated modules. Disconnecting the power ensures protection for electronic components and that the data stored in the feature cartridge will not be corrupted.
4. Remove your old Norstar MICS software cartridge.
5. This step determines the type of MICS system you will ultimately upgrade to.

Insert the MICS NVRAM cartridge. Refer to the illustration below.

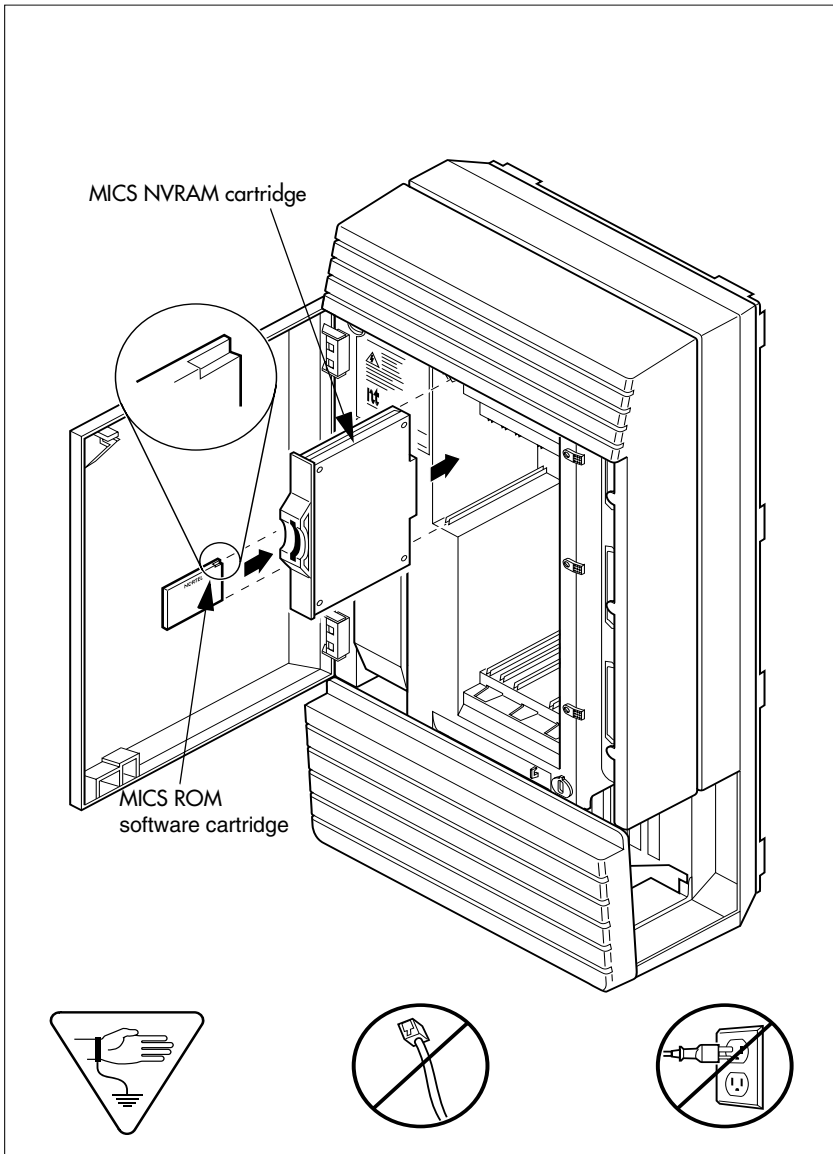

6. Insert the appropriate MICS upgrade tool ROM.
7. Reconnect all amphenol cables.
8. Power up. Wait until display flashing stops. **Insert MICS Card** is displayed.
9. Power down.
10. Remove the NVM RAM Upgrade tool.
11. Insert the Modular ICS 6.1 ROM software cartridge to perform the final stage of the upgrade to 6.1. Verify that you are using the proper software cartridge.
12. Power up.

If no alarm-event messages are observed, the upgrade to the new MICS software has been performed.

If alarm codes are displayed, refer to *Alarm codes* on page 533 for definitions.

If event messages are displayed refer to *Event messages* on page 541 for definitions.

Upgrading from MICS 6.1 to MICS-XC 6.1

MICS 6.1 mini to XC 6.1 mini

1. Install XC 6.1 ROM software cartridge.
2. Use module 1 (ports 101 to 132) for telephones only and module 2 for Trunk Cartridges only.

MICS 6.1 mini to XC 6.1 midi

1. Install XC 6.1 ROM software cartridge.
2. Install two-port Expansion Cartridge in slot 2.
3. Connect trunk modules beginning at port 4 and station modules beginning at port 3.

MICS 6.1 mini to XC 6.1 maxi

1. Install XC 6.1 ROM software cartridge.
2. Install a Combination Fiber 6-port Services Cartridge in slot 2.
3. Connect trunk modules beginning at port 8 and work down and station modules beginning at port 3 and work up.

MICS 6.1 midi to XC 6.1 midi

1. Install XC 6.1 ROM software cartridge.

MICS 6.1 midi to XC 6.1 maxi

1. Install XC 6.1 ROM software cartridge.
2. Replace two-port Expansion Cartridge with either a Combination Fiber 6-port Services Cartridge or a 6-port Fiber Expansion Cartridge in ICS slot 2.
3. Connect trunk modules beginning at port 8 and work down and station modules beginning at port 3 and work up. Refer to page 226.

MICS 6.1 maxi to XC 6.1 maxi

Install XC 6.1 ROM software cartridge.

MICS 6.1 maxi to XC 6.1 mega

1. Install XC 6.1 ROM software cartridge.
2. Replace two-port Expansion Cartridge with two Combination 6-port fiber Expansion Cartridges or one 6-port Fiber Expansion Cartridge and one Combination Fiber 6-port Services Cartridge in ICS slots 1 and 2.

3. Connect trunk modules beginning at port 8 and work down.
4. Connect station modules beginning at port 3 and work up.



Tips - Trunk modules cannot be connected to the Combination Fiber 6-port Services Cartridge in slot 1. (fiber interface ports 9 through 14.

To add Station Modules to ports 13 and 14 in a mega system refer to Modular ICS Companion Installer Guide.

Slots on ICS

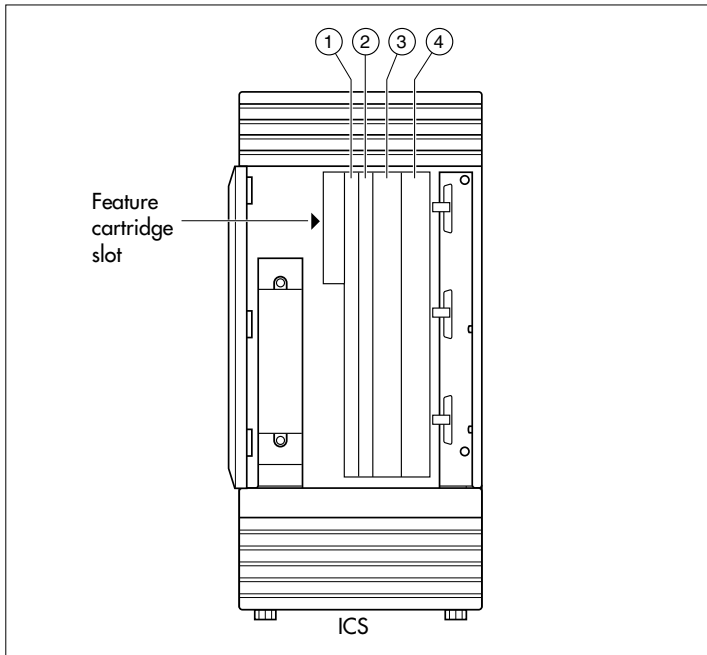

Trunk and Station Modules

If you are not adding digital T1 trunks to your system, or expanding to a mega configuration, you may reuse your existing copper Trunk and/or Station Modules with the Modular 0X32 ICS in MICS 6.1/XC 6.1. One 6-port copper expansion cartridge can be supported on the maxi configuration.

If you are adding digital T1 trunks to your system or expanding to a mega configuration, you must replace any copper Trunk and/or Station Modules with the new modules that have fiber connectors, and use a new fiber Expansion Cartridge in the ICS. You can reuse your old Trunk Cartridges in the new Trunk Module with fiber connectors.

Trunk modules cannot be installed on the second expansion (6-port) cartridge. You must relocate station modules to the second expansion cartridge to free up ports on the first 6-port expansion cartridge.

Global Analog Trunk Cartridge/CLI Cartridge

These cartridges have dip switches that may need to be set if your system is not running with the North American profile (Profile 1). Set the dip switches before you install the cartridge.

GATC dip switch settings (default is North America)(

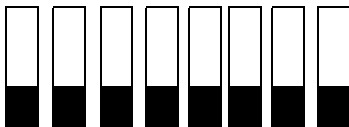

The following table lists the various dip switch settings. However, for this release, only the North America, Taiwan, and Australia settings are active.

DIP switch setting	Country profile
00000000	North America
10000000	Taiwan
01000000	Australia
11000000	*Chili
00100000	*Peru
10100000	*Argentina
01100000	*Mexico
11100000	*Sweden
00010000	*South America
10010000	*Brazil
01010000	*Norway
11010000	*France
00110000	*Germany
10110000	*Korea
XXXXXXX1	*Reserved
XXXXXXX1X	*Reserved
XXXXX1XX	*Reserved
* Reserved for future development	

Off-core DTI card

MICS 6.0 introduced the opportunity to expand the number of DTI cards in a system running Profile 1 or 4 by adding a DTI card to the expansion modules in a midi or maxi system. The card must be installed in either module 3 or 4 on a midi system. On the maxi system, the card can only be installed in module 7 or 8. One DTI card requires the entire module resources, so it is installed in the first slot of the module, and the other two slots must be left empty. Ensure these slots are covered with a

blank slot cover. The off-core DTI is configured in the same way as the other DTIs on your system.



Tips - *The off-core DTI module cannot be set to either secondary or primary clock source. This module is always free run.*

Equipment note: The DTI card released in conjunction with MICS 6.0 can be used either on or off-core. However, any previous versions of the DTI card can only be used on the core KSU hardware. Refer to your equipment supplier for the correct ordering codes.

Replacing a Modular 8x24 KSU

If you are upgrading your old KSU (8X24) and adding digital T1 trunks to your new system (0X32 ICS):

1. Verify your system programming, and update your *Programming Record*.
2. Follow the procedures outlined in *Installation* on page 219 for installing a new system.

If you are upgrading your 8X24 KSU, but not adding digital T1 trunks to a 0X32 system:

1. Verify your system programming, and update your *Programming Record*.
2. Disconnect the 50-pin connector for telephones from the KSU.
3. Disconnect the 50-pin connector for external lines and auxiliary equipment from the KSU.
4. Remove power from your system.

5. If your system includes Trunk Modules and Station Modules with DS-30 copper connectors, disconnect the DS-30 copper connectors from the Expansion Cartridge.
6. Remove any cables from the KSU cable trough.
7. Remove the KSU and wall-mount bracket from the wall.
8. Install the new 0X32 ICS following the procedures in the *Installation* on page 219.
9. If your system includes Trunk Modules and or Station Modules with DS-30 copper connectors, install a compatible Expansion Cartridge with copper connectors in slot 1 of the ICS. The faceplate will cover slots 1 and 2.

***Do not reuse 8X24 Expansion Cartridge***

You cannot reuse an 8X24 Expansion Cartridge in the 0X32 ICS. You must install a supported Expansion Cartridge.

10. If you have installed a copper Expansion Cartridge in the 0X32 ICS, clip the ferrite bead that was shipped with the Expansion Cartridge onto the ICS power supply power cord.

Locating the ferrite bead

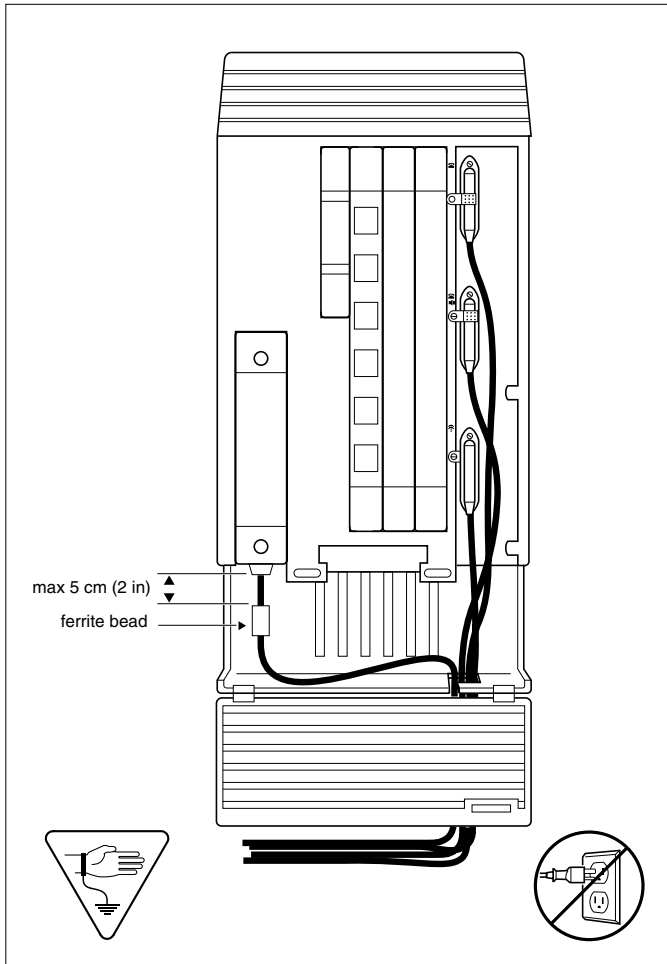

Ferrite bead required to meet EMI requirements

When using a copper Expansion Cartridge, you must install the ferrite bead on the ICS power cord to ensure that the product continues to meet FCC Part 15 Class A EMI requirements.

11. If your system includes Trunk Modules and or Station Modules with DS-30 copper connectors, reconnect the fiber interface cables to the Expansion Cartridge.
12. Power up the system.
13. Reconnect your 50-pin connector for internal telephones to the internal telephone connector on the ICS.
14. Reconnect your external line and auxiliary equipment wiring according to the procedures and wiring charts in the *Installation* on page 219. You cannot reuse your original 50-pin connector for external lines and auxiliary equipment, because the pin-outs have changed (unless connections are rewired).



DNs on Station Modules will change

If you simply reconnect the 50-pin connector for telephones on the ICS, and leave your Station Modules telephone connectors alone, your directory numbers will change.

The new 0X32 ICS can accommodate 32 telephones. The old 8X24 KSU connected only 24 telephones. Port numbering has been changed accordingly.

To preserve existing directory numbers consult the wiring charts in *Connecting the wiring* on page 247 and change the DNs using **Change DNs** in **System Programming**.

Trunk module line numbering

In MICS 6.0/MICS-XC 6.0 software, the line numbering for all profiles was adjusted to accommodate the Profile 2 ETSI requirement of 30 lines. The chart below shows the line numbering transitions between the various versions of software. Note also that target lines have been renumbered.

If you are upgrading to version 6.1 from a 6.0 system, no line programming changes are required. However, if you are upgrading from a system version previous to 6.0, you will need to note the line changes and make the programming adjustments.

Note: Line numbering varies, depending on the profile you choose for your system, which type of trunk module you are using, or what protocol you choose for the module (DTI). Refer to *TrunkMod* on page 494.

Line numbering for upgrades

Module	Cartridge	MICS 1.0 and 1.1 lines	MICS 2.0, 3.0, 4.0, and 5.0 lines	MICS 6.0 and later lines
Mod 08	Cd1-Mod8	49-52	49-56	61-68
	Cd2-Mod8	53-56	57-64	69-76
	Cd3-Mod8	57-60	65-72	77-84
Mod 07	Cd1-Mod7	61-64	73-80	85-92
	Cd2-Mod7	65-68	81-88	93-100
	Cd3-Mod7	69-72	89-96	101-108
Mod 06	Cd1-Mod6	73-76	97-100	109-112
	Cd2-Mod6	77-80	101-104	113-116
	Cd3-Mod6	81-84	105-108	117-120

Module	Cartridge	MICS 1.0 and 1.1 lines	MICS 2.0, 3.0, 4.0, and 5.0 lines	MICS 6.0 and later lines
Mod 05	Cd1-Mod5	85-88	109-112	121-124
	Cd2-Mod5	89-92	113-116	125-128
	Cd3-Mod5	93-96	117-120	129-132
Mod 04	Cd1-Mod4	97-100	121-124	133-136
	Cd2-Mod4	101-104	125-128	137-140
	Cd3-Mod4	105-108	129-132	141-144
Mod 03	Cd1-Mod3	109-112	133-136	145-148
	Cd2-Mod3	113-116	137-140	149-152
	Cd3-Mod3	117-120	141-144	153-156
Target lines			145-272 145-336 (expanded)	157-284 157-348 (expanded)

Upgrading ILG functionality with hunt groups

In MICS 4.0, Hunt groups replaced ILG functions from previous versions of MICS. The hunt group broadcast mode contains the equivalent of ILG functionality.

Hunt groups allow the following call programming:

- calls can be queued when all the members in a hunt group are busy
- call forwards are overridden by the hunt group routing, allowing calls to be distributed to other members in the hunt group in a way that does not depend on the busy situation of its members
- the ring / call distribution pattern can be programmed to determine who receives what call and in what order

- an overflow position can be programmed to another hunt group
- sequential and rotary modes are also available to provide versatility to hunt group configurations

New in MICS 6.1: External Hunt group calls can be monitored through telephones that are designated as supervisor telephones.

For more information about hunt groups, see *Hunt groups* on page 409.

Planning Hospitality functions

MICS 4.1 introduced the Hospitality feature, which allows businesses such as hotels to monitor and set room conditions and status, and to program alarms from both an administrative telephone and individual room telephones.

Hospitality features allow the following programming:

- Administrative telephone (password access)
 - monitor and set room condition
 - monitor and set room occupancy
 - monitor and set or cancel alarms
- Room telephone
 - Allow staff to set room condition (password access)
 - Allow guests to set or cancel wakeup alarms

For detailed information about setting up this feature, refer to *Programming Hospitality Services* on page 463.

Installation



Only qualified persons should service the system.

The installation and service of this unit is to be performed only by service personnel having appropriate training and experience. It is critical that installers have the necessary awareness about hazards to which they are exposed in performing a task, and of the measures required to minimize the danger to themselves or other persons.

Electrical shock hazards from the telecommunication network and AC mains are possible with this equipment. To minimize risk to service personnel and users, the ICS must be connected to an outlet with a third-wire ground. In addition, all unused slots should have filler faceplates installed and the doors should be in place at the completion of any servicing.

Service personnel must be alert to the possibility of high leakage currents becoming available on metal system surfaces during power line fault events near network lines. A risk point on the ICS is the power cord earth ground pin. These leakage currents normally safely flow to Protective Earth ground via the power cord.

Therefore, it is mandatory that connection to a grounded outlet is performed first and removed last when cabling to the unit. Specifically, operations requiring the unit to be powered down must have the network connections (central office lines) removed first.

Installation checklist

- test all ISDN network connections, if any
- mount the Integrated Communications System (ICS)
- mount the expansion modules (as required)
- install the Modular ICS NVRAM cartridge
- install the Expansion Cartridge, Trunk Cartridges (DTI, PRI, or BRI cards, as required)
- install the optional equipment
- install power bars, as required
- mount the distribution panel
- complete the wiring
- install the fiber cables
- install the emergency telephone(s)
- install the telephones
- power up the system
- connect the cables between the distribution block and the expansion modules
- install the door
- select the default template using System Startup programming
- program to customer requirements
- record programming details in the *Programming Record*
- ensure that all telephone keys are properly labelled
- ensure that all telephones are working
- check that the system is working properly

- ensure that all relevant documentation is left with the person in charge of the system
- train the Administrator using the *Getting Started* section in the *Modular ICS 6.1 System Coordinator Guide*
- for information on upgrading your ICS without adding digital T1, see *Trunk and Station Modules* on page 210.



To avoid electrical shock hazard to personnel or equipment damage, observe the following precautions when installing telephone equipment.

- Always disconnect telecommunication network connectors before disconnecting the AC power plug.
- Never connect the central office connectors until you have connected the power plug.
- Never install telephone wiring during a lightning storm.
- Never install telephone jacks in wet locations unless the jack is specifically designed for wet locations.
- Never touch non-insulated telephone wires or terminals unless the telephone line has been disconnected at the network interface.
- Use caution when modifying or installing telephone lines.

Testing the ISDN BRI network connection

Before you install a Norstar system which uses BRI cards you should test your connection to the ISDN network.

If you are installing a system which connects to the network using BRI-ST cards, the network connection must be equipped with an NT1. See the ISDN chapter and the wiring information in this chapter for more information about installing an NT1.

To test the ISDN BRI connection:

1. Connect ISDN terminal equipment (TE) that conforms to Bellcore standard to your central office ISDN jack or NT1. U interface TE can connect directly to the central office jack. S interface TE connect to the central office through an NT1.
2. Program the TE with the appropriate switch type, service profile identifier (SPID), and Network directory number (DN) using the instructions that come with the TE.
3. Check for dial tone, then place a call and verify the quality and clarity of the connection. If there is a problem, contact your service provider.
4. Repeat steps one through three for each network connection.

Installing the cartridges

The following table shows you which cartridges can be installed in which ICS and TM slots.

Cartridge type	ICS Slot	TM Slot
Modular ICS NVRAM cartridge	Feature Cartridge Slot	
Modular ICS ROM software cartridges: USA-MICS-XC 6.1 CDA-MICS-XC 6.1 NA-MICS 6.1	NVRAM Cartridge Slot	
Services Cartridge	1	
Fiber Expansion Cartridge (2-port)	2	
Fiber Expansion Cartridge (6-port)	1 or 2 (see note below)	
Combination Fiber 6-port Services Cartridge	1 or 2 (see note below)	
Digital Trunk Interface (DTI) card configured for T1 card or PRI	3 or 4	1
Starting in MICS 6.0: Global Analog LS/DS trunk cartridge replaces: Loop Start Disconnect Supervision (LS/DS) Trunk Cartridge	3 or 4	1, 2 or 3
Starting in MICS 6.0: Global Analog CLI trunk cartridge replaces: Caller Identification (CI) Trunk Cartridge	3 or 4	1, 2 or 3
E&M Trunk Cartridge		1, 2 or 3
DID Trunk Cartridge		1, 2 or 3
Copper Expansion (2-port)	1	
Copper Expansion (6-port)	1	
BRI-ST card	3 or 4	1, 2 or 3
BRI-U2 card	3 or 4	1, 2 or 3
BRI-U4 card	3 or 4	1, 2 or 3

Note: Use Slot 1 only when installing cartridges for 12-port, fully expanded systems. In this case, both slots 1 and 2 are installed with 6-port Expansion or a Combination Fiber 6-port Services Cartridge. If you use both slot 1 and 2, the software must be MICS-XC.

- LS/DS Global Analog Trunk Cartridges and CI Global Analog Trunk Cartridges both support loop start external lines.
- The Digital trunk Interface (DTI) supports both digital T1 and PRI lines. The DTI card can be configured to support ISDN PRI. Systems running Profile 1 or 4 can support 1 off-core DTI module.
- The Loop Start Trunk Cartridge supports loop start external lines.
- The E&M Trunk Cartridge supports E&M lines and provides direct inward system access (DISA).
- The DID Trunk Cartridge supports direct inward dialing lines.
- The BRI-ST card supports ISDN BRI S or T reference point loops.
- The BRI-U2 and BRI-U4 cards support two or four ISDN BRI U reference point loops, respectively.
- The Analog Extension Module (AEM), also known as an Analog Station Module (ASM), connects up to eight standard analog devices through eight ports connected to the CCU through a fibre cable link.

Mounting the modules

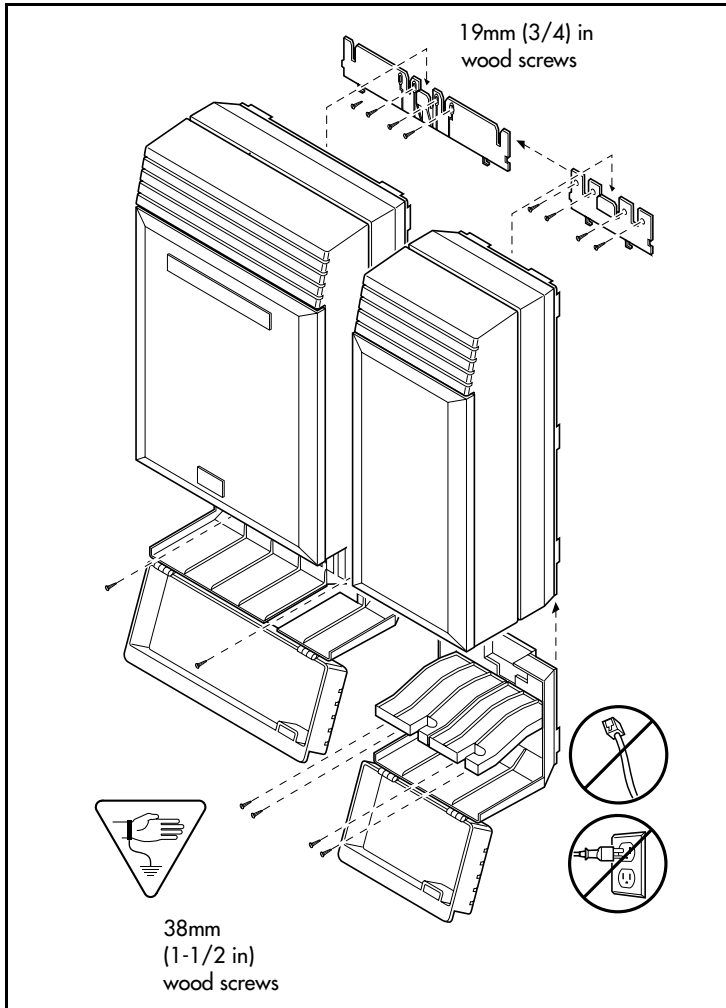

Attach bracket to secure surface.

Do not screw bracket directly to drywall. Use the two inner screw holes on the bracket.

1. Secure a 19 mm wood backboard to a wall. It must be capable of supporting a 20 kg mass.
2. Position the module mounting bracket on the backboard, smooth side against the backboard, with the screw holes at the top. Ensure that the bracket is level.
3. Fasten the bracket to the backboard with two 3/4-inch No. 10 round head wood screws through the inner pair of holes. The other two holes are optional.
4. Slide the module down onto the center bracket flange. Line up the notches on the far side of the bracket to the flanges on the module.
5. Open the front cable trough door. Fasten the bottom of the module to the backboard. Use two 3/4-inch No. 10 round head wood screws through the screw holes on each side of the cable trough.

See *T1 or ISDN-PRI configurations* on page 509 for configurations of Trunk Cartridges on the ICS slots.

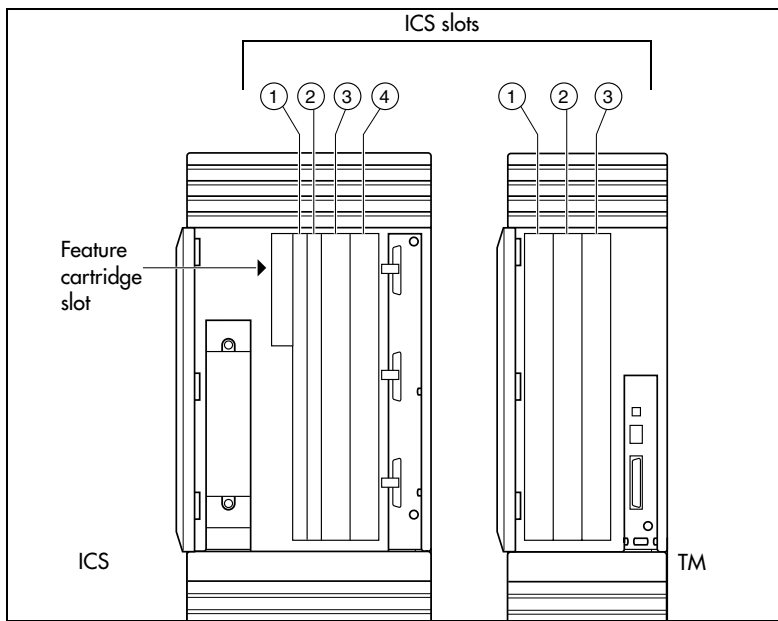

**Avoid risk of electrical shock.**

Voltages of up to 130 V may be present on the 1.544 Mbps circuit and on portions of the DTI circuitry.

Installation tips

- For a two-port (midi) system, a two-port fiber Expansion Cartridge is installed only in ICS slot 2.
- For a six-port (maxi) system, a six-port fiber Expansion Cartridge or a Combination Fiber six-port Services Cartridge is installed only in ICS slot 2.
- When a six-port fiber Expansion Cartridge is installed in ICS slot 2, either an additional six-port fiber Expansion Cartridge, for a fully analog trunk system, or a Combination Fiber 6-port Services Cartridge, can be installed in ICS slot 1 for a 12-port (mega) system with digital or BRI lines.
- Two Combination Fiber 6-port Services Cartridge are supported on a mega configuration using both ICS slots 1 and 2. When expanding beyond 6 ports, it is recommended two Combination Fiber 6-port Services Cartridge be used if two DTI cards are installed.
- For a 12-port (mega) system, any combination of the 6-port fiber Expansion and the Combination Fiber 6-port Services Cartridge is supported using both ICS slots 1 and 2.
- A copper Expansion Cartridge is a full-width cartridge and covers both ICS slots 1 and 2.
- One 6-port copper Expansion Cartridge is supported for a maxi configuration and can only be installed in slot 1.

- One two-port copper Expansion Cartridge is supported for a midi configuration and can only be installed in slot 1.
- Depending on your system configuration, BRI-ST, BRI-U2, BRI-U4, the off-core DTI cards can only reside in certain trunk modules. In a midi system, the cards must be in trunk modules 3 or 4, for a maxi or mega system, the cards must be in trunk modules 7 or 8. The cards can reside in the ICS regardless of system size.



Alarm Telephone will indicate a warm or cold reset.

An alarm and a prompt indicating warm or cold reset will occur on the alarm telephone if an expansion cartridge is installed in the wrong ICS slot or when the system size has been decreased.

Installing the ROM Software Cartridge

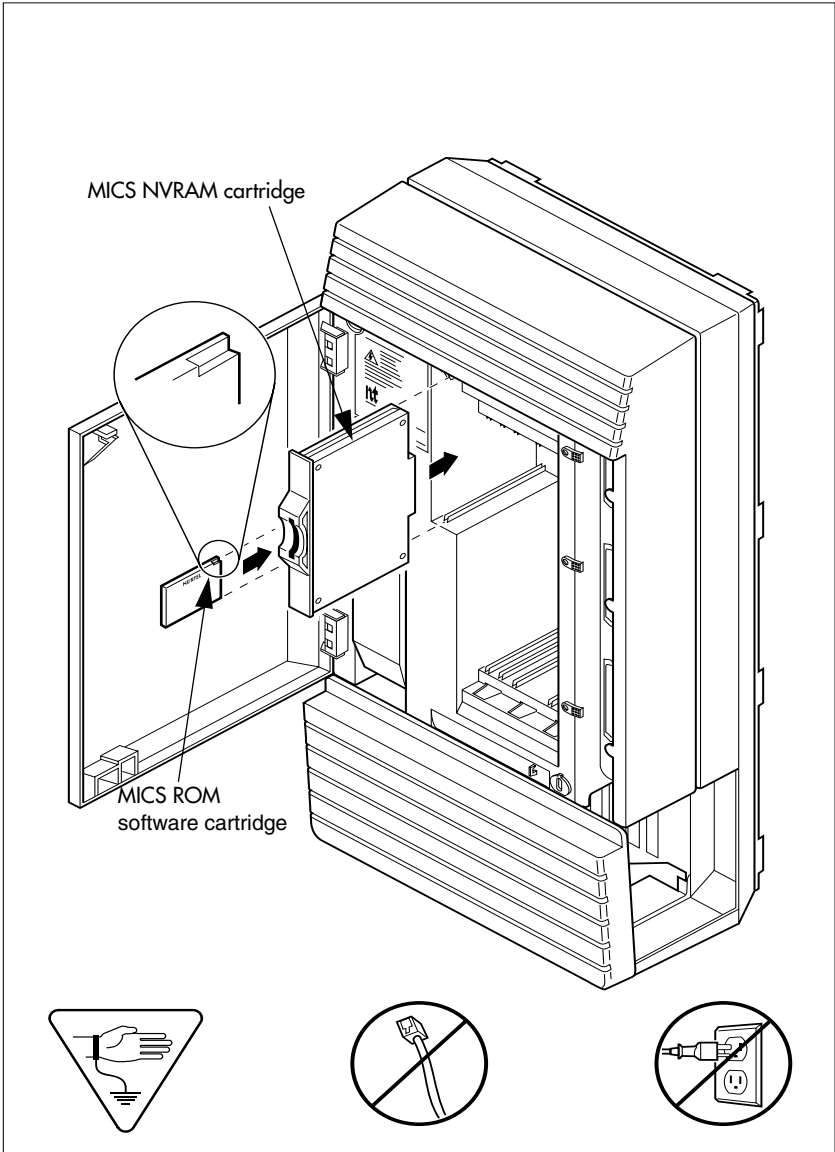

MICS ROM software cartridge

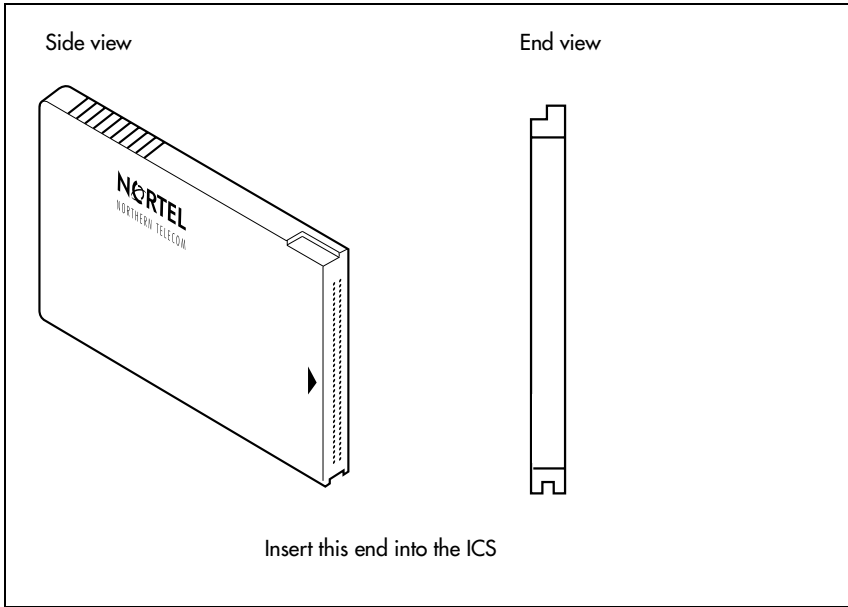

Inserting a cartridge

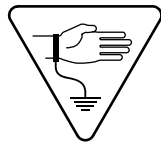
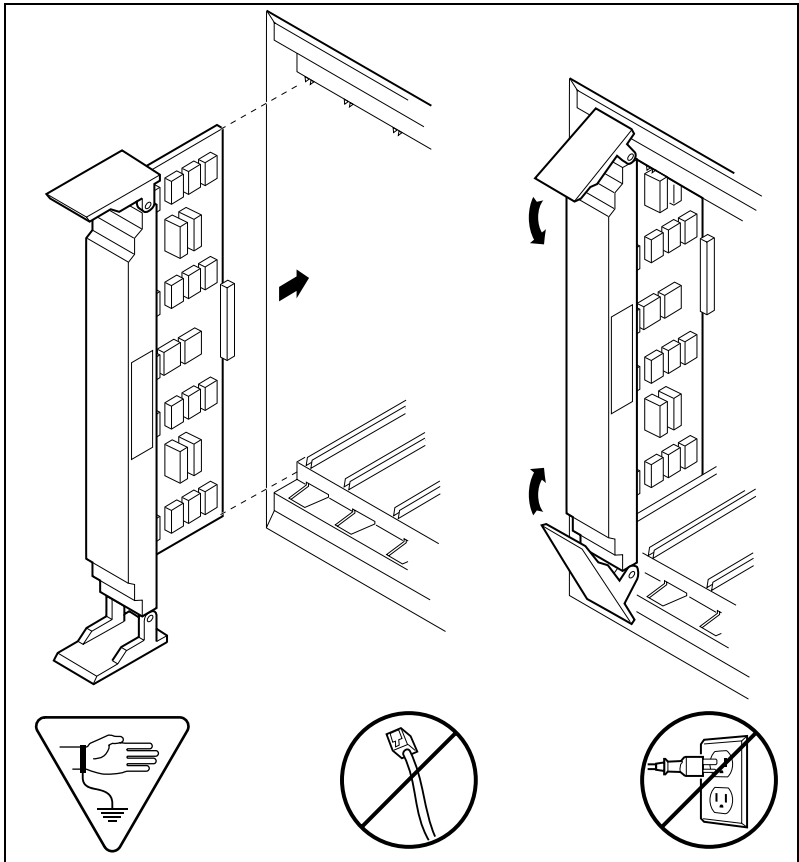

Close clips simultaneously.



It is important to center and close the two clips on the cartridge simultaneously, otherwise the cartridge may become misaligned in its slot or with its connector. If improperly inserted, the connector will be damaged.

PCB is electrostatic-sensitive.



Do not touch the printed circuit board on a cartridge. This is an electrostatic-sensitive device.

1. Install trunk cartridges in the ICS beginning with Slot 4 then Slot 3.
2. Install trunk cartridges in the trunk modules beginning with Slot 1 then Slot 2 and then Slot 3.

For easier wiring, install similar type Trunk Cartridges together in the same Trunk Module.

If you install an E&M or a DID or BRI Trunk Cartridge in the left-most slot (slot 1) of a TM, emergency telephones cannot be supported for that Trunk Module.

Terminating resistors on BRI-ST Cards

The standard ISDN user-network interface wiring requires terminating resistors at each end of the loop for point-to-point operation. This ensures correct timing of the signaling circuits.

Loop termination can be provided at either the point where the ISDN terminal is attached, or by the device attached to the loop which has built-in termination. Because the Modular ICS is usually at one end of the loop, the BRI-ST card is shipped with termination built-in for each ISDN loop. It is ready to be used where the ICS is located at one end of the loop, as in the following illustration:

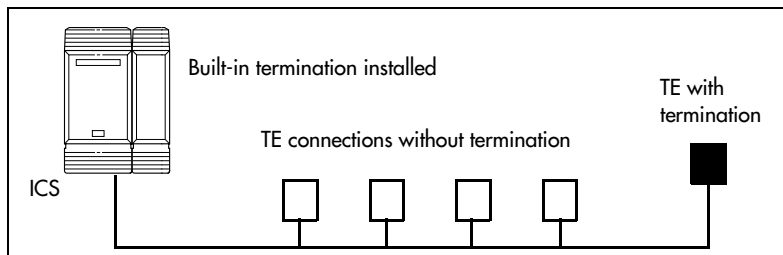

Shorting straps on a BRI-ST card

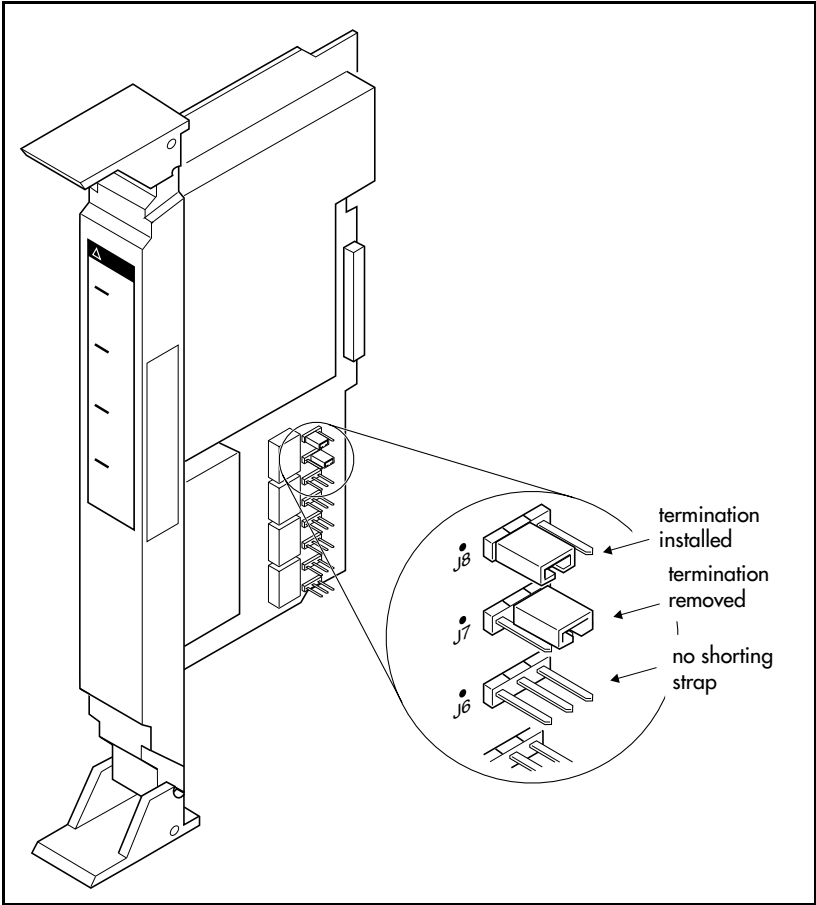

Ensure that the shorting straps are installed on both the receive and transmit jumpers for the loop. Refer to the illustration above.

The jumpers are numbered top to bottom, but the loops associated with each pair of jumpers does not follow the same top-to-bottom sequence. Refer to the table on the next page.

Receive and transmit jumper loop connections

Loop	RX and TX shorting straps
1	J3 and J4
2	J7 and J8
3	J1 and J2
4	J5 and J6

Connecting expansion modules

If your system includes fiber Trunk Modules, fiber Station Modules, Data Modules or Analog Station Modules, you need to connect the modules to the Expansion Cartridge by means of fiber cables.

Order of connection

In order to keep the default port and telephone numbering:

- Connect Trunk Modules to the Expansion Cartridge beginning at the top and working down.
- Connect Station Modules to the Expansion Cartridge beginning at the bottom and working up.

Analog Station Module

If you are installing the ICS system with an ASM, refer to the diagram below.

Connect jack 1 on the ASM to the first available fibre cable link on the CCU.

ASM cable connections

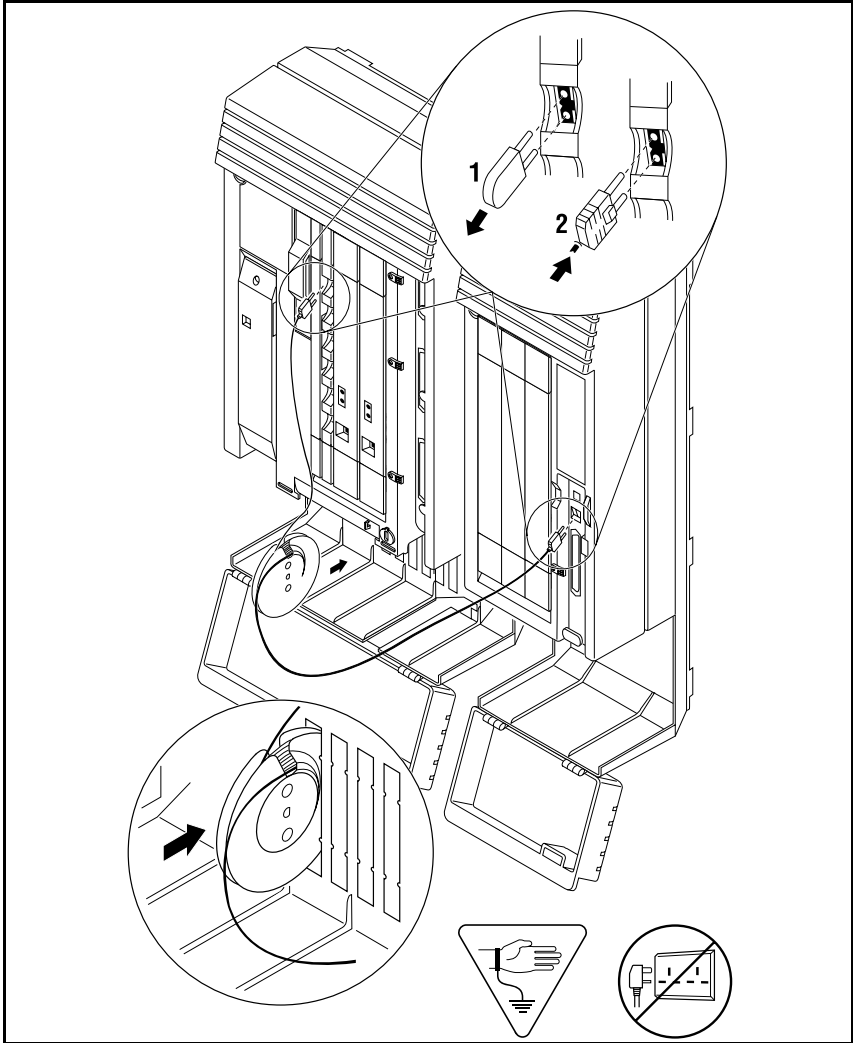

The cable trough can accommodate two fibre cable spools. Either slot may be used.

The ASM has three connectors, two fibre cable links and a 25-pair pin connector. Refer to the wiring section for the pinout for the 25-pair pin connector.

Connecting more than one ASM

You can connect additional ASMs.

1. Connect jack 1 on the second ASM to jack 2 on the first ASM.
2. Connect jack 1 on the third ASM to the next available fibre cable link on the ICS.
3. The fourth module is connected to the third, and so on.
4. Each fibre cable link can support two ASMs.

Connecting multiple modules

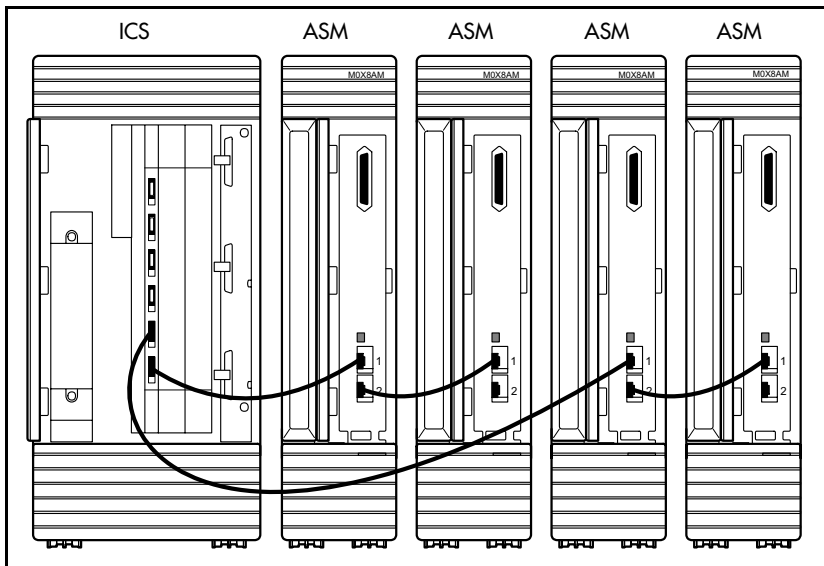

After the modules are mounted and connected, feed the cables through the cable trough.



Tips - *On a midi system, ports 3 and 4 can be used for Trunk Modules or Station Modules. In this case, connect Trunk Modules beginning at the top (port 4). Connect Station Modules beginning at the bottom (port 3).*

On a maxi system, ports 3 through 8 can be used for Trunk Modules or Station Modules. In this case, Trunk Modules should be connected beginning at the top (port 8) and working down. Station Modules should be connected beginning at the bottom (port 3) and working up.

On a fully expanded 12-port (mega) system, connect Trunk Modules beginning at the top (port 8) and working down. Station Modules would be connected beginning at the bottom (port 3) and working up. Trunk Modules cannot be connected to the Expansion Cartridge in slot 1.

When no more Station Modules can be added to the Expansion Cartridge in slot 2, connect additional Station Modules to the Expansion Cartridge in slot 1, beginning at the bottom (port 9) and working up.

Two-port Expansion Cartridge

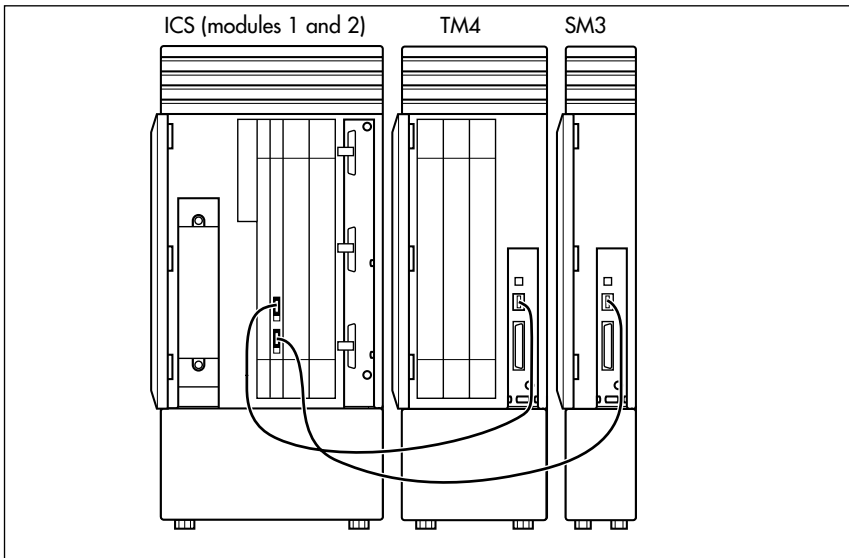

Six-port Expansion Cartridge

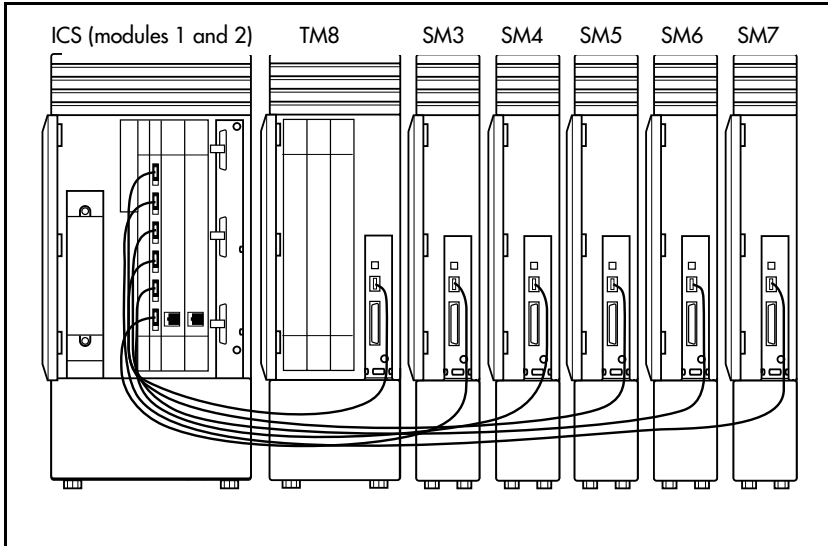

Twelve-port Expansion Cartridge

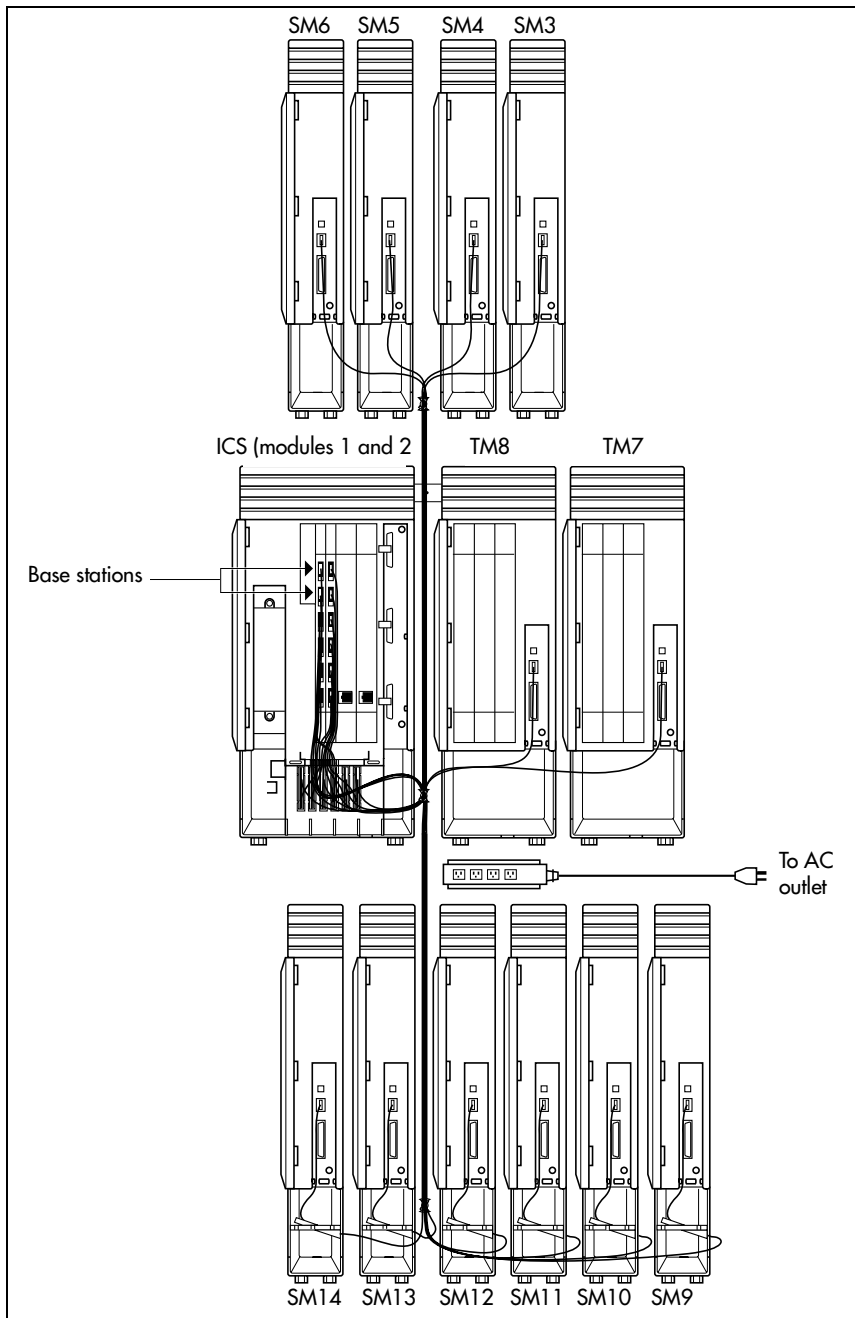

Installing fiber cables



Installing fiber cables.

Fiber cables are durable, but can be damaged. Damaged cables can affect the transmitted signals.

To avoid damaging the cables, observe the following:

- Coil excess fiber cable on the spool provided for the installation.
- Secure the fiber cable spool in the ICS cable trough.
- Ensure that bends in the cable are no tighter than 100 mm. (4 in.) in diameter.
- When using cable ties, bundle fiber cables loosely.
- Avoid excessive pulling, compression or impact.
- Do not grasp the fiber cable, or the clasp where the cable joins the plug, when connecting or disconnecting a fiber cable plug into a port.
- Do not leave fiber cables in an environment with excessively high temperatures (for example, on top of radiators).

Fiber cable management system

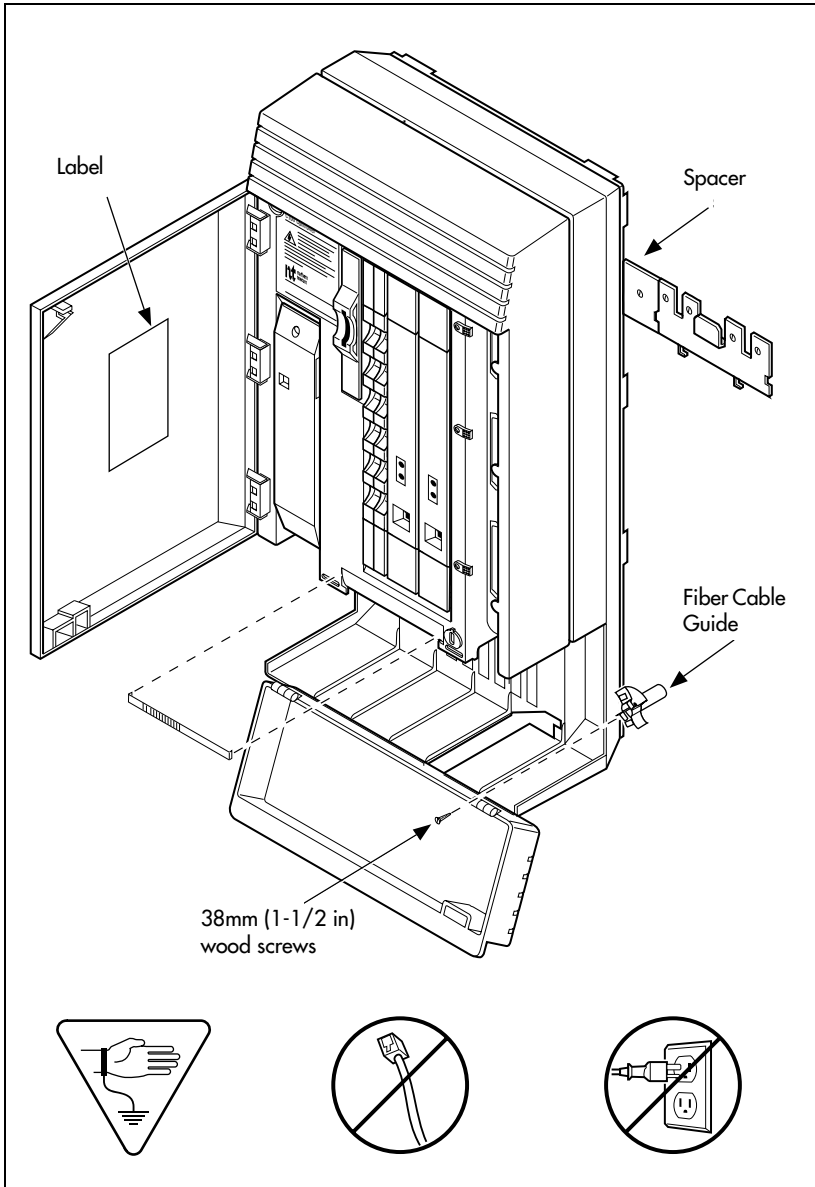

Using the fiber cable management system

To facilitate the installation of systems using fiber cables, the Fiber Cable Management System ensures that power cords are located outside of the cable tray. It also ensures that a 2.6 cm (1 in.) space exists between the ICS module and other modules.

The following hardware components are used in the Fiber Cable Management System:

- **Fiber Comb (one per system):** The Fiber Comb, is installed, using an adhesive back, on the ICS, below the fiber expansion cartridges. The Fiber Comb keeps the fiber cable in place and prevents the cables from being pinched between doors. Use the comb to keep fiber cables organized as they are routed to each Station Module, as shown in the 12-port example below.

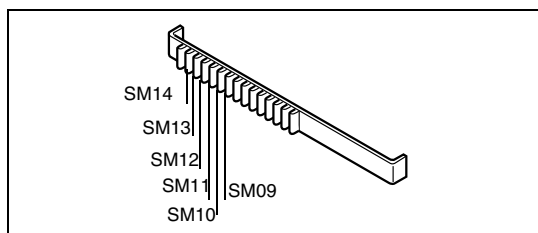

- **Fiber Cable Guide (three per system):** install in the entrance and exit of the cable trough. The Fiber Cable Guide allows fibers to be correctly routed to maintain a minimum bend radius when going through the cable trough.

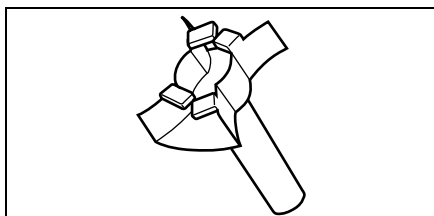

- **Spacer (three per system):** install between the mounting brackets of the ICS and an adjacent module. The Spacer provides a 2.6 cm (1 in.) space between modules and the ICS.

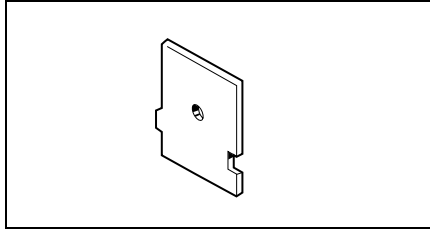

- **Fiber Spool Holder (six per system):** Replaces the trough shelf in modules requiring additional fiber spools. Install the spool holder in the right side of a Trunk Module.

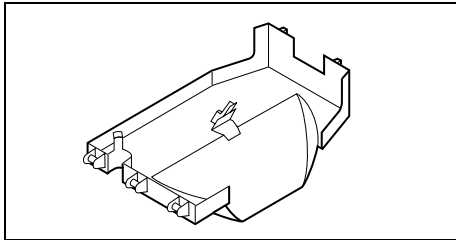

- **ICS Door Label:** Located on the inside of the ICS door, it provides space to identify fiber port allocation on the ICS.

Using the fiber spool

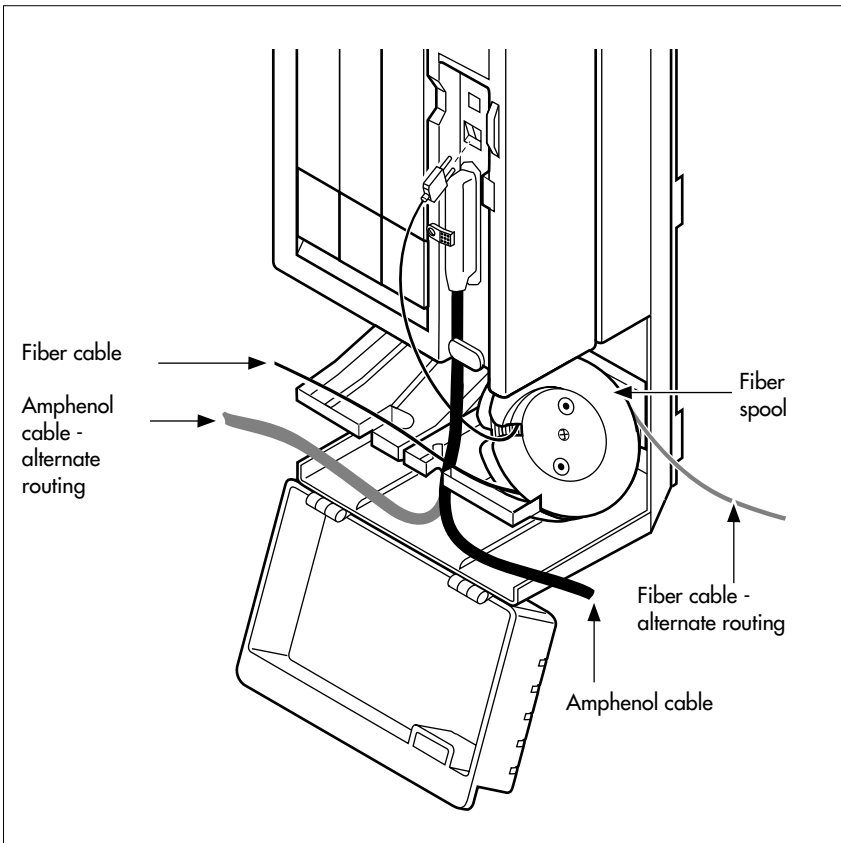

Making fiber connections

MICS-XC system

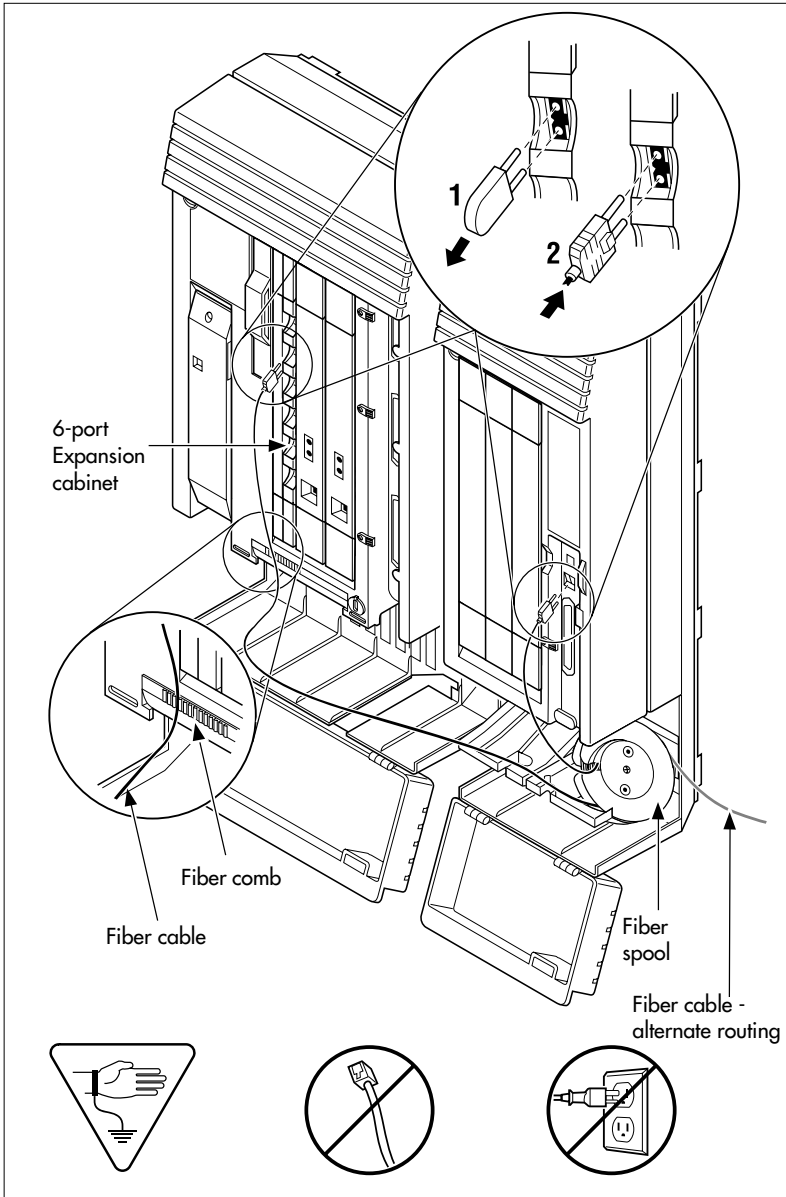

Routing fiber cables

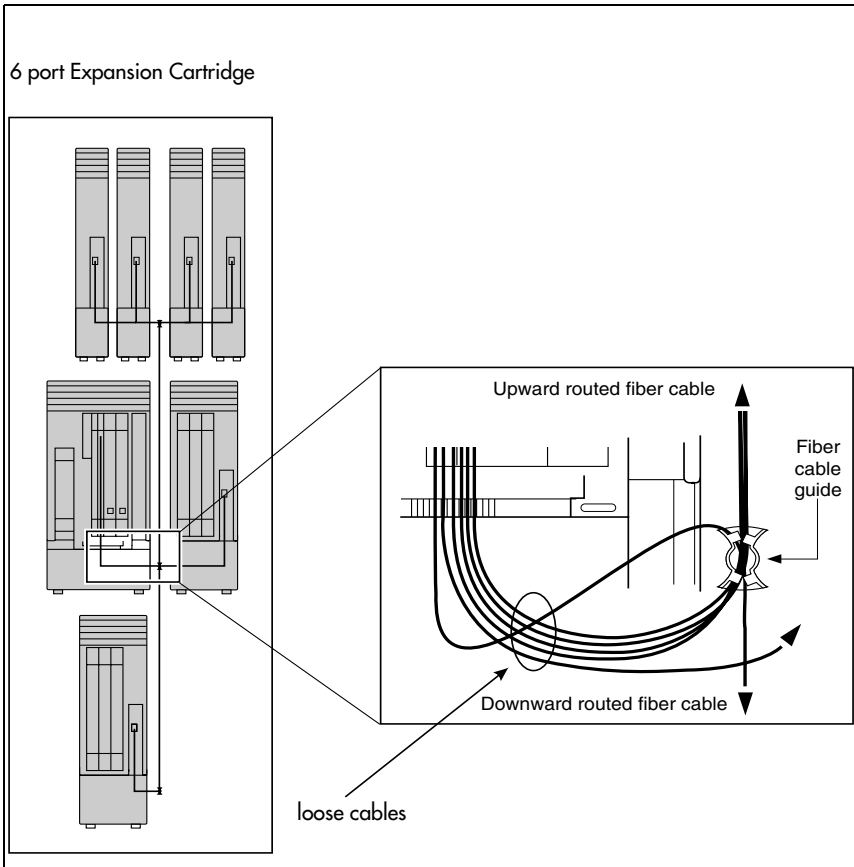

Connecting the wiring

This section describes the wire connections for your MICS system.

Connecting the wiring to the distribution panel

1. Route the cables through the hole in the ICS cable trough to the distribution panel.
2. Bundle the cables with cable ties and secure them to the wall to support their weight.
3. Connect the telephone and auxiliary equipment wires to the appropriate pins on the distribution block (refer to the wiring charts).
Note: If you are installing central answering positions (CAP) that require system auxiliary power supplies (SAPS), install the four-wire cable that comes with the SAP for each instance this is required.
4. Cross-connect the ICS telephone and auxiliary equipment wiring.
5. Connect the Station Module telephone wiring to the corresponding station pins.
6. Using a single pair of wires for each telephone, connect each of the telephones according to the wiring charts.
Note: If you are installing CAPs with SAPS, the SAPS connects to the second pair of wires in the four-wire pair provisioned for each CAP that requires SAPS support.
7. Cross-connect the external lines to the distribution block — loop start, E&M, DID, BRI. Refer to the wiring charts.
8. The DTI is equipped with an internal channel service unit (CSU). You can connect the DTI directly to the

termination point provided by your T1 or PRI service provider. If you disable the internal CSU, you can connect the DTI to an external CSU or multiplexer.

The DTI does not provide the DC connection required for through-fed repeaters. If through-fed repeaters are used on the T1 or PRI span, disable the internal CSU and connect the DTI to an external CSU.

Connecting an ICS with loop start lines

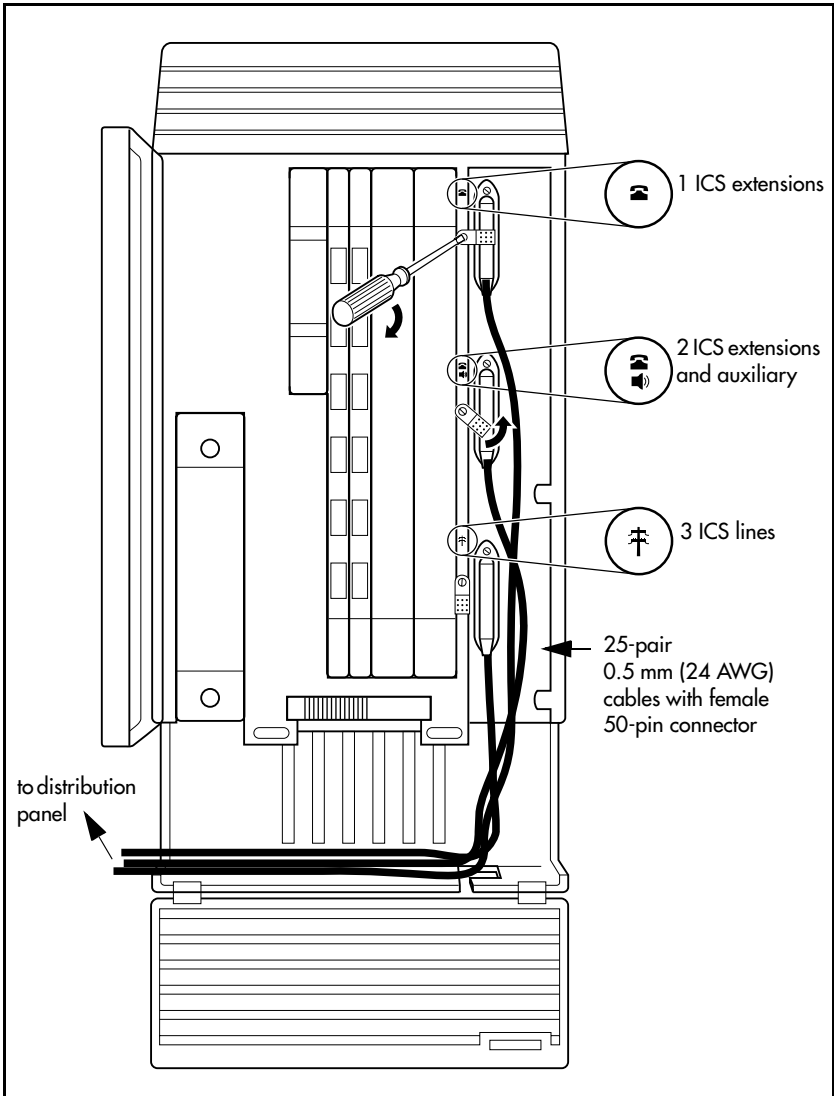

Do not attach central office connections to the ICS or Modules until power is connected to the units.

Connecting the wiring for an ICS with T1 or PRI lines MICS-XC system

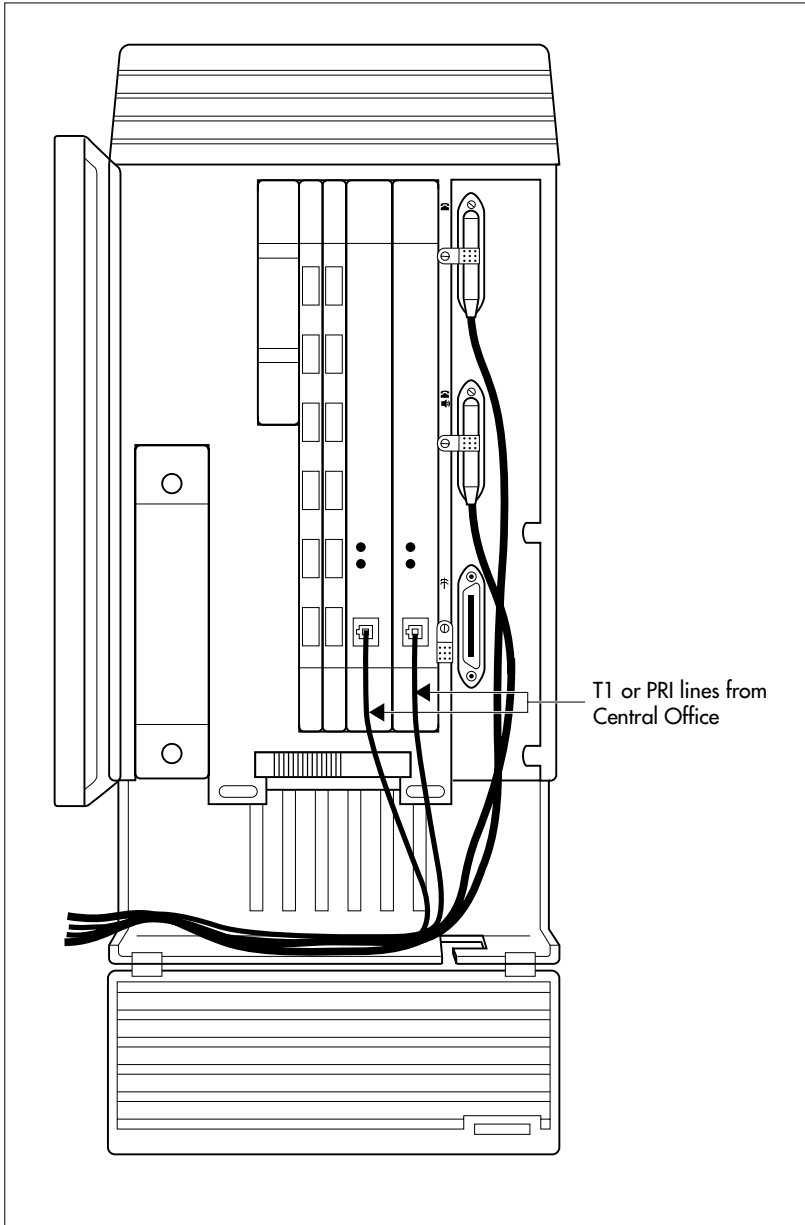

Connecting a module

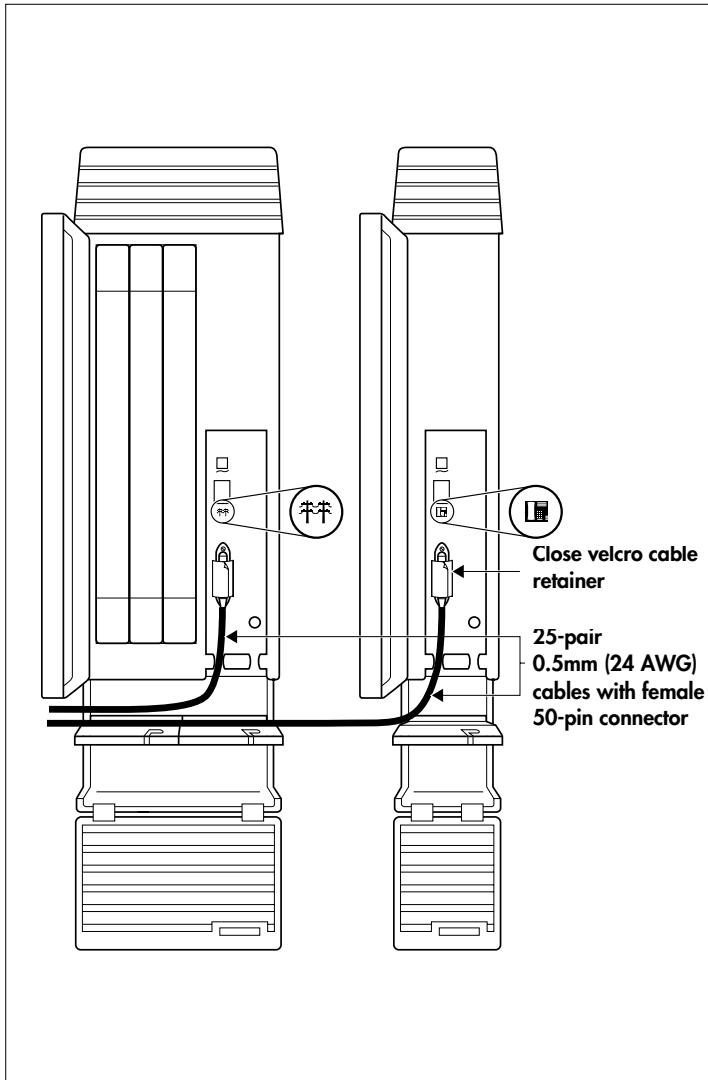

Wiring charts

Port numbering on the wiring charts

The port number listed on the wiring charts is useful in tracking down faults during a maintenance session where error codes appear on the alarm telephone display. Refer to *Alarm codes* on page 533.

The port numbers (for example: XX12) on the Trunk Cartridge and Station Module wiring charts have two components:

- XX corresponds to the number that appears on the face of the Expansion Cartridge port that the Trunk Module or Station Module is connected to.
- digits (for example, 01 or 12) identify an individual port number associated with that module.

For example:

The code 812 appearing as part of an error message for a Trunk Module indicates that the problem is with Expansion Cartridge port #8 and internal port 12. The corresponding Trunk Module pins on the distribution block are pin 47 (violet-orange) and pin 22 (orange-violet).

Integrated Communications System (ICS)

In the charts on the following pages, notice that the ICS has two internal modules, ICS #1 and ICS #2. ICS #1 handles telephones and auxiliary equipment. ICS #2 handles lines.

B1 and B2 directory numbers

The terms B1 and B2 correspond to channels on Norstar for transmitting voice and data. Each DN port number has a B1 DN and a B2 DN. Devices such as the Norstar and

Business Series telephones use only the B1 DN. Other devices may need both B1 and B2 channels, requiring B1 and B2 DNs.

Non-expanded system (ICS alone) numbering

Module	Lines	Line ports	B1 DN	B2 DN	DN ports
ICS (#2)	001-060	201-260	---	---	---
ICS (#1)	---	---	21-52	53-84	101-132

Two-port Expansion Cartridge and ICS numbering

Module	Lines	Line ports	B1 DN	B2 DN	DN ports
Mod 04	061-084	401-424	269-284	333-348	401-416
Mod 03	085-108	301-324	253-268	317-332	301-316
ICS (#2)	001-060	201-260	---	---	---
ICS (#1)	---	---	221-252	285-316	101-132

Six-port Expansion Cartridge and ICS numbering

Module	Lines	Line ports	B1 DN	B2 DN	DN ports
Mod 08	061-084	801-812	333-348	461-476	801-816
Mod 07	085-108	701-712	317-332	445-460	701-716
Mod 06	109-120	601-612	301-316	429-444	601-616
Mod 05	121-132	501-512	285-300	413-428	501-516
Mod 04	133-144	401-412	269-284	397-412	401-416
Mod 03	145-156	301-312	253-268	381-396	301-316
ICS (#2)	001-060	201-260	---	---	---
ICS (#1)	---	---	221-252	349-380	101-132

Twelve-port expanded system and ICS numbering

Module	Lines	Line ports	B1 DN	B2 DN	DN ports
Mod 14	---	---	---	---	---
Mod 13	---	---	---	---	---
Mod 12	---	---	397-412	589-604	1201-1216
Mod 11	---	---	381-396	573-588	1101-1116
Mod 10	---	---	365-380	557-572	1001-1016
Mod 09	---	---	349-364	541-556	901-916
Mod 08	061-084	801-812	333-348	525-540	801-816
Mod 07	085-108	701-712	317-332	509-524	701-716
Mod 06	109-120	601-612	301-316	493-508	601-616
Mod 05	121-132	501-512	285-300	477-492	501-516
Mod 04	133-144	401-412	269-284	461-476	401-416
Mod 03	145-156	301-312	253-268	445-460	301-316
ICS (#2)	001-060	201-260	---	---	---
ICS (#1)	---	---	221-252	413-444	101-132



Tips - A 12-port expanded system is available on a MICS-XC 6.1 system.

Depending on your system configuration, BRI-ST, BRI-U2, and BRI-U4 cards can only reside in certain trunk modules. On a Midi system, the cards must be in trunk modules 03 or 04. On a Maxi or Mega system, the cards must be in trunk modules 07 or 08. The cards can reside in the ICS regardless of system size.

Expansion module #13 and #14 are reserved for Companion Wireless capability. Refer to your Modular ICS Companion Installer Guide for information about using expansion module #13 and #14.



(continued)

Port 3 is the bottom fiber cable port on both the two-port and the six-port Expansion Cartridge in slot 2. Port 9 is the bottom fiber cable port located on the left most expansion card in slot 1.

B1 and B2 directory numbers reflect the default numbering scheme.

If you expand your system after initial installation and programming, there may appear to be gaps in your B1 DN numbering. This is because the system has already assigned DN numbers to B2 channels. You can correct these gaps by performing Startup programming and resetting the system memory, or by changing the individual DNs. See Change DNs under System Programming.



Startup programming erases the system memory.

ICS telephone wiring chart

Pin	Wire color	Port	Service	Devices (ICS)	Default DN
26	White-Blue	101	T	1	
1	Blue-White	101	R	1	21/221/2221
27	White-Orange	102	T	2	
2	Orange-White	102	R	2	22/222/2222
28	White-Green	103	T	3	
3	Green-White	103	R	3	23/223/2223
29	White-Brown	104	T	4	
4	Brown-White	104	R	4	24/224/2224
30	White-Slate	105	T	5	
5	Slate-White	105	R	5	25/225/2225
31	Red-Blue	106	T	6	
6	Blue-Red	106	R	6	26/226/2226
32	Red-Orange	107	T	7	
7	Orange-Red	107	R	7	27/227/2227
33	Red-Green	108	T	8	
8	Green-Red	108	R	8	28/228/2228
34	Red-Brown	109	T	9	
9	Brown-Red	109	R	9	29/229/2229

Pin	Wire color	Port	Service	Devices (ICS)	Default DN
35	Red-Slate	110	T	10	
10	Slate-Red	110	R	10	30/230/2230
36	Black-Blue	111	T	11	
11	Blue-Black	111	R	11	31/231/2231
37	Black-Orange	112	T	12	
12	Orange-Black	112	R	12	32/232/2232
38	Black-Green	113	T	13	
13	Green-Black	113	R	13	33/233/2233
39	Black-Brown	114	T	14	
14	Brown-Black	114	R	14	34/234/2234
40	Black-Slate	115	T	15	
15	Slate-Black	115	R	15	35/235/2235
41	Yellow-Blue	116	T	16	
16	Blue-Yellow	116	R	16	36/236/2236
42	Yellow-Orange	117	T	17	
17	Orange-Yellow	117	R	17	37/237/2237
43	Yellow-Green	118	T	18	
18	Green-Yellow	118	R	18	38/238/2238
44	Yellow-Brown	119	T	19	
19	Brown-Yellow	119	R	19	39/239/2239
45	Yellow-Slate	120	T	20	
20	Slate-Yellow	120	R	20	40/240/2240
46	Violet-Blue	121	T	21	
21	Blue-Violet	121	R	21	41/241/2241
47	Violet-Orange	122	T	22	
22	Orange-Violet	122	R	22	42/242/2242
48	Violet-Green	123	T	23	
23	Green-Violet	123	R	23	43/243/2243
49	Violet-Brown	124	T	24	
24	Brown-Violet	124	R	24	44/244/2244
50	Violet-Slate	----	----	no connection	----
25	Slate-Violet	----	----	no connection	----

T and R represent station connections and should not be confused with Tip and Ring on external lines. Station connections are non-polarized.

Note: Central Answering Positions (CAPs) that require a station auxiliary power supply (SAPS) must be connected with a four-wire cord, as the SAPS is connected to the second wire pair. This includes any T7324 and CAP module combination, and any T7316E telephone attached to more than 4 KIMs. Refer to the SAPS installation card for detailed installation instructions.

ICS telephone and auxiliary equipment wiring chart

Pin	Wire color	Port	Service	Telephones (ICS)	Default DN
26	White-Blue	125	T	25	
1	Blue-White	125	R	25	45/245/2245
27	White-Orange	126	T	26	
2	Orange-White	126	R	26	46/246/2246
28	White-Green	127	T	27	
3	Green-White	127	R	27	47/247/2247
29	White-Brown	128	T	28	
4	Brown-White	128	R	28	48/248/2248
30	White-Slate	129	T	29	
5	Slate-White	129	R	29	49/249/2249
31	Red-Blue	130	T	30	
6	Blue-Red	130	R	30	50/250/2250
32	Red-Orange	131	T	31	
7	Orange-Red	131	R	31	51/251/2251
33	Red-Green	132	T	32	
8	Green-Red	132	R	32	52/252/2252
34	Red-Brown	----	----	no connection	
9	Brown-Red	----	----	no connection	
35	Red-Slate	----	----	no connection	
10	Slate-Red	----	----	no connection	
36	Black-Blue	----	----	no connection	
11	Blue-Black	----	----	no connection	
37	Black-Orange	----	----	no connection	
12	Orange-Black	----	----	no connection	
38	Black-Green	----	----	no connection	
13	Green-Black	----	----	no connection	
39	Black-Brown	----	----	no connection	
14	Brown-Black	----	----	no connection	
40	Black-Slate	----	T	Page	
15	Slate-Black	----	R	Page	
41	Yellow-Blue	----	Make	External page	
16	Blue-Yellow	----	Common	External page	
42	Yellow-Orange	----	T	Music	
17	Orange-Yellow	----	R	Music	
43	Yellow-Green	----	----	reserved	
18	Green-Yellow	----	----	reserved	
44	Yellow-Brown	----	Make	Auxiliary ringer - 1	
19	Brown-Yellow	----	Common	Auxiliary ringer - 1	
45	Yellow-Slate	----	----	reserved	
20	Slate-Yellow	----	----	reserved	

Pin	Wire color	Port	Service	Telephones (ICS)	Default DN
46	Violet-Blue	----	----	no connection	
21	Blue-Violet	----	----	no connection	
47	Violet-Orange	----	----	reserved	
22	Orange-Violet	----	----	reserved	
48	Violet-Green	----	----	reserved	
23	Green-Violet	----	----	reserved	
49	Violet-Brown	----	----	reserved	
24	Brown-Violet	----	----	reserved	
50	Violet-Slate	----	----	reserved	
25	Slate-Violet	----	----	reserved	

T and R represent station connections and should not be confused with Tip and Ring on external lines. Station connections are non-polarized.

ICS external loop start lines wiring (profile 1, 3, or 4)

Pin	Wire color	Port	Service	Line
26	White-Blue	201	T	1
1	Blue-White	201	R	1
27	White-Orange	202	T	2
2	Orange-White	202	R	2
28	White-Green	----	----	----
3	Green-White	----	----	----
29	White-Brown	----	----	----
4	Brown-White	----	----	----
30	White-Slate	203	T	3
5	Slate-White	203	R	3
31	Red-Blue	204	T	4
6	Blue-Red	204	R	4
32	Red-Orange	----	----	----
7	Orange-Red	----	----	----
33	Red-Green	----	----	----
8	Green-Red	----	----	----
34	Red-Brown	225	T	31
9	Brown-Red	225	R	31
35	Red-Slate	226	T	32
10	Slate-Red	226	R	32
36	Black-Blue	----	----	----
11	Blue-Black	----	----	----
37	Black-Orange	----	----	----
12	Orange-Black	----	----	----

Pin	Wire color	Port	Service	Line
38	Black-Green	227	T	33
13	Green-Black	227	R	33
39	Black-Brown	228	T	34
14	Brown-Black	228	R	34
40	Black-Slate	----	----	----
15	Slate-Black	----	----	----
41	Yellow-Blue	----	----	----
16	Blue-Yellow	----	----	----
42	Yellow-Orange	----	----	----
17	Orange-Yellow	----	----	----
43	Yellow-Green	----	T	ET1
18	Green-Yellow	----	R	ET1
44	Yellow-Brown	----	T	ET2
19	Brown-Yellow	----	R	ET2
45	Yellow-Slate	----	----	----
20	Slate-Yellow	----	----	----
46	Violet-Blue	----	----	----
21	Blue-Violet	----	----	----
47	Violet-Orange	----	----	----
22	Orange-Violet	----	----	----
48	Violet-Green	----	----	----
23	Green-Violet	----	----	----
49	Violet-Brown	----	----	----
24	Brown-Violet	----	----	----
50	Violet-Slate	----	----	----
25	Slate-Violet	----	----	----

For an explanation of port numbering, see *Port numbering on the wiring charts* on page 252.

ICS external loop start lines wiring (profile 2)

Pin	Wire color	Port	Service	Line
26	White-Blue	201	T	1
1	Blue-White	201	R	1
27	White-Orange	202	T	2
2	Orange-White	202	R	2
28	White-Green	----	----	----
3	Green-White	----	----	----
29	White-Brown	----	----	----
4	Brown-White	----	----	----
30	White-Slate	203	T	3
5	Slate-White	203	R	3

Pin	Wire color	Port	Service	Line
31	Red-Blue	204	T	4
6	Blue-Red	204	R	4
32	Red-Orange	----	----	----
7	Orange-Red	----	----	----
33	Red-Green	----	----	----
8	Green-Red	----	----	----
34	Red-Brown	231	T	31
9	Brown-Red	231	R	31
35	Red-Slate	232	T	32
10	Slate-Red	232	R	32
36	Black-Blue	----	----	----
11	Blue-Black	----	----	----
37	Black-Orange	----	----	----
12	Orange-Black	----	----	----
38	Black-Green	233	T	33
13	Green-Black	233	R	33
39	Black-Brown	234	T	34
14	Brown-Black	234	R	34
40	Black-Slate	----	----	----
15	Slate-Black	----	----	----
41	Yellow-Blue	----	----	----
16	Blue-Yellow	----	----	----
42	Yellow-Orange	----	----	----
17	Orange-Yellow	----	----	----
43	Yellow-Green	----	T	ET1
18	Green-Yellow	----	R	ET1
44	Yellow-Brown	----	T	ET2
19	Brown-Yellow	----	R	ET2
45	Yellow-Slate	----	----	----
20	Slate-Yellow	----	----	----
46	Violet-Blue	----	----	----
21	Blue-Violet	----	----	----
47	Violet-Orange	----	----	----
22	Orange-Violet	----	----	----
48	Violet-Green	----	----	----
23	Green-Violet	----	----	----
49	Violet-Brown	----	----	----
24	Brown-Violet	----	----	----
50	Violet-Slate	----	----	----
25	Slate-Violet	----	----	----

BRI Wiring charts

A BRI Card in Slot 4 uses loops 201 through 204. A BRI card in Slot 3 uses loops 225 through 228 (profile 1, 3, or 4) or 231-238 (profile 2). Because a BRI-U2 Card has only two loops, it only uses the first two loop numbers 201-202 and 225-226, (profile 1, 3, or 4) or 231-232 (profile 2) when it occupies an ICS slot.

The loops appearing on a BRI card may be automatically assigned lines, or you can assign one or more ISDN DN's under **Hardware**. If the loop is configured as T or NT, lines are automatically assigned. If the loop is configured as S or LT, you can assign one or more ISDN DN's to the loop.

The emergency telephone connections (ET2 and ET1) cannot be used if a BRI card is installed in Slot 3 or Slot 4.

For more information about configuring BRI cards refer to *BRI Card* on page 54 in *Welcome to ISDN* and *BRI card* on page 498 in *Hardware*.

ICS ST Interface Cards wiring (profile 1, 3 or 4)

Pin	Wire color	Port (loop)	Service	Lines (T-loop)	TE (S loop)
26	White-Blue	201	+Tx	001-002	Assigned DN
1	Blue-White	201	-Tx	001-002	Assigned DN
27	White-Orange	201	+Rx	001-002	Assigned DN
2	Orange-White	201	-Rx	001-002	Assigned DN
28	White-Green	202	+Tx	003-004	Assigned DN
3	Green-White	202	-Tx	003-004	Assigned DN
29	White-Brown	202	+Rx	003-004	Assigned DN
4	Brown-White	202	-Rx	003-004	Assigned DN
30	White-Slate	203	+Tx	005-006	Assigned DN
5	Slate-White	203	-Tx	005-006	Assigned DN
31	Red-Blue	203	+Rx	005-006	Assigned DN
6	Blue-Red	203	-Rx	005-006	Assigned DN
32	Red-Orange	204	+Tx	007-008	Assigned DN
7	Orange-Red	204	-Tx	007-008	Assigned DN
33	Red-Green	204	+Rx	007-008	Assigned DN
8	Green-Red	204	-Rx	007-008	Assigned DN

ICS ST Interface Cards wiring (profile 1, 3 or 4) (Continued)

Pin	Wire color	Port (loop)	Service	Lines (T-loop)	TE (S loop)
34	Red-Brown	225	+Tx	031-032	Assigned DN
9	Brown-Red	225	-Tx	031-032	Assigned DN
35	Red-Slate	225	+Rx	031-032	Assigned DN
10	Slate-Red	225	-Rx	031-032	Assigned DN
36	Black-Blue	226	+Tx	033-034	Assigned DN
11	Blue-Black	226	-Tx	033-034	Assigned DN
37	Black-Orange	226	+Rx	033-034	Assigned DN
12	Orange-Black	226	-Rx	033-034	Assigned DN
38	Black-Green	227	+Tx	035-036	Assigned DN
13	Green-Black	227	-Tx	035-036	Assigned DN
39	Black-Brown	227	+Rx	035-036	Assigned DN
14	Brown-Black	227	-Rx	035-036	Assigned DN
40	Black-Slate	228	+Tx	037-038	Assigned DN
15	Slate-Black	228	-Tx	037-038	Assigned DN
41	Yellow-Blue	228	+Rx	037-038	Assigned DN
16	Blue-Yellow	228	-Rx	037-038	Assigned DN
42	Yellow-Orange	----	----	----	---
17	Orange-Yellow	----	----	----	---
43	Yellow-Green	----	T	ET1	---
18	Green-Yellow	----	R	ET1	---
44	Yellow-Brown	----	T	ET2	---
19	Brown-Yellow	----	R	ET2	---
45	Yellow-Slate	----	----	----	---
20	Slate-Yellow	----	----	----	---
46	Violet-Blue	----	----	----	---
21	Blue-Violet	----	----	----	---
47	Violet-Orange	----	----	----	---
22	Orange-Violet	----	----	----	---
48	Violet-Green	----	----	----	---
23	Green-Violet	----	----	----	---
49	Violet-Brown	----	----	----	---
24	Brown-Violet	----	----	----	---
50	Violet-Slate	----	----	----	---
25	Slate-Violet	----	----	----	---

BRI S or T wiring is polarity sensitive.

Tx and Rx are Transmit and Receive for Norstar.

ICS ST Interface Cards wiring (profile 2)

Pin	Wire color	Port (loop)	Service	Lines (T-loop)	TE (S loop)
26	White-Blue	201	+Tx	001-002	Assigned DN
1	Blue-White	201	-Tx	001-002	Assigned DN
27	White-Orange	201	+Rx	001-002	Assigned DN
2	Orange-White	201	-Rx	001-002	Assigned DN
28	White-Green	202	+Tx	003-004	Assigned DN
3	Green-White	202	-Tx	003-004	Assigned DN
29	White-Brown	202	+Rx	003-004	Assigned DN
4	Brown-White	202	-Rx	003-004	Assigned DN
30	White-Slate	203	+Tx	005-006	Assigned DN
5	Slate-White	203	-Tx	005-006	Assigned DN
31	Red-Blue	203	+Rx	005-006	Assigned DN
6	Blue-Red	203	-Rx	005-006	Assigned DN
32	Red-Orange	204	+Tx	007-008	Assigned DN
7	Orange-Red	204	-Tx	007-008	Assigned DN
33	Red-Green	204	+Rx	007-008	Assigned DN
8	Green-Red	204	-Rx	007-008	Assigned DN
34	Red-Brown	231	+Tx	031-032	Assigned DN
9	Brown-Red	231	-Tx	031-032	Assigned DN
35	Red-Slate	231	+Rx	031-032	Assigned DN
10	Slate-Red	231	-Rx	031-032	Assigned DN
36	Black-Blue	232	+Tx	033-034	Assigned DN
11	Blue-Black	232	-Tx	033-034	Assigned DN
37	Black-Orange	232	+Rx	033-034	Assigned DN
12	Orange-Black	232	-Rx	033-034	Assigned DN
38	Black-Green	233	+Tx	035-036	Assigned DN
13	Green-Black	233	-Tx	035-036	Assigned DN
39	Black-Brown	233	+Rx	035-036	Assigned DN
14	Brown-Black	233	-Rx	035-036	Assigned DN
40	Black-Slate	234	+Tx	037-038	Assigned DN
15	Slate-Black	234	-Tx	037-038	Assigned DN
41	Yellow-Blue	234	+Rx	037-038	Assigned DN
16	Blue-Yellow	234	-Rx	037-038	Assigned DN
42	Yellow-Orange	----	----	----	---
17	Orange-Yellow	----	----	----	---
43	Yellow-Green	----	T	ET1	---
18	Green-Yellow	----	R	ET1	---
44	Yellow-Brown	----	T	ET2	---
19	Brown-Yellow	----	R	ET2	---

ICS ST Interface Cards wiring (profile 2) (Continued)

Pin	Wire color	Port (loop)	Service	Lines (T-loop)	TE (S loop)
45	Yellow-Slate	----	----	----	---
20	Slate-Yellow	----	----	----	---
46	Violet-Blue	----	----	----	---
21	Blue-Violet	----	----	----	---
47	Violet-Orange	----	----	----	---
22	Orange-Violet	----	----	----	---
48	Violet-Green	----	----	----	---
23	Green-Violet	----	----	----	---
49	Violet-Brown	----	----	----	---
24	Brown-Violet	----	----	----	---
50	Violet-Slate	----	----	----	---
25	Slate-Violet	----	----	----	---

ICS U Interface Cards wiring (profile 1, 3 or 4)

Pin	Wire color	Port (loop)	Service	Lines(U-NT)	TE (U-LT)
26	White-Blue	201	T	001-002	Assigned DN
1	Blue-White	201	R	001-002	Assigned DN
27	White-Orange	202	T	003-004	Assigned DN
2	Orange-White	202	R	003-004	Assigned DN
28	White-Green	----	----	----	----
3	Green-White	----	----	----	----
29	White-Brown	----	----	----	----
4	Brown-White	----	----	----	----
30	White-Slate	203	T	005-006	Assigned DN
5	Slate-White	203	R	005-006	Assigned DN
31	Red-Blue	204	T	007-008	Assigned DN
6	Blue-Red	204	R	007-008	Assigned DN
32	Red-Orange	----	----	----	----
7	Orange-Red	----	----	----	----
33	Red-Green	----	----	----	----
8	Green-Red	----	----	----	----
34	Red-Brown	225	T	031-032	Assigned DN
9	Brown-Red	225	R	031-032	Assigned DN
35	Red-Slate	226	T	033-034	Assigned DN
10	Slate-Red	226	R	033-034	Assigned DN
36	Black-Blue	----	----	----	----
11	Blue-Black	----	----	----	----

ICS U Interface Cards wiring (profile 1, 3 or 4) (Continued)

Pin	Wire color	Port (loop)	Service	Lines(U-NT)	TE (U-LT)
37	Black-Orange	----	----	----	----
12	Orange-Black	----	----	----	----
38	Black-Green	227	T	035-036	Assigned DN
13	Green-Black	227	R	035-036	Assigned DN
39	Black-Brown	228	T	037-038	Assigned DN
14	Brown-Black	228	R	037-038	Assigned DN
40	Black-Slate	----	----	----	----
15	Slate-Black	----	----	----	----
41	Yellow-Blue	----	----	----	----
16	Blue-Yellow	----	----	----	----
42	Yellow-Orange	----	----	----	----
17	Orange-Yellow	----	----	----	----
43	Yellow-Green	----	----	----	----
18	Green-Yellow	----	----	----	----
44	Yellow-Brown	----	----	----	----
19	Brown-Yellow	----	----	----	----
45	Yellow-Slate	----	----	----	----
20	Slate-Yellow	----	----	----	----
46	Violet-Blue	----	----	----	----
21	Blue-Violet	----	----	----	----
47	Violet-Orange	----	----	----	----
22	Orange-Violet	----	----	----	----
48	Violet-Green	----	----	----	----
23	Green-Violet	----	----	----	----
49	Violet-Brown	----	----	----	----
24	Brown-Violet	----	----	----	----
50	Violet-Slate	----	----	----	----
25	Slate-Violet	----	----	----	----

BRI U wiring is not polarity sensitive.

For an explanation about port numbering, see *Port numbering on the wiring charts* on page 252.

ICS U Interface Cards wiring (profile 2)

Pin	Wire color	Port (loop)	Service	Lines (U-NT)	TE (U-LT)
26	White-Blue	201	T	001-002	Assigned DN
1	Blue-White	201	R	001-002	Assigned DN
27	White-Orange	202	T	003-004	Assigned DN
2	Orange-White	202	R	003-004	Assigned DN
28	White-Green	----	----	----	----
3	Green-White	----	----	----	----
29	White-Brown	----	----	----	----
4	Brown-White	----	----	----	----
30	White-Slate	203	T	005-006	Assigned DN
5	Slate-White	203	R	005-006	Assigned DN
31	Red-Blue	204	T	007-008	Assigned DN
6	Blue-Red	204	R	007-008	Assigned DN
32	Red-Orange	----	----	----	----
7	Orange-Red	----	----	----	----
33	Red-Green	----	----	----	----
8	Green-Red	----	----	----	----
34	Red-Brown	231	T	031-032	Assigned DN
9	Brown-Red	231	R	031-032	Assigned DN
35	Red-Slate	232	T	033-034	Assigned DN
10	Slate-Red	232	R	033-034	Assigned DN
36	Black-Blue	----	----	----	----
11	Blue-Black	----	----	----	----
37	Black-Orange	----	----	----	----
12	Orange-Black	----	----	----	----
38	Black-Green	233	T	035-036	Assigned DN
13	Green-Black	233	R	035-036	Assigned DN
39	Black-Brown	234	T	037-038	Assigned DN
14	Brown-Black	234	R	037-038	Assigned DN
40	Black-Slate	----	----	----	----
15	Slate-Black	----	----	----	----
41	Yellow-Blue	----	----	----	----
16	Blue-Yellow	----	----	----	----
42	Yellow-Orange	----	----	----	----
17	Orange-Yellow	----	----	----	----
43	Yellow-Green	----	----	----	----
18	Green-Yellow	----	----	----	----
44	Yellow-Brown	----	----	----	----
19	Brown-Yellow	----	----	----	----

ICS U Interface Cards wiring (profile 2) (Continued)

Pin	Wire color	Port (loop)	Service	Lines (U-NT)	TE (U-LT)
45	Yellow-Slate	----	----	----	---
20	Slate-Yellow	----	----	----	---
46	Violet-Blue	----	----	----	---
21	Blue-Violet	----	----	----	---
47	Violet-Orange	----	----	----	---
22	Orange-Violet	----	----	----	---
48	Violet-Green	----	----	----	---
23	Green-Violet	----	----	----	---
49	Violet-Brown	----	----	----	---
24	Brown-Violet	----	----	----	---
50	Violet-Slate	----	----	----	---
25	Slate-Violet	----	----	----	---

BRI U wiring is not polarity sensitive.

Wiring the BRI network interface

A network interface provides the connection between the ISDN network and the Modular ICS.

If the card in the ICS is configured as a T-loop, the ICS is wired to the network connection using an NT1.

See *T reference points* on page 58 for more information about the NT1.

Wiring for T network connection

Pin (jack or plug)	NT1 connection (for jack)	ICS and optional TE connection (plug)
1	not used	optional power source 3 (+)
2	not used	optional power source 3 (-)
3	+Rx	+Tx
4	+Tx	+Rx
5	-Tx	-Rx
6	-Rx	-Tx
7	not used	optional power sink 2 (-)
8	not used	optional power sink 2 (+)

The Modular ICS supplies the NT1 functionality to a U-NT loop, allowing a direct connection to the network. The connection may use a plug and jack, or may be directly wired.

Wiring for U-NT network interface

Pin (jack or plug)	Norstar connection (for plug to network interface jack)	Network interface connection (jack)
1	not used	optional battery status indicator (+)
2	not used	optional battery status indicator (-)
3	not used	no connection
4	R	R
5	T	T
6	not used	no connection
7	not used	optional power supply (-)
8	not used	optional power supply (+)

The BRI-U Card does not use or provide optional power.

Some installations may not use a plug and jack for connections between the ICS (NT) and the network.

The following illustration shows the pin arrangement for a Bellcore standard ISDN plug and jack. Other pin arrangements are possible.

Jack and plug pin numbering

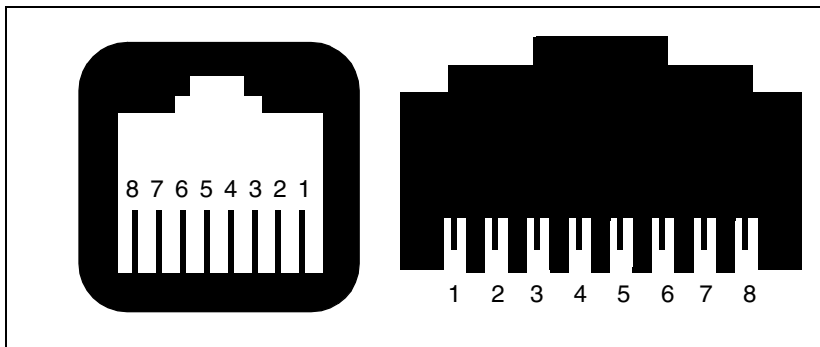

DTI wiring

Connecting the DTI to the T1 or PRI service provider

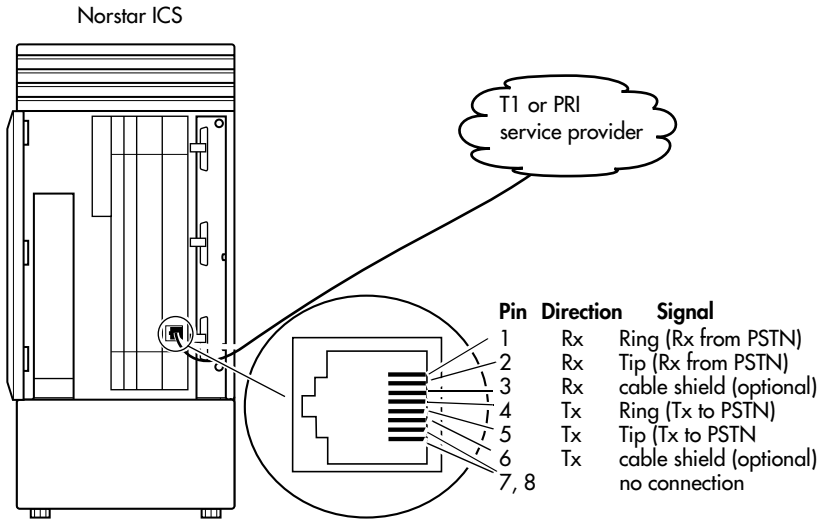

Connecting the DTI to an external CSU

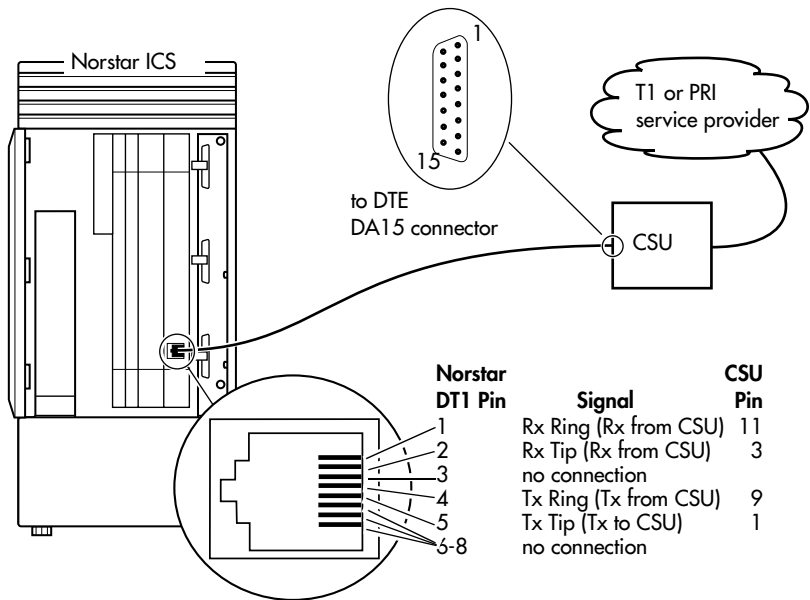

Station Module wiring chart

Pin	Wire color	Port	Service	Telephones SM
26	White-Blue	X01	T	1
1	Blue-White	X01	R	1
27	White-Orange	X02	T	2
2	Orange-White	X02	R	2
28	White-Green	X03	T	3
3	Green-White	X03	R	3
29	White-Brown	X04	T	4
4	Brown-White	X04	R	4
30	White-Slate	X05	T	5
5	Slate-White	X05	R	5
31	Red-Blue	X06	T	6
6	Blue-Red	X06	R	6
32	Red-Orange	X07	T	7
7	Orange-Red	X07	R	7
33	Red-Green	X08	T	8
8	Green-Red	X08	R	8
34	Red-Brown	X09	T	9
9	Brown-Red	X09	R	9
35	Red-Slate	X10	T	10
10	Slate-Red	X10	R	10
36	Black-Blue	X11	T	11
11	Blue-Black	X11	R	11
37	Black-Orange	X12	T	12
12	Orange-Black	X12	R	12
38	Black-Green	X13	T	13
13	Green-Black	X13	R	13
39	Black-Brown	X14	T	14
14	Brown-Black	X14	R	14
40	Black-Slate	X15	T	15
15	Slate-Black	X15	R	15
41	Yellow-Blue	X16	T	16
16	Blue-Yellow	X16	R	16
42	Yellow-Orange	----	----	no connection
17	Orange-Yellow	----	----	no connection
43	Yellow-Green	----	----	no connection
18	Green-Yellow	----	----	no connection
44	Yellow-Brown	----	----	no connection
19	Brown-Yellow	----	----	no connection
45	Yellow-Slate	----	----	no connection
20	Slate-Yellow	----	----	no connection
46	Violet-Blue	----	----	no connection

Station Module wiring chart (Continued)

Pin	Wire color	Port	Service	Telephones SM
21	Blue-Violet	----	----	no connection
47	Violet-Orange	----	----	no connection
22	Orange-Violet	----	----	no connection
48	Violet-Green	----	----	no connection
23	Green-Violet	----	----	no connection
49	Violet-Brown	----	----	no connection
24	Brown-Violet	----	----	no connection
50	Violet-Slate	----	----	no connection
25	Slate-Violet	----	----	no connection

T and R represent station connections and should not be confused with Tip and Ring on external lines. Station connections are non-polarized.

For an explanation about port numbering, see *Port numbering on the wiring charts* on page 252.

Note: Central Answering Positions (CAPs) that require a station auxiliary power supply (SAPS) must be connected with a four-wire cord, as the SAPS is connected to the second wire pair. This includes any T7324 and CAP module combination, and any T7316E telephone attached to more than 4 KIMs. Refer to the SAPS installation card for detailed installation instructions.

Loop Start or CI Trunk Cartridge wiring chart

TC Slot	Pin	Wire color	Port	Service	Line
Slot 1	26	White-Blue	X01	T	1
	1	Blue-White	X01	R	1
	27	White-Orange	X02	T	2
	2	Orange-White	X02	R	2
	28	White-Green	----	No connection	----
	3	Green-White	----	No connection	----
	29	White-Brown	----	No connection	----
	4	Brown-White	----	No connection	----
	30	White-Slate	X03	T	3
	5	Slate-White	X03	R	3
	31	Red-Blue	X04	T	4
	6	Blue-Red	X04	R	4
	32	Red-Orange	----	No connection	----
	7	Orange-Red	----	No connection	----
	33	Red-Green	----	No connection	----
	8	Green-Red	----	No connection	----
Slot 2	34	Red-Brown	X05	T	5
	9	Brown-Red	X05	R	5
	35	Red-Slate	X06	T	6
	10	Slate-Red	X06	R	6
	36	Black-Blue	----	No connection	----
	11	Blue-Black	----	No connection	----
	37	Black-Orange	----	No connection	----
	12	Orange-Black	----	No connection	----

Loop Start or CI Trunk Cartridge wiring chart (Continued)

TC Slot	Pin	Wire color	Port	Service	Line
	38	Black-Green	X07	T	7
	13	Green-Black	X07	R	7
	39	Black-Brown	X08	T	8
	14	Brown-Black	X08	R	8
	40	Black-Slate	----	No connection	----
	15	Slate-Black	----	No connection	----
	41	Yellow-Blue	----	No connection	----
Slot 3	42	Yellow-Orange	X09	T	9
	17	Orange-Yellow	X09	R	9
	43	Yellow-Green	X10	T	10
	18	Green-Yellow	X10	R	10
	44	Yellow-Brown	----	No connection	----
	19	Brown-Yellow	----	No connection	----
	45	Yellow-Slate	----	No connection	----
	20	Slate-Yellow	----	No connection	----
	46	Violet-Blue	X11	T	11
	21	Blue-Violet	X11	R	11
	47	Violet-Orange	X12	T	12
	22	Orange-Violet	X12	R	12
	48	Violet-Green	----	No connection	----
	23	Green-Violet	----	No connection	----
	49	Violet-Brown	----	No connection	----
	24	Brown-Violet	----	No connection	----
	50	Violet-Slate	----	ET	----
	25	Slate-Violet	----	ET	----

For an explanation about port numbering, see *Port numbering on the wiring charts* on page 252.

E&M/DISA Trunk Cartridge wiring chart

Use the table, *Trunk Module with E&M/DISA Trunk Cartridges*, on page 273 when a Trunk Module has only E&M/DISA Trunk Cartridges.

If the Norstar system is being connected to another Norstar system or private branch exchange by connecting two RJ2HX/CA2HA distribution blocks together, use the following table to determine the required cross-connections.

Back-to-back cross-connections

1st distribution block	T	R	T1	R1	E	SG	M	SB
Next distribution block	T1	R1	T	R	SB	M	SG	E



Tips - *When installing a mixture of E&M/DISA, DID, BRI, or Loop Start Trunk Cartridges, it is important to cross-connect the wiring for each type of TC to a separate distribution block.*

To verify the operation of the Norstar E&M cards and the target lines, wire the two E&M lines on the Norstar E&M back to back.

The cross-connections to each distribution block must always begin at pins 26 and 1. To retain emergency telephone function (when it is available on the trunk module), install a Loop Start Trunk Cartridge in the left-most slot (slot 1) of the TM.

Trunk Module with E&M/DISA Trunk Cartridges

TC Slot	Pin	Wire color	Port	Service	Line
Slot 1	26	White-Blue	X01	T	1
	1	Blue-White	X01	R	1
	27	White-Orange	X01	T1	1
	2	Orange-White	X01	R1	1
	28	White-Green	X01	E	1
	3	Green-White	X01	SG	1
	29	White-Brown	X01	M	1
	4	Brown-White	X01	SB	1
	30	White-Slate	X02	T	2
	5	Slate-White	X02	R	2

Trunk Module with E&M/DISA Trunk Cartridges (Continued)

TC Slot	Pin	Wire color	Port	Service	Line
Slot 2	31	Red-Blue	X02	T1	2
	6	Blue-Red	X02	R1	2
	32	Red-Orange	X02	E	2
	7	Orange-Red	X02	SG	2
	33	Red-Green	X02	M	2
	8	Green-Red	X02	SB	2
	34	Red-Brown	X05	T	5
	9	Brown-Red	X05	R	5
	35	Red-Slate	X05	T1	5
	10	Slate-Red	X05	R1	5
	36	Black-Blue	X05	E	5
	11	Blue-Black	X05	SG	5
	37	Black-Orange	X05	M	5
	12	Orange-Black	X05	SB	5
	38	Black-Green	X06	T	6
	13	Green-Black	X06	R	6
Slot 3	39	Black-Brown	X06	T1	6
	14	Brown-Black	X06	R1	6
	40	Black-Slate	X06	E	6
	15	Slate-Black	X06	SG	6
	41	Yellow-Blue	X06	M	6
	16	Blue-Yellow	X06	SB	6
	42	Yellow-Orange	X09	T	9
	17	Orange-Yellow	X09	R	9
	43	Yellow-Green	X09	T1	9
	18	Green-Yellow	X09	R1	9
	44	Yellow-Brown	X09	E	9
	19	Brown-Yellow	X09	SG	9
	45	Yellow-Slate	X09	M	9
	20	Slate-Yellow	X09	SB	9
	46	Violet-Blue	X10	T	10
	21	Blue-Violet	X10	R	10
47	Violet-Orange	X10	T1	10	
22	Orange-Violet	X10	R1	10	
48	Violet-Green	X10	E	10	
23	Green-Violet	X10	SG	10	
49	Violet-Brown	X10	M	10	
24	Brown-Violet	X10	SB	10	
50	Violet-Slate	----	reserved	----	
25	Slate-Violet	----	reserved	----	

For an explanation about port numbering, see *Port numbering on the wiring charts* on page 252.

Trunk Module with DID Trunk Cartridges

TC Slot	Pin	Wire color	Port	Service	Line
Slot 1	26	White-Blue	X01	T	1
	1	Blue-White	X01	R	1
	27	White-Orange	X02	T	2
	2	Orange-White	X02	R	2
	28	White-Green	----	No connection	----
	3	Green-White	----	No connection	----
	29	White-Brown	----	CCI NC1	----
	4	Brown-White	----	CCI Com1	----
	30	White-Slate	X03	T	3
	5	Slate-White	X03	R	3
	31	Red-Blue	X04	T	4
	6	Blue-Red	X04	R	4
	32	Red-Orange	----	No connection	----
	7	Orange-Red	----	No connection	----
	33	Red-Green	----	No connection	----
	8	Green-Red	----	No connection	----
Slot 2	34	Red-Brown	X05	T	5
	9	Brown-Red	X05	R	5
	35	Red-Slate	X06	T	6
	10	Slate-Red	X06	R	6
	36	Black-Blue	----	No connection	----
	11	Blue-Black	----	No connection	----
	37	Black-Orange	----	CCI NC1	----
	12	Orange-Black	----	CCI Com1	----
	38	Black-Green	X07	T	7
	13	Green-Black	X07	R	7
	39	Black-Brown	X08	T	8
	14	Brown-Black	X08	R	8
	40	Black-Slate	----	No connection	----
	15	Slate-Black	----	No connection	----
	41	Yellow-Blue	----	No connection	----
	16	Blue-Yellow	----	No connection	----
Slot 3	42	Yellow-Orange	X09	T	9
	17	Orange-Yellow	X09	R	9
	43	Yellow-Green	X10	T	10
	18	Green-Yellow	X10	R	10
	44	Yellow-Brown	----	No connection	----
	19	Brown-Yellow	----	No connection	----
	45	Yellow-Slate	----	CCI NC1	----
	20	Slate-Yellow	----	CCI Com1	----
	46	Violet-Blue	X11	T	11

Trunk Module with DID Trunk Cartridges (Continued)

TC Slot	Pin	Wire color	Port	Service	Line
	21	Blue-Violet	X11	R	11
	47	Violet-Orange	X12	T	12
	22	Orange-Violet	X12	R	12
	48	Violet-Green	----	No connection	----
	23	Green-Violet	----	No connection	----
	49	Violet-Brown	----	No connection	----
	24	Brown-Violet	----	No connection	----
	50	Violet-Slate	----	ET	----
	25	Slate-Violet	----	ET	----

For an explanation about port numbering, see *Port numbering on the wiring charts* on page 252.

For CCI connections in Service column: NC1 stands for the normally closed relay and Com1, the common relay. CCI signaling is not supported by all carriers. For carriers or installations that do not use CCI signaling, the CCI and ET connections should be treated as "no connection". CCI wiring is a non-standard wiring arrangement which has been submitted to the DOC.

DID supervisory signaling

This equipment returns supervisory signals to the public switched telephone network (PSTN) when the DID calls are:

- answered by the called telephone
- answered by the attendant
- routed to a customer controlled recorded announcement
- routed to a dial prompt

This equipment is designed to return supervisory signals on all DID calls forwarded through the system back to the PSTN within 20 seconds of call forwarding being initiated.

Emergency transfer conditions

Every DID Trunk Cartridge has a Control Circuit Interface (CCI) which should be connected directly to the central office for monitoring purposes.

If the Norstar system loses power or the microcontroller on the DID Trunk Cartridge malfunctions, the CCI signals the central office that it can no longer handle DID calls. The central

office, by prearrangement, then forwards the DID lines to other numbers.

Connect the CCI com1 connection to a ground connection.
Connect the CCI NC1 connection to the central office demarcation.



Tips - *CCI signaling to report power loss or malfunction of the DID Trunk Cartridge is not supported by all carriers. For carriers or installations which do not use CCI signaling, the CCI and ET connections are treated as not connected.*

Wire each CCI independently to the central office. If the connections are wired in parallel, any CCI trouble disables all DID Trunk Cartridges. If the connections are wired in series, all DID Trunk Cartridges must fail before the central office recognizes the trouble condition.

Trunk Module with BRI-ST cartridge

TC slot	Pin	Wire color	Port (loop)	Service	Lines (T or S loop)	Terminal equipment S loop)
Slot 1	26	White-Blue	X01	+Tx	001-002	Assigned DN
	1	Blue-White	X01	-Tx	001-002	Assigned DN
	27	White-Orange	X01	+Rx	001-002	Assigned DN
	2	Orange-White	X01	-Rx	001-002	Assigned DN
	28	White-Green	X02	+Tx	003-004	Assigned DN
	3	Green-White	X02	-Tx	003-004	Assigned DN
	29	White-Brown	X02	+Rx	003-004	Assigned DN
	4	Brown-White	X02	-Rx	003-004	Assigned DN
	30	White-Slate	X03	+Tx	005-006	Assigned DN
	5	Slate-White	X03	-Tx	005-006	Assigned DN
	31	Red-Blue	X03	+Rx	005-006	Assigned DN
	6	Blue-Red	X03	-Rx	005-006	Assigned DN
	32	Red-Orange	X04	+Tx	007-008	Assigned DN
	7	Orange-Red	X04	-Tx	007-008	Assigned DN
	33	Red-Green	X04	+Rx	007-008	Assigned DN
	8	Green-Red	X04	-Rx	007-008	Assigned DN
Slot 2	34	Red-Brown	X05	+Tx	009-010	Assigned DN
	9	Brown-Red	X05	-Tx	009-010	Assigned DN
	35	Red-Slate	X05	+Rx	009-010	Assigned DN
	10	Slate-Red	X05	-Rx	009-010	Assigned DN
	36	Black-Blue	X06	+Tx	011-012	Assigned DN
	11	Blue-Black	X06	-Tx	011-012	Assigned DN
	37	Black-Orange	X06	+Rx	011-012	Assigned DN
	12	Orange-Black	X06	-Rx	011-012	Assigned DN
	38	Black-Green	X07	+Tx	013-014	Assigned DN
	13	Green-Black	X07	-Tx	013-014	Assigned DN
	39	Black-Brown	X07	+Rx	013-014	Assigned DN
	14	Brown-Black	X07	-Rx	013-014	Assigned DN
	40	Black-Slate	X08	+Tx	015-016	Assigned DN
	15	Slate-Black	X08	-Tx	015-016	Assigned DN
	41	Yellow-Blue	X08	+Rx	015-016	Assigned DN
	16	Blue-Yellow	X08	-Rx	015-016	Assigned DN

Trunk Module with BRI-ST cartridge (Continued)

TC slot	Pin	Wire color	Port (loop)	Service	Lines (T or S loop)	Terminal equipment (S loop)	
Slot 3	42	Yellow-Orange	X09	+Tx	017-018	Assigned DN	
	17	Orange-Yellow	X09	-Tx	017-018	Assigned DN	
	43	Yellow-Green	X09	+Rx	017-018	Assigned DN	
	18	Green-Yellow	X09	-Rx	017-018	Assigned DN	
	44	Yellow-Brown	X10	+Tx	019-020	Assigned DN	
	19	Brown-Yellow	X10	-Tx	019-020	Assigned DN	
	45	Yellow-Slate	X10	+Rx	019-020	Assigned DN	
	20	Slate-Yellow	X10	-Rx	019-020	Assigned DN	
	46	Violet-Blue	X11	+Tx	021-022	Assigned DN	
	21	Blue-Violet	X11	-Tx	021-022	Assigned DN	
	47	Violet-Orange	X11	+Rx	021-022	Assigned DN	
	22	Orange-Violet	X11	-Rx	021-022	Assigned DN	
	48	Violet-Green	X12	+Tx	023-024	Assigned DN	
	23	Green-Violet	X12	-Tx	023-024	Assigned DN	
	49	Violet-Brown	X12	+Rx	023-024	Assigned DN	
	24	Brown-Violet	X12	-Rx	023-024	Assigned DN	
	50	Violet-Slate	----		reserved	----	----
	25	Slate-Violet	----		reserved	----	----

To determine the assigned lines for a BRI card, refer to BRI and T1 lines on page 549.
For an explanation about port numbering, see Port numbering on the wiring charts on page 252.

Trunk Module with BRI-U cartridge

TC slot	Pin	Wire color	Port (loop)	Service	Lines (U-NT)	Terminal equipment (U-LT)
Slot 1	26	White-Blue	X01	T	001-002	Assigned DN
	1	Blue-White	X01	R	001-002	Assigned DN
	27	White-Orange	X02	T	003-004	Assigned DN
	2	Orange-White	X02	R	003-004	Assigned DN
	28	White-Green	----	----	----	----
	3	Green-White	----	----	----	----
	29	White-Brown	----	----	----	----
	4	Brown-White	----	----	----	----
	30	White-Slate	X03	T	005-006	Assigned DN
	5	Slate-White	X03	R	005-006	Assigned DN
	31	Red-Blue	X04	T	007-008	Assigned DN
	6	Blue-Red	X04	R	007-008	Assigned DN

TC slot	Pin	Wire color	Port (loop)	Service	Lines (U-NT)	Terminal equipment (U-LT)
	32	Red-Orange	----	----	----	----
	7	Orange-Red	----	----	----	----
	33	Red-Green	----	----	----	----
	8	Green-Red	----	----	----	----
Slot 2	34	Red-Brown	X05	T	009-010	Assigned DN
	9	Brown-Red	X05	R	009-010	Assigned DN
	35	Red-Slate	X06	T	011-012	Assigned DN
	10	Slate-Red	X06	R	011-012	Assigned DN
	36	Black-Blue	----	----	----	----
	11	Blue-Black	----	----	----	----
	37	Black-Orange	----	----	----	----
	12	Orange-Black	----	----	----	----
	38	Black-Green	X07	T	013-014	Assigned DN
	13	Green-Black	X07	R	013-014	Assigned DN
	39	Black-Brown	X08	T	015-016	Assigned DN
	14	Brown-Black	X08	R	015-016	Assigned DN
	40	Black-Slate	----	----	----	----
	15	Slate-Black	----	----	----	----
	41	Yellow-Blue	----	----	----	----
	16	Blue-Yellow	----	----	----	----
Slot 3	42	Yellow-Orange	X09	T	017-018	Assigned DN
	17	Orange-Yellow	X09	R	017-018	Assigned DN
	43	Yellow-Green	X10	T	019-020	Assigned DN
	18	Green-Yellow	X10	R	019-020	Assigned DN
	44	Yellow-Brown	----	----	----	----
	19	Brown-Yellow	----	----	----	----
	45	Yellow-Slate	----	----	----	----
	20	Slate-Yellow	----	----	----	----
	46	Violet-Blue	X11	T	021-022	Assigned DN
	21	Blue-Violet	X11	R	021-022	Assigned DN
	47	Violet-Orange	X12	T	023-024	Assigned DN
	22	Orange-Violet	X12	R	023-024	Assigned DN
	48	Violet-Green	----	----	----	---
	23	Green-Violet	----	----	----	---
	49	Violet-Brown	----	----	----	---
	24	Brown-Violet	----	----	----	---
	50	Violet-Slate	----	reserved	----	---
	25	Slate-Violet	----	reserved	----	---

BRI U wiring is not polarity sensitive.
 A BRI-U2 Card only uses the first two loop numbers (X01-X02, X05-X06, or X09-X10) when it occupies a trunk module slot.

Emergency telephone

You can connect an emergency telephone to an ICS or Trunk Module (TM) with a Loop Start Trunk Cartridge to provide emergency service when there is no power to the ICS. The ICS has emergency telephone connections for lines 002 and 026 (profile 1, 3 and 4) or 002 to 030 (profile 2). Each Trunk Module has one emergency telephone connection.



These versions of the Global Trunk module do not support emergency telephones:

NTBB1202 TM With Auto Ranging power supply.
NTBB20AD-93 UK Class B TM
NTBB20AE-93 Australia TM
NTBB20FD-93 Eng/Fr TM
NTBB20FF-93 Cala TM
NTBB20FG-93 International TM

1. Wire a modular jack or equivalent to each set of emergency telephone pins on the 50-pin distribution block for the ICS or Trunk Module external lines.
Refer to *Wiring charts* on page 252 for the pin numbers.
2. Connect a single-line telephone (500/2500) to the modular jack.
3. Prepare to test the emergency telephone by removing the Trunk Cartridge from the slot (slot 3 or 4 on the ICS, and slot 1 on the TM).
4. Connect the power, then connect the central office lines to the ICS.
5. Pick up the emergency telephone receiver and listen for dial tone.

6. Disconnect the central office lines, then remove power from the system.
7. Replace the Trunk Cartridge in the left slot.
8. Continue with procedures for powering up the system.



Tips - *The emergency telephone connections on the Trunk Module will not work if there is an E&M/DISA, a BRI-ST or BRI-U card, or a DID Trunk Cartridge in the first slot of the Trunk Module. The emergency telephone connections on the ICS will not work if DTIs or PRIs are used.*



Tips - *Norstar telephones and Business Series Terminals cannot be used as off-premise telephones (OPX). For OPX applications, use the Norstar Analog Terminal Adapter (ATA2) and a single-line telephone. Refer to the ATA Installation Card for details.*

Moving telephones

You can move a system telephone to a new location within the Norstar system without losing the programmed settings.

When **Set relocation** is enabled in system programming, the internal numbers, autodial settings, and personal speed dial codes remain with the telephone when it is unplugged.

To move a telephone, simply unplug it and plug it in again at another location. It may take up to 45 seconds for the ICS to recognize the telephone. Automatic telephone relocation is disabled by default.



Tips - *Relocate the disconnected system telephone before connecting a new telephone into the vacated jack. This allows the moved telephone to retain the programmed settings.*

If a new telephone is plugged into the vacated jack before the old telephone is reconnected at a new location, Norstar will give the current telephone information to the new telephone. The old telephone will no longer be recognized by the system.

When reprogramming the internal number of a telephone, wait one minute after Automatic Telephone Relocation.

When you relocate a telephone, the telephone must remain installed and connected in the new location for at least three minutes for the programming relocation to be complete. Moving the telephone again before the three-minute period may result in losing the programming on the telephone.

Installing ISDN BRI terminal equipment

For each S or T or U-LT reference point, an eight-position miniature unkeyed plug from the terminal equipment (TE) is plugged into a jack connected to Norstar wiring. The pin connections for the jack and plug are shown in the following charts.

S or T wiring for terminal equipment

Pin (jack or plug)	Norstar connection (for jack)	Equipment connection (plug)
1	not used	optional power source 3 (+)
2	not used	optional power source 3 (-)
3	+Rx	+Rx
4	+Tx	+Tx
5	-Tx	-Tx
6	-Rx	-Rx
7	not used	optional power sink 2 (-)
8	not used	optional power sink 2 (+)

S or T extension wiring configurations

The last connection on any ISDN S or T extension wiring must have terminating resistors to ensure correct timing of the signaling circuits. Failure to install terminating resistors will degrade performance. Terminating resistors should not be connected on a TE which is not the last connection on the loop.

Terminating resistors are provided on terminal equipment. See the instructions that come with your TE for information about how to enable or disable the termination, as required.

The maximum length of spur and ISDN connection cord (the extension from the main line or bus) is 10 m (30 ft).

Refer to *S reference point* on page 57 and *T reference points* on page 58 in the *Welcome to ISDN* chapter for information about wiring arrangements for ISDN terminal equipment (TE) on an S or T loop.

Additional power

A Norstar S or T-loop does not provide power on Power Source 1 (PS1), Power Source (PS2), or Power Source or Sink 3 (PS3). If you are installing ISDN terminal equipment at the S-reference point, and the equipment requires additional power on PS1, PS2, or PS3, then you can install a suitably-approved power supply unit. See ANSI T1.605 or the documentation that comes with your TE for details.

The Modular ICS does not require power on PS3.

Wiring arrangements using side circuits, also called phantom circuits, may affect loop performance when they are used to provide power to the TE (PS1). You must account for any effects. For example, you may need to reduce the number of TEs on a passive bus.

U-LT wiring for terminal equipment

Pin (jack or plug)	Norstar connection (for jack)	Equipment connection (plug)
1	not used	optional battery status indication (+)
2	not used	optional battery status indication (-)
3	not used	no connection
4	R	R

5	T	T
6	not used	no connection
7	not used	optional power (-)
8	not used	optional power (+)

No power supply is provided for the U-LT wiring. If equipment attached to the U-LT loop requires optional power, install an approved power supply unit. See ANSI T1.601-1992 Annex H or the documentation that comes with your TE for more information.

Jack and plug pin numbering

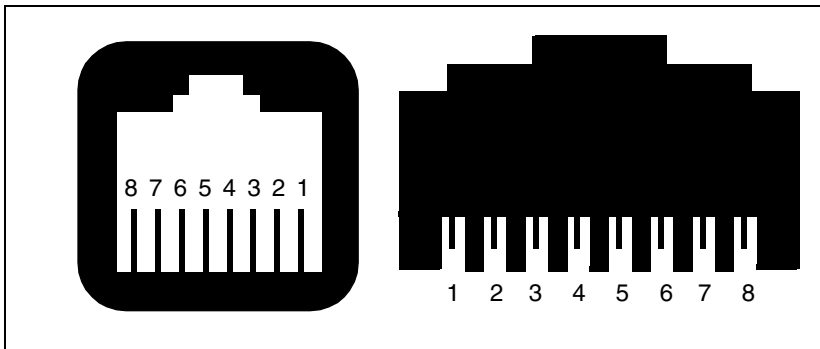

Installing optional equipment

This section describes the installation procedures for optional, customer-supplied equipment.

Auxiliary ringer (customer supplied)

The Norstar ICS provides a control contact to operate an auxiliary ringer.

1. Follow the installation instructions provided by the manufacturer.
2. Connect the auxiliary ring generator to the 50-pin distribution block as shown in the wiring charts.

The pins in this chart provide a control contact. They do not provide ring current or DC voltage. The ringer must not draw more than 50 mA from a 40 V DC source.



Auxiliary ringer programming

The auxiliary ringer can be activated by setting auxiliary ring for specific external lines, and auxiliary ring for specific telephones. Refer to the *Modular ICS 6.1 System Coordinator Guide* for programming details.

Heading
Trk/Line Data
Capabilities
Services

External music source (customer supplied)

The music source can be any approved low-power device such as a radio with a high-impedance earphone jack. The recommended ICS input level is 0.25 V rms across an input impedance of 3300 Ω .

1. Connect the music source output to the 50-pin distribution block, as shown in the wiring charts.
2. Adjust the volume of the music source to a comfortable level by activating Background Music (  ) and adjusting the volume at the music source.



Tips - *Background Music volume can also be adjusted at each telephone.*

External music source programming

Music for callers on Hold and for Background Music must be enabled through programming. Refer to *Backgrnd music* on page 419 for more details.

Confirm that the following settings are implemented:

Heading	Setting
Featr settings	On hold: Music
Featr settings	Backgrnd music: Y

External paging system (customer supplied)

You can connect an external paging system to provide paging over external loudspeakers. The paging output from the Norstar ICS is 100 mV rms across an input impedance of 600 Ω .

1. Follow the installation instructions provided by the manufacturer.
2. Connect the paging system audio input to the 50-pin distribution block as shown in the wiring charts.
3. Connect the paging system relay to the 50-pin distribution block as shown in the wiring charts.

External paging contacts

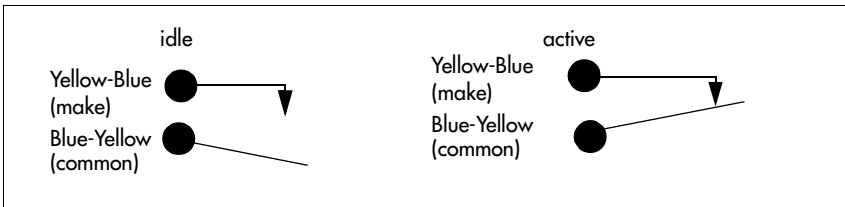

Tips - *Norstar external paging does not support talk-back paging equipment unless an external line port is used.*

The Norstar system provides paging over the Norstar telephone speakers, even when no external paging equipment is connected.

Powering up the system

1. Double-check all wiring before turning the system power on. Ensure all outlets where you will plug in the modules are non-switchable, third-wire ground AC outlets.



Do not connect central office line cables to the modules until after the system power is on.

2. Route the module power cords through the lower shelf of the cable trough and out through the bottom of the ICS cable trough.
3. Route the ICS power cord through the bottom of the ICS cable trough.



Companion: Install Base Stations before powering up the MICS-XC system.

4. Connect each power cord to an electrical outlet.

If you are using a power bar, plug the power cords into the power bar, and then connect the power bar to the AC outlet.



Do not fasten power supply cords.

Do not fasten the ICS power supply cord or module power supply cords to any building surface, including the backboard.



Close and lock the ICS door.

Close and lock the ICS door after installation is complete to avoid accidental shock and to provide containment in the event of fire.

Check the power

After the power is supplied, the ICS power supply LEDs will light up green. If a BRI cartridge is installed, the LEDs on the faceplate of the cartridge will flash for up to five minutes. Telephones and lines also may take up to five minutes to initialize.

1. Check that the power LEDs of the power supply, the TMs, and the SMs are on.
2. If none of the LEDs are on, verify that power is present at the outlet. If there is power at the outlet, see *Problems for network or remote users* on page 606.



Tips - *During system initialization, the system performs a self-diagnostic test on the hardware configuration size and expansion cartridge installation.*

Once the system is initialized and the telephone displays read **Jan 1 1:00 am**, you have 15 minutes in which to perform Profile, Dialpad, and Startup programming. After 15 minutes, access to Startup programming is denied.



Tips - *After system startup, you can turn the power off and on and retain any system data that has been entered. This is considered a warm start. A warm start takes approximately 5-10 minutes. However, if you run Startup again, the default programming will be reestablished.*



Call Log information may be lost.

If the Norstar system suffers a power failure or the system is manually restarted, Call Log information is not saved. Notify users if a system restart is planned so any log information can be written down first.

System power indicators

ICS LED (green)

TM LED (red)

SM LED (red)

IDM LED (green)

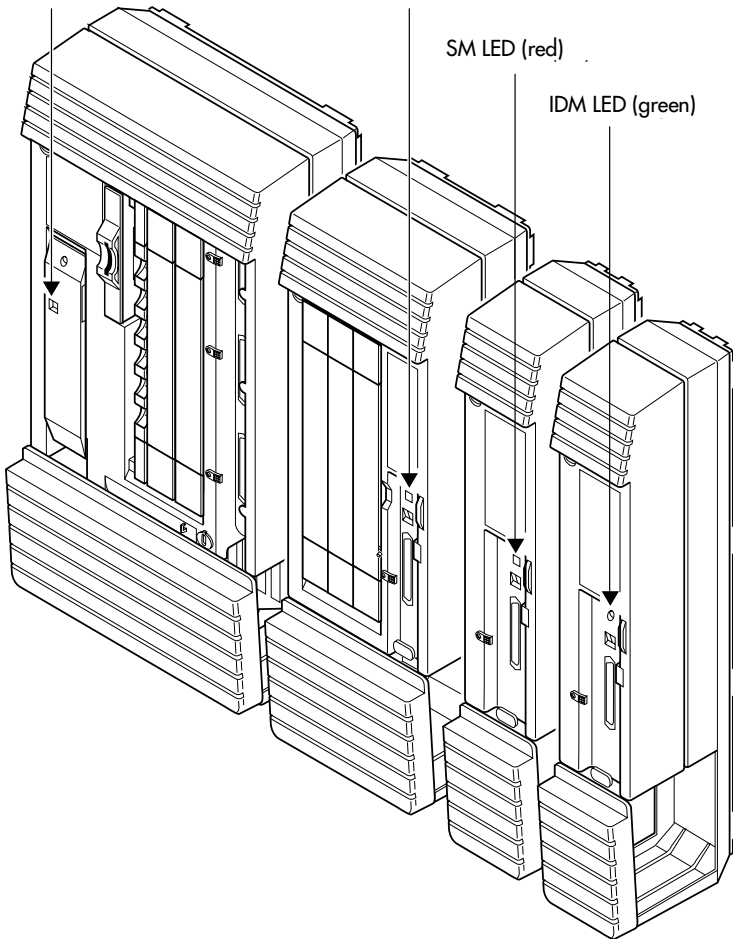

Programming

The installer or the customer service representative programs settings for the entire Norstar system, plus settings for individual telephones and external lines.

Most of the settings can also be programmed by a system coordinator who has a SysCoord+ password. The SysCoord+ password should only be used by individuals who are capable of programming the Norstar ICS. Further, this level of access should only be distributed to System Coordinators who are more experienced in programming the Norstar ICS.



Programming affects system operation.

Only a qualified installer or customer service representative should perform startup, installation and maintenance programming. Some of the settings affect the correct operation of the system.

Programming overview

Programming access is controlled by these passwords.

- Profile password — allows you to determine the system profile. The default profile is the profile used for North American applications.
- Dialpad password — allows you to determine the style of dialpad programming for your system. This setting determines which key you press to obtain the letters Q and Z. The default is non_CCITT (press 0 for both letters).
- Installer password — allows you to determine the defaults you will use as the basis for your system programming, including networking features. It also allows you to view these settings and change them, as required for your system requirements.
- System Coordinator Plus password — provides knowledgeable users with access to all but a few sensitive areas of programming. You should only distribute this password to experienced System Coordinators.
- System Coordinator password — allows an administrator responsible for the day-to-day operation privileges to view and change the settings that affect on-going operations.
- Basic password – provides a limited number of feature codes to change programming and control system services.

For information about programming using the System Coordinator and Basic passwords, see the *Modular ICS 6.1 System Coordinator Guide*.

The tables in this section provide an overview of what programming is seen by each type of user. For information about changing the passwords, see *Passwords* on page 401.

If you are new to programming, you may want to practice using the step-by-step programming instructions in the *Getting Started* section of the *Modular ICS 6.1 System Coordinator Guide* before attempting other programming.

Profile, Dialpad and Startup programming

Profile: (**7763453)

Dialpad: (**3425723)

Startup: (**7827887)

Default password: (266344)

Profile
Password: (CONFIG)
Region: PROF1 OK CHANGE

Dialpad
Password: (CONFIG)
QZ:0 CHANGE

Startup
Password: (CONFIG)
Reset Memory? YES
Template: CHANGE
Start DN: 2221 CHANGE
Applying Template (Install is complete when Date and Time appear on the display)

Installer or System Coordinator Plus programming

Entry code: (**266344)

Installer password: (266344)

System Coordinator Plus password: (727587)

Startup	Passwords (cont'd)	Telco features
Template	Reg. pswd	VMsg ctr tel#s
Start DN	Hospitality	ONN blocking
Terminals&Sets	SM Passwrđ	Software keys
Line access	Time&Date	SysID
Capabilities	System prgrming	Password keys
Name	Hunt groups	Hardware
User preferences	Change DN's	Cards on KSU
Restrictions	Featr settings	Mod 03 - Mod 14 (depending on type of system)
Telco features	Direct-dial	Maintenance
Lines	CAP/KIM assignment	System version
Trunk/Line data	Dialing Plan	Port/DN status
Name	Access codes	Module status
Restrictions	Remote access	Sys test log
Telco features	Change DN type	Sys admin log
Services	Companion	Network evt log
Ringing service	Rec'd # length	Provisioning
Restrtn service	DN length	Tests
Routing service	BusName	CSU stats
Common settings	CbC limits	Diagnostic tools
Sys speed dial	Release reasons	Link status
Passwords	Hospitality	Usage metrics
COS pswds	Network Services	Hunt groups
Call log pswds	SM sets	Call-by-Call
Progrming pswds		

Dark gray items are seen only if you are using the Installer password. As well, some headings will not appear unless the appropriate software code has been entered, for instance Network Services requires the PRI and MCDN software

codes. Other settings will not appear unless the appropriate cards or trunks are assigned. CbC headings, for instance, do not appear unless the NI-2 protocol is used on the DTI trunk card.

Light gray areas are only available with MICS-XC software. These headings provide programming access for the Companion wireless setup.

System Coordinator programming

Entry code: (**266344)

Default System Coordinator password: (23646)

Terminals&Sets	Services	Reg. pswd*
Capabilities	Ringin service	Hospitality
Name	Restrn service	Time&Date
User preferences	Routing service	System prgrming
Restrictions	Sys speed dial	Hunt Groups
Telco features	Passwords	Companion*
Lines	Call log pswds	BusName
Name	Progrming pswds	Hospitality

*These prompts only appear with XC software for Companion programming.

Admin/Basic programming

User code: (**8737)

Default Basic password: (22742)









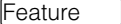

Set #####	
Model	Dialing opt'ns
Button prgrming	Language
User speed dial	Display cntrst
Call log opt'ns	Ring Type

Programming tools

This section describes how to set up a telephone for system programming.

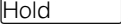
You will note that two different sheets of programming overlays came with your *Programming Record*. Use the one that was created for the telephone you plan to use to program your system.

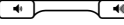
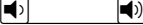
You can use T7316/T7316E Business Series Terminals or an M7310 or M7324 telephone for programming. These telephones have two-line displays. Use the appropriate template and refer to the table below for corresponding button faces:

Business Series Terminals T7316/T7316E	Button description	Norstar sets M7310, M7324
	Feature	
Handsfree:  (T7316E) Mute: 	Handsfree/Mute	
  	Hold	 
	Volume Control	
	Release	

The programming overlay

The programming overlay is a paper cutout that labels the four telephone buttons used during programming. You received two pages of overlays with your *Programming Record*. One page corresponds to the Business Series Terminals T7316/T7316E telephones. The second sheet corresponds to the Norstar M7310 and M7324 telephones.

Remove the appropriate overlay from the page and put it over the buttons indicated in the following diagrams.

The T7316 and T7316E telephones have different programming buttons, as indicated by the separate windows on the overlays.

Business Series Terminal with overlay

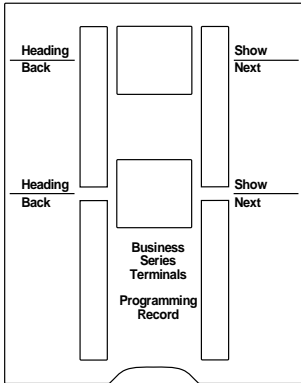

T7316E programming set

T7316 programming set

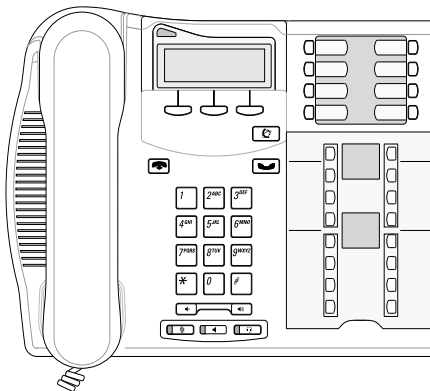

Overlay placed over keys with indicators

Norstar terminals M7310 and M7324 with overlays

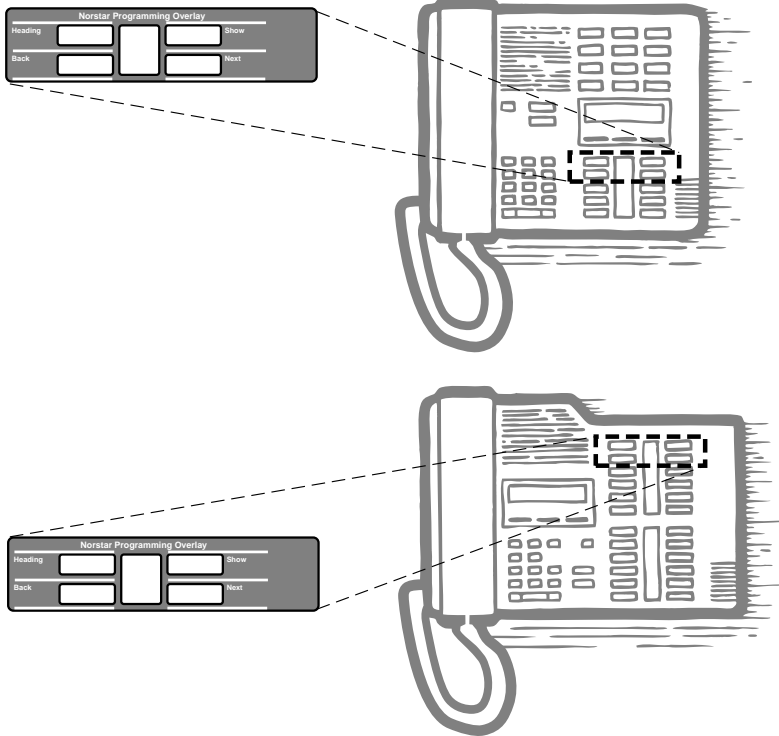

Using the telephone buttons for programming

On the overlay, each of the four programming buttons is assigned an action feature.

The indicators (▶) on the display beside the buttons show which buttons are active at each programming step. Press the appropriate button to move up or down through the Norstar programming menu.

The table below describes the action of each button.

Telephone overlay button definitions

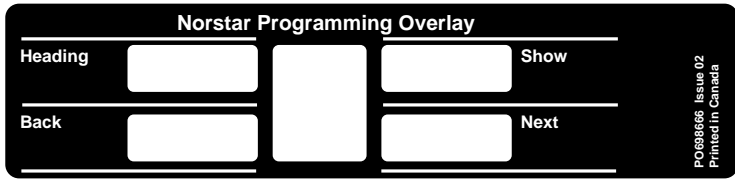

- moves to a higher level in the hierarchy of headings and subheadings.
- moves to a lower level in the hierarchy of headings and subheadings, or begins programming for a heading or subheading.
- moves backward at the same level in the hierarchy of headings and subheadings.
- moves forward at the same level in the hierarchy of headings and subheadings.

Special characters on the display

When a heading ends with a triangle (▶), you can press

to view the subheadings for that item.

When a heading ends with an ellipsis (...), you can press

to see further information about that heading.

The display buttons

Display buttons on the telephones perform a number of functions, depending on where you are in programming. Up to three display button messages may be available at any time.

Press the display button underneath the message for the function you want the system to perform.

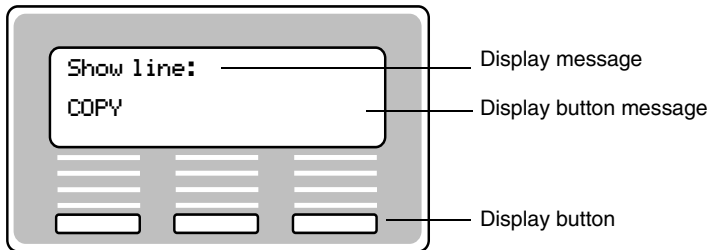

The most common display button labels are described in the following table:

Display button definitions

<u>CHANGE</u>	changes a programmable setting
<u>BKSP</u>	moves the cursor one space to the left (backspace) and deletes a character, allowing you to re-enter a number or letter
<u>COPY</u>	copies the settings of items like lines, telephones and filters to an item of the same type
<u>FIND</u>	allows you to enter specific code to go directly to a record
<u>VIEW+</u>	views the last part of a displayed message longer than 16 characters
<u>+VIEW</u>	views the first part of a displayed message longer than 16 characters
<u>_></u>	moves the cursor one position to the right when programming a name
<u><_</u>	moves the cursor one position to the left when programming a name
<u>OK</u>	confirms the change you made, or accepts the default, if you made no changes
<u>ANY</u>	Enters a wild card character that represents any digit between 1 and 9.

The Norstar Programming Record

The *Programming Record* can be used to help you plan your programming strategy. If you enter all your settings on the tables provided, you create a quick reference guide to your system.

Pages from the record may be photocopied, as necessary, for programming many telephones or lines. Additional Programming Records can also be ordered from your vendor.

Exiting

Norstar stores your changes automatically as soon as you alter any settings. If you changed something in error, you must re-enter the correct data.

In extreme situations, you may have to restart the system and reload with your backup material.

To exit the configuration interface, press . The display briefly reads **End of session**, then returns to the Date and Time display.

Viewing your programming updates

If any changes you made to programming have not taken effect yet, you will see an **UPDATE** display button when you leave programming. The display will show you how many telephones have not been updated yet because the system is busy with other programming or the telephone is in use.

Press **DN5** to see the specific telephones where programming changes have not been updated. Items will disappear from the list as they are updated, and **UPDATE** will disappear once all changes are complete.

Entering numbers

Numbers are entered from the telephone dialpad. The backspace display button may be used to edit the number.

A line number must always be entered as a three-digit number. Line numbers from 10 to 99 must be entered with a leading zero (line 020, for example). Similarly, line numbers less than 10 must be entered with two leading zeros (line 002, for example).

Internal telephone numbers, also referred to as directory numbers (DNs), can be from three to seven digits long. The default DN length is three. The DN length can be changed in programming.

Viewing long telephone numbers

External telephone numbers can be up to 24 digits, but the telephone display is only 16 character spaces long. To see a previously-programmed number that is longer than 16 digits, do the following:

Begin, for example, with **123456789012345...** The display shows only the first 15 digits. The three dots (...) at the end of the display indicate that more digits remain to the external number.

1. To see the remaining digits, press **VIEW**.
2. To see the first 15 digits again, press **+VIEW**.

Setting up User Preferences

The User Preferences feature allows you to program memory buttons, speed dial codes, and other settings for any telephone on the system.

For example, an employee may want to have the Do Not Disturb feature programmed onto a memory button or create a speed dial code. Instead of programming from the target telephone, you can program these features from another telephone.

To set up user preferences, refer to *User preferences* on page 338.

Copying telephone programming

Copying is done by using COPY under Terminals&Sets. You can copy programming from one telephone to another telephone, to a range of telephones, or to all telephones.

1. At Terminals&Sets ▶, press .
2. Enter the internal number (DN) of the telephone from which you wish to copy programming.
3. Press COPY.
4. Select what programming will be copied:
 - SYSTEM – the system administration programming (system data) of a telephone

OR

- SYSTEM+USER – the system administration programming PLUS the programming for a particular telephone (user data)

See the tables starting on page 308 to see which settings will and will not be copied with system and user data.

5. Press , then press CHANGE to select the telephone or telephones which will be programmed with the copied data: SINGLE, RANGE, ALL.

You can copy programming to telephones which are not yet hooked up to the system (unequipped).

6. Press , then CHANGE to select which telephones will be programmed: Only equipped DNs, All set DNs. This is not necessary when copying to a single telephone.

7. Press and enter the internal number of the telephone that will be programmed or the internal numbers of the first and last telephone in a range.
8. Press **OK** to proceed with the copy.
This step is not necessary when you are copying to a single telephone.

You can also use **COPY** to duplicate the settings found in the individual subheadings. The button is available in **Line access**, **Capabilities**, **User Preferences**, **Restrictions** and **Telco features** and will copy only the settings included in the subheading.

If you press **COPY** in one of these subheadings, you will not be asked to decide if user data will be copied. Otherwise, the procedure is the same.



Tips - *To copy to a group of telephones which are not part of a range, follow the steps for making a single copy and keep entering new numbers at the **COPY to:** display.*

Depending on the activities going on in the system, a copy may not take effect immediately. The brief display you see once you have finished a copying session does not indicate the process is complete.

You can leave the programming session even if the copy has not been completed. If you exit programming, the system continues copying, uninterrupted, until it is complete.

Event messages capture both the start and completion of the copying process. For more information, see Event messages on page 541.



Tips - *Some programming settings allow you to choose a delay according to the number of rings. The ring counts used are based on a North American standard of six seconds per ring cycle. The actual delay time may be different for a device other than a Norstar telephone.*

System Data that gets copied	System data that is NOT copied
<p>Line access</p> <ul style="list-style-type: none"> • Line assignment • Line pool access • Prime line designation • Number of intercom keys • Answer DN's (unless Answer button DN is same as telephone being copied to) 	<p>Line access</p> <ul style="list-style-type: none"> • Private line appearances
<p>Capabilities</p> <ul style="list-style-type: none"> • Call Forward No Answer (DN + delay + setting) • Call Forward Busy (DN + setting) • DND on busy • Handsfree setting • Handsfree answerback • Pickup group • Paging zone • Paging • Direct-dial (which set is reached by the D-Dial digit) • Priority calling • Hotline • Auxiliary ringer • Allow redirect • Redirect ring • ATA settings (except Use ringback setting) 	<p>Capabilities</p> <ul style="list-style-type: none"> • Set name • Use ringback setting under ATA settings • SM Supervisor
<p>Telco Features</p> <ul style="list-style-type: none"> • Call Log set (<i>Logging set</i>) • 1stDisplay 	<p>Telco features</p> <ul style="list-style-type: none"> • Log password • Log space
<p>Restrictions</p> <ul style="list-style-type: none"> • Set restrictions • Set lock • Allow Last Number Redial • Allow Saved Number Redial • Allow Link • Line/set restrictions 	<p>Direct-dial set designation (which set is the D-Dial set)</p> <p>CAP/TAP assignment</p> <p>ExtraDial set designation</p> <p>Service mode ringing set designation</p> <p>Prime set designation for a line</p> <p>Hunt group appearance</p>

User data that gets copied	User data that is not copied if destination set type is the same as the source set type
Language choice Ring type Calls log options (<i>Auto logging</i>) Display contrast Dialing options (automatic, pre-dial, standard)	External autodial button assignments Internal autodial button assignments Programmable button assignments

Ring volume, User speed dial and CAP/KIM module memory button programming are not copied with user data.

System ID

The System ID (or System Security number) can be accessed on a programming terminal display by pressing

* * S Y S I D or * * 7 9 7 4 3 .

Reviewing programmed settings



The Set Profile and Line Profile features help you to check your programming by allowing you to review the settings.

Programming that can be reviewed

Set Profile	Line Profile
Terminals&Sets settings	Lines settings
Set name	Line name
Line Access	Trunk data
Capabilities	Line data
Restrictions	Restrictions
Telco features	Telco features



Viewing the programming for a telephone

To display the programming for a set, follow these steps:

1. Press  * * S E T .
The display reads **Show set:**.
2. Enter the internal number of the telephone you wish to review.
3. Use BACK, NEXT, and SHOW to navigate through the settings.
4. Press  to exit.

Viewing the programming for a line

To view line programming for a telephone, follow these steps:

1. Press  * * L I N E .
The display reads **Show line:**.
2. Enter the number of the line you wish to review.
3. Use BACK, NEXT, and SHOW to navigate through the settings.
4. Press  to exit.

Programming sequence

The programming information in this guide is presented in the order that is useful for everyday changes and for upkeep of the system.

The following order of process is recommended as more suitable for an installation. However, the order in which you program your system will depend on a variety of variables and may differ from this list.

- Profile and Dialpad, if required (page 312 and page 316)
- Startup (initializes system) (page 317)
- Software keys for PRI and MCDN, if required. (page 479)
- Hardware (starting on page 482)
- Lines (including any networks) (starting on page 351)
- Terminals&Sets (starting on page 325)
- System prgrming (starting on page 409)
- Services (starting on page 371)
- Telco features (starting on page 474)
- Other software keys (Companion) (Companion Installer and Coordinator Guides)
- Sys speed dial (starting on page 400)
- Passwords (starting on page 401)
- Time&Date (starting on page page 408)
- customized programming, such as Voice Mail (refer to the documents for the specific application)

Profiles and Dialpads

Use Profile programming to determine which types of trunks are supported, and which are supported on and off core.

Use Dialpad programming to define how your system will handle the letters Q and Z from the dialpad.



You must perform this procedure **BEFORE** you run Startup, within the first 15 minutes after you plug in your KSU.

If you run this program after Startup, you will lose your settings.

Profile programming

If your system is outside of North America, you may require a slightly different operating profile for your system. You must choose these parameters before you perform your system startup programming.

If your system is in North America or you know that you want to run that profile, you do not need to run this program.

Profile parameters

Each market profile setting supports a different selection of trunk cards. In your situation you may require NI (primarily North America and some parts of South America) or ETSI (Europe, Asia, and some parts of South America) ISDN.

Analog to digital expansion and compression rates can be either a-law or mu-law, as well. The tables in the following sections show which trunks are supported, and where.

Note: If you are unsure of the ISDN protocol or companding law active in your area, consult with your ISDN service provider for details.

Profile 1

This profile is the default profile. It supports cards and protocols for Canada and the United States. This profile has language support for English, Canadian French, and Spanish. The mu-law companding law is used in this profile. The off-core DTI module also is supported for this profile.

Profile 2

This profile is for international systems that use ETSI ISDN lines with aLaw. The languages supported include: English, French, Spanish, and Turkish.

Cards supported on-core	Cards supported off-core
<ul style="list-style-type: none"> • Analog • DTI • 4-port BRI-ST • 2-port BRI-ST • PRI (E1) 	<ul style="list-style-type: none"> • Analog • E&M • 4-port BRI-ST • 2-port BRI-ST
Supported	Not supported
<ul style="list-style-type: none"> • ETSI MCDN (SL-1) and EURO protocols • aLaw companding law • Loops are provisioned • T7000 telephone 	<ul style="list-style-type: none"> • DID • UTAM

Profile 3

This profile provides language support in NA English, CDN French, US Spanish, and Turkey. This profile is for countries who use ETSI ISDN with mu-law (i.e. some Asian locations)

Cards supported on-core	Cards supported off-core
<ul style="list-style-type: none"> • Analog • T1 • 4-port BRI-ST • 2-port BRI-ST 	<ul style="list-style-type: none"> • Analog • E&M • DID • 4-port BRI-ST • 2-port BRI-ST
Supported	Not supported
<ul style="list-style-type: none"> • ETSI ISDN protocol • muLaw companding law • Loops are provisioned • T7000 telephone 	<ul style="list-style-type: none"> • PRI • UTAM

Profile 4

This profile provides language support in English, French, and Spanish. This profile is for countries who use NI ISDN protocol with mu-law (i.e. some areas in the Caribbean). This profile also can support one off-core DTI module.



Cards supported on-core	Cards supported off-core
<ul style="list-style-type: none"> • Analog • T1 • PRI • 4-port BRI-ST • 2-port U • 4-port U • DTI 	<ul style="list-style-type: none"> • Analog • E&M • DID • 4-port BRI-ST • 2-port U • 4-port U • DTI

Supported	Not supported
<ul style="list-style-type: none"> • NI ISD protocol • muLaw companding law • PRI, including MCDN • T7000 telephone 	<ul style="list-style-type: none"> • UTAM • Loops are not provisioned

Changing the profile

If your system is in North America or you know that you want to run the North American profile, you do not need to run this program.



If you need to change the profile, follow these steps:

1. Enter the Profile access code from a programming set by pressing  * * P R O F I L E (**7763453).
2. Enter the password, when prompted.
 (266344)
Region:PROF1 displays.
3. Press the key below **CHANGE** to scroll to another profile number.
4. Click the display key for **OK** when you reach the profile you want to choose.
5. Press  to exit.











Dialpad programming

Use this program to determine how the system will recognize the characters Q and Z from a telephone dialpad. The two types of configurations are called CCITT and non-CCITT.

The default is non-CCITT, where Q and Z are accessed through the  dialpad button.

CCITT systems access these characters through the  (Q) and  (Z) dialpad buttons.

To change the setting, follow these steps:

1. Enter the Dialpad access code from a programming set by pressing  *  *        (**3425723).
2. Q,Z:0 displays. To change it, press the key below CHANGE.
3. Press  to exit.

Startup programming

After the hardware has been installed and powered up, use Startup to initialize the system, and select the system template that best suits your system.



Startup erases programming.

Startup erases any existing programmed data, and resets the system to factory defaults.



Tip - *Ensure that you have current backups of your system programming and logs.*

All programming is retained for three days if the power fails or if the Norstar system is powered off. After three days, it may be necessary to perform Startup.

Performing Startup

1. Enter the Startup access code from a programming set, by pressing which is the same as .

To be accepted, the Startup code must be entered no later than 15 minutes after the Norstar system has been powered up.

If 15 minutes have elapsed since you powered up the system, turn system power off and on and wait for the system to power up again.

2. Enter the Installer password.
The default is which is the same as .



Tips - *The Installer password shown is the default normally used for Startup. For a system which has already been programmed, the Installer password might have been changed in programming and recorded in the Programming Record.*

Changing the default telephony template

After entering the Startup access code and Installer password the telephone displays **Reset memory?**.

1. Press **YES** to select a default telephony template.
The display shows the current template.
2. Press **CHANGE** to choose the appropriate template.



Changing the template resets programming!

If you change your system template on an existing system, your programming will be reset to the defaults.

If this happens, perform an immediate restore from your backups.

Changing the starting DN

You can change the starting number for your telephone directory numbers (DNs). This is helpful when your system is part of a network and you want to use a uniform series of directory numbers for all telephones in your network.

With the display showing the current template.

1. Press .

The display shows the current start DN.

2. Press **CHANGE**.
3. Enter the new directory number you want as the starting DN, and press **OK**.

The display shows the new range of DN numbers.

4. Press to store the programming.

The display shows **APPLYING template**.

This process takes a few minutes. When it is complete, the indicators begin to flash. When the set displays **Jan 1 1:00 am**, the initialization is complete.



The length of the directory number that you enter sets the length for all directory numbers. Target line received numbers are set to the same length when using the DID template. DNs can be from three to seven digits. If your system is part of a network, the DN length must be the same as all other systems.

A DN length change, if required, should be the first programming change on a newly-installed Norstar system.



Changing the DN length

If you reduce the length of the directory numbers in DN length in System Programming, the starting DN number is reset to the default value (221).

If you increase the length of directory numbers in DN length in System Programming, each increase in length places the digit 2 in front of any existing DN. For example, if DN 3444 was increased to a length of 6, the new DN would be 223444.

If the new DNs clash with the direct-dial digit, park prefix, or line pool codes or destination codes, those numbers are overridden and set to None.

Do not disable or enable ports in Maintenance programming during the first two minutes after Startup programming.

Programming

When Startup is complete, use programming to change default settings, as required. Use the programming record to orient yourself within the programming menus.

Programming for both MICS 6.1 and MICS-XC 6.1 has the following main headings:

Terminals&Sets	Allows you to assign settings to each telephone.
Lines	Allows you to assign settings to each trunk, external and target line.
Services	Allows you to create services such as night ringing, routing and restrictions for making external calls.
Sys speed dial	Allows you to create speed dial codes that can be used by any telephone in the system.
Passwords	Allows you to view and change passwords for programming and features.
Time&Date	Allows you to set the time and date on the system clock.
System Prgrming	Allows you to change system-wide settings.
Telco features	Allows you to assign settings for external voice message services.
Software keys*	Allows you to access system identification and password keys. Allows you to enter the software keys to activate PRI, Companion (MICS-XC, only), Hospitality, or the Private Networking (MCDN) protocol

Hardware	Allows you to configure the Trunk Cartridges and BRI cards used by the system.
Maintenance	Allows you to view diagnostic information about the system and provision BRI cartridges.
Usage metrics	Provides statistical information about Hunt groups.

*For information about programming for Companion, see the *Modular ICS Companion Installer Guide*.

Entering programming for installers

1. Enter the installer codes on a programming set by pressing



which is the same as .

The display shows **Password:**.

2. Enter the Installer password.

The default password is **CONFIG** (266344).

The display shows **Terminals&Sets**. Three triangular indicators ► appear on the vertical display between the rows of buttons.

3. Place the programming overlay over the buttons pointed to by the indicators ►. (Refer to *The programming overlay* on page 298.)



TIP - *T7316 and T7316E telephones look very similar. However, for programming, they have different sets of programming buttons, even though they use the same programming overlay. Once you enter programming, the indicators will make it clear which part of the overlay you need to use.*

Entering programming for system coordinators

The person on staff who is in charge of making changes on the Norstar system is called the system coordinator. The everyday programming done by system coordinators is described in the *Modular ICS 6.1 System Coordinator Guide*.

Some system coordinators need to be able to program more advanced settings and functions in order to carry out the day-to-day requests and upkeep of the Norstar. These coordinators are usually dedicated communications specialists who work with large Norstar systems or other telephone systems like PBX or Centrex.

By using a special password, a system coordinator can see and change many, but not all, of the programming settings used by an installer. In this guide, programming that can only be changed by an installer is marked in the heading. If you are programming using the System Coordinator plus password, you will not see these items when you move through the menus. This level of access is documented in the *Modular ICS 6.1 System Coordinator Guide*.

1. Enter the System Coordinator plus codes on a programming set by pressing

 , which is the same as .

The display shows **Password:**.

2. Enter the System Coordinator plus password.

The default password is **SCPLUS (727587)**.

The display shows **Terminals&Sets ▶**. Three triangular indicators ▶ appear on the vertical display between the rows of buttons.

3. Place the programming overlay over the buttons pointed to by the indicators ▶. (Refer to *The programming overlay* on page 298.)

Entering programming using other passwords

A set of the most often-used headings and subheadings is available by using a System Coordinator password. Refer to page 297. This level of access is designed for the average user who takes care of the day-to-day changes to the Norstar system, but who is not interested in more advanced programming. The default password is **ADMIN** (23646).

There is also a Basic password that can be used to perform a few programming tasks. The default password is **BASIC** (22742). By using this password, a system coordinator can delegate some responsibilities, and at the same time, keep secure more sensitive programming features. For more information, refer to *Modular ICS 6.1 System Coordinator Guide*.

Terminals&Sets

Terminals&Sets allows you to assign settings to each telephone.

This is the first heading that appears after you enter your password.

1. Press .

The prompt displays: **Show set:**

2. Enter the set number of the telephone you would like to program.
3. Press **COPY** to duplicate the programming for the telephone and apply it to another telephone, a range of telephones or all the telephones on the system.

For more information about copying set programming, refer to *Copying telephone programming* on page 306.

Line access

Line access allows you to assign lines to individual telephones. When you are finished programming Line access settings for one telephone, you can copy those settings to other telephones.

In some cases, Line access programming for Norstar Companion portables works differently than it does for desk sets. See the *Modular ICS Companion Installer Guide* for information.

PRI lines can only be configured as direct inward dialing (DID) lines. Therefore, PRI lines are always Auto Answer and cannot be Manual Answer.



Tip - *When you assign line access for BRI loops which have only one SPID, make sure that the programming for the two lines on a BRI loop is identical. For example, if line 001 on BRI loop 201 appears at a DN, line 002 on the same loop should appear at the DN as well. See the ISDN chapter for more information about programming BRI lines.*

In general, auto-answer loop start trunks and auto-answer BRI trunks are not assigned to telephones. If assigned, they are used for monitoring incoming call usage, or for making outgoing calls.

Line assignment

This setting allows you to assign physical trunks and target lines to each telephone. Target lines are assigned and removed in the same manner as other lines.

1. After you have chosen a set number, press and enter the line number.
2. Press **CHANGE** to change the setting for each line to one of the following: **Unassigned**, **Ring only**, **APPR&Ring**, and **APPR only**.

Telephones that are grouped together, and that are assigned multiple target lines, can be set to allow ringing at all telephones simultaneously (Broadcast ring).

Appearances

This setting only applies for direct inward dial (DID) digits mapped onto target lines.

The Norstar system can handle simultaneous calls to a telephone with multiple target line appearances (157 to 284 for MICS, 157 to 348 for XC). The number of target line appearances depends on the line assignment setting, which include: Appr&Ring, Ring only, and Appr only.

If Appr&Ring or Appr only is chosen, you can have as many simultaneous DID calls as there are target line key appearances. If Ring only is chosen, you can have as many simultaneous DID calls as you have intercom keys.



Users cannot access PRI lines directly through line appearances or line pools. All outgoing PRI calls are dialed through the intercom button, using destination codes.

When a trunk card is changed to PRI, all existing line appearances for that card are automatically removed.

Telephones without line buttons, telephones connected through an ATA2, portable telephones, and BRI ISDN S-terminals cannot process more than two simultaneous calls.

There is a suggested limit of four line keys per telephone. You can program more than four keys on a telephone by programming less than four on other telephones. For instance, you might program 20 keys on a receptionist telephone equipped with a CAP and only three keys on the 20 telephones connected to the CAP.

1. Enter the line number. The display shows the line number and its assignment.
2. Press until the display shows Appearances:1.
3. Press **CHANGE** and enter the number of target line appearances.
4. Press to exit or to continue programming.



Tips - Press **SCAN** to view the lines assigned to this telephone.

In general, auto-answer loop start trunks, auto-answer E&M trunks, and DID trunks are not assigned to telephones. If assigned, they are used for monitoring incoming call usage, or for making outgoing calls (auto-answer loop start and E&M trunks).

In general, fixed data channel trunks are not assigned to telephones. If assigned, they are used for monitoring call usage.

You cannot assign a line that is private to another telephone.

Each line assigned to appear at a telephone must appear at a button with an indicator on that telephone. The maximum number of line buttons are eight for the M7208 telephone and T7208 Business Series Terminal, 10 for the M7310 telephone and T7316/T7316E Business Series Terminals, and 24 for the M7324 telephone.

If you set a line to Ring only, incoming calls appear on an intercom button.

The M7100 and T700 sets have no line buttons or intercom keys, but can be assigned any number of lines, however, only two calls can be received at a time. Ensure that the lines assigned to these telephones are assigned to ring; otherwise, you cannot detect incoming calls on the lines.



TIPs - *CAP line programming: A central answering position (CAP), with one or two CAPs/eKIMs, can provide extra line buttons if more than 24 (M7324)/10 (T7316E) lines are assigned to the telephone attached to the modules. The extra lines automatically overflow onto the buttons on the module, as they are programmed. Note that new line assignments may overwrite existing programming on the CAP/eKIM.*

*Note: The CAP module and KIM must be set up under **System Programming, CAP/KIM assign** to accommodate line buttons. If the modules are not set up in system programming to be CAPs, the lines will remain assigned to the T7324/T7316E, but will not show up on a button on that telephone.*

Line pool access

This setting allows a telephone to access one or more of the 15 line pools available (A to O). When you assign a given line pool, the telephone being programmed can access any lines in that line pool.

Press , then press to scroll through the settings and display the line pool you want to program access to. Press **CHANGE** to select the setting: **N** (No) and **Y** (Yes).

There can be a maximum of two on-core DTI cards (PRI) on a Norstar system, regardless of profile.

Four line pools are available for PRI lines for profiles 1 and 4, which support two on-core DTI cards and one off-core DTI card (*Off-core DTI card* on page 211). The four possible line pools are PRI-A, PRI-B, PRI-C, or PRI-D.

- Only PRI lines can belong to a PRI pool. PRI lines cannot

belong to Line Pools A through O.

- All lines on a single DTI card (PRI) belong to the same pool.
- Lines from multiple DTI cards (PRI) can belong to the same pool if they are configured with the same protocol.
- PRI lines are assigned to pools with the **Line type** setting under Lines programming.

Prime line

This setting assigns a prime line to the telephone. A prime line is the first line that is automatically selected when the handset is lifted.

Press **CHANGE** to select one of these settings: **None**, **Pool** (A to O), or **I/C** (intercom). Only assigned lines and line pools appear.

PRI pools are not valid selections for a Prime line.



Tips - *An assigned prime line is not associated with the assignment of a prime telephone.*

- *An external line must be assigned to the telephone in Line assignment before it can be assigned as the prime line to the telephone.*
- *A line pool must be assigned to the telephone in line pool access before a line pool can be assigned as the prime line to the telephone.*
- *A target line cannot be a prime line for a telephone because it is incoming-only.*
- *A DID line should not be assigned as the prime line for a telephone. If assigned, it is treated as if no prime line has been assigned. The message **Select a line** appears when the receiver is lifted.*

Remember that if you set prime line to I/C (intercom), you may wish to assign loop start lines to the first line pools. When the system searches for an outgoing line, it begins at line pool A and chooses the first available line.

By assigning a line pool as a prime line, a telephone can be made to search automatically for an idle line in a pool. This is described in the section on programming Line type (TrkA-Line Data).

Intercom keys

This setting assigns the number of intercom buttons to a telephone. Intercom buttons provide a telephone with access to internal lines and line pools.

Press **CHANGE** to select the setting: 0, 1, **2**, 3, 4, 5, 6, 7, or 8.



Tips - *Each intercom button assigned during programming automatically appears on the telephone. The buttons start with the lower right-hand button, or one button above, if the handsfree/mute feature is assigned to the telephone.*

A telephone needs two intercom buttons to be able to establish a conference call with two other Norstar telephones.

Only one intercom button may be required if the button will only be used to make and receive internal calls, and to access line pools.

Two intercom buttons are required if a telephone has several lines assigned to ring only.

The M7100 and T7100 default assignment of two Intercom buttons can be changed to up to eight buttons. These buttons do not appear on the telephone and only two calls can be handled at a time.

Answer DNs

Calls for other Norstar telephones or Business Series Terminals can appear and be answered at the telephone being programmed. The DNs of the other telephones are referred to as Answer DNs.

This is commonly used when twinning Companion cordless handsets to allow mobile users to have one phone number that reaches them either at their desk or elsewhere within radio range.

1. Press and enter the Answer DN (the DN of the remote telephone).
2. Press **CHANGE** to change the setting for the Answer DN: **Unassigned, Affer&Ring** or **Affer only**.
3. To assign additional Answer DNs, press , then enter the next Answer DN.



Tips - Press **SCAN** to view the Answer DNs assigned to this telephone.

Every Answer DN assigned to the telephone automatically assigns an Answer button with an indicator to the telephone. These buttons should be labeled accordingly, identifying the telephone with its name or DN.

The maximum number of Answer DNs that can be assigned to a particular set is eight.

More than one telephone can have an Answer button for the same DN. In this way, more than one telephone can provide call alerting and call answering for any calls directed to that DN.

When a call to a Norstar telephone is received via Call Forwarding, the Answer DN for that telephone will not alert.

OLI

Some ISDN devices may require the network Called Number digits, called the outgoing line identification (OLI), to be able to accept a call. The **OLI as called #** parameter, available only for Profile 1 and 4, permits the OLI digits to replace the internal DN digits of the ISDN device during call setup. To enable this capability, set the **OLI as called #** parameter to **Y** for all DNs used by the device.

1. At **Terminals&Sets**, press and enter the ISDN set number.

The set displays 221:221.

2. Press twice to reach **Line Assignment**.
3. Press until the display shows **OLI#s**.
4. Press . The display shows **OLI as called #:N**.
5. Press **CHANGE** to select **Y** to allow for OLI substitution.
6. Press the  button to exit programming.

For PRI, the OLI# is based on the set number. However, when you make an outgoing call on a BRI line, the Call Display information which appears on the telephone you are calling is usually based on the first Network DN associated with the service profile identifier (SPID) and line.

If the SPID and line have more than one Network DN, you can program a DN to use a Network DN other than the first one for the outgoing Call Display information. When you program the alternate Network DN as the 10-digit OLI number, and you make a call using the line associated with the Network DN, the OLI number appears on the telephone you are calling.

If an outgoing call is made using a SPID and line that are not associated with the Network DN number used as the OLI

number, the network ignores the number and the default Call Display information is displayed. This is the first or only Network DN associated with the SPID and line.

1. At **Terminals&Sets**, press and enter the ISDN set number.

The set displays 221:221.

2. Press twice to reach **Line Assignment**.
3. Press until the display shows **OLI#s**.
4. Press **CHANGE** and enter the 10 digits used for the OLI.
5. Press **CLR** to choose **None**.

Note: If your system is equipped with a mixture of digital line cards, program the telephones to use line pools when making calls. If line pools are not properly configured, a telephone may use a line with a network range that does not include the calling line ID for the telephone, causing the network to present an incorrect CLID to the called party.

Capabilities

Settings that control how the system interacts with individual telephones and the calls they receive are found under **Capabilities**. The following table lists these headings. The default settings are shown in bold.

Setting	Description	Options
Fwd no answer		
Fwd to	Redirect all incoming calls when this telephone does not answer.	Enter DN None
Forward delay	Select the number of rings before an unanswered call is forwarded.	2, 3, 4 , 6, 10
Fwd on busy	Redirect all incoming calls when this telephone is busy with another call.	Enter DN None
DND on Busy	Select whether an incoming call rings if the user is already on another call.	Y, N
Handsfree	Select whether handsfree will be available to a telephone.	Auto, Std (Standard), None
HF answerback	Select whether a user can automatically answer a voice call without lifting the receiver or pressing the handsfree/mute button.	Y, N
Pickup grp	Assign this telephone to a pickup group.	None , 1 to 9
Page zone	Assign this telephone to page zone.	None, 1 to 6
Paging	Select whether paging announcements can be made from this telephone.	Y, N
D-Dial	Select whether you can call the Direct-dial telephone from this telephone using the Direct-dial digit.	Set1 to Set5, None
Priority call	Select whether to allow this telephone to interrupt calls or to override Do Not Disturb at another telephone.	Y, N

Setting	Description	Options
Hotline	Select whether a telephone number will be dialed automatically when a user lifts the receiver or presses the button labeled handsfree/mute.	Intrnl, Extrnl, None
Intrnl #	Appears if Hotline is Intrnl	Enter DN, None
Extrnl #	Appears if Hotline is Extrnl	None , <up to 24 digits>
<Extrnl> facility choice	Appears if Hotline is Extrnl and number is specified. Use routing tabl option routes numbers through the Routing Table. Target lines cannot be used as the facility.	Use Prime line Use line: Pool code: Use Routing tabl
Aux. ringer	Select whether an auxiliary ringer (if installed) will ring for incoming calls at this telephone.	Y, N
Allow redirect	Select whether to allow this telephone to redirect its lines.	Y, N
Redirect ring	Select whether a telephone rings briefly when a call on one of its lines is redirected by the Line Redirection feature (<input type="checkbox"/> <input type="checkbox"/> <input type="checkbox"/> 4).	Y, N
ATA settings		
ATA ans timer	Select the length of delay between the last digit you dial and when the ATA device is ready to receive DTMF tone. To accommodate the device attached to the ATA, you may need to change the delay. If a modem or fax machine is attached to the ATA, you will want to keep the delay short. If a call to a fax machine or modem cannot be connected, try shortening the delay. If an individual is dialing the number for a fax machine or modem, you may want to make the delay a little longer.	3, 5, 7, 10
ATA use	Select where the ATA can be used.	On site, Off site

Setting	Description	Options
MsgIndicate	Select the type of message indicator. When a message is received, Tone sends a Message Tone through the handset and Lamp turns on the Message Lamp.	None , Tone, Lamp
ATA dvc	Select the a device code for the telephone or terminal attached to your ATA. This feature enhances ATA telephone connects from an ATA over PRI/BRI lines.	Telephone Modem
Intrusion Protect lvl	Determine the level of access this telephone will have to allow the user to break into calls on other telephones in the system (Meridian 1 MCDN Break-in feature). To be able to use Break-in, the Protect lvl for this telephone must be less than that of the attendant telephone on the Meridian.	None , Low, Medium, High
SM Supervisor	Determine if this telephone will be allowed to monitor Hunt group calls.	N , Y

For more information, refer to the *Modular ICS 6.1 System Coordinator Guide*.

Name

The default name for a telephone is the DN, but it can be changed to any combination of letters and numbers to a maximum length of seven characters.

For more information, refer to the *Modular ICS 6.1 System Coordinator Guide*.

User preferences

Any programming a user can do at a set can also be done through **User Preferences**. In the following table, the default settings are given in bold.

Setting	Description
Mdl	Allows you to pre-program the model of telephone which will use this DN (M7208). Note: M7100 is used for T7100; M7208 is used for T7208, M7310 is used for T7316 and T7406; M7000 is used for T7000. The T7316E has settings for individual terminals, and settings for combination configurations of up to four KIMs.
Button prgrming	Allows you to program the buttons with internal and external autodialers and/or programmed feature keys.
User speed dial	Allows you to program user speed dialers (No defaults). (speed dial codes 256 to 279)
Call log opt'ns	Allows you to select how the telephone will log calls: Log all calls , No autologging , No one answered , or Unanswered by me .
Dialing opt'ns	Allows you to select how the system will dial for this telephone: Standard dial , Pre-dial or Automatic dial .
Language	Allows you to choose the language that will display on the set. The choices are based on the Profile chosen when the system was set up. Profile 1, 3 and 4: English , French or Spanish . Profile 2: English , French , Spanish or Turkish
Display cntrst	Allows you to adjust the contrast of the display 1, 2, 3, 4 , 5.....9
Ring type	Allows you to select a ring type 1 , 2 , 3 , 4

For more information, refer to the *Modular ICS 6.1 System Coordinator Guide*.

Restrictions

Restrictions prevent a user from making certain kinds of calls from a telephone or from lines that are available at the telephone. It also restricts some features.

When you are finished programming restriction settings for one telephone, you can copy those settings to other telephones by using COPY at the **Restrictions** ▶ display.

For ISDN PRI, all line restriction changes are applicable to all lines.

For more information about copying set programming, see *Copying telephone programming* on page 306.

Filters

Restriction filters group call restrictions and overrides in packages that allow you to make restriction assignments to lines and sets with just one package indicator.

In addition to restricting telephone numbers, you can prevent people from entering dialing sequences used by the public network to deliver special services and features. Some public network features provide the caller with dial tone after they have entered the special code, usually **#** or *****, so users may have an opportunity to bypass restrictions. To prevent this from happening, you should create filters that block these special codes.

You create a filter by defining the dialing sequences that are denied.

There will also be variations of each sequence that you will want users to be able to dial. Sequences that can be dialed are called overrides.

Once you create the filters, you can assign the restrictions to a telephone (**Terminals&Sets**), to a line (**Lines**), to a particular line on a telephone (**Terminals&Sets**), and to remote callers (**Remote access**).

1. Press and enter the number of the restriction filter you want to program, or press to move through all the available filters.
2. Press to see the first restriction in the filter. The first four digits of the number that will be denied are included in the display. The full number can be seen by pressing again.
3. Use **ADD**, the dialpad, and **OK** to program a restriction for each filter.
4. Press when the full restricted number is on the display (it shows **Deny:** and the number) to see any overrides to the restriction.
5. Use **ADD**, the dialpad, and **OK** to program overrides for each restriction filter.
6. Press **ANY** to enter a wild card character that represents any digit in a sequence of numbers when denying numbers or creating overrides.
7. You can press **REMOVE** to delete a restriction. The overrides will be deleted as well and the restrictions will renumber to fill the gap.

Default filters

Filter 00 permits unrestricted dialing and cannot be changed.

Filter 01 is pre-programmed with five restrictions and some associated overrides.

In Filter 01, restriction 02 and override 005 allow long distance directory assistance calls. Filter 01 reflects the fact that area codes can now have any digit as a second digit. This is designed to be used with the North American dialing plan.

The dialing string 911, the number for emergency assistance in North America, is included as both a restriction and an override in filter 01. This arrangement prevents anyone from blocking calls for emergency assistance on lines or sets using the default filter.

The following table lists the initial defaults for restriction filters.

Restriction filter defaults

Filter	Restrictions (denied)	Overrides
00	Unrestricted dialing	
01	01: 0	
	02: 1	001: 1800 002: 1877 003: 1888
	03: 911	001: 911
	04: 9411	
	05: 976	
	06: 1976	
	07: 1***976	
	08: 1900	
	09: 1***900	
	10: 5551212	
02 - 99	No restrictions or exceptions programmed	

Note: Default filters are only loaded at a cold start.

Filters 02, 03, and 04, although not preset with restrictions and overrides, are used as default filters in these programming headings:

Filter	Heading	Sub-heading
02	Terminals&Sets	Set restrns:
03	Lines	Line restrn:
04	Lines	Remote restrn:



Tips - *Filter 00 cannot be changed.*

Norstar can have up to 100 restriction filters (00 to 99).

Each programmable filter can have up to 48 restrictions. There is no limit on the number of overrides that can be allocated to a restriction.

There is a maximum of 400 restrictions and overrides allocated to the 100 programmable filters.

The maximum length of a restriction is 15 digits. The maximum length of an override is 16 digits.

A single dot (•) in a dialing sequence is a wild card (stands for any digit). It is inserted by pressing ANY.



You can use ***** and **#** in a sequence of numbers in either a restriction or an override. These characters are often used as part of feature codes for other systems or for features provided by the central office (the public network).

When restricting the dialing of a central office feature code, remember to create separate restrictions for the codes used for DTMF and pulse lines. Examples of dialing strings that may be restricted for this reason are *67 and 1167. Do not string together a central office feature code and a dialing sequence that you want to restrict. Create a separate restriction for each.

You can use **COPY** and the dialpad to copy restrictions and overrides from one filter to another.

Any restriction or override can be used in any number of filters. Each time it is used, it counts as one entry. For example, if restriction 411 exists in filters 01, 02 and 03, it uses up three entries of the 400 entries available.

Removing a restriction from a filter has no effect on the contents of other filters, even if the restriction was copied to them.

You cannot delete a filter. Removing the restrictions programmed on a filter makes it an unrestricted filter, but the filter itself is not removed.



Removing a restriction changes the identifying number of the restriction.

Removing a restriction also removes the overrides associated with it, and changes the identifying number of the restriction. For example, if you remove restriction 01, restrictions 02 to 08 are renumbered as 01 to 07.

Set restrns

Use this heading to assign a restriction filter to a telephone to prevent certain numbers from being dialed from that telephone. You can also use set restrictions to prevent certain features from being used by a telephone.

Filters

You can assign a different restriction filter for normal service and for each of the six schedules. Refer to *Services* on page 371 for more information about the schedules.

Use , **CHANGE** and the dialpad to enter the number of the restriction filter to be assigned to the set for each schedule.

The following table displays the default set filters.

Default filters for sets

Schedule	Restriction filter	Schedule	Restriction filter
Normal	02		
Sched 1 (Night)	11	Sched 4	00
Sched 2 (Evening)	12	Sched 5	00
Sched 3 (Lunch)	13	Sched 6	00

Based on the defaults, if you enter a set of restrictions for filter 11, they will be automatically applied when the Night schedule is in use.

Set lock

You can adjust the amount of personal programming and customizing that can be performed at a telephone.

Press CHANGE to select a set lock level of: **None**, **Partial**, or **Full**.

Allow last no

A telephone can be prevented from using Last Number Redial (5).

Press CHANGE to select the setting: **Y** (Yes) or **N** (No).

Allow saved no

A telephone can be prevented from using Saved Number Redial (6 7).

Press CHANGE to select the setting: **Y** (Yes) or **N** (No).

Allow link

A telephone can be prevented from using Link (7 1), an option that allows a caller to connect to an outside PBX.

Press CHANGE to select the setting: **Y** (Yes) or **N** (No).

For more information about host system signaling, refer to the *Modular ICS 6.1 System Coordinator Guide*.

Line/set restrns

Line/set restrns allows you to assign a restriction filter to a specific line that can be used for outgoing calls at a specific telephone. This type of filter replaces any line or set restriction filters which might otherwise apply. It restricts the numbers you can dial on a line, but only from that telephone. The same line on another telephone can have different restrictions.

As with set restrictions, you can apply a different line/set restriction for normal service and for each of six schedules.

Use , **CHANGE** and the dialpad to enter the number of the filter to be assigned as the line/set restriction for each schedule. There are no default line/set restrictions.



Tips - *A maximum of 255 line/set restrictions may be applied to lines at telephones.*

If a line/set restriction is assigned to a line at a particular telephone, it overrides any line restrictions or set restrictions which might otherwise apply.

If no line/set restrictions have been defined, the numbers are checked against the set restrictions and the line restrictions, if either of these have been defined. The numbers may be rejected by either restriction.

Telco features

Telco features can program the way the Norstar works with features and services that are based in the public network or other outside source. Norstar is designed to work with two of these kinds of services: Call Display and an external voice message service.

When you are finished programming Telco features settings for one telephone, you can copy those settings to other telephones by using **COPY** at the **Telco features...** display. For more information about copying set programming, see *Copying telephone programming* on page 306.

Feature assignment (CLID alignment)

If you subscribe to Call Display (Caller ID) services, external calls are identified on the display of telephones which have been programmed to display CLID. You may also have a message indicator from an external voice mail service show on the display. Feature assignment programming allows you to customize how this information is used.

Press and enter the number of the line you want to program with feature settings for the telephone.

Caller ID set

Caller ID set allows you to specify if a telephone displays the Call Display information when a call is ringing on an external line. After the call is answered, Call Display information is always shown at the telephone that answered the call.

The Caller ID set for target lines is the same telephone that has appearance on that target line. Press **CHANGE** to select the setting: **N** (No) or **Y** (Yes).



Tip - In order for a telephone to display the Call Display information for calls on an external line, it must also be programmed to appear and ring or ring for that line.

For systems that subscribe to Call Display services, Caller ID can be viewed on any telephone by entering the Call Information feature code **☎ 8 1 1**. See the Telephone Feature Card or Modular ICS 6.1 System Coordinator Guide for more information.

Call information does not automatically appear when the telephone has an Answer DN, or belongs to a Ring group activated by Ringing Service. Call information is still available for these calls by pressing **☎ 8 1 1**.

Extl VMsg set

If you subscribe to an external voice message service or central voice mail system that is not directly connected to your ICS, you can access that service through your Norstar system. The external voice message setting controls where the indicator shows up when there is a voice message waiting on a particular line. The line must be assigned to appear on that telephone.

Press **CHANGE** to select the setting: **N** (No) or **Y** (Yes).

To find out if your voice message service will work with Norstar, or if you have any problems with your service, contact your voice message service provider.

1stDisplay

Depending on the services you subscribe to, Call Display information may contain the number of the caller, the name of the line in your Norstar system that the call is on, or both. For each telephone, you can determine which information is displayed first.

Press **CHANGE** to select the setting: **Name**, **Numbr** or **Line**.



Tips - *The Call Information feature is used to display and toggle between the name and line number used for Call Display information. Refer to Modular ICS 6.1 System Coordinator Guide for more information.*

*You may see **Unknown number** on the display if the information is not available from your telephone company.*

*You may see **Private number** on the display if the caller blocks that information.*

Called ID

Called ID allows you to see the extension number and name of the set being called on the display. The Called ID set for target lines is the same telephone that has appearance on that target line.

Press **CHANGE** to select the setting: **N** (No) or **Y** (Yes).

Log space

Log space determines the number of items that can be stored in the Call log for each telephone.

Use , **ADD** and **REMOVE** to redistribute the log space. There is no log space assigned by default.



Tips - *There must be space available in the log pool in order for you to add space to a Call log. The maximum number of spaces available is 600.*

*System-wide log space allocation is performed in Call log space under **System Programming**. If you want to allocate the same log space to all telephones, use the Call log space setting instead.*

Lines

This chapter describes the settings that allow you to determine how the lines coming in and going out of the system will be assigned.

Lines, whether physical or virtual, are the connecting threads that allow users access into and out of the Norstar system to the public network or to other private networks.

Lines can be pooled so a number of telephones have access to more available lines, or they can be assigned specifically to one telephone. There are also a number of ways that a telephone can be configured to access line pools and special lines like tie lines and private network lines.

Trunk/Line data

Installer password required

Trunk data allows you to program settings for lines that affect how Norstar communicates with other switches. These settings also allow you to determine how lines, including target lines, will be used in the Norstar system.

Some Trunk data settings may not appear on the display during programming, depending on the type of trunk. Those that appear for a given Trunk type are indicated in the following table.

Trunk/Line data settings that appear for a given trunk type

Setting	Loop start Analog	Loop start Digital	E&M Analog	DID Analog	DID Digital	Target lines	PRI lines	BRI -ST BRI-U2 BRI-U4	Groundstart (T1)	E&M Digital	Fixed
Trunk type	✓	✓	✓	✓	✓	✓	✓	✓	✓	✓	✓
Line type	✓	✓	✓	✓	✓	✓	✓	✓	✓	✓	—
Dial mode	✓	✓	✓	✓	✓	—	—	—	✓	✓	—
Rec'd #	—	—	—	—	—	✓	—	—	—	—	—
If busy	—	—	—	—	—	✓	—	—	—	—	—
PrimeSet	✓	✓	✓	✓	✓	✓	✓	✓	✓	✓	—
Auto privacy	✓	✓	✓	✓	✓	—	—	✓	✓	✓	—
Trunk mode	✓	✓	—	—	—	—	—	—	—	—	—
Ans mode	✓	✓	✓	✓	—	—	—	✓	✓	✓	—
Ans with DISA	✓	✓	✓	—	—	—	—	✓	✓	✓	—
Link at CO	✓	—	—	✓	—	—	—	—	—	—	—
Aux. ringer	✓	✓	✓	✓	✓	✓	—	✓	✓	✓	—
Full AutoHold	✓	✓	—	—	—	—	—	✓	—	—	—
LossPkg	✓	—	—	—	—	—	—	—	—	—	—
Signal	—	—	✓	✓	✓	—	—	—	—	✓	—
ANI Number	—	—	✓	✓	✓	—	—	—	—	✓	—
DNIS Number	—	—	✓	✓	✓	—	—	—	—	✓	—
Gain	—	—	✓	✓	—	—	—	—	—	—	—

Copying Trunk and Line data

At the **Trk/Line data** display **COPY** appears. This allows you to copy programming from one line to other lines.



Tips - *In copying data from a physical trunk to a target line, or the other way around, only the data in common is copied. For example, copying a target line to an E&M trunk copies only the Line data settings because there are no Trunk data settings for a target line.*

*You cannot copy programming between lines on different types of Trunk Cartridges. If you try to copy line programming between lines on different types of Trunk Cartridges, the display shows **Incompatible Cd**, then returns to **Show line: _***

The Received number of a target line is a unique number and cannot be copied.

Trunk type

The **Trunk type** heading shows **Loop**, **DID**, **PRI**, **BRI-ST**, **BRI-U4**, **BRI-U2**, **E&M**, **Ground** or **Fixed**.

You can only change this setting for lines connected to a DTI. For all other lines, such as analog lines and BRI lines, the trunk type is determined by the Trunk Cartridge type. The system simply displays the trunk type; you cannot change it. To change the Trunk Cartridge or BRI Card, see *Hardware* on page 482.



Changing the settings for a trunk type on a system that is in use, may cause calls to be dropped.



Enable Trunk Cartridges

If you disabled any Trunk Cartridges to perform programming, enable them now using **Module status** under **Maintenance** or your system will not function properly. See *Module status on page 521* for information about enabling Trunk Cartridges in Module status.

Line type

This setting specifies how the line is to be used in relation to other lines in the system.

Press **CHANGE** to select the setting: **Public**, **Private to:**, or **Pool** (A to O or PRI-A to PRI-D).

- A **Public** line can be accessed by more than one telephone.
- A **Private** line can be assigned only to one telephone and the prime telephone for that line. Use **CHANGE** and the dialpad to enter the internal number of the telephone.
- **Pool** assigns the line to one of the line pools. If a line is assigned to a line pool, but is not assigned to any telephone, that line is available only for outgoing calls (for example, PRI lines).



Tips - *Line pools must never contain a mixture of loop start lines and E&M lines. All E&M lines in a given line pool should go to the same location.*

Try to avoid putting unsupervised loopstart lines in a line pool. These lines can become hung, especially when a remote user uses the line pool to make an external call.

There are two more programming settings that must be assigned before a line pool can be used:

- You must assign line pool access to telephones in **Line access** programming.
- You must assign system-wide line pool access codes in **System Programming** for line pools A to 0, and/or routes and destination codes. PRI line pools can only be accessed by being assigned to routes and destination codes.



Tips - *A telephone can be administered to search automatically for an idle line from several lines appearing on the telephone. Assign a line pool as the prime line (in **Line access**) and all the lines in the line pool must appear on that telephone.*

When the user lifts the receiver or presses the handsfree button, any one of the lines, if idle, can be selected by Automatic Outgoing Line selection.

This is not available for PRI line pools.

Line connected to a DTI

The Line setting shows the trunk type for a line.

For lines connected to a DTI, press **CHANGE** to select one of these settings: **Loop**, **E&M**, **DID**, **Ground**, **Fixed**, **PRI**.

- Loop is used for loop start trunks
- E&M is used for the first two line numbers on E&M trunks



Tips - *E&M Trunk Cartridges have two E&M lines and two DTMF receivers (instead of four lines, as in a Loop Start Trunk Cartridge). For example, if an E&M Trunk Cartridge has the range of line numbers 049 to 052, numbers 049 and 050 are E&M lines, and numbers 051 and 052 are the DTMF receivers. The display for line 050 appears as **Line050:E&M** and for line 051 appears as **Line051:DTMF**.*

- DID is used for direct inward dialing trunks
- ground is used for groundstart (T1) trunks
- PRI is used for ISDN-PRI, which includes the SL-1 MCDN protocol for networking.



Tips - *Changing the settings for a trunk type on a system that is in use, may cause calls to be dropped.*

When assigning lines to line pools, consider your network configuration. You may be able to create a unified dialing plan by assigning lines to the same location to the same line pool on each of your systems. For example, if system A and system B each have tie lines to system C, assign the tie lines to pool D on each of the systems.

If you plan to program the prime line as I/C (intercom) for some telephones, you may wish to assign loop start lines to the first line pool. Remember that when the system searches for an outgoing line, it begins at line pool A and chooses the first available line.

Assigning a single E&M trunk to a line pool allows features like Ring Again to help manage access to a shared resource.

You cannot assign target lines (157-284/348) to a line pool.

Dial mode

Dial mode allows you to specify whether dual tone multifrequency (DTMF) or pulse signaling is used on the trunk.

Press **CHANGE** to select the setting: **Tone** or **Pulse**.



Tips - *For DID and E&M lines connected to a DTI, the Tone setting does not appear if Signal is Immediate.*

Rec'd

The Received number setting applies only to target lines. Target lines are: 157 to 284 for systems running MICS version 6.0 and greater, and 157 to 348 for systems running MICS-XC version 6.0 and greater. It allows you to specify the digits which make a specific target line ring. The default value is **None**.

Use **CHANGE**, and the dialpad to program the digit string for each target line.



Tips - *A Received number can be from three to seven digits long. It is programmed under **System Programming**. The default length is three for all systems.*

A received number cannot be the same as, or be the start digits of a line pool access code, a destination code, the DISA DN or the Auto DN.

If you are configuring auto-answer BRI trunks to map to target lines, the received number should be the same as the Network DN supplied by your service provider. The call will be directed to the prime telephone for the incoming line if the Network DN is not used.

If busy

When a call is received on a target line that is already busy, you can choose if the caller gets a busy tone or if the call is forwarded to the prime set.

Busy tone only works for PRI and BRI trunks on target lines.

Programming is done in **Trunk/Line Data** under **Lines**. Press **CHANGE** to select one of these settings: **To Prime** or **BusyTone**.

Prime set

This feature allows you to assign a telephone to provide backup answering for calls on the line. Unanswered calls are redirected to the prime telephone.

Use **CHANGE** and the dialpad to enter the internal number of the prime telephone.

The default prime set for each line on a system with three-digit DNs is 221.



Tips - *For auto-answer trunks, calls ring only at the prime telephone for a trunk, and only when overflow call routing is active.*

Each line can be assigned only one prime telephone.

Auto privacy

This feature controls whether one Norstar user can select a line in use at another telephone to join an existing call. The default setting is Privacy on, so that nobody with a Norstar telephone can press a line appearance on their telephone to join a call in progress at another telephone.

Press **CHANGE** to select either: **Y** (on) or **N** (off).



Tips - *Users can change a line privacy setting for an individual call using the Privacy feature (**6** **8** **3**).*

Note: This feature does not work on target lines or PRI lines.

Trunk mode

Trunk mode allows you to specify either disconnect supervision or unsupervised. Disconnect supervision, also referred to as loop supervision, releases an external line when an open switch interval (OSI) is detected during a call on that line. This prevents the line from remaining unavailable for other Norstar users.

Press **CHANGE** to select the setting: **Unsupr** or **Super**.

- **Unsupr** (the default) turns disconnect supervision off for the line.
- **Super** assigns supervised mode, if supported by the line. otherwise, the line functions as unsupervised.



Tips - *The duration of an open switch interval (OSI) before Norstar disconnects a call is programmed by the **Discon** timer setting under **Hardware**.*

*Disconnect supervision is required for loop start trunks to operate in auto-answer mode or with DISA. It is also required to conference with two external callers. The line must be equipped with disconnect supervision from the central office for the **Super** option to work.*

Ans mode

The Answer mode setting appears on the display during programming for loop start and BRI lines with a Trunk mode setting of **Super**, for groundstart (T1) lines, and for E&M lines. Press **CHANGE** to select the setting: **Manual** or **Auto**.



Tips - *If loop start lines are set to **Auto**, you will require an E&M card for the DTMF receivers to function properly.*



Tips - Remember that disconnect supervision is required if loop start trunks need to operate in auto-answer mode.

You should change the Answer with DISA setting to **N** for E&M trunks in a private network operating in auto-answer mode. The default, **Y** (Yes), causes the system to expect a Class of Service password after it automatically answers a trunk.

Ans with DISA

When activated, the Answer with DISA setting specifies that a trunk is answered with stutter dial tone. This feature is only active if **Ans Mode** is set to **Auto**.

Press **CHANGE** to select the setting: **Y** (Yes) or **N** (No).



Tips - For loop start and E&M lines this setting only appears if **Answer mode** is **Auto**.

Set **Ans with DISA** to **No** for E&M lines on an enhanced switched network (ESN) to operate properly in auto-answer mode.



Tips - When an incoming call comes in on an auto-answer loop guarded or Earth calling line that is not configured to answer with DISA, the caller hears system dial tone. They can then enter a DID line public received number to dial direct to an extension, a line pool access code to break out, or a remote feature code from a DTMF telephone if a suitable remote access package has been assigned.

To program DISA on PRI trunk, see *Programming Direct Inward System Access (DISA) on PRI trunks* on page 72.

Link at CO (loop trunks only)

Some exchanges respond to a Link signal (6 7 1) by providing an alternative line for making outgoing calls.

- When **Link at CO** is set to **Y** (Yes), the system applies the restrictions on outgoing calls to the digits dialed after the Link signal, and the call on the alternative line will be subject to all restrictions.
- Setting **Link at CO** to **N** (No) prevents a Link signal from resetting the Norstar restrictions in cases where the host exchange does not provide an alternative line.

Press **CHANGE** to select the setting: **Y** (Yes) or **N** (No).

For more information about host signaling options, refer to *Modular ICS 6.1 System Coordinator Guide*.

Aux. ringer

This setting allows you to turn the auxiliary ringer on or off. An auxiliary ringer can be programmed on a line or a telephone. When programmed on a telephone, the auxiliary ringer rings every time a call is received. When programmed on a line, the auxiliary ringer does not ring when a transferred call is received.

Press **CHANGE** to select the setting: **Y** (Yes) or **N** (No).



Tips - *The auxiliary ringer is an optional device that should be connected by the installer.*

If you have an auxiliary ringer programmed to ring for calls on an external line, and you transfer a call on that line without announcing the transfer, the auxiliary ringer will ring for the call transfer.



Tips - *An auxiliary ringer can also be programmed in Services to ring for a line placed into a scheduled Ringing service. See the Modular ICS 6.1 System Coordinator Guide for more information.*

Full AutoHold

Full AutoHold on idle line is a variation of the Automatic Hold feature. If you select an idle line, but do not dial any digits, that line is automatically placed on hold if you select another line.

Press **CHANGE** to select the setting: **N** (No) or **Y** (Yes).

The line you first selected is held until you press the line button. The line is not available for use by anyone else.



Tips - *The Full AutoHold setting appears only during loop start trunk programming. Full AutoHold is always in place for E&M trunks, but it has no meaning for incoming-only DID trunks. Only change the default setting if Full AutoHold is required for a specific application.*

LossPkg

Loss Package allows you to select the appropriate loss/gain and impedance settings for each line. The setting is based on the distance between the ICS and the terminating switch, and the terminating switch type. When measuring the distance from ICS to CO and from ICS to PBX, use 600 ohms as the termination resistance setting.

A loss of 4 dB corresponds to a cable length of approximately 2700 m (9000 ft.).

Press **CHANGE** to select one of the following settings.

The following table describes the five types of loss packages.

Loss Pkg	Receive Loss	Transmit Loss	Impedance	Distance to switch/ cable loss/terminating switch
ShortCO	0 dB	3 dB	Short	Short/<2 dB/ICS to CO
MediumCO	0 dB	0 dB	TIA/EIA 464	Medium/>2 dB and <6 dB/ ICS to CO
LongCO	-3 dB	0 dB	TIA/EIA 464	Long/>6 dB/ICS to CO
ShortPBX	0 dB	0 dB	Short	Short/<2 dB/ICS to PBX
LongPBX	-3 dB	0 dB	TIA/EIA 464	Long/>2 dB/ICS to PBX



Tips - *This setting applies only to lines connected to an NT7B75GA-93 Loop Start Trunk Cartridge.*

When measuring the distance from ICS to CO and ICS to PBX, use 600 ohms as the termination resistance setting.

Signal

Select the signal type for the line.

Press **CHANGE** to select one of these settings: **WinkStart**, **Immediate**, **DelayDial**.



Tips - *The Signal setting appears on the display only for E&M or DID lines.*

Make sure that this matches the signal type programmed for the trunk at the other switch.

*For E&M and DID lines connected to a DTI, the **Immediate** setting does not appear if dial mode for the line is set to **Tone**.*

ANI Number

Select whether the telephone number of the caller will be collected for this line. The digits can then be displayed on Norstar telephones as part of Call Display services.

Press **CHANGE** to select either: **N** (No) or **Y** (Yes).



Tips - *The central office must deliver ANI/DNIS in DTMF mode. The delivery of ANI/DNIS depends on the network provider and the services they offer. This setting applies only to E&M and DID lines.*

*For E&M or DID lines connected to a DTI, the setting only appears if **Signal** is **WinkStart**. For lines connected to an E&M or DID Trunk Cartridge, the setting only appears if **Signal** is **WinkStart** or **Immediate**.*

If the conditions for signaling mode and start arrangement are not met, prompts are not presented to the user. No additional equipment is required.

DNIS Number

Select whether the digits dialed by an external caller on this line will be collected.

Press **CHANGE** to select either: **N** (No) or **Y** (Yes).



Tips - *This setting applies to E&M lines only.*

*For E&M lines connected to a DTI, this setting only appears if **Signal** is **WinkStart** and **Ans mode** is set to **Manual**. For E&M lines connected to an E&M Trunk Cartridge, this setting only appears if **Signal** is **WinkStart** or **Immediate** and **Ans mode** is set to **Manual**.*

These digits are required for some third-party software applications.

Gain

Select the appropriate gain level for the line.

Press **CHANGE** to select either: **Normal** or **High**.

The default value **Normal** induces zero loss. Use it when the E&M trunks are connected to facilities that present 0 dBm at the interface for both the transmit and receive paths.

Normal gain level (0dBm)

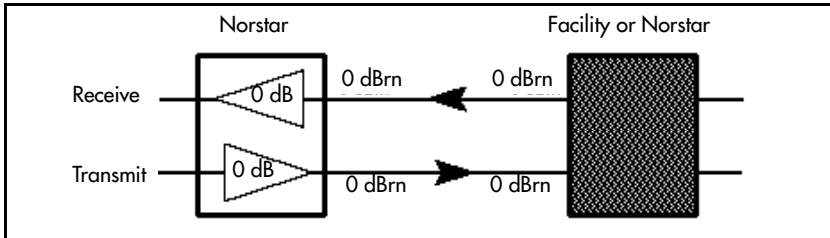

The value **High** induces 7 dB of loss in the receive path and 16 dB of loss in the transmit path. Use it when the E&M trunks are connected to facilities that present +7 dBm in the receive path and -16 dBm in the transmit path at the interface.

High gain levels

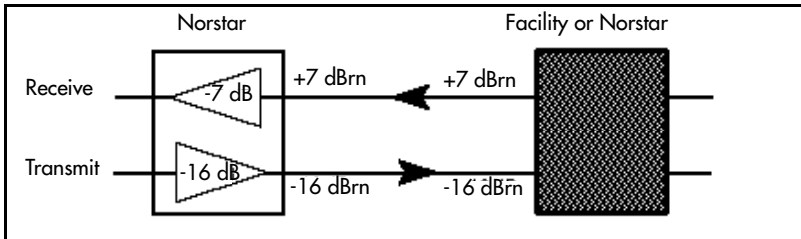

Tip - Control over the gain on transmission levels can only be set for lines on E&M Trunk Cartridges.

Programming distinctive ring patterns

When lines are configured on your system, they can be assigned one of four distinctive ring patterns (DRP). The default for all telephones is 1. The default for lines is None, which is the lowest priority.

Call ringing: When multiple calls are presented to the telephone, the call with the highest priority DRP setting will be the call that rings at the telephone.

Call answering: When multiple calls are presented to a telephone, and the user picks up the handset, the call with the highest priority DRP setting is the call that is presented.



TIPS - *External calls always have a higher priority than internal calls.*

If the ring type is changed on a telephone after the DRPs are set on the line, the line DRPs are overwritten by the telephone settings.

If the line DRPs are set after telephone programming, then the telephone ring programming is overridden by the DRP. Refer to the Modular ICS System Administrator Guide for details about setting ring types on a telephone.

If Hunt group DRP has a higher priority than the line DRP, the system will use the Hunt Group DRP within the Hunt Group. (Refer to Allowing/disallowing an auxiliary ringer on page 416.)

1. Place the programming overlay over the appropriate keys on your programming telephone.
2. Press * * 2 6 6 3 4 4 (CONFIG). The display shows **Password:**.
3. Press 2 6 6 3 4 4 (CONFIG). The display shows **Terminals&Sets**.

4. Press until the display shows **Lines**.
5. Press . The display shows **Show line ____**.
6. Press **FIND** until you reach the line to which you want to define a ring pattern.
7. Press and then until the display shows **TrunkType:PRI**.
8. Press until the display shows **Dstnct rings: NONE**.
9. Press **CHANGE** to toggle to the ring pattern number you want to assign to the line (**None, 2, 3, 4**).
10. Press to exit or to continue programming.

Name

The default name for a line is Line XXX, where XXX is the three-digit line identifier. For example, Line 001.

This can be changed to any combination of letters and numbers to a maximum length of seven characters.

For more information, refer to *Modular ICS 6.1 System Coordinator Guide*.

Restrictions

Restrictions are used to prevent a user from accessing a line for making certain kinds of calls. For example, users should not be able to make long-distance calls on lines used exclusively for local calling.

Restrnr filters

Restriction filters are groups of dialing restrictions and dialing overrides for external numbers or feature codes. By packing a set of restrictions and overrides in one group, you can assign them to a line in one step, as a single package.

You can make changes to restriction filters under both **Terminals&Sets**, and **Lines**. Any changes will take effect for any telephone, line, or line on a telephone, regardless of where the programming was changed.

See the description and procedures in *Restrictions* on page 367.

Line restrns

Specify the filter to be applied to this line to restrict the numbers that can be dialed on it. You can assign a different restriction filter for normal service and for each of the six schedules. See *Services* on page 371 for more information about the schedules.

Use , **CHANGE** and the dialpad to enter the number of the restriction filter to be assigned as the line restriction for each schedule.

The default restrictions are shown in the table below:

Default filters for lines

Schedule	Restriction filter
Normal	03
Sched 1 (Night)	21
Sched 2 (Evening)	22
Sched 3 (Lunch)	23

Schedule	Restriction filter
Sched 4	00
Sched 5	00
Sched 6	00



Tip - *When a remote user places an external call on a line, any filters used with the line still apply.*

Remote restrns

Specify the restriction filter to be applied to remote callers calling in to the Norstar system on this line. A restriction filter is a set or group of restrictions and overrides.

As with line restrictions, you can apply a different remote restriction for normal service and for each of six schedules.

Use **CHANGE** and the dialpad to program the remote restrictions for each schedule.

The default restrictions are shown in the following table.

Default filters for remote access

Schedule	Restriction filter	Schedule	Restriction filter
Normal	04		
Sched 1 (Night)	31	Sched 4	00
Sched 2 (Evening)	32	Sched 5	00
Sched 3 (Lunch)	33	Sched 6	00



Tip - *The remote restriction restricts the numbers that can be dialed on an incoming auto-answer line. If a remote user then selects a line to place an external call, any filter used with the line still applies.*

Telco features

This item allows you to assign features from a telco level.

VMsg center 1

If you subscribe to a voice message service, you can specify which voice message center is used for each external line that can receive message waiting indication.

1. For each line, press CHANGE to select a message center:
1, 2, 3, 4, 5, or N.

Note: If your system is part of a network that provides a central voice mail system on another site, you must use this field to specify that service.

Services

Using **Services**, you can control three types of service using the time of day and the day of week:

- alternate call ringing, see page 375
- alternate dialing restrictions, see page 379
- alternate call routing, see page 379

You can customize services in general under **Common Settings**. Refer to *Common settings* on page 372.

Within each type of service, you can customize six schedules.

For example, you may want to combine alternate call ringing with alternate dialing restrictions for lunchtime, evenings, and weekends (Schedules 1, 2, and 3). Then you may want to run alternate call routing using three separate schedules.



Tips - *Once you have programmed the different services and schedules, you can turn each of the services on separately. For example, the Night schedule might control both Ringing service and Restriction service. But you can turn on just the Ringing service part of the Night schedule if you wish.*

You can activate the services from the designated control telephone for each Norstar telephone and line in your system. You can have one control telephone for the whole system, or different control telephones for different Norstar telephones and lines.

If you want to have several services active at the same time, simply program them on for the same schedule.

Common settings

Services share the settings for control telephones, schedule names, and schedule times.

Control sets

A control telephone turns Services on and off for the lines and/or telephones assigned to it. You can assign several control telephones for your system.

A control telephone for lines controls Ringing service, Restriction service and Routing service for its assigned lines.

A control telephone for telephones controls Restriction service and Routing service for its assigned telephones. Assign a control telephone for each external line and telephone.

Use , , **CHANGE** and the dialpad to program the internal number of the control telephone for each line and each telephone.

Control set configurations for both lines and telephones can be copied from one set/line to another set/line or to a range of sets/lines, or to all sets/lines, using the **COPY** softkey.



Tips - *External lines and telephones must be programmed with a control telephone to use the three kinds of Services. You can assign a control telephone to more than one external line or telephone, but a line or telephone cannot be assigned to more than one control telephone.*

One recommendation is to have one control telephone for all lines and a different control telephone for all telephones.



Tips - *A service can be turned on manually or automatically for all external lines and telephones controlled by a given control telephone, but you cannot combine schedules. In other words, a service can only be active as normal service or one of the six schedules at any one time. You can have several schedules active, as long as they are using different services.*

The default control telephone for all lines and telephones is 221 (for systems with three-digit DNs).

Schedule names

The schedule name is shown on the display of the control telephone when the schedule is turned on. It identifies the active schedule.

Use , , and **CHANGE** and the dialpad to program the name.



Tips - *The default names of the six possible schedules are only suggestions and may be changed to any other name. A schedule name can be one to seven characters long. It is recommended that you reserve certain schedules (4, 5, and 6) exclusively for alternate call routing (Routing service).*

Schedule times

Schedule start and stop times are set at times you are most likely to want each service to be active.

Use , , and **CHANGE** and the dialpad to program the start and stop times for each schedule, on each day.

Default schedule times

Schedule	Start time	Stop time
Schedule 1: Night	23:00	07:00
Schedule 2: Evening	17:00	23:00
Schedule 3: Lunch	12:00	13:00
Schedule 4: Sched 4	00:00	00:00
Schedule 5: Sched 5	00:00	00:00
Schedule 6: Sched 6	00:00	00:00



Tips - *It is only necessary to program start and stop times for schedules that are activated automatically. See the instructions with Ringing service for information on activating schedules.*

The time may be entered in either 12 or 24-hour format. If the display is in English, and the hour entered is less than 13, the display prompts you to specify AM or PM.

If you assign identical start and stop times for a schedule, for example, 04:00 start and 04:00 stop, the schedule is in effect all day. The only exception to this is a start and stop time of 00:00. In that case the schedule is off for the day.

You may assign overlapping times. For example, if schedule 1 is assigned from 9:00 am to 4:00 pm, and schedule 2 is assigned from 1:00 pm to 5:00 pm, then the start time of the second schedule is treated as a stop time for the first schedule.



Tips - *This is also true if two schedules have the same start time but different stop times. In that case, the stop time of the shorter schedule is treated as the start time of the longer schedule.*

If one schedule starts and stops within the times of another schedule, the first service temporarily ends when the second service starts. The first service then resumes when the second service has ended.

Some schedules start and stop at the same times each day. Use COPY to copy the start and stop times from one day to the next.

**Start and stop times cannot span days.**

When you program a schedule to start in the evening and stop in the morning, it does not carry over into the next day. For example, if you program Night service for Friday (22:00 to 06:00), the system turns on Night service from midnight to 6 am on Friday, and then again from 10 pm to midnight on Friday.

Ringling service

At certain times or in certain situations, you may want additional telephones to begin ringing for incoming lines. The most common use of this feature is when a security desk telephone begins to ring for incoming lines after 5:00 p.m., a practice often called *night service*.

These features are programmed under **Ringling service**.

Ringling groups

Ringling groups allows you to define groups of extended ringing sets. A group can be assigned to any line for any of the schedules. You can create up to 100 ringling groups composed of up to 30 sets for each ringling group.

To define a ringling group use and enter the number of the group you want to program (01-100).

Once you define a ringling group, the display will prompt you to enter the number of the telephone you want to assign to this ringling group. You can use **SCAN** to display the sets that are assigned to the ringling group.



Tips - *You can assign any telephone on the Norstar system to a ringing group. The assigned control set for each schedule is added to each ringing group.*

A telephone can belong to more than one ringing group.

Sched:Night

Indicate how Ringing service should be activated for each of the schedules.

Service

Use and **CHANGE** to change the setting for each schedule to : **Off**, **Auto**, or **Manual**.

Off — prevents the service from being activated.

Auto — allows you to program a start and stop time for a service. You will be prompted to enter start and stop times. You can still start and stop the service by entering the appropriate Services feature code at a control telephone.

Manual — allows you to turn the service on and off at any time from a control telephone using the Ringing service feature code.

Trunk answer

Trunk answer allows you to answer, from any telephone, an external call that is ringing at another telephone in your office. This is useful if the other telephones have not been assigned the same lines as the telephone you are using to answer the call.

Press **CHANGE** to select the setting: **Y** (Yes) or **N** (No).



Tip - You can change the Trunk Answer setting only if Ringing service is set to Manual or Automatic.

ExtraDial telephone

ExtraDial telephone allows you to assign an additional direct-dial telephone in the Norstar system for each schedule you use.

Use **CHANGE** and the dialpad to enter the internal number of the extradial telephone.



Tip - The extradial telephone is activated during a schedule by entering the Ringing service feature code from a direct-dial telephone. This does not activate the Ringing service unless the direct-dial telephone is also a control telephone.

Line settings

The ring groups and auxiliary ringer for Ringing service is programmed for each line individually.

Ringling group

You can assign a predefined ringling group to a line for each schedule. See *Ringling groups* on page 375 to create groups of extra ringling telephones.

Use the dialpad to enter the line number to see which ringling group is assigned to the line.

To choose a different ringling group assignment, press **CHANGE** and enter the new ringling group number (01-100)



Tip - Only one ringing group can be assigned to a line for each schedule. To combine groups of ringing telephones, you must create a new ringing group which contains all the telephones you want to ring and assign the group to the line.

Aux. ringer

Indicate whether the auxiliary ringer, if installed, also rings when Ringing service is on.

Press **CHANGE** to select either: **Y** (Yes) or **N** (No).



Tips - The default ringing telephone is 221 (for systems with a DN length of 3). This means that all lines ring at telephone 221 when Ringing service is on.

You can use **COPY** and the dialpad to copy Ringing set and Auxiliary ringer programming from one line to another.

If you have an auxiliary ringer programmed to ring for calls on an external line, and you transfer a call on that line without announcing the transfer, the auxiliary ringer will ring for the call transfer.

Restrtn service

These settings indicate how the alternate dialing restrictions should be activated for each of the schedules.

Use and **CHANGE** to change the setting for each schedule: **Off**, **Automatic**, or **Manual**.

For information about using schedules, refer to the *Modular ICS 6.1 System Coordinator Guide*.



Tips - *A schedule must be active for overflow routing to be in effect. Overflow routing is not available in normal mode.*

You must create an overflow route to be used with each destination code. In this way, every route used with a scheduled mode that has overflow service must have an alternate route in normal service.

See *Ringng service* on page 375 for descriptions of the three activation settings.

See **Restrictions** under both **Terminals&Sets** and **Lines** to assign dialing restrictions for telephones, lines and remote users to the schedules.

Routing service

The programming for routing decides what path an outgoing call takes using the digits that are dialed. It is sometimes called Automatic Route Selection (ARS).

When you select an internal line and dial, the numbers you enter are checked against the routing tables. If the number you dialed starts with a destination code, the system uses the line pool and dials out digits specified by the route assigned to that destination code, and then dials the rest of the number that you dialed.



Plan your routing service before doing any programming.

Routing affects every call placed in the system and must be carefully planned to avoid conflicts and gaps in the programming. Use the tables in the *Programming Record* to design routes and destination codes, then check for potential problems before you start programming.

Routing service replaces a number of tasks that otherwise have to be done manually, including:

- entering a line pool code
- dialing an access code for a long distance carrier
- deciding which line pool to use according to the time and day

The installer can set up routing to take advantage of any leased or discounted routes using information supplied by the customer. The system itself cannot tell which lines are cheaper to use.

For Call by Call service selection (PRI only), the installer defines destination codes for various call types over PRI lines (e.g. Foreign Exchange, Tie Trunk, and OUTWATS). This information is then recorded in the routing and dialing plan section of the Programming Record for the PRI-A pool (and PRI-B, PRI-C or PRI-D if there are two or more PRI cards).

The user simply dials a number via the intercom button without entering any special information. For more information see, *Programming Call by Call service selection* on page 460.

How to use routing to create a uniform dialing plan (UDP) or coordinated dialing plan (CDP) is explained in *Dialing plans* on page 102.

Routes and destination codes

Installer password required

Programming for a route makes use of:

- destination codes (maximum of 500 available, with a maximum of 12 digits per code)
- a three-digit route number (000-999)
- a line pool
- DialOut digits (up to 24 digits)
- a schedule (programmed in Services), which allows three alternate routes per schedule



Routing table modifications

Changes to the routing tables can only be made during low-activity periods or on an idle system. Plan to program the routing tables when user activity is at a minimum.

Alternatively, Norstar Remote Utilities (NRU) can be used to back up, modify and restore these tables.



Tips - *To dial a telephone number which does not match any of the programmed destination codes, the user chooses a line and dials the number. For long distance dialing, area codes in the North American numbering plan can be programmed as destination codes.*

Routes

Installer password required

Press and enter a three-digit route number (000-999).

DialOut

DialOut is the number you want the route to use.

Press and enter the DialOut digits (up to 24), or press **CLR** to choose **No number**.

You can press to insert a 1.5-second pause in the dialing string, if necessary.

Route 000 has no DialOut by default and cannot be changed.

Link – if your Norstar system is connected to a private branch exchange (PBX), you can use a Link signal to access special features.

Pause – Enters a 1.5-second delay in a dialing sequence on an external line.

Programmed Release – performs same function as in a programmed dialing sequence. When the system encounters Programmed Release in a dialing sequence, it stops dialing and hangs up the call.

Run/Stop – inserts a break point into a sequence of dialed numbers or characters used for automatic dialing.

Wait for Dial Tone – causes a sequence of numbers to pause until dial tone is present on the line before continuing to dial.

See the *Modular ICS 6.1 System Coordinator Guide* for more information.

Use Pool

Press and **CHANGE** to select a line pool to be used with the route: **Pool A**, Pool B...Pool O or PRI-A to PRI-D.

Route 000 uses Pool A by default and cannot be changed.

Routing table

Call by Call Service information for outgoing calls is recorded in the Routing Service section of the Programing Record.

The following is an example of a Routing Table containing CbC programming.

Route # (000-999)	Dial Out (24 digits)	Use Pool	Service Type	Service Identifier
003		PRI-A	Public	
004		PRI-A	FX	xxxxx
005		PRI-A	Tie	xxxxx
006		PRI-B	OUTWATS	xxx
007		PRI-B	Private	
008		PRI-B	Switched Digital	

Note: The public DN lengths are used for all PRI calls except those whose routes use service type Private or service type Tie with DN Type specified as Private.

The service identifier (SID) depends on the selected service type. For example, with NI-2 protocol.

Service Type	Service Identifier description
Public	None
FX	Facility Number 1-5 digits
Tie	Facility Number 1-5 digits
OUTWATS *	Optional Band Number 1-3 digits
Private	None
Switched Digital	None

* For NI-2, do not program the Carrier Access Code for banded OUTWAT calls. This call may be rejected.

When a PRI protocol is selected or changed, the Service Type and Service ID fields are automatically cleared for each entry in the routing table for that PRI.

Programming the PRI routing table

The dialing plan must be thoroughly planned out in advance before programming the information into the Norstar system.

Programming the routing table takes place in **Services** under **Routing Service/Routes**

1. Press . The display shows **Show route**.
2. Press . The display shows **Rte001**.
3. Press . The display shows **Dial-Out:No numbr**.
4. Press **CHANGE** to enter a number (up to 24 digits).
5. Press . The display shows **Use: Pool A**.
The PRI pool(s) displayed depend on how the PRI lines are put into pools in the Trunk/Line data section of programming. It is possible to have only one PRI pool even if there are two or three PRI cards in the system.
6. Press . The display shows **Srvctype:Public**.
Press **CHANGE** to select a different Service Type.
Note: This parameter displays for specific protocols, such as N12, DMS100, DMS250.
7. Press . The display shows **Service ID:None**.
Press **CHANGE** to enter the Service ID number.
This parameter displays for specific protocols, such as N12, DMS100, DMS250.
8. Press . The display shows **DN type:Public**.
Press **CHANGE** to enter Public or Private.

Note: This variable displays only for service type Tie.

Dest codes

Installer password required

The first digit of the destination code cannot be the same as:

- Call Park Prefix (*Park prefix* on page 442)
- External Access code (*External code* on page 443)
- Direct Dial numbers (*Direct-dial #* on page 444)
- Line Pool code (*Line pool codes* on page 441)

The entire destination code cannot conflict with:

- internal set numbers (*Terminals&Sets* on page 325)
- DISA DN's (*DISA DN* on page 445)
- Auto DN's (*Auto DN* on page 444)

For instance, if your park prefix is 1, and you want to start your destination codes with 1, you must change the park prefix first.

If your line pool code for the local PBX is 9, and you want to start your destination codes with 9 to allow routing to the local PBX, you must create a destination code that includes the line pool for the PBX and delete the line pool code for 9.

The following are the *default* numbers automatically assigned in MICS-XC 6.1:

System type	Expansion used	Initial digits pre-assigned
mini	no expansion	0, 1, 2, 6 & 9
midi	one 2-port cartridge	0, 1, 2, 3, 6 & 9
maxi	one 6-port cartridge	0, 1, 2, 3, 4, 6 & 9
mega	two 6-port cartridges or two combo cartridges	0, 1, 2, 3, 4, 5, 6 & 9

The following are the *default* numbers automatically assigned in a MICS 6.1 system:

System type	Expansion used	Initial digits pre-assigned
mini	no expansion	0, 1, 2, 3, 4, 5, 6, 7, 8 & 9
midi	one 2-port cartridge	0, 1, 2, 3 & 9
maxi	one 6-port cartridge	0, 1, 2, 3, 4 & 9

To make the digits available for use with destination codes, you must change the DN length of B1 and B2 DNs, depending on your system size. This can be done either at system startup or in **System Programming**. The examples shown above use a three-digit DN length, unless stated otherwise.

Wild card character

When programming destination codes, you can use wild cards as the last number in a destination code string. By using wild cards, you can reduce the number of destination codes programmed in the system, maximizing the distribution of destination codes in the system.

The wild card character is added to the destination code by pressing the **ANY** key as the last digit of the code. This character represents any digit from 0 to 9, except for digits already programmed or used by other numbering plans. Should there be a conflict with other digits already programmed or used with by numbering plans, the digit will not be allowed.

The wild card character can only be used to group destination codes that use the same Route and Absorb Length.

Given the routes shown in the table below, the following two tables show you how to set up destination codes with or without wild card characters.

Example routes:

Route	DialOut	Line Pool
555	0162 237 625	Line Pool C
565	0173 133 2211	Line Pool A

Destination codes without using a wild card character

Destination codes	Route	Absorb Length	DialOut
0621	555	3	0162 237 6251
0622	555	3	0162 237 6252
0623	555	3	0162 237 6253
0624	555	3	0162 237 6254
0625	555	3	0162 237 6255
0626	555	3	0162 237 6256
0627	565	All	0173 133 2211
0628	555	3	0162 237 6258
0629	555	3	0162 237 6259

Destination codes using a wild card character

Destination codes	Route	Absorb Length	DialOut
062 •	555	3	0162 237 625X where X is the final dialout digit, from 1 to 9, but not 7
0627	565	All	0173 133 2211

Normal rte

Select which route a call using the destination code takes during normal service and for each of the schedules. The automatic schedule times are programmed under **Services**. The default Normal route is **000**, which has no DialOut digits and uses Pool A.

Digit Absorption

Select the portion of the destination code that is always absorbed by the system and not used in the dialing sequence.

Press **CHANGE** to select the number of digits to be deleted: (0 to 11) or **All**.



Tips - *The digit absorption setting (**Digit absorb**) only applies to a maximum of two schedules.*

Setting digit absorption to 0 (zero) minimizes the effort involved in preparing destination codes. With a 0 setting, the actual digits dialed by a caller are preserved in the dialout sequence. Programming a DialOut sequence as part of the route may or may not be necessary, depending on the required dialout.

Setting up a route for local calling Installer password required

An office may have different suppliers for local and long distance telephone service. By programming a destination code, any call that begins with 9, the most common dialout digit, will automatically use lines dedicated to local service.

The first step is to build a route (under `Services/Routing Service/Routing`).

1. At **Show route:** enter 001 (or any other available route number)
2. Press **SCAN** to view defined routes and press **CLEAR** to erase a defined route.
3. Choose the line pool that contains the lines for local calling.
4. Enter the DialOut digits (if any) which are needed to direct the call once it is connected to an external line.

Note: For local calls only, there are no DialOut numbers.

Compare this with *Setting up a route for long distance calling* on page 391.

5. Now you need to set up a destination code that will use this route during the various schedules. Since users will dial 9 to make an external call, 9 should be the destination code. (`Services/Routing Service/Dst Codes`)
6. At **Show DstCode:** press **ADD** and enter 9.



Tips - *If entering a code other than 9, a valid destination code must be used. See Dest codes on page 385.*

To view existing destination codes press before entering a new code.



Tip - The destination code can use a different route depending on which schedule is being used. Refer to *Services in the Modular ICS 6.1 System Coordinator Guide* for information about using schedules.

In the current example, Route 001 is used when someone dials 9 during normal mode. This is the mode used when the other Schedules are turned off.

7. Press .

The route for the first schedule appears after **Normal**:

8. Press **CHANGE** and enter the defined route number 001.

The following illustrations show the tables used for planning and recording routing service found in the *Programming Record*. They are filled out to match the examples of routes for local and long distance calling.

Recording the routes

Page 24		
Routing Service (Services: Routing Service)		
Route # (000-999)	DialOut (if required) (max. 24 characters)	Use Pool
001	none	A B C D E F G H I J K L M N O PRI-A PRI-B PRI-C PRI-D
002	none	A B C D E F G H I J K L M N O PRI-A PRI-B PRI-C PRI-D

Recording how the routes will be used

Destination codes (Services; Routing service; Destination codes)								
Service Schedule name (max. 8 digits)	Normal Rte		Other schedules:					
DestCode (max. 12 digits)	Use route (000-999)	Absorb Length	1st route (000-999)	Absorb Length	2nd route (000-999)	Absorb Length	3rd route (000-999)	Absorb Length
9	000 001	All		All		All		All
1	000 002	All-0		All		All		All
	000	All		All		All		All

Setting up a route for long distance calling

Installer password required

An office may have leased lines or E&M trunks which make it cheaper to call long distance.

The routing should take place automatically when the number of the outgoing call begins with 1.

The first step is to build a route (under **Services/Routing Service/Routing**).

1. At **AtRoute:**, enter 002 (or any other available route number)
2. Choose the line pool where the discounted lines for calling long distance have been placed. Example: Line pool B.
3. Then you need to assign the route to the destination code and to the destination code schedules. (under **Services/Routing Service/Dst Codes**)
4. At **DstCode:** enter a valid destination code.
Example: 1403

Refer to *Dest codes* on page 385.



Tip - To view existing destination codes press before entering a new code.



Tip - The destination code can use a different route depending on which schedule is being used. Refer to *Services in the Modular ICS 6.1 System Coordinator Guide* for information about using schedules. In the above example, the system uses Route 002, which uses Line pool B, to take advantage of the lower cost when the system is in normal mode.

5. Press .

The route for the first schedule appears: **Normal:**

6. Press **CHANGE** and enter the defined route number 002.
7. Press .

The **AbsorbLength** prompt appears. The default is **A11**.

8. Press **CHANGE** to choose the number of digits that need to be absorbed before dialout. In this case, it would be 0, as 1 needs to be dialed out before the rest of the digits.



Tips - *The digit absorption setting (**AbsorbLength**) only applies to a maximum of two schedules.*

*Setting **AbsorbLength** to 0 (zero) minimizes the effort involved in preparing destination codes. With a 0 setting, the actual digits dialed by a caller are preserved in the dialout sequence. Programming a **DialOut** sequence as part of the route is not necessary.*



Tips - *If rates change depending on the time of the day or week, a different route can be used for the same destination code 1 when a particular schedule is in use. See *Programming for least cost routing* on page 395.*

Adding a long distance carrier access code

Installer password required

In many cases, long distance service uses the same lines as local service but the call is switched to a specific carrier using an access number. This number is sometimes called an equal access code. Programming for routing can include this access number so users only need to dial the set number, as described below:

1. Create a route that uses a line pool containing local lines only.
2. Program the route to use a line pool containing the lines used to access the long distance carriers.
 - a. Enter the DialOut digits, which are the same as the carrier code digits. For example, if the access code was 10222, the DialOut digits would be 10222.
Carrier codes are defined in *Carrier Codes* on page 446.
 - b. Create a destination code 91.
9 (for outside access) and 1 (for long distance). Refer to *Dest codes* on page 385 to determine a valid code.
 - c. Set `AbsorbLength` to 1.
The 9 is only used internally and should be dropped.
The 1 is needed to direct the call to the public carrier network.



Tips - *The destination codes 9 and 91 used in the examples cannot be used together. If the destination code 91 is needed to direct long distance calls, you must create a separate set of codes that use local calling routes. These codes would be, for example, 90, 92, 93, 94, 95, 96, 97, 98 and 99. See Wild card character on page 386 for information about programming destination codes.*

Using destination codes to make a call

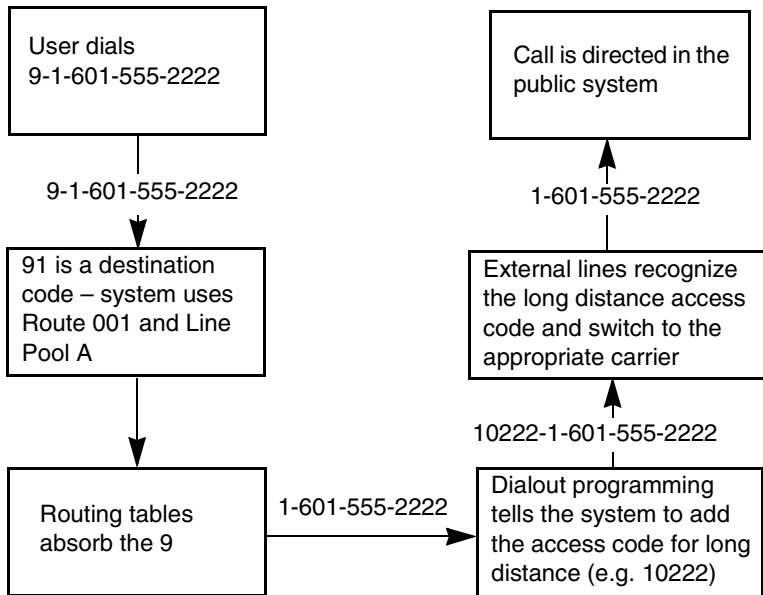

Programming for least cost routing

Installer password required

It may be cheaper to use another long distance carrier at another time of day.

Continuing with the example used in the previous flowchart, the lines that supply local service in Normal mode will also be used for long distance service after 6 p.m. because that is when rates become competitive. For the system to do this automatically, another route has to be built.

1. At **Route:** choose Route 007 (or any available route).
2. Press .
3. At **DialOut**, press **CLR** to choose **No numbr.**
4. Press .
5. Choose **Line Pool A**, or the pool with the local service carrier lines.

In this case, the change in route uses the start and stop times for Night Sched.

6. Return to the Routes heading and press to find the **Dest Code** heading.
7. Press and then .
8. At **DestCode:**, press **ADD**, then enter **91**.
9. Press and then to reach the Night schedule.
10. Press . The first route for the schedule appears.
11. Enter **Route 007**.
12. Press .

13. Set `AbsorbLength` to 1.

The 9 will be absorbed before the number is dialed out to the network. This means, that when the Night schedule is chosen, either automatically by time, or manually from a control telephone, the calls dialed with 91 will dial out to the long distance network without requiring a special access code.

To set up multiple alternative routes, refer to the next section, Multiple least cost routing.

Multiple least cost routing

An alternative to overflow routing, is to use multiple least cost routing, which is available to all schedules except Normal.

This feature allows you to specify three possible routes within each destination code schedule, in order of preference, if you are using active services for your routing.

In the route file for which you want to specify multiple routing:

1. Create a destination code file, then select this file.
2. Press .
The **Schedule** heading appears.
3. Press . The **Normal** heading appears.
4. Press until you find the schedule you want to program.
5. Press . The first route appears.
6. Enter the preferred route number.
7. Press and choose an absorb length.
8. Press and the second route appears.

9. Enter the route number for the second preferred route.
10. Press and choose an absorb length.
11. Press and the third route appears.
12. Enter the route number for the third preferred route.
13. Press and choose an absorb length.

Sched:Night

Indicate how the alternate routing should be activated for each of the schedules.

Service

Use , **CHANGE**, and to change the setting for each schedule to one of these settings: **Off**, **Automatic**, or **Manual**.

Off — prevents the routing service from being activated. In this case, the Normal schedule is used.

Auto — allows you to program a stop and start time for a service. You will be prompted to enter start and stop times. You can still start and stop the service by entering the appropriate Services feature code at a control telephone.

Manual — allows you to turn the service on and off at any time from a control telephone using the Ringing service feature code.

Refer to the *Modular ICS 6.1 Coordinator Guide* for a description of the feature codes used to work with Services.

Overflow routing

If all the lines used by a route are busy when a call is made, the mode may be programmed to overflow to the route used for

normal mode. If this happens, the telephone will sound a warning tone and display the message **Expensive route**. The caller can then release the call to avoid using the Normal route, or continue with the call.

Also refer to the section on Multiple least cost routing on the preceding page.

Overflow routing is turned on or off for each schedule when you program the destination codes schedule.

Press **CHANGE** to select the setting: **Y** (Yes) or **N** (No).

Refer to the *Overflow call routing* section of the *Modular ICS 6.1 Coordinator Guide* for details about how to set up overflow routing.



Tips - *A schedule must be active for overflow routing to be in effect. Overflow routing is not available in Normal mode.*

You must create an overflow route to be used with each destination code. In this way, every route used with a scheduled mode that has overflow service must have an alternate route in Normal service.

Using dialing restrictions with routing

Installer password required

Routing service can be further customized by adding dialing filters to lines in line pools. Filters restrict the use of the line to specific area codes. See *Restriction filters* on page 94 and the *Programming* chapter of the *Modular ICS 6.1 System Coordinator Guide* for more information.



Tips - You can also use routing as an alternative method for a direct-dial number. For example, create a destination code 0 and program the number of the internal or external destination as the DialOut. Digit absorption should be set to 1.

Because overflow routing directs calls using alternate line pools, a call may be affected by different line filters when it is handled by overflow routing.



Tips - Host system signaling codes can be part of the DialOut. See the *Modular ICS 6.1 System Coordinator Guide* for details on host system signaling codes.

Sys speed dial

System speed dial allows you to configure speed dial codes (001 - 255) that can be used by any telephone on the system to dial pre-programmed numbers.

If you specify a name with the speed dial entry, an incoming call on a CLID line with a dialed number that matches the speed dial entry will display the name as part of the CLID display on the receiving telephone or when is invoked to display call information. This method of using the system speed dial entries for CLID display is called Alpha tagging.

Note: Alpha tagging is only invoked when the CO line service does not supply a name for the incoming call. It will only occur on telephones that have Caller ID set turned on (*Telco features* on page 347).

The **CLID Match** setting (*CLID match* on page 432) determines how many digits of the received number must match the system speed dial number to be accepted as a CLID match to allow the name display to occur.

For more information about using and programming System speed dial, refer to the *Modular ICS 6.1 System Coordinator Guide*.

For information about configuring the system so that the name displays first, refer to *IstDisplay* on page 349.

Passwords

COS pswds

Class of Service (COS) passwords permit controlled access to system resources by both internal and remote users.

When you enter a COS password at a telephone, the restriction filters associated with your password apply instead of the normal restriction filters. Similarly, when a remote user enters a COS password on an incoming auto-answer line, the restriction filters and remote package associated with their COS password apply instead of the normal restriction filters and remote package.

COS Pswds allows you to define individual passwords and determine the restriction filters and remote package associated with each.



Tips - *The Class of Service passwords for a system should be determined randomly and should be changed on a regular basis.*

Users should memorize their COS passwords. COS passwords should be deleted when an employee leaves the company.



Tips - *Typically, each user has a separate password. Alternately, several users can share a password or one user can have several passwords.*

A system can have a maximum of 100 six-digit COS passwords (00 to 99).

*You can use **COPY** and the dialpad to copy the restriction filters and remote package from one COS password to another. COS passwords must be unique.*

Pswd

Pswd defines the six-digit Class of Service password.

There is no default password.

Use , **CHANGE** and the dialpad to program the six-digit password.

Use **BKSP** to edit numbers you have entered.

User flt

User filter allows you to assign a restriction filter to a COS password. The user filter associated with the COS password replaces any normally-applicable set restriction, line/set restriction, or remote restriction.

Use **CHANGE** and the dialpad to program the two-digit user filter.

The default setting (**None**), means that any normally-applicable filters still apply (set restriction, line/set restriction, or remote restriction).

Line flt

Line filter allows you to assign a specific line restriction to a COS password. The line filter associated with the COS password replaces any normally-applicable line restriction.

Use **CHANGE** and the dialpad to program the two-digit line filter.

The default setting (**None**), means that any normally-applicable line filter still applies.

Remote pkg

Remote pkg allows you to assign a specific remote access package to a COS password.

The remote access package associated with the COS password replaces any normally-applicable remote access package.

Use **CHANGE** and the dialpad to program the two-digit remote package.

The default setting (**None**), means that any normally-applicable remote access package still applies.

Call log pswds

This setting allows you to override any Call log password programmed with the Call log feature, and resets it to **None**. This feature is used when someone forgets a password.

1. Press .
2. Enter the DN of the telephone.
3. Press .
4. Press **CLR** to clear the programmed password.



Tips - You program a Call log password using the Call log Password feature. Refer to the Telephone Feature Card or the Modular ICS 6.1 System Coordinator Guide for more information.

Programing pswds

You can choose any combination of six digits for Passwords.



Tip - *It is easier to remember the password if the digits spell a word.*

Some passwords allow line assignments to be rearranged, which could disrupt your telephone service. Provide passwords only to selected personnel to prevent unauthorized access to programming.

Installer

The default Installer password is **266344 (CONFIG)**.

1. Use CHANGE, the dialpad, and OK to program the Installer password.
2. Record the password in the *Programming Record*.



Tips - *You can choose any combination of one to six digits. It is easier to remember the password if the digits spell a word. Provide this password only to selected personnel to prevent unauthorized access to programming. The implications of such access may include the rearrangement of line assignments, which could affect the operation of the Norstar system.*

SysCoord+

The default System Coordinator Plus password is **727587** (SCPLUS).

Use **CHANGE**, the dialpad, and **OK** to program the System Coordinator Plus password.



Tips - *You should only distribute this password to experienced System Coordinators. This level of access is documented in the Modular ICS 6.1 System Coordinator Guide.*

An overview of what programming is available by using the System Coordinator Plus password is on page 296

SysCoord

The default System Coordinator password is **23646** (ADMIN).

Basic

The default Basic password is **22742** (BASIC).



Tips - *For more information about the System Coordinator and Basic passwords, see the Modular ICS 6.1 System Coordinator Guide.*

Registration password (MICS-XC only)

For more information about the Registration password, refer to the *Modular ICS Companion Installer Guide*.

Hospitality password

There are two passwords within the Hospitality feature. **Desk Pswd** provides secure access to the administration set for programming the service, and **Cond Pswd** provides secure access to a room condition setting from each room set for housekeeping staff.

Desk pswd

Change this password frequently, to maintain security.

At Hospitality:

1. Press . **Desk Pswd:4677** displays.
2. Press **CHANGE**. **New Pswd:** displays
3. Enter a new password, then press **OK**.

Cond pswd

Change this password frequently, to maintain security.

At Hospitality:

1. Press .
2. Press **Cond Pswd:None** displays.
3. Press **CHANGE**. **New Pswd:** displays
4. Enter a new password, then press **OK**.

Silent Monitor password

Users must enter a password when they use to monitor Hunt group calls.

It is advisable to change this password frequently.

At **SM Passwd:**

1. Press . **SM Passwd:** displays.
(default: 745368 (SILENT))
2. Press CHANGE. **New Pswd:** displays
3. Use the keypad to enter a new password.
4. Press OK.

Time&Date

The time and date shown on the telephone display is used by the system for scheduled features. It can be changed in programming or by using a feature code

(* * T I M E or * * 8 4 6 3).

For more information, refer to the *Modular ICS 6.1 System Coordinator Guide*.

System prgrming

System Prgrming allows you to set up features and settings which are not associated with any specific line or telephone.

Hunt groups

The Hunt groups feature allows a group of telephones to be called by a single directory number, ensuring that calls are easily routed to the appropriate group.

The default setting for Hunt groups is **Broadcast**. Hunt group statistics are available under **Usage Metrics** on page 569.

Hunt groups can be used to route calls to a support service such as a Help Line for a software company. Specialists dealing with Product A can be in one group. Specialists dealing with Product B can be in another group. Incoming calls will target a specific group and hunt for the next available telephone in the group. If no telephone is available, the call can be placed in a queue or can be routed to an overflow telephone.

The Hunt groups subheading in system programming is the area that programming changes are made to the following:

- members of a group
- member position in a group
- what lines are assigned to a group
- how incoming calls are distributed
- how long the system looks for available agents
- where a call goes if all agents are busy

The hunt group setting impacts other features:

- Call forwards set on telephones that are members of a hunt group are overridden by the hunt group routing.
- Telephones which are members of a hunt group can temporarily leave a group by activating the DND feature.
- Wireless twinning can be enabled if a hunt group appears on the portable as well as the set.
- Priority calls to a hunt group will be rejected
- Hunt group set numbers cannot be in a ringing group.
- Hunt group set numbers cannot be in a page zone.
- Hunt group member line keys take precedence over Hunt group key, therefore, it is recommended that you do not assign any lines to telephones which are part of the hunt group. If you do assign lines to a hunt group telephone, ensure they do not duplicate any of the lines assigned to the Hunt Group DN.

Note: Do not program videophones as members of a hunt group. Hunt groups allow one B channel connection at a time and videophones use two B channels.

Adding or removing members from a group

- Members of the group can be any Norstar telephone or Business Series Terminal, ISDN set, or portables.
- A telephone can be in more than one hunt group, but is considered a member in each hunt group, increasing the total number of members in the system.
- There will be only one appearance of the same hunt group on a telephone, regardless of how many lines are assigned to the hunt group. The appearance can be set to: **APPR&Ring**, **APPR only**, or **Ring only**.

- The DN number range for hunt groups is 707 to 736.



Tip - You must program the DNs for telephones you want to use for hunt group members outside the hunt group DN range.

- If you want your central answering position to display Hunt Group appearances in order to monitor activity, the CAP must be a member of the hunt group. Hunt group appearances can be moved to CAPs using extended key indicator modules (eKIMs) with . Refer to *CAP/KIM assign* on page 435.
- If any of the telephones you want to add to the hunt group have lines assigned that are the same as the hunt group, remove the line from the telephone before assigning it to the hunt group.

Hunt groups can be programmed under **System programming**.

1. Press . The display shows **Hunt groups**.
2. Press . The display shows **Show group#:**
3. Enter the hunt group number you want to program (1-30).
4. Press . The display shows **Member DNs:**
5. Press . The display shows the members for that group.
6. Press **ADD** to add a member or press **REMOVE** to remove a member from the group.
7. Select **APPR&Ring**, **APPR only**, or **Ring only** for the hunt group member. See *Appearances* on page 327.

Note: Fixed external cadencing is provided for all external hunt group calls regardless of whether or not they have been answered and transferred.

Moving members of a group

Member order within a hunt group is important. The member order determines how a call is routed through a hunt group.

1. Press **MOVE** to move an existing member to another place within the hunt group. The display shows the member number followed by an arrow.
2. Enter the new position number for the telephone.

Assigning or unassigning lines to a group

To avoid delayed ring transfer of external hunt group calls to a prime set, ensure that the hunt group prime line is set to **None**.

A line can only be assigned to one hunt group.

1. When the display shows **Member DNs:**
2. Press . The display shows **Line assignment**.
3. Press . The display shows **Show line:**
4. Enter the line number you want to program, press **SCAN** to go the first line assigned to this group, or press **LIST** to go to the first line in the system.
5. Press **CHANGE** to program the line as **Unassigned** or **Assigned**.

HGnn means the line is assigned to another hunt group.

Setting the distribution mode

There are three modes of call distribution:

- **Broadcast** — rings each telephone in the group simultaneously. Calls are handled one at a time, other calls are queued. As soon as a call is picked up, the call next in the queue is presented to the hunt group without waiting for queue timeout.
- **Sequential** — starts the call at the first telephone in the hunt group. Distribution is complete when the first free telephone is found. This telephone is the only one that rings for this call. Simultaneous calls can be presented. Distribution is order based, so ensure your hunt group members are listed in priority. Refer to *Moving members of a group on page 412* and *Setting the hunt delay on page 414*.
- **Rotary** — the call starts at the telephone after the one which last answered a call. Distribution is complete when the next free telephone is found. Simultaneous calls can be presented. Distribution is order based, but this mode ensures that all members of the group are receiving calls, rather than one person receiving the majority of calls. Refer also to *Setting the hunt delay on page 414*.

When the display shows **Member DNs:**.

1. Press until the display shows **Mode:**.
2. Press **CHANGE** to set the mode: **Broadcast**, **Sequential**, **Rotary**.

If a hunt group has available agents but nobody answers the call, the call is routed according to what is set in the **Busy line** setting. Refer to *Programming busy line setting on page 414*.

Setting the hunt delay

This setting allows you to program the number of rings the system permits at a hunt group telephone before moving on to the next telephone in the hunt group. This display only shows if the distribution mode is set to sequential or rotary.

1. When the display shows **Member DNs:**.
2. Press until the display shows **Hunt delay:**.
3. Press **CHANGE** to select the setting: **1, 2, 3, 4, 5, 6, 7, 8, 9, 10**.

Programming busy line setting

There are three routing options if all agents are busy:

- **BusyTone**—the caller gets a busy tone for PRI or BRI, otherwise the telephone rings back.
- **Overflow**—the call is routed to an overflow position. You cannot use overflow if the overflow DN is a hunt group DN.
- **Queue**—the call stays in the system for a period of time. Within this period of time, the call will be presented to an agent if one becomes available. When the time-out occurs, the call will be presented to an overflow position.

1. When the display shows **Member DNs:**.
2. Press until the display shows **If busy:**.
3. Press **CHANGE** to set the mode: **BusyTone, Overflow, Queue**.

Programming the queue timeout

This setting allows you to program the number of seconds a call will remain in the hunt group queue before it is also routed to the overflow position.

1. When the display shows **Member DNs:**.
2. Press until the display shows **Q Timeout:**.
3. Press **CHANGE** to set the queue timeout: **15, 30, 45, 60, 120** or **180**.

Programming the overflow set

This setting allows you to indicate a telephone to which the hunt group calls will be routed when the queue is full.

- If the overflow telephone is not a hunt group member, the call ceases to be a hunt group call once it transfers.
- If the overflow telephone is a hunt group member, the call is treated as a new call and goes to the bottom of the queue.

The assigned overflow position can also can be a DN number associated with a voice mailbox.

1. When the display shows **Member DNs:**.
2. Press until the display shows **Overflow:**.
3. Press **CHANGE** to change the overflow position.
4. Enter the new overflow set or mailbox number.

Setting the Hunt group name

This setting allows you to program the hunt group function name, such as *Service* or *Sales*. The name can be up to seven characters in length.

1. When the display shows **Member DNs:**.
2. Press until the display shows **Name:**.
3. Press **CHANGE**.
4. Use the dialpad to enter the name of the hunt group.
5. Press to store the name.

Allowing/disallowing an auxiliary ringer

This setting allows you to allow/disallow an external ringer to sound when a call comes in for a specific hunt group. If you allow this service, you must have an auxiliary ringer properly installed on your system. Refer to *Auxiliary ringer (customer supplied)* on page 287.

1. When the display shows **Member DNs:**.
2. Press until the display shows **Aux. Ringer:**.
3. Press **CHANGE** to choose **Y** (yes) to turn the ringer on or **N** (No) to disallow an auxiliary ringer.
4. Press to exit or to continue programming.

Assigning a distinctive ring pattern to a Hunt Group

You can assign distinctive ring patterns to your Hunt Group so that calls can be rated in priority for the group.

These distinctive ring patterns have the same characteristics as for line and extension distinctive ring patterns. Refer to *Programming distinctive ring patterns* on page 366.

The Hunt Group distinctive ring pattern determines how a call will ring within the Hunt Group. If members of the group have ring patterns assigned to their telephones that are higher than the ring patterns of the incoming line or the Hunt Group, then the Hunt Group will use the ring of the corresponding member telephones. If the incoming call (line) has a higher ring pattern assigned, than the Hunt Group, the Hunt Group will ring with the line ring pattern.





1. Find the heading **Hunt groups**.
2. Press until the display shows **Member extns:**.
3. Press until the display shows **Dstinct Ring:NONE**.
4. Press **CHANGE** to toggle to the ring pattern number you want to assign to the Hunt group line. (**None, 2, 3, 4**)
5. Press to exit or to continue programming.

Monitoring Hunt groups

You can set up your system to allow a number of two-line display telephones to be used as monitoring devices for hunt group members.

Using the various supervisory features you can determine:

- the number of monitoring telephones you will allow on the system (default: 5). Refer to “SM sets” on page 466.
- which telephones will be allowed to act as silent monitor supervisors. Refer to “Capabilities” on page 335 for information about designating two-line display telephones as supervisor telephones.
- whether there will be an indicator tone when the monitoring telephone breaks into a call. Refer to “Silent Monitor” on page 432.

- what password the supervisor will enter on the supervisory telephone to gain access to the Silent Monitoring feature ( *   ) (Default password: SILENT (745368)). Refer to “Silent Monitor password” on page 407.

Refer to the *Modular ICS System Coordinator Guide* for detailed information about using the feature and for descriptions of the display messages that occur during the process.

Change DNs

Installer password required

Change DNs allows you to change the directory number (DN) or internal number of a telephone.



Changing DN locks programming session.

Changing an individual DN locks the programming session into the Change DNs programming mode. After you finish and press , re-enter the programming access code and the Installer password to continue with other programming.

Do not perform Startup again or all previous programming will be erased.

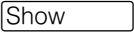
1. Use  and the dialpad to identify the DN you want to change.
2. Use the dialpad to enter the new DN.

Featr settings

The following section describes how to configure features for individual telephones.

Backgrnd music

Background Music allows you to listen to music through your telephone speaker. A customer-supplied music source must be connected to the Integrated Communication System.

Press CHANGE to select the setting: **N** (No) or **Y** (Yes).

Refer also to “External music source (customer supplied)” on page 288.

On hold

On hold allows you to choose what a caller hears on an external line when the line has been put on hold.

Press CHANGE to select the setting: **Tones**, **Music**, or **Silence**.

- **Tones** provides a periodic tone.
- **Music** provides any signal from a source such as a radio connected to the ICS.
- **Silence** provides no audio feedback.

Receiver volume

Receiver volume allows you to specify whether the volume level of a handset receiver or headset will return to the system default level when a call is ended or put on hold, or whether the volume will remain at the level set at the individual telephone.

Use and CHANGE to select either: **Use sys volume** or **Use set volume**.

This feature is not available on some older telephones.

Camp timeout

Camp timeout delay allows you to assign the number of seconds before an unanswered camped call is returned to the telephone which camped the call.

Press CHANGE to select the setting: **30, 45, 60, 90, 120, 150, 180** seconds.

Park timeout

Park timeout allows you to assign the number of seconds before a parked call on an external line returns to the originating telephone.

Press CHANGE to select the setting: **30, 45, 60, 90, 120, 150, 180, 300, 600** seconds.

Park mode

The Call Park feature allows you to suspend a call. The call can then be retrieved at any system telephone by entering the unique retrieval code. Park Mode is the setting which determines how a retrieval code is assigned to parked calls.

Press CHANGE to select the way that the system will choose a Call Park code: **Lowest** or **Cycle**.

- When set to **Lowest**, the system will choose the lowest code that is available when the call is parked.

- When set to **Cycle**, the system will choose the codes in sequence, from lowest to highest, until all the codes have been used.

Trnsfr callbk

Transfer callback delay allows you to specify the number of rings before a callback occurs on a transferred call.

Press **CHANGE** to select the setting: **3**, **4**, **5**, **6**, or **12** rings.



Tips - *You can estimate the delay in seconds if you multiply the number of rings by six.*

DRT to prime

Delayed Ring Transfer automatically forwards unanswered external calls to a prime telephone after a certain period of time. This helps ensure that no external call goes unanswered.

Press **CHANGE** to select the setting: **Y** (Yes) or **N** (No).



Tips - *An operational prime telephone must be assigned before this feature can operate. A prime telephone is assigned to one or more external lines in **Line** programming.*

DRT delay

Delayed Ring Transfer delay allows you to specify the number of rings before a call is transferred to a prime telephone. For this feature to work, **DRT to Prime** must be set to **Y** (yes).

Press CHANGE to select the setting: 1, 2, 3, 4, 6, or 10 rings.



Tips - *The DRT delay can be programmed only if DRT is activated. You can estimate the delay in seconds if you multiply the number of rings by six.*

Held reminder

When active, Held Line Reminder reminds you that a call at your telephone is still on hold. You periodically hear two tones from your telephone until you return to the call on hold.

Press CHANGE to select the setting: N (No) or Y (Yes).

Remind delay

Held Line Reminder delay allows you to choose the number of seconds before the Held Line Reminder feature begins at a telephone that has an external call on hold.

Press CHANGE to select the setting: 30, 60, 90, 120, 150, or 180 seconds.



Tips - *The Held Line Reminder delay can be programmed only if Held Line Reminder is activated.*

Directd pickup

Directed pickup allows you to answer any calls by specifying the internal number of the ringing telephone.

Press **CHANGE** to select the setting: **Y** (Yes) or **N** (No).



Tips - *Directed pickup is not to be confused with the Call Pickup Group feature in programming, which allows you to answer a call at any telephone within a specific group without specifying the internal number of the ringing telephone.*

Like Call Pickup Group, Directed pickup is useful when not all the telephones have been assigned the same lines, but you still want to allow your co-workers to answer a call on any external line from their telephones.

Page tone

You can choose whether a tone sounds before a page begins.

Press **CHANGE** to select the setting: **Y** (Yes) or **N** (No).

Page Timeout

The paging feature is automatically disconnected after a set length of time.

Press **CHANGE** to select the maximum number of seconds needed for a page: **15, 30, 60, 120, 180, 300, 600, 2700**.

Daylight time

When this feature is turned on, your system will automatically switch between standard time and daylight savings time.

Press CHANGE, to select the setting: **Y** (Yes) or **N** (No).



Tips - *The hour falls back one hour on the last Sunday of October at 2:00 am. It advances one hour on the first Sunday of April at 2:00 am. This function should only be programmed by your installer.*

*In regions where daylight savings time does not apply, make sure this setting is changed to **N** (No).*

AutoTime&Date

You can program the Automatic Time&Date feature to enable the Norstar system to automatically update the time and date after a power failure.

Whenever the clock is out of sync by more than two minutes, as a result of a power failure or a loss of power, the first incoming call updates the clock automatically after two rings.

Note: CLASS trunks are required for this feature to work. Consult your customer service representative to determine if you have CLASS trunks.

This feature also allows automatic changing between North American daylight savings and standard time. The Automatic Time and Date feature automatically overrides any manually-programmed changes to the time and date.

Note: The year is not included with the time and date information and must be programmed manually if the current year differs from the network time.

Press CHANGE to choose **Y** or **N**.

Call log space

Call log space programming customizes how log space is allocated to telephones in the system.

Reset all logs allows you to reallocate the Call log space equally to all telephones in your system.

1. Press **YES** and use the dialpad to enter the space allocation for the Call log at each telephone.

You must use a three-digit number (for example, 020 to give each set 20 spaces).

2. Press **YES** to accept the settings and end programming. The system automatically reallocates Log space.

Press **NO** to keep existing settings.



Tips - Use this heading only if you want to allocate an equal amount of log space to all the telephones in your system.

If you want to assign specific log space to individual telephones, see the information under **Terminals&Sets** in the *Modular ICS 6.1 System Coordinator Guide*.



Reallocating Call log space may destroy Call log data at telephones that lose space.

There are 600 Call log spaces available in the system. There are no spaces allocated by default.

Changing the space allocation using *Log Defaults* defines the log space available to all telephones in the system. Any remaining unassigned log space is available in a log pool, and can be reallocated under **Terminals&Sets** in *Telco features*.

Host delay

Host delay allows you to assign the delay between the moment an outgoing line is selected to make an external call, for

example, by lifting the receiver off the telephone, and the moment that Norstar sends dialed digits or codes on the line.

Press **CHANGE** to select the setting: **200**, **400**, **600**, **800**, **1000**, **1200**, **1400**, **1600**, **1800**, or **2000** milliseconds.



Tips - *Host delay is provided to ensure that a dial tone is present before the dialing sequence is sent. Minimizing this delay provides faster access to the requested features.*

Link time

Link time allows you to specify the duration of a signal required to access a feature through a remote system.

Press **CHANGE** to select the setting: **100**, **200**, **300**, **400**, **500**, **600**, **700**, **800**, **900**, or **1000** milliseconds.

For example, to program external dialing through a Centrex system, which requires a Link time of 400 ms, specify a Link time of 400.



Tips - *The Link time required depends on the requirements of the host switching system that must be accessed.*

Link is another name for Recall or Flash.

AlarmSet

Alarm set allows you to assign a telephone on which alarm messages appear when a problem has been detected in the system.

1. Use **CHANGE** and the dialpad to enter the internal number of the Alarm telephone.
2. Press to set the Alarm telephone to **None**.

The default setting is **221**.

Refer to “Alarm codes” on page 533 for details about reading alarms and troubleshooting with alarms.

Set relocation

Set relocation allows you to move any telephone to a new location within the Norstar system without losing the directory number, autodial settings, personal speed dial codes, and any programming for that telephone.

Press **CHANGE** to select the setting: **N** (No) and **Y** (Yes).



Tips - *It is advisable to activate Set relocation after the telephone installation and programming is complete. This provides you with more flexibility in testing equipment.*



Warning

If this feature is deactivated while a telephone is moved, the internal number and programming data for that telephone remain with the physical port on the ICS, and the telephone does not receive the original programming when it is reconnected elsewhere.

If you plug a new telephone into the original location before you reinstall the moved telephone, the programming moves to the new telephone and the moved telephone must be reprogrammed.



Msg reply enh

The Message reply enhancement feature allows for the message waiting indicator on analog telephones connected to an Analog Station Module (ASM) to be deactivated automatically if the reply call from the analog telephone to the designated direct-dial telephone is answered, no matter where the call is answered from by the user.

This feature also functions if the user invokes the Call Pickup feature to answer the reply call from the analog set. It does not, however, work with the Retrieve Parked Call feature.

Press **CHANGE** to select the setting: **Y** (Yes) and **N** (No).



Tips - *Direct-dial telephones are the only telephones that can send messages (using  ) to analog telephones connected to an Analog Station Module (ASM). The direct-dial telephone must be the designated direct-dial set for the analog telephone receiving a message.*

Answer key

Up to eight answer DNs can be assigned per telephone. The **Answer key** setting in **Featr settings** allows you to determine what types of calls will alert at the telephone for the Answer DNs assigned to any telephone.

Answer key changes do not apply to portables.

Press **CHANGE** to select the settings: **Basic**, **Enhanced**, and **Extended**.

On the **Basic** setting, answer keys do not ring for:

- Prime set call capture
- call forwarded calls
- other answer key calls
- priority calls
- voice calls
- ringing service
- callbacks

The **Enhanced** setting is the same as the Basic setting except:

- answer keys will ring for overflow call routed calls (special case of Prime set call capture)
- answer keys will not ring for line transferred calls

The **Extended** setting allows all call types to ring, except priority calls and voice calls.

Phantom DNs

A Phantom DN is the term used to describe a situation where a line is programmed to appear and ring on a telephone that does not physically exist. It allows you to create an Answer Key for the line that does not exist on an existing telephone. You would use a phantom DN in the case where you have taken a line out of service, such as a customer-response line,

but you still get calls to that number. To handle the calls, create an answer key using the phantom DN on the telephone where you want these calls to be taken.

Setting SWCA controls

You can assign up to 16 System Wide Call Appearance (SWCA) keys to each telephone in a group. This is performed under **Button Programming**, located under **Terminals&Sets, User Preferences**. SWCA controls are controlled by feature codes **[☎] [*] [5] [2] [0]** to **[☎] [*] [5] [3] [5]**. The user can also program this feature on their own telephones using these feature codes.

On the system, under **Feature Settings, SWCA Cntl** you define how incoming calls get associated to SWCA keys and how Hold will handle the calls.



Tips - *Since SWCA keys use the Park feature, ensure that you have Park turned on for your system by specifying a Park prefix (Access codes), and a park timeout setting (System programming, Featr settings).*

The **Auto Associate** setting determines if answered calls will automatically be assigned to SWCA keys (**Auto Associate = Y**).

If you want the user to press the Hold button or a free SWCA key before the call transfers to a SWCA key, set **Auto Associate** to **N**.

Calls remain assigned to SWCA keys for the duration of the call.

The **Invoke by Hold** setting determines if a SWCA call put on Hold can be picked up from other extensions in the group.

- If you want the call to be available to be picked up by other members of the groups when you put a call on Hold, set **Invoke by Hold:** to **Y**. A flashing indicator appears beside the SWCA key when the call assigned to that key is put on Hold.
- If you want calls to remain on Hold only at the telephone where the call is received, set **Invoke by Hold:** to **N**. Even if you set this field to **N**, users can still put selected calls on SWCA hold, by pressing a free SWCA key rather than the Hold key to camp the call.

Refer to the System Coordinator Guide sections for information about assigning key programming and for instructions about using the keys.

1. Under **Featr settings**, press . The display shows **Backgrnd music:**.
2. Press until the display shows **SWCA Cntrl:**.
3. Press . The display shows **Auto Associate:N**.
4. Press **CHANGE** to choose the **Y** or **N** option.
5. Press . The display shows **Invoke by Hold:N**.
6. Press **CHANGE** to choose the **Y** or **N** option.
7. Press to exit or to continue programming.

CLID match

This setting determines the minimum number of digits that an external call must match to an existing system speed dial number in order for the system to offer a name display for the CLID prompt, if the system speed dial number is set up to display the caller name.

1. Under **Featr settings**, press .
The display shows **Backgrnd music:**.
2. Press until the display shows **CLID match: 8**.
3. Press **CHANGE** to select the a number from **3** to **8**, or select **None**, if you do not require any number matching.
4. Press to exit or to continue programming.

Silent Monitor

You can monitor Hunt group members using a two-line display telephone that has been designated as a supervisor telephone.

You create the Silent Monitor feature capability by:

- determining how many system telephones will be allowed to be supervisors. (Refer to *SM sets* on page 466.)
- determining which telephones will be allowed to be supervisors. (Refer to the SM Supervisor field under *Capabilities* on page 335).
- determining the password that the supervisor enters after the feature code is entered to start monitoring Hunt group telephones. (Refer to *Silent Monitor password* on page 407.)

You have the choice of silently monitoring the conversation, or providing a tone to the other two parties to indicate that the line is being monitored. This setting is the same for all supervisor telephones. Refer to the process below to determine the setting.

1. Under **Featr settings**, press . The display shows **Backgrnd music: N**.
2. Press until the display shows **Silent Monitor: Y**.
3. Press **CHANGE** to select **Y** or **N**.
4. Press  to exit or to continue programming.

Refer to the *MICS ICS 6.1 System Coordinator Guide* for information about using the Silent Monitoring feature.

Note: Some market profiles do not allow silent break-ins. In those markets Silent Monitor can be disabled (set to N) or a monitoring tone can be configured.

Direct-dial

Direct-dial allows you to dial a single system-wide digit that can be used to call a specific telephone, called a Direct-dial telephone. The most common example of a Direct-dial telephone would be telephone for an operator, a receptionist, or an attendant.

D-Dial1

For the direct-dial telephone, indicate whether it is an internal or external number. A total of five Direct-dial telephones can be programmed on the system.

Use and **CHANGE** to select the setting: **Intrnl**, **Extrnl**, or **None**.

Intrnl/Extrnl#

Enter the internal or external number that the system will automatically dial when someone enters the direct-dial digit.

Use , **CHANGE**, and the dialpad to enter the telephone number.

The default number for the direct-dial telephone is **221**, on the default three-digit DN system.

Line selection

If you assign an external number as a direct-dial telephone, you must indicate which line to use for the call.

Use , **CHANGE**, and the dialpad to select the line for the external number.



Tips - *There is just one direct-dial digit for the entire system.*

The Norstar system cannot verify that the number you assign as an external direct-dial telephone is valid. Check the number before assigning it, then call the direct-dial telephone after you've assigned it to test it.

You cannot forward calls to any direct-dial telephone that is outside your Norstar system. For more information, refer to the Modular ICS 6.1 System Coordinator Guide.

CAP/KIM assign

Installer password required

This setting designates a telephone as a central answering position (CAP). A maximum of five designated CAPs can be installed in a Modular ICS system. The system can support more CAP configurations that are not designated in programming as CAPs. Refer to the Tips below for information about the difference between OKIMs and eKIMs.

CAPs can be configured as:

- M7324 telephones with attached CAP modules.
- T7316E telephones with attached T24 key indicator modules (KIMs). KIMs that have been designated as CAPs are called eKIMs. The eKIMs can support multiple lines, target lines and Hunt group appearances. A KIM attached to a T7316E telephone, but not assigned with the DN of the telephone under **CAP/KIM assign**, is called an ordinary KIM (OKIM) and is not programmed through the system. The user can configure features from the desktop.

The CAP can be used to:

- monitor the busy/not busy and Do Not Disturb status of Norstar telephones
- answer external calls on up to 120 lines on a CAP and 112 lines on a KIM, and extend calls to other Norstar telephones
- send up to 30 messages to other system telephones
- provide extra memory buttons for M7324 and T7316E telephones

Use , **CHANGE** and the dialpad to enter the internal number of the M7324 or the T7316E telephone.

Press to scroll through the five CAP/KIM positions.



Tips - *A station auxiliary power supply (SAPS) is required for M7324 telephones that have one or more CAP modules attached.*

A SAPs is not required for T7316E telephones with four or fewer KIMs. If the KIMs are designated as eKIMs, you can only attach a maximum of four modules to a T7316E telephone. You must add a SAPS if more than four KIMs are added to the T7316E. Note also that the line loop to the CAP cannot be greater than 304.8 m (1000 feet).

If a CAP module is relocated with the telephone, the settings are retained.

If you replace a M7324 CAP unit with a T7316E-based CAP unit, only the line assignments will be copied to the new telephone, but not to the KIM. The telephone programming will revert to the default settings. If you move an OKIM from one T7316E to another, the KIM will retain memory button programming. However, if you move an eKIM from one T7316E to another, programming will not follow.

Dialing Plan

Installer password required

The dialing plan acts as a system directive that determines how a number will be dialed out by the system. This feature works with enbloc dialing, and, therefore, is only used for PRI lines.

The Dialing Plan has these features:

- allows public or private routing for network calls
- private routing allows the choice of either the uniform dialing plan (UDP) or a coordinated dialing plan (CDP)
- allows enbloc dialing by buffering user-dialed digits until a complete DN has been dialed. Enbloc dialing is the default for PRI. However, you can specify Overlap Dialing

where you require a break in a dialing sequence to wait for a PRI line-generated dialtone.

- provides the ability to map user-dialed digits to a service type on a Call by Call basis
- allows incoming calls to be routed according to the service type and the digits received

DN lengths (enbloc dialing)

The Private DN Length must be set to the number of digits users dial to reach other nodes in a private network. The Private DN Length parameter is used by the PRI trunk to determine when a complete number has been dialed. The PSTN DN Length Table is used by the PRI trunk to determine when a complete PSTN DN has been dialed. Entries in the DN Length table consist of two fields: **Prefix** and **DN Length**.



TIP - *You do not need to use a Private DN Length if you are using the coordinated dialing plan (CDP), as the system identifier is part of the set DN.*

Defining dialing plans:

At **System Prgrming/Dialing Plan**:

1. Press . **Private Network:None** displays.
2. If you are defining a dialing table for a private network, press . Refer to *Private networks* on page 438.

If you are defining a dialing table for external (public) DNs for a network, press . Refer to “Public networks” on page 439.

Private networks

Private network: None

Choosing this setting turns off MICS private network functionality.

1. At **Type:None**, press .

Priv DN len:4 displays.

2. Press **CHANGE** to choose a new private DN length. (3-14)

Private network: CDP

If your dialing plan needs to use steering codes to navigate to other networks, specify a coordinated dialing plan (CDP).

1. At **Type:None**, press **CHANGE** until **CDP** displays.
2. Press . **PrivNet.ID:1** displays.
3. Press **CHANGE**, and enter a new private network id.

Note: If you are specifying a private network that has been created using SL-1 (MCDN) lines, the private network id is part of the set DN (for instance, system A might have DNs from 3201 to 3299, whereas system B might have a DN range starting with 2, such as 2201 to 2299). However, you must enter a number, so enter the number that appears first on the set DNs.

This code is defined by the network coordinator and must be unique to each system.

4. Press . **Priv DN len:3** displays.
5. Press **CHANGE** to choose a new private DN length. (3-14).

Note: The Private DN length must match the DN lengths being used by the other systems in the network. This is what enbloc dialing uses to determine when the complete number has been dialed.

Private network: UDP

If your dialing plan will be using Location codes to navigate to other systems, specify a uniform dialing plan (UDP).

1. At **Type:None**, press **CHANGE** until **UDP** displays.
2. Press . **PrivNetID:1** displays.
3. Press **CHANGE**, and enter a new private network id.
4. Press . **Loc code:None** displays.
5. Press **CHANGE** and use the dialpad to enter a location code.

Note: This code must be unique to your system.

6. Press . **Priv DN len:3** displays.
7. Press **CHANGE** to choose a new private DN length. (3-14)

Note: The Private DN length must match the DN lengths being used by the other systems in the network. This is what enbloc dialing uses to determine when the complete number has been dialed.

Public networks

When you identify public DNs on a network, use the Dialing Rules to define any prefixes that need to be dialed out. The public network refers to connections to the public switching network (PSTN).

1. At **Public Network**, press . **Pub DN lengths** displays.
2. Press . **PrivNetID:1** displays.
3. Press . **Show Prefix:** displays.
4. Press **ADD** and enter a prefix.

5. Press **OK** to accept the prefix.
6. Repeat steps 4 and 5 until all the prefixes have been added.



Tip - *If you want to view the prefix list, at the Show Prfix: display, press .*

*To remove a prefix, find the prefix, then press **REMOVE**.*

Dial Timeout

Dial Timeout (interdigit timeout) specifies how long the ICS will wait between user-dialed digits. This value allows the ICS to determine when the user has stopped dialing. The value is programmed under **System Prgrming, Dialing Plan**.

The user can also use the # key to tell the ICS that they are finished dialing. However, this is not usually required, except for international calls where the number of digits dialed for country codes varies.

With the display showing **System Prgrming**

1. Press then press until **Dialing Plan** displays.
2. Press then press until **Dial timeout** displays.
3. Press **CHANGE** to select a the timeout value (**3, 4, 5, 6, 8, 10, 15**) in seconds.

Too small a timeout value forces the user to enter the digits very quickly, one after the other.

Too large a value causes the system to wait for a long time after the last digit is entered before the call is dialed out.

For more information about non-PRI routing tables and destination codes, refer to *Routing service* on page 379.

Access codes

Installer password required

Access codes are used by the system to direct calls to the correct lines and destinations. If the codes conflict, some of the features on the system will not work.

The table of default settings can help you plan your access codes so there are no conflicts.

Digits assigned by default to settings

Digit	Use	Heading
0	direct-dial digit	Access Codes
1	Park prefix	Access Codes
2	the first digit of B1 DNs	Startup
9	line pool A access code Takes precedence over the External Line access code if there is a conflict.	Access Codes
— —	external line access code	Access Codes
— —	destination code	Routing Services

Line pool codes

Installer password required

This setting allows you to assign a line pool access code for each of the 15 line pools (A to O). These codes are used to specify the line pool you want to use for making an outgoing external call.

If your system is installed without expansion cards, the DN default is two digits. Therefore, B1 DNs will be from 21 to 52 and the B2 DNs are assigned from 53 to 84. The B2 DN range is 80 to 84. Therefore, the single digit 8 is not available for a line pool access code.

Use , **CHANGE**, the dialpad, and **OK** to program the access code.

The default access code is **9** for Line Pool A, and **None** for Line Pool B to O.

For ISDN-PRI line pool settings, see *Line Pools* on page 460.



Tips - *The code can be one to four digits in length.*

A line pool access code can be the same as an external line access code. In this case, the line pool access code takes priority over the external line access code, and a line from the line pool is selected.

A line pool access code cannot conflict with:

- *the Park prefix*
- *the Direct-dial digit*
- *the first digit of any Received number*
- *the first digit of any DN (including the Auto DN or the DISA DN)*
- *the first digit of a destination code.*

To avoid a conflict, refer to the table of default settings in the description of External code.

Park prefix

Installer password required

The Park prefix is the first digit of the call park retrieval code that must be entered to retrieve a parked call. If the Park prefix is set to **None**, calls cannot be parked.

Press **CHANGE** to select the setting: **1** to **9**, **None**, or **0**.



Tips - *The Park prefix cannot be the same as:*

- *the Direct-dial digit*
- *the External Line access code*
- *the first digit of a DN*
- *the first digit of a line pool access code*
- *the first digit of a destination code*

*If DN length is changed, and the changed DNs conflict with the Park prefix, the setting changes to **None**.*



Tips - *Other programmable settings may affect which numbers appear on the display during programming. Although the numbers 0 to 9 are valid Park prefix settings, some may have been already assigned elsewhere by default or by programming changes. To avoid a conflict, refer to the table of default settings in the description of External code. ■*



SWCA note: *If you want to use system wide access (SWCA) keys on your system, you must specify a valid Park Prefix to turn on the feature.*

External code

Installer password required

External code allows you to assign the external line access code. This code is used to allow M7100/T7100 telephones, and telephones connected through Analog Terminal Adapters (ATA2) to access external lines.

Press **CHANGE** to select the setting: 0 to 9, or None.



Tips - *The external line access code cannot conflict with:*

- *the Park prefix*
- *the direct-dial digit*
- *the first digit of a line pool access code*
- *the first digit of a DN*
- *the first digit of a destination code.*

If DN length is changed, and the changed DNs conflict with the Park prefix, the setting changes to None.

Direct-dial

Installer password required

Direct-dial digit allows you to dial a single system-wide digit to call a specific telephone, called a direct-dial telephone, such as a receptionist's station.

Press **CHANGE** to select the setting: 1 to 9, **None**, or **0**.



Tips - *Another direct-dial telephone, an extra-dial telephone, can be assigned for each schedule in Services programming.*

The direct-dial digit cannot be the same as the first digit of:

- a DN
- a line pool access code
- the external line access code
- the Call Park prefix
- the first digit of a destination code

If DN length is changed, and the changed DNs conflict with the Park prefix, the setting changes to None.

Auto DN

Installer password required

For calls answered without DISA, no password is required to access the Norstar system. The Class of Service (COS) that applies to the call is determined by the COS for the trunk on which the user is calling.

1. Use **CHANGE** and the dialpad to enter the digits to be received from the auto-answer trunk.
2. Press **CLR** to set the Auto DN back to **None**.



Tips - *The length of the Auto DN is the same as the Rec'd # length specified in System prgrming. The Auto DN is cleared if the Received number length is changed.*

The Auto DN cannot be the same as a line pool access code or a destination code.

DISA DN

Installer password required

For calls answered with DISA, the system presents a stuttered dial tone to prompt a caller to enter a valid password. The Class of Service (COS) that applies to the call is determined by this COS password.

Once a remote user is on the Norstar system, the DISA DN can be used to change the existing Class of Service. This gives you greater flexibility when you create access privileges. For example, you may want to have a shared DN for remote access and separate COS passwords with different dialing out privileges for individuals.

Use **CHANGE** and the dialpad to enter the digits to be received from the auto-answer trunk.

Press **CLR** to set the DISA DN to None.



Tips - *The length of the DISA DN is the same as the Rec'd # length specified in System Prgrming. The DISA DN is cleared if the Received number length is changed.*

The DISA DN cannot be the same as a line pool access code or a destination code.

PrivAccCode

Installer password required

If you have created a Private or Tandem network, you need to provide a specific code to access the network links.

1. Press **Change** and use the keypad to enter a code.
2. Press **OK** to save the code.

This code must not conflict with any other access code or call code within the system.

Assign this code as the destination code for the private line or line pool that connects to the next node in the network.

Carrier Codes

Installer password required

If you are routing calls with different carriers as you change schedules, you need to be able to define the access codes for each carrier you use.

A multi-digit Carrier Access Code (CAC) contains an Equal Access Identifier Code (EAIC) followed by a Carrier Identification Code (CIC). The CIC identifies the carrier to be used to handle the call. The Carrier Access Code table stores the CAC digit pattern that you define for your region.

In most cases it is not necessary to change the default values. The capability is there to modify overall patterns, if required.

- you can define up to five entries
- two entries will be pre-defined in North America, but you can remove these defaults
- each entry consists of an EAIC prefix (one to six digits) and a CIC length (one digit, 1 - 9)
- each entry is identified by the prefix digits themselves

This code becomes part of the External Number field in Route programming that will be used to access the carrier. Refer to *Adding a long distance carrier access code* on page 393.

1. From the **Access code** menu, press until you reach **Carrier Codes**.
2. Press . **Prfx:10** appears.
3. **Add** or **Remove** prefixes, as you require.
4. Press . **ID length:3** appears.
5. **Change** the length of the prefix, as you require.

This code must not conflict with any other access code or call code within the system.

Remote access

Remote access packages allow you to control the remote use of Norstar line pools. Create a remote access package by defining which of your system line pools will be accessible. You then assign the package to individual lines (using **Rem line access**), and to a particular Class of Service password (**Remote pk9 in COS Passwords**).

Rem access pkgs

Use and the dialpad to select the remote access package you want to program.

LinePool access

Press **CHANGE** to select the line pool access setting for each pool: **N** (No) or **Y** (Yes).

Remote Page

Press **CHANGE** to select the remote paging setting for each pool: **N** (No) or **Y** (Yes).

Rem line access

Enter the number of the line which will be accessible by remote users.

L001 Rem pk9

Press **CHANGE** and enter the number of the remote access package remote users accessing the line will be able to use. Refer to the table below for a list of default settings.

Remote access packages defaults

Parameter	Square	PBX	Hybrid	Centrex	DID
Package 00	Prohibits remote access to line pools, Page, remote monitoring and administration. Cannot be changed.				
Package 01 Line pool access	Y for Pool A N for Pools B to O and PRI-A and PRI-B (as well as PRI-C and PRI-D on systems using Profile 1 or 4).				
Packages 02 - 15 Line pool access	N for Pools A to O and PRI-A and PRI-B (as well as PRI-C and PRI-D on systems using Profile 1 or 4).				



Tips - You can use COPY and the dialpad to copy settings from one remote package to another.

The line pool access display shows an alphabetic line pool identifier, followed by a numeric line pool access code in brackets, for example, PoolA (9)N. If no access code has been identified, there is nothing between the brackets.

For example PoolA ()N.

The line pool access code can be programmed under **Terminals&Sets**.

Remote package 00 is the default setting and cannot be changed.

You can define up to 15 remote access packages (01 to 15).

Changing Companion DN type

Installer password required

This Companion setting is applicable for MICS-XC 6.1 systems.

On startup, the DN default ranges are:

- wired telephones: 221-605
- portables (Companion): 637-666
- ISDN devices: 667-696
BRI S-loops may have more than one DN associated to each loop.

Note that the DN range 637 to 696 can be used by either portable telephones or ISDN S-loops.

- You can assign all 60 of the DNs to portable telephones and none to S-loops.
- You can assign up to 30 DNs to S-loops, leaving 30 for portable telephones.

Within these two limits you can choose a combination of ISDN and portable telephone DNs.

If you try to assign more than 30 ISDN DNs, **Max 30 ISDN DNs** will appear.

Before you change a registered portable telephone DN to an ISDN DN, you must first deregister the number. Refer to *Modular ICS Companion Installer Guide*.



Tips - *When you change an S-loop DN to a portable telephone DN, service could be disrupted on one of the S-loops. If you want to change the DN type while people are using the Norstar system, use the Page feature (), to announce that calls may be disconnected.*

1. Press **CHANGE** to select the DN type setting: **ISDN** or **Portable**.
2. Press **STATE** to show whether the number is: **Assigned**, **Registered**, **Available**, **Pending**, or **In use by system** (currently being used by an ISDN device).

If an ISDN DN is being changed, the display may show **Disrupt service?** Press **No** to leave the value as ISDN, or **Yes** to remove the ISDN DN from use by the system.

Note: If you change an ISDN DN that has a device already assigned, the device will fail. To fix this issue: return the DN to ISDN and unplug and replug the device. For this reason, changing DNs should only be done when the system is not busy.

Rec'd # length

Installer password required

The Received number length setting allows you to change the number of digits received on auto-answer trunks. These digits are used to identify target lines, Auto DNs, and DISA DNs.

Press **CHANGE** to select the setting: 1, 2, **3**, 4, 5, 6, or 7. Then, press to make the change.



Tips - *The target line number (for example, line 052) and the Received number for the target line (for example, Rec'd #: 123 for line 052) are two different numbers.*



Tips - *The Received number length may be the same as the system DN length. However, network or central office constraints may require you to set it to some other value.*

Changing the Received number length causes all programmed received digits to be cleared.

DN length

Installer password required

This feature allows you to change the number of digits for all DNs. The maximum length is seven. The default, and minimum length, is **3**.

1. Press CHANGE to select the setting: **3**, **4**, **5**, **6**, or **7**.
2. Press to save the new DN length.
The display shows **Drop data calls?**.
3. Press YES to save the new DN length.
NO restores the original value.



Tips - *A DN length change, if required, should be the first programming change on a newly-installed Norstar system.*

Each increase in length places the digit 2 in front of any existing DN. For example, if DN 234 was increased to a length of 4, the new DN would be 2234.

*If the DN length is changed so that a conflict is created with the Park prefix, external line access code, direct-dial digit, or any line pool access code, the setting for the prefix or code is changed to **None**, and the corresponding feature is disabled.*



Do not change DN length immediately after a system startup.

You must wait for at least two minutes after a system startup before you change the DN length.

Data devices which use the B2 channel drop calls when the DN length is changed. Norstar telephones and Business Series Terminals retain their calls because they only use the B1 channel.



The DN length change is completed within two minutes, depending on the size of the installed Norstar system. System response may briefly slow down during this time. You cannot re-enter programming during this time. If you enter the programming access code, the message **In use: SYSTEM** appears on the display.

Nat'nl length (profile 2, only)

Installer password required

This feature allows you to change the number of digits that the system will expect to see for a national telephone number.

1. Press CHANGE to select the setting: (default is 10).
2. Press YES to save the new DN length.

Make/Break (profile 2, only)

Installer password required

This feature allows you to change the ratio of your system.

1. Press CHANGE to select the setting to either 40/60 or 30/70.

BusName

Norstar will display the name of the calling party when it is provided both Private or Public ISDN PRI and BRI interfaces. The displayed name may include information such as the Receiving Calling Name, Receiving Redirected Name, and/or Receiving Connected Name. The outgoing name is the business name concatenated with the set name.



Tip - *The outgoing name is not supported on BRI.*

Refer to Feature assignment (CLID alignment) on page 347.

Network Name Display is an optional feature that is available based on the interface to which you are subscribed.

Network name display supported by protocol

Feature	Interface			
	NI PRI	DMS Custom PRI	NI BRI	SL-1
Receiving Calling Name	Supported	Supported	Supported	Supported
Receiving Redirected Name	Supported		Supported	Supported
Receiving Connected Name		Supported		Supported
Sending Calling Party Name	Supported	Supported		Supported
Sending Connected Name		Supported		Supported

Receiving and Sending Calling Party Name

Network name display allows the name of an incoming PRI/ BRI call to be displayed on the Norstar set receiving the call.

- Calling Party Name with status of Private may be displayed on the Called Party telephone as **Private name**.
- If the incoming Calling Name is defined by the CO as a private name, then **Private name** appears on the answering telephone.
- If the Calling Party Name is unavailable, it may be displayed on the Called Party set as **Unknown name**.

- The system supports sending the calling party name, which is the Business Name and Set Name concatenated together, on calls originated by the Norstar system.

For information about programming your Feature assignment, see *Feature assignment (CLID alignment)* on page 347.

The Set Name will only be sent if the OLI for the Set is configured. See *OLI #* on page 333.

Receiving and Sending Connected Name

Outgoing calls record the Connected Name on outgoing calls. The Connected Name is stored and displayed on the Norstar telephone. In order for this to work, you need to set the **Called ID** to Yes. See *Called ID* on page 349.

The system also supports sending the Connected Name, which is the Business and Set Name concatenated together, with incoming calls.

If the call is answered by a hunt group, the hunt group name is used instead of the set name.

The Connected Name is a transient display that appears for about three seconds.

Network Name Display interactions

Calling and Connected Name information (if available) is passed between trunks with Selective Line Redirection (SLR). Only Calling Name information is passed between trunks in cases where Direct System Inward Access (DISA) has resulted in tandeming of trunks.

Programming Network Name Display

The Business Name and the Set Name make up the information that is used for the outgoing Calling name or connected name.

Calling/connected name is only sent once the Business Name is programmed.

To program the Business Name, start with the display showing **System Prgrming**.

1. Press .The display shows **Hunt Groups**.
2. Press until the display shows **BusName:**.
3. Press **CHANGE** and use the keypad to enter a Business Name.

You can enter a maximum of eight letters. It is recommended that you use a blank space for the last character to act as a separator between the Business name and Set name.

To program the Set Name start with the display showing **Terminals & Sets**.

1. Press and enter the set number of the telephone you would like to program.
2. Press . The display shows **Line access**.
3. Press until the display shows **Name:**.
4. Press **CHANGE** and use the keypad to enter a Set Name.
You can enter a maximum of seven letters.
5. Other areas that must also be programmed include:
 - the OLI number, see *OLI #* on page 333
 - under Telco features the Call ID must be set to yes, see *Called ID* on page 349

Outgoing Name and Number Blocking

When activated, blocks the outgoing name and number on a per call basis. When this feature is used, the call is flagged to the CO so that the name and number will not be presented to the person being called.

On analog and BRI trunks, a call blocking digit sequence is sent to the CO before sending the dialout digits. You can change this digit in a Norstar programming session and set it to the digit sequence recognized by the local CO for name and number blocking.

This programming is done in the main program heading **Telco Features**. To program the Name and Number blocking digit, start with the display showing **Telco features**.

Note: Step 1 through 3 are only for analog and BRI trunks.

1. Press . The display shows **UMs9 ctr tel#s**.
2. Press until the display shows **ONN Blocking:**.
3. Press . The display shows **Tone:None**. You can choose **F78, (0-9), *, #**.
4. Press **CHANGE** to enter a new tone dialing Name and Number blocking digit sequence.
5. Press . The display shows **Pulse:None**. You can choose **F78, (0-9), *, #**.
6. Press **CHANGE** to enter a new pulse dialing Name and Number blocking digit sequence.

Call by Call service selection for PRI

Installer password required

Call by Call service selection allows a user to access services or private facilities over a PRI line without the need for dedicated facilities. The different services represent different types of access to the network. Various services are available depending on the chosen protocol. The list below identifies the supported services

Call by Call service selection is supported for the following protocols:

- National ISDN 2 (NI-2)
- DMS-100 custom
- DMS-250 (MCI, Sprint, Generic)
- AT&T 4ESS custom

The following Call by Call Services are supported:

Public	Public calls connect Norstar and a Central Office (CO). Both incoming (DID) and outgoing (DOD) calls are supported. Dialed digits conform to the standard North American dialing plan (E.164 standard).
Foreign Exchange (FX)	Foreign exchange service connects a Norstar site to a remote central office (CO). This provides the equivalent of local service at the remote location.
Tie	Tie lines are private incoming and outgoing lines that connect Private Branch Exchanges (PBXs) such as Norstar.

OUTWATS (Outward Wide Area Telecommu- nications)	This outgoing call service allows a Norstar user to call telephones in a specific geographical area referred to as a zone or band. Typically a flat monthly fee is charged for this service.
INWATS (Inward Wide Area Telecommu- nications)	This long distance service allows a Norstar user to receive calls originating from specified areas without charge to the caller. A toll-free number is assigned to permit reverse billing.
Interna- tional INWATS	An international long distance service that allows a Norstar user to receive international calls originating from specified areas without charge to the caller. A toll-free number is assigned to permit reverse billing.
Switched Digital	This service provides premises-to-premises voice and data transport with call management and monitoring features.
Nine Hun- dred	This service is commonly referred to as fixed charge dialing.
Private	Private incoming and outgoing calls connect Norstar to a virtual private network. Dialed digits may conform to the standard North American dialing plan (E.164 standard) or the dialed digits may use a private dialing plan.

Norstar supported Call by Call Services by protocol

Norstar Service ^a	NI-2 ^f	DMS-100 (custom)	DMS-250 (MCI, Sprint, Generic)	AT&T 4ESS
FX	FX	FX ^b		
Tie ^c	Tie	Tie	Tie	SDN (software defined network)
INWATS	INWATS	INWATS	Eight Hundred	Toll Free MEGACOM
International INWATS	Same as INWATS	Same as INWATS	Same as INWATS	International Toll Free Service
OUTWATS	IntraLATA OUTWATS OUTWATS with bands InterLATA OUTWATS	OUTWATS	PRISM	MEGACOM
Private		DMS Private ^e	VNET (virtual network)	
Switched Digital				ACCUNET ^d
Nine Hundred			Nine Hundred	MultiQuest
Public	Public	Public	Public	

- A shaded box indicates that the protocol does not support the service.
- DMS-250 Sprint and UCS support incoming FX only (i.e. Network-to-Norstar). DMS-250 MCI does not support FX.
- NI-2 allows two Tie operating modes: senderized and cut-through. Norstar will only support senderized mode.
- Rates greater than 64 kbps will not be supported.
- Bell Canada VNET.
- Not all service types may be supported by a switch type. For information, contact your service provider.

Programming Call by Call on PRI requires you to program various areas of the Norstar system:

- under **Line access**, assign the line pool
- under **Services**, in routing services section, assign which pool to use for routing and which service type service id, if required
- under **System programming**, specify the minimum and maximum values for the pools
- under **Hardware** choose PRI card and select the protocol

Line Pools

All lines in a PRI interface are in the same PRI line pool. This pool cannot contain any non-PRI lines. There is one PRI pool available for each PRI interface on the CSU.

Depending on the order that the cards are configured as PRI, Pool PRI-A represents lines 1 to 30, and Pool PRI-B represents lines 31 to 60. If both PRIs are connected to the same service provider and use the same protocol, lines 1 to 30 and 31 to 60 can be put in the same pool. There are four PRI pools available for profile 1 and 4 systems, PRI-A, PRI-B, PRI-C, PRI-D because these profiles support the off-core DTI module.

Programming Call by Call service selection

Programming the Norstar system for Call by Call Service Selection with a PRI interface requires

- provisioning a PRI card if a PRI card is not already a part of the system, on page 483
- selecting a protocol, on page 484
- programming incoming call routing, on page 485
- programming routes that use the PRI pools (under **Services**), see *Routing service* on page 379

PRI Call by Call Limits

PRI pool limits for Call by Call services allows you to configure limits for service types without interacting with the CO. This feature sets the minimum and maximum number of incoming and outgoing calls per service type for the PRI pool.

The number of active calls will be tracked so that whenever a call is being set up, a check will be made to determine if it will be allowed. Calls will not be allowed if they exceed the

maximum value for that service type or if they will use lines needed to maintain the minimum value of other service types.

The summation of the minimum values for incoming or outgoing PRI services cannot exceed the total number of lines in the PRI pool.

The maximum value for an incoming or outgoing PRI service cannot exceed the total number of lines in the PRI pool.

Programming Call by Call Limits

With the card set to **PRI** and the display showing **System Prgrming**.

1. Press . The display shows **Hunt groups**.
2. Press until the display shows **CbC limits**.
3. Press . The display shows the first pool (PRI-A, PRI-B, PRI-C, or PRI-D) that supports CbC routing.
4. Press **NEXT** to show the other pool, if it is available.
5. Press . The display shows **Service:**. The service that is displayed depends upon the protocol.
6. Press **NEXT** to select a different service.
7. Press . If it applies, the display shows **Min incoming:2**.
8. Press **CHANGE** to enter a different number.
9. Press . If it applies, the display shows **Max incoming:23**.
10. Press **CHANGE** to enter a different number.
11. Press . The display shows **Min outgoing:4**.
12. Press **CHANGE** to enter a different number.

13. Press . The display shows **Max outgoing:23**.
14. Press **CHANGE** to enter a different number.

Release Reasons

Installer password required

This feature is useful for diagnostic purposes. It shows the reason why an ISDN call has been released. The Release Reason can be displayed as Simple or Detailed text. When the default **None** is selected, no release reasons appear on the set.

Release Reasons can be programmed under System prgming. With the display showing **System prgming**.

1. Press until the display shows **Release reasons**.
2. Press . The display shows **Text: None**.
3. Select the text to be displayed as **Simple** or **Detailed**.

Note: If you selected Simple text, press for Cause code. The **Cause code** is for diagnostics. Make sure it is set to **N**.

Programming Hospitality Services

The Hospitality heading accesses the settings for the room and alarm information.

With the display showing **System Prgrming** press until the display shows **Hospitality**.

Room/desk information

Use this setting to assign set DNs to a specific room.

1. At the **Hospitality** heading, press .
Room/desk info displays.
2. Press . **Show set: displays**.
3. Enter a room set number or press **LIST** and press until you find the DN of the set you want to assign to a room.
4. Press . **Room #:None** displays.
5. Press **CHANGE** and enter the room number, then press **OK** to accept the change.
6. Repeat step 5 for all the sets you want to assign.
7. Press . **Adm Fwd read:Y** displays
8. Press **CHANGE** and choose **Y** or **N**, depending on your security requirements.

Call restrns

You can set up call restrictions based on room occupancy states. This setting affects the Room occupancy feature.

1. At the **Hospitality** heading, press .
Room/desk info displays.
2. Press . **Call restrns** displays.
3. Press . **Vacant:00** displays.
4. Press **CHANGE** and enter the filter that defines the restrictions for your hospitality system. Refer to *Filters* on page 339
5. Repeat steps 2 and 3 for the other room occupancy states.

The table below shows an example of a call restrictions setup.

Room Occupancy	Filter	Description
Vacant	11	no calls allowed except 911
Basic	11	no calls allowed except 911 and internal extensions
Mid	12	no calls allowed except 911, 1800, 188 and internal extensions
Full	13	no call restrictions

Setting Service times

You can set the time when occupied rooms change from Service done to Service required. This setting affects the Room condition feature.

1. At the **HOSPITALITY** heading, press .
Room/desk info displays.
2. Press until **Service time** displays.
3. Press . **Hour: 00** displays.
4. Press **CHANGE** and enter the hour (00 to 23).

If the number is less than 13, the display shows **AM**. Press **CHANGE** to select **PM**, if required. Press **OK** to accept.

5. Press . **Minutes: 00** displays.
6. Press **CHANGE** and enter the minutes (00 to 59).

Configuring alarms and expired alarms settings

Use this feature to create the alarm settings that will govern the alarm features for both the administrative and room sets.

1. At the **HOSPITALITY** heading, press .
Room/desk info displays.
2. Press until **Alarm** displays.
3. Press . **Attn attempts:3** displays.
4. Press **CHANGE** until you find the number you want (1-5).
5. Press . **Retry intrvl:4** displays.
6. Press **CHANGE** until you find the number you want (2, 4, 6, or 8).
7. Press . **Attn duration: 15** displays.

8. Press **CHANGE** until you find the number of seconds you want (10, 15, 20, 30, 40, 50).
9. Press . **Time format:12 hr** displays.
10. Press **CHANGE** to choose either **12hr** or **24hr**.
11. Press . **Expired alarms** displays.
12. Press . **Notify set:None** displays.
13. Press **CHANGE** to enter a set DN to be notified.
14. Press . **Use tone:N** displays.
15. Press **CHANGE** to choose either **Y** (yes) or **N** (no).

SM sets

You can assign a maximum of 30 two-line display telephones to act as silent monitor telephones. These are the only telephones from which you can monitor Hunt group members with the silent monitoring feature.

1. At the System prgrming prompt, press until **SM sets:** displays.
2. Press **CHANGE** and enter the number of silent monitor telephones you want on your system. (Default: 5)

Network Services

The headings that appear under Network Services, depends on which profile the system is running.

Profiles 2 allows ETSI line connections, therefore, systems running this profile may have access to the two ETSI features. The service provided on the line by your service provider determines if these features are available.

Profiles 1, 2, and 4 support MCDN over PRI SL-1 lines.

ETSI: Network diversion and MCID^{installer password required}

Note: Profile 2, only.

If you are using Profile 2 for your system, and your service provider supports the features, you can configure your ETSI PRI lines to allow network diversion and/or MCID recording.

To program these features:

1. With the display showing **System Programming** press until the display shows **Network Services**.
2. Press . **ETSI** displays.
3. Press . **Network Redirection** displays.
4. Press **CHANGE** to choose either **Y** (yes) or **N** (no).
5. Press . The display shows **MCID**.
6. Press **CHANGE** to choose either **Y** (yes) or **N** (no).

Network Call Diversion

Norstar Network Call Diversion (NCD) is a network function that allows forwarding and redirection of calls outside the Norstar network when using an ETSI ISDN line. Functionality is similar to that of External Call Forward (ECF).

NCD redirects calls using the same line on which they arrive. Call forward is efficient since there is no need for additional outside lines.

Forwarding calls externally from an extension requires the user to enter either a Destination Code or Line Pool Access Code, and the number to which calls will be forwarded.

Examples of NCD include:

- redirecting all calls from an extension to a mobile phone
- forwarding calls to an external destination (rather than to voicemail), when an extension is busy or the user is unavailable.

Feature description

NCD is available only over ETSI ISDN lines. It can be invoked when calls are presented to Norstar/BST extensions over ISDN lines. The user must program the selected extension.

NCD is integrated with the following existing Norstar Call Forward features:

- Call Forward Unconditional (CFU)—implemented on Norstar Call Forward All Calls (CFAC) 4, and Selective Line Redirection (SLR) 8 4, also referred to as Line Redirection. This is programmable by the user.

- Call Forward on Busy (CFB)—implemented on Norstar Call Forward Busy.
- Call Forward on No Response (CFNR)—implemented on Norstar Call Forward No Answer.

Programming and restrictions

NCD features are accessed through existing Norstar features. Extensions requiring redirection must be programmed individually to either CFAC or SLR. CFB or CFNA must be set during programming. **Allow redirect** must be set to **Yes** for each extension, in **Terminals&Extns/Capabilities**.

Note: Any other programming applied to specific lines and extensions take precedence, for example **Restrictions(extns)** under **Terminals&Extns**.

NCD is used as long as the affected lines are ETSI ISDN, and the affected DID lines are accessible via ISDN lines. Incoming calls are diverted back to the ISDN. If NCD fails due to network errors, ECF is invoked. If ECF cannot be executed, the incoming call is routed to the prime extension for the line.

ATTENTION!

If a line is configured to appear on several extensions with redirection programmed, predicting which extension will divert the call is not possible. This should be considered during system configuration.

An extension with CFB, CFNA and CFAC programmed will give priority to CFAC for diversion.

Selective Line Redirection

Selective Line Redirection (SLR), also referred to as Line Redirection, is enhanced for use with digital lines and operates in conjunction with NCD.

Diversion by SLR takes precedence over diversion by CFAC. An SLR line cannot be diverted by CFAC. If the call arrives on an extension with SLR programmed, a ring splash will sound (if programmed).

For information on SLR restrictions refer to *Malicious call identification (MCID)* on page 471. For information on redirecting lines see Line Redirection in the *Modular ICS System Coordinator Guide*.





Programming Extensions

The User Interface for programming NCD is the same as for ECF.

Different types of Call Forward are available depending on the extension being programmed. Programming an extension to forward calls externally requires the user to enter a destination code or line pool number, in addition to the external phone number. Therefore, care should be taken to identify your network line types and record the available codes and line pools.

Enhanced Caller ID

When a Norstar/BST extension which has Call Line Identifier (CLID) active receives a redirected call due to NCD, the user will see the DN for the Calling Number. This is followed by an arrow icon (>) and the redirecting number. This is displayed for as long as the call is active (alerting or answered) at that telephone.

If the alerting extension is not the CLID extension for that line, the line appearance can be pressed to briefly display the information. Pressing     or **INFO** while the call is active invokes Call Info. Call Info on DPNSS displays the redirecting number and the reason for the redirection.

Note: When Norstar requests that an incoming call be redirected by the distance network, Norstar does not inform the network of the redirecting DN. In this case, the diverted-to party will not see the diverting party DN.

Malicious call identification (MCID)

The MCID feature allows the user to press to have call information recorded on the central office system for an incoming call on a specific line (ETSI PRI lines, only).

The user must invoke the feature code either during the active call or within 30 seconds (time varies on different networks) after the caller hangs up. The feature will not work once the called party hangs up.

Note: This feature must be allowed in network programming for your PRI lines from your service provider.

The following information registers on the network:

- called party number
- calling party number
- local time and date of the invocation in the network serving the called user
- service provider option: calling party subaddress, if provided by calling user)

MCDN services (profiles 1, 2, 4)

Installer password required

If your system is part of a private network using PRI SL-1 lines, you can determine the MCDN features that will be allowed by your system. These settings are described in detail in the networking section of this book. Refer to *MCDN trunk call features* on page 141.

- TRO: Trunk Route Optimization
- ICCL: ISDN Call Connection Limitation
- TAT: Trunk Anti-Tromboning

To program these features:

1. With the display showing **System Prgrming** press until the display shows **NetworkServices**.
2. Press . **ETSI** displays.
3. Press . **MCDN** displays.
4. Press . **NetwkICCL** displays.
5. Press **CHANGE** to choose either **Y** (yes) or **N** (no).
Default is No.
6. Press . **TRO** displays.
7. Press **CHANGE** to choose either **Y** (yes) or **N** (no).
Default is No.
8. Press . **TAT** displays.
9. Press **CHANGE** to choose either **Y** (yes) or **N** (no).
Default is No.

Note: TRO and TAT cannot both be set to Y, as TAT will not work if TRO is active.

Note: If you set NetwkICCL to yes, check the Max transits settings under ~~Hardware~~ to confirm the threshold at which you want the system to release the call rather than to continue cycling. Refer to “Max transits” on page 492.

Telco features

Currently the two features accessed under this heading are the settings for the voice mail connections for your system, and how to set up outgoing name and number blocking (ONN).

With the display showing **System Prgrming** press until the display shows **Telco features**.

VMsg ctr tel#s

If you subscribe to a voice message service outside of your local system, you can access it through your Norstar system. This includes centralized voice mail that is installed on another system within the private network to which your system is connected. Refer to *Central voice mail and Auto Attendant with Norstar* on page 156.

This setting specifies the external telephone numbers that are dialed by the Message feature to retrieve voice messages.

1. At the **Telco Features** prompt, press . **Vmsg ctr tel#** displays.
2. Press . **VMsg center 1** displays.
3. Press . **Use: Line** displays.
4. Press **CHANGE** to select either **Line** or **Routing tbl**.



Tip - *If you choose **Routing tbl**, you must ensure that this number contains the routing code, and that the number is entered in the routing table and routed to the correct line pool.*

5. Press . **Tel#: No number** displays.

6. Press **CHANGE** and enter the telephone number for the voice message system.
7. Press to move up a level.
8. Press to move to the next Voice message center.
9. Repeat steps 3 to 8 for however many voice message centers you want to enter.



Tips - *A telephone does not show that external voice messages are waiting unless Ext1 VMs9 set is set to Y (Yes). The setting is in CLASS assignment under Terminals&Sets.*

You can program up to five voice message center numbers, but most systems require only one.

Outgoing Name and Number Blocking

Outgoing Name and Number blocking blocks the outgoing name and number on a per call basis when the user presses

ONN blocking is cancelled with

When this feature is used, the call is flagged to the CO so that the name and number will not be presented to the person being called. Refer to *Outgoing Name and Number Blocking* on page 456 for more information.

1. At the **Telco Features** prompt, press .
ONN blocking displays.

Programming the analog vertical service code (VSC)

1. Press . **Analog VSC** displays.
2. Press . **Tone:None** displays.
3. Press **CHANGE** to enter a new tone dialing Name and Number blocking VSC.

The VSC for tone trunks can include a maximum of 10 digits consisting of the CO Pause (), and digits 0-9, *, and #.

4. Press . **Pulse:None** displays.
5. Press **CHANGE** to enter a new pulse dialing Name and Number blocking VSC.

The VSC for pulse trunks can include a maximum of 10 digits consisting of the digits 0-9. Pulse trunks do not support , * or #. The * is represented by 11 (two consecutive ones).

Programming the BRI VSC

1. Press until **BRI VSC** displays.
2. Press . **Code:None** displays.
3. Press **CHANGE** and enter a new BRI name and number blocking VSC. This entry can be up to 10 digits, consisting of CO Pause (), digits 0-9, *, or #.

Setting up the modules for ONN blocking

To utilize ONN blocking, the CO is alerted by two methods, either the Vertical Service Code (VSC) or the suppression bit method. Each method depends on the type of trunk involved in placing the outgoing call.

Analog trunks use a dialing digit sequence called VSC. Most COs use the suppression bit method for ONN. You will need to use the VSC ONN if your CO does not support the suppression bit method. The VSC differs from region to region and must be programmed.

- Analog trunks with both tone and pulse dialing trunks can have separate VSCs.
- BRI trunks support one VSC.
- PRI trunks do not utilize the VSC.

The second method used to alert the CO is by a suppression bit packaged within the call setup message. BRI trunks can use either method.

Note: PRI trunks only support the suppression bit method of signalling the CO to block the outgoing Name and Number to the calling party, therefore, no additional programming is required.

When you program ONN blocking on a BRI module, you must indicate which method the BRI trunk will use. The module loop setting supports two ONN states. You must program the BRI loop to match the method supported by your service provider.

- If `SrvcCode` is programmed, then the VSC programmed under `Telco Features` is used.
- If `SuprsBit` is programmed, then the suppression bit will be packaged in the call setup message.

Program ONN blocking BRI loop state

The display shows the loops found on the BRI card.

1. Press to display the settings for individual loops on a BRI card.
2. At the **LOOPS** display, press next to display the first loop number.
3. Press . **Type:T** displays.
4. Press until **ONNblk:SuprsBit** displays.
5. Press **CHANGE** to toggle the BRI loop state setting from **SuperBit** to **SrvcCode**.
6. Repeat these steps to program ONN blocking BRI loop state for other loops, as required.

ONN call blocking notes:

- Set, line and set/line restrictions have no effect on digits programmed within the ONN feature code.
- Call back from the CO is disallowed with this feature.

Software keys

Some of the MICS system features require special pass codes, called software keys, to make the feature work. This section describes each of these options. To obtain the required Software key, call the Integrated Voice Response (IVR) Center at: **1-800-4NORTEL (667835)**, then use Express Routing Code **1599**.

ISDN-PRI

A software key is required so that you can configure a DTI card as a PRI card for Profiles 1, 3 and 4.

Not PRI software key is required for Profile 2 PRI lines.

MCDN

To create a private network using MCDN or tandem linking, you need a PRI key and a key specific to MCDN.

Not PRI software key is required for Profile 2 PRI lines.

Companion (MICS-XC only)

Software keys are used to activate Companion components on systems running the MICS-XC 6.1 software. See the *Modular ICS Companion Installer Guide* for more information.

You will need to provide the following information:

- the System ID of the Norstar ICS
- the authorization number printed on the Bandwidth Allocation License Instruction Sheet
- the number of Directory numbers (DNs) configured in the system
- the number of lines configured in the system



Re-entering software keys.

Should the system be powered down for 72 hours or more, you will need to obtain and enter new software keys.

System Identification Number

Obtain the System ID (SysID) by pressing

* * S Y S I D , or * * 7 9 7 4 3

on any system programming telephone.

This information is also available by accessing **Software keys** in an Installer programming session:

1. Press The display reads **SysID:** followed by the unique System Identification Number.
2. Press to continue in **Software keys** or to exit.
3. Record the SysID in the Modular ICS *Programming Record*.

Call the Nortel Customer Response Center

1. Call the number given in the description of the software key you need.
2. Follow the voice prompts.
3. You will be given three separate numeric strings that contain eight digits each.
4. Record the Password keys in the Modular ICS *Programming Record*.

Entering the software keys

Keys are entered by accessing **Software keys** in a programming session.

1. Press . The display reads **SysID:**.
2. Press . The display reads **Password keys.**
3. Press . The display reads **Key 1:..**
4. Enter the eight-digit password number for Key 1.
Use **BACKSP** to make corrections. The display reads **Key 2:..**
5. Enter the eight-digit password number for Key 2.
6. Proceed as above until you have finished entering Key 3.
The display reads **Entry successful.**
7. Press until the display reads **Software keys**
or press to exit.

Note: If the entry is unsuccessful, the display shows **Invalid password.** If this happens, re-enter the code or call Nortel Customer Response Center at 1-800-4-NORTEL (667835) for assistance.

Hardware

Hardware is where you view and change settings for cartridges installed in the ICS, Trunk Modules, Station Modules, and Data Modules.

Show module

Installer password required

The Show module setting automatically displays the modules connected to the system. Press to select the setting: **KSU, Mod 03, Mod 04, Mod 05, Mod 06, Mod 07, Mod 08.**

Note: MICS-XC has 14 modules.

Cards on KSU

Installer password required

The Cards on KSU setting allows you to specify the type of Trunk Cartridges in the ICS.

Press to select the setting: **T1, PRI, BRI-U4, BRI-U2, BRI-ST, E&M, DID, or LOOP.**

Note: KSU is also known as the Integrated Communication System (ICS).

- **LOOP** is the default setting used for Loop Start and Call Information (CI) Trunk Cartridges.
- Select the **T1** or **PRI** setting for DTIs cards.



Tips - *You cannot change this setting unless you first disable the Trunk Cartridge using **Module status** in Maintenance.*

*Remember to enable the Trunk Cartridge once you have completed programming. See **Module status** on page 521 for details. The Trunk Cartridge slots in the ICS are numbered from right to left.*

Once you specify the type of Trunk Cartridge in the ICS slot, press to display the range of line numbers for the lines on the Trunk Cartridge.

Provisioning the DTI card for PRI

The **Cards on KSU** setting allows you to specify the type of Trunk Cards in the ICS.

Note: Remember, you require a software password to activate PRI on your system.

Start with the display showing **Hardware**.

1. Press . The display shows **Show module**.
2. Press . The display shows **Cards on KSU**.
3. Press . The display shows **Cd1-KSU:**
4. Press **CHANGE** to view the different cards: **Loop**, **T1**, **PRI**, **BRI-U4**, **BRI-U2**, or **BRI-ST**.
5. Select **PRI**. The display shows **Clear line data**.
6. Select **Y (Yes)** to confirm your selection.

For more information about provisioning cards see *Hardware* on page 482.

Selecting a protocol

Now that the DTI card has been provisioned as PRI (or is already part of the system) you can select a protocol.

With the display showing **PRI**

1. Press .
2. Press until the display shows **Protocol:**.
3. Press **CHANGE** to select a different protocol from the table that follows:

Protocol	Type
NI-2, DMS100, DMS250, AT&T4ESS	Public
SL-1	Private Note: This will not display unless you have entered the MCDN software code.

If you selected the **NI-2 Protocol**, and you are using call-by-call services, you must specify how Norstar should handle the NSF (Network Specific Facilities) information element as follows:

- Press .
- Press until the display shows **the default protocol NSF EXT: None**.
- Press **CHANGE** to select another setting, based on your switch type, as shown in the following table:

Central Office	NSF Extension Setting
DMS100	None
Siemens ESWD, Lucent 5ESS	WATS
GTD5, DMS10	ALL

The Network Specific Facilities (NSF) information element is used to request a particular service from the network.

- When you select **NONE**, the NSF extension bit is not set for any service.
 - When you select **WATS**, the NSF extension bit is set for unbanded **OUTWATS** calls.
 - When you select **ALL**, the NSF extension is always set for all CbC services.
-

4. Press . If the display shows **Clear Routes**, press **Y** (yes) to confirm your selection.

BchanSeq

B-channel sequence allows you to select either **ascending** or **descending**. You need to choose the opposite setting of your service provider.

However, if all lines for two DTI cards (configured as PRI) are in the same PRI pool, then both cards must be set to use the descending B-channel sequence mode. As a result, the service provider must use ascending mode

Press **CHANGE** to select either **ascending** or **descending**.

Call-by-call routing

By default, incoming calls are routed based on the Called Party Number. You program the received number length to include however many digits your system requires. This many digits from the end of the called party number are then used as Received Digits to find a target line.

For example, the incoming calling party number is 800-555-1234. The received digit number length is 4. Therefore, 1234 is used to route the call.

Depending on the protocol and the service, alternate routing maps may be defined.

To change the incoming call routing for a service, with the display showing **Protocol:**, do the following:

1. Press until the display shows **CbC Routing**.
2. Press . The display shows **FX:**.
3. Press **NEXT** to display a different service.

Note: The display shows the first applicable service for the given protocol, in this example the service is **FX**.

4. Press **CHANGE** to change the mapping that is applied to incoming calls of this service type to obtain the received digits. In all cases, the received digits are used to find a target line or to activate Remote Access.

None — No mapping is applied. The received number length determines the number of digits of the Called Party Number which will be used as received digits.

If there is no called party number, which may occur with some FX calls, the call will ring at the incoming trunk Prime set.

All — Allows you to define the received digits used for all calls with this service type, regardless of the called party number or service identifier (SID). For this option, all calls with this service type on this PRI will ring the same target line.

Map table — Allows you to associate different received digits with different calls of this service type, depending on the call party number and/or the service identifier. Incoming calls that do not match any entry defined in the map table will ring at the prime set. Depending on the service type and the protocol, you may be able to map the called party number and the service identifier.

The following table shows the different options.

Protocol	FX	Service			
		800	I-800	SDS	900
NI-2	SID	CDN	n/a	n/a	n/a
DMS-100	SID	SID or CDN	n/a	n/a	n/a
DMS-250	SID	SID or CDN	n/a	n/a	SID or CDN
4ESS	n/a	CDN	CDN	CDN	CDN

Discon timer

Disconnect timer allows you to specify the duration of an Open Switch Interval (OSI) before a call on a supervised external line is considered disconnected.

Press **CHANGE** to select the setting: **60**, **100**, **260**, **460**, or **600** milliseconds.



Tips - *Disconnect Supervision is assigned to each line with the Trunk mode setting. See Trunk/Line data on page 351.*

This setting must match the setting for the line at the central office (CO).

This setting only appears for DTI (T1) and Loop Trunk Cartridges.

Answer timer

Answer timer allows you to set the minimum duration of an answer signal before a call is considered to be answered.

Press **CHANGE** to select the setting: **1**, **2**, **3**, **4** or **5** seconds.

Note: This setting only appears for DTI (T1) and E&M Trunk Cartridges.

CO fail

Select the carrier failure standard used by your T1 or PRI service provider.

Press **CHANGE** to select the setting: **TIA-547A** or **TR62411**.



Tips - *This setting only appears for DTIs.*

Consult your T1 or PRI service provider for the proper setting.

I/F levels

Interface levels defaults to the ISDN loss plan setting.

Press **CHANGE** to select setting: **ISDN**, **PSTN** or **ISDN/TT** interface levels.



Tips - *Find out if your Norstar system is connected to a central office (CO) with digital network loss treatment (ISDN I/F levels) or analog network loss treatment (PSTN I/F levels) by checking with your telecommunications service provider.*

The ISDN setting requires digital access lines (DAL) that have digital network loss treatment. On a DAL network, it is the PBX that administers the dB loss. DALs may have ISDN signaling or digital (such as T1 and so on) signaling. To have DAL network loss treatment on a line with digital signaling, you must contact your service provider.

The PSTN setting requires analog access lines (AAL) that have analog network loss treatment and digital signaling. On an AAL network, the CO administers the dB loss.



Tips - *The ISD/TT setting is only for T1 and PRI interfaces (MCI services only). ISD/TT provides a loss level that is similar to DAL except for certain analog connections where the DB level increases by three.*

Each loss plan uses a transmit objective loudness rating of -46 dB. The ISDN and ISD/TT loss plan uses a receive objective loudness rating (ROLR) of 51dB and the PSTN loss plan uses a ROLR of 48 dB.

Choosing the wrong setting may affect voice quality.

Framing

Framing allows you to select the framing format used by your T1 or PRI service provider.

Press **CHANGE** to select the setting: **ESF** (Extended Superframe) or **SF** (Superframe).



You must disable the Trunk Cartridge using Module status in Maintenance before you can change this setting. See Module status on page 521 for details.



Tips - *This setting only appears for DTIs. Consult your T1 or PRI service provider for the proper setting.*

SF or Superframe is sometimes known as D4.

Internal CSU

Internal CSU allows you to turn the internal T1 channel service unit on or off. The channel service unit gathers performance statistics for your T1 lines or PRI with public interface.

Press **CHANGE** to select the setting: **On** or **Off**.



You must disable the Trunk Cartridge using Module status in Maintenance before you can change this setting. See Module status on page 521 for details.



Tips - *This setting only appears for DTIs. Consult your service provider for the proper settings.*

You can view the performance statistics for your T1 lines in Maintenance under the CSU stats heading.

If you use an external CSU with your T1 lines, then set the internal CSU to off.

CSU line bld

CSU line build allows you to set the gain level of the transmitted signal.

Press **CHANGE** to select the setting: **0**, **7.5** or **15** dB.



You must disable the Trunk Cartridge using Module status in Maintenance before you can change this setting. See Module status on page 521 for details.



Tips - *This setting only appears for DTIs that have the internal CSU turned on.*

Line coding

Select the standard used by your T1 service provider for encoding signals on the T1 lines.

Press **CHANGE** to select the setting: **B8ZS** or **AMI**.



You must disable the Trunk Cartridge using **Module status** in **Maintenance** before you can change this setting. See *Module status* on page 521 for details.



Tips - *This setting only appears for DTIs.*

Consult your T1 service provider for the proper setting.



Enable Trunk Cartridges

If you disable any Trunk Cartridges to perform programming, enable them now using **Module status** in **Maintenance** or your system will not function properly. See *Module status* on page 521 for information about enabling Trunk Cartridges in **Module status**.

ClockSrc

Clock Source allows you to designate which of the system Digital Trunk Interfaces (DTIs) obtains the timing reference from the network, which the system synchronizes to. For more about Clock Source settings, see page 504.

Max transits

If you allow ISDN Call Connection Limitation (ICCL) on your MCDN PRI system, you need to determine a threshold at which the system will release the call, rather than allow continued line tieups. This threshold is called Max(imum) transits. The default value for this feature is 31.

Modules

Installer password required

The **Mod** setting allows you to specify the type of module you wish to configure.



Tip - *MICS-XC can have up to 14 modules. Other MICS configurations have up to 8.*

Press **CHANGE** to select the setting: **StnMod**, **ASM**, **TrunkMod** or **DataMod**.

Note: ASM is the same as AEM, the analog station module.

StnMod

If a Station Module is selected and connected to the Modular ICS, no extra programming is required. Each Station Module represents 16 new DNs. For more information about lines and DNs used by the Station Module, see *Wiring charts* on page 252.

ASM

If an Analog Station Module is selected and connected to the Modular ICS, no extra programming is required.

The module defaults to:

- two extension lines are assigned
- Full handsfree is disabled
- handsfree is enabled
- all exchange lines are assigned to Ring
- Answer Keys cannot be assigned to the AEM
- allow Redirect

To verify the status of the module:

1. Navigate to **Maintenance** and **Module Status**.
Show module: displays.
2. Enter the module number you want to verify.
8 extns on EM displays.
3. Press **STATE**.
"x" sets busy displays

To verify the status of each port:

1. Navigate to **Maintenance** and **Port/Extn stat**.
Show Port: displays.
2. Enter the port number you want to verify.
The display shows the port number.

TrunkMod

TrunkMod setting allows you to configure the Trunk Cartridges in the Trunk Module.

Press **CHANGE** to select the setting: **LOOP**, **E&M**, **DID**, **BRI-ST**, **BRI-U2**, **BRI-U4** or **PRI**.

Loop is the default setting used for Loop start and Call Information (CI) Trunk Cartridges.



Tips - *You cannot change this setting unless you first disable the Trunk Cartridge using **Module status** in **Maintenance**. Remember to enable the Trunk Cartridge once you have completed programming. See **Module status** on page 521 for details.*

The Trunk Cartridge slots in the Module are numbered from left to right. Trunk Modules are numbered 3 to 4 for a midi, 3 to 8 for a maxi and a mega system.

Depending on your system configuration, off-core DTI, PRI, BRI-ST, BRI-U2, and BRI-U4 cards can only reside in certain trunk modules. In a midi system, the cards must be in trunk modules 3 or 4. In a maxi or mega system, the cards must be in trunk modules 7 or 8. The cards can reside in the ICS regardless of system size.

Once you specify the type of Trunk Cartridge in the ICS slot, press **SHOW** to display the line number range for the lines on the Trunk Cartridge.



TIP - *If you upgraded your system from a version previous to 6.0, note the line numbering changes, particularly for profile 2, from your previous system. Line number changes were introduced in version 6.0 software.*

Midi line number chart

Line numbers								
Midi	Loop	ST	U-2	U-4 (prfl 1)	DTI (PRI SL1- N12)	DTI (T1) (prfl 1)	E&M	DID (prfl1)
Cd1 ICS Mod 2	1-4	1-8	1-4	1-8	1-23 (prfl 1) 1-30 (prfl 2)	1-24	NA	NA
Cd2 ICS Mod 2	31-34	31-38	31-34	31-38	31-53 (prfl 1) 31-60 (prfl 2)	31-54	NA	NA
Cd1 Mod 04	61-64	61-68	61-64	61-68	61-83 (prfl 1)	61-84	61-64	61-64
Cd2 Mod 04	69-72	69-76	69-72	69-76	NA	NA	69-72	69-72
Cd3 Mod 04	77-80	77-84	77-80	77-84	NA	NA	77-80	77-80
Cd1 Mod 03	85-88	85-92	85-88	85-92	85-107 (prfl 1)	85-108 (prfl 1)	85-88	85-88
Cd2 Mod 03	93-96	93- 100	93-96	93-100	NA	NA	93-96	93-96
Cd3 Mod 03	101- 104	101- 108	101- 104	101- 108	NA	NA	101- 104	101- 104

Target lines: 157-284

Note: Off-core DTI uses line numbers for all three card positions in whichever module (3 or 4) it is installed in.

Maxi/Mega line number chart

Line numbers								
Maxi/ Mega	Loop	ST	U-2	U-4 (prfl 1)	DTI (PRI SL1-N12)	DTI (T1) (prfl 1)	E&M	DID
Cd1 ICS Mod 2	1-4	1-8	1-4	1-8	1-23 (prfl 1) 1-30 (prfl 2)	1-24	NA	NA
Cd2 ICS Mod 2	31-34	31-38	31-34	31-38	31-53 (prfl 1) 31-60 (prfl 2)	31-54	NA	NA
Cd1 Mod 08	61-64	61-68	61-64	61-68	61-83 (prfl 1)	61-84	61-64	61-64 (prfl 1)
Cd2 Mod 08	69-72	69-76	69-72	69-76	NA	NA	69-72	69-72 (prfl 1)
Cd3 Mod 08	77-80	77-84	77-80	77-84	NA	NA	77-80	77-80 (prfl 1)
Cd1 Mod 07	85-88	85-92	85-88	85-92	85-107 (prfl 1)	85-108 (prfl 1)	85-88	85-88 (prfl 1)
Cd2 Mod 07	93-96	93- 100	93-96	93-100	NA	NA	93-96	93-96 (prfl 1)
Cd3 Mod 07	101- 104	101- 108	101- 104	101- 108	NA	NA	101- 104	101- 104 (prfl 1)
Cd1 Mod 06	109- 112	NA	NA	NA	NA	NA	109- 112	109- 112
Cd2 Mod 06	113- 116	NA	NA	NA	NA	NA	113- 116	113- 116
Cd3 Mod 06	117- 120	NA	NA	NA	NA	NA	117- 120	117- 120
Cd1 Mod 05	121- 124	NA	NA	NA	NA	NA	121- 124	121- 124
Cd2 Mod 05	125- 128	NA	NA	NA	NA	NA	125- 128	125- 128

Maxi/Mega line number chart (Continued)

Line numbers								
Maxi/ Mega	Loop	ST	U-2	U-4 (prfl 1)	DTI (PRI SL1-N12)	DTI (T1) (prfl 1)	E&M	DID
Cd3 Mod 05	129- 132	NA	NA	NA	NA	NA	129- 132	129- 132
Cd1 Mod 04	133- 136	NA	NA	NA	NA	NA	133- 136	133- 136
Cd2 Mod 04	137- 140	NA	NA	NA	NA	NA	137- 140	137- 140
Cd3 Mod 04	141- 144	NA	NA	NA	NA	NA	141- 144	141- 144
Cd1 Mod 03	145- 148	NA	NA	NA	NA	NA	145- 148	145- 148
Cd2 Mod 03	149- 152	NA	NA	NA	NA	NA	149- 152	149- 152
Cd3 Mod 03	153- 156	NA	NA	NA	NA	NA	153- 156	153- 156

Target lines: 157-284 (expanded: 157-348)

Note: Off-core DTI uses line numbers for all three card positions in whichever module (7 or 8) it is installed in.

BRI card

Installer password required

Loop

The display shows the loops found on the BRI card.

Press to display the settings for individual loops on a BRI card.

Type

Press **CHANGE** to select the loop type.

- If the card type is BRI-ST, the loop type can be **S**, or **T**.
- If the card type is BRI-U2 or BRI-U4, the loop type can be **LT** or **NT**.



The BRI card must be disabled in **Module status** before this setting can be changed.
You can change the setting if the card has not yet been installed in the ICS slot.

Lines

There are two lines for each T or NT loop.

Loop	Default lines
201	001-002
202	003-004
203	005-006
204	007-008
225 (profile 1, 3 and 4); 231 (profile 2)	031-032
226 (profile 1, 3 and 4); 232 (profile 2)	033-034
227 (profile 1, 3 and 4); 233 (profile 2)	035-036
228 (profile 1, 3 and 4); 234 (profile 2)	037-038

No SPIDs assigned

T and NT loops can be assigned a system profile identifier (SPID) as supplied by your service provider. No SPIDs are assigned by default.

When the loop type is T, calls on the loop are handled for a network connection only. If any other ISDN equipment is connected to the loop, it must be configured as an S loop to ensure proper call handling.

1. Press **ADD** and enter the first or second SPID assigned to the loop.
If there are two SPIDs already assigned to the loop, **ADD** will not appear until one is removed.
2. Press **REMOVE** to clear a SPID.

Note: Profile 2 loops do not require SPIDs.

of B-channels

Press **CHANGE** to select the number of B-channels that are associated with the SPID: 1 or 2.

When you order an ISDN capability package that supplies two B-channels, you may receive one or two SPIDs from your service provider.

- If you receive one, it usually means you will configure the SPID to use two B-channels.
- If you receive two, it usually means you will configure each SPID with one B-channel. Check with your service provider if you are not sure about the proper configuration.

Network DNs

1. Press to display the DNs which are used with the SPID.
2. Press **ADD** and enter the appropriate number to assign additional Network DNs to the SPID.

The Modular ICS can have a maximum of 128 Network DNs for the system. There is no limit to the number of Network DNs for each SPID, but you cannot exceed the limit of 128 Network DNs for the system.

If the Network DN you try to enter is already assigned to a SPID with a call type of Both, you will not be able to assign the DN again.

If the Network DN you enter is already assigned to a SPID and the call type is Voice or Data, it will be automatically programmed with the unused call type. For example, if the DN has Call type set to Voice in the previous SPID assignment, it will be automatically set to handle Data calls when the same DN is added to the other SPID.

Call type

Press **CHANGE** to select the call type of the Network DN: **Voice**, **Data**, or **Both**.

CHANGE will not appear if the Network DN is already in use by the system and the call type will be automatically programmed with the unused call type. For example, if the DN has Call type set to **Voice** in a previous SPID assignment, it will be automatically set to handle Data calls when the DN is entered the second time.



Tips - *If our service provider does not specify the call type for each Network DN, it is probably available for both voice and data. Check with your service provider if you are not certain about the proper configuration.*

D-packet service

1. Press to view and program D-packet service for T or NT loops. You can have two D-packet service configurations for each BRI card.
2. Press CHANGE to turn D-packet service for this loop on (Y) or off (N).



Tips - *An LT loop must already be assigned.*

Lp

1. Select the S loop (for BRI-S/T cards) or LT loop for BRI-U2 or BRI-U4 cards that supports the D-packet service.
2. Press CHANGE to move through a list of the loops which are available on this card.

Note: If only one loop is available, you will not see CHANGE.

TEIs

Press **Show** to view and program the Terminal Endpoint Identifiers (TEIs). Each TEI is supplied by your service provider and is associated with an ISDN D-channel packet device.

No TEIs on loop

Press **ADD** to program up to eight TEIs to this loop.

Sampling

Press **CHANGE** to select the sampling used by an S loop:

- **Fixed** — select if two or more S-interface devices use the loop and the length of the loop is less than 200 m (650 ft.).
- **Adaptive** — select if two or more S-interface devices use the loop and the length of the loop is greater than 200 m (650 ft.), select Adaptive.

If one S-interface device is using the loop, the length of the loop can be up to 1000 m (3,250 ft.) and the rate should be set to **Adaptive**.

The BRI card must be disabled under **Module status** in **Maintenance** programming, before you can change this setting. You can change the setting if the card has not yet been installed in the ICS slot.

DNs on Loop

Installer password required

Press to view and program the ISDN DN assigned to the loop.

Assign DNs

1. Press and enter the ISDN DN you wish to assign to this loop, or press SCAN to move through a list of DNs already assigned to the loop.

The display shows:

- **Availabl, Assigned** — assigned to this loop
 - ***Lnnnn*** — assigned as the default DN of another loop
 - **Lnnnn** — assigned to another loop
2. Press LIST to view the DNs assigned as ISDN DNs.
The default ISDN DN range is 667-696. For information about changing ISDN DN type, see *Changing Companion DN type* on page 449.
 3. Press CHANGE to assign the DN to the loop or to remove it.

Loop DN

Press CHANGE to move through the ISDN DNs you have assigned to the loop.

This will assign the main ISDN DN to the loop.
You can also set Loop DN to **None**.

Clock Src

Installer password required

Systems with digital interfaces need to synchronize to the network in order to function. Synchronization is performed in a hierarchical way, where each device/switch obtains the network clock from the device/or switch above it in the synchronization hierarchy and passes the network clock to the device/switch below it in the synchronization hierarchy. The synchronization levels are referred to as strata.

Norstar systems are stratum 4E equipment and are usually used as termination points in a network.

For each on-core DTI, choose one of the following settings:

- **Primary reference:** The DTI obtains the timing reference from the network, to which the system synchronizes. This is the default value for the DTI in slot 1 in the ICS. If the system is configured with a DTI card that has been configured as PRI, the setting should be set to **Primary**.
- **Secondary reference (Secondary):** The DTI acts as a standby reference. If there are excessive errors on the primary reference T1 link, or the DTI designated as primary reference fails, this DTI will obtain the timing reference from the network, which the system synchronizes to. This is the default value for the DTI in slot 2 in the ICS.
- **Timing master (TimeMst):** The DTI does not obtain timing from the network, but transmits the systems timing to equipment connected to it.



WARNING: An off-core DTI needs to be left on free run



Tips - *If a BRI card becomes clock source, it will have up to four clock sources available (T, S, U-NT, NT loops only). Only when all four clock sources have an alarm will the card cause a switch to the secondary or hold-over state.*

BRI -T, S, and U-NT interface loops may be autonomously powered down by the network. This will be treated as a loss of clock source on that loop.

The installer should ensure that clock source loops are either not powered down or are among the last to be powered down.

If BRI cards are used only for S-loops, a Service Card is required only if the DTI is T1. However, a Services Card is recommended when a T1 is not used, since the card improves clock accuracy and performance.

If BRI cards are used off-core, they still require a connection to the network, which requires the SC, and an on-core digital clock source.

For more information about network synchronization, consult the appropriate private digital network synchronization standards.

The following illustrations show some typical network configuration and the appropriate clock source settings for your DTIs.

Norstar connected directly to the service provider in a T1 network

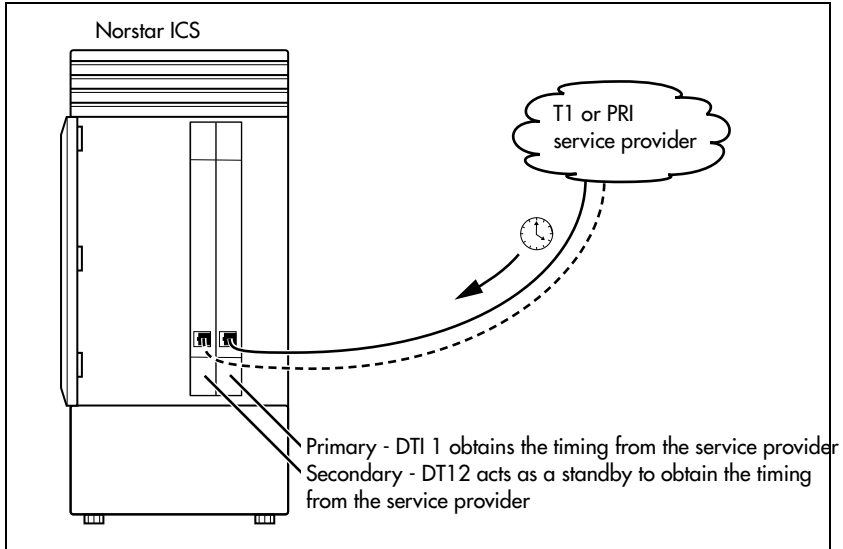

Norstar connected to another switch or MUX in a T1 or PRI network

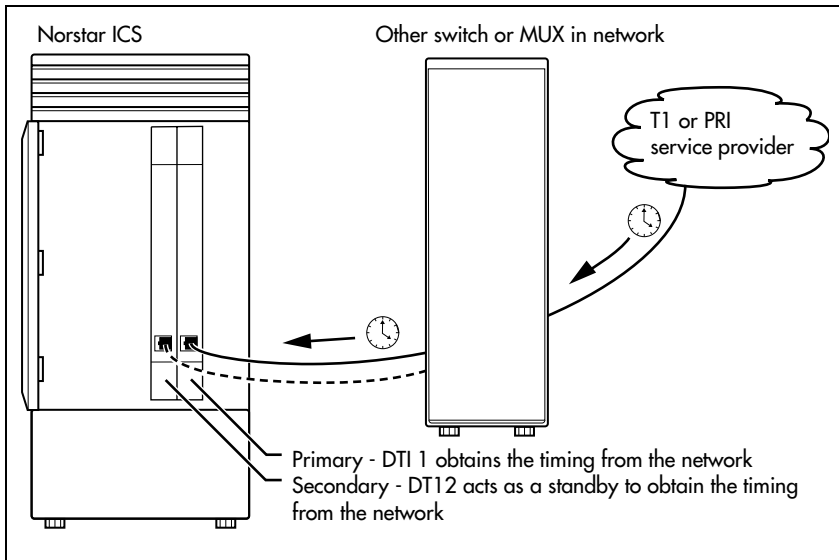

Norstar connected to another switch in a closed T1 or PRI network

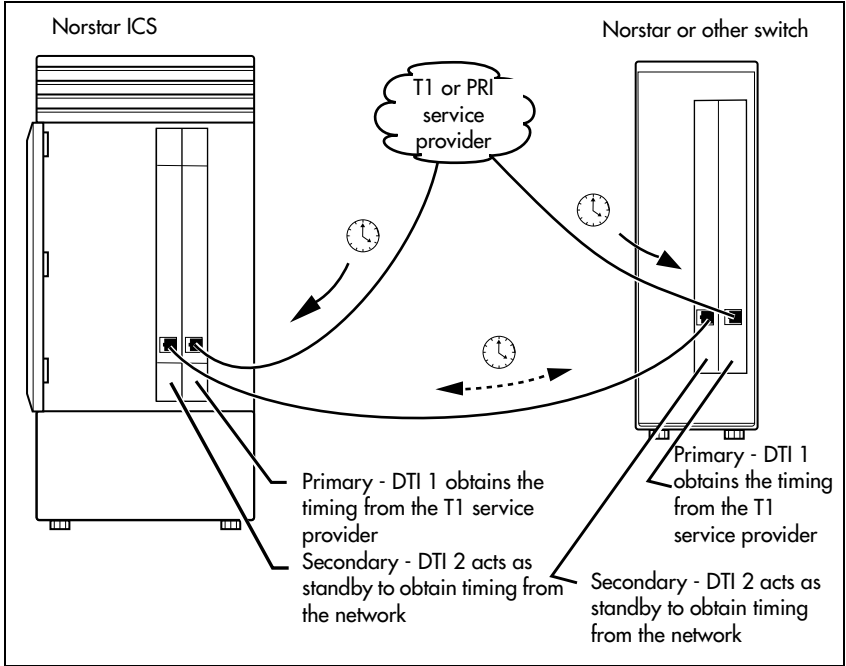

Norstar connected in a series of switches in a T1 or PRI network

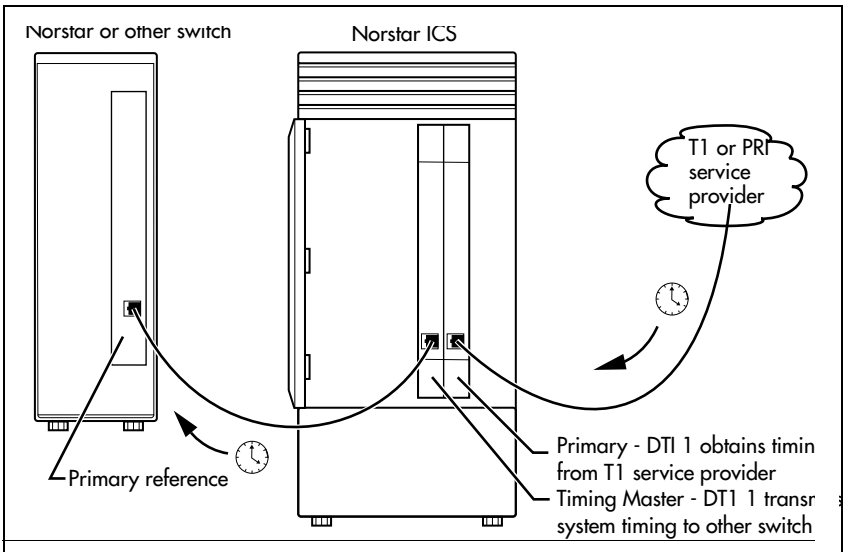

Norstar connected by a T1 link to another switch in an analog network

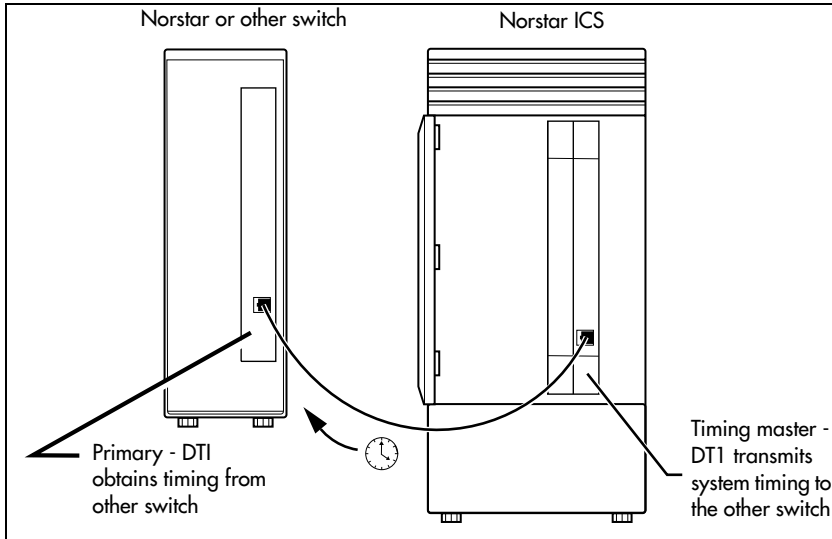

Setting the clock source for DTIs and PRI



Changing clock source may disconnect calls.

Changing the clock source for your system may cause your system to restart itself, resulting in dropped calls. Choose a suitable time to change the clock source and use the Page feature to inform people of possible service disruptions.

Start with the display showing **Hardware**.

1. Press .
2. Press . The display shows **Cards on KSU**.
3. Press .
4. Press until the display shows the card you want to view.

5. Press .
6. Press until the display shows **ClockSrc.**
7. Press **CHANGE** to toggle the setting.
8. Press to exit or to continue in **Hardware.**



Tips - *In most T1 network configurations, you need one DTI or DTI card configured as PRI in your ICS to act as a primary reference. The only application where you might not have a DTI or a DTI card configured as PRI designated as primary reference is in a network where your Norstar system is connected back-to-back with another switch using a T1 link. If the other switch is loop-timed to your Norstar system, your DTI or DTI card configured as PRI can be designated as a timing master.*



Tips - *(continued) If your Norstar system has two or more DTIs, you cannot assign more than one DTI as primary reference or all of the DTIs as secondary reference.*

You can only have one primary reference and one secondary reference per system. See T1 or ISDN-PRI configurations for more information.

T1 or ISDN-PRI configurations

The following tables indicate proper and improper T1 or ISDN-PRI configurations:

Valid digital trunk configurations

	Option 1	Option 2	Option 3
Card 1	T1 or PRI	T1 or PRI	BRI-ST, BRI-U2, BRI-U4
Secondary Card 2	T1 or PRI	BRI-ST, BRI-U2, BRI-U4	BRI-ST, BRI-U2, BRI-U4

Invalid digital trunk configuration

Option 1	
Primary Card 1	BRI-ST, BRI-U2, BRI-U4
Secondary Card 2	T1 or PRI

Valid mixed trunking configuration

	Option 1	Option 2
Primary Card 1	T1 or PRI	BRI-ST, BRI-U2, BRI-U4
Card 2	Analog	Analog

Invalid mixed trunking configuration

	Option 1	Option 2
Card 1	Analog	Analog
Secondary Card 2	T1 or PRI	BRI-ST, BRI-U2, BRI-U4

Invalid configurations will raise an alarm. In these invalid configurations, digital links are likely to suffer errors, slips, etc.

DataMod

Installer password required

Mod XX:DataMod

DataMod allows you to configure the settings for any data modules you may have on your system.

Type

The display shows the type of data module selected.

Maintenance

Use Norstar Maintenance to help you understand and diagnose system problems that occur on your Norstar system.

Maintenance includes settings to determine how the system will deal with T1 digital lines. It also provides a means for provisioning and testing digital lines.

The Maintenance section of programming has these headings.

<code>System version</code>	displays the version number of the system processor
<code>Port/DN status</code>	allows you to check and change the status of ports in your system
<code>Module status</code>	allows you to check and change the status of modules in your system
<code>Sys test log</code>	displays a list of test results, event messages, and alarm codes
<code>Sys admin log</code>	displays a list of system initialization sessions, invalid password attempts and password changes
<code>Network evt log</code>	displays a list of events and alarms
<code>Provisioning</code>	allows you to add or remove individual T1 lines, PRI lines, and BRI loops in and out of service
<code>Tests</code>	allow you to test incoming T1 signals to evaluate transmission quality, the connection between the ICS and telephones, and the connection between a DTI (configured as PRI) or BRI Card and the network
<code>CSU stats</code>	displays T1 performance information supplied by the Channel Service Unit
<code>Link status</code>	allows you to view status of b-channels on PRI

You can run a Maintenance session from any working M7310, M7324 or T7316/T7316E telephone.



Tip - Only one person at a time can access a Maintenance session.

Photocopy the Maintenance records found in the Programming Record, and record the information the session provides.

Beginning a Maintenance session

1. Release all calls on your telephone.
2. Press which is the same as . **Password:** displays.
3. Enter the Installer password. **Terminals&Sets** displays. Three triangular indicators ► appear on the vertical display between the rows of buttons.
4. Place the programming overlay over the buttons pointed to by the indicators ►.
5. Press until the display shows **Maintenance**.

System version

System version allows you to note the version number of the System Processor (SP) software, which resides in the Feature Cartridge.

Use the SP version number to determine whether you have the latest software release, and to trace a software fault if one occurs.

For instance:

- SP version number can indicate a Feature Cartridge incompatibility.
- SP and telephone version numbers can indicate a telephone version incompatibility.
- SP and functional terminal version numbers can indicate a functional terminal incompatibility.

Checking the version of the system

To check the version number, start with the display showing **Maintenance**.

1. Press . **System version** displays.
2. Press .

The display shows the version number of the SP.

3. Write the SP version number on the appropriate Maintenance record.
4. Press . **System version** displays.

Port/DN status

Port/DN status allows you to:

- identify any device or line connected to the system
- check the version number of a device for compatibility with the system, for instance for an analog terminal adapter (ATA).
- check the state of a device or line, for example, idle or busy
- disable or enable a device
- determine which port number corresponds to each DN
- determine the port number of a malfunctioning device
- determine if a malfunctioning device is incompatible with the Norstar system
- disable a device before replacing it



Tips - *You cannot disable the telephone from which you are accessing the Maintenance session. If you try to do this, a message appears on the display and you hear an error tone. If you want to disable that particular telephone, conduct the Maintenance session from another telephone.*



Pick a suitable time to disable devices

Wait until after regular user hours to disable devices to cause the least disruption to your customers.

Do **not** enable or disable ports at the following times:

- during the first two minutes after Startup programming
- before fiber cables are connected

If you do so, incorrect ports may be enabled or disabled. To recover from this, disable, then enable, the affected modules using `Module status`.

`Port/DN status` allows you to check lines and devices on the system. Although the following procedures describe how to check devices, you can use the same procedures to check lines.

Lines can only be disabled in `Module status`.

Identifying a connected device

Installer password required

Start with the display showing `System version`.

1. Press . `Port/DN status` displays
2. Press . `Show Port:` displays
3. Enter the port number of the device, or press `DN`, then enter the directory number of the device. The display shows device information, as illustrated in the following sample device identification display. This identifies the device connected to the B1 channel.
4. If there is an add-on device attached to a Norstar telephone, such as a central answering position module or a Busy Lamp Field, press to display the add-on device.
5. Press `>B2` to display the device connected to the B2 channel.
6. Press until the display shows `Port/DN status`.

Displays

Sample device identification display

```
P104 7324 224
DEVICE >B2 STATE
```

This sample display indicates that port 104 has an M7324 telephone whose DN is 224. Press DEVICE to see the device attached to the port.

The following table lists some of the device types that may appear on the Norstar device identification display.

Explanation of device type

Display	Explanation
7100	M7100 or T7100 set
7208	M7208 or T7208 set
7310	M7310 telephone or T7316 or T7406 Business Series Terminal telephones
7316E	T7316E Business Series telephone
7324	M7324 telephone
RAD	Remote access device
1: CAP ... 2: CAP 2	CAP module attached to an M7324 telephone.
KIM1 ... KIM 4	KIM attached to a T7316E telephone.
ATA	Analog Terminal Adapter or Analog Station Module
BLF	Busy Lamp Field

Checking the device version number

Installer password required

From the Norstar device identification display:

1. Press VERS# (if it is available).

The display shows the version number of the device.

2. Write this number on the appropriate Maintenance record.

To return to the Norstar device identification display from the display showing the version number, do one of the following:

- Press OK to retain the same port number.
- Press HEADING.
- Press to see information about the next port number (or DN if that is how you entered).

OR

Press to see information about the previous port number (or DN if that is how you entered).

Checking the state of the device

Installer password required

From the Norstar device identification display.

1. Press STATE.

The display shows one of the states listed in the table that follows. If you want, you can disable or enable the device. Refer to *Disabling a device* on page 519 or *Examples of display messages* on page 519.

2. Press OKK to return to the device identification display.

How the device state is shown on the display

Display	State of device
Busy DISABLE OK	The device is in use.
Disabling... OK	The device is being disabled.
Enabling... OK	The device is being enabled.
Idle DISABLE OK	The device is not in use.
Unequipped DISABLE OK	There is no device connected to that port.
Disabled by user ENABLE OK	The device has been disabled by someone running a Maintenance session.
Disabled by sys. ENABLE OK	The device has been disabled by the system because it is faulty or because a test is running.
Not available DISABLE OK	There is no state available.

Disabling a device

Installer password required



Give notice that you are disabling equipment.

Inform your users well in advance that you are going to disable their devices.

To disable immediately when the display indicates the device is busy:

1. Press D**ISABLE**. **Disable at once?** displays.
2. Press Y**ES**.

The system prompts the device user and disables the device in one minute (or immediately, if the device is idle). Press N**O** to leave this display without disabling the device.

Displays

The following table shows examples of the sequence of messages that might appear on a telephone when you disable a device.

Examples of display messages

<pre>Please hang up Maintenance test</pre>	Occurs on a busy telephone before disabling
<pre>48 seconds until disconnect</pre>	
<pre>Please hang up In Maintenance</pre>	Occurs after disabling

Enabling the device

Installer password required

When the display shows you that the device is disabled:

Press **ENABLE**. **Enabling...** briefly displays.

The device is immediately enabled and the display shows **Idle**.



Tips - *The display may briefly show **Enabling...**, then either **Disabled by sys.** or **Disabled by user.** In this case, the system is waiting to enable the module. This may occur after someone has run a Maintenance session and used **Module status**. You cannot enable the device until its module has been enabled.*

*Individual lines cannot be disabled in **Port/DN status**. To disable a **Trunk Cartridge**, see **Module status** on page 521.*

Returning to the beginning

Installer password required

From the display showing the state of the device:

1. Press **OK**.
2. Press until the you reach **Port/DN status**.

Module status

Module status allows you to:

- look at the inventory of Station Modules, Trunk Modules, Data modules, and modules inside the Integrated Communication System (ICS)
- check the number of Trunk Cartridges in a module
- check the state of the module or its cartridges
- disable or enable the module or its cartridges
- isolate any malfunctioning modules
- disable a module before replacing it
- clear a hung line by disabling and enabling the affected Trunk Cartridge



Tips - *Modules 1 and 2 are located inside the ICS.
Module 1 connects telephones.
Module 2 connects Trunk Cartridges.*

Looking at the module inventory

Installer password required

Start with the display showing **Port/DN status**.

1. Press . The display shows **Module status**.
2. Press . The display shows **Show module:**.
3. Enter the module number.



Tips - *Norstar devices may occupy both the B1 and B2 channels. This may increase the number of devices indicated on the module inventory display. The display is different for Analog Station Modules (ASM) where it will show either 8 sets on ASM or 16 sets on ASM.*

Checking the number of Cartridges

Installer password required

Start from the module inventory display, which shows the number of Trunk Cartridges connected to the module you chose, for example, **Mod 04: 3 cards.**

1. Press **CARD**.

If there is a Trunk Cartridge in a slot, the display shows that four lines are connected, for example,
Card 1: 4 lines.

2. Press or to check for Trunk Cartridges in the other slots.
3. Press **MODULE** to return to the module inventory display.

Checking the state of a module

Installer password required

Start from the module inventory display, which shows the number of Trunk Cartridges connected to the module you chose, for example, **Mod 04: 3 cards.**

1. Press **STATE**.

The state of the module is shown on the display.

2. Press **OK** to return to the module inventory display.

Module or cartridge state is shown on the display

Example display	State of module or cartridge
<pre>3 sets busy DISABLE OK</pre>	There are three devices in use that are connected to the module or cartridge.
<pre>2 ports busy DISABLE OK</pre>	There are two ports in use that are connected to the module or cartridge.

Module or cartridge state is shown on the display (Continued)

Example display	State of module or cartridge
4 lines busy DISABLE OK	There are four lines in use that are connected to the module or cartridge.
Disabling... OK	The module or cartridge is being disabled.
Enabling... OK	The module or cartridge is being enabled.
Unequipped DISABLE OK	There is no module or cartridge connected to that DS-30 port.
Disabled by user ENABLE OK	The module or cartridge has been disabled from a Maintenance session.
Disabled by sys. ENABLE OK	The module or cartridge has been disabled by the system because it is faulty or because there is a test running.
Updating state...	The system is verifying the state of the module or cartridge.

Checking the state of a cartridge

Installer password required

Start from the display that shows the number of lines connected to the Trunk Cartridge you chose, for example, **Card 1: 4 lines.**

1. Press STATE.

The display shows the state of the cartridge. Some examples of this display are shown in the previous table.

2. Press or to check the Trunk Cartridges connected to the other Trunk Modules.
3. If required, you can disable or enable the cartridge. Refer to *Disabling a module or its cartridges* on page 524 or *Enabling a module or its cartridge* on page 524.

4. Press **OK** to return to the display showing how many lines are connected to the Trunk Cartridge.

Disabling a module or its cartridges

Installer password required



Use Page feature prior to disabling.

Use the Page feature to inform people that you are about to disable a module. Mention that they may experience delays in the performance of their devices.

From the display showing the state of the module or cartridge:

1. Press **DISABLE**. **Disable at once?** displays.
2. Press **YES**.

The system disables the module or cartridge in one minute. If the status is idle, the system disables the module or cartridge immediately.

Press **NO** to leave this display without disabling the module or cartridge.

Enabling a module or its cartridge

Installer password required

From the display showing the state of the module or cartridge:

1. Press **ENABLE**.

The display briefly shows **Enabling...**

The module or cartridge is immediately enabled.

The display then shows the state of the module or cartridge.

Returning to the beginning

Installer password required

From any display showing the state of the module or cartridge:

1. Press **OK**.
2. Press until the display shows **Module status**.

System test log

The System test log shows you a list of diagnostic test results, audits, event messages, and alarm codes. By using this feature you can:

- check the items in the log
- check the current alarm (if there is one)
- check when each item in the log occurred
- check the number of consecutive occurrences of an event or an alarm
- erase the log

The System test log holds a maximum of 20 items. You should check and record these items at regular intervals. Erase the log after dealing with all the items.

Checking the items in the log

Installer password required

Start with the display showing **Module status**:

1. Press . The display shows **Sys test log**.
2. Press . The display shows **Items in log:**. (If there is no log entry, the display shows **Items in log:0** and returns to **Sys test log**.)
3. Press or . The display shows a log item.
4. Write down the item on the System test log record.
5. If the log item is an event message or an alarm code, refer to *Alarm codes* on page 533 or *Event messages* on page 541.
6. Repeat steps 3, 4, and 5 until you have recorded all the items.

Checking the current alarm

If you want to quickly check the highest severity alarm before viewing all the log items, start with the display showing **Items in log**:

1. Press **ALARM**.

The display shows an alarm code if there is a current alarm. If there is no current alarm, **ALARM** does not appear on the display.

2. Press **OK** to return to **Items in log**.

All alarms are recorded as items in the System test log.

Checking when each item occurred

Start with any display showing a log item:

1. Press **TIME**. The display briefly shows the date and time.
2. Write the date and time on the System test log record.

Checking consecutive repetitions of an event or alarm

If **REPEAT** appears under a display showing a log item:

1. Press **REPEAT**.

The display shows the number of consecutive times the event or alarm occurred.

Erasing the log

Start with the display showing **Items in log:**.

1. Press ERASE. **Erase log?** displays.
2. Press YES.

If no new items have been added since the list was entered, the log is erased and the display shows **Log erased**.

If new items have been added since the list was entered, the display briefly reads **Cancel-new items** and returns to the display **Items in log:**.

3. Press to return to **Sys test log**.

System administration log

The System administration log keeps a record of administrative events, such as sessions in which a change was made, invalid password attempts, and password changes.

You can use this feature to:

- check the items in the log
- erase the log
- check when each item in the log occurred

The System administration log holds a maximum of 10 items. Erase the log after dealing with all the items.

Checking the items in the log

Start with the display showing `Sys test log`:

1. Press . The display shows `Sys admin log`.
2. Press . The display reads `Items in log:`.
(If there is no log entry, the display reads `Items in log:0`.)
3. Press or . The display shows a log item.
4. Write down the item on the System administration log record.
5. Repeat steps 3 and 4 until you have recorded all the items.

Checking the current alarm

Start with the display showing **Items in log:**.

1. Press **ALARM**. The display shows an alarm code.
If there is no current alarm, **ALARM** does not appear on the display.
2. Press **OK** to return to the display showing **Items in log:**.

Checking when each item in the log occurred

Start with any display showing a log item:

1. Press **TIME**. The display shows the date and time.
2. Write the date and time on the System administration log record.

Erasing the log

Start with the display showing **Items in log:**.

1. Press **ERASE**. The display shows **Erase log?**.
2. Press **YES**.

If no new items have been added since the list was entered, the display shows **Log erased**.

If new items have been added since the list was entered, the display briefly reads **Cancel-new items** and returns to the display **Items in log:**.

3. If the display shows **Log has changed**, press **SHOW** to show the new log, or press **EXIT** to return to **Sys admin log**.

Network evt log

The Network evt log keeps a record of events and alarms that are specific to the T1 network interface.

You can:

- check the items in the log
- erase the log
- check when each item in the log occurred

The Network evt log holds a maximum of 20 items. Erase the log after dealing with all the items.

Checking the items in the log

Installer password required

Start with **Sys admin log** on the display:

1. Press . **Network evt log** displays.
2. Press . **Items in log:** displays.

If there is no log entry, the display reads **Items in log:0**.

3. Press or . The display shows a log item.
4. Write down the item on the Network event log record.
5. Repeat steps 3 and 4 until you have recorded all the items.

Checking the current alarm

Start with the **Items in log:** on the display.

1. Press **ALARM**.

The display shows an alarm code if there is a current alarm.

2. Press **OK** to return to **Items in log:**.

Erasing the log

Start with **Items in log:** on the display.

1. Press **ERASE**.

The display shows **Erase log?**.

2. Press **YES**.

If no new items have been added since the list was entered, the display shows **Log erased**.

If new items have been added since the list was entered, the display briefly reads **Cancel-new items** and returns to the display **Items in log:**.

3. Press to return to **Network evt log**.

Checking when each item in the log occurred

Start with any display showing a log item:

1. Press **TIME**.

The display shows the date and time.

2. Write down the date and time on the Network event log record.

Alarm codes

The Norstar ICS system generates alarm codes after system disconnections or after certain anomalies in system operation. All alarm codes appear at the Alarm telephone and in the System test log of a Maintenance session.

For a more complete description of alarm and event codes, consult your technical support representative. The following figure shows an alarm code appearing on a Norstar Alarm telephone display.

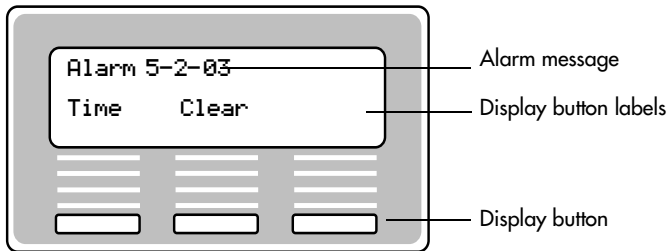

Tips - *The Alarm telephone is assigned in Feature settings of system programming.*

Alarms have a higher severity than events. Attend to alarm codes before event messages.

Alarm code information that is specific to Companion components is included in the Modular ICS Companion Installer Guide.

If you see an alarm code

1. Write the alarm code on the Sys test log record.
2. Determine the cause of the alarm from the following table.
3. Follow *Alarm troubleshooting* on page 537.
4. Press **TIME** to see when the alarm occurred.
5. Press **CLEAR** to clear the alarm.

An alarm code may not be displayed until two minutes after it has been triggered. If the ICS is powered off when the alarm is triggered, the alarm code is not displayed until two minutes after the ICS is powered on.

For a complete list of Norstar alarms, refer to the *Norstar Alarm & Event Code Manual*.

Displays

Example display	Meaning	Possible causes
Alarm: 10	All ICS devices disconnected.	The last device on Norstar bus 1 (port numbers 101-124) has been removed. A 25-pair cable was disconnected from the ICS. There is an internal ICS fault.

Example display	Meaning	Possible causes
Alarm: 37 ABBC DD	An error has occurred in the download of a protocol to a BRI Card. A: the maintenance index of the BRI BB: a code describing the nature of the error C: the current download state DD (appears when the error is limited to one protocol): the two-character product identifier of the protocol	The BRI Card is not properly installed.
Alarm: 40 Alarm: 41 Alarm: 42 Alarm: 43 Alarm: 44 Alarm: 45 Alarm: 46 Alarm: 47	There is a problem with the T1 signal	The cable connecting the DTI to the network termination point or external CSU is disconnected. There is a problem with the T1 signal from the network.
Alarm: 50 X	All devices on SM disconnected.	The last device on Norstar bus X (port numbers X01-X16) has been removed. The 25-pair cable was disconnected from the SM. The fiber cable from the SM to the ICS is disconnected. The SM was powered down.
Alarm: 51 X	Trunk Module disconnected.	All Trunk Cartridges are disconnected from the TM on DS-30 port X. The TM was powered down. The fiber cable from the TM to the ICS is disconnected.

Example display	Meaning	Possible causes
Alarm: 52 X Y	TC disconnected from TM	Trunk Cartridge Y on DS-30 port X is disconnected from the TM.
Alarm: 61 X Y	Incompatible Trunk Cartridge	Trunk Cartridge Y on DS-30 port X cannot operate with the Trunk type assigned to it in Configuration.
Alarm: 62 X Y	Unsupported Auto-answer setting (Loop Start TCs)	Trunk Cartridge X on DS-30 port Y does not support the auto-answer setting.
Alarm: 63 Z	No available DTMF receivers	DTMF receivers are busy, not working properly, or have not been installed.
Alarm: 68-Z	A device has been connected to a port which is not available for the device type.	Power down the system and disconnect the device from the port identified. Reconnect it to a valid port.
Alarm: 76 X	Data Module disconnected.	The Data Module is disconnected from the DM on DS-30 port X. The DM was powered down. The fiber cable from the DM to the ICS is disconnected.

X = DS-30 port numbers, Y = Trunk Cartridge number (numbered from left to right), and Z = Trunk port number

Alarm troubleshooting

Refer to the previous table before following these procedures.

Alarm: 10

1. Check to see if there is a device connected to the ICS (that has a port number beginning with the number 1).
2. If there are no devices connected to the ICS, connect one and then press **CLEAR**.
3. If there are any devices connected to the ICS, check all the wiring associated with the devices.
4. Refer to *Problems with BRI service* on page 600.

Alarm: 37

1. Check that the BRI Card is properly installed.
2. Remove and re-install the BRI Card.
3. If the alarm persists, replace the BRI Card with another BRI Card of the same type.

Alarm: 40 to Alarm: 47

1. Check the System Network evt log for events in the range 315-336 to verify the frequency of the alarms.
2. Refer to *Digital Trunk Interface trouble* on page 597.

Alarm: 50-X

1. Check that there is a device connected to the Station Module, which has a port number beginning with a number from three to eight.
2. If there are no devices connected to the Station Module, connect one and then press **CLEAR**.
3. If there are any devices connected to the Station Module, check all the wiring associated with the devices.
4. Refer to *Data Module down* on page 605.

Alarm: 51-X

1. Check the wiring from the ICS to the TM.
2. Refer to *Problems with trunk cartridges service* on page 596.

Alarm: 52-X-Y

1. Follow the procedure in *Problems with trunk cartridges service* on page 596.
2. If the problem persists, replace Trunk Cartridge Y on DS-30 port X.
Refer to the previous table for the definition of X and Y.

Alarm: 61-X-Y

1. Check that the proper Trunk Cartridges are inserted in the proper slots of the ICS or Trunk Module.
2. Enter programming and look under the **Trk/Line data** heading. Check that the Trunk Cartridge type is correctly configured.

Check that the Trunk mode and Answer mode settings do not conflict for every line connected to Trunk Cartridge Y. If Trunk mode is set to unsupervised, Answer mode must be set to manual.

OR

Install a Trunk Cartridge in slot Y that matches the type of trunk you have configured.

Alarm: 62-X-Y

1. Check that the proper Trunk Cartridges are inserted in the proper slots of the Trunk Module.
2. Enter programming and look under the **Trk/Line data** heading.

Check that the Trunk mode and Answer mode settings do not conflict for every line connected to Trunk Cartridge Y. If Trunk mode is set to unsupervised, Answer mode must be set to manual.

Alarm: 63-Z

1. Check that you have the required E&M Trunk Cartridges. There should be a maximum of one for every two auto-answer loop start lines installed in a Trunk Module.
2. Enter programming and look under the **Trk/Line data** heading. Check that the Answer mode is correct for all the loop start lines.
3. Make sure that all of your E&M trunks installed in a Trunk Module are configured as E&M or DTMF, whichever applies, so that the system knows the receivers are there.

4. If the problem persists, an E&M Trunk Cartridge may be malfunctioning. Replace one E&M Trunk Cartridge at a time until the problem is resolved.

Alarm 68-Z

1. Locate the device(s) connected to port(s) not available for that device type.
2. Power down the system.
3. Disconnect the device from the port identified.
4. Reconnect it to a valid port.

Alarm 75

1. Check the connection to your ISDN service provider.

Alarm: 76-X

1. Check the wiring from the ICS to the DM.
2. Refer to *Problems with trunk cartridges service* on page 596.
3. Refer to *Data Module down* on page 605.

Event messages

Event messages appear as items in the System administration log or the System test log of the Maintenance session. Most of these event messages can only be caused by an unusual combination of events, and should rarely occur.

Each event is assigned a severity number. An S preceding this number, S4 for example, may appear in the event message. S9 is the most severe. If the log is full, new event messages with a higher severity number replace existing event messages of a lower severity. For this reason, you should check event messages at regular intervals. You can then deal with all messages before they are replaced.

Event message information that is specific to Companion components is included in the *Modular ICS Companion Installer Guide*.

Dealing with event messages

For every event message that you see:

1. Record the event on the appropriate Maintenance record.
2. Refer to *Significant event messages*.
3. To see if the event caused the Norstar system to automatically restart, consult the table on *Event Message* on page 547.

Significant event messages

The following table lists event messages that are relevant to Maintenance activities. The time that the message is recorded is also provided.

Displays

Event message		The event message is recorded when...
Evt:210-YYYY	S4	Loopback test YYY on Trunk Cartridge Z has started
Evt:211-YYYY	S4	Loopback test YYY on Trunk Cartridge Z has stopped
Evt:220-3546	S4	the Sys admin log has been cleared by the DN (3546 in this case)
Evt:221-3546	S4	the Sys test log has been cleared by the DN (3546 in this case)
Evt:222-3546	S5	the DN (3546 in this case) enters the debugging facility that is password protected
Evt:255	S9	administered mode is not supported by the cartridge plugged into the slot
Evt:260-0302	S8	the ICS takes the access line on port 0302 out of service because no current was detected
Evt:261-0302	S1	the access line on port 0302 is returned to service after current was detected (see Evt:260)
Evt:263-302	S8	the ICS takes the E&M line on port 302 out of service because the far end did not respond to a disconnect signal
Evt:264-302	S1	the E&M line on port 302 is returned to service after the far end finally responded to a disconnect signal (see Evt:263)
Evt:265-302	S7	the E&M line on port 302 did not receive an expected wink signal or delay dial signal from the far end
Evt:267	S9	a data module has been disconnected
Evt:268-07	S8	Dialing filter 07 has lost data due to a fault in the system memory

Event message		The event message is recorded when...
Evt:269-3546	S8	the Line/set filter for the DN (3546 in this case) has lost data due to a fault in the system memory
Evt:299	S1	the system powers up after a power failure
Evt:327	S5	short term alarm threshold has been surpassed in the DTI cartridge
Evt:328	S5	short term alarm threshold has been surpassed in the DTI cartridge
Evt:329	S5	short term alarm threshold has been surpassed in the DTI cartridge
Evt:330	S5	short term alarm threshold has been surpassed in the DTI cartridge
Evt:336	S5	long term alarm has been surpassed in the DTI cartridge
Evt:373	S5	the ICS restart diagnostic tool has been activated
Evt:400	S9	Startup programming is performed using ☎ * * S T A R T U P
Evt:407	S2	there are no more codes for Speed Dial numbers
Evt:408	S2	there is no more memory for Speed Dial codes
Evt:412-3546	S5	the Installer password has been changed by the DN (3546 in this case)
Evt:413-3546	S3	the System Coordinator password has been changed by the DN (3546 in this case)
Evt:414-3546	S5	an invalid Installer password has been entered by the DN (3546 in this case)
Evt:415-3546	S3	an invalid customer password has been entered by the DN (3546 in this case)
Evt:416-3546	S4	programming is performed using ☎ * * C O N F I G
Evt:417-3546	S2	programming is performed using ☎ * * A D M I N
Evt:418	S7	a DN change is successful
Evt:419	S2	the time setting has been changed
Evt:421	S8	a DN change failed

Event message		The event message is recorded when...
Evt:422-3546	S6	a length change by the DN (3546 in this case) has been requested
Evt:423-3546	S6	an individual DN change has been requested by the DN (3546 in this case)
Evt:441	S2	a timeout occurred while waiting for ANI or DNIS digits to be received
Evt:442	S5	a timeout occurred while waiting for ANI or DNIS digits to be received
Evt:453	S4	Someone entering **CONFIG
Evt:454	S5	Invalid password entered
Evt:458	S4	Call-by-Call NVRAM data is corrupt
Evt:459	S9	DN length has been changed to less than 3 digits
Evt:680	S9	wireless system is disabled
Evt:681	S9	activation or recovery code entered
Evt:683	S9	new base station configuration detected
Evt:687	S4	the data driver has received a bad call reference
Evt:688	S4	the data driver has received a bad data event
Evt:689	S4	the data driver could not allocate a new index
Evt:690	S4	no response to the ICS within 10 seconds of being sent an initialization message
Evt:691	S4	no response to the ICS within 3 seconds
Evt:692	S4	a bad parameter value has been received in a stimulus message from the data device
Evt:693	S3	old data to be discarded has been detected
Evt:694	S4	RADAR flow control has received a bad stimulus message from an off-core application
Evt:695	S4	attached set denied request for a B-channel
Evt:696	S2	corrupt CLID length
Evt:697	S2	an asynchronous data report generated by SDI module

Event message		The event message is recorded when...
Evt:698	58	incorrect software key entered
EVT799-00040B	57	a call processing error on the fourth BRI loop; see <i>Event message 799</i> on page 545.
Evt:822	58	Alarm code 63 is sent because there are no DTMF receivers for an incoming call
Evt:882	59	mobility data re-evaluation sequence initiated
Evt:883	54	an invalid dial pulse signal was received by the DTI
Evt:992	56	auto attendant error

Event message 799

Event message 799 indicates a call processing error has occurred on an ISDN line. The event number is followed by a number representing the line or loop number, and a code for the type of error.

EVT799-XXXX YY57 In this example, the error has occurred on line XXX and the error code is YY.

Error code	Meaning
01	Internal software error. Cannot acquire the B-channel from the B-channel arbitrator.
02	Internal software error. There is no free line available for the call.
03	A call that is not on the B-channel has been attempted. These kind of calls are part of EKTS service, which is not supported by this version of the software. Check with your service provider to make sure your package does not include EKTS service.
04	Internal software error. Failed to instantiate on the chain.
05	Internal software error. Activation procedure failed.

Error code	Meaning
06	Internal software error. Index conversion failed.
07	Unexpected digits on a Manual answer mode line. Configuration of the ICS and the network connection may not match.
08	Internal software error. Cannot seize central office (CO) line on a BRI connection.
09	Cannot get vterm (virtual terminal) from the Vterm Server.
0A	Central office did not respond to the SPID initialization request.
0B	Central office has rejected the SPID. Verify your SPID information programmed under Hardware and with your ISDN service provider.
0C	Internal software error. Already instantiated on the chain.

Displays

You should rarely see any event messages that are not described in the *Significant event messages* on page 542. If you do see one of these event messages, the Norstar system has followed its normal recovery from an unusual combination of system events. Although the problem is not a serious one, repeated occurrences of the event number should be reported as soon as possible.

As a result of some events, the Norstar system automatically restarts itself. The table on the next two pages lists all the event numbers and tells you which of these events are associated with Norstar system restarts.

Most of these events are recorded in the Sys test log. The few exceptions to this are recorded in the Sys admin log, as indicated.

Event Message	System Restart	Event Message	System Restart
101-106	Yes	400 (Admin log)	Yes
107	No	401-403	No
108-112	Yes	405-411	No
113	No	412-419 (Admin log)	No
114-116	Yes	421-423 (Admin log)	No
117	No	424-425	No
118-120	Yes	426-430	Yes
121-123	No	431	No
124-125	Yes	432	Yes
126-129	No	433	No
130	Yes	441-442	No
131-132	No	453	No
133-134	Yes	454	No
135-136	No	458-459	No
137	Yes	600-602	Yes
138-150	No	603-613	No
151	Yes	614	Yes
152	No	615-629	No
160-164	No	630	Yes
170-173	No	631-646	No
200-211	No	680	No
220 (Admin log)	No	681	No
221-222	No	683	No
223 (Admin log)	No	689-698	No

Event Message	System Restart	Event Message	System Restart
224	Yes	799	No
225-228	No	800-802	No
229 (Admin log)	No	803	Yes
230-235	No	804-807	No
245-248	Yes	808	Yes
250-256	No	809	No
260-271	Yes	810	Yes
280-283	No	811-820	No
285-298	Yes	823	Yes
299	No	824-825	No
327	No	851	No
328	No	882	No
329	No	883	No
330	No	900	No
336	No	940-943	No
373	No	950-989	No

Provisioning BRI and PRI lines

This section discusses how you put BRI and PRI lines into and out of service.

BRI and T1 lines

Installer password required

Provisioning applies to BRI and T1 loops and lines. It allows you to place loops and lines in or out of service, either before or after the BRI Cards have been installed in the ICS.

When you provision a loop, ISDN terminals on the loop can be used to make outgoing calls or receive incoming calls (S or U-LT loop).

Loop lines are also available for use by the devices attached to the system (T, S, or U-NT loop). When you are configuring a T, S, or NT loop, you must also provision each line on the loop to place the lines in service.

Cd1-ICS

The card type will appear with the setting. If no card has been installed, you can change the card type under **Hardware**.

1. Press to display the loops found on the card.
2. Press **REMOVE** to take the loop out of service.
3. If lines on the loop are busy, the display will ask if you still want to remove the loop from service.
Press **YES** to go ahead.

L001

If the loop is configured as a U-NT, T or S loop, press and to display the individual lines. There are no lines associated with an S or U-LT loop.

1. Press **REMOVE** to take the line out of service.
2. If line is busy, the display will ask if you still want to remove it from service. Press **YES** to go ahead.

Provisioning a T1 line

Start with the display showing **Network evt log**.

1. Press . **Provisioning** displays.
2. Select a module and card type, see *Show module* on page 482.
3. Press . **Show module:** displays.
4. Enter the number of the line to be provisioned. The display shows the line and its current status.
5. Press **PORT** to identify the logical port number for the line. Lines cannot be provisioned from the **PORT** display. Press **LINE** to return to the line number display.
6. Press to view settings for the next line number.
7. Press until you return to **Provisioning**.

Provisioning a PRI line

Installer password required

ISDN lines are provisioned by default. For information on adding a DTI card (configured as PRI) see *Cards on KSU* on page 482.

Deprovisioning a line

Installer password required

Deprovisioning all of the lines on a DTI does not disable the cartridge.

Disabling a PRI Channel

Installer password required

PRI channels can be disabled. However, there is no association between a line number and a b-channel. Disabling a b-channel can be done when you have fractional PRI. See *Working with fractional PRI* on page 567.

Tests

Norstar allows you to run tests which verify the integrity of the installation wiring for the telephones.

In addition, you can evaluate the transmission quality of a BRI loop through your service provider using a loopback test to evaluate different aspects and segments of the T1 digital transmission path. You can only run one loopback test at a time on any one DTI.



Choose an appropriate time to run tests.

Do not run the loopback tests while ports are being disabled or during the first two minutes after Startup programming. If you do, the tests may stop running with ports still disabled. To recover from this, unplug the ICS from the power outlet, then plug it in again.

The loopback tests disrupt service. Do not run tests during busy user times.

Loopback tests for T1 or ISDN-PRI lines

Installer password required

The following messages may appear on the Alarm Telephone during Loopback tests.

Message	Explanation
EUT: 210-YYYY	Loopback test YYY on Trunk Cartridge Z has started
EUT: 211-YYYY	Loopback test YYY on Trunk Cartridge Z has ended

Line loopback

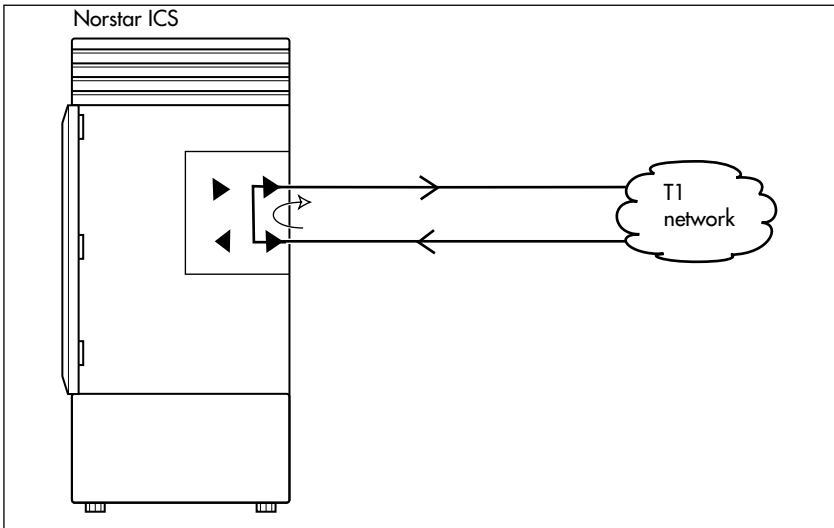

The line loopback test loops the full 1.544 Mbps signal received from the network back to the network. The looped signal is regenerated without any change in the framing format and without the removal of any bipolar violations. The line loopback test can also be invoked and stopped remotely using the in-band signal or via the facility data link (FDL) in extended super frame (ESF) format.

The line loopback test must be run in coordination with the T1 or PRI service provider. Some test patterns can cause the DTI to reset. To avoid this, start the line loopback test from your system before the T1 or PRI service provider begins their test, and stop the line loopback test from your system after the T1 or PRI service provider ends their test.

Payload loopback

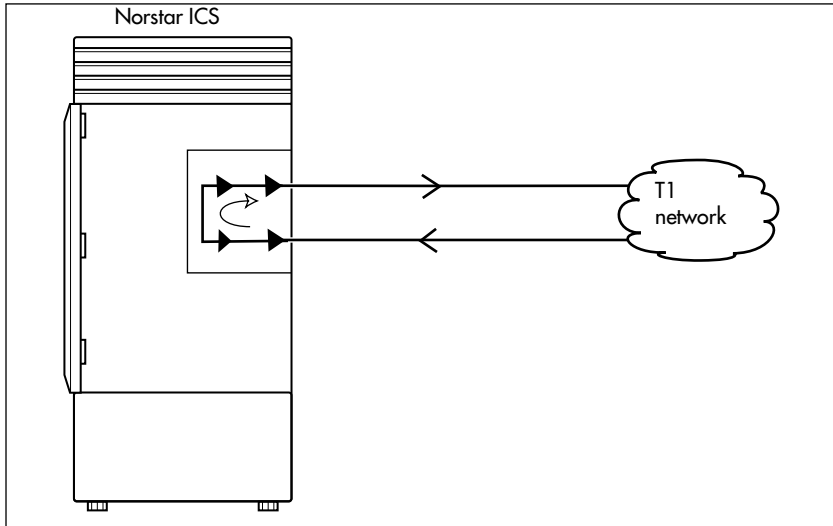

The payload loopback test loops the received information bits (192 per frame) back to the network. The payload loopback test can also be invoked and stopped remotely via the facility data link (FDL) in extended super frame (ESF) format.

The payload loopback test must be run in coordination with the T1 service provider. Some test patterns can cause the DTI to reset. To avoid this, start the payload loopback test from your system before the T1 service provider begins their test, and stop the payload loopback test from your system after the T1 service provider ends their test.

Card edge loopback

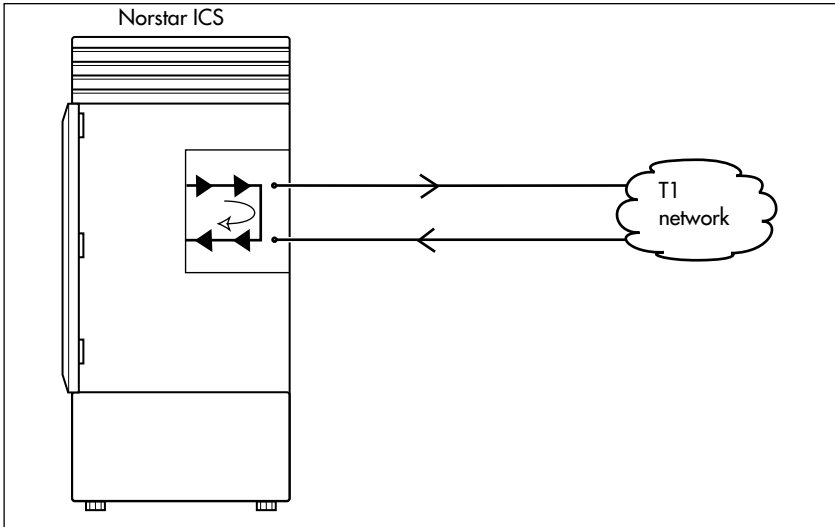

The card edge loopback test loops the outgoing signal on the DTI back to its internal received signal path. Signal paths to the external network are disconnected.

Continuity loopback

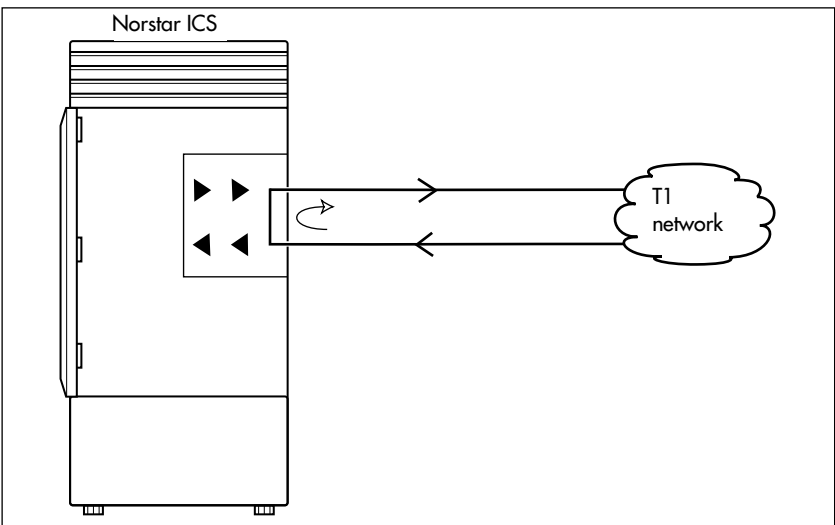

The continuity loopback test shorts the tip and ring pair of the receive signal path with the transmit signal path. This test allows you to check the metallic continuity of the external wiring.

Tests initiated from Norstar

You can start and stop Loopback tests in **Maintenance** programming under the heading **Loopback tests**. You can also push a button on the DTI faceplate to start and stop the continuity test.

You can run DTE and DS30 Loopback tests to verify the SDI data transfer capabilities. Under the **Hardware** heading, ensure that the **Type** setting for data module is **SDI** before choosing the Loopback test you will run.

Tests initiated by the central office

If the internal CSU is administered on line loopback and payload loopback tests can also be invoked and stopped by the central office. In order to be able to run a payload loopback test, the DTI must be configured for extended superframe format.

Starting a loopback tests

Installer password required



Give notice that you are running a loopback test.

Calls on all T1 or PRI lines on the DTI will be automatically dropped when a loopback test is invoked. Use the Page feature to notify people using the system that a test is about to begin and that calls will be disconnected.

Start with the display showing **Loopback tests:**

1. Press . **Show Module:** displays.
2. Press . **Cards on KSU** displays.

If you want to test cartridges on another module, press until the display shows the module.

3. Press . **Cd1-KSU** displays.

If you want to test the second cartridge on the KSU, press . The display shows **Cd2-KSU**.

4. Press .

If there is an analog cartridge in the slot or the slot is empty, the display shows **Need digital crd.**

5. Press until the display shows the test you want to run: **Continuity loopback**, **Line loopback**, **Payload loopback**, **Card edge loopback**.
6. Press **START** to begin the test. The display shows the test name followed by **running**.
7. Press **STOP** to end the test.

Operating a Continuity loopback test

Installer password required

You start the Continuity loopback test by pressing the button on the front of the DTI. Calls on all lines on the cartridge are automatically dropped when a loopback test is invoked.



Give notice that you are running a loopback test.

Calls on all T1 or PRI lines on the DTI will be automatically dropped when a loopback test is invoked. Use the Page feature to notify people using the system that a test is about to begin and that calls will be disconnected.

- The red LED above the button remains on until the test is canceled.
- Invoking a continuity loopback test automatically cancels any other test in progress.
- To stop the continuity loopback test, press the button on the DTI. The red LED above the button turns off when the test is canceled.

Loopback test for BRI lines

Installer password required

The loopback test for BRI lines loops the incoming BRI payload back to the local exchange (service provider) for evaluation of the transmission quality. Loopback tests should be conducted only under the guidance of the service provider, and the results from these tests are returned to the service provider.

You can run loopback payload tests simultaneously on multiple loops or multiple cards. The loop must be provisioned to perform the test. All calls on the card you are testing will be dropped at the start of a loop payload test.

Operating a payload loopback test installer password required



All calls on a BRI loop are dropped when you start loopback test.

While the loopback test is in progress, the BRI lines go out of service. There is no warning from the system. Pick an appropriate time to do a test and warn users that they will lose any calls in progress.

Start with the display showing **Loopback tests:**

1. Press . **Show Module:** displays.
2. Enter a module number or press **LIST** to scroll through modules. **Cards on KSU** or **Card on Mod X** displays.
3. If you want to test cartridges on another module, press until the display shows the module.
4. Press . **Cd1-KSU** or **Cd1-ModX** displays.

If you want to test the second cartridge on the KSU, press

to display **Cd2-KSU** or **Cd1-ModX**.

5. Press .
 - If there is an analog cartridge in the slot or the slot is empty, the display shows **Need digital crd.**
 - If there is a BRI cartridge with U-NT or S/T loops, the display shows **LOOP nnn.**
6. Press . **Payload loopback** displays.
7. Press **START** to begin the test. **Payload running** displays.
8. Press **STOP** to end the test.

Note: You can exit programming or move on to other programming or loop testing while the test is running.

CSU stats

Each DTI is equipped with an internal channel service unit (CSU). When enabled, the internal CSU monitors the quality of the received T1 signal and provides performance statistics and diagnostic information.

DTIs must be individually programmed to establish parameters for collecting and measuring transmission performance statistics by the CSU.

Statistics

Installer password required

The CSU provides both performance and alarm statistics. Three performance parameters are accumulated:

- errored seconds (ES-P)
- severely errored seconds (SES-P)
- unavailable seconds (UAS-P)

These parameters are defined as per TIA-547A. Errored seconds are enhanced to include control slip (CS) events.

The parameters are stored for the previous 15-minute interval, the 15-minute intervals in the last 24 hours, and the previous 24-hour interval. Only near-end performance data is recorded.

The internal CSU continuously monitors the received signal and detects four types of transmission defects:

- any active carrier failure alarms (CFA) — loss of signal LOS, out of frame OOF, alarm indication signal AIS, remote alarm indication RAI
- the number of bipolar violations that occurred in the last minute

- any defects that occurred in the last minute — loss of signal LOS, out of frame OOF, alarm indication signal AIS
- the number of milliseconds of short term alarms in the last minute — loss of signal LOS, out of frame OOF, alarm indication signal AIS, remote alarm indication RAI.
A shortterm alarm is declared when the detected defects persist for tens of milliseconds.

A carrier failure alarm (CFA) is a duration of carrier system outage. CFA types reported can be mapped to CFAs defined in TIA-547A and TR62411 as follows:

Norstar	TIA-547A	TR62411
LOS CFA	Red CFA	Red CFA
OOF CFA	Red CFA	Red CFA
AIS CFA	Red CFA	AIS CFA
RAI CFA	Yellow CFA	Yellow CFA

The criteria for declaring and clearing the alarms is selectable to meet those in TIA-547A or TR64211.

Checking the performance statistics

To check the performance statistics, start with the display showing **CSU stats**:

1. Press . **Show card:** displays.

If the ICS is not equipped with DTIs, or if both cartridges have their internal CSU setting programmed to off, the display shows **Unequipped**.

2. Press or depending on which Trunk Cartridge you are checking. **Cd1-KSU** or **Cd2-KSU:** displays.
3. Press to see the results.

4. Press **TIMER**. The display shows the date and time that the system began collecting statistics.
5. Press . **Performance stats** displays.
6. Press to view the performance stats. **Current interval** displays.
7. Press to display the duration of the current interval.

OR

Press until the display shows the type of interval statistics you want to check. Options are:

- **15 min intervals** for intervals in the last 24 hours, numbered from the most recent (01) to the oldest (96). Press , then enter an interval number, or press to view the most recent interval. The display shows the start time of the interval.
 - **24 hour summary** for a summary of the previous 24 hours. Press to display the number of intervals in the summary.
8. Press . **ES:** displays the number of errored seconds.
 9. Press . **SES:** displays the number of severely errored seconds.
 10. Press . **UAS:** displays the number of unavailable time seconds.
 11. Press until the display shows **Performance stats**.

Checking the CSU alarms

Installer password required

To check the CSU alarms, start with **Performance stats**.

1. Press . **Alarm stats** displays.
2. Press . **Active alarms** displays.

Checking active alarms

Start with the display showing **Active alarms**.

1. Press . The display shows the first active alarm or no active alarms.
2. Press or to cycle through the complete list of active alarms.
3. Press to return to **Active alarms**.

Checking carrier failure alarms

Start with the display showing **Active alarms**.

1. Press . **CFA alarms** displays.
2. Press .

The display shows one of the following:

LOS CFA history, **DOF CFA history**, **RAI CFA history** or **AIS CFA history**.

3. Press until the display shows the type of alarms you wish to view.
4. Press . The display shows the first history item and the time that the alarm started.
5. Use and to move through the history items.

Checking bipolar violations

Start with **Active alarms**.

1. Press until you find **Bipolar violatn**.
2. Press . The display shows the number of bipolar violations that occurred in the last minute.

Checking short term alarms

Start with **Active alarms**.

1. Press until you find **ShortTerm alarms**.
2. Press .

The display shows the first type of shortterm alarm and the number of milliseconds, not necessarily contiguous, it was active in the last minute.

3. Press and to move through the short term alarms.

Checking defects

Start with **Active alarms**.

1. Press until you find **Defects**.
2. Press .

The display shows the first type of defect and the number of milliseconds, not necessarily contiguous, the hardware reported it active in the last minute.

3. Press and to move through the defects.

Resetting all statistics

Start with the display showing **Alarm stats**:

1. Press . **Stats log** displays.
2. Press . **Reset stats?** displays.
3. Press **YES** to erase all the current statistics and begin collecting statistics again.

Diagnostic tools

The command under this heading allows you to perform a warm restart on your system.

1. At the **Diagnostic** prompt, press .
Restart system? displays.
2. If you are sure you want to perform a warm start on your system, press **YES**. Otherwise, press **CANCEL**.

Link Status

Working with fractional PRI

Installer password required

When you purchase PRI from your service provider, you can request the number of B-channels that are allocated for you to use. For example, you may want to use only 12 B-channels instead of 23 B-channels. If this is your situation, you should disable all the B-channels that you do not need.

It is recommended that the number of lines that are deprovisioned on a DTI card (configured as PRI) be the same as the number of B-channels that are disabled. For example when B-channels 13-23 are disabled, you should deprovision lines 13 to 23.

Start with the display showing **Maintenance**

1. Press . **System version** displays.
2. Press until you find **Link status**.
3. Press . **Cards on KSU** displays.
4. Press . **Cd1-KSU: PRI** displays.
5. Press . **B channel** displays.
6. Press . You can view the status of the PRI channel, for example: **PRI:B01 Idle**.

Note: When the display shows **PRI:B01 Near**, it means that the channel has been disabled by Norstar.

When the display shows **PRI:B01 Far**, it means that the channel has been disabled by the CO.

7. Press **Enable** or **Disable** key to change the setting for the channel or press to move to the next B-channel.

Usage Metrics

Hunt groups

This feature gives you statistical information about hunt group calls.

From **Usage Metrics**, start with the display showing **Hunt groups**.

1. Press . **Show group#:** displays.
2. Enter the group number. **H91 metrics** displays.
3. Press . The display shows the date the information was last cleared.
4. Press . **TotalCalls:** displays.

The displayed value is the total number of calls received by the hunt group, up to a maximum value of 99999.

5. Press . **Ans:** displays.

The displayed values are the number of calls that were answered up to a maximum value of 99999 and the percentage of answered calls versus total calls up to a maximum value of 999.

6. Press . **Avg ans: .sec** displays.

The displayed value is the average time in seconds that it took to answer a call, up to a maximum value of 999.

7. Press . **Abndrn:** displays.

The displayed values are the number of calls that were abandoned up to a maximum value of 99999 and the percentage of abandoned calls versus total calls up to a maximum value of 999.

8. Press . **Busy:** displays.

The displayed values show the number of times the hunt group was busy up to a maximum value of 99999 and the percentage of busy call versus total calls up to a maximum value of 999.

9. Press . **Overfl:** displays.

The displayed values show the number of calls that were sent to the overflow position up to a maximum value of 99999 and the percentage of overflow calls versus total calls up to a maximum value of 999.

10. Press . **Av9 Q: sec** displays.

The displayed value is the average time, in seconds, that the call waited in the queue, up to a maximum value of 999.

Call-by-Call

Installer password required

This feature gives you statistical information on call-by-call limit settings for PRI when the protocol is set to call-by-call routing.

From Usage Metrics, start with the display showing **CbC limit stats**.

1. Press .

The display shows the first pool (for instance, PRI-A) which supports CbC routing. Press **NEXT** to show the other pool if it is supported.

2. Press . **Service:** displays.

The service that is displayed depends upon the protocol.
Press **NEXT** to select a different service.

3. Press .

The display shows the supported call type for the selected service.

4. Press to select the next supported call type, either **Incoming calls** or **Outgoing calls**.

For **Incoming calls** press .

The display shows **Min denied: _**.

Press . The display shows **Max denied: _**

For **Outgoing calls** press .

The display shows **Min denied: _**. Press .

The display shows **Max denied: _**

Note: The value for Min denied and Max denied can be from 0 to 999.

Clearing the metrics

After step 1 in the previous section, press **CLR** to clear the Min and Max denied metrics values for all call types and all supported services for that pool.

Troubleshooting

These troubleshooting procedures allow you to solve many problems in the Norstar system.

Follow these procedures before replacing any components.



Only qualified persons should service the system.

The installation and service of this unit is to be performed only by service personnel having appropriate training and experience necessary to be aware of hazards to which they are exposed in performing a task and of measures to minimize the danger to themselves or other persons.

Electrical shock hazards from the telecommunication network and AC mains are possible with this equipment. To minimize risk to service personnel and users, the ICS must be connected to an outlet with a third-wire ground. In addition, all unused slots should have filler faceplates installed and the doors should be in place at the completion of any servicing.

Service personnel must be alert to the possibility of high leakage currents becoming available on metal system surfaces during power line fault events near network lines. A risk point on the ICS is the power cord earth ground pin. These leakage currents normally safely flow to Protective Earth ground via the power cord.

Therefore, it is mandatory that connection to an grounded outlet is performed first and removed last when cabling to the unit. Specifically, operations requiring the unit to be powered down must have the network connections (central office lines) removed first.

Where more than one procedure is given, the procedures represent different options from which you can select one.

Troubleshooting procedures for Companion components are included in the *Modular ICS Companion Installer Guide*.

Getting ready

Before you begin troubleshooting, gather all the information that is relevant to your network configuration:

- the *Modular ICS Programming Record*
- records from people who use the network
- information about other hardware and non-Norstar features within the public or private network



Notify service provider of T1 or PRI signaling disruption.

Notify your T1 or PRI service provider before disconnecting your T1 or PRI lines, removing power to your system, or performing any other action that disrupts your T1 or PRI signaling. Failure to notify your T1 or PRI service provider may result in a loss of T1 or PRI service.



Tips - Remember that you can check many of the system parameters without having to go into a programming session.

Use Line Profile () from a T7316/T7316E, an M7310 or an M7324 set, to check programming for any line.

Use Set Profile () from a T7316/T7316E, an M7310, or an M7324 telephone, to check programming for any telephone.

Use Button Inquiry () to check the buttons on a particular telephone.

Types of problems

The problems you encounter will likely occur into one of the following categories:

Misunderstanding a feature

A problem may be reported because a Norstar user is unfamiliar with the operation of a given feature. You may be able to solve the problem simply by demonstrating how to use the feature correctly.

Programming errors

You may encounter problems caused by errors in programming. A feature may have been programmed incorrectly or may not have been programmed at all. Refer to the section on programming the feature to ensure all the parameters have been correctly programmed.

Wiring connections

Wiring problems are caused by loose, unconnected, or incorrect wiring. Use the procedures in the section on Checking the hardware as a guide.

Equipment defects

You may encounter problems caused by Norstar equipment defects. See the appropriate section for problems related to the system hardware.

General troubleshooting procedure

1. Diagnose the trouble by determining:
 - the types of problems users have experienced
 - the frequency of the problems
 - how many telephones are affected
2. Check how a feature is being used.

A problem may have been reported because of a misunderstanding about how a feature works. Confirm that the person who reported a problem understands the intended use and operation of any feature in question.
3. Check for programming errors.

Check that the programming recorded in the *Programming Record* is correct for the intended operation of the system, and verify that the programming has been correctly entered.
4. Run a Station set test (☎ 8 0 5).

Instructions are included in the *Modular ICS 6.1 System Coordinator Guide*.
5. Check the wiring and hardware connections.
6. If the problem persists, run a Maintenance session as described in *Beginning a Maintenance session* on page 512.
7. If hardware is defective, replace it.
8. If the trouble requires expert advice, follow your company procedure for obtaining assistance.

Problems with telephones



Set has faulty buttons, display, handset or other hardware problems

Run a Station Set Test (   ).

Detailed instructions are contained in the *Modular ICS 6.1 System Coordinator Guide*.

Unreadable set display





If the trouble is with M7310, T7316/T7316E, or M7324 sets

1. Press   .
2. Press UP or DOWN to adjust the display to the desired level.
3. Press OK.



Tip - *The number of contrast settings varies with the model of telephone.*

If the trouble is with M7100/T7100 or M7208/T7208 sets

1. Press   .
2. Press a number on the dialpad to adjust the display to the desired level.
3. Press .

If the display is still unreadable

1. Go into **Maintenance** in programming and disable the problem telephone.
2. Replace the problem telephone with a working one.
3. Enable the working telephone.

Telephone dead

1. Run a Station Set Test ().

Detailed instructions are contained in the *Modular ICS 6.1 System Coordinator Guide*.

2. If more than one telephone is affected, refer to *Data Module down* on page 605.
3. Check for dial tone.
4. Check the display.
5. If the problem persists, replace the telephone with a working set of the same type. This ensures the programming is downloaded to the new set.
6. Check the internal wiring at both the modular jack and the distribution cross-connect. A TCM port should have between 15 and 26 V DC across the Tip and Ring when the telephone is disconnected.
7. Check the line cord.

Running a Maintenance session to test a dead telephone

1. Run a Maintenance session to ensure that the telephone is not disabled. See *Port/DN status* on page 514.
2. Disable the port to which the telephone is connected, using *Port/DN status*.
3. Enable the port to which the telephone is connected, using *Port/DN status*.

Replacing a telephone

In a powered-up system, an existing telephone can be replaced by a new telephone. A new telephone is one that was not previously in service within the system.

Replacing telephones of the same type

If an existing telephone is unplugged, and a new telephone of the same type is then plugged into the same jack, for example, replacing a T7208 set with another T7208 set, the new telephone acquires the programming and the internal number of the old telephone. This is normally done to replace a defective telephone.

Replacing telephones of different types

If an existing telephone is unplugged, and a new telephone of a different type is plugged into the same jack, the new telephone keeps the old internal number. The new telephone receives a default profile for a telephone of its type. You then need to program the terminal as described in the *Modular ICS 6.1 System Coordinator Guide*.

If the telephone being replaced has more lines than the new telephone, automatic outgoing line selection may not work with the handsfree feature. A line must be selected manually.

Status of a telephone that was replaced

The old telephone that was unplugged and replaced by a new telephone loses its programming and internal number. The internal number of the old telephone has been given to the new telephone. The programming has either been removed or given to the new telephone when it was plugged into the old jack. The replaced telephone, if it is plugged back into the system, is now treated by the system as a telephone not previously in service.

Emergency telephone dead

1. Verify that the power at the ICS or Trunk Module is not on.
2. Verify that there is no dial tone at the emergency telephone.
3. Check that the external line and emergency telephone connections have been made correctly.
4. Ensure that the emergency telephone is not faulty by connecting it directly to the external line and listening for dial tone.
5. Verify that the ICS has a Loop Start Trunk Cartridge installed in slot 4. Verify that the Trunk Module has a Loop Start Trunk Cartridge installed in the left-most slot.
6. Verify that there is dial tone on lines 002 (ET1 on CD1) and 026 (ET2 on CD2) of the ICS and on the first line of each Trunk Module.
7. Replace the ICS if the emergency telephone is connected to the ICS or replace the Trunk Module if the emergency telephone is connected to the Trunk Module.

Problems with lines

The troubleshooting problems listed here focus on trouble with making calls or using lines. For problems which are specific to BRI lines, refer to *Problems with BRI service* on page 600.

Calls cannot be made (but can be received)

1. Press .
2. Press a line button.
3. If an incorrect line number or name appears, or if neither appears, on the display, check the programming settings.

OR

If the correct line number or name appears on the display, make sure the external lines are properly cross-connected.

4. Check external lines by attaching a test telephone directly on the distribution block.
5. Ensure that the 25-pair cable is properly connected to the modules or the ICS.
6. Run a Maintenance session.
7. Use **Module status** to verify that the module on which the Trunk Cartridge is installed is not disabled or unequipped.
8. Run a Maintenance session and disable the appropriate ports using **Port/DN status**.
Charts showing external line port number defaults appear under *Wiring charts* on page 252.
9. Enable the appropriate ports using **Port/DN status**.



10. If you still cannot make external calls, power down, then power up the system. This should be done after business hours to avoid losing calls.
11. To check the line, contact your service provider or central office.



Notify service provider of T1 signaling disruption.

Notify your T1 service provider before disconnecting your T1 lines, removing power to your system, or performing any other action that disrupts your T1 signaling. Failure to notify your T1 service provider may result in a loss of T1 service.

Dial tone absent on external lines

1. Use Button Inquiry (  ) to display the number of the external line you are testing.
2. Check for dial tone using a test telephone at the connections for the external line on the distribution block.
3. Make sure that a Trunk Cartridge for the line is properly installed in the ICS or Trunk Module.
4. Make sure that the Trunk Module fiber cable is properly connected to the Expansion Cartridge on the ICS. Refer to *Problems with trunk cartridges service* on page 596 and *Trunk or Station Module down* on page 604.
5. Run a Maintenance session to ensure that the line is not disabled. See *Port/DN status* on page 514.

Hung lines at a telephone

Line indicators that have been solid for a long time are the only visible indication that lines are hung.

Possible problem

A line that has been redirected using Line Redirection may, under some circumstances, remain busy after a call is over. If this happens, the outgoing line for the redirection also remains busy. You can clear this kind of hung line only at the telephone that was used to redirect the line.

Solution

1. Enter the Button Inquiry feature code () at the telephone that was used to redirect the line.
2. Press the button of the redirected line.
3. Press **SHOW** or .
4. Press **DROP** or .

Both the redirected line and the outgoing line for the redirection should now be cleared.

Possible problem

The supervision and/or Discon timer programming for the line do not match the settings for the line at the central office.

Solution

Verify that your programming for the line matches the central office settings.

Possible problem

Lines are still hung after all the above solutions have been investigated or tried out.

Solution

For lines that are hung for any other reason, you will have to run a Maintenance session.

1. Run a Maintenance session and go to **Module status**.
2. Disable and enable the affected Trunk Cartridge.

Follow the procedures in the *General troubleshooting procedure* on page 576 before proceeding.

Auto-answer line rings at a telephone

This section describes possible problems and solutions if an auto-answer line mistakenly rings at a telephone.

Possible problem

You configured a loop start trunk as auto-answer but the installed hardware does not support disconnect supervision. In this case, the symptom would be accompanied by the Alarm 62 code symptom.

Solution

Reconfigure the trunk as manual-answer.

OR

Replace the Trunk Cartridge with one that provides disconnect supervision.

Possible problem

The line is configured as auto-answer and unsupervised.

Solution

Reconfigure the line as manual-answer.

OR

Reconfigure the line as supervised.

Possible problem

The line is not equipped for disconnect supervision at the central office.

Solution

Reconfigure the trunk as manual-answer.

Possible problem

The Discon timer setting for the Trunk Cartridge in **Trk/Line data** does not match the setting for the line at the central office.

Solution

Reconfigure the Discon timer to match the setting at the central office.

Prime telephone gets misdialed calls

This section describes possible problems if the Prime telephone is receiving calls that it should be routed elsewhere.

Possible problem

The digits sent by a switch at a central office or in the private network did not match any Received number, the Auto DN, or the DISA DN. The call has been routed to the prime telephone for the incoming trunk.

Solution

1. Verify that the switch is sending the correct number of digits for the Received number length defined in your system.
2. Verify all the digit strings that the switch should be sending.
3. Check that you have defined the corresponding Received number for every target line in your system.
4. Make sure that the published telephone numbers for your network are correct.

Selected lines reads Not in service or Not available

When a user selects a line button and the set displays either **Not in service** or **Not available**, refer to the problem explanations in this section.

Possible problem

You have configured a line number associated with an E&M Trunk Cartridge DTMF receiver to appear at the telephone.

Solution

Reconfigure the line so that it does not appear at any telephone and configure another line to replace it at the telephone.

OR

Reconfigure the line as a different type and install trunk hardware to support the new type of line.

Possible problem

The Norstar system has taken an E&M line out of service because the far end did not respond to a disconnect signal from the Norstar system. The symptom would be accompanied by event code 263 in the System test log.

Solution

1. Check with the operators of the system at the far end and find out if their system is operating.
2. Check that your system hardware is receiving signals properly.
3. Check the trunk between your system and the far end system for a break.
4. Check that your trunk is properly configured.

5. Run a Maintenance session and go to the heading **Module status**.
6. Disable and enable the affected Trunk Cartridge.

Possible problem

The Norstar system has detected no response on an E&M line from the system at the far end. The symptom will be accompanied by Event code 265 in the System test log.

Solution

Check with the operators of the system at the far end and get them to troubleshoot their system.

Possible problem

The line is connected to a DTI which is currently not in service.

Solution

1. Check if the green LED on the DTI is flashing to indicate that service is suspended.
2. Check if any yellow LEDs are on to indicate an alarm or error condition.
3. Check if the red test LED is on to indicate that a continuity loopback test is running.
4. Check that the cable connecting the DTI to the termination point from the central office or network is properly connected.
5. Check that the DTI is properly inserted in the ICS.
6. Run a Maintenance session to verify the status of the DTI.

Possible problem

The line has been disabled for maintenance purposes.

Solution

Enable the line.

OR

If the line will be out of service for some time, configure another line to replace it on the telephone.

Possible problem

The loop or line has not been provisioned.

Solution

Provision the loop or line.

Selected line pool displays: No free lines

If the user selects a line pool and the telephone displays **No free lines**, refer to this section for solutions.

Possible problem

If this happens often, there are not enough lines in the line pool to serve the number of line pool users.

Solution

If the line pool contains loop start trunks, enter programming and move under-used loop start trunks from other line pools into the deficient line pool.

OR

If the line pool contains E&M trunks, order more trunks from the telephone company or private network vendor. Install

additional Trunk Cartridges of the appropriate type. In programming, add the new trunks to the deficient line pool.

Problems with optional equipment

Analog Terminal Adapter

1. Check the connections to the jack.
2. Check the connections to the ATA.
3. Disconnect the ATA and replace it with a working telephone. If the telephone still works properly, the ICS and/or the station modules (SM) are operating properly.
4. Verify that the programming has been done as described in the *Programming Record* and the *Norstar Analog Terminal Adapter Installation Card*.
5. If the trouble seems to be in the ICS or SM, double-check all wiring and programming options. Also refer to *Problems with BRI service* on page 600 or *Data Module down* on page 605.

OR

If the trouble seems to be with the ATA, disable the ATA and replace it with a known working one.

Running a Maintenance session to test an ATA

1. Run a Maintenance session to ensure that the ATA is not disabled. See *Port/DN status* on page 514.
2. Disable the port connected to the ATA using `Port/DN status`.
3. Enable the port connected to the ATA using `Port/DN status`.

Auxiliary ringer

1. If the auxiliary ringer is used for **Schedules** (Night, Evening, or Lunch service), ensure that **Schedules** is activated from the control telephone.
2. Check the wiring between the auxiliary ringer generator and the ringing device. Refer to the auxiliary ringer wiring chart.
3. Check the wiring between the auxiliary ringer generator and the distribution block:

Auxiliary ringer wiring

Feature	Pin
Auxiliary ring (Make)	44 (Yellow-Brown)
Auxiliary ring (Common)	19 (Brown-Yellow)

4. Ensure that the auxiliary ringer contacts are operating properly by checking with an ohmmeter across the auxiliary ringer pin contacts listed above.
5. Check that the auxiliary ringer pin contacts are programmed to operate in conjunction with any or all of the features in the auxiliary ringer programming chart shown below.

Auxiliary ringer programming

Feature	Programmed in
Auxiliary ringer	Terminals&Sets
Auxiliary ringer	Lines
Schedules	Services

The current capacity of the Norstar relay contacts is 50 mA DC. They are designed to operate with the auxiliary ringer generator, or equivalent.

External paging

1. Use the Button Inquiry feature () to verify the feature of a programmable memory button.
2. Check the wiring between the 50-pin connector and the paging amplifier or between the connections shown in the external paging wiring chart.

External paging wiring

Feature	Pin
Page out (Tip)	40 (Black-Slate)
Page out (Ring)	15 (Slate-Black)
Page (Make)	41 (Yellow-Blue)
Page (Common)	16 (Blue-Yellow)

3. Test external paging to ensure that it is working. The nominal output signal from the Norstar ICS is 100 mV across 600 Ω .

Music on Hold/Background Music trouble

Although Music on Hold and Background Music are separate features, they share the same wiring and customer-supplied music source.

1. Ensure that the proper feature access code () is turned on. Adjust the volume using the volume control bar.
2. Use the Button Inquiry feature () to verify the feature on a programmable memory button.
3. If there is trouble with Music on Hold or Background Music, check **Featr settings** in **System Prgrmg**.
4. Check the wiring between the music source and the 50-pin connector. See *Wiring charts* on page 252.

5. Ensure that the music source is turned on, is operational, and the volume control is set properly.
6. Any music source with a low-output impedance, less than $3,300 \Omega$, can be connected. The output level must be less than one volt.

KIM not working

The key interface module (KIM) that attaches to a T7316E telephone to create a central answer position (CAP) can be reset in two ways.

- If you want to maintain the programming, you can warm start the module by physically unplugging the module from the telephone. When plugged back in, the module will perform a startup. Try this first when you receive an **Addon** error message on the telephone display.
- If you want to restart the module and erase the programming, you can perform one of two cold starts described below.

Cold starting the KIM

If the KIM does not recover after a warm reset, or if you want to reset the programming for the KIM, there are two types of cold starts for the modules:

For both types of cold starts:

1. Unplug and replug the T7316E line cable.

The telephone restarts and all the icons flash.

When the telephone icons stop flashing, the KIM module icons start flashing.

2. When the KIM icons start flashing, do one of the following:

- **KIM single-module cold start**

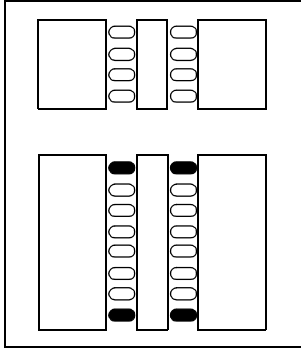

If you just want to cold start an individual module, on that module, simultaneously press the two top and two bottom buttons on the lower button set, as shown in the following diagram. The KIM displays a random pattern of icons as the KIM resets.

- **KIM multi-module cold start**

If you want to cold start all the KIMs attached to your telephone, simultaneously press the top two buttons on the upper button set, and the bottom two buttons on the lower button set, as shown in the following diagram.

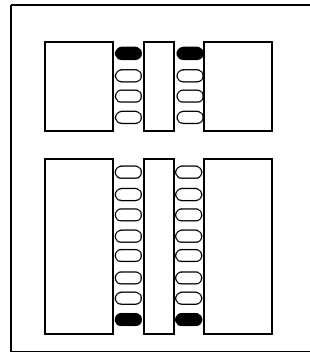

Problems with trunk cartridges service

Check first for user problems, then wiring and programming errors before replacing Norstar equipment.



Notify service provider of T1 or PRI signaling disruption.

Notify your T1 or PRI service provider before disconnecting your T1 or PRI lines, removing power to your system, or performing any other action that disrupts your T1 or PRI signaling. Failure to notify your T1 or PRI service provider may result in a loss of T1 or PRI service.

1. Check that the cartridge is properly inserted in the ICS or Trunk Module.
2. Run a Maintenance session to ensure that the cartridge is not disabled.

If the problem persists:

If the Trunk Cartridge is installed in the ICS and the AC power is present and the LED indicator on the ICS is off, replace the ICS.

If the Trunk Cartridge is installed in a Trunk Module:

1. If AC power is present and the LED indicator on the Trunk Module is off, replace the Trunk Module.
2. Replace the fiber cable.
3. Replace the Trunk Cartridge.
4. Replace the Expansion Cartridge.
5. Replace the ICS.

Refer to *Installation* on page 219 for information about replacing components.

Digital Trunk Interface trouble

1. Run a Maintenance session to verify that the Trunk Cartridge is enabled and that the lines are provisioned.
2. Check the LEDs on the front of the DTI:

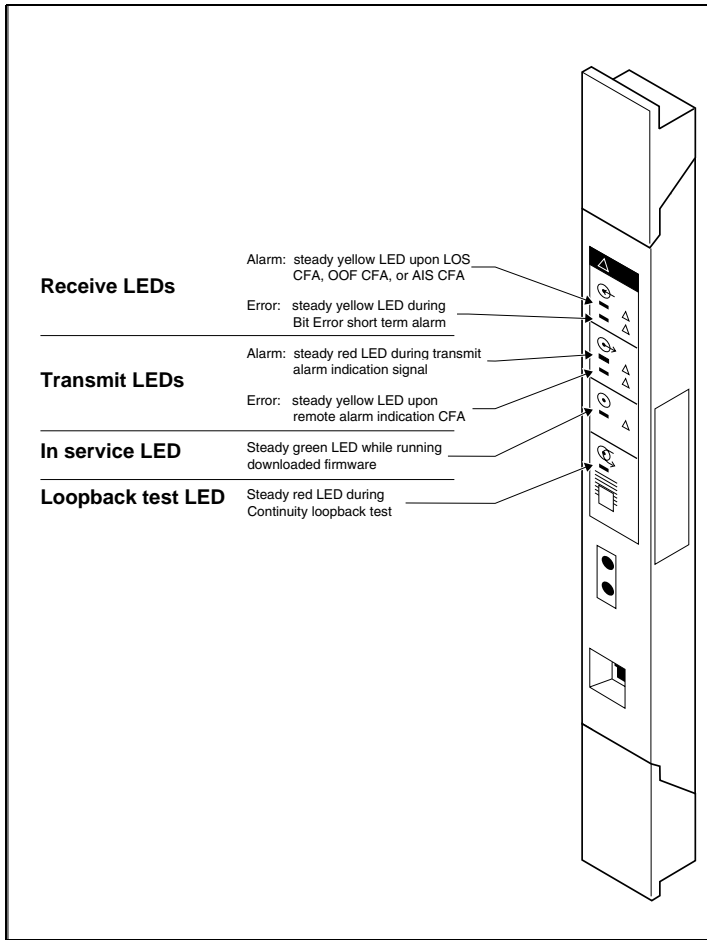

- **Receive Alarm** — yellow LED on indicates a problem with the digital transmission being received. This half-duplex link is unusable.
 - **Receive Error** — yellow LED indicates a minor error as a result of degraded digital transmission. Possible causes are an ohmic connection, water ingress, or too long a loop.
 - **Transmit Alarm** — red LED on indicates an inability to transmit. Alarm indication signal (AIS) is being transmitted to the terminating switch. This half-duplex link is unusable.
 - **Transmit Error** — yellow LED on indicates a remote alarm indication (RAI) carrier failure alarm (CFA) is being sent to the terminating switch. If the Transmit Alarm is not on, this indicates a far-end or cable problem.
 - **In service** — a flashing green LED indicates that the T1 or PRI trunks are out of service because of a running loopback test, or because the DTI is being initialized.
 - **Loopback test** — red LED on while a continuity loopback test is running.
 - **All LEDs flashing continuously** — the DTI is being initialized.
3. Run a Maintenance session and any loopback tests as appropriate.
 4. Check the pinout of the cable that connects the DTI to the termination point from the T1 or PRI service provider or the external channel service unit, and check that the cable is properly connected.
 5. Check with your T1 or PRI service provider to see if through-fed repeaters are used on the T1 or PRI span. The DTI does not provide the DC connection required for through-fed repeaters.

If through-fed repeaters are used on the T1 span, disable the internal CSU and connect the DTI to an external CSU.

6. If the problem persists, replace the DTI.



Notify service provider of T1 or PRI signaling disruption.

Notify your T1 or PRI service provider before disconnecting your T1 or PRI lines, removing power to your system, or performing any other action that disrupts your T1 or PRI signaling. Failure to notify your T1 or PRI service provider may result in a loss of T1 or PRI service.

Monitoring the T1 or PRI signal

If you are finding minimal faults with the T1 or PRI signal, you can monitor the signal to try and isolate the problem. The monitor jack on the DTI faceplate provides non-intrusive, bridged in-service monitoring of the T1 or PRI signal. Connect a protocol analyzer or other test equipment into the monitor jack to monitor the signal received from the network, and the signal transmitted by Norstar.

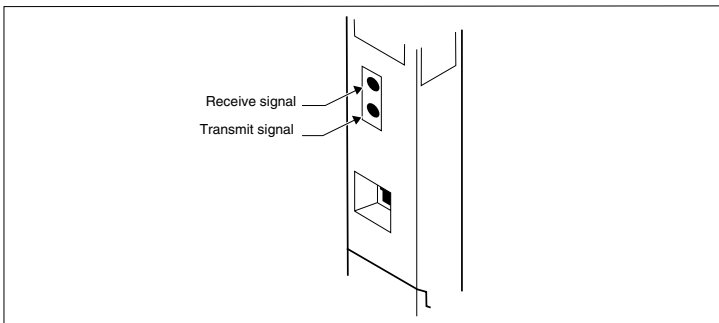

Problems with BRI service

Each LED on front of a BRI-ST or BRI-U Card corresponds with a loop, or indicates an overall state of the BRI connections.

BRI Card indicators

LED status	S, T or U-NT loop	S or U-LT loop
on	normal operation	
off	no synchronization with ISDN network	no synchronization with TE
all flashing	Card is not recognized by ICS (not configured in Hardware as a valid BRI loop). <i>All the LEDs on a BRI Card are flashing on page 601.</i>	
bottom LED only flashing	ICS is downloading firmware to the card; card is new or has changed location, or Feature Cartridge has been upgraded	

The BRI card is connected to the ISDN network (U loop) but the LED for one of more loops is not lit

Possible problem

The physical connection or configuration for the network connection is not correct (no Layer 1).

Solution

1. Verify the wiring from the network to the distribution block.
2. Verify the wiring from the distribution block to the ICS.
3. Use a Meridian 2500 set to test for data on the BRI trunk.

4. Test the network connection by connecting Bellcore standard terminal equipment (TE) directly to the network.
5. Verify that the loop is provisioned.
6. Verify that the loop is properly configured, including the proper loop type, SPIDs, and Network DNs.
7. Disable and re-enable the BRI Card.
8. Disable and enable the module for the Card.

Out of service displays when a BRI is selected (LED for loop is lit)

Possible problem

The loop is configured incorrectly. Layer 1 is present but Layers 2 and 3 are not working.

Solution

1. Verify that the SPIDs and Network DNs are programmed correctly in Hardware.
2. Verify that the loop and lines are provisioned.

All the LEDs on a BRI Card are flashing

Possible problem

The card is not configured properly.

Solution

Verify that the loop is properly configured, including the proper loop type, SPIDs, and Network DNs.

Possible problem

The card is not recognized by the ICS.

Solution

1. Verify that an Expansion Cartridge with Clocking, or Clocking Cartridge is installed in the ICS.
2. Replace the card with another card of the same type.

Caller hears one ring and then a fast busy signal when placing a call on a BRI line

Possible problem

CACH or EKTS, which are not supported by Modular ICS, is included in the ISDN services package.

Solution

1. Contact your service provider and ensure that CACH or EKTS are not part of the ISDN services package. These services must be turned off at the switch.
2. Verify that the network DNs have been programmed correctly, and verify the numbers with your service provider.

ICS down

1. If AC power is present and the LED indicator on the ICS is off, replace the ICS power supply.
2. Disconnect all central office and station lines from the ICS. Power down the ICS by unplugging it.

Replacing the ICS power supply

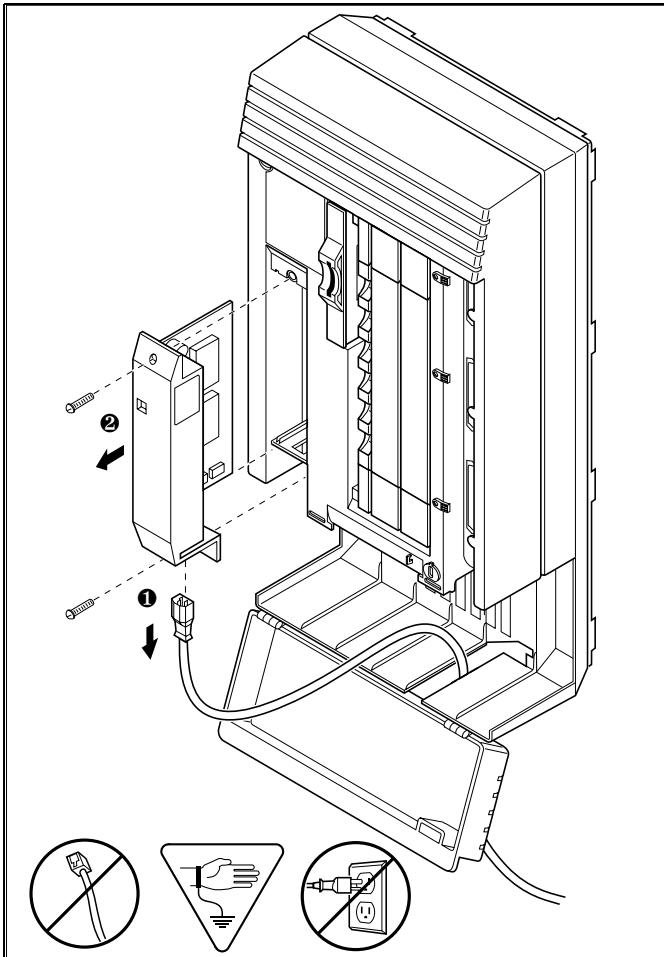

Trunk or Station Module down

1. Run a Maintenance session to ensure that the Trunk Module is not disabled. See *Module status* on page 521.
2. Disable the module using the **Maintenance** heading **Module status**.
3. Enable the module using the **Maintenance** heading **Module status**.
4. For Trunk Module

Check the external line by terminating a single-line telephone directly on the distribution block, or equivalent, which connects to the Trunk Module.

5. For Station Module

If the Station Module is still down, power down, then power up the ICS.

If the problem persists

1. If AC power is present and the LED indicator on the Trunk Module is off, replace the Trunk Module.
2. Replace the fiber cable.
3. Replace the Trunk Cartridge.
4. Replace the Expansion Cartridge.
5. Replace the ICS.

Refer to *Installation* on page 219 for information on replacing components.

Data Module down

1. Run a Maintenance session to ensure that the module is not disabled. See *Module status* on page 521.
2. Disable the Data Module using **Module status**.
3. Enable the Data Module using **Module status**.
4. If the Data Module is still down, power down, then power up the ICS and the Data Module.

If the problem persists

1. If AC power is present and the LED indicator on the Data Module is off, replace the Data Module.
2. Replace the Fiber cable.

Problems for network or remote users

Remote feature code gets no response

Possible problem

A Norstar user has called into another Norstar system and is trying to activate a remote feature but gets no response after dialing the feature code.

Solution

1. Make sure that the remote caller is dialing the feature code correctly. Use the asterisk (*) character, followed by the feature code, to activate a remote feature.
Do not use for accessing features on a remote Norstar system.
2. Make sure that the remote user is dialing tones, not pulses, once the call is answered.

Dialed number gets ringback and the wrong person

Possible problem

The digits sent by a switch at a central office or in the private network did not match any Received number, the Auto DN, or the DISA DN. The call has been routed to the prime telephone for the incoming trunk.

Solution

1. Verify that the switch is sending the correct number of digits for the Received number length defined in your system.
2. Verify all the digit strings that the switch should be sending.
3. Check that you have defined the corresponding Received number for every target line in your system.
4. Make sure that the published telephone numbers for your network are correct.

Dialed number gets stuttered dial tone instead of ringback

Possible problem

The remote caller has tried to reach a Norstar target line, but has reached a trunk with DISA instead.

Alternatively, the Norstar system has mapped incoming digits onto the DISA DN.

Solution

1. Verify all the digit strings that the switch should be sending.
2. Check that you have defined a corresponding Received number for every target line in your system.
3. Check that you have defined the correct DISA DN for your system.
4. Make sure that the published telephone numbers for your network are correct.

Dialed number gets dial tone instead of ringback

Possible problem

The remote caller has tried to reach a Norstar target line, but has reached the Norstar system instead. Norstar has mapped the incoming digits onto the Auto DN.

Solution

1. Verify all the digit strings that the switch should be sending.
2. Check that you have defined the corresponding Received number for every target line in your system.
3. Check that you have defined the correct Auto DN for your system.
4. Make sure that the published telephone numbers for your network are correct.

Dialed number gets busy tone

Possible problem

The target line that the incoming digits map onto is busy, and there is no prime telephone for the incoming trunk.

Solution

For maximum call coverage, make sure that you configure a prime telephone for every incoming trunk.

Dialed number does not get through

Possible problem

The digits sent by a switch at a central office or in the private network did not match any Received number, the Auto DN, or the DISA DN. There is also no prime telephone assigned for the incoming trunk. In this case, the caller may hear overflow tone from the Norstar system or a recorded message from the originating switch.

Solution

1. Configure a prime telephone for every incoming trunk.
2. Verify that the switch is sending the correct number of digits for the Received number length defined in your system.
3. Verify all the digit strings that the switch should be sending.
4. Check that you have defined a Received number for every target line in your system.
5. Make sure that the published telephone numbers for your network are correct.

Possible problem

The Norstar system did not receive some or all of the incoming digits.

Solution

1. Check that the system hardware is receiving signals properly.

2. Verify that the switch is sending the correct number of digits for the Received number length defined in your system.
3. If the switch at the far end is sending pulse signals, make sure they are being sent at the proper rate. Pulse digits must be 300 ms or more apart for Norstar to receive them.

Possible problem

If remote callers are having difficulty getting through from the public network, there may be a problem with your DID Trunk Cartridge.

Solution

1. Connect a single-line DTMF telephone to a DID trunk input on the DID Trunk Cartridge.
2. Use the single-line telephone to enter a Received number that has been programmed for a target line in your system. Listen for ringback.
3. If you do not hear ringback, check that the target line is assigned to a telephone and that there is a prime telephone assigned for the DID trunk.
4. If you now hear ringback, but you also hear the noise of your unanswered call ringing, check the cross-connections. If all the cross-connections are correct replace the Trunk Cartridge.

Possible problem

If remote callers are having difficulty getting through from the private network, there may be a problem with your E&M/DISA Trunk Cartridge.

Solution

1. Check the cross-connections for the E&M/DISA Trunk Cartridge.
2. If the E&M trunks are connected to another Norstar system, make sure that connections have been made as indicated in *Installation* on page 219.
3. Use the following table to check for correct voltage on the E&M/DISA leads:

Voltages on E&M leads

Leads	Voltage: active	Voltage: inactive
V _{T-R}	125 mV AC on steady dial tone	0 V AC
V _{T1-R1}	125 mV AC on steady dial tone	0 V AC
V _{E-SG}	0 V DC to -5 V DC	-48 V DC
V _{M-SB}	0 V DC to + 2 V DC	-48 V DC

Dialed DISA number gets ringback instead of stuttered dial tone

The remote caller has dialed a DISA number, but has instead reached a target line, or has been routed to the prime telephone for the auto-answer trunk. The Norstar system has mapped the incoming digits from a switch onto a target line, or has been unable to map the digits anywhere.

Solution

1. Verify that the switch is sending the correct number of digits for the Received number length defined in your system.
2. Verify all the digit strings that the switch should be sending.

3. Check that you have defined the correct DISA DN for your system.
4. Make sure that the published telephone numbers for your network are correct.

Dialed DISA number gets dial tone instead of stuttered dial tone

Possible problem

The remote caller has dialed a DISA number, but has reached the Norstar system instead. The Norstar system has mapped the incoming digits from a switch onto the Auto DN.

Solution

1. Verify that the switch is sending the correct number of digits for the Received number length defined in your system.
2. Verify all the digit strings that the switch should be sending.
3. Check that you have defined the correct DISA DN for your system.
4. Make sure that the DISA DN and Auto DN are different enough to prevent misdialing.
5. Make sure that the published telephone numbers for your network are correct.

DISA user gets overflow tone when entering COS password

Possible problem

The remote caller may have entered an invalid password.

Solution

Check programming under COS passwords and verify that the caller has a valid password.

Possible problem

The remote caller may have entered an asterisk (*) as one of the six digits.

Solution

Instruct remote callers to enter their COS password correctly: enter six digits.

Possible problem

The remote caller may have entered a number sign (#) as one of the six digits.

Solution

Instruct remote callers to enter their COS password correctly: enter six digits. The number sign (#) may be entered after the sixth digit, but is not required.

Possible problem

The remote caller may have waited more than 15 seconds between entering digits.

Solution

Instruct remote callers to enter their COS password correctly: enter six digits, and do not pause too long between digits.

Possible problem

The caller may be dialing from a rotary-dial telephone or from a push-button telephone that uses pulse signaling.

Solution

Inform remote callers that they must dial from a push-button telephone that uses DTMF tone signaling.

Dialed feature code gets overflow tone

Possible problem

The remote caller does not have access to that feature.

Solution

1. If the call came in on a trunk with DISA, check the Class of Service that is associated with the COS password of the remote caller. If it is too restrictive, modify the remote package assigned to the COS password, or assign another COS password that is more suitable.
2. If the call came in on a trunk without DISA, check the remote package that you assigned to the incoming trunk. Make sure that it gives the appropriate access to the remote caller.

Possible problem

The feature code is not valid.

Solution

1. Make sure that remote callers have a correct listing of the features that are programmed for remote access.
2. Ensure that remote callers are dialing the feature code correctly. Press followed by the feature code to activate a remote feature.

Possible problem

The caller may be dialing on a rotary-dial telephone or on a push-button telephone that uses pulse signaling.

Solution

Inform remote callers that they must dial from a push-button telephone that uses DTMF tone signaling.

Dialed feature code gets busy tone

Possible problem

A resource that the remote feature uses may currently be in use. For example, a remote caller trying to use the paging feature would get a busy tone if the auxiliary speaker were being used at the time.

Solution

If repeated attempts to use the remote feature get busy tone, there may be a malfunction in a resource that the feature uses. Check that the remote feature hardware is functioning normally.

Line pool access code gets overflow tone

Possible problem

If the published line pool access code is valid, the remote caller does not have access to that line pool.

Solution

If the incoming trunk answers with DISA, give the remote caller a COS password that permits access to that line pool.

OR

Change the remote package for the incoming trunk so that it permits access to that line pool.

OR

Give the remote caller a line pool access code that is permitted within the Class of Service on the incoming trunk.

Possible problem

If the published line pool access code is invalid, the system has attempted, without success, to match the invalid code to a Norstar target line internal number, and there is no prime telephone for the auto-answer trunk.

Solution

1. Make sure that the published line pool access codes are correct.

2. Check that the line pool access codes have been entered correctly under **Access codes** in **System prgming**.

Possible problem

The caller may be dialing from the network on a rotary-dial telephone or on a push-button telephone that uses pulse signaling.

Solution

Inform remote callers that they must dial from a push-button telephone that uses DTMF tone signaling.

Line pool access code gets ringback

Possible problem

The published line pool access code is invalid, and the system has routed the call to the prime telephone for the incoming trunk.

Solution

1. Make sure that the published line pool access codes are correct.
2. Check that the line pool codes have been entered correctly under **Access codes** in **System prgming**.

Line pool access code gets busy tone

Possible problem

There are not enough lines in the line pool to serve the number of users.

Solution

If the line pool contains loop start trunks, enter programming and move under-used loop start trunks from other line pools into the deficient line pool.

OR

If the line pool contains E&M trunks, order more trunks from the telephone company or private network vendor. Install additional E&M Trunk Cartridges. In programming, add the new trunks to the deficient line pool.

OR

Create a separate line pool for remote users only.

Possible problem

There are DID lines in the line pool.

Solution

In programming, make sure that there are no DID lines in any of the line pools.

Dialed number gets no response

Possible problem

The remote caller, after accessing a line in a line pool, may have started dialing before the far end was ready to receive.

Solution

Instruct remote callers to wait until they hear feedback before entering any digits.

Possible problem

There may be a malfunction in the line that the remote caller accessed.

Solution

If the problem is persistent, check that all lines in the affected line pool are functioning normally.

Possible problem

There may be a malfunction in the system that the caller is trying to reach.

Solution

Inform the operators of the system at the far end that the dialed number is not getting through.

Specifications

Norstar system

Service tone cadences

Tone	Cadence (seconds)
Busy	0.5 on / 0.5 off
Expensive Route	0.3 on / 0.3 off (3 bursts)
Overflow	0.25 on / 0.25 off
Ringback	2.0 on / 4.0 off
Confirmation	1.0 on / 1.0 off (three bursts followed by no tone)
Recall	1.0 on / 1.0 off (three bursts followed by steady tone)
Ring splash	0.2 on (one burst)

Power specifications

Characteristic	ICS	TM	SM
Voltage V ac	110-120	110-120	110-120
Current A rms (max)	2.6	1.75	1.0
Frequency Hz	47-63	45-70	45-70
Crest factor	4.0	4.0	4.0

Telephone loop specifications

Characteristic	Value
Loop resistance	64 $\frac{3}{4}$ (300 m of 0.5 mm wire or 1000 ft. of 24 AWG wire)
Loop length	300 m (1000 ft.) without station auxiliary power supply 790 m (2500 ft.) with station auxiliary power supply
Minimum voltage at telephone	10 V dc

Current at telephone (idle)	45 mA nominal
Current at telephone (active)	80 mA maximum

Electrical requirements

Characteristic	Spec/Value
Electrostatic discharge	
ICS and telephones	IEC 801-2 severity level 3 maximum of 15 kV with a 300 μ /150 pF probe
Connectors	IEC 801-2 severity level 2
Radiated immunity	maximum of 5 V/m from 100 kHz to 1 GHz
Conducted immunity	maximum of 3 V rms from 0.1 MHz to 30 MHz

Environmental requirements

Characteristic	Spec/Value
Operating temperature range	0°C to 50°C (32°F to 122°F) IEC. 68-2-1 Tests Ad and IEC 68-2-2, Method A
Storage temperature range	-50°C to 70°C (-31°F to 158°F) IEC. 68-2-2 Test Bd
Humidity above 34°C (93°F)	5% to 95% (non-condensing) <52 mbar of water vapor pressure

ISDN network synchronization*

Characteristic	Spec/Value
----------------	------------

- * These specifications only apply when the system clock is not derived from a Digital Trunk Interface connection to the network.

Digital Trunk Interface

Network interface

Characteristic	Spec/Value
Physical	RJ48C 8-pin modular jack
Line rate	1.544 +/- 32 Mbps
Framing	Superframe/extended superframe*
Line code	AMI/B8ZS*
Impedance	100 $\frac{3}{4}$

* These values are set in Hardware programming. See the *Hardware on page 482* for details.

DSX1 operation

Characteristic	Value
Pre-equalization	0-210 m (0-700 ft.)*

* This value is set in Hardware programming. See the *Hardware on page 482* for details.

CSU operation

Characteristic	Spec/Value
Line build out	0, 7.5 or 15 dB*
Input dynamic range	0 to -26 dB (typical)
Performance reporting	Simultaneous support of TR 54016 or TIA-547A
Line loopback support	Remote activation/deactivation via in-band code or FDL as per TR 54016 or TIA-547A
Payload loopback support	Remote activation/deactivation via FDL as per TR 54016 or TIA-547A
Carrier failure alarms (CFA)	Alarm indication signal (AIS), Red Yellow

* This value is set in Hardware programming. See the *Hardware on page 482* for details.

Synchronization performance

Characteristic	Spec/Value
Stratum	4E

Digital trunk signaling support

Types	Options
Loop Start with answer and disconnect supervision	OSI interval* Pulse/DTMF dialing*
E&M	Immediate start (Pulse dialing only), Wink start, Delay start or ring-down tie line* Pulse/DTMF dialing*
DID	Immediate start (Pulse dialing only), Wink start or Delay start* Pulse/DTMF dialing* Ground start

* These values are set in Hardware programming. See the *Hardware on page 482* for details.

Local test support

Characteristic	Value
Monitor jack	Bridging via Bantam jack
Line loopback	activate/deactivate via maintenance*
Payload loopback	activate/deactivate via maintenance*
Card edge loopback	activate/deactivate via maintenance*
Continuity loopback	activate/deactivate via push button on faceplate*

* See *Tests on page 552* for details on running these tests.

Glossary

A

AbsorbLength: A setting that determines how many of the digits in a destination code will not be dialed by the system. AbsorbLength is assigned under **Destination codes in Services**.

access code: Different sequences of characters used to gain access to these Norstar features: Line pools, Call park, external lines, Direct-Dial telephone, Auto DN, and DISA DN.

alarm code: A number that appears on the alarm telephone display, informing you that the ICS has detected a fault in the system.

alarm telephone: A telephone that is designated to receive reports of Norstar system problems. This function is usually assigned to a prime telephone, but this can be changed under **Feature settings in Sys Programming**.

Analog Terminal Adapter (ATA): A device that permits analog telecommunication devices such as fax machines, answering machines, and single line telephones to be connected to the Norstar system. Programmed defaults for the ATA are automatically assigned by the Norstar system.





ANSI: American National Standards Institute.

Answer button: A telephone button with an indicator that is used to monitor another telephone. The answer button indicates incoming calls destined for the other telephone. Someone working at a telephone with answer buttons (an attendant, for example) can receive all





ringing and visual indication of incoming calls for other telephones, and answer those calls when necessary.

One telephone can have up to eight Answer buttons. An Answer button is automatically assigned to a telephone when that telephone is assigned an Answer DN.

Answer DN: The internal or directory number (DN) of a telephone that is monitored by an Answer button. You can assign up to eight Answer DNs to a telephone under **Line Access in Terminals and Sets programming**.

Autobumping:    
A feature that determines what the system does with new Call Log items when your Call Log is full. When Autobumping is on, a new log entry causes the oldest entry to be deleted. If Autobumping is off, your Norstar system does not log calls when your log is full.

autodial button: A memory button that, if programmed, provides one-touch dialing of external or internal numbers.

autolog options:    
A feature that allows you to select the type of calls that are stored in your Call Log. You can choose to log calls that were not answered by anyone within the system, to log calls that were unanswered at this telephone but which were answered elsewhere in the system, to log all calls answered and not answered at this telephone, or to not have calls automatically logged.

Automatic Dial: A feature that allows you to dial without having to pick up the receiver or select a line. You must have a prime line to use Automatic Dial.

Automatic Dial is assigned under **Dialing options** in **Terminals&Sets** programming.

Automatic handsfree: A feature which automatically activates handsfree operation when you make or answer a call. Automatic handsfree is assigned under handsfree in **Terminals&Sets** programming.

Automatic Hold: A feature that automatically places an active call on hold when you select another line. Automatic Hold (**Full AutoHold**) is assigned in **Lines** programming.

Automatic Privacy: See Privacy.

Automatic Daylight Savings Time: A feature that switches the system to standard or daylight savings time at pre-programmed times. It is turned on or off under **Daylight time** in **Sys Prgrmmng**.

Automatic Telephone Relocation: A feature that allows a telephone to retain personal and system programming when the telephone is plugged into a different Norstar modular jack. **Automatic Telephone Relocation** is enabled under **Set relocation** in **Sys Prgrmmng**.

auxiliary ringer: A separate external telephone ringer or bell which can be programmed to ring when a line or a telephone rings. An auxiliary ringer may be programmed to ring only when the system is in a particular schedule. Programming of an auxiliary ringer is done in **Services** programming after the feature has been enabled under **Capabilities** in **Terminals&Sets** programming.

AWG: American wire gauge.

B

B channel (Bearer channel). An ISDN standard transmission channel used for voice or data transmission.

Base station (XC 3.0 only): A Companion component that is mounted on walls and ceilings to provide a radio link to an office or other area where Companion portable telephones are used. Each base station houses two radios that allow portables to send and receive calls through the ICS. (See also Companion Wireless)

Background Music: A feature that allows you to hear music from the speaker of your Norstar telephone. It is available only if a music source has been attached to the ICS and the feature has been enabled under **Feature settings** in **Sys Prgrmmng**.

Basic password: A one- to six-digit password that prevents unauthorized access to the most commonly-used telephone settings. The Basic password can be assigned and changed in **Passwords** programming.

Basic Rate Interface (BRI): An ISDN interface which uses two B channels and a D channel (2B+D).

Bearer channel: See B channel.

Business series terminals These terminals were developed to replace the Norstar M-series terminals. Therefore, their functionality closely parallels the M-series terminals.

busy lamp field (BLF): A device with a liquid crystal display (LCD) panel of indicators that shows the status of up to 24 telephones in the Norstar system. The BLF attaches to the M7310 and T7316 telephones. **Note:** T7316E telephones do not support BLF.

button caps: Interchangeable plastic caps that fit over the buttons of Norstar telephones. They are used to indicate the features programmed onto each programmable memory button. Button caps are either pre-printed or have clear windows that allow you to insert labels.

Button Inquiry: *

With this feature you can check the function of each programmable button on your system telephone.

C

Call Duration timer: 7 7

A feature that allows you to see how long you spent on your last call, or how long you have been on your present call.

Call Forward: 4

A feature that forwards all the calls arriving at your telephone to another telephone in your Norstar system. To have calls forwarded outside the system, use Line Redirection.

Call Forward No Answer: A feature that forwards all calls arriving at your telephone to another designated telephone in your Norstar system after a specific number of rings. **Call Forward No Answer** is assigned under **Capabilities** in **Terminals&Sets** programming.

Call Forward On Busy: A feature that forwards all calls at your telephone to another designated telephone if your telephone is busy. This feature is assigned under **Capabilities** in **Terminals&Sets** programming.

Call Forward Override: An automatic system feature that allows you to call someone and ask them to stop forwarding their calls to you.

Call Information: 8 1 1

Call Information allows you to display information about incoming calls. For external calls, you can display the caller name, telephone number and the line

name. For an internal call, you can display the name of the caller and the internal number. You can obtain information about ringing, answered, or held calls.

Call Information Trunk Cartridge:

The Trunk Cartridge that allows you to connect loop start trunks with Call Information capability to the Norstar system.

Call Log: 8 1 2

Enter your Call Log to view a record of incoming calls. The log could contain the following information for each call: sequence number in the Call Log, name and number of caller, long distance indication, indication if the call was answered, time and date of the call, number of repeated calls from the same source, and name of the line that the call came in on. See **Autobumping**, **Autolog** options, and **Call Log** for further information.

Call Park: 7 4

With this feature you can place a call on hold so that someone can retrieve it from any other telephone in the Norstar system by selecting an internal line and entering a retrieval code.

The retrieval code appears on the display of your telephone when you park the call. You can park up to 25 calls on the system at one time.

Call Park Callback: See **Callback**.

Call Park prefix: The first digit of the retrieval code of a parked call. This digit cannot conflict with the first digit of any existing DNs, Line Pool access codes, the Direct-dial digit, or the external line access code. The default Call Park prefix digit is 1. It may be set to none, in which case Call Park is disabled. **Call Park Prefix** is assigned under **Access codes** in **Sys Programming**.

Call Pickup Directed: 7 6

A feature that allows you to answer a call ringing at any system telephone by entering the internal number of that telephone before taking the call. Call Pickup Directed is enabled under **Feature settings** in **Sys Programming**.

Call Pickup Group: See Pickup Group.

Call Queuing: 8 0 1

If you have several calls waiting at your telephone, you can invoke the Call Queuing feature to answer them in order of priority. Priority is given to incoming calls, followed by callback and camped calls.

Callback: If you park, camp, or transfer a call to another telephone and it is not answered there, it will ring again at your telephone. How long the system will wait before Callback occurs is set under **Feature settings** in **Sys Programming**.

Camp-on: 8 2

A feature that allows you to reroute a call to a telephone even if all the lines on that telephone are busy. To answer a camped call, use Call Queuing or select a line if the camped call appears on your telephone. Priority is given to queued calls.

Camp timeout: The length of a delay before a camped call is returned to the telephone that camped the call. The length of delay is set under **Feature settings** in **Sys Programming**.

Central answering position

(CAP): An M7324 telephone that has been designated as a CAP under **CAP assignment** in **Sys Programming**. The CAP provides backup answering and can be used to monitor the telephones within a Norstar system.

Central answering position (CAP)

module: A module connected to an M7324 telephone which provides 48 additional buttons that can be used as autodial buttons or feature buttons. A maximum of two CAP modules can be connected to a single M7324 telephone.

Centralized voice mail and Auto Attendant:

A Norstar VAM can be configured to service other systems connected to the Norstar where the NVAM resides. The connection must be made using PRI SL-1 lines with the MCDN protocol active. Both a PRI and an MCDN software codes (as well as any required voice mail codes) are required for this feature.

Channel Service Unit (CSU):

A device on the Digital Trunk Interface that is the termination point of the T1 lines from the T1 provider. The CSU collects statistics on the quality of the T1 signal. The CSU ensures network compliance with FCC rules and protects the network from harmful signals or voltages.

Class of Service (COS):

The set of Norstar features and lines available to the user for a call. The Class of Service for a call is determined by the restriction filters and remote access packages assigned to the telephone in **Lines programming**. The Class of Service for a call can be changed by entering a six-digit Class of Service password. (Internal users cannot change their access to features with a COS password, only their restriction filters.) **Class of Service** and **Class of Service Passwords** are assigned in **Passwords programming**. See Remote Access.

Class of Service password:

6 8

A six-digit code that allows you to switch from your current Class of

Service to one that allows you to dial numbers prohibited by your current Class of Service.

CLID on busy Starting with version 6.1 systems, on telephones that allow CLID display, incoming calls that arrive when the telephone is busy will briefly display a CLID.

cold start: When all system programming is lost. This can happen because you have entered the Startup feature code **[☎][*][*][S][T][A][R][T][U][P]**, or after a major event, such as an extended power failure.

Combo Cartridge: A cartridge that allows you to connect Trunk Modules and Station Modules to the ICS to expand the system capacity for trunks and telephones. Combo Cartridges provide six-port or 12-port expansion and Services functionality with each cartridge. See also Expansion Cartridge.

Companion Wireless: The name for Nortel Networks communication systems which use radio technology to transmit and receive signals between its components and the Norstar system. Companion Wireless provides mobility in the workplace. Calls that used to ring just at your Norstar set can also appear and ring at your portable.

Companion portable telephone: Hand-held wireless sets which allow complete mobility within the reach of Companion base stations or an external antenna. Portables offer many, but not all, Norstar features and share much of the same programming as wired desk sets.

Conference: **[☎][3]**

A feature allows you to establish a three-person call at your Norstar telephone.

contrast adjustment: **[☎][*][7]**
Allows you to set the contrast level of your telephone display.

control telephone: A control telephone can place the lines for which it has responsibility in or out of a Service Mode.

The direct-dial telephone is a control telephone for directing calls to the extra direct-dial telephone. A telephone is made a control telephone and has lines assigned to it in Services programming.

Coordinated Dialing Plan: (CDP)
This dialing plan uses a steering code to identify each node in a private network. This one-digit code becomes part of the set DN number rather than a separate code. In this way, system A might have codes in range 2100 to 2999, whereas system B might have codes in range 3100 to 3999.

COS: See Class of Service.

cursor: A short horizontal line that appears on the system telephone display to indicate that characters can be entered using the dialpad.

D

D channel (Data channel): An ISDN standard transmission channel which is packet-switched, and is used for call setup, signalling and data transmission.

Data channel: See D channel.

Data Communications Interface (DCI): A Norstar device that allows you to attach an RS-232 data device to the Norstar system.

data terminal: A device, such as a modem, that can be used to transfer data instead of sound over a telephone network. You cannot use Norstar programming to set up such devices. See the documentation that accompanies the device.

date: See Show Time or Time and Date.

defaults: The settings for all Norstar features when the system is first installed. Settings are changed from their defaults in programming. In this manual, default settings are shown in **bold** text.



Delayed Ring Transfer (DRT) to prime: After a specified number of rings, this feature transfers an unanswered call on an external line, to the prime telephone associated with that line. This feature is activated under **Feature settings** in **Sys Prgrmmng**.

destination code: A two- to 12-digit number that the system interprets and then translates into the digits that you want dialed out. Both the code and its associated dialed digits are assigned under Routing service in Services programming.

DID trunk: See Direct Inward Dial trunks.

DID Trunk Cartridge: The Trunk Cartridge that allows you to connect DID trunks to the Norstar system.

dialing restriction: See Restriction filter.

dialing modes:  
This feature allows you to set the dialing mode of your telephone. Norstar supports three dialing modes: Automatic Dial, Pre-Dial, and Standard Dial. All three modes support on-hook dialing, meaning you can dial a call without picking up the receiver. The special features of the Automatic and Pre-Dial modes are available only when you dial on-hook.

Digital Trunk Interface: The Trunk Cartridge connects digital T1 AND ISDN trunks to the Norstar system.

Direct-dial: A feature that allows you to dial a designated telephone in your Norstar system with a single digit, such as the main receptionist. As many as five direct dial sets can be established. Each telephone in the system is assigned to one direct-dial telephone. There is a single, system wide digit for calling the assigned direct-dial telephone of any telephone. Direct-dial telephones are established in System programming. Telephones are assigned to a direct-dial telephone under **Capabilities** in **Terminal&Sets** programming.

Direct-dial #: A digit used system-wide to call the Direct-dial telephone. The digit is assigned under **Access codes** in **Sys Prgrmmng**.

Direct-dial number: The digit used to call the direct-dial telephone.

Direct Inward Dial trunk: Trunks that allow direct inward dialing from the public network to the Norstar system.

Direct inward system access (DISA): The feature that allows remote users to dial directly into the Norstar system and use Norstar features. Callers will hear stuttered dial tone and will be required to enter a Class of Service password to gain access to the system. See Remote Access.

directed pickup: See Call Pickup Directed.

Directory number (DN): A unique number that is automatically assigned to each telephone or data terminal. The DN, also referred to as an internal number, is often used to identify a telephone when settings are assigned during programming.

Default DN assignments start at 221.

DISA DN: The received number assigned to the Norstar direct inward system access facility. If a caller dials a number that is assigned to the

DISA DN, the caller hears stuttered dial tone and must enter a Class of Service password. Once the password is accepted, the caller hears system dial tone and can use Remote Access features. See Remote Access.

Disconnect Supervision: A setting that enables the Norstar system to detect if an external caller hangs up. Once an external caller hangs up, the Norstar system can disconnect its line. **Disconnect Supervision** is enabled under **Trunk/Line** data in **Lines** programming.

display: A liquid crystal display (LCD) on the telephone that guides you through feature operation and programming.

display button: The Norstar M7310 telephone and M7324 telephone and the Business Series Terminal T7316 and T7316E are each equipped with three buttons located directly beneath the display. During feature operation or programming, some or all of these buttons may be used to provide further options. If an option is available, it is shown in the bottom row of the two-row display, directly above the corresponding display button. Display buttons are represented in this manual as underlined capital, such as OK.

Distinctive ring: Lines, telephones, and hunt group DNs can be configured with a distinctive ring that also determines the priority of a call.

DN: See Directory number.

Do Not Disturb:   

A feature that stops calls from ringing at your telephone. Only Priority Calls will ring at your telephone. A line button will flash when you receive a call, but the call will not ring.

DTMF: See Dual tone multifrequency.

dual tone multifrequency: Two distinct telephone signaling tones used for dialing.

DTI: See Digital Trunk Interface.

E

E&M/DISA Trunk Cartridge: The Trunk Cartridge that allows you to connect E&M trunks to the Norstar system. The E&M Trunk Cartridge also allows DISA access to the system by providing DTMF receivers for auto-answer trunks.

Emergency 911 dialing: The capability to access a public emergency response system by dialing the digits 9-1-1. State and local requirements for support of Emergency 911 Dialing service by Customer Premises Equipment vary. Consult your local telecommunications service provider regarding compliance with applicable laws and regulations.

emergency telephone: A single-line telephone, also referred to as a 500/2500 telephone, that becomes active when there is no power to the ICS.

evening schedule: See Schedules, and Services.

event message: Event messages are stored in the system log and displayed during a Maintenance session. They record a variety of events and activities in the Norstar system.

exceptions: See Overrides.

Expansion Cartridge: A cartridge that allows you to connect Trunk Modules and Station Modules to the ICS to expand system capacity for trunks and telephones.

There are two Expansion Cartridges: a two-port Expansion Cartridge and a six-port Expansion Cartridge. (See also Combo Cartridge.)

external call: A call to a destination outside the Norstar system.

External Call Forward: See Line Redirection.

external code: The number you dial to get an external line. By default it is 9, but this can be changed under **Access codes** in **Sys Programming**. You do not always need an external code. It is primarily to support the M7100 and T7100 telephones, and single-line telephones using an Analog Terminal Adapter.

external line: A line on your system telephone used for making calls to destinations outside the Norstar system.

external music source: See Music source.

external paging: A feature you can use to make voice announcements over an externally-mounted loudspeaker connected to the ICS. The external speaker is not a Norstar component and must be supplied by the customer.

F

feature button: Many Norstar features are invoked by pressing the Feature () button followed by a feature code. The feature button is also used to exit a feature.

Feature Cartridge: A replaceable cartridge containing the Norstar features. The Feature Cartridge is inserted into the ICS.

feature code: A number that is used to activate a particular feature.

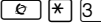
Feature programming:  Allows you to program a feature code onto a memory button.

Forward: See Call Forward.

Full Autohold (on idle line): When this feature is on, if you select an available line and then do something

that selects another line, the first line is put on hold. **Full Autohold** is enabled under **Trunk/Line** data in **Lines** programming.

Full handsfree: See handsfree.

G

Ground Start trunk: Ground start trunks offer the same features as loop start trunks, but are used when the local service provider does not support disconnect supervision for the digital loop start trunks. By configuring lines as ground start, the system will be able to recognize when a call is released at the far end. Ground start trunks are provided only by a DTI.

Group Listening: 

A feature that allows you to have others in your office hear a caller through your telephone speaker. The caller hears you only when you speak into the receiver. They cannot hear other people in the office.

You can cancel Group Listen for the current call. Group Listen is cancelled automatically when you hang up the Group Listen call.

H

Handsfree: A feature you can use to make calls without using the telephone receiver. **Full Handsfree** is activated under **Capabilities** in **Terminals&Sets** programming. When it is activated, a handsfree/mute button is automatically assigned to the telephone.

Handsfree (HF) answerback: When activated, this feature automatically turns on the microphone at a telephone receiving a Voice Call so that the person receiving the call can respond without lifting the receiver. It is activated under **Capabilities** in **Terminals&Sets** programming.

Handsfree/mute button: See handsfree.

Hardware: A section in programming that shows what equipment has been installed in the ICS. This section is accessed by the installer.

headset: A head-mounted or ear-mounted telephone receiver that is used instead of the hand-held receiver. Headsets are not Norstar components and must be supplied by the customer.

Held (Line) Reminder: A system telephone rings and displays the message **On hold: LINENAM** when an external call has been placed on hold for a certain period of time. The **Held Line Reminder** feature and **Remind delay** are set under **Feature settings** in **System Programming**.

HF Answerback: See handsfree answerback.

Hold button: 

This button is used to suspend calls so that the person using the telephone can perform another task without disconnecting the caller.

Hook Switch Flash: See Link time.

Host system signaling: (Also referred to as end-to-end signaling.) System telephones can access a remote system or dial a number on an alternate carrier by means of host feature activation, such as Link, Pause and Run/Stop.

Hospitality The Hospitality features allow business which use hospitality telephones, or room-based telephones, to control access, alarms, and maintenance duties through the telephones.

Hotline: This feature automatically calls a pre-assigned number when the telephone receiver is lifted or the handsfree/mute button is pressed. A Hotline number can be an internal or

external number. Hotline is assigned under **Capabilities** in **Terminals&Sets** programming.

Hunt group: The hunt groups feature allows a group of sets to be called by a single directory number ensuring that calls are easily routed to the appropriate group.

I

I/C: An abbreviation of intercom.

ICS (integrated communication system): The central hardware component in the Norstar system. The ICS has its own processor and memory, and provides a physical point of connection for the various types of devices, telephones, and expansion modules used in Norstar.

The ICS can function on its own as a basic system (with 32 system telephones and up to 48 external lines), or with the addition of Trunk Modules (TM) that supports more external lines, or Station Modules (SM) that support more system telephones.

Installer password: A one-to six-digit password that prevents unauthorized access to programming. The Installer password can be assigned and changed in **Passwords** programming.

Integrated Services Digital Network (ISDN): A digital telephone service that allows for a combination voice and data connection over a single, high-speed connection. ISDN service can operate over the same copper twisted-pair telephone line as analog telephone service.

intercom button: A button that provides access to internal lines used for calls within a Norstar system and access to external lines through a line pool or external code. A telephone may be

assigned zero to eight Intercom buttons. This is done under **Line access** in **Terminals&Sets** programming.

intercom keys: See Intercom button.

internal line: A line on your telephone dedicated to making calls to destinations inside your Norstar system. An internal line may still connect you with an external caller if you use it to access a line pool or to pick up a call using Norstar call handling features such as Call Park or Call Pickup Directed.

internal number: A number, also referred to as a Directory Number or DN, that identifies a Norstar telephone or device.

internal user: Someone using a system telephone within a Norstar system.

ISDN: See integrated services digital network.

ISDN DN: A directory number (DN) used by ISDN terminal equipment connected to the ICS. The system uses a maximum of thirty ISDN DNs.

ISDN Call Connection Limitation (ICCL) This feature piggybacks on the call initiation request and acts as a check at transit PBX points to prevent misconfigured routes or calls with errors from blocking channels.

K

Key indicator module (KIM) This hardware unit allows you to expand the receive capability of a T7316E telephone. The function of this module is similar to the central answering position (CAP) modules which attach to the M7324 telephones.

Key service unit (KSU): See ICS.

L

Last Number Redial:  5

A feature that allows you to redial the last external number you dialed.

Fixed line:

A telecommunications line between two service points leased from a communications carrier for private use, usually incurring a monthly service rate. Fixed lines setting is used solely by data modules.

Least cost routing: See Routing service.

line: The complete path of a voice or data connection between one telephone (or other device) and another.

Lines: A programming section that allows you to assign settings to each trunk and external line. Lines programming can be done by an Installer or a System Coordinator Plus. A System Coordinator can program the name of a line.

Line number: A number that identifies an external line. The total number of lines depends on how many Trunk Modules are installed.

Line Pool:  6 4

A group of lines used for making external calls. Line pools provide an efficient way of giving a telephone access to external lines without taking up many line buttons. A line is assigned to be part of a line pool under **Trunk Line** data in **Lines** programming.

Line Redirection:  8 4

A feature that allows you to redirect all calls on an incoming line to a destination outside the Norstar system. Once a line is redirected it cannot be answered within the Norstar system. The system may be set up to give a brief ring when a call comes in on a redirected line, under **Capabilities** in **Terminals&Sets** programming.

This feature differs from Call Forward in two ways: It redirects only external calls, not internal calls, and it redirects calls to destinations outside the system. Call forward redirects calls only to destinations inside the Norstar system. See Call Forward.

Link:   

If your Norstar system is connected to a Private Branch Exchange (PBX), you can use a Link signal to access special features. The Link signal can also be included as part of a longer stored sequence on an External Autodial button or in a Speed Dial code. The Link symbol () uses two of the 24 spaces in a dialing sequence.

Long Tones:    

A feature that allows you to control the length of a tone so that you can signal devices such as fax or answering machines which require tones longer than the standard 120 milliseconds.

Loop Start Trunk Cartridge: The Trunk Cartridge that allows you to connect loop start trunks to the Norstar system.

Lunch schedule: See Schedules, and Services.

M

M7000 telephone This telephone has a no display. It does have four memory buttons. (Note this telephone is only supported on systems running Profile 2, 3, or 4).





M7100 telephone: A telephone with a single line display and one programmable memory button without an indicator.

M7208 telephone: A telephone with a single-line display and eight programmable memory buttons with indicators.

M7310 telephone: A telephone that has a two-line display, three display buttons, 10 programmable memory buttons with indicators, and 12 dual memory programmable buttons without indicators. An M7310 can be equipped with a Busy Lamp Field.

M7324 telephone: A telephone with a two-line display, three display buttons, and 24 programmable memory buttons with indicators. An M7324 telephone can be equipped with a CAP module.

Maintenance: A type of programming that is used to diagnose and repair problems in the Norstar system. Maintenance requires no programmable settings.

Malicious Caller ID (MCID) This feature is a European ETSI-based network feature that allows a user to use     record the caller information at the service provider.

memory buttons: Buttons that can be programmed to dial frequently used features or numbers automatically. See M7100/T7100, M7208/T7208, M7310, T7316/T7316E, and M7324 telephone entries for their exact memory button configurations.

MCDN: Meridian Customer Defined Network is a PRI SL-1 protocol that allows Norstar systems on a network with a Meridian system to share some Meridian call features.

message: A feature that allows you to send a message to another Norstar user. The Message feature also allows you to know if you have any messages waiting and maintains a Message Waiting List to keep a record of your internal messages and your (external) voice mail messages.

Message Waiting Indicator: PRI lines can provide the signal that cause the set to display a message-waiting message, or light a lamp on the set to

indicate a voice message. If your system is serviced by a remote voice mail system from a third-party vendor, the Meridian attendant telephone uses the MIC/MCK buttons to activate the MWI lamp on telephones at other sites.

Modular ICS NVRAM cartridge: A replaceable cartridge containing the Norstar features, commonly known as the Feature cartridge. The ICS NVRAM cartridge is inserted into the ICS.

Modular ICS ROM software cartridge: A PCMCIA cartridge containing the Norstar NA-MICS 4.0 features. The ICS ROM software cartridge is inserted into the Modular ICS NVRAM cartridge.

Module: A component of the Norstar 0X32 key system. Includes the Integrated Communication System, Trunk Module and Station Module.

Module status: A heading in Maintenance programming that shows what types of Trunk Cartridges are connected and whether they're busy, disabled, or malfunctioning.

Monitoring See Silent Monitoring.

Move Line buttons:



A feature that allows you to move assigned lines to different buttons (with indicators) on your telephone.

Music source: A radio or other source of music can be connected to the Integrated Communication System to provide music for the Music on Hold and Background Music features. A music source is not part of the Norstar system and must be supplied by the customer.

Multiple least cost routing (MLCR): This term refers to the ability to define more than one route for a destination code when schedules are

used. The system will attempt each route in turn to find an available route before routing the call to overflow.

N

Names: Names can be assigned to System Speed Dial numbers, external lines, telephones, and service schedules. This is done in programming. You can use up to 16 characters to name a System Speed Dial number, and seven characters to name a telephone, line, or schedule. If a Name has not been assigned, the line number or DN will appear on the display instead of a name.

Network Call Diversion (NCD) Norstar Network Call Diversion (NCD) is a network function that allows forwarding and redirection of calls outside the Norstar network when using an ETSI ISDN line. Functionality is similar to that of External Call Forward (ECF).

Network DN: A number supplied by the ISDN network service provider for ISDN terminal equipment.

Night schedule: See Schedules, and Services.

NT1 (Network termination type 1): A device used to connect the U interface of a service provider and the S or T interface (customer equipment). The Modular ICS can act as an NT1 when equipped with a BRI-U2 or BRI-U4 Card.

O

On hold: A setting, programmed under **Feature settings** in **System Programming**, that controls whether external callers hear music, periodic tones, or silence when they are placed on hold.

OPS: Off premise station.

OPX: Off premise set.

overlay: See Programming overlay.

overflow: A setting in **Routing Service** that allows users to decide what path an outgoing call will take if all the lines used in a particular route are in use when the call is made.

Overlap dialing: This feature allows you to turn off enbloc dialing for ETSI PRI lines (profile 2, only) to enable the telephone submit a series of numbers for a PRI pool, then to receive a dial tone from the PRI line before the final call numbers are dialed.

Overrides: One component of a restriction filter. Overrides are numbers you can dial even if they are forbidden by a more general restriction. See **Restrictions**.

P

Page:

A feature you can use to make announcements over the Norstar system. You can make page announcements over the telephone speakers and/or external speakers.

Page Time out: A setting that controls how long a Page Announcement can last. It can be assigned under **Feature settings** in **Sys PRGMMNG**.

Page zone: An area in the office that receives internal page announcements independently of the rest of the office.

Each page zone is identified by a number. Telephones are assigned to page zones under **Capabilities** in **Terminals&Sets** programming.

Park prefix: See Call park prefix.

Park timeout: The time before an unanswered parked call is routed back to the telephone that parked it. **Park timeout** is configured under **Feature settings** in **Sys PRGMMNG**.

Password: A password is a specific sequence of digits that you enter to gain access to Norstar programming, to override dialing restrictions, or to use remote access with DISA.

Passwords: A programming section that allows you to assign or change COS passwords, Call log passwords, or any of the programming passwords. Under **Passwords** programming, you can only modify the passwords for your level of programming.

Pause:

A feature that enters a 1.5-second delay in a dialing sequence on an external line. This is often required for signaling remote devices, such as answering machines, or when reaching through to PBX features or host systems. The Pause symbol (☎) uses one of the 24 spaces in a dialing sequence. For pulse dialing, [*] inserts a 1.5 second pause into the dialing sequence.

PBX: private branch exchange.

Pickup Group:

A telephone can be placed into one of nine call pickup groups. A call ringing at a telephone within a pickup group can be picked up at any other telephone within the same pickup group. A telephone is assigned to a pickup group under **Capabilities** in **Terminals&Sets** programming.

Pool: See Line pool.

portable telephone: See Companion portable telephone

Pre-dial: A feature that allows you to enter a number and check it on your telephone display before it is actually dialed. If the number is incorrect, you can edit it. The number is dialed only when you pick up the receiver or select a line.



Primary Rate Interface (PRI): An ISDN interface which uses

23 B channels and a D channel (23B+D).

Prime line: The line on your telephone that is automatically selected when you lift the receiver, press the handsfree/mute button or use an external dialing feature.

A **Prime Line** is assigned to a telephone under **Line** access in **Terminals&Sets** programming.

Prime Set (prime telephone): A telephone that provides backup answering for incoming calls on external lines. The prime telephone for a line will ring for any unanswered calls on that line. A prime telephone is assigned to a line under **Trunk/Line** data in **Lines** programming.

Priority Call:   

If you get a busy signal when you call someone in your office, you can interrupt them for an urgent call. This feature is enabled for a telephone under **Capabilities** in **Terminals&Sets** programming.

Privacy: This feature determines whether a Norstar user may select a line in use at another telephone and join an established call. **Privacy** is enabled under **Trunk/Line** data in **Lines** programming, but can be turned on and off by users during individual calls.

Private line: See Private to.

Private network: A telephone network consisting of owned or leased telephone lines used to connect different offices of an organization independently of the public network.

Private Network Identifier (PNI) this is an identifying digit or set of digits assigned to each system in a private network with a Meridian system. These codes are provided by the Meridian system administrator when the node is brought on to the network.

Private to: Allows you to select the telephone that will use the line exclusively. The line cannot appear on any other telephone, except the prime telephone for that line. Private lines cannot be placed into line pools.

Private lines are assigned under **Trunk/Line** data in **Lines** programming.

Programmed release:

 *  

A feature that performs the function of the  button in a programmed dialing sequence.

programming: Setting the way the Norstar system will work. Programming includes system-wide settings and individual telephone and line settings.

programming overlay: A paper template that is placed over the four memory buttons with indicators on the M7310, T7316, T7316E or M7324 telephone during programming. The overlay labels indicate the special function that each of the four buttons takes on in programming.

public line: An external line that can be assigned to any telephone and to many telephones. A line is assigned as Public under **Trunk/Line** data in **Lines** programming.

public network: The regular telephone network that connects most homes and businesses.

Public Safety Answering Point (PSAP): This is the first point of contact a caller reaches after dialing 911.

pulse/tone dialing: An external line setting for pulse or tone dialing. Pulse is the traditional method of dialing used by rotary-dial or push- button single-line telephones. Tone dialing allows telephones to communicate with other devices such as answering machines.

Tone dialing is required to access the features that PBX systems may offer or to use another Norstar system remotely.

R

recall: See Link time.

receiver: The handset of a telephone.

receiver card: An abbreviated list of system feature codes that is stored under the telephone receiver. The card is found on a perforated sheet that comes with a system telephone.

Regression Code: Restores the previous system security number so that previously applied UTAM Activation Codes and Portable Credit Codes can be reentered to restore full system operation. Also required in cases of system recovery. This code cannot be reused.

Remind delay: A feature that causes a telephone to beep and display the message **On hold: LINENUM** when a call has been on hold for a programmable period of time. This period is the Remind delay.

Remote access: The ability to dial into a Norstar system from outside the system and make use of selected Norstar features. The lines, features, and dialing capabilities available to a remote user are determined by the Class of Service. If the remote access line is answered with DISA, the user must enter a Class of Service password to gain access to the Norstar system features.

remote access dial restriction: See Remote restriction.

Remote capability: A subset of Norstar features that are available to users connected through remote access.

Remote monitoring: A feature that allows an off-site technician with a PC call in and troubleshoot your system through the built-in modem.

Remote paging: This feature allows remote users to use the Norstar paging feature. Access to this feature is governed by the Class of Service for the call. See Remote Access and Class of Service.

Remote restriction: A restriction filter applied to a line in order to control which digits can be dialed during an incoming remote access call. It is the equivalent of a set filter for a remote user.

remote user: Someone who calls into a Norstar system from a telephone outside that system and uses Norstar features or lines. See Remote Access.

Restriction filter: Through a combination of restrictions and overrides, restriction filters prevent certain telephone numbers or feature codes from being dialed. Restriction filters can be applied to lines, sets, specific lines on a set, and to Class of Service passwords. The Norstar system can handle up to 100 restriction filters.

Restriction service: A Services section that allows you to assign alternate dialing filters to lines, telephones, lines on a particular telephone, and alternate remote filters to lines at specified times of the day and on specified days.

restrictions: One component of a Dialing filter. Restrictions are numbers you cannot dial when that dialing filter is in effect. See Exceptions.

Ring Again: 

A feature that can be used when you can't get through to someone on your Norstar system because their telephone is busy or there is no answer. Ring Again instructs the Norstar system to inform you when they hang up or next use their telephone.

ring group: A setting under Services that allows you to assign a number of different telephones to ring during one of the schedules. Up to 20 ring groups can be programmed by an installer or a system coordinator plus.

ring type: *

A feature that allows you to select one of four distinctive rings for your telephone.

ring volume: *

A feature that allows you to set the volume at which your telephone rings.

ringing service: A Services section that allows you to make additional telephones ring at specified times of the day and on specified days.

RIIs button: Ends a call in the same way that hanging up the receiver does. The Release button may also be used to end programming, Maintenance sessions, and feature operations.

Routing: See Routing service.

Routing service: A programming section that allows outgoing calls to be directed automatically based on the numbers a caller dials. For Norstar systems linked in a network, routing can create a transparent or coordinated dialing plan. It can also be used to direct calls to the least expensive lines according to a Services schedule (sometimes called least cost routing).

Run/Stop: *

A feature that creates a break point in a programmed external dialing sequence. When you press a programmed key, the system dials the number up to the run/stop. When you press it again, the system dials the digits following the run/stop.

S

S loop: A type of loop provided by a BRI-ST Card. It connects the ICS to ISDN terminal equipment which uses an S interface.

SAPS: See station auxiliary power supply.

Saved Number Redial:

A feature that allows you to save the number of the external call you are on (providing you dialed the call) so that you can call it again later.

Schedules: Any of six different sets of services that can be applied to your Norstar system. A schedule can be activated manually from a control telephone or activated automatically at specified times. See also Services.

Selective line redirection: See Line Redirection.

Service modes See Services.

Service Profile Identifier: See SPID.

Services: A programming section that allows you to assign which telephones ring, which restrictions apply, and which call routing is used during any of six different schedules. There are three services: Ringing service, Restriction service and Routing service, all found in Services programming.

set: A telephone.

Set Copy: A programming section that allows you to copy programmable settings from one telephone to another of the same type. Set Copy provides two options: duplicating System Data and User Data, or duplicating System Data only. Set Copy does not provide the same copy capability as **COPY**, which is more selective of the settings that can be duplicated.

Set filter: See Restriction filter.

Set lock (telephone lock): This feature allows you to limit the number of features that may be used or programmed at a telephone. Full set lock allows very few changes or features, Partial set lock allows some changes and features, and No set lock allows any change to be made and any feature to be used. Set lock is assigned under Capabilities in Terminals and Sets programming.

Set relocation: See Automatic Telephone Relocation.

shift button: A small triangular button beside the dual memory buttons on the upper half of the M7310 telephone. You press the shift button to store or access features on the top half of the dual memory buttons.

Show Time:

While on a call, accessing this feature allows you to see the current date and time on the Norstar telephone display.

Silent Monitoring

This feature allows a user with a two-line display telephone that has been designated as a supervisor telephone, to monitor Hunt group calls from external sources using .

Software keys: A programming section used to enable the optional Remote monitoring feature. One setting provides a System ID, which an installer or system coordinator plus then uses to request three password keys from the Nortel Customer Response Center. Once these three passwords have been entered, the system will permit Remote monitoring.

SPID (Service Profile Identifier): A number that identifies devices connected to an ISDN network. A device may have more than one SPID depending on the number of channels it

uses. SPIDs may be used to identify terminal equipment to the ICS, or to the service provider.

Startup programming: When a Norstar system is first installed and powered up, Startup programming must be performed before any programming can be done. Startup initializes the system programming to defaults.

Station: An individual telephone or other Norstar device.

Station Auxiliary Power Supply (SAPS): A device which provides power to a Norstar telephone that is connected more than 300 m (975 ft.) and less than 1200 m (3900 ft.) from the ICS, or to a CAP module.

Station Module: A module that allows you to connect up to 16 additional telephone to your Norstar system.

Station set test:

A series of diagnostic tests for these components of a Norstar telephone: display, buttons, handset, speaker, and power.

System coordinator: The person responsible for customizing the Norstar system through programming and for helping co-workers use the Norstar system.

System coordinator password: A one- to six-digit password that prevents unauthorized access to programming. The System coordinator password can be assigned and changed in Passwords programming.

System coordinator plus: A system coordinator who also performs technical and maintenance functions for the Norstar system.

System coordinator plus

password: A one- to six-digit password that prevents unauthorized access to programming. The System coordinator plus password can be assigned and changed in Passwords programming.

System coordinator plus

programming: A combination of common and installer programming settings.

Press **[☎] [*] [*] C O N F I G**, then **[S] C P L U S** to access System coordinator plus programming.

System coordinator

programming: The programming settings that are most commonly changed once the Norstar system is installed.

Press **[☎] [*] [*] C O N F I G**, then **[A] D M I N** to access System coordinator programming.

system data: An option in the Set Copy function. System Data refers to the programmable system settings that apply to all telephones and lines.

System programming: A programming section that allows you to assign and maintain certain settings on the Norstar system. System programming is performed by an installer or system coordinator plus.

System speed dial code: A three-digit code (001 to 255) that can be programmed to dial a telephone number up to 24 digits long. System speed dial codes are programmed for the entire Norstar system under the System Speed programming heading.

System Startup: See Startup programming.

System Startup access code: To begin System Startup, press **[☎] [*] [*] S T A R T U P**. An Installer password is required before Startup programming can begin.

System ID: The System ID (or System Security number) can be accessed on any programming telephone display by pressing **[☎] [*] [*] S Y S I D**, or **[☎] [*] [*] 7 9 7 4 3**.

System-wide Call Appearance

(SWCA) keys **[☎] [*] 5 2 0** to

[☎] [*] 5 3 5 These 16 feature codes can be assigned to buttons with indicators on a group of telephones to provide call appearance for incoming calls that can be answered by any telephone in the group. At the same time, the indicator displays the current status of the call.

T

T1: Digital carrier system or line that carries data at 1.544 Mbps.

T7000 telephone This telephone has a no display. It does have four memory buttons. This telephone functions in the same way as the M7000 telephone. (Note this telephone is only supported on systems running Profile 2, 3, or 4).

T7100 Business Series Terminal:

A telephone with a single line display and one programmable memory button without an indicator.

T7208 Business Series Terminal:

A telephone with a single-line display and eight programmable memory buttons with indicators.

T7316 Business Series Terminal:

A telephone that has a two-line display, three display buttons, 16 programmable memory buttons with indicators, and 12 memory programmable buttons without indicators.

T7316E Business Series

Terminal: This telephone has the same functionality as the T7316, with some additional features, such as a separate handsfree key, special display icons (when running on a MICS 6.1 or newer

system), and CAP capability by adding KIMs.

T7406 telephone: This portable handset functions very similarly to the T7310 telephone. Functions and installation are all described in separate documentation specific to the telephone.

T loop: A type of loop provided by a BRI-ST Card. It connects the ICS to an ISDN network using an NT1.

Terminal Answering Position (TAP) This is the hardware combination of a T7316E telephone attached to one or more KIMs. This unit has the same functionality as the CAP module but can also support multiple target lines and as well as Hunt Group DNs.

Target lines: Lines used to answer incoming calls only. A target line routes a call according to digits it receives from an incoming trunk. They are referred to by line numbers in the same way as physical lines.

TE: See Terminal equipment.

TEI (Terminal Endpoint Identifier): A digit used to identify devices which are using an ISDN connection for D-channel packet service.

Telco features: A programming section that allows you to specify the external telephone numbers that are dialed by the Message feature to retrieve voice messages, or to set up CLASS (CMS) services for lines and sets. Telco features are accessed by an installer or a system coordinator plus.

Terminal Endpoint Identifier: See TEI.

Terminal equipment (TE): A generic term for devices that connect to an ISDN network. Examples of ISDN

TE are ISDN telephones, computers equipped with ISDN cards and video terminals.

Terminals and Sets: A programming section that allows you to assign and change settings that apply to the telephones and other devices connected to the Norstar system. Terminals and Sets programming is performed by an installer or a system coordinator.

Time and date: A programming section that allows you to manually change time or date. The time and date can also be changed by pressing and entering the Basic password or one of the programming passwords.

Transfer: A feature that allows you to redirect a call to another telephone in your Norstar system, over a network or outside your Norstar system.

Transfer Callback: If a transferred call is not answered after a specific number of rings, the call will return to the telephone that made the transfer. The number of rings is assigned under Feature settings in System programming. Transfer Callback does not apply to calls transferred externally.

Trunk: The physical connection between the Norstar system and the outside world using either the public telephone system or a private network.

Trunk Answer: A feature you can use to answer a call on any line that has an active Ringing service Service Mode, even if that line does not appear on your telephone. Trunk Answer is enabled in Services programming.

Trunk Anti-Tromboning (TAT): This MCDN network feature is a call-redirect feature that works to find better routes during a transfer of an active call.

This feature acts to prevent unnecessary tandeming and tromboning of trunks. This action occurs after the speech path has been established.

Trunk Module: A module that allows you to install additional Trunk Cartridges in your system to provide up to 12 additional trunks.

Trunk route optimization: (TRO) This is a private network feature that provides routing for forwarded calls along the shortest or best route on the private network.

U

U interface: A two-wire ISDN interface used for both network connections and terminal connections to the ICS.

U-LT: A type of loop provided by a BRI-U2 or BRI-U4 Card. It connects the ICS to ISDN terminal equipment which uses a U interface.

Uniform Dialing Plan: (UDP) This type of dialing plan uses a location code to identify each node on a private network. Dialing sequence: (destination code)+(location code)+DN.

U-NT loop: A type of loop provided by a BRI-U2 or BRI-U4 Card. It connects the ICS to an ISDN network.

Unsupervised line: A line for which disconnect supervision is disabled. If an external caller hangs up, the Norstar system does not detect the disconnection and does not hang up its line. See Disconnect Supervision.

User Data: User Data is an option in the Set Copy feature. User Data refers to the personal settings that are unique to an individual telephone, and are not programmed for the system. User Data is programmed at each telephone.

These settings, for example, include user Speed Dial and the assignment of programmable memory buttons.

User Filter: See Restriction filter.

User Preferences: a programming section that allows you to assign autodialers, user speed dial codes, display contrast, and other settings to a specific telephone or person. You do not have to program these settings at the person's telephone. User preferences are assigned in Terminals and Sets programming.

User Speed Dial:

 * 4

Three-digit codes (256-279) can be programmed to dial external telephone numbers. User Speed Dial numbers are programmed for each telephone, and can be used only at the telephone on which they are programmed.

V

Voice Call:  6 6

A feature you can use to make an announcement or begin a conversation through the speaker of another telephone in the Norstar system. The telephone you call will not ring. Instead, the person you call will hear a beep and then your voice. Their telephone will beep periodically to remind them that their microphone is open.

Voice Call deny:  8 8

A feature that prevents your telephone from receiving Voice Calls.

Voice message center: If you have subscribed to Call Display services you can receive visual Voice Message Waiting Indication, providing your telephone has a display. If you have Voice Message Waiting Indication, you can program the telephone numbers required to access up to five different

Voice Message Centers. You can also program which of the five Centers is to be accessed by each specific line.

W

Wait for dial tone: ☎ 8 0 4

A feature that causes of sequence of numbers to pause until dial tone is present on the line before continuing to dial. The Wait for dial tone symbol (☎) uses two of the 24 spaces in a dialing sequence. This feature requires a Services or Combo Cartridge.

wireless: See Companion.

Index

Symbols



- **79743 (System ID) 309
- **CONFIG (**266344) 322
- **DIALPAD (**3425723) 316
- **LINE 310
- **PROFILE (**7763453) 315
- **SET (set programming) 310
- **STARTUP (**7827887) 317
- **SYSID 309
- **SYSID (**79743) 480
- **TIME (**8463) 408
- *7, Contrast Adjustment 577
- 1, message reply enh 428
- 811 Call Display 348
- 819 ONN blocking 456

Numerics

0X32

- using old modules 210
- 1st display, programming 349
- 25-pair connector 235
- 2-way DID, PRI dialing plan 115
- 2-way service 116
- 900 CbC service
- 911, restrictions 341

A

absorb length, zero 392

access

- controlling on a network 93
- line pool programming 329
- passwords for programming 294

access codes

- auto DN 444
- carrier codes 446
- CDP 103
- conflicts 103, 441
- default codes 441
- direct dial number
 - system programming 444
- DISA DN 445
- external code 443

- line pool 110
- line pool and access code 448
- line pool codes 441
- listing 296
- long distance 393
- park prefix 442
- private access code 445
- programming 441
 - remote line access 447
- access package, COS 93
- access services, CbC services 457
- adaptive, BRI sampling 502
- administrative set, Hospitality services 218
- advanced private network, see APN and MCDN
- AEM
 - cable connections 235
 - see also ASM
- alarm
 - check active 563
 - check current 527
 - codes 533
 - CSU 563
 - network evt log 531
 - short term 564
 - system administration log 530
 - troubleshooting 537
- Alarm 10 534, 537
- Alarm 37 535
- Alarm 37 537
- Alarm 40 535, 537
- Alarm 41 535, 537
- Alarm 42 535, 537
- Alarm 43 535, 537
- Alarm 44 535, 537
- Alarm 45 535, 537
- Alarm 46 535, 537
- Alarm 47 535, 537
- Alarm 50-X 535, 538
- Alarm 51-X 535, 538
- Alarm 52-X-Y 536, 538
- Alarm 61-X-Y 536, 538
- Alarm 62-X-Y 536, 539
- Alarm 63-Z 536, 539

- Alarm 68-Z 536, 540
- Alarm 75 540
- Alarm 76-X 536, 540
- alarm messages
 - programming alarm set 427
- alarm set
 - programming 427
- alarm telephone 228
- alarms
 - hospitality 465
 - Hospitality services 218
- allow last number redial 345
- allow redirect 336
- allow saved number redial 345
- alpha tagging
 - CLID match 432
- alternate call ringing 371
- analog
 - message reply enh 428
 - name and number blocking 456
 - trunk data settings 352
 - trunk type 353
- analog access lines (AAL) 488
- analog E&M trunks, private network 85
- analog network loss treatment 488
- analog station module
 - cable connections 235
 - connecting 234
 - message reply enh
 - see also analog extension module
- Analog Station Module, see ASM and AEM
- analog telephones, external code 443
- Analog Terminal Adapter, see ATA or ATA2
- analog trunk
 - E&M 85
 - see also loop start trunks 83
- analog trunk cartridge 224
- analog VSC
 - programming 476
- ANI
 - E&M and DID lines on DTI 364
 - programming number
 - Winkstart 364
- ANI number 352
- answer calls
 - SWCA lines 430
- answer DN
 - Companion 332
 - programming 332
 - view 332
- answer keys
 - phantom DN 429
 - programming 429
 - setting features 429
- answer mode 352, 359
- answer timer 487
- answer with DISA 352, 360
- ANY key
 - destination codes 386
- APN
 - also see MCDN 128, 134
 - network features 118
 - networking features 117
 - using MCDN protocol
- appearance
 - auto privacy 358
 - DID lines, default numbering 327
 - DID target line 82
 - E&M trunk manual-answer 86
 - hunt group 410
 - loop start trunk, manual answer 83
 - message waiting indication 348
 - network route 110
 - trunks 80
 - using internal line for private call 173
- appearances
 - setting SWCA controls 430
 - SWCA keys 430
- applying template 295
- appr only 157, 162, 326, 332, 410
- appr&ring 157, 162, 326, 332, 410
- ascending mode, service provider 116
- ascending, B-channel sequence 485
- ASM
 - analog station module 493
 - see also AEM
 - verifying status 493
- assign
 - answer DN
 - 332
 - CAP lines 329
 - intercom buttons 331
 - line pools 329
 - lines 326
 - prime line 330
- assigned lines, viewing 328

assigned, BRI DNs 503
 ATA
 accessing external lines 443
 for OPX applications 282
 optional equipment list
 settings 336
 troubleshooting 591
 attn attempts 465
 Attn duration 465
 auto associate, SWCA 430
 auto attendant, bypassing
 auto DN
 access codes 82
 conflicts 357, 385, 444
 DID trunk 91
 PRI trunk 91
 private network auto-answer 91
 programming 444
 rec'd number length 444
 received number length 450
 auto number identification, see ANI
 auto privacy 352
 F83 358
 programming 358
 Auto time&Date
 programming 424
 auto-answer
 answer with DISA 360
 BRI trunks 326
 DID 81
 disconnect supervision 359
 E&M trunks 85
 E&M/DISA 84
 loop start trunk and DISA 83
 loop start trunks 83
 no DISA 83
 private network 91
 remote access 90
 remote access trunks 89
 remote restrictions 369
 restriction filters 90
 trunks, DISA 96
 autodial, network calls 111
 automatic ongoing line selection 355
 automatic route selection, see routing
 automatic telephone relocation
 programming 283
 Automatic Time and Date 424
 auxiliary equipment

wiring chart 257
 auxiliary ringer 287
 call transfer 361
 Hunt Groups 416
 maximum voltage 287
 optional equipment list 191
 programming 361, 378
 Terminals&Sets 336
 troubleshooting 593
 trunk type data 352
 available, BRI DNs 503

B

B1 and B2 directory numbers 252, 253–
 254
 back 301
 backboard 226
 background music
 installation 287
 programming 288, 419
 troubleshooting 593
 backspace (bksp) button 302
 back-to-back cross-connections 273
 backup
 maintaining records 201
 backup, NRU 381
 basic
 answer key 429
 hospitality 464
 basic password
 description 294
 programming the password 405
 basic programming
 common changes 324
 Basic Rate Interface, see BRI, see also
 ISDN
 B-channels
 BRI card 499
 port numbering 252
 programming static DID 2-way
 service 116
 sequence, PRI 485
 BchanSeq 485
 BchnSeq mode, static DID and two-way
 DID 116
 Bellcore standard 222
 Bellcore/National ISDN Users Forum
 (NIUF) 65

- BLF, M7310 only
 - bracket 225
 - break-in, MCDN 154
 - BRI
 - answer mode 359
 - assign DN 503
 - assign lines/loops 326
 - assigning SPIDs to T and NT loops 499
 - becoming a clock source 505
 - BRI-ST cartridge wiring 278
 - BRI-U wiring 264, 266
 - call type 500
 - card 54—60, 498—503
 - card programming 498
 - cards 261
 - clock source loops, power up or down 505
 - DNs on loop 503
 - D-packet service 501
 - handling calls 71
 - internet connection 76
 - lines on T/NT loop 498
 - lines pooled 71
 - loop DN 503
 - loop type on card 498
 - loopback test 559
 - loops on card 498
 - LT loop (Lp) 501
 - name and number blocking 456
 - network DN 500
 - network loop programming 77
 - network name display supporting protocols 453
 - network wiring 267
 - number of B-channels 499
 - ONN blocking 477
 - POSTA 77
 - profile support 313, 314
 - programming lines 71
 - programming VSC 476
 - SPID 326
 - ST card 224
 - ST card wiring 261, 263
 - T network wiring 267
 - target line, if busy 357
 - TEIs 502
 - terminal equipment 73
 - test network connection 222
 - trunk 87
 - trunk data settings 352
 - trunk module locations 494
 - trunk type 353
 - U2 card 224
 - U4 card 224
 - U-NT network wiring 268
 - view card 483
 - BRI (Basic Rate Interface)
 - U2 trunk modules 228
 - U4 trunk modules 228
 - BRI, see also ISDN
 - bridge taps 197
 - BRI-ST
 - terminating resistors 232
 - trunk modules 254
 - BRI-U2, trunk modules 254
 - BRI-U4, trunk modules 254
 - broadcast
 - hunt groups 413
 - ILG upgrade to Hunt Groups 217
 - broadcast ring 326
 - business name
 - network name display 455
 - programming 453
 - BusName, see business name and call display
 - Busy 518
 - busy
 - busy tone 414
 - lines, hunt groups 414
 - overflow set, hunt groups 415
 - routes, overflow routing 397
 - busy lamp field, see BLF
 - button prgrmg 338
 - buttons
 - Feature 298
 - handsfree 298
 - Hold 298
 - programming button definitions 301
 - programming telephones 298
 - Release 298
 - volume control 298
-
- ## C
- cable trough 235, 242, 290
 - cadence, service tone 621
 - call attendant, SL-1 network

- call blocking, ONN programming 456
- call by call
 - card settings 485
 - PRI limits 460
 - programming 459
 - programming PRI limits 461
 - programming service selection 460
 - protocols referenced with services 459
 - routing map table 486
 - routing table 383
 - routing, all 486
 - routing, incoming calls 485
 - routing, none 486
 - service selection for PRI 457
 - services, supporting protocols 457
 - supported services 457
 - usage metrics 570
- Call by Call, see also CbC
- call descriptions, public network 166
- call disconnect, OSI 359
- Call Display
 - programming 347
 - using CLASS assignment 347
- call display
 - ANI number 364
 - CI trunk cartridge 224
 - order of display 349
 - outgoing call 333
 - services, customizing 347
- call diversion
 - networks 177
- call forward, hunt groups 410
- call information feature 349
- call information trunk cartridges
 - loop start signaling 84
- call log
 - call log opt'ns 338
 - call log pswrds 296
 - information, power fail 292
 - password 403
 - resetting 425
 - space 349
 - space, available spaces 425
- call park prefix, conflicts 385
- call pickup, message answer enh 428
- call restriction
 - hospitality services 464
 - line restrictions 368
 - programming filters 339
 - users 367
- call routing
 - between switches 110
 - carrier codes 132
 - CDP 103, 139
 - CDP, Public DN 102
 - dialing plan
 - description 102
 - E&M dialing plans 105
 - external routing code 112
 - hunt groups 409
 - incoming DID calls 113
 - internal DID calls 113
 - prime set overflow 358
 - private network, routing codes 128
 - programming CbC services 460
 - Public DNs 132
 - restriction filters 110
 - setting up access code table 104
 - tandem networks 126
 - UDP 136
 - using E&M trunks 173
- call setup, ISDN and OLI 333
- call transfer, auxiliary ringer 361
- call type, BRI card 500
- call usage, monitoring set 80
- call waiting indications, see also CWI
- call, using destination codes 394
- called ID
 - network name display 454, 455
 - programming 349
- called number, OLI 333
- Called Party Number, see CDN
- caller features
 - through private network 101
 - through public network 100
 - within system 100
- Caller ID set 347
- caller ID, see call display services
- caller identification, ANI number 364
- caller information, see also CID 118
- calling party, BusName, programming 453
- camp timeout, programming 420
- camp-on
 - MCDN 152
- CAP
 - line assignment 329

- line keys 327
- M7324 telephone
- moving a set 436
- programming assignment 435
- capabilities
 - listing 296
 - programming 335
- card
 - answer timer 487
 - CO fail 488
 - edge loopback test 554
 - I/F levels 488
- cards on ICS 482
- cards on KSU
 - listing 296
 - show module 482, 483
- carrier access code
 - branded outwatt calls 383
 - conflicts 446
 - description 132
 - programming 446
- carrier failure
 - alarms 560
 - standard 488
- Carrier Identification Code (CIC) 446
- cartridge
 - checking the state 523
 - E&M Trunk 195
 - enabling 524
 - enabling/disabling 494
 - inserting 231
 - installation 223
 - installation tips 227
 - loop start trunk 195
- cause code 462
- CbC
 - destination codes 380
 - dialing plan 112
 - incoming routing for DISA 72
 - network 111
 - Private DN over Tie 112
 - requirements, no CbC 112
 - see also call by call
 - service options 487
- CCI, emergency transfer conditions
- CCITT 294
- CDN
 - DISA
 - service types 72
- Target Line Receive Digit Length 72
- CDP
 - access codes 103
 - call routing 103, 139
 - call scenarios 139
 - dialing plan features 436
 - dialing sequence 103
 - dialing string 138
 - DN range 138
 - DNs 102
 - overview 102
 - public DN 102
 - SL-1 network features
- central answering position, see CAP
- central office, ANI/DNIS service 364
- change
 - Hunt Group auxiliary ringer 416
- change DN type 296
- change DNs 255, 296
- change, button 302
- changing DNs 418
- Channel Service Unit, see CSU, CSU
 - internal
- channel, disabling PRI 551
- charts, wiring 252
- checking the system version 513
- CI trunk cartridge
 - installing 224
 - wiring chart 271
- CIC (Carrier Identification Code) 446
- Class of Service password, see COS
- CLASS trunks 424
- clear line data 483
- CLI, programming in pools 334
- CLID
 - CLID match for alpha tagging 432
 - CLID match 432
 - CLID set
 - network name display 455
- clock
 - automatic date and time 424
 - hospitality, setting time 465
- clock source
 - becoming a source 505
 - description 504
 - network clock settings 505
 - primary reference 504
 - programming 508

- sample configurations 506—508
- secondary reference 504
- timing master 504
- clocking cartridge 59
- ClockSrc 492
- CO fail, TI and PRI 488
- combo cartridg, installation planning 190
- common dialing plan 117
- common settings
 - list 296
 - programming 400
- Companion
 - answer DN 332
 - changing DNs 449
 - equipment list 191
 - expansion module numbering 254
 - hunt group 410
 - installing base stations 290
 - interface headings 296
 - listing 296
 - programming registration password 405
 - services cartridges 191
 - software key 479
 - supported 37
 - UTAM, upgrading 200
- cond pswd, programming 406
- configuration programming, default
 - access codes 441
- conflicts 451
- connect wiring 247
- connected name, network name display 454
- connection
 - expansion modules 234, 250
 - stand alone 60
- contact, external paging 289
- continuity loopback test 555, 558
- control circuit interface, see CCI
- control set
 - activating services 371
 - assigning to lines and sets 372
 - programming 372
 - schedules 373
- controlling schedules 376
- coordinated dialing plan, see CDP
- coordinator, system password 293
- copy
 - COS password 401
 - display button 302
 - list of copy/not copy 308
 - remote access packages 448
 - set programming 306, 325
 - single, range, all 306
 - system data 306
 - telco features 347
 - to a group of telephones, not part of a range 307
 - to a range of telephones 307
 - to a single telephone 306
 - trunk/line data 353
 - user data 306
- COS
 - auto DN 444
 - auto-answer E&M trunk 86
 - auto-answer system 90
 - auto-answer, no DISA 83
 - calls answered with DISA 445
 - changing 93
 - copy 401
 - dialing capabilities 89
 - dialing filters 93
 - incoming remote call 93
 - line filter 402
 - maximum 401
 - network 93
 - password 82, 84
 - programming 401
 - programming tips 401
 - public call 167
 - remote access package 447
 - remote access with DISA 90
 - remote pkg 403
 - restrictions 82
 - security 93
 - user filter 402
 - with DISA 96
- credit card verification 76
- cross connections, E&M/DISA trunk cartridge 273
- CSU
 - alarms 563
 - clock source 492
 - connecting DTI to external 269
 - disabling internal CSU 248
 - line build 490
 - line coding 491
 - listing 296

performance statistics 561
 stats 511, 560
 turning off/on, disable trunk 490
 customizing call display services 347
 CWI, SL-1 network
 cycle, park mode 420

D

data copied 308
 Data Module 510
 data modules, connecting 234
 data not copied 280
 data, call type 500
 date and time, see AutoTime&Date
 Daylight Savings Time, see daylight time
 daylight time, programming 423
 D-channel packet
 service 77
 service, see ISDN
 TEIs 502
 DDD, message reply enh, analog sets 428
 D-Dial 335
 debit machines 76
 default destination codes
 MICS 386
 default password
 basic 324
 system coordinator 324
 system coordinator plus 323
 default programming, returning to 291
 defaults
 basic password 405
 changing 321
 dialing restriction 341
 DN lengths 451
 filters, cold start 342
 Installer password 404
 line numbers 494
 remote access packages 448
 restrictions 341
 set restrictions 344
 System Coordinator password 405
 System Coordinator Plus password 405
 delay
 by number of rings 307
 camp timeout 420

dial signal type 363
 DRT 421
 held line reminder 422
 park timeout 420
 transfer callback 421
 delayed ring transfer
 hunt groups 412
 programming 421
 delayed ring transfer to prime, see also DRT
 deprovisioning a line 551
 descending mode 116
 descending, B-channel sequence 485
 desk information, hospitality 463
 desk pswd 406
 desktop conferencing 183
 destination codes
 conflicts 320, 357, 385, 442, 443, 444, 445
 defaults for MICS 386
 description 381, 385
 digit absorption 388
 E&M dialing plan 105
 network 104
 normal rte 388
 numbering 104
 using 82
 using to make a call 394
 wild card 386
 wild cards 386
 device
 disabling 519
 enabling 520
 state 518
 diagnostics
 release reasons 462
 T1 signal 560
 test results, system test log 526
 dial mode 352, 356
 dial tone, absent on external lines 582
 dialed digits
 CLID match 432
 DID trunk 91
 host delay 425
 PRI trunk, matching DNs 91
 dialed number identification, see DNIS
 number
 dialing
 CDP call scenarios 139

- filter, E&M trunk 95
- filter, remote 95
- line restrictions 368
- restriction filters 94
- restriction for remote callers 369
- UDP call scenarios 135
- unified dialing plan with line pools 356
- dialing opt'ns 338
- dialing plan
 - 2-way DID 115
 - CbC configuration 112
 - CDP 102
 - enbloc dialing 436
 - listing 296
 - network 437
 - prefix 440
 - PRI routing table 384
 - programming 436
 - public DNs 439
 - public network 439
 - shared line pools 109
 - transparent 102
 - UDP 103, 439
 - using E&M lines 105
 - using line pools 356
 - using public lines 104
- dialing plans 102
- dialing restriction
 - allocationed overrides 342
 - defaults 341
 - filters 368
 - line filter 402
 - line/set restriction 346
 - maximum length 342
 - maximum number 342
 - maximum restrictions and overrides 342
 - remote user 369
 - removing a filter 342
 - user filter, COS 402
 - wild card character 340, 386
- dialing rules
 - interdigit timeout 440
 - private DN length 439
 - private network ID 439
- dialing sequence
 - digit absorption, destination code 388
 - VSC 477
 - wild card 342
- dialing sequence restrictions 339
- dialout
 - programming 382
 - use pool 382
- dialpad
 - entering numbers 304
 - installation checklist 188
 - password 294
 - programming 312, 316
 - programming headings 295
- DID
 - ANI number 364
 - auto DN 82
 - auto-answer only 81
 - default line numbering for target lines 327
 - DISA DN 82, 97
 - DTMF
 - emergency transfer 276
 - incoming 84
 - line numbers 494
 - line setting 355
 - no DISA 91
 - PRI lines 112, 325
 - prime line 330
 - private network features 91
 - remote access, DISA 89
 - restrictions 82
 - simultaneous calls 327
 - supervisory signaling 276
 - target line 82
 - target lines 79, 81
 - trunk 91
 - trunk cartridge 224
 - trunk cartridge wiring 275
 - trunk data settings 352
 - trunk description 81
 - trunks
 - DID template, target lines 88
 - DID trunk
 - access codes allowed 82
 - no prime line 82
 - digit absorb, destination codes 388
 - digital
 - access lines 488
 - DTI wiring 269
 - interface, clock source 504

- network loss treatment 488
- T1 trunks, adding 210
- digital trunk
 - configurations 509, 510
 - Interface trunk, see DTI
- direct dial
 - intrnl/extrnl 434
 - line selection 434
 - programming 433
- direct dial digit
 - conflicts 320, 385, 442, 443, 451
 - programming, F1 428
- Direct dial extension 432
- direct dial set, extra-dial telephone 444
- Direct Inward Dial trunks, see DID trunks
- Direct Inward System Access, see DISA
- directd pickup 422
- direct-dial # 444
- direct-dial number
 - programming 444
- directory numbers
 - B1 and B2 252
 - changing 418
 - changing starting DN 319
 - conflicts 320
 - hunt groups 411
 - in a network 102
 - length 451
 - target line recieved number length 319
- DISA
 - accessing
 - auto DN 444
 - auto-answer no DISA 83
 - auto-answer trunks 83
 - Called Party Number (CDN) 72
 - calling name information 454
 - conflicts 385
 - DID trunk 91
 - DISA DN 72
 - disconnect supervision 359
 - DN 445
 - E&M network 105
 - E&M trunk cartridge 224
 - E&M trunks 86
 - loop start trunks 83
 - PRI trunk 91
 - private networks 167
 - programming answer with DISA 360
 - programming on PRI 72
 - remote access trunks 89
 - remote callers 96
 - trunk cartridge wiring 273
 - using 83
 - using COS password 96
 - wiring chart 273
- DISA DN
 - changing the COS password 93
 - conflicts 357, 445
 - DID trunk 82, 91
 - mapping to DID trunks 97
 - overriding filters 96
 - PRI trunk 91
 - private network auto-answer 91
 - public call 167
 - received number DN 450
 - received number length 445
 - using 82
- Disabled by sys 518, 523
- Disabled by user 518, 523
- Disabling 518, 523
- disabling
 - a device 519
 - a module 524
- disconnect OSI 359
- disconnect supervision
 - disconnect timer 487
 - loop start trunks 84, 90
 - programming trunk mode 359
 - T1 trunks 80
- disconnect time, hardware cards 487
- display buttons 301
- display cntrst 338
- display unreadable, troubleshooting 578
- distribution block, see distribution panel
- distribution mode, hunt groups 413
- distribution panel, connecting the wiring 247
- DN hunting, see multi-line hunt
- DN length
 - at startup 319
 - conflicts 451
 - listing 296
 - programming 451
- DND
 - leaving hunt group 410

- on busy 335
 - DNIS number
 - programming
 - trunk/line data settings 352
 - Winkstart 364
 - DNs
 - assign to BRI card 503
 - BRI loop DN 503
 - BRI network DNs 500
 - changing 418
 - conflicts 442, 443
 - default ranges 449
 - defaults 441
 - DISA 445
 - entering in programming 304
 - hunt groups 411
 - ISDN 70
 - length 451
 - on loop, BRI card 503
 - private DN length 439
 - D-packet service
 - BRI card 501
 - LT loop 501
 - POSTA 76
 - POSTA for BRI 77
 - TEI and DN
 - DRT delay 421
 - DRT, programming 421
 - DTI
 - (T1) disconnect timer 487
 - B-channel sequence 485
 - card PRI firmware download 68
 - clock source 492, 504
 - configurations 509
 - connecting 247
 - connecting to external CSU 269
 - connecting to service provider 269
 - continuity loopback test 558
 - CSU line build 491
 - E&M network 105
 - framing 489
 - ground start trunk 80
 - internal CSU 490
 - LEDs 598
 - line numbers 494
 - loop start signaling 84
 - network clock settings 505
 - PRI 189
 - PRI software key 479
 - PRI support 73
 - primary reference 504
 - programming clock source 508
 - programming lines 355
 - secondary reference, clock source 504
 - selecting a PRI protocol 484
 - specifications 623
 - timing master, clock source 504
 - trunk 79, 224
 - trunk type, changing 353
 - wiring chart 269
 - DTMF
 - answer mode 359
 - dial mode 356
 - E&M line settings 355
 - on DISA 82
 - receivers 82, 195
 - dualtone multifrequency, see DTMF
-
- ## E
-
- E&M
 - analog, private network 85
 - ANI number 364
 - answer mode 359
 - answer with DISA 360
 - auto- manual-answer 85
 - dialing plan 105
 - DISA 86
 - disconnect supervised 90
 - disconnect timer, on card 487
 - DNIS number 364
 - for target lines 88
 - full auto hold 362
 - gain level 365
 - line numbers 494
 - line pools 354
 - line setting 355
 - line settings 355
 - loop start requirements 84
 - network requirements 105
 - private network answer mode 360
 - private network, no DISA 90
 - profile support 313, 314
 - remote access 89
 - remote access, private network 90
 - set filters 95
 - single trunk to line pool 356

- trunk cartridge 195, 224
- trunk cartridge cross connections 273
- trunk cartridge wiring 273
- trunk cartridge wiring chart 273
- trunk data settings 352
- trunks 79
 - incoming calls, DISA 86
 - trunks, outgoing calls 86
- EAIC (equal access identifier code) 446
- electrical
 - outlet, power bar, extension cord 194
 - specifications 622
 - third-wire ground 194
- electrical connection 190
- electrical requirements 194
- emergency
 - numbers 33
 - transfer, DID trunk cartridge 276
- emergency telephone
 - BRI restrictions 261
 - installation 281
 - restrictions 282
 - troubleshooting 580
 - trunk module 232
 - with E&M/DISA trunk cartridge 273
- Enabling 518, 523
- enabling
 - a device 519
 - module or its cartridges 524
- enbloc dialing
 - description 437
 - dialing plan 436
- enhanced answer key 429
- entering numbers 304
- entering software keys 481
- environment
 - standards and specifications 36
- environmental specifications 622
- equal access identifier code (EAIC) 446
- equipment
 - installation checklist 189
 - installing optional equipment 287
 - optional auxiliary ringer installation 287
 - optional external paging 289
 - optional, external music source 288
- error message, description 252

- ETSI
 - MCID 180, 471
 - network call diversion 177
- ETSI specifications 36
- evening schedule 374
- event messages
 - maintenance 541
 - significant 542
 - system restarts 546
- Evt 210-YYYZ 542
- Evt 211-YYYZ 542
- Evt 220-3546 542
- Evt 221-3546 542
- Evt 222-3546 542
- Evt 255 542
- Evt 260-0302 542
- Evt 261-0302 542
- Evt 263-302 542
- Evt 264-302 542
- Evt 265-302 542
- Evt 267 542
- Evt 268-07 542
- Evt 269-3546 543
- Evt 299 543
- Evt 327 543
- Evt 328 543
- Evt 329 543
- Evt 330 543
- Evt 336 543
- Evt 373 543
- Evt 400 543
- Evt 407 543
- Evt 408 543
- Evt 412-3546 543
- Evt 413-3546 543
- Evt 414-3546 543
- Evt 415-3546 543
- Evt 416-3546 543
- Evt 417-3546 543
- Evt 418 543
- Evt 419 543
- Evt 421 543
- Evt 422-3546 544
- Evt 423-3546 544
- Evt 441 544
- Evt 442 544
- Evt 453 544
- Evt 454 544
- Evt 458 544

- Evt 459 544
- Evt 680 544
- Evt 681 544
- Evt 683 544
- Evt 687 544
- Evt 688 544
- Evt 689 544
- Evt 690 544
- Evt 691 544
- Evt 692 544
- Evt 693 544
- Evt 694 544
- Evt 695 544
- Evt 696 544
- Evt 697 544
- Evt 698 545
- Evt 822 545
- Evt 882 545
- Evt 883 545
- Evt 992 545
- EVT799-XXXX YY 545
- exception (see dialing restriction)
- exiting the program 303
- expanded system 237
- expansion cabinet
 - clip ferrite bead 213
- expansion cartridge
 - installation error 228
 - installation planning 190
 - not supported 196
 - numbering 253
 - six-port 238
 - system initialization 291
 - twelve-port 239
 - two-port 237
- expansion equipment
 - installation checklist 190
 - not supported 196
- expansion module
 - 12-port cartridge 239
 - 6-port cartridge 238
 - connecting 245, 246
 - routing fibers 246
- expansion modules
 - connecting 234, 245, 250
 - fiber cable guide 242
 - fiber comb 242
 - fiber spool holder 243
 - ICS door label 243
 - spacer 243
 - spacing 242
 - wiring 247
- expired alarms, hospitality 465
- extended
 - answer key 429
 - superframe (IESF) 489
- extension
 - Direct dial 432
- extension cord 194
- extension wiring, S or T 284
- external
 - CSU, connecting the DTI 269
 - music source, impedance 287
 - paging, troubleshooting 593
 - voice message telephone number 474
- external access code
 - conflicts 385
- external call
 - DNIS number
 - host delay 425
 - hunt group cadencing, fixed, hunt groups 411
- external code, access codes 443
- external equipment
 - music source 288
 - paging 289
- external line
 - access code conflicts 442, 443, 451
- external lines
 - auxiliary ringer 361
 - line/set restrictions 94
- external music source
 - input levels and impedance 288
 - optional equipment list 191
 - programming 288
- external paging
 - contacts diagram 289
 - external line port for talkback 289
 - output and input impedance 289
 - programming 289
- external terminal, tandem network 126
- external voice mail access, sets 348
- extra-dial telephone
 - direct dial set 444
 - programming 377

F**FCC**

- registration 25

FCC, radio/TV interference 26

featr settings 296

feature

- codes, troubleshooting 614

- hospitality services 218

- hunt groups 217

- line redirection 174

- settings programming 419

- settings, see also featr settings

- using remotely 89

feature button 298

feature button, T7316 icon 309

feature cartridge slot 226

feature cartridge slots 209

feature codes 451

Features (Restrictions)

- Link (71) 382

- Pause (78) 382

- Programmed Release (*89) 382

- Run/Stop (*9) 382

- Wait for Dial Tone (804) 382

Federal Communication Commission (FCC) see FCC

ferrite bead 213

fiber cable management system

- fiber cable guide 242

- fiber comb 242

- fiber spool holder 243

- ICS door label 243

- spacer 243

fiber cables

- connecting 245

- fiber comb 245

- fiber spool holder 245

- guide 242

- installation 240—246

- making connections 245

- routing 246

fiber comb, description 242

fiber expansion cartridge, installation tips 227

fiber port allocation, ICS door label 243

fiber spool holder, description 243

fiber spool, using 244

fiber cable 235

file transfer 184

filter 00 341

filter 01 341

filters

- default line restrictions 368

- default remote restrictions 369

- defaults 341

- dialing sequences 339

- hospitality room settings 464

- line restrictions 368

- maximum length 342

- overrides 368

- overriding 96

- programming 339

- remote restrictions 369

- removing 342

- removing restrictions 343

- restriction 368

- schedules 344

- see also restriction service 339—344

- wild card 342

filters, see also restriction service

fixed charge dialing, see 900

fixed trunk, data settings 352

fixed, BRI sampling 502

foreign exchange (FX), CbC service 457

framing

- disable trunk cartridge 489

- extended superframe 489

- format for T1 and PRI 489

- module status, disable trunk 489

- superframe 489

- T1 and PRI 489

full

- autohold programming 362

- autohold, trunk/line data 352

- hospitality 464

fwd no answer 335

fwd on busy 335

FX 380

- routing table 383

FX, INWATS, 900, nine hundred, see 900

G

gain

- high 365
 - normal level 365
 - programming 365
 - trunk/line data settings 352
 - gain level
 - CSU line bld 490
 - ground start trunk 80
 - grounded outlet 190
 - groundstart
 - answer mode 359
 - line setting 355
 - trunk data settings 352
 - Group 4 fax using ISDN applications 184
 - group function, naming hunt groups 416
- H**
-
- handset
 - standards and specifications 36
 - handsfree
 - programming 335
 - handsfree button 298
 - handsfree/mute, assigned 331
 - hardware
 - clock source 504
 - D-channel 77
 - disconnect timer, cards 487
 - installation checklist 188
 - interface list 296
 - modules 492
 - power software first 199
 - programming 482
 - programming CbC services 459
 - setting clock source 508
 - software install first 199
 - system initialization 291
 - top level 322
 - trunk cartridges in ICS 482
 - heading 301
 - headset 191
 - hearing aids 32
 - held line reminder
 - delay, programming 422
 - programming 422
 - HF answerback 335
 - Hold
 - button 298
 - setting SWCA controls 430
 - hold
 - full autohold, programming 362
 - tones, music, or silence 419
 - hospitality
 - administrative set features 218
 - call restrictions 464
 - features 218
 - password 406
 - password listing 296
 - room set features 218
 - room/desk information 463
 - service times 465
 - services programming 463
 - setting alarms 465
 - user interface 296
 - host delay 425
 - hotline 336
 - humidity, ICS 192
 - hung lines 583
 - hunt delay 414
 - hunt group
 - page zone 410
 - Hunt Groups
 - auxiliary ringer 416
 - Hunt groups
 - member order 412
 - usage metrics 569
 - hunt groups
 - adding and removing members 410
 - appearances 410
 - broadcast 413
 - busy tone 414
 - call forward override 410
 - delayed ring transfer 412
 - description of use 409
 - distributing hunt group calls 413
 - external cadencing 411
 - features 217, 410
 - hunt delay 414
 - hunt group DN 411
 - listing 296
 - member order 412
 - moving members 412
 - name display 454
 - naming the group 416
 - overflow 414
 - overflow set 415
 - priority calls 410
 - programming 411
 - programming options 409

- queue timeout 415
- queue, on busy 414
- ringing group 410
- rotary 413
- routing for busy lines 414
- sequential 413
- set number range 411
- temporarily leaving group 410
- unassigning lines 412
- upgrading from ILG 217
- videophones 410

I

I/F levels 488

icons on programming telephones 298

ICS

- background music 419
- BRI-U wiring 264, 266
- cable connections 249
- cable trough 290
- cards 482
- door label, description 243
- emergency telephone installation 281
- expansion cartridge numbering 253
- expansion module spacing 242
- external loop start lines wiring chart 258, 259
- feature cartridge slots 209
- humidity 192
- installation checklist 192
- internal modules 252
- minimum clearance 192
- minimum distance 192
- non-expanded numbering 253
- primary reference 504
- required equipment 189
- slot, installation alarm 228
- slots, diagram 226
- spacing requirements for MICS-XC 193
- ST interface card wiring 261, 263
- system coordinator passwords, using 293
- telephone and auxiliary equipment wiring chart 257
- telephone wiring chart 255
- temperature 192

- troubleshooting 600
- trunk cartridge slots 482
- trunk module location 494
- ventilation gap 192
- wiring 252

identify device connected to the system 515

identifying the system 309

Idle 518

idle line

- full autohold 362
- search for 355

if busy 352, 357

ILG, upgrading to Hunt Groups 217

immediate signal type 363

impedance

- external pacing equipment 289
- loss package settings 362

incoming

- call routing, call-by-call 485
- calls, loop start trunks 83
- changing the COS password 93
- E&M trunk, no DISA 86
- target lines 88
- using DID trunks 84

incoming external lines, restricting 95

indicators

- power 292
- telephone buttons 300

Industry Canada

- registration 25

initial configuration checklist 188

initializing the system, startup programming 317

inserting trunk and service cartridges 231

installation

- cartridges 223
- checklist 220
- clock source loops 505
- electrical requirements 194
- emergency telephone 281
- equipment and supplies checklist 189
- expansion equipment checklist 190
- expansion module spacing 242
- external paging system 289
- feature cartridge 229
- fiber cables 240, 242

- ICS and expansion modules
 - checklist 192
- ISDN terminal equipment 284–286
- location requirements 192
- module spacer 243
- music 287
- Norstar telephone 282
- optional equipment checklist 191
- planning checklist 188
- safety precautions 22–24
- Installer
 - interface list 296
 - password 294, 296, 317, 404
 - programming 322
- installing
 - auxiliary ringer 287
 - modules 225
 - optional equipment 287
- Integrated Communication System, see ICS
- Integrated Voice Response Center 479
- intercom
 - assigning buttons 331
 - button programming 328
 - prime line 331
- intercom DNs, conflicts 385
- intercom key
 - target lines 79, 87
- interdigit timeout, dialing rules 440
- interface levels 488
- interference, minimum distance 192
- internal CSU
- internal numbers
 - changing 418
 - length 451
- internal terminal, tandem network 127
- internal user access features 100
- internal wiring requirements 196
- internal/external number, direct dial 434
- international Inwats, CbC service 457
- Internet access 185
- internet access
 - ISDN router 76
- Internet service provider (ISP) 76
- invalid configurations, trunks 510
- Invoke by hold, SWCA 430
- Inwats, CbC service 457
- ISD/TT, I/F levels 488
- ISDN
 - applications 183–185
 - bearer capability 46
 - BRI card 54–60, 498
 - BRI card B-channels 499
 - BRI card call type 500
 - BRI card D-packet service 501
 - BRI card loop lines 498
 - BRI card loop types 498
 - BRI card loops 498
 - BRI card terminal equipment 73
 - BRI card, assign DNs 503
 - BRI card, DNs on loop 503
 - BRI card, loop DN 503
 - BRI card, LT loop 501
 - BRI card, network DNs 500
 - BRI card, sampling 502
 - BRI card, TEIs 502
 - BRI ICS wiring charts 261–265
 - BRI line, loopback test 559
 - BRI network interface wiring 267
 - BRI trunk 87
 - BRI trunk module wiring charts 278–280
 - BRI trunks
 - BRI, ST trunk modules 228
 - BRI, U2 trunk modules 228
 - BRI, U4 trunk modules 228
 - BRI-ST card 224
 - BRI-ST trunk modules 254
 - BRI-U2 card 224
 - BRI-U2 trunk modules 254
 - BRI-U4 card 224
 - BRI-U4 trunk modules 254
 - capabilities 43
 - clock source 504
 - clocking 59–60
 - data transmission speed 48
 - D-channel packet service 77, 501
 - default DNs 73
 - desktop conferencing using 183
 - devices 189
 - digital access lines (DAL) 488
 - DN 503
 - DN default range 449
 - DN range 70
 - DN range, default 503
 - equipment 183–185
 - file transfer using 184
 - framing format for T1 and PRI 489

- Group 4 fax using 184
- hardware configuration 54–58
- I/F levels 488
- installation programming 66
- integrated X.25 PAD 77
- Internet access using 185
- jack and plug pin numbering 268
- LAN access using 184
- LAN to LAN bridging using 185
- layers 45
- leased line backup using 184
- Loop DN, see also ISDN DN 74
- loop termination 232
- module port numbering 252
- network DNs 500
- network loop programming 77
- network synchronization 59–60
- OLI #, programming 333
- ordering 63
- planning service order 45
- PRI configurations 509
- PRI line setting 355
- PRI trunks 79, 87
- primary reference, clock source 504
- profile 313, 314
- profile support 313
- programing PRI lines 71
- programming BRI lines 71
- programming BRI resources 68
- programming clock source for DTI and PRI 508
- programming sequence 67
- router 76
- S interface 57
- S loop programming 73
- S loop, wiring requirements 197
- S or T loop, additional power 285
- S or T loop, wiring 284
- S reference point 57
- secondary reference, clock source 504
- see also Integrated Services Digital Network
- service provider protocol 66
- services and features 48
- set DNs 70
- software key 479
- SPID 74

- SPID, assigning to T and NT loops 499
- standards 61
- T network wiring 267
- T reference point 58
- telecommuting using 184
- terminal equipment configuration 55–57
- testing network connection 222
- timing master 504
- total DNs per system 74
- U interface 55
- U-LT loop programming 73
- U-LT reference point 55
- U-NT network wiring 268
- U-NT reference point 56
- videoconferencing and video telephony using 183
- wiring charts 261–268
- wiring requirements 196
- ISDN call connection limitation (ICCL), MCDN 51, 118, 144, 634
- ISDN loss plan 489
- ISDN, NIUF, see Bellcore/National ISDN Users Forum 65

J

- jack
 - pin numbering 268
 - U-LT pin-out 286
 - wiring for terminal 284

K

- KSU cards, Hardware setting 482

L

- LAN
 - access using ISDN applications 184
 - router 185
 - to LAN bridging ISDN applications 185
- languages
 - display 338
 - profile 1 313
 - profile 2 313
 - profile 3 314

- profile 4 314
- last dialed digits 90
- leased line backup using ISDN
 - applications 184
- least-cost routing
 - creating routing over private network 395
- leaving the program 303
- LEDs
 - DTI 597
 - power indicators 292
- lightning protectors 197
- line
 - assign prime set 358
 - assignment 326
 - BRI, about 87
 - capacity of trunk cartridges 195
 - default line restrictions 368
 - deprovisioning 551
 - filters 94
 - held reminder programming 422
 - liine pool types 354
 - loopback test 553
 - number range 494
 - pool
 - in a dialing plan 102
 - troubleshooting 616
 - profile, reviewing programming 309
 - programming alarmsset 427
 - programming ANI number
 - programming answer keys 429
 - programming answer mode 359
 - programming answer with DISA 360
 - programming auto privacy 358
 - programming auxiliary ringer 361
 - programming CAP assignment 435
 - programming dial mode 356
 - programming dialing plan 436
 - programming direct dial 433
 - programming DNIS number
 - programming DTI 355
 - programming full autohold 362
 - programming gain 365
 - programming host delay 425
 - programming if busy 357
 - programming line restrns 368
 - programming link signal (link at CO) 361
 - programming link time 426
 - programming loss package 362
 - programming message reply enh 428
 - programming name 367
 - programming received number 357
 - programming remote restrns 369
 - programming restrictions 367
 - programming restrn filters 368
 - programming set relocation 427
 - programming signal type 363
 - programming system telco features 370
 - programming trunk mode 359
 - programming trunk type 353
 - programming voice msg center 370
 - programming, viewing the settings 310
 - provisioning 551
 - public, private to, pool 354
 - redirection feature 174
 - restriction 94
 - ringing service, auxiliary ringer 362
 - search for idle 356
 - selecting first line 330
 - target line ring 357
 - troubleshooting 581—590
 - trunk/line data, copying 353
 - type 354
 - viewing assigned lines 328
 - voice message routing 474
- line access
 - listing 296
 - programming CbC services 459
 - programming for sets 325
- line build, CSU 490
- line buttons
 - loop start 84
 - maximum 328
 - no buttons 328
- line coding 491
- line feature, auto privacy 358
- line filter 402
- line keys, limits 327
- line numbers 304, 494
- line pool
 - access code 441, 448
 - access code coordination 110
 - access codes 355

- assign 354
- E&M trunk for ring again 356
- limit to outgoing 354
- loop start 84
- PRI trunks 79, 87
- prime line 330
- programming line access 355
- target lines 356
- types 354
- line pool access code 82
 - auto DN 82
 - conflicts 357, 442, 443, 444, 445, 451
 - programming 329
 - with DISA 82
- line pool codes
 - conflicts 320, 385
- line pools
 - dialing plan for shared pools 109
 - PRI 329
 - programming 460
 - programming tip 334
- line redirection, calling name information 454
- line restrictions
 - defaults 368
 - programming 368
 - remote access 82
- line selection, for a direct-dial telephone 434
- line settings, ringing 377
- line supervision, disconnect timer, on card 487
- line type
 - programming pool for prime line 331
 - trunk/line data settings 352
- line/set
 - filters 94
- line/set restriction
 - filters 94
 - maximum 346
 - user filter 402
- lines
 - assigning, hunt groups 412
 - BRI card 498
 - dialing filters 95
 - external codes 443
 - line button 71
 - listing 296
 - remote access package 447
 - setting auxiliary ring 287
 - single SPID 72
 - SWCA keys 430
 - top-level 321
 - trunk type data settings 352
 - trunk/line data programming 351
- link
 - blocking use of 345
 - F71 361
 - outgoing restrictions 361
 - programming link at CO 361
- link at CO 352
- link signal, dialout 382
- Link status 511
- link status, user interface 296
- link time 426
- local calling, setting up route 389
- location
 - private access codes 103
 - UDP code 439
 - UDP private DN length 103
- location requirements
 - installation planning 192
- log
 - network evt 531
 - system administration 529
 - system test 526
- log space
 - number of spaces 350
 - programming 349
- logging calls
 - MCID 180, 471
- long distance
 - adding an access code 393
 - carrier code 132
 - setting up route 391
- long telephone numbers 304
- longCO 363
- longPBX 363
- loop
 - BRI card 498
 - BRI card, DNs on loop 503
 - line numbers 494
 - network programming 77
 - view card 483
- loop DN
 - BRI card 74, 503

- loop performance 285
- loop start
 - answer mode 359
 - answer with DISA 360
 - as prime line 84
 - configuring 195
 - data settings 352
 - disconnect supervision 90, 359
 - E&M requirements 84
 - emergency telephone 281
 - for target lines 88
 - full autohold 362
 - line pools 354
 - line setting 355
 - loop start signalling 84
 - loss package settings 363
 - MICS-XC compatibility 85
 - no set lines 326
 - ONN blocking 478
 - outgoing 84
 - providing direct dialing capability 84
 - remote access 89
 - remote access, public network 90
 - trunk 83, 224
 - trunk cartridge wiring chart 271
 - trunks 79
 - wiring 196
 - wiring chart 258, 259
- loop start signalling, supporting trunk cartridges 84
- loop start trunk
 - auto-answer 83
 - incoming calls 83
- loop supervision, see disconnect supervision
- loop termination
 - ISDN terminal 232
 - shorting straps 233
- loop type, BRI card 498
- loopback test
 - BRI lines 559
 - initiated by the central office 556
 - initiated from Norstar 556
 - starting 557
- loops
 - no bridge taps 197
 - profile support 313
 - S or T extension wiring 284
- loss level 489

- loss package
 - descriptions 363
 - programming 362
 - trunk/line setting 352
- loss/gain settings 362
- lowest, park mode 420
- Lp, BRI LT loop 501
- LT loop
 - BRI card 501
 - D-packet service 501
- lunch schedule 374



M

- M1, see Meridian
- M7100 telephone, accessing external lines 443
- M7310, programming telephone 298
- M7324
 - CAP assignments 435
 - programming telephone 298
- maintenance 296
 - alarm codes 533
 - beginning a session 512
 - bipolar violations 564
 - carrier failure alarms 563
 - CSU stats 560
 - current alarm 527
 - device version number 517
 - disabling module/cartridges 524
 - enabling the module/cartridges 524
 - event messages 541
 - identify device connected to system 515
 - module 521
 - network event log 531
 - port/DN status 514
 - provisioning 549
 - short term alarms 564
 - state
 - of a cartridge 523
 - of a module 522
 - of device 518
 - system
 - administration log 529
 - test log 526
 - system administration log 529
 - system version 513
 - top level 322

- making a call using destination codes 394
- Malicious call identification (MCID)
 - programming 180, 471
- manual answer
 - E&M trunks 85
 - line appearances 86
 - loop start trunk 83
- map table, call by call routing 486
- maxi system
 - module ports 237
 - trunk module location 494
- maximum incoming calls, CbC limits 460
- maximum line buttons 328
- maximum outgoing calls, CbC
 - programming 460
- MCDN
 - APN network features 118
 - break-in 154
 - camp-on feature 152
 - ISDN call connection limitation (ICCL) 51, 118, 144, 634
 - Meridian configurations 133
 - message waiting indication (MWI) 151
 - network call redirection information (NCRI) 142
 - network features 150
 - see also PRI and APN
 - software code 117
 - software key 479
 - trunk anti-tromboning (TAT) 51, 118, 148
 - trunk route optimization (TRO) 146
- medium, hospitality 464
- mediumCO 363
- mega system 237
- member DNs 411
- member order, hunt groups 412
- memory button
 - loop start 84
- Meridian
 - advanced private networking 128, 134
 - MCDN 133
 - networking 97
 - networking with SL-1
 - SL-1 network 133
- message
 - reply enh programming 428
 - waiting indicator, see also MWI 348
- message waiting indication
 - MCDN 151
- messages
 - network features 150
- MICS
 - basic password 297
 - behind a PBX 101
 - default destination codes 386
 - default DID line numbering 327
 - electrical
 - connection 190
 - ISDN DNs 74
 - maximum 8 modules 482
 - mounting the modules 225
 - NVRAM cartridge 202
 - planning checklist 188
 - power the system 290
 - power, PS1, PS2, PS3 285
 - private network caller features 101
 - private network tandem calling (PNTC) 119
 - remote access caller features 100
 - software keys 479
 - software upgrade tool 205
 - station module 492
 - system coordinator password 297
 - system functionality 37
 - system internal caller features 100
 - system overview 198
 - trunk modules 494
 - upgrading to MICS-XC 207
- MICS-XC
 - basic password 297
 - Companion software key 479
 - connecting expansion modules 250
 - default DID line numbering 327
 - fiber connections 245
 - interface headings 296
 - loop start trunk compatibility 85
 - maximum 14 modules 482
 - mounting the modules 225
 - powering the system 290
 - software keys 479
 - software upgrade tool 205
 - station module 492
 - system coordinator password 297
 - system functionality 37

- system overview 198
 - trunk modules 494
 - upgrading from MICS 207
 - US systems, upgrading, UTAM 200
 - MICS-XC, see also ICS
 - midi system
 - module ports 237
 - trunk module location 494
 - minimum clearance 192
 - minimum incoming calls, CbC limits 460
 - minimum outgoing calls, CbC
 - programming 460
 - model 338
 - modify, NRU 381
 - Modular 8X24 KSU, replace with 0X32
 - ICS 201
 - Module status 511
 - module status
 - enabling/disabling cartridges 494
 - listing 296
 - modules
 - ASM features 493
 - brackets 225
 - BRI B-channels 499
 - BRI call type 500
 - BRI card, assign DNs 503
 - BRI card, DNs on loop 503
 - BRI card, D-packet service 501
 - BRI card, loop DN 503
 - BRI card, sampling 502
 - BRI loop lines 498
 - BRI loop types 498
 - BRI loops 498
 - BRI LT loop 501
 - BRI network DNs 500
 - BRI TEIs 502
 - check number of trunk cartridges
 - 522
 - checking the state 522
 - connecting 251
 - connecting multiple modules 236
 - Data Module 510
 - enabling 524
 - fiber cable guide 242
 - fiber spool holder 243
 - hardware 492
 - ICS and feature cartridge slots 226
 - ICS door label 243
 - mounting 225
 - non-expanded numbering 253
 - numbering 253–254
 - port DNs 252
 - port numbers 252
 - power LEDs 292
 - show system modules 482
 - showing inventory 521
 - spacer 243
 - Station Module 492
 - troubleshooting 600–619
 - Trunk Module 494
 - verifying ports 493
 - verifying status of analog module
 - 493
 - wiring 247
 - wiring charts 252
 - monitor
 - turning tone on/off 432
 - monitoring
 - call usage set 80
 - incoming call usage 326
 - mounting bracket 226
 - moving telephones 283
 - moving telephones, also see set
 - relocation
 - multi-line
 - hunt 48
 - hunt groups
 - ordering 65
 - multiple modules 236
 - multiple target lines, broadcast ring 326
 - music
 - adjust volume of external source
 - 288
 - background music 419
 - installation 287
 - license 32
 - on hold 419
 - source 29, 288
 - MWI, assigning to a line 348
- ## N
-
- name
 - programming for lines 367
 - terminals&sets 296, 337
 - trunk/line data 296
 - name display, ANI number 364
 - National ISDN standards 61

- national length, profile 2 452
- network
 - access, CbC services 457
 - APN features 118
 - APN, see also MCDN 128, 134
 - behind PBX 101
 - caller information on SL-1 118
 - calls within network 171
 - CDP call routing 139
 - clock source settings 505
 - configuration samples 166—181
 - configurations 99—139
 - controlling access 93
 - COS 93
 - destination code number 104
 - E&M dialing plan 105
 - equipment registration 25
 - event log 531
 - external termination, tandem
 - network 126
 - internal termination, tandem
 - network 127
 - line pool access codes 110
 - line pool access, set 110
 - log, check items 532
 - node 90
 - options 100
 - private access codes 103
 - private DN length 103
 - private systems to Norstar system
 - 101
 - private, call scenarios 170
 - public network to Norstar system
 - 100
 - restriction filter 94
 - SL-1 features 117
 - tandem 109
 - tandem network 119
 - target line 90
 - test BRI network connection 222
 - transparent dialing plan 102
 - troubleshooting 606—619
 - user problems 606
 - using destination codes 104
 - using E&M trunks 173
 - using SL-1 117
- Network Call Diversion 53, 176, 468, 636
- Network call diversion (NCD)
 - programming 177
- network call redirection information (NCRI), MCDN 142
- network calls
 - creating autodial 111
 - external calls 111
- Network DN
 - BRI card 500
- network DN 68
 - call type 500
 - incoming calls 71
 - received number 357
 - single SPID 71
- Network evt log 511
- network evt log 296
- network loop programming 77
- network name display
 - calling party name 453
 - connected name, receiving and sending 454
 - hunt group 454
 - interactions 454
 - OLI# 454
 - other programming, OLI#, Called ID, CLID set 455
 - private/unknown names 453
 - programming 455
 - programming BusName 453
 - protocols, supported 453
- network services
 - listing 296
- network specific facilities, see NSF
- networking
 - MCDN features 150
 - MCDN, break-in 154
 - MCDN, camp-on feature 152
 - MCDN, ISDN call connection
 - limitation (ICCL) 51, 118, 144, 634
 - MCDN, message waiting indication (MWI) 151
 - MCDN, network call redirection (NCRI) 142
 - MCDN, trunk anti-tromboning (TAT) 51, 118, 148
 - MCDN, trunk route optimization (TRO) 146
- next 301
- NI-2, protocol 484

- night ringing service schedule 376
 - night schedule 374
 - night service 375
 - nine hundred, see 900
 - NIUF, see Bellcore, National ISDN Users Forum
 - No free lines 589
 - node 90
 - Non Volatile Read-only Memory, see NVRAM
 - non-expanded system (ICS alone)
 - numbering 253
 - normal rte, destination codes 388
 - normal service
 - line restrictions 368
 - remote restrictions 369
 - Norstar
 - as off-premise extension 101
 - sets 189
 - starting the system 290
 - telephones 189
 - Norstar Remote Utilities, see NRU 381
 - Nortel Customer Response Center 479, 480
 - Not available 518, 587
 - Not in service 587
 - notify set, hospiality 465
 - NSF
 - extensions 484
 - NI-2 protocol, with CbC services 484
 - NT1 222, 267
 - stand alone connections 60
 - numbering, trunk module lines 216
 - numbers, entering 304
 - NVRAM cartridge
 - installation diagram 229
 - limitations 202
 - required equipment 189
- O**
-
- occupancy, room 464
 - OLI#
 - name display 454
 - network name display programming 455
 - PRI, call display 333
 - programming 333
 - on hold 419
 - ONN blocking 456
 -  819, ONN blocking 475
 -  819 456
 - listing 296
 - loop start on BRI card 478
 - on BRI 477
 - programming 456, 475
 - setting up modules 477
 - suppression bit 477
 - tone 456
 - VSC 476
 - open switch interval (OSI), description 359
 - disconnect timer 487
 - optional equipment
 - auxiliary ringer 287
 - auxiliary ringer, programming 361
 - external music source 288
 - external paging 289
 - installation 191
 - installation checklist 196
 - installing 287
 - troubleshooting 591—593
 - optional features
 - programming alarm set 427
 - programming answer keys 429
 - programming AutoTime&Date 424
 - programming background music 419
 - programming call log space 425
 - programming camp timeout 420
 - programming CAP assignments 435
 - programming daylight time 423
 - programming dialing plan 436
 - programming direct dial 433
 - programming directed pickup 422
 - programming DRT 421
 - programming DRT delay 421
 - programming held line remind delay 422
 - programming held reminder 422
 - programming host delay 425
 - programming link time 426
 - programming message reply enh 428
 - programming on hold 419

- programming page timeout 423
- programming page tone 423
- programming park mode 420
- programming park timeout 420
- programming receiver volume 419
- programming set relocation 427
- programming transfer callback 421

OPX 282

OSI (open switch interval) 359

outgoing

- calls, routing table 383
- E&M trunks 86
- external routing codes 112
- host delay 425
- PRI lines 112
- restriction filters 94
- using loop start 84

outgoing name and number block, see
ONN blocking

Outwats

- carrier access codes 383
- CbC service 457
- routing 380
- routing table 383

overflow

- Hunt group 217
- in queue 414
- routing, schedules 397

overflow set, hunt groups 415

overlay

- button definitions 301
- positioning on the set 299

overrides

- maximum
- restriction filters 94, 368

P

packet service 77

page timeout 423

page tone 423

page zone

- Capabilities 335
- hunt group 410

paging

- Capabilities 335
- equipment connections 289
- external output and input
- impedance 289

park mode 420

park prefix

- access codes 442
- conflicts 320, 442, 443, 451

park timeout 420

pass codes, see software keys

passive bus 285

password

- admin 297
- basic 294, 297, 405
- call log programming 403
- calls answered with DISA 445
- cond pswd 406
- COS 82
- COS user filter 402
- desk pswd 406
- dialpad 294
- Hospitality password 406
- Installer 294, 296, 317, 404
- profile 294
- registration 405
- registration password 405
- System Coordinator 294, 297, 405
- System Coordinator Plus 296, 405
- System Coordinator plus 323
- system coordinator Plus 294
- user 297

password keys, see software keys

passwords

- COS, using DISA 96
- interface list 296
- programming 293, 294, 401
- programming passwords 404
- top level 321

Pause (F78) 382

payload loopback test 553

PBX, using Norstar 101

phantom circuits 285

phantom DN 429

physical trunks 326

pickup grp 335

pin number, ISDN jack 268

planning checklist, installation 188

plug pin numbering 268

PNTC

- external termination 126
- internal termination 127
- networking features 117
- using SL-1

- point-of-sale terminal adapter, see
 - POSTA
- point-of-sale terminals 76
- port numbering 252
- port numbers 252
- port, verifying module ports 493
- Port/DN status 511
- port/DN status 296, 514
- positioning the overlays 299
- POSTA
 - BRI 77
 - Bri cards, D-packet service 76
- power
 - LEDs 291
 - losing call log information 292
 - S or T loops 285
 - specifications 621
 - system indicators 292
 - warm start 291
- power bar 194, 290
- power cords 194
- powering the system
 - process 290
 - service cable connections 290
- prefix
 - conflicts 451
 - public network, dialing plan 440
- PRI
 - B channel sequence 485
 - BusName, network name display 453
 - Call-by-call services over network 111
 - card download 68
 - carrier failure, standard 488
 - CbC destination codes 380
 - CbC limits 460
 - CbC service selection 457
 - CbC trunk allocation 112
 - choosing lines for call 327
 - CO fail 488
 - configurations 509
 - configuring CbC 112
 - connecting to service provider 269
 - connecting wiring 250
 - dialing plan, 2-way DID 115
 - dialing with intercom 327
 - DTI 189
 - framing 489
 - invalid digital trunk configurations 510
 - invalid mixed trunk configurations 510
 - ISD/TT 489
 - line appearances 327
 - line numbers 494
 - line pools 329
 - line restriction rules 339
 - line setting 355
 - Meridian 1 networking (MCDN) 128, 134
 - Meridian M1 network configuration 133
 - network name display 453
 - networking 132
 - networking using SL-1 117
 - no DISA on trunk 91
 - no prime line 330
 - OLI # 333
 - profile support 313, 314
 - programming call limits 461
 - programming CbC services 459
 - programming clock source 508
 - programming DISA 72
 - programming line pools 460
 - programming lines 71, 325
 - programming routing table 384
 - remote access trunk 91
 - remote access, DISA 89
 - selecting a protocol 484
 - service types routing table 383
 - SL-1 networking features 117
 - SL-1 tandem network 119
 - software code 117
 - software key 479
 - suppression bit 477
 - target line, if busy 357
 - through-fed repeaters 248
 - trunk 79, 87
 - trunk data settings 352
 - valid digital trunk configurations 509
 - valid mixed trunk configurations 510
 - view card 483
- PRI channel
 - disabling 551
- PRI channel, disabling 551

- PRI line
 - provisioning 550
- PRI line, provisioning 550
- PRI-A 329
- PRI-B 329
- Primary Rate Interface trunk, see PRI
- primary reference, clock source 504
- prime line
 - assign line pool 355
 - describing 330
 - DID 330
 - exception 82
 - external line assignment 330
 - intercom 331
 - line pool 330
 - no PRI 330
 - prime telephone 330
 - programming as intercom 356
 - programming line type pool 331
 - target line 330
- prime set
 - assign DN 358
 - auto-answer calls 358
 - DRT 421
 - prime line 330
 - received number 357
 - trunk type data 352
- priority call 335
- priority, hunt group 410
- PrivAccCode 445
- privacy, programming auto privacy 358
- private
 - CbC service 458
 - PRI protocol 484
 - routing table 383
- private access codes
 - conflicts 445
 - network 445
 - UDP 103
- private DN length
 - dialing rules 439
 - networking 103
- Private DN, CbC over Tie 112
- private line 354
- private name 453
- private network
 - additional configuration 132
 - auto-answer, DISA DN, Auto DN 91
 - call routing codes 128
 - CDP call routing 139
 - dialing plan 437
 - DID trunks 91
 - DISA 96
 - E&M no DISA 90
 - E&M trunk answer mode 360
 - E&M trunks 79
 - MCDN break-in 154
 - MCDN camp-on feature 152
 - MCDN ISDN call connection
 - limitation (ICCL) 51, 118, 144, 634
 - MCDN message waiting indication (MWI) 151
 - MCDN network call redirection information (NCRI) 142
 - MCDN software key 479
 - MCDN trunk anti-tromboning (TAT) 51, 118, 148
 - MCDN trunk route optimization (TRO) 146
 - PNTC call routing 123
 - private access code 445
 - private access codes 103
 - private network ID 439
 - PSTN calls 132
 - Public DN, CDP 102
 - public DNs 132
 - remote access 90
 - sample configurations 170–173
 - SL-1, private network tandem calling (PNTC) 119
 - tie lines 167
 - UDP 439
 - using E&M trunks 173
- private network tandem calling, see PNTC
- private networking (APN), see also MCDN 128, 134
- private number 349
- private numbering plan, CbC dialing 112
- profile
 - changing 315
 - installation checklist 188
 - password description 294
 - profile 1, North America 313
 - profile 2 313
 - profile 3 314
 - profile 4 314

- programming 312
- programming headings 295
- trunk cards, profile 1 313
- trunk cards, profile 2 313
- trunk cards, profile 3 314
- trunk cards, profile 4 314
- profile 1, languages 313
- profile 2, languages 313
- profile 3, languages 314
- profile 4, languages 314
- programmed release, dialout 382
- programming
 - 1st display 349
 - access 294
 - access codes 441
 - allow last number redial 345
 - allow link 345
 - allow saved number redial 345
 - analog and BRI ONN 456
 - analog VSC 476
 - ANI number
 - answer mode 359
 - answer with DISA 360
 - auto DN 444
 - auto privacy 358
 - auxiliary ringer 287, 361, 378
 - basic admin password 297
 - basic password 294, 405
 - BRI card 498–503
 - BRI lines 71
 - BRI resources 68
 - business name 455
 - BusName 453
 - busy lines, hunt groups 414
 - button definitions 301
 - call log password 403
 - call restrictions, hospitality 464
 - called ID 349
 - CAP assignment 435
 - capabilities 335
 - clock source for DTI and PRI 508
 - control telephone 372
 - copy trunk/liine data 353
 - copying telephone programming 306
 - COS line filter 402
 - COS password 401
 - day-to-day changes 324
 - dial mode 356
 - dialpad 294
 - dialpad headings 295
 - dialpad, CCITT 316
 - display buttons 301
 - DN length 451
 - DNIS number
 - enable/disable trunk cartridge 491
 - entering 323
 - exiting 303
 - external code 443
 - external music source 288
 - extra-dial telephone 377
 - feature settings 419
 - full autohold 362
 - gain for E&M line 365
 - handsfree/mute 331
 - hardware 482–510
 - hospitality cond password 406
 - hospitality desk password 406
 - hospitality password 406
 - hospitality services 463
 - hunt delay 414
 - hunt group function name 416
 - hunt groups 411
 - if busy 357
 - indicators, telephone programming
 - buttons 300
 - insaller 322
 - installer password 294, 404
 - ISDN 67
 - ISDN PRI lines 71
 - least cost routing 395
 - line access 325
 - line keys, limits 327
 - line name 367
 - line pools 354
 - line pools for CbC 460
 - line restrictions 368
 - line type 354
 - lines 351–370
 - lines to DTI 355
 - link at CO 361
 - log space 349
 - loss package 362
 - maintenance 511–565
 - ONN 456
 - overflow
 - defining set, hunt groups 415
 - overlay 298

- passwords 293, 294, 401—405
- PRI routing table 384
- prime set 358
- profile headings 295
- programming overview 294
- programming telephones 298
- received number 357
- registration password, Companion 405
- release reasons 462
- remote access 447
- remote restrictions 369
- restriction service 379
- restrictions 367
- reviewing lines 309
- reviewing sets 309
- ring delays 307
- ringing groups 377
- ringing service 375
- routing 103
- routing requirements 381
- routing service 379
- schedule names 373
- schedule times 373
- services 371—375
- set lock 345
- set name 455
- signal type 363
- software keys 479
- special characters 301
- startup 317—319
- startup headings 295
- system 293—309, 409—451
- system coordinator 323
- system coordinator password 294, 297, 405
- system coordinator plus password 294, 405
- system features 369
 - remote restrictions 369
 - restriction service 339—346
- system speed dial 400
- telco features 347, 370, 474
- telco features (system-wide) 370
- Terminals&Sets 325—350
- Time&Date 408
- timing for startup 317
- tools 298
- top-level 321
- trunk answer 375, 376
- trunk mode 359
- trunk type 353
- trunks and lines 351
- user preferences 305
- viewing assigned lines 328
- viewing line 310
- viewing updates 303
- VMsg center, on lines 370
- VSC for BRI 476
- programming record
 - about the overlays 298
 - description 303
 - planning the routing service 380
 - routing service 383
- programming system features
 - Caller ID set 347
- progmrng pswds 296
- protocol
 - selecting 484
 - service provider 66
 - supporting call by call services 457
- Provisioning 511
- provisioning
 - DTI card 483
 - listing 296
 - T1 lines 550
- PS1, power 285
- PS2, power 285
- PS3, power 285
- PST
 - adapter, RS-232 interface 78
 - network loop programming 77
- PSTN
 - analog access lines 488
 - external routing code 112
 - I/F levels 488
 - on a network 118
- PSU LEDS 291
- Pswd, see password
- public
 - CbC service 457
 - PRI protocol 484
 - routing table 383
- public calls, Auto DN 169
- Public DN
 - dialing plan 439
 - external routing code 112
 - private network 132

- public network call scenarios 166
- public networks, CDP 102
 - using with CDP 102
- Public DN length, private networking 132
- public line 354
- public network
 - call descriptions 166—174
 - carrier codes 132
 - dialing plan 437, 439
 - DID trunk
 - DISA 96
 - loop start trunks 79
 - PNTC routing 120
 - using DID 169
- pulse signalling 356

Q

- Q, dialpad 294, 316
- queue 414
- queue timeout, hunt groups 415
- queues, Hunt groups 217

R

- reallocating log space 425
- Rec'd # length 450
- Rec'd # length, listing 296
- receive objective loudness rating (ROLR) 489
- receive, setting gain 365
- received number
 - conflicts 357
 - target lines 357
 - trunk/line data 352
- received number length
 - DISA DN 445
 - programming 450
- receiver volume 419
- receiver, see also handset
- receiving
 - calling name 453
 - connected name 453
 - redirected name 453
- receiving calling name 453
- redirection
 - line redirection 174
 - ring 336
- re-entering software keys 480
- reg. pswrd 296

- region 295
- registration password 405
- regulatory information 25
- Release button
 - icons 298
- release button 303
- release reasons
 - listing 296
 - programming 462
- relocating
 - CAP module 436
 - telephones 283
- remind delay 422
- remot access packages
 - COS 447
- remote access
 - caller features 100
 - COS password 401
 - default restrictions 369
 - defaults 448
 - DID trunks 91
 - DISA 72
 - DISA DN, programming 445
 - E&M trunks 90
 - filters 95
 - line packages 447
 - line restrictions 369
 - listing 296
 - loop start trunks 83, 90
 - PRI trunk 91
 - private network 90
 - programming 447
 - public network 90
 - remote pkg 403
 - restricting 447
 - restricting outgoing calls 95
 - restrictions 84
 - setting link time 426
 - system access 89—91
 - through network 100
 - trunk types 89
 - users, troubleshooting 606—619
 - using Call by Call programming
- remote access packages
 - copy 448
- remote feature code 82
- remote feature request 90
- remote filters 82
- remote line access

- remote packages 447
- remote line access, programming 447
- remote packages 82
 - programming 403
 - remote line access 447
- remote restrictions
 - default filters 369
 - filters 402
 - process chart 95
 - programming 369
- repair
 - authorization 25
- repair facility 33
- replacing a telephone
 - of different types 579
 - of same type 579
 - status 580
- required equipment 189
- reset logs 425
- reset memory 295, 318
- restore, NRU 381
- restricting
 - line at telephone 346, 367
 - remote access 447
 - remote callers 369
 - telephones 339
- restriction
 - default 341—344
 - filters 368
 - service 339, 367—369
 - line/set 346
- restriction dialing, setting up routes 399
- restriction filters
 - assign to sets 344
 - auto-answer 90
 - call routing 110
 - COS 93
 - default line restrictions 368
 - network 94
 - overrides 94
 - remote restrictions 369
 - removing filters 343
- restriction service 367
- restrictions
 - 911 341
 - default filters 341
 - hospitality services 464
 - lines 296
 - link signal 361
 - programming 367, 379
 - programming for terminals and sets 339
 - removing filters 342
 - schedules 94
 - see also Terminals&Sets and Lines 379
 - set restrictons 344
 - terminals&sets 296
- Restrn service, list 296
- retrieving
 - calls, park prefix 442
 - voice messages 474
- retry intrvl 465
- reusing trunk and station modules 210
- reviewing line programming 309
- reviewing set programming 309
- RIN, see ringer equivalence number
- ring again, assign E&M trunk to line pool 356
- ring delay, programming 307
- ring only 157, 162, 326, 410
- ring transfer, hunt groups 412
- ring type 338
- ring/call distribution, Hunt group 217
- ringer equivalence number
 - Canada 32
 - US 31
- ringer, auxiliary ringer 361
- ringing
 - broadcast, hunt groups 413
 - hunt delay 414
 - rotary, hunt groups 413
 - sequential, hunt groups 413
 - target line 357
- ringing group
 - hunt group 410
 - programming 377
 - ringing service 375
 - schedules 378
- ringing service
 - auxiliary ringer 362
 - list 296
 - night schedule 376
 - ring group assignment 376
 - ringing groups 375
- RJ-21
 - DID wiring 275
- RJ2HX/CA2HA distribution block

- cross connections 273
- ROM software cartridge 189, 229
- room # 463
- room condition 218
- room occupancy 218, 464
- room vacancy 464
- room/desk information, hospitality 463
- rotary 217, 413
- route numbers 381
- router, ISDN 76
- routing
 - adding a long distance access code 393
 - carrier code 132
 - carrier codes 446
 - CDP 139
 - destination codes 381
 - dialing restrictions 399
 - dialout 382
 - for least cost routing 395
 - for long distance calling 391
 - hunt group 217
 - incoming DID calls 113
 - normal route 388
 - overflow 397
 - programming 103
 - programming CbC services 460
 - programming requirements 381
 - sample for local calling 389
 - sample for long distance calling 391
 - setting up leading digits 104
 - tandem networks 126
- routing service
 - list 296
 - planning 380
 - programming 379
- routing table
 - CbC service 383
 - checking internal dialing 379
 - PRI dialing plan 384
 - using SID 383
 - voice message routing, telco features 474
- Run/Stop, dialout 382

S

- S interface, ISDN 57
- S loop

- power 285
- sampling 502
- S or T reference point 57, 58
- S reference point 57
- safety precautions 22–24
- sample configurations, private network 170
- sampling
 - BRI card 502
 - S loop 502
- SAPS
 - optional equipment list
 - wiring loops 197
- Sched 4 374
- Sched 5 374
- Sched 6 374
- schedules
 - activating services 371
 - assigning filters 344
 - control sets 373
 - controls 376
 - default line restrictions 368
 - default names 373
 - default remote restrictions 369
 - default times 374
 - night ringing service 376
 - overflow routing 397
 - remote restrictions 369
 - restriction service 94
 - ringing groups 378
- SDS
 - secondary reference
 - clock source 504
- security
 - COS 93
 - dialing filters 94
- selective line redirection (SLR) 454
- self-test, system initialization 291
- sendiing calling party name 453
- sending calling name 453
- sending connected name 453
- sequential 413
- sequential mode 217
- service
 - schedule control 376
- service cartridge
 - installation tips 227
 - installing 231
- service ID (SID)

- service identifier, see SID
- service profile identifier, see ISDN and SPID
- service provider
 - connecting T1 and PRI 269
 - connecting to external CSU 269
 - ISDN protocol 66
- service time
 - hospitality 465
- service tone cadences 621
- service types 72
 - CbC limits 460
 - routing table 383
 - using SID 383
- services
 - activating from control set 371
 - assigning direct dial numbers 444
 - call ringing, dialing restrictions, call routing 371
 - cartridge, IVD services card 189
 - CbC selection for PRI 457
 - control set 372
 - control sets 372
 - evening 374
 - example of alternate call ringing 371
 - line restrictions 368
 - list 296
 - lunch 374
 - night 374
 - programming CbC services 459
 - programming common settings 400
 - programming restrn services 379
 - programming ringing groups 375
 - programming ringing sets 377
 - programming routing service 379
 - ringing service 375
 - ringing, auxiliary 362
 - Sched 4 374
 - Sched 5 374
 - Sched 6 374
 - schedule names 373
 - schedule times 373
 - start and stop times 373
 - top level 321
 - turning on separately 371
- services card, clock source 505
- set
 - feature and number restrictions 344
 - filters, description 94
 - filters, E&M trunks 95
 - profile, reviewing programming 309
 - user restrictions 94
- set interface, programming 293
- set lock 345
- set name
 - BusName 453
 - network name display 455
 - programming 455
- set relocation
 - deactivate 427
 - programming 427
 - relocation enabled 283
 - tips 283
- set restriction
 - default 344
 - filters 95
 - lines 82
 - Link 345
- sets
 - assigning target lines 326
 - basic password for programming 294
 - OLI as called # 333
 - programming, system coordinator password 294
 - setting auxiliary ring 287
 - viewing telephone programming 310
- shared line pools, dialing plan 109
- shedule names 373
- shortCO 363
- shorting straps 233
- shortPBX 363
- show 301
- show group 411
- show module 482, 483
- show set 157, 159, 162, 163, 325, 463
- SID
 - routing table 383
- side circuits 285
- signal
 - method 31
 - programming type 363
 - trunk/line data settings 352
- signal is immediate 356
- significant event messages 542
- silent monitor

- turning tone on/off 432
- silent, on Hold 419
- simultaneous calls 327
- single-line telephone
 - emergency phone 281
 - off-site 282
- six-port expansion cartridge 238
- SL-1
 - MCDN software key 479
 - network 128, 134
 - network caller information 118
 - networking features 117
 - private network tandem calling 119
 - private PRI protocol 484
 - software code 117
- SL-1 networking 117
- slots on ICS 209
- SLR, see selective line redirection
- softkeys, see display buttons
- software
 - DNIS for third-party 364
 - MICS and MICS-XC 37
 - NVRAM installation 229
- software key
 - Companion 479
 - ISDN 479
- software keys
 - entering 481
 - programming 479
 - re-entering 480
 - system ID 480
 - top level 321
 - user interface 296
- softwarey keys
 - MCDN 479
- space allocation, call log space 425
- spacer, description 243
- spacing requirements, ICS 193
- special characters on display 301
- specifications
 - CSU 623
 - DTI 623
 - electrical 622
 - environmental 622
 - power 621
 - service tone cadences 621
 - system standards 36
 - telephone loop 621
- SPID
 - assigning to BRI 499
 - B channels 71
 - creating terminal SPID 74
 - defining lines 326
 - OLI# 333
 - programming ISDN terminals 70
 - T/NT loops, assigned 499
- SrvcCode for VSC 477
- ST line numbers 494
- standard time, see daylight time
- start and stop times, services 373
- start DN
 - changing at startup 319
 - Startup 295
- starting the system 290
- startup 255
 - changing start DN 319
 - default filters 342
 - dialpad password 294
 - DN length settings 451
 - installer password 294
 - profile password 294
 - programming 317
 - programming headings 295
 - run Profile and Dialpad first 312
 - timing for startup 317
- Startup code, installation checklist 188
- startup programming 291
- state of device, check 518
- static DID 116
- station auxillary power supply, see SAPS
- Station Module 492
- station module
 - connecting 234
 - fiber comb 242
 - installation planning 196
 - port numbers 252
 - power 291
 - troubleshooting 605
 - wiring chart 270
- status, analog module 493
- super 359
- superframe (SF) 489
- supervisory signaling, DID 276
- supported upgrades 200
- suppression bit 477
 - PRI 477
 - SuprsBit, ONN blocking 477
- suttered dial tone 82

- SWCA
 - defining appearance keys 430
 - setting controls 430
- switched digital
 - CbC service 458
 - routing table 383
- switches
 - matching signal types 363
- switches, NSF extensions 484
- sys admin log 511
- sys admin log 296
- sys speed dial 296, 321
- sys test log 511
- sys test log 296
- SysID 296
- sysID 480
- system
 - administration log 529
 - basic password 294
 - coordinator password 294
 - coordinator plus password 294
 - network configurations 99–139
 - processor software 513
 - programming, see also system prgrmg 293–309
 - restarts, event messages 546
 - sample configurations 166–181
 - test log 526, 541, 547
- system admin, basic programming 297
- system configuration checklist 189
- system coordinator
 - changing the password 405
 - common changes 324
 - extra programming 323
 - passwords 293
 - programming 297
 - programming overlay 323
 - system programming 323
- system coordinator plus
 - interface headings 296
 - password description 294
 - programming the password 405
- system features, telco features, programming 370
- system ID
 - access 480
 - finding 309
 - software keys 480
- system initialization self-test 291
- system modules, view 482
- system overview 198
- system power, clock source loops 505
- system prgrmg
 - access codes 441
 - alarmset 427
 - answer key 429
 - auto DN 444
 - autotime&Date 424
 - backgrnd music 419
 - call log space 425
 - camp timeout 420
 - CAP assignment 435
 - daylight time 423
 - delayed ring transfer to prime(DRT) 421
 - dialing plan 436
 - direct-dial 433
 - directed pickup 422
 - DN length 451
 - DRT delay 421
 - featr settings 419
 - held reminder 422
 - hospitality services 463
 - message reply enh 428
 - on hold 419
 - page timeout 423
 - page tone 423
 - park mode 420
 - park timeout 420
 - programming CbC limits 461
 - receiver volume 419
 - release reasons 462
 - remind delay 422
 - remote access 447
 - set relocation 427
 - telco features 474
 - top level 321
 - transfer call back 421
 - user interface 296
- system prgrmg
 - BusName 453
 - programming CbC services 459
- system profile
 - choosing 312
- system profile startup 312
- System programming
 - ETSI programming 177, 180, 471
- system programming

- hunt groups 411
 - see also system prgrmr
 - setting SWCA controls 430
 - SWCA keys 430
- system settings
 - Answer key 429
 - Automatic Time and Date 424
 - Direct dial extension 432
 - host delay 425
 - link time 426
- system speed dial 400
- system startup
 - timing for programming 317
 - warm start 291
- System version 511
- system version
 - finding 513
 - listing 296
- system-wide call appearances, see SWCA

T

- T loop, power 285
- T network, wiring 267
- T reference point 58
- T/NT loops
 - BRI lines 498
- T1
 - adding digital trunks 210
 - answer mode 359
 - carrier failure standard 488
 - connecting to service provider 269
 - disconnect supervision 80
 - disconnect timer on card 487
 - ground start trunk mode 80
 - internal CSU
 - invalid mixed trunk configurations 510
 - invalid trunk configurations 510
 - line coding 491
 - line setting 355
 - profile support 313, 314
 - setting clock source 509
 - setting up CbC 112
 - signal diagnostics 560
 - through-fed repeaters 248
 - transmission performance 560
 - trunk data settings 352

- valid mixed trunk configurations 510
 - valid trunk configurations 509
- T7100 telephone
 - accessing external lines 443
- T7316
 - programming overlay 298
 - programming telephone 298
- talk-back paging, external line port 289
- tandem network
 - call routing 126
 - shared line pools 109
- target line DN
 - DID trunk 91
 - PRI trunk 91
- target line number 82
- target line receive digit length 72
- target lines
 - assigning to set 326
 - default DID numbering 327
 - DID 79, 81
 - DID template 88
 - DID trunk 82
 - E&M network 105
 - if busy 357
 - incoming calls 88
 - incoming only 79
 - line pool 356
 - loop start and E&M 88
 - multiple, broadcast ring 326
 - no prime line 330
 - numbering 79, 88
 - received number 357
 - received number length 450
 - simultaneous calls 327
 - trunk data settings 352
- TE, see ISDN terminal equipment
- TEI
 - BRI card 502
 - default range
 - D-packet service
- Tel #
 - voice message center 474
- telco features
 - copy 347
 - lines 296
 - programming 474
 - programming for lines and sets 347
 - programming system features 370

- terminals&sets 296
- top level 321
- voice message routing 474
- telecommuting using ISDN applications 184
- telephone
 - copy programming 306—309
 - emergency 281
 - emergency, single-line 281
 - Feature button 298
 - handsfree button 298
 - Hold button 298
 - installing Norstar sets 282
 - loop specifications 621
 - Release button 298
 - troubleshooting 577—580
 - voice message waiting indication 348
 - volume control 298
- telephone loud ring amplifier 191
- telephones
 - answer keys 429
 - assign prime set 358
 - basic password 294
 - button icons 298
 - call blocking ([]819) 456
 - CAP assignments 435
 - changing numbers 418
 - control sets 372
 - directed pickup 422
 - DRT on prime sets 421
 - equipment list 189
 - external access code 443
 - maintaining programming 283
 - manual-answer E&M trunks 86
 - maximum line buttons 328
 - message reply enh, programming 428
 - moving 283
 - moving tips 283
 - page timeout 423
 - prime line 330
 - programming 298
 - programming an alarm set 427
 - programming call log space 425
 - programming direct dial 433
 - programming display buttons
 - programming feature settings 419
 - programming overlays 298
 - programming, system coordinator password 294
 - programming, viewing the settings 310
 - relocation 427
 - selecting lines for direct dial 434
 - set name 337
 - set relocation 283
 - set restrictions 344
 - user restrictions 94
- telephones, programming a direct-dial number 444
- temperature ICS 192
- template
 - changing default 318
 - remote access package defaults 448
 - Startup 295
- terminal endpoint identifier, see TEI
- terminal endpoint identifiers, see TEI
- terminal equipment
 - S or T wiring 284
 - U-LT jack pinout 286
 - U-LT wiring 285
- terminal resistors 284
- Terminals&Sets 325—350
 - capabilities 335
 - allow redirect 336
 - ATA settings 336
 - auxiliary ringer 336
 - d-dial 335
 - DND on busy 335
 - fwd no answer 335
 - fwd on busy 335
 - handsfree 335
 - HF answerback 335
 - hotline 336
 - page zone 335
 - paging 335
 - pickup grp 335
 - priority call 335
 - redirect ring 336
 - line access 325
 - answer DNs 332
 - intercom keys 331
 - line assignment 326
 - line pool access 329
 - OLI# 333
 - prime line 330

- name 337
- restriction filters 368
- restrictions 339
- user preferences 338
- voice messages 475
- terminals&sets 321
- terminating resistors, see termination for ISDN loop
- termination for ISDN loop
 - description 232
 - shorting straps 233
- testing
 - ISDN network connection 222
 - loopback tests 552
 - system test log 526
- Tests 511
- third party software, DNIS number 364
- third-wire ground 194
- through-fed repeaters, disable internal CSU 248
- TI
 - CO fail 488
 - connecting wiring 250
 - framing 489
 - ISD/TT 489
- TIA-547A
 - carrier failure standard 488
- Tie
 - calling from within the network 170
 - calling other nodes within the network 171
 - CbC service 457
 - dialing plan 112
 - incoming calls 112
 - PRI lines 112
 - public call to private network 167
 - routing 380
 - routing table 383
- time display, hospitality 465
- time format, hospitality 465
- time switches
- time&date 321, 408
- time, see AutoTime&Date
- timeout
 - paging 423
- timer
 - answer 487
 - disconnect, on card 487
- times, service 465
- timing master, clock source 504
- timing reference, ClockSrc 492
- T-loop, terminating resistors 232
- toll calls over a private network 132
- tones
 - hospitality 465
 - on hold 419
 - ONN blocking 456
 - paging 423
 - programming analog VSC 476
- tools
 - programming 298
- TR64211, carrier failure standard 488
- transaction terminals 76
- transfer callback 421
- transmit
 - objective loudness 489
 - setting gain 365
- transparent dialing plan, see also CDP
- trnsfr callbk 421
- TRO
 - SL-1 network
- troubleshooting 573
 - alarms 537
 - ATA 591
 - auxiliary ringer 592
 - background music 593
 - DTI 597
 - emergency telephone 580
 - external paging 593
 - general procedure 576
 - line pools 616
 - lines 581—590
 - modules 596—599
 - network or remote users 606—619
 - optional equipment 591—593
 - replacing a telephone 579
 - T1 signal 599
 - telephones 578—580
 - trunk cartridge 596
 - trunk module 604
 - types of problems 575
 - voltages on E&M leads 611
- trunk
 - BRI 87
 - cartridge
 - checking the state 523
 - number attached to a module 522

- troubleshooting 596
- changing trunk type 353
- common data 353
- dial mode 356
- DID 81
- DID, restrictions 82
- disable cartridge 354
- DTI 79
- E&M 79, 83
- ground start 80
- loop start 79, 83
- module troubleshooting 604
- numbering 79
- PRI 79, 87
- prime set, overflow 358
- programming received number 357
- programming trunk mode 359
- programming type 353
- super, ans mode 359
- tandeming, calling name information 454
- types 79
- trunk answer, programming 376
- trunk antitromboning (TAT), MCDN 51, 118, 148
- trunk cards
 - profile 1 313
 - profile 2 313
 - profile 3 314
 - profile 4 314
- trunk cartridge
 - E&M wiring chart 273
 - enable/disable for programming 491
 - installation planning 195
 - installing 231
 - line capacity 195
 - mixing in a Trunk module 195
 - port numbers 252
 - programming, disable/enable 354
 - trunk module, E&M/DISA 273
 - types 224
- trunk mode
 - data settings 352
 - programming 359
- trunk module
 - BRI-ST cartridge wiring 278
 - connecting 234
 - description 494

- DID trunk cartridges and RJ-21 wiring connections 275
- E&M network 105
- emergency telephone installation 281
- line number 216
- power 291
- trunk route optimization (TRO), MCDN 146
- trunk route optimization, see TRO
- trunk type 352
- trunk/line data
 - copying 353
 - user interface 296
- trunks
 - assigning physical trunks 326
 - CLASS 424
 - MICS-XC loop start compatibility 85
 - operating modes 80
 - programming analog VSC 476
 - programming if busy 357
 - set appearances 80
 - trunk type data settings 352
- twelve-port Expansion Cartridge 239
- twinning, hunt group 410
- two-port expansion cartridge 237
- type, BRI card loops 498

U

- U interface 55
- U-2 line numbers 494
- U-4 line numbers 494
- UDP
 - call routing 136
 - call scenarios 135
 - dialing plan features 436
 - location code 103
 - overview 102
 - private access codes 103
 - private DN length 103
 - SL-1 network features
- U-LT
 - jack and plug pins 286
 - reference point 55
 - wiring chart 285
- unassigned 157, 162, 326, 332
- Un-equipped 518, 523
- uninterruptible power supply (UPS) 191

universal dialing plan, see UDP
 unknown name 453
 unknown number 349
 unsupervised, programming trunk mode 359
U-NT
 network wiring 268
 reference point 56
 updates
 viewing programming 303
Updating state 523
 upgrade tool 205
 upgrading 205
 0X32 release 1-T1 201
 8X24 212
 call log information lost 199
 from ILG to Hunt Groups 217
 MICS to MICS-XC 207
 Modular 8X24 Key Service Unit (KSU) 201
 software upgrade before hardware upgrade 199
 supported upgrades 200
 U.S. MICS-XC systems lose UTAM information 200
 upgrading system 199–216
 US regulations 25
 Usage metrics
 call by call 570
 Hunt groups 569
 usage metrics
 top level 322
 user interface 296
 use pool 382
 use set volume 420
 use sys volume 420
 user call restrictions 367
 user filter, line/set restriction 402
 user preferences
 listing 296
 programming 305, 338
 user restrictions 367
 set 94
 user speed dial
 user preferences 338

V

vacancy, room 464

ventilation
 ICS 192
 version number, check device 517
 vertical service code, see VSC
 videoconferencing and video using ISDN applications 183
 videophones, hunt groups 410
 view 302
 view prefix 440
 viewing
 assigned lines 328
 long telephone numbers 304
 programming for a telephone 310
 programming updates 303
VMsg center 370
VMsg ctr Tel#s 474
VMsg ctr tel#s 296
 voice mail
 external access 348
 on SL-1 network 118
 voice message
 accessing 348
 external center 474
 programming 370
 telephone setting 475
 waiting indication 348
 voice, call type 500
 volume, system or set 420
VSC
 ONN SrvcCode 477
 programming for BRI 476
 setting up the modules 477
VSC, analog vertical service code for ONN blocking 476

W

wait for dial tone, dialout 382
 wakeup 218
 warm start 291
 wild card
 destination codes 386
 dialing restrictions 342
 wild cards
 destination code 386
WinkStart signal type 363
 wireless
 hunt group twinning 410
 wiring

- auxiliary ringer 287
- BRI-ST 261, 263
- BRI-U 264, 266
- connecting 247
- cross-connect 247
- ICS 261—269
- ISDN S loop 197
- loopback test 552
- modules 251
- requirements 196

wiring chart

- auxiliary equipment 257
- BRI 261—265
- BRI trunk module 278—280
- BRI-ST cartridge 278
- BRI-ST wiring 261, 263
- DID trunk cartridge 275
- DTI 269
- E&M trunk cartridge 273
- E&M/DISA trunk cartridge 273
- ICS external loop start lines 258, 259
- ICS telephone 255, 257
- loop start or CI trunk 271
- port numbering 252
- S or T extension wiring 284
- S or T terminal equipment 284
- station module 270
- T network connection 267
- trunk module with DID trunk cartridge 276
- trunk modules with E&M/DISA 273
- U-LT terminal equipment 285
- U-NT network 268

X

X.25, converting ISDN protocol 77

Z

Z, dialpad 294, 316

zero absorb length 392

Backup programming overlays

