

---

# Table of Contents

---

## **1 Introduction** **1**

- How to Use This Guide / 1
- Language Choice / 2
- Key to Guide Symbols / 3
- Templates / 3

---

## **2 Norstar Orientation** **5**

- Before You Begin / 5
- Norstar Telephones / 5
  - Button Layout / 5
  - Button Caps / 6
  - Default Button Functions / 8
  - The M7324 Telephone / 9
  - The M7310 Telephone / 11
  - The M7208 Telephone / 14
- Other Pre-determined Settings / 16
  - Configuration settings / 17
- Preparing to Administer Your System / 20
  - Useful Aids / 20
  - Default Settings / 21
- Administration Flow Charts / 21

---

## **3 Norstar Administration** **23**

- Entering Administration / 23
- Norstar Administration Headings and Sub-Headings / 25
- Scanning Headings and Sub-Headings / 27
- Exiting from Administration / 27
  
- 1. System Speed Dial / 28
  - Procedures / 28
  - Overview Flow Chart / 31
  - Notes / 32

**Introduction**

- 2. Names / 33
  - Procedures / 34
  - Entering Characters / 34
  - Cursor Controls / 34
  - Overview Flow Chart / 38
  - Notes / 39

**Norstar  
Orientation**

- 3. Time and Date / 40
  - Procedures / 40
  - Overview Flow Chart / 43
  - Notes / 44

**Norstar  
Administration**

- 4. Restrictions / 45
  - Defaults / 46
  - Procedures / 47
  - Overview Flow Chart / 51
  - Notes / 53

**Feature  
Operations**

- 5. Overrides / 54
  - Defaults / 54
  - Procedures / 55
  - Overview Flow Chart / 59
  - Notes / 61

**Display  
Messages**

- 6. Permissions / 62
  - Defaults / 62
  - Procedures / 65
  - Overview Flow Chart / 70
  - Notes / 71

**Flow Charts**

**Job Aids**

- 7. Night Service / 74
  - Examples / 75
  - Procedures / 76
  - Overview Flow Chart / 80
  - Notes / 82

**Glossary**

**Index**

- 8. Passwords / 83
  - Procedures / 83
  - Overview Flow Chart / 87
  - Notes / 88

<b>4 Feature Operations</b>	<b>91</b>	Introduc
Programming Reference Guide / 92		
Programming Suggestions / 94		
Alphabetical Feature Reference Guide / 95		
<b>5 Display Messages</b>	<b>195</b>	Nors Orientati
<b>6 Flow Charts</b>	<b>225</b>	
<b>7 Job Aids</b>	<b>243</b>	Nors Administrati
Administration Information / 243		
Installation Information / 243		
1. System Speed Dial / 244		
2. Names / 246		
4. Restrictions / 248		
5. Overrides / 249		
6. Permissions / 250		
Line Pools / 252		
Page Zones / 254		
Pickup Groups / 256		
Using Handsfree/Mute / 258		
7. Night Service / 259		
8. Passwords / 260		
<b>8 Glossary</b>	<b>263</b>	Job Aid Flow Char
<b>9 Index</b>	<b>277</b>	Glossar Inde

Introduction

Norstar  
Orientation

Norstar  
Administration

Feature  
Operations

Display  
Messages

Flow Charts

Job Aids

Glossary

Index

# 1

# Introduction

## Why Program the Telephones ?

As your company grows and changes, the turnover in staff, new business contacts, and other changes will make many demands upon your communication system. Staff names and Speed Dial numbers are just two examples of data that need to be accurately recorded in the Norstar System if you are to use your telephones to their full potential.

Administration programming, described in this Guide, puts you in control of the many responsive Norstar features. Spend a few minutes reviewing this Guide and you will find that the programming procedures are both effective and easy to learn.

## How to Use This Guide

The Guide contains nine chapters: an Introduction, Norstar Orientation, Norstar Administration, Feature Operations, Display Messages, Flow Charts, Job Aids, a Glossary of Terms, and an Index.

### Introduction and Orientation

These first two chapters introduce you to the Norstar system and all of its components. They explain the different ways in which your system may be set up, the three different Norstar telephones, and the default settings of both the system and the telephones.

### Administration

This chapter provides background information and instructions for the eight headings of Administration programming:

1. System Speed Dial
2. Names
3. Time and Date
4. Restrictions
5. Overrides
6. Permissions
7. Night Service
8. Passwords

### **Feature Operations**

This is an alphabetical reference to all features of the Norstar system, explaining what each feature does and how to use it.

### **Display Messages**

This is a list of all messages that appear on the Norstar telephone display during normal service (Administration messages are not included). Each message is explained and, if appropriate, suggestions are given to assist you.

### **Flow Charts**

The flow charts are a visual aid to Administration programming. They are especially designed as a quick reference guide to the experienced System Coordinator and provide a good overview of Norstar Administration.

### **Job Aids**

These charts assist you in maintaining your system records most effectively. There are job aids for each of the sections of Norstar Administration Programming, excepting Time and Date.

### **Glossary of Terms**

This chapter provides definitions of terms used in this Guide which may be unfamiliar to you.

### **Index**

The index provides an alphabetical listing of subjects covered in the Guide, with page number references to help you locate information quickly.

### **Language Choice**

Administration programming, like other Norstar operations, can be performed in either English or an Alternate Language. All display messages are available in both languages on your telephones.

## Key to Guide Symbols

Telephone buttons and display messages are shown throughout this Guide in a consistent format, as demonstrated in the following examples.

Telephone button:

Dialpad button:

Display button:

Display message:

## Templates

When your system is first installed, your Installer or Service Representative assigns a default template, or form of organization, for your office telephones. These templates are designed to provide your Norstar Business Communication System with the most useful arrangement of lines and telephones in relationship to your office's situation. The four possible templates are as follows:

- Square** - This template assigns  and  to all telephones within your system. The Square template is the default when your system is first installed.
- Centrex** - This template is most useful for Norstar systems connected to a Centrex system. It assigns a separate outside line to each telephone until all lines are used. If there are more telephones than lines in your system, the telephones with higher Intercom numbers do not receive default line settings.
- Hybrid** - This template assigns  to each telephone in the system, as well as assigning a button for . All outside lines except  are in , and must be accessed using a Line Pool Access code.
- PBX** - No telephone in the PBX (Private Branch Exchange) template has direct access to outside lines. All Lines are assigned to , and must be accessed using a Line Pool Access code.

The difference between direct access to an outside line and the use of a Line Pool is simple: you can make and receive outside calls on a  button, but you can only make outside calls, not receive them, using a  button.

If outside lines are assigned to Line Pools, instead of being assigned individually to telephones, each telephone in your system is still able to make outgoing calls using any of the lines. By assigning lines to Line Pools, you are making more efficient use of outside lines and leaving more buttons on each telephone free to store Norstar features.

Remember that these descriptions are only defaults for the various templates. By the time you actually use your system, your Installer or Service Representative will probably have altered these settings to make your telephone system much more effective for your individual needs.



---

# 2 Norstar Orientation

---

## Before You Begin

The next few pages provide a general introduction to Norstar Administration programming.

If you are new to Administration programming, take a few minutes to look over this introduction. Take note of the overview flow chart of the system and read the descriptions of the settings which are controlled under the eight Administration headings. You can also refer to the complete flow charts at the end of this Guide.

When you begin your first Administration session, it is a good idea to follow the directions in the Norstar Orientation chapter of this Guide, to ensure that you can easily find your way through the Administration process. Make sure you have all the information you need before you begin to change settings (for example, the various charts in the Job Aids chapter of this Guide). Avoid changing any settings until you clearly understand the effects.

## Norstar Telephones

### Button Layout

Your Norstar system has three telephones designed specifically for use with Norstar features. These are the M7324, the M7310, and the M7208. The telephone displays and buttons are arranged to facilitate easy use. The layout of these displays and buttons is shown on the diagrams of the three telephones which appear on the following pages.

## Button Caps

Each Meridian Norstar telephone is provided with a number of printed or hand-labelled removable caps for the buttons with indicators. Dual memory buttons on the M7310 have clear plastic caps, and can be labelled using the split colored squares provided with the button caps.

Each Norstar telephone comes with default functions assigned to its buttons. The button caps for these functions are already placed on each telephone, and a selection of other pre-printed button caps is provided to label other features you may want to program on your telephone.

## Button Cap Colors

Green caps are placed on the  and  buttons, while grey caps are used for the  button,  buttons and buttons that can be programmed to access Norstar features. Caps with clear plastic windows and paper inserts are provided to assist people in labelling autodial buttons and buttons for extra Norstar features. Use the grey paper inserts for Norstar features and the green paper inserts for extra  and  buttons.

buttons are labelled using the clear plastic windows, so that in addition to the word "Answer", you can write the name of the person whose telephone the  button is monitoring. See the "Answer Groups" section of the Feature Operations chapter for more details.

The  and  buttons are brighter colors than the other telephone buttons. This makes it easy to locate these important and often-used buttons. The  button is red, and the  button is orange.



--	--	--	--

Nors  
Orientat



## Default Button Functions

The photographs and lists on the next few pages indicate where the various feature, Intercom and outside line buttons are positioned on each type of telephone when the telephone is first plugged into the system.

Norstar has an established order of precedence for your telephone buttons. If too many activities which require buttons are assigned to your telephone, the buttons are assigned in the following order:

is assigned first,  
 buttons are second,  
 buttons are third,  
 buttons are fourth, and the remaining buttons are assigned as programmable memory buttons.

The default settings in the descriptions which follow are for the Square Template. Differences between this and the other three Norstar templates are listed with each description.

## The M7324 Telephone

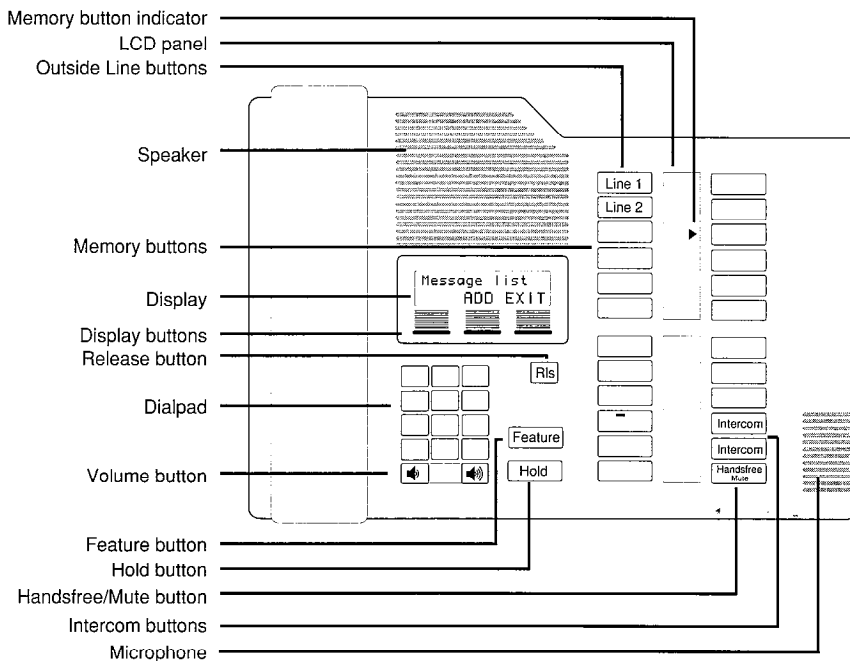

The M7324 has a two line display; the top line shows messages and prompts and the bottom line shows labels for the display buttons which are used with the M7324 and M7310 telephones.

The M7324 has two panels of twelve programmable buttons, each panel has its own liquid crystal display (LCD). When a line or programmed feature is in use, an triangular indicator ► appears on the display beside the appropriate button.

On the M7324 telephone, external  buttons usually appear on the left side at the top of the upper LCD panel. , and  buttons (if assigned) are usually located on the right side at the bottom of the lower LCD panel.

## M7324 Default Buttons (Square Template)



### The M7324 Telephone

#### Memory Buttons With Indicators

The diagram below shows the Square Template default functions which appear on each button before your system is configured by your Installer or Service Representative.

Line 1	Call Fwd
Line 2	Speed Dial
Blank	Last No
Blank	Saved No
Blank	Conference
Blank	Transfer

Blank	DND
Blank	Pickup
Blank	Voice Call
Blank	Page
Blank	Intercom
Blank	Intercom

For the **Centrex Template**,  is programmed as  ,  is blank, and  is programmed as .

For the **Hybrid Template**,  is programmed as .

For the **PBX Template**,  and  are both blank.

# The M7310 Telephone

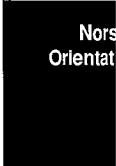
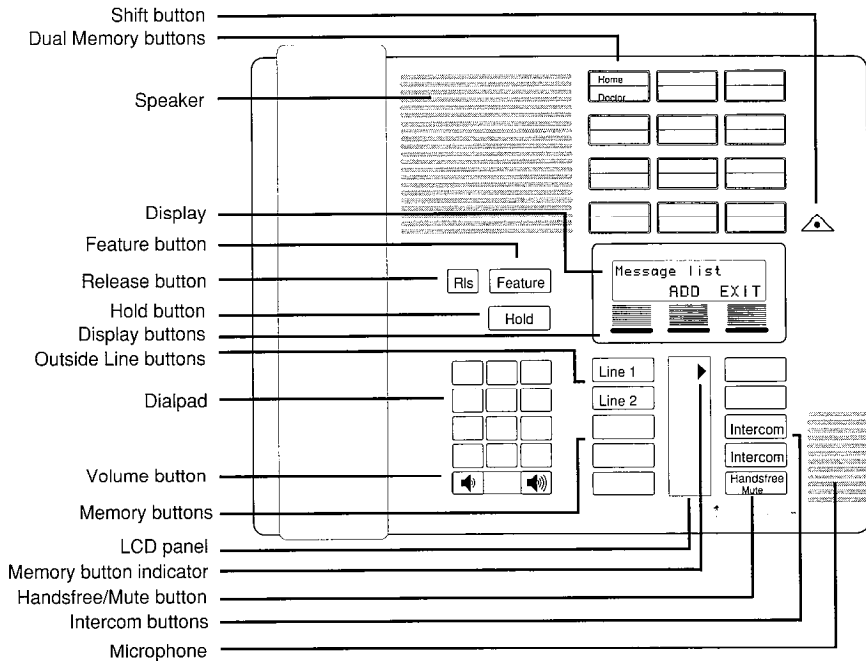

The M7310 telephone has the same display as the M7324; it shows both messages and prompts and labels the display buttons.

The M7310 telephone contains ten programmable memory buttons with triangular indicators ► on an LCD and twelve programmable dual memory buttons without indicators.

Each dual memory button can be programmed to perform two activities; one on the lower half of the button and one on the upper half of the button. To program and access the top half of the dual memory buttons, press the Shift button located beside the panel of dual memory buttons before pressing the dual memory button.

On the M7310 telephone, external  buttons usually appear on the left side at the top of the LCD panel. , , and  buttons (if assigned) are usually located on the right side at the bottom of the LCD panel.

## M7310 Default Buttons (Square Template)

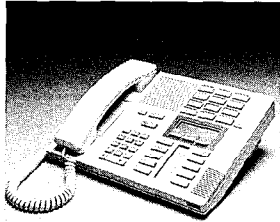

Norstar  
Orientation

### The M7310 Telephone

#### Dual Memory Buttons Without Indicators

The dual memory buttons for all four templates are the same. The diagram below shows the defaults for a Norstar system with three-digit Intercom numbers. The two-digit Intercom numbers are positioned the same, but begins at 21 rather than 221.

Dual memory buttons are pre-programmed as shown below even if the system does not have some of the telephones associated with the Intercom numbers.

Norstar telephones do not have Intercom buttons to dial their own numbers. Each telephone will have a blank button in place of its own Intercom number in the sequence of defaults shown below.

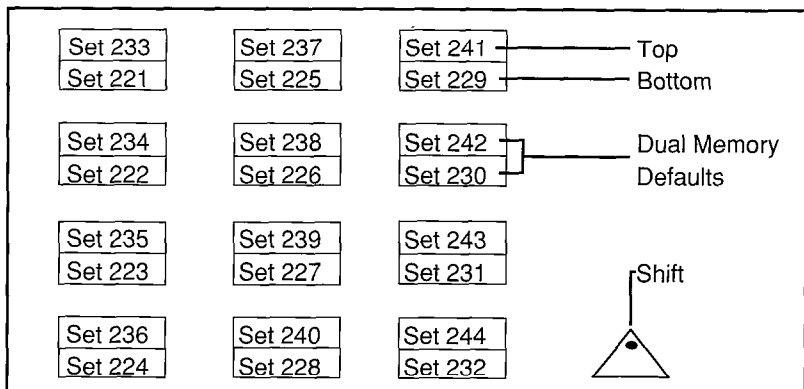



## Memory Buttons With Indicators

The diagram below shows the Square Template default functions which appear on each button before your system is configured by your Installer or Service Representative.

Line 1	Conference
Line 2	Last No
Call Fwd	Voice Call
Pickup	Intercom
Page	Intercom

Norstar  
Orientation

For the **Centrex Template**, all buttons are the same except that  is programmed as  ,  is programmed as  , and  is programmed as .

For the **Hybrid Template**, all buttons are the same except that  is programmed as .

For the **PBX Template**, all buttons are the same except that  is programmed as  and  is programmed as .

## The M7208 Telephone

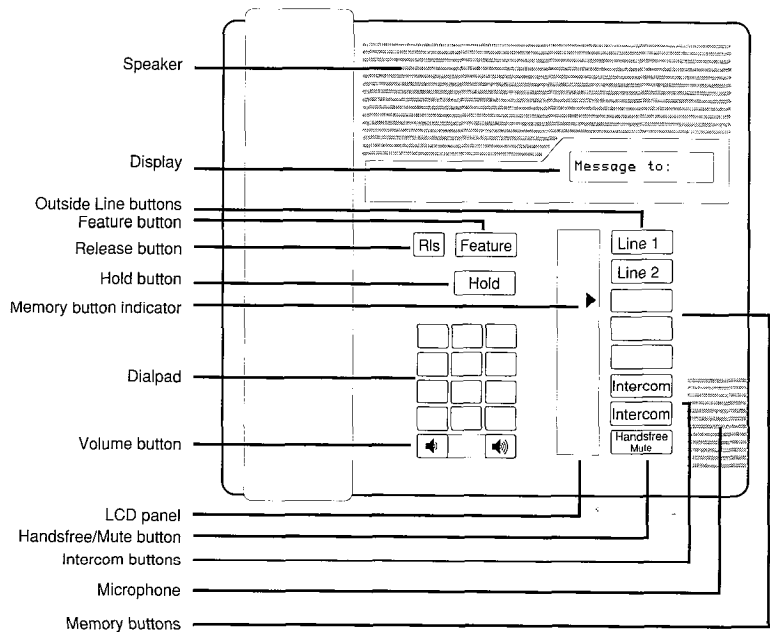

The M7208 is the simplest of the Norstar telephones. It has a one line display which displays messages and prompts. The M7208 does not have a bottom line on the display; therefore, it can not use display buttons with its features.

The M7208 has eight programmable buttons with triangular indicators ► arranged vertically beside an LCD panel.

On the M7208 telephone, external **Line** buttons usually appear at the top of the LCD panel; **Intercom**, **Answer**, and **Handsfree Mute** buttons (if assigned) are usually located at the bottom.

**The M7208 telephone cannot be used to access or program Norstar Administration.**

## M7208 Default Buttons (Square Template)

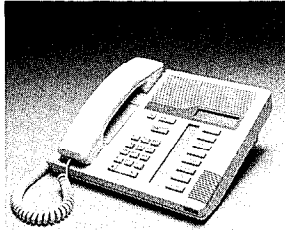

The M7208 Telephone

### Memory Buttons With Indicators

The diagram below shows the Square Template default functions which will appear on each button before your system is configured by your Installer or Service Representative.

Line 1
Line 2
Last No
Page
Conference
Speed Dial
Intercom
Intercom

For the **Centrex Template**,  is programmed as   
 is programmed as , and  is  
 programmed as

For the **Hybrid Template**,  is programmed as

For the **PBX Template**,  is programmed as ,  
 is programmed as , and  is  
 programmed as

## Other pre-determined settings

In addition to Norstar Administration programming, there is another type of system programming, which is not fully covered in this Guide. This is known as **Configuration** programming.

Configuration programming is performed by the Installer of your Norstar system or your Service Representative, and is not accessible to System Coordinators. If your system needs changes to any of the following Configuration settings, call your Installer or Service Representative.

To find out how your individual system has been configured, you can use the System Settings feature. This feature allows you to see all of your system settings without changing any of them. For more information, see the "System Settings" section of the Feature Operations chapter of this Guide.

While your Installer or Service Representative is programming in Configuration, you and your co-workers will be unable to program some of your Norstar features.

Definitions of Configuration settings are provided in the Glossary of this Guide. Default settings, which appear before the Installer or Service Representative changes the settings to suit your particular office needs, are shown in large **bold** letters.

# Configuration settings

## A. System Configuration

### 1. Line Data (settings for each outside line)

- Line type: **Public**, Pool or Private
- Mode: **Pulse** or Tone
- Auxiliary Ringer: **Yes** or No
- Full Auto-hold (on idle line): Yes or **No**
- Prime Phone: **21, 221, 2221** or Other

### 2. Line Access: (settings for each telephone)

- Line assignment (to telephones): **Lines 1 and 2**
- Answer DN: Intercom numbers associated with the  button on another telephone (there is no programmed default)
- Ringing lines: Ring or **No Ring** (The default for lines assigned to Set 21, 221 or 2221 is **Ring**)
- Use of line pool: Yes or **No**
- Number of Intercom buttons: 0 to 8 (Default: **2**)
- Prime line: **None**, Line number, Line Pool, or Intercom

### 3. Call Handling

- Held Line Reminder (HLR): Yes or **No**
- Remind delay: 30 to 180 seconds (This setting does not appear unless HLR is "Yes". The default is then **60** .)
- DRT to Prime: **Yes** or No
- DRT delay: 1, 2, **3**, 4, 6
- Transfer Callback: **3**, 4, 5, 6, 12
- Park timeout: 30, **45**, 60, 90, 120, 150, 180
- Directed Pickup: **Yes** or No
- On Hold: **Tones**, Music or Silence

#### 4. Miscellaneous

- Background Music: Yes or **No**
- Dial "0" set: **21, 221, 2221** or Other
- Alarm set number: **21, 221, 2221** or Other
- Link time: 100-1000 milliseconds (Default: **600** milliseconds)
- Set Relocation: Yes or **No**
- Line Pool Access codes: One to four-digit codes (no defaults)
- Installer password

#### 5. Change DNs

- Individual DNs
- DN length: 2, **3**, or 4 digits

### B. General Administration

This area allows the Installer or Service Representative to access your system's Administration through Norstar Configuration. This is necessary if the Installer assists you by partially or fully administering your system, or if you have forgotten the Administration password and cannot access Norstar Administration. As System Coordinator, you may be responsible for your system's Administration. Norstar Administration procedures are covered in detail for you later in this Guide.

### C. Set Copy

Under this heading, the Installer can copy all system settings from one telephone to another, or can copy both the system settings and the individual telephone's settings to another telephone.

---

## D. Maintenance

### 1. System Version

This section allows the Installer to make sure that the specified components of your system are compatible with one another.

### 2. Port/DN Status

This section allows the Installer to determine what piece of equipment (for example a Norstar telephone or an Analog Terminal Adapter) is connected to any given port in your system, and whether or not the equipment is compatible with your system. It also allows the Installer to discover the status of the piece of equipment (for example busy or idle), and to turn it ON or OFF as required.

### 3. Module Status

This section allows the Installer to check the Trunk and Station Modules connected to your Key Service Unit and to turn them ON or OFF as required.

### 4. Diagnostics

This section allows the Installer to perform various pre-defined tests to identify problems within your system.

### 5. System Test log

This section provides the Installer with a list of the 20 most recent tests which have been performed on your system or alarm messages which have appeared on the Alarm Set. This log shows each occurrence of problem related messages and tests.

### 6. System Administration log

This section provides the Installer with a list of the ten most recent system restarts, Configuration sessions in which changes were made, and unsuccessful attempts to enter your system's Configuration programming.

## Preparing to administer your system

**Choose the right telephone:** Administration can only be performed from an M7324 or M7310 telephone, and only one telephone can access Norstar Administration at one time.

**Choose the right time:** While you are operating Norstar Administration, the telephone you are using will be unable to make or receive calls. Your co-workers will still be able to make and receive calls on their telephones, but they will be unable to change some of the settings on their telephones, such as Autodial buttons and Personal Speed Dial codes.

**Ending the session:** At any time during Administration, you can end the session by pressing the orange **RLS** button on the Norstar telephone. Norstar records all changes to your system as you make them, so it is not possible to Exit from Administration without "saving" your changes.

### Useful aids

**User Cards:** Each Norstar telephone comes with its own User Card. These cards list the most commonly used Norstar features, and explain how to use them.

**Receiver Cards:** Located underneath the receiver of each Norstar telephone is a small card covered by a plastic window. This card lists the Feature codes for Norstar's most commonly used features in your requested language.

**Norstar Programming Overlay:** At the back of this Guide, you will find four copies of the Programming Overlay. One copy should be placed over the buttons of the telephone while you perform Administration tasks. The Overlay provides temporary labels for M7324 or M7310 telephone buttons used in Administration programming. Punch out an Overlay from the last page of this Guide to assist you in Administration programming.



Remember to use the Overlay when you see this symbol in the Norstar Administration chapter of this Guide.



**Norstar Programming Record:** The *Norstar Modular Programming Record* provides a convenient way of recording the settings for your system. Your Installer or Service Representative will fill in the Configuration settings, and may then leave the Programming Record with you for your records. If you do not have a copy of the Programming Record, you may record all of your Administration settings in the Job Aids chapter of this Guide. The Programming Record (or the Job Aids chapter) is represented in this Guide by the following symbol:



When you see this symbol, remember to record the changes you make in the appropriate area of the Programming Record or the Job Aids chapter of this Guide.

## Default Settings

If you are performing Administration on a new system, you will find that many of the settings are pre-selected. These are called the default settings. You have the option of leaving them as they are, or changing them.

## Administration Flow Charts

The Administration Headings Flow Chart is a convenient overview of Norstar Administration that should help you to follow the Orientation Tour and understand the system. A simplified flow chart illustrating the steps under each heading follows the procedures in each of the eight Administration sections of the Administration chapter.

In the Flow Charts chapter at the back of the Guide, you will find the charts in complete detail. After you have tried a few Administration tasks and read the general descriptions that follow, you may find that you can perform Administration using only the flow charts for reference.

# Administration Headings Flow Chart

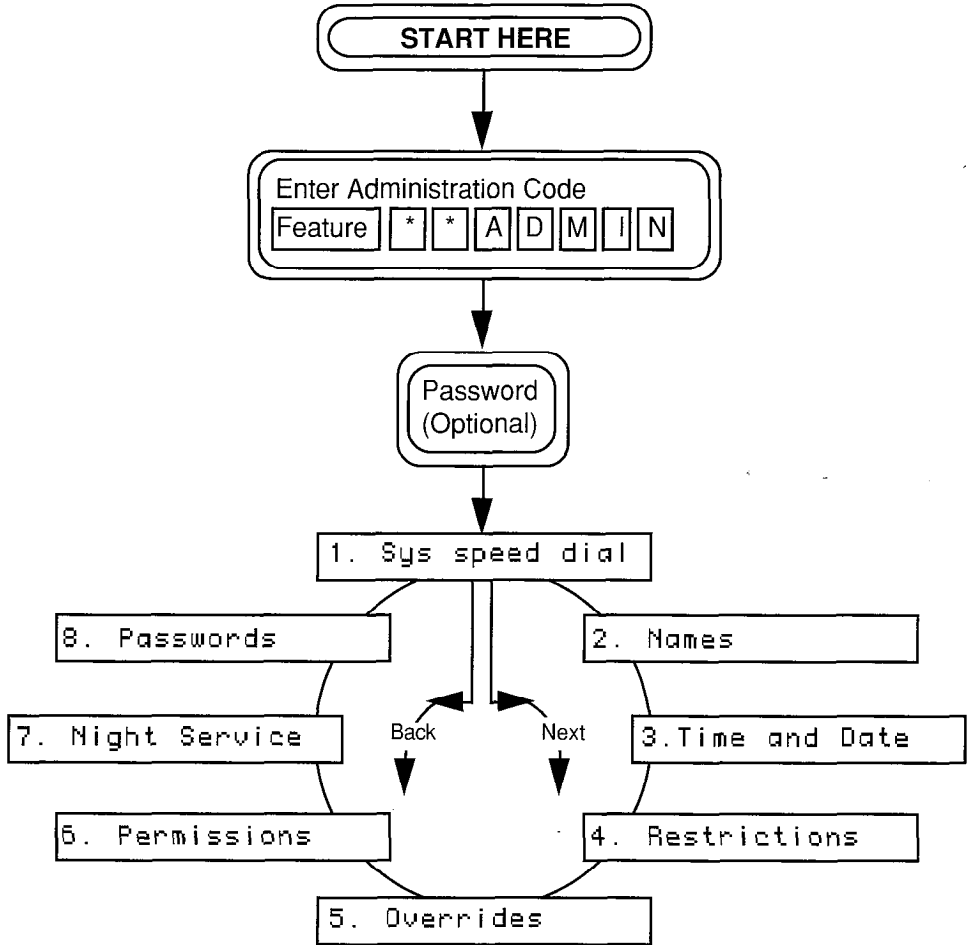
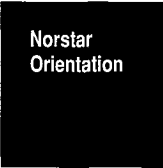

# 3 Norstar Administration

This chapter of the Guide will help you to understand the variety of features and settings available through Norstar Administration programming. The detailed descriptions and step-by-step instructions included in each of the following sections will enable you to be completely at ease with administering the Norstar System.

Read each section carefully in order to learn how the various features work together to make your office telephone system highly efficient.

Nor  
Administra

## Entering Administration

### To Enter Administration:

1. Release all calls on your M7324 or M7310 telephone. Indicators for calls on other telephones stay ON.
2. Enter the Administration code:

Feature  \* \* A D M I N

which is also

Feature  \* \* 2 3 6 4 6

3. If the display changes to  Password:  , enter the Administration password. The password does not appear on the display as you enter it.

**If the proper password is entered** (or no password is required) the display shows  1.Sys speed dial and three triangular indicators ► appear on the liquid crystal display (LCD) between the rows of buttons.

**If an incorrect password is entered**, no change occurs on the display. Check the password. Press the  RETRY display button and re-enter the password. The display should show  1.Sys speed dial

- Place an Overlay (available on the last page of this Guide) over the buttons pointed to by the indicators, as shown below. Follow the commands on the Overlay, rather than those printed on the tops of the buttons. The commands which are activated during Administration are as follows:

- Returns you to a sub-heading within the programming activity, or to one of the eight Administration headings.
- Allows you to enter a programming cycle.
- Moves you to the next display message.
- Moves you to the previous display message.



**M7324 Telephone with a Norstar Programming Overlay**

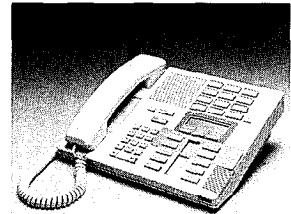

**M7310 Telephone with a Norstar Programming Overlay**

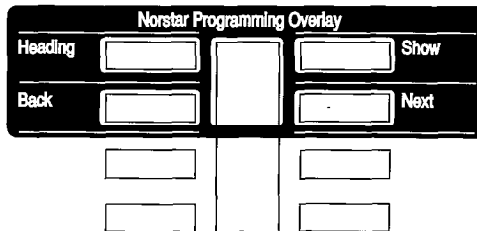

**The Norstar Programming Overlay over the telephone buttons**

**Display Buttons:** As you move through the Administration sections, words will appear on the bottom line of your telephone display. These words label the three display buttons which are located directly beneath the display. The four labels used for display buttons in Administration are  (backspace), , , and .

---

## Administration Headings and Sub-Headings

Under each of the **eight** Administration headings are various sub-headings which allow you to change the individual settings of each Administration section. The sub-headings associated with each heading are as follows:

### 1. Sys speed dial

The sub-headings in this section are the System Speed Dial codes into which you program outside telephone numbers.

### 2. Names

The sub-headings in this section are as follows:

Set names

Line names

### 3. Time and Date

The sub-headings in this section are as follows:

Time

Date

### 4. Restrictions

### 5. Overrides

The sub-headings in these two sections are the same. They are as follows:

Table entries

Applied to lines

Applied to sets

6. Permissions

The sub-headings in this section must be accessed by first entering a set number. The sub-headings are as follows:

Full handsfree

HF Answerback

Pickup group

Page zone

Aux. Ringer

Forward no answr

Priority call

7. Night service

The sub-headings in this section are as follows:

Trunk answer:

Night-0 set:

Show line:

8. Passwords

The sub-headings in this section are as follows:

Admin. password

Restriction pswd

---

## Scanning Headings and Sub-headings

### To Scan the Headings

1. Press  repeatedly to move from one heading to another.

### To Scan the Sub-Headings

From any one of the headings, move through the sub-headings without altering any settings by following the two steps below:

1. Press the  button.
2. Press the  button repeatedly until you arrive at the next numbered heading.

If you become lost within a loop, press  once or twice until a familiar numbered heading appears. If you wish to end the Administration session, follow the procedures below.

Norst  
Administratic

## Exiting from Administration

### To End the Orientation Tour

1. Press the  button. The display shows

If you have not pressed the  display button while in Administration, no settings in your system have been affected.

# 1. System Speed Dial

## How It Works

System Speed Dial provides a list of up to 70 telephone numbers that can be dialed from any telephone in your system by means of a two-digit code (01 to 70). The maximum length of a Speed Dial Number is **16 digits**.

Entries in the System Speed Dial list should be emergency numbers or outside telephone numbers that are called regularly by many people in the office. Numbers used by few people, or only one person, should be Autodial or Personal Speed Dial entries on individual telephones. The Personal Speed Dial feature works the same way as the System Speed Dial feature, but uses a different range of codes (71-94). Consult the "Autodial" and "Speed Dial - Personal" sections in the Feature Operation chapter of this Guide for further information.

In Administration, you can see the numbers entered in your system, and add or delete entries. A new system contains no default Speed Dial entries. To use System Speed Dial codes, follow the procedures in the Feature Operation chapter of this Guide, or on the User Cards for each telephone.

The Job Aids chapter of this Guide contains a convenient chart that you can photocopy, fill out, and distribute to your co-workers as a reference to System Speed Dial codes and the corresponding telephone numbers. Keep the page in the Job Aids chapter blank, and use it as a master copy.

## System Speed Dial Procedures

To make your task easier, use an Overlay found on the last page of this Guide:



Remember to record your changes in the Programming Record or Job Aids chapter of this Guide:





**Entering Administration:**

1. Release all calls on your M7324 or M7310 telephone. Indicators for calls on other telephones stay ON.
2. Enter the following code:  \* \*
3. If the display changes to  , enter the Administration password. If the proper password is entered, the display shows  and three triangular indicators ► appear on the LCD panel between the rows of buttons.  
If no password is required, the  display and the indicators appear as soon as the Administration code is entered.
4. Place the Overlay over the four buttons pointed to by the indicators. You are now at the starting point for each of the following procedures.

**To scan the System Speed Dial entries:**

Begin with  on the display, then follow the steps below.

1. Press  The display shows
2. Press  The display shows    
If a telephone number has been previously entered, it will appear after the colon.
3. Press  repeatedly to look at the System Speed Dial codes (01-70).  
To move backwards through the entries, press  repeatedly.
4. When you are finished, follow the Exit procedure on the next page.

**To enter a new telephone number for a code:**

Begin with  on the display, then follow the steps below.

1. Press  The display shows
2. Enter the two-digit Speed Dial code you wish to program  
**OR**  
Press  until the desired code (01-70) appears.
3. Press  **Any previous entry is erased.**
4. Enter the digits of the new telephone number, including all digits, such as an initial  or an area code, that must be dialed to call the number manually.
5. Press  to store the number and move to the next System Speed Dial code.
6. When you are finished, follow the Exit procedure below.

**To erase a System Speed Dial code:**

Begin with `1. Sys speed dial` on the display, then follow the steps below.

1. Press `Show` The display shows `Show entry: _`
2. Enter the two-digit Speed Dial code you wish to erase  
**OR**  
Press `Next` until the desired code (01-70) appears.
3. Press `CHANGE` The programmed telephone number disappears from the display.
4. Press `Next` The Speed Dial code is programmed with no telephone number and the display shows the next Speed Dial code in the sequence.
5. Follow the Exit procedure below.

**System Speed Dial Exit procedure:**

**To move to other Administration tasks:**

1. Press `Heading` twice. The display shows `1. Sys Speed Dial`
2. Press `Next` or `Back` to move to another heading.

**To Exit from Administration:**

1. Press `Rls`

## Programming Overview of System Speed Dial

This flow chart is intended to provide a basic outline of System Speed Dial programming. For a more complete view, see the "Flow Charts" chapter of this Guide.

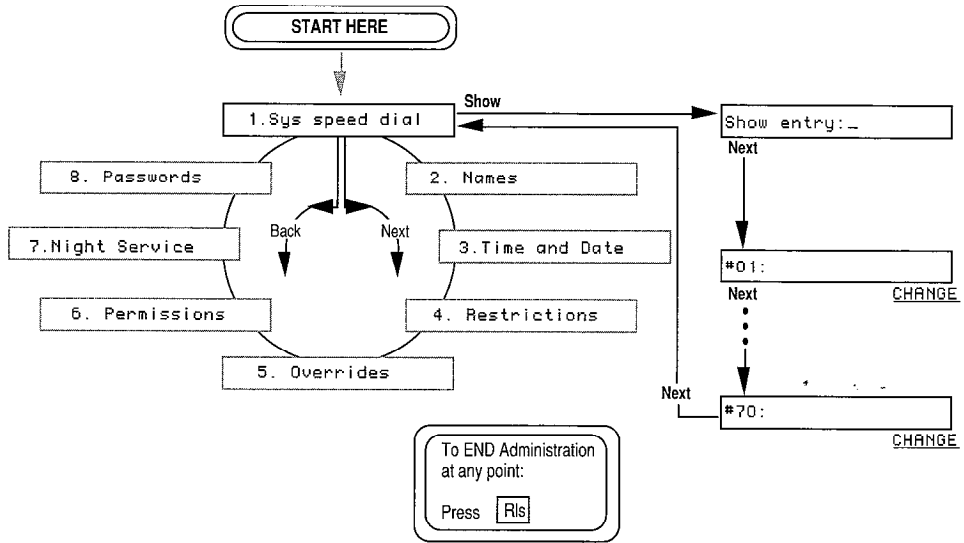

### FLOW CHART CONVENTIONS

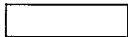

- Long square-cornered boxes represent display messages.

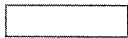

- Grey shaded boxes represent display messages which are not a part of the described procedures.

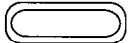

- Rounded double boxes contain instructions.

Show, Next, Back, Heading

- Programming buttons are labelled on the Norstar Programming Overlay.

CHANGE COPY OK

- Display buttons are labelled on the bottom line of the display when they are active.

## Explanation of System Speed Dial Overview

From the **1. Sys speed dial** heading, press **Show** to cause the **Show set: \_** sub-heading to appear. You can enter the two-digit Speed Dial code of the Speed Dial number you wish to see or press **Next** to see the entry (if there is one) for the lowest System Speed Dial code: number 01. Pressing **Next** repeatedly allows you to scroll forward through the list, moving up by one number with each press. You can scan the list as far as #70 if you wish. From #70, pressing **Next** twice moves you to the next heading: **2. Names**. When the display shows any Speed Dial code number, pressing **Back** scrolls backward through the list. When a particular code is shown on the display, you can enter a telephone number or change the existing entry by pressing the **CHANGE** display button, then entering the desired digits or symbols from the dialpad.

## Notes on System Speed Dial

The maximum length of a telephone number stored as a System Speed Dial code is **16 digits**.

The method for using both System and Personal Speed Dial codes is the same. The same Speed Dial button can access both System and Personal Speed Dial numbers, but the code used is different for the two types of Speed Dial features: System Speed Dial codes range from 01 to 70, Personal Speed Dial codes range from 71 to 94.

Personal Speed Dial numbers are programmed at individual telephones within your Norstar system. They can not be programmed using Norstar Administration.

## 2. Names

### How It Works

Programming Names allows you to assign names, consisting of letters and numbers, to your outside telephone lines and to your co-workers' telephones. As a result, when an outside call comes to a telephone, the display may show the line name (PRIVATE calling ) instead of the line number (Line 34 calling ). When an inside call comes to a telephone, the display may show the caller's name (DOUG calling ) instead of the phone's Intercom number.

This personal touch provides your company's staff with instant recognition of their calls. Conference/Transfer, Call Forward, Message, and other Norstar features are made more effective when the name of the line or caller appears on the display.

The word "set" is another name for a telephone. The set number for each telephone is the same as its Intercom number: the two, three, or four-digit number used to call between telephones within your office system.

Names can be assigned to lines which are used for only one specific purpose, such as a private line, or a line which is only assigned to one particular telephone (for example, "SHOP" or "RM 105"). Lines can also be named by the seven-digit telephone numbers associated with them (for example 555 1234). This makes it easy to identify which line a call is on, and therefore who is likely to be calling, and how important the call is likely to be.

The Name assigned to a line or telephone can be no longer than **seven** characters, and can contain both letters and numbers. Periods, hyphens, or other symbols cannot be used.

The Job Aids chapter of this Guide contains a convenient chart that you can photocopy, fill out, and distribute to your co-workers as a reference to Line and Intercom Numbers and the corresponding Names. Keep the page in the Job Aids chapter blank, and use it as a master copy.

Norstar  
Administrative

## Names Procedures

To make your task easier, use an Overlay found on the last page of this Guide:



Remember to record your changes in the Programming Record or Job Aids chapter of this Guide:



Norstar  
Administration

**Entering Characters:** While programming in the under the Names heading of Administration, you can enter the characters of Names from the numbered dialpad buttons on the telephone. Each button has three or four letters and numbers on it that are entered by pressing the button one, two, three or four times, depending on the letter or number desired. For example, one press on the **2** button on the dialpad enters an "A", a second press changes the entry to "B", a third press to the same button changes the entry to a "C", and a fourth changes the letter to the number "2". A fifth press would change the entry back to an "A".

**Cursor Controls:** The cursor is the small line which appears on the display beneath a blank space: **Set 221: \_**  
Characters which are entered using the dialpad appear above the cursor.

- #** Moves the cursor right
- \*** Moves the cursor left
- BKSP** Moves the cursor left, erasing the letter above the cursor
- >** Moves the cursor right
- <-** Moves the cursor left

Enter a blank space by pressing **#** or the **->** display button twice before entering the next character. This moves the cursor two spaces to the right, placing a blank space between characters. This is useful if you want to include an initial in the name. For example, you can differentiate between "PAT L" and "PAT M".

**Entering Administration:**

1. Release all calls on your M7324 or M7310 telephone. Indicators for calls on other telephones stay ON.
2. Enter the following code: **Feature** \* \* **2** **3** **6** **4** **6**
3. If the display changes to **Password:** , enter the Administration password. If the proper password is entered, the display changes to **1. Sys speed dial** and three triangular indicators ► appear on the LCD panel between the rows of buttons.  
If no password is required, the **1. Sys speed dial** display and the indicators appear as soon as the Administration code is entered.
4. Place the Overlay over the four buttons pointed to by the indicators.
5. Press the **Next** button. The display changes to **2. Names** You are now at the starting point for each of the following procedures.

Nors  
Administrat

**To scroll through the list of telephones:**

Begin with **2. Names** on the display.

1. Press **Show** twice. The display shows **Show set: \_**
2. Press **Next** repeatedly. At each set number, you can change the Name by following steps 4 to 8 below.

**To enter a new name or change the name of a telephone:**

Begin with **2. Names** on the display, then follow the steps below.

1. Press **Show** The display changes to **Set names**
2. Press **Show** again. The display changes to **Show set: \_**
3. Enter the Intercom number of the desired telephone  
**OR**  
Press **Next** to show the lowest numbered telephone in the system.
4. Press **CHANGE**
5. Enter the first character of the desired Name by pressing the appropriate dialpad button one, two, three, or four times. Example: Press **7** once for P, twice for R, three times for S, or four times for T. The character appears above the cursor.
6. Press **#** or **->** to move the cursor to the next space.
7. Enter the second character from the dialpad.

8. Continue entering other characters of the Name using the dialpad and cursor control keys. Remember that there is a seven-character limit on Name length. If you press **Next** or **Back** before entering any characters, the telephone's set number is stored in place of a name.
9. To enter the Name for another telephone, press **Back** to return to **Show set: \_** sub-heading  
**OR**  
 Press **Next** to show the next telephone in the numbering sequence.
10. When you are finished, follow the Exit procedure on the next page.

### To enter a new name or change the name of an outside line:

Begin with **2. Names** on the display, then follow the steps below.

1. Press **Show** The display shows **Set names**
2. Press **Next** The display shows **Line names**
3. Press **Show** The display shows **Show line: \_**
4. Enter the two-digit number of the desired line  
**OR**  
 Press **Next** to show the lowest numbered line in the system.
5. Press **CHANGE** A cursor appears beside the colon.
6. Enter the first character of the desired Name by pressing the appropriate dialpad button one, two, three, or four times.
7. Press **#** or **->** to move the cursor to the next space.
8. Enter the second character from the dialpad.
9. Continue entering other characters of the Name using the dialpad and cursor control keys. Remember that there is a seven-character limit on Name length. If you press **Next** or **Back** before entering any characters, the line number is stored in place of a name.
10. To enter the Name for another line, press **Back** to return to the **Show line: \_** sub-heading  
**OR**  
 Press **Next** to show the next line in your system.
11. When you are finished, follow the Exit procedure on the next page.



---

**Names Exit procedure:****To move to other Administration tasks:**

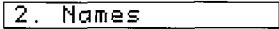
1. Press **Heading** two or three times until the display shows  

2. Press **Next** or **Back** to move to another heading.

**To Exit from Administration:**

1. Press **Ris**





Nors  
Administrat

# Programming Overview of Names

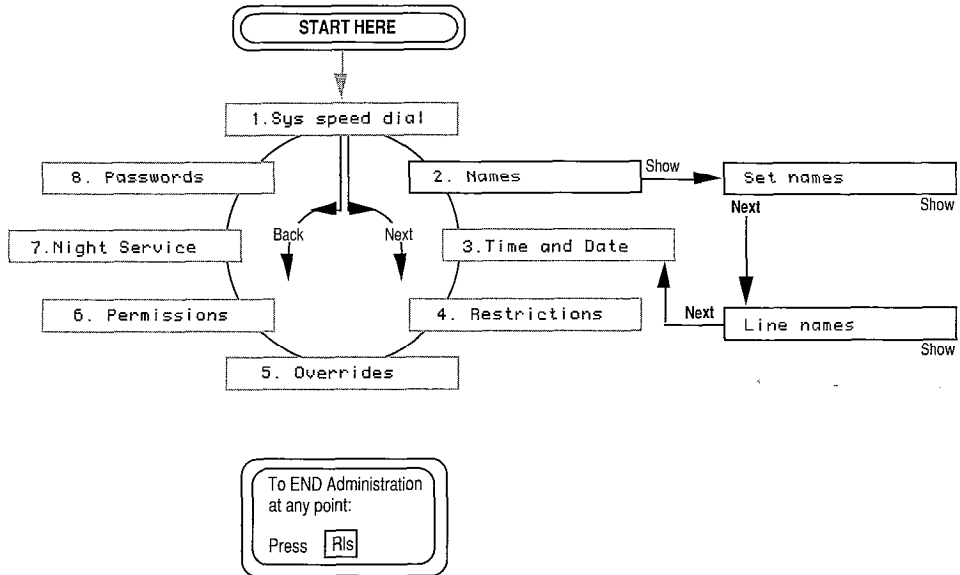
This flow chart is intended to provide a basic outline of Names programming. For a more complete view, see the "Flow Charts" chapter of this Guide.

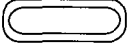

**FLOW CHART CONVENTIONS**

-  - Long square-cornered boxes represent display messages.
-  - Grey shaded boxes represent display messages which are not a part of the described procedures.
-  - Rounded double boxes contain instructions.
- Show, Next, Back, Heading - Programming buttons are labelled on the Norstar Programming Overlay.
- CHANGE COPY OK** - Display buttons are labelled on the bottom line of the display when they are active.

Norstar Administration

---

## Explanation of Names Overview

The **2. Names** Overview Flow Chart shows the two sub-headings which allow you to program Names for the telephones or outside lines in your system. By pressing **Show** and following the display prompts, you can scan through the assigned names of lines or telephones, and erase or change the Names.

## Notes on Names

Programmed Names of lines and telephones in your Norstar system can be no more than **seven characters** long. Hyphens, periods and other symbols cannot be used. Letters are automatically stored as upper case letters.

Entering letters from the dialpad only happens in Names programming. At all other times, pressing the dialpad buttons enters only the number of the button you press.

The Name and Intercom Number of a telephone will remain the same if the telephone is moved to another location within your system.

Before assigning Names to telephones, it is a good idea to check with the people involved to ensure that the proposed Names are acceptable.

Line names must be unique, in order that any line which may be having trouble can be reported correctly. If you enter a Line Name which has already been used, you will hear an error tone, and **Use unique name** will appear on your display.

Two or more telephones in your office, or a telephone and a line in your system, can be given the same Name. The system allows this, but it could become a source of confusion. Use creative combinations of initials, abbreviations, and possibly nicknames to give each telephone a unique Name.

If some of the telephones in your system are used by many people, it may be more sensible to name them after their location—such as LAB, GATE, or RM 123—rather than giving them a person's Name.



**Entering Administration:**

1. Release all calls on your M7324 or M7310 telephone. Indicators for calls on other telephones stay ON.
2. Enter the following code: **Feature** \* \* 2 3 6 4 6
3. If the display changes to **Password:** , enter the Administration password. If the proper password is entered, the display changes to **1.Sys speed dial** and three triangular indicators ► appear on the LCD panel between the rows of buttons.  
If no password is required, the **1.Sys speed dial** display and the indicators appear as soon as the Administration code is entered.
4. Place the Overlay over the four buttons pointed to by the indicators.
5. Press **Next** twice. The display changes to **3. Time and date** You are now at the starting point for each of the following procedures.

**To change the Time:**

Begin with **3. Time and date** on the display, then follow the steps below. This example uses the setting 3:45 pm, March 31, 1989.

1. Press **Show** The display shows **Time 15:45**
2. Press **CHANGE** The display shows **Hour: 15** If you do not wish to change this setting, go to step 5 below.
3. Press **CHANGE** The previous Hour setting is erased.
4. Enter the desired digit(s) from the dialpad.
5. Press **Next** The display shows **Minutes: 45**  
If you do not wish to change this setting, go to step 8 below.
6. Press **CHANGE** The previous Minutes setting is erased.
7. Enter the desired digit(s) from the dialpad.
8. Press **Next**  
If the display shows **Date 31 Mar 89**, follow step 11 below.  
If the display shows **AM** or **PM**, follow step 9 below.
9. Choose the proper AM / PM setting by pressing the **CHANGE** display button.
10. Press **Next** The display shows **Date 31 Mar 89**
11. Proceed to change the date or follow the Exit procedure on the next page.

Nors  
Administrat

**To change the Date:**

Begin with  on the display, then follow the steps below. This example uses the setting 3:45 pm, March 31, 1989.

1. Press  The display shows
2. Press  The display shows
3. Press  The display shows the Year in two-digit format:  If you do not wish to change this setting, go directly to step 6 below.
4. Press  The previous setting is erased.
5. Enter the last two digits of the desired year.
6. Press  The display shows  If you do not wish to change this setting, go directly to step 9 below.
7. Press  The previous setting is erased.
8. Enter the desired digit(s) from the dialpad.
9. Press  The display shows  If you do not wish to change this setting, go directly to step 12 below.
10. Press  The previous setting is erased.
11. Enter the number of the desired date.
12. When you are finished, follow the Exit procedure below.

**Time and Date Exit procedure:****To move to other Administration tasks:**

1. Press  until the display shows a numbered heading.
2. Press  or  to move to another heading.

**To Exit from Administration:**

1. Press

## Programming Overview of Time and Date

This flow chart is intended to provide a basic outline of Time and Date programming. For a more complete view, see the "Flow Charts" chapter of this Guide.

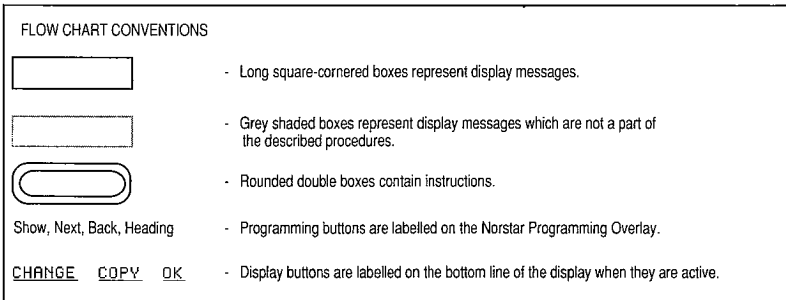
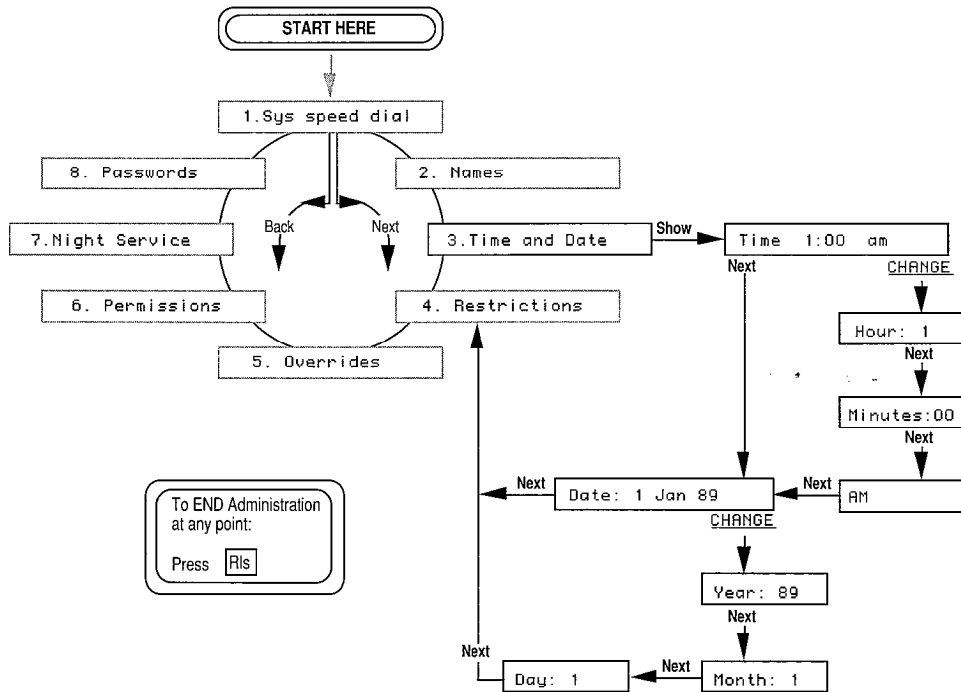

## Explanation of Time and Date Overview

From the **3. Time and Date** heading, pressing **Show** displays the Time sub-heading. Press **Next** to see the Date sub-heading. From either of these sub-headings, you can press the **CHANGE** display button and **Next** to see the separate divisions of the sub-section: for example, Hours and Minutes under the "Time" sub-heading. When one of these parts shows on the display, you can change it by pressing **CHANGE** and entering the correct digits from the dialpad. The AM/PM choice is presented only if you enter an hour of 12 or less while your telephone display is in English.

## Notes on Time and Date

The Time and Date display on each telephone indicates that the telephone is properly connected to the Key Service Unit (KSU) and is in its idle state (not active on a call or feature). If the display is blank, the telephone may be disconnected, or there may be no power to the KSU. If the power fails, your Norstar clock will stop. Once the power is restored to your system, the clock begins to run again, but the time will be incorrect.

Some Norstar features cause a particular message to appear on your display as long as the feature is active. The Message Waiting feature, for example, shows the display **Message for you**, rather than the Time and Date display, until you return or cancel the messages.

The time display in English is always in 12-hour format with "am" or "pm"; on the Alternate language display, the time is always displayed in 24-hour format:

English	<b>May 24 3:22 pm</b>
French	<b>24 mai 15h22</b>
Spanish	<b>24 May 15:22</b>

The Time and Date will revert to its default setting if the power is out for more than three consecutive days, or if your system defaults are intentionally reset. The display will show **Jan 1 1:00 am** when the system has been restarted.



---

## 4. Restrictions

### How It Works

A Restriction prohibits calls from your office to call numbers containing specified digits. You can apply these Restrictions to individual lines or telephones to prevent abuse of your office system. If anyone tries to dial a restricted number, they will hear an error tone and see the message `Restricted call`. The call will then be dropped.

Restrictions can range from the very general, such as preventing all long-distance calls from any telephone, to the very particular, such as preventing calls to a specific taxi company from the telephone near the front door.

Two other sections of Administration programming that relate to

Restrictions are `5. Overrides` and `8. Passwords`.

Each of these sections allows certain people or certain telephone numbers to avoid the programmed Restrictions.

Your Norstar system comes with the five pre-set (default) Restrictions listed on the following table, but they are not applied to any lines or telephone sets. In order for the default Restrictions to function, they must be applied to the appropriate lines and telephones. The following procedures explain how to apply the Restrictions to lines or sets to suit your office needs.

Norstar  
Administration

Restriction Number	Restricted Digit or Sequence	Purpose
#1	0	Prevents calls to the Operator, which could result in operator-handled long-distance calls.
#2	1	Prevents all direct-dialed long-distance calls.
#3	411	Prevents calls to local Directory Assistance, for which there is often a charge.
#4	1*1*	Prevents long-distance calls to any area code with a 1 as the middle digit. For example: 416. The asterisk (*) is a "wild card" character that stands for any digit.
#5	1*0*	Prevents long-distance calls to any area code with a 0 as the middle digit.

Restricted digits apply to the beginning of a dialed telephone number. The "1" Restriction, for example, will prohibit long-distance calls that begin with a 1, but will not prohibit the dialing of a number that contains a 1 in any other position.

The two default Restrictions 1\*1\* and 1\*0\* together prevent any long-distance calls outside your area code, while permitting long-distance calls within your area code.

The maximum length of a restricted sequence is **eight characters**. The maximum number of Restrictions allowed in any Norstar system is 30. Any or all of these Restrictions can be applied to any line or telephone in your office system.

A call can be prevented by a Restriction placed on either the line or the telephone being used. Restrictions applied to a telephone affect calls on any line from that telephone. Restrictions applied to a line affect calls on that line from any telephone set.

Restrictions that apply to a line can be easily copied as a group to another line, using the line copy routine described near the end of this section. Similarly, Restrictions that apply to a set can be copied to another set. This procedure is a great time saver, especially when new telephones or new lines are being added to an established system.

When entering line numbers during programming, use a two-digit format. Line numbers less than 10 must be preceded by a zero.

## Restrictions Procedures

To make your task easier, use an Overlay found on the last page of this Guide:

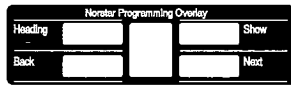

Remember to record your changes in the Programming Record or Job Aids chapter of this Guide:

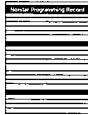

### Entering Administration:

1. Release all calls on your M7324 or M7310 telephone. Indicators for calls on other telephones stay ON.
2. Enter the following code: `Feature * * 2 3 6 4 6`
3. If the display changes to `Password: +`, enter the Administration password. If the proper password is entered, the display changes to `1. Sys speed dial` and three triangular indicators ► appear on the LCD panel between the rows of buttons. If no password is required, the `1. Sys speed dial` display and the indicators appear as soon as the Administration code is entered.
4. Place the Overlay over the four buttons pointed to by the indicators.
5. Press `Next` three times. The display changes to `4. Restrictions` You are now at the starting point for each of the following procedures.

Norsat  
Administration

**To scan the available Restrictions:**

Begin with **4. Restrictions** on the display, then follow the steps below.

1. Press **Show** The display shows **Table entries**
2. Press **Show** again. The display shows the first Restriction table entry.
3. Press **Next** repeatedly to scroll forward through the table entries, as far as #30 if you wish. While a table entry is displayed, you can press **Back** to scroll backwards through the entries. At #30, pressing **Next** changes the display to **Applied to lines**
4. When you are finished, follow the Exit procedure at the end of this section.

**To change a Restriction or enter a new one:**

Begin with **4. Restrictions** on the display, then follow the steps below.

1. Press **Show** The display shows **Table entries**
2. Press **Show** again. The display shows the first table entry.
3. Press **Next** repeatedly until the desired entry or blank space is showing on the display.
4. Press **CHANGE** **Any previous entry is erased.**
5. Enter the desired digit sequence from the dialpad. The maximum number of permitted digits or asterisks is eight.
6. Press **Next** to store the entry and move to the next Restriction.
7. When you are finished, follow the Exit procedure at the end of this section.

**To scan or change Restrictions that apply to a line:**

Begin with **4. Restrictions** on the display, then follow the steps below.

1. Press **Show** The display shows **Table Entries**
2. Press **Next** The display shows **Applied to lines**
3. Press **Show** The display shows **Show line: \_**

4. Enter the desired line number from the dialpad using a two-digit format. Line numbers less than 10 must be preceded by a zero.

The display shows the first Restriction from the table, together with a Y (Yes) or an N (No) to indicate whether the Restriction applies. For example:

If you wish to apply or remove the Restriction, pressing **CHANGE** causes the display to change from Y to N, or the reverse.

5. Press **Next** to see the next Restriction.
6. When the final table entry shows on the display, press **Next**

appears on the display. You can now repeat steps 4 and 5 to see the Restrictions for another line.

7. When you are finished, follow the Exit procedure at the end of this section.

#### To scan or change Restrictions that apply to a telephone set:

Begin with  on the display, then follow the steps below.

1. Press **Show** The display shows
2. Press **Next** twice. The display shows
3. Press **Show** The display changes to
4. Enter the desired set number from the dialpad.  
The display shows the first Restriction from the table, with a Y (Yes) or an N (No) to indicate whether the Restriction applies to the set. For example:  
 If you wish to apply or remove the Restriction, pressing **CHANGE** causes the display to change from Y to N, or the reverse.
5. Press **Next** to see the next Restriction.
6. When the final table entry shows on the display, press **Next**  
 appears on the display.  
You can now repeat steps 4 and 5 to see the Restrictions for another set.
7. When you are finished, follow the Exit procedure at the end of this section.

**To copy line Restrictions**

Begin with **4. Restrictions** on the display, then follow the steps below.

1. Press **Show** The display shows **Table entries**
2. Press **Next** The display shows **Applied to lines**
3. Press **Show** The display changes to **Show line: \_**
4. Press the **COPY** button under the display. The display shows **Source: \_**
5. Enter the two-digit line number of the line to be copied. The display changes to **Copy to line: \_**
6. Enter the two-digit line number of the line to receive the new Restrictions. The display temporarily shows **Copied XX to YY** with appropriate line numbers in place of the Xs and Ys. The display then changes to **Copy to line: \_** You may now copy the same Restrictions to another line.
7. When you are finished, follow the Exit procedure on the next page.

**To copy set Restrictions:**

Begin with **Applied to sets** on the display.

Follow steps 3-7 from the "Copy line Restrictions" procedures. All display messages are the same, but "sets" will appear instead of "lines".

**Restrictions Exit procedure:****To move to other Administration tasks:**

1. Press **Heading** once or several times until the display shows **4. Restrictions**
2. Press **Next** or **Back** to move to another heading.

**To Exit from Administration:**

1. Press **Rls**



## Explanation of Restrictions Overview

From the **4. Restrictions** heading, press **Show** to get to the first sub-heading **Table entries**. The other two sub-headings are **Applied to lines** and **Applied to sets**. You can move from one sub-heading to another by pressing **Back** or **Next**.

From the **Table entries** sub-heading you can see the actual entries (restricted digits) by pressing **Show** and then **Next** repeatedly. Enter a string of digits or erase an existing entry by pressing **CHANGE** when the desired entry number shows on the display, then entering the new digits from the dialpad or pressing **Next**.

Programming under **Applied to lines** follows the same format as programming under **Applied to sets**. From either sub-heading, press **Show** then enter the desired line or set number. As the last digit is pressed, the display shows the first table entry along with a Y (Yes) or N (No) to indicate whether the Restriction is applied. You can apply or remove any Restriction showing on the display by pressing **CHANGE**.

All of the Restrictions applied to a line or a telephone can be copied to others by returning to the appropriate sub-heading, pressing the **COPY** display button, and following the prompts which appear on the display.



---

## Notes on Restrictions

The maximum length of a Restriction sequence is **eight characters**, including digits and asterisks.

The maximum number of Restrictions which can be programmed for a system is 30. These can be assigned to individual lines and telephones in the system.

If the Restrictions in your system are too limiting, see the "Overrides" section which follows. Overrides allow you to disable Restrictions on individual lines or telephones, or to permit calls to certain numbers or area codes.

If the Restrictions in your system are not preventing certain types of calls as intended, look for the following conditions:

- The Restrictions may not be applied to all of the necessary lines or sets.
- If you have activated a Restriction Password, some unauthorized people may be using it.
- One of the Overrides may be too general, allowing too many calls to override a Restriction.

Centrex or PBX features, such as Link or Timed Release, cannot override Restrictions in your Norstar system.

If you want to reserve a certain line or telephone for incoming calls only, apply a Restriction that consists of a single asterisk \* . This blocks the dialing of any digit, thereby prohibiting all outgoing calls.

A Restriction only prevents calls to telephone numbers with the same or a greater number of digits. For example, a Restriction of eight asterisks \* \* \* \* \* \* \* \* applied to a line or telephone prevents all calls to telephone numbers longer than seven digits on that line or telephone.

## 5. Overrides

### How It Works

An Override is a sequence of digits that is programmed to bypass a corresponding Restriction. For example, if your system is programmed with a general Restriction against long-distance calls, you may still want to allow long distance calls to the head office of your company on certain lines or certain telephones. To do this, program the digits of the head office number as an Override, and apply it to the desired lines or telephones.

Your Norstar system comes with five pre-set (default), as listed on the table below; however, they are not applied to any lines or telephones. In order for the Overrides to function, they must be applied to the appropriate lines and telephones. The following procedures explain how to apply the Overrides to lines or telephones to suit your needs.

Override Number	Permitted Digit Sequences	Purpose
#1	<b>1800</b>	Permits long-distance calls to toll-free numbers beginning with 1800.
#2	<b>1555</b>	Permits calls to long-distance directory information within the caller's area code.
#3	<b>1*1*555</b>	Permits calls to long-distance directory information in any area code that has a middle digit of 1. Example: 416 The asterisk (*) is a "wild card" character that stands for any digit.
#4	<b>1*0*555</b>	Permits calls to long-distance directory information in any area code that has a middle digit of 0. For example: 709.
#5	<b>911</b>	Permits calls to the general emergency number (911) for fire, police, or ambulance service.

Notice that Override digits, like those above, are applied to the beginning of a dialed telephone number. The "1800" Override, for example, permits long-distance calls that begin with 1800, but does not allow long-distance calls that contain 1800 in any other position.

The maximum length of an Override sequence is **14 characters**. The maximum number of Overrides in any Norstar system is 10.

Overrides, like Restrictions, are applied independently to lines and telephones. For example, if a particular Restriction were applied to both Line 2 and Set 221, then the Override would need to be applied to both Line 2 and Set 221 for all telephones to use all lines. If the Override were applied only to Set 221, then Set 221 could make the restricted call on all lines except Line 2. If the Override were applied only to Line 2, then all telephones except Set 221 could make the call on Line 2. Set 221 could not make the call. An Override applied to a particular telephone will not remove any Restrictions applied to lines which that telephone uses.

Overrides that apply to a line can be easily copied as a group to another line, using the line copy routine described near the end of this section. Similarly, Overrides that apply to one telephone can be copied to another set. This procedure is a great time saver, especially when new sets or new lines are being added to an established system.

When entering line numbers during programming, use a two-digit format; line numbers less than 10 must be preceded by a zero.

## Overrides Procedures

To make your task easier, use an Overlay found on the last page of this Guide:



Remember to record your changes in the Programming Record or Job Aids chapter of this Guide:



**Entering Administration:**

1. Release all calls on your M7324 or M7310 telephone. Indicators for calls on other telephones stay ON.
2. Enter the following code: **Feature**
3. If the display changes to **Password:**  , enter the Administration password. If the proper password is entered, the display changes to **1. Sys speed dial** and three triangular indicators **▶** appear on the LCD panel between the rows of buttons.  
If no password is required, the **1. Sys speed dial** display and the indicators appear as soon as the Administration code is entered.
4. Place the Overlay over the four buttons pointed to by the indicators.
5. Press **Next** four times. The display changes to **5. Overrides**  
You are now at the starting point for each of the following procedures.

**To scan the available Overrides:**

Begin with **5. Overrides** on the display, then follow the steps below.

1. Press **Show** The display shows **Table entries**
2. Press **Show** again. The display shows the first table entry.
3. Press **Next** repeatedly to scroll forward through the table entries, as far as #10 if you wish. At #10, pressing **Next** changes the display to **Applied to lines**
4. While a table entry is displayed, you can press **Back** to scroll backwards through the list.
5. Follow the Exit procedure at the end of this section.

**To change an Override or enter a new one:**

Begin with **5. Overrides** on the display, then follow the steps below.

1. Press **Show** The display shows **Table entries**
2. Press **Show** again. The display shows the first table entry.
3. Press **Next** repeatedly until the desired entry or a blank entry appears on the display.
4. Press **CHANGE**

5. Enter the desired digit sequence from the dialpad.  
The maximum length of an Override is **14 characters**.
6. Press **[Next]** to store the entry. The display shows the next table entry. If you are at the last Override, the display will change to **[Applied to lines]**

### To scan or change Overrides that apply to a line:

Begin with **[5. Overrides]** on the display, then follow the steps below.

1. Press **[Show]** The display shows **[Table entries]**
2. Press **[Next]** The display shows **[Applied to lines]**
3. Press **[Show]** The display changes to **[Show line: \_]**
4. Enter the desired line number from the dialpad.  
Numbers less than 10 must be preceded by a zero. The display shows the first Override from the table, with Y (Yes) or N (No) to indicate whether the Override has been applied.  
If you wish to apply or remove the Override, pressing **[CHANGE]** causes the display to change from Y to N, or the reverse.
5. Press **[Next]** to see the next Override.
6. When the final table entry shows on the display, press **[Next]** **[Show line: \_]** appears on the display.  
You can now repeat steps 4 and 5 to see the Overrides for another line.
7. When you are finished, follow the Exit procedure at the end of this section.

### To scan or change Overrides that apply to a telephone set:

Begin with **[5. Overrides]** on the display, then follow the steps below.

1. Press **[Show]** The display shows **[Table entries]**
2. Press **[Next]** twice. The display changes to **[Applied to sets]**
3. Press **[Show]** The display changes to **[Show set: \_]**
4. Enter the desired set number from the dialpad. The display shows the first Override from the table, with Y (Yes) or N (No) to indicate whether the Override is applied. If you wish to apply or remove the Override, pressing **[CHANGE]** causes the display to change from Y to N, or the reverse.

5. Press **Next** to see the next Override.
6. When the final table entry shows on the display, press **Next**.  
**Show set: \_** appears on the display. You can now repeat steps 4 and 5 to see the Overrides for another set.
7. When you are finished, follow the Exit procedure at the end of this section.

### To copy line Overrides

Begin with **5. Overrides** on the display, then follow the steps below.

1. Press **Show**. The display shows **Table entries**.
2. Press **Next**. The display shows **Applied to lines**.
3. Press **Show**. The display changes to **Show line: \_**.
4. Press **COPY**. The display shows **Source: \_**.
5. Enter the two-digit number of the line to be copied.  
The display changes to **Copy to line: \_**.
6. Enter the two-digit number of the line to receive the Overrides.  
The display temporarily shows **Copied XX to YY** with appropriate numbers in place of the Xs and Ys.  
The display changes to **Copy to line: \_**.  
You may now copy the same Overrides to another line.
7. Follow the Exit procedure on the following page.

### To copy set Overrides:

Begin with **Applied to sets** on the display.

Follow steps 3-7 from the "Copy line Overrides" procedures. All display messages are the same, but "sets" appears instead of "lines".

### Overrides Exit procedure:

#### To move to other Administration tasks:

1. Press **Heading** as often as required until the display shows **5. Overrides**.
2. Press **Next** or **Back** to move to another heading.

#### To Exit from Administration:

1. Press **Rls**.

## Programming Overview of Overrides

This flow chart is intended to provide a basic outline of Override programming. For a more complete view, see the "Flow Charts" chapter of this Guide.

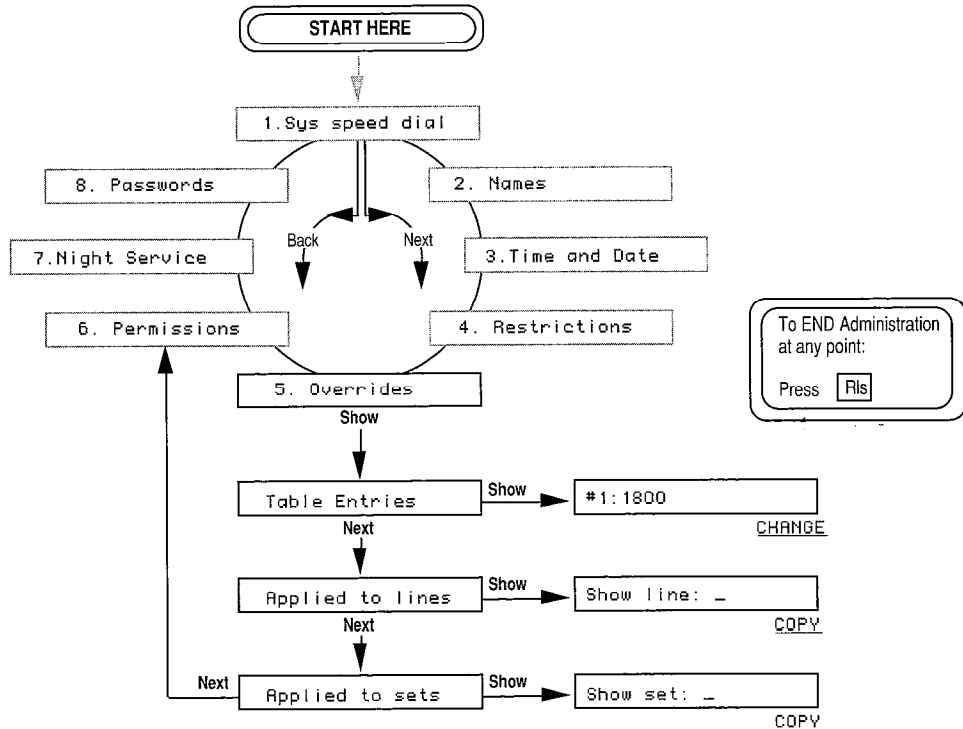

### FLOW CHART CONVENTIONS



- Long square-cornered boxes represent display messages.

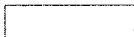

- Grey shaded boxes represent display messages which are not a part of the described procedures.

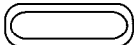

- Rounded double boxes contain instructions.

Show, Next, Back, Heading

- Programming buttons are labelled on the Norstar Programming Overlay.

CHANGE COPY OK

- Display buttons are labelled on the bottom line of the display when they are active.

## Explanation of Overrides Overview

Overrides programming is structured the same way as Restrictions programming. From the **5. Overrides** heading, press **Show** to get to the first sub-heading: **Table entries**. The other two sub-headings are **Applied to lines** and **Applied to sets**. You can move from one sub-heading to the others by pressing **Back** or **Next**.

From the **Table entries** sub-heading you can see the actual entries (permitted digits) by pressing **Show** and then pressing **Next** repeatedly. Enter a string of digits or erase an existing entry by pressing **CHANGE** when the desired entry number is showing on the display, then entering the new digits from the dialpad or pressing **Next**.

Programming under **Applied to lines** follows the same format as programming under **Applied to sets**. From either sub-heading, press **Show** then enter the desired line or set number. As the last digit is pressed, the display shows the first table entry along with a Y (Yes) or N (No) to indicate whether the Override is applied. You can apply or remove any Override showing on the display by pressing **CHANGE**.

All of the Overrides applied to a line or a telephone can be copied to others by returning to the appropriate sub-heading, pressing the **COPY** display button, and following the prompts which appear on the display.



## Notes on Overrides

The maximum length of an Override sequence is **14 characters**, including digits and asterisks.

The maximum number of Overrides which can be programmed for a system is 10. These can be turned ON and OFF for individual lines and telephones in the system.

The universal Override for all Restrictions is a string of 14 asterisks \* . When this Override is applied to a line or telephone, it bypasses all digits in any Restriction on that line or telephone.

If the Overrides in your system are not allowing certain types of calls as intended, look for the following conditions:

- The Overrides may not be applied to all of the necessary lines or sets.
- A certain telephone number may bypass one Restriction because of an Override, only to be prevented by another Restriction that also needs an Override.
- A telephone number may bypass a Restriction on a telephone set, but be prevented by a Restriction on a line.

Restrictions can also be overridden using Restriction Passwords, which you can activate and change under the **8. Passwords** section of Norstar Administration. If activated, these passwords will override all Restrictions applied to any lines or telephones within your Norstar office system.

Norstar  
Administratic

## 6. Permissions

### How It Works

Permissions are a series of seven features that you can control for each telephone in your system. The features are listed and briefly described in the table below.

Permission	Default Setting	Other Settings
<b>Full Handsfree:</b> Allows a person to make or receive calls without having to pick up the receiver. This feature also allows a headset to be used with the telephone.	No	Yes
<b>Handsfree Answerback:</b> Allows a person to answer a voice call without lifting the receiver on their telephone.	Yes	No
<b>Pickup group:</b> Telephones in the same pickup group can be used to answer any calls ringing on another telephone in the group, even if the telephones do not normally use the same outside lines.	No	1/2/3/4/5/ 6/7/8/9
<b>Page Zone:</b> You can assign each telephone in your system to one of six Page Zones, or prevent any telephones from receive page messages	1	2/3/4/5/6/No
<b>Auxiliary Ringer:</b> You can allow all incoming calls that ring on a particular telephone to also drive the Auxiliary Ringer.	No	Yes
<b>Call Forward No Answer:</b> Each telephone in your system can be programmed to forward all calls which are not answered. You can control both the telephone to which the calls are forwarded and the number of times a call will ring before it is forwarded.	None  3	telephone set number  2/3/4/6/10
<b>Priority Call:</b> You can control whether or not each telephone in your system can override active calls and Do Not Disturb in order to place important inside calls.	No	Yes

The default settings for permissions may be the best for your office, or you may wish to experiment a bit before arriving at the ideal arrangement. Here are some points to consider about Permissions:

**Full Handsfree** is necessary for a person who wants to use a headset or the telephone speaker and microphone. As the name implies, Handsfree is appreciated by anyone who wants to keep their hands free for writing or other manual tasks while talking on the telephone. It is also useful in executive offices or meeting rooms where two or more people may want to hold a teleconference with another person. Full Handsfree is seldom used on telephones in open work areas where people need to use the receiver to keep conversations private, or where background noise would be picked up by the Handsfree microphone.

**Handsfree Answerback** can be turned OFF at a telephone that never receives Voice Calls—such as a courtesy telephone in a reception area—or a telephone in any location where the person receiving the Voice Call does not need to respond, or wishes to respond only by using the receiver.

**Pickup groups** are generally formed within working units of the office so that an outside caller can speak to someone who works with the person he or she is trying to reach. If, for example, the Sales Department does not want to take messages for the Engineering Department, they should be in different Pickup groups.

**Page Zone** should be specified as NO at telephones where page announcements would be disruptive or would convey irrelevant information, such as in a conference room. Before programming this feature, consider who in your company will use page messages, and who they will wish to contact, so that you assign the most appropriate Page Zone to each telephone.

**Auxiliary Ringer** should receive calls only from telephones and lines that are accessible to people hearing the ringer. Otherwise, the calls may go unanswered.

Norst  
Administrati

**Call Forward No Answer:** Make sure that you only forward unanswered calls to telephones where those calls will be answered. A Central Answering Position, Prime Phones, receptionist's or secretary's telephones are useful for receiving calls forwarded by this feature.

**Priority Call:** This feature permits the person using the programmed telephone to interrupt a co-worker who is active on a call or using Do Not Disturb mode. Only permit this feature at telephones where this will be necessary for important office communications.

Norstar  
Administration

## Permissions Procedures

To make your task easier, use an Overlay found on the last page of this Guide:

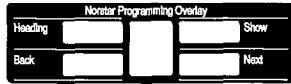

Remember to record your changes in the Programming Record or Job Aids chapter of this Guide:



Norstar  
Administration

### Entering Administration:

1. Release all calls on your M7324 or M7310 telephone. Indicators for calls on other telephones stay ON.
2. Enter the following code: **Feature**
3. If the display changes to **Password:** , enter the Administration password. If the proper password is entered, the display changes to **1.Sys speed dial** and three triangular indicators ► appear on the LCD panel between the rows of buttons.  
If no password is required, the **1.Sys speed dial** display and the indicators appear as soon as the Administration code is entered.
4. Place the Overlay over the four buttons pointed to by the indicators.
5. Press the **Back** button three times. The display changes to **6. Permissions**. You are now at the starting point for each of the following procedures.

### To check the Permissions on a telephone:

Begin with **6. Permissions** on the display, then follow the steps below.

1. Press **Show**. The display changes to **Show Set: \_**
2. Enter the Intercom Number of the set you want to check. After the final digit is entered, the display changes to **Full handsfree:** , with a Y (Yes) or N (No) to indicate whether Handsfree is active.
3. Press **Next** to see the status of the next permission, **HF Answerback:**

4. Repeat step 3 to check the five remaining Permissions, or press **Back** to move backward through the list. From the last Permission, **Priority call:**, you can return to the **Show Set: \_** sub-heading by pressing **Next**. This allows you to check the permissions on another telephone by repeating steps 2 and 3 above.
5. Follow the Exit procedure at the end of this section.

### To apply or remove Full Handsfree:

Begin with **6. Permissions** on the display, then follow the steps below.

1. Press **Show**. The display changes to **Show Set: \_**.
2. Enter the Intercom Number of the telephone you want to check. After the final digit is entered, the display changes to **Full handsfree:** with a Y (Yes) or N (No) to indicate whether Handsfree is active.
3. Press **CHANGE** to alter the Handsfree setting. Another press changes it back again.
4. Follow the Exit procedure at the end of this section.
5. Install the **Handsfree Mute** button caps on the proper buttons of telephones receiving Full Handsfree

**OR**

Remove the **Handsfree Mute** button caps from telephones which will no longer have the feature.

**Handsfree Mute** always appears on the button in the lower right corner of the LCD panel, and shifts the **Intercom** line(s) and **Answer** buttons up one position. If the feature is removed, the **Intercom** line(s) and **Answer** buttons move down to take over the Handsfree/Mute position.

If **Handsfree Mute** is added or removed from any telephones in your system, remember to notify your co-workers so that they can change the button cap of the **Handsfree Mute** button.

**To apply or remove Handsfree Answerback:**

Begin with **5. Permissions** on the display, then follow the steps below.

1. Press **Show** The display changes to **Show Set: \_**
2. Enter the Intercom Number of the telephone you want to check. After the final digit is entered, the display changes to **Full handsfree:**
3. Press **Next** The display shows **HF Answerback:** , with a Y (Yes) or N (No) to indicate if the feature is active.
4. Press **CHANGE** to alter the Handsfree Answerback setting. Another press changes it back again.
5. Follow the Exit procedure at the end of this section.

**To change the Pickup Group of a telephone:**

Begin with **5. Permissions** on the display, then follow the steps below.

1. Press **Show** The display changes to **Show Set: \_**
2. Enter the Intercom Number of the telephone you want to check. After the final digit is entered, the display changes to **Full handsfree:**
3. Press **Next** twice. The display shows **Pickup group:** , with a number to indicate the present group.
4. Press **CHANGE** until you have selected the desired pickup group number

**OR**

- Press **CHANGE** until NO appears beside the colon. This removes the telephone from all pickup groups.
5. When you are finished, follow the Exit procedure at the end of this section.

**To change the Page Zone of a telephone:**

Begin with **5. Permissions** on the display, then follow the steps below.

1. Press **Show** The display changes to **Show Set: \_**
2. Enter the Intercom Number of the set you want to check. After the final digit is entered, the display changes to **Full handsfree:**
3. Press **Next** three times. The display shows **Page zone:** , with a number indicating the Page Zone to which the telephone belongs.

4. Press **CHANGE** until you have selected the desired Page Zone
- OR  
Press **CHANGE** until NO appears beside the colon. This removes the telephone from all Page Zones.
5. Follow the Exit procedure at the end of this section.

### To change the Auxiliary Ringer setting of a telephone:

Begin with **5. Permissions** on the display, then follow the steps below.

1. Press **Show** The display changes to **Show Set: \_**
2. Enter the Intercom Number of the telephone you want to check. After the final digit is entered, the display changes to **Full handsfree:**
3. Press **Next** four times. The display shows **Aux. ringer:**, with a Y (Yes) or N (No) to indicate whether the Auxiliary Ringer is activated from the telephone being checked.
4. Press **CHANGE** to alter the setting. Another press changes it back.
5. Follow the Exit procedure at the end of this section.

### To set the Call Forward No Answer feature for a telephone:

Begin with **5. Permissions** on the display, then follow the steps below.

1. Press **Show** The display changes to **Show Set: \_**
2. Enter the Intercom Number of the telephone you want to check. After the final digit is entered, the display changes to **Full handsfree:**
3. Press **Next** five times. The display shows **Forward no answr**
4. Press **Show** The display changes to **Forward to:** with the destination set (or None) specified after the colon.
5. Press **CHANGE** The display shows **Forward to: \_**
6. Enter the Intercom number of the telephone to which you wish to forward calls. The display shows the numbers after the colon.
7. Press **Next** The display shows **Forward delay:** with a number to specify how many times a call rings before it is forwarded.
8. Press **CHANGE** until the appropriate number appears after the colon.
9. When you are finished, follow the Exit procedure at the end of this section.



**To permit Priority Calls at a telephone:**

Begin with **6. Permissions** on the display, then follow the steps below.

1. Press **Show**. The display changes to **Show Set: \_**
2. Enter the Intercom Number of the telephone you want to check. After the final digit is entered, the display changes to **Full handsfree:**
3. Press **Next** six times. The display shows **Priority call:** with a Y (Yes) or N (No) to show if this feature is permitted.
4. Press **CHANGE** to alter the setting. Another press changes it back again.
5. When you are finished, follow the Exit procedure on the next page.

**To copy Permissions from one telephone to another:**

Begin with **6. Permissions** on the display, then follow the steps below.

1. Press **Show**. The display changes to **Show set: \_**
2. Press **COPY**. The display changes to **Source: \_**
3. Enter the number of the telephone you want to copy. The display changes to **Copy to set: \_**
4. Enter the number of the telephone that is to receive the Permissions. The message **Copied XXX > YYY** (with appropriate set numbers in place of the Xs and Ys) appears for a few seconds on the display to indicate that copying has been successful. After a few seconds, the display changes to **Copy to set: \_**. This allows you to copy the same Permissions to another telephone.
5. When you are finished, follow the Exit procedure below.

**Permissions Exit procedure:****To move to other Administration tasks:**

1. Press **Heading** until the display shows **6. Permissions**
2. Press **Next** or **Back** to move to another heading.

**To Exit from Administration:**



1. Press **Rls**

## Programming Overview of Permissions

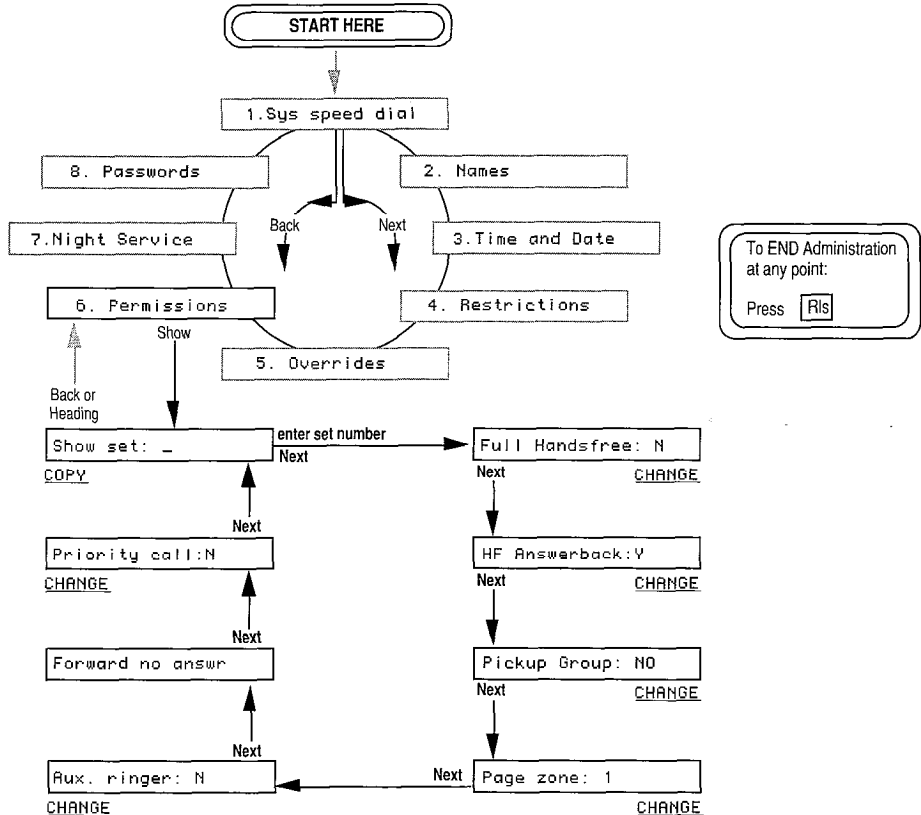
This flow chart is intended to provide a basic outline of Permissions programming. For a more complete view, see the "Flow Charts" chapter of this Guide.

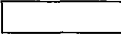

**FLOW CHART CONVENTIONS**

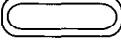
-  - Long square-cornered boxes represent display messages.
-  - Grey shaded boxes represent display messages which are not a part of the described procedures.
-  - Rounded double boxes contain instructions.
- Show, Next, Back, Heading - Programming buttons are labelled on the Norstar Programming Overlay.
- CHANGE COPY OK - Display buttons are labelled on the bottom line of the display when they are active.



## Explanation of Permissions Overview

From the **5. Permissions** heading, press **Show** to reach the **Show set: \_** sub-heading. This is a point to which you will return several times if you are programming a number of telephones. After entering an Intercom Number, you can scroll through the Permissions settings for the specified telephone. Any setting can be changed by pressing **CHANGE** when the setting appears on the display.

All of the permissions for a telephone can be copied to other telephones by returning to the **Show set: \_** sub-heading, pressing the **COPY** display button, and following the prompts which appear on the display.

## Notes on Permissions

When you change any of the settings in the “Permissions” section of Administration programming, you **must** notify your co-workers of any changes. They can then change the button caps on their telephones if necessary, and begin to use the features. Remind your co-workers to use the Button Inquiry feature when changing button caps in order to avoid activating the feature programmed on each button.

**Full Handsfree:** People who want to use Handsfree will probably need a brief demonstration of how it works. Instructions are available in the Feature Operations chapter of this Guide and on the User Cards for the telephones. The following activities are particularly important:

- Placing a Handsfree call
- Receiving a Handsfree call
- Muting the microphone during a call, then turning it ON again
- Changing from Handsfree mode to Receiver mode, then back to Handsfree
- Placing a Handsfree call on hold to answer another call, then returning to the call on hold.

When Handsfree/Mute is assigned to a telephone in Administration programming, a **Handsfree Mute** button appears on the lowest programmable button on the right side of the panel of triangular indicators.

People who wish to use a headset with their telephone need a **Handsfree Mute** button. See “Headset” in the Feature Operations chapter for more details.

**Handsfree Answerback:** People with telephones that have this feature activated may need to be reminded that when they receive a voice call, the microphone on their telephone is turned ON and the caller can hear them.

**Pickup group:** Each telephone can be in only one of Norstar's nine Pickup groups. Calls on private lines cannot usually be picked up on another telephone, even if both telephones are in the same Pickup group. If a group of telephones have the same lines appearing on their telephones, they can answer each other's calls directly. They do not need to be in the same Pickup group and do not need to use the Call Pickup feature.

**Page Zone:** Page reception can be temporarily prevented or interrupted at any telephone by activating Do Not Disturb. A page announcement will also be cut off if a person makes a call, answers a call, or rejoins a call on hold.

**Auxiliary Ringer:** The Auxiliary Ringer is an external ringer, purchased separately and connected to your Norstar system. A customer supplied external ringer must be connected to your system before this feature can function.

The ringer may be driven not only by the telephones you select in Permissions, but also by all calls on certain outside lines. If this causes confusion, contact your Installer or Service Representative and request a change to the configuration of your system.

Inside calls will not cause the Auxiliary Ringer to ring if the telephone which receives the calls is in Do Not Disturb mode.

No call will cause the Auxiliary Ringer to ring if the telephone which receives the call is forwarded to a telephone which cannot drive the Auxiliary Ringer.

For temporary assignment of calls to an Auxiliary Ringer, forward your calls to a telephone that is already programmed to drive the ringer. This redirects all calls from the forwarded telephone, even if they are on lines not normally accessible to the telephone that drives the ringer.

Night Ringing Phones can also be administered to drive the Auxiliary Ringer. You can easily control this in the "Night Service" section of Administration programming.

**Call Forward No Answer:** Norstar will permit a call to be forwarded repeatedly, which could result in a call being forwarded from one phone to another, then back again. At any point, the call can be answered at one telephone or the other. You may wish to use this aspect of the Call Forward No Answer feature to enable two co-workers to answer each other's calls at all times. You may wish to avoid a Call Forward loop, however, if it means that calls will go unanswered.

**Priority Call:** This feature allows you or one of your co-workers to interrupt another person's telephone call, or override the Do Not Disturb setting on a telephone. It should only be permitted where this will be necessary to allow important calls to be answered immediately.

A black rectangular box containing the text "Norstar Administration" in white, sans-serif font. The text is arranged in two lines: "Norstar" on the top line and "Administration" on the bottom line.

Norstar  
Administration

## Notes on Night Service

Night Service can only be turned ON or OFF from the designated Night Control Phone. To make this easier, you can program the feature code **Feature 87** onto a programmable button, and label the button **Night Service**. Instructions for programming features can be found on each telephone's individual User Card, or under "Feature Access" in the Feature Operations chapter of this Guide. Once the feature is programmed, you can activate Night Service by pressing only one button.

In order to have your system's Night Dial Zero Phone work, you must turn Night Service ON at the regular Dial Zero Phone (by pressing **Feature 87** or **Night Service**).

A Prime Phone can be designated as a Night Ringing Phone if you wish. The main reason for doing this would be to enable a Prime Phone to drive the Auxiliary Ringer only when it is in Night Service mode.

When Night Service is active, calls will not ring at the Night Ringing Phone if it is in either Do Not Disturb or Call Forward mode. Do Not Disturb will cause the calls to ring at an appropriate Prime Phone if it does not ring on any other telephones in your system; Call Forward will cause the calls to ring at the specified destination telephone.

## 8. Passwords

### How It Works

Norstar Passwords are an optional feature that can be activated to prevent abuse of your telephone system. The following two types of passwords can be programmed:

- **Administration password:** When activated, this code of six digits or less must be entered before any Administration tasks can be performed. The Administration Password prevents any unauthorized changes to Norstar Administration settings.
- **Restriction passwords:** Your Norstar system supports up to 100 four-digit codes which can be used to override all call Restrictions in your system. When Restriction Passwords are implemented, they are usually provided only to senior executives of the company and others whose jobs require them to make long-distance calls.

Copy your Passwords in a safe place. If you lose the Administration password, you will not be able to access Norstar Administration. There is a section for recording your Passwords in the Job Aids chapter of this Guide, but you may wish to record the passwords elsewhere if this Guide is made available to your entire office.

For security purposes, it is a good idea to change passwords periodically. The procedure for doing this is described in the following pages.

### Passwords Procedures

To make your task easier, use an Overlay found on the last page of this Guide:

Remember to record your changes in the Programming Record or Job Aids chapter of this Guide:

**Entering Administration:**

1. Release all calls on your M7324 or M7310 telephone. Indicators for calls on other telephones stay ON.
2. Enter the following code: **Feature**
3. If the display changes to **Password:** , enter the Administration password. If the proper password is entered, the display changes to **1. Sys speed dial** and three triangular indicators  appear on the LCD panel between the rows of buttons. If no password is required, the **1. Sys speed dial** display and the indicators appear as soon as the Administration code is entered.
4. Place the Overlay over the four buttons pointed to by the indicators.
5. Press the **Back** button. The display changes to **8. Passwords**  You are now at the starting point for each of the following procedures.

**To change the Administration password:**

Begin with **8. Passwords**  on the display, then follow the steps below.

1. Press **Show**. The display shows **Admin. password**
2. Press **CHANGE**. The display shows **New pswd: -**
3. Enter the digits of the new password (maximum six digits) from the dialpad. The display shows the digits.
4. Press **OK** to confirm the new password. The display shows **Re-enter: -** , asking you to re-enter the password.
5. Enter the new password again.
6. Press **OK**. The display shows either **Password changed**  or **Pswd not changed** . If the password is not changed, you will hear an error tone.
7. When you are finished, follow the Exit procedure at the end of this section.
8. **Do not forget** to record the new Administration Password and keep it in a safe but easily remembered place.



**To erase the Administration password:**

Begin with  on the display, then follow the steps below.

1. Press  The display shows
2. Press  The display shows
3. Press  The display shows  for a few seconds, then shows
4. When you are finished, follow the Exit procedure at the end of this section.

**To change a Restriction password:**

Begin with  on the display, then follow the steps below.

1. Press  The display shows
2. Press  The display shows
3. Press  The display shows
4. Enter the two-digit number of the password-you wish to change. The display shows the number you enter followed by the corresponding password.

**OR**

Press  The display shows the lowest numbered password.

5. Press  The programmed password disappears.
6. Enter the new four-digit password from the dialpad.
7. Press  to continue to the next password

**OR**

Follow the Exit procedure at the end of this section.

Nors  
Administrat

**To erase a Restriction password:**

Begin with `8. Passwords` on the display, then follow the steps below.

1. Press `Show` The display shows `Admin. password`
2. Press `Next` The display shows `Restriction pswd`
3. Press `Show` The display shows `Show pswd: _`
4. Enter the two-digit number of the password you wish to erase. The display shows the number you enter, followed by the corresponding password.

**OR**

- Press `Next` The display shows the first password.
5. Press `CHANGE` The programmed password disappears.
6. Press `Next` The password is erased; the display does not change.
7. Press `Next` to continue to the next password in the sequence

**OR**

Follow the Exit procedure below.

**Passwords Exit procedure:****To move to other Administration tasks:**

1. Press `Heading` until the display shows `Restriction pswd`
2. Press `Next` until the display shows `i, Sys speed dial`
3. Press `Next` or `Back` to move to another heading.

**To Exit from Administration:**

1. Press `RLS`

## Programming Overview of Passwords

This flow chart is intended to provide a basic outline of Passwords programming. For a more complete view, see the "Flow Charts" chapter of this Guide.

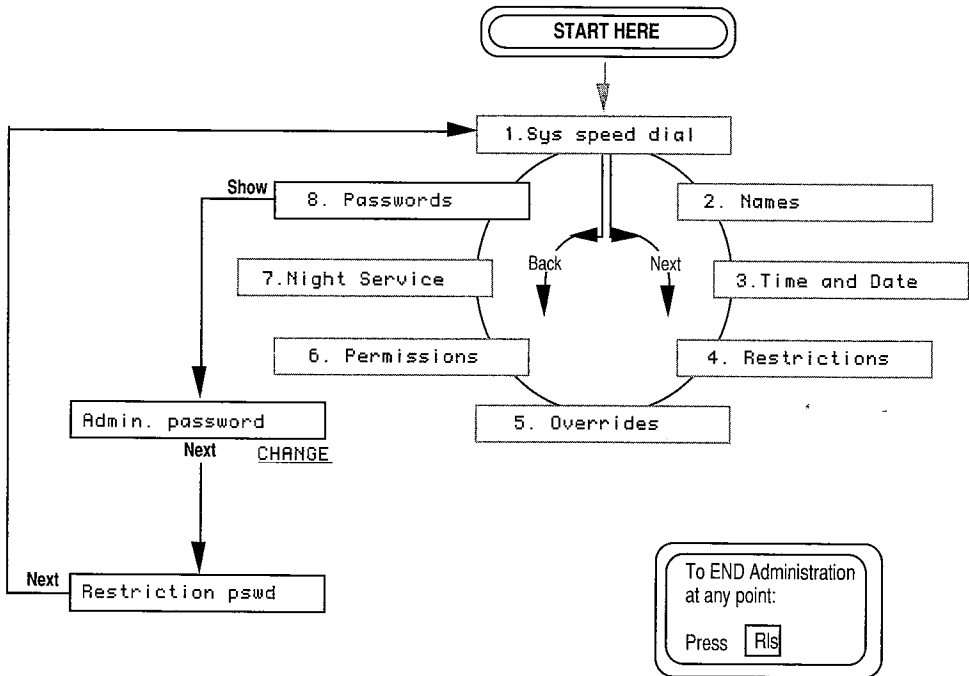

### FLOW CHART CONVENTIONS

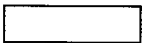

- Long square-cornered boxes represent display messages.

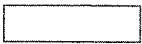

- Grey shaded boxes represent display messages which are not a part of the described procedures.

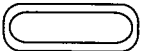

- Rounded double boxes contain instructions.

Show, Next, Back, Heading

- Programming buttons are labelled on the Norstar Programming Overlay.

CHANGE COPY OK

- Display buttons are labelled on the bottom line of the display when they are active.

## Explanation of Passwords Overview

From the **8. Passwords** heading, press **Show** to see the first sub-heading: **Admin. password**. Move between here and the other sub-heading, **Restriction pswd**, by pressing **Back** or **Next** as required.

From the **Admin. password** sub-heading, you can change, create, or erase the Password by pressing the **CHANGE** display button and following the prompts which appear on the display.

From the **Restriction pswd** sub-heading, you can change, create, or erase the Password by pressing **Show**, then the **CHANGE** display button and following the prompts which appear on the display.

## Notes on Passwords

### Administration password

**Be sure to write your password somewhere that is safe and secure. If you lose the password, you cannot enter**

**Administration programming.** In this case, call your Installer or Service Representative for assistance, as he or she can cancel your password or create a new one through Norstar Configuration.

### Restriction password

For security purposes, it is a good idea to change passwords periodically, and inform only those who are entitled to use the password.

See **5. Overrides** for an alternate way to bypass call Restrictions on certain lines or telephones.

The Job Aids chapter of this Guide has an appropriate place for recording your passwords, but you may not want to record your passwords in the Job Aids chapter if this Guide is made accessible to your co-workers. Keep the pages in this Guide blank, and use them as a master copy. Photocopy the pages and fill in the duplicates, which can then be kept in a safe place.

## Keeping your Norstar System up to date

You have now finished programming in Norstar Administration, and should be quite familiar with the necessary procedures. Through Norstar Administration, you can continue to keep your office telephone system running smoothly and efficiently.

Keeping your Norstar Administration settings up to date is even easier than programming the feature settings the first time. Changes only need to be made when your office organization changes, or if you discover that different feature settings would be more advantageous to you and your co-workers.

The following chapters of this Guide should help you and your co-workers learn even more about the various features available with your Norstar Business Communication System.



Norstar  
Administration

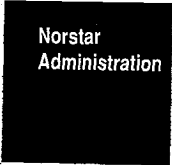

---

# 4 Feature Operations

---

This chapter has been written for you and your co-workers to use as a reference to how Norstar features operate.

Some Norstar features may not be available in your system because of the settings assigned in Norstar Configuration or Administration programming. If a feature is controlled by this programming, there will be a note telling where in Administration or Configuration the settings can be changed. This will help you to know whether you can change the appropriate settings, or whether you must contact your Installer or Service Representative.

The Norstar system has many more features than any telephone could have buttons. You can help your co-workers determine which features they will use frequently and help them program these features onto memory buttons. When the Norstar system is first installed, every telephone will function with pre-programmed (default) features.

Remember while reading this chapter that “set” is another word for a telephone.

Before you begin programming memory buttons, you should be aware of what features are already programmed on your telephone. The steps below explain how to use the Button Inquiry feature to determine what each button is programmed to do.

## To determine which features are already programmed:

1. Press **Feature** **\*** **0**
2. Press any button. The button's function will appear on the display.

## To determine the set number (Intercom number) of a telephone:

1. Press **Feature** **\*** **0**
2. Press **Intercom**  
The Intercom number, set Name, and port number (for the Installer's use only) appear on the display.

---

# Programming Reference Guide

## Checking programmed buttons using Button Inquiry

1. Press **Feature** \* **0**
2. One at a time, press the buttons you wish to check. The display shows the name of the feature programmed on each button.
3. Press **Feature** to cancel the Button Inquiry. You can now continue on and program new features on your telephone buttons.

Activate this feature as you label your telephone buttons. This will prevent accidental activation of the programmed features.

## Programming Outside Autodial Buttons

1. Press **Feature** \* **1**
2. Press the memory button you wish to program.
3. Enter the telephone number from the dialpad.
4. Press the **Hold** button or the **OK** display button (M7310 and M7324 telephones).  
**Key programmed** appears on the display.
5. Label the button with the appropriate name or telephone number.

## Programming Inside Autodial Buttons

1. Press **Feature** \* **2**
2. Press a memory button.
3. Enter the Intercom number.  
**Key programmed** appears on the display.
4. Label the button with the appropriate name or Intercom number.

## Programming Feature Access Buttons

1. Press **Feature** \* **3**
2. Press a memory button.
3. Press **Feature** and the appropriate code.  
**Key programmed** appears on the display.
4. Label the button with the feature name.



### Programming Personal Speed Dial Codes

1. Press **Feature** \* **4**
2. Press the Personal Speed Dial code (71 to 94).
3. Press the phone number to be stored (up to 16 digits).
4. Press the **Hold** button or the **OK** display button (M7310 and M7324 telephones).
5. Record the Personal Speed Dial code and the telephone number on your Personal Speed Dial Card (located on a pull-out tray beneath your telephone) or in an appropriate place near your telephone.

### Setting Ring Type

1. Press **Feature** \* **6**
2. Press **1**, **2**, **3** or **4** or the **NEXT** display button (M7310 and M7324 telephones) to choose a suitable ring type.
3. Press **Hold** (M7208 telephone) or **OK** display button (M7310 and M7324 telephones).  
The display shows **New ring stored**

### Setting Display Contrast

1. Press **Feature** \* **7**
2. Press **1**, **2**, **3** or **4** or use the **UP** and **DOWN** display buttons (M7310 and M7324 telephones) to adjust the contrast to suit the lighting in your workplace.
3. Press the **Hold** button (M7208 telephone) or the **OK** display button (M7310 and M7324 telephones) when you have the correct contrast adjustment.

### Setting Ring Volume

1. Press **Feature** \* **8** **0**
2. Press either end of the Volume Bar repeatedly until you reach the desired volume.

## Autodial Access Signaling

You can store dialed sequences of up to **16 characters** in length on Autodial buttons or in Speed Dial codes. These sequences can include feature codes such as the five listed above. If, for example, you often make calls which require an access code and an account code, these codes can be stored on a memory button to be dialed with a single press. Features for Centrex and similar systems can also be stored on Autodial buttons by storing the Norstar **Link** sequence (**Feature** **7** **1**) followed by the Centrex or other system's feature code.

### To store an Access Signal on an Autodial button:

1. Press **Feature** **\*** **1**  
The display prompts you to **Press a key** (A "key" is the same as a button).
2. Press the memory button you want to program. The display prompts you to **Enter digits** (M7324 and M7310 telephones) or **Program and HOLD** (M7208 telephone).
3. Enter the complete sequence of digits and characters required for the access signal.
4. Press **Hold** or the **OK** display button (M7324 and M7310 telephones). The display shows **Key programmed**

### To store a Pause between two codes (for pulse or tone lines):

1. Follow steps 1 and 2 of "To store an access signal on an autodial button".
2. Enter the first code.
3. Press **Feature** **7** **8** to provide a 1.5 second pause.
4. Enter the second code. This code is stored as three digits in the access sequence (maximum 16 digits).

### To store a Pause between two codes (for pulse lines only):

1. Follow steps 1 and 2 of "To store an access signal on an autodial button".
2. Enter the first code.
3. Press **\*** to provide a 1.5 second pause.
4. Enter the second code. This code is stored as only one digit in the access sequence (maximum 16 digits).

---

## Speed Dial Access Signaling

Access sequences can also be stored in System Speed Dial codes (01-70) or Personal Speed Dial codes (71-94). As with Autodial buttons, Speed Dial codes can store a maximum of **16 characters**. Access codes used by many people on the system are best stored as System Speed Dial entries. Personal Speed Dial is better for storing codes tailored to the needs of individual office workers. See the entries for "Speed Dial—Personal" and "Speed Dial—System" for further information and instructions.

---

## Accidental Disconnect Protection

This feature allows you to retain a call if you accidentally drop the receiver back into the cradle while trying to pick it up. As long as the receiver is picked up within one second of being dropped, the call will remain connected.

This feature does not need to be programmed all Norstar systems support Accidental Disconnect Protection.

### To retrieve your call:

1. Pick up the receiver.

**OR**

Press 

Featur  
Operatio

## Alarm Set

Your Norstar Business Communication System has an Alarm Set which is programmed and turned ON or OFF by your Installer or Service Representative in Configuration programming.

The Alarm Set is used very rarely; it signals you that a problem has occurred with your system. If a problem does arise, the Alarm Set display will show the appropriate alarm message ("Alarm" followed by a number and possibly one or two letters). For example:

`Alarm 52-X-Y`

These number and letters are the Alarm code, which the Installer or Service Representative needs to know in order to determine what has gone wrong.

You and your co-workers do not need to know what each numbered Alarm code means, nor how to assign the Alarm Set. This is handled only by the Installer or Service Representative.

If an Alarm message appears on the Alarm Set's display, **do not panic** and **do not attempt to fix the system yourself**. Follow the instructions below to get assistance.

1. **Record the Alarm number.**
2. Press the `TIME` display button. The display shows the time at which the alarm occurred.
3. **Record the time shown on the display.**
4. Press the `CLEAR` display button.  
The display shows `Alarm cleared`
5. **Call your Installer or Service Representative.** They are able to identify and correct the problems which cause alarm messages. Be sure to notify them of the Alarm number you have recorded.

This feature is controlled by your Installer or Service Representative in the "Miscellaneous" section of Configuration programming.

## Answer Groups

An Answer Group consists of two telephones connected by means of an **Answer** button. This is most useful for a secretary who monitors all incoming calls to a manager's telephone, but is not necessarily responsible for answering all of them.

The **Answer** button is a memory button with an indicator. It is controlled through Norstar Configuration, and appears immediately above the Intercom and **Handsfree** buttons (if programmed) on all telephones.

Once an **Answer** button is assigned to a telephone, features cannot be programmed on that button. If there are not enough buttons on the telephone to represent all the lines assigned to the telephone, **Handsfree** button and **Intercom** lines take precedence over the **Answer** button, but all three take precedence over **Line** buttons and programmable memory buttons.

When an outside or inside call arrives at the manager's telephone, the indicator beside the **Answer** button on the secretary's telephone flashes ON and OFF, and the secretary's telephone may ring. The secretary then has the option of answering the call, or letting the manager respond to it. In most cases, the secretary would answer the call, find out who is calling, and transfer the call to the manager if appropriate.

The **Answer** button on the secretary's telephone stays OFF if a call is on an outside line which is shared between both telephones, if a call is forwarded to the manager's telephone, or if a call arrives at the manager's telephone on a Private Line.

As with other calls, there are two ways to respond to an incoming call which appears on the **Answer** button.

**To answer any ringing call (inside or outside):**

1. Lift the receiver

**OR**

Press the  button.

The call to the manager's telephone is automatically selected if it is the highest priority call ringing at the secretary's telephone. If it is not the highest priority call, you must use the procedures below.

**To answer any call (ringing or not ringing):**

1. Press the  button.  
The system selects a line for the call to appear on.
2. Lift the receiver

**OR**

Press

If more than one call is ringing at the manager's telephone, the first call to ring appears on the secretary's  button. The following calls will appear on the secretary's  buttons if they are available.

**Calls within an Answer Group**

The  button cannot be used to place outgoing calls. Calls from the secretary's telephone to the manager's telephone can be made using a programmed Inside Autodial button. Label the Autodial button with the manager's name, and the  button with "Answer" followed by the manager's name. This creates a distinction between Autodial and  buttons, as well as between  buttons for different telephones in the system.

If a secretary calls the manager or the manager calls the secretary, the call appears on an  button. It does not appear on the secretary's  button.

buttons cannot be linked together to form a chain. For example, if a call appears on an  button at the manager's telephone, it will not appear on the secretary's  button for the manager's telephone.

## Other ways to use Answer Groups

The **Answer** button monitors calls to specified line and Intercom numbers whether or not the telephone to which those numbers are assigned actually exists. By programming lines and telephones to an Answer Group which has no “manager’s” telephone, the “secretary” can expand the number of private inside and outside lines available at the telephone with the **Answer** button.

More than one telephone can have an **Answer** button for one manager’s telephone. This allows two or more secretaries to handle the calls for a busy manager. In a similar way, one secretary can handle the calls for up to four managers, using separate **Answer** buttons for each manager’s telephone.

A small group of co-workers (up to five members) can form an Answer Group, each person having an **Answer** button for each of the other group members. This allows one person to take the calls of any of the others at any time.

## Assigning extra lines to a telephone

If you wish to assign a large number of lines to a telephone within your Norstar system, but do not want to use a large number of Outside Line buttons, you can use the Answer Group feature. This is especially useful for telephones with CAP Modules or for telephones which are used to answer many people’s calls.

Your Installer or Service Representative can configure your system so that an **Answer** button monitors a non-existent telephone. Any lines you want to ring at the telephone with the **Answer** button can be assigned to the non-existent telephone. Calls on those lines can then be answered at the monitoring telephone, and redirected to the appropriate people.

Make sure that a telephone which has an **Answer** button for many other lines also has as many **Intercom** buttons assigned to it as possible. These **Intercom** buttons will be used to answer calls on the monitored lines if the **Answer** button is already in use.

## Answer Groups and Other Norstar Features

Answer Groups work in conjunction with many other Norstar features, and occasionally perform very similar functions. The following descriptions show the differences between Answer Groups and similar Norstar features, as well as the interactions between Answer Groups and other call processing features. All other features work in the same way with a call ringing in an Answer Group as they do with a regular ringing call.

### Autodial buttons

A secretary will almost certainly have an Inside Autodial button for the manager. In normal functioning (without the Answer Group feature), the Autodial button may or may not monitor the busy/not busy status of the manager's telephone. The secretary using the **Answer** button must know whether or not the manager's telephone is busy in order to efficiently deal with incoming calls. For this reason, the Answer Group feature allows the busy/not busy status of the manager's telephone to be monitored in all situations, provided that the secretary's telephone has a memory button **with an indicator** programmed as the Inside Autodial button for the manager's telephone.

### Call Forward

If the secretary's telephone is forwarded, all calls including calls ringing at the **Answer** button are forwarded to the destination telephone. If the **Answer** button is not programmed to ring, however, calls arriving at the **Answer** button will not be forwarded.

If the manager's telephone is forwarded to a telephone outside the Answer Group, the **Answer** button will show all incoming calls as if the manager's telephone were not forwarded.

### Callback

Call Park Callback and Transfer Callback are both directed to a particular telephone within the system: more specifically, to the telephone which attempted the Call Park or Transfer. If Callback occurs at the manager's set, it does not appear on the secretary's **Answer** button. When the manager answers the call, the indicator beside the Inside Autodial button on the secretary's telephone appears beside the button.



**Do Not Disturb**

If the secretary's telephone is in Do Not Disturb mode, calls which normally ring at the **Answer** button will not ring, but the indicator beside the button will flash to show that a call is arriving at the manager's telephone.

If the manager's telephone is in Do Not Disturb mode, calls arriving at it still ring on the secretary's **Answer** button. If the secretary wishes to transfer a call to the manager, a normal Intercom call or Transfer will not work. In order to transfer the call, the secretary must first place it on Hold or use the Call Park feature. Then, in order to contact the manager, the secretary must use the Priority Call or Page features, or contact the manager personally. The manager can then either turn Do Not Disturb OFF, or retrieve the call from a held or parked state.

**Priority Call**

If a telephone outside the Answer Group attempts to use the - Priority Call feature to contact the Answer Group, the call will take effect at the manager's telephone. The call does not appear on the secretary's **Answer** button.

**Ring Again**

If the manager turns Ring Again ON, the secretary's telephone is not notified when the Ring Again offer is made to the manager's telephone.

**Voice Call**

If a telephone outside the Answer Group attempts to make a Voice Call to the manager, and is successful, the call does not appear on the secretary's **Answer** button. If the Voice Call is unsuccessful, and arrives at the manager's telephone as a regular ringing call, the call appears on the secretary's **Answer** button.

Answer Groups are assigned by your Installer or Service Representative in the "Line Access" section of Configuration programming.

## Autodial

The Autodial feature allows anyone to program buttons on their Norstar telephones for one-touch dialing of outside numbers, Intercom numbers, or feature codes. Autodial telephone numbers are described in the following pages. For details on programming Autodial buttons with feature codes, refer to Feature Access.

### Inside Autodial

For one-button access to frequently-dialed Intercom numbers within the Norstar system, use the Inside Autodial feature. Be sure that your co-workers know how to program Inside Autodial numbers, as they will probably have to change them from time to time.

Inside Autodial buttons can be programmed to dial any Intercom numbers within your Norstar system, with the exception of "0", which calls the Dial Zero Phone.

With the Central Answering Position, composed of an M7324 telephone and one or two CAP Modules, Inside Autodial buttons function in the same way as the Busy Lamp Field on an M7310 telephone. The indicators on the LCD panel indicate whether or not the telephone associated with a Autodial button is active on a call. For further details, see the "Busy Lamp Field" and "Central Answering Position" sections of this chapter.

#### To program Inside Autodial numbers:

1. Press **Feature** \* **2**. The display shows **Press a key**
2. Press a memory button. The display shows **Intercom #: -**  
On the M7310 telephone, remember to press the shift button to program into the top half of a dual memory button.
3. Enter the Intercom code to be stored. The display shows **Key programmed**
4. Label the memory button.

#### To use Inside Autodial:

1. Press an Inside Autodial button to make a call to a selected inside number. The system selects a free inside line, then places the call.

#### OR

Press an Inside Autodial button while connected to another call. The first call is held automatically and the new call is started.

## Default Dual Memory Buttons

The M7310 telephone has 12 dual memory buttons which can be programmed for access to features or Autodial numbers. By using the Shift button with the dual memory buttons, you can program up to 24 features or Autodial numbers. These buttons are located above the M7310 telephone's display, as shown on the photograph below.

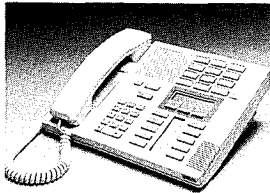

## The M7310 Telephone

Dual memory buttons (on the M7310 telephone only) are pre-programmed as Inside Autodial numbers corresponding to the various telephones in the Norstar system. The default arrangement of the Inside Autodial buttons is shown below. The diagram shows the defaults for a system with three-digit Intercom numbers. Norstar systems can have two, three, or four-digit Intercom numbers; the choice is controlled by your Installer or Service Representative in the "Change DNs" section of Configuration programming.

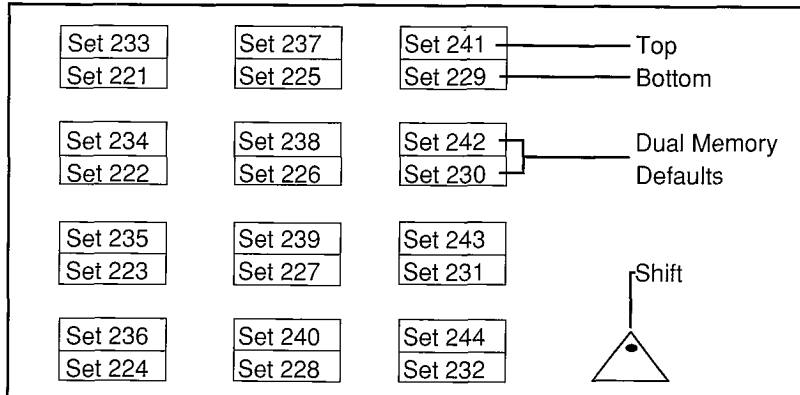

Default Dual Memory Buttons

Featu  
Operation

**Dual Memory Buttons** are pre-set, in the three-digit system, to dial the Intercom numbers shown above, even if there are not enough telephones in the system to match each of the numbers.

No telephone can have an Intercom button to dial its own number. Therefore, each telephone that has a number which would normally appear as a default setting has a blank button in place of its own number on the chart above.

If you move an Inside Autodial number from one button to another, it will automatically be erased from its former location. If this happens, the message **Feature moved** appears on the display to let you know that the move has been successful.

### Outside Autodial

For one-button access to frequently dialed numbers outside your office, use the Outside Autodial feature. You can store an outside number on any memory button.

Autodial numbers are subject to Call Restrictions and Overrides. If the power is OFF for more than three days, Autodial numbers may be lost.

### To program Outside Autodial numbers:

#### M7310 and M7324 Telephones

1. Press **Feature** \* **1** The display shows **Press a key**
2. Press a memory button. The display shows **Enter digits**  
On the M7310 telephone, remember to use the shift button to program the top of a dual-memory button.
3. Dial the telephone number to be stored.
4. Press the **Hold** or **OK** button.  
The display shows **Key programmed**
5. Label the memory button.

#### M7208 Telephone

1. Press **Feature** \* **1** The display shows **Press a key**
2. Press a memory button. The display shows **Program and HOLD**
3. Dial the telephone number to be stored.
4. Press **Hold** button. The display shows **Key programmed**
5. Label the memory button.

**To use Outside Autodial:****With Prime Line Select Feature**

1. Press an outside Autodial button.  
Your call will be dialed on the your telephone's Prime Line if it is free  
**OR**  
If your Prime Line is busy, you must first manually select a free line.

**Without Prime Line Select Feature**

1. Select an outside line manually or use
2. Press the Autodial button.  
The stored number is dialed on the selected line.

**Prime Line Selection**

If your telephone has Prime Line selection, Autodial selects that line, pauses for two seconds and then dials the stored sequence. If your telephone has no prime line selection, you are prompted to

Autodial feature is available to all telephones in your Norstar system. Prime Lines are assigned by your Installer or Service Representative in the "Line Access" section of Configuration.

Featu  
Operatio

**Automatic Line Selection****Incoming Calls**

When more than one call begins to ring at your telephone at the same time, your telephone automatically selects one call when you lift the receiver or press the  button. Calls are answered in the following order:

- calls on your Prime Line (if you have one)
- calls on outside lines
- calls on inside lines.

If there is more than one call on any one type of line, the call which has been ringing the longest is answered first.

**To override automatic line selection:**

1. Press the line button of the call you want to answer.
2. Pick up the receiver.

**OR**Press

## Outgoing Calls

### If your telephone has a Prime Line

1. Lift the receiver.

**OR**

Press

The Prime Line is selected for your call.

2. Make a call.

### If the Prime Line is in use

1. Select a line manually or use the Line Pool.
2. Lift the receiver.

**OR**

Press

3. Make a call.

## Automatic Phone Relocation

If Automatic Phone Relocation is turned ON in Configuration programming, you can move your telephone to a new location within the Norstar system without losing the settings you have programmed. The Intercom number, Autodial settings, Personal Speed Dial codes and features programmed on your memory buttons remain with your telephone when it is unplugged. To move a telephone, simply unplug it from one location, and plug it in again at another. Norstar will retain the information programmed into the telephone set. If you plug a **new** telephone into the Norstar system before you reconnect the old telephone at a new location, Norstar will assign your old telephone's information to the new telephone, and your old telephone will no longer be recognized by the system. Relocate all the telephones you wish to move **before** you add new telephones. This will allow the telephones you are moving to retain their programmed settings.

If the telephone you are replacing is of a different type and has more buttons than your new telephone, automatic outgoing line selection (See "Lines" in this chapter) may not work with the Handsfree/Mute feature. You may have to select a line manually.

This feature is controlled by your Installer or Service Representative in the "Miscellaneous" section of Configuration programming. If you wish to have your telephone's set number changed when you relocate, see your Installer or Service Representative.

## Auxiliary Ringer

An Auxiliary Ringer is a loud ringer device that allows you to hear your telephone ring when you are not within hearing distance of the actual telephone set. This device must be purchased separately and properly installed before it can be used with your Norstar system.

Calls on specific lines or to specific telephones may ring at an Auxiliary Ringer if one has been installed for your office. Night Ringing Phones can also be programmed to ring the Auxiliary Ringer.

A telephone programmed to ring at the Auxiliary Ringer can receive Voice Calls, but the Auxiliary Ringer will not be activated. The Auxiliary Ringer will not ring for inside calls if the telephone that drives it is in Do Not Disturb or is forwarded to a telephone which does not drive the Auxiliary Ringer.

This feature is controlled in the "Permissions" and "Night Service" sections of Administration and by your Installer in the "Line Data" section of Configuration programming.

Featur  
Operatio

## Background Music/Radio

You can listen to music or the radio through your telephone speaker if an external sound source is connected to the KSU. The music automatically stops when you make or answer a call. Adjust the level of the music with the Volume button.

### To turn Background Music ON:

1. Press the **Music** button.

**OR**

Press **Feature** **8** **6**

You will hear music through your telephone speaker.

### To cancel Background Music:

1. Press the **Music** button again.

**OR**

Press **Feature** **#** **8** **6**

The background music is cancelled.

This feature is controlled by your Installer in the "Miscellaneous" section of Configuration programming.

## Busy Lamp Field

The Busy Lamp Field (BLF) is an add-on device for the Norstar M7310 telephone that displays the busy/not busy and Do Not Disturb status of other Norstar telephones. It is particularly useful for a secretary or receptionist who is responsible for connecting calls to a number of other telephones.

The BLF replaces the regular M7310 telephone base and has a display that is mounted above and behind the dual memory buttons as shown in the photo below:

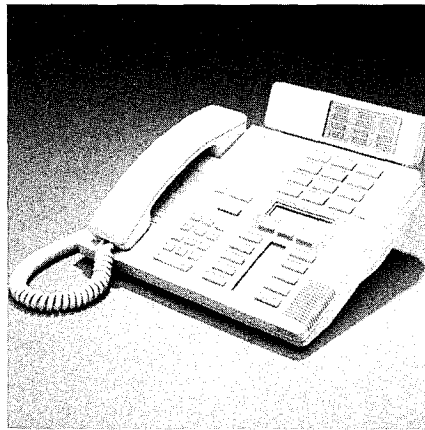

The Busy Lamp Field mounted on an M7310 Telephone

### How the Busy Lamp Field works

There are two states: ON (which indicates a telephone which occupied) and OFF (which indicates a telephone which is free to receive a call).

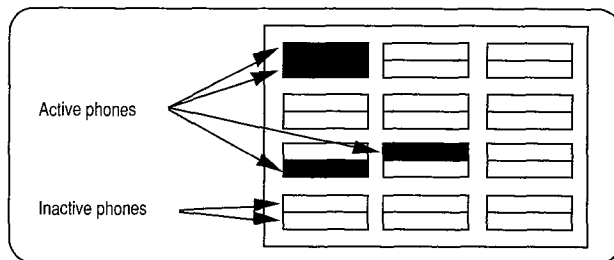



If a telephone's BLF indicator is active, the telephone may be connected on an inside or outside call, or be in Do Not Disturb mode, or be active in Norstar Administration. Calls on hold appear as idle lines on the BLF.

The 12 dual boxes on the BLF correspond to the 12 dual memory buttons on the telephone, which means that the BLF can monitor up to 24 telephones. All telephones that are to be monitored on the BLF must be programmed for Inside Autodial on one of the dual memory buttons of the telephone to which the BLF is attached. Either the top or bottom of a button may be used for this purpose. When a telephone is active on a call, the appropriate half of a BLF indicator will appear dark.

The Central Answering Position (CAP) also monitors the busy/not busy status of calls on Norstar telephones. A CAP Module must be connected to an M7324 telephone in order to monitor calls on the module's 48 Inside Autodial buttons. For further information, see the "Central Answering Position" section of this chapter.

## Button Inquiry

You can check the function of each **Line** , **Intercom** and memory button on your Norstar telephone. This is a very important feature, as it allows you to know what is currently programmed on a button before you attempt to reprogram the button's function.

When installing memory button labels, activate Button Inquiry so that the action of pressing the labels into place does not activate the feature programmed onto the button.

### Button Inquiry can not be used while you are on a call.

Incoming calls to your telephone will ring, and you can answer them by lifting your receiver. This turns the Button Inquiry feature OFF.

### To use Button Inquiry:

1. Press **Feature** \* **0** The display shows **Press any key**
2. Press a button you want to check.
3. Read the display.
4. Repeat Steps 2 and 3 as often as necessary.

### To return to normal operation:

1. Press **Feature**  
**OR**  
 Press the **EXIT** display button (M7324 and M7310 telephones only)  
**OR**  
 Press **Rls**

Press this button:	The display reads:
Intercom button	<Intercom code for your telephone> <name given to your telephone> P <port number> (for Installer)
Outside line button	<two-digit line number> <line name>
Handsfree/Mute	<b>H a n d s f r e e / M u t e</b>
Inside Autodial button Outside Autodial button	<b>A u t o d i a l</b> <name or Intercom number> <the outside telephone number>
Memory button	<the programmed feature name>
Line Pool button	<b>L i n e P o o l</b> <access code>

## Call Duration Timer

You can measure the duration of telephone calls for your records. The approximate length of time that the most recent call was connected, or the approximate time the current call has been connected, is displayed when requested.

Call Duration Timer begins to time a call on an outside line 10 seconds after the line is selected, whether or not the call is connected. On an inside line, timing begins only once the connection between telephones has been made.

Call Duration Timer also works for Voice Calls; if you receive a Voice Call, the time displayed when you use the Call Duration Timer feature is for your last call, whether that was a Voice Call or a regular ringing call.

### To measure the length of calls:

1. Press the **Timer** button.

**OR**

Press **Feature** **7** **7**

You can see the approximate length of the current or most recent call. The length is shown in hours, minutes and seconds. The time is displayed for a few seconds.

**Note:** The Call Duration Timer feature does not work for calls which are active while you are setting your system's clock.

Featu  
Operati

## Call Forward (All Calls)

If you wish to have another person answer your calls or want to answer your calls at another location, forward your calls to another telephone. Any inside or outside calls can then be directed to that telephone. If calls come to your telephone on outside lines that do not appear on the telephone to which your calls are forwarded, the calls will still go through using Intercom lines.

When Call Forward is used, the line indicators ► flash for incoming calls. Although the call has been forwarded to another telephone, you can still answer it by pressing the flashing line indicator. You can also continue to make outgoing calls while Call Forward is active.

### To use Call Forward:

1. Press the **Call Fwd** button.

**OR**

Press **Feature** **4**

**Forward to:** appears on the display.

2. Dial the Intercom number of the telephone to which the calls will be sent.

**OR**

Press the Inside Autodial button for the telephone to which the calls are sent.

When forwarding is in use, the display shows

**Forward>** **<name>** where **<name>** can be a

programmed name or the set number. The **>** symbol indicates that the call is being transferred to the specified telephone.

### To cancel Call Forward:

1. Press the **Call Fwd** button again.

**OR**

Press **Feature** **#** **4**

**OR**

Press **CANCEL** (M7324 and M7310 telephones only).

The display shows **Cancel Forward** for a few seconds, then returns to the current time and date display.

## Call Forward (No Answer)

Call Forward (No Answer) forwards all unanswered calls arriving at one telephone to another specified telephone. The destination telephone is controlled in Norstar Administration programming, as is the number of rings required before the call is forwarded.

If you are often absent from your desk, you may wish to have Call Forward (No Answer) assigned to your telephone, so that all inside and outside calls which you are unable to answer can be answered by an assigned co-worker.

Call Forward (No Answer) strongly resembles Norstar's Delayed Ring Transfer feature. The differences between these features are two: where Delayed Ring Transfer forwards all calls on a specific line, Call Forward (No Answer) forwards all calls arriving at a specific telephone, regardless of what line the call is on; and where Delayed Ring Transfer is turned ON or OFF for your entire system, Call Forward (No Answer) is controlled individually for each telephone.

When you telephone forwards a call using the Call Forward (No Answer) feature, the telephone which receives the call shows the display message `<name> > <name>` where the first `<name>` is the programmed name (or default number) of the line which the incoming call is on or the Norstar telephone which originated the call, and the second `<name>` is the programmed name or Intercom number of the telephone which forwarded the call.

If the call was originally placed at a telephone within your system, the display at that telephone shows the message `<name> > <name>` where the first `<name>` is the programmed name or Intercom number of the telephone which is being called, and the second `<name>` is the programmed name or Intercom number of the telephone to which the call is being forwarded.

Call Forward (No Answer) is turned ON or OFF, and the Forward Delay is set, in the "Permissions" section of Administration programming.

---

## Call Forward Override

If calls have been forwarded to your telephone, you can override Call Forward and call the forwarding party in the normal manner. This is useful when you have an important call for the person, or if you want to ask that forwarding be cancelled.

This feature is available at all telephones in your Norstar system to which another telephone's calls have been forwarded. Only the telephone to which the calls are forwarded call use the Call Forward Override feature.

Call Forward Override is sometimes called 'secretarial filtering'. If, for example, your manager places his or her telephone on Call Forward to the receptionist, all inside or outside calls to the manager will go to the receptionist's telephone. If the receptionist wants to contact the manager for any reason—for example, if a visitor has arrived—dialing the manager's Intercom number from the receptionist's telephone will override the Call Forward feature, and the call will go through. The manager can be called by either pressing the correct Autodial button, or dialing the manager's Intercom number.

Feature  
Operations

---

## Call Identification

Your telephone display shows the name or telephone number of the person you are talking to on all inside calls. When making an inside call, the display shows whether the telephone being called is busy, on another call, or is using Do Not Disturb or Call Forward.

Call Identification displays appear even if you are active on a call. When a new inside or outside call comes into your telephone, the display shows the Call Identification message for a few seconds before returning to the display message associated with your active call. Call Identification messages will not overwrite feature prompts.

When you make an outside call, the display shows the dialed number. When an outside call arrives at your telephone while you are busy on another call, the display shows the name or number of the line which the call is on. If your telephone is idle when an outside call arrives at your telephone, the display will not change.

For example, an incoming Intercom call from "Room 56" would appear on the display as shown below. The example shows the display of an M7324 or an M7310 telephone; on an M7208 telephone, the message is the same. ROOM 56 calling

## Call Park

Call Park is like Hold, except that it allows a parked call to be retrieved from any telephone within your Norstar system by means of a Retrieve Park code (101-109). When you park a call, your system assigns the Retrieve Park code, and the message **Parked on 10X** (where X is a number between 1 and 9) appears on your telephone display. You can then inform your co-workers of the Retrieve Park code so that the appropriate person responds to the call.

When you park a call, a **PAGE** display button appears in order to make paging easier and an **EXIT** display button appears in case you do not wish to use the Page feature. These buttons stay active until one of them is pressed, until the parked call is retrieved, or until the person who parked the call performs another activity on the telephone.

If a parked call is not retrieved after a specified amount of time, Callback occurs at the telephone which parked the call. For a busy office, this is more advantageous than the Hold feature, as it is an automatic reminder of calls which have been waiting for a long time. For more information, see the "Call Park Callback" section of this chapter.

If a outside call is parked, the indicator beside the line flashes ON and OFF, and the call can be retrieved using the Retrieve Park code on an Intercom line, or by pressing the line button on any telephone which has a button for that line. If an inside call is parked, the Intercom button becomes idle, in order to allow that Intercom button to be used for another call.

You cannot park a call which you have placed on Hold. In order to park the call, you must first reconnect yourself to it, and then activate the Call Park feature.

**Conference Calls cannot be parked.** In order to transfer a Conference Call using Call Park; split the Conference, park both parties, and inform your co-worker of your action. When the calls are retrieved, the Conference Call can be re-established.

**To park a call:**

1. Answer an incoming call and determine that the call should be parked.
2. Press the **Call Park** button

**OR**Press **Feature** **7** **4**

The display shows the Retrieve Park code:

**Parked on: 10x** where x is a digit between 1 and9. A **PAGE** display button appears on M7324 and M7310 telephones.

3. Record the code.
4. Use the Page feature ( **PAGE** or **Feature** **6** **0** ) to inform your co-workers of the Retrieve Park code and announce whom the call is for.

**To retrieve a parked call:**

1. When the Page announcement is aired, record the Retrieve Park code.
2. Lift the telephone receiver.
3. Select an Intercom line in order to hear an inside dial tone.
4. Press the digits of the Retrieve Park code on the dialpad, for example: **1** **0** **1**  
You are then connected to your call.

Feature  
Operations**Call Park Callback**

Callback to your telephone occurs if you have used the Call Park features and the call is not retrieved. After a specified time, the outside call returns to your telephone. Callback is a convenient feature for receptionists, as it allows them to take messages from outside callers. Callback does not occur with inside calls.

If the caller hangs up, Callback may still occur. When you answer the Callback call, you will hear a dial tone.

Callback occurs only at the telephone that parked the call. If the call came in on an outside line, the Callback call rings on that line if it is assigned to the telephone; otherwise, the call rings on an Intercom line. If no free line is available, the Callback call is transferred to the Prime Phone.



On a system that has a Prime Phone and Delayed Ring Transfer activated, a Callback call will be directed to the Prime Phone after three rings if the original telephone does not answer. If a Callback line is not answered at the Prime Phone within three minutes, the outside call is disconnected.

Because a Callback call is no longer in the "parked" state, it cannot be answered using the Retrieve Park code. It can only be answered at the telephone which originally parked the call.

Call Pickup, Call Forward, and the Auxiliary Ringer operate normally in relation to calls which activate the Callback feature. Do Not Disturb cancels the ringing for a Callback call, but not the flashing of the indicator.

Callback cannot occur at a telephone that is initializing your system, or is in an Administration, Configuration, or Maintenance session.

**To reconnect with your original caller (M7324 and M7310 telephones):**

1. Press the **CALLBACK** display button

**OR**

Press the line button which the call is on.

You are connected with the call you originally parked.

If you have parked more than one call, pressing

**CALLBACK** will connect you with the call which has been waiting to be answered for the longest period of time.

**To reconnect with your original caller (M7208 telephone):**

On the M7208 telephone, a call arriving at your telephone through the Callback feature will appear as a regular ringing call.

The amount of time before a Call Park Callback occurs is programmed by your Installer or Service Representative in the "Call Handling" section of Configuration programming.

## Call Pickup (Directed)

Call Pickup (Directed) enables you to answer any telephone which is ringing in your Norstar system by specifying that telephone's Intercom number. This allows calls to be answered at any telephone, regardless of its Pickup Group assignment.

In order for a call to be picked up, it must be ringing at a telephone. If, for example, the auxiliary ringer is ringing, but the call is not programmed to ring at a telephone, the call cannot be answered using Call Pickup. It must be answered at the telephone with a flashing indicator or using the Trunk Answer feature.

If a call is ringing in an Answer Group, Call Pickup (Directed) can be used to answer the call; entering either the secretary's Intercom number or the manager's Intercom number will connect you to the call.

Feature  
Operations

### To use Call Pickup (Directed):

1. Press

**OR**

Press a programmed  button.

The display shows

2. Enter the Intercom number of the telephone which is ringing

**OR**

Press the Inside Autodial button for the telephone which is ringing.

You are immediately connected to that call.

If you decide not to answer a ringing call once you have activated Call Pickup (Directed), you can cancel the feature by pressing  instead of entering an Intercom number or pressing an Inside Autodial button.

This feature is controlled by your Installer or Service Representative in the "Call Handling" section of Configuration programming.

## Call Pickup (Group)

Pickup Groups ensure that calls are answered by the most appropriate people when someone is out of the office.

Any member of a Pickup group can answer an inside or outside call ringing at another telephone in the group. Your office can have up to nine Pickup groups.

Call Pickup is used to connect with an outside call coming in on a line which does not ring at your telephone. If you attempt to use Call Pickup on a call which is ringing at your telephone, the display will show **Pickup denied** and an error tone will sound.

In order for you to pick up a call, it must be on a line which is programmed to ring at another telephone in your system (this is done by the Installer in Norstar Configuration). Call Pickup cannot be used to access Private Lines.

### To use Call Pickup (Group):

1. Press the **Pick-up** button.

**OR**

Press **Feature** **7** **5**

The highest priority call ringing in the group is answered. Priority is as follows:

- Prime Line (if applicable)
- outside line
- inside line.

The picked up call appears on the indicator beside a line or Intercom button.

You can pick up more than one call without losing your first call:

### To pick up a second call

1. Press the **Pick-up** button.

**OR**

Press **Feature** **7** **5**

This feature is controlled in the "Permissions" section of Administration programming.

---

## Call Restrictions and Overrides

### Restrictions

Call Restrictions are used to prohibit certain phone numbers, area codes, or types of calls from being used on the Norstar system. These Restrictions can be applied to specific telephones or telephone lines through Administration programming.

The maximum length of a Restriction sequence is **eight characters**. The maximum number of Restrictions allowed in any Norstar system is **30**.

A call can be prevented by a Restriction placed on either the line or the telephone set being used. Restrictions applied to a telephone set affect calls from that telephone set on any line. Restrictions applied to a line affect calls on that line from any telephone set.

### Overrides

An Override is a programmed sequence of digits that bypass an active Restriction. This enables selected lines and telephones to make calls that would otherwise be prevented by Norstar system Administration.

The maximum length of an Override sequence is **14 characters**. The maximum number of Overrides in any Norstar system is **ten**.

Overrides applied to a telephone set permit calls on any line from that telephone set, except where specific Line Restrictions apply. Similarly, Overrides applied to a line permit calls on that line from any telephone set, except where specific Set Restrictions apply.

For another method of overriding Restrictions, see the "Restriction Passwords" section of this chapter.

Restrictions and Overrides are programmed and applied to telephones and lines in the "Restrictions" and "Overrides" sections of Administration programming. For further information, see the "Restrictions" and "Overrides" sections of the Administration chapter of this Guide.

## Central Answering Position

The Central Answering Position (CAP) consists of one or two Norstar CAP Modules connected to a Norstar M7324 telephone.

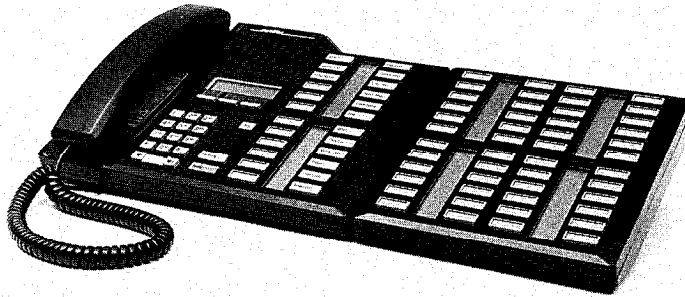

### The Central Answering Position

The CAP Module displays the busy/not busy and Do Not Disturb status of the telephones in your system by using the triangular ► indicators beside Inside Autodial buttons. Buttons on a CAP Module can only be programmed as Inside Autodial buttons. They cannot be programmed as Outside Autodial or feature buttons.

The triangular indicator beside an Inside Autodial button on a CAP Module ► is ON or OFF, depending upon the status of the Norstar telephone which is associated with the Inside Autodial button.

#### The indicator is ON

When the telephone is active on an inside or outside line

**OR**

When a call at the telephone has been put on Hold by another person

**OR**

When the telephone is using the Do Not Disturb feature.

#### The indicator is OFF

When the telephone is idle

**OR**

When the telephone is ringing

**OR**

When the telephone has one or more calls on Hold, but is not connected to any active calls.

If you dial the Intercom number of a telephone, instead of using an existing Inside Autodial button, the indicator beside the button on the CAP Module will still turn ON. If no Inside Autodial button is programmed for an Intercom number, the status of that telephone is not monitored by the CAP Module.

### Default settings

When a CAP Module is first plugged into your system each button is preset to automatically dial an Intercom (inside) number.

Your telephone system may have two, three, or four digit Intercom numbers, which are controlled by your Installer in Configuration programming. The CAP Module recognizes which system it is being plugged into, and assigns pre-determined (default) values for the Inside Autodial buttons accordingly.

The diagram below shows the three-digit system which ranges from 221 to 268 and 269 to 316; a two-digit system ranges from 21 to 68 and 69 to 99 (the remainder of the buttons will be blank); a four digit system ranges from 2221 to 2268 and 2269 to 2316.

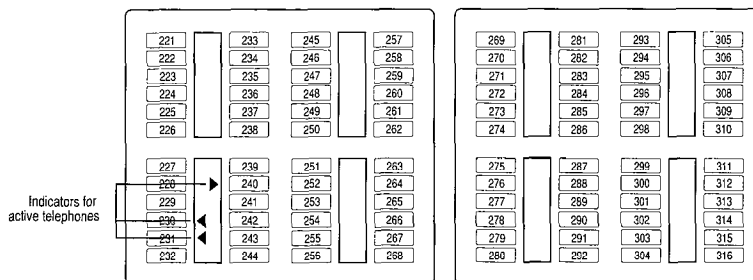

If an Inside Autodial number is already programmed on your M7324 telephone or on another CAP Module attached to the telephone, it will still appear in its default position. If an Autodial number is not assigned to a telephone within your system, it may still appear on a CAP Module. If you press this button, the telephone display will show the message `Not in service`

Your Autodial number may be pre-programmed on a CAP Module. If you press this button, the telephone display shows `Your number`

If you wish to have a CAP Module (or a second CAP Module) added to your M7324 telephone, contact your Installer or Service Representative.

## Centrex Features

If your system is located behind a Centrex system, Meridian Norstar offers you convenient access to Centrex features that require extra signals from the dialpad. Codes for Link, Long Tones, Pause, Run/Stop and Timed Release are provided below. These codes, along with other digits required by your Centrex, can be programmed onto Autodial buttons or placed in Speed Dial so that you can activate special features with a minimum number of button presses.

The basic Centrex feature codes are as follows:

<b>Link</b>	Feature	7	1	
<b>Long Tones:</b>	Feature	8	0	8
<b>Pause:</b>	Feature	7	8	
<b>Run/Stop:</b>	Feature	*	9	
<b>Timed Release:</b>	Feature	7	2	

If your outside lines are programmed for pulse dialing, pressing **#** allows you to switch from pulse to tone dialing. When you hang-up, your telephone returns to pulse dialing.

Further information about Link, Long Tones, Pause, Run/Stop, and Timed Release is provided in this chapter under separate entries for each feature.

See also **Access Signaling** for information about using Meridian Norstar telephones to contact remote devices and gain access to alternate telephone carriers.

## Autodial Centrex Features

Program an Autodial button on your telephone to activate a Centrex feature with one press. For example, if you must press Link to activate your Centrex transfer feature, follow the steps below to create an Autodial Link button.

### To program an Autodial Centrex feature button:

1. Press **Feature** **\*** **1**
2. Press the memory button on which you want to store the feature.
3. Press the desired Centrex feature code, for example, **Feature** **7** **1** to store a Link signal.
4. Label the button **Link**

Features for Centrex and similar systems can also be stored on Autodial buttons by storing the Norstar **Link** sequence (**Feature** **7** **1**) followed by the Centrex or other system's feature code.

You can also store an extension number to which you frequently transfer calls, such as the main reception desk after the Link signal on an Autodial button. This will give you a one step Centrex **Transfer** button.

### Speed Dial Centrex Features

Centrex features, with or without additional dialed characters, can be stored in System Speed Dial codes (01-70) or Personal Speed Dial codes (71-94). As with Autodial buttons, Speed Dial codes can store a maximum of **16 characters** (including a single character ("F") for each press of the **Feature** button). Centrex features that are used by many people on the system are appropriate for System Speed Dial entries. Personal Speed Dial is better for storing features that are tailored to individual requirements. For example, a person who regularly places his or her telephone in Call Forward to a particular telephone in the Centrex system could program one Speed Dial code to dial the Centrex Link and Call Forward codes and the extension number of the other telephone.



## Conference/Transfer

Conference/Transfer establishes a three-party conference between two calls at your telephone. This feature allows you to make or answer a call and set up a conference with a new or existing call.

Establish each call individually before using the Conference feature. If the second call is busy or there is no answer, disconnect the line by pressing **[Ris]**. This will not disconnect the original call.

When a three-way conference call is established, the display on one Norstar telephone connected to the call shows both other parties in the call. An outside call appears as the number of the line it is on; an inside call appears as the Intercom number or programmed name of the telephone.

### To establish a Conference call:

1. Make or answer the first call.
2. Put the call on hold. This can be done automatically (by pressing another **[Line]** or **[Intercom]** button) or manually (by pressing **[Hold]** ).
3. Dial the second call.

**OR**

Press the line button of an existing held call.

4. When the second call is connected, press **[Conf/Trans]**

**OR**

Press **[Feature]** **[3]**

The display shows **[Press held line]**

5. Press the line button of the first held call to establish a conference. The temporary message **[Conference call]** appears on the display. The display then changes to **[<name> <name>]** where the first **<name>** represents the first call, and the second **<name>** the second call.

### To establish a Conference call using Inside Autodial:

1. Make or answer the first call.
2. Press an Inside Autodial button.
3. Follow steps 3 through 5 above.

## Conference Operations

Once a conference is connected, several operations can be used:

- Consultation
- Split a Conference
- Disconnect one party
- Transfer from a Conference
- Independently Hold two calls

## Consultation

Consultation allows you to put a Conference call on hold while you consult with someone in your office or on another line.

1. To consult with an outside party while connected on a Conference call, press another **[Line]** or **[Intercom]** button to make or answer a call.

The Conference call is put on hold automatically.

### OR

Press **[Hold]** The conference call is put on Hold and you are free to make or answer a call, or to consult with someone in your office.

**The two other parties will still be able to confer.**

2. To reconnect to the conference, press either of the held line buttons.

## Disconnect one party

This method of using Conference/Transfer allows you to disconnect one of the parties from the Conference Call and remain connected with the other:

1. Press the **[Line]** or **[Intercom]** button of the call that you wish to disconnect.
2. The other party is automatically placed on hold.
3. Press **[Rls]** to disconnect.
4. Press the held line button to return to the first party.

## Independently Hold two calls

Another way to Hold a conference Call is to use both the Split and Consultation forms of Holding the call. This will place the two parties on Hold independently (unable to consult with one another).

### To put the two parties on Hold independently:

1. Press the **[Line]** or **[Intercom]** button of one party. The other party is automatically placed on hold.
2. Press **[Hold]** The second party is placed on Hold. **The two parties are unable to consult with one another.**

**To re-join the conference call:**

1. Press the **Line** or **Intercom** button of one held call.
2. Press **Conf/Trans**
3. Press the **Line** or **Intercom** button of the second held call. The conference call is re-established.

**Split a Conference**

Splitting a Conference Call allows the originator of the conference to talk with one of the parties while the other party is on hold.

**To split a conference call:**

1. Press the **Line** or **Intercom** button of the party with whom you wish to speak. The other party is automatically placed on hold.

**To re-join the conference call:**

1. Press the **Line** or **Intercom** button of the held call. You are reconnected to the conference call.

**Transfer from a Conference**

The Transfer feature allows you to leave the other two parties conferring while you disconnect from the conference. One of the two parties remaining must be inside the Norstar system. You cannot connect two outside calls with this procedure.

**To transfer a call to another telephone within your office**

1. Establish a conference call.
2. Press **Rls**

**OR**

Press **TRANSFER** (M7310 and M7324 telephones only).

**To connect two outside calls**

1. Establish a conference call with two outside lines.
2. Put the Conference on Hold. **You cannot disconnect yourself without dropping the conference call.** In order for the two outside lines to remain connected, they must be linked through your telephone set.
3. Monitor the active lines by occasionally reconnecting with the call. The indicator will stay ON until you disconnect from the conference call, even if the other parties have disconnected.
4. After both parties have hung up, press **Rls**

## Contrast Adjustment

The contrast on your telephone display can be adjusted so you can read it more easily under different lighting conditions. The contrast is different if you are standing or sitting (and have a different angle of vision to the telephone), so make sure you adjust the contrast level from the position in which you use the telephone most often.

### M7310 and M7324 Telephones

1. Press **Feature** **\*** **7**
2. Press the **UP** or **DOWN** display button to adjust the display to the desired level.
3. Press the **OK** display button

**OR**

Press **Feature**

**OR**

Wait 15 seconds until **Feature timeout** appears.

The new contrast level is stored.

### M7208 Telephone

1. Press **Feature** **\*** **7**
2. Press **1** , **2** , **3** or **4** from the dialpad to adjust the display to the desired level.
3. Press **Hold**

**OR**

Press **Feature**

**OR**

Wait 15 seconds as above.

## Delayed Ring Transfer (DRT)

Delayed Ring Transfer forwards your unanswered outside calls to a Prime Phone. This feature ensures that your outside calls will be answered.

If one of your outside lines is assigned a Prime Phone which is using Delayed Ring Transfer, an unanswered outside call on that line will begin to ring at the Prime Phone after a specified number of rings. The Prime Phone displays the message **DRT <name>** where **<name>** is the number or programmed name of the line that the call is on.

This feature is controlled by your Installer or Service Representative in the "Call Handling" section of Configuration programming.

## Dial-0 Set

The Dial Zero Phone is the one telephone in your Norstar system which can be reached from any other telephone merely by dialing "0". This is most useful if it is located at the receptionist's or secretary's desk or in a central location. The Dial Zero Phone is most often part of a Central Answering Position (CAP), or has been assigned as a Prime Phone and is used to monitor much of your office's telephone activity.

Using the Messages feature, the Dial Zero Phone can send up to 30 messages, which allows for better communication between you and your co-workers.

In addition to the presence of a Dial Zero Phone, Norstar also supports a Night Dial Zero Phone. See "Night Service" in this chapter for further details.

This feature is controlled by your Installer or Service Representative in the "Miscellaneous" section of Configuration programming.

## Do Not Disturb (DND)

If you activate DND while you are not active on a call, you are in DND mode. DND mode suppresses ringing, paging announcements and Ring Again. It stops all tones and ringing, except Held Line Reminder. When the telephone is in DND mode, the display will continually show the `Do not disturb` reminder message. An incoming outside call will cause the line indicator to flash, but the call will be forwarded to the Prime Phone if it is not answered at another telephone which has the same line. This feature is useful when you wish to program your telephone without interruption.

If you press DND while an outside call is ringing at your telephone, the call will be transferred to the Prime Phone. For more information, see the "Selective Call Forward" section of this chapter.

A telephone in DND mode can still be used for outgoing calls.

### To activate Do Not Disturb:

1. Press the `DND` button.

**OR**

Press `Feature` `8` `5`

The display shows `Do not disturb`

All tones and ringing except for Held Line Reminder tones are stopped. Outside calls are transferred to the Prime Phone.

**To cancel Do Not Disturb:**

1. Press the **DND** button again.

**OR**

Press **Feature # 8 5** The temporary message **Allow calls** appears on the display.

---

## Do Not Disturb Override

If the telephone you are trying to reach is in Do Not Disturb mode, and it is essential that you get through, you may be able to use the Priority Call feature to override the Do Not Disturb setting.

By making a Priority Call, you are effectively placing a Voice Call to your co-worker. Your co-worker will have the option of denying your Priority Call, but will nonetheless be notified that an important message is waiting.

For further information about Priority Call, see the "Priority Call" section of this chapter.

This feature is controlled in the "Permissions" section of Administration programming.

---

## Emergency Transfer/Power Failure Cut-Through

This feature provides basic telephone service if the power fails or if a system error occurs.

A dial or push-button single line telephone must be connected to the Key Service Unit (KSU). This single line telephone acts independently of the Norstar system and can be used as an Emergency Telephone.

Each KSU can support two Emergency Telephones, and each Trunk Module can support an additional Emergency Telephone.

Power failures can be reported using these telephones. Check the appropriate area of your *Norstar Modular Programming Record* to find out whether or not you have an Emergency Telephone or, if no other information is available, contact your Installer or Service Representative.

## Erasing a Button

To erase the setting on a programmable button, follow the procedures below:

### M7310 and M7324 Telephones

1. Press **Feature** \* **1** The display shows **Press a key**
2. Press the button you wish to erase.  
The display shows **Enter digits**
3. Press the **OK** display button  
**OR**  
Press **Hold**  
The display shows **Key erased**

### M7208 Telephone

1. Press **Feature** \* **1** The display shows **Press a key**
2. Press the button you wish to erase.  
The display shows **Program and HOLD**
3. Press **Hold** The display shows **Key erased**

## Feature Access

Every Norstar telephone has numerous buttons that can be programmed to dial frequently called numbers (see Autodial), or to activate Norstar features. Any button not programmed as an outside **Line**, an **Intercom** line, **Answer** button or **Handsfree Mute** is available for programming features.

You can program any feature on a memory button, whether or not your system supports that feature. Pressing a programmed memory button is like pressing the entire feature code manually, but easier. If the feature is not supported by your system, pressing the memory button will cause an error message and tone.

When you store a feature on a programmable memory button, your Norstar system automatically stores the cancellation code after the feature code, if a cancellation code exists for the feature. Long Tones, for example, does not have a feature cancellation code, and therefore does not create a toggled button. For toggled memory buttons, you can activate the feature by pressing the memory button, and when the feature is active, you can cancel the feature by pressing the same memory button. If a feature does not have a cancellation code, the **Feature** button can often be used to turn the feature OFF.

If your system does not support a particular feature, check your Administration and Configuration settings. You may be able to change your Administration settings, or get your Installer to change your Configuration settings, to allow the use of that feature.

### To program for Feature Access:

1. Press **Feature** \* **3**  
The display shows **Press a key**
2. Press any memory button except the **Line**, **Intercom**, **Answer** or **Handsfree** buttons.  
The display shows **Feature code:**  
(On the M7310, remember to press the shift button before programming the top half of the dual memory buttons.)
3. Press **Feature** and the desired feature code.  
The display shows **Key programmed**

### To Erase a Feature:

#### M7310 and M7324 Telephones

1. Press **Feature** \* **1** The display shows **Press a key**
  2. Press the memory button you wish to erase.  
The display shows **Enter digits**
  3. Press the **OK** display button
- OR**
- Press **Hold**  
The display shows **Key erased**

#### M7208 Telephone

1. Press **Feature** \* **1** The display shows **Press a key**
2. Press the button you wish to erase.  
The display shows **Program and HOLD**
3. Press **Hold**  
The display shows **Key erased**



---

## Flexible Numbering Plan

Your Norstar system can have two, three, or four-digit Intercom numbers. It can also have one to four-digit Line Pool Access codes which must be entered before you can use one of Norstar's nine Line Pools. These numbers are controlled by your Installer in Configuration programming, but it may be interesting for you to understand how they are related.

All Intercom numbers must all be the same number of digits in length, but Line Pool Access codes do not have to be the same length as one another.

Intercom numbers and Line Pool Access codes cannot begin with the same digit. If two Line Pool Access codes begin with the same digit, they must then be the same length. For example, the Line Pool Access code 2345 can co-exist with code 321, but not with code 231.

No Intercom number or Line Pool Access code can begin with the numbers "0" or "1"; "0" is reserved for the Dial Zero Phone, and "1" is reserved as the first digit of Retrieve Park codes.

Symbols such as an asterisk (\*) or a pound sign (#) cannot be used in Intercom numbers or Line Pool Access codes.

The same sequence of digits cannot be used for two Intercom numbers, for two Line Pool Access codes, or for both an Intercom number and a Line Pool Access code. All numbers must be unique.

For more information about Intercom numbers and Line Pool Access code, see the "Intercom numbers" and "Line Pools" sections of this chapter.

This feature is controlled by your Installer or Service Representative in the "Change DNs" section of Configuration programming.

## Handsfree/Mute

 allows you to use your telephone without picking up the receiver. The Mute function allows you to turn OFF the microphone temporarily if you wish to speak privately with someone else in the room.

 is available to the system or to an individual telephone through Administration programming. When

 is in use, you can adjust the volume of the Handsfree/Mute speaker with the Volume button.

You may wish to photocopy the “Using Handsfree/Mute” Job Aid in the Job Aids chapter of this Guide and distribute it to your co-workers. This Job Aid lists hints to be followed for the most effective Handsfree communication.

### Using Handsfree /Mute



To make a call:

1. Press 
2. If no line is selected, press a free line. Once a line is selected the Handsfree/Mute microphone is turned ON.
3. Make a call.

While on a regular call:

1. Press 
2. Hang-up the receiver and continue your call.

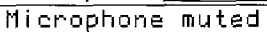
### To mute the microphone

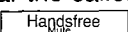
1. While on a Handsfree call, press . The display shows . The indicator  flashes beside the  button to show that the caller cannot hear you, although you can still hear the caller.
2. Press  again to turn the microphone back ON to continue your Handsfree call.

### To end Handsfree:

1. Lift the receiver to conduct a private conversation.  
**OR**  
Press  to end the call.

This feature is controlled under the “Full Handsfree” and the “HF Answerback” sub-headings in the “Permissions” section of Administration programming.

---

## Headset

A headset provides convenient Handsfree telephone operation while maintaining the privacy of calls.

When you plug a headset into your telephone while on a call, your telephone microphone and speaker (or your receiver if you are on a regular call) are turned OFF and your headset microphone and earpiece are turned ON. If you unplug your headset while on a call, your telephone microphone and speaker turn ON (the call becomes a Handsfree call).

While you are using the headset, the receiver and the "hook-switch" do not work. To cancel a call, press **[Ris]**

Make sure you have **[Handsfree Mute]** assigned to your telephone if you wish to use a headset. If you do not have a **[Handsfree Mute]** button, you cannot turn your microphone ON and OFF nor use **[Handsfree Mute]** to select an incoming call.

If you press **[Handsfree Mute]** while you are active on a headset call, your headset microphone turns ON or OFF. If you press **[Handsfree Mute]** while an incoming call is ringing, the Handsfree/Mute feature selects the line that the ringing call is on, and enables your headset so that you can respond to the call.

The Headset volume can be adjusted using the Volume button.

While you are using the headset, tones associated with some features (such as Page and Held Line Reminder) will be transmitted through your telephone's speaker rather than through your Headset.

Handsfree/Mute is controlled under the "Full Handsfree" and the "HF Answerback" sub-headings in the "Permissions" section of Administration programming.

---

## Hearing Aid Compatibility

The receivers on your Norstar M7324, M7310 and M7208 telephones are compatible with hearing aids.

## Hold

The Hold feature is used to temporarily suspend a call while you perform another task.

When a call is on hold, its indicator ► flashes on all telephones having access to that line. Any of these telephones can be used to retrieve the call. This is useful when transferring a call within your office.

A call can be held either by pressing the **Hold** button or by activating another line on your telephone (Automatic Hold).

The **Exclusive Hold** feature assures that your call can only be retrieved at the telephone from which it was put on hold. The line indicator does not flash on any other telephone.

**Listen on Hold** allows a person who has been put on hold to hang-up their receiver and continue working while listening for the other person to return to the call.

### To use Automatic Hold:

While on a call:

1. Press another line button.

**OR**

Press an Autodial button.

You can return to the first call by pressing its line button.

You can switch from one call to another using the line buttons.

### To transfer using Automatic Hold:

While on a call:

1. Press another line button and call the telephone to which the first call will be transferred.

**OR**

Press an Autodial button.

2. Tell the person you are calling on which line the first call is being held. The destination telephone must have a button for the line which the call is on. Pressing this button transfers the call.

Refer to the Conference/Transfer or Transfer features for other methods of transferring calls.

**To use Exclusive Hold:**

While on an outside call:

1. Press the **Exclusive Hold** button.

**OR**

Press the **Feature** button and then the **Hold** button.

**OR**

Press **Feature** **7** **9**

The call on hold can only be picked up on the telephone from which it was put on hold.

**To use Listen on Hold:**

Using the **Hold** button:

1. While on a call, press **Hold**
2. Hang up the receiver.
3. Press the line button for the call.
4. Listen through the speaker.
5. When you are ready to speak, lift the receiver

**OR**

press **Handsfree Mute**

Using the **Handsfree Mute** button:

1. While on a call, press **Handsfree Mute** twice. The call is muted.
2. Hang up the receiver.
3. Listen through the speaker.
4. When you are ready to speak, lift the receiver

**OR**

press **Handsfree Mute**

**Held Line Reminder**

When an outside call is placed on hold, two periodic reminder tones are heard until the call is removed from hold. Inside calls on hold do not activate this feature.

**Music/Tone/Silence on Hold for Outside Callers**

A caller on hold hears either music, a periodic tone or silence depending on the setting for your office system.

Held Line Reminder and Music/Tones/Silence on Hold are controlled by your Installer or Service Representative in the "Call Handling" section of Configuration programming.



## Intercom (Inside Telephone) Numbers

Communication inside your office is easy with Norstar inside telephone numbers. Each telephone in the Norstar system has its own two, three, or four-digit Intercom number. The length of your system's Intercom numbers is controlled by your Installer or Service Representative in Configuration programming. These numbers can only be called on the Intercom lines of your system.

Each Norstar telephone can have up to eight Intercom lines assigned to it which can be used to contact other telephones within your Norstar system.

The lowest default Intercom numbers in any system are 21 for the two-digit system, 221 for the three digit-system, and 2221 for the four-digit system. Your system can have a combination of 120 Intercom numbers and outside telephone lines. Normally, the range of your Intercom numbers will begin at 21, 221, or 2221 and end at no more than 44, 340, or 2340. They can, however, be changed by your Installer or Service Representative.

### To use Intercom Numbers:

1. Press a free **Intercom** line button.  
The indicator is turned ON.  
A dial tone is heard.
2. Dial the Intercom number from the list in the Job Aids chapter of this Guide.  
When dialing is complete, Call Identification is displayed at both the originating and destination telephones.  
The display shows **Calling <name>** at the originating telephone and **<name> calling** at the destination telephone.

**Note:** Ensure that all your co-workers know how to use Intercom lines to contact one another.

Distribute a list of names and Intercom numbers to everyone on your office telephone system. Refer to the Job Aids chapter this Guide for a table that you can photocopy and fill in.

This feature is controlled by your Installer or Service Representative in the "Line Access" and "Change DNs" sections of Configuration programming.

## Language Choice

The buttons, labels and display information on your Norstar telephones are provided in a bilingual format. On systems sold in the United States, the two languages are English and Spanish. If your company has bought a Canadian system, the two languages are English and French.

When your system is first installed, the default language is English. If you wish to change the setting, follow the steps below.

### To make a Language Choice:

1. Press **Feature** \* **5** **0** **1**

The display shows **In English...**

**OR**

- Press **Feature** \* **5** **0** **2**

The display shows **En español...** or

**En français...** depending upon the system your company has purchased.

The Language Choice feature can be assigned to a programmable memory button using the code: **Feature** \* **5** **0** **1**

The memory button can then be used to alternate between the two available languages. Label the Language Choice memory button:

**Language**

## Last Number Redial

Last Number Redial saves time when you are trying to reach an outside number that was previously busy or unanswered. This feature automatically redials the last outside number dialed. The maximum length of a stored number is **16 digits**.

### To use Last Number Redial:

1. Press **Feature** **5**

**OR**

Press **Last No.** after getting a dial tone on an outside line.

If a line is not selected before Last Number Redial is used, Automatic Line Selection selects a free line if one is available.

## Lines

### **Inside Line Access** (see also “Intercom Numbers”)

You can use Intercom (inside) lines to make and answer calls within the Norstar system. Each telephone has its own associated two, three or four-digit Intercom number, and up to eight Intercom lines which can be used to contact other Norstar telephones. Make sure all the people in your office are supplied with a list of Intercom numbers.

### **To use inside (Intercom) lines:**

If an  Intercom line is free, the indicator beside the button is OFF.

1. Press an  Intercom line button.  
The indicator turns ON.  
You hear a dial tone.
2. Dial an inside number using the dialpad.

**OR**

Press an Inside Autodial button.

### **Line Pools**

Line Pools allow each telephone to access a collection of outside lines using Norstar’s Intercom lines,  Feature  6  4 and a Line Pool Access code, or a programmed  Line Pool button.

For further information, see the Line Pools section of this chapter.

### **Manual Line Selection**

Manual Line Selection allows you to select any free or ringing line and to override Automatic Line Selection. For example, if your telephone is on Do Not Disturb or Call Forward and you see a line indicator flashing with an incoming call, you can take the call by pushing the indicated line button.

You must select an outside line when there is no Prime Line defined for the telephone.

### **Multiple Line Buttons**

Multiple Line buttons give you immediate access to more than one line, and allow you to handle and monitor calls easily. These buttons also have a Call Waiting function when you are on another call. The indicator beside the line button flashes when a line is ringing or on hold.



Line indicators flash at three different rates, depending on whether the line is ringing, held by you, or held on another telephone. If a call is ringing, the indicator turns ON and OFF for equal amounts of time. If you have put a call on Hold, the indicator flashes more quickly. If one of your co-workers has put a call on Hold on a line appears at your telephone, the indicator stays ON for a longer period of time than it is OFF.

Each telephone has a maximum number of outside line buttons which it can support. As their names suggest, the M7324 telephone can have up to 24 outside line buttons, the M7310 telephone can have 10, and the M7208 telephone can have eight. If the maximum possible outside lines are assigned to a telephone, however, nothing else can be programmed on the programmable memory buttons with indicators. In order to assign more lines to a telephone than the telephone has line buttons, you can either use Line Pools (see "Line Pools" in this chapter) or the Answer Group feature (see "Answer Groups" in this chapter).

## Outside Line Access

Your Norstar system can have many outside lines. The number of telephones and outside lines in your system can add up to as many as 120. Each telephone can have as many lines assigned to it as the system has, but for practical purposes the number of lines assigned to a telephone is limited by the number of buttons which can be used as outside **Line** buttons. The outside **Line** buttons are used to make and answer calls to or from parties outside the Norstar system.

### To use outside lines:

If the line is free, the indicator is OFF.

1. Press an outside **Line** button. The indicator appears beside the button.  
You hear a dial tone.
2. Dial an outside number using:
  - the dialpad
  - a Speed Dial number using **Speed Dial** or **Feature** **0** (plus the two-digit number)
  - an Autodial button.

Inside and outside line assignments are controlled by your Installer or Service Representative in the "Line Access" section of Configuration programming.

## Line Pools

Line Pools let you make efficient use of outside lines. A number of outside lines in a line pool can be shared by a group of telephones without requiring each telephone to have a button for each line in the pool. Telephones gain access to outside lines through Intercom lines, leaving more buttons free to store Autodial numbers or features.

Each Norstar system has nine Line Pools. Each Line Pool can be accessed by entering the one to four-digit Line Pool Access code on the dialpad. A Line Pool cannot be used unless your Installer has assigned a Line Pool Access code to the Line Pool in Configuration programming.

### To program a **Line Pool** button:

1. Press **Feature** \* **3**
2. Press the button you wish to program.
3. Press **Feature** **6** **4** and the Line Pool Access code for a Line Pool. Direct access to that Line Pool is programmed on the button.
4. Label the button **Line Pool**

### To use a Line Pool:

1. Press **Intercom** and dial the Line Pool Access code  
**OR**  
 Press **Feature** **6** **4** and dial the Line Pool Access code  
**OR**  
 Press **Line pool**  
**Note:** Pressing **Feature** **6** **4** or **Line Pool** selects a line automatically.
2. Listen for the dial tone. If there is none, the display message provides an explanation.
3. Dial the number you wish to call.

A **Line Pool** button cannot be used to answer outside calls.

The Job Aids chapter of this Guide has a list of your system's nine Line Pools. Photocopy this page, and keep the original as a master copy. In the Job Aid, record each Line Pool Access code (provided by your Installer) and the telephones which can use each Line Pool.

Your Installer or Service Representative assigns telephones to Line Pools in the "Line Access" section of Configuration programming and assigns Line Pool Access codes in the "Miscellaneous" section of Configuration programming.

---

## Link

If your Meridian Norstar system is located behind a Private Branch Exchange (PBX) or Centrex system, you may want to use a Link signal to access special features on the PBX or Centrex.

The Link signal is a short “hook-switch flash” with a programmable duration. The default value is 600 milliseconds, but it can be set from 100 to 1000 milliseconds, in increments of 100 milliseconds.

You can generate a Link signal by pressing **[Feature] 7 1**

To obtain the signal with a single press, store the feature code on an Autodial button. See “Feature Access” in this chapter for specific instructions. The Link signal can also be included as part of a longer stored sequence on an Autodial button or in a Speed Dial code. See “PBX Features” or “Centrex Features” in this chapter for further details.

A programmed **[Link]** button works only on an active line.

The duration of a Link signal is controlled by your Installer or Service Representative in the “Miscellaneous” section of Configuration programming.

Featu  
Operatio

---

## Long Tones

If your Norstar system uses Access signaling, it may be necessary to transmit Dual Tone Multi-Frequency (DTMF) tones of a longer duration than the standard 120ms (short tone) duration. This is necessary for use with some devices which use tones with a continual (long) duration, such as FAX and message machines.

The Long Tones feature code allows you to control the length of the tone. A Long Tone lasts as long as you press a dialpad key after activating the feature. Long Tones feature remains active until it is turned OFF, or until the call has ended or is placed on Hold.

Long Tones can be used on either an outside or an inside call. This allows you to use Norstar Intercom lines to activate a device in another area of your office.

Long Tones cannot be used on a Conference call, or during a Page. If you press **[Long Tones]** while on a Conference call, you hear an error tone and the display shows **[Tones denied]**. If you attempt to use **[Long Tones]** while making a Page announcement, the announcement is cancelled.

Because the Long Tones feature is controlled manually, the feature code cannot be stored in an Autodial or Speed Dial sequence. The Long Tones feature code, however, can be stored on one of the programmable memory buttons on any of the Norstar telephones.

**To use Long Tones for Access signaling:**

1. Place a call.
2. Press the **[Long Tones]** button

**OR**

Press **[Feature][8][0][8]**

This changes the mode to Long Tones.

3. At the appropriate time, press any dialpad button. Hold the button down for as long as is necessary.
4. When you are finished, end the call

**OR**

Cancel Long Tones using one of the methods below.

**To cancel Long Tones without disconnecting your call:**

1. Press the **[Feature]** button

**OR**

Press **[Hold]** (The call is placed on Hold and Long Tones is cancelled).

Long Tones feature is also cancelled if you are using it on an inside call and the person you are calling presses **[Hold]**

When Long Tones is cancelled, the telephone dial mode reverts to the mode it was in when Long Tones was activated (either short tones or pulse dialing).

The choice between Tone and Pulse dialing is made by your Installer or Service Representative in the "Line Data" section of Configuration programming.

## Messages (Send/Reply/Waiting)

You can leave messages on the telephone displays of your co-workers to request that they call you back. The display on a telephone which receives a message shows `Message for you`, or `Messages for you` if more than one message has been received.

After you have sent a message, you or the person who received it may wish to cancel it. Any message can be cancelled by either the person who sent it or the person who received it. If you have sent a message and wish to cancel it, use the Cancel Sent Message feature. If you wish to cancel a message which has been sent to you, use the Cancel Message Waiting feature.

If you respond to a message and your call is picked up at a different telephone by the Call Pickup feature, the message you are answering remains on your telephone until you cancel the message or successfully contact the telephone which left the message.

Each message list can send or store up to four different messages before `Their list full` or `Your list full` appears on the displays. The Dial Zero Phone, however, can send up to 30 messages.

### To Send a message:

1. Press `Feature 1`  
**OR**  
 Press `Send Message`
2. Press the `ADD` display button (M7324 and M7310 telephones only). The display then shows `Message to:` On the M7208, the `Message to:` display appears as soon as you press the feature access code or button.
3. Dial the Intercom number  
**OR**  
 Press an Inside Autodial button.  
 The display shows `Message> <name>` where `<name>` is the programmed name of another Norstar telephone in your system.

**To Reply to a message:****M7324 and M7310 Telephones**

When **Message for you** is on the display of your telephone:

1. Press the **MSG** display button. The display shows the first (or only) message, as in the example:  
**1. JILL called**, along with the following display buttons: **CALL** and **ERASE**  
 The **NEXT** display button also appears if there is more than one message waiting. If the message which appears is not the message to which you want to reply, move through the list by pressing **NEXT** repeatedly.
2. Press **CALL**. A call is automatically dialed to the person who left the message.

**M7208 Telephone**

When **Message for you** is on the display of your telephone:

1. Press **Feature 65**  
 A call is automatically dialed to the person who left the first message. The display shows the programmed name of the telephone which you are calling.

To reply to other messages without replying to the first, you must record the name which appears on the display, cancel the first message, and then use the Reply Message feature.

**To Show a Waiting Message (M7310 and M7324 only):**

When **Message for you** is on the display of your telephone:

1. Press **MSG**  
**OR**  
 Press **Feature 65**  
 The display shows the first (or only) message, as in the example  
**1. JILL called**, along with the following display buttons: **CALL** and **ERASE**. The **NEXT** display button also appears if there is more than one message waiting.
2. Press **NEXT** again if there is more than one message.
3. Press **Feature** to end the "show message" cycle.

**To Cancel a Waiting Message:**

When **Message for you** shows on the display of your telephone:

**M7324 and M7310 Telephones**

1. Follow the above procedure for "How to Show a Waiting Message" until the desired message is on the display.
2. Press the **ERASE** display button. The next Message Waiting replaces the erased message.

**M7208 Telephone**

1. Press **Feature** **#** **6** **5**. The display shows the cancellation as in the following example:

**Cancel > JILL**

**To Show a Sent Message (M7324 and M7310 only):**

1. Press **Feature** **1**

**OR**

Press **Send Message**

The display shows **Message List** along with the three display buttons: **SHOW**, **ADD** and **EXIT**

2. Press the **SHOW** display button. The first (or only) message is shown. If the **SHOW** button label disappears, there are no more messages. If the label changes to **NEXT**, there are more messages.
3. Press **NEXT** to see other messages in the list.
4. Press **EXIT** (M7324 and M7310 telephones only)

**OR**

Press **Feature** to end the "show message" cycle.

### To Cancel a Sent Message:

#### M7324 and M7310 Telephones

1. Follow the above procedure for "How to Show a Sent Message" until the desired message is on the display.
2. Press the **ERASE** display button.

#### M7208 Telephone

1. Press **Feature** **#** **1**

**OR**

Press **Cancel Send Msg**

The display shows **Cancel for: \_**

2. Dial the Intercom number

**OR**

Press an Inside Autodial button.

The display shows **Cancel > <name>** with the appropriate name or set number.

---

## Names

Each Norstar telephone and outside line can have an individual name assigned to it. This personal touch provides your company's staff with instant recognition of their calls.

When a call arrives at your telephone, or a feature forwards a call to you, your telephone display shows the name of the telephone that is calling (if it is within your Norstar system) or the name of the outside line which the call is on.

For example, if you receive a call on your Private line while you are busy on another line, **PRIVATE calling** appears on your display if the programmed name of that line is "PRIVATE".

The programmed Name of a telephone or line can be no more than **seven** characters in length. Names for lines and telephones can consist of letters and numbers, but no symbols such as periods or hyphens can be used. Characters are entered using the telephone's dialpad.

It is convenient to use numbers rather than letters for situations such as naming a telephone according to its location ("RM 321") or naming an outside line by the telephone number used to dial onto it ("555 1234").



Line names must be unique, in order that any line which may be having trouble can be reported correctly. If you enter a Line Name which has already been used, you will hear an error tone, and `Use unique name` will appear on the display.

Two or more telephones in your office can be given the same Name. The system allows this, but it could become a source of confusion. Use creative combinations of initials, abbreviations, and possibly nicknames to give each telephone a unique Name.

The Name of a telephone will remain the same if the telephone is moved to another location within your system.

Telephone and line Names are programmed in the "Names" section of Administration programming. For instructions on how to enter characters and assign Names, see the appropriate section of the Norstar Administration chapter.

---

## Night Service

Night Service allows you to change your office telephone system for more efficient after hour service. For each outside line in your system, you can assign a Night Ringing Phone which receives calls when Night Service is ON and a Night Control Phone which turns Night Service ON or OFF for that line. You can also control whether or not calls arriving on lines which are in Night Service will drive an auxiliary ringer (if one is connected to your system). Night Service also allows you to control two system-wide features: the Night Dial Zero Phone and the Trunk Answer feature.

For further information on how to program Night Service settings, see the "Night Service" section of the Administration chapter of this Guide.

### Multiple Night Ringing Phones

Norstar supports a Night Ringing Phone for each outside line connected to your system. When a Night Ringing Phone is assigned to a line and Night Service is turned ON, all calls on that line will ring as usual, and also ring at the Night Ringing Phone.

Each line can have only one Night Ringing Phone, but one telephone can be the Night Ringing Phone for any or all of your outside lines. The Night Ringing Phone and the Night Control Phone for a line can be the same telephone, but do not have to be and usually are not.

Night Ringing Phones are assigned under the "Night ring" sub-heading of the "Night Service" section of Administration.

### **Night Auxiliary Ringer**

If an Auxiliary Ringer is present, it can be used as a Night Auxiliary Ringer for calls that ring at the Night Ringing Phone.

If your Auxiliary Ringer is programmed to ring for some lines and telephones during normal service, it will continue to do so and will also ring for calls arriving on a line that is in Night Service.

### **Night Control Phone**

A separate Night Control Phone can be assigned for each outside line which will be using Night Service. Each line can have only one Night Control Phone, but one telephone can control Night Service for any or all of your outside lines.

Night Service can only be turned ON and OFF at the Night Control Phone.

### **Night Dial Zero Phone**

A Dial Zero Phone which is different from the normal Dial Zero Phone can be assigned to lines which use Night Service. In order to contact the Night Dial Zero Phone by dialing "0", Night Service must be turned ON at the regular Dial Zero Phone.

If the Dial Zero Phone is changed while Night Service (and therefore the Night Dial Zero Phone) is ON, you must turn the Night Dial Zero Phone OFF at the new Dial Zero Phone. Turning Night Service OFF at the old Dial Zero Phone cancels Night Service for outside lines, but will not turn the Night Dial Zero Phone OFF.

### **Trunk Answer (from any telephone)**

This feature is turned ON or OFF for your entire system. If it is turned ON, calls ringing on a line which is in Night Service can be answered from any telephone within your system. For further information on the Trunk Answer feature, see the "Trunk Answer" section of this chapter.

## Using Night Service

### To use Night Service:

1. Press the **Night Service** button.

**OR**

Press **Feature** **8** **7**

The display shows **Night Service ON**

### To cancel Night Service:

1. Press the **Night Service** button again.

**OR**

Press **Feature** **#** **8** **7**

The display shows **Normal service**

The features described in the previous section are controlled in the "Night Service" section of Administration programming.

## On-Hook Dialing

On-hook dialing allows you to dial a call without picking up the receiver.

### To use On-Hook Dialing

1. Press a **Line** button for a free line.
2. Dial a call.
3. Listen through the speaker and when the call is answered, lift the receiver or press **Handsfree** (if equipped).

The call may be dialed using the dialpad, or one of the following Norstar features: Autodial, Last Number Redial, Saved Number Redial, or Speed Dial. The call can also be placed using the Message Reply feature or the Ring Again feature.

## Page Origination and Reception

Announcements through Norstar telephones or extension speakers give you fast, effective communication to many people at once.

The announcement does not disturb a person on an active call or using Norstar Administration, but can be heard by anyone near a paged telephone that is not in use.

There are three possible types of paging announcements:

- Internal
- External
- External and Internal.

Each telephone in your Norstar system may be assigned to one of six different Page Zones, or be assigned to no zone, through the "Permissions" section of Administration programming. You can page to any specified zone, or to all zones at once, by using the different Page Zone codes described below.

The various different options for Norstar paging are as follows:

- Page -General                      Feature 6 0 + code (1-3)
- Page -Zone                         Feature 6 1 + Zone (1-6)
- Page -External                     Feature 6 2
- Page -Zone and External         Feature 6 3 + Zone (1-6)

Two different Page Zones may be activated at one time, providing that both do not attempt to use the External speaker. When a second page using the speaker is attempted, the display at the originating telephone shows the `Paging busy` error message.

External pages can only be made if your company has supplied an external speaker for the purpose. This speaker is not standard Meridian Norstar equipment.

Page announcements are restricted to a maximum of two minutes, after which the page call ends automatically.

**To make a Paging announcement using Feature 6 0 :**

1. Press the Page button

**OR**Press Feature 6 0The display shows Page choice:

2. Select the desired type of page by pushing 1 , 2 or 3 :

1— **Internal** page through speakers on other telephones

2— **External** page through the extension speaker, if your office has such a speaker

3— **Both** internal and external page.

**OR**

Select the desired type of page from the following three display buttons (M7310 and M7324 telephones only):

SETS — Internal page

SPKR — External page

BOTH — Both internal and external page.

3. If you select 2 / SPKR proceed directly to step 5. below.

**OR**

If you select 1 / SETS or 3 / BOTH , the display will show Enter zone:

4. Enter the desired zone number (1-6)

**OR**

Press 0 / ALL to make a general page.

5. Make your announcement by speaking through your receiver

**OR**

Press Handfree Mute and speak :

**Express paging method:**

1. Press Feature
2. Select one of the following dialpad codes:
  - 6 1 + zone number ("x") for Internal Page Zone "x"
  - 6 2 for External page
  - 6 3 + zone number ("x") for Internal Page Zone "x" and External speaker.
3. Make your announcement.

Features for Centrex and similar systems can also be stored on Autodial buttons by storing the Norstar **[Link]** sequence followed by the Centrex or other system's feature code.

The preceding instructions explain how to store a single feature code on a button. Follow the steps below to store the Link signal plus an extension number to which you frequently transfer calls.

#### **To program an Autodial PBX feature and a dialing sequence:**

1. Press **[Feature]** **\*** **1**
2. Press the memory button on which you want to store the sequence.
3. Press the desired PBX feature code.
4. Press the sequence of digits or characters to be dialed after the feature code. The button can store a total of **16 characters**.
5. Press the **[Hold]** button or the **[OK]** display button (M7324 or M7310 telephones only) to end the programming.

#### **Speed Dial PBX Features**

PBX features, with or without additional dialed characters, can be stored in System Speed Dial codes (01-70) or Personal Speed Dial codes (71-94). As with Autodial buttons, Speed Dial codes can store a maximum of 16 characters, including a single character ("F") for each press of the **[Feature]** button. PBX features that are used by many people on the system are appropriate for System Speed Dial entries. Personal Speed Dial is better for storing features that are tailored to individual requirements. For example, a person who regularly places his or her telephone in Call Forward to a particular telephone in the PBX system could program a Speed Dial code to dial the PBX Link and Call Forward codes plus the extension number of the other telephone.

#### **Pickup Group**

When a call is ringing on a telephone, it can be answered on any telephone in the same Pickup group. This feature makes it easy for people to answer calls for absent co-workers.

Norstar provides nine Pickup Groups so that groups of people who can effectively answer one another's telephone calls can be assigned to an individual Pickup Group. Each telephone can be in one of the groups, or excluded from all groups. For example, a telephone in a customer waiting area may be left out of Pickup groups within the office to prevent customers from answering incoming calls by mistake.

Answering a call from another telephone in your Pickup group requires the use of the **Pick-up** button or **Feature 7|5**. For complete instructions, see the “Call Pick-up” section of this chapter.

Calls ringing on a telephone’s private line cannot be picked up from another telephone in your Pickup group, but any other call (inside or outside) can be answered.

For another method of answering a call which is ringing at another telephone, see “Call Pickup (Directed)” in this chapter.

Each telephone in your system can be assigned to a Pickup Group, or to none, in the “Permissions” section of Administration programming.

---

## Prime Line

Your telephone can be programmed to automatically select one of the following line types whenever the receiver is lifted or the **Handsfree** button is pushed:

- Outside line
- Intercom line
- Line Pool
- None

If an outside line or Line Pool has been assigned as the Prime Line for your telephone, there is no need to first select an outside line before making a call or using outside Autodial, Speed Dial or Last Number Redial. Automatic Outgoing Line Selection will select a free line if you are not already using your telephone and the Prime Line is free.

If your telephone has no Prime Line or if the Prime Line is busy, press an outside line button before using outside Autodial, Speed Dial, or Last Number Redial.

This feature is controlled by your Installer or Service Representative in the “Line Access” section of Configuration programming.

## Prime Phones (Multiple)

Prime Phones occupy a central position in the Norstar system and provide backup answering for lines that normally ring at other telephones. If your office has a main reception area, that is where a Prime Phone is most useful.

Multiple Prime Phones allows you to distribute the responsibility for call handling among numerous telephones within your Norstar system. Each outside telephone line supported by your system can have its own Prime Phone assigned in Configuration programming. Each line can have only one Prime Phone, but a single telephone can be the Prime Phone for more than one line. This allows various areas of your office which share outside lines to also share a Prime Phone to handle unanswered calls.

If your system has lines that are not assigned to any telephones, incoming calls on these lines will ring on Intercom buttons at the Prime Phone.

If your outside line has a Prime Phone, you can use the following Norstar features to help manage your calls:

**Delayed Ring Transfer (DRT)** transfers your outside calls to the Prime Phone if they are unanswered after a specified number of rings. DRT functions only for calls on an outside line which has a Prime Phone assigned to it. DRT is turned ON or OFF in Administration programming.

**Do Not Disturb** transfers incoming calls on an outside line to that line's Prime Phone.

If **Call Forward** directs your calls to a telephone that is unable to take a call, the call will be directed to the Prime Phone assigned to the outside line which the call is on.

If a call resulting from **Call Park Callback** or **Transfer Callback** cannot ring at the telephone which parked or transferred the call, the call will be forwarded to the Prime Phone assigned to the outside line which the call was originally on.

**Held Line Reminder** is activated at a Prime Phone two minutes after it begins at the originating telephone. Held Line Reminder functions only for calls on a line which is not private and has a Prime Phone assigned to it.



If your telephone is designated as a Prime Phone, you can use **Call Forward (No Answer)**, **Call Forward (All Calls)** or **Do Not Disturb** to prevent incoming calls. When Call Forward is active, all calls arriving at your telephone will be redirected to the specified telephone, whether or not they have already been forwarded to your telephone from another. Because a Prime Phone is a backup answering telephone for various lines in your system, make sure that you do not forward calls to a telephone at which they will remain unanswered.

Prime Phone assignment is controlled by your Installer or Service Representative in the "Line Data" section of Configuration programming.

## Priority Call

This feature should be used carefully, or only for urgent calls.

Priority Call allows you to force a connection with another telephone in your office, when that telephone is busy or using Do Not Disturb. You can also use Priority Call to make a Voice Call to a telephone which has Voice Call Deny turned ON.

Priority Call will not override Call Forward. If this feature is active at the telephone you are trying to reach, your call will be forwarded. You can use Priority Call (if necessary) to contact the telephone to which your call is forwarded, but not to contact the original destination telephone.

There are three perspectives to a Priority Call: that of the person making the call, that of the person receiving the call, and that of a third person whose call is forced onto Exclusive Hold. The ways in which Priority Call feature affects these three people are explained below.

### When you make a Priority Call:

If the telephone you are trying to contact has an available Intercom button, your call will proceed as a Voice Call on that button. In this case, both telephones can put the call on Hold. If a Priority Call is placed on Hold at either telephone, or is transferred, it is no longer a Priority Call.

If the telephone you are trying to contact does not have an available Intercom button, your call will proceed like a Page. The person you are contacting will only be able to use the **[Ris]** button.

If you contact one of your co-workers, and **[Do not disturb]** appears on your display, the Priority Call feature will connect your call as a Voice Call immediately. During the Priority Call, the person you are calling will hear a periodic tone which indicates that the telephone microphone is ON, and you can hear the person whom you are calling.

If you contact one of your co-workers, and your display shows **[On another call]** or **[<name> busy]**, the Priority Call feature will place your co-worker's active call on Exclusive Hold, and connect you with your co-worker's telephone.

If your display shows **[On another call]**, you will not hear a busy signal. This means that your co-worker is active on another call, but still has an available Intercom line.

**When you receive a Priority Call:**

If you are active on a call and someone makes a Priority call to your telephone, **Priority <name>** appears on your display, and the indicator beside a programmed **DND** (Do Not Disturb) button flashes. On the M7324 and M7310 telephones, **BLOCK** appears beneath the display message. You have the option of preventing the Priority Call by pressing the **DND** button or the **BLOCK** display button. If you do not, the Priority Call will force your active call on Exclusive Hold after eight seconds. **Remember to notify the person to whom you are speaking that the call is about to be placed on Hold.**

If you use the **DND** button to block a Priority Call, the Do Not Disturb feature is **not** turned ON at your telephone. Your telephone will continue to function as normal.

When a Priority Call ends, you are immediately re-connected to your original call. When you accept a Priority Call which places an active call on Exclusive Hold, do not end the call yourself. If both you and the person who made the Priority Call happen to press **RLs** at the same time, your active call may be disconnected.

If you are not active on a call, but have Do Not Disturb or Voice Call Deny turned ON, a Priority Call to your telephone will proceed immediately as a Voice Call. You will not be given the option of blocking the call.

**When the person you are speaking to receives a Priority Call:**

If the person you are speaking to receives a Priority Call attempt, the call will either be blocked or accepted.

If the person presses the **BLOCK** display button, or the **DND** button, the Priority Call is blocked. You will be unable to detect that a Priority Call attempt has been made.

If the person accepts the Priority Call, you will be warned that your call will be placed on Hold within eight seconds. While your call is Held, it can only be retrieved from the telephone at which it was placed on Hold.

**To make a Priority Call:**

1. Make an inside call. `Calling <name>` appears on your display for three seconds.
2. Wait for the Call Identification message to change and show the status of the telephone you are calling. If the display shows `Do not disturb`, `On another call` or `<name> busy`,
3. Press `Feature 69`  
**OR**  
 Press the `Priority Call` button  
**OR**  
 Press `PRIORITY` (M7324 and M7310 telephones only).  
 If your co-worker's telephone is in Do Not Disturb mode, your call is connected immediately.  
 If you are interrupting an active call, your display will show `Please wait...` for eight seconds while your co-worker has the option of blocking your call.  
 If your co-worker blocks your call, `Call blocked` appears on your display. If not, your call is connected.
4. When your call is finished, press `Rls`

**To block a Priority Call:**

When a Priority Call attempts to interrupt an active call on your telephone, your display shows `Priority call`, the indicator beside a programmed `DND` button flashes, and the `BLOCK` display button appears beneath the message on M7324 and M7310 telephones.

1. Press `DND`  
**OR**  
 Press `BLOCK` (M7324 and M7310 telephones only).  
 The Priority Call is blocked. The display on the phone that attempted the Priority Call shows the temporary message `Call blocked` to confirm that the block has been successful.
2. Continue with your original call. The person with whom you are speaking cannot tell that there has been a Priority Call attempted at your telephone.

The Priority Call feature is assigned to a telephone in the "Permissions" section of Administration programming.

---

## Privacy

When you are on an inside or outside call, no other telephone with the same line can disturb your call. If you put a call on Hold, the call can be picked up on another telephone. Once the call is taken off hold, it is private again.

Use **Exclusive Hold** to keep a call private while on hold. The call's indicator ► will flash only on your telephone. From other telephones, the call will appear to be a connected call.

---

## Private Line

A Private Line guarantees call privacy and line availability.

If your telephone is assigned a Private Line, that line is exclusive to your telephone (and the Prime Phone if desired). Calls that are put on hold or left unanswered on this line cannot be picked up on any other telephone. If unanswered after three rings, **Delayed Ring Transfer** causes your calls to ring at the Prime Phone.

**Call Forward, Transfer**, and other call handling features operate in the same way on a private line as on a public or pool line.

This feature is controlled by your Installer or Service Representative in the "Line Data" section of Configuration programming.

---

## Pulse/Tone Dialing

Each outside line is assigned either pulse or tone dialing by the Installer or Service Representative in Configuration programming.

Pulse dialing is the traditional method of dialing used by rotary dial or push button single line telephones. It is less advantageous than tone dialing, but is necessary to gain access to certain types of outside lines.

Tone dialing is a more advanced system, as the tones allow telephones to communicate with other devices such as a data communication device or computer. Tone dialing is also necessary to access Centrex or PBX features if your system is connected to a Centrex or Public Branch Exchange.

You can check to see whether your telephone is programmed for Pulse or Tone dialing by using the System Settings feature described later in this chapter.

This feature is controlled by your Installer or Service Representative in the "Line Data" section of Configuration programming.

---

---

## Release Button **Rls**

Pressing **Rls** ends a call without putting the receiver down, ends a Handsfree call, or ends feature programming.

Do not press the orange **Rls** to end a feature that you are using while active on a call (such as Contrast Adjustment or Show Message). The grey **Feature** button should be used in such cases, as the **Rls** button will disconnect the active call.

---

## Restriction Passwords

A Restriction Password is a **four-digit** password which allows a person to make calls normally not permitted because of Call Restrictions. Norstar supports the use of up to 100 separate Restriction Passwords.

The Restriction Password feature code ( **Feature** **6** **8** or the **Override** ) button can be pressed either before or after selecting a line for your call. The Restriction Password feature does not select a line automatically.

If you do not enter a four-digit password within 15 seconds after activating the Restriction Password feature, your display shows **Feature timeout** and you hear an error tone.

### To use a Restriction Password:

1. Press the **Override** button  
**OR**  
Press **Feature** **6** **8**
2. Enter the password recorded in your Programming Record or in the Job Aids chapter of this Guide.
3. Dial your call.

Restriction Passwords are programmed in the "Passwords" section of Administration programming.

## Ring Again on Busy

Ring Again eliminates the need to make repeated attempts to contact people within your office. Ring Again on Busy alerts you when a busy inside telephone becomes available.

This feature must be activated before you disconnect your call. When you call a telephone which is busy, your display shows **Calling <name>** for three seconds, and then shows **On another call** or **<name> busy**. On the M7324 and M7310 telephones, the **LATER** display button appears (and a **PRIORITY** button, if programmed).

### To use Ring Again on Busy:

1. While the call is ringing, press **Ring Again**  
**OR**  
 Press **Feature 2**.  
 The call is disconnected.  
 The display shows **Ring Again ON**.
2. When the telephone you were calling becomes available, you hear an alerting tone. **Call <name>?** appears on the display, and an indicator beside the **Handsfree** button or an **Intercom** button flashes. Press the button beside the flashing indicator. The Ring Again feature dials the Intercom number of the telephone you wish to contact.

### To use Ring Again on Busy (M7310 or M7324 telephones only):

1. While the call is ringing, press the **LATER** display button. The display shows **Ring again?**
2. Press the **YES** display button.
3. When the telephone you were calling becomes available, you hear an alerting tone. **Call <name>?** appears on the display, and an indicator beside the **Handsfree** button or an **Intercom** button flashes. Press the **YES** display button or the button beside the flashing indicator. The Ring Again feature dials the Intercom number of the telephone you wish to contact.

**To cancel Ring Again:**

1. Press **Ring Again** again.

**OR**Press **Feature # 2****Ring Again on Busy Line Pool**

Norstar allows up to three Ring Again requests to exist for each Line Pool in your system. If you get a busy signal or the **No free lines** message when you attempt to use a Line Pool, activate Ring Again. When a line becomes available in the Line Pool, you will hear an alerting tone and your display will show **Use line pool?**

If more than one Ring Again request is active on a single Line Pool, a free line will offer the free line to the first telephone which activated Ring Again.

**Ring Again on No Answer**

Ring Again on No Answer alerts you when activity next occurs at an inside telephone where there was previously no answer. When the activity at the other telephone ends, your telephone alerts you. Ring Again cannot be used on a call made as a Voice Call.

**To use Ring Again on No Answer:**

1. While the call is ringing, press **Ring Again**

**OR**Press **Feature 2**

The call is disconnected. The display shows the temporary message: **Ring Again ON**

When the telephone you were calling becomes available, you hear an alerting tone. **Call <name>?** appears on the display, and an indicator beside the **Handsfree** button or an **Intercom** button flashes.

2. Press the button beside the flashing indicator. The Ring Again feature dials the Intercom number of the telephone you wish to contact.



**To use Ring Again on No Answer (M7310 or M7324 telephones):**

1. While the call is ringing, press the **LATER** display button.  
The display shows **Ring again?**
2. Press the **YES** display button.  
The call is disconnected. The display shows the temporary message: **Ring Again ON**  
When the telephone you were calling becomes available, you hear an alerting tone. **Call <name>?** appears on the display, and an indicator beside the **Handsfree** button or an **Intercom** button flashes.
3. Press the **YES** display button or the button beside the flashing indicator. The Ring Again feature dials the Intercom number of the telephone you wish to contact.

**To cancel Ring Again:**

When Ring Again is active:

1. Press **Ring Again**  
**OR**  
Press **Feature # 2**

## Ring Type

One of four different tone combinations can be selected to give your telephone a distinctive ring. This makes it easier to identify your telephone's ring where telephones are grouped together in an open office.

### To select a Ring Type:

#### M7324 and M7310 Telephones

1. Press **Feature** \* **6**

You hear one of the ring types for two seconds.

2. Press the **NEXT** display button

**OR**

Press **1**, **2**, **3**, or **4** from the dialpad.

The display shows **Ring type <x>** where x is 1, 2, 3, or 4.

You hear the selected ring type for two seconds.

3. Repeat step 2 until you hear the ring type you prefer.
4. Press the **OK** display button.

**OR**

Press the **Feature** button.

**OR**

Wait a few seconds.

The telephone records the last ring type selected.

#### M7208 Telephone

1. Press **Feature** \* **6**

You hear one of the ring types for two seconds.

2. Press **1**, **2**, **3**, or **4** on the dialpad.

You hear the selected ring type for two seconds.

3. Repeat step 2 until you hear the type of ring you prefer.
4. Press the **Hold** button

**OR**

Press the **Feature** button

**OR**

Wait a few seconds.

The telephone records the last ring type selected.

---

## Ringing Line Preference

Each telephone in a Meridian Norstar system can be programmed to ring for incoming calls on some or all of the outside lines that appear on the telephone. For example, a telephone can have buttons for Lines 1 to 6, but have only Lines 3 and 4 programmed as ringing lines. An incoming call on any of the six lines will cause the appropriate line button indicator to flash, and the telephone can be used to answer the call. But only calls on lines 3 and 4 will cause the telephone to ring. This is especially useful for people who monitor other telephone lines, but only want their own lines to actually ring.

If a telephone has a Prime Line, that line is usually a ringing line. A Prime Phone or a receptionist's telephone usually has many ringing lines.

The ringing lines for a telephone are specified by the Installer in the "Line Access" section of Configuration programming.

---

## Ring Volume

The volume of the ring on a Meridian Norstar telephone can be adjusted either when it is ringing with an incoming call, or when ringing is caused by following the procedures below. Once adjusted, the telephone will ring at the same volume each time until it is adjusted again.

### To adjust Ring Volume:

1. Press **Feature** **\*** **8** **0**  
The telephone rings for four seconds.
  2. Press the Volume bar repeatedly to adjust the ring volume.
- 

## Run/Stop Code

The Run/Stop code **Feature** **\*** **9** is used to insert a break point in a sequence of dialed numbers or characters that is stored for automatic dialing. It is best to make sure that your telephone is using "Tone" rather than "Pulse" dialing, as pulse signals may not be understood by PBX, Centrex, nor similar systems.

Whereas Pause and Timed Release insert time delays of a specific length into a dialed sequence, the Run/Stop code allows you to manually control the delay period, or to dial certain sequences in a repeating cycle.

---

When you use Run/Stop codes, one press of an Autodial button or Speed Dial code dials the programmed sequence up to the break point. The next press dials from the break point to the next break point or to the end of the sequence. Another press begins again from the beginning of the sequence.

Your Norstar system only stores up to **three** Run/Stop sequences on each Personal Speed Dial code or Autodial button. Digits stored after a fourth Run/Stop sequence are ignored. A System Speed Dial code can hold only **one** Run/Stop sequence.

Each Meridian Norstar telephone retains its position in a Run/Stop sequence indefinitely, even across power interruptions. If a memory button is used to dial a stored sequence up to a break point, and the button is not pressed again for several months, the next press will still dial the sequence after the break point.

Each Meridian Norstar telephone uses sequences containing break points independently. If one telephone is left in a position to dial the sequence after the break point, another telephone in the system still dials the first part of the sequence by using the same Autodial button or Speed Dial code.

Refer to the "Centrex" and "PBX" sections of this chapter for further information regarding the Run/Stop code.

The following instructions provide a good example of the uses of the Run/Stop feature is placing a call to a company which has an Automated Attendant. When your call reaches the main switchboard, you are prompted to dial the extension number of the person with whom you want to speak. If you call often to one particular person in that company, you may wish to program the company number, a break point, then the extension number as one Autodial button. The following instructions show how this can be done.

**To program an Autodial button using Run/Stop:**

1. Press **Feature** **\*** **1**
2. Press the Autodial (memory) button which you wish to program.
3. Dial the first part of the dialing sequence (the company phone number).
4. Press **Feature** **\*** **9** to store a break point in the sequence.
5. Dial the remainder of the sequence (the extension number you wish to reach).
6. Press **Hold** or **OK** The display shows  
**Key programmed**

**To use the Autodial button with Run/Stop:**

1. Press the Autodial button.  
The Run/Stop feature dials the first half of the programmed number sequence, then stops.
2. Wait for the recording to prompt you to dial the extension number.
3. Press the Autodial button again.  
The Run/Stop feature dials the remaining digits of the sequence and your call is connected.

## Saved Number Redial

Saved Number Redial allows you to store the number of your active outside call in Norstar's memory, and dial the same number later by pressing only one button.

Saved Number Redial stores up to **16** digits if the number you have dialed is longer, only the first 16 digits will be stored.

You can use the dialpad, Speed Dial, an Autodial button, or Last Number Redial to dial a number which you want to save. If you are using a Line Pool when you save an outside telephone number, Saved Number Redial does not store the Line Pool Access code. Saved Number Redial stores one number for each telephone in your system, but if you have more than one outside line on your telephone, Saved Number Redial **does not** store a number for each line.

### To save a number:

1. Make a call to an outside telephone number.
2. At any point during the call, press **Feature** **6** **7**

**OR**

Press the **Saved Number** button.

Your display shows **Number saved** and then shows the digits of the number which it has saved.

### To use Saved Number Redial (with an outside Prime Line):

1. Press **Feature** **6** **7**

**OR**

Press the **Saved Number** button.

Your display shows the saved number, and the Saved Number Redial feature automatically selects a line.

If no number is stored for your telephone, the display shows

**No saved number**

2. Wait for two seconds. After this time, the Saved Number Redial feature dials the number shown on the display.

If the Prime Line setting for your telephone is assigned in Configuration as "None", the Saved Number Redial feature will not select an outside line automatically. When you attempt to use this feature, you will hear an error tone and your display will show

**Select a line**

If the Prime Line setting for your telephone is assigned in Configuration as an Intercom line, the Saved Number Redial feature attempts to dial the outgoing call on a Line Pool line. If your telephone is not assigned to a Line Pool, you will hear an error tone and your display will show `Select a line`

#### To use Saved Number Redial (with no Prime Line):

1. Press a `Line` button.
2. Press `Feature` `6` `7`

OR

Press the `Saved Number` button.

The display shows the digits of the saved number. If no number is stored for your telephone, the display shows

`No saved number`

3. Wait for two seconds. After this time, the Saved Number Redial feature dials the number shown on the display.

If you attempt to use Saved Number Redial while you are on either an incoming outside call or on an inside call, your display will show `No number saved` and you will hear an error tone.

Prime Lines is assigned to your telephones by your Installer or Service Representative in the "Line Access" section of Configuration programming.

Featu  
Operatio

## Selective Call Forward

Selective Call Forward is a means of using the Do Not Disturb feature to send an incoming call on an outside line to the Prime Phone instead of answering it yourself. Your telephone will be left in Do Not Disturb mode after using this feature.

#### To use Selective Call Forward:

While an outside call is ringing:

1. Press the `DND` (Do Not Disturb) button.

OR

Press `Feature` `8` `5`

The display shows `Do not disturb`

The call is transferred to the Prime Phone associated with the outside line the call is on. Your telephone remains in Do Not Disturb mode.

Prime Phone line assignment is determined by your Installer or Service Representative in the "Line Access" section of Configuration programming.

## Speed Dial — Personal

Speed Dial gives you fast access to frequently-called numbers by entering a two-digit code. Anyone with a Norstar telephone can store up to 24 outside phone numbers using Personal Speed Dial codes and can change the phone numbers at any time.

The Personal Speed Dial memory for each telephone is independent; if the telephone is moved within the system, the Personal Speed Dial numbers will be retained with the phone.

The Personal Speed Dial codes range from 71 to 94. Each Speed Dial number may contain up to **16 digits**.

You may have a Personal Speed Dial card attached to the base of your telephone in a pull out drawer. When you need a quick reference to programmed Personal Speed Dial numbers, pull the tab, and the chart will swing out so that you can check the numbers. If you do not have Personal Speed Dial cards for your office's telephones, see your Service Representative to place an order.

Other Norstar features that also provide convenient access to stored phone numbers are System Speed Dial and Autodial.

### To store Personal Speed Dial codes (M7208):

1. Press **Feature** **\*** **4** The display shows **Enter code:**
2. Enter a two-digit code between 71 and 94.  
The display shows **Program and HOLD**
3. Enter the desired outside number, including all digits that you must dial when placing the call manually.
4. Press **Hold** The number is now stored.
5. Record the name and the assigned two-digit code on the Speed Dial Card beneath your telephone (if available), or in a convenient place near your telephone.

### To store Personal Speed Dial codes (M7324 and M7310):

1. Press **Feature** **\*** **4** The display shows **Enter code:**
2. Enter a two-digit code between 71 and 94.  
The display shows **Enter digits:**
3. Enter the desired outside number, including all digits that you must dial when placing the call manually.



4. Press **Hold** or **OK**. The number is now stored.
5. Record the name and the assigned two-digit code on the Speed Dial Card beneath your telephone (if available), or in a convenient place near your telephone.

#### To erase a Personal Speed Dial code:

1. Press **Feature** **\*** **4**.  
The display shows **Enter code:**
2. Enter a two-digit code between 71 and 94.  
The display shows **Enter digits:** (M7324 and M7310) or **Program and HOLD** (M7208).
3. Press **Hold** or **OK** (M7324 and M7310 telephones only). **Entry<xx> erased** appears on the display. <xx> is the number of the Personal Speed Dial code (71-94) which has been erased.

#### To use Personal Speed Dial:

1. Press the **Speed Dial** button.  
**OR**  
Press **Feature** **0**.  
The display shows **Speed dial >**
2. Enter a Personal Speed Dial code (from 71 to 94). The Speed Dial feature selects a line automatically, and dials the programmed telephone number.

Featur  
Operati

## Speed Dial — System

System Speed Dial provides fast access to numbers that are frequently used by everyone in your Norstar Office System. This feature allows up to 70 phone numbers to be shared among all your co-workers. System Speed Dial numbers are stored in the memory of the Key Service Unit (KSU), and can be accessed from all telephones in your Norstar system.

System Speed dial entry numbers range from 01 to 70 inclusive. The entries can be changed only by the System Coordinator in Administration programming.

A chart is printed in the System Speed Dial part of the Job Aids chapter of this Guide for your convenience. You can photocopy the chart, fill it out, then distribute copies to your co-workers.

**To use System Speed Dial:**

1. Press the **Speed Dial** button.

**OR**

Press **Feature** **0**

The display shows **Speed dial >**

2. Press a System Speed Dial code (01-70). The Speed Dial feature selects a line automatically, and dials the programmed telephone number.

**System Speed Dial does not work under the following conditions:**

**The caller enters an invalid code.**

Entering codes outside the range of 01 through 94 (for both Personal and System Speed Dial) causes an error tone and the display message: **Invalid code**

**The caller enters a code which does not correspond to a telephone number.**

An error tone sounds and the display shows **No number stored**

**The stored telephone number is prohibited by a system-wide Restriction.**

Remove the Restriction or program an Override for this telephone.

System Speed Dial numbers are assigned for your system in the "System Speed Dial" section of Administration programming.

---

## System Settings

Norstar provides a feature which allows you to see all of the Configuration and Administration settings for any individual line or telephone. While using the System Settings feature, you cannot change any settings. The feature is intended to permit you only to check what the settings are in order to understand how each line and telephone in your system is programmed.

**The System Settings feature can only be used on Norstar M7324 and M7310 telephones.**

This feature does not show the settings assigned at individual telephones, but only the settings assigned in Configuration and Administration programming.

If you are having problems with a line or telephone, System Settings is the ideal place to look to discover what the problem might be. Before you call your Installer or Service Representative for assistance, check the setting of the line or telephone and make sure that there are no obvious problems. If you call your Installer or Service Representative, be prepared to describe the line or telephone settings over the telephone. With this information, it is very likely that your Installer or Service Representative will be able to help you immediately.

You can use this feature while you are active on a call. This makes it easy to inform another person of the settings you are checking as you check them, and saves you the trouble of recording each setting and introducing possible error.

This feature uses **BACK** , **SHOW** and **NEXT** display buttons in the same way that Administration programming uses the buttons labelled by the Programming Overlay.

### How to check telephone settings

The following procedures describe how to check the settings for a telephone in your system. If a particular setting does not apply to the telephone you are checking, it will not appear on the display of your telephone as you scan these settings. For example, if no Restrictions are applied to the telephone you are checking, the **x Restrictions** message appears as **0 Restrictions** and no **SHOW** display button appears.

#### To check the Name of a telephone:

1. Press **Feature** \* \* **S E T**

**OR**

**Feature** \* \* **7 3 8**

The display shows **Show set: \_**

2. Enter the Intercom number of the telephone you wish to check. The digits appear above the cursor.

The display changes to the programmed name of that telephone: for example, **Set 221: Pat W**

**OR**

Press the **FIRST** display button. The display shows the programmed name of the telephone with the lowest Intercom number in the system.

### To check the lines assigned to a telephone:

Begin with the `Set<xxx>:<name>` message on the display and follow the steps below. <xxx> can be a two, three, or four-digit number, depending upon the size of your system.

1. Press `SHOW` The display shows `Line Access`
2. Press `SHOW` The display shows `Line xx:Ring` or `Line xx:No ring` to tell whether or not the Line numbered xx is programmed to ring.
3. Press `NEXT` The display shows the next line assigned to the telephone you are checking. Repeat this step until all lines assigned to the telephone have been shown.
4. Press `NEXT` The display shows `<name>:Ring` or `<name>:No ring` to tell whether or not calls arriving at an `Answer` button on this telephone will ring. The <name> is the programmed name of the telephone with which the `Answer` button is associated.
5. Press `NEXT` The display shows `Line pool 1:xxx` where xxx is the Line Pool Access Code for this Line Pool.
6. Press `NEXT` The display shows the next Line Pool which is assigned to the telephone. Repeat this step until all assigned Line Pools have been shown.
7. Press `NEXT` The display shows `Intercom keys: x` where x indicates the number of Intercom buttons assigned to this telephone. This number will not be greater than eight.
8. Press `NEXT` The display shows `Prime line:xx` where xx is the line number of the Prime Line at this telephone, or is I/C (Intercom) or Pool x (Line Pool "x").
9. Press `NEXT` This moves you to the next series of settings for this telephone: `x Restrictions`

### To check Restriction settings for a telephone:

Begin with the `Set<xxx>: <name>` message on the display and follow the steps below.

1. Press `SHOW` The display shows `Line Access`
2. Press `NEXT` The display shows `x Restrictions` where x is the number of Restrictions assigned to this telephone.
3. Press `SHOW` The display shows the first Restriction assigned to this telephone: for example, `0:Y` if the default Restrictions have been applied to this telephone.
4. Press `NEXT` The display shows the next assigned Restriction. Repeat this step until all Restrictions assigned to this telephone have been shown.
5. Press `NEXT` This moves you to the next series of settings for this telephone: `x Overrides`

### To check Override settings for a telephone:

Begin with the `Set<xxx>: <name>` message on the display and follow the steps below.

1. Press `SHOW` The display shows `Line Access`
2. Press `NEXT` twice. The display shows `x Overrides` where xx is the number of Overrides assigned to this telephone.
3. Press `SHOW` The display shows the first Override assigned to this telephone: for example, `1800:Y` if the default Overrides have been applied to this telephone.
4. Press `NEXT` The display shows the next assigned Override. Repeat this step until all Overrides assigned to this telephone have been shown.
5. Press `NEXT` This moves you to the next series of settings for this telephone: `Permissions`

Featur  
Operatio

## To check Permissions for a telephone:

### To access the Permissions settings:

Begin with the `Set<xxx>: <name>` message on the display and follow the steps below.

1. Press `SHOW`. The display shows `Line Access`.
2. Press `NEXT` three times. The display shows `Permissions`.

### To view the Permissions:

The display shows `Permissions`.

1. Press `SHOW`. The display shows `Full handsfree:` with a Y (Yes) or N (No) to indicate if this feature is permitted at this telephone.
2. Press `NEXT`. The display shows `HF Answerback:` with a Y (Yes) or N (No) to indicate if this feature is permitted at this telephone.
3. Press `NEXT`. The display shows `Pickup group:x`. The x indicates the number of the Pickup Group to which the telephone is assigned, or is None.
4. Press `NEXT`. The display shows `Page zone:x` if that feature is turned ON in Administration. The x indicates the number of the Page Zone to which the telephone is assigned.
5. Press `NEXT`. The display shows `Aux. Ringer:` with a Y (Yes) or N (No) to indicate if calls at this telephone will drive the Auxiliary Ringer.
6. Press `NEXT`. The display shows `Forward no answer`.

### To check the Forward No Answer settings:

The display shows `Forward no answer`.

1. To view the Intercom number of the destination telephone, press the `SHOW` display button. The display shows `Forward to xxx` where xxx is the Intercom number of the telephone to which unanswered calls are forwarded. If the display shows `Forward to None`, press `NEXT` to go to `Priority call:`.
2. Press `NEXT`. The display changes to `Forward delay:x` where x is the number of rings before unanswered calls are forwarded.

**To continue checking Permissions:**

The display shows

1. Press  The display shows  with a Y (Yes) or N (No) to indicate if this feature is permitted at this telephone.
2. Press  This causes the display to return to the  message, allowing you to check the settings for another telephone in your system.
3. To check another telephone, press the  display button to check the telephone with the next Intercom number in the sequence.

**How to check the settings for an outside line**

The following procedures describe how to check the settings for an outside line for your system. If a particular setting does not apply to the line you are checking, it will not appear on the display of your telephone as you scan these settings. For example, if no Overrides are applied to the line you are checking, the  message appears as  and no  display button appears.

**To check the Name of an outside line:**

1. Press

**OR**

The display shows

2. Enter the two-digit number of the line you wish to check. The digits appear above the cursor.

The display changes to the programmed name of that line: for example,

**OR**

Press the  display button. The display shows the programmed name of the line with the lowest two-digit number.

**To check the settings of an outside line**

Begin with the `Line<xx>: <name>` message on the display and follow the steps below. <xx> is the two-digit number of an outside line in your system.

1. Press `SHOW` The display shows `Line data`
2. Press `SHOW` again. The display shows `Type:` with `public`, `private` or `pool` after the colon.
3. Press `NEXT` The display shows `Mode:` with `pulse` or `tone` after the colon.
4. Press `NEXT` The display shows `Aux. ringer:` with a `Y` (Yes) or `N` (No) to indicate if this line is programmed in Configuration to drive the Auxiliary Ringer.
5. Press `NEXT` The display shows `Full autohold` with a `Y` (Yes) or `N` (No) to indicate whether or not this feature is turned ON for this line.
6. Press `NEXT` The display shows `Prime set: xxx`  
The number `xxx` is the Intercom number of the Prime Phone assigned to the line, or is `None`.
7. Press `NEXT` This moves you to the next series of settings for this line: `x Restrictions`

**To check Restriction settings for an outside line:**

Begin with the `Line<xx>: <name>` message on the display and follow the steps below.

1. Press `SHOW` The display shows `Line data`
2. Press `NEXT` The display shows `x Restrictions` where `x` is the number of Restrictions assigned to this line.
3. Press `SHOW` The display shows the first Restriction assigned to this line: for example, `0:Y` if the default Restrictions have been applied to this line.
4. Press `NEXT` The display shows the next assigned Restriction. Repeat this step until all Restrictions have been shown.
5. Press `NEXT` This moves you to the next series of settings for this line: `x Overrides`



### To check Overrides for an outside line

Begin with the `Line<xx>: <name>` message on the display and follow the steps below.

1. Press `SHOW`. The display shows `Line data`
2. Press `NEXT` twice. The display shows `x Overrides` where x is the number of Overrides assigned to this line.
3. Press `SHOW`. The display shows the first Override assigned to this line: for example, `1800:Y` if the default Overrides have been applied to this line.
4. Press `NEXT`. The display shows the next assigned Override. Repeat this step until all Overrides assigned to this line have been shown.
5. Press `NEXT`. This moves you to the next series of settings for this line: `Night service`

### To check the Night Service settings for an outside line:

Begin with the `Line<xx>: <name>` message on the display and follow the steps below.

1. Press `SHOW`. The display shows `Line data`
2. Press `NEXT` three times. The display shows `Night service`
3. Press `SHOW`. The display shows `Night ctrl: xxx` where xxx is the Intercom number of the telephone at which Night Service for this line can be turned ON or OFF, or is None.
4. Press `NEXT`. The display shows `Night ring: xxx` where xxx is the Intercom number of the telephone which will ring for calls coming in on this line while Night Service is turned ON, or is None.
5. Press `NEXT`. The display shows `Night aux ring:` with a Y (Yes) or N (No) to indicate if calls coming in on this line will drive the Auxiliary Ringer.
6. Press `NEXT`. This causes the display to return to the `Line<xx>: <name>` message, allowing you to check the settings for another line in your system.
7. To check another line, press the `NEXT` display button to check the line with the next highest two-digit number.

### To Exit from the System Settings feature:

At any point during your use of the System Settings feature, you can exit from the feature and return to telephone to its regular display message by following the steps below.

1. Press **Feature**

The System Settings feature will be cancelled.

**OR**

Press the **QUIT** display button under the

**Show set: \_** or **Show line: \_** message.

The System Settings feature will be cancelled.

## Time and Date

The Time and Date appear on the display of your telephone when you are not on a call. The default setting for Time and Date is 1 Jan 1989 1:00 am at the time of initial installation.

Jan 1 1:00 am

If your Norstar system suffers a power interruption, the Time and Date display stops, then resumes counting when power is restored. The difference between the displayed time and the actual time is the length of the power interruption.

The English Time and Date display is in 12-hour format, with “am” or “pm” following the time. Alternate language displays are in 24-hour format.

English	Sept 13 2:37 pm
Spanish	13 Sep 14:37
French	13 sept 14h37

**Note:** The Call Duration Timer feature does not work for calls which are active while you are setting your system's clock.

Time and date are adjusted in the “Time and Date” section of Administration programming.

## Timed Release

Dial a Timed Release signal whenever you want to release a call from your line but retain the use of the line for another call.

The Timed Release is also required as part of some dialing sequences when signaling a remote device or reaching through a PBX or Centrex system. It inserts a 1.5 second pause into the sequence. For more information, see the "Centrex Features" and "PBX Features" sections of this chapter.

Generate a Timed Release signal by pressing **Feature 7 2**. You can create a **Timed Release** button to send the signal with one press if you program an Autodial button with the feature code. See the "Feature Access" section of this chapter for instructions.

**Timed Release** works only when a line is active.

## Transfer

The Meridian Norstar system offers three convenient ways to transfer calls:

Transfer	<b>Feature 7 0</b>
Transfer using Conference	<b>Feature 3</b>
Transfer using Hold	<b>Hold</b>

**Transfer** provides two ideal means of transferring an outside call to someone else in your office.

The fastest method, **Transfer without Announcement**, transfers an incoming call directly to a co-worker's telephone. If there is no answer, the call returns to ring at your telephone.

The second method, **Transfer with Announcement**, allows you to discuss the call with your co-worker before transferring the call. Transfer With Announcement is also useful if your manager asks you to connect him with a person who is hard to reach. Once you have the person on the line, you can call your manager and connect the two calls.

Both methods allow you to reconnect with the party you are attempting to transfer, up until the time you press the final button of the transfer sequence. The procedures for transferring calls using this feature are given in the following pages and on the User Cards for each Norstar telephone.

**Transfer using Conference** allows you to introduce two people to each other in a three-way conversation before leaving them connected. This feature works best when one of the parties is on your Norstar system, but it does allow you to connect two outside parties by putting a conference on Hold at your telephone. If this method is used, you must monitor the call and disconnect when the two outside parties have finished their call. If you release yourself from the call, both parties will be disconnected.

**Transfer using Hold**, is a simple but effective method of transferring calls. Transfer Using Hold allows you to privately tell someone in your office that there is a call for him on a certain outside line. To accept the call, your co-worker presses the flashing line indicator on his telephone. Otherwise, you can return to the caller and take a message or explain that the other person is unavailable.

### Transferring a call to someone in your office

The following procedures show how a call can be transferred using the methods described above.

#### Transfer without Announcement

While on a call:

1. Press **Transfer**

**OR**

Press **Feature** **7** **0**

**OR**

Press **TRANSFER** (M7324 and M7310 telephones only).

The display shows **Transfer to:**

2. Dial the Intercom number of the person to whom the call will be sent.

**OR**

Press the line button of a held inside call to connect the two parties. The call is immediately transferred, and you are disconnected.

#### Transfer Callback

If the telephone to which you have transferred a call is busy, or if your transferred call is not answered after a specified length of time, the Transfer Callback feature returns the call to your telephone.

Refer to "Transfer Callback" in this chapter of the Guide for further information.

**Transfer with Announcement** (M7324 and M7310 telephones only).

1. While on a call, press **Transfer**  
**OR**  
 Press **Feature** **7** **0**  
**OR**  
 Press **TRANSFER**  
 The display shows **Transfer to:**
2. Press **ANNOUNCE** The display changes to **Announce to:**
3. Dial the Intercom number of the person to whom the call will be sent.  
**OR**  
 Press the line button of a held inside call.
4. When the call you have placed is answered, announce the call you are transferring.
5. Press the **JOIN** display button to connect the two calls. The display shows **Call transferred** for three seconds and you are disconnected from the call.

#### **To cancel Transfer:**

This feature works only with the Transfer (with or without Announcement) feature.

1. While you are attempting to transfer a call, **Transfer to:** or **Announce to:** appears on the display. At this point, you can cancel the transfer.
2. Press the **CANCEL** display button or the line button with the flashing indicator for the call you were attempting to transfer. You are automatically reconnected to the call.

#### **Transfer Using Conference**

While on a call:

1. Call the person to whom the first call will be transferred. (The first call will be automatically placed on hold).
2. After the call is answered, press **Conf/Trans**  
**OR**  
 Press **Feature** **3**
3. Press the line button of the held call.
4. To disconnect yourself from the call, press **TRANSFER** (M7324 and M7310 telephones only)  
**OR**  
 Press **Rls**

Feature  
Operation

### Transfer using Hold

**Note:** This method can only be used to transfer an outside call to another telephone that has a button for the line that the outside call is using.

While on an outside call:

1. Press **Hold**

**OR**

Place an inside call to your co-worker. The outside call is automatically placed on hold.

2. Tell your co-worker which line button to press to pick up the call.
3. After the line indicator ► stops flashing on your telephone, hang up or proceed with other calls.

### Transferring an outside call to another outside party

While on a call:

1. Put the first call on hold by pressing the **Hold** button or selecting another line (Automatic Hold).
2. Call the person to whom the first call will be transferred. Wait until the call is answered before going to step 3.
3. Press **Conf/Trans**  
**OR**  
Press **Feature** **3**
4. Press the line button of the held call.
5. To remove yourself from the call, press **Hold**  
If both parties are outside your office, their two lines must remain busy at your telephone until the conversation is finished. If this method is used, go to step 6 only after both parties have hung up.
6. Press **RLS**

## Transfer Callback

Callback to your telephone occurs if you have Transfer without Announcement to send an outside call to a co-worker's telephone, and your co-worker does not answer. After a specified number of ring cycles, the outside call returns to your telephone. Callback is a convenient feature for receptionists, as it allows them to take messages from outside callers who have been transferred. Callback does not occur with inside calls.

If a transferred call cannot ring at the destination telephone, Callback occurs immediately. If the caller hangs up, Callback may still occur. When you answer the Callback call, you will hear a dial tone.

Callback occurs only at the telephone that attempted the transfer. If the call came in on an outside line, the Callback call rings on that line if it is available; otherwise, the call rings on an Intercom line. If no free line is available, the Callback call is transferred to the Prime Phone.

On a system that has a Prime Phone and Delayed Ring Transfer activated, a Callback call will be directed to the Prime Phone after a specified number of rings if the original telephone does not answer. If a Callback line is not answered at the Prime Phone within three minutes, the outside call is disconnected.

Do Not Disturb (if it is turned ON at the transferring telephone) cancels the ringing for a Callback call, but not the flashing of the indicator.

Callback cannot occur at a telephone that is initializing your system, or is in an Administration, Configuration, or Maintenance session.

### **To reconnect with your original caller (M7324 and M7310 telephones):**

1. Press the **CALLBACK** display button

**OR**

Press the line button which the call is on. You are connected with your original call. If you have attempted to transfer more than one call, pressing **CALLBACK** will connect you with the call which has been waiting to be answered for the longest period of time.

### **To reconnect with your original caller (M7208 telephone):**

On the M7208 telephone, a call arriving at your telephone through the Callback feature will appear as a regular ringing call.

The Callback delay time is controlled by the Installer or Service Representative in the "Call Handling" section of Configuration programming.

## Trunk Answer (from any telephone)

Trunk Answer (from any telephone) allows you to answer a telephone which is ringing in your office from any other telephone within your Norstar system.

This feature only works with calls which are ringing on lines that have Night Service turned ON. If the line does not have Night Service turned ON, it must be answered using another method, such as Call Pickup (Directed or Group).

Trunk Answer cannot be used to answer calls on Private lines.

### To use Trunk Answer (from any telephone):

1. While a call is ringing on a line that is in Night Service, lift the receiver

OR

Press

2. Press

OR

Press

The display shows  where <name> is the number or programmed name of the line on which the call is ringing. The call is immediately connected.

This feature is controlled in the "Night Service" section of Administration programming.

## Voice Call

The Voice Call feature allows you to make a voice announcement or begin a conversation through the speaker of another telephone in your system. The person you call will hear an alerting tone, followed by your voice. If Handsfree Answerback is active at the called telephone, the person will be able to answer you without picking up the receiver. If Handsfree Answerback is not active, the person will either have to press  or pick up the receiver to talk to you.

You cannot make a Voice Call if the receiving telephone is busy or if any of the following features are active on the receiving telephone: Call Forward, Do Not Disturb, or Voice Call Deny. Under these conditions,  appears on your display and the call is handled as a regular ringing call.

Once a Voice Call has been answered, it can be held, transferred, or otherwise treated as a normal call.



**To make a Voice Call:**

1. Press the **Voice Call** button before dialing the call.

**OR**Press **Feature 66****Dial Voice Call** appears on the display.

2. Dial the Intercom number of the person you wish to speak to.

After you see the display **Voice call**, the line is open for you to speak. If the display shows**No voice call**, your call proceeds as a regular ringing call. This may mean that you will hear a busy signal, or that the call is being redirected.**Handsfree Answerback**

The Handsfree microphone is activated when a Voice Call occurs. A tone is given every 15 seconds to remind you that the microphone remains ON until you pick up the receiver or press

**Handsfree** to acknowledge the call.

Handsfree Answerback is controlled by the System Coordinator in the "Permissions" section of Administration programming.

Featu  
Operatio

**Voice Call Deny**

This feature prevents a telephone from receiving Voice Calls. All incoming inside calls must then be received as ringing calls.

**To use Voice Call Deny:**

1. Press the **Voice Call Deny** button.

**OR**Press **Feature 88**The display shows **No voice calls****To cancel Voice Call Deny:**

1. Press the **Voice Call Deny** button again.

**OR**Press **Feature #88**The display shows **Allow voice call**

## Volume Button

The Volume Button is a multi-purpose control for adjusting the volume of the receiver, telephone ring, Handsfree speaker, Headset and Background Music. As you use each feature or Norstar component, press either end of the volume button until the correct level of sound is reached.

lower volume   higher volume

Refer to the “Ring Volume” section of this chapter for a separate procedure to adjust this feature.

---

## Wall - Mounted Telephones

All Norstar Telephones can be mounted on a wall. Contact your Installer or Service Representative to have any telephones in your system wall-mounted.

# 5

## Display Messages

All messages that can appear on the display of your Meridian Norstar telephones—as error messages or to prompt you while using Norstar features—are listed below in alphabetical order. The meaning of each message is explained and, where appropriate, suggestions are given to assist you in using the feature correctly.

For further information concerning the messages which appear on your telephone display, see the appropriate sections of the Feature Operations or Norstar Administration chapters of this Guide.

Programmed line and telephone names that appear in the display messages are listed as <name>; messages beginning with <name> are located at the end of the alphabetical listing.

The arrangement of information is as follows:

Message
---------

### Feature(s) in which the message occurs

Explanation of the message and possible suggestions.

Access denied
---------------

#### Administration

You have attempted to access Norstar Administration from an M7208 telephone.

Use an M7324 or M7310 telephone to access Administration.

#### Night Service

The telephone you are using is not a Night Control Phone.

In order to activate Night Service, you must use a telephone which is designated as a Night Control Phone.

Display  
Message

Alarm: <xxx>

### **Alarm Set**

This message appears on the designated Alarm Phone and indicates a loss of electrical power to your system or the failure of a system component.

### **Do not panic.**

Write down the code numbers that appear on the display and report these to your Installer or Service Representative as soon as possible.

Allow calls

### **Cancel Do Not Disturb**

This temporary message indicates that the telephone will accept calls (the telephone is no longer in Do Not Disturb mode).

Allow voice call

### **Cancel Voice Call Deny**

This temporary message indicates that the telephone will accept Voice Calls (Voice Call Deny is no longer activated).

Already joined

### **Call Identification**

Your telephone is already connected to the telephone you are trying to call.

Check your active line and Intercom buttons, and use the existing connection for your call.

### **Call Pickup**

You are already connected to the telephone which made the call. This can happen if you attempt to pick up a call which a co-worker is making while you are already connected on a call to that same co-worker's telephone.

Announce to: \_

### **Transfer (with Announcement)**

This message prompts you to dial the Intercom number (or press the Autodial button) of the telephone to which you want to transfer a call.

Call blocked

### **Priority Call**

The person you are attempting to contact has blocked your call. Contact the person by using the Page or Message feature, or try to call the person later.

Call transferred

### **Conference/Transfer and Transfer**

This message indicates that the call has been successfully transferred.

Call <name>?

### **Ring Again**

This prompt asks whether or not your telephone should dial the number of the telephone indicated. <name> is the programmed name or Intercom number of another telephone within the Norstar system.

Calling Set<xxx>

### **Call Identification**

This prompt shows the set number of the telephone (within the Norstar system) that is being called. The set number appears because no name has been entered for the set.

Calling <name>

### **Call Identification**

This prompt shows the programmed name of the telephone (within the Norstar system) that is being called.

Display  
Message

Cancel forward

### Cancel Call Forward

This message indicates that Call Forward has been successfully cancelled. Incoming calls to the telephone will no longer be forwarded to another number.

Cancel for: -

### Message (Cancel Sent Message)

This prompt asks which sent message you wish to cancel.

Cancel > <name>

### Message

#### (Cancel Message Waiting and Cancel Sent Message)

This temporary prompt indicates that the sent message or message waiting has been successfully cancelled.

Can't ring again

### Ring Again

The call you have made will not allow the Ring Again feature (for example, an outside call), or your telephone has no active call.

Use Ring Again only on inside calls when the telephone you are calling is busy, not answering, or when all lines are in use. In any other situation, the call must be attempted later.

### Ring Again to an Answer Group

The telephone you are attempting to contact is not in service. Contact the person who has an  button for this telephone, and leave a message.

Code:

### Line Pools

This message prompts you to enter the Line Pool Access code to access one of the nine possible Line Pools in your Norstar system.

**Conference busy****Conference/Transfer**

The maximum number of conference calls which your system can support has been reached. Depending upon the size of your system, there can be up to 5, 10 or 21 conference calls active at any one time.

**Denied in admin****Call Pickup (Directed)**

This feature is not permitted at your telephone due to the programmed settings of your system.

Your Installer or Service Representative controls this feature in the "Call Handling" section of Configuration programming.

**Call Pickup (Group)**

Your telephone is not a member of a Call Pickup Group.

Call Pickup Groups are defined under "Permissions" in Administration programming.

**Line Pools**

Your telephone does not have access to the requested Line Pool.

Your Installer or Service Representative can assign telephones in your system to the required Line Pools in the "Line Access" section of Configuration programming.

**Priority Call**

Your telephone is not permitted to make Priority Calls due to Administration programming.

You can turn the Priority Call feature ON for a telephone in the "Permissions" section of Administration programming.

**Dial memory full****Outside Autodial and Personal Speed Dial**

This message indicates that the memory space allotted for storing Outside Autodial and Personal Speed Dial numbers in your Norstar system is full.

Display  
Message

Dial Voice Call

### **Voice Call**

This message prompts you to proceed in dialing a Voice Call after initiating the Voice Call feature.

Do not disturb

### **Call Identification**

The telephone you have called is in Do Not Disturb mode. After three rings your call may be directed to a Prime Phone.

### **Do Not Disturb**

This message remains on the display when your telephone is in Do Not Disturb mode.

DND from <name>

### **Do Not Disturb**

This message appears on a Prime Phone when it receives a call forwarded from a telephone using the Do Not Disturb feature.

DND transfer

### **Do Not Disturb**

This message appears on a Prime Phone when a call forwarded from a telephone using the Do Not Disturb feature has the highest call priority.

DRT line <x>

### **Delayed Ring Transfer**

This message appears on a Prime Phone when it receives a call forwarded from a telephone by means of the Delayed Ring Transfer (DRT) feature.



---

En español...

**Language Choice**

This message indicates that the Language Choice feature has been used to change the display language from English to Spanish. All further prompts and messages on the display will appear in Spanish, until the language is changed again.

En français...

**Language Choice**

This message indicates that the display language has just been changed from English to French. All further prompts and messages on the display will appear in French until the language is changed again.

Enter zone:

**Page**

This message prompts you to enter the number of the Page Zone on which you wish to broadcast after activating the Page Zone feature.

Feature timeout

**Restriction Passwords**

The 15 seconds allowed for you to enter the four-digit password have elapsed.

Enter the feature code again, and remember to enter the Restriction Password immediately.

Forward denied

**Call Forward**

An incorrect Intercom number or autodial button has been used, or you are trying to forward a telephone to another telephone that is already forwarded to the telephone you are using (Call Forward—All Calls). This would create an endless loop, and therefore is not permitted.

Check your number and try to forward your telephone again.

Display  
Message

Forward to:

### Call Forward

This message prompts you to dial the Intercom number of the telephone to which you wish to forward your calls.

Forward > <name>

### Call Forward

This message shows the name of the telephone to which your calls are being forwarded.

Get call first

### Call Park

You have attempted to park a call when you are not connected to an active call, but do have one or more calls on Hold.

If the call you wish to park is on Hold, you must reconnect to the call before you can park it.

Held by <name>

### Held Line Reminder

This message appears on the Prime Phone if an outside call is held on any telephone in the system for more than two minutes. The message shows which telephone placed the call on hold, and is accompanied by a Held Line Reminder tone.

Held call

### Held Line Reminder

This temporary message appears on the display of both the telephone which has the call on hold and the Prime Phone if an outside call is on hold for an excessive length of time. The length of time required to activate this feature is programmed by your Installer or Service Representative.

**Held exclusively****Exclusive Hold**

This temporary display will appear when an outside call is placed on Exclusive Hold.

**In English...****Language Choice**

This message indicates that the Language Choice feature has been used to change the display language to English from the Alternate language. All further prompts and messages will appear in English, until the language is changed again.

**In maintenance****Maintenance**

This message appears on your display while your telephone is being tested in a Norstar Maintenance session.

**In use: <name>****Administration**

Another telephone in your system (specified by <name>) is presently using Norstar Administration or Configuration. Locate and use the telephone which is being used, or wait until Norstar Administration or Configuration is no longer in use.

**Invalid code****Call Park (Retrieval)**

You have entered a number other than 101 through 109. All Retrieve Park codes are between, and include, these two values.

**Feature Access**

An incorrect or unprogrammed code has been dialed. Check the code and try again.

Displ  
Messag

### **Line Pool**

You have entered an invalid Line Pool Access code.  
Check the Job Aids chapter of this Guide for a record of the correct programmed codes.

### **Speed Dial**

A number outside of the code range (01-70 for System Speed Dial, 71-94 for Personal Speed Dial) has been dialed.

Invalid number

### **Call Identification**

An unavailable Intercom number (beyond the range of your system) has been dialed.

Invalid password

### **Restriction Passwords**

You have entered a password which is not programmed in your system.  
See your System Coordinator for a list of the passwords which you are permitted to use.

Invalid zone

### **Page**

You have entered a code which is not between 1 and 6, the possible Page Zone choices. Enter a valid Page Zone and attempt your page again.

Line denied

### **Prime Phone**

You have attempted to pick up a private call.  
Private lines can only be accessed from the telephone to which the line is assigned.

---

Line in use

**Exclusive Hold**

You have attempted to pick up a call which is exclusively held on another telephone.

**Lines (Outside Line Access)**

The line is in use at another set.

Use a different line, or wait until the line is free.

**Line Pool**

The line chosen by the system became active before connecting with your call. Retry the line pool request.

Line <x>

**Manual Line Selection**

This message appears on the display when a line button is pressed on an idle telephone, such as when a line is selected prior to making an outside call.

**Automatic Line Selection**

This message appears when the receiver is picked up or when the Handsfree/Mute button is pressed, if the telephone has the Automatic Line Selection feature assigned.

Line <x> calling

**Call Identification**

This message shows the number of the line that an incoming external call is using. This message only appears when the call would not normally ring at the telephone (for example, if it is redirected from another telephone by Call Forward).

Line <x> >pickup

**Call Pickup**

This temporary message indicates a successful Call Pickup and shows the number (<x>) of the line used by an outside call that you are picking up from another telephone in your pickup group.

Displ  
Messag

Line<x> to prime

### **Prime Phone**

This message indicates that a call is on an outside line (<x>) which rings at the Prime Phone, but is not administered to ring at any other telephone within the system.

Maintenance test

### **Maintenance**

When this message flashes on your display message indicates that your telephone or lines will be tested in a Norstar Maintenance session within one minute.

If this message remains on your display, it indicates that a Maintenance test is currently being performed on your telephone set or lines.

Make call first

### **Call Duration Timer**

No call has been made since the last power interruption (since your telephone's clock was last stopped).

### **Priority Call**

You have attempted to activate the Priority Call feature while you have no ringing or busy tone on the line.

Wait until you hear ringing or a busy signal before activating Priority Call.

### **Transfer**

You have attempted to transfer a call when you are not connected to one.

Make calls first

### **Conference/Transfer**

No calls have been established to form a conference call.

---

Make second call

**Conference/Transfer**

There is no held call to complete the conference call.

Message denied

**Messages (Send Message)**

An incorrect Intercom number has been dialed, or the set to which you are sending the message is out of service.

Retry the call, or see your check the Job Aids chapter of this Guide for a list of correct Intercom numbers.

**Messages (Send Message) to an Answer Group**

The telephone you are attempting to contact is not in service. Contact the person who has an  button for this telephone, and leave a message. You can use the System Settings feature to determine which telephone in your system has an  button for the telephone you are trying to reach.

Message for you

**Messages (Message Waiting)**

This display indicates that there is one message recorded in your Message Waiting list.

Message to:

**Messages (Send Message)**

This message prompts you to dial the Intercom number of the telephone to which you want to send a message.

Message > <name>

**Messages (Send Message)**

This temporary display indicates that your message has been successfully sent.

Displa  
Message

Messages for you

### **Messages (Message Waiting)**

This display indicates that there are two or more messages recorded in your Message Waiting list.

Microphone muted

### **Handsfree/Mute**

This message indicates that the microphone on your telephone has been turned OFF. The speaker, however, is still operating. You can hear the person on the other end of the line, but he or she cannot hear you.

Music OFF

### **Cancel Background Music**

This temporary message indicates that the Background Music feature has been turned OFF.

Music ON

### **Background Music**

This temporary message indicates that music can be heard through your telephone speaker when no call is in progress.

Need Handsfree

### **Headset**

This message indicates that Handsfree/Mute is not programmed for your telephone. In order to use a Headset, make sure the Handsfree/Mute feature is turned ON in the "Permissions" section of Administration programming.

If you are not using a Headset, this message indicates that you have plugged your telephone receiver into the Headset outlet on the bottom of the telephone. Check to make sure that your receiver is plugged into the correct outlet.



---

New Ring Again

### Ring Again

This temporary message indicates that you have activated the Ring Again feature, replacing a previously requested Ring Again.

Night service ON

### Night Service

This message appears on the Night Control Phone, and indicates that the Night Service feature has been activated for the specified line.

No call answered

### Answer Groups

This message appears if you press your  button when there is no call ringing at the telephone associated with that button.

No call on: <xxx>

### Call Park (Retrieval)

There was no call parked on the Retrieve Park code you have entered. Enter the correct code to retrieve the parked call.

No call to park

### Call Park

You have attempted to park a call when there are no calls at your telephone.

No free lines

### Line Pool

No lines are available in your line pool. Set Ring Again or retry the call later.

Display  
Message

No key available

**Line Identification**

No appropriate line is available for your feature or call.

Wait until the type of line you need becomes available, and attempt to use the feature or place the call again.

No last number

**Last Number Redial**

No outside number has been dialed since the last power interruption.

No line selected

**Lines (Outside Line Access)**

The prime line is in use or not defined.

Select a line manually.

**Handsfree/Mute**

No line has been selected.

Select a line manually.

Display  
Messages

No messages

**Messages (Cancel Message Waiting)**

There are no messages in your Message Waiting list. This display appears for this reason on the M7208 telephone only.

**Messages (Cancel Sent Message)**

You have not sent any messages.

**Messages (Show Message)**

There are no messages waiting on your telephone.

No number saved

**Saved Number Redial**

You have attempted to save the number of an incoming outside call , or an Intercom call. You can only save outside numbers which you have dialed.

No number stored

### Speed Dial

The two-digit code you dialed is a blank Speed Dial entry. It contains no outside number to be dialed.

No saved number

### Saved Number Redial

You have not saved an outside number since the last time your system was restarted. The Saved Number Redial memory is empty.

No voice call

### Voice Call

The telephone receiving the call cannot accept Voice Calls for one of the following reasons:

- the telephone is active or ringing with another call
- the telephone is in Call Forward mode
- the telephone is in Do Not Disturb mode
- the telephone has Voice Call Deny turned ON.

The call proceeds automatically as a regular ringing call.

Try your Voice Call later, after the condition that prevented the Voice Call has been removed, or use Priority Call to make a forced Voice Call, if this feature is permitted at your telephone in Administration programming.

No voice calls

### Voice Call Deny

This temporary message indicates that no Voice Calls will be accepted by your telephone. It does not prevent you from making Voice Calls to other telephones.

Normal service

### Night Service

This temporary message appears on the Night Control Phone to indicate that the line has been taken off Night Service and returned to normal functioning.

Displ  
Messag

Not in service

### **Call Forward**

Two or more telephones are linked in a forwarding chain, and one of the telephones is out of service; a telephone is out of service when it is disconnected or when it is being used for programming the system.

Wait until the Call Forward has been turned OFF at the telephone which is forwarded to a telephone which is out of service.

### **Call Identification**

An invalid Intercom number has been used, or the telephone being called is in an Administration or Configuration session, or has been disconnected.

### **Priority Call**

You have attempted to contact a telephone which is busy in an Administration or Configuration session.

Wait until the telephone is free, or use the Page feature to contact the person you are trying to reach.

### **Transfer Callback**

The telephone to which you are trying to transfer a call is out of service. Notify your caller that the connection cannot be made at this time.

Not set

### **Ring Again**

The Ring Again feature has not been activated.

Number saved

### **Saved Number Redial**

You have successfully stored the outside telephone number which you have dialed. Activating the Saved Number Redial feature will dial the number which appears after this temporary display.

**On another call****Call Identification**

The telephone you have called is active on another call.

If your call is not answered (using the Call Pickup feature), turn Ring Again ON, or try the call later.

**Out of service****Maintenance**

This message appears on your telephone when you attempt to use a line which is being tested in a Norstar Maintenance session.

Use another line to make your call, or wait until the Maintenance session is over.

**Page choice:****Page**

When you activate Page - General (Feature **6|0**), this message asks you to press **1**, **2** or **3** on the dialpad (or use the display buttons provided by the system) to specify the zone in which your page will be heard:

- 1** — internal ( **SETS** )
- 2** — external ( **SPKR** )
- 3** — both internal and external ( **BOTH** )

**Page timeout****Page**

The two minutes allotted for paging have expired.

Page again to complete the message.

**Paging ALL****Page**

This message appears while you are paging all zones in your system.

Please hang up

### **Maintenance**

This temporary message indicates that the line or telephone you are using will be tested in a Norstar Maintenance session after approximately one minute.

Please wait...

### **Priority Call**

This message appears once you have attempted to place a Priority Call to an active telephone. It lasts for five seconds, during which period the person you are attempting to contact can block your call.

Press held line

### **Conference/Transfer**

This message prompts you to press the line button of the call on hold in order to connect it to your conference call.

Priority call

### **Priority Call**

This message appears on your telephone display while you are connected on a Priority Call.

Priority denied

### **Priority Call**

You have attempted to place a Priority call to an Answer Group in which the destination telephone is not connected. Contact the telephone which has the  button for the Group and leave a message.

Priority ><name>

### **Priority Call**

This message appears on your telephone display when someone is attempting to contact you using the Priority Call feature.

---

To accept the call, wait five seconds for it to connect. To reject the call, press **DND** (Do Not Disturb) or the **BLOCK** display button which appears with this message (M7324 and M7310 telephones only).

**Restricted call**

### Call Restrictions and Overrides

The call you are attempting to make is prevented by a system Restriction. Check the Job Aids chapter of this Guide, or use the System Settings feature. There may be another line or telephone on which your call is permitted, or a Restriction Password which will allow you to dial your call.

**Ring again?**

### Autodial (Inside)

On the M7324 and M7310 telephones, this message asks whether you want to set the Ring Again feature when you cannot get through on a particular inside call. The message appears on the display of an M7324 or M7310 telephone if you press **LATER** while you hear either ringing or a busy signal on an inside call. The message is accompanied by the display buttons: **YES** **NO** and **EXIT**, with which you can indicate your decision.

**Ring again OFF**

### Cancel Ring Again

This temporary message indicates that a request for Ring Again has been cancelled.

**Ring again ON**

### Ring Again

This temporary message indicates that a Ring Again request has been accepted.

Displa  
Message

<xx> seconds  
until disconnect

### **Maintenance**

This temporary message indicates that the line or telephone you are using will be tested in a Norstar Maintenance session after <xx> seconds. On the M7208 telephone, this message appears in two parts; each line is displayed for three seconds.

Select a line

### **Lines (Inside and Outside)**

This message occurs if no Prime Line has been assigned in Configuration or if the feature you are using does not automatically select a line.

Send message?

### **Autodial (Inside)**

This message asks whether you wish to send a message to a co-worker who is not able to take your call.

Speed dial >

### **Speed Dial**

This message appears before you dial the Speed Dial code for a given number.

Testing line<xx>

### **Maintenance**

This temporary message indicates that Line <xx> will be tested in a Norstar Maintenance session after approximately one minute. Line <xx> must be assigned to your telephone in order for the message to appear.

Their list full

### **Message (Send Message)**

The Message Waiting list is full on the telephone to which you are trying to send a message.



3 parties only

### **Conference/Transfer**

You are trying to add a fourth party to your conference call, or trying to join two conferences together.

Release one person from the conference call before adding another, or keep the two conference calls separate.

Tones denied

### **Long Tones**

You have attempted to use the Long Tones feature while you are connected in a Conference Call.

Disconnect one party from the conference call before attempting to use the Long Tones feature.

Transfer denied

### **Transfer**

You have attempted to transfer an outside call to an outside party while someone else is trying to place you in a conference call, thereby preventing you from transferring the call.

Transfer to:

### **Transfer**

This message prompts you to enter the Intercom number (or press the Autodial button) of the telephone to which you wish to transfer a call.

Use line pool?

### **Ring Again**

If you have turned the Ring Again feature ON for a busy Line Pool, this message appears when a line in the Pool becomes free.

Displa  
Message

Use unique name

### **Administration: Names**

You have attempted to program a name which has already been used for another line. Use a different name for the second line.

Voice call

### **Voice Call**

This temporary message indicates that your Voice Call has been successfully connected and you can begin talking.

Your list full

### **Message (Send Message)**

Your telephone's list of sent messages is full.

Cancel one of the messages you have sent (if possible) or wait until you have received a reply to another message.

Your number

### **Call Identification**

You have dialed the telephone or Intercom number of the telephone you are using.

< name >

### **Call Identification**

This message shows the name of the telephone in your office with which you are connected.

< digits >

### **All features**

Digits appearing on the display indicate the number you are dialing, or the number that is being dialed automatically by the telephone.

`< name > busy`

### Answer Groups

The telephone you are attempting to call has no button to show your line, and the `Answer` button associated with that telephone is in use.

### Call Identification

The telephone you have called has no Intercom lines available. Turn Ring Again ON, retry the call later, or connect using an outside line.

### Transfer Callback

The person to whom you are attempting to transfer a call is on another call.

Notify the caller that the call cannot be completed, but may be attempted again later.

`< name > callback`

### Call Park Callback

This message appears on a Prime Phone to indicate that an incoming call is a forwarded Callback Call from an unretrieved Call Park.

### Delayed Ring Transfer

This message appears on the display of a Prime Phone when a Callback call is transferred to the Prime Phone by the Delayed Ring Transfer feature.

`< x > < name > called`

### Messages

This message shows the name of a co-worker who has sent you a message. The `< x >` represents the number of the entry in your Message Waiting list, with number one being the oldest message.

`< name > calling`

### Call Identification

This message shows the name of a co-worker calling you, or the name of the telephone being used for an inside call. It also shows you the name or number of the line on which an outside call has arrived.

### **Transfer**

This message shows the name of the co-worker who is transferring a call to your telephone using the Transfer with Announcement feature.

< name > DND

### **Transfer Callback**

The telephone to which you are attempting to transfer a call is in Do Not Disturb mode.

Notify the caller that the call cannot be completed, but may be attempted again later.

< name > forward

### **Night Service**

This is a warning that the Night Ringing Phone is in Call Forward, which transfers the Night Service function to the destination telephone.

< name > hung up

### **Transfer**

This message indicates that the party you have attempted to transfer has hung up before the transfer was completed.

< name > no reply

### **Transfer Callback**

This message indicates that the call you attempted to transfer was not answered at the destination telephone, and has now returned to your telephone as a Callback call.

Notify the caller that the call cannot be completed, but may be attempted again later.

```
< name > > pickup
```

### Call Pickup Trunk Answer

This temporary message shows the name or number of the line or telephone which you are answering using Call Pickup or Trunk Answer (from any telephone).

```
< name > transfer
```

### Transfer

This message shows the name or line number of the call which is being transferred to your telephone.

```
< name > < name >
```

### Conference/Transfer

This message shows the names or line numbers of the two parties connected with you in a conference call.

```
< name > > < name >
```

### Answer Groups

This message appears on the secretary's telephone when a call arrives at the manager's telephone. The first < name > shows the name of the caller's line or telephone; the second < name > shows the name of the manager's telephone. The ">" symbol indicates the direction of the call (the first < name > placed the call to the second < name >).

### Callback (Call Park and Transfer)

When a Callback from a parked call is forwarded to another telephone, this message shows the name or number of the outside line which the original call is on and the name or Intercom number of the telephone which is forwarding the call.

### Call Forward

If you place a call and this message appears, it indicates the person you are calling (first name or Intercom number) and the telephone to which all its calls are forwarded (second name or Intercom number).

Displa  
Message

If you are active on a call and this message appears, it indicates that a call has been forwarded to your telephone from another telephone in your system. The first <name> is the name or number of the line or Norstar telephone which originally placed the call; the second <name> is the name or Intercom number of the telephone which is forwarding its calls to you.

### **Transfer**

This message shows the names or line numbers of the call you are transferring and the party to whom you are transferring the call.

<name> h:mm:ss





### **Call Duration Timer**

This message on any telephone shows the length of that telephone's most recent call in hours, minutes, and seconds. If the call was an inside call, <name> represents the name of the other telephone involved. If the call was an outside call, <name> represents the line used.

# 6

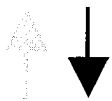
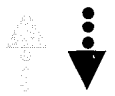
## Flow Charts

The symbols used in these diagrams are the same as in the Section Overviews within the Administration chapter of this guide. The chart below will remind you of these symbols:

Symbol	Explanation
	The solid arrows indicate a direct route from one display message to the next. This is achieved by pressing the indicated button.
	The dotted arrows indicate that in order to progress from one display message to the next, the button shown must be pressed a number of times
Show, Next	The <b>Show</b> and <b>Next</b> buttons are labelled on the Norstar Programming Overlay. They are printed in bold on the flow charts to indicate that pressing them moves you forward in the Administration process.
Back, Heading	The <b>Back</b> and <b>Heading</b> buttons are labelled on the Norstar Programming Overlay. They are not printed in bold on the flow charts to indicate that pressing them moves you backwards in the Administration process.
<u>CHANGE</u>	The underlined words in capital letters appear on the second line of the M7324 and M7310 displays. The actual buttons are located beneath the display panel.
	The bold boxes represent the main headings in Norstar Administration.
	Boxes of normal thickness represent the sub-headings and display messages which appear in Norstar Administration.
	Boxes with round edges represent instructions which DO NOT appear on your telephone display.
	Grey boxes represent the next display heading which appears after you have finished programming under one heading. The headings in the grey boxes are fully explained in the appropriate areas of the "Administration" and "Flow Charts" sections of this Guide.

Job Aid  
Flow Chart

# Administration Overview

The following two diagrams show the relationships between the various headings and sub-headings within Norstar Administration. They do not show every display within the system, but do show clearly how the various headings and sub-headings are connected. For more complete procedure flow charts, see the pages of this chapter which follow.

On the diagram below, the **Next** arrow which follows the **4. Restrictions** heading leads into the **5. Overrides** heading which begins the diagram on the opposite page.

## Administration Overview Flow Chart

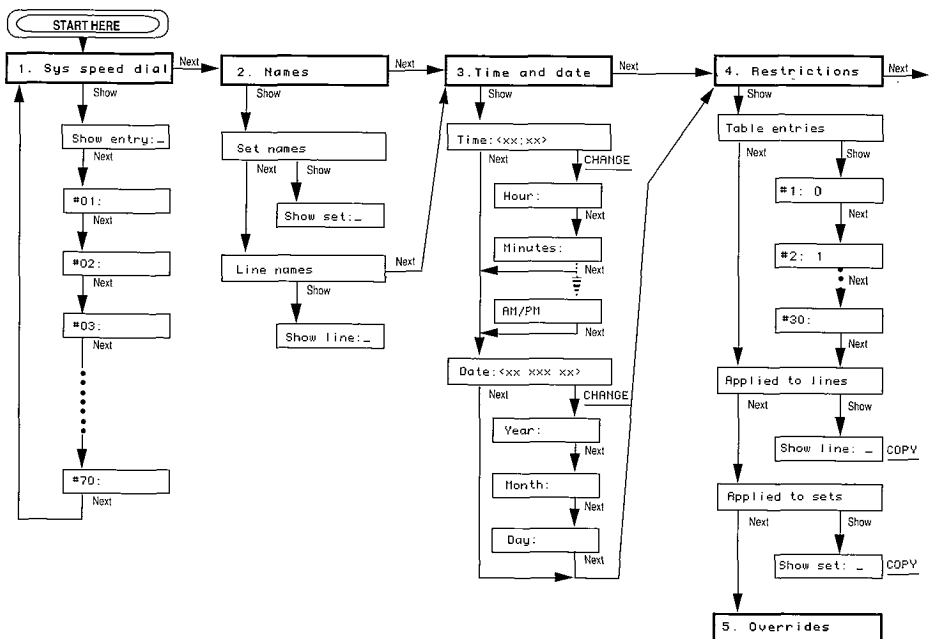

Flow Charts

Job Aids



# Administration Overview Flow Chart (continued)

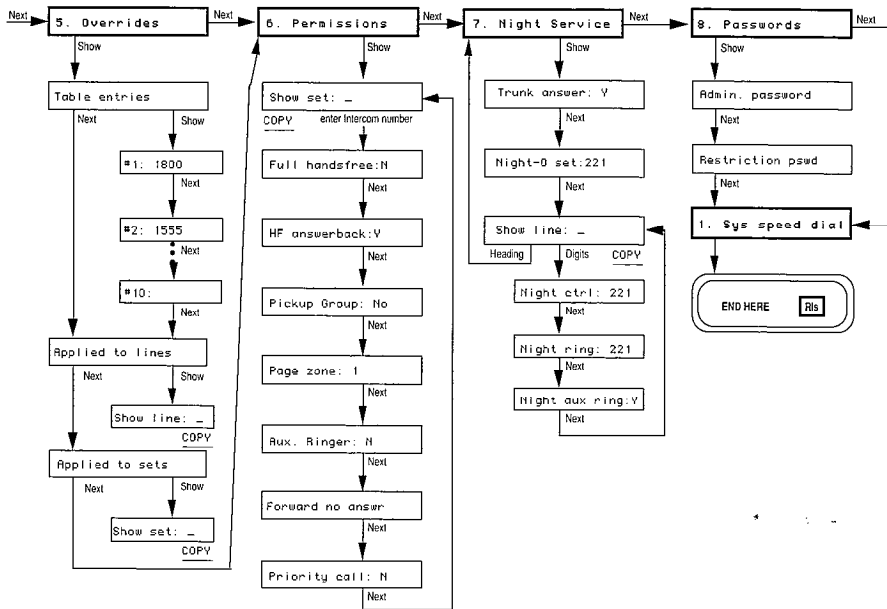

Job A  
Flow Cha

## Entering Administration

To access Norstar Administration, you must enter the correct entry code: Feature [\* \* A D M I N] and the correct password if one has been previously programmed for your system. The following flow chart shows the procedures for entering Norstar Administration:

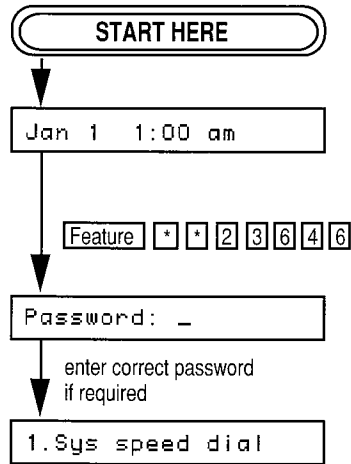

# System Speed Dial

The following flow chart shows the relationship between the various display messages which appear in the System Speed Dial section of Norstar Administration.

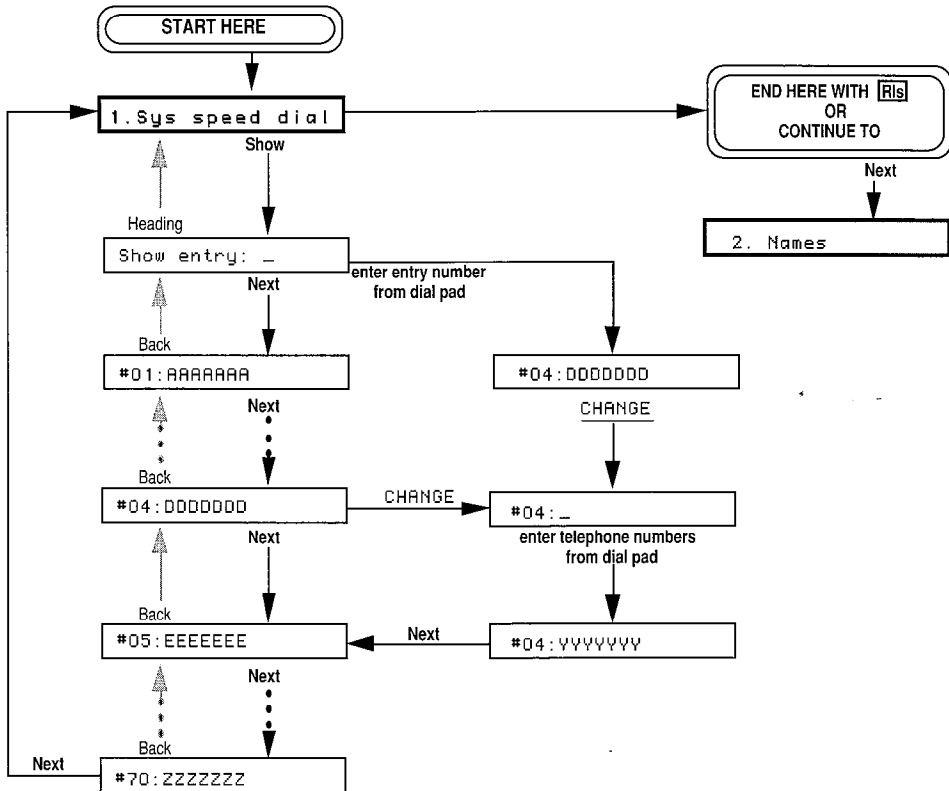

Job Ai  
Flow Cha

# Names

The following flow chart shows the relationship between the various display messages which appear in the Names section of Norstar Administration.

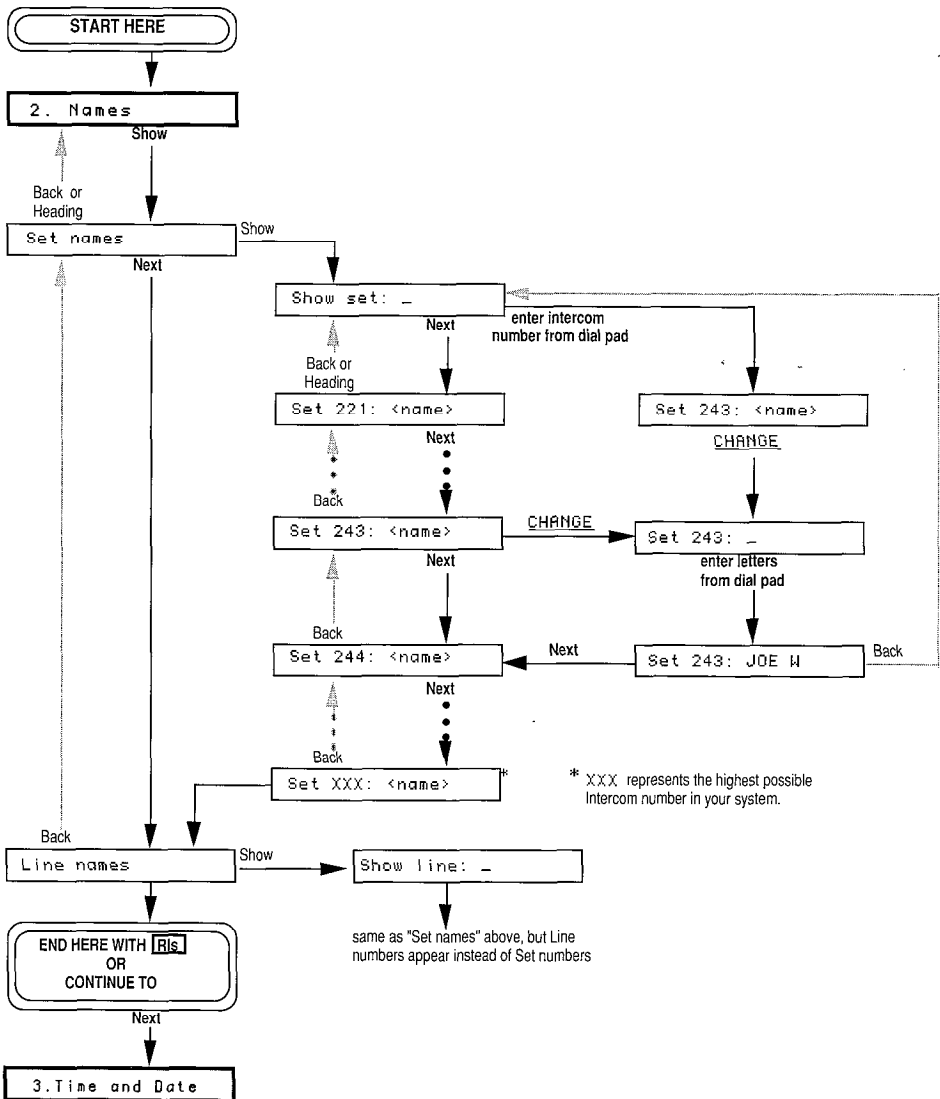

Flow Charts  
Job Aids

# Time and Date

The following flow charts show the relationship between the various display messages which appear in the Time and Date section of Norstar Administration. The first flow chart shows the procedures for changing the time, and the second flow chart shows the procedures for changing the date.

## Time Flow Chart

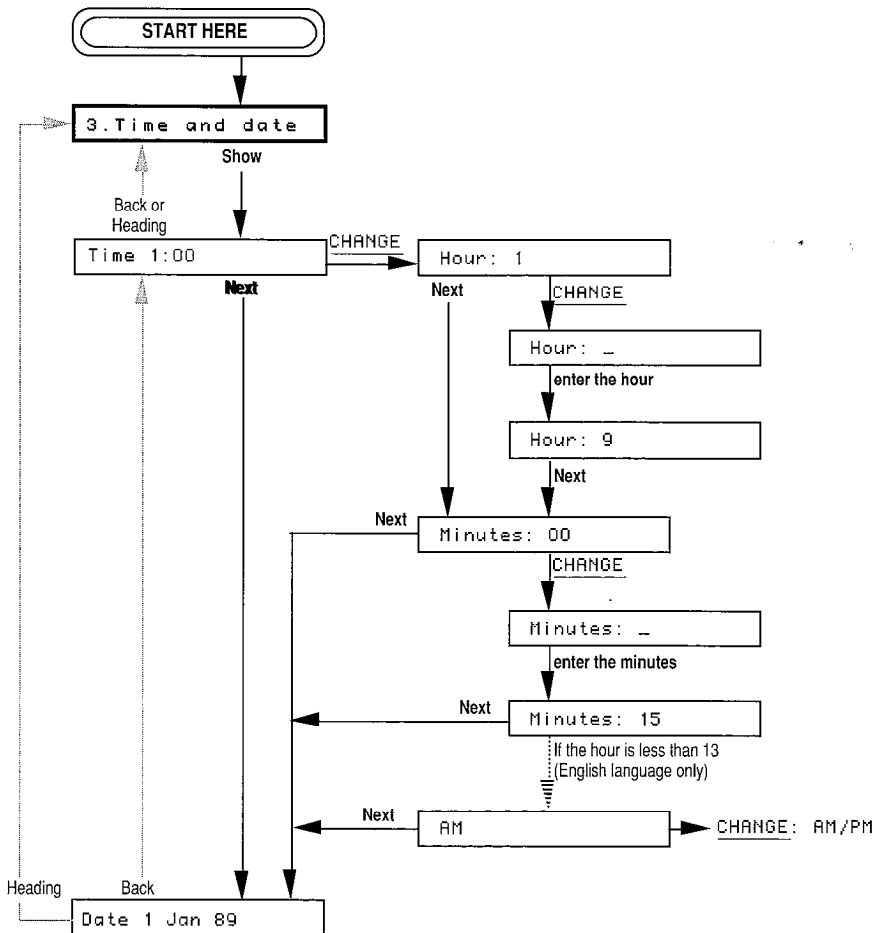

Job Aid  
Flow Chart

continued on next page

### Time and Date (continued)

## Date Flow Chart

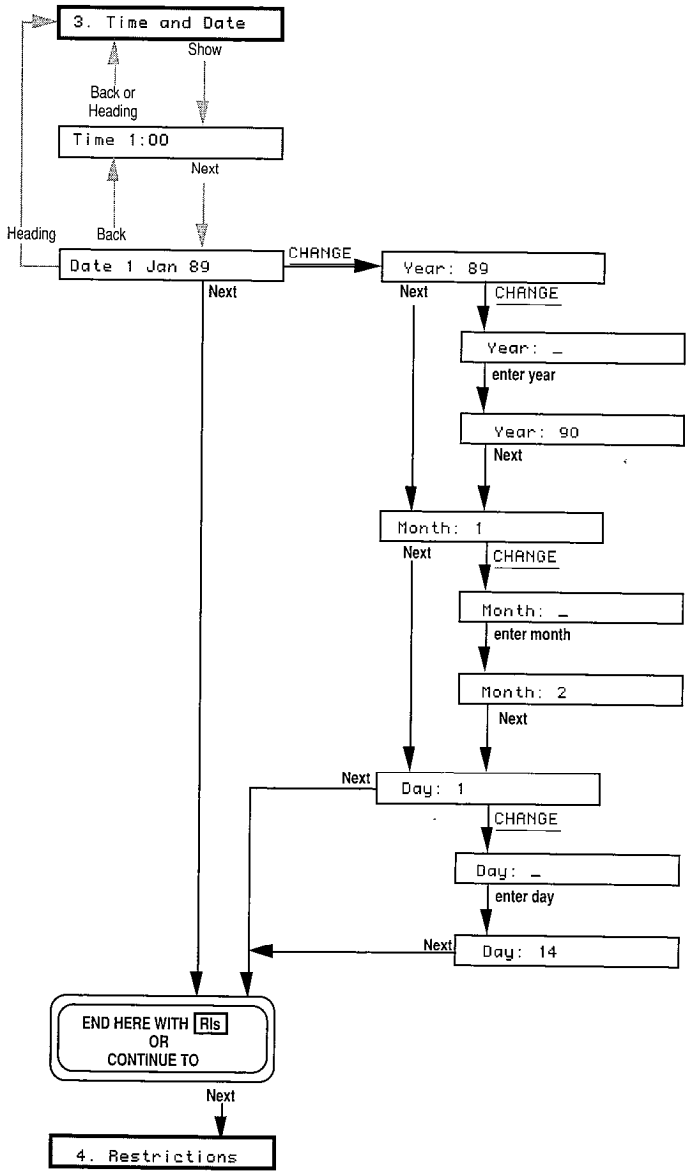

Flow Charts  
Job Aids

# Restrictions

The following flow chart shows the relationship between the various display messages which appear in the Restrictions section of Norstar Administration.

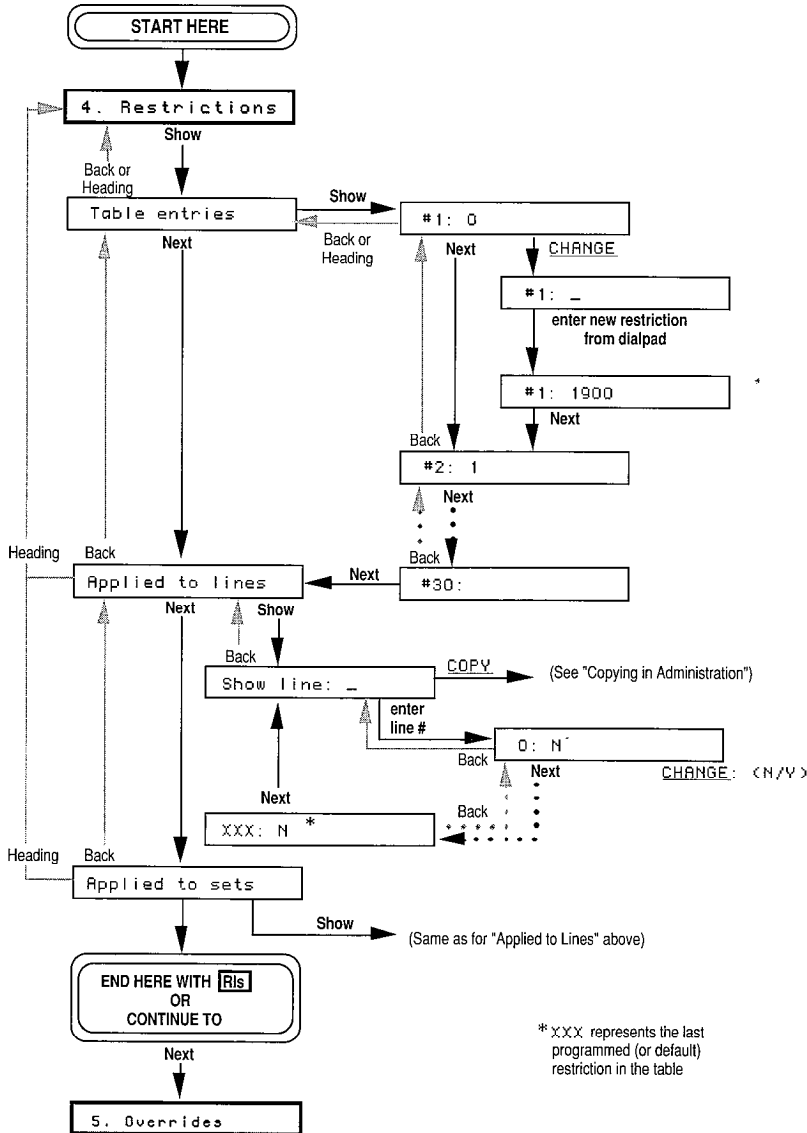

Job Aid  
Flow Chart

# Overrides

The following flow chart shows the relationship between the various display messages which appear in the Overrides section of Norstar Administration.

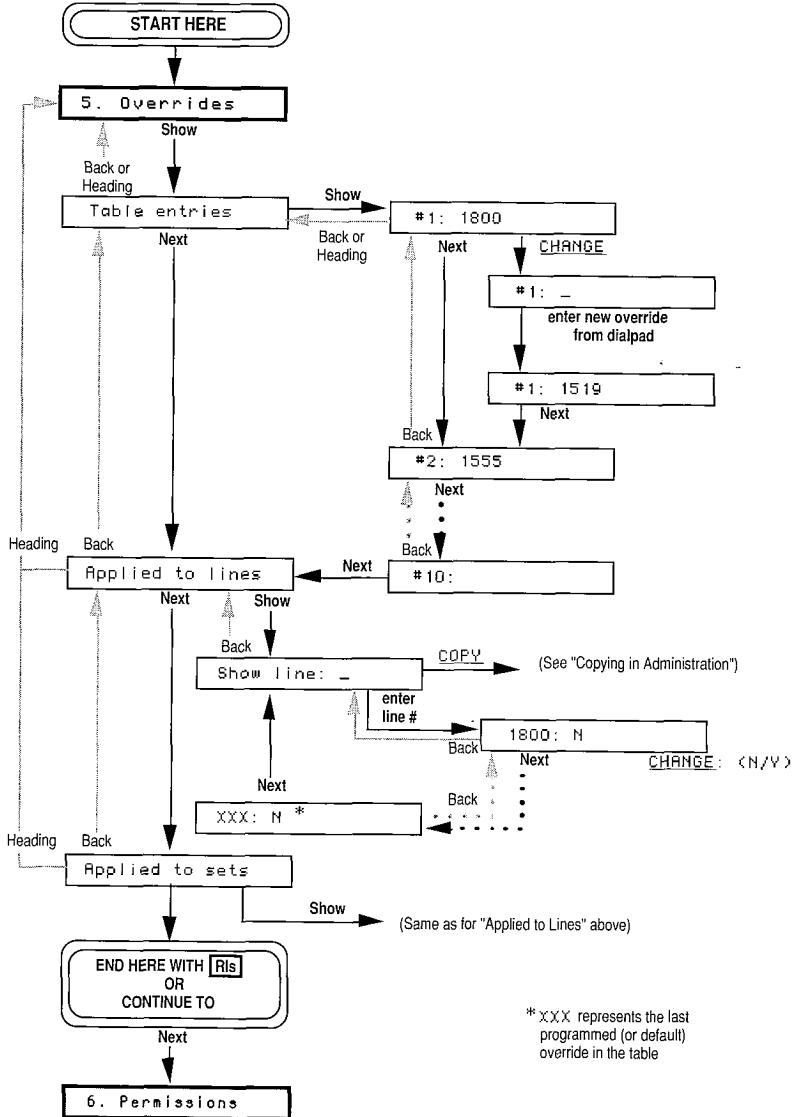

\* XXX represents the last programmed (or default) override in the table

Flow Charts  
Job Aids



# Permissions

The following flow chart shows the relationship between the various display messages which appear in the Permissions section of Norstar Administration.

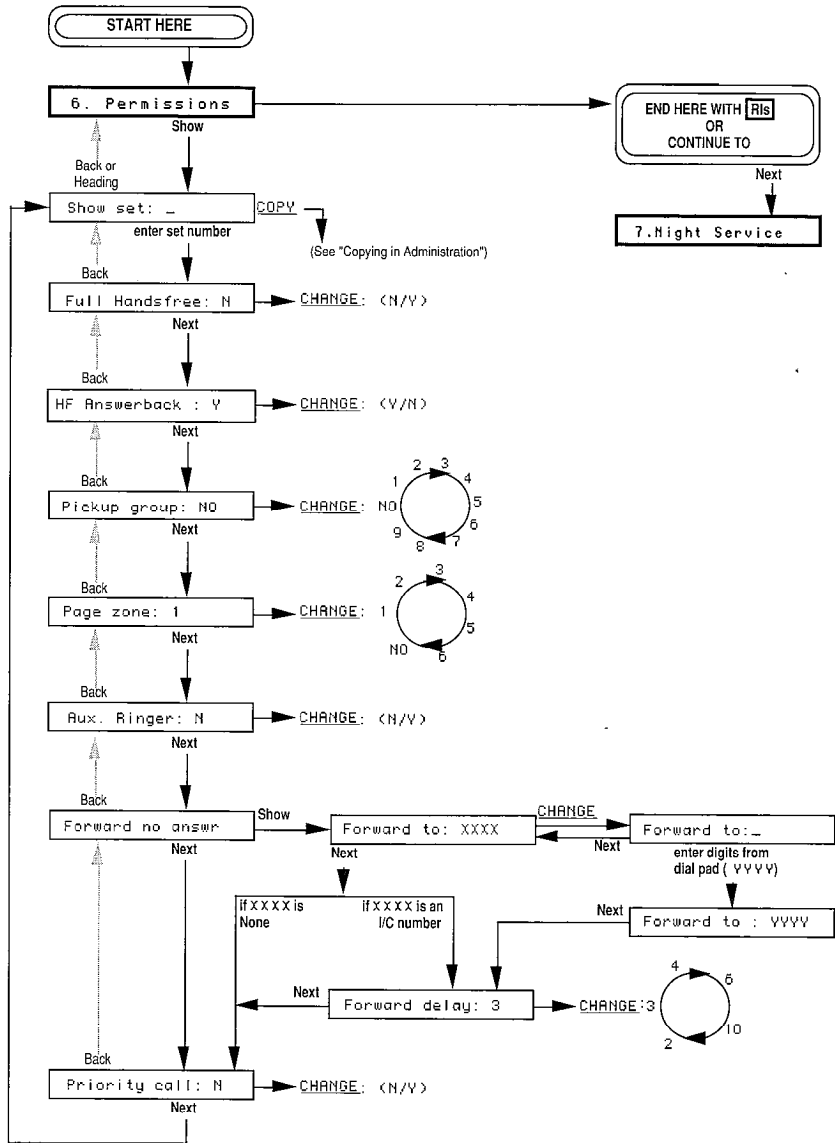

Job Aid  
Flow Chart

# Night Service

The following flow chart shows the relationship between the various display messages which appear in the Night Service section of Norstar Administration.

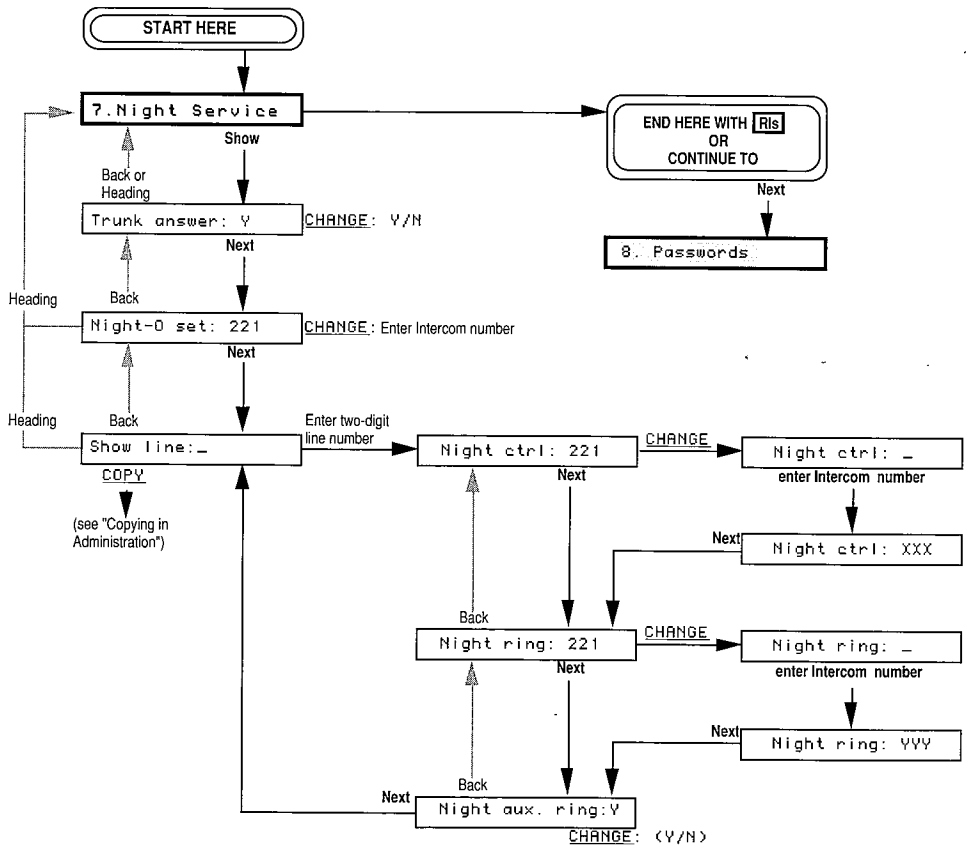

Flow Charts

Job Aids

# Passwords

The following flow chart shows the relationship between the various display messages which appear in the Passwords section of Norstar Administration.

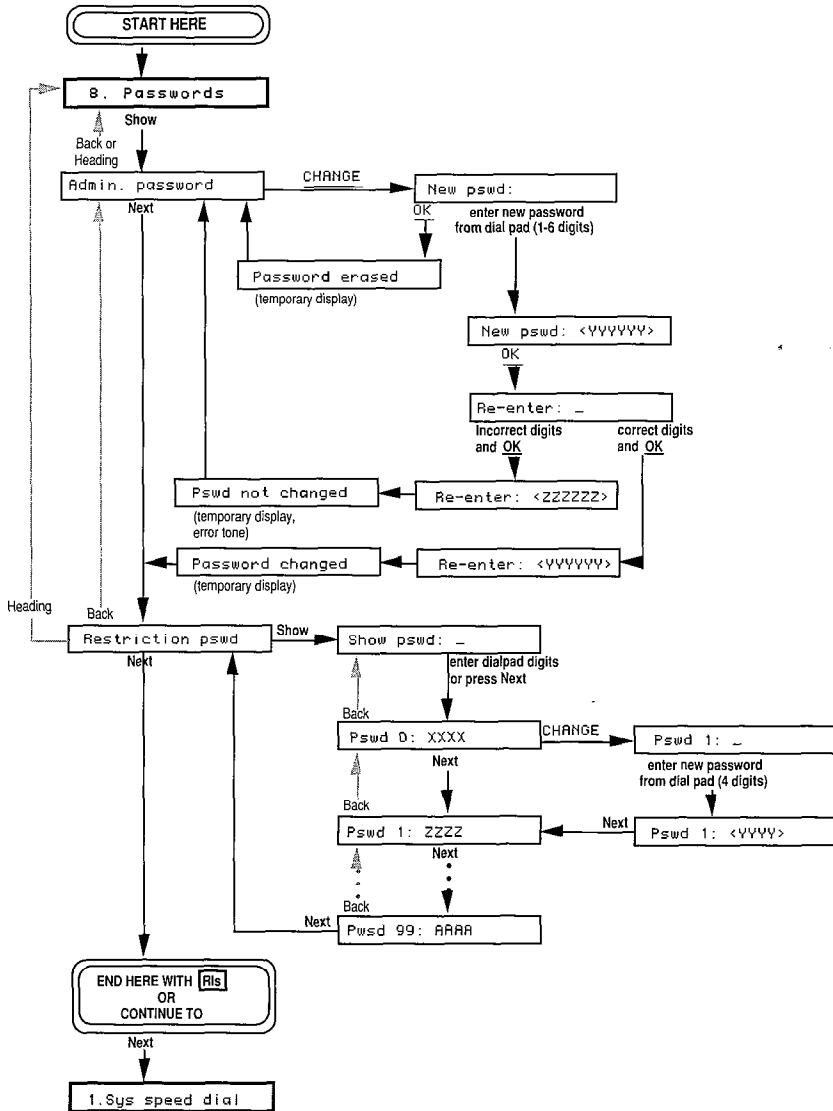

Job Aid  
Flow Chart

## Copying in Administration

There are four sections in Norstar Administration which allow you to copy settings from one line or telephone to another:

4. Restrictions	6. Permissions
5. Overrides	7. Night service

The following flow charts illustrate how to copy Restrictions or Overrides from one line to another, how to copy Restrictions or Overrides from one telephone to another, how to copy Permissions from one telephone set to another, and how to copy Night Service information from one line to another.

### Restrictions and Overrides: Copying Lines

When you copy Restrictions and Overrides from one line to another, **all** the Restrictions or Overrides from the original line are copied to the new line. If you wish to copy only a few restrictions or overrides, you must apply the individual restriction or override to the line using the "Applied to lines" sub-heading under the appropriate heading in Norstar Administration.

The following flow chart shows the relationship between the various display messages which appear as you use the Copy feature in the Restrictions and Overrides sections of Norstar Administration.

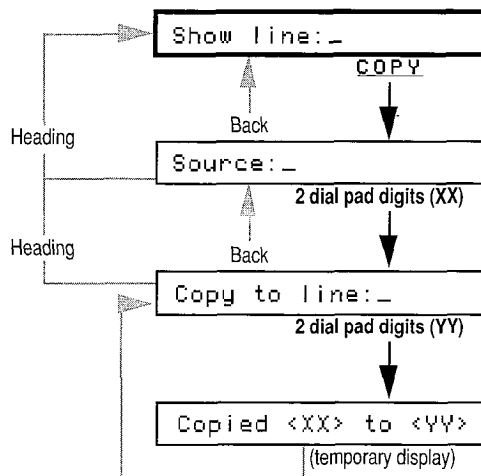

Flow Charts

Job Aids

## Restrictions and Overrides: Copying Sets

When you copy Restrictions and Overrides from one telephone to another, **all** the restrictions or overrides from the original telephone set are copied to the new one. If you wish to copy only a few restrictions or overrides, you must apply the individual restriction or override to the telephone using the "Applied to sets" sub-heading under the appropriate heading in Norstar Administration.

The following flow chart shows the relationship between the various display messages which appear as you use the Copy feature in the Restrictions and Overrides sections of Norstar Administration.

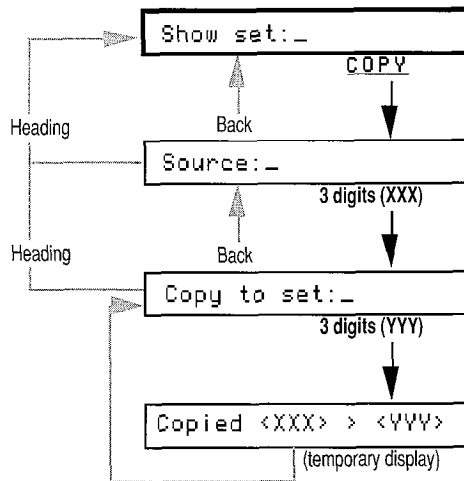

Job A

Flow Cha

## Copying Permissions

Copying Permissions from one telephone to another is very similar to copying Restrictions or Overrides. When you copy Permissions, **all** the permission settings of the original telephone are copied to the new telephone. To program individual permission settings, you must set each individual feature in the Permissions section of Norstar Administration.

The following flow chart shows the relationship between the various display messages which appear as you use the Copy feature in the Permissions section of Norstar Administration.

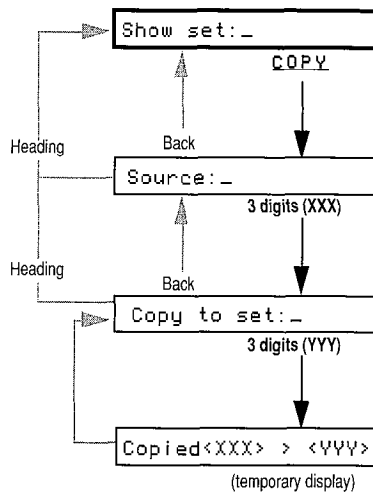

Flow Charts

Job Aids

## Copying Night Service

When you copy Night Service information from one line to another, **all** the settings from the original line are copied to the new line. If you wish to copy only a few of the settings, you must program them individually for each line.

The following flow chart shows the relationship between the various display messages which appear as you use the Copy feature in the Night Service section of Norstar Administration.

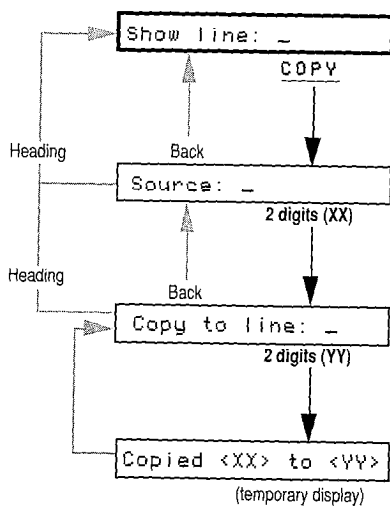

Job Aids

Flow Charts

## Page Zones

To make a Page announcement using **Feature 60**:

1. Press **Feature 60**. The display shows
2. Select the desired type of page by pushing one of the following dialpad or display buttons (M7324 and M7310 telephones only):
  - or **SETS** — **Internal** page through speakers on other telephones
  - or **SPKR** — **External** page through the extension speaker, if your office has such a speaker
  - or **BOTH** — **Both** internal and external page.
3. If you select  / **SPKR** proceed directly to step 5 below.  
**OR**  
 If you select  / **SETS** or  / **BOTH**, the display will show
4. Enter the desired zone number (1-6). See the accompanying Job Aid for a list of your co-workers' assigned Page Zones.  
**OR**  
 Press  on the dialpad or **ALL** (M7324 and M7310 telephones only) to make an announcement to all Page Zones.
5. Make your announcement by speaking through your receiver  
**OR**  
 Press  and speak .

To make a Page announcement:

1. Press
2. Select one of the following dialpad codes:
  - for Internal Page Zone
  - for External speaker
  - for Internal Page Zone and External speaker.
 The display shows
3. Enter the desired Page Zone (1-6). See the accompanying Job Aid for a list of your co-workers' assigned Page Zones.  
**OR**  
 Press  on the dialpad or **ALL** (M7324 and M7310 telephones only) to make an announcement to all Page Zones.
4. Make your announcement.



- In the columns below each numbered Page Zone, record the Intercom (Set) number and programmed name of each telephone within that zone.

Page Zone 1		Page Zone 2		Page Zone 3	
Set	Name	Set	Name	Set	Name

Page Zone 4		Page Zone 5		Page Zone 6	
Set	Name	Set	Name	Set	Name



## Pickup Groups

- In the columns below each numbered Pickup Group, record the Intercom (Set) number and programmed name of each telephone in that Pickup Group.

Pickup Group 1		Pickup Group 2		Pickup Group 3	
Set	Name	Set	Name	Set	Name

Pickup Group 4		Pickup Group 5		Pickup Group 6	
Set	Name	Set	Name	Set	Name

Flow Charts

Job Aids

(Continued on next page)

Pickup Groups (continued)

Pickup Group:7		Pickup Group:8		Pickup Group:9	
Set	Name	Set	Name	Set	Name



---

## Using Handsfree/Mute

Norstar's Handsfree/Mute capabilities can be of great benefit in effective use of your telephone. With the Handsfree/Mute button, you can carry on a telephone conversation without having to hold your receiver or be connected to your telephone by a headset cord. This allows you to have more than one person participating in a call at one telephone.

Your Norstar telephone's microphone and speaker will not both function at the same time. The telephone detects the level of noise in the vicinity, and activates the microphone (to send your voice to another telephone) when the noise level reaches a certain point.

In order to get the maximum amount of benefit from Handsfree communication, below is a list of suggestions which will help you to use Handsfree/Mute more effectively.

### Handsfree etiquette

1. Direct your voice towards the telephone. The closer you are to the telephone, the easier it is for the microphone to transmit a clear voice to your listener.
2. Wait for your caller to finish speaking before you begin. Because the microphone and speaker cannot both be ON, your caller's voice may be cut off if you both speak at the same time.
3. To prevent a possible echo, keep the area around your telephone free of papers and other objects which might screen your microphone. Turning down your microphone volume (using the Volume bar below the telephone dialpad) will also help prevent echo.
4. Always tell the person or people to whom you are speaking that you are using Handsfree, and let them know who else is listening to the conversation.
5. Handsfree telephone calls may be heard in nearby offices. In open office environments, use a receiver or headset when Handsfree conversation is not necessary, or when you need privacy for a call.
6. Speak at a normal level. If you speak too loudly, your voice may have a hollow sound. If this is a problem, try moving your telephone to a more sheltered location.

### Working in a noisy environment

1. Place the telephone so that any unavoidable local noise (such as an air conditioner) is behind it. This will limit the amount of background noise in your calls.
2. It is possible for noises such as a tapping pencil to be loud enough to turn your microphone ON, which may cut off your caller's speech.
3. Keep your office as quiet as possible during the call. Remember that all sounds in the room are picked up by the microphone.

# 7. Night Service

- If your system supports more than 25 outside lines, photocopy this page as a master-copy.
- Default settings are printed in large **bold** type.

Trunk answer: Y

**Yes**

No

Night-0 set: 221

**21, 221 or 2221**

Other:

Show Line: _	Night ctrl: <b>221</b>	Night ring: <b>221</b>	Night aux ring: <b>Y</b>	Copy to line:
			<b>Yes</b> No	
			<b>Yes</b> No	
			<b>Yes</b> No	
			<b>Yes</b> No	
			<b>Yes</b> No	
			<b>Yes</b> No	
			<b>Yes</b> No	
			<b>Yes</b> No	
			<b>Yes</b> No	
			<b>Yes</b> No	
			<b>Yes</b> No	
			<b>Yes</b> No	
			<b>Yes</b> No	
			<b>Yes</b> No	
			<b>Yes</b> No	
			<b>Yes</b> No	
			<b>Yes</b> No	
			<b>Yes</b> No	
			<b>Yes</b> No	
			<b>Yes</b> No	
			<b>Yes</b> No	
			<b>Yes</b> No	
			<b>Yes</b> No	
			<b>Yes</b> No	
			<b>Yes</b> No	
			<b>Yes</b> No	
			<b>Yes</b> No	
			<b>Yes</b> No	
			<b>Yes</b> No	
			<b>Yes</b> No	
			<b>Yes</b> No	
			<b>Yes</b> No	
			<b>Yes</b> No	
			<b>Yes</b> No	

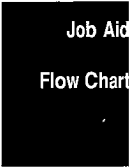

## 8. Passwords

(6 digits or less):

(4 digits only)

Record your system's Restriction Passwords in the following chart:

Show pswd : _	Record password	Show pswd : _	Record password
Pswd 00:		Pswd 20:	
Pswd 01:		Pswd 21:	
Pswd 02:		Pswd 22:	
Pswd 03:		Pswd 23:	
Pswd 04:		Pswd 24:	
Pswd 05:		Pswd 25:	
Pswd 06:		Pswd 26:	
Pswd 07:		Pswd 27:	
Pswd 08:		Pswd 28:	
Pswd 09:		Pswd 29:	
Pswd 10:		Pswd 30:	
Pswd 11:		Pswd 31:	
Pswd 12:		Pswd 32:	
Pswd 13:		Pswd 33:	
Pswd 14:		Pswd 34:	
Pswd 15:		Pswd 35:	
Pswd 16:		Pswd 36:	
Pswd 17:		Pswd 37:	
Pswd 18:		Pswd 38:	
Pswd 19:		Pswd 39:	

(continued on next page)

Flow Charts

Job Aids

Show pswd: _	Record password	Show pswd: _	Record password
Pswd 40:		Pswd 70:	
Pswd 41:		Pswd 71:	
Pswd 42:		Pswd 72:	
Pswd 43:		Pswd 73:	
Pswd 44:		Pswd 74:	
Pswd 45:		Pswd 75:	
Pswd 46:		Pswd 76:	
Pswd 47:		Pswd 77:	
Pswd 48:		Pswd 78:	
Pswd 49:		Pswd 79:	
Pswd 50:		Pswd 80:	
Pswd 51:		Pswd 81:	
Pswd 52:		Pswd 82:	
Pswd 53:		Pswd 83:	
Pswd 54:		Pswd 84:	
Pswd 55:		Pswd 85:	
Pswd 56:		Pswd 86:	
Pswd 57:		Pswd 87:	
Pswd 58:		Pswd 88:	
Pswd 59:		Pswd 89:	
Pswd 60:		Pswd 90:	
Pswd 61:		Pswd 91:	
Pswd 62:		Pswd 92:	
Pswd 63:		Pswd 93:	
Pswd 64:		Pswd 94:	
Pswd 65:		Pswd 95:	
Pswd 66:		Pswd 96:	
Pswd 67:		Pswd 97:	
Pswd 68:		Pswd 98:	
Pswd 69:		Pswd 99:	

Job Aids  
Flow Charts

ssa  
Inde

**Answer Group:** An Answer Group consists of at least two telephones that are associated by an **Answer** button. The **Answer** button, on one of these telephones, indicates incoming calls destined for the other telephone. Someone working at a telephone with **Answer** buttons (a receptionist, for example) can monitor the Answer Group (a group of managers), receive all ringing and visual indication of incoming calls, and answer the calls accordingly.

**Applied to lines:** This sub-heading appears in section "4. Restrictions" and section "5. Overrides" of Administration programming. If you select **Show**, you will be prompted to assign Restrictions or Overrides to each line.

**Applied to sets:** This sub-heading appears in section "4. Restrictions" and section "5. Overrides" of Administration programming. If you select **Show**, you will be prompted to assign Restrictions or Overrides to each telephone.

**Autodial Button:** The Autodial button provides one-touch dialing of outside numbers, Intercom numbers, or feature codes. You program a button to be an Autodial button.

**Automatic Hold:** This feature will automatically place an active call on hold if another line is selected.

**Automatic Phone Relocation:** The Automatic Phone Relocation feature allows a telephone to retain its personal and system programming when it is reconnected to another physical location. This feature is activated in section "4. Miscellaneous" of Configuration programming.

**Auxiliary Ringer:** This is a separate external telephone ringer or bell. It is typically mounted on a wall, and is louder than a regular telephone so that it can be heard over a wide area. It can be programmed to ring when a line (section "1. Line Data" of Configuration), a telephone (section "6. Permissions" of Administration), or both ring; or, when Night Service (section "7. Night Service" of Administration) is active.

**Background Music:** This feature allows music from an external source, such as a radio, to play over the speaker of the telephone. This feature should not be activated unless a music source (customer supplied) has been connected to the Norstar System. Background Music is activated in section "4. Miscellaneous" of Configuration programming.

**Busy Lamp Field (BLF):** This device, which attaches onto the M7310 telephone, has a panel of Liquid Crystal Display (LCD) indicators that show the busy/not busy and DND (Do Not Disturb) status of up to 24 telephones in the Norstar system. Each of the dual memory buttons that are programmed as Inside Autodial buttons on the M7310 will indicate the status of an office telephone. The BLF will also indicate if a telephone is involved in a programming session. The BLF is typically used on a receptionist's telephone.

**Button Caps:** These interchangeable plastic squares fit over the buttons of Norstar telephones, and allow you to label the features programmed onto each programmable button location. Button caps can be either pre-printed or have clear windows which allow people to label other features, lines, and autodial numbers.



**Button Inquiry:** This feature allows you to check the function of each programmable memory button on a Norstar telephone.

**Call Forward (No Answer):** This feature forwards all unanswered calls at one telephone to another designated telephone after a specified number of rings (see "Forward Delay"). This feature is useful if you will temporarily be unavailable to answer calls at your telephone, or you will be working near another telephone. The Call Forward feature is assigned in section "6. Permissions" of Administration programming.

**Call Handling:** A collection of some Norstar features and their parameters which are programmed in section "3. Call Handling" of Configuration programming. Call Handling includes settings for the following features: Held Line Reminder, Delayed Ring Transfer, Transfer Callback, Park Timeout, Directed Pickup, and Music/Tones/Silence On Hold.

**Call Park:** Call Park places a connected call on hold, allowing it to be retrieved from any other telephone in your system. You can retrieve the call from any telephone by selecting an intercom line, and then entering the Retrieve Park code (which automatically appears on the display of the telephone which parked the call). Up to nine calls can be parked at once in the system.

**Call Park Callback:** See "Callback".

**Call Pickup (Directed):** This feature allows anyone to answer a call ringing at any telephone by specifying the Intercom number of that telephone before taking the call. Call Pickup (Directed) is activated in section "3. Call Handling" of Configuration programming.

**Callback:** Callback occurs at a telephone which attempts an unsuccessful Transfer or Call Park for an outside call. After a specified period of time, an unanswered call returns to the telephone which originally made the Transfer or parked the call.

**CAP Module:** The CAP Module provides 48 Inside Autodial buttons, and is connected to the M7324 telephone to create the Central Answering Position. An M7324 with CAP Modules can assist an office receptionist in monitoring and answering calls. A maximum of two CAP Modules can be connected to a single M7324 telephone.

**Central Answering Position (CAP):** The CAP consists of an M7324 telephone and one or two CAP Modules. The CAP can be used to monitor the telephones in a Norstar system, and to control incoming telephone calls.

**Centrex (Template):** This is one of the four Norstar system Templates. Centrex is a business system service provided by the telephone company, offering local lines and a variety of other features. The Centrex Template assigns one unique outside line to each telephone until the maximum number of lines is reached (example: Line 1 to telephone 221, Line 2 to telephone 222, and so on). Any remaining telephones do not receive a default line assignment.

The Centrex Template also modifies the Restriction and Override tables (a "9" precedes the default entries) to accommodate dialing outside the Centrex system, rather than within it. The Centrex Template is assigned when your system is first installed.

**Change DNs:** The Installer can change the length of all DNs in the system or replace an existing DN with a new number in section "5. Change DNs" of Configuration programming (for more information, see "Directory Number Length".)

**CO Line (Central Office Line):** This is an external or outside telephone line.

**Configuration:** This is a type of programming that assigns certain settings to lines and telephones, as well as some system-wide settings. Configuration is performed by the telephone company Installer or Service Representative rather than by System Coordinators. "Installer Only" appears in the *Meridian Norstar Modular Programming Record* for each Configuration programming section to be programmed by the Installer.

**Configuration Access Code:** A sequence of digits which are dialed on the dialpad to provide access to Configuration programming. The Installer Password must be entered before any Configuration programming can be done.

**Copy:** The COPY display button appears during Configuration and Administration programming. This button allows you to duplicate certain programmed settings from one line to another, or from one telephone to another. Line programmable settings that can be copied are Line Data, Restrictions, Overrides, and Night Service. Telephone (set) programmable settings that can be copied are Line Access, Restrictions, Overrides, and Permissions.

**Cursor:** This is a short line which appears on the telephone display to indicate that digits or letters can be entered using the dialpad.

**Date:** See "Time and Date".

**Data Terminals:** Devices which can be used to transfer data instead of only voice (as with a telephone). The settings for these devices are not programmed with Configuration or Administration programming.

**Default Setting:** This is a feature setting which is in effect upon initial installation unless manually changed through programming. Default settings are automatically assigned to correspond to the Square Template during your system's installation. In the *Meridian Norstar Modular Programming Record*, default settings are shown in **Bold** text.

**Delay:** The time period before certain features become active. A delay can be programmed for the following features: Call Forward (No Answer), Call Park Callback, Delayed Ring Transfer, Held Line Reminder, and Transfer Callback features.

**Delayed Ring Transfer (DRT) to Prime:** After a specified number of rings, this feature transfers an unanswered ringing call to the Prime Phone associated with the line the call is on. This feature is activated in section "3. Call Handling" of Configuration programming.

**Dial-0 Set (Dial Zero Phone):** A telephone which is assigned to ring when someone dials "0" from another Norstar telephone. Dial-0 provides an easily remembered number and quick access to a central telephone, such as an operator at a Central Answering Position. This feature is assigned in section "4. Miscellaneous" of Configuration programming.

**Directed Pickup:** See "Call Pickup (Directed)".

**Directory Number (DN):** A unique number which is automatically assigned to each telephone or Data Terminal during your system's installation. The DN, also referred to as an Intercom number, allows the Norstar system to identify each device connected to the Key Service Unit or Expansion Module. The DN is often used to identify a telephone when settings are assigned during Configuration and Administration programming.

**Directory Number (DN) Length:** A non-expanded system can have a DN length of 2, 3, or 4 digits. An expanded system (a system with an Expansion Cartridge installed) can have a DN length of 3 or 4 digits. All Directory numbers for the system must be the same length. The default DN length is two digits for a non-expanded system, and three digits for an expanded system. The lowest default DN is "21" in a two digit system, "221" in a three digit system, and "2221" in a four digit system.

**Display:** A Liquid Crystal Display (LCD) on the telephone that provides information related to feature operation and programming.

**Display Button:** The Norstar M7310 and M7324 telephones are each equipped with three buttons located directly beneath the Liquid Crystal Display. During feature operation or programming, some or all of these buttons may be used to provide you with further options. If an option is available, it is shown in the bottom row of the two column display, directly above the corresponding display button.

**DRT Delay:** The number of rings before a Delayed Ring Transfer occurs. This is assigned in section "3. Call Handling" of Configuration programming.

**DRT to Prime:** See "Delayed Ring Transfer to Prime".

**Emergency Telephone:** A single line telephone (also referred to as a 500/2500 telephone) that becomes active when there is no power to the Key Service Unit.

**Expansion Cartridge:** The Expansion Cartridge allows Expansion Modules to connect to the Key Service Unit, providing the opportunity to increase the number of outside and Intercom lines that the system can handle (beyond the 8X24 Key Service Unit). The Expansion Cartridge is inserted into the Key Service Unit, and a DS-30 cable connects the Expansion Cartridge to each Expansion Module. Expansion Cartridges are available with two or six ports.

**Expansion Module:** A Trunk Module or a Station Module. A maximum of six Modules may be installed with the use of the six port Expansion Cartridge. A maximum of two Modules may be installed with a two port Expansion Cartridge.

**External Paging:** A Norstar feature that allows voice announcements to be made over an externally mounted loudspeaker (supplied by the customer) connected to the Key Service Unit.

**Feature:** A Norstar feature performs a useful task that uses system-wide, telephone, or line parameters in helping you to optimize your use of the Norstar equipment.

**Feature Button:** This oblong grey button is the first button you press when using a feature, or to gain access to programming with an Access Code. This button indicates to the system that the string of digits which follows is a feature code.

**Night Ringing Phone:** See "Night Ring".

**Night Service:** Certain features become active when Norstar is placed into an operating mode called "Night Service". This is usually done to provide special ringing and Dial Zero access after normal office hours or when there are few people available to answer calls. These features are: Trunk Answer, Night Zero Set, Night Control, Night Ring, and Night Auxiliary Ring. Night Service settings are programmed in section "7. Night Service" of Administration programming.

**Night-0 Set (Night Dial Zero Phone):**

This setting assigns a certain telephone as an additional Dial Zero telephone when Night Service is active (Note: Calls which ring at the Night Dial Zero telephone will also ring at the other Dial Zero telephone assigned in section "4. Miscellaneous" of Configuration programming). Night-0 Set is assigned in section "7. Night Service" of Administration programming.

**Norstar Programming Overlay:** This Overlay is placed over the top four memory buttons on the M7310 or M7324 telephones. The Overlay labels indicate the special function that each of the four buttons have during programming. The functions are: Heading, Back, Show, and Next. You use these buttons to provide options for moving through the display messages.

**On Hold:** This setting controls whether your callers hear music, periodic tones, or silence when they are placed on hold. This system-wide feature is assigned in section "3. Call Handling" of Configuration programming.

**Overlay:** See "Norstar Programming Overlay".

**Overrides:** These are selected exceptions to the call Restrictions placed on lines and telephones. There is a system-wide maximum of 10 Overrides. A telephone caller may, for example, be prevented from dialing numbers which start with the digit "1", but may have an override of "1403". This would allow the user to dial any number which starts with "1403". Overrides are defined, and then assigned to certain lines or telephones, in section "5. Overrides" of Administration programming.

**Override Index Number:** A number between 1 and 10 which identifies an Override.

**Page:** This Norstar feature allows you to make announcements from your telephone which can be heard by many people at the same time. There are three Page options, selected by you at your telephone when the Page is made: Internal Page (announce over the telephone speakers), External Page (announce over an externally mounted, customer supplied loudspeaker), and both Internal and External Page together.

**Page Zone:** A local area in the office that can receive directed Page announcements independently of the remainder of the office. Each Page Zone is identified by a number from 1 to 6. Each telephone is assigned to a unique Page Zone in section "6. Permissions" of Administration programming.

**Park Timeout:** This is the period of time before an unanswered Call Park call is redirected to the Prime Phone for the line the call is on. Park Timeout is defined in "3. Call Handling" of Configuration programming.

**Password:** A Password is a specific sequence of digits which is entered from the dialpad to gain access to Norstar programming. A Password is required for to initialize your system, and for Administration and Configuration programming (also, see "Restriction Override Password".)

**PBX:** See "Private Branch Exchange (Template)".

**Permissions:** These are specific characteristics that can be assigned to an individual telephone. Permissions includes Full Handsfree, Handsfree Answerback, Pickup Group, Page Zone, Auxiliary Ringer, Forward No Answer, and Priority Call. Permissions are programmed in section "6. Permissions" of Administration programming.

**Personal Speed Dial:** These two-digit code numbers (71-94) can be programmed to dial outside telephone numbers up to 16 digits in length. Personal Speed Dial codes are programmed on individual telephones within your system and can only be used from the telephone on which they are programmed.

**Pickup Group:** A telephone can be placed into one of nine Call Pickup Groups. A call ringing at a telephone within a Pickup Group can be picked up by any other telephone within the same Pickup Group. A Pickup Group is assigned to a telephone in section "6. Permissions" of Administration programming

**Pool:** See "Line Pool".

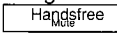
**Prime Line:** A telephone can be programmed to automatically select a certain line type whenever a call is made by lifting the receiver or pressing the  button. This line is called the Prime Line, and is assigned in section

"2. Line Access" of Configuration programming.

**Prime Set (Prime Phone):** This telephone provides backup answering for incoming calls on outside lines. The Prime Phone is typically used by a receptionist. Special features which redirect the unanswered calls are available at a Prime Phone (such as Delayed Ring Transfer and Held Line Reminder). A Prime Phone may be assigned to a line in section "1. Line Data" of Configuration programming. The default Prime Phone DN is 21 for a non-expanded system, and 221 or 2221 for an expanded system (depending on the DN length in effect).

**Priority Call:** This feature allows you to make an urgent Voice Call to another telephone when the other telephone is busy or has Do Not Disturb activated. Priority Call should not be made available to everyone, and should be selectively programmed. This feature is enabled for a telephone in section "6. Permissions" of Administration programming.

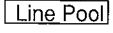
**Private Branch Exchange (Template):** This is one of the four Norstar System Templates. In the Private Branch Exchange (PBX) Template, specified Lines are in a Line Pool. You must first press an Intercom button and then dial , or press a  button, to make outside calls. Each telephone is assigned access to Line Pool 1.

**Private to:** An external (CO) line may be assigned to one telephone as a private line. The line does not appear on any other telephone. Private lines cannot be placed in Line Pools. A line may be assigned as a Private line in section "1. Line Data" of Configuration programming.

**Programming:** The designation of various characteristics within the Norstar system. This includes the activation of certain optional features (turning the feature ON or OFF), the assigning of parameters used by certain features (such as a DN), and the designation of various settings for lines and telephones. Programming can only be done from the M7310 or M7324 telephones, and makes use of a sequence of steps that prompts the Installer or System Coordinator to enter a value or choose a menu option.

**Programming Overlay:** See "Norstar Programming Overlay".

**Public:** This refers to an outside line which can be assigned to any telephone. A line is assigned as Public in section "1. Line Data" of Configuration programming.

**Pulse:** This is a dialing mode for outside lines that is traditionally used by rotary dial telephones. In section "1. Line Data" of Configuration programming, the Installer can select this option on any line for which Pulse dialing is necessary.

**Release button:** The **[RIS]** button ends a call in the same way that hanging up your receiver does. It also ends any current feature programming. If there is any activity on your telephone, pressing **[RIS]** cancels it.

**Remind Delay:** The period of time from when a call is put on hold to when a reminder tone is heard and a message appears on the telephone display. Remind Delay, a parameter of the Held Line Reminder feature, is assigned in section "3. Call Handling" of Configuration programming.

**Restriction Index Number:** A number between 1 and 30 which identifies a Restriction.

**Restrictions:** Preselected telephones and lines may be restricted from dialing certain telephone numbers (such as long distance, directory assistance and other toll calls). Restrictions are defined and assigned to certain lines or telephones in section "4. Restrictions" of Administration programming. There is a maximum of 30 Restrictions.

**Restriction Override Password:** This four-digit Password allows a caller to override system-wide Restrictions when making an outside call. This Password must be entered before the call is dialed. Up to 100 Restriction Override Passwords may be defined in section "8. Passwords" of Administration programming.

**Ring/No ring:** See "Ringling".

**Ringling:** In section "2. Line Access" of Configuration programming, a line can be assigned to ring or not to ring at a telephone for incoming calls. If a line has been assigned as "No ring", an incoming call is still shown by a flashing indicator.

**Set:** Set is another name for a telephone.

**Set Copy:** Set Copy allows the Installer to duplicate the characteristics of one telephone to another telephone. Set Copy is available through menu heading "C. Set Copy". The Installer has the option of duplicating System data (data from Configuration and Administration programming) and User data (from personal programming), or just System data. Set Copy does not provide the same copy capability as does the **[COPY]** display button, which allows you to be more selective of the settings which are to be duplicated.

**Set Names:** This sub-heading of section "2. Names" of Administration Programming allows you to assign Names to telephones.

**Set Relocation:** See "Automatic Phone Relocation".

**Set/Line Profile:** This feature allows you to review, from a M7310 or M7324 telephone, the settings programmed to telephones (sets) and lines in Configuration and Administration programming. You can not change any of the settings with this feature.

**Shift Button:** This small triangular button is located beside the dual memory buttons on the upper half of the M7310 telephone. The shift button must be pressed to store or access features on the top half of the dual memory buttons.

**Shoulder Rest:** The shoulder rest is designed to allow you to comfortably rest the receiver on your shoulder so that your hands are free to do other tasks.

**Square (Template):** This is one of the four Norstar system Templates. In the Square Template, Lines 1 and 2 are assigned to each telephone. The Square Template is the default assigned during your system's installation. All defaults shown in the *Meridian Norstar Modular Programming Record* correspond to the Square Template settings.

**Station:** This is another way of referring to an individual telephone or to a telephone's location.

**Station Auxiliary Power Supply:** This device is used to provide power to a CAP Module, or a Norstar telephone that is connected more than 300 m (1000 ft.) and less than 760 m (2500 ft) from the Key Service Unit.

**Station Module (SM):** An Expansion Module that provides the Norstar system with access to 16 more telephones. Up to six of these Modules may be installed with the use of a six-port Expansion Cartridge.

**System Coordinator:** This is the title assigned to the person responsible for Norstar Administration programming and the training of co-workers on the Norstar system.

**System Data:** Programmable settings from your system's installation, and from Configuration and Administration programming.

**System Speed Dial:** These two digit numbers (01 to 70) can each be programmed to dial telephone numbers up to 16 digits in length. System Speed Dial codes are programmed for the entire system in section "1. System Speed Dial" of Administration programming.

**Table entries:** A sub-heading in sections "4. Restrictions" and "5. Overrides" of Administration programming. Table entries allows you to assign a Restriction to one or more of the 30 Restriction numbers, and an Override to one or more of the 10 Override numbers.

**Template:** A system-wide setting assigned during your system's installation. The most important effects of a Template are the number of lines assigned to the telephones, and the assignment of Line Pool Access. Templates will also assign other system-wide defaults, such as Prime Line and Ringing Line assignment. The choice of one of four Templates is not affected by Configuration or Administration programming. It is important to understand that a Template is only provided as a convenience, and that any settings effected by the Template can be changed.

**Time and Date:** The current Time and Date appear on the display of idle Norstar telephones. The Time and Date can be changed in section "3. Time and date" of Administration programming.

**Tone:** This is a dialing access for outside lines. Tone is also referred to as "Touchtone" or DTMF (Dual Tone Multi-Frequency) Tones. Tones may be required for Access Signalling to PBX or Centrex systems. In section "1. Line Data" of Configuration programming, the Installer can select this option on any line for which Tone dialing is necessary.

**Transfer:** This feature allows you to redirect a call to another telephone. There are three types of Transfer: Transfer using Hold, Transfer using Conference, and Transfer (with or without Announcement.)

**Transfer Callback:** After a specified number of rings, an unanswered transferred call will return to the telephone which originally made the transfer. The number of rings can be assigned in section "3. Call Handling" of Configuration programming.

**Trunk Answer:** This feature lets you answer a ringing call from any Norstar telephone in the system on any line that has Night Service activated. Trunk Answer is assigned in section "7. Night Service" of Administration programming.

**Trunk Cartridge (TC):** A cartridge that is inserted into the Trunk Module, and provides the connection to outside lines. Up to three cartridges can be used in one Trunk Module. Each cartridge can support four outside lines.

**Trunk Module (TM):** An expansion module that provides the Norstar system

with up to 12 additional outside lines, depending on the number of Trunk Cartridges installed.

**Type:** This setting controls whether each line assigned to a telephone is Public, Private, or assigned to one of Norstar's nine Line Pools. Line Type is assigned in section "1. Line Data" of Configuration programming.

**User Data:** User Data is an option in the Set Copy function. User Data refers to the personal settings which are unique to an individual telephone, and are not programmed in Configuration or Administration programming. You program these settings for your telephone at your telephone. Such settings, for example, include Personal Speed Dial and the assignment of programmable buttons.

**Voice Call:** This feature allows you to make a voice announcement or begin a conversation through the speaker of another telephone in your system.