

C6150

User's Guide

Copyright Information

Copyright © 2008 by Oki Data. All Rights Reserved
C6150 User's Guide
P/N 59299201, Revision 1.0

Disclaimer

Every effort has been made to ensure that the information in this document is complete, accurate, and up-to-date. The manufacturer assumes no responsibility for the results of errors beyond its control. The manufacturer also cannot guarantee that changes in software and equipment made by other manufacturers and referred to in this guide will not affect the applicability of the information in it. Mention of software products manufactured by other companies does not necessarily constitute endorsement by the manufacturer .

While all reasonable efforts have been made to make this document as accurate and helpful as possible, we make no warranty of any kind, expressed or implied, as to the accuracy or completeness of the information contained herein.

The most up-to-date drivers and manuals are available from the web site:

<http://www.okiprintingsolutions.com>

Trademark Information

Oki and Microline are registered trademarks of Oki Electric Industry Company Ltd.

Apple, Macintosh and Mac OS are registered trademarks of Apple Computers Inc.

ENERGY STAR is a trademark of the United States Environmental Protection Agency.

Hewlett-Packard, HP, and LaserJet are registered trademarks of Hewlett-Packard Company.

Microsoft, MS-DOS and Windows are either registered trademarks or trademarks of Microsoft Corporation in the United States and/or other countries.

Other product names and brand names are registered trademarks or trademarks of their proprietors.

Contents

Notes, Cautions, etc.	12
Introduction	13
Features	13
Options	13
Parts of the Printer	14
Front	14
Rear	15
Paper (Print Media)	16
General Information	16
Driver Settings	17
General Information	17
Choices	17
Face up / Straight through / Rear Exit	18
Windows	19
Macintosh OS 10.2 and 10.3	20
Paper, US Bond	20
General Information	20
Recommendations	21
Driver Settings	22
Index Paper (Card Stock)	22
General Information	22
Recommendations	23
Driver Settings	24
Letterhead	24
General Information	24
Recommendations	25
Driver Settings	26
Loading	26
Envelopes	28
General Information	28
Recommendations	28
Driver Settings	29
Loading	29
Envelope Exit Path	29
Labels	30
General Information	30
Recommendations	30
Driver Settings	30
Loading Multi-purpose Tray (Manual Feed)	31
Label Exit Path	31

Transparencies32
General Information32
Recommendations32
Driver Settings.32
Loading.33
Transparency Exit Path33
Paper Trays	34
General Information.34
Select in the driver35
Windows PostScript35
Windows PCL.36
Macintosh37
Paper Size, Feed, and Exit38
Tray 1 and Optional Tray 238
Multi-Purpose Tray39
Tray 140
General Information40
Choose in the driver40
Tray 1 Duplexing Restrictions40
Tray 1 Paper Sizes and Exit Paths41
Tray 242
General Information42
Choose in the driver42
Tray 2 Duplexing Restrictions42
Tray 2 Paper Sizes and Exit Paths43
Multi-Purpose Tray (MP Tray)	
[Manual Feed].44
General Information44
Choose in the driver44
MO Tray Duplexing Restrictions45
MP Tray Paper Sizes and Exit Paths46
Auto Tray Select47
General Information47
Windows PostScript47
Windows PCL.48
Macintosh OS 10.248
Macintosh OS 10.348
Auto Switching49
General Information49
Printer Menu50
Windows PostScript50
Windows PCL.51
Macintosh OS 10.252

Macintosh OS 10.3	52
Paper Size Check	53
General Information	53
Windows PostScript	53
Windows PCL	54
Macintosh	54
Paper Exit Paths	55
Face Down (Top Exit)	55
Face Up (Rear Exit)	56
Loading Paper	58
Trays 1 and 2	58
Multi-purpose Tray	61
(MP Tray/Manual Feed)	61
Consumables and Replacement Supplies	64
Part Numbers	64
Toner	64
Image Drums	64
Fusers	64
Transfer Belt	64
Replace a Toner Cartridge	65
Replace an Image Drum	72
Replace the Fuser	81
Replace the Belt Unit	85
Printer Settings (Menu Settings)	90
Print a list of the current settings	90
Changing Settings	91
Example: Power Save Time	92
Reset to Factory Defaults	93
Lists of Available Settings by Menu	94
Information Menu	94
Print Menu	94
Media Menu	95
Color Menu	97
System Configuration Menu	98
USB Menu	99
Network Menu	99
Memory Menu	100
System Adjust M\menu	101
Maintenance Menu	102
Usage Menu	103
Menu Defaults	104
Information, Print, and Media Menus	104
Color, System Configuration, and USB Menus	105

Network and Memory Menus	106
System Adjust and Maintenance Menus	107
Usage Menu.	108
Options	109
Additional Memory (RAM)	109
Duplex Unit.	110
Hard Disk Drive.	110
Second Paper Tray.	111
Specifications	112
Troubleshooting	114
General Information.	114
Display Panel Messages	115
Paper Jams	119
General Information	119
If paper jams are frequent	120
Jam is cleared, but printer does not print.	120
Jam 370, 373 and 383	121
Jam 371	123
Jam 372 and 380	125
Jam 381	127
Jam 382	133
Jam 390	136
Jam 391 and 392	138
Print Quality Problems	140
Blurred print (letter edges)	140
Blurred print (one side of page)	140
Fading (in patches).	140
Fading (Vertical)	140
Light Print	141
Lines, Black (Vertical).	141
Lines, White (Vertical)	142
Shading on unprinted sections	142
Toner rubs off when you rub the printed surface.	142
Ultra Heavy	142
USB Problems	143
Cannot configure for USB connection	143
Cannot print	144
Application error	145
General Protection Fault	145
Paper Size Change Request	145
Printer does not go online.	145
Printer makes a strange noise.	146
Printer takes a long time to start printing	146

Printing cancels	146
Printing does not start	147
Printing is slow	147
Cleaning Page	148
General Information	148
Windows	148
Macintosh	148
Printer Drivers	149
General Information	149
Install	149
Windows and Macintosh	149
Which Printer Driver to Use?	150
Windows	150
Change Driver Settings	151
All Print Jobs (Default)	151
Single Print Job	151
Save Driver Settings	152
Windows	152
Check to see if saved Driver Settings are used	153
Restore Default Driver Settings	154
Windows	154
Macintosh	154
General Information	154
Summary	155
Presets	155
Scheduler	156
Paper Handling	157
Printer Features	158
Overview	158
Banners	159
General Information	159
Specifications	159
Windows	159
Macintosh	161
Black Finish	162
General Information	162
Windows: Individual Print Jobs	162
Windows: All Print Jobs (Default)	162
Macintosh OS 10.2 and 10.3	163
Black Overprint	164
General Information	164
Restrictions	164
Windows PostScript	165

Windows PCL	165
Macintosh OS 10.2 and 10.3	165
Black Printing	166
General Information	166
Windows, PostScript	166
Windows PCL	169
Macintosh OS 10.2 and 10.3	170
Booklets (Binding Print)	171
General Information	171
Restrictions	172
Windows PostScript	173
Windows PCL	174
Macintosh OS 10.2 and 10.3	174
Collating	175
General Information	175
Windows	176
Macintosh OS 10.2 and 10.3	177
Color Matching	178
Overview	178
Basics	179
What this guide describes	180
Background Information	180
Factors that Affect Color Printing	181
Color Settings	187
Hue, Brightness, and Saturation	188
How To	189
Color Match Precision	189
List of Color Matching Methods	189
Descriptions of Color Matching Methods	190
Automatic	191
Office Color	192
Graphic Pro	196
No Color Matching	209
Grayscale	210
Color Synch	212
Custom Page Sizes	216
General Information	216
Custom Size Ranges	217
Restrictions	218
Special Print Media (Paper)	219
Windows PostScript	220
Windows PCL	221
Macintosh OS 10.2 and 10.3	222

Duplex Printing	223
(Printing on Both Sides of the Paper)	223
General Information	223
Paper Types	223
Paper Weights	223
Paper Sizes	224
Long Edge vs. Short Edge	224
Duplexing Restrictions	225
Windows PostScript: All Print Jobs (Default)	226
Windows PostScript: Single Job	226
Windows PCL: All Print Jobs (Default)	227
Windows PCL: Single Print Job	228
Macintosh OS 10.2	229
Macintosh OS 10.3	229
Grayscale	231
N-Up Printing	232
Printing Multiple Pages on One Sheet	232
General Information	232
Windows PostScript	233
Windows PCL	234
Macintosh	235
Photographs	236
General Information	236
Posters	237
General Information	237
Print Resolution	239
General Information	239
Resolution Choices	240
Windows, All Print Jobs (Default)	241
Windows, Single Print Job	242
Macintosh OS 10.2 and 10.3	242
Save as File	243
(Print to File)	243
General Information	243
Windows, Single Print Job	244
Windows, All Print Jobs (Default)	244
Macintosh OS 10.2 and 10.3	245
Toner Saving.	246
General Information	246
Windows, Single Print Job	247
Windows, All Print Jobs (Default)	248
Macintosh OS 10.2 and 10.3	248
Watermarks	249

General Information	249
Windows PostScript	250
Windows PCL	253
Macintosh OS 10.2 and 10.3	255
Utilities	256
Descriptions of Utilities	257
Installing the Utilities	260
Windows	260
Macintosh OS 10.2 and 10.3	260
Color Correction Utility	261
General Information	261
How to Install	261
Additional Information	261
Change the Pallet Color	262
Adjust the Gamma Value and Hue	270
Color Swatch Utility	274
General Information	274
How to Install	275
Additional Information	275
Printing Color Swatches	275
Creating Custom Swatch Colors	277
Direct Network Printing Utility (LPR)	278
General Information	278
How to Install	278
Direct Network Printing Utility (LPR) Status Box	279
Additional Information	279
Display Language Utility	280
General Information	280
How to Install	280
Additional Information	280
Network Printer Status Utility	281
Windows	281
General Information	281
Installation	282
Using	282
Checking the Printer Status	283
Network Setup Utility	285
General Information	285
How to Install	285
Additional Information	285
PS Gamma Adjuster Utility	286
General Information	286
How to Install	286

Additional Information286

Notes, Cautions, etc.

Illustrations and components are representative only. Your unit may differ slightly from those pictured in this document.

NOTE

A note appears like this. A note provides additional information to supplement the main text which helps you to use and understand the product.

Important!

An important message appears like this. An important message provides supplemental information which can prevent potential problems.

CAUTION!

A caution appears like this. A caution provides additional information which, if ignored, may result in equipment malfunction or damage.

WARNING!

A warning appears like this. A warning provides additional information which, if ignored, may result in a risk of personal injury.

Introduction

Your new printer is designed with advanced features to give you clear, vibrant color printing and crisp black and white pages at high speed on a range of print media.

Features

- Up to 26 pages per minute full color.
- Up to 32 pages per minute in black and white.
- 600 x 1200 dpi (dots per inch) print resolution.
- Single Pass Color Digital LED technology.
- 10 Base-T and 100 Base-TX network connection.

Options

- Additional Memory: see page 109
256 MB or 512 MB
- Duplex Unit: see page 110
for automatic two-sided printing
- Hard disk drive: see page 110
allows you to use secure (confidential) printing, spool print jobs, and store print jobs for later use
- Second Paper Tray: see page 111.
capacity 530 sheets 20-lb. paper

Parts of the Printer

Front

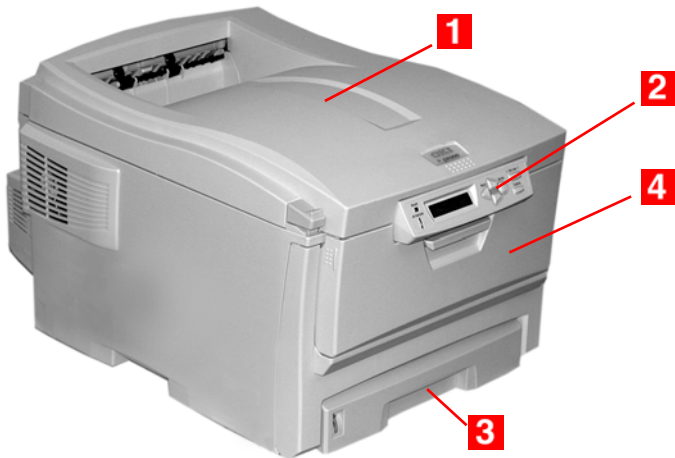

- 1.** Output Stacker, face down
 - Standard printed copy delivery point.
 - Holds up to 250 sheets of 20-lb. (75 g/m²) paper.
- 2.** Operator Panel
 - Menu driven operator controls and LCD display panel
- 3.** Paper Tray
 - Standard paper tray.
 - Holds up to 300 sheets of 20-lb. (75 g/m²) paper.
- 4.** Multi-Purpose Tray
 - Used for feeding transparencies, heavier paper stocks, envelopes and other special media.
 - Also for manual feeding of single sheets when required.

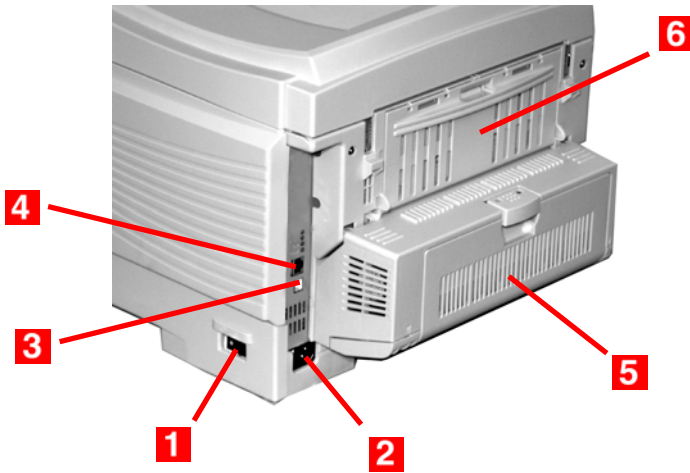

1. On/Off Switch
2. Socket for Power Cord
3. USB Interface
4. Network Interface
5. Duplex Unit
6. Rear Stacker (face up)
 - Capacity 100 sheets
 - When the rear paper stacker is folded down, paper exits the printer through the rear of the printer and is stacked face up.
 - This is used for labels, heavy print media, envelopes and custom paper sizes.
 - When used with the Multi-Purpose Tray, the paper path through the printer is essentially straight. This avoids bending the print media around curves in the paper path and makes paper feeding more reliable.

Paper (Print Media)

General Information

CAUTION!

Print media must be able to withstand 446°F (230°C) for 0.2 second.

You need to know three characteristics about any paper (print media) you want to use with your printer:

- Type
- Weight
- Size

The type, weight, and size of the paper (print media) determine:

- which paper feed tray can be used
Choices are multipurpose tray (MP Tray/manual feed) or Trays 1 - 2
- which paper exit path can be used
Choices are face-down or face-up (straight-through)
- whether you can use double sided (duplex) printing

For type, see

- Paper: US Bond (Metric): see page 20
- Paper: Index: see page 22
- Letterhead: see page 24
- Envelopes: see page 28
- Transparencies: see page 32
- Labels: see page 30

For weight, refer to the correct paper type. Each paper type has a table (matrix) of paper size, paper weight, paper feed, paper exit, simplex/duplex correlations.

For general information on paper sizes, see "Paper Size, Feed, and Exit" on page 38.

Driver Settings

General Information

Select the thickness/type of media on which you are printing a particular job, to produce optimum print results. This setting overrides the setting in the printer menu.

If you are printing on a thick media such as card stock, be sure to select one of the thicker settings (Heavy, Ultra Heavy, Labels1, Labels 2) to get proper fusion of the toner to the page and to prevent possible damage to the printer.

If the Ultra Heavy setting does not give proper toner fusion, you can try the Label settings.

The default printer menu setting is Medium.

Choices are: Printer Setting, Light, Medium, Heavy, Ultra Heavy, Labels1, Labels2, Transparency, Glossy, User Type 1, User Type 2, User Type 3, User Type 4, and User Type 5.

Choices

Choices are: Printer Setting, Light, Medium, Heavy, Ultra Heavy, Labels1, Labels2, Transparency, Glossy, User Type 1, User Type 2, User Type 3, User Type 4, and User Type 5.

Light

16-19 lb. US Bond (64-74 g/m²)

Medium

20-27 lb. US Bond (75-104 g/m²)

Heavy

28-32 lb. US Bond (105-120 g/m²)

58-67 lb. Index

Ultra Heavy

33-54 lb. US Bond (124-203 g/m²)

68-113 lb. Index

If the Ultra Heavy setting does not give proper toner fusion, you can try the Label settings.

Labels1

For labels 0.1 to 0.169 mm thick.

Labels2

For labels 0.17 to 0.2 mm thick.

Driver Setting	Actual Weight	Feed Tray	Duplexer?	Exit Tray
Light	16-19 lb. US Bond 64-74 g/m ² 55-64 Kg	Tray 1 Tray 2	No	Top ^a Rear ^b
Medium	20-27 lb. US Bond 75-104 g/m ² 65 - 89 Kg	Tray 1 Tray 2 MP Tray	Yes	Top Rear
Heavy	28-32 lb. US Bond (105-120 g/m ²) 90 - 103 Kg	Tray 1 Tray 2 MP Tray	Yes (restricted to 28 lb. maximum)	Rear Only
Ultra Heavy ^c	33-54 lb. US Bond 121-200 g/m ² 104 - 172 Kg	Tray 2 ^d MP Tray	No	Rear Only

- a. Face Down Stacker
- b. Face Up Stacker
- c. If the Ultra Heavy setting does not give proper toner fusion, try the Label settings.
- d. 47 lb. (177 g/m²) maximum for Tray 2

Face up / Straight through / Rear Exit

If you are using heavy media, transparencies, envelopes or labels, use the face up (straight through) paper feed path.

For face up printing (straight-through path), make sure the rear exit is open and the paper support is extended.

- Paper is stacked in reverse order.
- Tray capacity is about 100 sheets. Actual capacity depends on paper weight.



Windows

The normal default for these items is automatic detection.

CAUTION!

1. If type and weight are not correctly set,
 - print quality deteriorates
 - the fuser roller may be damaged.
2. If the settings in the printer differ from those selected on your computer, the printer does not print. An error message displays.
3. The following printer settings are given as a guide only. Some software applications require the paper feed, size and media settings to be selected from within the application (page setup).

1. Open the file you want to print.
2. Click File → Print.
3. Select your printer.
4. Click Properties.
5. Under Layout, click Advanced.
6. Under Document Options, Printer Features, click Media Type.
7. Use the drop down list to make your selection.
See "Driver Settings" on page 17.
See "Face up / Straight through / Rear Exit" on page 18.
8. Change any other settings as desired.
9. Click OK.
10. The Layout tab screen appears.
11. Change any other settings as desired.
12. Click OK.
13. The main Print screen appears.
14. Change any other settings as desired.
15. Click OK.
16. The document prints.

Macintosh OS 10.2 and 10.3

CAUTION!

1. If type and weight are not correctly set,
 - print quality deteriorates
 - the fuser roller may be damaged.
2. If the settings in the printer differ from those selected on your computer, the printer does not print. An error message displays.
3. The following printer settings are given as a guide only. Some software applications require the paper feed, size and media settings to be selected from within the application (page setup).

1. Open the file you want to print.
2. Click File → Print.
3. Open the drop-down list below Presets. Select Printer Option.
4. At Media Weight, make your selection.
See "Driver Settings" on page 17.
See "Face up / Straight through / Rear Exit" on page 18.
5. Change any other settings as desired.
6. Click Print.

Paper, US Bond

General Information

NOTE

To determine if a paper weight is US Bond or Index, check the metric equivalent.

35 lb US Bond = 132 g/m²

35 lb Index = 64 g/m²

For more information, go to www.paper-paper.com/weight.html

The size, weight, and type of the paper (print media) determine:

- which paper feed tray can be used
- which paper exit path can be used
- whether you can use double sided (duplex) printing

Single sided printing is also known as simplex printing.

These settings can be made in the printer menu or in the printer driver.

Application settings override driver settings.

Driver settings override printer menu settings.

The best performance is obtained when using paper designed for use in copiers and laser printers. Suitable types include:

- Hammermill® Laser Printer Radiant White, 24 lb. US Bond (90 g/m²)
- Xerox® 4024, 20 lb. US Bond (75 g/m²)
- Oki® 52206101 Bright White Proofing Paper, 32 lb. US Bond (120 g/m²)

Recommendations

- Check www.okiprintingsolutions.com for the latest information on recommended papers for your printer.
- Paper should be stored flat, away from moisture, direct sunlight and heat sources.
- **The use of heavily laid or textured paper will seriously affect the life of the image drum and give poor print quality.** Print quality can be improved by changing the media setting to 'Ultra Heavy.' However, this will reduce the output speed and prevent the use of the duplex option.

If the Ultra Heavy setting does not give proper toner fusion, you can try the Label settings.

● *Avoid:*

- Damp, damaged or curled paper.
- Very smooth, shiny or glossy paper.
- Heavily embossed letterhead paper, very rough paper or paper that has a large grain difference between the two sides.
- Paper with perforations, cut-outs or ragged edges.
- Carbon paper, recycled paper, NCR paper, photosensitive paper, pressure sensitive paper or thermal transfer paper.

Driver Settings

To select a paper type in the driver, see:

Windows: page 19

Macintosh: page 20

Index Paper (Card Stock) _____

General Information

NOTE

To determine if a paper weight is US Bond or Index, check the metric equivalent.

- **35 lb US Bond = 132 g/m²**
- **35 lb Index = 64 g/m²**

For more information, go to www.paper-paper.com/weight.html

The size, weight, and type of the paper (print media) determine:

- which paper feed tray can be used
- which paper exit path can be used
- whether you can use double sided (duplex) printing

Single sided printing is also known as simplex printing.

These settings can be made in the printer menu or in the printer driver.

Application settings override driver settings.

Driver settings override printer menu settings.

The best performance is obtained when using paper designed for use in copiers and laser printers. Suitable types include:

- Hammermill® Laser Printer Radiant White, 24 lb. US Bond (90 g/m²)
- Xerox® 4024, 20 lb. US Bond (75 g/m²)
- Oki® 52206101 Bright White Proofing Paper, 32 lb. US Bond (120 g/m²)

Recommendations

- Check www.okiprintingsolutions.com for the latest information on recommended papers for your printer.
- Paper should be stored flat, away from moisture, direct sunlight and heat sources.
- **The use of heavily laid or textured paper will seriously affect the life of the image drum and give poor print quality.** Print quality can be improved by changing the media setting to 'Ultra Heavy.' However, this will reduce the output speed and prevent the use of the duplex option.

If the Ultra Heavy setting does not give proper toner fusion, you can try the Label settings.

- *Avoid:*
 - Damp, damaged or curled paper.
 - Very smooth, shiny or glossy paper.
 - Heavily embossed letterhead paper, very rough paper or paper that has a large grain difference between the two sides.
 - Paper with perforations, cut-outs or ragged edges.
 - Carbon paper, recycled paper, NCR paper, photosensitive paper, pressure sensitive paper or thermal transfer paper.

Driver Settings

To select a paper type in the driver, see:

Windows: page 19

Macintosh: page 20

Letterhead

General Information

The size, weight, and type of the paper (print media) determine:

- which paper feed tray can be used
- which paper exit path can be used
- whether you can use double sided (duplex) printing

Single sided printing is also known as simplex printing.

These settings can be made in the printer menu or in the printer driver.

Application settings override driver settings.

Driver settings override printer menu settings.

When using heavily laid or textured paper

- the life of the image drum is seriously shortened
- print quality may deteriorate
- change the media setting to 'Ultra Heavy'.

This will improve print quality.

When using 'Ultra Heavy':

- print speed slows
- duplexing *cannot* be used.

If the Ultra Heavy setting does not give proper toner fusion, you can try the Label settings.

Recommendations

CAUTION

Print media must be able to withstand 446°F (230°C) for 0.2 second.

Only use letterhead designed for color laser printers and photocopiers.

Don't use very smooth, shiny or glossy paper.

Don't use heavily embossed headed paper, very rough paper or paper that has a large grain difference between the two sides.

- Check www.okiprintingsolutions.com for the latest information on recommended papers for your printer.
- Paper should be stored flat, away from moisture, direct sunlight and heat sources.
- **The use of heavily laid or textured paper will seriously affect the life of the image drum and give poor print quality.** Print quality can be improved by changing the media setting to 'Ultra Heavy.' However, this will reduce the output speed and prevent the use of the duplex option.

If the Ultra Heavy setting does not give proper toner fusion, you can try the Label settings.

- *Avoid:*
 - Damp, damaged or curled paper.
 - Very smooth, shiny or glossy paper.
 - Heavily embossed letterhead paper, very rough paper or paper that has a large grain difference between the two sides.
 - Paper with perforations, cut-outs or ragged edges.
 - Carbon paper, recycled paper, NCR paper, photosensitive paper, pressure sensitive paper or thermal transfer paper.

Driver Settings

To select a paper type in the driver, see:

Windows: page 19

Macintosh: page 20

Loading

Trays 1 and 2

Long edge feed

Face down, top toward the back of the printer.

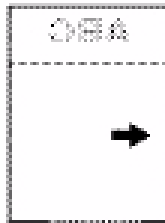

Short edge feed

face down, top to the right

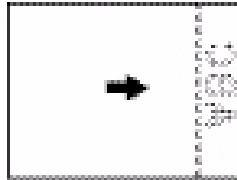

Loading

Multi-purpose Tray (Manual Feed)

Long edge feed

Face up, top to the back of the printer

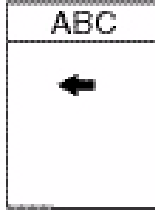

Short edge feed

Face up, top to the left

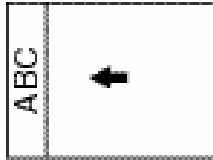

Envelopes

General Information

Envelopes can *only* be fed from the multi-purpose (MP / manual feed) tray.

Envelopes can *only* exit the printer *face-up* (straight through, rear exit).

Recommendations

CAUTION

Print media must be able to withstand 446°F (230°C) for 0.2 second.

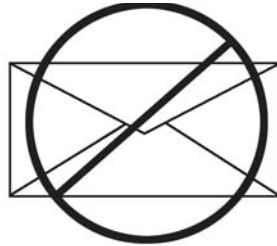
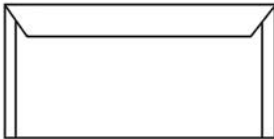

1. Use only recommended envelopes.

Oki 52206301 and 52206302

For more information, see "Print Media, Oki" in your *Handy Reference Guide* or www.okiprintingsolutions.com.

2. Store envelopes flat and away from

- moisture
- direct sunlight
- heat sources

3. Don't use envelopes with

- windows
- metal clasps
- self-sealing flaps
- damp, damaged or curled paper envelopes

Driver Settings

To select a paper type in the driver, see:

Windows: page 19

Macintosh: page 20

Loading

Trays 1 - 2

Envelopes *cannot* be fed from paper trays 1 - 2.

Multi-purpose Tray (Manual Feed)

Face up (flap side *down*), top to the left (into the printer)

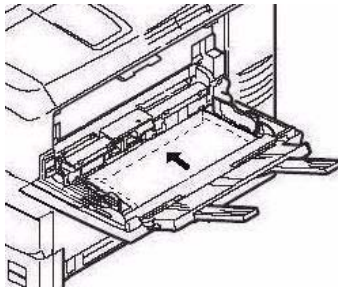

Envelope Exit Path

If you are using heavy media, transparencies, envelopes or labels, use the face up (straight through) paper feed path.

For face up printing (straight-through path), make sure the rear exit is open and the paper support is extended.

- Paper is stacked in reverse order.
- Tray capacity is about 100 sheets. Actual capacity depends on paper weight.



Labels

General Information

Labels can *only* be fed from the multi-purpose (MP / manual feed) tray.

Labels can *only* exit the printer *face-up* (*straight through, rear exit*).

Avery 5161 White Laser Labels (letter size) work well with your printer.

Check www.okiprintingsolutions.com for the latest information on media for your printer.

Recommendations

CAUTION

Print media must be able to withstand 446°F (230°C) for 0.2 second.

- Only use labels designed for color laser printers and photocopiers.
- Labels must cover the entire carrier sheet.
- The carrier sheet or adhesive must not be exposed to any part of the printer.

Driver Settings

To select a paper type in the driver, see:

Windows: page 19

Macintosh: page 20

Loading Multi-purpose Tray (Manual Feed)

NOTE

Labels cannot be fed from paper trays 1 - 2.

- Face up (print side *up*)
- Default = long edge feed.

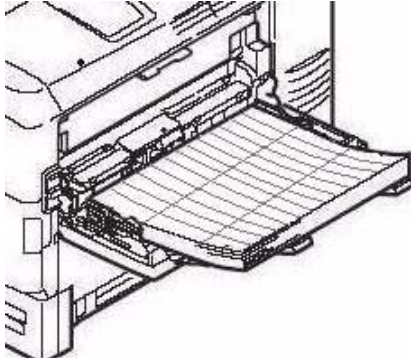

Label Exit Path

If you are using heavy media, transparencies, envelopes or labels, use the face up (straight through) paper feed path.

For face up printing (straight-through path), make sure the rear exit is open and the paper support is extended.

- Paper is stacked in reverse order.
- Tray capacity is about 100 sheets. Actual capacity depends on paper weight.



Transparencies

General Information

Transparencies can *only* be fed from the multi-purpose (MP / manual feed) tray.

Transparencies can *only* exit the printer *face-up (straight through, rear exit)*.

Recommendations

CAUTION

Print media must be able to withstand 446°F (230°C) for 0.2 second.

1. Only use transparencies designed for color laser printers and photocopiers.
2. Only use recommended transparencies
Oki 52205701
3M CG3720
3. Avoid office transparencies designed for use by hand with marker pens.
These will melt in the fuser and cause damage.

Driver Settings

To select a paper type in the driver, see:

Windows: page 19

Macintosh: page 20

Loading

Trays 1 - 2

Transparencies *cannot* be fed from paper trays 1 - 2.

Multi-purpose Tray (Manual Feed)

Face up (print side *up*)

Default = long edge feed.

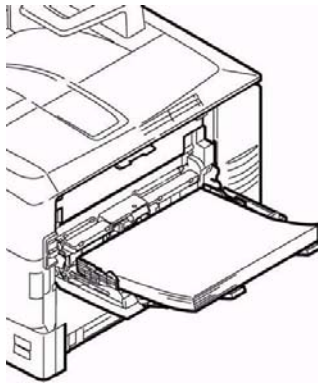

Transparency Exit Path

If you are using heavy media, transparencies, envelopes or labels, use the face up (straight through) paper feed path.

For face up printing (straight-through path), make sure the rear exit is open and the paper support is extended.

- Paper is stacked in reverse order.
- Tray capacity is about 100 sheets. Actual capacity depends on paper weight.



Paper Trays

General Information

You can select

- the paper tray used by your print job
- if the printer checks whether the size paper loaded in the selected tray matches that required for the document being printed (Paper Size Check)
- if the printer automatically matches the printer job's paper size to a paper tray (Auto Select)
- if a paper tray (Tray 1) runs out of paper, your printer can automatically switch to another paper tray (MP Tray, optional Tray 2) loaded with the same type of paper (Auto Switching).

The settings for Paper Feed (Paper Tray/Source), Paper Size, Paper Exit, and Paper Weight interact. For more information, see "Paper Size, Feed, and Exit" on page 38.

Select in the driver

Windows PostScript

1. Open the file you want to print.
2. Click File → Print.
3. Select your printer.
4. Click Properties.
5. Click the Paper/Quality tab.
6. Under Tray Selection, at Paper Source, click on the arrow to open the drop down list. Make your selection.

Choices are: Automatically select, Multi-purpose tray, Tray 1, Tray 2, Plain Paper, Letterhead, Transparency, Labels, Bond Paper, Recycled Paper, Card Stock, Rough Paper, Envelopes.

Automatically select

The printer automatically selects the paper tray.

Multi Purpose Tray / Tray1 / Tray 2

Tray 2 appears only if an optional tray is installed.

Select a specific paper tray.

For example:

You are printing a job on special media (letterhead).

Place the media in the Multi Purpose Tray.

Select the Multi Purpose Tray here (in the driver) when printing the job.

7. Change any other settings as desired.
8. Click OK.
9. The main Print screen appears.
10. Change any other settings as desired.
11. Click OK.
12. The document prints.

Windows PCL

1. Open the file you want to print.
2. Click File → Print.
3. Select your printer.
4. Click Properties.
5. Click the Setup tab.
6. Under Source, click on the arrow to open the drop down list. Make your selection.

Choices are: Automatically select, Multi-purpose tray, Tray 1, Tray 2, Plain, Recycled, Letterhead, Bond, Card Stock, Rough, Labels, Transparency

Automatically select

The printer automatically selects the paper tray.

Multi Purpose Tray / Tray1 / Tray 2

Tray 2 appears only if an optional tray is installed.

Select a specific paper tray.

For example:

You are printing a job on special media (letterhead).

Place the media in the Multi Purpose Tray.

Select the Multi Purpose Tray here (in the driver) when printing the job.

7. Change any other settings as desired.
8. Click OK.
9. The main Print screen appears.
10. Change any other settings as desired.
11. Click OK.
12. The document prints.

Macintosh

1. Open the file you want to print.
2. Click File → Print.
3. Open the drop-down list below Presets. Select Paper Source.
4. Make your selection.

Auto

The printer automatically selects the paper tray.

Multi Purpose Tray / Tray1 / Tray 2

Tray 2 appears only if an optional tray is installed.

Select a specific paper tray.

For example:

You are printing a job on special media (letterhead).

Place the media in the Multi Purpose Tray.

Select the Multi Purpose Tray here (in the driver) when printing the job.

5. Change any other settings as desired.
6. Click Print.

Paper Size, Feed, and Exit

Tray 1 and Optional Tray 2

Paper size	Feed		Exit	
	Tray 1	Tray 2	Top ^a	Rear ^b
Letter (8½ x 11")	S, D ^c	S, D	S, D	S, D
Legal-14 (8½ x 14")	S, D	S, D	S, D	S, D
Legal-13.5 (8½ x 13.5")	S, D	S, D	S, D	S, D
Legal-13 (8½ x 13")	S, D	S, D	S, D	S, D
Executive (7¼ x 10½")	S, D	S, D	S, D	S, D
A4 (210 x 297 mm)	S, D	S, D	S, D	S, D
A5 (145 x 210 mm)	S, D	S, D	S, D	S, D
A6 (105 x 148 mm)	S	Not Usable	Not Usable	S
B5 (182 x 257 mm)	S, D	S, D	S, D	S, D
Custom	S: <i>min.</i> 3.94 x 5.83" [100 x 148 mm], D: <i>min.</i> 5.8 x 8.25" [148 x 210 mm] S, D: <i>max.</i> 8.5 x 14" [215.9 x 355.6 mm]	S: <i>min.</i> 3.94 x 5.83" [100 x 148 mm], D: <i>min.</i> 5.8 x 8.25" [148 x 210 mm] S, D: <i>max.</i> 8.5 x 14" [215.9 x 355.6 mm]	S, D	Not Usable.

- Use the Top Exit (Face Down Stacker) only for paper up to 47 lb. US Bond (98 lb. Index, 177 g/m²).
- Switch to the Rear Exit (Face Up Stacker) when you are printing paper heavier than 47 lb. US Bond (98 lb. Index, 177 g/m²).
- S = Simplex; D = Duplex (printing on both sides)

Multi-Purpose Tray

Paper size	Feed MP Tray	Exit Rear ^a	Exit Top ^b
Letter 8½ x 11"	Yes	Yes	Yes
Legal-14 8½ x 14"	Yes	Yes	Yes
Legal-13.5 8½ x 13.5"	Yes	Yes	Yes
Legal-13 8½ x 13"	Yes	Yes	Yes
Executive 7¼ x 10½"	Yes	Yes	Yes
A4 210 x 297 mm	Yes	Yes	Yes
A5 145 x 210 mm	Yes	Yes	Yes
B5 182 x 257 mm	Yes	Yes	Yes
Envelopes COM-10	Yes	Yes	No
Custom Minimum 3.94 to 5.83" 100 x 148 mm Maximum 8½ x 14" 216 x 356 mm Banner ^c	Yes	Yes	No

- a. Use the Rear Exit (Face Up Stacker) for heavy paper, transparencies, envelopes, and labels.
- b. Use the Top Exit (Face Down Stacker) only for paper up to 47 lb. US Bond (98 lb. Index, 177 g/m²).
- c. Banner specifications:
 - Length: up to 47" (1.2 m)
 - Width Range = 8¼ to 8½" (210 to 215.9 mm)
 - Weight Range = 28 to 34 lb. US Bond (105 to 128 g/m²)
 - Path = Rear Exit (Face Up Stacker) only
 - Feed one sheet at a time.

Tray 1

General Information

Use Tray 1 for regular paper, standard sizes, standard weights.

If a paper tray (Tray 1) runs out of paper, your printer can automatically switch to another paper tray (MP Tray, optional Tray 2) loaded with the same type of paper. This is called Auto Switching. See "Auto Switching" on page 49.

- Capacity
 - about 300 sheets (20-lb. [75 g/m²] paper)
- Loading
 - See Loading Paper, "Trays 1 and 2" on page 58.
- Exit path
 - top exit (Face Down Stacker), best for general use
 - rear exit (Face Up Stacker)
 - See "Tray 1 Paper Sizes and Exit Paths" on page 41

Choose in the driver

See Paper Trays, "Select in the driver" on page 35.

Tray 1 Duplexing Restrictions

Important!

You can duplex

- paper
- paper weights up to
 - 28 lb. US Bond
 - 58 lb. Index
 - 105 g/m² metric

You *cannot* duplex

- labels
- envelopes
- transparencies
- paper weights above
 - 28 lb. US Bond
 - 58 lb. Index
 - 105 g/m² metric

Tray 1 Paper Sizes and Exit Paths

Paper size	Feed		Exit	
	Tray 1	Tray 2	Top ^a	Rear ^b
Letter (8½ x 11")	S, D ^c	S, D	S, D	S, D
Legal-14 (8½ x 14")	S, D	S, D	S, D	S, D
Legal-13.5 (8½ x 13.5")	S, D	S, D	S, D	S, D
Legal-13 (8½ x 13")	S, D	S, D	S, D	S, D
Executive (7¼ x 10½")	S, D	S, D	S, D	S, D
A4 (210 x 297 mm)	S, D	S, D	S, D	S, D
A5 (145 x 210 mm)	S, D	S, D	S, D	S, D
A6 (105 x 148 mm)	S	Not Usable	Not Usable	S
B5 (182 x 257 mm)	S, D	S, D	S, D	S, D
Custom	S: <i>min.</i> 3.94 x 5.83" [100 x 148 mm], D: <i>min.</i> 5.8 x 8.25" [148 x 210 mm] S, D: <i>max.</i> 8.5 x 14" [215.9 x 355.6 mm]	S: <i>min.</i> 3.94 x 5.83" [100 x 148 mm], D: <i>min.</i> 5.8 x 8.25" [148 x 210 mm] S, D: <i>max.</i> 8.5 x 14" [215.9 x 355.6 mm]	S, D	Not Usable.

- a. Use the Top Exit (Face Down Stacker) only for paper up to 47 lb. US Bond (98 lb. Index, 177 g/m²).
- b. Switch to the Rear Exit (Face Up Stacker) when you are printing paper heavier than 47 lb. US Bond (98 lb. Index, 177 g/m²).
- c. S = Simplex; D = Duplex (printing on both sides)

Tray 2

General Information

Use Tray 2 for regular paper, standard sizes, standard weights.

If a paper tray (Tray 1) runs out of paper, your printer can automatically switch to another paper tray (MP Tray, optional Tray 2) loaded with the same type of paper. This is called Auto Switching. See "Auto Switching" on page 49.

- Capacity
 - about 530 sheets (20-lb. [75 g/m²] paper)
- Loading
 - See Loading Paper, "Trays 1 and 2" on page 58.
- Exit path
 - top exit (Face Down Stacker), best for general use
 - rear exit (Face Up Stacker)
 - See "Tray 1 Paper Sizes and Exit Paths" on page 41

Choose in the driver

See Paper Trays, "Select in the driver" on page 35.

Tray 2 Duplexing Restrictions

Important!

You can duplex

- paper
- paper weights up to
 - 28 lb. US Bond
 - 58 lb. Index
 - 105 g/m² metric

You *cannot* duplex

- labels
- envelopes
- transparencies
- paper weights above
 - 28 lb. US Bond
 - 58 lb. Index
 - 105 g/m² metric

Tray 2 Paper Sizes and Exit Paths

Paper size	Feed		Exit	
	Tray 1	Tray 2	Top ^a	Rear ^b
Letter (8½ x 11")	S, D ^c	S, D	S, D	S, D
Legal-14 (8½ x 14")	S, D	S, D	S, D	S, D
Legal-13.5 (8½ x 13.5")	S, D	S, D	S, D	S, D
Legal-13 (8½ x 13")	S, D	S, D	S, D	S, D
Executive (7¼ x 10½")	S, D	S, D	S, D	S, D
A4 (210 x 297 mm)	S, D	S, D	S, D	S, D
A5 (145 x 210 mm)	S, D	S, D	S, D	S, D
A6 (105 x 148 mm)	S	Not Usable	Not Usable	S
B5 (182 x 257 mm)	S, D	S, D	S, D	S, D
Custom	S: <i>min.</i> 3.94 x 5.83" [100 x 148 mm], D: <i>min.</i> 5.8 x 8.25" [148 x 210 mm] S, D: <i>max.</i> 8.5 x 14" [215.9 x 355.6 mm]	S: <i>min.</i> 3.94 x 5.83" [100 x 148 mm], D: <i>min.</i> 5.8 x 8.25" [148 x 210 mm] S, D: <i>max.</i> 8.5 x 14" [215.9 x 355.6 mm]	S, D	Not Usable.

- Use the Top Exit (Face Down Stacker) only for paper up to 47 lb. US Bond (98 lb. Index, 177 g/m²).
- Switch to the Rear Exit (Face Up Stacker) when you are printing paper heavier than 47 lb. US Bond (98 lb. Index, 177 g/m²).
- S = Simplex; D = Duplex (printing on both sides)

Multi-Purpose Tray (MP Tray) [Manual Feed]

General Information

Use the Multi-Purpose Tray (MP Tray) for printing card stock, labels, envelopes and transparencies.

If a paper tray (Tray 1) runs out of paper, your printer can automatically switch to another paper tray (MP Tray, optional Tray 2) loaded with the same type of paper. This is called Auto Switching. See "Auto Switching" on page 49.

- Capacity

- stack of media about 3/8" (10 mm) high

- about 10 envelopes

- 50 transparencies

- Loading

- print side *up*, top edge facing into the printer.

- See Loading Paper, "Multi-purpose Tray" on page 61.

- Exit path

- rear exit (Face Up Stacker), best for general use

- top exit (Face Down Stacker), with restrictions

- See "Tray 1 Paper Sizes and Exit Paths" on page 41

- duplex (printing on both sides), with restrictions

- See "Tray 1 Duplexing Restrictions" on page 40

Choose in the driver

See Paper Trays, "Select in the driver" on page 35.

MO Tray Duplexing Restrictions

Important!

You can duplex

- paper
- paper weights up to
 - 28 lb. US Bond
 - 58 lb. Index
 - 105 g/m² metric

You *cannot* duplex

- labels
- envelopes
- transparencies
- paper weights above
 - 28 lb. US Bond
 - 58 lb. Index
 - 105 g/m² metric

MP Tray Paper Sizes and Exit Paths

Paper size	Feed MP Tray	Exit Rear ^a	Exit Top ^b
Letter 8½ x 11"	Yes	Yes	Yes
Legal-14 8½ x 14"	Yes	Yes	Yes
Legal-13.5 8½ x 13.5"	Yes	Yes	Yes
Legal-13 8½ x 13"	Yes	Yes	Yes
Executive 7¼ x 10½"	Yes	Yes	Yes
A4 210 x 297 mm	Yes	Yes	Yes
A5 145 x 210 mm	Yes	Yes	Yes
B5 182 x 257 mm	Yes	Yes	Yes
Envelopes COM-10	Yes	Yes	No
Custom Minimum 3.94 to 5.83" 100 x 148 mm Maximum 8½ x 14" 216 x 356 mm Banner ^c	Yes	Yes	No

- Use the Rear Exit (Face Up Stacker) for heavy paper, transparencies, envelopes, and labels.
- Use the Top Exit (Face Down Stacker) only for paper up to 47 lb. US Bond (98 lb. Index, 177 g/m²).
- Banner specifications:
 - Length: up to 47" (1.2 m)
 - Width Range = 8¼ to 8½" (210 to 215.9 mm)
 - Weight Range = 28 to 34 lb. US Bond (105 to 128 g/m²)
 - Path = Rear Exit (Face Up Stacker) only
 - Feed one sheet at a time.

Auto Tray Select

General Information

Your printer can automatically match the printer job's paper size to a paper tray (1-5 and Manual Feed [Multipurpose Tray]).

NOTE

The Paper Size for Manual Feed (Multipurpose Tray) must be set through the operator panel for Auto Tray Select to work.

For more information,

Windows, PostScript: see page 47

Windows, PCL: see page 48

Macintosh OS 10.2: see page 48

Macintosh OS 10.3: see page 48

Windows PostScript

For more information, see "General Information" on page 47.

1. Open the file you want to print.
2. Click File → Print.
3. Select your printer.
4. Click Properties.
5. Click the Layout tab.
6. On Paper Quality, next to Paper Source, click Automatically Select.
7. Change any other settings as desired.
8. Click OK.
9. The main Print screen appears.
10. Change any other settings as desired.
11. Click OK.
12. The document prints.

Windows PCL

For more information, see "General Information" on page 47.

1. Open the file you want to print.
2. Click File → Print.
3. Select your printer.
4. Click Properties.
5. On Setup, under Media, beside Source, click Automatically Select.
6. Change any other settings as desired.
7. Click OK.
8. The main Print screen appears.
9. Change any other settings as desired.
10. Click OK.
11. The document prints.

Macintosh OS 10.2

For more information, see "General Information" on page 47.

1. Open the file you want to print.
2. Click File → Print.
3. On the Paper Feed panel, select All Pages.
4. Select Automatic Selection.

Macintosh OS 10.3

For more information, see "General Information" on page 47.

1. Open the file you want to print.
2. Click File → Print.
3. On the Paper Feed panel, select All Pages.
4. Select Automatic Selection.

Auto Switching

General Information

NOTE

When a paper tray runs out of paper, the printer automatically switches to the next available paper tray when

- **more than one paper tray is installed**
and
- **AUTO TRAY SWITCH is set to ON.**

**This setting is in the Tray Configuration Sub Menu of the top level menu Menus.
Refer to "Printer Menu" on page 50.**

If you use the Multi-Purpose (MP) Tray, you must set a paper size for the MP Tray through the control panel. See "Changing Settings" on page 91. In the menu, if "Media Type" is set to anything other than "Regular Paper", you must select a specific "Tray". You cannot use Automatic Selection.

If a paper tray (Tray 1) runs out of paper, your printer can automatically switch to another paper tray (MP Tray, optional Tray 2) loaded with the same type of paper. This is called Auto Switching.

This feature is enabled either through the printer menu or the printer driver.

Application settings override driver settings.

Driver settings override printer menu settings.

For more information,

Printer Menu: see page 50

Windows, PostScript: see page 47

Windows, PCL: see page 51

Macintosh OS 10.2: see page 52

Macintosh OS 10.3: see page 52

Printer Menu

This function is enabled in the Print Menu.

The factory default is ON.

To change the setting:

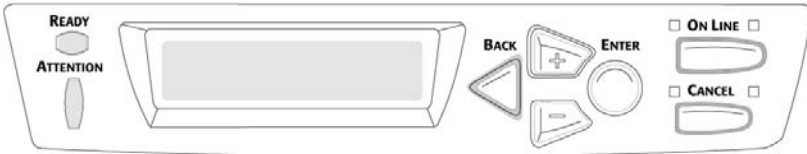

1. Press MENU + repeatedly until you see

PRINT MENU
AUTO TRAY SWITCH

2. Press ENTER.
3. Press MENU + repeatedly until you see

PRINT MENU
AUTO TRAY SWITCH

4. Press ENTER.
5. Press MENU + and/or MENU - repeatedly until you see the desired setting (ON or OFF).
6. Press ENTER to select the new setting.
7. Press ON LINE to exit the menu and return the printer to standby.

Windows PostScript

For more information, see "General Information" on page 49.

1. Open the file you want to print.
2. Click File → Print.
3. Select your printer.
4. Click Properties.
5. Click the Layout tab.
6. Click Advanced.

7. Under Document Options, Printer Features, next to Tray Switch, select ON.
8. Change any other settings as desired.
9. Click OK.
10. The main Print screen appears.
11. Change any other settings as desired.
12. Click OK.
13. The document prints.

Windows PCL

For more information, see “General Information” on page 49.

1. Open the file you want to print.
2. Click File → Print.
3. Select your printer.
4. Click Properties.
5. Click the Setup tab.
6. Click Paper Feed Options.
7. Click in the box next to Media Check.
If the box has a check mark, the feature is ON.
If the box is empty, the feature is OFF.
8. Change any other settings as desired.
9. Click OK.
10. The Setup tab screen appears.
11. Change any other settings as desired.
12. Click OK.
13. The main Print screen appears.
14. Change any other settings as desired.
15. Click OK.
16. The document prints.
- 17.

Macintosh OS 10.2

For more information, see “General Information” on page 49.

1. Open the file you want to print.
2. Click File → Print.
3. On the Paper Feed panel, select All Pages.
4. Select Automatic Selection.

Macintosh OS 10.3

For more information, see “General Information” on page 49.

1. Open the file you want to print.
2. Click File → Print.
3. Open the drop-down list below Presets. Select Printer Option.
4. At Auto tray switch, make your selection.
If the box has a check mark, the feature is ON.
If the box is empty, the feature is OFF.
5. Change any other settings as desired.
6. Click Print.

Paper Size Check

General Information

If Paper Size Check is turned on (enabled), the printer checks whether the size paper loaded in the selected tray matches that required for the document being printed.

For more information,

Windows, PostScript: see page 53

Windows, PCL: see page 54

Macintosh: see page 54

Windows PostScript

1. Open the file you want to print.
2. Click File → Print.
3. Select your printer.
4. Click Properties.
5. Click the Layout tab.
6. Click Advanced.
7. Under Document Options, Printer Features, click Media Check.
8. Change any other settings as desired.
9. Click OK.
10. The Layout tab screen appears.
11. Change any other settings as desired.
12. Click OK.
13. The main Print screen appears.
14. Change any other settings as desired.
15. Click OK.
16. The document prints.

Windows PCL

1. Open the file you want to print.
2. Click File → Print.
3. Select your printer.
4. Click Properties.
5. Click the Setup tab.
6. Click Paper Feed Options.
7. Click in the box next to Media Check.
If the box has a check mark, the feature is ON.
If the box is empty, the feature is OFF.
8. Change any other settings as desired.
9. Click OK.
10. The Setup tab screen appears.
11. Change any other settings as desired.
12. Click OK.
13. The main Print screen appears.
14. Change any other settings as desired.
15. Click OK.
16. The document prints.

Macintosh

1. Open the file you want to print.
2. Click File → Print.
3. Open the drop-down list below Presets. Select Printer Option.
4. Make your selection for Paper size check.
If the box has a check mark, the feature is ON.
If the box is empty, the feature is OFF.
5. Change any other settings as desired.
6. Click Print.

Paper Exit Paths

Face Down (Top Exit) _____

CAUTION!

Don't open or close the rear paper exit while printing.

If you do, it may cause a paper jam.

Always use the face up (rear) stacker [straight through exit path] for thick paper (card stock etc.).

- Capacity
 - up to 250 sheets of standard paper
 - 20-lb. US Bond
 - 42 lb. Index, 75 g/m² metric
- Paper Weights
 - up to 47 lb. US Bond
 - 98 lb. Index, 176 g/m² metric
- Print Sequence
 - Pages are printed in reading order
 - Page 1 first; last page on top, facing down

Face Up (Rear Exit) ---

CAUTION!

Don't open or close the rear paper exit while printing.

If you do, it may cause a paper jam.

Always use the face up (rear) stacker [straight through exit path] for thick paper (card stock etc.).



Open the face up stacker at the rear of the printer and pull out the tray extension.

When the face up stacker is open, paper exits via this path, regardless of driver settings.

- Capacity up to 100 sheets of standard paper 20 lb. US Bond (42 lb. Index, 75 g/m²)

NOTE

Always use this stacker and the Multi-Purpose Tray for paper stocks heavier than 47 lb. US Bond (98 lb. Index, 176 g/m² metric).

- Paper Weights up to 54 lb. US Bond (113 lb. Index 203 g/m² metric)
- Print Sequence: Papers are printed *face up*.

For multi-page documents, select "Reverse print order" in your application Print dialog box (Click

File → Print → Options) This puts the printed stack in the correct order.

Loading Paper

Trays 1 and 2

NOTE

If you have the optional second paper tray installed:

- If you are printing from the 1st (upper) tray, you can pull out the 2nd (lower) tray and reload it while the printer is printing.
- If you are printing from the 2nd (lower) tray, *do not pull out the 1st (upper) tray while printing*. This will cause a paper jam.

1. Remove the paper tray from the printer.



2. Fan the paper to be loaded at the edges (1) and in the middle (2). Then tap the edges of the stack on a flat surface to make it flush again (3).

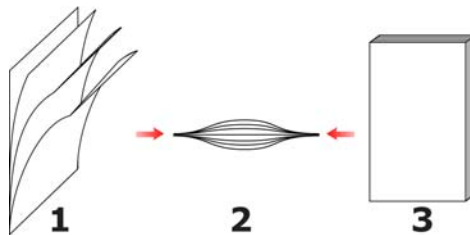

3. Load paper print side down. Make sure the rear stopper (1) and paper guides (2) are snug against the paper.

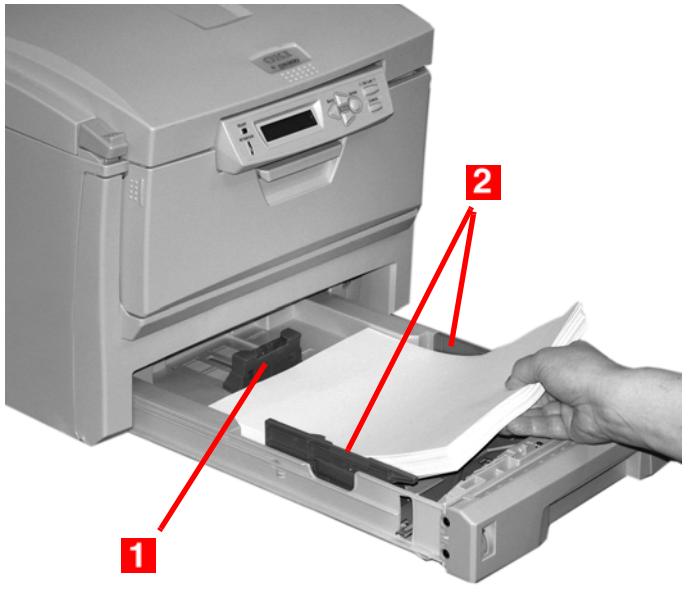

NOTE

Load letterhead paper face *down*. The top edge is aimed towards the front of the printer.

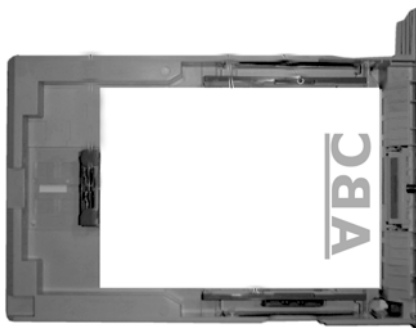

4. Gently close the paper tray.



NOTE

To prevent paper jams:

- Do not leave space between the paper and the guides and rear stopper.
- Do not overfill the paper tray. Capacity depends on the type of paper stock.
- Do not load damaged paper.
- Do not load paper of different sizes or types at the same time.
- Do not pull the paper tray out during printing (except as described above for the 2nd tray).

Multi-purpose Tray

(MP Tray/Manual Feed)

NOTE

The MP Tray will take

- a stack of media about 3/8" (10 mm) high
- about 10 envelopes
- about 50 transparencies.

Do not exceed the 3/8" (10 mm) media stack height.

1. Open the MP Tray.

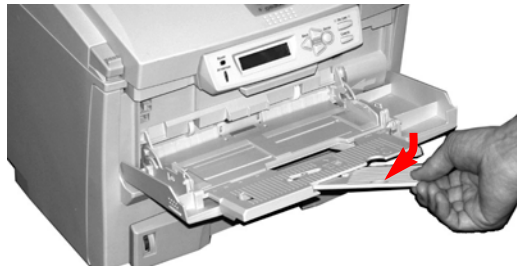
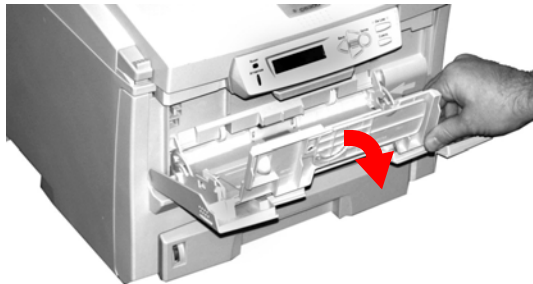

2. Press down on the loading platform.

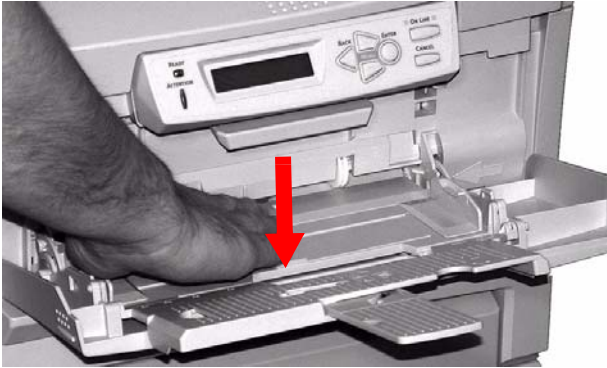

3. Load the print media. Adjust the guides (1) to the size media being used.

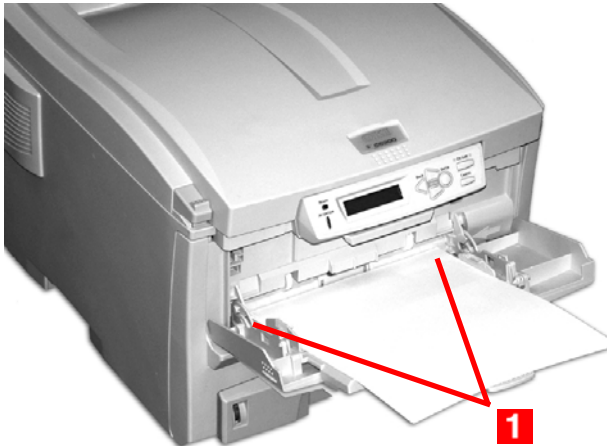

Letterhead

Single-sided printing

load with pre-printed side *up* and the top edge *into* the printer.

Double-sided printing (duplex)

load with pre-printed side *down* and top edge *away from* the printer (duplex unit must be installed).

Envelopes

Load print side up (flap down) with top edge to the left and short edge into the printer.

You cannot duplex envelopes.

4. Press the blue tray latch (1) toward the paper stack to lift the paper platform into the feed position.



Consumables and Replacement Supplies

Part Numbers

Toner

Color	Capacity	P/N
Black	8K	43865720
Cyan	6K	43865719
Magenta	6K	43865718
Yellow	6K	43865717

Image Drums

Color	P/N
Black	43381720
Cyan	43381719
Magenta	43381718
Yellow	43381717

Fusers

Voltage	P/N
120V	43853101
230V	43853102

Transfer Belt

P/N 43363411

Replace a Toner Cartridge



REPLACE TONER
nnn: zzzz TONER EMPTY

nnn: ZZZZ =

410: YELLOW

411: MAGENTA

412: CYAN

413: BLACK

1. Press the cover release. Open the printer's top cover fully.



WARNING!

If the printer has been powered on, the fuser is HOT. This area is clearly labelled. Do not touch it.

2. Note the positions of the four cartridges: Cyan (1), Magenta (2), Yellow (3), Black (4).

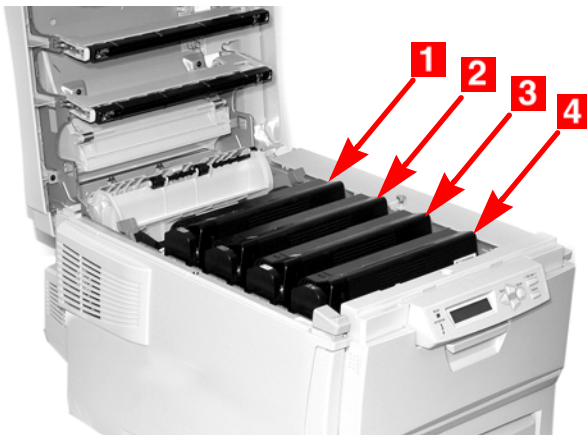

3. Pull the colored toner release lever on the cartridge to be replaced towards the front of the printer.

Shown: replacement of the black toner cartridge

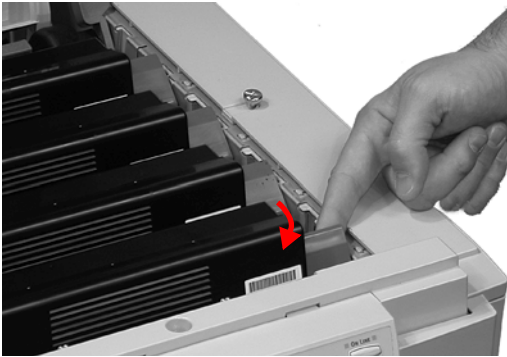

4. Lift the right-hand end of the cartridge. Then, pull the cartridge to the right to release the left-hand end. Remove the toner cartridge. Discard it in accordance with your local regulations.

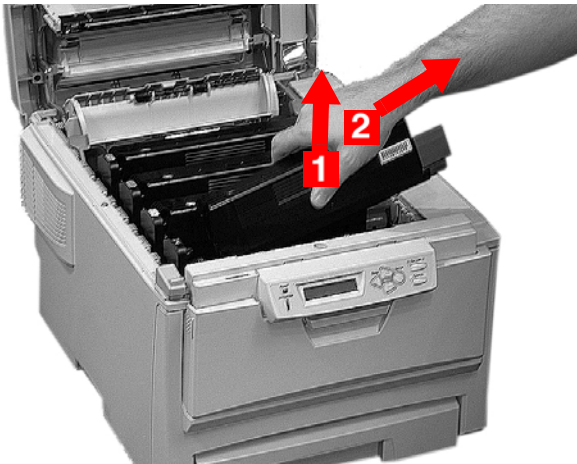

5. Unpack the new toner cartridge. Gently shake it *from side to side* to loosen and distribute the toner evenly inside the cartridge.



6. Remove the adhesive tape from the underside of the cartridge.



CAUTION!

Do not touch the toner release lever until the toner cartridge is installed in the image drum. If you do, it will open the toner release slot and spill toner.

7. Hold the cartridge by its top center with the colored release lever to the right. Insert the left end of the cartridge into the top of the image drum. Push it firmly

against the spring on the drum unit.

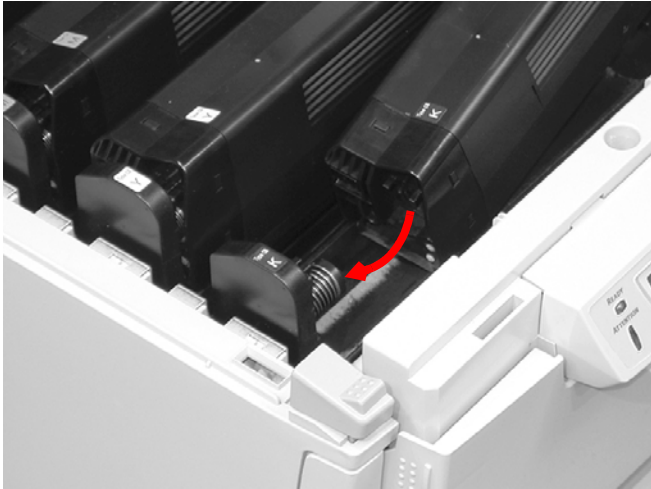
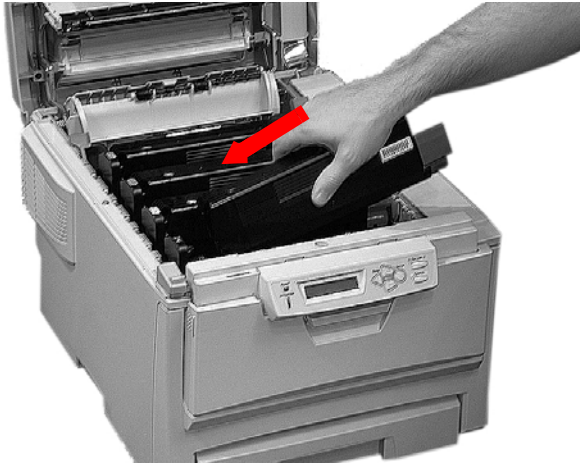

- 8.** Lower the right end of the cartridge into the image drum unit. Press it firmly down in place. Then, push the

colored lock lever back to open the toner slot and lock it in place.

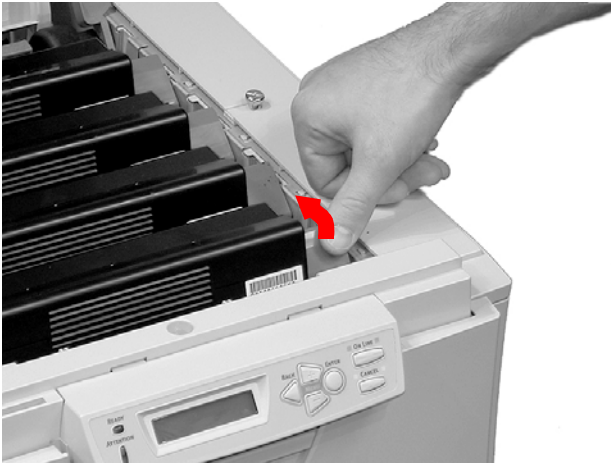

IMPORTANT!

The lever should move easily.

If it does not, ***STOP!***

Push down on the toner cartridge to be sure that it is properly seated in the image drum. Press back on the lever again.

To avoid toner spillage, **DO NOT** open the toner release lever until the toner cartridge is firmly seated in the image drum.

9. Use the provided LED lens cleaner. Gently wipe the LED.



10. Close and latch the top cover.



Replace an Image Drum



REPLACE IMAGE DRUM
nnn: ZZZZ DRUM LIFE

nnn: ZZZZ =

350: YELLOW

351: MAGENTA

352: CYAN

353: BLACK

Important!

You must replace the toner cartridge when you replace the image drum. The life expectancy of the cartridge will be reduced as the toner charges the new drum.

1. Press the cover release and open the top cover fully.



WARNING!

If the printer has been powered on, the *fuser* is *HOT*. This area is clearly labelled. Do not touch it.

2. Note the positions of the four image drums: Cyan (1), Magenta (2), Yellow (3), Black (4).

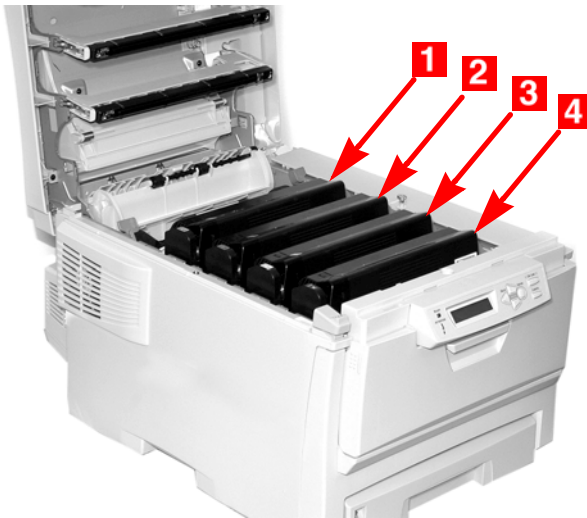

- 3.** Lift the image drum, complete with its toner cartridge, out of the printer. Discard it in accordance with your local regulations.



4. Unpack the new image drum.

CAUTION!

Image drum handling

The image drum contains toner. To avoid spilling toner, be careful to keep it upright.



CAUTION!

The green surface at the base of each image drum is very delicate and light sensitive.

- Do not touch the green surface.
- Never expose the drum to direct sunlight or to very bright room lighting.
- Do not expose it to normal room light for more than 5 minutes.
- If the image drum must be out of the printer for longer than 5 minutes, place the image drum inside a black plastic bag or carefully place it in a drawer or cabinet to keep it away from light.

5. Grasp the white tape tab and peel the tape off the drum.



6. Remove the paper sheet.

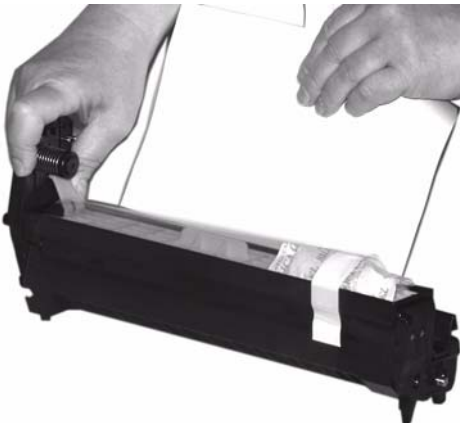

7. Remove the clear plastic film.

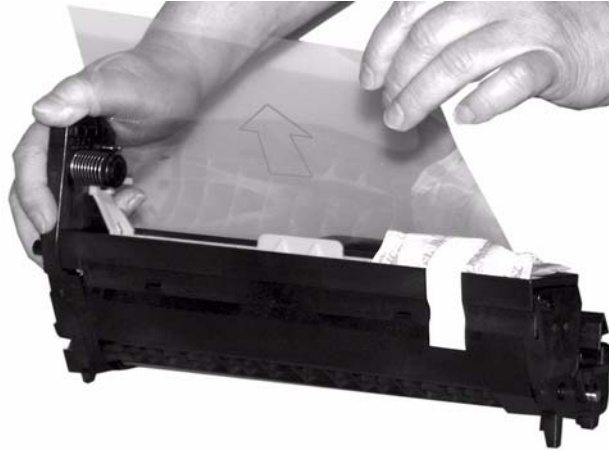

8. If present, remove the silica gel pack.



9. Place the image drum in the printer.

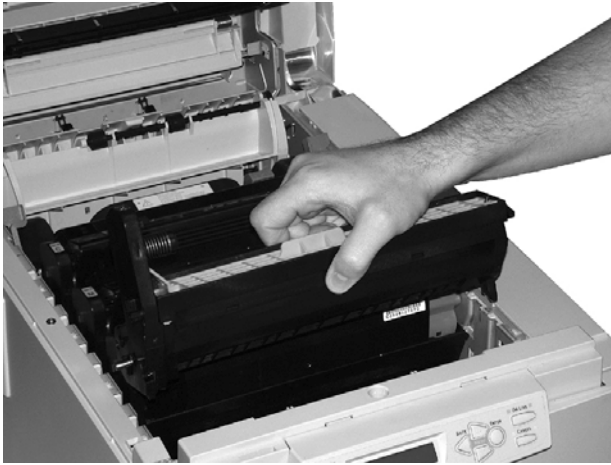

10. Remove the orange drum seal.



11. Install the new toner cartridge in the image drum.

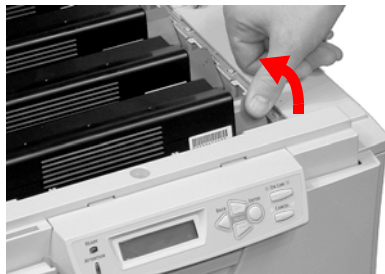
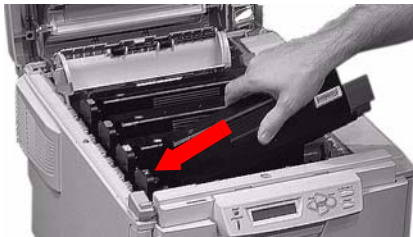

12. Use the provided LED lens cleaner. Gently wipe the LED.



13. Close and latch the top cover.



Replace the Fuser



REPLACE FUSER
354: FUSER LIFE

WARNING!

If the printer has been powered on, the *fuser is HOT*. This area is clearly labelled. Do not touch it. Handle the fuser with extreme care. Hold it only by its handle, which is only mildly warm to the touch.

If in doubt, switch the printer off. Wait at least 10 minutes for the fuser to cool before opening the printer cover.

1. Press the cover release. Fully open the printer's top cover.



2. Pull the two blue fuser lock levers (1) towards the front of the printer.

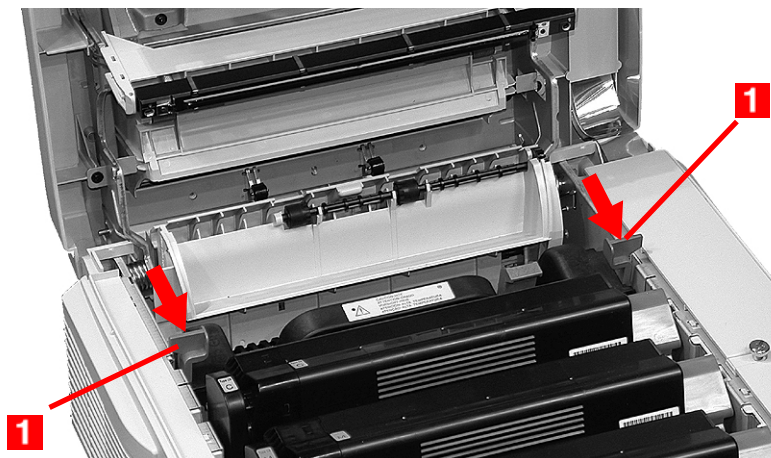

3. Hold the fuser **by its handle**. Lift the fuser out of the printer. *If the fuser is still warm, place it on a flat surface which will not be damaged by heat. After letting the fuser cool down, discard it.*



4. Remove the new fuser from its packaging. Remove any packing tape.
5. Push the orange transport lock to the left to release it. You'll hear it snap. Remove it.

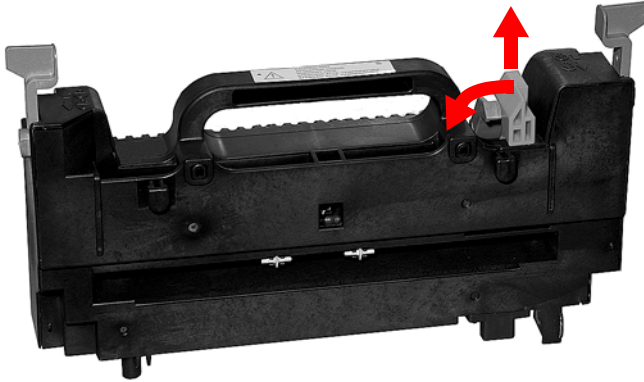

6. Hold the new fuser by the handle. The fuser pressure release lever (1) should be on the right. Lower the fuser into the printer.



7. Push the two blue retaining levers (1) toward the rear of the printer to lock the fuser in place.

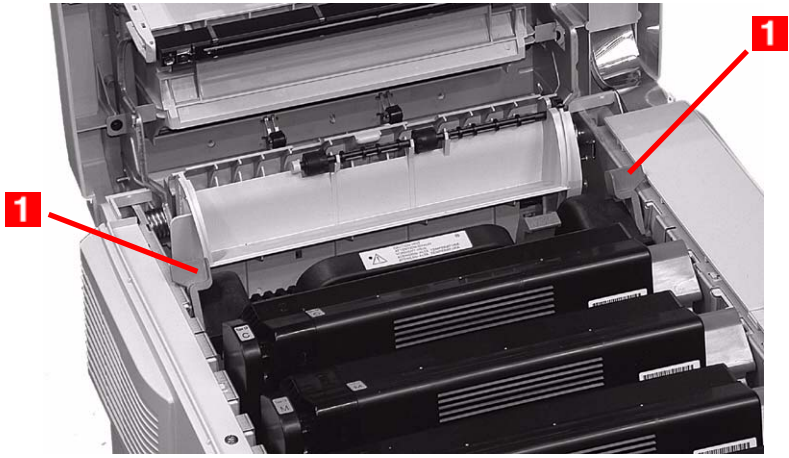

8. Close and latch the top cover.



Replace the Belt Unit

REPLACE BELT
355: BELT LIFE

The belt unit is located under the four image drums.

1. Press the cover release and open the top cover fully.



WARNING!

If the printer has been powered on, the fuser is HOT. This area is clearly labelled. Do not touch it.

2. Note the positions of the four image drums: Cyan (1), Magenta (2), Yellow (3), Black (4). **It is essential that they go back in the correct order!**

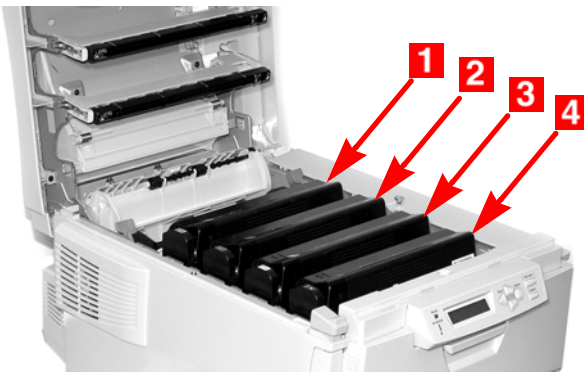

3. Lift each of the image drum units out of the printer. Place them on a *flat* surface in a safe place away from direct sources of heat and light.

CAUTION!

The green surface at the base of each image drum is very delicate and light sensitive.

- Do not touch the green surface.
- Never expose the drum to direct sunlight or to very bright room lighting.
- Do not expose it to normal room light for more than 5 minutes.
- If the image drum must be out of the printer for longer than 5 minutes, place the image drum inside a black plastic bag or carefully place it in a drawer or cabinet to keep it away from light.

4. Locate the two blue locks (1) and the handle (2).

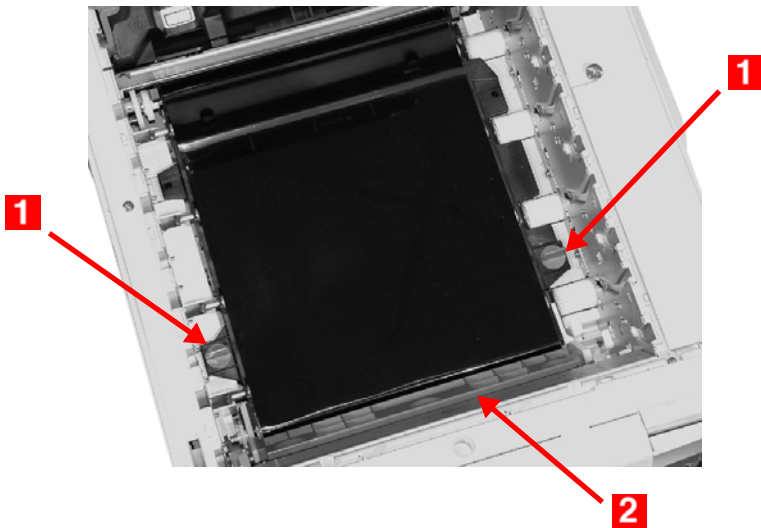

5. Turn the two locks about 45° *counterclockwise* to release the belt.

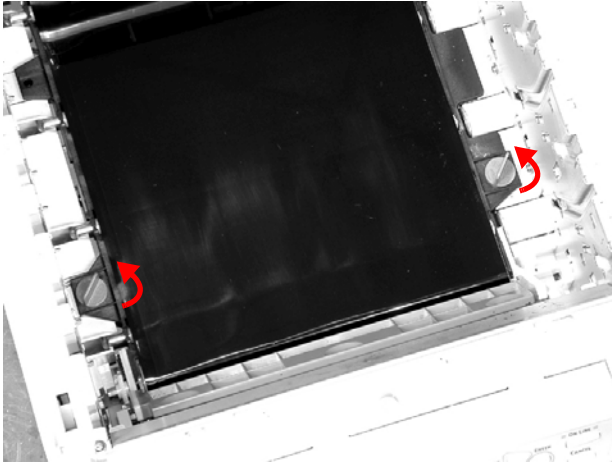

6. Pull up the handle and lift the belt unit out of the printer.

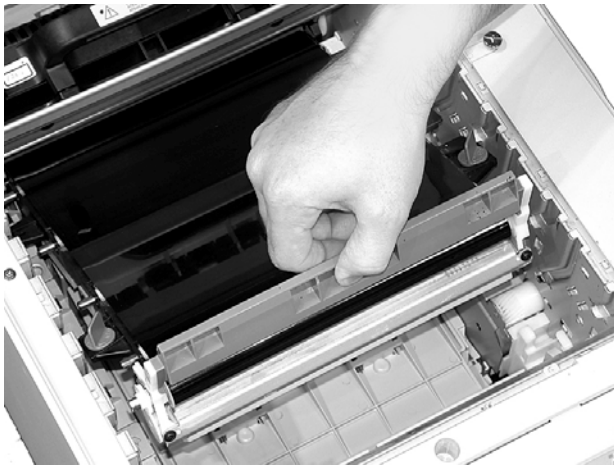

7. Unpack the new belt unit. Hold it with the blue handle toward the front of the printer.

- 8.** Place the drive gear at the back of the belt unit in the gear at the left rear corner of the printer. Lower the belt unit into the printer.

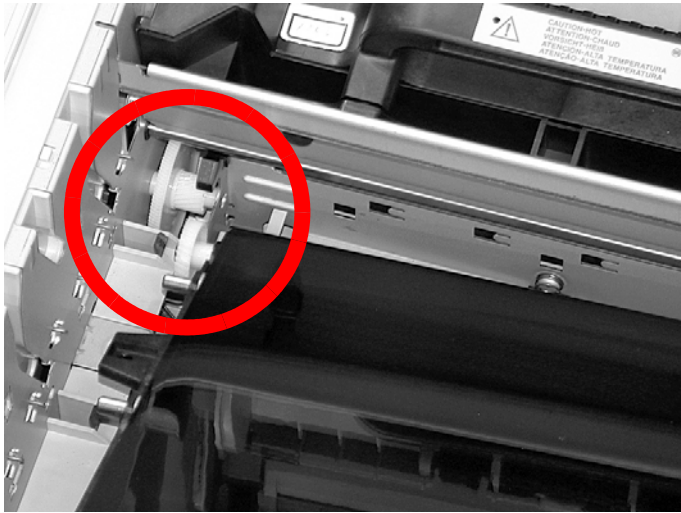

- 9.** Turn the two belt locks about 45° clockwise to secure the belt unit in place.

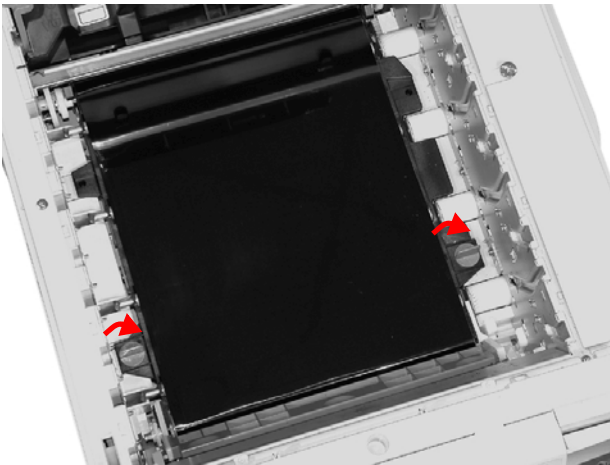

- 10.** Place the four image drums/toner cartridges back in the printer (**1** = Cyan, **2** = Magenta, **3** = Yellow, **4** = Black). ***It is essential that they go back in the correct order!***

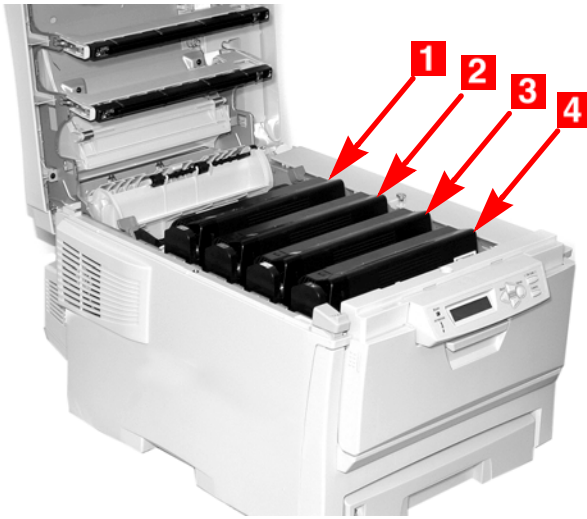

- 11.** Close and latch the top cover.



Printer Settings (Menu Settings)

This section lists the menus accessed via the controls on the printer's operator panel and displayed in the LCD window.

Many of these settings can be overridden by settings in the printer driver. However, several of the driver settings can be left at "Printer Setting," which will then default to the settings entered in these printer menus

Print a list of the current settings

NOTE

.. = keep pressing the button repeatedly until you see the display indicated.

To print a list of the current menu settings:

1. Press + ...

INFORMATION MENU

2. Press ENTER ...

PRINT MENU MAP
Execute

3. Press ENTER.
4. The Menu Map prints. The printer goes back on line.

Changing Settings

1. Press + to enter the menu mode.
2. Press +/- to scan through the available menus until the menu you wish to enter appears on the display.

NOTE

The menus and their various listings vary depending on which options you have installed on your printer.

3. Press ENTER to enter the menu.
4. Use +/- to move up and down through the items in the selected menu. When the item you want to change is displayed, press ENTER to edit that item.
5. Use +/- to move up and down through the available settings for this item.
6. When the setting you wish to use appears on the display, press ENTER.
An asterisk () appears next to the setting. The setting flashes.*
7. To finish:
 - a. If you are through making settings in the menu, press ON LINE to engage the setting and exit the menu.
 - b. If you wish to make additional changes in the menu, press BACK to engage the setting.
 - To change another setting in the same menu, use +/- to move through the list of menu items to the one you wish to change, then follow steps 5 through 7.
 - To change the setting for an item in a different menu, press BACK again, then follow steps 2 through 7.

Example: Power Save Time

To change the time interval for the printer to wait before going into Power Save mode (default setting is 60 MIN):

1. Press + to enter the menu mode.
2. Press + and/or – repeatedly until you see

SYS CONFIG MENU

3. Press ENTER to go into the Sys Config Menu.

POW SAVE TIME
60 MIN *

4. Press ENTER to select the Power Save Time item.
The value on the second line of the display begins flashing.

POW SAVE TIME
60 MIN *

5. Press + repeatedly until the interval (e.g., 240 MIN) you wish to select appears on the second line.

POW SAVE TIME
240 MIN

6. Press ENTER to select the new setting:
An asterisk appears on the second line of the display.

POW SAVE TIME
240 MIN *

7. Press ON LINE to engage the new setting and to exit the menu.
The printer returns to standby mode.

Reset to Factory Defaults

NOTE

... = keep pressing the button repeatedly until you see the display indicated.

To reset the printer menu to its original default settings:

1. Press + to enter the Menu mode.
2. Press + ...

MAINTENANCE MENU

3. Press ENTER.

MENU RESET
Execute

4. Press ENTER.
5. The printer resets and returns to the on-line state.

Lists of Available Settings by Menu

Information Menu

Item	Action	Explanation
PRINT MENU MAP	EXECUTE	Prints the MenuMap (menu listing) with current settings shown. Information about your printer is also shown at the top of each MenuMap page.
DEMO1	EXECUTE	Prints the built-in Demo page.

Print Menu

Notes:

Factory default settings are shown in **bold**.

Settings with a dagger (†) only appear when the appropriate option is installed.

Item	Settings	Explanation
COPIES	1 to 999	Enter the number of copies of a document to be printed.
DUPLEX†	ON OFF	Enables or disables duplex printing. †
PAPER FEED	TRAY1 TRAY2† MP TRAY	Selects the default tray for paper feed.
AUTO TRAY SWITCH	ON OFF	If two trays contain identical print media, the printer can switch to an alternate tray when the current tray runs out in the middle of a print job.
TRAY SEQUENCE	DOWN UP PAPER FEED TRAY	Sets the sequence in which the printer will seek an alternate tray with the same media size should the currently selected tray run out of media while printing a job.
MP TRAY USAGE	DO NOT USE WHEN MISMATCHXXX	If a document to be printed demands a paper size not installed in the selected tray, the printer can automatically feed from the Multi-Purpose Tray instead. If this function is not enabled, the printer will stop and request that the correct size be loaded.

Item	Settings	Explanation
MEDIA CHECK	ENABLE DISABLE	Set to DISABLE if you do not wish the printer to check to see if the size paper loaded in the selected tray matches that required for the document being printed.
MONO-PRINT SPEED	AUTO SPEED COLOR SPEED	Sets the print engine speed. If you are printing only color documents, switch to COLOR SPEED . AUTO SPEED sets the speed of printing based on whether the first page is color or monochrome.

Media Menu

Notes:

- Factory default settings are shown in **bold**.
- Items with a dagger (†) only appear when the appropriate option is installed.

Item	Settings	Explanation
TRAY1 PAPERSIZE	A4, A5, A6, B5, LEGAL14, LEGAL13.5, LEGAL13, LETTER , EXECUTIVE, CUSTOM	Defines the size of paper loaded in Tray 1.
TRAY1 MEDIATYPE	PLAIN LETTERHEAD BOND RECYCLED ROUGH	Defines the type of media loaded in Tray 1. This will help the printer to adjust its internal operating parameters, such as engine speed and fusing temperature.
TRAY1 MEDIAWEIGHT	LIGHT, MEDIUM , HEAVY, ULTRA HEAVY	Adjusts the printer for the weight of paper stock loaded in the tray. See "Driver Settings" on page 17. If the Ultra Heavy setting does not give proper toner fusion, you can try the Label settings.
TRAY2 PAPERSIZE†	A4, A5, B5, LEGAL14, LEGAL13.5, LEGAL13, LETTER , EXECUTIVE, CUSTOM	Defines the size of paper loaded in optional Tray 2.

Item	Settings	Explanation
TRAY2 MEDIATYPE†	PLAIN , LETTERHEAD, BOND, RECYCLED, ROUGH	Defines the type of media loaded in optional Tray 2.
TRAY2 MEDIAWEIGHT†	LIGHT, MEDIUM , HEAVY, ULTRA HEAVY	Adjusts the printer for the weight of paper stock loaded in the tray. See "Driver Settings" on page 17. If the Ultra Heavy setting does not give proper toner fusion, you can try the Label settings.
MPT PAPERSIZE	LETTER , EXECUTIVE, LEGAL14, LEGAL13.5, LEGAL13, A4, A5, A6, B5, CUSTOM, COM-9 ENVELOPE, COM-10 ENVELOPE, MONARCH ENV, DL ENVELOPE, C5 ENVELOPE	Defines the size of paper to be fed from the Multi-Purpose Tray.
MPT PAPERTYPE	PLAIN , LETTERHEAD, TRANSPARENCY, LABELS, BOND, RECYCLED, CARD STOCK, ROUGH	Defines the type of media to be fed from the Multi-Purpose Tray so that the printer can adjust its internal parameters for the media.
MPT MEDIAWEIGHT	MEDIUM , HEAVY, ULTRA HEAVY	Adjusts the printer for the weight of paper stock loaded in the tray. See "Driver Settings" on page 17. If the Ultra Heavy setting does not give proper toner fusion, you can try the Label settings.
UNIT OF MEASURE	MILLIMETER INCH	Defines the unit of measure for the next two items.
X-DIMENSION	3 to 8.5 INCH Default = 8.5 INCH	Defines the width of paper defined by the "CUSTOM" settings.
Y-DIMENSION	5 to 35.5 INCH Default = 11 INCH	Defines the length of paper defined by the "Custom" settings. Note that media of up to 47" (1.2 m) in length can be fed one sheet at a time from the Multi-Purpose Tray- for banner printing.

Color Menu

Note: Factory default settings are shown in **bold**.

The printer automatically adjusts color balance and density at appropriate intervals, optimizing the printed output for bright white paper viewed in natural daylight conditions.

The items on this menu provide a means of changing the default settings for special or particularly difficult print jobs. Settings revert to their default values when the next print job is complete.

Item	Settings	Explanation
DENSITY CONTROL	AUTO MANUAL	AUTO = image density is automatically adjusted: <ul style="list-style-type: none">• at power on• when a new image drum or toner cartridge is installed• at intervals of 100, 300 and 500 drum counts Auto adjustment takes up to 55 seconds. Switch to manual only if you wish to initiate Density Control manually using the printer menu.
ADJUST DENSITY	[EXECUTE]	Selecting this will perform the auto density set up.
AJST REGISTRATION	[EXECUTE]	Performs automatic color registration adjustment. Normally this is done at power on and when the top cover is opened and then closed. This process accurately aligns the cyan, magenta and yellow images to the black image.
C REG FINE ADJUST M REG FINE ADJUST Y REG FINE ADJUST	-3 to + 3 in increments of 1 Default = 0	Performs fine adjustment of image timing in relation to the black image component. A positive setting will darken the color; a negative setting will lighten the color.

System Configuration Menu

Note: Factory default settings are shown in **bold**.

Items	Settings	Explanation
POW SAVE TIME	5 15 30 60 240	Adjusts the time before the printer automatically switches into power saving mode. In this mode power consumption is reduced, but when a job is sent the printer will require a warm-up time of up to 1 minute before printing can begin.
CLEARABLE WARNING	ON JOB	When ON, non-critical warnings, such as requests for a different paper size, can be cleared by pressing the ON LINE button. When set to JOB, they are only cleared when the print job resumes.
MANUAL TIMEOUT	OFF 30 60	Specifies how many seconds the printer will wait for paper to be fed before cancelling the job.
WAIT TIMEOUT	5 to 300 SEC Default = 90 seconds	Specifies how many seconds the printer will wait when received data pauses before forcing a page eject.
LOW TONER	CONTINUE STOP	Specifies whether the printer should continue printing after a low toner condition is detected. If you change this to STOP, when low toner is detected, the printer goes off line.
JAM RECOVERY	ON OFF	Specifies whether the printer should perform jam recovery after a paper jam has occurred. If ON, the printer will attempt to print again any pages lost due to a paper jam once the jam has been cleared.
ERROR REPORT	ON OFF	Change this to ON if you wish the printer to print the error details when an error occurs.

USB Menu

Note: Factory default settings are shown in **bold**.

Item	Settings	Explanation
SOFT RESET	ENABLE DISABLE	Enables or disables the SOFT RESET command.
SPEED	480Mbps 12Mbps	Sets the maximum transfer speed for the USB interface.
SERIAL NUMBER	ENABLE DISABLE	ENABLE allows your computer to identify the printer by its USB interface serial number.

Network Menu

Note: Factory default settings are shown in **bold**.

Item	Settings	Explanation
TCP/IP	ENABLE DISABLE	Enables or disables this network protocol.
NETBEUI	ENABLE DISABLE	Enables or disables this network protocol.
IP ADDRESS SET	AUTO MANUAL	Change this to Manual to specify the IP address through the front panel (see next entry). Required for non-DHCP networks.
IP ADDRESS	xxx.xxx.xxx.xxx Default = 198.168.100.100	Current assigned IP address. To change: <ul style="list-style-type: none">• Press ENTER.• Use +/- keys to increment first octet.• Press ENTER to move on to the next octet.• Repeat for each octet.• Press ENTER to register the new address.
SUBNET MASK	xxx.xxx.xxx.xxx Default = 255.255.255.000	Current assigned subnet mask. To change, proceed as above.
GATEWAY ADDRESS	xxx.xxx.xxx.xxx Default = 192.168.100.254	Current assigned gateway address. To change, proceed as above.
Factory Default	[EXECUTE]	Initializes the network card.

Item	Settings	Explanation
WEB/IPP	ENABLE DISABLE	Enables or disables Web config. facility and Internet Printing Protocol. This item will not appear in the menu if TCP/IP is set to DISABLE.
TELNET	ENABLE DISABLE	Enables or disables Telnet config. facility. This item will not appear in the menu if TCP/IP is set to DISABLE.
FTP	ENABLE DISABLE	Enables or disables communication via FTP. This item will not appear in the menu if TCP/IP is set to DISABLE.
SNMP	ENABLE DISABLE	Enables or disables SNMP protocol.
LAN	NORMAL SMALL	Normal = Global network Small = Local network
HUB LINK SETTING	AUTO NEGOTIATE 100BASE-TX FUL 100BASE-TX HALF 10BASE-T FULL 10BASE-T HALF	Sets full or half duplex for communication via a network hub.

Memory Menu

Note: Factory default settings are shown in **bold**.

Item	Settings	Explanation
RECEIVE BUF SIZE	AUTO 0.5MB 1MB 2MB 4MB 8MB 16MB	Sets the size of the receive buffer.

System Adjust M\menu

Notes:

- Factory default settings are shown in **bold**.
- Items with a dagger (†) only appear when the appropriate option is installed.

Item	Settings	Explanation
X ADJUST	-2.00MILLIMETER TO +2.00MILLIMETER Default = 0.00	Adjusts overall print position horizontally in 0.25 increments.
Y ADJUST	-2.00MILLIMETER TO +2.00MILLIMETER Default = 0.00	Adjusts overall print position vertically in 0.25 increments.
DUPLEX X ADJUST†	-2.00MILLIMETER TO +2.00MILLIMETER Default = 0.00	Adjusts overall print position of print face horizontally in 0.25 increments.
DUPLEX Y ADJUST†	-2.00MILLIMETER TO +2.00MILLIMETER Default = 0.00	Adjusts overall print position of print face vertically in 0.25 increments.
DRUM CLEANING	OFF ON	If you are experiencing horizontal white lines on your printed pages, enter the menu and temporarily change this setting to ON, then send a one page print job. This will cause an extra blank sheet to print, cleaning the drum prior to printing. Careful! Leaving this set to ON will reduce the image drum life.

Maintenance Menu

Note: Factory default settings are shown in **bold**.

Item	Settings	Explanation
MENU RESET	[EXECUTE]	Resets menus to the default settings.
SAVE MENU	[EXECUTE]	Saves current menu settings as default values. At confirmation prompt, press ENTER to confirm save, or CANCEL.
POWER SAVE	ENABLE DISABLE	Change this setting to Disable if you do not want the printer to enter the power save mode after the specified time.
PAPER BLACK SETTING	-2 to +2 in increments of 1 Default = 0	Used for small adjustment when you experience faded print or light specks / streaking in monochrome printing on white paper. Select a higher value to reduce fading, or a lower value to reduce specks or streaking in high density print areas.
PAPER COLOR SETTING	-2 to +2 in increments of 1 Default = 0	As above, but for color printing.
TRANSPR BLACK SETTING	-2 to +2 in increments of 1 Default = 0	As above, but for mono printing on transparencies.
TRANSPR COLOR SETTING	-2 to +2 in increments of 1 Default = 0	As above, but for color printing on transparencies.

Usage Menu

This menu is for information only. It provides an indication of total usage of the printer and the expected life left in its consumable items. This is particularly useful if you do not have a full set of replacement consumables on hand and you need to know how soon you will need them.

- Items with a dagger (†) only appear when the appropriate option is installed.

Item	Explanation
TOTAL PAGE COUNT	The total number of pages printed.
TRAY1 PAGE COUNT	The total number of pages fed from Tray 1.
TRAY2 PAGE COUNT†	The total number of pages fed from optional Tray 2. Appears only if the optional Second Paper Tray is installed. See "Second Paper Tray", on page 111.
MPT PAGE COUNT	The total number of pages fed from the Multi-Purpose Tray.
COLOR PAGE COUNT	The total number of pages printed in color.
MONO PAGE COUNT	The total number of pages printed in monochrome.
K DRUM LIFE C DRUM LIFE M DRUM LIFE Y DRUM LIFE BELT LIFE FUSER LIFE	Percentage of life remaining in these items is indicated as nn%.
K TONER C TONER M TONER Y TONER	Current remaining toner is indicated as nn%. 2k= standard cartridge 5K= high-capacity cartridge

Menu Defaults

Information, Print, and Media Menus

Note: Menus/Items with a dagger (†) only appear when the appropriate option is installed.

Menu	Item	Default Setting
INFORMATION MENU	PRINT MENU MAP	[EXECUTE]
	DEMO1	[EXECUTE]
PRINT MENU	COPIES	1
	DUPLEX†	OFF
	PAPER FEED	TRAY1
	AUTO TRAY SWITCH	ON
	TRAY SEQUENCE	DOWN
	MP TRAY USAGE	DO NOT USE
	MEDIA CHECK	ENABLE
	MONO-PRINT SPEED	AUTO SPEED
MEDIA MENU	TRAY1 PAPERSIZE	LETTER
	TRAY1 MEDIATYPE	PLAIN
	TRAY1 MEDIAWEIGHT	MEDIUM
	TRAY2 PAPERSIZE†	LETTER
	TRAY2 MEDIATYPE†	PLAIN
	TRAY2 MEDIAWEIGHT†	MEDIUM
	MPT PAPERSIZE	LETTER
	MPT MEDIATYPE	PLAIN
	MPT MEDIAWEIGHT	MEDIUM
	UNIT OF MEASURE	INCH
	X DIMENSION	8.5 INCH
	Y DIMENSION	11.0 INCH

Color, System Configuration, and USB Menus

Note: Menus/Items with a dagger (†) only appear when the appropriate option is installed.

Menu	Item	Default Setting
COLOR MENU	DENSITY CONTROL	AUTO
	ADJUST DENSITY	[EXECUTE]
	AJST REGSTRATION	[EXECUTE]
	C REG FINE AJST	0
	M REG FINE AJST	0
	Y REG FINE AJST	0
SYS CONFIG MENU	POW SAVE TIME	60 MIN
	CLRABLE WARNING	ON
	MANUAL TIMEOUT	60 SEC
	WAIT TIMEOUT	90 SEC
	LOW TONER	CONTINUE
	JAM RECOVERY	ON
	ERROR REPORT	OFF
USB MENU	SOFT RESET	DISABLE
	SPEED	480Mbps

Network and Memory Menus

Note: Menus/Items with a dagger (†) only appear when the appropriate option is installed.

Menu	Item	Default Setting
NETWORK MENU	TCP/IP	ENABLE
	NETBEUI	DISABLE
	IP ADDRESS SET	AUTO
	IP ADDRESS	192.168.100.100
	SUBNET MASK	255.255.255.000
	GATEWAY ADDRESS	192.168.100.254
	INITIALIZE NIC?	[EXECUTE]
	WEB/IPP	ENABLE
	TELNET	ENABLE
	FTP	ENABLE
	SNMP	ENABLE
	LAN	NORMAL
	HUB LINK SETTING	AUTO NEGOTIATE
	MEMORY MENU†	RECEIVE BUF SIZE
FLASH INITIALIZE		[EXECUTE]

System Adjust and Maintenance Menus

Note: Menus/Items with a dagger (†) only appear when the appropriate option is installed.

Menu	Item	Default Setting
SYS ADJUST MENU	X ADJUST	0.00 MILLIMETER
	Y ADJUST	0.00 MILLIMETER
	DUPLEX X ADJUST†	0.00 MILLIMETER
	DUPLEX Y ADJUST†	0.00 MILLIMETER
	DRUM CLEANING	OFF
MAINTENANCE MENU	MENU RESET	[EXECUTE]
	SAVE MENU	[EXECUTE]
	POWER SAVE	ENABLE
	PAPER BLACK SET	0
	PAPER COLOR SET	0
	TRNSPR BLACK SET	0
	TRNSPR COLOR SET	0

Usage Menu

Menu	Item	Default Setting
USAGE MENU	TOTAL PAGE COUNT	nnnn
	TRAY1 PAGE COUNT	nnnn
	TRAY2 PAGE COUNT†	nnnn
	MPT PAGE COUNT	nnnn
	COLOR PAGE COUNT	nnnn
	MONO PAGE COUNT	nnnn
	K DRUM LIFE	REMAINING nn%
	C DRUM LIFE	REMAINING nn%
	M DRUM LIFE	REMAINING nn%
	Y DRUM LIFE	REMAINING nn%
	BELT LIFE	REMAINING nn%
	FUSER LIFE	REMAINING nn%
	K TONER	REMAINING nn%
	C TONER	REMAINING nn%
	M TONER	REMAINING nn%
	Y TONER	REMAINING nn%

Options

The following options are available for your printer:

- Additional memory (FAM) (see below)
- Duplex Unit (see page 110)
- Hard Disk Drive (see page 110)
- Second Paper Tray (see page 111)

Instructions for installing these options are found in the packaging with the option.

Additional Memory (RAM) ---



Oki 70051601 (256 MB)

Oki 70051701 (512 MB)

The basic printer comes equipped with 256 MB of main memory. This can be upgraded with an additional memory board containing

- 256 MB, increasing the memory to 512 MB
- or
- 512 MB, increasing the memory to 768 MB.

Duplex Unit

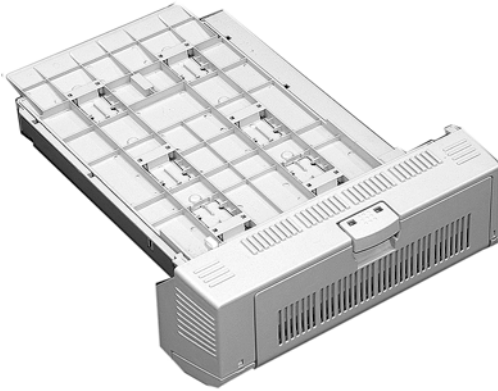

Oki 43347501

The Duplex Unit enables your printer to print on both sides of the page.

See "Duplex Printing" on page 223.

Hard Disk Drive

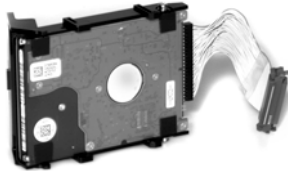

Oki 70043502

The hard disk drive enables

- spooled printing
- verified printing

Second Paper Tray

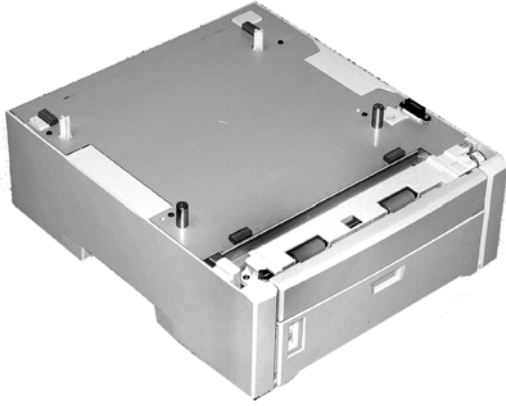

Oki 43347601

The second paper tray takes:

- Up to 530 sheets of 20-lb. paper.
- All the same size media as Tray 1 except A6.
- Paper weight range 16 to 57 lbs. (60 to 203 g/m²).

Specifications

Item	Specification
Dimensions	17.13" W x 24.45" D x 15.73" H (435 mm W x 621 mm D x 399.5 mm H)
Net Weight	63.3 lbs. (28.7 Kg)
Print speeds	<ul style="list-style-type: none"> • 26 pages per minute (ppm) color • 32 ppm monochrome • <i>For Transparencies:</i> 9 ppm color, 10 ppm monochrome
Resolution	600 dpi or 600 x 1200 dpi
Emulation	PCL5e, IBM PPR II XL, Epson FX, PS3
Environmental	<p><i>Temperature</i></p> <ul style="list-style-type: none"> • Operating: 50 to 90°F (10 to 32°C) • Storage (packed up): -14 to 110°F (-10 to 43 °C) • Power Off: 32 to 110°F (0 to 43°C) <p><i>Relative Humidity</i></p> <ul style="list-style-type: none"> • Operating: 20 to 80% RH • Storage (packed up): 10 to 90% RH • Power Off: 10 to 90% RH
Electrical	<p>110-127 volts, 60 Hz (±2 Hz) 220-240 volts, 50 Hz (±2 Hz)</p> <p><i>Power Consumption:</i></p> <ul style="list-style-type: none"> • Operating, Typical: 490 watts • Max.: 1200 watts • Power Save Mode: 17 watts
Auto Features	<p>Auto registration Auto density adjustment Auto consumable counter reset</p>
Memory	256 MB standard, upgradable to 512 MB or 768MB See "Additional Memory (RAM)" on page 109.
Paper capacity (20-lb. [75 g/ m ²] paper)	<p><i>Tray 1:</i> 300 sheets <i>Optional Tray 2:</i> 530 sheets <i>Multi-Purpose Tray:</i> 100 sheets</p>
Paper weight Range	<p><i>Tray 1:</i> 17 to 32 lb. (64 to 120 g/m²) <i>Optional Tray 2:</i> 17 to 47 lb. (64 to 177 g/m²) <i>Multi-Purpose Tray:</i> 20 to 54 lb. (75 to 203 g/m²)</p>
Paper output	<p><i>Top Exit (Face Down Stacker):</i> 250 sheets 20-lb. 75 g/m² paper <i>Rear Exit (Face Up Stacker):</i> 100 sheets 20-lb. 75 g/m²</p>
Printer life	420,000 pages or 5 years, whichever comes first

Item	Specification
Duty cycle	<i>Maximum:</i> 60,000 pages per month at 5% coverage (equivalent to an average business letter) <i>Average:</i> 6,000 pages per month
Toner life	Approximately 5,000 pages at 5% coverage
Image drum life	20,000 pages at 3 pages per job
Belt life	60,000 letter-size pages
Fuser life	60,000 letter-size pages

Troubleshooting

General Information

This section provides information to help you deal with problems that may arise when using the printer.

Troubleshooting is divided into the following sections:

- "Display Panel Messages" see page 115
- "Paper Jams" see page 119
- "Print Quality Problems" see page 140
- "USB Problems" see page 143
- "Application error" see page 145
- "General Protection Fault" see page 145
- "Paper Size Change Request" see page 145
- "Printer does not go online" see page 145
- "Printer makes a strange noise" see page 146
- "Printer takes a long time to start printing" see page 146
- "Printing cancels" see page 146
- "Printing does not start" see page 147
- "Printing is slow" see page 147
- "Cleaning Page" see page 148

Display Panel Messages

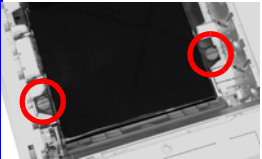
Message	Meaning	What to Do
* TONER SENSOR ERROR	Flashes across the second line of the display: the indicated color toner (*) is missing from the printer.	Open the top cover and make sure the indicated toner is there and properly seated in the printer: C = Cyan, Y = Yellow, M = Magenta, K = Black.
ADD MORE MEMORY 420: MEMORY OVERFLOW	The document size is too large for the printer's memory.	Reduce the size of the document. If this happens frequently, install additional memory (see "Additional Memory (RAM)", on page 109).
CANCELLING JOB (JAM)	The setting for Jam Recovery in the menu has been changed to off and a paper jam has occurred. Any unprinted data is being deleted.	Clear the jam and resend the missing pages of the print job.
CHECK BELT 330: BELT MISSING	The belt unit is not properly installed.	Open the top cover and lift out the black (K) and Yellow (Y) image drums, placing them on a <i>flat</i> surface. Check to be sure that the belt unit latches are fully in the latched position:  then reinstall the image drums.

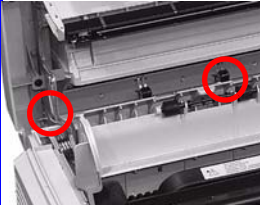
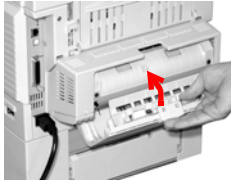
Message	Meaning	What to Do
CHECK FUSER 320: FUSER MISSING	The fuser unit is not properly installed.	<p>Open the top cover and check to be sure that the fuser unit is properly seated in the printer and that the lock levers are pushed all the way toward the back of the printer:</p> 
CHECK MP TRAY 390: PAPER JAM	Paper has jammed while exiting the MP Tray.	Clear the jam. See "Jam 390", on page 136.
CLOSE COVER 316: DUPLEX COVER OPEN	The duplex cover is open or not properly latched.	<p>Close the duplex cover:</p> 
CLOSE COVER nnn: COVER OPEN	Either the top cover or the front cover is open.	Be sure both the top cover and the front cover are firmly closed.
INSTALL PAPER CASSETTE 430: TRAY 1 MISSING	Tray 1 is not installed in the printer.	Install the missing tray.
INSTALL PAPER CASSETTE 440: TRAY 1 OPEN	Tray 1 is not properly installed in the printer.	Make sure the tray is pushed fully into the printer.

Message	Meaning	What to Do
LOAD mmm AND PRESS ONLINE SWITCH 490: MP TRAY EMPTY	Print job from MP Tray has been received and the MP Tray is empty.	Load the requested media (mmm) in the MP Tray and press ON-LINE.
LOAD mmm nnn: tttt EMPTY	A print job has been received and the indicated paper tray is empty.	Load mmm media in the indicated (tttt) tray.
LOAD mmm/ppp AND PRESS ONLINE SWITCH nnn: tttt MEDIA MISMATCH	The media type in the indicated tray (tttt) does not match that specified in the print job being processed.	Load the appropriate media in the tray and press ON-LINE.
LOAD mmm/ppp AND PRESS ONLINE SWITCH nnn: tttt SIZE MISMATCH	The media size (mmm) and/or type (ppp) loaded in the indicated tray (tttt) does not match that specified in the print job being processed.	Load the appropriate media in the tray and press ON-LINE.
OPEN DUPLEX COVER nnn: PAPER JAM	Paper has jammed entering or exiting the duplexer.	Clear the jam. See page 121 and page 123.
OPEN FRONT COVER nnn: PAPER JAM	Paper jam.	Clear the jam. See page 125 and page 138
OPEN TOP COVER nnn: PAPER JAM	Paper jam.	Clear the jam. See page 133 and page 127.
ORDER xxx	Appears on the second line of the display to indicate that consumable xxx (e.g., belt, fuser, toner, image drum) is nearing end of life.	Make sure you have a replacement unit on hand.
POWER ON/OFF 300: NETWORK ERROR	An error has occurred involving the network.	Shut the printer off, then turn it back on. If the message still appears, check with your network administrator.

Message	Meaning	What to Do
PRESS ONLINE SW INVALID DATA	The printer has received invalid data.	Press ON-LINE. Reprocess and resend the print job.
REPLACE TONER nnn: * TONER EMPTY	The indicated toner needs replacement.	Replace the indicated toner: 410: Y = Yellow 411 M = Magenta 412: C = Cyan 413: K = Black
REPLACE yyyy nnn: yyyy LIFE	The indicated component is nearing end of life and should be replaced.	Replace the indicated component: YYYY = Fuser, Belt, C Drum, Y Drum, M Drum, K Drum.
tttt EMPTY	Appears on the second line of the display to indicate that ttt tray has run out of media.	Load media in tray tttt.
xxx LIFE	Appears on the second line of the display to indicate that consumable xxx (e.g., belt, fuser, image drum) will need to be replaced soon.	Replace the indicated item.
YYYY nnn: FATAL ERROR	An error has occurred which requires service. YYYY = the general cause. nnn = error number.	Try turning off the printer then turning it back on. If this does not remedy the problem, write down the message including the error number "nnn," then call your authorized Oki Data Service Dealer for service. Note: If you see a series of octets containing letters and numbers scrolling across the display, be sure to write these down also and report them to the Service Dealer.

Paper Jams

General Information

Jams can occur due to paper misfeeding from a paper tray or at any point along the paper path.

When a jam occurs, the printer immediately stops. The control panel displays an error message. This message tells you where the first sheet is jammed.

All jammed sheets must be removed in order to restore the printer to normal operation.

Once you clear a jam and close the cover, you may see a new jam message indicating another jammed sheet which must be cleared. This is especially likely if you are printing a multi-page document or multiple copies of a single document.

Once all jams have been cleared, the printer should automatically try to reprint any pages lost due to paper jams. If it doesn't, check the Jam Recovery setting in the System Configuration Menu. It must be set to ON. See "Changing Settings" on page 91.

- If paper jams are frequent: see page 120
- Jam is cleared, but printer does not print: see page 120
- Jam 370: see page 121
- Jam 371: see page 123
- Jam 372: see page 125
- Jam 373: see page 121
- Jam 380: see page 125
- Jam 381: see page 127
- Jam 382: see page 133
- Jam 383: see page 121
- Jam 390: see page 136
- Jam 391: see page 138
- Jam 392: see page 138

If paper jams are frequent

- More than one sheet feeds at a time.
- Paper curls.
- Paper feeds at an angle.

Possible cause	Remedy
The printer is not horizontal.	Place the printer on a stable, level surface.
The paper is too thin.	Use the correct type of paper. See "Paper (Print Media)" on page 16.
The paper is moist or affected by static.	Store paper within specified temperature and humidity levels. See "Specifications" on page 112.
The paper is creased or wrinkled.	Remove the creased/wrinkled paper from the feed tray.
The paper is not aligned correctly.	Adjust tray or manual feed guides.
Paper doesn't feed.	Correct paper feed selection in the Properties Setup tab in the printer driver.

Jam is cleared, but printer does not print.

Possible cause	Remedy
The top cover has not remained open until all paper jams have been cleared.	Removing a paper jam is not sufficient: Raise and <i>gently</i> lower the top cover, especially if the paper jam has been removed from behind the front cover.

Jam 370, 373 and 383

OPEN DUPLEX COVER
nnn: PAPER JAM

nnn = 370, 373, 383

1. Press the duplex cover release. Open the duplexer cover.

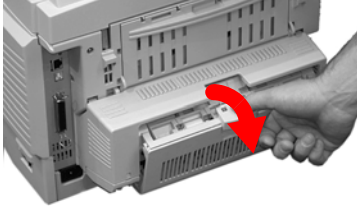

2. Remove any jammed sheets.

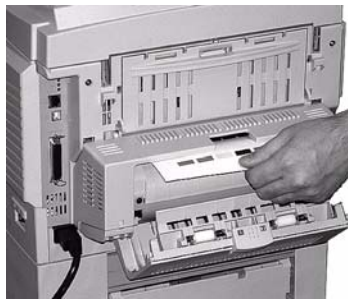
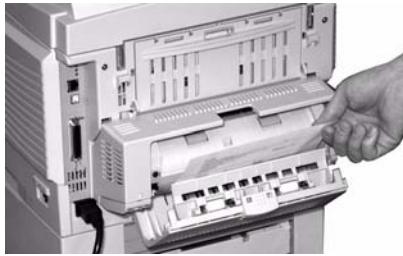
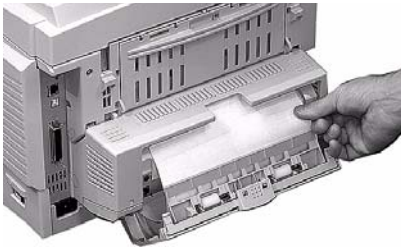

3. Close the duplex unit cover.

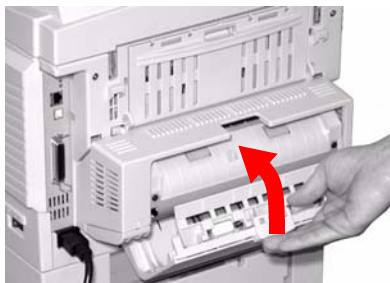

Jam 371

OPEN DUPLEX COVER 371: Paper Jam

1. Turn off the printer.
2. Pull out the duplexer.



3. Pull the duplexer lid to unlock it.

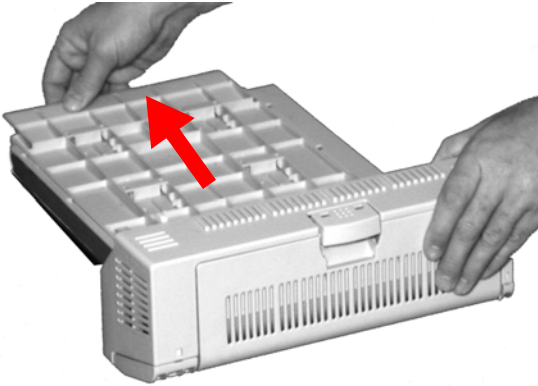

4. Open the lid. Remove the jammed sheet.



5. Close the lid. Push it back to lock it in place.



6. Push the duplexer back into the printer.

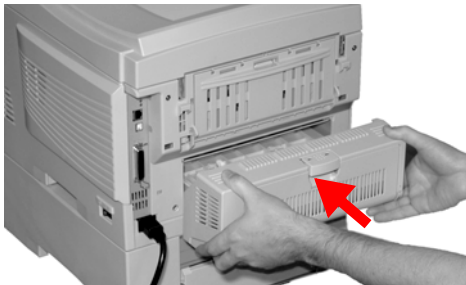

7. Turn on the printer.

Jam 372 and 380

OPEN FRONT COVER
nnn: PAPER JAM

nnn = 372 or 380.

1. Lift the front cover release. Pull open the front cover.



2. Remove any jammed sheets.



3. Close the front cover.



Jam 381

OPEN TOP COVER
381: Paper Jam

1. Press the cover release. Fully open the printer's top cover.



WARNING!

**If the printer has been powered on, the fuser is hot.
This area is clearly labelled. Do not touch it.**

2. Note the positions of the four image drums: Cyan (**1**), Magenta (**2**), Yellow (**3**), Black (**4**). *It is essential that they go back in the correct order!*

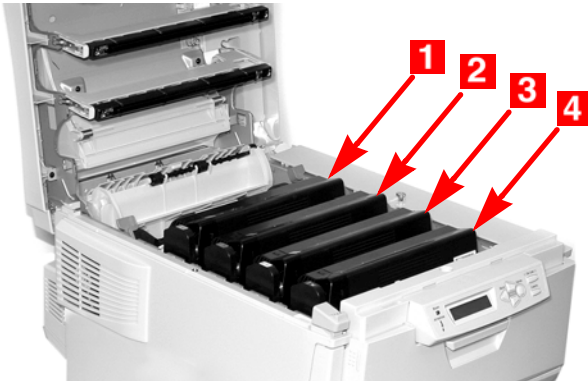

3. Lift each of the image drum/toner cartridge units out of the printer. Place them on a *flat* surface in a safe place away from *direct sources of heat and light*.



CAUTION!

The green surface at the base of each image drum is very delicate and light sensitive.

- Do not touch the green surface.
- Never expose the drum to direct sunlight or to very bright room lighting.
- Do not expose it to normal room light for more than 5 minutes.
- If the image drum must be out of the printer for longer than 5 minutes, place the image drum inside a black plastic bag or carefully place it in a drawer or cabinet to keep it away from light.

4. Remove any sheets of paper on the belt unit.



CAUTION!

Do not use any sharp or abrasive objects to separate sheets from the belt. This may damage the belt surface.

NOTE

Warning! If the printer has been printing, the fuser will be *HOT!*

If the sheet is well advanced into the fuser (only a short length is still visible), do not attempt to pull it back. See step 4 under "Jam 382" .

To remove a sheet trapped in the fuser:

1. Grasp the edge of the sheet.
2. Push the fuser pressure release lever (1) towards the front and down.
3. Lift out the sheet.
4. Let go of the fuser pressure release lever.

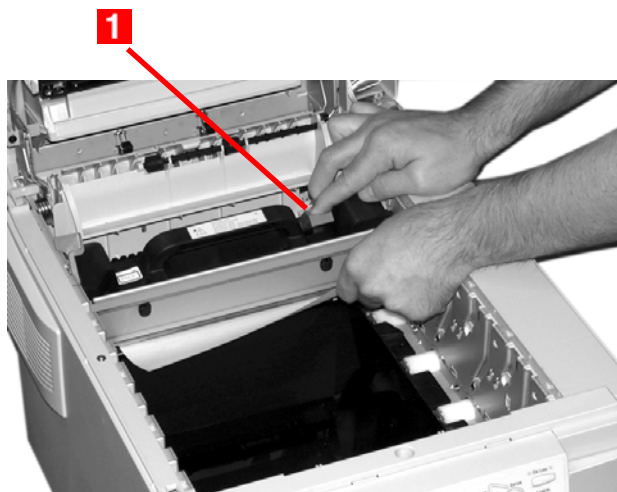

- 5.** Place the four image drums/toner cartridges back in the printer. Be sure to place them in the proper sequence (**1** = Cyan, **2** = Magenta, **3** = Yellow, **4** = Black).

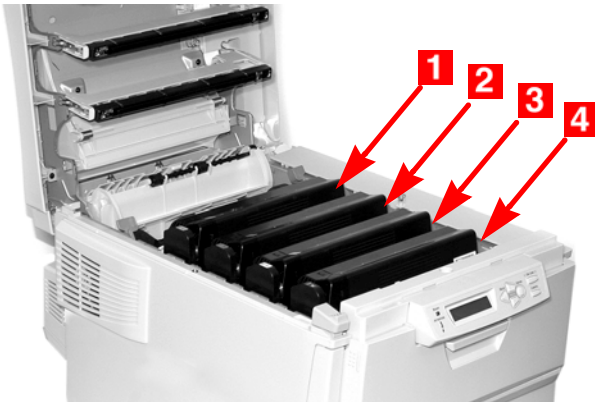

- 6.** Close the top cover.



Jam 382

OPEN TOP COVER 382: Paper Jam

1. Open the top cover.

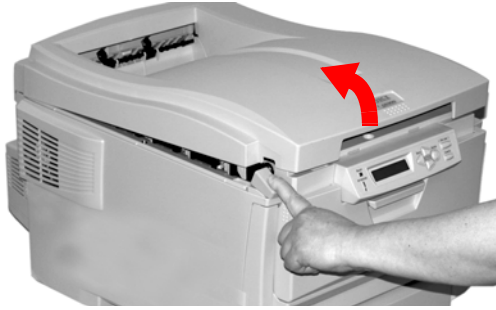

2. Gently pull the sheet out.
 - If the sheet does *not* come out easily, go to the next step.
 - If the sheet does come out, close the cover.



3. Lower the rear exit tray.

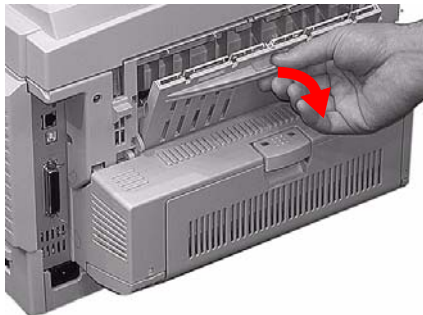

4. Pull out the jammed sheet.

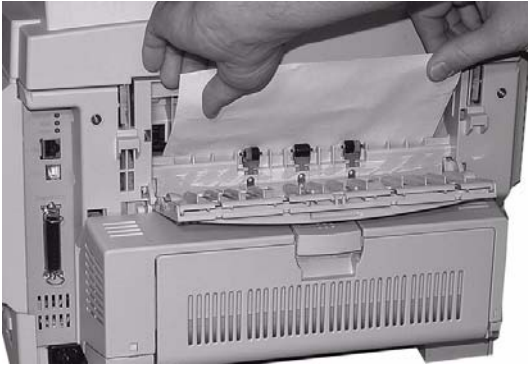

Important!

WARNING! The fuser may be HOT!

If the sheet is difficult to remove, it is partially jammed in the fuser. To get it out, reach around the top cover and press down on the fuser pressure release lever (1) before pulling the sheet out. Then let go of the fuser pressure release lever.

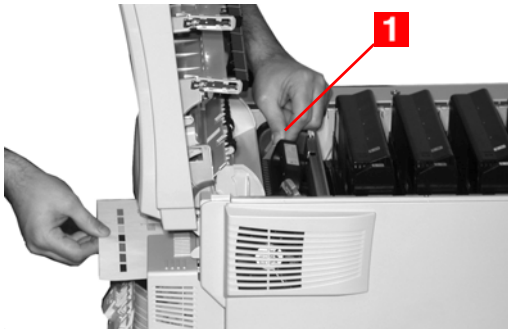

5. Close the rear exit.

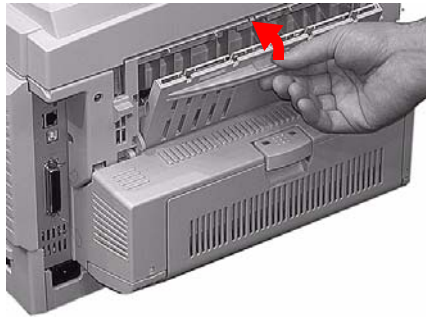

6. Close the top cover.



Jam 390

CHECK MP TRAY
390: Paper Jam

Sheet has just entered the printer

1. Gently pull the sheet out of the printer.



Sheet can't easily be pulled out from the front

1. Lift the front cover release. Pull open the front cover.

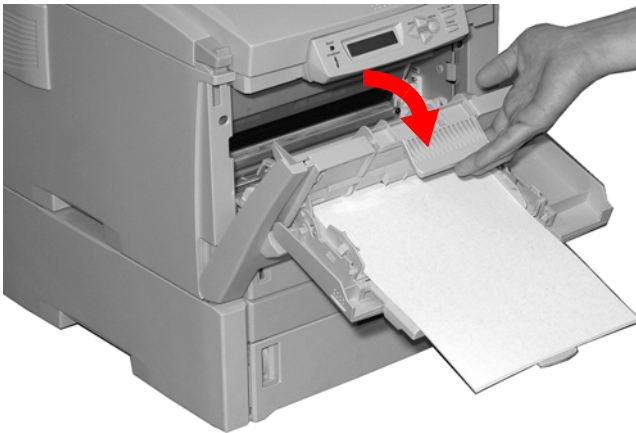

2. Remove any jammed sheets.

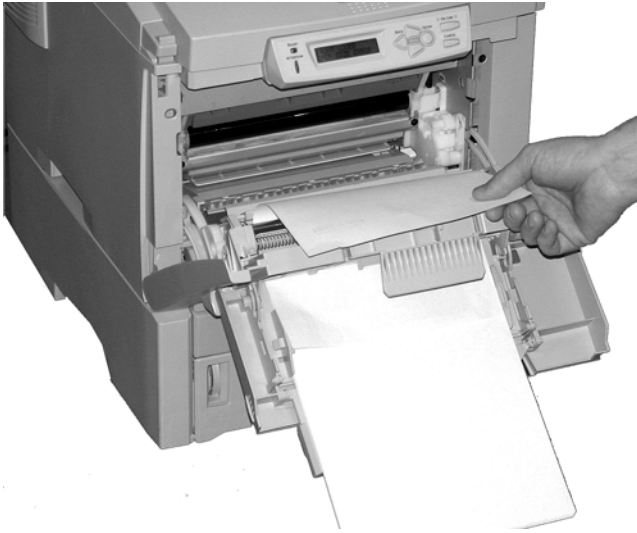

3. Close the front cover.

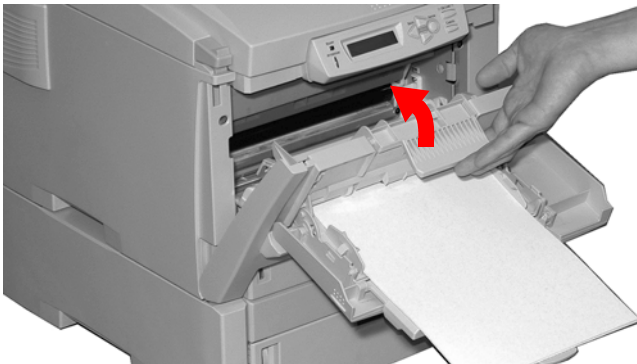

Jam 391 and 392

OPEN FRONT COVER
nnn: PAPER JAM

nnn = 391 or 392

1. Pull out the appropriate tray.
391 = Tray 1
392 = Optional Tray 2.
2. Remove any sheet jammed as it exited the tray.



391

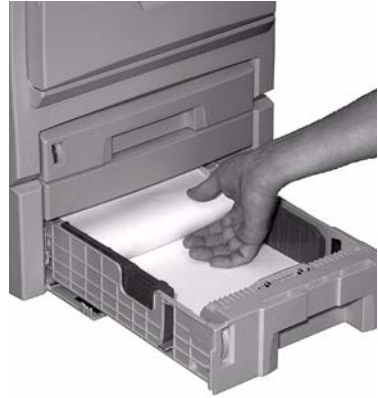

392

3. Open the front cover.



4. Remove any jammed sheets.

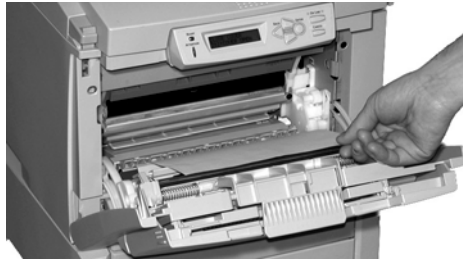

5. Close the front cover.



Print Quality Problems ---

Blurred print (letter edges)

Possible cause	Remedy
LED is dirty.	Clean LED with lens cleaner or soft tissue.
Cannot print desired color because toner is low.	Replace toner cartridge. See "Replace a Toner Cartridge" on page 65.

Blurred print (one side of page)

Possible cause	Remedy
Top cover is not properly closed.	Press the cover release latch and open, then close, the cover.
One or more of the toner cartridges is not seated properly.	Open the top cover and check to be sure that each toner cartridge is fully seated and that each toner cartridge lock lever is pushed all the way back.

Fading (in patches)

Possible cause	Remedy
The paper is moist.	Store paper within specified temperature and humidity levels. See "Specifications" on page 112.

Fading (Vertical)

Possible cause	Remedy
LED head is dirty.	Clean LED head with lens cleaner or soft tissue.
Toner is low.	Change toner cartridge.
Paper is unsuitable for printer.	Use recommended paper.

Light Print

Possible cause	Remedy
The toner cartridge is incorrectly installed.	Reinstall the toner cartridge. See "Replace a Toner Cartridge" on page 65.
Toner is low.	Change toner cartridge. See "Replace a Toner Cartridge" on page 65.
The paper is moist.	Store paper within specified temperature and humidity levels. See "Specifications" on page 112.
Paper is unsuitable for printer.	Use recommended paper. See "Paper (Print Media)" on page 16.

Lines, Black (Vertical)

Possible cause	Remedy
Image drum is damaged.	Replace image drum. See "Replace an Image Drum" on page 72.
Toner is low.	Change toner cartridge. See "Replace a Toner Cartridge" on page 65.
Periodic black lateral lines or spots.	<p>If the lines or spots occur at intervals of approximately</p> <p>44 to 94 mm</p> <p>The green surface of the image drum is damaged or dirty. If damaged, replace the image drum cartridge. See "Replace an Image Drum" on page 72. If dirty, wipe the image drum gently with soft tissue. If this does not work, replace the image drum. See "Replace an Image Drum" on page 72.</p> <p>113 mm</p> <p>The fuser roller is damaged. Change the fuser. See "Replace the Fuser" on page 81.</p>
The image drum has been exposed to light.	Remove the image drum from the printer and store it in a dark place for several hours. If this does not work, replace the image drum. See "Replace an Image Drum" on page 72.

Lines, White (Vertical)

Remedy
Clean LED head with lens cleaner or soft tissue.
Change toner cartridge.
Change image drum.

Shading on unprinted sections

Possible cause	Remedy
Paper has been affected by static electricity.	Store paper within specified temperature and humidity levels. See "Specifications" on page 112.
Paper is too thick.	Use recommended paper. See "Paper (Print Media)" on page 16.
Toner is low.	Replace toner cartridge. See "Replace a Toner Cartridge" on page 65.

Toner rubs off when you rub the printed surface.

Possible cause	Remedy
Media Weight and Media Type settings may not be appropriate.	Set the value of media weight in the menu to the next heaviest one (MEDIA MENU → YYY MEDIA WEIGHT).
Packing materials were left on the fuser when it was installed.	Careful! Fuser may be HOT! Open the top cover and check to be sure that all the packing materials were removed from the fuser. See "Replace the Fuser" on page 81.

Ultra Heavy

If the Ultra Heavy setting does not give proper toner fusion, you can try the Label settings.

USB Problems

Cannot configure for USB connection

NOTE

Windows NT 4.0 does not support USB. Windows 98 upgraded from Windows 95 may not support USB.

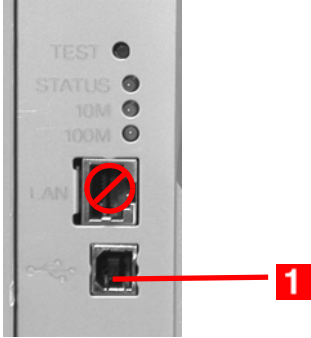
Possible cause	Remedy
USB cable does not meet specifications.	Use USB cable to specification Ver.2.0.
Interface is disabled.	Check that USB interface is set to Enable in the menu (USB MENU → USB → ENABLE).
Configuration procedure was not correctly followed or cancelled.	Configure again from the beginning.
USB cable is disconnected or faulty.	Reconnect or try another cable.
A USB hub is being used.	The printer cannot be used with a USB hub. Connect the printer and computer directly.
The USB cable is installed in the Ethernet port.	Make sure the USB cable is plugged into the black USB port (1) on the printer: 

Cannot print

- PRNUSBx write error is displayed.

Possible cause	Remedy
Interface is disabled.	In the printer menu settings, enable the USB interface (USB MENU → USB → ENABLE).
Printer is switched OFF.	Turn on the printer.
Printer interface cable is disconnected.	Reconnect the printer interface cable.
A converter, buffer, extension cable or USB hub is being used.	Test by connecting the printer and computer directly.
Printer driver output port is incorrect.	Set correct output port to which the printer interface cable is connected.
Printer is not selected in the printer driver.	Select the printer or set to default printer.
Incorrect printer driver is being used.	Delete this printer driver and install correct printer driver from the CD supplied with your printer.

Application error _____

or

General Protection Fault _____

Possible cause	Remedy
Application is not suitable for the operating system.	Upgrade the application.
Memory is insufficient for number of applications running.	Close all other applications.
Print file is corrupted.	Correct or recreate the file.
Memory is insufficient for application.	Increase computer's memory.
Printer driver is incorrectly configured.	Correctly configure printer driver.

Paper Size Change Request _____

Possible cause	Remedy
Paper loaded in tray is different size from that formatted in software application.	Either change paper in tray to match size formatted in application and press ON-LINE to continue, or continue printing on existing paper by pressing ON-LINE.

Printer does not go online _____

Possible cause	Remedy
Bad connection	Switch off the printer and disconnect the power cable. Reconnect the power cable and switch the printer on. If this does not clear the fault, call for service.

Printer makes a strange noise _____

Possible cause	Remedy
The printer is not horizontal.	Place the printer on a stable, level surface.
There are scraps of paper or other foreign matter inside the printer.	Check the inside of the printer and remove any such objects.
The top cover is not firmly shut.	Press the left and right sides of the top cover.

Printer takes a long time to start printing

Possible cause	Remedy
The printer has to warm up returning from power save mode.	In the printer menu settings, set power save to a higher value to increase the length of time before entering power save mode (SYS CONFIG MENU → POW SAVE TIME).
The image drum carries out a cleaning process to ensure print quality, which takes time.	Wait until this process has been completed.
The fuser unit adjusts temperature, which takes time.	Wait until this process has been completed.
The printer is processing data from another interface.	Wait until this data is processed.

Printing cancels _____

Possible cause	Remedy
The printer interface cable is faulty.	Replace the printer interface cable.
The time out setting is too short.	Reset time out in the menu to a higher value (SYS CONFIG MENU → WAIT TIMEOUT).

Printing does not start _____

Possible cause	Remedy
Printer error	Check the control panel. If an error message is displayed, correct the problem.

Printing is slow _____

Possible cause	Remedy
Print processing is carried out by the computer.	Use a computer with a faster processor.
Print resolution is set high.	Set lower print resolution in the printer driver Job Options tab.
Data is too complex.	Simplify data.

Cleaning Page

General Information

Use this to generate a cleaning page which runs through the printer before the job is printed. This should eliminate any fading, streaking or erratic marks from the printed pages.

Windows

1. Open the file you want to print.
2. Click File → Print.
3. Select your printer.
4. Click Properties.
5. Click the Job Options tab.
6. Click Advanced.
7. Click in the box next to Run Maintenance Cycle before printing.
If the box has a check mark, the feature is ON.
If the box is empty, the feature is OFF.
8. Change any other settings as desired.
9. Click OK.
10. The main Print screen appears.
11. Change any other settings as desired.
12. Click OK.
13. The document prints.

Macintosh

1. Open the file you want to print.
2. Click File → Print.
3. Open the drop-down list below Presets. Select Printer Option.
4. Select "Run maintenance cycle before printing".
If the box has a check mark, the feature is ON.
If the box is empty, the feature is OFF.
5. Change any other settings as desired.
6. Click Print.

Printer Drivers

General Information

The printer drivers allow you to adjust the settings for your print job. Driver settings can interact with each other. For example, the paper type, weight, and size you use restricts many of your job settings.

Changes to driver settings can be

- used for only a single print job
 - saved as the default settings for ALL print jobs
- or
- saved (under a name) for future use [only with PCL and Macintosh drivers].

NOTE

Most applications allow the printer properties to be accessed from within the document print dialog box.

Application settings override driver settings.

Driver settings override printer menu settings.

Install

Windows and Macintosh

See your printed Setup Guide for information on installing printer drivers.

The CD(s) supplied with your printer contain:

Drivers

Color Utilities

Network Utilities

Manuals

Which Printer Driver to Use? _____

Windows

Your printer comes with drivers for

- PCL
- Adobe® PostScript® (PS).

You can install only one driver, or all of these drivers.

Your choice depends upon your printing requirements.

PCL

Choose this if you use TrueType fonts, and you do not print PostScript (including “.eps” files) graphics.

This is more efficient and gives good results.

PostScript

Choose this if you use PostScript fonts or print PostScript graphics.

Performance is faster. Graphics print at their best quality.

NOTE

The line art graphics in this manual are PostScript. If you plan to print parts of this manual, choose the PostScript driver. Otherwise, the line art graphics print at low resolution. The print quality may not be satisfactory.

If neither driver seems to cover all your needs, you should install both drivers. Select the same printer port (LPT1 or Network Port) for both drivers during the installation.

Set the driver you plan to use most of the time to be your Windows default driver. Most applications allow you to choose a different printer from within the print dialog, so you can use the alternative driver for printing whenever you need to.

Change Driver Settings

When you change driver settings, you can apply the changes to:

all print jobs (default)

or

a single print job

All Print Jobs (Default)

To change the driver settings and apply the changes to all print jobs,

1. Click Start → Settings → Printers (Printers and Faxes for XP/Server 2003).
2. Right click on your printer.
3. Proceed with changing the driver settings.
4. Click OK until you return to the main Printers screen.
5. Close the screen.
6. Your changes are now the default settings for your printer.

Single Print Job

To change the driver settings and apply the changes to a single print job,

1. Open the file you want to print.
2. Click File → Print.
3. Select your printer.
4. Click Properties.
5. Proceed with changing the driver settings.
6. Click OK until you return to the main Printers screen.
7. Click OK.
8. The document prints.

Save Driver Settings

There are two ways to save your changes to the settings in the printer driver.

1. You can make changes to the driver settings and save them as the new default settings.

or

2. You can make changes to the driver settings and save them under a named driver.

This allows you to set up and save the driver settings you use for various printing situations.

You can save up to 14 named drivers.

For more information,

Windows, PostScript: You cannot make changes to the driver settings and save them under a named driver.

Windows, PCL: see page 152

Macintosh: see page 154

Windows

PostScript

You cannot make changes to the driver settings and save them under a named driver.

PCL

1. Next:

Windows XP/Server 2003: Click Start → Settings → Control Panel → Printer and Other Hardware → Printers & Faxes.

Windows 2000: Click Start → Settings → Printer.

2. Next:

Windows XP/Server 2003: Right click OKI C6150 (PCL). Select Printing Preferences.

Windows 2000: Right click OKI C6150 (PCL). Select Printer Preferences.

3. Change each setting.
4. On the Setup tab, under Driver Settings, click Add.
5. At Setting Name, enter the desired name.
6. You can save your media (paper) selection as part of your named driver. To do this, select Form Information is Kept.
7. Click OK.
8. Under Driver Settings, select a named setting to use.
9. Click OK.
10. Close the dialog screen.

Check to see if saved Driver Settings are used

You can make changes to the driver settings and save them (under a named driver) for later use. You can do this if you are using PCL and/or Mac drivers.

Before making changes to driver settings, always check to see if a Named Driver is being used.

To do this:

1. Open the file you want to print.
2. Click File → Print.
3. Select your printer.
4. Click Properties.
5. Click the Setup tab (if necessary).
6. Look at the list below Driver Settings. If you see any name other than Default, a Named Driver is being used.
7. If a Named Driver is being used, you can
select "Default" in the list below Driver. This restored all driver settings to the factory defaults. You can then proceed with your changes.
proceed with your changes and not save them. Use the changes for only a single print job.
proceed with your changes and save them as the same Named Driver.
proceed with your changes and save them under a new Named Driver.

Restore Default Driver Settings ---

Windows

Single Print Jobs

When working in the drivers, many of the screens have a Default button.

Click Default to restore the driver settings to the factory defaults.

Macintosh ---

General Information

Summary

Macintosh OS 10.2 and 10.3

The "Summary" lists all the printer settings currently made for your print job. See "Summary" on page 155.

Presets

Macintosh OS 10.2 and 10.3

"Presets" allow you to save a group of settings which you use for many documents, or to change the settings designated as the Standard Preset. See "Presets" on page 155.

Scheduler

Macintosh OS 10.3 only

"Scheduler" allows you to schedule when your job will print and its priority relative to other jobs in the print queue. See "Scheduler" on page 156.

Paper Handling

Macintosh OS 10.3 only

"Paper Handling" allows you to determine how the pages in your print job will print. Choices are: Reverse page order, All Pages, Odd numbered pages, or Even numbered pages.

Select "Reverse page order" to print the last page of the document first. This is useful when you are printing to the straight-through, rear (face up) exit required for heavy paper, labels, envelopes and transparencies.

See "Paper Handling" on page 157.

Summary

Macintosh OS 10.2 and 10.3

The “Summary” lists all the printer settings currently made for your print job.

1. Open the file you want to print.
2. Click File → Print.
3. Open the drop-down list below Presets. Select Summary.

Presets

Macintosh OS 10.2 and 10.3

Use/Save Presets

Presets allow you to save a group of settings which you use for many documents, or to change the settings designated as the Standard Preset.

For example, if you are using Job Accounting, you can enter your User Name and Job Account ID on the Job Accounting screen, then save the setting as part of the Standard Preset.

Create a New Preset

1. Make all the printer settings you wish to save as a Preset.
2. Select Summary. Review the settings to make sure you have all the settings you want to save.
3. Open the Presets drop-down list. Select Save As
4. Type in a name under which to save your settings. Click OK.
5. The new Preset appears in the drop-down list.

Change an Existing Preset

1. Make sure the Preset you wish to change is selected in the Preset box.
2. Make any needed changes in the printer settings.
3. Review the Summary screen to confirm that the settings are what you want.
4. Open the drop-down list. Select Save.
The revised settings are saved under that Preset.

Delete a Preset

CAUTION!

When you click **Delete**, the Preset is instantly deleted *without* prompting you to confirm the deletion.

1. Make sure the Preset you wish to change is selected in the Preset box.
2. Open the drop-down list. Select **Delete**.
The Preset is deleted from the list.

Scheduler

Macintosh OS 10.3 only

1. Open the file you want to print.
2. Click **File** → **Print**.
3. Open the drop-down list below **Presets**. Select **Scheduler**.
4. At **Print Document**, set the schedule for when your job prints.

Now (the default).

At [a specific time you specify in one minute increments]

On Hold [until you come back and select Now]

5. At **Priority**, select the urgency of your print job.
If your job competes with other documents in the print queue, this setting determines the printing priority of your job.

Paper Handling

Macintosh OS 10.3 only

1. Open the file you want to print.
2. Click File → Print.
3. Open the drop-down list below Presets. Select Paper Handling.

Reverse page order

Select this to print the last page of the document first. This is useful when you are printing to the straight-through, rear (face up) exit required for heavy paper, labels, envelopes and transparencies.

Print

All Pages

Odd numbered pages

Even numbered pages

Use this to print only the odd or only the even pages in your document.

Printer Features

Overview

Banners: see page 159

Black Finish: see page 162

Black Overprint: see page 164

Black Printing: see page 166

Booklets: see page 171

Collating: see page 175

Color Matching: see page 178

Custom Page Size: see page 216

Duplex Printing: see page 223

Grayscale: see page 231

N Up (multiple pages on one sheet): see page 232

Photographs: see page 236

Posters: see page 237

Print Resolution: see page 239

Save as File: see page 243

Toner Saving: see page 246

Watermarks: see page 249

Banners

General Information

A banner is a document printed on an extra-long sheet of paper.

To print a banner, you must:

- use an application that supports banners

Notes:

Word does not support banners. Word limits page length to 22 inches (558.8 mm).

Power Point does support banners.

- define a custom page size for your banner

See "Custom Page Sizes" on page 216.

- use the Multi Purpose Tray and the Face Up (Rear) Exit

See

Multi-Purpose Tray (MP Tray) [Manual Feed], on page 44

Face Up (Rear Exit), on page 56

Specifications

- Length: up to 48" (1.22 m)
- Width Range = 8¼ to 8½" (210 to 215.9 mm)
- Weight Range = 28 to 34 lb. US Bond (105 to 128 g/m²)
- Path = Rear Exit (Face Up Stacker) only
- Feed one sheet at a time.

Windows

PostScript

For important information about printing banners, see General Information, on page 159.

Before you print a banner, you must set Multi Purpose Tray is Manual feed to ON in the printer driver. The default is OFF.

The printer operator panel will prompt you to load the media before the job prints.

1. Open the file you want to print.
2. Click File → Print.
3. Select your printer.
4. Click Properties.
5. Click the Paper Quality tab.
6. Click Advanced.
7. Below Document Options, below Printer Features, at "Multipurpose tray is handled as manual feed", make your selection. Choices are Yes or No.
8. Change any other settings as desired.
9. Click OK.
10. The Paper Quality tab screen appears.
11. Change any other settings as desired.
12. Click OK.
13. The main Print screen appears.
14. Change any other settings as desired.
15. Click OK.
16. The document prints.

Windows

PCL

For important information about printing banners, see General Information, on page 159.

Before you print a banner, you must set Multi Purpose Tray is Manual feed to ON in the printer driver. The default is OFF.

The printer operator panel will prompt you to load the media before the job prints.

1. Open the file you want to print.
2. Click File → Print.
3. Select your printer.
4. Click Properties.
5. Click the Setup tab.
6. Click Paper Feed Options.
7. Click in the box next to "MPT is Manual Feed."
If the box has a check mark, the feature is ON.
If the box is empty, the feature is OFF.

8. Change any other settings as desired.
9. Click OK.
10. The Setup tab screen appears.
11. Change any other settings as desired.
12. Click OK.
13. The main Print screen appears.
14. Change any other settings as desired.
15. Click OK.
16. The document prints.

Macintosh

OS 10.2 and 10.3

For important information about printing banners, see General Information, on page 159.

Before you print a banner, you must set Multi Purpose Tray is Manual feed to ON in the printer driver. The default is OFF.

The printer operator panel will prompt you to load the media before the job prints.

1. Open the file you want to print.
2. Click File → Print.
3. Open the drop-down list below Presets. Select Printer Option.
4. Select "Multi Purpose Tray is Manual feed".
If the box has a check mark, the feature is ON.
If the box is empty, the feature is OFF.
5. Change any other settings as desired.
6. Click Print.

Black Finish

General Information

Your printer can print black with either a glossy (shiny) finish or a matte (dull/flat finish).

Windows: Individual Print Jobs

NOTE

The driver's color options are only designed to work with RGB data.

1. Open the file you want to print.
2. Click File → Print.
3. Click on the Color tab.
4. At Advanced Color, make your selection.
If the box has a check mark, the feature is ON.
If the box is empty, the feature is OFF.
5. Below Black Finish, make your selection.
Choices are Auto, Gloss, and Matte.

Gloss

This option produces printing with a more glossy finish.

Matte

This option uses more Black and less CMYK while producing a flatter black.

6. Change any other settings as desired.
7. Click Print.
8. The document prints.

Windows: All Print Jobs (Default)

1. Click Start → Settings → Printers [Printers and Faxes in Windows XP/Server 2003].
2. Right-click the printer name.
3. Select Properties. Click Printing Preferences.
4. Click on the Color tab.

5. At Advanced Color, make your selection.
If the box has a check mark, the feature is ON.
If the box is empty, the feature is OFF.
6. Below Black Finish, make your selection.
Choices are Auto, Gloss, and Matte.

Gloss

This option produces printing with a more glossy finish.

Matte

This option uses more Black and less CMYK while producing a flatter black.

7. Change any other settings as desired.
8. Click Print.
9. The document prints.

Macintosh OS 10.2 and 10.3

1. Open the file you want to print.
2. Click File → Print.
3. Open the drop-down list below Presets.
4. Under Color Mode, select Advanced Color.
5. Choose the type of black finish.

Gloss

This option produces printing with a more glossy finish.

Matte

This option uses more Black and less CMYK while producing a flatter black.

6. Change any other settings as desired.
7. Click Print.

Black Overprint

General Information

Black overprint eliminates the white edge between the printed fonts and the colored background.

Black overprint can only be used when printing 100 percent black text over a background color.

Restrictions

1. Black Overprint may not be available with some software applications.
2. The fonts (characters) must be 100 per cent black. If they are not, they are treated as graphics. Black overprint will not work.

Example:

If you print large letters on a color background using

- a Microsoft Office software application
- a True Type font
- Windows XP, Server 2003, or 2000

Black Overprint won't work.

Replace the True Type font with a printer font.

3. When the background color is very dark, the toner may not fuse correctly.

Change the background color to a lighter color.

4. Black Overprint can only be used in Mac OS 10.2 and 10.3 if you are using an application that specifies RGB color space and you are using PostScript Color Matching.

For more information,

Windows, PostScript: see page 165

Windows, PCL: see page 165

Macintosh OS 10.2 and 10.3: see page 165

Windows PostScript

1. Open the file you want to print.
2. Click File → Print.
3. Select your printer.
4. Next:
Windows XP/Server 2003: Click Advanced.
Windows 2000: Go to the next step.
5. On the Color tab, click Advanced.
6. Check Black Overprint.

Windows PCL

1. Open the file you want to print.
2. Click File → Print.
3. Select your printer.
4. Next:
Windows XP/Server 2003: Click Advanced.
Windows 2000: Go to the next step.
5. On the Job Options tab, click Advanced.
6. Check Black Overprint.

Macintosh OS 10.2 and 10.3

NOTES

Black Overprint can only be used in Mac OS 10.2+ if you are using an application that specifies RGB color space and you are using PostScript Color Matching.

1. Open the file you want to print.
2. Click File → Print.
3. Select your printer.
4. Open the drop-down menu. Select Printer Functions.
5. By Color Options, select Black Overprint.
Click the checkbox to enable the option.

General Information

NOTE

To use Black Generation, Office Color or GraphicPro must be the selected Print Mode.

Your printer prints the color black in one of two ways:

- Composite Black
- True Black

Composite Black

The cyan, magenta, yellow, and black toners are *combined* to create composite black.

Use composite black when printing photographs.

Composite Black can appear as a brownish-black.

True Black

Only black toner is used to print true black.

Use True Black when printing a combination of text and graphics.

If you use True Black to print photographs, dark sections of the photos may appear black.

For more information,

Windows, PostScript, Office Color: see page 166

Windows, PostScript, Graphic Pro: see page 168

Windows, PCL: see page 169

Macintosh OS 10.2 and 10.3: see page 170

Windows, PostScript

Office Color

1. Open the file you want to print.
2. Click File → Print.
3. Select your printer.

4. Next:

Windows XP/Server 2003: Click Properties.

Windows 2000: Go to the next step.

5. Click the Color tab.

6. Click Office Color.

7. Click Options.

8. At Black Finish, make your selection.

Auto

If Auto is selected, your printer automatically uses the best method (Composite or True Black) to print black, depending on the type of document you are printing.

Composite Black (CMYK)

The cyan, magenta, yellow, and black toners are combined to create composite black.

Use composite black when printing photographs.

Composite Black can appear as a brownish-black.

True Black (K)

Only black toner is used to print true black.

Use True Black when printing a combination of text and graphics.

If you use True Black to print photographs, dark sections of the photos may appear black.

- 9. Change any other settings as desired.**
- 10. Click OK.**
- 11. The Color tab screen appears.**
- 12. Change any other settings as desired.**
- 13. Click OK.**
- 14. The main Print screen appears.**
- 15. Change any other settings as desired.**
- 16. Click OK.**
- 17. The document prints.**

Windows, PostScript

Graphic Pro

- 1.** Open the file you want to print.
- 2.** Click File → Print.
- 3.** Select your printer.
- 4.** Next:
 - Windows XP/Server 2003: Click Properties.
 - Windows 2000: Go to the next step.
- 5.** Click the Color tab.
- 6.** Click Graphic Pro.
- 7.** Click Options.
- 8.** At Pure Black Text/Graphics, make your selection.
 - If the box has a check mark, the feature is ON.
 - If the box is empty, the feature is OFF.
- 9.** Change any other settings as desired.
- 10.** Click OK.
- 11.** The Color tab screen appears.
- 12.** Change any other settings as desired.
- 13.** Click OK.
- 14.** The main Print screen appears.
- 15.** Change any other settings as desired.
- 16.** Click OK.
- 17.** The document prints.

Windows PCL

- 1.** Open the file you want to print.
- 2.** Click File → Print.
- 3.** Select your printer.
- 4.** Next:
 - Windows XP/Server 2003: Click Properties.
 - Windows 2000: Go to the next step.
- 5.** Click the Job Options tab.
- 6.** Click Advanced.
- 7.** At "Always use K toner for 100% Black areas", make your selection.
 - If the box has a check mark, the feature is ON.
 - If the box is empty, the feature is OFF.
- 8.** Change any other settings as desired.
- 9.** Click OK.
- 10.** The Job Option tab screen appears.
- 11.** Change any other settings as desired.
- 12.** Click OK.
- 13.** The main Print screen appears.
- 14.** Change any other settings as desired.
- 15.** Click OK.
- 16.** The document prints.

Macintosh OS 10.2 and 10.3

For more information, see “General Information” on page 166.

1. Open the file you want to print.
2. Click File → Print.
3. Select your printer.
4. Open the drop-down menu and select Printer Functions.
5. At Print Mode, select Office Color or Graphic Pro 3.
6. At Black Generation, choose a method.

Automatic

If Auto is selected, your printer automatically uses the best method (Composite or True Black) to print black, depending on the type of document you are printing.

Generation from CMYK Toner

(Composite Black)

The cyan, magenta, yellow, and black toners are combined to create composite black.

Use composite black when printing photographs.

Composite Black can appear as a brownish-black.

Generation only from Black (K) Toner

(True Black)

Only black toner is used to print true black.

Use True Black when printing a combination of text and graphics.

If you use True Black to print photographs, dark sections of the photos may appear black.

Booklets (Binding Print)

General Information

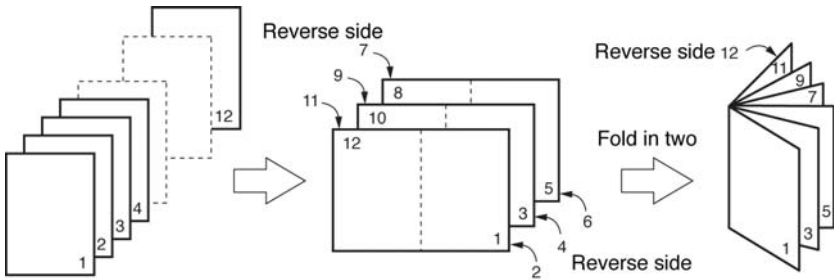

Booklet printing allows you to print a document like a brochure or greeting card.

Both the duplex unit and additional memory must be installed and enabled in the driver *before* using booklet printing.

Some applications do not support booklet printing.

Please read "Restrictions", on page 172.

For more information,

Windows, PostScript: see page 173

Windows, PCL: see page 174

Macintosh OS 10.2 and 10.3: This feature is not available in these operating systems

Restrictions

- 1.** Before booklet printing can be carried out, both the duplex unit and additional memory must be installed
enabled in the driver.
- 2.** Not available on some network connections. See the Help file.
- 3.** Some software applications may not support booklet printing.
- 4.** The right-to-left setting allows a booklet to be printed for right to left reading, which is used in some languages.
- 5.** PostScript
This feature is not available in these operating systems
Windows Me/98
Windows NT
- 6.** PCL
This feature is not available in this operating system
Windows 98 or 95.
Booklet printing is ONLY available in
Windows Me
Windows NT
- 7.** Booklet printing is restricted to four (4) pages per sheet [two (2) pages per side].
Example:
print a 5½ x 8½ inch booklet on 8½ x 11 inch paper
- 8.** Most applications allow the printer properties to be accessed from within the document print dialog box.
Application settings override driver settings.
Driver settings override printer menu settings.

Windows PostScript

For more information,

“General Information”, on page 171

“Restrictions”, on page 172

- 1.** Open the file you want to print.
- 2.** Click File → Print.
- 3.** Select your printer.
- 4.** Next:
 - Windows XP/Server 2003: Click the Properties button.
 - Windows 2000: Go to the next step.
- 5.** Click the Layout tab.
- 6.** Next:
 - Windows XP/Server 2003: Under Pages Per Sheet, in the drop-down list, select Booklet.
 - Windows 2000: Under Pages Per Sheet, in the drop-down list, select Booklet.
- 7.** Under Print on Both Sides (Duplex), select Flip on Short edge.
- 8.** Change any other settings as desired.
- 9.** Click OK.
- 10.** The main Print screen appears.
- 11.** Change any other settings as desired.
- 12.** Click OK.
- 13.** The document prints.

Windows PCL

For more information,

“General Information”, on page 171

“Restrictions”, on page 172

1. Open the file you want to print.
2. Click File - Print.
3. Select your printer.
4. Next:
Windows 2000: Click the Setup button.
Windows XP/Server 2003: Click Properties (or Setup, or your application’s equivalent).
5. Next:
Windows 2000: Under Finishing Mode, in the drop-down list, select Booklet.
Windows XP/Server 2003: On the Setup tab, under Finishing Mode, in the drop-down list, select Booklet.
6. Click the Options button.
7. Set the Signature, 2pages, Right to Left, and Bind Margin, as required.
See the online Help for information.
8. Click OK.
9. The Setup tab screen appears.
10. Change any other settings as desired.
11. Click OK.
12. The main Print screen appears.
13. Change any other settings as desired.
14. Click OK.
15. The document prints.

Macintosh OS 10.2 and 10.3

This feature is not available in these operating systems.

Collating

General Information

Important

If your software application has a collate option, use it instead of the collate option in the printer driver. This prevents any conflicts between the software application and the printer driver.

NOTE

Most applications allow the printer properties to be accessed from within the document print dialog box. Application settings override driver settings. Driver settings override printer menu settings.

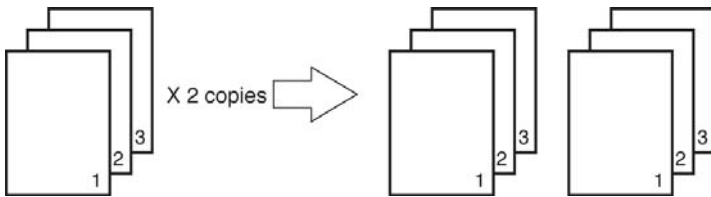

Collating is printing multiple copies of a multi-page job where each copy has the pages arranged in the correct order.

If you print multiple copies of a multi-page job and DO NOT specify collating, all of the copies of the first page print before the copies of the subsequent page(s) print.

Collating can be carried out with or without a hard disk drive installed. However, printers with a hard disk drive will provide greater performance.

For more information,

Windows : see page 176

Macintosh OS 10.2 and 10.3: see page 177

Windows

For more information, see “General Information” on page 175.

Important

If your software application has a collate option, use it instead of the collate option in the printer driver. This prevents any conflicts between the software application and the printer driver.

NOTE

Most applications allow the printer properties to be accessed from within the document print dialog box. Application settings override driver settings. Driver settings override printer menu settings.

1. Open the file you want to print.
2. Click File → Print.
3. Select your printer.
4. Under Copies, at Collate, make your selection.
If the box has a check mark, the feature is ON.
If the box is empty, the feature is OFF.
5. Change any other settings as desired.
6. Click OK.
7. The document prints.

Macintosh OS 10.2 and 10.3

For more information, see “General Information” on page 175.

Important

If your software application has a collate option, use it instead of the collate option in the printer driver. This prevents any conflicts between the software application and the printer driver.

NOTE

Most applications allow the printer properties to be accessed from within the document print dialog box. Application settings override driver settings. Driver settings override printer menu settings.

1. Open the file you want to print.
2. Click File → Print.
3. By Number of Copies, select the number of copies you want to print.
4. In the Print Function panel, select Collate.
5. Click OK.
6. Print the document.

Overview

NOTE

Most applications allow the printer properties to be accessed from within the document print dialog box. Application settings override driver settings. Driver settings override printer menu settings.

Color reproduction is a complex topic.

This topic is divided into two sections:

- background information

The background information explains the factors that affect color matching.

See page 178.

- how-to information

The how-to information explains how to perform color matching with your printer.

See page 178.

Basics

There are three methods by which your document's color can be managed and adjusted:

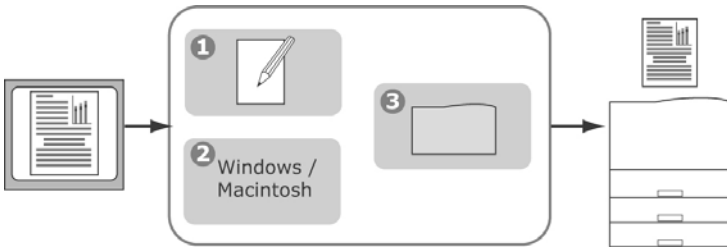

1. Application Color Management (1).

Some graphics and desktop publishing programs such as Adobe Photoshop, Adobe Illustrator, and Quark Xpress have their own built-in color management systems.

Most applications do not have these color management features and rely instead on the printer or operating system.

2. Operating System Color Management (2).

Windows 2000, XP and Server 2003 have Windows ICM color Management.

Mac OS and Mac OS 10.2 and 10.3 have Apple ColorSync.

3. Printer Color Management (3).

When you print your document and modify settings in the printer driver, the printer performs color adjustments.

Important!

Only use one color management system if you want the best results from your printer.

If you wish to use your printer's color management system, ensure that your application or operating system color management is switched off.

Applying color management in multiple places will give unpredictable results.

What this guide describes

This user guide only discusses the printer color management system.

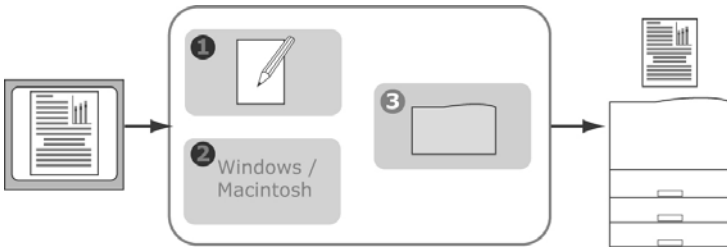

If you wish to learn more about your application program or operating system color management, please see the documentation that was supplied with your application software or computer.

Background Information

NOTE

Most applications allow the printer properties to be accessed from within the document print dialog box. Application settings override driver settings. Driver settings override printer menu settings.

Color reproduction is a complex topic.

This background information explains the factors that affect color matching.

Background information is divided into these sections:

1. Factors that Affect Color Printing: see page 181
2. For example, a printout on recycled paper can look duller than one on specially formulated glossy paper. Choosing a Color Matching Method: see page 184
3. Printing Vivid Colors: see page 186
4. Color Settings: see page 187
5. Hue, Brightness, and Saturation: see page 188

Factors that Affect Color Printing

There are many factors that affect color printing.

Some of the most important factors are:

- the differences between the range of colors a monitor can reproduce versus the range of colors that a printer can reproduce. See page 181.
- monitor settings. See page 182.
- color settings in your software application. See page 182.
- how your software application displays color. See page 183.
- color settings in your printer driver. See page 183.
- viewing (lighting) conditions. See page 183.
- paper type. See page 184.

Monitor Colors vs. Printer Colors

Differences between the range of colors a monitor or printer can reproduce

Neither a printer nor a monitor can reproduce the full range of colors seen by the human eye.

Each device is limited to a certain range of colors.

- A printer cannot reproduce all of the colors displayed on a monitor.
- A monitor cannot reproduce all of the colors printed by a printer.

Both devices use very different technologies to represent color.

- A monitor uses Red, Green and Blue (RGB) phosphors (or LCDs).
- A printer uses Cyan, Yellow, Magenta and Black (CMYK) toner or ink.

Very vivid colors (such as intense reds and blues) can be displayed on a monitor. These same colors cannot be easily produced on *any* printer using toner or ink.

There are certain colors (for example, some yellows), that can be printed, but cannot be displayed accurately on a monitor.

These differences between monitor colors and printer colors are the main reasons why printed colors do not always match the colors displayed on screen.

Monitor Settings

The brightness and contrast controls on your monitor can change how your document looks on-screen.

Your monitor color temperature also influences how "warm" or "cool" the colors look.

NOTE

Several of the Color Matching options make reference to your monitor's Color Temperature. Many monitors allow you to adjust the color temperature through their control panels.

There are several settings found on a typical monitor:

5000k * or D50

Warmest; yellowish lighting.

Typically used in graphics arts environments.

6500k * or D65

Cooler

Approximates daylight conditions.

9300k *

Cool

The default setting for many monitors and television sets.

*k = degrees Kelvin, a measurement of temperature

Macintosh OS 10.2 and 10.3

You can calibrate your monitor's color regimen in System Preferences → Displays → Color.

Software Settings

Many software applications have their own color settings.

The application settings may override the settings in the printer driver.

Please refer to the documentation for your software application for details on how that particular program's color management functions.

How the application displays color

Some graphics applications such as CorelDRAW®, Adobe® Photoshop®, or Macromedia Freehand® may display color differently from "office" applications such as Microsoft® Word.

For more information, please see your application's online help or user manual.

Printer Driver Settings

The color settings in your printer driver can change the appearance of a document.

There are several options available to help match the printed colors with those displayed on screen.

See page 178.

For Windows

The printer drivers supplied with your printer provide several controls for changing the color output.

The default driver settings produce good results for most documents.

For Macintosh

The install utility provides

- a color matching profile for your printer and
- a Color Option utility in the print driver.

The **Auto** settings produce good results for most documents.

See "Automatic" on page 191.

Lighting (Viewing) Conditions

A document can look very different under various lighting conditions.

For example, the colors may look different when viewed standing next to a sunlit window compared to how they look under standard office fluorescent lighting.

Paper Type

The type of paper used can also significantly affect the printed color.

For example, a printout on recycled paper can look duller than one on specially formulated glossy paper. Choosing a Color Matching Method

General Information

NOTE

These suggestions are for guidance only. Your results may vary depending on the application from which you are printing. Some applications override, without warning, any color matching settings in the printer driver.

There is no one way to achieve a good match between the document displayed on your monitor, and its printed equivalent.

There are many factors involved in achieving accurate and reproducible color.

However, the following guidelines may help in achieving good color output from your printer.

There are several suggested methods. The method you choose is determined by the type of document you are printing.

- most common [RGB]. See page 184.
- professional desktop publishing and graphics [CMYK]. See page 184.
- photographic images. See page 185.
- specific colors (i.e., a company logo). See page 186.
- printing vivid colors. See page 186.

RGB or CMYK?

The RGB color model is based on the three primary colors of light; Red, Green and Blue. This model is used by scanners, digital cameras and computer monitors.

The CMYK color model is based on Cyan, Magenta, Yellow and Black printer inks or toners.

Most documents you print are in RGB format. This is the most common method. If you do not know your document's color mode, assume that it is RGB.

CMYK documents are typically only supported in professional Desktop Publishing and Graphics applications.

About the Printer Drivers

	Support for RGB data	Support for CMYK Data
PCL driver (Windows)	Yes	No
PostScript driver (Windows)	Yes	Yes
PostScript driver (Mac)	Yes	Yes

Matching Photographs

RGB only

Select a matching method appropriate to your monitor.

Windows

Natural is generally a good choice. Select a matching method appropriate to your monitor.

Macintosh

OS 10.2 and 10.3

Natural is a generally a good choice. Select a matching method appropriate to your monitor.

RGB or CMYK

If you are printing photographic images from a graphics application such as Adobe Photoshop, you may be able to use Soft-Proofing to simulate the printed image on your monitor.

Matching Specific Colors

(Example: Company logo)

RGB only

Color Swatch Utility

Use the Color Swatch Utility to print out a chart of RGB swatches. Select your desired RGB values from the swatches. Enter the values in your application's color picker

See "Color Swatch Utility" on page 274.

RGB or CMYK

If you are printing from a graphics application such as Adobe Photoshop, you may be able to use Soft-Proofing to simulate the printed image on your monitor.

Printing Vivid Colors

RGB only

Choices are

- Monitor 6500k Vivid
- sRGB
- Digital Camera settings.

See "Color Settings" on page 187.

RGB or CMYK

Auto is a generally a good choice.

See "Automatic" on page 191.

Color Settings

This is a list of all possible options.

The list you see varies according to your computer platform, operating system, color production method, and printer driver type.

You can modify these settings by selecting Advanced Color, then Natural.

Monitor (6500k) Auto

The default setting (in Macintosh) that selects the best options for your printer. This selection works best for office situations.

Optimized for printing general documents when using a monitor with a color temperature of 6500K.

Monitor (6500k) Perceptual

This is best choice for printing photographic images.

Optimized for printing photographs when using a monitor with a color temperature of 6500K.

Monitor (6500k) Vivid

Ideal for office graphics and text.

Optimized for printing bright colors when using a monitor with a color temperature of 6500K. Vivid or Digital Camera settings produce brightest colors.

Monitor (9300k)

Optimized for printing photographs when using a monitor with a color temperature of 9300K.

Digital Camera

Optimized for printing photographs taken with a digital camera. This tends to produce prints with lighter and brighter colors.

For some photographs, other settings may be better depending on the subjects and the conditions under which they were taken. Vivid or Digital Camera settings produce brightest colors.

sRGB

This option attempts to simulate RGB color.

Optimized for matching specific colors, such as a company logo color. The colors within the printer's color gamut are printed without any modification. Only colors that fall outside the printable colors are modified.

Hue, Brightness, and Saturation

There are three main components to color: Hue, Brightness, and Saturation.

Hue

The component that determines the frequency of light or the position in the spectrum or the relative amounts of red, green and blue. Hue corresponds to the common definition of color, e.g. "red", "orange", "violet" etc.

Brightness

The component that determines the total amount of light (white) in the color. Zero brightness is black. 100% Brightness is white. Intermediate values are "light" or "dark" colors.

Windows and Macintosh 10.3

Brightness can be adjusted when using the Gray Scale color mode (color matching method).

Gray Scale: see page 210

Saturation

The degree of saturation of a color is its relative purity, or freedom from, mixture with white.

Windows and Macintosh 10.3

Saturation can be adjusted when using the Gray Scale color mode (color matching method).

Gray Scale: see page 210

How To

NOTE

Most applications allow the printer properties to be accessed from within the document print dialog box. Application settings override driver settings. Driver settings override printer menu settings.

Color reproduction is a complex topic.

This how-to information explains how to perform color matching with your printer.

Color Match Precision

When the printer performs color matching, it must do many calculations to convert between different color formats (RGB, CMYK, etc). These calculations can take time to process.

The [Color Match Precision] option allows you to choose between higher quality color matching (more time consuming) or faster but less accurate color matching.

List of Color Matching Methods

This is a list of all possible options.

The list you see varies according to your computer platform, operating system, color production method, and printer driver type.

To change these settings in your printer driver, refer to the appropriate section.

Automatic

Office Color

Graphic Pro

No Color Matching

Grayscale

Mac ColorSync

Descriptions of Color Matching Methods

Automatic

Your printer automatically uses the best method to match color, depending on the type of document you are printing.

See page 190

Office Color

This is a simpler color management system designed for ease of use. Office Color is recommended for users who are not experts in color but want good results when printing from programs such as Microsoft Office.

See page 190

Graphic Pro

This is a powerful color management system based on ICC color profiles.

Profiles can be downloaded to the printer hard disk using a special utility, and then color matching can be applied to all incoming print jobs.

The Graphic Pro color management system is recommended for users who are already familiar with ICC profile-based color matching and require more control over color.

See page 190

No Color Matching

Use this option to turn off all printer color matching.

No color correction occurs when selected.

Use No Color Matching when you are using another color matching method in your application (such as Color Simulation).

See "CMYK ink simulations – CMYK source data" on page 206.

See page 190

Grayscale

This option prints all documents as monochrome.

No color prints.

The printer interprets all colors as a variation of grays.

See page 190

Mac ColorSync

This is the color matching system built into the Mac OS

See page 212.

Automatic

Your printer automatically uses the best method to match color, depending on the type of document you are printing.

Windows

Individual Print Jobs

1. Open the file you want to print.
2. Click File → Print.
3. Click on the Color tab.
4. At Automatic, make your selection.
If the box has a check mark, the feature is ON.
If the box is empty, the feature is OFF.
5. Click OK until you return to the Print dialog box.
6. Print the document.

Windows

All Print Jobs (Default)

1. Click Start → Settings → Printers [Printers and Faxes in Windows XP/Server 2003].
2. Right-click the printer name.
Select Properties. Click Printing Preferences.
3. Click on the Color tab.
4. At Automatic make your selection.
If the box has a check mark, the feature is ON.
If the box is empty, the feature is OFF.
5. Click OK until you return to the Print dialog box.
6. Print the document.

Macintosh

OS 10.2 and 10.3

- 1.** Open the file you want to print.
- 2.** Click File → Print.
- 3.** Open the drop-down list below Presets. Select Color.
- 4.** Below Color Mode, at Auto Color, make your selection.
If the box has a check mark, the feature is ON.
If the box is empty, the feature is OFF.
- 5.** Click Print.
- 6.** The document prints.

Office Color

Overview

from C9600 Print Guide

This is a simple color management system designed for ease of use. Office Color is recommended for users who are not experts in color but want good results when printing from programs such as Microsoft Office.

There are two different sets of options in Office Color:

RGB Options	CMYK Options (PostScript only)
Monitor (6500K) – Auto	SWOP
Monitor (6500K) – Perceptual	Euroscale
Monitor (6500K) – Vivid	Japan Color
Monitor (9300K)	
Digital Camera	
sRGB	

Important!

The options for CMYK data are not present in the Windows PCL printer drivers. These printer drivers only support RGB color data.

Although the Office Color options contain controls for CMYK data, it is strongly recommended that you use the Graphic Pro options instead. If you are printing CMYK data, the Graphic Pro options provide more power and flexibility.

RGB Options

Office Color provides a collection of several different color matching presets for RGB data.

These presets each change the color of your print in a slightly different way.

These RGB color matching options are available in all printer drivers.

Preset	Explanation
Monitor (6500K) – Auto	The best color match preset will be selected based on the type of document. 6500K - Perceptual will be selected if printing photographs. 6500K - Vivid will be selected if printing graphics and text.
Monitor (6500K) – Perceptual	Optimized for printing photographs. Colors are printed with emphasis on saturation.
Monitor (6500K) – Vivid	Optimized for printing photographs and for office graphics. The printer uses even more saturation than the Monitor (6500k) Perceptual setting.
Monitor (9300K)	Colors are printed with emphasis on Lightness. Use this setting if you are having problems achieving the correct color when printing from Microsoft Office applications.
Digital Camera	Optimized for printing photos taken with a digital camera. Your results will vary depending on the subject and the conditions under which the photograph was taken.
sRGB	The printer will try to reproduce the sRGB color space. This may be useful if color matching from an sRGB input device such as a scanner or digital camera.

Windows

This information applies to the Windows PCL and PostScript drivers.

1. On the printer driver [Color] tab, select [Office Color] (1) and click the [Options] button.
2. Select a preset from [Color matching options] (2).

Mac OS 9

1. Choose [File] → [Print].
2. From the [Printer] menu, select your printer model.
3. Select [Color Options].
4. From the [Color Mode] menu, select [Office Color].
5. Select [Color - Office Color].
6. Select the Office Color Preset you wish to use.

Important!

When printing from some applications on Mac OS X, these RGB color match options may not affect the color of your print. If you discover that the color of your print has not changed after applying one of the Office color Match presets, then the application is incompatible with this type of printer color matching.

As an alternative, Mac OS X 10.3.x users may be able to adjust the color of their document using ColorSync Quartz filters.

1. In your application program, choose [File] → [Print].
2. From the [Printer] menu, select your printer model.
3. Select [Printer Features].
4. From the [Feature Sets] menu, select [Color Options].
5. From the [Color Mode] menu, select [Office Color].
6. From the [Feature Sets] menu, select [Color – Office Color].
7. Select the [Office Color] Preset you wish to use.

Customising RGB Office Color with the Color Correct Utility (Windows)

If the Office Color presets are not sufficient for your needs, the color Correct utility provides a means of further adjustment. The Color Correct utility provides two methods for adjusting the Office Color settings:

1. You can adjust the overall appearance of the print by modifying Hue, Saturation and Gamma.
2. You can adjust the specific palette colors used in Microsoft Office applications. These adjustments only affect one specific palette color at a time.

NOTE

The Color Correct Utility is available for Windows only.

For more details, see page 274.

Graphic Pro

Overview

This section describes the color matching options available for Graphic Pro.

The Graphic Pro color matching system is based around ICC profiles. These profiles are downloaded to the printer using the Profile Assistant utility and then selected in the printer driver. When a job is sent to the printer, the ICC profiles are applied to the print job on the printer.

Important!

Some features of Graphic Pro color matching can only be used if your printer is fitted with a hard disk. The printer hard disk is required if you wish to download and use your own ICC profiles to the printer.

If your printer does not have a hard disk fitted, you will only be able to select the factory default profiles that are built-in to the printer.

NOTE

The printer's internal hard disk is an optional accessory.

What can you do with Graphic Pro?

The Graphic Pro color matching system is both powerful and flexible. Here are some examples of how the Graphic Pro color matching system can be used:

Matching printer color to an RGB input device

By using the ICC profiles of a scanner, digital camera or monitor, the printer's color can be matched to the input device.

Printer simulation

Your printer can be used to simulate the color output of another printer, even when printing RGB documents. For best results, use CMYK documents when simulating the color output of other printers.

CMYK ink simulation

Your printer can be used to simulate the color output of a commercial printing press (SWOP, Euroscale or Japan Color inks).

More accurate printer color

If you have created your own profiles with third-party ICC profile creation software, these can be downloaded to the printer and used when printing.

Types of ICC profile supported

There are four classes of ICC profile supported by the Graphic Pro color matching system:

Profile type	Description
RGB Source (RGB Input)	These profiles describe the device that was used to capture RGB data (e.g. scanner or digital camera). The RGB Input Profile may also be your monitor profile if you are trying to match to your screen.
CMYK Simulation (CMYK input)	These profiles describe the CMYK device whose colors you are trying to simulate. Typically this would be another manufacturer's printer or an offset printing press. Profiles are already built-in to the printer for commercial printing press inks such as SWOP or Euroscale.
Printer (CMYK Output)	This profile describes the color characteristics of your own printer. The printer already has factory default profiles built-in, but you can replace these profiles with your own if required.
Link Profile	This is a special type of ICC profile that converts directly from CMYK to CMYK. For example, a link profile could convert directly from the CMYK space of another printer to the CMYK space of your printer.

Graphic Pro Workflow – overview

There are three steps to using the Graphic Pro color matching system:

1. Gather or create ICC profiles (see below)
2. Download ICC profiles to the printer hard disk (page 198)
3. Select the ICC profiles in the printer driver when printing (page 199)

Step 1 - Gather or create the ICC profiles

Where can I get the profiles I need?

Profile type	Where to get profiles
RGB Source (RGB Input)	Obtain your RGB source profiles from your scanner, camera or monitor manufacturer.
CMYK Simulation (CMYK input)	Obtain the simulation profile from the manufacturer of the printer you wish to simulate.
Printer (CMYK Output)	The factory default profiles for your printer are built-in. If you need greater accuracy, you should create your own printer profile using third-party ICC profile creation software.
Link Profile	You can create Link profiles using third-party ICC profile creation software. Note that not all ICC profile creation software can create Link profiles.

Step 2 - Downloading ICC profiles to the printer hard disk

You can download profiles to the printer hard disk using the Profile Assistant utility.

Using Profile Assistant

1. Launch Profile Assistant
2. Select a printer

If this is the first time you have used Profile Assistant, you should allow the utility to search for compatible printers. Select the connection types that you wish to search – Parallel, USB or Network (TCP/IP), and click [Start].

If you know the Printer's IP address, you can enter it manually.

3. The main screen of Profile Assistant displays the profiles resident on the selected printer's hard disk. To download a new profile to the printer:

- a. Click [Add].
- b. Select an ICC profile from your computer's hard disk.
- c. Once you have selected a profile, you can add it to the printer as one of the 4 profile types - RGB Source, CMYK Simulation, Printer or Linked.

The options available will depend on which ICC profile you have selected. For example, if you have selected a CMYK profile, you may only be able to add this to the printer as a CMYK Simulation or Printer output profile.

- d. Select a number from 1 to 12. This number is used to identify the profile in the printer driver.
- e. Click [OK] to download the ICC profile to the printer.

Step 3 - Select ICC profiles in the printer driver

What you select in the printer driver depends on the color matching task that you wish to perform.

Examples of selecting ICC profiles for different color matching tasks are shown in the next sections of this guide.

Matching the color of a monitor, scanner or camera

The Graphic Pro color matching system can be used to match the printer color to an RGB input device such as a monitor, scanner or digital camera.

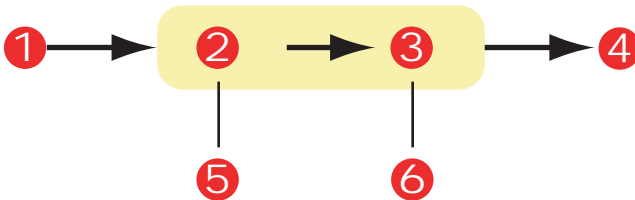

1. RGB data	2. Printed document
3. RGB source profile	4. Scanner, monitor, camera, etc.
5. Printer output profile	6. Leave on Auto or select your custom profile.

To match an RGB input device, first download the RGB source profile and printer profile (optional) to the printer hard disk

using Profile Assistant. See “Using Profile Assistant” on page 198.

Once the profile(s) have been downloaded, make the appropriate selections in the printer driver. These are described in the next section (Windows page 200, Mac OS 9 page 200. Mac OS X page 201).

Windows

This information applies to the Windows PCL and PostScript drivers.

1. To match the color of an input RGB device such as a monitor, scanner or digital camera, make the following selections in the printer driver:
2. On the printer driver [Color] tab, select [Graphic Pro] and click [Options].
3. Select [ICC Profile color Matching].
4. Select the ICC profile that corresponds to the device you are trying to match such as your monitor, scanner or digital camera.

Remember that the names “RGB Source 1”, “RGB Source 2” and so on relate to the number assigned to the profile using Profile Assistant. See “Using Profile Assistant” on page 198.

5. Select a Printer Output Profile.

If [Auto] is selected, the factory default profiles that are embedded in the printer will be used. If you have created a printer profile yourself using profile creation software, select it here.

Tip—If you have selected your own printer output profile, you will also be able to adjust the rendering intent.

Mac OS 9

1. In your application program, choose [File] → [Print].
2. From the [Printer] menu, select your printer model.
3. Select [Color Options].
4. From the [Color Mode] menu, select [Graphic Pro].
5. Select [Color – Graphic Pro 1].
6. From the [color Matching Task] menu, select [ICC Profile color Matching].

7. From the RGB Profile source, select the ICC profile that corresponds to the device you are trying to match such as your monitor, scanner or digital camera.

Remember that the names "RGB Source 1", "RGB Source 2" and so on relate to the number assigned to the profile using Profile Assistant. See "Using Profile Assistant" on page 198.

Select [color – Graphic Pro 2].

From the [Printer Output Profile] menu, select your printer profile.

If [Auto] is selected, the factory default profiles that are embedded in the printer will be used. If you have created a printer profile yourself using profile creation software, select it here and choose a rendering intent.

Mac OS 10.2 and 10.3

1. Choose [File] → [Print].
2. From the [Printer] menu, select your printer model.
3. Select [Printer Features].
4. From the [Feature Sets] menu, select [Color Options].
5. From the [color Mode] menu, select [Graphic Pro].
6. From the [Feature Sets] menu, select [Color - Graphic Pro 1].
7. From the [Color Matching Task] menu, select [ICC Profile color Matching].
8. From the [Feature Sets] menu, select [Color - Graphic Pro 2].
9. From the [RGB Profile source], select the ICC profile that corresponds to the device you are trying to match such as your monitor, scanner or digital camera.
Remember that the names "RGB Source 1", "RGB Source 2" and so on relate to the number assigned to the profile using Profile Assistant. See "Using Profile Assistant" on page 198.
10. From the [Feature Sets] menu, select [color - Graphic Pro 3].
11. From the [Printer Output Profile] menu, select your printer profile.

If Auto is selected, the factory default profiles that are embedded in the printer will be used. If you have created a printer profile yourself using profile creation software, select it here and choose a rendering intent.

Simulating another printer – RGB source data

The Graphic Pro color matching system can be used to simulate the color output of another printer.

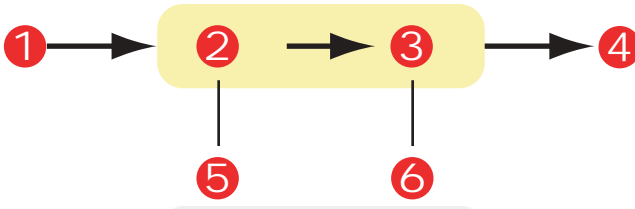

- | | |
|---------------------------|---|
| 1. RGB data | 2. Printed document |
| 3. RGB source profile | 4. Scanner, monitor, camera, etc. |
| 5. Printer output profile | 6. Leave on Auto or select your custom profile. |

Important!

Be aware that if the device you are trying to simulate has different color capabilities from your own printer, exact color simulation will not be possible. For example, it may be difficult to reproduce the exact colors of an inkjet printer on a toner-based printer.

Additionally, differences in the range of printable colors between different devices can make simulation using RGB source data inaccurate. To achieve best results when simulating the color output of other printers, you are strongly advised to use CMYK data as a source. See [CMYK Ink Simulations](#) on page 206.

To simulate the output of another printer, you need to download at least 2 profiles to your printer using Profile Assistant:

- RGB Source Profile
- Simulation Target Profile
- Printer Output Profile (optional)

Once the profile(s) have been downloaded, make the appropriate selections in the printer driver. These are described in the next section (Windows page 203, Mac OS 9 page 204, Mac OS X page 205).

Windows

This information applies to the Windows PCL 5c, PCL 6 and PostScript drivers.

If you are using a source RGB document, simulate the output of another printer by making the following selections in the printer driver:

1. On the printer driver [color] tab, select [Graphic Pro] and click [Options].
2. Select [Printer Simulation].
3. Select the ICC profile that corresponds to the device used to capture or display your source document - this could be a monitor, scanner or digital camera.

Remember that the names "RGB Source 1", "RGB Source 2" and so on relate to the number assigned to the profile using Profile Assistant. See "Using Profile Assistant" on page 198.

4. Select a Simulation Target Profile.

This profile corresponds to the printer you want to simulate.

If you wish to produce black and grey colors that are printed using only black toner, enable the [Preserve Black] option. Although this produces a better quality print, the black and grey colors will not be simulated accurately.

5. Select your printer output profile.

If [Auto] is selected, the factory default profiles that are embedded in the printer will be used. If you have created a printer profile yourself using profile creation software, select it here and choose a rendering intent.

Mac OS 9 / Classic

If you are using a source RGB document, simulate the output of another printer by making the following selections in the printer driver:

1. Choose [File] → [Print].
2. From the [Printer] menu, select your printer model.
3. Select [Color Options].
4. Choose [Color Mode] → [Graphic Pro].
5. Choose [Color] → [Graphic Pro 1].
6. Choose [color Matching Task] → [Printer Simulation].
7. From the [RGB Profile source], select the ICC profile that corresponds to the device you are trying to match such as your monitor, scanner or digital camera.

Remember that the names "RGB Source 1", "RGB Source 2" and so on relate to the number assigned to the profile using Profile Assistant. See "Using Profile Assistant" on page 198.

8. From the [Simulation Target Profile] menu (7), select the profile of the device you wish to simulate.

Remember that the names "CMYK Source 1", "CMYK Source 2" and so on relate to the number assigned to the profile using Profile Assistant. See "Using Profile Assistant" on page 198.

If you wish to produce black and grey colors that are printed using only black toner, enable the [Preserve Black] option. Although this produces a better quality print, the black and grey colors will not be simulated accurately.

9. Choose [Color] → [Graphic Pro 2].
10. From the [Printer Output Profile] menu, select your printer profile.

If [Auto] is selected, the factory default profiles that are embedded in the printer will be used. If you have created a printer profile yourself using profile creation software, select it here and choose a rendering intent.

Mac OS 10.2 and 210.3

1. Choose [File] → [Print].
2. From the [Printer] menu, select your printer model.
3. Select [Printer Features].
4. From the [Feature Sets] menu, [Color Options].
5. From the [color Mode] menu, select [Graphic Pro].
6. From the [Feature Sets] menu, select [color – Graphic Pro 1].
7. From the [color Matching Task] menu, select [Printer Simulation].

If you wish to produce black and grey colors that are printed using only black toner, enable the [Preserve Black] option. Although this produces a better quality print, the black and grey colors will not be simulated accurately.

8. From the [Feature Sets] menu, select [color – Graphic Pro 2].
9. From the [RGB Profile source], select the ICC profile that corresponds to the device you are trying to match such as your monitor, scanner or digital camera.
Remember that the names “RGB Source 1”, “RGB Source 2” and so on relate to the number assigned to the profile using Profile Assistant. See “Using Profile Assistant” on page 198.
10. From the [Simulation Target Profile] menu, select the profile of the device you wish to simulate.
Remember that the names “CMYK Source 1”, “CMYK Source 2” and so on relate to the number assigned to the profile using Profile Assistant. See “Using Profile Assistant” on page 198.
11. From the [Feature Sets] menu, select [color – Graphic Pro 3].
12. From the [Printer Output Profile] menu, select your printer profile.

If [Auto] is selected, the factory default profiles that are embedded in the printer will be used. If you have created a printer profile yourself using profile creation software, select it here and choose a rendering intent.

CMYK ink simulations – CMYK source data

The ICC-based color matching system can be used to simulate the output on commercial printing presses.

You can select from the ink types most commonly used in different regions of the world:

- Euroscale – Europe
- SWOP – North America
- Toyo – Japan

To print CMYK Ink Simulations, you must use PostScript printer driver supplied.

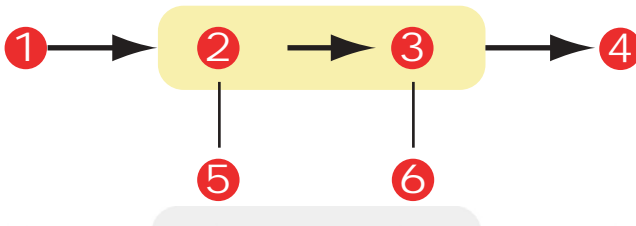

1. CMYK data	4. Printed document
2. CMYK input profile	5. CMYK device you wish to simulate (e.g. SWOP press)
3. Printer output profile	6. Leave on Auto or select your custom profile

Although it is possible to perform CMYK ink simulations using the Office Color options in the printer driver, we recommend that you use the Graphic Pro color matching system to perform CMYK ink simulations, as this provides additional controls, such as using the “Preserve Black” feature, or specifying an alternative printer output profile.

Instructions on how to apply Ink Simulations appear in the next section (Windows page 206, Mac OS 9 page 207, Mac OS X page 208).

Windows

NOTE

This information applies to the Windows PostScript driver only.

If you are using a source CMYK document, use the following printer driver settings to perform a CMYK Ink Simulation:

1. On the printer driver [color] tab, select [Graphic Pro] (1) and click [Options].
2. Select [ICC Profile color Matching] (2).
3. Select the [CMYK Input profile] (3) that corresponds to the device you are trying to match such as a SWOP or Euroscale Press. If you have another CMYK Ink profile that you wish to use, select it here as the appropriate "CMYK Source x" profile.

Remember that the names "CMYK Source 1", "CMYK Source 2" and so on relate to the number assigned to the profile using Profile Assistant. See "Using Profile Assistant" on page 198.

Use the [Preserve Black] option to keep the original grey component (K channel) information. If [Preserve Black] is disabled, the grey components may be printed using a mixture of CMYK toner, instead of just K (black) toner.

4. Select a Printer Output Profile (4).

If [Auto] is selected, the factory default profiles that are embedded in the printer will be used. If you have created a printer profile yourself using profile creation software, select it here.

If you have selected a profile other than [Auto], select the [Rendering Intent] (5).

Mac OS 9 / Classic

If you are using a source CMYK document, use the following printer driver settings to perform a CMYK Ink Simulation:

1. Choose [File] → [Print].
2. From the [Printer] menu (1), select your printer model.
3. Select [color Options] (2).
4. From the [color Mode] menu (3), select [Graphic Pro].
5. Select [color – Graphic Pro 1] (4).
6. From the [color Matching Task] menu (5), select [ICC Profile color Matching].
7. From the [CMYK Input Profile source] (6), select the CMYK Input profile that corresponds to the device you are trying to match such as a SWOP or Euroscale Press. If you have another CMYK Ink profile that you wish to use, select it here as the appropriate "CMYK Source x" profile.

Remember that the names “CMYK Source 1”, “CMYK Source 2” and so on relate to the number assigned to the profile using Profile Assistant. See “Using Profile Assistant” on page 198.

Use the [Preserve Black] option to keep the original grey component (K channel) information. If [Preserve Black] is disabled, the grey components may be printed using a mixture of CMYK toner, instead of just K (black) toner.

8. Select [color – Graphic Pro 2] (7).
9. From the [Printer Output Profile] menu (8), select your printer profile.

If [Auto] is selected, the factory default profiles that are embedded in the printer will be used. If you have created a printer profile yourself using profile creation software, select it here and choose a rendering intent.

Mac OS X10.2 and 10.3

If you are using a source CMYK document, use the following printer driver settings to perform a CMYK Ink Simulation:

1. Choose [File] → [Print].
2. From the [Printer] menu (1), select your printer model.
3. Select [Printer Features] (2).
4. From the [Feature Sets] menu (3), select [color Options].
5. From the [color Mode] menu (4), select [Graphic Pro].
6. From the [Feature Sets] menu (5), select [color – Graphic Pro 1].
7. From the [color Matching Task] menu (6), select [ICC Profile color Matching].

Use the [Preserve Black] option to keep the original grey component (K channel) information. If [Preserve Black] is disabled, the grey components may be printed using a mixture of CMYK toner, instead of just K (black) toner.

8. From the [Feature Sets] menu (7), select [color – Graphic Pro 2].
9. From the [CMYK Profile Type] menu (8), select [CMYK Input Profile].
10. From the [CMYK Input Profile source] (9), select the CMYK Input profile that corresponds to the device you

are trying to match such as a SWOP or Euroscale Press. If you have another CMYK Ink profile that you wish to use, select it here as the appropriate “CMYK Source x” profile.

Remember that the names “CMYK Source 1”, etc., relate to the number assigned to the profile using Profile Assistant. See “Using Profile Assistant” on page 198.

11. From the [Feature Sets] menu, select [color – Graphic Pro 3] (10).
12. From the [Printer Output Profile] menu (11), select your printer profile.

If [Auto] is selected, the factory default profiles that are embedded in the printer will be used. If you have created a printer profile yourself using profile creation software, select it here and choose a rendering intent.

No Color Matching

Use this option to turn off all printer color matching.

No color correction occurs when selected.

Use No Color Matching when you are using another color matching method in your application (such Color Simulation).

See “Ink Simulation” on page 313.

Printer driver settings for ICC profile creation or no color matching

If you are creating ICC profiles using third-party software, select [Disable color Matching for ICC Profile Creation]. This option switches off all printer color management and also prevents the printer from restricting toner layer thickness.

If you are using your application color matching, select [Use Application color Matching]. This option switches off all printer color management. (Mac OS 9 page 210, Mac OS X page 210.)

Windows

1. On the printer driver [Color] tab, select [Graphic Pro] (1) and click [Options].
2. Select [Disable Color Matching for Profile Creation] (2) if you are creating an ICC profile using third-party profile

creation software. Select [Use Application color Matching] (3) if you wish to switch off all printer color management and use your application's color matching.

Mac OS 9

1. Choose [File] → [Print].
2. From the [Printer] menu (1), select your printer model.
3. Select [Color Options] (2).
4. From the [Color Mode] menu (3), select [Graphic Pro].
5. Select [Color – Graphic Pro 1] (4).
6. From the [color Matching Task] menu (5), select [Disable color Matching for Profile Creation] if you are creating an ICC profile using third-party profile creation software. Select [Use Application color Matching] if you wish to switch off all printer color management and use your application's color matching.

Mac OS 10.2 and 10.3

1. Choose [File] → [Print].
2. From the [Printer] menu (1), select your printer model.
3. Select [Printer Features] (2).
4. From the [Feature Sets] menu (3), select [color Options].
5. From the [color Mode] menu (4), select [Graphic Pro].
6. From the [Feature Sets] menu (5), select [color – Graphic Pro 1].
7. From the [color Matching Task] menu (6), select [Disable color Matching for Profile Creation] if you are creating an ICC profile using third-party profile creation software. Select [Use Application color Matching] if you wish to switch off all printer color management and use your application's color matching.

Grayscale

This option prints all documents as monochrome.

No color prints.

The printer interprets all colors as a variation of grays.

Windows

Individual Print Jobs

1. Open the file you want to print.
2. Click File → Print.
3. Click on the Color tab.
4. At Grayscale, make your selection.
If the box has a check mark, the feature is ON.
If the box is empty, the feature is OFF.
5. Change any other settings as desired.
6. Click Print.
7. The document prints.

All Print Jobs (Default)

1. Click Start → Settings → Printers [Printers and Faxes in Windows XP/Server 2003].
2. Right-click the printer name.
3. Select Properties. Click Printing Preferences.
4. Click on the Color tab.
5. At Grayscale, make your selection.
If the box has a check mark, the feature is ON.
If the box is empty, the feature is OFF.
6. Change any other settings as desired.
7. Click Print.
8. The document prints.

NOTE

Once Grayscale is set as the default, you must select either Auto Color or Manual Color on the Color tab when you print color documents.

Macintosh

OS 10.2 and 10.3

1. Open the file you want to print.
2. Click File → Print.
3. Open the drop-down list below Presets. Select Color.
4. Below Color Mode, at Gray Scale, make your selection.
If the box has a check mark, the feature is ON.
If the box is empty, the feature is OFF.
5. Change any other settings as desired.
6. Click Print.

Color Matching

Color Synch

Macintosh OS 10.3

1. To access the print features, open your print driver from within an application by selecting File → Print.
2. Open the drop-down list below Presets. Select Color Synch.
3. At Color Conversion, select Standard.
4. At Quartz Filter, make your selection.

Choices are:

None, Black & White, Blue Tone, Gray Tone, Lightness Decrease, Lightness Increase, Reduce File Size, Sepia Tone, and Add Filters.

The following section has examples and explanations of each filter.

NOTE

To see the affect of any of these filters on your document, select Add Filters. Click the filter in the list. Click Apply.

Filters

None

The default. No filters are applied to the document.



Black & White

Converts the document to black and white, with no gray shades.



Blue Tone

Converts the document to shades of blue.



Gray Tone

Converts the document to shades of gray.



Lightness Decrease (A) / Lightness Increase (B)

Darkens or lightens the document. The middle picture below is with no filters applied.



A



B

Reduce File Size

This filters the document to reduce its file size.

Sepia Tone

Converts the document to shades of brown.



Add Filters

Clicking this brings up a Preview screen.

Here you can see the effect produced by selecting any of the standard filters.

To do this, click the name in the Filters box. Then, click Apply.

You can also

- add New filters of your choice
- Delete filters you have added to the list
- set color conversion options such as Rendering Intent (Automatic, Perceptual, Relative, Saturation, Absolute), etc.

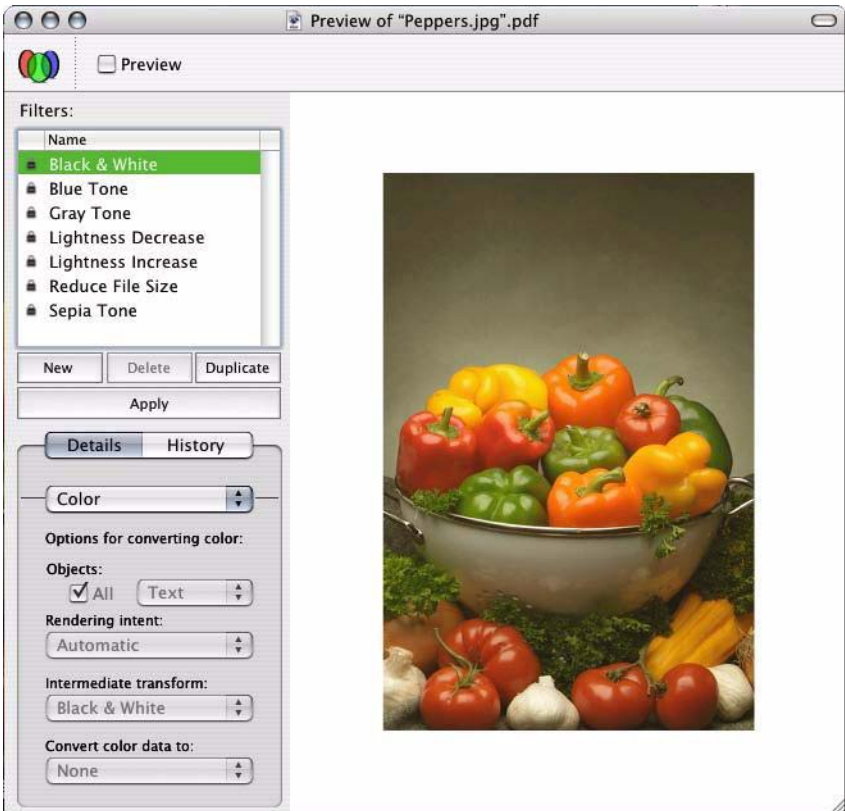

Custom Page Sizes

General Information

Custom Page Size allows you to setup your printer (by customizing settings in your printer driver) to work with non-standard size sheets of print media.

You save the settings. Then, the saved settings can be used for printing, the same way you use standard page sizes.

To use Custom Page Size, you must complete two steps.

- 1.** You must set up your custom page in your printer driver. This is also known as registering the custom page.
- 2.** To use a registered custom page, you must select it when you print a document.

For more information,

Custom Size Ranges: see page 217

Restrictions: see page 218

Special Print Media: see page 219

Windows PostScript: see page 220

Windows PCL: see page 221

Macintosh OS 10.2 and 10.3: This feature does not work with these operating systems.

Custom Size Ranges

Tray 1 and Tray 2

The range varies slightly, depending on the printer driver.

Printing may not work on papers longer than 18 inches (457.2 mm).

Width: 2 to 12.9 inches [51 to 328 mm]

Length: 5 to 47.25 inches [128 to 1200 mm]

MP Tray

The range varies slightly, depending on the printer driver.

Printing may not work on papers longer than 18 inches (457.2 mm).

Width: 2 to 12.9 inches [51 to 328 mm]

Length: 5 to 47.25 inches [128 to 1200 mm]

Banners

from 8¼" to 8½" (210 to 215.9 mm) wide by up to 47¼" (1.2 m) long. Banners must be fed one sheet at a time.

Restrictions

1. Custom Page Size may not work with all software applications.
2. Custom page sizes can only be printed from the manual feed (multi purpose (MP) tray).
 - one-sided printing only
 - rear exit only.

If the sheet of paper you are using is too long to be supported by the MP tray, use your hands.

3. Custom page sizes can only be printed to the face-up exit (straight-through paper feed/rear exit).
4. Before using Custom Paper Size, you must change the printer driver setting for the multi-purpose tray Paper (Media) Size to Custom Paper Size.
5. The paper size must be set to portrait (Width is less than Length).
6. If you use Custom Page, and are not satisfied with the print quality, try setting the PRINT QUALITY to Normal or Quick.
7. The number of custom page sizes that can be defined varies according to the type of the printer driver and the operating system.

PostScript: One

PCL: up to 32

8. Most applications allow the printer properties to be accessed from within the document print dialog box. Settings in your applications override settings in the printer driver.

Settings in the printer driver override settings in the printer menus.

Special Print Media (Paper)

If you are using heavy media, transparencies, envelopes or labels, use the face up (straight through) paper feed path.

If the Ultra Heavy setting does not give proper toner fusion, you can try the Label settings. See "Driver Settings" on page 17.

For face up printing (straight-through path), make sure the rear exit is open and the paper support is extended.

- Paper is stacked in reverse order.
- Tray capacity is about 100 sheets.

Actual capacity depends on paper weight.

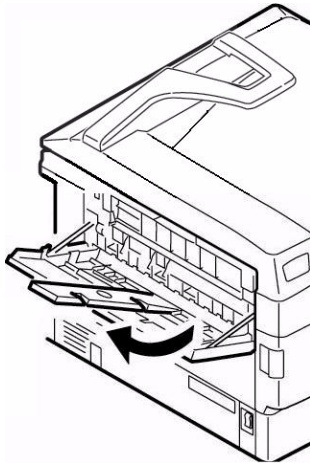

Windows PostScript

For more information,

General Information: see page 216

Custom Size Ranges: see page 217

Restrictions: see page 218

Special Print Media (Paper): see page 219

1. Open the file you want to print.
2. Click File → Print.
3. Select your printer.
4. Click Properties.
5. Click the Layout tab.
6. Under Tray Selection, in the Paper Source drop-down list, select Multi Purpose Tray.
7. Click Advanced.
8. Below Paper/Output, click the down arrow to open the drop-down list.
9. Click "PostScript Custom Page Size."
10. Enter the width and length measurements.
See "Custom Size Ranges" on page 217.
11. Select the Paper Feed Direction.
Long Edge First = media feeds in long edge first
Short Edge First = media feeds in short edge first
Long Edge First (flipped) = Reserved for future use.
Short Edge First (flipped) = Reserved for future use.
12. Change any other settings as desired.
13. Click OK.
14. The Advanced Options screen appears.
15. Change any other settings as desired.
16. Click OK.
17. The Paper Quality tab screen appears.
18. Change any other settings as desired.
19. Click OK.
20. The main Print screen appears.
21. Change any other settings as desired.
22. Click OK. The document prints.

Windows PCL

For more information,

General Information: see page 216

Restrictions: see page 218

Custom Size Ranges: see page 217

Special Print Media (Paper): see page 219

1. Open the file you want to print.
2. Click File → Print.
3. Select your printer.
4. Click Properties (or Setup, or your application's equivalent).
5. Click the Setup tab.
6. Under Media, in the Size drop-down list, select User Defined Size.
7. The Set Free Size dialog box appears.

NOTE

You may see a Warning dialog box indicating a conflict. If you do, click OK. The driver automatically makes the needed changes to correct for the conflict.

8. Select the unit of measurement.
9. Enter the width and length measurements.
See "Custom Size Ranges" on page 217.
10. Click OK.
11. Make sure that User Defined now appears in the Size list on the Setup tab.
12. You now have two choices.
If you only want to use your settings for this single print job, go to the next step.
If you want to save your settings for future use, below.
13. Change any other settings as desired.
14. Click OK.
15. The main Print screen appears.
16. Change any other settings as desired.
17. Click OK.

18. The document prints.

Save the Setting for Future Use

- 1.** Click Paper Feed Options.
- 2.** Click Custom Size.
- 3.** At Name, give your custom size a name.
- 4.** Change any other settings as desired.
- 5.** Click Add. Click OK.
- 6.** Click OK.

The Custom Page Size is added to the bottom of the Paper Size list.

- 7.** Change any other settings as desired.
- 8.** Click OK.
- 9.** The main Print screen appears.
- 10.** Change any other settings as desired.
- 11.** Click OK.
- 12.** The document prints.

Macintosh OS 10.2 and 10.3

This feature does not work with these operating systems.

Duplex Printing

(Printing on Both Sides of the Paper)

General Information

The Duplex Unit enables your printer to print on both sides of the page.

For more information,

- Paper Types: see page 223
- Paper Sizes: see page 224
- Paper Weights: see page 223
- Long Edge vs. Short Edge: see page 224
- Duplexing Restrictions: see page 225
- Windows, PostScript
 - All Jobs (Default): see page 226
 - Single Job: see page 226
- Windows, PCL
 - All Jobs (Default) see page 227
 - Single Job: see page 228
- Macintosh OS 10.2: see page 229
- Macintosh OS 10.3: see page 229

Paper Types

- Paper *only*
- Cannot duplex
 - labels
 - envelopes
 - transparencies

Paper Weights

- 20 to 28-lb. US Bond
- 42 to 58 lb. Index
- 75 to 105 g/m² metric

Paper Sizes

Size	Inches	Millimeters
Letter	8½ x 11	215.9 x 279.4
Legal-14	8½ x 14	215.9 x 355.6
Legal-13.5	8½ x 13.5	215.9 x 342.9
Legal-13	8½ x 13	215.9 x 330.2
Executive	7¼ x 10½	184.15 x
A4	8.27 x 11.69	210 x 297
A5	5.71 x 8.27	145 x 210
B5	7.17 x 10.12	182 x 257

Long Edge vs. Short Edge

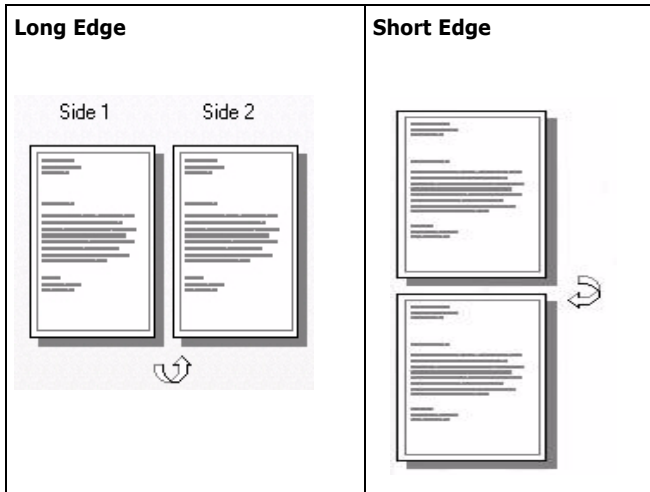

Duplexing Restrictions

1. Before you can perform duplex printing, unit must be installed in the printer
and
enabled in the driver.
2. Paper must be loaded print side *up*.
3. You can duplex
 - paper
 - paper weights up to
28 lb. US Bond
58 lb. Index
105 g/m² metric
 - *only* standard paper sizes
4. You *cannot* duplex
 - labels
 - envelopes
 - transparencies
 - paper weights above
28 lb. US Bond
58 lb. Index
105 g/m² metric
5. Any tray (Tray 1, optional Tray 2, MP tray) can be used for duplex printing.
6. Most applications allow the printer properties to be accessed from within the document print dialog box.
Application settings override driver settings.
Driver settings override printer menu settings.

Windows PostScript: All Print Jobs (Default)

For more information,

Paper Types: see page 223

Paper Weights: see page 223

Paper Sizes: see page 224

Long Edge vs. Short Edge: see page 224

Duplexing Restrictions: see page 225

To change the settings for all print jobs:

- 1.** Click Start → Settings → Printers (Printers and Faxes for XP/Server 2003).
- 2.** Right click on your printer.
- 3.** Click Properties.
- 4.** Next:
Windows XP/Server 2003: Click the General tab.
Windows 2000: Go to the next step.
- 5.** Next:
Windows XP/Server 2003: Click Printing Preferences.
Windows 2000: Go to the next step.
- 6.** Click Print on Both Sides.
- 7.** Select Flip on Long Edge or Flip on Short Edge.
See "Long Edge vs. Short Edge" on page 224.
- 8.** Change any other settings as desired.
- 9.** Click OK.
- 10.** The General tab screen appears.
- 11.** Change any other settings as desired.
- 12.** Click OK.
- 13.** The Printers and Faxes screen appears.
- 14.** Close the screen.

Windows PostScript: Single Job

For more information,

Paper Types: see page 223

Paper Weights: see page 223

Paper Sizes: see page 224

Long Edge vs. Short Edge: see page 224

Duplexing Restrictions: see page 225

To change the settings for only one print job:

1. Open the file you want to print.
2. Click File → Print.
3. Select your printer.
4. Click Properties (or Setup, or your application's equivalent).
5. Next:
Windows XP/Server 2003: Click the Layout tab.
Windows 2000: Go to the next step.
6. Next: Click Print on Both Sides
7. Select Flip on Long Edge or Flip on Short Edge.
See "Long Edge vs. Short Edge" on page 224.
8. Change any other settings as desired.
9. Click OK.
10. The main Print screen appears.
11. Change any other settings as desired.
12. Click OK.
13. The document prints.

Windows PCL: All Print Jobs (Default)

For more information,

Paper Types: see page 223

Paper Weights: see page 223

Paper Sizes: see page 224

Long Edge vs. Short Edge: see page 224

Duplexing Restrictions: see page 225

To change the settings for all print jobs:

1. Click Start → Settings → Printers (Printers and Faxes for XP/Server 2003).
2. Right click on your printer.
3. Click Properties.
4. Next:
Windows XP/Server 2003: Click the General tab.
Windows 2000: Go to the next step.
5. Next:
Windows XP/Server 2003: Click Printing Preferences.
Click the Setup tab.
Windows 2000: Go to the next step.
6. Next: Click Print on Both Sides.
7. Under 2-Sided Printing, select Long Edge or Short Edge.
See "Long Edge vs. Short Edge" on page 224.
8. Change any other settings as desired.
9. Click OK.
10. The Properties screen appears.
11. Change any other settings as desired.
12. Click OK.
13. The Printers and Faxes screen appears.
14. Close the screen.

Windows PCL: Single Print Job

For more information,

Paper Types: see page 223

Paper Weights: see page 223

Paper Sizes: see page 224

Long Edge vs. Short Edge: see page 224

Duplexing Restrictions: see page 225

To change the settings for only one print job:

1. Open the file you want to print.
2. Click File → Print.
3. Select your printer.

4. Click Properties.
5. Click the Setup tab (if necessary)
6. Under 2-Sided Printing, select Long Edge or Short Edge.
See "Long Edge vs. Short Edge" on page 224.
7. Change any other settings as desired.
8. Click OK.
9. The main Print screen appears.
10. Change any other settings as desired.
11. Click OK.
12. The document prints.

Macintosh OS 10.2

For more information,

Paper Types: see page 223

Paper Weights: see page 223

Paper Sizes: see page 224

Long Edge vs. Short Edge: see page 224

Duplexing Restrictions: see page 225

1. Open the file you want to print.
2. Click File → Print.
3. Select your printer.
4. Open the drop-down menu at left.
5. Select Duplex.
6. From the Duplex screen, make your choices.
For Duplexing (printing on both sides of the sheet), select Print on Both Sides.

Select which Binding you prefer. Normally, the first option is the default.

See "Long Edge vs. Short Edge" on page 224.
7. Click OK.
8. Print the document.

Macintosh OS 10.3

For more information,

General Information: see page 223

Paper Types: see page 223

Paper Sizes: see page 224

Paper Weights: see page 223

Duplexing Restrictions: see page 225

Long Edge vs. Short Edge: see page 224

- 1.** Open the file you want to print.
- 2.** Click File → Print.
- 3.** Select your printer.
- 4.** Open the drop-down menu directly below your printer name.
- 5.** Select Layout.
- 6.** Under Two Sided Printing, select the binding.
See "Long Edge vs. Short Edge" on page 224.
- 7.** Click OK.
- 8.** Print the document.

Grayscale

This feature is described in the Color Matching section.
See “Grayscale” on page 231.

N-Up Printing

Printing Multiple Pages on One Sheet

General Information

N-Up printing allows you to reduce several full-size pages and print them on a single sheet.

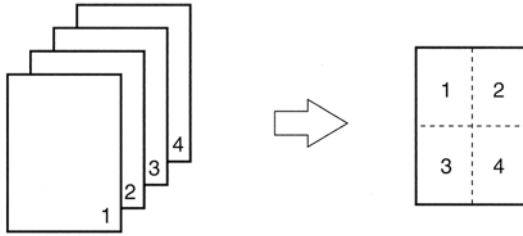

For more information,

Windows, PostScript: see page 233

Windows, PCL: see page 234

Macintosh: see page 235

Windows PostScript

NOTE

Most applications allow the printer properties to be accessed from within the document print dialog box. Settings in your applications override settings in the printer driver.
Settings in the printer driver override settings in the printer menus.

For more information, see “General Information” on page 232.

1. Open the file you want to print.
2. Click File → Print.
3. Select your printer.
4. Click Properties (or Setup, or your application’s equivalent).
5. Select the required number of pages per sheet.
Windows XP/Server 2003: Click the Layout tab. Under Pages Per Sheet, select the required number.
Windows 2000: Under Pages Per Sheet.
6. Change any other settings as desired.
7. Click OK.
8. The main Print screen appears.
9. Change any other settings as desired.
10. Click OK.
11. The document prints.

NOTE

Most applications allow the printer properties to be accessed from within the document print dialog box. Settings in your applications override settings in the printer driver.
Settings in the printer driver override settings in the printer menus.

For more information, see "General Information" on page 232.

1. Open the file you want to print.
2. Click File → Print.
3. Select your printer.
4. Click Properties (or Setup, or your application's equivalent).
5. Select the required number of pages per sheet.
Windows XP/Server 2003: Click the Setup tab (if necessary). Under Finishing Mode.
Windows 2000: Under Finishing Mode
6. Click the Options button. Select the Page Borders, Page Layout and Bind Margin.
7. Click OK.
8. The Setup tab screen appears.
9. Change any other settings as desired.
10. Click OK.
11. The main Print screen appears.
12. Change any other settings as desired.
13. Click OK. The document prints.

NOTE

Most applications allow the printer properties to be accessed from within the document print dialog box. Settings in your applications override settings in the printer driver.
Settings in the printer driver override settings in the printer menus.

For more information, see “General Information” on page 232.

This section ONLY applies to the Oki Printer Driver (Max OS 10.2+).

For other drivers, refer to the guidelines provided by each driver’s manufacturer.

- 1.** Open the file you want to print.
- 2.** Click File → Print.
- 3.** Select your printer.
- 4.** Open the drop-down menu directly underneath the printer.
- 5.** Select Layout.
- 6.** From the Layout screen, make your choices.
 - a. At Pages per sheet, select the required number of pages per sheet.
 - b. At Layout Direction, select the way the pages are arranged on the sheet.
 - c. At Border, select a border between the sheets, if desired.
- 7.** To print, click Print.
or
To save, click Save Settings.
- 8.** Close the printer dialog box.

Photographs

General Information

For the best quality when printing photographs, select Photo Enhance in the driver.

For more information, see “Print Resolution” on page 239.

Posters

General Information

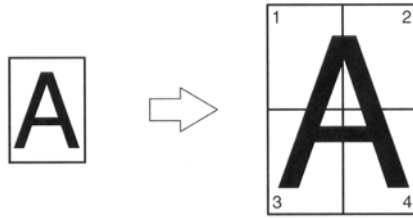

This option allows you to print posters by dividing a single document page into multiple pieces. Each piece prints, enlarged, on a separate sheet. Then, you combine the separate sheets to create a poster.

Poster Print is only available with the Windows PCL printer driver and Mac OS 9.x.

NOTE

Most applications allow the printer properties to be accessed from within the document print dialog box. Settings in your applications override settings in the printer driver. Settings in the printer driver override settings in the printer menus.

- Windows, PostScript: This feature is not available in this operating system
- Windows, PCL: see below.
- Macintosh OS 10.2 and 10.3: This feature is not available in these operating systems

Windows PCL

For more information, see "General Information" on page 237.

1. Open the file you want to print.
2. Click File → Print.

- 3.** Select your printer.
- 4.** Click Properties (or Setup, or your application's equivalent).
- 5.** Click the Setup tab. Under Finishing Mode, select Poster Print.
- 6.** Click Options. Adjust the configuration details.
- 7.** Click OK.
- 8.** The Setup tab screen appears.
- 9.** Change any other settings as desired.
- 10.** Click OK.
- 11.** The main Print screen appears.
- 12.** Change any other settings as desired.
- 13.** Click OK.
- 14.** The document prints.

Print Resolution

General Information

Adjusting the resolution for a print job allows you to control the print speed and print quality of a job. Adjusting the resolution also allows you to improve your toner mileage.

When printing proofs or drafts, you usually don't need the best possible print quality. You usually do need the fastest possible print speed. Using a lower print resolution can accomplish these goals.

Lowering the print resolution can reduce the need for toner and the wear on the image drum. This increases the mileage of your toner and drum.

Raising the print resolution can maximize the image quality of a print job. You usually do this for final versions of documents or when printing images (photographs).

For more information,

Windows, All Print Jobs (Default) : see page 241

Windows, Single Print Job: see page 242

Macintosh OS 10.2 and 10.3: see page 242

Resolution Choices

High Quality

The best quality image the printer provides.

Choose this for optimum results when printing graphics.

Fine/Detail (600 x 1200)

high resolution printing

Normal (600 x 600)

standard resolution. The default.

Image Smoothing

PostScript only

Refines the jagged or blurred appearance of images and/or text that often results after scaling an image.

Draft (600 x 600)

PCL only

lower resolution

Photo Enhance

PCL only

The best quality when printing photographs

Choose this for optimum results when printing photographs.

Windows, All Print Jobs (Default)

For more information, see "General Information" on page 239.

- 1.** Click Start → Settings → Printers (Printers and Faxes for XP/Server 2003).
- 2.** Right click on your printer.
- 3.** Click Properties.
- 4.** Click the General tab (if necessary).
- 5.** Click Printing Preferences.
- 6.** Click the Job Options tab.
- 7.** Under Quality, make your selection.
For more information, see "Resolution Choices" on page 240.
- 8.** Change any other settings as desired.
- 9.** Click OK.
- 10.** The General tab screen appears.
- 11.** Change any other settings as desired.
- 12.** Click OK.
- 13.** The Printers and Faxes screen appears.
- 14.** Close the screen.

Windows, Single Print Job

For more information, see “General Information” on page 239.

1. Open the file you want to print.
2. Click File → Print.
3. Select your printer.
4. Click Properties.
5. Click the Job Options tab.
6. Under Quality, select the required printing resolution.
For more information, see “Resolution Choices” on page 240.
7. Change any other settings as desired.
8. Click OK.
9. The main Print screen appears.
10. Change any other settings as desired.
11. Click OK.
12. The document prints.

Macintosh OS 10.2 and 10.3

For more information, see “General Information” on page 239.

1. Open the file you want to print.
2. On File, click Print.
3. In the Printer Function panel, under Print Quality, make your choice.
Fast: 600 x 600 dpi
Fine: 600 x 1200 dpi
4. Click OK.
5. Print the document.

Save as File

(Print to File)

General Information

Use Save as File to save print data to a file, without actually printing a hardcopy.

Save as File captures either a PDF or a PostScript file.

You can use the LPR Utility to print the saved file.

See "Direct Network Printing Utility (LPR)" on page 278.

For more information,

Windows, Single Print Job: see page 244

Windows, All Print Jobs (Default): see page 244

Macintosh OS 10.2 and 10.3: see page 245

Windows, Single Print Job

For more information, see "General Information" on page 243.

1. Open the file you want to print.
2. Click File → Print.
3. Select your printer.
4. At Print to File, make your selection.
 - If the box has a check mark, the feature is ON.
 - If the box is empty, the feature is OFF.
5. Click OK.
6. Next:
 - select where to save the file
 - give the file a name
 - determine the type of the file
7. Click OK.
8. The document "prints."

Windows, All Print Jobs (Default)

For more information, see "General Information" on page 243.

1. Click Start → Settings → Printers (Printers and Faxes for XP/Server 2003).
2. Right click on your printer.
3. Click Properties.
4. On the Ports tab, select File: Print to File.
5. Click OK.

Macintosh OS 10.2 and 10.3

For more information, see “General Information” on page 243.

1. Open the file you want to print.
2. Click File → Print.
3. In Output Options, select Save as File.
4. In Formats, select PostScript.
5. In the PostScript Settings panel, make your choices for this print job.

Type: specify the PostScript type.

PostScript Level: this must match the PostScript level of your printer.

Format: select ASCII or Binary. If you select Binary, make sure that binary data transfer is supported.

Font Data: specify downloading fonts to the file. If you are only using PostScript fonts, select None.

6. Click Save.
7. At Save as a new name, enter the desired filename.
8. Specify where you want the file saved (location).
9. Click Save.

Toner Saving

General Information

Use Toner Save to maximize the life of your toner cartridges.

Toner Save uses less toner to create the printed images. Toner Save adjusts the darkness of the color halftones. Images may appear lighter than normal.

Print quality is reduced when toner saving is used.

For more information,

Windows, Single Print Job: see page 247

Windows, All Print Jobs (Default): see page 248

Macintosh OS 10.2 and 10.3: see page 248

NOTES

1. Toner Save does not work if you are printing 100 per cent black.
2. Toner Save does not work if Gray Scale is the selected print mode.
3. Toner Save does not work with applications that allow CMYK printing when using a PostScript driver.
4. Toner Save does not work with applications and operating systems that create print data in CIE color space.

Windows, Single Print Job

For more information, see "General Information" on page 246.

- 1.** Open the file you want to print.
- 2.** Click File → Print.
- 3.** Select your printer.
- 4.** Click Properties.
- 5.** Click the Color tab.
- 6.** At Toner Saving, make your selection.
Print quality is reduced when toner saving is used.
If the box has a check mark, the feature is ON.
If the box is empty, the feature is OFF.
- 7.** Change any other settings as desired.
- 8.** Click OK.
- 9.** The main Print screen appears.
- 10.** Change any other settings as desired.
- 11.** Click OK.
- 12.** The document prints.

Windows, All Print Jobs (Default)

For more information, see "General Information" on page 246.

1. Click Start → Settings → Printers (Printers and Faxes for XP/Server 2003).
2. Right click on your printer.
3. Click Printing Preferences.
4. Click the Color tab.
5. At Toner Saving, make your selection.
Print quality is reduced when toner saving is used.
If the box has a check mark, the feature is ON.
If the box is empty, the feature is OFF.
6. Change any other settings as desired.
7. Click OK.

Macintosh OS 10.2 and 10.3

For more information, see "General Information" on page 246.

1. Click File → Print.
2. Select your printer.
3. Open the drop-down menu. Select Printer Features.
4. In Feature Sets, select Set 3.
5. At Toner Saving, make your selection.
Print quality is reduced when toner saving is used.
If the box has a check mark, the feature is ON.
If the box is empty, the feature is OFF.

Watermarks

General Information

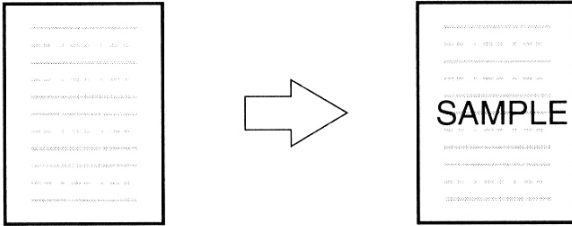

Traditionally, a watermark is a mark which is made on some types of paper during its production which can only be seen if it is held against the light.

Your printer can print an element that performs as a watermark. This element is separate from the actual contents of a document. Examples are printing **SAMPLE** or **INTERNAL USE ONLY** on copies of document.

There are three steps in working with Watermarks:

- 1.** Create a watermark.
- 2.** Edit a watermark.
- 3.** Print, using a watermark.

For more information,

Windows, PostScript: see page 250

Windows, PCL: see page 253

Macintosh OS 10.2 and 10.3: This feature is not available in these operating systems

Windows PostScript

Create a Watermark

For more information, see “General Information” on page 249.

1. Open the file you want to print.
2. Click File → Print.
3. Select your printer.
4. Click Properties.
5. Click the Job Options tab.
6. Click Watermarks.
7. Click New.
8. Enter the text for your watermark.
9. Select the attributes (font, size, angle) for your watermark.
10. Click OK.

The new watermark appears in the Watermark list.

Windows PostScript

Edit a Watermark

For more information, see “General Information” on page 249.

1. Open the file you want to print.
2. Click File → Print.
3. Select your printer.
4. Click Properties.
5. Click the Job Options tab.
6. Click Watermarks.
7. Select a name from the watermark list.
8. Click Edit.
9. Modify the text for your watermark.
10. Modify the attributes (font, size, angle) for your watermark.
11. Click OK.
12. The Watermarks main screen appears.
13. Change any other settings as desired.
14. Click OK.
15. The Job Options tab screen appears.
16. Change any other settings as desired.
17. Click OK.
18. The main Print screen appears.
19. Change any other settings as desired.
20. Click OK.
21. The document prints.

Windows PostScript

Print, using a Watermark

For more information, see “General Information” on page 249.

1. Open the file you want to print.
2. Click File → Print.
3. Select your printer.
4. Click Properties.
5. Click the Job Options tab.
6. Click Watermarks.
7. The Watermarks main screen appears.
8. Select a name from the watermark list.
9. Adjust where and how the watermark prints, if necessary.
Choices are: First page only, Print in background.
10. Click OK.
11. The Job Options tab screen appears.
12. Change any other settings as desired.
13. Click OK.
14. The main Print screen appears.
15. Change any other settings as desired.
16. Click OK.
17. The document prints.

Windows PCL

Create a Watermark

For more information, see “General Information” on page 249.

- 1.** Open the file you want to print.
- 2.** Click File → Print.
- 3.** Select your printer.
- 4.** Next:
Windows XP/Server 2003: Click Properties (or Setup, or your application’s equivalent).
Windows 2000: Click the Job Options button.
- 5.** Next:
Windows XP/Server 2003: Click Job Options. Click Watermark.
Windows 2000: Click Watermark.
- 6.** The Watermark dialog box appears.
- 7.** Click New.
- 8.** Enter the text for your watermark.
- 9.** Select the attributes (font, size, angle) for your watermark.
- 10.** Click OK.
The new watermark appears in the Watermark list.
- 11.** Click OK.
- 12.** The Job Options tab screen appears.
- 13.** Change any other settings as desired.
- 14.** Click OK.
- 15.** The main Print screen appears.
- 16.** Change any other settings as desired.
- 17.** Click OK. The document prints.

Windows PCL

Edit a Watermark

For more information, see “General Information” on page 249.

- 1.** Open the file you want to print.
- 2.** Click File → Print.
- 3.** Select your printer.
- 4.** Next:
 - Windows 2000: Click the Job Options tab.
 - Windows XP/Server 2003: Click Properties (or Setup, or your application’s equivalent).
- 5.** Next:
 - Windows XP/Server 2003: Click Job Options. Click Watermark.
 - Windows 2000: Click Watermark.
- 6.** The Watermark dialog box appears.
- 7.** Select a name from the watermark list.
- 8.** Click Edit.
- 9.** Modify the text for your watermark.
- 10.** Modify the attributes (font, size, angle) for your watermark.
- 11.** Click OK.
- 12.** The main Watermark screen appears.
- 13.** Click OK.
- 14.** The Job Options tab screen appears.
- 15.** Change any other settings as desired.
- 16.** Click OK.
- 17.** The main Print screen appears.
- 18.** Change any other settings as desired.
- 19.** Click OK. The document prints.

Windows PCL

Print, using a Watermark

For more information, see “General Information” on page 249.

1. Open the file you want to print.
2. Click File → Print.
3. Select your printer.
4. Next:
XP/Server 2003: Click Properties (or Setup, or your application’s equivalent).
Windows 2000: Click the Job Options tab.
5. Next:
Windows XP/Server 2003: Click Job Options. Click Watermark.
Windows 2000: Click Watermark.
6. The Watermark dialog box appears.
7. Select a name from the watermark list.
8. Adjust where and how the watermark prints, if necessary.
Choices are: First page only, All Pages.
9. Click OK.
10. The Job Options tab screen appears.
11. Change any other settings as desired.
12. Click OK.
13. The main Print screen appears.
14. Change any other settings as desired.
15. Click OK.
16. The document prints.

Macintosh OS 10.2 and 10.3

This feature is not available in these operating systems.

Utilities

The following utilities are provided on the CD shipped with your printer.

- Color Correction Utility see page 261
- Color Swatch Utility see page 274
- Direct Network Printing Utility (LPR) see page 278
- Display Language Utility see page 280
- Network Print Status Utility see page 281
- Network Setup Utility see page 285
- PS Gamma Adjuster Utility see page 286

The following utilities are provided via download.

- OKI Profile Assistant
- Print Job Accounting Utility
- PrintSuperVision
- Storage Device Manager
- Web Driver Installer

Descriptions of Utilities

1. Color Correction Utility

This utility allows you to fine tune the printer's color settings and save them for future use.

See "Color Correction Utility" on page 261.

2. Color Swatch Utility

This utility allows you to print color samples or swatches on your color printer. The swatches are used with your software program to select and reproduce color accurately. The swatches represent selected samples of the your printer's color palette and can be used to find the desired colors for your printed documents.

See "Color Swatch Utility" on page 274.

3. Direct Network Printing Utility (LPR)

The Direct Network Printing Utility (LPR) allows you to print directly to a printer on the network without a print server. It creates a Printer Port, and installs a pop-up status box so you can monitor printer status.

The Direct Network Printing Utility (LPR) operates in Windows 2000, XP and Server 2003 operating systems.

See "Direct Network Printing Utility (LPR)" on page 278.

4. Display Language Utility

This utility allows you to change the language of the front panel of your printer.

See "Display Language Utility" on page 280.

5. Network Print Status Utility

This utility allows you to view (but not change) the status of the following on the Status tab:

- paper trays installed and the media assigned to them.
- total size and percentage used of disk/memory.
- percentage of toner remaining.

See "Network Printer Status Utility" on page 281.

6. Network Setup Utility

This utility provides an easy way to configure your printer on a network.

See the online Network User's Guide for details on how to use this utility. See "Network Setup Utility" on page 285.

7. Oki Profile Assistant

This utility helps you to load and manage color profiles.

For more information, see the on-line help in the utility.

8. Print Job Accounting Utility

The Print Job Accounting software, designed specifically for Sharp printers in a network environment, provides job accounting features that allow you to track printer usage, calculate printing costs, and specify access available to each client (user).

9. PrintSuperVision

PrintSuperVision is a web-based application for managing printing devices connected to a network. PrintSuperVision provides access to networked printer data for monitoring, reporting and managing networked printers. It provides a full range of management functions for Sharp printers, and for other brands of printers as well.

10. PS Gamma Adjuster Utility

The PS Gamma Adjuster Utility allows you to customize the CMYK data curves used with your printer driver. Once you have created the customized curve in the utility, you must save the curve (new PPD). Then, you must reconfigure your printer driver to use the new PPD.

See "PS Gamma Adjuster Utility" on page 286.

11. Storage Device Manager

This utility allows you to manage the printer's internal flash memory and hard disk drive. It also lets you download files, overlays, etc. to the internal memory and hard disk drive.

12. Web Driver Installer

This utility is a web-based application. It automates tasks for a network administrator.

- Discovering printers connected to a TCP/IP network
- Displaying discovered printers on a web page
- Sending users e-mail notification of the URL that permits the downloading of printer driver installation programs for discovered printers.

Administrators can use this utility to manage printers and users organized in groups, such as departments or floors.

Installing the Utilities

Windows

Utilities on the CD

Load the utilities from the Menu Installer located on the CD supplied with your printer.

Download Utilities

Download the utilities from the internet, accessed through the Menu Installer on the CD.

Macintosh OS 10.2 and 10.3

Utilities on the CD

The utilities on the CD are not available for Mac OS 10.2 and 10.3.

Download Utilities

Download the utilities from the internet, accessed through the Menu Installer on the CD.

Color Correction Utility ---

General Information

This utility allows you to fine tune the printer's color settings and save them for future use.

The Color Correct Utility is the best choice for working with Microsoft Excel or Word.

You can use the Color Correct Utility to:

- Change the Pallet Color: see page 262
- Adjust the Gamma Value and Hue: see page 270

How to Install

Load this program from the Menu Installer located on the CD.

Additional Information

For more information, see the on-line help in the utility.

Change the Pallet Color

General Information

NOTES

This feature is not available for Windows Me/98.
This feature is not available for shared printers.
When test printing, use paper larger than B5 size.

There are four steps in changing the Pallet Color.

- 1.** Print the Sample Color Chart.
See page 263.
- 2.** Print the Color Adjustment Chart.
See page 264.
- 3.** Make the adjustments. Save the adjustments, using a name you select.
See page 266.
- 4.** When printing a document, select the name of the saved adjustment settings.
See page 269.

Change the Pallet Color

Step 1: Print the Sample Color Chart

- 1.** Click Start → Programs → All Applications.
Windows XP/Server 2003
Click Start → Programs → Okidata → Color Correct Utility → Color Adjustment Utility.
- 2.** Select Adjust Pallet Color. Click Next.
- 3.** The Select Printer screen appears. Select the printer you are using. Click Next.
The Color Correct Utility starts.
Installed printer drivers display. You must setup each driver.
- 4.** The Select Setting screen appears. From the list, select the desired setting. Click Sample Print.
- 5.** The Sample Color Chart prints.

Change the Pallet Color

Step 2: Print the Color Adjustment Chart

First, you must perform the steps in "Step 1: Print the Sample Color Chart" see page 263.

6. Click Next.

7. The Pallet Color Matching screen appears.

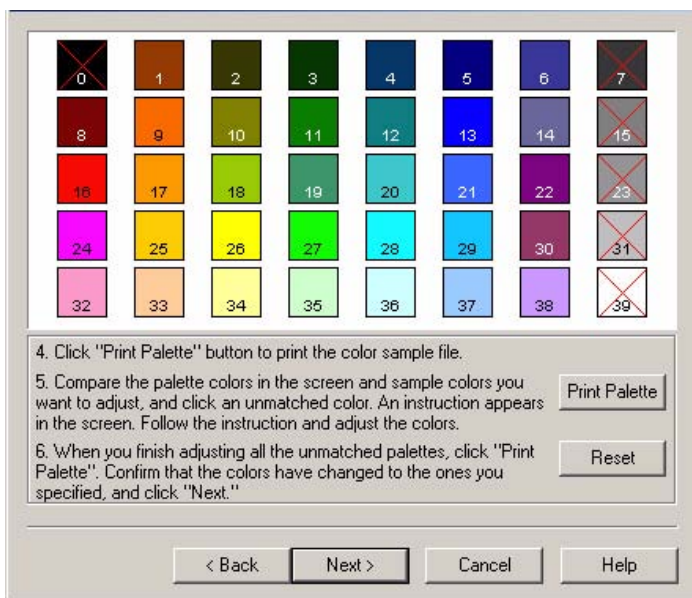

8. Click Test print.

The Color Adjustment Chart prints.

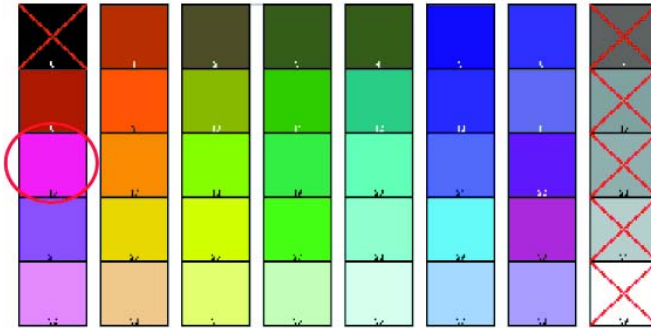

9. Compare the printed Color Adjustment Chart to the Pallet Color Matching screen.

If the printed colors do not match the screen, perform an adjustment.

You cannot adjust colors marked with an X.

Change the Pallet Color

Step 3: Make the adjustments and save the settings

First, you must perform the steps in "Step 1: Print the Sample Color Chart" see page 263 and "Step 2: Print the Color Adjustment Chart" see page 264.

When making the adjustments, you are obtaining the best possible match between the values for Hue and Brightness on your Sample Color Chart and the Pallet Color Matching screen.

10. On the Pallet Color Matching screen, click the color you want to adjust.

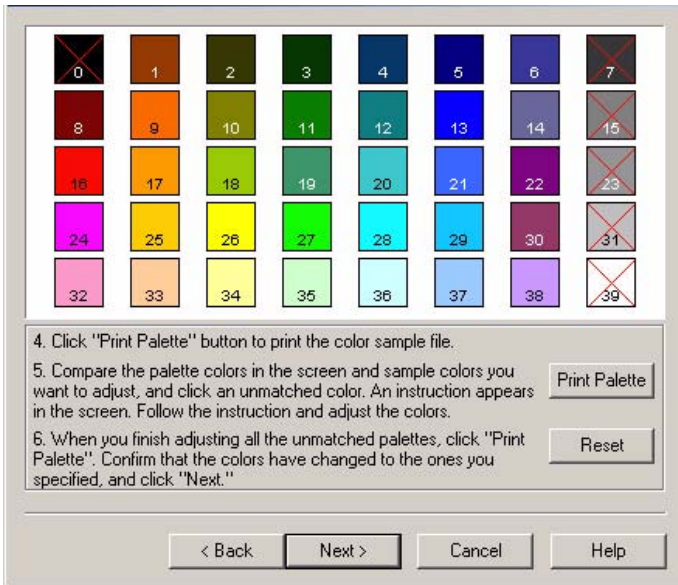

- 11.** The Enter Adjustment Value screen appears.
 - View the pull down menus for the Hue (X) and Brightness (Y) values.
 - You are finding the available ranges for both Hue (X) and Brightness (Y).
 - The available ranges (values) vary according to color.
- 12.** Use the Sample Color Chart.
 - Find the color you want to adjust.
 - Locate the desired color within the identified available ranges (values) from Step 10.
 - Find the values for both Hue (X) and Brightness (Y)
- 13.** On the Pallet Color Matching screen, click the color you want to adjust.
 - The Enter Adjustment Value screen appears.
 - View the pull down menus for the Hue (X) and Brightness (Y) values.
 - Adjust the values for Hue and Brightness to match the values from Step 11.

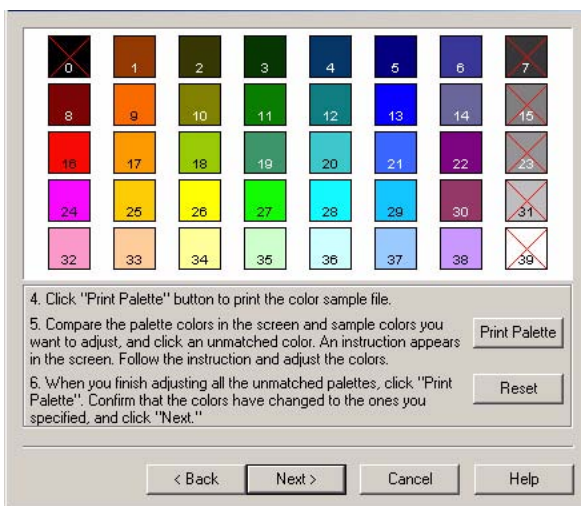

14. Click OK.

15. The Pallet Color Matching screen appears.

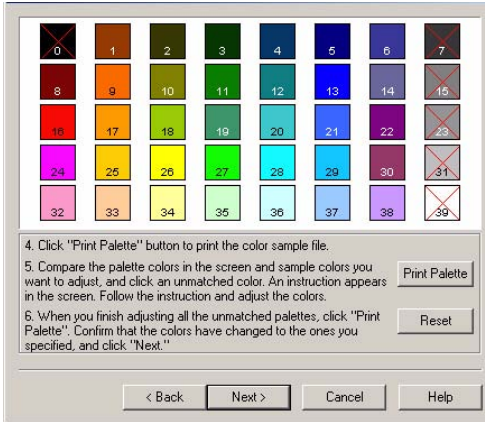

16. Click Test Print.

The Color Adjustment Chart prints.

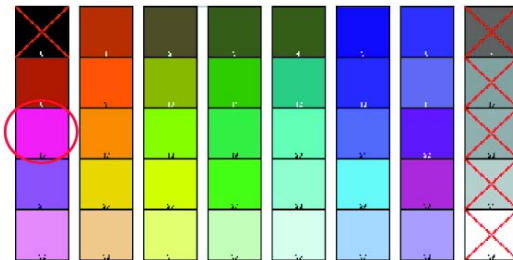

17. Compare the printed Color Adjustment Chart to the Pallet Color Matching screen.

- If you are satisfied with the comparison, go to the next step.
- If you are not satisfied, repeat steps 10 through 16.

18. If you have another color you want to adjust, repeat 10 through 16.

19. When you have finished adjusting all desired colors, click Next.

20. Enter the setting name. Remember the name for future use.

21. Click Save.

22. Click OK.

Change the Pallet Color

Step 4: Use the saved settings to print a document

Windows

- 1.** Open the file you want to print.
- 2.** Click File → Print.
- 3.** Select your printer.
- 4.** Next:
 - Windows XP/Server 2003: Click Properties. Click Advanced.
 - Windows 2000: go to the next step.
- 5.** On the Color tab, under Color Mode, under User Setting, select the Color Matching name you created using the Color Correct Utility
- 6.** Click OK.
- 7.** Print the document.

Adjust the Gamma Value and Hue

General Information

NOTES

This feature is not available for Windows Me/98.
This feature is not available for shared printers.
When test printing, use paper larger than B5 size.
You must have Administrator authority when setting up a network connection in Windows XP/2000/Server 2003.

- 1.** Click Start → Programs → All Applications.
- 2.** Next:
 - Windows XP/Server 2003: Click Okidata → Color Correct Utility → All Applications.
 - Windows 2000: Go to the next step.
- 3.** Select Correct gamma and hue.
- 4.** Click Next.
- 5.** The “Select printer” screen appears. Select the printer you want to adjust.
- 6.** Click Next.
- 7.** The Color Correct Utility starts.
 - The installed printer drivers display.
 - You must setup the Color Correct Utility for each driver.
- 8.** In the list box, select the mode.
- 9.** Click Next.

- 10.** Change the slide bar values of gamma, hue, brightness, and saturation to adjust the color.

Use primary colors of ink

Select this to adjust the settings to the standard hues for the printer.

Hue	Toner printing
R (Red)	50% yellow and 50% magenta
Y (Yellow)	100% yellow
G (Green)	50% cyan and 50% yellow
C (Cyan)	100% cyan
B (Blue)	50% magenta and 50% cyan
M (Magenta)	100% magenta

The Gamma slide bar adjusts *total* brightness.

The Hue/Brightness slide bar adjusts output color.

Use the printer color buttons to switch to a different color.

Brightness

For Brighter color, slide the Gamma bar to the *left*.

Hue

Adjustments are made relative to positions on the color wheel.

Move forward = + (counter-clockwise)

Move backward = - (clockwise)

Example: adjust the Y (yellow) slide bar:

Move forward = + (counter-clockwise), the color becomes more green.

Move backward = - (clockwise), the color becomes more red.

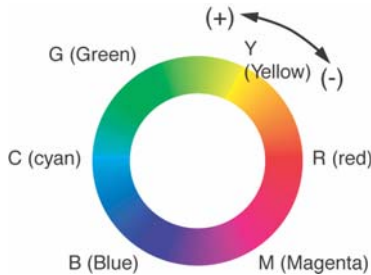

11. Click Test Print.

12. The Adjustment Confirmation Sample prints.

13. If the sample meets your requirements, click Set.

If the sample does not meet your requirements, repeat Steps 10 - 12 until your requirements are met. Then, click Set.

14. Click Save.

15. Enter the setting name.

16. Click OK.

17. Click OK.

NOTE

When you update or reinstall a printer driver, the Color Correct Utility reloads the created Color Matching names. Make sure that the Color Matching names appear in the [Setting Selection]. Click Complete.

18. Click Complete to exit the Color Correct Utility.

19. When printing a document, select the setting name.

Adjusting the Gamma Value and Hue

Use the saved settings to print a document Windows

1. Open the file you want to print.
2. Click File → Print.
3. Select your printer.
4. Next:
Windows XP/Server 2003: Click Properties. Click Advanced.
Windows 2000: Go to the next step.
5. On the Color tab, under Color Mode, under User Setting, select the Color Matching name you created using the Color Correct Utility.

NOTE

When you update or reinstall a printer driver, the Color Correct Utility reloads the created Color Matching names. Make sure that the Color Matching names appear in the [Setting Selection]. Click End.

6. Click OK.
7. Print the document.

Color Swatch Utility

General Information

The Color Swatch Utility allows you to

- print color samples (swatches) on your color printer.
- create custom color swatches

The swatches are used with your software program to select and reproduce color accurately.

The swatches represent selected samples of the printer's color palette. Use the swatches to find the desired colors for your printed documents.

NOTE

- **The Swatch Utility does not guarantee that the printer prints the same color as displayed on your monitor. Consider the displayed color as a reference.**
- **The printer may not be able to print the exact color that you desire.**
- **Your software may not be able to match colors using the swatch information. You may need to use other matching methods.**
- **The color swatch samples do not show all the colors your printer can print.**
- **Other factors influence how you see color: the color and finish of the paper, ambient light, even the color surrounding the one you are looking at.**

How to Install

Load this program from the Menu Installer located the CD.

Additional Information

For additional information, see the Swatch Utility Read-me file located in the Windows Programs list.

Printing Color Swatches

NOTE

- The color swatch samples do not show all the colors your printer can print.
- The Swatch Utility does not guarantee that the printer prints the same color as displayed on your monitor. Consider the displayed color as a reference.
- The printer may not be able to print the exact color that you desire.

1. Install the utility from the CD using the Menu Installer (Windows).
2. Click Start → Programs → Color Swatch → Color Swatch Utility.
3. A swatch page displays, showing commonly used colors.
4. Select print to print sample pages.

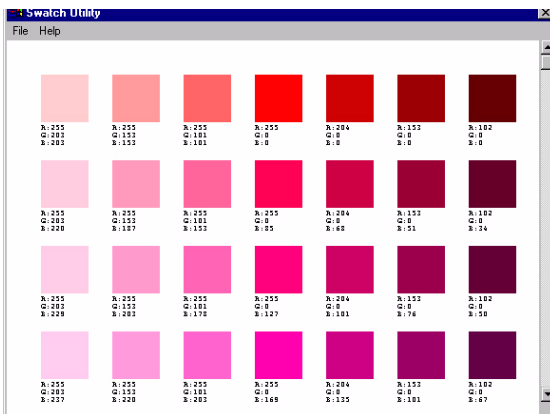

- 5.** Use the color blocks to pick the specific colors that you want to appear in your printed document.

Each color block, or sample, is identified with information your software package needs to reproduce that color accurately.

The numbers under each block specify the amounts of the primary colors—red (R), green (G), and blue (B)—that mix to form each particular shade.

The amounts are given as a numerical value between 0 and 255.

Creating Custom Swatch Colors

NOTE

The Swatch Utility does not guarantee that the printer prints the same color as displayed on your monitor. Consider the displayed color as a reference. The printer may not be able to print the exact color that you desire.

If you don't find your desired color, you can create or customize colors:

1. Select Custom Swatch from the File menu.
2. On the pop-up window, there are 3 slide bars that allow you to customize swatches:
 - Hue bar changes the hue of the swatches, for example, red to green or blue to yellow.
 - Saturation bar changes vividness.
 - Lightness bar changes darkness.
3. Adjust the bars until you see the desired color. Color variations are created to help you find the best match.
4. Click OK.
5. Print the custom swatch page.
6. Repeat these steps until you find the desired printed color.
7. For additional information, see the Swatch Utility Read-me file located in the Windows Programs list. The file includes:
 - Applying Color Value in your Application
 - Setting Monitor Color

Direct Network Printing Utility (LPR) _____

General Information

The Direct Network Printing Utility (LPR) allows you to print directly to a printer on the network without a print server. It creates a Printer Port, and installs a pop-up status box so you can monitor printer status.

The Direct Network Printing Utility (LPR) operates in Windows Windows 2000, Windows XP and Windows Server 2003 operating systems.

Load this program from the Menu Installer located the CD.

How to Install

The Direct Network Printing Utility (LPR) supports TCP/IP. Your network administrator will first need to set up an IP address and TCP/IP properties for your printer.

Your network administrator may have already installed this software. If you need to install it manually, load it from the Menu Installer on the CD:

- 1.** Place the CD supplied with your printer in your CD-ROM drive. Wait for the Menu Installer to open.
If the CD does not AutoPlay, click Start → Run → Browse. Browse to your CD-ROM. Double-click Install.exe. Click OK.
- 2.** Click Next to accept the terms in the license agreement.
- 3.** Click Optional Utilities → Install Direct Network Printing Utility. Follow the on-screen instructions.

Direct Network Printing Utility (LPR) Status Box

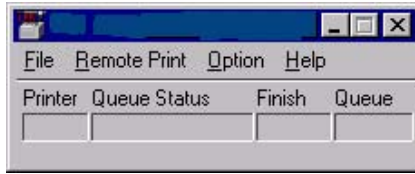

The Direct Network Printing Utility (LPR) Status Box displays the following information:

- Printers
Names of added printers (You can add up to 30 printers)
- Status
Direct Network Printing Utility (LPR) status (empty, connecting, sending, paused, checking status, not connected)
- Finish
Number of completed jobs.
- Queue
Number of jobs waiting to be printed.

Additional Information

For help, click on **HELP** in the program.

Display Language Utility ---

General Information

This utility allows you to change the language of the front panel of your printer.

How to Install

Load this program from the Menu Installer located on the CD.

Follow the onscreen instructions to change the language of the messages on the front panel.

Additional Information

For help, click on **HELP** in the program.

Network Printer Status Utility

Windows

- Available on TCP/IP network connection only.

The Network Printer Status utility is available if your administrator has installed it.

If the utility is installed, the printer driver **Properties** dialog box changes.

- a new **Status** tab is added.
- an **Option** button is added to the **Device Option** tab.

This utility allows you to view (but not change) the status of the following on the **Status** tab:

- paper trays installed and the media assigned to them.
- total size and percentage used of disk/memory.
- percentage of toner remaining.

Important!

If you select **Automatic Status Update** in the **Status** tab, the driver automatically pings the printer for the latest status information every time you open the **Properties** dialog box.

This causes a significant delay until the Properties dialog box opens.

To avoid this, use the **Update Status** button in the **Status** tab to manually update the information on demand.

General Information

This utility creates an additional tab (STATUS) in the PostScript and PCL drivers that allows the client to monitor the selected printer's status.

Load this program from the Menu Installer located on CD1.

Installation

1. Insert the Drivers, Color, and Network Utilities disk into the CD-ROM drive.

If CD does not AutoPlay, click Start → Run → Browse. Browse to your CD-ROM. Double-click Install.exe. Click OK.

2. Click Network Software → Administration Tools → Network Printer Status. Follow the on-screen instructions.

Using

1. Click Start → Settings → Printers. Right-click the Sharp Printer icon. Click Properties.
2. Click on the STATUS tab.
3. Click the UPDATE button to see device settings.

The following screen displays:

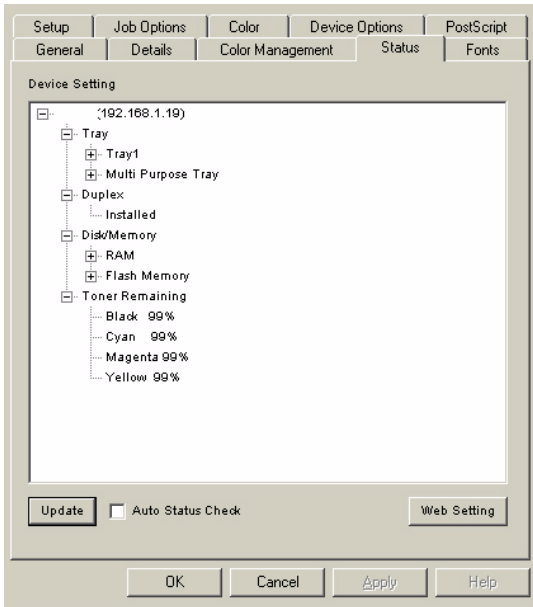

Click on an item to see this information:

Trays:	Paper Type, weight
Duplex:	Installed/not installed
Disk/Memory:	RAM size and % used; Flash Memory size and % used
Toner Remaining:	% toner remaining in all cartridges

NOTE

If the Automatic Status Check box is checked, this utility “pings” the printer every time you open the Printer Properties dialog in the printer driver. This *severely* slows opening Printer Properties.

Checking the Printer Status

Click the WEB SETTING button. The following screen displays:

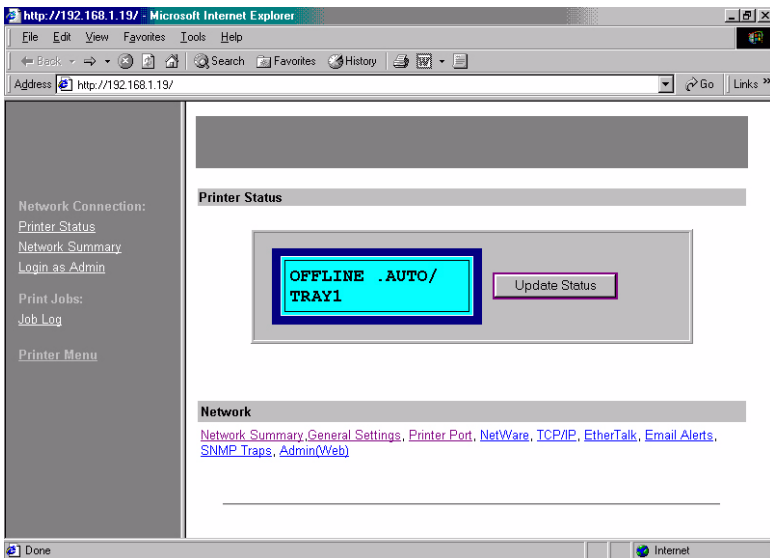

Click on the items listed on the left to see:

- Network Summary
- Login for Administrators
- Job Login
- Printer Menu

To see real-time printer status, click the UPDATE STATUS button.

Network Setup Utility ---

General Information

This utility provides an easy way to configure your printer on a network.

How to Install

Load this program from the Menu Installer located on the CD.

Additional Information

See the online Network User's Guide for details on how to use this utility. The Network User's Guide is found on the CD shipped with your printer.

PS Gamma Adjuster Utility

General Information

The PS Gamma Adjuster Utility is available in Windows and Mac OS 10.2 and 10.3. It only works with CMYK.

The PS Gamma Adjuster Utility allows you to customize the CMYK data curves used with your printer driver. Once you have created the customized curve in the utility, you must save the curve (new PPD). Then, you must reconfigure your printer driver to use the new PPD. The new setting will appear under the driver's print properties.

How to Install

Windows

The Windows version installs from the Menu Installer, under Productivity Software.

Macintosh

The PS Gamma Adjuster Utility is part of the Mac Installer. If you run the typical or classic Mac Installer, the utility is automatically installed.

If you run a Custom Install, you choose whether or not the PS Gamma Adjuster Utility is installed.

Additional Information

For more information, see the on-line help in the utility.