

Operating Instructions

PROPRIETARY TELEPHONE
FOR KX-T123210

INTEGRATED
TELEPHONE SYSTEM
MODEL NO. **KX-T123250**

EASA-PHONE

Basic Operation

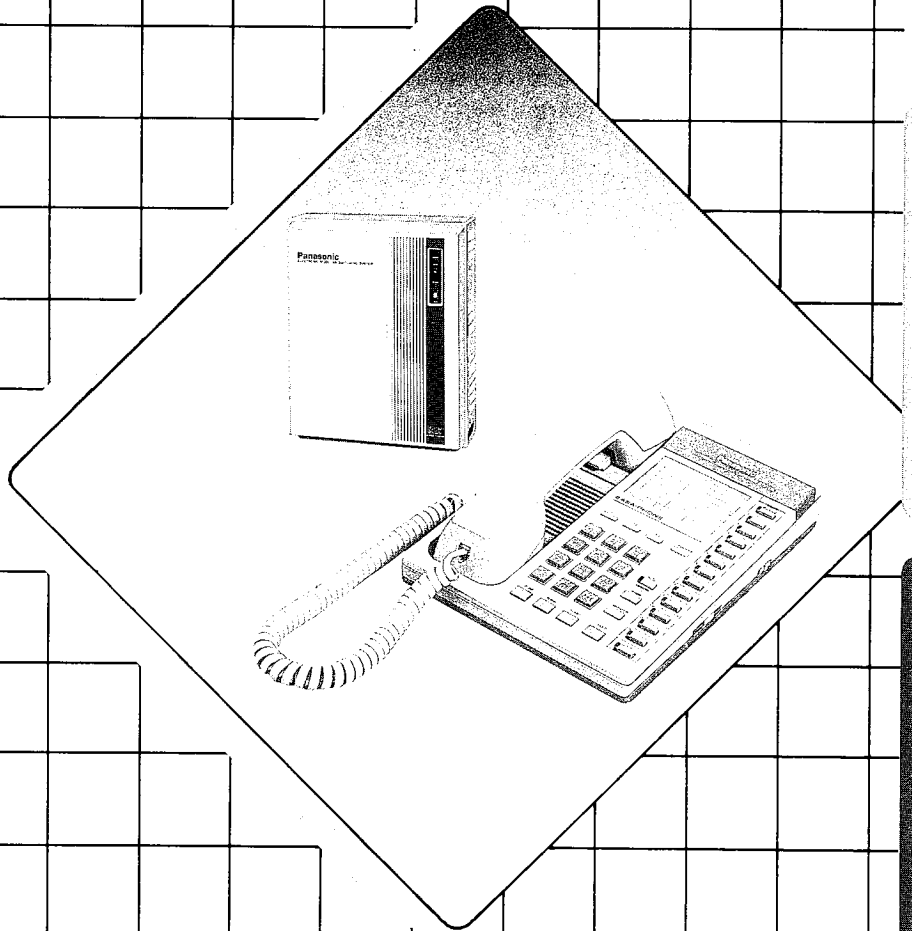

General Information

Panasonic

Please read before use.

Thank you for purchasing the Panasonic Telephone.

Features

- **Designed Exclusively** for Electronic Modular Switching Systems except KX-T616 and KX-T616D.
- **12 Flexible CO Line Buttons** for CO line access and status. These buttons can also be programmed for one button trunk group access, direct station selection (DSS) with busy lamp field (BLF), one-touch auto dialing, and one-touch system feature access.
- **Message Waiting Lamp** notifies you that a call has been received by the operator while you were away.
- **3 Programmable Soft Buttons** for one-touch access to system features such as automatic call-back and paging. Can also store numbers for automatic dialing.
- **Call Transfer** switches either outside or internal calls to another extension.
- **One-Touch Redial** lets you dial the last number dialed, up to 32 digits long, at the touch of Redial button.
- **3-Way Conference** lets you converse with two parties simultaneously whether they are internal or external calls.
- **On-Hook Dialing** with monitor speaker lets you dial without lifting the handset.

Accessories

Extension line cord	1
Handset	1
Handset cord	1

- DSS console KX-T123240 or KX-T61640 is provided as option.
See "System Component" described on the reverse of the front cover in INSTALLATION MANUAL.

- If you use a DSS console KX-T123240 or KX-T61640, you can access another extension by one touch of a DSS button instead of pressing an extension number, and system features of KX-T123210 by one touch of PROGRAMMABLE FEATURE button on a DSS console.
For further details, see OPERATING INSTRUCTIONS of KX-T123240 or KX-T61640.

For further details, see the INSTALLATION MANUAL.

Quick Reference Card



Detach this position

MAKING CALLS	
<ul style="list-style-type: none"> ● Lift the handset or press the MONITOR button first. ● After finishing your conversation, hang up the handset. 	
INTER OFFICE CALLING (Intercom)	<div style="border: 1px solid black; padding: 5px; display: inline-block;">Dial extension no. (100 through 199)</div>
OUTWARD DIALING Individual Line Access	<div style="display: flex; align-items: center;"> <div style="border: 1px solid black; padding: 2px; margin-right: 10px;">CO □</div> <div style="border: 1px solid black; padding: 5px; flex-grow: 1;">Dial phone number</div> </div>
Automatic Line Access	<div style="display: flex; align-items: center;"> <div style="border: 1px solid black; padding: 2px; margin-right: 10px;">WXY 9</div> <div style="border: 1px solid black; padding: 5px; flex-grow: 1;">Dial phone number</div> </div>
Individual Trunk Group Access	<div style="display: flex; align-items: center;"> <div style="border: 1px solid black; padding: 2px; margin-right: 10px;">TUV 8</div> <div style="border: 1px solid black; padding: 5px; margin-right: 10px;">Dial Trunk Group number (1 through 8)</div> <div style="border: 1px solid black; padding: 5px; flex-grow: 1;">Dial phone number</div> </div>
SPEED DIALING	<div style="display: flex; align-items: center;"> <div style="border: 1px solid black; padding: 2px; margin-right: 10px;">AUTO □ MEMORY</div> <div style="border: 1px solid black; padding: 5px; flex-grow: 1;">Dial speed access code (00 through 99)</div> </div>
ONE TOUCH DIALING	<div style="display: flex; align-items: center;"> <div style="border: 1px solid black; padding: 2px; margin-right: 10px;">F □</div> <div>(Press the PROGRAMMABLE FEATURE button.)</div> </div>
CALLING DOORPHONE	<div style="display: flex; justify-content: space-around;"> <div style="text-align: center;"> <p>For doorphone 1</p> <div style="display: flex; gap: 5px;"> <div style="border: 1px solid black; padding: 2px;">DEF 3</div> <div style="border: 1px solid black; padding: 2px;">1</div> <div style="border: 1px solid black; padding: 2px;">1</div> </div> </div> <div style="text-align: center;"> <p>For doorphone 2</p> <div style="display: flex; gap: 5px;"> <div style="border: 1px solid black; padding: 2px;">DEF 3</div> <div style="border: 1px solid black; padding: 2px;">1</div> <div style="border: 1px solid black; padding: 2px;">ABC 2</div> </div> </div> </div>
OPERATOR CALL	<div style="display: flex; flex-direction: column; gap: 10px;"> <div style="display: flex; gap: 10px;"> <div style="border: 1px solid black; padding: 2px;">OPER 0</div> <div style="border: 1px solid black; padding: 2px;">OPER 0</div> <div>: Operator 1</div> </div> <div style="display: flex; gap: 10px;"> <div style="border: 1px solid black; padding: 2px;">OPER 0</div> <div style="border: 1px solid black; padding: 2px;">1</div> <div>: Operator 2</div> </div> </div> <ul style="list-style-type: none"> ● In case one operator is programmed, you have only to dial 0.

WHEN A LINE IS BUSY	
AUTOMATIC CALL BACK BUSY (Camp-on) For Outside Calls	<div style="display: flex; align-items: center; gap: 10px;"> <div style="border: 1px solid black; padding: 2px;">CO □</div> <div>Hear a busy tone</div> <div style="border: 1px solid black; padding: 2px;">MNO 6</div> <div>Hang up handset or press "MONITOR"</div> </div>
For Intercom Calls	<div style="display: flex; align-items: center; gap: 10px;"> <div style="border: 1px solid black; padding: 5px;">Dial extension no. (100 through 199)</div> <div style="border: 1px solid black; padding: 5px;">Hear a busy tone</div> <div style="border: 1px solid black; padding: 2px;">MNO 6</div> <div style="border: 1px solid black; padding: 5px;">Hang up handset or press "MONITOR"</div> </div>



WHEN A LINE IS BUSY (CONT.)

BUSY STATION SIGNALING	<div style="display: flex; justify-content: space-around;"> <div style="border: 1px solid black; padding: 2px;">Dial extension no. (100 through 199)</div> <div style="border: 1px solid black; padding: 2px;">Hear a busy tone</div> <div style="border: 1px solid black; padding: 2px; text-align: center;">1</div> </div>
LAST NUMBER REDIAL	<div style="display: flex; justify-content: space-around;"> <div style="border: 1px solid black; padding: 2px;">Lift handset or press "MONITOR"</div> <div style="border: 1px solid black; padding: 2px; text-align: center;">REDIAL <input type="checkbox"/></div> </div>







































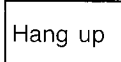

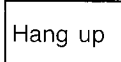

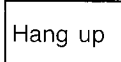

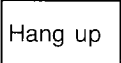

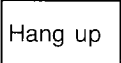

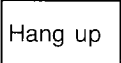

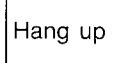
RECEIVING CALLS

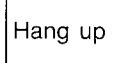
ANSWER	Lift handset
DIAL CALL PICKUP	<div style="display: flex; justify-content: space-around; align-items: center;"> <div style="border: 1px solid black; padding: 2px;">Lift handset</div> <div style="border: 1px solid black; padding: 2px; text-align: center;">GHI 4</div> <div style="border: 1px solid black; padding: 2px; text-align: center;">OPER 0</div> </div> <ul style="list-style-type: none"> ● You may dial the ringing extension number instead of 0.

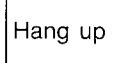
WHILE HAVING A CONVERSATION

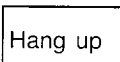
HOLD-CO Call on Hold	To place call on hold	
	<div style="border: 1px solid black; padding: 2px; display: inline-block;">HOLD <input type="checkbox"/></div>	
	To retrieve at the holding extension	To retrieve from another extension
	<div style="border: 1px solid black; padding: 2px; display: inline-block;">CO <input type="checkbox"/></div> <ul style="list-style-type: none"> ● Press the CO button whose indicator is flashing slowly (green color). 	<div style="border: 1px solid black; padding: 2px; display: inline-block;">CO <input type="checkbox"/></div> <ul style="list-style-type: none"> ● Press the CO button whose indicator is flashing slowly (red color).
Call on Exclusive Hold	To place call on hold	
	<div style="display: flex; justify-content: space-around;"> <div style="border: 1px solid black; padding: 2px; text-align: center;">HOLD <input type="checkbox"/></div> <div style="border: 1px solid black; padding: 2px; text-align: center;">HOLD <input type="checkbox"/></div> </div>	
	To retrieve	
	<div style="border: 1px solid black; padding: 2px; display: inline-block;">CO <input type="checkbox"/></div> <ul style="list-style-type: none"> ● Press the CO button whose indicator is flashing in groups of 2 (green color). 	

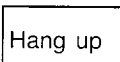
Quick Reference Card

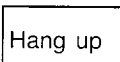
WHILE HAVING A CONVERSATION (CONT.)						
HOLD-INTERCOM Call on Hold	To place call on hold 					
	<table border="0" style="width: 100%;"> <tr> <td style="width: 50%; vertical-align: top;"> To retrieve at the holding extension  </td> <td style="width: 50%; vertical-align: top;"> To retrieve from another extension  Dial holding extension no. (100 through 199) </td> </tr> </table>	To retrieve at the holding extension 	To retrieve from another extension  Dial holding extension no. (100 through 199)			
	To retrieve at the holding extension 	To retrieve from another extension  Dial holding extension no. (100 through 199)				
Call on Exclusive Hold <table border="0" style="width: 100%;"> <tr> <td style="width: 50%; vertical-align: top;"> To place call on hold   </td> <td style="width: 50%; vertical-align: top;"> To retrieve  </td> </tr> </table>	To place call on hold  	To retrieve 				
To place call on hold  	To retrieve 					
CONFERENCE <table border="0" style="width: 100%;"> <tr> <td></td> <td>Dial 2nd party</td> <td>Consult with 2nd party</td> <td></td> </tr> </table>		Dial 2nd party	Consult with 2nd party			
	Dial 2nd party	Consult with 2nd party				
CALL WAITING To terminate the Original Call and Talk to the New Caller To Place the Original Call on Hold and Talk to the New Caller	Hear a call waiting tone  or  					
	Hear a call waiting tone   or  Consult with new caller while original call is on hold <ul style="list-style-type: none"> If both original and new calls are intercom calls, you need not to press the ICM button. 					
CALL TRANSFER-TO EXTENSION To Transfer after the Other Extension Answers	<table border="0" style="width: 100%;"> <tr> <td></td> <td>Dial extension no. (100 through 199)</td> <td>Announce and wait for answer</td> <td></td> </tr> </table>		Dial extension no. (100 through 199)	Announce and wait for answer		
		Dial extension no. (100 through 199)	Announce and wait for answer			
<table border="0" style="width: 100%;"> <tr> <td></td> <td>Dial extension no. (100 through 199)</td> <td></td> </tr> </table>		Dial extension no. (100 through 199)				
	Dial extension no. (100 through 199)					
CALL TRANSFER-TO OUTSIDE LINE To Transfer after the Other Outside Party Answers	<table border="0" style="width: 100%;"> <tr> <td></td> <td></td> <td>Dial phone number</td> <td>Announce and wait for answer</td> <td></td> </tr> </table>			Dial phone number	Announce and wait for answer	
			Dial phone number	Announce and wait for answer		
<table border="0" style="width: 100%;"> <tr> <td></td> <td></td> <td>Dial phone number</td> <td></td> </tr> </table>			Dial phone number			
		Dial phone number				

PAGING

● Lift the handset first.

PAGING ALL EXTENSIONS

To Access

DEF 3	DEF 3	OPER 0	Hear 1 beep	Page
----------	----------	-----------	----------------	------

PAGING GROUP

To Access

DEF 3	DEF 3	Dial extension group (1 through 8)	Hear 1 beep	Page
----------	----------	---------------------------------------	----------------	------

Wait for answer
and talk

PAGING-EXTERNAL

To Access to External Paging
Equipment

DEF 3	ABC 2	Dial the external paging number	Hear 1 beep	Page
----------	----------	------------------------------------	----------------	------

Wait for answer
and talk

Paging number "0": for external paging equipments 1 and 2
 Paging number "1": for external paging equipment 1
 Paging number "2": for external paging equipment 2

PAGING AND TRANSFER

To Transfer Call to
Paged Person

During a conversation;

TRANSFER □	DEF 3	DEF 3	OPER 0	Hear 1 beep	Page
---------------	----------	----------	-----------	----------------	------

Wait for answer
and hang up

- You may dial 331 through 338 or 320 through 322 instead of 330.
- You need not to lift the handset.

ANSWER

To Paging from Built-in
Speaker

GHI 4	DEF 3	Hear 1 beep	Talk
----------	----------	----------------	------

To Paging from External
Equipment

GHI 4	ABC 2	Dial the external paging number	Hear 1 beep	Talk
----------	----------	------------------------------------	----------------	------

Paging number "1": for external paging equipment 1
 Paging number "2": for external paging equipment 2



Detach this position



Quick Reference Card



OTHER FEATURES

- Lift the handset or press the MONITOR button first.
- After hearing confirmation tone (1 or 2 beep), hang up the handset or press the MONITOR button.

CALL FORWARDING-ALL CALLS

Setting

Dial extension no. (100 through 199)

- To use the F3 button, it is required to be programmed beforehand. (See page 41.)

To cancel

CALL FORWARDING-BUSY OR NO ANSWER

Setting

Dial extension no. (100 through 199)

- To use the F3 button, it is required to be programmed beforehand. (See page 41.)

To cancel

CALL FORWARDING-TO OUTSIDE LINE

Setting

Dial phone number

- You may dial 81 through 88 instead of 9.
- To use the F3 button, it is required to be programmed beforehand.

To cancel

DIAL CALL PICKUP DENY

Setting

To cancel

DO NOT DISTURB

Setting

- To use the F3 button, it is required to be programmed beforehand. (See page 41.)

To cancel

BACKGROUND MUSIC

To Listen

- Be sure the handset is in the cradle, the MONITOR button is off and a call is not reaching.

To Cancel

Detach this position



OTHER FEATURES (CONT.)

STATION FEATURE CLEAR

PRS 7	WXY 9	#
----------	----------	---

- Following features can be reset to the default data. Dial Call Pickup Deny, Do Not Disturb, Call Forwarding, Call Waiting Tone From CO/ Extension Deny, Data Line Security, Absent Message Capability, Background Music, Executive Override Deny, Message Waiting.

ABSENT MESSAGE CAPABILITY

Absent Message will be Informed to the Proprietary Telephone with LCD of Calling Party, when Dialing.

Setting

Message 1. "Will Return Soon"

PRS 7	JKL 5	1	#
----------	----------	---	---

Message 2. "Gone Home"

PRS 7	JKL 5	ABC 2	#
----------	----------	----------	---

Message 3. "At Ext. extension no."

PRS 7	JKL 5	DEF 3	Dial extension no. (100 through 199)	#
----------	----------	----------	---	---

Message 4. "Back at 10:23 AM"

PRS 7	JKL 5	GHI 4	Enter "Hour" (01 through 12)	Enter "Minute" (00 through 59)
----------	----------	----------	---------------------------------	-----------------------------------

"0": for AM "1": for PM	#
----------------------------	---

Message 5. "Out Until 10/23"

PRS 7	JKL 5	JKL 5	Enter "Month" (01 through 12)
----------	----------	----------	----------------------------------

Enter "Day" (01 through 31)	#
--------------------------------	---

Message 6. "In a Meeting"

PRS 7	JKL 5	MNO 6	#
----------	----------	----------	---

To cancel the message ("Message Cancel")

PRS 7	JKL 5	OPER 0	#
----------	----------	-----------	---

MESSAGE WAITING

To Leave the Message at each Extension from the Operator

Dial extension no. (100 through 199)	MESSAGE []	Hear 1 beep
---	----------------	----------------

To Call the Operator from the Extension where the Message is Left

MESSAGE []	Talk
----------------	------









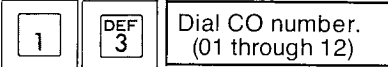
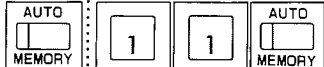
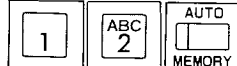
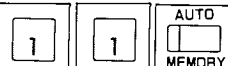
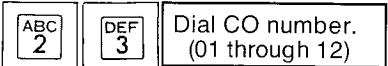
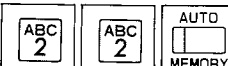

To Cancel the Message which is left in the extension

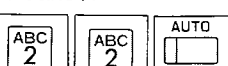
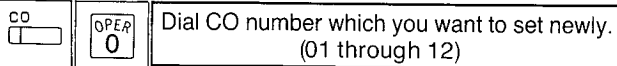
At the extension	From the operator	
PRS 7	OPER 0	#
Dial extension no. (100 through 199)	MESSAGE []	MESSAGE []

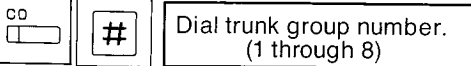
Quick Reference Card

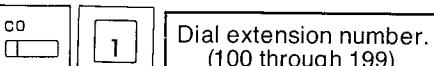
STATION PROGRAMMING

- Be sure the handset is in the cradle, the MONITOR button is OFF and a call is not reaching.
- Set the MEMORY switch of the KX-T123250 to "PROGRAM" position first.
- After programming, return the MEMORY switch to "SET" position.

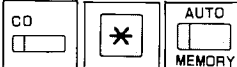
AUTO CO HUNTING Prime Line Preference	Setting  To cancel 
Idle Line Preference	Setting  To cancel 
AUTOMATIC ANSWERING SELECTION Prime Line Preference	Setting  To cancel 
NO Line Preference	Setting  To cancel 
FLEXIBLE CO BUTTON To Change into Other CO Number	 
To Assign to Trunk Group Access Number	 
To Change into DSS Button	 
To Change into One Touch Dialing Button	  <ul style="list-style-type: none"> ● You may dial 81 through 88 instead of 9.
To Change into Other All CO Numbers	

STATION PROGRAMMING (CONT.)



CO LINE RINGING SELECTION	<div style="display: flex; align-items: center; gap: 10px;"> <div style="border: 1px solid black; padding: 2px; text-align: center;">DEF 3</div> <div style="border: 1px solid black; padding: 5px;">Dial CO numbers that you want to ring (01 through 12)</div> <div style="border: 1px solid black; padding: 2px; text-align: center;">AUTO MEMORY</div> </div>		
INTERCOM VOICE ALERTING MODE	<table style="width: 100%; border-collapse: collapse;"> <tr> <td style="width: 50%; padding: 5px;"> Setting (Voice Alerting) <div style="display: flex; align-items: center; gap: 10px; margin-top: 5px;"> <div style="border: 1px solid black; padding: 2px; text-align: center;">GHI 4</div> <div style="border: 1px solid black; padding: 2px; text-align: center;">ABC 2</div> <div style="border: 1px solid black; padding: 2px; text-align: center;">AUTO MEMORY</div> </div> </td> <td style="width: 50%; padding: 5px;"> To cancel (Tone Alerting) <div style="display: flex; align-items: center; gap: 10px; margin-top: 5px;"> <div style="border: 1px solid black; padding: 2px; text-align: center;">GHI 4</div> <div style="border: 1px solid black; padding: 2px; text-align: center;">1</div> <div style="border: 1px solid black; padding: 2px; text-align: center;">AUTO MEMORY</div> </div> </td> </tr> </table>	Setting (Voice Alerting) <div style="display: flex; align-items: center; gap: 10px; margin-top: 5px;"> <div style="border: 1px solid black; padding: 2px; text-align: center;">GHI 4</div> <div style="border: 1px solid black; padding: 2px; text-align: center;">ABC 2</div> <div style="border: 1px solid black; padding: 2px; text-align: center;">AUTO MEMORY</div> </div>	To cancel (Tone Alerting) <div style="display: flex; align-items: center; gap: 10px; margin-top: 5px;"> <div style="border: 1px solid black; padding: 2px; text-align: center;">GHI 4</div> <div style="border: 1px solid black; padding: 2px; text-align: center;">1</div> <div style="border: 1px solid black; padding: 2px; text-align: center;">AUTO MEMORY</div> </div>
Setting (Voice Alerting) <div style="display: flex; align-items: center; gap: 10px; margin-top: 5px;"> <div style="border: 1px solid black; padding: 2px; text-align: center;">GHI 4</div> <div style="border: 1px solid black; padding: 2px; text-align: center;">ABC 2</div> <div style="border: 1px solid black; padding: 2px; text-align: center;">AUTO MEMORY</div> </div>	To cancel (Tone Alerting) <div style="display: flex; align-items: center; gap: 10px; margin-top: 5px;"> <div style="border: 1px solid black; padding: 2px; text-align: center;">GHI 4</div> <div style="border: 1px solid black; padding: 2px; text-align: center;">1</div> <div style="border: 1px solid black; padding: 2px; text-align: center;">AUTO MEMORY</div> </div>		
CALL WAITING TONE SELECTION	To select <div style="display: flex; align-items: center; gap: 10px; margin-top: 5px;"> <div style="border: 1px solid black; padding: 2px; text-align: center;">JKL 5</div> <div style="border: 1px solid black; padding: 5px;">Dial 1 (for Tone 1) or 2 (for Tone 2)</div> <div style="border: 1px solid black; padding: 2px; text-align: center;">AUTO MEMORY</div> </div>		
F3-ONE TOUCH BUTTON MODE SELECTION	<div style="display: flex; align-items: center; gap: 10px;"> <div style="border: 1px solid black; padding: 2px; text-align: center;">PRS 7</div> <div style="border: 1px solid black; padding: 5px;">Dial 1 (for Programmable feature) or 2 (DND/FWD/Account code)</div> <div style="border: 1px solid black; padding: 2px; text-align: center;">AUTO MEMORY</div> </div>		
STATION PROGRAM CLEAR	<div style="display: flex; align-items: center; gap: 10px; margin-bottom: 10px;"> <div style="border: 1px solid black; padding: 2px; text-align: center;">#</div> <div style="border: 1px solid black; padding: 2px; text-align: center;">*</div> <div style="border: 1px solid black; padding: 2px; text-align: center;">AUTO MEMORY</div> </div> <ul style="list-style-type: none"> ● Following programs can be reset to the default data. Auto CO Hunting, Automatic Answering Selection, Intercom Voice Alerting Mode, CO Line Ringing Selection, Call Waiting Tone Selection, F3-One Touch Button Mode Selection. 		

Detach this position



Contents

Preparation	11
Location of Controls	12
Basic Operation	
Making Calls	
Outward Dialing	13
Inter Office Calling (Intercom)	14
Speed Dialing	14
Operator Call	14
Calling Doorphone	14
One Touch Dialing	15
When a Line is Busy	
Automatic Call Back Busy (Camp-on)	16
Busy Station Signaling	16
Last Number Redial	16
Executive Override (Barge-In)	17
Receiving Calls	
Answer	17
Dial Call Pickup	17
Directed Call Pickup	18
Doorphone	18
Call Park	18
While Having a Conversation	
Hold-CO	19
Hold-Intercom	20
Conference	20
Call Splitting-Between CO and Intercom	21
Call Splitting-Intercom	21
Call Waiting	22
Call Transfer-To Extension	23
Call Transfer-To Outside Line	23
Privacy Release	24
Paging	
Paging All Extensions	24
Paging Group	24
Paging-External	25
Paging and Transfer	25
Answer	25
Detailed Operation	
Use of Other Features	
Call Forwarding-All Calls	26
Call Forwarding-Busy or No Answer	26
Call Forwarding-To Outside Line ..	27
Dial Call Pickup Deny	27
Do Not Disturb	28
Do Not Disturb Override	28
Switching to Tone Alerting	28
Monitor Operation	29
External Feature Access	29
Absent Message Capability	30
Message Waiting	31
Account Code	32
Pulse/Tone Conversion	33
Executive Override Deny	33
Call Waiting Tone From CO/Extension Deny	34
Data Line Security	35
Background Music	35
Station Feature Clear	35
Station Programming	
One touch Access for System Features	36
CO Line Ringing Selection	36
Auto CO Hunting	37
Automatic Answering Selection	38
Flexible CO Button	39
Call Waiting Tone Selection	40
Intercom Voice Alerting Mode	41
Station Program Clear	41
F3-One Touch Button Mode Selection	41
Example of Operation	42
Busy Lamp Field	44
Table of System Features	45
General Information	46 through 49
Warranty	back cover

Preparation

① Connect as shown.

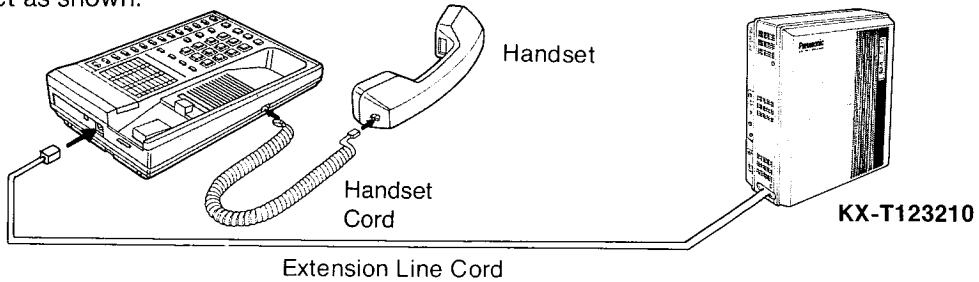

- When power failure takes place, we recommend to use a standard telephone or KX-T123230 as extension of jack number 01, 02, 09, 10, 17 or 18 because the KX-T123250 will not operate.
- Even if this unit is connected to telephone line (central office line), this unit will not operate.

② **RINGER VOLUME Selector:**

Set to "HIGH".

LOW: The ringing sound will be low.

OFF: The telephone will not ring.

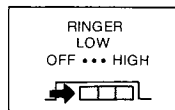

③ **MEMORY Switch:**

Set to "SET".

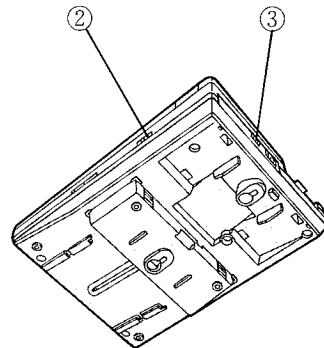
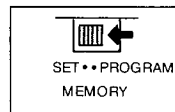

If the unit does not operate properly, disconnect the unit from the extension line cord and then connect again.

Location of Controls

For your convenience, keep this page open when you read the following instructions.

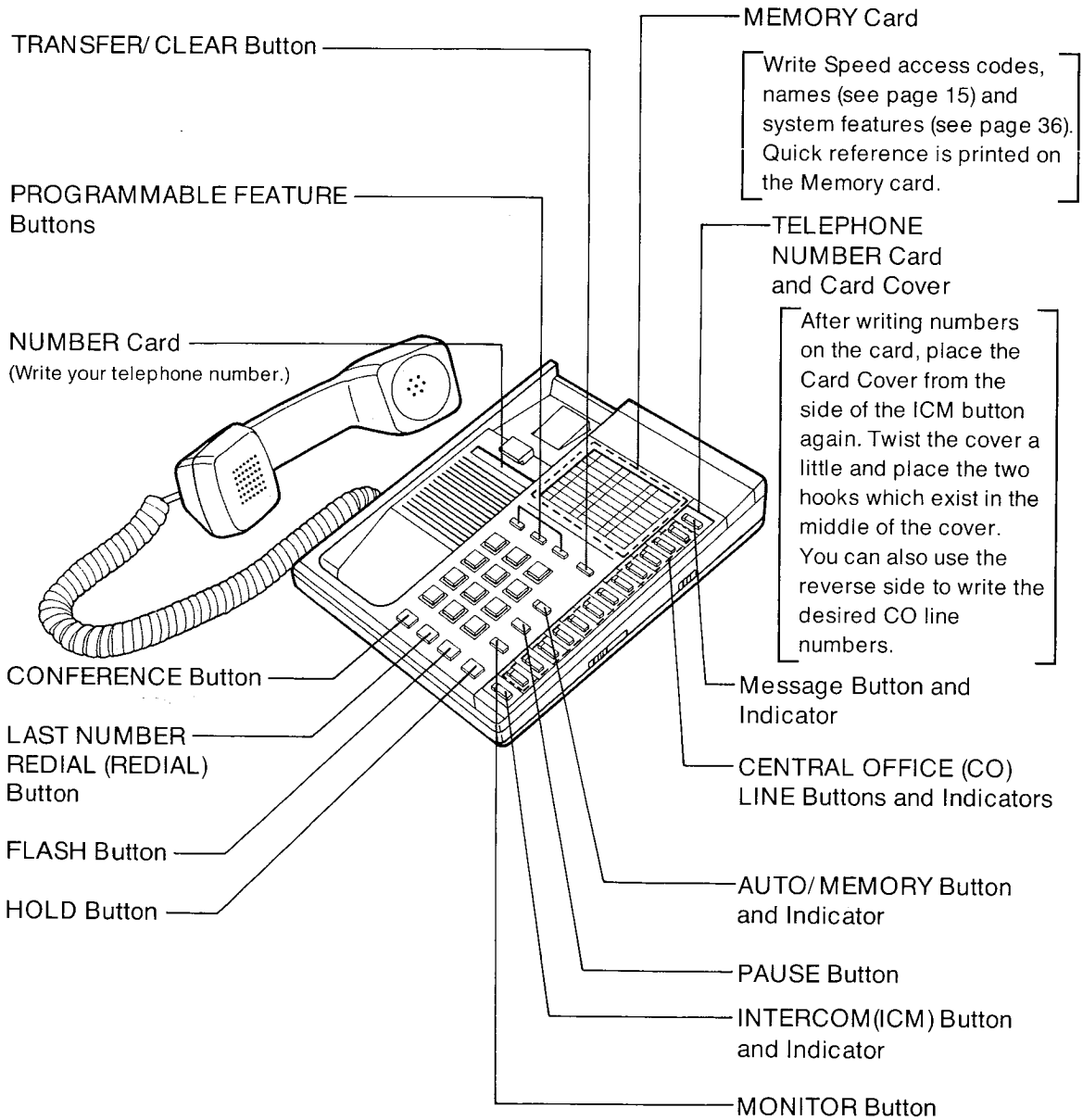

Making Calls

Outward Dialing

Individual Line Access

Any of the 12 CO's may be directly selected.

Using the Handset



Lift handset

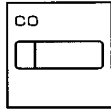

Press CO

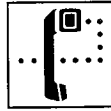

Wait for
C. O. dial
tone

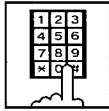

Dial phone
number

- When you finish, hang up the handset.

On-hook Calling

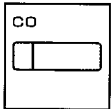

Press CO



Wait for
C.O. dial
tone

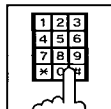

Dial phone
number



When
other party
answers, lift
handset
and talk

- When you finish, hang up the handset.
- You may dial 9 instead of CO button. In this case, you must lift the handset or press the MONITOR button first.
 - 9: Each extension can automatically select an idle CO (Central Office) line within the KX-T123210.
- You can not use the CO button whose indicator has been already lighting (red color) since anyone is using the CO line.
- The CO indicator will be lit (green color) at your extension and lit (red color) at other extensions.

- To access new CO line without hanging up while having a conversation:

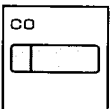

Press another CO

- The original conversation will be terminated and new CO line can be accessed.

Individual Trunk Group Access

Each extension can automatically select an idle CO line within the same trunk group. Through programming, 12 CO lines can be divided up to 8 groups.



Lift handset
or press
MONITOR

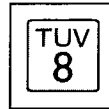

Dial "8"

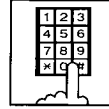

Dial trunk
group number
(1 through 8)

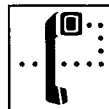

Wait for
C.O. dial
tone

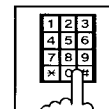

Dial phone
number



Hang up when
conversation
is completed

- You may press CO button instead of dialing 8 and the trunk group number (1 through 8). In this case, you must assign the trunk group access number to the CO button. To assign, see "Flexible CO button" on page 39.
- The CO lines that is assigned to the trunk group are set below. Through programming, you may change the trunk group assignment of CO lines. See the page 3-46 in INSTALLATION MANUAL.

Default:

CO 1 is assigned to Trunk group 1.
 CO 2 is assigned to Trunk group 2.
 CO 3 is assigned to Trunk group 3.
 CO 4 is assigned to Trunk group 4.
 CO 5 is assigned to Trunk group 5.
 CO 6 is assigned to Trunk group 6.
 CO 7 is assigned to Trunk group 7.
 CO 8 through CO 12 is assigned to Trunk group 8.

- The CO line which is not assigned to the CO button can not be dialed.

Making Calls (cont.)

Inter Office Calling (Intercom)

Station to station dialing within the KX-T123210 system.

Using the Handset



Lift handset

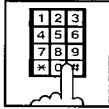

Dial extension number (100 through 199)



Talk



Hang up

On-hook Calling

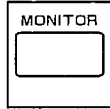

Press MONITOR

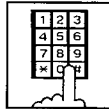

Dial extension number



When other party answers, lift handset and talk



Hang up

- You may press CO button instead of dialing the extension number (100 through 199). In this case, you must change CO button into DSS button. To change, see "Flexible CO button" on page 39.
- The extension number is set below. You may change the extension number to other number. See the page 3-8 in INSTALLATION MANUAL.

Default;

101: is assigned to extension of Jack number 01
 102: is assigned to extension of Jack number 02
 ...
 132: is assigned to extension of Jack number 32

- You may press the ICM button instead of the first MONITOR button.
- The ICM indicator will be lit (green color) while using the unit.
- When you converse with the other party through KX-T123250, use the handset by all means. You can hear the other party's voice but the other party can not hear your voice in the on-hook mode (see "Monitor Operation" on page 29).

Speed Dialing

There are 100 memory locations of system speed dialing available.



Lift handset or press MONITOR

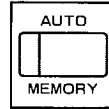

Press AUTO

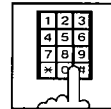

Dial speed access code (00 through 99)

- You may press the CO button to select the CO line directly after lifting the handset or pressing the MONITOR button.

Operator Call

You can call the operator within the KX-T123210 system.

This feature is required to be set beforehand in the KX-T123210.

For programming, see page 3-9 in INSTALLATION MANUAL.



Lift handset or press MONITOR

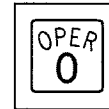

Dial "0"

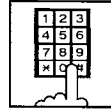

Dial "0" or "1"

"0":for Operator 1
 "1":for Operator 2

- In case one operator is programmed, you have only to dial 0.

Calling Doorphone

Up to two doorphones (KX-T30865) can be connected to the KX-T123210.

■ Doorphone 1



Lift handset or press MONITOR

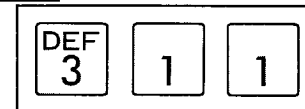

Dial "311"

■ Doorphone 2

At step 2 above, dial 312 instead of 311.

Making Calls (cont.)

One Touch Dialing

There are 3 memory locations for automatic dialing available.

Up to 16 digits can be stored into each memory location (PROGRAMMABLE FEATURE button). For your convenience, program private phone numbers into the KX-T123250.

The F3 button can be changed from the PROGRAMMABLE FEATURE button into the Call Forwarding button, Do Not Disturb button and Account Code button by programming. (See pages 26, 28, 32, 41)

In this case, the F3 button can not be used for programming a system feature.

Programming

- Be sure the handset is in the cradle, the MONITOR button is off and a call is not reaching.
- Set the MEMORY switch of the KX-T123250 to "PROGRAM".

■ Storage

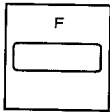

Press PROGRAMMABLE FEATURE (F1 through F3)

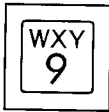

Dial "9"

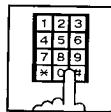

Dial phone number

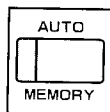

Press MEMORY

- You may dial 81 through 88 instead of 9. 9 ... Each extension can automatically select an idle CO line. 81 through 88... Each extension can select a trunk group designated.
- You may program "*", "#", "FLASH" and "PAUSE".

After programming all the numbers, return the MEMORY switch to the "SET" position.

■ To Correct an Error while Programming



Press CLEAR (TRANSFER) instead of MEMORY

- After pressing the CLEAR button, re-program the correct number.
- The TRANSFER button is used as the CLEAR button.

■ To Change a Stored Number

Repeat "Storage".

■ To Confirm a Stored Number

Repeat programming the same number into the same station.

When the MEMORY button is pressed, a beep will be heard.

- two beeps The entry is the same as what was previously stored.
- one beep The entry is different from the one that was previously stored.

■ To Erase after Programming

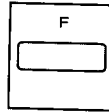

Press PROGRAMMABLE FEATURE

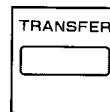

Press CLEAR (TRANSFER)

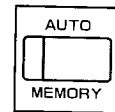

Press MEMORY

- The TRANSFER button is used as the CLEAR button.

Dialing



Lift handset or press MONITOR

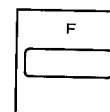

Press PROGRAMMABLE FEATURE

- You may press the CO button to select the CO line directly after lifting the handset or pressing the MONITOR button.

When a Line is Busy

Automatic Call Back Busy (Camp-on)

If the intercom extension or the outside line (CO line) you have dialed is busy, you will be automatically called back when the extension or the outside line (CO line) becomes free using this function.

This feature is also known as camp-on.

For outside (CO line) calls

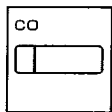

Press CO



You will hear a busy tone



Dial "6"



Confirmation tone of 2 beeps will be heard



Hang up or press MONITOR

For intercom calls

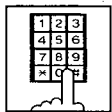

Dial extension number (100 through 199)



You will hear a busy tone



Dial "6"



Confirmation tone



Hang up or press MONITOR

When hearing the ring back on intercom call or an outside call, lift the handset or press the MONITOR button.

- If you make or receive a call during camp-on mode, the camp-on mode will be canceled.

Busy Station Signaling

If the extension you have dialed is busy, you can inform the extension that another intercom call is reaching by three beeps.

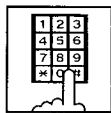

Dial extension number



You will hear a busy tone

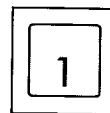

DIAL "1" and wait for an answer

- To answer your signal, see "Call Waiting" on page 22.
- While the other party is setting "Call Waiting Tone-From Extension Deny" on page 34 or is using a data terminal equipment, you may not be able to use this feature. (A reorder tone is heard after dialing 1.)

Last Number Redial

The last phone number dialed on an outside line (CO line) can be redialed.



Lift handset or press MONITOR

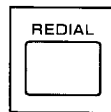

Press REDIAL

- You may press the CO button to select the CO line directly after lifting the handset or pressing the MONITOR button.
- You may dial the 8 and trunk group number (1 through 8) to select the trunk group directly after lifting the handset or pressing the MONITOR button.

When a Line is Busy (cont.)

Executive Override (Barge-In)

Allows an extension user to intrude into another extension that is in conversation with an outside party or inside party. This feature is required to be set beforehand in the KX-T123210. For programming, see page 3-73 in INSTALLATION MANUAL.



Lift handset or press MONITOR

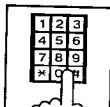

Dial extension number (100 through 199)

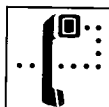

You will hear a busy tone

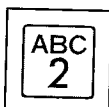

Dial "2"
[A3-party conference is now established.]

- If the other party is using data equipment or is setting "Executive Override Deny" on page 33, you can not intrude into the other party that is in conversation. (A reorder tone is heard after dialing 2.)

Receiving Calls

Answer



Lift handset

- If "Automatic Answering Selection" feature is selected for "No Line Preference-Incoming" in the extension and outside call reaches, lift the handset and then press the CO button whose indicator is flashing (red color) quickly.
- You can distinguish a CO call, a Intercom call or a doorphone call by a kind of ring tones. For further details see page 6-6 in INSTALLATION MANUAL.

Dial Call Pickup

Through the use of this feature, an extension user can answer any ringing extension within their own extension group.



Lift handset

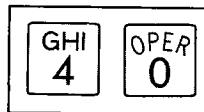

Dial "40"

Receiving Calls (cont.)

Directed Call Pickup

An extension may answer an incoming call that is ringing at another extension regardless of the extension group.



Lift handset



Dial "4"

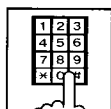

Dial ringing extension number (100 through 199)

Doorphone

This feature is required to be set beforehand in the KX-T123210. For programming, see page 3-75 in INSTALLATION MANUAL.

For Answering Doorphones



Lift handset

- If calls from doorphones are not answered within 15 seconds, the calls will be cancelled.

Call Park

Extension user can place up to ten calls in the call park zones.

Allows extension user to retrieve a parked call (intercom or outside) at any extension.

To Park a Call

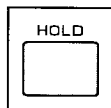

Press HOLD

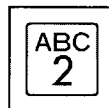

Dial "2"

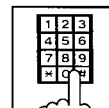

Dial parking station number (20 through 29)

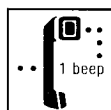

Confirmation tone



Replace handset

- A call may be placed in any of ten call park zones.
- If a busy tone is heard after the station number is dialed, dial only last 1 digit of the other parking station number (0 through 9).

To Retrieve a Parked Call at Any Extension



Lift handset

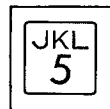

Dial "5"

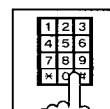

Dial parking station number (20 through 29)

When you want to make an outside call while an outside call is reaching, press the CO button.

If the dial tone (continuous tone) changes to a reorder tone (intermittent tone) or a mistake is made, hang up and start again.

While Having a Conversation

Hold-CO

Call on Hold

If you wish to leave your phone unattended but want the caller you are in conversation with to wait, call on hold may be used. Outside calls may be placed on hold.

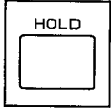

Press
HOLD

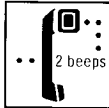

Confirmation tone
of 2 beeps will
be heard

- The indicator of the CO button which is on hold will flash slowly (green color).
- The indicator of the CO button which is on hold will flash slowly (red color) at other extensions.

Call on Exclusive Hold

Calls on exclusive hold can not be released by any extensions other than the phone which placed the call on hold.

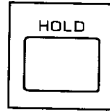

Press
HOLD

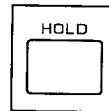

Press
again

- The indicator of the CO button which is on hold will flash in groups of 2 (green color).
- The indicator of the CO button which is on hold will light (red color) at other extensions.

To Retrieve

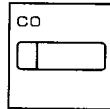

Press CO

- Press the CO button whose indicator is flashing in groups of 2 (green color).

To Retrieve a Call on Hold

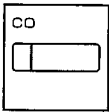

Press CO

- Press the CO button whose indicator is flashing slowly (green color).

To Retrieve a Call on Hold from Another Extension



Lift handset

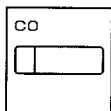

Press CO

- Press the CO button whose indicator is flashing slowly (red color).

or



Lift handset

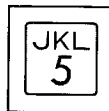

Dial "5"

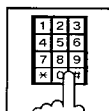

Dial holding
extension
number
(100 through 199)

- In case held call is outside call, you may dial "53" and then held CO line number (01 through 12).

While Having a Conversation (cont.)

Hold-Intercom

Call on Hold

Extension user can place an intercom call on hold.

An Intercom hold can be activated on one extension only.

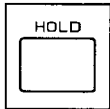

Press HOLD

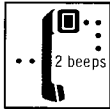

Confirmation tone

- The ICM indicator will flash slowly.

■ To Retrieve a Call on Hold

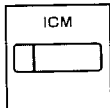

Press ICM

- The ICM indicator will be on.

■ To Retrieve a Call on Hold from Another Extension



Lift handset

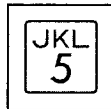

Dial "5"

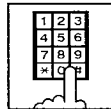

Dial holding extension number

Call on Exclusive Hold

Calls on exclusive hold can not be released by any extensions other than the phone which placed the call on hold. An Intercom hold can be activated on one extension only.

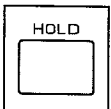

Press HOLD

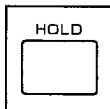

Press again

- The ICM indicator will flash in groups of 2.

■ To Retrieve a Call on Hold

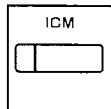

Press ICM

- The ICM indicator will be on.

Conference

Allows for up to a three party conference, (2-outside/ 1-inside), (1-outside/ 2-inside) or (3-inside).

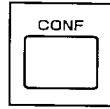

Press CONF

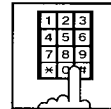

Dial 2nd party



Consult with 2nd party

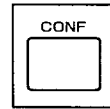

Press CONF

A 1st party is placed on hold.

A 3-party conference is now established.

- You may press the HOLD button instead of the first CONFERENCE button.

■ To Terminate One Caller and Talk to the Another Caller

- If both the conference parties are on the CO line; Press the CO button to talk to the desired party.
- If the conference parties are on the CO line and extension; To talk to the CO party, press the CO button. To talk to the extension party, press the ICM button.

■ To Place the Other Two Parties on Hold at the Same Time

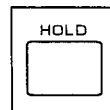

Press HOLD

- In case the other two parties are on the extension, the other two parties can not be placed on hold.

While Having a Conversation (cont.)

Call Splitting- Between CO and Intercom

Allows an extension user to alternate between a CO party and an Intercom party.

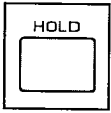

Press HOLD to place 1st party on hold

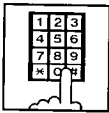

Dial 2nd party



Consult with 2nd party while 1st party is on hold

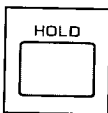

Press HOLD to place 2nd party on hold

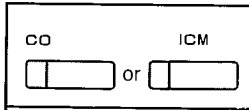

Press CO or ICM whose indicator is flashing slowly



Consult with 1st party

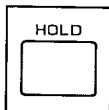

Press HOLD to place 1st party on hold

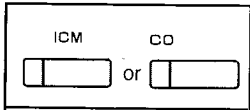

Press "ICM" or "CO" whose indicator is flashing slowly



Consult with 2nd party

- To release the call splitting mode, press the CO or ICM button without pressing the HOLD button.
Conversation will be terminated and call on hold will be returned to conversation.

Call Splitting-Intercom

Allows an extension user to alternate between two intercom parties.

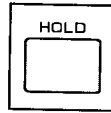

Press HOLD to place 1st party on hold

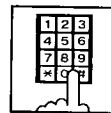

Dial 2nd party



Consult with 2nd party while 1st party is on hold

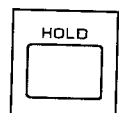

Press HOLD to place 2nd party on hold



Consult with 1st party

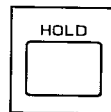

Press HOLD to place 1st party on hold



Consult with 2nd party

- To release the call splitting mode, press the ICM button instead of the HOLD button.
Conversation will be terminated and call on hold will be returned to conversation.

While Having a Conversation (cont.)

Call Waiting

Call Waiting Tone during a conversation indicates there is a new incoming CO call or Intercom call. Call waiting tone is heard from the handset receiver of the KX-T123250.

This feature has been set beforehand in the extension. There are Tone 1 and Tone 2 in the Call Waiting Tone.

For changing Tone 1 into Tone 2, see "Call Waiting Tone Selection" on page 40.

- If a call waiting tone is heard and the CO or ICM indicator does not flash, this tone indicates a call waiting tone by special company service. In this case, see "Call Waiting-Outside Line" on page 29.

■ To Terminate the Original Call and Talk to the New Caller



Will hear a call waiting tone

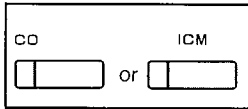

Press CO or ICM whose indicator is flashing quickly.
[The original call is now terminated.]



Talk

■ To Place the Original Call on Hold and Talk to the New Caller

- If both original call and new call are intercom calls: (The ICM indicator will change lighting into flashing quickly when new call reaches.)



Will hear a call waiting tone

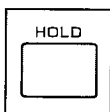

Press HOLD
[The dial tone is not heard.]



Consult with new caller while original call is on hold

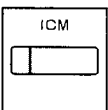

Press ICM to terminate 2nd call and to return to original call

- If original call is CO call, and new call is CO call or intercom call: or If original call is intercom call and new call is CO call:

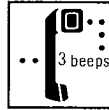

Will hear a call waiting tone

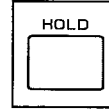

Press HOLD
[The dial tone is heard.]

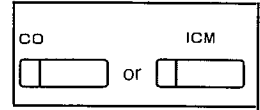

Press CO or ICM whose indicator is flashing quickly



Consult with new caller while original call is on hold

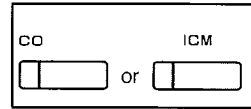

Press CO or ICM whose indicator is flashing slowly to terminate 2nd call and to return to original call

While Having a Conversation (cont.)

Call Transfer-To Extension

Outside calls or intercom calls may be transferred to any extension manually.

■ To Transfer after the Other Extension Answers

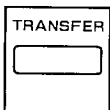

Press
TRANSFER

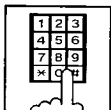

Dial
extension
number
(100 through
199)



Announce
and wait
for an
answer



Hang up

- When busy, you may access the other extension by dialing 1. Also you may return to the calling party by pressing the CO or ICM button whose indicator is flashing slowly (green color).

■ To Transfer without Announcing to the Other Extension



Press
TRANSFER

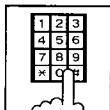

Dial extension
number



Hang up

■ To Retrieve the Call

If the other extension did not receive the transferred call within 30 seconds after the call has been transferred, the call will return to you. In this case:

While the ring back is hearing, lift the handset or press the SP-PHONE button to return to the calling party.

- To change the party to whom a call is transferred before hanging up: Press the CO or ICM button whose indicator is flashing slowly to retrieve the call, then repeat the procedure of Call Transfer.
- The time that the transferred call which is not received returns to you, may be set to 15 seconds. For changing, see page 3-27 in INSTALLATION MANUAL.

Call Transfer-To Outside Line

Outside calls or intercom calls may be transferred to any outside line manually. This feature is required to be set beforehand in the KX-T123210. For programming, see page 3-71 in INSTALLATION MANUAL.

■ To Transfer after the Other Outside Party Answers



Press
TRANSFER

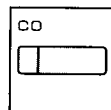

Press CO

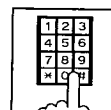

Dial phone
number



Announce
and wait
for an
answer



Hang up

- If you misdial the phone number, press the FLASH button and then redial the phone number.
- You may return to the calling party by pressing the CO or ICM button whose indicator is flashing slowly (green color) before hanging up.

■ To Transfer without Announcing to the Other Outside Party

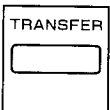

Press
TRANSFER

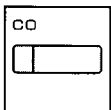

Press CO

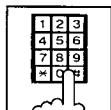

Dial phone
number



Hang up

- If outside call is transferred to any outside line, the KX-T123210 will disconnect the call from the line after 10 minutes. For changing the time, see "CO to CO Duration Time Limit" on page 3-30 in INSTALLATION MANUAL.

While Having a Conversation (cont.)

Privacy Release

Allows an extension user that is in conversation with an outside party to make a 3 party conference by having another extension join into the conversation.

While you are speaking on a CO line;

- Before pressing the CO button, inform another extension user to join into the conversation by word of mouth.

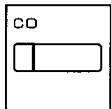

Press CO button already in use

- The indicator of the CO button will flash quickly (green color).

At the another extension that want to join into the conversation;

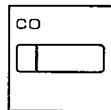

Press CO which is quickly flashing in green for 5 seconds

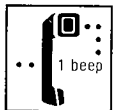

Confirmation tone of 1 beep will be heard

A 3-party conference is now established (1-outside/2-inside).

- After an extension user presses the CO button, the CO indicator of the other extensions flashes for only 5 seconds. Another press of the CO button can add 5 seconds' flashing time.

Paging

Paging All Extensions

Allows paging to all extensions.

The page can only be heard from proprietary telephones (KX-T123230, KX-T123220 or KX-T123250 etc.)

To Access



Lift handset

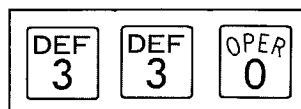

Dial "330"

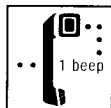

Confirmation tone of 1beep will be heard



Page



Wait for an answer and talk

- Paging will be heard from built-in speaker.



Paging Group

Allows paging to one of eight extension groups.

The page can only be heard from proprietary telephones (KX-T123230, KX-T123220 or KX-T123250 etc.)

To Access



Lift handset

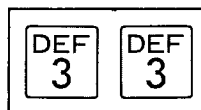

Dial "33"

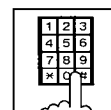

Dial extension group number (1 through 8)

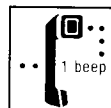

Confirmation tone of 1 beep will be heard



Page



Wait for an answer and talk

- Page will be heard from built-in speaker.

Paging (cont.)

Paging-External

Allows access to external paging equipment.

■ To Access



Lift handset

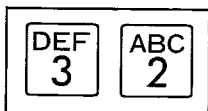

Dial "32"

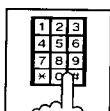

Dial external paging number

"0": for external paging equipments 1 and 2
 "1": for equipment 1
 "2": for equipment 2

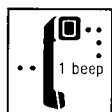

Confirmation tone



Page



Wait for an answer and talk

- Paging will be heard from external paging equipment (1 and/or 2).



Paging And Transfer

■ To Transfer a Call to the Paged Person



While having a conversation



Press TRANSFER

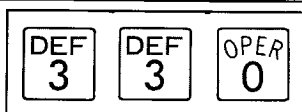

Dial "330"

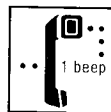

Confirmation tone



Page

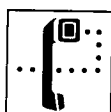

Wait for an answer



Hang up

- You may dial 331 through 338 or 320 through 322 instead of 330.

Answer

A page from built-in speaker or external paging equipment can be answered from any extension.

■ To Paging from Built-in Speaker



Lift handset

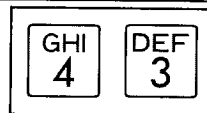

Dial "43"

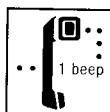

Confirmation tone



Talk

■ To Paging from External Equipment



Lift handset

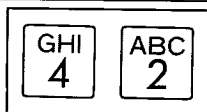

Dial "42"

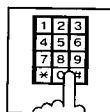

Dial external paging number

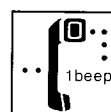

Confirmation tone



Talk

"1": for external paging equipment 1
 "2": for external paging equipment 2

- If a call and CO number has been paged and transferred, you may answer by pressing the CO button whose number has been paged and indicator is flashing slowly (red color), instead of dialing 43, 421 or 422.

Use of Other Features

Call Forwarding-All Calls

All intercom calls to your extension can be automatically forwarded to any extension within the system.

For outside calls to your extension, if your extension is programmed to the Direct In Line (DIL) mode, the outside calls can be automatically forwarded to any extension within the system.

For programming to the DIL mode, see page 3-54 in INSTALLATION MANUAL.

The PROGRAMMABLE FEATURE (F3 only) button can also be used for "Call Forwarding-All Calls/ Busy or No Answer" and "Call Forwarding-To Outside Line". In this case, programming should be done beforehand in accordance with page 41.

Even if the F3 button is not programmed as the Call Forwarding button, this feature can be used by dialing "71" instead of pressing F3 button.

■ Setting



Lift handset or press MONITOR

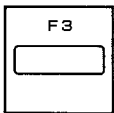

Press "F3"

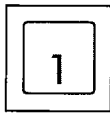

Dial "1"

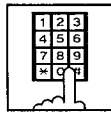

Dial extension number to whom call is forwarded

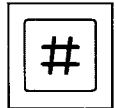

Dial "#"



Hang up or press MONITOR

■ To Cancel



Lift handset or press MONITOR

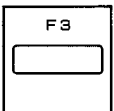

Press "F3"

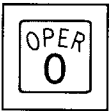

Dial "0"

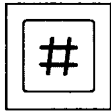

Dial "#"



Hang up or press MONITOR

Call Forwarding-Busy or No Answer

If your extension is busy or does not receive the call within 3 rings, Intercom calls to your extension can be automatically forwarded to any extension within the system.

For outside calls to your extension, if your extension is programmed to the Direct In Line (DIL) mode, the outside calls can be automatically forwarded to any extension within the system. For programming to the DIL mode, see page 3-54 in INSTALLATION MANUAL.

The 3 rings may be changed to 1 ring, 2 rings or 4 rings by programming. (See page 3-28 in INSTALLATION MANUAL.)

This feature will not function in "Intercom Voice Alerting" mode on page 41.

■ Setting



Lift handset or press MONITOR

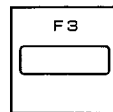

Press "F3"

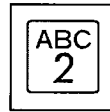

Dial "2"

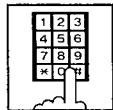

Dial extension number to whom call is forwarded

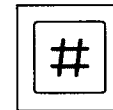

Dial "#"



Hang up or press MONITOR

■ To Cancel



Lift handset or press MONITOR

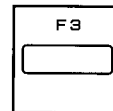

Press "F3"

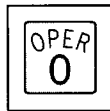

Dial "0"

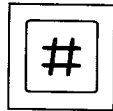

Dial "#"



Hang up or press MONITOR

Use of Other Features (cont.)

Call Forwarding- To Outside Line

Intercom calls to your extension can be automatically forwarded to any outside line. For outside calls to your extension, if your extension is programmed to the Direct In Line (DIL) mode, the outside calls can be automatically forwarded to any outside line. For programming to the DIL mode, see page 3-54 in INSTALLATION MANUAL. This feature is required to be set beforehand in the KX-T123210. For programming, see page 3-72 in INSTALLATION MANUAL.

■ Setting



Lift handset or press MONITOR

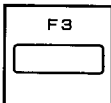

Press "F3"

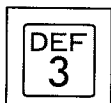

Dial "3"

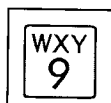

Dial "9"

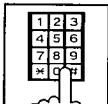

Dial phone number to whom call is forwarded

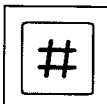

Press "#"



Hang up or press MONITOR

- You may dial 81 through 88 instead of 9. 9:..... Each extension can automatically select an idle CO line.
- 81 through 88: Each extension can select a trunk group designated.

■ To Cancel



Lift handset or press MONITOR

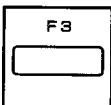

Press "F3"

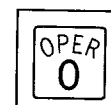

Dial "0"

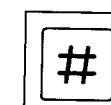

Press "#"

- After cancelling, hang up or press MONITOR.
- If outside call is forwarded to any outside line, the KX-T123210 will disconnect the call from the line after 10 minutes. For changing the time, see "CO to CO Duration Time Limit" on page 3-30 in INSTALLATION MANUAL.

Dial Call Pickup Deny

Allows you to prohibit any other extension user from answering calls directed to you.

■ Setting



Lift handset or press MONITOR

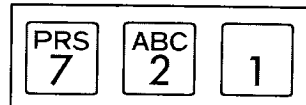

Dial "721"

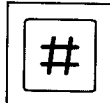

Dial "#"



Hang up or press MONITOR

■ To Cancel



Lift handset or press MONITOR

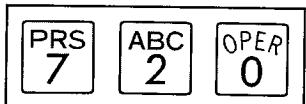

Dial "720"

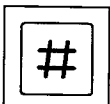

Dial "#"



Hang up or press MONITOR

Use of Other Features (cont.)

Do Not Disturb

Each extension can be individually prohibited from receiving intercom and outside calls. The PROGRAMMABLE FEATURE (F3 only) button can also be used for "Do Not Disturb". In this case, programming should be done beforehand in accordance with page 41. Even if the F3 button is not programmed as the Do Not Disturb button, this feature can be used by dialing "71" instead of pressing F3 button.

Setting



Lift handset or press MONITOR

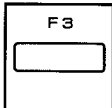

Press "F3"



Dial "4"

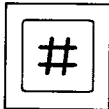

Dial "#"



Hang up or press MONITOR

To Cancel



Lift handset or press MONITOR

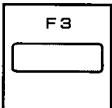

Press "F3"



Dial "0"

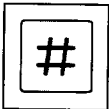

Dial "#"



Hang up or press MONITOR

Do Not Disturb Override

Allow you to dial to the extension on which the Do Not Disturb is set. This feature is required to be set beforehand in the KX-T123210. For programming, see page 3-74 in INSTALLATION MANUAL.



Lift handset or press MONITOR

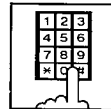

Dial extension number (100 through 199)

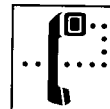

Do not disturb tone is heard

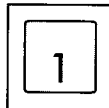

Dial "1"

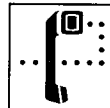

Ring back tone is heard and wait for answer

Do not disturb tone

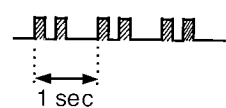

Switching to Tone Alerting

"Voice alerting" (through built-in speaker) that is established at the called party's extension, can be switched to "Tone alerting" (ringing).

This feature is required to be set beforehand at the called party's extension.

For programming, see page 41.



Lift handset or press MONITOR

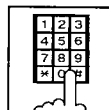

Dial extension number

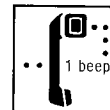

Wait until a confirmation tone is heard

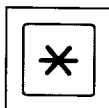

Dial "*"

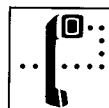

Ring back tone

Use of Other Features (cont.)

Monitor Operation

During Monitor operation, the incoming voice can be monitored, but the outgoing voice will not be heard by the other party (this is mute operation).

■ For Monitor and Mute Operation

While having a conversation using the handset;

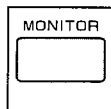

Press
MONITOR

- The other party's voice will be heard through the MONITOR speaker.
- Your voice will not be heard by the other party.

■ To Cancel Monitor and Mute Operation

When the handset is in the cradle:



Lift
handset

- You can talk to the other party through the handset. If you press the MONITOR button instead of lifting the handset, the call will be terminated.

When the handset is being lifted:



Press
MONITOR

- 2-way conversations through the handset will be resumed.

External Feature Access

Allows extension user to access features of the central office or host PBX.
(e.g. CALL WAITING FEATURE can be supplied by Central Office.)

The external feature (e.g. CALL WAITING FEATURE) can only be accessed when engaged on an outside call.

The following example shows you one of the procedures.

■ Call Waiting-Outside Line



Will hear a
call waiting
tone

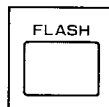

Press
FLASH



Consult with
new caller while
original call is
on hold

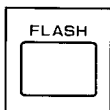

Press
FLASH



Consult with
original caller while
2nd call is on hold

If the calling
party on hold
hangs up, the
line is terminated.

- "Flash" can be stored into memory in the same way as "Storage" on page 15.
- You may access some features of host PBX using the FLASH button. If KX-T123210 is connected to host PBX and flash operation is required, follow the procedure of flash operation which is required in the host PBX.

Use of Other Features (cont.)

Absent Message Capability

Absent messages (Message 1 through 6) which are programmed can be informed to calling party. Programming can be done at any telephone (either proprietary telephones or standard telephones). When a caller using the proprietary telephone with LCD dials the extension in which the message is programmed, it will be displayed on the LCD.

■ Setting

■ Message 1. "Will Return Soon"



Lift handset or press MONITOR

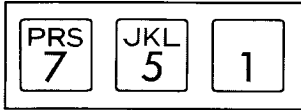

Dial "751"

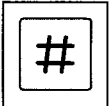

Dial "#"



Hang up or press MONITOR

■ Message 2. "Gone Home"



Lift handset or press MONITOR

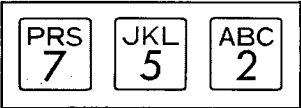

Dial "752"

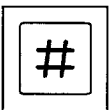

Dial "#"



Hang up or press MONITOR

■ Message 3. "At Ext. 123"

extension number



Lift handset or press MONITOR

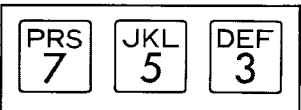

Dial "753"

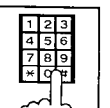

Dial extension number

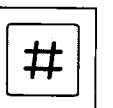

Dial "#"



Hang up or press MONITOR

■ Message 4. "Back at 10:23 AM"

minute
hour AM/PM



Lift handset or press MONITOR

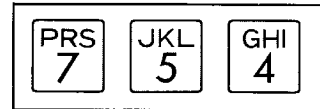

Dial "754"

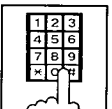

Enter hour (01 through 12)

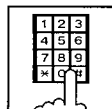

Enter minute (00 through 59)

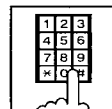

Dial "0" or "1"

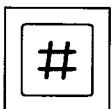

Dial "#"

"0": for AM
"1": for PM



Hang up or press MONITOR

■ Message 5. "Out Until 10/23"

day
month



Lift handset or press MONITOR

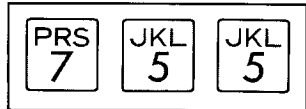

Dial "755"

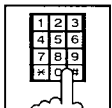

Enter month (01 through 12)

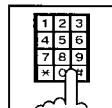

Enter day (01 through 31)

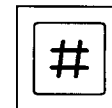

Dial "#"



Hang up or press MONITOR

www.cisco.com

Use of Other Features (cont.)

Absent Message Capability (cont.)

■ Message 6. "In a Meeting"



Lift handset or press MONITOR

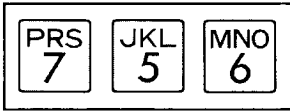

Dial "756"

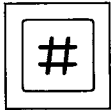

Dial "#"



Hang up or press MONITOR

■ To Cancel the message



Lift handset or press MONITOR

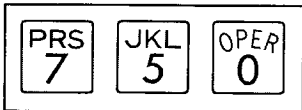

Dial "750"

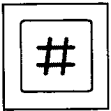

Dial "#"



Hang up or press MONITOR

Message Waiting

If the intercom extension operator has dialed is busy or does not answer, operator can inform the called extension that there is a message which have to be informed. It will be indicated by the MESSAGE indicator.

■ Setting (Operator only)



Lift handset or press MONITOR

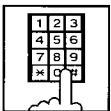

Dial extension number (100 through 199)



Ring back tone or busy tone will be heard



Press MESSAGE



Confirmation tone



Hang up or press MONITOR

- The MESSAGE indicator will be lit at the called extension.

■ To Call the Operator from the Extension where the Message is Left.



Lift handset or press MONITOR

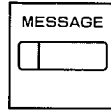

Press MESSAGE

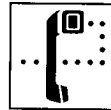

Ring back tone will be heard



Talk

- When the operator answers, the MESSAGE indicator will go out.

■ To Cancel the Message at the Extension where the Message is Left.



Lift handset or press MONITOR

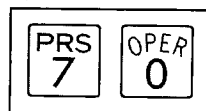

Dial "70"

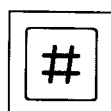

Dial "#"



Hang up or press MONITOR

- The MESSAGE indicator will go out.

■ To Cancel the Message which is Left at the Extension from the Operator



Lift handset or press MONITOR

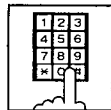

Dial extension number (100 through 199)

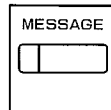

Press MESSAGE

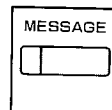

Press MESSAGE

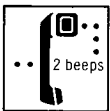

Confirmation tone



Hang up or press MONITOR

- The MESSAGE indicator will go out.

Use of Other Features (cont.)

Account Code

This feature gives each message of the SMDR an account code of the called or calling party. (Station Message Detail Recording-SMDR is cost saving feature that records all incoming and outgoing calls through CO line.)

This feature has two modes-"Forced" and "Option".

In the "Forced" mode, the account code must be entered every time the extension user dials. In the "Option" mode, the account code may be entered when a record of the account code is needed. When setting to the "Forced" mode, see page 3-70 in INSTALLATION MANUAL.

For use of this feature, the PROGRAMMABLE FEATURE (F3 only) button must be programmed beforehand as the Account Code button. For programming, see page 41.

- If the account codes are programmed with the telephone numbers for one touch dialing or system speed dialing, you need not dial the account code when making a call. Program as follows.

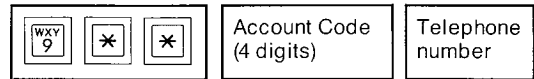

Receiving a Call

If you want to record a calling party's account code in the SMDR, follow the below-mentioned procedure.

Within 30 seconds of finishing your conversation or while having a conversation,

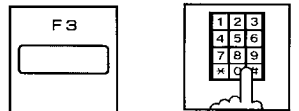

Press "F3"

Dial account code

- Dialing the account code must be done before hanging up.

Option Mode

Making or Receiving a Call

If you want to record a calling or called party's account code in the SMDR, follow the below-mentioned procedure.

Within 30 seconds of finishing your conversation or while having a conversation,

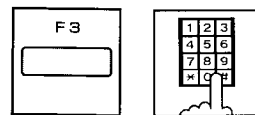

Press "F3"

Dial account code

- Dialing the account code must be done before hanging up.

[Account code is 4 digits.]

- If you enter the wrong account code, press the F3 button and enter the correct code.

Forced Mode

Making a Call



Lift handset or press MONITOR

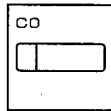

Press CO

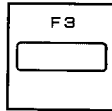

Press "F3"

[Intermittent tone is heard.]

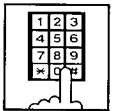

Dial account code



Wait for C.O. dial tone

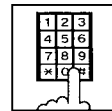

Dial phone number

[Account code is 4 digits.]

- You may dial 9 or 81 through 88 instead of pressing the CO button.
- Account code must be required 4 numerical digits except for the "#" and "*" buttons.

Use of Other Features (cont.)

Pulse/Tone Conversion

When the dialing mode is required to change a pulse mode to a tone mode in one dialing sequence, this feature is used. (e.g. computer-accessed long distance service)

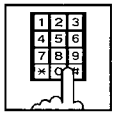

Dial phone number (Pulse mode)

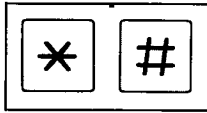

Dial "* #"

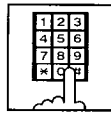

Dial phone number (Tone mode)

- When you dial using this feature, you must use the line set to a pulse mode. Phone number after dialing "* #" will be changed to tone mode.

Example: (Computer-accessed long distance service)

- Local access telephone number of the alternate long distance service company 765-4321, Authorization no. 0123456, Long distance no. 543-210-9876
- Pulse mode is required by local access telephone number of the alternate long distance service company.
- Service of MCI, SPRINT, METRO or other systems is used.

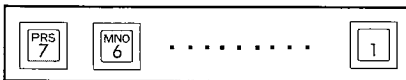

long distance service company no.

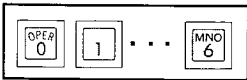
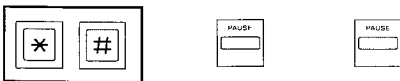

Authorization no.

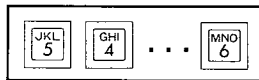

Long distance no.

Executive Override Deny

Allows you to prohibit another extension user from intruding into your extension that is in conversation with an outside party or inside party. Default is "Allow".

To Deny Executive Override



Lift handset or press MONITOR

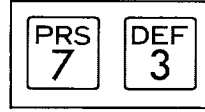

Dial "73"



Dial "3"

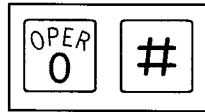

Dial "0#"



Hang up or press MONITOR

To Allow Executive Override



Lift handset or press MONITOR

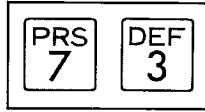

Dial "73"



Dial "3"

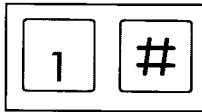

Dial "1#"



Hang up or press MONITOR

Use of Other Features (cont.)

Call Waiting Tone-From CO/Extension Deny

During a conversation, a call waiting tone will be heard when a third party on an outside line or intercom calls you. Call waiting tone can be removed at customer's request. Default is "Allow".

■ To Deny CO Call Waiting Tone

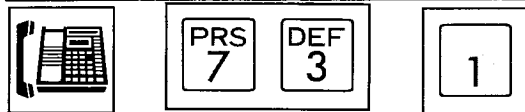

Lift handset or press MONITOR

Dial "73"

Dial "1"

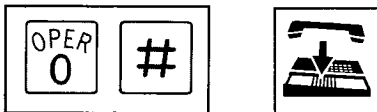

Dial "0#"

Hang up or press MONITOR

■ To Allow CO Call Waiting Tone

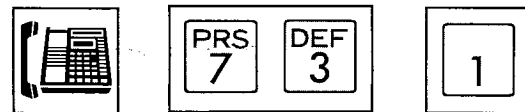

Lift handset or press MONITOR

Dial "73"

Dial "1"

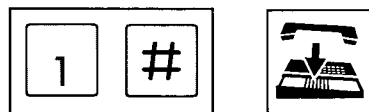

Dial "1#"

Hang up or press MONITOR

■ To Deny Extension Call Waiting Tone

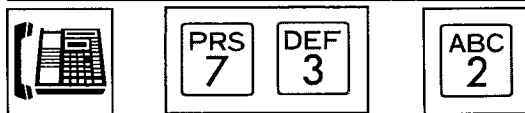

Lift handset or press MONITOR

Dial "73"

Dial "2"

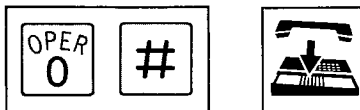

Dial "0#"

Hang up or press MONITOR

■ To Allow Extension Call Waiting Tone

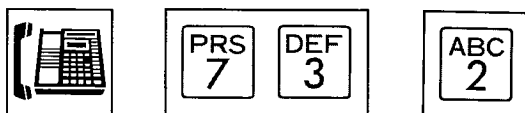

Lift handset or press MONITOR

Dial "73"

Dial "2"

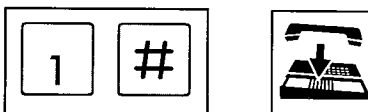

Dial "1#"

Hang up or press MONITOR

Detailed Operation

Use of Other Features (cont.)

Data Line Security

This feature provides security when transmitting data through an extension of the KX-T123210.

The parallel connection of the KX-T123250 and a data terminal equipment is impossible. Executive override, Call waiting tone and Hold time reminder tone from KX-T123210 are prohibited in this mode.

■ Setting



Lift handset or press MONITOR

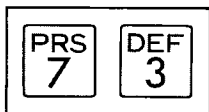

Dial "73"

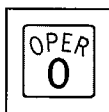

Dial "0"

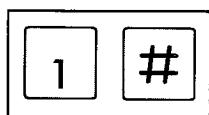

Dial "1#"



Hang up or press MONITOR

■ To Cancel



Lift handset or press MONITOR

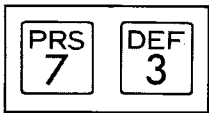

Dial "73"



Dial "0"

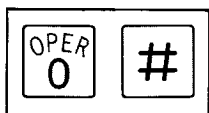

Dial "0#"



Hang up or press MONITOR

Background Music

Music from an external source (e.g. radio) can be listened to on the built-in speaker of the telephone.

- Be sure the handset is in the cradle, the MONITOR button is off and a call is not reaching.

■ To Listen

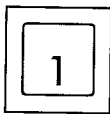

Dial "1"



Will hear music

■ To Cancel

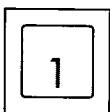

Dial "1"

Station Feature Clear

Dialing (79 #) will reset station features on an extension to the default data.



Lift handset or press MONITOR

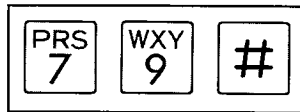

Dial "79#"



Hang up or press MONITOR

■ The following features can be reset to the default data.

- Dial Call Pickup Deny
- Call Waiting Tone
- From CO/Extension Deny
- Data Line Security
- Background Music
- Executive Override Deny
- Do Not Disturb
- Call Forwarding
- Absent Message Capability
- Message Waiting

Station Programming

- Be sure the handset is in the cradle, the MONITOR button is off and a call is not reaching.

One Touch Access for System Features

Features that can be accessed by using the dialing button also can be programmed into memory. (e.g. Paging All Extensions)

The F3 button can be changed from the PROGRAMMABLE FEATURE button into the Call Forwarding button, Do Not Disturb button and Account Code button by programming. (See pages 26, 28, 32, 41)

In this case, the F3 button can not be used for programming a system feature.

■ To Program

- Set the MEMORY switch of the KX-T123250 to **"PROGRAM"**.

Example:

Paging All Extensions (Dial 330)

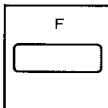

Press PROGRAMMABLE FEATURE (F1 through F3)

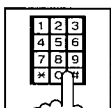

Dial "330"

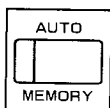

Press MEMORY

- System features described in the table on page 45 can be programmed into memory.
- After programming all the system features, return the MEMORY switch to the **"SET"** position.

■ To Access



Lift handset or press MONITOR

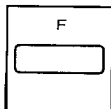

Press PROGRAMMABLE FEATURE

CO Line Ringing Selection

Through programming the CO numbers, you can select whether the extension ring or not when an outside call reaches through the CO line. Program the CO numbers which you want to ring. "Flexible Ringing Assignment" on page 3-49 in INSTALLATION MANUAL should be set to "Enable".

■ To Change the CO Numbers desired to Ring

- Set the MEMORY switch of the KX-T123250 to **"PROGRAM"**.



Dial "3"

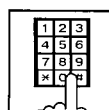

Dial CO numbers which you want to ring (01 through 12)

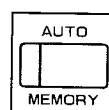

Press MEMORY

- After programming, return the MEMORY switch to the **"SET"** position.
- When an outside call reaches through the CO line not to ring, the CO indicator will flash. If you want to answer the outside Call, press the flashing CO button.

Station Programming (cont.)

Auto CO Hunting

Prime Line Preference-Outgoing

You can access the prime CO line directly by picking up the handset or pressing the MONITOR button.

- Set the MEMORY switch of the KX-T123250 to "PROGRAM".

■ Setting

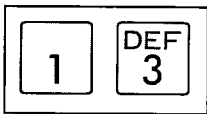

Dial "13"

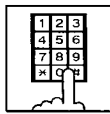

Dial CO number
(01 through 12)

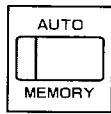

Press
MEMORY

■ To Cancel

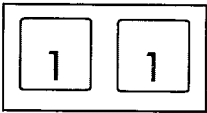

Dial "11"

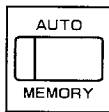

Press
MEMORY

- After programming, return the MEMORY switch to the "SET" position.

■ Dialing through CO line



Lift handset
or press
MONITOR

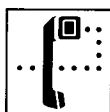

Wait for C.O.
dial tone

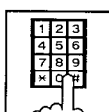

Dial phone
number

[CO indicator
will light.]

- When you access an extension in the Auto CO Hunting Mode, press the ICM button and then dial the extension number.

Idle Line Preference-Outgoing

You can access any CO line which is not in use directly by picking up the handset or pressing the MONITOR button.

- Set the MEMORY switch of the KX-T123250 to "PROGRAM".

■ Setting

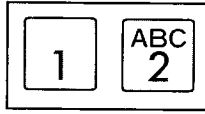

Dial "12"

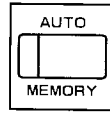

Press
MEMORY

■ To Cancel

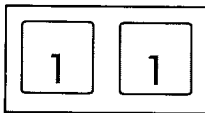

Dial "11"

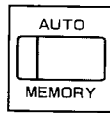

Press
MEMORY

- After programming, return the MEMORY switch to the "SET" position.

■ Dialing through CO line



Lift handset
or press
MONITOR

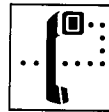

Wait for C.O.
dial tone

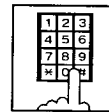

Dial phone
number

[CO indicator
will light.]

- When you access an extension in the Auto CO Hunting Mode, press the ICM button and then dial the extension number.

Station Programming (cont.)

Automatic Answering Selection

Prime Line Preference-Incoming

When incoming calls from the Central Office are received at the same time, you can receive the call on the preferred CO line first by only lifting the handset.

- Set the MEMORY switch of the KX-T123250 to "PROGRAM".

■ Setting

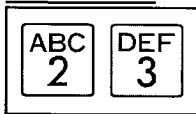

Dial "23"

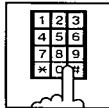

Dial CO number (01 through 12)

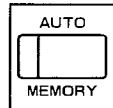

Press MEMORY

■ To Cancel

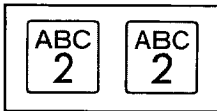

Dial "22"

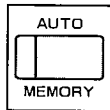

Press MEMORY

- After programming, return the MEMORY switch to the "SET" position.

■ To Answer



Lift handset

- If any incoming calls from the Central Office are received at the same time except preferred CO line, you must lift the handset and then press the CO button whose indicator is flashing (red color) quickly.

No Line Preference-Incoming

If programmed for the No Line Preference-Incoming mode, the extension user must lift the handset and then press the flashing CO button.

- Set the MEMORY switch of the KX-T123250 to "PROGRAM".

■ Setting

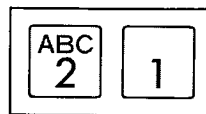

Dial "21"

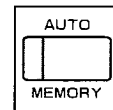

Press MEMORY

■ To Cancel

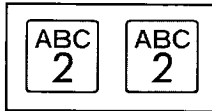

Dial "22"

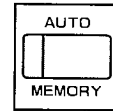

Press MEMORY

- After programming, return the MEMORY switch to the "SET" position.

■ To Answer



Lift handset

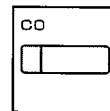

Press CO whose indicator is flashing quickly

Station Programming (cont.)

Flexible CO Button

To Change into Other CO Number

Allows each CO button to change into CO number which is different from printed CO number.

- Set the MEMORY switch of the KX-T123250 to "PROGRAM".

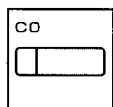

Press CO which you want to change into different CO number

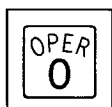

Dial "0"

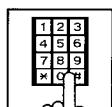

Dial CO number which you want to set newly (01 through 12)

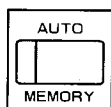

Press MEMORY

- After programming all CO buttons, return the MEMORY switch to the "SET" position.

To Change into DSS Button

Allows each CO button to change into the DSS (Direct Station Selection) button. DSS button can be used instead of dialing an extension number.

- Set the MEMORY switch of the KX-T123250 to "PROGRAM".

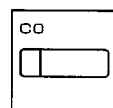

Press CO which you want to change into DSS button

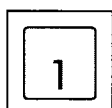

Dial "1"

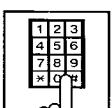

Dial extension number (100 through 199)

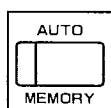

Press MEMORY

- After programming all CO buttons, return the MEMORY switch to the "SET" position.

■ Dialing



Lift handset

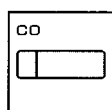

Press CO which has been changed into DSS

To Assign to Trunk Group Access Number

Allows each CO button to change into the trunk group access number (81 through 88).

- Set the MEMORY switch of the KX-T123250 to "PROGRAM".

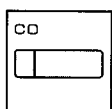

Press CO which you want to change into trunk group access number

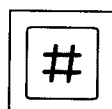

Dial "#"

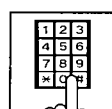

Dial trunk group number (1 through 8)

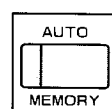

Press MEMORY

- After programming all CO buttons, return the MEMORY switch to the "SET" position.

To Change into Other All CO Numbers

Allows CO button to change into all CO numbers which are not assigned to CO button.

- Set the MEMORY switch of the KX-T123250 to "PROGRAM".

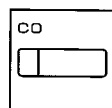

Press CO which you want to change into other all CO numbers

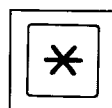

Dial "*"

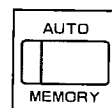

Press MEMORY

- After programming all CO buttons, return the MEMORY switch to the "SET" position.

Station Programming (cont.)

Flexible CO Button (cont.)

To Change into One Touch Dialing Button

Allows each CO button to change into the one touch dialing button.
Up to 16 digits can be stored into each of the 12 CO buttons.

- Set the MEMORY switch of the KX-T123250 to **"PROGRAM"**.

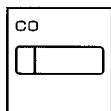

Press CO which you want to change into one touch dialing

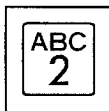

Dial "2"

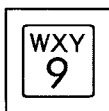

Dial "9"

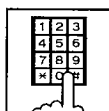

Dial phone number

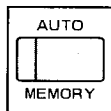

Press MEMORY

You may dial 81 through 88 instead of 9.

9... Each extension can automatically select an idle CO line.

81 through 88... Each extension can select a trunk group designated.

- After programming all CO buttons, return the MEMORY switch to the **"SET"** position.
- For dialing, refer to "One Touch Dialing" on page 15.

Call Waiting Tone Selection

You can change the Call Waiting Tone from Tone 1 to Tone 2 shown below to prevent the user from missing the tone.

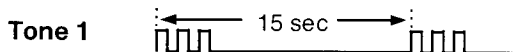

To Select

- Set the MEMORY switch of the KX-T123250 to **"PROGRAM"**.

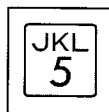

Dial "5"

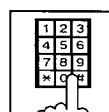

Dial "1" or "2"

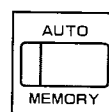

Press MEMORY

["1": for Tone 1
"2": for Tone 2]

- After programming, return the MEMORY switch to the **"SET"** position.

Station Programming (cont.)

Intercom Voice Alerting Mode

The intercom alerting mode (tone/voice) at a receiving extension can be selected through programming.

VOICE... Voice alerting instead of Tone alerting is heard through the speaker on the receiving extension.

TONE.. Tone alerting (ringing) sound at the receiving extension.

- Set the MEMORY switch of the KX-T123250 to "PROGRAM".

■ Setting (Voice Alerting Mode)

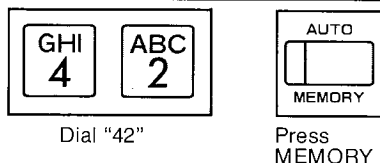

■ To Cancel (Setting Tone Alerting Mode)

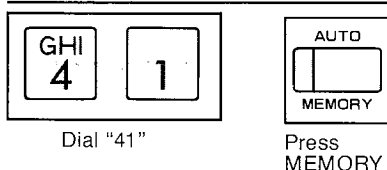

- After programming, return the MEMORY switch to the "SET" position.

Station Program Clear

Pressing (# * MEMORY) will reset station programs on an extension to the default data.

- Set the MEMORY switch of the KX-T123250 to "PROGRAM".

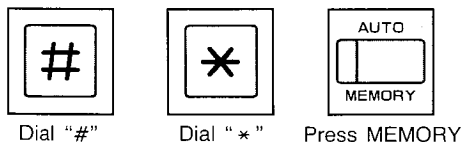

- After clearing, return the MEMORY switch to the "SET" position.

■ The following programs can be reset to the default data.

- Auto CO Hunting
 - Prime Line Preference-Outgoing
 - Idle Line Preference-Outgoing
- Automatic Answering Selection
 - Prime Line Preference-Incoming
 - No Line Preference-Incoming
- Intercom Voice Alerting Mode
- CO Line Ringing Selection
- Call Waiting Tone Selection
- F3-One Touch Button Mode Selection

F3-One Touch Button Mode Selection

3 programmable feature (F1, F2, F3) buttons are provided with the KX-T123250, and only "F3" button can be changed from programmable feature button to call forwarding (see page 26 for operation)/do not disturb (see page 28 for operation)/account code (see page 32 for operation) button.

- dial 1 mode....
programmable feature function
- dial 2 mode....
call forwarding/do not disturb/account code function

- Set the MEMORY Switch of the KX-T123250 to "PROGRAM".

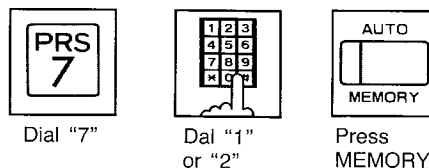

["1": for Programmable feature
"2": for DND/FWD/Account code]

- After programming the F3 button, return the MEMORY Switch to the "SET" position.

Example of Operation

■ To Place a Call on Hold, and to Make Another Call

Example (CO line):

Call in progress CO 1
 New call CO 2

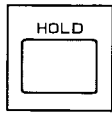

Press
HOLD

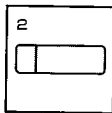

Press
CO 2

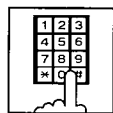

Make a
new call



Consult with
the new caller
while the
call on CO 1
is on hold

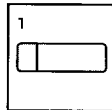

Press CO 1 to
terminate the
call on CO 2 and
to return to the
call on CO 1

Example (Intercom):

Call in progress on extension 102
 New call on extension 103

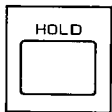

Press
HOLD

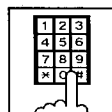

Dial
extension
number 103



Consult with
the new caller
while extension
102 is on hold

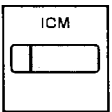

Press ICM
to terminate
the call on
extension 103
and to return
to the call on
extension 102

■ To Make a Call and Transfer a Called Party to Another Extension

Example:

Call in progress CO 1
 Extension to whom a call
 is transferred Extension 102

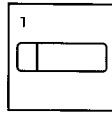

Press
CO 1

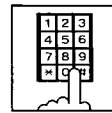

Dial phone
number



When the
other party
answers, lift
handset and
talk

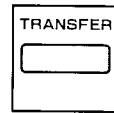

Press
TRANSFER

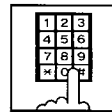

Dial
extension
number 102



Announce
and wait for
an answer



Hang up

■ To Place One Call on Hold and Transfer the New Call to an Extension

Example:

Call in progress CO 1
 New call CO 2
 Extension to whom a call
 is transferred Extension 102

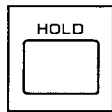

Press
HOLD

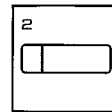

Press
CO 2

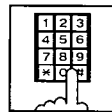

Make or
receive a
new call



Consult with
the new
caller
while the
call on CO 1
is on hold



Press
TRANSFER

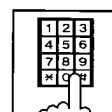

Dial
extension
number 102



Hang up

- CO 2 call is now transferred to extension 102.
- CO 1 call is still on hold.

Example of Operation (cont.)

■ To Place Three Calls on Hold, Transfer Two of the Calls to Extensions and Talk to Call on Hold

Example :

Call in progress CO 1
 New call CO 2, CO 3
 CO 1 is transferred to extension 104.
 CO 2 is transferred to extension 105.

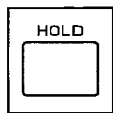

Press HOLD

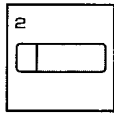

Press CO 2

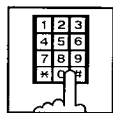

Make or receive a new call

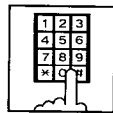

Dial extension number 104

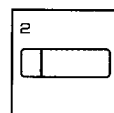

Press CO 2



Consult with the caller on CO 2 while the caller on CO 3 is on hold



Consult with the new caller on CO 2 while the call on CO 1 is on hold

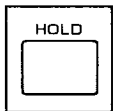

Press HOLD

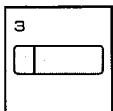

Press CO 3



Press TRANSFER

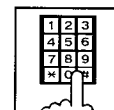

Dial extension number 105

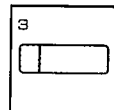

Press CO 3

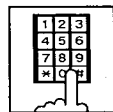

Make or receive a new call



Consult with the new caller on CO 3 while the callers on CO 1 and CO 2 are on hold

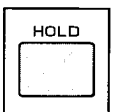

Press HOLD



Talk

- The call on CO 1 is now transferred to extension 104.
- The call on CO 2 is now transferred to extension 105.
- The call on CO 3 is now returned into conversation.

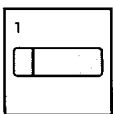

Press CO 1



Consult with the caller on CO 1 while the callers on CO 2 and CO 3 are on hold



Press TRANSFER

- You can transfer a desired call on CO to an extension in desired order regardless of order of placing on hold.

Busy Lamp Field

The indicators corresponding to the ICM (Intercom) and the CO buttons will indicate the status of the extensions.

- CO indicator light

Light	Status
off	idle
on (green color)	in use
slow flashing (green color)	on hold
flashing in groups of 2 (green color)	on exclusive hold
quick flashing (green color)	Privacy Release
on (red color)	in use at another extension
slow flashing (red color)	on hold at another extension
quick flashing (red color)	receiving a call

Note:

- If a call on CO line to which the CO line number is not assigned, is placed on hold, the ICM indicator will flash.

- ICM indicator light

Light	Status
off	idle
on	in use for intercom
slow flashing	on hold
flashing in groups of 2	on exclusive hold
quick flashing	receiving

- DSS indicator light

(Indicator of CO button which has been changed into DSS button.)

Light	Status (another extension)
off	idle
on (red color)	in use

Table of System Features

The following system features can be programmed into memory.

Dial Plan Code	System Features	Dial Plan Code	System Features
Extension no. (100 through 199)	Individual Inter Office Calling	PRS 7 1 ABC 2	Call Forwarding-Busy or No Answer
DEF 3 1 Doorphone number (1 or 2)	Calling Doorphone 1 or 2	Extension no. (100 through 199) #	
DEF 3 ABC 2 OPER 0	Paging-External Equipment 1 and 2	PRS 7 1 DEF 3 WXY 9	Call Forwarding-To Outside Line
DEF 3 ABC 2 1	Paging-External Equipment 1	Phone no. #	
DEF 3 ABC 2 ABC 2	Paging-External Equipment 2	PRS 7 1 GHI 4 #	Do not Disturb
DEF 3 DEF 3 Group no. (1 through 8)	Paging Group	PRS 7 ABC 2 OPER 0 #	Cancelling Dial Call Pickup Deny
DEF 3 DEF 3 OPER 0	Paging All Extensions	PRS 7 ABC 2 1 #	Dial Call Pickup Deny
GHI 4 OPER 0	Dial Call Pickup	PRS 7 JKL 5 OPER 0 #	Cancelling Absent Message
GHI 4 ABC 2 External paging no. (1 or 2)	Paging Answer-External Equipment 1 or 2	PRS 7 JKL 5 1 #	Message "Will Return Soon"
GHI 4 DEF 3	Paging Answer-Group-All Extensions	PRS 7 JKL 5 ABC 2 #	Message "Gone Home"
JKL 5	Call Park Retrieve	PRS 7 JKL 5 DEF 3	Message "At Ext 101" extension no. ↙
Parking Station no. (20 through 29)		Extension no. #	
MNO 6	Camp-on	PRS 7 JKL 5 GHI 4	Message "Back at 10:00 AM."
PRS 7 OPER 0 #	Cancelling Message Waiting	Hour (01 through 12)	
PRS 7 1 OPER 0 #	Cancelling Call Forwarding or Do Not Disturb	Minute (00 through 59)	
PRS 7 1 1	Call Forwarding-All Calls	0: for AM or 1: for PM #	
Extension no. (100 through 199) #		PRS 7 JKL 5 JKL 5	Message "Out Until 10/23"
		Month (01 through 12)	
		Day (01 through 31) #	

General Information



Troubleshooting Guide



Problem

Cause & Remedy

<p>The unit does not ring.</p>	<ul style="list-style-type: none"> ● Ringer Volume Selector is set to "OFF". Set to "HIGH" or "LOW". ● See "CO Line Ringing Selection" on page 36.
<p>The unit does not operate during power interruption.</p>	<p>This is normal. We recommend to use a standard telephone or KX-T123230 as an extension of jack number 01, 02, 09, 10, 17 or 18.</p>
<p>I have transferred a call to the different party by mistake.</p>	<p>Press the CO or ICM button whose indicator is flashing slowly to retrieve the call, then repeat the procedure of Call Transfer.</p>
<p>I placed a call on hold and hung up once, then seized a line and tried to place a call on exclusive hold, but I can not.</p>	<p>Retrieve a call once and place a call on exclusive hold again.</p>
<p>I can seize a CO line but can not make a call.</p>	<p>The CO line which you used is set the Toll Restriction. We recommend to use another CO line to which the Toll Restriction has not been setting.</p>

For your future reference

SERIAL NO. _____ DATE OF PURCHASE _____
 (found on the bottom of the unit)

NAME OF DEALER _____

DEALER'S ADDRESS _____

General Information

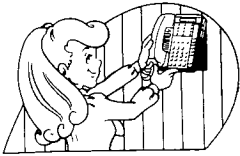

Wall Mounting

This unit can be mounted on a wall phone plate.

To rotate the handset guide for wall mounting

1. Pull up in the direction of arrow (A).
2. Set by rotating as shown.

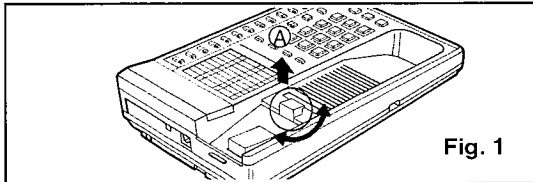

Fig. 1

To temporarily place the handset down during a conversation, hook as shown.

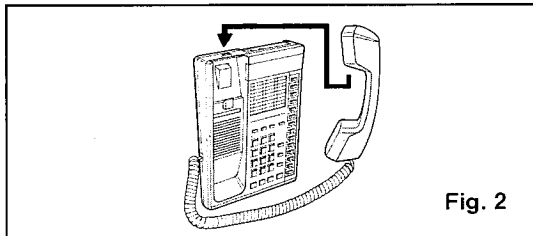

Fig. 2

To mount the unit on a wall phone plate

1. Remove the rest by pulling in the direction of the arrow (B) while pushing the two snap tabs simultaneously in the direction of the arrow (A), as shown in Fig. 3.
2. Insert the hooks of the rest into the hole of the unit then replace the rest by pushing it in the direction of the arrow (C), as shown in Fig. 4.
3. Connect the telephone cord to the unit.

4. Mount the unit to the wall phone plate then seat securely by hooking as shown in Fig. 5.
5. Connect the cord to the telephone line jack.

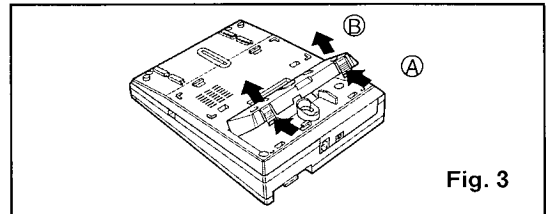

Fig. 3

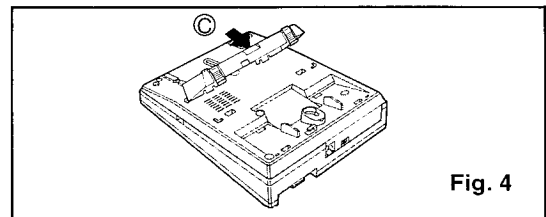

Fig. 4

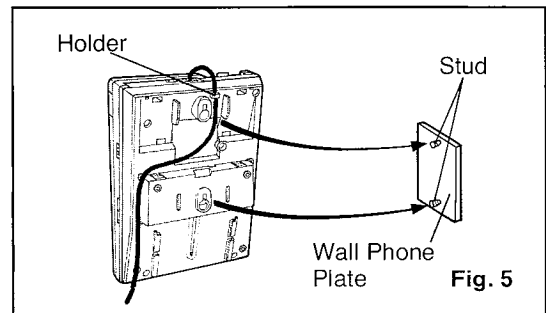

Fig. 5

When you want to connect the unit to a wall phone plate using a short telephone cord, have a house-wiring installed by the telephone company or a qualified installer, purchase a short telephone cord of 4-conductor and connect the cord to a wall phone plate.

Others

- If there is any trouble, disconnect the unit from the extension line and connect a known working phone. If the known working phone operates properly, have it repaired by one of the specified Panasonic Factory Service Centers. If the known working telephone does not operate properly, check the Electronic Modular Switching System (KX-T123210).
- Keep the unit away from heating appliances and electrical noise generating devices such as fluorescent lamps and motors.
- The unit should be kept free of dust, moisture and vibration, and should not be exposed to direct sunlight.
- Do not use benzine, thinner, or the like, or any abrasive powder to clean the cabinet. Wipe it with a soft cloth.

WARNING:

TO PREVENT FIRE OR SHOCK HAZARD, DO NOT EXPOSE THIS PRODUCT TO RAIN OR ANY TYPE OF MOISTURE.

Do not use any handset other than Panasonic handset for model KX-T123250 use.

"WARNING"

This equipment generates, uses, and can radiate radio frequency energy and if not installed and used in accordance with the instructions manual, may cause interference to radio communications. It has been tested and found to comply with the limits for a Class A computing device pursuant to Subpart J of Part 15 of FCC Rules, which are designed to provide reasonable protection against such interference when operated in a commercial environment. Operation of this equipment in a residential area is likely to cause interference in which case the user at his own expense will be required to take whatever measures may be required to correct the interference.

Important Information

This telephone does not provide magnetic coupling to hearing aids.

FCC rules prohibit the use of non-hearing aid-compatible telephones in the following locations or applications:

- (1) All public or semipublic coin-operated or credit card telephones.
- (2) Elevators, highways and tunnels (automobile, subway, railroad or pedestrian) where a person with impaired hearing might be isolated in an emergency.
- (3) Places where telephones are specifically installed to alert emergency authorities such as fire, police or medical assistance personnel.
- (4) Hospital rooms, residential health care facilities, convalescent homes, and prisons.
- (5) Workstations for hearing impaired personnel.
- (6) Hotel, motel, apartment lobbies; in stores where telephones are used by patrons to order merchandise; in public transportation terminals where telephones are used to call taxis, or to reserve lodging or rental automobiles.
- (7) Hotel and motel rooms. (At least ten percent of the rooms must contain hearing aid-compatible telephones; or contain jacks for plug-in hearing aid-compatible telephones which will be provided to hearing impaired customers upon request.)

Limited Warranty

Panasonic Company, PHI or PSC will repair this product with new or rebuilt parts, free of charge, in the U.S.A. or Puerto Rico for one (1) year from the date of original purchase in the event of a defect in materials or workmanship.

Batteries (if included) — New rechargeable batteries in exchange for defective rechargeable batteries for ten (10) days from the date of original purchase. Non-rechargeable batteries are not warranted.

Carry-in or mail-in service in the continental U.S.A. can be obtained during the warranty period from a Matsushita Services Company (MSC) Factory Servicenter listed in the Servicenter Directory. Or call 1-800-447-4700, toll free, to locate an authorized MSC Servicenter. Carry-in or mail-in service in Puerto Rico or Hawaii can be obtained during the warranty period by calling the telephone numbers listed in the Servicenter Directory.

This warranty is extended only to the original purchaser. A purchase receipt or other proof of date of original purchase will be required before warranty performance is rendered.

This warranty only covers failures due to defects in materials or workmanship which occur during normal use. It does not cover damage which occurs in shipment or failures which are caused by products not supplied by Panasonic Company, PHI or PSC or failures which result from accident, misuse, abuse, neglect, mishandling, misapplication, alteration, faulty installation, modification, or service by anyone other than a MSC Factory Servicenter or authorized MSC Servicenter or damage that is attributable to acts of God.

LIMITS AND EXCLUSIONS

There are no express warranties except as listed above.

PANASONIC COMPANY, PHI AND PSC SHALL NOT BE LIABLE FOR INCIDENTAL OR CONSEQUENTIAL DAMAGES RESULTING FROM THE USE OF THIS PRODUCT, OR ARISING OUT OF ANY BREACH OF THIS WARRANTY.

ALL EXPRESS AND IMPLIED WARRANTIES, INCLUDING THE WARRANTIES OF MERCHANTABILITY AND FITNESS FOR A PARTICULAR PURPOSE, ARE LIMITED TO THE APPLICABLE WARRANTY PERIOD SET FORTH ABOVE.

Some states do not allow the exclusion or limitation of incidental or consequential damages, or limitations on how long an implied warranty lasts, so the above exclusions or limitations may not apply to you.

This warranty gives you specific legal rights and you may also have other rights which vary from state to state.

If a problem with this product develops during the warranty period, you may contact your dealer or Servicenter. If the problem is not handled to your satisfaction, then write to the Consumer Affairs Division at the company address indicated below.

Panasonic Company
Division of Matsushita Electric Corporation of America
One Panasonic Way, Secaucus, New Jersey 07094

Panasonic Hawaii, Inc. ("PHI")
91-238 Kauhi St. Ewa Beach, Honolulu, Hawaii 96808-0774

Panasonic Sales Company ("PSC"),
Division of Matsushita Electric of Puerto Rico, Inc.
Ave. 65 De Infanteria, KM 9.7 Victoria Industrial Park, Carolina, Puerto Rico 00630

Printed in Japan

PQQX5447ZA

S1087T0

-PANUG-024

Servicenter Directory

To locate an Authorized Servicenter in Your Area within the Continental U. S. A.

DIAL TOLL FREE: 1-800-447-4700

24Hours a Day, 7 Days a Week

Requests for assistance in obtaining repairs or technical information...contact any one of the following Service Administration offices:

EASTERN

2250 Cabot Boulevard
West Langhorne, PA 19047
215-741-0676

MIDWEST

425 East Algonquin Road
Arlington Heights, IL 60005
312-981-4842

WESTERN

6550 Katella Avenue
Cypress, CA 90630
714-895-7438

SOUTHERN

1854 Shackleford Court
Norcross, GA 30093
404-925-6860

Correspondence requesting product information should be sent to:

Panasonic Consumer Affairs, Matsushita Services Company, Division of Matsushita Electric Corporation of America, 50 Meadowland Parkway, Secaucus, NJ 07094.

Service in Puerto Rico

MATSUSHITA ELECTRIC OF PUERTO RICO, INC.

Panasonic Sales Company
Factory Servicenter
Calle Rosarito, Edif D
Ceramica Industrial Park
Carolina, Puerto Rico 00630
809-750-5135, 809-750-5235

Service in Hawaii

PANASONIC HAWAII, INC.

91-238 Kauhī Street, Ewa Beach
P.O. Box 774
Honolulu, Hawaii 96808-0774
808-682-1521

Service in the Continental
U.S.A. ...
Factory Servicenters

MATSUSHITA SERVICES COMPANY

Division of Matsushita Electric Corporation of America,
50 Meadowland Parkway, Secaucus, New Jersey 07094

1575 NORTHSIDE DRIVE
SUITE 325
ATLANTA, GA 30318
(404) 351-8978

Accessory Order Information

- Replacement parts and accessories are available through your local authorized parts distributor.
- For the authorized distributor in your area, call toll free: 1-800-447-4700.

Part No.	Picture	Description	Comment
KX-J07G		Handset cord	7 feet
KX-J15G			15 feet
KX-J25G			25 feet

General Information

