

Operating Instructions

PROPRIETARY TELEPHONE WITH
LCD FOR KX-T61610

INTEGRATED
TELEPHONE SYSTEM
MODEL NO. **KX-T61630**
EASA-PHONE

Basic Operation

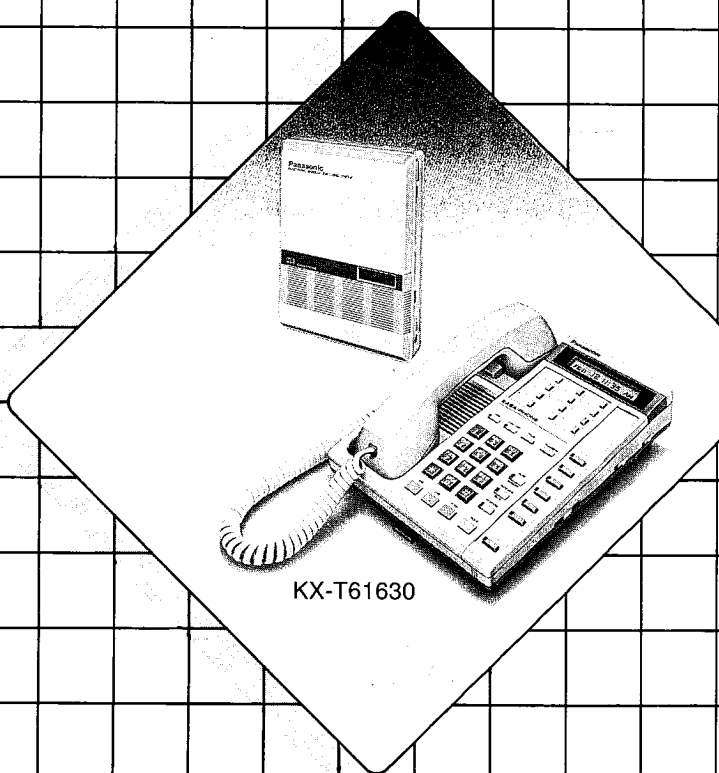

KX-T61630

General Information

Panasonic

Please read before use.

Thank you for purchasing the Panasonic Telephone.

Features

- **Designed Exclusively** for Electronic Modular Switching Systems except KX-T616 and KX-T616D.
- **LCD Readout** shows date, time and call duration. HELP screen-style 16-digit display helps you program system features.
- **Auto-Answer Speakerphone** lets you set intercom for automatic “hands free” answering. Also allows on-hook dialing.
- **12 Soft Buttons (Programmable Feature)** for one-touch access to system features such as automatic call-back and paging. Can also store numbers for automatic dialing.
- **Call Transfer** switches either outside or internal calls to another extension.
- **Call Forwarding** automatically re-routes door intercom and internal and external calls to a different extension.
- **CO Line BLF** indicates status of each CO line and lets you connect to a CO line by pressing a CO line button.
- **Power Failure Protection** lets you make and receive calls on extensions 11–16 during power failures.
- **Optional Headset** combines the privacy of a headset with the hands free operation of a speakerphone.

Accessories

Extension line cord	1
Handset	1
Handset cord	1

- Headset KX-T30890 and DSS console KX-T61640 are provided as option.
See “System Component” described on the reverse of the front cover in INSTALLATION MANUAL.

- If you use a DSS console KX-T61640, you can access another extension by one touch of a DSS button instead of pressing an extension number, and system features of KX-T61610 by one touch of PROGRAMMABLE FEATURE button on a DSS console.
For further details, see OPERATING INSTRUCTIONS of KX-T61640.

For further details, see the Installation Manual.



Detach this position



TO MAKE CALLS			
<ul style="list-style-type: none"> •Lift the handset or press the SP-PHONE button first. •After finishing your conversation, hang up the handset or press the SP-PHONE button. 			
INTER OFFICE CALLING <i>(Intercom)</i>	Dial extension no. (11 through 26)		
OUTWARD DIALING <i>Individual Line Access</i>	<input type="checkbox"/> CO Dial phone number •You may dial 81 through 86 instead of pressing the CO button.		
<i>Automatic Line Access</i>	<input type="checkbox"/> WXYZ 9 Dial phone number		
SPEED DIALING	<input type="checkbox"/> AUTO MEMORY Dial speed access code (00 through 99)		
ONE TOUCH DIALING	<input type="checkbox"/> No. 0 (Press the PROGRAMMABLE FEATURE button.)		
CALLING DOORPHONE	<table style="width: 100%; border-collapse: collapse;"> <tr> <td style="text-align: center; width: 50%; border-right: 1px dashed black;"> <i>For doorphone 1</i> <input type="checkbox"/> DEF 3 1 </td> <td style="text-align: center; width: 50%;"> <i>For doorphone 2</i> <input type="checkbox"/> DEF 3 <input type="checkbox"/> ABC 2 </td> </tr> </table>	<i>For doorphone 1</i> <input type="checkbox"/> DEF 3 1	<i>For doorphone 2</i> <input type="checkbox"/> DEF 3 <input type="checkbox"/> ABC 2
<i>For doorphone 1</i> <input type="checkbox"/> DEF 3 1	<i>For doorphone 2</i> <input type="checkbox"/> DEF 3 <input type="checkbox"/> ABC 2		

WHEN A LINE IS BUSY	
AUTOMATIC CALL BACK BUSY <i>For Outside Calls</i>	<input type="checkbox"/> CO Hear a busy tone MNO 6 Hang up handset or press "SP-PHONE"
<i>For Intercom Calls</i>	Dial extension no. (11 through 26) Hear a busy tone MNO 6 Hang up handset or press "SP-PHONE"
BUSY STATION SIGNALING	Dial extension no. (11 through 26) Hear a busy tone 1
LAST NUMBER REDIAL	Lift handset or press "SP-PHONE" LNR(REDIAL)

TO RECEIVE CALLS

ANSWER	Lift handset or <input type="checkbox"/> <small>SP-PHONE</small> ● You may press the CO or ICM button.				
AUTOMATIC ANSWER-INTERCOM	<table style="width: 100%; border: none;"> <tr> <td style="width: 50%; border: none; vertical-align: top;"> <i>To set</i> <input type="checkbox"/> <small>AUTO ANS</small> ● The AUTO ANSWER indicator will be lit. <input type="checkbox"/> <small>MUTE</small> </td> <td style="width: 50%; border: none; vertical-align: top;"> <i>To cancel</i> <input type="checkbox"/> <small>AUTO ANS</small> <input type="checkbox"/> <small>MUTE</small> </td> </tr> </table>	<i>To set</i> <input type="checkbox"/> <small>AUTO ANS</small> ● The AUTO ANSWER indicator will be lit. <input type="checkbox"/> <small>MUTE</small>	<i>To cancel</i> <input type="checkbox"/> <small>AUTO ANS</small> <input type="checkbox"/> <small>MUTE</small>		
<i>To set</i> <input type="checkbox"/> <small>AUTO ANS</small> ● The AUTO ANSWER indicator will be lit. <input type="checkbox"/> <small>MUTE</small>	<i>To cancel</i> <input type="checkbox"/> <small>AUTO ANS</small> <input type="checkbox"/> <small>MUTE</small>				
DIAL CALL PICKUP	<table style="width: 100%; border: none;"> <tr> <td style="width: 60%; border: none;">Lift handset or press "SP-PHONE"</td> <td style="width: 10%; border: none; text-align: center;"><input type="checkbox"/> <small>GHI</small> 4</td> <td style="width: 10%; border: none; text-align: center;"><input type="checkbox"/> <small>OPER</small> 0</td> <td style="width: 20%; border: none;">● You may dial the ringing extension number instead of 0.</td> </tr> </table>	Lift handset or press "SP-PHONE"	<input type="checkbox"/> <small>GHI</small> 4	<input type="checkbox"/> <small>OPER</small> 0	● You may dial the ringing extension number instead of 0.
Lift handset or press "SP-PHONE"	<input type="checkbox"/> <small>GHI</small> 4	<input type="checkbox"/> <small>OPER</small> 0	● You may dial the ringing extension number instead of 0.		

WHILE HAVING A CONVERSATION

HOLD-CO <i>Call On Hold</i>	<i>To place call on hold</i> <input type="checkbox"/> <small>HOLD</small>			
	<i>To retrieve at the holding extension</i> <input type="checkbox"/> <small>CO</small> ● Press the CO button whose indicator is flashing slowly (green color).	<i>To retrieve from another extension</i> <input type="checkbox"/> <small>CO</small> ● Press the CO button whose indicator is flashing slowly (red color).		
	<i>Call on Exclusive Hold</i>	<table style="width: 100%; border: none;"> <tr> <td style="width: 50%; border: none;"><i>To place call on hold</i> <input type="checkbox"/> <small>HOLD</small> <input type="checkbox"/> <small>HOLD</small></td> <td style="width: 50%; border: none; vertical-align: top;"> <i>To retrieve</i> <input type="checkbox"/> <small>CO</small> ● Press the CO button whose indicator is flashing in groups of 2 (green color). </td> </tr> </table>		<i>To place call on hold</i> <input type="checkbox"/> <small>HOLD</small> <input type="checkbox"/> <small>HOLD</small>
<i>To place call on hold</i> <input type="checkbox"/> <small>HOLD</small> <input type="checkbox"/> <small>HOLD</small>	<i>To retrieve</i> <input type="checkbox"/> <small>CO</small> ● Press the CO button whose indicator is flashing in groups of 2 (green color).			
HOLD-INTERCOM <i>Call on Hold</i>	<i>To place call on hold</i> <input type="checkbox"/> <small>HOLD</small>			
	<i>To retrieve at the holding extension</i> <input type="checkbox"/> <small>ICM</small>	<i>To retrieve from another extension</i> <input type="checkbox"/> <small>JKL</small> 5 Dial holding extension no. (11 through 26)		
	<i>Call on Exclusive Hold</i>	<table style="width: 100%; border: none;"> <tr> <td style="width: 50%; border: none;"><i>To place call on hold</i> <input type="checkbox"/> <small>HOLD</small> <input type="checkbox"/> <small>HOLD</small></td> <td style="width: 50%; border: none; vertical-align: top;"> <i>To retrieve</i> <input type="checkbox"/> <small>ICM</small> </td> </tr> </table>		<i>To place call on hold</i> <input type="checkbox"/> <small>HOLD</small> <input type="checkbox"/> <small>HOLD</small>
<i>To place call on hold</i> <input type="checkbox"/> <small>HOLD</small> <input type="checkbox"/> <small>HOLD</small>	<i>To retrieve</i> <input type="checkbox"/> <small>ICM</small>			

WHILE HAVING A CONVERSATION

CONFERENCE	<input type="checkbox"/> CONF Dial 2nd party Consult with 2nd party <input type="checkbox"/> CONF
CALL WAITING <i>To Terminate the Original Call and Talk to the New Caller</i> <i>To Place the Original Call on Hold and Talk to the New Caller</i>	<p>Hear a call waiting tone <input type="checkbox"/> CO or <input type="checkbox"/> ICM Talk</p> <p>Hear a call waiting tone <input type="checkbox"/> HOLD <input type="checkbox"/> CO or <input type="checkbox"/> ICM •If both original and new calls are intercom calls, you need not to press the ICM button.</p> <p>Consult with new caller while original call is on hold</p>
CALL TRANSFER <i>To Transfer after the Other Extension Answers</i>	<input type="checkbox"/> TRANSFER Dial extension no. (11 through 26) Announce and wait for answer Hang up
<i>To Transfer without Announcing to the Other Extension</i>	<input type="checkbox"/> TRANSFER Dial extension no. (11 through 26) Hang up

PAGING

Lift the handset or press the SP-PHONE button first.

PAGING ALL EXTENSIONS <i>To Access</i>	<input type="checkbox"/> DEF 3 <input type="checkbox"/> GHI 4 Hear 1 beep Page Wait for answer and talk
PAGING GROUP <i>To Access</i>	<p><i>For pickup group 1</i></p> <input type="checkbox"/> DEF 3 <input type="checkbox"/> JKL 5 Hear 1 beep Page Wait for answer and talk
PAGING-EXTERNAL <i>To Access</i>	<input type="checkbox"/> DEF 3 <input type="checkbox"/> DEF 3 Hear 1 beep Page Wait for 1 beep and talk
PAGING AND TRANSFER <i>To Transfer Call to Paged Person</i>	<input type="checkbox"/> TRANSFER <input type="checkbox"/> DEF 3 <input type="checkbox"/> GHI 4 Hear 1 beep Page Wait for answer and hang up <ul style="list-style-type: none"> • You may dial 35, 36, 37, 38 or 33 instead of 34. • You need not to lift the handset or press the SP-PHONE button first.
ANSWER	<input type="checkbox"/> GHI 4 <input type="checkbox"/> DEF 3 Hear 1 beep Talk



OTHER FEATURES

- Lift the handset or press the SP-PHONE button first.
- After hearing confirmation tone (1 or 2 beep), hang up the handset or press the SP-PHONE button.

BACKGROUND MUSIC	<i>To enable</i> PRS 7 JKL 5 1 #	<i>To cancel</i> PRS 7 JKL 5 OPER 0 #
CALL FORWARDING	<i>Setting</i> FWD/DND Dial extension no. (11 through 26) []	<i>To cancel</i> FWD/DND OPER 0
DIAL CALL PICKUP DENY	<i>Setting</i> PRS 7 DEF 3 1 #	<i>To cancel</i> PRS 7 DEF 3 OPER 0 #
DO NOT DISTURB	<i>Setting</i> FWD/DND 1 OPER 0	<i>To cancel</i> FWD/DND OPER 0
FLEXIBLE NIGHT SERVICE (extension 11 only)	<i>Setting</i> PRS 7 TUV 8 ABC 2 #	<i>To cancel</i> PRS 7 TUV 8 1 #
TO CANCEL FEATURES	PRS 7 WXY 9 # •Following features can be canceled. Dial Call Pickup Deny, Do Not Disturb, Call Forwarding, Background Music, Data Line Security, Auto CO Hunting.	
SAVED NUMBER REDIAL	AUTO SNR(SAVE) •You need not to lift the handset or press the SP-PHONE button. MEMORY [] SNR(SAVE) []	
TIME SETTING (extension 11 only)	PRS 7 PRS 7 Enter "Hour" (01 through 12) Enter "Minute" (00 through 59) OPER 0 or 1 # "0": for AM "1": for PM	
AUTO CO HUNTING	<i>Setting</i> PRS 7 ABC 2 1 #	<i>To Cancel</i> ICM PRS 7 ABC 2 OPER 0 #

Detach this position



Contents

Preparation	7	Detailed Operation	
Location of Controls ..	8	Use of Other Features	
Basic Operation		Background Music	24
To Make Calls		Mute Operation	24
Outward Dialing	9	One Touch Access for	
Inter Office Calling (Intercom) ..	10	System Features	25
Speed Dialing	11	External Feature Access	26
One Touch Dialing	11	Switching between Using	
Calling Doorphone	12	Handset and Hands-Free	27
		Pulse/Tone Conversion	28
		Time Setting	29
		Intercom Alerting Mode	29
		Flexible CO Button	30
		Auto CO Hunting	30
		Account Code	31
When a Line is Busy			
Automatic Call Back Busy			
(Camp-on)	13		
Busy Station Signaling	13		
Last Number Redial	13		
To Receive Calls		Station Programming	
Answer	14	Call Forwarding	33
Automatic Answer—Intercom ..	14	Data Line Security	33
Dial Call Pickup	14	Dial Call Pickup Deny	34
Directed Call Pickup	15	Do Not Disturb	34
Call Park Retrieve	15	Flexible Night Service	35
Doorphone	15	Saved Number Redial	36
		Station Program Clear	36
		System Speed Dialing Entry ..	37
		Example of Operation	39
		Busy Lamp Field	42
		Liquid Crystal Display	43
		Table of System Features	45
While Having a Conversation			
Hold-CO	16		
Hold-Intercom	17		
Conference	18		
Call Waiting	19		
Call Splitting—Between CO			
and Intercom	20		
Call Splitting—Intercom	20		
Call Transfer	21		
Paging		General Information	
Paging All Extensions	22	Troubleshooting Guide	46
Paging Group	22	Connection to Telephone Line	47
Paging-External	23	Power Failure	47
Paging and Transfer	23	Wall Mounting	48
Answer	23	Important Information	49
		Others	50
		Servicenter Directory	51
		Accessory Order Information	51
		Warranty	back cover

Preparation

- 1** Connect as shown.

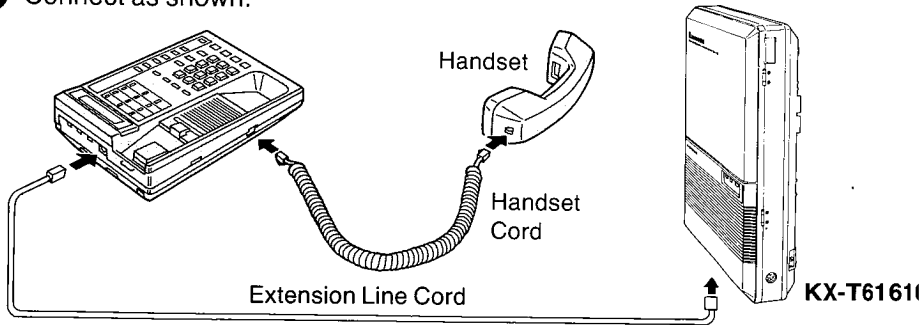

For other connection, see page 47.

Even if a power failure takes place, the unit can be used as a standard telephone if the unit is connected to "EXT11" through "EXT16" of the KX-T61610.

For further details, see page 47.

- 2 RINGER VOLUME Selector:**

Set to "HIGH".

LOW: The ringing sound will be low.

OFF: The telephone will not ring.

- 3 CONTRAST Selector:**

Set to "L", "M", or "H"

to choose the best display intensity.

- 4 DIALING MODE Selector during Power Failure:**

TONE: For tone dialing

PULSE: For pulse dialing

- 5 POWER FAILURE Switch:**

Set to "OFF".

For further details, See page 47.

- 6 MEMORY Switch:**

Set to "SET".

- 7 HANDSET/HEADSET Selector:**

Set to "HANDSET".

If you use the optional headset KX-T30890, set to "HEADSET".

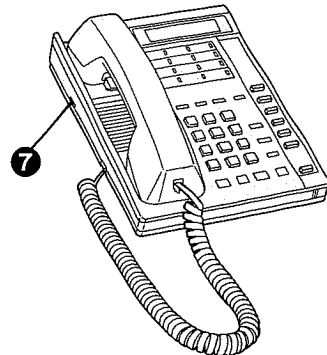
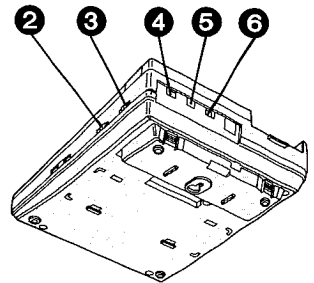
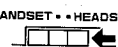
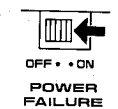
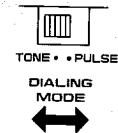
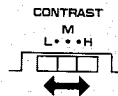
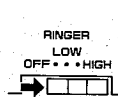

If the unit does not operate properly, disconnect the unit from the extension line cord and then connect again.

Location of Controls

For your convenience, keep this page open when you read the following instructions.

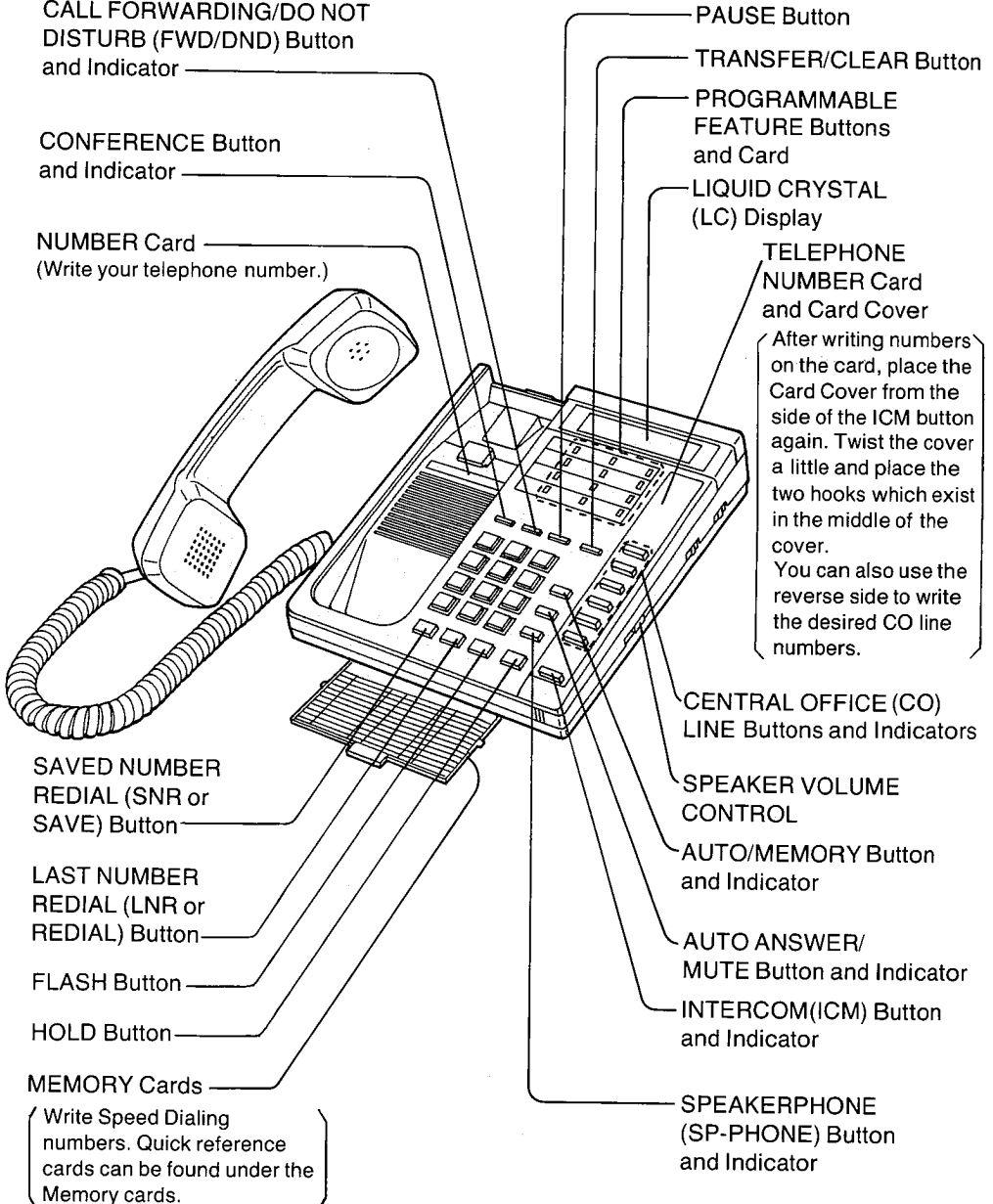

To Make Calls

When the unit is not in use, the Liquid Crystal Display will show the month, day and the present time. The unit will also show the corresponding mode activated. See pages 43 and 44.

Outward Dialing

Any of the 6 CO's may be directly selected.

■ Individual Line Access



LIFT THE
HANDSET

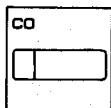

PRESS "CO"

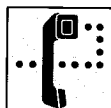

WAIT FOR THE
C.O. DIAL TONE

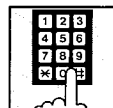

DIAL THE PHONE
NUMBER



HANG UP
WHEN THE
CONVERSATION
IS COMPLETED

or

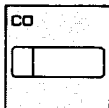

PRESS "CO"



WAIT FOR THE
C.O. DIAL TONE

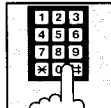

DIAL THE PHONE
NUMBER



PRESS
"SP-PHONE"
WHEN THE
CONVERSATION
IS COMPLETED

- You may dial 9 or 81 through 86 instead of CO button. In this case, you must lift the handset or press the SP-PHONE button first.

9: Each extension can automatically select an idle CO (Central Office) line within the KX-T61610.

81 through 86:

Any of the 6 CO lines may be selected by dial access.

81: line access number of CO 1

82: line access number of CO 2

83: line access number of CO 3

84: line access number of CO 4

85: line access number of CO 5

86: line access number of CO 6

- You can not use the CO button whose indicator has been already lighting (red color) since anyone is using the CO line.
- The CO indicator will be lit (green color) at your extension and lit (red color) at other extensions.

Each extension can access new CO line without hanging up.

While having a conversation;

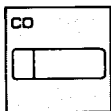

PRESS ANOTHER "CO"

- The original conversation will be terminated and new CO line can be accessed.

Inter Office Calling (Intercom)

Station to station dialing within the KX-T61610 system.

Using the Handset



LIFT THE HANDSET

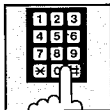

DIAL THE EXTENSION NUMBER (11 through 26)



TALK



HANG UP

Hands-free



PRESS "SP-PHONE"

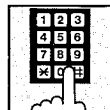

DIAL THE EXTENSION NUMBER (11 through 26)



TALK

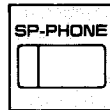

PRESS "SP-PHONE"

- You may press the ICM button instead of the first SP-PHONE button.
- The ICM indicator will be lit (green color) while using the unit.

To Make Calls (cont.)

Speed Dialing

There are 100 memory locations of system speed dialing available.

For programming, refer to "System Speed Dialing Entry" on page 37.



LIFT THE HANDSET
OR PRESS
"SP-PHONE"

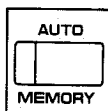

PRESS
"AUTO"

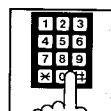

DIAL THE SPEED
ACCESS CODE
(00 through 99)

- You may press the CO button to select the CO line directly after lifting the handset or pressing the SP-PHONE button.

One Touch Dialing

There are 12 memory locations for automatic dialing available.

Up to 32 digits can be stored into each memory location.

For your convenience, program private phone numbers into the KX-T61630.

Programming

- Be sure the handset is in the cradle and the SP-PHONE button is off.
- Set the MEMORY switch of the KX-T61630 to "PROGRAM".

Storage

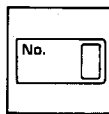

PRESS
"PROGRAMMABLE
FEATURE"



DIAL "9"

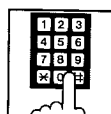

DIAL THE
PHONE
NUMBER

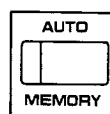

PRESS
"MEMORY"

- You may dial 81 through 86 instead of 9.
 - 9... Each extension can automatically select an idle CO line.
 - 81 through 86... Each extension can select a CO line designated.
- 9 or 81 through 86 must be dialed for storage.
- You may program "∗", "#", "–", "FLASH" and "PAUSE". The SNR button is used as the "–" button.

■ To Correct an Error while Programming



PRESS "CLEAR
(TRANSFER)"
INSTEAD OF
"MEMORY"

- After pressing the CLEAR button, re-program the correct number.
- The TRANSFER button is used as the CLEAR button.

■ To Change a Stored Number

Repeat "Storage" on page 11.

■ To Erase after Programming

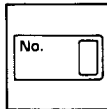

PRESS
"PROGRAMMABLE
FEATURE"

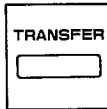

PRESS
"CLEAR
(TRANSFER)"

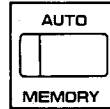

PRESS
"MEMORY"

- The TRANSFER button is used as the CLEAR button.

After programming all the numbers, return the MEMORY switch to "SET".

Dialing



LIFT THE HANDSET
OR PRESS
"SP-PHONE"

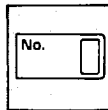

PRESS
"PROGRAMMABLE
FEATURE"

- You may press the CO button to select the CO line directly after lifting the handset or pressing the SP-PHONE button.

Calling Doorphone

Up to two doorphones (KX-T30865) can be connected to the KX-T61610.

■ Doorphone 1



LIFT THE HANDSET
OR PRESS
"SP-PHONE"

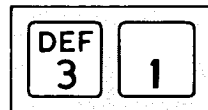

DIAL "31"

■ Doorphone 2

At step 2 left, dial 32 instead of 31.

When a Line is Busy

Basic Operation

Automatic Call Back Busy (Camp-on)

If the intercom extension or outside line (CO line) you have dialed is busy, you will be automatically called back when the extension or the outside line (CO line) becomes free using this function.

This feature is also known as camp-on.

For outside (CO line) calls

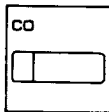

PRESS "CO"



YOU WILL HEAR A BUSY TONE



DIAL "6"



CONFIRMATION TONE OF 2 BEEPS WILL BE HEARD



HANG UP OR PRESS "SP-PHONE"

For intercom calls

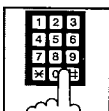

DIAL THE EXTENSION NUMBER (11 through 26)



YOU WILL HEAR A BUSY TONE



DIAL "6"



CONFIRMATION TONE



HANG UP OR PRESS "SP-PHONE"

When hearing the ring back on intercom calls or an outside call, lift the handset or press the SP-PHONE button.

- If you make or receive a call during camp-on mode, the camp-on mode will be canceled.

Busy Station Signaling

If the extension you have dialed is busy, you can inform that extension that another intercom call is reaching by three beeps. For use of this feature, the other extension is required to be set this feature beforehand in the KX-T61610.

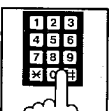

DIAL THE EXTENSION NUMBER



YOU WILL HEAR A BUSY TONE

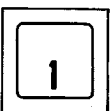

DIAL "1" AND WAIT FOR AN ANSWER

- To answer your signal, see "Call Waiting" on page 19.

- While the other party is using a data terminal equipment, you may not be able to use this feature.
- If a busy tone is heard after dialing 1, it indicates that the other party has not set this feature.

Last Number Redial

The last phone number dialed on an outgoing CO can be redialed.



LIFT THE HANDSET OR PRESS "SP-PHONE"

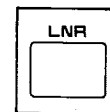

PRESS "LNR" (or "REDIAL")

- You may press the CO button to select the CO line directly after lifting the handset or pressing the SP-PHONE button.

To Receive Calls

Answer



LIFT THE
HANDSET

or



PRESS
"SP-PHONE"

- When "Automatic Answering Selection" feature is selected "manual" mode in the KX-T61610 and outside call reaches, lift the handset and then press the CO button whose indicator is flashing (red color) quickly.
- When an intercom call reaches, you may press the ICM button whose indicator is flashing quickly and talk.
- When an outside call reaches, you may press the CO button whose indicator is flashing (red color) quickly and talk.

Automatic Answer-Intercom

Allows an extension user to answer an intercom call in the automatic hands-free mode without any operation.

This feature is required to be set beforehand while the unit is not in use.

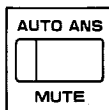

PRESS
"AUTO ANS"

- The AUTO ANSWER indicator will be lit.

■ To Cancel

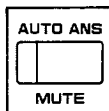

PRESS
"AUTO ANS"

- The AUTO ANSWER indicator will go out.

Dial Call Pickup

Through the use of this feature, an extension user can answer any ringing extension within their own pickup group.



LIFT THE HANDSET
OR PRESS
"SP-PHONE"

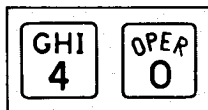

DIAL "40"

To Receive Calls (cont.)

Directed Call Pickup

An extension may answer an incoming call that is ringing at another extension regardless of the pickup group.



LIFT THE HANDSET
OR PRESS
"SP-PHONE"



DIAL "4"

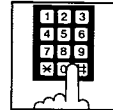

DIAL THE
RINGING
EXTENSION
NUMBER

Call Park Retrieve

Allows extension user to retrieve a call (intercom or outside) on hold at any extension.

■ To Park a Call

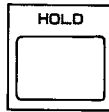

PRESS
"HOLD"



REPLACE THE
HANDSET OR
PRESS
"SP-PHONE"

See "Call on Hold" on
pages 16 and 17.

■ To Retrieve a Parked Call at Any Extension



LIFT THE HANDSET
OR PRESS
"SP-PHONE"

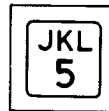

DIAL "5"

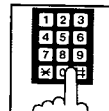

DIAL PARKED
EXTENSION
NUMBER

- In case parked call is outside call, you may dial parked CO line number (81 through 86) instead of parked extension number.

Doorphone

This feature is required to be set beforehand in the KX-T61610. For programming, see page 3-32 in INSTALLATION MANUAL.

■ For Answering Doorphones



LIFT THE
HANDSET

or



PRESS
"SP-PHONE"

When you want to make an outside call while an outside call is reaching, press the CO button.

While Having a Conversation

Hold-CO

Call on Hold

If you wish to leave your phone unattended but want the caller you are in conversation with to wait, call hold may be used. Outside calls may be placed on hold.

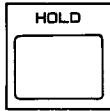

PRESS
"HOLD"



CONFIRMATION TONE
OF 2 BEEPS WILL
BE HEARD

- The indicator of the CO button which is on hold will flash slowly (green color).
- The indicator of the CO button which is on hold will flash slowly (red color) at other extensions.

■ To Retrieve a Call on Hold

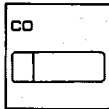

PRESS "CO"

- Press the CO button whose indicator is flashing slowly (green color).

■ To Retrieve a Call on Hold from Another Extension



LIFT THE HANDSET
OR PRESS
"SP-PHONE"

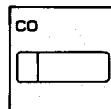

PRESS "CO"

- Press the CO button whose indicator is flashing slowly (red color).

or



LIFT THE HANDSET
OR PRESS
"SP-PHONE"

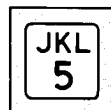

DIAL "5"

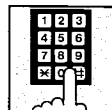

DIAL THE
HOLDING
EXTENSION
NUMBER

While Having a Conversation (cont.)

Hold-CO

Call on Exclusive Hold

Calls on exclusive hold can not be released by any extensions other than the phone which placed the call on hold.

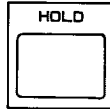

PRESS
"HOLD"

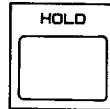

PRESS
AGAIN

- The indicator of the CO button which is on hold will flash in groups of 2 (green color).
- The indicator of the CO button which is on hold will light (red color) at other extensions.

■ To Retrieve

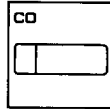

PRESS
"CO"

- Press the CO button whose indicator is flashing in groups of 2 (green color).

Hold-Intercom

Call on Hold

Extension user can place an intercom call on hold. An Intercom hold can be activated on one extension only.

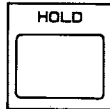

PRESS
"HOLD"

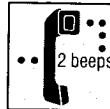

CONFIRMATION
TONE

- The ICM indicator will flash slowly.

■ To Retrieve a Call on Hold

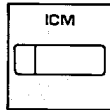

PRESS "ICM"

- The ICM indicator will be on.

■ To Retrieve a Call on Hold from Another Extension



LIFT THE HANDSET
OR PRESS
"SP-PHONE"

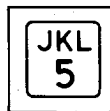

DIAL "5"

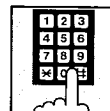

DIAL THE
HOLDING
EXTENSION
NUMBER

Hold-Intercom

Call on Exclusive Hold

Calls on exclusive hold can not be released by any extensions other than the phone which placed the call on hold. An Intercom hold can be activated on one extension only.

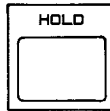

PRESS
"HOLD"

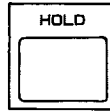

PRESS
AGAIN

- The ICM indicator will flash in groups of 2.

■ To Retrieve

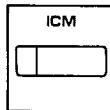

PRESS
"ICM"

Conference

Allows for up to a three party conference, (2-outside/1-inside), (1-outside/2-inside) or (3-inside).

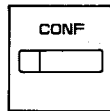

PRESS
"CONF"

(A 1st party
is placed
on hold.)

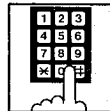

DIAL 2ND PARTY



CONSULT WITH
THE 2ND PARTY

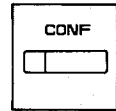

PRESS
"CONF"

(A 3-party
conference
is now
established.)

- You may press the HOLD button instead of the CONFERENCE button first.

■ To Terminate One Caller and Talk to the Another Caller

- If both the conference parties are on the CO line; Press the CO button to talk to the desired party.
- If both the conference parties are on the extension; Press the ICM button. You will be connected to the first participant.
- If the conference parties are on the CO line and extension; To talk to the CO party, press the CO button. To talk to the extension party, press the ICM button.

While Having a Conversation (cont.)

Call Waiting

Call Waiting Tone during a conversation indicates there is a new incoming CO call or Intercom call. This feature is required to be set beforehand in the KX-T61610. For programming, see page 3-28 in INSTALLATION MANUAL.

- If a call waiting tone is heard and the CO or ICM indicator does not flash, this tone indicates a call waiting tone by special company service. In this case, see "Call Waiting-Outside Line" on page 26.

■ To Terminate the Original Call and Talk to the New Caller



WILL HEAR A CALL WAITING TONE

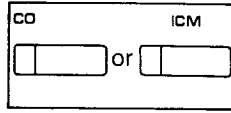

PRESS "CO" OR "ICM" WHOSE INDICATOR IS FLASHING QUICKLY
(The original call is now terminated.)



TALK

■ To Place the Original Call on Hold and Talk to the New Caller

- If both original call and new call are intercom calls: (The ICM indicator will change lighting into flashing quickly when new call reaches.)



WILL HEAR A CALL WAITING TONE

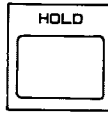

PRESS "HOLD"
(The dial tone is not heard.)



CONSULT WITH THE NEW CALLER WHILE THE ORIGINAL CALL IS ON HOLD

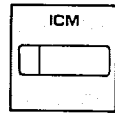

PRESS "ICM" TO TERMINATE THE 2ND CALL AND TO RETURN TO THE ORIGINAL CALL

- If original call is CO call, and new call is CO call or intercom call: or

If original call is intercom call and new call is CO call:



WILL HEAR A CALL WAITING TONE

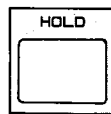

PRESS "HOLD"
(The dial tone is heard.)

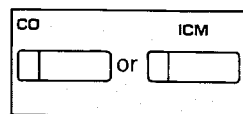

PRESS "CO" OR "ICM" WHOSE INDICATOR IS FLASHING QUICKLY



CONSULT WITH THE NEW CALLER WHILE THE ORIGINAL CALL IS ON HOLD

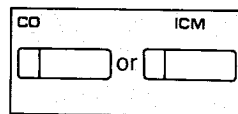

PRESS "CO" OR "ICM" WHOSE INDICATOR IS FLASHING SLOWLY TO TERMINATE THE 2ND CALL AND TO RETURN TO THE ORIGINAL CALL

Call Splitting—Between CO and Intercom

Allows an extension user to alternate between a CO party and an Intercom party.

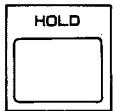

PRESS "HOLD" TO PLACE 1ST PARTY ON HOLD

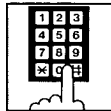

DIAL 2ND PARTY



CONSULT WITH THE 2ND PARTY WHILE THE 1ST PARTY IS ON HOLD

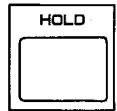

PRESS "HOLD" TO PLACE THE 2ND PARTY ON HOLD

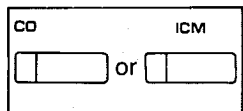

PRESS "CO" OR "ICM" WHOSE INDICATOR IS FLASHING SLOWLY



CONSULT WITH THE 1ST PARTY

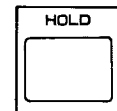

PRESS "HOLD" TO PLACE THE 1ST PARTY ON HOLD

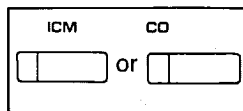

PRESS "ICM" OR "CO" WHOSE INDICATOR IS FLASHING SLOWLY



CONSULT WITH THE 2ND PARTY

- To release the call splitting mode, press the CO or ICM button without pressing the HOLD button. Conversation will be terminated and call on hold will be returned to conversation.

Call Splitting—Intercom

Allows an extension user to alternate between two intercom parties.

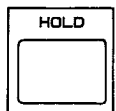

PRESS "HOLD" TO PLACE 1ST PARTY ON HOLD

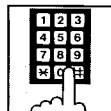

DIAL 2ND PARTY



CONSULT WITH THE 2ND PARTY WHILE THE 1ST PARTY IS ON HOLD

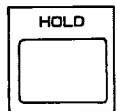

PRESS "HOLD" TO PLACE THE 2ND PARTY ON HOLD



CONSULT WITH THE 1ST PARTY

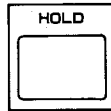

PRESS "HOLD" TO PLACE THE 1ST PARTY ON HOLD



CONSULT WITH THE 2ND PARTY

- To release the call splitting mode, press the ICM button instead of the HOLD button. Conversation will be terminated and call on hold will be returned to conversation.

While Having a Conversation (cont.)

Call Transfer

Outside calls or intercom calls may be transferred to any extension manually.

■ To Transfer after the Other Extension Answers



PRESS
"TRANSFER"

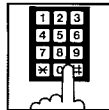

DIAL THE
EXTENSION
NUMBER
(11 through 26)



ANNOUNCE
AND WAIT
FOR AN
ANSWER



HANG UP OR
PRESS
"SP-PHONE"

- When busy, you may access the other extension by dialing 1. Also you may return to the calling party by pressing the CO or ICM button whose indicator is flashing slowly (green color).

■ To Transfer without Announcing to the Other Extension



PRESS
"TRANSFER"

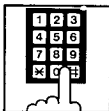

DIAL THE
EXTENSION
NUMBER



HANG UP OR
PRESS
"SP-PHONE"

■ To Retrieve the Call

If the other extension did not receive the transferred call within 30 seconds after the call has been transferred, the call will return to you. In this case:

Outside call

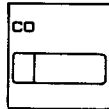

PRESS "CO"
TO RETURN TO THE
CALLING PARTY
(The CO indicator is
flashing slowly.)

Intercom call

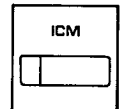

PRESS "ICM"
TO RETURN TO THE
CALLING PARTY
(The ICM indicator
is flashing slowly.)

- To change the party to whom a call is transferred before hanging up: Press the CO or ICM button whose indicator is flashing slowly to retrieve the call, then repeat the procedure of Call Transfer.

Paging

Paging All Extensions

Allows paging to all extensions.

The page can only be heard from a proprietary telephone such as KX-T61630.

■ To Access



LIFT THE HANDSET
OR PRESS
"SP-PHONE"

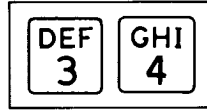

DIAL "34"



CONFIRMATION
TONE OF 1 BEEP
WILL BE HEARD



PAGE



WAIT FOR AN
ANSWER
AND TALK

- Page will be heard from built-in speaker.



Paging Group

Allows paging to one of four groups.

The page can only be heard from a proprietary telephone such as KX-T61630.

■ To Access

For Pickup Group 1



LIFT THE HANDSET
OR PRESS
"SP-PHONE"

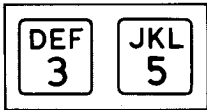

DIAL "35"



CONFIRMATION
TONE OF 1
BEEP WILL
BE HEARD



PAGE



WAIT FOR AN
ANSWER
AND TALK

- Page will be heard from built-in speaker.



- For Pickup Group 2: At step 2 above, dial 36 instead of 35.
- For Pickup Group 3: At step 2 above, dial 37 instead of 35.
- For Pickup Group 4: At step 2 above, dial 38 instead of 35.

If the dial tone (continuous tone) changes to a reorder tone (intermittent tone) or a mistake is made, hang up and start again.

Paging (cont.)

Paging-External

Allows access to external paging equipment.

To Access



LIFT THE HANDSET
OR PRESS
"SP-PHONE"

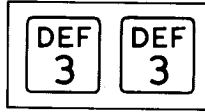

DIAL "33"

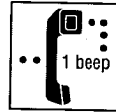

CONFIRMATION
TONE



PAGE

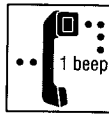

WAIT FOR
CONFIRMATION
TONE AND TALK

■ Page will be heard from external paging equipment.



Paging And Transfer

To Transfer a Call to the Paged Person



WHILE HAVING
A CONVERSATION



PRESS
"TRANSFER"

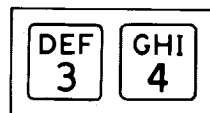

DIAL "34"

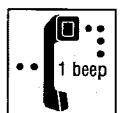

CONFIRMATION
TONE



PAGE

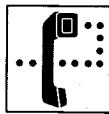

WAIT FOR
AN ANSWER



HANG UP
OR PRESS
"SP-PHONE"

■ You may dial
35, 36, 37,
38 or 33
instead of
34.

Answer

A page from built-in speaker or external paging equipment can be answered from any extension.



LIFT THE HANDSET
OR PRESS
"SP-PHONE"

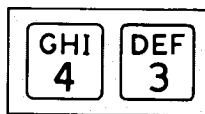

DIAL "43"

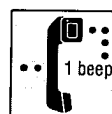

CONFIRMATION
TONE



TALK

● If a call and CO number has been paged and transferred, you may answer by pressing the CO button whose number has been paged and indicator is flashing slowly (red color), instead of dialing 43.

Use of Other Features

Background Music

Music from an external source (e.g. radio) can be listened to on the built-in speaker of the telephone.

■ To Enable



LIFT THE HANDSET
OR PRESS
"SP-PHONE"

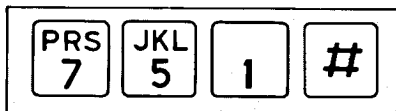

DIAL "751#"



HANG UP OR
PRESS
"SP-PHONE"



WILL HEAR
MUSIC

■ To Cancel



LIFT THE HANDSET
OR PRESS
"SP-PHONE"

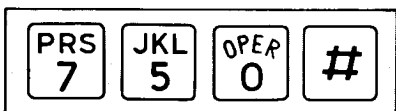

DIAL "750#"

Mute Operation

Use when you do not want your voice to be heard by the other party.

This feature can be activated in speakerphone mode only.

■ To Enable

Be sure the SP-PHONE indicator is on.

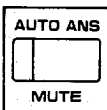

PRESS
"MUTE"

- The MUTE indicator will flash.

■ To Cancel



PRESS
AGAIN

- The MUTE indicator will go out.

Use of Other Features (cont.)

One Touch Access for System Features

Features that can be accessed by using the Dialing button also can be programmed into memory. (e.g. Paging All Extensions, Background Music.)

■ To Program

- Be sure the handset is in the cradle and the SP-PHONE button is off.
- Set the MEMORY switch of the KX-T61630 to "PROGRAM".

Example:

Paging All Extensions (Dial 34)

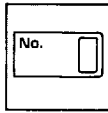

PRESS
"PROGRAMMABLE
FEATURE"

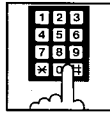

DIAL "34"

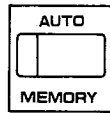

PRESS
"MEMORY"

- System features described in the table on page 45 can be programmed into memory.
- After programming all the system features, return the MEMORY switch to "SET".

■ To Access



LIFT THE HANDSET
OR PRESS
"SP-PHONE"

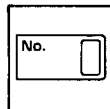

PRESS
"PROGRAMMABLE
FEATURE"

External Feature Access

Allows extension user to access features of the central office or host PBX. (e.g. CALL WAITING FEATURE can be supplied by Central Office.)

The external feature (e.g. CALL WAITING FEATURE) can only be accessed when engaged on an outside call.

The following example shows you one of the procedures.

■ Call Waiting—Outside Line



WILL HEAR A CALL WAITING TONE

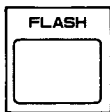

PRESS "FLASH"



CONSULT WITH THE NEW CALLER WHILE THE ORIGINAL CALL IS ON HOLD

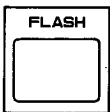

PRESS "FLASH"



CONSULT WITH THE ORIGINAL CALLER WHILE THE 2ND CALL IS ON HOLD
(If the calling party on hold hangs up, the line is terminated.)

■ "Flash" can be stored into memory in the same way as "Storage" on page 11.

■ You may access some features of host PBX using the FLASH button.

If KX-T61610 is connected to host PBX and flash operation is required, follow the procedure of flash operation which is required in the host PBX.

Use of Other Features (cont.)

Switching between Using Handset and Hands-free

You may choose the handset or hands-free.

■ To Use the Handset

While having a conversation using speakerphone



LIFT THE
HANDSET

■ To Use Hands-free

While having a conversation using the handset



PRESS
"SP-PHONE"



HANG UP THE
HANDSET

- When the other party finds it difficult to hear your voice:
Lower the sound level using the **SPEAKER VOLUME CONTROL** or speak louder.
- Absorbing echoes:
Use in a room which has curtains or carpeting.
- To avoid lost conversations:
If some part of the conversation is lost while talking, speak alternately.

Pulse/Tone Conversion

When the dialing mode is required to change a pulse mode to a tone mode in one dialing sequence, this feature is used.

(e.g. computer-accessed long distance service)

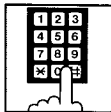

DIAL THE
PHONE
NUMBER

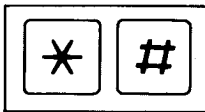

DIAL "*" #"

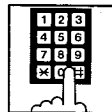

DIAL THE
PHONE
NUMBER

- When you dial using this feature, you must use the line set to a pulse mode.
Phone number after dialing "*" # " will be changed to tone mode.

■ Example: (Computer-accessed long distance service)

- Local access telephone number of the alternate long distance service company 765-4321, Authorization no. 0123456, Long distance no. 543-210-9876
- Pulse mode is required by local access telephone number of the alternate long distance service company.
- Service of MCI, SPRINT, METRO or other systems is used.

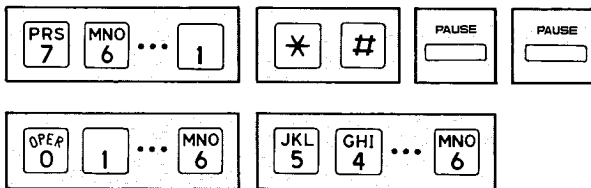

Use of Other Features (cont.)

Time Setting (extension 11 only)

When the present time is out of order, you can adjust by following procedure.



LIFT THE
HANDSET OR
PRESS "SP-PHONE"

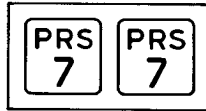

DIAL "77"

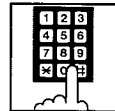

ENTER
THE HOUR
(01 through
12)

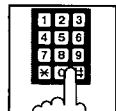

ENTER THE
MINUTE
(00 through 59)

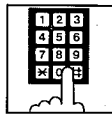

DIAL "0" OR
"1"
"0": for AM
"1": for PM

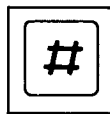

DIAL "*"#"

Intercom Alerting Mode

"Voice alerting" (through built-in speaker) that is established at the called party's extension, can be switched to "Tone alerting" (ringing).

This feature is required to be set beforehand in the KX-T61610.

For programming, see page 3-31 in INSTALLATION MANUAL.

■ Switching to "Tone Alerting" Activation when "Voice Alerting" has been Established on the Called Party's Extension



LIFT THE HANDSET
OR PRESS
"SP-PHONE"

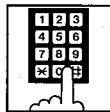

DIAL THE
EXTENSION
NUMBER

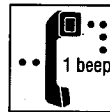

WAIT UNTIL A
CONFIRMATION
TONE IS HEARD

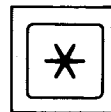

DIAL "*"x"

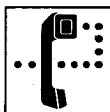

RING BACK
TONE

Flexible CO Button

Allows each CO button to change into CO number which is different from printed CO number.

- Be sure the handset is in the cradle and the SP-PHONE button is off.
- Set the MEMORY switch of the KX-T61630 to "PROGRAM".

■ Setting

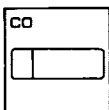

PRESS "CO" WHICH IS CHANGED INTO DIFFERENT CO NUMBER

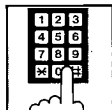

DIAL THE CO NUMBER WHICH IS SET NEWLY (1 through 6)

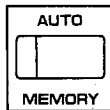

PRESS "MEMORY"

- After programming all CO buttons, return the MEMORY switch to "SET".

Auto CO Hunting

Can access any CO line which is not in use directly by picking up the handset or the speakerphone on and tell an extension user which line is accessing by lighting the CO line indicator.

■ Setting



LIFT THE HANDSET OR PRESS "SP-PHONE"

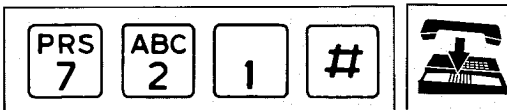

DIAL "721#"

HANG UP OR PRESS "SP-PHONE"

■ To Cancel



LIFT THE HANDSET OR PRESS "SP-PHONE"

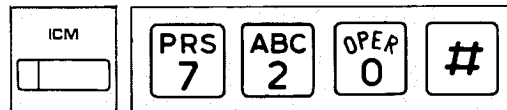

DIAL "720#"



HANG UP OR PRESS "SP-PHONE"

Use of Other Features (cont.)

Detailed Operation

■ Dialing through CO Line



LIFT THE HANDSET
OR PRESS
"SP-PHONE"

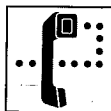

WAIT FOR THE
C.O. DIAL TONE

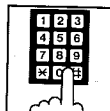

DIAL THE PHONE
NUMBER

- When you access an extension in the Auto CO Hunting Mode, press the ICM button after lifting the handset or pressing the SP-PHONE button.

Account Code

This feature gives each message of the SMDR an account code of the called or calling party.

(Station Message Detail Recording—SMDR is cost saving feature that records all incoming and outgoing calls through CO line.) This feature has two modes—"Forced" and "Option". In the "Forced" mode, the account code must be entered every time the extension user dials. In the "Option" mode, the account code may be entered when a record of the account code is needed. When setting to the "Forced" mode, see page 3-34 in INSTALLATION MANUAL.

Forced Mode

■ Making a Call



LIFT THE HANDSET
OR PRESS
"SP-PHONE"

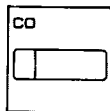

PRESS "CO"
(The FWD/DND
indicator
flashes.)

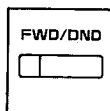

PRESS
"FWD/DND"
(The FWD/DND
indicator
lights. And an
intermittent
tone is
heard.)

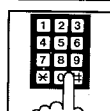

DIAL THE
ACCOUNT
CODE
(Account
code is
required
4 digits.)

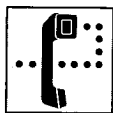

WAIT FOR THE
C.O. DIAL TONE

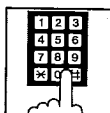

DIAL THE PHONE
NUMBER

- You may dial 9 or 81 through 86 instead of pressing the CO button.
- Account code must be required 4 numerical digits except for the $\#$ and \ast buttons.
- If the account codes are programmed with the telephone numbers for one touch dialing or system speed dialing, you need not dial the account code when making a call. Program as follows.

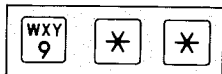

Account code
(4 digits)

Telephone
number

■ Receiving a Call

If you want to record a calling party's account code in the SMDR, follow the below-mentioned procedure.

Within 30 seconds of finishing your conversation or while having a conversation,

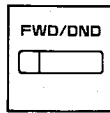

PRESS
"FWD/DND"

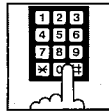

DIAL THE
ACCOUNT CODE

- Dialing the account code must be done before hanging up.

Option Mode

■ Making or Receiving a Call

If you want to record a calling or called party's account code in the SMDR, follow the below-mentioned procedure.

Within 30 seconds of finishing your conversation or while having a conversation,

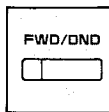

PRESS
"FWD/DND"

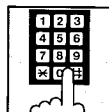

DIAL THE
ACCOUNT
CODE

(Account
code is
required
4 digits.)

- Dialing the account code must be done before hanging up.

- If you enter the wrong account code, press the FWD/DND button and enter the correct code.

Station Programming

Call Forwarding

Intercom or outside calls to your extension can be automatically forwarded to any extension within the system.

■ Setting



LIFT THE HANDSET
OR PRESS
"SP-PHONE"

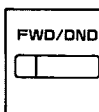

PRESS
"FWD/DND"

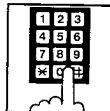

DIAL THE
EXTENSION
NUMBER
TO WHOM THE
CALL IS
FORWARDED



HANG UP OR
PRESS
"SP-PHONE"

- The FWD indicator will flash slowly.

■ To Cancel



LIFT THE HANDSET
OR PRESS
"SP-PHONE"



PRESS
"FWD/DND"

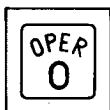

DIAL "0"



HANG UP OR
PRESS
"SP-PHONE"

- The FWD indicator will go out.

Data Line Security

This feature provides security when transmitting data through an extension of the KX-T61610.

The parallel connection of the KX-T61630 and a data terminal equipment is impossible.

■ Setting



LIFT THE HANDSET
OR PRESS
"SP-PHONE"



DIAL "741#"



HANG UP OR
PRESS
"SP-PHONE"

■ To Cancel



LIFT THE HANDSET
OR PRESS
"SP-PHONE"



DIAL "740#"



HANG UP OR
PRESS
"SP-PHONE"

Dial Call Pickup Deny

Allows you to prohibit any other extension user from answering calls directed to you.



LIFT THE HANDSET
OR PRESS
"SP-PHONE"

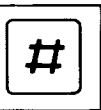

DIAL "731#"



HANG UP OR
PRESS
"SP-PHONE"

■ To Cancel



LIFT THE HANDSET
OR PRESS
"SP-PHONE"

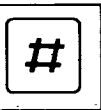
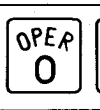

DIAL "730#"



HANG UP OR
PRESS
"SP-PHONE"

Do Not Disturb

Each extension can be individually programmed from receiving intercom or outside calls.



LIFT THE HANDSET
OR PRESS
"SP-PHONE"

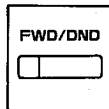

PRESS
"FWD/DND"



DIAL "10"



HANG UP OR
PRESS
"SP-PHONE"

- The DND indicator will be lit.

■ To Cancel



LIFT THE HANDSET
OR PRESS
"SP-PHONE"

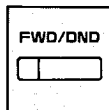

PRESS
"FWD/DND"



DIAL "0"



HANG UP OR
PRESS
"SP-PHONE"

<http://www.panasonic.com>

Station Programming (cont.)

Flexible Night Service (extension 11 only)

Normal system operation is set for day time. Night service allows for the CO assignments to be rearranged via programming.

Night service is enabled or disabled through extension 11 using this feature, at any time.

Without activating this feature, the day/night services are automatically switched (default times are 9:00 AM and 5:00 PM) by the internal clock if the Switching Mode (Day/Night Service) is selected "Auto" mode in the KX-T61610.

■ To Enable Night Service



LIFT THE HANDSET
OR PRESS
"SP-PHONE"

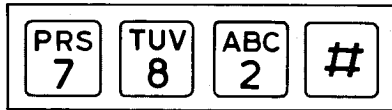

DIAL "782#"



HANG UP OR
PRESS
"SP-PHONE"

■ To Disable Night Service



LIFT THE HANDSET
OR PRESS
"SP-PHONE"

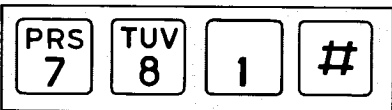

DIAL "781#"



HANG UP OR
PRESS
"SP-PHONE"

When the unit is not in use, the present mode selected will be shown by pressing the [#] button.

Saved Number Redial

The phone number of an outgoing call to the CO when dialing, can be stored and then redialed.

Programming

- When the Called Line is Busy or while You are Speaking on the CO Line

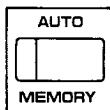

PRESS
"AUTO"

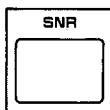

PRESS "SNR"
(or "SAVE")

Dialing



LIFT THE HANDSET
OR PRESS
"SP-PHONE"

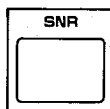

PRESS "SNR"
(or "SAVE")

- You may press the CO button to select the CO line directly after lifting the handset or pressing the SP-PHONE button.

Station Program Clear

Dialing (79#) will clear station programs on that extension.



LIFT THE
HANDSET
OR PRESS
"SP-PHONE"

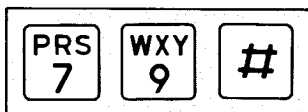

DIAL "79#"



HANG UP OR
PRESS
"SP-PHONE"

- The following feature can be canceled.

- Dial Call Pickup Deny
- Do Not Disturb
- Background Music
- Call Forwarding
- Data Line Security
- Auto CO Hunting

Integrated Network

Station Programming (cont.)

System Speed Dialing Entry (extension 11 only)

100 phone numbers each with up to 32 digits may be stored for speed dialing.

All speed dial entries must be entered at Extension 11 (KX-T61630) with the System Program Switch set to the PROGRAM position within the KX-T61610.

For your convenience, program common phone numbers into the KX-T61610.

Be sure the handset is in the cradle and the SP-PHONE button is off.

■ Storage

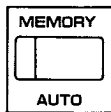

PRESS
"AUTO"

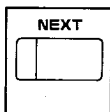

PRESS
"NEXT"

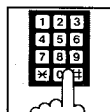

DIAL THE SPEED
ACCESS CODE
(00 through 99)

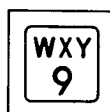

DIAL "9"

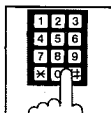

DIAL THE
PHONE
NUMBER

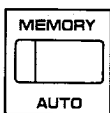

PRESS
"MEMORY"

■ To advance to the next speed access code;



PRESS
"SELECT"



DIAL THE
SPEED
ACCESS CODE
(00 through 99)



DIAL "9"



DIAL THE
PHONE
NUMBER



PRESS
"MEMORY"

- To program the next speed access code continuously, press the NEXT button instead of pressing the SELECT button and dialing the speed access code.
- To program the previous speed access code, press the PREVIOUS button instead of pressing the SELECT button and dialing the speed access code.

- You may dial 81 through 86 instead of 9.
 - 9... Each extension can automatically select an idle CO line.
 - 81 through 86... Each extension can select CO line designated.

- After programming all the numbers, return the System Program Switch to the SET position.
(For more information see page 3-5 in INSTALLATION MANUAL.)

■ To Change a Stored Number

Repeat "Storage" on page 37.

■ To Erase after Programming

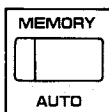

AUTO
PRESS
"AUTO"

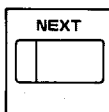

PRESS
"NEXT"

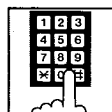

DIAL THE SPEED
ACCESS CODE
(00 through 99)

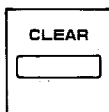

PRESS
"CLEAR"

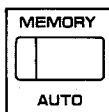

AUTO
PRESS
"MEMORY"

■ To advance to the next speed access code;



PRESS
"SELECT"



DIAL THE SPEED
ACCESS CODE
(00 through 99)



PRESS
"CLEAR"



PRESS
"MEMORY"

- You may use the NEXT button or the PREVIOUS button instead of pressing the SELECT button and dialing the speed access code.

Example of Operation

■ To Place a Call on Hold, and to Make Another Call

Example (CO line):

Call in progress CO 1
 New call CO 2

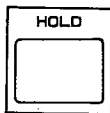

PRESS
"HOLD"

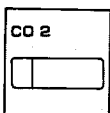

PRESS
"CO 2"

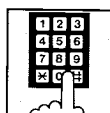

MAKE A
NEW CALL



CONSULT WITH
THE NEW
CALLER
WHILE THE
CALL ON CO 1
IS ON HOLD

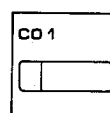

PRESS "CO 1"
TO TERMINATE
THE CALL ON
CO 2 AND TO
RETURN TO
THE CALL
ON CO 1

Example (Intercom):

Call in progress on extension 12
 New call on extension 13

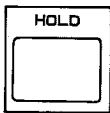

PRESS
"HOLD"

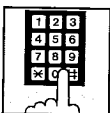

DIAL THE
EXTENSION
NUMBER 13



CONSULT WITH
THE NEW
CALLER
WHILE
EXTENSION
12 IS ON HOLD

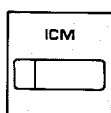

PRESS "ICM"
TO TERMINATE
THE CALL ON
EXTENSION 13
AND TO RETURN
TO THE CALL ON
EXTENSION 12

■ To Make a Call and Transfer a Called Party to Another Extension

Example:

Call in progress CO 1
 Extension to whom a call is transferred .. Extension 12

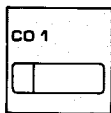

PRESS
"CO 1"

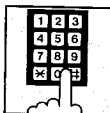

MAKE A
CALL



PRESS
"TRANSFER"

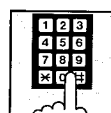

DIAL THE
EXTENSION
NUMBER 12



ANNOUNCE
AND WAIT FOR
AN ANSWER



PRESS
"SP-PHONE"
TO TERMINATE
A CALL

■ To Place One Call on Hold and Transfer the New Call to an Extension

Example:

Call in progress CO 1
 New call CO 2
 Extension to whom a call is transferred .. Extension 12

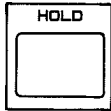

PRESS
"HOLD"

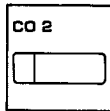

PRESS
"CO 2"

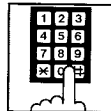

MAKE OR
RECEIVE A
NEW CALL



CONSULT WITH
THE NEW
CALLER
WHILE THE
CALL ON CO 1
IS ON HOLD

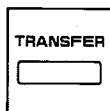

PRESS
"TRANSFER"

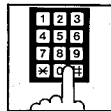

DIAL THE
EXTENSION
NUMBER 12



HANG UP OR
PRESS
"SP-PHONE"

- CO 2 call is now transferred to extension 12.
- CO 1 call is still on hold.

■ To Place Three Calls on Hold, Transfer Two of the Calls to Extensions and Talk to Call on Hold

Example:

Call in progress CO 1
 New calls CO 2, CO 3
 CO 1 is transferred to extension 14.
 CO 2 is transferred to extension 15.

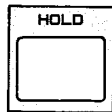

PRESS
"HOLD"

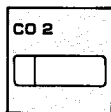

PRESS
"CO 2"

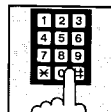

MAKE OR
RECEIVE A
NEW CALL



CONSULT WITH
THE NEW
CALLER
WHILE THE
CALL ON CO 1
IS ON HOLD

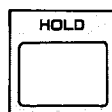

PRESS
"HOLD"

Example of Operation (cont.)



PRESS
"CO 3"

MAKE OR
RECEIVE A
NEW CALL

CONSULT WITH
THE NEW
CALLER
WHILE THE
CALL ON CO 2
IS ON HOLD

PRESS
"HOLD"

PRESS
"CO 1"



CONSULT WITH
THE CALLER ON
CO 1
WHILE THE
CALLER'S ON
CO 2 AND CO 3
ARE ON HOLD

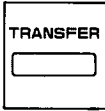

PRESS
"TRANSFER"

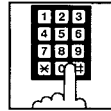

DIAL THE
EXTENSION
NUMBER 14

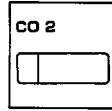

PRESS
"CO 2"



CONSULT WITH
THE CALLER ON
CO 2
WHILE THE
CALLER ON
CO 3 IS ON HOL



PRESS
"TRANSFER"

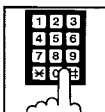

DIAL THE
EXTENSION
NUMBER 15

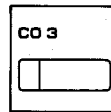

PRESS
"CO 3"



TALK

- The call on CO 1 is now transferred to extension 14.
- The call on CO 2 is now transferred to extension 15.
- The call on CO 3 is now returned into conversation.

■ You can transfer a desired call on CO to an extension in desired order regardless of order of placing on hold.

Busy Lamp Field

The indicators corresponding to the ICM (Intercom) and the CO buttons will indicate the status of the extensions.

●ICM indicator light

Light	Status
off	idle
on	in use for intercom
slow flashing	on hold
flashing in groups of 2	on exclusive hold
quick flashing	receiving

●CO indicator light

Light	Status
off	idle
on (green color)	in use
slow flashing (green color)	on hold
flashing in groups of 2 (green color)	on exclusive hold
on (red color)	in use at another extension
slow flashing (red color)	on hold at another extension
quick flashing (red color)	receiving

Notes:

- If a call reaches through the CO line to which the CO line number is not assigned, the ICM indicator will flash quickly.
And the CO call can be received by pressing the ICM or the SP-PHONE button or lifting the handset.
- If a call on CO line to which the CO line number is not assigned, is placed on hold, the ICM indicator will flash.

101123456789101112131415

Liquid Crystal Display

When the unit is not in use, the LC Display will show the month, day and the present time. Also the LC Display will show the year, month, day and the day of the week for about 5 seconds by pressing the  key.

DISPLAY TYPE	WHEN THE DISPLAY SHOWS
DURATION 2:15'30	While you are in conversation through a CO line. ● "2:15'30" indicates that the length of time that you have been speaking is about 2 hours 15 minutes and 30 seconds.
PROGRAM MODE	When the MEMORY switch is set to "PROGRAM".
MO1: NOT STORED	When memory location 01 is stored no telephone number.
CAMP ON EXT12	When "Camp-on" is set for an extension 12.
CAMP ON CO-1	When "Camp-on" is set for the CO 1.
DOOR 1	When "Doorphone 1" is called.
EXT 11	When an intercom call reaches from the extension 11.
CO 1	When an outside call reaches the CO 1.
CONF EXT13 CO-2	When "Conference" has been established among you and the extension 13 and the CO 2.
PAGING(ALL)	When all extensions are paged.
PAGING(GRP2)	When group 2 is paged.
EXTERNAL PAGING	When a page has been accessed from an external paging equipment.
BGM ON	When "Background Music" is set on.
BGM OFF	When "Background Music" is canceled.

DISPLAY TYPE	WHEN THE DISPLAY SHOWS
FORWARDING EXT18	When "Call Forwarding" is set for an extension 18.
FWD/DND CANCEL	When "Call Forwarding" is canceled.
C.PICKUP DENY	When "Dial Call Pickup Deny" is set.
C.PICKUP ALLOW	When "Dial Call Pickup Deny" is canceled.
DO NOT DISTURB	When "Do Not Disturb" is set.
NIGHT MODE	When "Flexible Night Service" is set.
DAY MODE	When "Flexible Night Service" is canceled.
ENTER PGM CODE	When the SYSTEM PROGRAM switch in the KX-T61610 is set to "PROGRAM".
SPEED DIALING	When the AUTO button is pressed to program a speed dialing number.
ENTER SPEED CODE	When the NEXT button or SELECT button is pressed to program a speed dialing number after the AUTO button is pressed.
RESTRICTED	When "Toll Restriction" is set.
ENTER ACNT CODE	When the FWD/DND button is pushed to enter an account code.
AUTO CO HUNT ON	When "Auto CO Hunting" is set.
AUTO CO HUNT OFF	When "Auto CO Hunting" is canceled.
BACK CO-1 EXT15	When the CO1 call that is transferring to extension 15 is returned.

Table of System Features

The following system features can be programmed into memory.

Dial Plan Code	System Features
Extension no. (11 through 26)	Individual Inter Office Calling
DEF 3 1 or DEF 3 ABC 2	Calling Doorphone 1 or Doorphone 2
DEF 3 DEF 3	Paging-External
DEF 3 GHI 4	Paging All Extensions
DEF 3 JKL 5, DEF 3 MNO 6, DEF 3 PRS 7 or DEF 3 TUV 8	Paging Group 1, 2, 3 or 4
GHI 4 OPER 0	Dial Call Pickup
GHI 4 Extension no. (11 through 26)	Directed Call Pickup
GHI 4 DEF 3	Paging Answer
JKL 5 Extension no. (11 through 26)	Call Park Retrieve
MNO 6	Camp-on
PRS 7 OPER 0 #	Cancelling Call Forwarding or Do Not Disturb
PRS 7 1 Extension no. (11 through 26) #	Call Forwarding
PRS 7 1 1 OPER 0 #	Do Not Disturb
PRS 7 DEF 3 OPER 0 #	Cancelling Dial Call Pickup Deny
PRS 7 DEF 3 1 #	Dial Call Pickup Deny
PRS 7 JKL 5 OPER 0 #	Cancelling Background Music
PRS 7 JKL 5 1 #	Background Music
PRS 7 TUV 8 1 #	Flexible Night Service—Day Mode
PRS 7 TUV 8 ABC 2 #	Flexible Night Service—Night Mode

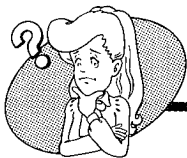

Troubleshooting Guide



Problem

Cause & Remedy

The unit does not ring.

Ringer Volume Selector is set to "OFF". Set to "HIGH" or "LOW".

The unit does not operate during power interruption.

The unit is used as extension 17 through 26. Use another KX-T61630/KX-T61631 which is used as extension 11 through 16 and switch the POWER FAILURE switch to "ON". Then the unit can be used as a standard telephone.

The unit does not operate in spite of using the optional headset KX-T30890.

The HANDSET/HEADSET selector is set to "HANDSET". Switch the selector to "HEADSET".

System programming can not be done into the KX-T61610.

You may have programmed without using an extension 11. The system programming can be done by using an extension 11 only.

I have transferred a call to the different party by mistake.

Press the CO or ICM button whose indicator is flashing slowly to retrieve the call, then repeat the procedure of Call Transfer.

Power failure does not take place but the unit does not operate except in manual dialing and receiving.

The POWER FAILURE switch may be set to the ON position. Change the switch to the OFF position.

I placed a call on hold and hung up once, then seized a line and tried to place a call on exclusive hold, but I can not.

Retrieve a call once and place a call on exclusive hold again.

Connection to Telephone Line

The KX-T61630 may be connected to a telephone line. But will only operate in Manual Dialing and Receiving.

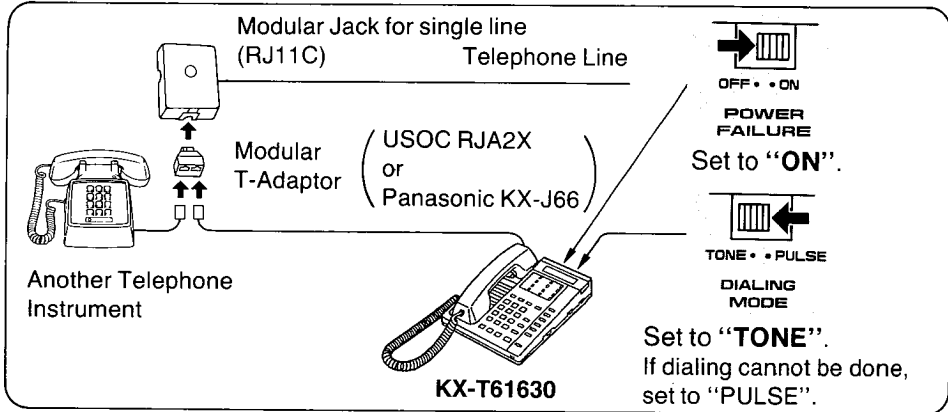

- In this case, if you are required from the telephone company, inform the followings.
 - FCC Registration No;
 - (found on the bottom of the unit)
 - Ringer Equivalence; 1.0 B
 - The particular line to which the equipment is connected.
- Do not use any handset other than Panasonic handset for model KX-T61630 use.
- This unit must not be connected to a coin operated line. If you are on a party line, check with your local telephone company.
- **Ringer Equivalence Number (REN):**
The REN is useful to determine the quantity of devices you may connect to your telephone line and still have all of those devices ring when your telephone number is called. In most, but not all areas, the sum of the REN's of all devices connected to one line should not exceed five (5.0). To be certain of the number of devices you may connect to your line, as determined by the REN, you should contact your local telephone company to determine the maximum REN for your calling area.

Power Failure

In the event of a power failure, each CO line will be connected to assigned extension if the KX-T61630 is used as an extension 11, 12, 13, 14, 15 or 16.

CO 1 will be assigned to extension 11
CO 2 will be assigned to extension 12
CO 3 will be assigned to extension 13
CO 4 will be assigned to extension 14
CO 5 will be assigned to extension 15
CO 6 will be assigned to extension 16

In this case, set the POWER FAILURE switch to "ON".

If dialing cannot be done, switch the DIALING MODE selector to the other position ("PULSE" or "TONE").

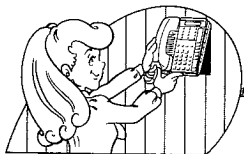

Wall Mounting

This unit can be mounted on a wall phone plate.

To rotate the handset guide for wall mounting

1. Pull up in the direction of arrow (A).
2. Set by rotating as shown.

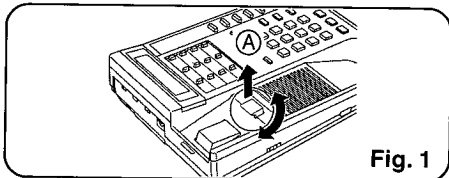

Fig. 1

4. Mount the unit to the wall phone plate then seat securely by hooking as shown in Fig. 5.
5. Connect the cord to the telephone line jack.

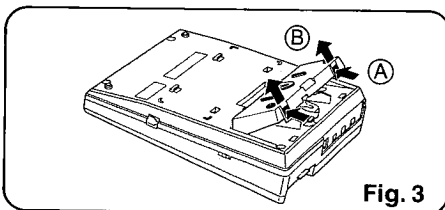

Fig. 3

To temporarily place the handset down during a conversation, hook as shown.

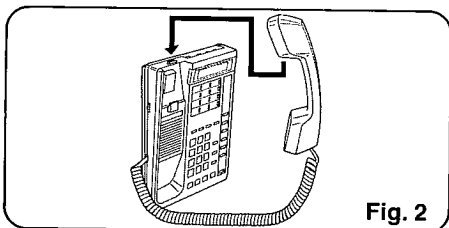

Fig. 2

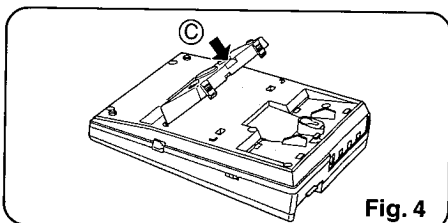

Fig. 4

To mount the unit on a wall phone plate

1. Remove the rest by pulling in the direction of the arrow (B) while pushing the two snap tabs simultaneously in the direction of the arrow (A), as shown in Fig. 3.
2. Insert the hooks of the rest into the hole of the unit then replace the rest by pushing it in the direction of the arrow (C), as shown in Fig. 4.
3. Connect the telephone cord to the unit.

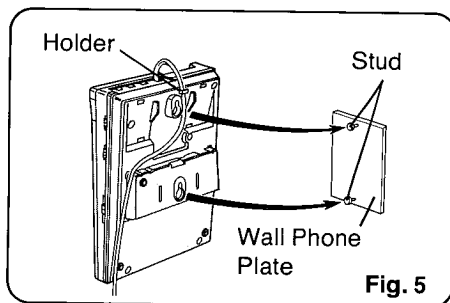
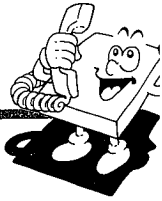

Fig. 5

- When you want to connect the unit to a wall phone plate using a short telephone cord, have a house-wiring installed by the telephone company or a qualified installer, purchase a short telephone cord of 4-conductor and connect the cord to a wall phone plate.

Important Information



In the event terminal equipment causes harm to the telephone network, the telephone company should notify the customer, if possible, that service may be stopped. However, where prior notice is impractical, the company may temporarily cease service providing that they:

This telephone provides magnetic coupling to hearing aids.

- (a) Promptly notify the customer.
- (b) Give the customer an opportunity to correct the problem with their equipment.
- (c) Inform the customer of the right to bring a complaint to the Federal Communication Commission pursuant to procedures set out in F.C.C. Rules and Regulations Subpart E of Part 68.

The Telephone Company may make changes in its communications facilities, equipment, operations or procedures, where such action is reasonably required in the operation of its business and is not inconsistent with the rules and regulations in F.C.C. Part 68. If such changes can be reasonably expected to render any customer terminal equipment incompatible with telephone company communications facilities, or require modification or alteration of such terminal equipment, or otherwise materially affect its use or performance, the customer shall be given adequate notice in writing, to allow the customer an opportunity to maintain uninterrupted service.

Others

- If there is any trouble, disconnect the unit from the extension line and connect a known working phone. If the known working phone operates properly, have it repaired by one of the specified Panasonic Factory Service Centers. If the known working telephone does not operate properly, check the Electronic Modular Switching System (KX-T61610).
- Keep the unit away from heating appliances and electrical noise generating devices such as fluorescent lamps and motors.

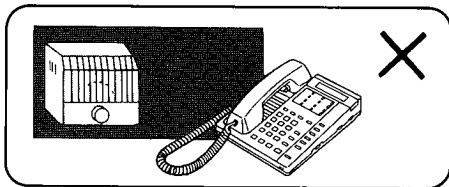

- The unit should be kept free of dust, moisture and vibration, and should not be exposed to direct sunlight.

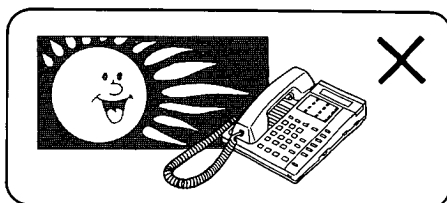

- Do not use benzine, thinner, or the like, or any abrasive powder to clean the cabinet. Wipe it with a soft cloth.

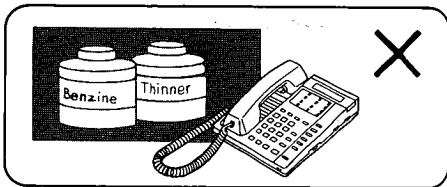

WARNING:

TO PREVENT FIRE OR SHOCK HAZARD, DO NOT EXPOSE THIS PRODUCT TO RAIN OR ANY TYPE OF MOISTURE.

"This equipment has been tested and found to comply with the limits for a Class B computing device in accordance with the specifications set forth in Subpart J of Part 15 of the FCC Rules. If this equipment does cause interference to radio or television reception which can be determined by turning the equipment on and off, use the equipment in another location and/or utilize an electrical outlet different from that used by the receiver."

For your future reference

SERIAL NO. _____
(found on the bottom of the unit)

DATE OF PURCHASE _____

NAME OF DEALER _____

DEALER'S ADDRESS _____

Limited Warranty

Panasonic Company or Panasonic Sales Company (collectively referred to as "PANASONIC") will repair this product with new or rebuilt parts, free of charge, in the U.S.A. or Puerto Rico for one (1) year from the date of original purchase in the event of a defect in materials or workmanship.

Batteries (if included)—New rechargeable batteries in exchange for defective rechargeable batteries for ten (10) days from the date of original purchase. Non-rechargeable batteries are not warranted.

Carry-in or mail-in service in the U.S.A. can be obtained during the warranty period from a Matsushita Services Company (MSC) Factory Servicenter listed in the Servicenter Directory. Or call 1-800-447-4700, toll free, to locate an authorized MSC Servicenter. Carry-in or mail-in service in Puerto Rico can be obtained during the warranty period by calling the telephone numbers listed in the Servicenter Directory.

This warranty is extended only to the original purchaser. A purchase receipt or other proof of date of original purchase will be required before warranty performance is rendered.

This warranty only covers failures due to defects in materials or workmanship which occur during normal use. It does not cover damage which occurs in shipment or failures which are caused by products not supplied by Panasonic Company, Panasonic Sales Company or failures which result from accident, misuse, abuse, neglect, mishandling, misapplication, alteration, faulty installation, modification, or service by anyone other than a MSC Factory Servicenter or authorized MSC Servicenter or damage that is attributable to acts of God.

LIMITS AND EXCLUSIONS

There are no express warranties except as listed above.

PANASONIC COMPANY AND PANASONIC SALES COMPANY SHALL NOT BE LIABLE FOR INCIDENTAL OR CONSEQUENTIAL DAMAGES RESULTING FROM THE USE OF THIS PRODUCT, OR ARISING OUT OF ANY BREACH OF THIS WARRANTY.

ALL EXPRESS AND IMPLIED WARRANTIES, INCLUDING THE WARRANTIES OF MERCHANTABILITY AND FITNESS FOR A PARTICULAR PURPOSE, ARE LIMITED TO THE APPLICABLE WARRANTY PERIOD SET FORTH ABOVE. Some states do not allow the exclusion or limitation of incidental or consequential damages, or limitations on how long an implied warranty lasts, so the above exclusions or limitations may not apply to you.

This warranty gives you specific legal rights and you may also have other rights which vary from state to state.

If a problem with this product develops during the warranty period, you may contact your dealer or Servicenter. If the problem is not handled to your satisfaction, then write to the Consumer Affairs Division at the company address indicated below.

Panasonic Company

Division of Matsushita Electric Corporation of America

One Panasonic Way, Secaucus, New Jersey 07094

Panasonic Sales Company ("PSC"),

Division of Matsushita Electric of Puerto Rico, Inc.

San Gabriel Industrial Park, 65th Infantry Avenue, KM 9.5, Carolina, P.R. 00980

— PANUG-018