

INSTALLATION MANUAL

KX-T616

EASA-PHONE®

ELECTRONIC MODULAR SWITCHING SYSTEM

Panasonic

Please read this manual before connecting the KX-T616.

Thank you for purchasing the Panasonic Model KX-T616, Electronic Modular Switching System.

LIMITED WARRANTY

Panasonic Company, PHI or PSC will repair this product with new or rebuilt parts, free of charge, in the U.S.A. or Puerto Rico for one (1) year from the date of original purchase in the event of a defect in materials or workmanship.

Batteries (if included)—New rechargeable batteries in exchange for defective rechargeable batteries for ten (10) days from the date of original purchase. Non-rechargeable batteries are not warranted.

Carry-in or mail-in service in the continental U.S.A. can be obtained during the warranty period from a Matsushita Services Company (MSC) Factory Servicenter listed in the Servicenter Directory below. Or call 1-800-447-4700, toll free, to locate an authorized MSC Servicenter. Carry-in or mail-in service in Puerto Rico or Hawaii can be obtained during the warranty period by calling the telephone numbers listed in the Servicenter Directory below.

To locate an Authorized Servicenter in Your Area within the Continental U.S.A.

DIAL TOLL FREE: 1-800-447-4700
24 Hours a Day, 7 Days a Week

Requests for assistance in obtaining repairs or technical information...contact any one of the following Service Administration offices:

EASTERN

45 Hartz Way
Secaucus, NJ 07094
201-348-7460

MIDWEST

425 East Algonquin Road
Arlington Heights, IL 60005
312-981-4842

WESTERN

6550 Katella Avenue
Cypress, CA 90630
714-895-7438

SOUTHERN

1854 Shackle-Ford Court,
Suite 105
Norcross, GA 30093
404-925-6860

Correspondence requesting product information should be sent to:

Panasonic Consumer Affairs, Panasonic Company, Division of Matsushita Electric Corporation of America
1 Panasonic Way, Secaucus, NJ 07094.

Service in Puerto Rico

MATSUSHITA ELECTRIC OF PUERTO RICO, INC.
Panasonic Sales Company
Factory Servicenter
Calle Rosarito, Edif
D Ceramica Industrial Park
Carolina, Puerto Rico 00630
809-750-5135

Service in Hawaii

PANASONIC HAWAII, INC.
91-238 Kauhī Street, Ewa Beach
P.O. Box 774
Honolulu, Hawaii 96808-0774
808-682-1521

Service in the Continental U.S.A. ...

Factory Servicenters

1575 NORTHSIDE DRIVE
SUITE 325
ATLANTA, GA 30318
(404) 351-8978

MATSUSHITA SERVICES COMPANY

Division of Matsushita Electric Corporation of America
50 Meadowland Parkway, Secaucus, New Jersey 07094

This warranty is extended only to the original purchaser. A purchase receipt or other proof of date of original purchase will be required before warranty performance is rendered.

This warranty only covers failures due to defects in materials or workmanship which occur during normal use. It does not cover damage which occurs in shipment or failures which are caused by products not supplied by Panasonic Company, PHI or PSC or failures which result from accident, misuse, abuse, neglect, mishandling, misapplication, alteration, faulty installation, modification, or service by anyone other than a MSC Factory Servicenter or authorized MSC Servicenter or damage that is attributable to acts of God.

LIMITS AND EXCLUSIONS

There are no express warranties except as listed above.

PANASONIC COMPANY, PHI AND PSC SHALL NOT BE LIABLE FOR INCIDENTAL OR CONSEQUENTIAL DAMAGES RESULTING FROM THE USE OF THIS PRODUCT, OR ARISING OUT OF ANY BREACH OF THIS WARRANTY. ALL EXPRESS AND IMPLIED WARRANTIES, INCLUDING THE WARRANTIES OF MERCHANTABILITY AND FITNESS FOR A PARTICULAR PURPOSE, ARE LIMITED TO THE APPLICABLE WARRANTY PERIOD SET FORTH ABOVE. Some states do not allow the exclusion or limitation of incidental or consequential damages, or limitations on how long an implied warranty lasts, so the above exclusions or limitations may not apply to you.

This warranty gives you specific legal rights and you may also have other rights which vary from state to state.

If a problem with this product develops during the warranty period, you may contact your dealer or Servicenter. If the problem is not handled to your satisfaction, then write to the Consumer Affairs Division at the company address indicated on the back cover.

Alexander T.V.
(913) 232-2071
1 800 - 922 0028

ST-LOUIS 312 981 480
+4191
TECH 01 392-4693
4677

NOTIFY THE TELEPHONE COMPANY

When you are required from the telephone company, notify the following:

- Telephone number to which the system will be connected
- Make Panasonic
- Model KX-T616
- FCC Registration No. ACJ96N-15172-MF-E
- Ringer Equivalence 0.4B

- The Jack Code needed will depend upon the requirements of the telephone system to which the system will be connected.
The specific jack code needed can and should be ascertained by the telephone company at the time of installation.
- Present FCC Regulations prohibit connecting this unit to a party line, or to a coin operated telephone.

Please read the section on "Telephone Company and FCC Requirements and Responsibilities" on page 84.

The serial number of this product may be found on the label affixed to the bottom of the unit. You should note the serial number of this unit in the space provided and retain this book as a permanent record of your purchase to aid in identification in the event of theft.

MODEL NO.: **KX-T616**

SERIAL NO. _____

For your future reference

DATE OF PURCHASE _____

NAME OF DEALER _____

DEALER'S ADDRESS _____

TABLE OF CONTENTS

Name and Location	4
Installation	5
Connection	7
Frame Ground, Rechargeable Battery	8
Telephone Cords from Central Office	9
Modular Connection to Extensions	10
25-Paired Pin Connection to Extensions	12
External Music Source, Paging Equipment	13
To Connect Printer	14
To Connect Optional Back-up Adaptor	15

Programming

Programming Instructions	16
Example of Programming	17

	Default	
Trunk TONE/PULSE Conversion	non-conversion	18
Switchhook Flash Timing	0.6 sec	20
Disconnect Time	1.5 sec	21
Calling Party Control Signal	400 msec	22
Busy Tone Selection	tone type 1	23
Hold Recall Time Set	30 seconds	24
Hold Time Reminder	3 minutes	25
Trunk Assignment	all trunks have been assigned on all extensions	26
Dial Call Pickup Group Assignment	all extensions have been assigned to pickup group 1	37
Toll Restriction	has not been restricted	39
Toll Restriction—Area Code Selection	has not been stored	40
Toll Restriction—Trunk Selection	has been assigned to C.O. line	41
Programmable Howler	has been removed	42
Programmable Paging Access Tone	has been added	43
Station Message Detail Recording	(see pages)	44
System Speed Call Entry	has not been stored	57

Detailed Feature Description and Operation

<i>Automatic Call Back Busy Trunk or Extension</i>	60
<i>Automatic Station Release</i>	61
<i>Background Music</i>	61
<i>Call Forwarding</i>	62
<i>Call Hold</i>	64
<i>Call Park</i>	65
<i>Call Splitting</i>	66
<i>Call Transfer</i>	66
<i>Conference</i>	67
<i>Data Line Security</i>	67
<i>Dial Call Pickup</i>	68
<i>Dial Call Pickup Deny</i>	68
<i>Directed Call Pickup</i>	69
<i>Direct Outward Dialing</i>	69
<i>Distinctive Ringing</i>	70
<i>Distinctive Dial Tone</i>	70
<i>Do Not Disturb</i>	71
<i>External Feature Access</i>	71
<i>Flexible Night Service</i>	72
<i>Inter Office Dialing (Intercom)</i>	72
<i>Internal Call Waiting</i>	73
<i>Last Number Redial</i>	73
<i>Lockout</i>	74
<i>Mixed Station Dialing</i>	74
<i>Paging</i>	75
<i>Power Failure Transfer</i>	75
<i>Pickup Dial</i>	76
<i>Speed Calling</i>	77
<i>Station Program Clear</i>	77
<i>Troubleshooting</i>	78
<i>List of Tones</i>	82
<i>List of Ringing</i>	82
<i>Specification</i>	83
<i>Telephone Company and FCC Requirements and Responsibilities</i>	84
<i>Others</i>	85

NAME AND LOCATION

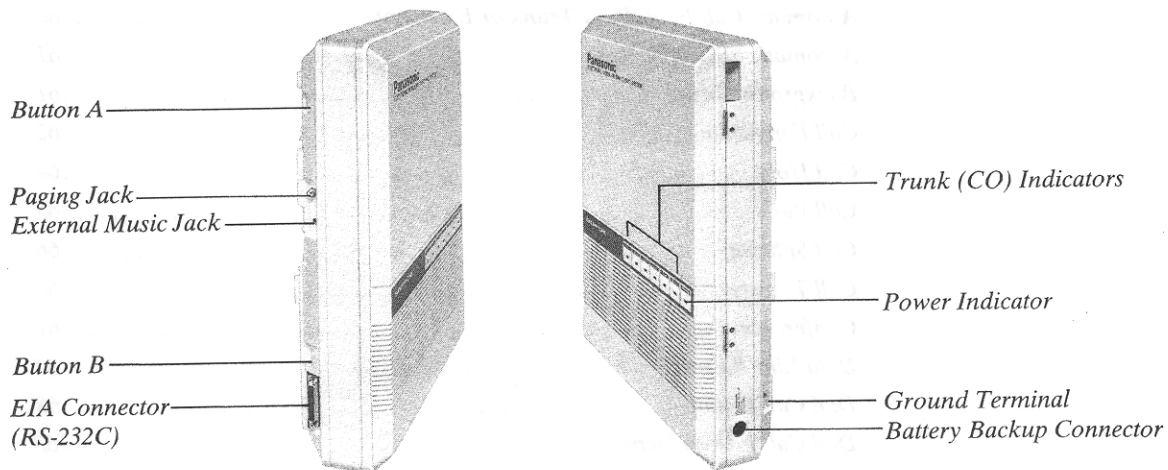

Push Buttons A and B simultaneously to open Front Cover.

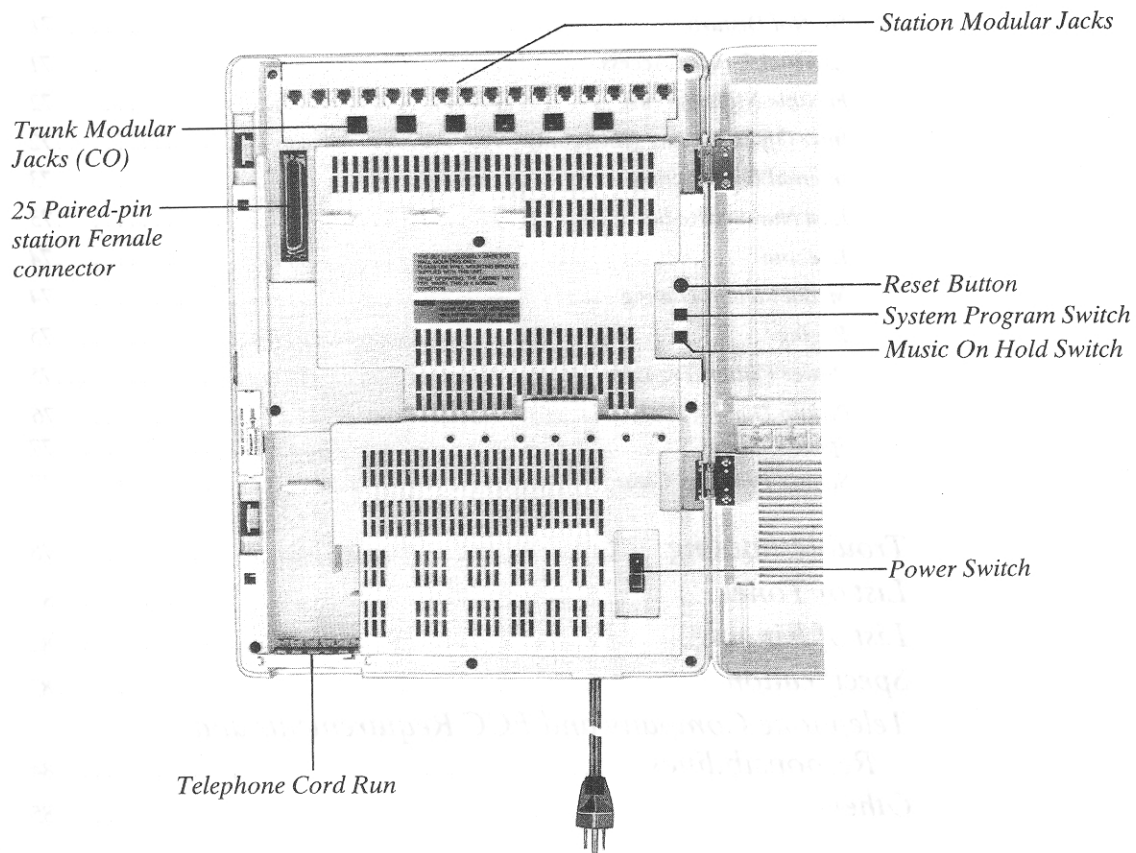

INSTALLATION

The wall where the KX-T616 is to be mounted must be able to support a weight of 77 pounds. If screws other than the ones supplied are used, use the same-sized screws with the enclosed ones.

To Mount on the Wooden Wall:

1. Mark 6 screw positions.
(For easy mounting, drill a small hole)
2. Position the Wall-Mounting Bracket and screw to the wall.
3. Hook the KX-T616 onto the Wall-Mounting Bracket.

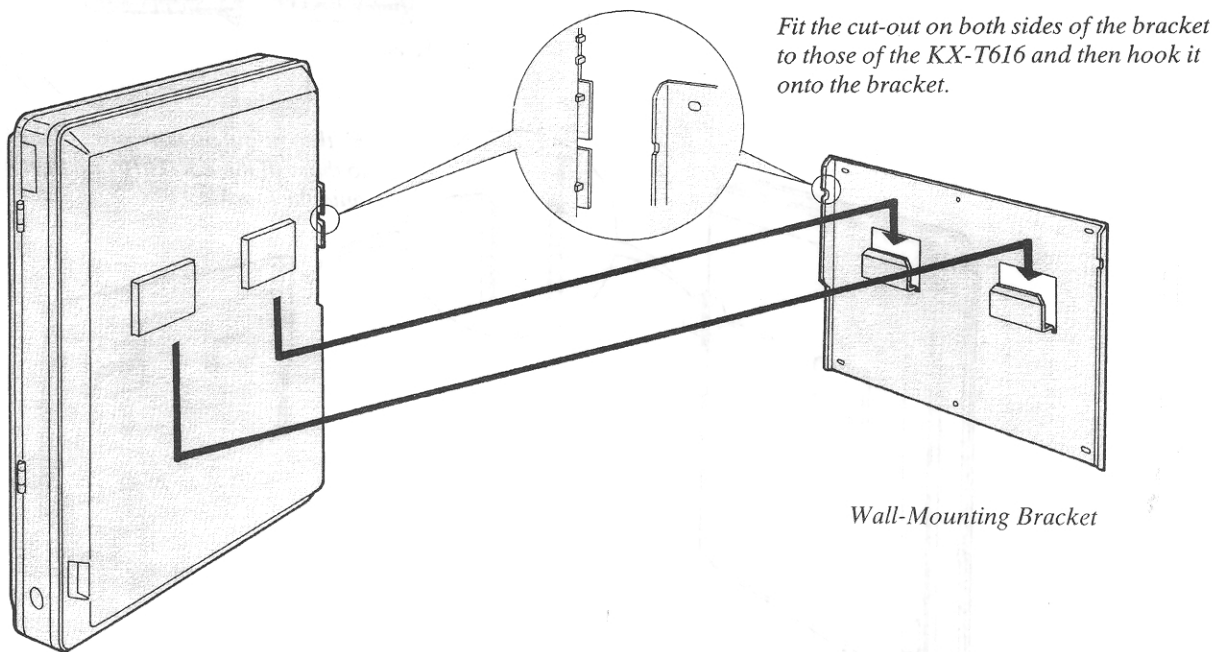
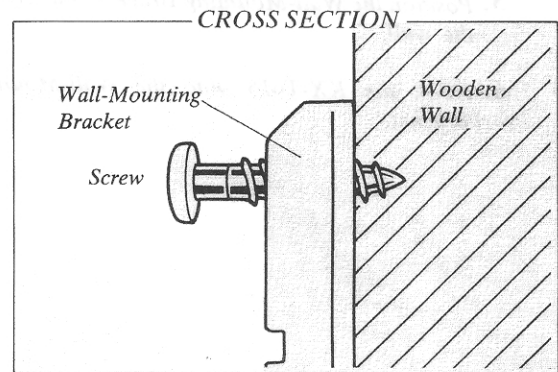
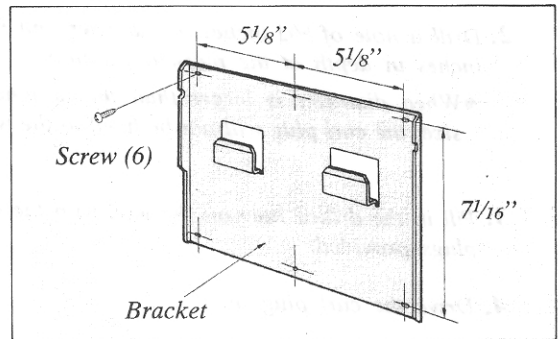

To Mount on the Concrete or Mortar Wall:

1. Mark 6 screw positions.
2. Drill a hole of $\frac{9}{32}$ inches in diameter and $\frac{27}{32}$ inches in depth at the marked position.
 - When diameter is larger than the designated size, the curl plug will not be fixed to the wall.
3. Fill in the drilled hole on the wall with the curl plugs provided.
4. Drive the curl plug in.
5. Position the Wall-Mounting Bracket and screw to the wall.
6. Hook the KX-T616 onto the Wall-Mounting Bracket.

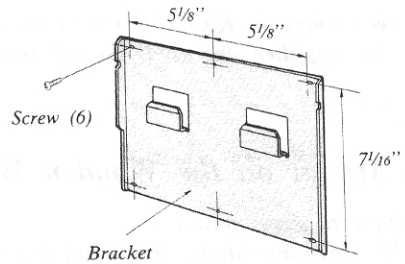

CROSS SECTION

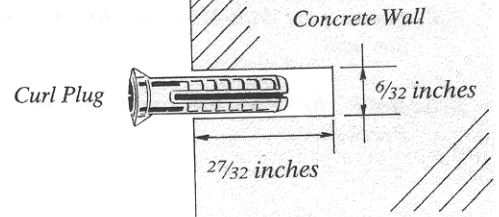

To the wall surface.

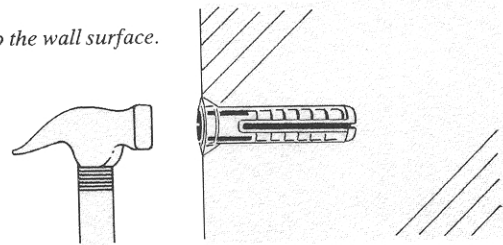

Wall-Mounting Bracket

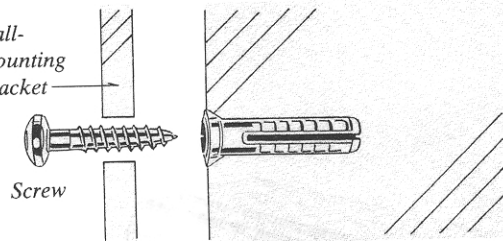

Screw

Fit the cut-out on both sides of the bracket to those of the KX-T616 and then hook it onto the bracket.

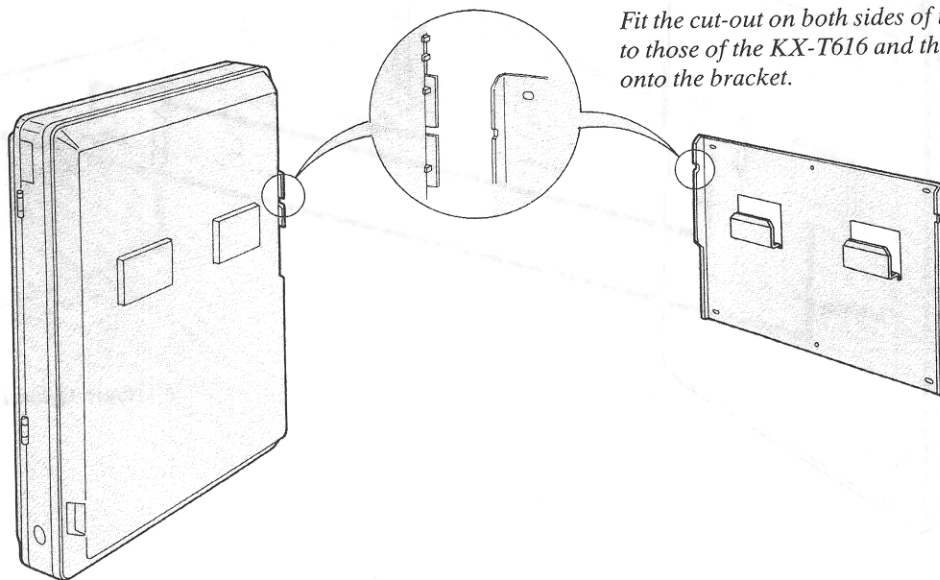

CONNECTION

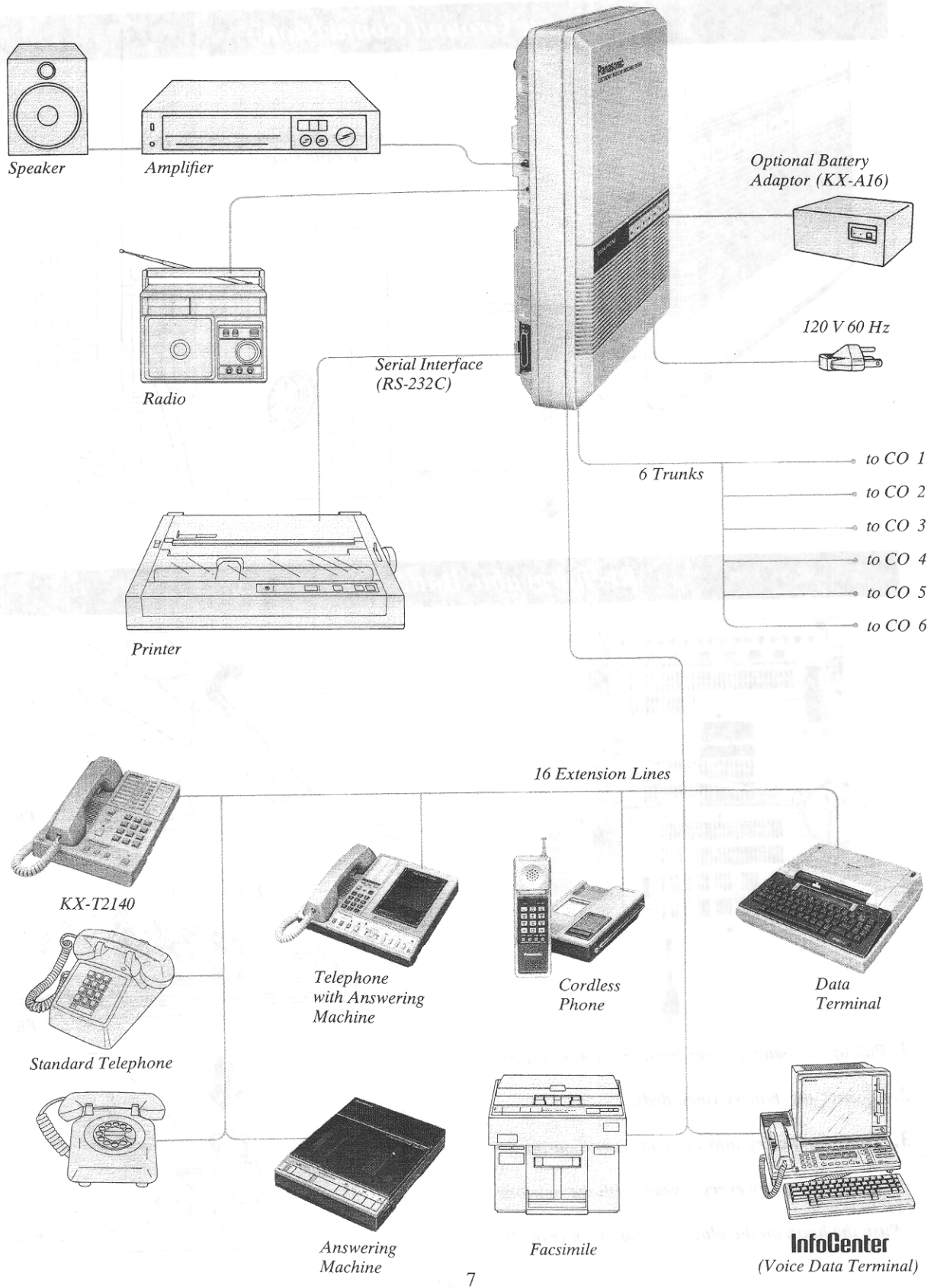

Frame Ground Connection

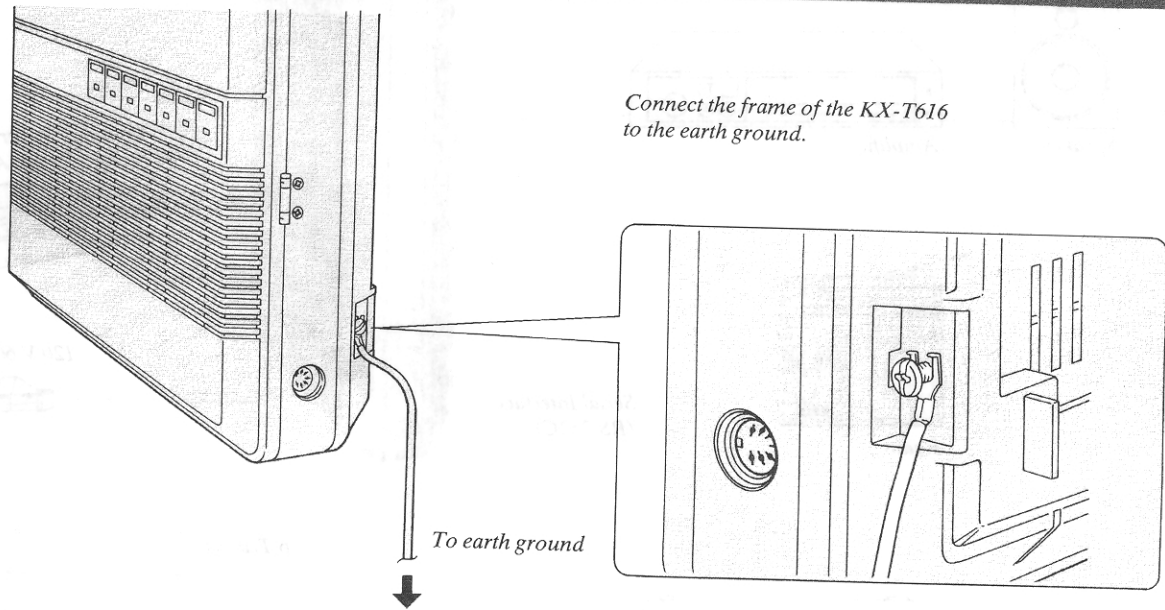

Rechargeable Battery Installation

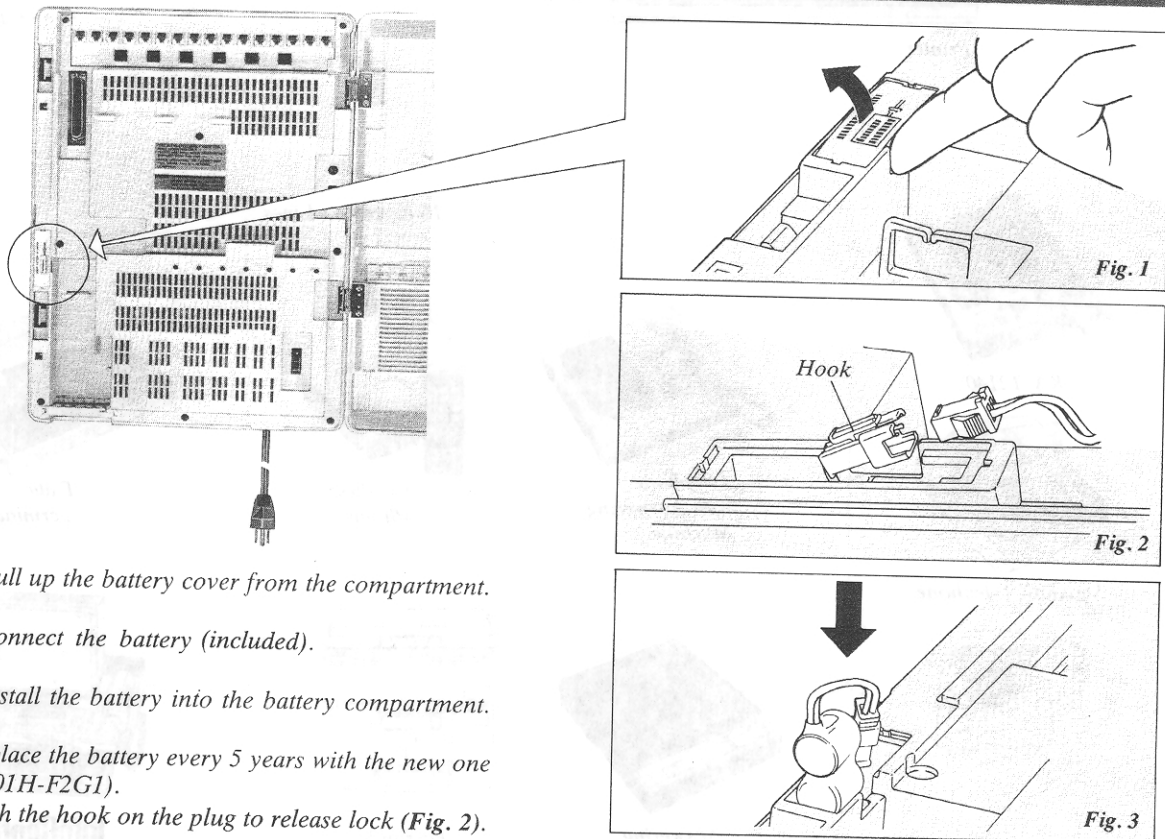

Telephone Cords from Central Office

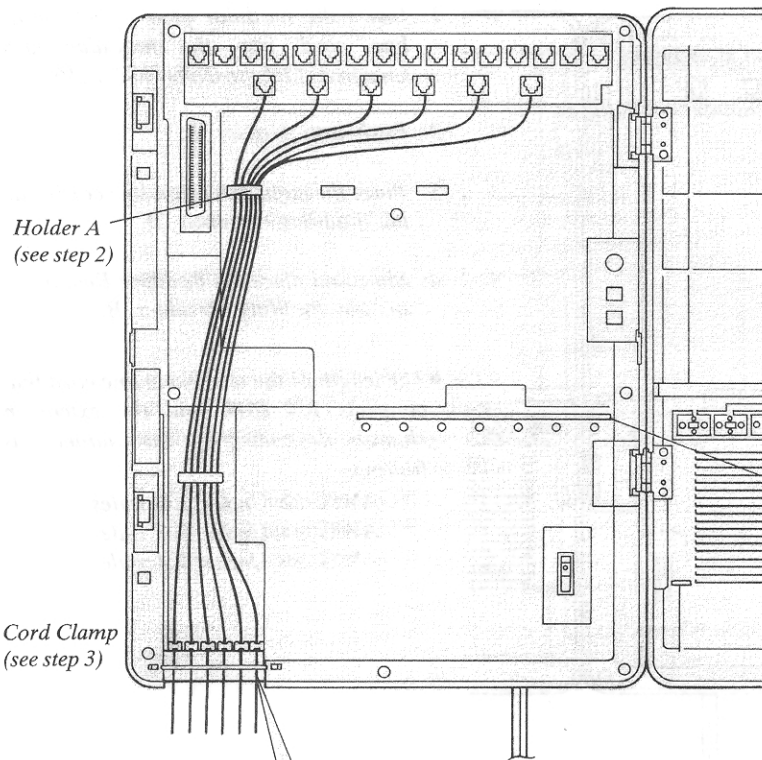

1. Insert the modular plug of telephone line cord into the modular jack (marked CO) on the KX-T616.
2. Push the six telephone line cords into Holder A.
3. Push the Cord Clamps to separate and secure the six telephone line cords.
4. Place the six telephone line cords into the Retainer A.
5. Slide and place the Padding Retainer B on the Retainer A.

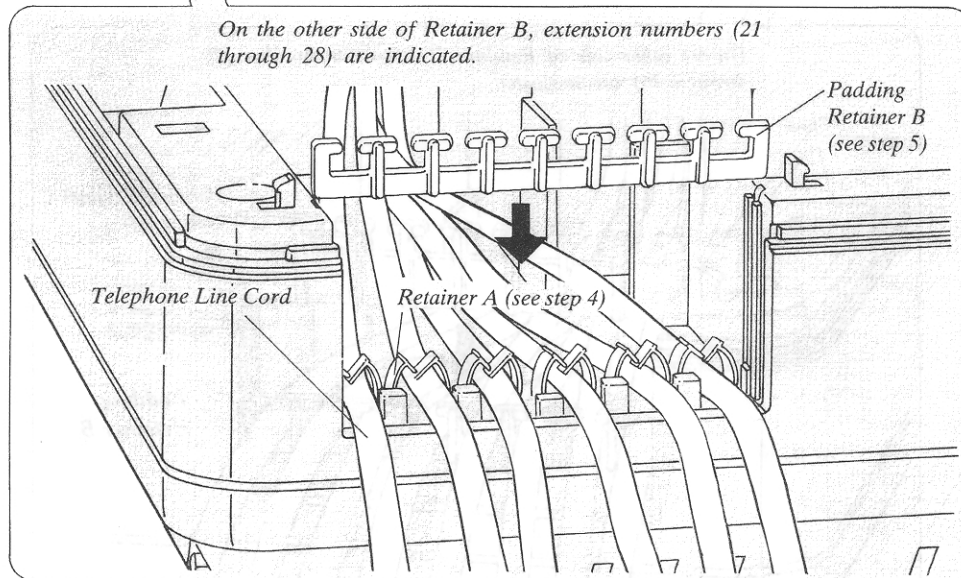

Modular Connection to Extensions (21–28)

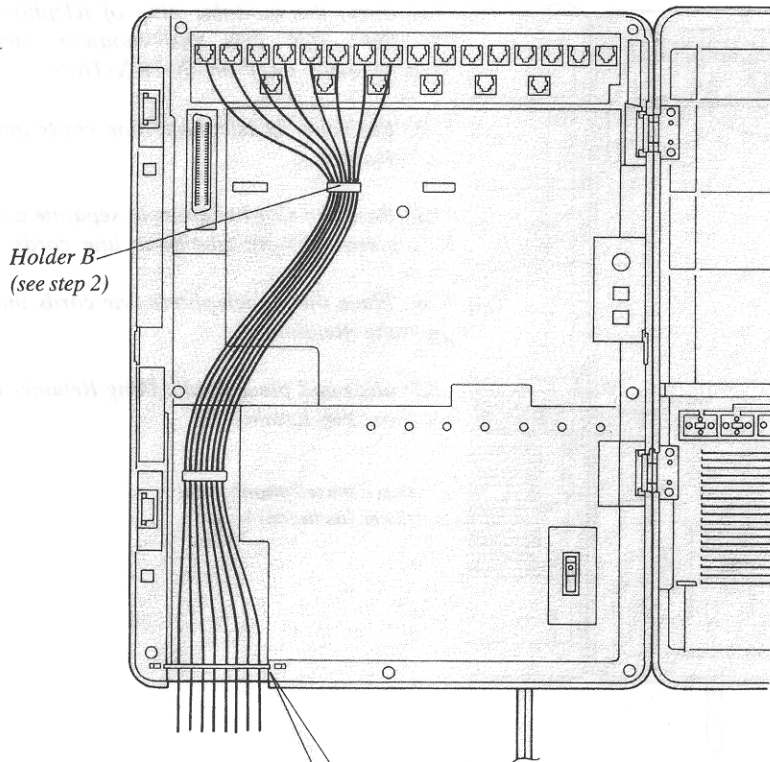

1. Insert the modular plug of telephone line cord into the modular jack (marked TEL) on the KX-T616.
2. Push into Holder B.
3. Place the eight extension line cords into the Padding Retainer B.
4. Slide and place the Padding Retainer C on the Padding Retainer B.

• The length of the telephone line cord that connects KX-T616 and the extension changes depending on the diameter as follows:

- AWG 22: Under 1.2 miles
- AWG 24: Under 0.6 mile
- AWG 26: Under 0.4 mile

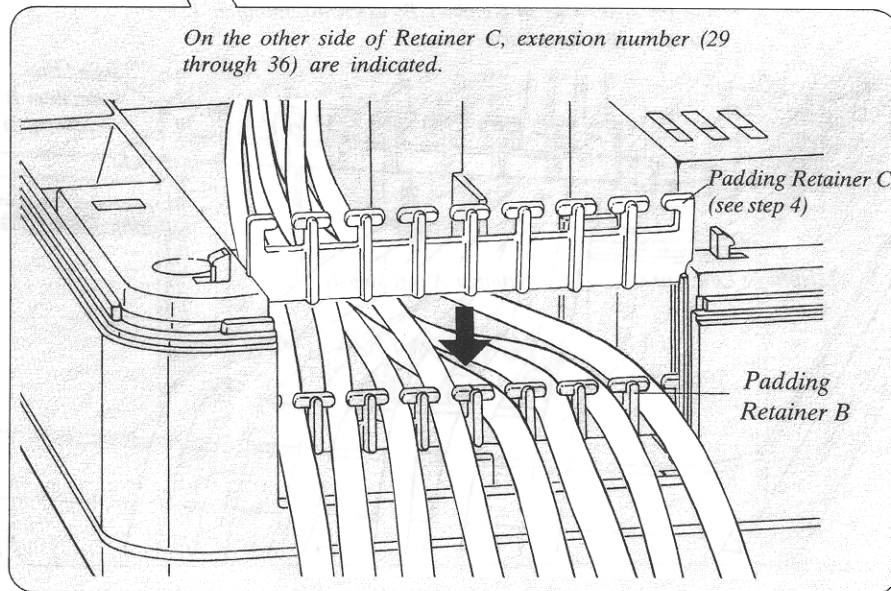

Modular Connection to Extensions (29-36)

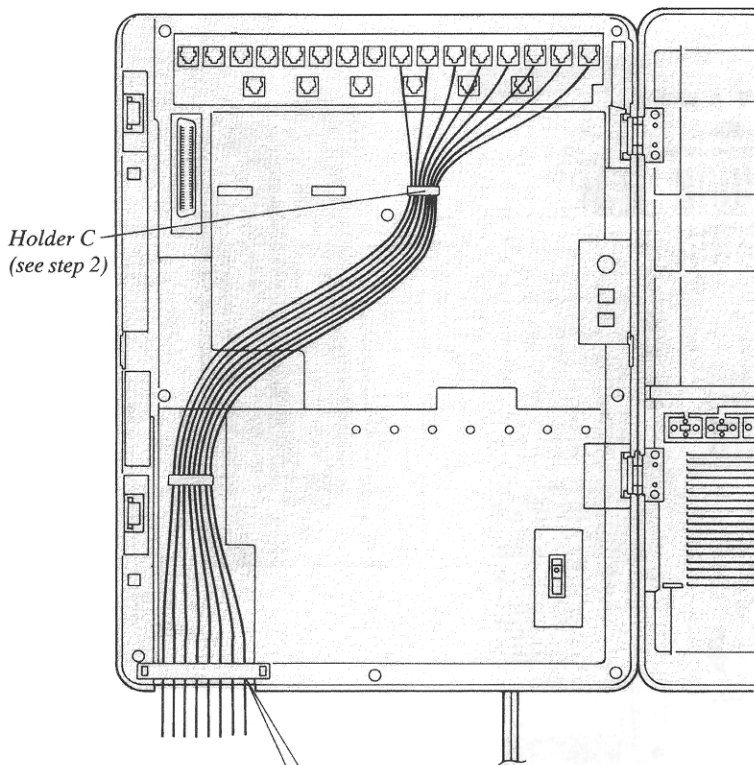

1. Insert the modular plug of telephone line cord into the modular jack (marked TEL) on the KX-T616.
2. Push into Holder C.
3. Place the eight extension line cords into the Padding Retainer C.
4. Insert the Padding Retainer D.

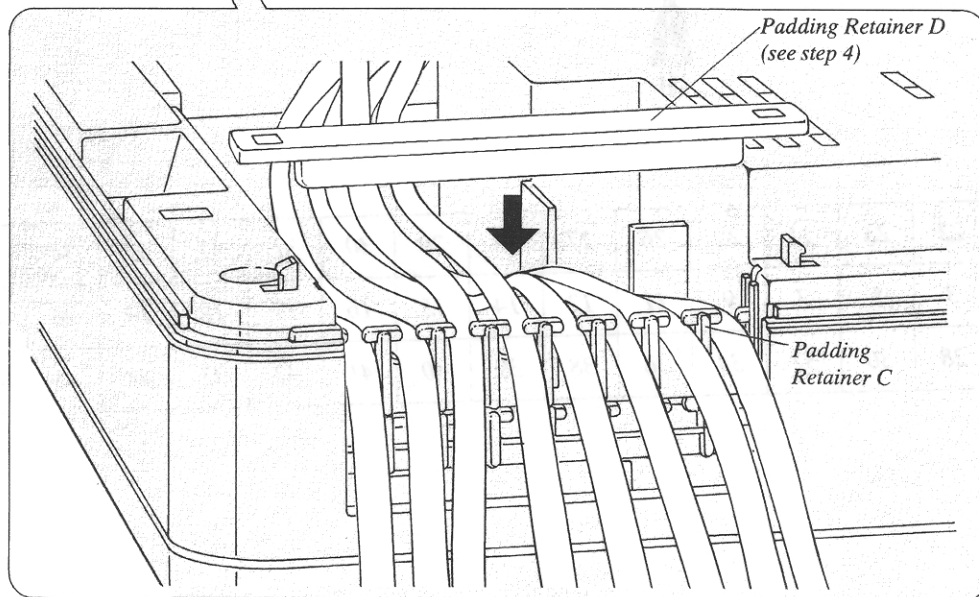

25-Paired Pin Connection to Extensions (21-36)

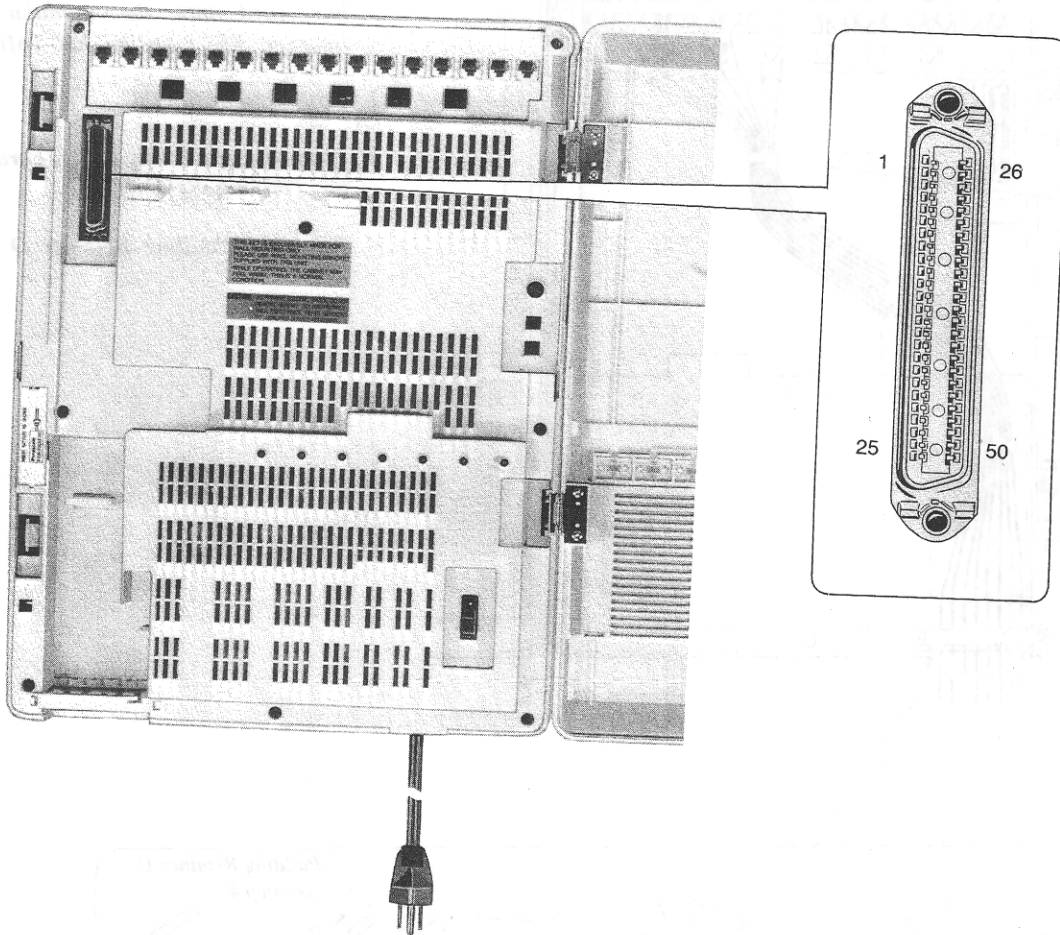

T/R \ Ext.	21	22	23	24	25	26	27	28	29	30	31	32	33	34	35	36
T	1	3	5	7	9	11	13	14	15	16	17	18	19	20	21	22
R	26	28	30	32	34	36	38	39	40	41	42	43	44	45	46	47

External Music Source

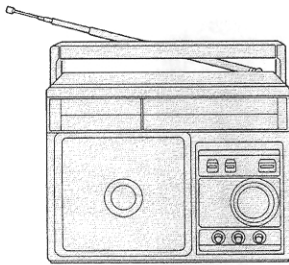

External Music Source

Adjust the sound level of the music on hold with the Volume Control to the same level of the internal music source.

Use a two-conductors plug ($\frac{9}{64}$ inch in diameter)

- Input impedance $5\text{ k}\Omega$
- Input Level -10 dBm .

Please use the cord that has the internal resistance 10Ω

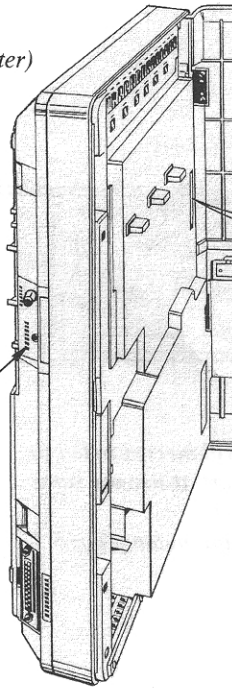
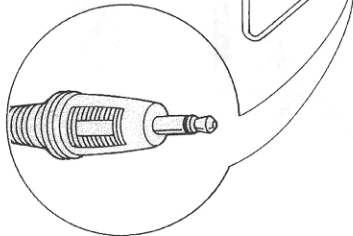

Set MUSIC ON HOLD SWITCH to "EXT".

MUSIC ON HOLD
INT.  EXT.

In the "INT" position, the internal music source plays music.

Paging Equipment

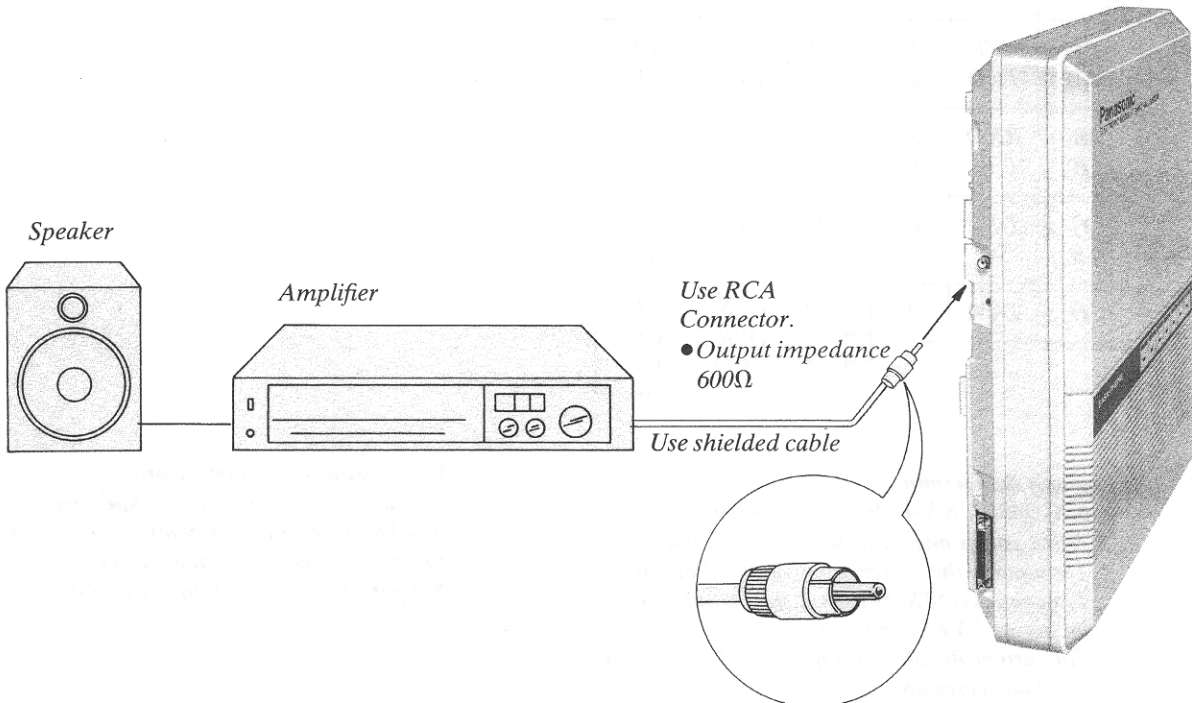

To Connect Printer

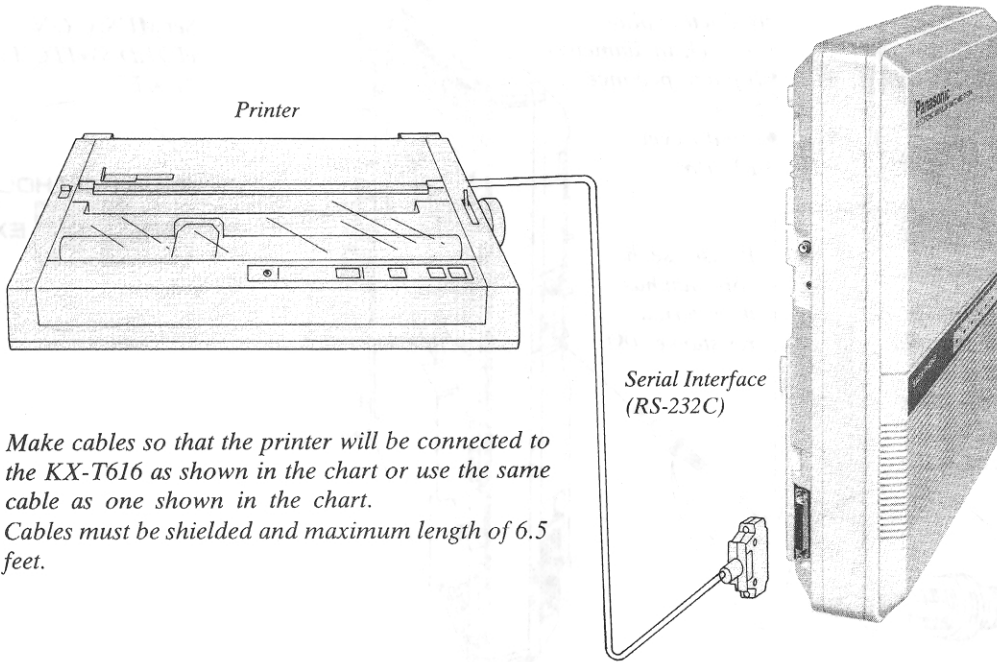

Make cables so that the printer will be connected to the KX-T616 as shown in the chart or use the same cable as one shown in the chart. Cables must be shielded and maximum length of 6.5 feet.

Connection Chart:

KX-T616 RS-232C			Printer RS-232C		
Circuit Type (EIA)	Signal Name	Pin No.	Pin No.	Signal Name	Circuit Type (EIA)
AA	FG	1	1	FG	AA
BA	TXD	2	3	RXD	BB
BB	RXD	3	2	TXD	BA
CB	CTS	5	5	CTS	CB
CC	DSR	6	20	DTR	CD
AB	SG	7	7	SG	AB
CD	DTR	20	6	DSR	CC
			8	DCD	CF

*Panasonic data terminal;

KX-D4910, KX-D4911, KX-D4920, etc.

When you connect this unit to Panasonic Data Terminal, the Communication Parameter Transmit XON/XOFF on Data Terminal must be set to "YES" position.

For further details, see Operating Instructions of Data Terminal.

When using special accessories such as cable, the user should use those specified in this installation manual to comply with the limits for a Class B computing device pursuant to Subpart J of Part 15 of FCC Rules.

To Connect Optional System Back-up Unit (KX-A16)

1. Connect the cord from the optional KX-A16 to the KX-T616.
2. Plug in the AC power cord from the KX-A16.
3. Turn on the Power Switch located on the KX-A16.
 - About 24 hours may be required to recharge the KX-A16.
 - The KX-A16 will work for about 4 hours (on the average) in the event of power failure.
 - The Battery is good for 3 years.
 - A simple way to check the KX-A16 is to disconnect the KX-T616 and the KX-A16 from the AC outlets, and then to observe if the KX-T616 operates.

- **AC Primary Fuse, (250 V, 1.25 A)×1:**
Replace the fuse which is in the fuse holder located on the rear, when the CHARGE Indicators turn off.

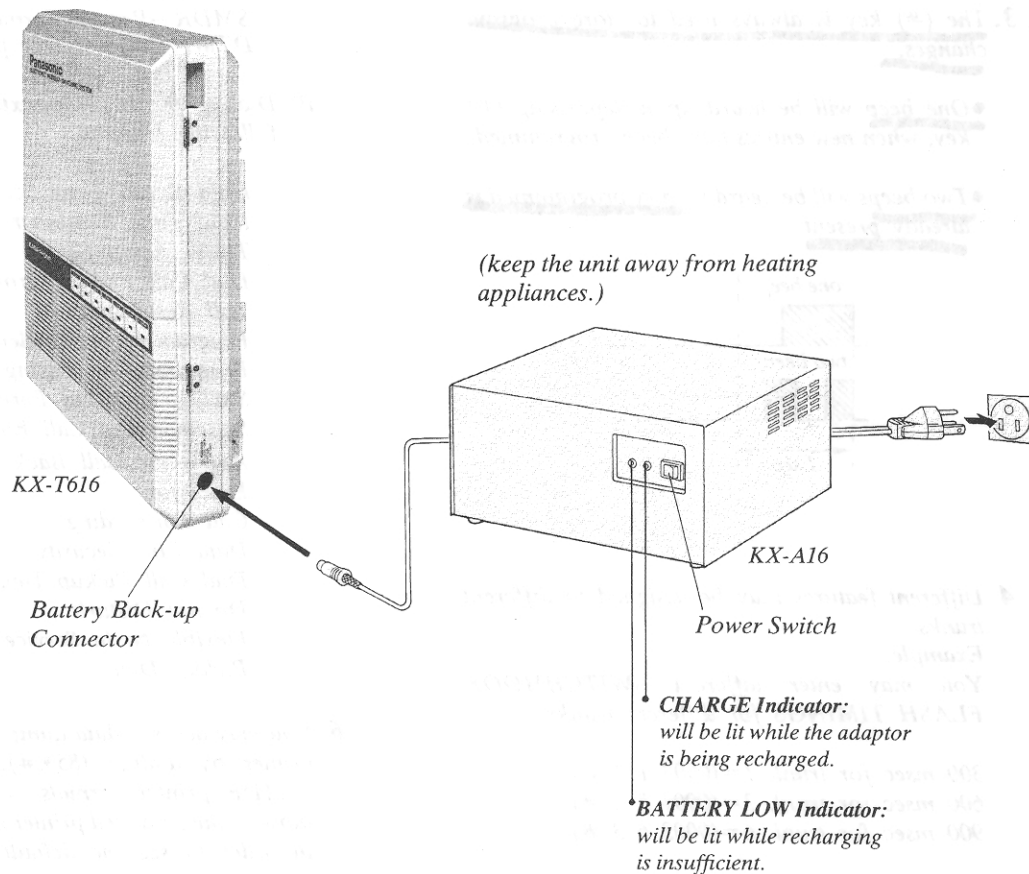

PROGRAMMING

To activate this system, the requirements from telephone company and the customer must be programmed once the Power Switch has been turned on.

Programming Instructions

1. All system programming changes (example: trunk Tone/Pulse conversion, system speed call entry) are done through extension 21.

- Extension 21 must always be a touch tone instrument.

2. The System Program Switch must be always set to the PROGRAM position to make program changes.

After all programming changes are completed, return the program switch to the SET position.

3. The (#) key is always used to store program changes.

- One beep will be heard upon depressing (#) key, when new entries have been programmed.

- Two beeps will be heard if entry programmed is already present.

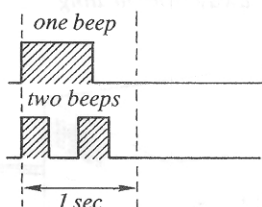

4. Different features may be assigned to different trunks.

Example:

You may enter different SWITCHHOOK FLASH TIMINGS for different trunks.

300 msec for trunk 1=(0003 1 1 #)

600 msec for trunk 3=(0003 3 2 #)

900 msec for trunk 6=(0003 6 3 #)

If 600 msec were to be used on all six trunks programming would look like (0003 * 2 #).

5. Before system programming changes, you may dial (0 0 0 9 0 0 0 #) and wait for two beeps, and then dial (9 0 0 0 #) and wait for two beeps in order to clear all system program.

A. Dialing (0009000#) from extension 21 clears the following features.

Trunk-Tone/Pulse Conversion
Switchhook Flash Timing
Disconnect time
CPC (Calling Party Control) Signal
Busy Tone Selection
SMDR—Printer Format
DTMF Receiver (see page 80)

B. Dialing (9000#) from extension 21 clears the following features.

Hold Recall Time Set
Hold Time Reminder
Trunk Assignment
Dial Call Pickup Group Assignment
Toll Restriction
Programmable Howler
Programmable Paging Access Tone
SMDR—Printout Format
System Speed Call Entries
Automatic Call Back Busy Trunk or Extension
Call Forwarding
Data Line Security
Dial Call Pickup Deny
Do not Disturb
Flexible Night Service
Pickup Dial

6. You may access "data dump (on page 47)" on a printer by dialing (85*#). After setting the "SMDR printer formats" of the KX-T616 to those of the provided printer or setting vice versa, in order to see the default programs (system parameters, trunk parameters, extension parameters and speed dial entries).

- For further details refer to pages 44 to 52.

Example of Programming

1. Turn the Power Switch to ON.

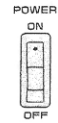

2. Set the System Program Switch to PROGRAM



3. To program **NON-CONVERSION** on all the trunks.

1.	Lift handset.	 Touch tone telephone at extension 21.
2.	Dial (0001*0#)	<div style="border: 1px solid black; padding: 2px; display: inline-block;"> 0 0 0 1 * 0 # </div>
3.	Wait for confirmation tone.	will hear beep(s).
4.	Hang up.	

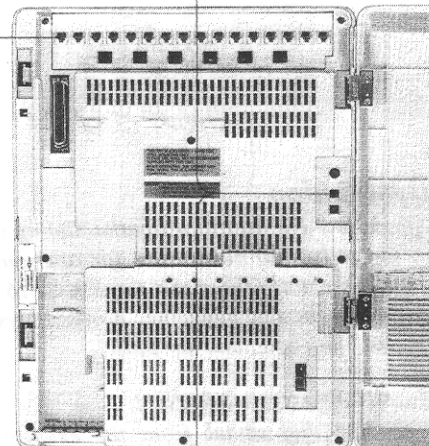

4. Return the System Program Switch to SET

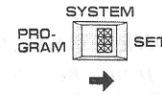

■ To make program change, start from the beginning.

■ While programming if a mistake is made,

1. Hang up.



2. Lift handset.



3. Start programming procedure from the beginning.

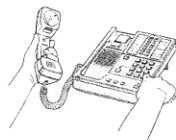

While programming if a mistake is made, hang up and then start programming procedure from the beginning.

Trunk Tone/Pulse Conversion

A=X: to assign the same on all 6 trunks ...default
1: to assign to trunk 1 only
 ...
6: to assign to trunk 6 only

B=0: non-conversion ... default
1: tone (DTMF) mode
2: pulse mode

1 0001 A B #
 2 0001 2 2 #
 3 0001 3 2 #
 4
 5

Description

Allows the user to select the dialing mode (tone or pulse) for each trunk for operation between the Central Office and the KX-T616. There are three choices available, non-conversion, pulse to tone and tone to pulse.

•NON-CONVERSION:

The dial signal from the extension will be transmitted to the Central Office on through the trunk without Tone or Pulse conversion.

•PULSE TO TONE CONVERSION:

The dial signal from the extension will be converted to TONE. TONE will then be transmitted to the Central Office.

•TONE TO PULSE CONVERSION:

The dial signal from the extension will be converted to PULSE. PULSE will then be transmitted to the Central Office.

Programming

1. Lift handset of extension 21.
2. Dial (0001).
3. Select trunk (1 through 6) or X if you wish conversion to be common to all six trunks.
4. Enter conversion parameter.
(0=non-conversion), (1=tone mode) or (2=pulse mode).
5. Dial (#) and wait for confirmation tone.
6. Repeat above procedure on each trunk.
7. Hang up.

Example

NON CONVERSION on all 6 trunks=
 (0001 * 0 #)
 Refer to page 17.

Programming Table

	Trunk(s) *	non-conversion (pulse to pulse, tone to tone)	tone (DTMF) mode (pulse to tone, tone to tone)	pulse mode (tone to pulse, pulse to pulse)
Default	<u>123456</u>	x		
To make program change	123456			X
	1	X		
	2			X
	3			X
	4			
	5			
	6			

A= [X]: to assign the same on all 6 trunks.

[1]: to assign to trunk 1 only.

⋮

[6]: to assign to trunk 6 only.

B= [0]: non-conversion

[1]: tone (DTMF) mode

[2]: pulse mode

[0001] [A] [B] [#]

Conditions

- Both Rotary and Touch Tone instruments will operate with the KX-T616 even when NON-CONVERSION, PULSE TO TONE CONVERSION or TONE TO PULSE CONVERSION mode is programmed.
- If KX-T616 is installed behind a host PBX or Central Office which allows any telephone, either rotary or touch tone to be used, select NON-CONVERSION.
- When KX-T616 is connected to the Pulse trunk of which Dial tone frequency is 600 Hz, set Tone/Pulse conversion to "Pulse mode" and use the extension provided with the Pulse mode.

Switchhook Flash Timing

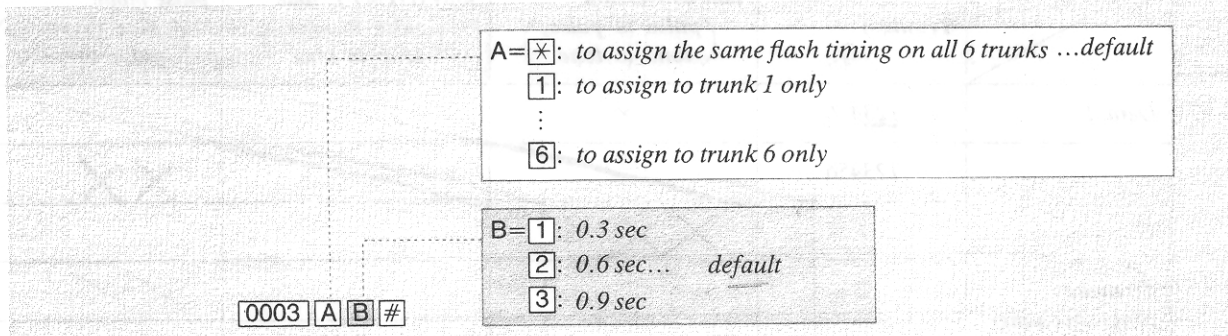

Description

The timing of the switchhook flash signal length must be within Central Office requirements. There are three choices available 0.3, 0.6 or 0.9 second.

Programming

1. Lift handset of extension 21.
2. Dial (0003).
3. Select Trunk (1 through 6) or (*) if you wish timing to be common to all six trunks.
4. Enter timing parameter.
(1=0.3 sec), (2=0.6 sec) or (3=0.9 sec).
5. Dial (#) and wait for confirmation tone.
6. Repeat above procedure to program on each trunk.
7. Hang up.

Example

- 0.3 sec on all 6 trunks=(0003 * 1 #)
- 0.3 sec trunk 1=(0003 1 1 #)
- 0.6 sec trunk 2=(0003 2 2 #)
- 0.9 sec trunk 3=(0003 3 3 #)
- 0.9 sec trunk 4=(0003 4 3 #)
- 0.3 sec trunk 5=(0003 5 1 #)
- 0.6 sec trunk 6=(0003 6 2 #)

Programming Table

	trunks *	0.3 sec	0.6 sec	0.9 sec
Default	123456		×	
To make program change	123456 *		X	
	1			
	2			
	3			
	4			
	5			
	6			

Calling Party Control (CPC) Signal

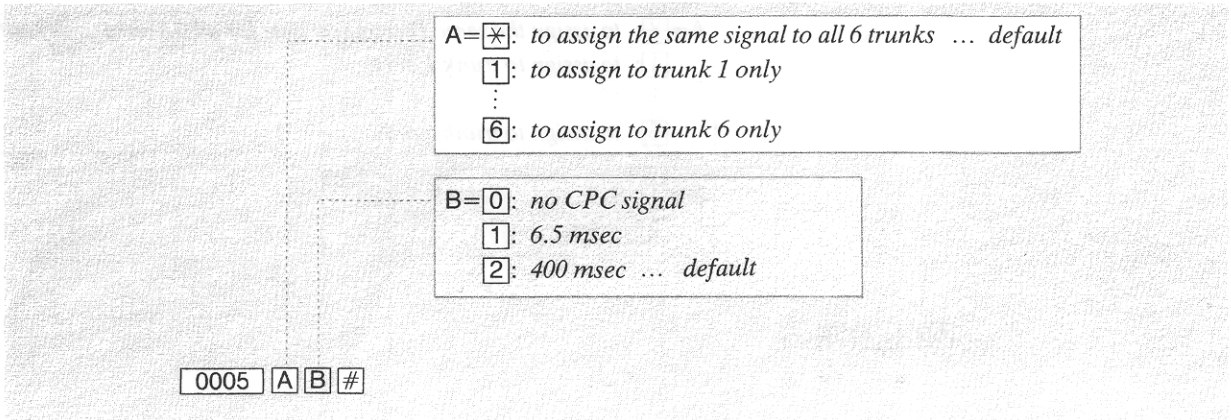

Description

To detect an outside party hanging up and then terminate the trunk (after a conversation, conference etc.), a CPC signal of either 6.5 or 400 msec is needed.

Conditions

- If KX-T616 is installed behind a host PBX, no CPC signal is required.

Programming

1. Lift handset of extension 21.
2. Dial (0005).
3. Dial (*) if CPC signal is to be the same on all six trunks or just enter the desired trunk number.
4. Dial (1 for 6.5 msec) or (2 for 400 msec).
5. Dial (#) and wait for confirmation tone.
6. Hang up.

Example

- 6.5 msec trunk 1=(0005 1 1 #)
- 400 msec trunk 2=(0005 2 2 #)
- 400 msec trunk 3=(0005 3 2 #)
- 6.5 msec trunk 4=(0005 4 1 #)
- 6.5 msec trunk 5=(0005 5 1 #)
- 400 msec trunk 6=(0005 6 2 #)

Programming Table

	trunks	no CPC signal	6.5 msec	400 msec
Default	123456			×
To make program change	*123456			✗
	1			
	2			
	3			
	4			
	5			
	6			

Busy Tone Selection

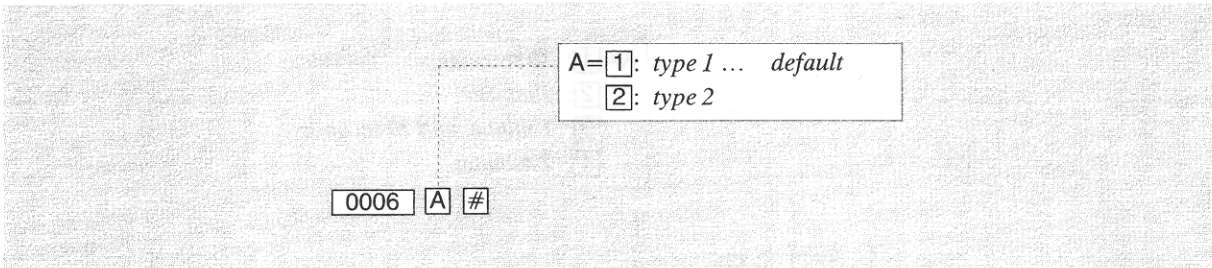

Description

For telephone instruments that have automatic busy tone detection, it is suggested that busy tone type (1) be used. Selection of busy tone type (1) insures that the camp on feature on Panasonic ITS phones will operate.

Conditions

- Because Panasonic ITS phones (KX-T2130, KX-T2131, KX-T2140, etc.) are equipped with automatic busy tone detection in the speakerphone mode, calls will be terminated upon hearing a busy signal of busy tone type (2) therefore camp on feature cannot be activated.

Programming

1. Lift handset of extension 21.
2. Dial (0006).
3. Dial (1 for busy tone type 1) or (2 for busy tone type 2).
4. Dial (#) and wait for confirmation tone.
5. Hang up.

Programming Table

	<i>busy tone type 1</i>	<i>busy tone type 2</i>
<i>Default</i>	×	/
<i>To make program change</i>		

Hold Recall Time Set

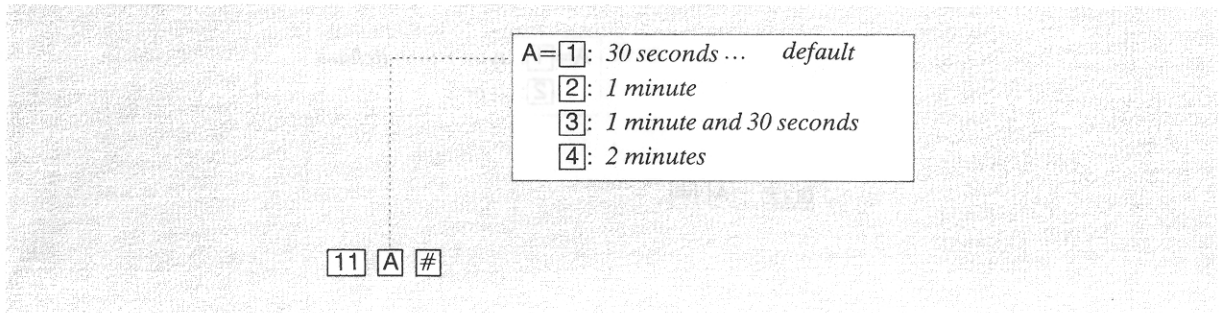

Description

When a handset of holding extension is replaced on trunk calls and intercom calls, you may have automatic hold recall after the desired time elapses.

Programming

1. Lift handset of extension 21.
2. Dial (11).
3. Enter the desired time.
(1 for 30 seconds) (2 for 1 minute) (3 for 1 minute and 30 seconds) (4 for 2 minutes)
4. Dial (#) and wait for confirmation tone.
5. Hang up.

Programming Table

	30 seconds	1 minute	1 minute 30 seconds	2 minutes
Default	×			
To make program change				

Hold Time Reminder

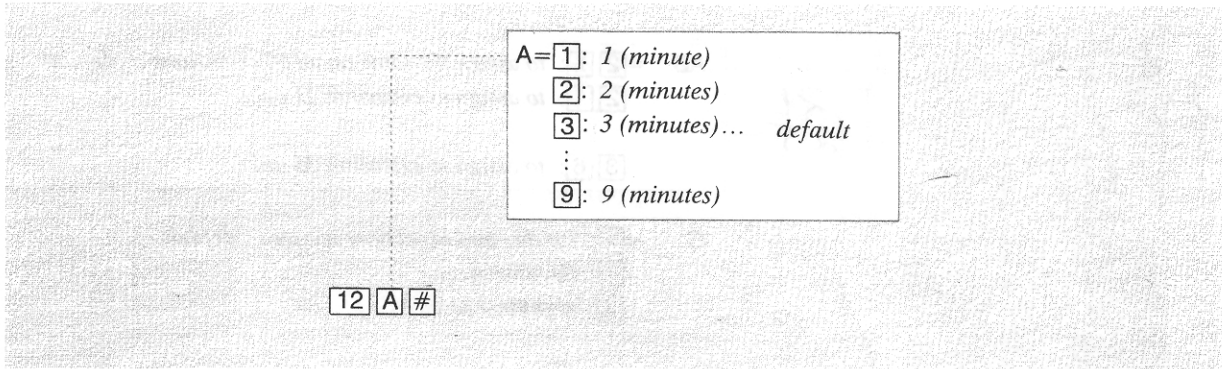

Description

A tone indication will be heard at the holding extension to remind user that he still has a call on hold. The reminder will be sounded after 3 minutes, but can be changed. There are 9 choices ranging from (1) minute to (9).

21

Programming

1. Lift handset of extension 21.
2. Dial (12).
3. Enter number of minutes (1 through 9).
4. Dial (#) and wait for confirmation tone.
5. Hang up.

Example

4 minutes = (12 4 #).

Programming Table

	minutes									
	1	2	3	4	5	6	7	8	9	
Default	/		×	/						
To make program change										

For NO RINGING
Do not program 10 Trunk #'s

Ext. # 21

Trunk Assignment

21 781 #

21
25

AB = : to assign the same on all 16 extensions ... default
 : to assign to extension 21 only
 ...
 : to assign to extension 36 only

C = : for day and night time service ... default
 : daytime service
 : nighttime service

D = : outgoing and incoming calls ... default
 : outgoing calls
 : incoming calls Ring

E...F = : trunk
 (string of trunk number)
 : all 6 trunks... default
 (or)

25-36-X

• Another way to reset default plan is to dial (2*#).

Description

Using Trunk Assignment you may select the following:

Flexible Ringing:

Through programming you can select what extensions will ring on incoming trunk calls.

Flexible Outward Dialing:

You can assign, through programming, the trunks each extension may have access to.

Flexible Ringing and Flexible Outward Dialing:

Two plans are available. A daytime plan and a nighttime plan.

Programming

If Default Plan is not used, each extension must be programmed for Day and Night as well as Incoming and Outgoing. It is possible that each extension could be programmed 4 different times, to assign desired trunk assignment (see example).

TRUNK NO.

It is important the ↑ trunks are programmed, otherwise extension user will be unable to place outside calls.

Example: COMPANY XYZ
(3 trunks by 7 extensions)

Company XYZ wants only extension 21 and 25 to have access to trunks 1, 2, 3 on outgoing calls during the day. Extensions 22, 23, 24, 26 and 27 are to be programmed for access to only trunks 1 and 2.

- (21 1 1 1 2 3 #) (25 1 1 1 2 3 #)
 (22 1 1 1 2 #) (26 1 1 1 2 #)
 (23 1 1 1 2 #) (27 1 1 1 2 #)
 (24 1 1 1 2 #)

But company XYZ wants only Extension 21 to have access to outside trunks 1, 2 and 3 during the night, and any other extensions to have no access to outside trunks at nighttime.

- (21 2 1 1 2 3 #) (25 2 1 #)
 (22 2 1 #) (26 2 1 #)
 (23 2 1 #) (27 2 1 #)
 (24 2 1 #)

Incoming calls during the daytime are programmed to ring at extensions 21 and 27 only.

- (21 1 2 1 2 3 #) (25 1 2 #)
 (22 1 2 #) (26 1 2 #)
 (23 1 2 #) (27 1 2 1 2 3 #)
 (24 1 2 #)

Finally Company XYZ would like all incoming calls to ring at all extensions during the nighttime.

- (21 2 2 1 2 3 #) (25 2 2 1 2 3 #)
 (22 2 2 1 2 3 #) (26 2 2 1 2 3 #)
 (23 2 2 1 2 3 #) (27 2 2 1 2 3 #)
 (24 2 2 1 2 3 #)

Extension 21	Trunk Number		
	1	2	3
1 Day Outgoing	x	x	x
2 Day Incoming	x	x	x
3 Night Outgoing	x	x	x
4 Night Incoming	x	x	x

Extension 22	Trunk Number		
	1	2	3
1 Day Outgoing	x	x	
2 Day Incoming			
3 Night Outgoing			
4 Night Incoming	x	x	x

Extension 23	Trunk Number		
	1	2	3
1 Day Outgoing	x	x	
2 Day Incoming			
3 Night Outgoing			
4 Night Incoming	x	x	x

Extension 24	Trunk Number		
	1	2	3
1 Day Outgoing	x	x	
2 Day Incoming			
3 Night Outgoing			
4 Night Incoming	x	x	x

Extension 25	Trunk Number		
	1	2	3
1 Day Outgoing	x	x	x
2 Day Incoming			
3 Night Outgoing			
4 Night Incoming	x	x	x

Extension 26	Trunk Number		
	1	2	3
1 Day Outgoing	x	x	
2 Day Incoming			
3 Night Outgoing			
4 Night Incoming	x	x	x

Extension 27	Trunk Number		
	1	2	3
1 Day Outgoing	x	x	
2 Day Incoming	x	x	x
3 Night Outgoing			
4 Night Incoming	x	x	x

Programming Table

Default Table

Extensions 21 through 36	Trunk Number					
	1	2	3	4	5	6
Day Outgoing	x	x	x	x	x	x
Day Incoming	x	x	x	x	x	x
Night Outgoing	x	x	x	x	x	x
Night Incoming	x	x	x	x	x	x

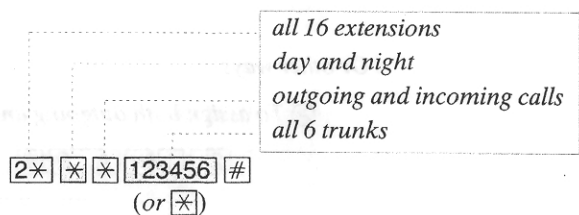

To make program change

Extension 21	Trunk Number					
	1	2	3	4	5	6
1 Day Outgoing						
2 Day Incoming						
3 Night Outgoing						
4 Night Incoming						

① Day Outgoing (outgoing calls for daytime)

A...B=string of trunk number

21 1 1 A...B #

outgoing calls code

day plan code

② Day Incoming (incoming calls for daytime)

A...B=string of trunk number

21 1 2 A...B #

incoming calls code

day plan code

③ Night Outgoing (outgoing calls for nighttime)

A...B=string of trunk number

21 2 1 A...B #

outgoing calls code

night plan code

④ Night Incoming (incoming calls for nighttime)

A...B=string of trunk number

21 2 2 A...B #

incoming calls code

night plan code

Or other ways

Ⓐ To assign both outgoing and incoming calls to the same trunks, for daytime.

21 1 * A...B #

outgoing and incoming

day

Ⓑ To assign both outgoing and incoming calls to the same trunks, for nighttime.

21 2 * A...B #

outgoing and incoming

night

Or to assign for daytime and nighttime to the same trunks

© Outgoing calls

21 * 1 A...B #

outgoing
day and night

Ⓓ Incoming calls

21 * 2 A...B #

incoming
day and night

Or to assign both outgoing and incoming calls to the same trunks, for both daytime and nighttime

Ⓔ 21 * * A...B #

outgoing and incoming
day and night

Extension 22	Trunk Number					
	1	2	3	4	5	6
1 Day Outgoing						
2 Day Incoming						
3 Night Outgoing						
4 Night Incoming						

- ① Day Outgoing 22 1 1 A...B #
- ② Day Incoming 22 1 2 A...B #
- ③ Night Outgoing 22 2 1 A...B #
- ④ Night Incoming 22 2 2 A...B #

- or
- Ⓐ Day, Outgoing & Incoming (①, ②) 22 1 * A...B #
 - Ⓑ Night, Outgoing & Incoming (③, ④) 22 2 * A...B #

- or
- Ⓒ Day & Night, Outgoing (①, ③) 22 * 1 A...B #
 - Ⓓ Day & Night, Incoming (②, ④) 22 * 2 A...B #

- or
- Ⓔ Day & Night, Outgoing & Incoming (①, ②, ③, ④) 22 * * A...B #

← will Allow RING IN when TRUNKS ARE Put in AB spot.

Extension 23	Trunk Number					
	1	2	3	4	5	6
1 Day Outgoing						
2 Day Incoming						
3 Night Outgoing						
4 Night Incoming						

- ① Day Outgoing 23 1 1 A...B #
- ② Day Incoming 23 1 2 A...B #
- ③ Night Outgoing 23 2 1 A...B #
- ④ Night Incoming 23 2 2 A...B #

- or
- Ⓐ Day, Outgoing & Incoming (①, ②) 23 1 ✕ A...B #
 - Ⓑ Night, Outgoing & Incoming (③, ④) 23 2 ✕ A...B #

- or
- Ⓒ Day & Night, Outgoing (①, ③) 23 ✕ 1 A...B #
 - Ⓓ Day & Night, Incoming (②, ④) 23 ✕ 2 A...B #

- or
- Ⓔ Day & Night, Outgoing & Incoming (①, ②, ③, ④) 23 ✕ ✕ A...B #

Extension 24	Trunk Number					
	1	2	3	4	5	6
1 Day Outgoing						
2 Day Incoming						
3 Night Outgoing						
4 Night Incoming						

- ① Day Outgoing 24 1 1 A...B #
- ② Day Incoming 24 1 2 A...B #
- ③ Night Outgoing 24 2 1 A...B #
- ④ Night Incoming 24 2 2 A...B #

- or
- Ⓐ Day, Outgoing & Incoming (①, ②) 24 1 ✕ A...B #
 - Ⓑ Night, Outgoing & Incoming (③, ④) 24 2 ✕ A...B #

- or
- Ⓒ Day & Night, Outgoing (①, ③) 24 ✕ 1 A...B #
 - Ⓓ Day & Night, Incoming (②, ④) 24 ✕ 2 A...B #

- or
- Ⓔ Day & Night, Outgoing & Incoming (①, ②, ③, ④) 24 ✕ ✕ A...B #

Extension 25	Trunk Number					
	1	2	3	4	5	6
1 Day Outgoing	X	X	X			
2 Day Incoming						
3 Night Outgoing	X	X	X			
4 Night Incoming						

NO RING

NO RING

① Day Outgoing	25	1	1	A...B	#
② Day Incoming	25	1	2	A...B	#
③ Night Outgoing	25	2	1	A...B	#
④ Night Incoming	25	2	2	A...B	#

or

Ⓐ Day, Outgoing & Incoming (①, ②)	25	1	*	A...B	#
Ⓑ Night, Outgoing & Incoming (③, ④)	25	2	*	A...B	#

or

Ⓒ Day & Night, Outgoing (①, ③)	25	*	1	A...B	#
Ⓓ Day & Night, Incoming (②, ④)	25	*	2	A...B	#

or

Ⓔ Day & Night, Outgoing & Incoming (①, ②, ③, ④)	25	*	*	A...B	#
---	----	---	---	-------	---

Extension 26	Trunk Number					
	1	2	3	4	5	6
1 Day Outgoing						
2 Day Incoming						
3 Night Outgoing						
4 Night Incoming						

① Day Outgoing	26	1	1	A...B	#
② Day Incoming	26	1	2	A...B	#
③ Night Outgoing	26	2	1	A...B	#
④ Night Incoming	26	2	2	A...B	#

or

Ⓐ Day, Outgoing & Incoming (①, ②)	26	1	*	A...B	#
Ⓑ Night, Outgoing & Incoming (③, ④)	26	2	*	A...B	#

or

Ⓒ Day & Night, Outgoing (①, ③)	26	*	1	A...B	#
Ⓓ Day & Night, Incoming (②, ④)	26	*	2	A...B	#

or

Ⓔ Day & Night, Outgoing & Incoming (①, ②, ③, ④)	26	*	*	A...B	#
---	----	---	---	-------	---

Extension 27	Trunk Number					
	1	2	3	4	5	6
1 Day Outgoing						
2 Day Incoming						
3 Night Outgoing						
4 Night Incoming						

① Day Outgoing	27	1	1	A...B	#
② Day Incoming	27	1	2	A...B	#
③ Night Outgoing	27	2	1	A...B	#
④ Night Incoming	27	2	2	A...B	#

or	Ⓐ Day, Outgoing & Incoming (①, ②)	27	1	*	A...B	#
	Ⓑ Night, Outgoing & Incoming (③, ④)	27	2	*	A...B	#

or	Ⓒ Day & Night, Outgoing (①, ③)	27	*	1	A...B	#
	Ⓓ Day & Night, Incoming (②, ④)	27	*	2	A...B	#

or	Ⓔ Day & Night, Outgoing & Incoming (①, ②, ③, ④)	27	*	*	A...B	#
----	---	----	---	---	-------	---

Extension 28	Trunk Number					
	1	2	3	4	5	6
1 Day Outgoing						
2 Day Incoming						
3 Night Outgoing						
4 Night Incoming						

① Day Outgoing	28	1	1	A...B	#
② Day Incoming	28	1	2	A...B	#
③ Night Outgoing	28	2	1	A...B	#
④ Night Incoming	28	2	2	A...B	#

or	Ⓐ Day, Outgoing & Incoming (①, ②)	28	1	*	A...B	#
	Ⓑ Night, Outgoing & Incoming (③, ④)	28	2	*	A...B	#

or	Ⓒ Day & Night, Outgoing (①, ③)	28	*	1	A...B	#
	Ⓓ Day & Night, Incoming (②, ④)	28	*	2	A...B	#

or	Ⓔ Day & Night, Outgoing & Incoming (①, ②, ③, ④)	28	*	*	A...B	#
----	---	----	---	---	-------	---

Extension 29	Trunk Number					
	1	2	3	4	5	6
1 Day Outgoing						
2 Day Incoming						
3 Night Outgoing						
4 Night Incoming						

① Day Outgoing 29 1 1 A...B #
 ② Day Incoming 29 1 2 A...B #
 ③ Night Outgoing 29 2 1 A...B #
 ④ Night Incoming 29 2 2 A...B #

or A Day, Outgoing & Incoming (①, ②) 29 1 × A...B #
 B Night, Outgoing & Incoming (③, ④) 29 2 × A...B #

or C Day & Night, Outgoing (①, ③) 29 × 1 A...B #
 D Day & Night, Incoming (②, ④) 29 × 2 A...B #

or E Day & Night, Outgoing & Incoming (①, ②, ③, ④) 29 × × A...B #

Extension 30	Trunk Number					
	1	2	3	4	5	6
1 Day Outgoing						
2 Day Incoming						
3 Night Outgoing						
4 Night Incoming						

① Day Outgoing 30 1 1 A...B #
 ② Day Incoming 30 1 2 A...B #
 ③ Night Outgoing 30 2 1 A...B #
 ④ Night Incoming 30 2 2 A...B #

or A Day, Outgoing & Incoming (①, ②) 30 1 × A...B #
 B Night, Outgoing & Incoming (③, ④) 30 2 × A...B #

or C Day & Night, Outgoing (①, ③) 30 × 1 A...B #
 D Day & Night, Incoming (②, ④) 30 × 2 A...B #

or E Day & Night, Outgoing & Incoming (①, ②, ③, ④) 30 × × A...B #

Extension 31	Trunk Number					
	1	2	3	4	5	6
1 Day Outgoing						
2 Day Incoming						
3 Night Outgoing						
4 Night Incoming						

- ① Day Outgoing 31 1 1 A...B #
- ② Day Incoming 31 1 2 A...B #
- ③ Night Outgoing 31 2 1 A...B #
- ④ Night Incoming 31 2 2 A...B #

- or
- Ⓐ Day, Outgoing & Incoming (①, ②) 31 1 * A...B #
 - Ⓑ Night, Outgoing & Incoming (③, ④) 31 2 * A...B #

- or
- Ⓒ Day & Night, Outgoing (①, ③) 31 * 1 A...B #
 - Ⓓ Day & Night, Incoming (②, ④) 31 * 2 A...B #

- or
- Ⓔ Day & Night, Outgoing & Incoming (①, ②, ③, ④) 31 * * A...B #

Extension 32	Trunk Number					
	1	2	3	4	5	6
1 Day Outgoing	✓	✓	✓			
2 Day Incoming						
3 Night Outgoing	✓	✓	✓			
4 Night Incoming						

- ① Day Outgoing 32 1 1 A...B #
- ② Day Incoming 32 1 2 A...B #
- ③ Night Outgoing 32 2 1 A...B #
- ④ Night Incoming 32 2 2 A...B #

- or
- Ⓐ Day, Outgoing & Incoming (①, ②) 32 1 * A...B #
 - Ⓑ Night, Outgoing & Incoming (③, ④) 32 2 * A...B #

- or
- Ⓒ Day & Night, Outgoing (①, ③) 32 * 1 A...B #
 - Ⓓ Day & Night, Incoming (②, ④) 32 * 2 A...B #

- or
- Ⓔ Day & Night, Outgoing & Incoming (①, ②, ③, ④) 32 * * A...B #

Extension 33		Trunk Number					
		1	2	3	4	5	6
1	Day Outgoing	✓	✓	✓			
2	Day Incoming						
3	Night Outgoing	✓	✓	✓			
4	Night Incoming						

- ① Day Outgoing 33 1 1 A...B #
- ② Day Incoming 33 1 2 A...B #
- ③ Night Outgoing 33 2 1 A...B #
- ④ Night Incoming 33 2 2 A...B #

- or
- Ⓐ Day, Outgoing & Incoming (①, ②) 33 1 × A...B #
 - Ⓑ Night, Outgoing & Incoming (③, ④) 33 2 × A...B #

- or
- Ⓒ Day & Night, Outgoing (①, ③) 33 × 1 A...B #
 - Ⓓ Day & Night, Incoming (②, ④) 33 × 2 A...B #

AB = 123
AB = no trunk #s

- or
- Ⓔ Day & Night, Outgoing & Incoming (①, ②, ③, ④) 33 × × A...B #

Extension 34		Trunk Number					
		1	2	3	4	5	6
1	Day Outgoing						
2	Day Incoming						
3	Night Outgoing						
4	Night Incoming						

- ① Day Outgoing 34 1 1 A...B #
- ② Day Incoming 34 1 2 A...B #
- ③ Night Outgoing 34 2 1 A...B #
- ④ Night Incoming 34 2 2 A...B #

- or
- Ⓐ Day, Outgoing & Incoming (①, ②) 34 1 × A...B #
 - Ⓑ Night, Outgoing & Incoming (③, ④) 34 2 × A...B #

- or
- Ⓒ Day & Night, Outgoing (①, ③) 34 × 1 A...B #
 - Ⓓ Day & Night, Incoming (②, ④) 34 × 2 A...B #

- or
- Ⓔ Day & Night, Outgoing & Incoming (①, ②, ③, ④) 34 × × A...B #

Extension 35	Trunk Number					
	1	2	3	4	5	6
1 Day Outgoing						
2 Day Incoming						
3 Night Outgoing						
4 Night Incoming						

- ① Day Outgoing 35 1 1 A...B #
- ② Day Incoming 35 1 2 A...B #
- ③ Night Outgoing 35 2 1 A...B #
- ④ Night Incoming 35 2 2 A...B #

- or
- Ⓐ Day, Outgoing & Incoming (①, ②) 35 1 * A...B #
 - Ⓑ Night, Outgoing & Incoming (③, ④) 35 2 * A...B #

- or
- Ⓒ Day & Night, Outgoing (①, ③) 35 * 1 A...B #
 - Ⓓ Day & Night, Incoming (②, ④) 35 * 2 A...B #

- or
- Ⓔ Day & Night, Outgoing & Incoming (①, ②, ③, ④) 35 * * A...B #

Extension 36	Trunk Number					
	1	2	3	4	5	6
1 Day Outgoing						
2 Day Incoming						
3 Night Outgoing						
4 Night Incoming						

- ① Day Outgoing 36 1 1 A...B #
- ② Day Incoming 36 1 2 A...B #
- ③ Night Outgoing 36 2 1 A...B #
- ④ Night Incoming 36 2 2 A...B #

- or
- Ⓐ Day, Outgoing & Incoming (①, ②) 36 1 * A...B #
 - Ⓑ Night, Outgoing & Incoming (③, ④) 36 2 * A...B #

- or
- Ⓒ Day & Night, Outgoing (①, ③) 36 * 1 A...B #
 - Ⓓ Day & Night, Incoming (②, ④) 36 * 2 A...B #

- or
- Ⓔ Day & Night, Outgoing & Incoming (①, ②, ③, ④) 36 * * A...B #

N/A

Dial Call Pickup Group Assignment

To set

A= [1]: pickup group 1
 ⋮
 [4]: pickup group 4

BC...DE=(string of extension number to be added to pickup group)
 [2][*]: to assign all extensions

[4] [A] [BC...DE] [#]

Default program
 (All extensions have been assigned to pickup group 1.
 There are no extension assigned to pickup groups 2, 3 and 4.)

- The way to set default program is to dial (4*#).

To cancel

A= [1]: to cancel pickup group 1
 ⋮
 [4]: to cancel pickup group 4

[4] [A] [#]

Description

Permits an extension user to answer other ringing telephones, provided they are in the same pickup group setting.

Conditions

- Each Pickup Group may contain all sixteen extensions.
- Each extension may belong to more than one pickup group, up to four.

Programming

1. Lift handset of extension 21.
2. Dial (4).
3. Dial pickup group number.
4. Enter the desired extension numbers to be added to pickup group.
5. Dial (#) and wait for confirmation tone.

Examples

Accounting department;
 Pickup group 1 is extensions 24, 25 and 26. (4 1 24 25 26 #)

Order entry department;
 Pickup group 2 is extensions 32, 33, 34 and 35. (4 2 32 33 34 35 #)

Customer service;
 Pickup group 3 is extensions 22, 23, 24, 25, 26, 32, 33, 34, 35, 36.
 (4 3 22 23 24 25 26 32 33 34 35 36 #)

Programming Table

Extension	Groups							
	Default				To make program change			
	1	2	3	4	1	2	3	4
21	×							
22	×							
23	×							
24	×							
25	×							
26	×							
27	×							
28	×							
29	×							
30	×							
31	×							
32	×							
33	×							
34	×							
35	×							
36	×							

A = 1: pickup group 1

⋮

4: pickup group 4

BC...DE = extensions to be added to pickup group

4 A BC...DE #

Toll Restriction

5 21-1 #
+
5 25-1 #

AB= : to assign the same on all 16 extensions.
 : to assign to extension 21 only.
 ...
 : to assign to extension 36 only.

Class of service (see below for selection.)

5

AB

C

#

Default program is

5

2*

1

#

3

Description

Can be used to prohibit selected extensions from making long distance calls. Toll Restriction can help eliminate telephone abuse, and contribute to controlling telephone costs. There are four classes service available.

	Class of Service Selections (COS)	
	Allowed	Denied
1	all calls	
2	toll calls, local calls	international calls
* 3	local calls, selected area-codes	international telephone calls, any calls other than specific area-code programmed
4	local calls	international calls, toll calls

*For Class of Service 3, up to 10 area codes can be selected for use in toll dialing (See "Toll Restriction—Area Code Selection" on page 40).

Programming:

1. Lift handset of extension 21.
2. Dial (5).
3. Enter the extension number.
4. Select the Class of Service.
5. Dial (#) and wait for confirmation tone.
6. Repeat above procedure to assign the Class of Service to all extensions.
7. Hang up.

Example:

To prohibit international calls on extension 28 but allow local and toll calls enter.
(5 28 2 #)

To prohibit international calls and toll calls on extension 29, 30 and 31 but allow local calls:
(5 29 4 #)
(5 30 4 #)
(5 31 4 #)

Programming Table

Ext.	Default	To make program change			
	all calls	all calls	toll calls, local calls	selected area-codes, local calls	local calls
21	×				
22	×				
23	×				
24	×				
25	×				
26	×				
27	×				
28	×				
29	×				
30	×				
31	×				
32	×				
33	×				
34	×				
35	×				
36	×				

↓
Proceed to "Area code selection"

Toll Restriction—Area Code Selection

up to 10 area codes each with 3 digits

6 ABC...DEF #

Description

For Class of Service 3 (see "Toll Restriction" on page 39), up to 10 area codes can be selected for use in toll dialing. All area codes except those entered will be denied. All extensions programmed for COS 3 shall be assigned to the same area code selection plan.

Programming

When Class of Service 3 is programmed;

1. Dial as shown above at extension 21.
(Up to 10 area codes can be entered.)

Example

To allow extension 34 access to New York City and entire state of New Jersey, program the following.

STEP 1...At extension 21, enter
(5 34 3 #)

STEP 2...At extension 21, enter
(6 212 718 201 609 #)

New York City has 2 area codes 212, 718 and New Jersey 201, 609.

Programming Table

	1st	2nd	3rd	4th	5th	6th	7th	8th	9th	10th
area code entry	800	0								

Toll Restriction—Trunk Selection

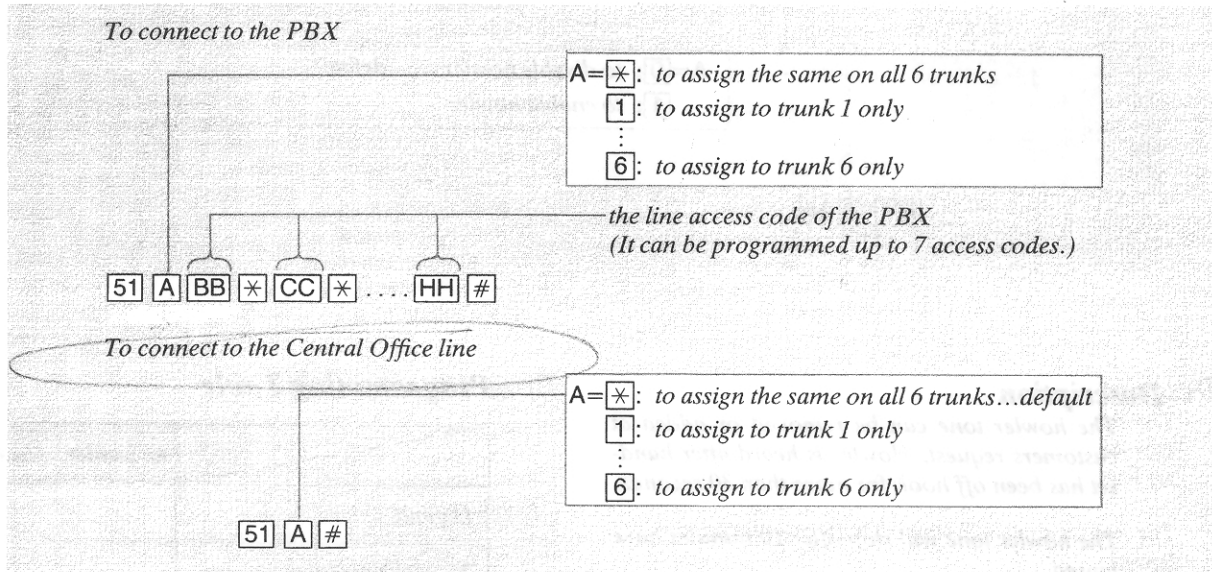

Description

Allows the KX-T616 which is connected to the host PBX to activate the Toll Restriction.

The line access code of the host PBX can be programmed up to 7 numbers each consists of 1 or 2 digits.

Programming

To connect to the PBX

1. Lift handset of extension 21.
2. Dial (51).
3. Dial Trunk number (1 through 6) or (*) if Trunk Selection is to be the same for all six trunks.
4. Dial the line access codes of the host PBX, up to 7 access codes.
5. Dial (#) and wait for confirmation tone.
6. Repeat above procedure on each trunk.
7. Hang up.

To connect to the Central Office line

1. Lift handset of extension 21.
2. Dial (51).
3. Dial Trunk number (1 through 6) or (*) if Trunk Selection is to be the same for all six trunks.
4. Dial (#) and wait for confirmation tone.
5. Repeat above procedure on each trunk.
6. Hang up.

Conditions

51 1 3 * 31 * 41 * 32---

When some line access codes that consist of 1 and 2-digit numbers are programmed, the 2-digit code which begins with the same number with the 1-digit code can not be programmed.

Programmable Table

Trunks	Default	To make program change						
	C.O.	C.O.	line access codes of PBX					
1	×							
2	×							
3	×							
4	×							
5	×							
6	×							

Programmable Howler

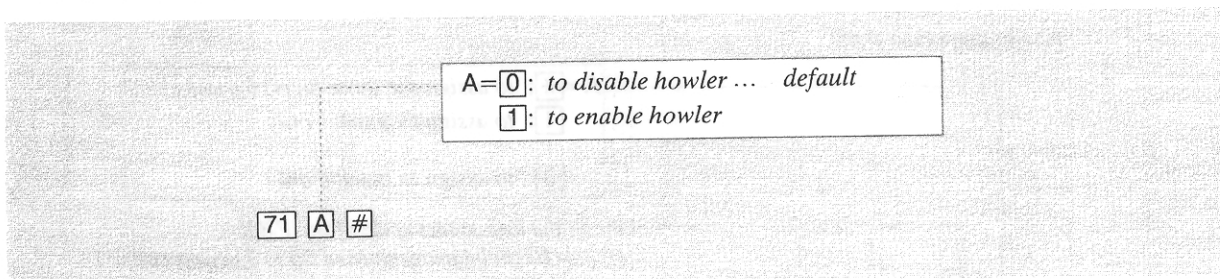

Description

The howler tone can be removed or added at customers request. Howler is heard after handset has been off hook for more than 30 seconds.

The howler tone will stop after 10 minutes have lapsed.

Programming

1. Lift handset of extension 21.
2. Dial (71).
3. Dial (1) to enable howler.
4. Dial (#) and wait for confirmation tone.
5. Hang up.

Programming Table

	no howler	howler
Default	×	/
To make program change		

Programmable Paging Access Tone

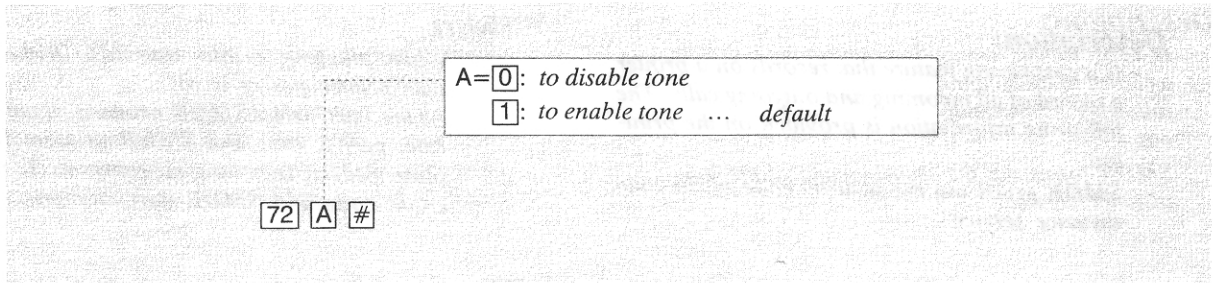

Description

After user has accessed paging, they will hear 2 beeps.

These beeps can be removed or added at customers request.

Programmable Table

	tone	no tone
Default	×	/
To make program change		

Programming

1. Lift handset of extension 21.
2. Dial (72).
3. Dial (0) to disable tone.
4. Dial (#) and wait for confirmation tone.
5. Hang up.

When the page is accessed, this is informed to a person accessing the page by two tones.

Station Message Detail Recording (SMDR)

Description:

Is a cost saving feature that records on a printer a record of all incoming and outgoing calls. The following information is provided on the print-out.

SMDR prints out the security code of the long distance service.

NOTE:

When plugging printer into KX-T616, make sure printer power is off.

At the start, select SMDR printer format (baud rate, parity, etc.) and SMDR printout format (date, SMDR-Incoming/outgoing selection, Account code and SMDR-start time selection).

Date	Time	Ext. CO	Dial Number	Duration	Code
4/20/86	8:00 AM	26 6	1-201-234-5678	00:00'30"	0123
----- ----- year ----- day ----- month		----- ----- trunk ----- number ----- extension	----- ----- called ----- party	----- ----- second ----- minute ----- hour	

- When you have an incoming call, the display shows <<incoming>>.
- When "=" appears in the Dial Number, the previous number of "=" indicates the line access number of the Host PBX.

SMDR Printer Format Selection

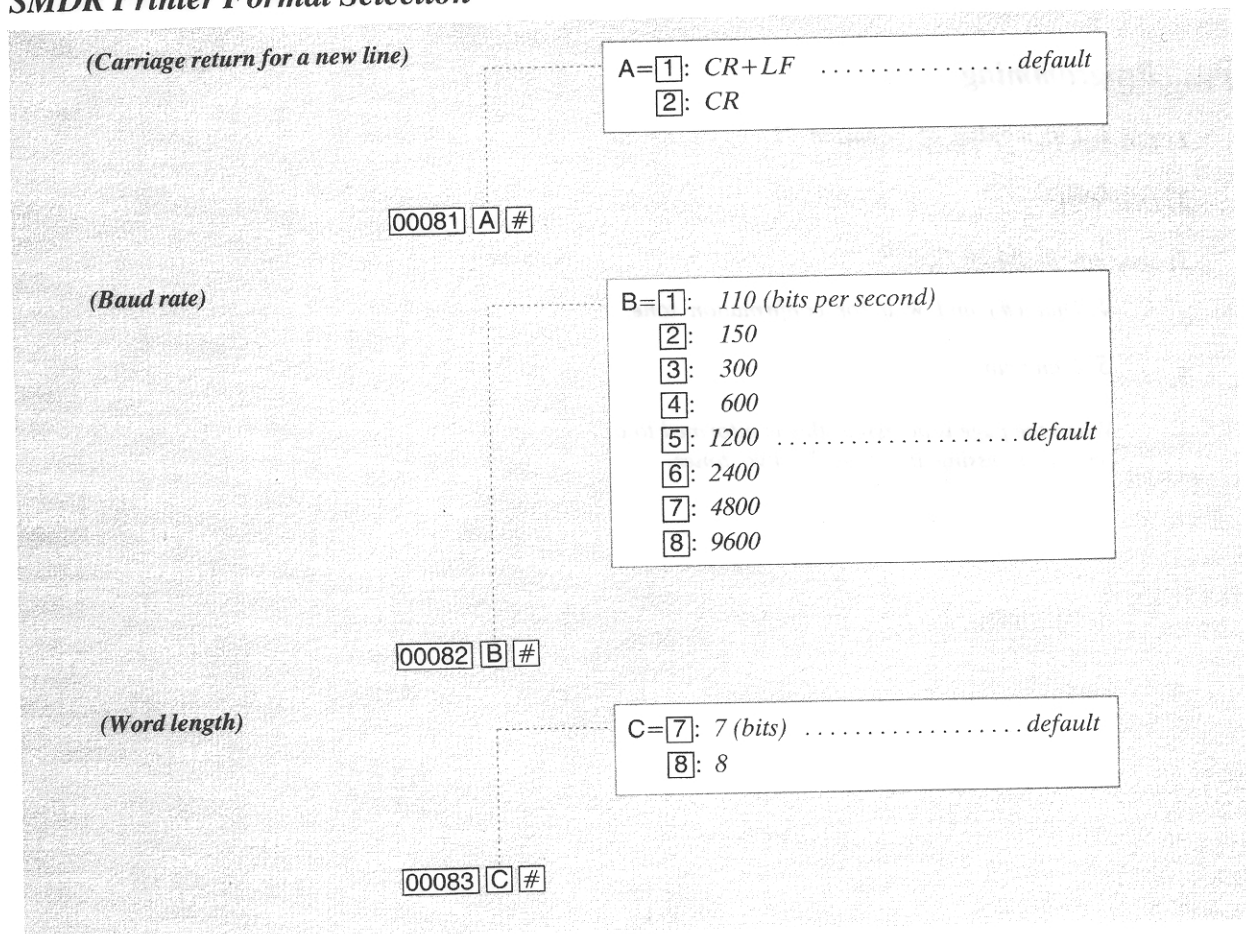

(Parity)

D=0: none
1: mark default
2: space
3: even
4: odd

00084 D #

(Stop bit length)

E=1: 1 (bit) default
2: 2

00085 E #

(Page length)

FG=0 4: 4 (lines)
⋮
6 6: 66 default
⋮
9 9: 99

00086 FG #

(Skip perforation)

HI =0 0: no line default
⋮
9 5: 95 lines

00087 HI #

Default value is the same as that of Panasonic Data Terminal (KX-D4910, 4911, etc.) except baud rate.

● To halt printing, press 85 #.

Example: If a printer runs misprinting pressing 85 # causes printing to stop.

SMDR Printout Format

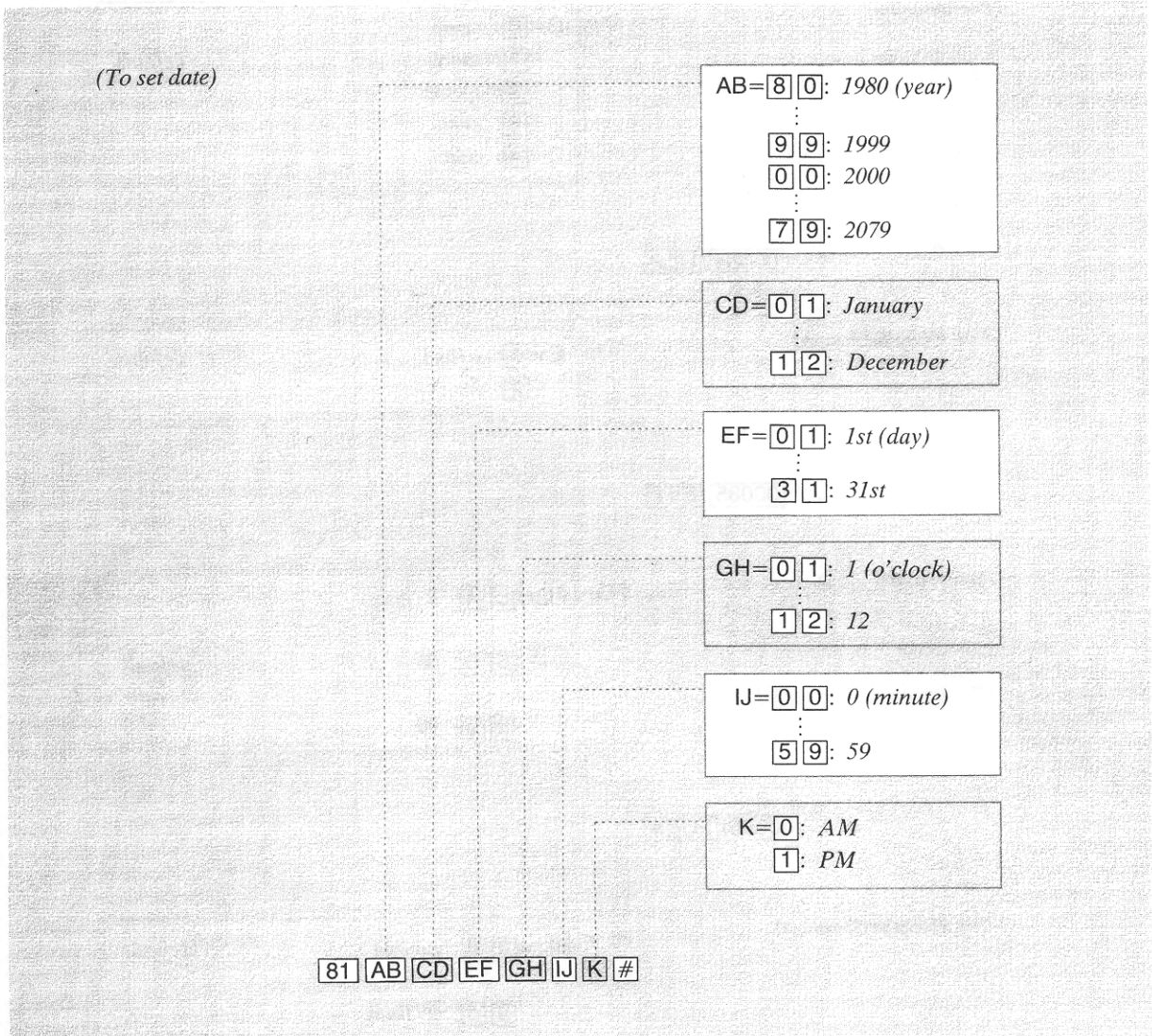

Example

March 15, 1986 12:05 PM = (81 86 03 15 12 05 1 #)

(SMDR-Incoming/Outgoing selection)

82 A #

A = : to print incoming and outgoing calls default
: no print
: to print outgoing trunk calls only
: to print incoming trunk calls only

(Account code entry)

83 AB CDEF #

AB = : to assign the same on all 16 extensions...default
 : to assign to extension 21.
 ⋮
 : to assign to extension 36.

CDEF = : (4 digit account) default
 ⋮

(SMDR start time selection)

84 A #

A = : instantly
: 5 seconds default
: 10 seconds

Data Dump

(To halt printing)

85 #

(Master Printout)

85 * #

(System Parameters)

851 #

(Trunk Parameters)

852 A #

A = : on all trunks
: on trunk 1
 ⋮
: on trunk 6

(Extension Parameters)

853 AB #

AB = : on all extensions
 : on extension 21
 ⋮
 : on extension 36

(System Speed Call Codes)

854 #

Carriage return for a new line

00081 A #

new line code

A new line code indicates what type of code is needed for print head on a printer to move to the first character position on the next line.

A	description
1	CR+LF when "CR+LF" is required from a printer.
2	CR when "CR" is required from a printer.

"CR+LF" is default.

CR means Carriage Return and LF means Line Feed.

Baud rate

00082 B #

baud rate code

A baud rate code indicates the data transmission speed from the system to a printer.

B	description
1	110 baud (when 110 baud is required.)
2	150 baud (when 150 baud is required.)
3	300 baud (when 300 baud is required.)
4	600 baud (when 600 baud is required.)
5	1200 baud (when 1200 baud is required.)
6	2400 baud (when 2400 baud is required.)
7	4800 baud (when 4800 baud is required.)
8	9600 baud (when 9600 baud is required.)

"1200 baud" is default.

Default value is the same as that of Panasonic data terminal, KX-D4910, KX-D4911 etc, except baud rate.

Word length

00083 C #

word length code

A word length code indicates how many bits compose a character.

C	description
7	7 bits (when 7 bits are required.)
8	8 bits (when 8 bits are required.)

"7 bits" is default.

Parity

00084 D #

parity code

A parity code indicates what type of parity is used to detect an error in a string of bits composing a character.

D	description
0	NONE: when error checking function is not required from a printer.
1	MARK: when Mark is required from a printer.
2	SPACE: when Space is required from a printer.
3	EVEN: when EVEN is required from a printer.
4	ODD: when Odd is required from a printer.

"MARK" is default.

Stop bit length

00085 E #

stop bit length code

A stop bit length code indicates the end of a bit string which composes a character.

E	description
1	1 stop bit: when one bit is required for end indication.
2	2 stop bits: when two bits are required for end indication.

"1 stop bit" is default.

Page length

The page length may be selected to position a title and data on each page.

00086 FG #

page length code

A page length code indicates the number of lines per page.

A title will be printed on the first 3 lines of each page.

FG	description
04	4 lines per page
.	.
99	99 lines per page

"66 lines" is default.

STANDARD CONTINUOUS PAPER (11 inches)

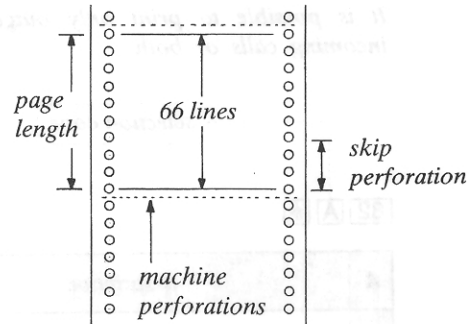

To print data, page length must be longer than skip perforation by 4 or more lines.

Skip perforation

00087 HI #

skip perforation code

A skip perforation code indicates the number of lines to be skipped. When the print head reaches the line designated, the print head moves to the top position of the next page.

HI	description
00	0 (a print head does not skip.)
01	1 (a print head skips the last 1 line.)
02	2 (a print head skips the last 2 lines.)
.	.
95	95 (a print head skips the last 95 lines.)

"0" is default.

SMDR—Incoming/outgoing selection

It is possible to print only outgoing calls, incoming calls or both.

selection code

82 | A | #

A	description
*	to print incoming and outgoing calls
0	no print
1	to print outgoing trunk calls only
2	to print incoming trunk calls only

Default program is 82*#.

Account code entry

Four digit Account Codes can be assigned to extensions for billing and budgeting purposes.

extension number
(21 through 36)

4 digit account

83 | AB | CDEF | #

CDEF	description
0000	to assign "0000".
⋮	
9999	to assign "9999".

Default program is 83 2* 0000 #.

Example

To assign Account Code 4669 to extension 26, 27 and 28,
(83 26 4669 #), (83 27 4669 #), (83 28 4669 #)

SMDR Start Time Selection

The time at which the SMDR begins to record the call duration can be selected.

A=1: instantly
2: 5 seconds
3: 10 seconds

84 | A | #

A	description
1	Instantly Timing begins as soon as a trunk is accessed.
2	5 seconds Timing begins 5 seconds after last digit of telephone number is dialed.
3	10 seconds Timing begins 10 seconds after last digit of telephone number is dialed.

Default program is 84 2 #.

Data Dump

Five separate printouts are available. To access DATA DUMP, the System Program Switch must be set to PROGRAM position and request must be entered at extension 21.

To halt printing

85 #

Master Printout

85 * #

System parameters
Trunk parameters
Extension parameters
Speed dial entries

System Parameters

851 #

Day/Night mode
Hold recall time
Hold time reminder
Busy tone (selection)
Active DTMF-receiver
Howler Option (Programmable howler)
Area codes of Class-3
Pickup group (assignments)
SMDR format
(Programmable) paging access tone

Trunk Parameters

852 A #

A = * : on all trunks
1 : on trunk 1
⋮
6 : on trunk 6

Parameters on the desired trunk may be printed by dialing as shown above.

Dialing Type (Tone/Pulse conversion)
Switchhook flash timing
Disconnect time
CPC signal

Extension Parameters

AB = 2 * : on all extensions
2 1 : on extension 21
⋮
3 6 : on extension 36

853 AB #

Parameters on the desired extension may be printed by dialing as shown above.

Do not disturb
Call forwarding
Dial call pickup deny
Data Line Security
Pickup dial
Toll restriction
Code Number of SMDR
Outgoing CO (Day/Night)
Incoming CO (Day/Night)

Pickup dial number

The dial number of the tone mode appears in the display following "T".
The dial number of the pulse mode appears in the display following "R".

System Speed Call Codes

854 #

Speed access codes (00 through 99) in which phone numbers are stored may be printed. The dial number of the tone mode appears in the display following "T". The dial number of the pulse mode appears in the display following "R".

"SMDR Printer Format Selection" and "SMDR Printout Format" can not be programmed during a data dump except to halt printing (Dial 85 #).

Conditions

The following combinations are disallowed.

parity	word length	stop bit length
mark	8	2
space	8	1
space	8	2

If any of the above disallowed combinations are selected, System goes to Default Value for Parity, Word length and Stop bit length.

The pin configuration of EIA (RS-232C) connector is as follows.

Pin Number	Signal Name		Circuit Type	
			EIA	CCITT
1	FG	Frame Ground	AA	101
2	TXD	Transmitted Data	BA	103
3	RXD	Received Data	BB	104
4	RTS	Request To Send	CA	105
5	CTS	Clear To Send	CB	106
6	DSR	Data Set Ready	CC	107
7	SG	Signal Ground	AB	102
8	DCD	Data Carrier Detect	CF	109
20	DTR	Data Terminal Ready	CD	108.2

EIA SIGNALS:

Frame Ground (FG);

Connects to the unit frame and the earth ground conductor of the AC power cord.

Transmitted Data (TXD); (output)

Conveys signals from the unit to the printer. A "MARK" condition is held unless data or BREAK signals are being transmitted.

Received Data (RXD); (input)

Conveys signals from the printer.

Request To Send (RTS); (output)

This lead is held ON whenever DSR is ON.

Clear To Send (CTS); (input)

An ON condition of circuit CTS indicates that the printer is ready to receive data from the unit. The unit does not attempt to transfer data or receive data when circuit CTS is OFF.

Data Set Ready (DSR); (input)

An ON condition of circuit DSR indicates the printer is ready. Circuit DSR ON does not indicate that communication has been established with the printer.

Signal Ground (SG);

Connects to the DC ground of the unit for all interface signal.

Data Terminal Ready (DTR) (output)

This signal line is turned ON by the unit to indicate that it is ON LINE.

Circuit DTR ON does not indicate that communication has been established with the printer.

It is switched OFF when the unit is OFF LINE.

Data Carrier Detect (DCD) (input)

The ON condition is an indication to data terminal (DTE) that the carrier signal is being received.

Programming Table

Printer format selection

Carriage return
for a new line

	CR+LF	CR
Default	×	/
To make program change		

A= [1]: CR+LF
[2]: CR

00081 A #

Baud rate

	110	150	300	600	1200	2400	4800	9600
Default	/	/	/	/	×	/	/	/
To make program change								

B= [1]: 110 (bits per second)
[2]: 150
[3]: 300
[4]: 600
[5]: 1200
[6]: 2400
[7]: 4800
[8]: 9600

00082 B #

Word length

	7 bits	8 bits
Default	×	/
To make program change		

C= [7]: 7 (bits)
[8]: 8

00083 C #

Parity

	<i>none</i>	<i>mark</i>	<i>space</i>	<i>even</i>	<i>odd</i>
<i>Default</i>		×			
<i>To make program change</i>					

- D = 0: none
 1: mark
 2: space
 3: even
 4: odd

00084 D #

Stop bit length

	<i>1 bit</i>	<i>2 bits</i>
<i>Default</i>	×	
<i>To make program change</i>		

- E = 1: 1 (bit)
 2: 2

00085 E #

Page length

	<i>lines per page</i>
<i>Default</i>	66
<i>To make program change</i>	

- FG = 0 4: 4 (lines per page)
 ⋮
 9 9: 99

00086 FG #

Skip perforation

	<i>skipping lines</i>
<i>Default</i>	0
<i>To make program change</i>	

- HI = 0 0: no line
 0 1: 1 (line)
 ⋮
 9 5: 95

00087 HI #

Printout format

To set date

AB= : 1980 year

 : 2000
 : 2001

 : 2079

CD= : January

 : December

EF= : 1st day

 : 31st day

GH= : 1 o'clock

 : 12 o'clock

IJ= : 0 minute

 : 59 minutes

K = : AM
 : PM

81 AB CD EF GH IJ K #

SMDR-Incoming/
Outgoing selection

	Incoming and Outgoing	No Print	Outgoing	Incoming
Default	×	/		
To make program change				

A= : Incoming and Outgoing
 : No print
 : Outgoing only
 : Incoming only

82 A #

Account code entry

<i>Extension</i>	<i>Default</i>	<i>To make program change</i>
21	0000	
22	0000	
23	0000	
24	0000	
25	0000	
26	0000	
27	0000	
28	0000	
29	0000	
30	0000	
31	0000	
32	0000	
33	0000	
34	0000	
35	0000	
36	0000	

AB = extension (21 through 36)

CDEF = : 4 digits of 0000
 : : : :
 : 4 digits of 9999

SMDR start time selection

	<i>instantly</i>	<i>5 seconds</i>	<i>10 seconds</i>
<i>Default</i>		×	
<i>To make program change</i>			

A = : instantly
 : 5 seconds
 : 10 seconds

System Speed Call Entry

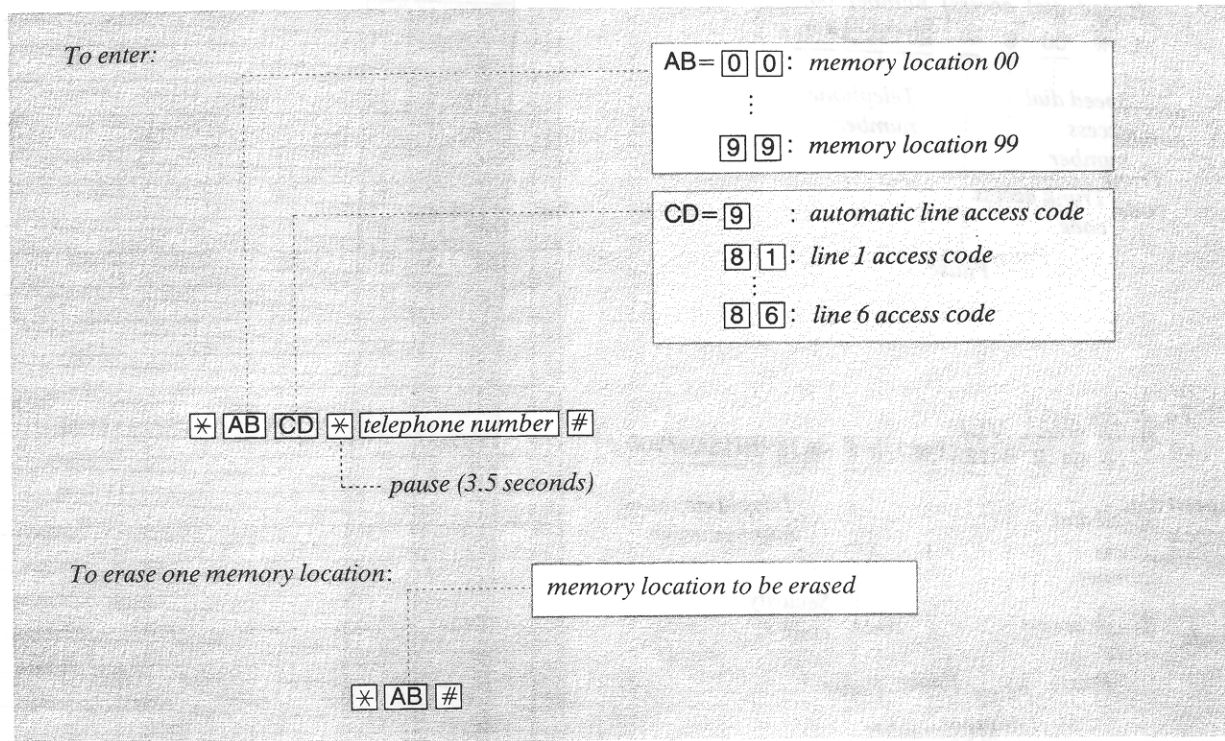

Description

100 numbers each with up to 30 digits may be entered into programming for speed dial use. All speed dial entries must be entered at Extension 21 with System Program Switch set to the PROGRAM position. Pushing the [*] (pause) button counts as 1 digit.

Programming

1. Lift handset of extension 21.
2. Dial [*].
3. Dial memory location. (00 through 99).
4. Dial trunk access code, (9) or (81 through 86).
5. Dial [*] for a pause.
6. Enter phone number.
7. Dial [#] and wait for confirmation tone.
8. Repeat steps 2 to 7 until all entries are completed.

Conditions

- Sometimes when entering alternate long distance services, pauses are necessary. The [*] key when entered will provide a 3.5 seconds pause.
 [*]=3.5 seconds
 [*] [*]=7.0 seconds
 [*] [*] [*]=10.5 seconds
- When in the pulse mode a telephone number is programmed, hang up once and start with the step 1.

Examples

1) To enter 201-392-4669 into memory location (speed dial access) number 00.

(* 00 9 * 2013924669 #)

Speed dial access number
Trunk access code
Pause
Telephone number

2) To access MCI (* 01 9 * 1234567 ** 9876 2013487000 #)

Speed dial access number
Trunk access code
Pause
MCI number
Pause
Security code
Telephone number

To eliminate Security Code abuse, keep it secret.

3) To access ITT (* 02 9 * 7654321 ** 2013487000 6789 #)

Speed dial access number
Trunk access code
Pause
ITT number
Pause
Telephone number
Security code

Access code	Name & Phone number
00	
01	
02	
03	
04	
05	
06	
07	
08	
09	
10	
11	
12	
13	
14	
15	
16	
17	
18	
19	
20	
21	
22	
23	
24	
25	
26	
27	
28	
29	
30	
31	
32	
33	
34	
35	
36	
37	
38	
39	

Access code	Name & Phone number
40	
41	
42	
43	
44	
45	
46	
47	
48	
49	
50	
51	
52	
53	
54	
55	
56	
57	
58	
59	
60	
61	
62	
63	
64	
65	
66	
67	
68	
69	

Access code	Name & Phone number
70	
71	
72	
73	
74	
75	
76	
77	
78	
79	
80	
81	
82	
83	
84	
85	
86	
87	
88	
89	
90	
91	
92	
93	
94	
95	
96	
97	
98	
99	

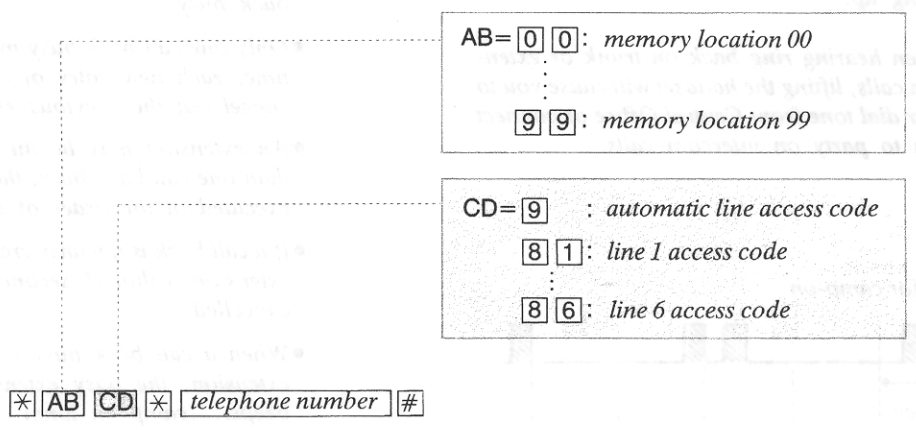

DETAILED FEATURE DESCRIPTION AND OPERATION

When a rotary phone is used at extensions (22 through 36), dialing (0) in place of (#) will serve to store station program.

Automatic Call Back Busy Trunk or Extension

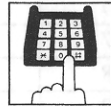

DIAL EXTENSION
OR TRUNK



WILL HEAR
BUSY TONE



DIAL (4)

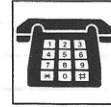

HANG UP

Description

If all trunks are busy or the intercom extension dialed is busy you will become automatically connected to the trunk or extension after it becomes free.

This feature is also known as camp on.

Operation

1. Lift handset.
2. Dial trunk or extension.
3. After busy signal is heard, dial (4).
4. Wait for confirmation tone (2 beeps).
5. Hang up.
6. When hearing ring back on trunk or extension calls, lifting the handset will cause you to hear dial tone from Central Office or connect you to party on intercom calls.

Recall for camp-on

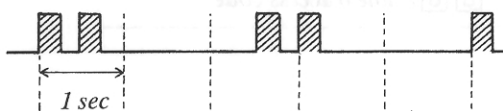

Conditions

- Call back busy can be initiated after speed dialing or redialing with (#) button only. When busy tone is heard after using speed dial number, dial 4. As soon as a trunk becomes free, your extension will be rung, lifting your handset will automatically transmit the previously attempted speed dial number. If two beeps and reorder tone are not heard after dialing 4, the number attempted by speed dialing is busy. (Trunk is not busy.) If this occurs, reattempt speed dial number later. (When trunk is not busy after redialing, dial the number manually later).
- Call back busy feature must be used within (7) seconds of hearing busy tone.
- Use of FLASH key or SWITCHHOOK when reorder tone is heard or lifting handset before automatic ringback is activated will cancel call back busy.
- Only one call back busy may be initiated at a time, each new entry of call back busy will cancel out the previous entry.
- An extension may be the recipient of more than one call back busy, the call backs will be executed in the order of their arrival.
- If a call back is not answered at the originating extension within 10 seconds, the call back is cancelled.
- When a call back busy is placed on a busy extension, the busy extension will hear (3) beeps... (camp on tone)
- A call back busy cannot be activated on an extension which has another call on hold.

Automatic Station Release

Description

Extensions are automatically released if user does not dial within prescribed time (10 seconds).

Operation

Automatic

Conditions

- Stations are released if dialing does not begin within ten seconds.
- If dialing begins, but ten-second interruption occurs, station will be released and reorder tone will be heard.

Background Music

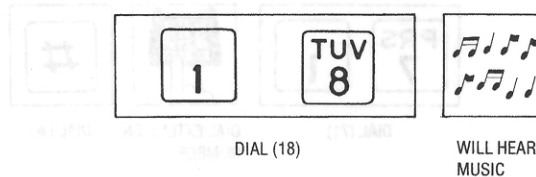

Description

Music from an external source (e.g. radio) can be listened to on a telephone instrument that is equipped with a speaker.

Operation

1. Press the speakerphone button on any extension that is equipped with speaker.
2. Dial (1 8).

Conditions

- An extension with a call on hold can not be used for listening to music.
- If listening to background music, music will be interrupted by a series of two tones for intercom calls, and one tone for trunk calls. To answer a new call, press the FLASH key or the speakerphone button and then lift the handset.

Call Forwarding

To set call forwarding:

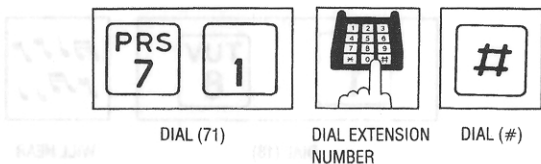

To cancel:

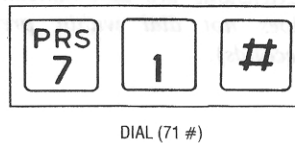

Description

Intercom calls to your extension can be forwarded to another extension automatically within the system. All calls directed to you are forwarded during your absence.

Operation

1. Lift handset and then dial (7 1).
2. Dial number of extension to which calls are to be forwarded (21 through 36).
3. Dial (#) to store entry.
4. To cancel call forwarding dial (7 1 #).

Conditions

- Do Not Disturb is cancelled when call forwarding is established.
- When a call directed to the forwarding extension is originated, the forwarded extension will be rung but the forwarding extension will not be rung.

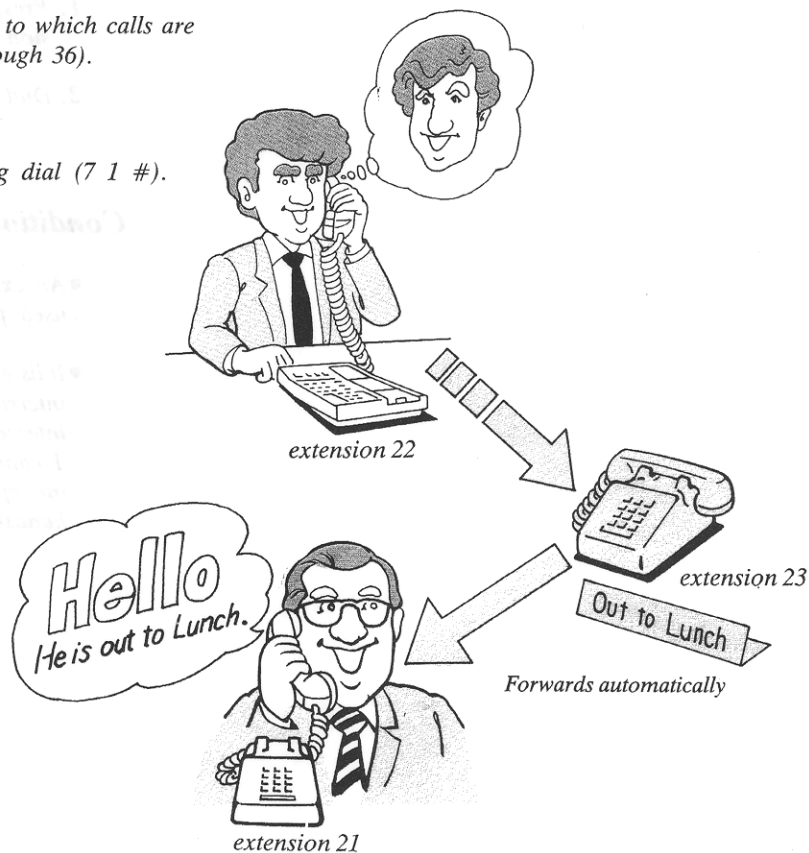

- The tone (busy tone or do not disturb tone), the call a party receives depends on the condition of the forwarded extension.

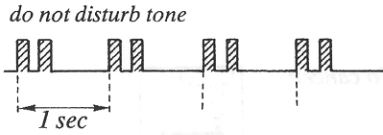

- When an intercom call to the forwarding extension is originated from the forwarded extension, the forwarded extension user hears reorder tone.

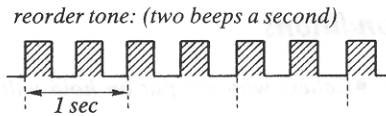

- An extension can not accommodate more than one forwarded extension. At each time of newly setting "Call Forwarding", a destination (forwarded extension code) will be renewed. Old entry will be cancelled.

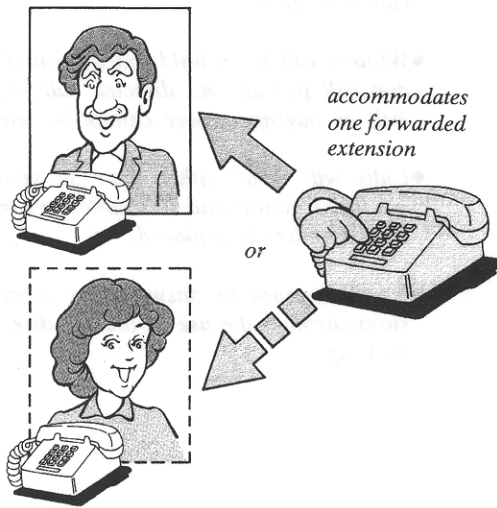

- If extension A is forwarding all calls to extension B and B is forwarding all calls to C, if any extension calls A, they will be connected to C. (If you attempt to forward a call to a forwarding extension, reorder tone is heard instead of confirmation tone to prevent an endless loop.)

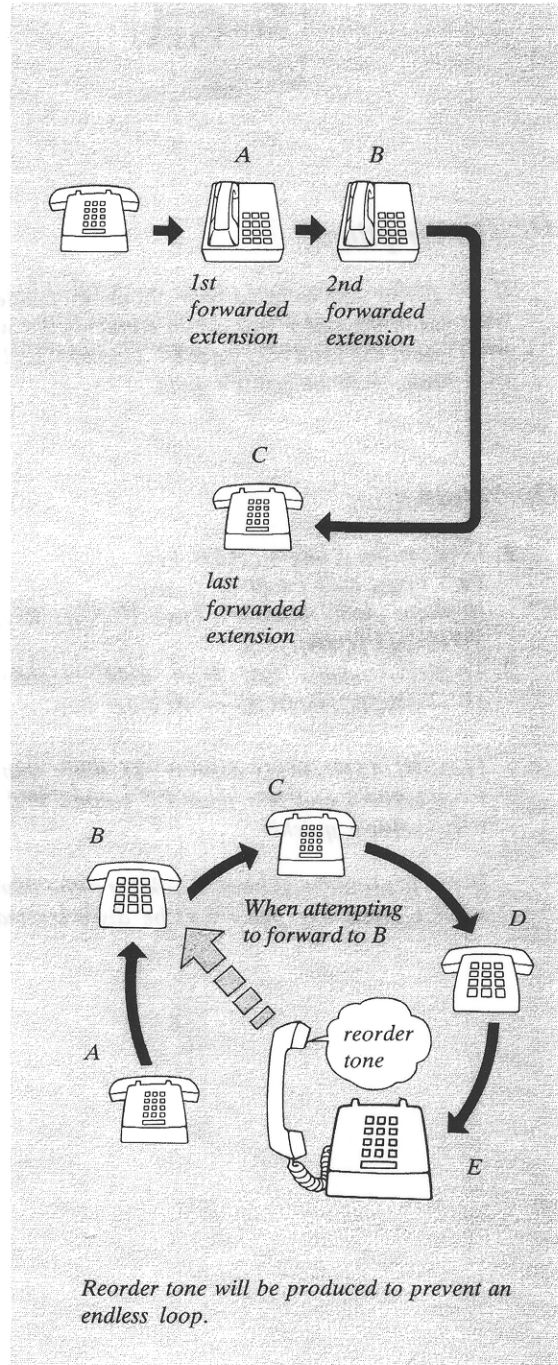

Call Hold

To place a call on hold:

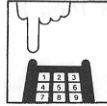

FLASH
SWITCHHOOK

To cancel:

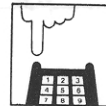

FLASH
SWITCHHOOK

Description

If you wish to leave your phone unattended but want the caller you are in conversation with to wait, call hold may be used. Intercom and trunk calls may be put on hold.

Operation

1. Depress the FLASH key.
Two beeps will be heard.
If phone does not have FLASH key, use SWITCHHOOK.
2. To release call from hold, depress the SWITCHHOOK or FLASH key.

FLASH means depress for more than 0.3 second and less than 1.0 second and then release quickly.

If you depress switchhook for more than one second, the party will be disconnected.

Conditions

- Callers who are put on hold will hear music.
- If the party who was placed on hold hangs up, the call is terminated.
The handset may be placed on to the cradle at the holding extension during call hold.
- If a call is on hold for more than 30 minutes, it will be terminated automatically.
- An extension user can not hold more than one call at a time.
- While a call is on hold, back ground music, dial call pickup and directed call pickup as well as paging answer cannot be used.
- Calls will recall either after 30 seconds, 1 minute, 1 minute and 30 seconds or 2 minutes, once handset is replaced.
- Recalls cannot be answered by other extensions through the use of dial or directed call pick up.

Call Park

To park a call

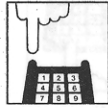

FLASH SWITCHHOOK



HANG UP

To retrieve a parking call at any other extension



LIFT HANDSET



DIAL (6)

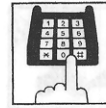

DIAL PARKING EXTENSION NUMBER

Description

You may place an intercom or trunk call on hold at your extension and retrieve it at any other extension within the system.

Example:

Mark is talking with extension 25 on his desk, and then moves to another room keeping the call on hold.

He resumes the conversation using another extension.

Operation

1. Depress the FLASH key to place call on hold.
2. Replace the handset.
3. Go to any extension, dial (6) and the extension number of the phone on which you placed the call on hold.
4. Connection is now made with party who was on hold.

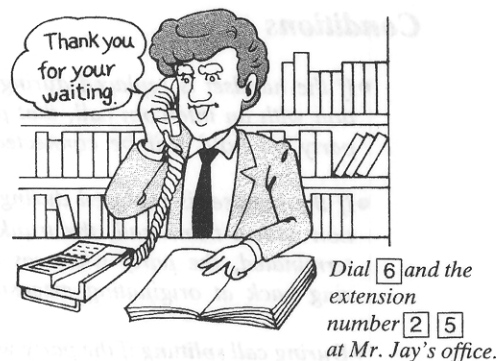
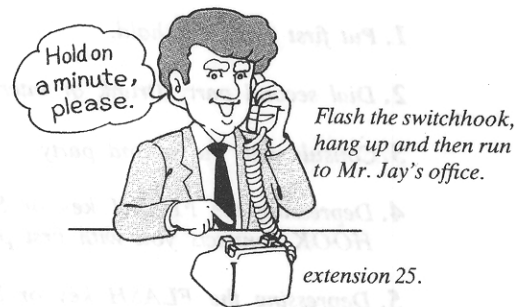

Conditions

None

- To answer a paging call, you may use the call park function.

1. Dial 6.
2. Dial the extension number of the phone on which the call is placed on hold.

Call Splitting



CONSULT
2ND PARTY
1ST PARTY
ON HOLD



FLASH
SWITCHHOOK



CONSULT
1ST PARTY
2ND PARTY
ON HOLD

Description

Allows station user to alternate between two parties, either intercom or trunk

Operation

1. Put first Party on hold.
2. Dial second party (trunk or intercom).
3. Consult with the second party.
4. Depressing the FLASH key or SWITCHHOOK connects you with first party.
5. Depressing the FLASH key or SWITCHHOOK again will connect you with the second party.
6. Repeat steps 4 & 5.

Conditions

- If the handset is replaced during a conversation with an intercom call, that party and the party on hold will be connected.
- If the handset is replaced during a conversation with a trunk call, the trunk call will be terminated, the party who was on hold will ring back at originating extension.
- During call splitting if the party who is on hold hangs up, he will become disconnected.

Call Transfer

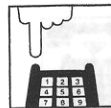

FLASH
SWITCHHOOK

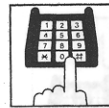

DIAL
TRANSFERRED
EXTENSION
NUMBER



REPLACE
HANDSET

Description

Trunk or intercom calls may be transferred to any extension within the system.

Operation

1. First you must be engaged in a call (intercom or trunk).
2. Depress the FLASH key or SWITCHHOOK.
3. Dial number of desired extension.
- 4-A. For Unscreened call transfer replace handset after dialing desired extension.
- 4-B. For Screened call transfer wait for new party to answer and announce call, then replace handset.

To cancel a call transfer, depress FLASH key or SWITCHHOOK.

Conditions

- Dial extension number to transfer a call within 10 seconds after flashing.
- If transferred call is not answered in a predetermined time (see Hold Recall Time Set), it will cease to ring at transferred extension and will recall back to extension.
- Upon recall to transferring extension, if call is not answered in 30 minutes, it will be terminated.

Conference



CONSULT
2ND PARTY WITH
1ST PARTY
ON HOLD

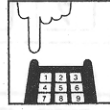

FLASH
SWITCHHOOK

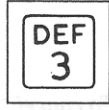

DIAL (3)

Description

The KX-T616 allows for three party conference, (2 outside parties/1 inside) (2 inside /1 outside) or (3 inside).

Operation

1. To put first party on hold, depress the FLASH key or SWITCHHOOK.
2. Dial number of second party.
If second party does not answer, depress the FLASH key to be reconnected with first party.
3. Talk with second party (with 1st party on hold).
4. Depress FLASH key or SWITCHHOOK.
5. Dial (3).
3 party conference is now established.

Conditions

- When one intercom party replaces handset during a conference, the other two parties are directly connected together and can converse with each other. (Intercom calls and intercom to trunk are OK, trunk to trunk is not possible.)
If a trunk party replaces handset, a howler tone may be heard by the other parties.
- No more than 3 parties may enter into a conference.

Data Line Security

Setting

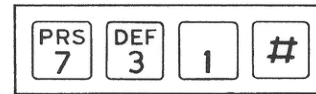

DIAL (731 #)

To cancel

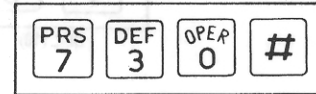

DIAL (730 #)

Description

This feature provides security when transmitting data through an extension of the KX-T616. Camp on tones, internal call waiting tones and hold time alerts are prohibited in this mode.

Operation

1. Lift handset.
2. Dial (731 #).
3. To cancel dial (730 #).

Conditions

- The maximum baud rate at which data may be transmitted is 1200 baud.
- This mode cannot prevent external Call waiting tone from coming into KX-T616 system. We recommend that this mode is established on a line which has no special telephone company services.

Dial Call Pickup

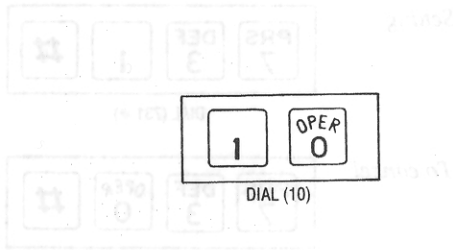

Description

Through the use of this feature, an extension user can answer any ringing extension within their own pickup group.

To answer ringing extension

1. Lift handset.
2. Dial (10).

Conditions

If an extension user dials 10 to answer a ringing extension outside pickup group, Dial Call Pickup will not work. Directed Call Pickup must be used.

Dial Call Pickup Deny

Setting

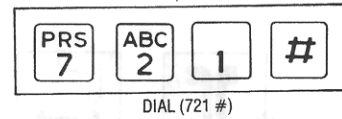

To cancel

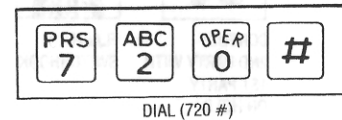

Description

An extension may remove themselves from a Dial Call Pickup group. This feature is used when you want to prohibit other extensions from answering your phone.

Operation

1. Lift handset.
2. Dial (721#).
3. To cancel dial (720#).

Conditions

From your extension which is in the "dial call pickup deny" mode, you may pickup a call ringing at another extension using the feature, "dial call pickup".

Directed Call Pickup



DIAL (1)

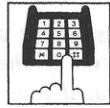

DIAL RINGING
EXTENSION
NUMBER
(21 through 36)

Description

By dialing the directed call pickup code, an extension may answer an incoming trunk or intercom call that is ringing at another extension regardless of pickup group.

Operation

1. Lift handset.
2. Dial (1) and then an extension number.

Conditions

It is possible to answer calls outside your assigned pickup group.

Example

Mr Brown's extension number is 26.
He is now out of office.
Mark receives the call instead of Mr. Brown with the telephone on his desk, extension 25.

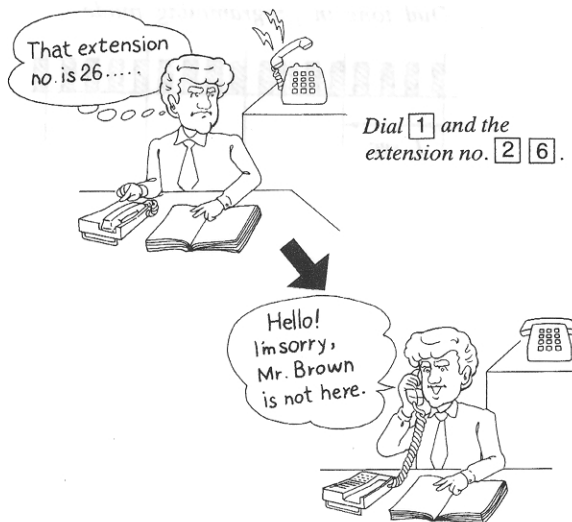

Direct Outward Dialing

Automatic Line Access

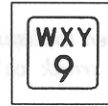

DIAL (9)



WAIT FOR C.O.
DIAL TONE

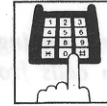

DIAL TELEPHONE
NUMBER

Individual Line Access



DIAL (8)

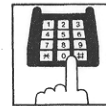

DIAL TRUNK
NUMBER
(1 through 6)



WAIT FOR C.O.
DIAL TONE

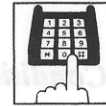

DIAL TELEPHONE
NUMBER

Description

Each extension can choose the first available trunk within the KX-T616. An alternative method is to dial 8 and a trunk number. System will access individually any of the 6 trunks.

Operation

Dialing the number 9 will select for the user the first available trunk from the pool of trunks in use.

Individual line access codes

- DIAL 81 for trunk 1
- DIAL 82 for trunk 2
- DIAL 83 for trunk 3
- DIAL 84 for trunk 4
- DIAL 85 for trunk 5
- DIAL 86 for trunk 6

Conditions

- If a busy tone is heard after accessing a trunk, call back busy (dialing 4) may be used.
- If an extension hears reorder tone, this is an indication that they are restricted from making outside calls.
- If there is a different dial mode (see page 18) among 6 trunks, use the access codes 81 to 86.
- If one dial sequence requires a combination of tone dialing and pulse dialing, access the trunk which is in NON CONVERSION.

Distinctive Ringing

Description

A different ringing pattern is used to distinguish intercom calls from incoming trunk calls.

Operation

None

Conditions

Automatic ring back for the camp on feaure will ring differently from the ringing on intercom and trunk calls.

Incoming trunk calls (including trunk hold recall)

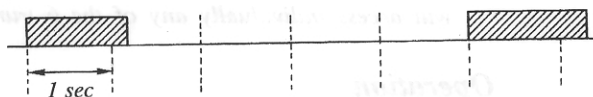

Intercom calls (including intercom hold recall)

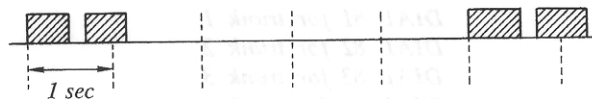

Distinctive Dial Tone

Description

A distinctive dial tone will be heard from the handset if the extension user has previously activated any of the following features.

Do Not Disturb,
Dial Call Pickup Deny
Call Forwarding,
Data Security
Pickup Dial

Operation:

None

Conditions

- An extension will generate a feature activation tone to indicate they are in DO NOT DISTURB, DIAL CALL PICKUP DENY, CALL FORWARDING, PICKUP DIAL or DATA SECURITY mode.

Feature activation tone

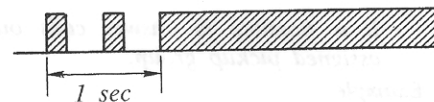

- A distinctive dial tone will also be heard when in the programming mode at extension 21.

Dial tone in programming mode

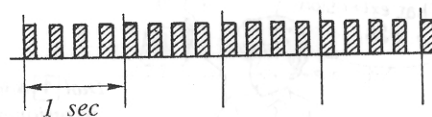

Do Not Disturb

Setting

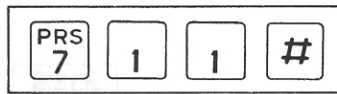

DIAL (711 #)

To cancel

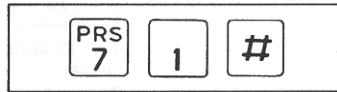

DIAL (71 #)

Description

Each extension can be individually programmed from receiving intercom calls.

Operation

1. Lift handset of extension.
2. Dial (711 #).
3. To cancell, Dial (71 #).

Conditions

- Incoming trunk calls will still be received.
- When Do Not Disturb is entered, Call forwarding if entered will be cancelled.
- Do Not Disturb does not affect outgoing calls.
- A party who dials the number of an extension which is in "do not disturb", will hear the do not disturb tone.
- From your extension which is in the "do not disturb" mode, you may pickup a call ringing at another extension using the feature, "dial call pickup".

Do not disturb tone

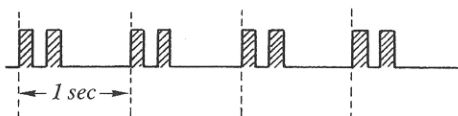

External Feature Access



WILL HEAR
CENTRAL
OFFICE TONE

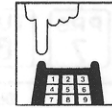

FLASH
SWITCHHOOK

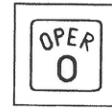

DIAL (0)

Description

Allows extension user to access features of central office or host PBX. (example: call waiting feature can be supplied by central office.)

Operation

1. Depress the FLASH key or SWITCHHOOK to access feature, after hearing tone from external source (CO or host PBX).
2. Dial (0).

Conditions

- External feature access can only be used when engaged on an outside trunk call.
- FLASH means to depress for more than 0.3 second and less than 1.0 second and then release quickly.
- If it is difficult to distinguish between CO tone and internal call waiting tone, do the following. Flash the SWITCHHOOK and dial (5). If reorder tone is heard, flash the SWITCHHOOK to return to the first call, then flash SWITCHHOOK to hold the first call and dial (0) for external feature access.

Flexible Night Service

To enable night service:

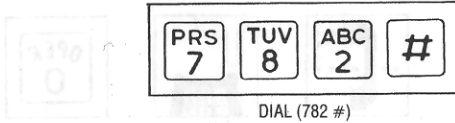

To disable night service:

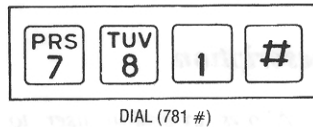

Default program is **781#**

Description

Normal system operation is set for day time, Night service allows for the trunk assignments to be rearranged via programming. Night service is enabled or disabled through extension 21.

Operation

1. Lift handset of extension 21.
2. Dial (782#).
Night service is enabled.
3. To return to day service, Dial (781#).

Inter Office Dialing (Intercom)

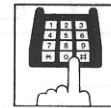

DIAL EXTENSION NUMBER (21 through 36)

Description

Station to station dialing within the KX-T616 system.

Operation

1. Lift handset of any extension.
2. Dial any extension (21 through 36).

Conditions

- If extension is busy, hang up and try again or initiate call back busy.
- If extension dialed is in Do Not Disturb mode, you hear Do Not Disturb tone. Hang up and try again later, call back busy cannot be initiated.

Internal Call Waiting



WILL HEAR
CALL WAITING
TONE

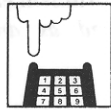

FLASH
SWITCHHOOK

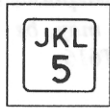

DIAL (5)

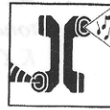

CONSULT WITH
NEW CALLER
ORIGINAL CALL
ON HOLD

Description

2 beeps indicate there is a new incoming call. Flashing the switchhook and dialing 5 enable user to put first call on hold and answer the second call.

Operation

1. Upon hearing tone, depress FLASH key or SWITCHHOOK (this puts first party on hold).
2. Dial (5) (connection is now made to new incoming call.)
3. To return to the original call, hang up and lift handset.

Conditions

Call waiting tone will not be sent under the following conditions.

- When an extension is restricted from answering incoming trunk calls.
- When an extension is on hold.
- When an extension is in a conversation with another call on hold.
- When an extension is in a three party conference.
- When an extension is using call splitting.
- When an extension is using paging.
- When an extension is programming a station feature. (call forwarding, etc.)
- When an extension is in Data Line Security mode.

Last Number Redial

When touch
tone phone

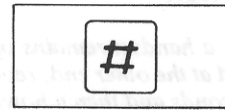

DIAL (#)

When rotary
phone

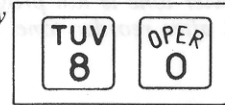

DIAL (80)

Description

The last number dialed on an outgoing trunk can be redialed.

Operation

1. Lift handset.
2. Dial (#) on touch tone telephone or dial (80) on rotary phone.

The last number that was dialed will be redialed.

Conditions

- Up to 30 digits can be stored and redialed.
- If more than a 10-second interruption occurs during manual dialing, only those numbers dialed before the interruption, will be redialed.
- Last number redial will not work on intercom calls.
- Redial operation must be done before accessing a trunk.
- If busy tone is heard after using Last Number Redial, camp on may be used.
 - If two beeps and then reorder tone are heard "camp-on" is accepted.
 - If busy tone continues to sound, "Camp-on" is not accepted. Should this happen, dial a phone number again.

Lockout

Description

When a handset remains off hook or is disconnected at the other end, reorder tone is heard for 30 seconds and then a howler tone will be heard if programmed.

If howler tone is not programmed, nothing is heard after reorder tone.

Operation

None

Conditions

Upon hearing reorder tone hang up.

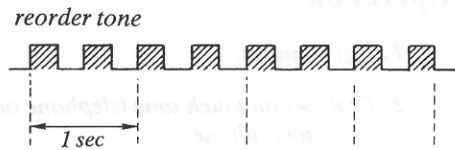

Mixed Station Dialing

Description

Any telephone instrument either rotary or touch tone may be used as an extension of the KX-T616.

Operation

None

Conditions

None

Paging

To access

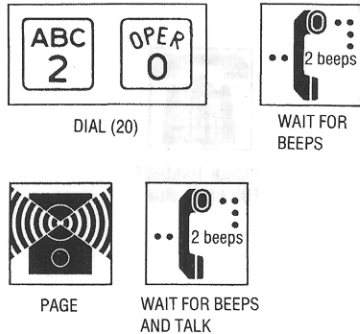

To answer

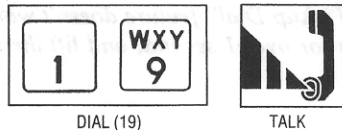

Description

Extension users can access external paging equipment.
Any extension can answer a page.

Operation

To access paging;

1. Lift handset.
2. Dial 20 and wait for confirmation tone two beeps (see page 43).
3. Start paging.
When paging is answered, two beeps will be heard. Start talking.

To answer page;

1. Lift handset.
2. Dial 19.

Conditions

Paging can be accessed even with a call on hold. Replacing handset after accessing page, with call on hold, will cause call on hold to be connected to the extension who answers the page.

Power Failure Transfer

Description

In the event of a power failure all trunks will ring in at assigned extensions.

- Trunk 1 is assigned to extension 21
- Trunk 2 is assigned to extension 22
- Trunk 3 is assigned to extension 23
- Trunk 4 is assigned to extension 24
- Trunk 5 is assigned to extension 25
- Trunk 6 is assigned to extension 26

Operation

None

Conditions

- During power outage all features are lost except for incoming and outgoing trunk calls from extensions 21 through 26.
- Use the same type extension phone (rotary or touch tone) as its trunk dialing mode, because trunk TONE/PULSE conversion is switched to "non-conversion".
- There is no memory loss except for the camp on and the last number redial during power failure, memory is protected by 21 day rechargeable battery.

Rechargeable battery is good for 5 years.

- The Backup Adaptor (KX-A16) is available for power supply to the KX-T616 to operate all the features in the event of power failure. Refer to page 15.

Specification of KX-A16

3 "Sealed lead-acid Batteries" (12 V, 6.5 AH)
Backup duration is greater than 4 hours in average usage
(one trunk call and one intercom call simultaneously in continuous operation.)

Pickup Dial

To program



To enable or disable

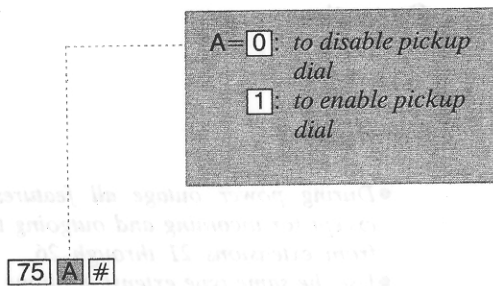

Description

Picking up handset automatically dials a programmed phone number.

Operation

To program at each extension

1. Dial (74).
2. Dial the desired phone number.
3. Dial (#).

To enable or disable at each extension

1. Dial (75).
2. Dial (0) to disable it or dial (1) to enable it.

To dial by picking up

1. Lift handset for 4 seconds.

To dial



PICKUP HANDSET
FOR 4 SECONDS

If the "Pickup Dial" feature doesn't work well, hang up for over 1 second, and lift the handset again.

Condition

- Dialing (speed calling and manual dialing) is possible within 3.5 seconds.
- When you program an outward dialing, enter the trunk number, [*], and then the desired number.
- The [*] key will provide a 3.5 seconds pause.
- The pickup dial function at extension 21 is prohibited when in the PROGRAM mode.
- The pickup dial will not be activated by picking up handset during a hold and when receiving a call.
- Different phone number may be programmed at each extension.
- When you make "Pickup dial" using a telephone with monitor function, use the handset to avoid the automatic termination after 1 minute.
- Speakerphone provided with tone detectable function doesn't detect busy tone in the "Pickup Dial" mode.

Speed Calling

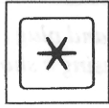

DIAL (*)

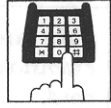

DIAL SPEED
ACCESS
NUMBER
(00 through 99)

Description

There are 100 numbers of speed dialing available.

Operation

1. Lift handset.
2. Dial (*) and speed dial number.

Condition

- When the System Program Switch is on the PROGRAM position, speed calling at extension 21 is prohibited.
- Speed calling must be done before accessing a trunk.
- The camp on is available when a trunk is busy (not the called party-busy) after speed calling. Refer to page 60.

Station Program Clear



DIAL (7900#)

Description

Dialing (7900#) will clear the following station programs on a extension all together.

- Call Forwarding
- Data Line Security
- Dial Call Pickup Deny
- Do not Disturb
- Pickup Dial
- Call Back Busy
- Last Number Redial

Operation

1. Lift handset.
2. Dial (7900#).

TROUBLESHOOTING

During Installation

PROBLEM	PROBABLE CAUSE	POSSIBLE SOLUTION
<i>Extension does not operate.</i>	<i>Bad connection between system and extension</i>	<i>Take extension and plug into the same extension port using a short telephone cord. If telephone does not work, connection between system and extension must be repaired.</i>
	<i>Bad extension</i>	<i>Take extension and plug into another extension port that is working. If telephone does not work, replace phone.</i>
<i>SMDR improper operation</i>	<i>Bad connection between system and printer through RS-232C connector</i>	<i>Check signals on each pin number on RS-232C to see if they are correct. Check the RS-232C cable to see whether or not any wires are broken.</i>
	<i>Wrong baud rate setting</i>	<i>Check baud rate on printer and on system</i>
<i>Improper reset operation</i>		<i>Press the Reset Button.</i>
<i>Call disconnected during connection operation.</i>	<i>Instantaneous drop of DC voltage from Central Office (or host PBX) when in operation of connection between C. O. and system.</i>	<i>Select 400 milli second-CPC signal or no CPC signal. CPC means Calling Party Control.</i>
<i>Noise in paging</i>	<i>Induced noise on the wire between System and an Amplifier.</i>	<i>Use a shielded cable as a connection wire between System and Amplifier. A shorter shielded cable is recommended.</i>
<i>Volume distortion from external music source</i>	<i>Excessive input level from external music source</i>	<i>Decrease Output level of external music source with using Volume Control on the music source.</i>
<i>Speed Calling does not operate.</i>	<i>Bad programming</i>	<ul style="list-style-type: none"> ● <i>Enter the line access code into programming.</i> ● <i>Enter the <input type="checkbox"/> (pause) into programming.</i>
<i>A dial tone (short tone continuously) was heard and telephone line hung up at once when accessing a trunk during speakerphone mode.</i>	<i>The host PBX may cause a line to hang up when the KX-T616 is connected to it.</i>	<i>Use a handset instead of a speakerphone.</i>

Reset Button

If the system is not operating properly, use the Reset Button.

- Before using Reset Button, try again the system feature which does not work several times to confirm there definitely is a problem.
- Pressing the Reset Button causes the followings.
 1. Camp-on is cleared.
 2. Redial number is cleared.
 3. Calls on hold are terminated.
 4. Calls in progress are terminated.

Data that is stored in memory other than above mentioned will not be cleared by use of the Reset Button.

Note

If the system does not operate properly, push the Reset Button.

If no difference still occurs, switch the power off and on again after 5 minutes. If the system still does not work, switch the power off.

The following extensions will be directly connected to each of the central office lines (C.O.).

Extension 21...C.O.1

Extension 22...C.O.2

Extension 23...C.O.3

Extension 24...C.O.4

Extension 25...C.O.5

Extension 26...C.O.6

If the KX-A16 is connected to the system, switch off the power of the KX-A16.

During Operation

PROBLEM	PROBABLE CAUSE	POSSIBLE SOLUTION
Redial Number is lost. Calls on hold are lost. Line connections are lost.	Electrical power to System cut off	Restore electrical power.
Extension does not operate	Bad connection between System and extension	Take extension and plug into the same extension port using a short telephone cord. If telephone does not work, connection between system and extension must be repaired.
	Bad extension	Take extension and plug into another extension port that is working. If telephone does not work, replace the phone.

DTMF Receiver Check

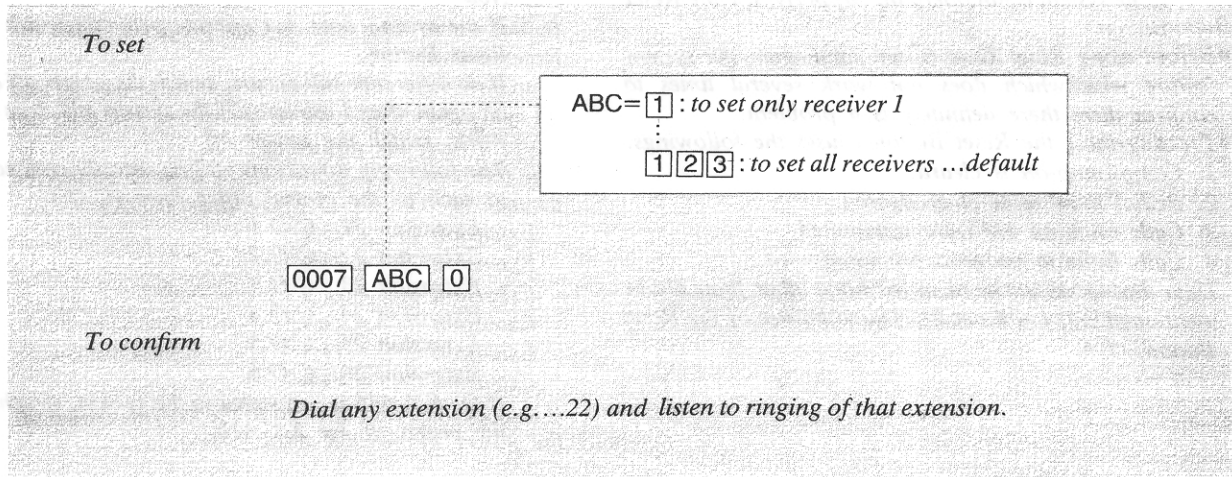

Description

To check the DTMF receivers which allows you to use touch tone telephones these steps must be followed.

(NOTE) A pulse to tone switchable set must be used, see example below.

Operation

1. Set system program switch to PROGRAM position.
2. Set extension 21 to rotary dial pulse position.
3. Dial (0 0 0 7 1 0) to check DTMF receiver 1.
4. Return system program switch to SET position.
5. Return extension 21 back to touch tone position.
6. From extension 21 dial extension 22. If extension 22 rings DTMF (1) is good, if extension 22 does not ring DTMF (1) is bad.
7. Repeat steps 1 through 6 for each DTMF receiver 1, 2, & 3.
8. If faulty DTMF receiver is found, it should be removed via programming.

EXAMPLE

DTMF receiver 2 is found to be bad.

To remove, do the following.

1. Set system program switch to PROGRAM position.
2. Set extension 21 to rotary dial pulse position.
3. Dial (0 0 0 7 1 3 0).
4. Return system program switch to SET position.
5. DTMF receiver 2 has been removed, 1 & 3 remain.

■ **DTMF Receiver Check Table**

DTMF Receiver	position on System Program Switch	mode on extension 21	dial at extension 21		good or bad (on receiver)
			to set	to confirm	
Receiver 1	PROGRAM	pulse	000710		If DTMF Receiver 1 is good, dialed extension will ring.
	SET	tone		any extension number (e.g....22)	
Receiver 2	PROGRAM	pulse	000720		If DTMF Receiver 2 is good, dialed extension will ring.
	SET	tone		any extension number (e.g....22)	
Receiver 3	PROGRAM	pulse	000730		If DTMF Receiver 3 is good, dialed extension will ring.
	SET	tone		any extension number (e.g....22)	

■ **To remove faulty DTMF receiver**

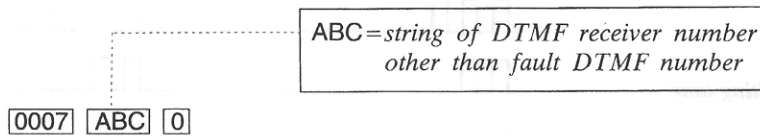

LIST OF TONES

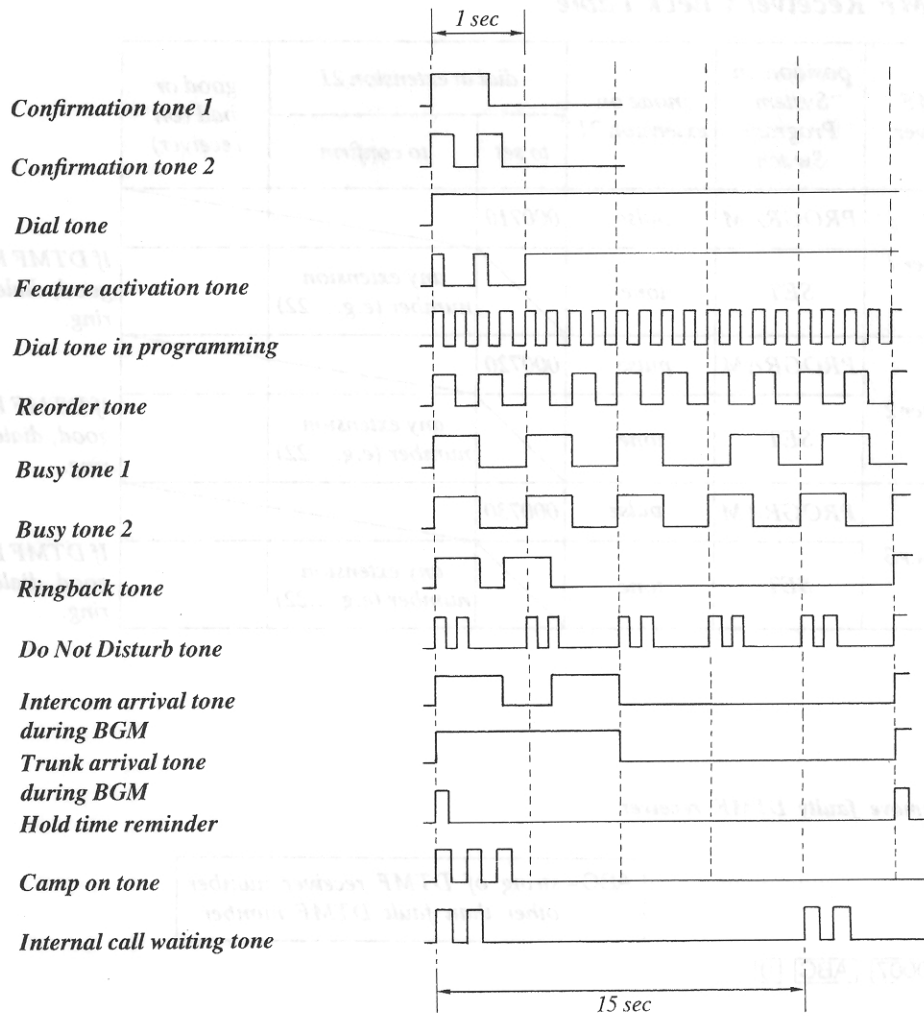

LIST OF RINGING

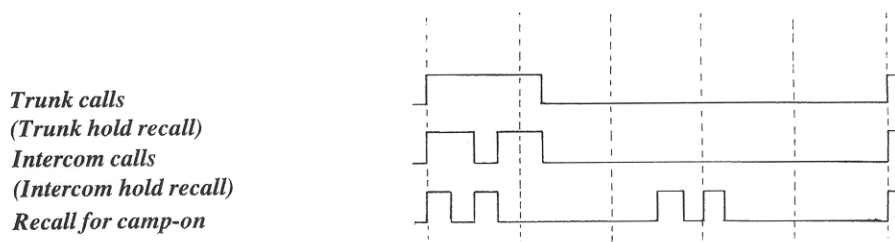

SPECIFICATION

General Description

- | | | |
|-------------------|---------------------------------------|--|
| 1. Capacity | Trunks (COL) | 6 |
| | Stations | 16 |
| 2. Control Method | Stored Program CPU: 8 bits CPU | |
| | Control ROM: 32KB, Control RAM: 8 KB | |
| 3. Switching | Space Division CMOS Crosspoint Switch | |
| 4. Power Supplies | Primary | AC120 V 60 Hz |
| | Secondary | Station Supply Volt: -24 V,
Circuit Volt: +5 V, ±12 V, ±7 V |
| | Power Failure | •6 trunks assigned to stations (1 through 6)...power failure transfer
•System operation for 4 hours by optional Backup Adaptor. |
| 5. Dialing | Outward | Dial Pulse 10PPS
Tone Dial |
| | Internal | Dial Pulse 10PPS
Tone Dial |
| | Mode Conversion | No Convert DP-DTMF, DTMF-DP |
| 6. Connector | Trunk (COL) | Modular Jack (RJ-11) |
| | Station | Modular Jack, 25-paired pin connector. |
| | Paging Output | Pin Jack (RCA JACK) |
| | External Music Input | two-conductors Jack (MINI JACK 3/64 inch diameter) |
| 7. EXT Connection | Cable | 1 pair wire |
| 8. SMDR | Interface | RS-232C |
| | Output Equipment | Printer, Data Terminal |
| | Detail Recording | Date, Time, STA Number, COL Number, Calling Number, Calling Time, Account Code |

Characteristics

- | | |
|---|--|
| 1. Station Loop Limit | 600 ohms including set/at 20 mA
360 ohms including set/at 25 mA |
| 2. Minimum Leak Resistance | 15,000 ohms |
| 3. Maximum Number of Station Instruments per Line | 3 |
| 4. Ring Voltage | 90 Vrms at 20 Hz depends on Ringing Load |
| 5. Primary Power | 120 Vac, 60 Hz, 0.6 A maximum |
| 6. Central Office Loop Limit | 1600 ohms maximum |
| 7. Environmental Requirements | 0-40°C, 10%-90% |
| 8. Switchhook Flash Timing Range | 204-1000 msec |

TELEPHONE COMPANY and F.C.C. REQUIREMENTS AND RESPONSIBILITIES

In compliance with the requirements of Part 68 of the F.C.C. Rules and Regulations for connection of terminal system (this device is classified as terminal system) to the telephone network and for your convenience, the following information is presented:

1. Notification to The Telephone Company

Customers connecting terminal equipment to the telephone network shall, upon request of the Telephone Company, inform the Telephone Company of the particular line(s) to which such connection is made, the F.C.C. registration number and (see label on bottom of unit.) ringer equivalence number of the registered terminal equipment.

2. Direct connection to A Party-line or Coin-operated Telephone Line is Prohibited

3. Incidence of Harm to The Telephone lines

Should Terminal Equipment cause harm to the Telephone Network, the Telephone Company shall, where practical, notify the customer that temporary discontinuance of service may be required. However, where prior notice is not practical, the Telephone Company may temporarily discontinue service forthwith, if such action is reasonable in the circumstances. In case of such unnotified temporary discontinuance of service, the Telephone Company shall:

- (a) Promptly notify the customer of such temporary discontinuance of service.
- (b) Afford the customer the opportunity to correct the situation which gave rise to the temporary discontinuance.
- (c) Inform the customer of the right to bring a complaint to the Commission pursuant to the procedures set out in Subpart E of Part 68 of FCC Telephone Equipment Rules.

4. Compatibility of The Telephone Network and Terminal Equipment

(a) Availability of telephone interface information.

Technical information concerning interface parameters and specifications not specified in FCC Rules, including the number of Ringers which may be connected to a particular telephone line, which is needed to permit Terminal Equipment to operate in a manner compatible with Telephone Company communications facilities, shall be provided by the Telephone Company upon customer's request.

(b) Changes in Telephone Company Communications Facilities, Equipment, Operations and Procedures.

The Telephone Company may make changes in its communications facilities, equipment, operations or procedures, where such action is reasonably required in the operation of its business and is not inconsistent with the rules and regulations in FCC Part 68 of the FCC Rules and Regulations. If such changes can be reasonably expected to render any customer Terminal Equipment incompatible with Telephone Company Communications Facilities, or require modification or alteration of such Terminal Equipment, or otherwise materially affect its use or performance, the customer shall be given adequate notice in writing, to allow the customer an opportunity to maintain uninterrupted service.

OTHERS

- *Keep the unit away from heating appliances and electrical noise generating devices such as fluorescent lamps, motors and television. These noise sources can interfere with the performance of the EASA-PHONE.*
- *This unit should be kept free of dust, moisture, high temperature and vibration, and should not be exposed to direct sunlight.*
- *Never attempt to insert wires, pins, etc. into the vents or other holes of this unit.*
- *If there is trouble, disconnect the unit from the telephone line. Plug the telephone directly into the telephone line. If the telephone operates properly, do not reconnect the unit to the line until the trouble has been repaired by an authorized Panasonic Factory Service Center. If the telephone does not operate properly, chances are that the trouble is in the telephone system, and not in the unit.*
- *Do not use benzine, thinner, or similar solvents. Do not use abrasive powder to clean the cabinet. Wipe it with a soft cloth.*

This equipment generates and uses radio frequency energy and if not installed and used properly, that is, in strict accordance with the manufacturer's instructions, may cause interference to radio and television reception. It has been type tested and found to comply with the limits for a Class B computing device in accordance with the specifications in Subpart J of Part 15 of FCC Rules, which are designed to provide reasonable protection against such interference in a residential installation. However, there is no guarantee that interference will not occur in a particular installation. If this equipment does cause interference to radio or television reception, which can be determined by turning the equipment off and on, the user is encouraged to try to correct the interference by one or more of the following measures:

- ...Reorient the receiving antenna*
- ...Relocate the equipment with respect to the receiver*
- ...Move the equipment away from the receiver*
- ...Plug the equipment into a different outlet so that equipment and receiver are on different branch circuits.*

If necessary, the user should consult the dealer or an experienced radio/television technician for additional suggestions. The user may find the following booklet prepared by the Federal Communications Commission helpful:

"How to Identify and Resolve Radio-TV Interference Problems".

This booklet is available from the US Government Printing Office, Washington, D.C., 20402, Stock No. 004-000-00345-4.

WARNING: TO PREVENT FIRE OR SHOCK HAZARD, DO NOT EXPOSE THIS PRODUCT TO RAIN OR MOISTURE.

Keep the unit away from heating appliances and electrical noise containing devices
which may cause the unit to malfunction. (The unit may not work properly with
the performance of the BATA-PHONE)

*This unit should be kept free of dust, moisture, high temperature and vibration, and
should not be exposed to direct sunlight.

*Even in light rain, water, pour, or into the case or other parts of this unit.

off the unit to make the connection the unit from the telephone line. Plug the telephone
hook into the telephone line. If the telephone operation is not correct, do not reconnect
the unit to the line until the trouble has been repaired by an authorized Panasonic
factory service center. If the telephone does not operate properly, chances are that
the telephone or the telephone system, and not the unit.

*Do not use the unit in areas where there is a high concentration of dust or
other particles. Do not use the unit in a soft cloth.

The equipment should be used only for the purpose intended and should not be used
for any other purpose. It is not recommended to use the unit for any other purpose,
such as a radio receiver, or for any other purpose. It is not recommended to use
the unit for any other purpose. It is not recommended to use the unit for any
other purpose. It is not recommended to use the unit for any other purpose.
It is not recommended to use the unit for any other purpose. It is not
recommended to use the unit for any other purpose. It is not recommended to
use the unit for any other purpose. It is not recommended to use the unit for
any other purpose. It is not recommended to use the unit for any other
purpose. It is not recommended to use the unit for any other purpose.

Panasonic Company ("PC")
Division of Matsushita Electric Corporation of America
One Panasonic Way, Secaucus, New Jersey 07094

Panasonic Hawaii, Inc. ("PHI")
91-238 Kauhi St. Ewa Beach, Honolulu, Hawaii 96808-0774

Panasonic Sales Company ("PSC")
Division of Matsushita Electric of Puerto Rico, Inc.
Ave. 65 De Infanteria, KM9.7 Victoria Industrial Park Carolina, Puerto Rico 00630