

Panasonic®



Advanced Hybrid & Wireless PBX Operating Manual

Model No. **KX-TAW848**



Thank you for purchasing a Panasonic Advanced Hybrid & Wireless PBX.
Please read this manual carefully before using this product and save this manual for future use.

PSMPR Software File Version 3.0000 or later

Document Version: 2006-02

Feature Highlights

Call Center

This PBX can establish Incoming Call Distribution Groups (ICD Groups) by which a large volume of calls from external customers can be received.

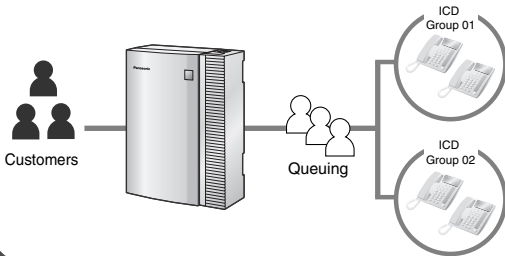

1.3.34 ICD GROUP FEATURES (Page 75)

Voice Mail Integration

You can forward your calls to a voice processing system and let calling parties leave messages in your mailbox when you are unable to receive calls.

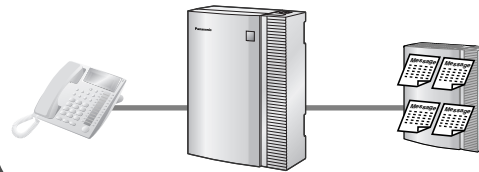

1.3.55 Voice Mail Features—Voice Mail Integration (Page 104)

Wireless System

This PBX optionally supports a Portable Station (PS) system. PSs can be used in the PBX with other wired telephones.



Appendix (Page 147)

Call Record

(Station Message Detail Recording)

This PBX can record or print out call information: date, time, extension no., dialed no., duration, etc.

Date	Time	Ext
01/02/02	10:03AM	1230
01/02/02	11:07AM	2230

Refer to the Feature Manual

Easy Operation

A Panasonic telephone that is equipped with a Navigator Key and a display helps you to access the desired feature easily. Also, you will be informed of the arrival of an incoming call or a message waiting by the lamp if it is equipped.

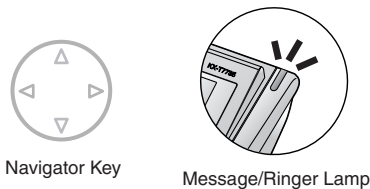

1.1 Before Operating the Telephones (Page 14)

Simplified Voice Message

You can set incoming calls to be redirected to your message box to let callers leave voice messages when you are unable to answer the phone.

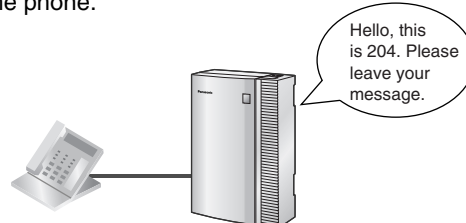

1.3.47 SVM (Simplified Voice Message) (Page 87)

In This Manual,

- Proprietary Telephone is abbreviated as "PT".
Single Line Telephone is abbreviated as "SLT".
Portable Station is abbreviated as "PS".
Proprietary Telephone with a Display is abbreviated as "Display PT".
- The following icons are used frequently.



Hints



Conditions

NOTES

- The contents of this manual apply to PBXs with a certain software version, as indicated on the cover of this manual. To confirm the software version of your PBX, refer to the PC Programming Manual or PT Programming Manual.
- Product specifications are subject to change without notice.

Important Notice

Prior to connection of this product, please verify that the intended operating environment is supported. Satisfactory performance cannot be guaranteed for the following:

- interoperability and compatibility with all devices and systems connected to this product
- proper operation and compatibility with services provided by telecommunications companies over connected networks

Important Information

WARNING

- **IF DAMAGE TO THE UNIT EXPOSES ANY INTERNAL PARTS, DISCONNECT THE POWER SUPPLY CORD IMMEDIATELY AND RETURN THE UNIT TO YOUR DEALER.**
- **UNPLUG THIS UNIT FROM THE AC OUTLET IF IT EMITS SMOKE, AN ABNORMAL SMELL OR MAKES UNUSUAL NOISE. THESE CONDITIONS CAN CAUSE FIRE OR ELECTRIC SHOCK. CONFIRM THAT SMOKE HAS STOPPED AND CONTACT AN AUTHORIZED PANASONIC FACTORY SERVICENTER.**
- **WHEN RELOCATING THE EQUIPMENT, FIRST DISCONNECT THE TELECOM CONNECTION BEFORE DISCONNECTING THE POWER CONNECTION. WHEN THE UNIT IS INSTALLED IN THE NEW LOCATION, RECONNECT THE POWER FIRST, AND THEN RECONNECT THE TELECOM CONNECTION.**
- **THIS UNIT IS EQUIPPED WITH A GROUNDED PLUG. FOR SAFETY REASONS THIS PLUG MUST ONLY BE CONNECTED TO A GROUNDED OUTLET THAT HAS BEEN INSTALLED ACCORDING TO APPLICABLE REGULATIONS.**
- **TO PREVENT POSSIBLE FIRE OR ELECTRIC SHOCK, DO NOT EXPOSE THIS PRODUCT TO RAIN OR MOISTURE.**
- **THE POWER SUPPLY CORD IS USED AS THE MAIN DISCONNECT DEVICE. ENSURE THAT THE AC OUTLET IS LOCATED NEAR THE EQUIPMENT AND IS EASILY ACCESSIBLE.**
- **TO PROTECT THIS UNIT FROM STATIC ELECTRICITY, DO NOT TOUCH ANY EXTERNAL CONNECTORS OF THE UNIT.**

IMPORTANT SAFETY INSTRUCTIONS

When using your telephone equipment, basic safety precautions should always be followed to reduce the risk of fire, electric shock and injury to persons, including the following:

1. Read and understand all instructions.
2. Follow all warnings and instructions marked on the product.
3. Unplug the product from the wall outlet before cleaning. Do not use liquid cleaners or aerosol cleaners. Clean with a damp cloth.
4. Do not use the product near water, for example, near a bathtub, wash bowl, kitchen sink, or laundry tub, in a wet basement, or near a swimming pool.
5. Do not place this product on an unstable surface, as a fall may cause serious internal damage.
6. Slots and openings in the front, back and bottom of the cabinet are provided for ventilation; to protect it from overheating, these openings must not be blocked or covered. The openings should never be blocked by placing the product on a bed, sofa, rug, or other similar surface while in use. The product should never be placed near or over a radiator or other heat source. This product should not be placed in a sealed environment unless proper ventilation is provided.
7. The product should only be connected to the type of electrical power supply specified on the product label. If you are not sure of the type of power supply to your home, consult your dealer or local power company.
8. For safety purposes this unit is equipped with a grounded plug. If you do not have a grounded outlet, please have one installed. Do not bypass this safety feature by tampering with the plug.
9. Do not allow anything to rest on the power cord. Do not locate this product where the power cord may be stepped on or tripped on.
10. To reduce the risk of fire or electric shock, do not overload wall outlets and extension cords.
11. Do not insert objects of any kind into this product through its slots and openings, as they may touch dangerous voltage points or short out parts that could result in a risk of fire or electric shock. Never spill liquid of any kind on or in the product.
12. To reduce the risk of electric shock, do not disassemble this product. Only qualified personnel should service this product. Opening or removing covers may expose you to dangerous voltages or other risks. Incorrect reassembly can cause electric shock.
13. Unplug this product from the wall outlet and have it serviced by qualified service personnel in the following cases:
 - a) When the power supply cord or plug is damaged or frayed.
 - b) If liquid has been spilled into the product.
 - c) If the product has been exposed to rain or water.
 - d) If the product does not operate according to the operating instructions. Adjust only the controls that are explained in the operating instructions. Improper adjustment of other controls may result in damage and may require service by a qualified technician to restore the product to normal operation.
 - e) If the product has been dropped or the cabinet has been damaged.
 - f) If product performance deteriorates.
14. Avoid using wired telephones during an electrical storm. There is a remote risk of electric shock from lightning.
15. Do not use a telephone in the vicinity of a gas leak to report the leak.

SAVE THESE INSTRUCTIONS

Attention

- Keep the unit away from heating appliances and devices that generate electrical noise such as fluorescent lamps, motors and televisions. These noise sources can interfere with the performance of the PBX.
- This unit should be kept free of dust, moisture, high temperature (more than 40 °C [104 °F]) and vibration, and should not be exposed to direct sunlight.
- If you are having problems making calls to outside destinations, follow this procedure to test the CO lines:
 1. Disconnect the PBX from all CO lines.
 2. Connect known working single line telephones (SLTs) to those CO lines.
 3. Make a call to an external destination using those SLTs.

If a call cannot be carried out correctly, there may be a problem with the CO line that the SLT is connected to. Contact your telephone company.

If all SLTs operate properly, there may be a problem with your PBX. Do not reconnect the PBX to the CO lines until it has been serviced by an authorized Panasonic Factory Servicenter.
- Wipe the unit with a soft cloth. Do not clean the unit with abrasive powders or with chemical agents such as benzene or thinner.
- When using a Panasonic proprietary telephone (PT), use only the correct Panasonic handset.

When you ship the product

Carefully pack and send it prepaid, adequately insured and preferably in the original carton. Attach a postage-paid letter, detailing the symptom, to the outside of the carton. **DO NOT** send the product to the Executive or Regional Sales offices. They are **NOT** equipped to make repairs.

Product Service

Panasonic Factory Servicenters for this product are listed in the servicenter directory. Consult your certified Panasonic dealer for detailed instructions.

For Future Reference

Please print, record, and retain the following information for future reference.

Note

The serial number of this product can be found on the label affixed to the unit. You should record the model number and the serial number of this unit as a permanent record of your purchase to aid in identification in the event of theft.

MODEL NO.	_____
SERIAL NO.	_____
DATE OF PURCHASE	_____
NAME OF DEALER	_____
DEALER'S ADDRESS	_____ _____ _____ _____
DEALER'S TEL. NO.	_____

Table of Contents

1	Operation.....	13
1.1	Before Operating the Telephones	14
1.1.1	Before Operating the Telephones	14
1.2	Basic Operations	22
1.2.1	Making Calls	22
1.2.2	Answering Calls	24
1.3	Telephone Features and Operation.....	26
1.3.1	Absent Message	26
1.3.2	Account Code Entry.....	27
1.3.3	Alternate Calling—Ring/Voice.....	28
1.3.4	Automatic Callback Busy (Camp-on)	28
1.3.5	BGM (Background Music).....	30
1.3.6	Call Hold	30
1.3.7	Call Monitor.....	32
1.3.8	Call Park	32
1.3.9	Call Pickup	34
1.3.10	Call Splitting.....	35
1.3.11	Call Transfer.....	36
1.3.12	CALL WAITING FEATURES	38
1.3.13	Call Waiting Tone	43
1.3.14	Character Entry.....	43
1.3.15	Conference	45
1.3.16	Conference, Unattended.....	49
1.3.17	Data Line Security	50
1.3.18	DISA (Direct Inward System Access)	51
1.3.19	DND (Do Not Disturb)	53
1.3.20	Door Open	56
1.3.21	Doorphone Call.....	57
1.3.22	EFA (External Feature Access).....	58
1.3.23	Executive Busy Override.....	58
1.3.24	Extension Dial Lock	60
1.3.25	Extension Feature Clear	61
1.3.26	Extension PIN (Personal Identification Number).....	62
1.3.27	External Relay.....	64
1.3.28	External Sensor	64
1.3.29	FWD (Call Forwarding)	65
1.3.30	Hands-free Answerback.....	70
1.3.31	Hands-free Operation	71
1.3.32	Headset Operation.....	71
1.3.33	Hot Line	74
1.3.34	ICD GROUP FEATURES.....	75
1.3.35	ICD Group Features—Log-in/Log-out.....	76
1.3.36	ICD Group Features—Manual Queue Redirection	78
1.3.37	Message Waiting	79
1.3.38	Mute.....	81
1.3.39	One-touch Dialing	82
1.3.40	Paging.....	82

1.3.41	Printing Message	84
1.3.42	Privacy Release	85
1.3.43	Quick Dialing	85
1.3.44	Redial, Last Number	86
1.3.45	Speed Dialing, Personal.....	86
1.3.46	Speed Dialing, System.....	87
1.3.47	SVM (Simplified Voice Message)	87
1.3.48	TAFAS (Trunk Answer From Any Station).....	97
1.3.49	Timed Reminder.....	97
1.3.50	Time Service	99
1.3.51	Verification Code Entry	100
1.3.52	VOICE MAIL FEATURES	100
1.3.53	Voice Mail Features—LCS (Live Call Screening).....	101
1.3.54	Voice Mail Features—Two-way Record.....	103
1.3.55	Voice Mail Features—Voice Mail Integration	104
1.3.56	Wake-up Call.....	105
1.3.57	Walking COS.....	107
1.3.58	Walking Extension.....	108
1.3.59	Wireless XDP Parallel Mode	109
1.4	Display Features	110
1.4.1	Directories	110
1.4.2	Call Log, Incoming	112
2	Manager Operation	115
2.1	Manager Service Features	116
2.1.1	Dial Tone Transfer	116
2.1.2	External BGM (Background Music).....	116
2.1.3	OGM (Outgoing Messages)	117
2.1.4	Remote Extension Dial Lock.....	119
2.1.5	Time Service Mode Control	119
3	Customizing Your Phone & System.....	121
3.1	Personal Programming.....	122
3.1.1	Programming Information.....	122
3.1.2	Personal Programming.....	122
3.1.3	Programming Feature Clear.....	129
3.1.4	Customizing the Buttons	131
3.2	Manager Programming	136
3.2.1	Programming Information.....	136
3.2.2	Manager Programming	137
3.3	System Programming	139
3.3.1	Programming Information.....	139
3.3.2	System Programming.....	142
4	Appendix	147
4.1	Troubleshooting	148
4.1.1	Troubleshooting.....	148
4.2	Feature Number Table	151
4.2.1	Feature Number Table.....	151
4.3	Tone.....	159
4.3.1	Tone	159

4.4	Revision History	163
4.4.1	PSMPR Software File Version 1.1xxx.....	163
4.4.2	PSMPR Software File Version 2.0xxx.....	163
4.4.3	PSMPR Software File Version 3.0xxx.....	163
	Index	165



Section 1

Operation

*This chapter shows you step by step how to use each feature.
Read this chapter to become familiar with the many useful
features of this PBX.*

1.1 Before Operating the Telephones

1.1.1 Before Operating the Telephones

◆◆ What Kind of Telephone Can Be Used?

You can use a single line telephone (SLT), such as a rotary pulse telephone or a Panasonic proprietary telephone (PT) such as the KX-T7737. You can also use a Panasonic Portable Station (PS), e.g., KX-TD7690. Use the feature depending on the telephone you are using. If you are using a Panasonic

proprietary telephone with a special feature button such as  or a display (Display PT) or both, you can follow the operation with the button or display messages for easy programming.

If you use a large display telephone (e.g., KX-T7737), you can follow the displayed messages to use the features. If your telephone does not have feature buttons and/or a display, you may operate the PBX by entering a feature number instead. Follow the operation for your type of telephone.

If you use a Console, you can use the buttons on the Console as the buttons on the connected proprietary telephone.

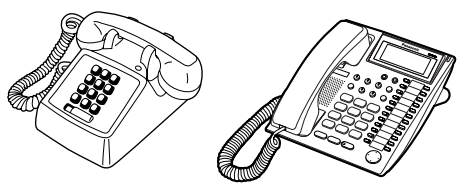

- If you use a Panasonic proprietary telephone which does not have feature buttons, you may change one of the unused flexible buttons to a feature button. Refer to "3.1.4 Customizing the Buttons".

Portable Station (PS) Registration

You must register your PS in the PBX and determine its extension number before initial use. For PS registration, refer to the Feature Manual.

◆◆ Feature Numbers

To use certain features, you need to enter specified feature numbers (and an additional parameter, if required).

There are two types of feature numbers as follows:

- Flexible feature number
- Fixed feature number

Fixed feature numbers cannot be changed. However, you can change the flexible numbers to other numbers for easier use. If you want to change the numbers, refer to the Feature Manual. In this manual, the default numbers (factory installed) are used for operations.

A flexible number is shown as  (half-shaded key). Use the new programmed number if you have changed the feature number. Write the new number in the "Feature Number Table" (Appendix).



If you use a single line telephone which does not have the "*" or "#" keys;
it is not possible to access features that have "*" or "#" in their feature numbers.

◆◆ Tone

You will hear various tones, during or after an operation, for confirmation. Refer to "4.3.1 Tone" (Appendix).

◆◆ Display

In this manual, you will see "the display ...". This refers to the display of a Panasonic proprietary telephone. If your telephone is not a Panasonic display proprietary telephone, the message will not be displayed. If you use a Panasonic display proprietary telephone, the display helps you confirm the settings. Some proprietary telephones also give you easy access to features. A message is displayed depending on the feature. By pressing the Navigator Key, you can access the desired feature. Furthermore, depending on the display proprietary telephone, you can operate features or make calls using the display message. Refer to "1.4 Display Features".

Your Extension Number

If you use a Panasonic display proprietary telephone, you can check your own extension number on the display. Press the TRANSFER button while on-hook.

◆◆ Examples







The displays and the illustrations shown as examples are from a telephone connected to the KX-TAW848.

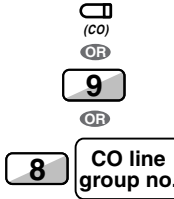

◆◆ Restrictions

Some features may be restricted at your extension under the system programming. Refer to the Feature Manual.

◆◆ Icon Descriptions

The following icons show you the feature availability, notes and action to use the features.











	<p>This feature cannot be used with a single line telephone.</p>		<p>Seize a CO line (One of the following).</p> <ul style="list-style-type: none"> • Press the CO button. • Dial automatic line access number 9. • Dial CO line group access number and CO line group number.
	<p>See "Programming" for Related Programming if necessary.</p>		<p>Press the Call button on the Doorphone.</p>
	<p>Off-hook (One of the following).</p> <ul style="list-style-type: none"> • Lift the handset. • Press the SP-PHONE button. • Press the MONITOR button. (To start talking, lift the handset.) • Press TALK button. 		<p>Press the hookswitch lightly.</p>
	<p>On-hook (One of the following).</p> <ul style="list-style-type: none"> • Hang up. • Press the SP-PHONE button. • Press the MONITOR button. 		









	Press the corresponding feature button on the proprietary telephone.		Talk.
desired no.	Enter the required number. <Example> account code Enter the account code.		You will hear a busy, confirmation, dial, ring or ringback tone. B. Tone: Busy Tone C. Tone: Confirmation Tone D. Tone: Dial Tone R. Tone: Ring Tone R. B. Tone: Ringback Tone
extension no.	Dial an extension number.	outside phone no.	Dial outside phone number.
phone no.	Dial the telephone number.	dial key	Press any dial key (0–9, *, #).

◆◆ When You Use a Panasonic Proprietary Telephone

If you use a Panasonic proprietary telephone and the Console, they may have some of the useful feature buttons described below. For a PS user, refer to "Operating Instructions" for PS. These buttons make operations simple. The illustrations may differ from the buttons on your telephone.

Fixed Buttons

	CO: Used to make or receive an outside call. (Button assignment is required.) Also used as feature buttons. (Button assignment is required.) (Only the CO line "number" [e.g., 1, 2] may be shown on some telephones.)		SP-PHONE: Used for hands-free operation.
	AUTO DIAL/STORE: Used for System/Personal Speed Dialing or storing program changes.		PAUSE: Used to insert a pause when storing a telephone number. This button also functions as the PROGRAM button when there is no PROGRAM button on your telephone.
	REDIAL: Used to redial the last dialed number.		MESSAGE: Used to leave a message waiting indication or call back the party who left the message waiting indication.
	INTERCOM: Used to make or receive intercom calls.		AUTO ANS (Auto Answer)/MUTE: Used to receive an incoming call in hands-free mode or mute the microphone during a conversation.
	MONITOR: Used for hands-free dialing. You can monitor the party's voice in hands-free mode.		HOLD: Used to place a call on hold.

	<p>TRANSFER: Used to transfer a call to another party.</p>		<p>CONF (Conference): Used to establish a multiple party conversation.</p>
	<p>FLASH/RECALL: Used to disconnect the current call and make another call without hanging up. This button can also be used as a CANCEL button while on-hook.</p>		<p>Call Forwarding (FWD)/Do Not Disturb (DND): Used to perform Call Forwarding (FWD) or Do Not Disturb (DND).</p>
	<p>VOICE CALL: Used to monitor an intercom call automatically, but it cannot be used for hands-free conversations. It also mutes the handset microphone during a conversation.</p>		<p>Navigator Key/Volume Key: Used to adjust the volume and the display contrast or select desired items.</p>
	<p>PROGRAM: Used to enter and exit the Programming mode.</p>		<p>Programmable Feature (PF): <i>Located on the right part of the CO button array or on the DSS Console.</i> Assigns the desired button and used to access the stored feature. Mostly used as a One-touch Dialing button. (Only the "F and number" may be shown on some telephones.)</p>

Customized Buttons

If the term is in parentheses like (Account) in this section, it means a flexible button has been made into an "Account" button. To customize, refer to "3.1.4 Customizing the Buttons".

Buttons	Feature
Loop-CO (L-CO)	Used to access an idle CO line for making outside calls. Incoming outside calls from any CO line arrive at this button.
Group-CO (G-CO)	Used to access an idle CO line in a specified CO line group for making outside calls. Incoming calls from CO lines in the assigned CO line group arrive at this button.
Single-CO (S-CO)	Used to access a specified CO line for making or receiving outside calls.
Direct Station Selection (DSS)	Used to access an extension with one touch. It is also possible to be changed to the other feature button.
One-touch Dialing	Used to access a desired party or system feature with one touch.
Incoming Call Distribution Group (ICD Group)	Used to access a specified incoming call distribution group for making or receiving calls.
Message	Used to leave a message waiting indication or call back the party who left the message waiting indication.

1.1 Before Operating the Telephones

Buttons	Feature
Message for Another Extension	Used to have a Message button for another extension.
Call Forwarding (FWD)/Do Not Disturb (DND)—Both calls	Used to forward all calls to a specified destination or refuse.
FWD/DND—Outside calls	Used to forward CO line calls to a specified destination or refuse.
FWD/DND—Intercom calls	Used to forward intercom calls to a specified destination or refuse.
Group FWD—Both calls	Used to forward all the calls to your group to a specified destination.
Group FWD—Outside calls	Used to forward the CO line calls to your group to a specified destination.
Group FWD—Intercom calls	Used to forward the intercom calls to your group to a specified destination.
Account	Used to enter an account code.
Conference	Used to establish a multiple party conversation.
Terminate	Used to disconnect the current call and make another call without hanging up.
External Feature Access (EFA)	Used to access special features offered by a host PBX or a telephone company.
Call Park	Used to park or retrieve a call in a preset parking zone.
Call Park (Automatic Park Zone)	Used to park a call in an idle parking zone automatically.
Call Log	Used to show the incoming call information.
Call Log for ICD Group	Used to have a Call Log button for incoming call distribution group.
Log-in/Log-out	Used to switch between the log-in and log-out mode.
Log-in/Log-out of a specified group	Used to have a Log-in/Log-out button for another incoming call distribution group.
Log-in/Log-out for all groups	Used to have a Log-in/Log-out button for all groups.
Hurry-up	Used to transfer the longest waiting call in the queue of an incoming call distribution group to the overflow destination.
Wrap-up	Used to switch the wrap-up status, Ready and Not Ready mode.
System Alarm	Used to confirm a PBX error. For more details, refer to the Feature Manual.
Time Service (Day/Night/Lunch/Break)	Used to switch the time service mode.
Answer	Used to answer an incoming call.
Release	Used to disconnect the line during or after a conversation or to complete a Call Transfer.
Toll Restriction (TRS)	Used to change the toll restriction level of other extension users temporarily.
Time Service Switching Mode (Automatic/Manual)	Used to switch the time service mode, Automatic or Manual.
Two-way Record	Used to record a conversation into your own mailbox.
Two-way Transfer	Used to record a conversation into the mailbox of a specific extension.

Buttons	Feature
One-touch Two-way Transfer	Used to record a conversation into the mailbox of a specific extension with one touch.
Live Call Screening (LCS)	Used to monitor your own voice mailbox while an incoming caller is leaving a message and, if desired, intercept the call.
Voice Mail Transfer	Used to transfer a call to the mailbox of a specified extension.

◆◆ How to Follow the Steps

An example of system operation is shown below.

◆◆

Calling Another Extension

Feature title

Intercom Call

PT/SLT/PS



Off-hook.

extension no.



(DSS)



Talk.

Operation steps
The description of the icons are explained on "Icon Descriptions".



- The DSS button light shows the current status as follows:
 - Off:** The extension is idle.
 - Red on:** Your or another extension is using the line.

Conditions



- To call using a directory, refer to "1.11.2 Directories".
- For quick operation**
If you are an operator or dial some extensions frequently, DSS buttons are useful.
- Hands-free Operation**
You can make an intercom call and have a conversation in hands-free mode using the SP-PHONE button (refer to "1.3.31 Hands-free Operation").

Hints



Customizing Your Phone

- 3.1.2 Settings on the Programming Mode—**Preferred Line Assignment—Outgoing**
Select the seized line when going off-hook.
- 3.1.3 Customizing the Buttons
Create or edit a Direct Station Selection (DSS) button.

Programming References: The related or required programming is noted.

◆◆ Connection Example

This diagram shows you a connection example.

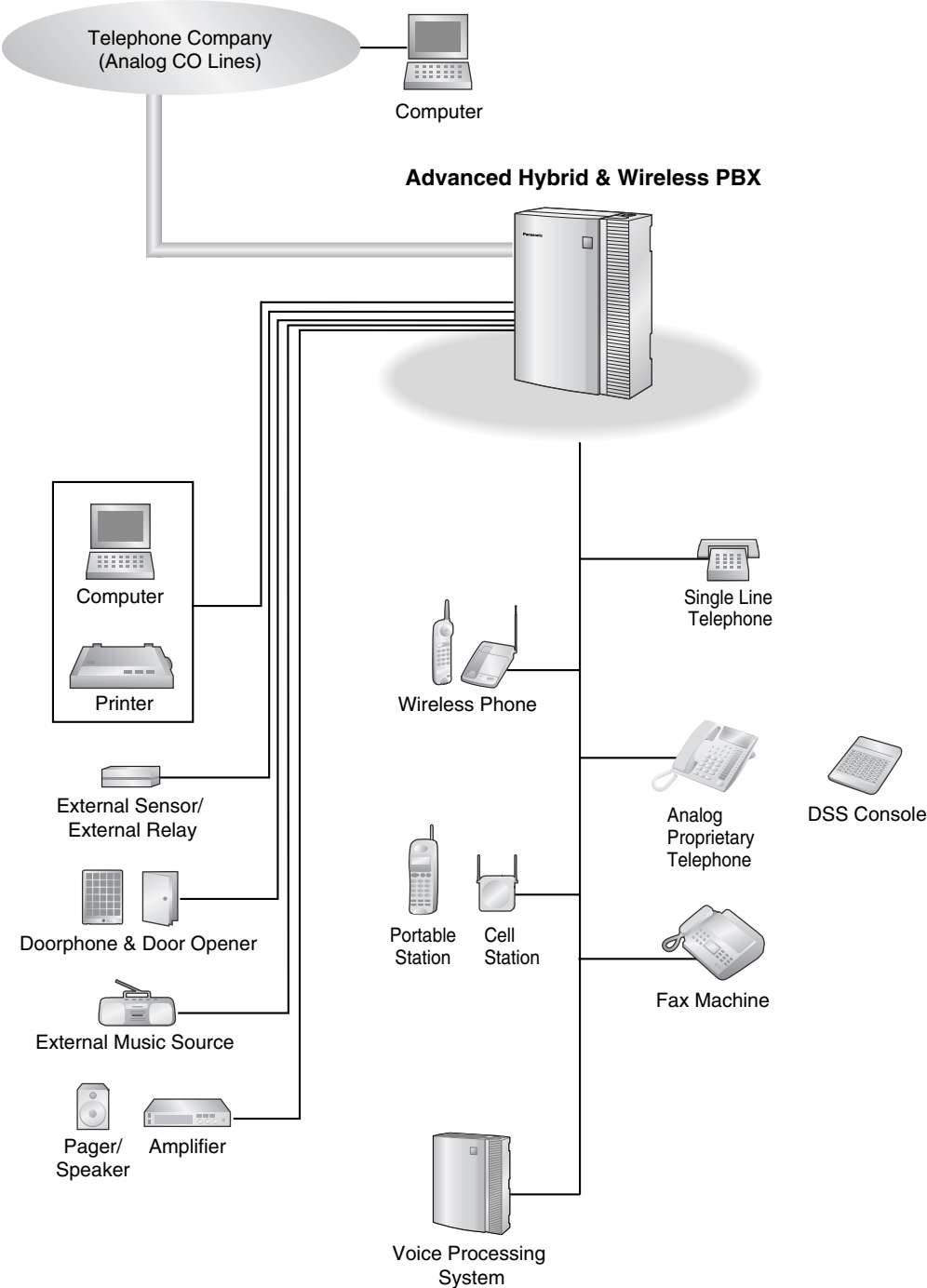

1.2 Basic Operations

1.2.1 Making Calls

- Intercom Call
- Operator Call
- Calling an Outside Party

◆◆ Intercom Call

You can call another extension user.

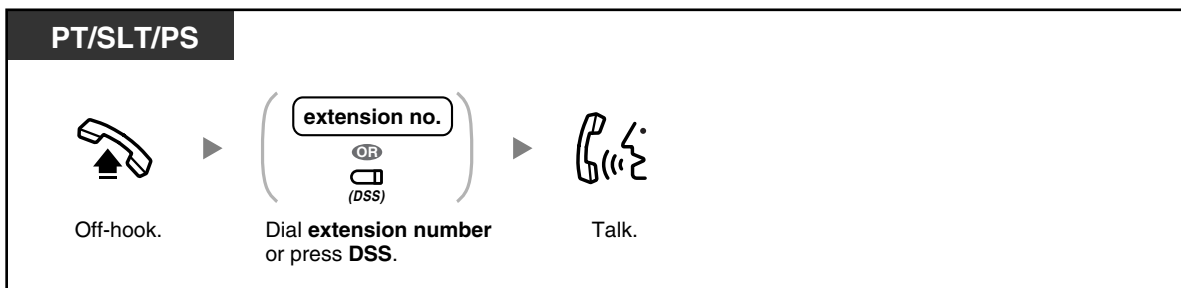

- The DSS button light shows the current status as follows:
Off: The extension is idle.
Red on: Your or another extension is using the line.



- To call using a directory, refer to "1.4.1 Directories".
- **For quick operation**
If you are an operator or dial some extensions frequently, DSS buttons are useful.
- **Hands-free Operation**
You can make an intercom call and have a conversation in hands-free mode using the SP-PHONE button (refer to "1.3.31 Hands-free Operation").



Customizing Your Phone

- 3.1.2 Personal Programming—**Preferred Line Assignment—Outgoing**
Select the seized line when going off-hook.
- 3.1.4 Customizing the Buttons
Create or edit a Direct Station Selection (DSS) button.

◆◆ Operator Call

You can call an extension or a group assigned as the operator.

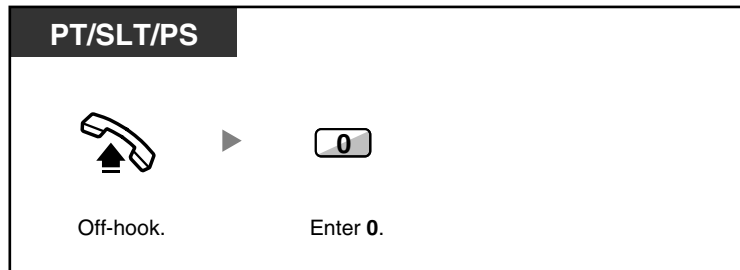

◆◆ Calling an Outside Party

You have to seize a CO line before dialing an outside phone number because external calls are made via your PBX.

Select one of the following methods:

Automatic Line Access

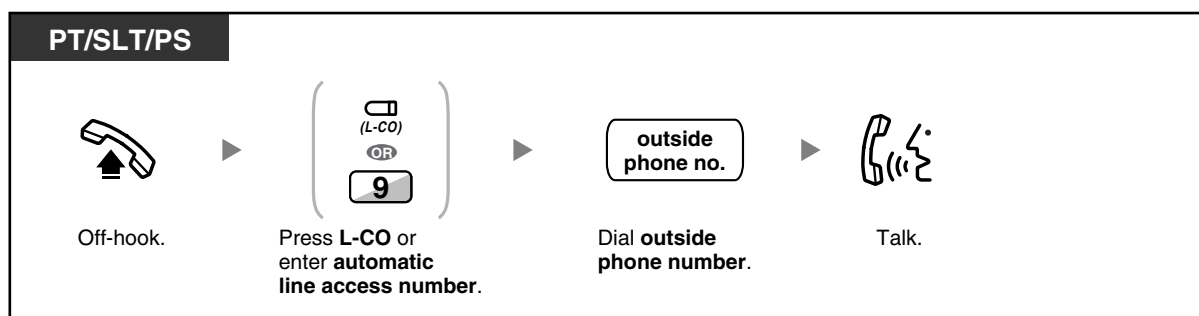

CO Line Group Access

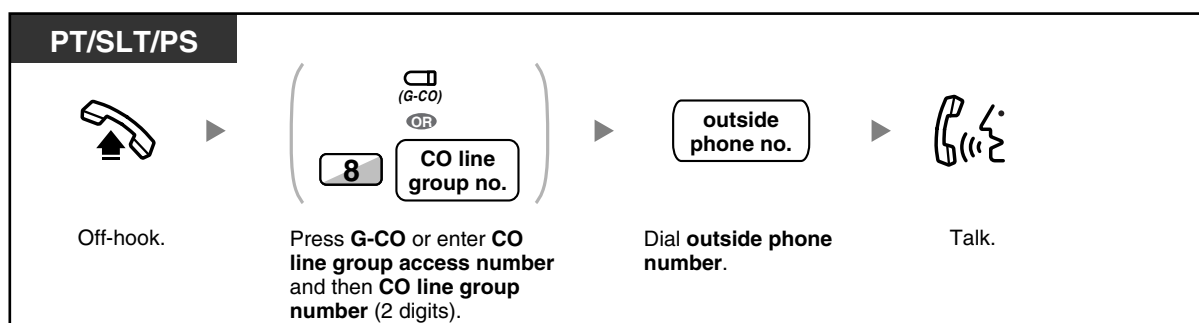

S-CO Line Access

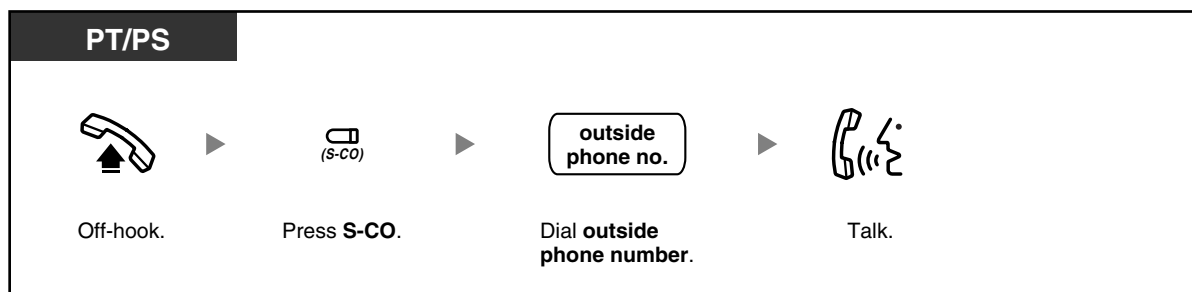

- Each of the S-CO button or G-CO button light shows the current status as follows:
Off: The line is idle.
Red on: The line is in use.
- You may be restricted from making a call to the specified outside party. To make a call, refer to "1.3.51 Verification Code Entry" or "1.3.57 Walking COS".



- **To confirm number before dialing**, you can enter a phone number and confirm it on the display and then go off-hook. (Predialing)
- **To make a call to another party without going on-hook**, press the FLASH/RECALL button. It will re-access the CO line and provide external dial tone. Pressing the Terminate button will provide intercom dial tone. You can dial the new phone number without going on/off-hook.
- **Hands-free Operation**
 You can make an outside call and have a conversation in hands-free mode using the SP-PHONE button (refer to "1.3.31 Hands-free Operation").



Customizing Your Phone

- 3.1.2 Personal Programming—Preferred Line Assignment—Outgoing
 Select the seized line when going off-hook.
- 3.1.4 Customizing the Buttons
 Create or edit a Loop-CO (L-CO) button, a Group-CO (G-CO) button, a Single-CO (S-CO) button or a Terminate button.

1.2.2 Answering Calls

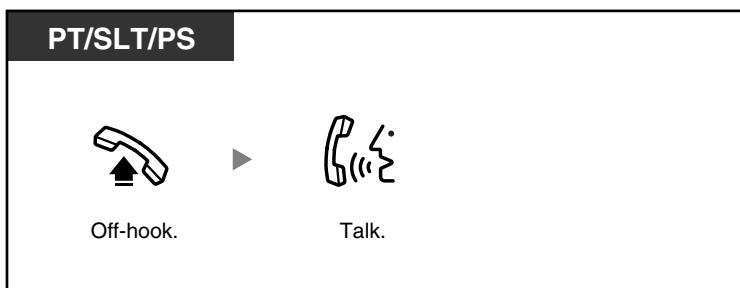



- You can select one of the following methods to answer calls:
 - Lift the handset to receive the preferred line.
(Default: Ringing line is selected.)
 - Press the SP-PHONE button.
(Refer to "1.3.31 Hands-free Operation".)
 - Press the flashing CO, INTERCOM, or ICD Group button directly.
 - Press the Answer button.
- The ICD Group button light shows the current status as follows:
 - Off:** Idle
 - Green on:** The line is in use. (You are using the line.)
 - Red on:** Your extension is in Log-out mode from the incoming call distribution group.



Customizing Your Phone

- 3.1.2 Personal Programming—
 - Preferred Line Assignment—Incoming**
Select the seized line when going off hook.
 - Alternate Receiving—Ring/Voice**
Select the alerting method, either ring or the other party's voice.
- 3.1.4 Customizing the Buttons
Create or edit an Incoming Call Distribution Group (ICD Group) button.

1.3 Telephone Features and Operation

1.3.1 Absent Message

You can show the reason you do not answer, if the caller uses a Panasonic display proprietary telephone. There are eight preprogrammed messages and one for your personal message (16 characters). The selected message is shown on the display of your telephone.

Message no.	Message (Example)
1	Will Return Soon
2	Gone Home
3	At Ext %%% (Extension number)
4	Back at %:% (Hour:Minute)
5	Out until %/% (Month/Day)
6	In a Meeting
7	
8	
9	A message assigned for each extension. (Personal Absent Message)

To set

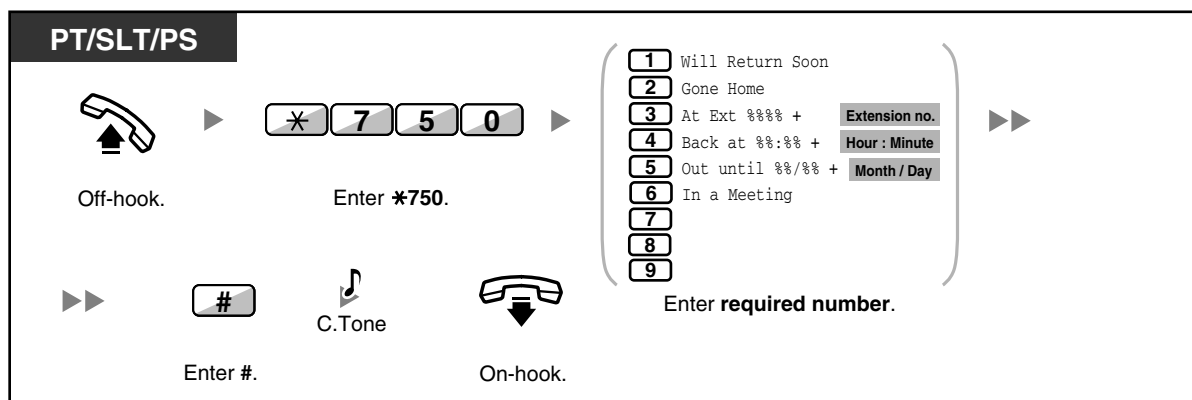

To cancel

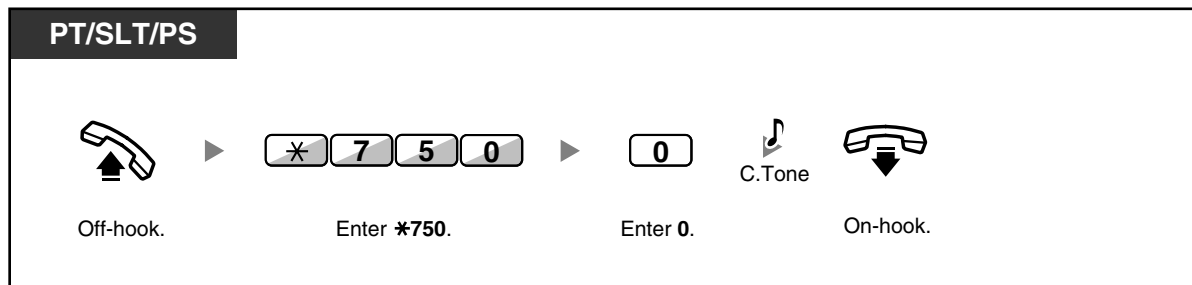



- Enter the desired value in the "%" positions. You must enter the correct number of characters as represented by the "%" using 0 to 9 or *.
- The default messages can be changed. For more details, refer to the Feature Manual.
- To create your personal message (Message no. 9), refer to "3.1.2 Personal Programming".

1.3.2 Account Code Entry

You may give a specified account code to extension users and check their telephone usage. You can specify an account code for each client and check the call duration.

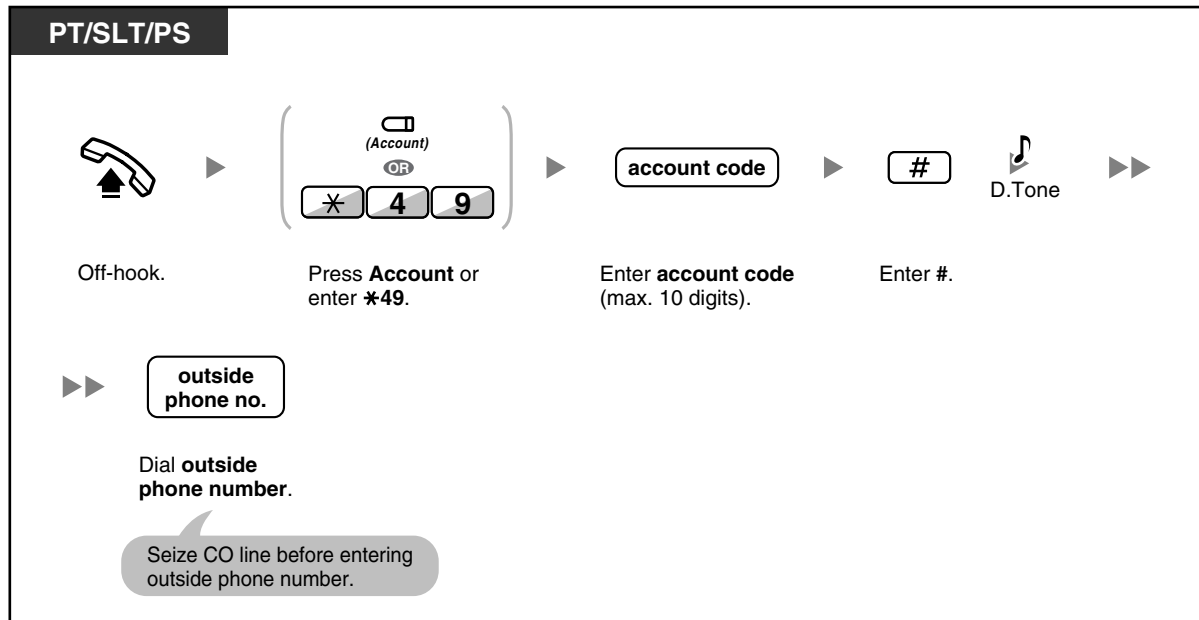

- **A Panasonic proprietary telephone extension user** can enter an account code during a conversation and when hearing reorder tone after the other party hangs up.
- Account codes may use the digits "0" through "9".
- **If you enter the wrong code**, press the "*" key and re-enter the account code.



- You may not be able to make an outside call without an account code. Entry mode is assigned to each user. For more details, refer to the Feature Manual.
- **For your convenience**, you can store the code with the phone number in the memory (e.g., Speed Dialing).



Customizing Your Phone

- 3.1.4 Customizing the Buttons
Create or edit an Account button.

1.3.3 Alternate Calling—Ring/Voice



The caller can alternate the alerting method, either ring or voice, when making an intercom call. On the other hand, any extension can set the alerting method, either ring or voice, when receiving an intercom call.

Ringing (Default): You can call the other party with a ring tone.

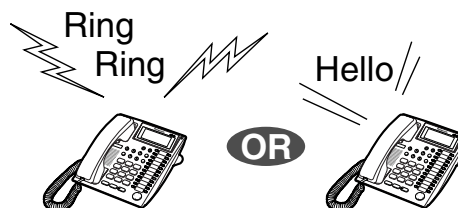
Voice-Calling: You can talk to the other party immediately after confirmation tone.



To change the method

PT/SLT/PS		
<i>After dialing</i>		
		
Enter *.		Talk.



- If the called party uses a single line telephone or portable station, Voice-Calling is not available.
- This feature is not available when the called party's telephone is in the Voice Call Deny mode.



Customizing Your Phone

- 3.1.2 Personal Programming—**Alternate Receiving—Ring/Voice**
Select the alerting method, either ring or the other party's voice.

1.3.4 Automatic Callback Busy (Camp-on)

If a dialed extension or a desired CO line is busy, you can set the telephone to receive callback ringing:

- when a dialed extension becomes idle.
- when your desired CO line that is in use by another extension becomes idle.

You cannot set Automatic Callback Busy for a busy party outside of the PBX.

When you answer the callback ringing:

- For an outside call: The line is seized.
- For an intercom call: The called extension starts ringing automatically.

To set (for both extension and CO line)

PT/SLT/PS

While hearing a busy tone



Enter **6**. C.Tone On-hook.

To answer the callback ringing from an idle extension

PT/SLT/PS

While hearing a callback ringing



Off-hook. R.B.Tone Talk.

To answer the callback ringing from an idle CO line

PT/SLT/PS

While hearing a callback ringing

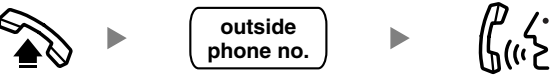

Off-hook. Dial **outside phone number**. Talk.



- If you do not answer the callback ringing within 10 seconds, this feature will be canceled.

Automatic Callback Busy Cancel

PT/SLT/PS



Off-hook. Enter ***46**. C.Tone On-hook.

1.3.5 BGM (Background Music)

You can listen to the background music through your telephone speaker while on-hook. An external music source, such as a radio, must be connected. If your extension becomes busy (off-hook, making or receiving a call etc.), the music stops temporarily. When you go back on-hook, the music starts again.



To set/cancel

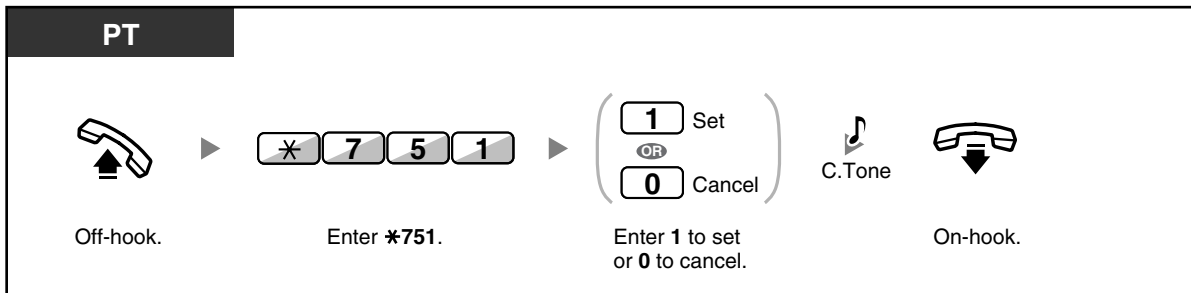

1.3.6 Call Hold

There are two types of hold. The difference between them is whether other people can retrieve your held call (Regular Hold) or not (Exclusive Call Hold). As they can be alternated, ask your manager what the current mode is.

Call Hold

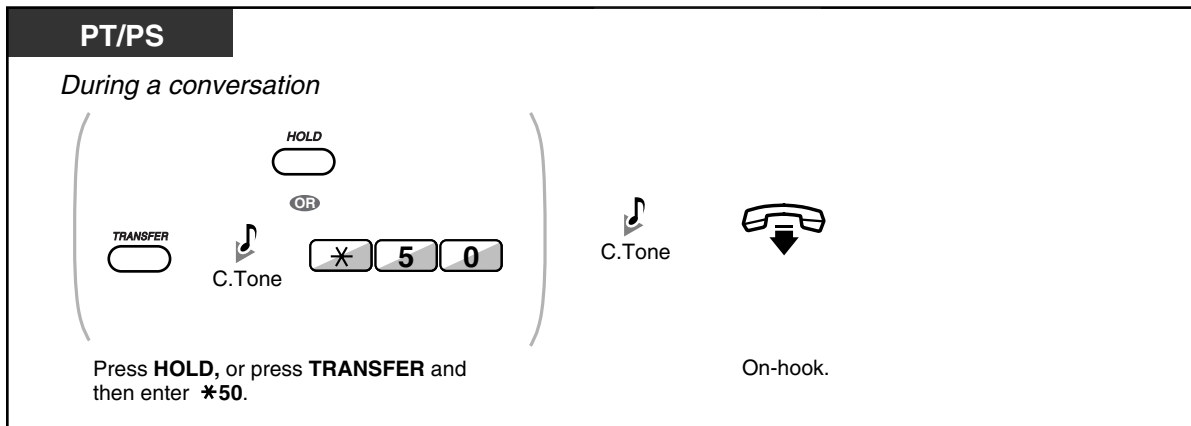

Call Hold Retrieve

PT/SLT/PS

- **At the holding extension (Call Hold Retrieve)**

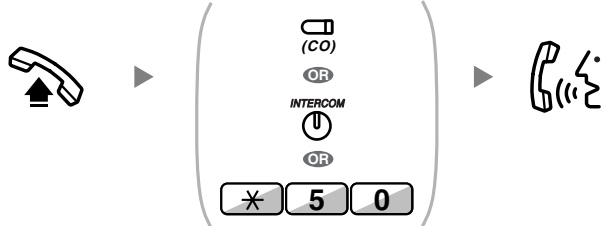

Off-hook. Press flashing **CO** or **INTERCOM**, or enter *** 50**. Talk.
- **To retrieve an outside call from another extension—only Regular Hold (Call Hold Retrieve—Specified with a held line number)**

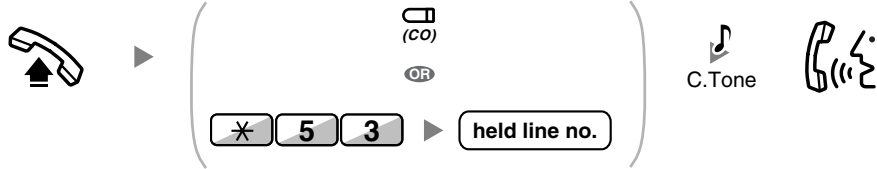

Off-hook. Press **CO**, or enter *** 53** and then **held line number** (3 digits). C.Tone Talk.
- **To retrieve an intercom call or outside call from another extension—only Regular Hold (Call Hold Retrieve—Specified with a holding extension number)**

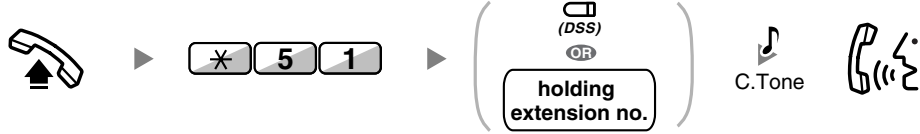

Off-hook. Enter *** 51**. Press **DSS** or dial **holding extension number**. C.Tone Talk.



- The CO or INTERCOM button light shows the current status as follows:

 - Regular Hold mode
 - Flashing green slowly:** Your held call
 - Flashing red:** Another extension's held call
 - Exclusive Call Hold mode
 - Flashing green rapidly:** Your held call
 - Red on:** Another extension's held call
- If a call is not retrieved within a specified time**, you will hear an alarm as a reminder. If an outside call is not answered within a specified time, it is automatically disconnected.
- Hold Mode Change (PT only)**
After pressing the HOLD button, if you press the HOLD button again, the status switches from the Regular Hold mode to the Exclusive Call Hold mode or from the Exclusive Call Hold mode to the Regular Hold mode.



- **For simple operation**, you can automatically hold a call by pressing another CO, ICD Group or INTERCOM button, only if preprogrammed (**Automatic Call Hold**). For more details, refer to the Feature Manual.

1.3.7 Call Monitor

A preprogrammed extension user can listen to the ongoing conversation of a busy extension user.

To monitor

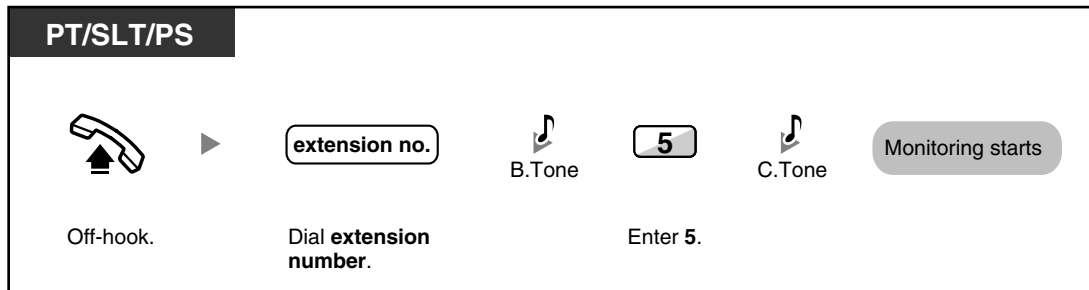

1.3.8 Call Park

You can put a call on hold in a common parking zone of the PBX so that any extension can retrieve the parked call. You can use this feature as a transferring feature.

A call can be put into either a specified parking zone (Specified) or any idle parking zone (Auto). If a Call Park button and Call Park (Automatic Park Zone) button have been established, you can select either way to park by simply pressing the corresponding button.

When a call is parked automatically, or more than one call has been parked at the same time, you need to specify the parking zone number to retrieve the required call.

To set



PT/PS

During a conversation

Press **TRANSFER**. Enter ***52**. Enter a specified **parking zone number** (2 digits) or press ***** to park at an idle parking zone automatically. C.Tone On-hook.

*If you hear a busy tone, enter another parking zone number or press * again.*

SLT

During a conversation

Press **Recall/hookswitch**. Enter ***52**. Enter a specified **parking zone number** (2 digits). C.Tone On-hook.

If you hear a busy tone, enter another parking zone number.

Call Park Retrieve

PT/PS

Press a flashing **Call Park**.

PT/SLT/PS

Off-hook. Enter ***52**. Dial **stored parking zone number** (2 digits). C.Tone Talk.



- If a call is parked automatically, confirm the parking zone number on the display.
- **If a call is not retrieved within a specified time**, you will hear an alarm as a reminder. If an outside call is not answered within a specified time, it is automatically disconnected.



- If you hear a reorder tone when retrieving a parked call, there is no held call. Confirm the stored parking zone number.
- After you park a call, you can perform other operations.



Customizing Your Phone

- 3.1.4 Customizing the Buttons
Create or edit a Call Park button or Call Park (Automatic Park Zone) button.

1.3.9 Call Pickup

- Call Pickup
- Call Pickup Deny

◆◆ Call Pickup

You can answer an incoming call that is ringing at another extension or group from your phone without leaving your desk.

The following types of pickup are available:

Group Call Pickup: Picks up a call within your group.

Directed Call Pickup: Picks up a specified extension's call.

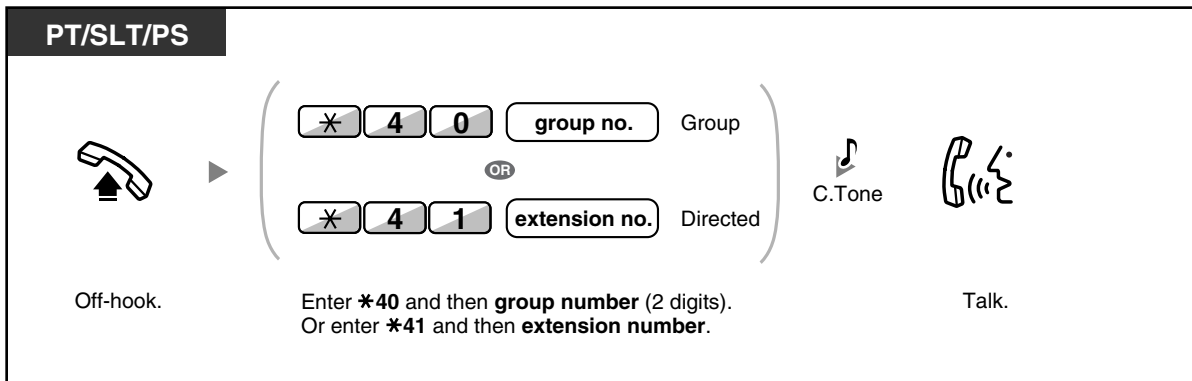

- If you receive a call waiting tone, you can ask a third party to pick up your second call with Directed Call Pickup.



- You can also pick up a call by pressing a flashing DSS button. System programming is required to allow this operation. For more details, refer to the Feature Manual.

◆◆ Call Pickup Deny

You can deny or allow other people to pick up your calls.

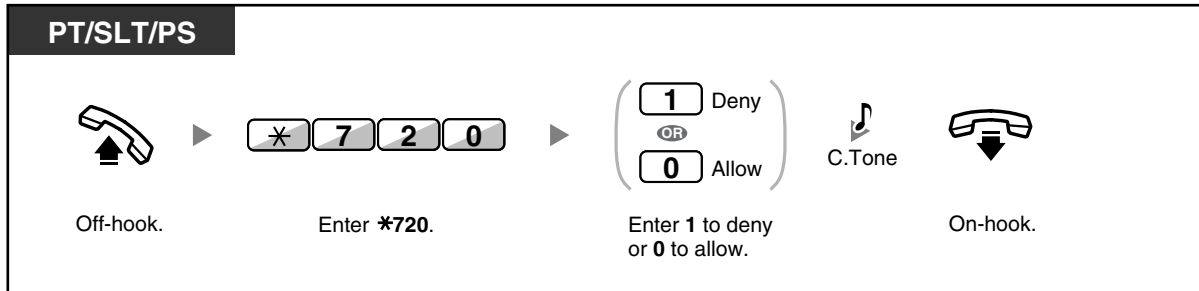

1.3.10 Call Splitting

When talking to one party while the other party is on hold, you can swap the calls back and forth (alternately).

To alternate between the parties leaving one party on hold temporarily

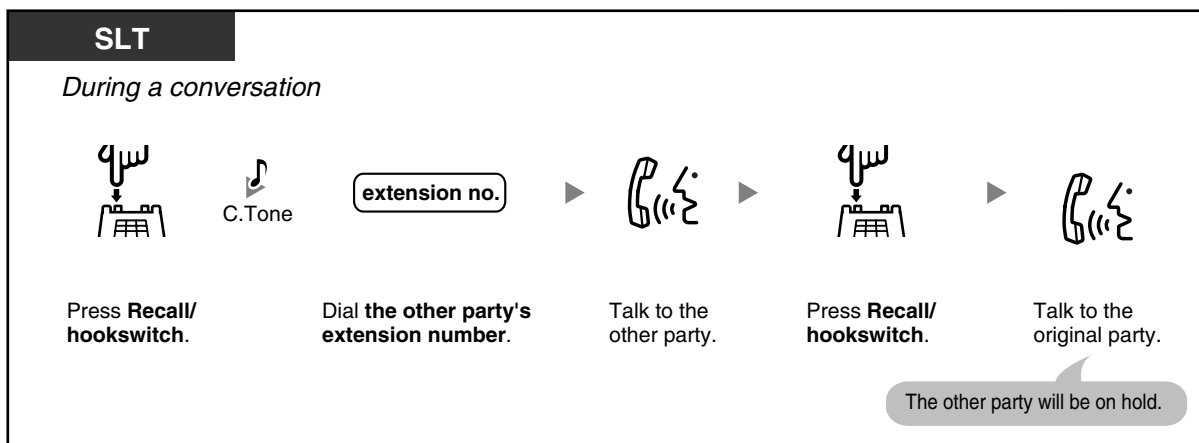
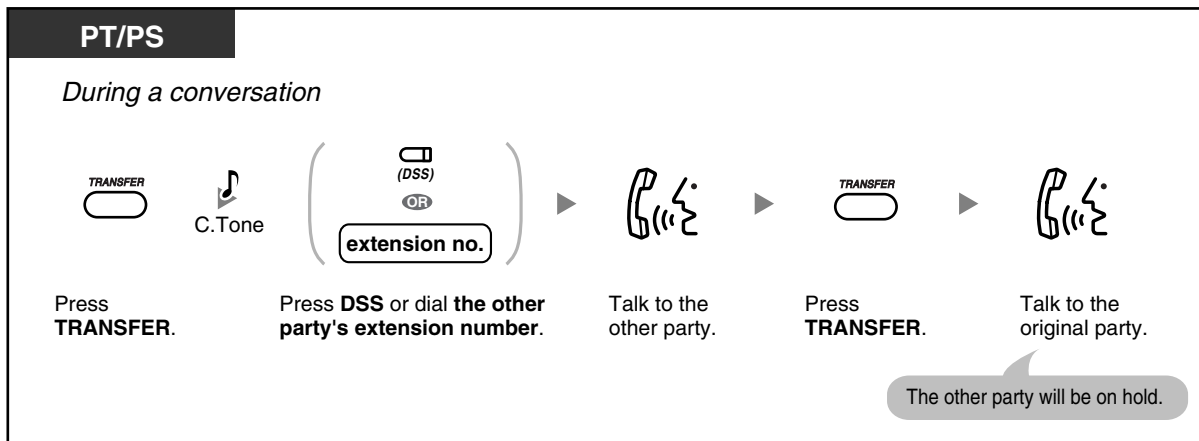

To leave the conversation and then let the two parties talk

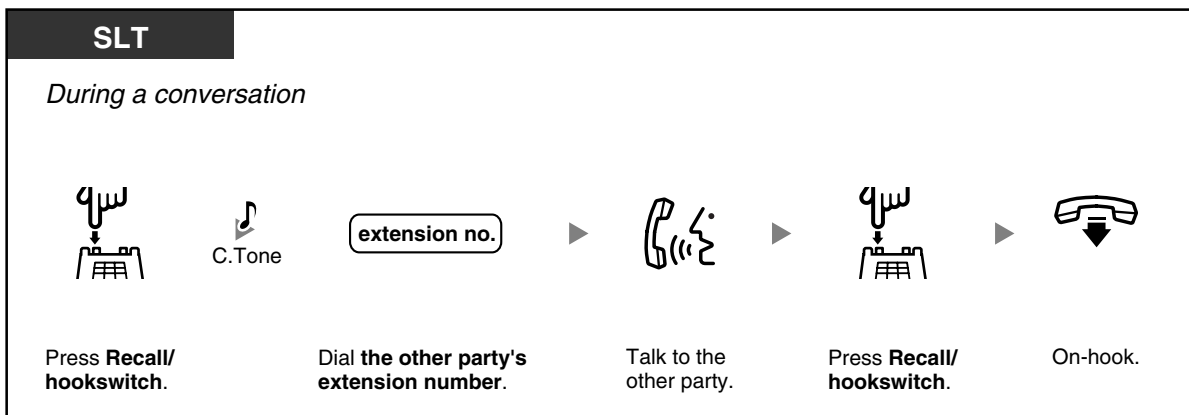
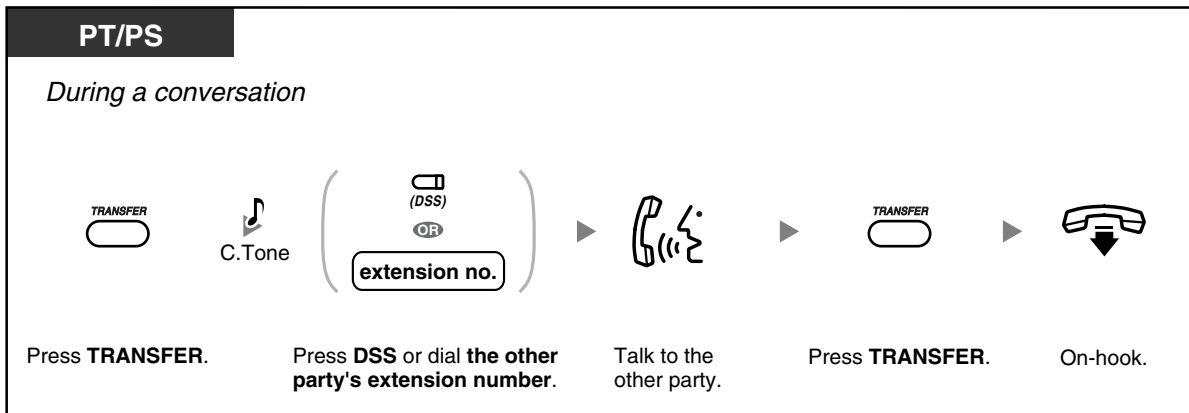

1.3.11 Call Transfer

- Transferring to an Extension in the PBX
- Transferring to an Outside Party Using the PBX Service



- You can transfer a held call without talking, and go on-hook even if the transferred party does not answer the call. If a transferred call is not answered within a specified time, it will ring at a preprogrammed extension, if set, or at your extension again. If you are off-hook at that time, you will hear an alarm tone. If an outside call is not answered within a specified time, it is automatically disconnected.

◆◆ Transferring to an Extension in the PBX

To transfer

PT/PS

During a conversation

Press **TRANSFER**.

C.Tone

(**(DSS)**
OR
extension no.)

Talk.

On-hook.

You do not have to inform the destination extension about where the call has been transferred from. This can be disregarded.

SLT

During a conversation

Press **Recall/hookswitch**.

C.Tone

extension no.

Talk.

On-hook.

You do not have to inform the destination extension about where the call has been transferred from. This can be disregarded.

To transfer with one touch (One-touch Transfer)

PT/PS

During a conversation with an outside party

Press **DSS**.

Talk.

On-hook.

You do not have to inform the destination extension about where the call has been transferred from. This can be disregarded.



- System programming is required to use the One-touch Transfer feature during a conversation with an extension. For more details, refer to the Feature Manual.

◆◆ Transferring to an Outside Party Using the PBX Service

Some extensions may be restricted from performing this feature.

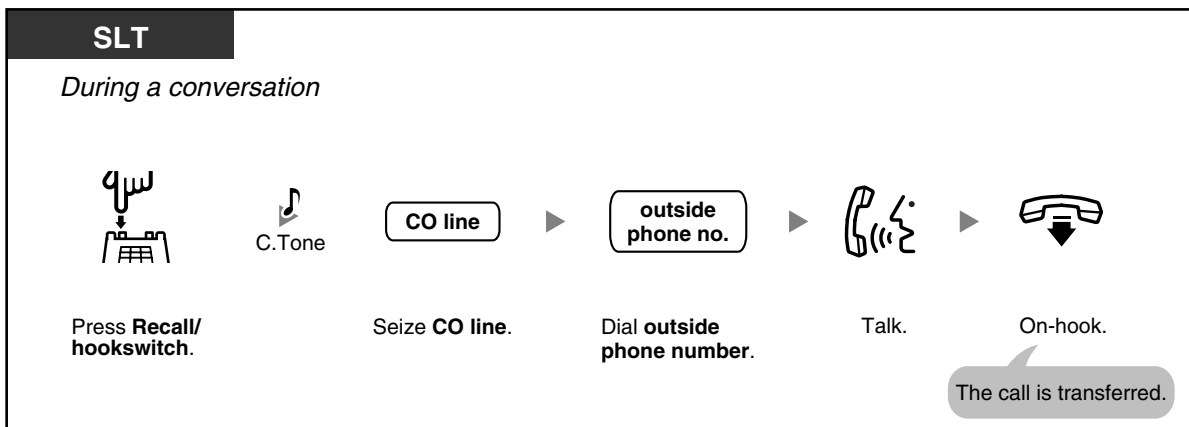
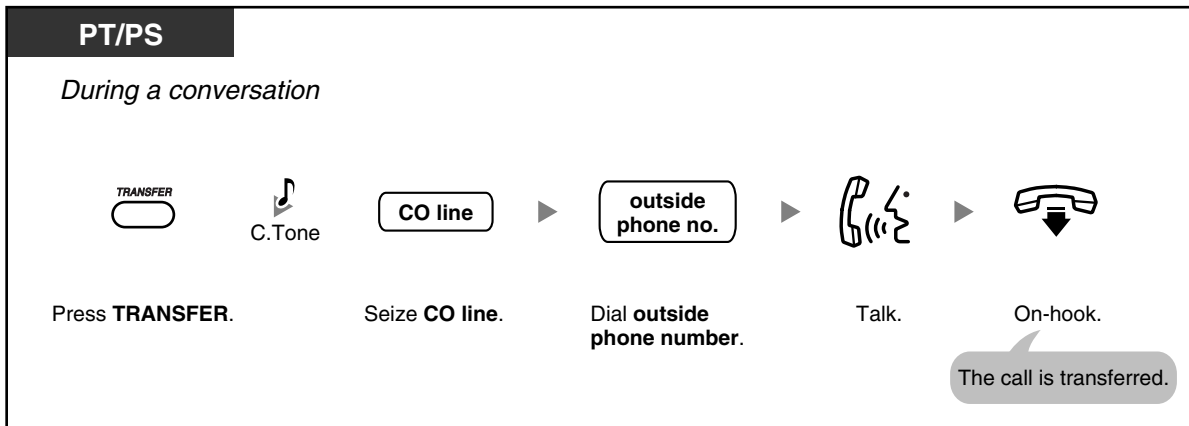

- **Time limit**
Both the caller and the transferred party will hear an alarm tone fifteen seconds before a specified time period.
- **To return to the held call before the destination answers**, press the TRANSFER button, corresponding CO, ICD Group or INTERCOM button, or the hookswitch.



Customizing Your Phone

- 3.1.4 Customizing the Buttons
Create or edit a Direct Station Selection (DSS) button.

1.3.12 CALL WAITING FEATURES

- Call Waiting (BSS [Busy Station Signaling])
- Answering Call Waiting in the PBX
- Answering Call Waiting from the Telephone Company

◆◆ Call Waiting (BSS [Busy Station Signaling])

◆ For a caller

You can inform a busy extension user that your call is waiting.

To send a call waiting

PT/SLT/PS

While hearing a busy tone



Enter 1.

◆ *For a called extension*

A call waiting tone is sent to the busy extension user to notify him or her that a new incoming call is waiting (1.3.13 Call Waiting Tone). The extension can then answer the second call by either disconnecting the current call or placing it on hold.

◆◆ Answering Call Waiting in the PBX

During a conversation, a call waiting tone through the speaker or the handset occurs when an outside call has been received or another extension is letting you know a call is waiting. You must activate this feature to use it. (Default: Enable—Tone)

You can answer the second call by disconnecting (1) or holding (2) the current call.

1. To disconnect the current call and then talk to the new party

PT/SLT/PS

While hearing a tone

On-hook.

Off-hook.

Talk to the new party.

2. To hold the current call and then talk to the new party

PT/PS

While hearing a tone

Press **HOLD**.

Press **CO** or
INTERCOM.

Talk to the new party.

Disregard this step if both parties are extensions.

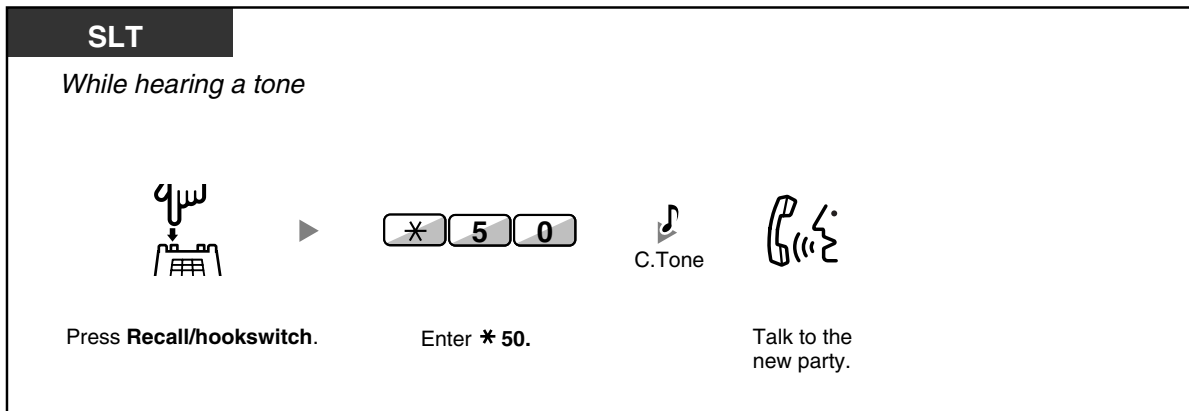

After talking to the new party (second call), you can disconnect (2.1) or hold (2.2) it and then retrieve the first call.

2.1 To disconnect the second call and then talk to the original party

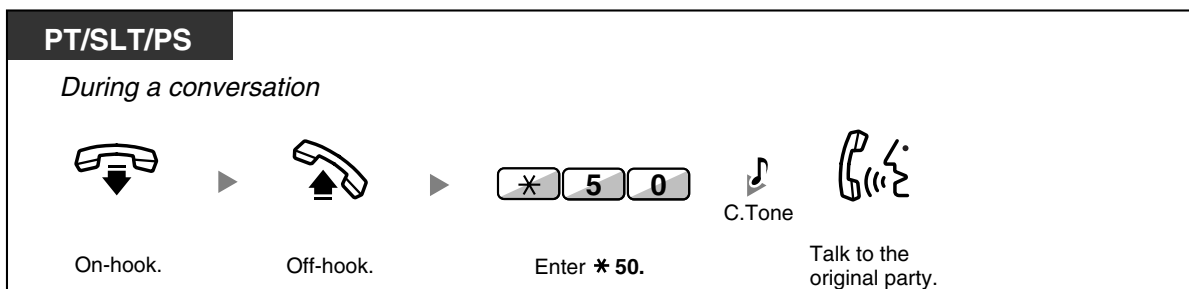
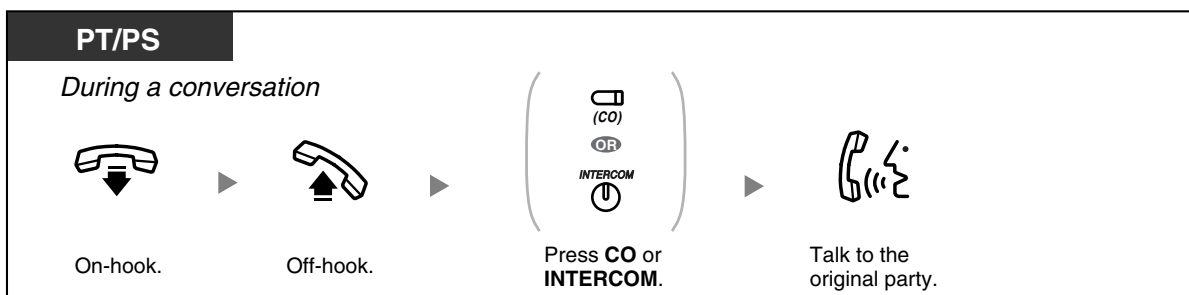

2.2 To hold the second call and then talk to the original party

After holding it, you can talk to the original party. Then, you can disconnect it and then talk to the new party again.

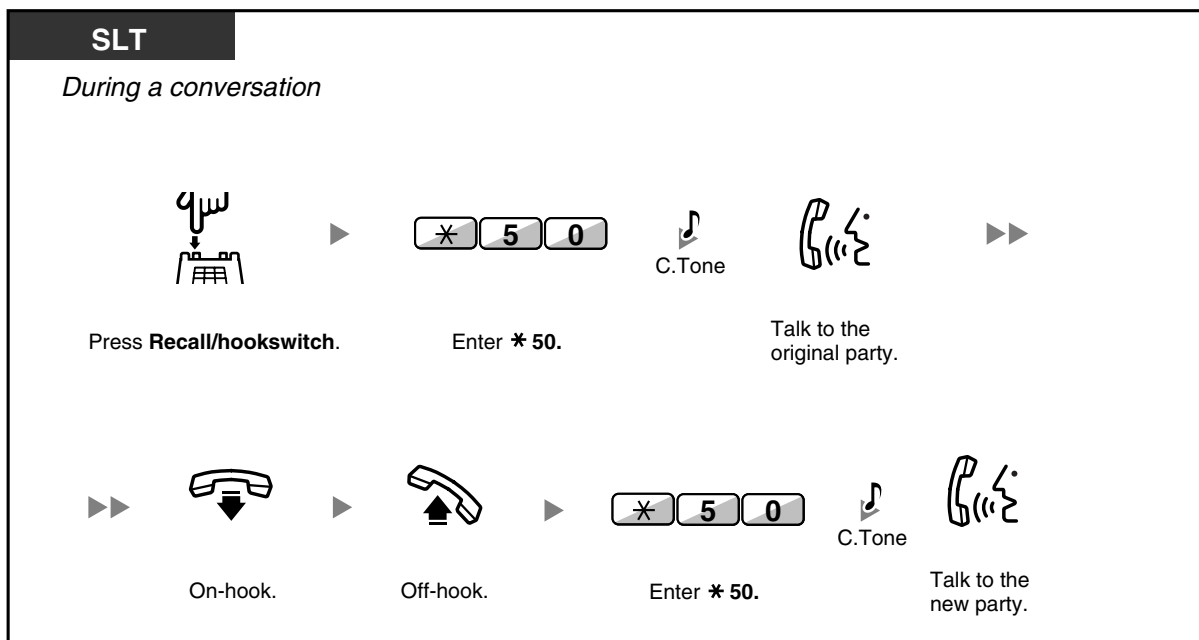
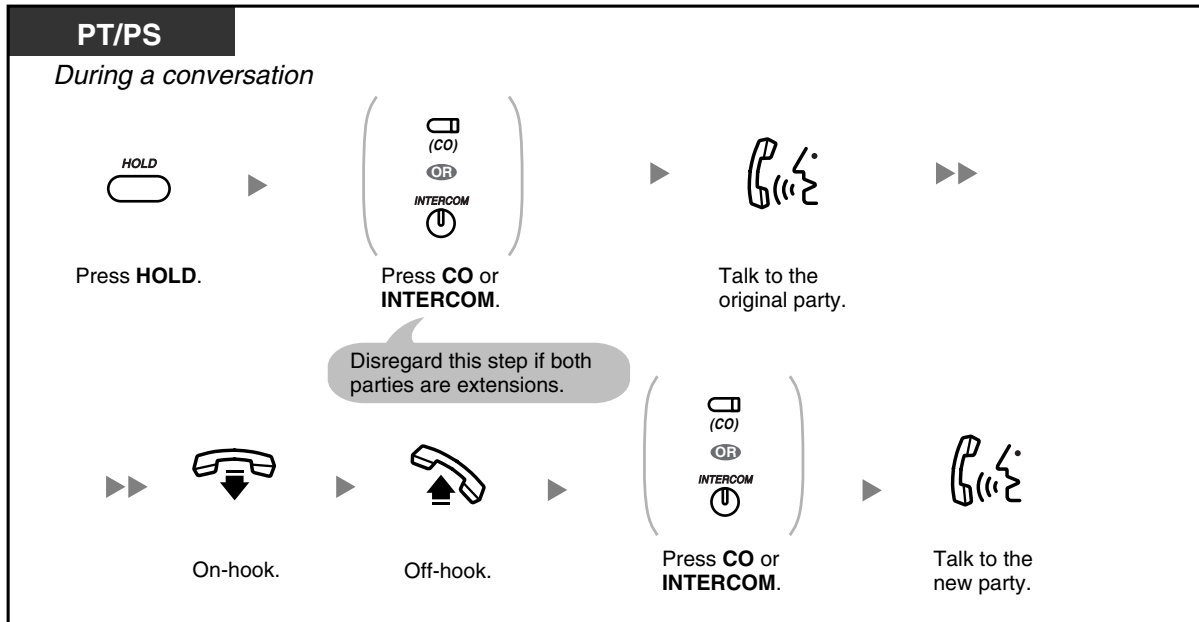



Customizing Your Phone

- 3.1.2 Personal Programming—**Call Waiting Tone Type Selection**
 If you select "Tone 1", you will hear the same tone for Call Waiting from an outside party and an extension. If you select "Tone 2", you will hear different tones for Call Waiting from an outside party and an extension.

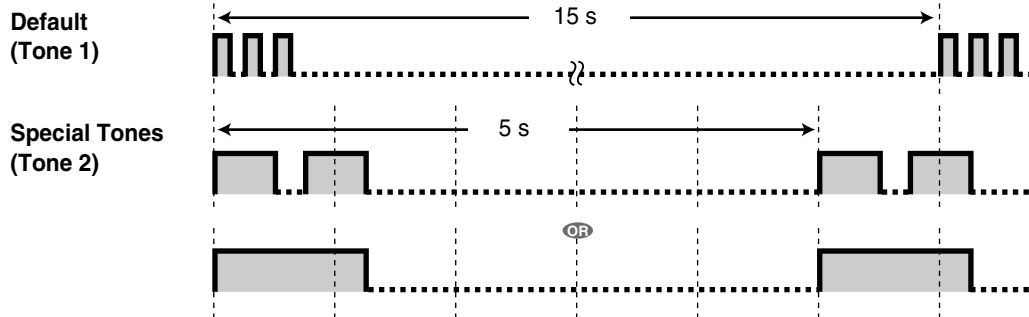

Answering Call Waiting from the Telephone Company

This is an optional telephone company service. You can receive a call waiting tone with the caller's name or telephone number information. For details, consult your telephone company.

PT/PS	PT/SLT/PS
<p><i>While hearing a tone</i></p> <p>FLASH/RECALL</p> <p>○</p> <p>OR</p> <p>⏏ (EFA)</p> <p>Press FLASH/RECALL or EFA.</p>	<p><i>While hearing a tone</i></p> <p>TRANSFER</p> <p>OR</p> <p>📞</p> <p>Press TRANSFER or Recall/hookswitch.</p>
	<p>▶ * 6 0</p> <p>Enter *60.</p>



- To return to the original party, repeat the operation.
- In this case, the FLASH/RECALL button on proprietary telephones must be in External Feature Access (EFA) mode. For information about setting the mode of your FLASH/RECALL button, refer to the Feature Manual.
- The caller's information will not be displayed on telephones or wireless phones connected to SLT ports.



Customizing Your Phone

- 3.1.4 Customizing the Buttons
 Create or edit an External Feature Access (EFA) button.

1.3.13 Call Waiting Tone

During a conversation, you can be informed of a waiting call with a call waiting tone through the built-in speaker of your PT or the handset of your SLT. (Default: Enable—Tone)

To set/cancel for intercom calls

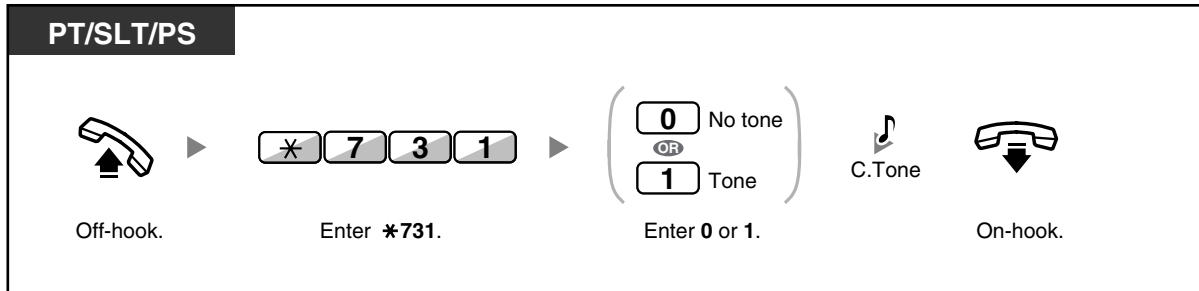

To set/cancel for outside calls

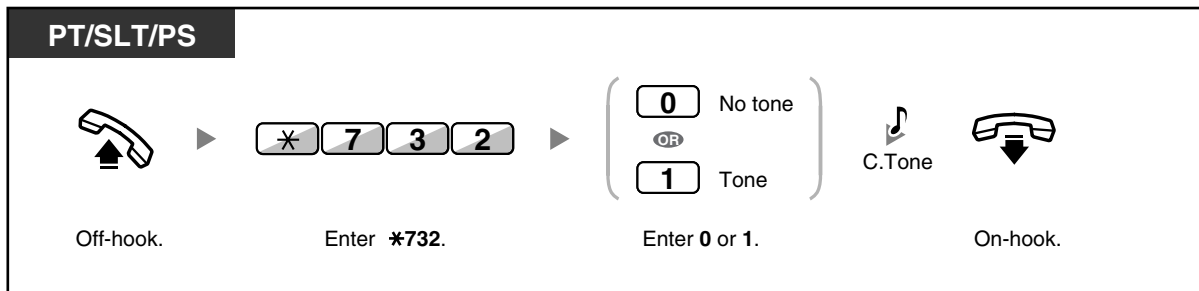

- To change the tone from a PT, refer to "3.1.2 Personal Programming".



- For information about answering a waiting call, refer to "1.3.12 CALL WAITING FEATURES".

1.3.14 Character Entry

You can enter the following characters. The table shows you the characters available for each button.



1.3 Telephone Features and Operation

Times Buttons	1	2	3	4	5	6	7	8	9
1	!	?	"	1					
2	A	B	C	a	b	c	2		
3	D	E	F	d	e	f	3		
4	G	H	I	g	h	i	4		
5	J	K	L	j	k	l	5		
6	M	N	O	m	n	o	6		
7	P	Q	R	S	p	q	r	s	7
8	T	U	V	t	u	v	8		
9	W	X	Y	Z	w	x	y	z	9
0	(space)	.	,	'	:	;	0		
*	/	+	-	=	<	>	*		
#	\$	%	&	@	()			#

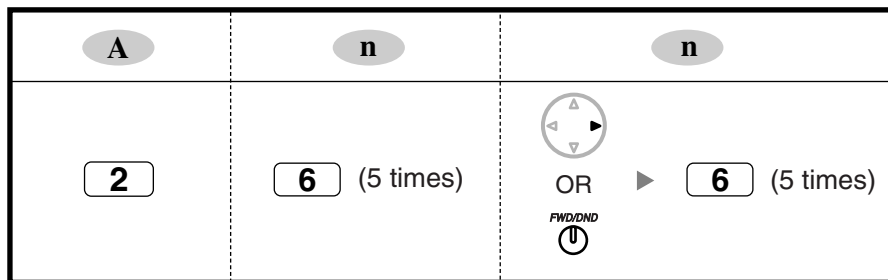
<Example> To enter "Ann"



Notes

- To erase the character on the cursor, press CLEAR.
- To move the cursor to the left, press .
- To move the cursor to the right, press . When entering two or more characters that use the same button consecutively (e.g. "G" and "I"), you must press this button or the FWD/DND button after entering the first character.
- If the SELECT button is pressed, the characters for each button will be displayed in reverse order.

1.3.15 Conference

- Conference
- Leaving Three-party Conference

◆◆ Conference

You can add one or more parties to your conversation.

To establish a conference call

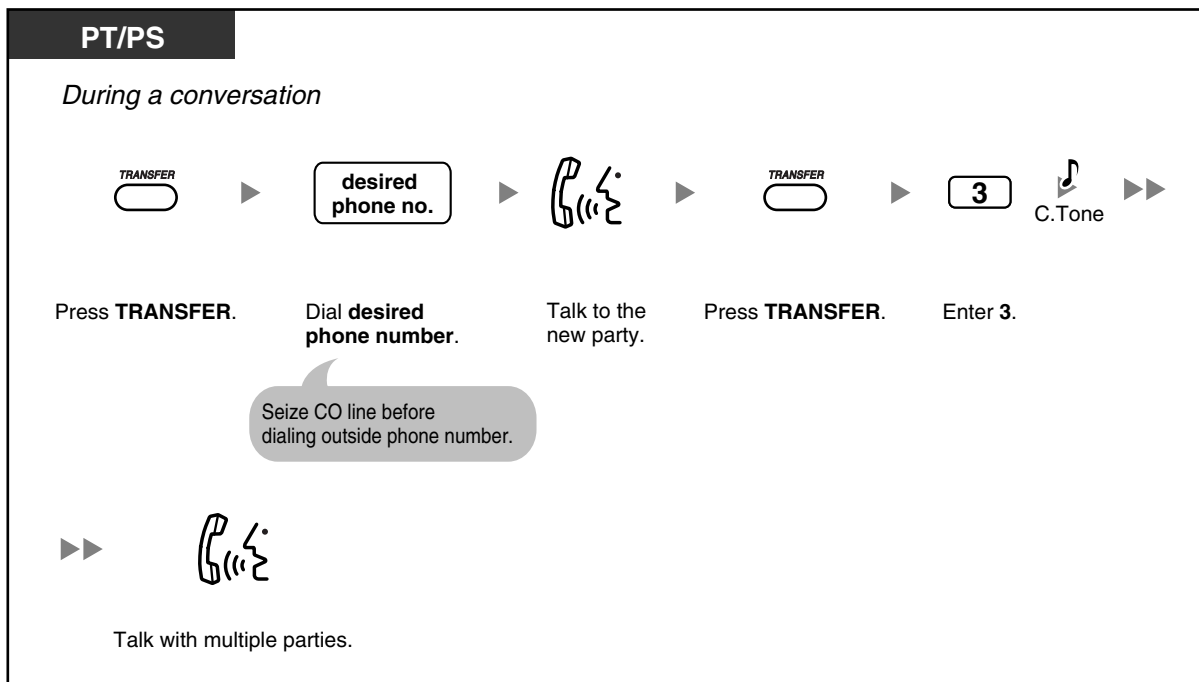
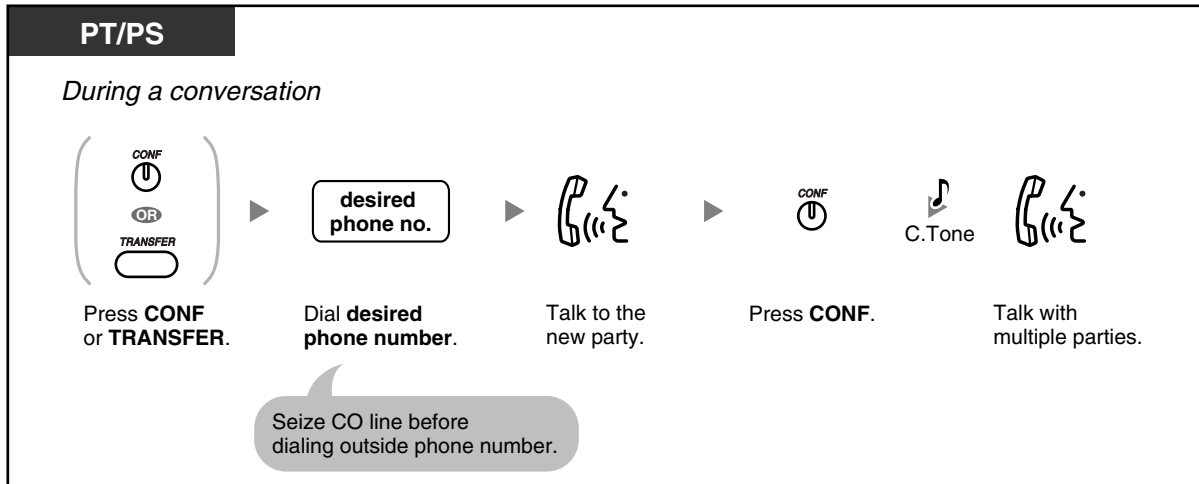

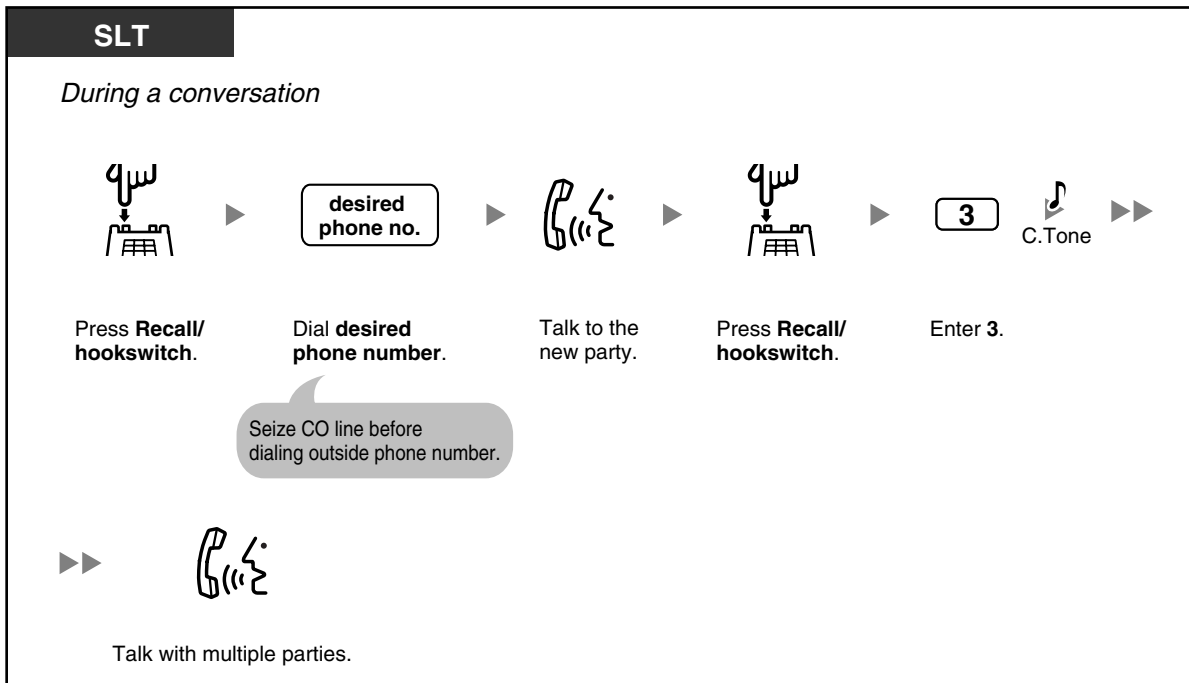

To establish a conference call when receiving a call from an outside party during a two-party conversation

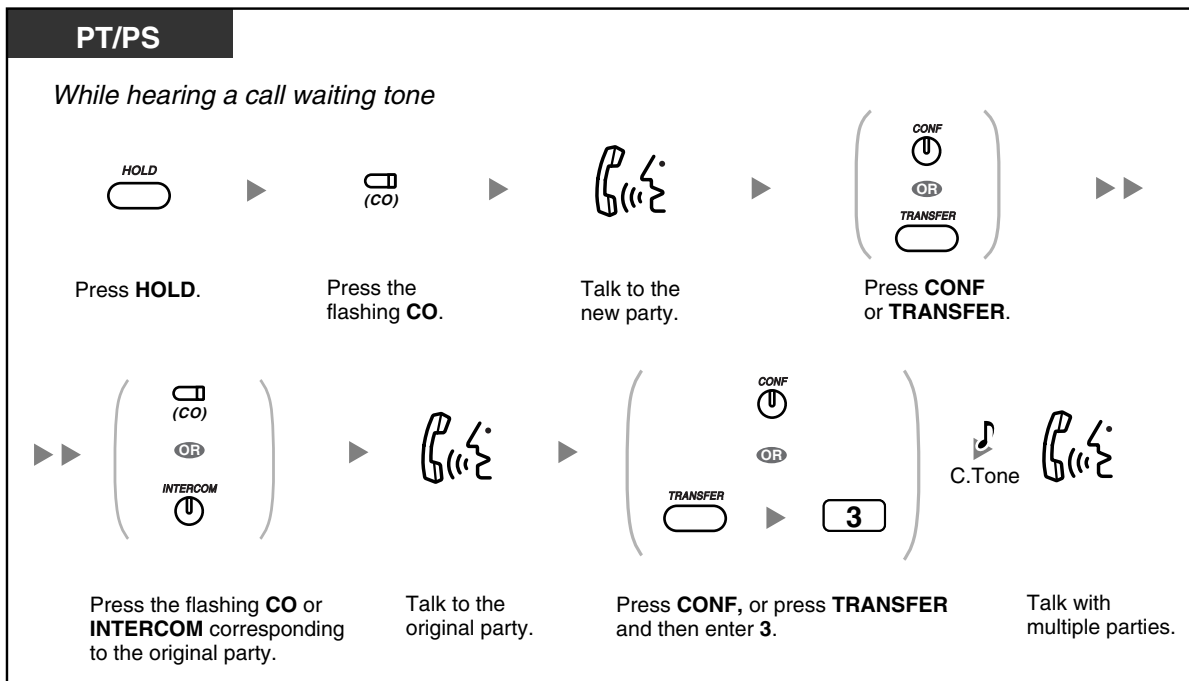

To add four or more parties to a conference

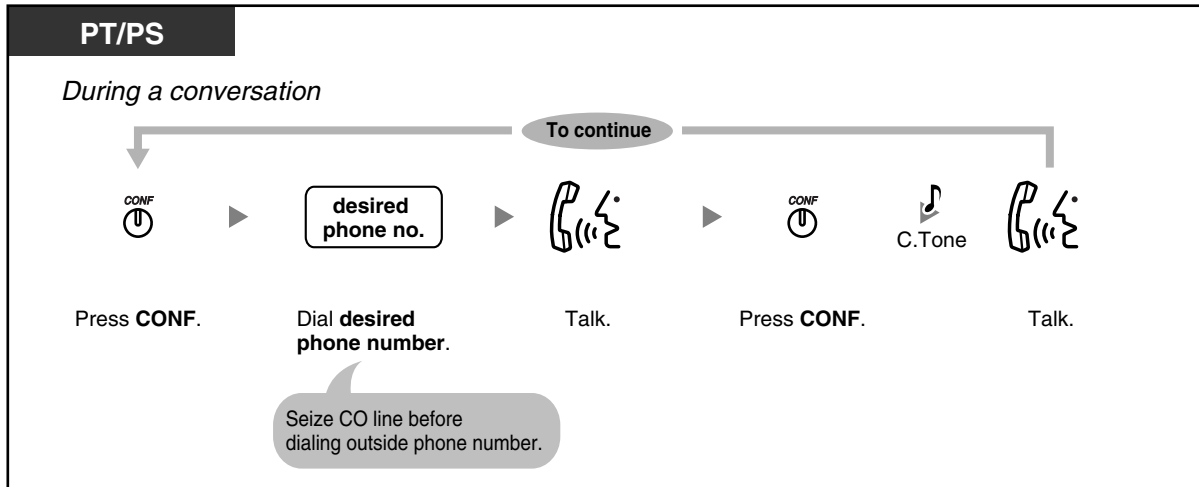

To add an outside party on hold to a conference

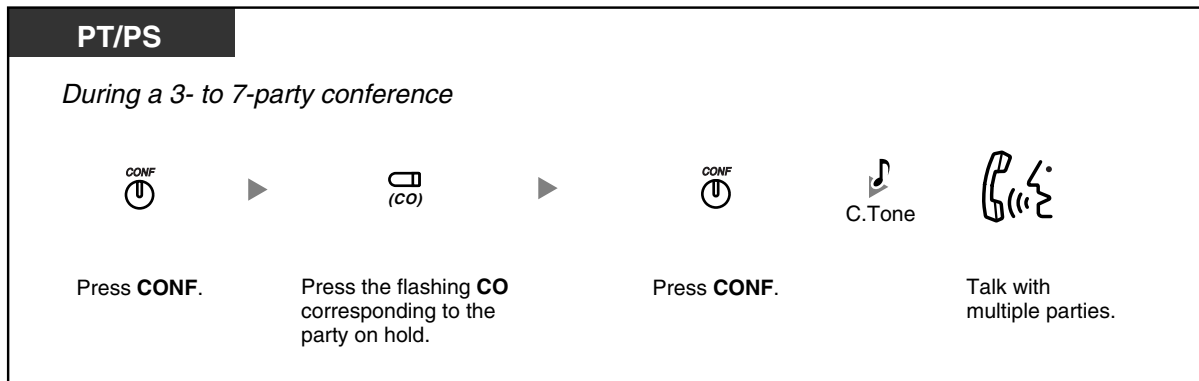

To talk to two parties alternately in a three-party conversation

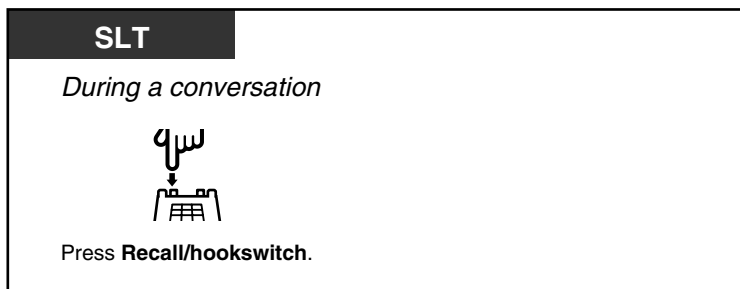
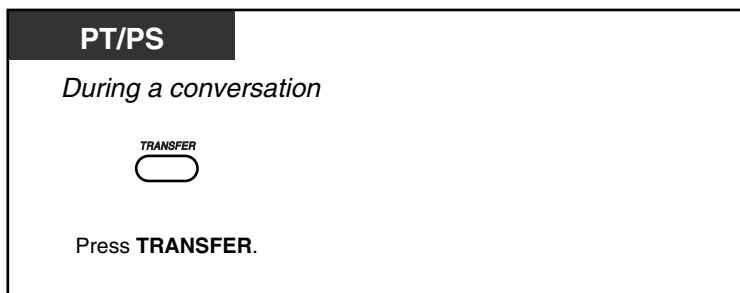

To disconnect one party and then talk to the other in a three-party conversation

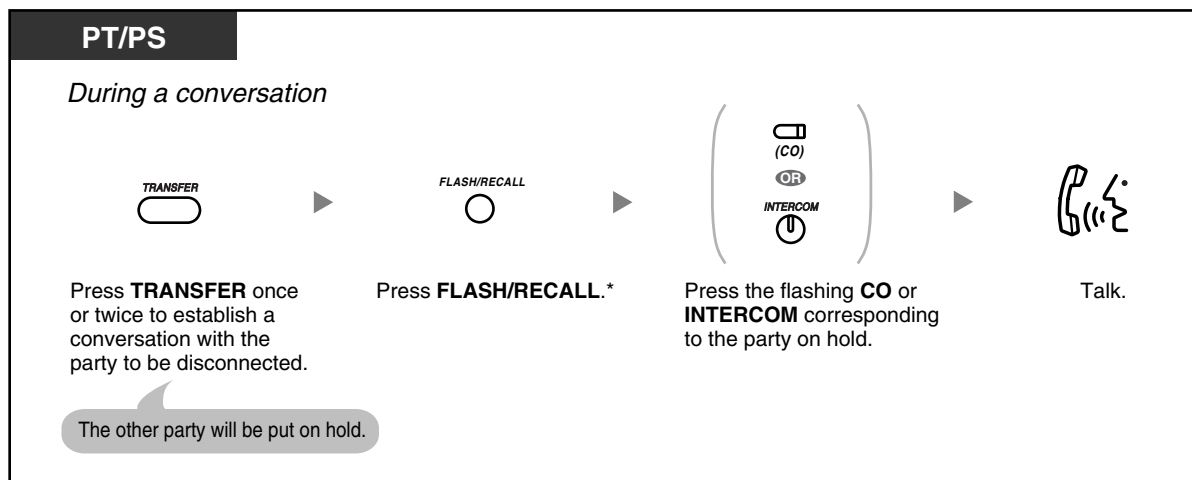

- * In this case, the FLASH/RECALL button on a proprietary telephone must be in Flash/Recall mode. For information about setting the mode of your FLASH/RECALL button, refer to the Feature Manual.
- During a three-party conversation, pressing the TRANSFER button or Recall/hookswitch alternates between the two other parties in the conversation.
- You can have a conference with a maximum of eight parties (comprising intercom or CO lines) simultaneously.
- During a conversation involving four or more parties, you cannot disconnect one party and maintain the conversation with the other parties.



Customizing Your Phone

- 3.1.4 Customizing the Buttons
Create or edit a Conference button.

◆◆ Leaving Three-party Conference

The person who originated a conference with two other parties can leave the conference, and allow the other parties to continue the conversation.

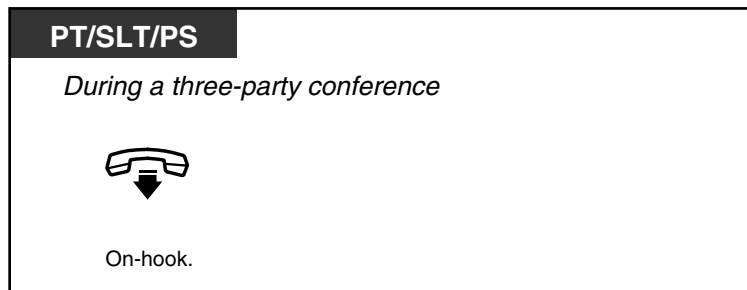

To leave a conference involving at least one other extension



To leave a conference involving two outside parties

PT/PS

During a three-party conference

Press **TRANSFER**. On-hook.

SLT

During a three-party conference

Press **Recall/hookswitch**. On-hook.



- To leave a conference call involving two outside parties and have the conversation continue, your extension must be enabled to transfer calls to CO lines through COS programming. For details, refer to the Feature Manual.

1.3.16 Conference, Unattended

The person who originated a conference can leave the conference, and allow the other parties to continue the conversation.



To leave a conference

PT/PS



During 3- to 7-party conference

Press **CONF**. On-hook.

To return while others are talking

PT/PS



(CO)

INTERCOM

Press flashing green **CO** or **INTERCOM**.

To complete a conversation

PT/PS

During a conversation



On-hook.



- Time limit**
 Both parties will hear an alarm tone before a specified timeout. The originating extension user will hear an alarm tone before timeout. The call is disconnected when the timer runs out unless the originating extension returns to the conference.



Customizing Your Phone

- 3.1.4 Customizing the Buttons
 Create or edit a Conference button.





1.3.17 Data Line Security



You can protect the line against audible notification tones, such as a call waiting tone during a conversation. Set this feature if your extension has a data communication device, such as a computer or fax machine connected to ensure secure data transmission.

To set/cancel

PT/SLT/PS

 Off-hook.

▶     ▶
 Enter ***730**.

( Set
OR
 Cancel)
 Enter **1** to set
 or **0** to cancel.

 C.Tone

 On-hook.

1.3.18 DISA (Direct Inward System Access)

- Calling through DISA

◆◆ Calling through DISA

When outside callers access extensions in the PBX, a prerecorded message greets the caller and gives information about how to access an extension. You do not need the operator's assistance.

You may be able to access system features or call an outside party with your password depending on the security mode. For more details, refer to the Feature Manual.

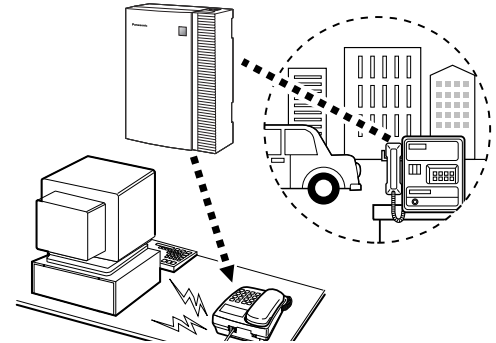

To call an extension

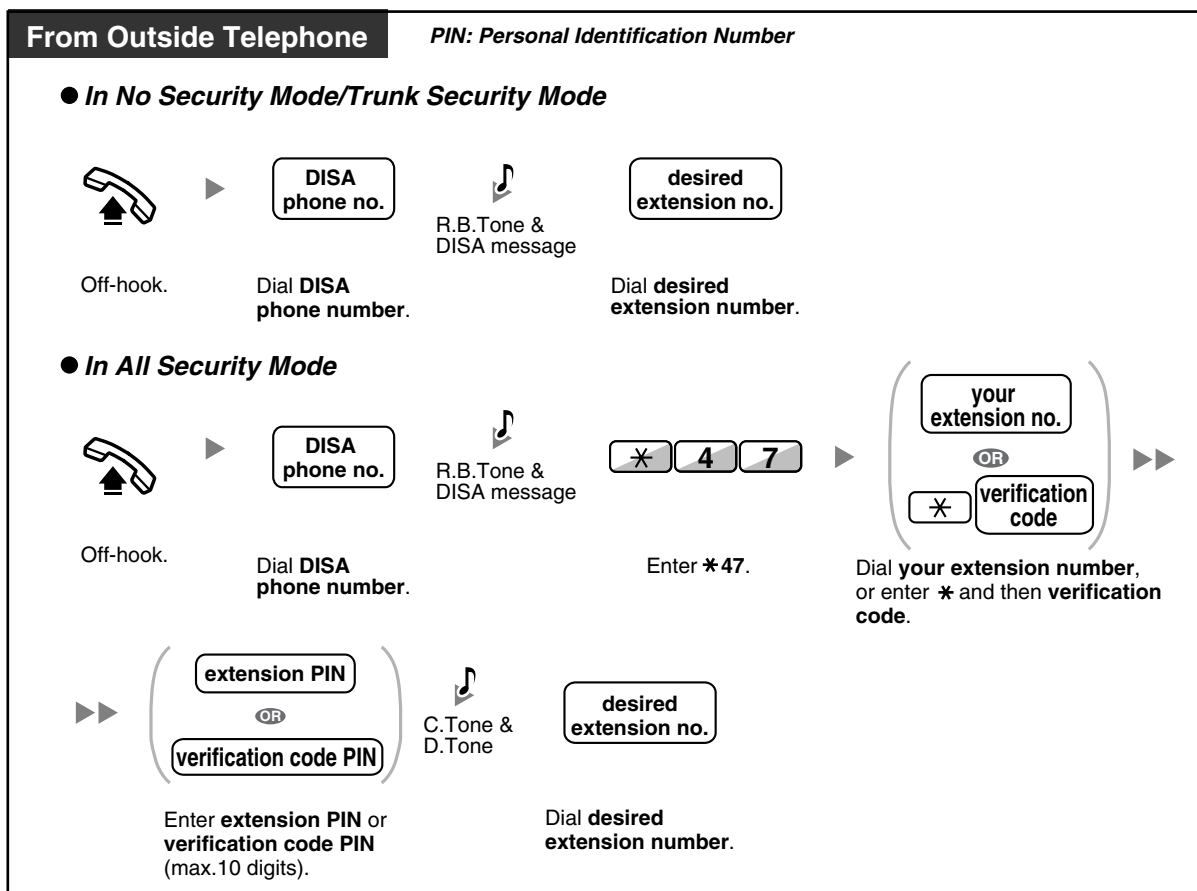

To call an outside party

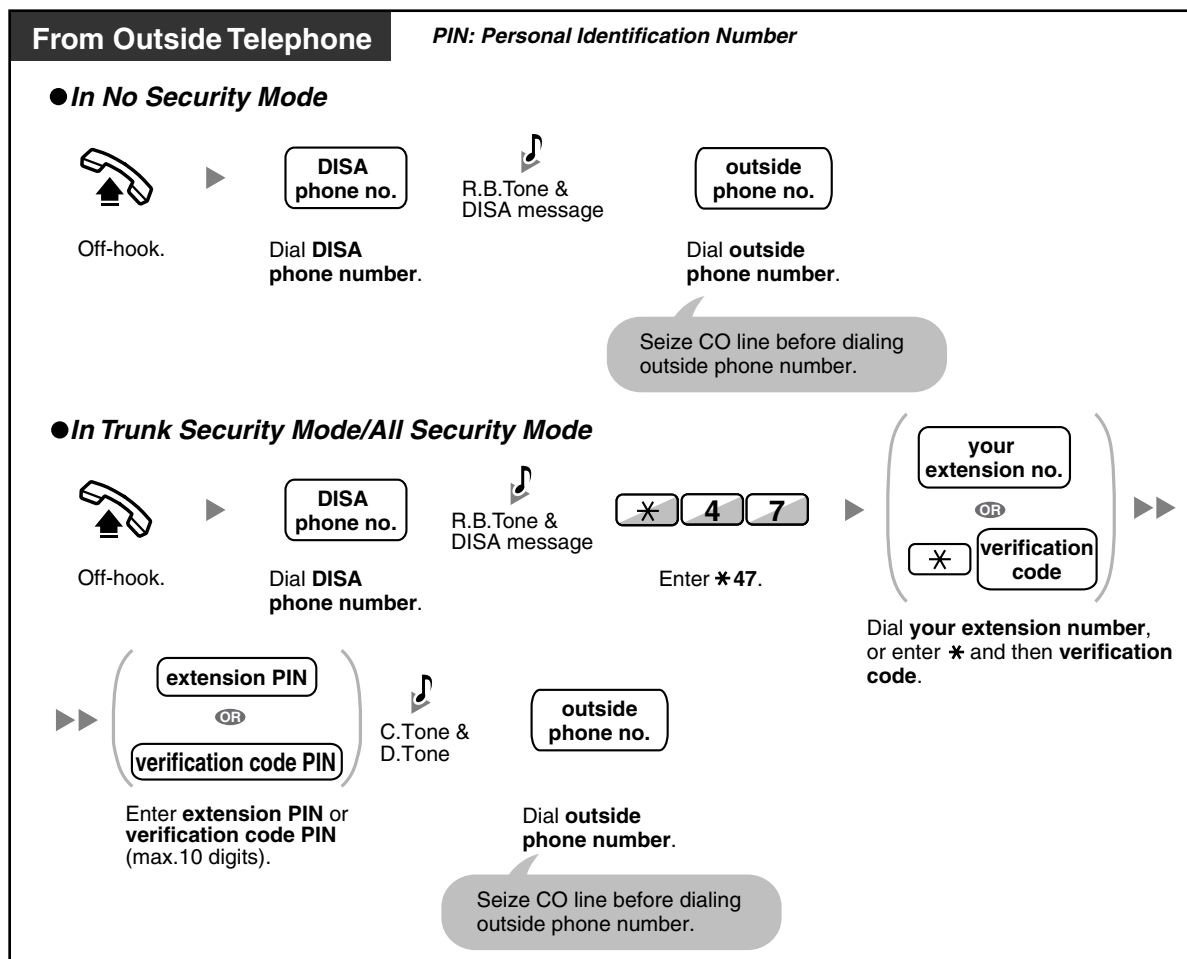

To retry

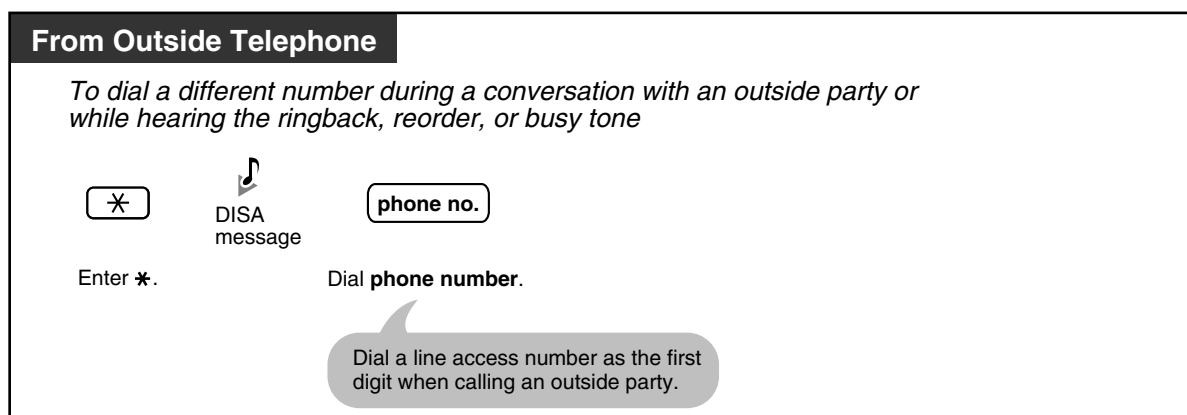



- **WARNING**
There is a risk that fraudulent telephone calls will be made using the CO-to-CO Line Call feature of DISA.
The cost of such calls will be billed to the owner/renter of the PBX.
To protect the PBX from this kind of fraudulent use, we strongly recommend:
 - a) Enabling DISA security (CO Line Security or All Security).
 - b) Keeping your passwords (verification code PIN/extension PIN) secret.
 - c) Selecting complex, random PINs that cannot be easily guessed.
 - d) Changing PINs regularly.
- **Time limit**
Both parties will hear an alarm tone fifteen seconds before the specified time limit. To extend, press any dial button except *.
- **If Built-in Automated Attendant service is set**, you can access the desired extension simply by pressing a single digit (0–9) from the options given the prerecorded message.

1.3.19 DND (Do Not Disturb)

- DND (Do Not Disturb)
- DND Override
- Switching FWD/DND Status Using Fixed FWD/DND Button

◆◆ DND (Do Not Disturb)

You can set this feature to prevent incoming calls from ringing at your extension. This can be useful, for example, when you are in a meeting or busy.

To set/cancel

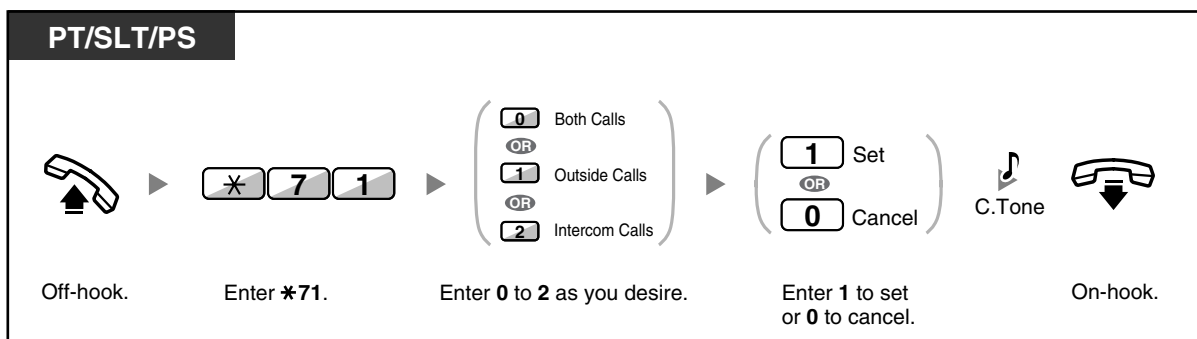

- When using a proprietary telephone, you can set or cancel DND by pressing the FWD/DND button (fixed button) instead of "*710".



- The FWD/DND button light shows the current status as follows:
Off: Both features are not set.
Flashing red slowly: FWD mode
Red on: DND mode
- The system has two modes: (1) FWD/DND Cycle Switch Mode and (2) FWD/DND Setting Mode. Ask your manager what mode your system is in if you are not sure.

(1) When in FWD/DND Cycle Switch Mode:

Pressing the FWD/DND button (fixed button) while in idle status will cycle the setting as shown below:



(2) When in FWD/DND Setting Mode:

Pressing the FWD/DND button (fixed button) while in idle status allows you to switch the FWD/DND status and set the FWD destination (refer to "Switching FWD/DND Status Using Fixed FWD/DND Button").

Note

A FWD/DND button (customized button) is always in FWD/DND Cycle Switch Mode: the mode cannot be changed.

- If your extension has set this feature, a calling extension will hear DND tone.
- If this feature is set, the Call Forwarding (FWD) feature does not work.
- Specified extensions can override this feature and call DND extensions (DND Override).
- When intercom calls are set to be handled differently from outside calls (DND set/cancel), we recommend establishing buttons for both FWD/DND—Outside calls and FWD/DND—Intercom calls, because:
 - a) the light patterns of the FWD/DND—Both calls button (including FWD/DND button [fixed button]) will indicate the setting for either outside calls or intercoms calls, but not both.

Note

The DND icon on PS display reflects the setting for outside calls only.

- b) pressing the FWD/DND—Both calls button (including FWD/DND button [fixed button]) will not change the FWD or DND mode for intercom calls and outside calls separately.



Customizing Your Phone

- 3.1.4 Customizing the Buttons
Create or edit FWD/DND (Both calls, Outside calls, Intercom calls) buttons.

◆◆ DND Override

The preprogrammed extension can call someone who has set the DND feature.

To call

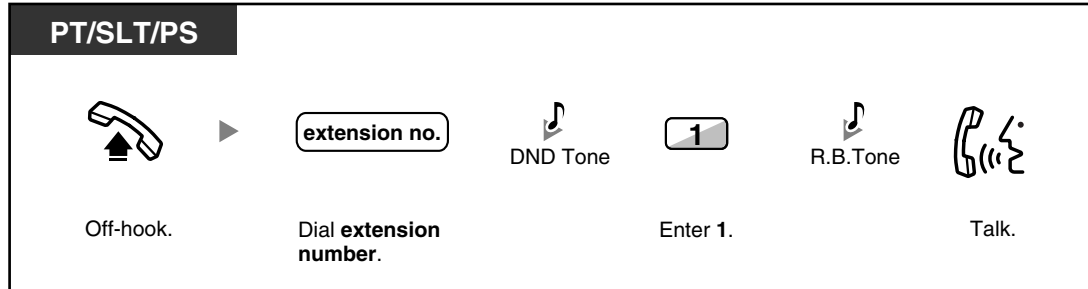

◆◆ Switching FWD/DND Status Using Fixed FWD/DND Button

Using a proprietary telephone (PT), you can easily switch the FWD/DND status for outside/intercom calls without clearing any FWD destination that was set previously.



To switch the FWD/DND status for outside calls

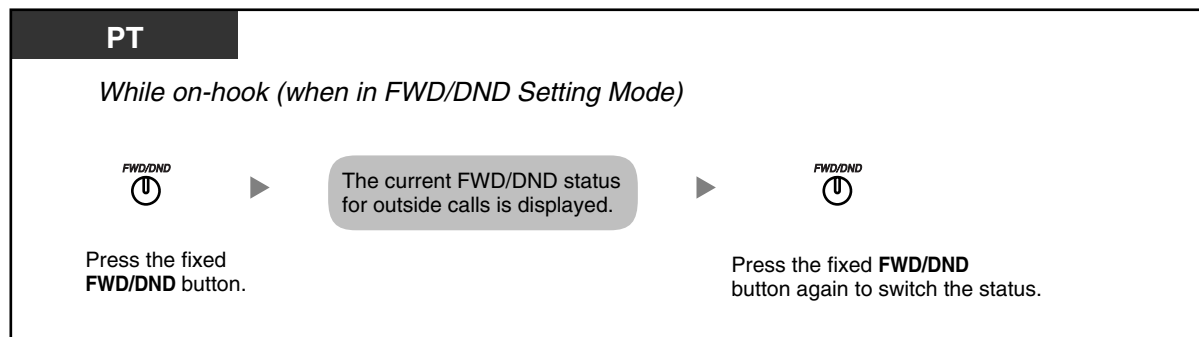

To switch the FWD/DND status for intercom calls

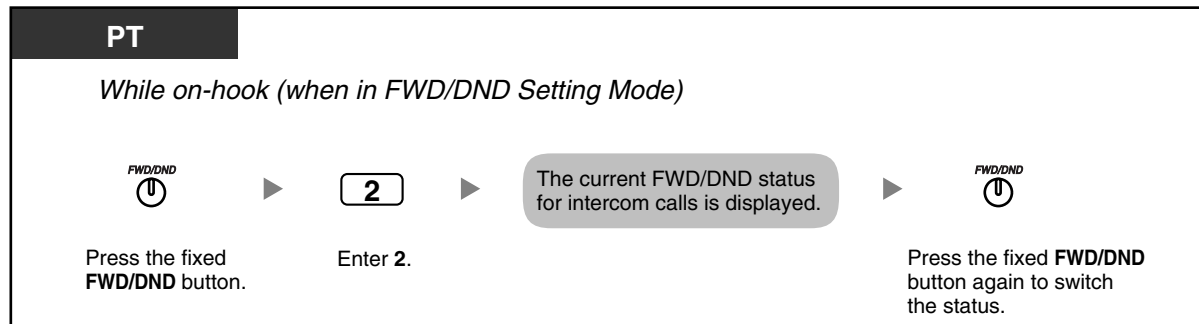

To set and clear FWD/DND for outside/intercom calls

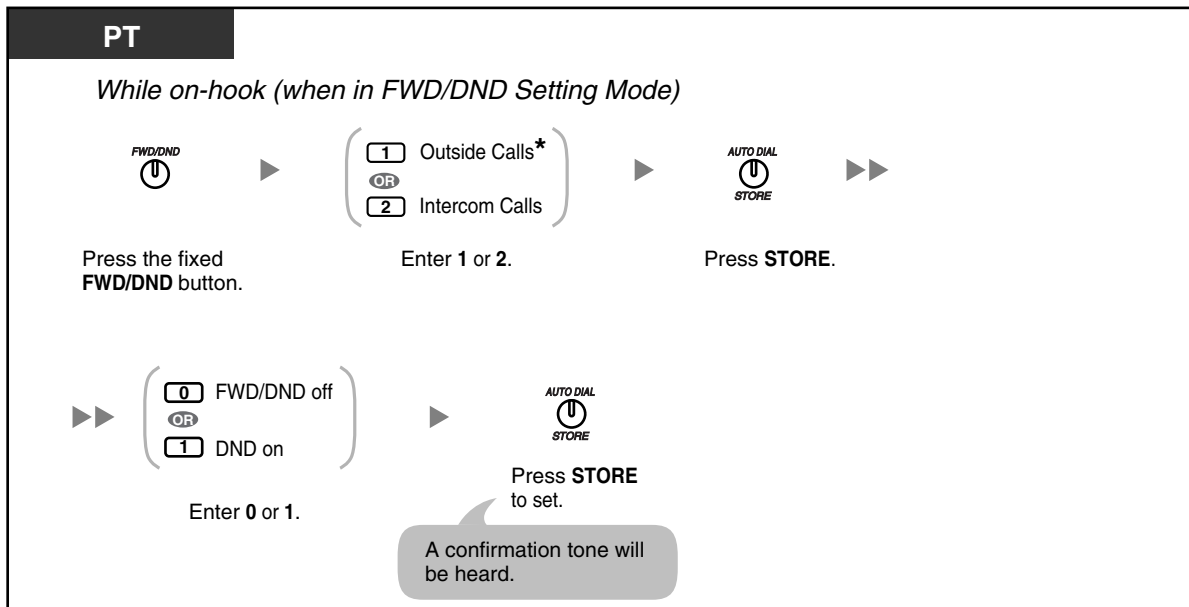

- * This step can be omitted.

1.3.20 Door Open

A preprogrammed extension can open a door from the extension.

From a preprogrammed extension

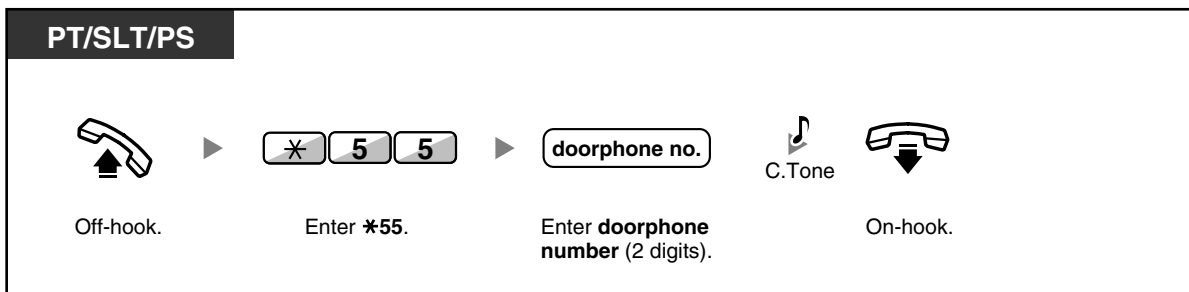

From any extension while talking to the doorphone

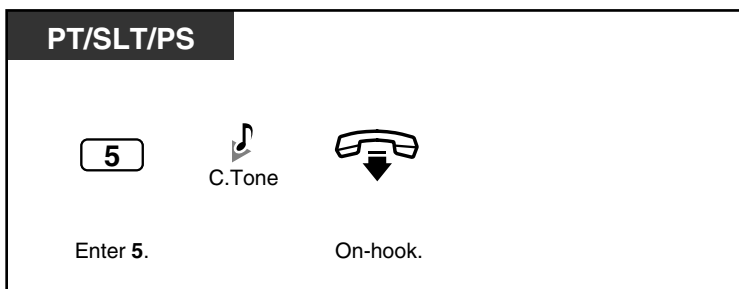



- The door open will be triggered for a specified time period.

1.3.21 Doorphone Call

Preprogrammed extensions or an outside party can receive a call from a doorphone, and talk to the person through the doorphone.

To call from the doorphone

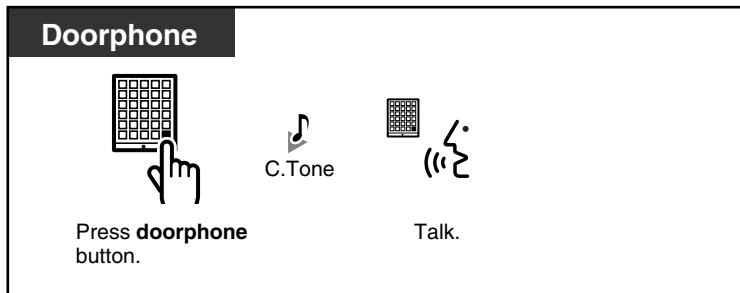

To answer a call from the doorphone



To call the doorphone

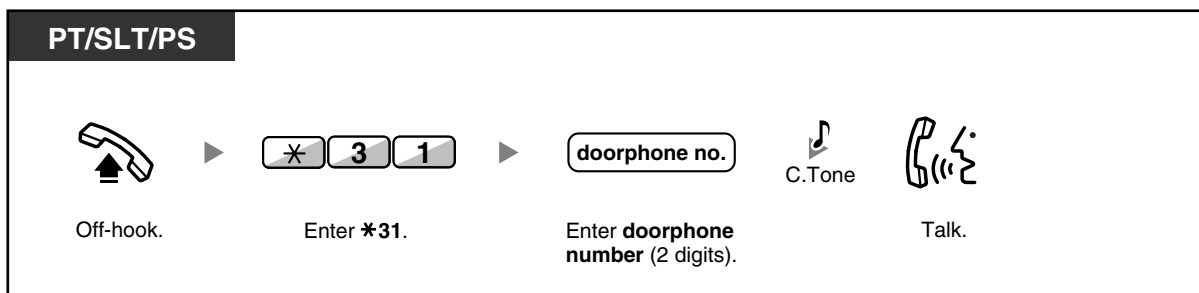

- If no one answers a doorphone call within a specified time period, the call is canceled.

1.3.22 EFA (External Feature Access)

You can access special features (e.g., Call Waiting) offered by a host PBX or telephone company. This feature is only effective for an outside call.

<Example> To hold the current call and then talk to the new party

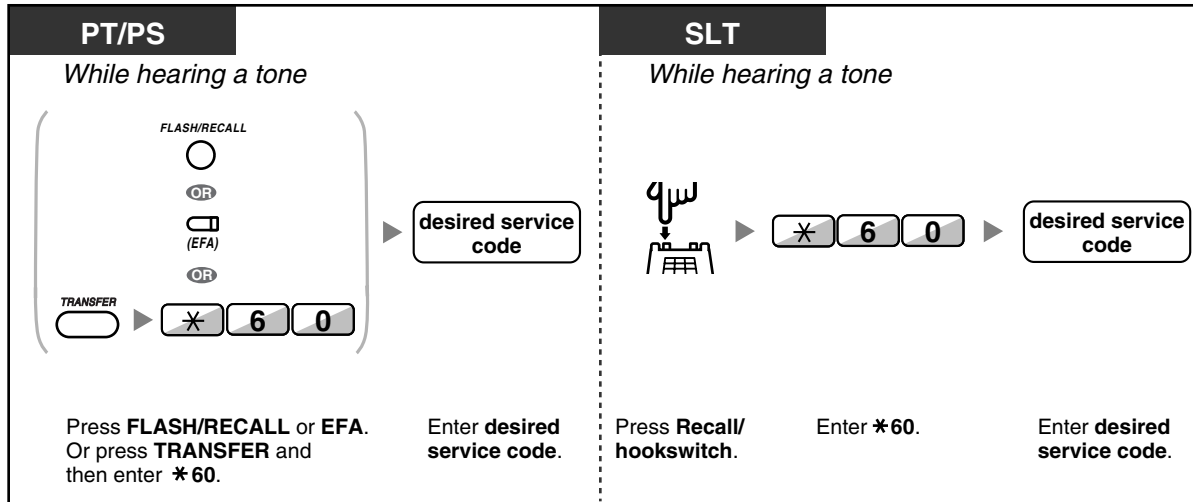

- In this case, the FLASH/RECALL button on a proprietary telephone must be in External Feature Access (EFA) mode. For information about setting the mode of your FLASH/RECALL button, refer to the Feature Manual.
- Regarding the service code, refer to the Feature Manual.



Customizing Your Phone

- 3.1.4 Customizing the Buttons
Create or edit an External Feature Access (EFA) button.

1.3.23 Executive Busy Override

- Executive Busy Override
- Executive Busy Override Deny

◆◆ Executive Busy Override

A preprogrammed extension can call someone who is busy on the telephone and establish a three-party conversation.

To join an intercom call

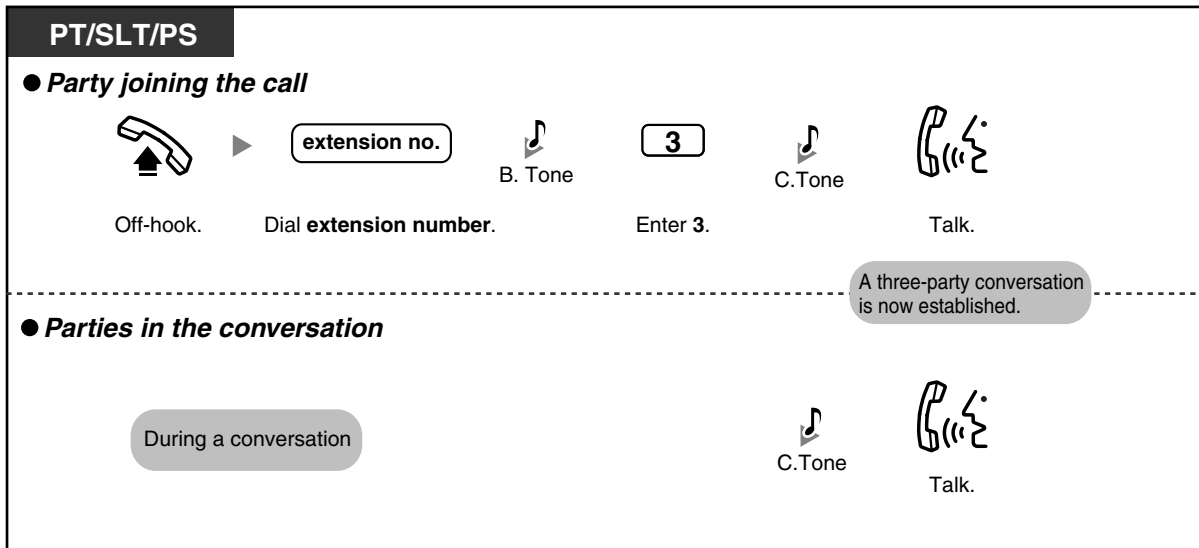

To join an outside call

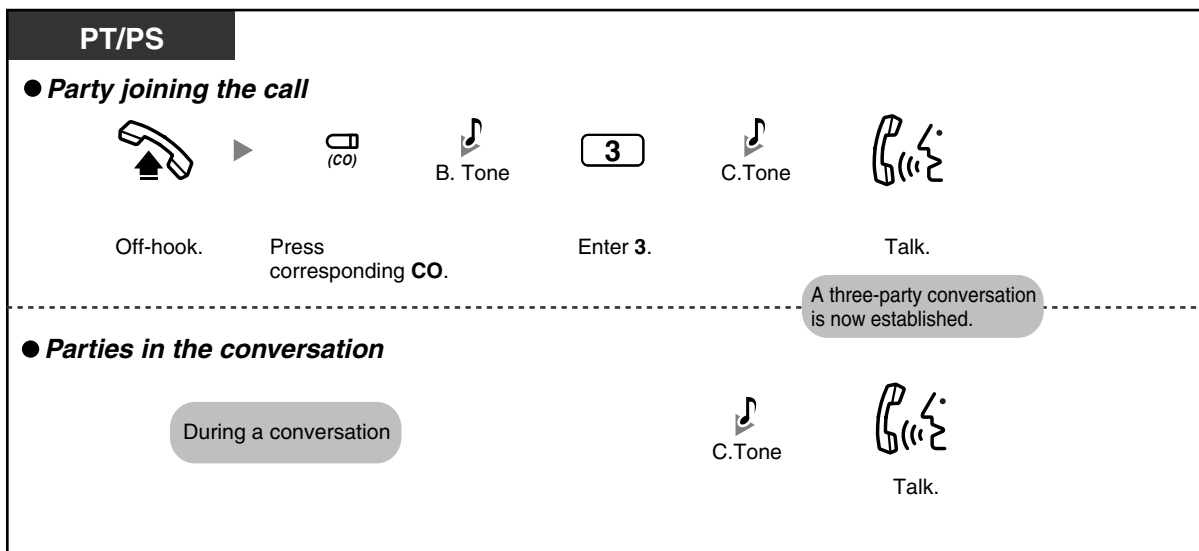

- To join another conversation, you must have Executive Busy Override enabled at your extension. For more details, refer to the Feature Manual.
- It is possible for an originating extension to leave a three-party conversation with an outside party and let the two other parties talk by simply going on-hook.

◆ For the originating extension

To talk to each party alternately

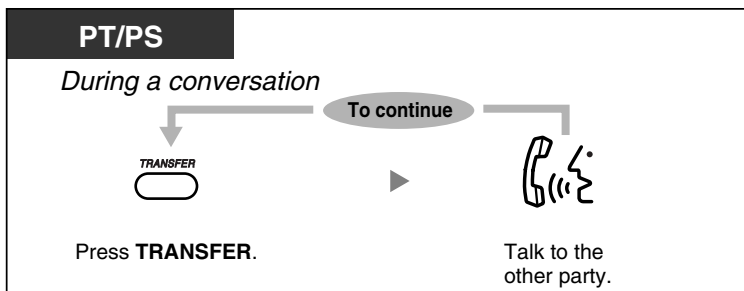

◆◆ **Executive Busy Override Deny**

A preprogrammed extension user can prevent his calls from being interrupted by another extension user (Default: Allow other users to interrupt calls).

To set

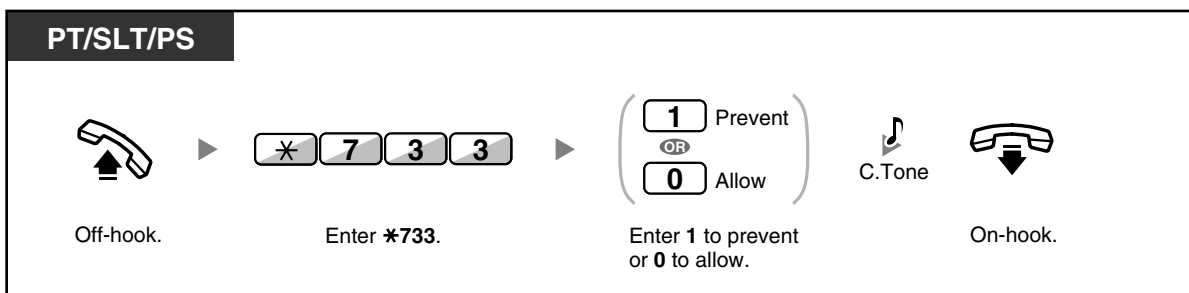

1.3.24 Extension Dial Lock

You can lock your extension so that other users cannot make inappropriate outside calls. This feature is also known as Electronic Station Lockout.

To lock

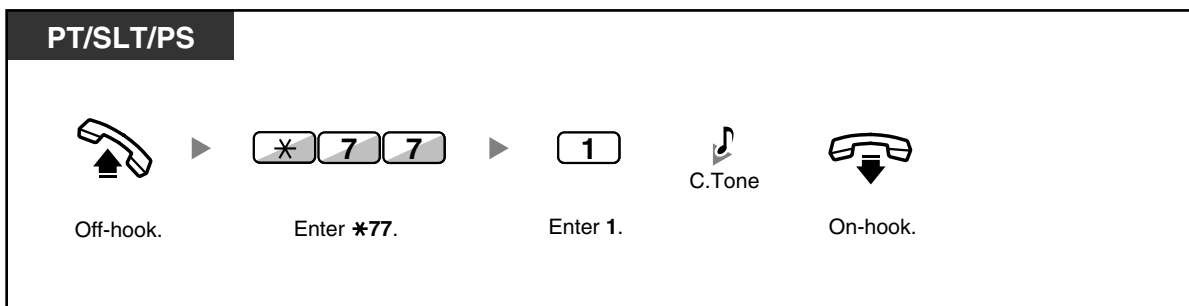

To unlock

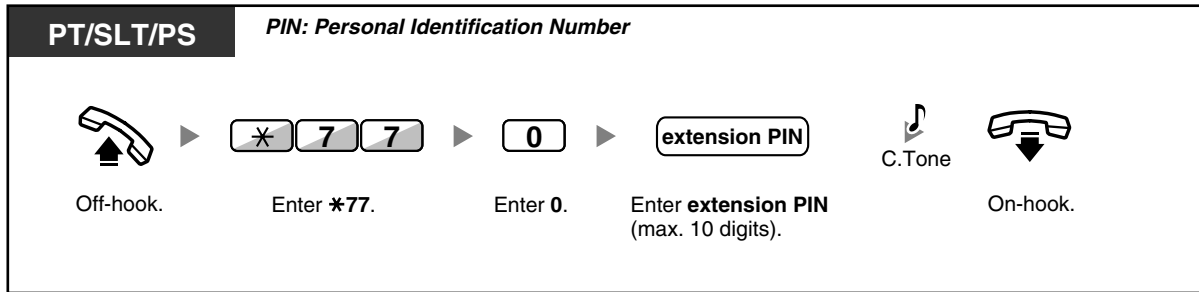

- **If you forget the extension PIN or cannot unlock your extension**, consult your manager. The manager can clear your extension PIN, or unlock your extension. Then, you can set the new PIN and unlock your extension by entering it.
- If your extension is locked by this feature, it cannot perform the following operations:
 - Making outside calls
 - Changing the call forwarding destination
- If you do not set extension PIN, you cannot lock and unlock your extension.

To make an outside call while your extension is locked

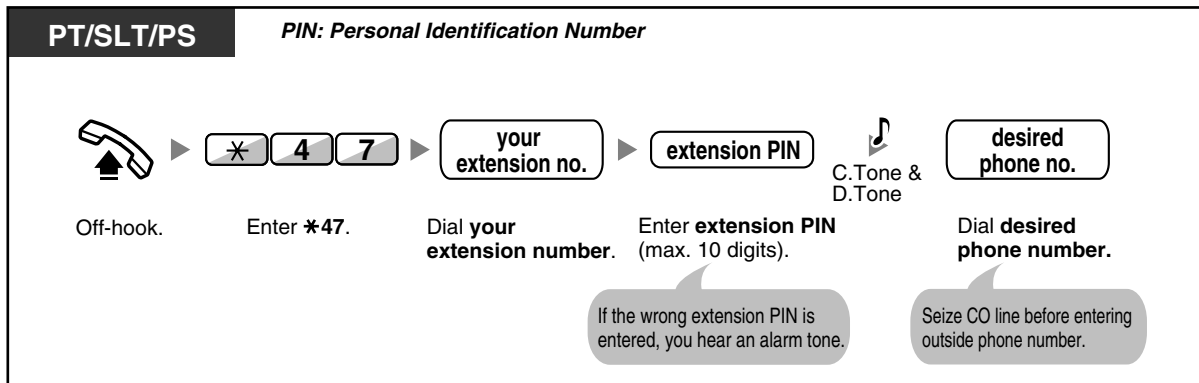

- After you make an outside call, Extension Dial Lock is automatically activated again.

1.3.25 Extension Feature Clear

You can reset the settings of the following features on your extension to the default settings with one operation.

This feature is also known as Station Program Clear.

Features	Default Setting
Hot Line*	Off
Message Waiting—(All the messages that have been left by other extension users)	Off
Call Pickup Deny	Allow
Call Forwarding (FWD)*	Off

Features	Default Setting
Absent Message	Off
Paging Deny	Allow
Timed Reminder	Cleared
Do Not Disturb (DND)*	Off
Call Waiting*	Enable—Tone
Executive Busy Override Deny	Allow
BGM	Off
Data Line Security	Off
Log-in/Log-out	Log-in

* These features may not be reset, depending on system programming.

To reset

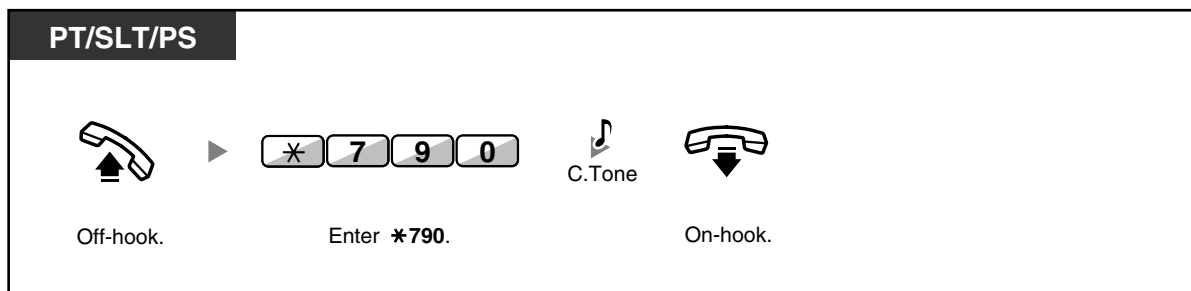

- After performing Extension Feature Clear, the setting of Call Waiting becomes "Enable—Tone". In this case, dial tone 2 will be heard when you go off-hook.

1.3.26 Extension PIN (Personal Identification Number)

You can assign a password to each extension.
The following features require an extension PIN.

1. Screening calls (1.3.53 Voice Mail Features—LCS (Live Call Screening))
2. Prohibiting other people from seeing your personal speed dialing directory, call log, and SVM log (Display Lock)
3. Using the same settings as your extension at other extensions (1.3.58 Walking Extension)
4. Remote Control Operation (1.3.57 Walking COS)
5. Extension Dial Lock Clear

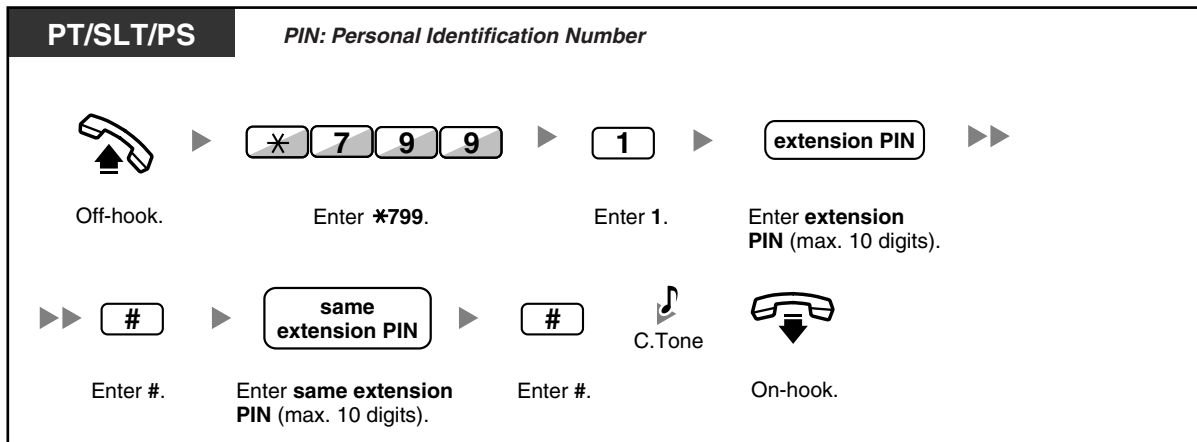
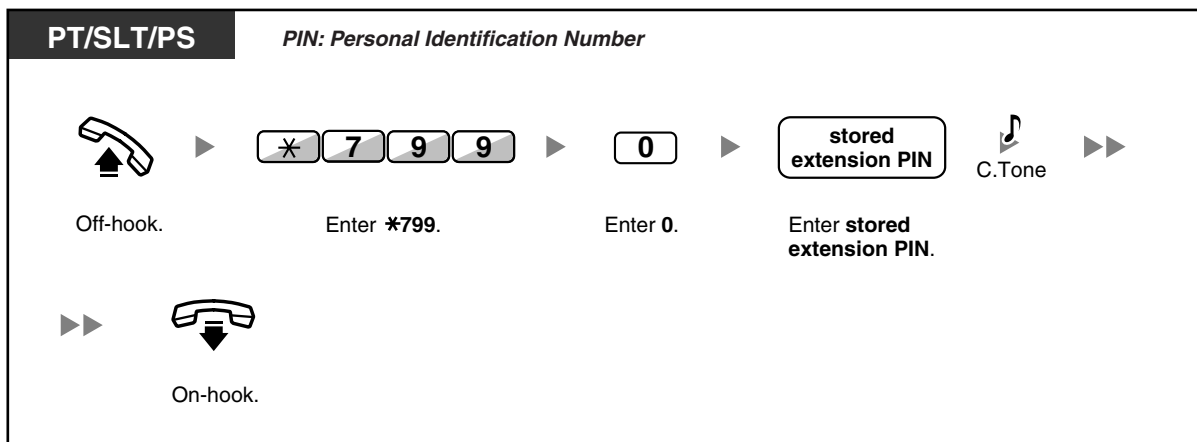
To set**To cancel**

- **WARNING**
 There is a risk that fraudulent telephone calls will be made if a third party discovers your password (extension PIN).
 The cost of such calls will be billed to the owner/renter of the PBX.
 To protect the PBX from this kind of fraudulent use, we strongly recommend:
 - a) Keeping your PIN secret.
 - b) Selecting a complex, random PIN that cannot be easily guessed.
 - c) Changing your PIN regularly.
- Valid numbers for an extension PIN are "0" through "9".
- If the wrong extension PIN is entered for a preprogrammed number of times, the PIN is locked.
- If you forget your extension PIN or your extension PIN is locked, your manager can clear the extension PIN and extension PIN lock.

1.3.27 External Relay

Preprogrammed extensions can switch on a relay (e.g., alarm) connected to the PBX.

To switch on the relay

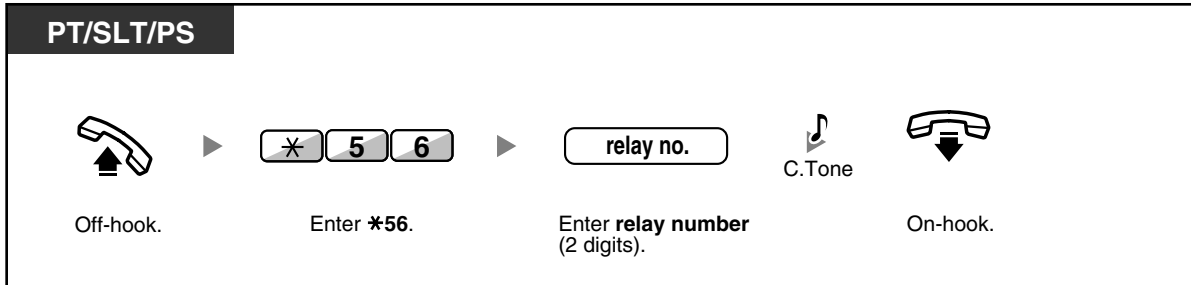

- The relay will be switched off after a specified time period.

1.3.28 External Sensor

Preprogrammed extensions can receive an alert call from an external sensor (e.g., security alarm) connected to the PBX.

To answer a sensor call

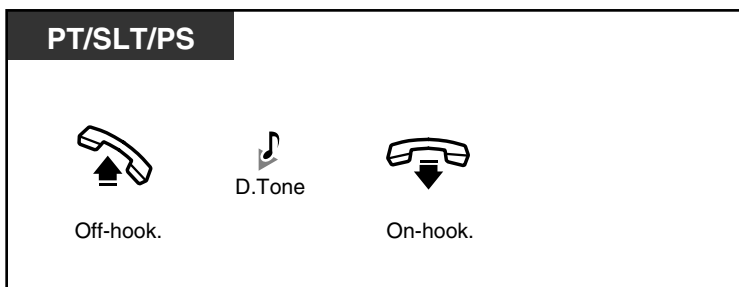

- If you do not answer a sensor call within a specified time period, the sensor call will stop.

1.3.29 FWD (Call Forwarding)

- FWD (Call Forwarding)
- FWD/DND Settings Using Fixed FWD/DND Button

◆◆ FWD (Call Forwarding)

You can have your incoming calls forwarded to a specified destination.

All Calls:

All calls are forwarded. Preset extensions may also forward from their own receiving group.

Busy:

All calls are forwarded when your extension is busy.

No Answer:

All calls are forwarded when you do not answer the call within a specified time period.

Busy/No Answer (BSY/NA):

All calls are forwarded when you do not answer within a specified time period or when your extension is busy.

Follow Me (From):

If you fail to set the above-mentioned "All Calls" to forward before you leave your desk, you can set the same feature from the destination extension.

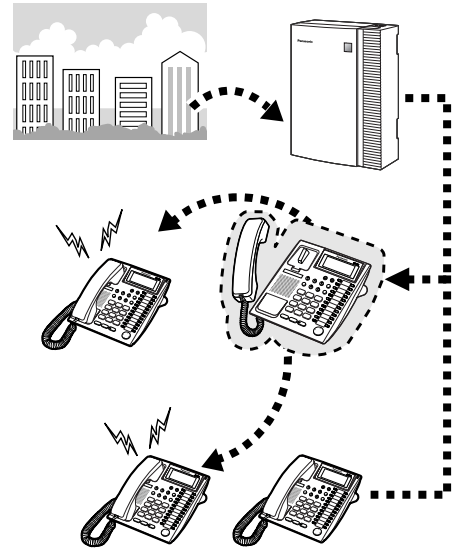

- You can set the floating extension number of a voice mail group or the SVM card as a forward destination.
- Incoming calls can be forwarded up to four times.
- **Boss & Secretary feature**
The extension which has been set as the destination can call the forwarding extension.

<Example>

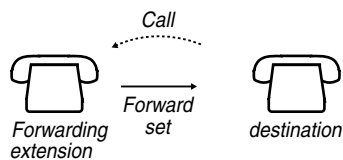

To set/cancel

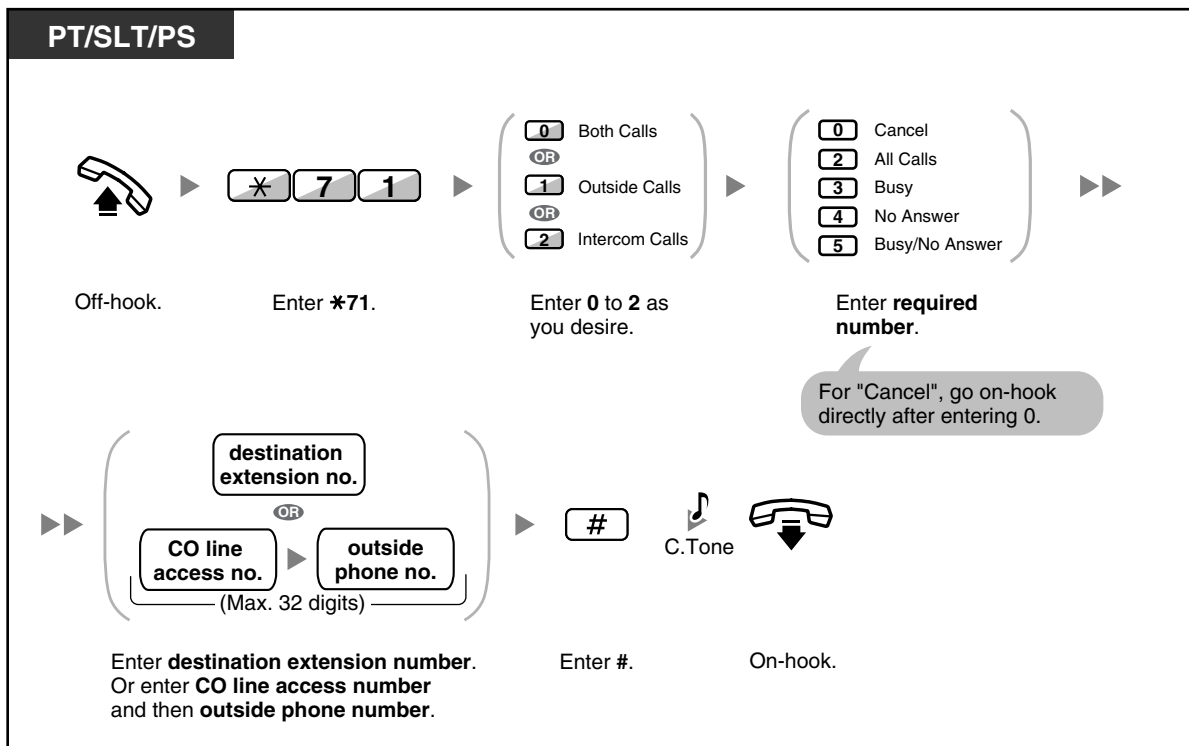

To set from another extension

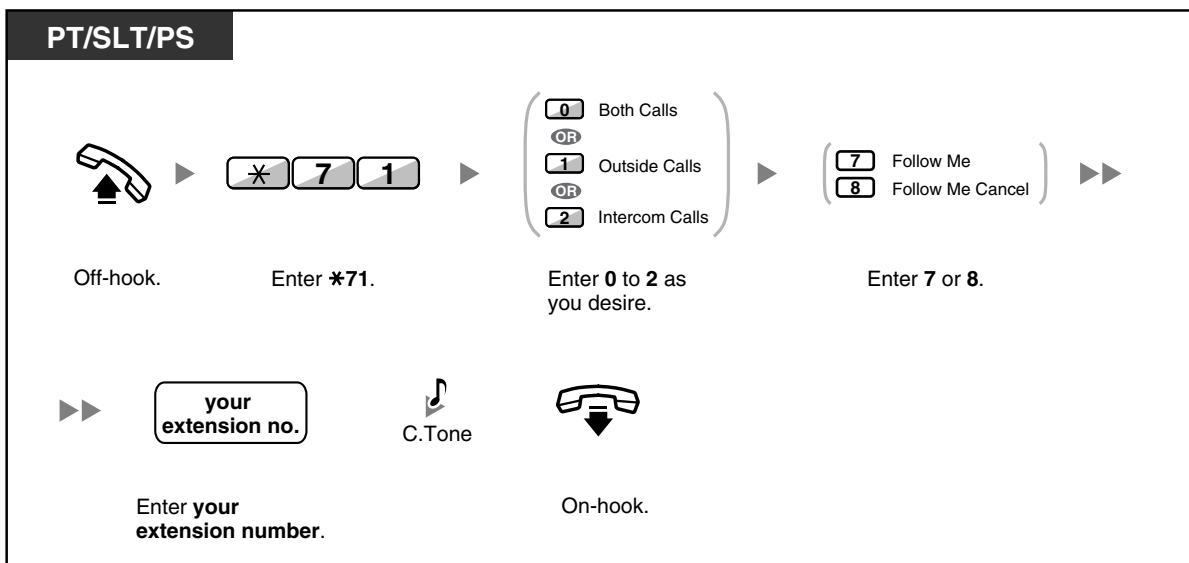

- When using a proprietary telephone, you can set or cancel Call Forwarding by pressing the FWD/DND button (fixed button) instead of "*710".

To set the timer for "No Answer" and "Busy/No Answer"

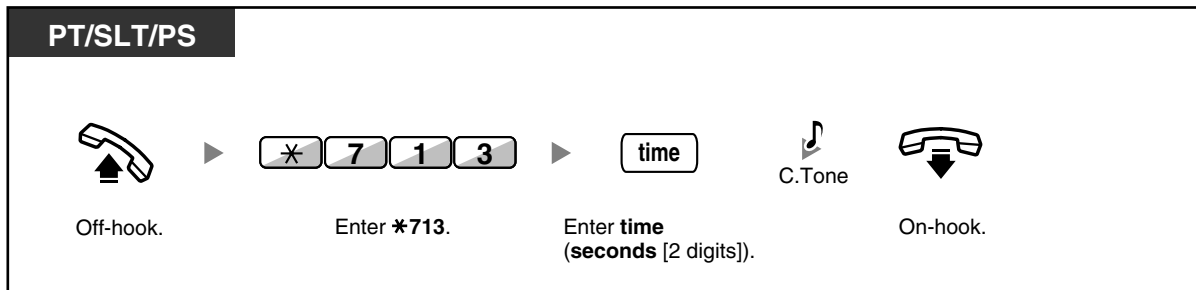

Call Forwarding (FWD) for your Incoming Call Distribution Group

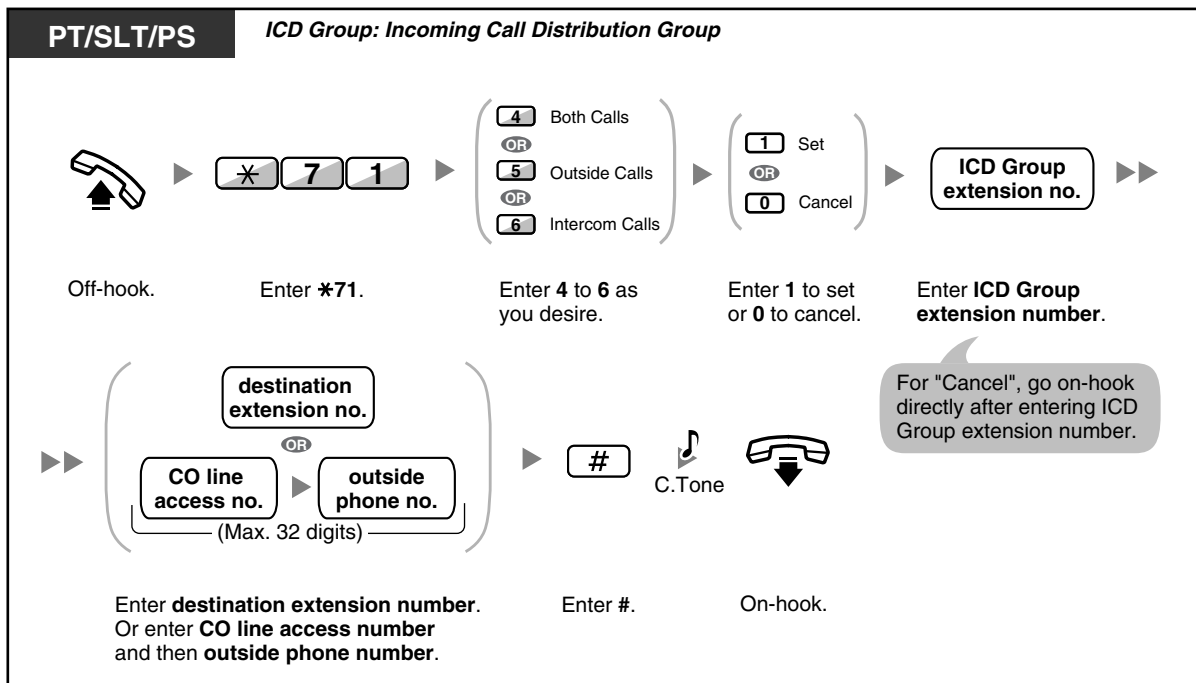

- The FWD/DND button light shows the current status as follows:
Off: Both features are not set.
Flashing red slowly: FWD mode
Red on: DND mode
- The Group FWD button light shows the current status as follows:
Off: No set
Flashing red slowly: FWD mode

- The system has two modes: (1) FWD/DND Cycle Switch Mode and (2) FWD/DND Setting Mode. Ask your manager what mode your system is in if you are not sure.

(1) When in FWD/DND Cycle Switch Mode:

Pressing the FWD/DND button (fixed button) while in idle status will cycle the setting as shown below:



(2) When in FWD/DND Setting Mode:

Pressing the FWD/DND button (fixed button) while in idle status allows you to switch the FWD/DND status and set the FWD destination (refer to "FWD/DND Settings Using Fixed FWD/DND Button").

Note

A FWD/DND button (customized button) is always in FWD/DND Cycle Switch Mode: the mode cannot be changed.

- Transferred outside calls are also forwarded to the destination assigned for outside calls.
- When intercom calls are set to be handled differently from outside calls (forwarding type, forward destination), we recommend establishing buttons for both FWD/DND—Outside calls and FWD/DND—Intercom calls, and/or Group FWD—Outside calls and Group FWD—Intercom calls, because:
 - the light patterns of the FWD/DND—Both calls button (including FWD/DND button [fixed button]) and the Group FWD—Both calls button will indicate the setting for either outside calls or intercom calls, but not both.

Note

The FWD icon on PS display reflects the setting for outside calls only.

- pressing the FWD/DND—Both calls button (including FWD/DND button [fixed button]) or the Group FWD—Both calls button will not change the FWD or DND mode for intercom calls and outside calls separately.



Customizing Your Phone

- 3.1.4 Customizing the Buttons
Create or edit FWD/DND (Both calls, Outside calls, Intercom calls) buttons, or Group FWD (Both calls, Outside calls, Intercom calls) buttons.

◆◆ FWD/DND Settings Using Fixed FWD/DND Button

Using a proprietary telephone (PT), you can easily switch the FWD/DND status, and set the forward destination for outside/intercom calls without clearing any FWD destination that was set previously.

The following settings are available:



- Switching the FWD/DND status and setting FWD destination for outside/intercom calls
- Timer for "No Answer" and "Busy/No Answer"

To switch FWD/DND status for outside calls

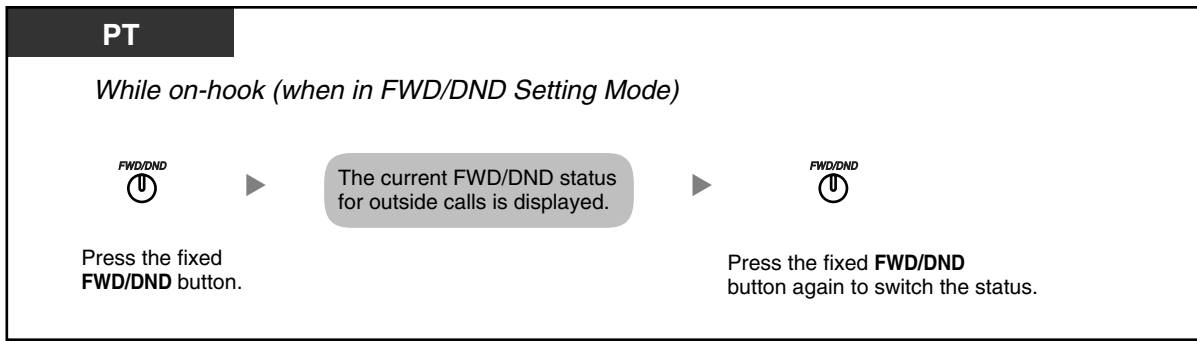

To switch FWD/DND status for intercom calls

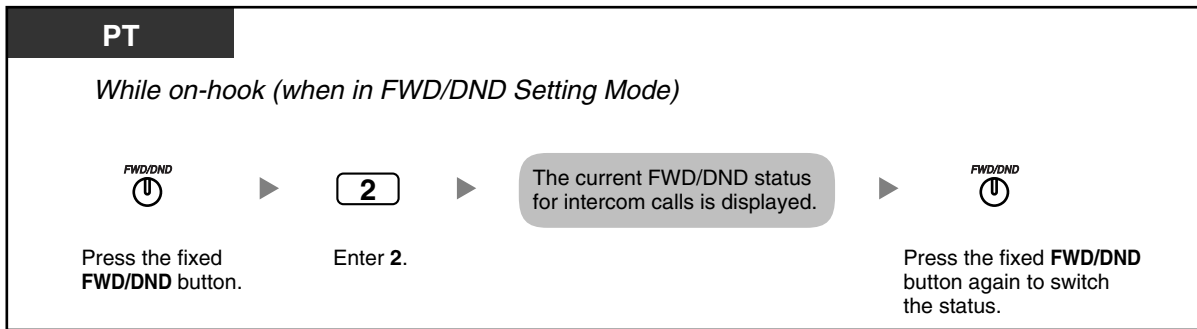

To set and clear FWD/DND for outside/intercom calls

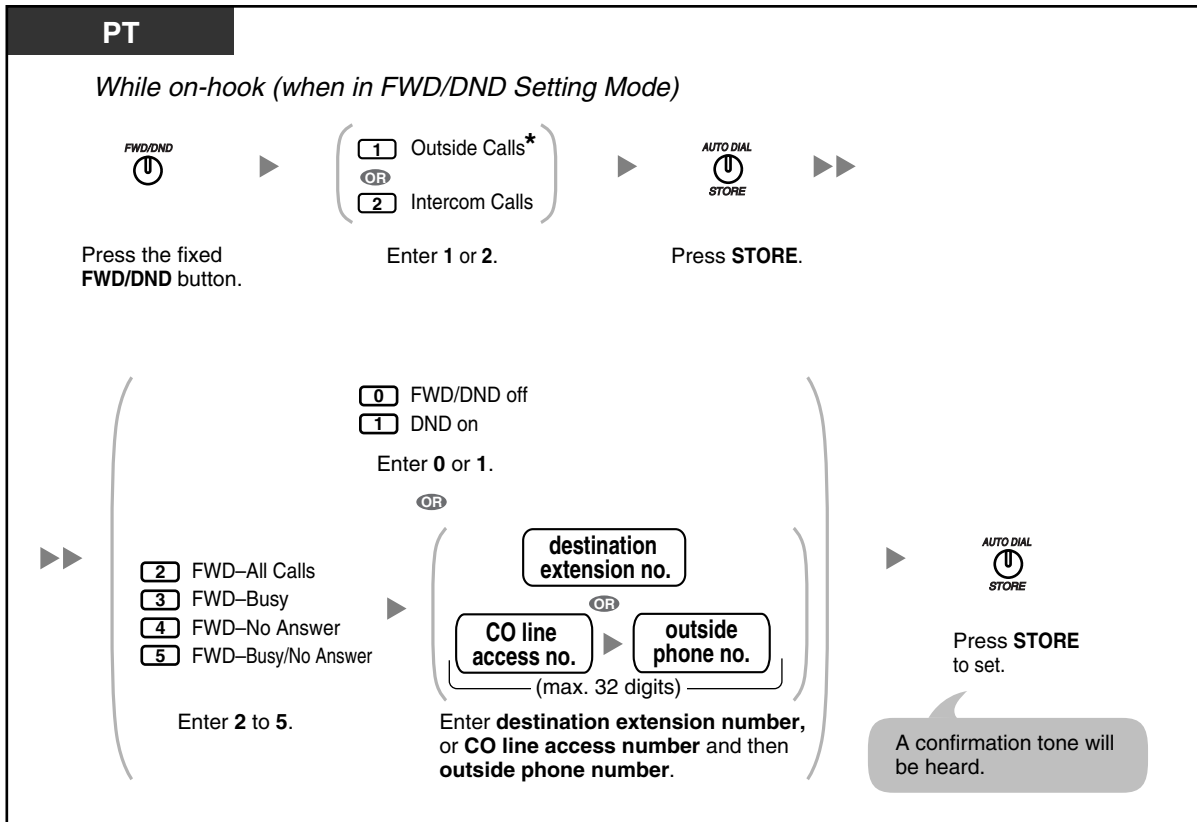



- * This step can be omitted.

To set the timer for "No Answer" and "Busy/No Answer"

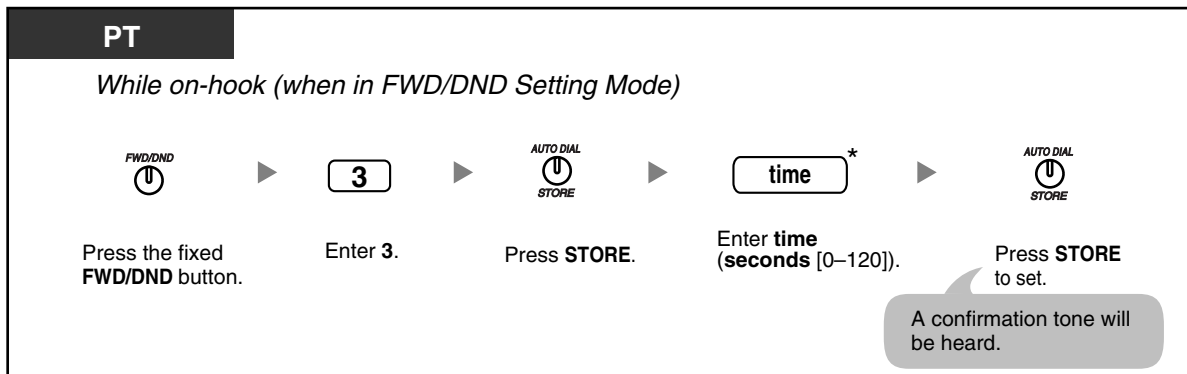

- * You can enter the time as a 1–3 digit number. For example, 15 seconds can be entered as "15" or "015".

1.3.30 Hands-free Answerback

You can answer an incoming call without going off-hook as soon as the line is connected. When an intercom call arrives, you will hear the caller talking without the phone ringing. When an outside call arrives, you will hear the caller talking after a preprogrammed number of rings. Hands-free Answerback for outside calls requires System Programming. For more details, refer to the Feature Manual.



To set/cancel



- The AUTO ANS button light shows the current status as follows:
 - Off:** Not set
 - Red on:** Set
- PS users: Refer to "Operating Instructions" for PS.

1.3.31 Hands-free Operation

You can have a conversation in hands-free mode using the SP-PHONE button.



To make/answer a call

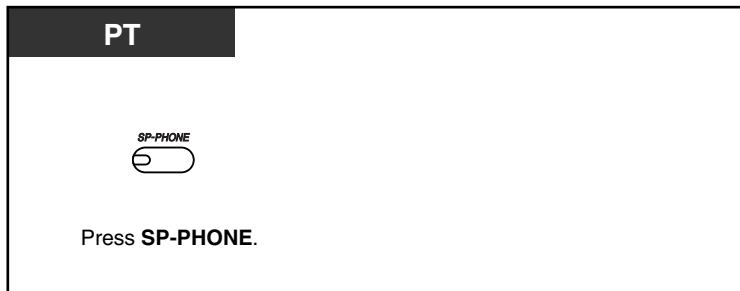

- When performing hands-free operation:
 - **If it is difficult to hear the other party's voice,**
Increase the volume using the Navigator Key or Volume Key.
 - **If the other party has difficulty hearing you,**
Decrease the volume.
 - **If the other party reports that your voice echoes,**
Use the telephone in a room that has curtains, carpeting or both.
 - **If parts of the conversation cannot be heard,**
If you and the other party speak at the same time, parts of your conversation may be lost.
To avoid this, try to speak alternately.

1.3.32 Headset Operation

- Headset Operation
- Answer/Release Button

◆◆ Headset Operation

You can have a conversation using a headset.



To talk using the headset

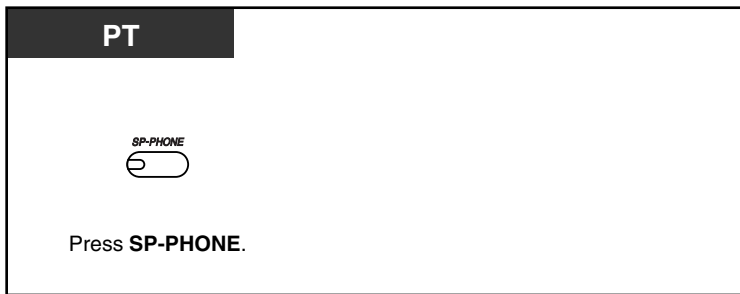

To use the handset during a conversation using the headset

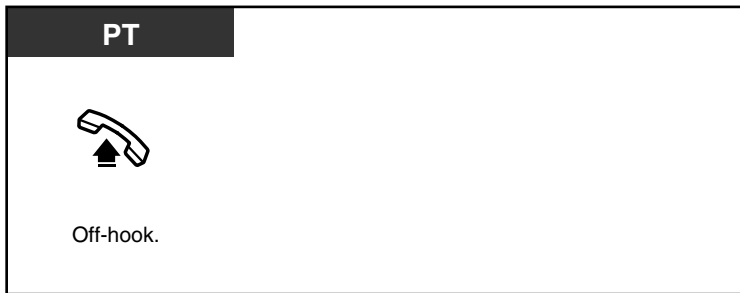

◆◆ Answer/Release Button

Customized Answer and Release buttons can make using a headset much easier. You can answer incoming calls or disconnect the line with these buttons. Some DSS Consoles have fixed ANSWER and RELEASE buttons.



To answer



To transfer a call

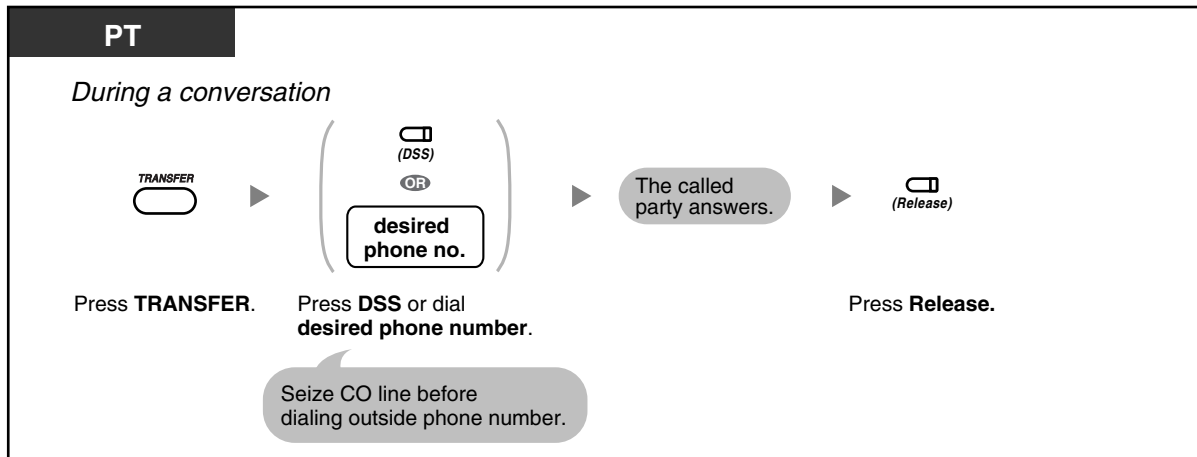

To talk to a waiting caller

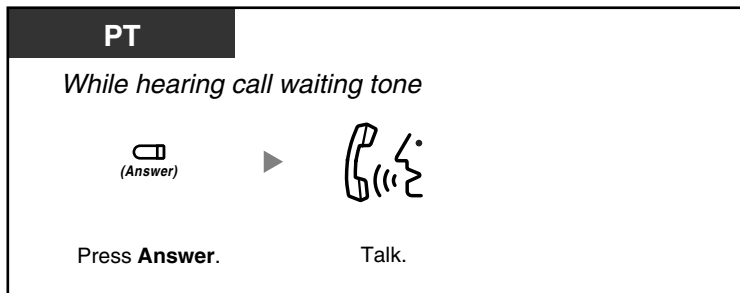

To transfer an outside call to an extension with a one-touch operation

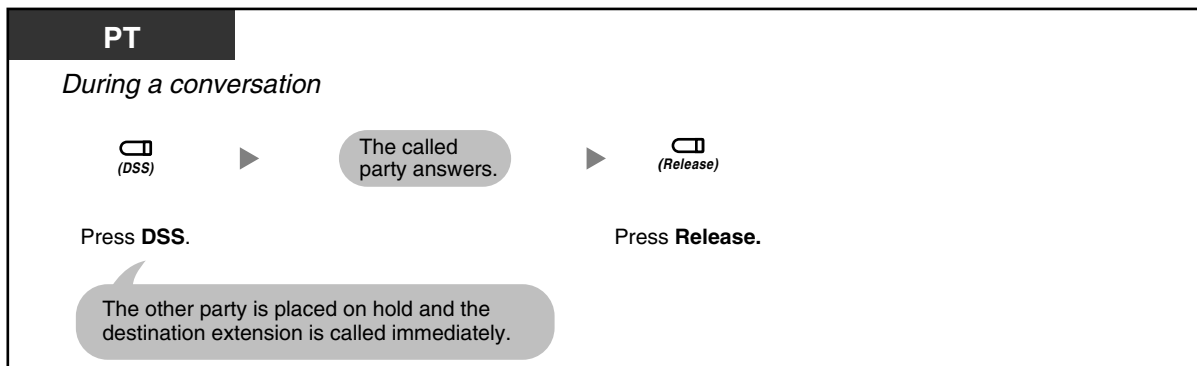

To end a conversation

PT

During a conversation



(Release)

Press **Release**.



Customizing Your Phone

- 3.1.4 Customizing the Buttons
Create or edit an Answer button or a Release button.

1.3.33 Hot Line





You can make an outside call simply by going off-hook if you have preprogrammed your phone. This feature is also known as Pickup Dialing.

To store a phone number

PT/SLT/PS



Off-hook.

▶    

Enter *740.

▶ 

Enter 2.

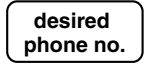
▶ 

Enter **desired phone number** (max. 32 digits).

▶ 

Enter #.

▶  C.Tone

▶ 

On-hook.





Enter CO line access number before outside phone number.

To set/cancel



PT/SLT/PS



Off-hook.

▶    

Enter *740.

▶  Set
OR
 Cancel

Enter 1 to set or 0 to cancel.

▶  C.Tone

▶ 

On-hook.

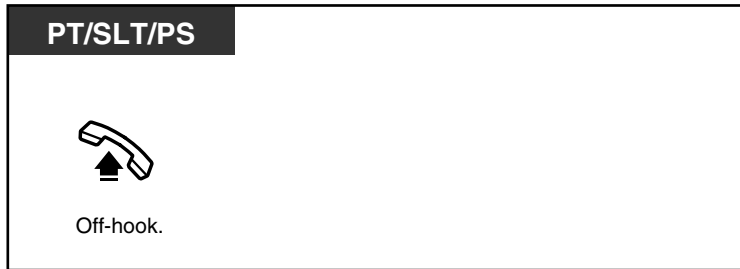
To dial

- **To call another party**, dial the desired party's phone number before the preprogrammed number is dialed.
- You should assign the intercom line as the seized line when going off-hook. (Preferred Line Assignment—Outgoing)
- If canceling Hot Line is difficult because this feature is activated immediately after going off-hook, refer to the Feature Manual for more details.

**Customizing Your Phone**

- 3.1.2 Personal Programming—**Preferred Line Assignment—Outgoing**
Select the seized line when going off-hook.

1.3.34 ICD GROUP FEATURES

An incoming call distribution (ICD) group is a group of extensions assigned through system programming to receive calls (for example, as a call center). The PBX has several features that support using extensions in ICD groups, as follows:

Features	Description
Log-in/Log-out	You can log in to or out of an ICD group, to control whether you receive calls from the group. (→ 1.3.35 ICD Group Features—Log-in/Log-out)
Manual Queue Redirection (Hurry-up Transfer)	You can forward the longest waiting call in the queue of calls to the ICD group to a preprogrammed destination manually. (→ 1.3.36 ICD Group Features—Manual Queue Redirection)
Call Forwarding (FWD) for your ICD Group	You can set a forward destination for your ICD group. (→ Call Forwarding (FWD) for your Incoming Call Distribution Group)

1.3.35 ICD Group Features—Log-in/Log-out

You can control your status in an incoming call distribution (ICD) group. When in the Log-out mode, incoming calls to the group will not ring at your extension. When you return, calls will again ring at your extension. (Default: Log-in) Even if your extension is logged-in, you can have a specified time period (wrap-up time) when you will not receive calls after completing a previous call. This time can be used for you to write a report and so on. You can also manually select "Not Ready" mode to temporarily leave an ICD group.

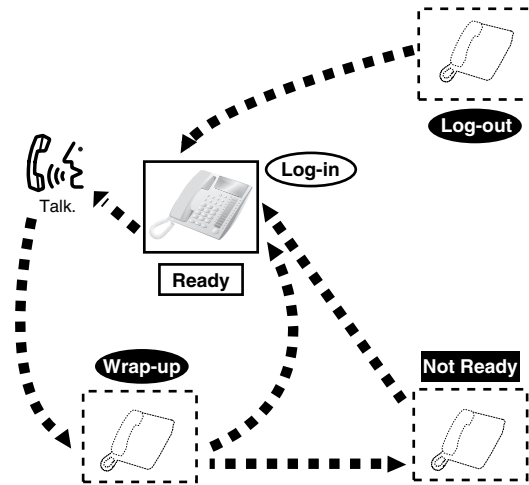

To set Log-in/Log-out

PT/SLT/PS *ICD Group: Incoming Call Distribution Group*



Off-hook.

* 7 3 6

Enter *736.

0 Log-out
OR
1 Log-in

Enter 0 or 1.

ICD Group extension no.

Specified

OR

*

All

Enter ICD Group extension number or *.



C.Tone



On-hook.

PT/PS *ICD Group: Incoming Call Distribution Group*

While on-hook

Press **Log-in/Log-out**. Enter **ICD Group extension number** or *****.

PT/PS

While on-hook

Press **Log-in/Log-out of a Specified Group**.

To enter/leave Not Ready mode

PT/SLT/PS

Off-hook. Enter *** 7 3 5**. Enter **1** or **0**. C.Tone On-hook.

To set/cancel Not Ready mode or to leave Wrap-up mode (To enter Ready mode)

PT/PS

While on-hook

Press **red or flashing red Wrap-up.***



- * The status will be as follows:
Ready → Not Ready
Not Ready → Ready
Wrap-up → Not Ready
- The Log-in/Log-out of a specified group button light shows the current status as follows:
Off: Log-in mode
Red on: Log-out mode
- The Wrap-up button alternates the setting of Wrap-up mode, Not Ready mode or Ready mode.
The Wrap-up button light shows the current status as follows:
Off: Ready mode
Red on: Not Ready mode
Flashing red: Wrap-up mode
- In Wrap-up mode/Not Ready mode, your extension does not receive calls through any group, even if it belongs to multiple groups.
- The last remaining logged-in extension may not be allowed to log out, depending on system programming.



- For information about other ICD group features, refer to "1.3.34 ICD GROUP FEATURES".



Customizing Your Phone

- 3.1.4 Customizing the Buttons
Create or edit a Log-in/Log-out button, a Log-in/Log-out of a specified group button or a Wrap-up button.

1.3.36 ICD Group Features—Manual Queue Redirection

When your incoming call distribution (ICD) group is busy and other outside calls arrive, the arriving calls are put in a waiting queue.

Extensions can check the status of the queue with the Hurry-up button light, and forward the longest waiting call in the queue to a preset destination manually.

This feature is also known as Hurry-up Transfer.



To forward the waiting call

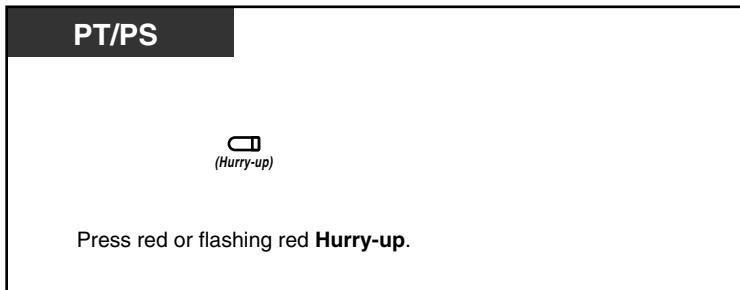



- The Hurry-up button light shows the current status as follows:
Off: No waiting call.
Red on: Some calls are waiting.
Flashing red: The number of calls exceeds the manual queue redirection level.



- For information about other ICD group features, refer to "1.3.34 ICD GROUP FEATURES".



Customizing Your Phone

- 3.1.4 Customizing the Buttons
 Create or edit a Hurry-up button.

1.3.37 Message Waiting

◆ **For a caller**

When the called extension is busy or does not answer your call, you can leave a notification so that the called party may call you back.

◆ **For a called extension**

As a message receiver, the Message button light or Message/Ringer Lamp lets you know that a call has been received. If you receive notification, you can call back the caller by a simple operation.

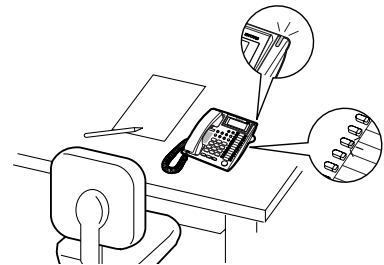

◆ **For a caller**

To leave a message waiting indication

PT/SLT/PS

When the called extension is busy or does not answer

Press **MESSAGE**
or enter **4**.

C.Tone

On-hook.

To leave/cancel a message waiting indication

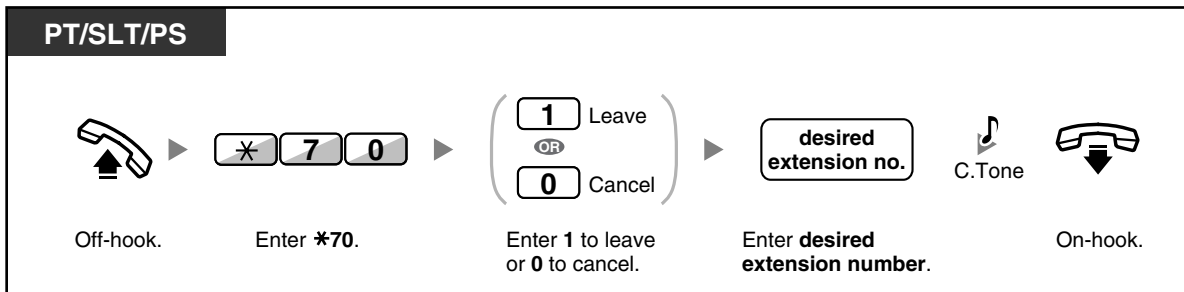

◆ For a called extension

To check the left message and call back

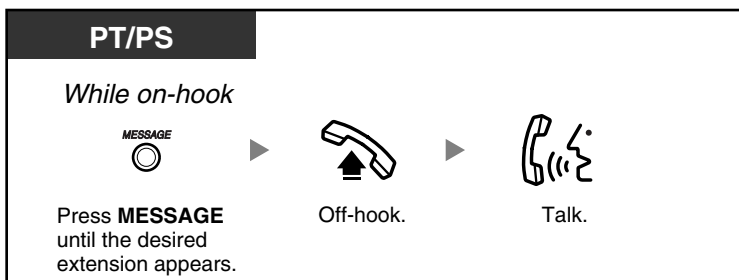

To call back

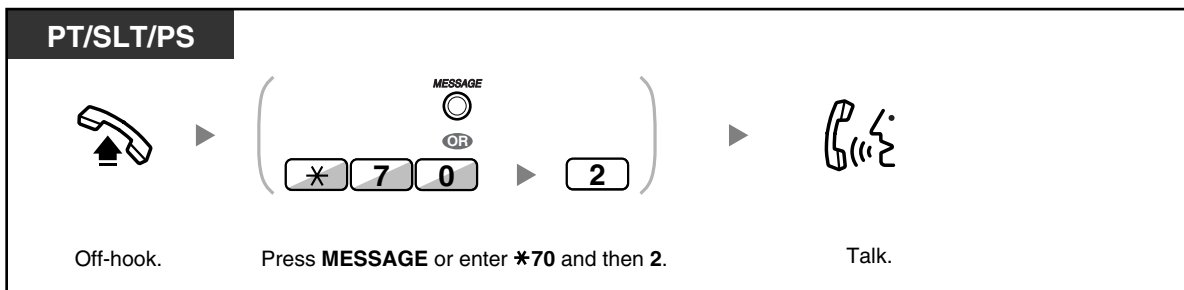

To clear message waiting indications left on your extension

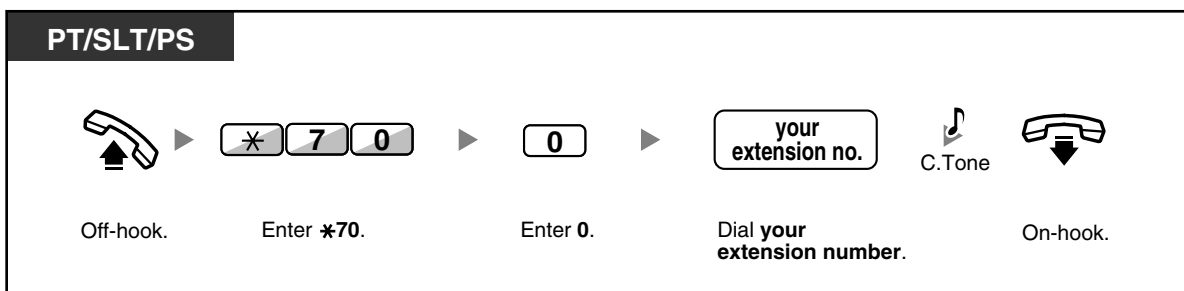



- The Message button light or Message/Ringer Lamp shows the current status as follows:
Off: No message
Red on: You have a message.
- The display shows the messages starting with the most recent call.
- On your PT, you can establish one or more Message for Another Extension buttons. These buttons can accept the message waiting notification of other extensions or various incoming call distribution groups. In other words, you can monitor the message waiting notifications of other telephones.
- A single line telephone extension user will receive a special dial tone as message waiting notification when going off-hook.



Customizing Your Phone

- 3.1.4 Customizing the Buttons
Create or edit a Message button or Message for Another Extension button.

1.3.38 Mute

You can disable the microphone or the handset to consult privately with others in the room while listening to the other party on the phone through the speaker or the handset.



To set/cancel



- The AUTO ANS/MUTE button light shows the current status as follows:
Off: Normal
Flashing red: Mute

1.3.39 One-touch Dialing

You can store a phone number into the flexible button for one-touch operation.

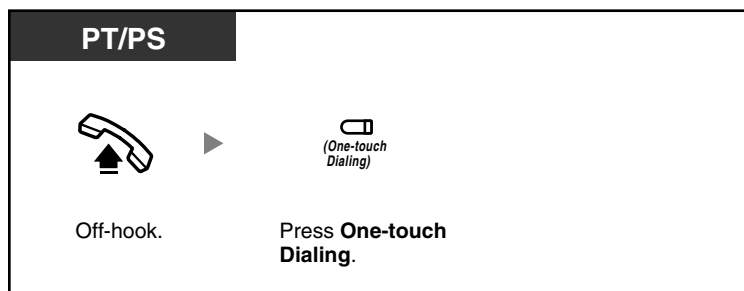

Customizing Your Phone

- 3.1.4 Customizing the Buttons
Create or edit a One-touch Dialing button, store the desired phone number or feature number.

1.3.40 Paging

- Group Paging
- Paging and then Transferring a Call
- Paging Deny

◆◆ Group Paging

You can make a voice announcement to proprietary telephones or external speakers or both in the preset group simultaneously. A person who has been paged can answer the page at any extension.

To page

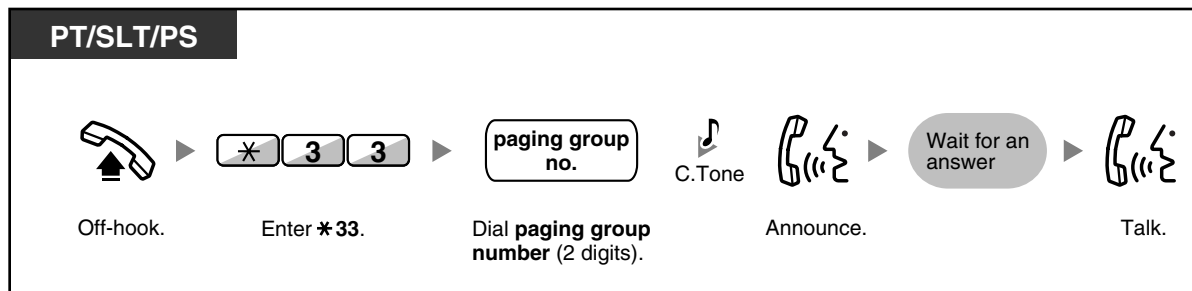

- If the group which you paged is already being used for paging, you hear a busy tone.

To answer

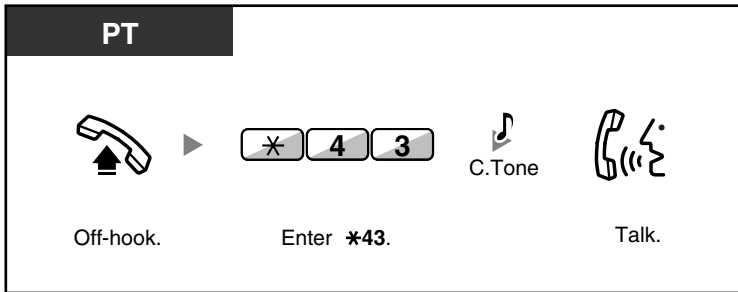

- The following are extensions that cannot receive a paging announcement:
 - Portable station
 - Single line telephone
 - Proprietary telephone that is ringing or busy
 - Proprietary telephone in Paging Deny mode
 - Proprietary telephone in DND mode
- Even if the announcement is not paging your extension, you can answer it, if it is paging your group.

◆◆ **Paging and then Transferring a Call**

You can transfer a call after making paging announcements.

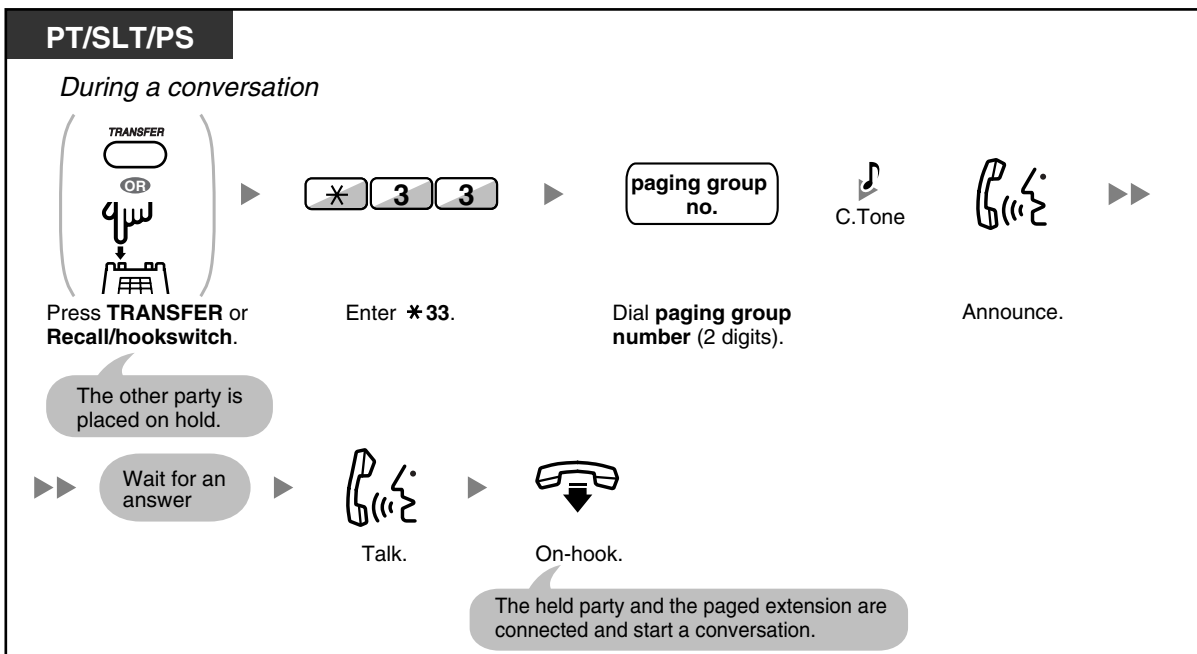

- After you go on-hook, the caller can talk to the person who answers the page.

◆◆ Paging Deny

You can set your extension not to receive paging announcements.

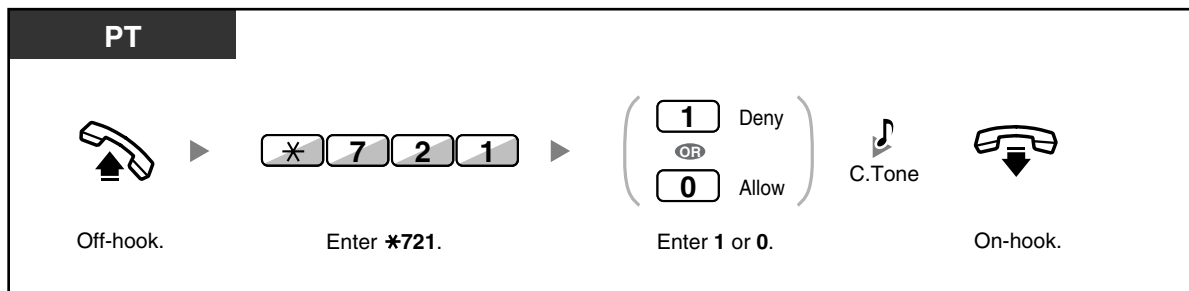

1.3.41 Printing Message

You can record a variety of information from your extension using up to 8 preprogrammed messages. Message information from all extensions is recorded with the PBX. For example, it is possible to use this feature as a time card by selecting preprogrammed "sign in" and "sign out" messages. In a hotel-type environment, this feature can be used to record room information from a room extension. For a list of preprogrammed messages, consult your dealer.

To record

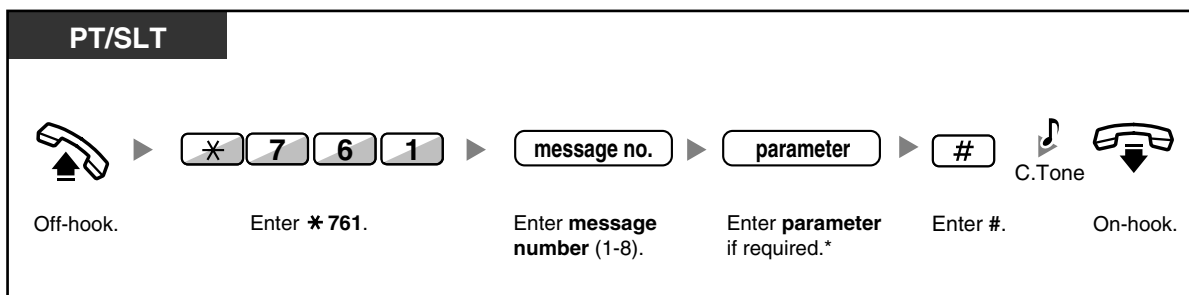

- * Depending on the content of the selected message, you may be required to enter a numeric parameter, such as a price or time. Enter the correct number of characters as required for the message. For information about required parameters, consult your dealer.

<Example>

If "Snack %%.%" has been programmed as message number 1 (for recording charges for room snacks consumed), hotel employees would enter data as in the example below using the room extension:

```

* 761      1      0300      #
            |      |
            |      |
            v      v
            message no.    parameter
                        (Snack charge)
  
```

- When a preprogrammed message is selected, detailed information is recorded automatically, as shown below:

Date	Time	Ext	CO	Dial Number
02/02/00	10:45AM	1234		Snack 03.00

1.3.42 Privacy Release

You can let a third party join your current outside call and establish a three-party conversation. You can also leave the conversation and then let the two other parties talk.



To let a third party join your conversation and establish a three-party conversation

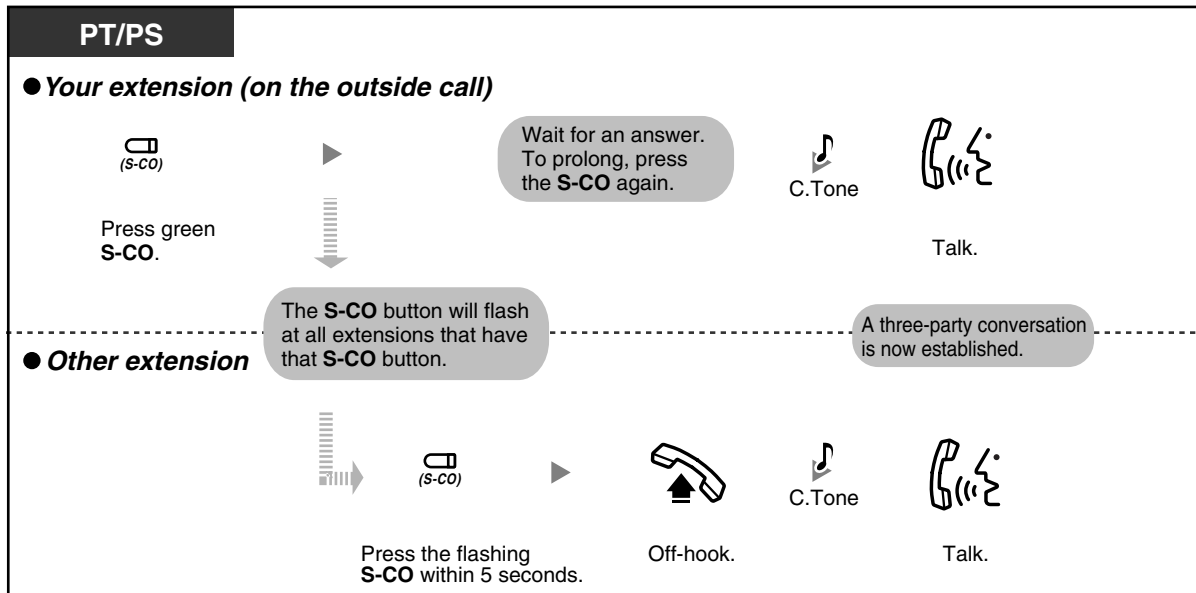

- Only an S-CO button can be used for this operation.
- You can leave a three-party conversation and let the two other parties talk by simply going on-hook.

1.3.43 Quick Dialing

You can make a call simply by pressing the preprogrammed number for quick dialing. For details, refer to the Feature Manual.

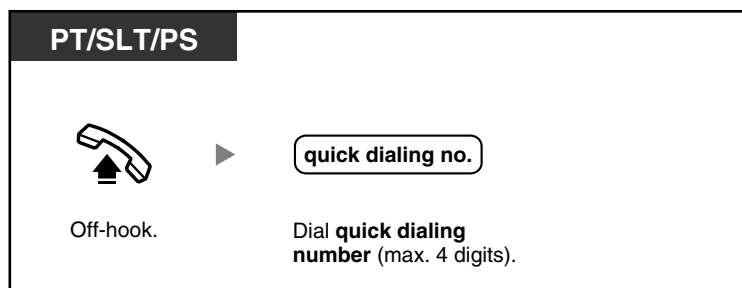

- This is a useful feature for hotels. For example, to dial Room Service, dial the digit "3", not the full extension number.

1.3.44 Redial, Last Number

This is convenient when calling the same outside party again.

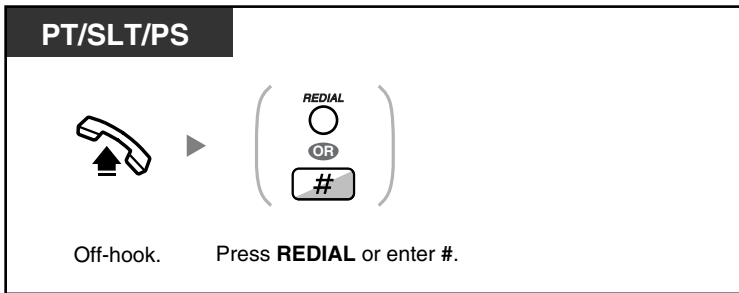

- Up to 32 digits can be stored and redialed.
- After pressing REDIAL, if you hear a busy tone again, press REDIAL to retry.

1.3.45 Speed Dialing, Personal

You can store numbers at your extension for your personal use. (Default: 10 numbers, 00-09)
This feature is also known as Station Speed Dialing.

To store a phone number

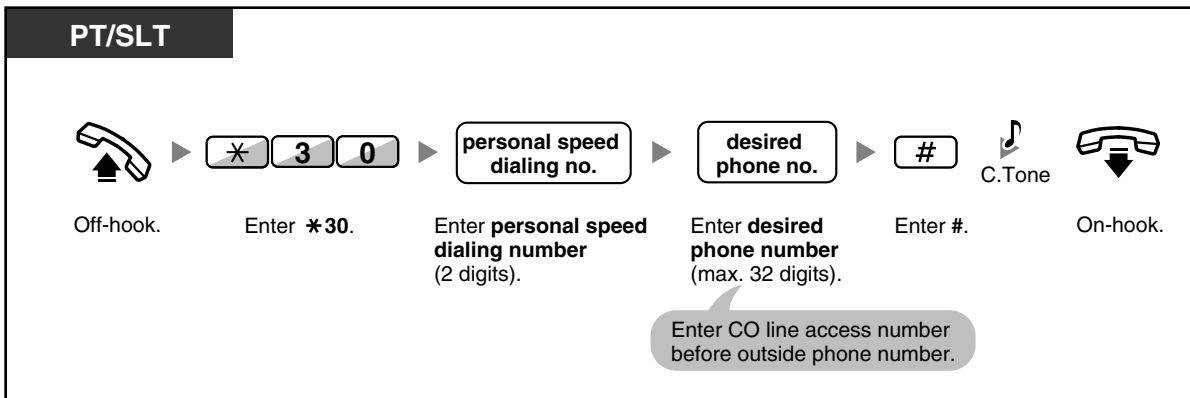

To dial

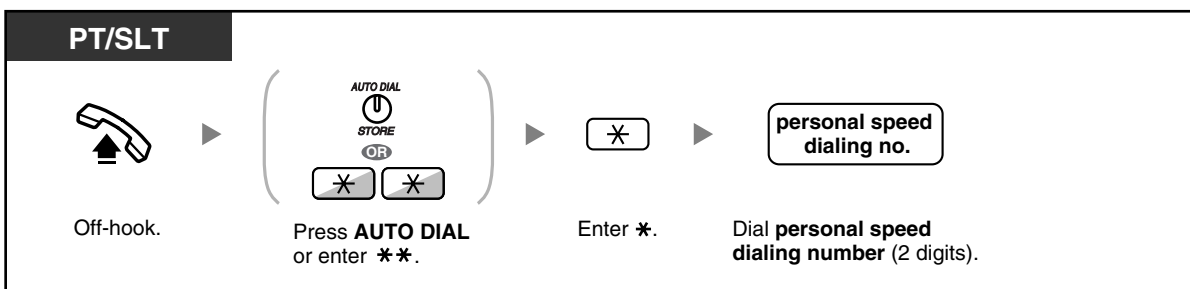



- To call using a directory, refer to "1.4.1 Directories".

1.3.46 Speed Dialing, System

You can make calls using speed dialing numbers stored in the PBX.

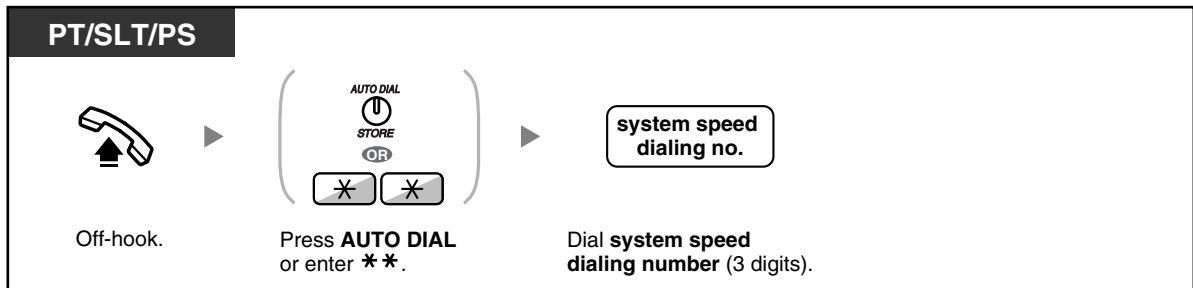

- To call using a directory, refer to "1.4.1 Directories".

1.3.47 SVM (Simplified Voice Message)

Your PBX can provide you with answering machine service if an SVM card is installed. Your extension is assigned a message box, into which callers can leave voice messages for you. After callers reach your message box, they will hear your personal greeting message. You can record two kinds of personal greetings: a normal greeting message and a greeting message for each time mode. You can also play back and clear your greeting messages and the voice messages left by callers.

- Recording a Normal Greeting Message
- Recording a Greeting Message for Each Time Mode
- Redirecting Your Calls to Your Message Box
- Leaving Voice Messages
- Listening to Voice Messages Left by Callers
- Accessing Your Message Box from an Outside Telephone
- Accessing the Message Box of Another Extension from Your Extension



- You may hear a busy tone when trying to access your message box if too many other users are already accessing their message boxes. In that case, wait a few minutes and try again.
- If the used recording space (including greeting messages and voice messages left by callers) for the SVM card reaches a certain limit, the display informs you that the recording space is almost full, and you will hear dial tone 3 when going off-hook.

Dial Tone 3





- Operation Reference When Accessing Your Message Box**
 After entering the SVM feature number (*38), the operations below are available by entering the corresponding numbers.

Operation No.	Operation
0	To clear the normal greeting message
1	To record a normal greeting message
2	To play back the normal greeting message
3	To listen to voice messages left by callers
8	To set a greeting message for each time mode
# 6	To leave a voice message to another extension's message box

◆◆ Recording a Normal Greeting Message

To record

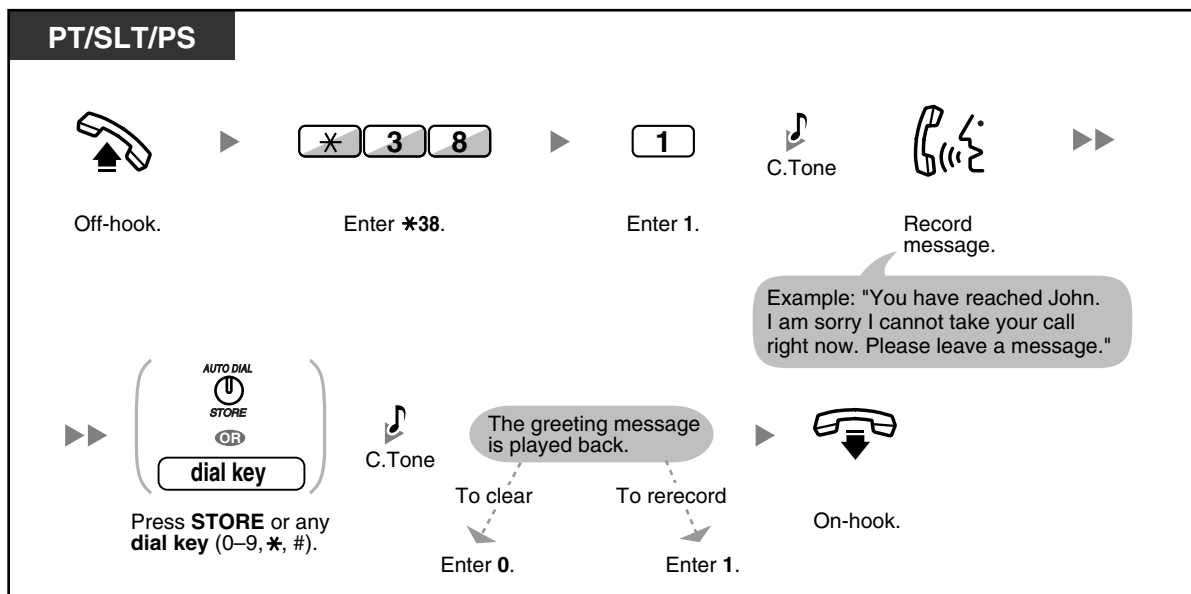

To play back

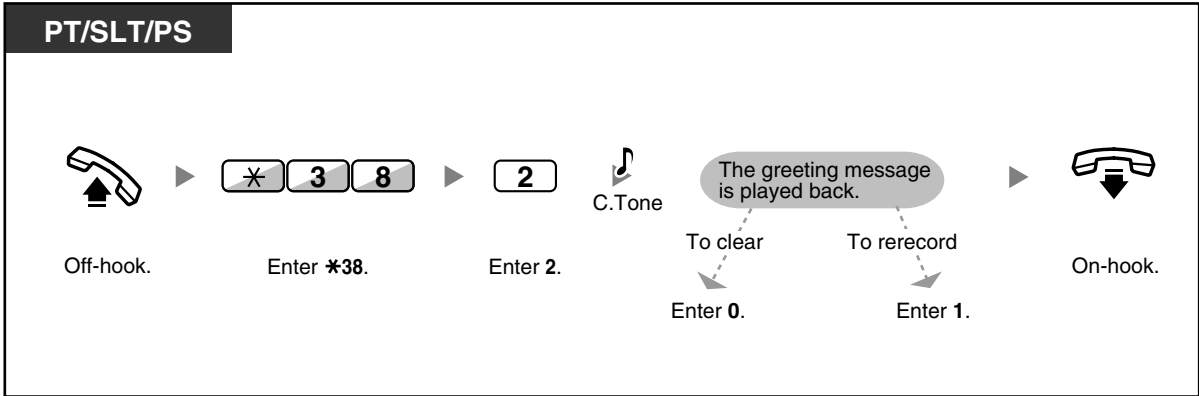

To clear

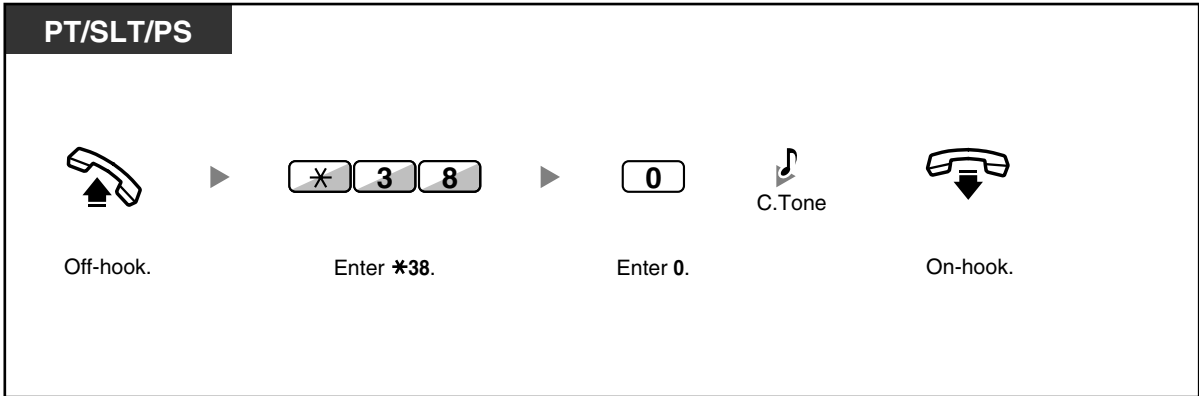

◆◆ Recording a Greeting Message for Each Time Mode

In addition to a normal greeting message, you can record a specific greeting message for each time mode (day/lunch/break/night).

To record

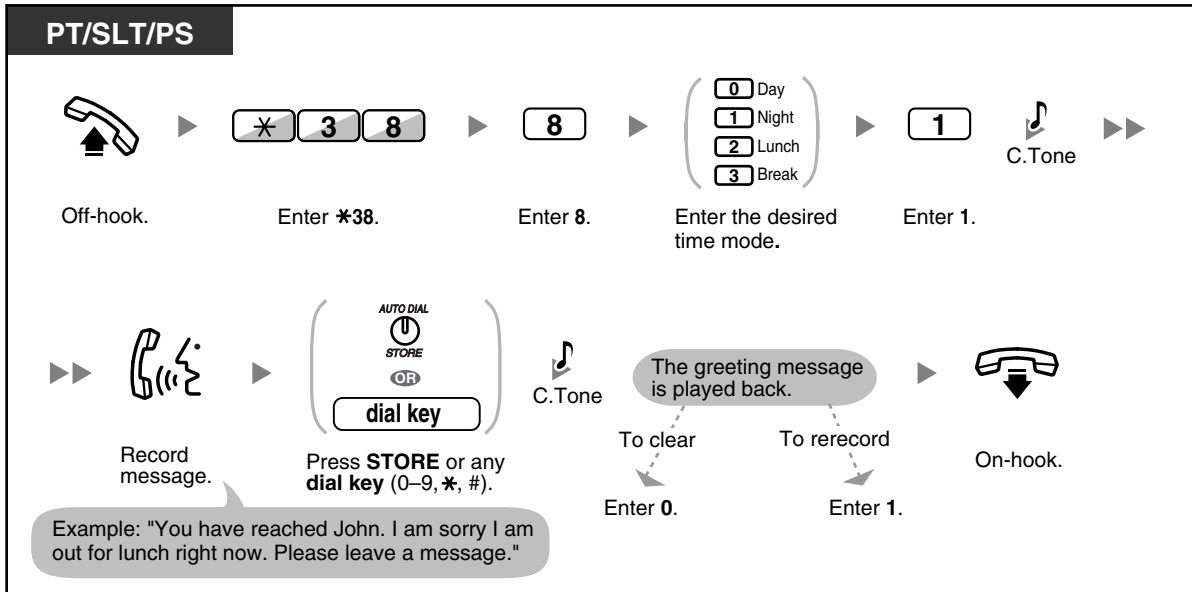

To play back

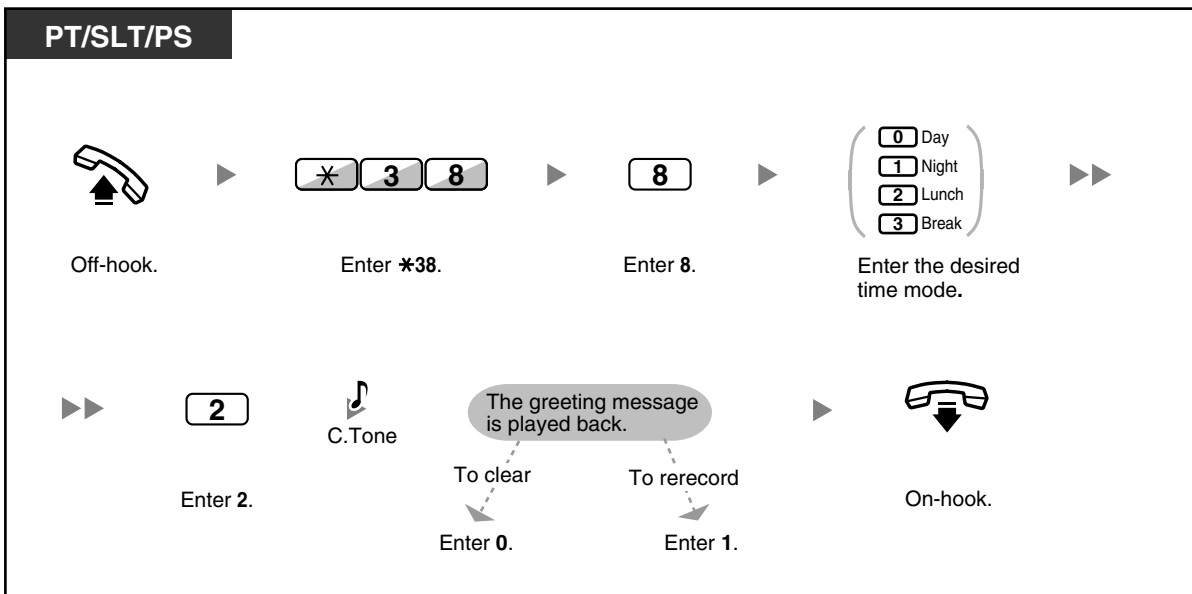

To clear

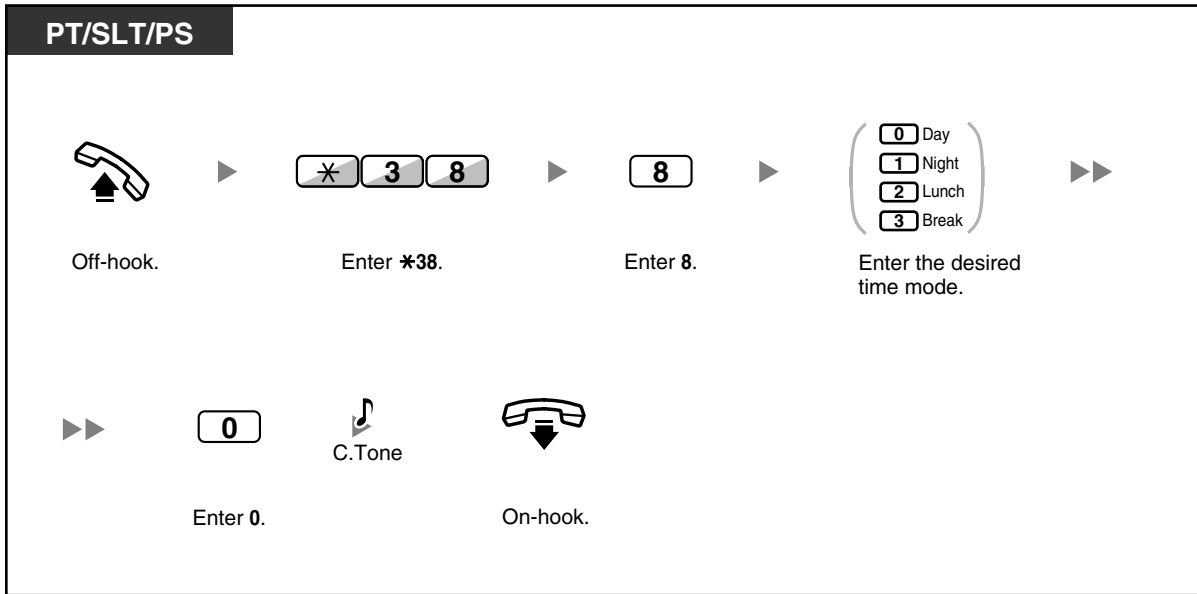

- If both the greeting message for a certain time mode and the normal greeting message have been recorded, callers will hear the greeting message for that time mode. However, if no greeting message has been recorded for a certain time mode, the normal greeting message will be played instead.

◆◆ **Redirecting Your Calls to Your Message Box**

You can set incoming calls to be redirected to your own message box so that callers can leave voice messages when you cannot answer the phone.

To set/cancel

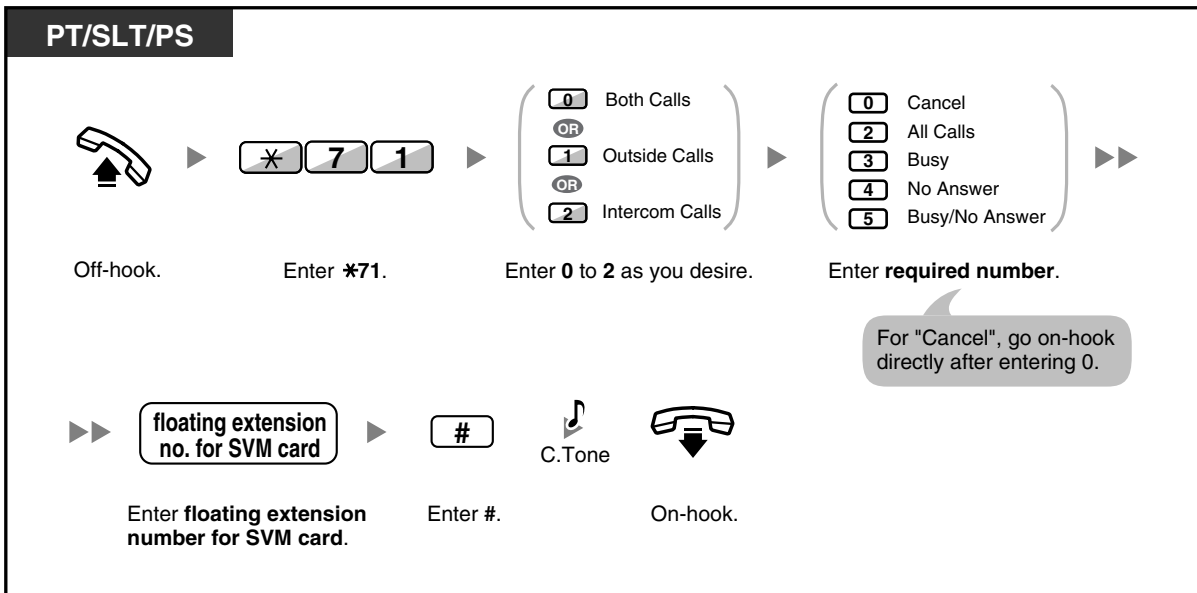



- The default floating extension numbers are 591 for SVM card 1, and 592 for SVM card 2.

◆◆ Leaving Voice Messages

If the extension user you called is not able to answer your call, and your call is redirected to the message box, you will hear the greeting message. Then, you can leave a voice message for that extension. It is also possible to leave a voice message directly in the message box of a desired extension by following the steps below:

To leave a voice message directly to another extension's message box

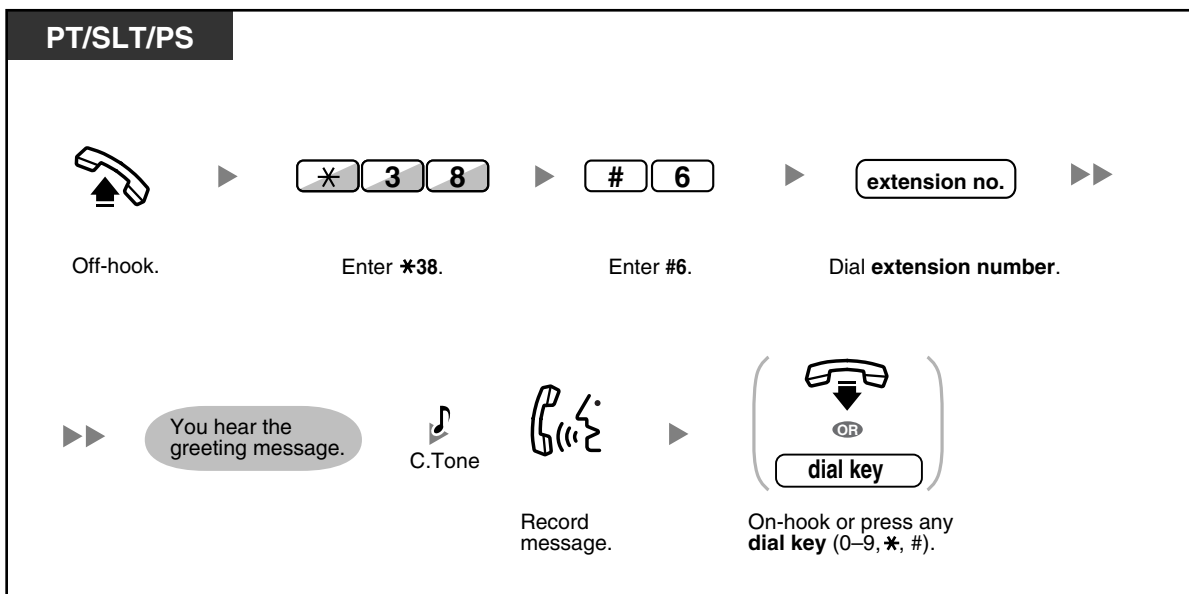

- Voice message recording will stop, you will hear a notification tone, and the call will be disconnected, in the following cases:
 - the recording time for the voice message reaches the preprogrammed limit. (default: 120 seconds)
 - the recording space for the SVM card reaches the limit.



- When you are on the phone, you can transfer the call directly to the message box of a desired extension by placing the call on hold temporarily, then pressing *38 + #6 + the desired extension number. This allows the caller to leave a voice message in the message box of the desired extension.

◆◆ Listening to Voice Messages Left by Callers

When a caller leaves a voice message, information about that caller is also recorded as the SVM Log. The SVM Log can be viewed using the display of a PT or PS by pressing the Message button.

To listen to voice messages

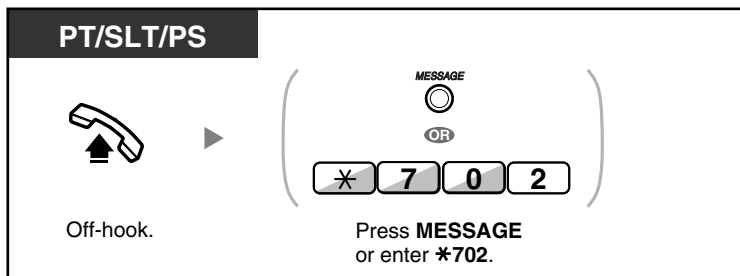
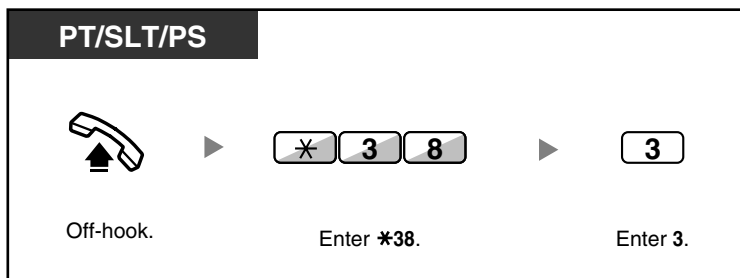
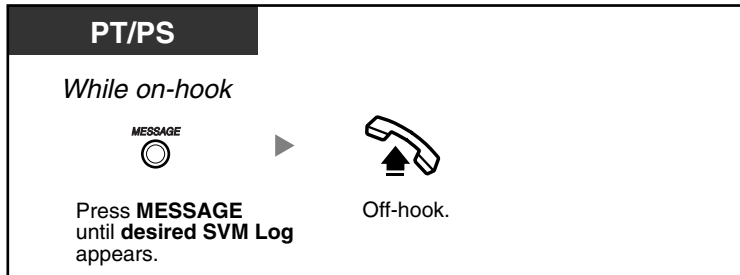

To clear the voice message that you are listening to

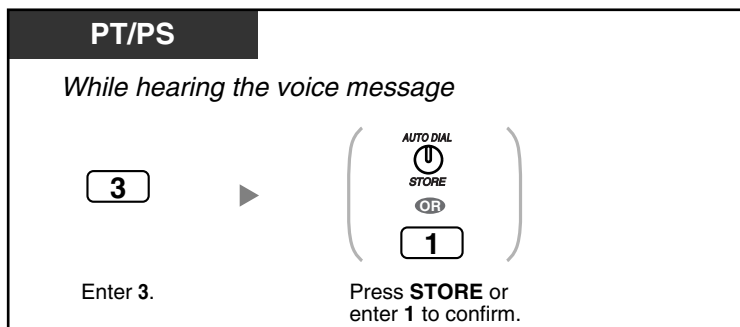



- Various operations are available by entering numbers while you are listening to a recorded voice message using any of the methods described above. The available options are as follows:

Operation No.	Operations
[1] / [#] [*]	To play back the voice message from the beginning
[2]	To go to the next voice message
[3]	To clear the voice message (Press the AUTO DIAL/STORE button or enter 1 to confirm.)
[4]	To call back the caller who left the voice message
[5]	To go back to the previous voice message
[#] [6]	To leave a voice message directly in the message box of another extension (Enter desired extension number.)
[#] [8]	To play back your greeting message and record a voice message in your own message box
[#] [9]	To end the call

- In addition to the caller information that is recorded in the Call Log, the following SVM Log information is recorded with voice messages left by callers:
 - Caller's Name
 - Caller's Telephone Number
 - Time recording started
 - Voice Message Status
 - "New" is displayed for voice messages that have not previously been listened to.
 - "Old" is displayed for voice messages that have previously been listened to.

Please note that the information shown on the display may vary depending on the information that was received and the type of telephone used.

- You can lock the SVM Log display by using an extension PIN (Personal Identification Number) to prevent other users from viewing the information and from playing back your voice messages (Display Lock). Refer to "3.1.2 Personal Programming".
- If your telephone has a Message for Another Extension button, you can access the message box of another extension and listen to voice messages for that extension.
- If a new voice message has been left in your message box, you will hear dial tone 4 after going off-hook. In addition, if your telephone has a Message button or Message/Ringer Lamp, the corresponding button or lamp will light when a voice message has been left.

Dial Tone 4



To listen to voice messages while your display is locked

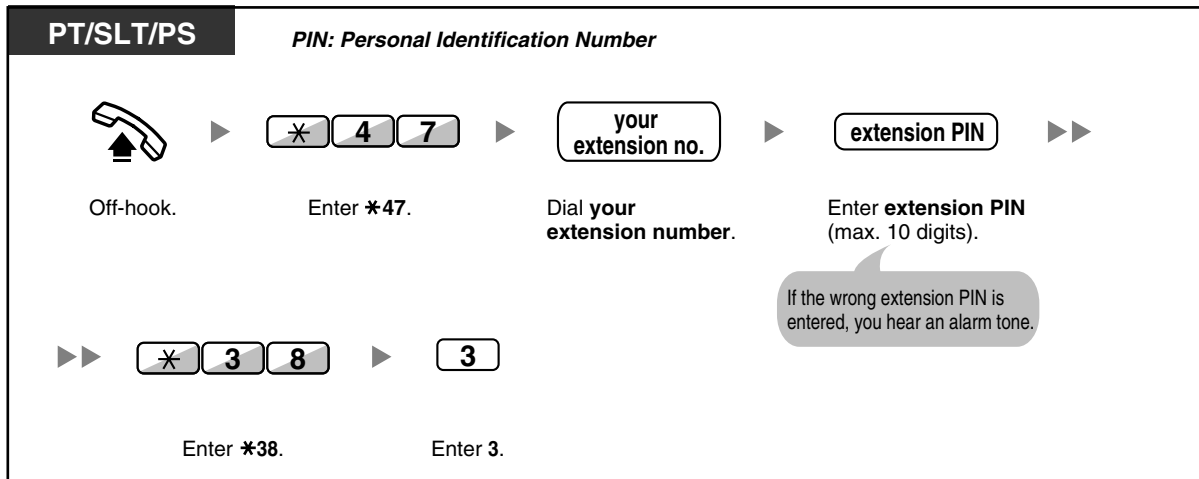

- When you press the Message button while on-hook to play back voice messages, Display Lock is temporarily deactivated.

To clear voice messages from the SVM Log

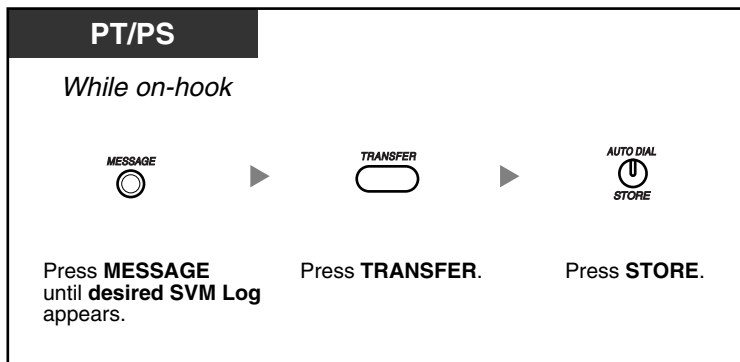

◆◆ Accessing Your Message Box from an Outside Telephone

You can remotely access your message box and perform any operations of the SVM feature through a CO line as if you were at your own extension.

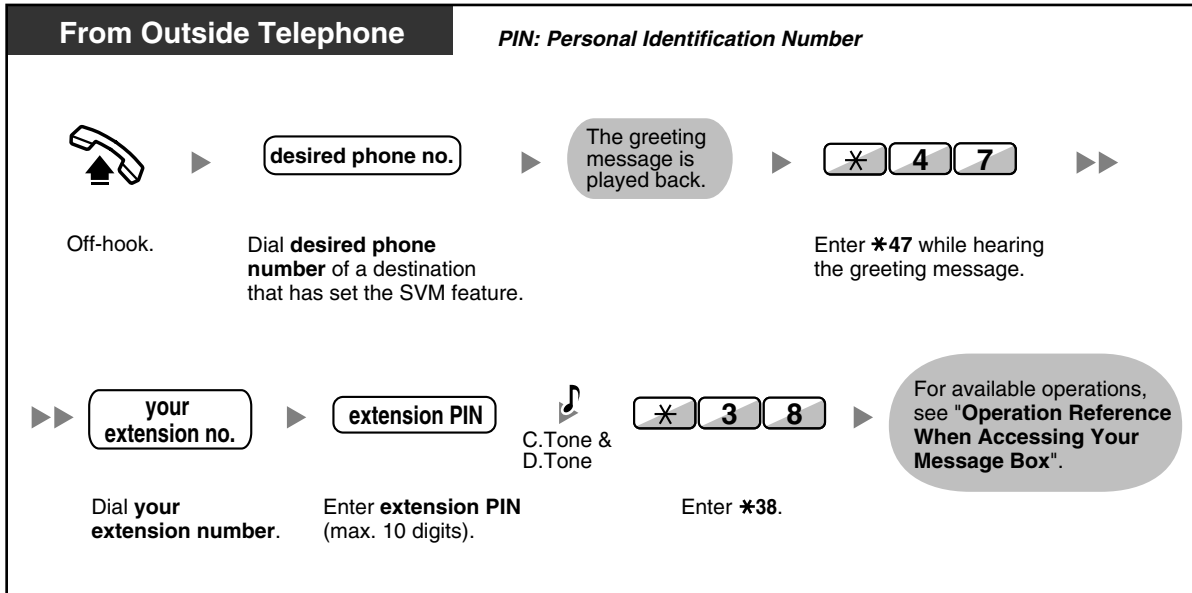

Dial **your extension number**. Enter **extension PIN** (max. 10 digits).



- If you hear a reorder tone when you try to leave a voice message directly in the message box of another extension, that message box is unavailable. You can enter another extension number by pressing "*".
- When accessing your message box from an outside telephone, you cannot call back callers who have left voice messages by pressing 4 while hearing the voice message.

To listen to voice messages left in the message box of another extension

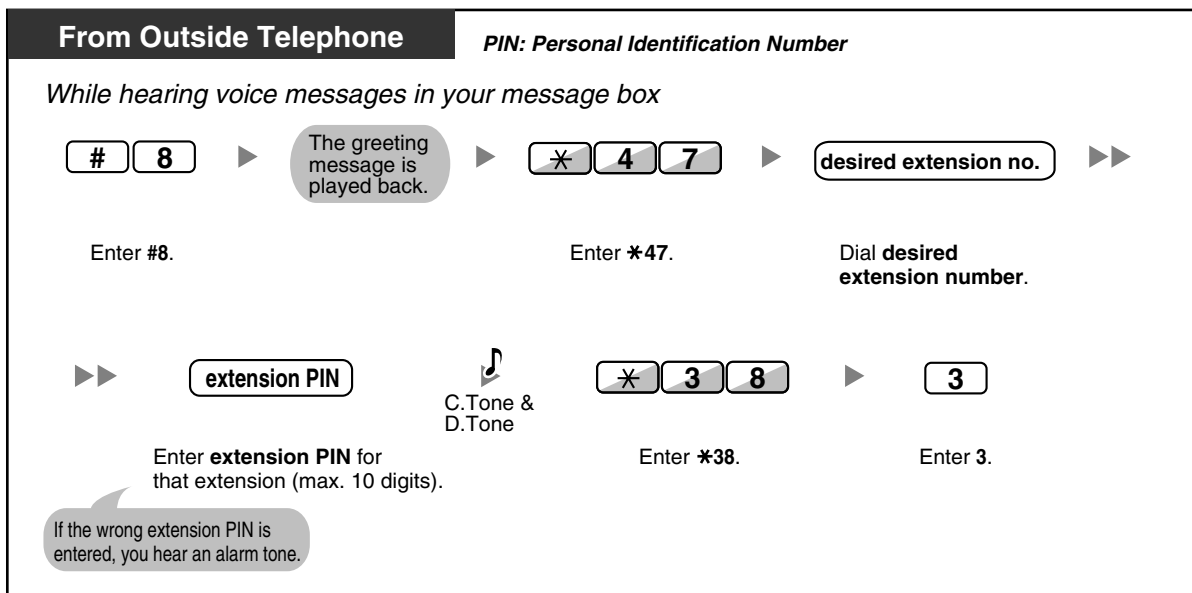

Enter **extension PIN** for that extension (max. 10 digits).

If the wrong extension PIN is entered, you hear an alarm tone.

◆◆ Accessing the Message Box of Another Extension from Your Extension

You can access the message box of another extension (for example, to record a greeting message for that extension) by following the steps below:

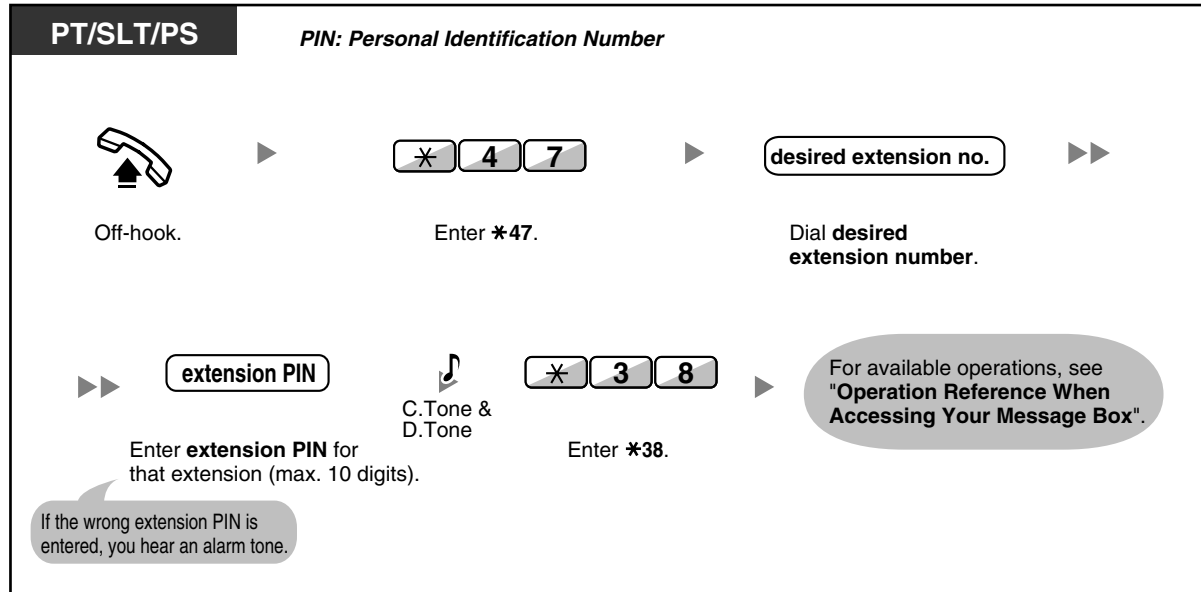

1.3.48 TAFAS (Trunk Answer From Any Station)

You can be notified of incoming outside calls through an external speaker. These calls can be answered from any extension.

Through an external speaker

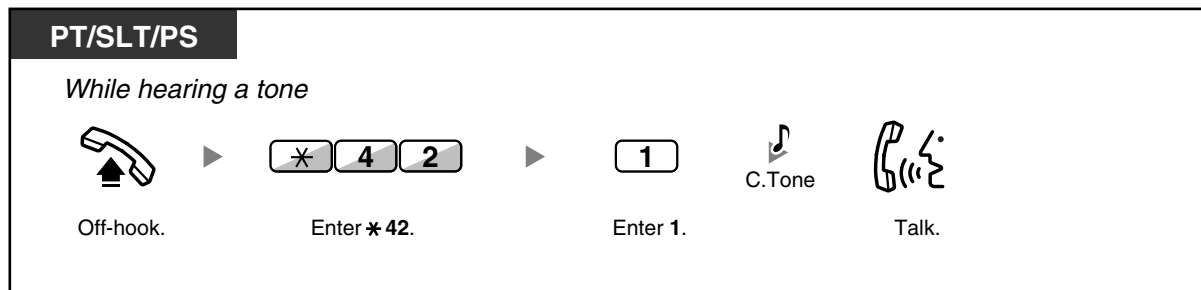

- You can also receive a paging announcement via a speaker with this operation.

1.3.49 Timed Reminder

You can set an alarm at your telephone as a reminder of a meeting or appointment. The alarm can occur either once or daily (every day until canceled) at a preset time. When you go off-hook to answer, you will hear a special dial tone or prerecorded message.



- This feature can also be set remotely by an extension assigned as a hotel operator (Remote Wake-up Call). The most recent setting will be valid no matter which extension made the setting. For information about setting a Remote Wake-up Call, refer to "1.3.56 Wake-up Call".

To set

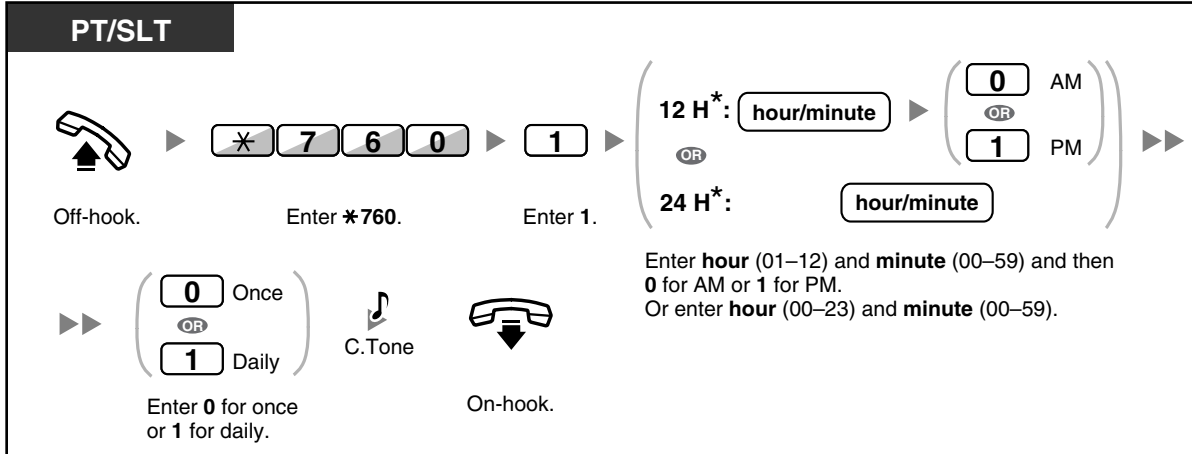

- * Enter the time in the format assigned to your PBX (12-hour or 24-hour). For more details, refer to the Feature Manual.

To cancel

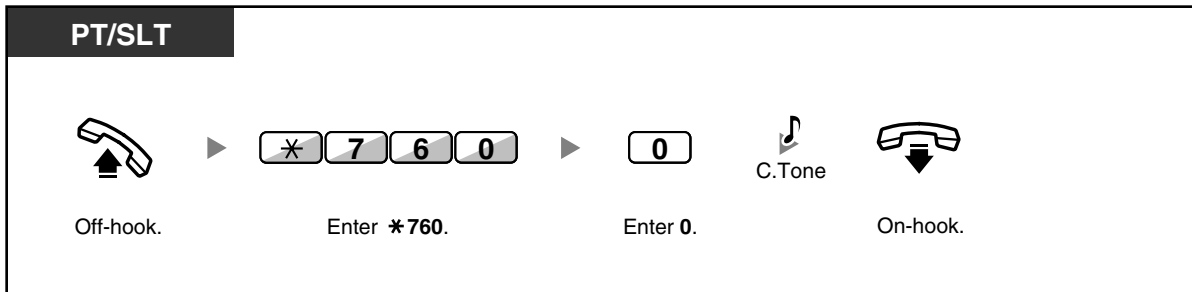

To stop or answer the ringback

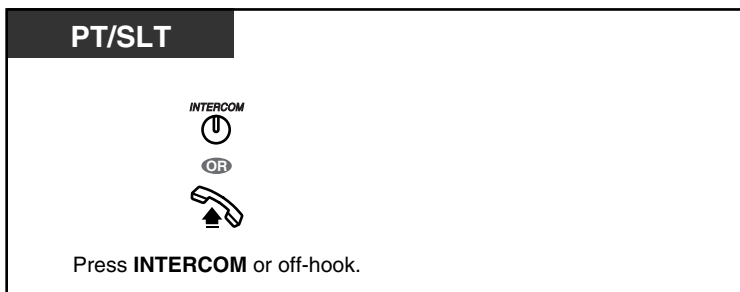

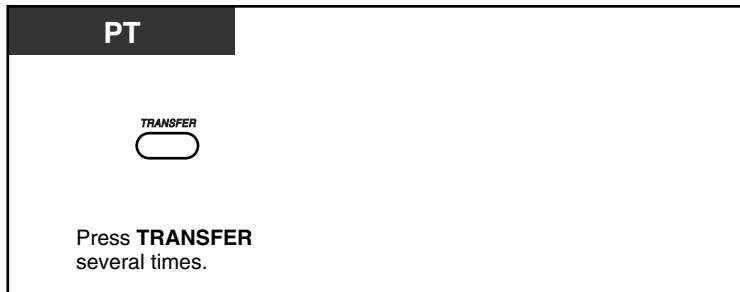
To confirm

- The alarm keeps ringing for preprogrammed seconds.
- **If you receive an incoming call during ringback**, the ringing starts after the ringback stops.
- **If you are having a conversation exceeding alarm ringing period**, the ringback will start after your conversation.

1.3.50 Time Service

You can check the current status of the Time Service on the display.

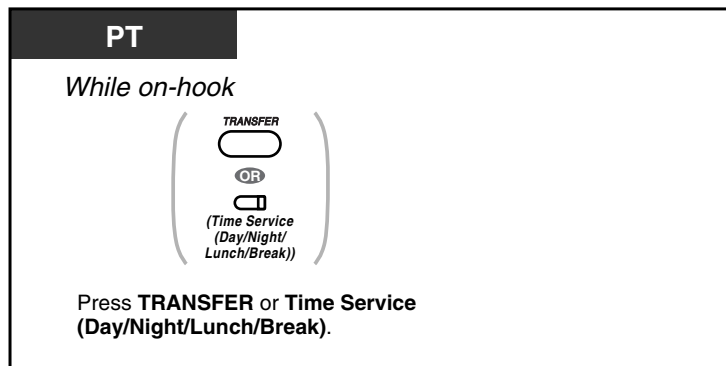

- The Time Service (Day/Night/Lunch/Break) button light always shows the current status as follows:
 - Off:** Day mode
 - Green on:** Lunch mode
 - Flashing green:** Break mode
 - Red on:** Night mode
 - Flashing red:** Holiday mode
- Any extension user except the managers can check the current status by pressing the Time Service (Day/Night/Lunch/Break) button.

**Customizing Your Phone**

- 3.1.4 Customizing the Buttons
 - Create or edit a Time Service (Day/Night/Lunch/Break) button.

1.3.51 Verification Code Entry

You can use your calling privileges (Class of Service) at another extension. You can override restrictions which have been set at that extension. To use this feature, a verification code and verification code PIN (Personal Identification Number) are required. For information about verification code, refer to the Feature Manual.

To call

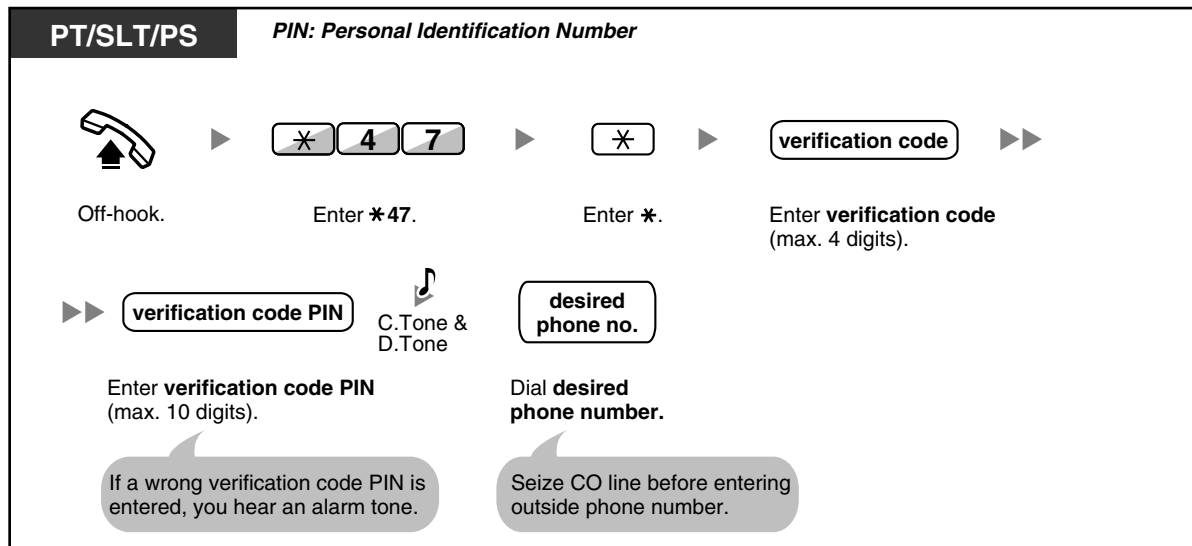

1.3.52 VOICE MAIL FEATURES

The following services are available using a Voice Processing System:

Features	Description
Voice Mail Integration	You or an outside party can access the Voice Processing System from a telephone. (→ 1.3.55 Voice Mail Features—Voice Mail Integration)
Live Call Screening (LCS)	Using a Panasonic Voice Processing system that supports digital integration (e.g., KX-TVA series), you can monitor a call without answering while the caller is leaving a message in your mailbox. (→ 1.3.53 Voice Mail Features—LCS (Live Call Screening))
Two-way Record	Using a Panasonic Voice Processing system that supports digital integration (e.g., KX-TVA series), you can record a conversation into a mailbox while talking on the phone. (→ 1.3.54 Voice Mail Features—Two-way Record)

1.3.53 Voice Mail Features—LCS (Live Call Screening)

Using a Panasonic Voice Processing system that supports digital integration (e.g., KX-TVA series), you can monitor a call without answering while the caller is leaving a message in your mailbox. If you so desire, you can answer the call while monitoring. There are two methods available as follows:



Hands-free mode (Default):

You can monitor the message automatically, live through the telephone speaker.

Private mode:

You will hear an alarm tone while the caller is leaving a message.

Before operating

- Create a Live Call Screening (LCS) button (Personal Programming).
- Select the mode, either Hands-free or Private (Personal Programming).
- Set the extension PIN (Personal Identification Number).
- Set the Live Call Screening feature.

To set Live Call Screening

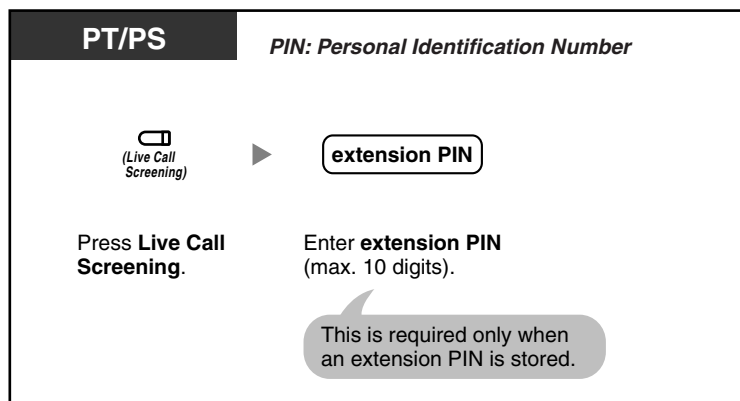

To cancel Live Call Screening

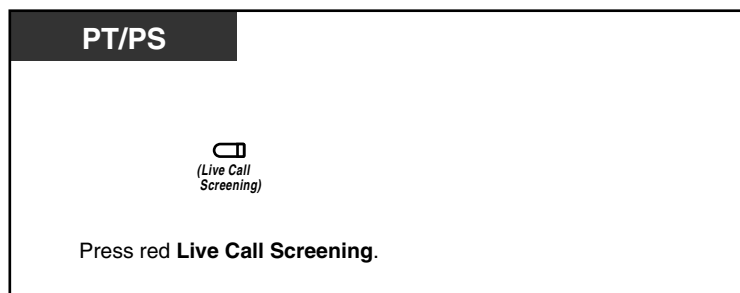

Operation Flowchart

The operations in the shaded areas can be done hands-free.

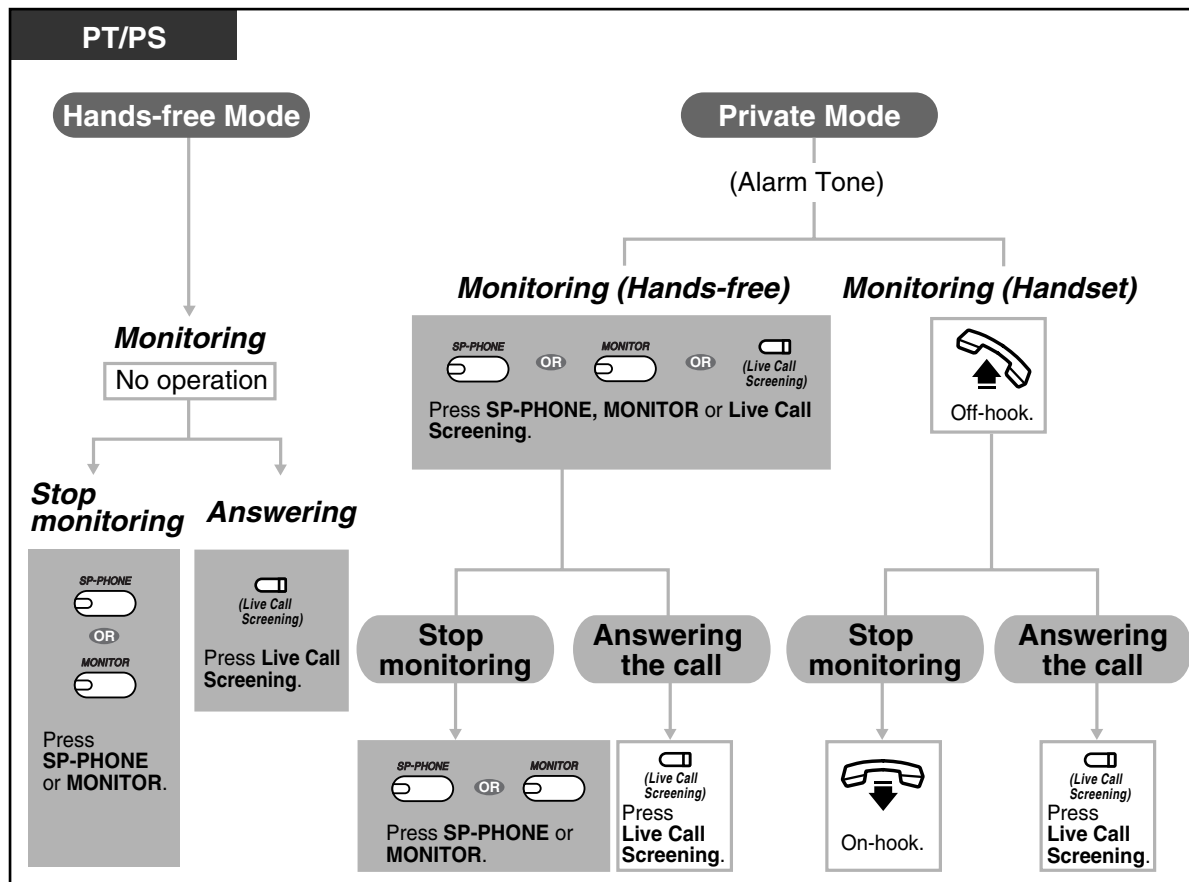

- The Live Call Screening (LCS) button light shows the feature status as follows:
 - Off:** LCS is off.
 - Flashing green rapidly:** Alerting in the Private mode.
 - Flashing green slowly:** Monitoring.
 - Red on:** LCS is on.
- The manager extension can clear an extension PIN.
- This feature is available for a single line telephone if it is connected to a proprietary telephone in parallel. (Private mode only)
To answer the call while monitoring, press Recall/hookswitch.
- Only the handset monitoring in the Private mode is available for PS users.



- For information about other Voice Mail features, refer to "1.3.52 VOICE MAIL FEATURES".



Customizing Your Phone

- 3.1.2 Personal Programming—**Live Call Screening Mode Set**
Select the mode, either monitoring the message through the speaker automatically or receiving, while the caller leaves a message.
- 3.1.4 Customizing the Buttons
Create or edit a Live Call Screening (LCS) button.

1.3.54 Voice Mail Features—Two-way Record

Using a Panasonic Voice Processing system that supports digital integration (e.g., KX-TVA series), you can record a conversation into a mailbox while talking on the phone. You can select the mailbox each time you record a conversation.



To record into your mailbox

PT/PS

During a conversation

 (Two-way Record)

To stop recording, press this button again.

Press **Two-way Record**.



To record into another mailbox (Two-way Transfer)

PT/PS

During a conversation

 (Two-way Transfer)

Press **Two-way Transfer**.

 (DSS)
OR

another extension no.

Press **DSS** or enter another extension number.

To stop recording, press this button again.

To record into another mailbox with one touch (One-touch Two-way Transfer)

PT/PS

During a conversation

 (One-touch Two-way Transfer)

Press **One-touch Two-way Transfer**.



- The Two-way Record button light, Two-way Transfer button light or One-touch Two-way Transfer button light shows the current status as follows:
Off: Not recording.
On: Recording the conversation.



- Note:**
 Many states have imposed regulations on the manner in which 2-way telephone conversations may be recorded, so you should inform the other party that the conversation is being recorded.
 Consult your local telephone company for further information.
- For information about other Voice Mail features, refer to "1.3.52 VOICE MAIL FEATURES".



Customizing Your Phone

- 3.1.4 Customizing the Buttons
 Create or edit a Two-way Record button, a Two-way Transfer button and a One-touch Two-way Transfer button.

1.3.55 Voice Mail Features—Voice Mail Integration

If you cannot answer calls, you can forward them to your mailbox. You can select the type of incoming calls (Intercom Calls/Outside Calls/Both Calls). If your telephone has a Message button, the Message light turns on and lets you know you have messages. Even if a Message button is not provided, you will hear an indication tone* when going off-hook.

You can also transfer received outside calls to a mailbox so that calling parties can leave messages. If you create a Voice Mail Transfer button on your phone, the transfer is done without knowing the mailbox number (**Voice Mail Transfer**).

The duration for recording depends on the voice processing system.

To forward your calls to your mailbox

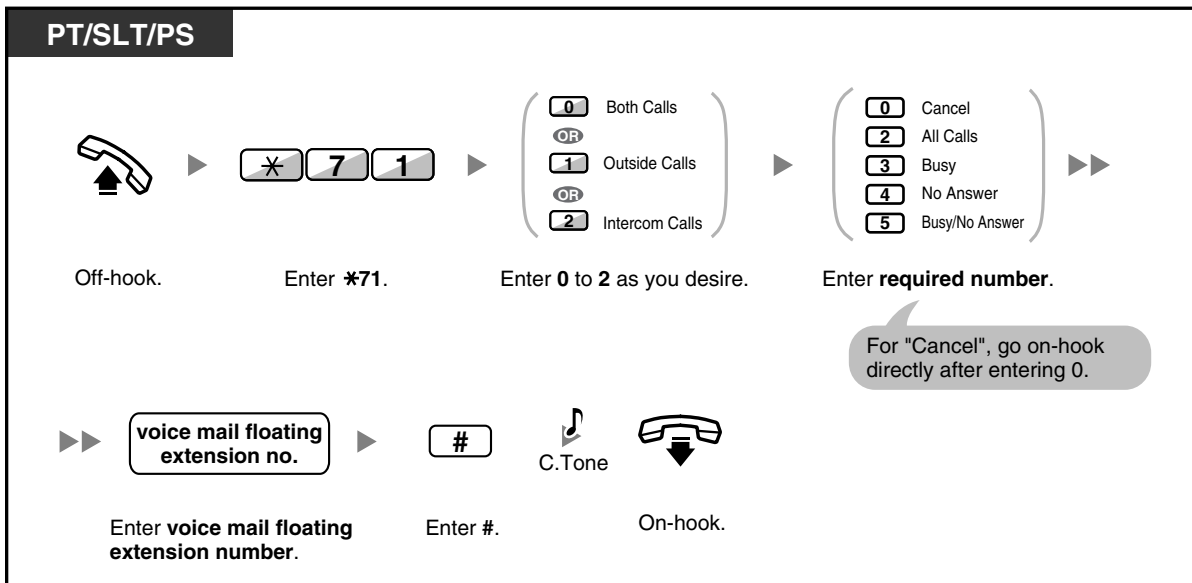

To transfer a call to a mailbox (Voice Mail Transfer)

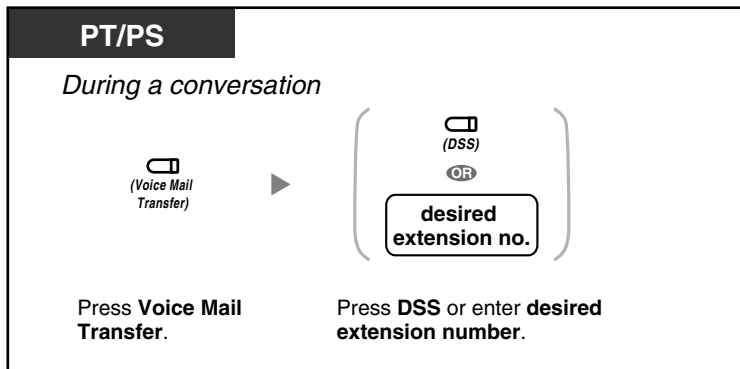

To listen to messages

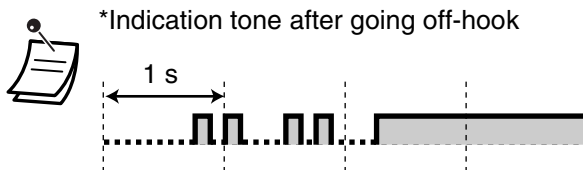
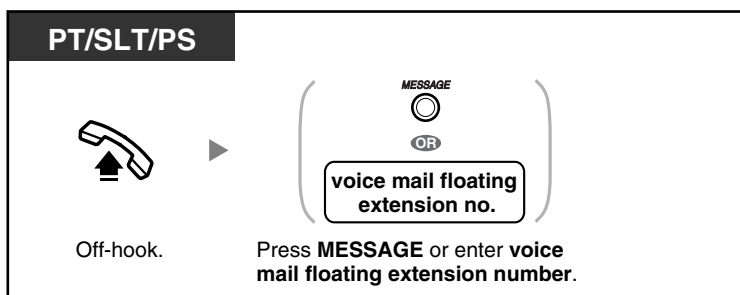

- You can access a voice mail with one-touch.



- The default voice mail floating extension number is 500.
- For information about other Voice Mail features, refer to "1.3.52 VOICE MAIL FEATURES".



Customizing Your Phone

- 3.1.4 Customizing the Buttons
Create or edit a Voice Mail Transfer button or a Message button.

1.3.56 Wake-up Call

In a hotel-type environment, an extension assigned as a hotel operator can remotely set or cancel a timed reminder to a room extension (Remote Wake-up Call). This allows guests to request wake-up calls without having to program the extension themselves. The hotel operator can also confirm the current timed reminder setting for a room extension.



- This feature can also be set from a room extension (Timed Reminder). The most recent setting will be valid no matter which extension made the setting. For information about setting a Timed Reminder, refer to "1.3.49 Timed Reminder".

To set

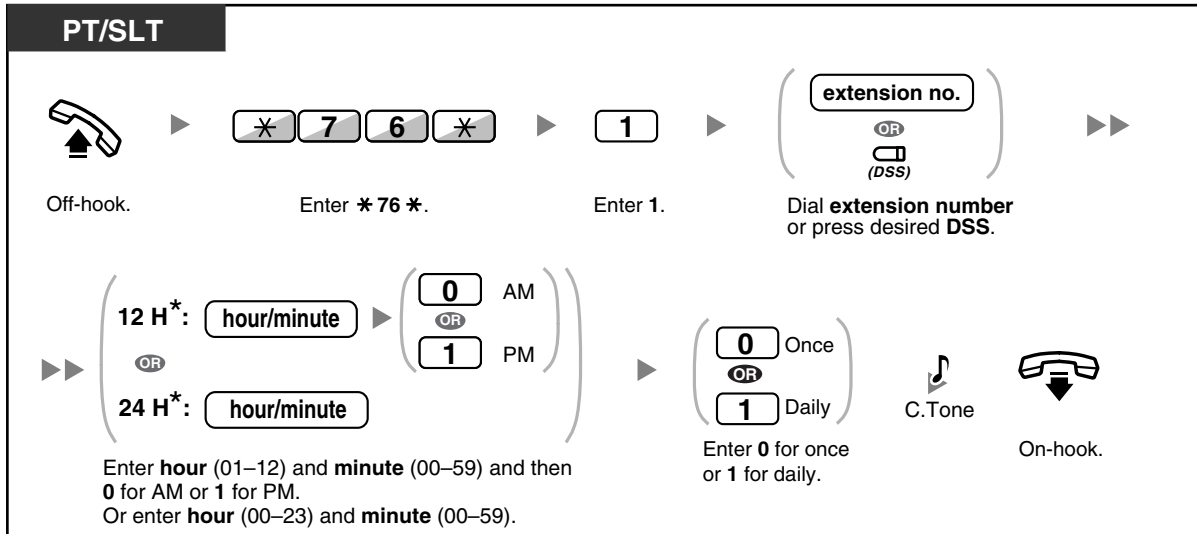

- * Enter the time in the format assigned to your PBX (12-hour or 24-hour). For more details, refer to the Feature Manual.

To cancel

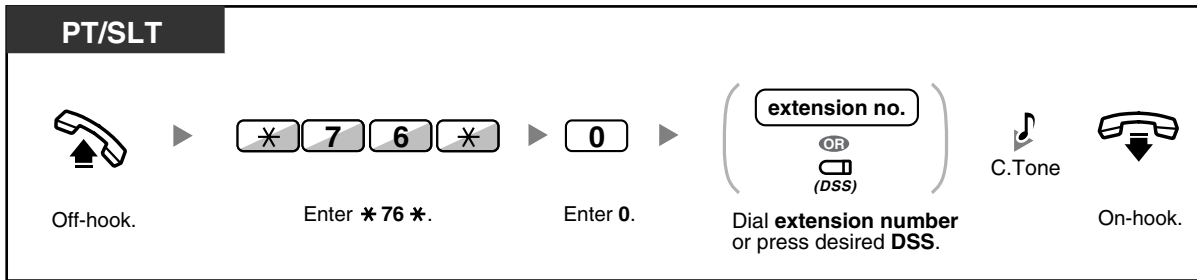

To confirm

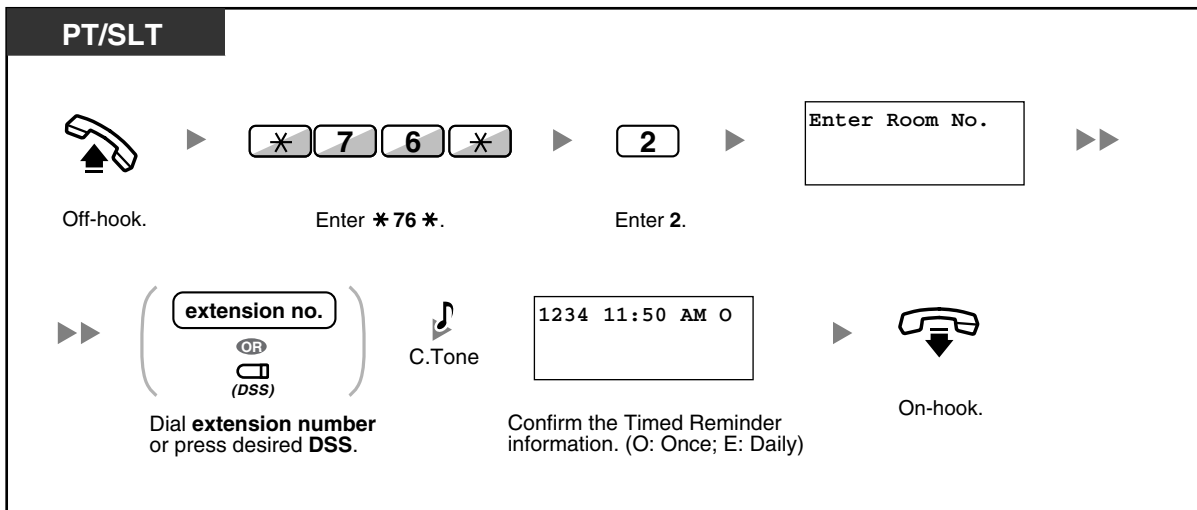



- When a timed reminder starts, and when it is answered or not answered, detailed timed reminder information is recorded automatically. This requires system programming. <Example>

Date	Time	Ext	CO	Dial Number
02/02/00	02:45PM	1234		Timed Reminder/Start
02/02/00	02:46PM	1234		Timed Reminder/No Answer
02/02/00	02:47PM	1234		Timed Reminder/Answer



- Users of PTs without displays and SLTs can confirm only whether a timed reminder has been set or not by following the steps shown above. If set, a confirmation tone will be heard.

1.3.57 Walking COS

You can use your calling privileges (Class of Service) at another extension. You can override restrictions which have been set at that extension. To use this feature, an original extension number and an extension PIN (Personal Identification Number) are required.

After performing the Walking COS feature, you can set the following features on your telephone from another extension or through DISA.

- Call Forwarding (FWD)/Do Not Disturb (DND)
- Changing the Log-in/Log-out Status of Extensions
- Absent Message
- Extension Dial Lock
- Time Service—Changing the Time Mode (Day/Night/Lunch/Break)

To make a call or set features from another extension

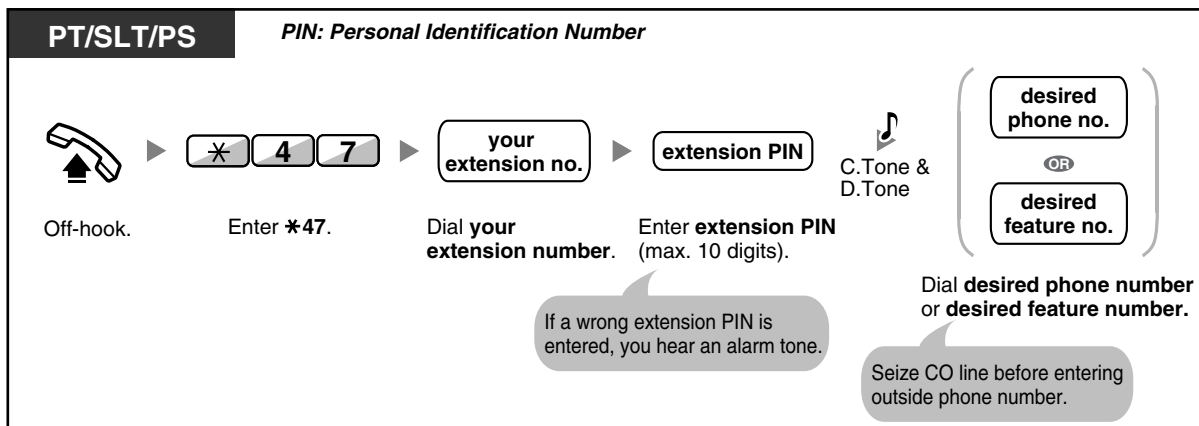

To make a call or set features through DISA

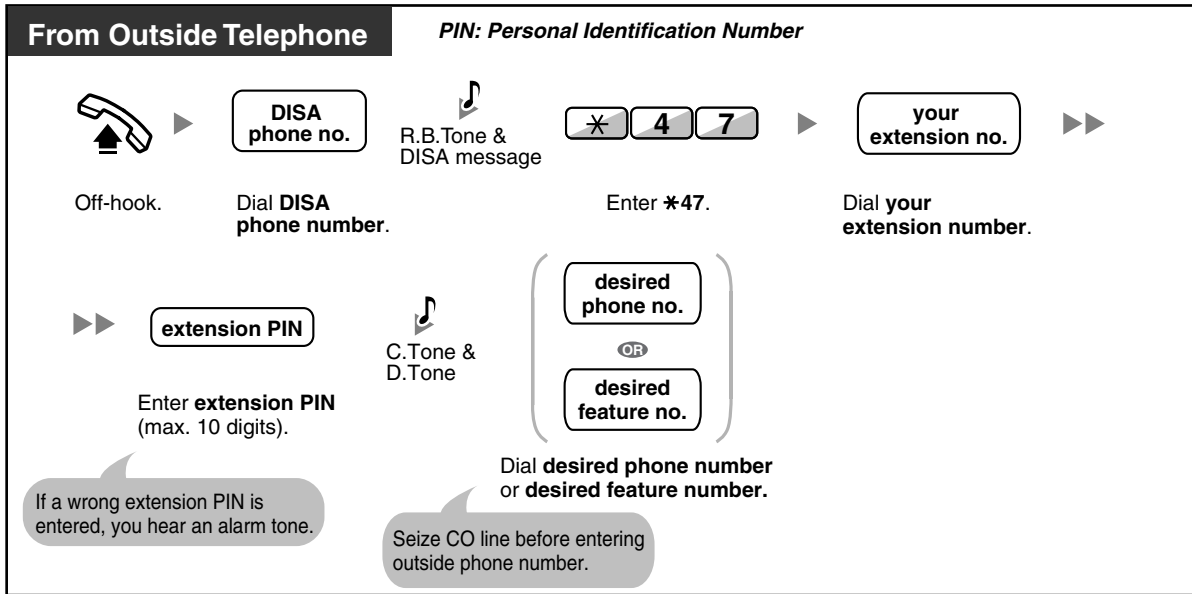

1.3.58 Walking Extension

You can use the same functions assigned on your previous extension even if you move to another extension in the office.

You can retain your settings such as extension number or One-touch Dialing memory etc. on the new extension.

This feature is also known as Walking Station.

To set

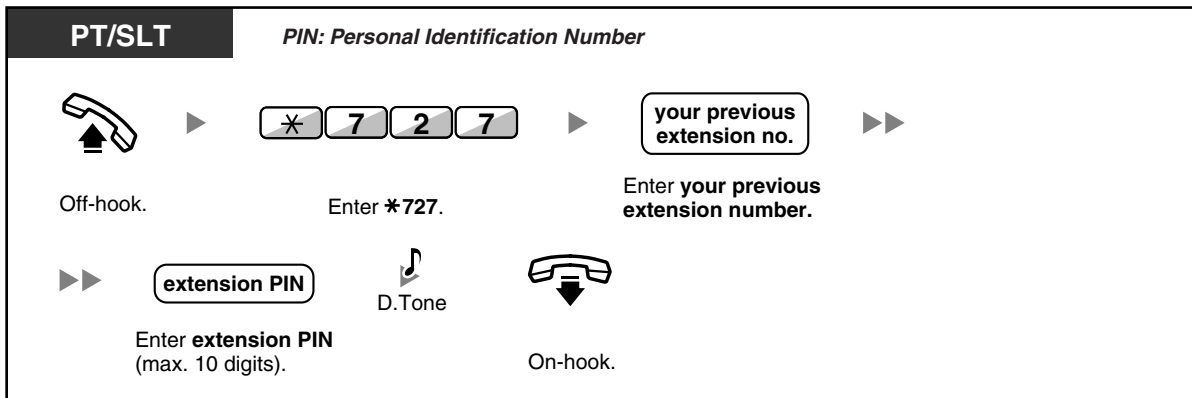

- Your previous extension will get the old settings of your new extension.
- This feature is available for movement between SLT and SLT, PT and PT or SLT and PT.
- For more information, refer to "3.1.2 Personal Programming".

1.3.59 Wireless XDP Parallel Mode

Your PS can be used in parallel with a PT or SLT.
When in this mode, incoming calls to a wired telephone also ring the paired PS.



To set

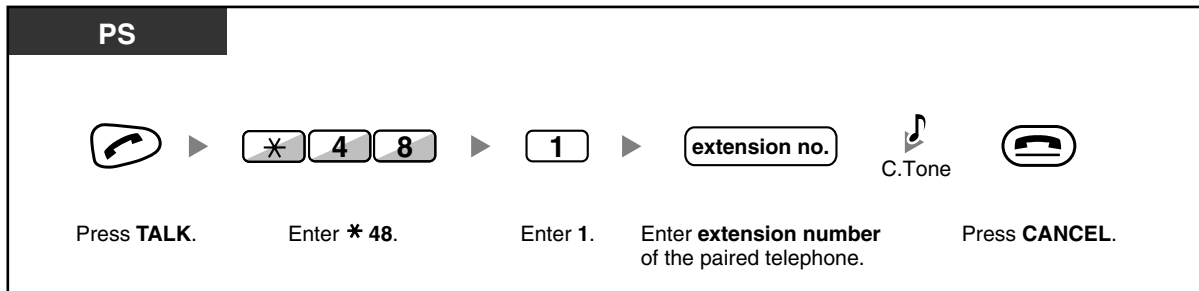

To cancel

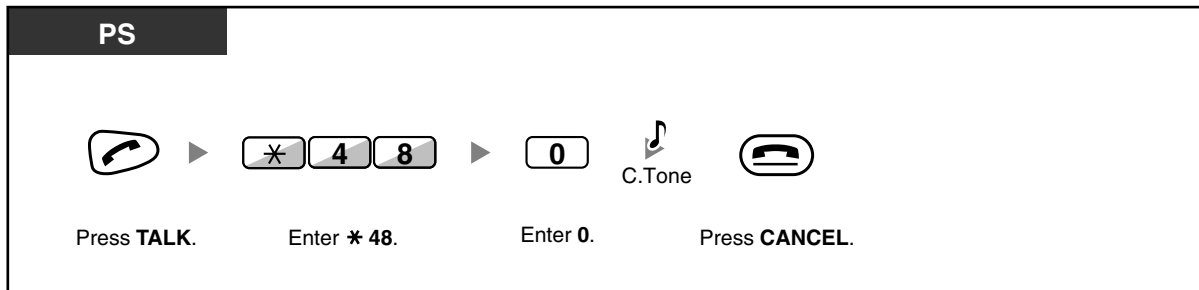

- Some wired telephones are prohibited from using this feature.
- **If you go off-hook while your paralleled telephone is in use, the call will switch over to you.**

1.4 Display Features

1.4.1 Directories

You can select and call using the directories (*Personal Speed Dialing Directory, System Speed Dialing Directory and Extension Number Directory*).

Only personal directories can be stored, edited or deleted on your extension.

If a call arrives while you are using a directory, the display will be replaced with the caller's information.

- Calling with the Directory
- Storing New Names and Numbers

◆◆ Calling with the Directory

To select and call with a System Speed Dialing Directory

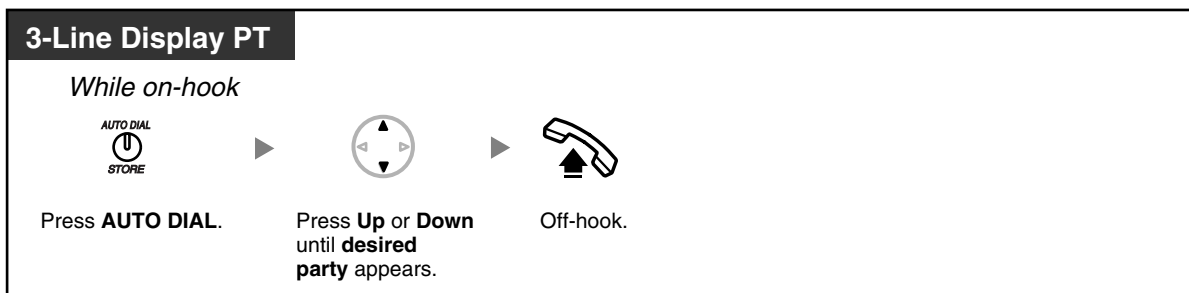

To select and call with a Personal Speed Dialing Directory



To select and call with an Extension Number Directory





- To cancel or exit, press the FLASH/RECALL button.
- You can lock your personal speed dialing directory by using an extension PIN (Personal Identification Number), so that you can prohibit access to it. Refer to "3.1.2 Personal Programming".



- Directory entries generally should include name and number. If the name is not registered, an entry cannot be displayed.

◆◆ Storing New Names and Numbers

To store a Personal Speed Dialing Directory item

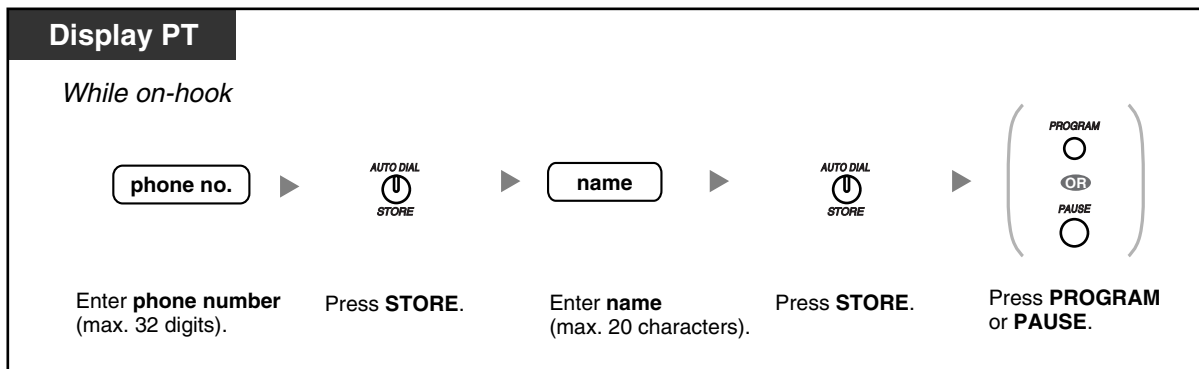

<Operation Example: Storing a name and an outside phone number in the Personal Speed Dialing Directory>

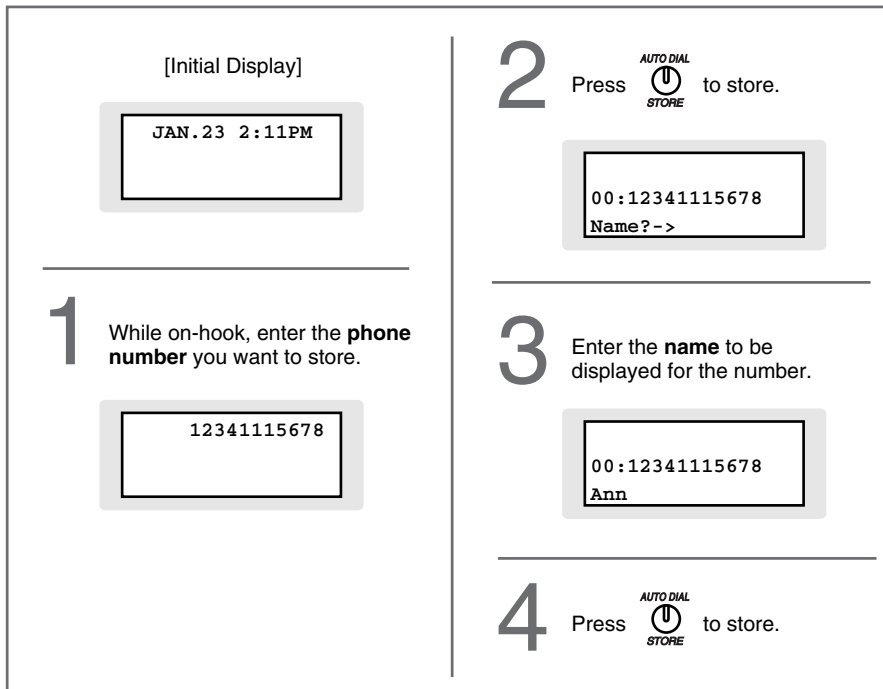

1.4 Display Features



- Telephone number and name on the display are stored using the first spare Personal Speed Dialing memory available.
- PS user: Refer to "Operating Instructions" for PS.



- To enter characters, refer to "1.3.14 Character Entry".
- For more details, refer to "To store the names and numbers in personal speed dialing" in "3.1.2 Personal Programming".

1.4.2 Call Log, Incoming

When you receive an outside call or an external sensor call, call information is recorded automatically in the incoming call log. A preprogrammed number of calls can be logged per extension. When the call log is full and other call arrives, the oldest call is deleted.

You can modify the logged telephone number using the display proprietary telephone or the portable station. When the Call Log button light turns on, there is a call which you did not answer.

The following information is logged.

Telephone Information	KX-TD7690/KX-TD7680	3-line display PT	1-line display PT
			Wireless phone (KX-TD7895/KX-T7885)
Caller's Name or Caller's Phone Number*	✓	✓	✓
Date/Time call received	✓	✓	—
Answered or Not Answered Confirmed or Not Confirmed	✓	✓	—

*: If the caller's name is not logged, the caller's phone number is displayed.
If the caller's name is logged, the caller's phone number is not displayed.

The incoming call log information is displayed as follows:

[With Caller's Name]

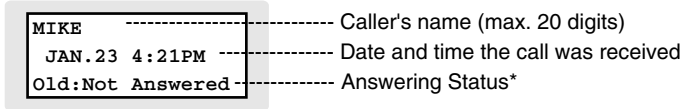

↓ Press  to display a caller's name.

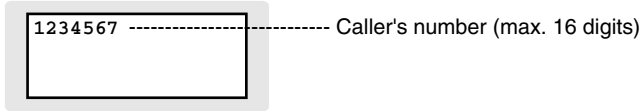

[Without Caller's Name]

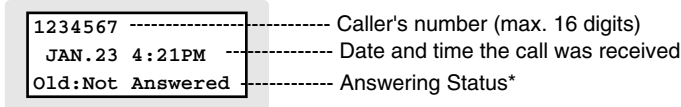

*: "New" is displayed for call logs which have not previously been viewed;
 "Old" is displayed for call logs which have previously been viewed.

To view the log information with the Call Log button

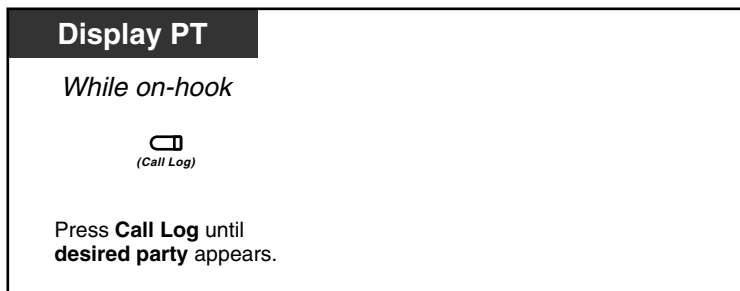

To clear the log information

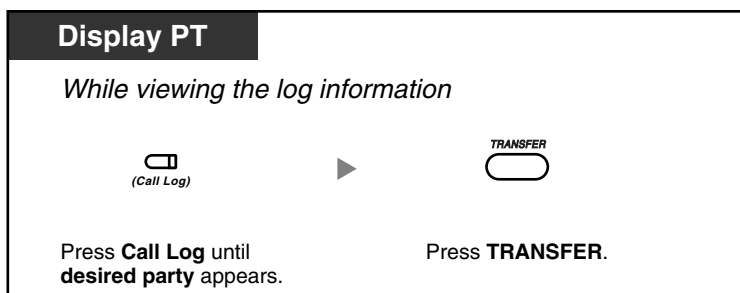

To call

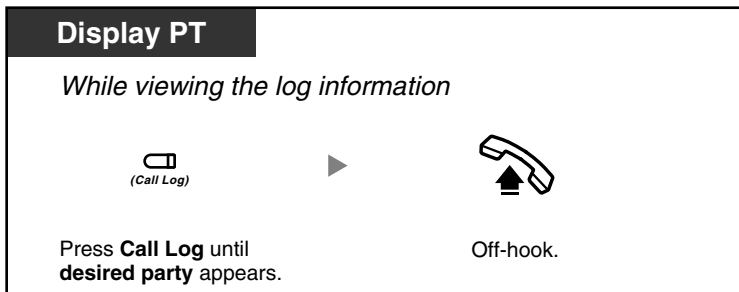

- The Call Log button light shows the current status as follows:
Off: No incoming call, or you have already viewed the call log.
Red on: You have missed calls to view.
- If your call is answered by another extension, the caller's information is recorded in the logs of both your extension and the answering extension.
- You can lock your call log display by using an extension PIN (Personal Identification Number), so that you can prohibit access to your logged information. Refer to "3.1.2 Personal Programming".
- You can also have a Call Log button for an ICD Group (Incoming Call Distribution Group).
- If a call arrives while you are using the call log, the call log display will be replaced with the caller's information.
- PS user: Refer to "Operating Instructions" for PS.
- Caller information received with a call waiting tone from the telephone company will not be logged in the call log.



Customizing Your Phone

- 3.1.4 Customizing the Buttons
Create or edit a Call Log button or Call Log for ICD Group button.

Section 2

Manager Operation

This chapter shows the manager how to control the other extensions or the PBX.

2.1 Manager Service Features

2.1.1 Dial Tone Transfer

The manager can change the restriction level, permitting an extension to make a call.

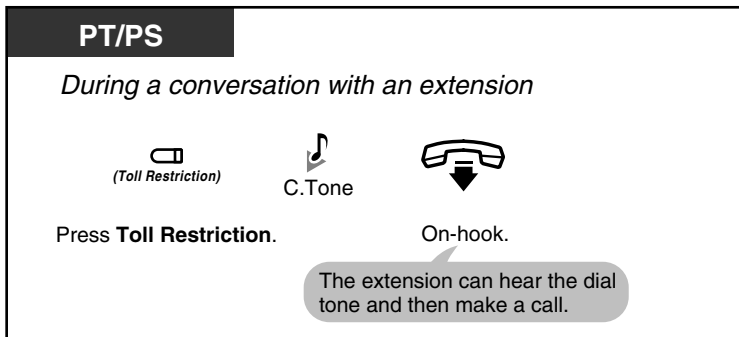

- The restriction level is changed to the preprogrammed level of Toll Restriction button.



Customizing Your Phone

- 3.1.4 Customizing the Buttons
Create or edit a Toll Restriction (TRS) button.

2.1.2 External BGM (Background Music)

The manager extension can broadcast background music in the office through external speakers.

To start/stop the background music

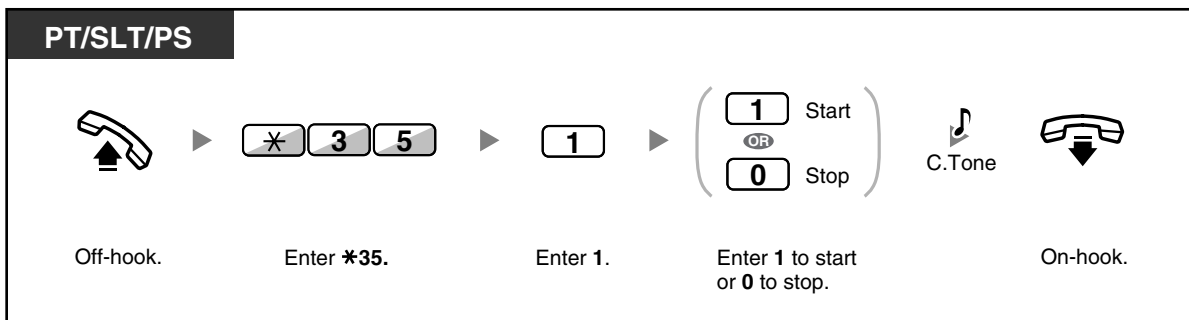

2.1.3 OGM (Outgoing Messages)

The manager extension can record three kinds of greeting messages (OGM) as follows:

1. **DISA message:** Used to greet and guide callers so that they access extension user group or outside party without operator assistance.
2. **Incoming Call Distribution Group message:** Used to greet and guide callers to an incoming call distribution group.
3. **Timed Reminder message:** Used when the extension answers the Timed Reminder.



All messages have their own extension numbers. You can select the desired message. You have two methods for recording a message. One is recorded using the handset, and the other is recorded from an external BGM (MOH) port.

To record

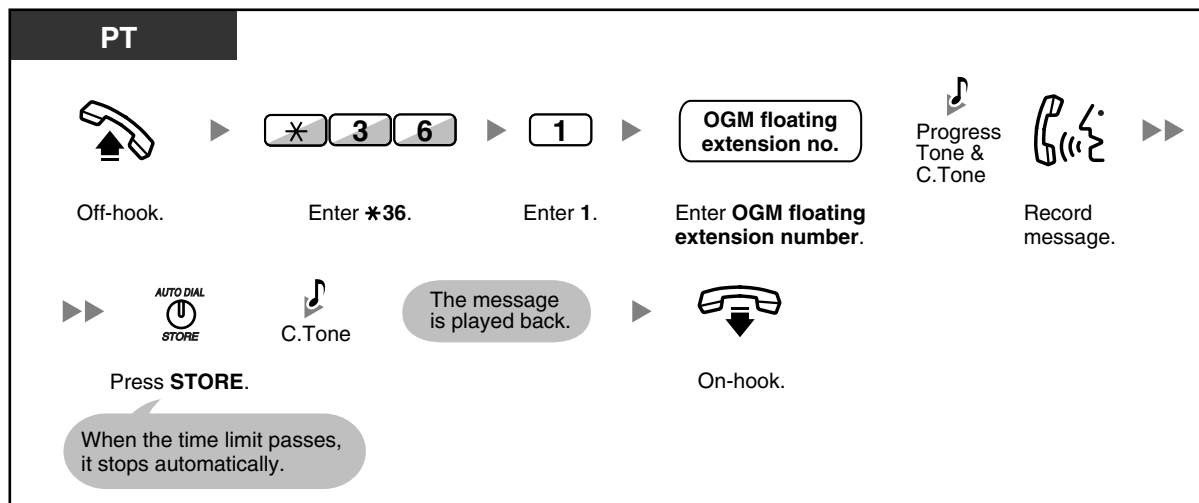

To play back

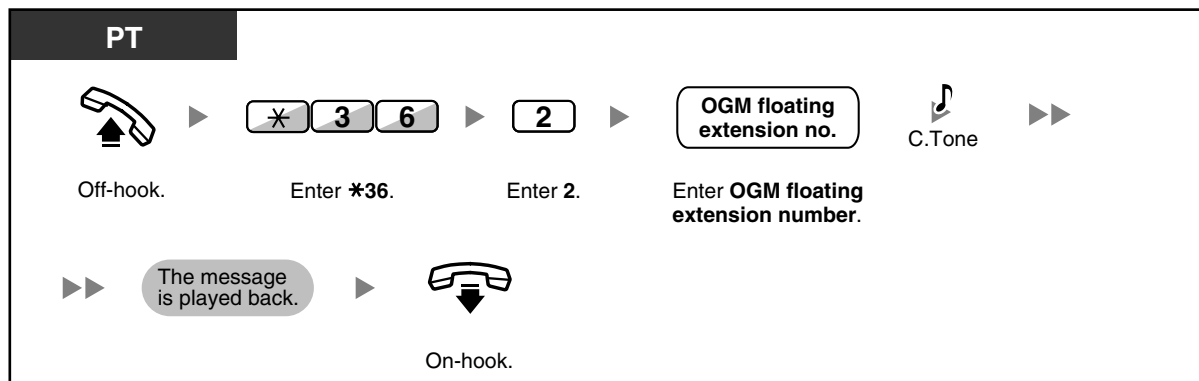

To record from an external BGM (MOH) port

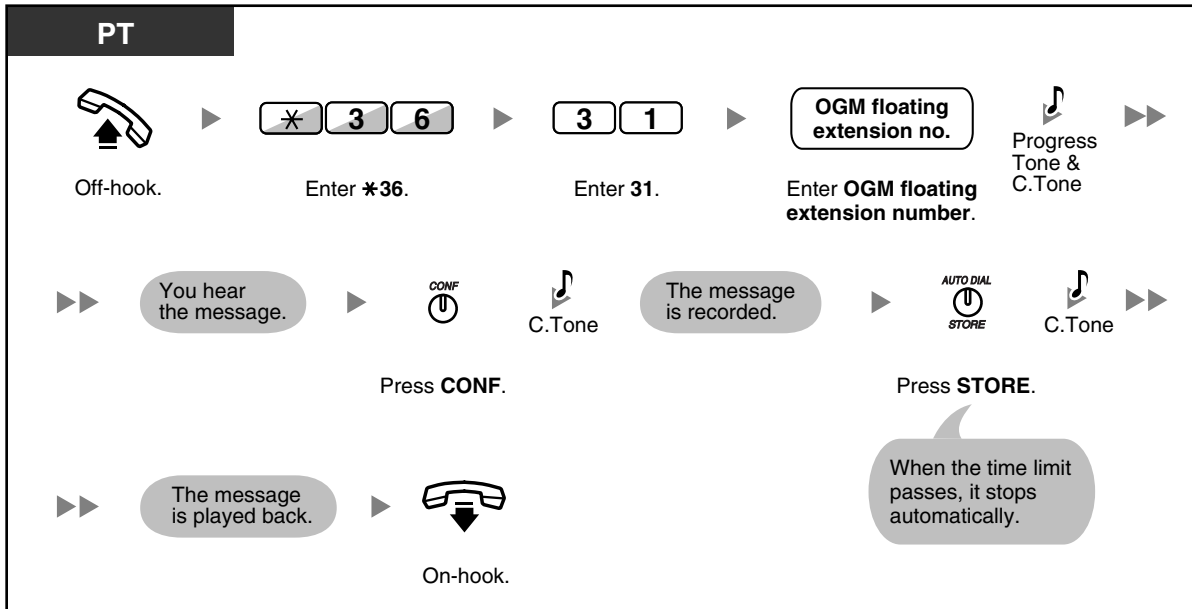

To clear the message

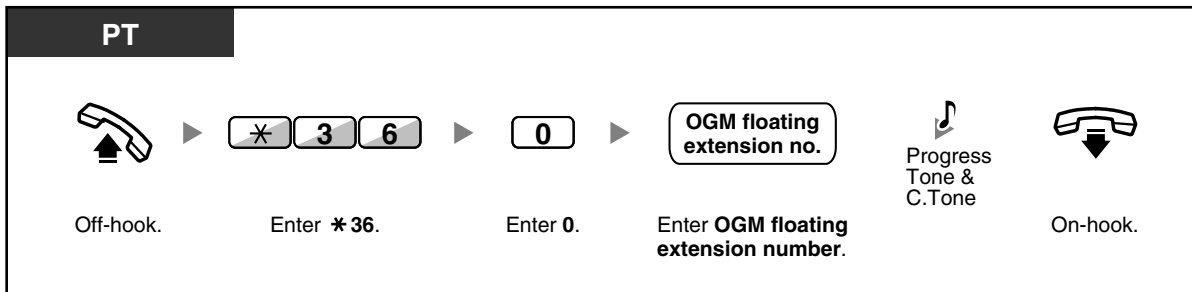

- Record voice messages only; avoid the recording of music.



- The default of OGM floating extension numbers is 5xx (xx: two-digit number of message).

2.1.4 Remote Extension Dial Lock

This feature can override Extension Dial Lock (refer to 1.3.24 Extension Dial Lock) that has been set by an extension user. If the manager extension locks the extension, the extension user cannot unlock it. This feature is also known as Remote Station Lock Control.

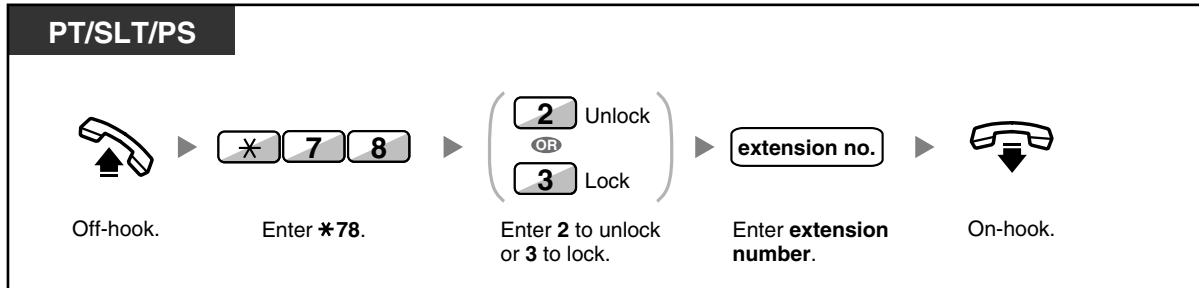

2.1.5 Time Service Mode Control

The manager extension or the preprogrammed extension can change the time mode (Day, Lunch, Break or Night).

There are two methods (Automatic or Manual) of changing the time modes.

Automatic: enables the time mode for each day of the week to change automatically. You may also change it manually.

Manual: enables to change a mode in manual as follows.

To change the time mode (Day/Night/Lunch/Break)

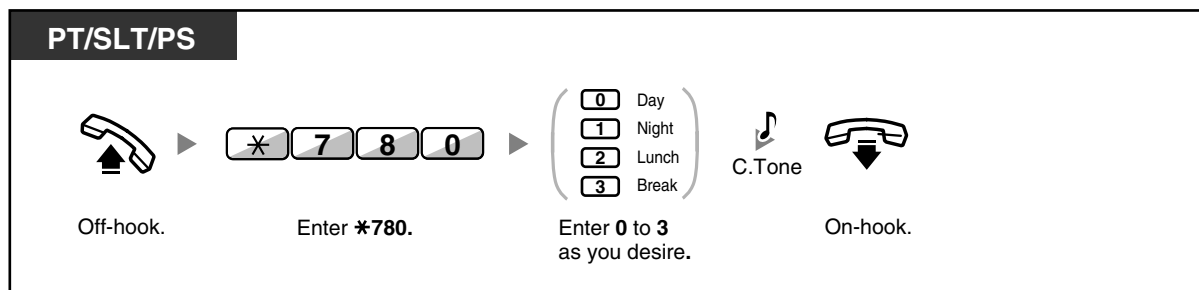
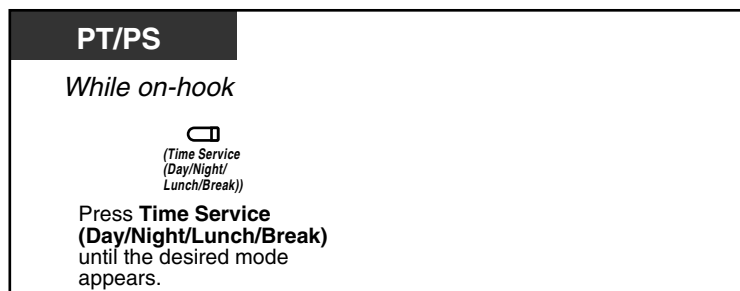

To select the time service switching mode (Automatic/Manual)

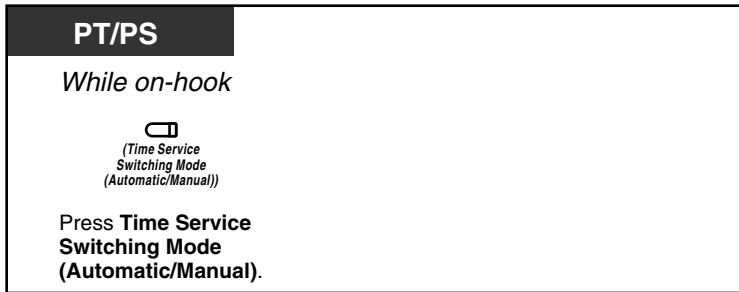

- Besides the time mode, there is Holiday mode. It can change mode once on a specified date.
- The Time Service (Day/Night/Lunch/Break) button light shows the current status as follows:
 - Off:** Day mode
 - Green on:** Lunch mode
 - Flashing green:** Break mode
 - Red on:** Night mode
 - Flashing red:** Holiday mode
- The Time Service Switching Mode (Automatic/Manual) button light shows the current status as follows:
 - Off:** Automatic
 - Red on:** Manual



Customizing Your Phone

- 3.1.4 Customizing the Buttons
Create or edit a Time Service (Day/Night/Lunch/Break) button or a Time Service Switching Mode (Automatic/Manual) button.

Section 3

Customizing Your Phone & System

This chapter shows you how to customize your individual telephone or PBX according to your needs. Find the desired setting and program as necessary.

3.1 Personal Programming

3.1.1 Programming Information

You can customize your telephone features. For example, you can change the initial settings or button features according to your needs.

Available Extension

Any extension in the PBX

Required Telephone

A Panasonic Proprietary Telephone (PT), Portable Station (PS)

Conditions

Programming extensions must be idle, on-hook and holding no calls.

3.1.2 Personal Programming

You can program features using the programming mode.



- To exit at any time, lift the handset.
- To enter the programming mode when using a PS, refer to "Operating Instructions" for PS.



- If you change your desk and extension, refer to "1.3.58 Walking Extension".

◆◆ Setting Features

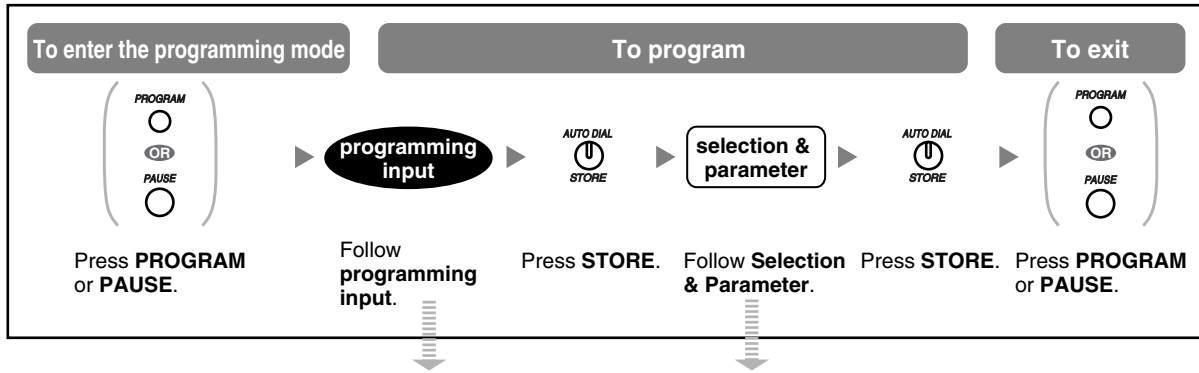

The default settings are shown in bold letters. For later reference, place a check mark in the boxes below to indicate your customized setting.

The following items with "*" (asterisk) are not available for a PS.



Item	Programming Input	Selection & Parameter
Your extension information	<input type="text" value="0"/> <input type="text" value="0"/>	PT: The display shows the PBX number, slot number and port number. <example> EXT1050:10308 PBX no. <input type="text" value="1"/> <input type="text" value="1"/> <input type="text" value="1"/> Port no. Slot no. PS: The display shows the PS number. <example> EXT3001:99001 PS no.
Which display language do you prefer? (Display Language Selection)	<input type="text" value="0"/> <input type="text" value="2"/>	<input type="text" value="1"/> <input type="checkbox"/> English
		<input type="text" value="2"/> <input type="checkbox"/> 2nd Language
		<input type="text" value="3"/> <input type="checkbox"/> 3rd Language
		<input type="text" value="4"/> <input type="checkbox"/> 4th Language
		<input type="text" value="5"/> <input type="checkbox"/> 5th Language
Would you like the call duration to be shown automatically on the display when answering an outside call? (Display Switching Mode)	<input type="text" value="0"/> <input type="text" value="3"/>	<input type="text" value="0"/> <input type="checkbox"/> No—Manual (The display keeps showing all of the outside caller's information unless you change it to the call duration manually.)
		<input type="text" value="1"/> <input type="checkbox"/> Yes—Automatic (The first line of the display will change to the call duration automatically when you answer an outside call.)

3.1 Personal Programming

Item	Programming Input	Selection & Parameter	
Would you like to dial a preset number simply by going off-hook?	1 1	desired no. (max. 32 digits)	
		0	<input type="checkbox"/> Do not use
	1 2	1	<input type="checkbox"/> Use
Which do you prefer to seize when you go off-hook to make calls? (Preferred Line Assignment—Outgoing)	1 9	0	<input type="checkbox"/> No line
		1	<input type="checkbox"/> An idle CO line
		2 + CO button no. (01–12) or  (CO)	<input type="checkbox"/> A CO/ICD Group button
		3 or  INTERCOM	<input type="checkbox"/> Intercom
Which line do you prefer to answer when you go off-hook? (Preferred Line Assignment—Incoming)	2 0	0	<input type="checkbox"/> No line
		1	<input type="checkbox"/> The longest ringing line (when multiple calls arrive)
		2 + CO button no. (01–12) or  (CO)	<input type="checkbox"/> An assigned outside button
How do you prefer to receive an intercom call? (Alternate Receiving—Ring/Voice)*	2 1	0	<input type="checkbox"/> Ringing (Tone Call)
		1	<input type="checkbox"/> Directly—The party's voice is heard without ringing.
		2	<input type="checkbox"/> Ring only—Prohibiting the caller switching to the voice mode.
Do you prefer to answer a call without going off-hook regardless of the AUTO ANS button status? (Forced Answerback Selection)*	2 3	0	<input type="checkbox"/> No—Disable
		1	<input type="checkbox"/> Yes—Enable

Item	Programming Input	Selection & Parameter	
Which service do you prefer when a calling party is recording a message in your mailbox? (Live Call Screening Mode Set)*	2 5	0	<input type="checkbox"/> You can monitor the message through the telephone speaker. (Hands-free mode)
		1	<input type="checkbox"/> Only an alarm tone is heard. (Private mode)
Would you like to keep recording after answering the call in the LCS mode? (LCS Mode Set [After Answering])	2 6	0	<input type="checkbox"/> No—Stop recording
		1	<input type="checkbox"/> Yes—Keep recording
Do you prefer to receive call waiting for outside calls?	3 0	0	<input type="checkbox"/> No (No tone)
		1	<input type="checkbox"/> Yes (Tone)
Do you prefer to receive call waiting for intercom calls?	3 1	0	<input type="checkbox"/> No (No tone)
		1	<input type="checkbox"/> Yes (Tone)
Which type of call waiting tone do you prefer? (Call Waiting Tone Type Selection)	3 2	0	<input type="checkbox"/> Tone 1
		1	<input type="checkbox"/> Tone 2
Would you like to show a message on the caller's telephone display? (Absent Message)	4 0	0	<input type="checkbox"/> No—Off
		message no. (1–8)	<input type="checkbox"/> Yes—Shows the selected message.
		9	<input type="checkbox"/> Yes—Shows your personal message.
Creating your personal message. (Personal Absent Message)	4 1	message (max. 16 characters)	

3.1 Personal Programming

Item	Programming Input	Selection & Parameter	
To forward or refuse some or all of your incoming calls (Call Forwarding [FWD]/Do Not Disturb [DND])		0	<input type="checkbox"/> Off
	5 0 / ^{FWD/DND} ⬆	1	<input type="checkbox"/> Do Not Disturb (DND)
	(for both calls)	2 + desired no. (max. 32 digits)	<input type="checkbox"/> All—Forward all calls
	5 1 (for outside calls)	3 + desired no. (max. 32 digits)	<input type="checkbox"/> Busy—Forwarded when your extension is busy.
	5 2 (for intercom calls)	4 + desired no. (max. 32 digits)	<input type="checkbox"/> No Answer—Forwarded when you do not answer.
		5 + desired no. (max. 32 digits)	<input type="checkbox"/> Busy/No Answer—Forwarded when you do not answer or when your extension is busy.
To set the timer for "No Answer" and "Busy/No Answer". (FWD N/A Timer)	5 3	<input type="text"/> (0–120) seconds (Default: 15 seconds)	
Should you prohibit other people from picking up your calls? (Call Pickup Deny)	6 0	0	<input type="checkbox"/> No—Allow
		1	<input type="checkbox"/> Yes—Deny
Do you prohibit other people from joining your conversation? (Executive Busy Override Deny)	6 2	0	<input type="checkbox"/> No—Allow
		1	<input type="checkbox"/> Yes—Deny
Would you like to prohibit paging announcements? (Paging Deny)*	6 3	0	<input type="checkbox"/> No—Allow
		1	<input type="checkbox"/> Yes—Deny
Do you prefer to hear the key pad tone? (Key Pad Tone Set)*	6 4	0	<input type="checkbox"/> No—Off
		1	<input type="checkbox"/> Yes—On
Do you want background music through your telephone speaker while on-hook? (Background Music [BGM])*	6 5	0	<input type="checkbox"/> No—Off
		1 1	<input type="checkbox"/> Yes—On

Item	Programming Input	Selection & Parameter	
Would you like to set your extension PIN or change a stored extension PIN to new one? (Extension PIN [Personal Identification Number])	9 0	extension PIN (max. 10 digits) + STORE + same extension PIN	To set an extension PIN
		stored extension PIN + new extension PIN (max. 10 digits) + STORE + same extension PIN	To change a stored extension PIN to new one
To prevent other people from using your telephone. (Extension Dial Lock)	9 1	extension PIN (max. 10 digits) + 0	<input type="checkbox"/> To unlock
		extension PIN (max. 10 digits) + 1	<input type="checkbox"/> To lock
To prevent other people from seeing your personal speed dialing directory, call log, and SVM log (Display Lock)*	9 2	extension PIN (max. 10 digits) + 0	<input type="checkbox"/> To unlock
		extension PIN (max. 10 digits) + 1	<input type="checkbox"/> To lock
Do you prefer to set the One-touch dialing only? (One-touch Dialing Assignment Mode Selection)	# *	0	<input type="checkbox"/> No—Normal (Any Flexible CO buttons can be modified.)
		1	<input type="checkbox"/> Yes—Only One-touch dialing buttons can be modified. However, to modify them, there is no need to enter "2" before the number.



- WARNING**

There is a risk that fraudulent telephone calls will be made if a third party discovers your password (extension PIN). The cost of such calls will be billed to the owner/renter of the PBX. To protect the PBX from this kind of fraudulent use, we strongly recommend:

 - Keeping your PIN secret.
 - Selecting a complex, random PIN that cannot be easily guessed.
 - Changing your PIN regularly.
- After the program number is entered, the program title is displayed. The programming screen can be changed with the Navigator key (Up or Down).



- You can select the parameter with the Navigator Key (Up or Down) instead of entering a number.

To store the names and numbers in personal speed dialing

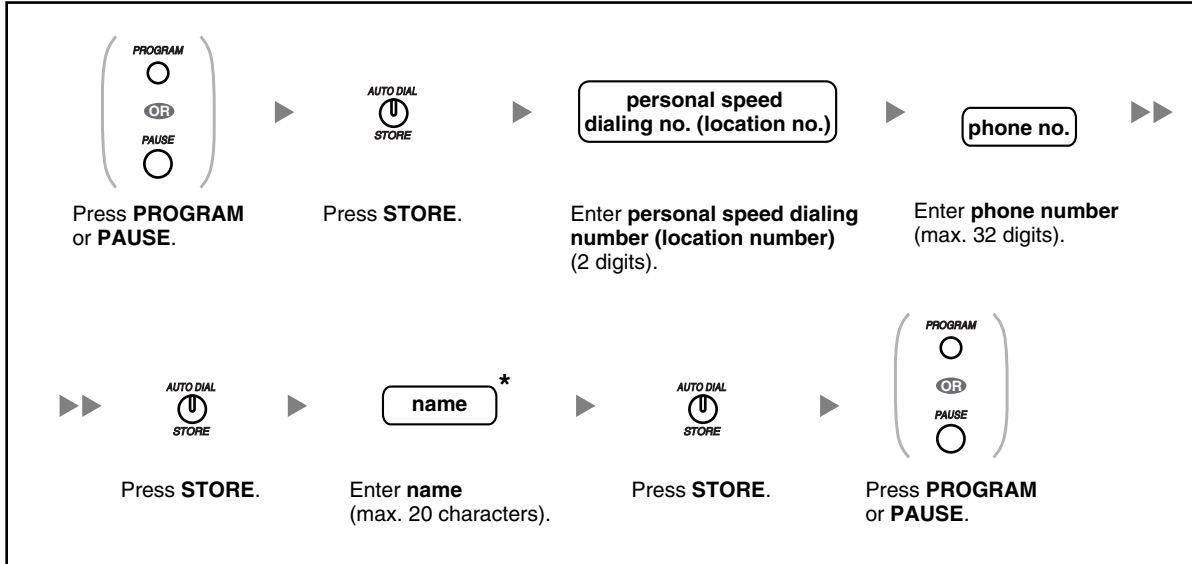

- * To enter characters, refer to "1.3.14 Character Entry".

To edit the names and numbers of personal speed dialing

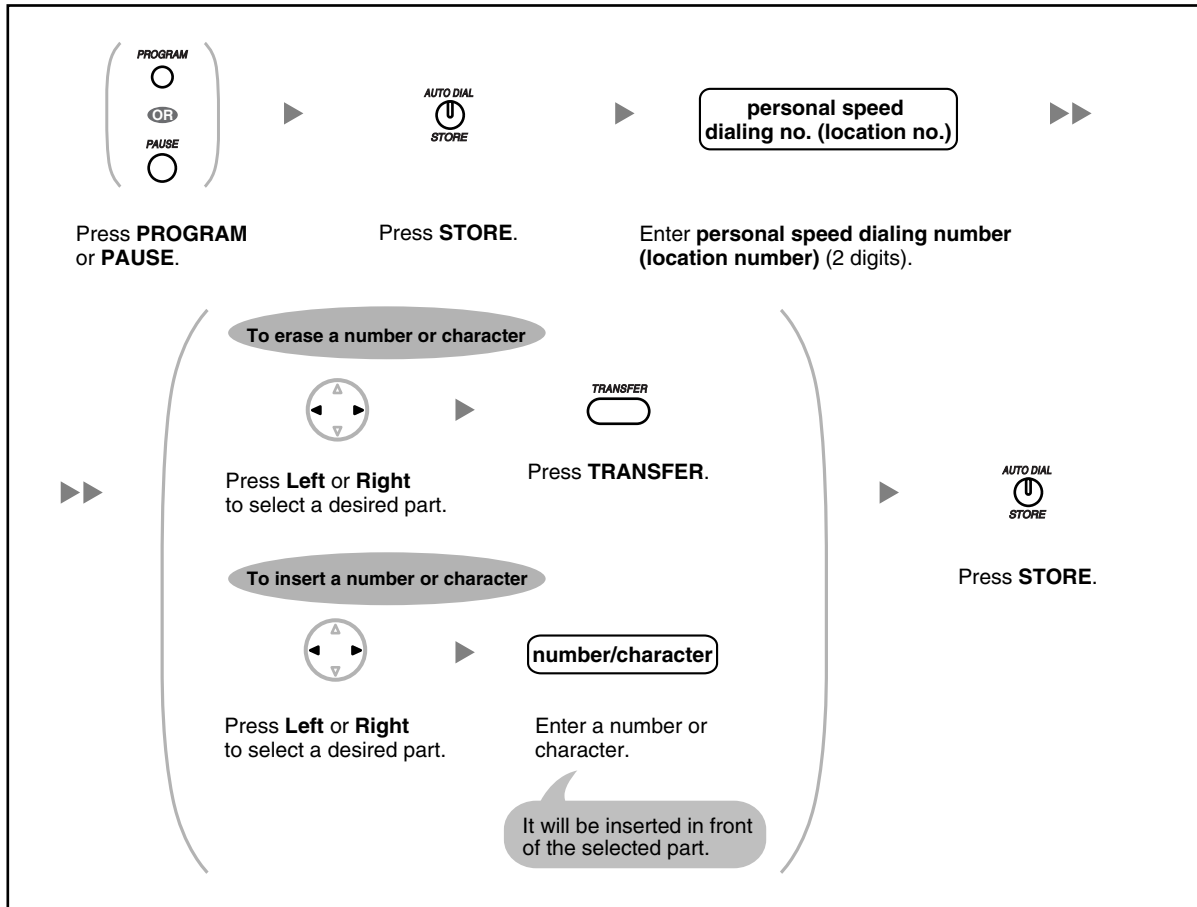

3.1.3 Programming Feature Clear

You can reset the settings of the following features on your extension to the default settings with one operation.

Features	Default Setting
Display Switching Mode	Automatic
Hot Line	Off
Preferred Line Assignment—Outgoing	Intercom
Preferred Line Assignment—Incoming	The longest ringing line
Alternate Receiving—Ring/Voice	Ringing (Tone Call)
Forced Answerback Selection	Disable
Live Call Screening Mode Set	Hands-free mode
LCS Mode Set [After Answering]	Stop recording
Call Waiting—Intercom Calls/Outside Calls	Enable (Tone)

3.1 Personal Programming

Features	Default Setting
Call Waiting Tone Type Selection	Tone 1
Absent Message	Off
Personal Absent Message	Cleared
Call Forwarding [FWD]/Do Not Disturb [DND]—Intercom Calls/ Outside Calls	Off
FWD N/A Timer	15 seconds
Call Pickup Deny	Allow
Executive Busy Override Deny	Allow
Paging Deny	Allow
Key Pad Tone Set	On
Background Music [BGM]	Off
Data Line Security	Off
Log-in/Log-out	Log-in
Message Waiting	Off
Timed Reminder	Cleared

To set

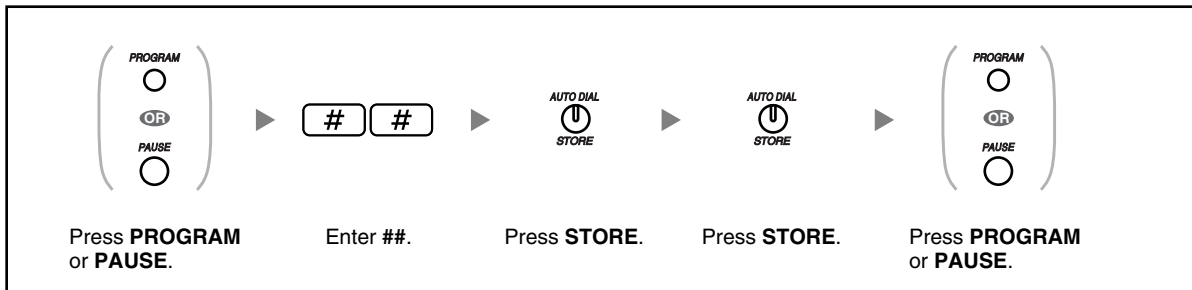

- The Call Waiting, FWD/DND and Hot Line features may not be cleared by this operation, depending on system programming.

3.1.4 Customizing the Buttons

You can change the flexible CO buttons/DSS buttons, and programmable feature (PF) buttons on PTs, DSS Consoles, Add-on Key Modules, and PSs to the following function buttons. For example, if your telephone has more CO buttons than available CO lines, you may change unused CO buttons to one-touch buttons.



- To enter the programming mode when using a PS, refer to "Operating Instructions" for PS.

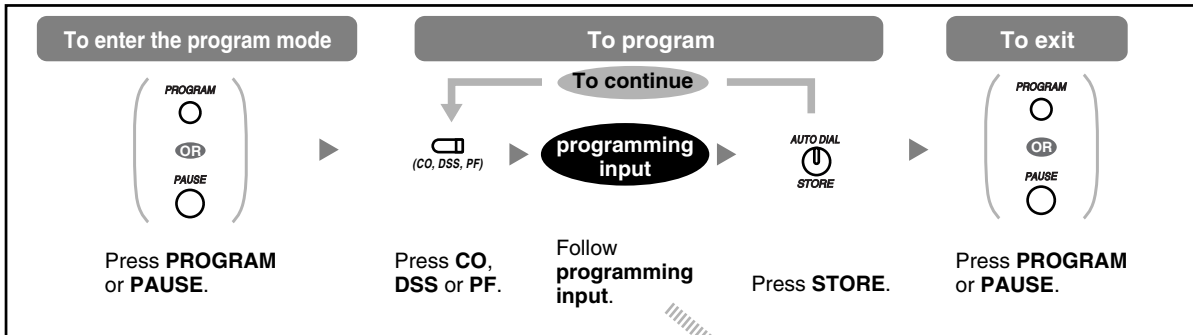

Buttons	Programmable Button			Programming Input
	CO	DSS	PF	
Loop-CO (L-CO)	✓	✓		*
Group-CO (G-CO)	✓	✓		# + CO line group no. (2 digits)
Single-CO (S-CO)	✓	✓		0 + CO line no. (3 digits)
Direct Station Selection (DSS)	✓	✓		1 + Extension no.
One-touch Dialing*1	✓	✓	✓	2 *2 + Desired no. (max. 32 digits)
Incoming Call Distribution Group (ICD Group)	✓	✓		3 0 + Incoming call distribution group extension no.
Message	✓	✓		4 0
Message for Another Extension	✓	✓		4 0 + Extension no./Incoming call distribution group extension no.
Call Forwarding (FWD)/Do Not Disturb (DND)—Both calls	✓	✓		4 1
FWD/DND—Outside calls	✓	✓		4 2
FWD/DND—Intercom calls	✓	✓		4 3

3.1 Personal Programming

Buttons	Programmable Button			Programming Input
	CO	DSS	PF	
Group FWD—Both calls	✓	✓		[4] [4] + Incoming call distribution group extension no.
Group FWD—Outside calls	✓	✓		[4] [5] + Incoming call distribution group extension no.
Group FWD—Intercom calls	✓	✓		[4] [6] + Incoming call distribution group extension no.
Account	✓	✓		[4] [8]
Conference	✓	✓		[4] [9]
Terminate	✓	✓		[5] [0]
External Feature Access (EFA)	✓	✓		[5] [1]
Call Park	✓	✓		[5] [3] + Parking zone no. (2 digits)
Call Park (Automatic Park Zone)	✓	✓		[5] [3] [*]
Call Log* ³	✓	✓		[5] [4]
Call Log for ICD Group* ³	✓	✓		[5] [4] + Incoming call distribution group extension no.
Log-in/Log-out	✓	✓		[5] [5]
Log-in/Log-out of a specified group	✓	✓		[5] [5] + Incoming call distribution group extension no.
Log-in/Log-out for all groups	✓	✓		[5] [5] [*]
Hurry-up	✓	✓		[5] [6] + Incoming call distribution group extension no.
Wrap-up	✓	✓		[5] [7]
System Alarm* ³	✓	✓		[5] [8]
Time Service (Day/Night/Lunch/Break)	✓	✓		[5] [9] + 0/1/2/3* ⁴ (+ [#] + Tenant no.)
Answer* ³	✓	✓		[6] [0]
Release* ³	✓	✓		[6] [1]

Buttons	Programmable Button			Programming Input
	CO	DSS	PF	
Toll Restriction (TRS)	✓	✓		6 2 + Toll Restriction (TRS) Level (1-7)
Time Service Switching Mode (Automatic/Manual)	✓	✓		6 8 (+ Tenant no.)
Two-way Record* ⁵	✓	✓		9 0 + Voice mail floating extension no.* ⁶
Two-way Transfer* ⁵	✓	✓		9 1 + Voice mail floating extension no.* ⁶
One-touch Two-way Transfer* ⁵	✓	✓		9 1 + Voice mail floating extension no.* ⁶ + # + Extension no./Incoming call distribution group extension no.
Live Call Screening (LCS)* ⁵	✓	✓		9 2
Voice Mail Transfer* ⁵	✓	✓		9 4 + Voice mail floating extension no.* ⁶

<Programming Example: Customizing a CO button as a One-touch Dialing button using Secret dialing>

[Initial Display]
JAN. 23 2:11PM

1 Press PROGRAM or PAUSE

Program No?->

2 Press (CO)

Single Line-001

3 Enter the **programming input** (**2**), and **desired phone number**.

9123

4 Press INTERCOM in front of the number you want to keep secret.

9123 [

5 Press INTERCOM again after entering the number you want to keep secret.

9123 [4567]

6 Press AUTO DIAL STORE to store.



- *1 "×," "#," FLASH/RECALL, PAUSE, Secret (INTERCOM) and TRANSFER can also be stored.

If you do not want to display the stored number when making a call, press the Secret (INTERCOM) button before and after the numbers you wish to conceal.

If you store an outside party's number, you should first store a line access number.

If you need to enter an account code, you can enter the specified account code before the line access number.

<Example>

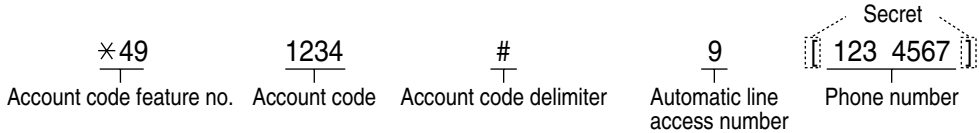

- *2 For a PF button, "2" is not required to enter before the desired number.
- *3 This button is not available for a PS.
- *4 0: Day/Night/Lunch/Break, 1: Day/Night/Break, 2: Day/Night/Lunch, 3: Day/Night
- *5 This button is used for the integrated voice mail features.
- *6 The default voice mail floating extension number is 500.
- **To exit at any time**, lift the handset.



- You can select the parameter with the Navigator key (Up or Down) instead of entering a number.

To clear the button

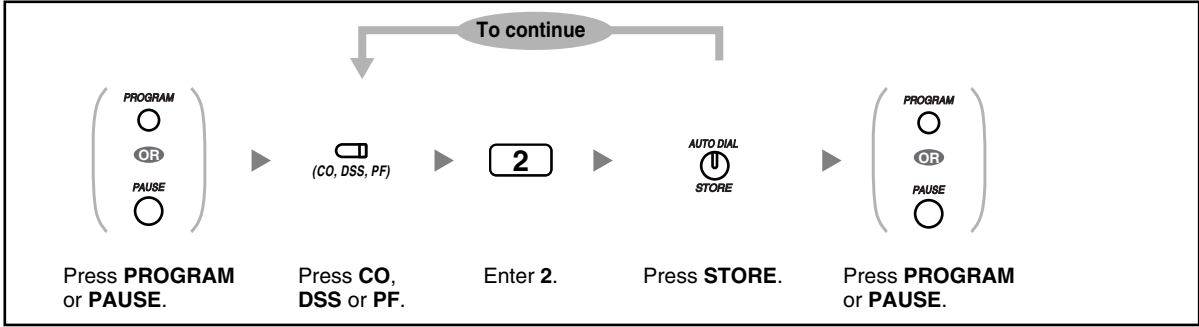

3.2 Manager Programming

3.2.1 Programming Information

The manager can program the following item.

- Other Extensions Control

Available Extension

The extension assigned as a manager

Required Telephone

A Panasonic Proprietary Telephone with display
(e.g., KX-T7737)

Manager Password

To enter programming mode, the manager password (max. 10 digits) is required. (Default: 1234)

WARNING

- The PBX has a default password preset. For security, change the password the first time that you programme the PBX.
- It is strongly recommended that a password of 10 numbers or characters be used for maximum protection against unauthorized access. For a list of numbers and characters that can be used in the password, refer to "1.3.14 Character Entry".
- To avoid unauthorized access to the PBX, keep the password secret. If it becomes known to others, the PBX may be misused.
- Change the password periodically.

Conditions

The programming extension must be idle, on-hook and holding no calls.

3.2.2 Manager Programming

◆◆ Changing the Settings and Extension Control

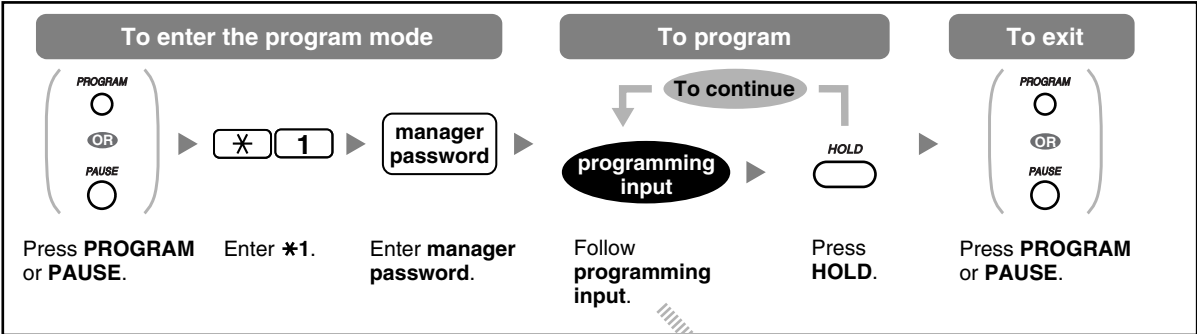

Item	Programming Input
Changing the manager password.	[0] [0] + + Password (max. 10 digits) +
Locking/unlocking other extensions. (Remote Extension Dial Lock)	[9] [0] + + Extension no. + [1] (to lock)/ [0] (to unlock) +
Clearing the PIN and PIN lock for extensions.	[9] [1] + + Extension no. +
Clearing the PIN and PIN lock for verification codes.	[9] [2] + + Verification code +
Setting the verification code PIN.	[9] [3] + + Verification code + PIN (max. 10 digits) +



- WARNING**
 There is a risk that fraudulent telephone calls will be made if a third party discovers your password (verification code PIN).
 The cost of such calls will be billed to the owner/renter of the PBX.
 To protect the PBX from this kind of fraudulent use, we strongly recommend:

 - Keeping your PIN secret.
 - Selecting a complex, random PIN that cannot be easily guessed.
 - Changing your PIN regularly.

<Programming Example: Changing the manager password>

[Initial Display]

JAN.23 2:11PM

1 Press PROGRAM or PAUSE

Program No?->

2 Enter * 1

Enter Password

3 Enter the current **manager password**.

Mngr-Pgm No?->

4 Enter the **programming input** (0 0).

Manager Password

5 Press AUTO DIAL STORE

1234

The current manager password appears.

6 Enter a new **manager password** (max. 10 digits).

1117

7 Press AUTO DIAL STORE to store.

3.3 System Programming

3.3.1 Programming Information

You can customize your system according to your requirements.
[Your system already has default settings (factory installed).]

The programming is shown below. (Program number)

- The date and time [000]
- System speed dialing numbers and names [001]/[002]
- Extension number and name [003]/[004]

Available Extension

The extension allowed through COS programming

Required Telephone

A Panasonic Proprietary Telephone with display
(e.g., KX-T7737)

System Password

To enter programming mode, the system password (max. 10 digits) is required. (Default: 1234)

WARNING

- The PBX has a default password preset. For security, change the password the first time that you programme the PBX.
- It is strongly recommended that a password of 10 numbers or characters be used for maximum protection against unauthorized access. For a list of numbers and characters that can be used in the password, refer to "1.3.14 Character Entry".
- To avoid unauthorized access to the PBX, keep the password secret. If it becomes known to others, the PBX may be misused.
- Change the password periodically.











Conditions

The programming extension must be idle, on-hook and holding no calls.

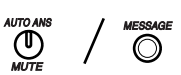
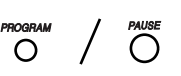
List

Before programming, decide the settings and write them down. Your notes will provide a useful record of the programming for future reference. Your dealer also has programming records which contain all of the system programming. You may ask for photocopies of these tables to be aware of the facilities and features available.

◆◆ Icon Descriptions

Fixed Buttons	Function
	PREVIOUS (PREV)
	NEXT
	➡
	⬅
	SELECT
	PROGRAM
	STORE
	END
	CLEAR
	FLASH
	SECRET

◆◆ Procedure

The basic steps are shown below.

1. Entering the programming mode

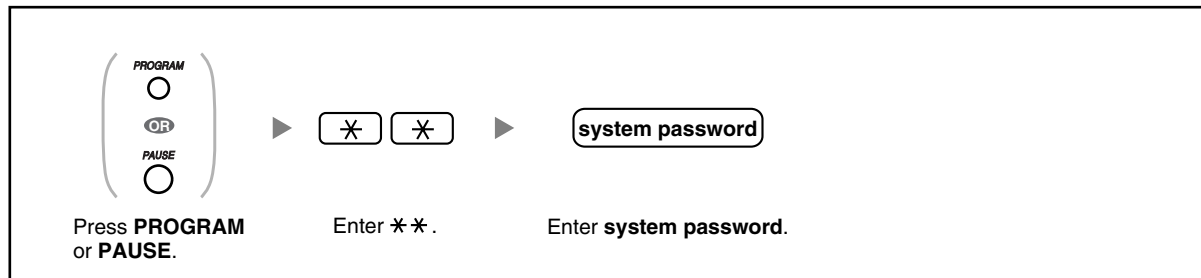

2. Programming

You can enter each program number (3 digits).



- To exit the programming mode at any time, lift the handset.

3. Exiting the mode

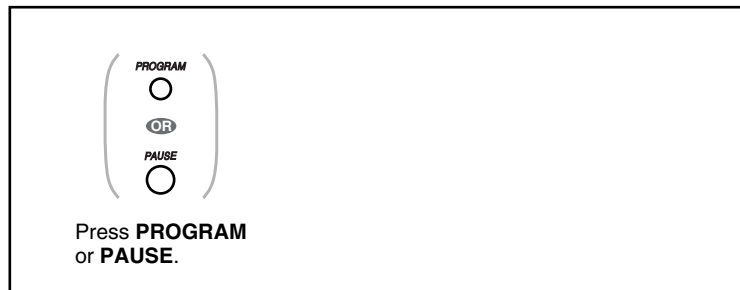

- To exit the programming mode at any time, lift the handset.

3.3.2 System Programming

◆◆ [000] Date & Time

The proprietary telephones display the current date and time while on-hook.

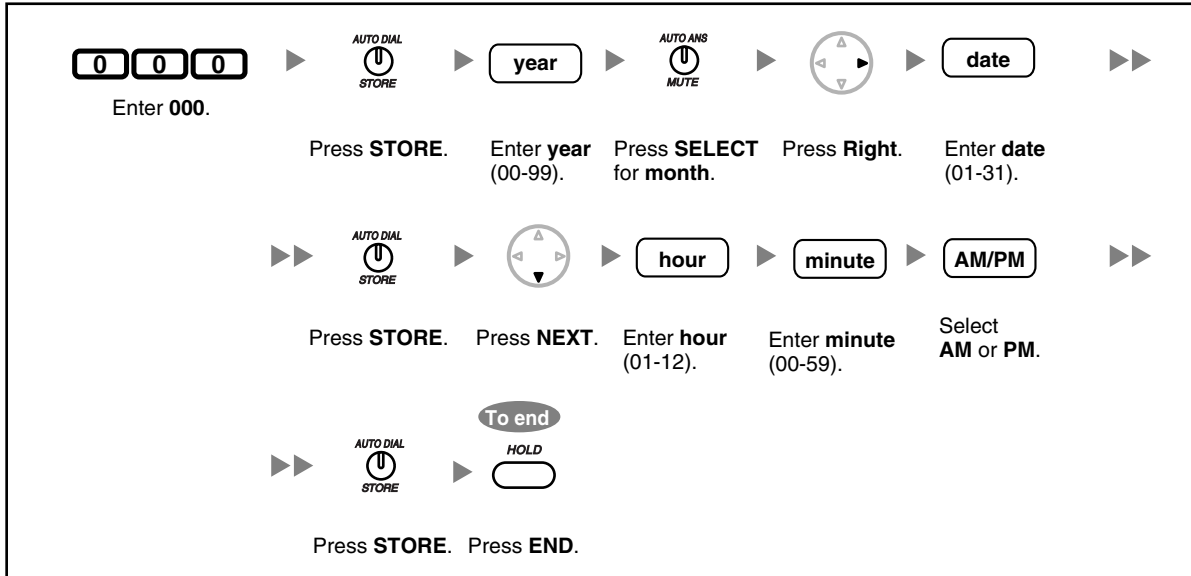

- **After changing the desired values**, you can press the STORE button. You do not have to perform the rest of the steps.
- The clock starts immediately after the STORE button is pressed.
- You cannot leave a value empty.
- You can clear the entry by pressing the CLEAR button.
- **To confirm your entry after storing data:**
 - The STORE button light: Lights red.
 - Confirmation Tone:
 - One beep: Your entry is accepted.
 - Three beeps: Your entry is rejected.

◆◆ [001] System Speed Dialing Number

You can store the phone numbers of frequently dialed numbers.

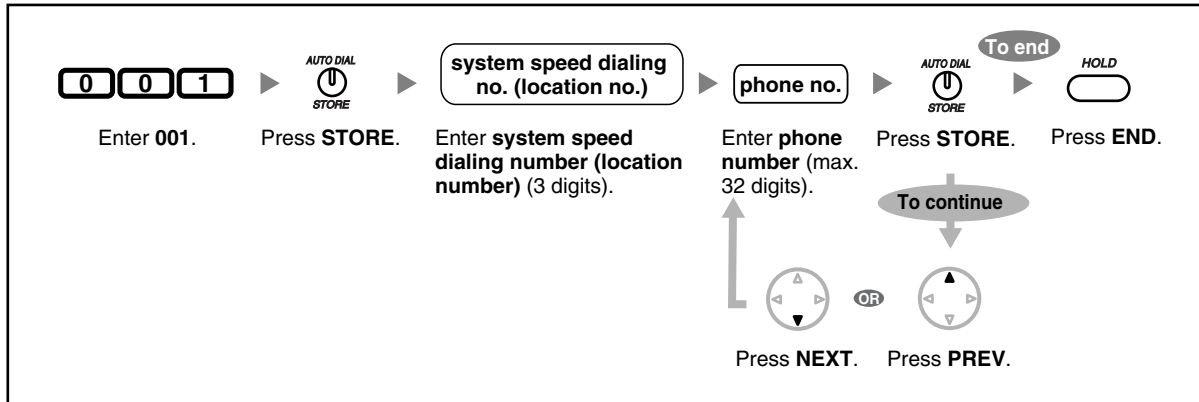

- If the desired number is more than 32 digits, divide the number and store it into more than one speed dialing number.
- "×", "#", FLASH/RECALL, PAUSE, and Secret (INTERCOM) can also be stored. If you do not want to display the stored number when making a call, press the Secret (INTERCOM) button before and after the numbers you wish to conceal. If you store an outside party's number, you should first store a line access number. If you need to enter an account code, you can enter the specified account code before the line access number.

<Example>

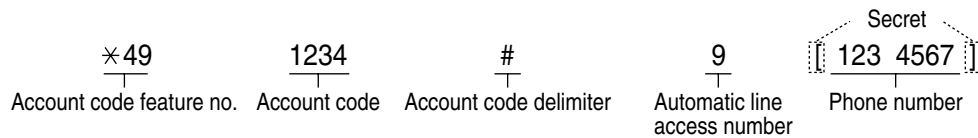

◆◆ [002] System Speed Dialing Name

You can store the name associated with the speed dialing number. These names are displayed when making calls using the display operation. To enter characters, refer to "1.3.14 Character Entry".

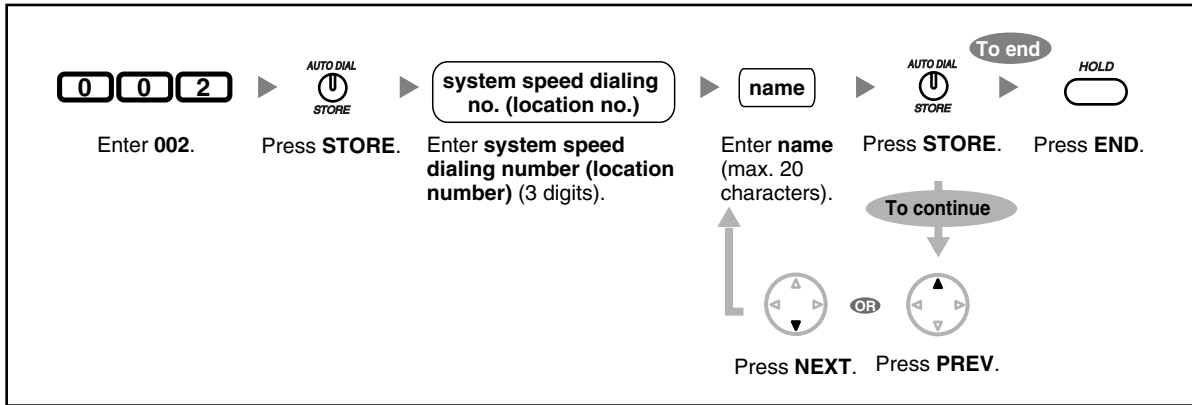

◆◆ [003] Extension Number

You can assign an extension number to each extension.

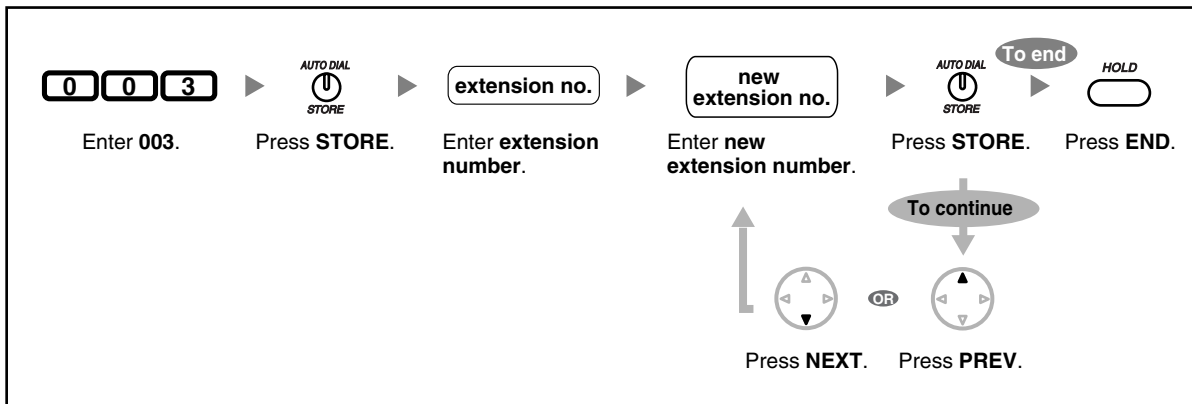

- The leading number(s) should be the same as the number(s) assigned for Flexible Numbering. For more details, refer to the Feature Manual.
- A duplicate entry is invalid.

◆◆ [004] Extension Name

You can store the name of an extension user. This is useful if you want to know who is calling, or who you are calling when making an intercom call using the directory.

To enter characters, refer to "1.3.14 Character Entry".

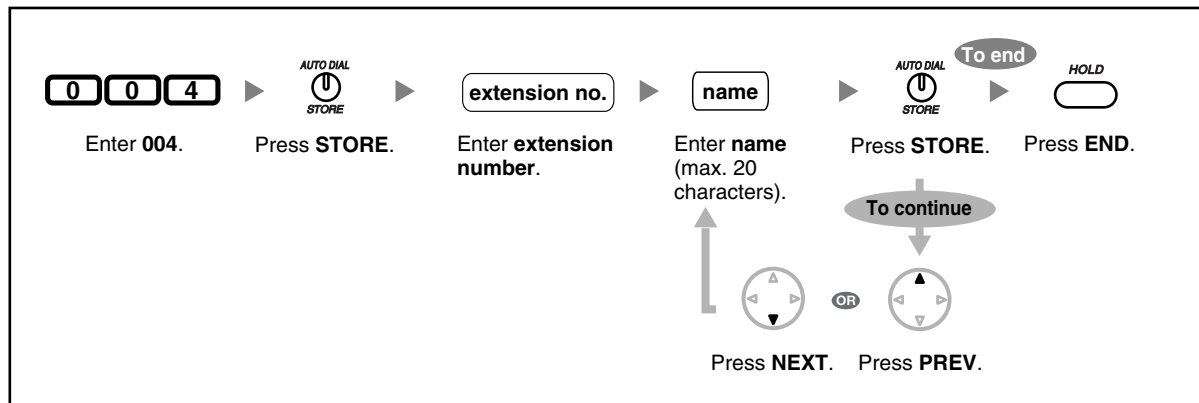

Section 4





Appendix













This chapter provides the Troubleshooting, the Feature Number Table and Tone List. Check the Troubleshooting section before consulting your dealer.

4.1 Troubleshooting



4.1.1 Troubleshooting

◆◆ Troubleshooting

Problem	Remedy
The telephone does not work properly.	<ul style="list-style-type: none"> ➡ Confirm with your manager that your settings are correct. ➡ If the problem persists, consult your dealer.
The telephone does not respond when buttons are pressed.	<ul style="list-style-type: none"> • The telephone is locked. <ul style="list-style-type: none"> ➡ Unlock your telephone. ( 1.3.24 Extension Dial Lock, 2.1.4 Remote Extension Dial Lock)
Some features do not work.	<ul style="list-style-type: none"> • System management may restrict certain features. <ul style="list-style-type: none"> ➡ Consult your manager. • The feature numbers have changed. <ul style="list-style-type: none"> ➡ Confirm the revised number and try again.
Even though following the manual instructions, none of the operations work when using a proprietary telephone.	<ul style="list-style-type: none"> • The Intercom line was not seized. The seized line, when going off-hook, was changed by personal setting. ( 3.1.2 Personal Programming) <ul style="list-style-type: none"> ➡ In the manual, going off-hook means an Intercom line is seized. If the setting has been changed, press the INTERCOM button after going off-hook and follow the instructions.
The telephone does not work using the personal settings or with other settings. (One-touch dialing, forwarding destination, etc.)	<ul style="list-style-type: none"> • The extension line has been changed. The previous telephone's settings have not been cleared. <ul style="list-style-type: none"> ➡ Clear the settings and then program your desired settings again. ( 1.3.25 Extension Feature Clear, 3.1.2 Personal Programming, 3.1.4 Customizing the Buttons)
My proprietary telephone does not have a feature button.	<ul style="list-style-type: none"> • Some models do not have the feature button. <ul style="list-style-type: none"> ➡ Change a flexible button to the desired button. ( 3.1.4 Customizing the Buttons) ➡ Enter the specified feature number instead of the feature button. ( 1.1.1 Before Operating the Telephones)

Problem	Remedy
A reorder tone is audible or "Restricted" is displayed.	<ul style="list-style-type: none"> • The telephone is locked. <ul style="list-style-type: none"> ➤ Unlock your telephone. ( 1.3.24 Extension Dial Lock, 2.1.4 Remote Extension Dial Lock) • Toll restriction is activated. <ul style="list-style-type: none"> ➤ Consult your manager or dealer. • An account code is required. ( 1.3.2 Account Code Entry, 1.3.51 Verification Code Entry, 1.3.57 Walking COS)
I cannot make an outside call using the One-touch Dialing button or speed dialing.	<ul style="list-style-type: none"> • A line access number was not stored. <ul style="list-style-type: none"> ➤ A line access number is required for outside calls. ( 1.2.1 Making Calls, 3.1.4 Customizing the Buttons)
I cannot remember the feature numbers.	<ul style="list-style-type: none"> • ➤ If the feature numbers have been changed from the default values, write the new feature numbers in the table in "4.2.1 Feature Number Table". • ➤ Ask your dealer to change the feature numbers for easier use.
While talking to an outside party, the line is disconnected.	<ul style="list-style-type: none"> • The time limit has run out. ( 1.3.11 Call Transfer, 1.3.16 Conference, Unattended) <ul style="list-style-type: none"> ➤ Consult your dealer to extend the time limit, if necessary.
Redialing does not function.	<ul style="list-style-type: none"> • The stored number was more than 32 digits or an extension number. ( 1.3.44 Redial, Last Number)
The personal computer and fax machine communication failed.	<ul style="list-style-type: none"> • An indication tone may have interrupted communication. ( 1.3.17 Data Line Security)
I cannot send a call waiting tone to the dialed extension.	<ul style="list-style-type: none"> • The other party has not set the Call Waiting feature. ( 1.3.13 Call Waiting Tone) • The other party has set Data Line Security. ( 1.3.17 Data Line Security)
I forgot the password.	<ul style="list-style-type: none"> • Ask the manager to assist you. ( 2.1.4 Remote Extension Dial Lock)
The background music started suddenly.	<ul style="list-style-type: none"> • ➤ Turn off the music. ( 1.3.5 BGM (Background Music), 2.1.2 External BGM (Background Music))
I do not want to display a number which is stored in memory.	<ul style="list-style-type: none"> • ➤ Conceal the number. ( Storing New Names and Numbers, 3.1.4 Customizing the Buttons)
I want to confirm my extension number.	<ul style="list-style-type: none"> • ( Your Extension Number in 1.1.1 Before Operating the Telephones)

4.1 Troubleshooting

Problem	Remedy
The date and time are not correct.	<ul style="list-style-type: none">• Set the date and time by system programming. ( [000] Date & Time in 3.3.2 System Programming)
The display is not shown well.	<ul style="list-style-type: none">•  Change the Display contrast level. ( 3.1.2 Personal Programming)
The MESSAGE button light lit.	<ul style="list-style-type: none">• Another extension left you a message waiting indication while you were on the phone or away from your desk.

4.2 Feature Number Table

4.2.1 Feature Number Table

Numbers listed below are the default settings. There are flexible feature numbers and fixed feature numbers. If you change the flexible feature numbers, fill in your assigned numbers (new) in the list for future reference.

Feature (While dial tone is heard)	Default (New)	Additional digits
1.2.1 Making Calls		
Operator Call	0 ()	
Automatic Line Access	9 ()	outside phone no.
CO Line Group Access	8 ()	CO line group no. (2 digits) + outside phone no.
1.3.1 Absent Message	×750	
– To set	()	1–9 (+ parameter) + #
– To cancel		0
1.3.2 Account Code Entry	×49 ()	account code + # + outside phone no.
1.3.4 Automatic Callback Busy (Camp-on)		
Automatic Callback Busy Cancel	×46 ()	
1.3.5 BGM (Background Music)	×751	
– To select	()	1
– To cancel		0
1.3.6 Call Hold		
Call Hold/Call Hold Retrieve	×50 ()	
Call Hold Retrieve		
– Specified with a held line number	×53 ()	CO line no. which is held (3 digits)
– Specified with a holding extension number	×51 ()	extension no. which has a held call
1.3.8 Call Park	×52	
– To set	()	parking zone no. (2 digits)/×
– To retrieve		stored parking zone no. (2 digits)

4.2 Feature Number Table

Feature (While dial tone is heard)	Default (New)	Additional digits
1.3.9 Call Pickup Call Pickup – Group – Directed Call Pickup Deny – To deny – To allow	*40 () *41 () *720 ()	group no. (2 digits) extension no. 1 0
1.3.12 CALL WAITING FEATURES Answering Call Waiting in the PBX Answering Call Waiting from the Telephone Company	*50 () *60 ()	
1.3.13 Call Waiting Tone – For intercom calls (No Tone/Tone) – For outside calls (No tone/Tone)	*731 () *732 ()	0 (No tone)/1 (Tone) 0 (No tone)/1 (Tone)
1.3.17 Data Line Security – To set – To cancel	*730 ()	1 0
1.3.18 DISA (Direct Inward System Access) Calling through DISA – To an extension (In All Security Mode only) – To an outside party (In Trunk Security Mode/All Security Mode only)	*47 ()	your extension no./(* + verification code) + extension PIN/verification code PIN + extension no. your extension no./(* + verification code) + extension PIN/verification code PIN + outside phone no.

Feature (While dial tone is heard)	Default (New)	Additional digits
1.3.19 DND (Do Not Disturb) – Both Calls – Outside Calls – Intercom Calls	*710 () *711 () *712 ()	0 (Cancel)/ 1 (Set)
1.3.20 Door Open	*55 ()	doorphone no. (2 digits)
1.3.21 Doorphone Call	*31 ()	doorphone no. (2 digits)
1.3.22 EFA (External Feature Access)	*60 ()	service code
1.3.23 Executive Busy Override Executive Busy Override Deny – To prevent – To allow	*733 ()	1 0
1.3.24 Extension Dial Lock – To lock – To unlock – To make an outside call while your extension is locked	*77 () *47 ()	1 0 + extension PIN your extension no. + extension PIN + phone no.
1.3.25 Extension Feature Clear	*790 ()	
1.3.26 Extension PIN (Personal Identification Number) – To set – To cancel	*799 ()	1 + extension PIN + # + same extension PIN + # 0 + stored extension PIN
1.3.27 External Relay	*56 ()	relay no. (2 digits)

4.2 Feature Number Table

Feature (While dial tone is heard)	Default (New)	Additional digits
1.3.29 FWD (Call Forwarding)		
– Both Calls	×710 ()	0 (Cancel)/
– Outside Calls	×711 ()	2 (All calls) + phone no. + #/
– Intercom Calls	×712 ()	3 (Busy) + phone no. + #/ 4 (No Answer) + phone no. + #/ 5 (Busy/No Answer) + phone no. + #/ 7 (Follow Me) + your extension no./ 8 (Follow Me Cancel) + your extension no.
–To set the timer for "No Answer" and "Busy/No Answer"	×713 ()	00–99 (second)
Call Forwarding (FWD) for your Incoming Call Distribution Group		
– Both Calls	×714 ()	1 (Set) + ICD group extension no. + phone no. + #/0 (Cancel) + ICD group extension no.
– Outside Calls	×715 ()	
– Intercom Calls	×716 ()	
1.3.33 Hot Line	×740 ()	
– To store		2 + phone no. + #
– To set		1
– To cancel		0
1.3.35 ICD Group Features—Log-in/Log-out		
Log-in	×736 ()	1 + ICD group extension no./×
Log-out		0 + ICD group extension no./×
To enter/leave Not Ready mode	×735 ()	1 (Not Ready)/0 (Ready)

Feature (While dial tone is heard)	Default (New)	Additional digits
1.3.37 Message Waiting For a caller – To leave/cancel For a called extension – To call back – To clear	×70 ()	1/0 + extension no. 2 0 + your extension no.
1.3.40 Paging Group Paging – To answer – To deny – To allow	×33 () ×43 () ×721 ()	paging group no. (2 digits) 1 0
1.3.41 Printing Message	×761 ()	message no. (+ parameter) + #
1.3.44 Redial, Last Number	# ()	
1.3.45 Speed Dialing, Personal – To store – To dial	×30 () ×× ()	personal speed dialing no. (2 digits) + outside phone no. + # × + personal speed dialing no. (2 digits)
1.3.46 Speed Dialing, System – To dial	×× ()	system speed dialing no. (3 digits)

4.2 Feature Number Table

Feature (While dial tone is heard)	Default (New)	Additional digits
<p>1.3.47 SVM (Simplified Voice Message)</p> <p>Recording a Normal Greeting Message</p> <ul style="list-style-type: none"> – To record – To play back – To clear <p>Recording a Greeting Message for Each Time Mode</p> <ul style="list-style-type: none"> – To record – To play back – To clear <p>To leave a voice message directly to another extension's message box</p> <p>Listening to Voice Messages Left by Callers</p> <p>Redirecting Your Calls to Your Message Box</p> <ul style="list-style-type: none"> – Both Calls – Outside Calls – Intercom Calls 	<p>×38 ()</p> <p>×710 ()</p> <p>×711 ()</p> <p>×712 ()</p>	<p>1</p> <p>2</p> <p>0</p> <p>8 + 0 (Day)/1 (Night)/2 (Lunch)/3 (Break) + 1</p> <p>8 + 0 (Day)/1 (Night)/2 (Lunch)/3 (Break) + 2</p> <p>8 + 0 (Day)/1 (Night)/2 (Lunch)/3 (Break) + 0</p> <p># + 6 + extension no.</p> <p>3</p> <p>0 (Cancel)/</p> <p>2 (All Calls) + floating extension no. for SVM card*1 + #/</p> <p>3 (Busy) + floating extension no. for SVM card*1 + #/</p> <p>4 (No Answer) + floating extension no. for SVM card*1 + #/</p> <p>5 (Busy/No Answer) + floating extension no. for SVM card*1 + #</p>
<p>1.3.48 TAFAS (Trunk Answer From Any Station)</p> <ul style="list-style-type: none"> – Calls through an external speaker 	<p>×42 ()</p>	<p>KX-TDA100/KX-TDA200/KX-TDA600: speaker no. (1 digit)</p> <p>KX-TDA50: 1</p>
<p>1.3.49 Timed Reminder</p> <ul style="list-style-type: none"> – To set – To cancel 	<p>×760 ()</p>	<p>12H: 1 + time (hour/minute) + 0 (AM)/1 (PM) + 0 (once)/1 (daily)</p> <p>24H: 1 + time (hour/minute) + 0 (once)/1 (daily)</p> <p>0</p>
<p>1.3.51 Verification Code Entry</p>	<p>×47 ()</p>	<p>× + verification code + verification code PIN + phone no.</p>

Feature (While dial tone is heard)	Default (New)	Additional digits
1.3.55 Voice Mail Features—Voice Mail Integration <ul style="list-style-type: none"> – Both Calls – Outside Calls – Intercom Calls 	*710 () *711 () *712 ()	0 (Cancel)/ 2 (All Calls)/ 3 (Busy)/ 4 (No Answer)/ 5 (Busy/No Answer) + voice mail floating extension no.*2 + #
1.3.56 Wake-up Call* ³ <ul style="list-style-type: none"> – To set – To cancel – To confirm 	*76* ()	12H: 1 + extension no. + hour/minute + 0 (AM)/ 1 (PM) + 0 (once)/1 (daily) 24H: 1 + extension no. + hour/minute + 0 (once)/1 (daily) 0 + extension no. 2 + extension no.
1.3.57 Walking COS <ul style="list-style-type: none"> – To make a call or set features from another extension – To make a call or set features through DISA 	*47 ()	your extension no. + extension PIN + phone no./ feature no.
1.3.58 Walking Extension	*727 ()	your previous extension no. + extension PIN
1.3.59 Wireless XDP Parallel Mode <ul style="list-style-type: none"> – To set – To cancel 	*48 ()	1 + paired wired extension no. 0
2.1.2 External BGM (Background Music)* ⁴ <ul style="list-style-type: none"> – To start – To stop 	*35 ()	11 10
2.1.3 OGM (Outgoing Messages)* ⁴ <ul style="list-style-type: none"> – To record – To play back – To record from an external BGM (MOH) port – To clear 	*36 ()	1 + OGM floating extension no.* ⁵ 2 + OGM floating extension no.* ⁵ 31 + OGM floating extension no.* ⁵ 0 + OGM floating extension no.* ⁵

4.2 Feature Number Table

Feature (While dial tone is heard)	Default (New)	Additional digits
2.1.4 Remote Extension Dial Lock – To unlock	✕782 ()	extension no.
– To lock	✕783 ()	extension no.
2.1.5 Time Service Mode Control*6 – Day/Night/Lunch/Break	✕780 ()	0/1/2/3

*1 : The default floating extension numbers are 591 for SVM card 1, and 592 for SVM card2.

*2 : The default voice mail floating extension number is 500.

*3 : Hotel operator only

*4 : Manager only

*5 : The default of OGM floating extension numbers is 5xx (xx: two-digit number of message).

*6 : Manager and preprogrammed extension user only

Feature (While busy, DND or call tone is heard)	Default
Call Waiting (BSS [Busy Station Signaling])	1
DND Override	
1.3.3 Alternate Calling—Ring/Voice	✕
1.3.4 Automatic Callback Busy (Camp-on)	6
1.3.7 Call Monitor	5
1.3.23 Executive Busy Override	3
1.3.37 Message Waiting	4

Feature (While dialing or talking)	Fixed Number
Conference	3
1.3.20 Door Open From any extension while talking to the doorphone	5

4.3 Tone

4.3.1 Tone

While on-hook

Ring Tones

The following tones are programmable allowing recognition of call type (Outside, Intercom or Doorphone).

Tone 1



Tone 2



Tone 3

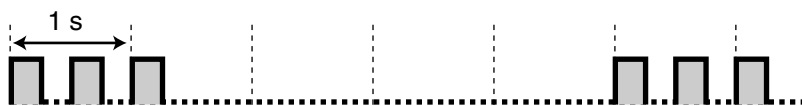

Tone 4

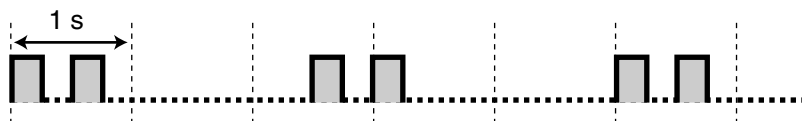

When going off-hook

Dial Tones

Tone 1

Normal

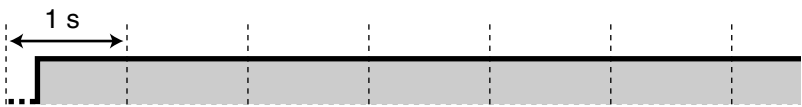

Tone 2

- When there are messages that have previously been listened to and no new messages on the SVM card
- When any of the following features are set:
 - Absent Message
 - Background Music
 - Call Forwarding
 - Call Pickup Deny
 - Call Waiting
 - Do Not Disturb
 - Extension Dial Lock
 - Executive Busy Override Deny
 - Hot Line
 - Timed Reminder

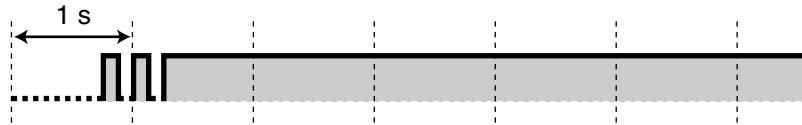

Tone 3

- After pressing TRANSFER or Recall/ hookswitch to hold a call temporarily (e.g., Call Splitting)
- When the recording space of the Simplified Voice Message feature becomes almost full
- While a called PS is being searched
- When Account Code Entry is performed
- When answering a Timed Reminder call with no message
- When answering an external sensor call



Tone 4

Message waiting indication was received.

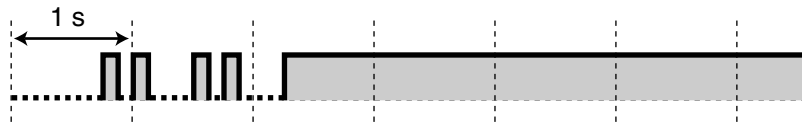

When you make calls

Busy Tone

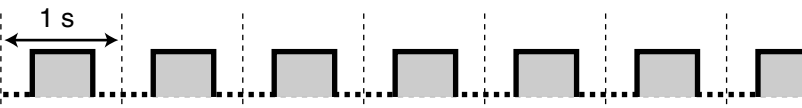

Reorder Tone

The CO line you tried to seize is not assigned or denied.



Ringback Tones

Tone 1



Tone 2



Do Not Disturb (DND) Tone

The dialed extension is refusing incoming calls.



While off-hook

Indication Tones

Tone 1

Call waiting tone

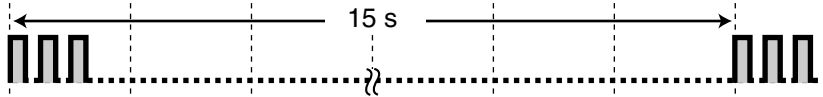

Tone 2

A call is on hold longer than the specified time.

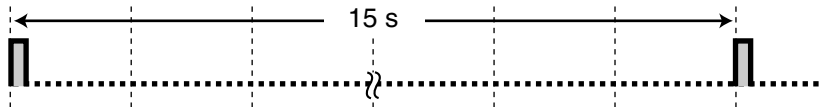

When talking to an outside party

Warning Tone

This tone is sent 15, 10 and 5 seconds before the specified time for disconnection.



When setting the features or programming

Confirmation Tones

Tone 1

The feature setting was set successfully.



Tone 2

Before receiving a page through an external speaker



Tone 3

Before the following features activate:

- Retrieving a held call
- Picking up another call
- Paging/Answering a paging announcement
- Answering the call through a speaker



Tone 4

Establishing or leaving a conference



Tone 5

A call has been put on hold.

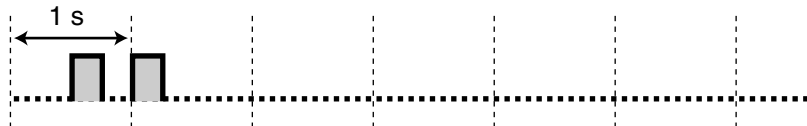

4.4 Revision History

4.4.1 PSMPR Software File Version 1.1xxx

Changed Contents

- 1.3.9 Call Pickup
Call Pickup
- 1.3.12 CALL WAITING FEATURES
Answering Call Waiting from the Telephone Company

4.4.2 PSMPR Software File Version 2.0xxx

Changed Contents

- 1.3.27 External Relay
- 1.3.28 External Sensor
- 1.3.41 Printing Message
- 1.3.56 Wake-up Call

4.4.3 PSMPR Software File Version 3.0xxx

New Contents

- 1.3.19 DND (Do Not Disturb)
Switching FWD/DND Status Using Fixed FWD/DND Button
- 1.3.29 FWD (Call Forwarding)
FWD/DND Settings Using Fixed FWD/DND Button
- 1.3.47 SVM (Simplified Voice Message)

Changed Contents

- 1.3.11 Call Transfer
Transferring to an Extension in the PBX
 - To transfer with one touch (One-touch Transfer)

Index

Symbols

[000] Date & Time 142
 [001] System Speed Dialing Number 143
 [002] System Speed Dialing Name 144
 [003] Extension Number 144
 [004] Extension Name 145

A

Absent Message 26, 125, 151
 Absent Message, Personal 26, 125
 Account Button 18, 132
 Account Code Entry 27, 151
 Alternate Calling—Ring/Voice 28, 158
 Alternate Receiving—Ring/Voice 124
 Answer Button 18, 72, 132
 Answering Calls 24
 AUTO ANS (Auto Answer)/MUTE Button 16
 AUTO DIAL/STORE Button 16
 Automatic Call Hold 32
 Automatic Callback Busy 28, 158
 Automatic Callback Busy Cancel 29, 151
 Automatic Line Access 23, 151

B

Background Music (BGM) 30, 126, 151
 Before Operating the Telephones 14
 BGM → Background Music 30, 126, 151
 BGM, External 116, 157
 Boss & Secretary feature 65
 Busy Station Signaling (BSS) → Call Waiting 38, 158
 Busy Tone 160
 Buttons, Customizing 131
 Buttons, Fixed 16
 Buttons, Flexible 17
 Buttons, Proprietary Telephone 16

C

Call Forwarding (FWD) 65, 154
 Call Forwarding (FWD) Button 17
 Call Forwarding (FWD) for your Incoming Call Distribution Group 67
 Call Forwarding (FWD)/Do Not Disturb (DND)—Both calls Button 131
 Call Hold 30, 151
 Call Hold Retrieve 31, 151
 Call Log Button 18, 132
 Call Log for ICD Group Button 18, 132
 Call Log, Incoming 112
 Call Monitor 32, 158
 Call Park 32, 151
 Call Park (Automatic Park Zone) Button 18, 132
 Call Park Button 18, 132
 Call Park Retrieve 33
 Call Pickup 34, 152
 Call Pickup Deny 35, 152
 Call Splitting 35
 Call Transfer 36
 Call Waiting 38, 158
 CALL WAITING FEATURES 38

Call Waiting Tone 43
 Call Waiting Tone Type Selection 125
 Call Waiting, Answering from PBX 39, 152
 Call Waiting, Answering from Telephone Company 42, 152
 Calling, Outside Party 23
 Calling, Through DISA 51
 Camp-on → Automatic Callback Busy 28, 158
 Character Entry 43
 CO Button 16
 CO Line Group Access 23, 151
 CONF (Conference) Button 17
 Conference 45
 Conference (Three-party), Leaving 48
 Conference Button 18, 132
 Conference, Unattended 49
 Confirmation Tones 161
 Connection Example 21

D

Data Line Security 50, 152
 Dial Tone Transfer 116
 Dial Tones 159
 Direct Inward System Access (DISA) 51, 152
 Direct Station Selection (DSS) Button 17, 131
 Directories 110
 DISA → Direct Inward System Access 51, 152
 Display 15
 Display Features 110
 Display Language Selection 123
 Display Lock 127
 Display Switching Mode 123
 DND → Do Not Disturb 53, 153
 DND Override 158
 Do Not Disturb (DND) 53, 153
 Do Not Disturb (DND) Button 17
 Do Not Disturb (DND) Tone 161
 Door Open 56, 153
 Doorphone Call 57, 153
 DSS → Direct Station Selection 17, 131

E

EFA → External Feature Access 58, 153
 Electronic Station Lockout → Extension Dial Lock 60, 127, 153
 Exclusive Call Hold 30
 Executive Busy Override 58, 158
 Executive Busy Override Deny 60, 126, 153
 Extension Dial Lock 60, 127, 153
 Extension Feature Clear 61, 153
 Extension Number, Confirming Your Own 15
 Extension PIN (Personal Identification Number) 62, 127, 153
 External BGM 116, 157
 External Feature Access (EFA) 58, 153
 External Feature Access (EFA) Button 18, 132
 External Relay 64, 153
 External Sensor 64

F

Feature Highlights 2
 Feature Number Table 151

Feature Numbers 14
 Fixed Buttons 16
 FLASH/RECALL Button 17
 Flexible Buttons 17
 Forced Answerback Selection 124
 FWD → Call Forwarding 65, 154
 FWD N/A Timer 126
 FWD/DND Cycle Switch Mode 54, 68
 FWD/DND Setting Mode 54, 68
 FWD/DND settings, FWD/DND fixed button 68
 FWD/DND status, switching with FWD/DND fixed button 55, 68
 FWD/DND—Intercom calls Button 18, 131
 FWD/DND—Outside calls Button 18, 131
 FWD—All Calls 65
 FWD—Busy 65
 FWD—Busy/No Answer 65
 FWD—Follow Me 65
 FWD—No Answer 65

G

G-CO → Group-CO 17, 131
 Greeting Message (SVM), Recording 88, 90
 Group FWD—Both calls Button 18, 132
 Group FWD—Intercom calls Button 18, 132
 Group FWD—Outside calls Button 18, 132
 Group Paging 155
 Group-CO (G-CO) Button 17, 131

H

Handset/Headset Selection → Headset Operation 71
 Hands-free Answerback 70
 Hands-free Operation 71
 Headset Operation 71
 HOLD Button 16
 Hot Line 74, 154
 Hurry-up Button 18, 132
 Hurry-up Transfer → Manual Queue Redirection 78

I

ICD Group → Incoming Call Distribution Group 75
 ICD GROUP FEATURES 75
 Icon Description, Preparations 15
 Icon Description, System Programming 140
 Incoming Call Distribution Group (ICD Group) Button 17, 131
 Incoming Call Log 112
 Indication Tones 161
 INTERCOM Button 16
 Intercom Call 22

K

Key Pad Tone Set 126

L

L-CO → Loop-CO 17, 131
 LCS → Live Call Screening 101
 LCS Mode Set (After Answering) 125
 Live Call Screening (LCS) 101
 Live Call Screening (LCS) Button 19, 133

Live Call Screening Mode Set 125
 Lock, Display 127
 Lock, Extension Dial 60, 127, 153
 Lock, Remote Extension Dial 119, 158
 Log-in/Log-out 76, 154
 Log-in/Log-out Button 18, 132
 Log-in/Log-out for all groups Button 18, 132
 Log-in/Log-out of a specified group Button 18, 132
 Loop-CO (L-CO) Button 17, 131

M

Making Calls 22
 Manager Password 136
 Manager Programming 136, 137
 Manual Queue Redirection 78
 Message Box, Accessing from Outside 96
 Message Box, Accessing Other Extension's 97
 Message Box, Redirecting to 91
 Message Button 16, 17, 131
 Message for Another Extension Button 18, 131
 Message Waiting 79, 155, 158
 Message, Absent 26, 151
 Message, OGM 117, 157
 Message, SVM 87, 156
 MONITOR Button 16
 Mute 81

N

Navigator Key 17

O

OGM → Outgoing Messages 117, 157
 One-touch Dialing 82
 One-touch Dialing Assignment Mode Selection 127
 One-touch Dialing Button 17, 131
 One-touch Transfer 37
 One-touch Two-way Transfer 103
 One-touch Two-way Transfer Button 19, 133
 Operator Call 23, 151
 Outgoing Messages (OGM) 117, 157

P

Paging 82, 155
 Paging Deny 84, 126, 155
 Paging, and Transferring 83
 Paging, Group 82, 155
 Password, Manager 136
 Password, System 139
 PAUSE Button 16
 Personal Absent Message 26, 125
 Personal Programming 122
 Personal Speed Dialing 86, 155
 PF → Programmable Feature 17
 Pickup Dialing → Hot Line 74, 154
 PIN → Extension Personal Identification Number 62, 127
 PIN → Verification Code Personal Identification Number 100
 Portable Station (PS), Registration 14
 Predialing 24

Index

Preferred Line Assignment—Incoming 124
Preferred Line Assignment—Outgoing 124
Printing Message 84, 155
Privacy Release 85
PROGRAM Button 17
Programmable Feature (PF) Button 17
Programming Feature Clear 129
Programming Information, Manager 136
Programming Information, Personal 122
Programming Information, System 139
Programming, Manager 137
Programming, Personal 122
Programming, System 142
PS, Registration 14
Purchase Information 8

Q

Quick Dialing 85

R

REDIAL Button 16
Redial, Last Number 86, 155
Relay → External Relay 64, 153
Release Button 18, 72, 132
Remote Extension Dial Lock 119, 158
Remote Station Lock Control → Remote Extension Dial Lock 119, 158
Remote Wake-up Call 98, 105, 157
Reorder Tone 161
Revision History, PSMR Software File Version 1.1xxx 163
Revision History, PSMR Software File Version 2.0xxx 163
Revision History, PSMR Software File Version 3.0xxx 163
Ring Tones 159
Ringback Tones 161

S

S-CO → Single-CO 17, 131
S-CO Line Access 24
Sensor → External Sensor 64
Simplified Voice Message (SVM) 87, 156
Single-CO (S-CO) Button 17, 131
Speed Dialing, Personal 86, 155
Speed Dialing, System 87, 155
SP-PHONE Button 16
Station Program Clear → Extension Feature Clear 61, 153
Station Speed Dialing → Personal Speed Dialing 86, 155
Storing New Names and Numbers 111
SVM → Simplified Voice Message 87, 156
SVM Log 93
System Alarm Button 18, 132
System Password 139
System Programming 139, 142
System Speed Dialing 87, 155

T

TAFAS → Trunk Answer From Any Station 97, 156
Telephone Types 14
Terminate Button 18, 132
Time Service 99

Time Service (Day/Night/Lunch/Break) Button 18, 132
Time Service Mode Control 119, 158
Time Service Switching Mode (Automatic/Manual) Button 18, 133
Timed Reminder 97, 105, 156
Toll Restriction (TRS) Button 18, 133
Tone Types 159
TRANSFER Button 17
Transferring Calls, To Other Extension 37
Transferring Calls, To Outside Party 38
Troubleshooting 148
Trunk Answer From Any Station (TAFAS) 97, 156
Two-way Record 103
Two-way Record Button 18, 133
Two-way Transfer 103
Two-way Transfer Button 18, 133

U

Unattended Conference 49

V



















Verification Code Entry 100, 156
Verification Code PIN (Personal Identification Number) 100
VOICE CALL/MUTE Button 17
VOICE MAIL FEATURES 100
Voice Mail Integration 104, 157
Voice Mail Transfer 104, 105
Voice Mail Transfer Button 19, 133
Voice Messages (SVM), Leaving 92
Voice Messages (SVM), Listening to 93
Volume Key 17

W

Wake-up Call, Remote 98, 157
Walking COS 107, 157
Walking Extension 108, 157
Walking Station → Walking Extension 108, 157
Warning Tone 161
Wireless XDP Parallel Mode 109, 157
Wrap-up 76
Wrap-up Button 18, 132

Quick Reference Guide

Please print or photocopy this page and the following page back to back, and distribute them to proprietary telephone or single line telephone users.

Quick Reference Guide for Proprietary Telephone	Quick Reference Guide for Proprietary Telephone
To make calls	To make calls
Intercom: Extn. no.	Intercom: Extn. no.
Operator: 0 *	Operator: 0 *
Outside party:  + Phone no.	Outside party:  + Phone no.
Personal speed dialing:  + * + Personal speed dialing no.	Personal speed dialing:  + * + Personal speed dialing no.
System speed dialing:  + System speed dialing no.	System speed dialing:  + System speed dialing no.
Redial: 	Redial: 
When a line is busy	When a line is busy
Reserving a busy line: 6 *	Reserving a busy line: 6 *
Sending a call waiting tone: 1 *	Sending a call waiting tone: 1 *
To pick up someone's call	To pick up someone's call
Specified extension: * 41 * + Extn. no.	Specified extension: * 41 * + Extn. no.
Group: * 40 * + Group no.	Group: * 40 * + Group no.
During a conversation	During a conversation
Holding:  + 	Holding:  + 
Retrieving:  + the corresponding button	Retrieving:  + the corresponding button
Transferring:  + Phone no.	Transferring:  + Phone no.
Answering a call waiting:  + the corresponding button	Answering a call waiting:  + the corresponding button
* You can change the flexible numbers to other numbers for easier use. If you want to change the numbers, consult your dealer.	* You can change the flexible numbers to other numbers for easier use. If you want to change the numbers, consult your dealer.
Frequently used features at your extension	Frequently used features at your extension

Quick Reference Guide for Single Line Telephone

To make calls

Intercom: Extn. no.
Operator: 0 *
Outside party: 9 * + Phone no.
Personal speed dialing:
* * * + * + Personal speed dialing no.
System speed dialing:
* * * + System speed dialing no.
Redial: # *





When a line is busy

Reserving a busy line: 6 *
Sending a call waiting tone: 1 *

To pick up someone's call

Specified extension: * 41 * + Extn. no.
Group: * 40 * + Group no.

During a conversation

Holding:  + * 50 * + 
Retrieving:  + * 50 *
Transferring:  + Phone no.
Answering a call waiting:  + * 50 *

* You can change the flexible numbers to other numbers for easier use. If you want to change the numbers, consult your dealer.

Frequently used features at your extension

Quick Reference Guide for Single Line Telephone

To make calls

Intercom: Extn. no.
Operator: 0 *
Outside party: 9 * + Phone no.
Personal speed dialing:
* * * + * + Personal speed dialing no.
System speed dialing:
* * * + System speed dialing no.
Redial: # *





When a line is busy

Reserving a busy line: 6 *
Sending a call waiting tone: 1 *

To pick up someone's call

Specified extension: * 41 * + Extn. no.
Group: * 40 * + Group no.

During a conversation

Holding:  + * 50 * + 
Retrieving:  + * 50 *
Transferring:  + Phone no.
Answering a call waiting:  + * 50 *

* You can change the flexible numbers to other numbers for easier use. If you want to change the numbers, consult your dealer.

Frequently used features at your extension

[MEMO]

[MEMO]

[MEMO]

**Panasonic Consumer Electronics Company,
Division of Panasonic Corporation of North America**

One Panasonic Way, Secaucus, New Jersey 07094

Panasonic Puerto Rico, Inc.

San Gabriel Industrial Park, Ave. 65 de Infantería, Km. 9.5,
Carolina, Puerto Rico 00985

<http://www.panasonic.com/csd>

Copyright:

This material is copyrighted by Panasonic Communications Co., Ltd., and may be reproduced for internal use only. All other reproduction, in whole or in part, is prohibited without the written consent of Panasonic Communications Co., Ltd.

© 2006 Panasonic Communications Co., Ltd. All Rights Reserved.