

Panasonic®

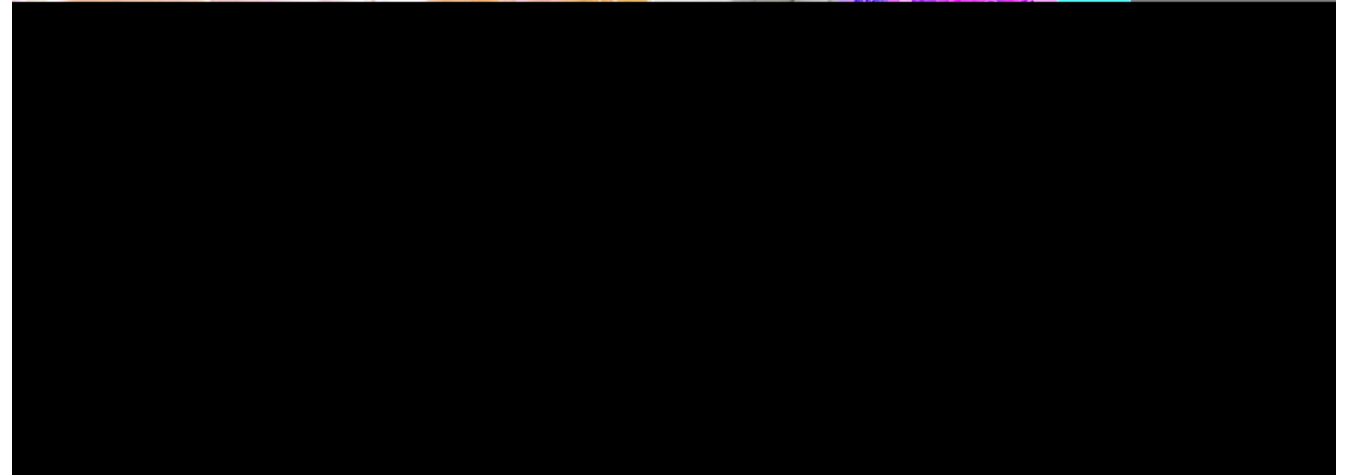

Advanced Hybrid & Wireless PBX User Manual

Model No. **KX-TAW848**

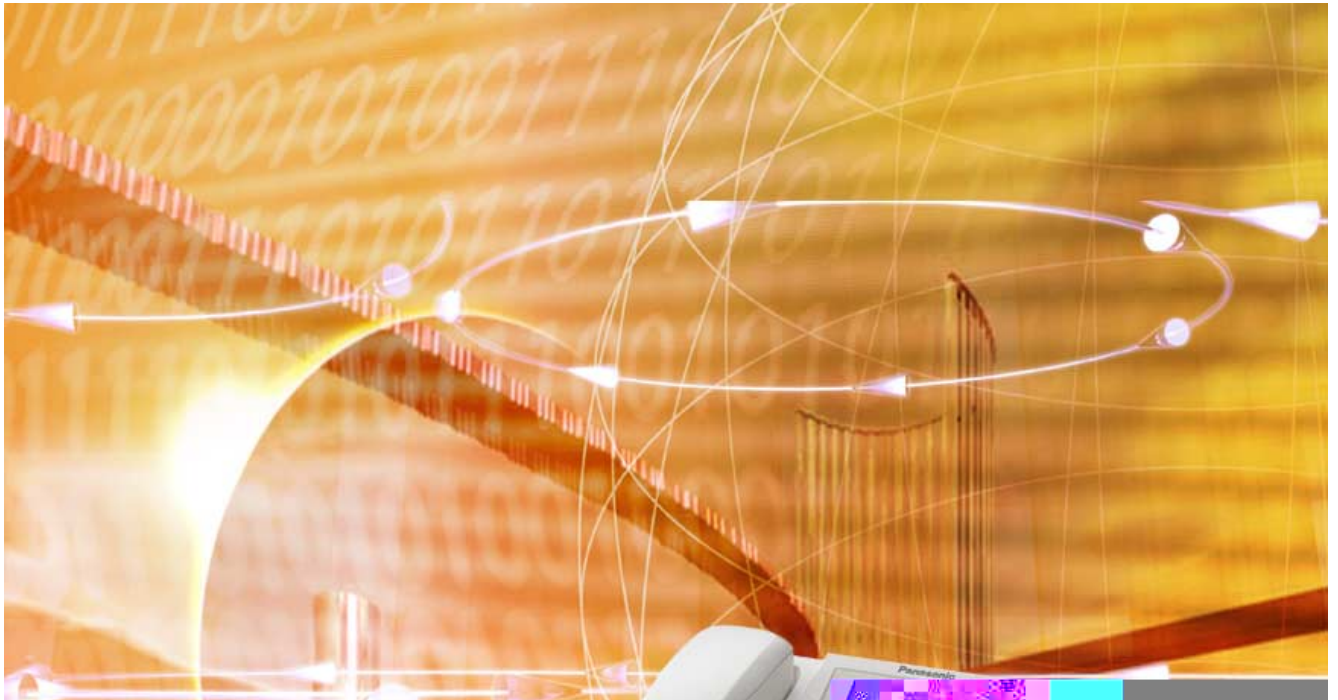

Thank you for purchasing a Panasonic Advanced Hybrid & Wireless PBX.
Please read this manual carefully before using this product and save this manual for future use.

KX-TAW848: MPR Version 2.0

Feature Highlights

Call Center

This PBX can establish Incoming Call Distribution Groups (ICD Group) by which a large volume of calls from the external customers could be received.

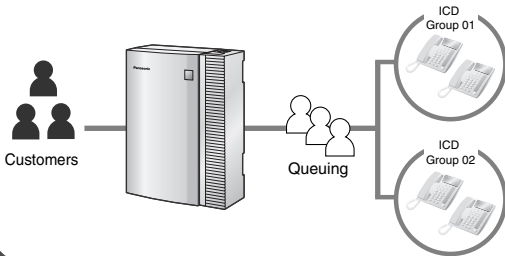

1.8 Call Center (Page 82)

Voice Mail Integration

You can forward your calls to a voice processing system and let calling parties leave messages in your mailbox when you are unable to receive calls.

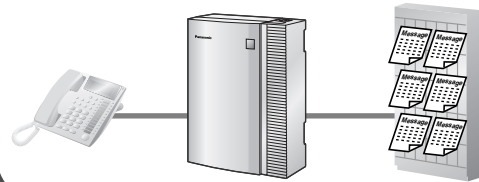

1.9.5 Voice Processing System (Page 88)

Wireless System

This PBX optionally supports a Portable Station (PS) system. PSs can be used on the PBX with other wired telephones.



Appendix (Page 133)

Call Record (Station Message Detail Recording)

This PBX can record or print out call information: date, time, extension no., dialed no., duration, etc.

Date	Time	Ext
01/02/02	10:03AM	1230
01/02/02	11:07AM	2230

Consult your dealer

Easy Operation

If you are using a certain Panasonic telephone that is equipped with a Navigator Key and a display, it helps you to access the desired feature easily. Also, you will be informed of the arrival of an incoming call or a message waiting by the lamp if it is equipped.



Navigator Key



Message/Ringer Lamp

1.1 Before Operating the Telephones (Page 12)

In This Manual,

- Proprietary Telephone is abbreviated as "PT".
Single Line Telephone is abbreviated as "SLT".
Portable Station is abbreviated as "PS".
Proprietary Telephone with a Display is abbreviated as "Display PT".
- The following icons are used frequently.



Hints



Conditions

Important Information

WARNING

- IF DAMAGE TO THE UNIT EXPOSES ANY INTERNAL PARTS, DISCONNECT THE POWER SUPPLY CORD IMMEDIATELY AND RETURN THE UNIT TO YOUR DEALER.
- UNPLUG THIS UNIT FROM THE AC OUTLET IF IT EMITS SMOKE, AN ABNORMAL SMELL OR MAKES UNUSUAL NOISE. THESE CONDITIONS CAN CAUSE FIRE OR ELECTRIC SHOCK. CONFIRM THAT SMOKE HAS STOPPED AND CONTACT AN AUTHORIZED PANASONIC FACTORY SERVICENTER.
- WHEN RELOCATING THE EQUIPMENT, FIRST DISCONNECT THE TELECOM CONNECTION BEFORE DISCONNECTING THE POWER CONNECTION. WHEN THE UNIT IS INSTALLED IN THE NEW LOCATION, RECONNECT THE POWER FIRST, AND THEN RECONNECT THE TELECOM CONNECTION.
- THIS UNIT IS EQUIPPED WITH A GROUNDED PLUG. FOR SAFETY REASONS THIS PLUG MUST ONLY BE CONNECTED TO A GROUNDED OUTLET THAT HAS BEEN INSTALLED ACCORDING TO APPLICABLE REGULATIONS.
- TO PREVENT POSSIBLE FIRE OR ELECTRIC SHOCK, DO NOT EXPOSE THIS PRODUCT TO RAIN OR MOISTURE.
- THE POWER SUPPLY CORD IS USED AS THE MAIN DISCONNECT DEVICE. ENSURE THAT THE AC OUTLET IS LOCATED NEAR THE EQUIPMENT AND IS EASILY ACCESSIBLE.
- TO PROTECT THIS UNIT FROM STATIC ELECTRICITY, DO NOT TOUCH ANY EXTERNAL CONNECTORS OF THE UNIT.

IMPORTANT SAFETY INSTRUCTIONS

When using your telephone equipment, basic safety precautions should always be followed to reduce the risk of fire, electric shock and injury to persons, including the following:

1. Read and understand all instructions.
2. Follow all warnings and instructions marked on the product.
3. Unplug the product from the wall outlet before cleaning. Do not use liquid cleaners or aerosol cleaners. Clean with a damp cloth.
4. Do not use the product near water, for example, near a bathtub, wash bowl, kitchen sink, or laundry tub, in a wet basement, or near a swimming pool.
5. Do not place this product on an unstable surface, as a fall may cause serious internal damage.
6. Slots and openings in the front, back and bottom of the cabinet are provided for ventilation; to protect it from overheating, these openings must not be blocked or covered. The openings should never be blocked by placing the product on a bed, sofa, rug, or other similar surface while in use. The product should never be placed near or over a radiator or other heat source. This product should not be placed in a sealed environment unless proper ventilation is provided.
7. The product should only be connected to the type of electrical power supply specified on the product label. If you are not sure of the type of power supply to your home, consult your dealer or local power company.
8. For safety purposes this unit is equipped with a grounded plug. If you do not have a grounded outlet, please have one installed. Do not bypass this safety feature by tampering with the plug.
9. Do not allow anything to rest on the power cord. Do not locate this product where the power cord may be stepped on or tripped on.
10. To reduce the risk of fire or electric shock, do not overload wall outlets and extension cords.
11. Do not insert objects of any kind into this product through its slots and openings, as they may touch dangerous voltage points or short out parts that could result in a risk of fire or electric shock. Never spill liquid of any kind on or in the product.
12. To reduce the risk of electric shock, do not disassemble this product. Only qualified personnel should service this product. Opening or removing covers may expose you to dangerous voltages or other risks. Incorrect reassembly can cause electric shock.
13. Unplug this product from the wall outlet and have it serviced by qualified service personnel in the following cases:
 - a) When the power supply cord or plug is damaged or frayed.
 - b) If liquid has been spilled into the product.
 - c) If the product has been exposed to rain or water.
 - d) If the product does not operate according to the operating instructions. Adjust only the controls that are explained in the operating instructions. Improper adjustment of other controls may result in damage and may require service by a qualified technician to restore the product to normal operation.
 - e) If the product has been dropped or the cabinet has been damaged.
 - f) If product performance deteriorates.
14. Avoid using wired telephones during an electrical storm. There is a remote risk of electric shock from lightning.
15. Do not use a telephone in the vicinity of a gas leak to report the leak.

SAVE THESE INSTRUCTIONS

Attention

- Keep the unit away from heating appliances and devices that generate electrical noise such as fluorescent lamps, motors and televisions. These noise sources can interfere with the performance of the PBX.
- This unit should be kept free of dust, moisture, high temperature (more than 40 °C [104 °F]) and vibration, and should not be exposed to direct sunlight.
- If you are having problems making calls to outside destinations, follow this procedure to test the CO lines:
 1. Disconnect the PBX from all CO lines.
 2. Connect known working single line telephones (SLTs) to those CO lines.
 3. Make a call to an external destination using those SLTs.

If a call cannot be carried out correctly, there may be a problem with the CO line that the SLT is connected to. Contact your telephone company.

If all SLTs operate properly, there may be a problem with your PBX. Do not reconnect the PBX to the CO lines until it has been serviced by an authorized Panasonic Factory Servicenter.
- Wipe the unit with a soft cloth. Do not clean the unit with abrasive powders or with chemical agents such as benzene or thinner.
- When using a Panasonic proprietary telephone (PT), use only the correct Panasonic handset.

When you ship the product

Carefully pack and send it prepaid, adequately insured and preferably in the original carton. Attach a postage-paid letter, detailing the symptom, to the outside of the carton. **DO NOT** send the product to the Executive or Regional Sales offices. They are **NOT** equipped to make repairs.

Product Service

Panasonic Factory Servicenters for this product are listed in the servicenter directory. Consult your dealer for detailed instructions.

For Future Reference

Please print, record, and retain the following information for future reference.

Note

The serial number of this product can be found on the label affixed to the unit. You should record the model number and the serial number of this unit as a permanent record of your purchase to aid in identification in the event of theft.

MODEL NO.	_____
SERIAL NO.	_____
DATE OF PURCHASE	_____
NAME OF DEALER	_____
DEALER'S ADDRESS	_____ _____ _____ _____
DEALER'S TEL. NO.	_____

Table of Contents

1	Operation	11
1.1	Before Operating the Telephones	12
1.1.1	Before Operating the Telephones	12
1.2	Making Calls	20
1.2.1	Basic Calling	20
1.2.2	Easy Dialing	23
1.2.3	Redial	27
1.2.4	When the Dialed Line is Busy or There is No Answer	27
1.2.5	Alternate Calling—Ring/Voice	33
1.2.6	Calling without Restrictions	34
1.2.7	Direct Inward System Access (DISA)	35
1.2.8	Remote Setting	38
1.3	Receiving Calls	40
1.3.1	Answering Calls	40
1.3.2	Hands-free Answerback	41
1.3.3	Call Pickup	41
1.3.4	Trunk Answer From Any Station (TAFAS)	42
1.3.5	Answer/Release Button	42
1.4	During a Conversation	45
1.4.1	Call Transfer	45
1.4.2	Call Hold	47
1.4.3	Call Splitting	51
1.4.4	Call Waiting	52
1.4.5	Multiple Party Conversation	56
1.4.6	Mute	63
1.4.7	Headset Operation	63
1.5	Absence Settings	65
1.5.1	Call Forwarding	65
1.5.2	Absent Message	68
1.5.3	Extension Dial Lock	70
1.6	Paging	72
1.6.1	Paging	72
1.6.2	Answering/Denying a Paging Announcement	73
1.7	Extension Settings	74
1.7.1	Timed Reminder	74
1.7.2	Do Not Disturb (DND)	75
1.7.3	Call Waiting	77
1.7.4	Executive Busy Override Deny	77
1.7.5	Background Music (BGM)	78
1.7.6	Data Line Security	78
1.7.7	Time Service	79
1.7.8	Wireless XDP Parallel Mode	79
1.7.9	Extension Feature Clear	80
1.8	Call Center	82
1.8.1	Log-in/Log-out, Wrap-up	82
1.8.2	Manual Queue Redirection	84
1.9	User-supplied Equipment	85

1.9.1	Doorphone/Door Opener	85
1.9.2	External Relay	86
1.9.3	External Sensor	87
1.9.4	Host PBX	87
1.9.5	Voice Processing System.....	88
1.10	Walking Extension	94
1.10.1	Walking Extension.....	94
1.11	Display Proprietary Telephone	95
1.11.1	Call Log	95
1.11.2	Directories.....	97
2	Manager Operation	101
2.1	Control Features	102
2.1.1	Extension Control.....	102
2.1.2	Time Service Mode Control	102
2.1.3	Dial Tone Transfer	104
2.1.4	External Background Music (BGM).....	104
2.1.5	Outgoing Messages (OGM)	105
2.1.6	Hospitality Features	106
3	Customizing Your Phone & System.....	109
3.1	Personal Programming.....	110
3.1.1	Personal Programming.....	110
3.1.2	Settings on the Programming Mode.....	111
3.1.3	Customizing the Buttons	120
3.2	Manager Programming	124
3.2.1	Programming Information.....	124
3.2.2	Manager Programming	124
3.3	System Programming	126
3.3.1	Programming Information.....	126
3.3.2	System Programming.....	129
4	Appendix	133
4.1	Troubleshooting	134
4.1.1	Troubleshooting.....	134
4.2	Feature Number Table	137
4.2.1	Feature Number Table.....	137
4.3	Tone.....	145
4.3.1	Tone	145
4.4	Quick Reference Guide.....	149
4.4.1	Quick Reference Guide	149
4.5	Revision History	151
4.5.1	MPR Version 1.1	151
4.5.2	MPR Version 2.0	151
Index	153	

Section 1

Operation

This chapter shows you step by step how to use each feature. Read this chapter to become familiar with the many useful features of this PBX.

1.1 Before Operating the Telephones

1.1.1 Before Operating the Telephones

◆◆ What Kind of Telephone Can Be Used?

You can use a single line telephone (SLT), such as a rotary pulse telephone or a Panasonic proprietary telephone (PT) such as the KX-T7735. You can also use a Panasonic Portable Station (PS), e.g., KX-TD7690. Use the feature depending on the telephone you are using. If you are using a Panasonic

proprietary telephone with a special feature button such as  or a display (Display PT) or both, you can follow the operation with the button or display messages for easy programming.

If you use a large display telephone (e.g., KX-T7735), you can follow the displayed messages to use the features. If your telephone does not have feature buttons and/or a display, you may operate the PBX by entering a feature number instead. Follow the operation for your type of telephone.

If you use a Console, you can use the buttons on the Console as the buttons on the connected proprietary telephone.

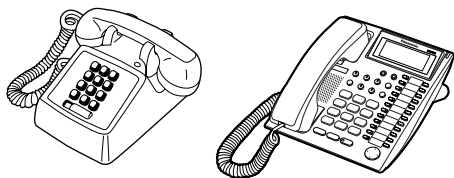

- If you use a Panasonic proprietary telephone which does not have feature buttons, you may change one of the unused flexible buttons to a feature button. Refer to "3.1.3 Customizing the Buttons".

Portable Station (PS) Registration

You must register your PS in the PBX and determine its extension number before initial use. For PS registration, consult your dealer.

◆◆ Feature Numbers

To use certain features, you need to enter specified feature numbers (and an additional parameter, if required).

There are two types of feature numbers as follows:

- Flexible feature number
- Fixed feature number

Fixed feature numbers cannot be changed. However, you can change the flexible numbers to other numbers for easier use. If you want to change the numbers, consult your dealer. In this manual, the default numbers (factory installed) are used for operations.

A flexible number is shown as  (half-shaded key). Use the new programmed number if you have changed the feature number. Write the new number in "Feature Number Table" (Appendix).



If you use a single line telephone which does not have the "*" or "#" keys; it is not possible to access features that have "*" or "#" in their feature numbers.

◆◆ Tone

You will hear various tones, during or after an operation, for confirmation. Refer to "4.3.1 Tone" (Appendix).

◆◆ Display

In this manual, you will see "the display ...". This refers to the display of a Panasonic proprietary telephone. If your telephone is not a Panasonic display proprietary telephone, the message will not be displayed.

If you use a Panasonic display proprietary telephone, the display helps you confirm the settings. Some proprietary telephones also give you easy access to features. A message is displayed depending on the feature. By pressing the Navigator Key, you can access the desired feature.

Furthermore, depending on the display proprietary telephone, you can operate features or make calls using the display message. Refer to "1.11 Display Proprietary Telephone".

Your Extension Number

If you use a Panasonic display proprietary telephone, you can check your own extension number on the display. Press the TRANSFER button while on-hook.

◆◆ Examples











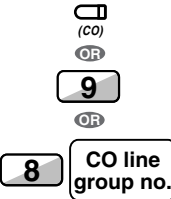

The displays and the illustrations shown as examples are from a telephone connected to the KX-TAW848.

◆◆ Restrictions

Some features may be restricted at your extension under the system programming. Consult your manager or dealer.

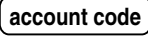
◆◆ Icon Descriptions

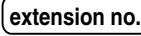













The following icons show you the feature availability, notes and action to use the features.





	This feature cannot be used with a single line telephone.		Seize a CO line (One of the following). <ul style="list-style-type: none"> • Press the CO button. • Dial automatic line access number 9. • Dial CO line group access number and CO line group number.
	See "Programming" for Related Programming if necessary.		
	Off-hook (One of the following). <ul style="list-style-type: none"> • Lift the handset. • Press the SP-PHONE button. • Press the MONITOR button. (To start talking, lift the handset.) • Press TALK button. 		Press the Call button on the Doorphone.
	On-hook (One of the following). <ul style="list-style-type: none"> • Hang up. • Press the SP-PHONE button. • Press the MONITOR button. 		Press the hookswitch lightly.
	Press the corresponding feature button on the proprietary telephone.		Talk.
 <p><Example></p> 	Enter the required number. <Example> Enter the account code.		You will hear a busy, confirmation, dial, ring or ringback tone. <ul style="list-style-type: none"> B. Tone: Busy Tone C. Tone: Confirmation Tone D. Tone: Dial Tone R. Tone: Ring Tone R. B. Tone: Ringback Tone
	Dial an extension number.		Dial outside phone number.
	Dial the telephone number.		

◆◆ When You Use a Panasonic Proprietary Telephone

If you use a Panasonic proprietary telephone and the Console, they may have some of the useful feature buttons described below. For a PS user, refer to "Operating Instructions" for PS. These buttons make operations simple. The illustrations may differ from the buttons on your telephone.

Fixed Buttons

	<p>CO : Used to make or receive an outside call. (Button assignment is required.) Also used as feature buttons. (Button assignment is required.) (Only the CO line "number" [e.g., 1, 2] may be shown on some telephones.)</p>		<p>SP-PHONE : Used for hands-free operation.</p>
	<p>AUTO DIAL/STORE : Used for System/Personal Speed Dialing or storing program changes.</p>		<p>PAUSE : Used to insert a pause when storing a telephone number. This button also functions as the PROGRAM button when there is no PROGRAM button on your telephone.</p>
	<p>REDIAL : Used to redial the last dialed number.</p>		<p>MESSAGE : Used to leave a message waiting indication or call back the party who left the message waiting indication.</p>
	<p>INTERCOM : Used to make or receive intercom calls.</p>		<p>AUTO ANS (Auto Answer)/MUTE : Used to receive an incoming call in hands-free mode or mute the microphone during a conversation.</p>
	<p>MONITOR : Used for hands-free dialing. You can monitor the party's voice in hands-free mode.</p>		<p>HOLD : Used to place a call on hold.</p>
	<p>TRANSFER : Used to transfer a call to another party.</p>		<p>CONF (Conference) : Used to establish a multiple party conversation.</p>
	<p>FLASH/RECALL : Used to disconnect the current call and make another call without hanging up.</p>		<p>Call Forwarding (FWD)/Do Not Disturb (DND) : Used to perform Call Forwarding (FWD) or Do Not Disturb (DND).</p>

	<p>VOICE CALL : Used to monitor an intercom call automatically, but it cannot be used for hands-free conversations.</p>		<p>Navigator Key/Volume Key : Used to adjust the volume and the display contrast or select desired items.</p>
	<p>PROGRAM : Used to enter and exit the Programming mode.</p>		<p>Programmable Feature (PF) : <i>Located on the right part of the CO button array or on the DSS Console.</i> Assigns the desired button and used to access the stored feature. Mostly used as a One-touch Dialing button. (Only the "F and number" may be shown on some telephones.)</p>

Customized Buttons

If the term is in parentheses like (Account) in this section, it means a flexible button has been made into an "Account" button. To customize, refer to "3.1.3 Customizing the Buttons".

Buttons	Feature
Loop-CO (L-CO)	Used to access an idle CO line for making outside calls. Incoming outside calls from any CO line arrive at this button.
Group-CO (G-CO)	Used to access an idle CO line in a specified CO line group for making outside calls. Incoming calls from CO lines in the assigned CO line group arrive at this button.
Single-CO (S-CO)	Used to access a specified CO line for making or receiving outside calls.
Direct Station Selection (DSS)	Used to access an extension with one touch. It is also possible to be changed to the other feature button.
One-touch Dialing	Used to access a desired party or system feature with one touch.
Group Directory Number (G-DN)	Used to access a specified incoming call distribution group for making or receiving calls.
Message	Used to leave a message waiting indication or call back the party who left the message waiting indication.
Message for Another Extension	Used to have a Message button for another extension.
Call Forwarding (FWD)/Do Not Disturb (DND)—Both calls	Used to forward all calls to a specified destination or refuse.
FWD/DND—Outside calls	Used to forward CO line calls to a specified destination or refuse.
FWD/DND—Intercom calls	Used to forward intercom calls to a specified destination or refuse.
Group FWD—Both calls	Used to forward all the calls to your group to a specified destination.

Buttons	Feature
Group FWD—Outside calls	Used to forward the CO line calls to your group to a specified destination.
Group FWD—Intercom calls	Used to forward the intercom calls to your group to a specified destination.
Account	Used to enter an account code.
Conference	Used to establish a multiple party conversation.
Terminate	Used to disconnect the current call and make another call without hanging up.
External Feature Access (EFA)	Used to access special features offered by a host PBX or a telephone company.
Call Park	Used to park or retrieve a call in a preset parking zone.
Call Park (Automatic Park Zone)	Used to park a call in an idle parking zone automatically.
Call Log	Used to show the incoming call information.
Call Log for ICD Group	Used to have a Call Log button for incoming call distribution group.
Log-in/Log-out	Used to switch between the log-in and log-out mode.
Log-in/Log-out of a specified group	Used to have a Log-in/Log-out button for another incoming call distribution group.
Log-in/Log-out for all groups	Used to have a Log-in/Log-out button for all groups.
Hurry-up	Used to transfer the longest waiting call in the queue of an incoming call distribution group to the overflow destination.
Wrap-up	Used to switch the wrap-up status, Ready and Not Ready mode.
System Alarm	Used to confirm a PBX error. For more details, consult your dealer.
Time Service (Day/Night/Lunch/Break)	Used to switch the time service mode.
Answer	Used to answer an incoming call.
Release	Used to disconnect the line during or after a conversation or to complete a Call Transfer.
Toll Restriction (TRS)	Used to change the toll restriction level of other extension users temporarily.
Time Service Switching Mode (Automatic/Manual)	Used to switch the time service mode, Automatic or Manual.
Two-way Record	Used to record a conversation into your own mailbox.
Two-way Transfer	Used to record a conversation into the mailbox of a specific extension.
One-touch Two-way Transfer	Used to record a conversation into the mailbox of a specific extension with one touch.
Live Call Screening (LCS)	Used to monitor your own voice mailbox while an incoming caller is leaving a message and, if desired, intercept the call.
Voice Mail Transfer	Used to transfer a call to the mailbox of a specified extension.

◆◆ How to Follow the Steps

An example of system operation is shown below.

◆◆ **Calling Another Extension** Feature title

Intercom Call

PT/SLT/PS

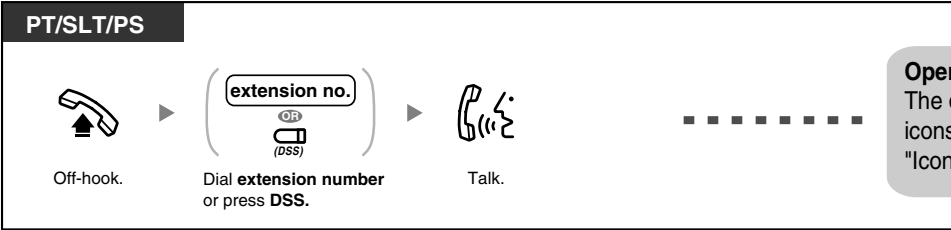

Off-hook. Dial **extension no.** or press **DSS**. Talk.

Operation steps
The description of the icons are explained on "Icon Descriptions".

 • The DSS button light shows the current status as follows:
Off: The extension is idle.
Red on: Your or another extension is using the line. Conditions

 • To call using a directory, refer to "1.11.2 Directories". Hints
• **For quick operation**
If you are an operator or dial some extensions frequently, DSS buttons are useful.
• **Hands-free Operation**
You can make an intercom call and have a conversation in hands-free mode using the SP-PHONE button.

 **Customizing Your Phone**

- 3.1.2 Settings on the Programming Mode—**Preferred Line Assignment—Outgoing**
Select the seized line when going off-hook.
- 3.1.3 Customizing the Buttons
Create or edit a Direct Station Selection (DSS) button.

Programming References: The related or required programming is noted.

◆◆ Connection Example

This diagram shows you a connection example.

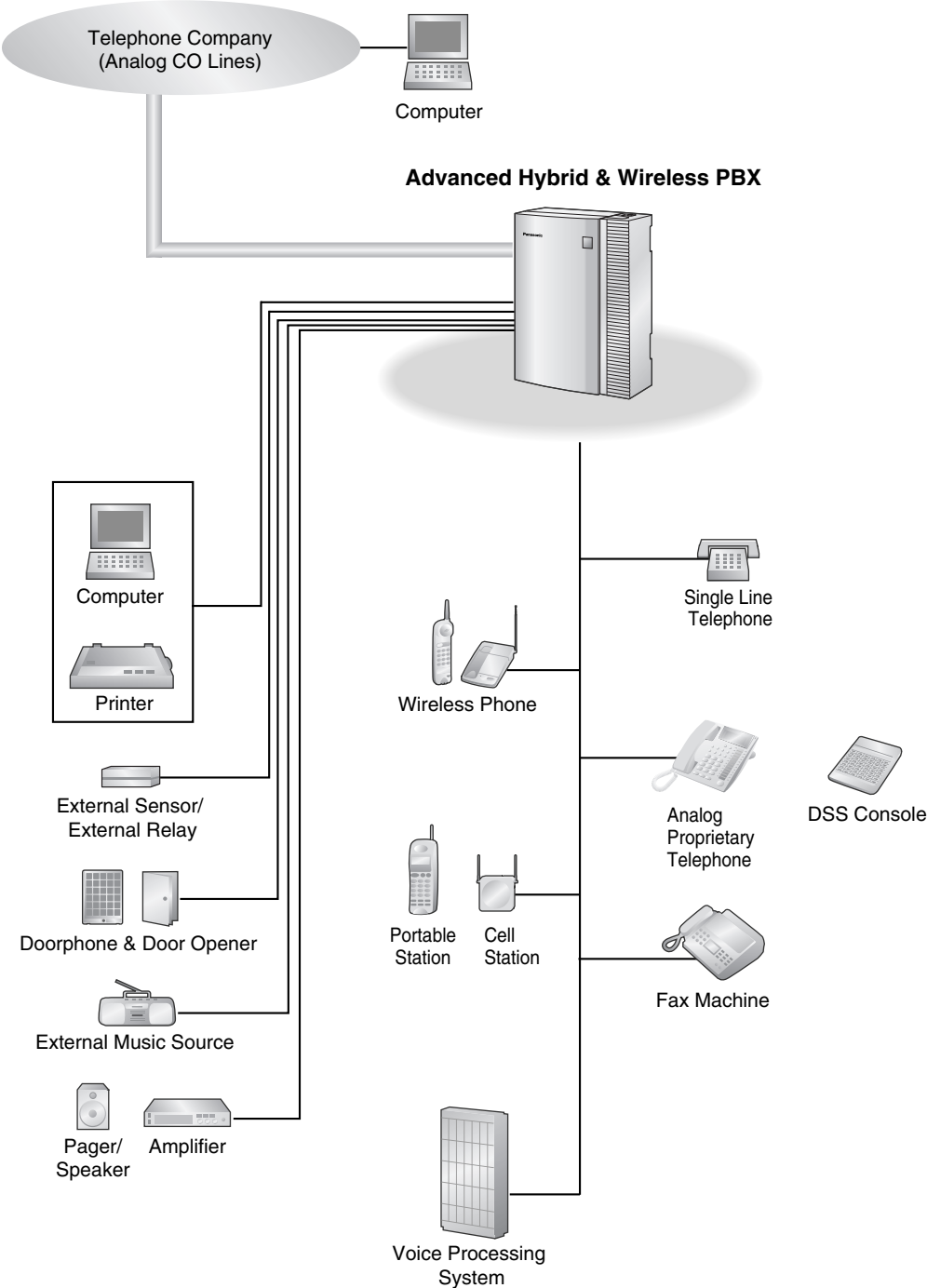

1.2 Making Calls

1.2.1 Basic Calling

- Calling Another Extension
- Calling an Outside Party
- Account Code Entry

◆◆ Calling Another Extension

Intercom Call

When your telephone does not access a CO line automatically

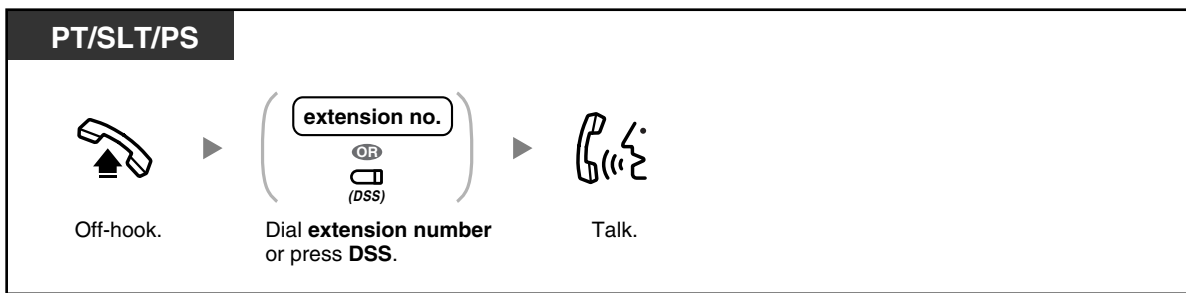

When your telephone accesses a CO line automatically

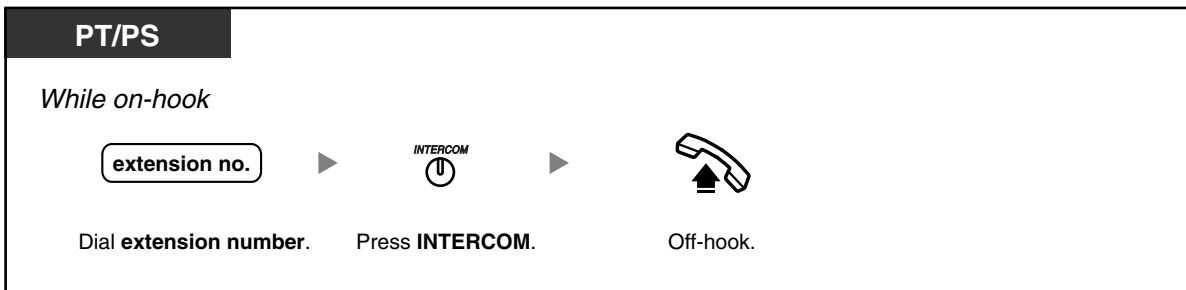

- The DSS button light shows the current status as follows:
Off: The extension is idle.
Red on: Your or another extension is using the line.



- To call using a directory, refer to "1.11.2 Directories".
- **For quick operation**
If you are an operator or dial some extensions frequently, DSS buttons are useful.
- **Hands-free Operation**
You can make an intercom call and have a conversation in hands-free mode using the SP-PHONE button.



Customizing Your Phone

- 3.1.2 Settings on the Programming Mode—**Preferred Line Assignment—Outgoing**
Select the seized line when going off-hook.
- 3.1.3 Customizing the Buttons
Create or edit a Direct Station Selection (DSS) button.

Operator Call

You can call an extension or a group assigned as the operator.

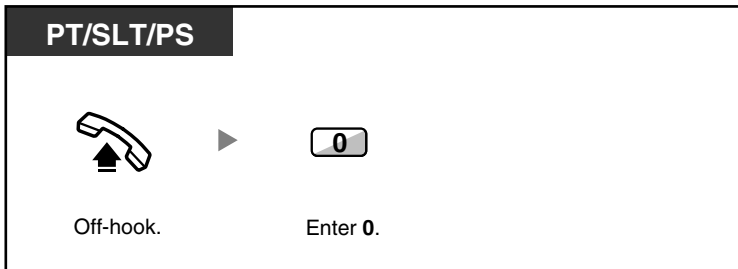

◆◆ **Calling an Outside Party**

You have to seize a CO line before dialing an outside phone number because external calls are made via your PBX.

Select one of the following methods:

Automatic Line Access

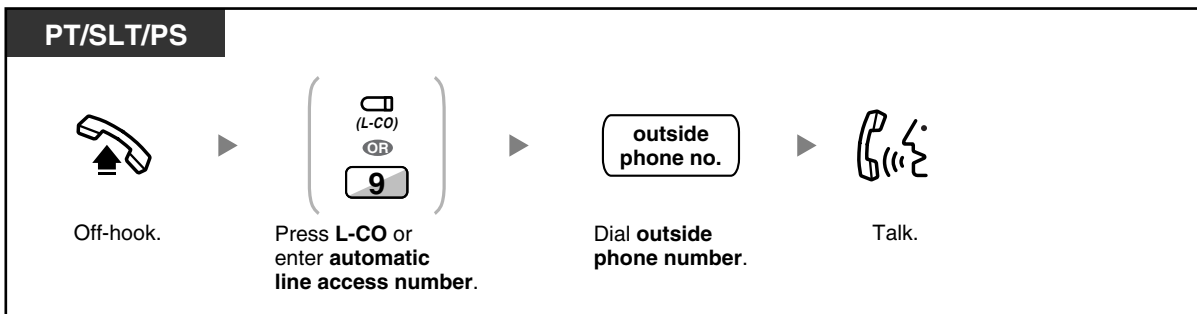

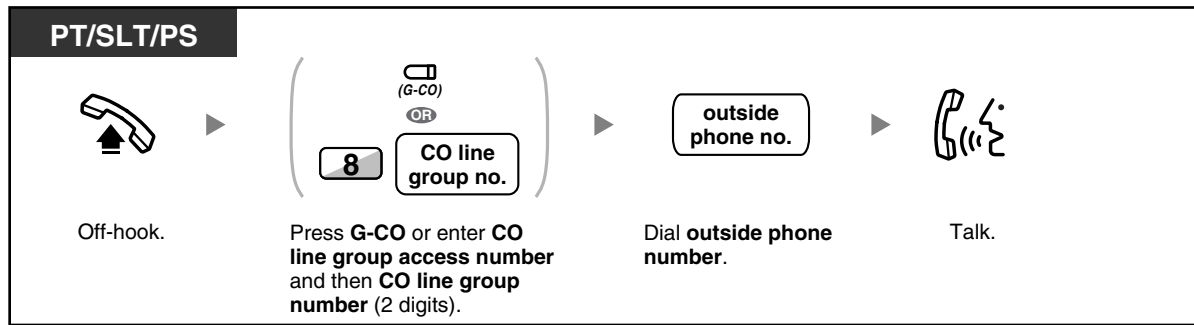

CO Line Group Access

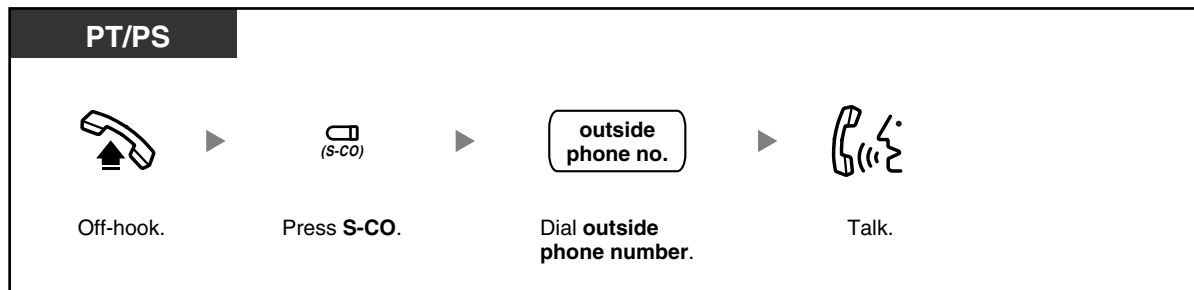

To select the specified CO line



- 
 - Each of the S-CO button or G-CO button light shows the current status as follows:
 - Off:** The line is idle.
 - Red on:** The line is in use.
 - You may be restricted from making a call to the specified outside party. To make a call, refer to "1.2.6 Calling without Restrictions".
- 
 - To confirm number before dialing**, you can enter a phone number and confirm it on the display and then go off-hook. (Predialing)
 - To make a call to another party without going on-hook**, press the FLASH/RECALL button. It will re-access the CO line and provide external dial tone. Pressing the Terminate button will provide intercom dial tone. You can dial the new phone number without going on/off-hook.
 - Hands-free Operation**
You can make an outside call and have a conversation in hands-free mode using the SP-PHONE button.

Customizing Your Phone

- 3.1.2 Settings on the Programming Mode—**Preferred Line Assignment—Outgoing**
Select the seized line when going off-hook.
- 3.1.3 Customizing the Buttons
Create or edit a Loop-CO (L-CO) button, a Group-CO (G-CO) button, a Single-CO (S-CO) button or a Terminate button.

◆◆ Account Code Entry

You may give a specified account code to extension users and check their telephone usage. You can specify an account code for each client and check the call duration.

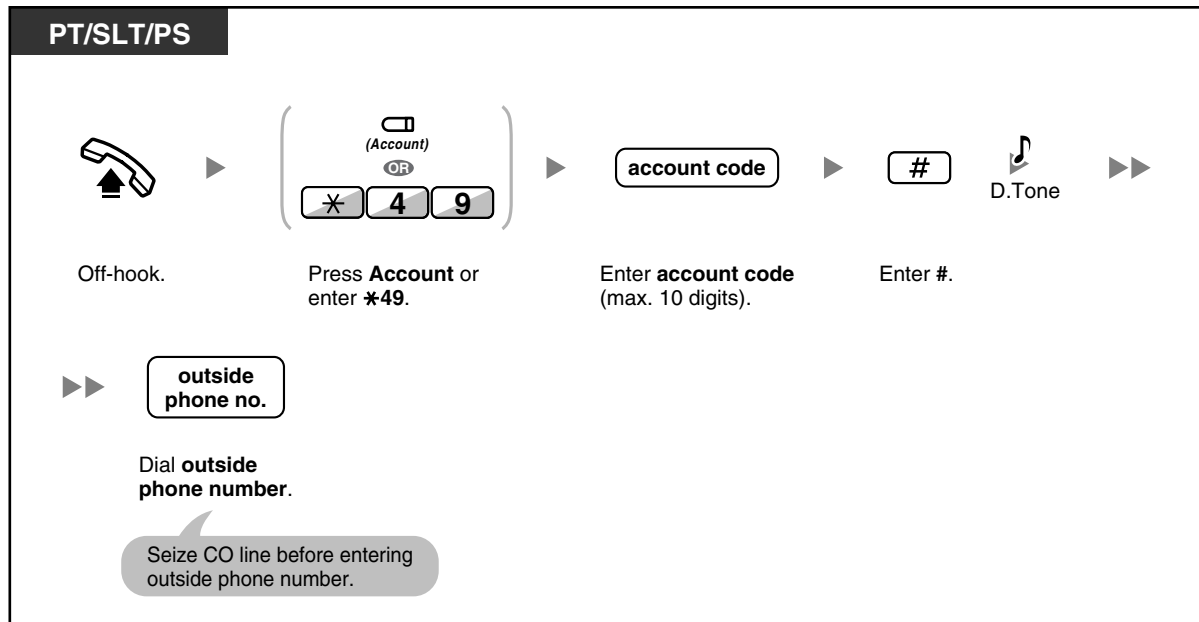

- **A Panasonic proprietary telephone extension user** can enter an account code during a conversation and when hearing reorder tone after the other party hangs up.
- Account codes may use the digits "0" through "9".
- **If you enter the wrong code**, press the "*" key and re-enter the account code.
- You may not be able to make an outside call without an account code. Entry mode is assigned to each user. Ask your manager for your mode.
- **For your convenience**, you can store the code with the phone number in the memory (e.g., Speed Dialing).



Customizing Your Phone

- 3.1.3 Customizing the Buttons
Create or edit an Account button.

1.2.2 Easy Dialing

This is convenient for frequently dialed phone numbers.

- One-touch Dialing
- Personal Speed Dialing
- System Speed Dialing
- Hot Line
- Quick Dialing

◆◆ One-touch Dialing

You can store a phone number into the flexible button for one-touch operation.

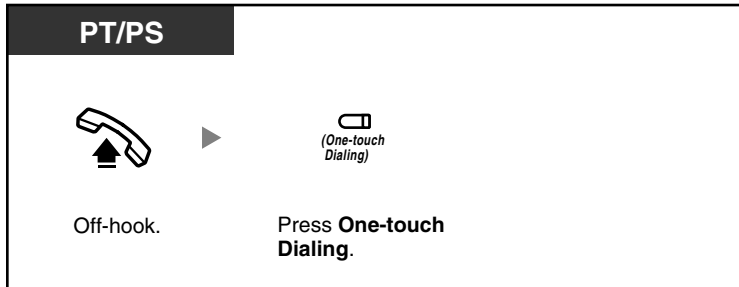

Customizing Your Phone

- 3.1.3 Customizing the Buttons
Create or edit a One-touch Dialing button, store the desired phone number or feature number.

◆◆ Personal Speed Dialing

You can store numbers at your extension for your personal use. (Default: 10 numbers, 00-09)
This feature is also known as Station Speed Dialing.

To store a phone number

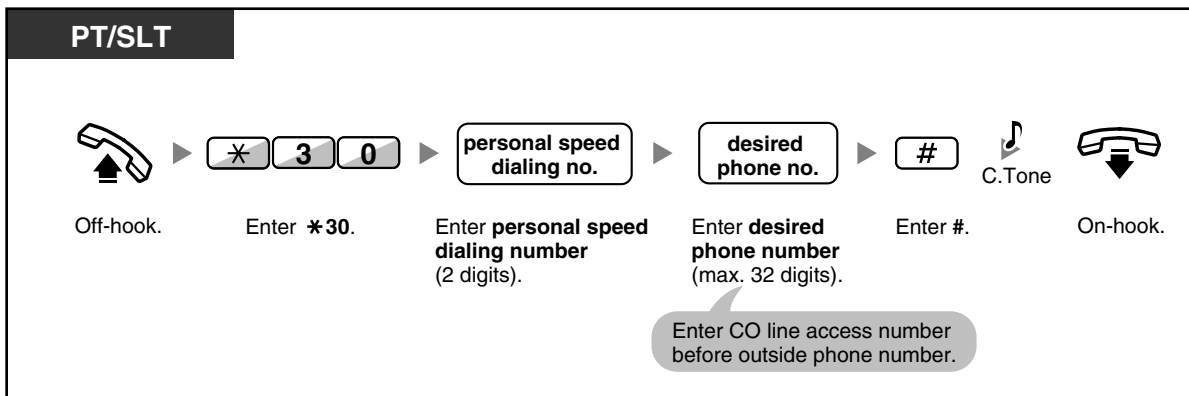

To dial

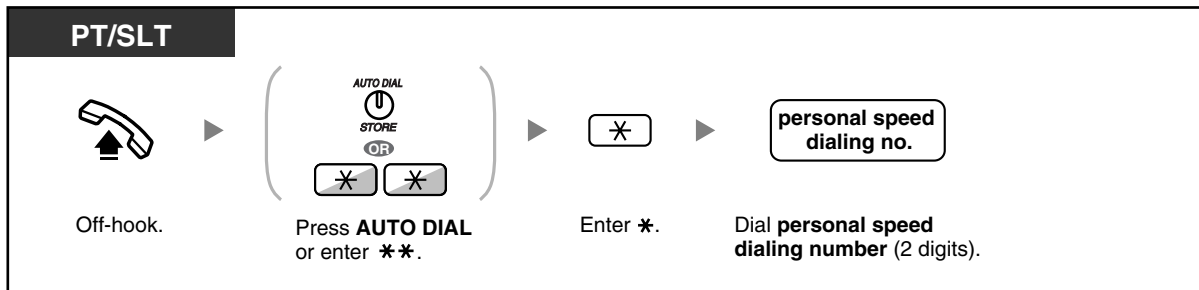

- To call using a directory, refer to "1.11.2 Directories".

◆◆ **System Speed Dialing**

You can make calls using speed dialing numbers stored in the PBX.

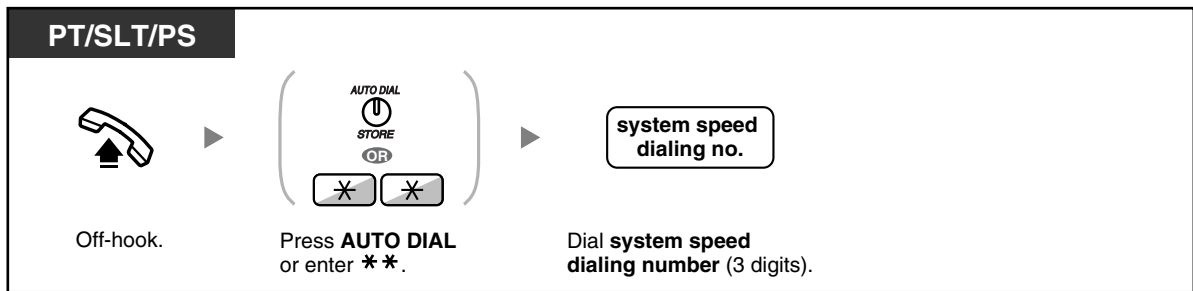

- To call using a directory, refer to "1.11.2 Directories".

◆◆ **Hot Line**

You can make an outside call simply by going off-hook if you have preprogrammed your phone. This feature is also known as Pickup Dialing.

To store a phone number

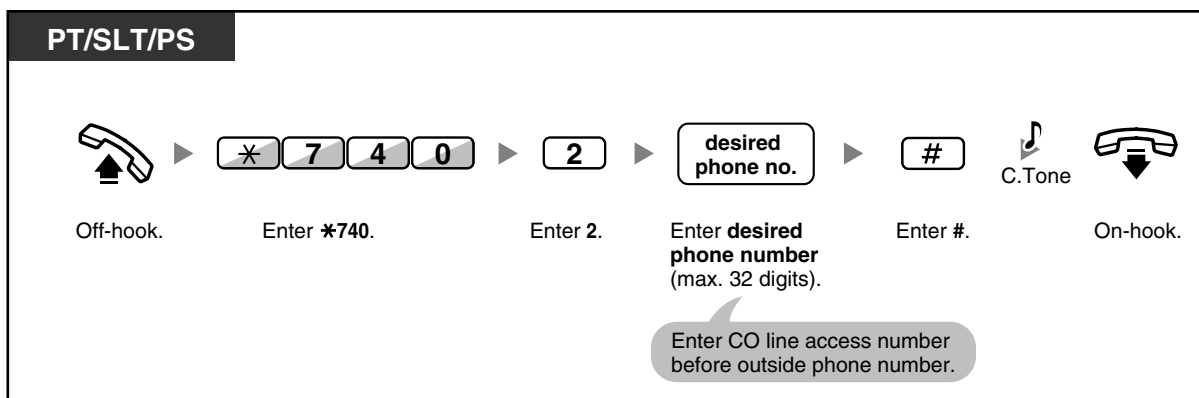

To set/cancel

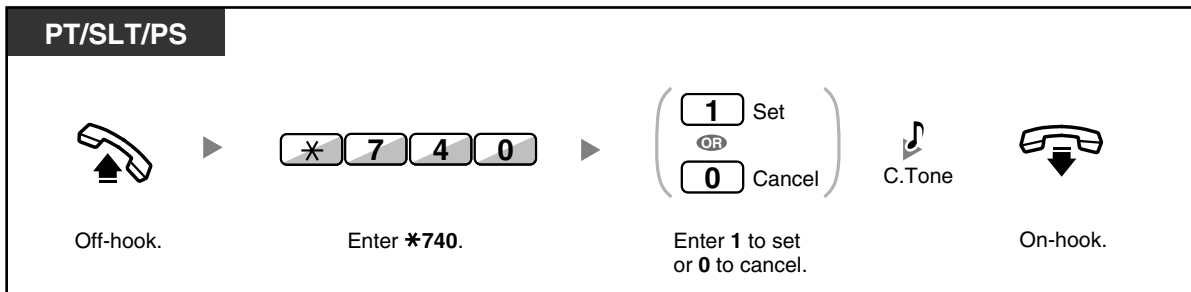

To dial



- **To call another party**, dial the desired party's phone number before the preprogrammed number is dialed.
- You should assign the intercom line as the seized line when going off-hook. (Preferred Line Assignment— Outgoing)
- If canceling Hot Line is difficult because this feature is activated immediately after going off-hook, consult your dealer.

Customizing Your Phone

- 3.1.2 Settings on the Programming Mode—**Preferred Line Assignment—Outgoing**
Select the seized line when going off-hook.

Quick Dialing

You can make a call simply by pressing the preprogrammed number for quick dialing. For details, consult your manager or dealer.

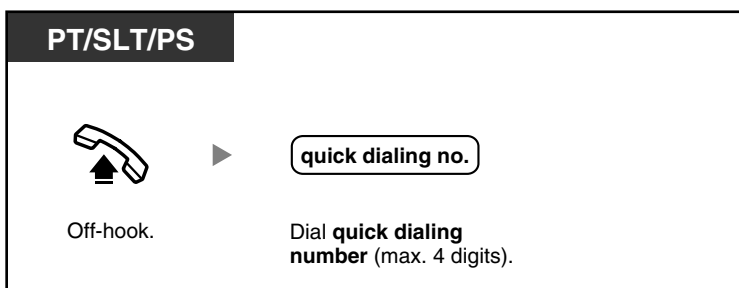

- It is a useful feature for Hotel.
For example, to dial the Room Service, dial the digit "3", not the full extension number.

1.2.3 Redial

This is convenient when calling the same outside party again.

- Last Number Redial

◆◆ Last Number Redial

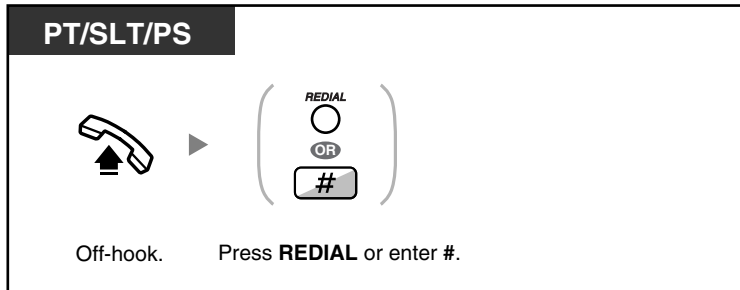

- Up to 32 digits can be stored and redialed.
- After pressing REDIAL, if you hear a busy tone again, press REDIAL to retry.

1.2.4 When the Dialed Line is Busy or There is No Answer

- Automatic Callback Busy
- Call Waiting
- Message Waiting
- Executive Busy Override
- Call Monitor
- DND Override

◆◆ Automatic Callback Busy

You can set the telephone to receive callback ringing:

- when a dialed extension becomes idle.
- when your desired CO line that is in use by another extension becomes idle.

You cannot set Automatic Callback Busy for a busy party outside of the PBX.



When you answer the callback ringing:

- For an outside call: The line is seized.
- For an intercom call: The called extension starts ringing automatically.

To set (for both extension and CO line)

PT/SLT/PS

While hearing a busy tone



  

Enter 6. On-hook.

To answer the callback ringing from an idle extension

PT/SLT/PS

While hearing a callback ringing



  

Off-hook. Talk.

To answer the callback ringing from an idle CO line

PT/SLT/PS

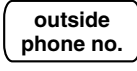
While hearing a callback ringing





  

Off-hook. Dial **outside phone number.** Talk.

- If you do not answer the callback ringing within 10 seconds, this feature will be canceled.

Automatic Callback Busy Cancel

PT/SLT/PS

Off-hook. Enter ***46.** On-hook.

◆◆ Call Waiting

You can inform the called party that your call is waiting.
This feature is also known as Busy Station Signaling (BSS).

PT/SLT/PS

While hearing a busy tone

1

Enter 1.

◆◆ Message Waiting

◆ For a caller

When the called extension is busy or does not answer your call, you can leave a notification so that the called party may call you back.

◆ For a called extension

As a message receiver, the Message button light or Message/Ringer Lamp lets you know that a call has been received. If you receive notification, you can call back the caller by a simple operation.

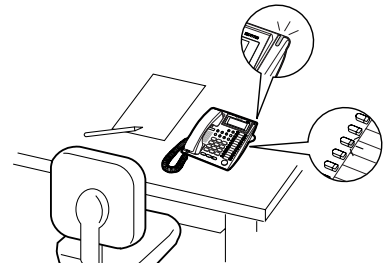

◆ For a caller

To leave a message waiting indication

PT/SLT/PS

When the called extension is busy or does not answer

MESSAGE

○

OR

4

Press **MESSAGE**
or enter 4.

↓

C.Tone

☎

↓

On-hook.

To leave/cancel a message waiting indication

PT/SLT/PS

☎

↑

Off-hook.

▶

*70

▶

Enter ***70**.

▶

1

OR

0

Leave
OR
Cancel

▶

Enter **1** to leave
or **0** to cancel.

▶

desired
extension no.

▶

Enter **desired
extension number**.

▶

↓

C.Tone

▶

☎

↓

On-hook.

◆ For a called extension

To check the left message and call back

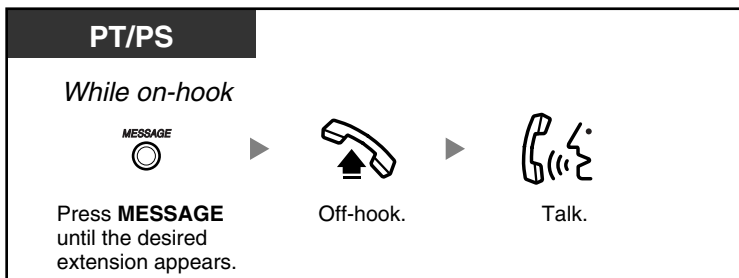

To call back

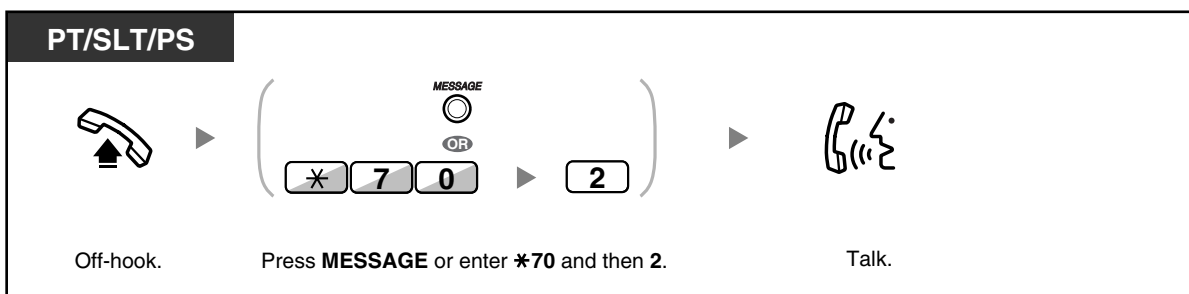

To clear message waiting indications left on your extension

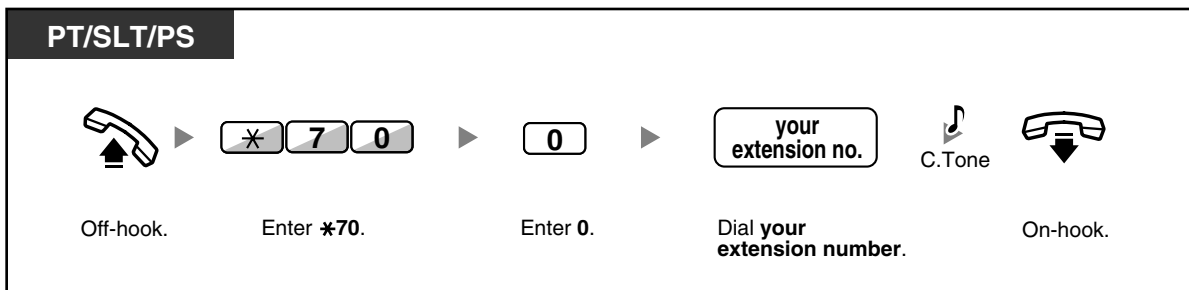

- The Message button light or Message/Ringer Lamp shows the current status as follows:
 - Off:** No message
 - Red on:** You have a message.
- The display shows the messages starting with the most recent call.
- On your PT, you can establish one or more Message for Another Extension buttons. These buttons can accept the message waiting notification of other extensions or various incoming call distribution groups. In other words, you can monitor the message waiting notifications of other telephones.
- A single line telephone extension user will hear a special dial tone as the message waiting notification when going off-hook.

 **Customizing Your Phone**

- 3.1.3 Customizing the Buttons
 - Create or edit a Message button or Message for Another Extension button.

◆◆ Executive Busy Override

The preprogrammed extension can call someone who is busy on the telephone and establish a three-party conversation.

To join an intercom call

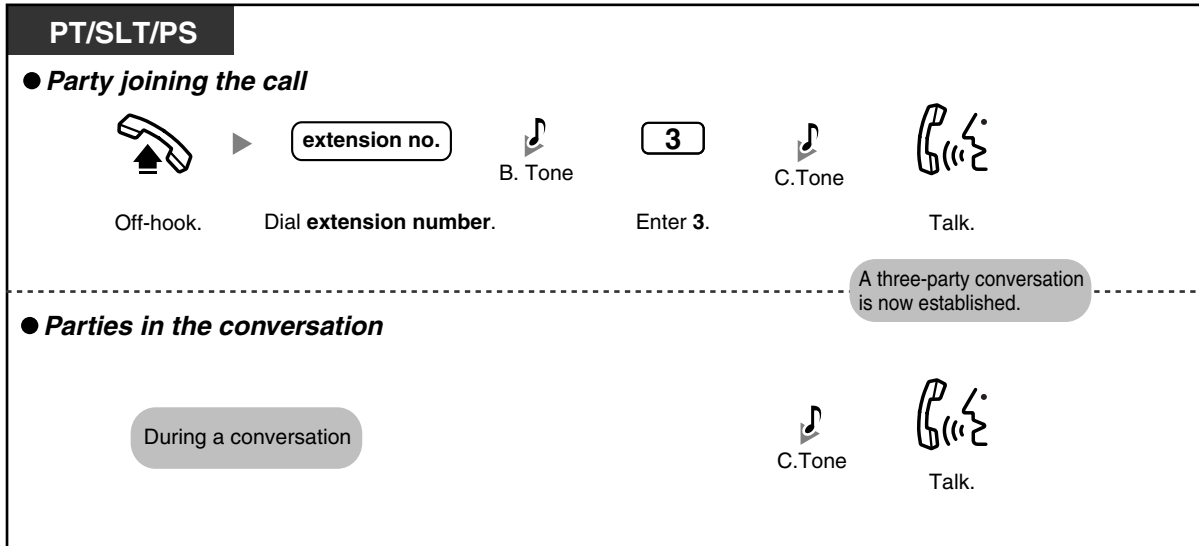

To join an outside call

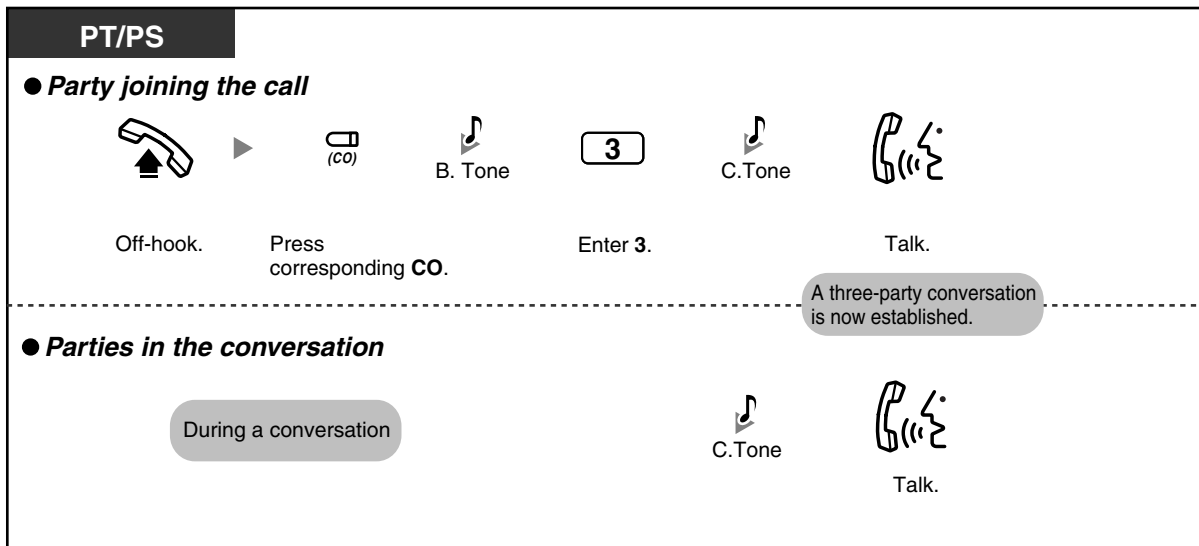

To leave a three-party conversation with an outside party and let the two other parties talk (originating extension only)

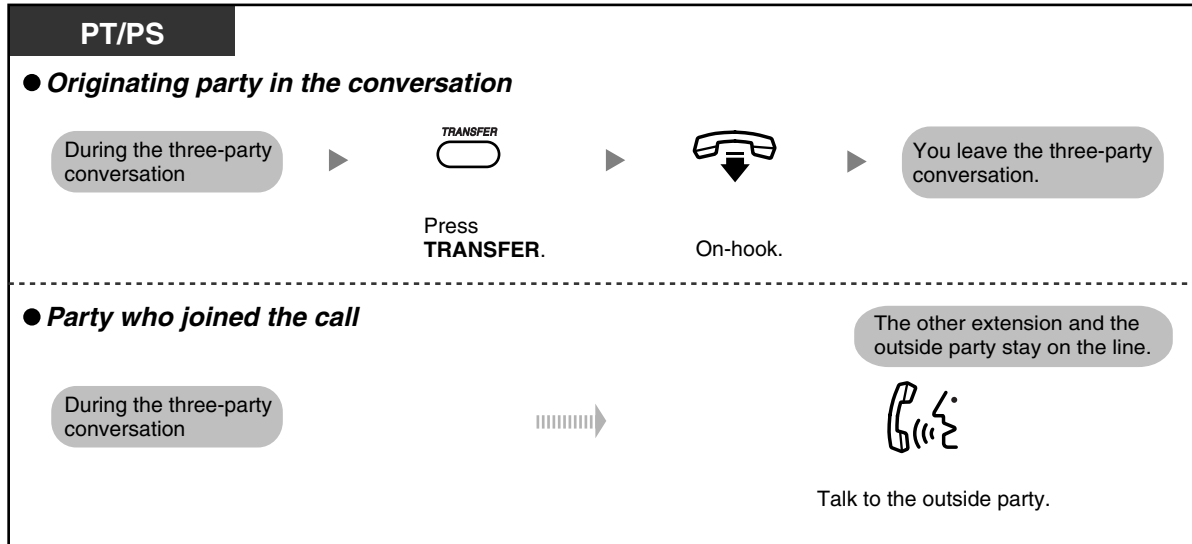

- To join another conversation, you must have Executive Busy Override enabled at your extension. For more details, consult your dealer.
- For the originating extension to leave a three-party conversation, that party's extension must be enabled through COS programming to transfer calls to CO lines.
- The third party can leave the conversation by simply going on-hook.

◆ For the originating extension

To talk to each party alternately

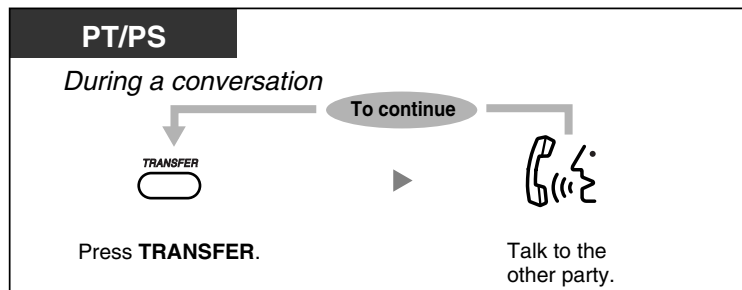

- You can also deny others the possibility of joining your conversation (Default: Allow). Refer to "1.7 Extension Settings".

◆◆ Call Monitor

The preprogrammed extension can monitor another extension.

To monitor

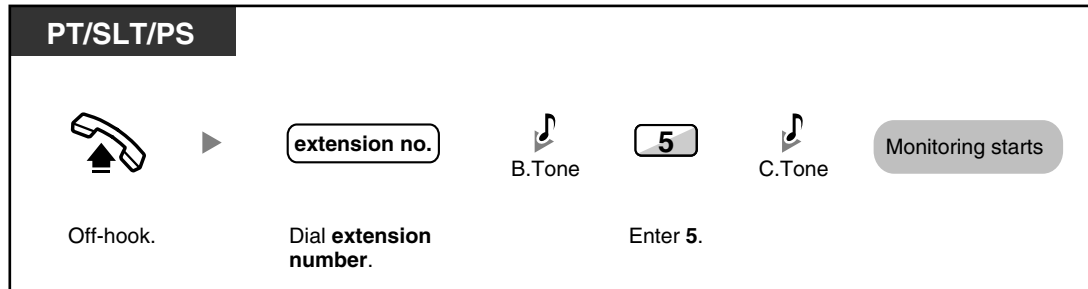

◆◆ DND Override

The preprogrammed extension can call someone who has set the DND feature.

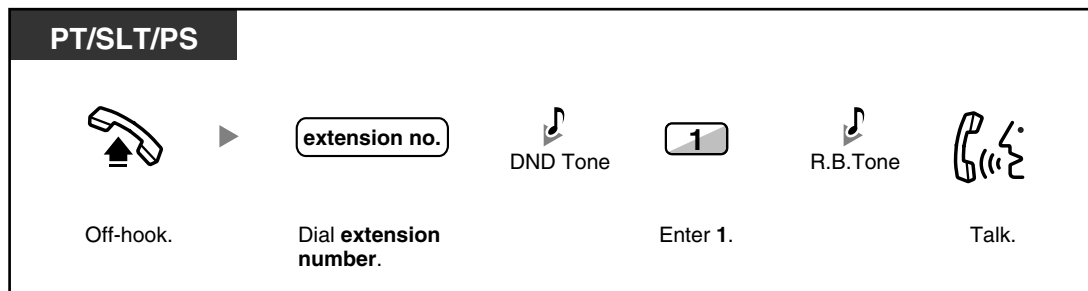

1.2.5 Alternate Calling—Ring/Voice

The caller can alternate the alerting method, either ring or voice, when making an intercom call. On the other hand, any extension can set the alerting method, either ring or voice, when receiving an intercom call.

Ring (Default): You can call the other party with a ring tone.

Voice-Calling: You can talk to the other party immediately after confirmation tone.

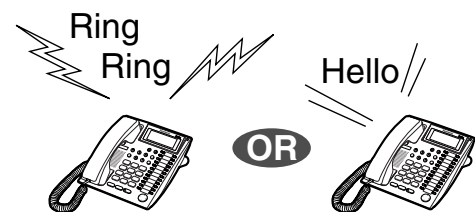

To change the method

PT/SLT/PS

After dialing



Enter *.



C.Tone



Talk.



- If the called party uses a single line telephone or portable station, Voice-Calling is not available.
- This feature is not available when the called party's telephone is in the Voice Call Deny mode.



Customizing Your Phone

- 3.1.2 Settings on the Programming Mode—**Alternate Receiving—Ring/Voice**
Select the alerting method, either ring or the other party's voice.

1.2.6 Calling without Restrictions

- Remote COS Access

◆◆ Remote COS Access

You can use your calling privileges (Class of Service) at another extension. You may override restrictions which have been set. To use this feature, an original extension number and an extension PIN (Personal Identification Number) are required. You can make a call by entering a verified code and verified code PIN. For the available verified code, ask your manager.

To call (Walking COS)

PT/SLT/PS *PIN: Personal Identification Number*



Off-hook.

*

4

7

Enter *47.

your
extension no.

Dial **your
extension number.**

extension PIN

Enter **extension PIN**
(max. 10 digits).



C.Tone &
D.Tone

desired
phone no.

Dial **desired
phone number.**

If a wrong extension PIN is entered, you hear an alarm tone.

Seize CO line before entering outside phone number.

To call (Verified Code Entry)

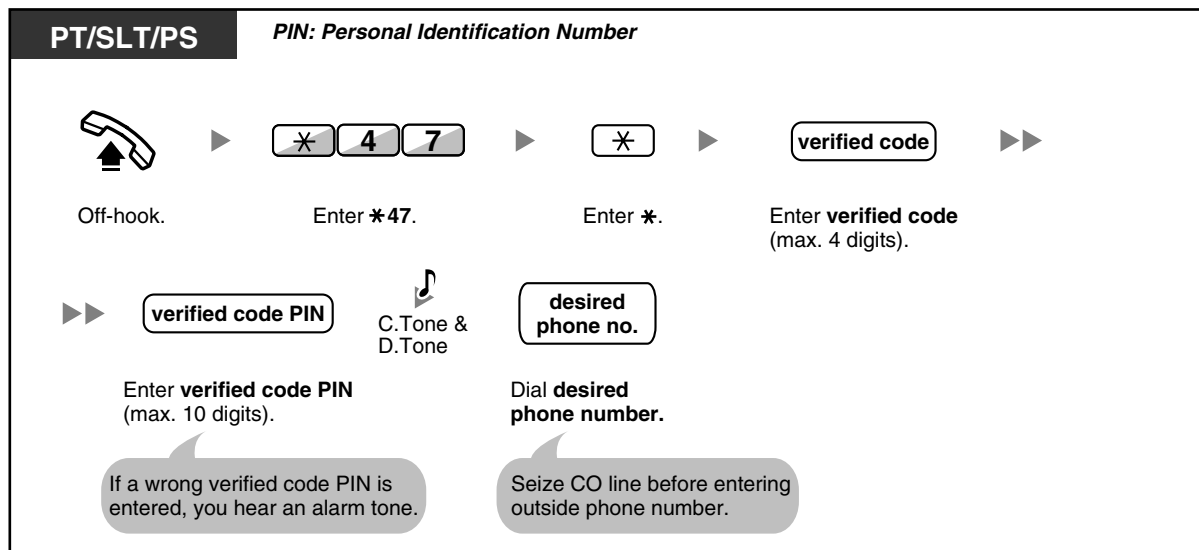

1.2.7 Direct Inward System Access (DISA)

- Calling through DISA

◆◆ Calling through DISA

When outside callers access extensions in the PBX, a prerecorded message greets the caller and gives information about how to access an extension. You do not need the operator's assistance.

You may be able to access system features or call an outside party with your password depending on the security mode. Ask your manager for the mode assigned to your PBX.

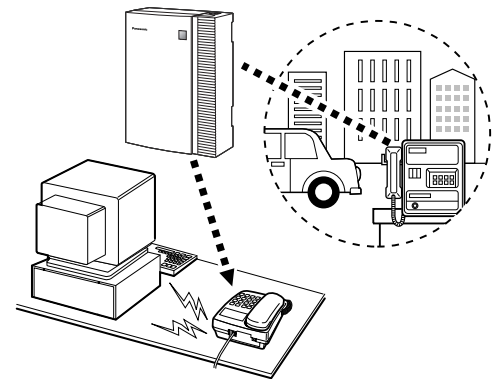

To call an extension

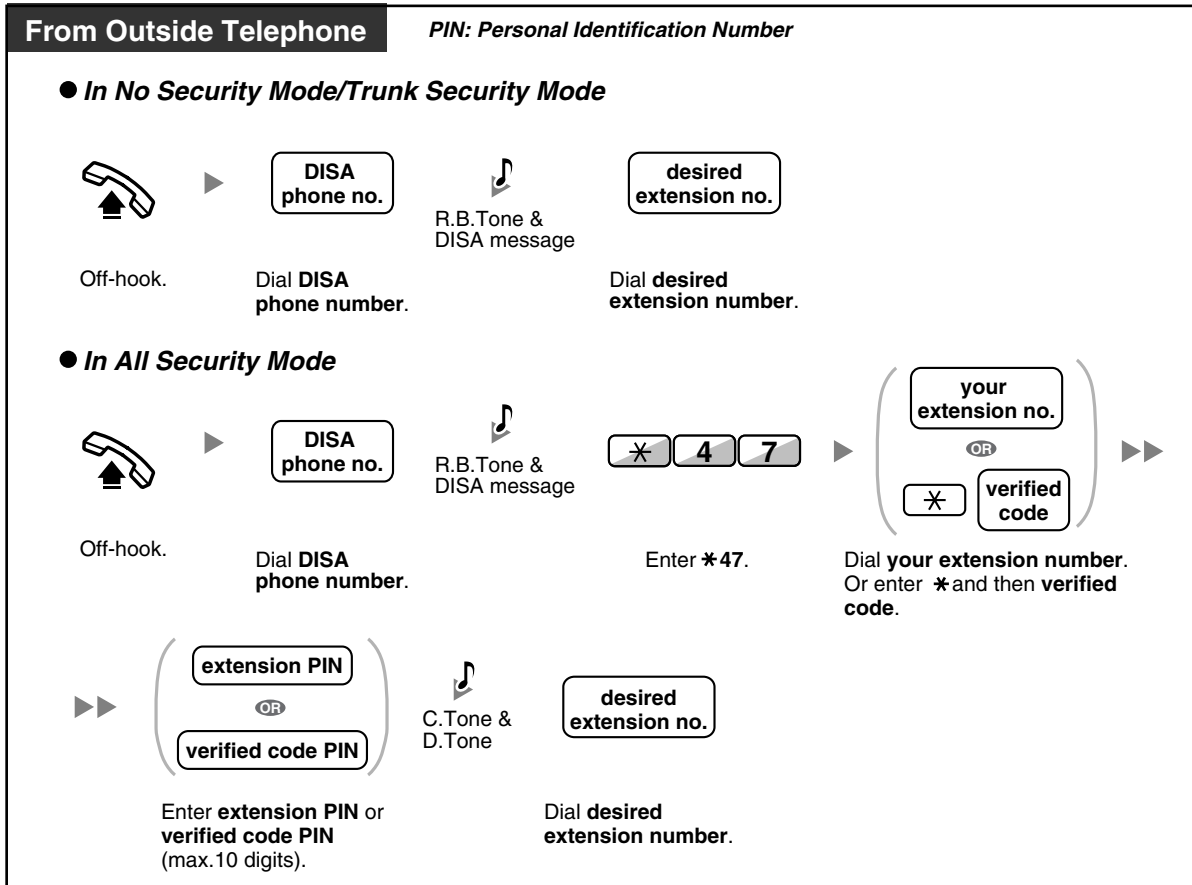

To call an outside party

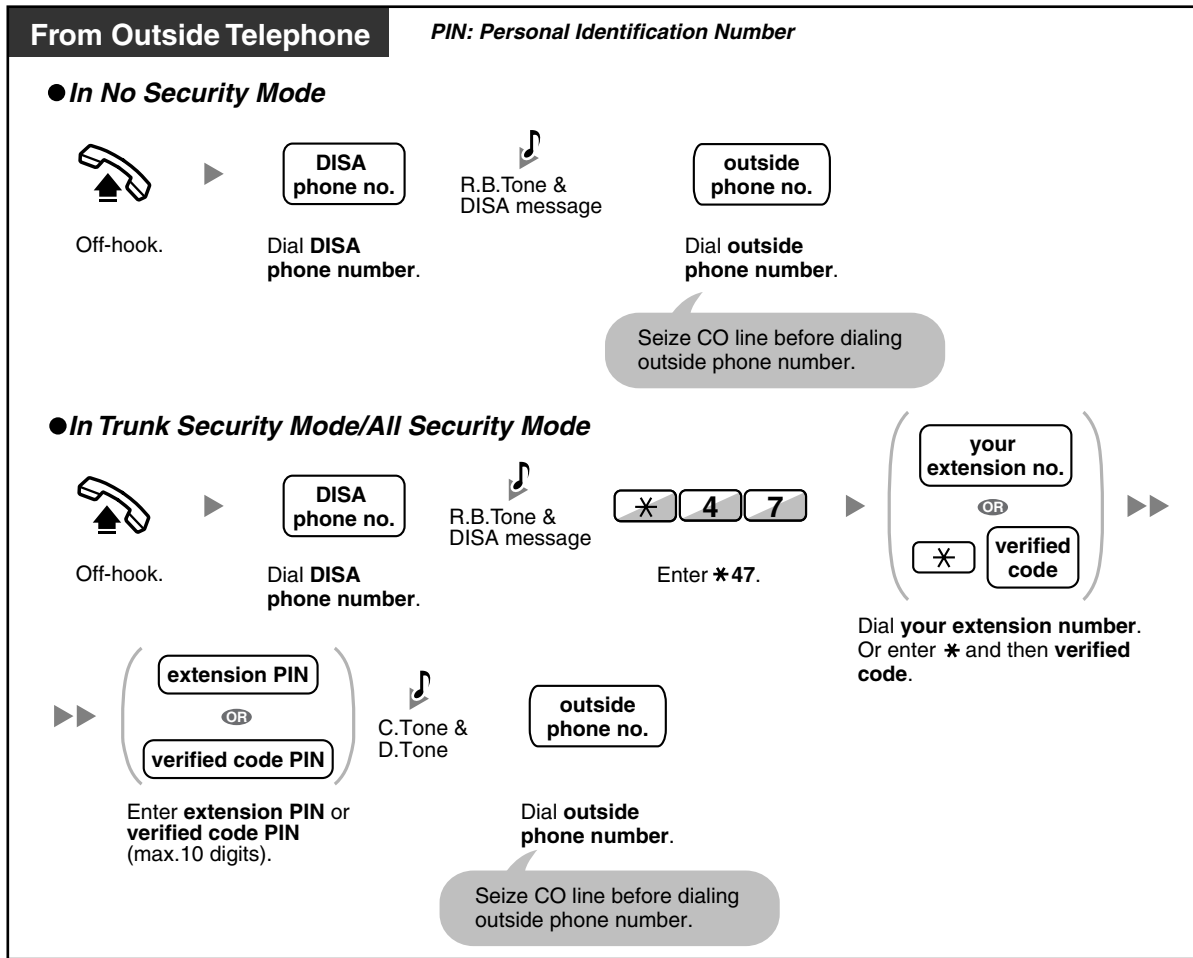

To retry

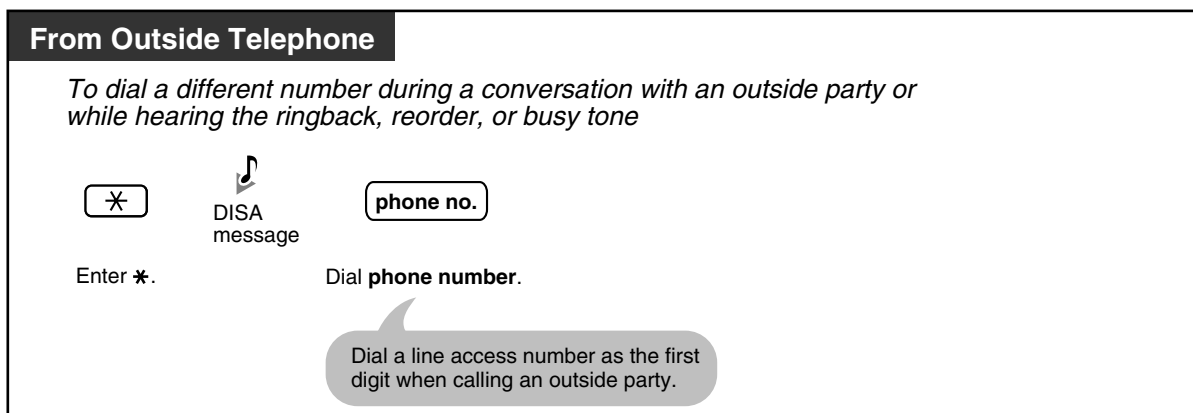



- **WARNING**
 There is a risk that fraudulent telephone calls will be made using the CO-to-CO Line Call feature of DISA.
 The cost of such calls will be billed to the owner/renter of the PBX.
 To protect the PBX from this kind of fraudulent use, we strongly recommend:
 - a) Enabling DISA security (CO Line Security or All Security).
 - b) Keeping your passwords (verified code PIN/extension PIN) secret.
 - c) Selecting complex, random PINs that cannot be easily guessed.
 - d) Changing PINs regularly.
- **Time limit**
 Both parties will hear an alarm tone fifteen seconds before the specified time limit. To extend, press any dial button except ✖.
- **If Built-in Automated Attendant service is set**, you can access the desired extension simply by pressing a single digit (0-9) from the options given the prerecorded message.

1.2.8 Remote Setting

You can set the following features on your telephone from another extension or through DISA.

- Call Forwarding (FWD)/Do Not Disturb (DND)
- Changing the Log-in/Log-out Status of Extensions
- Absent Message
- Extension Dial Lock
- Time Service—Changing the Time Mode (Day/Night/Lunch/Break)

From another extension

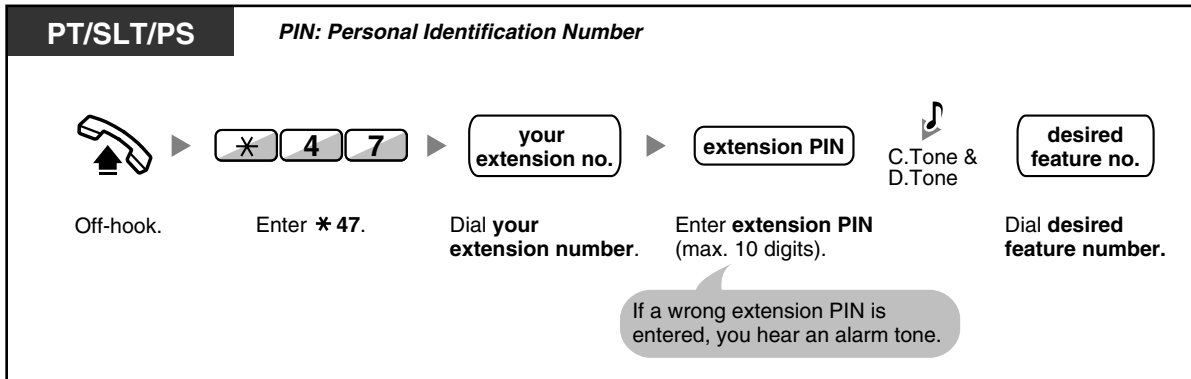

Through DISA

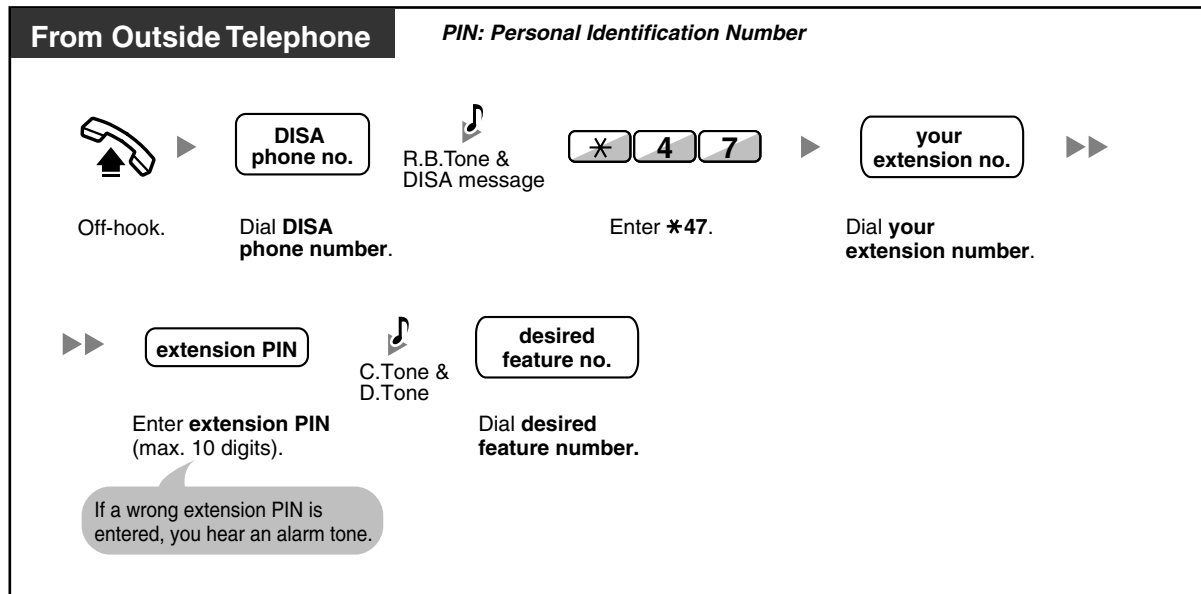

1.3 Receiving Calls

1.3.1 Answering Calls

PT/SLT/PS



Off-hook.

▶



Talk.

Select one of the following methods:

- Lift the handset to receive the preferred line.
(Default: Ringing line is selected.)
- Press the SP-PHONE button.
- Press the flashing CO, INTERCOM or G-DN button directly.
- Press the Answer button.



- The G-DN button light shows the current status as follows:
 - Off:** Idle
 - Green on:** The line is in use. (You are using the line.)
 - Red on:** Your extension is in Log-out mode from the incoming call distribution group.



- **Hands-free operation**
You can receive a call and have a conversation in hands-free mode using the SP-PHONE button. You can perform other tasks simultaneously.
Helpful hints for hands-free operation:
 - **If it is difficult to hear the other party's voice:**
Increase the volume using the Navigator Key or Volume Key.
 - **If the other party has difficulty hearing you:**
Decrease the volume.
 - **If the other party reports that your voice echoes:**
Use the telephone in a room that has curtains, carpeting or both.
 - **If parts of the conversation cannot be heard:**
If you and the other party speak at the same time, parts of your conversation may be lost. To avoid this, try to speak alternately.



Customizing Your Phone

- 3.1.2 Settings on the Programming Mode—
Preferred Line Assignment—Incoming
Select the seized line when going off hook.
Alternate Receiving—Ring/Voice
Select the Calling method, either ring or the other party's voice.
- 3.1.3 Customizing the Buttons
Create or edit a Group Directory Number (G-DN) button.

1.3.2 Hands-free Answerback

You can answer an incoming call without going off-hook as soon as the line is connected. When an intercom call arrives, you will hear the caller talking without the phone ringing. When an outside call arrives, you will hear the caller talking after a preprogrammed number of rings. Hands-free Answerback for outside calls requires System Programming. Consult your dealer.



To set/cancel



- The AUTO ANS button light shows the current status as follows:
 - Off:** Not set
 - On:** Set
- For a PS user, refer to "Operating Instructions" for PS.

1.3.3 Call Pickup

- Call Pickup
- Call Pickup Deny

◆◆ Call Pickup

You can answer an incoming call that is ringing at another extension or group from your phone without leaving your desk.

The following types of pickup are available:

Group Call Pickup: Picks up a call within your group.

Directed Call Pickup: Picks up a specified extension's call.

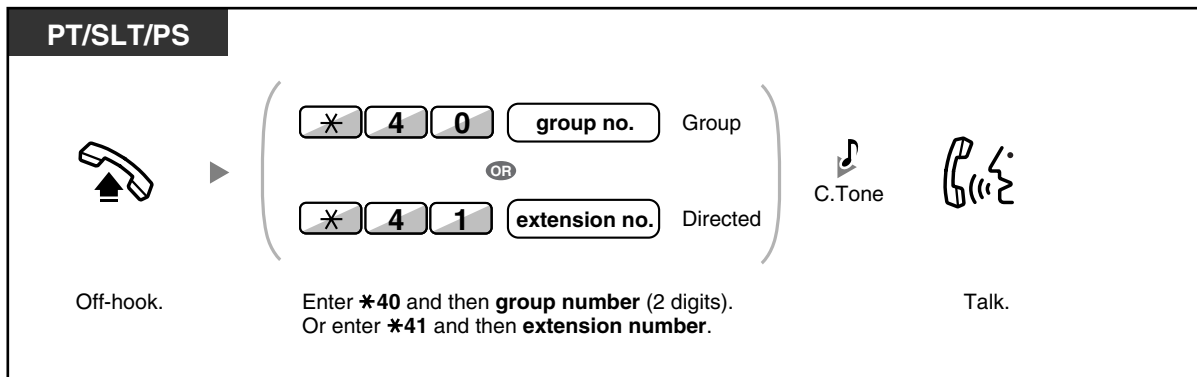

1.3 Receiving Calls



- **If you receive a call waiting tone**, you can ask a third party to pick up your second call with Directed Call Pickup.
- If there are multiple incoming calls for the same group, the longest waiting call is received first.



- You can also pickup a call by pressing a flashing DSS button. System programming is required to allow this operation. Consult your dealer.

◆◆ Call Pickup Deny

You can deny or allow other people to pick up your calls.

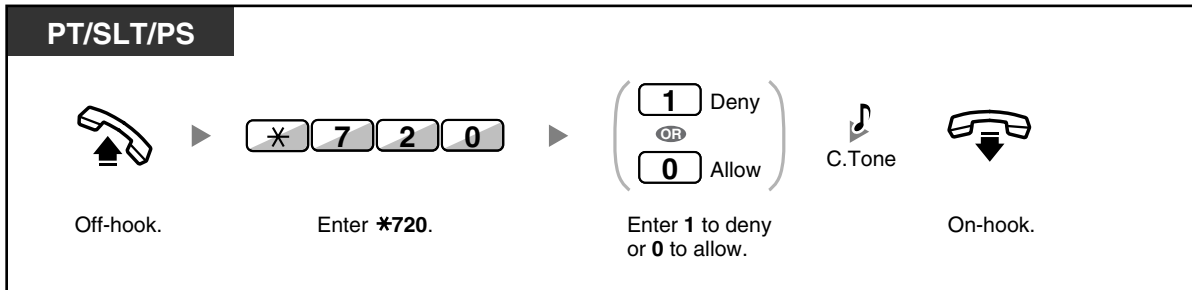

1.3.4 Trunk Answer From Any Station (TAFAS)

You can be notified of incoming outside calls through an external speaker. These calls can be answered from any extension.

Through an external speaker

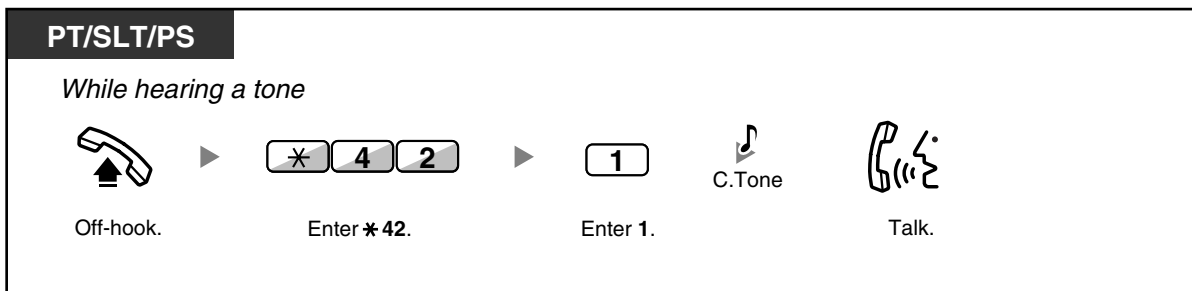

- You can also receive a paging announcement via a speaker with this operation.

1.3.5 Answer/Release Button

The Answer and Release buttons are convenient for operators using headsets.

With the Answer button, you can answer all incoming calls.

With the Release button, you can disconnect the line during or after a conversation, or complete transferring a call.



To answer



To transfer a call

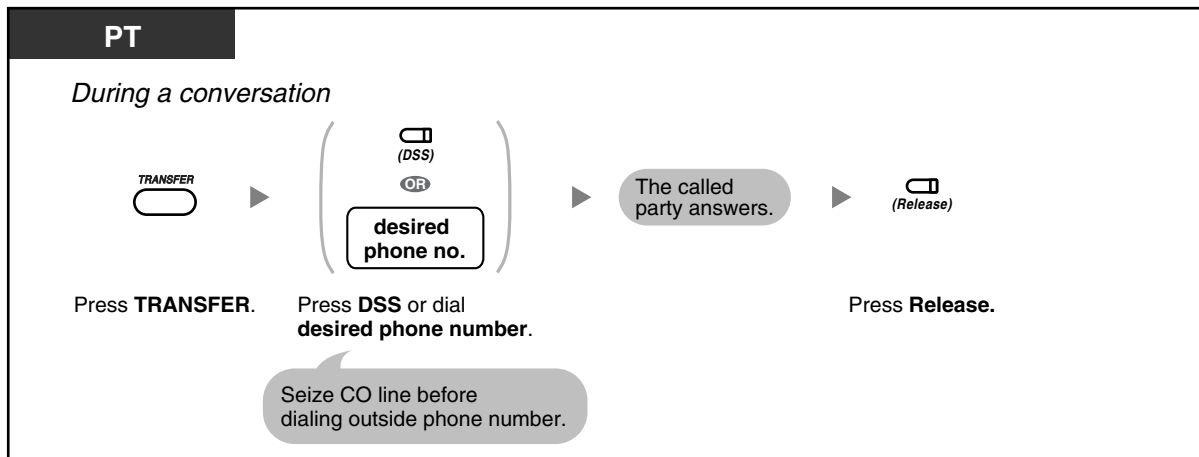

To talk to a waiting caller



To transfer an outside call to an extension with a one-touch operation

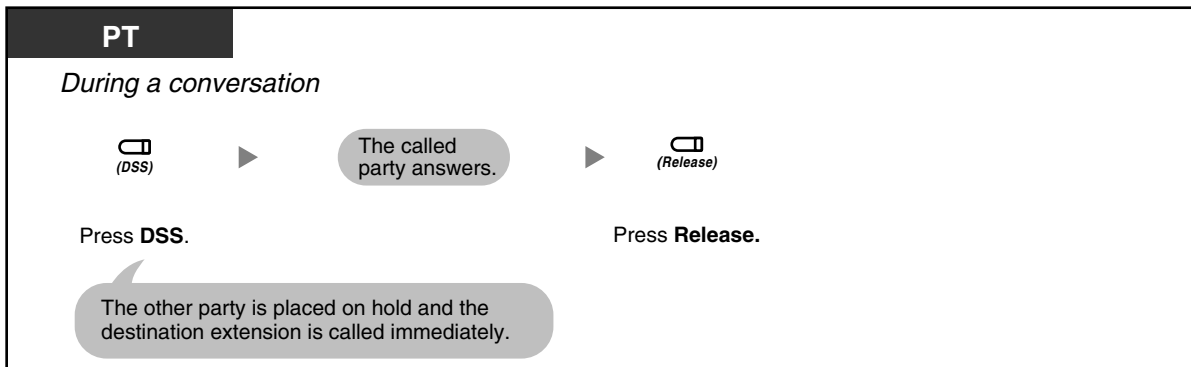

To end a conversation

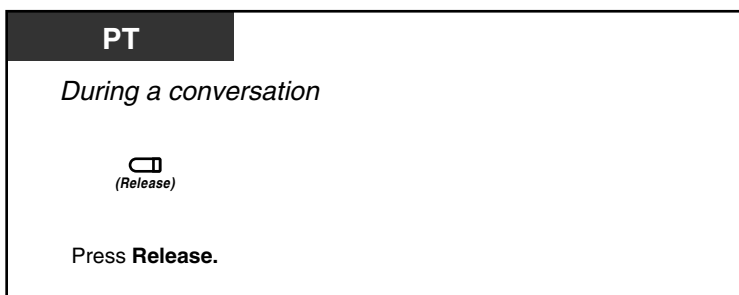

Customizing Your Phone

- 3.1.3 Customizing the Buttons
Create or edit an Answer button or a Release button.

1.4 During a Conversation

1.4.1 Call Transfer

- Transferring to an Extension on the PBX
- Transferring to an Outside Party Using the PBX Service



- You can transfer a held call without talking by going on-hook. If a call is not retrieved within a specified time, you will hear an alarm as a reminder. And, if an outside call is not answered within a specified time, it is automatically disconnected.
- **If you hear an alarm tone**, the destination extension did not answer the call. Answer the call.

◆◆ Transferring to an Extension on the PBX

To transfer

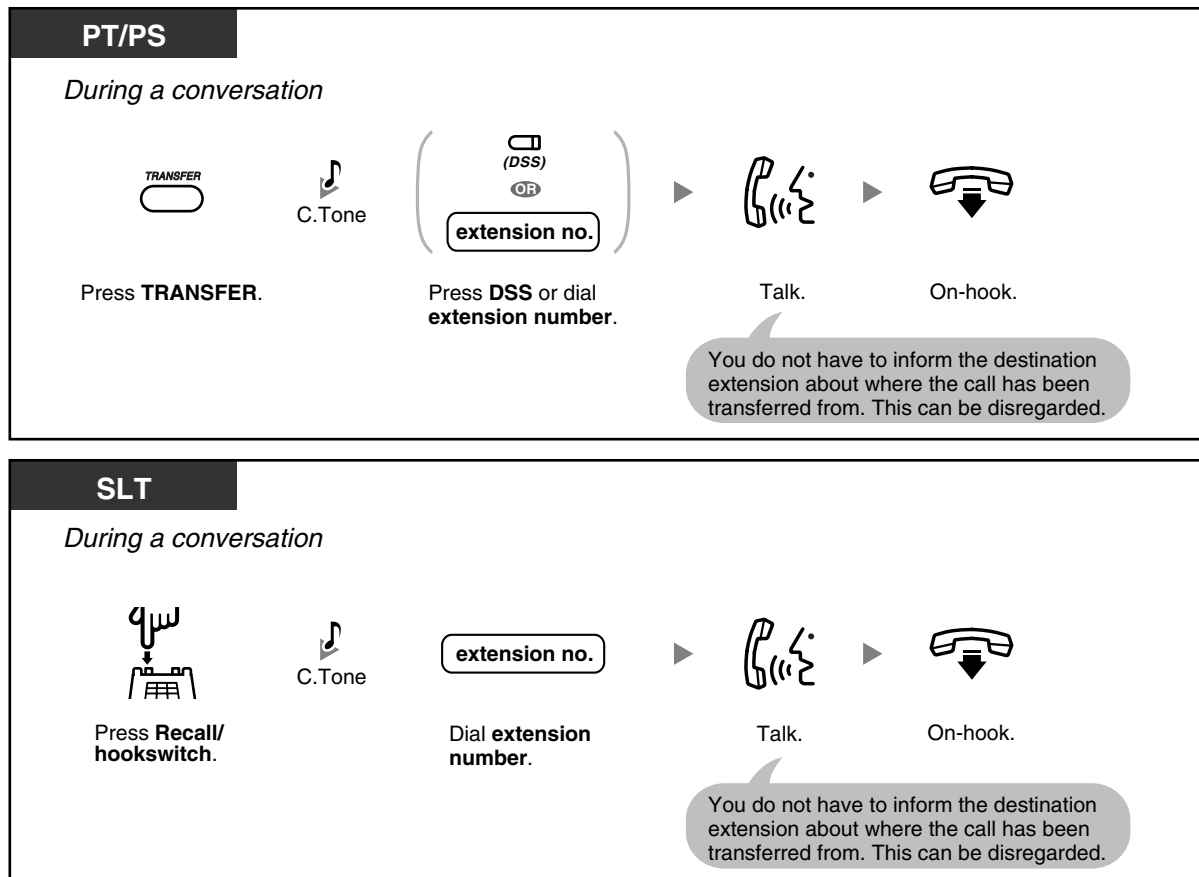

To transfer with one touch (One-touch Transfer)

PT/PS

During a conversation



Press **DSS**. Talk. On-hook.

You do not have to inform the destination extension about where the call has been transferred from. This can be disregarded.



- Even if the transferred party does not answer, you can go on-hook.

◆◆ **Transferring to an Outside Party Using the PBX Service**

Some extensions may be restricted from performing this feature.

PT/PS

During a conversation

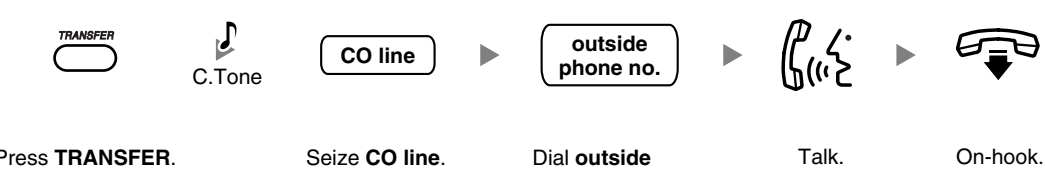

Press **TRANSFER**. C.Tone Seize **CO line**. Dial **outside phone number**. Talk. On-hook.

The call is transferred.

SLT

During a conversation

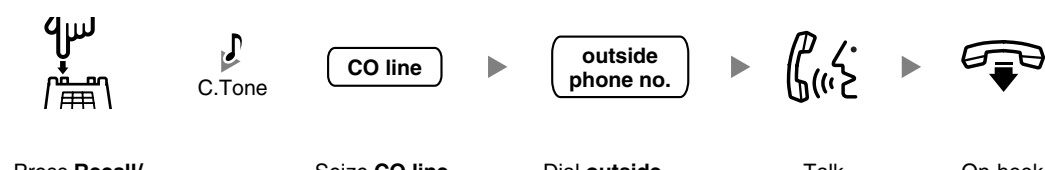

Press **Recall/hookswitch**. C.Tone Seize **CO line**. Dial **outside phone number**. Talk. On-hook.

The call is transferred.



- **Time limit**
Both the caller and the transferred party will hear an alarm tone fifteen seconds before a specified time period.
- **To return to the held call before the destination answers**, press the TRANSFER button, corresponding CO, G-DN or INTERCOM button, or the hookswitch.



Customizing Your Phone

- 3.1.3 Customizing the Buttons
Create or edit a Direct Station Selection (DSS) button.

1.4.2 Call Hold

- Call Hold
- Call Park



- **If a call is not retrieved within a specified time**, you will hear an alarm as a reminder. And, if an outside call is not answered within a specified time, it is automatically disconnected.

◆◆ Call Hold

There are two types of hold. The difference between them is that other people can retrieve your held call (Regular Hold) or not (Exclusive Call Hold). As they can be alternated, ask your manager what the current mode is.

Call Hold

PT/PS

During a conversation



TRANSFER



C.Tone

OR



HOLD

OR



* 5 0



C.Tone



On-hook.

Press **HOLD**, or press **TRANSFER** and then enter ***50**.

SLT

During a conversation



Recall/
hookswitch.



* 5 0

Enter ***50**.



C.Tone



On-hook.

Call Hold Retrieve

PT/SLT/PS

- **At the holding extension (Call Hold Retrieve)**

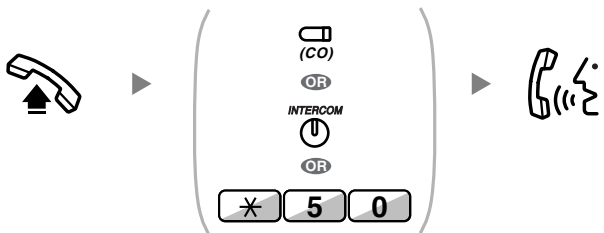

Off-hook. Press flashing **CO** or **INTERCOM**, or enter *** 50**. Talk.
- **To retrieve an outside call from another extension—only Regular Hold (Call Hold Retrieve—Specified with a held line number)**

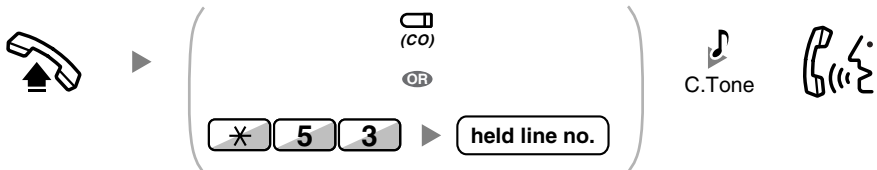

Off-hook. Press **CO**, or enter ***53** and then **held line number** (3 digits). C.Tone. Talk.
- **To retrieve an intercom call or outside call from another extension—only Regular Hold (Call Hold Retrieve—Specified with a holding extension number)**

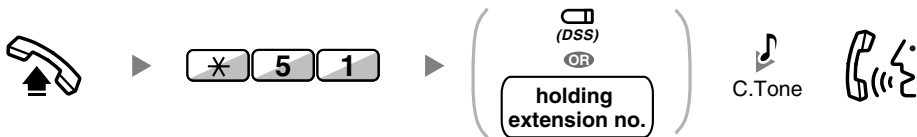

Off-hook. Enter ***51**. Press **DSS** or dial **holding extension number**. C.Tone. Talk.



- The CO or INTERCOM button light shows the current status as follows:

 - Regular Hold mode
 - Flashing green slowly:** Your held call
 - Flashing red:** Another extension's held call
 - Exclusive Call Hold mode
 - Flashing green rapidly:** Your held call
 - Red on:** Another extension's held call
- Hold Mode Change (PT only)**

After pressing the HOLD button, if you press the HOLD button again, the status switches from the Regular Hold mode to the Exclusive Call Hold mode or from the Exclusive Call Hold mode to the Regular Hold mode.



- **For simple operation**, you can automatically hold a call by pressing another CO, G-DN or INTERCOM button, only if preprogrammed (**Automatic Call Hold**). Consult your dealer.

◆◆ Call Park

You can put a call on hold in a common parking zone of the PBX so that any extension can retrieve the parked call. You can use this feature as a transferring feature.

A call can be put into either a specified parking zone (Specified) or any idle parking zone (Auto). If a Call Park button and Call Park (Automatic Park Zone) button have been established, you can select either way to park by simply pressing the corresponding button.

When a call is parked automatically, or more than one call has been parked at the same time, you need to specify the parking zone number to retrieve the required call.

To set

PT/PS

During a conversation

(Call Park)

Press **Call Park**.

PT/PS

During a conversation

TRANSFER

▶

*

5

2

▶

parking zone no.

Specified

OR

*

Auto

▶

C.Tone

▶



On-hook.

Press **TRANSFER**. Enter ***52**. Enter a specified **parking zone number** (2 digits) or press ***** to park at an idle parking zone automatically.

If you hear a busy tone, enter another parking zone number or press ***** again.

SLT

During a conversation

Recall/hookswitch

▶

*

5

2

▶

parking zone no.

▶

C.Tone

▶

On-hook.

Press **Recall/hookswitch**. Enter ***52**. Enter a specified **parking zone number** (2 digits).

If you hear a busy tone, enter another parking zone number.

Call Park Retrieve

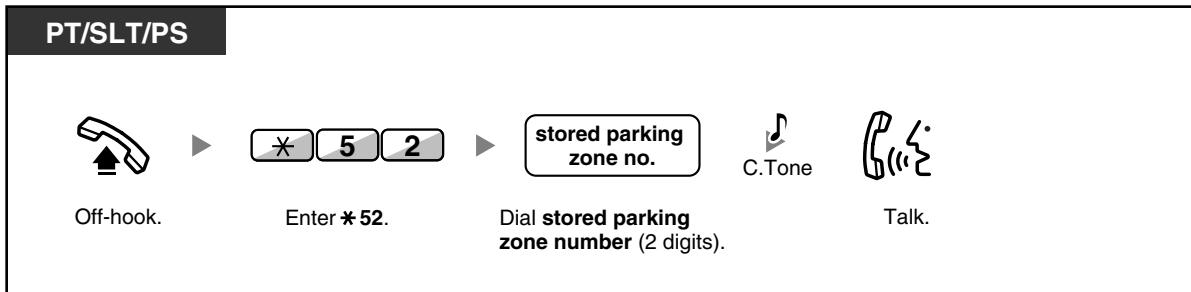
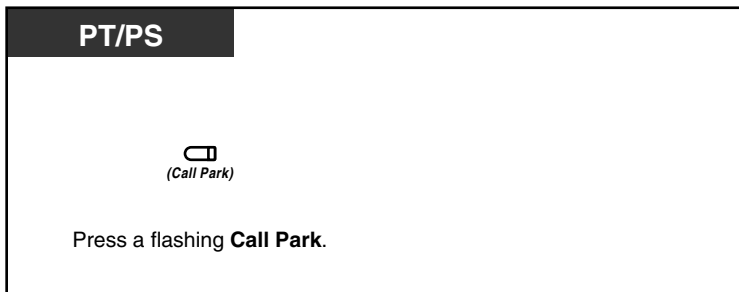

- If a call is parked automatically, confirm the parking zone number on the display.



- **If you hear a reorder tone when retrieving a parked call**, there is no held call. Confirm the stored parking zone number.
- After you park a call, you can perform other operations.



Customizing Your Phone

- 3.1.3 Customizing the Buttons
Create or edit a Call Park button or Call Park (Automatic Park Zone) button.

1.4.3 Call Splitting

When talking to one party while the other party is on hold, you can swap the calls back and forth (alternately).

To alternate between the parties leaving one party on hold temporarily

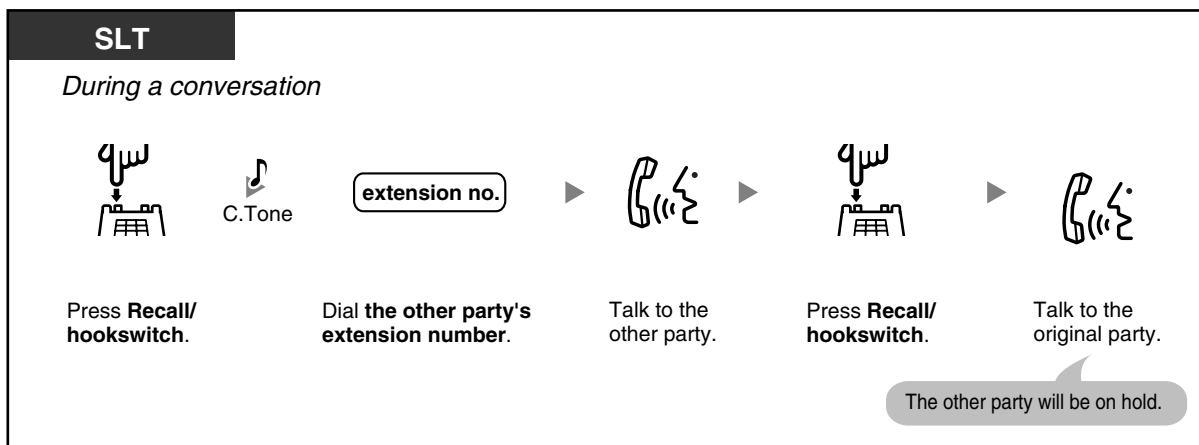
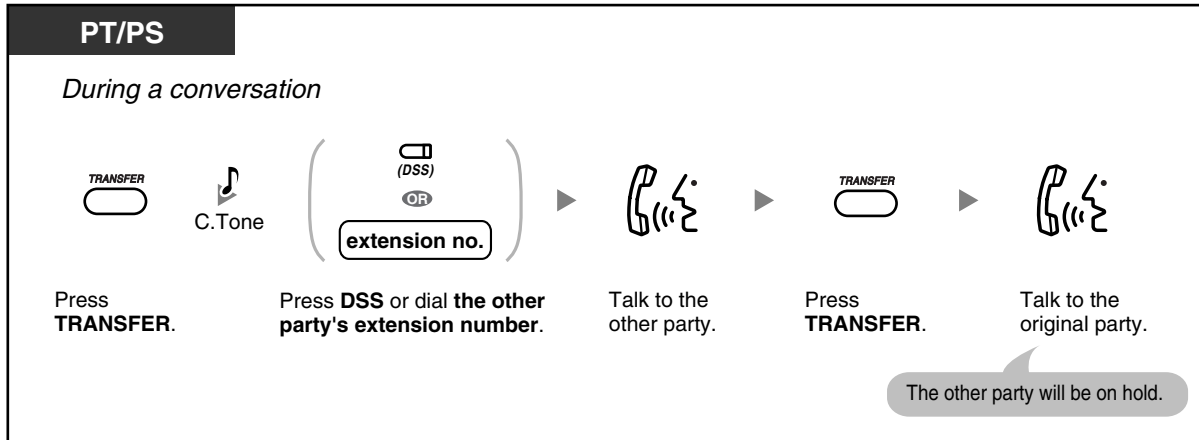

To leave the conversation and then let the two parties talk

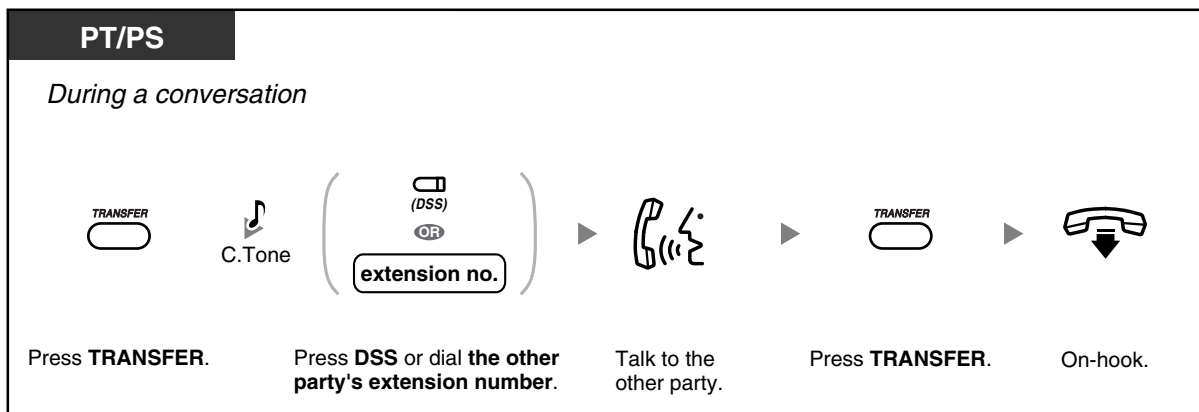

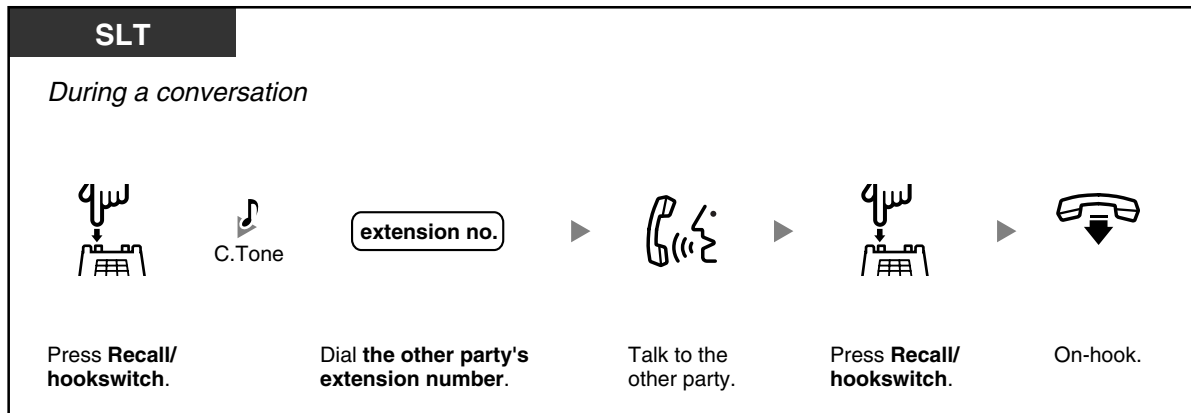

1.4.4 Call Waiting

- Answering Call Waiting in the PBX
- Answering Call Waiting from the Telephone Company

◆◆ Answering Call Waiting in the PBX

During a conversation, a call waiting tone through the speaker or the handset occurs when an outside call has been received or another extension is letting you know a call is waiting. You must activate this feature to use it. (Default: Enable—Tone)

You can answer the second call by disconnecting (1) or holding (2) the current call.

1. To disconnect the current call and then talk to the new party

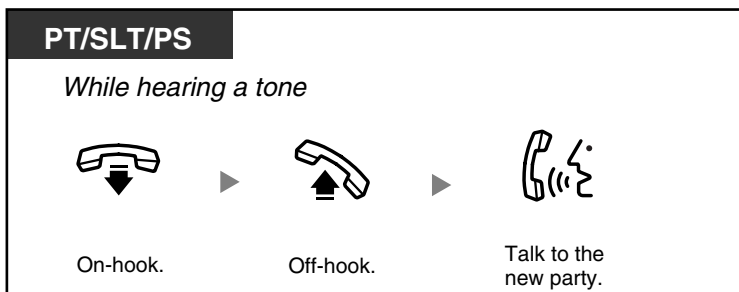

2. To hold the current call and then talk to the new party

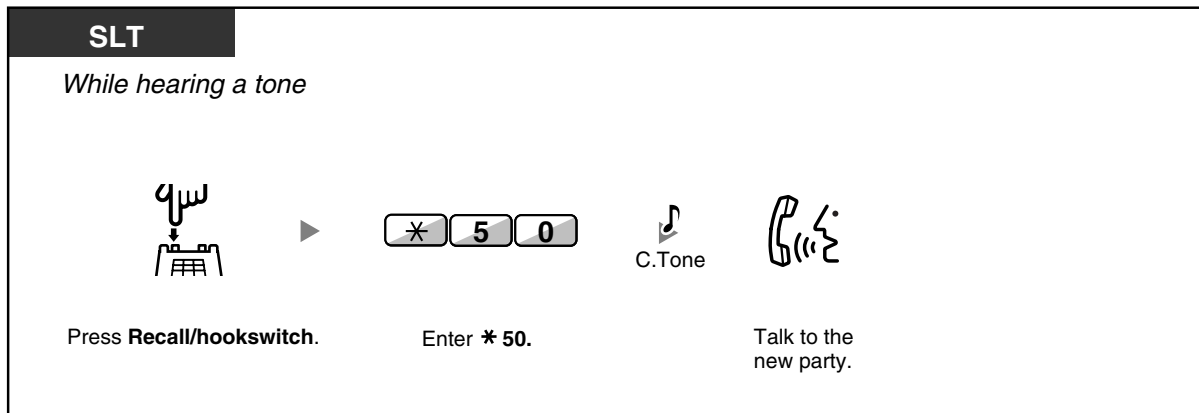
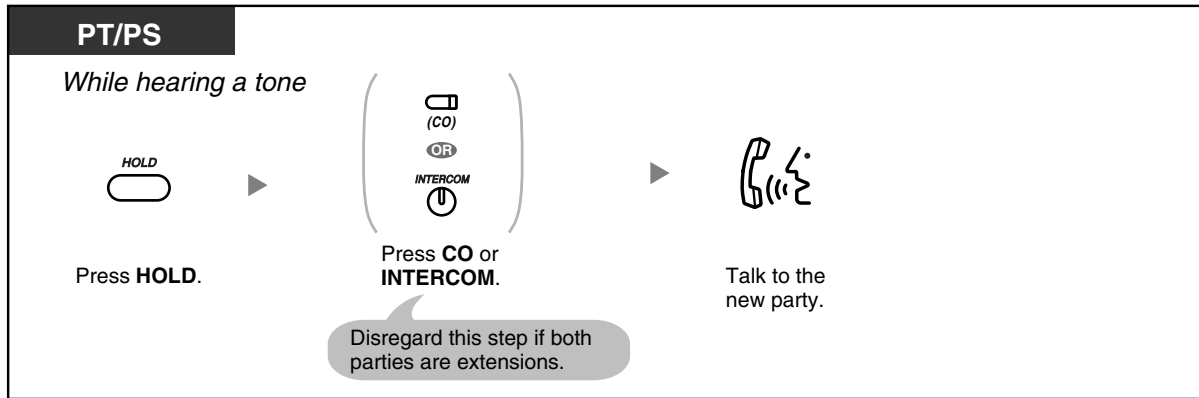

After talking to the new party (second call), you can disconnect (2.1) or hold (2.2) it and then retrieve the first call.

2.1 To disconnect the second call and then talk to the original party

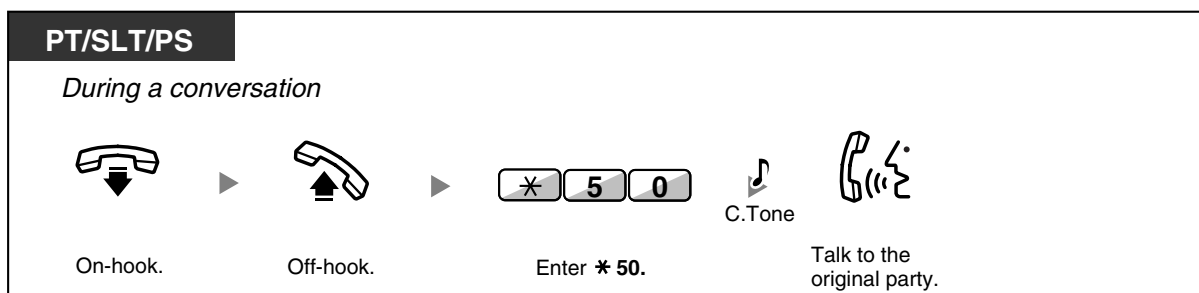
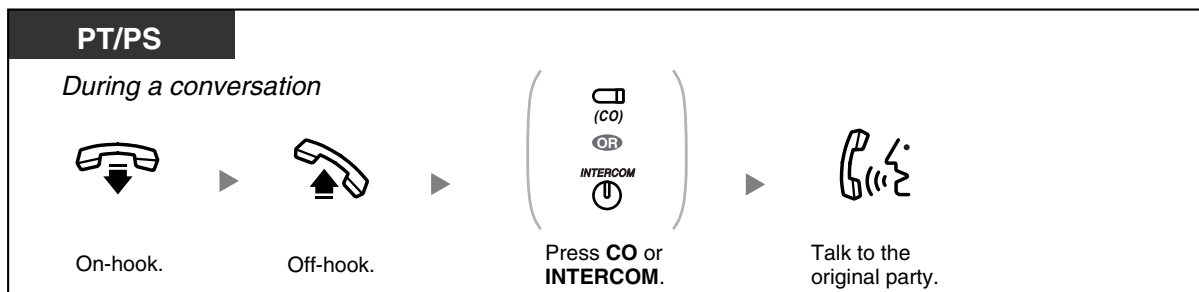

2.2 To hold the second call and then talk to the original party

After holding it, you can talk to the original party. Then, you can disconnect it and then talk to the new party again.

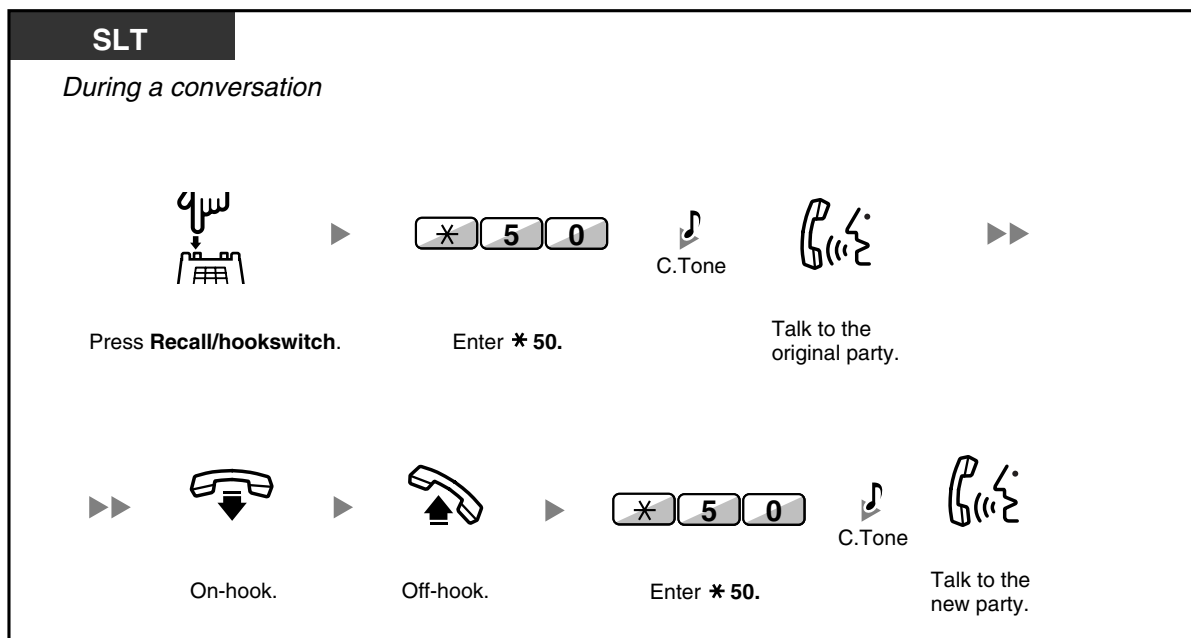
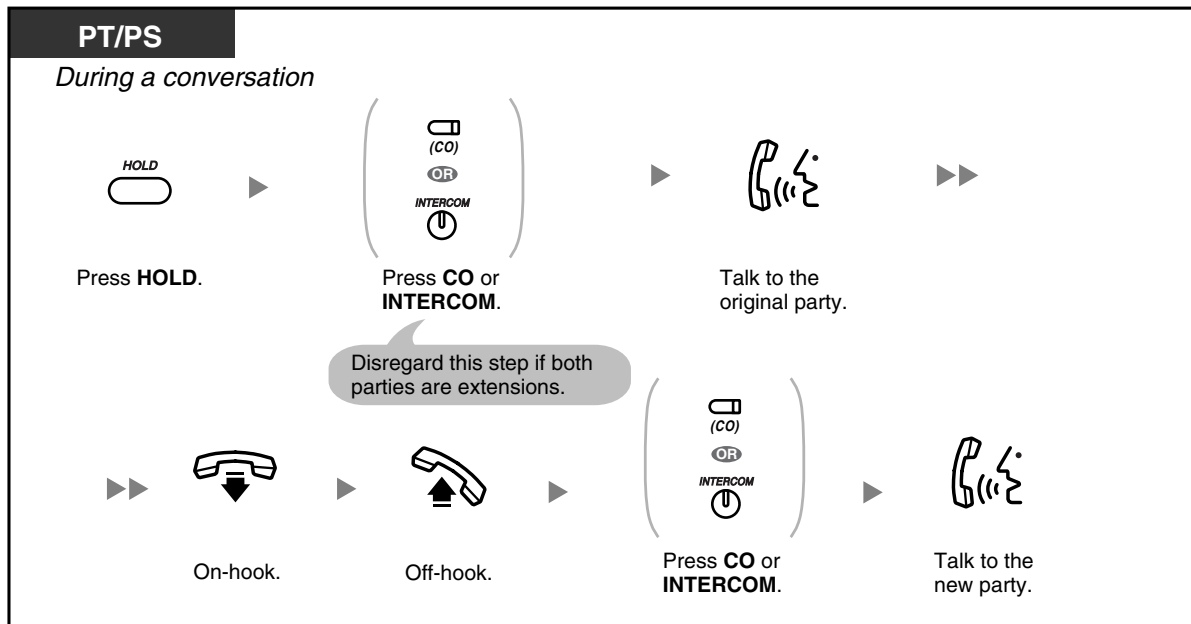

- The caller's name or number is displayed for five seconds in fifteen second intervals while waiting to be answered.



Customizing Your Phone

- 3.1.2 Settings on the Programming Mode—**Call Waiting Tone Type Selection**
If you select "Tone 1", you will hear the same tone for Call Waiting from an outside party and an extension. If you select "Tone 2", you will hear different tones for Call Waiting from an outside party and an extension.

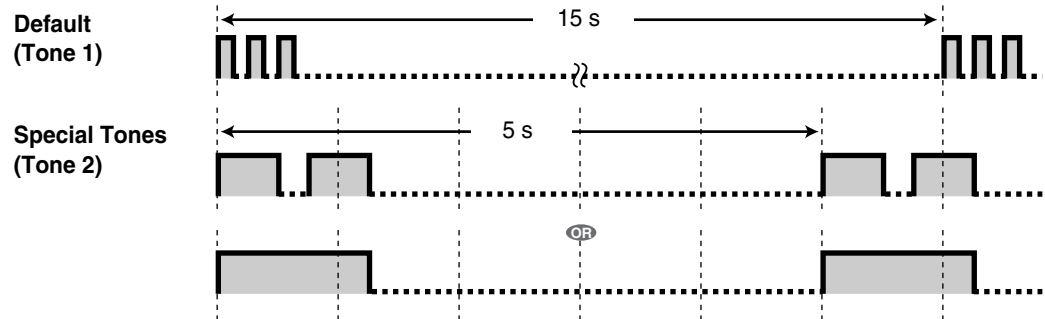

◆◆ Answering Call Waiting from the Telephone Company

This is an optional telephone company service. You can receive a call waiting tone with the caller's name or telephone number information. For details, consult your telephone company.

PT/PS	PT/SLT/PS
<p><i>While hearing a tone</i></p> <p>FLASH/RECALL ○ OR EFA (EFA)</p> <p>Press FLASH/RECALL or EFA.</p>	<p><i>While hearing a tone</i></p> <p>TRANSFER ○ OR س ↓ [Phone Icon]</p> <p>Press TRANSFER or Recall/hookswitch.</p>
	<p>▶ [*] [6] [0]</p> <p>Enter *60.</p>



- To return to the original party, repeat the operation.
- In this case, the FLASH/RECALL button on proprietary telephones must be in External Feature Access (EFA) mode. For information about setting the mode of your FLASH/RECALL button, consult your dealer.
- The caller's information will not be displayed on telephones or wireless phones connected to SLT ports.



Customizing Your Phone

- 3.1.3 Customizing the Buttons
Create or edit an External Feature Access (EFA) button.

1.4.5 Multiple Party Conversation

- Conference
- Unattended Conference
- Leaving Three-party Conference
- Privacy Release

◆◆ Conference

You can add one or more parties to your conversation.

To establish a conference call

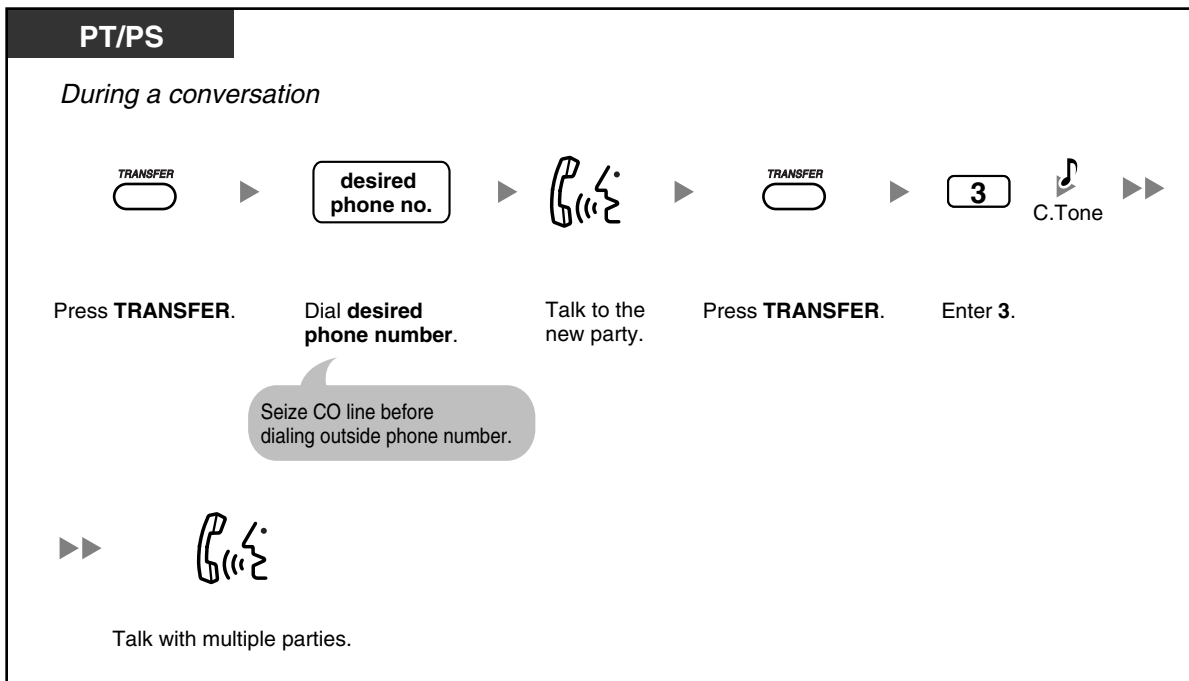
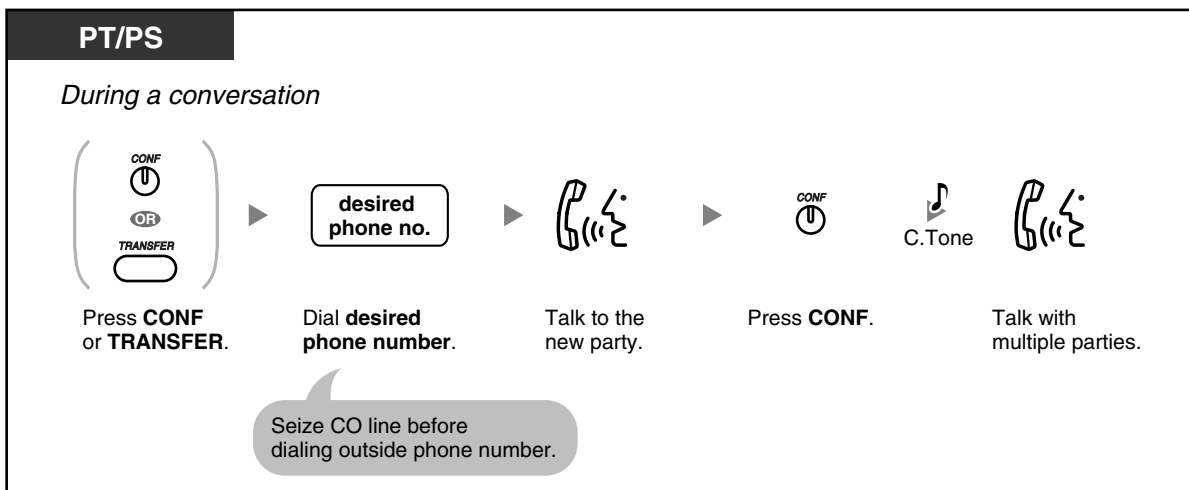

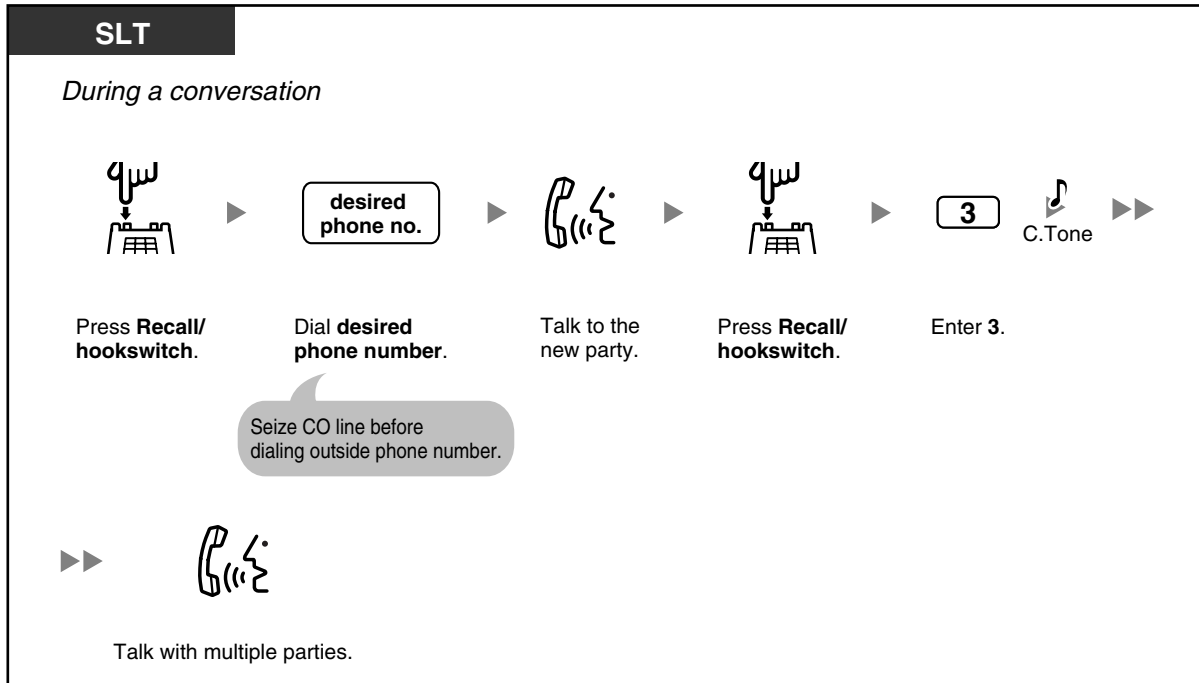

To establish a conference call when receiving a call from an outside party during a two-party conversation

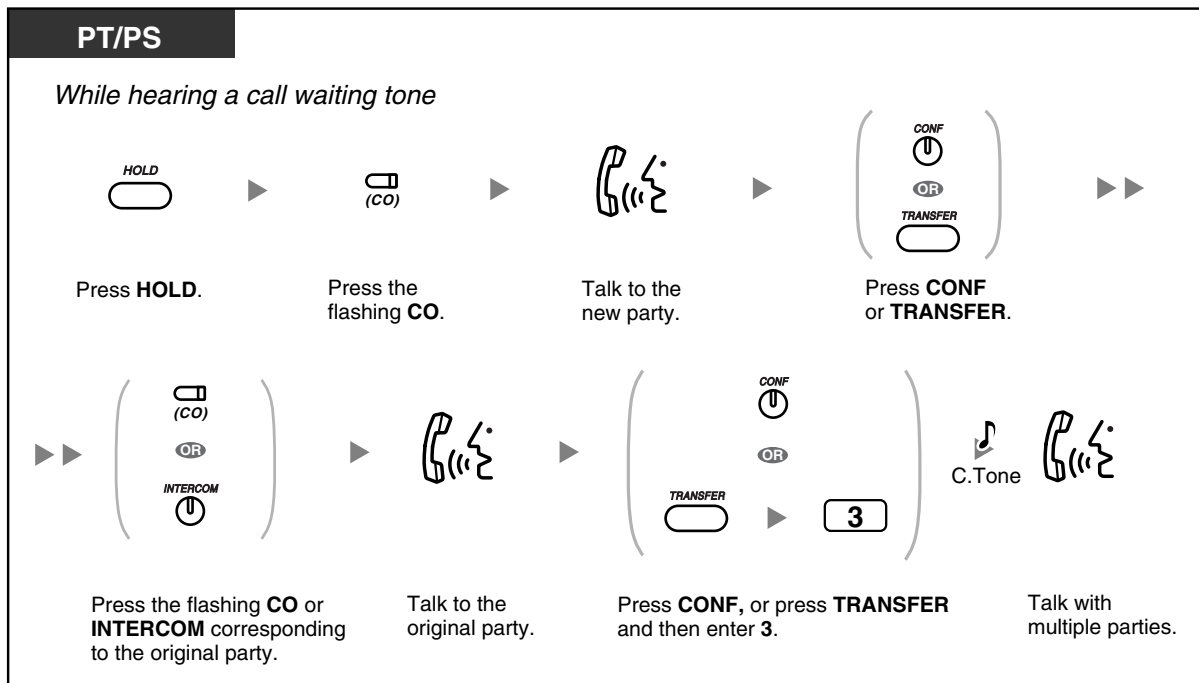

To add four or more parties to a conference

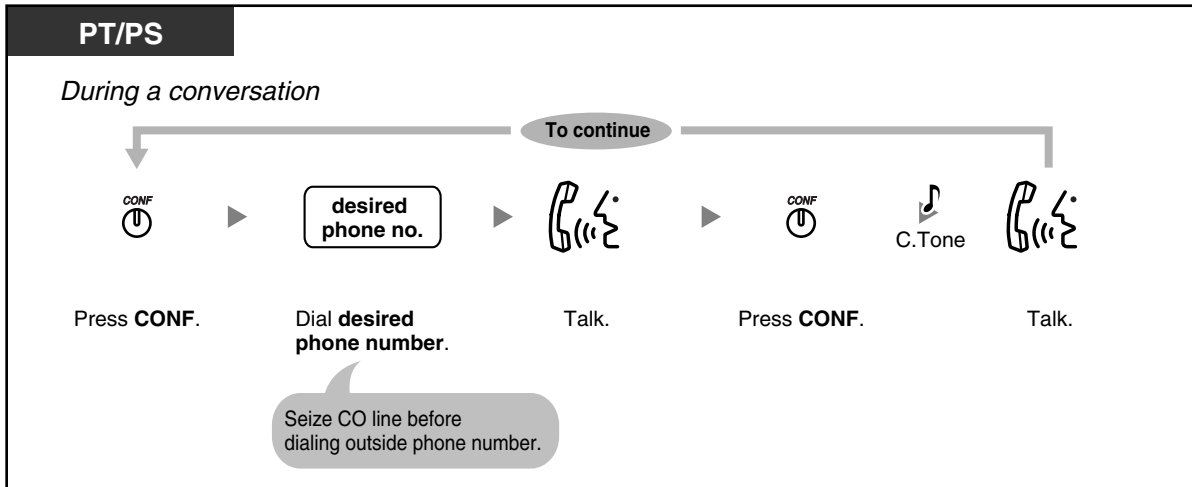

To add an outside party on hold to a conference

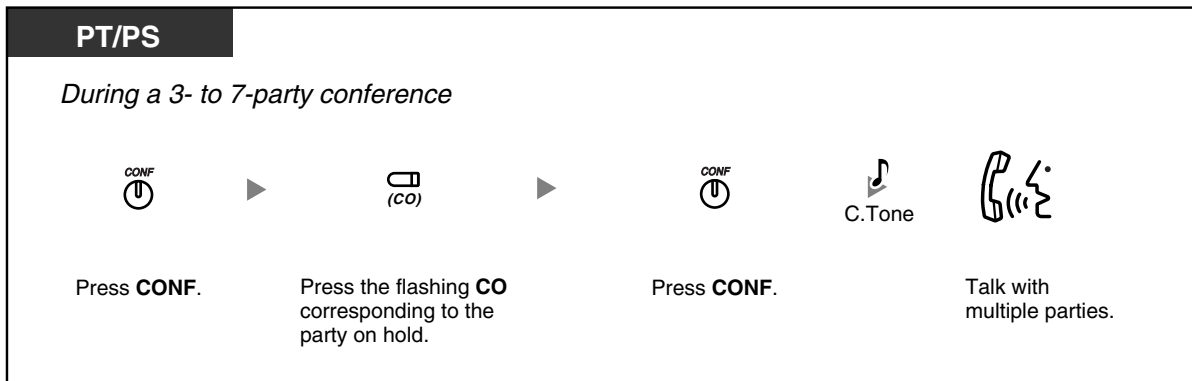

To talk to two parties alternately in a three-party conversation

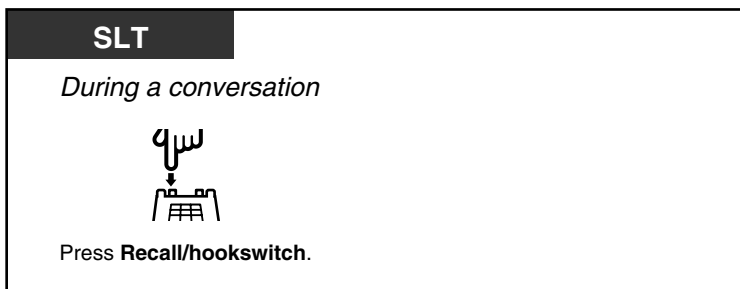
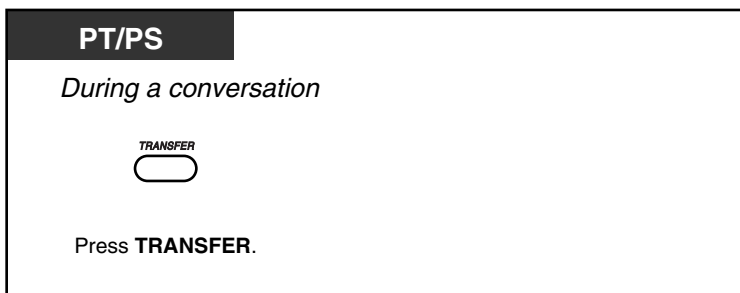

To disconnect one party and then talk to the other in a three-party conversation

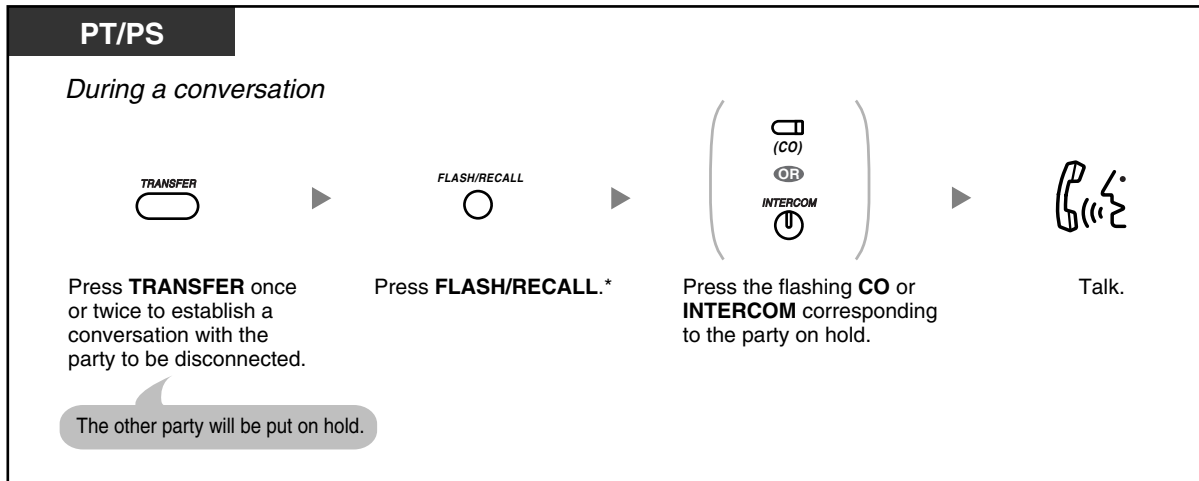

- * In this case, the FLASH/RECALL button on a proprietary telephone must be in Flash/Recall mode. For information about setting the mode of your FLASH/RECALL button, consult your dealer.
- During a three-party conversation, pressing the TRANSFER button or Recall/hookswitch alternates between the two other parties in the conversation.
- You can have a conference with a maximum of eight parties (comprising intercom or CO lines) simultaneously.
- During a conversation involving four or more parties, you cannot disconnect one party and maintain the conversation with the other parties.



Customizing Your Phone

- 3.1.3 Customizing the Buttons
Create or edit a Conference button.

◆◆ Unattended Conference

The person who originated a conference can leave the conference, and allow the other parties to continue the conversation.

To leave a conference



To return while others are talking

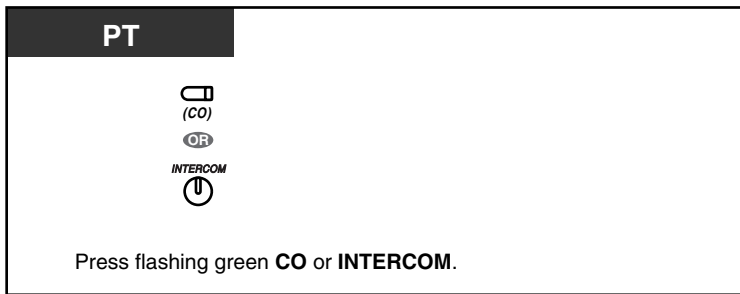

To complete a conversation



- **Time limit**

Both parties will hear an alarm tone before a specified timeout. The originating extension user will hear an alarm tone before timeout. The call is disconnected when the timer runs out unless the originating extension returns to the conference.



Customizing Your Phone

- 3.1.3 Customizing the Buttons
Create or edit a Conference button.

◆◆ Leaving Three-party Conference

The person who originated a conference with two other parties can leave the conference, and allow the other parties to continue the conversation.

To leave a conference



SLT

During a three-party conference



Press **Recall/hookswitch**. On-hook.

To complete a conversation

PT/SLT/PS

During a conversation



On-hook.



- To leave a conference call involving an outside party or parties and have the conference continue, it is necessary to enable your extension to transfer calls to CO lines through COS programming. Consult your dealer.

◆◆ Privacy Release

You can let a third party join your current outside call and establish a three-party conversation. You can also leave the conversation and then let the two other parties talk.



To let a third party join your conversation and establish a three-party conversation

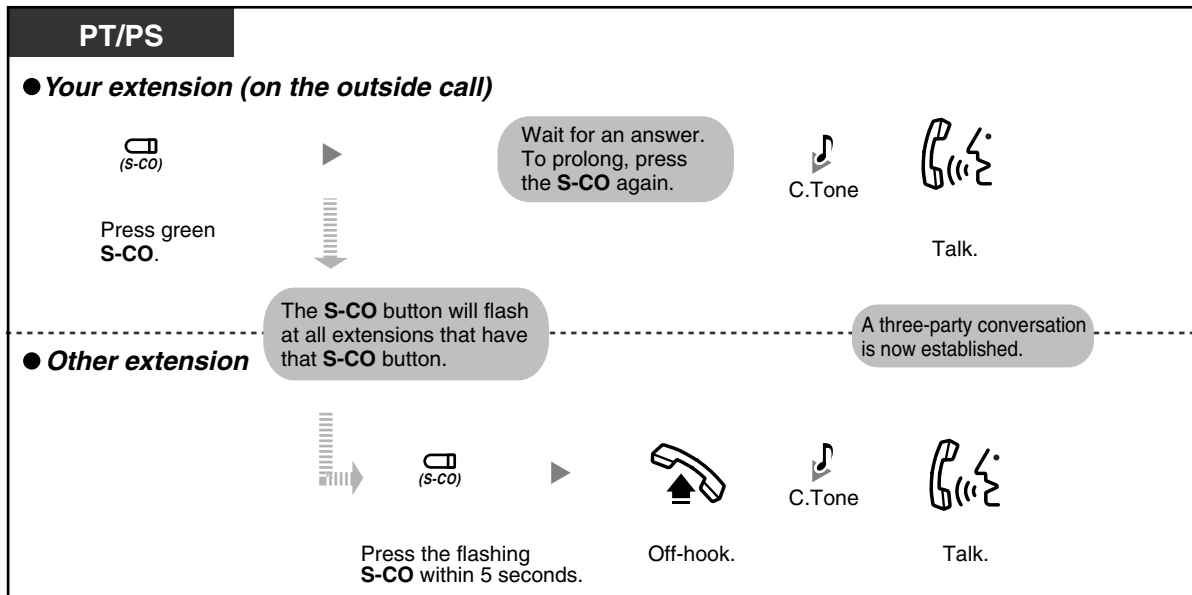

To leave the conversation and let the two other parties talk

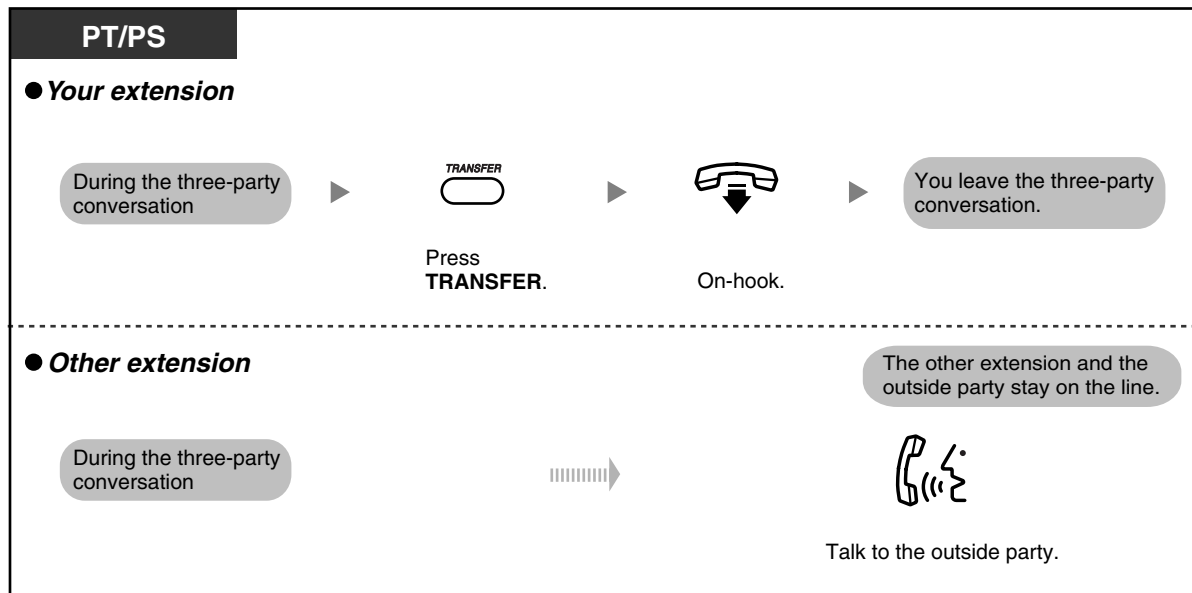

- Only an S-CO button can be used for this operation.
- To leave a three-party conversation and have the conversation continue, it is necessary to enable your extension to transfer calls to CO lines through COS programming. For more details, consult your dealer.

1.4.6 Mute

You can disable the microphone or the handset to consult privately with others in the room while listening to the other party on the phone through the speaker or the handset.



To set/cancel



- The AUTO ANS/MUTE button light shows the current status as follows:
Off: Normal
Flashing red: Mute

1.4.7 Headset Operation

You can have a conversation using a headset.



To talk using the headset

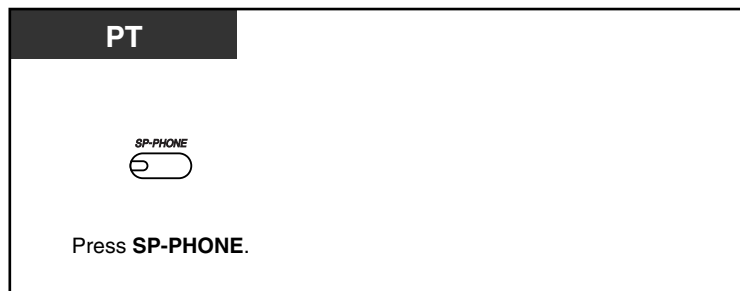

To use the handset during a conversation using the headset

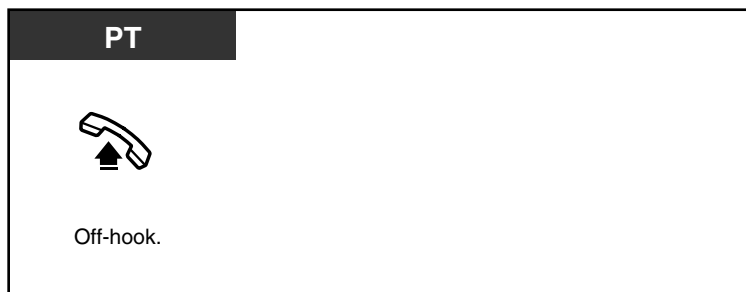

1.5 Absence Settings

1.5.1 Call Forwarding

— Call Forwarding (FWD)

◆◆ Call Forwarding (FWD)

You can have your incoming calls forwarded to a specified destination.

All Calls:

All calls are forwarded. Preset extensions may also forward from their own receiving group.

Busy:

All calls are forwarded when your extension is busy.

No Answer:

All calls are forwarded when you do not answer the call within a specified time period.

Busy/No Answer (BSY/NA):

All calls are forwarded when you do not answer within a specified time period or when your extension is busy.

Follow Me (From):

If you fail to set the above-mentioned "All Calls" to forward before you leave your desk, you can set the same feature from the destination extension.

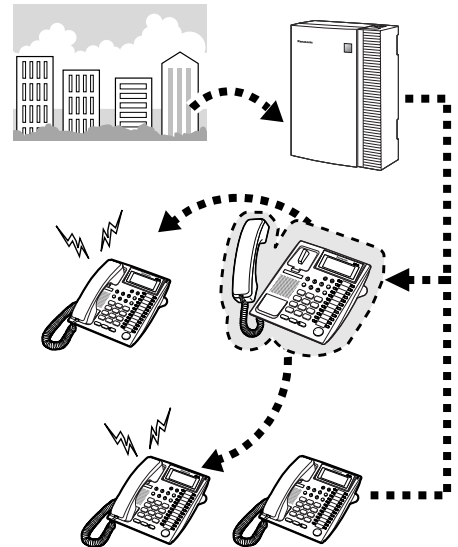

- You can set the voice mail floating extension number as a forward destination to receive calls into your mailbox.
- You can set your mobile telephone as the forward destination. The voice mail can be used to receive calls if you are unable to answer.
- Incoming calls can be forwarded up to four times.
- **Boss & Secretary feature**
The extension which has been set as the destination can call the forwarding extension.

<Example>

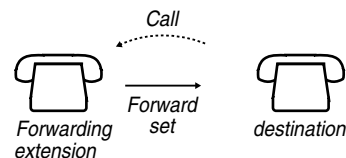

To set/cancel

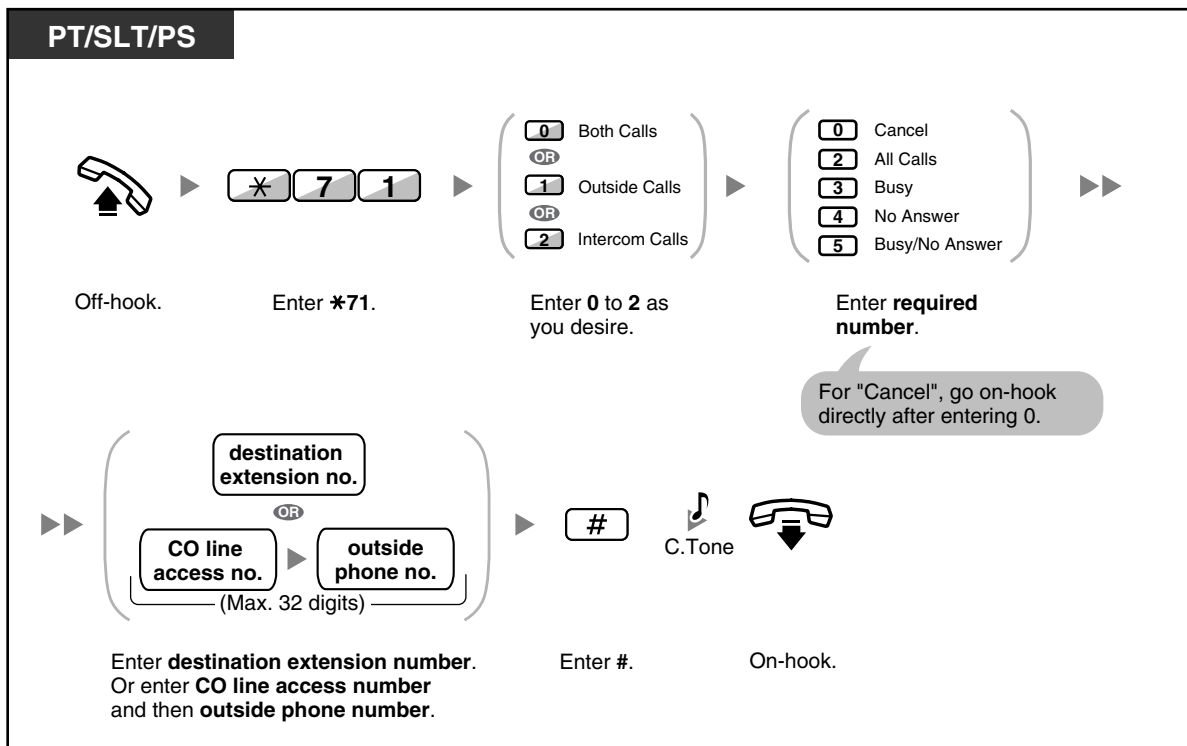

To set from another extension

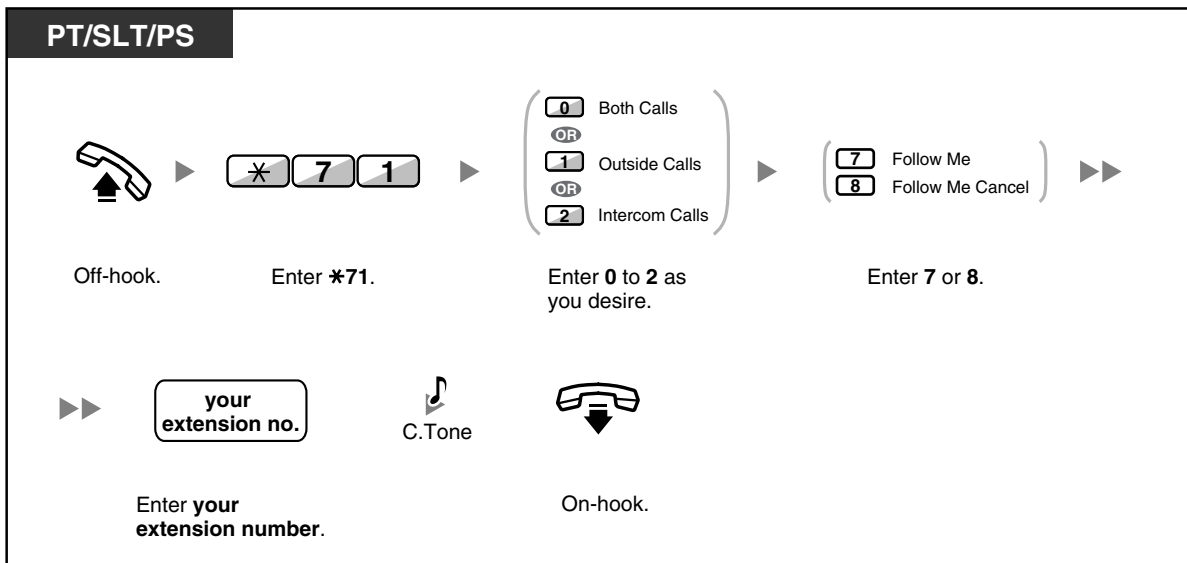

- When using a proprietary telephone, you can set or cancel Call Forwarding by pressing the FWD/DND button (fixed button) instead of "*710".

To set the timer for "No Answer" and "Busy/No Answer"

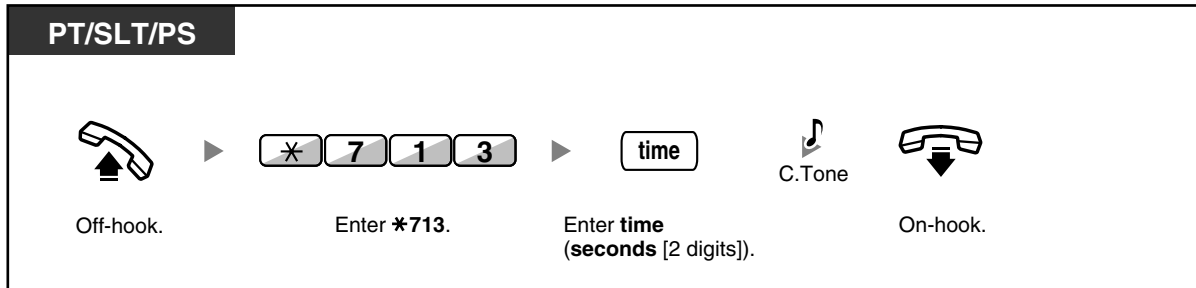

Call Forwarding (FWD) for your Incoming Call Distribution Group

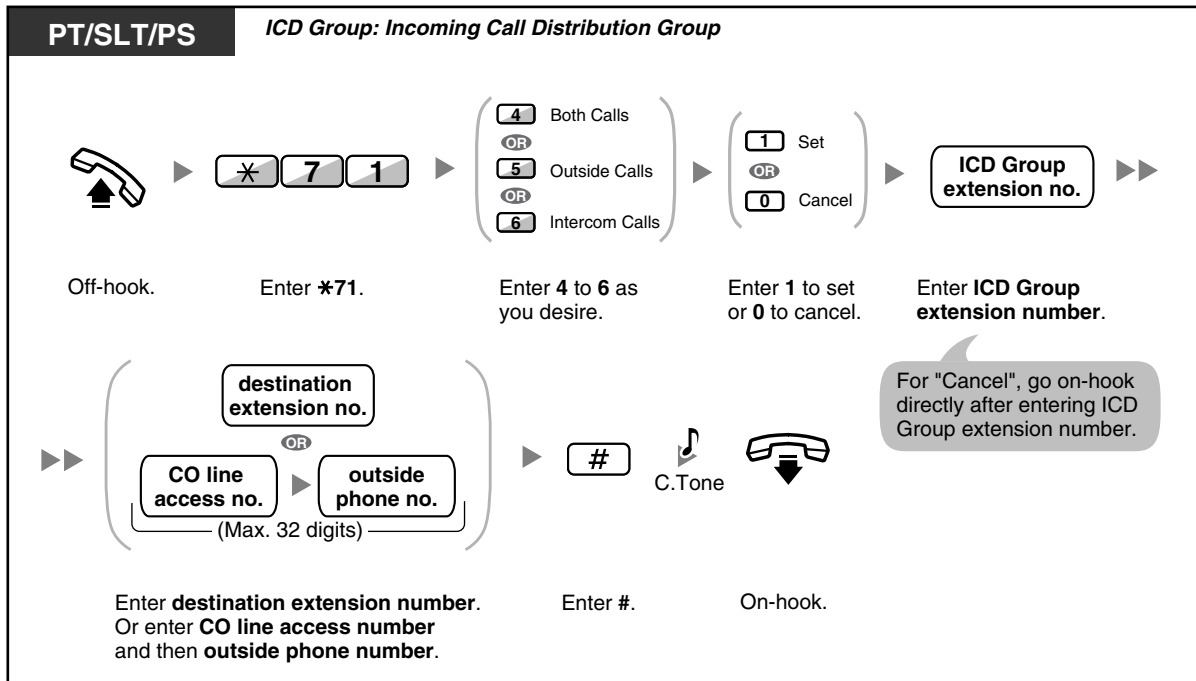

- The FWD/DND button light shows the current status as follows:
 - Off:** Neither feature is set.
 - Flashing red slowly:** FWD mode
 - Red on:** DND mode
- The Group FWD button light shows the current status as follows:
 - Off:** No set
 - Red on:** FWD mode

- The system has two modes: (1) FWD/DND Cycle Switch Mode and (2) FWD/DND Setting Mode. Ask your manager what mode your system is in if you are not sure.

(1) When in the FWD/DND Cycle Switch Mode:

Pressing the FWD/DND button (fixed button) while in idle status will cycle the setting as shown below:



(2) When in the FWD/DND Setting Mode:

Pressing the FWD/DND button (fixed button) while in idle status will take you directly to the programming mode for the FWD/DND setting. (Refer to "3.1.2 Settings on the Programming Mode".)

Note

A FWD/DND button (customized button) is always in FWD/DND Cycle Switch Mode: the mode cannot be changed.

- Transferred outside calls are also forwarded to the destination assigned for outside calls.
- When intercom calls are set to be handled differently from outside calls (forwarding type, forward destination), we recommend establishing buttons for both FWD/DND—Outside calls and FWD/DND—Intercom calls, and/or Group FWD—Outside calls and Group FWD—Intercom calls, because:
 - the light patterns of the FWD/DND—Both calls button (including FWD/DND button [fixed button]) and the Group FWD—Both calls button will indicate the setting for either outside calls or intercom calls, but not both.

Note

The FWD icon on PS display reflects the setting for outside calls only.

- pressing the FWD/DND—Both calls button (including FWD/DND button [fixed button]) or the Group FWD—Both calls button will not change the FWD or DND mode for intercom calls and outside calls separately.



Customizing Your Phone

- 3.1.3 Customizing the Buttons
Create or edit FWD/DND (Both calls, Outside calls, Intercom calls) buttons, or Group FWD (Both calls, Outside calls, Intercom calls) buttons.

1.5.2 Absent Message

You can show the reason you do not answer, if the caller uses a Panasonic display proprietary telephone. There are eight preprogrammed messages and one for your personal message (16 characters). The selected message is shown on the display of your telephone.

Message no.	Message (Example)
1	Will Return Soon
2	Gone Home
3	At Ext %%% (Extension number)
4	Back at %:% (Hour:Minute)

Message no.	Message (Example)
5	Out until %%/%% (Month/Day)
6	In a Meeting
7	
8	
9	A message assigned for each extension. (Personal Absent Message)

To set

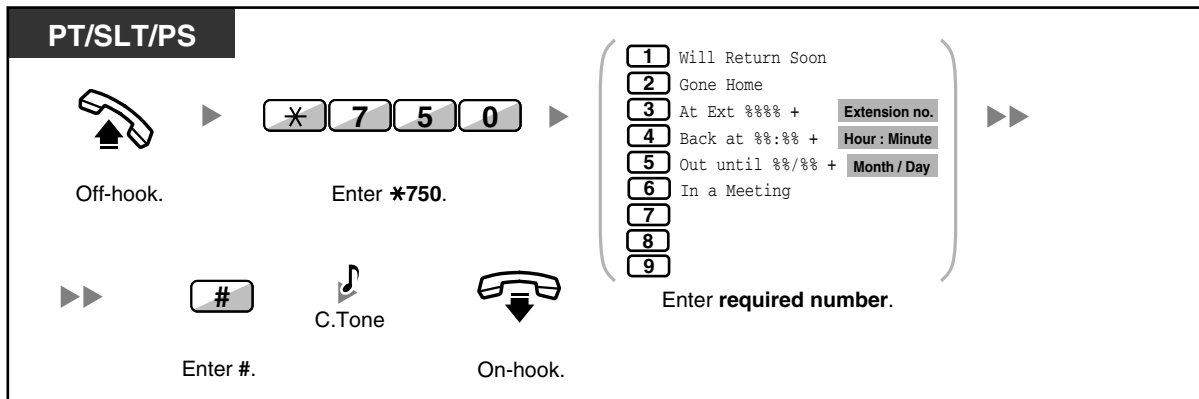

To cancel

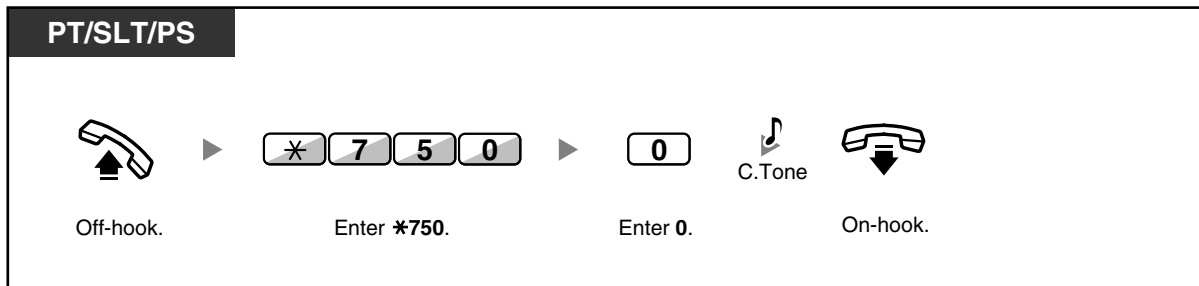

- Enter the desired value in the "%" positions. You must enter the correct number of characters as represented by the "%" using 0 to 9 or *.
- The default messages can be changed. Consult your dealer.
- To create your personal message (Message no. 9), refer to "3.1.2 Settings on the Programming Mode".

1.5.3 Extension Dial Lock

You can lock your extension so that other users cannot make inappropriate outside calls. This feature is also known as Electronic Station Lockout.

To lock

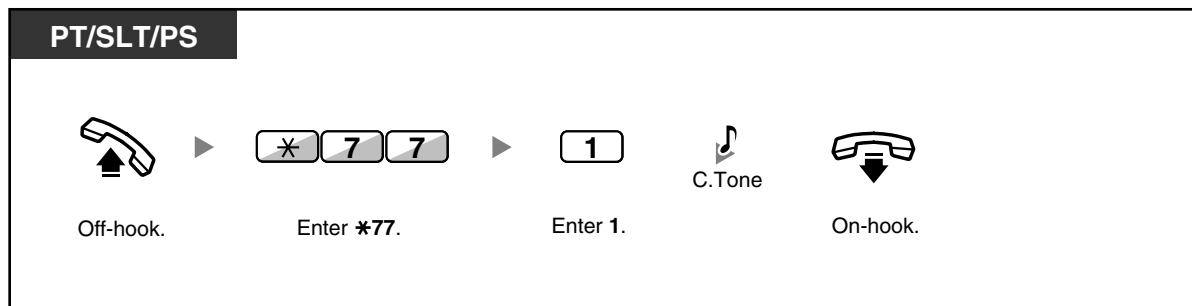

To unlock

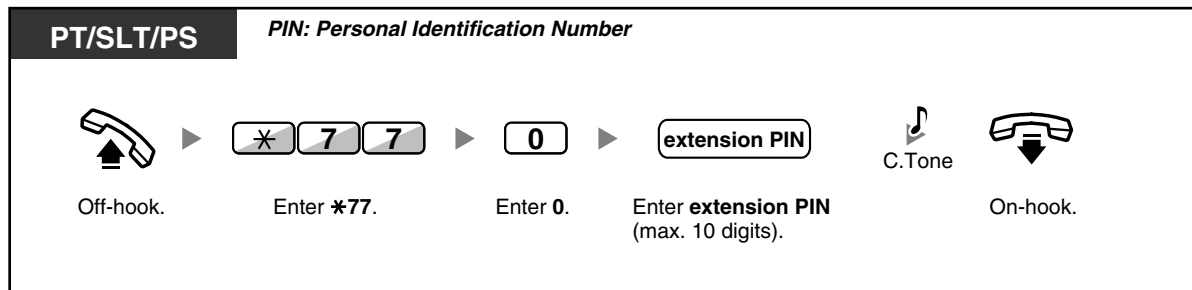

-  **If you forget the extension PIN or cannot unlock your extension**, consult your manager. He can clear your extension PIN. Then, you can set the new PIN and unlock your extension by entering it.
- If your extension is locked by this feature, it cannot perform the following operations:
 - Making outside calls
 - Changing the call forwarding destination
- If you do not set extension PIN, you cannot lock and unlock your extension.

To make an outside call while your extension is locked

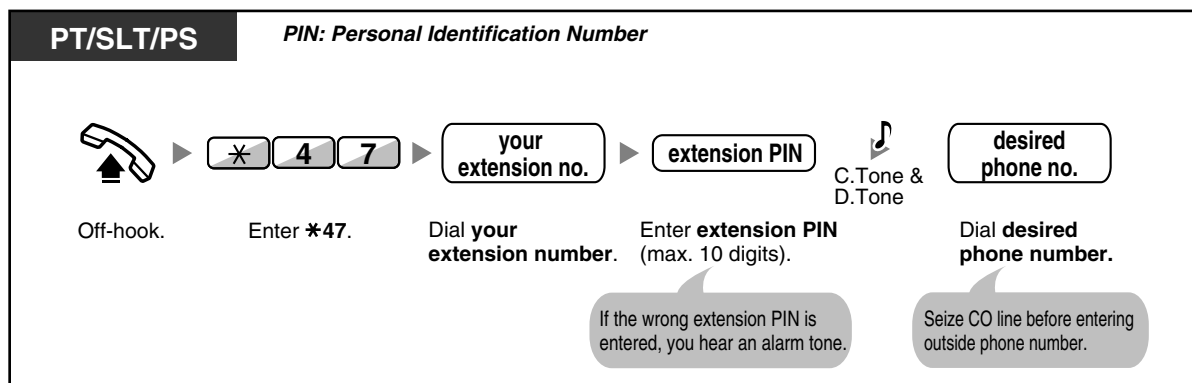



- After you make an outside call, Extension Dial Lock is automatically activated again.

1.6 Paging

1.6.1 Paging

- Group Paging
- Paging and then Transferring a Call

◆◆ Group Paging

You can make a voice announcement to proprietary telephones or external speakers or both in the preset group simultaneously.

To page

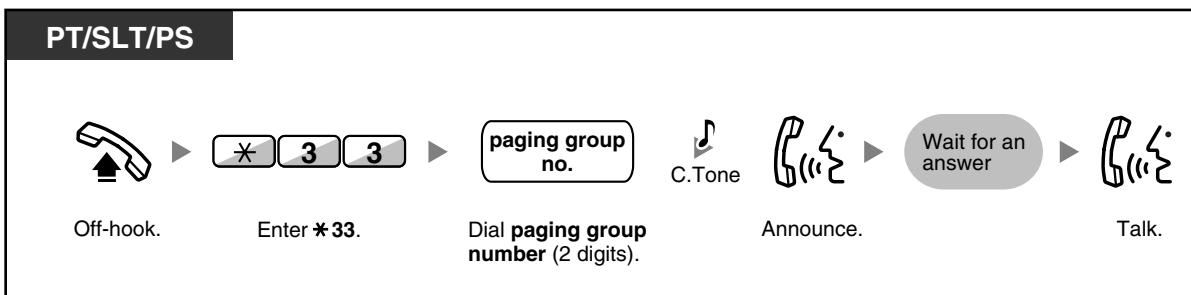

- If the group which you paged is already being used for paging, you hear a busy tone.

◆◆ Paging and then Transferring a Call

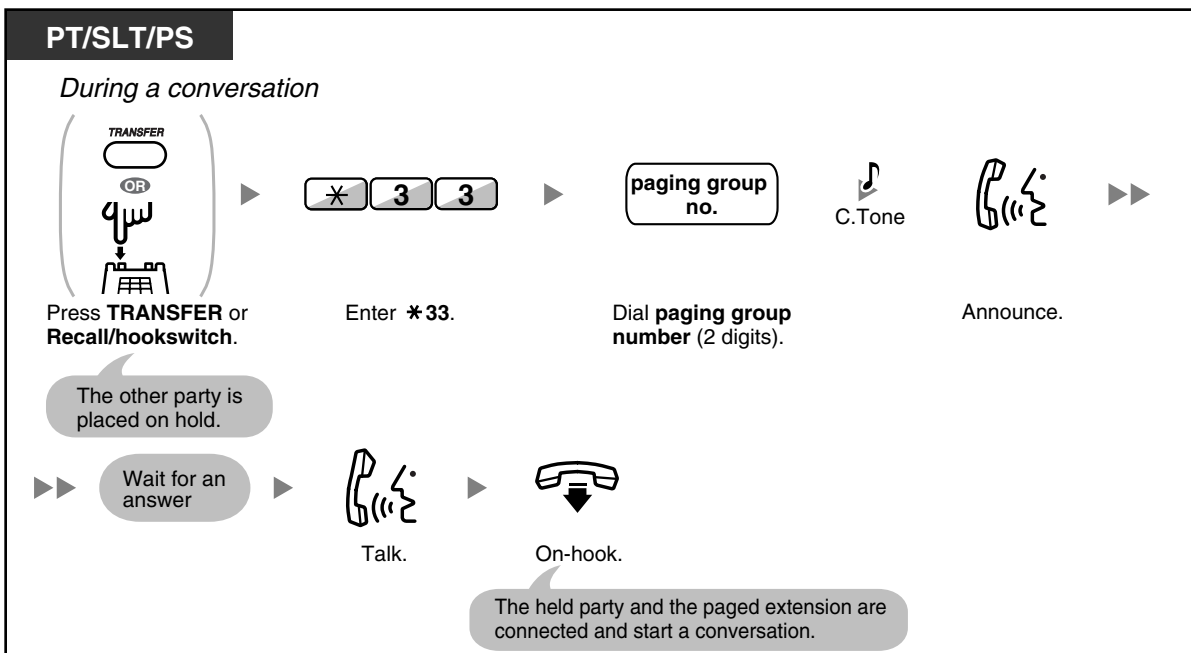



- After you go on-hook, the caller can talk to the person who answers the page.

1.6.2 Answering/Denying a Paging Announcement

To answer

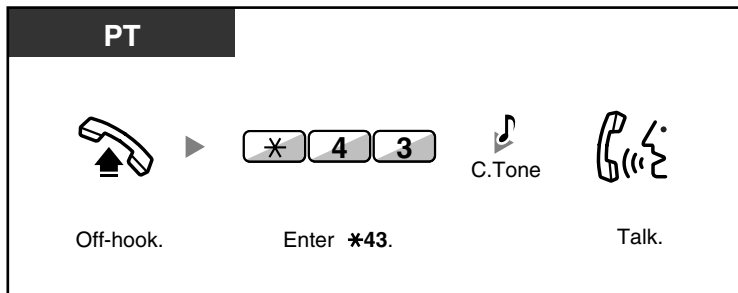

Paging Deny

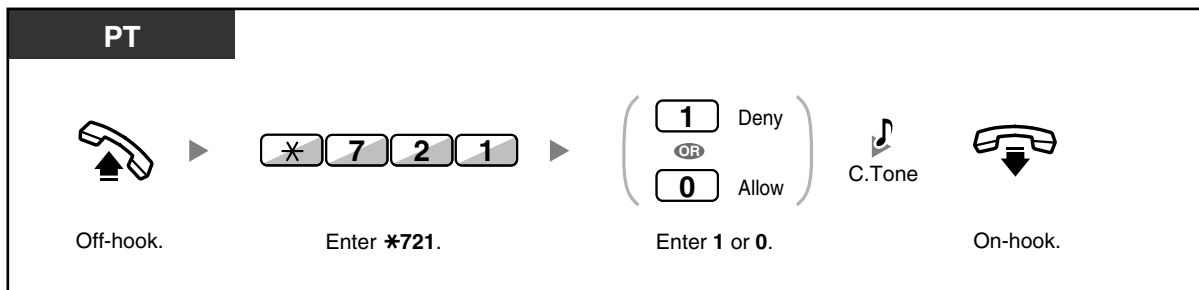

- The following are extensions that cannot receive a paging announcement:
 - Portable station
 - Single line telephone
 - Proprietary telephone that is ringing or busy
 - Proprietary telephone in Paging Deny mode
 - Proprietary telephone in DND mode
- Even if the announcement is not paging your extension, you can answer it, if it is paging your group.

1.7 Extension Settings

1.7.1 Timed Reminder

You can receive an alarm at your telephone to remind you of a meeting, appointment or as a wake-up call. The alarm can occur either once or daily (every day until canceled) at a preset time. When you go off-hook to answer, you will hear a special dial tone or prerecorded message.

To set

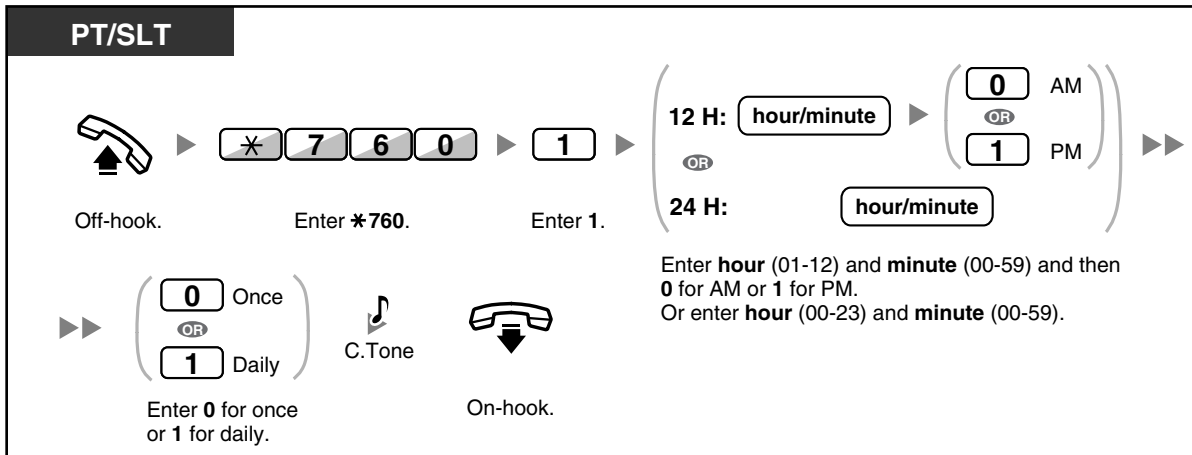

To cancel

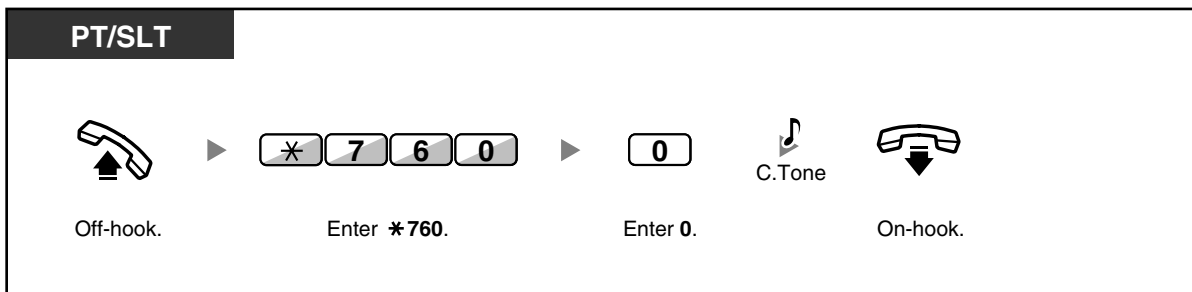

To stop or answer the ringback

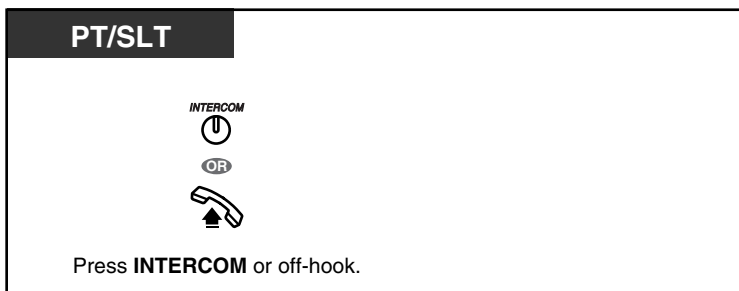

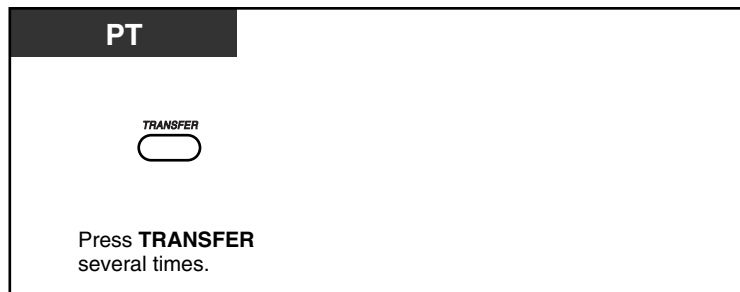
To confirm

- The alarm keeps ringing for preprogrammed seconds.
- **If you receive an incoming call during ringback**, the ringing starts after the ringback stops.
- **If you are having a conversation exceeding alarm ringing period**, the ringback will start after your conversation.

1.7.2 Do Not Disturb (DND)

You may set this feature when you are in a meeting or busy.

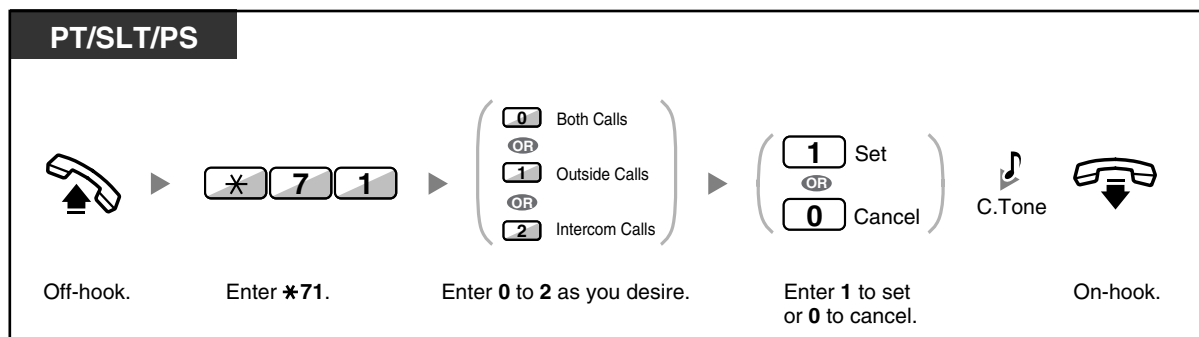
To set/cancel

- When using a proprietary telephone, you can set or cancel Do Not Disturb by pressing the FWD/DND button (fixed button) instead of "*710".



- The FWD/DND button light shows the current status as follows:
Off: Both features are not set.
Flashing red slowly: FWD mode
Red on: DND mode
- The system has two modes: (1) FWD/DND Cycle Switch Mode and (2) FWD/DND Setting Mode. Ask your manager what mode your system is in if you are not sure.

(1) When in the FWD/DND Cycle Switch Mode:

Pressing the FWD/DND button (fixed button) while in idle status will cycle the setting as shown below:



(2) When in the FWD/DND Setting Mode:

Pressing the FWD/DND button (fixed button) while in idle status will take you directly to the programming mode for the FWD/DND setting. (Refer to "3.1.2 Settings on the Programming Mode".)

Note

A FWD/DND button (customized button) is always in FWD/DND Cycle Switch Mode: the mode cannot be changed.

- If your extension has set this feature, a calling extension will hear DND tone.
- If this feature is set, the Call Forwarding (FWD) feature does not work.
- Specified extensions can override this feature and call DND extensions (DND Override).
- When intercom calls are set to be handled differently from outside calls (DND set/cancel), we recommend establishing buttons for both FWD/DND—Outside calls and FWD/DND—Intercom calls, because:
 - a) the light patterns of the FWD/DND—Both calls button (including FWD/DND button [fixed button]) will indicate the setting for either outside calls or intercoms calls, but not both.

Note

The DND icon on PS display reflects the setting for outside calls only.

- b) pressing the FWD/DND—Both calls button (including FWD/DND button [fixed button]) will not change the FWD or DND mode for intercom calls and outside calls separately.



Customizing Your Phone

- 3.1.3 Customizing the Buttons
Create or edit FWD/DND (Both calls, Outside calls, Intercom calls) buttons.

1.7.3 Call Waiting

During a conversation, you can be informed of a call waiting with a tone through your built-in speaker or handset. (Default: Enable—Tone)

Call Waiting Tone:

a waiting tone through the built-in speaker of PT/handset of SLT. To change the tone from PT, refer to "3.1.2 Settings on the Programming Mode".

To set/cancel for intercom calls

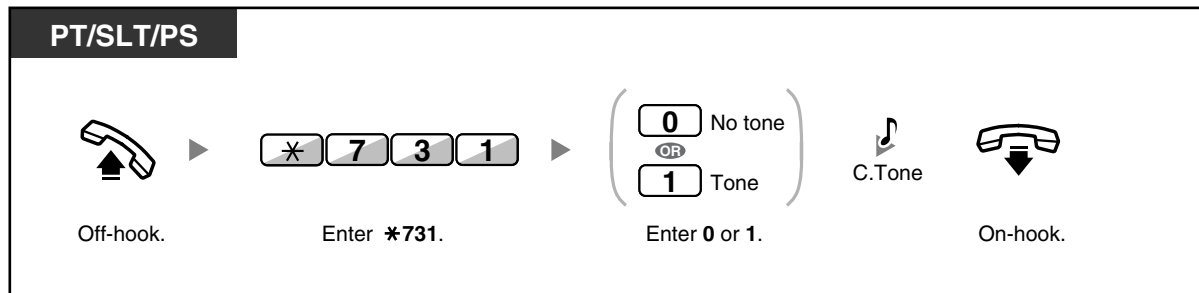

To set/cancel for outside calls

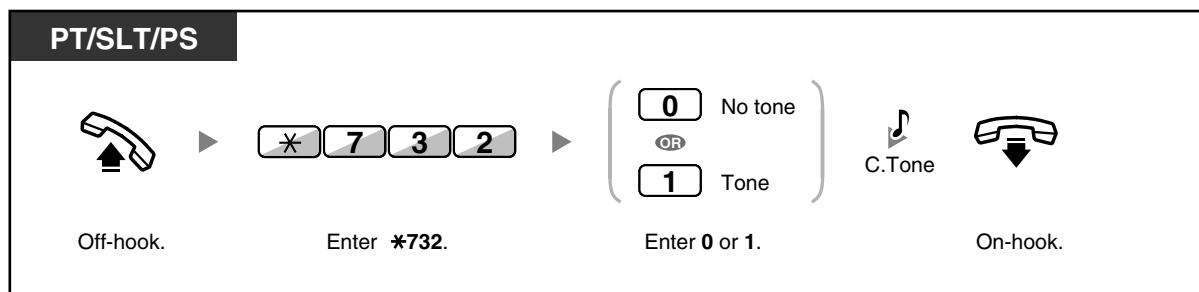

1.7.4 Executive Busy Override Deny

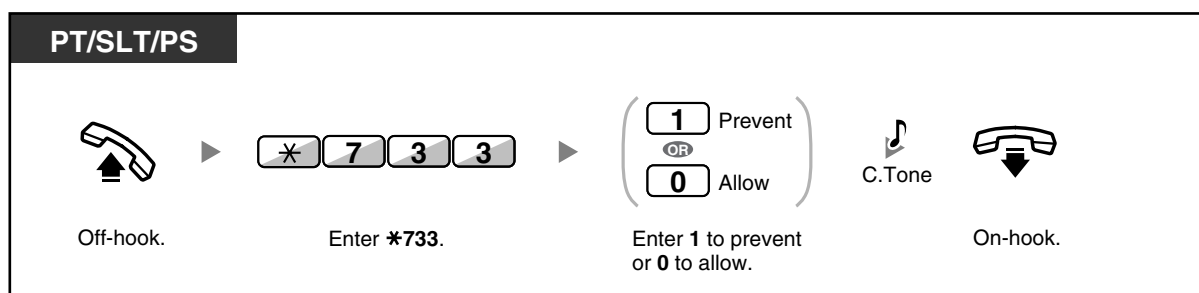

- Some extensions may be prohibited from performing this feature.

1.7.5 Background Music (BGM)

You can listen to the background music through your telephone speaker while on-hook. An external music source, such as a radio, can be connected.

If your extension becomes busy (off-hook, making or receiving a call etc.), the music stops temporarily. When you go back on-hook, the music starts again.



To select and set/cancel

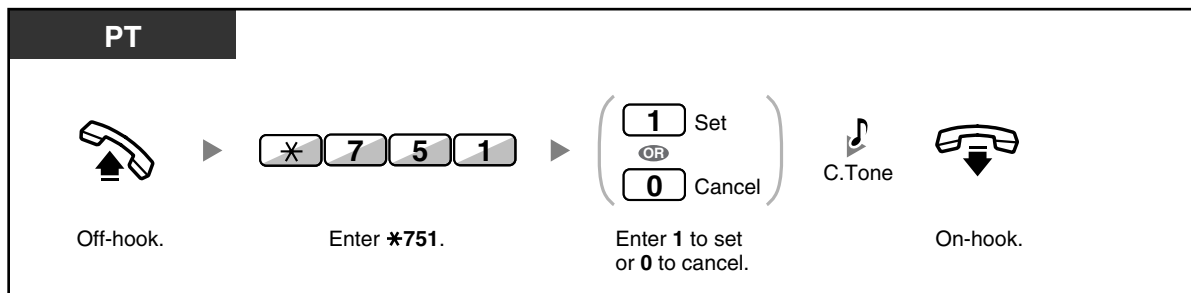

1.7.6 Data Line Security

You can protect the line against audible notification tones, such as a call waiting tone during a conversation. Set this feature if your extension has a data communication device, such as a computer or fax machine connected to ensure secure data transmission.

To set/cancel

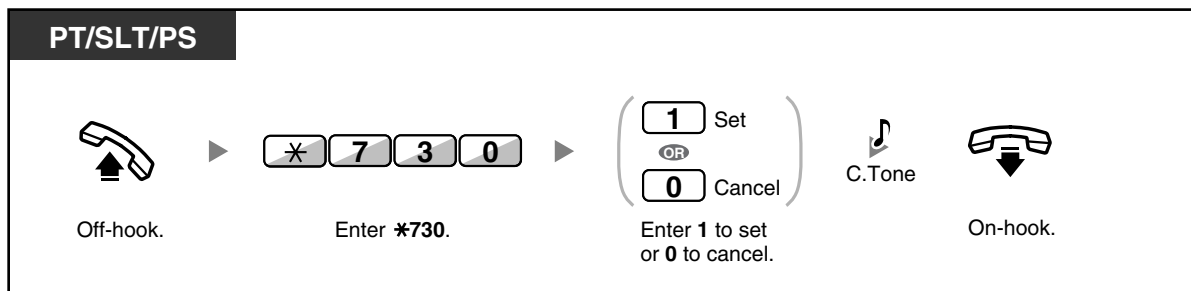

1.7.7 Time Service

You can check the current status of the Time Service on the display.

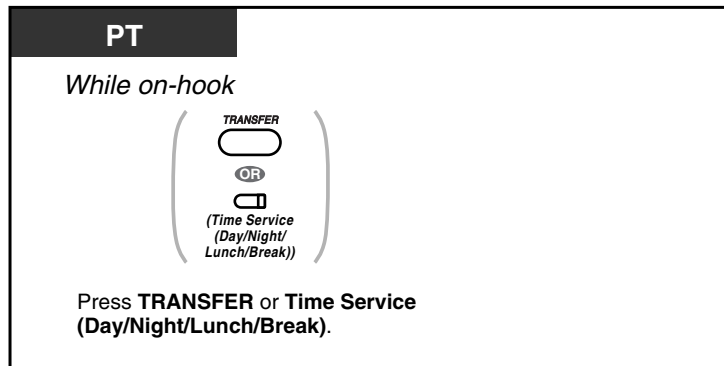

- The Time Service (Day/Night/Lunch/Break) button light always shows the current status as follows:
 - Off:** Day mode
 - Green on:** Lunch mode
 - Flashing Green:** Break mode
 - Red on:** Night mode
 - Flashing Red:** Holiday mode
- Any extension user except the managers can check the current status by pressing the Time Service (Day/Night/Lunch/Break) button.



Customizing Your Phone

- 3.1.3 Customizing the Buttons
Create or edit a Time Service (Day/Night/Lunch/Break) button.

1.7.8 Wireless XDP Parallel Mode

Your PS can be used in parallel with a PT or SLT.

When in this mode, incoming calls to a wired telephone also ring the paired PS.

To set

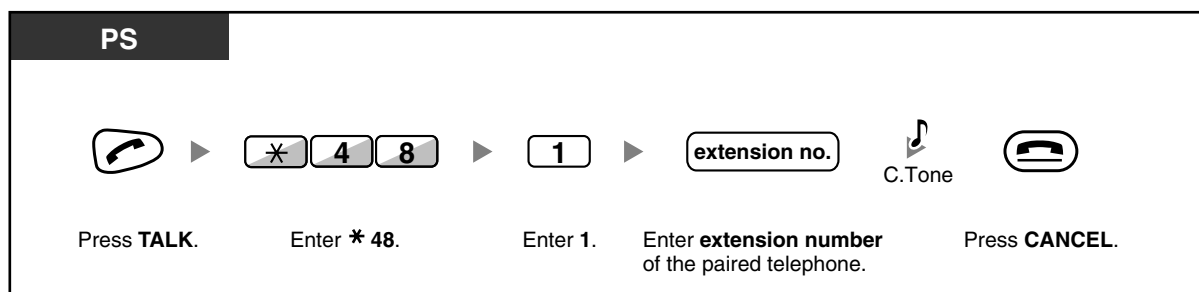

To cancel

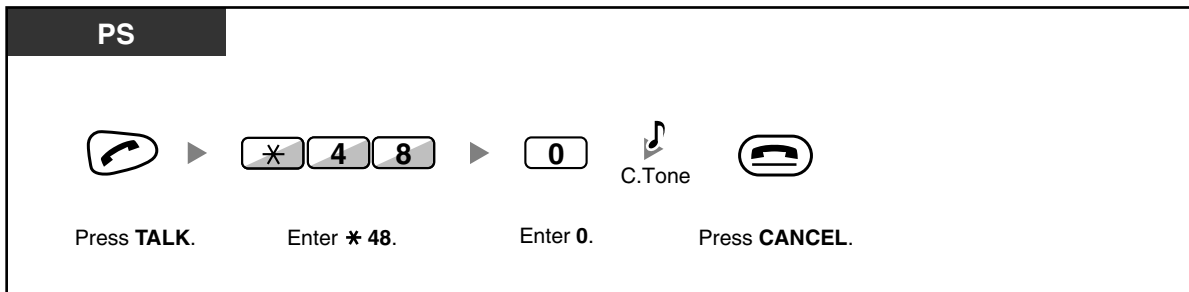

- Some wired telephones are prohibited from using this feature.
- **If you go off-hook while your paralleled telephone is in use, the call will switch over to you.**

1.7.9 Extension Feature Clear

You can reset the settings of the following features on your extension to the default settings with one operation.

This feature is also known as Station Program Clear.

Features	Default Setting
Hot Line*	Off
Message Waiting—(All the messages that have been left by other extension users)	Off
Call Pickup Deny	Allow
Call Forwarding (FWD)*	Off
Absent Message	Off
Paging Deny	Allow
Timed Reminder	Cleared
Do Not Disturb (DND)*	Off
Call Waiting*	Enable—Tone
Executive Busy Override Deny	Allow
BGM	Off
Data Line Security	Off
Log-in/Log-out	Log-in

* These features may not be reset depending on the system programming.

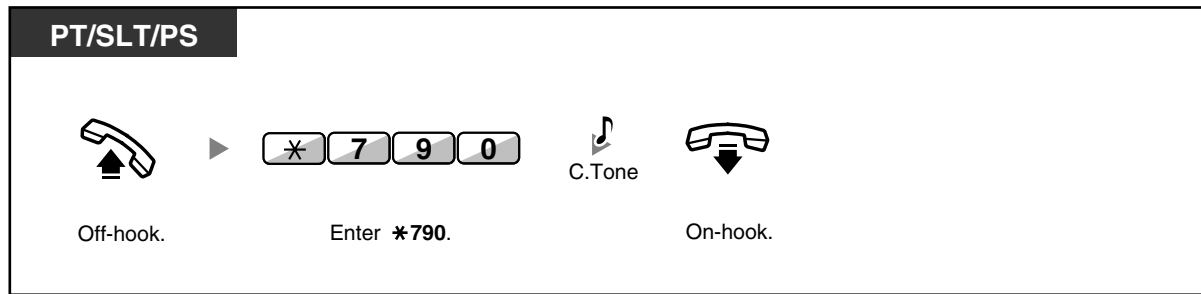

- After performing Extension Feature Clear, the setting of Call Waiting becomes "Enable—Tone". In this case, dial tone 2 will be heard when you go off-hook.

1.8 Call Center

1.8.1 Log-in/Log-out, Wrap-up

You can control your status in an incoming call distribution group. When in the Log-out mode, incoming calls to the group will not ring at your extension. When you return, calls will again ring at your extension. (Default: Log-in) Even if your extension is logged-in, you can have a specified time period (wrap-up time) when you will not receive calls after completing a previous call. This time can be used for you to write a report and so on. You can also manually select "Not Ready" mode to temporarily leave a distribution group.

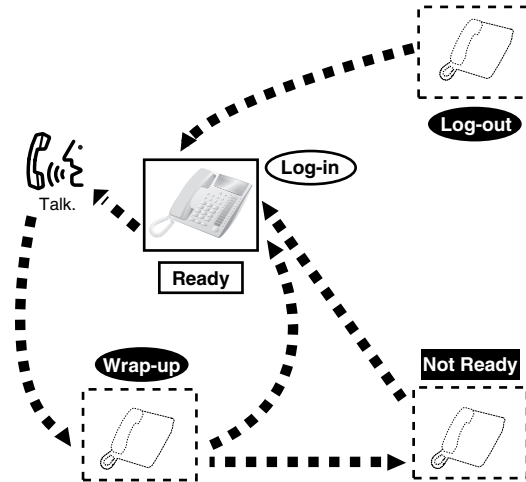

To set Log-in/Log-out

PT/SLT/PS *ICD Group: Incoming Call Distribution Group*



Off-hook.

* 7 3 6

Enter *736.

0 Log-out
OR
1 Log-in

Enter 0 or 1.

ICD Group extension no.

Specified

OR

*

All

Enter ICD Group extension number or *.



C.Tone



On-hook.

PT/PS *ICD Group: Incoming Call Distribution Group*

While on-hook

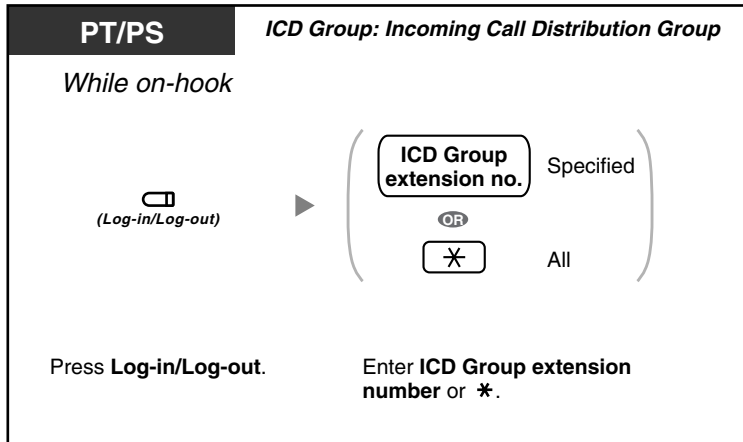

Press **Log-in/Log-out**. Enter **ICD Group extension number** or *****.

PT/PS

While on-hook

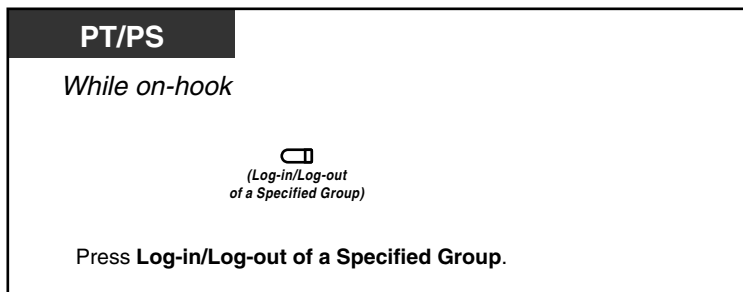

Press **Log-in/Log-out of a Specified Group**.

To enter/leave the Not Ready mode

PT/SLT/PS

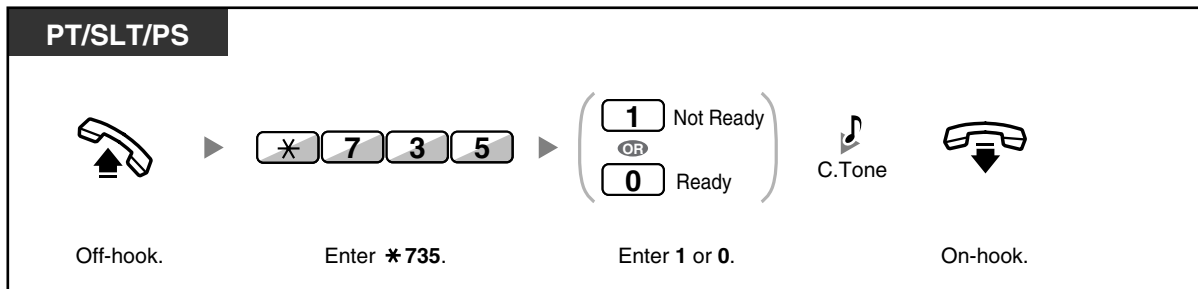

Off-hook. Enter *** 735**. Enter **1** or **0**. C.Tone On-hook.

To set/cancel the Not Ready mode or to leave the Wrap-up mode (To enter the Ready mode)

PT/PS

While on-hook

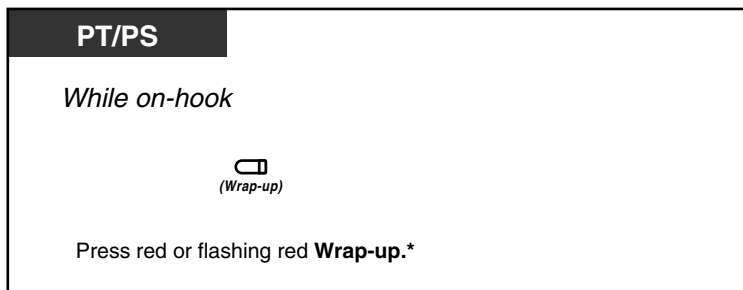

Press red or flashing red **Wrap-up.***



- * The status will be as follows:
Ready → Not Ready
Not Ready → Ready
Wrap-up → Not Ready
- The Log-in/Log-out of a specified group button light shows the current status as follows:
Off: Log-in mode
Red on: Log-out mode
- The Wrap-up button alternates the setting of Wrap-up mode, Not Ready mode or Ready mode. The Wrap-up button light shows the current status as follows:
Off: Ready mode
Red on: Not Ready mode
Flashing red: Wrap-up mode
- In Wrap-up mode/Not Ready mode, your extension does not receive calls through any group, even if it belongs to multiple groups.
- There may be at least one extension in the incoming call distribution group that is in the Log-in mode.



Customizing Your Phone

- 3.1.3 Customizing the Buttons
Create or edit a Log-in/Log-out button, a Log-in/Log-out of a specified group button or a Wrap-up button.

1.8.2 Manual Queue Redirection

When your incoming call distribution group is busy and other outside calls arrive, the arriving calls are put in a waiting queue.

Extensions can check the status of the queue with the Hurry-up button light, and forward the longest waiting call in the queue to a preset destination manually.

This feature is also known as Hurry-up Transfer.

To forward the waiting call

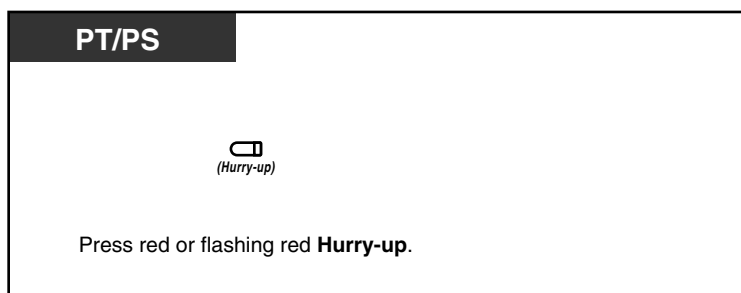

- The Hurry-up button light shows the current status as follows:
Off: No waiting call.
Red on: Some calls are waiting.
Flashing red: The number of calls exceeds the manual queue redirection level.



Customizing Your Phone

- 3.1.3 Customizing the Buttons
Create or edit a Hurry-up button.

1.9 User-supplied Equipment

1.9.1 Doorphone/Door Opener

You can talk to a person at the door through the doorphone. Preprogrammed extensions or an outside party can receive the calls from the doorphone. You can open the door.

- Doorphone Call
- Door Open

◆◆ Doorphone Call

To call from the doorphone

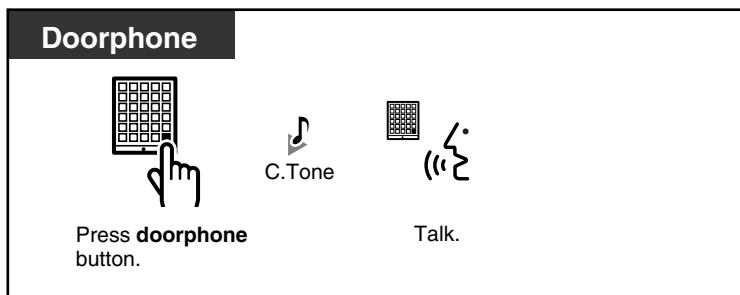

To answer a call from the doorphone



To call the doorphone

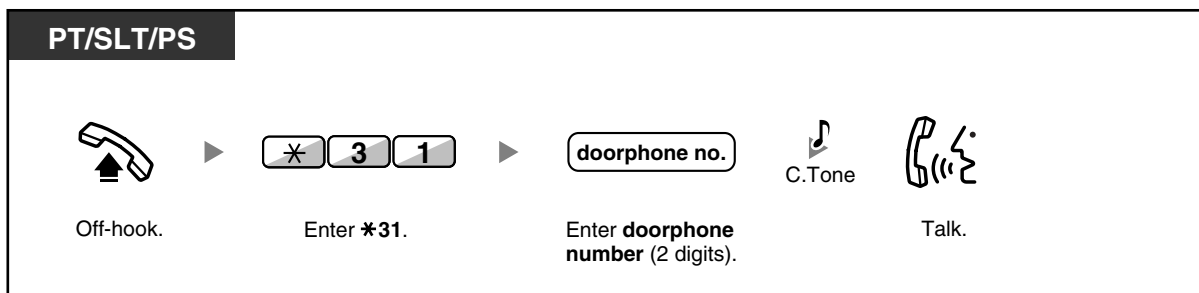

- If no one answers a doorphone call within a specified time period, the call is canceled.

◆◆ Door Open

Some extensions may be prohibited from using this feature.

From a specified extension

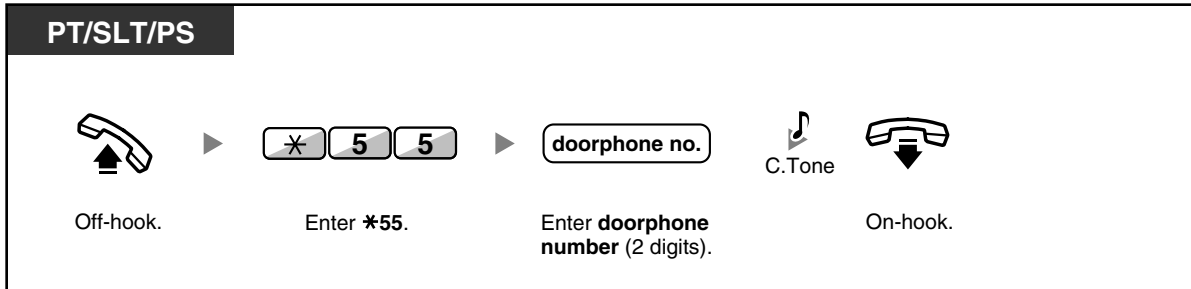

From any extension while talking to the doorphone

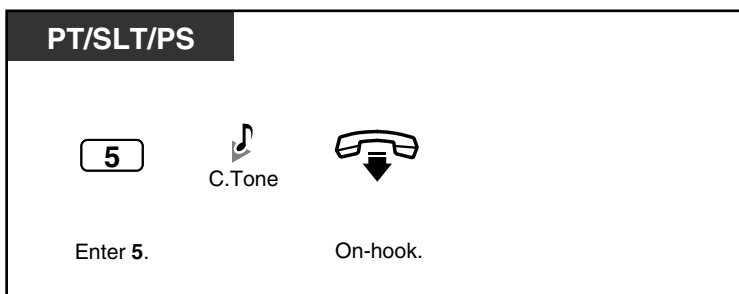

- The door open will be triggered for a specified time period.

1.9.2 External Relay

Preprogrammed extensions can switch on a relay (e.g., alarm) connected to the PBX.

To switch on the relay

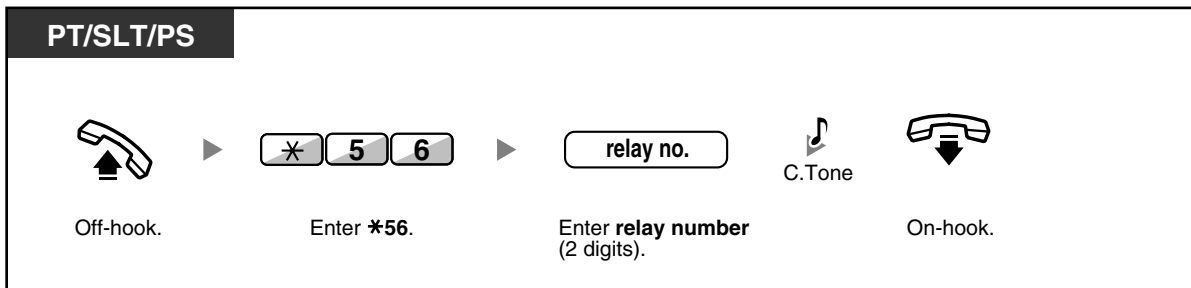

- The relay will be switched off after a specified time period.

1.9.3 External Sensor

Preprogrammed extensions can receive an alert call from an external sensor (e.g., security alarm) connected to the PBX.

To answer a sensor call

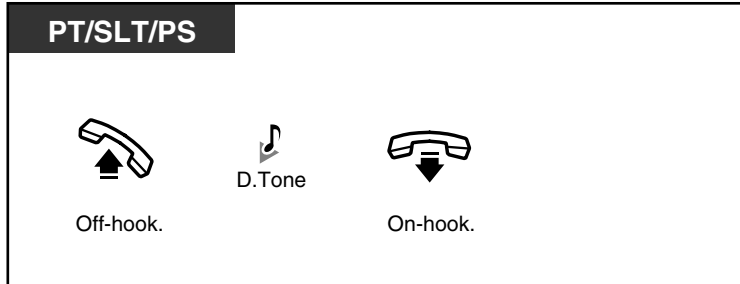

- If you do not answer a sensor call within a specified time period, the sensor call will stop.

1.9.4 Host PBX

- External Feature Access (EFA)

◆◆ External Feature Access (EFA)

You can access special features (e.g., Call Waiting) offered by a host PBX or telephone company. This feature is only effective for an outside call.

<Example> To hold the current call and then talk to the new party

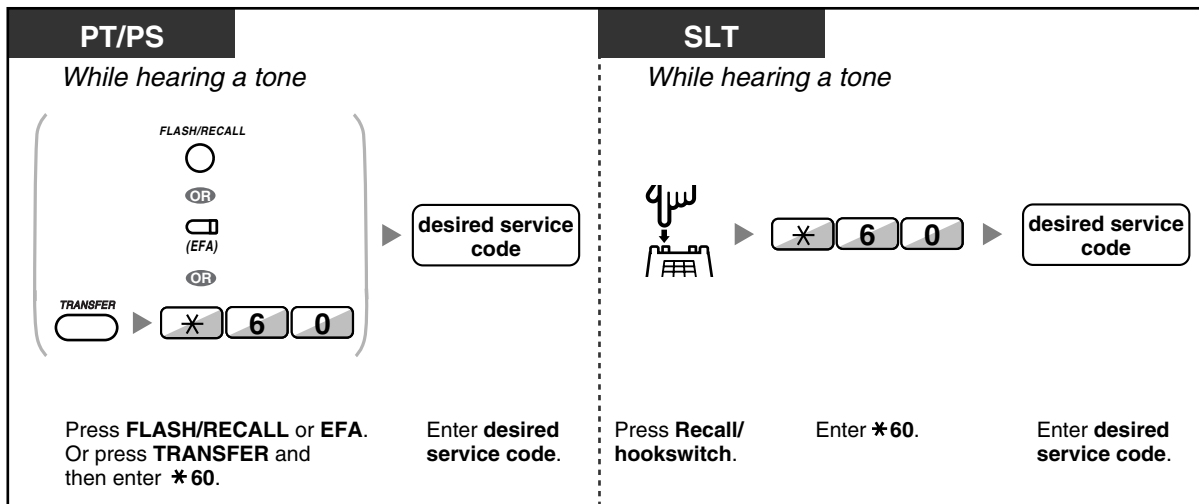



- In this case, the FLASH/RECALL button on a proprietary telephone must be in External Feature Access (EFA) mode. For information about setting the mode of your FLASH/RECALL button, consult your dealer.
- Regarding the service code, consult your dealer.



Customizing Your Phone

- 3.1.3 Customizing the Buttons
Create or edit an External Feature Access (EFA) button.

1.9.5 Voice Processing System

You or an outside party can access the Voice Processing System from a telephone.

- Call Forwarding to Voice Mail (Voice Mail Integration)

If your PBX has a Panasonic Voice Processing System connected (e.g., KX-TVS series) using digital integration, the following features are also available:

- Live Call Screening (LCS)
- Two-way Record

◆◆ Call Forwarding to Voice Mail (Voice Mail Integration)

- To forward your calls to your mailbox
- To transfer a call to a mailbox
- To listen to messages

If you cannot answer calls, you can forward them to your mailbox. You can select the type of incoming calls (Intercom Calls/Outside Calls/Both Calls) that are forwarded.

If your telephone has a Message button, the Message light turns on when a message is left in your mailbox. You will hear an indication tone* when going off-hook, regardless of whether or not your telephone has a Message button.

You can also transfer received outside calls to a mailbox so that calling parties can leave messages. If you create a Voice Mail Transfer button on your phone, the transfer is done without knowing the mailbox number (Voice Mail Transfer).

The duration for recording depends on the voice processing system.

To forward your calls to your mailbox

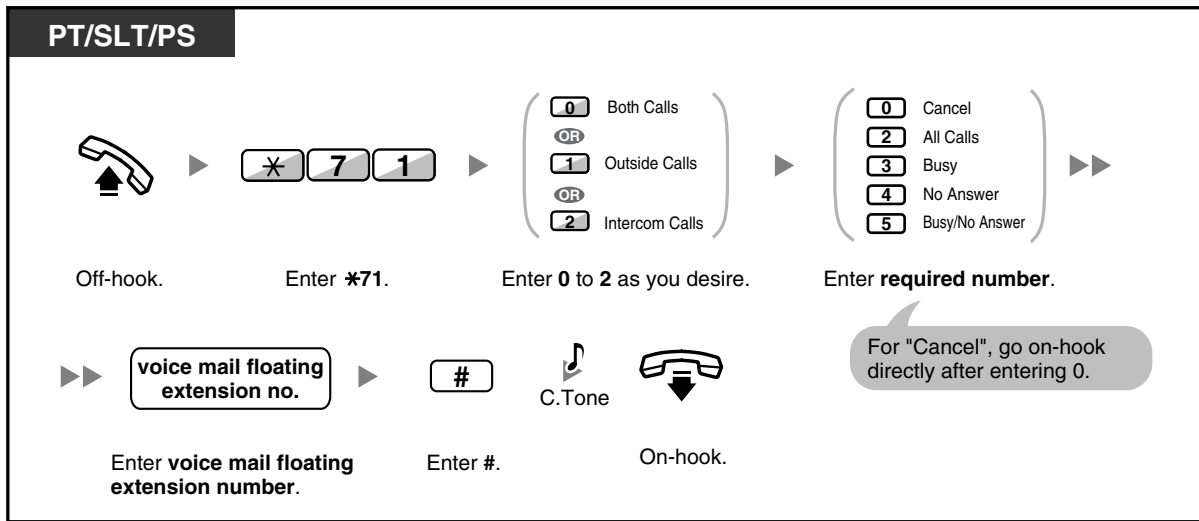

To transfer a call to a mailbox

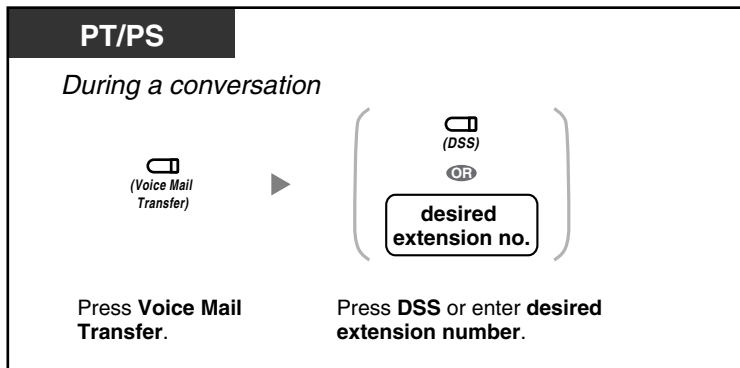

To listen to messages

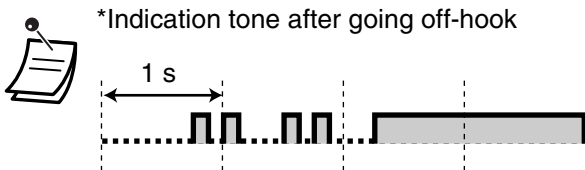
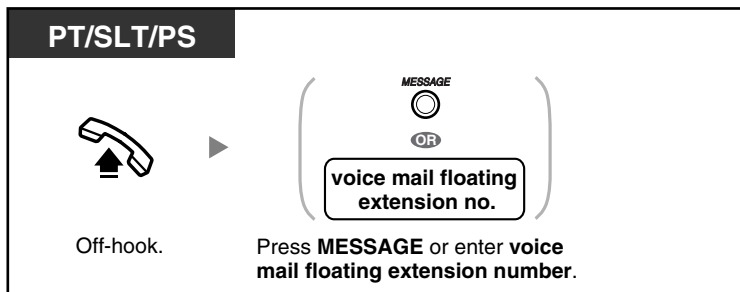

- You can access a voice mail with one-touch.



- The default voice mail floating extension number is 500.



Customizing Your Phone

- 3.1.3 Customizing the Buttons
Create or edit a Voice Mail Transfer button or a Message button.

◆◆ Live Call Screening (LCS)

While a caller is leaving a message in your mailbox, you can monitor the call without answering. If you so desire, you can answer the call while monitoring. There are two methods available (Default: Hands-free mode).

Hands-free mode:

You can monitor the message automatically, live through the telephone speaker.

Private mode:

You will hear an alarm tone while the caller is leaving a message.

Before operating

- Create a Live Call Screening (LCS) button (Personal Programming).
- Select the mode, either Hands-free or Private (Personal Programming).
- Set the extension PIN (Personal Identification Number).
- Set the Live Call Screening feature.

To set Live Call Screening

PT/PS *PIN: Personal Identification Number*

(Live Call Screening)

▶ **extension PIN**

Press **Live Call Screening**.

Enter **extension PIN**
(max. 10 digits).

This is required only when an extension PIN is stored.

To cancel Live Call Screening

PT/PS

(Live Call Screening)

Press red **Live Call Screening**.

Operation Flowchart

The operations in the shaded areas can be done hands-free.

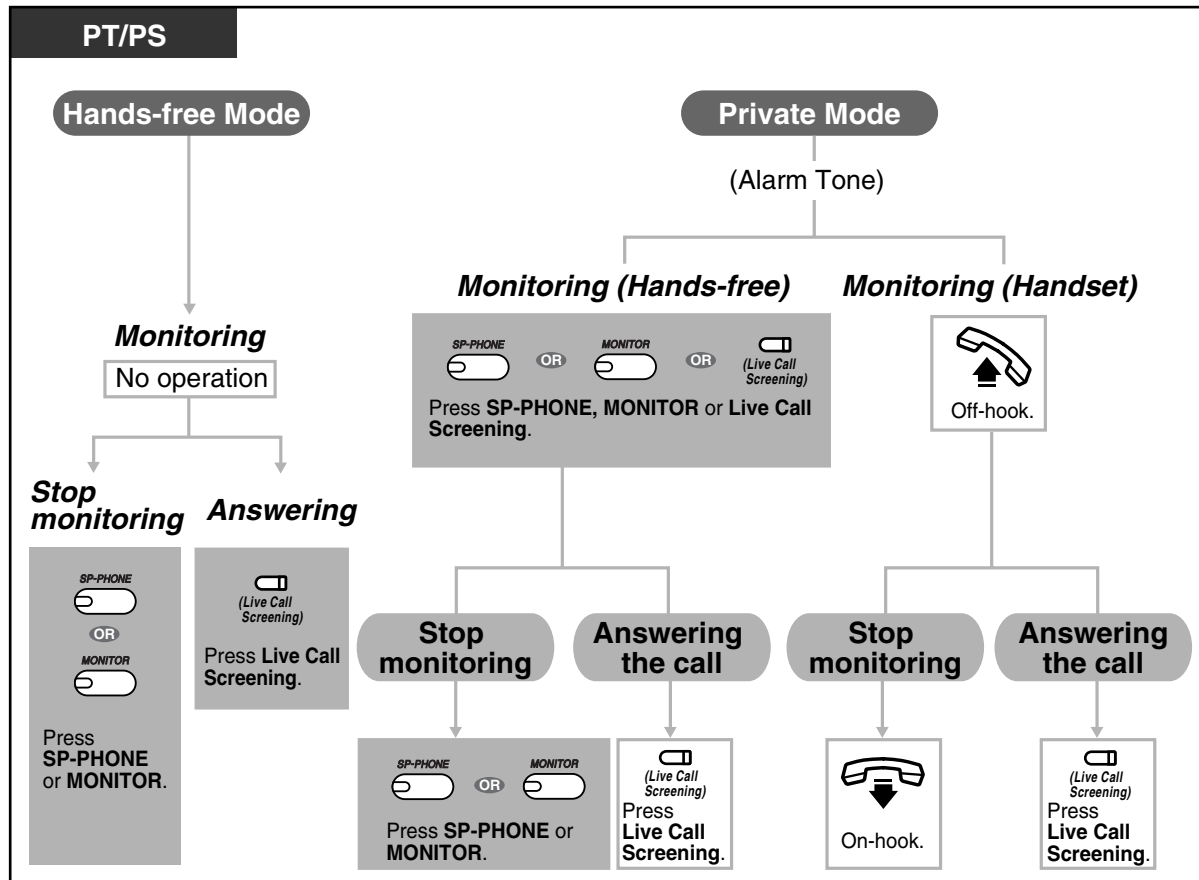

- The Live Call Screening (LCS) button light shows the feature status as follows:
 - Off:** LCS is off.
 - Flashing green rapidly:** Alerting in the Private mode.
 - Flashing green slowly:** Monitoring.
 - Red on:** LCS is on.
- The manager extension can clear an extension PIN.
- This feature is available for a single line telephone if it is connected to a proprietary telephone in parallel. (Private mode only)
To answer the call while monitoring, press Recall/hookswitch.
- Only the handset monitoring in the Private mode is available for PS users.



Customizing Your Phone

- 3.1.2 Settings on the Programming Mode—**Live Call Screening Mode Set**
Select the mode, either monitoring the message through the speaker automatically or receiving, while the caller leaves a message.
- 3.1.3 Customizing the Buttons
Create or edit a Live Call Screening (LCS) button.

◆◆ Two-way Record

You can record a conversation into a mailbox while talking on the phone.
You can select the mailbox each time you record a conversation.



To record into your mailbox

PT/PS

During a conversation

 (Two-way Record)

To stop recording, press this button again.

Press **Two-way Record**.



To record into another mailbox (Two-way Transfer)

PT/PS

During a conversation

 (Two-way Transfer)

Press **Two-way Transfer**.

 (DSS)
OR

another extension no.

Press **DSS** or enter another extension number.

To stop recording, press this button again.

To record into another mailbox with one-touch (One-touch Two-way Transfer)

PT/PS

During a conversation

 (One-touch Two-way Transfer)

Press **One-touch Two-way Transfer**.

- The Two-way Record button light, Two-way Transfer button light or One-touch Two-way Transfer button light shows the current status as follows:
Off: Not recording.
On: Recording the conversation.



- **Note:**
Many states have imposed regulations on the manner in which 2-way telephone conversations may be recorded, so you should inform the other party that the conversation is being recorded. Consult your local telephone company for further information.



Customizing Your Phone

- 3.1.3 Customizing the Buttons
Create or edit a Two-way Record button, a Two-way Transfer button and a One-touch Two-way Transfer button.

1.10 Walking Extension

1.10.1 Walking Extension

You can use the same functions assigned on your previous extension even if you move to another extension in the office.

You can retain your settings such as extension number or One-touch Dialing memory etc. on the new extension.

This feature is also known as Walking Station.

To set

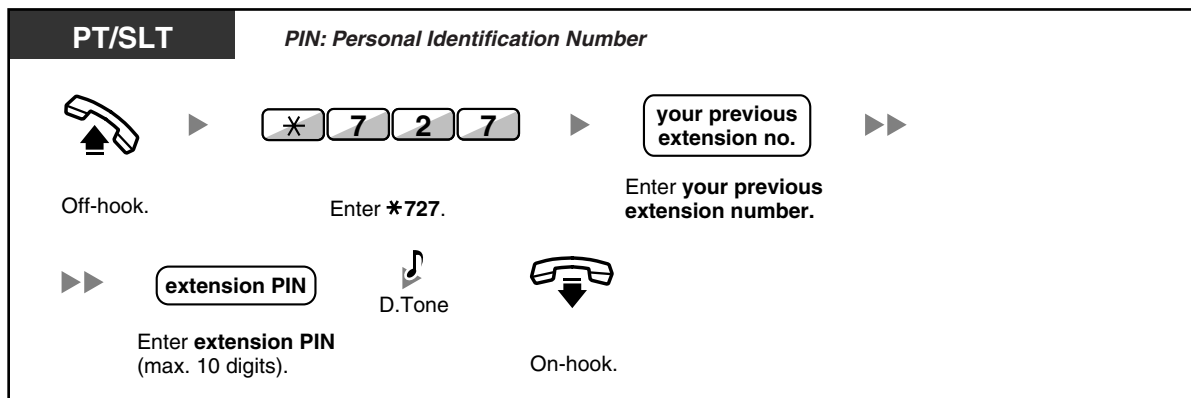

- Your previous extension will get the old settings of your new extension.
- This feature is available for movement between SLT and SLT, PT and PT or SLT and PT.
- For more information, refer to "3.1.1 Personal Programming".

1.11 Display Proprietary Telephone

1.11.1 Call Log

This is available for the display proprietary telephone and the portable station.

- Incoming Call Log

◆◆ Incoming Call Log

When you receive an outside call or an external sensor call, call information is recorded automatically in the incoming call log. A preprogrammed number of calls can be logged per extension.

When the call log is full and other call arrives, the oldest call is deleted.

You can modify the logged telephone number.

When the Call Log button light turns on, there is a call which you did not answer.

The following information is logged.

Telephone Information	KX-TD7690/KX-TD7680	KX-T7735	1-line display PT
			Wireless phone (KX-T7885/KX-TD7895)
Caller's Name or Caller's Phone Number*	✓	✓	✓
Date/Time call received	✓	✓	—
Answered or Not Answered Confirmed or Not Confirmed	✓	✓	—

*: If the caller's name is not logged, the caller's phone number is displayed.
If the caller's name is logged, the caller's phone number is not displayed.

To view the log information

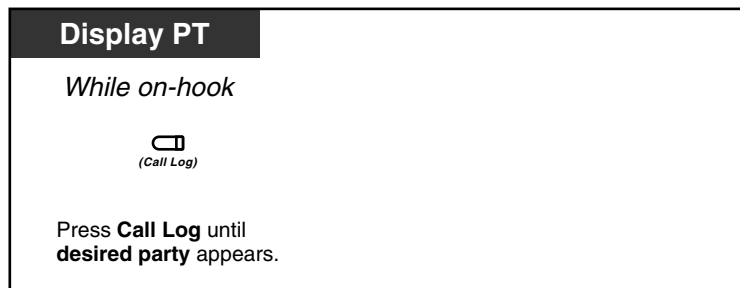

To clear the log information

Display PT

While viewing the log information



Press **Call Log** until **desired party** appears. Press **TRANSFER**.

To call

Display PT

While viewing the log information



Press **Call Log** until **desired party** appears. Off-hook.



- The Call Log button light shows the current status as follows:
Off: No incoming call. Or you have already viewed the call log.
Red on: You have missed calls to view.
- If your call is answered by another extension, the caller's information is recorded on the displays of both your extension and the answering extension.
- You can lock your call log display by using an extension PIN (Personal Identification Number), so that you can prohibit access to your logged information. Refer to "3.1.2 Settings on the Programming Mode".
- You can also have a Call Log button for an ICD Group (Incoming Call Distribution Group).
- If a call arrives while you are using the call log, the call log display will be replaced with the caller's information.
- For a PS user, refer to "Operating Instructions" for PS.



Customizing Your Phone

- 3.1.3 Customizing the Buttons
Create or edit a Call Log button or Call Log for ICD Group button.

1.11.2 Directories

You can select and call using the directories (*Personal Speed Dialing Directory, System Speed Dialing Directory and Extension Number Directory*).

Only personal directories can be stored, edited or deleted on your extension.

If a call arrives while you are using a directory, the display will be replaced with the caller's information.

- Calling with the Directory
- Storing Names and Numbers
- Entering Characters

◆◆ Calling with the Directory

To select and call with a System Speed Dialing Directory

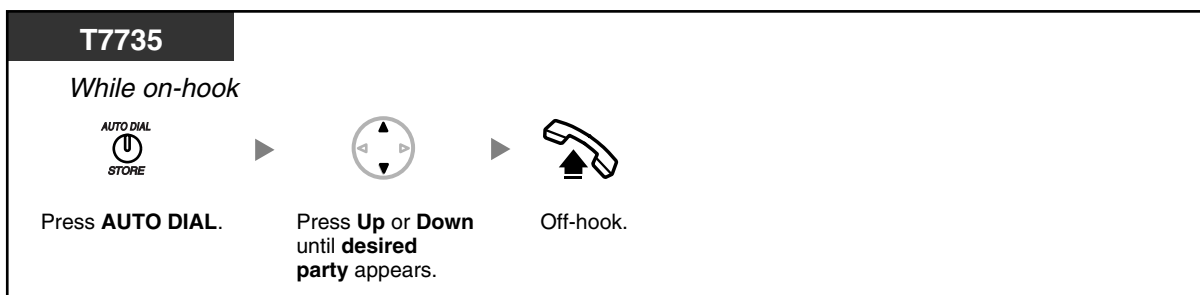

To select and call with a Personal Speed Dialing Directory



To select and call with an Extension Number Directory





- To cancel or exit, press the FLASH/RECALL button.
- You can lock your personal speed dialing directory by using an extension PIN (Personal Identification Number), so that you can prohibit access to it. Refer to "3.1.2 Settings on the Programming Mode".



- Directory entries generally should include name and number. If the name is not registered, an entry cannot be displayed.

To make an intercom call using Extension Number Directory when your telephone accesses a CO line automatically



◆◆ **Storing Names and Numbers**

To store a Personal Speed Dialing Directory item

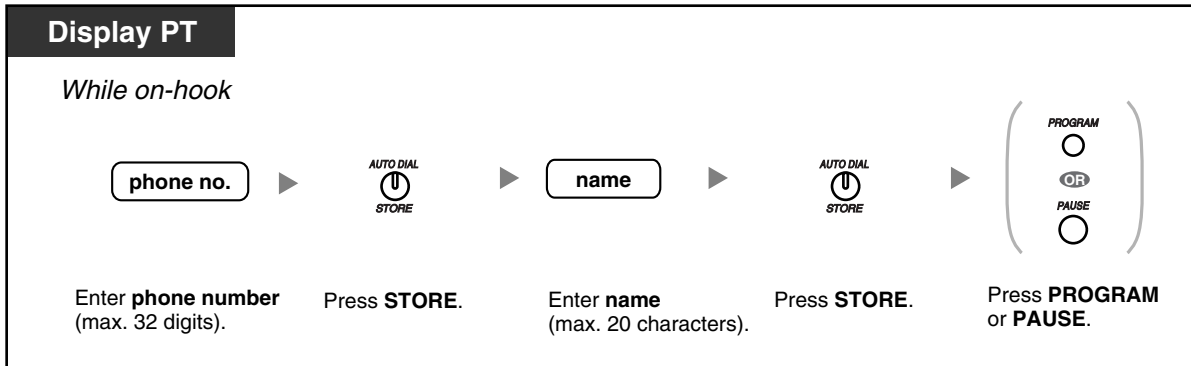

- Telephone number and name on the display are stored using the first spare Personal Speed Dialing memory available.
- For a PS user, refer to "Operating Instructions" for PS.



- For more details, refer to "To store the names and numbers in personal speed dialing" in "3.1.2 Settings on the Programming Mode".

◆◆ Entering Characters

You can enter the following characters. This table shows you the characters available for each button.

Times Buttons	1	2	3	4	5	6	7	8	9
1	!	?	"	1					
2	A	B	C	a	b	c	2		
3	D	E	F	d	e	f	3		
4	G	H	I	g	h	i	4		
5	J	K	L	j	k	l	5		
6	M	N	O	m	n	o	6		
7	P	Q	R	S	p	q	r	s	7
8	T	U	V	t	u	v	8		
9	W	X	Y	Z	w	x	y	z	9
0	(space)	.	,	'	:	;	0		
*	/	+	-	=	<	>	*		
#	\$	%	&	@	()			#

Section 2

Manager Operation

This chapter shows the manager how to control the other extensions or the PBX.

2.1 Control Features

2.1.1 Extension Control

The manager extension can control the settings of other extensions.

- Changing the Settings of Other Extensions

◆◆ Changing the Settings of Other Extensions

Remote Extension Dial Lock

This feature is also known as Remote Station Lock Control.

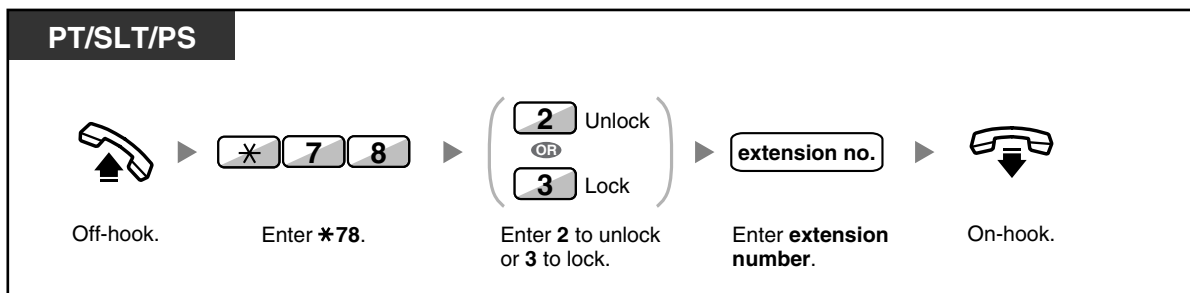

- The manager can use Remote Extension Dial Lock to unlock any extension, whether that extension was locked remotely (Remote Extension Dial Lock) or from the extension itself (Extension Dial Lock).

2.1.2 Time Service Mode Control

The manager extension or the preprogrammed extension can change the time mode (Day, Lunch, Break or Night).

There are two methods (Automatic or Manual) of changing the time modes.

Automatic: enables the time mode for each day of the week to change automatically. You may also change it manually.

Manual: enables to change a mode in manual as follows.

To change the time mode (Day/Night/Lunch/Break)

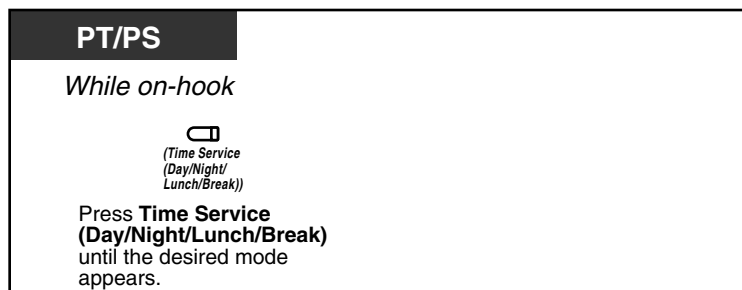

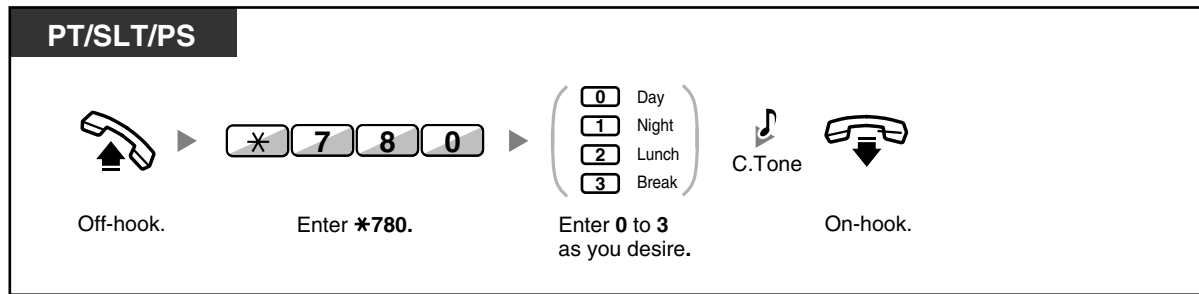

To select the time service switching mode (Automatic/Manual)

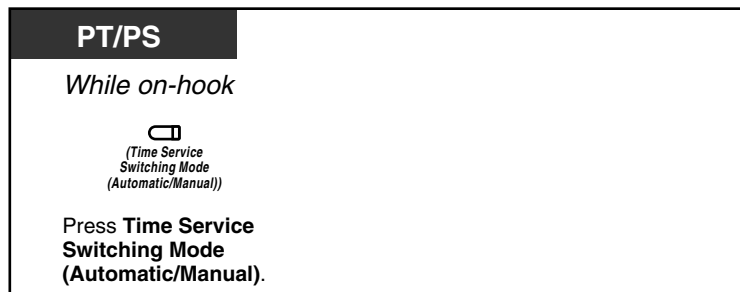

- Besides the time mode, there is Holiday mode. It can change mode once on a specified date.
- The Time Service (Day/Night/Lunch/Break) button light shows the current status as follows:
 - Off:** Day mode
 - Green on:** Lunch mode
 - Flashing Green:** Break mode
 - Red on:** Night mode
 - Flashing Red:** Holiday mode
- The Time Service Switching Mode (Automatic/Manual) button light shows the current status as follows:
 - Off:** Automatic
 - Red on:** Manual

Customizing Your Phone

- 3.1.3 Customizing the Buttons
Create or edit a Time Service (Day/Night/Lunch/Break) button or a Time Service Switching Mode (Automatic/Manual) button.

2.1.3 Dial Tone Transfer

The manager can change the restriction level, permitting an extension to make a call.

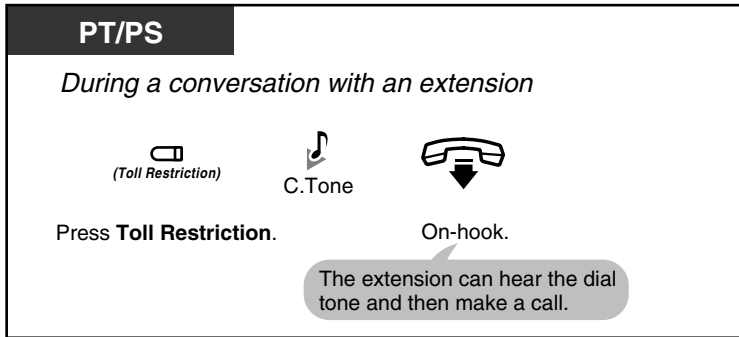

- The restriction level is changed to the preprogrammed level of Toll Restriction button.



Customizing Your Phone

- 3.1.3 Customizing the Buttons
Create or edit a Toll Restriction (TRS) button.

2.1.4 External Background Music (BGM)

The manager extension can broadcast background music in the office through external speakers.

To start/stop the background music

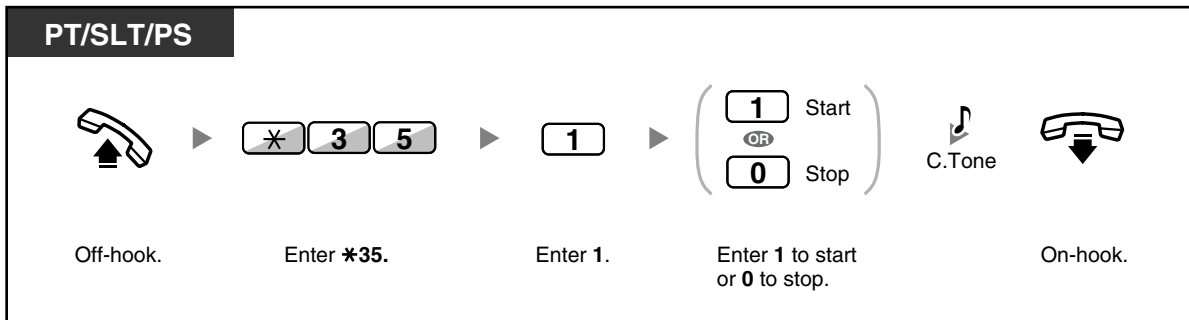

2.1.5 Outgoing Messages (OGM)

The manager extension can record three kinds of greeting messages (OGM) as follows:

1. **DISA message:** Used to greet and guide callers so that they access extension group or outside party without operator assistance.
2. **Incoming Call Distribution Group message:** Used to greet and guide callers to an incoming call distribution group.
3. **Timed Reminder message:** Used for a wake-up call message when the extension answers the Timed Reminder.



All messages have their own extension numbers. You can select the desired message. You have two methods for recording a message. One is recorded using the handset, and the other is recorded from an external BGM (MOH) port.

To record

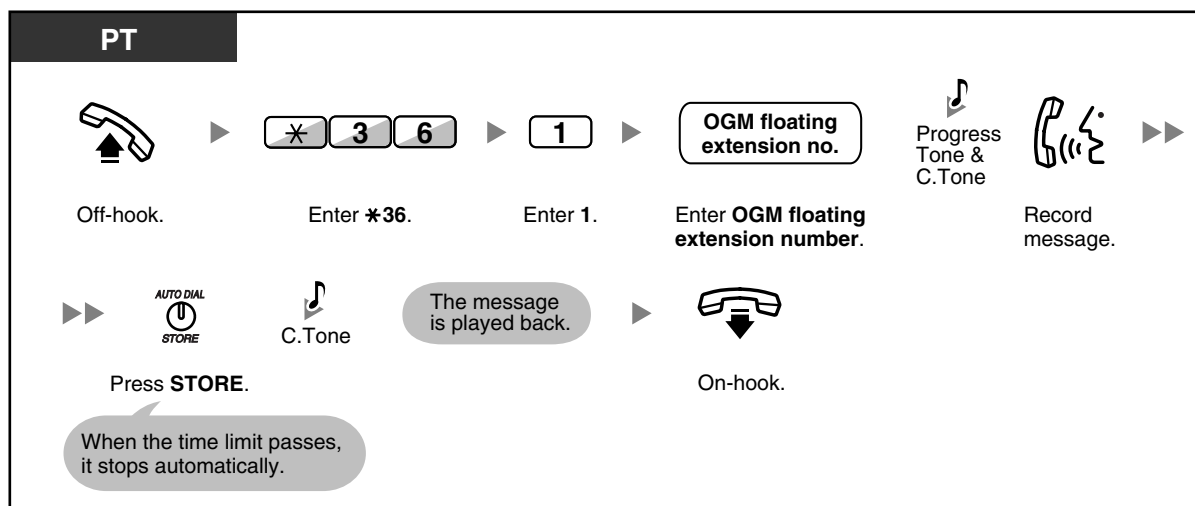

To play back

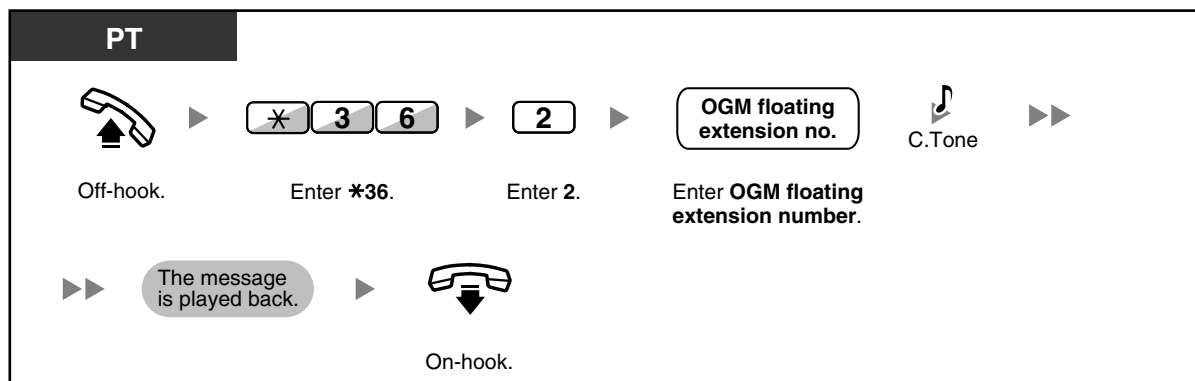

To record from an external BGM (MOH) port

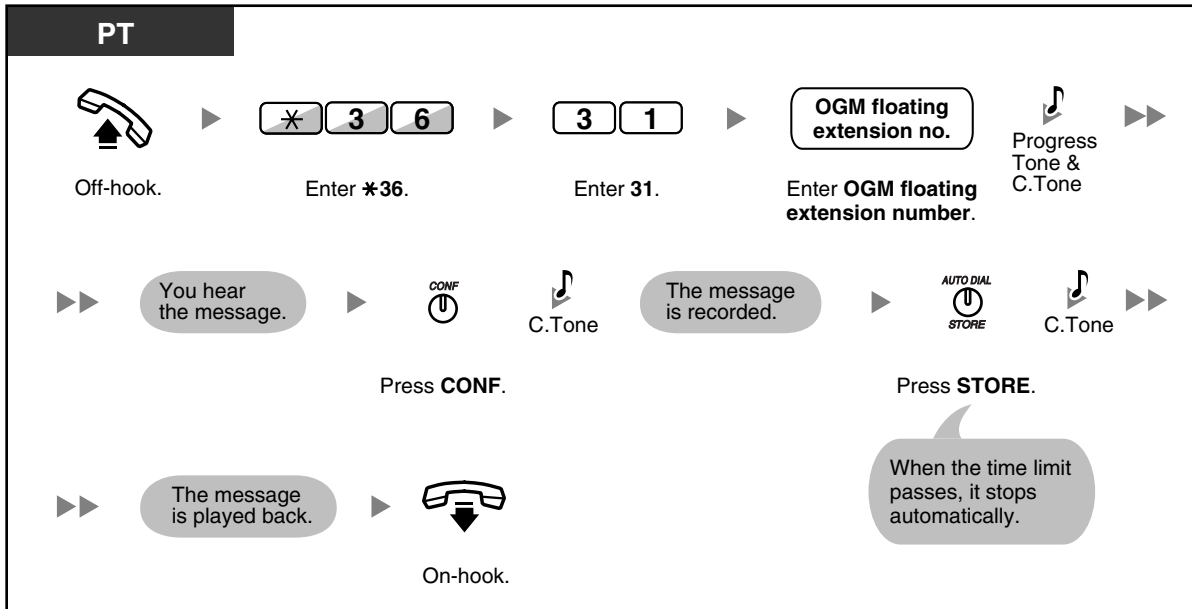

To clear the message

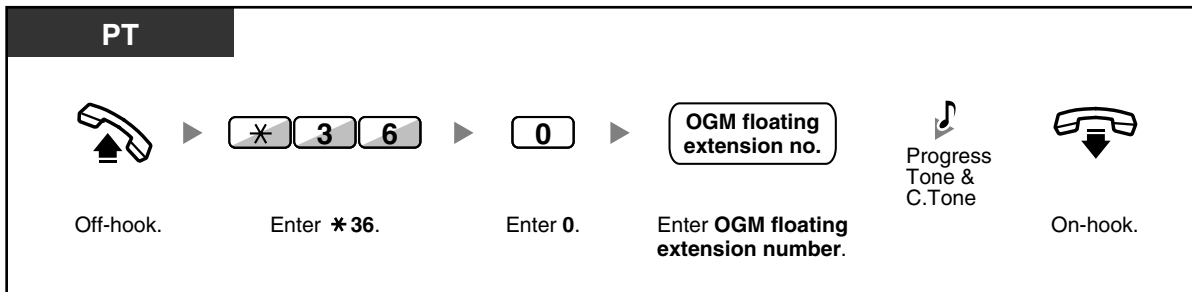

- Record voice messages only; avoid the recording of music.



- The default of OGM floating extension numbers is 5xx (xx: two-digit number of message).

2.1.6 Hospitality Features

The extension designated as a hotel operator can check or set Timed Reminders for room extensions. It is also possible to record room information from a room extension.

- Setting a Timed Reminder to a Room Extension (Remote Wake-up Call)
- Recording room information using a room extension

◆◆ Setting a Timed Reminder to a Room Extension (Remote Wake-up Call)

The hotel operator can remotely set/cancel a Timed Reminder to a room extension. He can also confirm the current setting.

To set

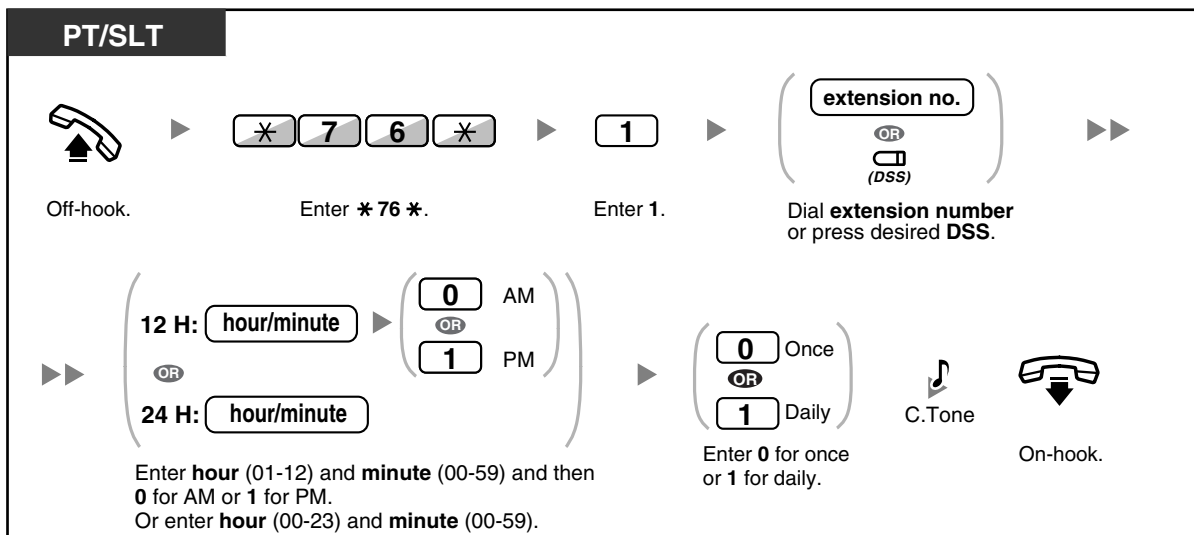

To cancel

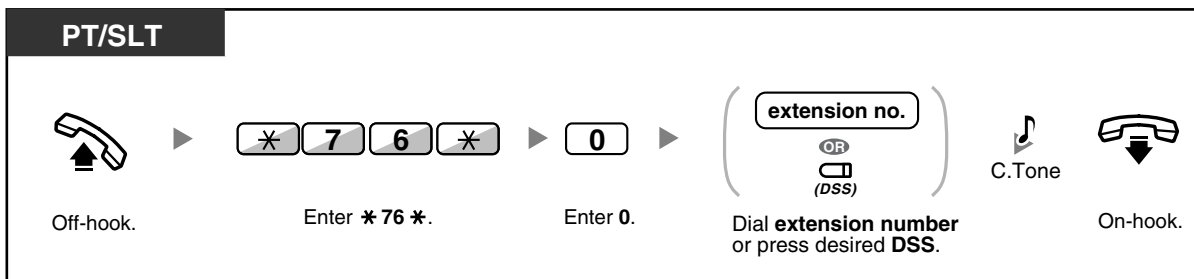

To confirm

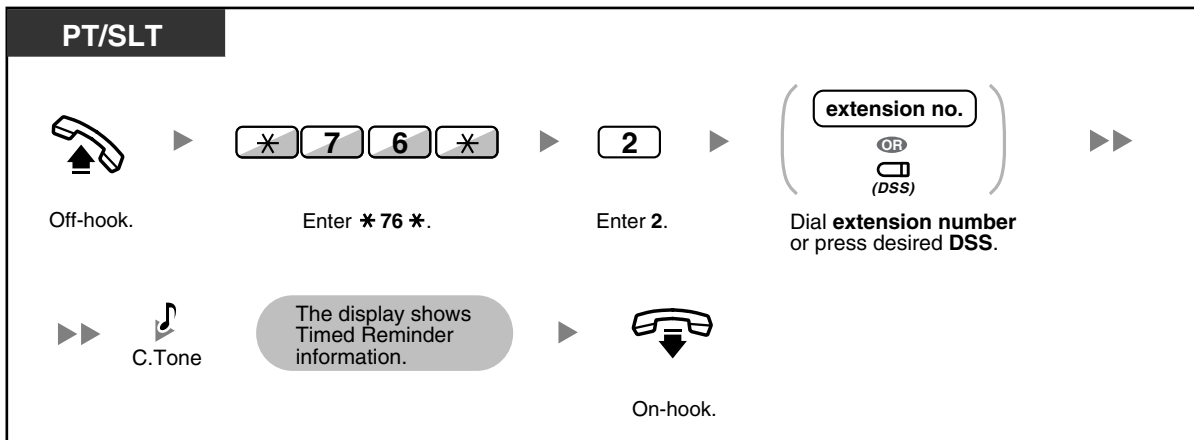



- Timed Reminder can also be set from the room extension. (For information about setting Timed Reminder, refer to "1.7.1 Timed Reminder".) The most recent setting will be valid no matter which extension made the setting.
- When a Timed Reminder starts, and when it is answered or not answered, detailed Timed Reminder information is recorded automatically. This requires system programming. Consult your dealer.
<Example>

Date	Time	Ext	CO	Dial Number
02/02/00	02:45PM	1234		Timed Reminder/Start
02/02/00	02:46PM	1234		Timed Reminder/No Answer
02/02/00	02:47PM	1234		Timed Reminder/Answer

◆◆ Recording room information using a room extension

Room information can be recorded from a room extension using up to 8 preprogrammed messages (1-8). Depending on the content of the messages, a variety of information can be recorded. For a list of preprogrammed messages, consult your dealer.

To record

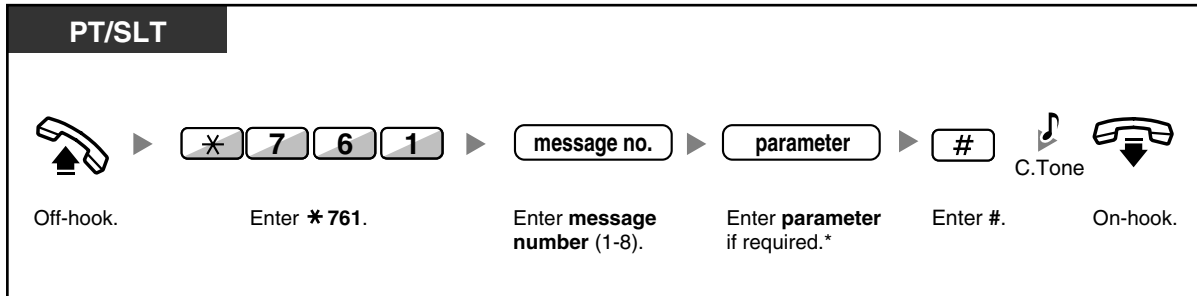

- * If you see "%" signs, you are required to enter a parameter. Enter values in the "%" positions using 0 to 9 or *.
- <Example>
If "Snack %%.%" has been preprogrammed as message number 1 (for recording charges for room snacks consumed), hotel employees would enter data as in the example below using the room extension:

* 761 1 0300 #
 message no. parameter
 (Snack charge)

Data similar to the example below is recorded.

Date	Time	Ext	CO	Dial Number
02/02/00	10:45AM	1234		Snack 03.00

Section 3

Customizing Your Phone & System

This chapter shows you how to customize your individual telephone or PBX according to your needs. Find the desired setting and program as necessary.

3.1 Personal Programming

3.1.1 Personal Programming

You can customize your telephone features. For example, you can change the initial settings or button features according to your needs.

- Extension PIN (Personal Identification Number)



- If you change your desk and extension, refer to "1.10.1 Walking Extension".

◆◆ Extension PIN (Personal Identification Number)

You can assign a password to each extension.
The following features require an extension PIN.

1. Screening calls (Live Call Screening [LCS])
2. Prohibiting other people from seeing your personal speed dialing directory and call log (Display Lock)
3. Using the same settings as your extension at other extensions (Walking Extension)
4. Remote Control Operation (Walking COS)
5. Extension Dial Lock Clear

To set

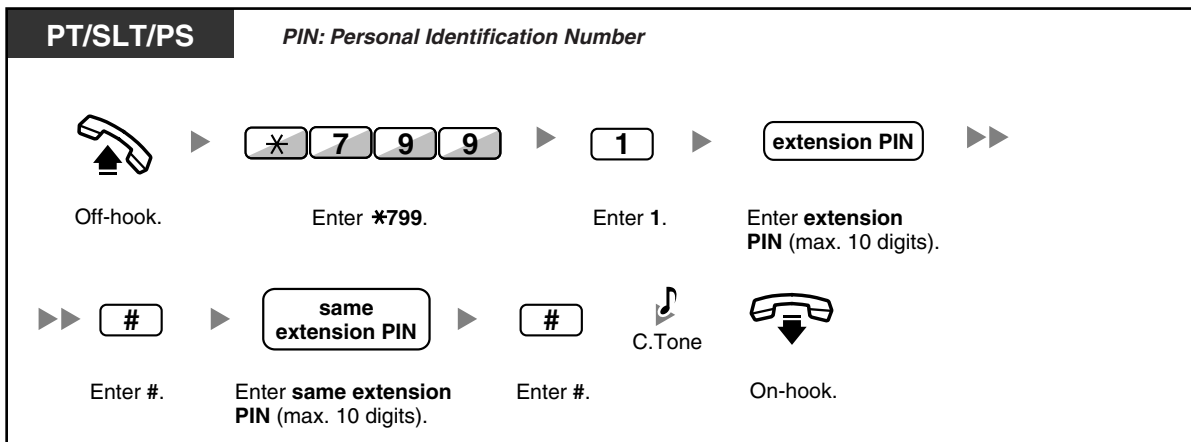

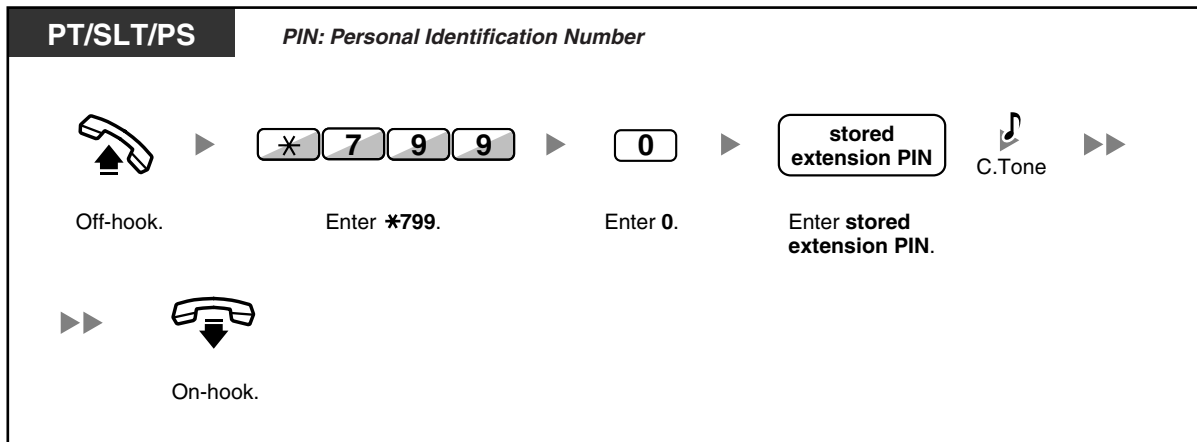
To cancel

- **WARNING**
There is a risk that fraudulent telephone calls will be made if a third party discovers your password (extension PIN). The cost of such calls will be billed to the owner/renter of the PBX. To protect the PBX from this kind of fraudulent use, we strongly recommend:
 - a) Keeping your PIN secret.
 - b) Selecting a complex, random PIN that cannot be easily guessed.
 - c) Changing your PIN regularly.
- Valid numbers for an extension PIN are "0" through "9".
- If the wrong extension PIN is entered for a preprogrammed number of times, the PIN is locked.
- If you forget your extension PIN or your extension PIN is locked, your manager can clear the extension PIN and extension PIN lock.

3.1.2 Settings on the Programming Mode

You can program features using the programming mode.

- Setting Features
- Clearing Features





- To exit at any time, lift the handset.
- To enter the programming mode when using a PS, refer to "Operating Instructions" for PS.
- The following items with "*" (asterisk) are not available for a PS.

◆◆ Setting Features

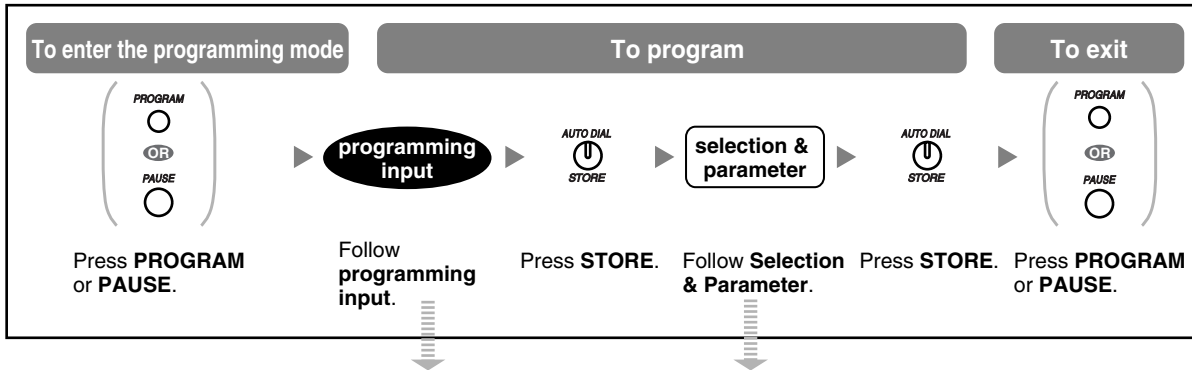
The default settings are shown in bold letters. For later reference, place a check mark in the boxes below to indicate your customized setting.



Item	Programming Input	Selection & Parameter
Your extension information	<input type="text" value="0"/> <input type="text" value="0"/>	<p>PT: The display shows the PBX number, slot number and port number. <example></p> <p>EXT1050:10308 PBX no. <input type="text" value="1"/> <input type="text" value="2"/> <input type="text" value="3"/> Port no. Slot no.</p> <p>PS: The display shows the PS number. <example></p> <p>EXT3001:99001 PS no.</p>
Which display language do you prefer? (Display Language Selection)	<input type="text" value="0"/> <input type="text" value="2"/>	<input type="text" value="1"/> <input type="checkbox"/> English
		<input type="text" value="2"/> <input type="checkbox"/> 2nd Language
		<input type="text" value="3"/> <input type="checkbox"/> 3rd Language
		<input type="text" value="4"/> <input type="checkbox"/> 4th Language
		<input type="text" value="5"/> <input type="checkbox"/> 5th Language
Would you like the call duration to be shown automatically on the display when answering an outside call? (Display Switching Mode)	<input type="text" value="0"/> <input type="text" value="3"/>	<input type="text" value="0"/> <input type="checkbox"/> No—Manual (The display keeps showing all of the outside caller's information unless you change it to the call duration manually.)
		<input type="text" value="1"/> <input type="checkbox"/> Yes—Automatic (The first line of the display will change to the call duration automatically when you answer an outside call.)

Item	Programming Input	Selection & Parameter	
Would you like to dial a preset number simply by going off-hook?	1 1	desired no. (max. 32 digits)	
		0	<input type="checkbox"/> Do not use
	1 2	1	<input type="checkbox"/> Use
Which do you prefer to seize when you go off-hook to make calls? (Preferred Line Assignment—Outgoing)	1 9	0	<input type="checkbox"/> No line
		1	<input type="checkbox"/> An idle CO line
		2 + CO button no. (01-12) or  (CO)	<input type="checkbox"/> A CO/G-DN button
		3 or INTERCOM 	<input type="checkbox"/> Intercom
Which line do you prefer to answer when you go off-hook? (Preferred Line Assignment—Incoming)	2 0	0	<input type="checkbox"/> No line
		1	<input type="checkbox"/> The longest ringing line (when multiple calls arrive)
		2 + CO button no. (01-12) or  (CO)	<input type="checkbox"/> An assigned outside button
How do you prefer to receive an intercom call? (Alternate Receiving—Ring/Voice)*	2 1	0	<input type="checkbox"/> Ringing (Tone Call)
		1	<input type="checkbox"/> Directly—The party's voice is heard without ringing.
		2	<input type="checkbox"/> Ring only—Prohibiting the caller switching to the voice mode.
Do you prefer to answer a call without going off-hook regardless of the AUTO ANS button status? (Forced Answerback Selection)*	2 3	0	<input type="checkbox"/> No—Disable
		1	<input type="checkbox"/> Yes—Enable

3.1 Personal Programming

Item	Programming Input	Selection & Parameter	
Which service do you prefer when a calling party is recording a message in your mailbox? (Live Call Screening Mode Set)*	2 5	0	<input type="checkbox"/> You can monitor the message through the telephone speaker. (Hands-free mode)
		1	<input type="checkbox"/> Only an alarm tone is heard. (Private mode)
Would you like to keep recording after answering the call in the LCS mode? (LCS Mode Set [After Answering])	2 6	0	<input type="checkbox"/> No—Stop recording
		1	<input type="checkbox"/> Yes—Keep recording
Do you prefer to receive call waiting for outside calls?	3 0	0	<input type="checkbox"/> No (No tone)
		1	<input type="checkbox"/> Yes (Tone)
Do you prefer to receive call waiting for intercom calls?	3 1	0	<input type="checkbox"/> No (No tone)
		1	<input type="checkbox"/> Yes (Tone)
Which type of call waiting tone do you prefer? (Call Waiting Tone Type Selection)	3 2	0	<input type="checkbox"/> Tone 1
		1	<input type="checkbox"/> Tone 2
Would you like to show a message on the caller's telephone display? (Absent Message)	4 0	0	<input type="checkbox"/> No—Off
		message no. (1-8)	<input type="checkbox"/> Yes—Shows the selected message.
		9	<input type="checkbox"/> Yes—Shows your personal message.
Creating your personal message. (Personal Absent Message)	4 1	message (max. 16 characters)	

Item	Programming Input	Selection & Parameter	
Where are your incoming calls forwarded or refused? (Call Forwarding [FWD]/Do Not Disturb [DND])		0	<input type="checkbox"/> Off
	5 0 / ^{FWD/DND} 1	1	<input type="checkbox"/> Do Not Disturb (DND)
	(for both calls)	2 + desired no. (max. 32 digits)	<input type="checkbox"/> All—Forward all calls
	5 1 (for outside calls)	3 + desired no. (max. 32 digits)	<input type="checkbox"/> Busy—Forwarded when your extension is busy.
	5 2 (for intercom calls)	4 + desired no. (max. 32 digits)	<input type="checkbox"/> No Answer—Forwarded when you do not answer.
		5 + desired no. (max. 32 digits)	<input type="checkbox"/> Busy/No Answer—Forwarded when you do not answer or when your extension is busy.
To set the timer for "No Answer" and "Busy/No Answer". (FWD N/A Timer)	5 3	<input type="checkbox"/> (0-120) seconds (Default: 15 seconds)	
Should you prohibit other people from picking up your calls? (Call Pickup Deny)	6 0	0	<input type="checkbox"/> No—Allow
		1	<input type="checkbox"/> Yes—Deny
Do you prohibit other people from joining your conversation? (Executive Busy Override Deny)	6 2	0	<input type="checkbox"/> No—Allow
		1	<input type="checkbox"/> Yes—Deny
Would you like to prohibit paging announcements? (Paging Deny)*	6 3	0	<input type="checkbox"/> No—Allow
		1	<input type="checkbox"/> Yes—Deny
Do you prefer to hear the key pad tone? (Key Pad Tone Set)*	6 4	0	<input type="checkbox"/> No—Off
		1	<input type="checkbox"/> Yes—On
Do you want background music through your telephone speaker while on-hook? (Background Music [BGM])*	6 5	0	<input type="checkbox"/> No—Off
		1 1	<input type="checkbox"/> Yes—On

Item	Programming Input	Selection & Parameter	
Would you like to set your extension PIN or change a stored extension PIN to new one? (Extension PIN [Personal Identification Number])	<input type="text" value="9"/> <input type="text" value="0"/>	extension PIN (max. 10 digits) + STORE + same extension PIN	To set an extension PIN
		stored extension PIN + new extension PIN (max. 10 digits) + STORE + same extension PIN	To change a stored extension PIN to new one
To prevent other people from using your telephone. (Extension Dial Lock)	<input type="text" value="9"/> <input type="text" value="1"/>	extension PIN (max. 10 digits) + <input type="text" value="0"/>	<input type="checkbox"/> To unlock
		extension PIN (max. 10 digits) + <input type="text" value="1"/>	<input type="checkbox"/> To lock
To prevent other people from seeing your personal speed dialing directory and call log. (Display Lock)*	<input type="text" value="9"/> <input type="text" value="2"/>	extension PIN (max. 10 digits) + <input type="text" value="0"/>	<input type="checkbox"/> To unlock
		extension PIN (max. 10 digits) + <input type="text" value="1"/>	<input type="checkbox"/> To lock
Do you prefer to set the One-touch dialing only? (One-touch Dialing Assignment Mode Selection)	<input type="text" value="#"/> <input type="text" value="✳"/>	<input type="text" value="0"/>	<input type="checkbox"/> No—Normal (Any Flexible CO buttons can be modified.)
		<input type="text" value="1"/>	<input type="checkbox"/> Yes—Only One-touch dialing buttons can be modified. However, to modify them, there is no need to enter "2" before the number.



- **WARNING**
There is a risk that fraudulent telephone calls will be made if a third party discovers your password (extension PIN). The cost of such calls will be billed to the owner/renter of the PBX. To protect the PBX from this kind of fraudulent use, we strongly recommend:
 - a) Keeping your PIN secret.**
 - b) Selecting a complex, random PIN that cannot be easily guessed.**
 - c) Changing your PIN regularly.**
- After the program number is entered, the program title is displayed. The programming screen can be changed with the Navigator key (Up or Down).



- You can select the parameter with the Navigator Key (Up or Down) instead of entering a number.

To store the names and numbers in personal speed dialing

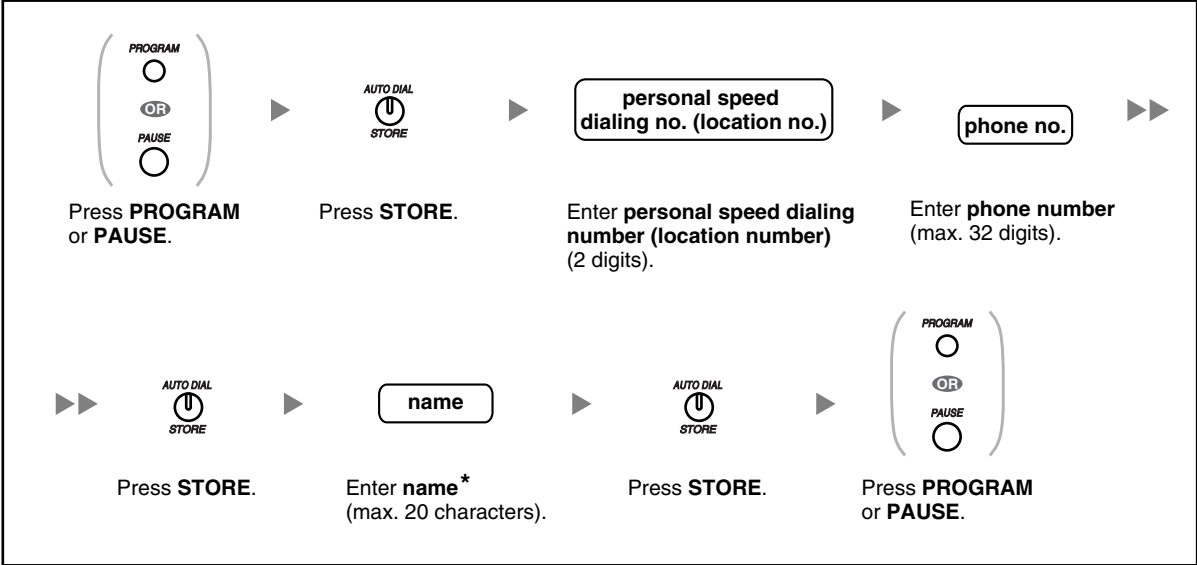

- * To enter characters, refer to "Entering Characters".

To edit the names and numbers of personal speed dialing

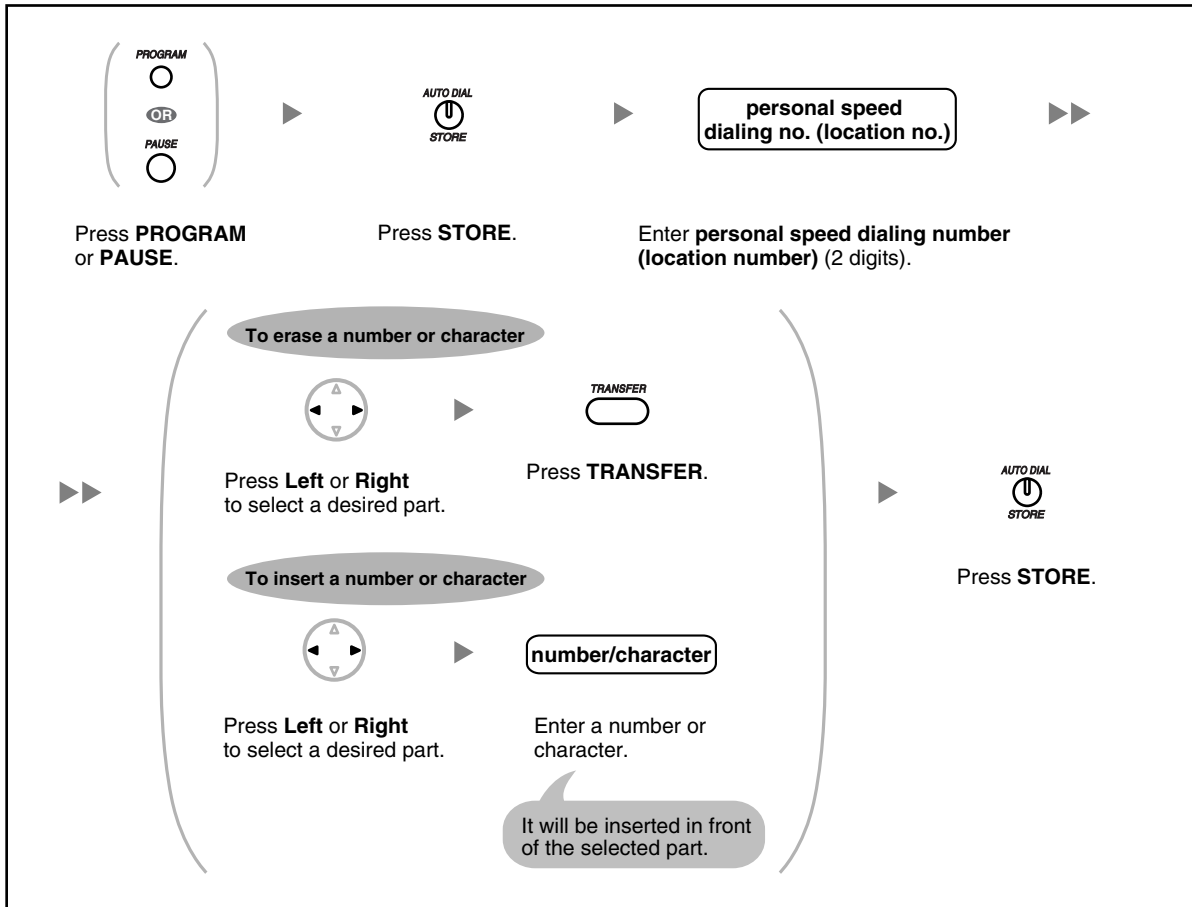

◆◆ Clearing Features

You can reset the settings of the following features on your extension to the default settings with one operation.

Features	Default Setting
Display Switching Mode	Automatic
Hot Line	Off
Preferred Line Assignment—Outgoing	Intercom
Preferred Line Assignment—Incoming	The longest ringing line
Alternate Receiving—Ring/Voice	Ringing (Tone Call)
Forced Answerback Selection	Disable
Live Call Screening Mode Set	Hands-free mode
LCS Mode Set [After Answering]	Stop recording
Call Waiting—Intercom Calls/Outside Calls	Enable (Tone)
Call Waiting Tone Type Selection	Tone 1

Features	Default Setting
Absent Message	Off
Personal Absent Message	Cleared
Call Forwarding [FWD]/Do Not Disturb [DND]—Intercom Calls/ Outside Calls	Off
FWD N/A Timer	15 seconds
Call Pickup Deny	Allow
Executive Busy Override Deny	Allow
Paging Deny	Allow
Key Pad Tone Set	On
Background Music [BGM]	Off
Data Line Security	Off
Log-in/Log-out	Log-in
Message Waiting	Off
Timed Reminder	Cleared

To set



- If you do not desire that the Call Waiting, FWD/DND or Hot Line to be cleared by this feature, please ask your dealer.

3.1.3 Customizing the Buttons

You can change the flexible CO buttons/DSS buttons, and programmable feature (PF) buttons on PTs, DSS Consoles, Add-on Key Modules, and PSs to the following function buttons. For example, if your telephone has more CO buttons than available CO lines, you may change unused CO buttons to one-touch buttons.



- To enter the programming mode when using a PS, refer to "Operating Instructions" for PS.

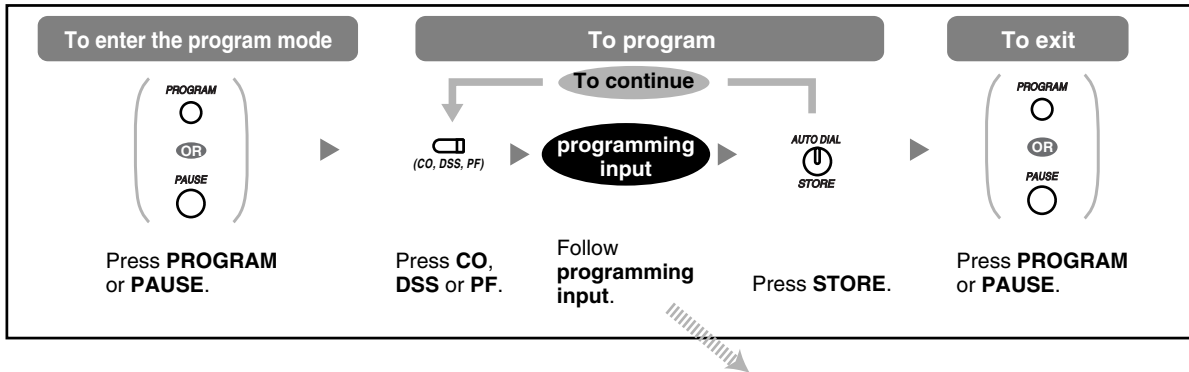

Buttons	Programmable Button			Programming Input
	CO	DSS	PF	
Loop-CO (L-CO)	✓	✓		* (star)
Group-CO (G-CO)	✓	✓		# (hash) + CO line group no. (2 digits)
Single-CO (S-CO)	✓	✓		0 + CO line no. (3 digits)
Direct Station Selection (DSS)	✓	✓		1 + Extension no.
One-touch Dialing*1	✓	✓	✓	2*2 + Desired no. (max. 32 digits)
Group Directory Number (G-DN)	✓	✓		3 0 + Incoming call distribution group extension no.
Message	✓	✓		4 0
Message for Another Extension	✓	✓		4 0 + Extension no./Incoming call distribution group extension no.
Call Forwarding (FWD)/Do Not Disturb (DND)—Both calls	✓	✓		4 1
FWD/DND—Outside calls	✓	✓		4 2
FWD/DND—Intercom calls	✓	✓		4 3

Buttons	Programmable Button			Programming Input
	CO	DSS	PF	
Group FWD—Both calls	✓	✓		4 4 + Incoming call distribution group extension no.
Group FWD—Outside calls	✓	✓		4 5 + Incoming call distribution group extension no.
Group FWD—Intercom calls	✓	✓		4 6 + Incoming call distribution group extension no.
Account	✓	✓		4 8
Conference	✓	✓		4 9
Terminate	✓	✓		5 0
External Feature Access (EFA)	✓	✓		5 1
Call Park	✓	✓		5 3 + Parking zone no. (2 digits)
Call Park (Automatic Park Zone)	✓	✓		5 3 *
Call Log* ³	✓	✓		5 4
Call Log for ICD Group* ³	✓	✓		5 4 + Incoming call distribution group extension no.
Log-in/Log-out	✓	✓		5 5
Log-in/Log-out of a specified group	✓	✓		5 5 + Incoming call distribution group extension no.
Log-in/Log-out for all groups	✓	✓		5 5 *
Hurry-up	✓	✓		5 6 + Incoming call distribution group extension no.
Wrap-up	✓	✓		5 7
System Alarm* ³	✓	✓		5 8
Time Service (Day/Night/Lunch/Break)	✓	✓		5 9 + 0/1/2/3* ⁴ (+ # + Tenant no.)
Answer* ³	✓	✓		6 0
Release* ³	✓	✓		6 1

Buttons	Programmable Button			Programming Input
	CO	DSS	PF	
Toll Restriction (TRS)	✓	✓		[6] [2] + Toll Restriction (TRS) Level (1-7)
Time Service Switching Mode (Automatic/Manual)	✓	✓		[6] [8] (+ Tenant no.)
Two-way Record*5	✓	✓		[9] [0] + Voice mail floating extension no.*6
Two-way Transfer*5	✓	✓		[9] [1] + Voice mail floating extension no.*6
One-touch Two-way Transfer*5	✓	✓		[9] [1] + Voice mail floating extension no.*6 + # + Extension no./Incoming call distribution group extension no.
Live Call Screening (LCS)*5	✓	✓		[9] [2]
Voice Mail Transfer*5	✓	✓		[9] [4] + Voice mail floating extension no.*6



- *1 "×," "#," FLASH/RECALL, PAUSE, SECRET (INTERCOM) and T (Transfer) can also be stored.

If you do not want to display the stored number when making a call, press the SECRET (INTERCOM) button before and after the numbers you wish to conceal.

If you store an outside party's number, you should first store a line access number.

If you need to enter an account code, you can enter the specified account code before the line access number.

<Example>

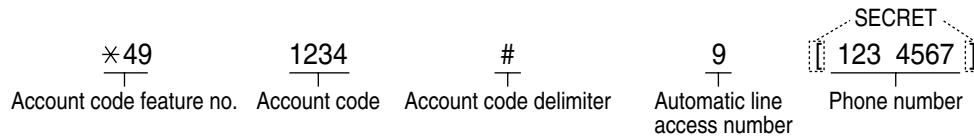

- *2 For a PF button, "2" is not required to enter before the desired number.
- *3 This button is not available for a PS.
- *4 0: Day/Night/Lunch/Break, 1: Day/Night/Break, 2: Day/Night/Lunch, 3: Day/Night
- *5 This button is used for the integrated voice mail features.
- *6 The default voice mail floating extension number is 500.
- To exit at any time, lift the handset.**



- You can select the parameter with the Navigator key (Up or Down) instead of entering a number.

To clear the button

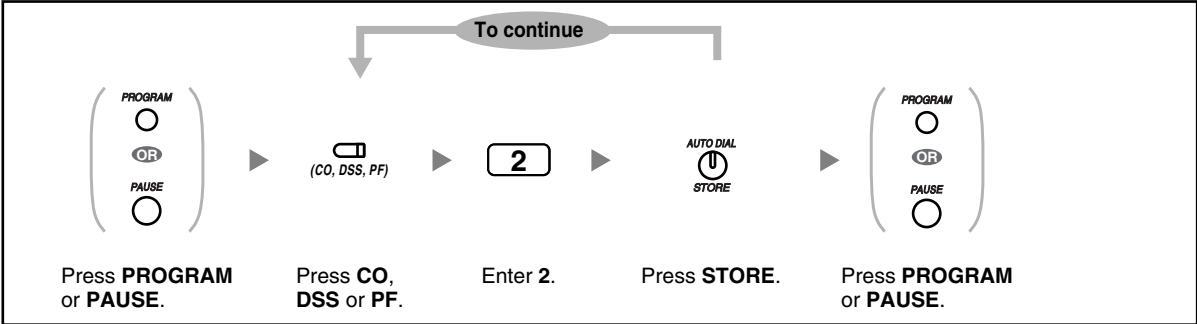

3.2 Manager Programming

3.2.1 Programming Information

The manager can program the following item.

- Other Extensions Control

Available Extension

The extension assigned as a manager

Required Telephone

A Panasonic Proprietary Telephone with display
(e.g., KX-T7735)

Manager Password

To enter programming mode, the manager password (max. 10 digits) is required. (Default: 1234)

Conditions







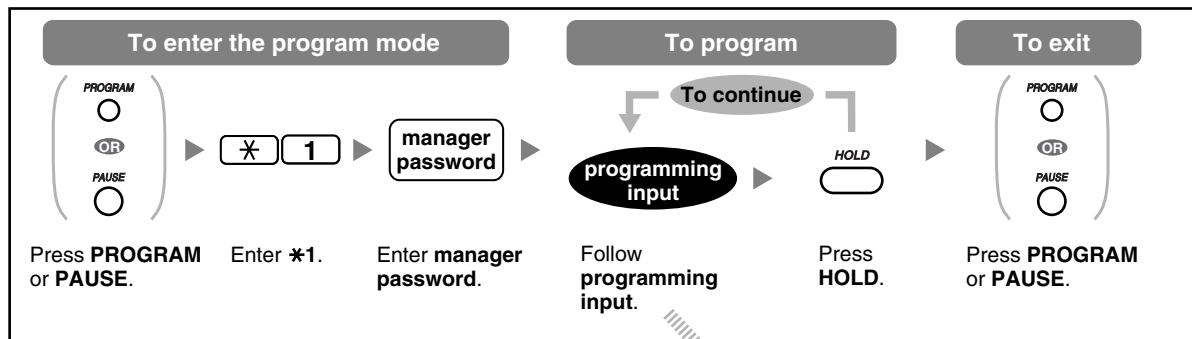

The programming extension must be idle, on-hook and holding no calls.

3.2.2 Manager Programming

◆◆ Changing the Settings and Extension Control



Item	Programming Input
Changing the manager password.	[0] [0] + + Password (max. 10 digits) +
Locking/unlocking other extensions. (Remote Extension Dial Lock)	[9] [0] + + Extension no. + [1] (to lock)/ [0] (to unlock) +
Clearing the PIN and PIN lock for extensions.	[9] [1] + + Extension no. +

Item	Programming Input
Clearing the PIN and PIN lock for verified codes.	  +  + Verified code + 
Setting the verified code PIN.	  +  + Verified code + PIN (max. 10 digits) + 



- WARNING**
 There is a risk that fraudulent telephone calls will be made if a third party discovers your password (verified code PIN).
 The cost of such calls will be billed to the owner/renter of the PBX.
 To protect the PBX from this kind of fraudulent use, we strongly recommend:

 - a) Keeping your PIN secret.
 - b) Selecting a complex, random PIN that cannot be easily guessed.
 - c) Changing your PIN regularly.

3.3 System Programming

3.3.1 Programming Information

You can customize your system according to your requirements.
[Your system already has default settings (factory installed).]

The programming is shown below. (Program number)

- The date and time [000]
- System speed dialing numbers and names [001]/[002]
- Extension number and name [003]/[004]

Available Extension

The extension allowed through COS programming

Required Telephone

A Panasonic Proprietary Telephone with display
(e.g., KX-T7735)

System Password

To enter programming mode, the system password (max. 10 digits) is required. (Default: 1234)











Conditions

The programming extension must be idle, on-hook and holding no calls.

List

Before programming, decide the settings and write them down. Your notes will provide a useful record of the programming for future reference. Your dealer also has programming records which contain all of the system programming. You may ask for photo copies of these tables to be aware of the facilities and features available.

◆◆ Icon Descriptions

Fixed Buttons	Function
	PREVIOUS (PREV)
	NEXT
	➔
	➔
	SELECT
	PROGRAM
	STORE
	END
	CLEAR
	FLASH
	SECRET

◆◆ Procedure

The basic steps are shown below.

1. *Entering the programming mode*

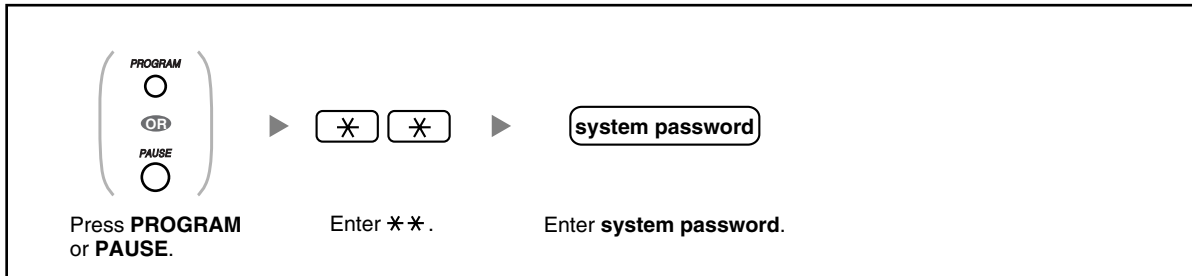

2. *Programming*

You can enter each program number (3 digits).

- To exit the programming mode at any time, lift the handset.



3. *Exiting the mode*

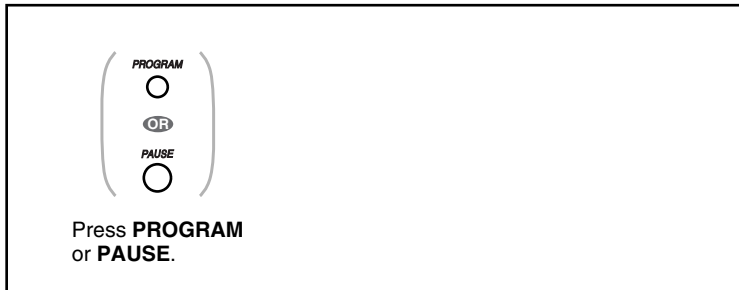

- To exit the programming mode at any time, lift the handset.



3.3.2 System Programming

◆◆ Date & Time [000]

The proprietary telephones display the current date and time while on-hook.

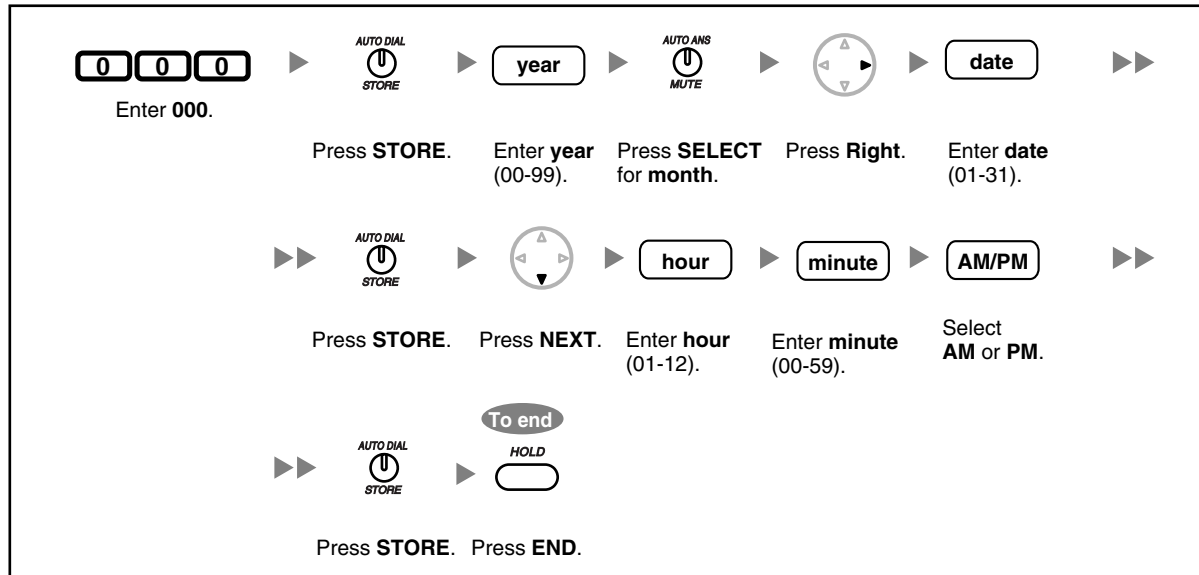

- **After changing the desired values**, you can press the STORE button. You do not have to perform the rest of the steps.
- The clock starts immediately after the STORE button is pressed.
- You cannot leave a value empty.
- You can clear the entry by pressing the CLEAR button.
- **To confirm your entry after storing data:**
 - The STORE button light: Lights red.
 - Confirmation Tone:
 - One beep: Your entry is accepted.
 - Three beeps: Your entry is rejected.

◆◆ System Speed Dialing Number [001]

You can store the phone numbers of frequently dialed numbers.

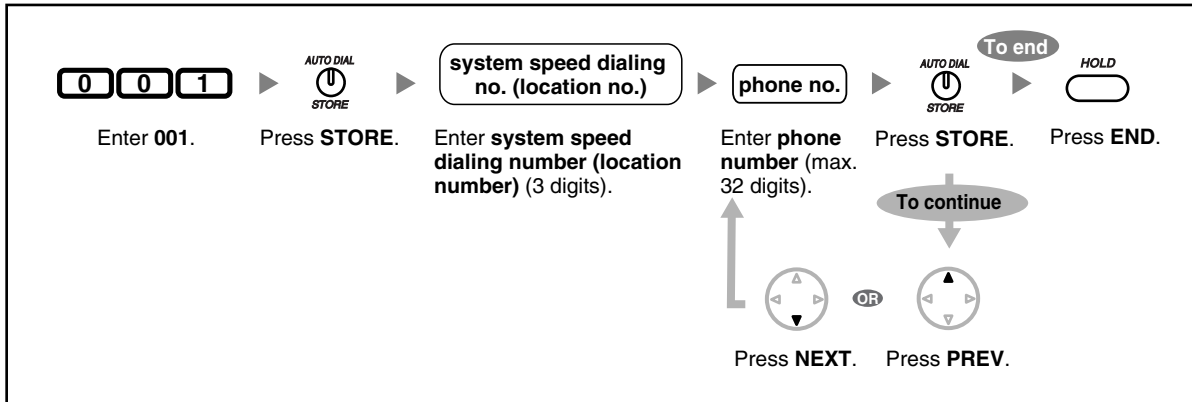

- If the desired number is more than 32 digits, divide the number and store it into more than one speed dialing number.
- "*", "#", FLASH/RECALL, PAUSE, and SECRET (INTERCOM) can also be stored.
If you do not want to display the stored number when making a call, press the SECRET (INTERCOM) button before and after the numbers you wish to conceal.
If you store an outside party's number, you should first store a line access number.
If you need to enter an account code, you can enter the specified account code before the line access number.

<Example>

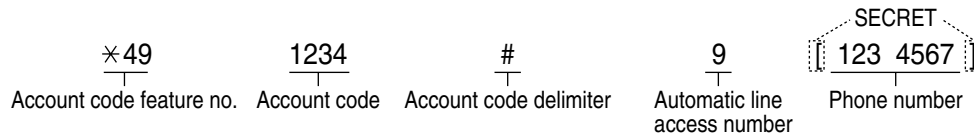

◆◆ System Speed Dialing Name [002]

You can store the name associated with the speed dialing number. These names are displayed when making calls using the display operation. To enter characters, refer to "Entering Characters".

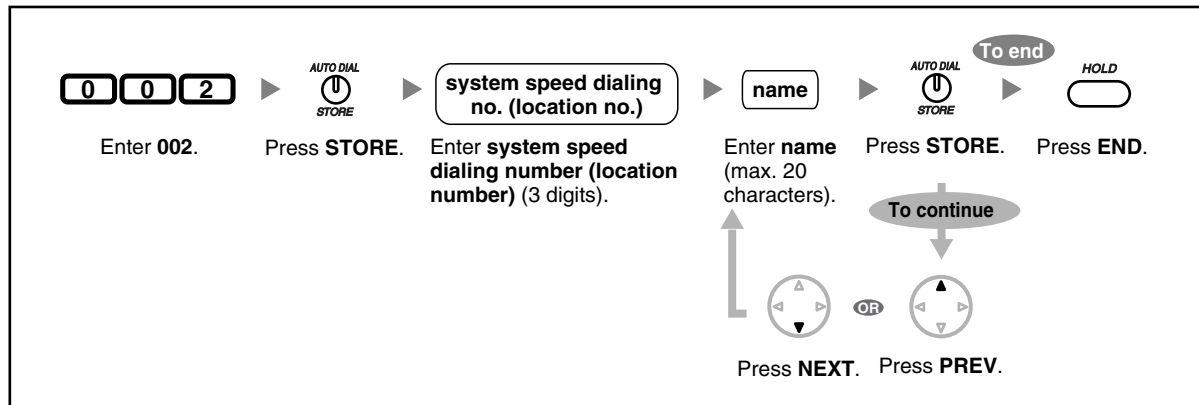

◆◆ Extension Number [003]

You can assign an extension number to each extension.

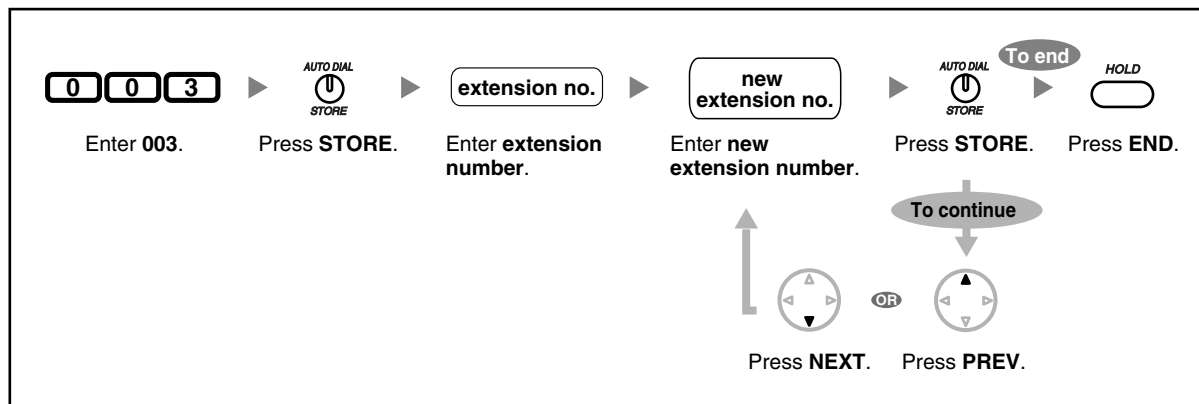

- The leading number(s) should be the same as the number(s) assigned for Flexible Numbering. Consult your dealer.
- A duplicate entry is invalid.

◆◆ Extension Name [004]

You can store the name of an extension user. This is useful if you want to know who is calling, or who you are calling when making an intercom call using the directory.

To enter characters, refer to "Entering Characters".

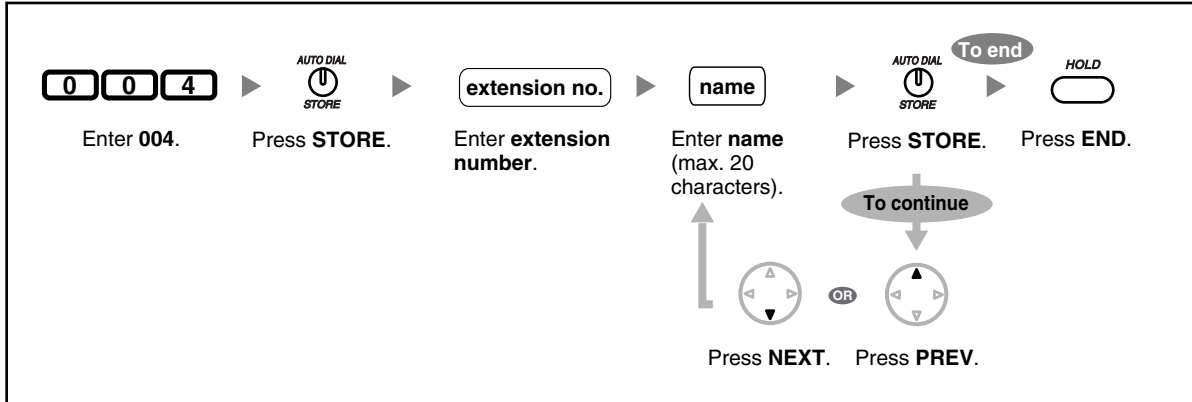

Section 4

Appendix













This chapter provides the Troubleshooting, the Feature Number Table and Tone List. Check the Troubleshooting section before consulting your dealer.



4.1 Troubleshooting

4.1.1 Troubleshooting

◆◆ Troubleshooting

Problem	Remedy
The telephone does not work properly.	<ul style="list-style-type: none"> ➡ Consult your dealer.
I cannot use the telephone.	<ul style="list-style-type: none"> • The telephone is locked. <ul style="list-style-type: none"> ➡ Unlock your telephone. (👉 1.5.3 Extension Dial Lock, 2.1.1 Extension Control)
Some features do not work.	<ul style="list-style-type: none"> • System management may restrict certain features. <ul style="list-style-type: none"> ➡ Consult your manager. • The feature numbers have changed. <ul style="list-style-type: none"> ➡ Confirm the revised number and try again.
Even though following the manual instructions, none of the operations work when using a proprietary telephone.	<ul style="list-style-type: none"> • The Intercom line was not seized. The seized line, when going off-hook, was changed by personal setting. (👉 3.1.2 Settings on the Programming Mode) <ul style="list-style-type: none"> ➡ In the manual, going off-hook means an Intercom line is seized. If the setting has been changed, press the INTERCOM button after going off-hook and follow the instructions.
The telephone does not work using the personal settings or with other settings. (One-touch dialing, forwarding destination, etc.)	<ul style="list-style-type: none"> • The extension line has been changed. The previous telephone's settings have not been cleared. <ul style="list-style-type: none"> ➡ Clear the settings and then program your desired settings again. (👉 1.7.9 Extension Feature Clear, 3.1.1 Personal Programming, 3.1.3 Customizing the Buttons)
My proprietary telephone does not have a feature button.	<ul style="list-style-type: none"> • Some models do not have the feature button. <ul style="list-style-type: none"> ➡ Change a flexible button to the desired button. (👉 3.1.3 Customizing the Buttons) ➡ Enter the specified feature number instead of the feature button. (👉 1.1.1 Before Operating the Telephones)

Problem	Remedy
A reorder tone is audible or "Restricted" is displayed.	<ul style="list-style-type: none"> • The telephone is locked. <ul style="list-style-type: none"> ➡ Unlock your telephone. ( 1.5.3 Extension Dial Lock, 2.1.1 Extension Control) • Toll restriction is activated. <ul style="list-style-type: none"> ➡ Consult your manager or dealer. • An account code is required. ( 1.2.6 Calling without Restrictions, Account Code Entry in 1.2.1 Basic Calling)
I cannot make an outside call using the One-touch Dialing button or speed dialing.	<ul style="list-style-type: none"> • A line access number was not stored. <ul style="list-style-type: none"> ➡ A line access number is required for outside calls. ( 1.2.1 Basic Calling, 3.1.3 Customizing the Buttons)
I cannot remember the feature numbers.	<ul style="list-style-type: none"> • ➡ Ask your dealer to change the feature numbers for easier use.
While talking to an outside party, the line is disconnected.	<ul style="list-style-type: none"> • The time limit has run out. ( 1.4.1 Call Transfer, 1.4.5 Multiple Party Conversation) <ul style="list-style-type: none"> ➡ Consult your dealer to extend the time, if necessary.
Redialing does not function.	<ul style="list-style-type: none"> • The stored number was more than 32 digits or an extension number. ( 1.2.3 Redial)
The personal computer and fax machine communication failed.	<ul style="list-style-type: none"> • An indication tone may have interrupted communication. ( 1.7.6 Data Line Security)
I cannot send a call waiting tone to the dialed extension.	<ul style="list-style-type: none"> • The other party has not set the Call Waiting feature. ( Call Waiting, 1.4.4 Call Waiting, 1.7.3 Call Waiting) • The other party has set Data Line Security. ( 1.7.6 Data Line Security)
I forgot the password.	<ul style="list-style-type: none"> • Ask the manager to assist you. ( 2.1.1 Extension Control)
The background music started suddenly.	<ul style="list-style-type: none"> • ➡ Turn off the music. ( 1.7.5 Background Music (BGM), 2.1.4 External Background Music (BGM))
I do not want to display a number which is stored in memory.	<ul style="list-style-type: none"> • ➡ Conceal the number. ( Storing Names and Numbers, 3.1.3 Customizing the Buttons)
I want to confirm my extension number.	<ul style="list-style-type: none"> • ( Your Extension Number in 1.1.1 Before Operating the Telephones)
The date and time are not correct.	<ul style="list-style-type: none"> • Set the date and time by system programming. ( Date & Time [000] in 3.3.2 System Programming)

Problem	Remedy
The display is not shown well.	<ul style="list-style-type: none"><li data-bbox="734 247 1349 317">•  Change the Display contrast level. ( 3.1.2 Settings on the Programming Mode)
The MESSAGE button light lit.	<ul style="list-style-type: none"><li data-bbox="734 338 1390 426">• Another extension left you a message waiting indication while you were on the phone or away from your desk.

4.2 Feature Number Table

4.2.1 Feature Number Table

Numbers listed below are the default settings. There are flexible feature numbers and fixed feature numbers. If you change the flexible feature numbers, fill in your assigned numbers (new) in the list for future reference.

Feature (While dial tone is heard)	Default (New)	Additional digits
1.2.1 Basic Calling		
Operator Call	0 ()	
Automatic Line Access	9 ()	outside phone no.
CO Line Group Access	8 ()	CO line group no. (2 digits) + outside phone no.
Account Code Entry	*49 ()	account code + # + outside phone no.
1.2.2 Easy Dialing		
Personal Speed Dialing		
– To store	*30 ()	personal speed dialing no. (2 digits) + outside phone no. + #
– To dial	** ()	* + personal speed dialing no. (2 digits)
System Speed Dialing		
– To dial	** ()	system speed dialing no. (3 digits)
Hot Line		
– To store	*740 ()	2 + phone no. + #
– To set		1
– To cancel		0
1.2.3 Redial		
Last Number Redial	# ()	

4.2 Feature Number Table

Feature (While dial tone is heard)	Default (New)	Additional digits
<p>1.2.4 When the Dialed Line is Busy or There is No Answer</p> <p>Automatic Callback Busy Cancel</p> <p>Message Waiting</p> <p>For a caller</p> <ul style="list-style-type: none"> - To leave/cancel <p>For a called extension</p> <ul style="list-style-type: none"> - To call back - To clear 	<p>✖46 ()</p> <p>✖70 ()</p>	<p>1/0 + extension no.</p> <p>2 0 + your extension no.</p>
<p>1.2.6 Calling without Restrictions</p> <p>Remote COS Access</p> <p>To call (Verified Code Entry)</p>	<p>✖47 ()</p>	<p>extension no. + extension PIN + phone no.</p> <p>✖ + verified code + verified code PIN + phone no.</p>
<p>1.2.7 Direct Inward System Access (DISA)</p> <p>Calling through DISA</p> <ul style="list-style-type: none"> - To an extension (In All Security Mode only) - To an outside party (In Trunk Security Mode/All Security Mode only) 		<p>your extension no./(✖ + verified code) + extension PIN/verified code PIN + extension no.</p> <p>your extension no./(✖ + verified code) + extension PIN/verified code PIN + outside phone no.</p>
<p>1.2.8 Remote Setting</p> <ul style="list-style-type: none"> - From another extension - Through DISA 		<p>your extension no. + extension PIN + feature no.</p>
<p>1.3.3 Call Pickup</p> <p>Call Pickup</p> <ul style="list-style-type: none"> - Group - Directed <p>Call Pickup Deny</p> <ul style="list-style-type: none"> - To deny - To allow 	<p>✖40 ()</p> <p>✖41 ()</p> <p>✖720 ()</p>	<p>group no. (2 digits)</p> <p>extension no.</p> <p>1 0</p>

Feature (While dial tone is heard)	Default (New)	Additional digits
1.3.4 Trunk Answer From Any Station (TAFAS) <ul style="list-style-type: none"> – Calls through an external speaker 	*42 ()	1
1.4.2 Call Hold <p>Call Hold/Call Hold Retrieve</p> <p>Call Hold Retrieve</p> <ul style="list-style-type: none"> – Specified with a held line number – Specified with a holding extension number <p>Call Park</p> <ul style="list-style-type: none"> – To set – To retrieve 	*50 () *53 () *51 () *52 ()	CO line no. which is held (3 digits) extension no. which has a held call parking zone no. (2 digits)/* stored parking zone no. (2 digits)
1.4.4 Call Waiting <p>Answering Call Waiting in the PBX</p> <p>Answering Call Waiting from the Telephone Company</p>	*50 () *60 ()	

4.2 Feature Number Table

Feature (While dial tone is heard)	Default (New)	Additional digits
1.5.1 Call Forwarding Call Forwarding (FWD)/ 1.7.2 Do Not Disturb (DND) <ul style="list-style-type: none"> – Both Calls – Outside Calls – Intercom Calls – To set the timer for "No Answer" and "Busy/No Answer" Call Forwarding (FWD) for your Incoming Call Distribution Group <ul style="list-style-type: none"> – Both Calls – Outside Calls – Intercom Calls 	*710 () *711 () *712 () *713 () *s714 () *715 () *716 ()	0 (Cancel)/ 1 (Do Not Disturb [DND])/ 2 (All calls) + phone no. + #/ 3 (Busy) + phone no. + #/ 4 (No Answer) + phone no. + #/ 5 (Busy/No Answer) + phone no. + #/ 7 (Follow Me) + your extension no./ 8 (Follow Me Cancel) + your extension no. 00-99 (second) 1 (Set) + ICD Group extension no. + phone no. + #/0 (Cancel) + ICD Group extension no.
1.5.2 Absent Message <ul style="list-style-type: none"> – To set – To cancel 	*750 ()	1-9 (+ parameter) + # 0
1.5.3 Extension Dial Lock <ul style="list-style-type: none"> – To lock – To unlock 	*77 ()	1 0 + extension PIN
1.6.1 Paging Group Paging	*33 ()	paging group no. (2 digits)

Feature (While dial tone is heard)	Default (New)	Additional digits
1.6.2 Answering/Denying a Paging Announcement <ul style="list-style-type: none"> – To answer – To deny – To allow 	<ul style="list-style-type: none"> ×43 () ×721 () 	<ul style="list-style-type: none"> 1 0
1.7.1 Timed Reminder <ul style="list-style-type: none"> – To set – To cancel 	<ul style="list-style-type: none"> ×760 () 	<ul style="list-style-type: none"> 12H: 1 + time (hour/minute) + 0 (AM)/1 (PM) + 0 (once)/1 (daily) 24H: 1 + time (hour/minute) + 0 (once)/1 (daily) 0
1.7.3 Call Waiting <ul style="list-style-type: none"> – For intercom calls (No tone/Tone) – For outside calls (No tone/Tone) 	<ul style="list-style-type: none"> ×731 () ×732 () 	<ul style="list-style-type: none"> 0 (No tone)/1 (Tone) 0 (No tone)/1 (Tone)
1.7.4 Executive Busy Override Deny <ul style="list-style-type: none"> – To prevent – To allow 	<ul style="list-style-type: none"> ×733 () 	<ul style="list-style-type: none"> 1 0
1.7.5 Background Music (BGM) <ul style="list-style-type: none"> – To set – To cancel 	<ul style="list-style-type: none"> ×751 () 	<ul style="list-style-type: none"> 1 0
1.7.6 Data Line Security <ul style="list-style-type: none"> – To set – To cancel 	<ul style="list-style-type: none"> ×730 () 	<ul style="list-style-type: none"> 1 0
1.7.8 Wireless XDP Parallel Mode <ul style="list-style-type: none"> – To set – To cancel 	<ul style="list-style-type: none"> ×48 () 	<ul style="list-style-type: none"> 1 + paired wired extension no. 0
1.7.9 Extension Feature Clear	<ul style="list-style-type: none"> ×790 () 	
1.8.1 Log-in/Log-out, Wrap-up Log-in Log-out To enter/leave the Not Ready mode	<ul style="list-style-type: none"> ×736 () ×735 () 	<ul style="list-style-type: none"> 1 + ICD Group extension no./× 0 + ICD Group extension no./× 1 (Not Ready)/0 (Ready)

4.2 Feature Number Table

Feature (While dial tone is heard)	Default (New)	Additional digits
1.9.1 Doorphone/Door Opener Doorphone Call Door Open	×31 () ×55 ()	doorphone no. (2 digits) doorphone no. (2 digits)
1.9.2 External Relay	×56 ()	relay no. (2 digits)
1.9.4 Host PBX External Feature Access (EFA)	×60 ()	service code
1.9.5 Voice Processing System Call Forwarding to Voice Mail (Voice Mail Integration) – Both Calls – Outside Calls – Intercom Calls	×710 () ×711 () ×712 ()	0 (Cancel)/ 2 (All Calls)/ 3 (Busy)/ 4 (No Answer)/ 5 (Busy/No Answer) + voice mail floating extension no.*4 + #
1.10.1 Walking Extension	×727 ()	your previous extension no. + extension PIN
2.1.1 Extension Control *1 Remote Extension Dial Lock – To unlock – To lock	×782 () ×783 ()	extension no. extension no.
*2 2.1.2 Time Service Mode Control – Day/Night/Lunch/Break	×780 ()	0/1/2/3
*1 2.1.4 External Background Music (BGM) – To start – To stop	×35 ()	11 10

Feature (While dial tone is heard)	Default (New)	Additional digits
*1 2.1.5 Outgoing Messages (OGM) <ul style="list-style-type: none"> – To record – To play back – To record from an external BGM (MOH) port – To clear 	*36 ()	1 + OGM floating extension no.*5 2 + OGM floating extension no.*5 31 + OGM floating extension no.*5 0 + OGM floating extension no.*5
2.1.6 Hospitality Features <ul style="list-style-type: none"> *3 Setting a Timed Reminder to a Room Extension (Remote Wake-up Call) <ul style="list-style-type: none"> – To set – To cancel – To confirm Recording room information using a room extension 	*76* ()	12H: 1 + extension no. + hour/minute + 0 (AM)/ 1 (PM) + 0 (once)/1 (daily) 24H: 1 + extension no. + hour/minute + 0 (once)/1 (daily) 0 + extension no. 2 + extension no. message no. (+ parameter) + #
3.1.1 Personal Programming <ul style="list-style-type: none"> Extension PIN (Personal Identification Number) <ul style="list-style-type: none"> – To set – To cancel 	*799 ()	1 + extension PIN + # + same extension PIN + # 0 + stored extension PIN

*1 : Manager only

*2 : Manager and preprogrammed extension user only

*3 : Hotel operator only

*4 : The default voice mail floating extension number is 500.

*5 : The default of OGM floating extension numbers is 5xx (xx: two-digit number of message).

4.2 Feature Number Table

Feature (While busy, DND or call tone is heard)	Default
1.2.4 When the Dialed Line is Busy or There is No Answer	
Call Waiting	1
DND Override	
Executive Busy Override	3
Message Waiting	4
Call Monitor	5
Automatic Callback Busy	6
1.2.5 Alternate Calling—Ring/Voice	*

Feature (While dialing or talking)	Fixed Number
1.4.5 Multiple Party Conversation	
Conference	3
1.9.1 Doorphone/Door Opener	
From any extension while talking to the doorphone	5

4.3 Tone

4.3.1 Tone

While on-hook

Ring Tones

The following tones are programmable allowing recognition of call type (Outside, Intercom or Doorphone).

Tone 1



Tone 2



Tone 3



Tone 4

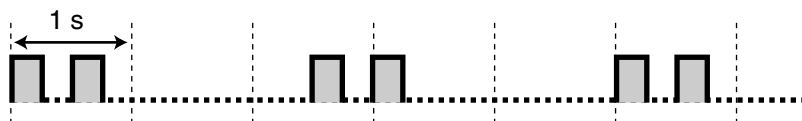

When going off-hook

Dial Tones

Tone 1

Normal



Tone 2

Any one of the following features is set:

- Absent Message
- Background Music
- Call Forwarding
- Call Pickup Deny
- Call Waiting
- Do Not Disturb
- Extension Dial Lock
- Executive Busy Override Deny
- Hot Line
- Timed Reminder

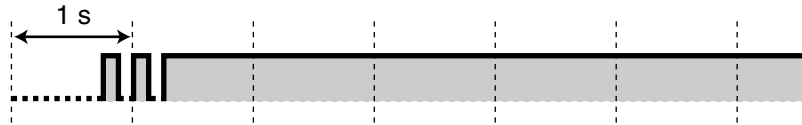

Tone 3

- After pressing TRANSFER or Recall/hookswitch to hold a call temporarily (e.g., Call Splitting)
- While a called PS is being searched
- When Account Code Entry is performed
- When answering a Timed Reminder call with no message
- When answering an external sensor call



Tone 4

Message waiting indication was received.

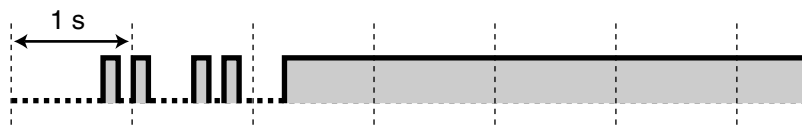

When you make calls

Busy Tone

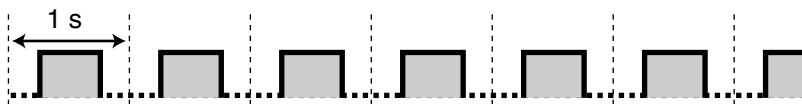

Reorder Tone

The CO line you tried to seize is not assigned or denied.

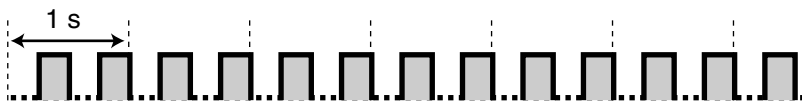

Ringback Tone 1



Ringback Tone 2**Do Not Disturb (DND) Tone**

The dialed extension is refusing incoming calls.

**While off-hook****Indication Tones****Tone 1**

Call waiting tone

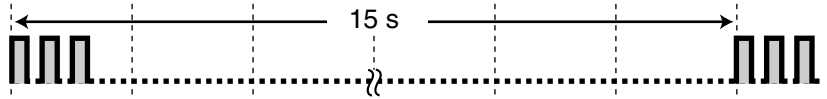
**Tone 2**

A call is on hold longer than the specified time.

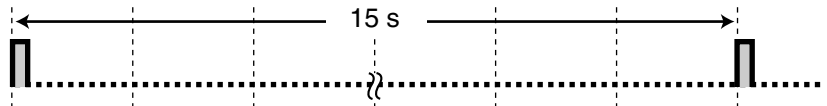
**When talking to an outside party****Warning Tone**

This tone is sent 15, 10 and 5 seconds before the specified time for disconnection.

**When setting the features or programming****Confirmation Tones****Tone 1**

The feature setting was set successfully.

**Tone 2**

Before receiving a page through an external speaker

**Tone 3**

Before the following features activate:

- Retrieving a held call
- Picking up another call
- Paging/Answering a paging announcement
- Answering the call through a speaker

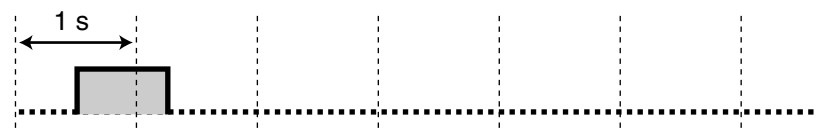

4.3 Tone

Tone 4

Establishing or leaving a conference

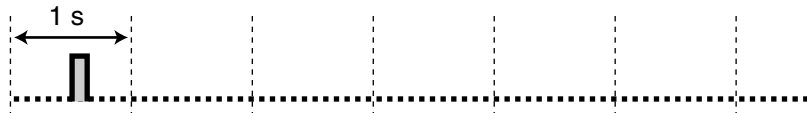

Tone 5



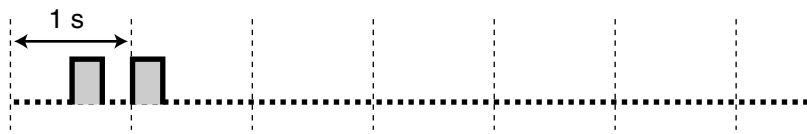















A call has been put on hold.













4.4 Quick Reference Guide

4.4.1 Quick Reference Guide

Please make a photocopy of the following cards and distribute them to proprietary telephone or single line telephone users.

Quick Reference Guide for Proprietary Telephone	Quick Reference Guide for Proprietary Telephone
To make calls	To make calls
Intercom: Extn. no.	Intercom: Extn. no.
Operator: 0 *	Operator: 0 *
Outside party:  (CO) + Phone no.	Outside party:  (CO) + Phone no.
Personal speed dialing:  + * + Personal speed dialing no.	Personal speed dialing:  + * + Personal speed dialing no.
System speed dialing:  + System speed dialing no.	System speed dialing:  + System speed dialing no.
Redial: 	Redial: 
When a line is busy	When a line is busy
Reserving a busy line: 6 *	Reserving a busy line: 6 *
Sending a call waiting tone: 1 *	Sending a call waiting tone: 1 *
To pick up someone's call	To pick up someone's call
Specified extension: * 41 * + Extn. no.	Specified extension: * 41 * + Extn. no.
Group: * 40 * + Group no.	Group: * 40 * + Group no.
During a conversation	During a conversation
Holding:  + 	Holding:  + 
Retrieving:  + the corresponding button	Retrieving:  + the corresponding button
Transferring:  + Phone no.	Transferring:  + Phone no.
Answering a call waiting:  + the corresponding button	Answering a call waiting:  + the corresponding button
* You can change the flexible numbers to other numbers for easier use. If you want to change the numbers, consult your dealer.	* You can change the flexible numbers to other numbers for easier use. If you want to change the numbers, consult your dealer.
Frequently used features at your extension	Frequently used features at your extension

Quick Reference Guide for Single Line Telephone	Quick Reference Guide for Single Line Telephone
To make calls	To make calls
Intercom: Extn. no.	Intercom: Extn. no.
Operator: 0 *	Operator: 0 *
Outside party: 9 * + Phone no.	Outside party: 9 * + Phone no.
Personal speed dialing: * * * + * + Personal speed dialing no.	Personal speed dialing: * * * + * + Personal speed dialing no.
System speed dialing: * * * + System speed dialing no.	System speed dialing: * * * + System speed dialing no.
Redial: # *	Redial: # *
When a line is busy	When a line is busy
Reserving a busy line: 6 *	Reserving a busy line: 6 *
Sending a call waiting tone: 1 *	Sending a call waiting tone: 1 *
To pick up someone's call	To pick up someone's call
Specified extension: * 41 * + Extn. no.	Specified extension: * 41 * + Extn. no.
Group: * 40 * + Group no.	Group: * 40 * + Group no.
During a conversation	During a conversation
Holding:  + * 50 * + 	Holding:  + * 50 * + 
Retrieving:  + * 50 *	Retrieving:  + * 50 *
Transferring:  + Phone no.	Transferring:  + Phone no.
Answering a call waiting:  + * 50 *	Answering a call waiting:  + * 50 *
* You can change the flexible numbers to other numbers for easier use. If you want to change the numbers, consult your dealer.	* You can change the flexible numbers to other numbers for easier use. If you want to change the numbers, consult your dealer.
Frequently used features at your extension	Frequently used features at your extension

4.5 Revision History

4.5.1 MPR Version 1.1

Changed Contents

- 1.3.3 Call Pickup
Call Pickup
- 1.4.4 Call Waiting
Answering Call Waiting from the Telephone Company

4.5.2 MPR Version 2.0

New Contents

- 1.9.2 External Relay
- 1.9.3 External Sensor
- 2.1.6 Hospitality Features

Index

- A**
- Absence Settings 65
 - Absent Message 68, 114, 140
 - Account 17, 121
 - Account Code Entry 23, 137
 - Alternate Calling—Ring/Voice 33, 144
 - Alternate Receiving—Ring/Voice 113
 - Answer 17, 42, 121
 - Answer/Release Button 42
 - Answering Call Waiting from the Telephone Company 55
 - Answering Call Waiting in the PBX 52
 - Answering Calls 40
 - Answering/Denying a Paging Announcement 73
 - Appendix 133
 - AUTO ANS (Auto Answer)/MUTE 15
 - AUTO DIAL/STORE 15
 - Automatic Call Hold 49
 - Automatic Callback Busy 27, 144
 - Automatic Callback Busy Cancel 28, 138
 - Automatic Line Access 21, 137
- B**
- Background Music (BGM) 78, 115, 141
 - Basic Calling 20
 - Before Operating the Telephones 12
 - Boss & Secretary feature 65
 - Busy Station Signaling (BSS) → Call Waiting 29
 - Busy Tone 146
- C**
- Call Center 82
 - Call Forwarding 65
 - Call Forwarding (FWD) 15, 65
 - Call Forwarding (FWD)/Do Not Disturb (DND)—Both calls 16, 120
 - Call Forwarding [FWD] for your Incoming Call Distribution Group 67
 - Call Forwarding to Voice Mail (Voice Mail Integration) 88
 - Call Hold 47, 139
 - Call Hold Retrieve 48, 139
 - Call Log 17, 121
 - Call Log for ICD Group 17, 121
 - Call Monitor 33, 144
 - Call Park 17, 49, 121, 139
 - Call Park (Automatic Park Zone) 17, 49, 121, 139
 - Call Park Retrieve 50
 - Call Pickup 41
 - Call Pickup Deny 42, 138
 - Call Splitting 51
 - Call Transfer 45
 - Call Waiting 29, 52, 77, 141, 144
 - Call Waiting from the Telephone Company 139
 - Call Waiting in the PBX 139
 - Call Waiting Tone Type Selection 114
 - Calling an Outside Party 21
 - Calling Another Extension 20
 - Calling through DISA 35
 - Calling without Restrictions 34
 - Changing the Settings and Extension Control 124
 - Changing the Settings of Other Extensions 102
 - Clearing Features 118
- CO** 15
- CO Line Group Access 22, 137
 - Conference 15, 17, 56, 121
 - Confirmation Tones 147
 - Connection Example 19
 - Control Features 102
 - Customized Buttons 16
 - Customizing the Buttons 120
 - Customizing Your Phone & System 109
- D**
- Data Line Security 78, 141
 - Date & Time [000] 129
 - Dial Tone Transfer 104
 - Dial Tones 145
 - Direct Inward System Access (DISA) 35
 - Direct Station Selection (DSS) 16, 120
 - Directories 97
 - Display 13
 - Display Language Selection 112
 - Display Lock 116
 - Display Proprietary Telephone 95
 - Display Switching Mode 112
 - DND Override 33, 144
 - Do Not Disturb (DND) 15, 75
 - Do Not Disturb (DND) Tone 147
 - Door Open 86, 142
 - Doorphone Call 85, 142
 - Doorphone/Door Opener 85
 - During a Conversation 45
- E**
- Easy Dialing 23
 - Electronic Station Lockout → Extension Dial Lock 70, 116, 140
 - Entering Characters 99
 - Examples 13
 - Exclusive Call Hold 47
 - Executive Busy Override 31, 144
 - Executive Busy Override Deny 77, 115, 141
 - Extension Control 102
 - Extension Dial Lock 70, 116, 140
 - Extension Feature Clear 80, 141
 - Extension Name [004] 132
 - Extension Number [003] 131
 - Extension PIN (Personal Identification Number) 110, 116, 143
 - Extension Settings 74
 - External Background Music (BGM) 104, 142
 - External Feature Access (EFA) 17, 87, 121, 142
 - External Relay 86
 - External Sensor 87
- F**
- Feature Highlights 2
 - Feature Number Table 137
 - Feature Numbers 12
 - Fixed Buttons 15
 - FLASH/RECALL 15
 - For Future Reference 8
 - Forced Answerback Selection 113

FWD N/A Timer 115
 FWD/DND Cycle Switch Mode 68, 76
 FWD/DND Setting Mode 68, 76
 FWD/DND—Intercom calls 16, 120
 FWD/DND—Outside calls 16, 120

G

Group Directory Number (G-DN) 16, 120
 Group FWD—Both calls 16, 121
 Group FWD—Intercom calls 17, 121
 Group FWD—Outside calls 17, 121
 Group Paging 72, 140
 Group-CO (G-CO) 16, 120

H

Handset/Headset Selection → Headset Operation 63
 Hands-free Answerback 41
 Hands-free Operation 40
 Headset 63
 Headset Operation 63
 HOLD 15
 Hospitality Features 106
 Host PBX 87
 Hot Line 25, 137
 How to Follow the Steps 18
 Hurry-up 17, 121
 Hurry-up Transfer → Manual Queue Redirection 84

I

Icon Descriptions 14, 127
 Incoming Call Log 95
 Indication Tones 147
 INTERCOM 15
 Intercom Call 20

K

Key Pad Tone Set 115

L

Last Number Redial 27, 137
 LCS Mode Set (After Answering) 114
 Leaving Three-party Conference 60
 Live Call Screening (LCS) 17, 90, 122
 Live Call Screening Mode Set 114
 Log-in/Log-out 17, 82, 121, 141
 Log-in/Log-out for all groups 17, 121
 Log-in/Log-out of a specified group 17, 121
 Log-in/Log-out, Wrap-up 82
 Loop-CO (L-CO) 16, 120

M

Making Calls 20
 Manager Operation 101
 Manager Password 124
 Manager Programming 124
 Manual Queue Redirection 84
 Message 15, 16, 120
 Message for another extension 16, 120

Message Waiting 29, 138, 144
 MONITOR 15
 MPR Version 1.1 151
 MPR Version 2.0 151
 Multiple Party Conversation 56
 Mute 63

N

Navigator Key 16

O

One-touch Dialing 16, 24, 120
 One-touch Dialing Assignment Mode Selection 116
 One-touch Transfer 46
 One-touch Two-way Transfer 17, 92, 122
 Operation 11
 Operator Call 21, 137
 Outgoing Messages (OGM) 105, 143

P

Paging 72
 Paging and then Transferring a Call 72
 Paging Deny 73, 115
 PAUSE 15
 Personal Absent Message 114
 Personal Programming 110
 Personal Speed Dialing 24, 137
 Pickup Dialing → Hot Line 25, 137
 Portable Station (PS) Registration 12
 Predialing 22
 Preferred Line Assignment—Incoming 113
 Preferred Line Assignment—Outgoing 113
 Privacy Release 62
 PROGRAM 16
 Programmable Feature (PF) 16
 Programming Information 124, 126

Q

Quick Dialing 26
 Quick Reference Guide 149

R

Receiving Calls 40
 Recording room information using a room extension 108
 Redial 15, 27
 Release 17, 42, 121
 Remote COS Access 34, 138
 Remote Extension Dial Lock 102, 142
 Remote Setting 38, 138
 Remote Station Lock Control → Remote Extension Dial Lock 102, 142
 Reorder Tone 146
 Required Telephone 124, 126
 Restrictions 13
 Revision History 151
 Ring Tones 145

S

Setting a Timed Reminder to a Room Extension (Remote Wake-up Call)

Index

107
Setting Features 112
Settings on the Programming Mode 111
Single-CO (S-CO) 16, 120
SP-PHONE 15
Station Program Clear → Extension Feature Clear 80, 141
Station Speed Dialing → Personal Speed Dialing 24, 137
Storing Names and Numbers 98
System Alarm 17, 121
System Password 126
System Programming 126, 129
System Speed Dialing 25, 137
System Speed Dialing Name [002] 131
System Speed Dialing Number [001] 130

T

Terminate 17, 121
Time Service 79
Time Service (Day/Night/Lunch/Break) 17, 79, 102, 121, 142
Time Service Mode Control 102
Time Service Switching Mode (Automatic/Manual) 17, 103, 122
Timed Reminder 74, 141
Toll Restriction 17, 122
Tone 13, 145
TRANSFER 15
Transferring to an Extension on the PBX 45
Transferring to an Outside Party Using the PBX Service 46
Troubleshooting 134
Trunk Answer From Any Station (TAFAS) 42, 139
Two-way Record 17, 92, 122
Two-way Transfer 17, 92, 122

U

Unattended Conference 59
User-supplied Equipment 85

V

Verified Code Entry 35, 138
VOICE CALL 16
Voice Mail Integration 88, 142
Voice Mail Transfer 17, 88, 122
Voice Processing System 88
Volume Key 16

W

Walking COS 34
Walking Extension 94, 142
Walking Station → Walking Extension 94, 142
Warning Tone 147
What Kind of Telephone Can Be Used? 12
When the Dialed Line is Busy or There is No Answer 27
When You Use a Panasonic Proprietary Telephone 15
Wireless XDP Parallel Mode 79, 141
Wrap-up 17, 82, 121

Y

Your Extension Number 13

**Panasonic Consumer Electronics Company
Division of Panasonic Corporation of North America**

One Panasonic Way
Secaucus, NJ 07094

Panasonic Puerto Rico, Inc.

Ave. 65 de Infantería, Km. 9.5
San Gabriel Industrial Park
Carolina, Puerto Rico 00985

<http://www.panasonic.com/csd>

Copyright:

This material is copyrighted by Panasonic Communications Co., Ltd., and may be reproduced for internal use only. All other reproduction, in whole or in part, is prohibited without the written consent of Panasonic Communications Co., Ltd.

© 2003 Panasonic Communications Co., Ltd. All Rights Reserved.