

# Panasonic

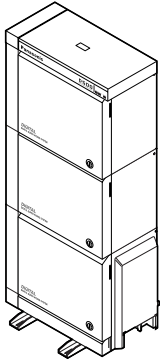

## Digital Super Hybrid System User Manual

---

Model No. **KX-TD500**



Please read this manual before connecting the Digital Super Hybrid System and save this manual for future reference.

---

Thank you for purchasing the Panasonic Model KX-TD500, Digital Super Hybrid System.

---

# *System Components*

	<b>Model No.</b>	<b>Description</b>
<b>Service Unit</b>	KX-TD500	Digital Super Hybrid System
<b>Telephone</b>	KX-T7220	Digital Proprietary Telephone
	KX-T7230	Digital Proprietary Telephone with Display
	KX-T7235	Digital Proprietary Telephone with Large Display
	KX-T7250	Digital Proprietary Telephone
	KX-T7420	Digital Proprietary Telephone
	KX-T7425	Digital Proprietary Telephone
	KX-T7431	Digital Proprietary Telephone with Display
	KX-T7433	Digital Proprietary Telephone with Display
	KX-T7436	Digital Proprietary Telephone with Large Display
<b>Optional Equipment</b>	KX-T7240	DSS Console
	KX-T7440	DSS Console
	KX-T7441	DSS Console with Answer and Release buttons
<b>User-supplied Equipment</b>	Single Line Telephones	

# Cautions

**When using the KX-T7200 and KX-T7400 series, keep the following conditions in mind:**

- If there is any trouble, unplug the extension line and connect a known working phone. If the known working phone operates properly, have the defective phone repaired by a specified Panasonic Factory Service Center. If the known working phone does not operate properly, check the Digital Super Hybrid System and the internal extension wiring.
- Keep the unit away from heating appliances and electrical noise generating devices such as fluorescent lamps and motors.
- The unit should be kept free of dust, moisture and vibration, and should not be exposed to direct sunlight.
- Do not use benzine, thinner, or any abrasive powder to clean the cabinet. Wipe it with a soft cloth.
- Do not use any handset other than a Panasonic handset.

**When you ship the product**

Carefully pack and send it prepaid, adequately insured and preferably in the original carton. Attach a postage-paid letter, detailing the symptom, to the outside of the carton. **DO NOT** send the product to the Executive or Regional Sales offices. They are **NOT** equipped to make repairs.

**Product service**

Panasonic Factory Servicenters for this product are listed in the servicenter directory. Consult with your authorized Panasonic dealer for detailed instructions.

The serial number of this product may be found on the label affixed to the bottom of the unit. You should note the model number and the serial number of this unit in the space provided and retain this book as a permanent record of your purchase to aid in identification in the event of theft.

MODEL No.: \_\_\_\_\_

SERIAL No.: \_\_\_\_\_

---

---

**For your future reference**

DATE OF PURCHASE \_\_\_\_\_

NAME OF DEALER \_\_\_\_\_

DEALER'S ADDRESS \_\_\_\_\_

\_\_\_\_\_

\_\_\_\_\_

\_\_\_\_\_

DEALER'S TELEPHONE NO. \_\_\_\_\_

**WARNING**

**TO PREVENT FIRE OR SHOCK HAZARD, DO NOT EXPOSE THIS PRODUCT TO RAIN OR ANY TYPE OF MOISTURE.**

**Note**

If you connect the Panasonic Wireless System (model KX-TD336900) to the Digital Super Hybrid System, the following features do not work with the Wireless System:

- a) Call Forwarding — Follow Me
- b) Limited Call Duration (Please refer to Programming Guide)

---

**Accessory Order Information**

- Replacement parts and accessories are available through your local authorized parts distributor.
- For ordering accessories, call toll free: 1-800-332-5368.

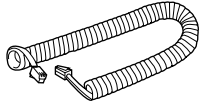
<b>Part No.</b>	<b>Picture</b>	<b>Description</b>	<b>Comment</b>
KX-J07W/B		Handset cord	213.36 cm (7 feet)
KX-J15W/B			457.2 cm (15 feet)
KX-J25W/B			762 cm (25 feet)

W: White, B: Black

---

---

# Introduction

## Who Should Use This Manual

This manual is designed for users of Digital Super Hybrid System KX- TD500. It is to be used after the system is installed and System Programming is completed. The focus is Digital Proprietary Telephones (DPTs); KX-T7220/KX-T7230/KX-T7235/KX-T7250/KX-T7420/KX-T7425/KX-T7431/KX-T7433/KX-T7436, Digital DSS Consoles; KX-T7240/KX-T7440/KX-T7441, Single Line Telephones (SLTs) and their features. The step-by-step procedures required to activate each feature are discussed in detail. Illustrations of the KX-TD500 system and the required System Programming are provided under separate cover in the Installation Manual and the Programming Guide.

## Construction of This Manual

This manual consists of the following sections:

### (Section 1) DPT Overview

Provides configuration information on DPTs. It provides an illustration of each telephone, identifies their feature buttons, supplies background information on these feature buttons, and provides initial settings.

### (Section 2) Station Programming

Provides the steps required to assign features to DPT flexible buttons and to the DPT system.

### (Section 3) User Programming

Provides the steps required to assign some features to the system using a PT.

### (Section 4) Station Features and Operation (PT/SLT)

Provides background information on the PT features and lists the steps required to activate each feature.

### (Section 5) DSS Console Features

Provides configuration information on the DSS Console. It gives background information on the DSS Console features and lists the steps required to activate each feature.

### (Section 6) Appendix

Provides Display Examples, a Feature Number List, Tone List, and other information are explained in this section.

## Features and Capabilities

The KX-TD500 System is a sophisticated and powerful system that satisfy just what you expect of an office communication's system. Some of the remarkable features are listed below. "\*" are only available for the KX-7235 and KX-T7436.

- **Automatic Callback Busy (Camp-On)** informs you when the selected CO line or the called party becomes idle.
- **Call Log, Incoming (— Option)** allows you to confirm the incoming CO call information on the display. You can also call back the caller by selecting one of the memorized numbers. This feature is available only for the KX-T7230, KX-T7235, KX-T7433 and KX-T7436.

- **Call Log, Outgoing\*** redials by selecting one of the last five CO calls you made, according to the number information on the display.
- **Conference, Unattended** When you are in a conference with two outside parties, you can leave the conference and allow the other two parties to continue the conversation. You can also return to the conference.
- **Data Line Security** prohibits various tones, such as call waiting tone or hold recall tone, from sounding at the extension in the data communication mode. It also blocks overriding by other extensions, such as Executive Busy Override.
- **Doorphone and Door Opener (— Option)** enables the conversation between you and a visitor at door. You can also unlock the door a few seconds from your phone.
- **Executive Busy Override** allows you to enter into an existing conversation at an extension/CO line.
- **Full One-Touch Dialing** allows you to have easy access to a desired party or system feature by pressing just one button.
- **Message Waiting** allows you to leave a message notification for another extension. The message waiting lamp (MESSAGE indicator) gives a visual indication that a message notification has been received.
- **Paralleled Telephone Connection** allows you to connect your DPT in parallel with an SLT. Each telephone can have the same extension number so that you can use either telephone. If the eXtra Device Port (XDP) feature is available through System Programming, each telephone can be connected to the same extension port but have different extension numbers so that they can act as completely different extensions.
- **System Feature Access Menu\*** allows you to access various features easily by following the display on the large LCD and pressing corresponding buttons.
- **VPS Integration (— Option)** enables forwarding any incoming call to Voice Mail. Recording or Playing back the message(s) is also available. To use Voice Mail services, installing a Voice Processing System (VPS) is required.

## Terms used in the Descriptions

### Feature Numbers

A feature number is an access code for various functions when programming or executing features using proprietary or single line telephones connected to the system. You can access available features by dialing the corresponding feature number (and additional number, if required).

There are two types of feature numbers as follows:

- Flexible feature number
- Fixed feature number

While fixed feature numbers cannot be changed, flexible feature numbers can be changed. Please refer to the Programming Guide for details. In this manual, the default numbers are used to describe each operation and illustration. Use the new programmed number if you have changed a flexible feature number. The lists of fixed numbers and default flexible feature numbers are shown in Section "6 Appendix."

### If you use a dial pulse (DP) type Single Line Telephone (SLT);

It is not possible to access features that have "\*" or "#" in their feature numbers.



**Illustration**

All illustrations of DPTs used in the operating instructions are KX-T7235's.

**Tones**

Various tone types, such as Confirmation tone, Dial tone, Call Waiting tone, etc., are explained in Section "6 Appendix."

**Display**

The display examples are in each operation step, if required. The display information list is in Section "6 Appendix" for your convenience.

**Installation Manual References**

The required installation instruction titles described in the *Installation Manual* are noted for your reference.

**Programming Guide References**

The related and required programming titles described in the *Programming Guide* are noted for your reference.

**System Programming** should be done with PC.

**Features Guide References**

The related feature titles described in the *Features Guide* are noted for your reference.

**User Manual References**

The operation(s) required to implement the feature described in this *User Manual* is (are) noted for your reference.

**Note**

- Throughout this manual the term "he" or "she," "his" or "her" may be used. In order to improve readability rather than continually use he / she we have only used one of these terms. The term "he" or "she" should be taken as being interchangeable.

**About the Other Manuals**

Along with this User Manual, the following manuals are available:

**Features Guide**

Describes every basic, optional and programmable features of the KX-TD500 System in alphabetical order.

**Installation Manual**

Provides instructions for installing the hardware and system maintenance.

**Programming Guide**

Describes step-by-step instruction for performing System Programming using the Maintenance Console software for a PC.

# *Telephone Company and F.C.C. Requirements and Responsibilities*

## **Telephone Company and F.C.C. Requirements and Responsibility**

### **1. Notification to the Telephone Company**

Customers, before connecting terminal equipment to the telephone network, shall upon request of the Telephone Company, inform the Telephone Company of the particular line(s) to which such connection is made, the F.C.C. registration number (see the label on the bottom of the unit) and ringer equivalence number (REN) of the registered terminal equipment.

The REN is useful in determining the quantity of devices you may connect to your telephone line and still have all of those devices ring when your telephone number is called. In most, but not all areas, the sum of the REN's of all devices connected to one line should not exceed five (5.0). To be certain of the number of devices you may connect to your line, as determined by the REN, you should contact your local telephone company to determine the maximum REN for your calling area.

### **2. Connection to Telephone Line**

This unit must not be connected to a coin operated line. If you are on a party line, check with your local telephone company.

### **3. Incidence of Harm to the Telephone Lines**

Should terminal equipment cause harm to the telephone network, the telephone company shall, where practical, notify the customer that temporary discontinuance of service may be required. However, where prior notice is not practical, the telephone company may temporarily discontinue service forthwith, if such action is reasonable in the circumstances. In case of such unnotified temporary discontinuance of service, the telephone company shall:

- 1) Promptly notify the customer of such temporary discontinuance of service.
- 2) Afford the customer the opportunity to correct the situation which gave rise to the temporary discontinuance.
- 3) Inform the customer of the right to bring a complaint to the Federal Communication Commission pursuant to the procedures set out in Subpart E of Part 68 of FCC Telephone Equipment Rules.

### **4. Compatibility of the Telephone Network and Terminal Equipment**

#### **a) Availability of telephone interface information.**

Technical information concerning interface parameters and specifications not specified in FCC Rules, including the number of Ringers which may be connected to a particular telephone line, which is needed to permit Terminal Equipment to operate in a manner compatible with Telephone Company communications facilities, shall be provided by the Telephone Company upon customer's request.

#### **b) Changes in Telephone Company Communications Facilities, Equipment, Operations and Procedures.**

The Telephone Company may make changes in its communications facilities, equipment, operations or procedures, where such action is reasonably required in the

operation of its business and is not inconsistent with the rules and regulations in FCC Part 68.

If such changes can be reasonably expected to render any customer Terminal Equipment incompatible with Telephone Company Communications Facilities, or require modification or alteration of such Terminal Equipment, or otherwise materially affect its use or performance, the customer shall be given adequate notice in writing, to allow the customer an opportunity to maintain uninterrupted service.

### **Notify the Telephone Company**

Installation must be performed by a qualified professional installer. Before connecting this equipment to any telephone, call the telephone company and inform them of the following:

- Telephone numbers to which the system will be connected
- Make: Panasonic
- Model: KX-TD500 and KX-TD520
- FCC Registration No.: found on the rear side of the unit
- Ringer Equivalence No.: 0.4B
- Facility Interface Code: 02LS2,02GS2, 02RV2-T, OL13C, 04DU9-BN/1KN/1SN
- Service Order Code: 9.0F, AS.2, 6.0P
- Required Network Interface Jack: RJ21X, RJ11, RJ48C

### **Note**

Allowing this equipment to be operated in such a manner as to not provide for proper answer supervision is a violation of Part 68 of the FCC's rules.

and:

Proper answer supervision is when:

- A.** This equipment returns answer supervision to the PSTN when DID calls are:
  - Answered by the called station
  - Answered by the attendant
  - Routed to a recorded announcement that can be administered by the CPE user.
  - Routed to a dial prompt
- B.** This equipment returns answer supervision on all DID calls forwarded to the PSTN. Permissible exceptions are:
  - A call is unanswered
  - A busy tone is received
  - A reorder tone is received

### **Note**

This equipment has been tested and found to comply with the limits for a Class A digital device, pursuant to Part 15 of the FCC Rules. These limits are designed to provide reasonable protection against harmful interference when the equipment is operated in a commercial environment. This equipment generates, uses, and can radiate radio frequency energy and, if not installed and used in accordance with the instructions manual, may cause harmful interference to radio communications. Operation of this equipment in a residential area is likely

to cause harmful interference in which case the user will be required to correct the interference at his own expense.

**Caution:**

Any changes or modifications not expressly approved by the party responsible for compliance could void the users authority to operate this device.

---

# Table of Contents

<b>1</b>	<b>DPT Overview</b>	
<b>1.1</b>	<b>Configuration</b>	<b>20</b>
1.1.1	Configuration	20
1.1.2	Location of Controls	21
1.1.3	Connection	30
1.1.4	Feature Buttons	31
1.1.5	Initial Setting for KX-T7400 Series	39
1.1.6	Initial Setting for KX-T7200 Series	43
1.1.7	LED Indication	46
<b>2</b>	<b>Station Programming</b>	
<b>2.1</b>	<b>Station Programming Instructions</b>	<b>50</b>
2.1.1	Station Programming Instructions	50
<b>2.2</b>	<b>Station Programming</b>	<b>56</b>
2.2.1	Bilingual Display Selection	56
2.2.2	Call Waiting Tone Type Assignment	57
2.2.3	Flexible Button Assignment	58
2.2.4	Full One-Touch Dialing Assignment	82
2.2.5	Handset / Headset Selection	83
2.2.6	Initial Display Selection	84
2.2.7	Intercom Alert Assignment	85
2.2.8	Live Call Screening (LCS) Mode Set	86
2.2.9	PDN/SDN Button Delayed Ringing Assignment	87
2.2.10	Phantom Button Ringing On/Off Assignment	88
2.2.11	Preferred Line Assignment — Incoming	89
2.2.12	Preferred Line Assignment — Outgoing	92
2.2.13	Ringling Tone Selection for CO Buttons	95
2.2.14	Ringling Tone Selection for INTERCOM Button	96
2.2.15	Self-Extension Number Confirmation	97
2.2.16	Station Programming Data Default Set	98
2.2.17	Station Speed Dialing Number/Name Assignment [KX-T7235/KX-T7431/KX-T7433/KX-T7436 only]	99
<b>3</b>	<b>User Programming</b>	
<b>3.1</b>	<b>User Programming Instructions</b>	<b>108</b>
3.1.1	General Programming Instructions	108
3.1.2	Programming Methods	112
<b>3.2</b>	<b>User Programming</b>	<b>114</b>
3.2.1	[000] Date and Time Set	114
3.2.2	[001] System Speed Dialing Number Set	117
3.2.3	[002] System Speed Dialing Name Set	120
3.2.4	[004] Extension Name Set	123
3.2.5	[005] Flexible CO Button Assignment	126
3.2.6	[006] Caller ID Dial Set	131
3.2.7	[007] Caller ID Name Set	134
3.2.8	[008] Absent Messages Set	137

3.2.9	[009] Quick Dial Number Set.....	140
3.2.10	[010] DISA / TIE User Code Set.....	143
<b>4 Station Features and Operation (PT/SLT)</b>		
<b>4.1</b>	<b>Before Operating .....</b>	<b>148</b>
4.1.1	Before Operating .....	148
<b>4.2</b>	<b>Basic Operations.....</b>	<b>151</b>
4.2.1	Making Calls .....	151
4.2.2	Receiving Calls.....	154
<b>4.3</b>	<b>Station Features and Operation .....</b>	<b>156</b>
4.3.1	Absent Message Capability .....	156
4.3.2	Account Code Entry .....	159
4.3.3	Alternate Calling — Ring / Voice.....	163
4.3.4	ANSWER and RELEASE buttons Operation .....	166
4.3.5	Answering, Direct Trunk .....	168
4.3.6	Automatic Callback Busy (Camp-On) .....	170
4.3.7	Background Music (BGM).....	173
4.3.8	Busy Station Signaling (BSS) .....	175
4.3.9	Call Forwarding.....	177
4.3.10	Call Forwarding — All Calls to an Incoming Group .....	186
4.3.11	Call Hold .....	189
4.3.12	Call Park .....	194
4.3.13	Call Pickup .....	197
4.3.14	Call Pickup Deny.....	200
4.3.15	Call Splitting.....	202
4.3.16	Call Transfer .....	204
4.3.17	Call Waiting.....	211
4.3.18	Call Waiting from Central Office .....	216
4.3.19	Calling Line Identification Presentation (CLIP) .....	219
4.3.20	Calling Line Identification Restriction (CLIR) / Calling Name Identification Restriction (CNIR).....	221
4.3.21	Conference, 3-Party .....	223
4.3.22	Conference, 5-Party .....	228
4.3.23	Conference, Unattended .....	231
4.3.24	CTI (Computer Telephony Integration) Code Entry .....	234
4.3.25	Data Line Security .....	235
4.3.26	Direct Inward System Access (DISA).....	237
4.3.27	Do Not Disturb (DND).....	244
4.3.28	Do Not Disturb (DND) Override.....	248
4.3.29	Doorphone Call .....	250
4.3.30	Electronic Station Lockout .....	255
4.3.31	Emergency Call .....	257
4.3.32	End-to-End DTMF Signaling (Tone Through).....	258
4.3.33	Executive Busy Override .....	261
4.3.34	Executive Busy Override Deny .....	264
4.3.35	External Feature Access .....	266
4.3.36	External Modem Control.....	268
4.3.37	Flash .....	270
4.3.38	Full One-Touch Dialing.....	271

---

4.3.39	Handset Microphone Mute .....	273
4.3.40	Hands-free Answerback .....	275
4.3.41	Hands-free Operation .....	277
4.3.42	Inter Office Calling .....	279
4.3.43	Live Call Screening (LCS) .....	282
4.3.44	Lockout.....	292
4.3.45	Log-In / Log-Out .....	293
4.3.46	Message Waiting .....	297
4.3.47	Microphone Mute.....	302
4.3.48	Night Service On/Off .....	304
4.3.49	Off-Hook Call Announcement (OHCA) .....	311
4.3.50	Off-Hook Call Announcement (OHCA) —Whisper.....	316
4.3.51	Off-Hook Monitor .....	321
4.3.52	One-Touch Dialing .....	323
4.3.53	Operator Call .....	325
4.3.54	Outward Dialing, Trunk Access .....	327
4.3.55	Paging .....	333
4.3.56	Paging — Answer .....	338
4.3.57	Paging Deny .....	340
4.3.58	Paging and Transfer.....	342
4.3.59	Paralleled Telephone Connection .....	345
4.3.60	PDN Call .....	347
4.3.61	Phantom Extension.....	350
4.3.62	Pickup Dialing (Hot Line).....	355
4.3.63	Privacy Release.....	357
4.3.64	Pulse to Tone Conversion .....	359
4.3.65	Quick Dialing .....	360
4.3.66	Redial .....	361
4.3.67	Released Link Operation .....	364
4.3.68	Ringing Transfer.....	366
4.3.69	Secret Busy Override.....	368
4.3.70	Secret Dialing .....	370
4.3.71	Station Program Clear .....	372
4.3.72	Station Speed Dialing .....	374
4.3.73	System Speed Dialing .....	376
4.3.74	Timed Reminder (Wake-Up Call) .....	378
4.3.75	Toll Restriction Override .....	384
4.3.76	Toll Restriction Override by Account Code Entry .....	385
4.3.77	Toll Restriction Override for System Speed Dialing.....	386
4.3.78	Trunk Answer From Any Station (TAFAS) .....	387
4.3.79	Two-Way Recording into the Voice Mail .....	389
4.3.80	UCD Login Monitor.....	392
4.3.81	UCD Monitor Mode .....	393
4.3.82	Voice Mail Transfer .....	395
4.3.83	VPS Integration .....	397
4.3.84	Walking COS.....	401
4.3.85	Walking Station .....	404
<b>4.4</b>	<b>Operator / Manager Service Features .....</b>	<b>406</b>
4.4.1	Operator / Manager Service Features .....	406

4.4.2	Background Music (BGM) — External .....	407
4.4.3	Call Log Incoming, Log Lock .....	411
4.4.4	Live Call Screening (LCS) Password Clear .....	412
4.4.5	Local Alarm.....	413
4.4.6	Outgoing Message (OGM) Record/Playback.....	417
4.4.7	Remote DND (Do Not Disturb) Control .....	426
4.4.8	Remote FWD (Call Forwarding) Cancel — Once .....	430
4.4.9	Remote Station Lock Control.....	434
4.4.10	Switching COS .....	436
4.4.11	Timed Reminder, Remote (Wake-Up Call) .....	439
4.4.12	Trunk Busy-Out Setting.....	449
4.4.13	Trunk Route Control.....	455
<b>4.5</b>	<b>Special Display Features .....</b>	<b>458</b>
4.5.1	Special Display Features .....	458
4.5.2	Call Forwarding / Do Not Disturb (KX-T7436 / KX-T7235 only).....	459
4.5.3	Call Information Display (KX-T7436 / KX-T7433 / KX-T7235 / KX-T7230 only).....	461
4.5.4	Call Log, Incoming (KX-T7436 / KX-T7433 / KX-T7235 / KX-T7230 only) .....	464
4.5.5	Call Log Incoming, Log Lock (KX-T7436 / KX-T7433 / KX-T7235 / KX-T7230 only) 471	
4.5.6	Call Log, Outgoing (KX-T7436 / KX-T7235 only).....	473
4.5.7	KX-T7235 Display Features.....	474
4.5.8	KX-T7235 Display Features - Call Directory .....	475
4.5.9	KX-T7235 Display Features - System Feature Access Menu .....	477
4.5.10	KX-T7431 / KX-T7433 / KX-T7436 Display Features .....	487
4.5.11	KX-T7431 / KX-T7433 / KX-T7436 Display Features - Call Directory .....	490
4.5.12	KX-T7431 / KX-T7433 / KX-T7436 Display Features - System Feature Access Menu 496	
<b>5</b>	<b>DSS Console Features</b>	
<b>5.1</b>	<b>Configuration .....</b>	<b>502</b>
5.1.1	Configuration.....	502
5.1.2	Location of Controls.....	503
5.1.3	Feature Buttons.....	505
<b>5.2</b>	<b>DSS Console Features.....</b>	<b>506</b>
5.2.1	Station Programming.....	506
5.2.2	Account Button (Assignment).....	507
5.2.3	Answer Button (Assignment).....	508
5.2.4	Conference (CONF) Button (Assignment).....	509
5.2.5	DAY / NIGHT Button (Assignment).....	510
5.2.6	Direct Station Selection (DSS) Button (Assignment) .....	511
5.2.7	FWD/DND Button (Assignment).....	512
5.2.8	Group-CO (G-CO) Button (Assignment).....	513
5.2.9	Group FWD Button (Assignment) .....	514
5.2.10	Live Call Screening (LCS) Button (Assignment).....	515
5.2.11	Live Call Screening (LCS) Cancel Button (Assignment).....	516
5.2.12	Message Waiting (MESSAGE) Button (Assignment).....	517
5.2.13	One-Touch Dialing Button (Assignment).....	518
5.2.14	One-Touch Access Assignment for System Features.....	519
5.2.15	Release Button (Assignment).....	520



---

5.2.16	SAVE Button (Assignment) .....	521
5.2.17	Single-CO (S-CO) Button (Assignment) .....	522
5.2.18	Tone Through Button (Assignment).....	523
5.2.19	Two-Way Record Button (Assignment) .....	524
5.2.20	Two-Way Transfer Button (Assignment) .....	525
5.2.21	Voice Mail (VM) Transfer Button (Assignment) .....	526
5.2.22	Direct Station Dialing.....	530
5.2.23	One-Touch Dialing .....	531
5.2.24	One-Touch Access for System Features.....	532
5.2.25	Call Transfer.....	533
5.2.26	ANSWER and RELEASE Buttons Operation .....	534
5.2.27	Monitoring an outside line activity .....	536
<b>6</b>	<b>Appendix</b>	
<b>6.1</b>	<b>Appendix .....</b>	<b>538</b>
6.1.1	Display Examples.....	538
6.1.2	Feature Numbers List .....	546
6.1.3	Tone List.....	551
6.1.4	Troubleshooting.....	553



# ***Section 1***

## ***DPT Overview***

*Note: All illustrations used in the initial setting are based on model KX-T7235.*

# 1.1 Configuration

## 1.1.1 Configuration

Panasonic Digital Proprietary Telephones (DPTs) are available to utilize various features of the KX-TD500 System, in addition to supporting basic telephone services (making or receiving calls).

There are the following nine DPT models.

### KX-T7400 Series

	<b>KX-T7420</b>	<b>KX-T7425</b>	<b>KX-T7431</b>	<b>KX-T7433</b>	<b>KX-T7436</b>
Display	None	None	16 char./line, 1-line LCD	Tilt-up, 16 char./line, 3-line LCD	Tilt-up, 24 char./line, 6-line LCD
Soft Buttons and Function Buttons	None	None	None	3 Soft Buttons	3 Soft Buttons/ 10 Function Buttons
Jog Dial	Yes	Yes	Yes	Yes	Yes
CO Buttons	12	24	12	24	24
Fixed Feature Buttons	Please refer to "Fixed Buttons" in Section "1.1.4 Feature Buttons."				

### KX-T7200 Series

	<b>KX-T7220</b>	<b>KX-T7230</b>	<b>KX-T7235</b>	<b>KX-T7250</b>
Display	None	16 char./line, 2-line LCD	Tilt-up, 24 char./line, 6-line LCD	None
Soft Buttons and Function Buttons	None	3 Soft Buttons	3 Soft Buttons/ 10 Function Buttons	None
Speakerphone	Yes	Yes	Yes	Monitor only
CO Buttons	24	24	12	6
Fixed Feature Buttons	Please refer to "Fixed Buttons" in Section "1.1.4 Feature Buttons."			

## 1.1.2 Location of Controls

### KX-T7420

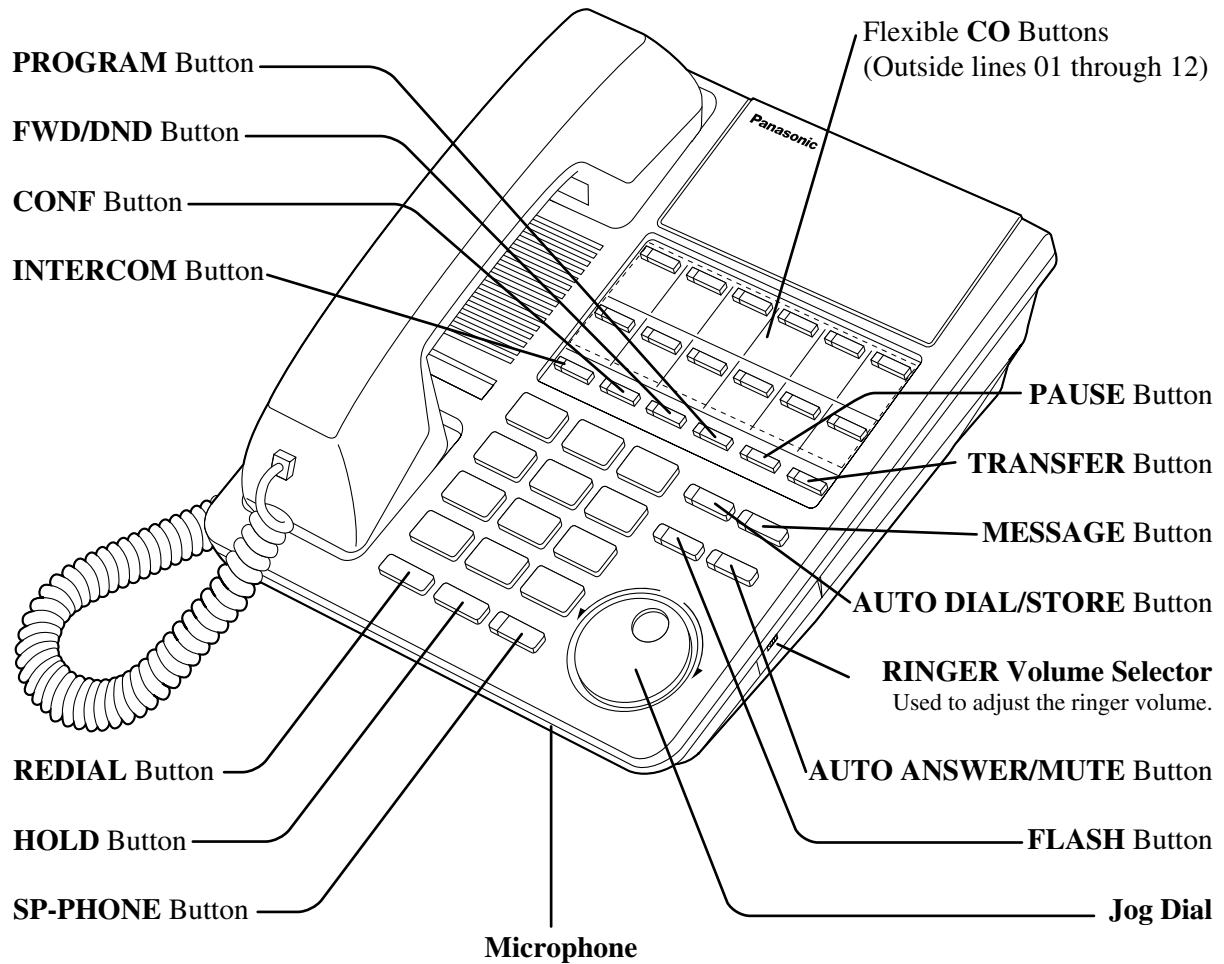

### KX-T7425

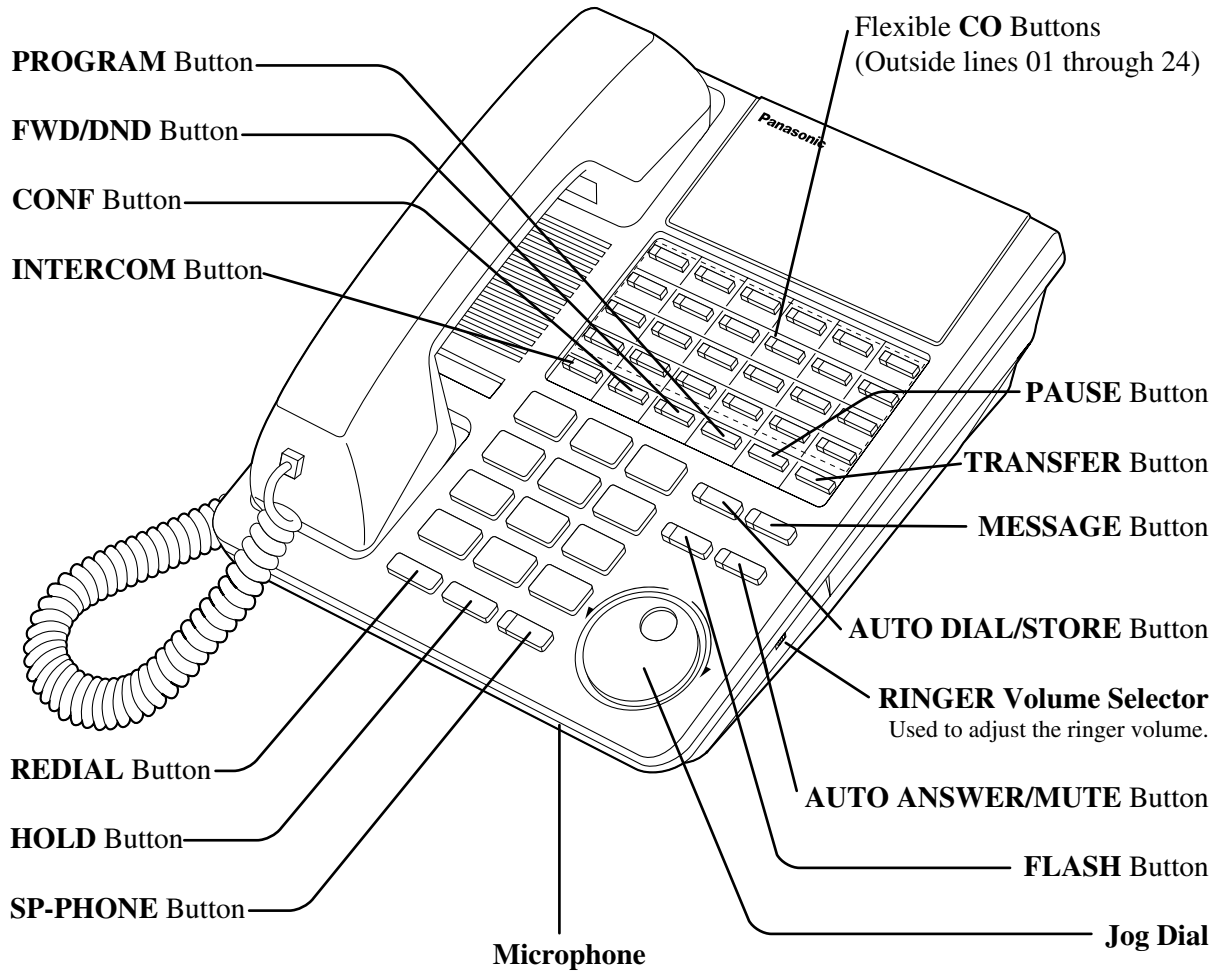

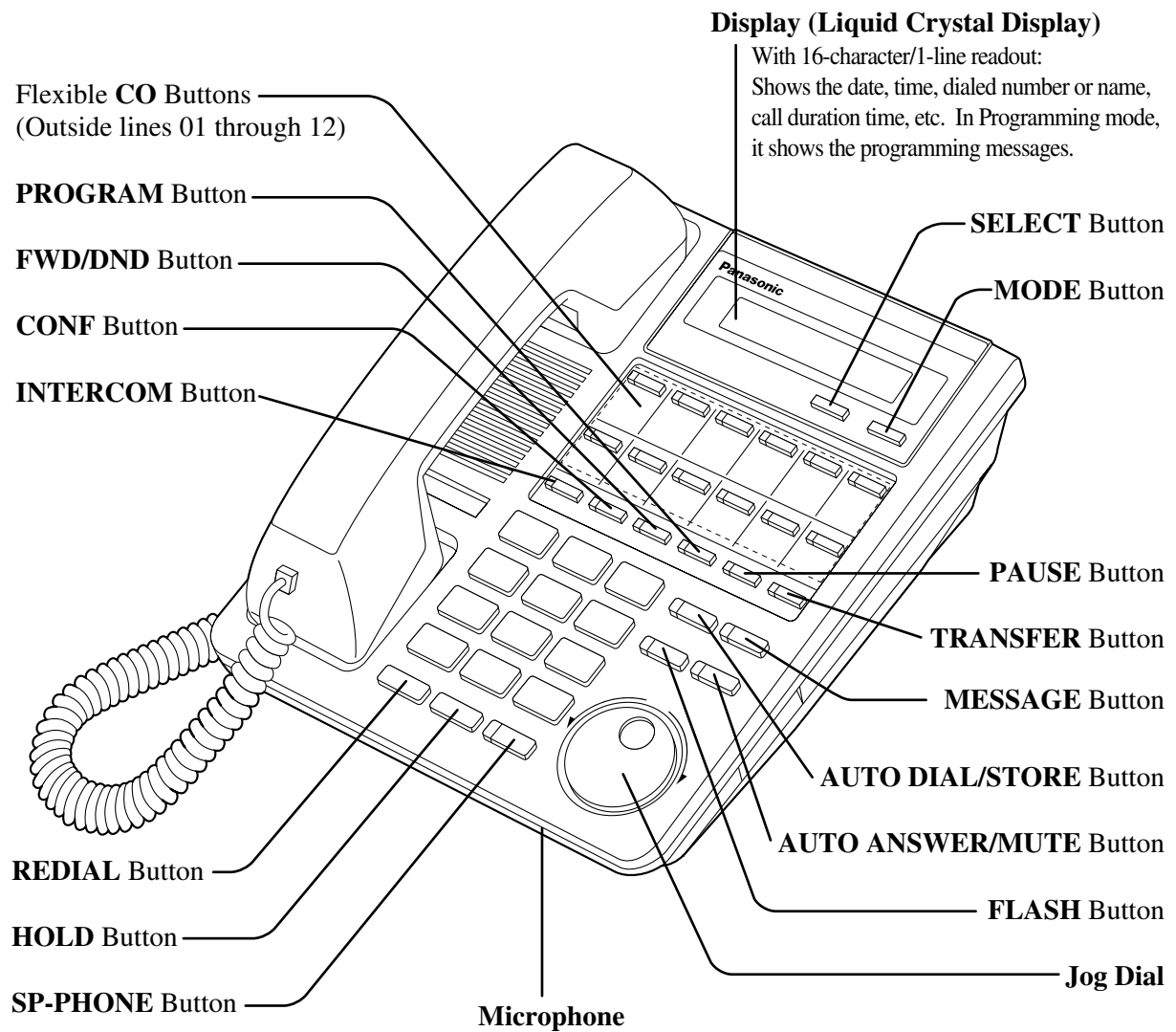
**KX-T7431**

## KX-T7433

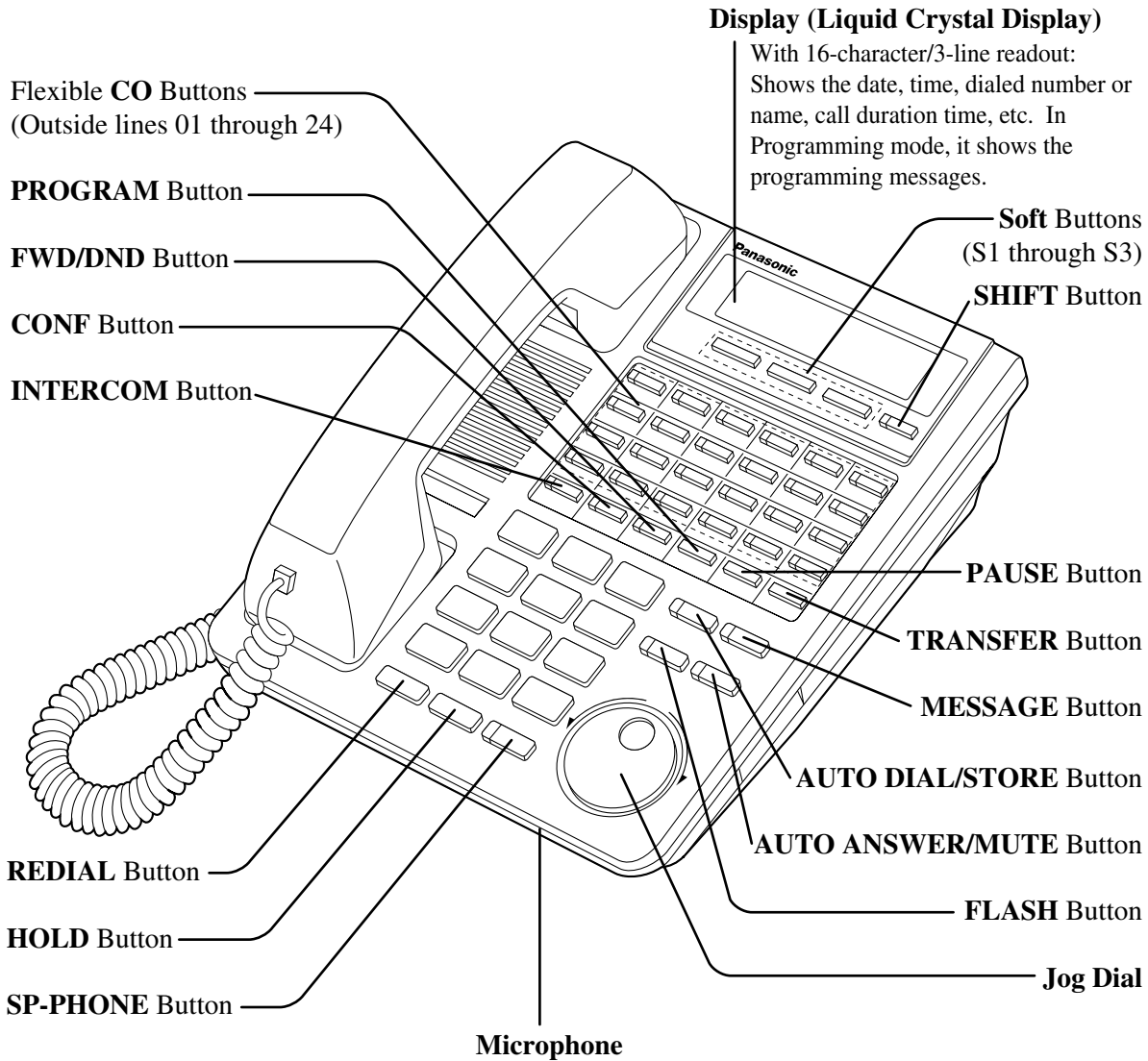

### To lift or set down the display:

**- To lift the display**

- 1 Press the LCD ADJ button.
- 2 Lift up the display.

**- To set down the display**

- 1 Press the LCD ADJ button.
- 2 Press down the display.

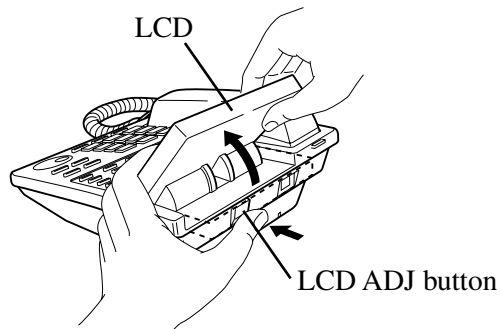

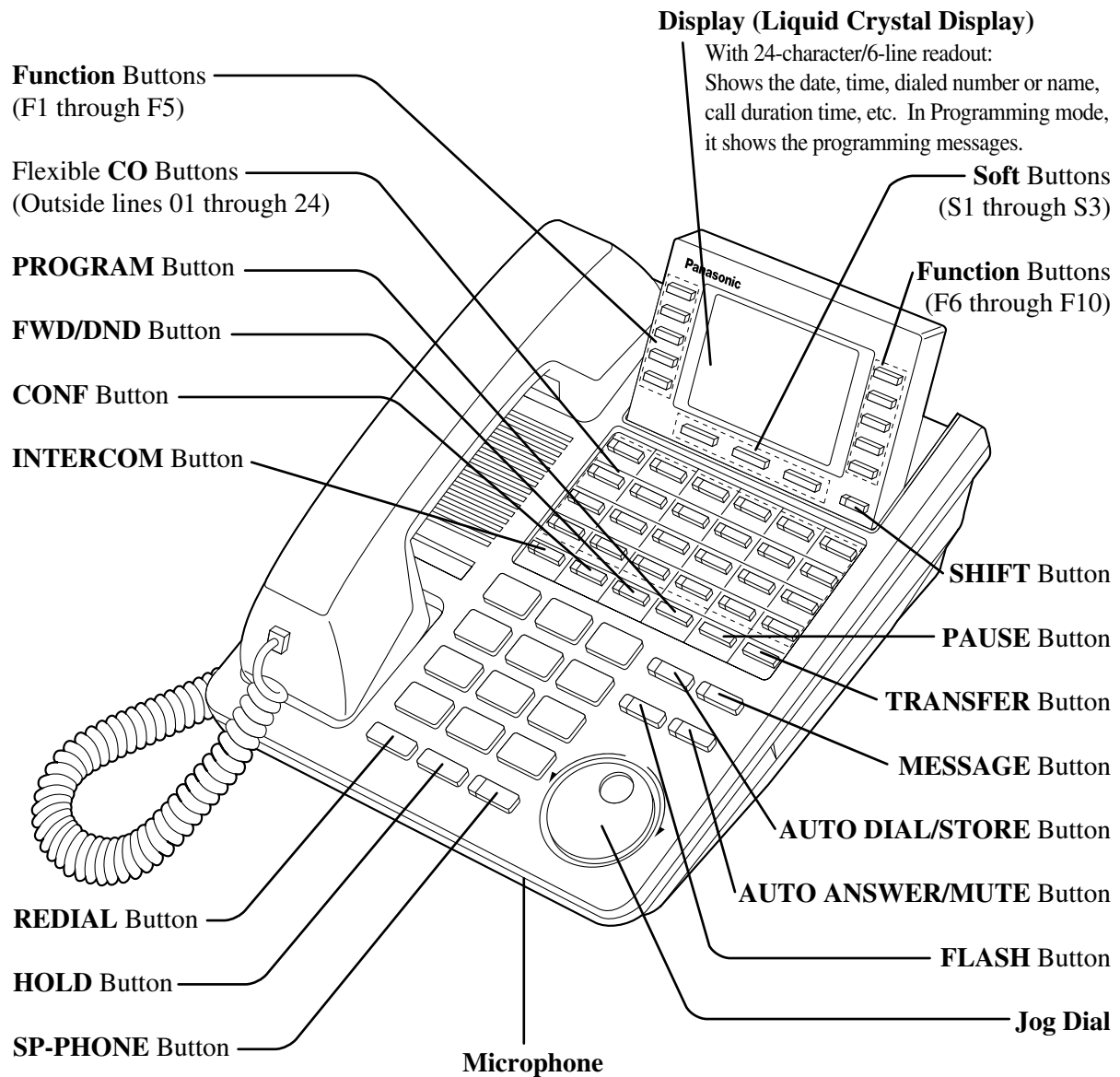

**KX-T7436****To lift or set down the display:**

- **To lift the display**
  - 1 Press the LCD ADJ button.
  - 2 Lift up the display.
- **To set down the display**
  - 1 Press the LCD ADJ button.
  - 2 Press down the display.

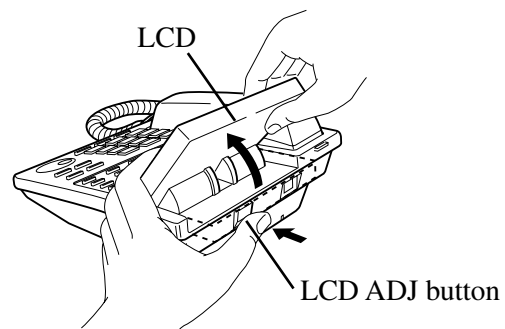

### KX-T7220

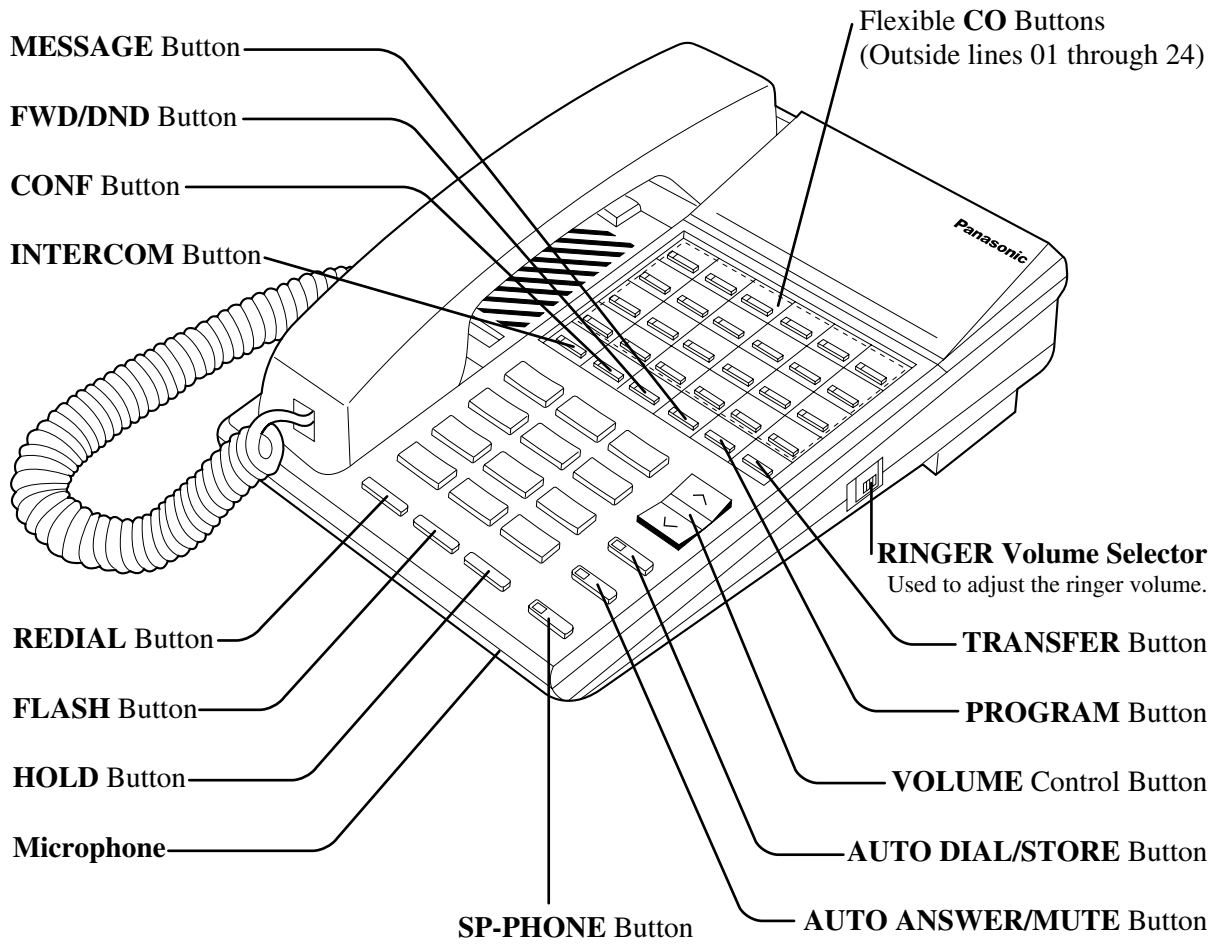

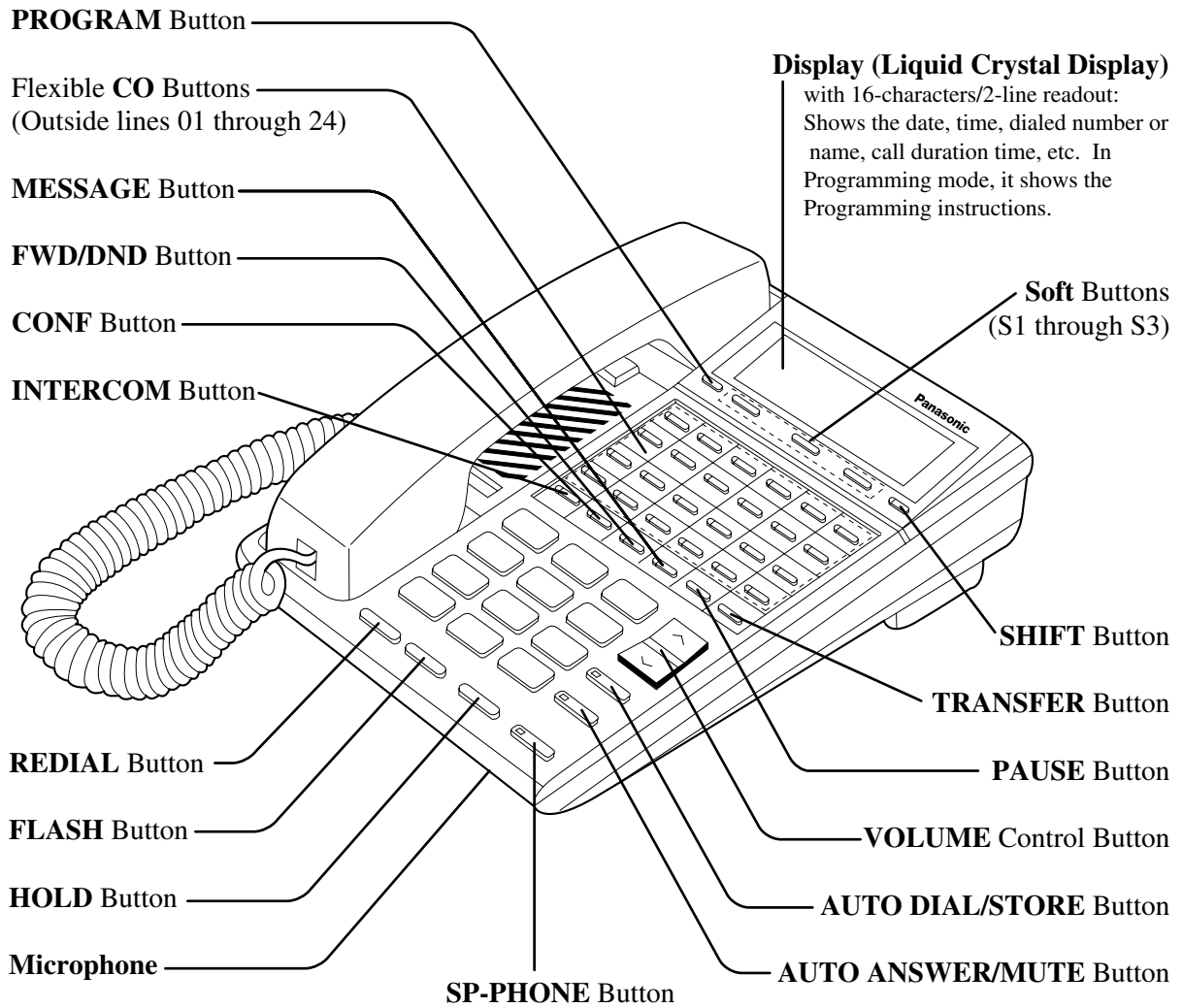
**KX-T7230**

### KX-T7235

**Function Buttons**  
(F1 through F5)

**PROGRAM** Button

**MESSAGE** Button

**FWD/DND** Button

**CONF** Button

**INTERCOM** Button

**REDIAL** Button

**FLASH** Button

**HOLD** Button

**Microphone**

**SP-PHONE** Button

**AUTO ANSWER/MUTE** Button

### Display (Liquid Crystal Display)

with 24-characters/6-line readout:  
Shows the date, time, dialed number or name, call duration time, etc. In Programming mode, it shows the Programming instructions.

**Function Buttons**  
(F6 through F10)

**SHIFT** Button

**Soft Buttons**  
(S1 through S3)

**Flexible CO Buttons**  
(Outside lines 01 through 12)

**TRANSFER** Button

**PAUSE** Button

**VOLUME** Control Button

**AUTO DIAL/STORE** Button

#### To lift or set down the display:

##### - To lift the display

- 1 Press the LCD ADJ button.
- 2 Lift up the display.

##### - To set down the display

- 1 Press the LCD ADJ button.
- 2 Press down the display.

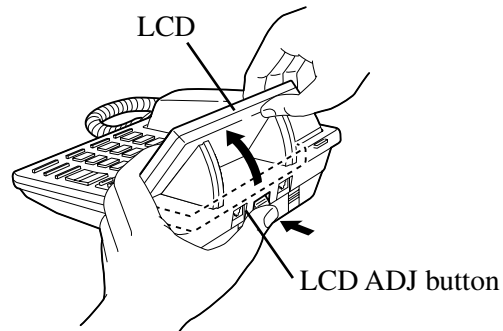

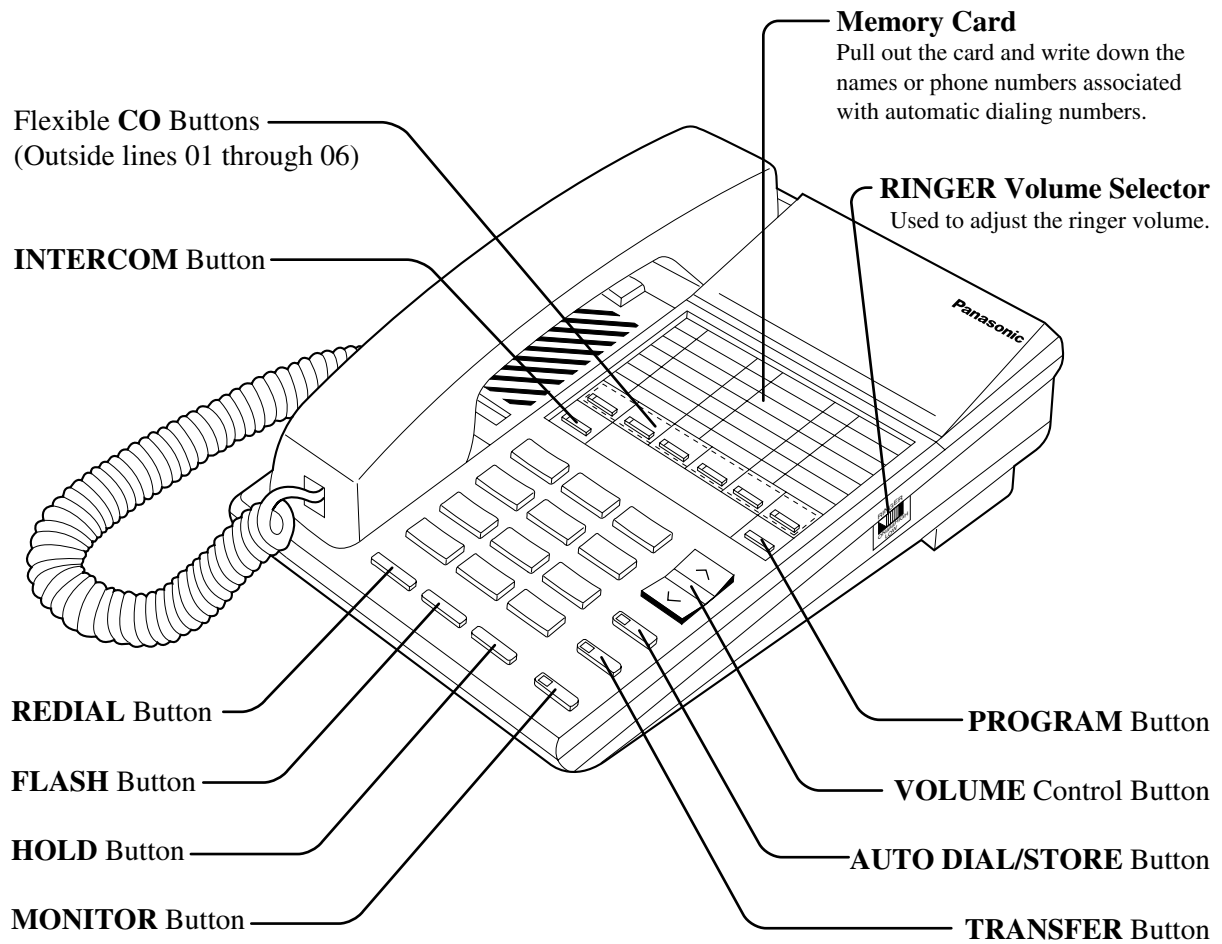
**KX-T7250**

### 1.1.3 Connection

Connect as shown.

#### KX-T7400 Series DPTs

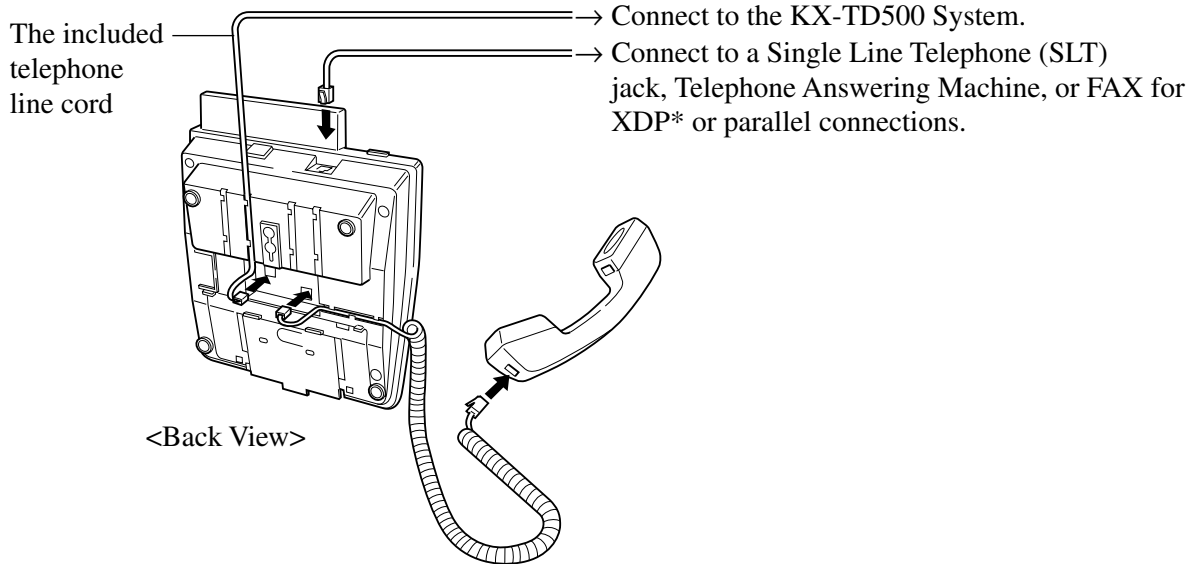

\* XDP(eXtra Device Port) expands the number of telephones available in the system by allowing an extension port to contain two telephones. For more details, please consult your dealer.

#### KX-T7200 Series DPTs

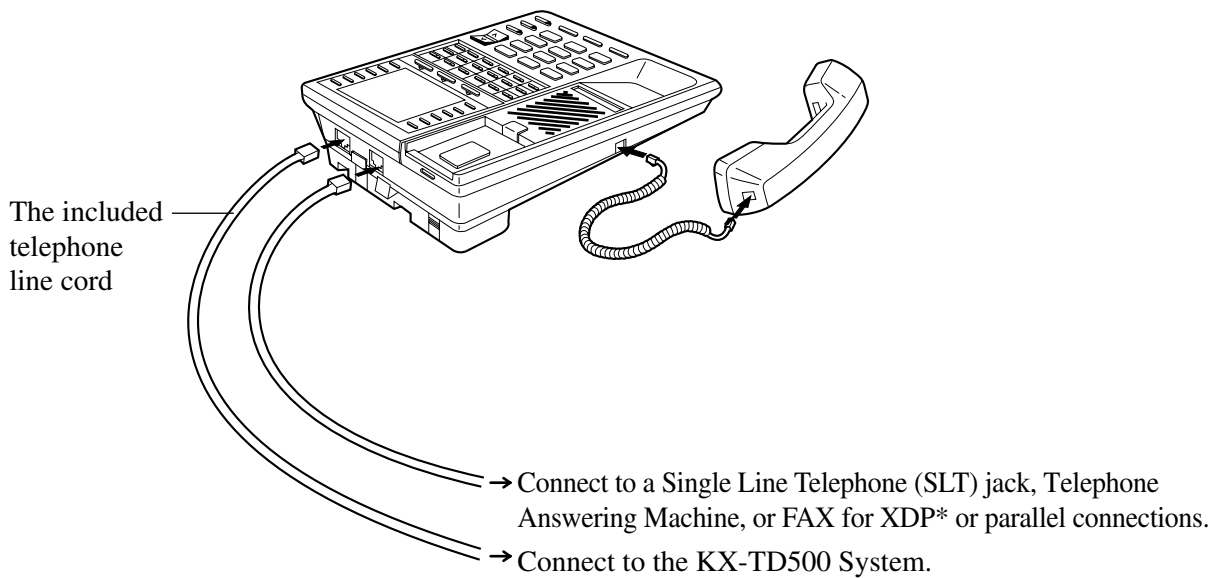

\* XDP(eXtra Device Port) expands the number of telephones available in the system by allowing an extension port to contain two telephones. For more details, please consult your dealer.

## 1.1.4 Feature Buttons

Digital Proprietary Telephones (DPTs) have the following types of Feature Buttons:

- **Fixed Buttons**
- **Flexible Buttons**

### Fixed Buttons

Fixed buttons have specific functions permanently assigned to them. These default function assignments cannot be changed. The following table lists the fixed buttons located on each DPT model.

Feature Button	T7420	T7425	T7431	T7433	T7436	T7220	T7230	T7235	T7250
AUTO ANSWER/MUTE	✓	✓	✓	✓	✓	✓	✓	✓	
AUTO DIAL/STORE	✓	✓	✓	✓	✓	✓	✓	✓	✓ <sup>*1</sup>
CONF	✓	✓	✓	✓	✓	✓	✓	✓	
FLASH	✓	✓	✓	✓	✓	✓	✓	✓	✓
Function					✓			✓	
FWD/DND	✓	✓	✓	✓	✓	✓	✓	✓	
HOLD	✓	✓	✓	✓	✓	✓	✓	✓	✓
INTERCOM	✓	✓	✓	✓	✓	✓	✓	✓	✓
Jog Dial	✓	✓	✓	✓	✓				
MESSAGE	✓	✓	✓	✓	✓	✓	✓	✓	
MODE			✓						
MONITOR									✓
PAUSE	✓	✓	✓	✓	✓		✓	✓	
PROGRAM	✓	✓	✓	✓	✓	✓	✓	✓	✓
REDIAL	✓	✓	✓	✓	✓	✓	✓	✓	✓
SELECT			✓						
SHIFT				✓	✓		✓	✓	
Soft				✓	✓		✓	✓	
SP-PHONE	✓	✓	✓	✓	✓	✓	✓	✓	

Feature Button	T7420	T7425	T7431	T7433	T7436	T7220	T7230	T7235	T7250
TRANSFER	✓	✓	✓	✓	✓	✓	✓	✓	✓
VOLUME						✓	✓	✓	✓

\*1 The button is not provided with an LED (Light Emitting Diode).

" ✓ " indicates the button is available.

## Usage

### **AUTO ANSWER/MUTE Button**

Used for Hands-free answer back; and it turns the microphone off during a conversation.

### **AUTO DIAL/STORE Button**

Used for System Speed Dialing and storing program changes.

### **CONF (Conference) Button**

Used to establish a 3-party/5-party conference call.

### **FLASH Button**

Sends an External Feature Access signal to the central office or host PBX to access their system features. If a PBX is not being used, this button can be used to disconnect the current call and start another call without hanging up.

### **Function (F1 through F10) Buttons**

Used to perform the corresponding displayed function or operation.

### **FWD/DND (Call Forwarding/Do Not Disturb) Button**

Used to program the Call Forwarding feature or set the Do Not Disturb (DND) feature.

### **HOLD Button**

Used to place a call on hold.

### **INTERCOM Button**

Used to make or receive extension calls.

### **Jog Dial**

Used to adjust the volume of the handset receiver, headset, ringer and speaker. It also adjusts the display contrast. Please refer to Section "1.1.5 Initial Setting for KX-T7400 Series." For KX-T7431, KX-T7433 and KX-T7436 users, it is also used to select data from the Call Directory and the System Feature Access Menu.

### **MESSAGE Button**

Used to leave a notification to a busy extension or call back the message notification sender.

### **MODE Button**

Used to shift the display in order to access various features.

### **MONITOR Button**

Used for a hands-free dialing operation.

### **PAUSE Button**

Inserts a pause in speed dial numbers or in One-Touch dial numbers.

### **PROGRAM Button**

Used to enter or exit the Programming mode.



**REDIAL Button**

Used for the Last Number Redialing.

**SELECT Button**

Used to select the displayed function or to call the displayed phone number.

**SHIFT Button**

Used to access the next level of Soft Button functions.

**Soft (S1 through S3) Buttons**

Used to perform the function or operation that appears on the bottom line of the display.

**SP-PHONE (Speakerphone) Button**

Used for a hands-free speakerphone operation.

**TRANSFER Button**

Transfers a call to another extension or external destination.

**VOLUME Control Button**

Used to adjust the volume of the handset receiver, headset, ringer and speaker; it also adjusts the display contrast. Please refer to Section "1.1.6 Initial Setting for KX-T7200 Series."

## Flexible Buttons

Flexible Buttons do not have specific features permanently assigned to them. Features are assigned to Flexible Buttons by Station, User or System Programming. "Flexible Button Assignment" is addressed in "Station Programming." The three types of Flexible Buttons are as follows:

- **Flexible CO buttons** (located on PT only)
- **Flexible DSS buttons** (located on DSS Console only)
- **Flexible PF (Programmable Feature) buttons** (located on PT / DSS Console only)

The following table outlines the features that can be assigned to the Flexible Buttons:

Features to be assigned	Button	CO (PT)	DSS (DSS)	PF (PT/DSS)
Single-CO		✓	✓*1	
Group-CO		✓	✓*1	
Loop-CO		✓		
DSS (Direct Station Selection)		✓	✓	
Phantom		✓		
PDN (Primary Directory Number)		✓		
SDN (Secondary Directory Number)		✓		
ONE-TOUCH (One-Touch Dialing)		✓	✓	✓
MESSAGE (Owner Extension)		✓	✓	
MESSAGE-OTHER (Another/Phantom Extension)		✓*2	✓*3	
FWD/DND (Call Forwarding/Do Not Disturb)		✓	✓	✓
Group FWD		✓	✓	
SAVE (Saved Number Redial)		✓	✓	✓
ACCOUNT (Account Code Entry)		✓	✓	✓
CONF (Conference)		✓	✓	✓
VTR (Voice Mail Transfer)		✓	✓	✓
Log-In / Log-Out		✓		
Group Log-In / Log-Out		✓		
2WAY-REC (Two-Way Record)†		✓	✓	

<b>Features to be assigned</b>	<b>Button</b>	<b>CO (PT)</b>	<b>DSS (DSS)</b>	<b>PF (PT/DSS)</b>
2WAY-TRAN (Two-Way Transfer) <sup>†</sup>		✓	✓	
LCS (Live Call Screening) <sup>†</sup>		✓	✓	
LCS (Live Call Screening) Cancel <sup>†</sup>		✓	✓	
DAY/NIGHT (Day/Night Switch)		✓	✓	
Alarm		✓		
Answer		✓	✓	✓
Release		✓	✓	✓
Tone Through		✓	✓	
Alert		✓		

\*<sup>1</sup> Available for monitoring the call activity only.

\*<sup>2</sup> Can only be assigned by User or System Programming.

\*<sup>3</sup> Can only be assigned by System Programming.

† Available when the Digital Super Hybrid System is connected to a Digital Proprietary Telephone capable Panasonic Voice Processing System (one that supports Digital Proprietary Telephone [DPT] integration; e.g., KX-TVS100).

" ✓ " indicates that the feature is available.

### Line Access Buttons

The following three types of CO buttons can be used to seize a CO line when making a CO call.

- **Single-CO (S-CO) button**
- **Group-CO (G-CO) button**
- **Loop-CO (L-CO) button**

### Conditions

- A flexible CO button can be assigned as a Line Access Button (S-CO, G-CO or L-CO) by Station, User or System Programming. Once a flexible CO button is assigned as a Line Access Button, it provides the line status by lighting patterns and green/red indication. Please refer to Section "1.1.7 LED Indication."
- You can set S-CO, G-CO and L-CO buttons on one Proprietary Telephone. Incoming and outgoing calls on the line are shown on the button in the following priority.  
S-CO > G-CO > L-CO

### **Single-CO (S-CO) button**

An S-CO button is a CO line access button. This allows you to access a specific CO line by pressing an S-CO button. An incoming CO call can be directed to an S-CO button.

#### **Conditions**

- The same CO line cannot be assigned to more than one S-CO button on a PT.
- It is possible to assign the same CO line to an S-CO button, a G-CO button and an L-CO button respectively.

#### **Programming Guide References**

- 4.3 Extension Line
  - CO Key
- 4.4 DSS Console
  - DSS Key

#### **Features Guide References**

- 1.16 Button Features
  - Button, Line Access

#### **User Manual References**

- 1.1.4 Feature Buttons
- 2.2.3 Flexible Button Assignment
- 3.2.5 [005] Flexible CO Button Assignment
- 4.3.54 Outward Dialing, Trunk Access

### **Group-CO (G-CO) button**

To support efficient utilization of CO lines, a group of CO lines (trunk group) can be assigned to a CO button. This button is referred to as Group-CO (G-CO) button. Any incoming calls from any CO line in the same trunk group arrive at the G-CO button. To make a CO call, you can access an idle CO line in the trunk group by simply pressing the assigned G-CO button.

#### **Conditions**

- It is possible to assign the same CO line to an S-CO button, a G-CO button, and an L-CO button.
- It is necessary to program the extension for making or receiving calls or both in trunk groups.

- 
- When your extension is assigned as an incoming call destination for a CO line, you cannot receive any incoming CO calls unless a G-CO, L-CO or S-CO button associated with the CO line is assigned.

### **Programming Guide References**

- 4.3 Extension Line
  - CO Key
- 4.4 DSS Console
  - DSS Key

### **Features Guide References**

- 1.16 Button Features
  - Button, Line Access

### **User Manual References**

- 1.1.4 Feature Buttons
- 2.2.3 Flexible Button Assignment
- 3.2.5 [005] Flexible CO Button Assignment
- 4.3.54 Outward Dialing, Trunk Access

### **Loop-CO (L-CO) button**

All CO lines can be assigned to a flexible CO button on a Proprietary Telephone. The assigned button serves as an L-CO button. An incoming call on any CO line arrives at the L-CO button, unless there are S-CO or G-CO buttons associated with the CO line or unless the button is already in use. To make a CO call, you simply press the dedicated L-CO button. Pressing the L-CO button provides the same operation as dialing the feature number for "Local CO Line Access/ARS" (default = 9).

### **Programming Guide References**

- 4.3 Extension Line
  - CO Key

### **Features Guide References**

- 1.16 Button Features
  - Button, Line Access

## **User Manual References**

- 1.1.4 Feature Buttons
- 2.2.3 Flexible Button Assignment
- 3.2.5 [005] Flexible CO Button Assignment
- 4.3.54 Outward Dialing, Trunk Access

## 1.1.5 Initial Setting for KX-T7400 Series

The Jog Dial can be used for the display contrast and the volume control. Rotate the Jog Dial in either direction as desired. The contrast or the volume level will change as follows.

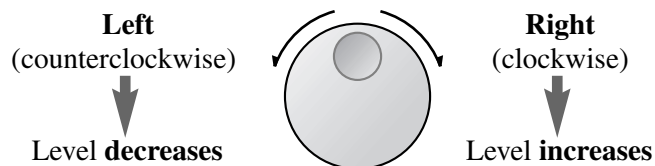

### Display Contrast Adjustment

The MODE button and the Jog Dial for KX-T7431 users, and a Soft button and the Jog Dial for KX-T7433 and KX-T7436 users are used to adjust the display contrast. The contrast level is indicated on the display by the number of asterisks.

#### —KX-T7431

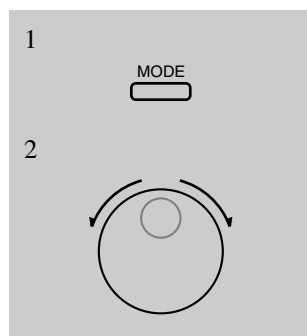

*While on-hook*

1. Press the **MODE** button six times.

- The display shows:  
<Example>

Contrast : \*\*\* (— contrast level 3)

2. Rotate the **Jog Dial** in the desired direction.

#### —KX-T7433 and KX-T7436

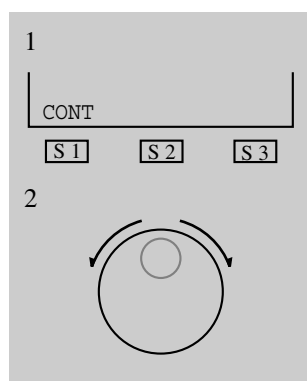

*While on-hook or during a conversation*

1. Press the **CONT (S1)** button.

2. Rotate the **Jog Dial** in the desired direction.

- The display shows:  
<Example>

Contrast : \*\*\* (— contrast level 3)

## When using the headset

The Panasonic Digital Super Hybrid System supports the use of a headset with a Proprietary Telephone (PT). When you use the headset (optional), you should switch the selection mode first. Selection is explained in Section "2.2.5 Handset / Headset Selection."

### To change to the headset mode

Press: [PROGRAM] [9] [9] [9] [2] [STORE] [PROGRAM].

## Changing the ringing tone of a CO button / INTERCOM button

There are eight ringer frequencies available for each CO (Single-CO, Group-CO, Loop-CO) button, DN (PDN, SDN) button and INTERCOM button. If you wish to change them, please refer to Section "2.2.13 Ringing Tone Selection for CO Buttons" or Section "2.2.14 Ringing Tone Selection for INTERCOM Button."

## Volume Control — Handset Receiver/Headset/Ringer/Speaker

Allows you to adjust the following volumes as required.

- Handset Receiver volume (levels 1 through 4)
- Headset volume (levels 1 through 4)
- Ringer volume (levels 0 through 3)
- Speaker volume (levels 1 through 12)

If your Digital Proprietary Telephone is provided with a display (display DPT), the volume level is indicated on the display by the number of asterisks. For ringer volume adjustment, three levels (OFF/LOW/HIGH) are available with the KX-T7420 and KX-T7425.

### To adjust the handset receiver volume

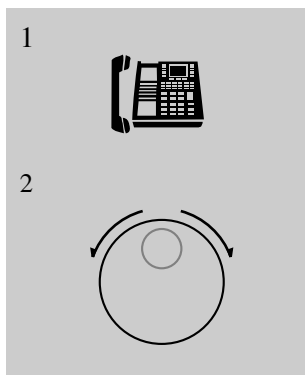

#### 1. Lift the **handset**.

#### 2. Rotate the **Jog Dial** in the desired direction.

- The display shows:  
<Example>

Handset : \*\*\* (— volume level 3)

- You may also adjust the handset receiver volume during a conversation using the handset receiver.



## To adjust the headset volume

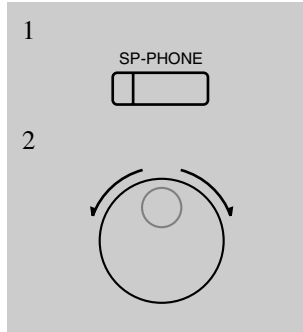

*Be sure the headset is connected.*

1. Press the **SP-PHONE** button.
2. Rotate the **Jog Dial** in the desired direction.

- The display shows:  
<Example>

Headset:\*\*\* (—volume level 3)

## To adjust the ringer volume —KX-T7433 and KX-T7436

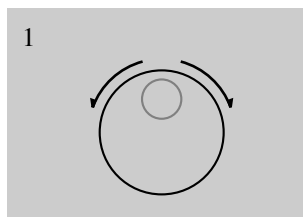

*While the telephone is ringing*

1. Rotate the **Jog Dial** in the desired direction.

- The display shows:  
<Example>

Ringer:\*\*\* (— volume level 3)

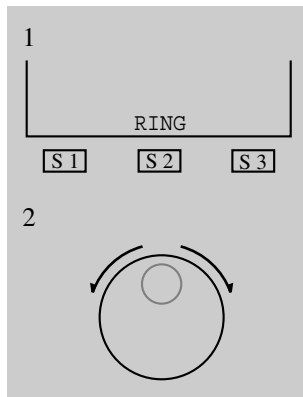

*While the telephone is idle and on-hook*

1. Press the **RING** (S2) button.
  - The telephone will ring.
2. Rotate the **Jog Dial** in the desired direction.
  - The telephone will stop ringing in about 4 seconds.
  - When the volume level is 0 (no "\*" indication), the display shows "RNGOFF."

**—KX-T7431**

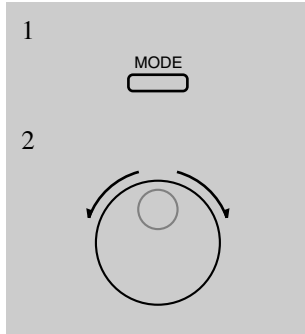

*While the telephone is idle and on-hook*

**1.** Press the **MODE** button five times.

- The display shows:  
<Example>

`Ringer:***` (— volume level 3)

**2.** Rotate the **Jog Dial** in the desired direction.

- The telephone will stop ringing in about 4 seconds.
- When the volume level is 0, no "\*" is indicated.

**—KX-T7420 and KX-T7425**

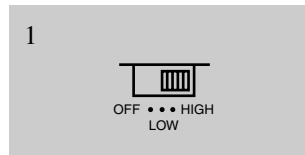

**1.** Adjust the **RINGER Volume Selector** lever to the desired setting (**OFF/LOW/HIGH**).

**To adjust the speaker volume**

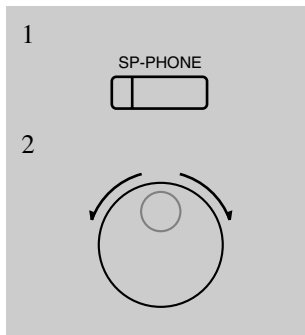

**1.** Press the **SP-PHONE** button.

**2.** Rotate the **Jog Dial** in the desired direction.

- The display shows:  
<Example>

`SP:*****` (— volume level 12)

- You may also adjust the speaker volume while listening to background music (BGM On mode), receiving a voice call, receiving a page or hearing a call progress tone such as a dial tone.

**Conditions**

- **If the ringer volume of the KX-T7431 is set to OFF**, the display while on-hook is as follows.

`Ring Off 12:00P`

- By pressing "\*" , the display changes to show your extension number and name.

`101: John Smith`

## 1.1.6 Initial Setting for KX-T7200 Series

### Display Contrast Adjustment (KX-T7230 and KX-T7235 only)

A Soft button and the VOLUME Control button are used to adjust the display contrast. The contrast level is indicated on the display by the number of asterisks. You can adjust the contrast level under the following conditions:

- a) When on-hook, or
- b) During an outside/intercom call.

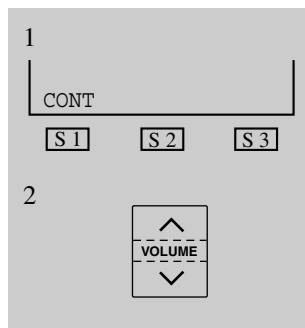

1. Press the **CONT** (S1) button.
2. Press the **VOLUME** (UP ^ / DOWN v ) Control button.
  - The display shows:
    - <Example>

Contrast : \*\*\* (— contrast level 3)

### When using the headset

The Panasonic Digital Super Hybrid System supports the use of a headset with a Proprietary Telephone (PT). When you use the headset (optional), you should switch the selection mode first. Selection is explained in Section "2.2.5 Headset / Headset Selection."

### To change to the headset mode

Press: [PROGRAM] [9] [9] [9] [2] [STORE] [PROGRAM].

### Changing the ringing tone of a CO button / INTERCOM button

There are eight ringer frequencies available for each CO (Group-CO, Loop-CO, Single-CO) button, DN(PDN, SDN) button and INTERCOM button. If you wish to change them, please refer to Section "2.2.13 Ringing Tone Selection for CO Buttons" or Section "2.2.14 Ringing Tone Selection for INTERCOM Button."

### Volume Control — Handset Receiver/Headset/Ringer/Speaker

Allows you to adjust the following volumes as necessary:

- Handset Receiver volume (level 1 through 3)
- Headset volume (level 1 through 3)
- Ringer volume (level 0 through 3)
- Speaker volume (level 1 through 12)

If your Digital Proprietary Telephone is provided with a display (display DPT), the volume level is indicated on the display by the number of asterisks. For ringer volume adjustment, three levels (OFF/LOW/HIGH) are available with the KX-T7220 and KX-T7250.

### To adjust the handset receiver volume

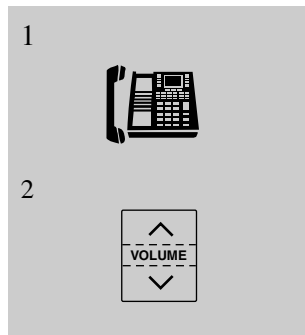

1. Lift the **handset**.
2. Press the **VOLUME** (UP ^ / DOWN v ) Control button.

- The display shows:  
<Example>

Handset : \*\*\* (— volume level 3)

- You may also adjust the handset receiver volume during a conversation using the handset receiver.

### To adjust the headset volume

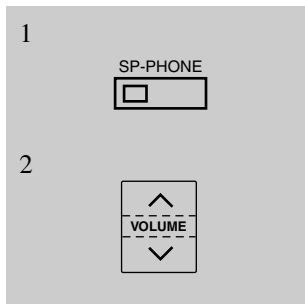

*Be sure the headset is connected.*

1. Press the **SP-PHONE** button.
2. Press the **VOLUME** (UP ^ / DOWN v ) Control button.

- The display shows:  
<Example>

Headset : \*\*\* (— volume level 3)

### To adjust the ringer volume —KX-T7230 and KX-T7235

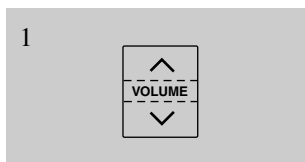

*While the telephone is ringing;*

1. Press the **VOLUME** (UP ^ / DOWN v ) Control button.

- The display shows:  
<Example>

Ringer : \*\*\* (— volume level 3)

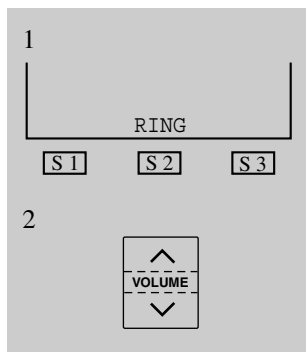

While the telephone is idle and on-hook;

1. Press the **RING** (S2) button.
  - The telephone will ring.
2. Press the **VOLUME** (UP ^/ DOWN v) Control button.
  - The telephone will stop ringing in about 4 seconds.
  - When the volume level is 0 (no "\*" indication), the display shows "RNGOFF."

### —KX-T7220 and KX-T7250

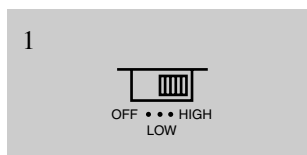

1. Adjust the **RINGER Volume Selector** lever to the desired setting (**OFF/LOW/HIGH**).

### To adjust the speaker volume

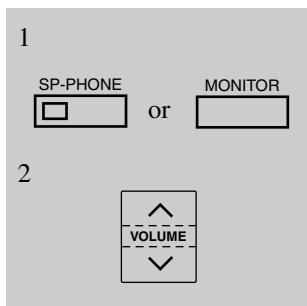

1. Press the **SP-PHONE** or **MONITOR** button.
2. Press the **VOLUME** (UP ^/ DOWN v) Control button.
  - The display shows:  
<Example>  

SP : \*\*\*\*\*

 (—volume level 12)
  - You may also adjust the speaker volume while listening to the background music (BGM On mode), receiving a voice call, receiving a page or hearing a call progress tone such as a dial tone.

## 1.1.7 LED Indication

The Light Emitting Diode (LED) buttons indicate the line conditions with lighting patterns.

### Flashing light patterns

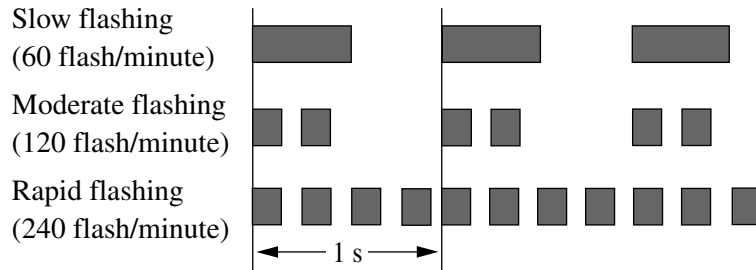

### LED Indication on the INTERCOM Button

The table below shows the lighting patterns for intercom line conditions.

INTERCOM button	Intercom Line Condition
Off	Idle
Green On	Intercom call / Conference established
Green slow flashing	Intercom call hold
Green moderate flashing	On exclusive hold / Consultation hold
Green rapid flashing	Incoming intercom/doorphone call

### LED Indication on the CO Button

The table below shows the lighting patterns for CO line conditions.

<b>CO Button</b>	<b>CO Line Condition</b>
Off	Idle
Green On	You are using the line.
Green slow flashing	You have a held call.
Green moderate flashing	You have one of the following: (1) Exclusive hold, (2) CO-to-CO line call, or (3) Conference, unattended
Green rapid flashing	Privacy Release possible* / Hold Recall / Incoming call (A CO call is coming in on a single extension).
Red On	Other-use
Red slow flashing	Other-hold*
Red rapid flashing	Incoming call (A CO call is coming in on multiple extensions simultaneously).

— Items marked with "\*" are only available on the Single-CO button.

### **BLF on DSS Button**

The Busy Lamp Field (BLF) indicator button is red when the corresponding extension is busy. This is available for Direct Station Selection (DSS) buttons on DSS Consoles and for flexible CO buttons assigned as DSS buttons on Proprietary Telephones.

The following table shows the DSS Button indication and the status of Corresponding Extension.

<b>DSS Button indication</b>	<b>Status of Corresponding Extension</b>
Off	Log-in
Red On	Incoming call/You or another extension is using the line.
Red slow flashing	Log-out





# *Section 2*

## *Station Programming*

*Note: All illustrations used in this section are based on model KX-T7235.*

## 2.1 Station Programming Instructions

### 2.1.1 Station Programming Instructions

Station Programming allows you, the Proprietary Telephone (PT) users, to program certain features from your telephone individually. To program, you need to switch your telephone to the Station Programming mode. During programming mode, your telephone is in the busy condition to both inside and outside callers. If you want to make a normal call handling operation, you must finish the programming mode.

#### Programming Mode Display

When you enter into the Station Programming mode, the display shows the following message as the initial programming mode;

PT- PGM Mode

We recommend a PT with display for Station Programming to avoid mis-operation. The display also gives you helpful or stored data information related to your programming steps. In this section, we note the display example in the programming steps, if required. You can also refer to the "Display Examples" in Section "6 Appendix."

#### Entering Station Programming mode

PT

Be sure that the telephone is idle and on-hook.

PROGRAM

9

9

Press **PROGRAM**.                      Dial 99.

- The STORE indicator lights.
- If 99 is not dialed within 5 seconds after the PROGRAM button is pressed, the Station Programming mode is canceled.

**<PT Display Example>**

PT- PGM Mode

— Initial programming display

- If there is no entry within one minute, the Station Programming mode is canceled and normal call handling mode resumes automatically.

---

## Exiting Station Programming mode

**PT**

When the display shows the initial programming mode;

PROGRAM  

Press **PROGRAM**.

- To exit the Station Programming mode, press PROGRAM. You are in the call handling mode.

## Confirming the assigned function data

— Be sure that you are in the Station Programming mode: Press [PROGRAM] [9] [9].

PT

program access number

HOLD

Enter the program access number.      Press **HOLD (END)**.

- The display shows the initial programming mode.
- Enter the **program access number\*** as follows.
  - 1:Preferred Line Assignment — Outgoing
  - 2:Preferred Line Assignment — Incoming
  - 3:Full One-Touch Dialing Assignment
  - 4:Intercom Alert Assignment
  - 5:Call Waiting Tone Type Assignment
  - 6:Self-Extension Number Confirmation
  - 7:Live Call Screening Mode Set†
  - 81:Initial Display Selection
  - 82:Bilingual Display Selection
  - 9:Handset/Headset Selection
  - 01:Remote Station Look Control (— Operator / Manager only)
  - 02:Call Log Lock Control, Incoming (— Operator / Manager only)
  - 03:Live Call Screening Password Control (— Operator / Manager only)
  - #:Station Programming Data Default Set
- The display shows the programmed data.

**<PT Display Example>**  
When you press [5], the display shows:

C . W .   T o n e 1
(— The Call Waiting tone is currently programmed to Tone 1.)

† Available when the Digital Super Hybrid System is connected to a Digital Proprietary Telephone capable Panasonic Voice Processing System (one that supports Digital Proprietary Telephone [DPT] integration; e.g., KX-TVS100).

—To exit the Station Programming mode: Press [PROGRAM].

— If you wish to change the data, follow the programming procedure explained in this section.

\* **A programming access number** is required to program/confirm the function data by Station Programming.

## Confirming the assigned data on the Flexible button

—Be sure that you are in the Station Programming mode: Press [PROGRAM] [9] [9].

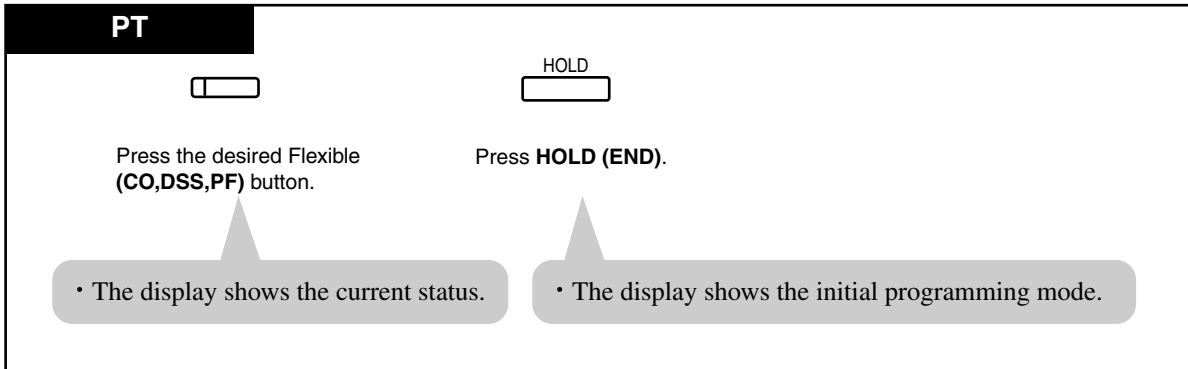

—To exit Station Programming mode: Press [PROGRAM].

—If you wish to change the data, follow the programming procedure explained in this section.

## Clearing the data on the Flexible button

— Be sure that you are in the Station Programming mode: Press [PROGRAM] [9] [9].

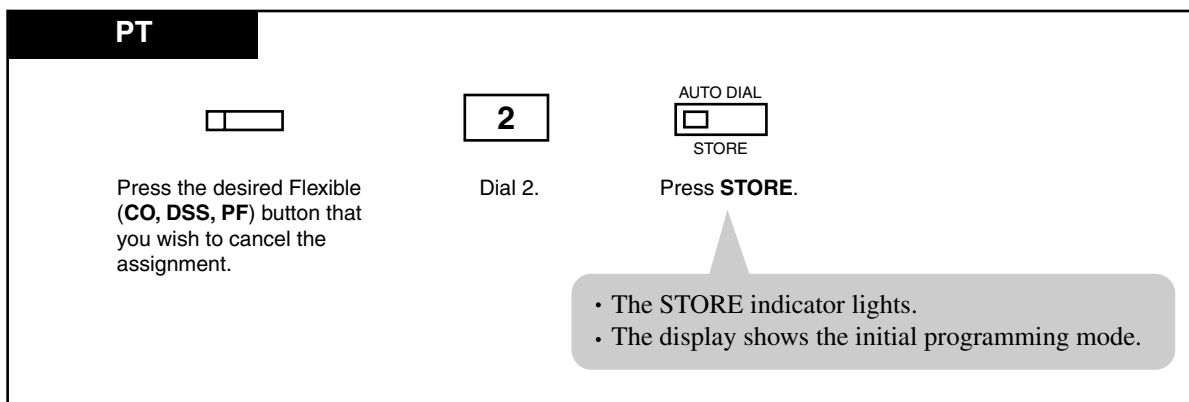

— To exit Station Programming mode: Press [PROGRAM].

—The following lists are the buttons and programming access numbers used for Station Programming. Detailed operating instructions are explained on each page in this section.

**Station Programming Outline [Flexible Button Assignment]**

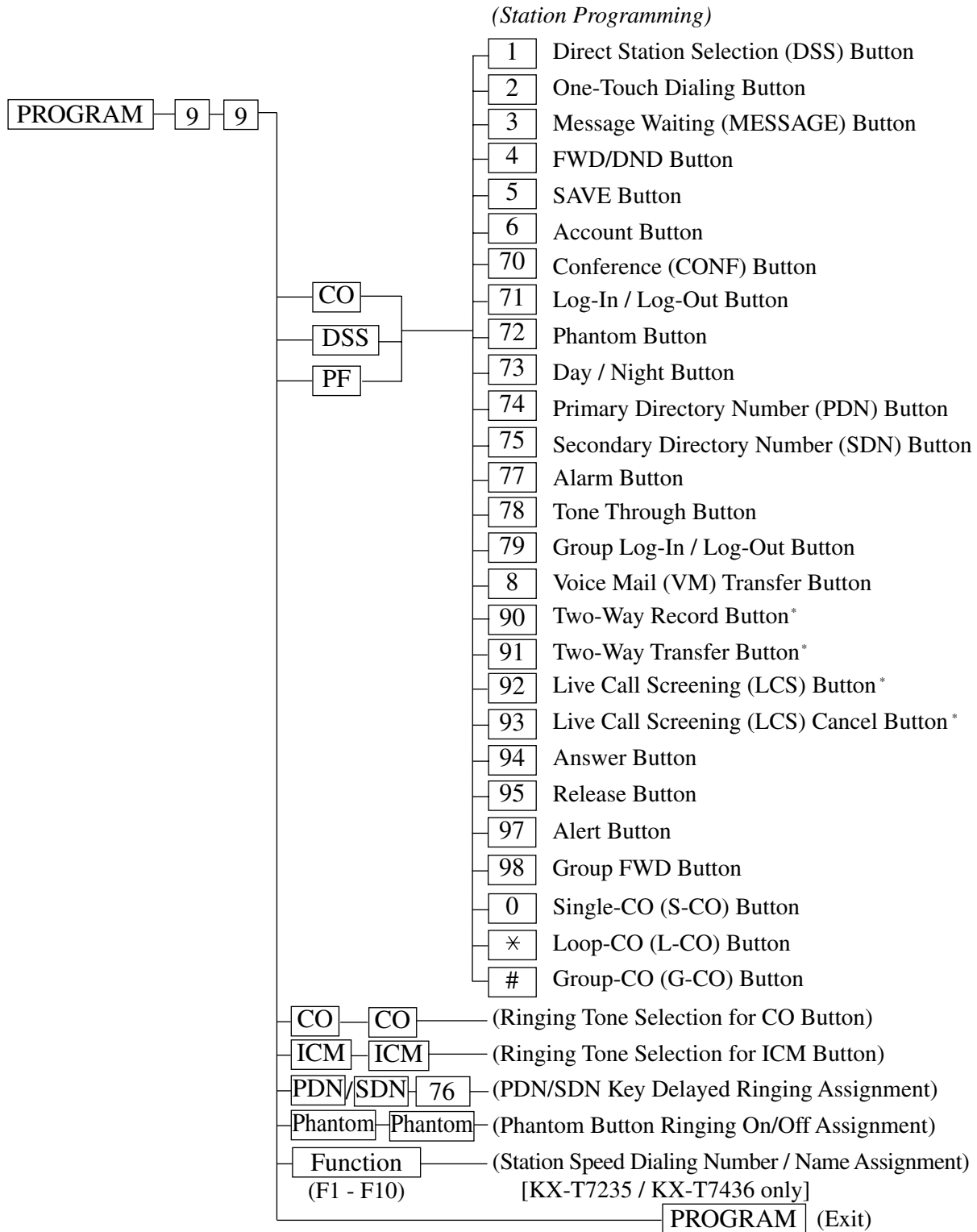

\* : Available when the Digital Super Hybrid System is connected to a Digital Proprietary Telephone capable Panasonic Voice Processing System (one that supports Digital Proprietary Telephone [DPT] integration; e.g., KX-TVS100).

**Note**

- Please refer to "Flexible Buttons" in Section "1.1.4 Feature Buttons" for applicability of CO / DSS / PF buttons.

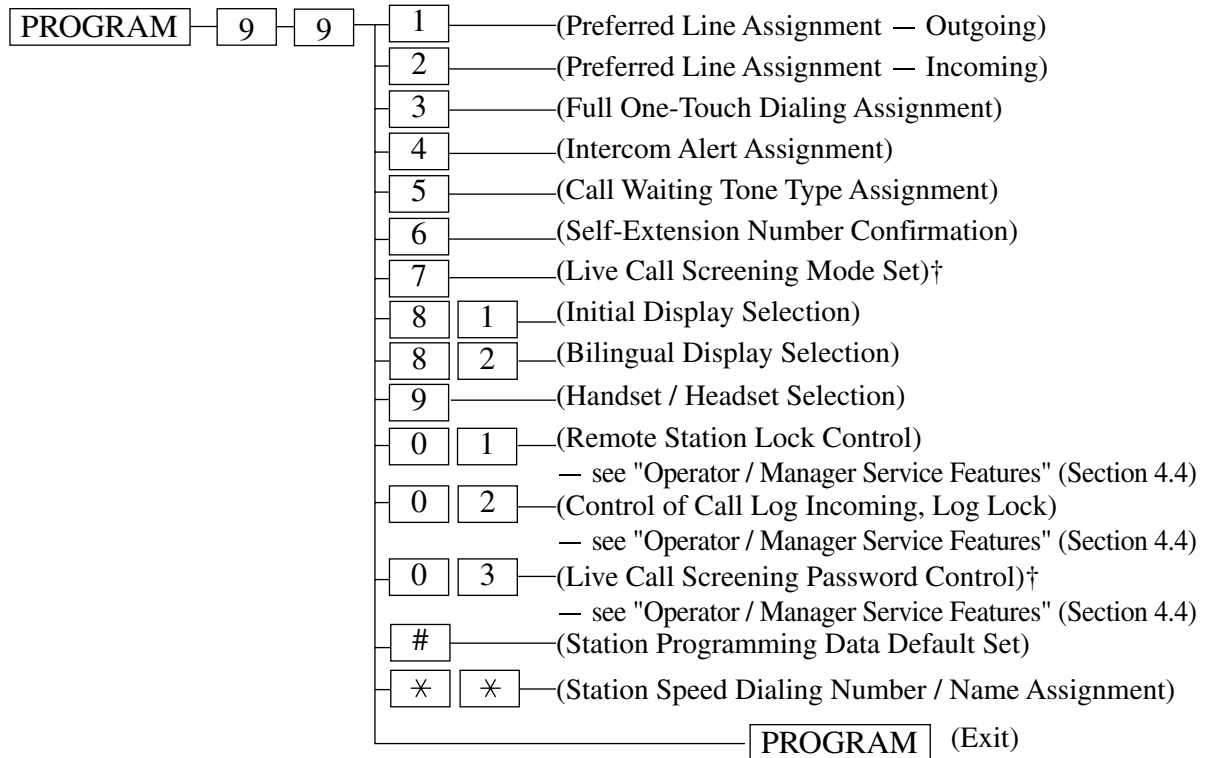
**[Function Assignment]**

<sup>†</sup> Available when the Digital Super Hybrid System is connected to a Digital Proprietary Telephone capable Panasonic Voice Processing System (one that supports Digital Proprietary Telephone [DPT] integration; e.g., KX-TVS100).

## 2.2 Station Programming

### 2.2.1 Bilingual Display Selection

Allows you to select the display in English or French.

— Be sure that you are in the Station Programming mode: Press [PROGRAM] [9] [9].

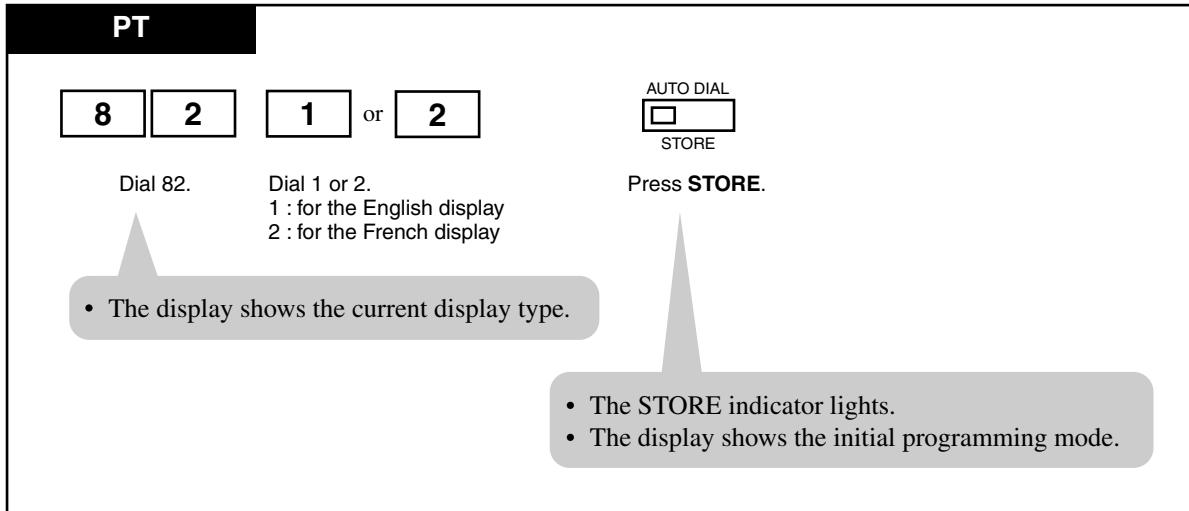

— To exit the Station Programming mode: Press [PROGRAM].

#### Conditions

- The default is "English display" mode.



## 2.2.2 Call Waiting Tone Type Assignment

Allows you to select the call waiting tone type (Tone 1 or Tone 2).

— Be sure that you are in the Station Programming mode: Press [PROGRAM] [9] [9].

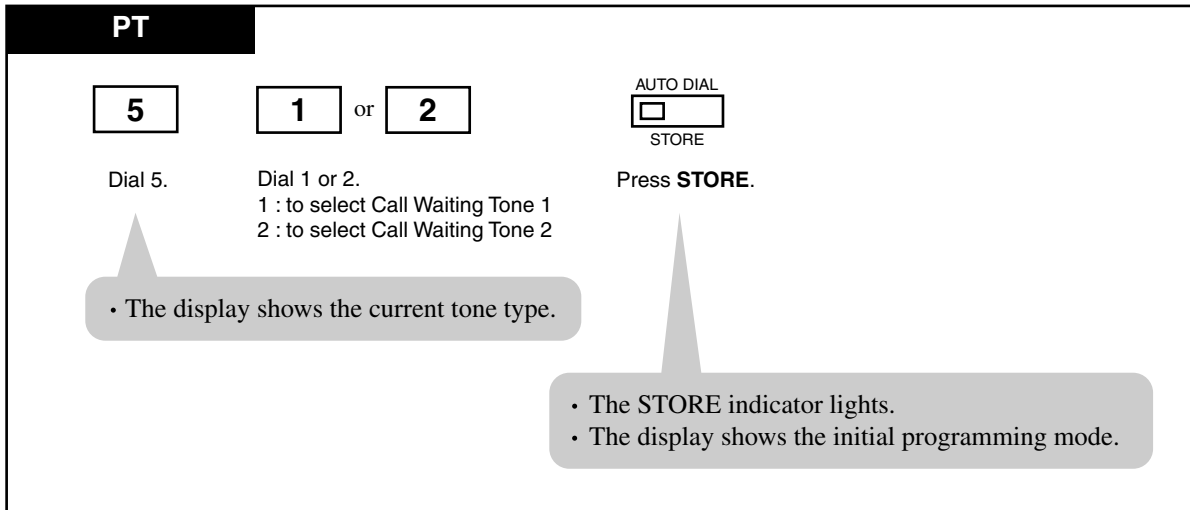

— To exit the Station Programming mode: Press [PROGRAM].

### Conditions

- The tone type patterns are described in Section "6 Appendix."
- The default is "Tone 1."

## 2.2.3 Flexible Button Assignment

Each Flexible (CO,DSS,PF) button on your PT and DSS Console can be assigned as various feature buttons such as an Account Button, FWD/DND Button, etc. The features assignable are limited by the button type. Please refer to "Flexible Buttons" in Section "1.1.4 Feature Buttons." The "Flexible CO Button Assignment" by User or System Programming can be used for this assignment.

### Account Button (Assignment)

Allows you to assign a Flexible (CO, DSS, PF) button as an Account button.

— Be sure that you are in the Station Programming mode: Press [PROGRAM] [9] [9].

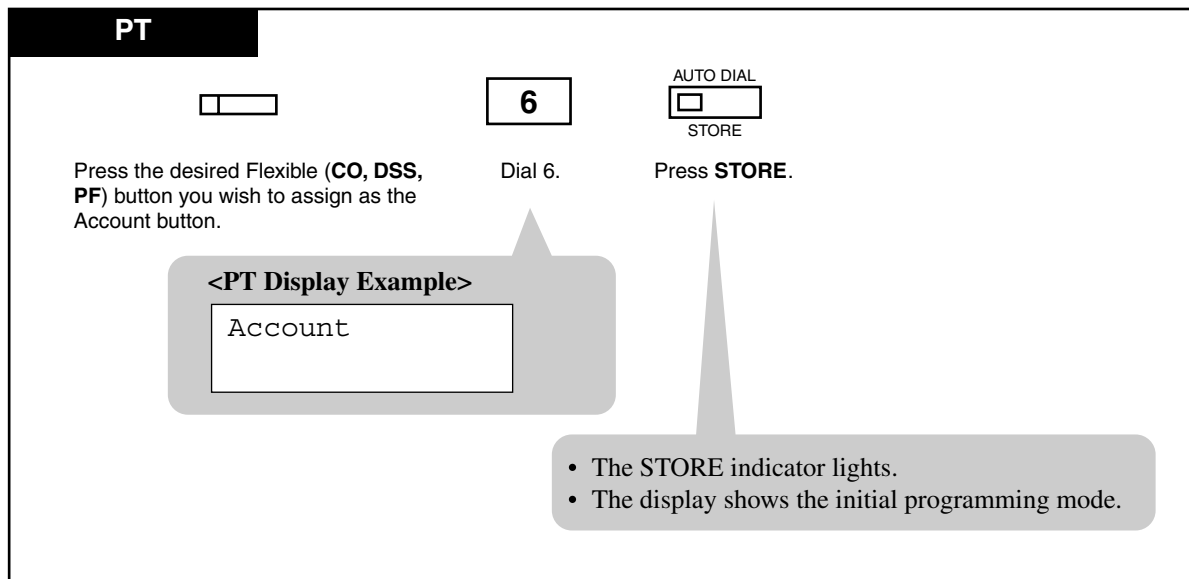

— To exit the Station Programming mode: Press [PROGRAM].

## Alarm Button (Assignment)

Allows you to assign a Flexible (CO) button as an Alarm button.

— Be sure that you are in the Station Programming mode: Press [PROGRAM] [9] [9].

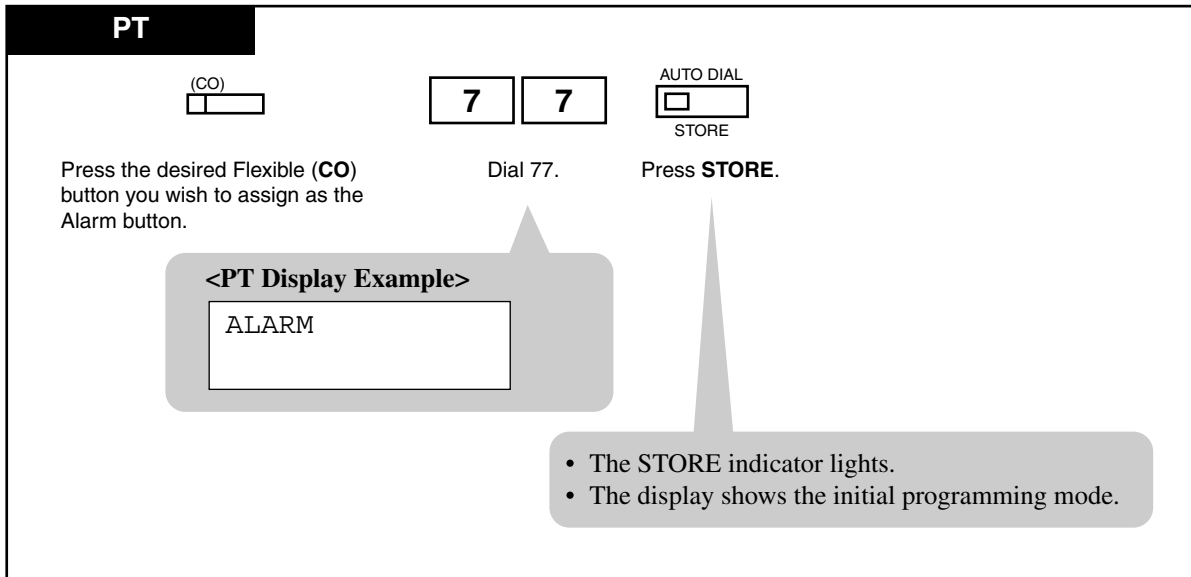

— To exit the Station Programming mode: Press [PROGRAM].

## Conditions

- Alarm button is available for the Manager only.

### Alert Button (Assignment)

Allows you to assign a Flexible (CO) button as an Alert button.

— Be sure that you are in the Station Programming mode: Press [PROGRAM] [9] [9].

**PT**

(CO)

**9** **7**

AUTO DIAL  STORE

Press the desired Flexible (CO) button you wish to assign as the Alert button.

Dial 97.

Press **STORE**.

<PT Display Example>

ALERT

- The STORE indicator lights.
- The display shows the initial programming mode.

— To exit the Station Programming mode: Press [PROGRAM].

## Answer Button (Assignment)

Allows you to assign a Flexible (CO, DSS, PF) button as an Answer button.

— Be sure that you are in the Station Programming mode: Press [PROGRAM] [9] [9].

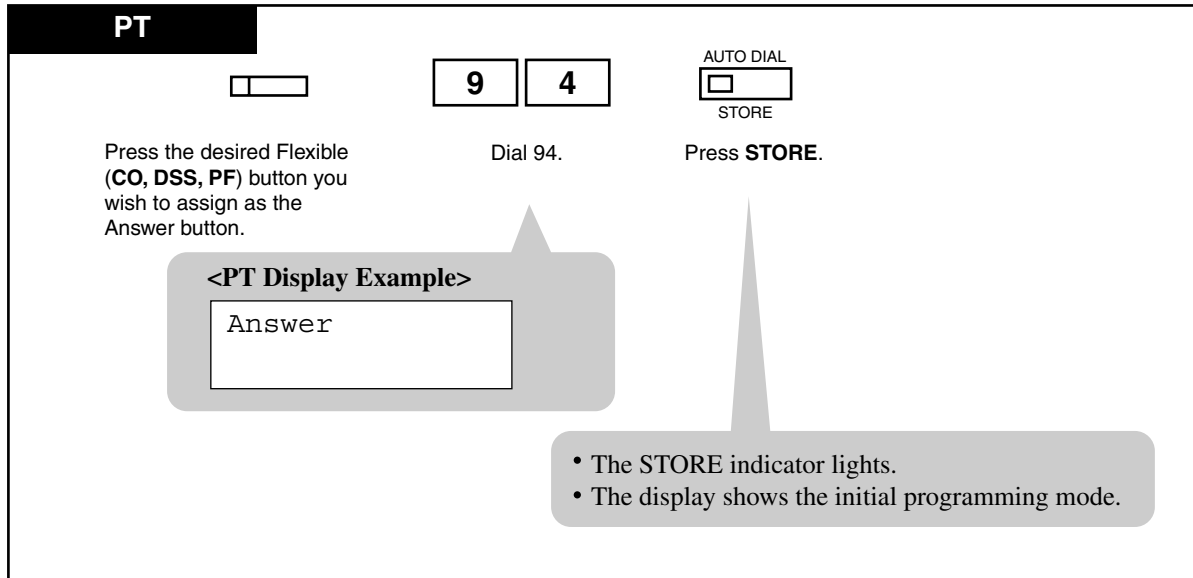

— To exit the Station Programming mode: Press [PROGRAM].

### Conference (CONF) Button (Assignment)

Allows you to assign a Flexible (CO, DSS, PF) button as a Conference (CONF) button.

— Be sure that you are in the Station Programming mode: Press [PROGRAM] [9] [9].

The diagram illustrates the steps for assigning a Conference button. It features a control panel with a display and several buttons. The display shows '<PT Display Example>' and 'Conference'. The buttons include 'PT', '7', '0', 'AUTO DIAL', and 'STORE'. The 'AUTO DIAL' button has a small square indicator light. A callout box points to the 'STORE' button with the following instructions:

- The STORE indicator lights.
- The display shows the initial programming mode.

— To exit the Station Programming mode: Press [PROGRAM].

## DAY/NIGHT Button (Assignment)

Allows you to assign a Flexible (CO, DSS) button as a DAY/NIGHT button.

— Be sure that you are in the Station Programming mode: Press [PROGRAM] [9] [9].

The diagram illustrates the station programming interface. At the top left, a black box contains the text "PT". Below it, a small rectangular display shows a blank space. To the right, two buttons labeled "7" and "3" are shown. Further right, a button labeled "AUTO DIAL" with a small square icon and the word "STORE" below it is shown. Text instructions are provided: "Press the desired Flexible (CO, DSS) button you wish to assign as the DAY/NIGHT button." points to the "7" button; "Dial 73." points to the "3" button; and "Press STORE." points to the "STORE" button. A callout box titled "<PT Display Example>" shows a display with "DAY/NIGHT" text. Another callout box lists two bullet points: "• The STORE indicator lights." and "• The display shows the initial programming mode."

— To exit the Station Programming mode: Press [PROGRAM].

## Direct Station Selection (DSS) Button (Assignment)

Allows you to assign a Flexible (CO, DSS) button as a DSS button.

— Be sure that you are in the Station Programming mode: Press [PROGRAM] [9] [9].

PT



Press the desired Flexible (CO, DSS) button you wish to assign as a DSS button.



Dial 1.



Enter the extension number (3 or 4 digits).



Press **STORE**.

**<PT Display Example>**

EXT-  
CLR

**<PT Display Example>**

EXT-xxxx  
CLR

(-xxxx:extension number)

- To erase an incorrect entry, press the **CLR (S2)** button or the **TRANSFER (CLEAR)** button. (The TRANSFER button becomes the CLEAR button in the Station Programming mode.)

- The STORE indicator lights.
- The display shows the initial programming mode.

— To exit the Station Programming mode: Press [PROGRAM].

### Conditions

- DSS buttons are provided on a DSS Console without default setting. You can assign the desired extension number or feature on each DSS button from the paired PT.
- You *cannot* enter non-existent extension numbers.



## FWD/DND Button (Assignment)

Allows you to assign a Flexible (CO, DSS, PF) button as an FWD/DND button.

— Be sure that you are in the Station Programming mode: Press [PROGRAM] [9] [9].

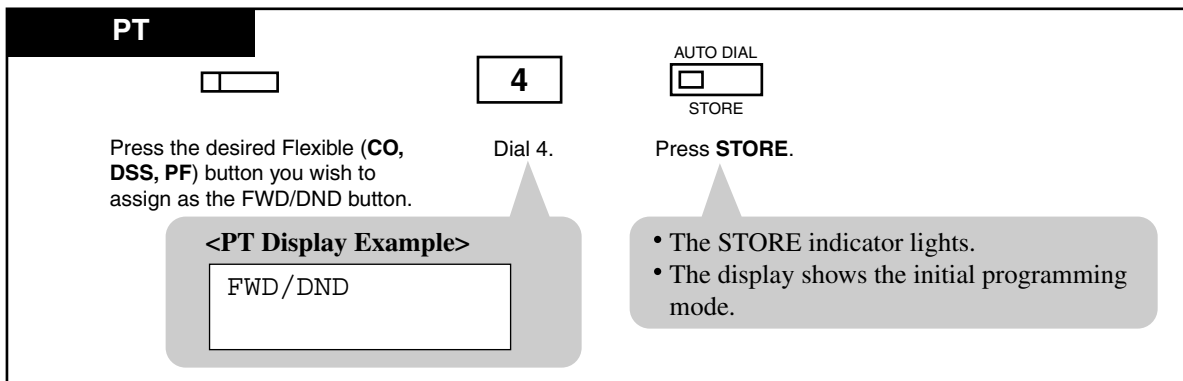

— To exit the Station Programming mode: Press [PROGRAM].

## Group FWD Button (Assignment)

Allows you to assign a Flexible (CO, DSS) button as a Group FWD button.

—Be sure that you are in the Station Programming mode: Press [PROGRAM] [9] [9].

PT

Press the desired Flexible (CO, DSS) button you wish to assign as the Group FWD button.

9

8

Dial 98.

FDN

Enter FDN of Incoming group (3 or 4 digits).

AUTO DIAL

STORE

Press **STORE**.

**<PT Display Example>**

G - FWD FDN -  
CLR

**<PT Display Example>**

G - FWD FDN - xxxx  
CLR

(-xxxx:Incoming group number)

- To erase an incorrect entry, press the **CLR (S2)** button or the **TRANSFER (CLEAR)** button.  
(The TRANSFER button becomes the CLEAR button in the Station Programming mode.)

- The STORE indicator lights.
- The display shows the initial programming mode.

— To exit the Station Programming mode: Press [PROGRAM].

### Conditions

- You cannot enter non-existent extension or a floating directory number.\*<sup>1</sup>  
Please refer to "Floating Station" of Section "1.3 System Features" in the Features Guide.

### Programming Guide References

- 3.5 Incoming Group
  - FDN
  - Group Type

\*<sup>1</sup> A Floating Directory Number (FDN) is a virtual extension number which appears to be an extension.

## Group Log-In / Log-Out Button (Assignment)

Allows you to assign a Flexible (CO) button as a Group Log-In / Log-Out button.

— Be sure that you are in the Station Programming mode: Press [PROGRAM] [9] [9].

PT

AUTO DIAL  
STORE

Press the desired Flexible (CO) button you wish to assign as the Group Log-In / Log-Out button.

Dial 79.

Enter FDN of Incoming group (3 or 4 digits).

Press **STORE**.

<PT Display Example>

G-Login FDN-  
CLR

<PT Display Example>

G-Login FDN-xxxx (-xxxx:Incoming group number)  
CLR

To erase an incorrect entry, press the **CLR (S2)** button or the **TRANSFER (CLEAR)** button.  
(The TRANSFER button becomes the CLEAR button in the Station Programming mode.)

- The STORE indicator lights.
- The display shows the initial programming mode.

— To exit the Station Programming mode: Press [PROGRAM].

### Conditions

- You cannot enter non-existent extension or a floating directory number.\*1  
Please refer to "Floating Station" of Section "1.3 System Features" in the Features Guide.

### Programming Guide References

- 3.5 Incoming Group
  - FDN
  - Group Type

\*1 A Floating Directory Number (FDN) is a virtual extension number which appears to be an extension.

### Group-CO (G-CO) Button (Assignment)

Allows you to assign a Flexible (CO, DSS) button as a Group-CO button.

— Be sure that you are in the Station Programming mode: Press [PROGRAM] [9] [9].

**PT**

Press the desired Flexible (CO, DSS) button you wish to assign as a G-CO button.

Dial #.

Enter the trunk group number (01 through 48).

Press **STORE**.

**<PT Display Example>**

TRK GRP-  
CLR

- The STORE indicator lights.
- The display shows the initial programming mode.

- To erase an incorrect entry, press the **CLR (S2)** button or the **TRANSFER (CLEAR)** button. (The TRANSFER button becomes the CLEAR button in the Station Programming mode.)

— To exit the Station Programming mode: Press [PROGRAM].

### Conditions

- A G-CO button assigned to a DSS button is available for monitoring the call activity only, not available for making or receiving a call.

### Live Call Screening (LCS) Button (Assignment)\*1

Allows you to assign a Flexible (CO, DSS) button as a Live Call Screening (LCS) button.

— Be sure that you are in the Station Programming mode: Press [PROGRAM] [9] [9].

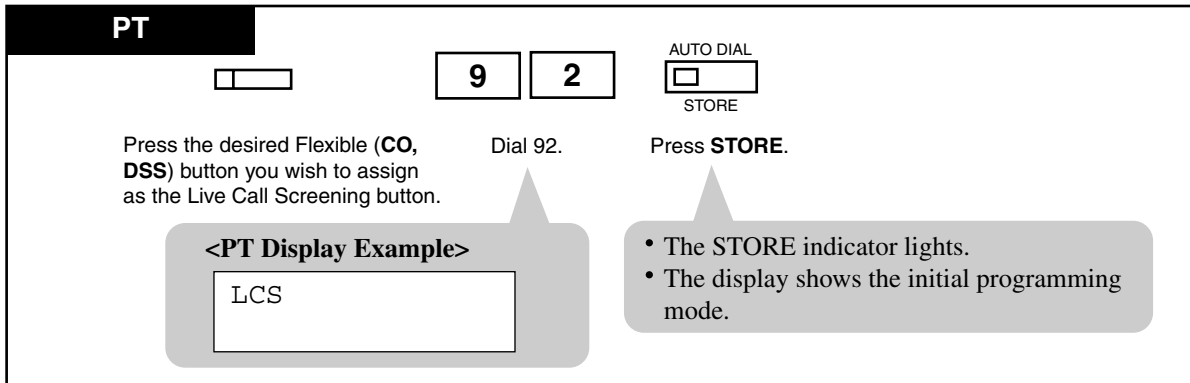

— To exit the Station Programming mode: Press [PROGRAM].

### Live Call Screening (LCS) Cancel Button (Assignment)\*1

Allows you to assign a Flexible (CO, DSS) button as a Live Call Screening (LCS) Cancel button.

— Be sure that you are in the Station Programming mode: Press [PROGRAM] [9] [9].

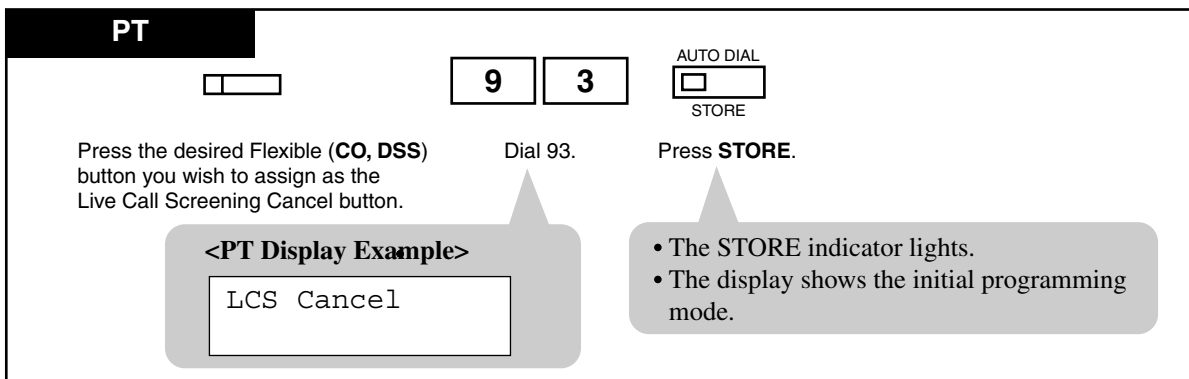

— To exit the Station Programming mode: Press [PROGRAM].

\*1 Available when the Digital Hybrid System is connected to a Digital Proprietary Telephone capable Panasonic Voice Processing System (one that supports Digital Proprietary Telephone [DPT] integration; e.g., KX-TVS100).

### Log-In / Log-Out Button (Assignment)

Allows you to assign a Flexible (CO) button as a Log-In / Log-Out button.

— Be sure that you are in the Station Programming mode: Press [PROGRAM] [9] [9].

**PT**

(CO) 7 1 AUTO DIAL  
STORE

Press the desired Flexible (CO) button you wish to assign as the Log-In/Log-Out button.

Dial 71.

Press **STORE**.

**<PT Display Example>**

Login/Logout

- The STORE indicator lights.
- The display shows the initial programming mode.

— To exit the Station Programming mode: Press [PROGRAM].

### Loop-CO (L-CO) Button (Assignment)

Allows you to assign a Flexible (CO) button as a Loop-CO button.

— Be sure that you are in the Station Programming mode: Press [PROGRAM] [9] [9].

**PT**

(CO) \* AUTO DIAL  
STORE

Press the desired Flexible (CO) button you wish to assign as the L-CO button.

Dial \*.

Press **STORE**.

**<PT Display Example>**

Loop-CO

- The STORE indicator lights.
- The display shows the initial programming mode.

— To exit the Station Programming mode: Press [PROGRAM].

## Message Waiting (MESSAGE) Button (Assignment)

Allows you to assign a Flexible (CO, DSS) button as a Message Waiting (MESSAGE) button.

— Be sure that you are in the Station Programming mode: Press [PROGRAM] [9] [9].

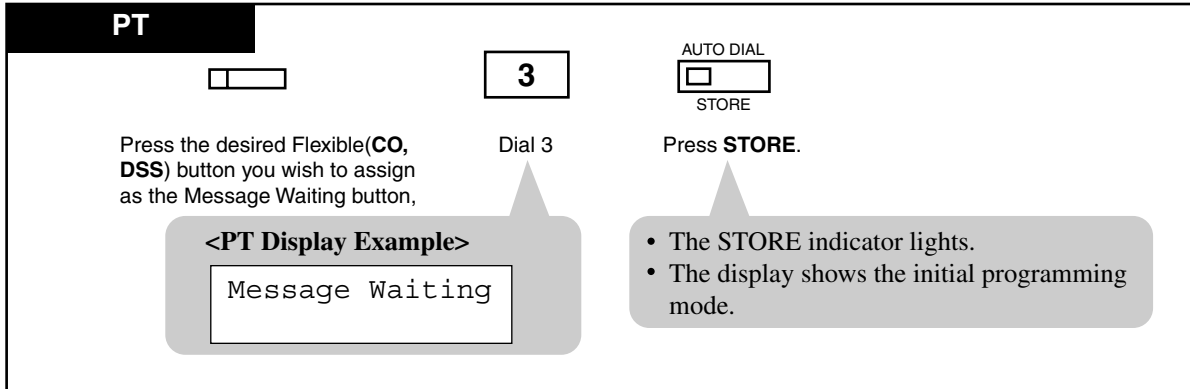

— To exit the Station Programming mode: Press [PROGRAM].

## One-Touch Dialing Button (Assignment)

Allows you to assign a Flexible (CO, DSS, PF) button as a One-Touch Dialing button.

— Be sure that you are in the Station Programming mode: Press [PROGRAM] [9] [9].

**PT**

Press the desired Flexible (CO, DSS, PF) button you wish to assign as a One-Touch Dialing button.

Dial 2.

Enter the desired number (extension number, phone number, etc.).

Press **STORE**.

**<PT Display Example>**

CLR

- Up to 24 digits can be stored.
- To erase an incorrect entry, press the **CLR (S2)** button or the **TRANSFER (CLEAR)** button. (The TRANSFER button becomes the CLEAR button in the Station Programming mode.)

- The STORE indicator lights.
- The display shows the initial programming mode.

— To exit the Station Programming mode: Press [PROGRAM].

## Conditions

- The number can be an extension number, telephone number or a feature number. Up to 24 digits can be stored in a One-Touch Dialing button.
- To store the telephone number of an outside party, a line access code (9, or 801 through 848) must be stored as the leading digit.
- You can store a number consisting of 25 digits or more by dividing it and assigning it in two One-Touch Dialing buttons. In this case, the line access code should be stored in the first button.
- You can use 0 through 9, \*, #, PAUSE, FLASH, CONF and INTERCOM for storing.
  - FLASH: hook flash
  - PAUSE: pause
  - CONF: — (hyphen)
  - INTERCOM: for secret dialing
  - \*#: for changing the dialing mode (Pulse to Tone)
- KX-T7220 and KX-T7250 telephones do not have a PAUSE button. The PROGRAM button can be used instead of the PAUSE button while programming.



## Phantom Button (Assignment)

Allows you to assign a Flexible (CO) button as a Phantom button.

— Be sure that you are in the Station Programming mode: Press [PROGRAM] [9] [9].

PT

AUTO DIAL  
STORE

Press the desired Flexible (CO) button you wish to assign as a Phantom button.

Dial 72.

Enter the phantom extension number (3 or 4 digits).

Press **STORE**.

**<PT Display Example>**

Phantom:  
CLR

**<PT Display Example>**

Phantom:xxxx  
CLR

(-xxxx:Phantom extension number)

- To erase an incorrect entry, press the **CLR (S2)** button or the **TRANSFER (CLEAR)** button. (The TRANSFER button becomes the CLEAR button in the Station Programming mode.)

- The STORE indicator lights.
- The display shows the initial programming mode.

— To exit the Station Programming mode: Press [PROGRAM].

## Conditions

- The phantom extension numbers must be assigned by System Programming <Section 5.3 Phantom Extension in the Programming Guide> before assigning the Phantom button.
- If you assign the Phantom button to one of the CO buttons (CO 13 through CO 24) on a PT with 24 CO buttons, such as KX-T7230, and change the telephone to a PT with 12 CO buttons, such as KX-T7235, you must re-program the setting because CO 13 through CO 24 are not provided with the PT with 12 CO buttons. If you do not change the setting, the phantom extension call appears on the INTERCOM (ICM type PT) or PDN (DN type PT) button.
- More than one identical Phantom button cannot be assigned on a single extension.

### Primary Directory Number (PDN) Button (Assignment)

Allows you to assign a Flexible (CO) button as a PDN button.

— Be sure that you are in the Station Programming mode: Press [PROGRAM] [9] [9].

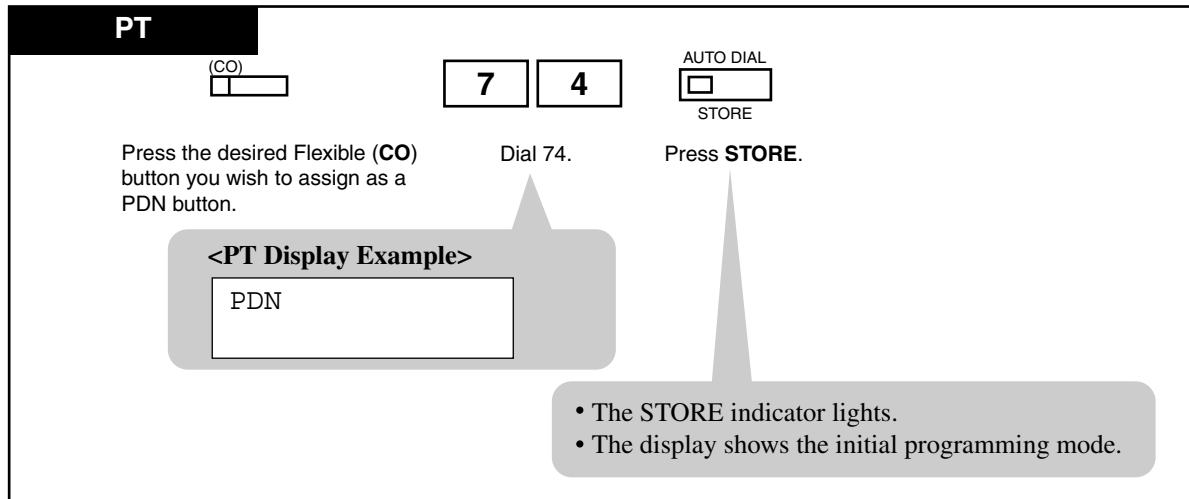

— To exit the Station Programming mode: Press [PROGRAM].

### Conditions

- A PDN button can be assigned to any one of the flexible CO buttons on a PT by Station, User or System Programming. Up to three PDN buttons can be assigned to any flexible CO button on a PT. However, the first PDN button should always be assigned to the CO 01 button regardless of the number of the PDN buttons assigned.

## Release Button (Assignment)

Allows you to assign a Flexible (CO, DSS, PF) button as a Release button.

— Be sure that you are in the Station Programming mode: Press [PROGRAM] [9] [9].

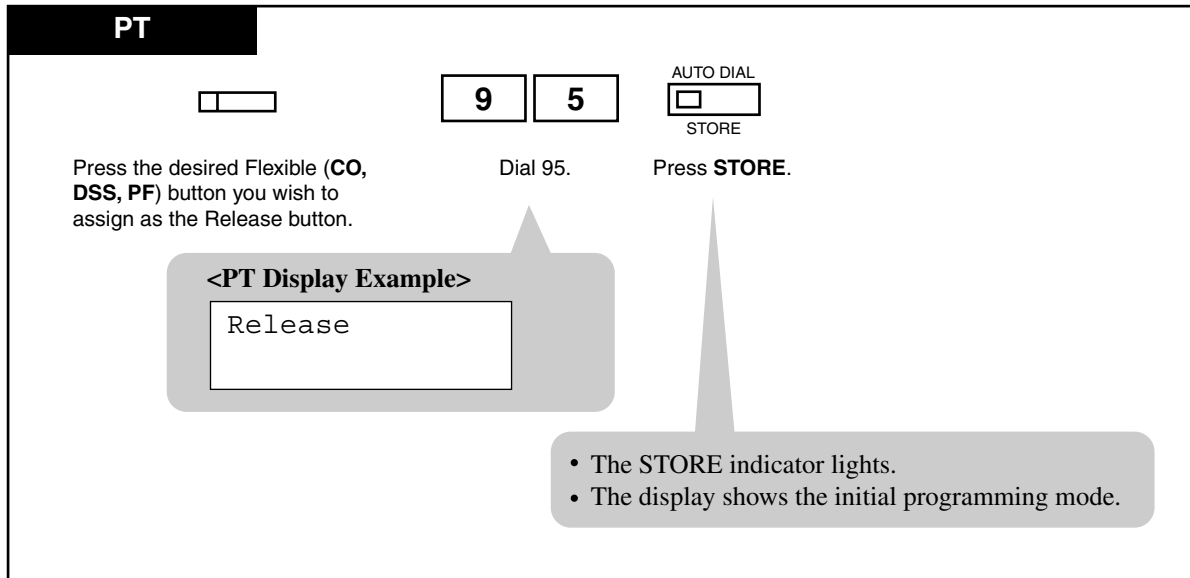

— To exit the Station Programming mode: Press [PROGRAM].

## SAVE Button (Assignment)

Allows you to assign a Flexible (CO, DSS, PF) button as a SAVE button.

— Be sure that you are in the Station Programming mode: Press [PROGRAM] [9] [9].

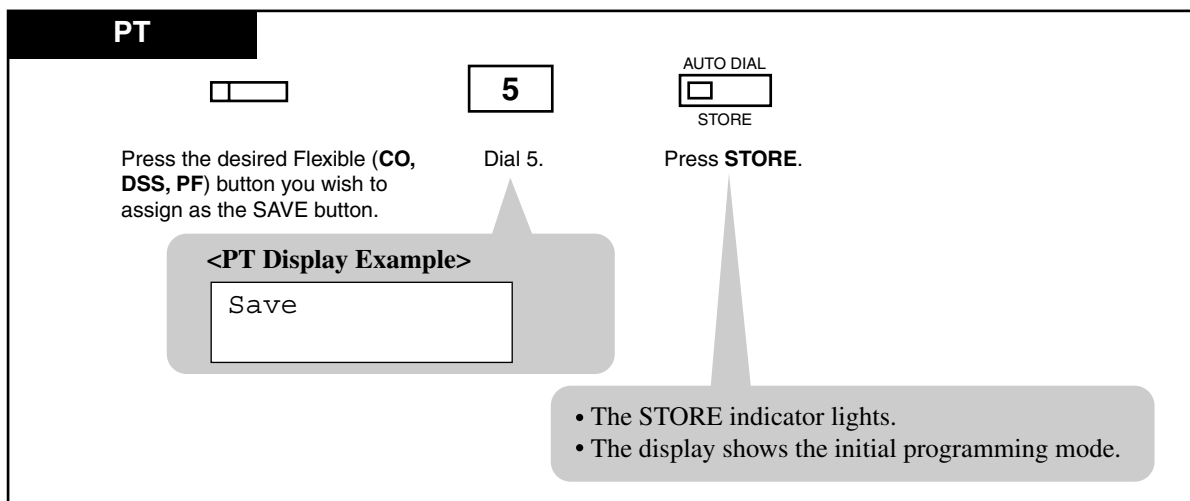

— To exit the Station Programming mode: Press [PROGRAM].

## Secondary Directory Number (SDN) Button (Assignment)

Allows you to assign a Flexible (CO) button as an SDN button.

— Be sure that you are in the Station Programming mode: Press [PROGRAM] [9] [9].

PT

(CO)

7

5

extension no. of the  
owner extension

AUTO DIAL

STORE

Press the desired Flexible (CO) button you wish to assign as an SDN button.

Dial 75.

Enter the extension number (3 or 4 digits) of the owner extension.

Press **STORE**.

**<PT Display Example>**

SDN—

CLR

**<PT Display Example>**

SDN—xxxx

CLR

(-xxxx:extension number)

- To erase an incorrect entry, press the **CLR (S2)** button or the **TRANSFER (CLEAR)** button. (The TRANSFER button becomes the CLEAR button in the Station Programming mode.)

- The STORE indicator lights.
- The display shows the initial programming mode.

— To exit the Station Programming mode: Press [PROGRAM].

### Conditions

- An SDN button should have its associated PDN button of another extension. This assignment is available for extensions on which at least one PDN button is already assigned (DN type PT). Otherwise, the SDN button dose not function.
- Up to three different SDN buttons can be assigned to a PT.
- Up to eight SDN buttons per PDN button can be assigned to eight different PTs respectively.

## Single-CO (S-CO) Button (Assignment)

Allows you to assign a Flexible (CO, DSS) button as a Single-CO button.

— Be sure that you are in the Station Programming mode: Press [PROGRAM] [9] [9].

PT

Press the desired Flexible (CO, DSS) button you wish to assign as an S-CO button.

0

Dial 0.

trunk port physical number

Enter the trunk port physical number.

AUTO DIAL  
STORE

Press **STORE**.

**<PT Display Example>**

CO—  
CLR

**<PT Display Example>**

CO—xxxxxx (-xxxxx: trunk port physical number)  
CLR

- To erase an incorrect entry, press the **CLR (S2)** button or the **TRANSFER (CLEAR)** button. (The TRANSFER button becomes the CLEAR button in the Station Programming mode.)

- The STORE indicator lights.
- The display shows the initial programming mode.

— To exit the Station Programming mode: Press [PROGRAM].

### Conditions

- You cannot assign the same CO line to more than one S-CO button on a PT.
- You can assign the same CO line to an S-CO button, a G-CO button and an L-CO button respectively.
- An S-CO button assigned to a DSS button is available for monitoring the call activity only, not available for making or receiving a call.

### Tone Through Button (Assignment)

Allows you to assign a Flexible (CO, DSS) button as a Tone Through button.

— Be sure that you are in the Station Programming mode: Press [PROGRAM] [9] [9].

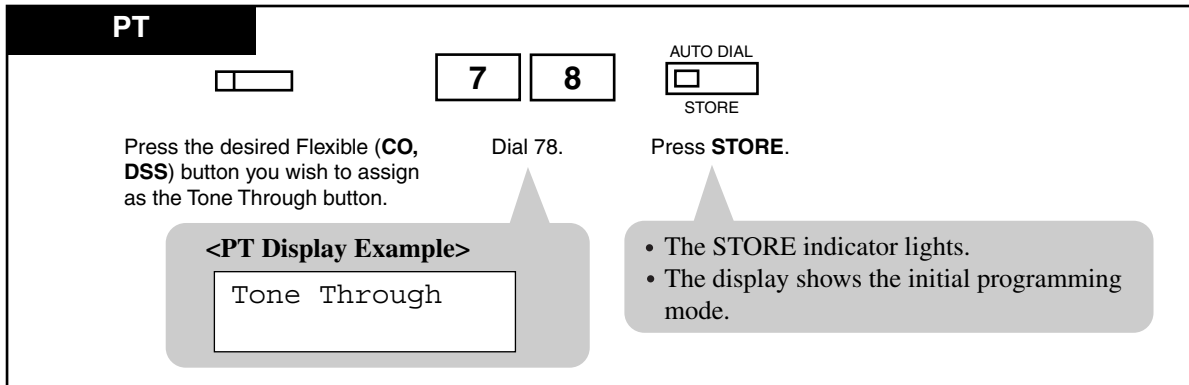

— To exit the Station Programming mode: Press [PROGRAM].

### Features Guide References

#### 1.12 Conversation Features

- End-to-End DTMF Signaling (Tone Through)

## Two-Way Record Button (Assignment)\*1

Allows you to assign a Flexible (CO, DSS) button as a Two-Way Record button. This allows you to record a conversation into your own mailbox.

— Be sure that you are in the Station Programming mode: Press [PROGRAM] [9] [9].

PT

9

0

Voice Mail  
extension no.

AUTO DIAL  
STORE

Press the desired Flexible (CO, DSS) button you wish to assign as the Two-Way Record button.

Dial 90.

Enter the Voice Mail extension number (3 or 4 digits).

Press **STORE**.

**<PT Display Example>**

2 WAY-REC :  
CLR

**<PT Display Example>**

2 WAY-REC :xxxx (-xxxx:VM extension number)  
CLR

- To erase an incorrect entry, press the **CLR (S2)** button or the **TRANSFER (CLEAR)** button.  
(The TRANSFER button becomes the CLEAR button in the Station Programming mode.)

- The STORE indicator lights.
- The display shows the initial programming mode.

— To exit the Station Programming mode: Press [PROGRAM].

## Conditions

- You cannot enter a non-existent extension or floating directory number.<sup>\*2</sup> Please refer to "Floating Station" of Section "1.3 System Features" in the Features Guide.
- You should use a voice mail extension number that has been assigned by System Programming. Please refer to Programming Guide References below.

## Programming Guide References

- 1.5 VPS (DPT) Port Assignment
  - [EXT No.1] DN
  - [EXT No.1] Group No.
  - [EXT No.2] DN

<sup>\*1</sup> Available when the Digital Super Hybrid System is connected to a Digital Proprietary Telephone capable Panasonic Voice Processing System (one that supports Digital Proprietary Telephone [DPT] integration; e.g., KX-TVS100).

<sup>\*2</sup> A Floating Directory Number (FDN) is a virtual extension number which appears to be an extension.

– [EXT No.2] Group No.

### Two-Way Transfer Button (Assignment)\*1

Allows you to assign a Flexible (CO, DSS) button as a Two-Way Transfer button. This allows you to record a conversation into a desired mailbox.

— Be sure that you are in the Station Programming mode: Press [PROGRAM] [9] [9].

**PT**

Press the desired Flexible (CO, DSS) button you wish to assign as the Two-Way Transfer button.

Dial 91.

Enter the Voice Mail extension number (3 or 4 digits).

Press **STORE**.

**<PT Display Example>**

2 WAY-TRANS :  
CLR

**<PT Display Example>**

2 WAY-TRANS :xxxxx (-xxxx:VM extension number)  
CLR

- The STORE indicator lights.
- The display shows the initial programming mode.

• To erase an incorrect entry, press the **CLR (S2)** button or the **TRANSFER (CLEAR)** button. (The TRANSFER button becomes the CLEAR button in the Station Programming mode.)

— To exit the Station Programming mode: Press [PROGRAM].

### Conditions

- You cannot enter a non-existent extension or floating directory number.\*2 Please refer to "Floating Station" of Section "1.3 System Features" in the Features Guide.
- You should use a voice mail extension number that has been assigned by System Programming. Please refer to Programming Guide References below.

### Programming Guide References

- 1.5 VPS (DPT) Port Assignment  
– [EXT No.1] DN

\*1 Available when the Digital Super Hybrid System is connected to a Digital Proprietary Telephone capable Panasonic Voice Processing System (one that supports Digital Proprietary Telephone [DPT] integration; e.g., KX-TVS100).

\*2 A Floating Directory Number (FDN) is a virtual extension number which appears to be an extension.



- [EXT No.1] Group No.
- [EXT No.2] DN
- [EXT No.2] Group No.

### Voice Mail (VM) Transfer Button (Assignment)

Allows you to assign a Flexible (CO, DSS, PF) button as a VM Transfer button.

— Be sure that you are in the Station Programming mode: Press [PROGRAM] [9] [9].

PT

8

Voice Mail  
extension no.

AUTO DIAL  
STORE

Press the desired Flexible (CO, DSS, PF) button you wish to assign as the VM Transfer button.

Dial 8.

Enter the Voice Mail extension number (3 or 4 digits).

Press **STORE**.

**<PT Display Example>**

VTR -

CLR

**<PT Display Example>**

VTR - xxxx

CLR

(-xxxx:VM extension number)

- To erase an incorrect entry, press the **CLR (S2)** button or the **TRANSFER (CLEAR)** button. (The TRANSFER button becomes the CLEAR button in the Station Programming mode.)

- The STORE indicator lights.
- The display shows the initial programming mode.

— To exit the Station Programming mode: Press [PROGRAM].

### Conditions

- You cannot enter non-existent extension or a floating directory number.<sup>\*1</sup>  
Please refer to "Floating Station" of Section "1.3 System Features" in the Features Guide.

### Programming Guide References

- 3.3 Extension Group
  - FDN
  - Group Type
- 5.10 VPS Integration

<sup>\*1</sup> A Floating Directory Number (FDN) is a virtual extension number which appears to be an extension.

## 2.2.4 Full One-Touch Dialing Assignment

Allows you to enable or disable the "Full One-Touch Dialing" function. The "Hands-free Operation" mode is activated by pressing a One-Touch Dialing button, DSS button, REDIAL button or SAVE button.

— Be sure that you are in the Station Programming mode: Press [PROGRAM] [9] [9].

**PT**

**3** Dial 3.

**1** or **2** Dial 1 or 2.  
1 : to select the off mode  
2 : to select the on mode

**AUTO DIAL**  
**STORE**  
Press **STORE**.

- The STORE indicator light turns off.

**<PT Display Example>**  
Hands-free: Off (-When disabled)

- The STORE indicator lights.
- The display shows the initial programming mode.

— To exit the Station Programming mode: Press [PROGRAM].

### Conditions

- The default is "On."

## 2.2.5 Handset / Headset Selection

Allows you to select the handset mode or headset mode.

— Be sure that you are in the Station Programming mode: Press [PROGRAM] [9] [9].

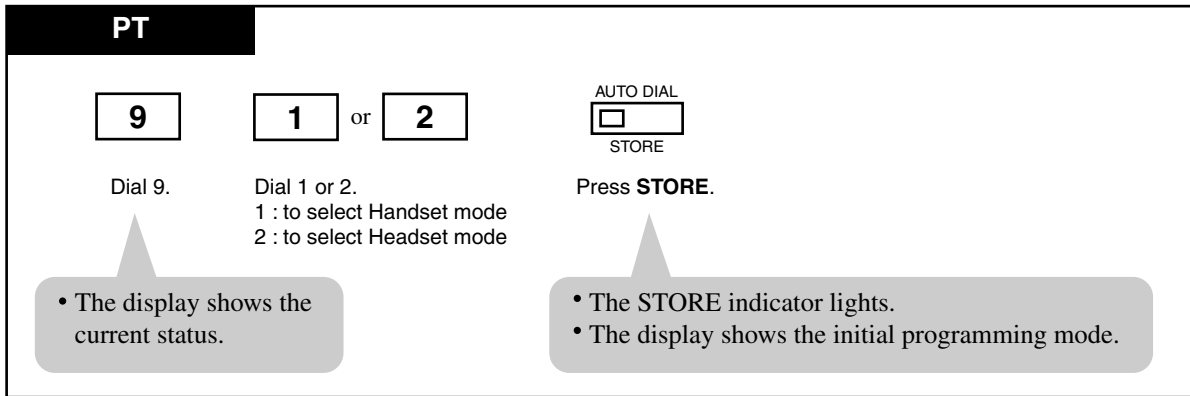

— To exit the Station Programming mode: Press [PROGRAM].

### Conditions

- The default is "Handset."

## 2.2.6 Initial Display Selection

Allows you to select the initial display, Caller ID, CO line name or DID name which is shown on the display when a call is received.

— Be sure that you are in the Station Programming mode: Press [PROGRAM] [9] [9].

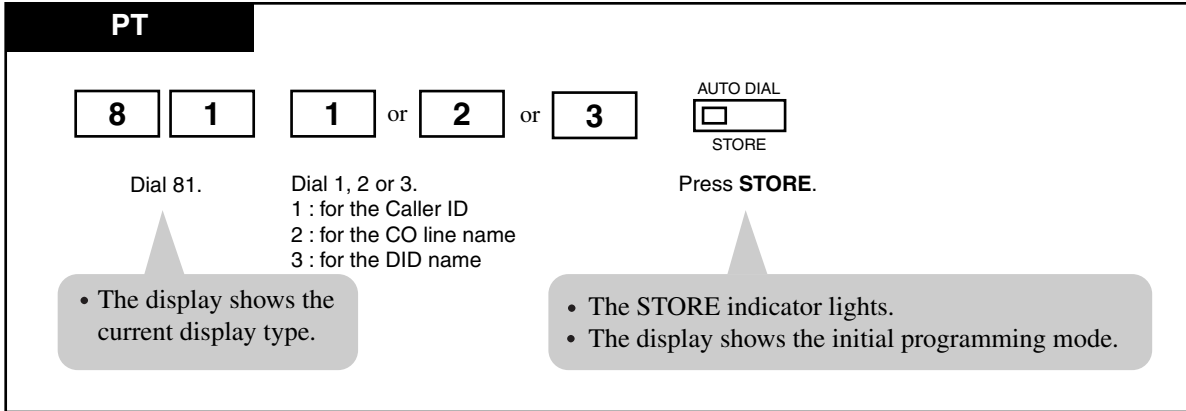

— To exit the Station Programming mode: Press [PROGRAM].

### Conditions

- The default is "Caller ID" mode.

## 2.2.7 Intercom Alert Assignment

Allows you to select the alert mode (tone / voice) when receiving an intercom (extension) call.

— Be sure that you are in the Station Programming mode: Press [PROGRAM] [9] [9].

The diagram shows a control panel with a display and several buttons. At the top left, a black bar contains the text "PT". Below it, there are three buttons: a button with the number "4", a button with the number "1" followed by "or", and a button with the number "2". To the right of these buttons is a control labeled "AUTO DIAL" with a small square indicator and the word "STORE" below it. Below the "4" button, the text "Dial 4." is present. Below the "1 or 2" buttons, the text "Dial 1 or 2." is present, followed by "1 : to select the Ring-Calling (Tone Call) mode" and "2 : to select the Voice-Calling mode". Below the "AUTO DIAL" control, the text "Press STORE." is present. A callout box points to the "STORE" indicator with the following text:

- The STORE indicator lights.
- The display shows the initial programming mode.

Another callout box points to the display area with the following text:

**<PT Display Example>**

- When Ring-Calling (Tone Call) mode is selected;
 

Tone Call
- When Voice-Calling mode is selected;
 

Voice Call

— To exit the Station Programming mode: Press [PROGRAM].

### Conditions

- The default is "Ring-Calling (Tone Call)."

## 2.2.8 Live Call Screening (LCS) Mode Set<sup>\*1</sup>

Assigns whether the recording message is monitored through the built-in speaker (Hands-free mode) or an alert tone is sent (Private mode) while incoming callers are leaving a message in the called extension's mailbox.

— Be sure that you are in the Station Programming mode: Press [PROGRAM] [9] [9].

The diagram shows a telephone display with a black header labeled 'PT'. Below the header, there are three main sections:

- Left Section:** A box containing the number '7'. Below it, the text reads 'Dial 7.' A callout bubble points to this section.
- Middle Section:** Two boxes containing the numbers '1' and '2' with the word 'or' between them. Below them, the text reads 'Dial 1 or 2. 1 : for the Hands-free 2 : for the Private mode'.
- Right Section:** A box containing the text 'AUTO DIAL' above a small square icon with a horizontal line through it, and the word 'STORE' below it. Below this, the text reads 'Press STORE.' A callout bubble points to this section.

Below these sections is a large grey callout box containing the following information:

- <PT Display Example>**
- When the Hands-free mode is selected;
  - Hands-free
- When the Private mode is selected;
  - Private

Another callout bubble points to the right section with the following text:

- The STORE indicator lights.
- The display shows the initial programming mode.

— To exit the Station Programming mode: Press [PROGRAM].

### Conditions

- The default is "Hands-free" mode.

<sup>\*1</sup> Available when the Digital Super Hybrid System is connected to a Digital Proprietary Telephone capable Panasonic Voice Processing System (one that supports Digital Proprietary Telephone [DPT] integration; e.g., KX-TVS100).

## 2.2.9 PDN/SDN Button Delayed Ringing Assignment

Allows you to assign a delayed ringing function on the PDN/SDN button.

— Be sure that you are in the Station Programming mode: Press [PROGRAM] [9] [9].

PT

(PDN) or (SDN)

**7** **6**

delayed ringing type no.

AUTO DIAL

STORE

Press **PDN** or **SDN** you wish to assign the delayed ringing function.

Dial 76.

Enter the delayed ringing type number (0 through 4).

-0: Immediate Ring

-1: 1-ring Delay

-2: 3-ring Delay

-3: 6-ring Delay

-4: No Ring

Press **STORE**.

**<PT Display Example>**

Immediate Ring

**<PT Display Example>**

1-ring Delay

- If you want to change the delayed ringing type, enter another type number again.

- The STORE indicator lights.
- The display shows the initial programming mode.

— To exit the Station Programming mode: Press [PROGRAM].

### Conditions

- If more than one PDN button is assigned on a PT, Delayed Ringing can be set to the first PDN button (assigned to the CO 01) only. This Delayed Ringing setting applies to all PDN buttons on the same PT.

## 2.2.10 Phantom Button Ringing On/Off Assignment

Allows you to assign a ringing On/Off function on a Phantom button.

— Be sure that you are in the Station Programming mode: Press [PROGRAM] [9] [9].

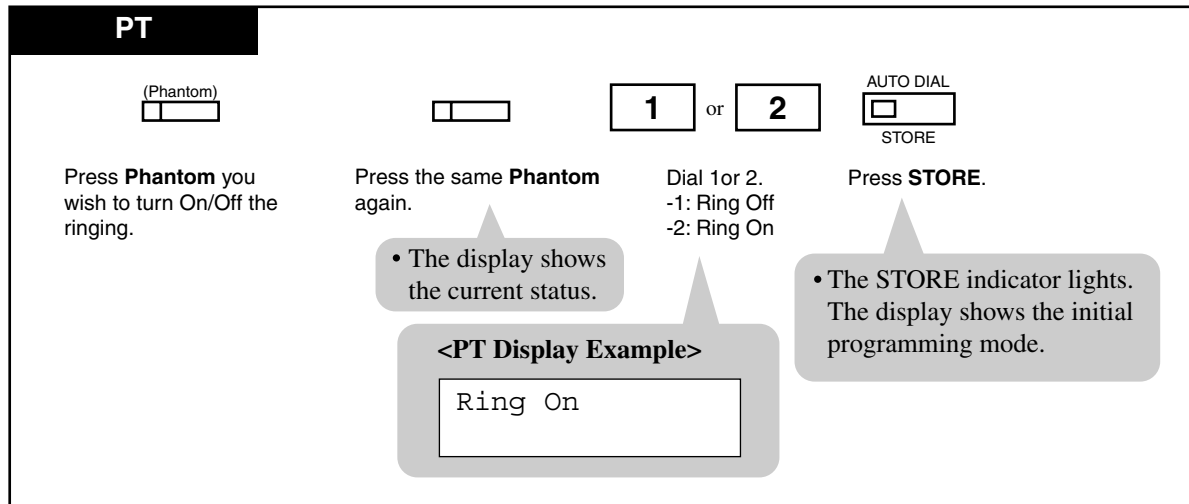

— To exit the Station Programming mode: Press [PROGRAM].



## 2.2.11 Preferred Line Assignment — Incoming

Allows you to select the method used to answer incoming calls from the following three line preferences:

- a) No Line Preference
- b) Ringing Line Preference (— default)
- c) Prime Line Preference

Follow the corresponding programming procedure according to your selection.

### No Line Preference — Incoming (Assignment)

No line is selected when you go off-hook to answer a call. You must select a line to answer an incoming call.

— Be sure that you are in the Station Programming mode: Press [PROGRAM] [9] [9].

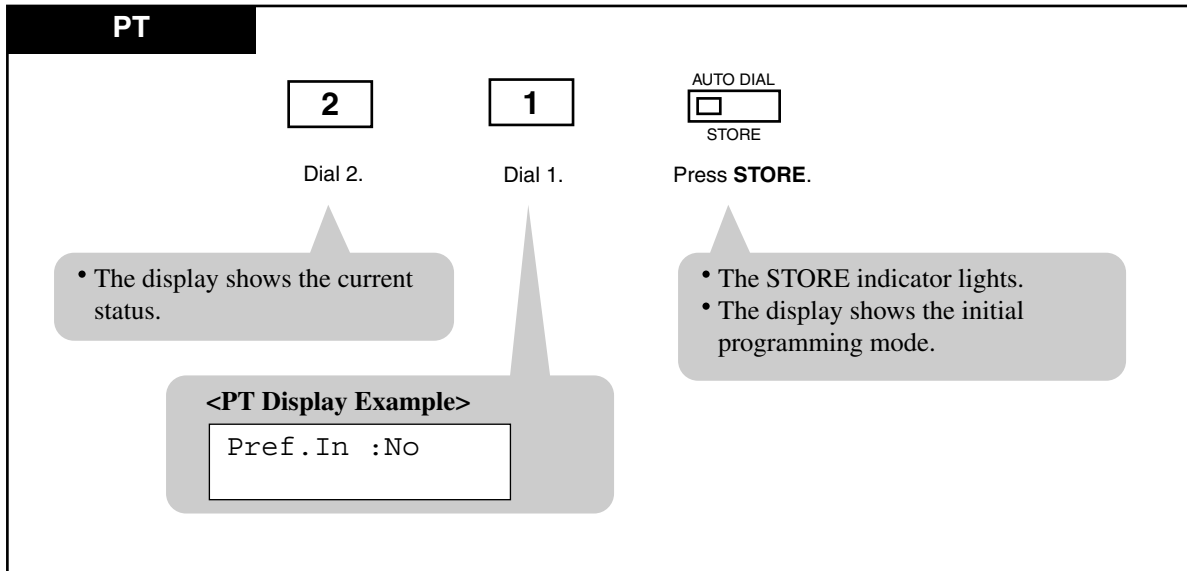

— To exit the Station Programming mode: Press [PROGRAM].

### Ring Line Preference — Incoming (Assignment)

You are connected to a call ringing on your extension automatically, when you go off-hook to answer a call.

— Be sure that you are in the Station Programming mode: Press [PROGRAM] [9] [9].

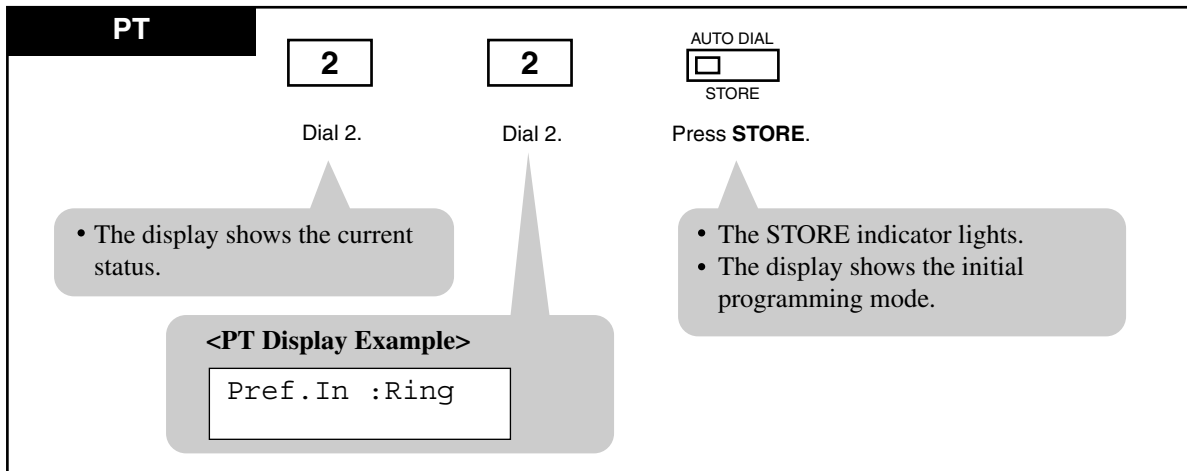

— To exit the Station Programming mode: Press [PROGRAM].

## Prime Line Preference — Incoming (Assignment)

You are connected to a call on the line assigned as the prime line automatically, when you go off-hook to answer a call.

— Be sure that you are in the Station Programming mode: Press [PROGRAM] [9] [9].

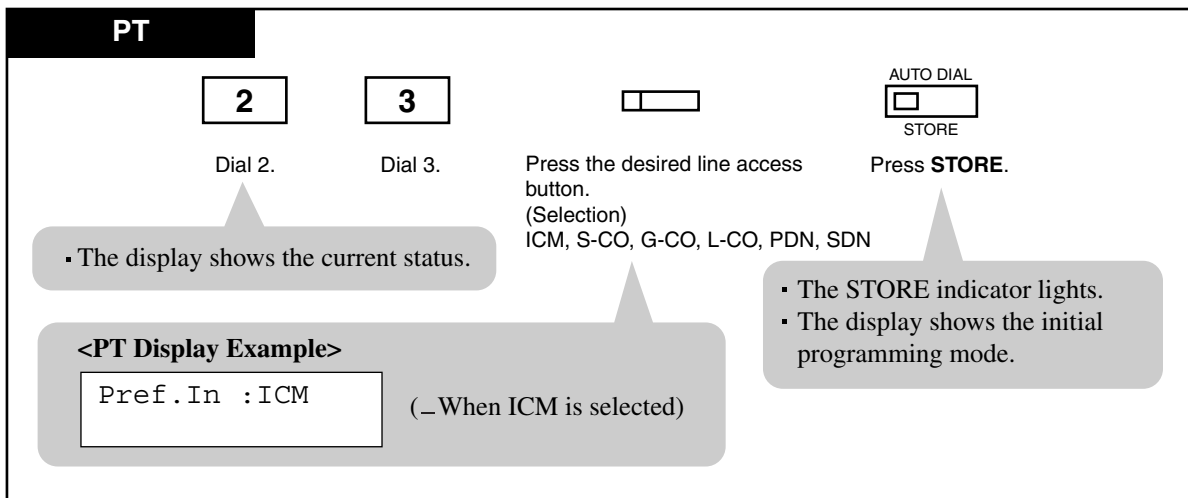

— To exit the Station Programming mode: Press [PROGRAM].

### **Note**

- If your PT is DN type, then you cannot select "ICM."

## 2.2.12 Preferred Line Assignment — Outgoing

Allows you to select the desired outgoing line preference to originate calls from the following three line preferences:

- a) No Line Preference
- b) Idle Line Preference
- c) Prime Line Preference (INTERCOM) (— default<sup>\*1</sup>)

Follow the programming procedure according to your selection.

### Note

- If "Idle Line Preference," "No Line Preference" or "Prime Line Preference (S-CO, G-CO or L-CO)" is selected, it is **not** possible to access any PT features after going off-hook. To access these PT features, press the INTERCOM (ICM type PT) or PDN (DN type PT) button before or after going off-hook.

### No Line Preference — Outgoing (Assignment)

When you go off-hook to make a call, you are not connected to any line. You must choose the line.

— Be sure that you are in the Station Programming mode: Press [PROGRAM] [9] [9].

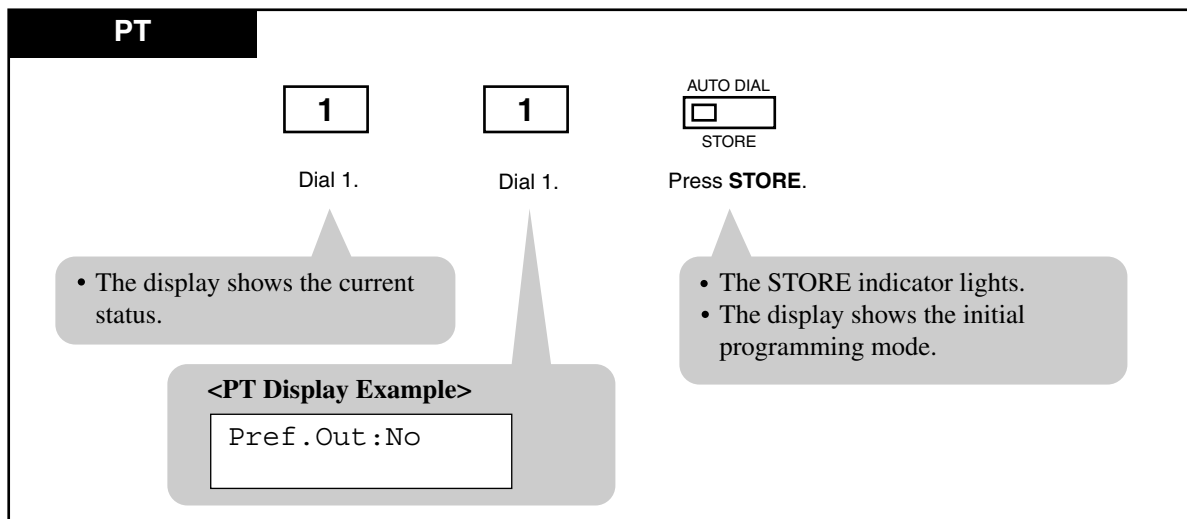

— To exit the Station Programming mode: Press [PROGRAM].

<sup>\*1</sup> If PT is DN type, then the default is PDN.

## Idle Line Preference — Outgoing (Assignment)

When you go off-hook to make a call, you are connected to an idle line automatically.

— Be sure that you are in the Station Programming mode: Press [PROGRAM] [9] [9].

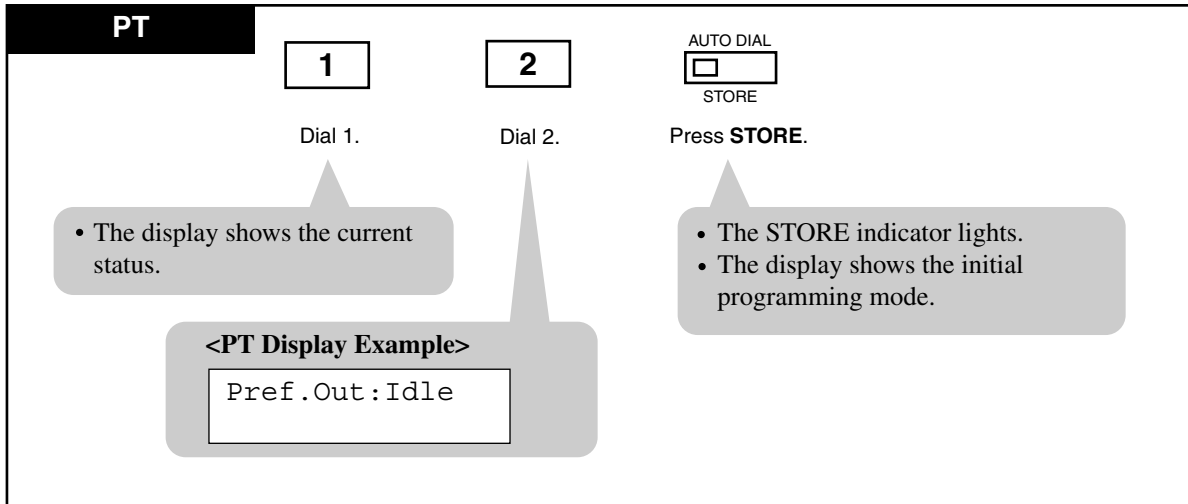

— To exit the Station Programming mode: Press [PROGRAM].

### Prime Line Preference — Outgoing (Assignment)

When you go off-hook to make a call, you are connected to a line assigned as the prime line automatically.

— Be sure that you are in the Station Programming mode: Press [PROGRAM] [9] [9].

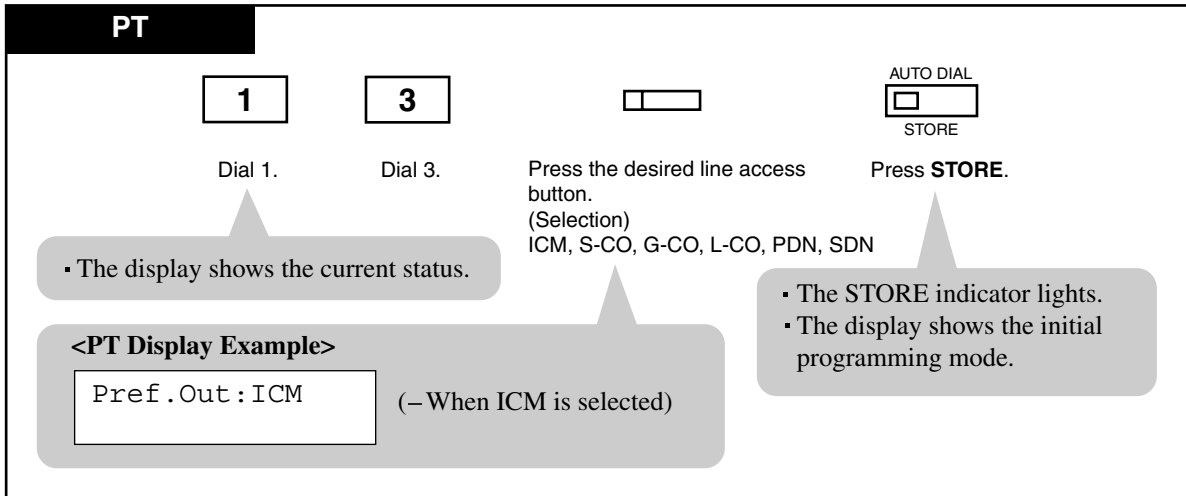

— To exit the Station Programming mode: Press [PROGRAM].

**Note**

- If your PT is DN type, then you cannot select "ICM."

## 2.2.13 Ringing Tone Selection for CO Buttons

Allows you to assign a ringer frequency to each CO (S-CO, G-CO, L-CO) or DN (PDN, SDN) button.

— Be sure that you are in the Station Programming mode: Press [PROGRAM] [9] [9].

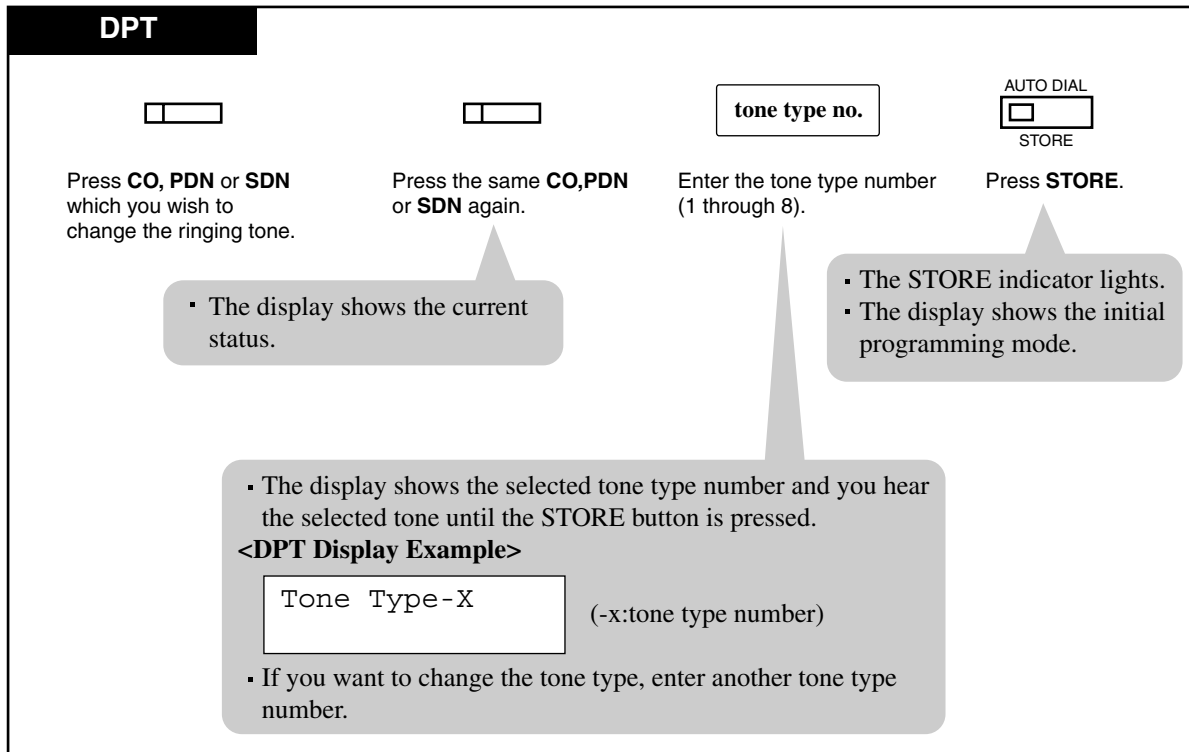

— To exit the Station Programming mode: Press [PROGRAM].

### Conditions

- The default is Ringing Tone Type 2.
- This feature applies to the following line access buttons:  
S-CO, G-CO, L-CO, PDN, SDN

## 2.2.14 Ringing Tone Selection for INTERCOM Button

Allows you to assign a ringer frequency to the INTERCOM button.

— Be sure that you are in the Station Programming mode: Press [PROGRAM] [9] [9].

DPT

INTERCOM

Press **INTERCOM**.

INTERCOM

Press **INTERCOM** again.

tone type no.

Enter the tone type number  
(1 through 8).

AUTO DIAL

STORE

Press **STORE**.

- The display shows the current status

- The display shows the selected tone type number and you hear the selected tone until the STORE button is pressed.

**<DPT Display Example>**

Tone Type-X

(-x:tone type number)

- If you want to change the tone type, enter another tone type number.

- The STORE indicator lights.
- The display shows the initial programming mode.

— To exit the Station Programming mode: Press [PROGRAM].

### Conditions

- The default is Ringing Tone Type 3.



## 2.2.15 Self-Extension Number Confirmation

Allows you to display your extension port physical number and extension number.

— Be sure that you are in the Station Programming mode: Press [PROGRAM] [9] [9].

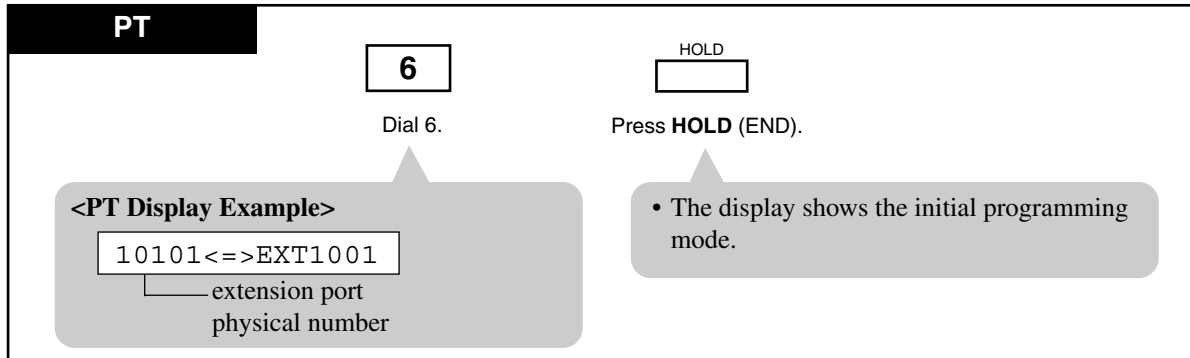

— To exit the Station Programming mode: Press [PROGRAM].

## 2.2.16 Station Programming Data Default Set

Allows you to return each of the following items assigned by Station Programming to their default settings.

- a) Bilingual Display Selection (default: English)
- b) Call Waiting Tone Type Assignment (default: Tone 1)
- c) Full One-Touch Dialing Assignment (default: On)
- d) Handset/Headset Selection (default: Handset)
- e) Initial Display Selection (default: Caller ID)
- f) Intercom Alert Assignment (default: Tone Call)
- g) Live Call Screen Mode Set (default: Hands-free)
- h) Preferred Line Preference — Incoming (default: Ringing Line)
- i) Preferred Line Preference — Outgoing (default: INTERCOM Line)

— Be sure that you are in the Station Programming mode: Press [PROGRAM] [9] [9].

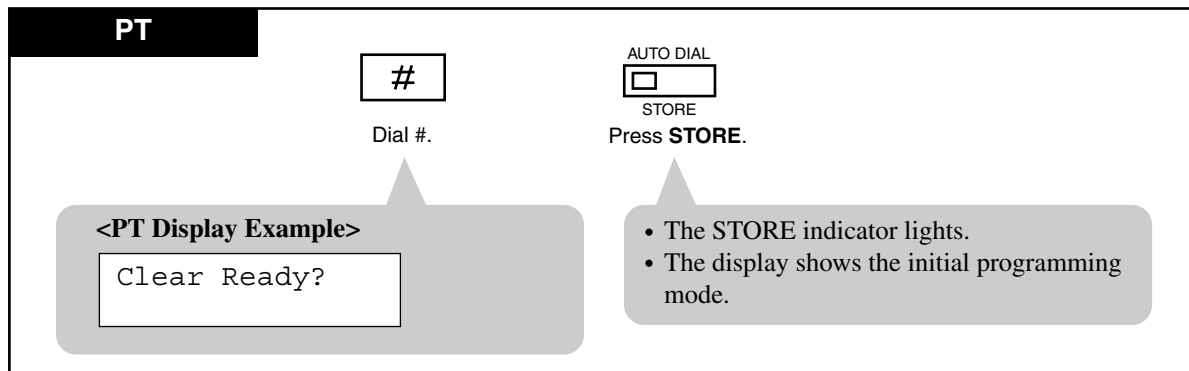

— To exit the Station Programming mode: Press [PROGRAM].

## 2.2.17 Station Speed Dialing Number/Name Assignment [KX-T7235/KX-T7431/KX-T7433/KX-T7436 only]

Allows you to assign frequently dialed numbers and names to each Function button on your PT.

### For KX-T7235 and KX-T7436 users

#### To store a number

— Be sure that you are in the Station Programming mode: Press [PROGRAM] [9] [9].

7235/7436

F1	PT-PGM Mode	F6
F2		F7
F3		F8
F4		F9
F5		F10

Press **Function** (F1-F10).

desired number

Enter the desired number  
(extension number,  
phone number, etc.).

AUTO DIAL  
  
 STORE

Press **STORE**.

- The STORE indicator light turns off.
- The display shows the current status.  
(If nothing is stored, “Not Stored” is displayed.)

**<PT Display Example>**

9 - 123 - 4567
(- Outside number, 123-4567,  
is now programmed.)

CLR
NEXT

- Up to 24 digits, consisting of 0 through 9, \*, #, FLASH, PAUSE, INTERCOM, (“[” or “]” : secret) and CONF (-:hyphen), can be stored.
- To store the telephone number of an outside party, the line access code (9 or 801 through 848) must be stored as the leading digit.
- To erase the line, press the **CLR (S2)** button.
- To store a name, press the **NEXT(S3)** button and go to step 3 in “To store a name” as described in the following procedure.

— To exit the Station Programming mode: Press [PROGRAM].

### To store a name

— Be sure that you are in the Station Programming mode: Press [PROGRAM] [9] [9].

7235/7436

F1	PT-PGM Mode	F6
F2		F7
F3		F8
F4		F9
F5		F10

Press **Function** (F1-F10).

NEXT

S 1 S 2 S 3

Press **NEXT** (S3).

- The STORE indicator light turns off.
- The display shows the current status.

- The display shows the current status. (If nothing is stored, "Not Stored" is displayed.)

**<PT Display Example>**

Bob Graham
(— Name is now programmed.)

CLR NEXT

desired name

Enter the name.\*

AUTO DIAL  
  
STORE

Press **STORE**.

- The STORE indicator lights.
- The display shows the initial programming mode.

— To exit the Station Programming mode: Press [PROGRAM].

\* Please refer to "Combination Table 1" and "Combination Table 2" in Section "2.2.17 Station Speed Dialing Number/Name Assignment [KX-T7235/KX-T7431/KX-T7433/KX-T7436 only]" for information on how to enter each character.

### Conditions

- Up to 10 characters can be stored.

## For KX-T7431 and KX-T7433 users

### To store a number

— Be sure that you are in the Station Programming mode: Press [PROGRAM] [9] [9].

7431/7433

\*

\*

Dial \*.\*.

station speed dial no.

Enter a station speed dial number (0 through 9).

desired number

Enter the desired number (extension number, phone number, etc.).

AUTO DIAL  
  
STORE

Press **STORE**.

The STORE indicator light turns off.

- The display shows the current status. (If nothing is stored, “Not Stored” is displayed.)

**<PT Display Example>**

9 - 123 - 4567

CLR    NEXT

(—Outside number, 123-4567, is now programmed.)

- The STORE indicator lights.
- The display shows the initial programming mode.

- Up to 24 digits, consisting of 0 through 9, \*, #, FLASH, PAUSE, INTERCOM, (“[” or “]” : secret) and CONF (-:hyphen), can be stored.
- To store the telephone number of an outside party, the line access code (9 or 801 through 848) must be stored as the leading digit.
- To erase the line, press the **CLR (S2)** button or **TRANSFER** button.
  - CLR (S2) button: for KX-T7433 users
  - TRANSFER button: for KX-T7431 users
- To store a name, press the **NEXT(S3)** button (KX-T7433) or **MODE** button (KX-T7431) and go to step 4 in “To store a name” as described in the following procedure.

— To exit the Station Programming mode: Press [PROGRAM].

## To store a name

— Be sure that you are in the Station Programming mode: Press [PROGRAM] [9] [9].

7431/7433

✖

✖

Dial ✖✖.

station speed dial no.

Enter a station speed dial number (0 through 9).

NEXT

S1

S2

S3

or

MODE

Press **NEXT (S3)** or **MODE**.

- The STORE indicator light turns off.
- The display shows the current status.  
(If nothing is stored, "Not Stored" is displayed.)

**<PT Display Example>**

Bob Graham
(— Name is now programmed.)

CLR
NEXT

desired name

Enter the name.\*

AUTO DIAL

STORE

Press **STORE**.

- The STORE indicator lights.
- The display shows the initial programming mode.

— To exit the Station Programming mode: Press [PROGRAM].

\* Please refer to "Combination Table 1" and "Combination Table 2" in Section "2.2.17 Station Speed Dialing Number/Name Assignment [KX-T7235/KX-T7431/KX-T7433/KX-T7436 only]" for information on how to enter each character.

## Conditions

- Up to 10 characters can be stored.

## Combination Table

Each character can be entered by using the dial key pad, various buttons or the Jog Dial for storing names.

**Combination Table 1** shows the combination of the keys and the number of times to press the SELECT (AUTO ANSWER/MUTE) button, or the combination of the key and the SHIFT and Soft buttons to enter each character. (The AUTO ANSWER/MUTE button becomes the SELECT button when using the overlay.)

To enter a character, find the key and number of times to press the SELECT button or the corresponding SHIFT and Soft button combination from the table. Press the corresponding key first, then press the SELECT button the required number of times. Or you can use the SHIFT button and a Soft button (S1 through S3) instead of the SELECT button.

**Combination Table 2** shows the combination of keys and the number of pulses to move the Jog Dial (click tones) to the right. To enter a character, find the key and number pulses to rotate the Jog Dial. Press the corresponding key first, then rotate the Jog Dial the required number of times. Or, if you keep rotating the Jog Dial after pressing any dialing key, all of the characters in the table will be displayed.

**Combination Table 1**

SHIFT & Soft Combination		S1	SHIFT + S1	S2	SHIFT + S2	S3	SHIFT+ S3	SHIFT+ SHIFT+ S1	SHIFT+ SHIFT+ S2
<b>Pressing SELECT (Times)</b>	<b>0</b>	<b>1</b>	<b>2</b>	<b>3</b>	<b>4</b>	<b>5</b>	<b>6</b>	<b>7</b>	<b>8</b>
<b>keys</b>									
1	1	Q	q	Z	z	!	?		
2	2	A	a	B	b	C	c		
3	3	D	d	E	e	F	f		
4	4	G	g	H	h	I	i		
5	5	J	j	K	k	L	l		
6	6	M	m	N	n	O	o		
7	7	P	p	Q	q	R	r	S	s
8	8	T	t	U	u	V	v		
9	9	W	w	X	x	Y	y	Z	z
0	0	(Space)	.	,	'	:	;		
*	*	/	+	-	=	<	>		
#	#	\$	%	&	@	(	)		

Combination Table 2

Rotating Jog Dial (Pulses)	0	1	2	3	4	5	6	7	8
keys									
1	1	Q	q	R	r	S	s	T	t
2	2	A	a	B	b	C	c	D	d
3	3	D	d	E	e	F	f	G	g
4	4	G	g	H	h	I	i	J	j
5	5	J	j	K	k	L	l	M	m
6	6	M	m	N	n	O	o	P	p
7	7	P	p	Q	q	R	r	S	s
8	8	T	t	U	u	V	v	W	w
9	9	W	w	X	x	Y	y	Z	z
0	0	(Space)	!	?	.	,	'	:	;
*	*	/	+	-	=	<	>	#	\$
#	#	\$	%	&	@	(	)	A	a

< Example > To enter "Mike"

— Using the SELECT button;

See Combination Table 1.

- 1) Press 6 and then press the SELECT button once to enter "M."
- 2) Press 4 and then press the SELECT button six times to enter "i."
- 3) Press 5 and then press the SELECT button four times to enter "k."
- 4) Press 3 and then press the SELECT button four times to enter "e."

— Using the SHIFT button and a Soft button;

See Combination Table 1.

- 1) Press 6 and then press the S1 button to enter "M."
- 2) Press 4 and then press the SHIFT and S3 button to enter "i."
- 3) Press 5 and then press the S2 button to enter "k."
- 4) Press 3 and then press the S2 button to enter "e."



— Using the Jog Dial (With a KX-T7431 / KX-T7433 / KX-T7436 only)  
See Combination Table 2.

- 1) Press 6 and then rotate the Jog Dial *one* pulse to enter "M."
- 2) Press 4 and then rotate the Jog Dial *six* pulses to enter "i."
- 3) Press 5 and then rotate the Jog Dial *four* pulses to enter "k."
- 4) Press 3 and then rotate the Jog Dial *four* pulses to enter "e."

OR

- 1) Press 2 and then rotate the Jog Dial until "M" appears.
- 2) Press 2 and then rotate the Jog Dial until "i" appears.
- 3) Press 2 and then rotate the Jog Dial until "k" appears.
- 4) Press 2 and then rotate the Jog Dial until "e" appears.

### Notes

- Pressing the SHIFT button alternates between capital and lower case letters. Once this button is pressed, that letter SHIFT mode remains until SHIFT is pressed again.
- To erase the last character (to backspace), press the CONF button.  
(The CONF button becomes the "←" (backspace) key when using the overlay.)
- To erase the line, press CLR (S2) button or TRANSFER button.
- If you keep rotating the Jog Dial, all of the characters will be displayed in order.  
<Example> If you rotate the Jog Dial after pressing 2, all of the characters will appear in the following order:  
A A B b ... Z z (space) ! ? . , ' : ; \* / + - = < > # \$ % & @ ( ) A a B b ...

### **Conditions**

- The default is "Not Stored."
- Up to 10 dialing numbers and names can be assigned. Each dialing number has a maximum of 24 digits and each name has a maximum of 10 characters.
- The number can be an extension number, telephone number or a feature number.
- To store the telephone number of an outside party, a line access code (9, or 801 through 848) must be stored as the leading digit.
- You can use 0 through 9, \*, #, PAUSE, FLASH, CONF and INTERCOM for storing.
  - FLASH: hook flash
  - PAUSE: pause
  - CONF: — (hyphen)
  - INTERCOM: for secret dialing



# *Section 3*

## *User Programming*

## 3.1 User Programming Instructions

### 3.1.1 General Programming Instructions

User Programming allows you, any PT extension user who knows the User Programming Password, to program the following system features from your telephone individually.

- 3.2.1 [000] Date and Time Set
- 3.2.2 [001] System Speed Dialing Number Set
- 3.2.3 [002] System Speed Dialing Name Set
- 3.2.4 [004] Extension Name Set
- 3.2.5 [005] Flexible CO Button Assignment
- 3.2.6 [006] Caller ID Dial Set
- 3.2.7 [007] Caller ID Name Set
- 3.2.8 [008] Absent Messages Set
- 3.2.9 [009] Quick Dial Number Set
- 3.2.10 [010] DISA / TIE User Code Set

To program, you need to switch your PT extension to the User Programming mode. During the programming mode, your extension is treated as a busy extension. If you want to make a normal call operation, you must finish the programming mode.

#### Default Setting

This system has default factory settings.

#### Required Telephone Set

One of the following Proprietary Telephone (PT) sets with display is required for User Programming:

- Digital Proprietary Telephone (DPT): KX-T7436, KX-T7433, KX-T7431, KX-T7235, KX-T7230
- Analog Proprietary Telephone (APT): KX-T7130, KX-T7030, KX-T7330, KX-T7335

#### Soft Buttons and SHIFT Button on the Display PT

Three soft buttons are provided just below the display of the following Digital Proprietary Telephones (DPTs): KX-T7230, KX-T7235, KX-T7433, KX-T7436.

Functions of these Soft buttons vary as the programming procedures advance step by step. Those functions that are currently assigned to the buttons are shown on the lower line of the display. If the **SHIFT** button indicator is on, two functions are available for each Soft button. To alternate between the two functions, press the **SHIFT** button on the right side of the display.

## Using the Overlay

A programming overlay is packed with the telephone at the factory. This overlay should be used at all times in the programming mode since the functions of the telephone keys change in the programming mode as follows: (The original functions are in parentheses.)

<b>During Normal Operation</b>	<b>During Programming</b>
(PAUSE/PROGRAM)	<b>PAUSE/PROGRAM</b>
(SP-PHONE)	<b>NEXT</b>
(REDIAL)	<b>PREV (PREVIOUS)</b>
(AUTO ANSWER/MUTE)	<b>SELECT</b>
(FLASH)	<b>FLASH</b>
(TRANSFER)	<b>CLEAR</b>
(FWD/DND)	<b>➡</b>
(CONF)	<b>— / ◀</b>
(INTERCOM)	<b>SECRET</b>
(AUTO DIAL/STORE)	<b>STORE</b>
(HOLD)	<b>END</b>
(Up/Down/JOG)	<b>Skip+/Skip-</b>

## Location of Controls with the Overlay

The pictures below show the functions of the buttons of the KX-T7433, KX-T7436, KX-T7230 and KX-T7235 in the programming mode. KX-T7431 is the same as KX-T7433 except for the Soft and SHIFT buttons.

**KX-T7431**

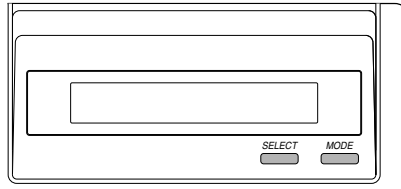

**KX-T7433**

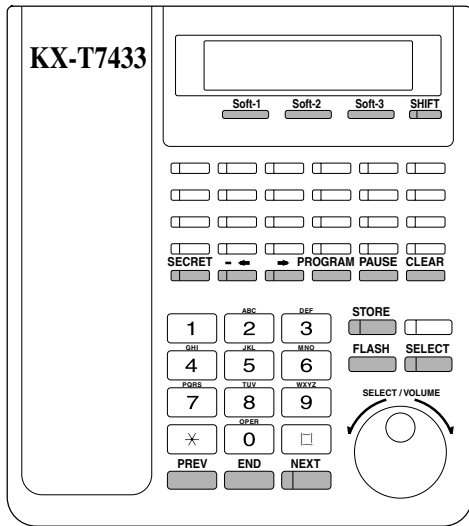

**KX-T7436**

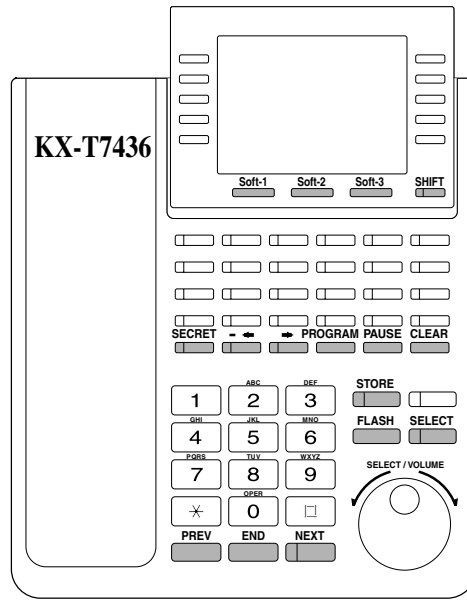

**KX-T7230**

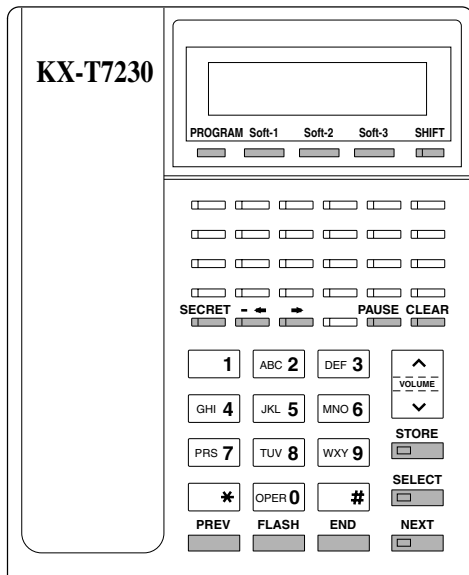

**KX-T7235**

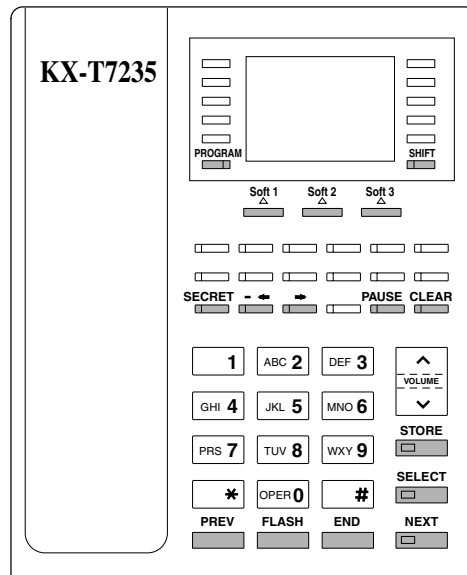

---

## Before entering the User Programming mode

Before entering the User Programming mode, confirm that:

- Your telephone is on-hook, and
- No calls are on hold at your telephone.

## Entering the User Programming mode

To enter the User Programming mode:

Press <b>PROGRAM + * + *</b> + User Programming Password (default:1234)
---

- The display shows the Initial Message: SYS-PGM NO? →

### Notes

- If nothing is entered within five seconds after the **PROGRAM** button is pressed, programming mode is canceled.
- During the programming mode, your extension is treated as a busy extension.
- Only one Proprietary Telephone can be in programming mode at any one time.
- The User Programming Password is not shown on the display for security reason. The password can be changed by System Programming.

## Programming Guide References

- 10.6 System Parameters
  - [Password] User Programming – PT

## 3.1.2 Programming Methods

### Advancing to the next stage

When "SYS-PGM NO? →" is displayed, you can select one of the following:

- To go to program [000], press the **NEXT** button.
- To go to another program, enter the 3-digit program address.

### Entering Characters

You can enter characters to store names for speed dial numbers, extension numbers, etc., by using the dialing key pad and buttons.

Each of the twelve dialing keys on the dialing key pad represents seven characters. Please refer to Section "2.2.17 Station Speed Dialing Number/Name Assignment [KX-T7235/KX-T7431/KX-T7433/KX-T7436 only]."

### Storing your data

Press **STORE** to store your data.

- The **STORE** indicator lights in red and a confirmation tone sounds.

#### \*Confirmation tone (one beep)

After pressing **STORE**, you will hear a beep. This informs you that storage is completed.

#### \*Alarm tone (three beeps)

If you hear this alarm, your entry is not valid.

### Making another selection within the same program address

- To go to the next selection, press **NEXT**.
- To go to the previous selection, press **PREV**.
- To make a specific selection, press **SELECT** and then enter the number.



### Accessing another program address

After pressing **STORE**, you can access another program by one of the following two methods:

- a) To go to the next program address:
  - **Higher program address**  
<KX-T7200 series>  
Press **Soft 1 (SKP+)** or **VOLUME ∨ (DOWN)**.  
<KX-T7400 series>  
Rotate the **Jog Dial** clockwise.
  - **Lower program address**  
<KX-T7200 series>  
Press **SHIFT + Soft 1 (SKP-)** or **VOLUME ∧ (UP)**.  
<KX-T7400 series>  
Rotate the **Jog Dial** counterclockwise.
- b) To go to a specific program address:  
Press **END**, then enter the program address.

### Returning to the operation mode

When the Initial Message: **SYS - PGM NO? →** is displayed, press the **PROGRAM** button.  
(To display the Initial Message, press **END**.)

## 3.2 User Programming

### 3.2.1 [000] Date and Time Set

#### Notice

It is assumed that you have read Section "3.1 User Programming Instructions." Soft button usage is explained in that section, therefore no references will be made to them in the following instructions. The soft buttons can be used in place of the overlay keys at any time.

#### **Description**

Sets the current date and time.

#### **Selection**

- Year: **00 through 99**
- Month: **JAN. through DEC.**
- Day: **1 through 31**
- Day of the week: **SUN / MON / TUE / WED / THU / FRI / SAT**
- Hour: **01 through 12**
- Minute: **00 through 59**
- **AM / PM**
- Clock hour: **12 or 24**

#### **Default**

'00 JAN. 1 SAT 12:00 AM 12-hour clock time

## Programming

### Display PT

1. <Date Setting>

000

Dial 000.

2. NEXT

□

Press NEXT.

3. year

year

Enter the year (last 2 digits).

4. →

□

Press →.

<PT Display>

000 DATE / TIME

<PT Display Example>

'00 JAN. 1 SAT

• To change the current entry, press CLEAR and enter the new year.

5. SELECT

□

Keep pressing SELECT until the desired month is displayed.

6. →

□

Press →.

7. day

day

Enter the day (01 through 31).

8. →

□

Press →.

9. SELECT

□

Keep pressing SELECT until the desired day of the week is displayed.

• To change the current entry, press CLEAR and enter the new day.

10. STORE

□

Press STORE.

<Time Setting>

11. NEXT

□

Press NEXT.

12. hour

hour

Enter the hour (00 through 12).

13. →

□

Press →.

14. minute

minute

Enter the minute (00 through 59).

<PT Display Example>

12:00 AM 12

• To change the current entry, press CLEAR and enter the new hour.

• To change the current entry, press CLEAR and enter the new minute.

15. →

□

Press →.

16. SELECT

□

Press SELECT for AM or PM.

17. →

□

Press →.

18. SELECT

□

Press SELECT for 12 or 24 (clock hour).

19. STORE

□

Press STORE.

20. END

□

Press END.

### **Conditions**

- After changing an entry, you can press **STORE**. You do not have to perform the rest of the steps.
- To return to the previous field, press **←** in steps 4 through 9 and steps 13 through 16.
- If you hear an alarm after pressing **STORE**, check that the date is valid.
- The clock starts immediately after the **STORE** button is pressed.
- You cannot leave an entry empty.

### **Features Guide References**

#### 1.17 Display Features

- Display, Date and Time

## 3.2.2 [001] System Speed Dialing Number Set

### Description

Used to program the System Speed Dialing numbers. These numbers are available for any extension user in the system.

### Selection

- Speed dial numbers: **000 through 999**
- Telephone number: **24 digits (max.)**

### Default

All speed dial numbers — Not Stored

## Programming

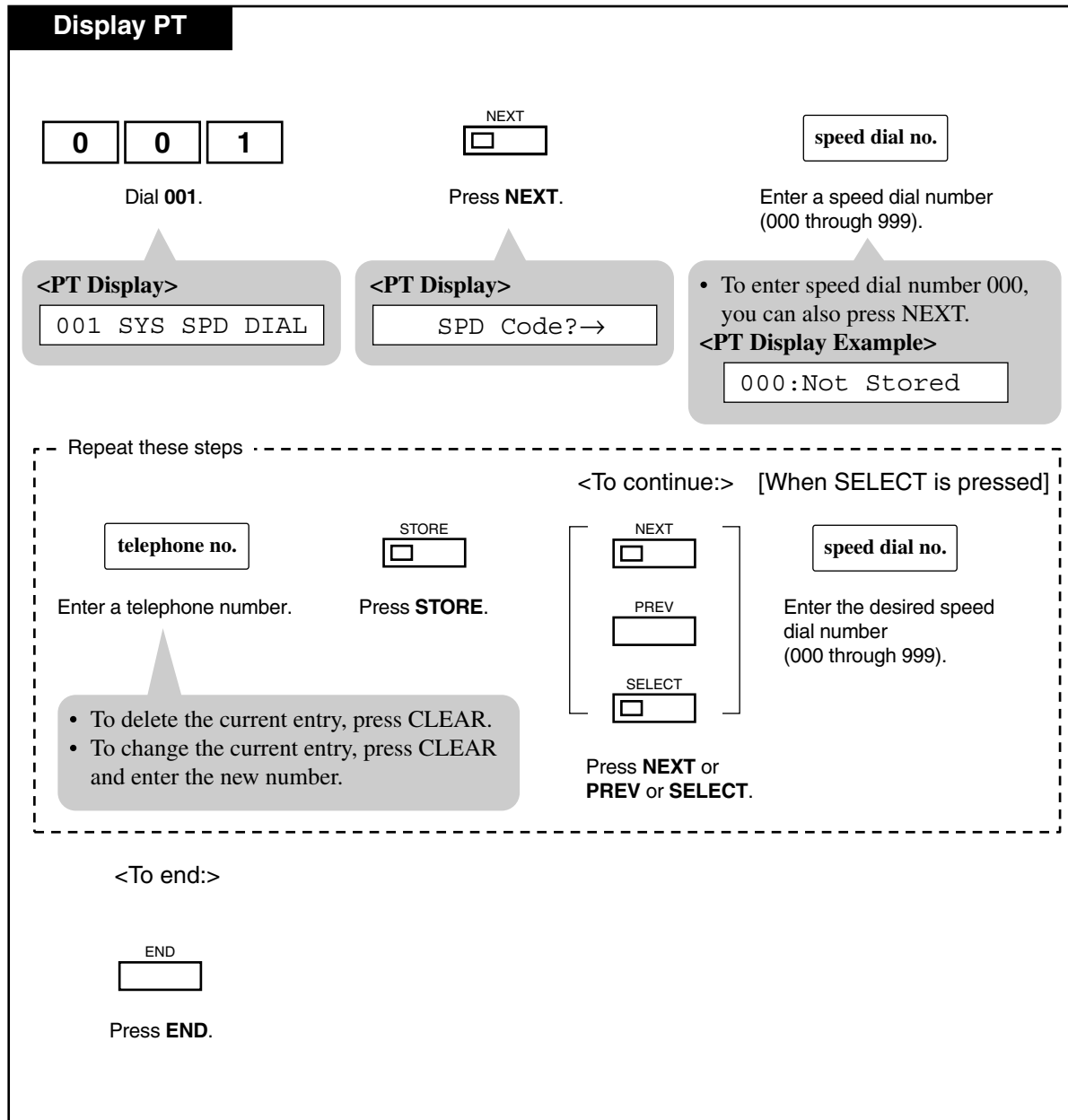

## Conditions

- There is a maximum of 1000 speed dial numbers per tenant. However, this can be changed by System programming. System supports a maximum of 2000 speed dial numbers, being shared among up to 8 tenants. Each speed dial number has a maximum of 24 digits. The valid characters are **0 through 9, \*, and # keys, and the FLASH, PAUSE, SECRET and "-" (hyphen) buttons.**  
—To store the flash signal, press **FLASH**.

### Notes

- The stored flash will only be effective during an established call. (Please refer to "External Feature Access" in Section "1.12 Conversation Features" of the Features Guide.)  
  
—To store a hyphen, press the "—" button.  
—To store a pause, press **PAUSE**.  
(Please refer to "Pause Insertion, Automatic" in Section "1.7 Dialing Features" of the Features Guide.)  
– To prevent displaying all or part of the number, press **SECRET** before and after the confidential parts of the number. (Please refer to "Secret Dialing" in Section "1.3 System Features" of the Features Guide.)
- If you are storing an external number, enter the line access code (default=9, 801 through 848) before the number. When dialing, a pause is automatically inserted after the code.
- If you are storing an account code, enter the account code before the line access code. (Please refer to "Account Code Entry" in Section "1.3 System Features" of the Features Guide.)
- It is possible to store a number consisting of 25 digits or more by storing it in two speed dial numbers. The line access code should be stored in the first speed dial number.
- To display parts of the number which have scrolled off the display, press **➡** or **⬅**.
- Program [002] "System Speed Dialing Name Set" is used to name the speed dial numbers.
- CO line access code must be placed before placing secret dial code 'S' or '['.

## User Manual References

- 4.3.73 System Speed Dialing

### 3.2.3 [002] System Speed Dialing Name Set

#### Description

Assigns names to the system speed dial numbers assigned in program [001] "System Speed Dialing Number Set." The KX-T7431, KX-T7433, KX-T7436 and KX-T7235 show the stored name during System Speed Dialing.

#### Selection

- Speed dial number: **000 through 999**
- Name: **10 characters (max.)**

#### Default

All speed dial numbers — Not Stored



## Programming

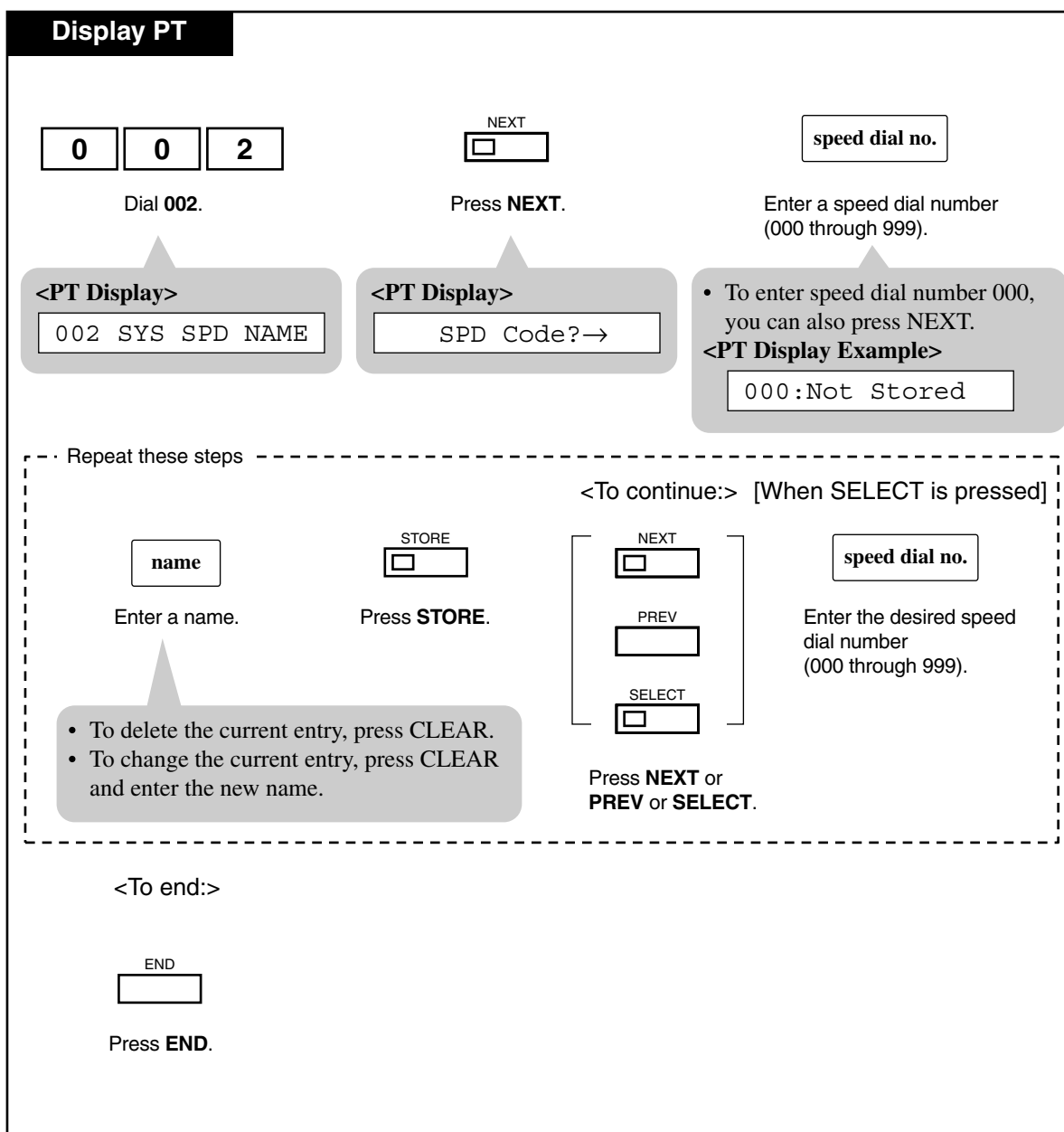

<To end:>

END

□

Press **END**.

## Conditions

- Speed dial numbers are programmed in program [001] "System Speed Dialing Number Set."
- There is a maximum of 1000 names, with a maximum of 10 characters for each.
- For entering characters, please refer to Section "2.2.17 Station Speed Dialing Number/ Name Assignment [KX-T7235/KX-T7431/KX-T7433/KX-T7436 only]."

## **User Manual References**

- 4.3.73 System Speed Dialing

## 3.2.4 [004] Extension Name Set

### Description

Assigns names to the extension numbers.

### Selection

- Extension number: **3 or 4 digits**
- Name: **10 characters (max.)**

### Default

All extension ports — Not Stored

## Programming

Display PT

0

0

4

Dial **004**.

NEXT

Press **NEXT**.

extension no.

Enter an extension number  
(3 or 4 digits).

<PT Display>

004 EXT NAME SET

<PT Display>

EXT NO?→

- To enter the lowest extension number, you can also press NEXT.

<PT Display Example>

1001 :Not Stored

Repeat these steps

name

Enter a name.

STORE

Press **STORE**.

NEXT

PREV

SELECT

Press **NEXT** or  
**PREV** or **SELECT**.

extension no.

Enter the desired  
extension number  
(3 or 4 digits).

<To continue:> [When SELECT is pressed]

<To end:>

END

Press **END**.

### Conditions

- Each name has a maximum of 10 characters.
- For entering characters, please refer to Section "2.2.17 Station Speed Dialing Number/ Name Assignment [KX-T7235/KX-T7431/KX-T7433/KX-T7436 only]."

## **User Manual References**

- 4.5.8 KX-T7235 Display Features - Call Directory
- 4.5.11 KX-T7431 / KX-T7433 / KX-T7436 Display Features - Call Directory

## 3.2.5 [005] Flexible CO Button Assignment

### Description

Used to determine the use of the flexible CO buttons on Proprietary Telephones in the system.

### Selection

- Extension number: **3 or 4 digits**
- Button Code (plus parameter, if required):

Button Code	Parameter
<b>0</b> (Single-CO)	<b>10101 through 31408</b> (trunk port physical number)
<b>1</b> (DSS)	<b>3 through 4 digits</b> (Extension number)
<b>2</b> (One-Touch Dialing)	<b>24 digits max.</b> (Telephone number)
<b>3</b> (Message Waiting)	None (Owner Extension) or <b>3 through 4 digits</b> (Another/Phantom extension number)
<b>4</b> (FWD/DND)	None
<b>5</b> (Save)	None
<b>6</b> (Account)	None
<b>70</b> (Conference)	None
<b>71</b> (Log-In/Log-Out)	None
<b>72</b> (Phantom)	<b>3 through 4 digits</b> (Phantom extension number)
<b>73</b> (Day/Night)	None
<b>74</b> (PDN)	None
<b>75</b> (SDN)	<b>3 through 4 digits</b> (Owner extension number)
<b>76</b> (PDN/SDN Delayed Ringing)	<b>0 through 4</b> (delayed ringing type)
<b>77</b> (Alarm)	None
<b>78</b> (Tone Through)	None
<b>79</b> (Group Log-In/Log-Out)	<b>3 through 4 digits</b> (FDN of Incoming group)
<b>8</b> (Voice Mail Transfer)	<b>3 through 4 digits</b> (VM Extension number)
<b>90</b> (Two-Way Record) <sup>†</sup>	<b>3 through 4 digits</b> (VM Extension number)
<b>91</b> (Two-Way Transfer) <sup>†</sup>	<b>3 through 4 digits</b> (VM Extension number)
<b>92</b> (Live Call Screening) <sup>†</sup>	None
<b>93</b> (Live Call Screening Cancel) <sup>†</sup>	None
<b>94</b> (Answer)	None

---

---

<b>Button Code</b>	<b>Parameter</b>
<b>95</b> (Release)	None
<b>97</b> (Alert)	None
<b>98</b> (Group FWD)	<b>3 through 4 digits</b> (FDN of Incoming group)
<b>*</b> (Loop-CO)	None
<b>#</b> (Group-CO)	<b>01 through 48</b> (trunk group number)
<b>CO/INTERCOM</b> (ringer frequency)	<b>1 through 8</b> (ring tone type number)
<b>Phantom</b> (ringing on/off)	<b>1</b> (off) / <b>2</b> (on)

† Available when the Digital Super Hybrid System is connected to a Digital Proprietary Telephone capable Panasonic Voice Processing System (one that supports Digital Proprietary Telephone [DPT] integration; e.g., KX-TVS100).

### **Default**

For all PTs - CO button 1 = Loop-CO;  
Ring tone type 2  
Others = Not Stored.

## Programming

Display PT

0

0

5

Dial **005**.

NEXT

Press **NEXT**.

extension no.

Enter an extension number  
(3 or 4 digits).

**<PT Display>**

005 FLEXIBLE CO

**<PT Display>**

EXT NO? →

- To enter the lowest extension number, you can also press NEXT.

**<PT Display Example>**

PT-PGM Mode

- To program another CO button of the same extension port:

Repeat these steps

CO

Press **CO** which is changed to another button.

button code

Enter a button code.

parameters

Enter parameters, if required.

STORE

Press **STORE**.

- The display shows the contents pre-assigned to the button.

**<PT Display Example>**

CO-10101

- To change the parameter, press CLEAR and enter the new parameter.

- To program another extension port:

SELECT

Press **SELECT**.

extension no.

Enter an extension number  
(3 or 4 digits).

Repeat these steps.

Go to "Repeat these steps" above.

<To end:>

END

Press **END**.

128

User Manual



## Canceling

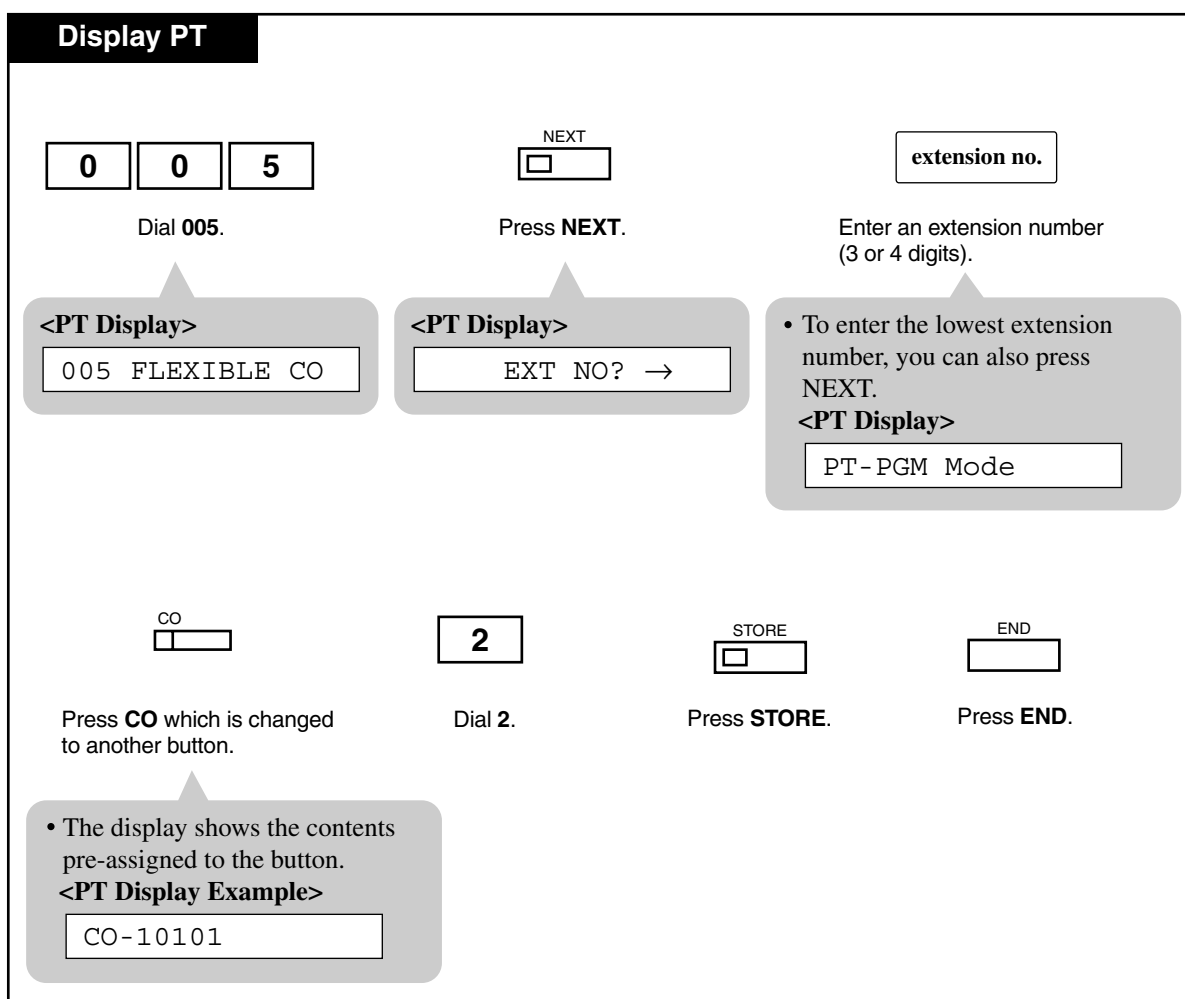

## Conditions

- The number of the CO buttons available for each PT varies depending on the telephone type <Section 1.16 Button Features, "Buttons on Proprietary Telephones and DSS Consoles" in the Features Guide>. To program 24 CO buttons, use the proprietary telephone with 24 CO buttons, such as KX-T7230.
- If you press the same CO button again at step 5, you can select a desired ringer frequency for the CO button from eight types of ring tones. When you enter the tone type number (1 through 8), you will hear the selected tone type until STORE is pressed. This selection is possible only for the CO buttons that have been assigned to Single-CO, Group-CO, Loop-CO, PDN or SDN.

## **Features Guide References**

### 1.16 Button Features

- Button, Flexible
- Buttons on Proprietary Telephones and DSS Consoles

## 3.2.6 [006] Caller ID Dial Set

### Description

Sets the identification code of the calling party (Caller ID Code) to utilize Caller ID Service provided by a specific central office (CO). If an ID Code transmitted from CO is found in the Caller ID Code Table, the caller's ID Code or a name given to the code in program [007] "Caller ID Name Set" is displayed on the telephone, allowing the called party to recognize the caller.

### Selection

- Location number: **000 through 999**
- Caller ID Code: **24 digits (max.), consisting of 0 through 9, \* or #**

### Default

All locations — Not Stored

## Programming

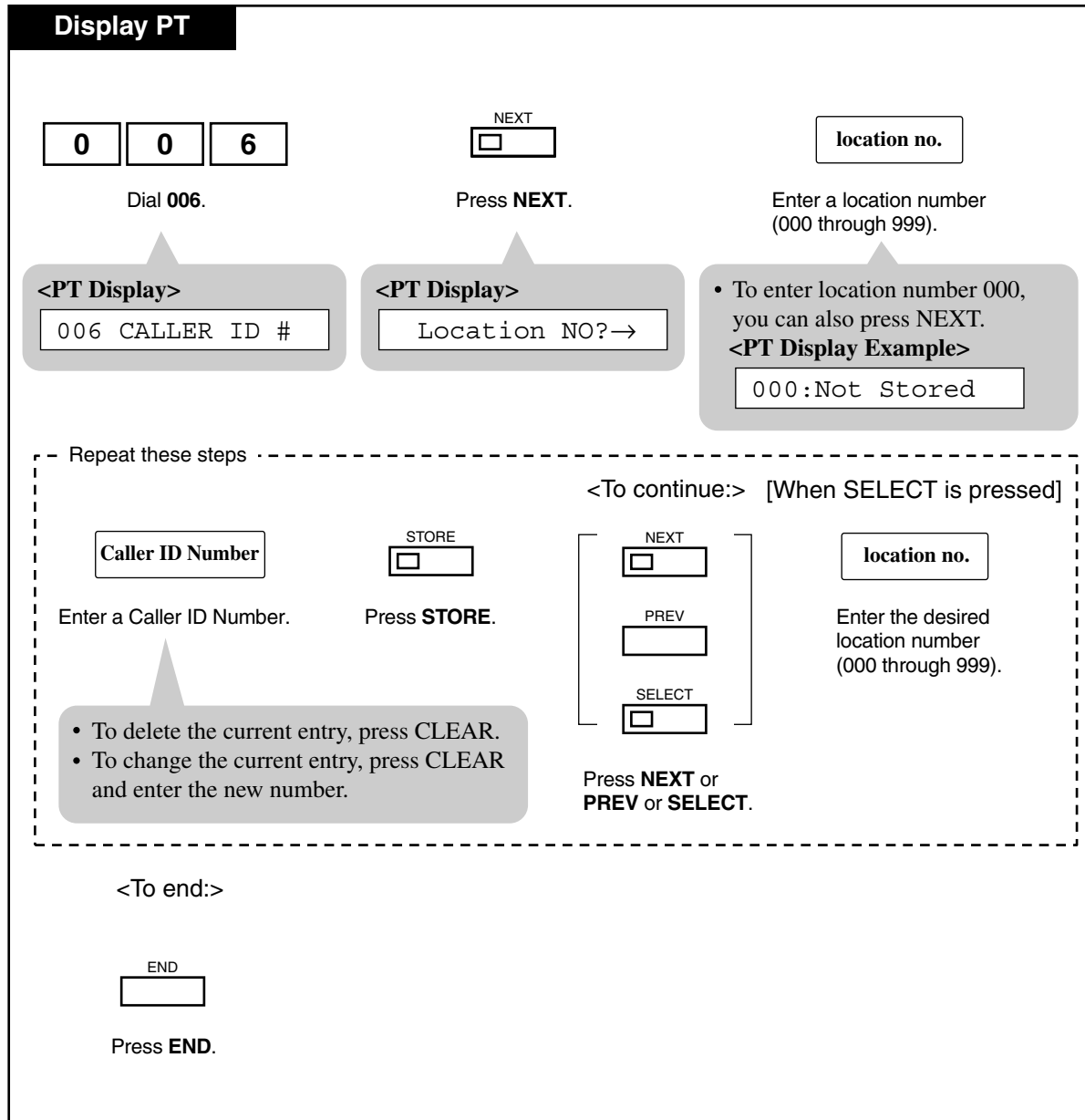

## Conditions

- Up to 1000 Caller ID Codes per tenant, 2000 per system, can be assigned.
- Program [007] "Caller ID Name Set" is used to give names to Caller ID Codes. If an ID Code is given a name, the called party's telephone shows the name with the ID Code.

## **Features Guide References**

### 1.5 Attended Features

- Caller ID Service

## 3.2.7 [007] Caller ID Name Set

### Description

With Caller ID Service, the calling party is displayed either by its ID Code or by its name. If the name display is required, use this program to give a name to a Caller ID Code stored in program [006] "Caller ID Dial Set."

### Selection

- Location number: **000 through 999**
- Caller ID Name: **16 characters (max.) consisting of 0 through 9, A through Z, a through z or the following marks: ! # \$ % & \* ' ( ) + , - . / : ; < = > ? @**

### Default

All locations —Not Stored

## Programming

Display PT

0

0

7

Dial **007**.

NEXT

Press **NEXT**.

location no.

Enter a location number  
(000 through 999).

<PT Display>

007 CALLER NAME

<PT Display>

Location NO?→

- To enter location number 000, you can also press NEXT.

<PT Display Example>

000:Not Stored

Repeat these steps

Caller ID Name

Enter a Caller ID Name.

STORE

Press **STORE**.

<To continue:> [When SELECT is pressed]

NEXT

PREV

SELECT

Press **NEXT** or  
**PREV** or **SELECT**.

location no.

Enter the desired  
location number  
(000 through 999).

- To delete the current entry, press CLEAR.
- To change the current entry, press CLEAR and enter the new number.

<To end:>

END

Press **END**.

### Conditions

- Up to 1000 Caller ID Names per tenant, 2000 per system, can be assigned. Each name corresponds to a Caller ID Code programmed by [006] "Caller ID Dial Set."
- A Caller ID Name cannot be assigned if the corresponding Caller ID Dial is not assigned.
- For entering characters, please refer to Section "2.2.17 Station Speed Dialing Number/ Name Assignment [KX-T7235/KX-T7431/KX-T7433/KX-T7436 only]."

## **Features Guide References**

### 1.5 Attended Features

- Caller ID Service



---

## 3.2.8 [008] Absent Messages Set

### Description

Used to program the absent messages. An absent message, if set by the extension user, is displayed on the display of calling extension's PT to show the reason for the user's absence.

### Selection

- Message number: **1 through 9**
- Message: **16 characters (max.)**



### Default

- 1: Will Return Soon
- 2: Gone Home
- 3: At Ext %%%%
- 4: Back at %%:%%
- 5: Out Until %%/%%
- 6: In a Meeting
- 7: through 9: Blank (not stored)

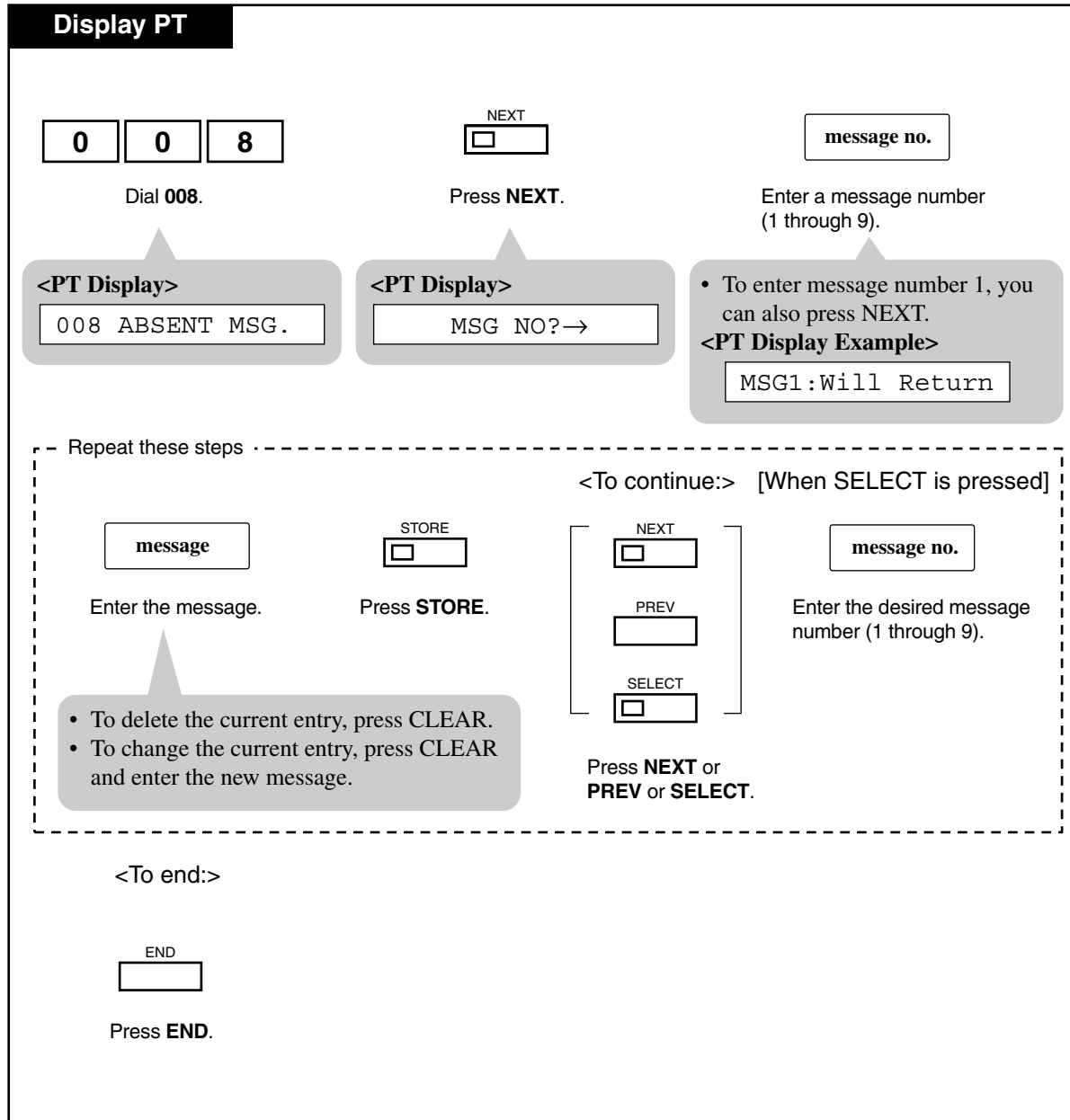
## Programming



## Conditions

- There is a maximum of nine messages. Messages 1 through 6 are programmed at the factory but can be changed. Each message has a maximum of 16 characters.
- For entering characters, please refer to Section "2.2.17 Station Speed Dialing Number/ Name Assignment [KX-T7235/KX-T7431/KX-T7433/KX-T7436 only]."
- You can enter a maximum of seven "%" characters per message which can be programmed at each user's station. The extension user can enter 0 through 9, "\*" and "#" for the % characters. If the user enters digits less than the number of "%" characters, it is recommended to fill the remaining "%" characters with "#" or "\*."
- To display parts of the message which have scrolled off the display, press  or .

## Features Guide References

### 1.17 Display Features

- Absent Message Capability

## 3.2.9 [009] Quick Dial Number Set

### Description

Stores up to eight quick dial numbers.

### Selection

- Location number: **1 through 8**
- Desired number: **24 digits (max.)**

### Default

All location numbers — Not Stored

## Programming

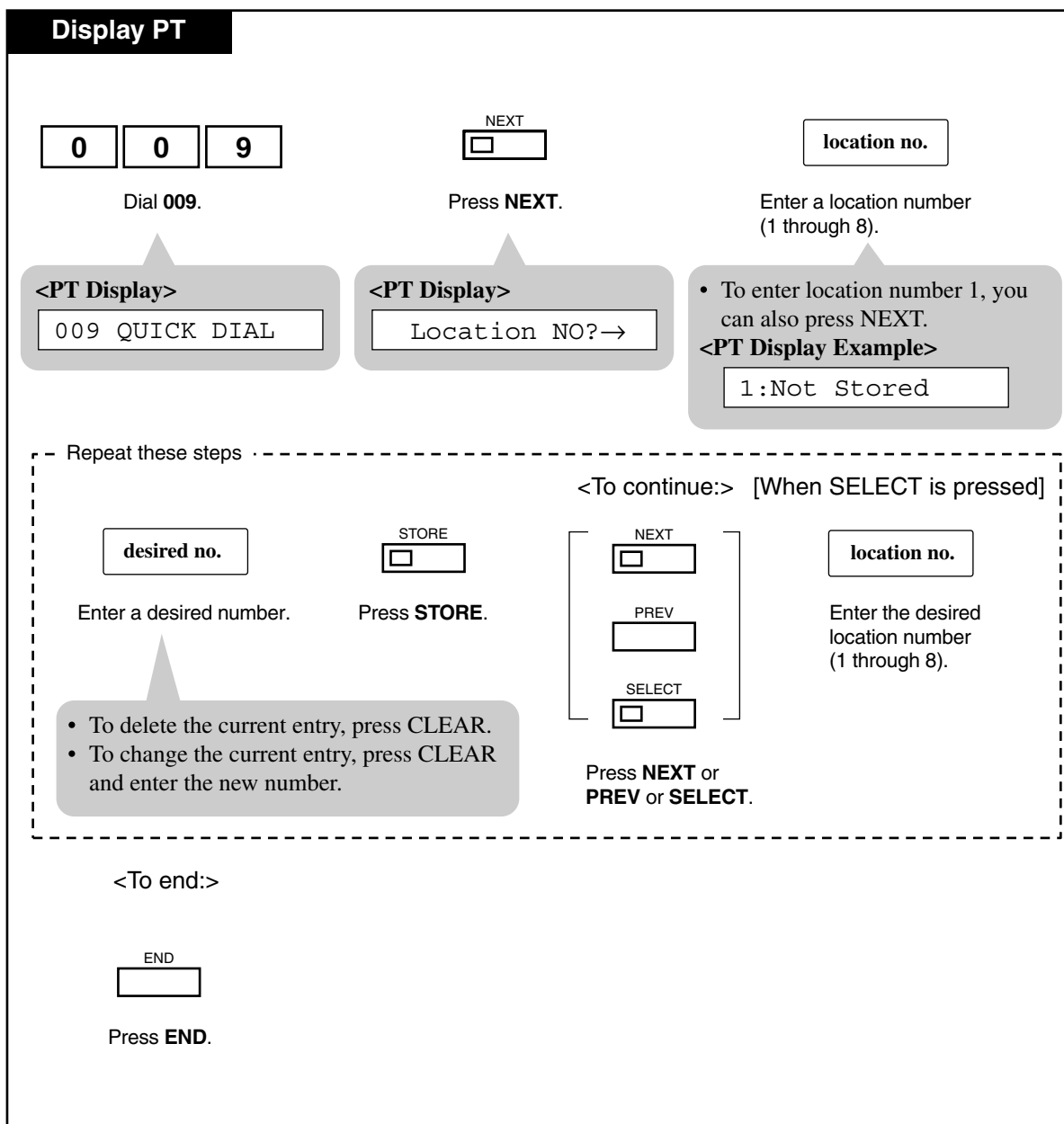

### Conditions

- There is maximum of eight location numbers (Quick dial 1-8).  
A maximum of 24 digits, consisting of 0 through 9, \*, and # keys, and the FLASH, PAUSE, SECRET and "-" (hyphen) buttons can be assigned to a quick dial number.
- Before programming this program, a feature number for each location should be programmed by System Programming <Section 2.3 Numbering Plan in the Programming Guide>.

## **Features Guide References**

### 1.7 Dialing Features

- Quick Dialing

### 3.2.10 [010] DISA / TIE User Code Set

#### Description

Used to program a list of up to 32 DISA/TIE User Codes. Each code is appended with a COS level.

#### Selection

- Location number: **01 through 32**
- DISA / TIE User Code: **4 through 10 digits consisting of 0 through 9**
- COS number: **1 - 96**

#### Default

All locations — Blank

All COS — 96

## Programming

Display PT

0
1
0

Dial **010**.

NEXT

Press **NEXT**.

location no.

Enter a location number  
(01 through 32).

• To enter location number 1, you can also press NEXT.

**<PT Display Example>**  
1:Not Stored

Repeat these steps

DISA User Code

Enter a DISA User Code.

Press →.

COS no.

Enter a COS number  
(1 through 96).

Press **STORE**.

NEXT

PREV

SELECT

location no.

Enter the desired location number  
(01 through 32).

• To delete the current entry, press CLEAR.  
• To change the current entry, press CLEAR and enter the new number.

Press **NEXT** or **PREV** or **SELECT**.

<To end:>

END

Press **END**.

### Conditions

- The KX-TD500 System can store up to 32 programmable DISA user codes with a COS level for each. Each code should be unique.

### User Manual References

- 4.3.26 Direct Inward System Access (DISA)



## **Features Guide References**

### 1.5 Attended Features

- Direct Inward System Access (DISA)

### 3.1 TIE Line Features

- TIE Line Service

## **Programming Guide References**

- 5.9 DISA/TIE User Code



***Section 4***  
***Station Features and Operation (PT/SLT)***

## 4.1 Before Operating

### 4.1.1 Before Operating

#### What kind of telephone do you use?

In this manual, you will find your way to operate the feature depending on the telephone you use. Please use the proper operation for your telephone.

**If you use single line devices** such as a Single Line Telephone or data terminal, you will follow the steps which enter the feature number.

- If you use a dial pulse (DP) type single line device which does not have the "\*" and "#" keys, it is impossible to access features that have "\*" or "#" in their feature numbers.
- When the "Pickup Dialing (Hot Line)" feature is set on your telephone, the dialing sequence should be done within a certain period of time (Pickup Dial Waiting Time=default: 1 s) after lifting the handset.  
This time can be changed by System Programming.

**If you use a Panasonic Proprietary Telephone** which has the special function button or the display or both, you will follow the operation with the button or display for easy access.

- If you use a Panasonic Proprietary Telephone which does not have the function button, you may change one of the unused buttons to another button. Please refer to Section "2.2 Station Programming."
- A Panasonic Proprietary Telephone has the Light Emitting Diode (LED) button indicators, so you can see the line conditions by the lighting patterns.
- If "Idle Line Preference — Outgoing," "No Line Preference — Outgoing" or "Prime Line Preference (CO Line) — Outgoing" is assigned on the extension, it is **not** possible to have access to any DPT features after simply going off-hook. To access DPT features, press the INTERCOM (ICM type PT) or PDN button (DN type PT) directly or after going off-hook.

Please refer to "Button, Line Access" in Section "1.16 Button Features" of the Features Guide for further information on "ICM type PT" and "DN type PT."

#### For ISDN Extension Users:

The KX-TD500 System also supports the connection of Terminal Equipment with separate power supplies. For example, ISDN Telephones, G4 Facsimiles or Personal Computers which are connected to an ISDN S0 bus on a BRI (Basic Rate Interface) card (KX-TD50288). A maximum of eight Terminal Equipment can be connected to each ISDN S0 bus with Point-to-Multipoint configuration. However, only up to two Terminal Equipment can be used simultaneously. Each Terminal Equipment connected to the S0 bus can be addressed individually with Multiple Directory Numbers (MDNs). The MDN consists of the ISDN extension number and an additional digit, 0 through 9.

If MDN is not assigned, all equipment on the same S0 bus are called simultaneously.

The functions of Terminal Equipment are similar to Single Line Telephone functions except for the following features:

- Absent Message
- Alternate Calling - Ring / Voice
- Automatic Callback Busy
- Call Forwarding
- Call Hold
- Call Hold Retrieve
- Call Log Incoming, Log Lock
- Call Park
- Call Pickup
- Call Transfer
- Call Waiting
- Caller ID
- Conference
- Data Line Security
- DIL 1:N Service
- Do Not Disturb (DND)
- Executive Busy Override
- Extension Group / Incoming Group Service (Hunting, Operator, Ring, UCD)
- External Feature Access (EFA)
- Extra Device Port
- Log-In / Log-Out
- Manager Extension
- Message Waiting
- Paging - Group Answer
- Phantom Extension
- Paralleled Telephone
- Pickup Dialing
- Released Link Operation
- Remote Station Lock
- Timed Reminder
- Trunk Answer From Any Station (TAFAS)
- Voice Mail Service

### Operation Step Box

In this section, operations for extension users are described using the following Operation Step Box.

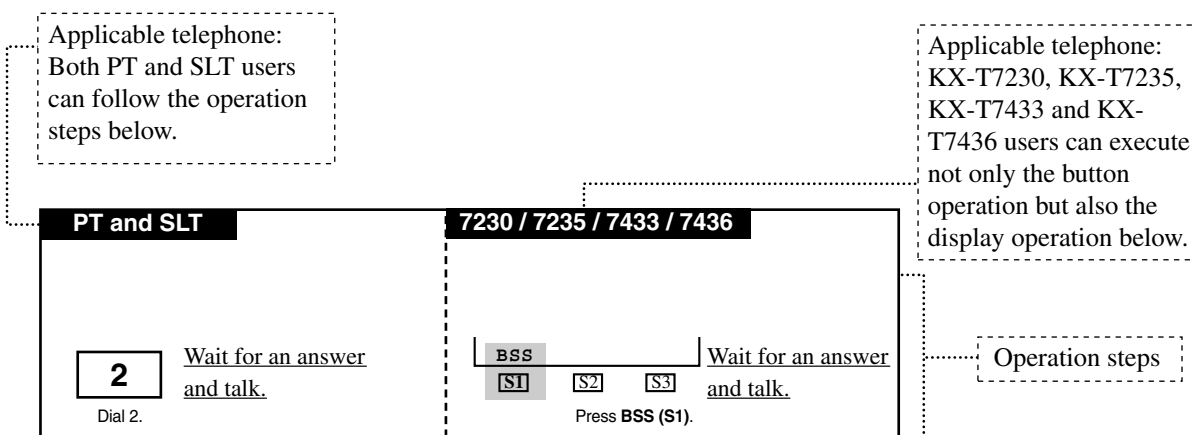

### **Notes**

- If your telephone is not noted in the operating step box (ex. only "PT" is noted), this means your telephone does not have the ability to execute that feature.
- If your telephone has the ability to perform several operations for one feature, you can select the method according to your needs.
- In this manual, the default feature numbers are used to describe each operation and illustration. Use the new programmed numbers if default feature numbers are changed by System Programming.
- For Proprietary Telephone operations, all button illustrations are based on the model KX-T7235.

### **Description of Symbols Used**

In this section, many symbols are used. Most symbols do not need a description, but some symbols do. They are as follows.



Lift the handset, or press the SP-PHONE or MONITOR button. (Off-hook)



Replace the handset, or press the SP-PHONE or MONITOR button. (On-hook)



Flash the switchhook on a Single Line Telephone.



Tones which vary depending on the condition (Please refer to Section "6.1.3 Tone List").

## 4.2 Basic Operations

### 4.2.1 Making Calls

#### Inter Office Calling

You can make a call to another extension.

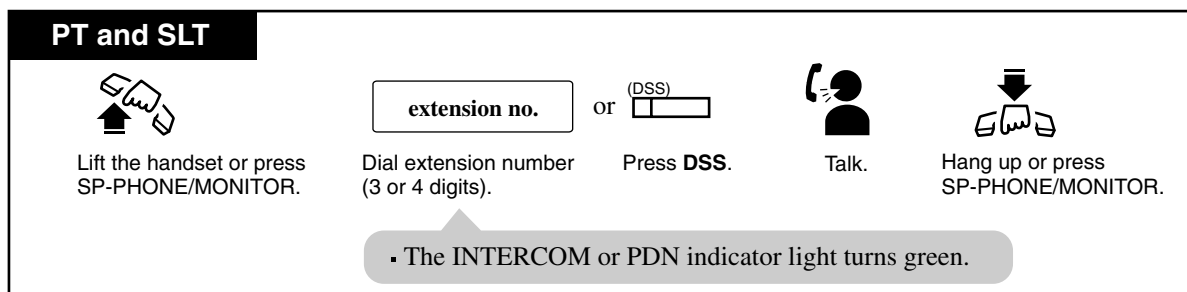

#### Outward Dialing

You can make a call to an outside party using one of the following three Trunk Access ways.

- Trunk Access, Idle
- Trunk Access, Trunk Group
- Trunk Access, Individual Trunk (PT only)

#### Making Outside Calls by "Trunk Access, Idle"

Allows you to access an idle trunk line automatically.

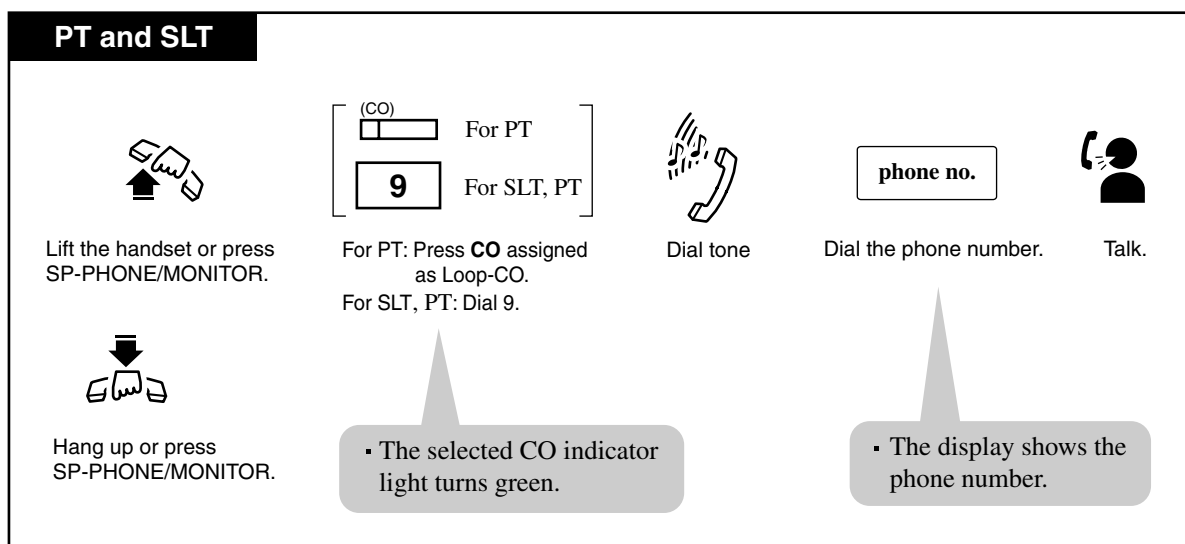

## Making Outside Calls by "Trunk Access, Trunk Group"

Allows you to access an idle trunk line within a designated trunk group.

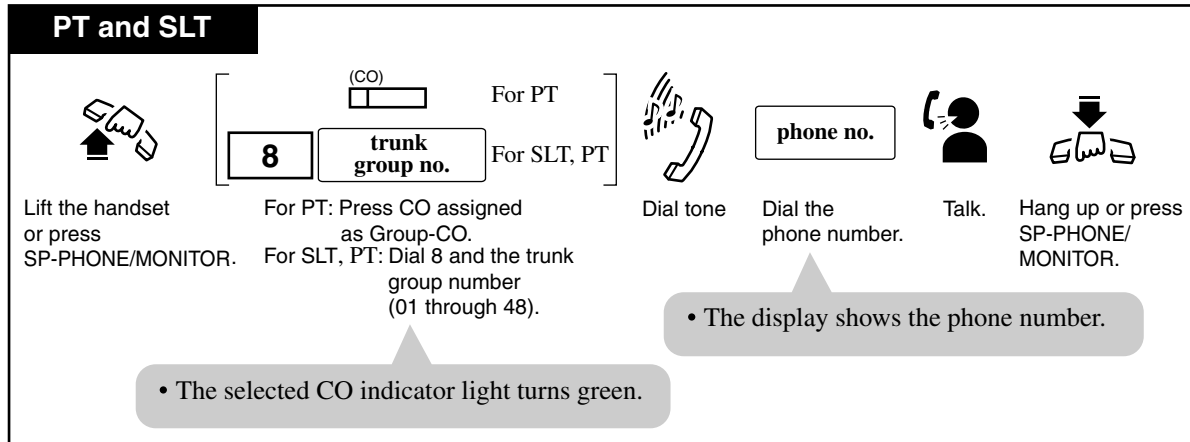

## Making Outside Calls by "Trunk Access, Individual Trunk"

Allows you to select the desired trunk line without dialing the line access code.

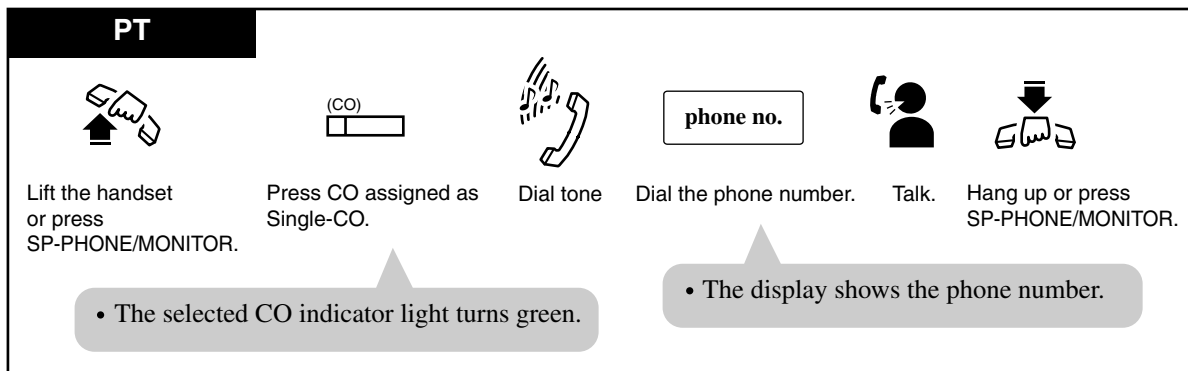

### Conditions

- **PT**  
There are three types of Line Preference for outgoing calls (— Idle Line/No Line/Prime Line). Each preference can be selected by Station or System Programming.
- With the KX-T7431, KX-T7433, KX-T7436 or KX-T7235, you can make an inter office call using the "Call Directory-Extension Dialing" display operation.
- **Inter-digit Time**  
When you make an outside call using an ISDN PRI23 line, the dialed number will be sent to the Central Office immediately, before the inter-digit time expires, by dialing "#" after the telephone number.



## **Programming Guide References**

- 2.2 Tenant
  - Automatic Route Selection
- 2.3 Numbering Plan
  - Local CO Line Access / ARS
  - Trunk Group Access
- 2.4 Class of Service (COS)
  - Trunk Group Setting
- 2.6 Local Hunt Sequence
- 3.2 Trunk Group
  - Line Hunting Order
- 4.3 Extension Line
  - CO Key
  - [Preferred Line] Outgoing

## **Features Guide References**

- 1.3 System Features
  - Trunk Group
- 1.6 Originating Features
  - Automatic Route Selection (ARS)
  - Line Preference—Outgoing (Idle Line/No Line/Prime Line)
  - Trunk Access
  - Trunk Connection Assignment—Outgoing
- 1.16 Button Features
  - Button, Line Access

## **User Manual References**

- 2.2.12 Preferred Line Assignment — Outgoing
- 2.2.3 Flexible Button Assignment
- 3.2.5 [005] Flexible CO Button Assignment
- 4.3.41 Hands-free Operation
- 4.3.42 Inter Office Calling
- 4.3.54 Outward Dialing, Trunk Access
- 4.5.8 KX-T7235 Display Features - Call Directory
- 4.5.11 KX-T7431 / KX-T7433 / KX-T7436 Display Features - Call Directory

## 4.2.2 Receiving Calls

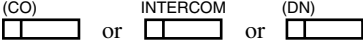
PT and SLT	PT
 <p>Lift the handset or press SP-PHONE.</p>	<div style="text-align: center;">  </div> <p>Press a rapid flashing <b>CO</b> or <b>INTERCOM</b> or <b>DN</b>.</p> <div style="border: 1px solid gray; padding: 5px; margin-top: 10px;"> <ul style="list-style-type: none"> <li>The CO or INTERCOM or DN indicator light turns steady green.</li> </ul> </div>

### Conditions

- PT

There are three types of Line Preference for incoming calls (— No Line/Prime Line/Ringing Line). Each preference can be selected by Station or System Programming.
- PT

Helpful hints for the Hands-free (speakerphone) operation are noted in the "Hands-free Operation" feature.
- PT

If you want to answer an intercom call without going off-hook, press the AUTO ANSWER button (Hands-free Answerback). To cancel the Hands-free Answerback, press the AUTO ANSWER button again.

### Programming Guide References

- 4.3 Extension Line
  - CO Key
  - [Preferred Line] Incoming

### Features Guide References

- 1.9 Answering Features
  - Answering, Direct Trunk
- 1.16 Button Features
  - Button, Line Access

## **User Manual References**

- 2.2.11 Preferred Line Assignment — Incoming
- 2.2.3 Flexible Button Assignment
- 3.2.5 [005] Flexible CO Button Assignment
- 4.3.5 Answering, Direct Trunk
- 4.3.40 Hands-free Answerback
- 4.3.41 Hands-free Operation

## 4.3 Station Features and Operation

### 4.3.1 Absent Message Capability

You can select one of nine pre-programmed Absent Messages (1-9) for your extension. The display PT users calling your extension see the message you select. Absent messages are used to inform the party calling your extension of the reason for your absence. By default, Messages No. 1-6 are provided with default messages and the other three messages are left blank.

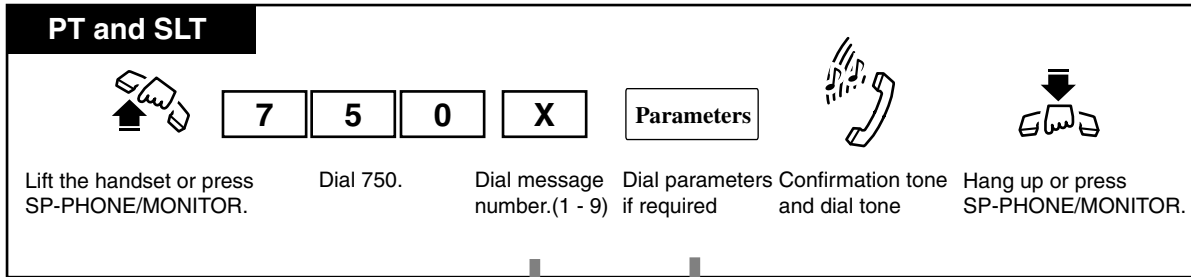

DISPLAY MESSAGE	MESSAGE NO.	PARAMETER
Will Return Soon	1	None
Gone Home	2	None
At Ext %%%%	3	extension no. Dial extension number.
Back at %:%:%%(time)	4	hour      minute Enter hour (00 - 23) and minute (00 - 59).
Out Until %%/%%% (month/day)	5	month      day Enter month (01 - 12) and day (01 - 31).
In a Meeting	6	None
(Programmable)	7	
(Programmable)	8	
(Programmable)	9	

**Note**

- % indicates the digit where you enter the desired parameter.

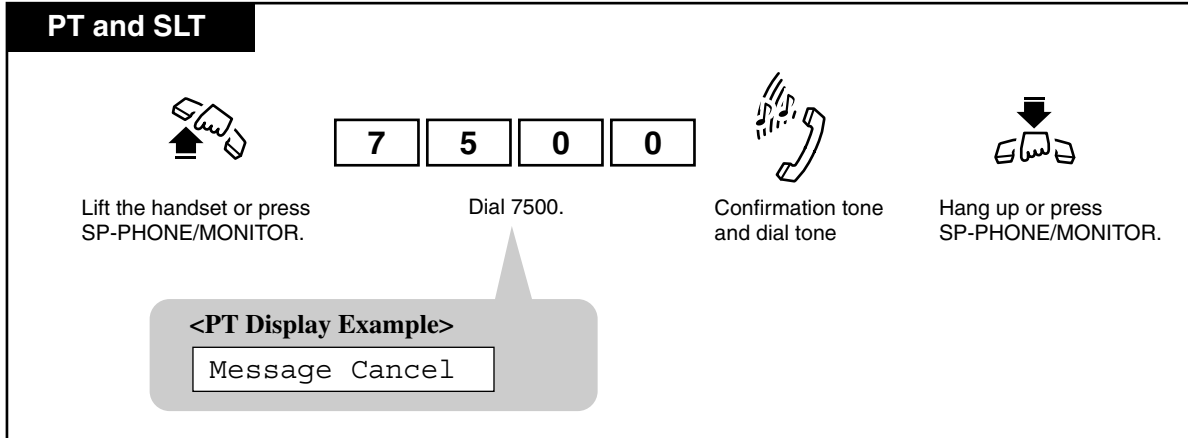
**Canceling the absent message****Conditions**

- All nine messages can be programmed either by User or System Programming.
- A maximum of seven parameters ("% characters) can be stored per message. You can enter "0 through 9," "\*" and "#" for the parameters.
- display PT  
The message you select is shown on the display of your PT whenever you go off-hook.
- **Distinctive Dial Tone**  
When this feature is assigned to the extension, the extension user may hear a distinctive dial tone (dial tone 2) after going off-hook depending on System Programming <Section 2.8 System Option, "15. Special dial tone after setting feature" in the Programming Guide>.
- With the KX-T7431, KX-T7433, KX-T7436 or KX-T7235, you can execute this feature using the display operation.

**Programming Guide References**

- 2.3 Numbering Plan
  - Absent Message Set / Cancel
- 2.8 System Option
  - Special dial tone after setting feature
- 5.8 Absent Message

**Features Guide References**

- 1.17 Display Features

- Absent Message Capability

### **User Manual References**

- 3.2.8 [008] Absent Messages Set
- 4.5.9 KX-T7235 Display Features - System Feature Access Menu
- 4.5.12 KX-T7431 / KX-T7433 / KX-T7436 Display Features - System Feature Access Menu

## 4.3.2 Account Code Entry

An Account Code (max. 10 digits) is used to identify incoming and outgoing CO calls for accounting and billing purposes. The account code is appended to the "Station Message Detail Recording (SMDR)" call record. For incoming CO calls, account code entry is optional. For outgoing CO calls, you may be required to enter an account code. This depends on your Account Code Entry mode determined by System Programming on a "Class of Service\*" basis.

### Entering account codes before dialing

7230 / 7235 / 7433 / 7436



Lift the handset or press SP-PHONE/MONITOR.

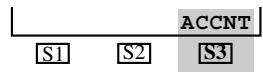

Press **ACCNT (S3)**.



Dial tone 3\*

account code

#



Confirmation tone and dial tone

<PT Display Example>

Enter ACCNT Code

CO

Press **CO**.

phone no.

Dial the phone number.

\* One of the dial tones. Refer to the "Tone List" in the Appendix.

PT and SLT



Lift the handset or press SP-PHONE/MONITOR.

(Account)

4

9

For PT: Press **Account** (flexible button).  
For SLT, PT: Dial 49.



Dial tone 3\*

account code

#

Enter an account code (10 digits max., 0...9).

Dial #.

• If you dial a feature number, you hear no tone.



Confirmation tone and dial tone

CO

line access code

Press **CO** or enter a line access code (9 or 801 through 848).

phone no.

Dial the phone number.

\* One of the dial tones. Refer to the "Tone List" in the Appendix.

\*1 Class of Service (COS) is used to define the features which are allowed for a group of extensions.

## Entering account codes during or after a conversation

During a conversation or within 15 seconds after the other party hangs up;

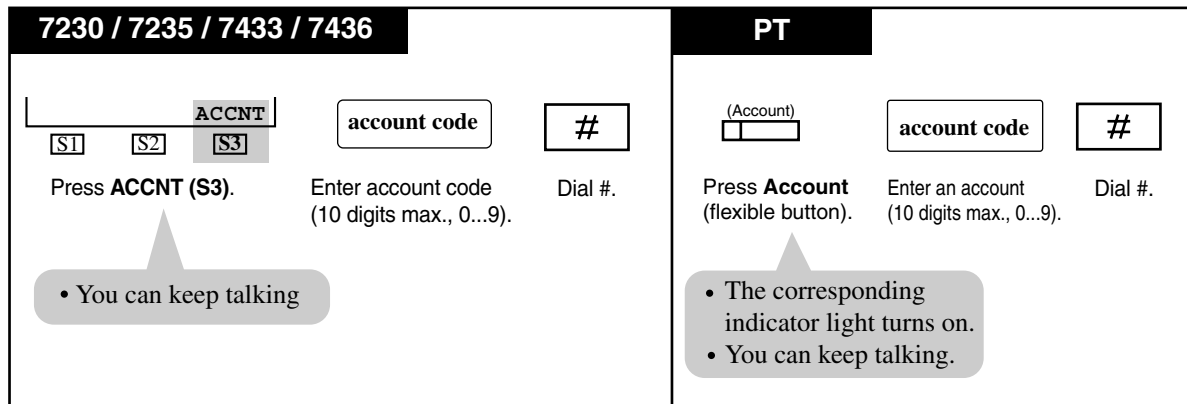

### Conditions

Your Account Code Entry mode is set to one of the following three modes by System Programming.

#### In "Verified - All Calls" mode

- You must always enter a system-registered account code to make a CO call.
- If the account code you entered is not found in the System Account Code Table <Section 5.6 Account Code in the Programming Guide>, you hear a reorder tone.
- You can enter any account code during and after a call (after a CPC signal<sup>\*1</sup> is detected).

#### In "Verified - Toll Restriction Override" mode

- You can override the Toll Restriction imposed on your extension by entering a system-registered account code before making a CO call (Toll Restriction Override by Account Code Entry).
- If the account code you entered is not found in the System Account Code Table <Section 5.6 Account Code in the Programming Guide>, you hear a reorder tone.

#### In "Option" mode

- You can enter any account code when needed. It is possible to record a calling or called party's account code in the SMDR, during a conversation or within 15 seconds after the other party hangs up.
- You can enter any account code during and after a call (after a CPC signal<sup>\*1</sup> is detected).

### General

- To clear and re-enter the account code, press "\*."

<sup>\*1</sup> A Calling Party Control (CPC) signal is an on-hook indication sent from a CO line when the other end hangs up. You hear a reorder tone when the signal is detected.



- An account code can be up to 10 numeric digits (0 through 9). FLASH, PAUSE, etc., are not allowed. After entering an account code, the delimiter "#" must be entered.
- **Memory Dialing**  
An account code can be stored into Memory Dialing ("One-Touch Dialing," "System / Station Speed Dialing"). The sequence to enter an account code into Memory Dialing is:  
— [Feature Number] [Account Code] [#] [Line Access Code] [Phone Number]
- **PT**  
Pressing the Account button (flexible button) while entering an account code cancels the entry.
- **SLT**  
You cannot enter an account code during a call or while hearing a reorder tone.
- **SLT**  
Flashing the switchhook while entering an account code cancels the entry.
- **SLT**  
The delimiter "99" is available for rotary type SLTs only.
- **Account button**  
The Account button can be used instead of dialing the feature number. It can be assigned to a flexible (CO, DSS, PF) button by Station, User or System Programming.

### Programming Guide References

- 2.3 Numbering Plan
  - Account Code
- 2.4 Class of Service (COS)
  - Account Code Mode
- 4.3 Extension Line
  - CO Key
  - PF Key
- 4.4 DSS Console
  - DSS Key
  - PF Key
- 5.6 Account Code
  - Tenant No.
  - Entry No.
  - Code
  - TRS Level
- 10.4 SMDR
  - Print out Account Code

## **Features Guide References**

### 1.3 System Features

- Account Code Entry
- Station Message Detail Recording (SMDR)

### 1.6 Originating Features

- Toll Restriction Override by Account Code Entry

## **User Manual References**

- 2.2.3 Flexible Button Assignment
- 3.2.5 [005] Flexible CO Button Assignment
- 4.3.76 Toll Restriction Override by Account Code Entry

### 4.3.3 Alternate Calling — Ring / Voice

You can voice-announce your intercom call or have the called extension ring. When you make an intercom call by voice-announcement, the other party hears your voice over the built-in speaker of PT and can speak in the hands-free mode.

#### Alternating (to Voice-Calling mode)

**7230 / 7235 / 7433 / 7436**

*If the extension you are calling is in Ring-Calling mode, you hear a ringback tone.*

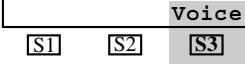

Press **Voice** (S3).



Confirmation tone

• Voice-Calling mode is established.

---

**PT and SLT**

*If the extension you are calling is in Ring-Calling mode, you hear a ringback tone.*



Dial \*.



Confirmation tone

• Voice-Calling mode is established.

### Alternating (to Ring-Calling mode)

**7230 / 7235 / 7433 / 7436**

*If the extension you are calling is in Voice-Calling mode, you hear a confirmation tone.*

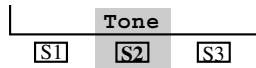

Press **Tone (S2)**.



Ringback tone

- Ring-Calling mode is established.

### PT and SLT

*If the extension you are calling is in Voice-Calling mode, you hear a confirmation tone.*



Dial \*.



Ringback tone

- Ring-Calling mode is established.

### Conditions

- **PT**  
**Mode Selection**  
 You can select either to be ring-signaled or voice-signaled by Station Programming. The default is Ring-Calling mode.
- Any extension (PT, SLT) user can use this feature during an intercom call if the other party is a PT extension.
- If the party you are calling is using a Single Line Telephone (SLT), only Ring-Calling mode is available.
- **One time switching**  
 You can switch the desired calling mode only once during a call.
- **Voice-signaling is not available in the following cases:**
  - if the other extension is an SLT.
  - if the other extension is busy on another call.
  - if another call is ringing on the other extension.

## **Programming Guide References**

System Programming is not required.

## **Features Guide References**

### 1.6 Originating Features

- Alternate Calling—Ring/Voice
- Inter Office Calling

### 1.9 Answering Features

- Hands-free Answerback

## **User Manual References**

- 2.2.7 Intercom Alert Assignment
- 4.3.40 Hands-free Answerback
- 4.3.42 Inter Office Calling

### 4.3.4 ANSWER and RELEASE buttons Operation

ANSWER and RELEASE buttons are useful when using the headset or in hands-free mode. With the ANSWER button, you can answer all incoming calls to the paired telephone. With the RELEASE button, you can disconnect the line during or after a conversation or complete a Call Transfer.

This is convenient for the extension users, especially operators, who handle a large volume of calls.

**PT and DSS Console**

*When a call comes in on your extension;*



Press **ANSWER**.



Talk.



Press **RELEASE**.

- The call is disconnected.
- You hear no tone.

### Call Transfer

**PT and DSS Console**

*During a conversation;*



Press **TRANSFER**.



Confirmation tone and dial tone

extension no.

 or 

(DSS)

Press **DSS** (flexible button).

- The other party is placed on hold.

- The destination is confirmed before transferring the call. This step can be skipped.

- Ringing starts at the destination extension.

- The call is transferred.



Talk.



Press **RELEASE**.

## Conditions

- **PT**  
**ANSWER and RELEASE Buttons Assignment**  
ANSWER and RELEASE buttons are provided as a fixed button on the KX-T7441 (DSS Console). For other PTs and DSS Consoles, these buttons can be assigned to a flexible (CO, DSS, PF) button by Station, User or System Programming.
- **PT**  
**What if the ANSWER button is pressed during a call?**  
If a new call comes in while engaged in the current call, you can answer it simply by pressing the ANSWER button. In this case, the current call will be disconnected.
- **PT**  
**Delayed Ringing or No Ringing Calls**  
If a call which comes in on the extension is not ringing (Delayed ringing or no ring), it can not be answered by pressing the ANSWER button.

## Programming Guide References

- 4.3 Extension Line
  - CO Key
  - PF Key
- 4.4 DSS Console
  - DSS Key
  - PF Key

## Features Guide References

- 1.9 Answering Features
  - ANSWER and RELEASE buttons Operation

## User Manual References

- 2.2.3 Flexible Button Assignment
- 3.2.5 [005] Flexible CO Button Assignment
- 5.2.26 ANSWER and RELEASE Buttons Operation

## 4.3.5 Answering, Direct Trunk

You can answer a CO call by pressing a flashing CO button directly. You do not have to lift the handset or press the SP-PHONE/MONITOR button.

### To answer an incoming CO call

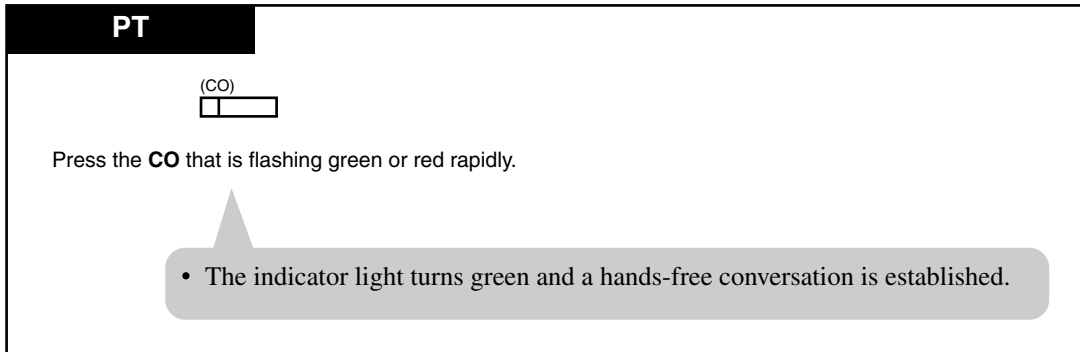

### Conditions

- **PT**  
You can choose the desired line to answer when more than one call is ringing on your PT by this feature.
- **PT**  
There are three types of CO buttons: Group-CO (G-CO) button, Loop-CO (L-CO) button and Single-CO (S-CO) button. These can be assigned to flexible CO buttons by Station, User or System Programming.

### Programming Guide References

- 4.3 Extension Line  
– CO Key

### Features Guide References

- 1.9 Answering Features
  - Answering, Direct Trunk
- 1.16 Button Features
  - Button, Line Access



### **User Manual References**

- 2.2.3 Flexible Button Assignment
- 3.2.5 [005] Flexible CO Button Assignment
- 4.3.41 Hands-free Operation

### 4.3.6 Automatic Callback Busy (Camp-On)

When the selected CO line or extension you have dialed is busy, dial the camp-on code and hang up. Your telephone will ring when the selected CO line or the called party becomes idle.

#### Setting

**7230 / 7235 / 7433 / 7436**

*If you hear a busy tone after making a call (intercom or outside);*

Press **C. BCK (S3)**.      Confirmation tone and reorder tone      Hang up or press SP-PHONE.      Wait for the Camp-On recall.

**PT and SLT**

*If you hear a busy tone after making a call (intercom or outside);*

Dial **6**.      Confirmation tone and reorder tone      Hang up or press SP-PHONE/MONITOR.      Wait for the Camp-On recall.

**<PT Display Example>**  
 Callback Extxxxx  
 — extension number

## Answering an intercom recall

### PT and SLT

If you hear the telephone ringing;



Lift the handset or press SP-PHONE/MONITOR.

#### <PT Display Example>

xxxx: Free

extension number

- You hear a ringback tone and the other extension begins to ring automatically.

## Answering a CO line recall

### PT and SLT

If you hear the telephone ringing;



Lift the handset or press  
SP-PHONE/MONITOR.



Dial tone

phone no.

Dial the phone number.

#### <PT Display Example>

10101: Free

Trunk port physical number

## Canceling

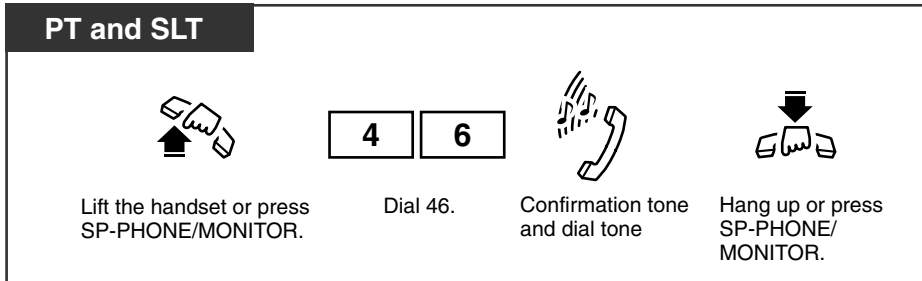

## Conditions

- If you do not answer the recall ringing within 10 seconds (four callback ring signals), this feature is canceled automatically.
- If the called party becomes busy again after the callback ringing starts, the ringing stops but this feature will be executed again when the extension becomes free.
- **FWD/DND Override**  
Call Forwarding or Do Not Disturb feature does not work for the callback ringing. It always rings the extension on which this feature was activated.
- With the KX-T7431, KX-T7433, KX-T7436 or KX-T7235, you can cancel this feature using the display operation.

## Programming Guide References

- 2.3 Numbering Plan
  - Automatic Callback Busy Cancel

## Features Guide References

- 1.6 Originating Features
  - Automatic Callback Busy (Camp-On)
  - Automatic Route Selection (ARS)
  - Trunk Access

## User Manual References

- 4.5.9 KX-T7235 Display Features - System Feature Access Menu
- 4.5.12 KX-T7431 / KX-T7433 / KX-T7436 Display Features - System Feature Access Menu

## 4.3.7 Background Music (BGM)

You can hear background music through the built-in speaker of your PT. An external music source, such as a radio, must be connected. The music stops whenever a call comes in or when you go off-hook.

### Setting / Canceling

7230 / 7235 / 7433 / 7436

*When the handset is on the cradle and the SP-PHONE button is off;*

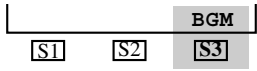

Press **BGM (S3)**.

- To turn off the BGM, press this button again.

---

PT

*When the handset is on the cradle and the SP-PHONE/MONITOR button is off;*



Dial 1.

- The display shows either one of the following for five seconds depending on whether BGM is on or off:  
<PT Display Example>

BGM On

or

BGM Off

### Conditions

- **Hardware Requirements**  
A user-supplied external music source, such as a radio, is required to utilize this feature. Up to two external music sources can be connected to the system.
- **PT**  
**Turning on/off**  
You can turn on/off the BGM only when your PT is not in use.

- **Distinctive Dial Tone**

When this feature is assigned to the extension, the extension user may hear a distinctive dial tone (dial tone 2) after going off-hook depending on System Programming <Section 2.8 System Option, "15. Special dial tone after setting feature" in the Programming Guide>.

### **Installation Manual References**

- 2.8.2 External Music Source

### **Programming Guide References**

- 2.2 Tenant
  - BGM Source
- 2.8 System Option
  - Special dial tone after setting feature

### **Features Guide References**

- 1.3 System Features
  - Background Music (BGM)—External
  - Music on Hold
- 1.15 Proprietary Telephone Features
  - Background Music (BGM)

### **User Manual References**

None

### 4.3.8 Busy Station Signaling (BSS)

You can prompt a busy extension (ringing or during a call) to answer your call. The other extension hears three beeps and knows that you are waiting.

**7230 / 7235 / 7433/ 7436**

*If you hear a busy tone after making an intercom call;*

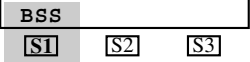

Press BSS (S1).



Wait for an answer and talk.

---

**PT and SLT**

*If you hear a busy tone after making an intercom call;*



Dial 1.



Wait for an answer and talk.

#### Conditions

- BSS feature functions, when the often busy extension is an ICM type PT in the following status.
  - a) The extension is off-hook.
  - b) ICM button is idle
  - c) "Call Waiting" feature is enabled.
- BSS, OHCA and Whisper OHCA do not function, if the other extension is a DN type PT.

- **BSS / OHCA / Whisper OHCA**

If an extension user dials "1" while hearing a busy tone, BSS or OHCA or Whisper OHCA may be activated at the called extension.

This is determined by the following conditions.

Calling extension	Called extension			
COS-OHCA assignment	Call Waiting setting			
	OFF	ON		
	0	1	2	3
Disable	————	BSS	BSS	BSS
Enable	————	BSS	OHCA*1 → BSS	W-OHCA*2 → OHCA → BSS

\*1 OHCA (Off-Hook Call Announcement) is activated when the called extension is KX-T7130, KX-T7235 or KX-T7436.

\*2 Whisper OHCA is activated when both calling and called extensions are using one of the KX-T7400 series PTs.

- If the other extension is provided with "Off-Hook Call Announcement (OHCA)" function (KX-T7130, KX-T7235, KX-T7436), you can announce through the speaker.

### Programming Guide References

- 2.3 Numbering Plan
  - Call Waiting Set / Cancel

### Features Guide References

- 1.6 Originating Features
  - Busy Station Signaling (BSS)
  - Off-Hook Call Announcement (OHCA)
  - Off-Hook Call Announcement (OHCA), Whisper
- 1.9 Answering Features
  - Call Waiting

### User Manual References

- 4.3.17 Call Waiting
- 4.3.49 Off-Hook Call Announcement (OHCA)
- 4.3.50 Off-Hook Call Announcement (OHCA) —Whisper



## 4.3.9 Call Forwarding

Automatically transfers incoming calls to the pre-assigned extension or to an external party. The following types are available:

Type	Description
Call Forwarding — All Calls	All incoming calls are forwarded to pre-assigned extension automatically regardless of the status of your extension.
Call Forwarding — Busy	All incoming calls are forwarded to the pre-assigned extension when your extension is busy.
Call Forwarding — No Answer	All incoming calls are forwarded to the pre-assigned extension when you do not answer the call within a pre-determined time.
Call Forwarding — Busy/No Answer	All incoming calls are forwarded to the pre-assigned extension when your extension is busy or you do not answer the call within a pre-determined time.
Call Forwarding — to CO or TIE Line	All incoming calls are forwarded to the pre-assigned external party via a CO or TIE line regardless of the status of your extension. The telephone number of the external party must be assigned beforehand. The call duration is limited. Some extensions may be restricted from setting this feature.
Call Forwarding — No Answer to CO or TIE Line	All incoming calls are forwarded to the pre-assigned external party via a CO or TIE line when you do not answer the call within a pre-determined time. The telephone number of the external party must be assigned beforehand. The call duration is limited. Some extensions may be restricted from setting this feature.
Call Forwarding — Follow Me	If you forget to set the "Call Forwarding — All Calls" feature before leaving your desk, you can set the same feature from the destination extension.

### **Note**

- You can also set Voice Mail as the forwarding destination. Please refer to Section "4.3.83 VPS Integration."

## Setting

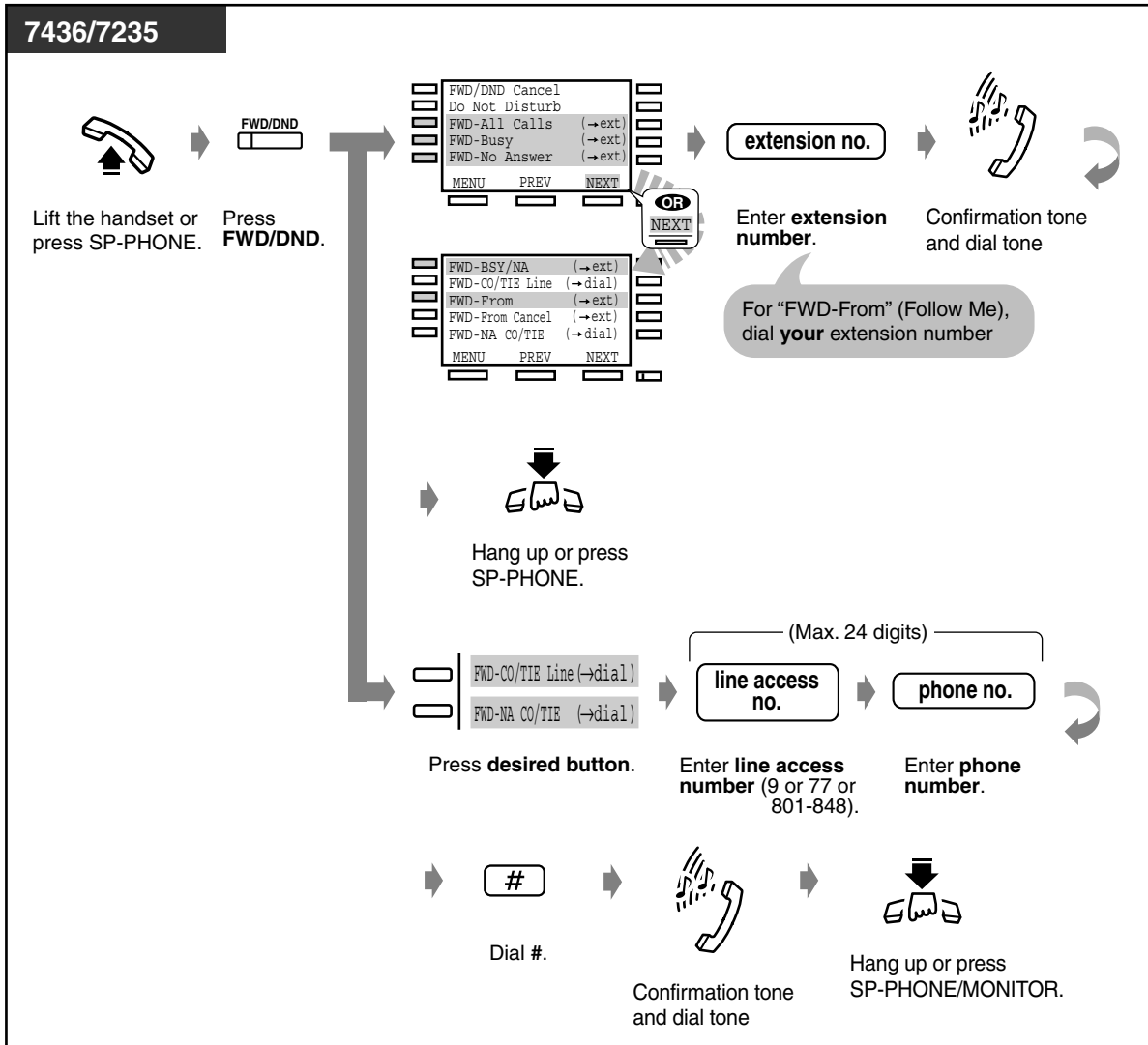

## Setting

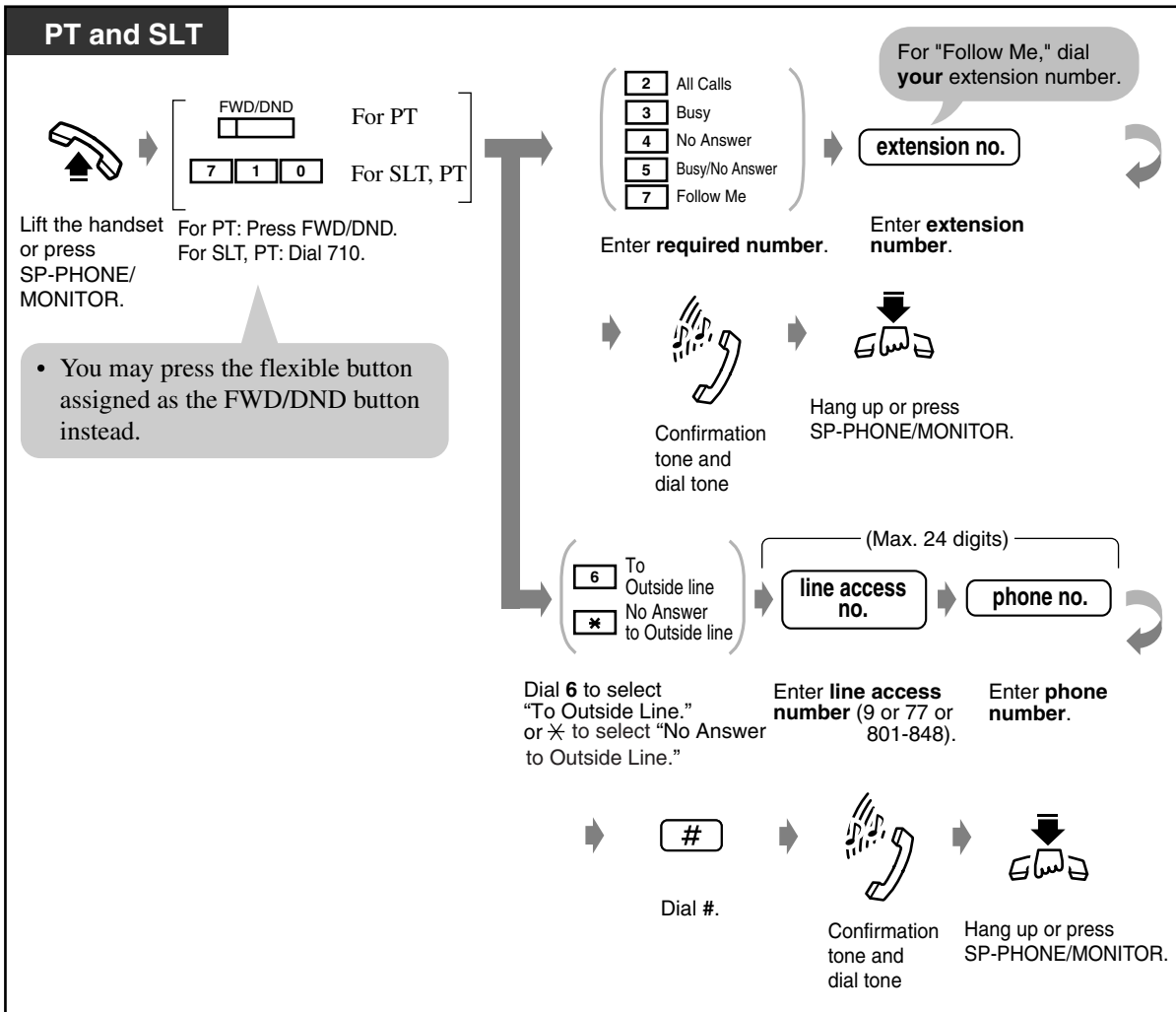

- You may press the flexible button assigned as the FWD/DND button instead.

## Canceling

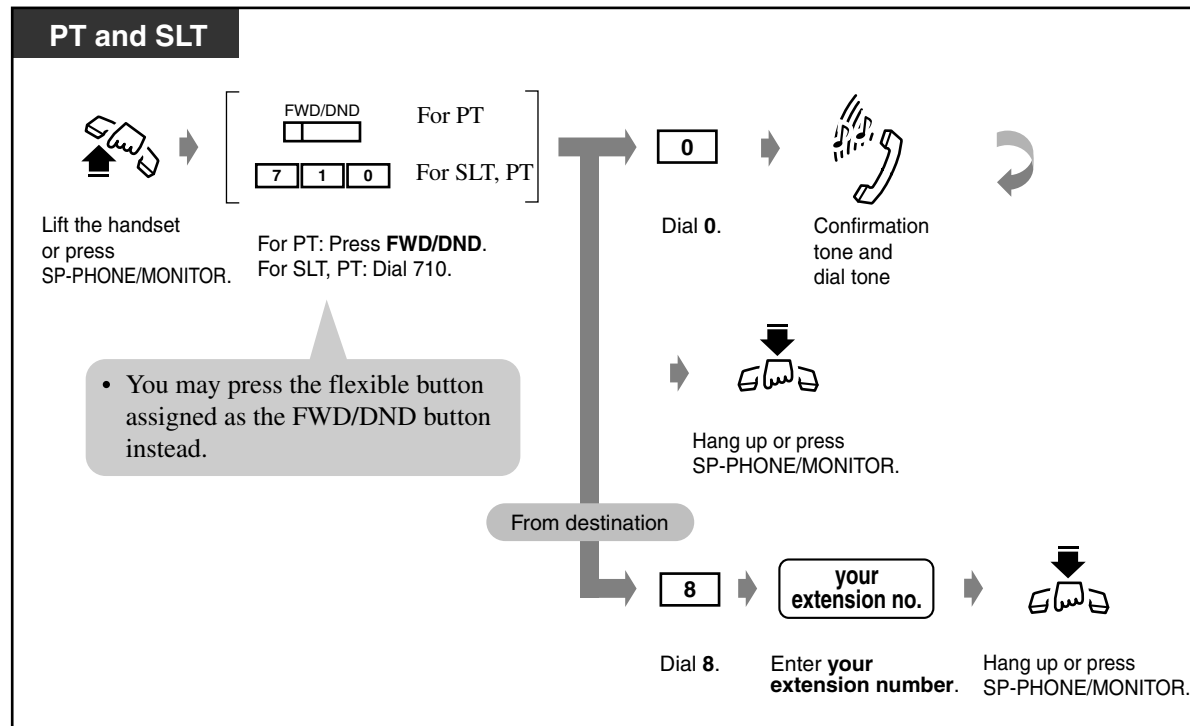
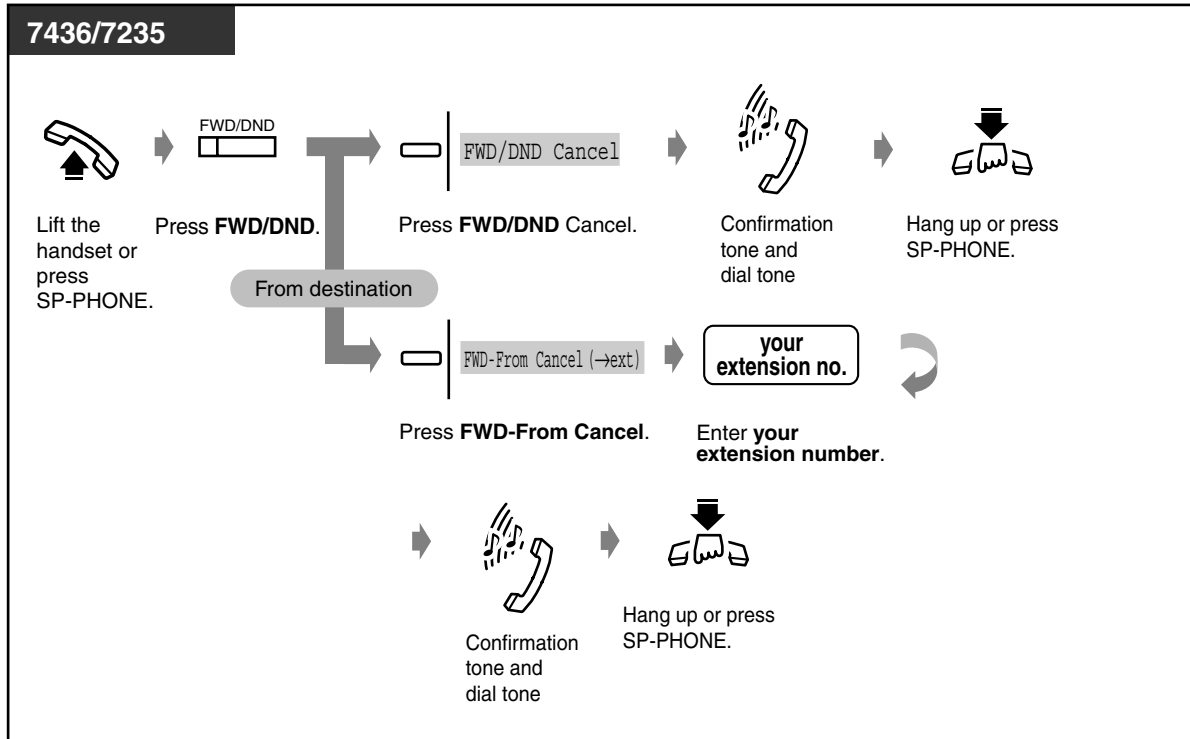

## Conditions

### [General]

- Types of calls which are forwarded by these features are:

Call Type	
Outside calls	Direct In Line (DIL) 1:1; Direct Inward Dialing (DID); Direct Inward Dialing (DID) (ISDN); Direct Inward System Access (DISA); Intercept Routing; Multiple Directory Number (MDN) TIE; Transfer*
Intercom calls	Extension; Transfer*

– Items marked with "\*" are not available with "Call Forwarding — No Answer to CO/TIE" feature.

- Forwarded call is not forwarded furthermore**  
Call Forwarding can only be extended to one target extension. For example, extension "A" is forwarded to extension "B," and extension "B" is forwarded to extension "C." A call to extension "A" is forwarded to extension "B," but the call would not be forwarded to extension "C." Consequently, extension "B" is treated as the final destination of Call Forwarding.

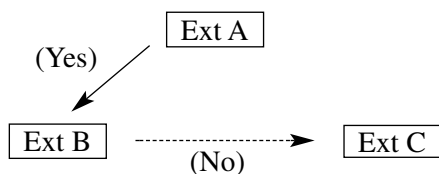

- Setting a new "Call Forwarding" feature (All Calls, Busy, Busy/No Answer, etc.) cancels any other "Call Forwarding" features previously assigned to the extension.
- Floating Station**  
A floating station such as a DISA, MODEM or external pager cannot be programmed as the call forwarding destination.
- Two extensions can set each other as the call forwarding destination extension. In this case, an intercom call to the other party while he is absent will not be forwarded back to the original extension.
- Message Waiting notification**  
A message waiting notification is left on the Call Forwarding setting extension regardless of a type of Call Forwarding feature except for "To CO / TIE Line" and "No Answer to CO / TIE Line."
- Station Hunting**  
Station Hunting applies to calls forwarded to a busy extension in a Station Hunting group.

- **Confirmation tone**

Confirmation tone 2 (two beeps) is sent when the previously programmed data is same as the new data. If it is not, confirmation tone 1 (one beep) is sent. Please refer to Section "6.1.3 Tone List" for further information on tones.

- You can call the original extension from the Call Forwarding destination extension.

- **PT**

Both the Call Forwarding and Do Not Disturb (DND) features can be programmed at the same time, but either one of them can be activated at a time. You can enable or disable Call Forwarding or Do Not Disturb (DND) feature by pressing the FWD/DND button while on-hook. In this case, pressing the button changes the setting as follows:



The lighting patterns of the FWD/DND button are as follows:

Off: Both features are not set.

Red on : DND mode

Red flash : FWD mode



This setting can be changed by System Programming

- **Station or User Programming mode**

This feature functions even if the extension is in Station or User Programming mode.

- **Remote FWD (Call Forwarding) Cancel — Once**

The Manager and the Operators can reach an extension that has set Call Forwarding.

- **FWD/DND button**

Regarding the PT without the FWD/DND button, it can be assigned to a flexible (CO, DSS, PF) button by Station, User or System Programming.

- **Distinctive Dial Tone**

When this feature is assigned to the extension, the extension user may hear a distinctive dial tone (dial tone 2) after going off-hook depending on System Programming <Section 2.8 System Option, "15. Special dial tone after setting feature" in the Programming Guide>.

### **[No Answer], [Busy/No Answer]**

- The number of rings before the call is forwarded is programmable <Section 2.5 System Timer / Section 4.3 Extension Line, "Call Forwarding – No Answer Time" in the Programming Guide>. If "0" is specified in Section 4.3 Extension Line, "Call Forwarding-No Answer Time" setting in Section 2.5 System Timer works.

### **[Follow Me]**

- This feature can be canceled either at your extension or from the destination extension.
- **Class of Service**  
Class of Service programming determines the extension that can perform this feature <Section 2.4 Class of Service (COS), "Call Forwarding Follow me" in the Programming Guide>.

**[To CO / TIE Line]**

- **Class of Service**  
Class of Service programming determines the extension that can perform this feature <Section 2.4 Class of Service (COS), "Call FWD to CO / TIE" in the Programming Guide>.
- **Treatment of the forwarded call**  
Toll Restriction, Automatic Route Selection (ARS) and Account Code Entry requirements of the extension in Call Forwarding mode still apply to the call forwarded by this feature.
- If you are storing an account code, enter the account code and then the delimiter "99" before the line access code.
- **Extension-to-CO Line Call**  
If a call between an extension and an outside party is established by this feature, the call duration can be restricted by System Programming <Section 2.5 System Timer, "Extension-to-CO Line Call Duration Time" in the Programming Guide>. This restriction applies to the extension whose "Time Limit of Outside Calls" setting (Class of Service programming) is set to "Yes" by System Programming.
- **CO-to-CO Line Call**  
If a call between two outside parties is established by this feature, the call duration is determined by System Programming <Section 2.5 System Timer, "CO-to-CO Line Call Duration Time" in the Programming Guide>.  
An alarm tone is sent to both outside parties 15 seconds before the time-out.  
The call is disconnected at the time-out.
- **Trunk-to-Trunk Connection**  
Before utilizing this feature, "Trunk to Trunk Restriction" should be enabled by System Programming.
- You can store the telephone number up to 24 digits. Valid digits are "0 through 9," "\*" and PAUSE. PAUSE can also be stored by dialing "\* \*."

**[No Answer - To CO / TIE Line]**

- The number of rings before the call is forwarded is programmable <Section 2.5 System Timer / Section 4.3 Extension Line, "Call Forwarding-No Answer Time" in the Programming Guide>. If "0" is specified in Section 4.3 Extension Line, "Call Forwarding-No Answer Time" setting in Section 2.5 System Timer works.
- **Class of Service (COS) programming**  
COS programming <Section 2.4 Class of Service (COS), "Call FWD to CO / TIE" in the Programming Guide> determines the extension that can perform this feature.
- **Treatment of the forwarded call**  
Toll Restriction, Automatic Route Selection (ARS) and Account Code Entry requirements of the extension in Call Forwarding mode still apply to the call forwarded by this feature.
- If you are storing an account code, enter the account code and then the delimiter "99" before the line access code.
- **Extension-to-CO Line Call**  
If a call between an extension and an outside party is established by this feature, the call duration can be restricted depending on the setting of the system timer <Section 2.5 System Timer, "Extension-to-CO Line Call Duration Time" in the Programming Guide>.

- **Co-to-CO Line Call**  
If a call between two outside parties is established by this feature, the call duration is determined by System Programming <Section 2.5 System Timer, "CO-to-CO Line Call Duration Time" in the Programming Guide>.  
An alarm tone is sent to both outside parties 15 seconds before the time-out. The call is disconnected at the time-out.
- **Trunk-to-Trunk Connection**  
Before utilizing this feature, "Trunk to Trunk Restriction" should be enabled by System Programming.
- You can store the telephone number up to 24 digits. Valid digits are "0 through 9," "\*" and PAUSE. PAUSE can also be stored by dialing "\*.\*"
- This feature does not apply to the unscreened transfer call.

### Programming Guide References

- 2.3 Numbering Plan
  - Call FWD - Do Not Disturb Set / Cancel
- 2.4 Class of Service (COS)
  - Call FWD to CO / TIE
  - Time Limit of Outside Calls
  - Trunk Group Setting
  - Call FWD Follow me
- 2.5 System Timer
  - Call Forwarding - No Answer Time
  - Extension-to-CO Line Call Duration Time
  - CO-to-CO Line Call Duration Time
- 2.7 Trunk to Trunk Restriction
- 2.8 System Option
  - Special dial tone after setting feature
  - FWD / DND lamp pattern
- 4.3 Extension Line
  - CO Key
  - PF Key
  - Call Forwarding - No Answer Time
- 4.4 DSS Console
  - DSS Key
  - PF Key

### Features Guide References

- 1.3 System Features
  - Limited Call Duration



1.8 Ringing Features

- Do Not Disturb (DND)

1.11 Transferring Features

- Call Forwarding

3.1 TIE Line Features

- TIE Line and Outside (CO) Line Connection

**User Manual References**

- 2.2.3 Flexible Button Assignment
- 3.2.5 [005] Flexible CO Button Assignment
- 4.3.27 Do Not Disturb (DND)
- 4.3.83 VPS Integration

### 4.3.10 Call Forwarding — All Calls to an Incoming Group

Automatically transfers all calls to an Incoming Group to the pre-assigned Incoming Group or Extension Group.

#### Setting

PT and SLT



Lift the handset or press  
SP-PHONE/MONITOR.

7	1	4	1
---	---	---	---

Dial 7141.

FDN
-----

Enter the FDN for a  
source Incoming  
Group (3 or 4 digits).

FDN
-----

Enter the FDN for a  
destination Incoming/  
Extension Group  
(3 or 4 digits).



Confirmation tone  
and dial tone

<PT Display Example>

G - FWD
---------



Hang up or press  
SP-PHONE/MONITOR.

#### Canceling

PT and SLT



Lift the handset or press  
SP-PHONE/MONITOR.

7	1	4	0
---	---	---	---

Dial 7140.

FDN
-----

Enter the FDN for a  
source Incoming  
Group (3 or 4 digits).



Confirmation tone  
and dial tone



Hang up or press  
SP-PHONE/MONITOR.

<PT Display Example>

G - FWD
---------

## Conditions

- Types of calls which are forwarded by this feature are:

Call Type	
Outside calls	Direct In Lines (DIL); Direct Inward Dialing (DID); Direct Inward Dialing (DID) (ISDN); Direct Inward System Access (DISA); Intercept Routing; Multiple Directory Number (MDN); TIE; Transfer
Intercom calls	Extension; Transfer

- Class of Service (COS) programming**  
 COS programming <Section 2.4 Class of Service (COS), "Incoming Group FWD" in the Programming Guide> determines the extension that can perform this feature.  
 The Call Forwarding setting extension varies depending on the following three modes:
  - Disable:**  
Disables this feature.
  - Own Group(s):**  
Enables forwarding all calls to other Incoming Groups or Extension Groups. Only its own group(s) can be set as the Call Forwarding setting extension.
  - Any Group:**  
Enables forwarding all calls to other Incoming Groups or Extension Groups. Any group can be set as the Call Forwarding setting extension.
- Forwarded call is not forwarded furthermore**  
 There can be only one stage of Call Forwarding. If a call is forwarded to an extension in Call Forwarding mode, the call is not forwarded furthermore.
- Confirmation Tone**  
 A confirmation tone is sent to the extension user before being connected to the caller. Eliminating the tone is programmable <Section 2.8 System Option, "9. Confirmation tone for Call Pickup, Paging, Paging-Answer, TAFAS-Answer, Hold Retrieve and Call Park Retrieve" in the Programming Guide>.
- Group FWD button**  
 Group FWD button can be assigned to a flexible (CO, DSS) button by Station, User or System Programming.
- Distinctive Dial Tone**  
 When this feature is assigned to the extension, the extension user may hear a distinctive dial tone (dial tone 2) after going off-hook depending on System Programming <Section 2.8 System Option, "15. Special dial tone after setting feature" in the Programming Guide>.
- Assignable destination is FDN of Incoming Group or Extension Group.  
 If "DIL 1:N" is specified in "Group Type" setting of Incoming Group, this feature does not work.
- Regarding the PT with the Group FWD button, if Incoming Group FWD feature is assigned to the PT extension, the Group FWD indicator lights in red.

- While setting, you can temporarily cancel this feature by pressing the Group FWD button. Pressing the Group FWD button alternates between setting and canceling the mode.

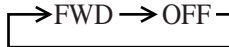

The lighting patterns of the Group FWD button are as follows:

Off: This feature is not set.

Red on: Group FWD mode

- The Group FWD button cannot be used to store or cancel this feature. Please use the feature number for "Group FWD" instead.

### **Programming Guide References**

- 2.3 Numbering Plan
  - Group FWD
- 2.4 Class of Service (COS)
  - Incoming Group FWD
- 2.8 System Option
  - Special dial tone after setting feature
  - Confirmation tone for Call Pickup, Paging, Paging – Answer, TAFAS – Answer, Hold Retrieve and Call Park Retrieve
- 4.3 Extension Line
  - CO Key
- 4.4 DSS Console
  - DSS Key

### **Features Guide References**

#### 1.11 Transferring Features

- Call Forwarding—All Calls to an Incoming Group

### **User Manual References**







- 2.2.3 Flexible Button Assignment
- 3.2.5 [005] Flexible CO Button Assignment

## 4.3.11 Call Hold



You can place a call (intercom or outside) on hold (**Call Hold**). While the call is on hold, you can make or receive other calls. The held call can be retrieved not only from your extension but from any other extension in the same tenant (**Call Hold Retrieve**).

Preventing other extension users from retrieving a call held at your extension is also possible [PT user only] (**Exclusive Call Hold**). In this case, the call can only be retrieved from your extension.

### Holding a call (regular)

PT	SLT
<p><i>During a conversation;</i></p> <div style="text-align: center;">  </div> <p>Press <b>HOLD</b>.</p> <div style="text-align: right;">  <p>Confirmation tone and dial tone</p> </div> <ul style="list-style-type: none"> <li>• You may replace the handset.</li> <li>• The corresponding CO or INTERCOM or DN indicator light flashes green slowly.</li> </ul>	<p><i>During a conversation;</i></p> <div style="text-align: center;">  </div> <p>Flash the switchhook.</p> <div style="text-align: center;">  </div> <p>Dial 50.</p> <div style="text-align: right;">  <p>Confirmation tone and dial tone</p> </div> <div style="text-align: right;">  <p>Confirmation tone and dial tone</p> </div> <ul style="list-style-type: none"> <li>• You may replace the handset.</li> </ul>

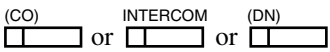
### Retrieving a call held at your extension

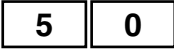
PT	SLT
<p><i>At your extension;</i></p> <div style="text-align: center;">  </div> <p>Press the <b>CO</b> or <b>INTERCOM</b> or <b>DN</b> that is flashing green slowly.</p> <ul style="list-style-type: none"> <li>• The CO or INTERCOM or DN indicator light turns steady green.</li> </ul>	<p><i>At your extension;</i></p> <div style="text-align: center;">  </div> <p>Lift the handset.</p> <div style="text-align: center;">  </div> <p>Dial 50.</p>

## Retrieving an outside call held at another extension

**PT and SLT**

*At another extension;*

 Lift the handset or press SP-PHONE/MONITOR.

**5** **3** Dial 53.

**trunk port physical no.** Enter the held trunk port physical number.

 Confirmation tone (optional)

**PT**

*At another extension;*

**(CO)**  
 Press **CO** whose indicator is flashing red slowly.

 Confirmation tone (optional)

- The CO indicator light turns steady green.

## Retrieving an intercom call / an outside call held at another extension

**PT and SLT**

*At another extension;*

 Lift the handset or press SP-PHONE/MONITOR.

**5** **1** Dial 51.

**holding extension no.** Dial the holding extension number.

 Confirmation tone (optional)

## Placing a call on exclusive hold

**PT**

*During a conversation;*

Press **HOLD**.

Confirmation tone (optional)

Press **HOLD** again.

- The CO or INTERCOM or DN indicator light flashes green slowly.
- The current call is placed on hold.

- The CO or INTERCOM or DN indicator light flashes green moderately.
- The current call is placed on exclusive hold.

## Retrieving a call on exclusive hold

**PT**

(CO) OR INTERCOM OR (DN)

Press the **CO** or **INTERCOM** or **DN** that is on exclusive hold.

- The CO or INTERCOM or DN indicator light turns steady green.
- You can talk to the held party again.

## Conditions

- **Music on Hold**  
"Music on Hold" is sent to the party on hold, if available.
- **What if a call on hold is not retrieved?**  
If a call (intercom, outside) on hold is not retrieved in a specified period of time (**Hold Recall Time**), ringing or an alarm tone is sent to the extension user who held the call as a reminder.  
**Hold Recall tone:**  
If the extension user is on-hook and its speaker phone (PT only) is off when the Hold Recall Time expires, the phone will ring.  
**Hold Alarm Tone:**  
If the extension user is engaged in a call when the Hold Recall Time expires, an alarm tone is sent from the built-in speaker of a PT or from the handset receiver of an SLT at 15-second intervals.  
In this case, "Call Waiting" feature should be set at the extension beforehand.  
For further information on Tone Patterns, please refer to Section "6.1.3 Tone List."
- Placing a call on Exclusive Call Hold is not available for an SLT user.
- **Exclusive Call Hold → Regular Call Hold**
- After Hold Recall or Hold Alarm Tone is emitted, the held call can be retrieved from any extension even if it is placed on Exclusive Call Hold.

- It is possible to disable the Hold Recall tone by System Programming <Section 2.5 System Timer, "Hold Recall Time" in the Programming Guide>.
- **Automatic Disconnection**  
If an inside / outside call put on hold is not retrieved within 30 minutes, it is disconnected automatically.
- **The number of calls that can be placed on (exclusive) hold at an extension**  
It differs depending on the telephone type as follows.
  - **Intercom calls**
    - <ICM type PT> One, <SLT>: One (Not available)
    - <DN type PT>: as many intercom calls as the number of DN (PDN, SDN) buttons on it.
  - **Outside calls**
    - <ICM type PT>: as many outside calls as the number of CO (S-CO, G-CO, L-CO) buttons on it.
    - <DN type PT>: as many outside calls as the number of CO (S-CO, G-CO, L-CO) buttons and DN buttons on it.
    - <SLT>: One (Not available)
- An SLT user can hold only one call, either an intercom or outside, at a time. To hold multiple calls, use the Call Park feature.
- **Tenant Service**  
If "Tenant Service" is utilized, retrieving a held call (intercom or outside) is only available within the same tenant.
- **Confirmation Tone**  
A confirmation tone is sent to the extension user who retrieved the held call, when it is retrieved by dialing the feature number.  
This tone can be eliminated by System Programming <Section 2.8 System Option, "9. Confirmation tone for Call Pickup, Paging, Paging – Answer, TAFAS – Answer, Hold Retrieve and Call Park Retrieve">.
- The extension user cannot retrieve the following calls.
  - Unattended Conference Calls
  - Calls held at the System Call Parking Area
  - Calls placed on Exclusive Call Hold

### Programming Guide References

- 2.2 Tenant
  - Music on Hold Source
- 2.3 Numbering Plan
  - Hold
  - Hold Retrieve – Station
  - Hold Retrieve – Trunk
  - Call Waiting Set/Cancel
- 2.5 System Timer
  - Hold Recall Time
- 2.8 System Option



– Confirmation tone for Call Pickup, Paging, Paging – Answer, TAFAS – Answer, Hold Retrieve and Call Park Retrieve

### **Features Guide References**

- 1.3 System Features
  - Music on Hold
- 1.10 Holding Features
  - Call Hold
  - Call Park
- 1.13 Audible Tone Features
  - Hold Recall

### **User Manual References**

- 4.3.17 Call Waiting

## 4.3.12 Call Park

Allows you to place a held call into a system parking area. You can be released from the parked call to perform other operations. The parked call can be retrieved from any extension.

### Parking a call

PT and SLT

*During a conversation;*

TRANSFER

For PT

For SLT

5

2

parking zone no.

For PT: Press **TRANSFER**.  
For SLT: Flash the switchhook.

Confirmation tone and dial tone

Dial 52.

Enter a parking zone number (00 through 99).

Confirmation tone and dial tone

**<PT Display Example>**

C. Parked at xx

Parking zone number (00 through 99)

- If you hear a busy tone, it indicates the specified parking zone is unavailable.

**<PT Display Example>**

Park at xx N/A

- You can change the parking zone simply by entering the parking zone number while hearing the busy tone.

## Retrieving a parked call

PT and SLT



Lift the handset or press  
SP-PHONE/MONITOR.

5

2

Dial 52.

parking zone no.

Enter a parking zone number  
(00 through 99) where the call  
is parked.



Confirmation tone  
(optional)

You can talk  
to the party.

- If there is no held call, you will hear a reorder tone.

<PT Display Example>

No Held Call

### Conditions

- Up to 800 calls can be parked at the same time in the system.
- **Tenant Service**  
If "Tenant Service" is employed, each tenant can use up to 100 parking areas (00-99) independently.
- **Call Park Recall**  
If a parked call is not retrieved in a specific period of time, Call Park Recall rings back the extension who parked the call.
- **Automatic Disconnection**  
If a parked call is not retrieved in 30 minutes, it is automatically disconnected.
- **Confirmation Tone**  
A confirmation tone is sent to the extension user who retrieved the parked call. Eliminating the tone is programmable.
- With the KX-T7431, KX-T7433, KX-T7436 or KX-T7235, you can execute this feature using the display operation.

### Programming Guide References

- 2.3 Numbering Plan
  - Call Park / Call Park Retrieve
- 2.5 System Timer
  - Call Parking Recall Time
- 2.8 System Option
  - Confirmation tone for Call Pickup, Paging, Paging-Answer, TAFAS-Answer, Hold Retrieve and Call Park Retrieve

## **Features Guide References**

### 1.10 Holding Features

- Call Park

### 1.12 Conversation Features

- Conference, 5-Party

## **User Manual References**

- 4.3.22 Conference, 5-Party
- 4.5.9 KX-T7235 Display Features - System Feature Access Menu
- 4.5.12 KX-T7431 / KX-T7433 / KX-T7436 Display Features - System Feature Access Menu

### 4.3.13 Call Pickup

Allows you to answer a call (intercom, outside, doorphone) ringing at any other extension. The following types are available.

Feature Type	Picking up call type
<b>Directed</b>	A specific extension's call.
<b>Group</b>	A call within your extension group.
<b>CO Line</b>	An outside call.

Preventing other extensions from picking up calls ringing at your extension is also possible (**Call Pickup Deny**).

#### Call Pickup, CO Line

PT and SLT



Lift the handset or press SP-PHONE/MONITOR.

4

\*

Dial 4\*.



Confirmation tone (optional)



Talk.

#### Call Pickup, Directed

PT and SLT



Lift the handset or press SP-PHONE/MONITOR.

4

1

Dial 41.

extension no.

Dial the extension number where the call is ringing.



Confirmation tone (optional)



Talk.

## Call Pickup, Group

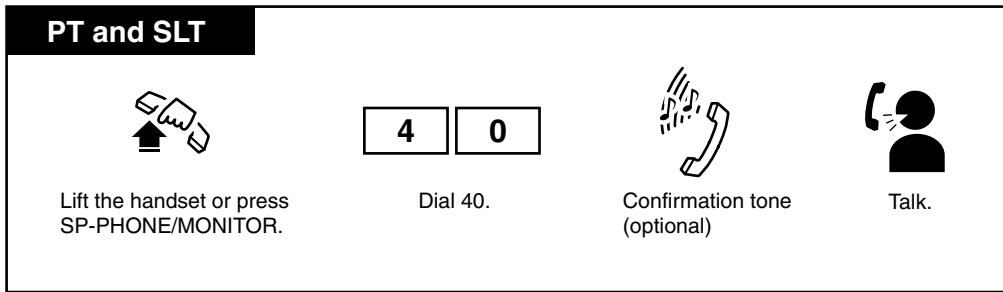

## Conditions

### [General]

- **Confirmation Tone**  
A confirmation tone is sent to the extension user who picked up the call. Eliminating the tone is programmable <Section 2.8 System Option, "9. Confirmation tone for Call Pickup, Paging, Paging-Answer, TAFAS-Answer, Hold Retrieve and Call Park Retrieve " in the Programming Guide>.
- This feature is not available to answer the following calls:
  - a call ringing at an extension in "Call Pickup Deny" mode
  - a call which shows the call arrival indication but is not ringing yet (Delayed Ringing)
- With the KX-T7431, KX-T7433, KX-T7436 or KX-T7235, you can execute this feature using the display operation.

### [Directed]

- **Tenant Service**  
If "Tenant Service" is utilized, this feature is only available for the calls ringing on an extension within the same tenant.
- **Doorphone Call**  
Doorphone calls can be picked up from extensions that are not programmed to answer doorphone calls.
- **Call Waiting Call**  
This feature applies to a call waiting call.

### [Group]

- **Group Call Pickup Priority:**  
Outside call > Transferred call > Extension call > Doorphone call
- If more than one call is ringing on an extension, Call Pickup to that extension works for the first arrived call.
- **Call Waiting Call**  
This feature does not apply to a call waiting call.

**[CO Line]**

- **Tenant Service**  
If "Tenant Service" is utilized, this feature is only available for an outside call ringing on an extension within the same tenant.
- If more than one CO call is ringing on an extension, Call Pickup starts with the first arrived CO call.
- **Call Waiting Call**  
This feature does not apply to a call waiting call.

**Programming Guide References**

- 2.3 Numbering Plan
  - CO Call Pickup
  - Group Call Pickup
  - Directed Call Pickup
  - Dial Call Pickup Deny Set/Cancel
- 2.8 System Option
  - Confirmation tone for Call Pickup, Paging, Paging - Answer, TAFAS - Answer, Hold Retrieve and Call Park Retrieve
- 3.3 Extension Group

**Features Guide References**

- 1.3 System Features
  - Extension Group
- 1.9 Answering Features
  - Call Pickup

**User Manual References**

- 4.3.17 Call Waiting
- 4.5.9 KX-T7235 Display Features - System Feature Access Menu
- 4.5.12 KX-T7431 / KX-T7433 / KX-T7436 Display Features - System Feature Access Menu

### 4.3.14 Call Pickup Deny

Allows you to prevent another extension from picking up your calls with the "Call Pickup" feature.

#### Setting / Canceling

PT and SLT



Lift the handset or press  
SP-PHONE/MONITOR.

7	2	0	1	To set
7	2	0	0	To cancel

To set: Dial 7201.  
To cancel: Dial 7200.



Confirmation tone  
and dial tone



Hang up or press  
SP-PHONE/MONITOR.

**<PT Display Example>**

- When setting:  

C.Pickup Deny
- When canceling:  

C.Pickup Allow

#### Conditions

- This feature does not apply to calls coming in on multiple extensions simultaneously.
- **Applicable calls**  
This feature applies to the following calls.

Call Type	
Outside calls	Direct In Lines (DIL) 1:1; Direct Inward System Access (DISA); TIE
Intercom calls	Calls ringing on a single extension

- **Distinctive Dial Tone**  
When this feature is assigned to the extension, the extension user may hear a distinctive dial tone (dial tone 2) after going off-hook depending on System Programming <Section 2.8 System Option, "15. Special dial tone after setting feature" in the Programming Guide>.
- With the KX-T7431, KX-T7433, KX-T7436 or KX-T7235, you can execute this feature using the display operation.



### **Programming Guide References**

- 2.3 Numbering Plan
  - Dial Call Pickup Deny Set / Cancel
- 2.8 System Option
  - Special dial tone after setting feature
- 4.3 Extension Line
  - Call Pickup Deny

### **Features Guide References**

- 1.9 Answering Features
  - Call Pickup



### **User Manual References**

- 4.3.13 Call Pickup
- 4.5.9 KX-T7235 Display Features - System Feature Access Menu
- 4.5.12 KX-T7431 / KX-T7433 / KX-T7436 Display Features - System Feature Access Menu

### 4.3.15 Call Splitting

Allows you to have two callers on a line and alternate between them. If a call comes in while you are already on the line, you can place the current call (1st call) on hold and have a conversation with the other party (2nd call).

**When you are engaged in the 2nd call (inside/outside), while placing the 1st call (inside/outside) on hold temporarily (Consultation Hold\*1)**

<b>PT</b>	<div style="text-align: center;"><p>TRANSFER</p></div> <p>Press <b>TRANSFER</b>.</p> <div style="border: 1px solid gray; background-color: #f0f0f0; padding: 5px; margin-top: 10px;"><ul style="list-style-type: none"><li>▪ You are connected to the 1st caller.</li><li>▪ Pressing the TRANSFER button alternates between two callers.</li></ul></div>
<b>SLT</b>	<div style="text-align: center;"></div> <p>Flash the switchhook.</p> <div style="border: 1px solid gray; background-color: #f0f0f0; padding: 5px; margin-top: 10px;"><ul style="list-style-type: none"><li>▪ You are connected to the 1st caller.</li><li>▪ Flashing the switchhook alternates between two callers.</li></ul></div>

**When you are engaged in the 2nd call (inside), while placing the 1st call (inside) on (exclusive) hold**

<b>PT</b>	<p>(ICM/CO type PT only)</p> <p><i>Between two extensions;</i></p> <div style="text-align: center;"><p>HOLD</p></div> <p>Press <b>HOLD</b>.</p> <div style="border: 1px solid gray; background-color: #f0f0f0; padding: 5px; margin-top: 10px;"><ul style="list-style-type: none"><li>▪ Pressing the HOLD button alternates between two callers.</li></ul></div>
-----------	---

\*1 Consultation Hold places a call on hold temporarily to transfer it or makes a Conference call or Call Splitting.

---

---

**When you are engaged in the 2nd call (inside/outside), while placing the 1st call (inside/outside) on (exclusive) hold**

**PT**

HOLD       (CO) or  INTERCOM or  (DN)

Press **HOLD**.      Press **CO** or **INTERCOM** or **DN**.

▪ Repeating these operations (steps 1 and 2) alternates between two callers.

**Conditions**

- This feature does not work during a doorphone call or paging.

**Programming Guide References**

System Programming is not required.

**Features Guide References**

- 1.10 Holding Features
  - Call Splitting
  - Consultation Hold
- 1.12 Conversation Features
  - Conference, 3-Party

**User Manual References**

- 4.3.11 Call Hold

### 4.3.16 Call Transfer

You can transfer a call (intercom, CO, TIE) to another extension or external party. The following types are available.

Feature Type		Transferring Method
Screened	to Extension	Transfers a call to the extension or the external party after a voice announcement.
	to CO/TIE Line	
Unscreened	to Extension	Transfers a call to the extension or the external party without a voice announcement.
	to CO/TIE Line	While listening for the ringback tone after dialing the destination number, you can replace the handset.

#### Transferring a call to an extension (Screened)

**PT and SLT**

*During a conversation;*

TRANSFER

For PT

For SLT

extension no.

OR

(DSS)

Confirmation tone and dial tone

Dial the destination extension number (3 or 4 digits) or press **DSS** (flexible button).

Ringback tone

Wait for an answer.

Announce.

Hang up or press SP-PHONE.



▪ The other party is placed on hold.

▪ The call is transferred.

## Transferring a call to an extension (Unscreened)

**PT and SLT**

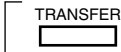
*During a conversation;*

 For PT  
 For SLT





Confirmation tone and dial tone

extension no.

  
 OR  

(DSS)

 Ringback tone  
 Hang up or press SP-PHONE/MONITOR.

For PT: Press **TRANSFER**.  
For SLT: Flash the switchhook.



Dial the destination extension number (3 or 4 digits) or press **DSS** (flexible button).

- The other party is placed on hold.
- Ringing starts at the destination extension.
- The call is transferred.

## Transferring a call to the Remote Resource (Unscreened)

**PT and SLT**

*During a conversation;*

 For PT  
 For SLT



Confirmation tone and dial tone

floating directory no.

 Hang up or press SP-PHONE/MONITOR.

For PT: Press **TRANSFER**.  
For SLT: Flash the switchhook.

Dial the floating directory number (3 or 4 digits) for Remote Resource.

- The other party is placed on hold.
- The call is transferred.

## One-Touch Transfer

**PT**

*During a conversation with an external party;*

(DSS)

Press **DSS** (flexible button).

- The other party is placed on hold and the destination extension is called immediately.

## Transferring a call to an external party via a CO or TIE line (Screened)

**PT and SLT**

*During a conversation;*

TRANSFER For PT  
For SLT

For PT: Press **TRANSFER**.  
For SLT: Flash the switchhook.

Confirmation tone and dial tone

(CO)  
line access code

Press **CO** or enter a line access code (9 or 77 or 801 through 848).

phone no.

Dial the phone number where calls will be transferred.

- The current call is placed on hold.



Ringback tone



Wait for an answer.



Announce.



Hang up or press SP-PHONE.

- The call is transferred.

## Transferring a call to an external party via a CO or TIE line (Unscreened)

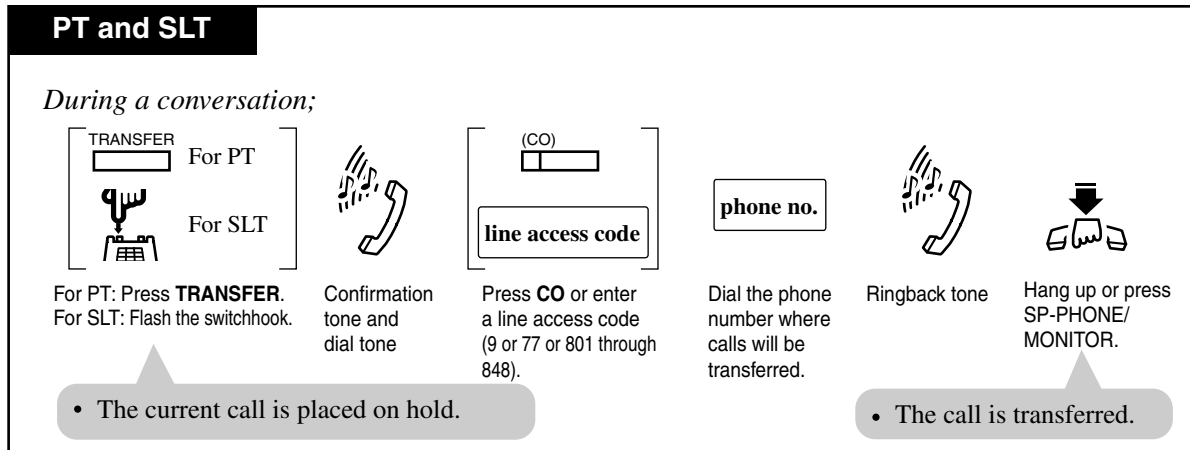

### Conditions

#### [General]

- **Music on Hold or Ringback Tone**

If "Music on Hold" is enabled, music is sent to the caller while being transferred. It is system programmable whether to send a ringback tone or "Music on Hold" to the caller <Section 2.8 System Option, "Sound source during transfer" in the Programming Guide>.

- **PT**

If you mis-dial the destination telephone number, press the FLASH button to clear the number entered. Then you can enter a new number again.

- **PT**

If you want to return to the held call, press the TRANSFER or corresponding CO/INTERCOM/DN button before the destination party answers the transferred call.

- **SLT**

If you want to return to the held call, press the switchhook lightly.

#### [Screened, Unscreened – to Extension]

- **One-Touch Transfer by DSS Button (PT only)**

Allows the PT user to transfer the outside call (CO, TIE) to an extension simply by pressing the DSS button associated with the destination extension. This feature can be enabled or disabled on a system-wide basis by System Programming <Section 2.8 System Option, "25. Pressing DSS key operation in CO talking" in the Programming Guide>. However, it cannot be performed when there is another call on Consultation Hold.

- **One-Touch Transfer by DSS or Phantom Button (PT only)**

Allows the PT user to transfer the call (intercom, CO, TIE) to an extension simply by pressing the DSS button associated with the destination extension. This feature can be enabled or disabled on a COS (Class of Service) basis by System Programming <Section

2.4 Class of Service (COS), "Automatic Hold" in the Programming Guide>. However, it cannot be performed when there is another call on Consultation Hold.

- **DSS Button**

DSS buttons are provided on a DSS Console by default.

A flexible CO/DSS button can be assigned as a DSS button by Station, User or System Programming.

- **Ringing Pattern**

A call transferred to an extension will ring following the regular ringing pattern depending on the type of call (intercom, outside) being transferred.

### [Screened, Unscreened – to CO/TIE Line]

- **Class of Service**

Class of Service programming determines the extension that can perform this feature <Section 2.4 Class of Service (COS), "Transfer to CO" in the Programming Guide>.

- **CO-to-CO call**

If a CO call is transferred to an outside party, "CO-to-CO call" is established and the duration is restricted by System Programming <Section 2.5 System Timer, "CO-to-CO Line Call Duration Time" in the Programming Guide>.

**Hold Recall tone:**

Hold Recall tone is generated to the extension user who transferred the call 50 seconds before the time-out.

**Hold Alarm tone:**

Hold Alarm tone is generated to both outside parties 15 seconds before the time-out. The call is disconnected at the time-out unless the extension user (who transferred the call) joins the CO-to-CO call to establish a 3-party conference call.

- **CO-to-TIE call**

If a CO call is transferred to the destination party via TIE line, a CO-to-TIE call is established and the call duration is restricted by System Programming <Section 2.5 System Timer, "CO-to-CO Line Call Duration Time" in the Programming Guide>.

- **PT**

If you want to join the conversation after transferring the call or while hold recall tone is sent, press the corresponding CO button. A 3-party conference call is established.



**[Unscreened – To Extension]**

- **Transfer Recall Destination**  
If the call (intercom, CO, TIE) transferred to the destination extension is not answered within a specified period of time <Section 2.5 System Timer, "Transfer Recall Time" in the Programming Guide>, it may ring an Operator extension instead of the extension who originally transferred it. This is determined by System Programming <Section 2.8 System Option, "6. Transfer recall destination" in the Programming Guide>.
- When "Transfer Recall" occurs, the display shows:  
<Example>  

RCL:Ext 1003
- **Automatic Disconnection**  
If there is no answer for 30 minutes after "Transfer Recall" starts, the line will be disconnected.
- **Camp-on Transfer**  
When the transfer destination party is busy, the call is put in waiting status. If the destination party remains busy or does not answer the call within a specified period of time <Section 2.5 System Timer, "Transfer Recall Time" in the Programming Guide>, the call will ring back the extension who transferred the call or an Operator extension.
- **Remote Administration**  
Any extension user can transfer a call to the Remote Resource (Modem) for Remote Administration.
- A CO call can be transferred directly to a Uniform Call Distribution (UCD) group so that an idle extension is automatically hunted by UCD. If all extensions in a UCD group are busy, the incoming CO call will be handled by the UCD Time Table.
- During a call transfer to the Remote Resource (Modem), a confirmation tone is not emitted after dialing the FDN for the Remote Resource.

**Programming Guide References**

- 2.4 Class of Service (COS)
  - Trunk Group Setting
  - Transfer to CO
  - Automatic Hold
- 2.5 System Timer
  - Transfer Recall Time
  - CO-to-CO Line Call Duration Time
- 2.8 System Option
  - Sound source during transfer
  - Transfer recall destination
  - Pressing DSS key operation in CO talking
- 4.3 Extension Line
  - CO Key
- 4.4 DSS Console

– DSS Key

### **Features Guide References**

#### 1.3 System Features

- Limited Call Duration
- Music on Hold
- Released Link Operation

#### 1.10 Holding Features

- Automatic Hold—For Hold

#### 1.11 Transferring Features

- Call Transfer
- One-Touch Transfer

#### 1.12 Conversation Features

- Conference, 3-Party

#### 1.13 Audible Tone Features

- Hold Recall

#### 3.1 TIE Line Features

- TIE Line Service

### **User Manual References**

- 2.2.3 Flexible Button Assignment
- 3.2.5 [005] Flexible CO Button Assignment
- 5.2.6 Direct Station Selection (DSS) Button (Assignment)

## 4.3.17 Call Waiting

During a call, a Call Waiting tone informs you that there is another call waiting for you. You can answer the second call by disconnecting or placing the current call on hold. PT users can choose one of three Call Waiting modes.

### Setting

PT



Lift the handset or press  
SP-PHONE/MONITOR.

1. Call Waiting BSS	7	3	1	1
2. Call Waiting OHCA	7	3	1	2
3. Call Waiting W-OHCA	7	3	1	3



Confirmation tone  
and dial tone

1. Dial 7311.  
2. Dial 7312.  
3. Dial 7313.

**<PT Display Example>**

-1: C.Waiting BSS

-2: C.Waiting OHCA

-3: C.Waiting W-OHCA



Hang up or press  
SP-PHONE/MONITOR.

---

SLT



Lift the handset.

7	3	1	1
---	---	---	---

Dial 7311.



Confirmation tone  
and dial tone



Hang up.

## Canceling

PT and SLT



Lift the handset or press  
SP-PHONE/MONITOR.

7	3	1	0
---	---	---	---

Dial 7310.



Confirmation tone  
and dial tone







Hang up or press  
SP-PHONE/MONITOR.

<PT Display Example>

C.Waiting Off

## To talk to the new party by terminating the current call

PT	SLT
<p><i>While hearing a Call Waiting tone;</i></p> <div style="display: flex; align-items: center; margin-bottom: 10px;"> <div style="margin-right: 10px;">(CO) <input type="checkbox"/></div> <div style="margin-right: 10px;">INTERCOM <input type="checkbox"/></div> <div style="margin-right: 10px;">(DN) <input type="checkbox"/></div> <div style="margin-left: 20px;"></div> </div> <p>Press the flashing <b>CO</b> or <b>INTERCOM</b> or <b>DN</b>.</p> <p style="text-align: right;">Talk to the new caller.</p> <div style="background-color: #ccc; border: 1px solid #000; border-radius: 10px; padding: 5px; margin-top: 10px;"> <p>▪ The current call is disconnected.</p> </div>	<p><i>While hearing a Call Waiting tone;</i></p> <div style="display: flex; justify-content: space-around; align-items: center; margin-bottom: 10px;"> <div style="text-align: center;"> Hang up.</div> <div style="text-align: center;"> Lift the handset.</div> <div style="text-align: center;"> Talk to the new caller.</div> </div> <div style="background-color: #ccc; border: 1px solid #000; border-radius: 10px; padding: 5px; margin-top: 10px;"> <p>▪ The current call is disconnected.</p> </div>



## To talk to the new party by holding the current call

PT

*While hearing the Call Waiting tone and the CO or INTERCOM or DN indicator is flashing rapidly;*



Press **HOLD**.

(CO)  or INTERCOM  or (DN) 

Press the flashing  
**CO or INTERCOM or DN.**



Talk to the  
new caller.

- The current call is placed on hold.
- If both the current call and new call are extension calls, you will be connected to the new caller simply by pressing HOLD.

---

SLT

*While hearing a Call Waiting tone;*



Flash the  
switchhook.



Confirmation tone  
and dial tone

Dial 50.

5

0



Dial tone



Hang up.



Lift the  
handset.



Talk to the  
new caller.

- The current call is placed on hold.

**Conditions**

- **BSS / OHCA / Whisper OHCA**

If an extension user dials "1" while hearing a busy tone, BSS or OHCA or Whisper OHCA may be activated at the called extension.

This is determined by the following conditions.

Calling extension	Called extension			
	Call Waiting setting			
COS-OHCA assignment	OFF	ON		
	0	1	2	3
Disable	————	BSS	BSS	BSS
Enable	————	BSS	OHCA*1 → BSS	W-OHCA*2 → OHCA → BSS

\*1 OHCA(Off-Hook Call Announcement ) is activated when the called extension is KX-T7130, KX-T7235 or KX-T7436.

\*2 Whisper OHCA is activated when both calling and called extensions are using one of the KX-T7400 series PTs.

- The call waiting tone is generated when a CO call, a doorphone call is received, or when an extension caller executes Busy Station Signaling.

- **Data Line Security**

Setting Data Line Security temporarily cancels Call Waiting which has been turned on by an extension user.

- **PT(DN)**

BSS, OHCA and Whisper OHCA do not function, if the other extension is a DN type PT.

- **PT**

**Call Waiting Tone Selection**

For PT users, two types of call waiting tones are provided to prevent them from missing the tone. A Call Waiting Tone type can be selected either by Station or System Programming.

- **Distinctive Dial Tone**

When this feature is assigned to the extension, the extension user may hear a distinctive dial tone (dial tone 2) after going off-hook depending on System Programming <Section 2.8 System Option, "15. Special dial tone after setting feature" in the Programming Guide>.

- With the KX-T7431, KX-T7433, KX-T7436 or KX-T7235, you can execute this feature using the display operation.

**Programming Guide References**

- 2.3 Numbering Plan

- Call Waiting Set / Cancel
- 2.4 Class of Service (COS)
  - Off-Hook Call Announcement (OHCA)
- 2.8 System Option
  - Special dial tone after setting feature
  - Answering Call Waiting call by SLT hooking
- 4.3 Extension Line
  - Call Waiting Tone Type

### **Features Guide References**

- 1.6 Originating Features
  - Busy Station Signaling (BSS)
  - Off-Hook Call Announcement (OHCA)
  - Off-Hook Call Announcement (OHCA), Whisper
- 1.9 Answering Features
  - Call Waiting
- 1.12 Conversation Features
  - Data Line Security

### **User Manual References**

- 2.2.2 Call Waiting Tone Type Assignment
- 4.3.8 Busy Station Signaling (BSS)
- 4.3.25 Data Line Security
- 4.3.49 Off-Hook Call Announcement (OHCA)
- 4.3.50 Off-Hook Call Announcement (OHCA) —Whisper
- 4.5.9 KX-T7235 Display Features - System Feature Access Menu
- 4.5.12 KX-T7431 / KX-T7433 / KX-T7436 Display Features - System Feature Access Menu

### 4.3.18 Call Waiting from Central Office

During a conversation with an outside party, a call waiting tone offered by the local Central Office signals your extension that there is another incoming CO call that is waiting. You can answer the second call by placing the first call on hold.

**7230 / 7235 / 7433 / 7436**

*While hearing a Call Waiting tone through the handset;*

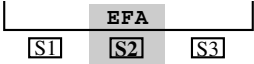

Press **EFA(S2)**.

- The current call is placed on hold and you can talk to the second caller.
- You can return to the first call by pressing the EFA(S2) button again.

#### Using the FLASH button

**PT**

*While hearing a Call Waiting tone through the handset;*

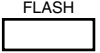

Press **FLASH**.

- The current call is placed on hold and you can talk to the second caller.
- You can return to the first call by pressing the FLASH button again.



## Using the feature number

PT and SLT

*While hearing a Call Waiting tone through the handset;*

TRANSFER

OR



Press **TRANSFER** or  
flash the switchhook.

6

Dial 6.

- The first party is placed on hold.
- You can talk to the second party.  
• You can return to the first party by flashing the switchhook and dialing "6" again.

### Conditions

- This is an optional telephone company service.  
For more information, consult the local telephone company.
- **FLASH Button Operation**  
Pressing the FLASH button on a PT results in either sending Flash signal or disconnecting the current call.  
This is determined by System Programming <Section 2.8 System Option, "3. FLASH button operation while CO talking" and "4. FLASH button operation when "Don't release the trunk" is selected at #3" in the Programming Guide>.
- **Flash Time**  
The flash time must be assigned as required by the Central Office.
- SLT  
This feature does not function, if an SLT has a call on Consultation Hold.

### Programming Guide References

- 2.3 Numbering Plan
  - External Feature Access
- 2.8 System Option
  - FLASH button operation while CO talking
  - FLASH button operation when "Don't release the trunk" is selected at #3
- 3.2 Trunk Group
  - Flash Time

## **Features Guide References**

### 1.9 Answering Features

- Call Waiting from Central Office

### 1.12 Conversation Features

- External Feature Access
- Flash

## **User Manual References**

- 4.3.35 External Feature Access

### 4.3.19 Calling Line Identification Presentation (CLIP)

When you make an outside call through an ISDN line, you can let the other party see your pre-assigned identification number. You can select to show an identification number assigned for an ISDN line or your extension. This is one of the ISDN supplementary service.

#### To select a CLIP number for an outside line

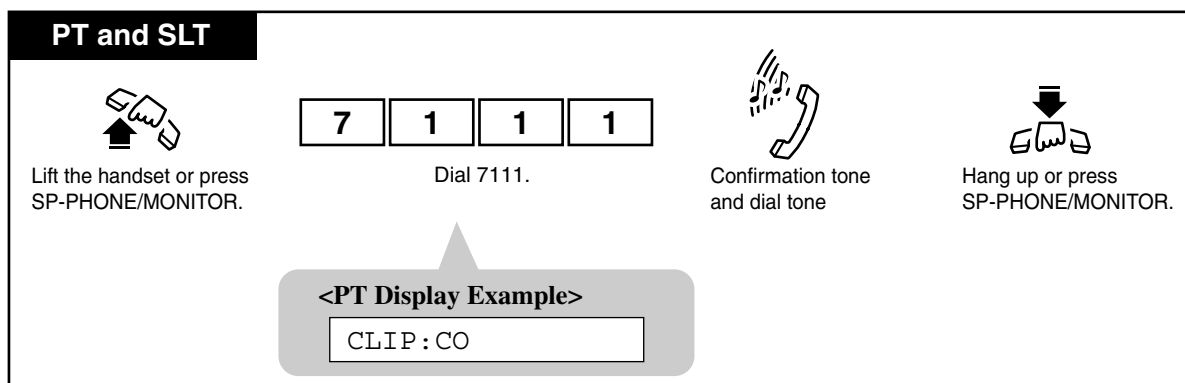

#### To select a CLIP number for an extension

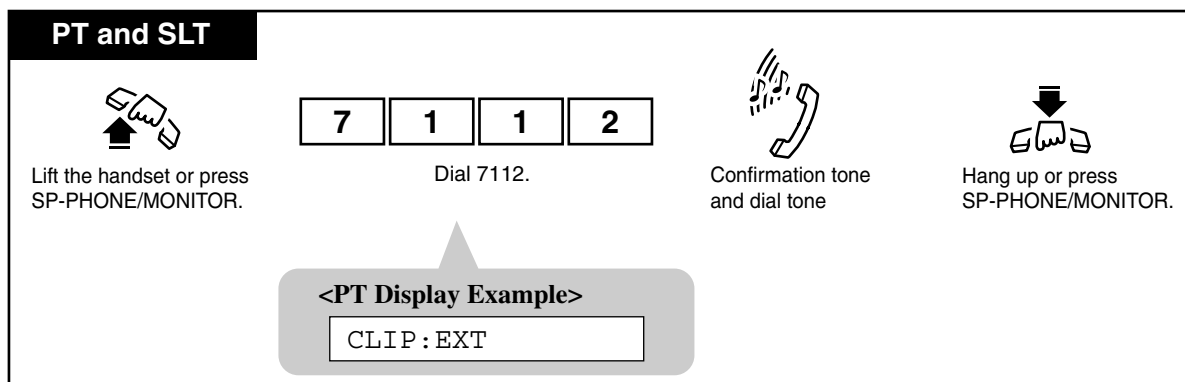

#### Conditions

- **CLIP Numbers for ISDN PRI Lines**

When you make an outside call using an ISDN PRI line, one of the following numbers (depending on your choice) is displayed on the telephone of the other party as the CLIP number.

- a) **CLIP number assigned to the trunk line**

The number stored in "Subscriber" <Section 4.2 Trunk Line in the Programming Guide>.

**b) CLIP number assigned to the extension line**

The number stored in "[CLIP Number] Public/Private" <Section 4.3 Extension Line in the Programming Guide>.

- **CLIP Number for ISDN BRI Line**

When you make an outside call using an ISDN BRI line, the number stored in "DN" <Section 1.2.10 Card Properties (BRI) – SPID/DN in the Programming Guide> is displayed on the telephone of the other party as the CLIP number.

In this case, above operations do not work.

- The CLIP number actually displayed on the telephone of the other party may be different from the system programmed CLIP number depending on the contract with your ISDN Service Provider.

- **Disabling the CLIP service**

You can choose whether to utilize the CLIP service or not before making an outside call <Section 4.3.20 Calling Line Identification Restriction (CLIR) / Calling Name Identification Restriction (CNIR)>.

### **Programming Guide References**

- 1.2 Slot Assignment
- 1.8 BRI Port Assignment
- 1.9 PRI Port Assignment
- 2.3 Numbering Plan
  - CLIP
- 4.2 Trunk Line
  - Subscriber
- 4.3 Extension Line
  - [CLIP Number] Public
  - [CLIP Number] Private
- 4.7 ISDN Extension Line
  - [CLIP Number] Public
  - [CLIP Number] Private

### **Features Guide References**

2.2 ISDN Originating Features

- Calling Line Identification Presentation (CLIP)
- Calling Line Identification Restriction (CLIR)

### **User Manual References**

- 4.3.20 Calling Line Identification Restriction (CLIR) / Calling Name Identification Restriction (CNIR)

### 4.3.20 Calling Line Identification Restriction (CLIR) / Calling Name Identification Restriction (CNIR)

When making an outside call through an ISDN line, you can prevent the other party from seeing your identification number/name. You can change the setting at any time for a particular call. This is one of the ISDN supplementary service.

#### To restrict the presentation of your number/name to the other party

PT and SLT



Lift the handset or press  
SP-PHONE/MONITOR.

5	9	2
---	---	---

Dial 592.



Confirmation tone  
and dial tone



Hang up or press  
SP-PHONE/MONITOR.

<PT Display Example>

CLIR	ON
------	----

#### To present your number/name to the other party

PT and SLT



Lift the handset or press  
SP-PHONE/MONITOR.

5	9	0
---	---	---

Dial 590.



Confirmation tone  
and dial tone



Hang up or press  
SP-PHONE/MONITOR.

<PT Display Example>

CLIR	OFF
------	-----

**To change the setting at any time for a particular call**

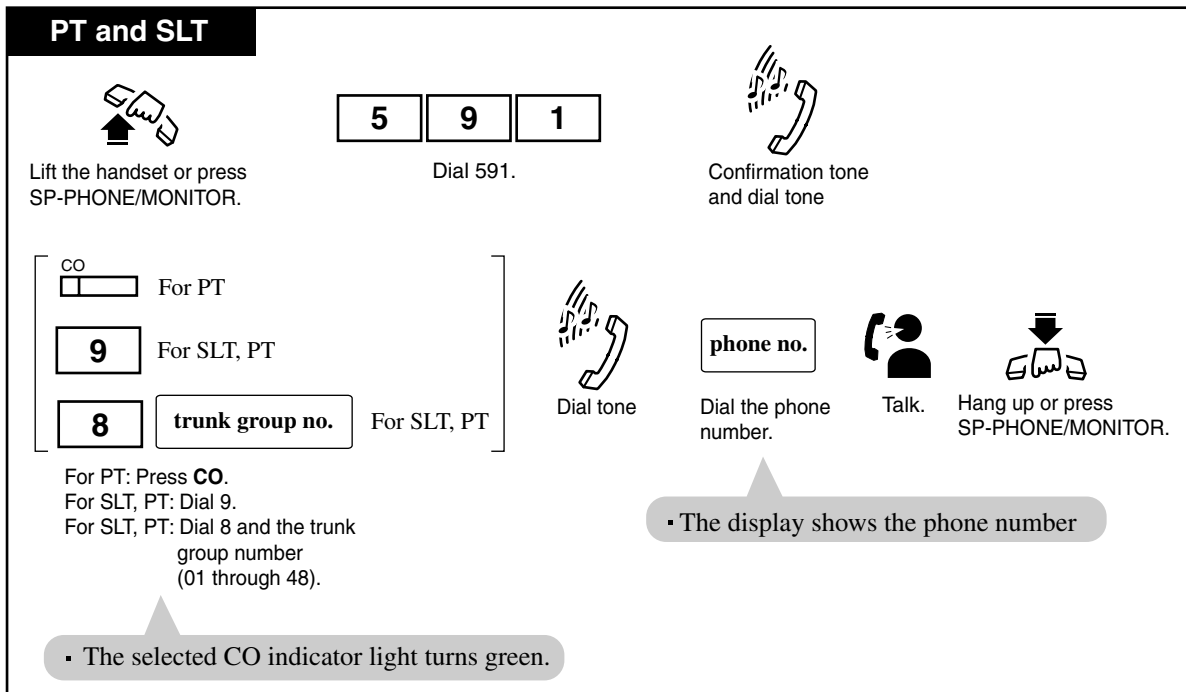

**Conditions**

- If the presentation is enabled, the other party can check the caller's number/name before answering the call.

**Programming Guide References**

- 2.3 Numbering Plan  
 – CLIR/CNIR

**Features Guide References**

- 2.2 ISDN Originating Features
- Calling Line Identification Presentation (CLIP)
  - Calling Line Identification Restriction (CLIR)
  - Calling Name Identification Presentation (CNIP)
  - Calling Name Identification Restriction (CNIR)

**User Manual References**

- 4.3.19 Calling Line Identification Presentation (CLIP)

## 4.3.21 Conference, 3-Party

During a two-party conversation, you can add a third party to make a three-party conference. The members of a conference on a line may be three extensions, one extension and two CO lines, or two extensions and one CO line.

### To establish a 3-party conference

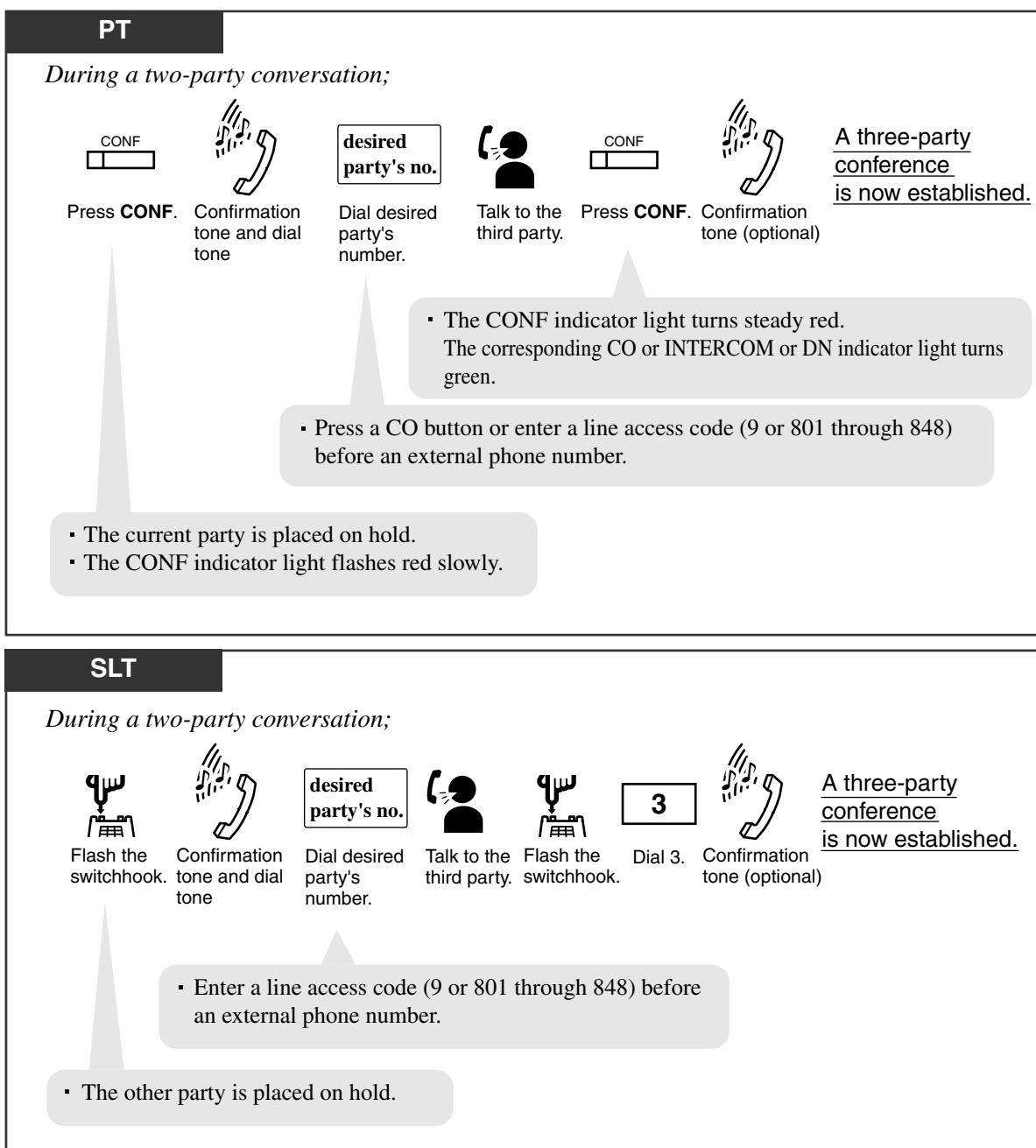

### To leave a 3-party conference

#### PT and SLT



Hang up or press SP-PHONE.

- The other two parties may continue their conversation.
- If both other two parties are on outside lines, they will be disconnected.

### To terminate one party and talk to the other

#### PT

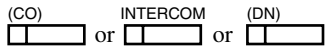

Press the **CO** or **INTERCOM** or **DN** of the party to remain connected.



Confirmation tone (optional)



Talk.

- A conversation with the desired party is established and the other party is disconnected.
- This operation is available only when the extension user established the conference call by using two different line access buttons. (Not available when only one button is used.)

### To talk to the third party while holding the original party

#### PT



Press **TRANSFER**.



Confirmation tone (optional)



Talk to the third party.

- If both other two parties are extensions, the **INTERCOM** or **PDN** indicator light flashes green moderately.



## To talk to the original party while holding the third party

SLT



Flash the switchhook.



Confirmation tone  
(optional)



Talk to the original party.

## To put both parties on hold

PT

HOLD

Press **HOLD**.

- For an ICM type PT, this operation is available only when at least one party is on a CO line.
- For a DN type PT, this operation is available only when the extension user established the conference call using two different line access buttons. (Not available when only one button is used.)

## Conditions

- Conference call arrangement**  
A conference call can be one of the following three arrangements: 1-inside and 2-outside; 2-inside and 1-outside; and 3-inside.
- Conference trunk**  
Up to eight conference calls are available at a time by default. If optional TSW Conference Expansion card is installed, up to 64 conference calls are available at a time.
- Executive Busy Override, Privacy Release**  
A 3-party conference call is also established by Executive Busy Override or Privacy Release.
- Confirmation tone**  
When a 2-party call is changed to a 3-party conference call and vice versa, a confirmation tone is sent to all three parties. Eliminating the tone is programmable.
- PT**  
Pressing a CO button which is not in the conference, allows you to exit from the conference

leaving the other two parties connected unless they both are on CO lines. If they both are on CO lines, they will be disconnected.

- **PT**  
You can return to the original party before the third party answers by pressing the TRANSFER button.
- If a CONF button is not provided on your PT, it can be assigned to a flexible (CO, DSS, PF) button by Station, User or System Programming.
- **Call Splitting**  
During a 3-party conference call, the conference originator can talk to either one of other two parties alternately by pressing the TRANSFER button (for PT user) or flashing the switchhook (for SLT user). In this case, the PT user is connected with the latter party first and the SLT user is connected with the previous party first.
- **SLT**  
If "Released Link Operation" is enabled on your extension by System Programming, you cannot establish a conference call.

### **Programming Guide References**

- 2.4 Class of Service (COS)
  - Released Link Operation
- 2.8 System Option
  - Confirmation tone for Override, Barge-in, Conference and Privacy Release
- 4.3 Extension Line
  - CO Key
  - PF Key
- 4.4 DSS Console
  - DSS Key
  - PF Key

### **Features Guide References**

- 1.6 Originating Features
  - Executive Busy Override
- 1.10 Holding Features
  - Call Splitting
- 1.12 Conversation Features
  - Conference, 3-Party
  - Conference, 5-Party
  - Conference, Unattended
  - Privacy Release

## **User Manual References**

- 2.2.3 Flexible Button Assignment
- 3.2.5 [005] Flexible CO Button Assignment
- 4.3.23 Conference, Unattended
- 4.3.33 Executive Busy Override
- 4.3.63 Privacy Release

### 4.3.22 Conference, 5-Party

A PT user can originate a 5-party conference call which includes outside or inside parties or both in any combination.

#### To establish a 5-party conference

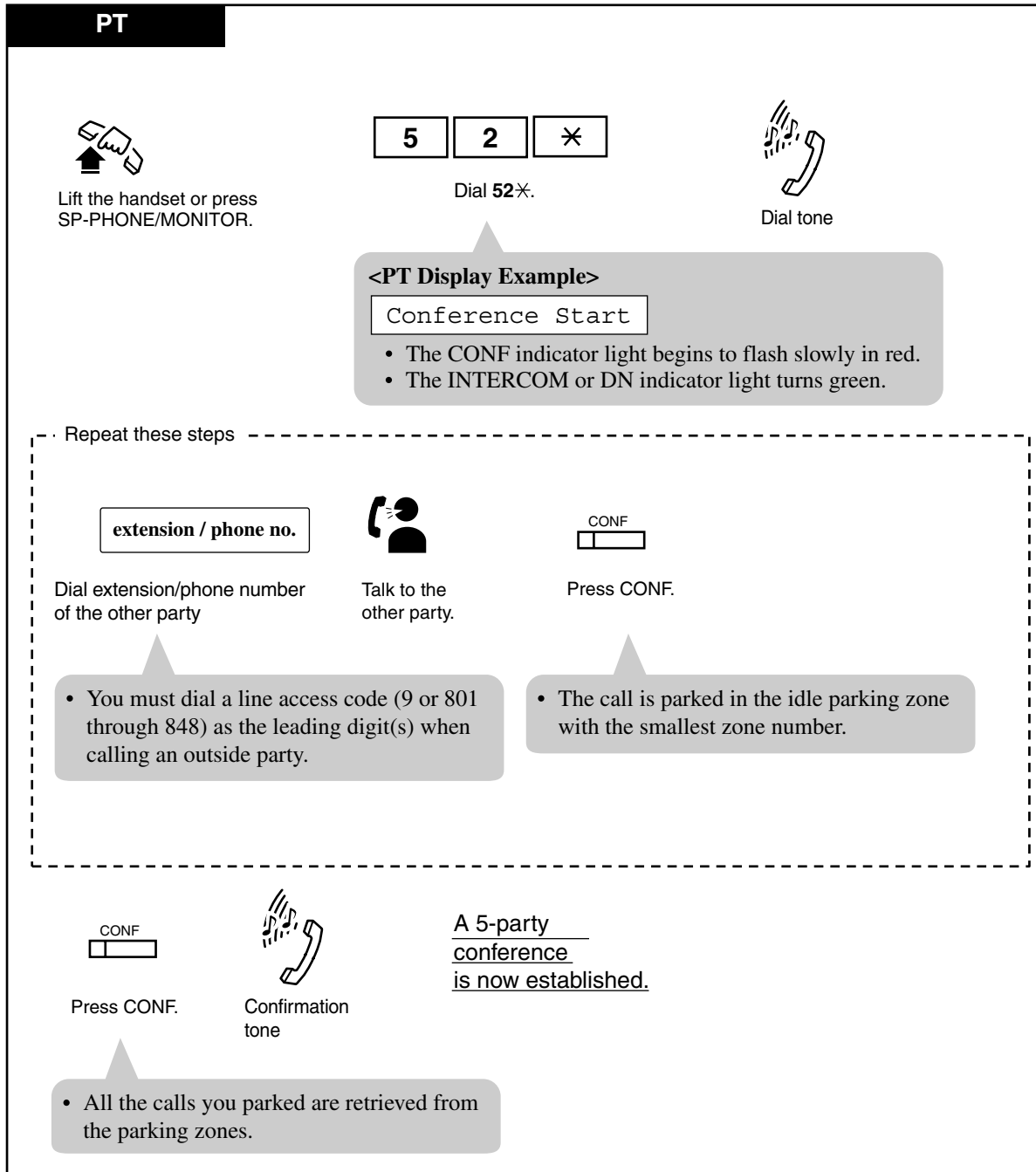

## To terminate the 5-party conference (conference originator only)

PT

*During the 5-party conference call*



Hang up or press  
SP-PHONE/MONITOR.

OR

(CO)

or

(DN)

Press an idle **CO** or **DN**  
button.

- All other participants are disconnected from the call.

### Conditions

- Up to two 5-party conference calls can be held at a time in the system, even if TSW Conference Expansion card is installed on the TSW card.
- **Conference call arrangement**  
A 5-party conference call can include both inside and outside parties in any combination.
- **Conference trunk**  
At least three idle conference trunks are required to establish a 5-party conference call.
- **Executive Busy Override**  
Executive Busy Override does not function to the extension engaged in the 5-party conference call.
- **CONF (Conference) button**  
If a CONF button is not provided on a PT, it can be assigned to a flexible (CO, DSS, PF) button by Station, User or System Programming.
- If the other party you called is in one of the following status, you can terminate the current call and call a new party by pressing the FLASH button.
  - the other party does not answer the call.
  - the other party refuses to join a five-party conference call.
  - the other party is a Voice Mail extension.

### Programming Guide References

- 2.3 Numbering Plan
  - Call Park / Call Park Retrieve
- 4.3 Extension Line
  - CO Key
  - PF Key
- 4.4 DSS Console
  - DSS Key
  - PF Key

## **Features Guide References**

### 1.12 Conversation Features

- Conference, 5-Party

## **User Manual References**

- 2.2.3 Flexible Button Assignment
- 3.2.5 [005] Flexible CO Button Assignment

### 4.3.23 Conference, Unattended

When you are in a conference with two outside parties, you can leave the three-party conference allowing the other two parties to continue their conversation.

#### To establish an Unattended Conference

**PT**

*During a conversation with two outside parties;*



CONF  

Press **CONF** to leave the conference.

- A CO-to-CO line call between the other two parties is established.

#### To return to the conference call

**PT**



(CO)  or (DN) 

Press **CO** or **DN** flashing green moderately.

#### To answer Hold Recall (To return to the conference on the line)

**PT**

*While hearing Hold Recall;*

 or (CO)  or (DN) 

Lift the handset or press SP-PHONE.      Press **CO** or **DN** button which is flashing rapidly.

## Conditions

- **Class of Service**<sup>\*1</sup>  
An Unattended Conference cannot be established unless the extension is allowed to transfer a call to an outside party by COS programming.
- **Limited Call Duration**  
The duration of an unattended conference is restricted by a system timer.  
Hold Recall tone  
Hold Recall tone is sent to the extension user who left the conference 50 seconds before the time-out.  
Hold Alarm tone  
An alarm tone is sent to both outside parties three times at 5-second interval 15 seconds before the time-out. The call is disconnected at the time-out unless the extension who originated the Unattended Conference returns to the call.
- **PT**  
If your extension is engaged in a call when Unattended Conference Recall occurs, the display flashes "10101 & 20211" for example, for 5 seconds at 15 seconds intervals. This is available when Call Waiting feature is enabled on your extension beforehand.
- **CONF (Conference) button**  
If a CONF button is not provided on a PT, it can be assigned to a flexible (CO, DSS, PF) button by Station, User or System Programming.

## Programming Guide Reference

- 2.4 Class of Service (COS)
  - Trunk Group Setting
  - Transfer to CO
- 2.5 System Timer
  - CO- to-CO Line Call Duration Time
- 4.3 Extension Line
  - CO Key
  - PF Key
- 4.4 DSS Console
  - DSS Key
  - PF Key

## Features Guide References

- 1.3 System Features
  - Limited Call Duration
- 1.12 Conversation Features
  - Conference, 3-Party

---

<sup>\*1</sup> Class of Service (COS) is used to define the features which are allowed for a group of extensions. Please refer to "Class of Service (COS)" of Section "1.3 System Features" in the Features Guide.



- Conference, Unattended

#### 1.13 Audible Tone Features

- Hold Recall

### **User Manual References**

- 2.2.3 Flexible Button Assignment
- 3.2.5 [005] Flexible CO Button Assignment
- 4.3.21 Conference, 3-Party

### 4.3.24 CTI (Computer Telephony Integration) Code Entry

A CTI Code (max. 16 digits) can be sent from the KX-TD500 to the CTI application (such as Panasonic Call Center Management Software, CMS). The code is interpreted by the application for suitable action. For example, in CMS, code 20 means the ACD agent wishes to take a break.

The feature number of CTI Code Entry is "Blank" by default.

You must specify it by System Programming. For details, consult your manager or dealer.

#### Entering CTI codes

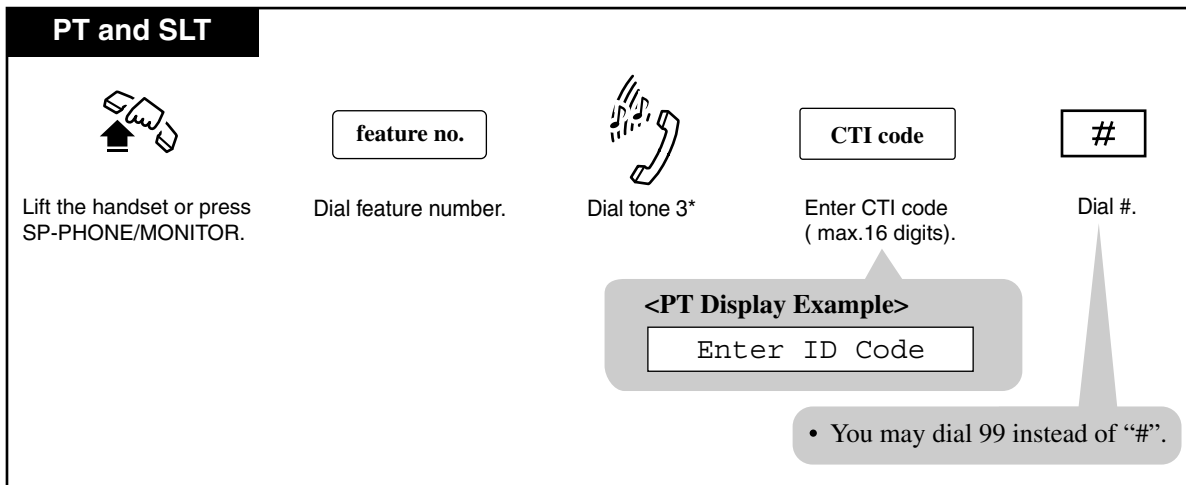

\* One of the dial tones. Please refer to Section "6.1.3 Tone List."

#### Conditions

- The delimiter "99" is available for rotary type SLTs only.

#### Programming Guide References

- 2.3 Numbering Plan  
 – Dial Information (CTI)

#### Features Guide References

None

#### User Manual References

- None

## 4.3.25 Data Line Security

Your extension is protected against interruptions from the "Call Waiting," "Hold Recall," and "Executive Busy Override" features. Data communication devices, such as computers and facsimiles, operate uninterrupted.

### Setting / Canceling

PT and SLT



Lift the handset or press  
SP-PHONE/MONITOR.

7	3	0	1	To set
7	3	0	0	

To set: Dial 7301.  
To cancel: Dial 7300.



Confirmation tone  
and dial tone



Hang up or press  
SP-PHONE/MONITOR.

**<PT Display Example>**

- When setting:

Data Mode On

- When canceling:

Data Mode Off

### Conditions

- **Automatic Privacy**  
Assigning Data Line Security always offers conversation privacy unless Privacy Release is executed.
- If one extension in a conversation has set Data Line Security, it applies to the both extensions.
- **Distinctive Dial Tone**  
When this feature is assigned to the extension, the extension user may hear a distinctive dial tone (dial tone 2) after going off-hook depending on System Programming <Section 2.8 System Option, "15. Special dial tone after setting feature" in the Programming Guide>.
- With the KX-T7431, KX-T7433, KX-T7436 or KX-T7235, you can execute this feature using the display operation.

### Programming Guide References

- 2.3 Numbering Plan
  - Data Line Security Set / Cancel
- 2.8 System Option

- Special dial tone after setting feature
- 4.3 Extension Line
  - Data Line Mode

### **Features Guide References**

- 1.6 Originating Features
  - Executive Busy Override
- 1.9 Answering Features
  - Call Waiting
- 1.12 Conversation Features
  - Data Line Security
  - Privacy Release

### **User Manual References**

- 4.3.17 Call Waiting
- 4.3.33 Executive Busy Override
- 4.3.63 Privacy Release
- 4.5.9 KX-T7235 Display Features - System Feature Access Menu
- 4.5.12 KX-T7431 / KX-T7433 / KX-T7436 Display Features - System Feature Access Menu

## 4.3.26 Direct Inward System Access (DISA)

Allows an outside caller to access specific system features as if the caller is an extension in the system. A DISA outgoing message is used to give outside callers assistance, such as listing the extension numbers in the system. You can also reach extensions using a single digit (DISA built-in auto attendant number).

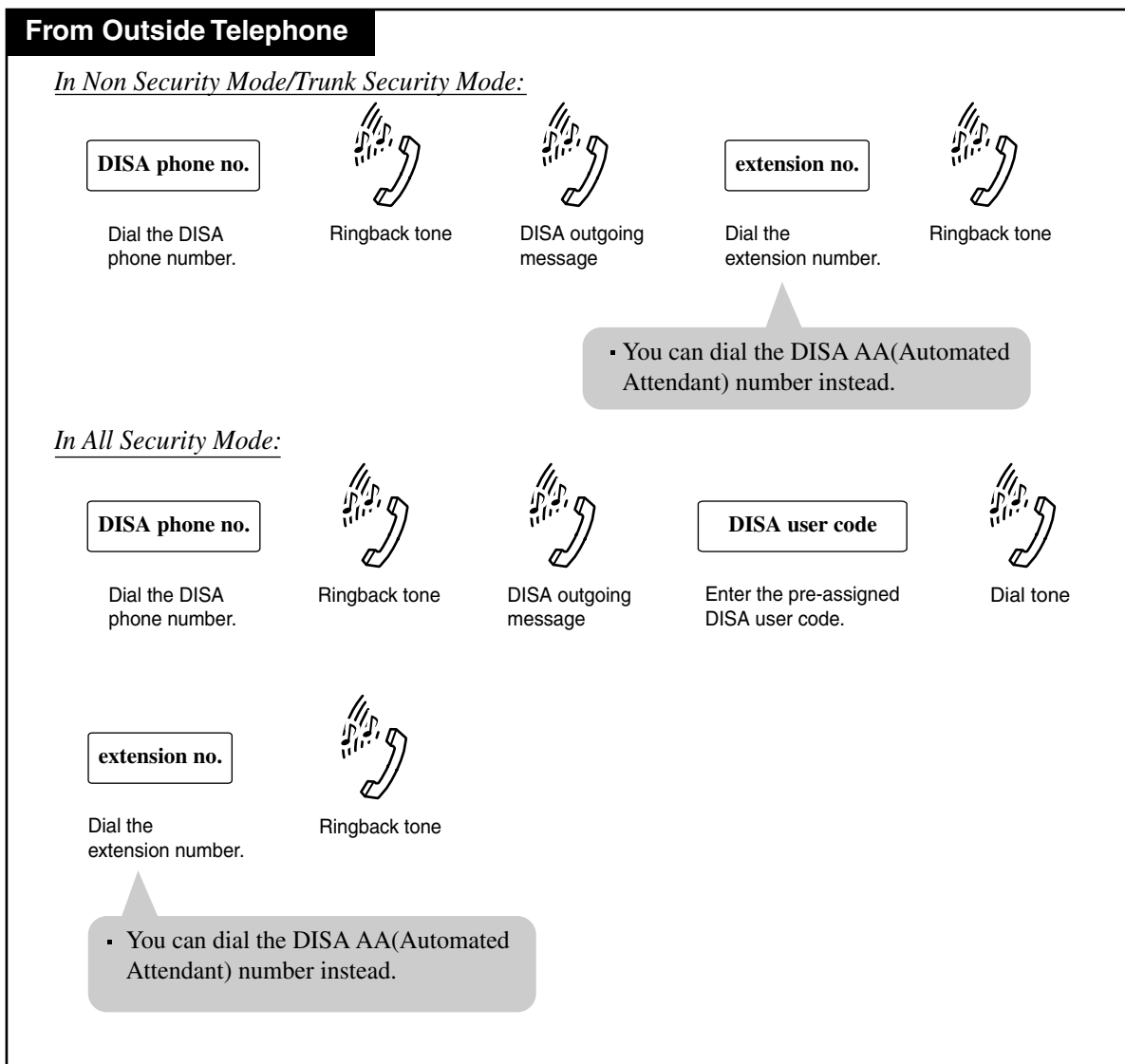

### Calling an extension







## Calling an outside party

### From Outside Telephone





*In Non Security Mode:*

<div style="border: 1px solid black; padding: 5px; width: fit-content; margin: 0 auto;"><b>DISA phone no.</b></div> <p>Dial the DISA phone number.</p>	 Ringback tone	 DISA outgoing message	<div style="border: 1px solid black; padding: 5px; width: fit-content; margin: 0 auto;"><b>line access code</b></div> <p>Enter a line access code (9 or 801 through 848).</p>	 Dial tone from Central Office
<div style="border: 1px solid black; padding: 5px; width: fit-content; margin: 0 auto;"><b>phone no.</b></div> <p>Dial the phone number of the outside party.</p>				

*In Trunk Security Mode:*

<div style="border: 1px solid black; padding: 5px; width: fit-content; margin: 0 auto;"><b>DISA phone no.</b></div> <p>Dial the DISA phone number.</p>	 Ringback tone	 DISA outgoing message	<div style="border: 1px solid black; padding: 5px; width: fit-content; margin: 0 auto;"><b>line access code</b></div> <p>Enter a line access code (9 or 801 through 848).</p>	 Dial tone 3*	<div style="border: 1px solid black; padding: 5px; width: fit-content; margin: 0 auto;"><b>DISA user code</b></div> <p>Enter the pre-assigned DISA user code.</p>
 Dial tone from Central Office	<div style="border: 1px solid black; padding: 5px; width: fit-content; margin: 0 auto;"><b>phone no.</b></div> <p>Dial the phone number of the outside party.</p>				

*In All Security Mode:*

<div style="border: 1px solid black; padding: 5px; width: fit-content; margin: 0 auto;"><b>DISA phone no.</b></div> <p>Dial the DISA phone number.</p>	 Ringback tone	 DISA outgoing message	 Dial tone 3*	<div style="border: 1px solid black; padding: 5px; width: fit-content; margin: 0 auto;"><b>DISA user code</b></div> <p>Enter the pre-assigned DISA user code.</p>	 Dial tone 3*
<div style="border: 1px solid black; padding: 5px; width: fit-content; margin: 0 auto;"><b>line access code</b></div> <p>Enter a line access code (9 or 801 through 848).</p>	 Dial tone from Central Office	<div style="border: 1px solid black; padding: 5px; width: fit-content; margin: 0 auto;"><b>phone no.</b></div> <p>Dial the phone number of the outside party.</p>			

\* One of the dial tones. Please refer to Section "6.1.3 Tone List."

## Extending the call duration while calling a CO line

### From Outside Telephone

*When you make a call to any CO line using the DISA feature, the line is disconnected after a pre-programmed time (default: 10 min)*

any key except "\*"

Dial any key except "\*" after the warning tone.

## Re-try

### From Outside Telephone

*It is possible (by System Programming) to dial a different number during a conversation with an outside party or while hearing a ringback, reorder, or busy tone.*

\*

Press \*.

desired no.

- You hear a dial tone.
- If you dial "\*" while hearing a DISA outgoing message, dial tone, or after the DISA outgoing message, the call will be disconnected.

You must dial a line access code (9 or 801 through 848) when calling an outside party.

## Warning for the Direct Inward System Access Users

When you enable the CO-to-CO Line Call feature of **Direct Inward System Access (DISA) function**, if a third party discovers the password (a DISA User Code) of the system, you have a risk that they will make illegal phone calls using your telephone line, and the cost may be charged to your account.

In order to avoid this problem, we strongly recommend the following points:

- 1: Carefully maintain the secrecy of the password.
- 2: Specify a complicated password as long and random as you can make it.
- 3: Change the password frequently.

## Conditions

### Calling an extension

- You can choose Non Security, Trunk Security or All Security mode. In All Security mode, the caller must enter a pre-assigned DISA user code to make intercom calls.
- If the DISA call is not answered within a specified period of time (DISA IRNA Time: 60 seconds [default]), the system redirects it to the pre-determined IRNA destination. If IRNA destination is not programmed, the DISA call will be disconnected 10 seconds later.

### Calling an outgoing CO line

- You can choose Non Security, Trunk Security or All Security mode. In Trunk Security mode, the caller must enter a pre-assigned DISA user code to make outside calls. In All Security mode, the caller must enter a pre-assigned DISA user code to make both CO and intercom calls.

### General

- If the caller does not dial any digits during and after the playback of DISA outgoing message, the system will direct him to the pre-determined destination (Intercept Routing). "Intercept Routing" is activated 5 seconds after (default) or immediately after the playback depending on System Programming.
- **DISA Delayed Answer Time**  
A DISA call is answered after a ringback tone is returned to the caller after the "DISA Delayed Answer Time" expires. The caller can dial while hearing the OGM message.
- **DISA User Code**  
The KX-TD500 System can store up to 32 programmable DISA user codes with a COS level for each. Each code should be unique.
- **DISA User Code Entry Failure**  
If the DISA caller fails to enter the valid DISA user code three times consecutively, the call will be disconnected.
- **DISA built-in Automated Attendant Table**  
This system can store up to eight DISA built-in auto attendant number tables and each table includes 10 one-digit numbers.
- **DISA built-in Automated Attendant Number**  
The DISA built-in auto attendant number may be the same as the first digit of other numbers (extension number, Floating Number, etc.). To avoid confusion, the system waits for the second digit for a pre-programmed amount of time (default: 1 second). If the second digit is not dialed until the timer expires, the system assumes that the first digit is a DISA built-in auto attendant number.
- **Call Forwarding-to CO or TIE Line**  
When a DISA call is forwarded to an outside party, the caller is not required to enter a DISA user code regardless of the Security modes.
- **CO-to-CO line call duration**  
The duration of CO-to-CO line calls can be limited by System Programming. When the specified time expires (default:10 min), both lines are disconnected unless the caller retries or extends the duration time, if available. A warning tone is sent to both parties 15 seconds before the time limit at 5-second intervals.
- During a CO-to-CO line call, the caller can prolong the duration of the call by pressing any dialpad key (except \*). The amount of prolonging is determined by System



Programming <Section 2.5 System Timer, "DISA Prolong Time" in the Programming Guide>. If this parameter is set to zero, the caller cannot prolong the call duration. The caller can repeat the prolonging operation 10 times or without limit depending on the System Programming <Section 2.8 System Option, "13. DISA prolonging operation" in the Programming Guide>.

- To detect the end of a CO-to-CO line call, CPC Signal Detection and Tone Detection can be assigned.
- **Tone Detection**  
The following three ways of "Tone Detection" are provided <Section "3.2 Trunk Group" in the Programming Guide> to disconnect a CO-to-CO line call.
  1. Cyclic Signal Detection:  
Used to disconnect the trunk line when the system detects a cyclic signal during a CO-to-CO line call by DISA or AGC.
  2. Continuous Signal Detection:  
Used to disconnect the trunk line when the system detects a continuous signal during a CO-to-CO line call by DISA or AGC.
  3. Silence Detection:  
Used to disconnect the trunk line when the system detects no signal during a CO-to-CO line call by DISA or AGC.
- **DISA Call Re-try by Pressing ✱**  
The "✱" key can be entered during a DISA call. The action taken by the system depends upon System Programming <Section 2.8 System Option, "14. Dialing "✱" in DISA CO-to-CO talking" in the Programming Guide>. If "Disconnect and make a new call" is selected, then the system will disconnect the current call and prepare for a new call. Otherwise, the ✱ will be transmitted down the line to the other party.
- **Intercept Routing**  
The Floating Number of a DISA OGM Group can be selected as the destination of Intercept Routing.
- **What if the destination extension is busy?**  
If the destination extension has enabled Call Waiting, then he will hear the Call Waiting tone. Otherwise, the caller may hear a busy tone, or the call is redirected to the IRNA destination. This is determined by System Programming <Section 2.8 System Option, "17. Destination Busy-DISA" in the Programming Guide>.
- **What if an illegal number is dialed?**  
The caller may hear a reorder tone, or the call is redirected to the IRNA destination. This is determined by System Programming <Section 2.8 System Option, "21. Illegal Number-DISA" in the Programming Guide>.
- **How many times does the IRNA destination ring?**  
This is determined by System Programming <Section 2.5 System Timer, "Call Forwarding — No Answer Time" in the Programming Guide>.

### Installation Manual References

- 2.6.1 DISA Card (KX-T96191)
- 2.6.3 RMT Card (KX-T96196)
- 2.6.4 ERMT Card (KX-TD50197)

## Programming Guide References

- 1.7 DISA Port Assignment
- 2.3 Numbering Plan
  - OGM Playback / Record
- 2.4 Class of Service (COS)
  - TRS Level – Day/Night
- 2.5 System Timer
  - CO-to-CO Line Call Duration Time
  - DISA Prolong Time
  - DISA Automated Attendant Time
  - DISA IRNA Time
  - Intercept Timer after OGM
- 2.7 Trunk to Trunk Restriction
- 2.8 System Option
  - DISA prolong operation
  - Dialing "\*" in DISA CO-to-CO talking
  - Destination Busy - DISA
  - Illegal Number - DISA
- 3.2 Trunk Group
  - Intercept Destination – Day / Night
  - Cyclic Signal Detection
  - Continuous Signal Detection
  - Silence Detection
- 3.6 OGM Group
  - FDN
  - Tenant No.
  - OGM Type
  - Security Mode
  - [DISA built-in Automated Attendant Tables] Dial 0 - Dial 9
- 4.2 Trunk Line
  - Incoming Type
  - Destination – Day / Night / Lunch / Break
  - [CPC Signal] OUT Detection
  - [CPC Signal] OUT Detection - Detection Time
  - [CPC Signal] IN Detection
  - [CPC Signal] IN Detection - Detection Time
- 5.9 DISA/TIE User Code
  - Code
  - COS

## **Features Guide References**

### 1.3 System Features

- Outgoing Message (OGM)

### 1.5 Attended Features

- Direct Inward System Access (DISA)

### 1.11 Transferring Features

- Intercept Routing

## **User Manual References**

- 3.2.10 [010] DISA / TIE User Code Set
- 4.4.6 Outgoing Message (OGM) Record/Playback

## 4.3.27 Do Not Disturb (DND)

Allows you to prevent other parties from disturbing you. Your extension will not receive intercom and outside calls.

### Setting

**7235 / 7436**

Lift the handset or press SP-PHONE.

Press **FWD/DND**.

Press **Do Not Disturb (F2)**.

Confirmation tone and dial tone

Hang up or press SP-PHONE.

**<PT Display Example>**  
Do Not Disturb  
• The FWD/DND indicator light turns red.

### Canceling

**7235 / 7436**

Lift the handset or press SP-PHONE.

Press **FWD/DND**.

Press **FWD/DND Cancel (F1)**.

Confirmation tone and dial tone

Hang up or press SP-PHONE.

**<PT Display Example>**  
FWD/DND Cancel  
• The FWD/DND indicator light turns red.

## Setting / Canceling

PT and SLT



Lift the handset  
or press  
SP-PHONE/MONITOR.

FWD/DND

7

1

0

For PT: Press **FWD/DND**.  
For SLT, PT: Dial 710.

1

To set

0

To cancel



Confirmation tone  
and dial tone

- When setting, the FWD/DND indicator light turns red.  

Do Not Disturb
- When canceling, the FWD/DND indicator light turns off.  

FWD/DND Cancel



Hang up or press  
SP-PHONE/MONITOR.

## Conditions

- DND also works for an incoming call from a doorphone.
- DND does not work for the following calls:**
  - Hold Recall
  - Timed Reminder Alarm Tone
  - Calls directed by Intercept Routing
- Do Not Disturb Override**  
An extension in DND mode can be called by other extension users who are allowed to override DND in their Class of Service.
- PT**  
An extension user may have only one type of Call Forwarding / Do Not Disturb feature in effect at any time. If one of Call Forwarding/Do Not Disturb feature is assigned, another does not function but the assignment itself is preserved for future use. The extension user can choose either one by pressing the FWD/DND button while on-hook.  
In this case, pressing the button changes the settings as follows:  

→DND →FWD →Off
- The lighting patterns of the FWD/DND button are as follows:  
 Off : Both functions are canceled.  
 Red on : DND mode      This setting can be changed  
 Red flash : FWD mode    by System Programming.

- **PT**  
**FWD/DND button**  
Regarding the PT (7050/7055/7250) without the FWD/DND button, it can be assigned to a flexible (CO, DSS, PF) button by Station, User or System Programming.
- **PT**  
A PT user in DND mode can answer a call by pressing a flashing button which shows the arrival of the call.
- **Distinctive Dial Tone**  
When this feature is assigned to the extension, the extension user may hear a distinctive dial tone (dial tone 2) after going off-hook depending on System Programming <Section 2.8 System Option, "15. Special dial tone after setting feature" in the Programming Guide>.

### Programming Guide References

- 2.3 Numbering Plan
  - Call FWD - Do Not Disturb Set / Cancel
- 2.4 Class of Service (COS)
  - DND Override
- 2.8 System Option
  - Special dial tone after setting feature
  - FWD / DND lamp pattern
- 4.3 Extension Line
  - CO Key
  - PF Key
- 4.4 DSS Console
  - DSS Key
  - PF Key

### Features Guide References

- 1.3 System Features
  - Remote Station Lock Control
- 1.6 Originating Features
  - Do Not Disturb (DND) Override
- 1.8 Ringing Features
  - Do Not Disturb (DND)
- 1.11 Transferring Features
  - Call Forwarding

### User Manual References

- 2.2.3 Flexible Button Assignment

- 3.2.5 [005] Flexible CO Button Assignment
- 4.3.28 Do Not Disturb (DND) Override
- 4.4.7 Remote DND (Do Not Disturb) Control

### 4.3.28 Do Not Disturb (DND) Override

You can override the "Do Not Disturb (DND)" feature set on the other extension, if permitted by System Programming beforehand.

**7230 / 7235 / 7433 / 7436**

*If you make an intercom call and hear the Do Not Disturb (DND) tone;*

Press **Over (S2)**.      Wait for an answer and talk.

**<PT Display Example>**  
101: DND

**PT and SLT**

*If you hear Do Not Disturb (DND) tone after making an intercom call;*

DND tone      Dial 1.      Wait for an answer and talk.

**<PT Display Example>**  
101: DND

#### Conditions

- **Class of Service**  
Class of Service (COS) programming determines the extension that can perform this feature.
- If you hear a reorder tone after dialing "1," your extension is not permitted to execute "Do Not Disturb (DND) Override" feature by System Programming.
- **What if a busy tone is heard after DND override?**  
The other extension in DND mode is busy.  
In this case, you may perform the following features.
  - Automatic Callback (Camp-on)
  - Busy Station Signaling (BSS)
  - Exclusive Busy Override – Extension



- Off-Hook Call Announcement (OHCA)
- Off-Hook Call Announcement (OHCA), Whisper

### **Programming Guide References**

- 2.4 Class of Service (COS)
  - DND Override

### **Features Guide References**

- 1.6 Originating Features
  - Do Not Disturb (DND) Override
- 1.8 Ringing Features
  - Do Not Disturb (DND)



### **User Manual References**

- 4.3.27 Do Not Disturb (DND)

## 4.3.29 Doorphone Call

Allows you to have a conversation with a visitor at your doorphone. You can also unlock the door from your telephone.

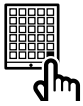
### Calling an extension from a doorphone — operation for a visitor

Doorphone	
	
Press the Doorphone button for one second.	Wait for an answer and talk.

### Answering a doorphone call

PT and SLT
<p><i>When you hear the doorphone ring tone at the extension;</i></p> 
Lift the handset or press SP-PHONE/MONITOR.

## Calling a doorphone

**PT and SLT**



Lift the handset or press SP-PHONE/MONITOR.

3

1

Dial 31.

doorphone no.

Enter a doorphone number (1 through 8).



Confirmation tone



Talk.

**<PT Display Example>**

Doorphone x

doorphone number  
(1 through 8)

## To unlock the door from an assigned extension

**PT and SLT**



Lift the handset or press SP-PHONE/MONITOR.

5

5

Dial 55.

door opener no.

Enter a door opener number (1 through 8).



Confirmation tone and dial tone



Hang up or press SP-PHONE/MONITOR.

- The door is left unlocked for the pre-programmed amount of time (default: 5 s).

**<PT Display Example>**

Door 1 Open

door opener number

**To unlock the door while talking to the visitor at the doorphone from any extension**

**7230/7235/7433/7436**

Press **OPEN (S3)**. Confirmation tone Hang up or press SP-PHONE.

- The door is left unlocked for the pre-programmed amount of time (default: 5 s).

**<PT Display Example>**

Door 1 Open

door opener number

**PT**

Dial 5. Confirmation tone Hang up or press SP-PHONE/MONITOR.

- The door is left unlocked for the pre-programmed amount of time (default: 5 s).

**<PT Display Example>**

Door 1 Open

door opener number

**SLT**

Flash the switchhook. Confirmation tone and dial tone Dial 5. Confirmation tone Hang up.

- The door is left unlocked for the pre-programmed amount of time (default: 5 s).

**Conditions**

- If you dial "5" again while the door is open, the door will stay open for another five seconds.
- Doorphone Call Destination**  
It is necessary to program the extensions that can receive doorphone calls during day and night mode.

- **What if a doorphone call is not answered?**  
If not answered within 30 seconds, the call stops ringing and is canceled.
- **Unlocking the door opener**  
During a doorphone call, any extension user can unlock the door opener (user-supplied) from their extensions by dialing "5" to let the visitor in.
- You cannot hold and transfer the doorphone call.
- The door can be unlocked by the following:
  - 1) Extensions that are programmed to receive doorphone calls.
  - 2) Any extension that is engaged in a doorphone call.
- While talking to a doorphone, you can unlock the door using the One-Touch dialing button instead of dialing "5." In this case, "5" must be stored in the One-Touch dialing button by Station, User or System Programming.
- With the KX-T7431, KX-T7433, KX-T7436 or KX-T7235, you can call a doorphone and open a door using the display operation.

### **Installation Manual References**

- 2.7.3 DPH Card (KX-T96161)

### **Programming Guide References**

- 2.3 Numbering Plan
  - Doorphone Call
  - Door Open
- 2.5 System Timer
  - Door Opener Time
- 4.3 Extension Line
  - CO Key
  - PF Key
- 4.4 DSS Console
  - DSS Key
  - PF Key
- 4.5 Doorphone
  - Destination – Day / Night

### **Features Guide References**

- 1.3 System Features
  - Door Opener
- 1.12 Conversation Features
  - Doorphone Call

### **User Manual References**

- 2.2.3 Flexible Button Assignment
- 3.2.5 [005] Flexible CO Button Assignment
- 4.5.9 KX-T7235 Display Features - System Feature Access Menu
- 4.5.12 KX-T7431 / KX-T7433 / KX-T7436 Display Features - System Feature Access Menu

### 4.3.30 Electronic Station Lockout

Allows you to lock your extension so that other users cannot make outgoing CO calls from your extension.

#### Locking

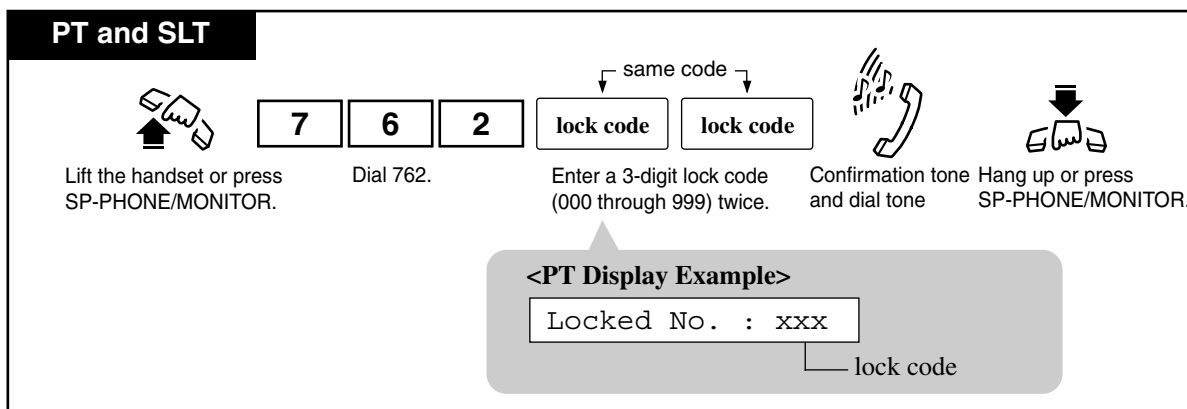

#### Unlocking

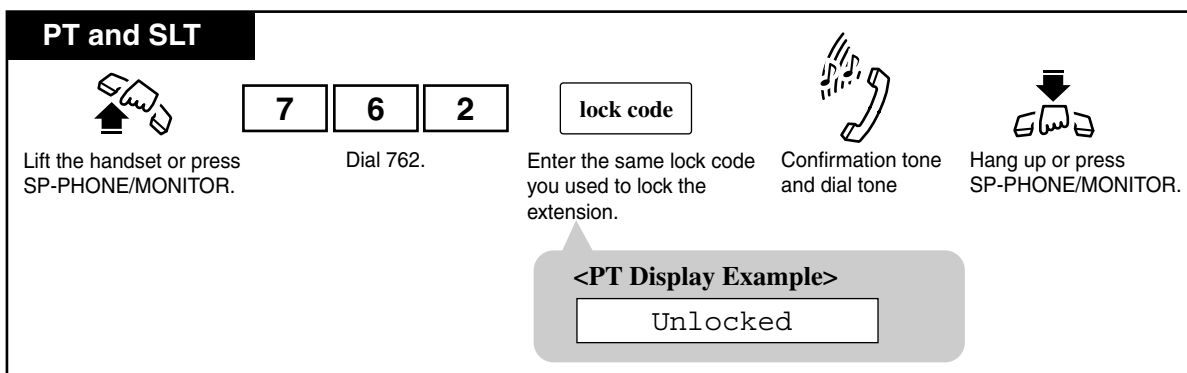

#### Conditions

- **How does this feature restrict the extension?**  
This feature restricts the extension from making an outside call only. Other operations are not affected.
- **Remote Station Lock**  
Remote Station Lock Control overrides Electronic Station Lockout. If the Manager or an Operator sets Remote Station Lock on an extension that has already been locked by the extension user, the extension user cannot unlock it.
- **PT**  
If someone tries to make an outgoing CO call from a locked extension, he hears a reorder tone and "Restricted" is shown on the display.

- **Distinctive Dial Tone**

When this feature is assigned to the extension, the extension user may hear a distinctive dial tone (dial tone 2) after going off-hook depending on System Programming <Section 2.8 System Option, "15. Special dial tone after setting feature" in the Programming Guide>.

- With the KX-T7431, KX-T7433, KX-T7436 or KX-T7235, you can execute this feature using the display operation.

### **Programming Guide References**

- 2.3 Numbering Plan
  - Station Lock Set / Cancel
- 2.8 System Option
  - Special dial tone after setting feature
- 4.3 Extension Line
  - Station Lock Password

### **Features Guide References**

- 1.3 System Features
  - Remote Station Lock Control
- 1.6 Originating Features
  - Electronic Station Lockout

### **User Manual References**

- 4.4.9 Remote Station Lock Control
- 4.5.9 KX-T7235 Display Features - System Feature Access Menu
- 4.5.12 KX-T7431 / KX-T7433 / KX-T7436 Display Features - System Feature Access Menu



### 4.3.31 Emergency Call

Allows you to dial out a pre-assigned emergency number after seizing a CO line regardless of the restrictions imposed on your extension. Up to 10 emergency dial numbers can be stored in the system.

#### Dialing

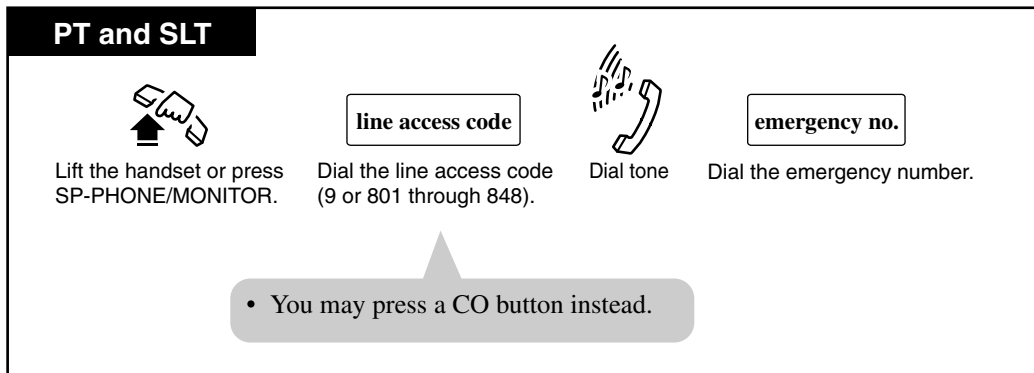

#### Conditions

- The emergency number "911" is already stored at the factory. System Programming is required to store other emergency numbers.
- Making an emergency call is allowed even in the following cases;
  - in Account Code – Verified (All Calls, Toll Restriction Override) mode
  - in any toll restriction level
  - in Electronic Station Lockout / Remote Station Lock
- If your KX-TD500 System is connected to a host PBX as a behind PBX, you must dial the host PBX line access code after dialing the line access code and it must be included as the first digit of the emergency number.

#### Programming Guide References

- 5.4 Emergency Dial Code

#### Features Guide References

- 1.6 Originating Features
  - Emergency Call

#### User Manual References

None

### 4.3.32 End-to-End DTMF Signaling (Tone Through)

DTMF signaling is required for access to special network services offered by some telephone companies. This system allows you to signal the other end using DTMF tones during an established call.

#### End-to-End DTMF Signaling (1)

**PT**

*During a conversation;*

**required code**

Dial the required code.

- DTMF signal is sent to the other end while dialing.

#### End-to-End DTMF Signaling (2) (When "Automatic Hold" is enabled)

**PT**

*During a conversation;*

(Tone Through)

**required code**

Press **Tone Through**  
(flexible button).

Dial the required code.

- DTMF signal is sent to the other end while dialing.

## Canceling End-to-End DTMF Signaling mode

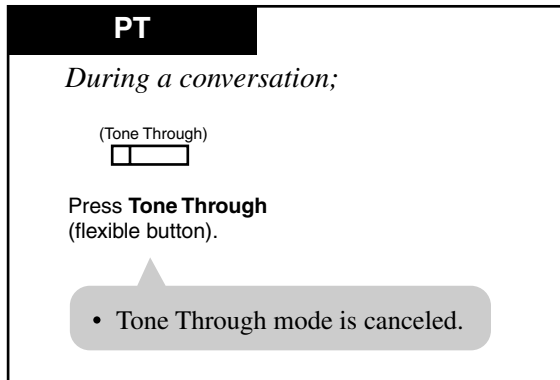

### Conditions

- If the dial type of the line is assigned to DTMF, Tone Through mode is established automatically after the dialing sequence is finished and the call is established.
- **PT**  
**Tone Through button**  
This button can be assigned to a flexible button (CO, DSS) by Station, User or System Programming.
- **PT**  
Tone Through button is effective during a call between two extensions, extension to outside or a conference call.

### Programming Guide References

- 2.4 Class of Service (COS)
  - Automatic Hold
- 4.3 Extension Line
  - CO Key
- 4.4 DSS Console
  - DSS Key

### Features Guide References

- 1.3 System Features
  - Dial Type Selection
- 1.12 Conversation Features
  - End-to-End DTMF Signaling (Tone Through)
  - Pulse to Tone Conversion

### **User Manual References**

- 2.2.3 Flexible Button Assignment
- 3.2.5 [005] Flexible CO Button Assignment

### 4.3.33 Executive Busy Override

You can interrupt an existing call. This establishes a 3-party conference call.

This feature can be categorized as follows:



#### **Executive Busy Override – Barge-In (PT only)**

Allows the PT user to interrupt an existing outside call (either "between two outside parties" or "between an outside party and an inside party") by pressing the red lit S-CO or DN button.

#### **Executive Busy Override – Extension**

Allows the extension (PT, SLT) user to interrupt an existing intercom call (either "between two inside parties" or "between an inside party and an outside party") by dialing "2" after hearing a busy tone.

#### To join an existing outside call (Barge-in)



PT			
			
Lift the handset or press SP-PHONE/MONITOR.	Press the red lit <b>CO</b> or <b>DN</b> corresponding to the desired caller.	Confirmation tone (optional)	<u>A three-party conference is now established.</u>

#### To join an existing intercom call (Extension)

7230 / 7235 / 7433 / 7436			
<i>If you hear a busy tone after making an intercom/outside call;</i>			
			
Press <b>Over (S2)</b> .	Confirmation tone (optional)		<u>A three-party conference is now established.</u>

PT and SLT			
<i>If you hear a busy tone after making an intercom call;</i>			
			
Dial <b>2</b> .	Confirmation tone (optional)		<u>A three-party conference is now established.</u>

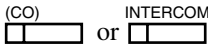
## To terminate one party and talk to the other

<b>PT</b>	
	
<p>Press <b>CO</b> or <b>INTERCOM</b> of the party to remain connected.</p>	<p>Confirmation tone (optional)</p>

## To leave the conference

<b>PT</b>	
	<p><u>The other two parties continue their conversation.</u></p>
<p>Hang up or press SP-PHONE/MONITOR.</p>	

## Conditions

### [General]

- **Class of Service**  
Class of Service programming determines the extension that can perform this feature.
- **Executive Busy Override Deny**  
It is possible for extension users to prevent this feature from being executed by another extension user.
- This feature does not work if "Executive Busy Override Deny" or "Data Line Security" is set at either one of two extensions or both of them.
- **Confirmation tone**  
When a 2-party call is changed to a 3-party call and vice versa, a confirmation tone is sent to all three parties. This tone can be eliminated by System Programming <Section 2.8 System Option, "8. Confirmation tone for Override, Barge-in, Conference and Privacy Release" in the Programming Guide>.
- **3-party call → 2-party call**  
During a 3-party conference call with an outside party and inside party, you can terminate either one of two parties and talk to the other.
- **Trunk Route Control**  
When the outside call made using a specific trunk is busy on another call, the Manager or the Operators can join the existing outside call by dialing "2" after hearing a busy tone.

**[Barge-in]**

- **PT**  
This feature is available between two extensions who share the same S-CO button.
- **PT(DN)**  
This feature is available when one extension has an SDN button associated with the PDN button of the other extensions.
- The pre-assigned extension users can interrupt an existing outside call even if access to that line is not allowed by System Programming.

**Programming Guide References**

- 2.3 Numbering Plan
  - Data Line Security Set / Cancel
  - Executive Busy Override Deny Set / Cancel
  - Trunk Route Control
- 2.4 Class of Service (COS)
  - Busy Override
  - Busy Override Deny
- 2.8 System Option
  - Confirmation tone for Override, Barge-in, Conference and Privacy Release

**Features Guide References**

- 1.3 System Features
  - Trunk Route Control
- 1.6 Originating Features
  - Executive Busy Override
- 1.9 Answering Features
  - Executive Busy Override Deny
- 1.12 Conversation Features
  - Conference, 3-Party
  - Conference, 5-Party

**User Manual References**

- 4.3.21 Conference, 3-Party
- 4.3.25 Data Line Security
- 4.3.34 Executive Busy Override Deny
- 4.4.13 Trunk Route Control

### 4.3.34 Executive Busy Override Deny

Allows you to prevent other extension users from interrupting your telephone conversation.

PT and SLT



Lift the handset or press  
SP-PHONE/MONITOR.

7	3	3	1	To set
7	3	3	0	To cancel

To set: Dial 7331.  
To cancel: Dial 7330.



Confirmation tone  
and dial tone



Hang up or press  
SP-PHONE/MONITOR.

**<PT Display Example>**

- When setting:  

Busy Ovrde Deny
- When canceling:  

Busy Ovrde Allow

#### Conditions

- **Class of Service**  
"Class of Service" programming determines the extensions that can perform this feature.
- **Distinctive Dial Tone**  
When this feature is assigned to the extension, the extension user may hear a distinctive dial tone (dial tone 2) after going off-hook depending on System Programming <Section 2.8 System Option, "15. Special dial tone after setting feature" in the Programming Guide>.
- With the KX-T7431, KX-T7433, KX-T7436 or KX-T7235, you can execute this feature using the display operation.

#### Programming Guide References

- 2.3 Numbering Plan
  - Executive Busy Override Deny Set / Cancel
- 2.4 Class of Service (COS)
  - Busy Override Deny
- 2.8 System Option
  - Special dial tone after setting feature

#### Features Guide References

- 1.6 Originating Features
  - Executive Busy Override



### 1.9 Answering Features

- Executive Busy Override Deny

### **User Manual References**

- 4.3.33 Executive Busy Override
- 4.5.9 KX-T7235 Display Features - System Feature Access Menu
- 4.5.12 KX-T7431 / KX-T7433 / KX-T7436 Display Features - System Feature Access Menu

### 4.3.35 External Feature Access

Allows you to access special features (e.g., Call Waiting) offered by a host PBX, Centrex or Central Office. This feature is effective only during an outside call.

**7230 / 7235 / 7433 / 7436**

*During a conversation with an outside party;*

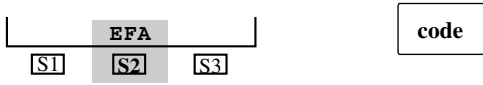

Press **EFA (S2)**.      Enter the desired service code.

#### Using the FLASH button

**PT**

*During a conversation with an outside party;*



Press **FLASH**.      Enter the desired service code.

- The current call is placed on hold.

#### Using the feature number

**PT and SLT**

*During a conversation with an outside party;*



For PT: Press **TRANSFER**.      Confirmation tone and dial tone      Dial 6.      Enter the desired service code.  
 For SLT: Flash the switchhook.

- The current call is placed on hold.

## Conditions

- **Flash Time**  
The flash time must be assigned as required by the Centrex, host PBX or CO line.
- **PT**  
**FLASH Button Operation**  
Pressing the FLASH button on a PT results in either sending Flash signal or disconnecting the current call.  
This is determined by System Programming <Section 2.8 System Option, "3. FLASH button operation while CO talking" and "4. FLASH button operation when "Don't release the trunk" is selected at #3." in the Programming Guide>.
- **PT**  
**Memory Dialing**  
During outside calls, a FLASH stored in System Speed Dialing, Station Speed Dialing or One-Touch Dialing works as External Feature Access, not as Flash (Disconnect Signal).
- **SLT**  
This feature does not function, if an SLT has a call on Consultation Hold.

## Programming Guide References

- 2.3 Numbering Plan
  - External Feature Access
- 2.8 System Option
  - FLASH button operation while CO talking
  - FLASH button operation when "Don't release the trunk " is selected at #3
- 3.2 Trunk Group
  - Flash Time
  - Max. Dial No. after EFA Signal

## Features Guide References

- 1.3 System Features
  - Host PBX Access
- 1.12 Conversation Features
  - External Feature Access
  - Flash

## User Manual References

- 4.3.18 Call Waiting from Central Office
- 4.3.37 Flash

### 4.3.36 External Modem Control

Allows you to control the external modem, connected to the RS-232C port 1 by sending a pre-assigned AT Command (for enabling Automatic Answer, etc.).

#### Activating an AT Command to the RS-232C port 1

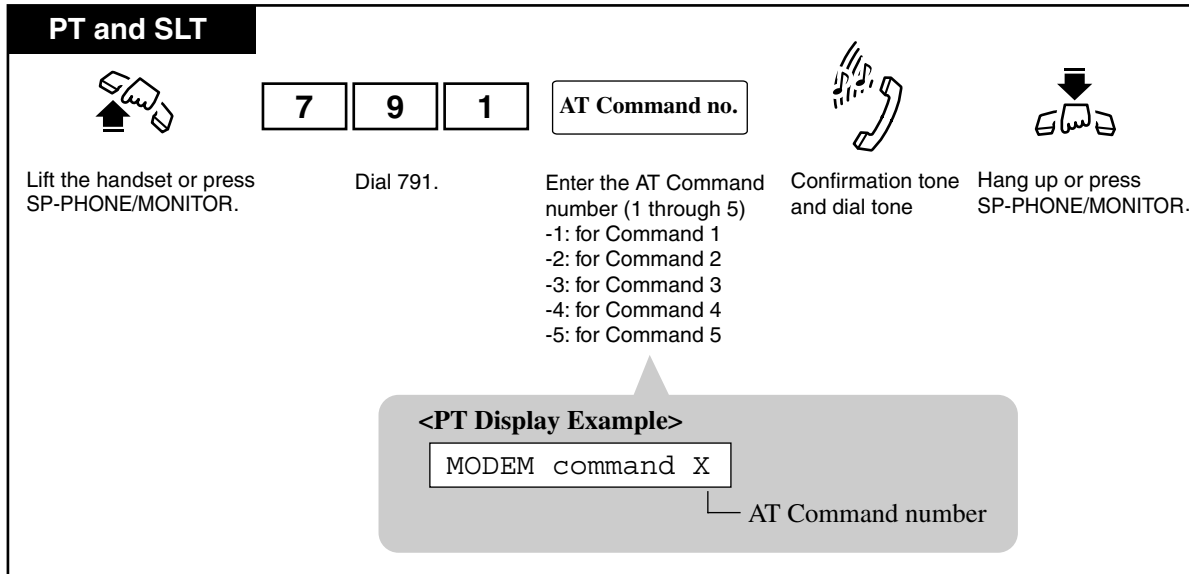

#### Conditions

- An AT Command can only be programmed by Serial Interface/remote programming software.
- For more information about the AT Command, please refer to the modem instructions.
- With the KX-T7431, KX-T7433, KX-T7436 or KX-T7235, you can execute this feature using the display operation.

#### Programming Guide References

- 2.3 Numbering Plan
  - MODEM Control
- 10.2 External Modem 1/2
  - Manual Initialization Command (1-5)
  - Automatic Initialization Command
- 10.3 External Modem 2/2
  - Connection Message (1-5)
  - Disconnection Message (1-5)
- 10.6 System Parameters

– [Serial Interface Port] PROG (Port 1)

### **Features Guide References**

#### 1.2 System Administration

- System Programming and Diagnosis with Personal Computer

#### 1.3 System Features

- External Modem Control

### **User Manual References**

- 4.5.9 KX-T7235 Display Features - System Feature Access Menu
- 4.5.12 KX-T7431 / KX-T7433 / KX-T7436 Display Features - System Feature Access Menu

### 4.3.37 Flash

You can disconnect the current call and make another call without hanging up.

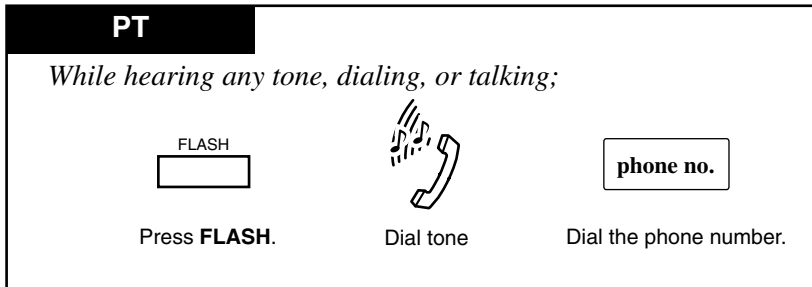

#### Conditions

- PT  
**Flash or External Feature Access**  
 Pressing the FLASH button on a PT results in either sending Flash signal (External Feature Access) or disconnecting the current call (Flash). This is determined by System Programming <Section 2.8 System Option, "3. FLASH button operation while CO talking" and "4. FLASH button operation when "Don't release the trunk" is selected at #3" in the Programming Guide>.
- PT  
 Pressing the FLASH button re-starts the conversation duration, outputs an SMDR record and checks toll restriction level again.

#### Programming Guide References

- 2.8 System Option
  - FLASH button operation while CO talking
  - FLASH button operation when "Don't release the trunk " is selected at #3
- 3.2 Trunk Group
  - Disconnecting Time

#### Features Guide References

- 1.12 Conversation Features
  - External Feature Access
  - Flash

#### User Manual References

- 4.3.35 External Feature Access

### 4.3.38 Full One-Touch Dialing

The hands-free speakerphone is automatically activated. You can enter a phone number or access a system feature with the touch of a button.

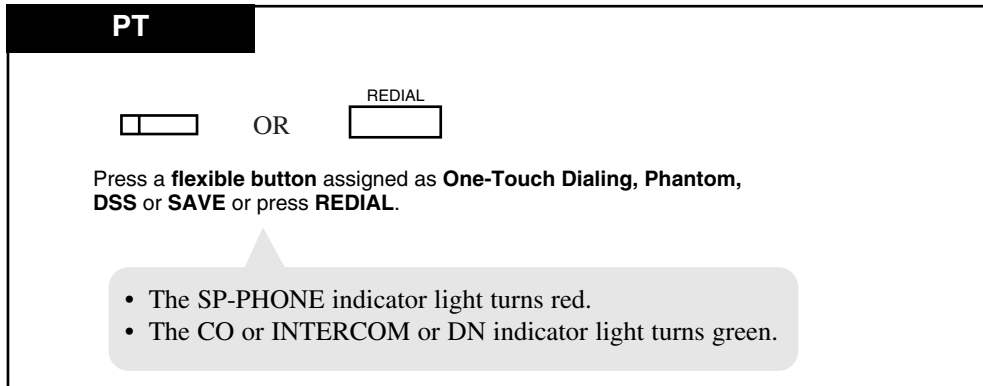

#### Conditions

- **PT**  
DSS buttons on a DSS Console can also activate this feature.
- **PT**  
This feature must be initially assigned by Station Programming.

#### Programming Guide References

- 4.3 Extension Line
  - CO Key
  - PF Key
- 4.4 DSS Console
  - DSS Key
  - PF Key

#### Features Guide References

- 1.7 Dialing Features
  - Full One-Touch Dialing
  - One-Touch Dialing
  - Redial
- 1.12 Conversation Features
  - Hands-free Operation
- 1.16 Button Features
  - Button, Direct Station Selection (DSS)

### 1.17 Display Features

- Call Directory

### **User Manual References**

- 2.2.3 Flexible Button Assignment
- 2.2.4 Full One-Touch Dialing Assignment
- 3.2.5 [005] Flexible CO Button Assignment
- 4.3.52 One-Touch Dialing
- 4.3.66 Redial



### 4.3.39 Handset Microphone Mute

While on a handset call, you can turn off your PT's handset microphone so that you can consult privately with others in the room. When you activate Handset Microphone Mute, you can still listen to the other party's voice but he cannot hear your voice.

#### Setting

**PT**

*While on a handset call;*

AUTO ANSWER  
  
MUTE  
Press **AUTO ANSWER/MUTE**

• The AUTO ANSWER/MUTE indicator light flashes red slowly.

#### Canceling

**PT**

*When handset microphone mute is established;*

AUTO ANSWER  
  
MUTE  
Press **AUTO ANSWER/MUTE**

• The AUTO ANSWER/MUTE indicator light turns off.

#### Conditions

- **T7436**  
If you press AUTO/ANSWER/MUTE button during an OHCA call, Handset Microphone Mute mode will be turned on.
- **T7400**  
If you press AUTO/ANSWER/MUTE button in Hands-free mode, Microphone Mute mode will be turned on.
- **PT**  
This feature is available for KX-T7400 series PT only.

### **Programming Guide References**

System Programming is not required.

### **Features Guide References**

#### 1.15 Proprietary Telephone Features

- Handset Microphone Mute
- Microphone Mute

### **User Manual References**

- 4.3.47 Microphone Mute

## 4.3.40 Hands-free Answerback

You can answer an intercom call and talk to the caller without lifting the handset.

### Setting

PT

*When the SP-PHONE and the AUTO ANSWER/MUTE indicator are off;*

AUTO ANSWER

MUTE

Press **AUTO ANSWER/MUTE**.

- The AUTO ANSWER/MUTE indicator light turns on.

### Canceling

PT

*When the AUTO ANSWER/MUTE indicator is on;*

AUTO ANSWER

MUTE

Press **AUTO ANSWER/MUTE**.

- The AUTO ANSWER/MUTE indicator light turns off.

### Conditions

- PT  
**Ring/Voice Intercom Alerting Mode Override**  
 This feature overrides the "Alternate Calling — Ring/Voice" feature. A hands-free conversation mode is established as soon as a confirmation tone is sent.
- PT  
 This feature does not work for the following calls:
  - CO calls
  - Doorphone calls
  - Calls to an Extension Group

- Calls to an Incoming Group
- Calls to a Phantom button
- Calls from a VM (Voice Mail) extension (except a call from a PT)
- Calls ringing on an SDN button
- **PT**
  - This feature is not available if your PT has no AUTO ANSWER/MUTE button.
  - It is programmable whether or not to answer the intercom call on Consultation Hold automatically by System Programming.

### **Programming Guide References**

- 2.8 System Option
  - Auto Answer with held call

### **Features Guide References**

- 1.6 Originating Features
  - Alternate Calling—Ring/Voice
- 1.9 Answering Features
  - Hands-free Answerback

### **User Manual References**

None

## 4.3.41 Hands-free Operation

You can make an intercom / CO call and talk to the caller without lifting the handset.

### Setting

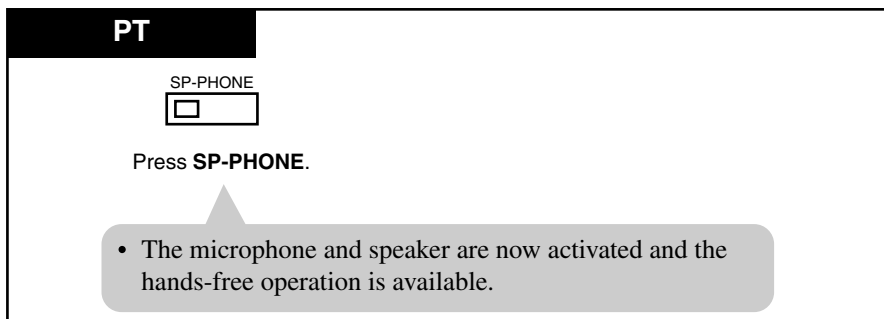

### Switching from the handset to hands-free mode

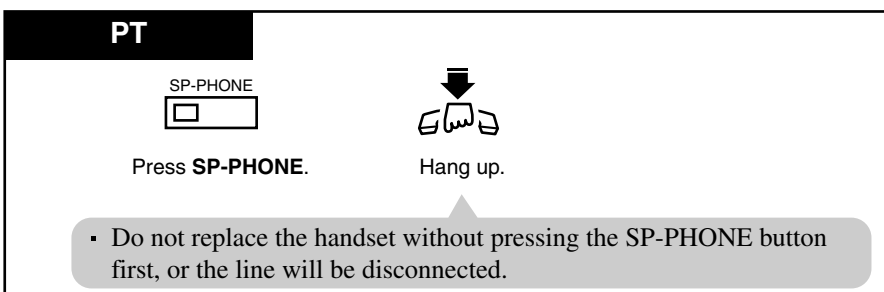

### Switching from hands-free to the handset mode



## Conditions

- **PT**  
The hands-free mode is canceled if you do not start dialing within 10 seconds.
- **PT**  
The KX-T7050, KX-T7350 and the KX-T7250 have a MONITOR button instead of a SP-PHONE button. It can be used for hands-free dialing, etc., but not for a hands-free conversation.
- **PT**  
You can execute hands-free mode by pressing a CO or INTERCOM or DN button without going off-hook.
- **PT**  
When "Full One-Touch Dialing" is enabled, pressing a One-Touch Dialing, DSS, REDIAL or SAVE button provides the hands-free mode.

## Helpful hints

- Use this unit in a quiet room for best performance.
- If the other party has difficulty hearing you, decrease the volume.
- If you and the other party speak at the same time, parts of your conversation will be lost. To avoid this, speak alternately.

## Programming Guide References

System Programming is not required.

## Features Guide References

- 1.6 Originating Features
  - Full One-Touch Dialing
- 1.12 Conversation Features
  - Hands-free Operation

## User Manual References

- 4.3.38 Full One-Touch Dialing

## 4.3.42 Inter Office Calling

You can make a call to another extension user within the system or a tenant.

### Using the handset

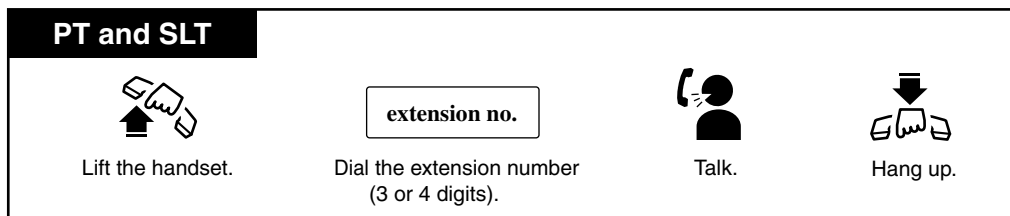

### Using the Speakerphone

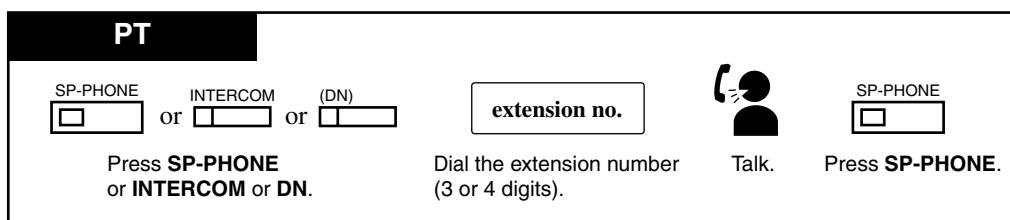

### Using a DSS (Direct Station Selection) button

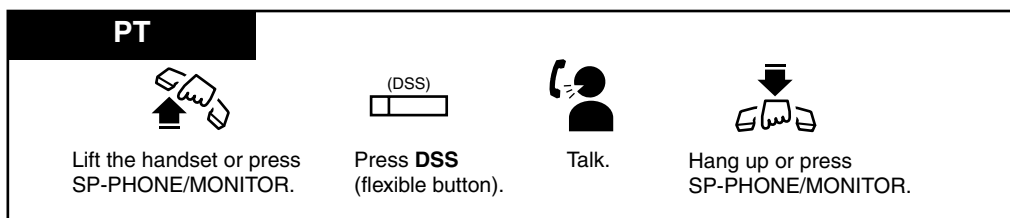

### Conditions

- **Extension Number Assignment**  
Extension numbers (3 or 4 digits) are assigned to all extensions by System Programming <Section 2.3 Numbering Plan in the Programming Guide>.
- **Tenant Service**  
If "Tenant Service" is employed, calling to other extensions in other tenants is enabled/disabled by System Programming.
- **Call Progress Tone**  
After dialing an extension number, you will hear one of the following tones:  
**Ringback tone:** Indicates the destination extension is being called.  
**Confirmation tone:** Indicates you can perform voice calling (e.g., Paging).  
**Busy tone:** Indicates the destination extension is busy.

**Do Not Disturb (DND) tone:** Indicates the destination extension has set the "Do Not Disturb (DND)" feature.

- **PT**

**DSS Button**

DSS buttons permit One-Touch access to an extension and provide Busy Lamp Field.

- **PT**

You can assign a DSS button on a Proprietary Telephone (PT) or DSS Console by Station, User or System Programming.

- **Definition of busy extension status**

**PT(ICM)**

- Off-hook
- ICM button is not idle

**PT(DN)**

- There is no idle DN buttons on a PT
- Off-hook
- While engaged in a call

**SLT**

- Off-hook
- an SLT is ringing
- an SLT has a call placed on hold

- **display PT**

Extension Names can be given to all extensions by User or System Programming. An extension number and a name, if programmed, are shown on the display PT during an intercom call.

- **Call Directory - Extension Dialing**

With the KX-T7431, KX-T7433, KX-T7436, or KX-T7235, you can make an extension call using the "Call Directory - Extension Dialing" display operation.

## Programming Guide References

- 1.4 Extension Port Assignment
  - Attribute
  - Tel. Type
  - DN
  - Group No.
- 2.2 Tenant
  - Inter-tenant Calling (1 - 8)
- 2.3 Numbering Plan
  - 1st Hundred Block Extension
  - 2nd Hundred Block Extension
  - 3rd Hundred Block Extension
  - 4th Hundred Block Extension



- 5th Hundred Block Extension
  - 6th Hundred Block Extension
  - 7th Hundred Block Extension
  - 8th Hundred Block Extension
  - 9th Hundred Block Extension
  - 10th Hundred Block Extension
  - 11th Hundred Block Extension - 16th Hundred Block Extension
- 4.3 Extension Line
  - Name
  - CO Key
- 4.4 DSS Console
  - DSS Key

### **Features Guide References**

- 1.6 Originating Features
  - Inter Office Calling
- 1.16 Button Features
  - Button, Direct Station Selection (DSS)
  - Button, Line Access
- 1.17 Display Features
  - Busy Lamp Field

### **User Manual References**

- 2.2.3 Flexible Button Assignment
- 3.2.4 [004] Extension Name Set
- 3.2.5 [005] Flexible CO Button Assignment
- 4.5.8 KX-T7235 Display Features - Call Directory
- 4.5.11 KX-T7431 / KX-T7433 / KX-T7436 Display Features - Call Directory

### 4.3.43 Live Call Screening (LCS)\*<sup>1</sup>

Allows a PT user to monitor his voice mailbox while incoming callers are leaving a message and, if desired, intercept the call.

#### Flowchart of the Live Call Screening (LCS) Feature

#### Preparation

- Activating the LCS mode (System Programming)
- Assigning the LCS button (Station/System Programming)
- Selecting the mode, Hands-free or Private (Station/System Programming)
- Setting the password (Feature Number/System Programming)
- Setting the LCS feature

---

\*<sup>1</sup> Available when the Digital Super Hybrid System is connected to a Digital Proprietary Telephone capable Panasonic Voice Processing System (one that supports Digital Proprietary Telephone [DPT] integration; e.g., KX-TVS100).

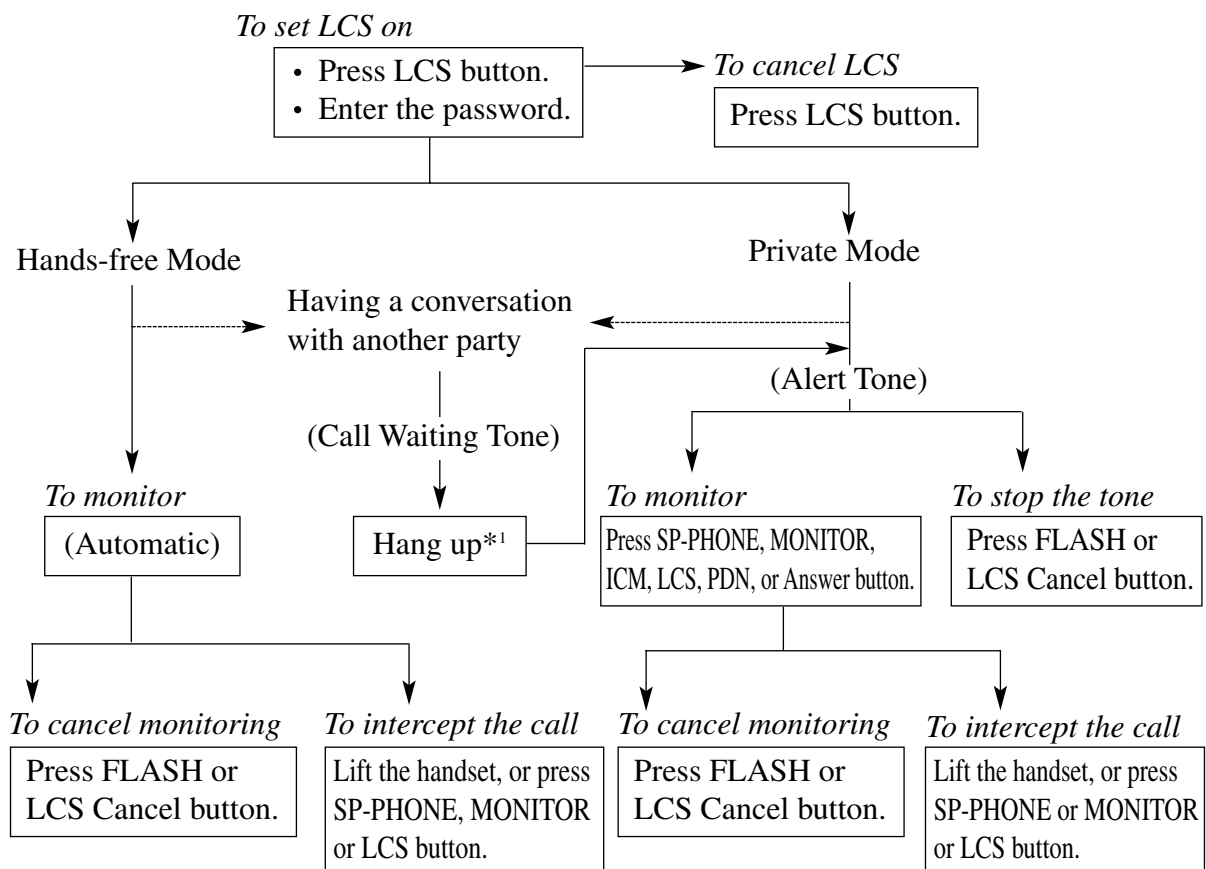
When using the SP-PHONE/MONITOR button in the Private Mode:

\*<sup>1</sup>: To hold the current call, press the HOLD button.

To return to the held call, press the CO button whose indicator light flashes green slowly.

When using the handset in the Private Mode:

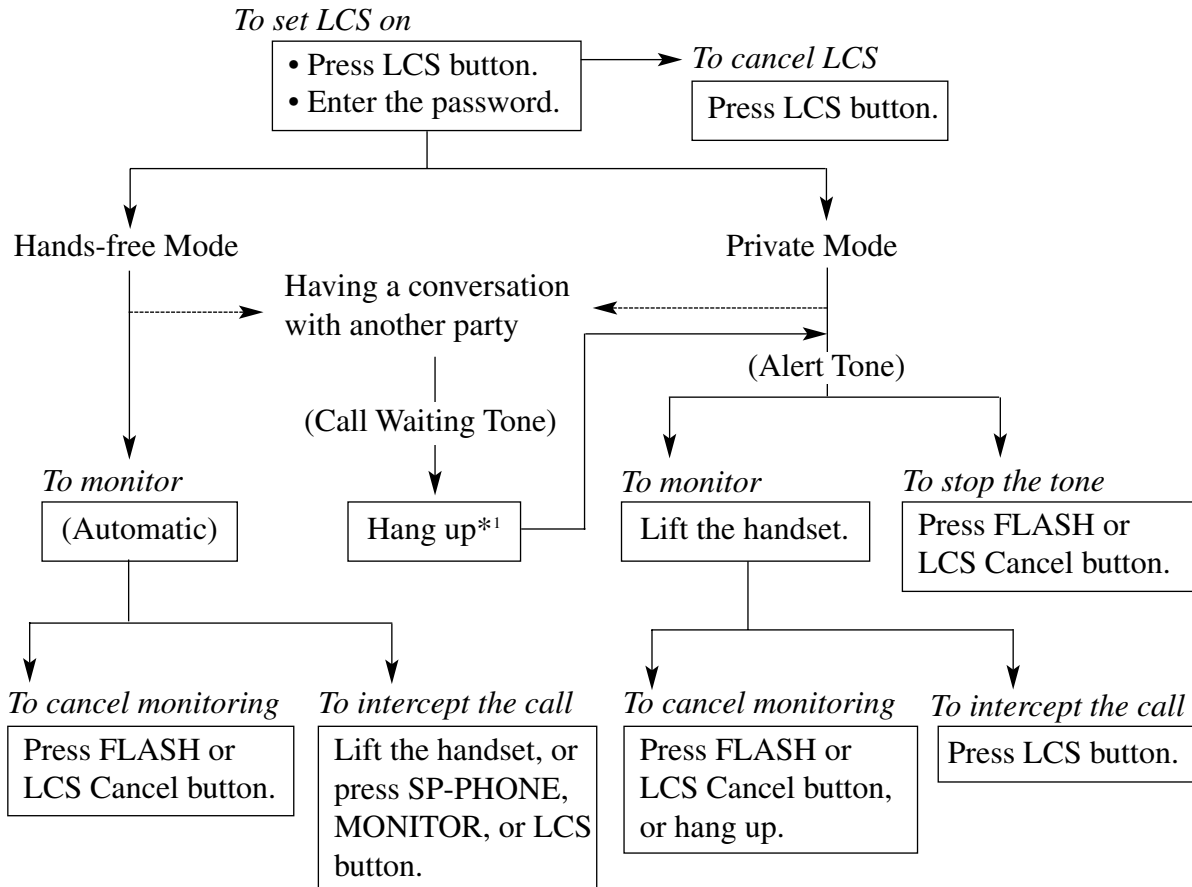

\*<sup>1</sup>: To hold the current call, press the HOLD button.

To return to the held call, press the CO button whose indicator light flashes green slowly.

**Setting the password**

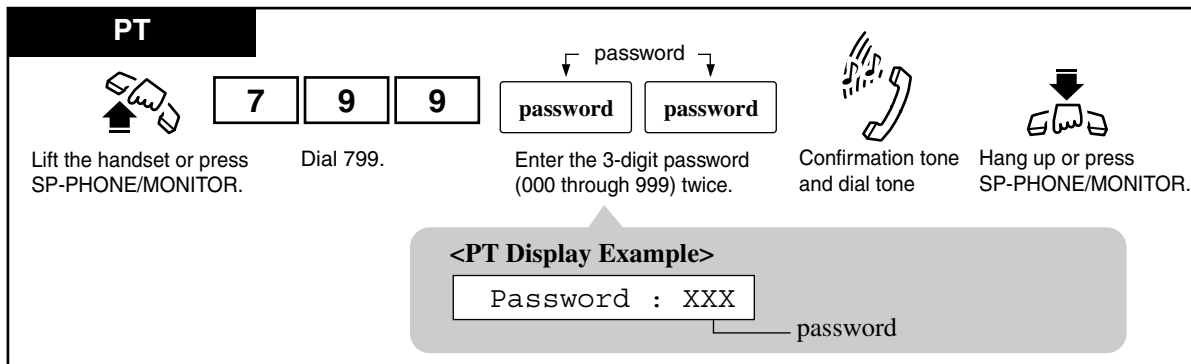

## Canceling the password

**PT**

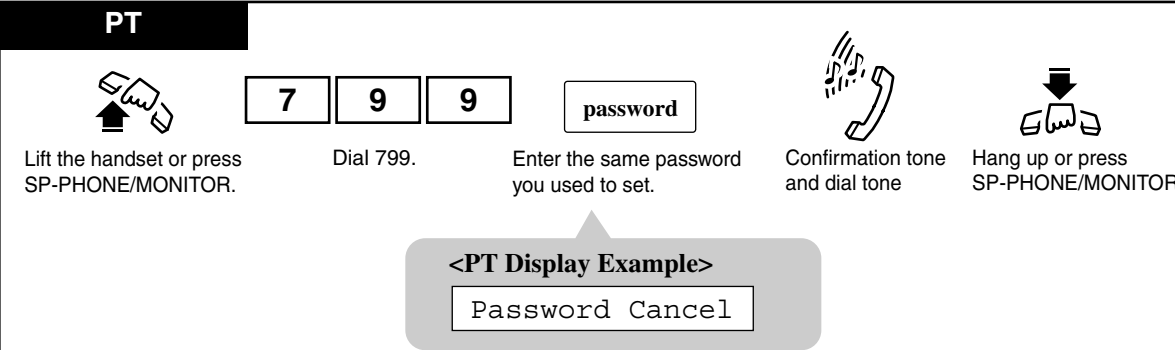

Lift the handset or press SP-PHONE/MONITOR.

Dial 799.

Enter the same password you used to set.

Confirmation tone and dial tone

Hang up or press SP-PHONE/MONITOR.

**<PT Display Example>**  
Password Cancel

## Setting Live Call Screening

**PT**

*When the telephone is idle and on-hook;*

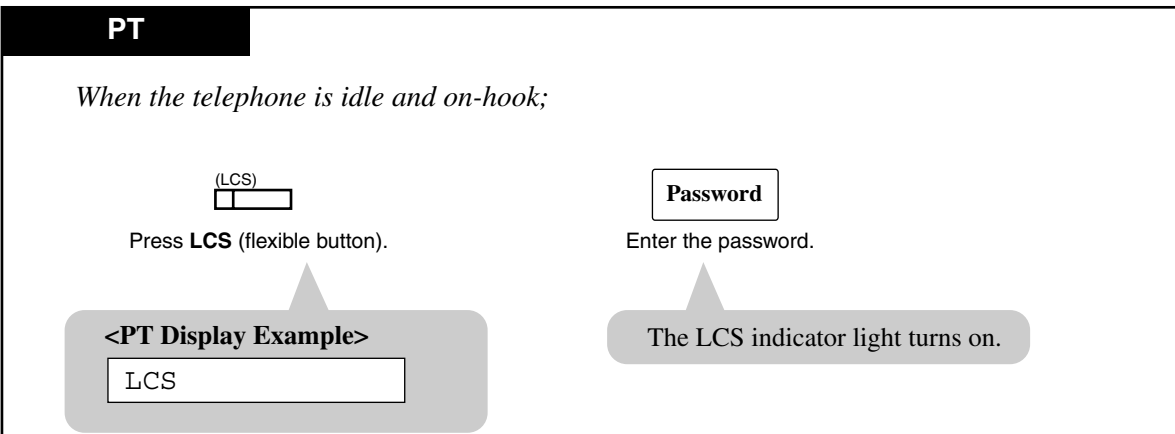

(LCS)

Press **LCS** (flexible button).

**Password**

Enter the password.

**<PT Display Example>**  
LCS

The LCS indicator light turns on.

## Canceling Live Call Screening

**PT**

*When the telephone is idle and on-hook;*

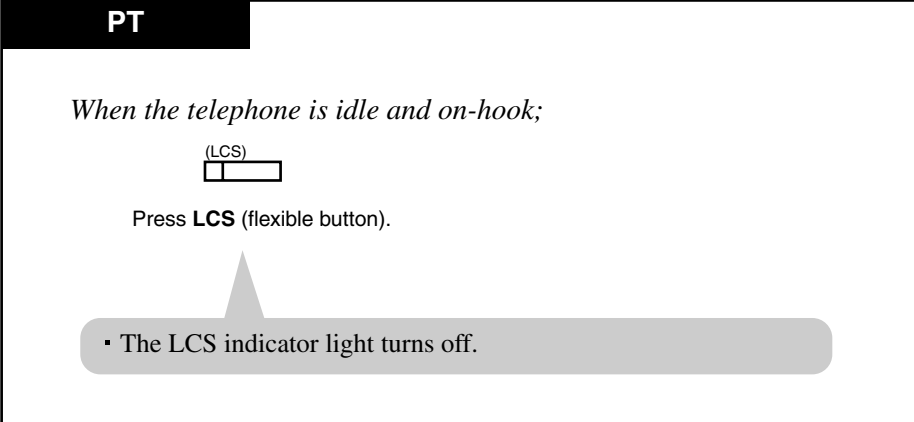

(LCS)

Press **LCS** (flexible button).

- The LCS indicator light turns off.

### In the Hands-free mode;

When callers are connected to your voice mailbox, the message recording is monitored automatically through your extension speaker. While monitoring in the Hands-free mode, the LCS indicator light flashes green slowly.

### Having a conversation with a party

**PT**



Lift the handset  
or press  
SP-PHONE/MONITOR.

or  (LCS)  
Press **LCS**  
(flexible button).

- The LCS indicator light turns red from flashing green slowly.
- In Keep Recording mode, the Two-Way Record indicator turns on. Pressing the Two-Way Record button cancel the recording and the light turns off.

### Stopping the monitoring

**PT**



FLASH

or  (LCS Cancel)

Press **FLASH** or **LCS Cancel** (flexible button).

- The LCS indicator light turns red from flashing green slowly.

## In the Private mode;

When callers are connected to your voice mailbox, an alert tone is sent. The LCS indicator light flashes green rapidly when a caller is connected to your voice mailbox. (When using a Single Line Telephone, which is connected with a Proprietary Telephone in parallel, you hear ringing.)

## Stopping the alert tone

**PT**



Press **FLASH**.

or



Press **LCS Cancel**  
(flexible button).

- The LCS indicator light turns red from flashing green rapidly
- The alert tone stops.

## Monitoring the recording message

**PT**



Lift the handset or press  
SP-PHONE/MONITOR.

or



Press the flashing  
**LCS** (flexible button).

or



Press **INTERCOM**.

or



Press **PDN**.

or



Press **ANSWER**.

- The LCS indicator light flashes green slowly.
- To stop monitoring, **Hang up**.  
The **FLASH** button or the **LCS Cancel** button can also be used to stop monitoring.  
The LCS indicator light turns red from flashing green slowly.

### Having a conversation with a party

PT



Lift the handset or press  
SP-PHONE/MONITOR.

or



Press the flashing  
**LCS** (flexible button).

- The LCS indicator light turns red from flashing green slowly.
- In Keep Recording mode, the Two-Way Record indicator lights.

### During a conversation with another party;

When the extension user is having a conversation, a call waiting tone is sent. The LCS indicator light flashes green rapidly.

- If you want to terminate the current call

### Monitoring

PT



Hang up or press  
SP-PHONE/MONITOR.



Lift the handset or press  
SP-PHONE/MONITOR.

or



Press **INTERCOM**

or



Press **LCS**  
(flexible button).

or



Press **PDN**.

or



Press **ANSWER**.

- An alarm tone is sent.

- Monitoring Starts.

### Having a conversation with a party

PT



Lift the handset or press  
SP-PHONE/MONITOR.

or



Press the flashing  
**LCS** (flexible button).



- If you want to hold the current call

## Monitoring

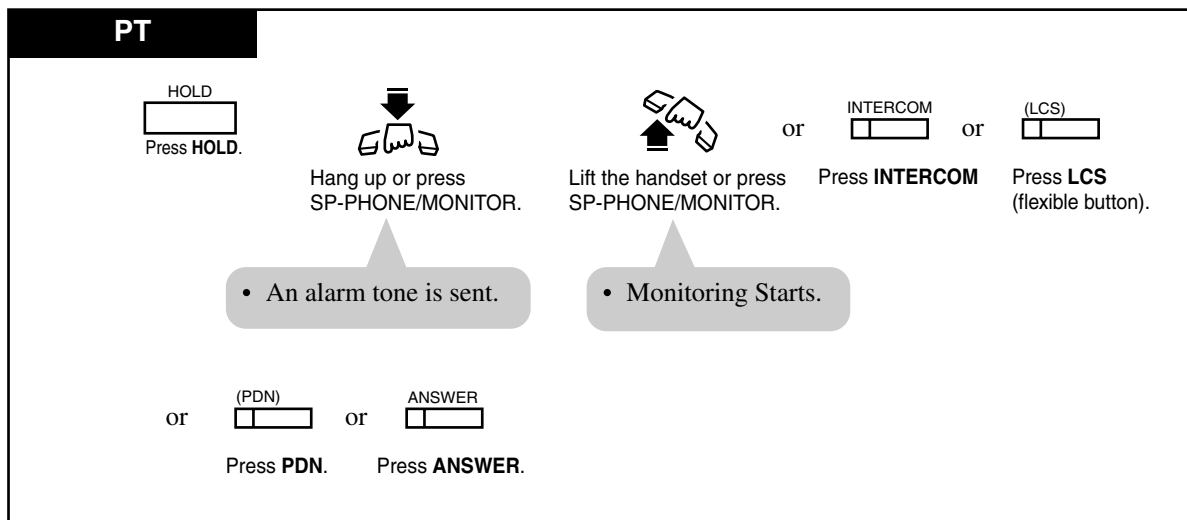

## Having a conversation with the party

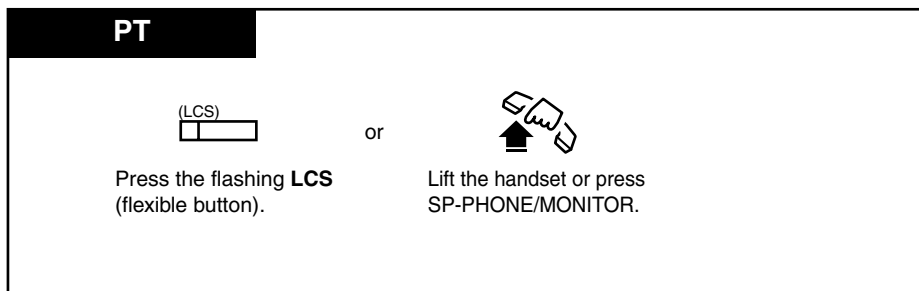

## Conditions

- **PT**  
The LCS indicator shows the feature status as follows.
  - Red (steady): The Live Call Screening mode is on.
  - Off: The Live Call Screening mode is off.
  - Flashing green slowly: Live Call Screening is acting.\*1
  - Flashing green rapidly: Alarm tone is ringing in the Private mode.\*1

\*1 The LCS button which is assigned on a DSS Console (except KX-T7440 and KX-7441) will flash in red. The LCS button which is assigned on the KX-T7440 or KX-T7441 will flash in red. The DSS button indicator lights in red steady while Live Call Screening is active.

- **PT**  
The Two-Way Record indicator shows the feature status as follows.  
On: Recording the conversation  
Off: Not recording
- **PT**  
During Keep Recording mode, if you want to stop recording the conversation, press the Two-Way Recording button.
- **PT**  
**Call Waiting**  
If the extension user is busy on a call when a caller begins to leave a message, a call waiting tone is sent (if programmed beforehand). The extension user can put the current call on hold before accessing LCS.
- **PT**  
**LCS button/LCS Cancel button**  
A flexible CO and DSS button can be assigned as an LCS/LCS Cancel button.
- **PT**  
**LCS Password Clear**  
To prevent unauthorized monitoring, a 3-digit password must be set by the extension user. If the user forgets their password, it can be cleared by the Manager extension or an Operator.
- **PT**  
**Recording Mode**  
Each extension can be programmed to either stop or continue recording the conversation after intercepting the recording in order to talk with the caller.
- **SLT**  
**LCS by an SLT (only in Private Mode)**  
An SLT which is connected with a PT in parallel, can also be used to monitor a message being recorded. Be sure that Live Call Screening on the connected PT has been activated.
- With the KX-T7431, KX-T7433, KX-T7436 or KX-T7235, you can execute this feature using the display operation.

### Programming Guide References

- 2.3 Numbering Plan
  - Live Call Screening
- 4.3 Extension Line
  - [LCS Setting] Status
  - [LCS Setting] Operation Mode
  - [LCS Setting] Recording Mode
  - [LCS Setting] LCS Password
  - CO Key
- 4.4 DSS Console
  - DSS Key

## **Features Guide References**

### 1.3 System Features

- Integration, DPT

### 1.9 Answering Features

- Live Call Screening (LCS)

## **User Manual References**

- 2.2.3 Flexible Button Assignment
- 2.2.8 Live Call Screening (LCS) Mode Set
- 3.2.5 [005] Flexible CO Button Assignment
- 4.4.4 Live Call Screening (LCS) Password Clear

### **4.3.44 Lockout**

If one party in a conversation goes on-hook, they both are disconnected from the speech path automatically. A reorder tone is sent to the off-hook party before it is disconnected. No operation is necessary.

## 4.3.45 Log-In / Log-Out

Allows the extension user to join (log-in) or leave (log-out) the group.

They can leave the group temporarily when they are away from their desks, to prevent calls being sent to their extensions.

They can return to the group when they are ready to answer calls.

This feature can be categorized as follows:

### **Log-In/Log-Out**

Allows members (extension users) of an Extension Group (except Group Type: None) and Phantom Extensions to join (log-in) or leave (log-out) the group.

### **Group Log-In / Log-Out**

Allows members (extension users) of an Incoming Group to join (group log-in) or leave (group log-out) the group.

The lighting patterns and status of the Log-In / Log-Out (Group Log-In/Log-Out) button are shown below:

**Off:** Log-In mode (no calls)

**Red On:** Log-Out mode

**Red Slow Flash:** Log-In mode (Calls are waiting in the UCD queue.)

### **Log-In / Log-Out for members of an Extension Group and Phantom Extensions (Using the Log-In / Log-Out button)**

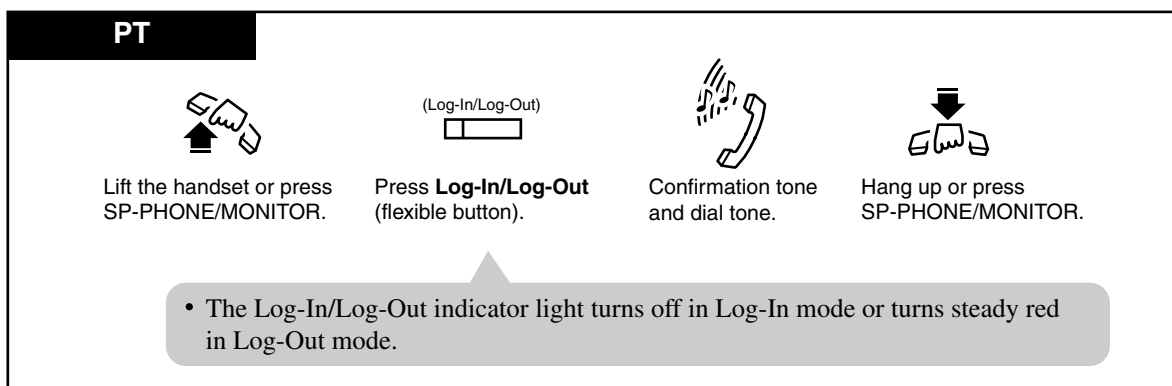

### Log-In / Log-Out for members of an Extension Group and Phantom Extensions (Using the feature number)

PT and SLT



Lift the handset or press SP-PHONE/MONITOR.

4	5	1	To Log-In
4	5	0	To Log-Out

For Log-In mode: Dial 451.  
For Log-Out mode: Dial 450.



Confirmation tone and dial tone



Hang up or press SP-PHONE/MONITOR.

**<PT Display Example>**

Log-in

or

Log-out

### Group Log-In / Log-Out for members of an Incoming Group (Using the Group Log-In / Log-Out button)

PT



Lift the handset or press SP-PHONE/MONITOR.

(Log-In/Log-Out)



Press **Group Log-In/Log-Out** (flexible button).



Confirmation tone and dial tone



Hang up or press SP-PHONE/MONITOR.

- The Group Log-In/Log-Out indicator light turns off in Group Log-In mode or turns steady red in Group Log-Out mode.

## Group Log-In / Log-Out for members of an Incoming Group (Using the feature number)

PT and SLT



Lift the handset  
or press  
SP-PHONE/MONITOR.

4	8	1
To Log-In		
4	8	0
To Log-Out		

For Log-In mode: Dial 481.  
For Log-Out mode: Dial 480.

FDN
For an Incoming group
✖
For all Incoming groups

For an Incoming group: Enter FDN (3 or 4 digits).  
For all Incoming groups: Dial ✖.



Confirmation tone  
and dial tone



Hang up or press  
SP-PHONE/MONITOR.

<PT Display Example>

Group Log-in

or

Group Log-out

### Conditions

- When extensions are logged out, calls directed to the above mentioned group do not come in on their extensions.  
However, calls directed to their individual extension (extension call, DIL 1:1, etc.) still ring at their extension.
- The extension user cannot leave the group (log-out), if at least one call is coming in on the group.
- PT
- **Log-In / Log-Out (Group Log-In / Log-Out) button**  
Log-In / Log-Out (Group Log-In / Log-Out) button can be assigned to a flexible CO button by Station, User or System Programming.
- With the KX-T7431, KX-T7433, KX-T7436 or KX-T7235, you can execute this feature using a display operation.
- **UCD Login Monitor**  
  - <For Extension Group members>  
Login / Logout status of the UCD Group members can be monitored through Busy Lamp Field of the corresponding DSS button. UCD Login Monitor is enabled or disabled by System Programming.
  - <For Incoming Group members>  
Login / Logout status of the UCD Group members can be monitored by the extension specified as the Supervisor Extension through Busy Lamp Field of the corresponding DSS button.
- **All Logout**  
All extensions in the Extension Group or Incoming Group can be logged-out. This is determined by System Programming <Section 2.8 System Option, "60. Empty Group" in the Programming Guide>. If this feature is disabled by System Programming, the extension user cannot leave the

group (log-out).

At least one extension must be logged in.

However, this does not apply to Auto-Logout of the UCD group extensions.

### **Programming Guide References**

- 2.3 Numbering Plan
  - Login / Logout
  - Group Login / Logout
- 2.8 System Option
  - Empty Group
- 3.3 Extension Group
  - [UCD Setting] LOGIN Monitor
- 3.5 Incoming Group
  - [UCD Setting] Supervisor Extension
- 4.3 Extension Line
  - CO Key

### **Features Guide References**

- 1.3 System Features
  - Extension Group
  - Incoming Group
  - Phantom Extension
- 1.8 Ringing Features
  - Log-In/Log-Out

### **User Manual References**



- 2.2.3 Flexible Button Assignment
- 3.2.5 [005] Flexible CO Button Assignment
- 4.3.80 UCD Login Monitor
- 4.5.9 KX-T7235 Display Features - System Feature Access Menu
- 4.5.12 KX-T7431 / KX-T7433 / KX-T7436 Display Features - System Feature Access Menu





## 4.3.46 Message Waiting

When the called extension or phantom extension is busy or does not answer your call, you can leave a notification so that the called party may call you back. As a message receiver, you will know that a call has been received by the MESSAGE button light and an indication tone which you will hear when going off-hook. If you receive a notification, you can call the original party back with a simple operation. If required, you can assign a Flexible CO button as the Another Extension Message Waiting button or the Phantom Extension Message Waiting button by program "[005] Flexible CO Button Assignment." For details, consult your dealer or manager.

### Setting

PT and SLT							
	<table border="1"><tr><td>7</td><td>0</td><td>1</td></tr></table>	7	0	1	<table border="1"><tr><td>extension no.</td></tr></table> or <table border="1"><tr><td>phantom extension no.</td></tr></table>	extension no.	phantom extension no.
7	0	1					
extension no.							
phantom extension no.							
Lift the handset or press SP-PHONE/MONITOR.	Dial 701.	Dial the extension number or the phantom extension number (3 or 4 digits) where a message notification will be left.					
							
Confirmation tone and dial tone	Hang up or press SP-PHONE/MONITOR.						

PT			
<i>If the called extension or the phantom extension number is busy or does not answer;</i>			
<table border="1"><tr><td>MESSAGE</td></tr></table>	MESSAGE		
MESSAGE			
Press <b>MESSAGE</b> .	Confirmation tone and dial tone	Hang up or press SP-PHONE/MONITOR.	

## Canceling

PT and SLT



Lift the handset or press  
SP-PHONE/MONITOR.

7

0

0

Dial 700.

extension no.

or

phantom extension no.

Dial the extension number or the phantom extension number  
(3 or 4 digits) where you left a message notification.



Confirmation  
tone and  
dial tone



Hang up or press  
SP-PHONE/MONITOR.

## Checking and Selecting a message waiting notification by the receiver

Display PT

*If there is any message waiting notification, the message waiting lamp, another extension message waiting lamp or phantom extension message waiting lamp (MESSAGE indicator) light will be on. When the telephone is idle and on-hook;*

MESSAGE <div style="border: 1px solid black; width: 40px; height: 15px; margin: 0 auto;"></div>	or	MESSAGE <div style="border: 1px solid black; width: 40px; height: 15px; margin: 0 auto;"></div>	or	MESSAGE <div style="border: 1px solid black; width: 40px; height: 15px; margin: 0 auto;"></div>
		(Another Extension Message Waiting)		(Phantom Extension Message Waiting)

Press **MESSAGE**, **Another Extension Message Waiting** or the **Phantom Extension Message Waiting** repeatedly until the desired message appears.

- The message notifications you received are shown on the display in the order they were received.

**<PT Display Example>**  
When Tony at extension 1123 left a message waiting notification:

1123 : Tony

## Calling back the message waiting notification sender

**PT**



Lift the handset or press SP-PHONE/MONITOR.



Dial tone 4\*, when a message has been received at your extension.

MESSAGE  OR MESSAGE  OR MESSAGE   
(Another Extension Message Waiting) (Phantom Extension Message Waiting)

Press **MESSAGE, Another Extension Message Waiting** or the **Phantom Extension Message Waiting**.



Talk.

- If there are more than one message waiting notification left on your extension, you can choose the desired message sender (display PT only).
- The message waiting notification is cleared after the conversation.

**SLT with Message Lamp**



Lift the handset or press SP-PHONE/MONITOR.



Dial tone 4\*, when a message has been received at your extension.

Dial 702.



Talk.

- The message waiting notification is cleared after the conversation.

\* One of the dial tones. Please refer to Section "6.1.3 Tone List."

## Clearing all message waiting notifications left on your extension

**PT and SLT with Message Lamp**



Lift the handset or press SP-PHONE/MONITOR.



Dial tone 4\*, when a message has been received at your extension.

Dial 700.

Dial your extension number.



Hang up or press SP-PHONE/MONITOR.

- All message waiting notifications are cleared.

\* One of the dial tones. Please refer to Section "6.1.3 Tone List."

## Conditions

- The system supports a maximum of 448 simultaneous message waiting notifications. If you try to set the 449th message, you will hear a reorder tone.
- **Callback Order**  
If multiple message waiting notifications are left at your extension, callback is executed in the order received.
- If you select a specific message to call back, callback is executed in the order received, starting with the one selected.
- **Hardware Requirements**  
To utilize the SLTs with Message Lamp, SLC-M card (KX-T96175) or an ESLC card (KX-TD50175) is required.
- **Turning off the light**  
Either the message sender or the receiver can turn off the light.
- **PT**  
**MESSAGE button**  
If a MESSAGE button is not provided on a PT, a flexible CO/DSS button can be assigned as the MESSAGE button by Station, User or System Programming.
- **PT**  
**VPS Integration**  
If VPS Integration is employed, a VM extension informs an extension that a message is left in his mailbox by turning on the MESSAGE lamp.  
The extension user can listen to the message in the mailbox simply by pressing the red lit MESSAGE lamp.
- **Call Forwarding**  
A message waiting notification is left on the Call Forwarding setting extension regardless of a type of Call Forwarding feature except for "To CO / TIE Line" and "No Answer to CO / TIE Line."
- **Station Hunting**  
A message waiting notification to an extension in the station hunting group is treated in the same manner as the ordinary call.
- With the KX-T7431, KX-T7433, KX-T7436 or KX-T7235, you can set or cancel this feature using the display operation.

## Programming Guide References

- 2.3 Numbering Plan
  - Message Waiting Set / Cancel / Call Back
- 2.8 System Option
  - Message Waiting lamp pattern
- 4.3 Extension Line
  - Message Lamp
  - CO Key
- 4.4 DSS Console
  - DSS Key

- 5.10 VPS Integration
  - Turn off control of Message Waiting lamp

### **Features Guide References**

#### 1.3 System Features

- Integration, Voice Mail (VM) Service

#### 1.17 Display Features

- Message Waiting

### **User Manual References**

- 2.2.3 Flexible Button Assignment
- 3.2.5 [005] Flexible CO Button Assignment
- 4.3.83 VPS Integration
- 4.5.9 KX-T7235 Display Features - System Feature Access Menu
- 4.5.12 KX-T7431 / KX-T7433 / KX-T7436 Display Features - System Feature Access Menu

### 4.3.47 Microphone Mute

During a conversation in the hands-free mode, you can turn off your PT's microphone so that you can consult privately with others in the room. When you activate Microphone Mute, you can still listen to your caller's voice but your caller cannot hear your voice.

#### Setting

**PT**

*During a conversation in the hands-free mode;*



Press **AUTO ANSWER/MUTE**.

- The AUTO ANSWER/MUTE indicator light flashes red slowly.

#### Canceling

**PT**

*When microphone mute is established;*



Press **AUTO ANSWER/MUTE**.

- The AUTO ANSWER/MUTE indicator light turns off.

#### Conditions

- This feature is only available during a hands-free conversation.
- You can hear the other party's voice while your PT is in Microphone Mute mode.
- This feature is available for the PT with AUTO ANSWER/MUTE button only.

#### Programming Guide References

System Programming is not required.

### **Features Guide References**

#### 1.15 Proprietary Telephone Features

- Handset Microphone Mute
- Microphone Mute

### **User Manual References**

- 4.3.39 Handset Microphone Mute

### 4.3.48 Night Service On/Off

Allows you to switch the Day / Night / Lunch / Break mode.

The KX-TD500 System supports both the Night and Day modes of operation. The Day mode includes the Lunch and Break mode. Only a DIL destination can perform in Lunch / Break mode. And, any other feature can perform in Day mode. The system operation for originating and receiving calls can be programmed differently in Day and Night modes. For example, Toll restriction calls can be programmed to prevent unauthorized toll calls at night.

#### Switching Day / Night / Lunch / Break mode (Display operation)

7235 / 7436



Lift the handset or press SP-PHONE.

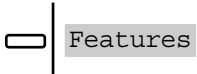

Press **Features**.

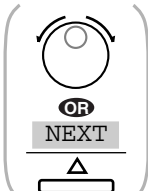

Rotate **Jog Dial** or press **NEXT** until the following is displayed.

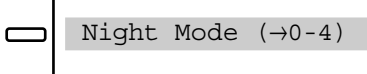

Press **Night Mode**.

<b>0</b>	For Auto Mode
<b>1</b>	For Day Mode
<b>2</b>	For Night Mode
<b>3</b>	For Lunch Mode
<b>4</b>	For Break Mode

For Auto : Dial 0.  
 For Day : Dial 1.  
 For Night : Dial 2.  
 For Lunch : Dial 3.  
 For Break : Dial 4.



Confirmation tone and dial tone



Hang up or press SP-PHONE.

- The display shows the current mode for five seconds.

**<PT Display Example>**

Auto Mode

or

Day Mode

or

Night Mode

or

Lunch Mode

or

Break Mode



## Switching Day / Night / Lunch / Break mode (Display operation)

7431



Lift the handset or  
press SP-PHONE.



Press **MODE** until  
"Feature Access"  
is displayed.



Rotate **Jog Dial** until  
"Night Mode" is displayed.

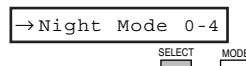

Press **SELECT**.

- |   |   |                |
|---|---|----------------|
| } | 0 | For Auto Mode  |
|   | 1 | For Day Mode   |
|   | 2 | For Night Mode |
|   | 3 | For Lunch Mode |
|   | 4 | For Break Mode |

For Auto : Dial 0.  
For Day : Dial 1.  
For Night : Dial 2.  
For Lunch : Dial 3.  
For Break : Dial 4.



Confirmation tone  
and dial tone



Hang up or press  
SP-PHONE.

- The display shows the current mode for five seconds.

### <PT Display Example>

Auto Mode or Day Mode or Night Mode or Lunch Mode or Break Mode

## Switching Day / Night / Lunch / Break mode (Display operation)

7433



Lift the handset or press SP-PHONE.



Press **SHIFT** until “**FEAT**” is displayed.





Press **FEAT**.

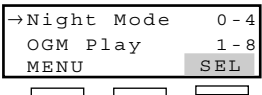

Rotate **Jog Dial** until “**Night Mode**” is at the arrow.



Press **SEL**.

<div style="border-left: 1px solid black; border-right: 1px solid black; padding: 5px;"> <p><b>0</b> For Auto Mode</p> <p><b>1</b> For Day Mode</p> <p><b>2</b> For Night Mode</p> <p><b>3</b> For Lunch Mode</p> <p><b>4</b> For Break Mode</p> </div>	 <p>Confirmation tone and dial tone</p>	 <p>Hang up or press SP-PHONE.</p>
---	--	---

For Auto : Dial 0.  
 For Day : Dial 1.  
 For Night : Dial 2.  
 For Lunch : Dial 3.  
 For Break : Dial 4.

- The display shows the current mode for five seconds.

**<PT Display Example>**

Auto Mode or Day Mode or Night Mode or Lunch Mode or Break Mode

### Switching Day / Night / Lunch / Break mode (DAY/NIGHT button operation)

PT



Lift the handset or press SP-PHONE/MONITOR.



Press DAY/NIGHT (flexible button).

<b>0</b>	For Auto Mode
<b>1</b>	For Day Mode
<b>2</b>	For Night Mode
<b>3</b>	For Lunch Mode
<b>4</b>	For Break Mode

For Auto : Dial 0.  
For Day : Dial 1.  
For Night : Dial 2.  
For Lunch : Dial 3.  
For Break : Dial 4.



Confirmation tone and dial tone



Hang up or press SP-PHONE/MONITOR.

• The status of DAY/NIGHT indicator.

Mode	CO button	DSS button (KX-T7440/KX-T7441)	DSS button (Others)
Day	Off	Off	Off
Night	On (Red)	On (Red)	On (Red)
Lunch	On (Green)	On (Green)	Off
Break	Slow Flash (Green)	Slow Flash (Green)	Off

**<PT Display Example>**

Auto Mode or 
 Day Mode or 
 Night Mode or 
 Lunch Mode or 
 Break Mode

## Switching Day / Night / Lunch / Break mode (Feature number operation)

PT and SLT



Lift the handset  
or press  
SP-PHONE/MONITOR.



Hang up or press  
SP-PHONE/MONITOR.

7

8

Dial 78.

0	For Auto Mode
1	For Day Mode
2	For Night Mode
3	For Lunch Mode
4	For Break Mode

For Auto : Dial 0.  
For Day : Dial 1.  
For Night : Dial 2.  
For Lunch : Dial 3.  
For Break : Dial 4.



Confirmation tone  
and dial tone

- The display shows the current mode for five seconds.

**<PT Display Example>**

Auto Mode

or

Day Mode

or

Night Mode

or

Lunch Mode

or

Break Mode

## Confirming the current mode

Display PT

*When the telephone is idle;*

#

Press #.

- The display shows the current mode for three seconds.

**<PT Display Example>**

In the automatic case;

Day Auto

or

Night Auto

or

Lunch Auto

or

Break Auto

In the manual case;

Day mode

or

Night Mode

or

Lunch Mode

or

Break Mode

---

## Conditions

- **Class of Service (COS) Programming**  
COS programming determines the extensions that can perform this feature.
- By System Programming, you can select either automatic Day/Night mode switching or manual Day/Night mode switching.
- In the automatic case, the default start/end time for each mode is as follows:
  - Day mode – 9:00 a.m.
  - Lunch\_Start mode – 12:00 p.m., Lunch\_End mode – 1:00 p.m.
  - Break\_Start mode – 3:00 p.m., Break\_End mode – 3:30 p.m.
  - Night mode – 5:00 p.m.
- Any extension user (with display PT) can confirm the current mode, Day, Night, Lunch or Break.
- The Manager and the Operator can also switch the Day / Night / Lunch / Break mode.
- You cannot switch the selection mode from Night to Lunch or Break.
- There are 2 types of switching modes: "Auto" and "Manual." The mode is set by the PC programming or by entering the feature number "Night Mode Set / Cancel" or pressing the DAY / NIGHT button by allowed extension on a tenant basis.  
When the system is in "Auto" mode, the mode will be switched automatically in accordance with timetable in 2-1 Tenant screen of the PC programming.  
When the system is in "Manual" mode, the system keeps the current mode even though the time to change the mode automatically has arrived.
- If DIL destination is not assigned for Lunch / Break mode, DIL destination performs in Day mode as usual.

## Programming Guide References

- 2.2 Tenant
  - DAY / NIGHT Switching Mode
  - Alert Extension – Day / Night
  - Day (SUN – SAT)
  - Night (SUN – SAT)
  - Lunch\_Start (SUN – SAT)
  - Lunch\_End (SUN – SAT)
  - Break\_Start (SUN – SAT)
  - Break\_End (SUN – SAT)
- 2.3 Numbering Plan
  - Night Mode Set / Cancel
- 2.4 Class of Service (COS)
  - Switching Day / Night Mode
  - TRS Level – Day / Night
  - Trunk Group Setting – Day / Night
- 3.2 Trunk Group

- Intercept Destination – Day / Night
- 3.3 Extension Group
  - [Overflow Setting] Destination – Day / Night
- 3.5 Incoming Group
  - [Overflow Setting] Destination – Day / Night
- 4.2 Trunk Line
  - Destination – Day / Night / Lunch / Break
- 4.3 Extension Line
  - CO Key
- 4.4 DSS Console
  - DSS Key
- 4.5 Doorphone
  - Destination – Day / Night
- 9.2 DID Dial Registration
  - Destination – Day/Night

### **Features Guide References**

- 1.3 System Features
  - Night Service

### **User Manual References**

- 2.2.3 Flexible Button Assignment
- 3.2.5 [005] Flexible CO Button Assignment

## 4.3.49 Off-Hook Call Announcement (OHCA)

Allows you to signal a busy extension on a handset call that your call is waiting. Your voice is heard through the built-in speaker of the called party's PT (KX-T7130, KX-T7235 or KX-T7436). The called extension user can select to talk to you or their initial caller.

### Setting

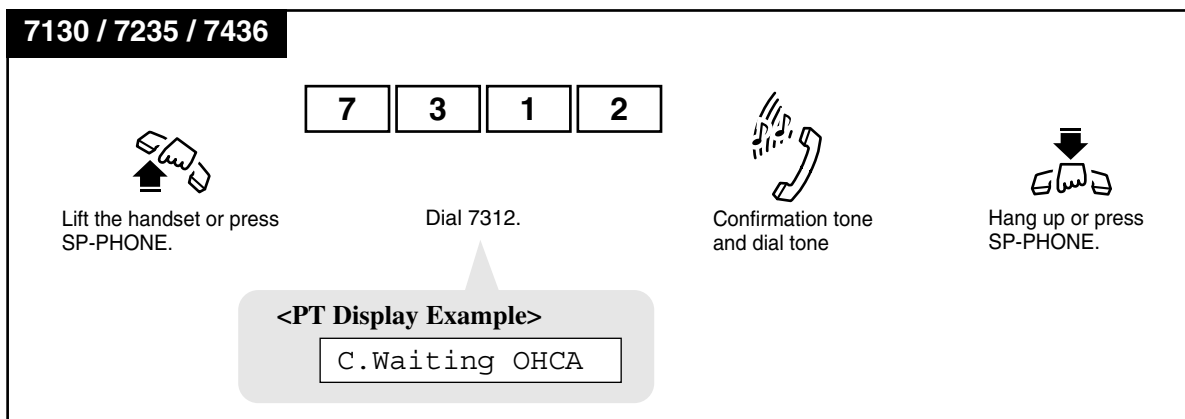

### Canceling

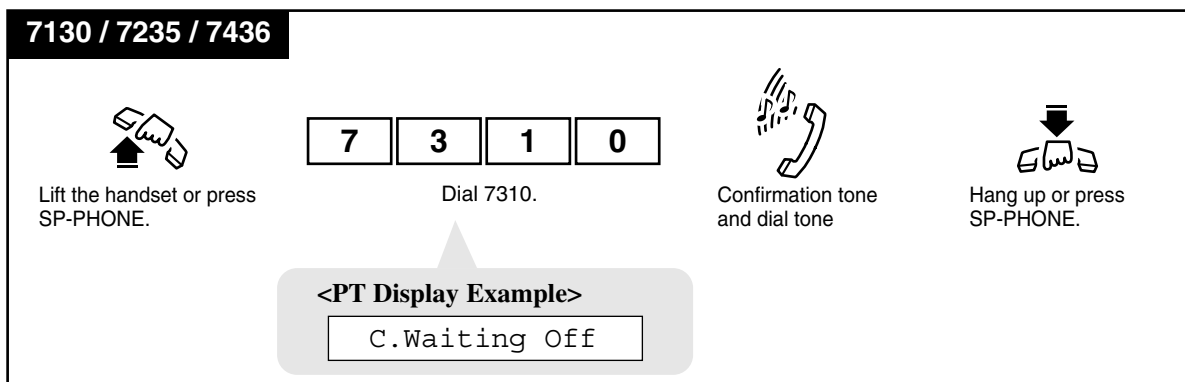

## Executing

**7230 / 7235 / 7433 / 7436**

*If you hear a busy tone after making an intercom call;*

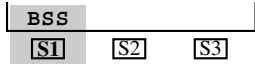

Press **BSS (S1)**.



Confirmation tone



Wait for an answer and talk.

## PT and SLT

*If you hear a busy tone after making an intercom call;*



Dial 1.



Confirmation tone



Wait for an answer and talk.

## To talk to the third party

**7130 / 7235 / 7436**

*If OHCA is activated by the other party when you are engaged in a call using the handset, you hear a confirmation tone and then the caller's voice through the built-in speaker of your PT.*



Speak with the third party through microphone.

- The caller's number and name are shown on the display for five seconds in 10 seconds intervals.

### <PT Display Example>

123 : Tony

Caller's extension number

- You can talk to two parties individually.



## To talk to the third party by terminating the current call in hands-free mode

**7130 / 7235 / 7436**

*If OHCA is activated by the other party when you are engaged in a call using the handset, you hear a confirmation tone and then the caller's voice through the built-in speaker of your PT.*



Hang up.

- The current call is disconnected.
- The INTERCOM indicator light turns green.



Speak with the third party through microphone.

- You can talk in hands-free mode.

## To talk to the third party by terminating the current call in handset mode

**7130 / 7235 / 7436**

*If OHCA is activated by the other party when you are engaged in a call using the handset, you hear a confirmation tone and then the caller's voice through the built-in speaker of your PT.*

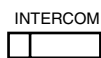

Press INTERCOM.

- The current call is disconnected.
- The INTERCOM indicator light turns green.



Talk.

- You can talk in handset mode.

### To talk to the third party after placing the current call on hold

7130 / 7235 / 7436

*If OHCA is activated by the other party when you are engaged in a call using the handset, you hear a confirmation tone and then the caller's voice through the built-in speaker of your PT.*

HOLD



Press HOLD.



Talk.

- The current call is placed on hold.
- The INTERCOM indicator light flashes green slowly.

### Conditions

- BSS / OHCA / Whisper OHCA**  
If an extension user dials "1" while hearing a busy tone, BSS or OHCA or Whisper OHCA will be activated at the called extension.  
This is determined by the following conditions.

Calling extension	Called extension			
COS-OHCA assignment	Call Waiting setting			
	OFF	ON		
	0	1	2	3
Disable	—	BSS	BSS	BSS
Enable	—	BSS	OHCA*1 → BSS	W-OHCA*2 → OHCA → BSS

\*1 OHCA (Off-Hook Call Announcement) is activated when the called extension is KX-T7130, KX-T7235 or KX-T7436.

\*2 Whisper OHCA is activated when both calling and called extensions are using one of the KX-T7400 series PTs.

- If "Do Not Disturb (DND)" feature is set at the called extension, you hear DND tone. In this case, to execute OHCA, you must first activate "Do Not Disturb (DND) Override" feature before OHCA is available.
- Call Waiting**  
OHCA is only effective when the called extension has set "Call Waiting" feature. If not, you will hear a reorder tone after dialing 1.
- PT(ICM)**  
This feature works when the called extension is having a conversation or a conference with extension(s) or CO line(s) using the handset.
- PT(DN)**  
BSS, OHCA and Whisper OHCA do not function, if the other extension is a DN type PT.

### **Installation Manual References**

- 2.3.3 DOHCA Card
- 2.7.2 OHCA Card (KX-T96136)

### **Programming Guide References**

- 2.3 Numbering Plan
  - Call Waiting Set / Cancel
- 2.4 Class of Service (COS)
  - Off-Hook Call Announcement (OHCA)

### **Features Guide References**

- 1.6 Originating Features
  - Busy Station Signaling (BSS)
  - Off-Hook Call Announcement (OHCA)
  - Off-Hook Call Announcement (OHCA), Whisper
- 1.9 Answering Features
  - Call Waiting

### **User Manual References**

- 4.3.17 Call Waiting

### 4.3.50 Off-Hook Call Announcement (OHCA) —Whisper

This is a version of the OHCA feature. The difference is, OHCA provides two-way communication between two extensions but this feature provides one-way communication. When this feature is activated, the called party can hear caller's voice through the handset but the caller cannot hear the called party's voice.

By default, this feature is available only when both calling and called extensions are using KX-T7400 series PTs.

#### Setting

7420 / 7425 / 7433 / 7436



Lift the handset or press SP-PHONE.

7	3	1	3
---	---	---	---

Dial 7313.



Confirmation tone and dial tone



Hang up or press SP-PHONE.

**<PT Display Example>**

C.Waiting W-OHCA

#### Canceling

7420 / 7425 / 7433 / 7436



Lift the handset or press SP-PHONE.

7	3	1	0
---	---	---	---

Dial 7310.



Confirmation tone and dial tone



Hang up or press SP-PHONE.

**<PT Display Example>**

C.Waiting Off

## Executing

### 7433 / 7436

*If you hear a busy tone after making an intercom call;*

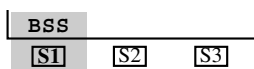

Press **BSS (S1)**.



Confirmation tone



Wait for an answer and talk.

### 7420 / 7425 / 7431 / 7433 / 7436

*If you hear a busy tone after making an intercom call;*



Dial 1.



Confirmation tone



Wait for an answer and talk.

## Receiving a voice announcement

### 7420 / 7425 / 7431 / 7433 / 7436

*If Whisper OHCA is activated by the other party when you are engaged in a call, you hear a confirmation tone. Then you will be engaged in both calls with the current caller (two-way) and the third party (one-way).*

#### <PT Display Example>

The caller's extension number and name are shown on the display for five seconds in 10 seconds intervals.

123 : Tony

— Caller's extension number

### To talk to the third party by terminating the current call in hands-free mode

**7420 / 7425 / 7431 / 7433 / 7436**

*If Whisper OHCA is activated by the other party when you are engaged in a call, you hear a confirmation tone. Then you will be engaged in both calls with the current caller (two-way) and the third party (one-way).*



Hang up.

- The current call is disconnected.
- The INTERCOM indicator light turns green.



Speak with the third party through microphone.

- You can talk in hands-free mode.

### To talk to the third party by terminating the current call in handset mode

**7420 / 7425 / 7431 / 7433 / 7436**

*If Whisper OHCA is activated by the other party when you are engaged in a call, you hear a confirmation tone. Then you will be engaged in both calls with the current caller (two-way) and the third party (one-way).*



Press INTERCOM.

or



Press FLASH.

- The current call is disconnected.
- The INTERCOM indicator light turns green.



Talk.

- You can talk in handset mode.

## To talk to the third party after placing the current call on hold

**7420 / 7425 / 7431 / 7433 / 7436**

*If Whisper OHCA is activated by the other party when you are engaged in a call, you hear a confirmation tone. Then you will be engaged in both calls with the current caller (two-way) and the third party (one-way).*

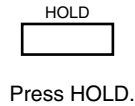

- The current call is placed on hold.
- The INTERCOM indicator light flashes green slowly.

### Conditions

- This feature can be enabled to any PTs (other than KX-T7400 series PT) by System Programming.
- Whisper OHCA is activated when both calling and called extensions are using the KX-T7400 series PTs by default. If either one of them is a non-KX-T7400 series PT, OHCA (when the called extension is an OHCA-capable PT) or BSS is activated. However, Whisper OHCA between two non-KX-T7400 series PTs can be enabled by System Programming < Section 2.8 System Option, "32. Whisper OHCA to extensions other than T74XX>.
- BSS, OHCA and Whisper OHCA do not function, if the other extension is a DN type PT.

Other conditions are the same as that of "Off-Hook Call Announcement (OHCA)."

### Programming Guide References

- 2.3 Numbering Plan
  - Call Waiting Set / Cancel
- 2.4 Class of Service (COS)
  - Off-Hook Call Announcement (OHCA)
- 2.8 System Option
  - Whisper OHCA to extensions other than T74XX

### Features Guide References

- 1.6 Originating Features
  - Busy Station Signaling (BSS)

- Off-Hook Call Announcement (OHCA)
- Off-Hook Call Announcement (OHCA), Whisper

#### 1.9 Answering Features

- Call Waiting

### **User Manual References**

- 4.3.17 Call Waiting



## 4.3.51 Off-Hook Monitor

While you are on a handset call, your call can be monitored by the other people in the room through SP-PHONE.

### Setting

DPT

*While on a handset call;*



SP-PHONE

Press **SP-PHONE**.

- The SP-PHONE indicator light turns red.
- Your handset call is heard through the SP-PHONE.

### Switching from off-hook monitor to handset call

DPT

*While in the off-hook monitor mode;*



SP-PHONE

Press **SP-PHONE**.

- The SP-PHONE indicator light turns off.
- Off-hook monitor mode is canceled and handset call mode is established.

### Switching from off-hook monitor to hands-free mode

DPT

*While in the off-hook monitor mode;*



Hang up.

- Off-hook monitor mode is canceled and hands-free mode is established.

### **Conditions**

- This feature is available for the following PT extensions only: KX-7431, KX-T7433, KX-T7436
- If the SP-PHONE button is pressed during a handset call, either Off-Hook Monitor or SP-PHONE mode (hands-free mode) will be established. This is determined by System Programming <Section 2.8 System Option, "20. Off-hook Monitor" in the Programming Guide>.
- Making an OHCA call is not available if the other extension is in Off-Hook Monitor mode.

### **Programming Guide References**

- 2.8 System Option
  - Off-hook Monitor

### **Features Guide References**

- 1.12 Conversation Features
  - Hands-free Operation
  - Off-Hook Monitor

### **User Manual References**

- 4.3.41 Hands-free Operation

## 4.3.52 One-Touch Dialing

Allows you to make a call (intercom or outside) or access a system feature with the touch of a button. This is done by storing an extension number, telephone number or feature number (up to 24 digits) in a One-Touch Dialing button.

### Dialing

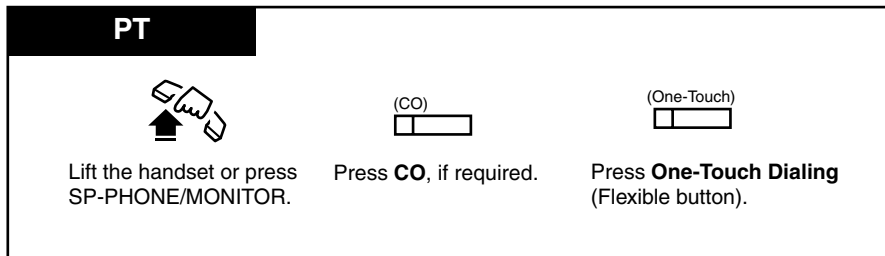

### Conditions

- **PT**  
One-Touch Dialing button can be programmed by Station, User or System Programming.
- **PT**  
If you store the telephone number of an outside party, a CO line access code (9, 801 through 848) must be stored as the leading digit.
- **PT**  
You may press a CO button to select a desired CO line directly before pressing the One-Touch Dialing button.
- **PT**  
**Combination dialing**  
Speed Dialing, One-Touch Dialing, manual dialing, Last Number Redial and Saved Number Redial can be used in a combination.
- **PT**  
**Storing more than 25 digits**  
It is possible to store a number consisting of 25 digits or more by dividing it and storing it in two One-Touch Dialing buttons. In this case, a CO line access code (9, 801 through 848) should be stored in the first button.
- **PT**  
**Full One-Touch Dialing**  
If "Full One-Touch Dialing" is enabled, press the One-Touch Dialing button directly without going off-hook.
- Any feature number can be stored in a One-Touch Dialing button.  
However, the feature numbers for "Speed Dialing – Station" and "Speed Dialing – Station Programming" do not function.

### **Programming Guide References**

- 4.3 Extension Line
  - CO Key
  - PF Key
- 4.4 DSS Console
  - DSS Key
  - PF Key

### **Features Guide References**

- 1.7 Dialing Features
  - Full One-Touch Dialing
  - One-Touch Dialing

### **User Manual References**

- 2.2.3 Flexible Button Assignment
- 2.2.4 Full One-Touch Dialing Assignment
- 3.2.5 [005] Flexible CO Button Assignment
- 5.2.13 One-Touch Dialing Button (Assignment)
- 5.2.14 One-Touch Access Assignment for System Features
- 5.2.23 One-Touch Dialing
- 5.2.24 One-Touch Access for System Features

### 4.3.53 Operator Call

Allows you to call an operator within the system.

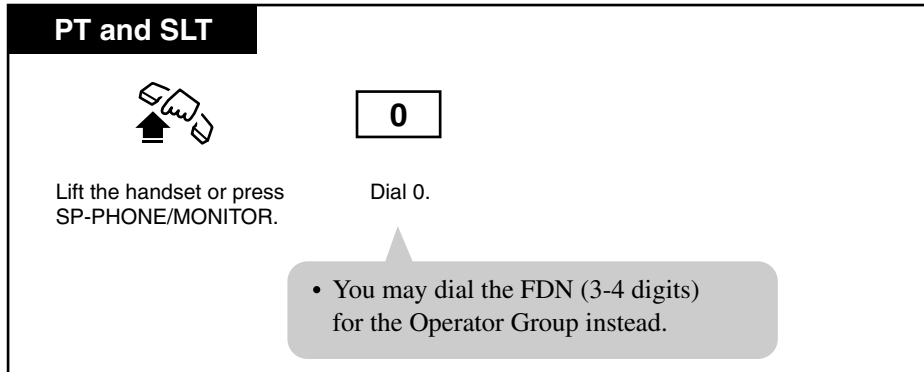

#### Conditions

- If no operator is assigned, this feature is not available and you will hear a reorder tone after dialing the feature number.
- **Operator FDN**  
The treatment of incoming calls to Operator is decided according to "Operator FDN" setting of the tenant <Section 2.2 Tenant, "Operator FDN" in the Programming Guide>.
  - If the FDN for Operator Group is set as the destination of Extension Group or Incoming Group, calls by the feature number for "Operator Call" will arrive at the destination.
  - If it is set to "Blank," calls will arrive at the destination of Extension Group.
- If the FDN except for Operator Group is set, or if the FDN for Operator Group is set as the destination of Extension Group in other tenants, calls will arrive at the destination of Extension Group.
- An operator-seeking incoming call to the PDN of owner extension does not appear on the SDN button.
- A call to a single operator hunts for an idle extension as follows;
  - <**For Extension Group members**>
    - in numerical order of the extension port physical numbers, starting at the extension following the last one called
  - <**For Incoming Group members**>
    - in the order assigned in the Incoming Group

It is programmable whether to start at the extension following the last one called or to always start at the first assigned extension by System Programming <Section 3.5 Incoming Group, "Search Mode" in the Programming Guide>.

#### Programming Guide References

- 1.4 Extension Port Assignment
  - Group No.
- 2.2 Tenant
  - Operator FDN

- 2.3 Numbering Plan
  - Operator Call
- 3.3 Extension Group
  - FDN
  - Group Type
  - Tenant No.
  - [Overflow Setting] Destination – Day / Night
  - [Overflow Setting] Timer
  - [Operator Setting] Ringing Type
  - [Operator Setting] Call Priority
- 3.5 Incoming Group
  - FDN
  - Group Type
  - [Overflow Setting] Destination - Day / Night
  - [Overflow Setting] Timer
  - [Operator Setting] Ringing Type
  - [Operator Setting] Call Priority
- 4.2 Trunk Line
  - Trunk Line – Destination – Day / Night / Lunch / Break

### **Features Guide References**

- 1.3 System Features
  - Operator Group
  - Manager Extension
- 1.6 Originating Features
  - Operator Call

### **User Manual References**

None

## 4.3.54 Outward Dialing, Trunk Access

There are the following your ways to select an idle CO line for making a call.

Type	Description	How to access
<b>Idle</b>	Selects an idle CO line automatically from the trunk groups assigned to the extension.	Dial the feature number for "Local CO Line Access / ARS" (default=9). Or press a Loop-CO (L-CO) Button. <PT only>
<b>Direct</b>	Selects an idle CO line by pressing an idle CO button directory.	Press an idle CO (S-CO, G-CO, L-CO) Button. <PT only>
<b>Individual Trunk</b>	Selects the desired CO line without dialing the line access number.	Press a Single-CO (S-CO) button. <PT only>
<b>Trunk Group</b>	Select an idle CO line from the desired trunk group assigned to the extension.	Dial the trunk group access number and a trunk group number. Or press a Group-CO (G-CO) button. <PT only>

### Trunk Access – Idle

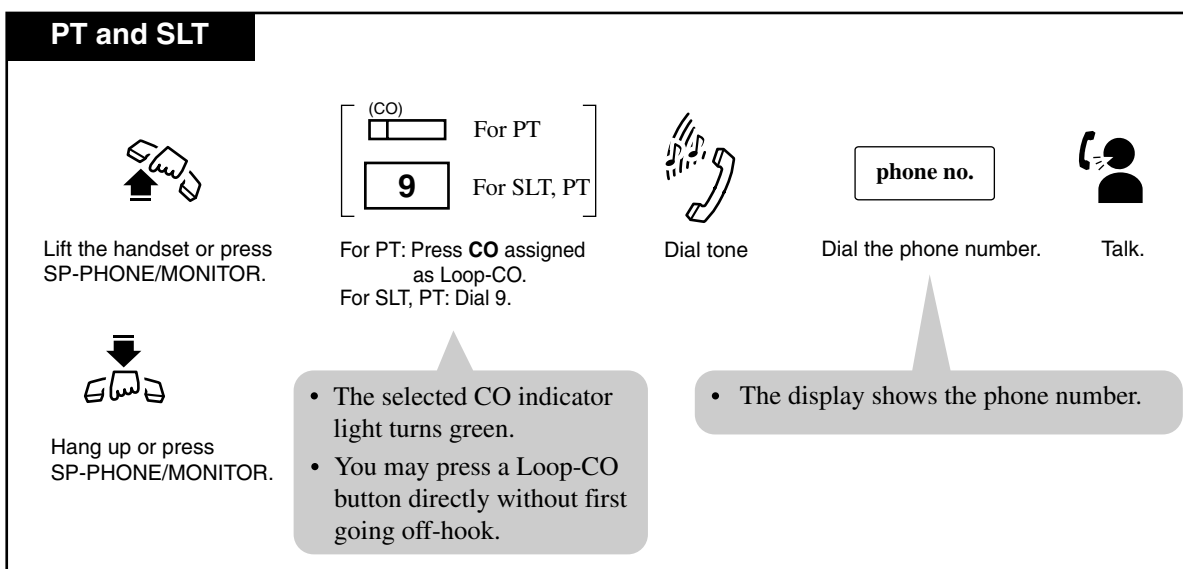

### Trunk Access – Direct

**PT**

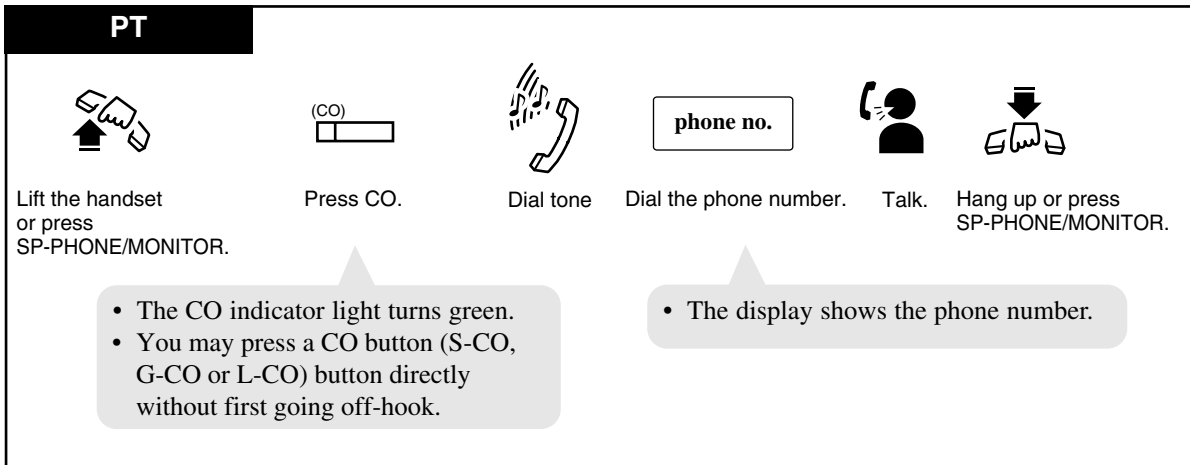

Lift the handset or press SP-PHONE/MONITOR.

Press CO.

Dial tone

Dial the phone number.

Talk.

Hang up or press SP-PHONE/MONITOR.

- The CO indicator light turns green.
- You may press a CO button (S-CO, G-CO or L-CO) button directly without first going off-hook.

- The display shows the phone number.

### Trunk Access – Individual Trunk

**PT**

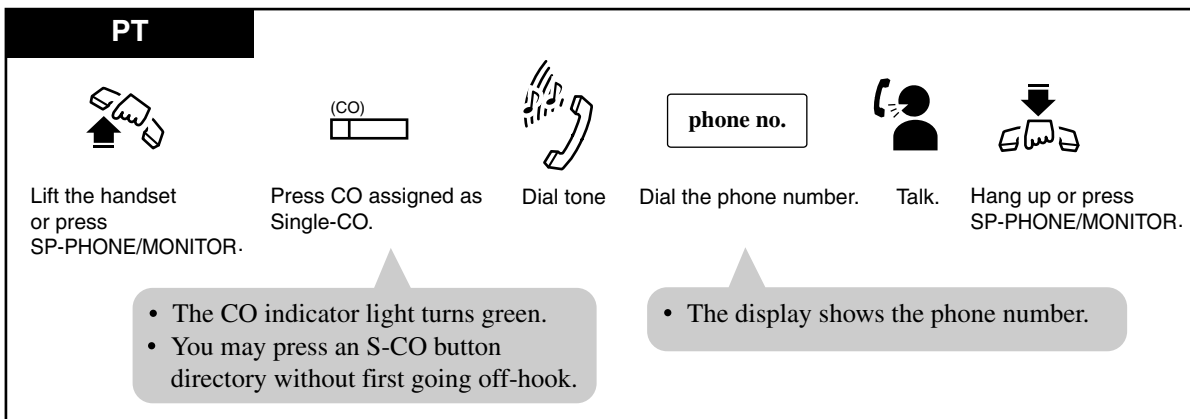

Lift the handset or press SP-PHONE/MONITOR.

Press CO assigned as Single-CO.

Dial tone

Dial the phone number.

Talk.

Hang up or press SP-PHONE/MONITOR.

- The CO indicator light turns green.
- You may press an S-CO button directory without first going off-hook.

- The display shows the phone number.



## Trunk Access – Trunk Group

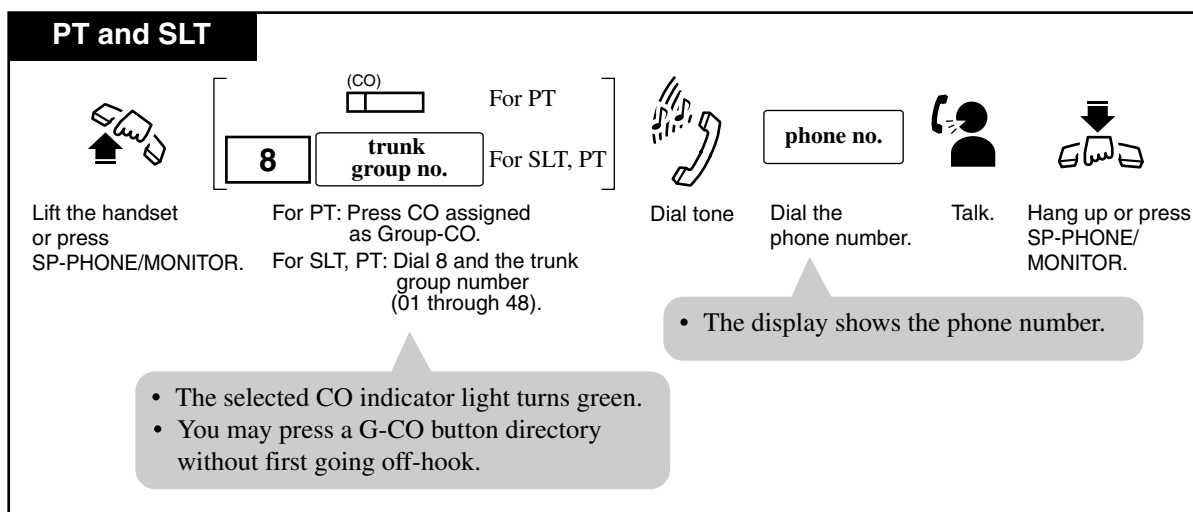

## Conditions

### [General]

- Class of Service (COS) programming**  
 COS programming determines the trunk group available for each extension user <Section 2.4 Class of Service (COS), "Trunk Group Setting" in the Programming Guide>.
- PT**  
 All PTs in the system have one L-CO button by default.
- Flexible CO Button Assignment**  
 A flexible CO button can be assigned as an S-CO, G-CO or L-CO button by Station, User or System Programming as follows:

Button Type	Assignable parameters
<b>Single-CO (S-CO)</b>	A specific outside line is assigned.
<b>Group-CO (G-CO)</b>	A trunk group is assigned.
<b>Loop-CO (L-CO)</b>	All outside lines are assigned.

- After dialing the feature number or pressing the CO button, you will hear one of the following tones:

**Dial tone:** Indicates an idle CO line is seized.

xxxxxx

—is shown on the display, if available. (xxxxxx: trunk port physical number)

**Busy tone:** Indicates the selected CO line is busy.

CO in use

—is shown on the display, if available.

**Reorder tone:**

1) Indicates the CO line you have attempted to access is not assigned.

CO Not Assigned

—is shown on the display, if available.

2) Indicates access to CO lines is denied.

Restricted

—is shown on the display, if available.

Restricted

- `Restricted` may show on the display for the following reasons.
  - The extension has been locked by the owner (**Electronic Station Lockout**) or the operator / manager (**Remote Station Lock Control**).
  - The extension is restricted by the account code mode, "Verified - All Calls" or "Verified - Toll Restriction Override" (**Account Code Entry**).
  - The extension is restricted from making toll calls (**Toll Restriction**).
- The same CO line can be assigned to an S-CO button and a G-CO button.
- The same trunk group can be assigned to more than one G-CO button.
- Each PT can have more than one L-CO button.
- **Ringling Tone Selection**  
The Digital Proprietary Telephone (DPT) user can choose a desired ringing frequency for each S-CO, G-CO or S-CO button <Section "2.2.13 Ringing Tone Selection for CO Buttons" in the User Manual>.
- **Idle Line Preference – Outgoing (PT only)**  
If a CO button (S-CO, G-CO or L-CO) is selected in "Idle Line Preference – Outgoing" setting by Station or System Programming, the PT user can get an idle CO line simply by going off-hook.
- **Automatic Callback Busy (Camp-On)**  
If the CO line which you try to access is busy, the system will inform you when the CO line becomes free.
- **Hands-free operation**  
When you press a CO button (S-CO, G-CO or L-CO) button directory, the hands-free operation mode is established and can perform on-hook dialing.

**[Idle]**

- **Automatic Route Selection (ARS)**  
"Trunk Access, Idle" functions when Automatic Route Selection (ARS) is not activated. If ARS is activated by System Programming <Section 2.2 Tenant, "Automatic Route Selection" in the Programming Guide>, the least expensive route for the destination is selected automatically.
- **Local Hunt Sequence**  
An idle CO line is selected from the Trunk Group assigned to the extension, If multiple Trunk Groups are available, the Trunk Group hunting sequence is determined by System Programming <Section 2.6 Local Hunt Sequence in the Programming Guide>.
- **For ICM type PT only**  
Dialing the CO line access code (default=9) selects a CO button on a PT according to the priority as follows:  
S-CO > G-CO > L-CO on a hunted Trunk Group

**[Direct]**

- By pressing an idle CO button, the hands-free operation mode is established and you can perform On-Hook Dialing. There is no need to press the SP-PHONE button, MONITOR button or lift the handset.

**[Individual Trunk]**

- **ARS Override**  
If Automatic Route Selection (ARS) is activated, it is overridden by an outgoing call made by pressing the S-CO button.

**[Trunk Group]**

- **Line Hunting Order**  
An idle CO line in a Trunk Group is selected in one of the following three line hunting orders: Normal, Reverse (default), Sequential.  
This is determined by System Programming <Section 3.2 Trunk Group, "Line Hunting Order" in the Programming Guide>.

**Programming Guide References**

- 2.2 Tenant
  - Automatic Route Selection
- 2.3 Numbering Plan
  - Local CO Line Access / ARS
  - Trunk Group Access
- 2.4 Class of Service (COS)
  - Trunk Group Setting
- 2.6 Local Hunt Sequence

- 3.2 Trunk Group
  - Line Hunting Order
- 4.3 Extension Line
  - CO Key
  - [Preferred Line] Outgoing

## Features Guide References

### 1.3 System Features

- Account Code Entry
- Remote Station Lock Control
- Trunk Group

### 1.6 Originating Features

- Automatic Callback Busy (Camp-On)
- Automatic Route Selection (ARS)
- Electronic Station Lockout
- Line Preference—Outgoing (Idle Line/No Line/Prime Line)
- Toll Restriction
- Trunk Access
- Trunk Connection Assignment—Outgoing

### 1.16 Button Features

- Button, Line Access

## User Manual References

- 2.2.3 Flexible Button Assignment
- 2.2.12 Preferred Line Assignment — Outgoing
- 3.2.5 [005] Flexible CO Button Assignment

## 4.3.55 Paging

Allows you to make a voice announcement to a lot of people in the office simultaneously. Your message is announced through built-in speakers of Proprietary Telephones (PTs) or external speakers (External Pagers) or both. The paged person can answer your paging announcement from any telephone in the office (**Paging Answer**). Making and answering a paging announcement is possible either from a PT or SLT. You can also make a paging announcement while putting a call on consultation hold in order to transfer it (**Paging and Transfer**). There are three types of paging as shown below. You can select the appropriate type according to your needs.

Type	Description
Paging — All	Paging through both built-in speakers of PTs and external pagers simultaneously.
Paging — External	Paging through all external pagers simultaneously.
	Paging through a specific external pager.
Paging — Group	Paging to all paging groups through built-in speakers of PTs.
	Paging to a particular paging group through built-in speakers of PTs.

Allows the PT user to deny receiving a paging announcement through built-in speaker of his own PT (**Paging Deny**).

### Paging – All: To access all external pagers and paging groups

PT and SLT



Lift the handset  
or press  
SP-PHONE/MONITOR.

3

2

\*

Dial 32\*.



Confirmation tone  
(Optional)



Announce.



Wait for  
an answer.



Talk.

**<PT Display Example>**

All Call Page

- You may dial "33\*" instead.

### Paging – External: To access all external pagers

PT and SLT



Lift the handset or press  
SP-PHONE/MONITOR.

3	2	0
---	---	---

Dial 320.



Confirmation tone  
(optional)



Announce.



Wait for  
an answer.



Talk.

**<PT Display Example>**

Extrnl Page All
-----------------

### Paging – External: To access a particular pager

PT and SLT



Lift the handset or press  
SP-PHONE/MONITOR.

3	2
---	---

Dial 32.

external pager no.
--------------------

Dial external pager  
number (1 or 2).



Confirmation tone  
(optional)



Announce.



Wait for  
an answer.



Talk.

**<PT Display Example>**

Extrnl Page X
---------------

external pager number

### Paging – Group: To access all paging groups (01-16) simultaneously

PT and SLT



Lift the handset or press  
SP-PHONE/MONITOR.

3	3	#
---	---	---

Dial 33#.



Confirmation tone  
(optional)



Announce.



Wait for an answer.



Talk.

**<PT Display Example>**

Group Page All
----------------

## Paging – Group: To access a particular paging group

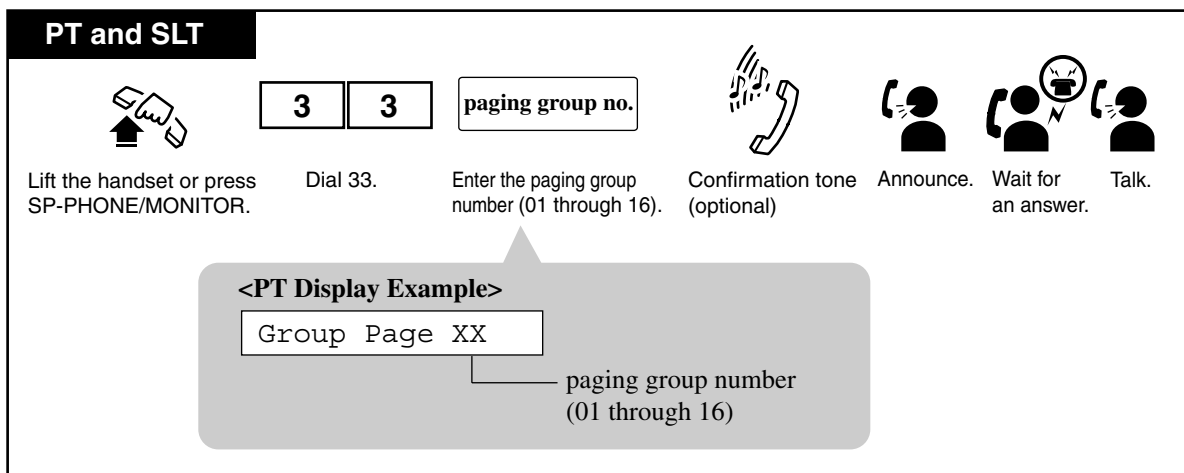

## Conditions

### [General]

- A confirmation tone is sent to extensions, when the paging announcement is made. Eliminating the tone is programmable <Section 2.2 Tenant, "Confirmation Tone for Station or External Paging" in the Programming Guide>.
- A confirmation tone is sent to extensions, when the paging announcement is answered. Eliminating the tone is programmable <Section 2.8 System Option, "9. Confirmation Tone for Call Pickup, Paging, Paging – Answer, TAFAS – Answer, Hold Retrieve and Call Park Retrieve" in the Programming Guide>.
- With the KX-T7431, KX-T7433, KX-T7436 or KX-T7235, you can execute "Paging" feature using the display operation.

### [All], [External]

- An external pager (user-supplied) must be connected to the System beforehand. Up to two external pagers can be connected to the KX-TD500 System.
- **External Paging Tone**  
External paging tone is emitted from external pagers, before the voice announcement. Eliminating the tone is programmable <Section 2.2 Tenant, "External Paging Tone" in the Programming Guide>.
- **External Paging Priority**  
External pagers can be used for TAFAS, Paging – External or Background Music (BGM) – External in this order.  
For example, if Paging – External is overridden by TAFAS, a reorder tone is returned to the performer of Paging – External. If Background Music (BGM) – External is overridden by another higher priority, it is interrupted and starts again when the higher priority is finished.
- If you hear a busy tone after dialing an external pager access number, the external pager(s) you specified is(are) busy.

### **[All], [Group]**

- A maximum of 16 station paging groups, each consisting of one or more extension groups, can be created in the System <Section 3.4 Paging Group in the Programming Guide>.
- A single Extension Group cannot belong to two or more different Paging Groups at a time.
- To page extensions, paged extensions must belong to some extension group(s), and this/these extension group(s) must belong to some paging group(s).
- "Paging – Group" to different paging groups can be performed simultaneously.
- "Paging – Group" feature overrides Do Not Disturb (DND) feature assigned to the paged extension.

### **Installation Manual References**

- 2.8.1 External Pager (Paging Equipment)

### **Programming Guide References**

- 2.2 Tenant
  - External Paging Tone
  - Confirmation Tone for Station or External Paging
- 2.3 Numbering Plan
  - External Paging
  - Station Paging
- 2.8 System Option
  - Confirmation tone for Call Pickup, Paging, Paging-Answer, TAFAS-Answer, Hold Retrieve and Call Park Retrieve
- 3.4 Paging Group
  - Paging Group No.
  - Extension Group No.

### **Features Guide Reference**

- 1.3 System Features
  - Background Music (BGM)—External
- 1.5 Attended Features
  - Trunk Answer From Any Station (TAFAS)
- 1.14 Paging Features
  - Paging

### **User Manual Reference**

- 4.3.56 Paging — Answer
- 4.3.57 Paging Deny



- 4.3.58 Paging and Transfer
- 4.3.78 Trunk Answer From Any Station (TAFAS)
- 4.4.2 Background Music (BGM) — External
- 4.5.9 KX-T7235 Display Features - System Feature Access Menu
- 4.5.12 KX-T7431 / KX-T7433 / KX-T7436 Display Features - System Feature Access Menu

## 4.3.56 Paging — Answer

Allows you to answer an announced page at any extension within the system.

### Answering a page sent through a built-in speaker

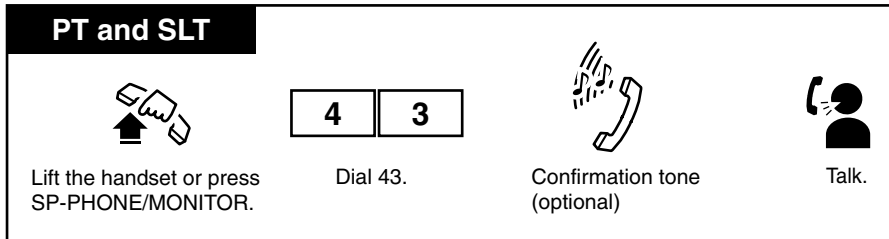

### Answering a page sent through a particular external pager

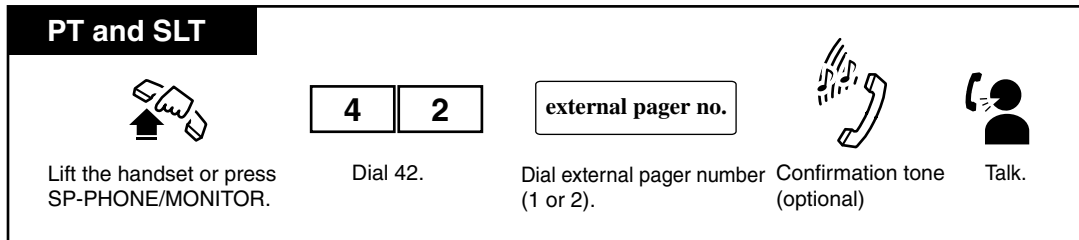

### Conditions

- Only extensions within the paged group can answer "Paging — Group."
- A confirmation tone is sent to extensions, when the page is made. Eliminating the tone is programmable <Section 2.2 Tenant, "Confirmation Tone for Station or External Paging" in the Programming Guide>.
- With the KX-T7431, KX-T7433, KX-T7436 or KX-T7235, you can execute this feature using the display operation.

### Programming Guide References

- 2.3 Numbering Plan
  - External Paging Answer / TAFAS Answer
  - Station Paging Answer
- 2.8 System Option
  - Confirmation tone for Call Pickup, Paging, Paging-Answer, TAFAS-Answer, Hold Retrieve and Call Park Retrieve
- 3.4 Paging Group
  - Paging Group No.

– Extension Group No.

### **Features Guide References**

1.14 Paging Features

- Paging

### **User Manual References**

- 4.3.55 Paging
- 4.5.9 KX-T7235 Display Features - System Feature Access Menu
- 4.5.12 KX-T7431 / KX-T7433 / KX-T7436 Display Features - System Feature Access Menu

## 4.3.57 Paging Deny

Allows you to deny receiving paging announcement through the built-in speakers of your PTs.

### Setting

PT



Lift the handset or press  
SP-PHONE/MONITOR.

7	2	1	1
---	---	---	---

Dial 7211.



Confirmation tone  
and dial tone



Hang up or press  
SP-PHONE/MONITOR.

<PT Display Example>

Paging Deny On

### Canceling

PT



Lift the handset or press  
SP-PHONE/MONITOR.

7	2	1	0
---	---	---	---

Dial 7210.



Confirmation tone  
and dial tone



Hang up or press  
SP-PHONE/MONITOR.

<PT Display Example>

Paging Deny Off

### Conditions

- **Distinctive Dial Tone**  
When this feature is assigned to the extension, the extension user may hear a distinctive dial tone (dial tone 2) after going off-hook depending on System Programming <Section 2.8 System Option, "15. Special dial tone after setting feature" in the Programming Guide>.
- With the KX-T7431, KX-T7433, KX-T7436 or KX-T7235, you can execute this feature using the display operation.

### Programming Guide References

- 2.3 Numbering Plan

- Paging Deny Set / Cancel
- 2.8 System Option
  - Special dial tone after setting feature

### **Features Guide References**

#### 1.14 Paging Features

- Paging

### **User Manual References**

- 4.3.55 Paging
- 4.5.9 KX-T7235 Display Features - System Feature Access Menu
- 4.5.12 KX-T7431 / KX-T7433 / KX-T7436 Display Features - System Feature Access Menu

### 4.3.58 Paging and Transfer

You can transfer a call after making a paging announcement via Paging — All, Paging — External, or Paging — Group.

#### Using Paging — All

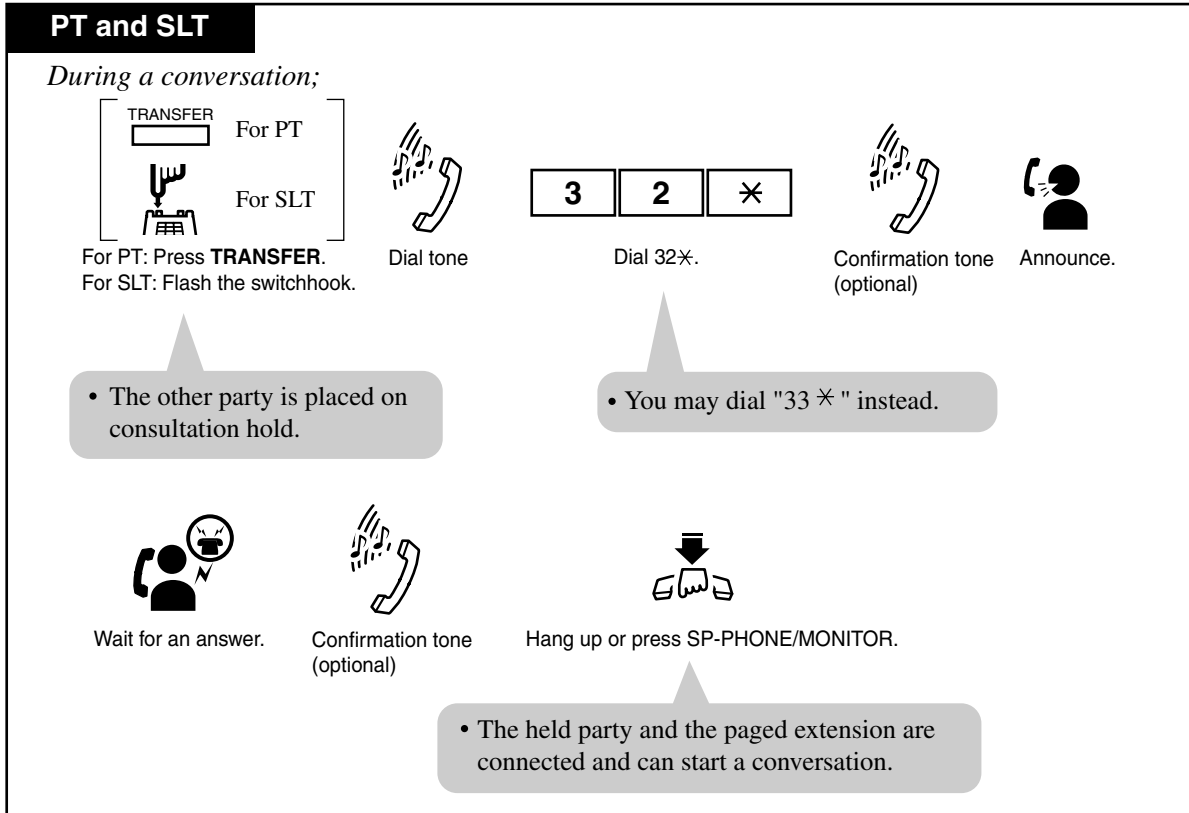

## Using Paging — External: to all external pagers

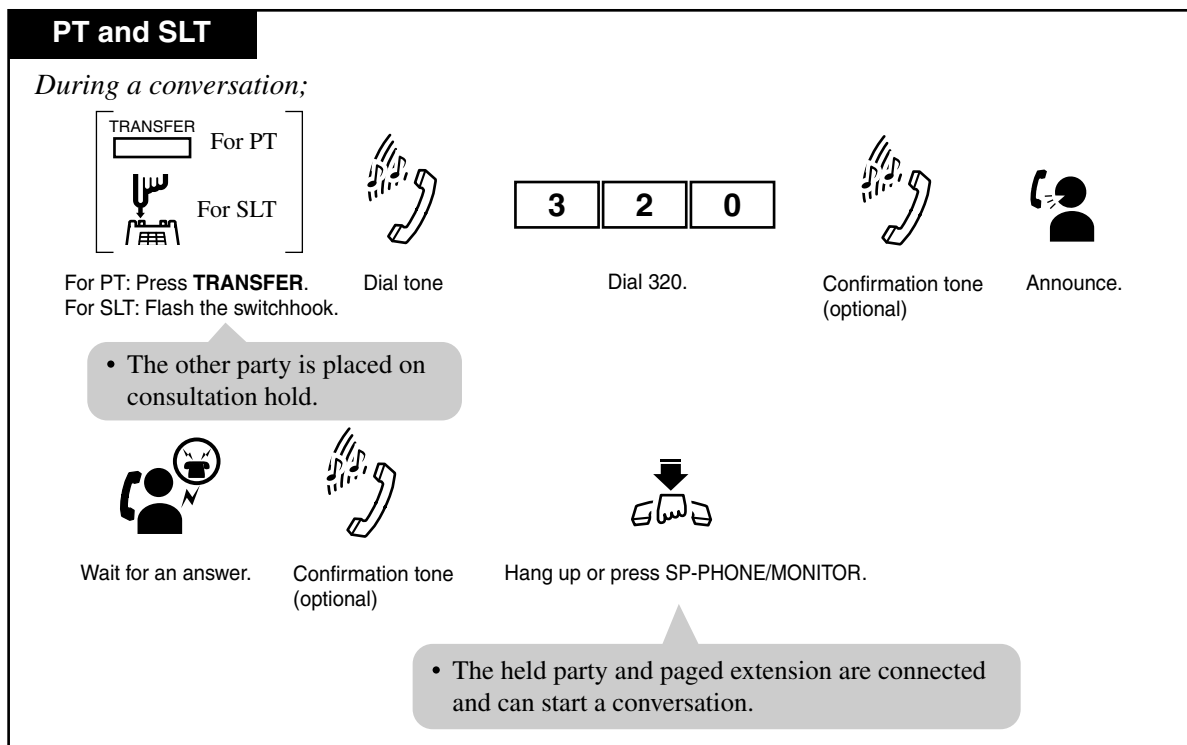

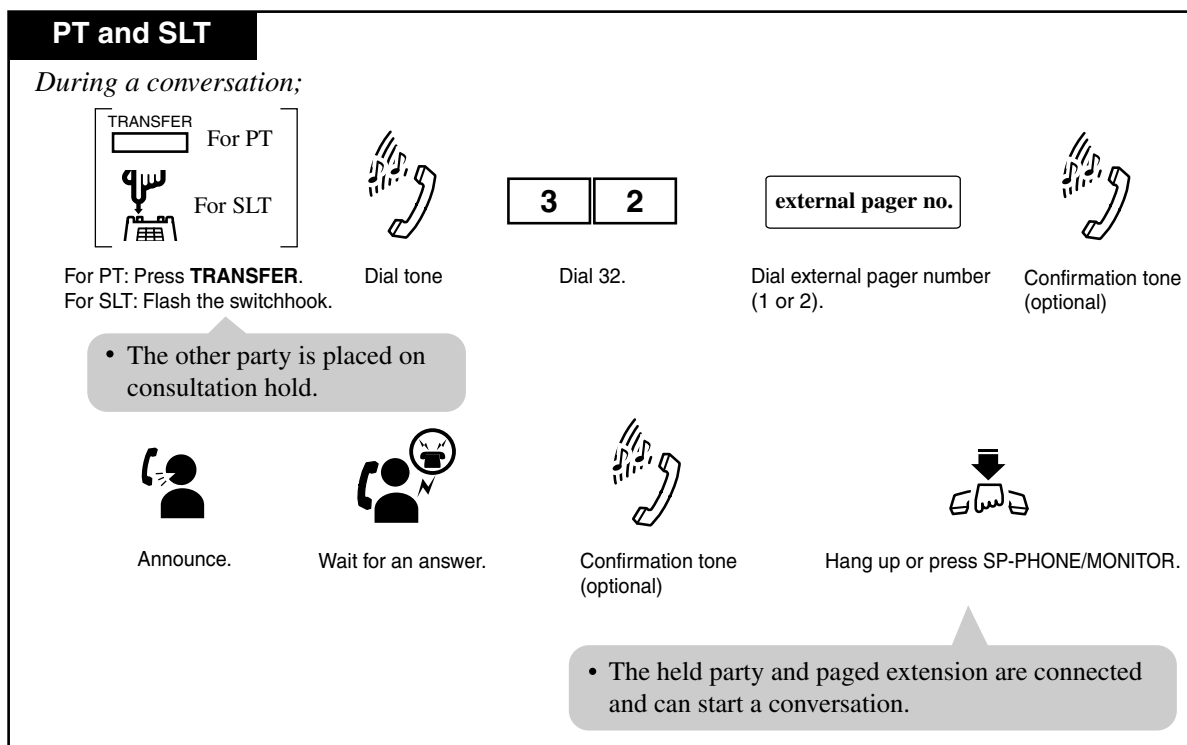

## Using Paging — External: to a particular external pager



## Using Paging — Group: to all paging groups (01-16)

PT and SLT

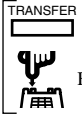
*During a conversation;*

 For PT  
 For SLT





3

3

#











For PT: Press **TRANSFER**.

For SLT: Flash the switchhook.

Dial tone

Dial 33 #.

Confirmation tone (optional)

Announce.

Wait for an answer.

Confirmation tone (optional)

Hang up or press SP-PHONE.



- The other party is placed on consultation hold.

- The held party and the paged extension are connected and can start a conversation.

## Using Paging — Group: to a particular paging group

PT and SLT

*During a conversation;*

 For PT  
 For SLT



3

3

paging group no.



For PT: Press **TRANSFER**.

For SLT: Flash the switchhook.

Dial tone

Dial 33.

Enter a paging group number (01 through 16).

Confirmation tone (optional)

- The other party is placed on consultation hold.



Announce.



Wait for an answer.



Confirmation tone (optional)



Hang up or press SP-PHONE.

- The held party and the paged extension are connected and can start a conversation.



## 4.3.59 Paralleled Telephone Connection

A Proprietary Telephone (PT) can be connected in parallel with a Single Line Telephone (SLT). This feature allows you to enable or disable SLT ringing. When a parallel connection is made, either telephone can be used.

### To enable / disable SLT ringing

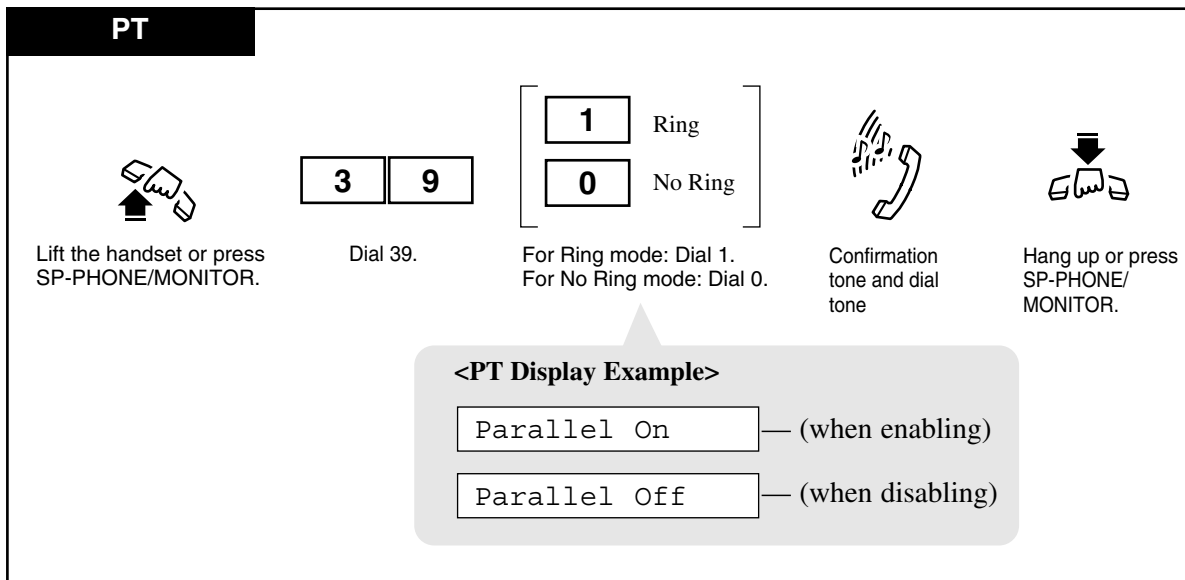

### Conditions

- The default is "Parallel Off (No ring)."
- The PT can be used to perform normal operations whether or not the SLT is set to ring.
- **When receiving a call:**
  - If SLT ringing is enabled, then both the PT and the SLT will ring except when the PT is in "Hands-free Answerback" mode or Voice-Calling mode with the "Alternate Calling —Ring/Voice" feature.
  - If SLT ringing is disabled, then the PT rings but the SLT does not. However, the SLT can answer the call.
- When the SLT is in use, the display and the indicators of the PT will work in the same way as if the PT is in use.
- In the DPT + SLT combination, if one telephone goes off-hook while the other telephone is on a call, the call is switched to the former.
- In the APT + SLT combination, if one telephone goes off-hook while the other telephone is on a call, a 3-party call is established. If one user goes on-hook, the other user continues the call.
- The "XDP<sup>®</sup>1" feature is available. Please refer to "EXtra Device Port (XDP)" in Section "1.1 System Expansion" of the Features Guide.

- This feature is only available for PT extensions that are connected to a DHLC or HLC card.
- With the KX-T7431, KX-T7433, KX-T7436, or KX-T7235, you can execute this feature using the display operation.

### **Installation Manual References**

- 2.4.12 Parallel Connection of the Extensions

### **Programming Guide References**

- 1.4 Extension Port Assignment
  - Parallel / XDP (DHLC card)
  - Parallel / XDP (HLC card)

### **Features Guide References**

- 1.1 System Expansion
  - EXtra Device Port (XDP)
- 1.3 System Features
  - Paralleled Telephone
- 1.6 Originating Features
  - Alternate Calling—Ring/Voice

### **User Manual References**

- 4.5.9 KX-T7235 Display Features - System Feature Access Menu
- 4.5.12 KX-T7431 / KX-T7433 / KX-T7436 Display Features - System Feature Access Menu

---

<sup>\*1</sup> XDP (eXtra Device Port) expands the number of telephones available in the system by allowing an extension port to contain two telephones. For more details, please consult your dealer.

## 4.3.60 PDN Call

If an SDN button (which corresponds with the PDN of another extension) is assigned on your PT, you can call that extension with a simple operation.

### Making a PDN call

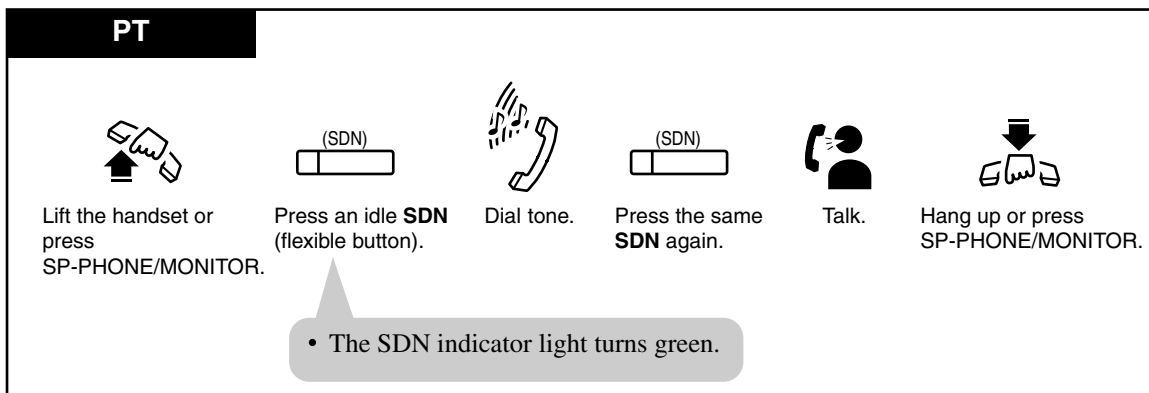

## Screened Call Transfer

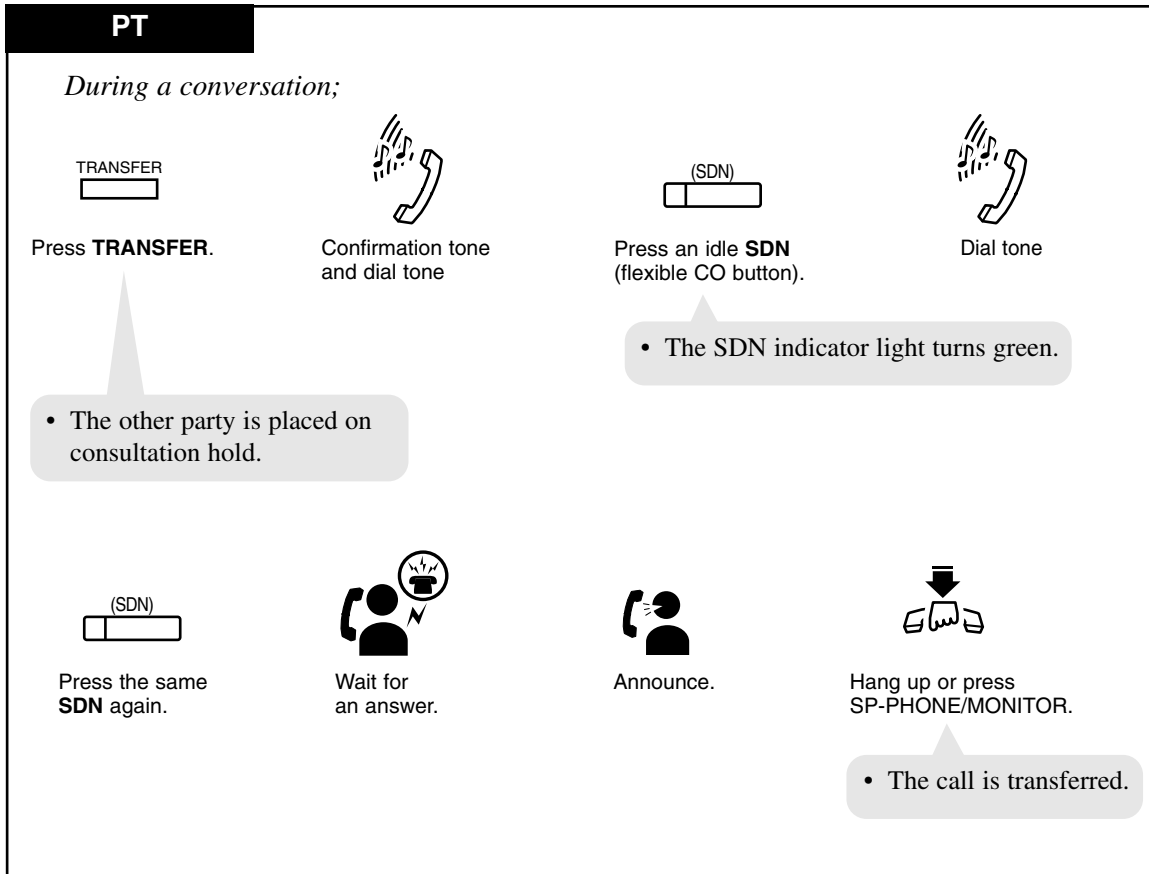

## Unscreened Call Transfer

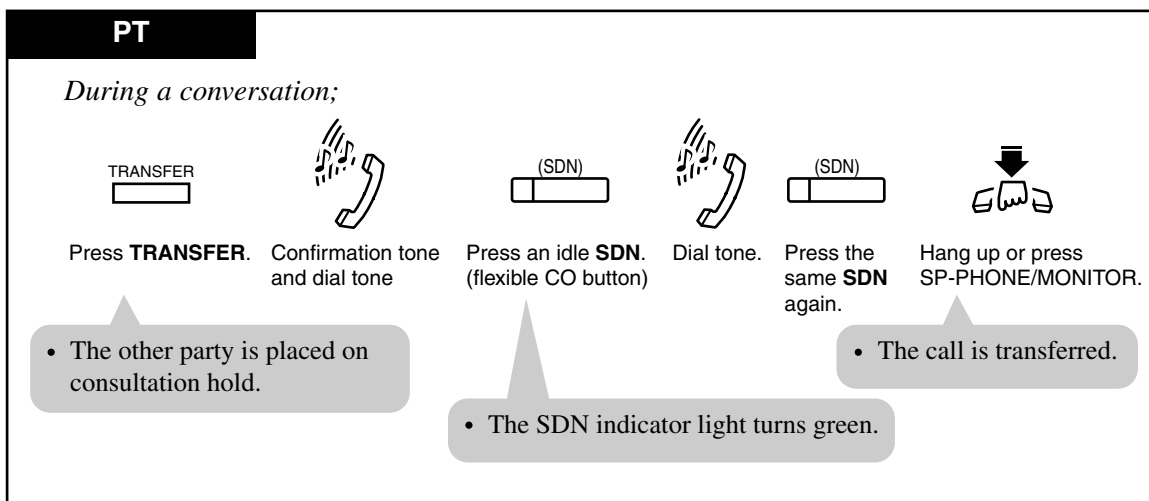

## Conditions

- PT(DN)  
**SDN button**  
An SDN button can be assigned to a flexible CO button on a DN type PT by Station, User or System Programming.
- PT(DN)  
**FWD/DND Override**  
The call originated by this feature overrides FWD/DND (Call Forwarding/Do Not Disturb) feature assigned on the PDN owner extension.
- PT(DN)  
A call made by this feature rings the destination PDN button immediately even if delayed ringing or no ring is set on that PDN button. Please refer to Section "2.2.9 PDN/SDN Button Delayed Ringing Assignment."

## Programming Guide References

- 4.3 Extension Line
  - CO Key

## Features Guide References

- 1.6 Originating Features
  - PDN Call
- 1.11 Transferring Features
  - Ringing Transfer
- 1.16 Button Features
  - Button, Line Access

## User Manual References

- 2.2.3 Flexible Button Assignment
- 2.2.9 PDN/SDN Button Delayed Ringing Assignment
- 3.2.5 [005] Flexible CO Button Assignment
- 4.3.68 Ringing Transfer

### 4.3.61 Phantom Extension

Allows you to route calls to a phantom extension. The call arrives at the extension who has the corresponding Phantom button. A flexible CO button can be assigned as the Phantom button. The lighting patterns of Phantom button and status are as follows.

Off: Idle

Red: You are calling a phantom extension.

Flashing green rapidly: Incoming call

#### To call a phantom extension

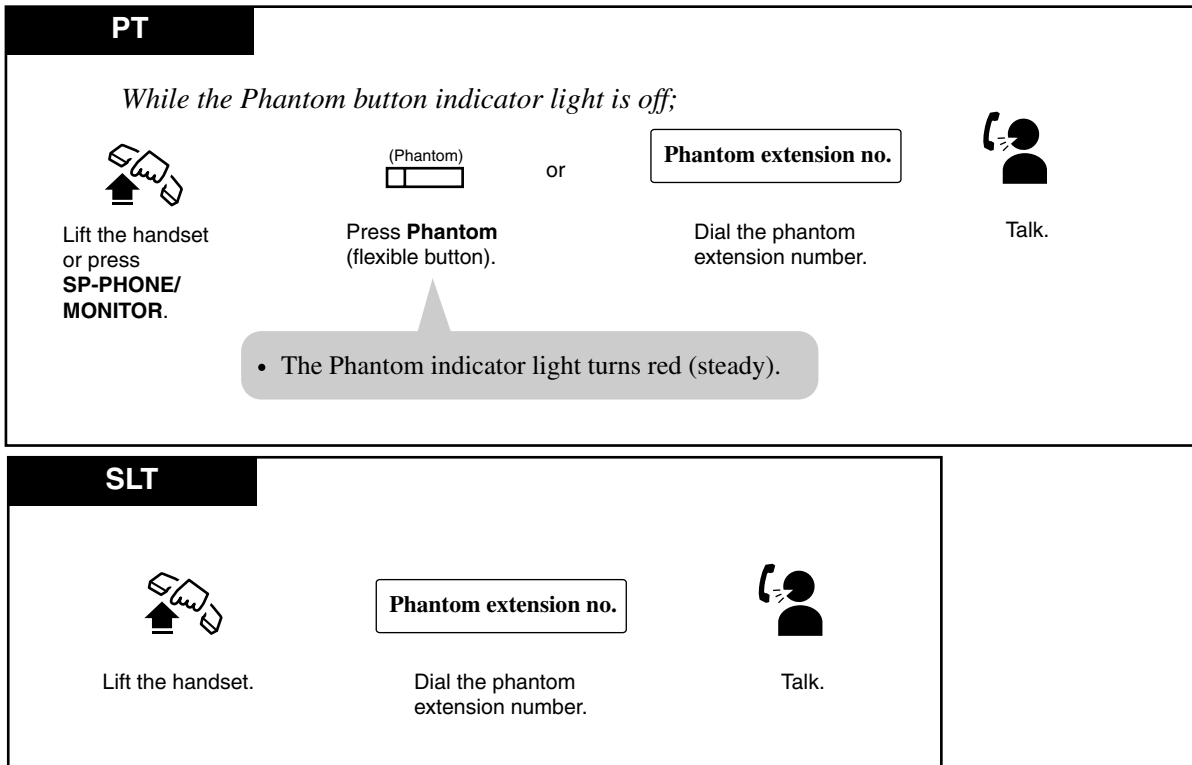

## To transfer a call to a phantom extension (Screened Call Transfer)

**PT**

*During a conversation;*

TRANSFER

Press **TRANSFER**.

Confirmation tone

Dial tone

(Phantom)

Press **Phantom** (flexible button).

Ringback tone

- The other party is placed on consultation hold.
- You may dial the phantom extension number instead.

Wait for an answer.

Announce.

Hang up or press SP-PHONE/MONITOR.

- The call is transferred.

**SLT**

*During a conversation;*

Flash the switchhook.

Confirmation tone

Dial tone

phantom extension no.

Dial the destination phantom extension number (3 or 4 digits).

Ringback tone

- The other party is placed on consultation hold.

Wait for an answer.

Announce.

Hang up.

- The call is transferred.

### To transfer a call to a phantom extension (Unscreened Call Transfer)

**PT**

*During a conversation;*

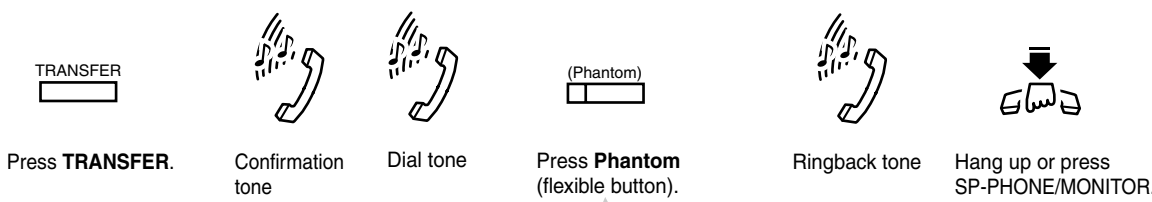

Press **TRANSFER**.

Confirmation tone

Dial tone

(Phantom)

Press **Phantom** (flexible button).

Ringback tone

Hang up or press SP-PHONE/MONITOR.

- The other party is placed on hold. consultation hold.
- Ringing starts at the destination extension.
- The call is transferred.

**SLT**

*During a conversation;*

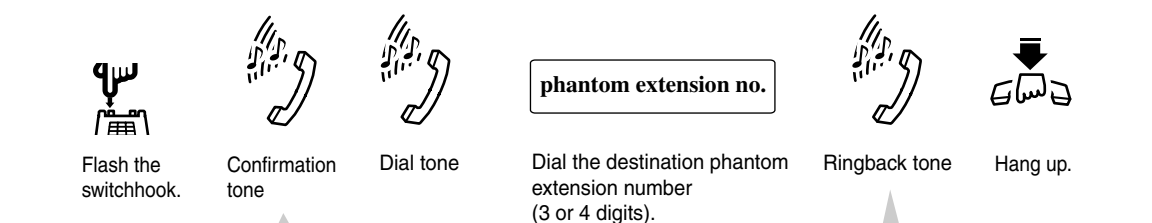

Flash the switchhook.

Confirmation tone

Dial tone

phantom extension no.

Dial the destination phantom extension number (3 or 4 digits).

Ringback tone

Hang up.

- The other party is placed on hold. consultation hold.
- Ringing starts at the destination extension.



## To answer a phantom extension call

**PT**

*While the Phantom button indicator light is flashing green, and INTERCOM button associated with the incoming call is flashing green or CO/DN button associated with the incoming call is flashing red;*

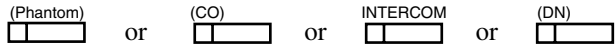

Press **Phantom** (flexible button).

Press **CO** or **INTERCOM** or **DN** associated with the incoming call.

**SLT**



Lift the handset.

### Conditions

- A phantom number must be assigned by System Programming before assigning the Phantom button by Station, User or System Programming.
- If several extensions have the same phantom extension number, they will ring simultaneously.
- A maximum of 448 phantom numbers can be assigned by System Programming.
- **PT**  
The Phantom button cannot be used for feature settings such as "Call Forwarding."
- **PT**  
**One-Touch Transfer by Phantom button**  
If Automatic Hold is enabled by COS programming, you can transfer the call without first pressing the TRANSFER button, that is, simply by pressing a Phantom button.
- **PT**  
An incoming CO call may come in on a Phantom button directly depending on System Programming. In this case, a CO button (S-CO, G-CO or L-CO) or a PDN button associated with the incoming CO call should be assigned on a PT.

### Programming Guide References

- 2.4 Class of Service (COS)
  - Automatic Hold
- 4.2 Trunk Line
  - Destination – Day / Night / Lunch / Break
- 4.3 Extension Line

- CO Key
- 5.3 Phantom Extension

### **Features Guide References**

- 1.3 System Features
  - Phantom Extension
- 1.8 Ringing Features
  - Log-In/Log-Out
- 1.10 Holding Features
  - Automatic Hold—For Transfer

### **User Manual References**

- 2.2.3 Flexible Button Assignment
- 2.2.10 Phantom Button Ringing On/Off Assignment
- 3.2.5 [005] Flexible CO Button Assignment

## 4.3.62 Pickup Dialing (Hot Line)

You can make a call to the pre-programmed party simply by going off-hook.

### Programming the phone number

PT and SLT



Lift the handset or press  
SP-PHONE/MONITOR.

7	4	2
---	---	---

Dial 742.

phone no.

Enter the phone number.

#

Dial #.



Confirmation  
tone and  
dial tone



Hang up or press  
SP-PHONE/MONITOR.

- You must dial a line access code (9 or 801 through 848) as the first digit when storing an outside phone number.

### Setting / Canceling

PT and SLT



Lift the handset or press  
SP-PHONE/MONITOR.

7	4	1	To set
7	4	0	To cancel

To set: Dial 741.  
To cancel: Dial 740.



Confirmation tone  
and dial tone



Hang up or press  
SP-PHONE/MONITOR.

### Dialing

PT and SLT



Lift the handset or press  
SP-PHONE/MONITOR.



Wait for an answer.



Talk.

### Conditions

- This feature does not work if you go off-hook to answer an incoming call or retrieve a call on hold.
- This feature does not work if a message notification is left on your extension.
- Up to 24 digits, consisting of "0 through 9" "\*" and P [Pause] can be stored. "#" cannot be stored.

- During the waiting time after going off-hook, you can dial another party and override this feature. This waiting time (between going off-hook and connecting with the called line) can be changed by System Programming (Default: 1 second).
- **PT**  
Regarding the PT with a PF12 button, the number stored in the PF12 button is used for Pickup Dialing.
- **Distinctive Dial Tone**  
When this feature is assigned to the extension, the extension user may hear a distinctive dial tone (dial tone 2) after going off-hook depending on System Programming <Section 2.8 System Option, "15. Special dial tone after setting feature" in the Programming Guide>.
- With the KX-T7431, KX-T7433, KX-T7436 or KX-T7235, you can execute this feature using the display operation.

### Programming Guide References

- 2.3 Numbering Plan
  - Pickup Dialing Program / Set / Cancel
- 2.5 System Timer
  - Pickup Dial Waiting Time
- 2.8 System Option
  - Special dial tone after setting feature
- 4.3 Extension Line
  - PF key
  - [Pickup Dialing] Mode
  - [Pickup Dialing] Dial

### Features Guide References

- 1.7 Dialing Features
  - Automatic Station Release
  - Pickup Dialing (Hot Line)

### User Manual References

- 4.5.9 KX-T7235 Display Features - System Feature Access Menu
- 4.5.12 KX-T7431 / KX-T7433 / KX-T7436 Display Features - System Feature Access Menu



## 4.3.63 Privacy Release

Allows you to establish a three-party conference call while connected to an existing call.

### Setting

PT

*During a conversation with an outside party, to allow another extension to join the conversation;*

<p>-at your extension</p> <div style="text-align: center;">(CO) </div> <p>Press the corresponding <b>CO</b>.</p>	<p>-at the other extension</p> <div style="text-align: center;">(CO) </div> <p>Press the flashing <b>CO</b> within five seconds.</p>	 <p>Confirmation tone (optional)</p>
---	---	---

- The corresponding CO indicator light flashes green rapidly.

- A three-party conference is now established.

### To leave the conference

PT



Hang up or press  
SP-PHONE/MONITOR.

- The other two parties may continue their conversation.

### To terminate one party and talk to the other

PT

(CO)  

or

INTERCOM  

or

(PDN)  

Press **CO** or **INTERCOM** or **PDN**  
of the desired party.

## Conditions

- PT  
The CO button pressed to join the conversation needs to be assigned as a Single-CO (S-CO) button.
- PT  
After the user presses the CO button, the CO indicator light of the other extension flashes rapidly for only 5 seconds. Pressing the CO button again gives you an additional 5 seconds.
- PT  
This feature overrides "Data Line Security" and "Executive Busy Override Deny."
- PT  
When a 2-party call is changed to a 3-party conference call and vice versa, a confirmation tone is sent to all three parties. Eliminating the tone is programmable.

## Programming Guide References

- 2.8 System Option
  - Confirmation tone for Override, Barge-in, Conference and Privacy Release
- 4.3 Extension Line
  - CO Key
- 4.4 DSS Console
  - DSS Key

## Features Guide References

- 1.9 Answering Features
  - Executive Busy Override Deny
- 1.12 Conversation Features
  - Conference, 3-Party
  - Data Line Security
  - Privacy, Automatic
  - Privacy Release

## User Manual References

- 2.2.3 Flexible Button Assignment
- 3.2.5 [005] Flexible CO Button Assignment

---

## 4.3.64 Pulse to Tone Conversion

You can change the dialing mode from Pulse to Tone temporarily to access services such as computer telephone services, Voice Mail, etc., that require a tone.

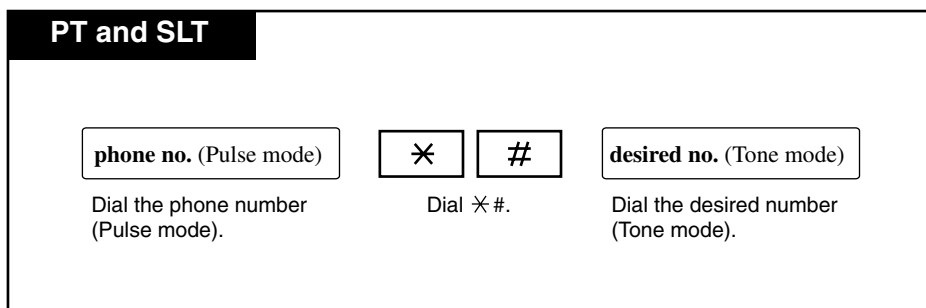

### Conditions

- This feature works only for CO lines set to Pulse Dialing mode.
- You cannot change the dialing mode from Tone to Pulse.

### Programming Guide References

- 4.2 Trunk Line
  - Dial Type

### Features Guide References

- 1.3 System Features
  - Dial Type Selection
- 1.12 Conversation Features
  - Pulse to Tone Conversion

### User Manual References

None

## 4.3.65 Quick Dialing

Allows you to make a quick dial call by dialing a pre-assigned quick dial number. For example, Quick Dialing is convenient for room service calls in a hotel.

### Dialing

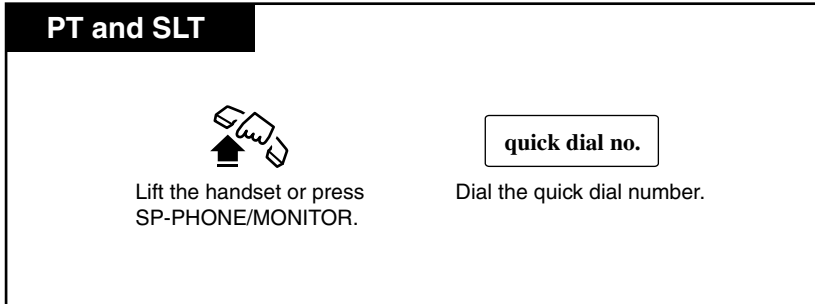

### Conditions

- Up to eight quick dial numbers can be stored by System or User Programming.
- To utilize this feature, please assign a feature number for "Quick dial 1-8" first by System Programming <Section 2.3 Numbering Plan, "63-70 Quick dial 1-8" in the Programming Guide. Then please assign a quick dial number by User Programming <Section "3.2.9 [009] Quick Dial Number Set" in this manual> or System Programming <Section 5.5 Quick Dialing in the Programming Guide>.

### Programming Guide References

- 2.3 Numbering Plan
  - Quick dial 1 - Quick dial 8
- 5.5 Quick Dialing

### Features Guide References

- 1.7 Dialing Features
  - Quick Dialing

### User Manual References

- 3.2.9 [009] Quick Dial Number Set





## 4.3.66 Redial

"Redial" feature can be categorized as the following two types.

Type	Description
<b>Last Number</b>	Saves the last telephone number dialed to a CO line and allows the extension user to dial the same number again.
<b>Saved Number</b>	Allows the PT user to save a telephone number while in conversation on a CO line or while hearing a busy tone and redial the number afterwards. The saved number can be redialed until another number is stored.

### Redialing the last outside phone number you dialed (Last Number Redial)

PT	SLT
 Lift the handset or press SP-PHONE/MONITOR.	 Lift the handset.
<div style="display: flex; align-items: center; justify-content: center;"> <div style="border: 1px solid black; padding: 2px 10px; margin-right: 5px;">REDIAL</div> <span style="margin: 0 5px;">or</span> <div style="border: 1px solid black; padding: 2px 10px; margin-left: 5px;">#</div> </div> Press <b>REDIAL</b> .      Dial #.	<div style="border: 1px solid black; padding: 2px 10px; margin: 0 auto;">#</div> Dial #.

### Saving the outside phone number for redialing (Saved Number Redial)

PT
<i>During a conversation or while hearing a busy tone;</i>
<div style="display: flex; justify-content: space-around; align-items: center;"> <div style="text-align: center;"> <div style="border: 1px solid black; padding: 2px 10px; margin-bottom: 2px;">AUTO DIAL</div> <div style="border: 1px solid black; padding: 2px 10px; margin-bottom: 2px;">[ ]</div> <div style="margin-bottom: 2px;">STORE</div>                     Press <b>STORE</b>.                 </div> <div style="text-align: center;"> <div style="border: 1px solid black; padding: 2px 10px; margin-bottom: 2px;">(SAVE)</div> <div style="border: 1px solid black; padding: 2px 10px; margin-bottom: 2px;">[ ]</div>                     Press <b>SAVE</b> (flexible button).                 </div> </div>

### Dialing

PT	
 Lift the handset or press SP-PHONE/MONITOR.	<div style="border: 1px solid black; padding: 2px 10px; margin: 0 auto;">(SAVE)</div> Press <b>SAVE</b> (flexible button).

## Conditions

### [General]

- Up to 24 digits (excluding the CO line access code) can be stored and redialed.
- "×," "#," "PAUSE," and "INTERCOM" (for secret dialing) are counted as one digit.
- If "Full One-Touch Dialing" feature is enabled at the extension, there is no need to go off-hook, before pressing the REDIAL or SAVE button.

### [Last Number]

- The memorized telephone number is replaced by a new one if at least one digit sent to a CO line is dialed. Dialing a CO line access code alone does not change the memorized number.
- **PT**  
If you hear a busy tone when attempting to redial, select another line and press the REDIAL button.

### [Saved Number]

- **SAVE button**  
If the SAVE button is not provided on your PT, it is possible to assign a flexible button (CO, DSS, PF) to be the SAVE button by Station, User or System Programming.

## Programming Guide References

- 2.3 Numbering Plan
  - Redial
- 4.3 Extension Line
  - CO Key
  - PF Key
- 4.4 DSS Console
  - DSS Key
  - PF Key

## Features Guide References

- 1.7 Dialing Features
  - Redial
- 1.16 Button Features
  - Button, Flexible

## User Manual References

- 2.2.3 Flexible Button Assignment

- 2.2.4 Full One-Touch Dialing Assignment
- 3.2.5 [005] Flexible CO Button Assignment

## 4.3.67 Released Link Operation

When Released Link Operation is enabled by System Programming, you will be automatically released from a call (extension, outside) after transferring it to the destination, if the destination extension is idle. This feature simplifies the transfer operation by eliminating the need for going on-hook or pressing the RELEASE button after transferring the call.

This feature is convenient for extension users, such as Operators, who handle a large volume of calls.

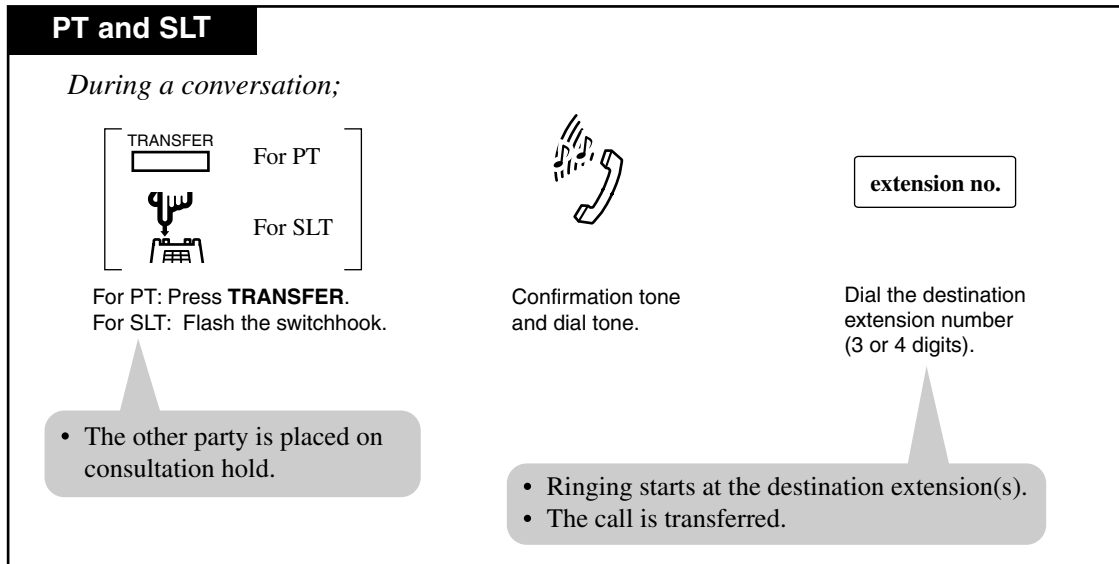

### Conditions

- **Class of Service**  
Class of Service programming determines the extension that can perform this feature.
- Released Link Operation functions when transferring a call to the ordinary extensions or floating extensions (extension group, incoming group, phantom extensions).
- If the destination party is busy, Camp-on Transfer is set by going on-hook.
- **SLT**  
The SLT extension user cannot establish a conference call, if "Released Link Operation" is enabled by System Programming.

### Programming Guide References

- 2.4 Class of Service (COS)  
– Released Link Operation

### Features Guide References

- 1.3 System Features
  - Released Link Operation

1.11 Transferring Features

- Call Transfer

**User Manual References**

None

### 4.3.68 Ringing Transfer

Allows a DN type PT user to transfer a call on the SDN button (flexible button) to the owner extension of the SDN which has the PDN button associated with it simply by pressing the SDN button.

Ringling transfer can be done either with or without announcement.

#### Screened Call Transfer

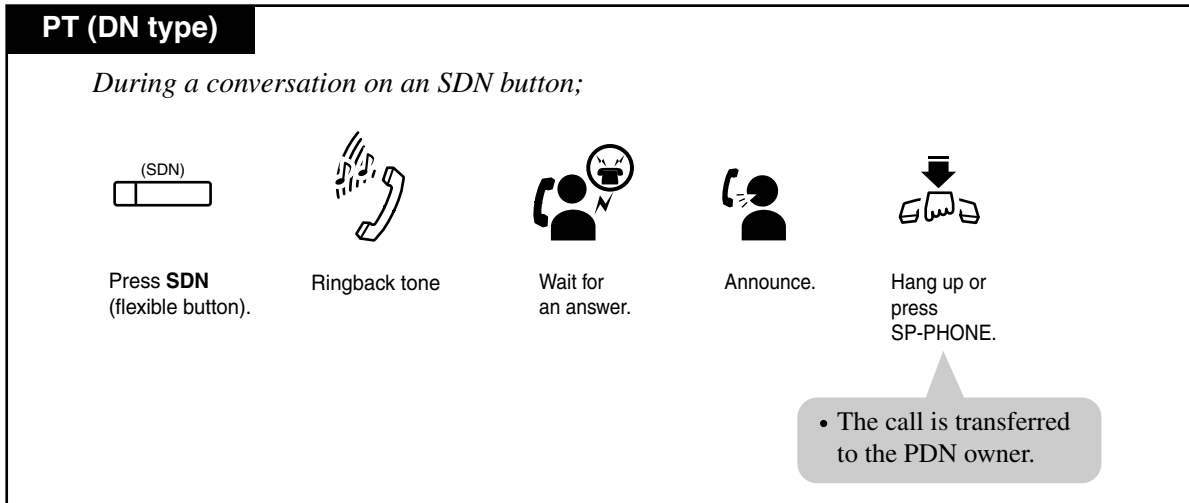

#### Unscreened Call Transfer

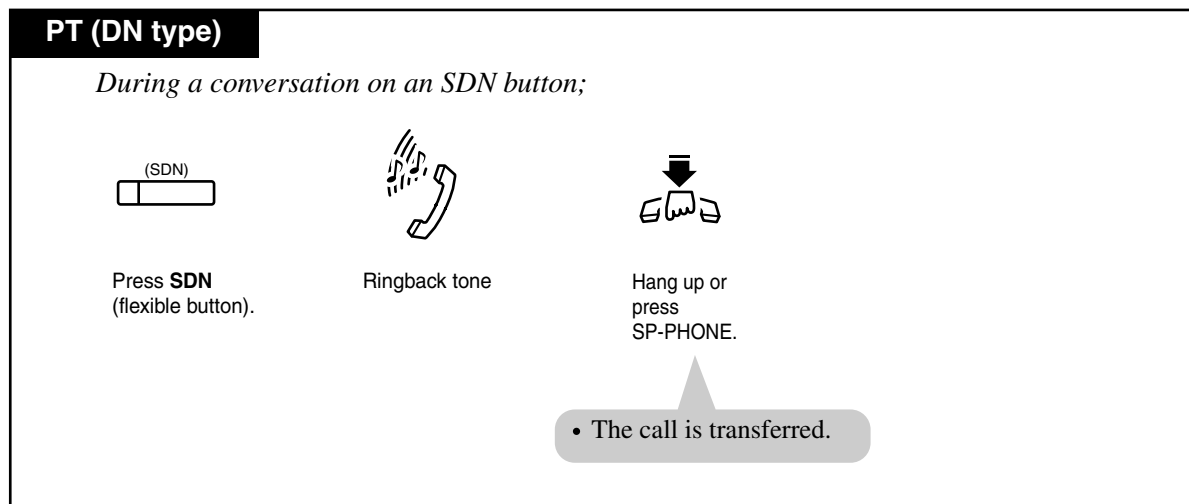

## Conditions

- **PT(DN)**  
If the owner extension is in the Station or User Programming mode, Ringing Transfer does not function.
- **FWD/DND Override**  
The call transferred by this feature rings the PDN owner extension even if Call Forwarding or Do Not Disturb feature is assigned on it.
- **PT(DN)**  
A call made by this feature rings the destination PDN button immediately even if delayed ringing or no ring is set on that PDN button. Please refer to Section "2.2.9 PDN/SDN Button Delayed Ringing Assignment."

## Programming Guide References

- 4.3 Extension Line  
– CO Key

## Features Guide References

- 1.11 Transferring Features
  - Ringing Transfer

## User Manual References

- 2.2.3 Flexible Button Assignment
- 2.2.9 PDN/SDN Button Delayed Ringing Assignment
- 3.2.5 [005] Flexible CO Button Assignment

### 4.3.69 Secret Busy Override

You can interrupt an existing call (either "between two inside parties" or "between an inside party and an outside party") without informing the other party.  
Some extensions may be restricted from performing this function.

#### To interrupt an existing call

**7230 / 7235 / 7433 / 7436**

*If you hear a busy tone after making an intercom call;*



Lift the handset or press SP-PHONE/MONITOR.

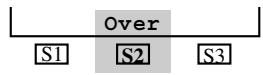

Press **Over (S2)**.

- Party A and Party B in conversation do not know that their conversation is being monitored by Party C.

**PT and SLT**

*If you hear a busy tone after making an intercom call;*



Lift the handset or press SP-PHONE/MONITOR.



Dial **2**.

- Party A and Party B in conversation do not know that their conversation is being monitored by Party C.

#### To change to the three-party conference call

**PT**

*When "Secret Busy Override" is executed.*

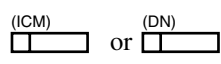

Press the **ICM** or **DN** corresponding to the desired caller.

A three-party conference is now established.



## Conditions

- **Class of Service (COS) programming**  
COS programming <Section 2.4 Class of Service (COS), "Busy Override" and "Secret Busy Override" in the Programming Guide> determines the extension users who can perform this feature.
- This feature does not work if "Executive Busy Override Deny" or "Data Line Security" is set at either one of two extensions or both of them.
- Party A and Party B are in conversation.  
This feature works as follows so that both party A and party B do not know that their conversation is being monitored by Party C:
  - The display and LED indicator at party A and party B show the status of a 2-party conversation.
  - A confirmation tone is not sent to either party A or party B even if it is enabled by System Programming.
  - The speech path from the party C to the party A and party B is not connected.
- If either one of two extensions or both of them is released from the call to perform other operations such as making a call or placing it on hold, this feature is terminated and then a reorder tone is sent to the calling extension.

## Programming Guide References

- 2.3 Numbering Plan
  - Data Line Security Set / Cancel
  - Executive Busy Override Deny Set / Cancel
- 2.4 Class of Service (COS)
  - Busy Override
  - Busy Override Deny
  - Secret Busy Override
- 2.8 System Option
  - Confirmation tone for Override, Barge-in, Conference and Privacy Release

## Features Guide References

- 1.6 Originating Features
  - Secret Busy Override
- 1.9 Answering Features
  - Executive Busy Override Deny
- 1.12 Conversation Features
  - Data Line Security

## User Manual References

- None

## 4.3.70 Secret Dialing

Allows you to conceal all or part(s) of a "System Speed Dialing" or "One-Touch Dialing" number assigned to a flexible button on your PT and DSS Console which normally appears on the display. Additionally, KX-T7431, KX-T7433, KX-T7436 and KX-T7235 Model Telephones are capable of Secret Dialing for "Station Speed Dialing" numbers.

PT

*When storing the phone number;*



Press **INTERCOM** before and after the part you wish to conceal.

**<PT Display Example>**

9-1-[123] . . .

— "123" is not shown on the display when you dial.

### Conditions

- PT  
The secret code, "[" or "]" (pressing the INTERCOM button), are counted as one digit.
- PT  
You can conceal one or more parts of a telephone number.
- PT  
If the phone number "9-1-[123]-456-7890" has been stored, the display shows the following when the call is made:

-1- . . . -456-7890

### Programming Guide References

- 5.2 System Speed Dialing

### Features Guide References

- 1.3 System Features
  - Secret Dialing
- 1.7 Dialing Features
  - One-Touch Dialing
  - System Speed Dialing
- 1.17 Display Features
  - Call Directory

## **User Manual References**

- 2.2.3 Flexible Button Assignment
- 3.2.5 [005] Flexible CO Button Assignment
- 4.3.52 One-Touch Dialing
- 4.3.72 Station Speed Dialing
- 4.3.73 System Speed Dialing

### 4.3.71 Station Program Clear

Allows you to reset the following station features to the default settings.

(a)	<b>Absent Message Capability</b> (The message set on your extension)
(b)	<b>Automatic Callback Busy</b>
(c)	<b>Background Music</b> that has been turned on
(d)	<b>Call Forwarding, Do Not Disturb (DND)</b>
(e)	<b>Call Log, Incoming</b>
(f)	<b>Call Pickup Deny</b>
(g)	<b>Call Waiting (BSS, OHCA, Whisper OHCA)</b>
(h)	<b>Data Line Security</b>
(i)	<b>Executive Busy Override Deny</b>
(j)	<b>Log-out</b>
(k)	<b>Message Waiting</b> (All messages that have been left on your extension by other extension users)
(l)	<b>Paging Deny</b>
(m)	<b>Paralleled Telephone enabled</b>
(n)	<b>Pickup Dialing</b> (The stored telephone number (One-Touch dial on PF12) will be removed)
(o)	<b>Timed Reminder</b>
(p)	<b>Walking Station</b>

#### Clearing the current feature settings

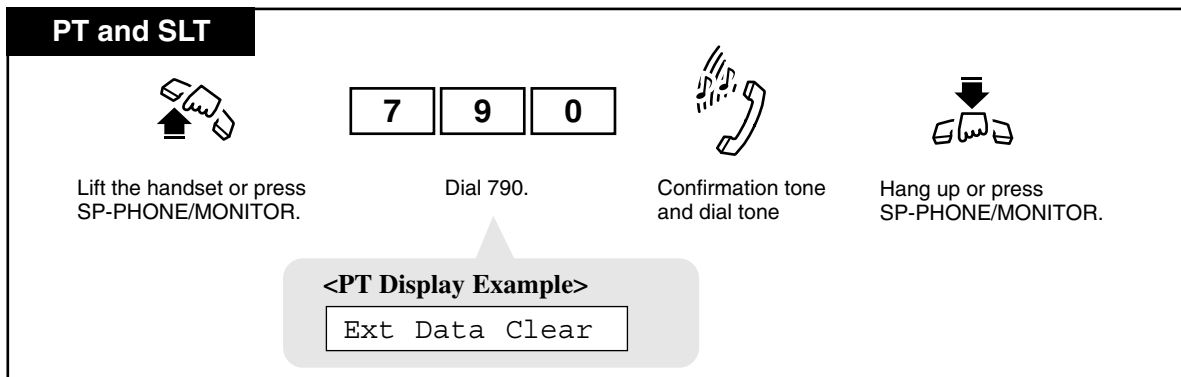

### **Conditions**

- With the KX-T7431, KX-T7433, KX-T7436 or KX-T7235, you can execute this feature using the display operation.

### **Programming Guide References**

- 2.3 Numbering Plan
  - Station Program Clear

### **Features Guide References**

- 1.15 Proprietary Telephone Features
  - Station Program Clear



### **User Manual References**

- 4.5.9 KX-T7235 Display Features - System Feature Access Menu
- 4.5.12 KX-T7431 / KX-T7433 / KX-T7436 Display Features - System Feature Access Menu

## 4.3.72 Station Speed Dialing

Allows you to store up to 10 speed dial numbers at your extension. These numbers are available for your extension only.

### Storing the phone number

PT and SLT						
	<b>3</b>	<b>0</b>	station speed dial no.	desired no.	#	
Lift the handset or press SP-PHONE/MONITOR.	Dial 30.		Enter the station speed dial number (0 through 9).	Enter the desired number.	Dial #.	Confirmation tone and dial tone
						
						Hang up or press SP-PHONE/MONITOR.

### Dialing

PT and SLT		
	<b>3</b>	<b>*</b>
Lift the handset or press SP-PHONE/MONITOR.	Dial 3*.	Enter the station speed dial number (0 through 9).
		station speed dial no.

### Conditions

- You can store an extension number, a telephone number, or a feature number up to 24 digits. Valid digits are "0 through 9," "\*" and PAUSE button. For SLT users, PAUSE (pausing time) can be stored by dialing "\* \*."
- To store the telephone number of an outside party, the line access code (9 or 801 through 848) must be stored as the leading digit.
- "Station Speed Dialing" can be followed by manual dialing to supplement the dialed digits.

#### PT

#### One-Touch Dialing

A PT user may make a call with One-Touch Dialing button, instead of Station Speed Dialing.

- The SLT may be replaced with a PT temporarily to store One-Touch dialing into memory. The Function Buttons (F1 through F10) correspond to speed dial numbers as follows:
  - F1 — 0
  - F2 — 1
  - F3 — 2
  - F4 — 3
  - F5 — 4
  - F6 — 5
  - F7 — 6
  - F8 — 7
  - F9 — 8
  - F10 — 9

### **Programming Guide References**

- 2.3 Numbering Plan
  - Speed Dialing - Station
  - Speed Dialing - Station Programming
- 4.3 Extension Line
  - CO Key
  - PF Key
- 4.4 DSS Console
  - DSS Key
  - PF Key

### **Features Guide References**

- 1.7 Dialing Features
  - One-Touch Dialing
  - Station Speed Dialing

### **User Manual References**

- 2.2.17 Station Speed Dialing Number/Name Assignment [KX-T7235/KX-T7431/KX-T7433/KX-T7436 only]
- 4.5.8 KX-T7235 Display Features - Call Directory
- 4.5.11 KX-T7431 / KX-T7433 / KX-T7436 Display Features - Call Directory

### 4.3.73 System Speed Dialing

Allows you to make a call using speed dial numbers programmed previously. This system supports **2000** speed dial numbers which are available to all extension users.

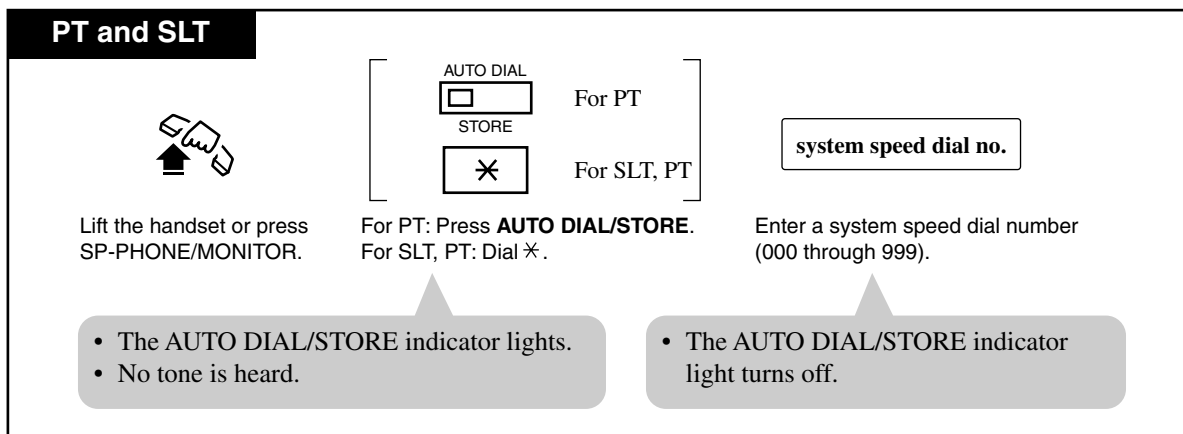

#### Conditions

- System Speed Dial numbers must be stored either by User or System Programming.
- Tenant Service**  
If "Tenant Service" is employed, up to 2000 Speed Dialing codes can be shared among each tenant under the condition of up to 1000 codes per tenant.
- Toll Restriction Override for System Speed Dialing**  
Overriding Toll Restriction for System Speed Dialing can be activated or deactivated per tenant by System Programming.
- PT**  
Continuous use of a speed dial number is possible, if the number is divided when stored.  
<Example>  
If the number is divided and stored in System Speed Dial numbers 001 and 002;  
Press: [AUTO DIAL/STORE] [0] [0] [1] [AUTO DIAL/STORE] [0] [0] [2]
- PT**  
You may press a CO button to select a desired CO line before pressing the AUTO DIAL/STORE button.
- PT**  
**Combination dialing**  
"Speed Dialing," "One-Touch Dialing," "Redial, Last Number/Saved Number" and manual dialing can be used in combination.
- display PT**  
The dialed number appears on the display.
- With the KX-T7431, KX-T7433, KX-T7436 or KX-T7235, you can execute this feature using the display operation.



- **SLT**

If a stored feature number includes "\*" or "#," rotary or pulse SLTs cannot use it.

### **Programming Guide References**

- 2.2 Tenant
  - System Speed Dialing Entries Max.
  - System Speed Dial TRS Level Override
- 2.3 Numbering Plan
  - Speed Dialing - System
- 5.2 System Speed Dialing
  - Name
  - Number

### **Features Guide References**

- 1.6 Originating Features
  - Toll Restriction Override for System Speed Dialing
- 1.7 Dialing Features
  - System Speed Dialing
- 1.17 Display Features
  - Call Directory

### **User Manual References**

- 3.2.2 [001] System Speed Dialing Number Set
- 3.2.3 [002] System Speed Dialing Name Set
- 4.3.77 Toll Restriction Override for System Speed Dialing
- 4.5.8 KX-T7235 Display Features - Call Directory
- 4.5.11 KX-T7431 / KX-T7433 / KX-T7436 Display Features - Call Directory

### 4.3.74 Timed Reminder (Wake-Up Call)

Allows you to set your extension to sound an alarm once or daily at a preset time. Each telephone can be set to generate an alarm tone at a preset time as a reminder. When this feature is set, an alarm tone will ring for 30 seconds (default) at the programmed time.

**Wake-up call**

If a voice message is recorded beforehand, wake-up message is heard instead of an alarm tone when an extension user goes off-hook.

This feature can be activated only once or everyday at a specified time.

**Setting**

PT and SLT



Lift the handset or press  
SP-PHONE/MONITOR.

7

6

1

1

Dial 7611.

hour

Enter the hour  
(01 through 12).

minute

Enter the minute  
(00 through 59).

0

or

1

For AM: Dial 0.  
For PM: Dial 1.

0

or

1

For a one time alarm\*<sup>1</sup>: Dial 0.  
For a daily alarm\*<sup>2</sup>: Dial 1.



Confirmation  
tone and  
dial tone



Hang up or press  
SP-PHONE/MONITOR.

\*<sup>1</sup> An alarm will be heard at the preset time and then the setting is cleared.  
 \*<sup>2</sup> An alarm will be heard daily at the preset time until the setting is changed or canceled.

## Canceling

**PT and SLT**



Lift the handset or press SP-PHONE/MONITOR.

7	6	1	0
---	---	---	---

Dial 7610.



Confirmation tone and dial tone



Hang up or press SP-PHONE/MONITOR.

**<PT Display Example>**  
Alarm Cancelled

## Checking the setting time

**Display PT**



Lift the handset or press SP-PHONE.

7	6	1	2
---	---	---	---

Dial 7612.



Dial tone



Hang up or press SP-PHONE.

- If "10:10 AM" has been set:  
**<PT Display Example>**  

Alarm	10:10AM	— one time
-------	---------	------------

or

Alarm	10:10AM*	— daily
-------	----------	---------

## Stopping the alarm

**PT and SLT**



Lift the handset.

- Pressing any key also stops the alarm (PT only).

**Unanswered Timed Reminder Alert [PT only]**

If an extension user has not responded to the wake-up call, the Alert button (assigned on the "Alert Extension") light turns red.

The Alert button can be used to confirm the not-responded room number and to call back the room.

**To confirm the extension which did not answer the timed reminder alert**

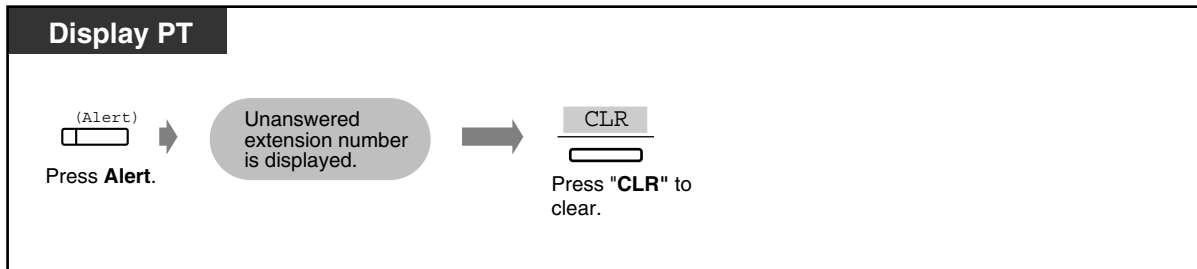

**To call the unanswered extension**

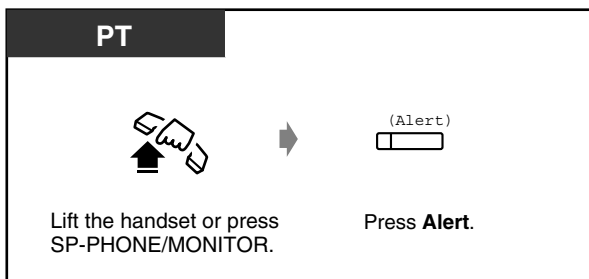

**Conditions**

- **System Time**  
The system clock must be set before the alarm is set.
- If an alarm time has not been set when you confirm the setting, the display shows the following:  

Alarm Not Stored
- Timed Reminder message can be recorded by the Manager or an Operator. ("Outgoing Message (OGM)"). When the alarm is heard, you can hear the message by going off-hook, if it has been recorded. You hear an intermittent tone (dial tone 3) instead of the message in the following cases:
  - a) A DISA Card is not equipped.
  - b) All DISA ports are busy or OUS (Out-of-Service).
  - c) The Timed Reminder message has not been stored.

- If other extension user calls your extension when the alarm is sounding, he will hear a busy tone. However, if your PT is DN type and there is an idle PDN button, the call comes in on that PDN button.  
In this case, the caller hears a ringback tone.
- If you receive an incoming CO call during the alarm, the ringing starts after the alarm stops.
- If you are having a conversation at the time the alarm is set to sound, the alarm starts after the conversation.
- **Station Message Detail Recording (SMDR)**  
SMDR automatically records the detailed Timed Reminder information (data, time, tenant no. extension number, start/answer/no answer). It is programmable by System Programming to print out when the Timed Reminder starts and the alarm is answered or not answered.

The print-out example is shown below.

Date	Time	T	Ext	CO	Dial Number	Ring Duration	Acct code	CC
22/02/00	01:31PM	1	E1017		Timed Reminder / Start			
22/02/00	01:31PM	1	E1017		Timed Reminder / No Answer			
22/02/00	01:31PM	1	E1017		Timed Reminder / Answer			

- Setting a new time clears the preset time.
- **Timed Reminder Ringing Time**  
The alarm tone continues to ring the destination extension for 30 seconds by default. This period of time, ranging from 30 to 240 seconds, can be changed by System Programming <Section 2.5 System Timer "Timed Reminder Ringing Time" in the Programming Guide>.
- **Timed Reminder Arrive Count**  
Timed Reminder ringing is repeated up to 3 times until the destination extension replies it by default. This number of times ranging from 1 to 5 times, can be changed by System Programming <Section 2.5 System Timer "Timed Reminder Arrive Count" in the Programming Guide>.
- **Timed Reminder Arrive Wait Time**  
The interval time between each Timed Reminder ringing is 60 seconds by default. This interval time ranging from 20 to 240 seconds, can be changed by System Programming <Section 2.5 System Timer "Timed Reminder Arrive Wait Time" in the Programming Guide>.
- **Hardware Requirements for a wake-up call**  
To utilize a wake-up call, DISA card (KX-T96191) is required.
- **OGM Recording**  
To utilize a wake-up call, set OGM Type of an OGM Group to "Wake-up." OGM Recording can be done only by the Manager or an Operator.
- **What if a wake-up message is not recorded?**  
An alarm tone is heard instead of a wake-up message.
- The number of extension users who can set this feature is not limited. However, the number of extension users who can hear the wake-up message at a time is limited to a maximum of 56 per DISA card. If the 57th or later extension user goes off-hook to hear the wake-up message, he will hear the alarm tone instead of the wake-up message.

- **Distinctive Dial Tone**  
When this feature is assigned to the extension, the extension user may hear a distinctive dial tone (dial tone 2) after going off-hook depending on System Programming <Section 2.8 System Option, "15. Special dial tone after setting feature" in the Programming Guide>.
- With the KX-T7431, KX-T7433, KX-T7436 or KX-T7235, you can execute this feature using the display operation.
- **Alert button assignment**  
The Alert button can be assigned to a flexible CO button on the Alert extension.
- An Alert extension can be assigned for Day / Night mode per tenant respectively by System Programming <Section 2.2 Tenant, "Alert Extension" in the Programming Guide>.
- **Alert Ringing**  
A Timed Reminder alert can be sent to the alert extension when the extension user does not respond to the Timed Reminder (wake-up call) by System Programming <Section 2.8 System Option, "65. Alert Ringing" in the Programming Guide>.

### **Installation Manual References**

- 2.6.1 DISA Card (KX-T96191)

### **Programming Guide References**

- 2.2 Tenant
  - Alert Extension – Day / Night
- 2.3 Numbering Plan
  - Timed Reminder Confirm / Set / Cancel
- 2.5 System Timer
  - Timed Reminder Ringing Time
  - Timed Reminder Arrive Count
  - Timed Reminder Arrive Wait Time
- 2.8 System Option
  - Special dial tone after setting feature
  - Alert Ringing
- 3.6 OGM Group
  - OGM Type
- 4.3 Extension Line
  - CO Key
- 10.4 SMDR
  - Print out Timed Reminder Information
- 10.7 System Time

## **Features Guide References**

### 1.3 System Features

- Outgoing Message (OGM)
- Station Message Detail Recording (SMDR)

### 1.8 Ringing Features

- Timed Reminder (Wake-Up Call)
- Timed Reminder, Remote (Wake-Up Call)

## **User Manual References**

- 3.2.1 [000] Date and Time Set
- 4.4.6 Outgoing Message (OGM) Record/Playback
- 4.4.11 Timed Reminder, Remote (Wake-Up Call)

## 4.3.75 Toll Restriction Override

There are two types of toll restriction override:

- **Toll Restriction Override by Account Code Entry**
- **Toll Restriction Override for System Speed Dialing**



## 4.3.76 Toll Restriction Override by Account Code Entry

Allows you to temporarily override toll restriction and make a toll call from a toll-restricted telephone. You can carry out this feature by entering an appropriate account code before dialing the telephone number. For operation procedure, please refer to Section "4.3.2 Account Code Entry."

### Conditions

- This feature changes the toll restriction level of the extension to that of the account code entered. This can be used by extension users assigned to restriction levels 2 through 6. Level 1 cannot be changed.
- A "Class of Service" which is assigned to the "Account Code Mode — Verified - Toll Restriction Override" permits the class members to override their toll restrictions.
- Up to 1000 account codes can be programmed for the Verified mode.
- If you do not enter an account code or you enter an invalid account code, standard toll restriction is in effect.

### Programming Guide References

- 2.3 Numbering Plan
  - Account Code
- 2.4 Class of Service (COS)
  - Account Code Mode
- 5.6 Account Code
  - Tenant No.
  - Entry No.
  - Code
  - TRS Level

### Features Guide References

- 1.3 System Features
  - Account Code Entry
- 1.6 Originating Features
  - Toll Restriction
  - Toll Restriction Override by Account Code Entry

### User Manual References

- 4.3.2 Account Code Entry

## 4.3.77 Toll Restriction Override for System Speed Dialing

Allows you to cancel toll restriction in "System Speed Dialing." Normally, calls originated by "System Speed Dialing" are restricted depending on the extension's toll restriction level. Once this option is set, it permits all extension users to make "System Speed Dialing" calls with no restrictions. You can override toll restriction for "System Speed Dialing" through System Programming.

### Conditions

- **Tenant Service**  
This feature can be activated or deactivated on a tenant basis by System Programming.

### Programming Guide References

- 2.2 Tenant
  - System Speed Dial TRS Level Override

### Features Guide References

- 1.6 Originating Features
  - Toll Restriction
  - Toll Restriction Override for System Speed Dialing
- 1.7 Dialing Features
  - System Speed Dialing

### User Manual References

- 4.3.73 System Speed Dialing

### 4.3.78 Trunk Answer From Any Station (TAFAS)

Allows you to answer an incoming CO call, paged through an external pager, from any extension.

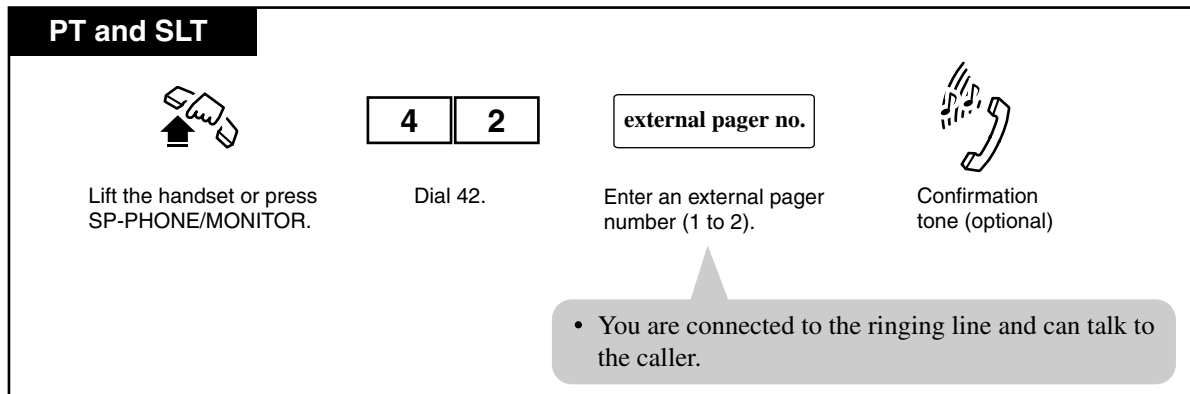

#### Conditions

- TAFAS can be used in the following cases:
  - a) The FDN<sup>\*1</sup> of an external pager is assigned as the DIL 1:1 destination. In this case all incoming CO calls on the specified line will be signaled.
  - b) A DISA caller dials the FDN<sup>\*1</sup> of an external pager.
  - c) The FDN<sup>\*1</sup> of an external pager is assigned as the Intercept Routing destination. In this case incoming CO calls redirected to the destination will be signaled.
  - d) When a TIE call comes in.
- **Confirmation Tone**  
A confirmation tone is sent to the extension user before being connected to the caller. Eliminating the tone is programmable.
- With the KX-T7431, KX-T7433, KX-T7436 or KX-T7235, you can execute this feature using the display operation.

#### Installation Manual References

- 2.8.1 External Pager (Paging Equipment)

#### Programming Guide References

- 2.3 Numbering Plan
  - External Paging Answer / TAFAS Answer
- 2.8 System Option

<sup>\*1</sup> A Floating Directory Number (FDN) is a virtual extension number which appears to be an extension. Please refer to Section "Floating Station" in the Features Guide.

- Confirmation tone for Call Pickup, Paging, Paging-Answer, TAFAS-Answer, Hold Retrieve and Call park Retrieve
- 4.2 Trunk Line
  - Incoming Type
  - Destination – Day / Night / Lunch / Break
- 4.6 External Paging
  - Tenant No.
  - FDN

### **Features Guide References**

- 1.3 System Features
  - Floating Station
- 1.5 Attended Features
  - Trunk Answer From Any Station (TAFAS)

### **User Manual References**

None

## 4.3.79 Two-Way Recording into the Voice Mail <sup>\*1</sup>

Allows you to record a conversation into your mailbox or the desired mailbox.

### Recording into your mailbox

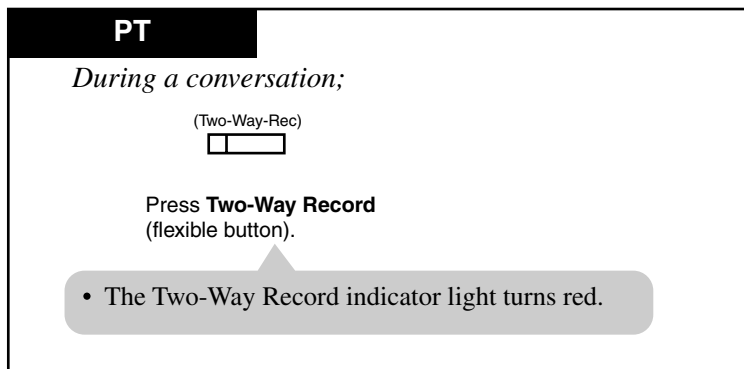

### Stopping recording

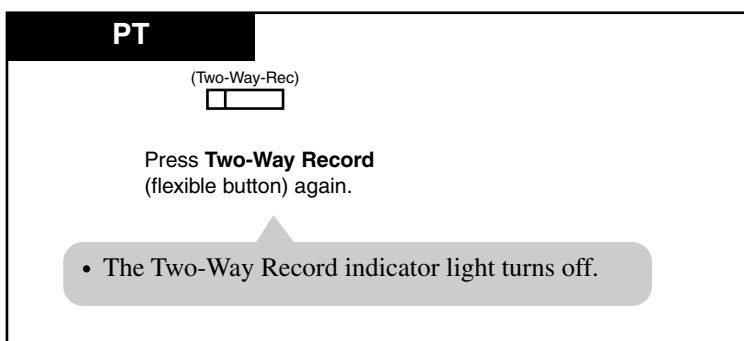

<sup>\*1</sup> Available when the Digital Super Hybrid System is connected to a Digital Proprietary Telephone capable Panasonic Voice Processing System (one that supports Digital Proprietary Telephone [DPT] integration; e.g., KX-TVS100).

## Recording into the mailbox of another extension

PT

*During a conversation;*

(Two-Way-Tran)

Press **Two-Way Transfer**  
(flexible button).

extension no.

Enter an extension  
number.

OR

(DSS)

Press **DSS**  
(flexible button).

- The Two-Way Transfer indicator light turns red.

## Stopping recording

PT

(Two-Way-Tran)

Press **Two-Way Transfer** (flexible button).

- The Two-Way Transfer indicator light turns off.

## Conditions

- PT  
A flexible CO and DSS button can be assigned as a Two-Way Record button or a Two-Way Transfer button by Station, User or System Programming.
- PT  
Pressing the Two-Way Record button sends an alarm tone, if no idle voice mail port exists.
- PT  
Pressing the Two-Way Transfer button followed by an extension number sends an alarm tone, if no idle voice mail port exists.
- PT  
When you record Two-way telephone conversations, you should inform the other party that the conversation is being recorded.

### **Programming Guide References**

- 4.3 Extension Line
  - CO Key
- 4.4 DSS Console
  - DSS Key

### **Features Guide References**

- 1.3 System Features
  - Integration, DPT
- 1.12 Conversation Features
  - Two-Way Recording into the Voice Mail

### **User Manual References**

- 2.2.3 Flexible Button Assignment
- 3.2.5 [005] Flexible CO Button Assignment
- 5.2.19 Two-Way Record Button (Assignment)
- 5.2.20 Two-Way Transfer Button (Assignment)

## 4.3.80 UCD Login Monitor

Allows an extension user (PT only) to see at a glance which UCD Group Members are logged in and which ones are logged out.

Write down the DNs of the UCD Group Members that you want to monitor. Write them on the "TEL CARD" of your PT.

Using Station Programming <Section "2.2.3 Flexible Button Assignment" in this manual>, User Programming <Section "3.2.5 [005] Flexible CO Button Assignment" in this manual> or System Programming <Section "4.3 Extension Line" in the Programming Guide>, assign each DN to a DSS button on your PT.

### **Extension Group**

Enable "LOGIN Monitor" <Section "3.3 Extension Group" in the Programming Guide> for your UCD group.

### **Incoming Group**

Specify the "Supervisor Extension" <Section "3.5 Incoming Group" in the Programming Guide> for your UCD group.

When a UCD Group Member is logged out, the corresponding DSS button on your PT will flash red.

## **Programming Guide References**

- 3.3 Extension Group
  - Group Type
  - [UCD Setting] LOGIN Monitor
- 3.5 Incoming Group
  - Group Type
  - [UCD Setting] Supervisor Extension
- 4.3 Extension Line
  - CO Key
- 4.4 DSS Console
  - DSS Key

## **Features Guide References**

### 1.5 Attended Features

- Uniform Call Distribution (UCD)

## **User Manual References**

- 2.2.3 Flexible Button Assignment
- 3.2.5 [005] Flexible CO Button Assignment



### 4.3.81 UCD Monitor Mode

Allows the extension user specified as the Supervisor Extension to monitor the number of calls put in the waiting queue.

#### Setting

**PT**

Lift the handset or press SP-PHONE/MONITOR.

Dial 725.

Enter the FDN for a UCD Group (3 or 4 digits).

Confirmation tone and dial tone

Hang up or press SP-PHONE/MONITOR.

**<PT Display Example>**  
UCD Monitor STRT

**<PT Display Example>**  
WAIT CALL 10  
the number of waiting calls  
• Monitoring the number of UCD calls waiting is started.

#### Canceling

**PT**

Lift the handset or press SP-PHONE/MONITOR.

Dial 725\*.

Confirmation tone and dial tone

Hang up or press SP-PHONE/MONITOR.

**<PT Display Example>**  
UCD Monitor End

• Monitoring the number of UCD calls waiting is canceled.

#### Conditions

- Any extension user (whether a member of the UCD Group or not) can be specified as the Supervisor extension for a UCD Group by System Programming.
- With the KX-T7431, KX-T7433, KX-T7436 or KX-T7235, you can execute this feature using the display operation.

- When this feature is started for Incoming Group members, not only the number of calls put in the waiting queue but also Login / Logout status of the UCD Group members can be monitored.

### **Programming Guide References**

- 2.3 Numbering Plan
  - UCD Monitor Mode
- 3.3 Extension Group
  - Group Type
  - [UCD Setting] Supervisor Extension
- 3.5 Incoming Group
  - Group Type
  - [UCD Setting] Supervisor Extension

### **Features Guide References**

- 1.5 Attended Features
  - Uniform Call Distribution (UCD)

### **User Manual References**

- 4.5.9 KX-T7235 Display Features - System Feature Access Menu
- 4.5.12 KX-T7431 / KX-T7433 / KX-T7436 Display Features - System Feature Access Menu

## 4.3.82 Voice Mail Transfer

You can transfer the calls to the Voice Processing System so that callers can leave their messages in a desired extension mailbox. When you transfer the call to the designated extension;

—**If the extension has set the "Call Forwarding" function whose destination is Voice Mail;**

The call will be forwarded to Voice Mail.

—**If the extension has not set the "Call Forwarding" function;**

You can retrieve the call and then transfer the call to Voice Mail by One-Touch.

**PT**

*If the call returns to you;*

(VM Transfer)

**extension no.**

or

(DSS)

Press **Voice Mail (VM)**  
**Transfer** (flexible button).

Dial the extension  
number.

Press **DSS**  
(flexible button).

- The call will be forwarded to the Voice Mail.
- The caller can leave the message according to the Voice Mail guidance.

### Conditions

- **PT**  
A flexible button can be assigned as the Voice Mail (VM) Transfer button by Station, User or System Programming.
- **PT**  
A user's Voice Mailbox number, password, etc., can be assigned as a Voice Mailbox ID.

### Programming Guide References

- 3.3 Extension Group
  - FDN
  - Group Type
- 4.3 Extension Line
  - CO Key
- 4.4 DSS Console
  - DSS Key
- 5.10 VPS Integration
  - [Voice Mail Command] Leave Message

- [Voice Mail Command] Get Message
- [Voice Mail Command] AA Message
- [Voice Mail Command] VM Message

## **Features Guide References**

### 1.3 System Features

- Integration, VPS

## **User Manual References**

- 2.2.3 Flexible Button Assignment
- 3.2.5 [005] Flexible CO Button Assignment
- 4.3.83 VPS Integration

## 4.3.83 VPS Integration

Allows you to have your calls forwarded to your Voice Processing System mailbox.

### Setting Call Forwarding destination to Voice Mail

PT and SLT



Lift the handset or press SP-PHONE/MONITOR.

FWD/DND

7

1

0

For PT: Press **FWD/DND.**  
For SLT, PT: Dial 710.

FWD no.

- You may press the flexible button assigned as the FWD/DND button instead.

Voice Mail extension no.

Dial Voice Mail extension number (3 or 4 digits).



Confirmation tone and dial tone



Hang up or press SP-PHONE/MONITOR.

**<PT Display Example>**

FWD (All) Extxxxx

└── VM extension number

- Calls directed to your extension are automatically forwarded to your mailbox.
- Callers can leave messages in your mailbox, according to the Voice Mail guidance.

## Canceling

PT and SLT



Lift the handset or press  
SP-PHONE/MONITOR.

FWD/DND

7

1

0

For PT: Press **FWD/DND**.  
For SLT, PT: Dial 710.

For PT  
For SLT, PT

0

Dial 0. Confirmation tone  
and dial tone



Hang up or press  
SP-PHONE/MONITOR.

- You may press the flexible button assigned as the FWD/DND button instead.

**<PT Display Example>**

FWD/DND Cancel

## Listening to a stored message

You can listen to the messages stored in your mailbox easily. There are two operations to play back messages.

### Using the Message Waiting (MESSAGE) button

PT

*If there is a message in the mailbox, the MESSAGE indicator light is on.*



Lift the handset or press  
SP-PHONE/MONITOR.

MESSAGE

MESSAGE

Press **MESSAGE**.

- You can listen to the stored message.

## Manual dialing

PT and SLT



Lift the handset or press  
SP-PHONE/MONITOR.

Voice Mail extension no.

Enter the Voice Mail extension number  
(3 or 4 digits).

- You can listen to the stored message by following the Voice Mail guidance.

### Conditions

- Outside callers can leave their messages in your mailbox. When an incoming CO call arrives, the Operator answers the call and transfers it to your extension. And...
  - If you set the "Call Forwarding" function whose destination is Voice Mail;**  
The call will be forwarded to Voice Mail automatically.
  - If you do not set the "Call Forwarding" function;**  
The Operator will retrieve the call. Then the Operator transfers the call to Voice Mail with Voice Mail Transfer button.
- Voice Mail can be assigned as the destination of the following features.
  - a) Call Forwarding — All Calls
  - b) Call Forwarding — Busy
  - c) Call Forwarding — No Answer
  - d) Call Forwarding — Busy/No Answer
  - e) Intercept Routing
- **How to listen to a voice message stored in your mail box**
  - <Inband integration case>
    - 1) Off-hook
    - 2) Then press the red lit MESSAGE button.
    - 3) After accessing the VPS, enter "\*" and your mailbox number.
    - 4) Enter the password if you have one.
    - 5) Follow the voice guidance provided the VPS.
  - <DPT integration case>
 

If your mailbox is a "Direct Mailbox Access" enabled one (VPS programming), you can skip steps (2) and (3) above.
- PT

A flexible button can be assigned as the MESSAGE or FWD/DND button.

### **Programming Guide References**

- 4.3 Extension Line
  - CO Key
  - PF Key
- 4.4 DSS Console
  - DSS Key
  - PF Key

### **Features Guide References**

- 1.3 System Features
  - Integration, VPS
- 1.11 Transferring Features
  - Call Forwarding
  - Intercept Routing

### **User Manual References**

- 2.2.3 Flexible Button Assignment
- 3.2.5 [005] Flexible CO Button Assignment
- 4.3.9 Call Forwarding
- 4.3.82 Voice Mail Transfer



## 4.3.84 Walking COS

Allows you to make a toll call at other lower level COS extensions (toll/outward restricted) by employing your own higher level COS temporarily.

### Making a call

PT and SLT

*At another extension;*



Lift the handset  
or press  
SP-PHONE/MONITOR.

4

7

Dial 47.

Walking COS password

extension no.



Confirmation  
tone and  
dial tone

**<PT Display Example>**  
 Set COS of Exxxxx  
└─ your extension number

phone no.

Dial the phone  
number.



Hang up or press  
SP-PHONE/MONITOR

- You must dial a line access code (9 or 801 through 848) or press the CO button.

- The COS level of the extension returns to the original level.

### Conditions

- Class of Service (COS) programming is used to define the features which are allowed for a group of extensions. A COS level (1-96) is assigned to each extension by System Programming.

Walking COS applies to the following COS items.

- Trunk Group Setting, Day/Night
- TRS (Toll Restriction) Level, Day/Night
- Time Limit of Outside Calls
- Transfer to CO
- Busy Override
- Busy Override Deny
- DND Override
- Digits Restriction in CO Talk Mode

- Switching Day/Night Mode
  - Account Code Mode
  - SDN COS
  - Off-hook Call Announcement (OHCA)
  - Released Link Operation
  - Automatic Hold
- With the KX-T7431, KX-T7433, KX-T7436 or KX-T7235, you can execute this feature using the display operation.

### **Programming Guide References**

- 2.3 Numbering Plan
  - Walking COS
- 2.4 Class of Service (COS)
  - Trunk Group Setting
  - TRS Level – Day / Night
  - Time Limit of Outside Calls
  - Transfer to CO
  - Busy Override
  - Busy Override Deny
  - DND Override
  - Digits Restriction in CO Talk Mode
  - Switching Day/Night mode
  - Account Code Mode
  - SDN COS
  - Off-Hook Call Announcement (OHCA)
  - Released Link Operation
  - Automatic Hold
- 4.3 Extension Line
  - [COS No.] Primary
  - [COS No.] Secondary
- 10.6 System Parameters
  - [Password] Walking COS

### **Features Guide References**

- 1.3 System Features
  - Class of Service (COS)
- 1.6 Originating Features
  - Toll Restriction
  - Walking COS

### **User Manual References**

- 4.5.9 KX-T7235 Display Features - System Feature Access Menu
- 4.5.12 KX-T7431 / KX-T7433 / KX-T7436 Display Features - System Feature Access Menu

### 4.3.85 Walking Station

Used to move an extension to a new location without re-programming. Extension data such as extension number, One-Touch dialing memory remain the same after the re-location of the extension.

This feature is convenient if you don't want to change the current extension setting (extension number, etc.) after your desk is moved to another location in the office.

#### Start

PT and SLT

*At the source extension;*



Lift the handset.

7	2	7	1
---	---	---	---

Dial 7271.



Confirmation tone and dial tone



Hang up.

**<PT Display Example>**

WST (E1234) On

#### End

PT and SLT

*At the destination extension;*



Lift the handset.

7	2	7	0
---	---	---	---

Dial 7270.

source extension no.

Dial the source extension number.



Confirmation tone



Hang up.

**<PT Display Example>**

WST (E1234) Off

**Conditions**

- The telephone type (PT, SLT, OPX) must be the same at the source and destination.
- Walking Station is not available in the following cases:
  - If the extension is connected to a DHLC card (KX-TD50170).
  - If the extension is connected to a HLC card (KX-T96170) in parallel.
  - If the extension is in hands-free mode.
- The status of the port must be INS (In-Service) at the source and destination.
- When the destination extension is in one of the following states,  is shown on the display.
  - Off-hook, incoming call
  - Call Hold
  - All buttons on PT are in use
- When you reset the system during this process, the setting is canceled.

**Programming Guide References**

- 2.3 Numbering Plan
  - Walking Station

**Features Guide References**

- 1.3 System Features
  - Walking Station

**User Manual References**

None

## 4.4 Operator / Manager Service Features

### 4.4.1 Operator / Manager Service Features

An extension assigned as the Manager or an Operator by System Programming has the ability to perform the following special features:

- a) Background Music (BGM) — External
- b) Call Log Incoming, Log Lock
- c) Live Call Screening Password Clear\*<sup>1</sup>
- d) Local Alarm Indication [**Manager only**]
- e) Outgoing Message (OGM) Record/Playback
- f) Remote DND (Do Not Disturb) Control
- g) Remote FWD (Call Forwarding) Cancel - Once
- h) Remote Station Lock Control
- i) Switching COS
- j) Timed Reminder, Remote (Wake-Up Call)
- k) Trunk Busy-out setting
- l) Trunk Route Control

#### Programming Guide References

- 2.2 Tenant
  - Manager Extension DN
- 3.3 Extension Group
  - FDN
  - Group Type
- 3.5 Incoming Group
  - FDN
  - Group Type

#### Features Guide References

- 1.3 System Features
  - Manager Extension
  - Operator Group

---

\*<sup>1</sup> Available when the Digital Super Hybrid System is connected to a Digital Proprietary Telephone capable Panasonic Voice Processing System (one that supports Digital Proprietary Telephone [DPT] integration; e.g., KX-TVS100).

## 4.4.2 Background Music (BGM) — External

Allows the Manager and the Operators to broadcast background music (BGM) in the office through the external pagers.

### Setting / Canceling

7235 / 7436



Lift the handset or press SP-PHONE.

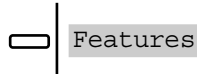

Press "**Features**."

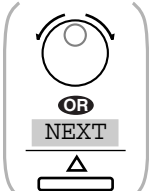

Rotate **Jog Dial** or press "**NEXT**" until the following is displayed.

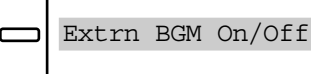

Press "**Extrn BGM On/Off**."



Confirmation tone and dial tone



Hang up or press SP-PHONE.

- Pressing this button alternates between "On" and "Off" modes.
- The display shows either one of the following depending on whether the BGM is on or off

**<PT Display Example>**

External BGM On

 — BGM is on  
or  

External BGM Off

 — BGM is off

## Setting / Canceling

7431



Lift the handset or press SP-PHONE.



Press **MODE** until "**Feature Access**" is displayed.



Rotate **Jog Dial** until "**Ext-BGM On/Off**" is displayed.

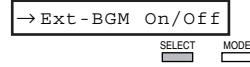

Press **SELECT**.



Confirmation tone and dial tone



Hang up or press SP-PHONE.

- Pressing this button alternates between "On" and "Off" modes.
  - The display shows either one of the following depending on whether the BGM is on or off
- <PT Display Example>**

External BGM On — BGM is on

or

External BGM Off — BGM is off



## Setting / Canceling

7433



Lift the handset or press SP-PHONE.



Press **SHIFT** until "FEAT" is displayed.



Press "FEAT."



Rotate **Jog Dial** until "Ext-BGM On/Off" is displayed.

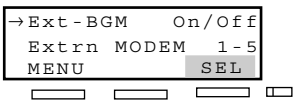

Press "SEL."



Confirmation tone and dial tone



Hang up or press SP-PHONE.

- Pressing this button alternates between "On" and "Off" modes.
- The display shows either one of the following depending on whether the BGM is on or off

**<PT Display Example>**

External BGM On

 — BGM is on  
or  

External BGM Off

 — BGM is off

PT and SLT



Lift the handset or press SP-PHONE/MONITOR.

3

5

Dial 35.



Confirmation tone and dial tone



Hang up or press SP-PHONE/MONITOR.

- The display shows either one of the following depending on whether the BGM is on or off.

**<PT Display Example>**

External BGM On

 — BGM is on  
or  

External BGM Off

 — BGM is off

## Conditions

- Hardware Requirements**

It is required to connect a user-supplied external pager. Up to two pagers and up to two external music sources can be installed in the system.

- To make BGM-External possible, you must enable BGM and select a music source by System Programming <Section 4.6 External Paging in the Programming Guide>.

- **External Pager Priority**  
Priority of access to external pager is: (1) TAFAS; (2) Paging; (3) BGM  
Higher priorities will override the BGM.
- The default is "External BGM Off."

### **Installation Manual References**

- 2.8.1 External Pager (Paging Equipment)
- 2.8.2 External Music Source

### **Programming Guide References**

- 2.2 Tenant
  - BGM Source
- 2.3 Numbering Plan
  - External BGM On / Off
- 4.6 External Paging
  - BGM
  - BGM Source

### **Features Guide References**

- 1.3 System Features
  - Background Music (BGM)—External
- 1.15 Proprietary Telephone Features
  - Background Music (BGM)

### **User Manual References**

None

### 4.4.3 Call Log Incoming, Log Lock

The Manager and the Operators can cancel the "Call Log Incoming, Log Lock" feature set at any other extension.

#### Programming

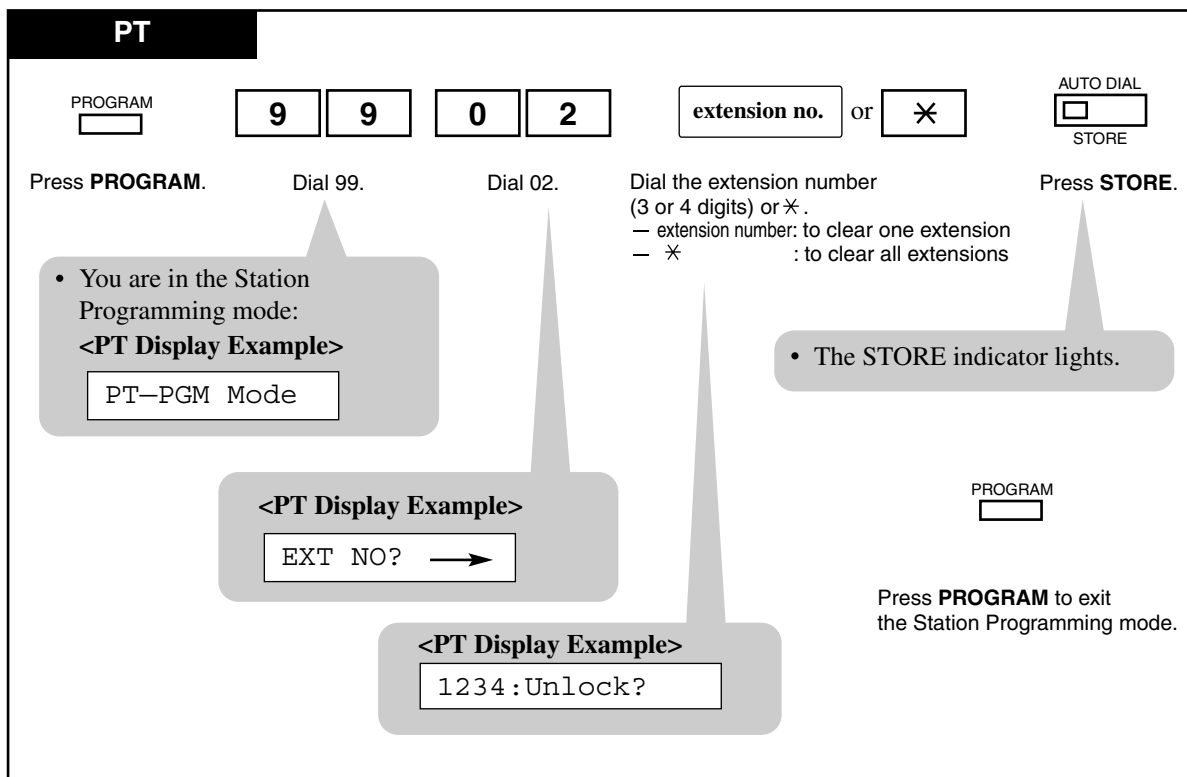

#### Conditions

- If the extension user forgets his pre-set password, he can ask the Manager or an Operator to clear the password.

#### User Manual References

- 4.5.5 Call Log Incoming, Log Lock (KX-T7436 / KX-T7433 / KX-T7235 / KX-T7230 only)

## 4.4.4 Live Call Screening (LCS) Password Clear\*1

The Manager and the Operators can clear the Live Call Screening password of any extension.

### Programming

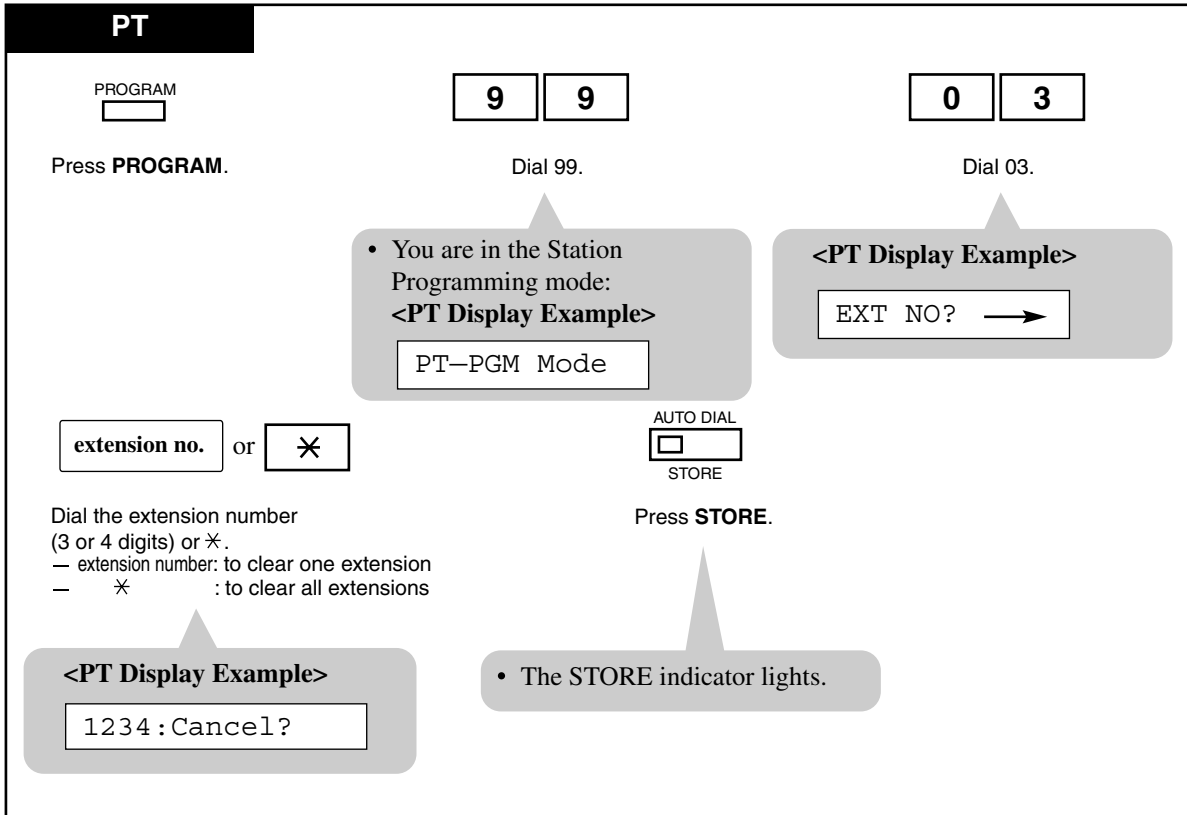

### Conditions

- If the extension users forget their pre-set password, they can ask the Manager or an Operator to clear the password.

### User Manual References

- 4.3.43 Live Call Screening (LCS)

\*1 Available when the Digital Super Hybrid System is connected to a Digital Proprietary Telephone capable Panasonic Voice Processing System (one that supports Digital Proprietary Telephone [DPT] integration; e.g., KX-TVS100).

## 4.4.5 Local Alarm

If a system error is detected during on-line communication mode, the Alarm light on the Manager extension turns red. The Manager can confirm the error message by pressing the red lit Alarm button.

If a major error occurs, minor errors will be neglected and only the first major error message will be displayed. The second error will be neglected, if the error priority is the same as the first one. Please refer to Section "5 Troubleshooting" in the Installation Manual for further information on error messages.

**Error Message List (Priority order)**

Error Message		Description	Priority	Alarm LED
ERR	CLCK IC	Calendar IC failure	1	A
ERR	DC DOWN	DC power down	1	B
B/S	FAN FLT!	Basic shelf fan alarm	1	E
E/S1	FAN FLT!	Expansion shelf 1 fan alarm	1	E
E/S2	FAN FLT!	Expansion shelf 2 fan alarm	1	E
B/S	OVER HEAT!	Basic shelf heat alarm	1	E
E/S1	OVER HEAT!	Expansion shelf 1 heat alarm	1	E
E/S2	OVER HEAT!	Expansion shelf 2 heat alarm	1	E
ERR	TSW DWN	TSW clock down	1	B
ERR	BAT ALM	CPU RAM battery alarm	1	A
ERR	AC DOWN	AC power down	2	B
ERR	xyy CRD ERR	Option Card failure	2	A
ERR	xyy DISCNCT	Card disconnect	2	B
ERR	xyy DTR AIS	Digital trunk AIS reception	2	D*1
ERR	xyy DTR FRM	Digital trunk frame failure	2	D*1
ERR	xyy DTR RAI	Digital trunk RAI reception	2	D*1
ERR	xyy DTR SYC	Digital trunk out of synchronization	2	D*1
ERR	xyy LPR RAM	Option Card RAM failure	2	A
ERR	xyy LPR ROM	Option Card ROM failure	2	A
ERR	xyyz MODEM	Modem failure	2	A
ERR	xyy OGM LOS	DISA OGM is lost	2	C
ERR	xyy OPX POW	OPX power failure	2	C
ERR	SMDR	Printer is not connected	2	B

**Error Message List (Priority order)**

<b>Error Message</b>	<b>Description</b>	<b>Priority</b>	<b>Alarm LED</b>
ERR xyy DSP1LNK	DSP-1 link failure	2	D*1
ERR xyy CD FLT	Card status fault	2	A

\*1 Regarding the T1 card, please refer to Reference Guide for T1 Digital Trunk card.

**[Legend]**

***Error Message***

- x: Shelf Number (1-3)
- yy: Slot Number (01-14)
- z: Error Number

***Priority***

- 1: Major Error
- 2: Minor Error

***Alarm LED***

(When a problem occurs)

- A: LED on PT / Top Shelf / Card.....OFF → ON
- B: LED on PT / Top Shelf.....OFF → ON
- C: LED on PT.....OFF → ON
- D: LED on PT / Card.....OFF → ON

The Alarm light turns red automatically. The corresponding error message is shown on the display PT, if it is idle, by pressing the red lit Alarm button.

If the red lit Alarm button is pressed again, whether the problem is solved or not, the Alarm light goes off and the display PT shows the initial display ("Date" and "Time" or "Self-Extension number").

- E: LED on PT / Top Shelf.....OFF → ON

The Alarm light turns red and the corresponding error message is shown on the display PT automatically, if it is idle. This situation continues until the problem will be solved.

(When the problem is solved)

- A/B/C/D: LED on PT.....ON (no change)  
LED on Top Shelf / Card.....ON → OFF
- E: LED on PT / Top Shelf.....ON → OFF

When the problem is solved, the Alarm light goes off and the display PT shows the initial display.

### Displaying an error message

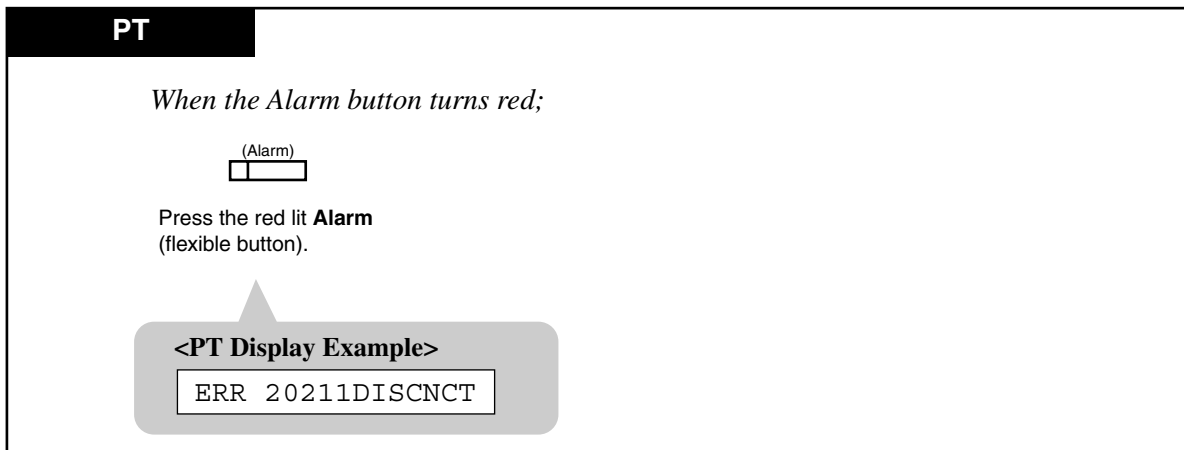

### Clearing the error message

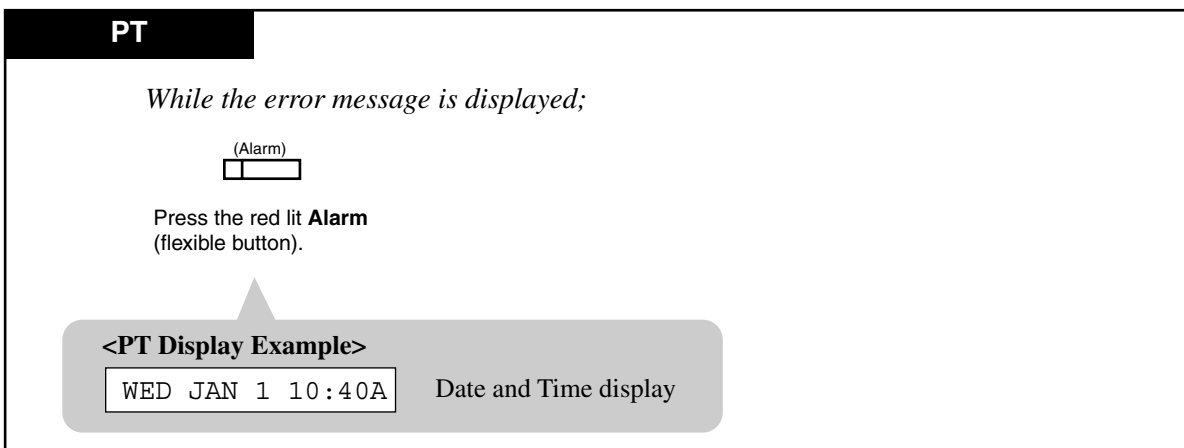

### Conditions

- **Alarm button assignment**  
Alarm button can be assigned to a flexible CO button on PT by Station, User or System Programming.
- **Alarm LED indication**  
Major alarm (Priority 1) – Red moderate flash  
Minor alarm (Priority 2) – Red On
- If multiple errors occur at a time, only the error with highest priority will be displayed by pressing the red lit Alarm button.

### **Programming Guide References**

- 4.3 Extension Line
  - CO Key

### **Features Guide References**

- 1.4 Fault Recovery/Diagnostics
  - Local Alarm

### **User Manual References**

- 2.2.3 Flexible Button Assignment
- 3.2.5 [005] Flexible CO Button Assignment



## 4.4.6 Outgoing Message (OGM) Record/Playback

The Manager and the Operators can record and play back outgoing voice messages.

### Recording a message

7235 / 7436



Lift the handset or press SP-PHONE.



Press **"Features."**

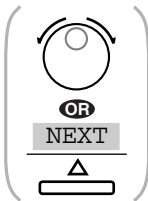

Rotate **Jog Dial** or press **"NEXT"** until the following is displayed.



Press **"OGM Recording."**

OGM Group no.



Enter OGM Group number (1 through 8).



Confirmation tone



Record a message (up to 30 seconds).

AUTO DIAL  
STORE

Press **STORE** or wait until a maximum recording time (30 seconds) has elapsed.

**<PT Display Example>**

OGM 2    Rec. : 00

- Time counter (seconds)
- OGM group number selected (1 through 8)

- The STORE indicator light flashes red slowly. Recording starts after the confirmation tone.

- The recording is stopped and STORE indicator light turns steady red.
- The recorded message will be played back automatically.

**<PT Display Example>**

OGM 2    Play : 28



Confirmation tone

AUTO DIAL  
STORE

Press **STORE** or wait until playback is finished.



Confirmation tone and dial tone



Hang up or press SP-PHONE.

- The STORE indicator light turns off.

## Recording a message

7431



Lift the handset or press SP-PHONE.



Press **MODE** until "Feature Access" is displayed.



Rotate **Jog Dial** until "OGM Record" is displayed.



Press **SELECT**.

OGM Group no.

Enter OGM Group number (1 through 8).



Confirmation tone



Record a message (up to 30 seconds).



Press **STORE** or wait until a maximum recording time (30 seconds) has elapsed.

### <PT Display Example>

OGM 2 Rec.:00

Time counter (seconds)  
OGM group number selected (1 through 8)

- The STORE indicator light flashes red slowly. Recording starts after the confirmation tone.

- The recording is stopped and STORE indicator light turns steady red.
- The recorded message will be played back automatically.

### <PT Display Example>

OGM 2 Play:28



Confirmation tone



Press **STORE** or wait until playback is finished.



Confirmation tone and dial tone



Hang up or press SP-PHONE.

- The STORE indicator light turns off.

## Recording a message

7433



Lift the handset or press SP-PHONE.



Press **SHIFT** until "FEAT" is displayed.

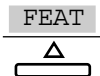

Press "**FEAT.**"



Rotate **Jog Dial** until "OGM Record" is at the arrow.



Press "**SEL.**"

OGM Group no.

Enter OGM Group number (1 through 8).



Confirmation tone



Record a message (up to 30 seconds).



Press **STORE** or wait until a maximum recording time (30 seconds) has elapsed.

### <PT Display Example>

OGM 2      Rec. : 00

Time counter (seconds)  
OGM group number selected (1 through 8)

- The STORE indicator light flashes red slowly. Recording starts after the confirmation tone.

- The recording is stopped and STORE indicator light turns steady red.
- The recorded message will be played back automatically.

### <PT Display Example>

OGM 2      Play : 28



Confirmation tone



Press **STORE** or wait until playback is finished.



Confirmation tone and dial tone



Hang up or press SP-PHONE.

- The STORE indicator light turns off.

## Recording a message

PT and SLT



Lift the handset or press SP-PHONE/MONITOR.

3	6	1
---	---	---

Dial 361.

OGM Group no.



Enter OGM Group number (1 through 8).  
Confirmation tone



Record a message (up to 30 seconds).

**<PT Display Example>**

OGM 2 Rec.:00

Time counter (seconds)

OGM group number selected (1 through 8)

- The STORE indicator light flashes red slowly. Recording starts after the confirmation tone.

- The recording is stopped and STORE indicator light turns steady red.
- The recorded message will be played back automatically.

**<PT Display Example>**

OGM 2 Play:28



Confirmation tone

AUTO DIAL

STORE

Press **STORE** or wait until a maximum recording time (30 seconds) has elapsed.



Confirmation tone and dial tone

AUTO DIAL

STORE

Press **STORE** or wait until playback is finished



Hang up or press SP-PHONE/MONITOR.

- The STORE indicator light turns off.

## Playing back a message

7235 / 7436



Lift the handset or press SP-PHONE.



Press "**Features.**"

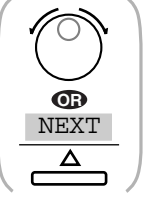

Rotate **Jog Dial** or press "**NEXT**" until the following is displayed.



Press "**OGM Playback (→1-8)**"

OGM Group no.

Enter OGM Group number (1 through 8).



Confirmation tone



Press **STORE** or wait until playback is finished.



Confirmation tone and dial tone



Hang up or press SP-PHONE.

- The STORE indicator light turns off.

**<PT Display Example>**

OGM 1
Play:28

Time counter (seconds)

- The STORE indicator lights.
- The message is played back and the counter starts.

## Playing back a message

7431



Lift the handset or press SP-PHONE.



Press **MODE** until "**Feature Access**" is displayed.



Rotate **Jog Dial** until "**OGM Play**" is displayed.

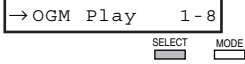

Press **SELECT**.



Enter OGM Group number (1 through 8).



Confirmation tone



Press **STORE** or wait until playback is finished.



Confirmation tone and dial tone



Hang up or press SP-PHONE.

- The STORE indicator light turns off.

**<PT Display Example>**

OGM 1
Play: 28

Time counter (seconds)

- The STORE indicator lights.
- The message is played back and the counter starts.

## Playing back a message

7433



Lift the handset or press SP-PHONE.



Press **SHIFT** until "FEAT" is displayed.



Press "FEAT."



Rotate **Jog Dial** until "OGM Play" is at the arrow.

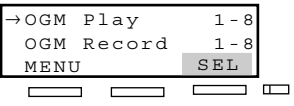

Press "SEL."



Enter OGM Group number (1 through 8).



Confirmation tone



Press **STORE** or wait until playback is finished.



Confirmation tone and dial tone.



Hang up or press SP-PHONE.

- The STORE indicator light turns off.

**<PT Display Example>**

OGM 1	Play:28
-------	---------

Time counter (seconds)

- The STORE indicator lights.
- The message is played back and the counter starts.

## Playing back a message

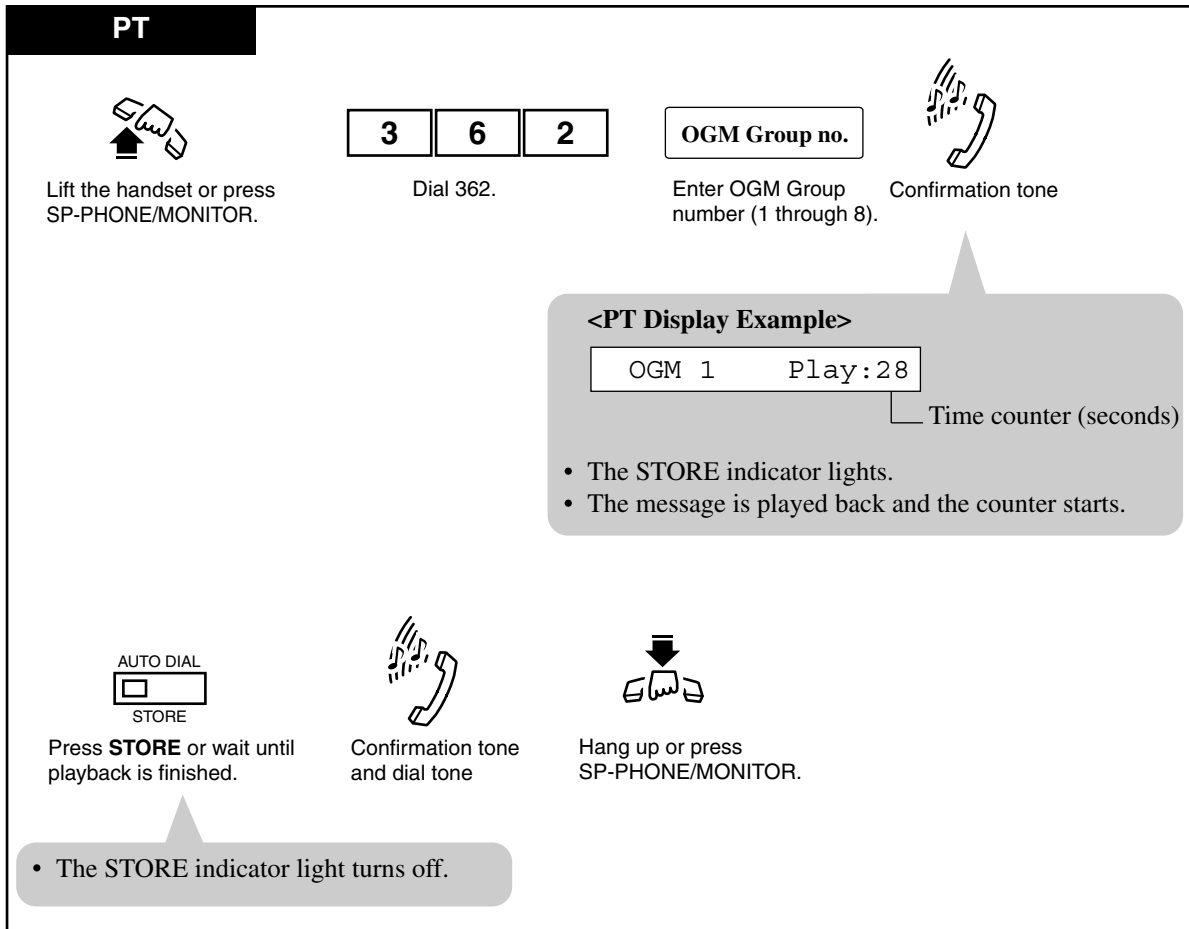

### Conditions

- The following three types of outgoing messages can be recorded.
  - DISA message:**  
This message is played when an outside caller accesses the system via DISA line.
  - Timed Reminder (wake-up) message:**  
This message is used in Timed Reminder. When answering the Timed Reminder alarm (often used as a wake-up call), the extension user will hear this message.
  - UCD (Uniform Call Distribution) message:**  
This message is played to the outside callers in conjunction with UCD feature.
- OGM Type**  
OGM Type is decided on an OGM Group basis by System Programming.
- Before recording your OGM, you must assign its OGM Group No. to a physical card (DISA Port Assignment)
- Hardware Requirements**  
A DISA card (KX-T96191) is required to record an OGM.  
Up to eight DISA cards can be installed in the system.



- **OGM Group**  
Recording of OGM is performed per OGM Group (1-8) which consists of one or more DISA cards. Up to eight OGM Groups are available in the system.
- Before recording your OGM, you must assign its OGM Group No. to a physical card (DISA Port Assignment)
- **Tenant Service**  
If Tenant Service is employed, the affiliation of OGM Group should be decided by System Programming.

### **Installation Manual References**

- 2.6.1 DISA Card (KX-T96191)

### **Programming Guide References**

- 1.7 DISA Port Assignment
- 2.3 Numbering Plan
  - OGM Playback / Record
- 3.6 OGM Group
  - FDN
  - Tenant No.
  - OGM Type

### **Features Guide References**

- 1.3 System Features
  - Outgoing Message (OGM)
  - Outgoing Message (OGM) Group
- 1.5 Attended Features
  - Direct Inward System Access (DISA)
  - Uniform Call Distribution (UCD)
- 1.8 Ringing Features
  - Timed Reminder (Wake-Up Call)
  - Timed Reminder, Remote (Wake-Up Call)

### **User Manual References**

None

## 4.4.7 Remote DND (Do Not Disturb) Control

The Manager and the Operators can set/cancel the DND feature to other extensions.

### Setting/Canceling

7235 / 7436



Lift the handset or press SP-PHONE.

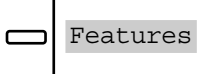

Press "**Features.**"

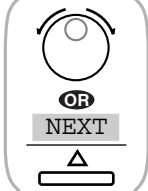

Rotate **Jog Dial** or press "**NEXT**" until the following is displayed.

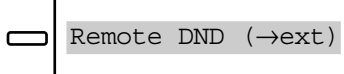

Press "**Remote DND.**"

destination extension no.



Confirmation tone and dial tone



Hang up or press SP-PHONE.

OR

(DSS)

Dial the destination extension number (3 or 4 digits) or press **DSS** (flexible button).

**<PT Display Example>**

DND Set : EXXXX
(When setting)

or

DND Cancel : EXXXX
(When canceling)

## Setting/Canceling

**7431**

Lift the handset or press SP-PHONE.

MODE

Press **MODE** until "Feature Access" is displayed.



Rotate **Jog Dial** until "Remote DND" is displayed.

→ Remote DND

Press **SELECT**.

destination extension no.

OR

(DSS)

Dial desired extension number (3 or 4 digits) or press **DSS** (flexible button).



Confirmation tone and dial tone



Hang up or press SP-PHONE.

### <PT Display Example>

DND Set : EXXXX

(When setting)

OR

DND Cancel : EXXXX

(When canceling)

## Setting/Canceling

7433



Lift the handset or press SP-PHONE.



Press **SHIFT** until "FEAT" is displayed.



Press "**FEAT.**"



Rotate **Jog Dial** until "Remote DND" is at the arrow.

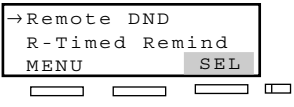

Press "**SEL.**"

destination extension no.

OR



Dial the destination extension number (3 or 4 digits) or press **DSS** (flexible button).



Confirmation tone and dial tone



Hang up or press SP-PHONE.

**<PT Display Example>**

DND Set : EXXXX

(When setting)

or

DND Cancel : EXXXX

(When canceling)

## Setting/Canceling

PT and SLT



Lift the handset or press  
SP-PHONE/MONITOR.

7	2	2
---	---	---

Dial 722.

destination extension no.



Confirmation tone  
and dial tone

OR

(DSS)

Dial the destination extension number (3 or 4 digits) or press **DSS** (flexible button).



Hang up or press  
SP-PHONE/MONITOR.

<PT Display Example>

DND Set : EXXXX

(When setting)

or

DND Cancel : EXXXX

(When canceling)

## Conditions

- Remote DND Control operation sets or cancels the DND feature to the specified extension. This depends on the status of the extension, whether DND is set by the extension user or not.

## Programming Guide References

- 2.3 Numbering Plan
  - Remote DND Control

## Features Guide Reference

- 1.3 System Features
  - Remote Station Feature Control
- 1.8 Ringing Features
  - Do Not Disturb (DND)

## User Manual References

- 4.3.27 Do Not Disturb (DND)

## 4.4.8 Remote FWD (Call Forwarding) Cancel — Once

The Manager and the Operators can ring an extension that has set Call Forwarding.

### Canceling FWD temporarily

**7235 / 7436**

Lift the handset or press SP-PHONE.

Press "**Features.**"

Rotate **Jog Dial** or press "**NEXT**" until the following is displayed.

Press "**FWD Cancel Once.**"

destination extension no.

OR

(DSS)

Dial the destination extension number (3 or 4 digits) or press **DSS** (flexible button).

Ringback tone

- Ringing starts at the destination extension.

## Canceling FWD temporarily

**7431**

Lift the handset or press SP-PHONE.



Press **MODE** until "**Feature Access**" is displayed.



Rotate **Jog Dial** until "**FWD Cancel Once**" is displayed.



Press **SELECT**.

destination extension no.

OR

(DSS)  
[ ]



Ringback tone

Dial the destination extension number (3 or 4 digits) or press **DSS** (flexible button).

- Ringing starts at the destination extension.

## Canceling FWD temporarily

7433



Lift the handset or press SP-PHONE.



Press **SHIFT** until "FEAT" is displayed.



Press "**FEAT.**"



Rotate **Jog Dial** until "FWD Cancel Once" is at the arrow.

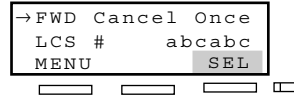

Press "**SEL.**"

destination extension no.

OR



Ringback tone

Dial the destination extension number (3 or 4 digits) or press **DSS** (flexible button).

- Ringing starts at the destination extension.



## Canceling FWD temporarily

PT and SLT



Lift the handset or press  
SP-PHONE/MONITOR.

7	2	3
---	---	---

Dial 723.

destination extension no.



Ringback tone

OR

(DSS)

Dial the destination extension  
number (3 or 4 digits) or press  
**DSS** (flexible button).

- Ringing starts at the destination extension.

### Conditions

- This feature cancels the Call Forwarding feature set at the extension temporarily so that the Manager or an Operator can call the extension user.

### Programming Guide References

- 2.3 Numbering Plan
  - Remote FWD Cancel-Once

### Features Guide References

- 1.3 System Features
  - Remote Station Feature Control
- 1.11 Transferring Features
  - Call Forwarding

### User Manual References

- 4.3.9 Call Forwarding

## 4.4.9 Remote Station Lock Control

The Manager and the Operators can remotely lock or unlock any extension. To lock an extension, you can select to lock outside calls or intercom calls.

### Programming

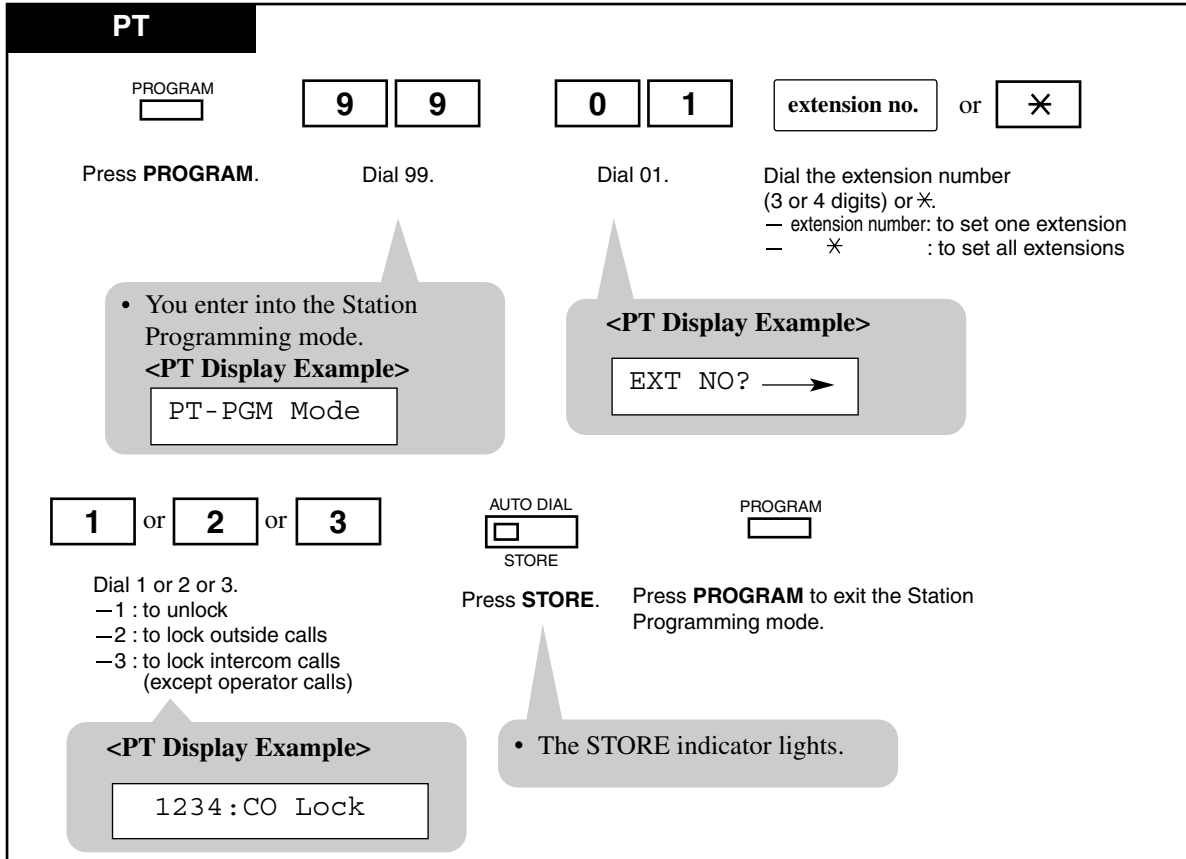

### Conditions

- This feature supersedes the "Electronic Station Lockout" feature. If "Electronic Station Lockout" has already been set by the extension user and this feature is set, the extension user cannot cancel the lock. Only the Manager and the Operators can cancel the lock.
- "Operator Call" is always available from any extension whether it is locked or not.

### Programming Guide References

System Programming is not required.

## **Features Guide References**

### 1.6 Originating Features

- Electronic Station Lockout

## **User Manual References**

- 4.3.30 Electronic Station Lockout

## 4.4.10 Switching COS

You can assign either primary or secondary level of COS (Class of Service) for each extension.

### Setting

7235 / 7436

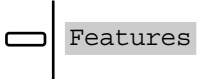

Press **"Features."**

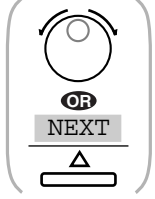

Rotate **Jog Dial** or press **"NEXT"** until the following is displayed.

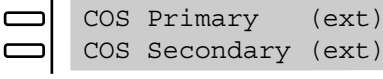

Press **"COS Primary"** or **"COS Secondary."**

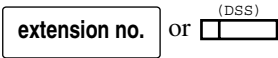

Dial the desired extension number (3 or 4 digits) or press **DSS** (flexible button).



Confirmation tone and dial tone



Hang up or press SP-PHONE.

7431



Press **MODE** until **"Feature Access"** is displayed.



Rotate **Jog Dial** until **"COS Primary"** or **"COS Second"** is displayed.

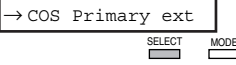

Press **SELECT.**

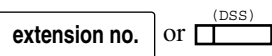

Dial the desired extension number (3 or 4 digits) or press **DSS** (flexible button).



Confirmation tone and dial tone



Hang up or press SP-PHONE.

## Setting

7433



Press **SHIFT** until "FEAT" is displayed.



Press "FEAT."



Rotate **Jog Dial** until "COS Primary" or "COS Second" is at the arrow.

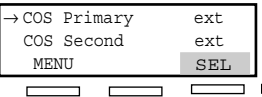

Press "SEL."

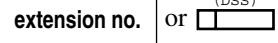

Dial the desired extension number (3 or 4 digits) or press **DSS** (flexible button).



Confirmation tone and dial tone



Hang up or press SP-PHONE.

PT and SLT



Lift the handset or press SP-PHONE/MONITOR.



Dial 79.

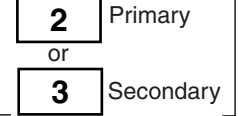

To set Primary: Dial 2.  
To set Secondary: Dial 3

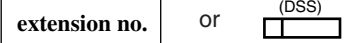

Dial the desired extension number (3 or 4 digits) or press DSS (flexible button).



Confirmation tone and dial tone



Hang up or press SP-PHONE/MONITOR.

• The display shows either one of the following:

**<PT Display Example>**

XXXX: Primary    or    XXXX: Secondary

## Conditions

- The Manager and the Operators can also change their own COS level.

### **Programming Guide References**

- 2.3 Numbering Plan
  - COS Primary
  - COS Secondary
- 2.4 Class of Service (COS)
- 4.3 Extension Line
  - [COS No.] Primary
  - [COS No.] Secondary
- 4.7 ISDN Extension Line
  - [COS No.] Primary
  - [COS No.] Secondary

### **Features Guide References**

- 1.3 System Features
  - Class of Service (COS)
- 1.6 Originating Features
  - Walking COS

### **User Manual References**

None

## 4.4.11 Timed Reminder, Remote (Wake-Up Call)

The Manager and the Operators can remotely set or cancel the Timed Reminder to the desired extension.

### Setting

7235 / 7436



Lift the handset or press SP-PHONE.



Press "Features."

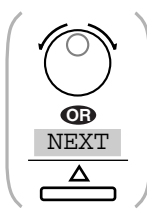

Rotate **Jog Dial** or press "NEXT" until the following is displayed.



Press "Remote Timed Reminder."

**<PT Display Example>**

Extension #:

extension no.

or

(DSS)

NEXT

S1

S2

S3

hour

minute

0

or

1

Dial the desired extension number (3 or 4 digits) or press **DSS** (flexible button).

Press "NEXT" (S3). Enter the hour (01 through 12). Enter the minute (00 through 59). For AM: Dial 0. For PM: Dial 1.

**<PT Display Example>**

Extension #:xxxx — (xxxx: extension number)  
 Time (hh:mm) : :  
 AM/PM (0/1) : :  
 Daily Y/N(1/0):0

0

or

1

For one time alarm\*<sup>1</sup>: Dial 0.  
For daily alarm\*<sup>2</sup>: Dial 1.

PROG

S1

S2

S3



Confirmation tone and dial tone



Hang up or press SP-PHONE.

Press "PROG" (S3).

\*<sup>1</sup> You hear an alarm ringing at the preset time and then the setting is cleared.  
 \*<sup>2</sup> You hear an alarm ringing daily at the preset time until the setting is changed or canceled.

## Setting

7431



Lift the handset or press SP-PHONE.



Press **MODE** until “Feature Access” is displayed.



Rotate **Jog Dial** until “R-Timed Remind” is displayed.

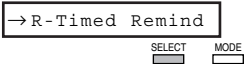

Press **SELECT**.

1

Dial 1.

extension no.

OR

(DSS)

hour

Enter the hour (01 through 12).

minute

Enter the minute (00 through 59).

0

OR

1

For AM: Dial 0.  
For PM: Dial 1.

0

OR

1

For one time alarm\*<sup>1</sup>: Dial 0.  
For daily alarm\*<sup>2</sup>: Dial 1.



Confirmation tone and dial tone



Hang up or press SP-PHONE.

\*<sup>1</sup> You hear an alarm ringing at the preset time and then the setting is cleared.  
\*<sup>2</sup> You hear an alarm ringing daily at the preset time until the setting is changed or canceled.

**<PT Display Example>**

Alarm 01:00AM\*



## Setting

7433



Lift the handset or press SP-PHONE.



Press **SHIFT** until "FEAT" is displayed.



Press "FEAT."



Rotate **Jog Dial** until "R-Timed Remind" is at the arrow.

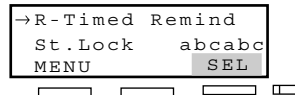

Press "SEL."

1

Dial 1.

extension no.

Dial the desired extension number (3 or 4 digits) or press **DSS** (flexible button).

(DSS)

hour

Enter the hour (01 through 12).

minute

Enter the minute (00 through 59).

0

 or 

1

For AM: Dial 0.  
For PM: Dial 1.

0

 or 

1

For one time alarm\*<sup>1</sup>: Dial 0.  
For daily alarm\*<sup>2</sup>: Dial 1.



Confirmation tone and dial tone



Hang up or press SP-PHONE.

\*<sup>1</sup> You hear an alarm ringing at the preset time and then the setting is cleared.  
\*<sup>2</sup> You hear an alarm ringing daily at the preset time until the setting is changed or canceled.

<PT Display Example>

Alarm    01:00AM\*

## Setting

### PT and SLT

 Lift the handset or press SP-PHONE/MONITOR.

Dial 7\*1.

or  Dial the desired extension number (3 or 4 digits) or press **DSS**.

Enter the hour (01 through 12).

Enter the minute (00 through 59).

or  For AM: Dial 0.  
For PM: Dial 1.

or  For a one time alarm\*<sup>1</sup>: Dial 0.  
For a daily alarm\*<sup>2</sup>: Dial 1.

 Confirmation tone and dial tone

 Hang up or press SP-PHONE/MONITOR.

\*<sup>1</sup> You hear an alarm ringing at the preset time and then the setting is cleared.  
\*<sup>2</sup> You hear an alarm ringing daily at the preset time until the setting is changed or canceled.

<PT Display Example>

## Canceling

7235 / 7436



Lift the handset or press SP-PHONE.



Press **"Features."**

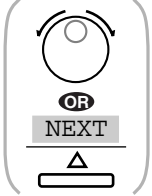

Rotate **Jog Dial** or press **"NEXT"** until the following is displayed.



Press **"Remote Timed Reminder."**

**<PT Display Example>**

Extension #:

extension no.

or

(DSS)

Dial the desired extension number (3 or 4 digits) or press **DSS** on which you have set the Timed Reminder.

NEXT

S1

S2

S3

Press **"NEXT" (S3).**

CLR

S1

S2

S3

Press **"CLR" (S2).**



Confirmation tone and dial tone

**<PT Display Example>**

Extension #:1234  
 Time (hh:mm) :07:00  
 AM/PM(0/1) :0  
 Daily Y/N(1/0) :0



Hang up or press the SP-PHONE.

## Canceling

7431



Lift the handset or press SP-PHONE.



Press **MODE** until **"Feature Access"** is displayed.



Rotate **Jog Dial** until **"R-Timed Remind"** is displayed.

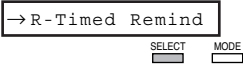

Press **SELECT**.



Dial 0.

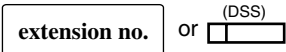

Dial the desired extension number (3 or 4 digits) or press **DSS** on which you have set the Timed Reminder.



Confirmation tone and dial tone



Hang up or press the SP-PHONE.

**<PT Display Example>**

Alarm Cancelled

7433



Lift the handset or press SP-PHONE.



Press **SHIFT** until **"FEAT"** is displayed.



Press **"FEAT."**



Rotate **Jog Dial** until **"R-Timed Remind"** is at the arrow.

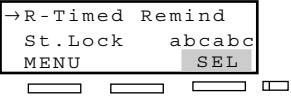

Press **"SEL."**



Dial 0.

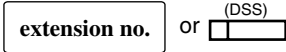

Dial the desired extension number (3 or 4 digits) or press **DSS** on which you have set the Timed Reminder.



Confirmation tone and dial tone



Hang up or press the SP-PHONE.

**<PT Display Example>**

Alarm Cancelled

## Canceling

PT and SLT



Lift the handset or press  
SP-PHONE/MONITOR.

7

\*

0

Dial 7\*0.

extension no.

or

(DSS)



Confirmation tone  
and dial tone



Hang up or press  
SP-PHONE/MONITOR.

**<PT Display Example>**

Alarm Cancelled

## Checking the time setting

Display PT



Lift the handset or press  
SP-PHONE.

7

\*

2

Dial 7\*2.

extension no.

or

(DSS)



Hang up or press  
SP-PHONE.

**<PT Display Example>**

- If "10:10" has been set, the display shows;

Alarm 10:10AM

— only one time

Alarm Not Stored

**or**

Alarm 10:10AM\*

— daily

**Unanswered Timed Reminder Alert [PT only]**

If an extension user has not responded to the wake-up call, the Alert button (assigned on the "Alert Extension") light turns red.

The Alert button can be used to confirm the not-responded room number and to call back the room.

**To confirm the extension which did not answer the timed reminder alert**

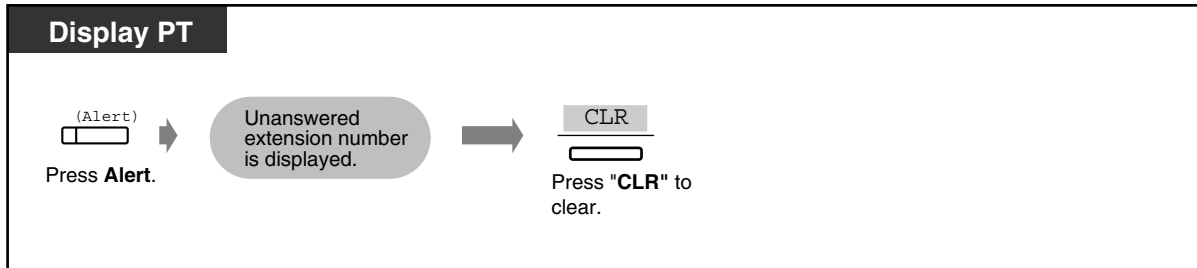

**To call the unanswered extension**

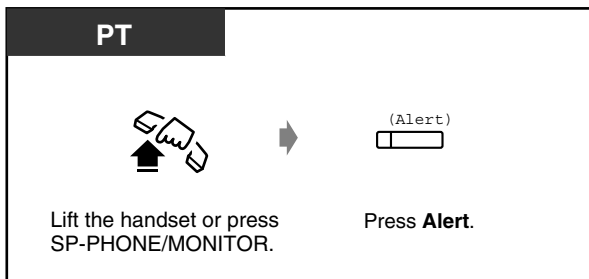

## Conditions

- The system clock must be set correctly beforehand.
- There is no limit to the number of the extensions who can set the Timed Reminder at the same time.
- Only the latest time setting is valid at the extension whether it was set by the extension user (Timed Reminder) or by the Manager extension or an Operator (Timed Reminder, Remote).
- **Station Message Detail Recording (SMDR)**  
SMDR automatically records the detailed Timed Reminder information (date, time, extension number, start/answer/no answer). It is programmable to be printed out when the Timed Reminder starts and the alarm is answered or not answered. Please refer to "Station Message Detail Recording (SMDR)" of Section "1.3 System Features" in the Features Guide for further information.

The print-out example is shown below.

Date	Time	T	Ext	CO	Dial Number	Ring Duration	Acct code	CC
22/02/00	01:31PM	1	E1017		Timed Reminder / Start			
22/02/00	01:31PM	1	E1017		Timed Reminder / No Answer			
22/02/00	01:31PM	1	E1017		Timed Reminder / Answer			

- **Distinctive Dial Tone**  
When this feature is assigned to the extension, the extension user may hear a distinctive dial tone (dial tone 2) after going off-hook depending on System Programming <Section 2.8 System Option, "15. Special dial tone after setting feature" in the Programming Guide>.
- An Alert extension can be assigned for Day / Night mode per tenant respectively by System Programming <Section 2.2 Tenant, "Alert Extension" in the Programming Guide>.
- **Alert button assignment**  
The Alert button can be assigned to a flexible CO button on the Alert extension.
- **Alert Ringing**  
A Timed Reminder alert can be sent to the alert extension when the extension user does not respond to the Timed Reminder (wake-up call) by System Programming <Section 2.8 System Option, "65. Alert Ringing" in the Programming Guide>.

## Installation Manual References

- 2.6.1 DISA Card (KX-T96191)

## Programming Guide References

- 2.2 Tenant
  - Alert Extension – Day / Night
- 2.3 Numbering Plan
  - Timed Reminder, Remote
- 2.5 System Timer

- Timed Reminder Ringing Time
  - Timed Reminder Arrive Count
  - Timed Reminder Arrive Wait Time
- 2.8 System Option
  - Special dial tone after setting feature
  - Alert Ringing
- 3.6 OGM Group
  - OGM Type
- 4.3 Extension Line
  - CO Key
- 10.4 SMDR
  - Print out Timed Reminder Information
- 10.7 System Time

### **Features Guide References**

- 1.3 System Features
  - Outgoing Message (OGM)
  - Station Message Detail Recording (SMDR)
- 1.8 Ringing Features
  - Timed Reminder (Wake-Up Call)
  - Timed Reminder, Remote (Wake-Up Call)

### **User Manual References**

- 3.2.1 [000] Date and Time Set
- 4.3.74 Timed Reminder (Wake-Up Call)
- 4.4.6 Outgoing Message (OGM) Record/Playback



## 4.4.12 Trunk Busy-Out Setting

Allows the Manager and the Operators to busy out a trunk.

### Setting / Canceling

7235 / 7436



Lift the handset or press SP-PHONE.

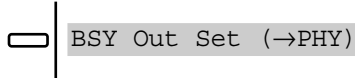

Press "**Features.**"

To set  Press "**BSY Out Set.**"

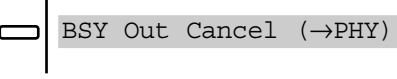
To cancel  Press "**BSY Out Cancel.**"

trunk port physical no.

Enter the trunk port physical number.



Confirmation tone and dial tone



Hang up or press SP-PHONE.

**<PT Display Example>**

- When setting:
 

B.Out      10201
- When canceling:
 

B.Out Cancelled

## Setting / Canceling

**7431**

 Lift the handset or press SP-PHONE.

 Press **MODE** until "**Feature Access**" is displayed.

 Rotate **Jog Dial** until the following is displayed.

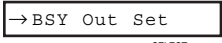
To set   
Press **SELECT**.

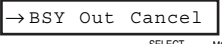

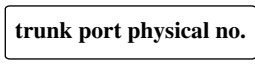
To cancel   
Press **SELECT**.

 trunk port physical no.

 Confirmation tone and dial tone

 Hang up or press SP-PHONE.

**<PT Display Example>**

- When setting:  

- When canceling:  

**Setting / Canceling**

7433



Lift the handset or press SP-PHONE.



Press **SHIFT** until **"FEAT"** is displayed.



Press **"FEAT."**



Rotate **Jog Dial** until the following is displayed.

**To set**

```
→BSY Out Set
BSY Ovr DNY 1/0
MENU SEL
```

Press **"SEL."**

**To cancel**

```
→BSY Out Cancel
BSY Out Confirm
MENU SEL
```

Press **"SEL."**

**trunk port physical no.**



Enter the trunk port physical number.



Confirmation tone and dial tone



Hang up or press SP-PHONE.

**<PT Display Example>**

- When setting:

```
B.Out      10201
```

- When canceling:

```
B.Out Cancelled
```

User Manual

451

## Setting / Canceling

PT and SLT



Lift the handset or press SP-PHONE/MONITOR.

To set	7	2	6	1
To cancel	7	2	6	0

To set: Dial 7261.  
To cancel: Dial 7260.

trunk port physical no.

Enter the trunk port physical number.



Confirmation tone and dial tone



Hang up or press SP-PHONE/MONITOR.

**<PT Display Example>**

- When setting:  

B.Out      10201
- When canceling:  

B.Out Cancelled

## Confirming

7235 / 7436



Lift the handset or press SP-PHONE.

Features

Press "Features."

BSY Out Confirm (→PHY)

Press "BSY Out Confirm.."

trunk port physical no.

Enter the trunk port physical number.



Dial tone



Hang up or press SP-PHONE.

**<PT Display Example>**

- When setting:  

B.Out      10201
- When no setting:  

B.Out      None

## Confirming

**7431**



Lift the handset or press SP-PHONE.



Press **MODE** until "Feature Access" is displayed.



Rotate **Jog Dial** until "BSY Out Confirm" is displayed.

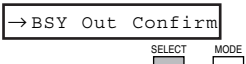

Press **SELECT**.

trunk port physical no.

Enter the trunk port physical number.



Dial tone



Hang up or press SP-PHONE.

**<PT Display Example>**

- When setting:

B.Out	10201
-------	-------

- When no setting:

B.Out	None
-------	------

**7433**



Lift the handset or press SP-PHONE.



Press **SHIFT** until "FEAT" is displayed.



Press "FEAT."



Rotate **Jog Dial** until "BSY Out Confirm" is at the arrow.

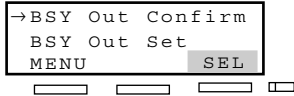

Press "SEL."

trunk port physical no.

Enter the trunk port physical number.



Dial tone



Hang up or press SP-PHONE.

**<PT Display Example>**

- When setting:

B.Out	10201
-------	-------

- When no setting:

B.Out	None
-------	------

## Confirming

### Display PT



Lift the handset or press SP-PHONE/MONITOR.



Dial tone



Hang up or press SP-PHONE/MONITOR.

7	2	6	2
---	---	---	---

Dial 7262.

trunk port physical no.

Enter the trunk port physical number.

**<PT Display Example>**

- When setting:

B.Out	10201
-------	-------
- When no setting:

B.Out	None
-------	------

## Programming Guide References

- 2.3 Numbering Plan
  - Trunk Busy-out
- 2.8 System Option
  - ELCOT / LCOT Busy-out Loop Relay
  - GCOT Busy-out Loop Relay

## Features Guide References

- 1.3 System Features
  - Trunk Busy-Out

## User Manual References

None

## 4.4.13 Trunk Route Control

Allows the Manager and the Operators to make a call using a specific trunk. They can verify the status of the specified trunk.

7235 / 7436



Lift the handset or press SP-PHONE.



Press "**Features.**"

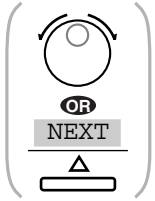

Rotate **Jog Dial** or press "**NEXT**" until the following is displayed.



Press "**TRK Route CTL.**"

**trunk port physical no.**

Enter the trunk port physical number.

7431



Lift the handset or press SP-PHONE.



Press **MODE** until "**Feature Access**" is displayed.



Rotate **Jog Dial** until "**TRK Route CTL**" is displayed.

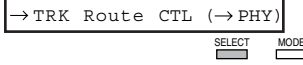

Press **SELECT**.

**trunk port physical no.**

Enter the trunk port physical number.

7433



Lift the handset or press SP-PHONE.



Press **SHIFT** until "**FEAT**" is displayed.



Press "**FEAT**."



Rotate **Jog Dial** until "**TRK Route CTL**" is at the arrow.

→TRK Route CTL  
 UCD Monitor End  
 MENU SEL

**trunk port physical no.**



Press "**SEL**."

Enter the trunk port physical number.

PT and SLT



Lift the handset or press SP-PHONE/MONITOR.

7
2
4

Dial 724.

**trunk port physical no.**

Enter the trunk port physical number.

**Conditions**

- This feature does not override Toll Restriction by COS or the Tenant Service.
- When the outside call made using a specific trunk is busy on another call, the Manager or the Operators can join the existing outside call by dialing "2" after hearing a busy tone.

**Programming Guide Reference**

- 2.3 Numbering Plan
  - Trunk Route Control
- 2.4 Class of Service (COS)
  - Busy Override

**Features Guide References**

- 1.3 System Features
  - Trunk Route Control



**User Manual References**

None

## 4.5 Special Display Features

### 4.5.1 Special Display Features

With the display telephone, KX-T7230, KX-T7235, KX-T7431, KX-T7433 or KX-T7436, you can easily access several features.

The display telephones have the ability to perform the following features.

Feature	KX-T7230	KX-T7235	KX-T7431	KX-T7433	KX-T7436
Call Forwarding/Do Not Disturb		✓			✓
Call Information Display	✓	✓	✓	✓	✓
Call Log, Incoming	✓	✓		✓	✓
Call Log Incoming, Log Lock	✓	✓		✓	✓
Call Log, Outgoing		✓			✓
Call Directory					
Extension Dialing		✓	✓	✓	✓
Station Speed Dialing		✓	✓	✓	✓
System Speed Dialing		✓	✓	✓	✓
System Feature Access Menu		✓	✓	✓	✓

"✓" indicates the feature is available.

#### Helpful Information about Display Operation

- Press **CONT** (S1) to adjust the display contrast.
- Press **RING** (S2) to adjust the ringer volume.
- Press **BGM** (S3) to turn on/off the BGM.
- Press **MENU** (S1) to return to the initial display.
- Press **PREV** (S2) to return to the previous display.
- Press **NEXT** (S3) to advance to the next display.
- Press **ACCNT** (S3) to enter an account code.
- Press **CALL** (S3) to call the desired party.
- Press **SELECT** (S3) to select the desired feature.

## 4.5.2 Call Forwarding / Do Not Disturb (KX-T7436 / KX-T7235 only)

You can set or cancel the Call Forwarding and Do Not Disturb features using the display.

### Features on the First Display

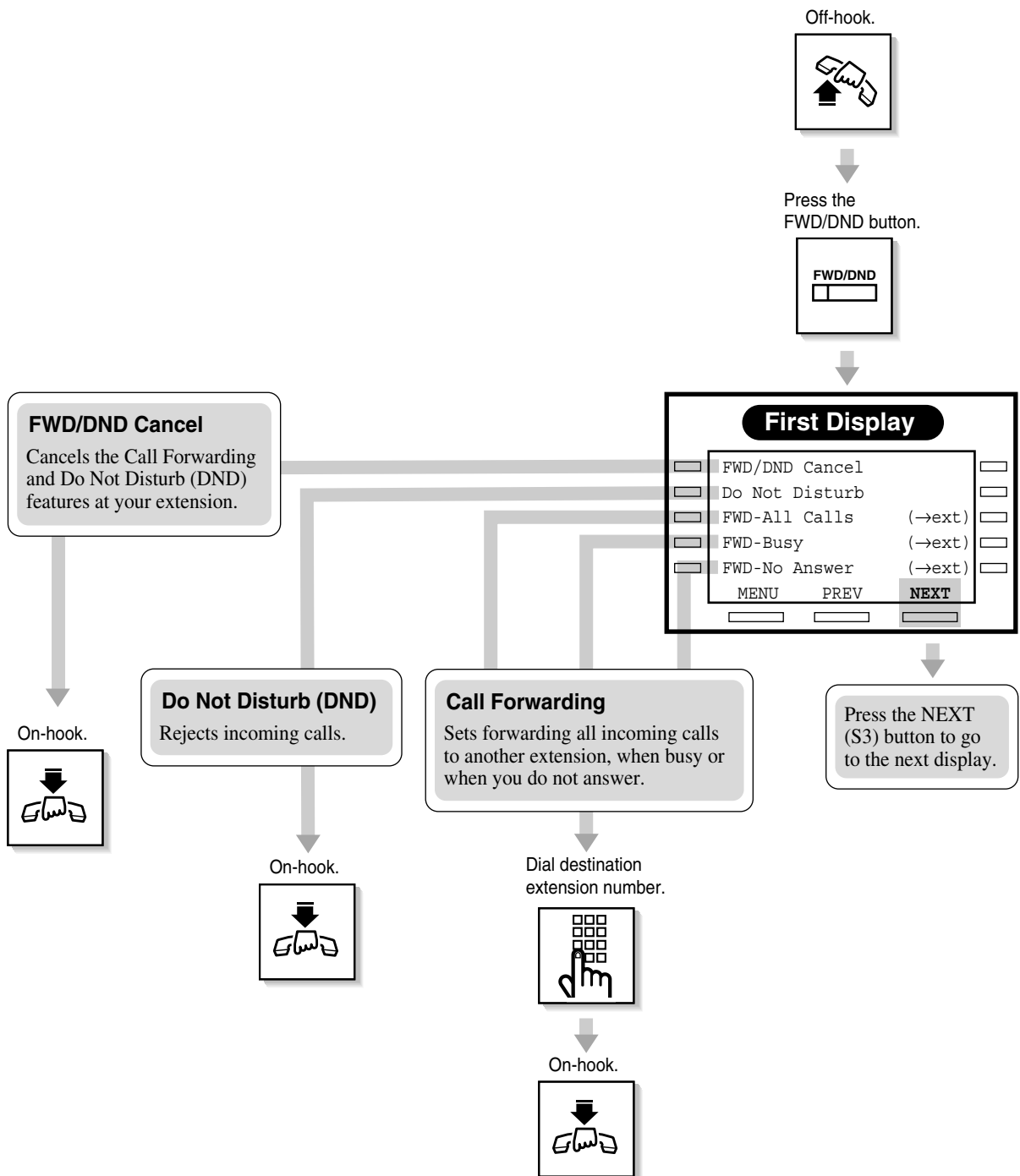

## Features on the Second Display

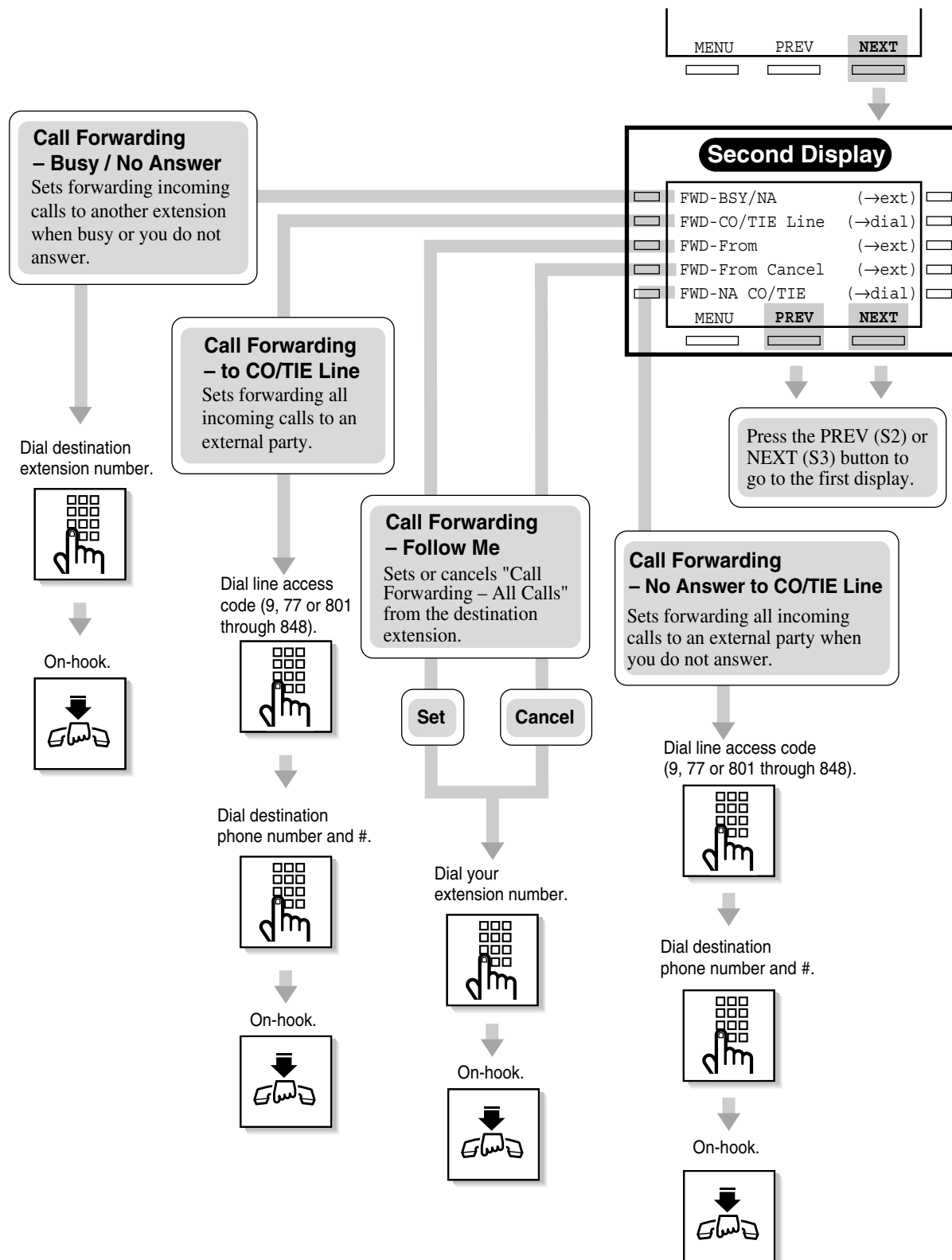

### 4.5.3 Call Information Display (KX-T7436 / KX-T7433 / KX-T7235 / KX-T7230 only)

When receiving a call from the CO line assigned to receive Caller ID service\*<sup>1</sup> calls, the caller's telephone number and name are displayed simultaneously. You can also record the information in the call log.

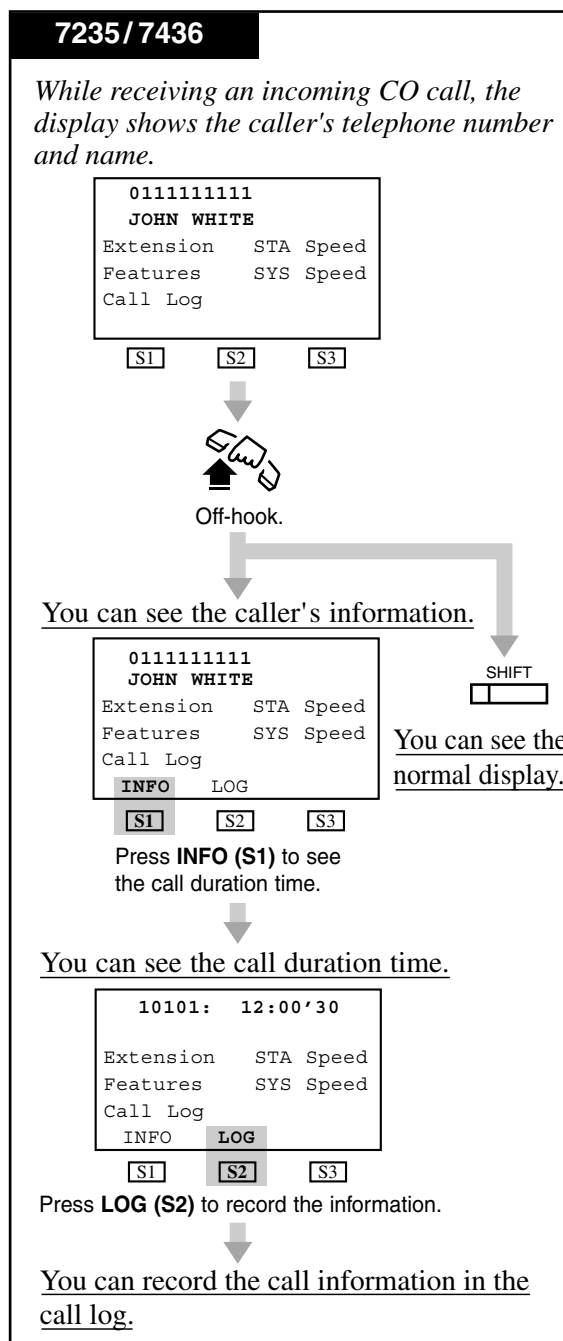
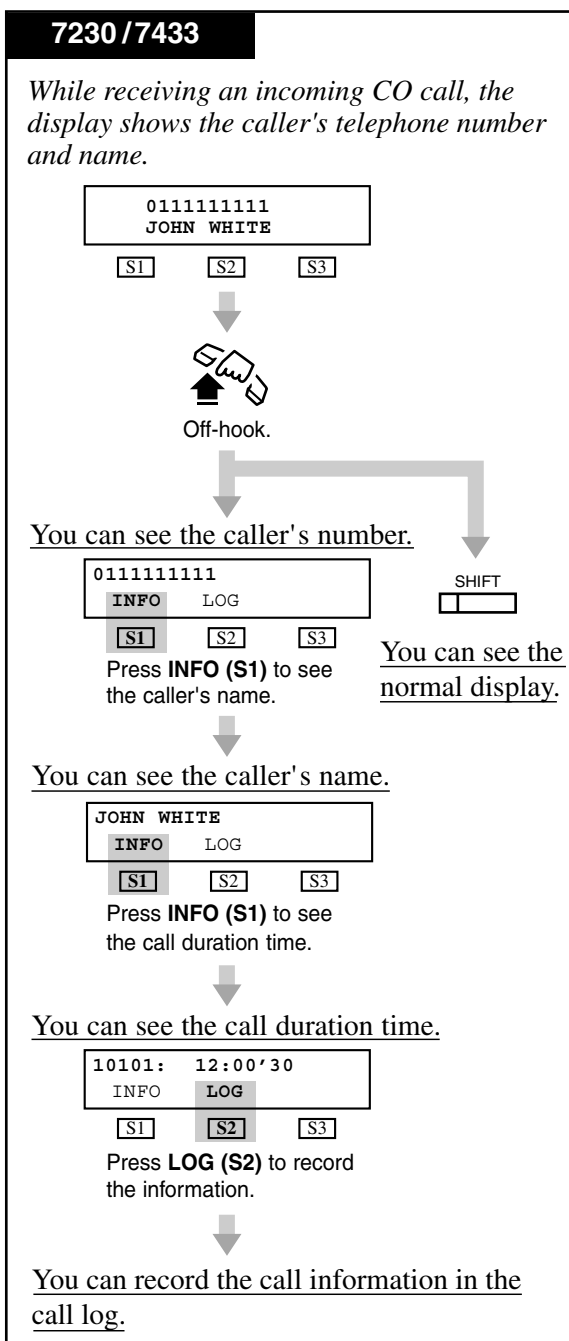

\*<sup>1</sup> The Caller ID service provides you with a caller's information, such as his name and telephone number, on the CO line assigned to receive Caller ID service calls. Please refer to "Caller ID Service" in Section "1.5 Attended Features" of the Features Guide for further information.

## Conditions

- This feature is available for KX-T7230, KX-T7235, KX-T7433 and KX-T7436 only.
- The SHIFT indicator light may turn on when receiving a call. Pressing this button provides you with more information about the caller.
- If a CO line name is assigned, you can select the initial display, Caller ID, DID name or CO line name by Station or System Programming.
- You can modify the logged numbers for callback purpose. Please refer to Section "4.5.4 Call Log, Incoming (KX-T7436 / KX-T7433 / KX-T7235 / KX-T7230 only)."
- **Caller ID or Call Duration**  
You can specify the initial display, Caller ID or Call Duration, which is shown on the display PT when you answer a CO call by System Programming.
- Call Information Display feature is also available for KX-T7431 and display APTs. However, the operation of KX-T7431 and display APTs is different from that of KX-T7230, KX-T7235, KX-T7433 and KX-T7436. The KX-T7431 and display APTs user can switch the display by pressing "✖" while receiving the Caller ID information.

## Programming Guide References

- 2.5 System Timer
  - Call Duration Count Start Time
- 2.8 System Option
  - LCD Display Mode while CO Talking
- 4.2 Trunk Line
  - Name
- 4.3 Extension Line
  - DN
  - Name
  - Initial Display Selection
- 5.12 Caller ID Registration

## Features Guide References

- 1.5 Attended Features
  - Caller ID Service
- 1.17 Display Features
  - Display, Call Information

## User Manual References

- 2.2.6 Initial Display Selection
- 3.2.6 [006] Caller ID Dial Set
- 3.2.7 [007] Caller ID Name Set
- 4.5.4 Call Log, Incoming (KX-T7436 / KX-T7433 / KX-T7235 / KX-T7230 only)

- 4.5.5 Call Log Incoming, Log Lock (KX-T7436 / KX-T7433 / KX-T7235 / KX-T7230 only)

## 4.5.4 Call Log, Incoming (KX-T7436 / KX-T7433 / KX-T7235 / KX-T7230 only)

If you do not answer an incoming CO call, your extension automatically records the call information from the Caller ID service,\*1 and the SHIFT button indicator lights. Up to 30 calls can be logged per extension. When the call log is full (30 calls are stored), you can select how the 31st call is treated. Either a new call can be disregarded or the new call overwrites the oldest call (default: Record the new call).

You can also modify the logged numbers for callback purpose.

### Setting overwriting the call log

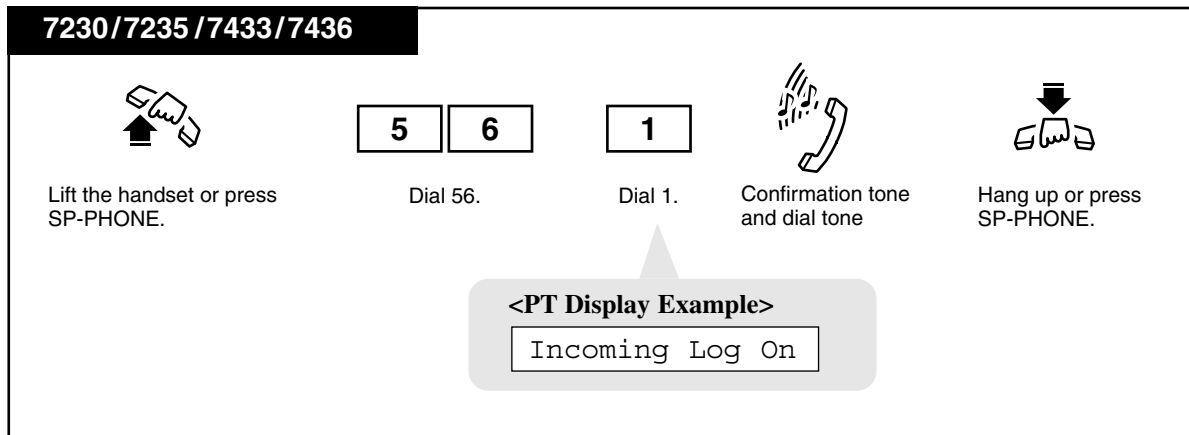

### Canceling overwriting the call log (Disregarding the 31st call)

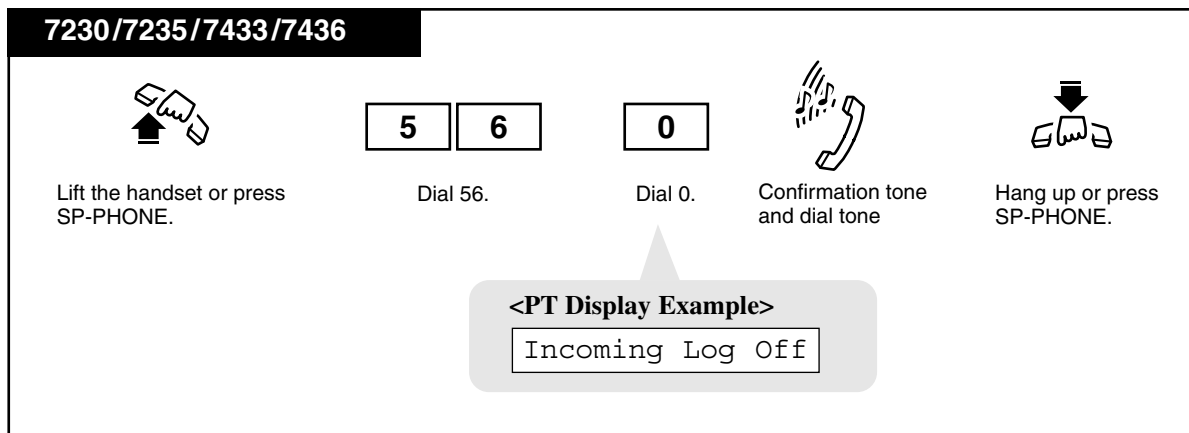

\*1 The Caller ID service provides you with a caller's information, such as his/her name and telephone number, on the CO line assigned to receive Caller ID service calls. Please refer to "Caller ID Service" in Section "1.5 Attended Features" of the Features Guide for further information.



## Logging a call information while talking

### KX-T7433 / KX-T7230

While receiving an incoming CO call, the display shows the caller's telephone number and name.

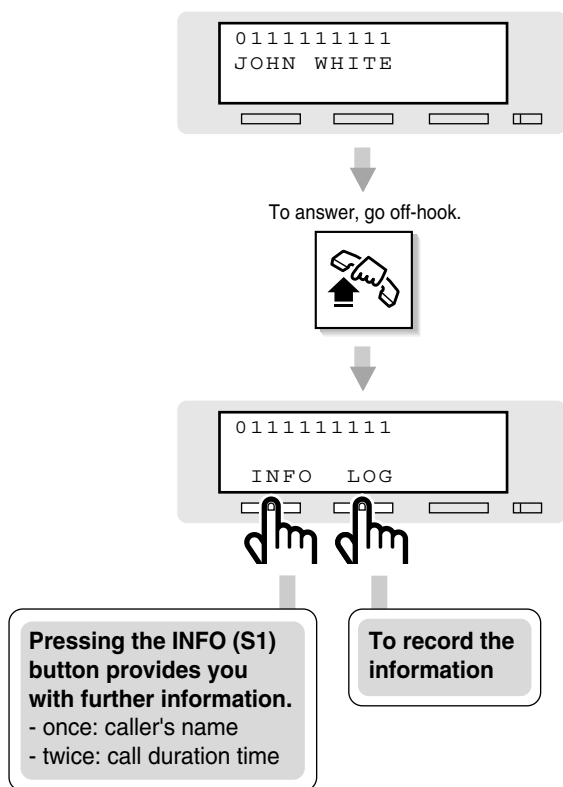

### Operating sequence

1. To answer the call, **go off-hook**.
2. Press the **LOG** (S2) button to log the information. Or press the **INFO** (S1) button repeatedly to see the information in detail.

### KX-T7436 / KX-T7235

While receiving an incoming CO call, the display shows the caller's telephone number and name.

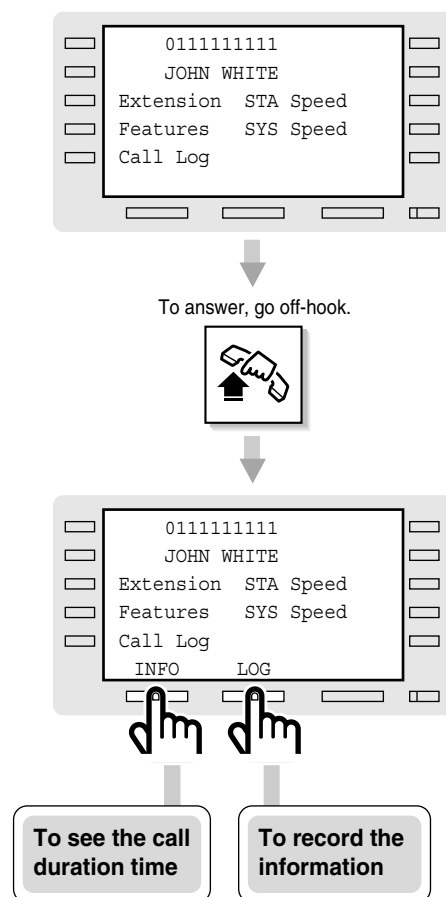

### Note

- Pressing the SHIFT button before answering a call provides you with more information about the caller, CO line number or name or both.
- You can select the initial display, Caller ID, DID name or CO line name, by Station or System Programming.
- After going off-hook, you can press the SHIFT button to change the bottom line on the display as follows:

CONT EFA ACCNT

## Confirming and calling back

When the SHIFT indicator is red, there are calls logged.

### KX-T7433 / KX-T7230

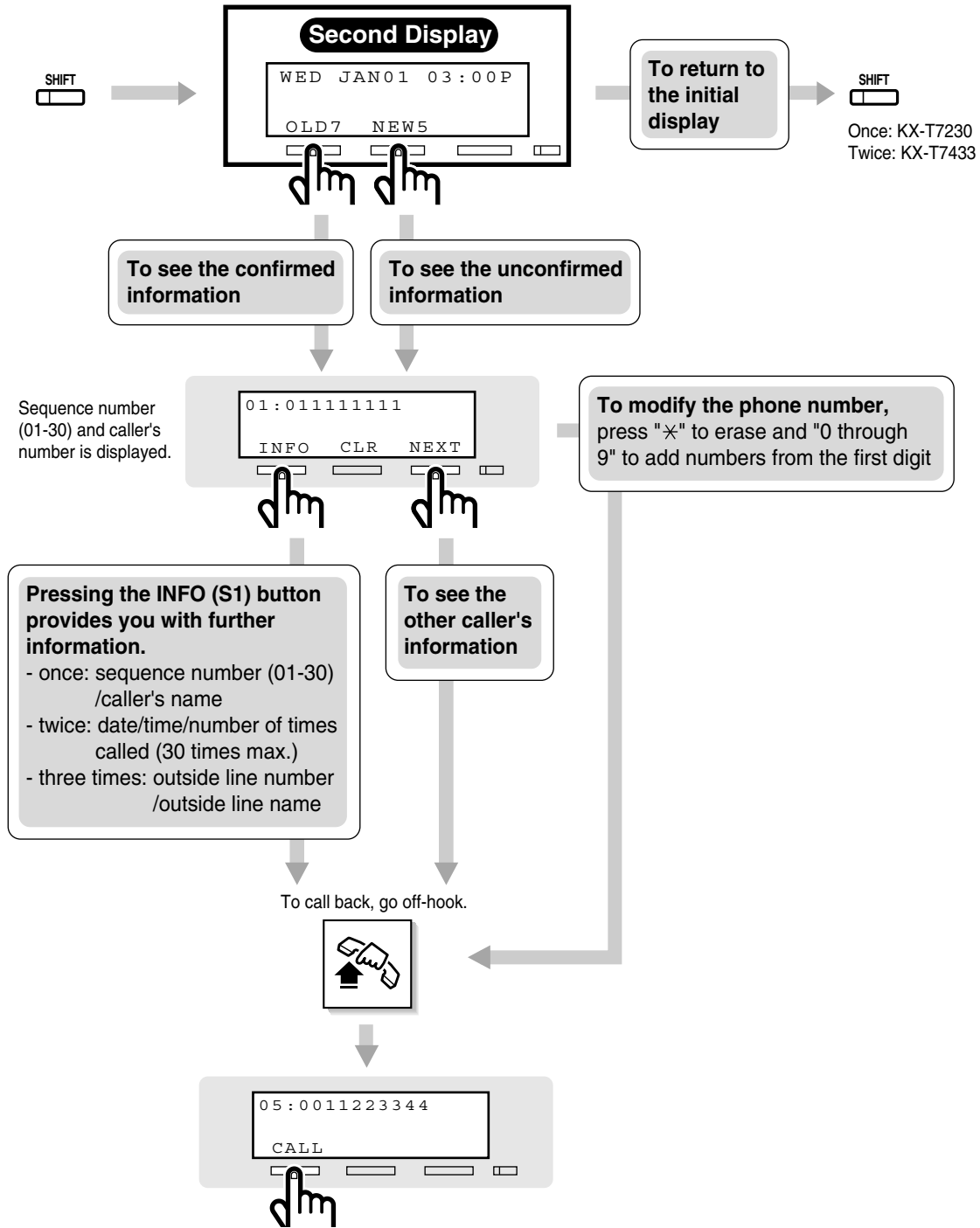

**Operating sequence**

1. Press the **SHIFT** button.
2. Press the **OLD** (S1) or **NEW** (S2) button to see the confirmed or unconfirmed information.
3. Press the **NEXT** (S3) or **PREV** (S3) button to see other caller's information. Or press the **INFO** (S1) button repeatedly to see the information in detail. Or **modify the number**, if required.
4. To call back, **go off-hook** and then press the **CALL** (S1) button.

**Notes**

- To delete the displayed number, press the **CLR** (S2) button.
- The **PREV** (S3) and **EXIT** (S1) button appear by pressing the **SHIFT** button while confirming. The **EXIT** (S1) button is used to return to the second display.
- When a new call is logged, the display changes to the second display automatically.

### KX-T7436 / KX-T7235

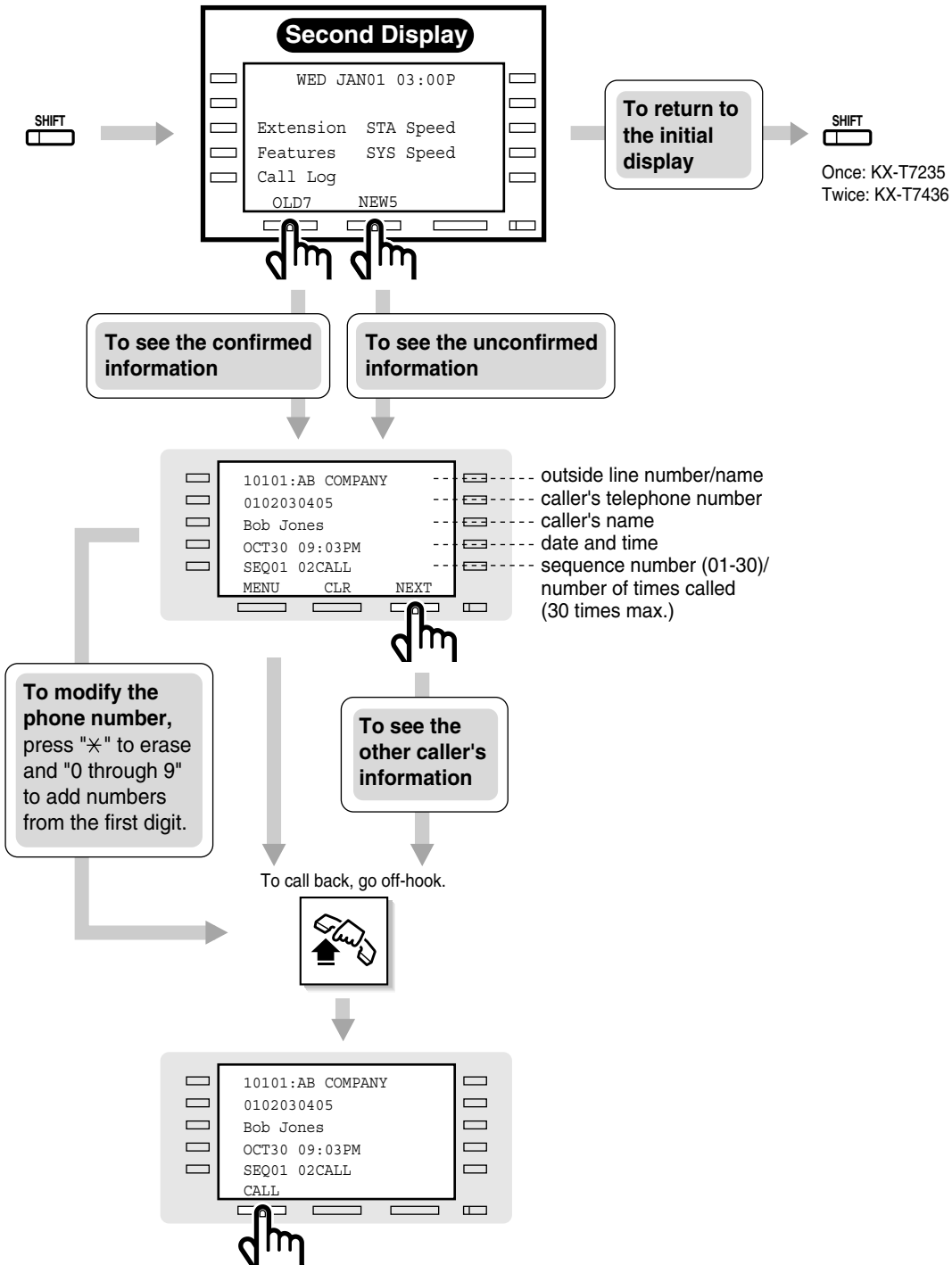

## Operating sequence

1. Press the **SHIFT** button.
2. Press the **OLD** (S1) or **NEW** (S2) button to see the confirmed or unconfirmed information.
3. Press the **NEXT** (S3) or **PREV** (S2) button to see other caller's information. Or **modify the number**, if required.
4. To call back, **go off-hook** and then press the **CALL** (S1) button.

## Notes

- To delete the displayed number, press the **CLR** (S2) button.
- The **PREV** (S3) button appears by pressing the **SHIFT** button while confirming.
- When a new call is logged, the display changes to the second display automatically.

## Conditions

- This feature is available for KX-T7230, KX-T7235, KX-T7433 and KX-T7436 only.
- If a Direct In Lines (DIL) 1:1 call is forwarded by Call Forwarding or IRNA feature, the data will be logged at both the forwarding and forwarded extension.
- You can lock the display so that incoming call information is not shown on the display.
- If you modify the displayed telephone number, the new number will be memorized.
- With the KX-T7433, KX-T7436 or KX-T7235, you can set or cancel overwriting the call log using the System Feature Access Menu (on the Fifth Display).

## Installation Manual References

- 2.5.5 ELCOT Card (KX-TD50180)
- 2.5.6 BRI Card (KX-TD50288)
- 2.5.7 PRI23 Card (KX-TD50290)
- 2.7.4 Caller ID Card (KX-TD193)

## Programming Guide References

- 2.3 Numbering Plan
  - Call Log Incoming, Overwrite Mode
  - Call Log Incoming, Log Lock
- 2.8 System Option
  - Automatic adjustment of the clock using Caller ID information
- 4.2 Trunk Line
  - Name
- 4.3 Extension Line
  - Initial Display Selection
  - [Call Log Incoming] Overwrite Mode
  - [Call Log Incoming] Lock Password
- 5.11 Caller ID Modification

- [Local Call] Area Code
- [Local Call] Digits to delete
- [Local Call] Number to be added
- [Long Distance Call] Digits to delete
- [Long Distance Call] Number to be added
- 5.12 Caller ID Registration
- 10.4 SMDR
  - Print out Caller ID Information

### **Features Guide References**

- 1.5 Attended Features
  - Caller ID Service
- 1.17 Display Features
  - Call Log, Incoming

### **User Manual References**

- 2.2.6 Initial Display Selection
- 4.4.3 Call Log Incoming, Log Lock
- 4.4.9 Remote Station Lock Control
- 4.5.5 Call Log Incoming, Log Lock (KX-T7436 / KX-T7433 / KX-T7235 / KX-T7230 only)
- 4.5.9 KX-T7235 Display Features - System Feature Access Menu
- 4.5.12 KX-T7431 / KX-T7433 / KX-T7436 Display Features - System Feature Access Menu

## 4.5.5 Call Log Incoming, Log Lock (KX-T7436 / KX-T7433 / KX-T7235 / KX-T7230 only)

Allows you to lock the display of your extension so that the "Call Log, Incoming" feature is not shown on the display, if you do not want others to see the information.

### Locking

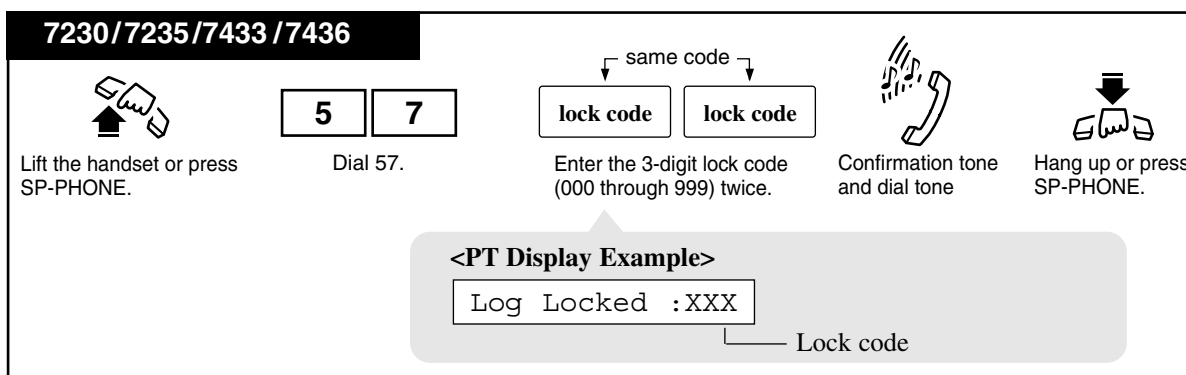

### Unlocking

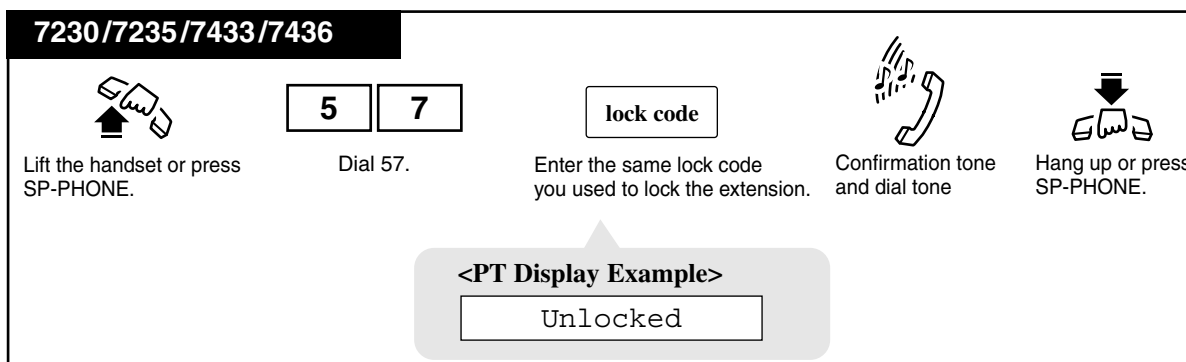

### Conditions

- This feature is available for KX-T7230, KX-T7235, KX-T7433 and KX-T7436 only.
- **Call Log Lock Control, Incoming**  
The Manager or an Operator can unlock the call log display for any extension, if you forget your lock code.
- With the KX-T7433, KX-T7436 or KX-T7235, you can execute this feature using the display operation.

### Programming Guide References

- 2.3 Numbering Plan

- Call Log Incoming, Log Lock
- 4.2 Trunk Line
  - Name
- 4.3 Extension Line
  - Initial Display Selection
  - [Call Log Incoming] Overwrite Mode
  - [Call Log Incoming] Lock Password

### **Features Guide References**

- 1.5 Attended Features
  - Caller ID Service
- 1.17 Display Features
  - Call Log, Incoming

### **User Manual References**

- 4.4.3 Call Log Incoming, Log Lock
- 4.5.4 Call Log, Incoming (KX-T7436 / KX-T7433 / KX-T7235 / KX-T7230 only)
- 4.5.9 KX-T7235 Display Features - System Feature Access Menu
- 4.5.12 KX-T7431 / KX-T7433 / KX-T7436 Display Features - System Feature Access Menu



## 4.5.6 Call Log, Outgoing (KX-T7436 / KX-T7235 only)

The last five outside telephone numbers (Up to 24 digits for each) you made are automatically logged. You can make a call using the call log.

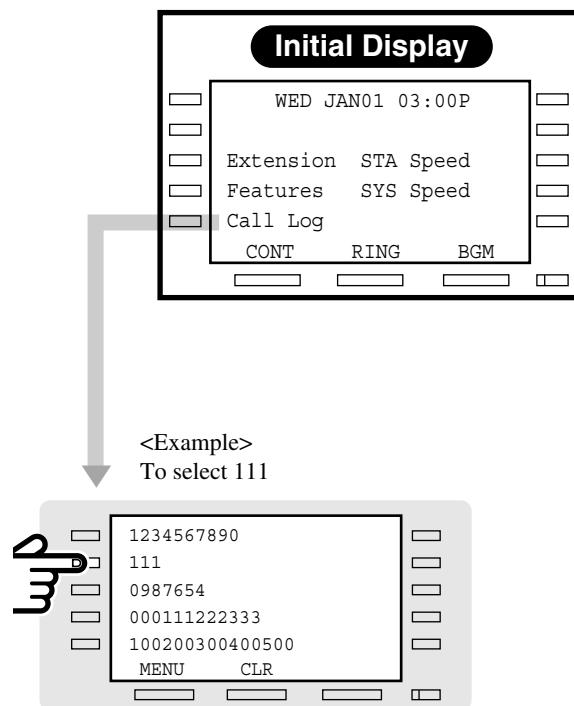

### Making a call using a call log

1. Press the **Call Log** (F5) button.
2. Press the **Function** button which is next to the desired number.

### Notes

- To delete all numbers, press the CLR (S2) button.
- To return to the initial display, press the MENU (S1) button.

## 4.5.7 KX-T7235 Display Features

The KX-T7235 telephone allows you to make a call or operate the features using the display message with the Function buttons.

### 1) Call Directory

- Extension Dialing
- Station Speed Dialing
- System Speed Dialing

### 2) System Feature Access Menu

The System Feature Access Menu provides a display of the system features which appear in alphabetical order. The available features are as follows:

Absent Message Capability	Message Waiting
Automatic Callback Busy (Camp-On), Cancel	Night Service On / Off
Background Music (BGM) — External	Outgoing Message (OGM)
Call Log, Incoming	Paging — External
Call Log Incoming, Log Lock	Paging — Group
Call Park	Paging — ANSWER
Call Pickup, CO Line	Paging — DENY
Call Pickup, Directed	Paralleled Telephone Connection
Call Pickup, Group	Pickup Dialing (Hot Line)
Call Pickup Deny	Remote DND (Do Not Disturb)
Call Waiting	Remote FWD Cancel – Once
Data Line Security	Station Program Clear
Door Opener	Switching COS
Doorphone Call	Timed Reminder
Electronic Station Lockout	Timed Reminder, Remote (Wake-Up Call)
Executive Busy Override Deny	Trunk Busy-out Setting
External Modem Control	Trunk Route Control
Group Call FWD	UCD Monitor Mode
Group Log-In / Log-Out	Walking COS
Live Call Screening (LCS), Password Set	
Log-In / Log-Out	

## 4.5.8 KX-T7235 Display Features - Call Directory

You can make a call using the call directory by pressing the desired button which is corresponding to the display message. The example operations are shown below.

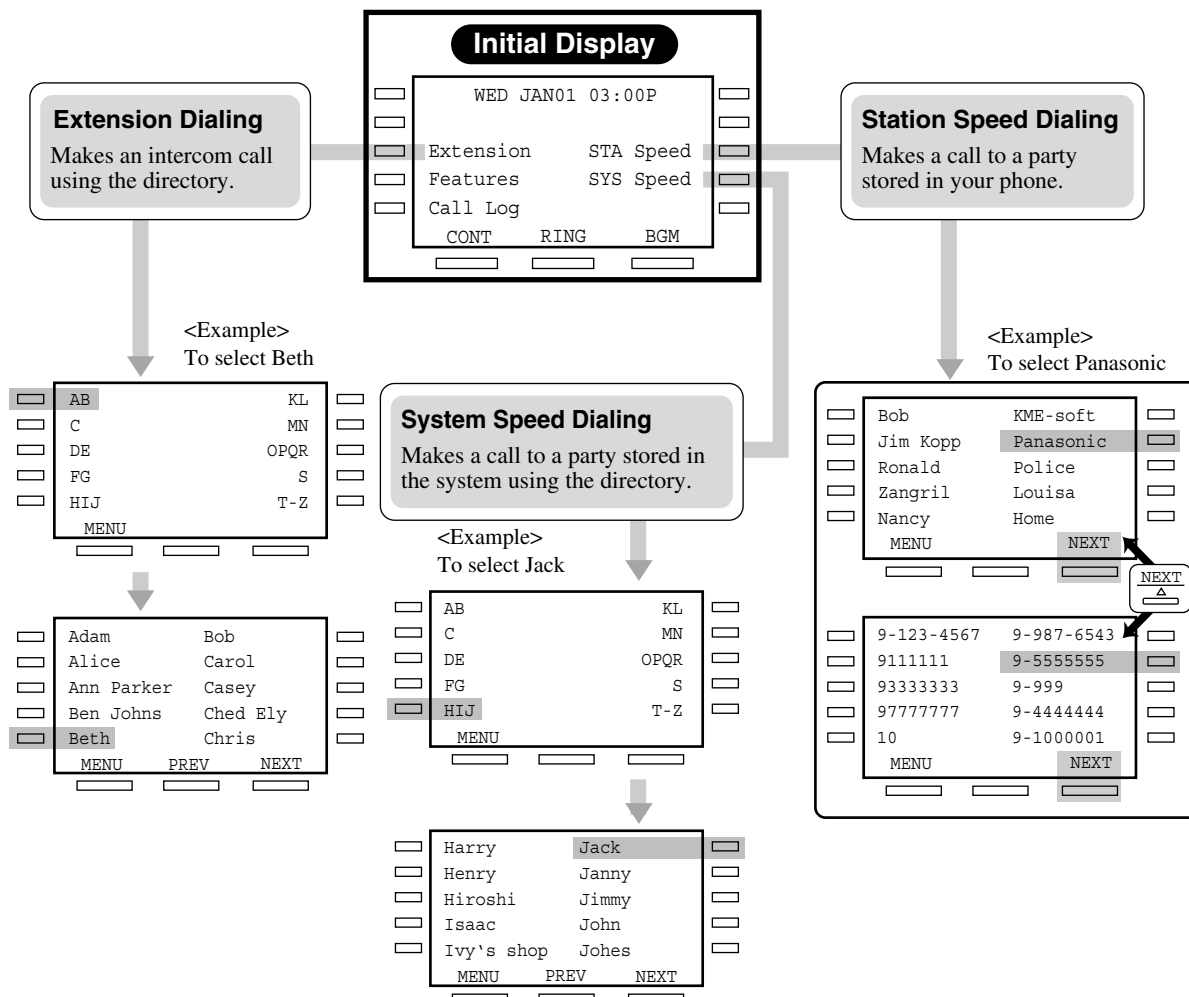

### Extension Dialing / System Speed Dialing

1. Press the **Extension** (F3) or **SYS Speed** (F9) button.
2. Press the **Function** button which is next to the desired alphabet.
3. Press the **Function** button which is next to the desired name.

### Station Speed Dialing

1. Press the **STA Speed** (F8) button.
2. Press the **Function** button which is next to the desired name or number.  
To alternate the display between name and number, press the **NEXT** (S3) button.

### Programming Guide References

- 1.4 Extension Port Assignment

– DN

- 2.8 System Option
  - Station Speed Dialing Initial display
- 4.3 Extension Line
  - Name
- 5.2 System Speed Dialing
  - Name
  - Number

### **Features Guide References**

- 1.7 Dialing Features
  - One-Touch Dialing
  - System Speed Dialing
- 1.17 Display Features
  - Call Directory

### **User Manual References**

- 2.2.17 Station Speed Dialing Number/Name Assignment [KX-T7235/KX-T7431/KX-T7433/KX-T7436 only]
- 3.2.2 [001] System Speed Dialing Number Set
- 3.2.3 [002] System Speed Dialing Name Set
- 3.2.4 [004] Extension Name Set

## 4.5.9 KX-T7235 Display Features - System Feature Access Menu

You can access various features using the messages which are displayed in alphabetical order. To access the features, press the Feature (F4) button on the initial display first, search for the desired feature message by pressing the NEXT (S3) button. Then press the Function button which is next to the message. Additional parameters may be required. To access the features while receiving a call (e.g., ringing), press the INTERCOM/DN button first. Then follow the procedures on the following pages.

### Features on the First Display

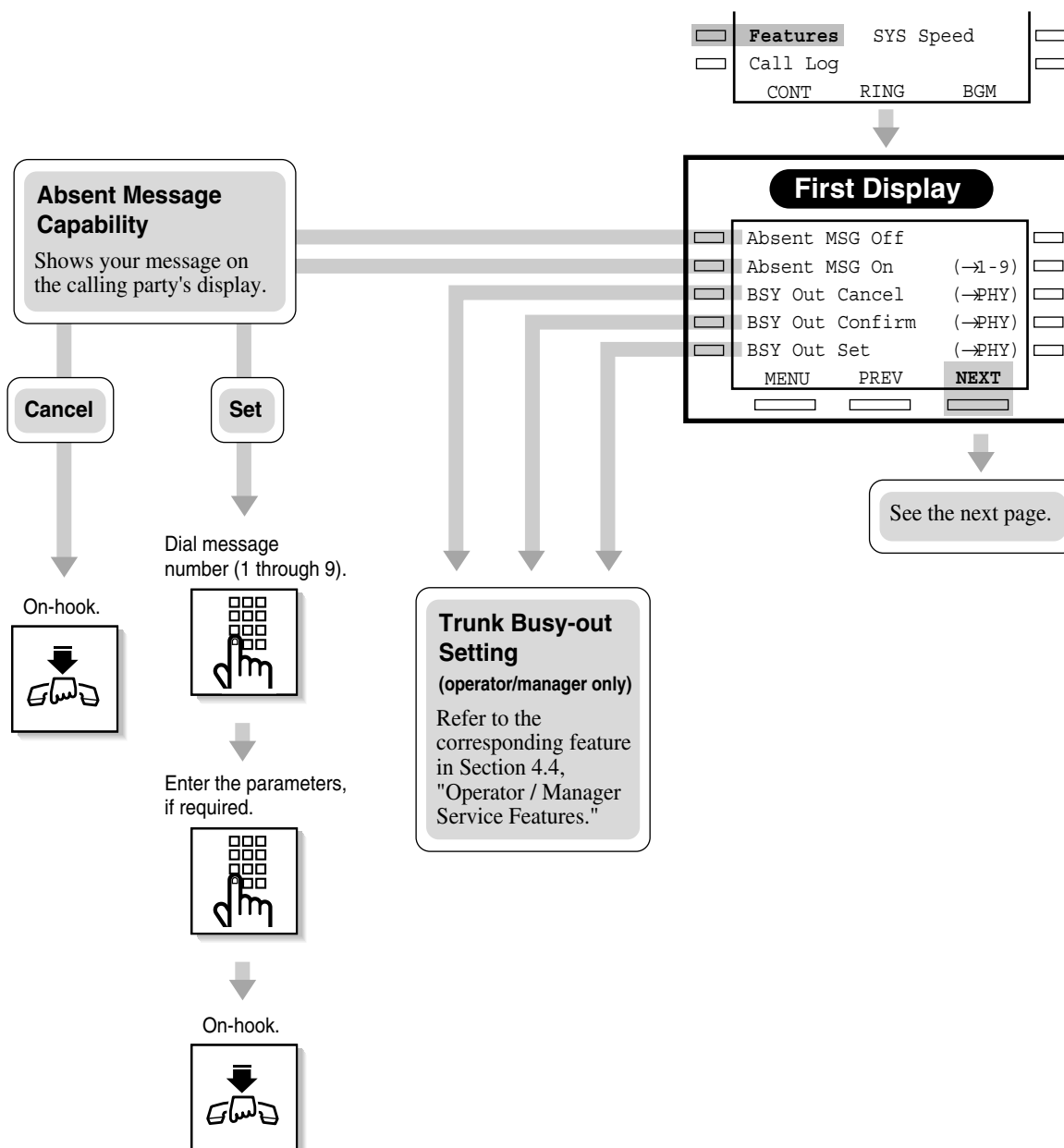

## Features on the Second Display

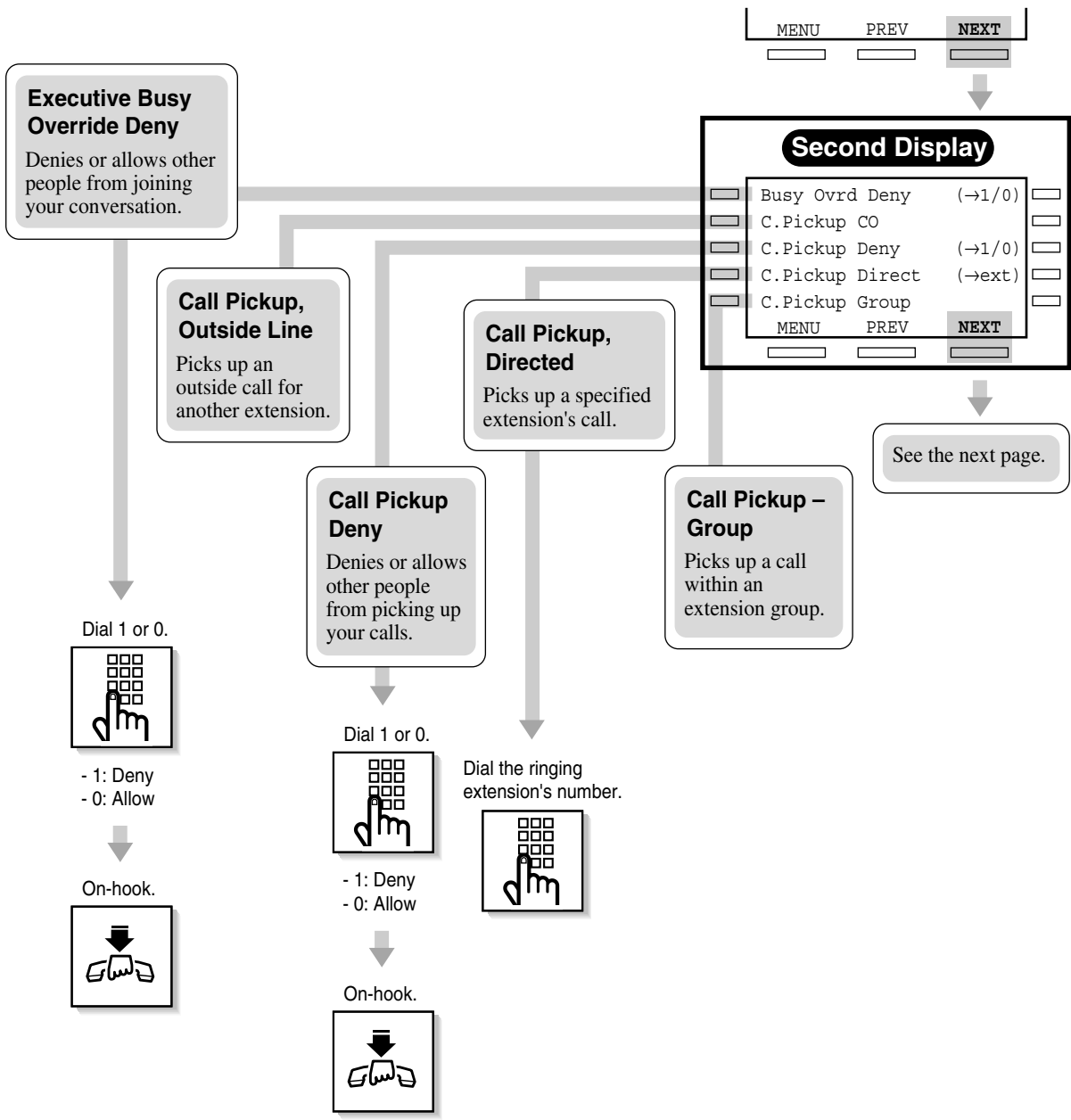

## Features on the Third Display

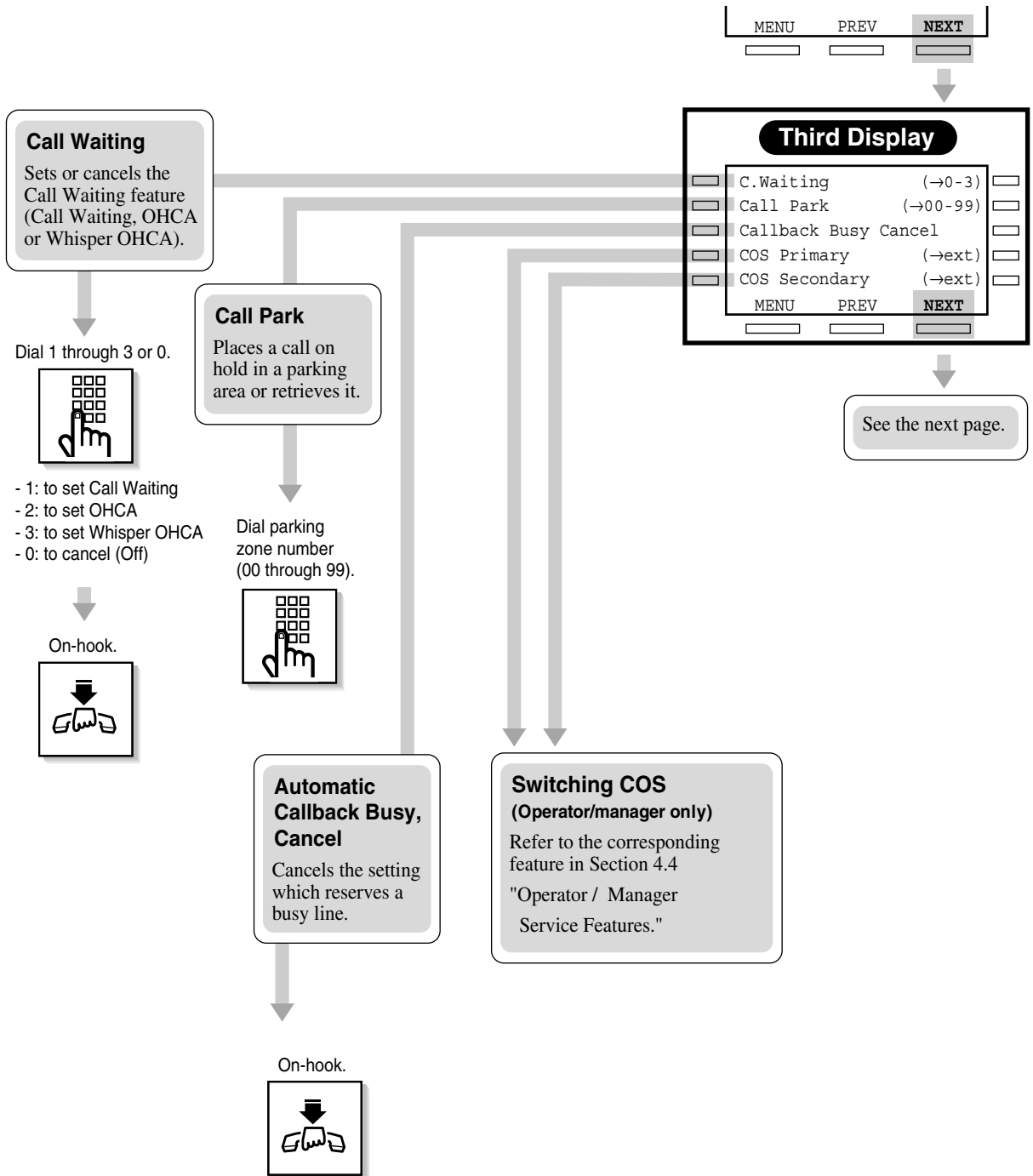

## Features on the Fourth Display

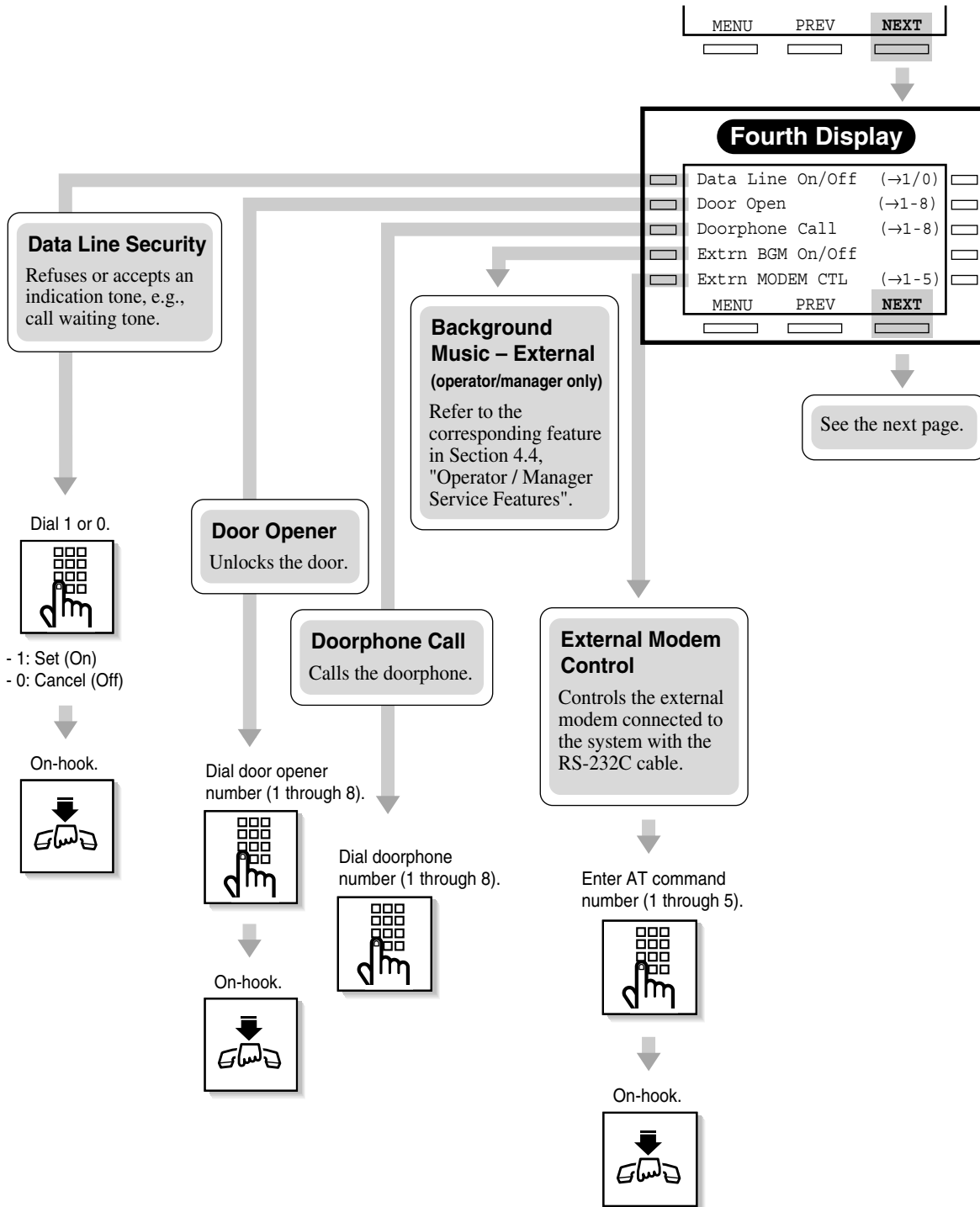



## Features on the Fifth Display

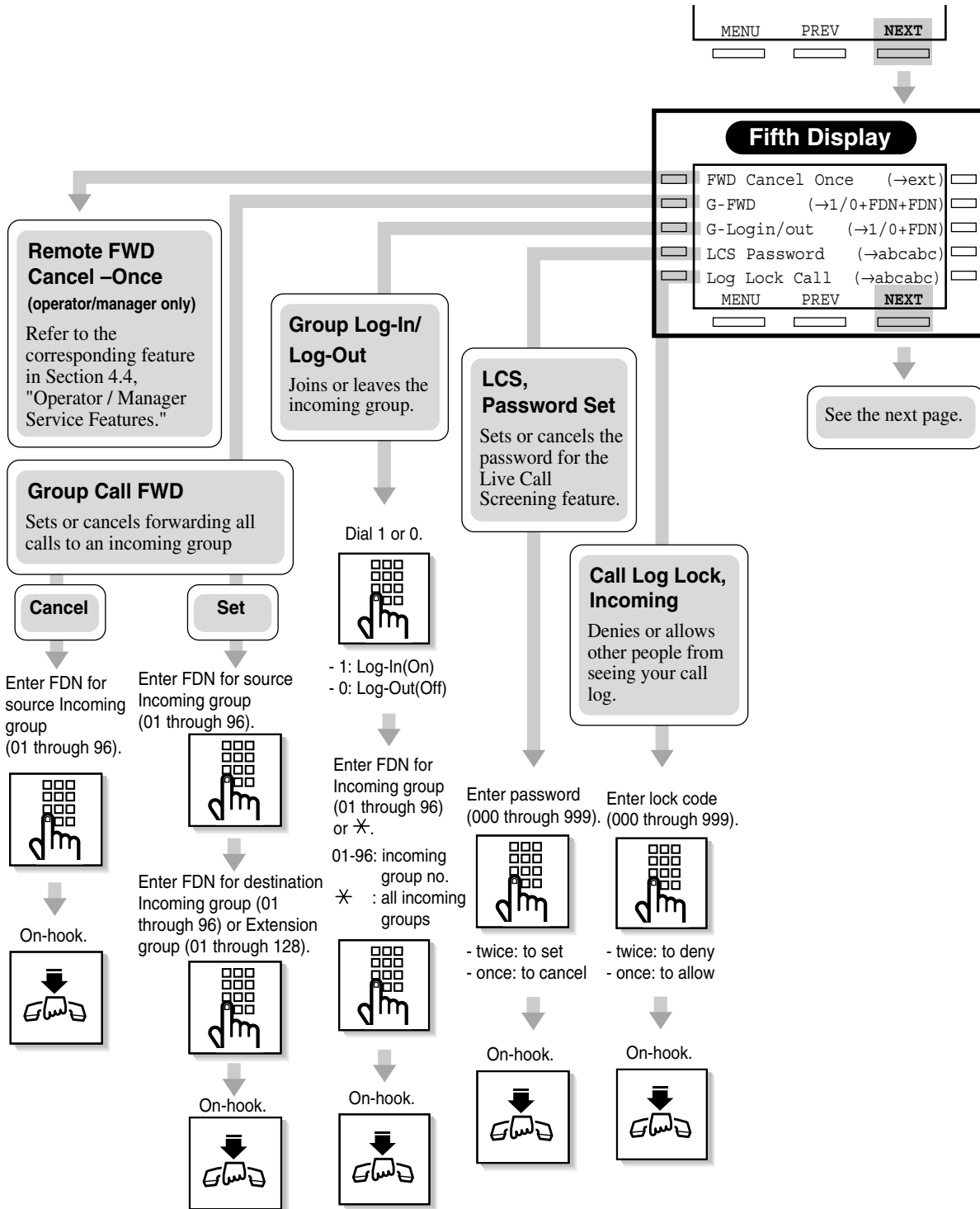

## Features on the Sixth Display

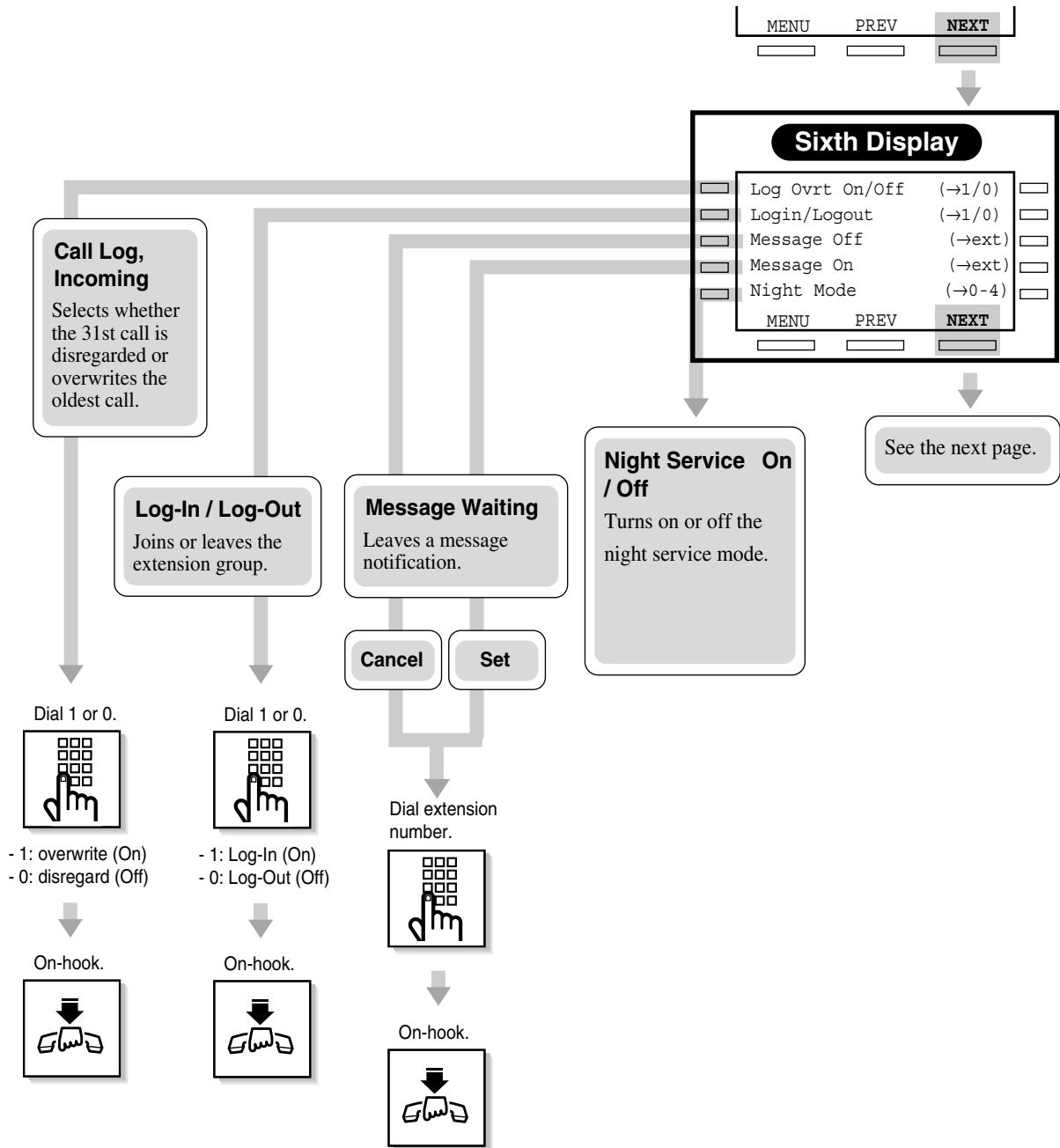

## Features on the Seventh Display

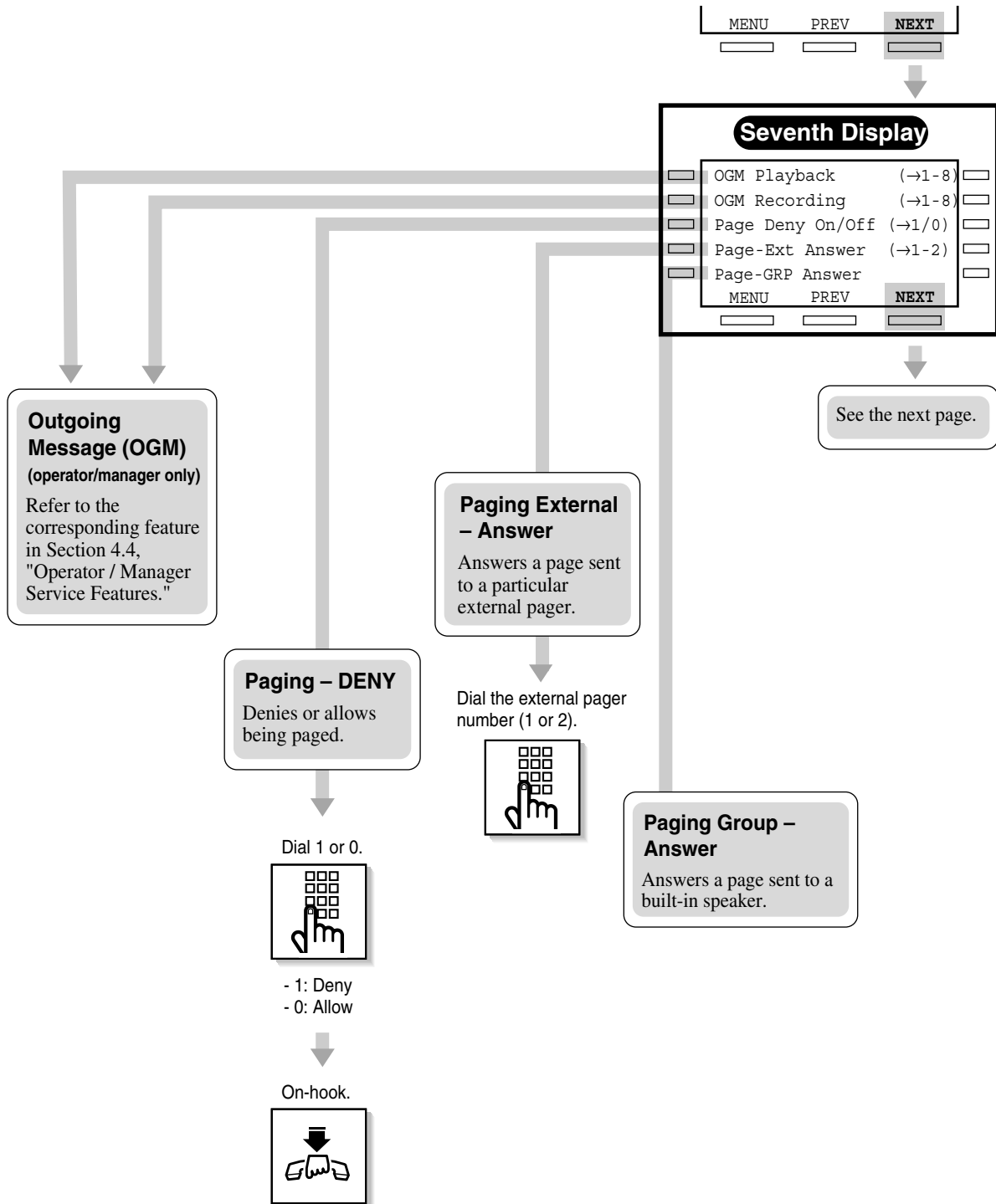

## Features on the Eighth Display

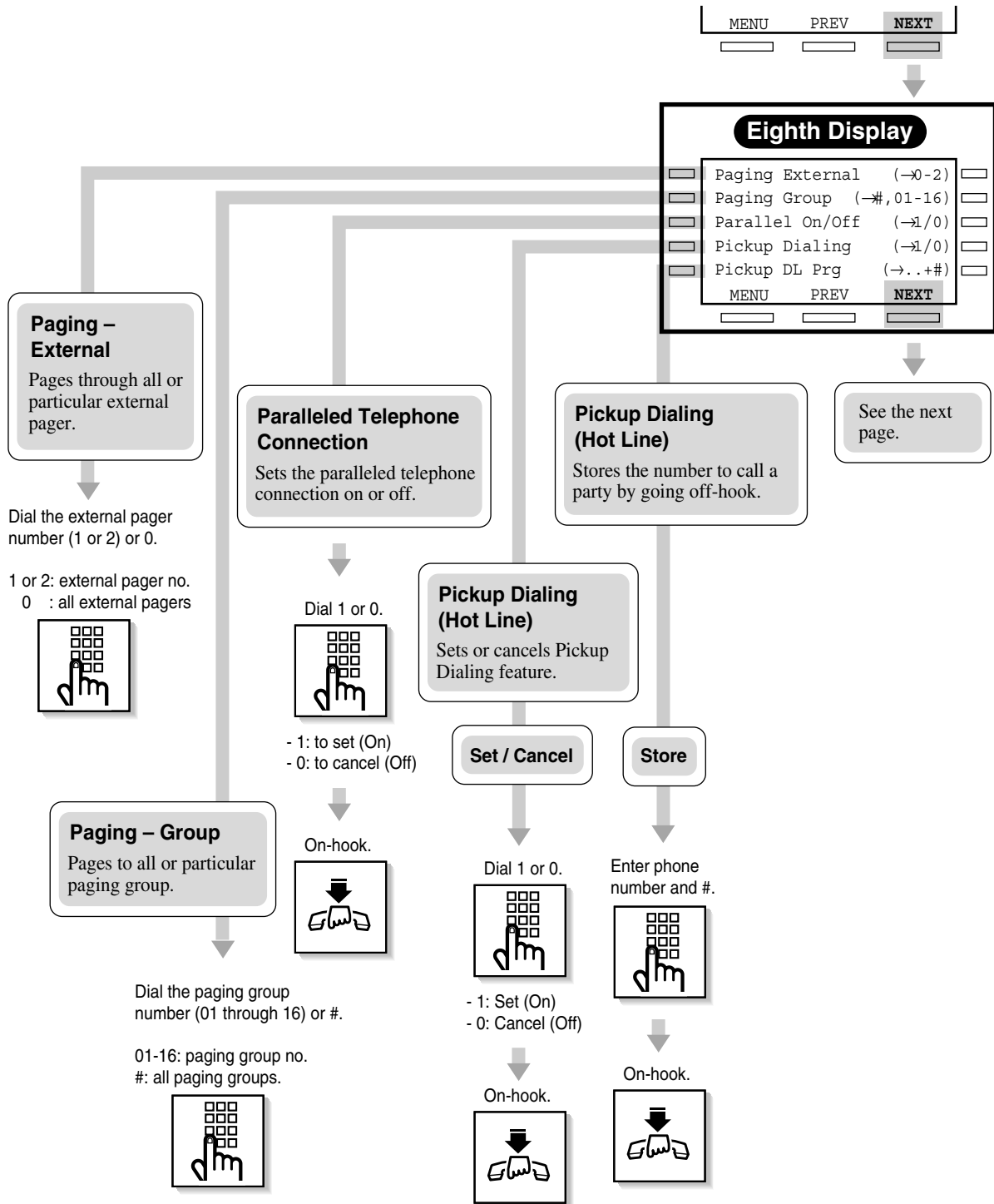

## Features on the Ninth Display

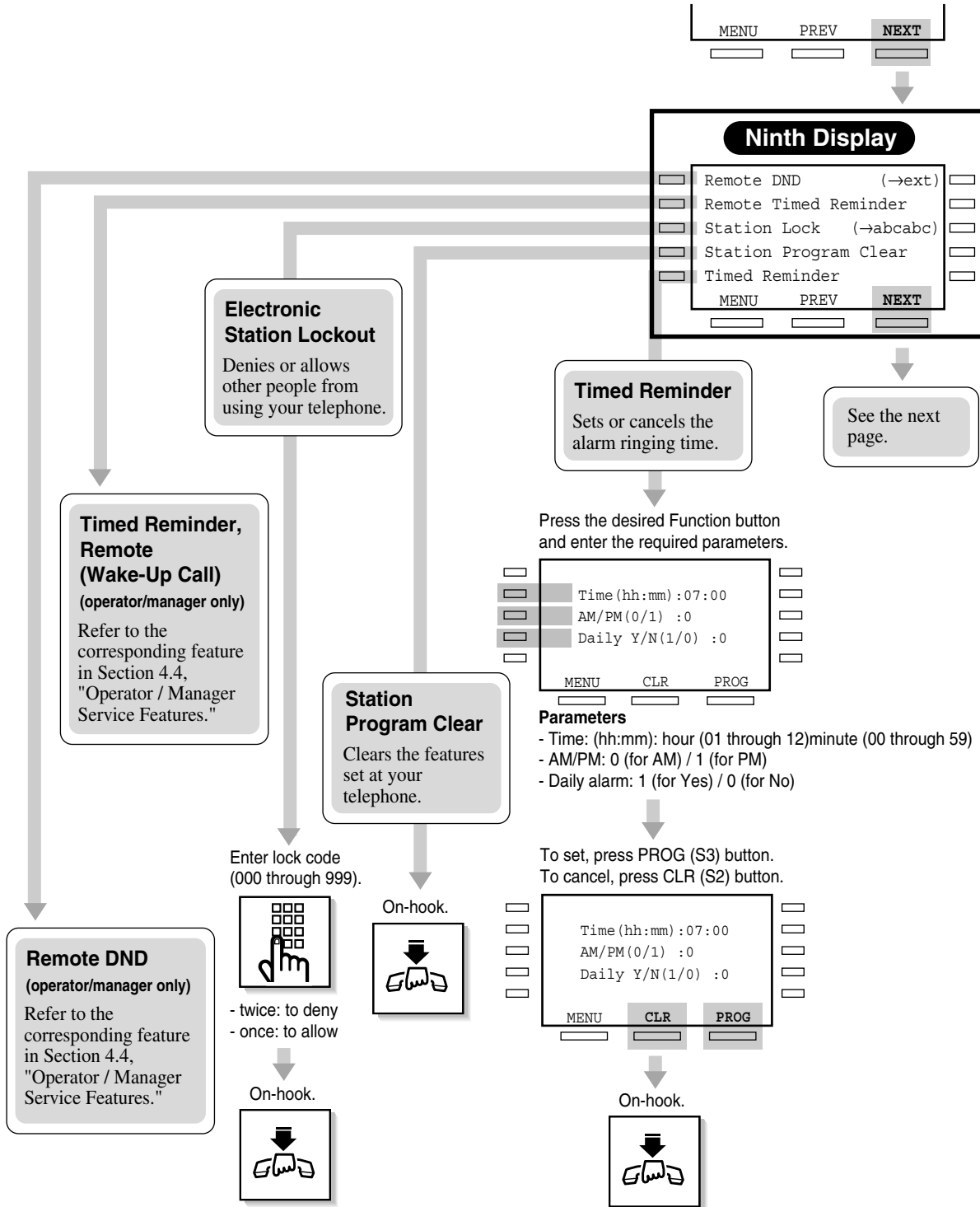

## Features on the Tenth Display

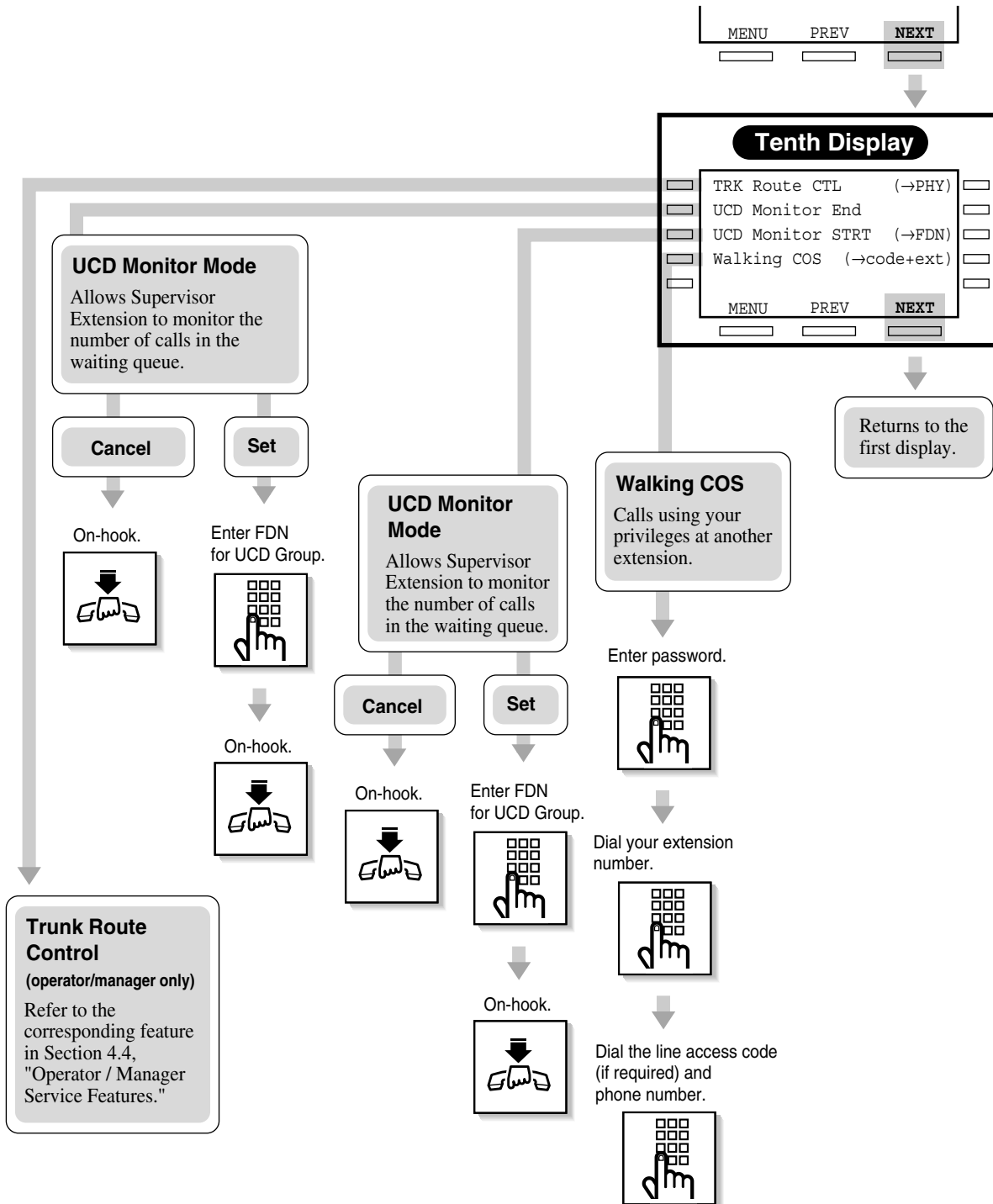

## 4.5.10 KX-T7431 / KX-T7433 / KX-T7436 Display Features

The KX-T7431, KX-T7433 and KX-T7436 telephones allow you to make a call or operate the features using the display message.

### 1) Call Directory

Extension Dialing  
Station Speed Dialing  
System Speed Dialing

### 2) System Feature Access Menu

The System Feature Access Menu provides a display of the system features which appear in alphabetical order. The available features are as follows:

Absent Message Capability	Night Service On / Off
Automatic Callback Busy (Camp-On), Cancel	Outgoing Message (OGM)
Background Music (BGM) — External	Paging — External
Call Log, Incoming	Paging — Group
Call Log Incoming, Log Lock	Paging — ANSWER
Call Park	Paging — DENY
Call Pickup, CO Line	Paralleled Telephone Connection
Call Pickup, Directed	Pickup Dialing (Hot Line)
Call Pickup, Group	Remote DND (Do Not Disturb)
Call Pickup Deny	Remote FWD Cancel - Once
Call Waiting	Station Program Clear
Data Line Security	Switching COS
Door Opener	Timed Reminder
Doorphone Call	Timed Reminder, Remote (Wake-Up Call)
Electronic Station Lockout	Trunk Busy-out Setting
Executive Busy Override Deny	Trunk Route Control
External Modem Control	UCD Monitor Mode
Group Call FWD	Walking COS
Group Log-In / Log-Out	
Live Call Screening (LCS), Password Set	
Log-In / Log-Out	
Message Waiting	

### Jog Dial Operation

You can search for desired items on the corresponding display menu by using the Jog Dial. Rotate the Jog Dial in either direction as desired. The items will be displayed as follows.

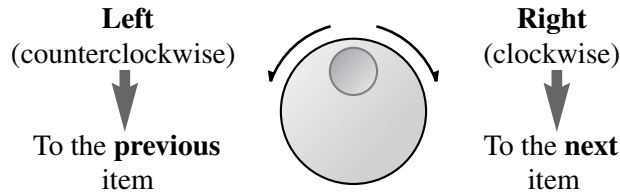

### Jog Dial Operation Display

— KX-T7431

While idle, the display changes as follows by pressing the MODE button. The Jog Dial operation is available in the second through seventh displays.

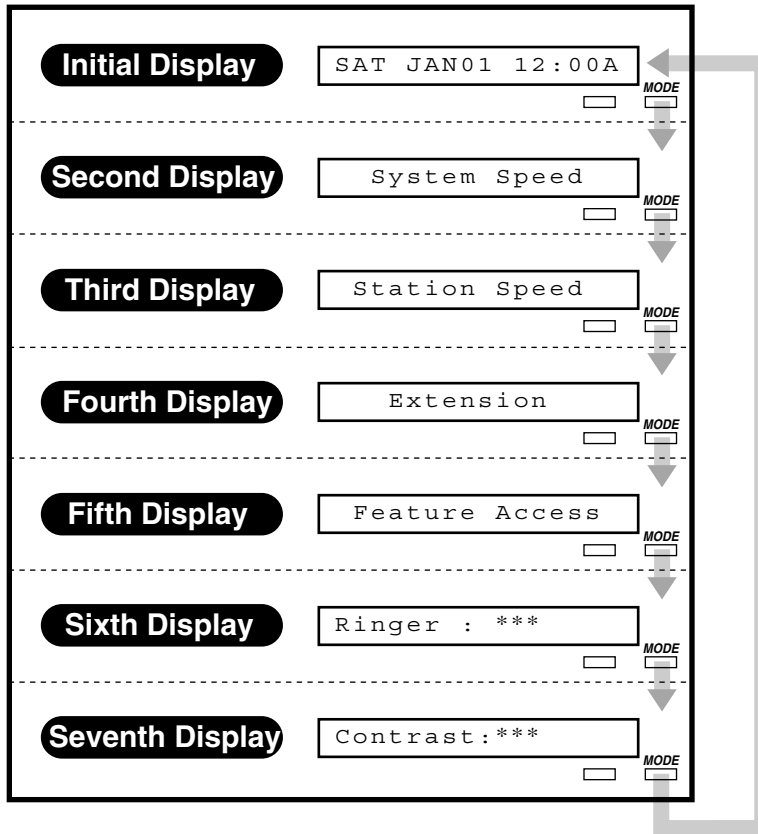



### — KX-T7433

The Jog Dial operation is available in the initial and third display. While idle, the bottom line of the display changes by pressing the SHIFT button as follows.

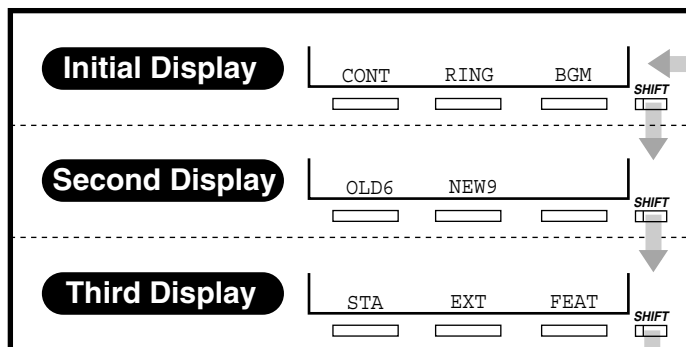

### — KX-T7436

The Jog Dial operation is available in the initial and third display. While idle, the bottom line of the display changes by pressing the SHIFT button as follows.

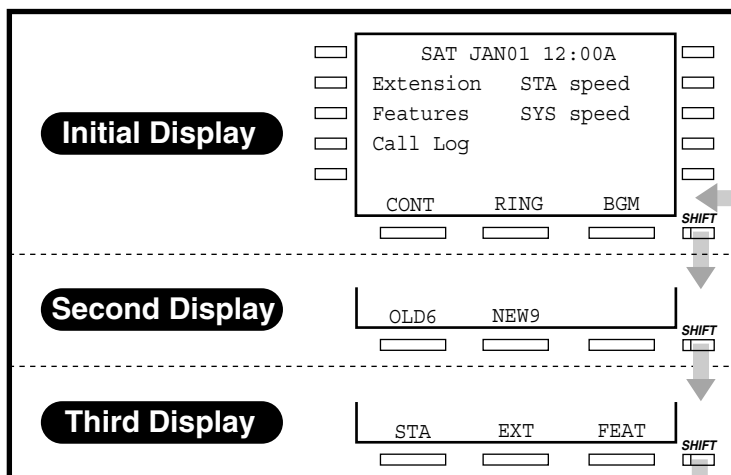

### Conditions

- The sixth and seventh displays of the KX-T7431 are used for the ringer volume and display contrast adjustments. For details, please refer to Section "1.1.5 Initial Setting for KX-T7400 Series."
- "Second Display" of the KX-T7433 and KX-T7436 is displayed only when you utilize the Caller ID.

## 4.5.11 KX-T7431 / KX-T7433 / KX-T7436 Display Features - Call Directory

There are three Call Directory features as follows.

Feature	Description	Condition
<b>Extension Dialing</b>	You can make an intercom call using the directory.	Only items which have a name assigned are displayed in alphabetical order.
<b>System Speed Dialing</b>	You can make a call to a party stored in the system using the directory.	
<b>Station Speed Dialing</b>	You can make a call to a party stored in your phone.	Items which have a name assigned are displayed by priority in stored order. If a name is not assigned, the number is displayed. The displaying mode, name or number, can be assigned by System Programming.

To use the Call Directory, you may shift the display to the Jog Dial Operation display by pressing the SHIFT button first. Then follow the procedures on the following pages.

### Programming Guide References

- 1.4 Extension Port Assignment
  - DN
- 2.8 System Option
  - Station Speed Dialing Initial display
- 4.3 Extension Line
  - Name
- 5.2 System Speed Dialing
  - Name
  - Number

### Features Guide References

- 1.17 Display Features
  - Call Directory

### User Manual References

- 2.2.17 Station Speed Dialing Number/Name Assignment [KX-T7235/KX-T7431/KX-T7433/KX-T7436 only]

- 3.2.2 [001] System Speed Dialing Number Set
- 3.2.3 [002] System Speed Dialing Name Set
- 3.2.4 [004] Extension Name Set

### KX-T7431

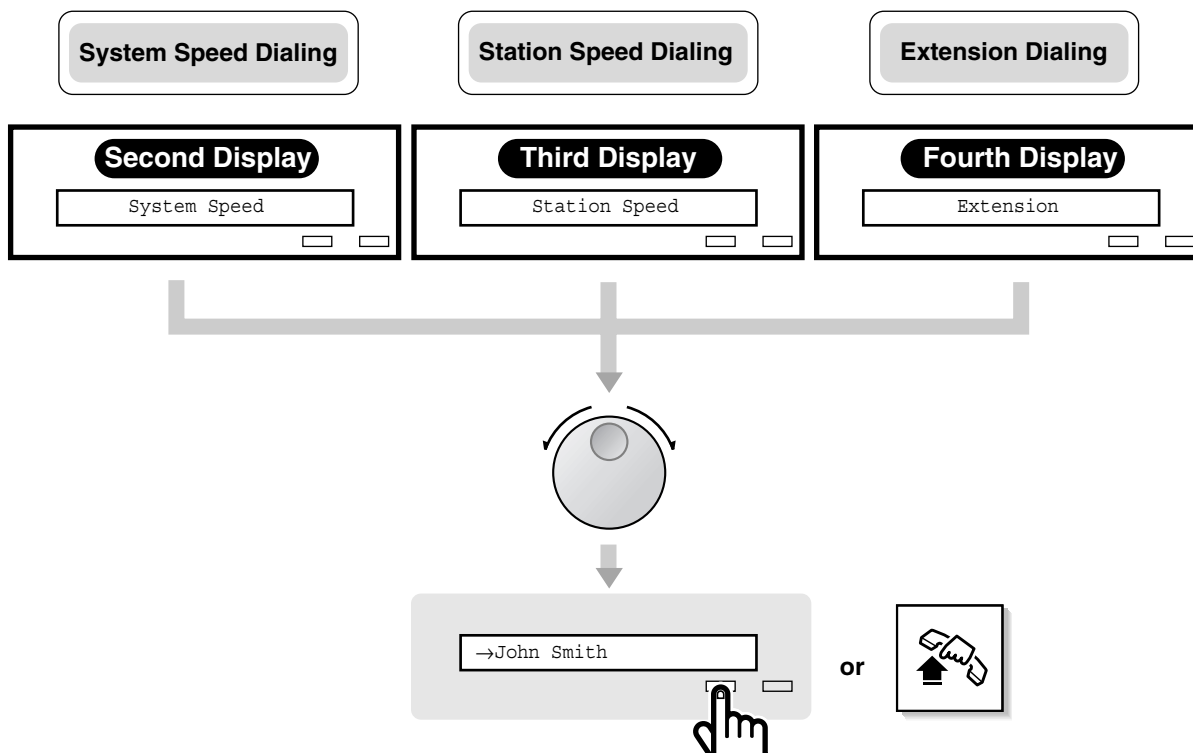

#### System Speed Dialing / Station Speed Dialing / Extension Dialing

1. Rotate the Jog Dial until the desired item is displayed.
2. Press the **SELECT** button or go off-hook.

#### Notes

- You can lift the handset or press the SP-PHONE button instead of the SELECT button.
- Press the MODE button to return to the initial display.
- For System Speed Dialing and Extension Dialing, before rotating the Jog Dial, you can press the corresponding alphabet key to select the desired letter.  
<Example> Press 2 twice to display "B" items.

## KX-T7433

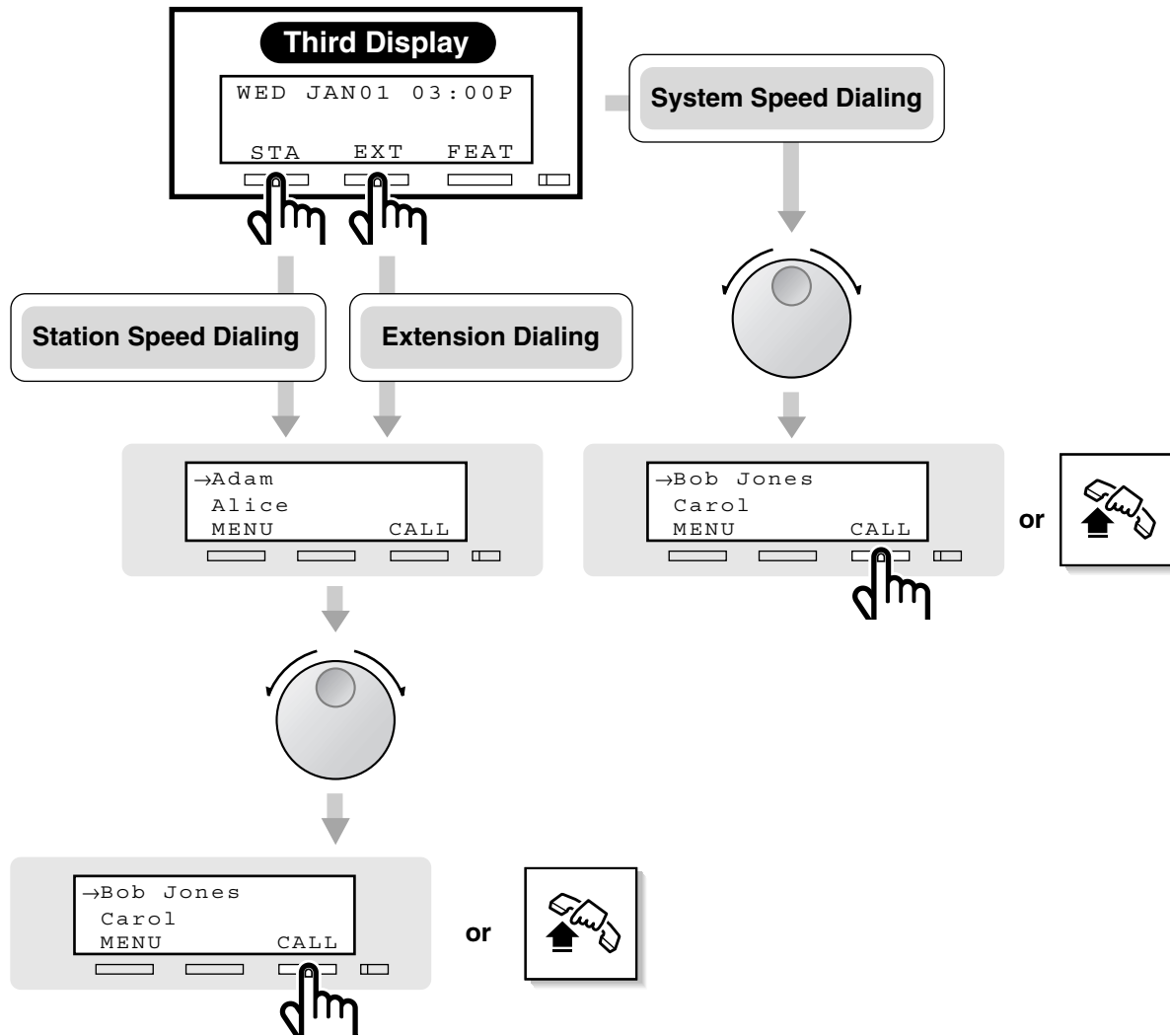

### System Speed Dialing

1. Rotate the Jog Dial until the desired item is at the arrow.
2. Press the CALL (S3) button or go off-hook.

### Note

- For System Speed Dialing and Extension Dialing, before rotating the Jog Dial, you can press the corresponding alphabet key to select the desired letter.  
<Example> Press 2 twice to display "B" items.

### Station Speed Dialing / Extension Dialing

1. Press the STA (S1) or EXT (S2) button.
2. Rotate the Jog Dial until the desired item is at the arrow.
3. Press the CALL (S3) button or go off-hook.

# KX-T7436

- Using the Function button -

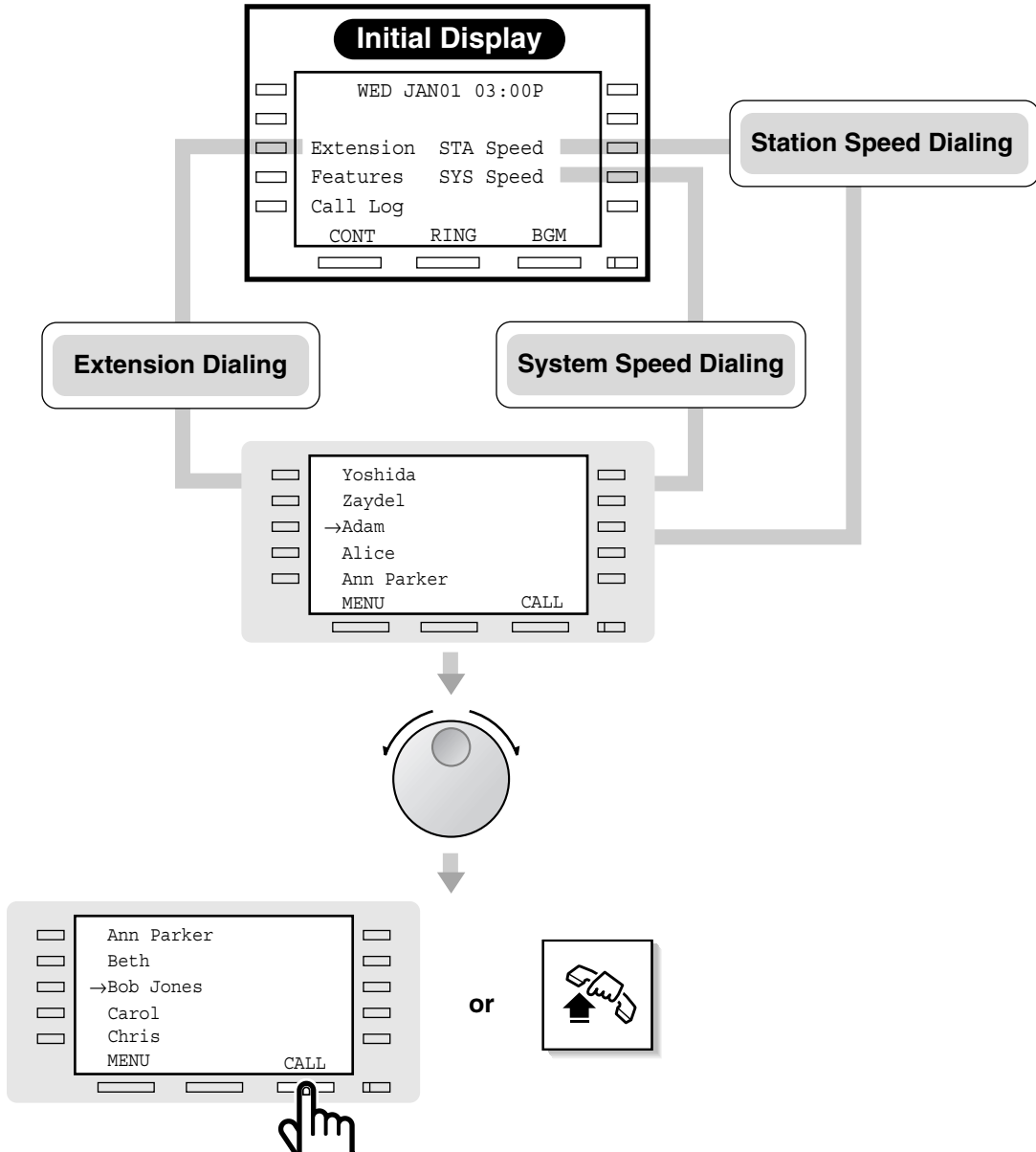

**Extension Dialing / Station Speed Dialing / System Speed Dialing**

1. Press the **Extension (F3)**, **STA Speed (F8)** or **SYS Speed (F9)** button.
2. **Rotate the Jog Dial** until the desired item is at the arrow.
3. Press the **CALL (S3)** button or **go off-hook**.

- You can press the Function button (F1 through F10) on the same line of the desired item instead of the CALL (S3) button.
- For System Speed Dialing and Extension Dialing, before rotating the Jog Dial, you can press the corresponding alphabet key to select the desired letter.  
<Example> Press 2 twice to display "B" items.

— Using the Soft button or rotating Jog Dial directly —

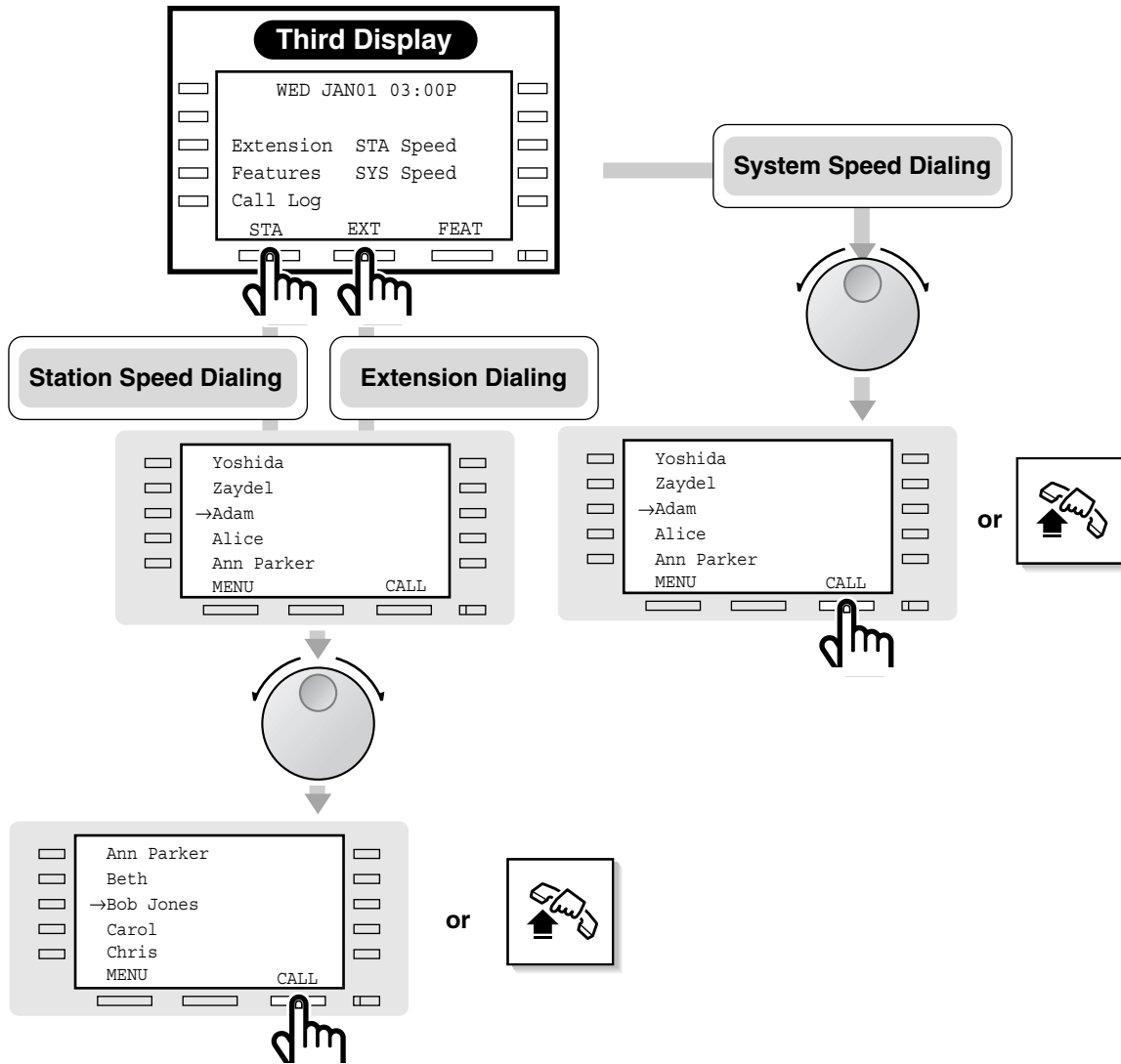

**System Speed Dialing**

1. **Rotate the Jog Dial** until the desired item is at the arrow.
2. Press the **CALL** (S3) button or **go off-hook**.

**Station Speed Dialing / Extension Dialing**

1. Press the **STA** (S1) or **EXT** (S2) button.
2. **Rotate the Jog Dial** until the desired item is at the arrow.
3. Press the **CALL** (S3) button or **go off-hook**.

**Notes**

- You can press the Function button (F1 through F10) on the same line of the desired item instead of the **CALL** (S3) button.
- For System Speed Dialing and Extension Dialing, before rotating the Jog Dial, you can press the corresponding alphabet key to select the desired letter.  
<Example> Press 2 twice to display "B" items.

## 4.5.12 KX-T7431 / KX-T7433 / KX-T7436 Display Features - System Feature Access Menu

You can access the features which are displayed in alphabetical order.

To access the features, you may shift the display to the Jog Dial Operation display by pressing the MODE or SHIFT button first. Then follow the procedures below.

To access the features while receiving a call (e.g., ringing), press the INTERCOM/DN button first. Then follow the procedures below.

### KX-T7431

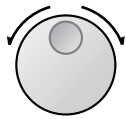

If a parameter is required, the feature name and parameter will flash.

Enter a parameter, if required.

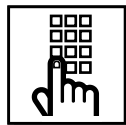

### KX-T7433

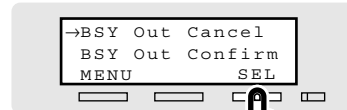
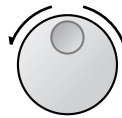
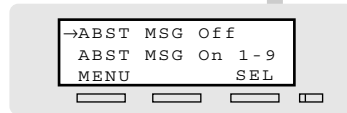
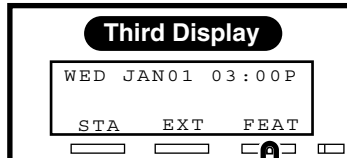

If a parameter is required, the feature name and parameter will flash.

Enter a parameter, if required.

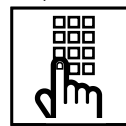

### KX-T7436

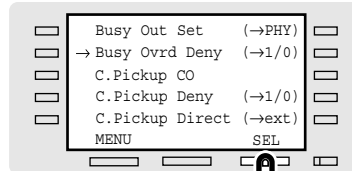
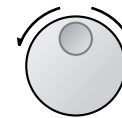
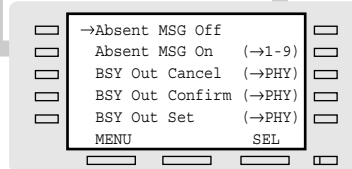
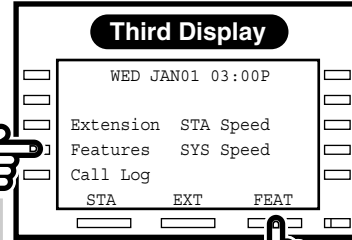

If a parameter is required, the parameter will flash.

Enter a parameter, if required.

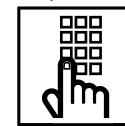



**KX-T7431**

1. **Rotate the Jog Dial** until the desired item is displayed.
2. Press the **SELECT** Button.
3. Enter the parameter, if required.
4. On-hook, if required.

**KX-T7433**

1. Press the **FEAT** (S3) button.
2. **Rotate the Jog Dial** until the desired item is at the arrow.
3. Press the **SEL** (S3) button.
4. Enter the parameter, if required.
5. On-hook, if required.

**KX-T7436**

1. Press the **Features** (F4) or **FEAT** (S3) button.
2. **Rotate the Jog Dial** until the desired item is at the arrow.
3. Press the **SEL** (S3) button.
4. Enter the parameter, if required.
5. On-hook, if required.

**Notes**

- When using a KX-T7436, you can press the Function button (F1 through F10) on the same line of the desired item instead of the SEL (S3) button.
- When using a KX-T7436, you can press the Feature (F4) button in any display (initial through third).
- Before rotating the Jog Dial, you can press the corresponding alphabet key to select the desired letter.  
<Example> Press 2 twice to display "B" items.

**System Feature List**

You can access the following features which are displayed in alphabetical order. For more details about the features and the required parameters, please refer to the respective features in Section "4.3 Station Features and Operation" and Section "4.4 Operator / Manager Service Features."

<b>Display (KX-T7436/KX-T7235)</b>	<b>Display (KX-T7431/KX-T7433)</b>	<b>Feature Description</b>
Absent MSG Off	ABST MSG Off	Cancel the absent message.
Absent MSG On (→1-9)	ABST MSG On 1-9	Set an absent message.
BSY Out Cancel (→PHY)	BSY Out Cancel	Cancel the Trunk Busy-out setting.* <sup>1</sup>
BSY Out Confirm (→PHY)	BSY Out Confirm	Confirm the Trunk Busy-out setting.* <sup>1</sup>
BSY Out Set (→PHY)	BSY Out Set	Busy out a specific trunk.* <sup>1</sup>

<b>Display (KX-T7436/KX-T7235)</b>	<b>Display (KX-T7431/KX-T7433)</b>	<b>Feature Description</b>
Busy OvrD Deny (→1/0)	BSY Ovr DNY 1/0	Deny or allow other people from joining your conversation.
C.Pickup CO	C.Pickup CO	Pick up a CO call for other extension(s).
C.Pickup Deny (→1/0)	C.PickupDNY 1/0	Deny or allow other people from picking up your calls.
C.Pickup Direct (→ext)	C.PickupDRT ext	Pick up a specific extension's call.
C.Pickup Group	C.Pickup Grp	Pick up a call within your extension group.
C.Waiting (→0-3)	C.Waiting 0-3	Cancel or set the Call Waiting feature (Call Waiting, OHCA or Whisper OHCA).
Call Park (→00-99)	Call Park 00-99	Place a call on hold in a system parking area.
Callback Busy Cancel	Callback Cancel	Cancel the setting which reserves a busy line.
COS Primary (→ext)	COS Primary ext	Assign the Primary COS.
COS Secondary (→ext)	COS Second ext	Assign the Secondary COS.
Data Line On/Off (→1/0)	Data Line 1/0	Refuse or accept an indication tone, e.g., call waiting tone.
Door Open (→1-8)	Door Open 1-8	Unlock the door.
Doorphone Call (→1-8)	Doorphone 1-8	Call the doorphone.
Extrn BGM On/Off	Ext-BGM On/Off	Turn on/off the background music through the external pagers.* <sup>1</sup>
Extrn MODEM CTL (→1-5)	Extrn MODEM 1-5	Control the external modem by sending a pre-assigned AT Command.
FWD Cancel Once (→ext)	FWD Cancel Once	Cancel the Call Forwarding feature set at other extensions.* <sup>1</sup>
G-FWD (→1/0+FDN+FDN)	G-FWD	Set or cancel forwarding all calls to an incoming group.
G-Login/out (→1/0+FDN)	G-Login/out	Join or leave an incoming group.
LCS Password (→abcabc)	LCS # abcabc	Assign the password for the Live Call Screening feature.
Log Lock Call (→abcabc)	Log Lock abcabc	Deny other people from seeing your call log.

<b>Display (KX-T7436/KX-T7235)</b>	<b>Display (KX-T7431/KX-T7433)</b>	<b>Feature Description</b>
Log Overt On/Off (→1/0)	Log Overt 1/0	Select how the 31st call is treated, either it is disregarded or overwrites the oldest call.
Login/Logout (→1/0)	Login/out 1/0	Join or leave an extension group.
Message Off (→ext)	MSG Off ext	Cancel a message waiting notification.
Message On (→ext)	MSG On ext	Leave a message waiting notification so that the called party may call you back.
Night Mode (→0-4)	Night Mode 0-4	Change the day/night mode.
OGM Playback (→1-8)	OGM Play 1-8	Playback the outgoing message.* <sup>1</sup>
OGM Recording (→1-8)	OGM Record 1-8	Record an outgoing message.* <sup>1</sup>
Page Deny On/Off (→1/0)	Page Deny 1/0	Deny or allow being paged.
Page-Ext Answer (→1-2)	Page-E ANS 1-2	Answer the page through an external speaker.
Page-GRP Answer	Page-GRP ANS	Answer the page through a telephone speaker in the same paging group.
Paging External (→0-2)	Page Extrn 0-2	Page through the external speaker.
Paging Group (→#, 01-16)	Page GRP 01-16	Page to all or a particular paging group.
Parallel On/Off (→1/0)	Parallel 1/0	Set whether a Single Line Telephone connected in parallel will ring or not when receiving a call.
Pickup Dialing (→1/0)	Pickup Dial 1/0	Set or cancel the feature, calling to a pre-set party by going off-hook.
Pickup DL Prg (→..+#)	Pickup DL PG..#	Store the extension or phone number to call a party by going off-hook.
Remote DND (→ext)	Remote DND	Set or cancel the DND feature set at other extensions.* <sup>1</sup>
Remote Timed Reminder	R-Timed Remind	Set the alarm ringing time for any extension.* <sup>1</sup>
Station Lock (→abcabc)	St. Lock abcabc	Prevent other people from making an outgoing CO call from your extension.

<b>Display (KX-T7436/KX-T7235)</b>	<b>Display (KX-T7431/KX-T7433)</b>	<b>Feature Description</b>
Station Program Clear	STA Prog Clear	Clear the features set at your telephone.
Timed Reminder	Timed Reminder	Set the alarm ringing time.* <sup>2</sup>
TRK Route CTL (→PHY)	TRK Route CTL	Verify the status of a specific trunk.* <sup>1</sup>
UCD Monitor End	UCD Monitor End	Cancel the monitoring of a UCD Group.
UCD Monitor STRT (→FDN)	UCD Monitor STR	Start the monitoring of a UCD Group.
Walking COS (→code+ext)	WK.COS code+ext	Call using your privileges at another extension.

\*<sup>1</sup> Only available for the Manager and the Operators.

\*<sup>2</sup> After selecting this message, follow the steps as follows. — KX-T7436: steps of the "Timed Reminder" feature in "KX-T7235 Display Features—System Feature Access Menu (Features on the Ninth Display)" in this section. — KX-T7431 and KX-T7433: steps after dialing the feature number (761) and 1 of "4.3.94 Timed Reminder" feature in Section "4.3 Station Features and Operation."

# *Section 5*

## *DSS Console Features*

*Note: All illustrations of the DPT (paired telephone) used in these operating instructions are based on model KX-T7235.*

## 5.1 Configuration

### 5.1.1 Configuration

With a Directed Station Selection (DSS) Console, you can make or transfer calls and access system features with the touch of a button. The DSS Console must be connected to the Panasonic KX-TD500 System and paired with a PT (Proprietary Telephone). System Programming is required to designate the extension number of the paired PT. With a paired telephone, you can carry out the following operations using the DSS Console:

- Direct access to an extension (Direct Station Dialing)
- Quick access to an outside party (One-Touch Dialing)
- Quick access to a system feature (One-Touch Access for System Features)
- Easy transfer to an extension (Call Transfer)

The above functions are enabled simply by pressing buttons on the console which are pre-programmed as function buttons by Station Programming.

Panasonic KX-T series DSS Consoles are categorized as follows:

KX-T7240 KX-T7040	DSS Console (32-DSS buttons, 16-PF buttons)
KX-T7440	DSS Console (66-DSS buttons)
KX-T7441	DSS Console for Attendant (48-DSS buttons, ANSWER button, RELEASE button)

#### Conditions

- The DSS Console and the PT should be placed side by side on your desk.
- Up to 8 DSS Consoles can be connected to a PT.
- A Single Line Telephone cannot be paired with the DSS Console.
- For System Programming, please refer to the Programming Guide of the KX-TD500 System.

#### Programming Guide References

- 4.4 DSS Console
  - Paired Extension
  - [DSS Console 1-8] Port No.
  - [DSS Console 1-8] Model
  - DSS Key
  - PF Key

## 5.1.2 Location of Controls

### KX-T7240/KX-T7040

#### DSS Buttons with Busy Lamp Field (BLF) (01 through 32):

Used to access extensions. The BLF indicates the busy or idle status of each corresponding extension in the system. These buttons can also be changed to other function buttons.

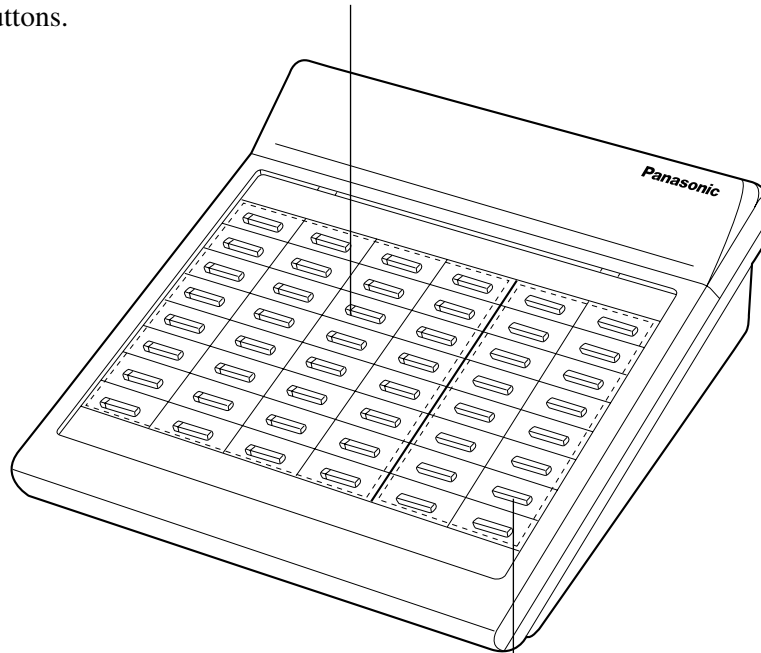

#### PF (Programmable Function) Buttons (01 through 16):

These buttons are provided with no default settings. With a paired telephone, you can program the buttons as other function buttons.

#### <Back View>

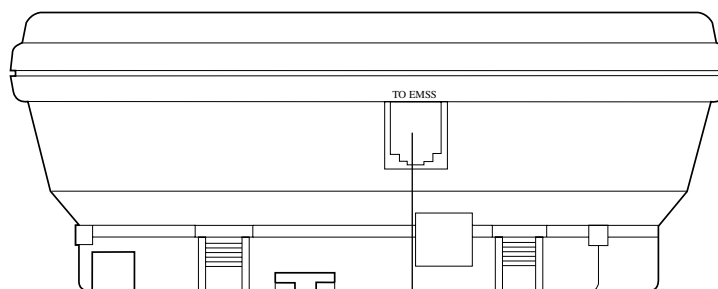

Used to connect to the KX-TD500 System

**KX-T7440**

**DSS Buttons with  
Busy Lamp Field (BLF)(01 through 66)**



**KX-T7441**

**DSS Buttons with  
Busy Lamp Field (BLF)(01 through 48)**

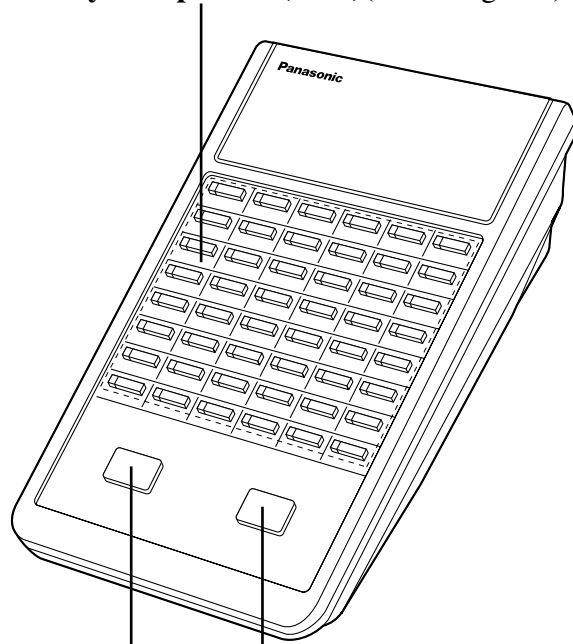

**ANSWER Button    RELEASE Button**

**Connection**

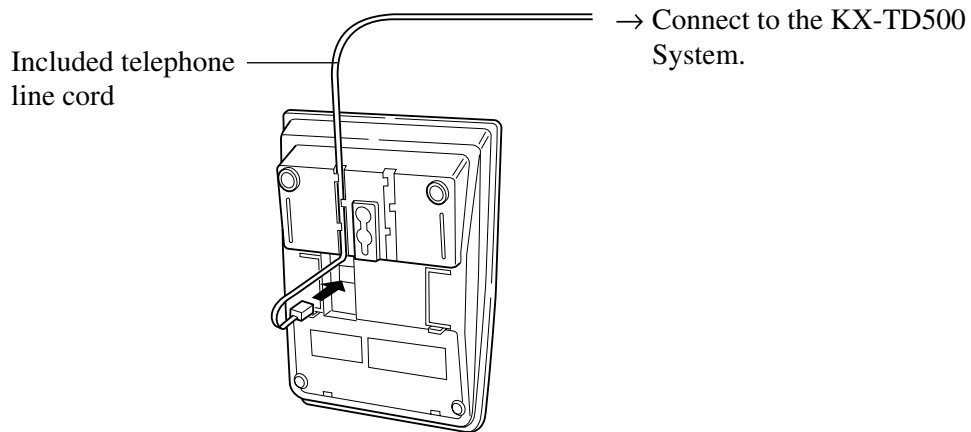



### 5.1.3 Feature Buttons

DSS Consoles have the following types of Feature Buttons:

**DSS Buttons with Busy Lamp Field (BLF)**

Used to access extensions. The BLF indicates the busy or idle status of each extension in the system. These buttons can also be changed to other function buttons.

**PF (Programmable Feature) Buttons [KX-T7040 / KX-T7240 only]**

These buttons are provided with no default settings. With a paired telephone, you can program the buttons as other function buttons.

**ANSWER Button [KX-T7441 only]**

Used to answer an incoming call.

**RELEASE Button [KX-T7441 only]**

Used to disconnect the line.

## **5.2 DSS Console Features**

### **5.2.1 Station Programming**

Both DSS buttons and PF buttons (KX-T7040 and KX-T7240 only) are provided with no default settings.

To meet your various needs, DSS buttons can be changed to other function buttons.

Every DSS or PF button can be assigned to another extension number, telephone number or feature number by Station Programming.

## 5.2.2 Account Button (Assignment)

You can assign a Flexible DSS or PF button as an Account button.

—Be sure that you are in the Station Programming mode: Press [PROGRAM] [9] [9].

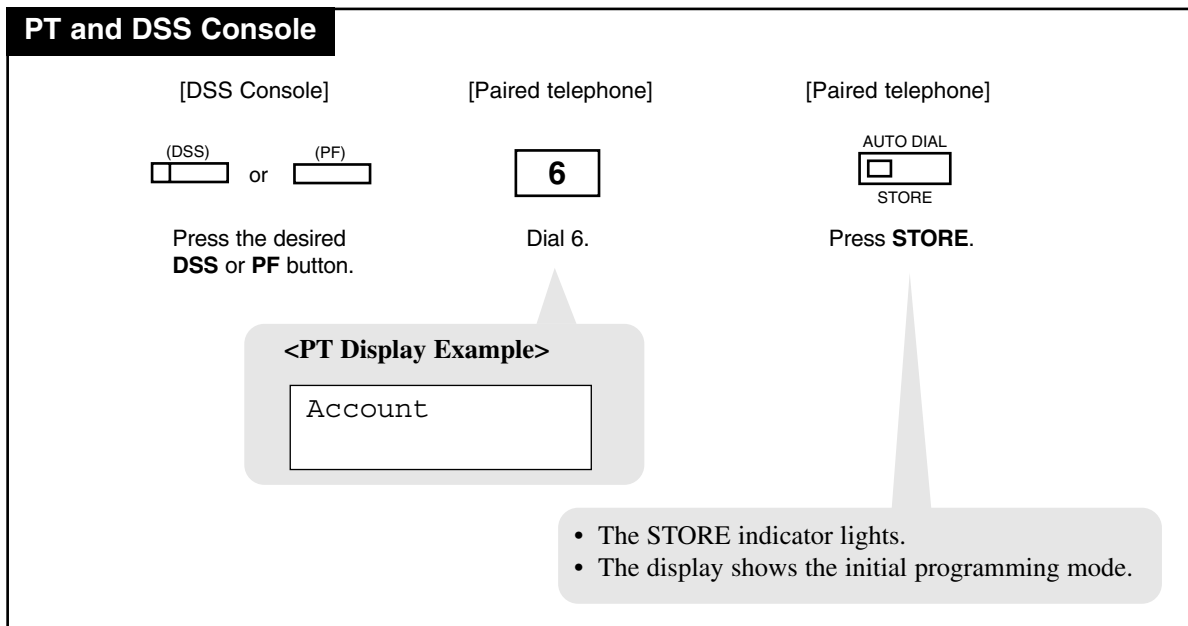

—To exit the Station Programming mode: Press [PROGRAM].

### 5.2.3 Answer Button (Assignment)

You can assign a Flexible DSS or PF button as an Answer button.

—Be sure that you are in the Station Programming mode: Press [PROGRAM] [9] [9].

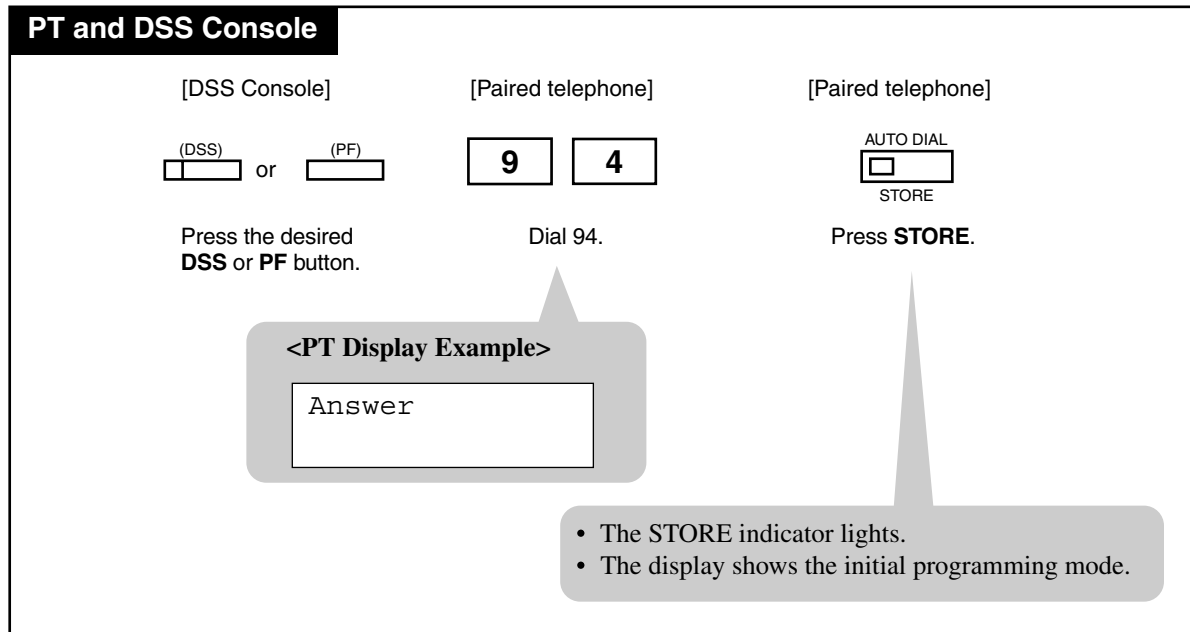

—To exit the Station Programming mode: Press [PROGRAM].

#### Conditions

- For the KX-T7441, the ANSWER button is provided as a fixed feature button.

## 5.2.4 Conference (CONF) Button (Assignment)

You can assign a Flexible DSS or PF button as a Conference (CONF) button.

—Be sure that you are in the Station Programming mode: Press [PROGRAM] [9] [9].

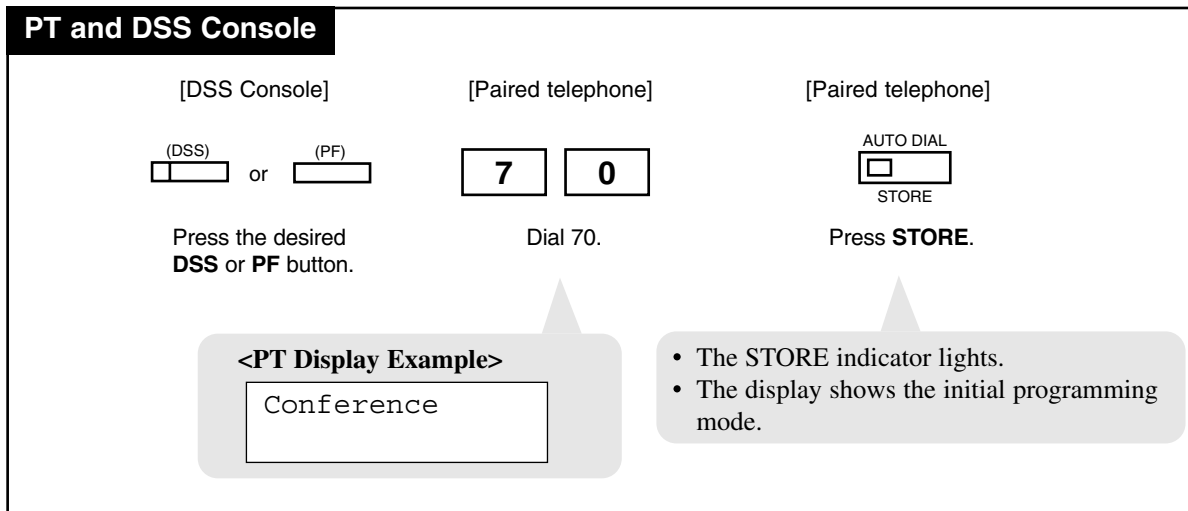

—To exit the Station Programming mode: Press [PROGRAM].

## 5.2.5 DAY / NIGHT Button (Assignment)

You can assign a Flexible DSS button as a DAY / NIGHT button.

—Be sure that you are in the Station Programming mode: Press [PROGRAM] [9] [9].

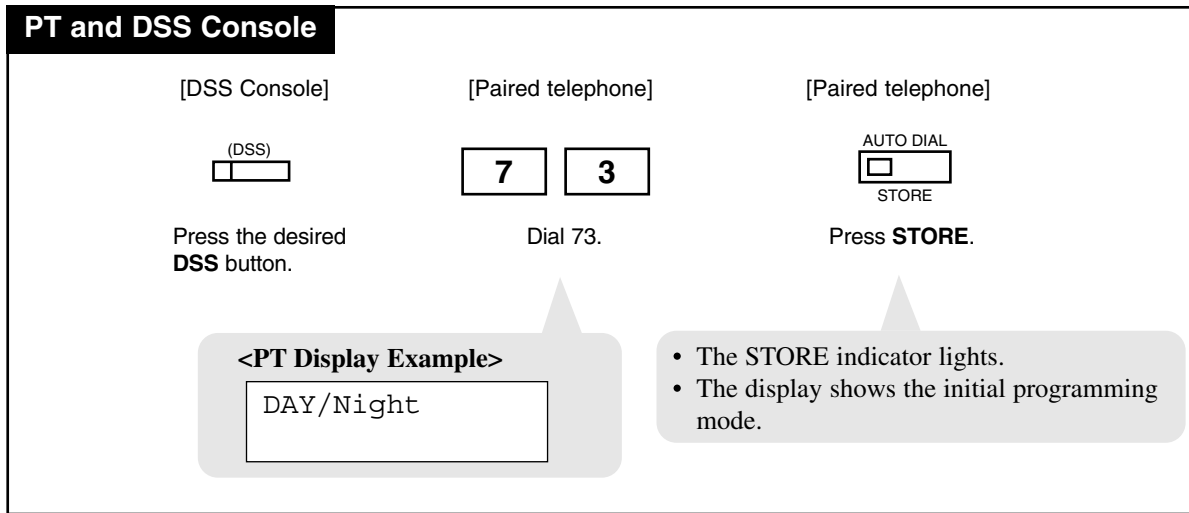

—To exit the Station Programming mode: Press [PROGRAM].

## 5.2.6 Direct Station Selection (DSS) Button (Assignment)

You can assign the desired extension number to a DSS button.

—Be sure that you are in the Station Programming mode: Press [PROGRAM] [9] [9].

**PT and DSS Console**

[DSS Console]	[Paired telephone]	[Paired telephone]	[Paired telephone]
<input type="text" value="(DSS)"/>	<input type="text" value="1"/>	<input type="text" value="extension no."/>	<input type="checkbox"/> AUTO DIAL STORE
Press the desired <b>DSS</b> button.	Dial <b>1</b> .	Enter the desired extension number (3 or 4 digits).	Press <b>STORE</b> .

**<PT Display Example>**

EXT-  
CLR

**<PT Display Example>**

EXT-xxxx  
CLR

(-xxxx:extension number)

- To erase an incorrect entry, press the **CLR (S2)** button or the **TRANSFER (CLEAR)** button. (The TRANSFER button becomes the CLEAR button in the Station Programming mode.)

- The STORE indicator lights.
- The display shows the initial programming mode.

—To exit the Station Programming mode: Press [PROGRAM].

## 5.2.7 FWD/DND Button (Assignment)

You can assign a Flexible DSS or PF button as an FWD/DND button.

—Be sure that you are in the Station Programming mode: Press [PROGRAM] [9] [9].

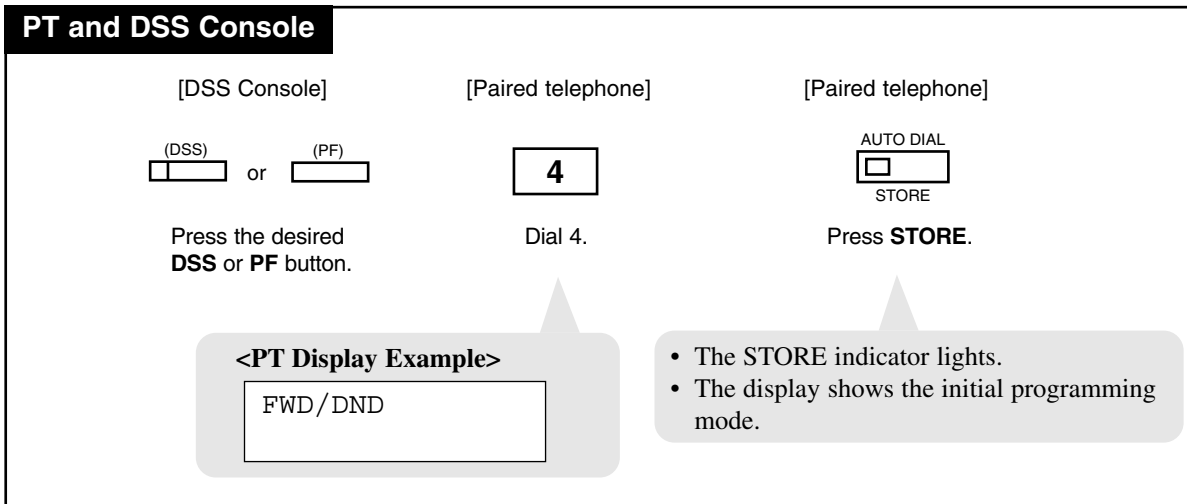

—To exit the Station Programming mode: Press [PROGRAM].



## 5.2.8 Group-CO (G-CO) Button (Assignment)

You can assign a Flexible DSS button as a Group-CO button.

—Be sure that you are in the Station Programming mode: Press [PROGRAM] [9] [9].

**PT and DSS Console**

<p>[DSS Console]</p> <div style="border: 1px solid black; width: 40px; height: 15px; margin: 0 auto; text-align: center; font-size: 8px;">(DSS)</div> <p>Press the desired <b>DSS</b> button.</p>	<p>[Paired telephone]</p> <div style="border: 1px solid black; width: 40px; height: 15px; margin: 0 auto; text-align: center; font-size: 16px;">#</div> <p>Dial #.</p>	<p>[Paired telephone]</p> <div style="border: 1px solid black; width: 100px; height: 15px; margin: 0 auto; text-align: center; font-size: 12px;">trunk group no.</div> <p>Enter the trunk group number (01 through 48).</p>	<p>[Paired telephone]</p> <div style="border: 1px solid black; width: 40px; height: 15px; margin: 0 auto; text-align: center; font-size: 8px;">AUTO DIAL STORE</div> <p>Press <b>STORE</b>.</p>
---	--	---	---

**<PT Display Example>**

TRK GRP-  
          CLR

- The STORE indicator lights.
- The display shows the initial programming mode.

- To erase an incorrect entry, press the **CLR (S2)** button or the **TRANSFER (CLEAR)** button. (The TRANSFER button becomes the CLEAR button in the Station Programming mode.)

—To exit the Station Programming mode: Press [PROGRAM].

### Conditions





- A G-CO button assigned to a DSS button is available for monitoring the call activity only, not available for making and receiving a call.

## 5.2.9 Group FWD Button (Assignment)

You can assign a Flexible DSS button as a Group FWD button.

—Be sure that you are in the Station Programming mode: Press [PROGRAM] [9] [9].

**PT and DSS Console**

[DSS Console]	[Paired telephone]	[Paired telephone]	[Paired telephone]
			
Press the desired <b>DSS</b> button.	Dial 98.	Enter FDN of Incoming group (3 or 4 digits).	Press <b>STORE</b> .

**<PT Display Example>**

G - FWD FDN -  
CLR

**<PT Display Example>**

G - FWD FDN - xxxx  
CLR

(-xxxx:Incoming group number)

- The STORE indicator lights.
- The display shows the initial programming mode.

- To erase an incorrect entry, press the **CLR (S2)** button or the **TRANSFER (CLEAR)** button.  
(The TRANSFER button becomes the CLEAR button in the Station Programming mode.)

—To exit the Station Programming mode: Press [PROGRAM].

## 5.2.10 Live Call Screening (LCS) Button (Assignment)\*<sup>1</sup>

You can assign a Flexible DSS button as a Live Call Screening (LCS) button.

— Be sure that you are in the Station Programming mode: Press [PROGRAM] [9] [9].

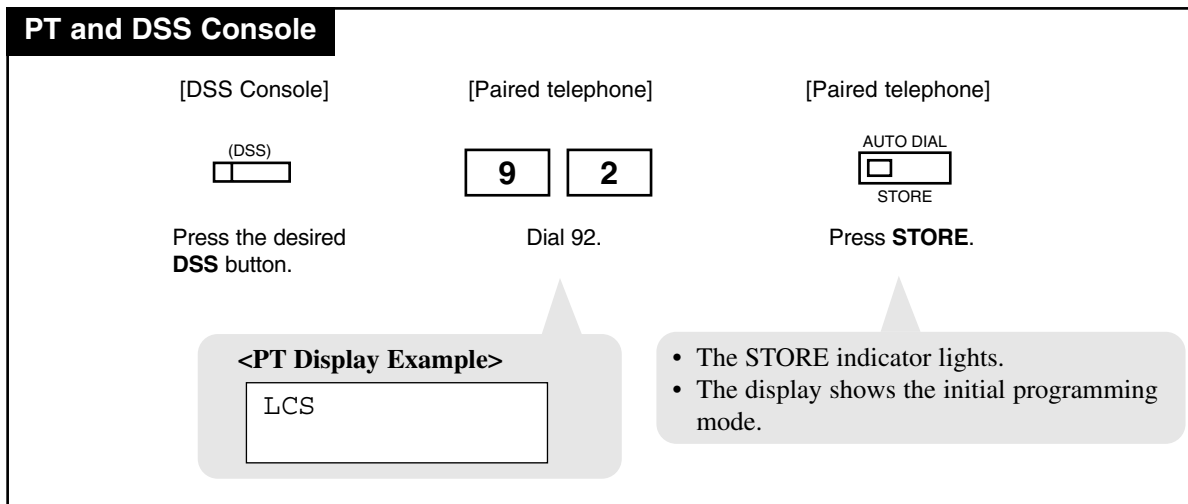

— To exit the Station Programming mode: Press [PROGRAM].

\*<sup>1</sup> Available when the Digital Super Hybrid System is connected to a Digital Proprietary Telephone capable Panasonic Voice Processing System (one that supports Digital Proprietary Telephone [DPT] integration; e.g., KX-TVS100).

## 5.2.11 Live Call Screening (LCS) Cancel Button (Assignment)\*<sup>1</sup>

You can assign a Flexible DSS button as a Live Call Screening (LCS) Cancel button.

— Be sure that you are in the Station Programming mode: Press [PROGRAM] [9] [9].

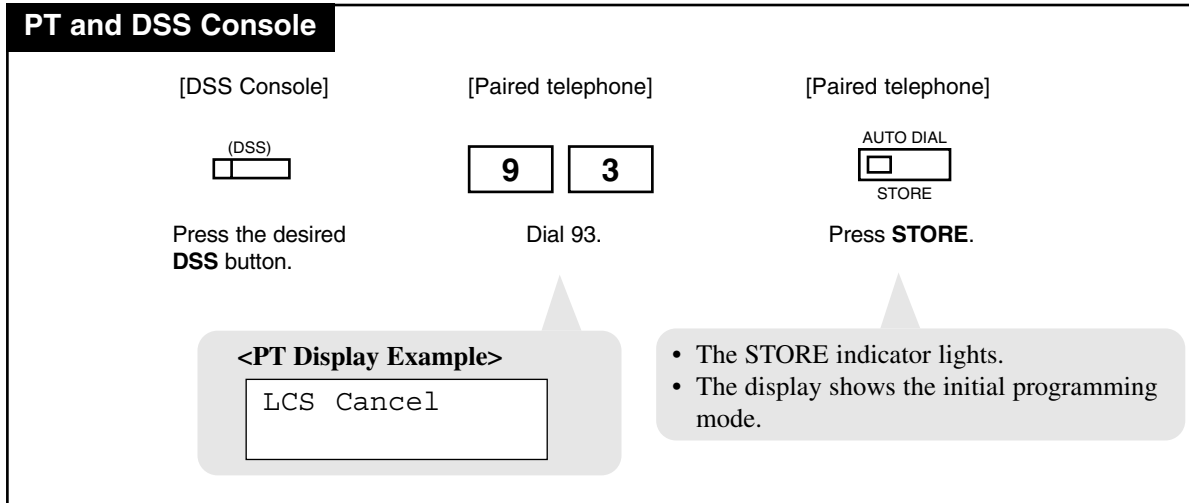

—To exit the Station Programming mode: Press [PROGRAM].

\*<sup>1</sup> Available when the Digital Super Hybrid System is connected to a Digital Proprietary Telephone capable Panasonic Voice Processing System (one that supports Digital Proprietary Telephone [DPT] integration; e.g., KX-TVS100).

## 5.2.12 Message Waiting (MESSAGE) Button (Assignment)

You can assign a Flexible DSS button as a Message Waiting (MESSAGE) button.

— Be sure that you are in the Station Programming mode: Press [PROGRAM] [9] [9].

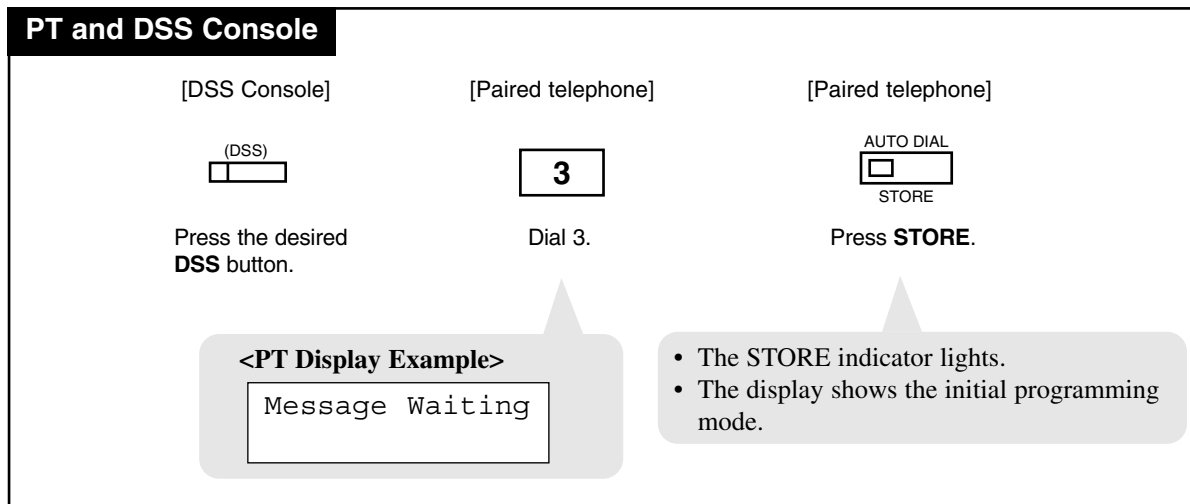

—To exit the Station Programming mode: Press [PROGRAM].

### 5.2.13 One-Touch Dialing Button (Assignment)

You can assign a DSS or PF button as a One-Touch Dialing button. The number can be an extension number or a telephone number. Up to 24 digits can be stored into each memory location.

—Be sure that you are in the Station Programming mode: Press [PROGRAM] [9] [9].

**PT and DSS Console**

<p>[DSS Console]</p> <p>(DSS) or (PF)</p> <div style="border: 1px solid black; width: 40px; height: 20px; margin: 0 auto;"></div>	<p>[Paired telephone]</p> <div style="border: 1px solid black; width: 40px; height: 20px; display: flex; align-items: center; justify-content: center; margin: 0 auto;">2</div>	<p>[Paired telephone]</p> <div style="border: 1px solid black; width: 80px; height: 20px; display: flex; align-items: center; justify-content: center; margin: 0 auto;">desired no.</div>	<p>[Paired telephone]</p> <p>AUTO DIAL</p> <div style="border: 1px solid black; width: 40px; height: 20px; display: flex; align-items: center; justify-content: center; margin: 0 auto;"> <span style="font-size: 8px;">□</span> </div> <p>STORE</p>
<p>Press the desired <b>DSS</b> or <b>PF</b> button.</p>	<p>Dial <b>2</b>.</p>	<p>Enter the desired number (extension number, phone number, etc).</p>	<p>Press <b>STORE</b>.</p>

**<PT Display Example>**

CLR

- Up to 24 digits can be stored.
- When you assign an outside phone number, you must enter a line access code first.
- To erase an incorrect entry, press the **CLR (S2)** button or the **TRANSFER (CLEAR)** button. (The TRANSFER button becomes the CLEAR button in the Station Programming mode.)

- The STORE indicator lights.
- The display shows the initial programming mode.

—To exit the Station Programming mode: Press [PROGRAM].

## 5.2.14 One-Touch Access Assignment for System Features

You can assign the desired feature number to a DSS or PF button.

—Be sure that you are in the Station Programming mode: Press [PROGRAM] [9] [9].

**PT and DSS Console**

<p>[DSS Console]</p> <p>(DSS) <input type="text"/> or (PF) <input type="text"/></p> <p>Press the desired <b>DSS</b> or <b>PF</b> button.</p>	<p>[Paired telephone]</p> <p><b>2</b></p> <p>Dial <b>2</b>.</p>	<p>[Paired telephone]</p> <p><b>feature no.</b></p> <p>Enter the desired feature number.</p>	<p>[Paired telephone]</p> <p>AUTO DIAL <input type="checkbox"/></p> <p>STORE</p> <p>Press <b>STORE</b>.</p>
--	---	--	---

**<PT Display Example>**

CLR

- Up to 24 digits can be stored.
- If you wish to access the "Station paging answer" feature, enter the feature number 43.
- To erase an incorrect entry, press the **CLR (S2)** button or the **TRANSFER (CLEAR)** button. (The TRANSFER button becomes the CLEAR button in the Station Programming mode.)

- The STORE indicator lights.
- The display shows the initial programming mode.

—To exit the Station Programming mode: Press [PROGRAM].

## 5.2.15 Release Button (Assignment)

You can assign a Flexible DSS or PF button as a Release button.

—Be sure that you are in the Station Programming mode: Press [PROGRAM] [9] [9].

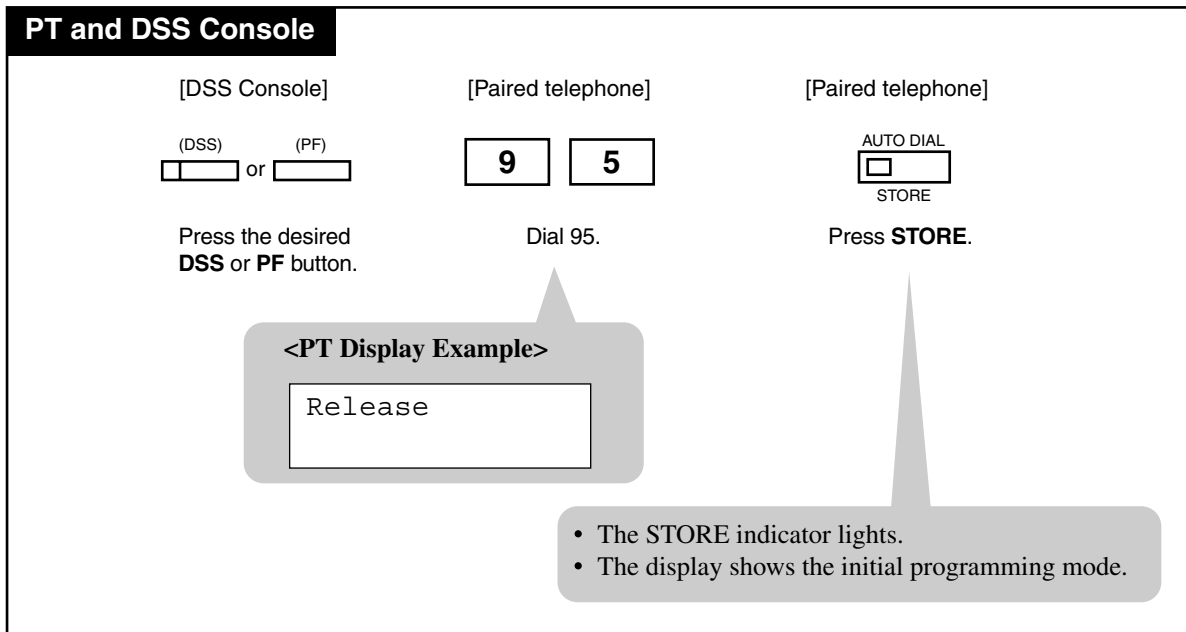

—To exit the Station Programming mode: Press [PROGRAM].

### Conditions

- For the KX-T7441, the RELEASE button is provided as a fixed feature button.



## 5.2.16 SAVE Button (Assignment)

You can assign a Flexible DSS or PF button as a SAVE button.

— Be sure that you are in the Station Programming mode: Press [PROGRAM] [9] [9].

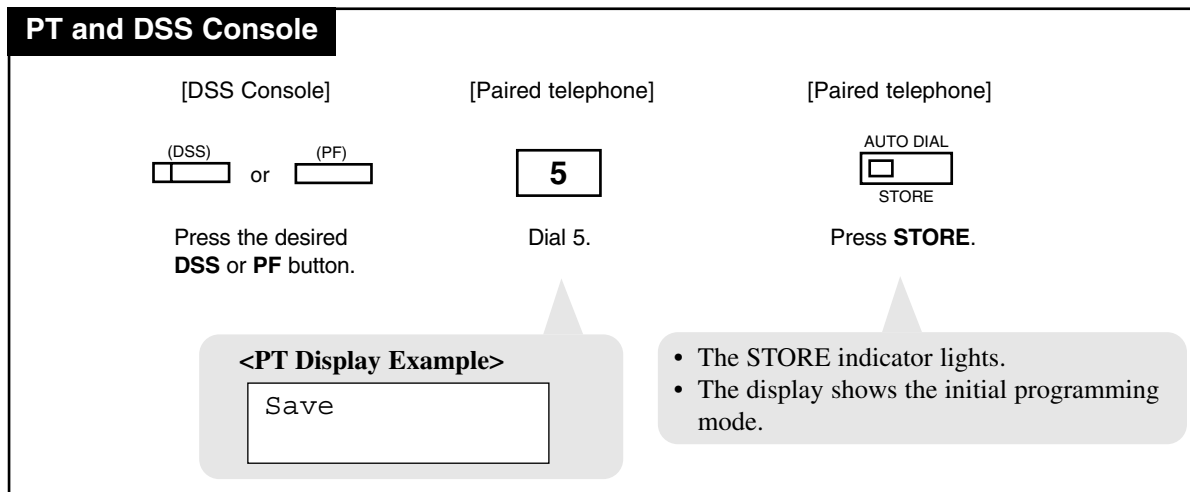





— To exit the Station Programming mode: Press [PROGRAM].

## 5.2.17 Single-CO (S-CO) Button (Assignment)

You can assign a DSS button as a Single-CO button.

—Be sure that you are in the Station Programming mode: Press [PROGRAM] [9] [9].

**PT and DSS Console**

[DSS Console]	[Paired telephone]	[Paired telephone]	[Paired telephone]
			
Press the desired <b>DSS</b> button.	Dial <b>0</b> .	Enter the trunk port physical number.	Press <b>STORE</b> .

**<PT Display Example>**

CO—  
CLR

**<PT Display Example>**

CO—xxxxxx  
CLR

(-xxxxxx: trunk port physical number)

- To erase an incorrect entry, press the **CLR (S2)** button or the **TRANSFER (CLEAR)** button.  
(The TRANSFER button becomes the CLEAR button in the Station Programming mode.)

- The STORE indicator lights.
- The display shows the initial programming mode.

—To exit the Station Programming mode: Press [PROGRAM].

### Conditions

- You can assign the same CO line to an S-CO and a G-CO button respectively.
- An S-CO button assigned to a DSS button is available for monitoring the call activity only, not available for making and receiving a call.

## 5.2.18 Tone Through Button (Assignment)

You can assign a Flexible DSS button as a Tone Through button.

— Be sure that you are in the Station Programming mode: Press [PROGRAM] [9] [9].

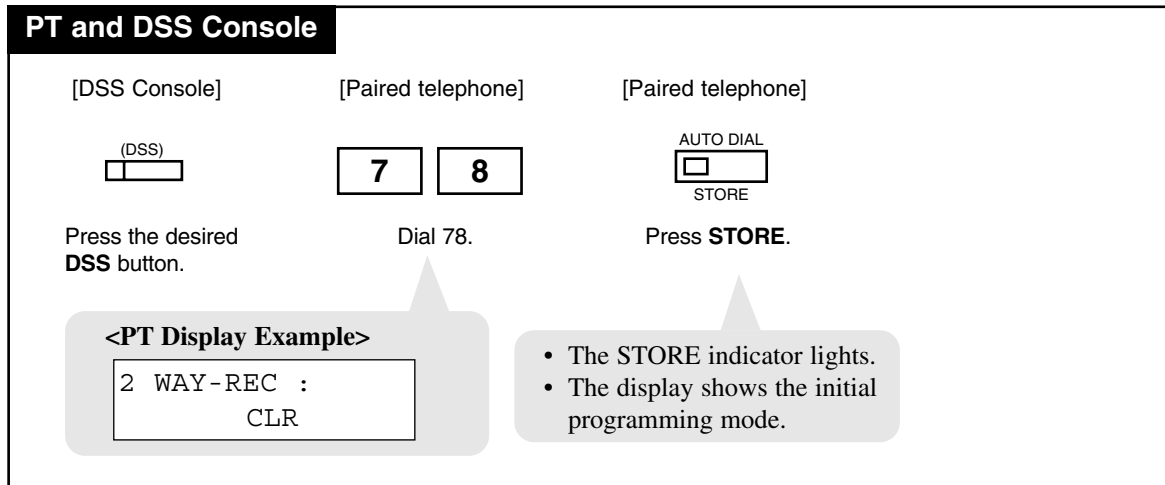

— To exit the Station Programming mode: Press [PROGRAM].

## 5.2.19 Two-Way Record Button (Assignment)\*<sup>1</sup>

You can assign a Flexible DSS button as a Two-Way Record button. This allows you to record a conversation into your own mailbox.

— Be sure that you are in the Station Programming mode: Press [PROGRAM] [9] [9].

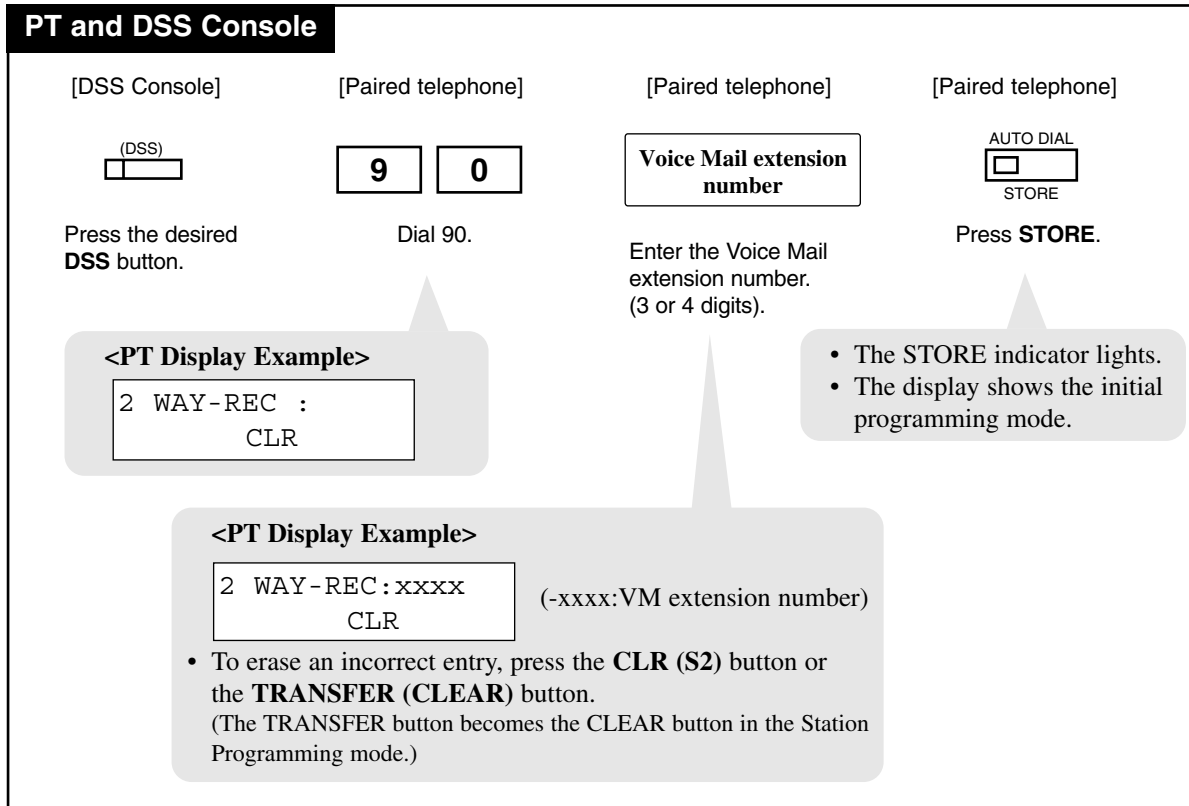

— To exit the Station Programming mode: Press [PROGRAM].

\*<sup>1</sup> Available when the Digital Super Hybrid System is connected to a Digital Proprietary Telephone capable Panasonic Voice Processing System (one that supports Digital Proprietary Telephone [DPT] integration; e.g., KX-TVS100).

## 5.2.20 Two-Way Transfer Button (Assignment)\*<sup>1</sup>

You can assign a Flexible DSS button as a Two-Way Transfer button. This allows you to record a conversation into your own mailbox.

— Be sure that you are in the Station Programming mode: Press [PROGRAM] [9] [9].

**PT and DSS Console**

<p>[DSS Console]</p> <div style="border: 1px solid black; width: 40px; height: 20px; margin: 5px auto; text-align: center; font-size: 8px;">(DSS)</div> <p>Press the desired <b>DSS</b> button.</p>	<p>[Paired telephone]</p> <div style="display: flex; justify-content: center; gap: 10px; margin: 5px 0;"> <div style="border: 1px solid black; width: 30px; height: 30px; text-align: center; font-size: 24px; line-height: 30px;">9</div> <div style="border: 1px solid black; width: 30px; height: 30px; text-align: center; font-size: 24px; line-height: 30px;">1</div> </div> <p>Dial 91.</p>	<p>[Paired telephone]</p> <div style="border: 1px solid black; padding: 5px; margin: 5px auto; width: 150px; text-align: center; font-size: 12px;"> <b>Voice Mail extension number</b> </div> <p>Enter the Voice Mail extension number. (3 or 4 digits).</p>	<p>[Paired telephone]</p> <div style="display: flex; justify-content: center; align-items: center; margin: 5px 0;"> <div style="border: 1px solid black; width: 40px; height: 20px; text-align: center; font-size: 8px;">AUTO DIAL</div> </div> <div style="border: 1px solid black; width: 40px; height: 20px; margin: 5px auto; text-align: center; font-size: 8px;">STORE</div> <p>Press <b>STORE</b>.</p>
---	--	--	---

**<PT Display Example>**

2 WAY - TRANS :  
CLR

**<PT Display Example>**

2 WAY - TRANS : xxxx  
CLR

(-xxxx:VM extension number)

- To erase an incorrect entry, press the **CLR (S2)** button or the **TRANSFER (CLEAR)** button. (The TRANSFER button becomes the CLEAR button in the Station Programming mode.)

- The STORE indicator lights.
- The display shows the initial programming mode.

— To exit the Station Programming mode: Press [PROGRAM].

\*<sup>1</sup> Available when the Digital Super Hybrid System is connected to a Digital Proprietary Telephone capable Panasonic Voice Processing System (one that supports Digital Proprietary Telephone [DPT] integration; e.g., KX-TVS100).

## 5.2.21 Voice Mail (VM) Transfer Button (Assignment)

You can assign a Flexible DSS or PF button as a VM Transfer button. This allows you to record a conversation into your own mailbox.

— Be sure that you are in the Station Programming mode: Press [PROGRAM] [9] [9].

**PT and DSS Console**

<p>[DSS Console]</p> <div style="display: flex; justify-content: space-around; align-items: center;"> <div style="text-align: center;"> <small>(DSS)</small>  <input style="width: 30px; height: 15px; border: 1px solid black;" type="text"/> </div> <div style="text-align: center;">or</div> <div style="text-align: center;"> <small>(PF)</small>  <input style="width: 30px; height: 15px; border: 1px solid black;" type="text"/> </div> </div> <p style="text-align: center; font-size: small;">Press the desired <b>DSS or PF</b> button.</p>	<p>[Paired telephone]</p> <div style="text-align: center; border: 1px solid black; width: 40px; height: 25px; margin: 0 auto; display: flex; align-items: center; justify-content: center; font-weight: bold; font-size: 1.2em;">8</div> <p style="text-align: center;">Dial 8.</p>	<p>[Paired telephone]</p> <div style="border: 1px solid black; padding: 5px; margin: 5px auto; width: 150px; text-align: center;"> <b>Voice Mail extension number</b> </div> <p style="text-align: center;">Enter the Voice Mail extension number. (3 or 4 digits).</p>	<p>[Paired telephone]</p> <div style="text-align: center; margin: 5px auto;"> <small>AUTO DIAL</small>  <input style="width: 40px; height: 15px; border: 1px solid black;" type="text"/>  <small>STORE</small> </div> <p style="text-align: center;">Press <b>STORE</b>.</p>
---	---	---	--

**<PT Display Example>**

VTR -  
CLR

**<PT Display Example>**

VTR - xxxx  
CLR

(-xxxx:VM extension number)

- To erase an incorrect entry, press the **CLR (S2)** button or the **TRANSFER (CLEAR)** button. (The TRANSFER button becomes the CLEAR button in the Station Programming mode.)

- The STORE indicator lights.
- The display shows the initial programming mode.

— To exit the Station Programming mode: Press [PROGRAM].

## To correct an error while programming

### 7230 / 7235 / 7433 / 7436

[Paired telephone]

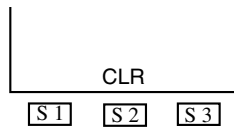

Press **CLR** (S2).

### PT

[Paired telephone]



Press **TRANSFER** (CLEAR).

- The TRANSFER button becomes the CLEAR button when using the overlay.

## To erase after programming

### PT and DSS Console

[DSS Console]

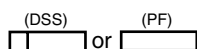

Press the desired **DSS** or **PF** button.

[Paired telephone]



Dial **2**.

[Paired telephone]



Press **STORE**.

## Conditions

- DSS buttons can be changed to any of the following feature buttons by Station, User or System Programming:

- a) Account Button
- b) Another DSS Button (Every DSS button can be assigned to another extension number.)
- c) Answer Button
- d) Conference (CONF) Button
- e) FWD/DND Button
- f) Group-CO (G-CO) Button
- g) Live Call Screening (LCS) Button<sup>\*1</sup>
- h) Live Call Screening (LCS) Cancel Button<sup>\*1</sup>
- i) Message Waiting (Owner Extension) Button
- j) Message Waiting (Another Extension/Phantom Extension) Button<sup>\*2</sup>
- k) One-Touch Dialing Button
- l) Release Button
- m) SAVE Button
- n) Single-CO (S-CO) Button
- o) Tone Through Button
- p) Two-Way Record Button<sup>\*1</sup>
- q) Two-Way Transfer Button<sup>\*1</sup>
- r) Voice Mail (VM) Transfer Button
- PF buttons can be changed to any of the following feature buttons by Station, User or System Programming:
  - a) Account Button
  - b) Answer Button
  - c) Conference (CONF) Button
  - d) FWD/DND Button
  - e) One-Touch Dialing Button
  - f) Release Button
  - g) SAVE Button
- When the STORE button is pressed after programming, you will hear beep tones as follows.
  - One beep: The entry is changed from one that was stored previously.
  - Two beeps: The entry is the same as one stored previously.

### Programming Guide References

- 4.4 DSS Console
  - Paired Extension
  - DSS Key
  - PF Key

---

<sup>\*1</sup> Available when the Digital Super Hybrid System is connected to a Digital Proprietary Telephone capable Panasonic Voice Processing System (one that supports Digital Proprietary Telephone [DPT] integration; e.g., KX-TVS100).

<sup>\*2</sup> Can only be assigned by System Programming.



## **Features Guide References**

### 1.15 Proprietary Telephone Features

- DSS Console

## **User Manual References**

- 2.2.3 Flexible Button Assignment

## 5.2.22 Direct Station Dialing

An extension can be called and accessed, simply by pressing a DSS button. The BLF shows if the extension is busy.

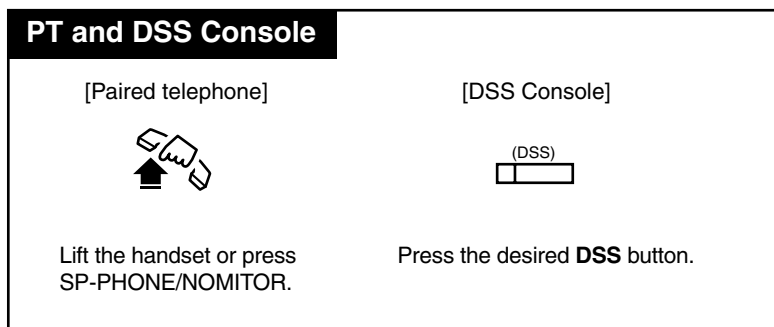

---

## 5.2.23 One-Touch Dialing

The stored number is dialed automatically by pressing a programmed DSS or PF button.

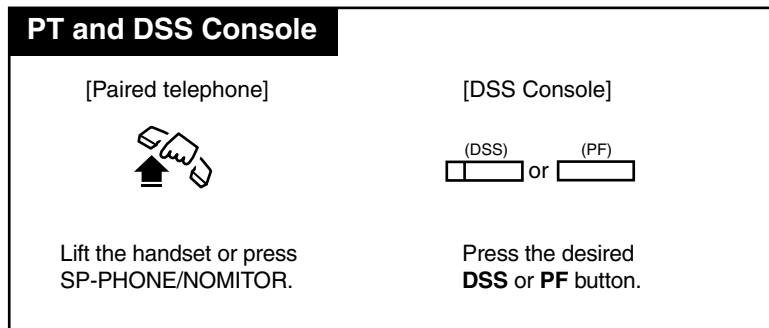

## 5.2.24 One-Touch Access for System Features

You can access system features by pressing a programmed DSS or PF button.

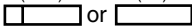
PT and DSS Console	
[Paired telephone]	[DSS Console]
	(DSS) or (PF) 
Lift the handset or press SP-PHONE/NOMITOR.	Press the desired <b>DSS</b> or <b>PF</b> button.

## 5.2.25 Call Transfer

A call can be transferred to an extension by using the DSS button.

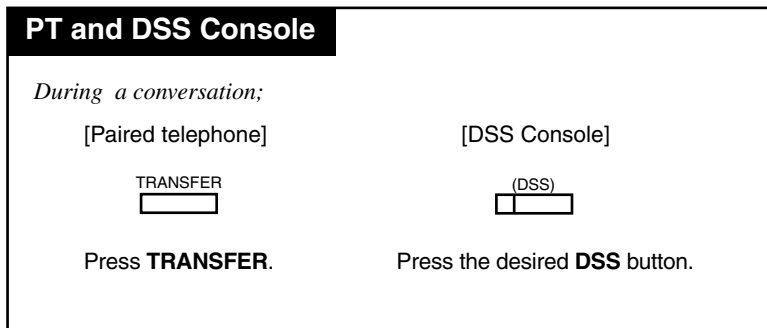

### One-Touch Transfer

An outside call can be transferred to an extension with a One-Touch operation. The One-Touch Transfer function must be set by System Programming.

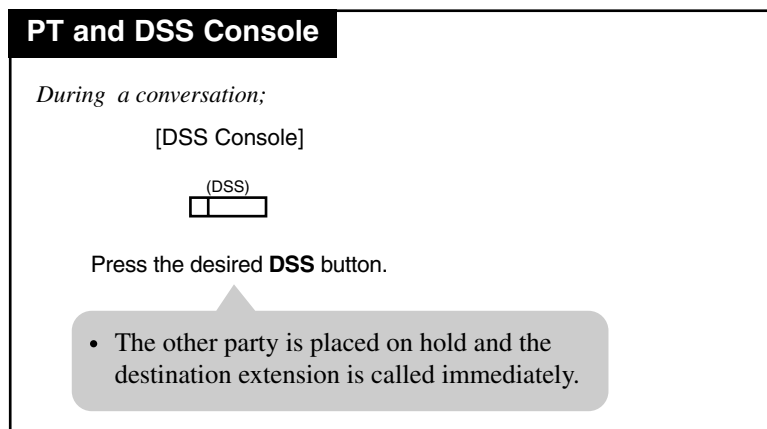

### Programming Guide References

- 2.8 System Option
  - Pressing DSS key operation in CO talking

## 5.2.26 ANSWER and RELEASE Buttons Operation

The DSS Console for Attendant KX-T7441 is provided with the ANSWER button and the RELEASE button which are useful for operators who use headsets.

For other DSS Consoles, ANSWER button and RELEASE button can be assigned to a DSS or PF button.

With the ANSWER button, you can answer all incoming calls to the paired telephone.

With the RELEASE button, you can disconnect the line during or after a conversation or complete a Call Transfer.

DSS Console

*When a call comes in on your extension;*

ANSWER



Press **ANSWER**.



Talk.

RELEASE



Press **RELEASE**.

- The call is disconnected.
- You hear no tone.

### Call Transfer

PT and DSS Console

*During a conversation;*

[Paired telephone]

TRANSFER



Press **TRANSFER**.



Confirmation tone and dial tone

[DSS Console]

(DSS)



Press the desired **DSS** button.



Talk.

[DSS Console]

RELEASE



Press **RELEASE**.

- The destination is confirmed before transferring the call. This step can be skipped.



---

## One-Touch Transfer

**PT and DSS Console**

*During a conversation with the headset or handset;*

(DSS)                      RELEASE

Press the desired **DSS** button.                      Press **RELEASE**.

- The other party is placed on hold and the destination is called immediately.

### Programming Guide References

- 2.8 System Option
  - Pressing DSS Key Operation in CO talking

## 5.2.27 Monitoring an outside line activity

You can monitor the activity of an outside line by assigning an S-CO button (Section 5.2.17 Single-CO (S-CO) Button (Assignment)) or a G-CO button (Section 5.2.8 Group-CO (G-CO) Button (Assignment)) or both.

### Conditions

- This feature is not available for the DSS Console connected to a PLC or HLC card.
- This feature is available for the DSS Console connected to a DLC or DHLC card whose LPR version is 1 or above.
- You can confirm the "LPR Version" <Section "1.2.4 Card Properties (DHLC/ESLC/DLC)" in the Programming Guide>.



***Section 6***  
***Appendix***

## 6.1 Appendix

### 6.1.1 Display Examples

Due to the Bilingual Display Selection Feature, you can select the display in English or French. The left part is the English display and the right part is the French display.

English Display	French Display	Description
Set Time & Date	REGLER HEUR/DATE	Factory setting. — Shown on the manager's display only.
FRI JAN01 12:00A	VEN JAN01 12:00A	The current date and time are not set. — Pressing "*" while on-hook alternates between this display and the self extension number and name display.
1234:	1234:	Make or receive an intercom call; name is not assigned.
1234:Tony Viola	1234:Tony Viola	Make or receive an intercom call; name is assigned. Confirm key programming on the DSS or MESSAGE button.
2345: Busy	2345: OCCUPE	Destination extension is busy.
4567: DND	4567: NPD	Destination extension is set to "Do Not Disturb (DND)."
5678: Free	5678: LIBRE	Called by "Camp-On" (intercom recall).
3456:MDM Access	3456: ACCES MDM	Destination is modem for remote access.
1234567890	1234567890	Called by a CO line with the Caller ID* <sup>1</sup> number.
Panasonic	Panasonic	Called by a CO line, with the Caller ID* <sup>1</sup> name.
950-1001PP12345&	950-1001PP12345&	Confirm key programming on the REDIAL, SAVE, or One-Touch Dialing button.
1234:Tony Viola	1234:Tony Viola	Make or receive an intercom call after the call is transferred; name is assigned.
1234→10101:Tony	1234→10101:Tony	Called by a CO line after a call is transferred.
2345: Busy	2345: OCCUPE	Destination extension is busy after the call is transferred.
4567: DND	4567: NPD	Destination extension is set to "Do Not Disturb (DND)" after the call is transferred.

English Display	French Display	Description
Account	COMPTE	Confirm key programming on the Account button.
Alarm 10:15AM	AVERT. 10:15AM	Complete to set or called by "Timed Reminder" (one-time mode). Confirm "Timed Reminder" programming.
Alarm 10:15AM*	AVERT. 10:15AM*	Complete to set or called by "Timed Reminder" (everyday mode). Confirm "Timed Reminder" programming.
Alarm Cancelled	AVERT. ANNULE	Cancel "Timed Reminder."
Alarm Not Stored	AVERT. NON REGLE	Confirm "Timed Reminder" programming when it is not stored.
All Call Page	RECH INT ET EXT	Access to "Paging — All."
At Ext 1234	At Ext 1234	Absent Message 3.
Back at 11:00	Back at 11:00	Absent Message 4.
BGM On	MUSIQUE:OUI	Start BGM.
BGM Off	MUSIQUE:NON	Stop BGM.
Busy	OCCUPE	Resource is busy.
Busy Ovrde Allow	ENT. TIERS:OUI	Cancel "Executive Busy Override Deny."
Busy Ovrde Deny	ENT. TIERS:NON	Complete to set "Executive Busy Override Deny."
C.Pickup Allow	PRSE APPL:OUI	Cancel "Call Pickup Deny."
C.Pickup Deny	PRSE APPL:NON	Complete to set "Call Pickup Deny."
C.Parked at 01	MISE EN ATT A 01	Complete to set "Call Park."
C.Waiting Off	APPEL EN ATT:NON	Cancel "Call Waiting."
C.Waiting BSS	AVERT.-PST OCC.	Complete to set "Call Waiting BSS."
Callback Ext1234	RAPPEL PSTE 1234	Complete to set "Camp-On."
Callback 10101	RAPPEL 10101	Complete to set "Camp-On."
Callback TRG 01	RAPPEL GR LR 01	Complete to set "Camp-On."
Callback CO *	RAPPEL LR *	Complete to set "Camp-On" when there is no idle CO line.
10101	10101	Idle CO line is captured.
10101:Tony	10101:Tony	Called by a CO line.
10101 0:01'15	10101 0:01'15	Duration time of incoming CO call.

English Display	French Display	Description
10101 & 10102	10101 & 10102	Conference with two CO lines. Called by hold recall. — "Conference, Unattended"
10101: Free	10101: LIBRE	Called by "Camp-On" (CO line recall).
10301:AB COMPANY	10301:AB COMPANY	Received a CO call with a Caller ID; the CO line number and the CO line name are assigned.
Conference	CONFERENCE	Confirm key programming on the Conference button.
CO in Use	LR OCCUPEE	The selected CO line is busy.
CO Not Assigned	LR NON ASSIGNEE	The desired CO line is restricted (not assigned).
CONT RNGOFF BGM	CONT SONN-N MUS	Ringer Volume is off.
Contrast:***	CONTRAST:***	Display Contrast — Adjustment.
Data Mode Off	PROTECTION:NON	Cancel "Data Line Security."
Data Mode On	PROTECTION:OUI	Complete to set "Data Line Security."
Day Mode	SERVICE DE JOUR	Day mode status. (Cancel Night mode.) — "Night Service"
Do Not Disturb	NE PAS DERANGER	Confirm key programming on the FWD/DND button. Complete to set "Do Not Disturb (DND)"
Door 1 Open	PORTE 1 OUVRIR	Complete to open the door.
Doorphone 1	PORTIER TEL. 1	Make or receive a doorphone call.
E1234 & 10101	P1234 & 10101	Conference with an extension and CO line.
E1234 & E2345	P1234 & P2345	Conference with two extensions.
Enter ACCNT Code	ENTRER NO COMPTE	Pressing Account Button. — "Account Code Entry"
Ext Data Clear	DONN. PST ANNUL.	Execute "Station Program Clear."
External BGM Off	MUS. EXT. : NON	Stop BGM through external pager. — "Background Music (BGM) — External"
External BGM On	MUS. EXT. : OUI	Start BGM through external pager. — "Background Music (BGM) — External"
Extrnl Page All	RECH EXT. - TOUS	Access to "Paging — External" (- to all external pager).

English Display	French Display	Description
Extrnl Page 1	RECH. EXT. 1	Access to "Paging — External" (- to a specific external pager).
FWD (ALL) Ext1234	RNV (TOUS) PST1234	Complete to set "Call Forwarding — All Calls." Confirm key programming on the FWD/DND button.
FWD (B/NA) Ext1000	RNV (O/SR) PST1000	Complete to set "Call Forwarding — Busy/ No Answer." Confirm key programming on the FWD/DND button.
FWD (BSY) Ext2345	RNV (OCC) PST2345	Complete to set "Call Forwarding — Busy." Confirm key programming on the FWD/DND button.
FWD (CO) 91201431	RNV (LR) 91201431	Complete to set "Call Forwarding — to Outside Line." Confirm key programming on the FWD/DND button.
FWD (From) Ext1234	RNV (DE) PST1234	Complete to set "Call Forwarding — Follow Me."
FWD (NA) Ext3456	RNV (SR) PST3456	Complete to set "Call Forwarding — No Answer." Confirm key programming on the FWD/DND button.
FWD (NACO) 91234	RNV (SRLR) 91234	Complete to set "Call Forwarding — No Answer to Outside Line." Confirm key programming on the FWD/DND button.
FWD Cancel E1234	ANNUL. RNV P1234	Cancel "Call Forwarding — Follow Me (All Calls)" at another extension.
FWD/DND Cancel	ANNULER RNV/NPD	Cancel "Call Forwarding" or "Do Not Disturb (DND)."
Gone Home	Gone Home	Absent Message 2.
Group Page 01	RECHERCHE GR 01	Access to "Paging — Group" (- to a particular paging group).
Group Page All	RECH. GR - TOUS	Access to "Paging — Group" (- to all paging groups).
Handset: **	COMBINE : **	Volume Control — handset on handset mode.
Headset: **	CASQUE: **	Volume Control — headset on headset mode.

English Display	French Display	Description
In a Meeting	In a Meeting	Absent Message 6.
Locked NO. : 123	CODE VERR. : 123	Complete to set "Electronic Station Lockout."
Log Locked :123	REG FERME : 123	Complete to set "Call Log Lock, Incoming."
Message Cancel	MESSAGE ANNULE	Cancel Absent Message.
MODEM command 1	COMMANDE MODEM 1	Complete to send an AT Command to the external modem. — "External Modem Control"
MW at Ext 1234	MESS. PST 1234	Complete to set "Message Waiting."
MW Not Accepted	MESS ATT. REFUSE	Not complete to set "Message Waiting."
MW Cancel:E1234	MESS ANNUL:P1234	Cancel "Message Waiting" of desired extension.
MW Cancelled	MESS ATT. ANNULE	Cancel one's own "Message Waiting."
Night Mode	SERVICE DE NUIT	Night mode status. (Cancel Day mode.) — "Night Service"
No Held Call	AUCUN APPEL ATT.	There is no held call when retrieving call on hold or parked call.
No Incoming Call	AUCUN APPEL ENT.	There is no incoming call when trying to pick up the call.
Not Valid	NON VALIDE	Illegal operation.
OGM 1 Play:28	REP 1 LECT:28	When playing back the OGM.
OGM 1 Rec.:12	REP 1 ENP:12	When recording the OGM.
Out Until 12/12	Out Until 12/12	Absent Message 5.
Paging Deny Off	APPEN GEN. NON	Cancel "Paging — DENY."
Paging Deny On	APPEN GEN. OUI	Complete to set "Paging — DENY."
Parallel Off	PARALLELE : NON	Cancel "Paralleled Telephone Connection."
Parallel On	PARALLELE:OUI	Complete to set "Paralleled Telephone Connection."
Park at 00 N/A	ATT. A 00N.VAL	Not complete to set "Call Park."
PT-PGM Mode	TP-MODE PROG	Entered the Station Programming mode.
RCL:Tony Viola	RAPL:Tony Viola	Called by transfer recall, with name. — "Call Transfer"
RCL:Ext 1234	RAPL:PST 1234	Called by transfer recall, without name. — "Call Transfer"
Restricted	RESTREINT	An outgoing call is restricted.

English Display	French Display	Description
Ringer : ***	SONN. : ***	Volume Control — ringer on idle status.
SP:*****	HP:*****	Volume Control — speaker on hands-free mode.
Transfer to CO	TRANSFERT A LR	The destination extension is set "Call Forwarding — to Outside Line."
Try Again	RESSAYER	When the destination extension is in one of the following states. — Off-hook, incoming call — Call Hold — All buttons on PT are in use
Unlocked	DEVERROUILLE	Cancel "Call Log Lock, Incoming." Cancel "Electronic Station Lockout."
Will Return Soon	Will Return Soon	Absent Message 1.

<sup>\*1</sup> Provides you with a caller's information, such as his name and telephone number, on the CO line assigned to receive Caller ID service calls. This requires a subscription for caller identification services. For more details, please consult with your dealer.

---



---

**Examples – in Station Programming mode**

<b>English Display</b>	<b>French Display</b>	<b>Description</b>
Account	COMPTE	Account button is assigned.
C.W. Tone1	TON.APPEL1	Select Call Waiting tone.
Clear Ready?	ANNULER DONNEES?	Available to clear Station Programming data.
CO-10101	LR-10101	Single-CO (S-CO) button is assigned.
Conference	CONFERENCE	Conference (CONF) button is assigned.
1400:CO Lock	1400:LR VERR.	Complete to lock the outside calls of other extension. — "Remote Station Lock Control."
1400:ICM Lock	1400:INTCM VERR.	Complete to lock the intercom calls of other extension. — "Remote Station Lock Control."
1400:Unlock	1400:DEVERR.	Cancel "Remote Station Lock Control"
Ext-1234	PST-1234	DSS button is assigned.
FWD/DND	RNV/NPD	FWD/DND button is assigned.
Hands-free:Off	MAINS LIB.:NON	Disable "Full One-Touch Dialing" mode.
Hands-free:On	MAINS LIB.:OUI	Enable "Full One-Touch Dialing" mode.
Handset	COMBINE	Select Handset mode.
Headset	CASQUE	Select Headset mode.
10101 <=>EXT1001	10101 <=> PST1001	Confirm jack number and extension number.
Loop-CO	BOUCLE DE LR	Loop-CO (L-CO) button is assigned.
Message Waiting	MESS. EN ATTENTE	Message Waiting (Owner Extension) button is assigned.
MW-1234	MW-1234	Message Waiting (Another Extension/ Phantom Extension) button is assigned.
DAY/NIGHT	JOUR/NUIT	Day/Night button is assigned.
Not Stored	NON MEMORISE	No programming is assigned.
Pref.In :CO-02	ENT.PREF:LR-02	Select "Prime Line (Outside Line) Preference — Incoming."
Pref.In :No	ENT.PREF:NON	Select "No Line Preference — Incoming."
Pref.In :Ring	ENT.PREF:SONN	Select "Ring Line Preference — Incoming."
Pref.Out:CO-02	SOR.PREF:LR-02	Select "Prime Line (Outside Line) Preference — Outgoing."



---



---

**Examples – in Station Programming mode**

<b>English Display</b>	<b>French Display</b>	<b>Description</b>
Pref.Out:ICM	SOR.PREF:INTCM	Select "Prime Line (INTERCOM) Preference — Outgoing."
Pref.Out:Idle	SOR.PREF:LIB.	Select "Idle Line Preference — Outgoing."
Pref.Out:No	SOR.PREF:NON	Select "No Line Preference — Outgoing."
Save	SAUVEGARDE	SAVE button is assigned.
Tone Call	APPEL-TON.	Select Ring-Calling mode.
Tone Type-2	TON. TYPE-2	Select ringing tone for a CO button or intercom calls.
TRK GRP-03	GR LR -03	Group-CO (G-CO) button is assigned.
VTR-1010	TMV-1010	Voice Mail (VM) Transfer button is assigned.
Voice Call	APPEL VOCAL	Select Voice-Calling mode.
092-555-2111	092-555-2111	One-Touch Dialing button is assigned.

**Conditions**

- If the displayed characters exceed 16 digits, "&" is shown at the right-hand edge.
- The duration time display is only shown when you make or receive an outside call. Count start time for outgoing calls can be programmed as desired.
- When you confirm key programming, be sure to press a button while on-hook. If the "Full One-Touch Dialing" feature is set, dialing mode will start when pressing PF (Programmable Feature), DSS (Direct Station Selection), SAVE or REDIAL button.

## 6.1.2 Feature Numbers List

Numbers listed below are the initial factory settings (default value). There are flexible feature numbers and fixed feature numbers. The flexible feature numbers can be changed by System Programming <Section 2.3 Numbering Plan in the Programming Guide>.

### Flexible Feature Numbers

Feature	Default	Additional Digits
1st hundred block extension	10	00-99
2nd hundred block extension	11	00-99
3rd hundred block extension	12	00-99
4th hundred block extension	13	00-99
5th hundred block extension	14	00-99
6th hundred block extension	20	00-99
7th hundred block extension	21	00-99
8th hundred block extension	22	00-99
9th hundred block extension	23	00-99
10th hundred block extension	24	00-99
11th through 16th hundred block extension	—	00-99
Absent Message set/cancel	750	1-9 / 0
Account Code Entry	49	Account code + #(99)
Automatic Callback Busy (Camp-On) cancel	46	
Background Music (BGM) — External on/off	35	
Call Forwarding — set/cancel	710	2-6,* / 0
Call Forwarding — Follow Me set/cancel	710	7/8 + your extension no.
Call Hold	50	
Call Hold, Retrieve outside call	53	trunk port physical no.
Call Hold, Retrieve intercom call	51	extension no.
Call Log Incoming, Overwrite Mode set/cancel	56	1 / 0
Call Log Incoming, Log lock	57	000-999 twice
Call Log Incoming, Log Unlock	57	000-999 (same lock code)
Call Park/Call Park Retrieve	52	00-99
Call Pickup, CO Line	4*	
Call Pickup, Directed	41	extension no.

---



---

**Flexible Feature Numbers**

<b>Feature</b>	<b>Default</b>	<b>Additional Digits</b>
Call Pickup, Group	40	
Call Pickup Deny set/cancel	720	1 / 0
Call Waiting set/cancel	731	1, 2, 3 / 0
Calling Line Identification Presentation (CLIP)	711	1 / 2
Calling Line Identification Restriction (CLIR)/ Calling Name Identification Restriction (CNIR)	59	0 / 1 / 2
Data Line Security set/cancel	730	1 / 0
Dial Information (CTI)	—	code + # / 99
Do Not Disturb (DND) set/cancel	710	1 / 0
Doorphone Call calling	31	1-8
Doorphone Call door open	55	1-8
Electronic Station Lockout set	762	000-999 twice
Electronic Station Lockout cancel	762	000-999
Executive Busy Override Deny set/cancel	733	1 / 0
External Feature Access	6	
External Modem Control	791	1-5
Group Login / Logout	48	(1-0)+ * / incoming group
Group FWD	714	(1-0) + source incoming group + destination incoming / extension group
Live Call Screening (LCS) Password set	799	000-999 twice
Live Call Screening (LCS) Password cancel	799	000-999
Log-In/Log-Out	45	1 / 0
Message Waiting set/cancel	70	1+extension no. / 0+extension no.
Message Waiting call back	70	2
Night Service set/cancel	78	0-4
Operator Call	0	
Other PBX 01-16	—	00-99
Outgoing Message (OGM) recording/playback	36	1 / 2+1-8
Outward Dialing — Local Access/ARS	9	
Outward Dialing — Trunk Group Access	8	01-48

---



---

**Flexible Feature Numbers**

<b>Feature</b>	<b>Default</b>	<b>Additional Digits</b>
Paging — All	32 / 33	*
Paging — External	32	0 / 1-2
Paging — External Answer/TAFAS Answer	42	1 / 2
Paging — Group	33	01-16
Paging — Group Answer	43	
Paging Deny set/cancel	721	1 / 0
Paralleled Telephone Connection set/cancel	39	1 / 0
Pickup Dialing (Hot Line) assign/set/cancel	74	2+phone no. +# / 1 / 0
Quick Dial 1-8	—	
Redial, Last Number	#	
Remote DND (Do Not Disturb) set/cancel	722	destination extension no.
Remote FWD (Call Forwarding) Cancel-Once	723	destination extension no.
Station Program clear	790	
Station Speed Dialing	3*	0-9
Station Speed Dialing programming	30	(0-9)+phone no. +#
Switching COS, Primary	792	
Switching COS, Secondary	793	
System Speed Dialing (for SLT)	*	000-999 (system speed dial number)
TIE Line Access	77	
Timed Reminder set	761	1+hhmm* <sup>1</sup> +(0 / 1)+(0 / 1)
Timed Reminder cancel/confirm	761	0 / 2
Timed Reminder, Remote set	7*	1+extension no. +hhmm* <sup>1</sup> +(0 / 1)+(0 / 1)
Timed Reminder, Remote cancel/confirm	7*	0+extension no. / 2+extension no.
Trunk Busy-out set/cancel	726	(1 / 0)+trunk port physical no.
Trunk Busy-out confirm	726	2+trunk port physical no.
Trunk Route control	724	trunk port physical no.
UCD Monitor mode set/cancel	725	FDN / *
Walking COS set	47	Walking COS password+your extension no.
Walking Station start	727	1
Walking Station end	727	0+source extension no.

\*1 hhmm hh: hour(01-12) mm: minute(00-59)

### Fixed Feature Numbers

Feature	Type-1 (Default)	Type-2
<b>While a busy tone is heard:</b>		
Automatic Callback Busy	6	6
Busy Station Signaling (BSS) / Off-Hook Call Announcement (OHCA) / Whisper OHCA	1	2
Executive Busy Override	2	3
<b>While a Do Not Disturb tone is heard:</b>		
Do Not Disturb Override	1	2
<b>While calling or talking:</b>		
Account Code Delimiter	# / 99	# / 99
Alternate Calling - Ring / Voice	×	×
Conference	3	3
Door Open	5	5
Pulse to Tone Conversion	× #	× #
<b>When the extension is on-hook:</b>		
Background Music (BGM) on / off	1	HOLD / TRANSFER
Day / Night mode display	#	#
Time display / Self-Extension Number display switching	×	×
<b>When a CO call is arriving (Receiving the Caller ID information):</b>		
Switching CO Line Name / Caller ID Number / Caller ID Name	×	×

### Conditions

- Extension numbers can be three or four digits in length. Any number can be set as the leading first or second digit.
- Flexible feature numbers can only be dialed while a dial tone is heard.
- If "×" or "#" is included in a feature number, it will not be possible for users with dial pulse (DP) telephones to access the feature.
- **Feature Number Conflicts**  
Examples: 1 and 11, 0 and 00, 2 and 21, 10 and 101, 32 and 321, etc.
- **Additional Digits**  
Some flexible feature numbers require additional digits to make the feature active. For

example, to set Call Waiting, the feature number for "Call Waiting" must be followed by "1" and to cancel it, the same feature number should be followed by "0."

- Fixed Feature Numbers Type-1 or Type-2 can be selected by System Programming. (Default = Type-1)

### **Programming Guide References**

- 1.4 Extension Port Assignment
  - Attribute
  - DN
- 2.3 Numbering Plan
- 2.8 System Option
  - Fixed Feature Number

### **Features Guide References**

- 1.3 System Features
  - Flexible Numbering

### **User Manual References**

None

### 6.1.3 Tone List

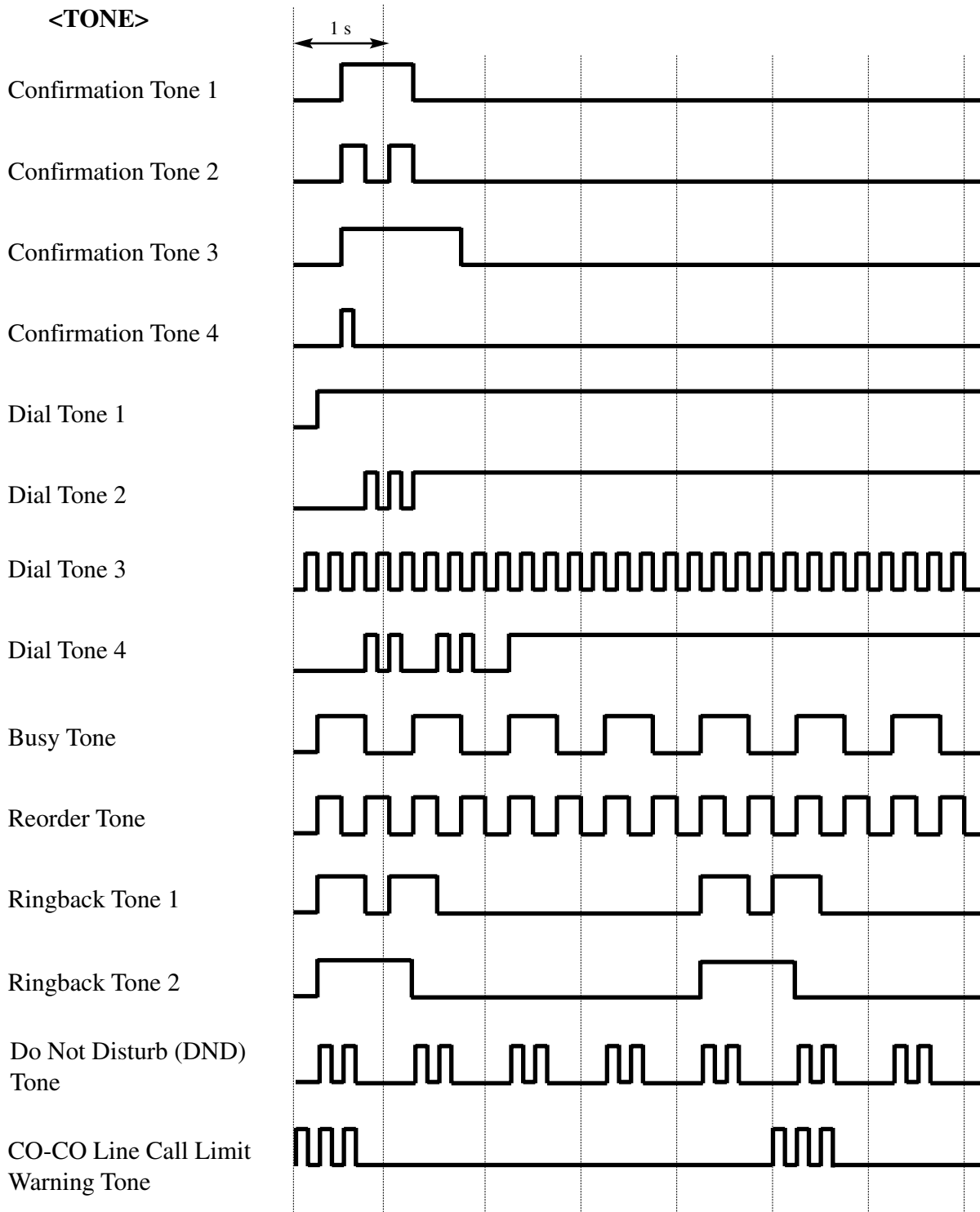

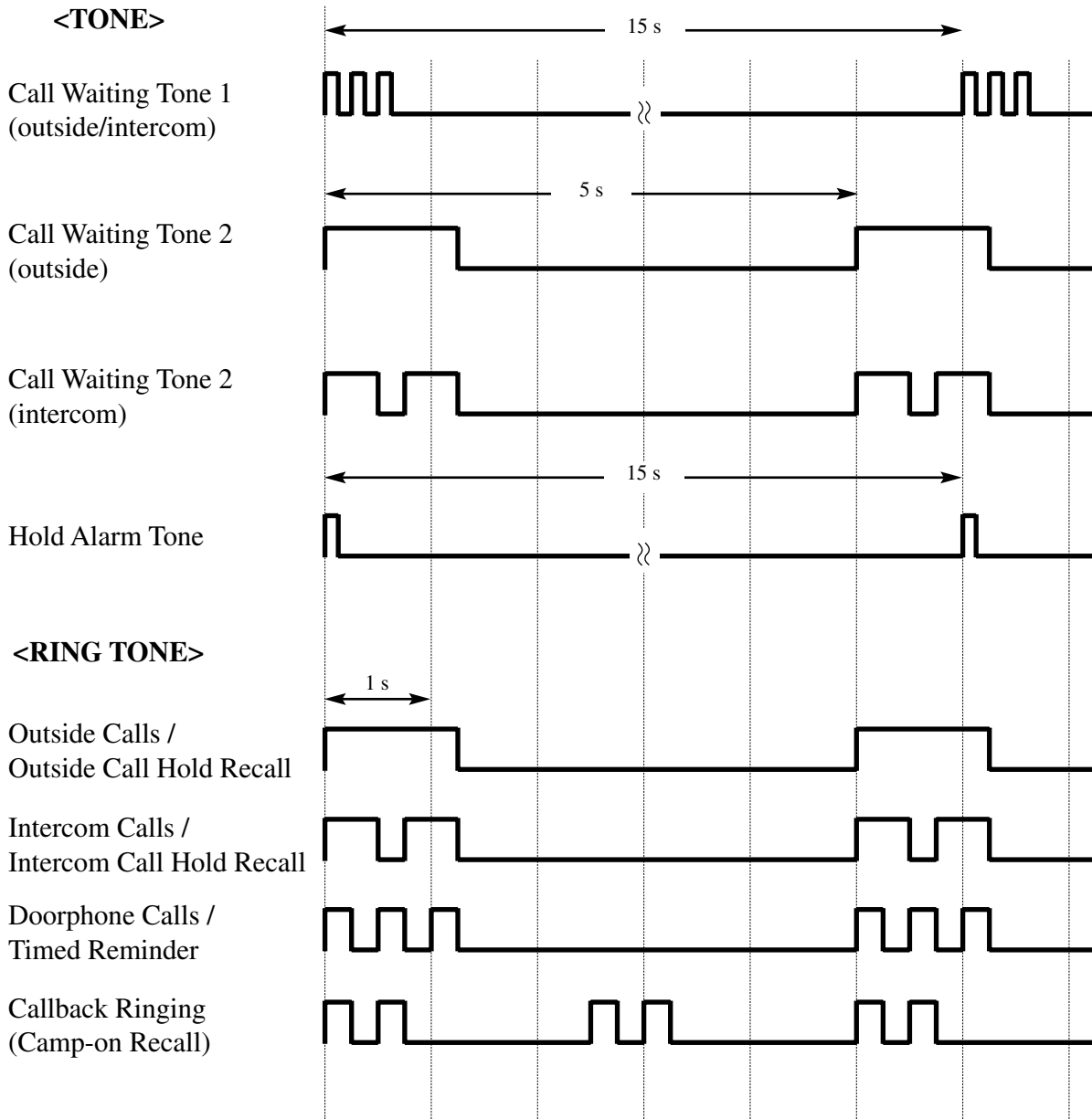



## 6.1.4 Troubleshooting

### If a power failure should occur...

Your KX-TD500 System enables conversations between specific CO lines and extensions (Power Failure Transfer), and supports system data backup.

### Power Failure Transfer

Specific extensions are automatically connected straight to specific CO lines. This provides CO line conversations between the pre-assigned extensions and CO lines:

- All other conversations are disconnected during a power failure.
- Digital Proprietary Telephones (DPTs) cannot be used during a power failure. SLTs can work in the event of a power failure.
- When power is restored after a power failure, your system automatically re-starts operation, maintaining as much of the previous system data as possible.

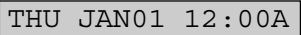
Problem	Probable Cause	Possible Solution
Nothing is heard in the hands-free mode.	The "Headset" mode is selected.	When the headset is not used, set the mode to "Handset." Refer to "Handset/Headset Selection" in Station Programming (Section 2), or "DPT Overview" (Section 1).
The unit does not ring.	<ul style="list-style-type: none"> <li>• The CO button is not assigned.</li> <li>• The Ringer Volume is set to "OFF."</li> </ul>	<ul style="list-style-type: none"> <li>• Assign the CO button.</li> <li>• Increase the Ringer Volume. Refer to "DPT Overview" (Section 1).</li> </ul>
The display flashes the following message: 	The system internal clock does not work properly.	Consult with an authorized Panasonic Factory Service Center.

**Panasonic Consumer Electronics Company  
Division of Matsushita Electric Corporation of America**

One Panasonic Way  
Secaucus, NJ 07094

**Panasonic Sales Company  
Division of Matsushita Electric of Puerto Rico, Inc.**

Ave. 65 de Infantería, Km. 9.5  
San Gabriel Industrial Park  
Carolina, Puerto Rico 00985

<http://www.panasonic.com/csd>

**Copyright:**

This manual is copyrighted by Panasonic Communications Co., Ltd. (PCC). You may print out this manual solely for internal use with this model. Except above, you may not reproduce this manual in any form, in whole or part, without the prior written consent of PCC and its licensee.

© 2000 Panasonic Communications Co., Ltd. All Rights Reserved.