

Panasonic

Telephone Answering System

Model No. **KX-TMC97-B**

Pulse-or-tone dialing capability

Operating Instructions



Jog Dial

Data Port 

Caller ID Compatibility

PLEASE READ BEFORE USE AND SAVE.

Preparation

Telephone

Answering System

Useful Information

Before Initial Use

Please read **IMPORTANT SAFETY INSTRUCTIONS** on pages 78–79 before use. Read and understand all instructions.

Thank you for purchasing your new Panasonic integrated telephone.

Caller ID and Visual Call Waiting (Call Waiting ID), where available, are telephone company services. After subscribing to Caller ID, this phone will display the caller's name and phone number. An added service, Visual Call Waiting, will display the second caller's name and phone number during call waiting.

Attach your purchase receipt here.

For your future reference

Serial No. _____

(found on the bottom of the unit)

Date of purchase _____

Name and address of dealer _____

Accessories (Included) To order, call 1-800-332-5368.

AC Adaptorone
(p. 10)
Order No. KX-A11-6

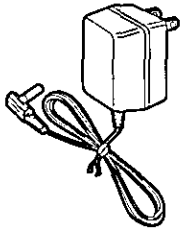

Wall Mounting Adaptorone
(p. 69)
Order No. PQKL28Z0

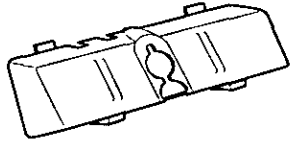

Handsetone
(p. 10)
Order No. PQJX2PML01Z

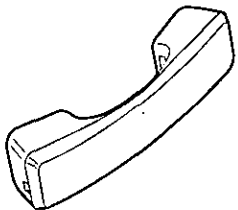

Handset Cordone
(p. 10)
Order No. PQJA212V

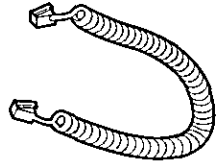

Telephone Line Cordone
(p. 11)

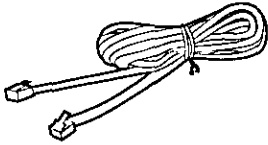

Contents

Preparation

Location of Controls	6
Display	8
Settings	10
Connecting the Handset/AC Adaptor	10
Connecting the Telephone Line Cord	11
Connecting a Communication Device	12
Selecting the Dialing Mode	13
Selecting the Line Mode	14
Selecting the Ringer Volume	15
Storing the Area Code	16
Programming Summary of Preparations	17
Preparing the Answering System	18
Greeting Message	18
Selecting the Caller's Recording Time	21
Date and Time Adjustment	22
Selecting the Number of Rings	24
Setting the CPC (Calling Party Control) Function	25
Setting the Greeting Monitor Function	25

Telephone

Making Calls	26
Answering Calls	29
Caller ID Service	30
Using the Caller List	32
Viewing the Caller List	32
Calling Back from the Caller List	34
Editing the Caller's Phone Number	35
Storing the Caller List Information in the Directory	36
Clearing the Caller List Information	38
Using the Directory	40
Storing Names and Numbers in the Directory	40
Steps for Entering Names and Symbols	42
Finding Items in the Directory	44
Dialing from the Directory	45
Changing an Item in the Directory	46
Clearing an Item from the Directory	47

Special Features	48
For Call Waiting Service Users	48
Temporary Tone Dialing (For Rotary or Pulse Service Users)	49
How to Use the PAUSE Button (For Analog PBX Line/Long Distance Service Users)	49

Answering System

Automatic Answering Operation	50
Setting the Unit to Answer Calls	50
Listening to Messages	51
Erasing Messages	53
Recording Your Telephone Conversation	54
Pager Call	55
Storing the Pager Number	55
Storing Your Home Telephone Number	57
Pager Mode Setting	59
Setting the Unit to Call a Pager	60
Remote Operation from a Touch Tone Phone	62
Setting the Remote Code	63
Voice Menu	64
Direct Remote Operation	66
Remote Operation Card	67

Useful Information

Wall Mounting	69
Using an Optional Headset	70
Connecting an Optional Headset to the Unit	70
Selecting the Headset/Speakerphone	71
How to Wear an Optional Headset	71
Making/Answering Calls	72
Before Requesting Help	74
Important Safety Instructions	78
FCC and Other Information	80

Location of Controls

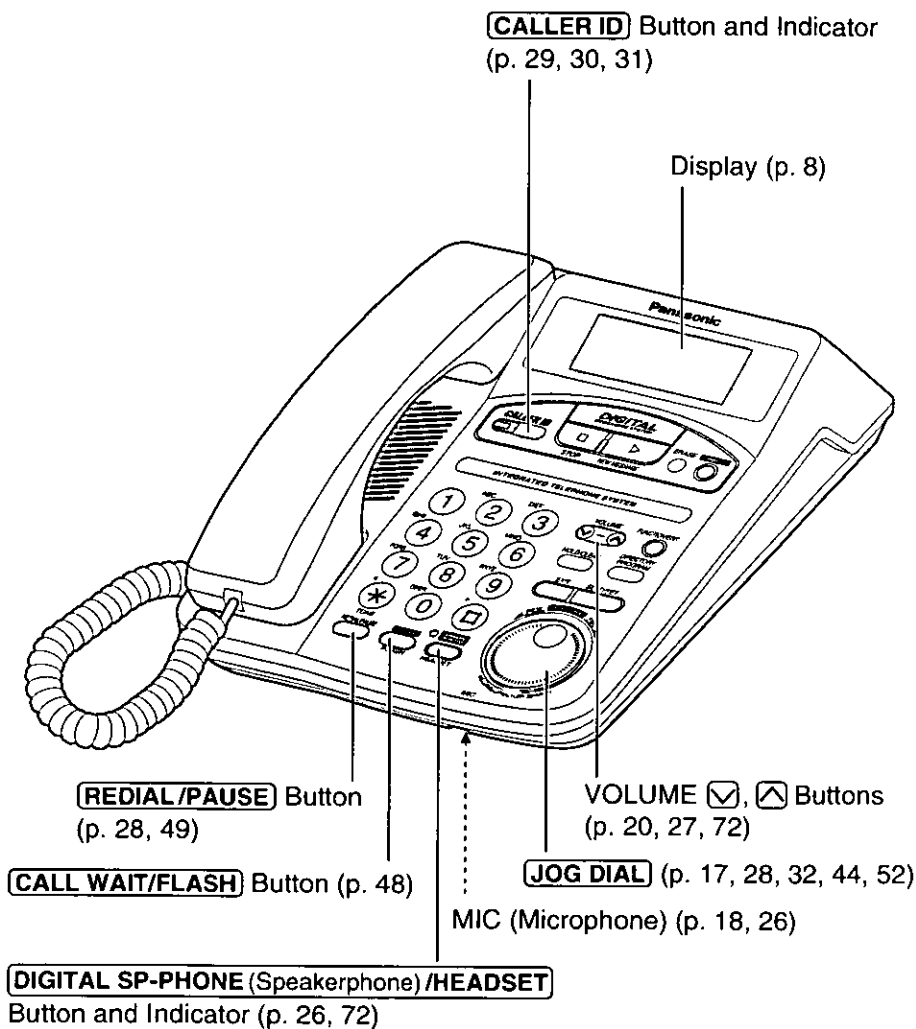

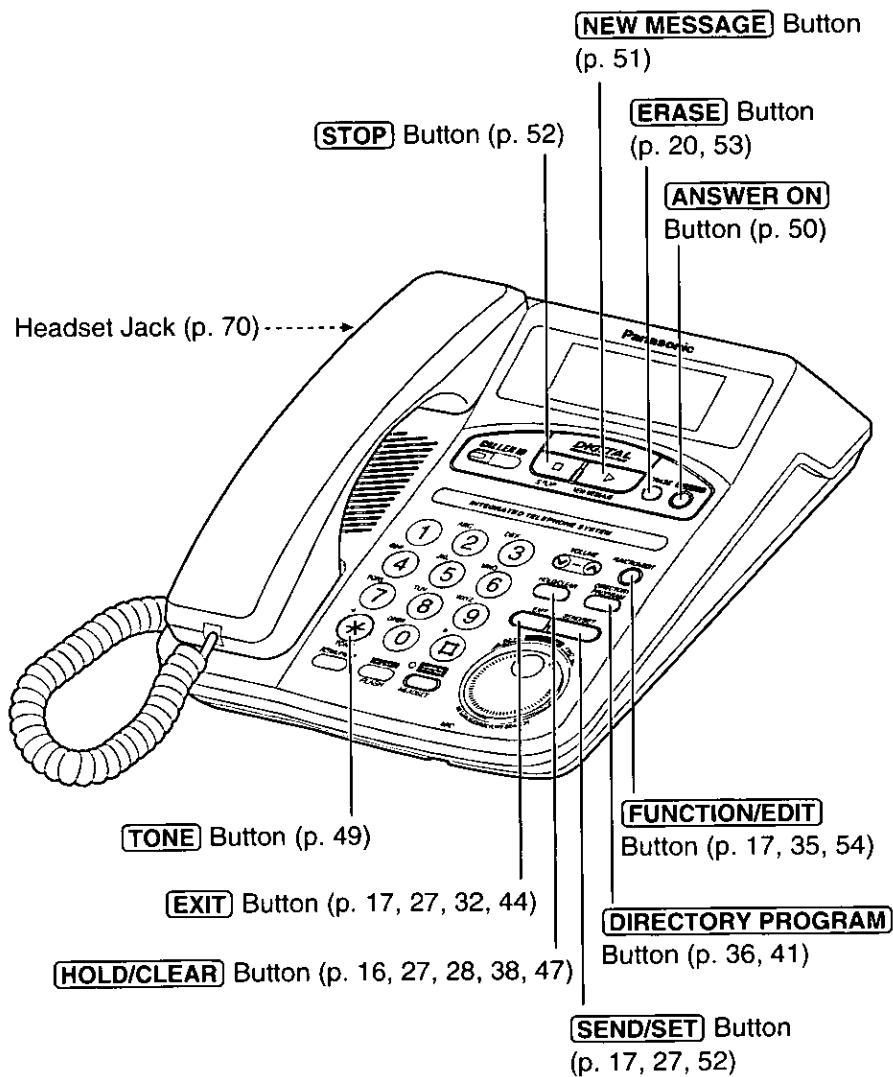

Display

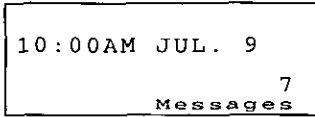

In the stand-by mode, the display shows the current time and date, and the number of recorded messages.
(Ex. 7 messages have been recorded.)

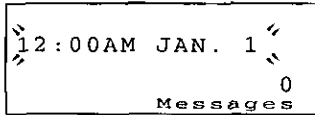

When the clock needs adjusting, the time and date flash (p. 22).

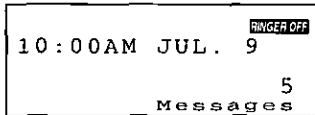

"**RINGER OFF**" is displayed when the ringer volume is set to "Off" (p. 15).

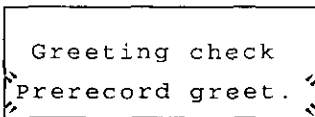

The pre-recorded message is being played (p. 19). ("Prerecord greet." flashes.)

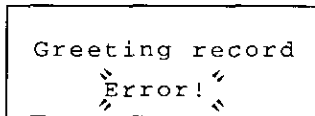

Your greeting message was not recorded correctly. ("Error!" flashes.)
Record it again (p. 18).

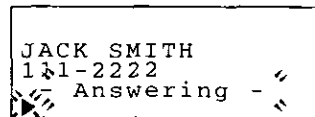

The answering system is recording a message (p. 50).
("- Answering -" flashes.)
"▶" flashes while messages are being recorded or played back.

Ex. Handset volume level: 2
Speaker volume level: 4



The display shows the volume level. You can select:
—4 levels (1–4) while using the handset (p. 27) or optional headset (p. 72).
—8 levels (1–8) while using the speakerphone (p. 27).
—9 levels (0–8) while using the answering system (p. 20, 51).

10:00AM JUL. 9
Greeting only

The recording time is set to "G.O. (greeting only)" (p. 21).

10:00AM JUL. 9
Message full
32
Messages

Message memory is full. ("Message full" flashes.) Erase some or all of the messages (p. 53).

No items stored

This display will be shown when:

- the redial list is empty,
- the Caller List is empty,
- the directory list is empty, or
- there are no stored items in the dialing button you pressed in the directory.

Tom Jones
098-765-4321
Private
-Directory list-

This is a name from the directory list. The stored name and phone number are displayed.

"Private ring" has been selected for this item (p. 40).

PAGER
10:00AM JUL. 9
7
Messages

"**PAGER**" indicates that the unit is set to alert a pager when it records an incoming message or receives a Caller ID call (p. 60). (Ex. The pager call mode is "On".)

End of new calls

You have finished viewing the NEW CALLS in the Caller List. To exit, press **EXIT**.

End of old calls

You have finished viewing the OLD CALLS in the Caller List. To exit, press **EXIT**.

E n d

You are at the end of the Caller List. To exit, press **EXIT**.

Settings

Connecting the Handset/AC Adaptor

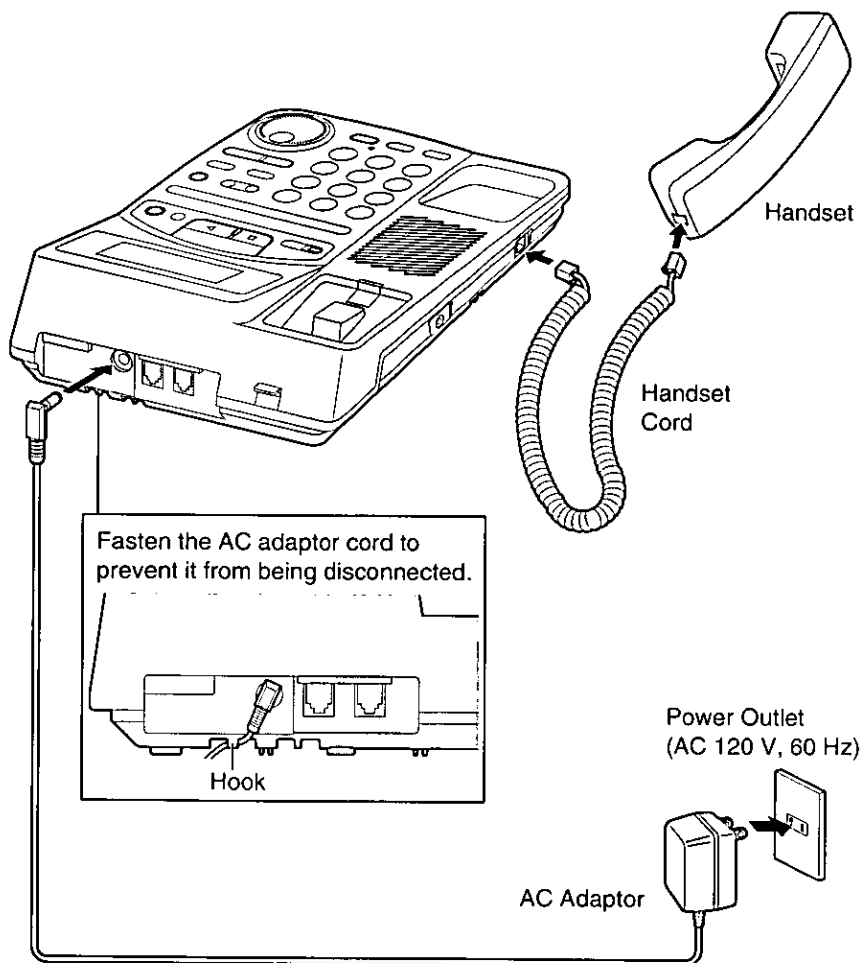

- Use only a Panasonic Handset for the KX-TMC97-B.
- **USE ONLY WITH** Panasonic AC ADAPTOR KX-A11 (Order No. KX-A11-6).
- The AC adaptor must remain connected at all times. (It is normal for the adaptor to feel warm during use.)
- During a power failure the unit will work as an ordinary telephone, but the speakerphone will not work.
- If your unit is connected to a PBX which does not support Caller ID services, you cannot access those services.



Connecting the Telephone Line Cord

Preparation

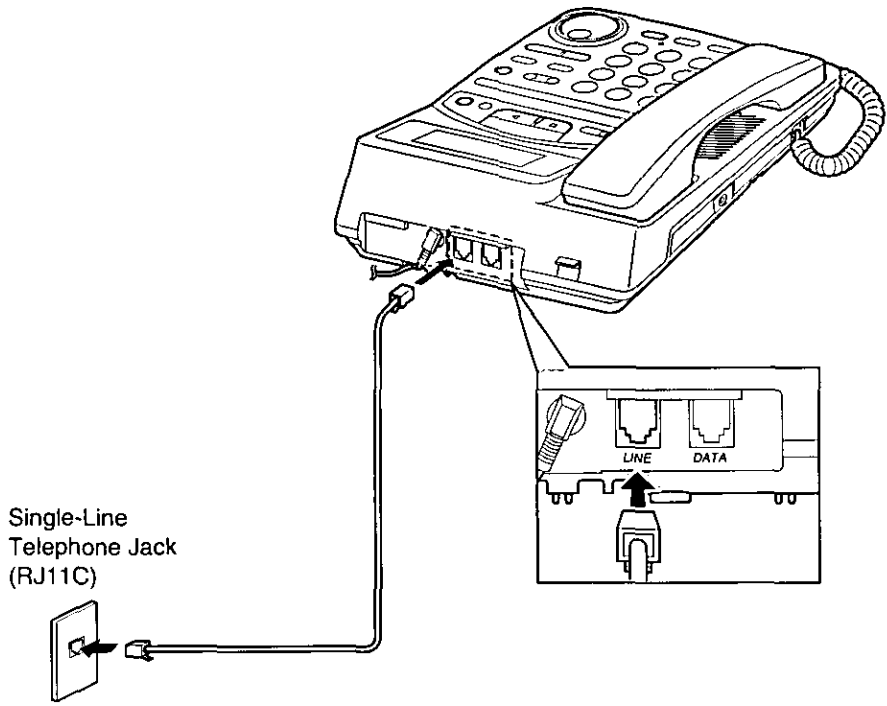

Single-Line Telephone Jack (RJ11C)

Connecting a Communication Device

If you connect a communication device (computer, modem, fax, etc.) to the telephone line, you can connect it through this unit using the DATA jack (-Data Port).

After connecting the handset, AC adaptor and telephone line cord, connect the communication device telephone line cord to the DATA jack.

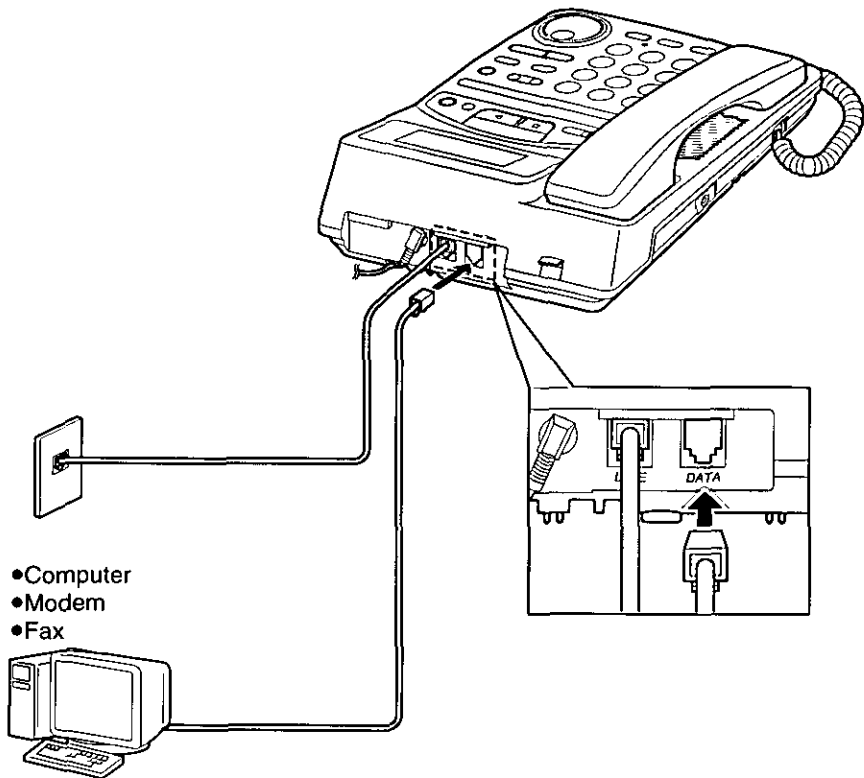

- Be sure that the communication device is not in use before making calls with this unit, or the device may not operate properly.



Selecting the Dialing Mode

You can select the dialing mode by programming. If you have touch tone service, set to "Tone". If rotary or pulse service is used, set to "Pulse". Your phone comes from the factory set to "Tone".

Be sure that the handset is on the cradle, the AC adaptor is connected and the DIGITAL SP-PHONE indicator light is off.

1 Press **FUNCTION/EDIT**.

- The display shows "Rotate JOG and press SET", then the function list.

```

→Date and time
  Greeting record
  Greeting check
-Function list-
  
```

2 Rotate **JOG DIAL** until "Dialing mode" is selected.

- The arrow points to "Dialing mode".

```

Home number
→Dialing mode
  Area code
-Function list-
  
```

3 Press **SEND/SET**.

- The current mode is displayed.

```

Dialing mode
           :Tone
           / \
SET=save
  
```

4 Rotate **JOG DIAL** until the desired mode is displayed.

```

Dialing mode
           :Pulse
           / \
SET=save
  
```

5 Press **SEND/SET** (Save key).

- A long beep sounds and the mode is saved.
- The display will return to the function list. To return to the stand-by mode, press **EXIT** or wait for 60 seconds.

```

Dialing mode
           :Pulse
  
```

- You can exit the programming mode any time by pressing **EXIT**.

Selecting the Line Mode

If the line is connected to a low voltage system such as a PBX, set to "B". If not, the following will not work: the unit will not ring, the Visual Call Waiting (Call Waiting ID) Service will not be available (p. 48), caller's messages will not be recorded and the unit will not alert your pager (p. 55). Your phone comes from the factory set to "A".

Be sure that the handset is on the cradle, the AC adaptor is connected and the DIGITAL SP-PHONE indicator light is off.

1 Press **FUNCTION/EDIT**.

- The display shows "Rotate JOG and press SET", then the function list.

```
→Date and time
Greeting record
Greeting check
-Function list-
```

2 Rotate **JOG DIAL** until "Line mode" is selected.

- The arrow points to "Line mode".

```
Headset select
→Line mode
Date and time
-Function list-
```

3 Press **SEND/SET**.

- The current mode is displayed.

```
Line mode  :A
SET=Save
```

4 Rotate **JOG DIAL** until the desired mode is displayed.

```
Line mode  :B
SET=Save
```

5 Press **SEND/SET** (Save key).

- A long beep sounds and the mode is saved.
- The display will return to the function list.
To return to the stand-by mode, press **EXIT** or wait for 60 seconds.

```
Line mode  :B
```

- You can exit the programming mode any time by pressing **EXIT**.



Selecting the Ringer Volume

You can select the ringer volume by programming. Set to "High" or "Low". When set to "Off", the unit will not ring. Your phone comes from the factory set to "High".

Be sure that the handset is on the cradle, the AC adaptor is connected and the DIGITAL SP-PHONE indicator light is off.

1 Press **FUNCTION/EDIT**.

- The display shows "Rotate JOG and press SET", then the function list.

```

→Date and time
  Greeting record
  Greeting check
  -Function list-
  
```

2 Rotate **JOG DIAL** until "Ringer volume" is selected.

- The arrow points to "Ringer volume".

```

→Ringer volume
  Headset select
  Line mode
  -Function list-
  
```

3 Press **SEND/SET**.

- The current setting is displayed.

```

Ringer volume
                :High
                :
SET=Save
  
```

4 Rotate **JOG DIAL** until the desired level is displayed.

```

Ringer volume
                :Low
                :
SET=Save
  
```

5 Press **SEND/SET** (Save key).

- The selected volume rings.
 - When set to "Off", a beep sounds.
 - The display will return to the function list.
- To return to the stand-by mode, press **EXIT** or wait for 60 seconds.

```

Ringer volume
                :Low
  
```

- You can exit the programming mode any time by pressing **EXIT**.
- When set to "Off", "**RINGER OFF**" will be displayed when you exit the function list.

Storing the Area Code

We recommend that you program your area code first before using the Caller ID feature (p. 30). Then incoming calls from the same area code will be recorded in the Caller List without the area code. You do not have to remove the area code before calling back or storing. Also, when incoming calls from a different area code are received, "1" will be added before the area code automatically.

Be sure that the handset is on the cradle, the AC adaptor is connected and the DIGITAL SP-PHONE indicator light is off.

- 1 Press **FUNCTION/EDIT**.
- The display shows "Rotate JOG and press SET", then the function list.

```
→Date and time
Greeting record
Greeting check
-Function list-
```

- 2 Rotate **JOG DIAL** until "Area code" is selected.
- The arrow points to "Area code".

```
Home number
Dialing mode
→Area code
-Function list-
```

- 3 Press **SEND/SET**.
- The current setting is displayed. The factory preset is "---".

```
Area code      :---
SET=Save
```

- 4 Enter your area code.
- If you enter a wrong number, press **HOLD/CLEAR**, then enter the correct number.

```
Area code      :123]
SET=Save
```

- 5 Press **SEND/SET** (Save key).
- A long beep sounds and the code is saved.
 - The display will return to the function list. To return to the stand-by mode, press **EXIT** or wait for 60 seconds.

```
Area code      :123
```

- You can exit the programming mode any time by pressing **EXIT**.

To clear the area code

Press **FUNCTION/EDIT** ➔ rotate **JOG DIAL** until "Area code" is selected ➔ press **SEND/SET** ➔ **HOLD/CLEAR** ➔ **SEND/SET** (SAVE key).

Programming Summary of Preparations

You can program the following functions. The display shows the programming instructions. See the corresponding pages for the function details.

Be sure that the handset is on the cradle, the AC adaptor is connected and the DIGITAL SP-PHONE indicator light is off.

Press **[FUNCTION/EDIT]**.

- "Rotate JOG and press SET" is displayed, then the display changes to the function list.



Rotate **[JOG DIAL]** until the desired function is selected.

- The arrow points to the selected function.



Press **[SEND/SET]**.

- To adjust the date and time, see page 22.
- To record the greeting message, see page 18.
- To check the greeting message, see page 20.
- To select the number of rings, see page 24.
- To select the caller's recording time, see page 21.
- To set the remote code, see page 63.
- To set the greeting monitor function, see page 25.
- To set the CPC (Calling Party Control) function, see page 25.
- To store the pager number, see page 55.
- To set the pager call on/off, see page 60.
- To call the pager, see page 58.
- To change the pager mode setting, see page 59.
- To store your home telephone number, see page 57.
- To select the dialing mode, see page 13.
- To store the area code, see page 16.
- To select the ringer volume, see page 15.
- To select the headset/speakerphone, see page 71.
- To select the line mode, see page 14.



When finished, press **[SEND/SET]** (Save key).

- You can exit the programming mode any time by pressing **[EXIT]**.

Preparing the Answering System

Greeting Message

You can record a personal greeting message. If a message is not recorded, one of two pre-recorded greetings will be played when a call is received (p. 19).

All messages (greeting, incoming, etc.) are stored in digital memory (p. 20). The total recording time is about 14 minutes.

We recommend you record a **brief greeting message** (see the sample on the next page) in order to leave more time in memory.

To record a greeting message

1 Press **FUNCTION/EDIT**.

```
-Date and time  
Greeting record  
Greeting check  
-Function list-
```

2 Rotate **JOG DIAL** until "Greeting record" is selected.

- The arrow points to "Greeting record".

```
  Date and time  
-Greeting record  
  Greeting check  
-Function list-
```

3 Press **SEND/SET**.

- "Record greeting after the beep" and a long beep are heard.

```
Greeting record
```

4 After the long beep, talk clearly about 8 inches (20 cm) away from the **MIC** (microphone).

- The display shows the elapsed recording time.

```
Greeting record  
00-00
```

5 When finished, press **SEND/SET**.

- A long beep sounds and the recorded message is played.
- The display will return to the function list. To change the message, start from step 3.
- To return to the stand-by mode, press **EXIT** or wait for 60 seconds.

```
Greeting record
```

```
Greeting record  
00-00
```



Greeting message sample

"Hello, this is (your name and/or number). Sorry I cannot take your call. Please leave a message after the beep. Thank you."

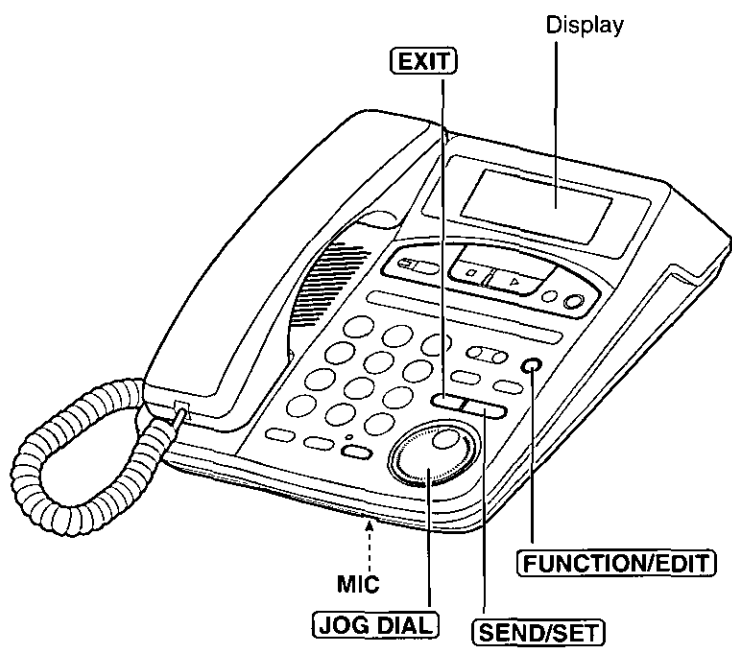

Pre-recorded greeting message

If you do not record a greeting message (p. 18), one of the following two messages will be played when a call is received depending on the caller's recording time (p. 21).

- When the recording time is set to "1 minute" or "unlimited";
"Hello, we are not available now. Please leave your name, message and phone number after the beep. We will return your call."

- When the recording time is set to "greeting only";
"Hello, no one is available to take your call. Please call back later. Thank you."

➔ Preparing the Answering System

To check the greeting message

1. Press **FUNCTION/EDIT**.
2. Rotate **JOG DIAL** until "Greeting check" is selected.
3. Press **SEND/SET**.
 - The greeting is played back.
 - The display will return to the function list. To return to the stand-by mode, press **EXIT** or wait for 60 seconds.

To erase the recorded greeting message

Repeat the checking procedure above, then press **ERASE** while the message is being played.

- The unit will answer a call with a pre-recorded greeting.

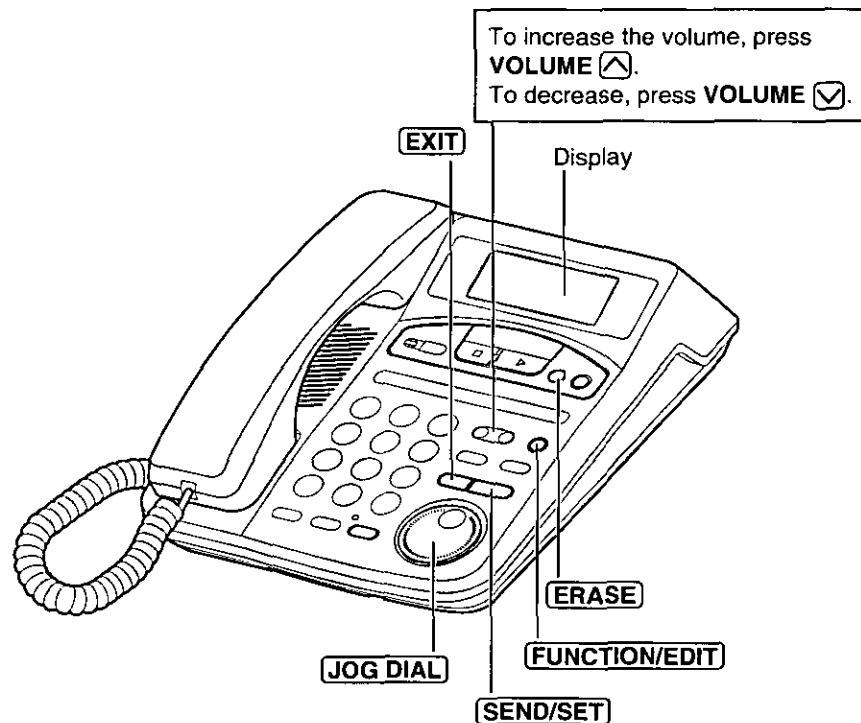

Flash Memory Message Backup

Messages are stored indefinitely on a "flash memory" IC chip and will not be affected by power failures. All of the messages are saved until you erase them.



Selecting the Caller's Recording Time

You may select the caller's recording time as either "1min (1 minute)", "Vox (unlimited)" or "G.O.(greeting only)". Your phone comes from the factory set to "Vox".

1 Press **FUNCTION/EDIT**.

```
→Date and time
Greeting record
Greeting check
-Function list-
```

2 Rotate **JOG DIAL** until "Recording time" is selected.

```
Number of rings
→Recording time
Remote code
-Function list-
```

- The arrow points to "Recording time".

3 Press **SEND/SET**.

- The current setting is displayed.

1min: 1 minute

G.O.: Greeting only

Vox: Unlimited

```
Recording time
:Vox
SET=Save
```

4 Rotate **JOG DIAL** until the desired setting is displayed.

```
Recording time
:1min
SET=Save
```

5 Press **SEND/SET** (Save key).

- A long beep sounds and the setting is saved.
- The display will return to the function list.

To return to the stand-by mode, press

EXIT or wait for 60 seconds.

```
Recording time
:1min
```

If you select "G.O.", the unit will answer a call with the greeting message, then hang up. The unit will not record any incoming messages.

➔ Preparing the Answering System

Date and Time Adjustment

Voice Date/Time Stamp: During playback, a synthesized voice will announce the date and time when each message was recorded.

If you subscribe to a Caller ID service (p. 30), please read the information on the next page.

1 Press **FUNCTION/EDIT**.

```
→Date and time
Greeting record
Greeting check
-Function list-
```

2 Rotate **JOG DIAL** until "Date and time" is selected.

```
→Date and time
Greeting record
Greeting check
-Function list-
```

- The arrow points to "Date and time".

3 Press **SEND/SET**.

- The current setting is displayed.

```
Date:1998.01.01
Time:12:00 AM
SET=Save
```

4 ① Enter the current year by using a 4-digit number, then the month and day using 2-digit number. (Ex. To set Sep. 5, 1998, enter "1998 09 05".)

```
Date:1998.09.05
Time:09:30 AM
SET=Save
```

- ② Enter the current time (hour and minute) by using a 4-digit number. (Ex. To set 9:30, enter "0930".)

- If you enter a wrong number, rotate **JOG DIAL** to move the cursor to the incorrect number. Then make the correction.

5 Press **1** (AM/PM key) to select "AM" or "PM".

```
Date:1998.09.05
Time:09:30 AM
1=AM/PM SET=Save
```



6 Press **SEND/SET** (Save key).

Date: 1998.09.05
Time: 09:30 PM

- A long beep sounds and the clock starts working.
- The display will return to the function list. To return to the stand-by mode, press **EXIT** or wait for 60 seconds.
- If 3 beeps sound, the entered date/time is not correct. Press **EXIT** and start from step 1.

- When you enter the hour in step 4, you cannot enter numbers greater than 12. **Do not use military time.** (To set 13:00, enter "0100" and select "PM" by pressing **1**.)
- The accuracy of the clock is approximately ± 45 seconds a month at room temperature.

If a power failure occurs, the adjusted date/time will be erased.

For Caller ID service users (p. 30)

- The date and time will be adjusted by the incoming Caller ID information after the first ring. In this case, the year will not be adjusted. To adjust the year, follow steps 1 to 3 on page 22. Enter the current year by using a 4-digit number, then press **SEND/SET**.
- The Caller ID information will re-set the clock if the adjusted time and/or date is incorrect.
- The Caller ID information will automatically set the clock ahead at the beginning of summer and back at the beginning of winter.

➔ Preparing the Answering System

Selecting the Number of Rings

You may select the number of rings before the answering system answers a call, from "2" to "7" or "T.S. (Toll Saver)". Your phone comes from the factory set to "T.S."

1 Press **FUNCTION/EDIT**.

```
→Date and time
Greeting record
Greeting check
-Function list-
```

2 Rotate **JOG DIAL** until "Number of rings" is selected.

```
→Number of rings
Recording time
Remote code
-Function list-
```

- The arrow points to "Number of rings".

3 Press **SEND/SET**.

- The current setting is displayed.
2-7: The unit will answer after the selected number of rings.

```
Number of rings
: T.S.
SET=Save
```

T.S.: Toll Saver*

4 Rotate **JOG DIAL** until the desired number of rings is displayed.

```
Number of rings
: 6
SET=Save
```

5 Press **SEND/SET** (Save key).

- A long beep sounds and the setting is saved.
- The display will return to the function list.
To return to the stand-by mode, press **EXIT** or wait for 60 seconds.

```
Number of rings
: 6
```

*Toll Saver

When you call the unit from a touch tone telephone:

If the unit answers on the 2nd ring, there is at least one new message.

If the unit answers on the 4th ring, there are no new messages.

Hang up when you hear the 3rd ring. This will save you the toll charge for the call.

Setting the CPC (Calling Party Control) Function

The CPC function is preset to "A". If you use a call waiting service, set to "B", or the call waiting tone will disconnect someone leaving a message.

1. Press **FUNCTION/EDIT**.
2. Rotate **JOG DIAL** until "CPC function" is selected.
3. Press **SEND/SET**.
 - The current setting, "A" or "B", is displayed.
4. Rotate **JOG DIAL** until the desired mode is displayed.
5. Press **SEND/SET** (Save key).
 - The display will return to the function list. To return to the stand-by mode, press **EXIT** or wait for 60 seconds.

Setting the Greeting Monitor Function

When your greeting message is being played to the caller, you can also listen to it through the speaker. To listen to your greeting, set to "On". Your phone comes from the factory set to "Off".

1. Press **FUNCTION/EDIT**.
2. Rotate **JOG DIAL** until "Greet. monitor" is selected.
3. Press **SEND/SET**.
 - The current setting, "Off" or "On", is displayed.
4. Rotate **JOG DIAL** until the desired mode is displayed.
5. Press **SEND/SET** (Save key).
 - The display will return to the function list. To return to the stand-by mode, press **EXIT** or wait for 60 seconds.

Making Calls

You can make a call by simply lifting the handset. To hang up, place the handset on the cradle.

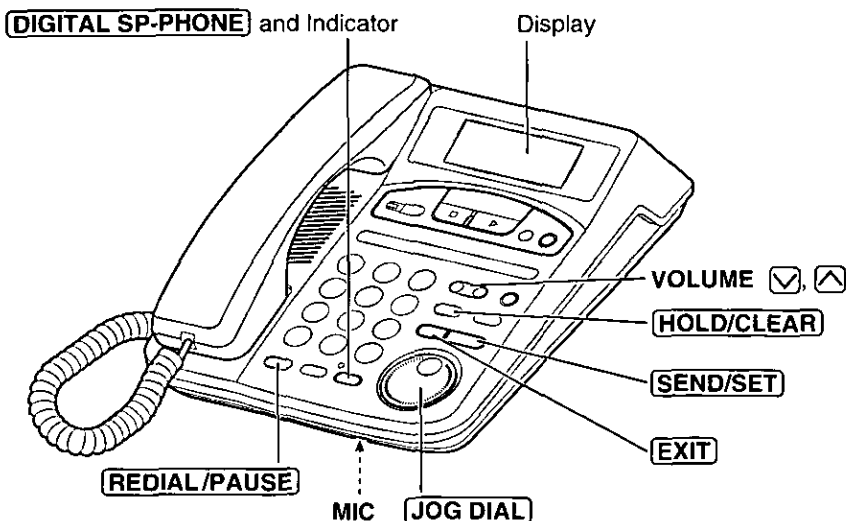

Using the digital duplex speakerphone

- 1 Press **DIGITAL SP-PHONE**.
 - The indicator lights.
- 2 Dial a phone number.
 - The dialed number is displayed.
 - If you misdial, hang up and dial again.
 - After a few seconds, the display will show the length of the call.
- 3 When the other party answers, talk into the **MIC** (microphone).
- 4 To hang up, press **DIGITAL SP-PHONE**.
 - The indicator light goes out.
 - The display will return to the stand-by mode.

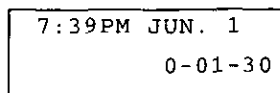
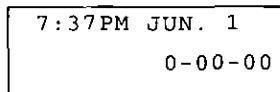
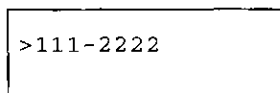
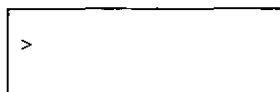



To dial after confirming the entered number

1 Enter a phone number.

- If you misdial, press **HOLD/CLEAR**.
Digits are erased from the right.
- To cancel, press **EXIT**.

111-2222

2 Lift the handset or press **DIGITAL SP-PHONE**.

- After a few seconds, the display will show the length of the call.
- You can also press **SEND/SET** instead of **DIGITAL SP-PHONE**.

>111-2222

7:37PM JUN. 1
0-00-00

3 When the other party answers, talk into the handset or **MIC**.

4 To hang up, place the handset on the cradle or press **DIGITAL SP-PHONE**.

- The display will return to the stand-by mode.

7:39PM JUN. 1
0-01-30

Telephone

To adjust the handset volume (4 levels) or the speaker volume (8 levels)

While using the handset or speakerphone, press **VOLUME** or .

Ex. Handset volume level: 4
Speaker volume level: 8

- The display shows the volume level.
- After a few seconds, the display will return to the length of the call.

Low High

Handsfree Digital Duplex Speakerphone

The digital duplex speakerphone enhances your telephone conversation. For best performance, please note the following:

- Use the speakerphone in a quiet room.
- Talk alternately with the caller.
- If the caller complains that your voice is hard to hear, press **VOLUME** to decrease the speaker volume.
- If the other party's voice from the speaker cuts in/out during a conversation, press **VOLUME** to decrease the speaker volume.
- You can switch to the handset by lifting up. To switch back to the speakerphone, press **DIGITAL SP-PHONE**.

➡ Making Calls

To redial the last number dialed

Lift the handset or press **[DIGITAL SP-PHONE]** ➡ press **[REDIAL/PAUSE]**.

To redial after confirming the numbers in the redial list

The unit automatically stores the last 5 numbers dialed into the redial list.

1. Press **[REDIAL/PAUSE]**.

- The display shows the last number dialed.

321-5555

-Redial list-

2. If necessary, rotate **[JOG DIAL]** until the desired number is selected.

- To search from the most recent to oldest number, rotate to the right.
To search from the oldest to most recent number, rotate to the left.
- To cancel, press **[EXIT]**.

3. Lift the handset or press **[DIGITAL SP-PHONE]**.

- You can also press **[SEND/SET]** instead of **[DIGITAL SP-PHONE]**.

To clear a number in the redial list, press **[REDIAL/PAUSE]** ➡ rotate **[JOG DIAL]** until the desired number is selected ➡ press **[HOLD/CLEAR]**.

To put a call on hold

Press **[HOLD/CLEAR]**.

- The DIGITAL SP-PHONE indicator flashes.
- If you are using the handset, you may place it on the cradle.

To release the hold

Lift the handset or press **[DIGITAL SP-PHONE]**.

- If another phone is connected on the same line, you can also release the hold by lifting its handset.

Answering Calls

When a call is being received, the unit rings and the CALLER ID indicator flashes quickly. You can answer a call by simply lifting the handset. If you subscribe to a Caller ID service, the calling party information will be displayed after the first ring (p. 30). Please wait until the second ring to answer a call in order to view the Caller ID information.

Using the digital duplex speakerphone

- 1 Press **DIGITAL SP-PHONE**.
- 2 Talk into the **MIC** (microphone).
- 3 To hang up, press **DIGITAL SP-PHONE**.

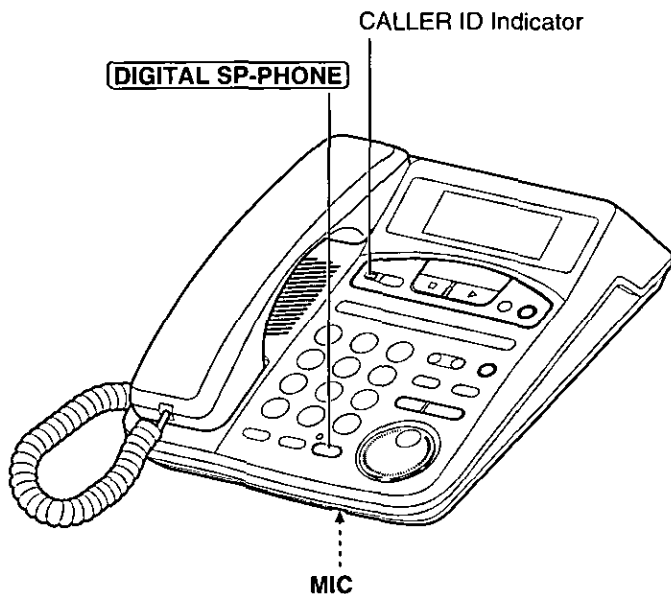

- When the ringer volume is set to "Off", the unit will not ring (p. 15).

Caller ID Service

This unit is compatible with a Caller ID service offered by your telephone company. After you subscribe to a Caller ID service, the calling party information will be displayed after the first ring.

The unit can record information of up to 30 different callers, including the time and date received and the number of times called, in the Caller List. The Caller List information is sorted by the most recent to oldest call.

Using the list, you can automatically call back a caller. You can store the caller's name and number from the Caller List into the directory.

If you subscribe to a Visual Call Waiting (Call Waiting ID) service, when a second call is received, the new caller's name and phone number will be displayed (p. 48).

How caller information is displayed when a call is received

The display shows the caller's name and number after the first ring.

TINA ROBINSON
1-000-222-3333



After you answer the call, the display will show the length of the call.

10:00AM JUN. 10
0-00-00

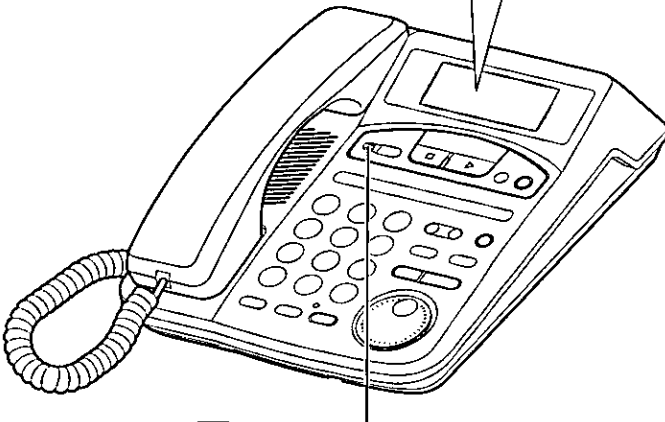

The CALLER ID indicator will flash quickly when a call is being received.

-
- In some cases, caller information cannot be displayed. The display will show as follows.

The caller dialed from an area which does not provide a Caller ID service.

Out of area

The caller has requested not to display their information.

Private caller

- If your unit is connected to a PBX which does not support Caller ID services, you cannot access those services.
- In some calling areas, the name display service may not be available. For further information, please contact your telephone company.

To check the number of new calls

Press **CALLER ID**.

- For example, if you have received 10 new calls, the display on the right will be shown.

10 new calls

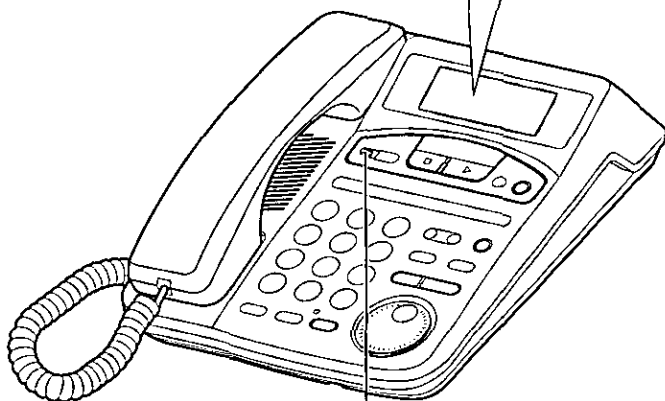

The CALLER ID indicator flashes slowly when new calls have been received.

Using the Caller List

Viewing the Caller List

To confirm who has called you, follow the steps below.

1 Press **CALLER ID** to enter the list.

- The number of new calls will be shown.

2 new calls

2 Rotate **JOG DIAL**.

- To search from the most recent to oldest call, rotate to the right.
- To search from the oldest to most recent call, rotate to the left.
- To move between callers, rotate **JOG DIAL**.

3 To exit the list, press **EXIT**.

- The display will return to the stand-by mode.

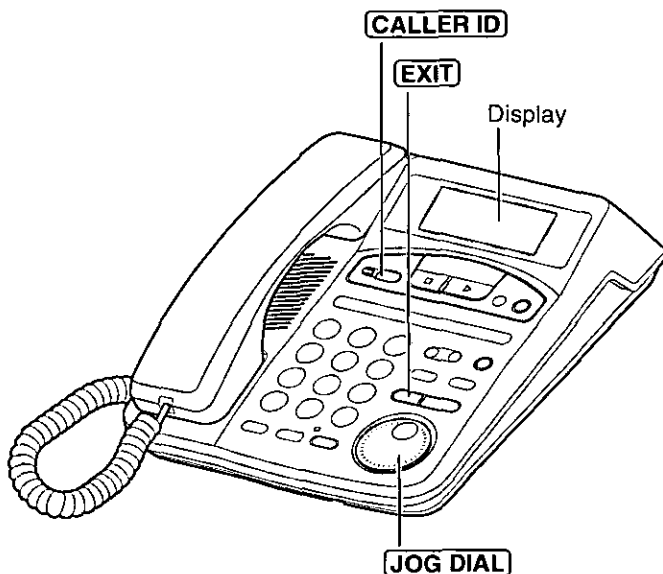

- Once NEW calls have been checked, they will be listed as OLD.
- When you answer a call or call back, the caller information will be listed as OLD.
- If "No items stored" is displayed in step 1, the Caller List is empty. Press **EXIT** to exit the list.
- If more than one call is received from the same caller, the date and time of the last call will be recorded. Also, when the same caller calls again, the OLD call entry will be deleted.



Ex. When you search from the most recent call:

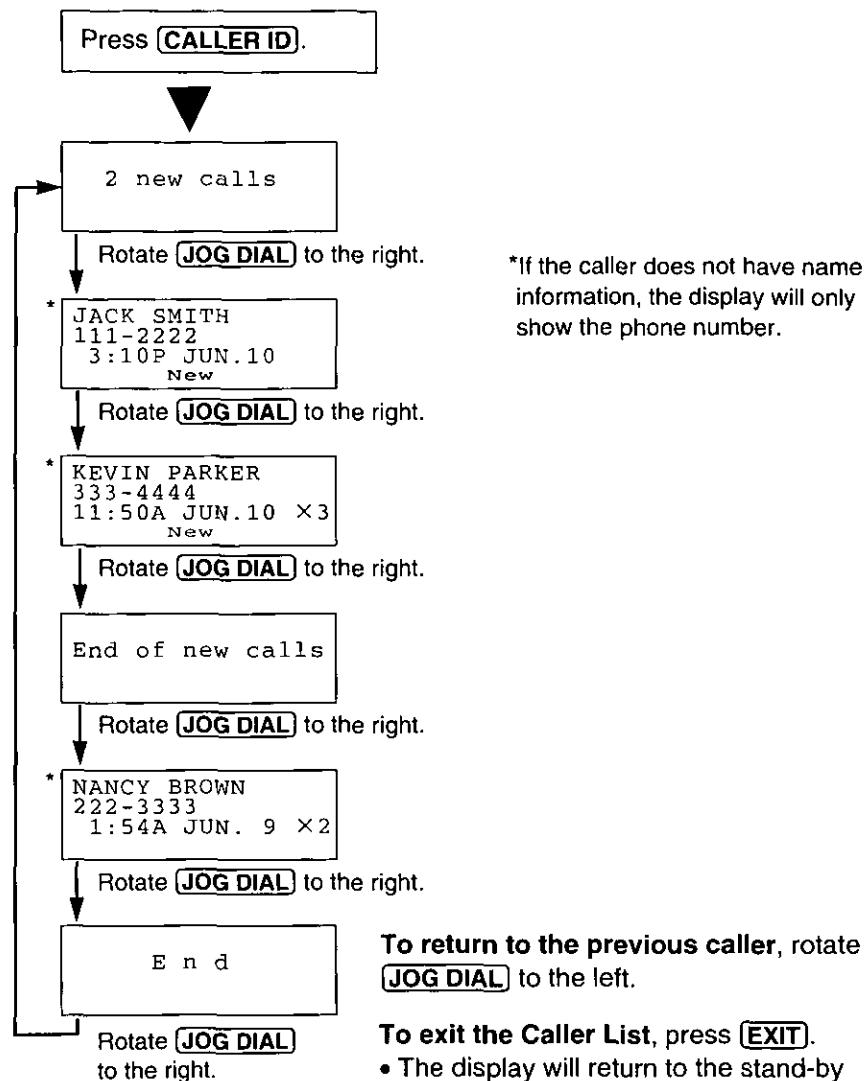

Telephone

Display signification:

New: You have not checked the caller information, answered the call or called back the caller.

x2-x9: The number of times they called (up to 9).

Calling Back from the Caller List

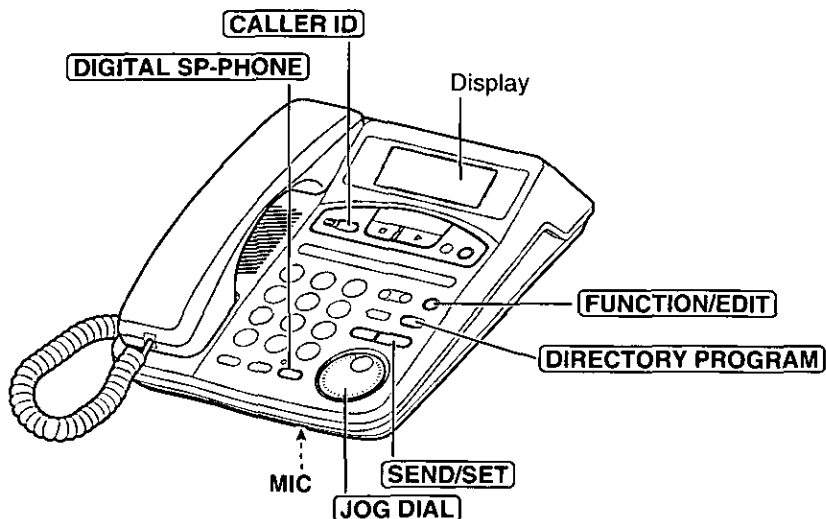

- 1 Press **CALLER ID** to enter the list.
 - The number of new calls will be shown.
- 2 Rotate **JOG DIAL** until the desired caller is displayed.
- 3 Lift the handset or press **DIGITAL-SP-PHONE**.
 - The displayed phone number is dialed automatically.
 - You can also press **SEND/SET** instead of **DIGITAL SP-PHONE**.

10 new calls

JACK SMITH 111-2222 3:10P JUN.10 New

JACK SMITH >111-2222

- 4 When the other party answers, talk into the handset or **MIC**.
- 5 To hang up, place the handset on the cradle or press **DIGITAL SP-PHONE**.

- In some cases, you may have to edit the number before dialing (p. 35). (Ex. You may have to add "1" for long distance calls.) If you did not store your area code (p. 16), the edited number will not be saved in the Caller List.
- If a phone number is not displayed in the caller information, you cannot call back that caller.



Editing the Caller's Phone Number

The unit can edit a phone number into one of 4 patterns.

- 1 Press **CALLER ID** to enter the list.
- The number of new calls will be shown.

10 new calls

- 2 Rotate **JOG DIAL** until the desired caller is displayed.

FRED PARKER
321-5555
3:10P JUN. 10
New

- 3 Press **FUNCTION/EDIT** to select a pattern. Each time you press **FUNCTION/EDIT**, the number is rearranged into one of 4 different patterns.

- (a) 1 -
- (b) 1 - -
- (c) -
- (d)

- The order in which patterns (a) - (d) are displayed depends on which pattern the telephone number is displayed in step 2.

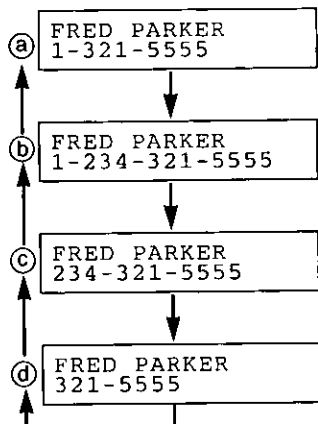

- 4 After you edit the number into the desired pattern, you can continue with calling back or storing procedures.

To call back, lift the handset or press **DIGITAL SP-PHONE** (p. 34).

To store the caller's name and number in the directory, press **DIRECTORY PROGRAM**, then follow the instructions on the display (see page 36, from step 3).

➔ Using the Caller List

Storing the Caller List Information in the Directory

You can store names and numbers that are in the Caller List into the directory. You can also select a separate ring tone for callers by selecting "Private ring" (p. 40).

- 1 Press **CALLER ID** to enter the list.
- The number of new calls will be shown.

```
10 new calls
```

- 2 Rotate **JOG DIAL** until the desired caller is displayed.
- If the number requires editing, see page 35.

```
JACK SMITH  
111-2222  
3:10P JUN.10  
New
```

- 3 Press **DIRECTORY PROGRAM**.

```
Save directory ?  
JACK SMITH  
111-2222  
*=Yes #=No
```

- 4 Press ***** (Yes key).

```
Private ring ?  
  
*=Yes #=No
```

If the caller information you want to store does not have name information, just follow the instructions on the display.

```
Save name ?  
111-2222  
*=Yes #=No
```

- a) If you do not need to enter a name, press **#** (NO key).

```
Private ring ?  
  
*=Yes #=No
```

- b) If you need to enter a name, press ***** (Yes key). Then enter the name (p. 42). When finished, press **SEND/SET** (Next key).

```
Enter name >  
□  
JOG=←→ SET=Next
```



5 a) If you do not want to select private ring, press **#** (NO key).

```
JACK SMITH
111-2222
*** Saved ***
```

b) If you want to select private ring, press ***** (YES key).

```
JACK SMITH
111-2222
Private
*** Saved ***
```

- A long beep sounds and the programming is completed.
- The display will return to step 2. You can continue storing another item. To return to the stand-by mode, press **EXIT** or wait for 60 seconds.

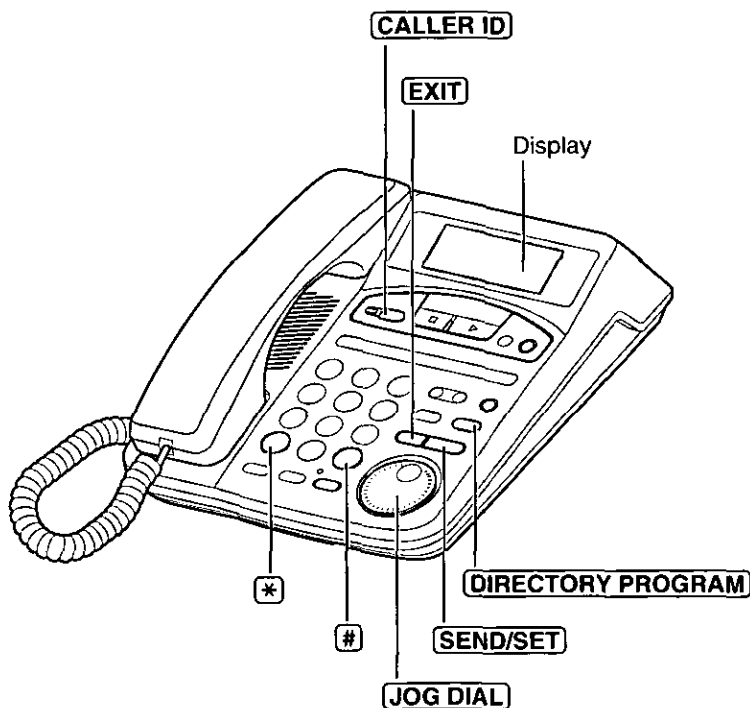

Telephone

- If the display shows "Directory full" in step 3 or 5, the display will return to the stand-by mode. To clear other stored items from the directory, see page 47.
- You cannot store caller information in the directory when a phone number is not displayed.

➔ Using the Caller List

Clearing the Caller List Information

You can clear some or all of the entries in the Caller List.

To clear a specific caller from the Caller List

- 1 Press **CALLER ID** to enter the list.
 - The number of new calls will be shown.
- 2 Rotate **JOG DIAL** until the caller you want to clear is displayed.
- 3 Press **HOLD/CLEAR**.
 - A long beep sounds and the information is erased.
 - In a few seconds, the display will show the previous caller information.
 - To return to the stand-by mode, press **EXIT** or wait for 60 seconds.

10 new calls

TOM REAGAN
444-5555
3:10P JUN.10

C l e a r

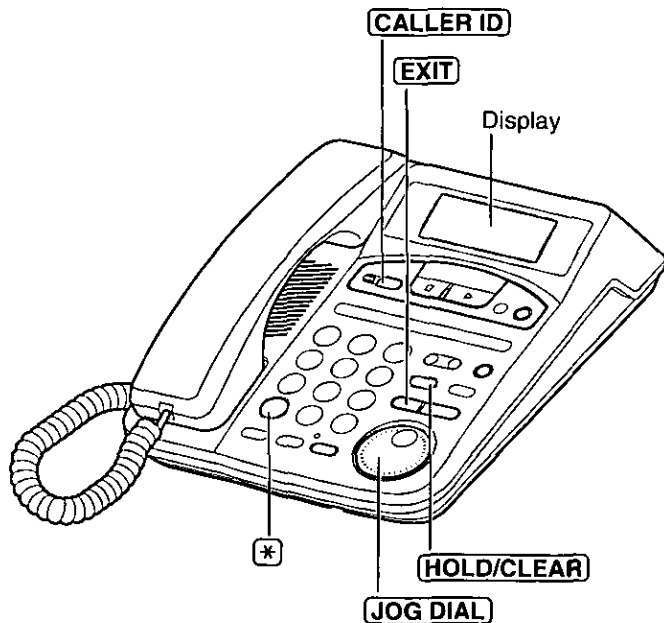

To clear all of the entries in the Caller List

- 1 Press **CALLER ID** to enter the list.
- The number of new calls will be shown.

0 new calls

- 2 Press **HOLD/CLEAR**.

All clear ?
* = Yes # = No

- 3 Press ***** (YES key).
- A long beep sounds and all of the entries are erased.
 - The display will return to the stand-by mode.

All clear

Telephone

- You can also clear all of the entries by setting the display to "End of new calls", "End of old calls" or "End" by rotating **JOG DIAL** after pressing **CALLER ID** in step 1.

Using the Directory

You can store up to 50 names and phone numbers in the directory. All directory items are sorted by the first word in alphabetical order. Using the directory, you can make a call by selecting a name on the display.

You can also select a separate ring tone for items by selecting "Private ring" during storing. "Private ring" will sound after the first ring.

Storing Names and Numbers in the Directory

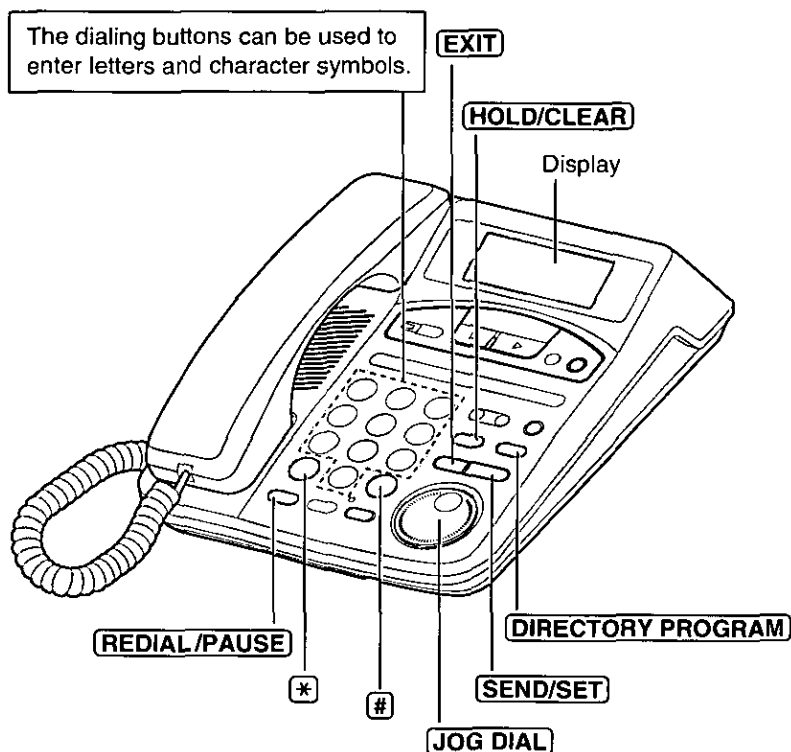



1 Press **DIRECTORY PROGRAM**.

- The display shows the number of remaining directory items, then "Enter name".

```

Program new
      directory
50
items remaining
  
```

```

Enter name >
□
JOG=(←)  SET=Next
  
```

2 Enter a name up to 16 characters with the dialing buttons, **JOG DIAL**, ***** (←) or **#** (→).

- See the steps for entering names and symbols (p. 42).

```

Enter name >
Tom Jones
JOG=(←)  SET=Next
  
```

3 Press **SEND/SET** (Next key).

```

Enter phone no.>
□
  
```

4 Enter a phone number up to 16 digits.

- If you misdial, press **HOLD/CLEAR**. The digit at the cursor is erased.
- You can use **JOG DIAL** to move the cursor to the right or left.

```

Enter phone no.>
0987654321□
JOG=(←)  SET=Next
  
```

5 Press **SEND/SET** (Next key).

```

Private ring ?
* = Yes      # = No
  
```

6 a) If you do not want to select private ring, press **#** (NO key).

- b) If you want to select private ring, press ***** (YES key).

- A long beep sounds and the item is saved.
- The display will return to step 1. You can continue storing another item.
- To return to the stand-by mode, press **EXIT** or wait for 60 seconds.

```

Tom Jones
098-765-4321
*** Saved ***
  
```

```

Tom Jones
098-765-4321
Private
*** Saved ***
  
```

- If a pause is required for dialing, **REDIAL/PAUSE** can be stored in a phone number counting as one digit (p. 49) in step 4.
- You can exit the programming mode any time by pressing **EXIT**.
- If the display shows "Directory full" in step 1 or 6, the display will return to the stand-by mode. Erase other stored items from the directory (p. 47).

➔ Using the Directory

Steps for Entering Names and Symbols

The dialing buttons can be used to enter letters and character symbols. Pressing each button selects a character as shown below.

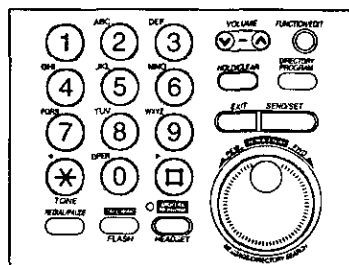

Keys	Number of times you press each key										
	1	2	3	4	5	6	7	8	9	10	11
①	#	&	'	()	*	,	-	.	/	1
②	A	B	C	a	b	c	2				
③	D	E	F	d	e	f	3				
④	G	H	I	g	h	i	4				
⑤	J	K	L	j	k	l	5				
⑥	M	N	O	m	n	o	6				
⑦	P	Q	R	S	p	q	r	s	7		
⑧	T	U	V	t	u	v	8				
⑨	W	X	Y	Z	w	x	y	z	9		
⑩	0	Blank									
JOG DIAL	To move the cursor □ to the right or left.										
*	To move the cursor □ to the left.										
#	To move the cursor □ to the right.										

If you make a mistake while entering a name

Use **JOG DIAL** to move the cursor to the incorrect character, then make the correction. You can also use * (←) or # (→) to move the cursor for corrections. You can delete one character by pressing **HOLD/CLEAR**.



For example, to enter "Tom Jones":

- 1 Press **DIRECTORY PROGRAM**.
 - The display shows the number of remaining directory items, and then the display on the right is shown.
- 2 Press **8**.
- 3 Press **6** six times, then press **#** (\rightarrow) to move the cursor to the right.
- 4 Press **6** four times.
- 5 Press **#** (\rightarrow) twice to enter a blank.
- 6 Press **5**.
- 7 Press **6** six times, then press **#** (\rightarrow) to move the cursor to the right.
- 8 Press **6** five times.
- 9 Press **3** five times.
- 10 Press **7** eight times.
- 11 When finished, press **SEND/SET** (NEXT key).
 - To continue entering a phone number, see page 41, from step 4.

```
Enter name >
□
JOG=(←→) SET=Next
```

```
Enter name >
T
JOG=(←→) SET=Next
```

```
Enter name >
To□
JOG=(←→) SET=Next
```

```
Enter name >
Tom
JOG=(←→) SET=Next
```

```
Enter name >
Tom □
JOG=(←→) SET=Next
```

```
Enter name >
Tom T
JOG=(←→) SET=Next
```

```
Enter name >
Tom Jo□
JOG=(←→) SET=Next
```

```
Enter name >
Tom Jon
JOG=(←→) SET=Next
```

```
Enter name >
Tom Jones
JOG=(←→) SET=Next
```

```
Enter name >
Tom Jones
JOG=(←→) SET=Next
```

```
Enter phone no.>
□
```

➔ Using the Directory

Finding Items in the Directory

Rotate **JOG DIAL** until the desired name is displayed.

- All directory items are sorted in the following order:

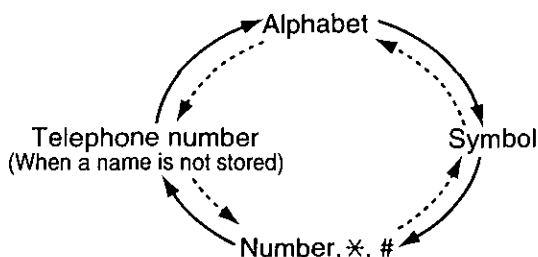

Rotate to the left. Rotate to the right.

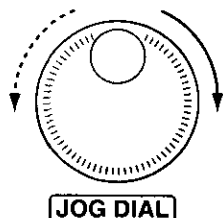

To search for a name by the initial

- 1 Rotate **JOG DIAL** to enter the directory.

```
ANN
456-7890
-Directory list-
```

- 2 Press the dialing button of the first letter of the desired name repeatedly (see the Index table below).

```
Fanny
123-4567
-Directory list-
```

Ex. To find "Frank", press **3** repeatedly until the first item under "F" is displayed.

- 3 Rotate **JOG DIAL** to the right until the desired name is displayed.

```
Frank
321-5555
-Directory list-
```

Keys	Index	Keys	Index
1	Other symbols, 1	6	M, N, O, 6
2	A, B, C, 2	7	P, Q, R, S, 7
3	D, E, F, 3	8	T, U, V, 8
4	G, H, I, 4	9	W, X, Y, Z, 9
5	J, K, L, 5	0	0

- You can leave the directory any time by pressing press **EXIT**.



Dialing from the Directory

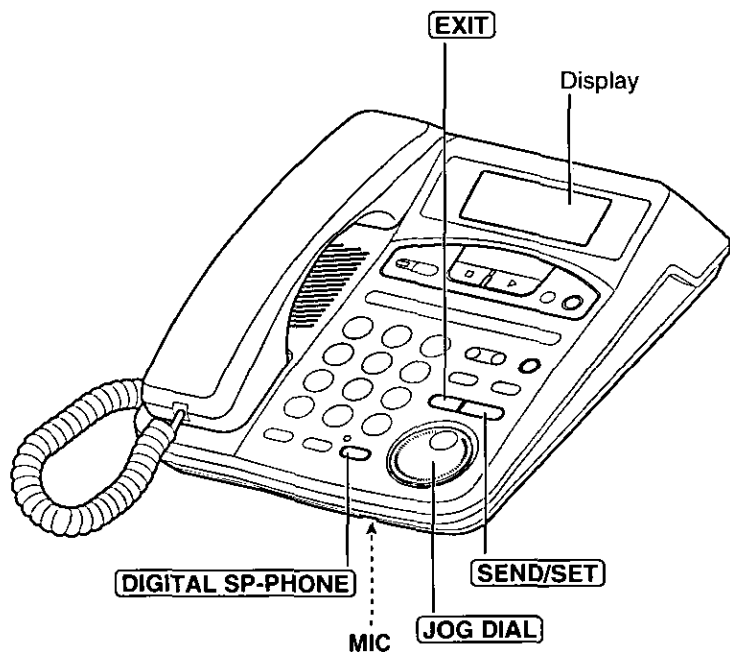

Telephone

1 Rotate **JOG DIAL** until the desired name is displayed.

- You can also find the item by searching by the initial (p. 44).
- To exit the directory, press **EXIT**.

Mary 456-7890 -Directory list-

2 Lift the handset or press **DIGITAL SP-PHONE**.

- The number is dialed automatically.
- You can also press **SEND/SET** instead of **DIGITAL SP-PHONE**.

Mary >456-7890

7:39PM JUN. 1 0-00-00

3 When the other party answers, talk into the handset or **MIC**.

4 To hang up, place the handset on the cradle or press **DIGITAL SP-PHONE**.

Changing an Item in the Directory

1 Rotate **[JOG DIAL]** until the desired item is displayed.

```
Jane  
123-4567  
-Directory list-
```

- You can also find the item by searching by the initial (p. 44).

2 Press **[FUNCTION/EDIT]**.

```
Enter name >  
Jane  
JOG=(←) SET=Next
```

- If you do not need to change the name, go to step 4.

3 Edit the name by using the dialing buttons, **[JOG DIAL]**, **[*]** (←) or **[#]** (→) (p. 42) up to 16 characters.

```
Enter name >  
Jane Walker  
JOG=(←) SET=Next
```

4 Press **[SEND/SET]** (Next key).

```
Enter phone no. >  
1234567  
JOG=(←) SET=Next
```

- If you do not need to change the number, go to step 6.

5 Enter the new number up to 16 digits.

```
Enter phone no. >  
0981234567  
JOG=(←) SET=Next
```

- You can use **[JOG DIAL]** to move the cursor for corrections.
- The digit at the cursor is erased by pressing **[HOLD/CLEAR]**.

6 Press **[SEND/SET]** (Next key).

```
Private ring ?  
*=Yes      #=No
```

7 a) If you do not want to select the private ring, press **[#]** (NO key).

```
Jane Walker  
098-123-4567  
*** Saved ***
```

b) If you want to select the private ring, press **[*]** (YES key).

```
Jane Walker  
098-123-4567  
Private  
*** Saved ***
```

- A long beep sounds and the changed item is saved.
- The display will return to step 1. You can continue editing another item.
- To return to the stand-by mode, press **[EXIT]** or wait for 60 seconds.

- You can exit the programming mode any time by pressing **[EXIT]**.

Clearing an Item from the Directory

1 Rotate **JOG DIAL** until the desired name is displayed.

- You can also find the item by searching by the initial (p. 44).

Ex. To erase "Helen"

```
Helen
333-4444
-Directory list-
```

2 Press **HOLD/CLEAR**.

```
Clear directory?
Helen
333-4444
*=Yes           #=No
```

3 Press ***** (Yes key).

- A long beep sounds and the item is erased.
- In a few seconds, the display will show the next caller information.

```
C l e a r
```

- You can exit the programming mode any time by pressing **EXIT**.

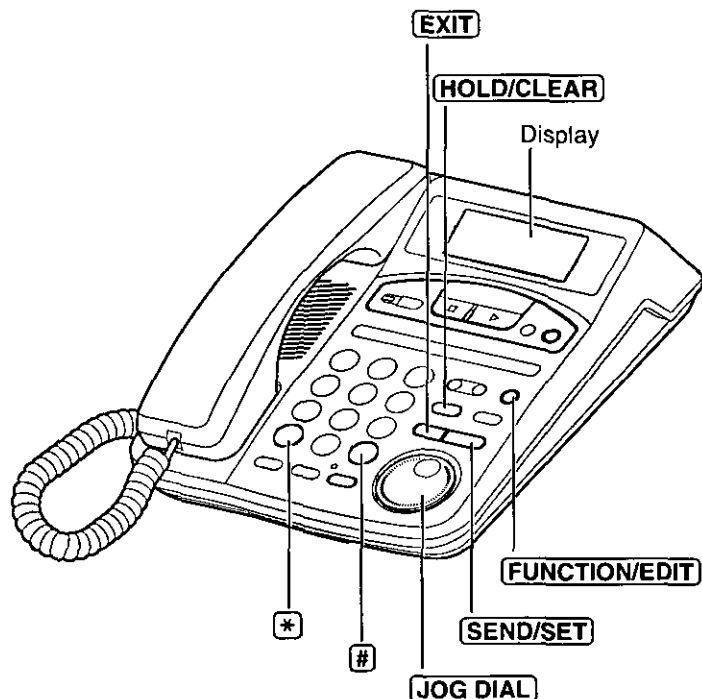

Special Features

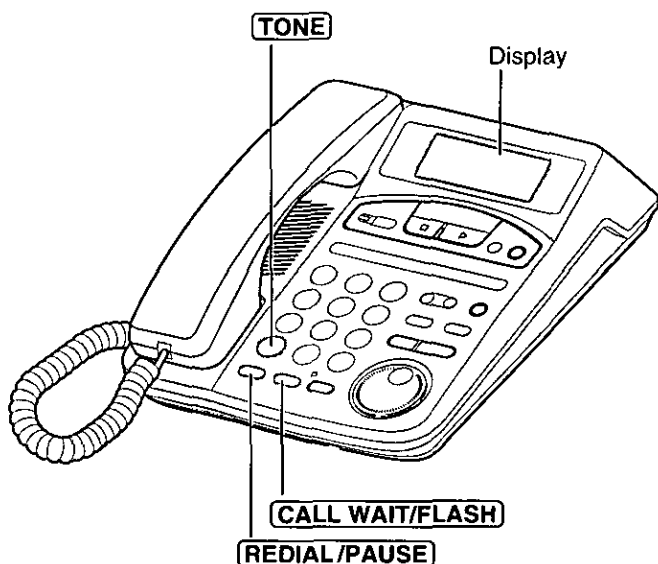

For Call Waiting Service Users

Press **CALL WAIT/FLASH** if you hear a call-waiting tone while talking.

- The first call is put on hold and you can answer the second call.
- To return to the first caller, press **CALL WAIT/FLASH** again.
- The call waiting service is not available when:
 - the answering system is recording a message,
 - you are recording your telephone conversation (p. 54), or
 - the parallel connected telephone is in use.

Visual Call Waiting (Call Waiting ID) Service

Visual Call Waiting (Call Waiting ID) Service allows the unit to display the second caller's information. After you hear a call-waiting tone while talking, the unit will display "- Call waiting -", and the caller's name and phone number.

- Call waiting - Nancy Brown 1-000-222-3333

- Please contact your telephone company for details and availability in your area.

Temporary Tone Dialing

(For Rotary or Pulse Service Users)

Press **(TONE)** before entering access numbers which require tone dialing.

- The dialing mode changes to tone. You can enter numbers to access an answering service, electronic banking service, etc. When you hang up, the mode will return to pulse.

How to Use the PAUSE Button

(For Analog PBX Line/Long Distance Service Users)

We recommend you press **(REDIAL/PAUSE)** if a pause is required for dialing with a PBX or to access a long distance service.

Ex. Line access number **(9)** (PBX)

(9) ⇒ **(REDIAL/PAUSE)** ⇒ Phone number

- Pressing **(REDIAL/PAUSE)** once creates a 3.5 second pause. This prevents misdialing when you redial or dial a stored number.
- Pressing **(REDIAL/PAUSE)** more than once increases the length of the pause between numbers.

Automatic Answering Operation

When the unit answers a call, a greeting message is played and the caller's message is recorded. While recording, "- Answering -" will be displayed.

- The total recording time (including the greeting message) is **about 14 minutes**. If messages are recorded in noisy rooms, the time may be shortened up to 4 minutes.
- A maximum of 64 messages (including the greeting message) can be recorded.

Setting the Unit to Answer Calls

Press **ANSWER ON** to turn on the answering system.

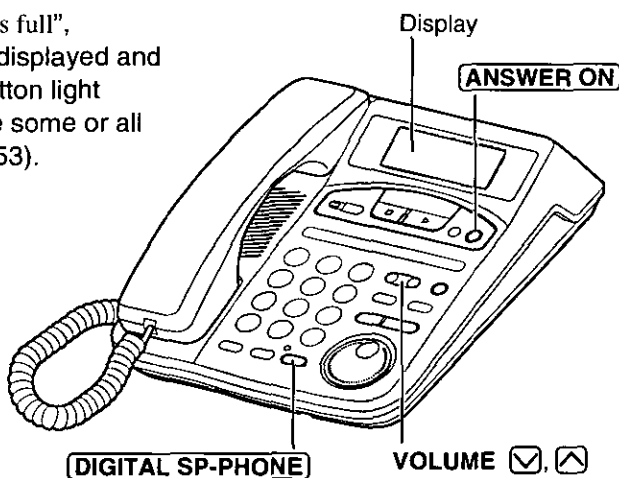

- The button lights and "Answer set" will be announced.
- The unit will announce the remaining recording time if it is less than 5 minutes.
- If you hear "Memory is full", "Message full" is displayed and the **ANSWER ON** button light flashes rapidly, erase some or all of the messages (p. 53).



- If you do not want the unit to answer calls, press **ANSWER ON** to turn off the answering system. The button light goes out and "Answer off" is heard.
- You can also turn on the answering system remotely (p. 67).

Monitoring incoming calls

While a call is being recorded, you can monitor it through the speaker. To answer the call, lift the handset or press **DIGITAL SP-PHONE**. The unit stops recording.

- You can adjust the monitor volume (9 levels) by pressing **VOLUME**  or .

Listening to Messages



The display shows the total number of recorded messages. If the **ANSWER ON** button light flashes, new messages have been recorded.

Listening to only the new messages

Press **NEW MESSAGE** briefly.

- The unit announces the number of new messages and plays them back.

Listening to all of the recorded messages

Press and hold **NEW MESSAGE** until a short beep sounds.

- The unit announces the number of messages and plays them back.



To adjust the speaker volume (9 levels):

While using the answering system, press **VOLUME** (up or down arrow).

- The display shows the volume level.

➔ Listening to Messages

During playback

To repeat the message	Rotate JOG DIAL to the left. (If you rotate within 5 seconds of playback, the previous message will be played.)
To skip the message	Rotate JOG DIAL to the right. The next message is played.
To stop the operation	Press STOP . <ul style="list-style-type: none">To resume playback, press NEW MESSAGE. To return to the stand-by mode, press EXIT.If you subscribe to a Caller ID service, you can call back the displayed caller by pressing SEND/SET (see below).

For Caller ID service users (p. 30)

- During playback, the display will show the caller's name and/or number whose message is being played.

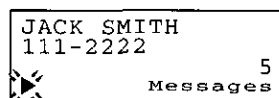

To call back the displayed number:

During playback, lift the handset or press **SEND/SET** to turn on the speakerphone.

- The unit stops playback and automatically dials the displayed phone number.

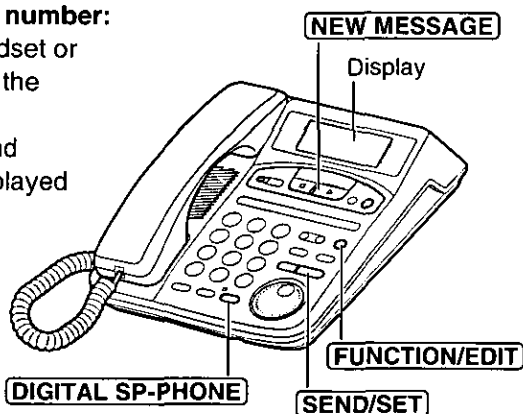

- You can also press **DIGITAL SP-PHONE** instead of **SEND/SET** to call back.
 - If you need to edit the number before calling back, press **FUNCTION/EDIT** repeatedly until the desired pattern is selected (p. 35).
 - To resume playback, press **NEW MESSAGE**.
- After you listen to the new incoming messages, the calls will be listed as OLD in the Caller ID Caller List (p. 32).

Erasing Messages

The unit will announce the remaining recording time after playback, if it is less than 5 minutes. New messages cannot be recorded when:

- “Memory is full” is heard.
- “Message full” is displayed.
- the **ANSWER ON** button light flashes rapidly.

Erase some or all of the messages. We recommend you erase unnecessary messages after each playback.

Erasing a specific message

Press **ERASE** while the message you want to erase is being played.

- The unit erases the message.
- A short beep will sound and the unit will continue to play the next message.

Erasing all of the messages

All of the recorded messages, except the greeting message, can be erased at one time.

- 1 Press **ERASE**.
 - “Press ERASE button again to erase all messages.” is heard.
- 2 Within 5 seconds, press **ERASE** again.
 - A long beep and “No messages” are heard.
 - The display shows “0”.
 - The display will return to the stand-by mode.

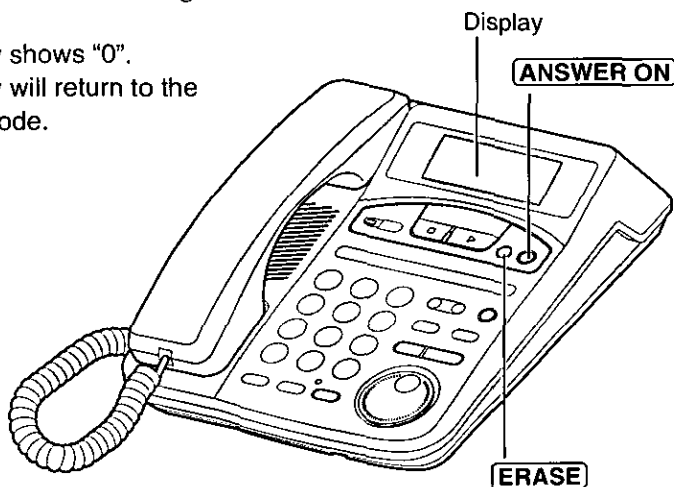

Answering System

- The information in the Caller List will not be erased.
To clear the Caller List information, see page 38.

Recording Your Telephone Conversation

You may record your telephone conversation in memory. This is not available when using the speakerphone.

- 1 During a conversation with the handset, press **FUNCTION/EDIT**.

```
2way recording ?
SET=Yes  EXIT=No
```

- 2 Press **SEND/SET** (Yes key).

```
7:38PM JUN. 1
- Recording -
0-01-90
```

- 3 Continue your conversation.

- 4 When you finished recording the conversation, press **SEND/SET**.

```
7:45PM JUN. 1
0-09-50
```

- A beep sounds.
- The recorded conversation is stored as a new message. To listen, press **NEW MESSAGE** briefly (p. 51).
- If 6 beeps sound, the conversation was not recorded.

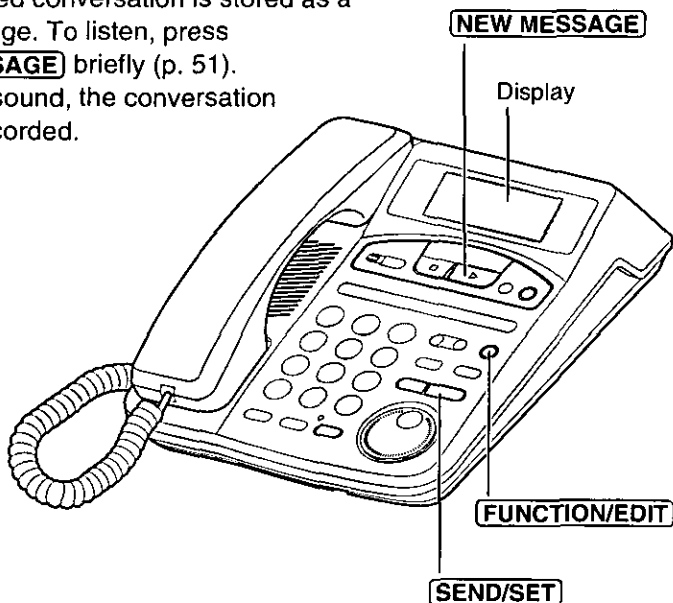

Many states have imposed regulations on the manner in which 2-way telephone conversations may be recorded, so you should inform the other party that the conversation is being recorded. Consult your local telephone company for further information.

Pager Call



This feature allows you to alert your pager when the unit records an incoming message or receives a Caller ID call (p. 59). You can retrieve the message from a touch tone telephone (p. 62). If you subscribe to a Caller ID service, the caller's telephone number will be displayed on your pager. First, program the following settings (p. 55–59), then set the unit to call a pager.

Be sure that the handset is on the cradle, the AC adaptor is connected and the DIGITAL SP-PHONE indicator light is off.

Storing the Pager Number

If you use a 1-800 pager number, see the next page for the storing procedure.

1 Press **FUNCTION/EDIT**.

```
→Date and time
Greeting record
Greeting check
-Function list-
```

2 Rotate **JOG DIAL** until "Pager number" is selected.

- The arrow points to "Pager number".

```
CPC function
→Pager number
Pager on/off
-Function list-
```

3 Press **SEND/SET**.

- "Enter pager no." is displayed.
- The current set number is displayed, if it was stored beforehand.

```
Enter pager no.>
□
SET=save
```

4 Enter your pager number, then press **REDIAL/PAUSE** twice.* Enter the access code, if required by your pager company, and then press **REDIAL/PAUSE** twice again.*

- If you misdial, press **HOLD/CLEAR**. Digits are erased from the right.
- You can enter a total of 44 digits.

```
12343215555PP□
SET=save
```

5 Press **SEND/SET** (Save key).

- A long beep sounds and the number is saved.
- The display will return to the function list.

To return to the stand-by mode, press **EXIT** or wait for 60 seconds.

```
12343215555PP
*** Saved ***
```

Answering System

* Pager companies require a delay after the pager number and/or the access code is dialed. Contact your pager company regarding the required pause time. Pressing **REDIAL/PAUSE** once creates a 3.5 second delay and counts as one digit.

- If the line has rotary or pulse service, press ***** between the pager number and **REDIAL/PAUSE** in step 4.

➔ Pager Call

Storing a 1-800 pager number

If you use a 1-800 pager number with a PIN code, store the pager number as follows.

- 1 Press **FUNCTION/EDIT**.

→Date and time
Greeting record
Greeting check
-Function list-

- 2 Rotate **JOG DIAL** until "Pager number" is selected.
 - The arrow points to "Pager number".

CPC function
→Pager number
Pager on/off
-Function list-

- 3 Press **SEND/SET**.
 - "Enter pager no." is displayed.
 - The current set number is displayed, if it was stored beforehand.

Enter pager no.>
□
SET=Save

- 4 ① Enter the 1-800 pager number, then press **REDIAL/PAUSE** 3 times.*

18002343215555PP
P□
SET=Save

② Enter the PIN code, then press **REDIAL/PAUSE** twice.*
 - If you misdial, press **HOLD/CLEAR**.
Digits are erased from the right.
 - You can enter a total of 44 digits.

18002343215555PP
P1111222PP□
SET=Save

- 5 Press **SEND/SET** (Save key).
 - A long beep sounds and the number is saved.
 - The display will return to the function list.
To return to the stand-by mode, press **EXIT** or wait for 60 seconds.

18002343215555PP
P1111222PP
*** Saved ***

* Pager companies require a delay after the pager number and the PIN code are dialed. Contact your pager company regarding the required pause time. Pressing **REDIAL/PAUSE** once creates a 3.5 second delay and counts as one digit.

- If the line has rotary or pulse service, press ***** between the pager number and **REDIAL/PAUSE** in step 4.
- Alphanumeric voice dispatch pager service will not work with this function.



Storing Your Home Telephone Number

Store your home telephone number. Then the number will be displayed on your pager when your family wants you to call home. (See the useful information on page 58.)

1 Press **FUNCTION/EDIT**.

```
→Date and time
  Greeting record
  Greeting check
-Function list-
```

2 Rotate **JOG DIAL** until "Home number" is selected.

```
Pager mode
→Home number
  Dialing mode
-Function list-
```

- The arrow points to "Home number".

3 Press **SEND/SET**.

- "Enter phone no." is displayed.
- The current set number is displayed, if it was stored beforehand.

```
Enter phone no.>
[ ]
SET=Save
```

4 Enter your home telephone number up to 10 digits.

- If you misdial, press **HOLD/CLEAR**. Digits are erased from the right.

```
Enter phone no.>
222-333-4444]
SET=Save
```

5 Press **SEND/SET** (Save key).

- A long beep sounds and the number is saved.
- The display will return to the function list. To return to the stand-by mode, press **EXIT** or wait for 60 seconds.

```
Enter phone no.>
222-333-4444
*** Saved ***
```

- Your pager will also display your home number when the unit receives a call from an area which does not provide the Caller ID service or the caller requests not to show their information. Please call home to check who alerted your pager.

➔ Pager Call

To confirm the stored pager and home numbers

1. Press **FUNCTION/EDIT**.
2. Rotate **JOG DIAL** until "Calling pager" is selected.
3. Press **SEND/SET**.

12343215555PP
Calling pager

- The unit dials the stored pager number.
- The pager beeps, and displays your home number and "11".
- If the pager does not beep or does not display your home number and "11", store the pager and home numbers again (p. 55–57).

Useful Information

Your family can let you know when they want you to call home by performing the above procedure.

* What "11" means

When your unit alerts your pager, "11" will be displayed after the caller's telephone number. "11" will not be displayed when another phone alerts your pager.

Ex. When the unit records a caller's message whose number is "2345678":
"234567811" will be displayed on your pager. If you selected the "Received call" mode (p. 59) and a caller did not leave a message, "00" will be displayed instead of "11".

Ex. When the caller whose number is "2345678" alerts your pager directly:
"2345678" will be displayed on your pager.

To clear the stored pager number

1. Press **FUNCTION/EDIT**.
2. Rotate **JOG DIAL** until "Pager number" is selected.
3. Press **SEND/SET**.
4. Press **HOLD/CLEAR**.
5. Press **SEND/SET** (Save key).
 - The pager call mode will automatically return to "Off" (p. 60).

To clear the stored home telephone number

1. Press **FUNCTION/EDIT**.
2. Rotate **JOG DIAL** until "Home number" is selected.
3. Press **SEND/SET**.
4. Press **HOLD/CLEAR**.
5. Press **SEND/SET** (Save key).



Pager Mode Setting

After subscribing to a Caller ID service (p. 30), you can select one of the following pager modes. The unit will alert your pager:

after the unit records an incoming message (**Recorded MSG mode**: factory preset),
OR
each time the unit receives a Caller ID call, even if the caller does not leave a message (**Received call mode**).

If you want to change the mode, proceed as follows.

1 Press **FUNCTION/EDIT**.

→Date and time
Greeting record
Greeting check
-Function list-

2 Rotate **JOG DIAL** until "Pager mode" is selected.

Calling pager
→Pager mode
Home number
-Function list-

- The arrow points to "Pager mode".

3 Press **SEND/SET**.

- The current mode is displayed.

Pager mode
:Recorded MSG:
SET=Save

4 Rotate **JOG DIAL** until the desired mode is displayed.

Pager mode
:Received call:
SET=Save

5 Press **SEND/SET** (Save key).

- A long beep sounds and the mode is saved.
- The display will return to the function list. To return to the stand-by mode, press **EXIT** or wait for 60 seconds.

Pager mode
:Received call

Answering System

- If you select "**Received call**" and set the unit to call a pager (p. 60), the unit will alert your pager even if the answering system is not turned on.
- Even if you select "**Received call**", the unit will not alert your pager when a Caller ID call which does not have a phone number is received.

➔ Pager Call

Setting the Unit to Call a Pager

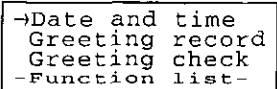
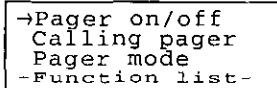
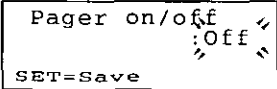
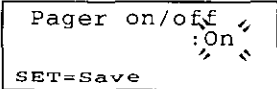
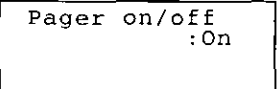
- 1 Press **FUNCTION/EDIT**.
→Date and time
Greeting record
Greeting check
-Function list-
 - 2 Rotate **JOG DIAL** until "Pager on/off" is selected.
→Pager on/off
Calling pager
Pager mode
-Function list-
 - 3 Press **SEND/SET**.
Pager on/off
:Off
SET=Save
 - 4 Rotate **JOG DIAL** until "On" is displayed.
Pager on/off
:On
SET=Save
 - 5 Press **SEND/SET** (Save key).
Pager on/off
:On
- A long beep sounds and the setting is saved.
 - The display will return to the function list.
 - To return to the stand-by mode, press **EXIT** or wait for 60 seconds. "**PAGER**" will be displayed.
 - If 3 beeps sound, the pager number is not stored. Store the number (p. 55, 56), then try again.

To turn off the pager call mode, select "Off" in step 4.

- "**PAGER**" will disappear.

If you have not subscribed to a Caller ID service, the caller's telephone number will not be displayed on your pager.

- If another message (or Caller ID call) is received before the unit alerts your pager for a previous message (or Caller ID call), the previous caller information will not be sent to your pager. Only the last call received will be sent to your pager.
- If someone else makes or answers another call with the unit or the parallel connected phone before the unit alerts your pager for a previous message (or Caller ID call), the unit will stop alerting your pager for that message (or Caller ID call).
- When you receive a caller's telephone number in your pager but can not recognize the caller, you may have received a direct inward dial (DID) call, such as from a PBX. Please call your unit to check the caller's message.

Remote Operation from a Touch Tone Phone

You can operate the answering system from any touch tone phone. A synthesized voice menu will guide you on how to operate the unit (p. 64).

- To skip the voice menu and operate the unit directly, see page 66.

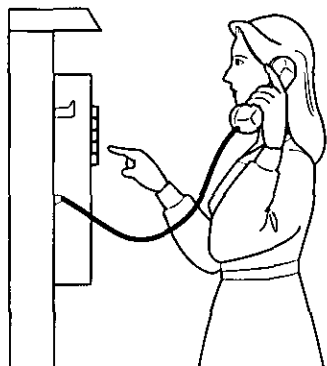

Summary of the remote operation

Call your unit from a touch tone phone.



During or after the greeting message playback, enter your remote code (p. 63).

- The number of new messages is heard.



After 3 seconds, the voice menu will start (p. 64).
Follow the menu or enter the direct commands (p. 66).



To end the remote operation, hang up.
• The messages are saved.



Setting the Remote Code

The remote code prevents unauthorized people from accessing your unit and listening to your messages. Choose any **3-digit number (000–999)**. The factory preset remote code is “111”. If you do not program your own remote code, you can use “111”.

Be sure that the handset is on the cradle, the AC adaptor is connected and the DIGITAL SP-PHONE indicator light is off.

1 Press **FUNCTION/EDIT**.

```
→Date and time
Greeting record
Greeting check
-Function list-
```

2 Rotate **JOG DIAL** until “Remote code” is selected.

```
Number of rings
Recording time
→Remote code
-Function list-
```

- The arrow points to “Remote code”.

3 Press **SEND/SET**.

```
Remote code      :111
SET=Save
```

- The current remote code is displayed.

4 Enter a remote code by using a **3-digit number (000–999)**.

```
Remote code      :123]
SET=Save
```

- If you enter a wrong number, press **HOLD/CLEAR**, then enter the correct number.

5 Press **SEND/SET** (Save key).

```
Remote code      :123
```

- A long beep sounds and the code is saved.
- The display will return to the function list.
To return to the stand-by mode, press **EXIT** or wait for 60 seconds.

Answering System

To clear the remote code

If you clear the code, the remote operation feature will not be available.

1. Press **FUNCTION/EDIT**.

2. Rotate **JOG DIAL** until “Remote code” is selected.

3. Press **SEND/SET**.

4. Press **HOLD/CLEAR**.

- “---” is displayed.

5. Press **SEND/SET** (SAVE key).

➔ Remote Operation from a Touch Tone Phone

Voice Menu

The shaded boxes are voice prompts.

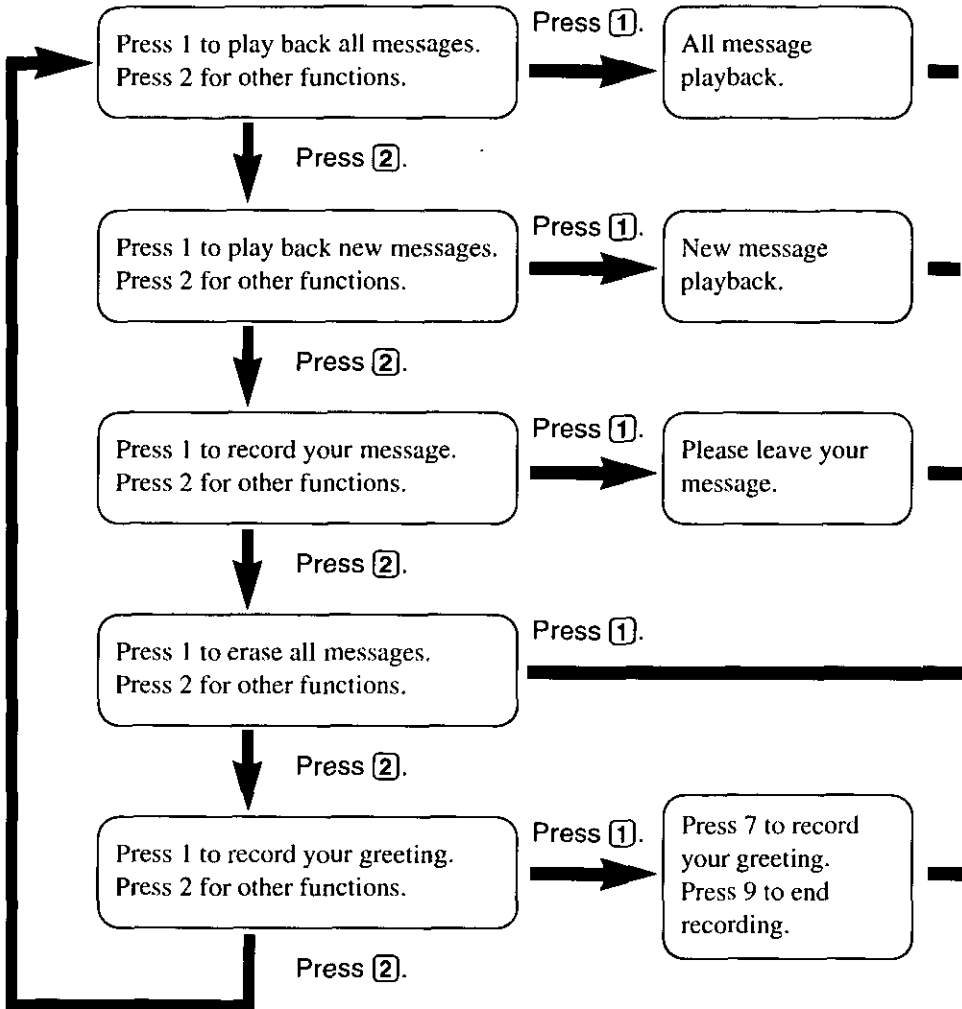



All Message Playback

All of the recorded messages are played back.

At the end of the last message, the unit will announce "End of final message" and the remaining recording time if it is less than 5 minutes.



New Message Playback

Only new messages are played back.



Recording a Memo Message

You can leave a personal message.

1. Talk after you hear "Please leave your message."
2. When you finish recording, hang up.



Erasing All Messages

All of the recorded messages are erased.



Recording a Greeting Message

You can re-record your greeting message.

1. Press **7**.
You hear a voice prompt followed by a long beep.
2. Talk after the long beep.
3. When you finish recording, press **9**.
4. Your greeting will be played back for confirmation.

- 3 seconds after playback, the voice menu will start from the beginning.
- If you hear "Memory is full" after playback, erase some or all of the messages (p. 66).

➔ Remote Operation from a Touch Tone Phone

Direct Remote Operation

Once you have entered the remote code, you can also control your unit by direct commands instead of using the voice menu. To end the remote operation, hang up anytime.

Direct commands

NEW MESSAGE PLAYBACK	4	<ul style="list-style-type: none">• Only new messages are played back.
ALL MESSAGE PLAYBACK	5	<ul style="list-style-type: none">• All of the messages are played back.
REPEAT (During playback)	1	<ul style="list-style-type: none">• The current message is repeated.
SKIP (During playback)	2	<ul style="list-style-type: none">• The current message is skipped. The next message is played.
STOP (During playback)	9	<ul style="list-style-type: none">• Playback is stopped temporarily.• To resume playback, press 9 again within 15 seconds, or the voice menu will start.
GREETING MESSAGE RECORDING	7 ↓ RECORD ↓ 9	<ul style="list-style-type: none">• A long beep sounds.• Talk immediately after the long beep.• The recording is stopped.• The recorded message is played.
ERASING A SPECIFIC MESSAGE (During playback)	* 4	<ul style="list-style-type: none">• The current message is erased.• A short beep will sound and the next message is played.
ERASING ALL MESSAGES	* 5	<ul style="list-style-type: none">• All of the recorded messages are erased.• A long beep and "No messages" are heard.
ANSWERING SYSTEM OFF	0	<ul style="list-style-type: none">• "Answer off" is heard and the answering system is turned off.• The voice menu will start. To end the remote operation, hang up.

ANSWERING SYSTEM ON

8

- "Answer set" is heard and the answering system is turned on.

Turning on the answering system

Call your unit and wait for 15 rings.

- The unit will answer and the greeting message will be played.
- The answering system will turn on. Hang up or enter the remote code for other options.
- When turning on the answering system using a rotary or pulse service telephone, you cannot enter a remote code for other options.

Skipping the greeting message

After calling your unit, press **[*]** during the greeting message playback.

- The unit skips the rest of the greeting and callers can start recording their message after the long beep.

Remote Operation Card



Answering System

OPERATION FROM A TOUCH TONE PHONE

Call your unit.



Enter your remote code _____.



Press the desired direct commands as shown here.

OR

Wait for 3 seconds and the voice menu will start. Follow the instructions. (See the reverse side.)



To end the remote operation, hang up.

No.	Direct Command
1	Repeat the message
2	Skip the message
4	New message playback
5	All message playback
7	Recording your greeting
8	Answer on
9	Stop
0	Answer off
*	Greeting message skip
*4	Erasing a specific message
*5	Erasing all messages

- When you press a button, press firmly.

➔ Remote Operation Card

- **To use the voice menu:**

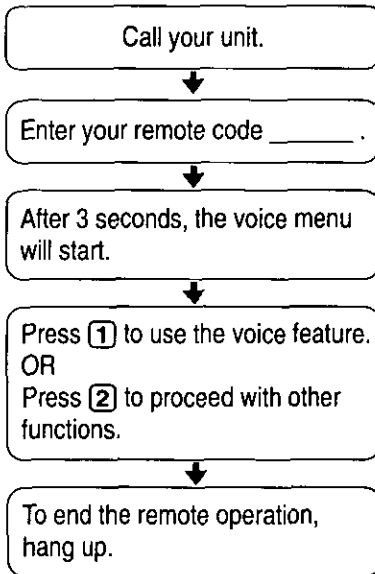

- **To turn on the answering system:**

Call your unit and wait for 15 rings. The unit will answer, then hang up.

- **To skip the greeting message:**

After calling your unit, press **[*]** during the greeting message playback. Callers can start recording their message after the long beep.

Wall Mounting

This unit can be mounted on a wall phone plate.

- 1 Pull down the handset hook until it locks, **so the tab holds the handset.**

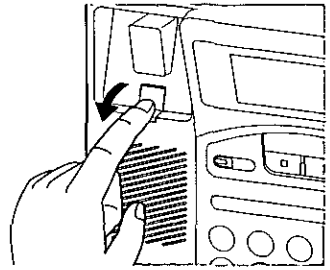

- 2 Connect the AC adaptor. Tuck the telephone line cord inside the wall mounting adaptor, then push it in the direction of the arrow.

- The word "UP" should face upward.

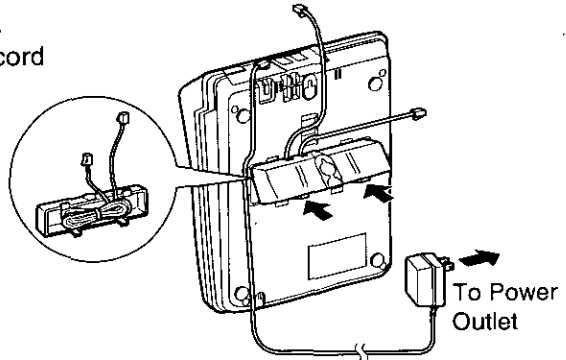

- 3 Connect the telephone line cord. Mount the unit, then slide down.

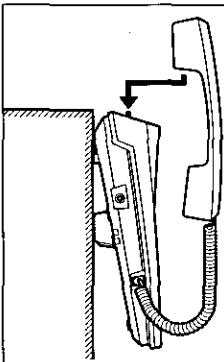
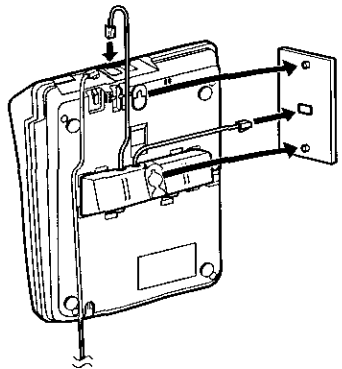

To temporarily set the handset down during a conversation, place it as shown here.

Using an Optional Headset

Plugging an optional headset into the unit provides a handsfree phone conversation.

Please use only a Panasonic KX-TCA80 or KX-TCA90 headset. To order, call 1-800-332-5368.

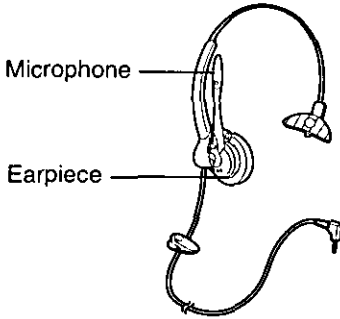

The headset illustration is a KX-TCA90.

Connecting an Optional Headset to the Unit

Connect an optional headset to the headset jack as shown below.

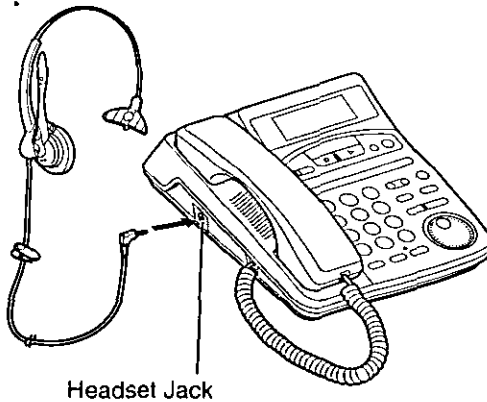

- During a power failure, you cannot use the optional headset.



Selecting the Headset/Speakerphone

When the optional headset is connected, you can select one of the following **DIGITAL SP-PHONE/HEADSET** button modes.

Each time you press **DIGITAL SP-PHONE/HEADSET**, you can switch to the optional headset or speakerphone (**SP key: SP/Head mode: factory preset**).

OR

If you do not want to use the speakerphone while the optional headset is connected, pressing **DIGITAL SP-PHONE/HEADSET** will make/answer a call or disconnect the line (**SP key: On/Off mode**).

If you want to change the mode, proceed as follows.

Be sure that the handset is on the cradle, the AC adaptor is connected and the DIGITAL SP-PHONE indicator light is off.

1. Press **FUNCTION/EDIT**.
2. Rotate **JOG DIAL** until "Headset select" is selected.
3. Press **SEND/SET**.
 - The current mode is displayed.
4. Rotate **JOG DIAL** until the desired mode is displayed.
5. Press **SEND/SET** (Save key).

Headset select SP key:SP/Head
SET=Save

Headset select SP key:On/Off
SET=Save

- A long beep sounds and the mode is saved.
- The display will return to the function list. To return to the stand-by mode, press **EXIT** or wait for 60 seconds.

How to Wear an Optional Headset

Place the headset on your head and adjust the microphone to a comfortable position.



- Place the microphone near your mouth. **71**

➔ Using an Optional Headset

Making/Answering Calls

If you select “SP key: SP/Head mode” (p. 71)

- 1 Press **DIGITAL SP-PHONE/HEADSET** to make or answer a call.
 - The DIGITAL SP-PHONE/HEADSET indicator light flashes quickly.
 - If you misdial when making a call, lift the handset and replace it back on the cradle to hang up. Then press **DIGITAL SP-PHONE/HEADSET** and dial again.
 - 2 To hang up, lift the handset and replace it.
- While using the optional headset, you can switch to the speakerphone by pressing **DIGITAL SP-PHONE/HEADSET**. Each time you press the button, the call will switch to the optional headset or speakerphone.

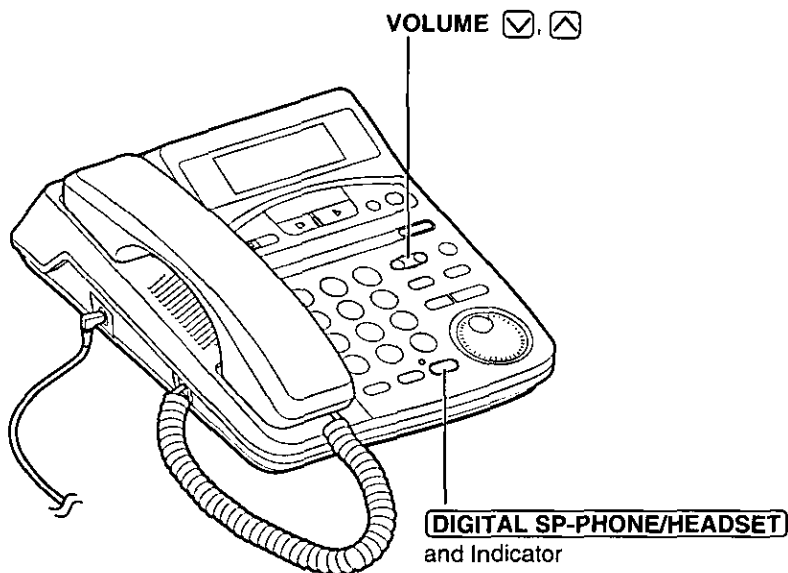

To adjust the headset receiver volume (4 levels):
While using the headset, press **VOLUME** or .

If you select “SP key: On/Off mode” (p. 71)

- 1 Press **DIGITAL SP-PHONE/HEADSET** to make or answer a call.
 - The DIGITAL SP-PHONE/HEADSET indicator light flashes quickly.
 - If you misdial when making a call, press **DIGITAL SP-PHONE/HEADSET** twice and dial again.
- 2 To hang up, press **DIGITAL SP-PHONE/HEADSET**.

During a conversation with an optional headset:

- The DIGITAL SP-PHONE/HEADSET indicator light flashes quickly.
- You can switch a call to the handset by lifting it off the cradle.
- If you disconnect the optional headset, you can continue the conversation with the speakerphone.

Before Requesting Help

Telephone

Problem	Remedy
The unit does not work.	<ul style="list-style-type: none">• Check the settings (p. 10–16).• Unplug the AC adaptor to reset. Plug in, then try again.
The unit does not ring.	<ul style="list-style-type: none">• The ringer volume is set to “Off”. Set to “High” or “Low” (p. 15).• When the line is connected to a low voltage system such as a PBX, the unit will not ring. Set the line mode to “B” (p. 14).
You cannot dial by pressing DIGITAL SP-PHONE , and the DIGITAL SP-PHONE indicator light flashes quickly.	<ul style="list-style-type: none">• The telephone line cord is disconnected. Check the connection (p. 11).
You cannot program function items, such as the dialing mode.	<ul style="list-style-type: none">• Programming is not available when the handset is off the cradle or the DIGITAL SP-PHONE indicator lights.• Do not pause for over 60 seconds while programming.
You cannot store a name and phone number in the directory.	<ul style="list-style-type: none">• Do not pause for over 60 seconds while storing.
You cannot search for directory items.	<ul style="list-style-type: none">• You cannot search when:<ul style="list-style-type: none">— the answering system is recording a message, or— you are recording a telephone conversation.
While programming or searching, the unit starts to ring and stops the program/search.	<ul style="list-style-type: none">• To answer the call, lift the handset or press DIGITAL SP-PHONE. Start from the beginning after hanging up.



Problem	Remedy
The unit does not display the caller name and/or phone number.	<ul style="list-style-type: none">• Other telephone equipment may be interfering with your phone. Disconnect them and try again.• Other electrical appliances connected to the same outlet may be interfering with the Caller ID information. Telephone line noise may be affecting the Caller ID information.
The display goes to the stand-by mode while viewing the Caller List or directory list items.	<ul style="list-style-type: none">• Do not pause for over 60 seconds while searching.
When a second call is received during a conversation, the unit does not display the new caller's name and/or phone number.	<ul style="list-style-type: none">• The line mode selection is incorrect. See page 14.
REDIAL/PAUSE does not function properly.	<ul style="list-style-type: none">• The button has a double function as either redial or pause. It will redial the last number dialed if pressed at the outset of a call (p. 28). If another number has been dialed first, it will operate as a pause button (p. 49).
You cannot have a conversation using the optional headset.	<ul style="list-style-type: none">• Make sure that the optional headset is connected properly (p. 70).• Press DIGITAL SP-PHONE/HEADSET to make or answer a call.• During a power failure, you cannot use the optional headset.

➔ Before Requesting Help

Answering system

Problem	Remedy
The answering system is on, but incoming messages are not recorded.	<ul style="list-style-type: none">• The recording time is set to "G.O.". Select "1min" or "Vox" (p. 21).• Memory is full. Erase some or all of the messages (p. 53).• The line mode selection is incorrect. See page 14.
"Message full" is displayed, the ANSWER ON button light flashes rapidly, and no new messages are recorded.	<ul style="list-style-type: none">• Memory is full. Erase some or all of the messages (p. 53). If "Message full" is still displayed and the ANSWER ON button light flashes rapidly, erase your greeting message and re-record a shorter greeting (p. 18–20).
Some incoming messages have not been recorded completely.	<ul style="list-style-type: none">• Set the CPC function to "B" (p. 25).
You cannot operate the answering system from a touch tone phone.	<ul style="list-style-type: none">• Be sure to enter the correct remote code.• The answering system may not respond if the tones are too short to activate the unit. Press each button firmly.• The answering system is off. Turn it on (p. 67).
While recording a greeting message, the unit starts to ring and stops recording.	<ul style="list-style-type: none">• To answer the call, lift the handset or press DIGITAL SP-PHONE. The recording will be stopped halfway. Start from the beginning after hanging up.
During playback, the unit starts to ring and stops playback.	<ul style="list-style-type: none">• To answer the call, lift the handset or press DIGITAL SP-PHONE. To resume playback, press NEW MESSAGE after hanging up.

Problem	Remedy
The unit does not display the caller's name and/or number whose message is being played.	<ul style="list-style-type: none"> • If the caller is not stored in the caller list, the unit will not display the caller's information.
You cannot record your telephone conversation.	<ul style="list-style-type: none"> • The conversation cannot be recorded when using the speakerphone.
The unit does not alert your pager.	<ul style="list-style-type: none"> • The line mode selection is incorrect. See page 14.

If you cannot solve your problem, call our customer call center at 1-800-211-PANA(7262).

Important Safety Instructions

When using this unit, basic safety precautions should always be followed to reduce the risk of fire, electric shock, or personal injury.

1. Read and understand all instructions.
2. Follow all warnings and instructions marked on this unit.
3. Unplug this unit from AC outlets before cleaning. Do not use liquid or aerosol cleaners. Use a damp cloth for cleaning.
4. Do not use this unit near water, for example, near a bathtub, washbowl, kitchen sink, or the like.
5. Place this unit securely on a stable surface. Serious damage and/or injury may result if the unit falls.
6. Do not cover slots and openings on the unit. They are provided for ventilation and protection against overheating. Never place the unit near radiators, or in a place where proper ventilation is not provided.
7. Use only the power source marked on the unit. If you are not sure of the type of power supplied to your home, consult your dealer or local power company.
8. Do not place objects on the power cord. Install the unit where no one can step or trip on the cord.
9. Do not overload wall outlets and extension cords. This can result in the risk of fire or electric shock.
10. Never push any objects through slots in this unit. This may result in the risk of fire or electric shock. Never spill any liquid on the unit.
11. To reduce the risk of electric shock, do not disassemble this unit. Take the unit to an authorized servicer when service is required. Opening or removing covers may expose you to dangerous voltages or other risks. Incorrect reassembly can cause electric shock when the unit is subsequently used.
12. Unplug this unit from the wall outlet and refer servicing to an authorized servicer when the following conditions occur:
 - A. When the power supply cord or plug is damaged or frayed.
 - B. If liquid has been spilled into the unit.
 - C. If the unit has been exposed to rain or water.
 - D. If the unit does not work normally by following the operating instructions. Adjust only controls covered by the operating instructions. Improper adjustment may require extensive work by an authorized servicer.
 - E. If the unit has been dropped or physically damaged.
 - F. If the unit exhibits a distinct change in performance.

-
13. During thunderstorms, avoid using telephones except cordless types.
There may be a remote risk of an electric shock from lightning.
 14. Do not use this unit to report a gas leak, when in the vicinity of the leak.

SAVE THESE INSTRUCTIONS

WARNING:

TO PREVENT FIRE OR SHOCK HAZARD, DO NOT EXPOSE THIS PRODUCT TO RAIN OR ANY TYPE OF MOISTURE.

FCC and Other Information

If requested by the telephone company, inform them as follows:

FCC Registration No.(found on the bottom of the unit)

Ringer Equivalence1.0B

The particular telephone line to which the equipment is connected.

This unit must not be connected to a coin operated line.

If you are on a party line, check with your local telephone company.

Ringer Equivalence No. (REN):

The REN is useful in determining the quantity of devices you may connect to your telephone line and still have all of those devices ring when your telephone number is called. In most, but not all areas, the sum of the REN's of all devices connected to one line should not exceed five (5.0). To be certain of the number of devices you may connect to your line, as determined by the REN, you should contact your local telephone company to determine the maximum REN for your calling area.

In the event terminal equipment causes harm to the telephone network, the telephone company should notify the customer, if possible, that service may be stopped.

However, where prior notice is impractical, the company may temporarily cease service providing that they:

- (a) Promptly notify the customer.
- (b) Give the customer an opportunity to correct the problem with their equipment.
- (c) Inform the customer of the right to bring a complaint to the Federal Communication Commission pursuant to procedures set out in FCC Rules and Regulations Subpart E of Part 68.

The Telephone Company may make changes in its communications facilities, equipment, operations or procedures, where such action is reasonably required in the operation of its business and is not inconsistent with the rules and regulations in FCC Part 68.

If such changes can be reasonably expected to render any customer terminal equipment incompatible with telephone company communications facilities, or require modification or alteration of such terminal equipment, or otherwise materially affect its use or performance, the customer shall be given adequate notice in writing, to allow the customer an opportunity to maintain uninterrupted service.

When programming emergency numbers and/or making test calls to emergency numbers:

1. Remain on the line and briefly explain to the dispatcher the reason for the call before hanging up.
2. Perform such activities in the off-peak hours, such as early morning hours or late evenings.

This device complies with Part 15 of the FCC Rules. Operation is subject to the following two conditions: (1) This device may not cause harmful interference, and (2) this device must accept any interference received, including interference that may cause undesired operation.

CAUTION:

Any changes or modifications not expressly approved by the party responsible for compliance could void the user's authority to operate this device.

Note:

This equipment has been tested and found to comply with the limits for a Class B digital device, pursuant to Part 15 of the FCC Rules. These limits are designed to provide reasonable protection against harmful interference in a residential installation. This equipment generates, uses, and can radiate radio frequency energy and, if not installed and used in accordance with the instructions, may cause harmful interference to radio communications. However, there is no guarantee that interference will not occur in a particular installation. If this equipment does cause harmful interference to radio or television reception, which can be determined by turning the equipment off and on, the user is encouraged to try to correct the interference by one or more of the following measures:

- Reorient or relocate the receiving antenna.
 - Increase the separation between the equipment and receiver.
 - Connect the equipment into an outlet on a circuit different from that to which the receiver is connected.
 - Consult the dealer or an experienced radio/TV technician for help.
- **Environment** — do not place the unit in room where the temperature is less than 5°C (41°F) or greater than 40°C (104°F). Allow 10 cm (4") clearance around the unit for proper ventilation. Avoid excessive smoke, dust, mechanical vibration, shock, or direct sunlight.
 - **Routine care** — wipe the unit with a soft cloth. Do not use benzine, thinner, or any abrasive powder. When you leave the unit unused for a long period of time, unplug the AC adaptor from the outlet.
 - **If there is any trouble** — disconnect the unit from the telephone line and connect a known working phone. If the known working phone operates properly, have your unit repaired by one of the authorized Panasonic Factory Service Centers. If the known working phone does not operate properly, consult with your telephone company.

For product service

- Panasonic Servicenters are listed in the servicenter directory.
- Call 1-800-211-PANA(7262) for the location of an authorized servicenter.

When you ship the product

- Carefully pack your unit, preferably in the original carton.
- Attach a letter, detailing the symptom, to the outside of the carton.

Symptom

- Send the unit to an authorized servicenter, prepaid and adequately insured.
- Do not send your unit to the Panasonic Consumer Electronics Company listed on the back cover or to executive or regional sales offices. These locations do not repair consumer products.



Panasonic Consumer Electronics Company,
Division of Matsushita Electric Corporation of America
One Panasonic Way, Secaucus, New Jersey 07094

Panasonic Sales Company,
Division of Matsushita Electric of Puerto Rico, Inc.
Ave. 65 de Infantería, Km. 9.5, San Gabriel Industrial Park
Carolina, Puerto Rico 00985